

PEPPM 2019 Product Line Bid Award List for California

Product Line	Description	Awarded Vendor	Contract Number
Absolute Software	Endpoint security and management solutions software for computers, laptops and devices	SYNNEX Corporation	528899-001
Acer	Hardware, software, related services and other branded products	Unistar-Sparco Computers, Inc.	528899-002
Acquia	Web content management system	Carahsoft Technology Corporation	528899-003
Adobe Systems, Inc.	Multimedia, creativity and Internet application software	Aventis Systems, Inc.	528899-004
Adtran, Inc.	Networking and unified communications/VOIP solutions	Unistar-Sparco Computers, Inc.	528899-005
Aerohive Networks	Wireless LAN products	Aerohive Networks	528899-006
Allied Telesis, Inc.	Networking products	En-Net Services, LLC	528899-007
Amazon Web Services	Cloud computing services	NWN Corporation	528899-008
Anchor Audio	Portable sound/microphone systems	Adorama Camera, Inc.	528899-009
AngelTrax	Mobile digital video recording surveillance solutions (DVR and NVR), wireless solutions, driver behavior and fleet management	AngelTrax	528899-010
APC	Power protection products	DISYS Solutions, Inc.	528899-011
App-Techs Corporation	Network video and digital video recorders	App-Techs Corporation	528899-012
Arecont Vision	Video surveillance cameras and equipment	App-Techs Corporation	528899-013
Asus Computer International, Inc.	Hardware, software, related services and other branded products	Unistar-Sparco Computers, Inc.	528899-014
Atlas IED	Audio solution products	Global CTI	528899-015
Avid	Audio headsets, ear pieces, and accessories	SupplyMaster, Inc	528899-016
Avizia, Inc.	Video conference solutions	SYNNEX Corporation	528899-017
Axiom	Memory, storage, network hardware, flash and battery products	SYNNEX Corporation	528899-018
Axis Communications	IP video surveillance products	Cxtec	528899-019
Barracuda	Network security, web security, application delivery, email security and storage	SYNNEX Corporation	528899-020
Belkin	Networking, connectivity products and accessories	En-Net Services, LLC	528899-021
BenQ America Corporation	Monitors and projectors	Unistar-Sparco Computers, Inc.	528899-022
Black Box	Charging carts, collaboration solutions, digital signage, communications, and infrastructure solutions	Unistar-Sparco Computers, Inc.	528899-023
Boomi, Inc.	Enterprise integration platform	EMC Corporation	528899-024
Boxlight Corporation	Presentation systems	Boxlight, Inc.	528899-025

Product Line	Description	Awarded Vendor	Contract Number
Bretford Furniture Manufacturing	Computer and classroom furniture	Unistar-Sparco Computers, Inc.	528899-026
Brother International Corporation	Printers, fax, multi-function printers, labelers and supplies	Unistar-Sparco Computers, Inc.	528899-027
Bump Armor	Protective cases	Bump Armor	528899-028
ByteSpeed Computers	Hardware, software, related services and other branded products	ByteSpeed, LLC	528899-029
Cables2Go	Cables and connectors	Unistar-Sparco Computers, Inc.	528899-030
Canon USA - Imaging Products	Digital, still, and video cameras, camcorders and projectors	Adorama Camera, Inc.	528899-031
Certwood	Educational furniture	OnPoint Technologies	528899-032
Checkpoint	Firewall and security products	SYNNEX Corporation	528899-033
Chief Manufacturing	Ceiling mounts and CoPilot classroom multimedia systems	Unistar-Sparco Computers, Inc.	528899-034
Ciena	Packet networking, optical transport and converged packet optical products	SYNNEX Corporation	528899-035
Cisco	Networking, security and telecommunication products	NWN Corporation	528899-036
Compulocks Brands, Inc.	Locks and enclosures for computers, tablets and other devices	SYNNEX Corporation	528899-037
Copernicus Educational Products	Furniture, library book storage, mobile carts, easels and other classroom products	Tequipment Inc.	528899-038
Corel	Office productivity and graphics software	SYNNEX Corporation	528899-039
Cradlepoint	Networking, security and telecommunication products	SYNNEX Corporation	528899-040
CTL	Chromebooks, carts, accessories, licenses, imaging, consoles and tagging	CTL Corporation	528899-041
Custom Educational Furniture	Technology furniture	CEF	528899-042
Da-Lite	Presentation products	Unistar-Sparco Computers, Inc.	528899-043
Data Management, Inc.	TimeClock Plus - automated time and attendance products	Data Management, Inc.	528899-044
Dell EMC	Storage systems, backup, software and services	EMC Corporation	528899-045
D-Link	Networking products	SYNNEX Corporation	528899-046
DMSI	Fiber cable and connectors	En-Net Services, LLC	528899-047
Druva	Cloud data protection and management	Carahsoft Technology Corporation	528899-048
EarthWalk	NetWize systems and notebooks	EarthWalk Communications, Inc.	528899-049
Eaton	Power distribution, protection, and infrastructure products	En-Net Services, LLC	528899-050
Epson America, Inc.	Printers, projectors, scanners and accessories	Unistar-Sparco Computers, Inc.	528899-051
Ergotech Group, Inc.	LCD monitor mounts, LCD arms and ergonomic workspace solution products	SYNNEX Corporation	528899-052

Product Line	Description	Awarded Vendor	Contract Number
Extreme Networks	Networking products	General Microsystems, Inc.	528899-053
Fidelis	Cybersecurity products and solutions	Carahsoft Technology Corporation	528899-054
FomCore	Foam-core furniture and custom shapes	FomCore, LLC	528899-055
Formax	Pressure seal, mailing, data destruction and digital print finishing products	SYNNEX Corporation	528899-056
Fortinet	Network security appliances	SYNNEX Corporation	528899-057
Front Row	Classroom amplification systems	Pivotal Communications Group, LLC	528899-058
Gaggle	Student safety management	Gaggle.Net, Inc.	528899-059
Gatekeeper Systems, Inc.	Mobile digital video products and accessories	Gatekeeper Systems, Inc.	528899-060
Google	Hardware, software, related services and other branded products	Carahsoft Technology Corporation	528899-061
Greene Mfg., Inc.	School, computer and laboratory furniture	Greene Manufacturing, Inc.	528899-062
Hann Manufacturing, Inc.	Computer and lab furniture	Hann	528899-063
Hanwha Techwin America	Video surveillance and recording products	App-Techs Corporation	528899-064
Hatch, Inc.	Computer learning center solutions and other early childhood education products	HATCH, Inc.	528899-065
Hewlett Packard Enterprise	Servers, storage systems, backup, networking, security, telecommunication products, software and related services	SYNNEX Corporation	528899-066
Higher Ground	Cases and accessories for tablets, mobile devices and other hardware	Trinity3 Technology	528899-067
HIKvision	Digital video surveillance equipment	App-Techs Corporation	528899-068
Hitachi Data Systems	Storage products and software	General Microsystems, Inc.	528899-069
HP Inc. - Printers/Imaging	Printers, scanners, multifunction devices, and supplies	Unistar-Sparco Computers, Inc.	528899-070
iBoss Web Filters	Internet content security appliances	iBoss	528899-071
Identocard Systems	Photo identification products	IDentocard Systems Worldwide, Inc	528899-072
Imation	Storage and data security products	Carahsoft Technology Corporation	528899-073
Infoblox	Network management and security solutions	Carahsoft Technology Corporation	528899-074
Infocus	Projection equipment	Unistar-Sparco Computers, Inc.	528899-075
Interior Concepts	Computer and classroom furniture	Interior Concepts	528899-076
IntraLogic Solutions	Security products and services	Intrallogic Solutions	528899-077
IPEVO	Document cameras and interactive whiteboards	IPEVO, Inc.	528899-078
ISE	Lecterns, computer and classroom furniture, and ergonomic workspace products	Workrite Ergonomics	528899-079

Product Line	Description	Awarded Vendor	Contract Number
IXL Learning, Inc.	Educational software	IXL Learning, Inc.	528899-080
Juniper Networks	Networking and security products	Cxtec	528899-081
Kajeet	Off campus education broadband solution for home	Kajeet	528899-082
KIBO	Coding blocks robot and accessories	Tequipment Inc.	528899-083
Kingston	Memory products and accessories	Adorama Camera, Inc.	528899-084
Kodak	Digital cameras, scanners and digitizing equipment	En-Net Services, LLC	528899-085
Labdisc	Data logging device	Boxlight, Inc.	528899-086
LaCie	Data storage	Adorama Camera, Inc.	528899-087
Lenovo	Hardware, software, related services and other branded products	Unistar-Sparco Computers, Inc.	528899-088
LENS	Automated lockdown and emergency notification system	Eastern Datacomm, Inc.	528899-089
Lexmark International, Inc.	Copiers, printers, fax and multi-function products	Unistar-Sparco Computers, Inc.	528899-090
LG Electronics	TV/audio/video products, monitors, projectors, notebooks and optical media products	Unistar-Sparco Computers, Inc.	528899-091
LifeSize Communications, Inc.	HD video conferencing equipment	SYNNEX Corporation	528899-092
Lightspeed Systems	Internet security products	Lightspeed Systems, Inc.	528899-093
Lightspeed Technologies, Inc.	Classroom amplification systems	Lightspeed Technologies, Inc.	528899-094
LittleBits	Electronic building blocks and robotics	Eduporium	528899-095
Luxor	Computer and classroom furniture	Adorama Camera, Inc.	528899-096
MakerBot	Desktop 3D printer	Tequipment Inc.	528899-097
Matter and Form, Inc.	3D scanning devices	STS Education	528899-098
Max Cases	Protective cases and accessories for Chromebooks and mobile devices	En-Net Services, LLC	528899-099
Microsoft - Hardware	Tablets and other branded hardware	SYNNEX Corporation	528899-100
Microsoft - Software	Operating systems and applications software	SYNNEX Corporation	528899-101
MiEN Company	Technology and classroom furniture	MiEN Company	528899-102
Mifram Security	Modular vehicle barrier systems and other branded products	Advanced Security Technologies LLC	528899-103
Minuteman	Power protection products	SYNNEX Corporation	528899-104
Mobotix	Video surveillance cameras	App-Techs Corporation	528899-105
Modular Robotics	Robot blocks	Tequipment Inc.	528899-106

Product Line	Description	Awarded Vendor	Contract Number
NAO Robot	Humanoid robotics	Tequipment Inc.	528899-107
Netop	Classroom management software	SYNNEX Corporation	528899-108
NetSupport, Inc.	Classroom management software	STS Education	528899-109
Neverware	CloudReady operating system	STS Education	528899-110
Newline Interactive	Interactive flat panel displays and video conferencing products	Newline Interactive	528899-111
NWN	Cloud solutions	NWN Corporation	528899-112
Oki Data	Copiers, printers, fax and multi-funtion products	Adorama Camera, Inc.	528899-113
Otter Box	Protective cases	SYNNEX Corporation	528899-114
Ozobot	Coding blocks robot and accessories	Tequipment Inc.	528899-115
Palo Alto	Next-generation firewalls and security software	SYNNEX Corporation	528899-116
Panasonic Corporation	Hardware, software, related services and other branded products	Panasonic System Solutions Company	528899-117
Paragon Furniture	Technology furniture	Paragon	528899-118
PCS Revenue Control Systems, Inc.	Food service management solutions	PCS Revenue Control Systems, Inc.	528899-119
Peerless	Television/electronic board mounts and projector brackets	Adorama Camera, Inc.	528899-120
PhishMe	Network security vulnerability staff training	Carahsoft Technology Corporation	528899-121
pi-top	Build-it-yourself laptops, computers, software, and management systems	Tequipment Inc.	528899-122
Promethean	Interactive whiteboards and classroom technology solutions	Promethean, Inc.	528899-123
Prowise	Interactive touch screens, mobile lift systems, cloud-based software, student devices	ELB US Inc	528899-124
Pyramid Time Systems	Time clocks, automated time clock systems and wireless clocks	SYNNEX Corporation	528899-125
Radio Engineering Industries, Inc.	Mobile video surveillance solution	Radio Engineering Industries, Inc.	528899-126
Radware	Cyber security and application delivery products	SYNNEX Corporation	528899-127
Rauland-Borg	Communication systems	Rauland-Borg Corporation	528899-128
Razberi Technologies	IP video surveillance appliances	Eastern Datacomm, Inc.	528899-129
Red Hat, Inc.	Open source enterprise operating system software	SYNNEX Corporation	528899-130
Remind	Communication platform	Remind101, INc.	528899-131
Renaissance Learning, Inc.	Cloud-based assessments, reading and math practice and intervention protrams, and professional development services	Renaissance Learning, Inc.	528899-132
Revolabs	Wireless voice amplification systems	SYNNEX Corporation	528899-133

Product Line	Description	Awarded Vendor	Contract Number
Riverbed	SD-WAN, WAN optimization, application, performance management and other networking products	immixTechnology, Inc.	528899-134
Robotis	Educational robots and kits	Tequipment Inc.	528899-135
RSA Security	Security products	EMC Corporation	528899-136
Ruckus Wireless, Inc.	Wireless networking products	Ruckus Wireless, Inc.	528899-137
Rugged Protection	Student series iPad and tablet cases, chromebook cases and MFI wired keyboards	Rugged Protection, LLC	528899-138
Russwood	Library/computer furniture and classroom technology solutions	Russwood	528899-139
SAFARI Montage	Multimedia distribution systems	SAFARI Montage	528899-140
Samsung - Consumer Products	Consumer grade digital cameras, camcorders, TVs, Blu-Ray/DVD players, theatre/audio, wearable technology and LED lighting	Unistar-Sparco Computers, Inc.	528899-141
Samsung - Enterprise Products	Displays, large format displays, notebooks, tablets, chromebooks, memory and storage	Unistar-Sparco Computers, Inc.	528899-142
Samsung - Networking and Voice	Networking and voice communication products	Unistar-Sparco Computers, Inc.	528899-143
Samsung - Telecommunications	Business telephones and data networking	Unistar-Sparco Computers, Inc.	528899-144
Scale Computing	Clustered IT infrastructure products	SYNNEX Corporation	528899-145
Scholar Craft Products	Computer and classroom furniture	Scholar Craft Products, Inc.	528899-146
Seal Shield	Protective waterproof peripherals	SYNNEX Corporation	528899-147
Securly	Internet content filtering software	Securly, Inc.	528899-148
Sennheiser	Audio products	Adorama Camera, Inc.	528899-149
Shuttle Furniture	Computer and classroom furniture	ShuttleSystem	528899-150
Sielox, LLC	Crisis lockdown alert status systems	Sielox, LLC	528899-151
SMARTdesks	Classroom and technology furniture	Smartdesks	528899-152
Solodev	Web content management system	Solodev	528899-153
SonicWall	Network security products	Unistar-Sparco Computers, Inc.	528899-154
Sony Electronics - Consumer	Consumer TVs, PlayStations, projectors, mobile devices, digital paper, digital cameras and KOOV educator kits	Adorama Camera, Inc.	528899-155
Sony Electronics - Professional	Professional cameras, monitors, decks and recorders, switchers, audio, projectors and displays	Adorama Camera, Inc.	528899-156
Spectrum Industries, Inc.	Lecterns, charging carts, collaboration solutions, computer and classroom furniture, and makerspace technology solutions	Spectrum Industries, Inc.	528899-157
Sphero	Educational coding robot and accessories	Tequipment Inc.	528899-158
STEM Fuse	STEM curricula	Tequipment Inc.	528899-159
Storagecraft	Backup and disaster recovery products	SYNNEX Corporation	528899-160

Product Line	Description	Awarded Vendor	Contract Number
Symantec	Remote access, anti-virus utility hardware and software, backup internet security	SYNNEX Corporation	528899-161
Syn-Apps	Notification software and hardware solutions	Global CTI	528899-162
Synology	Network attached storage (NAS) products	Aventis Systems, Inc.	528899-163
TabletKiosk	Windows and Linux compatible tablet PCs	TabletKiosk	528899-164
TekVisions, Inc.	Touch screen point of sale terminals, carts, pin pad and cash drawers	TekVisions, Inc.	528899-165
Telecor	Intercom, public address, and master clock systems	Telecor, Inc.	528899-166
Tenable	Cyber risk discovery and management	General Microsystems, Inc.	528899-167
Teq Online PD	Online professional development for technology instruction integration	Tequipment Inc.	528899-168
Tolemi	Location intelligence and data analytics software	Tolemi	528899-169
TouchIT Technologies	Interactive flat panels and software	Pivotal Communications Group, LLC	528899-170
Trend Micro	Antivirus and internet content security products	Carahsoft Technology Corporation	528899-171
Tripp Lite	Power protection products	Tripp Lite	528899-172
Ultimaker	3D printers	Tequipment Inc.	528899-173
Unitrends	Backup, data protection and disaster recovery appliances	General Microsystems, Inc.	528899-174
Universal Seating	Food court furniture and digital signage	Universal Seating Company	528899-175
Urban Armor Gear	Protective cases for phones and tablets	SYNNEX Corporation	528899-176
Varonis	Unstructured data protection and management products	SYNNEX Corporation	528899-177
Verkada	Cloud-based video surveillance systems	Verkada Inc.	528899-178
Vertiv	Power, thermal, and infrastructure management solutions	Liebert Corporation	528899-179
Vicon Industries, Inc.	Video surveillance equipment and software	Vicon Industries, Inc.	528899-180
ViewSonic	Displays, projectors, handhelds and presentation accessories	ViewSonic Corporation	528899-181
Virtustream	Cloud hosting services	EMC Corporation	528899-182
Visiplex, Inc.	Wireless voice paging and data messaging systems for emergency communication, mass notification, public address and intercom	Eastern Datacomm, Inc.	528899-183
WatchGuard	Web security products	SYNNEX Corporation	528899-184
Wisconsin Bench	Computer and classroom furniture	Wisconsin Bench	528899-185
Wonder Workshop	K-8 educational robots and coding	Tequipment Inc.	528899-186
Workrite Ergonomics	Ergonomic office products	Workrite Ergonomics	528899-187

Product Line	Description	Awarded Vendor	Contract Number
Xerox Corporation - Copiers	Copiers, multifunction devices, production systems and software	Xerox Corporation	528899-188
XYZprinting	3D printers	Choice Technical Services, Inc.	528899-189
Yuneec	Quadcopters, aerial drones and accessories	SYNNEX Corporation	528899-190
Zebra Technologies	Barcode printing and RTLS technology products	En-Net Services, LLC	528899-191
Zonar Systems	Electronic fleet management hardware and software	Zonar Systems, Inc.	528899-192

PEPPM 2019 Product Line Bid – California # 528899

AWARDED VENDOR AGREEMENT

BETWEEN

Kern County Superintendent of Schools (“Agency”)

AND

EMC Corporation

(Bidder's legal name referred to throughout this agreement as "Awarded Vendor")

For Bid Product Line:

Boomi, Inc.

(Product Line Name within PEPPM 2019 Product Line Bid – California # 528899)

This Agreement is made and entered into as of the date this Agreement is fully executed by the Kern County Superintendent of Schools (Agency) after an initial signature from the Awarded Vendor. This date of final execution shall be known as the “Effective Date.”

Whereas, Agency issued a Request for Bids for PEPPM 2019 Product Line Bid – California (“RFB”); and

Whereas that RFB is incorporated into this Agreement by reference and made a part hereof;

Whereas, the Awarded Vendor submitted a Bid in response to the Agency’s RFB for the Product Line referenced above;

Whereas, the Agency determined that Awarded Vendor was the lowest responsive and responsible bidder for the Product Line referenced above; and

Whereas, Awarded Vendor signs and executes this Awarded Vendor Agreement to indicate its acceptance of the terms and conditions of the Contract as defined below;

Now, therefore in consideration of the mutual covenants contained herein and other good and valuable consideration, the sufficiency of which is expressly acknowledged by both parties, and intending to be legally bound hereby, the parties mutually agree as follows:

1. This Agreement is a Contract and Contract Documents consist of the Request for Bids, bid Terms and Conditions, any applicable state-specific terms and conditions, all information incorporated into the electronic bid form by Agency or Bidder, the Bidder’s responses to Questions, the Bidder’s PEPPM Bid Quote Sheet(s), the Bidder’s pricing spreadsheet, the Bidder’s PEPPM State Selection Form, the Bidder’s Ancillary Services Form, this Agreement, all other attachments and exhibits to the request for bids, all addenda to the request for bids issued prior to the Bid Opening Date, and all subsequent written amendments to the Agreement (e.g. adding state-specific terms and conditions). The Contract Documents form the “Contract” between Agency for the Contract term, and during any authorized extensions.
2. Awarded Vendor agrees to furnish products and services related to the RFB in accordance with the RFB Terms and Conditions and Contract.

3. The Contract shall commence on January 1, 2019 and end on December 31, 2021. Agency and Awarded Vendor may elect to extend the term of the Contract as set forth in the Terms and Conditions.
4. Awarded Vendor agrees to honor submitted bid prices and pricing formulas according to all terms and conditions of the Contract Documents to all eligible buying organizations in California as authorized to purchase the products included in the Awarded Vendor's bid.
5. Where Awarded Vendor agreed to extend its quoted price formulas and effective prices to eligible LEAs in states and territories outside of California, Awarded Vendor agrees to extend those quoted bid prices and formulas according to all terms and conditions of the Contract Documents to those other LEAs and eligible agencies.
6. Awarded Vendor agrees to remit the Transaction Fee in accordance with the terms and conditions set forth in the Contract.
7. This Agreement shall be governed by and construed under the laws of the state of California, any disputes shall be determined in the court of general jurisdiction in the County of Kern.

IN WITNESS WHEREOF, the parties, intending to be legally bound, have caused their hands to be affixed.

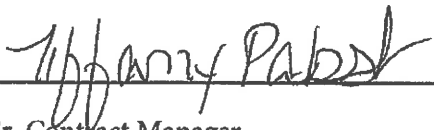
Vendor Signature 
 Signatory Title Sr. Contract Manager
 Vendor Name Tiffany Pabst
 Address 3017 Douglas Blvd, Suite 300
 City, State, Zip Roseville, CA 95661
 Date October 1, 2018

KCSOS Signature 
 Signatory Title For Mary C. Barlow, Kern County Superintendent of Schools
Priscilla Quinn
Interim KCSOS Assistant Superintendent
 Agency Name Kern County Superintendent of Schools
 Address 1300 17th Street
 City, State, Zip Bakersfield, CA 93301
 Date 12/14/18

PEPPM 2019 Product Line Bid – California # 528899

AWARDED VENDOR AGREEMENT

BETWEEN

Kern County Superintendent of Schools (“Agency”)

AND

EMC Corporation

(Bidder's legal name referred to throughout this agreement as "Awarded Vendor")

For Bid Product Line:

Dell EMC

(Product Line Name within PEPPM 2019 Product Line Bid – California # 528899)

This Agreement is made and entered into as of the date this Agreement is fully executed by the Kern County Superintendent of Schools (Agency) after an initial signature from the Awarded Vendor. This date of final execution shall be known as the “Effective Date.”

Whereas, Agency issued a Request for Bids for PEPPM 2019 Product Line Bid – California (“RFB”); and

Whereas that RFB is incorporated into this Agreement by reference and made a part hereof;

Whereas, the Awarded Vendor submitted a Bid in response to the Agency's RFB for the Product Line referenced above;

Whereas, the Agency determined that Awarded Vendor was the lowest responsive and responsible bidder for the Product Line referenced above; and

Whereas, Awarded Vendor signs and executes this Awarded Vendor Agreement to indicate its acceptance of the terms and conditions of the Contract as defined below;

Now, therefore in consideration of the mutual covenants contained herein and other good and valuable consideration, the sufficiency of which is expressly acknowledged by both parties, and intending to be legally bound hereby, the parties mutually agree as follows:

1. This Agreement is a Contract and Contract Documents consist of the Request for Bids, bid Terms and Conditions, any applicable state-specific terms and conditions, all information incorporated into the electronic bid form by Agency or Bidder, the Bidder's responses to Questions, the Bidder's PEPPM Bid Quote Sheet(s), the Bidder's pricing spreadsheet, the Bidder's PEPPM State Selection Form, the Bidder's Ancillary Services Form, this Agreement, all other attachments and exhibits to the request for bids, all addenda to the request for bids issued prior to the Bid Opening Date, and all subsequent written amendments to the Agreement (e.g. adding state-specific terms and conditions). The Contract Documents form the “Contract” between Agency for the Contract term, and during any authorized extensions.
2. Awarded Vendor agrees to furnish products and services related to the RFB in accordance with the RFB Terms and Conditions and Contract.

3. The Contract shall commence on January 1, 2019 and end on December 31, 2021. Agency and Awarded Vendor may elect to extend the term of the Contract as set forth in the Terms and Conditions.
4. Awarded Vendor agrees to honor submitted bid prices and pricing formulas according to all terms and conditions of the Contract Documents to all eligible buying organizations in California as authorized to purchase the products included in the Awarded Vendor's bid.
5. Where Awarded Vendor agreed to extend its quoted price formulas and effective prices to eligible LEAs in states and territories outside of California, Awarded Vendor agrees to extend those quoted bid prices and formulas according to all terms and conditions of the Contract Documents to those other LEAs and eligible agencies.
6. Awarded Vendor agrees to remit the Transaction Fee in accordance with the terms and conditions set forth in the Contract.
7. This Agreement shall be governed by and construed under the laws of the state of California, any disputes shall be determined in the court of general jurisdiction in the County of Kern.

IN WITNESS WHEREOF, the parties, intending to be legally bound, have caused their hands to be affixed.

Vendor Signature 
 Signatory Title Sr. Contract Manager
 Vendor Name Tiffany Pabst
 Address 3017 Douglas Blvd. Suite 300
 City, State, Zip Roseville, CA 95661
 Date October 1, 2018

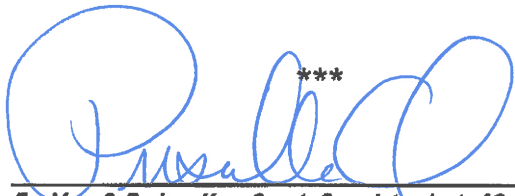
KCSOS Signature 
 Signatory Title For Mary C. Barlow, Kern County Superintendent of Schools
Priscilla Quinn
Interim KCSOS Assistant Superintendent
 Agency Name Kern County Superintendent of Schools
 Address 1300 17th Street
 City, State, Zip Bakersfield, CA 93301
 Date 12/14/18

PEPPM 2019 Product Line Bid – California # 528899

AWARDED VENDOR AGREEMENT

BETWEEN

Kern County Superintendent of Schools (“Agency”)

AND

EMC Corporation

(Bidder's legal name referred to throughout this agreement as "Awarded Vendor")

For Bid Product Line:

RSA Security

(Product Line Name within PEPPM 2019 Product Line Bid – California # 528899)

This Agreement is made and entered into as of the date this Agreement is fully executed by the Kern County Superintendent of Schools (Agency) after an initial signature from the Awarded Vendor. This date of final execution shall be known as the “Effective Date.”

Whereas, Agency issued a Request for Bids for PEPPM 2019 Product Line Bid – California (“RFB”); and

Whereas that RFB is incorporated into this Agreement by reference and made a part hereof;

Whereas, the Awarded Vendor submitted a Bid in response to the Agency's RFB for the Product Line referenced above;

Whereas, the Agency determined that Awarded Vendor was the lowest responsive and responsible bidder for the Product Line referenced above; and

Whereas, Awarded Vendor signs and executes this Awarded Vendor Agreement to indicate its acceptance of the terms and conditions of the Contract as defined below;

Now, therefore in consideration of the mutual covenants contained herein and other good and valuable consideration, the sufficiency of which is expressly acknowledged by both parties, and intending to be legally bound hereby, the parties mutually agree as follows:

1. This Agreement is a Contract and Contract Documents consist of the Request for Bids, bid Terms and Conditions, any applicable state-specific terms and conditions, all information incorporated into the electronic bid form by Agency or Bidder, the Bidder's responses to Questions, the Bidder's PEPPM Bid Quote Sheet(s), the Bidder's pricing spreadsheet, the Bidder's PEPPM State Selection Form, the Bidder's Ancillary Services Form, this Agreement, all other attachments and exhibits to the request for bids, all addenda to the request for bids issued prior to the Bid Opening Date, and all subsequent written amendments to the Agreement (e.g. adding state-specific terms and conditions). The Contract Documents form the “Contract” between Agency for the Contract term, and during any authorized extensions.
2. Awarded Vendor agrees to furnish products and services related to the RFB in accordance with the RFB Terms and Conditions and Contract.

3. The Contract shall commence on January 1, 2019 and end on December 31, 2021. Agency and Awarded Vendor may elect to extend the term of the Contract as set forth in the Terms and Conditions.
4. Awarded Vendor agrees to honor submitted bid prices and pricing formulas according to all terms and conditions of the Contract Documents to all eligible buying organizations in California as authorized to purchase the products included in the Awarded Vendor's bid.
5. Where Awarded Vendor agreed to extend its quoted price formulas and effective prices to eligible LEAs in states and territories outside of California, Awarded Vendor agrees to extend those quoted bid prices and formulas according to all terms and conditions of the Contract Documents to those other LEAs and eligible agencies.
6. Awarded Vendor agrees to remit the Transaction Fee in accordance with the terms and conditions set forth in the Contract.
7. This Agreement shall be governed by and construed under the laws of the state of California, any disputes shall be determined in the court of general jurisdiction in the County of Kern.

IN WITNESS WHEREOF, the parties, intending to be legally bound, have caused their hands to be affixed.

Vendor Signature Tiffany Pabst
 Signatory Title Sr. Contract Manager
 Vendor Name Tiffany Pabst
 Address 3017 Douglas Blvd. Suite 300
 City, State, Zip Roseville, CA 95661
 Date October 1, 2018

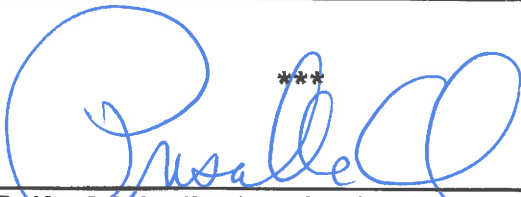
KCSOS Signature 
 Signatory Title For Mary C. Barlow, Kern County Superintendent of Schools
Priscilla Quinn
Interim KCSOS Assistant Superintendent
 Agency Name Kern County Superintendent of Schools
 Address 1300 17th Street
 City, State, Zip Bakersfield, CA 93301
 Date 12/14/18

PEPPM 2019 Product Line Bid – California # 528899

AWARDED VENDOR AGREEMENT

BETWEEN

Kern County Superintendent of Schools (“Agency”)

AND

EMC Corporation

(Bidder’s legal name referred to throughout this agreement as “Awarded Vendor”)

For Bid Product Line:

Virtustream

(Product Line Name within PEPPM 2019 Product Line Bid – California # 528899)

This Agreement is made and entered into as of the date this Agreement is fully executed by the Kern County Superintendent of Schools (Agency) after an initial signature from the Awarded Vendor. This date of final execution shall be known as the “Effective Date.”

Whereas, Agency issued a Request for Bids for PEPPM 2019 Product Line Bid – California (“RFB”); and

Whereas that RFB is incorporated into this Agreement by reference and made a part hereof;

Whereas, the Awarded Vendor submitted a Bid in response to the Agency’s RFB for the Product Line referenced above;

Whereas, the Agency determined that Awarded Vendor was the lowest responsive and responsible bidder for the Product Line referenced above; and

Whereas, Awarded Vendor signs and executes this Awarded Vendor Agreement to indicate its acceptance of the terms and conditions of the Contract as defined below;

Now, therefore in consideration of the mutual covenants contained herein and other good and valuable consideration, the sufficiency of which is expressly acknowledged by both parties, and intending to be legally bound hereby, the parties mutually agree as follows:

1. This Agreement is a Contract and Contract Documents consist of the Request for Bids, bid Terms and Conditions, any applicable state-specific terms and conditions, all information incorporated into the electronic bid form by Agency or Bidder, the Bidder’s responses to Questions, the Bidder’s PEPPM Bid Quote Sheet(s), the Bidder’s pricing spreadsheet, the Bidder’s PEPPM State Selection Form, the Bidder’s Ancillary Services Form, this Agreement, all other attachments and exhibits to the request for bids, all addenda to the request for bids issued prior to the Bid Opening Date, and all subsequent written amendments to the Agreement (e.g. adding state-specific terms and conditions). The Contract Documents form the “Contract” between Agency for the Contract term, and during any authorized extensions.
2. Awarded Vendor agrees to furnish products and services related to the RFB in accordance with the RFB Terms and Conditions and Contract.

3. The Contract shall commence on January 1, 2019 and end on December 31, 2021. Agency and Awarded Vendor may elect to extend the term of the Contract as set forth in the Terms and Conditions.
4. Awarded Vendor agrees to honor submitted bid prices and pricing formulas according to all terms and conditions of the Contract Documents to all eligible buying organizations in California as authorized to purchase the products included in the Awarded Vendor's bid.
5. Where Awarded Vendor agreed to extend its quoted price formulas and effective prices to eligible LEAs in states and territories outside of California, Awarded Vendor agrees to extend those quoted bid prices and formulas according to all terms and conditions of the Contract Documents to those other LEAs and eligible agencies.
6. Awarded Vendor agrees to remit the Transaction Fee in accordance with the terms and conditions set forth in the Contract.
7. This Agreement shall be governed by and construed under the laws of the state of California, any disputes shall be determined in the court of general jurisdiction in the County of Kern.

IN WITNESS WHEREOF, the parties, intending to be legally bound, have caused their hands to be affixed.

Vendor Signature 
 Signatory Title Sr. Contract Manager
 Vendor Name Tiffany Pabst
 Address 3017 Douglas Blvd. Suite 300
 City, State, Zip Roseville, CA 95661
 Date October 1, 2018

KCSOS Signature 
 Signatory Title For Mary C. Barlow, Kern County Superintendent of Schools
Priscilla Quinn
Interim KCSOS Assistant Superintendent
 Agency Name Kern County Superintendent of Schools
 Address 1300 17th Street
 City, State, Zip Bakersfield, CA 93801
 Date 12/14/18



PEPPM 2019 PRODUCT LINE BID FOR CALIFORNIA

For Technology Products, Including Equipment,
Software, Services, Supplies, And Other Items

Electronic Bid #528899

**THIS DOCUMENT IS NOT FOR UPLOAD. IT IS A WORKING
DOCUMENT THAT CONTAINS ALL PORTAL CONTENT THAT WAS
SUBMITTED.**

Contractor Point of Contact Title Page
Electronic #528899 | October 2, 2018 NLT 3pm PDT
PEPPM 2019 PRODUCT LINE BID FOR CALIFORNIA

EMC Contact Information for this Solicitation:

NAME	TITLE	ROLE	CONTACT INFORMATION
Pamela Kunhart	Manager, Strategic Contracts Program Office State & Local Government, Education (SLED)	Individual in charge of the SLED Strategic Contracts Office*	(877) 598-4915 Pamela.Kunhart@dell.com
Tiffany Pabst	Sr. Contract Manager	PEPPM DTD Contact / Individual Authorized to Obligate EMC Contractually	(916) 221-0294 Tiffany.Pabst@dell.com

*SLED Strategic Contracts Program Office Address: 3017 Douglas Blvd. Suite 300 / Roseville CA 95661; Phone: 1-877-598-4915

EMC Corporation:

EMC is a global leader in enabling businesses and service providers to transform their operations and deliver IT as a Service. Fundamental to this transformation is cloud computing. Through innovative products and services, EMC accelerates the journey to cloud computing, helping IT departments to store, manage, protect, and analyze their most valuable asset – information – in a more agile, trusted, and cost effective way.

EMC is a registered trademark of EMC Corporation. All other trademarks used herein are the property of their respective owners.

© Copyright 2018. EMC Corporation. All rights reserved.

EMC is now part of the Dell group of companies.

Table of Contents

Electronic Bid Form Questions	2
Basic Information.....	2
Vendor Responsibility Information.....	8
Marketing	11
Required Information Per Product Line	13
Final Steps.....	15
Additional Response Information.....	16
List of All Attachments Uploaded to the Portal.....	17

ELECTRONIC BID FORM QUESTIONS

To be a responsive bidder, you must answer any questions listed below. Some answers may be scored by the issuing agency as part of the bid evaluation process. Responses are limited to 4,000 characters. For longer responses, you may attach a file in the Upload Attachments section and note the file name here. If tagged "Yes" in the required column, the question must be answered in order for you to submit the bid.

Basic Information

In this section, we ask informational questions about your company so we can set up proper accounts if you win a bid.

1 What is your company's legal business name? Required = Yes

EMC Response:

EMC Corporation.

2 Are you doing business under a DBA ("Doing Business As")? Required = Yes

EMC Response:

No.

3 If Yes to Question 2, what is the DBA name? Required = No

EMC Response:

[Left blank]

4 What is the STREET ADDRESS of the physical location of your office headquarters? Required = Yes

EMC Response:

176 South Street

5 What is the CITY of the physical location of your office headquarters? Required = Yes

EMC Response:

Hopkinton

6 What is the STATE of the physical location of your office headquarters? Required = Yes

EMC Response:

Massachusetts

7 What is the ZIP code of the physical location of your office headquarters? Required = Yes

EMC Response:

01748

8 How long has your company been in business? Required = Yes

EMC Response:

Since 1979

9 What is your company's website URL? Required = Yes

EMC Response:

www.dellemc.com

10 What is the FIRST name of the contact for all questions related to this bid proposal? Required = Yes

EMC Response:

Tiffany

11 What is the LAST name of the contact for all questions related to this bid proposal? Required = Yes

EMC Response:

Pabst

12 What is the bid proposal contact's TITLE? Required = Yes

EMC Response

Sr. Contract Manager

13 What is the bid proposal contact's PHONE number? Required = Yes

EMC Response:

(916) 221-0294

14 What is the bid proposal contact's E-MAIL address? Required = Yes

EMC Response:

Tiffany.Pabst@dell.com

15 What is the bid proposal contact's FAX number?

EMC Response:

(916) 784-3855

16 If you are awarded any contracts as a result of your bid, what is the FIRST name of the Day-to-Day (DTD) contact person responsible for administration of the contract? Required = Yes

EMC Response:

Tiffany

17 If you are awarded any contracts as a result of your bid, what is the LAST name of the Day-to-Day (DTD) contact person responsible for administration of the contract? Required = Yes

EMC Response:

Pabst

18 What is the DTD contact's TITLE? Required = Yes

EMC Response:

Sr. Contract Manager

19 What is the DTD contact's ADDRESS? Required = Yes

EMC Response:

3017 Douglas Blvd. Suite 300

20 What is the DTD contact's CITY? Required = Yes

EMC Response:

Roseville

21 What is the DTD contact's STATE? Required = Yes

EMC Response:

CA

22 What is the DTD contact's ZIP code? Required = Yes

EMC Response:

95661

23 What is the DTD contact PHONE number? Required = Yes

EMC Response:

(916) 221-0294

24 What is the DTD contact's E-MAIL address? Required = Yes

EMC Response

Tiffany.Pabst@dell.com

25 What is the DTD contact's FAX number? Required = Yes

EMC Response:

(916) 784-3855

26 What is your Federal E-rate SPIN number?

If you do not currently have one, type "none" in the Response Column. Required = Yes

EMC Response:

143049511

27 Who is the company's contact for the Federal E-rate program? If you do not currently have one, type "none" in the Response Column. Required = Yes

EMC Response:

Pamela Kunhart

28 What is the E-rate contact's TITLE? If you do not currently have one, type "none" in the Response Column. Required = Yes

EMC Response:

Manager, Strategic Contracts Program Office, SLED

29 What is the E-rate contact's PHONE number? If you do not currently have one, type "none" in the Response Column. Required = Yes

EMC Response:

(877) 598-4915

30 What is the E-rate contact's E-MAIL address? If you do not currently have one, type "none" in the Response Column. Required = Yes

EMC Response:

Pamela.kunhart@dell.com

31 What is the E-rate contact's FAX number? If you do not currently have one, type "none" in the Response Column.

EMC Response:

(916) 784-3855

32 If you are awarded a contract as a result of your bid submission, who in your company will be the accounting contact for the payment of monthly transaction fees? Required = Yes

EMC Response:

Lynda McNiff

33 What is the PHONE number of the accounting contact? Required = Yes

EMC Response:

(916) 774-7161

34 What is the E-MAIL address of the accounting contact? Required = Yes

EMC Response:

Lynda.McNiff@dell.com

35 What is the FAX number of the accounting contact? Required = Yes

EMC Response:

(916) 784-3855

36 To what department should invoices be directed? Required = Yes

EMC Response:

Invoices for EMC Corporation administrative fees should be addressed to State, Local Government, and Education (SLED) Contracts. NOTE: If the products were sold to the Eligible Entity by a Reseller, the invoice should be delivered to the Reseller.

37 What is the address, city, state and zip code to which invoices should be sent? Separate each item with a comma.

EMC Response:

EMC Corporation, 3017 Douglas Blvd, Suite 300 Roseville, CA 95661

38 If you become a PEPPM Awarded Vendor, to whom will you expect POs to be delivered for your awarded product line(s)? Please provide a name and e-mail address separated by a comma.

EMC Response:

POs should be delivered to the appropriate Dell EMC Account Manager or to the Reseller Account Manager for the Partner that is engaged with the customer on the sale.

Dell EMC Account Managers:

Amanda Davis, Amanda.L.Davis@emc.com

Jeff Caruso, Jeff.Caruso@emc.com

39 If your firm is a publicly traded company, please enter your stock symbol. If not, write not applicable. Required = No

EMC Response:

Not applicable.

40 What is your company's Facebook URL? Required = No

EMC Response:

<https://www.facebook.com/DellEMC/>

41 What is your company's Twitter handle? If you use multiple accounts, separate each entry with a comma. Required = No

EMC Response:

www.dell EMC.com/slg

42 What is the address of your company's LinkedIn page? Required = No

EMC Response

<https://www.linkedin.com/company/dell EMC>

43 What is the address of your company's Google+ page? Required = No

EMC Response:

<https://plus.google.com/+dell EMC>

44 Please list the addresses of any other pertinent Internet or social media sites for your company here. Separate each address with a comma. Required = No

EMC Response:

None

45 Does your company fall into any of the following categories of a Historically Under-Utilized Business? (HUB). Required=Yes

EMC Response:

[Select from Drop-down. Choices are: Minority-owned, Woman-owned, Woman-owned and Minority-Owned, DVBE, Women-Owned DVBE, Minority-owned DVBE, None of the Above, Decline to State]

None of the above.

Vendor Responsibility Information

In this section we ask questions that ascertain whether the bidding company is a responsible vendor. Answers to questions in this section determine up to 20 points in the evaluation process.

46 Do you have a commercial, permanent place of business? If "No," please attach a letter as a PDF explaining the circumstances.

EMC Response:

Yes.

47 Is your firm currently in bankruptcy proceedings? If "Yes," please attach a letter as a PDF explaining the circumstances.

EMC Response:

[Select from Drop-down. Choices are Yes, No]

No.

48 Do you have any overdue tax liabilities? If "Yes," please attach a letter as a PDF explaining the circumstances.

EMC Response:

[Select from Drop-down. Choices are Yes, No]

No.

49 Do you have any overdue transaction fees from an existing or former PEPPM contract? If Yes, please attach a letter as a PDF explaining the circumstances. Required = Yes

EMC Response:

[Select from Drop-down. Choices are Yes, No]

No

50 Do you certify that you have NOT colluded in the development of your bid and that you are in compliance with Section V.1 of the Terms and Conditions?

EMC Response:

[Select from Drop-down. Choices are Yes, No]

Yes

51 Has your firm been suspended or debarred from any public sector contract? If Yes, please attach a letter as a PDF explaining the circumstances. Required = Yes

EMC Response:

[Select from Drop-down. Choices are Yes, No]

No

52 Do you have a sales structure that will facilitate and promote sales among education agencies?

EMC Response:

[Select from Drop-down. Choices are Yes, No]

Yes

53 Please list the education sales people who would be assigned to the PEPPM contract and their account or territory responsibilities. Use this format: John Doe, Southeastern Pennsylvania. Required = Yes

EMC Response:

Amanda Davis, Southern California

Jeff Caruso, Northern California

54 Please identify any sales offices that will serve PEPPM. Include address and phone information separated by a comma.

EMC Response:

Roseville Office, 3017 Douglas Blvd Ste 300, Roseville CA 95661, 916-797-6500

El Segundo Office, 2101 Rosecrans Ave Ste 3200, El Segundo CA 90245, 310-414-1617

San Francisco Office, 455 Market St Ste 400, San Francisco CA 94105, 415-777-4868

Santa Clara Office, 2811 Mission College Blvd Santa Clara CA 94103, 408-572-6000

55 You must provide three references for your company. The reference forms must be filed out and signed by your school customers. Scan all three references into a single PDF file and attach here. Have you attached the document?

EMC Response:

[Select from Drop-down. Choice is Yes]

Yes.

Attached:

56 What is your 2017 total revenue from all K-12 education accounts? Required = Yes

EMC Response:

The K12 Revenue for PEPPM for 2017 was \$56M.

57 What is your 2017 total revenue from all accounts? Required = Yes

EMC Response

EMC Corporation (Dell EMC) was a publicly held corporation until September 7, 2016. On this date, EMC became a wholly owned subsidiary of Dell Technologies Inc., a privately controlled company that reports

financial results via SEC filings due to the issuance of publicly traded tracking stock. Reported revenues for Dell Technologies Inc. for 2017 (Fiscal Year End February 2, 2018) was \$78.6 billion up from \$61.6 billion the previous Fiscal Year End February 3, 2017.

58 Describe your system of customer support and service to PEPPM's eligible buying agencies. Attachments are acceptable.

EMC Response:

Please see our attachment: Question 58 - prosupport-enterprise-suite-brochure for a description of our customer support and services available to PEPPM eligible buying agencies.

59 Will customer service be available between 8 a.m. and 8 p.m. Eastern Time? Required = Yes

EMC Response:

[Select from Drop-down. Choices are Yes, No]

Yes

60 If you have previously held a PEPPM contract, were you in compliance with its Terms and Conditions. If No, please attach a letter of explanation in PDF format.

EMC Response:

[Select from Drop-down. Choices are Yes, No]

Yes.

61 Please list your top five education clients over the past two years

EMC Response:

- #1 Moreno Valley Unified School District
- #2 Rialto Unified School District
- #3 Pasadena Unified School District
- #4 Kern High School District
- #5 Fontana Unified School District

62 Please list five top government clients over the past two years.

EMC Response:

- #1 State of California
- #2 City of Long Beach
- #3 Metropolitan Water District of Southern California
- #4 Orange County Sheriff's Department
- #5 Orange County Public Works

63 My company is a . . . Required = Yes

EMC Response:

[Select from Drop-down. Choices are: Manufacturer, Reseller, Distributor, Wholesaler, Aggregator, Publisher, Other]

Manufacturer.

64. Please list five of your top public agency purchasing **CONTRACTS** now in force or list any recent large-order fulfillments. Required = Yes

EMC Response:

1. NASPO ValuePoint MNWNC-109 Computer Equipment – 31 States and 8 local and education entities
2. New York OGS (PM20830 IT Umbrella)
3. Texas Department of Information Resources (DIR-TSO-TMP-422)
4. South Carolina State Term Contract (44000004247)
5. Virginia VITA (VA-101112-EMC)

65. Please describe your company structure, organization, ownership, and company history. Attach an organization chart and/or any documentation as a PDF that may be helpful. Required = Yes

EMC Response:

Attached:

Marketing

66. Describe your marketing plan for driving PEPPM education business. You may attached a separate document as a PDF by typing "see attached" in Response Column. (refer to Section X.10. of terms and conditions). Required = Yes

EMC Response:

See Attached.

67 Please write a narrative between 150 and 200 words that describes how your company is unique from your competition and how your customers will benefit by using your company's products and services. If applicable to boost sales, include information about how your company is structured, owned and organized. Write this narrative so that it can be published in complete sentences to potential customers on the PEPPM website and in catalog materials. To assist and attract potential buyers, you may also attach a photograph that is illustrative of your company, employees, or product line. (This narrative and photograph will be used only if you are awarded a contract.)

EMC Response:

EMC Corporation, which brands itself as Dell EMC, is part of a unique family of businesses that provides the essential infrastructure for organizations to build their digital future, transform IT and protect their most important asset, information. The combination created the #1 market leader with an expansive technology portfolio that solves complex problems for customers in the industry's fast-growing areas of hybrid cloud,

software defined data center, converged infrastructure, platform-as-a-service, data analytics, mobility and cybersecurity.

With over 30 years of experience, our value is in offering solutions that map to the government customers, which includes the U.S. Federal government and foreign government (both civilian and defense agencies) and state and local governments, provinces, counties, cities, as well as educational institutions around the world. EMC solutions help customers ensure that information is managed efficiently, effectively, and securely. EMC's understanding of government priorities enables us to work as a strategic partner—delivering value and helping achieve critical objectives for our customers.

Today, our storage solutions are helping State and Local Governments and Education (SLED) agencies ensure long-term sustainability, with the potential for reducing cost of ownership.

68. If you are awarded a contract, you will be required to provide product detail information corresponding to each item being sold under your product line contract (Section XII.4). Are you able to provide the descriptive product detail information for each line item you sell?

EMC Response:

[Select from Drop-down. Choices are Yes, No]

Yes.

69. Your products will have greater visibility and rank higher in search results on PEPPM's website if you have photographs of your products. Will you be able to provide PEPPM with photographs of your products?

EMC Response:

[Select from Drop-down. Choices are Yes, No]

No

70. Can you provide multiple photographic views for each line item under contract, that is, photos showing each of your products from multiple perspectives?

EMC Response

[Select from Drop-down. Choices are Yes, No]

No

71. For each product line contract you may be awarded, will your sales team be able to meet the requirement (Section XII.2) to sell a minimum of \$5,000 of product or services per quarter?

EMC Response:

[Select from Drop-down. Choices are Yes, No]

Yes.

Required Information Per Product Line

In this section, we help you provide the appropriate attachments so that your bid will be considered responsive. To start, the following questions and checklists refer to attachments that should be placed in the Product Line section above, alongside EACH respective product line you are bidding.

72. Have you placed a check mark in the white box in the Bid column, indicating which of the product lines you are bidding? Required = Yes

EMC Response:

[Select from Drop-down. Choice is Yes]

Yes.

73. Are you the manufacturer for any of the product lines you are bidding? Required = Yes

EMC Response

[Select from Drop-down. Choices are Yes, No]

Yes.

74 If "Yes" to Question 73, then you do not need not prove you have access to a supply of the product line, since you are the manufacturer. If "No" to Question 73 for any product line you are bidding, then, for each of those product line(s), you must attach a manufacturer's letter or other written evidence/documentation, including a narrative of relationships between you, your distributor and/or the manufacturer to each product line you are bidding. As per Section VI.8 of the Terms and Conditions, have you attached each required letter (labeled "Proof of Supply") in PDF format to each respective product line you are bidding?

EMC Response:

[Select from Drop-down. Choices are Yes, where appropriate or No, we are the manufacturer]

Yes, where appropriate

75 Do you offer any services directly or indirectly through third-parties such as installation, consulting, training, repair, etc. in conjunction with hardware or software your company is bidding? If "yes," fill out the Ancillary Services Form showing your PEPPM discounted rate structure for each product line you are bidding. Sign and date the form, and attach as a PDF document alongside each respective product line you are bidding. Have you attached the document (labeled Ancillary Services Form) to each product line? Required = Yes

EMC Response:

[Select from Drop-down. Choices are Yes, No]

Yes.

76 To be responsive, your bid must include the warranty provisions you provide for each of the product lines you are bidding or includes a document that links to warranty provisions. (Terms and Conditions Section VI.12). If bidding items where warranty may not apply, make such a statement in a document. Attach as a PDF document alongside each respective product line you are bidding. Have you attached the document (labeled "Warranty Statement") to each product line?

EMC Response:

[Select from Drop-down. Choices are Yes, No]

Yes.

Attachments:

77 Your bid will be evaluated on the existence of a statement explaining your policy on returned goods (Section VI.17). Please describe your policy on returned goods with enough detail that the information can be published and a buyer can understand if and how goods can be returned. If items cannot be returned, a statement of explanation still applies. Attach as a PDF document alongside each respective product line you are bidding. Have you attached the document (labeled "Returned Goods") to each product line?

EMC Response:

[Select from Drop-down. Choices are Yes, No]

Yes.

Attachments.

78 Although KCSOS is specifically bidding for California schools and agencies, it is PEPPM's intent to allow for "piggybacking" by entities (Section III.6) in other states. If you wish to extend your California bid pricing to eligible education agencies in other states, fill out the State Selection Form for each product line you are bidding. Attach the form as a PDF document alongside each respective product line you are bidding. Have you attached the document (labeled "State Selection Form") to each product line?

EMC Response:

[Select from Drop-down. Choices are: Yes, PEPPM State Selection Form is attached to each product line; or No, I am only bidding for sales in California.]

Yes, PEPPM State Selection Form is attached to each product line.

79 PEPPM does not wish to harm in any way the ability of vendors to provide lowest pricing to schools. However, many government agencies would like the ability to buy from PEPPM contracts. If you elect to extend your California PEPPM bid educational prices to government agencies, please check the appropriate box on the State Selection Form for each product line you are bidding. Have you marked the appropriate box on the State Selection Form used in Question 78?

EMC Response:

[Select from Drop-down. Choices are Yes, No]

Yes

80 Many four-year colleges and universities would like the ability to buy from PEPPM contracts. If you elect to extend your California PEPPM bid educational prices to four-year colleges and universities, please check the appropriate box on the State Selection Form for each product line you are bidding. Have you marked the appropriate box on the State Selection Form used in Question 78?

EMC Response:

[Select from Drop-down. Choices are Yes, No]

Yes.

81 The Bid Price Submission Template contains a Quote Sheet tab and a Bid Response tab. The Quote Sheet is where your bid discount or markup formulas are recorded. The Bid Response is where you bid pricing is recorded based on the discount or markup formulas on the Quote Sheet. Fill out a separate Bid Price Submission Template for each product line you are bidding. After attaching the respective Excel spreadsheet alongside the corresponding product line you are bidding, you must distinguish your Bid Price Submission Template from any other attachments. Do this by placing a check mark next to your Bid Price Submission Template for the product line and clicking on the "Identify SKU Attachment." It will then be marked with an asterisk by the eBid system. Have you attached and identified the Excel spreadsheet to each product line?

EMC Response:

[Select from Drop-down. Choice is Yes]

Yes

82 We request that you attach the published Price List or Catalog (preferably in Excel format) used as your Price Basis to determine your PEPPM pricing alongside the name of each product line you are bidding (See letter "K" on the Quote Sheet tab within the Bid Price Submission Template). Have you attached the Price Basis file (labeled "Price Basis") used for calculating PEPPM pricing to each product line?

EMC Response:

[Select from Drop-down. Choice is Yes]

Yes.

Attachments

83 We require a signed Awarded Vendor Agreement for each product line you are bidding. Fill in the product name, description (as it appears on the product line bid list) and company legal address on the first page of the agreement. Sign and date (affix Corporate Seal if appropriate) on the appropriate lines at the end of the agreement. Attach as a PDF document alongside each respective product line you are bidding. Have you attached the document (labeled "Vendor Agreement") to each product line?

EMC Response:

[Select from Drop-down. Choice is Yes]

Yes

Final Steps

In this section, we wrap up the bid. It is time to finish your bid by attesting to its truthfulness, accuracy and your willingness to comply with this bid's Terms and Conditions. Answers to questions in this section determine up to 10 points in the evaluation process.

84 If you are offering leasing terms, have you attached the leasing document in PDF format here (refer to Section XII.7)?

EMC Response:

[Select from Drop-down. Choice is Yes]

Yes.

Attachment

85 Have you checked in the External Notes section below for notices of any bid amendments or changes? Required = Yes

EMC Response

[Select from Drop-down. Choice is Yes]

Yes.

86 Have you read all the Terms and Conditions?

EMC Response:

[Select from Drop-down. Choice is Yes]

Yes.

87 Do you hereby certify your acceptance of the Terms and Conditions that are part of the bid document? (If "No," your bid may be labeled non-responsive in accordance with Section IX.6)

EMC Response:

[Select from Drop-down. Choices are Yes, No]

Yes.

88 If you answered "No" to Question 87, please express objections here or attach a document that details your objections.

EMC Response: N/A

89 In submitting this bid form with your electronic signature, do you swear that the answers to the questions herein are true to the best of your knowledge and that you have the authority to submit this bid to the Agency thereby binding your company to the Terms and Conditions, final pricing, statements and all commitments submitted to Agency? (If No, this form must be forwarded to another appropriate company representative who can answer "Yes"). Required = Yes

EMC Response:

Yes.

Additional Response Information

eBid Expiration date [TCs say 120 days]

EMC Response:

January 2, 2019

LIST OF ALL ATTACHMENTS UPLOADED TO THE PORTAL

EMC Response:

The following list represents all 36 attachments that were uploaded to the site. The actual documents are available in a separate folder (PEPPM 2019 CA – Final Attachments).

- Question 55 - Vendor References (3) for PEPPM CA 2019
- Question 58 - prosupport-enterprise-suite-brochure
- Question 65 - Corporate Profile
- Question 67 - Marketing Plan
- Question 74 - PEPPM 2019_CA_Proof of Supply_Boomi
- Question 74 - PEPPM 2019_CA_Proof of Supply_RSA
- Question 74 - PEPPM 2019_CA_Proof of Supply_Virtustream
- Question 75 - PEPPM 2019 CA_ ANCILLARY SERVICES FORM_Boomi
- Question 75 - PEPPM 2019 CA_ ANCILLARY SERVICES FORM_Dell EMC
- Question 75 - PEPPM 2019 CA_ ANCILLARY SERVICES FORM_RSA
- Question 75 - PEPPM 2019 CA_ ANCILLARY SERVICES FORM_Virtustream
- Question 76 - Warranty Statement_Boomi
- Question 76 - Warranty Statement_Dell EMC
- Question 76 - Warranty Statement_RSA
- Question 76 - Warranty Statement_Virtustream
- Question 77 - Returned Goods Statement_Boomi
- Question 77 - Returned Goods Statement_Dell EMC
- Question 77 - Returned Goods Statement_RSA
- Question 77 - Returned Goods Statement_Virtustream
- Question 78 - PEPPM 2019 State Selection Form_Boomi
- Question 78 - PEPPM 2019 State Selection Form_Dell EMC
- Question 78 - PEPPM 2019 State Selection Form_RSA
- Question 78 - PEPPM 2019 State Selection Form_Virtustream
- Question 81 - PEPPM_CA_PRODUCTLINE_TEMPLATE_Bid Price Submission_Boomi
- Question 81 - PEPPM_CA_PRODUCTLINE_TEMPLATE_Bid Price Submission_DELL EMC
- Question 81 - PEPPM_CA_PRODUCTLINE_TEMPLATE_Bid Price Submission_RSA
- Question 81 - PEPPM_CA_PRODUCTLINE_TEMPLATE_Bid Price Submission_Virtustream
- Question 82 - Boomi_Price Basis_August 2018
- Question 82 - Dell EMC_Price Basis_August 2018
- Question 82 - RSA_Price Basis_August 2018
- Question 82 - Virtustream_Price Basis_September 2018
- Question 83 - PEPPM 2019_CA_Awarded Vendor Agreement_Boomi
- Question 83 - PEPPM 2019_CA_Awarded Vendor Agreement_Dell EMC

- Question 83 - PEPPM 2019_CA_Awarded Vendor Agreement_RSA Security
- Question 83 - PEPPM 2019_CA_Awarded Vendor Agreement_Virtustream
- Question 84 - DFS Leasing Terms CA

DELL EMC

Vendor Reference for PEPPM Bid

You are completing a reference worksheet for a vendor who is planning to submit a bid to the PEPPM Technology Cooperative Purchasing Program. PEPPM (www.PEPPM.org) is a purchasing cooperative exercising best-practices to achieve competitive purchasing contracts on behalf of education and public agencies. We appreciate your reference. It helps us ensure that all PEPPM-awarded vendors are responsible, capable, and responsive. Please sign and promptly return this form to the vendor so, the company can include it with its bid. If you have any confidential information you would like to provide us, simply e-mail Jared Lehman (Supervising Manager) at jlehman@csiu.org.

Name of Vendor Seeking Reference EMC Corporation

Name of Person Providing Reference Chris Stevenson

Reference's Title IT Manager

School District or Agency Name Phoenixville Area School District

Address, State, Zip Code 386 City Line Avenue, Phoenixville, PA 19460

Reference's Direct Phone Number 484-927-5000

Alternate Phone Number _____

Reference's E-Mail Address StevensonC@pasd.com

Pre-Sale Service

True or Mostly True	No Opinion	Not True or Inaccurate	
<input checked="" type="checkbox"/>	<input type="checkbox"/>	<input type="checkbox"/>	Vendor was knowledgeable about the product you purchased.
<input checked="" type="checkbox"/>	<input type="checkbox"/>	<input type="checkbox"/>	Vendor could fully answer questions about the products you purchased.
<input checked="" type="checkbox"/>	<input type="checkbox"/>	<input type="checkbox"/>	Vendor's answers were truthful and accurate.
<input checked="" type="checkbox"/>	<input type="checkbox"/>	<input type="checkbox"/>	Vendor was knowledgeable and truthful about contracting options.

Quality of Product, Service and Delivery

<input checked="" type="checkbox"/>	<input type="checkbox"/>	<input type="checkbox"/>	Products delivered were exactly those specified.
<input checked="" type="checkbox"/>	<input type="checkbox"/>	<input type="checkbox"/>	Promised services were provided.
<input checked="" type="checkbox"/>	<input type="checkbox"/>	<input type="checkbox"/>	Deliveries were made correctly, safely, completely, and timely.

Post-Sale Services

<input checked="" type="checkbox"/>	<input type="checkbox"/>	<input type="checkbox"/>	Invoices were correct as to price, quantity, and contract terms.
<input checked="" type="checkbox"/>	<input type="checkbox"/>	<input type="checkbox"/>	Warranty and return options, if exercised, were honored.
<input checked="" type="checkbox"/>	<input type="checkbox"/>	<input type="checkbox"/>	Follow-up customer services, installations, or configurations were provided as promised.

Your Overall Impression

<input checked="" type="checkbox"/>	<input type="checkbox"/>	<input type="checkbox"/>	Vendor is honest.
<input checked="" type="checkbox"/>	<input type="checkbox"/>	<input type="checkbox"/>	Vendor is capable.
<input checked="" type="checkbox"/>	<input type="checkbox"/>	<input type="checkbox"/>	You would use this vendor again.
<input checked="" type="checkbox"/>	<input type="checkbox"/>	<input type="checkbox"/>	You would recommend this vendor to other public agencies.

Comment _____

Signature Chris Stevenson Digitally signed by Chris Stevenson Date: 2018.09.06 13:17:59 -04'00' Date 06SEP2018

Vendor Reference for PEPPM Bid

You are completing a reference worksheet for a vendor who is planning to submit a bid to the PEPPM Technology Cooperative Purchasing Program. PEPPM (www.PEPPM.org) is a purchasing cooperative exercising best-practices to achieve competitive purchasing contracts on behalf of education and public agencies. We appreciate your reference. It helps us ensure that all PEPPM-awarded vendors are responsible, capable, and responsive. Please sign and promptly return this form to the vendor so, the company can include it with its bid. If you have any confidential information you would like to provide us, simply e-mail Jared Lehman (Supervising Manager) at jlehman@csiu.org.

Name of Vendor Seeking Reference EMC Corporation

Name of Person Providing Reference Dan Maguire

Reference's Title Supervisor of Technology Services

School District or Agency Name Kennett Consolidated School District

Address, State, Zip Code 300 East South Street, Kennett PA 19348

Reference's Direct Phone Number 610.444.4136

Alternate Phone Number 610.444.2551

Reference's E-Mail Address dmaguire@kcsd.org

Pre-Sale Service

True or Mostly True	No Opinion	Not True or Inaccurate	
<input checked="" type="checkbox"/>	<input type="checkbox"/>	<input type="checkbox"/>	Vendor was knowledgeable about the product you purchased.
<input checked="" type="checkbox"/>	<input type="checkbox"/>	<input type="checkbox"/>	Vendor could fully answer questions about the products you purchased.
<input checked="" type="checkbox"/>	<input type="checkbox"/>	<input type="checkbox"/>	Vendor's answers were truthful and accurate.
<input checked="" type="checkbox"/>	<input type="checkbox"/>	<input type="checkbox"/>	Vendor was knowledgeable and truthful about contracting options.

Quality of Product, Service and Delivery

<input checked="" type="checkbox"/>	<input type="checkbox"/>	<input type="checkbox"/>	Products delivered were exactly those specified.
<input checked="" type="checkbox"/>	<input type="checkbox"/>	<input type="checkbox"/>	Promised services were provided.
<input checked="" type="checkbox"/>	<input type="checkbox"/>	<input type="checkbox"/>	Deliveries were made correctly, safely, completely, and timely.

Post-Sale Services

<input checked="" type="checkbox"/>	<input type="checkbox"/>	<input type="checkbox"/>	Invoices were correct as to price, quantity, and contract terms.
<input type="checkbox"/>	<input checked="" type="checkbox"/>	<input type="checkbox"/>	Warranty and return options, if exercised, were honored.
<input checked="" type="checkbox"/>	<input type="checkbox"/>	<input type="checkbox"/>	Follow-up customer services, installations, or configurations were provided as promised.

Your Overall Impression

<input checked="" type="checkbox"/>	<input type="checkbox"/>	<input type="checkbox"/>	Vendor is honest.
<input checked="" type="checkbox"/>	<input type="checkbox"/>	<input type="checkbox"/>	Vendor is capable.
<input checked="" type="checkbox"/>	<input type="checkbox"/>	<input type="checkbox"/>	You would use this vendor again.
<input checked="" type="checkbox"/>	<input type="checkbox"/>	<input type="checkbox"/>	You would recommend this vendor to other public agencies.

Comment _____

Signature  Date 9/5/18

Vendor Reference for PEPPM Bid

You are completing a reference worksheet for a vendor who is planning to submit a bid to the PEPPM Technology Cooperative Purchasing Program. PEPPM (www.PEPPM.org) is a purchasing cooperative exercising best-practices to achieve competitive purchasing contracts on behalf of education and public agencies. We appreciate your reference. It helps us ensure that all PEPPM-awarded vendors are responsible, capable, and responsive. Please sign and promptly return this form to the vendor so, the company can include it with its bid. If you have any confidential information you would like to provide us, simply e-mail Jared Lehman (Supervising Manager) at jlehman@csiu.org.

Name of Vendor Seeking Reference EMC Corporation

Name of Person Providing Reference Robert Hilinski

Reference's Title Director of Information Technology

School District or Agency Name Upper Darby School District

Address, State, Zip Code 4611 Bond Ave, Drexel Hill, Pa. 19026

Reference's Direct Phone Number 610-789-7200

Alternate Phone Number _____

Reference's E-Mail Address rhilinski@upperdarbysd.org

Pre-Sale Service

True or Mostly True	No Opinion	Not True or Inaccurate	
<input checked="" type="checkbox"/>	<input type="checkbox"/>	<input type="checkbox"/>	Vendor was knowledgeable about the product you purchased.
<input checked="" type="checkbox"/>	<input type="checkbox"/>	<input type="checkbox"/>	Vendor could fully answer questions about the products you purchased.
<input checked="" type="checkbox"/>	<input type="checkbox"/>	<input type="checkbox"/>	Vendor's answers were truthful and accurate.
<input checked="" type="checkbox"/>	<input type="checkbox"/>	<input type="checkbox"/>	Vendor was knowledgeable and truthful about contracting options.

Quality of Product, Service and Delivery

<input checked="" type="checkbox"/>	<input type="checkbox"/>	<input type="checkbox"/>	Products delivered were exactly those specified.
<input checked="" type="checkbox"/>	<input type="checkbox"/>	<input type="checkbox"/>	Promised services were provided.
<input checked="" type="checkbox"/>	<input type="checkbox"/>	<input type="checkbox"/>	Deliveries were made correctly, safely, completely, and timely.

Post-Sale Services

<input checked="" type="checkbox"/>	<input type="checkbox"/>	<input type="checkbox"/>	Invoices were correct as to price, quantity, and contract terms.
<input checked="" type="checkbox"/>	<input type="checkbox"/>	<input type="checkbox"/>	Warranty and return options, if exercised, were honored.
<input checked="" type="checkbox"/>	<input type="checkbox"/>	<input type="checkbox"/>	Follow-up customer services, installations, or configurations were provided as promised.

Your Overall Impression

<input checked="" type="checkbox"/>	<input type="checkbox"/>	<input type="checkbox"/>	Vendor is honest.
<input checked="" type="checkbox"/>	<input type="checkbox"/>	<input type="checkbox"/>	Vendor is capable.
<input checked="" type="checkbox"/>	<input type="checkbox"/>	<input type="checkbox"/>	You would use this vendor again.
<input checked="" type="checkbox"/>	<input type="checkbox"/>	<input type="checkbox"/>	You would recommend this vendor to other public agencies.

Comment _____

Signature Robert H Hilinski Date 9/6/18

A man in a blue plaid shirt is looking at a row of server racks in a data center. The racks are black with a perforated front panel and have several green indicator lights. The man is standing to the right of the racks, looking towards them. The background shows more server racks and a ceiling with lighting fixtures.

ProSupport Enterprise Suite

Support that accelerates
your IT transformation

DELLEMC

Comprehensive support for complex environments

The enterprise landscape is changing rapidly, and the pressure to introduce new technologies into your organization while efficiently maintaining existing servers, storage and networking has never been greater. Big Data, virtualization, application modernization, modular infrastructure and cloud computing can result in substantial benefits, but they require an even higher level of expertise. A complex environment means complex processes — and more potential problems. The more you depend on technology, the more important it is to have the right support.

To find time to focus on your business objectives and stay competitive, you need to manage:

- Maintenance costs
- Workload availability
- Multiple hardware and software vendors
- Automated proactive and predictive technologies

Today's complex environments require true enterprise-class support.



Proactive insights from Dell EMC

You're looking for efficiency. Most IT departments spend 80% of their time on routine maintenance and support instead of innovation — a fact that hasn't changed in years.¹ With the right support solution, Dell EMC can help shift more of your focus to where it should be — on your business.

When you're working with multiple vendors to keep your servers, storage and networking up and running, things get difficult very quickly.

With the ProSupport Enterprise Suite, you can get the most out of your investment with the support expertise and insights Dell EMC is known for across the globe. The ProSupport Enterprise Suite doesn't just extend your IT team. It enables you to resolve IT questions and problems in less time.

The ProSupport Enterprise Suite offers:

- Flexibility to choose support based on criticality of specific systems and the complexity of your environment
- A central point of accountability for all your hardware and software issues
- Broad, deep cross-domain experience that goes beyond a single piece of hardware
- Predictive, automated tools and innovative technology
- Consistent experience regardless of where you're located or what language you speak²

“Dell proactively monitors our network and our devices, and they give us a much better response time compared to other providers, thanks to Dell ProSupport.”

— Biju Samuel,
Director of IT,
Cardlytics, United States



Experts.



Insights.



Ease.

¹Source: IDC Converged and Integrated Systems End-User Survey, N = 300 (2012), N = 308 (2013), N=301 (2014)

²Availability and terms of Dell EMC Services vary by region and by product. For more information, contact your Dell EMC sales representative.

Why Dell EMC?

Smarter strategies for smarter support.

A strategy that allows you to fearlessly adopt new technology gives you freedom to focus on your business. Having the same enterprise-class support from Dell EMC on all of your platforms, brands and solutions across your infrastructure gives you that freedom.

As managing technology gets harder, Dell EMC support is getting smarter.

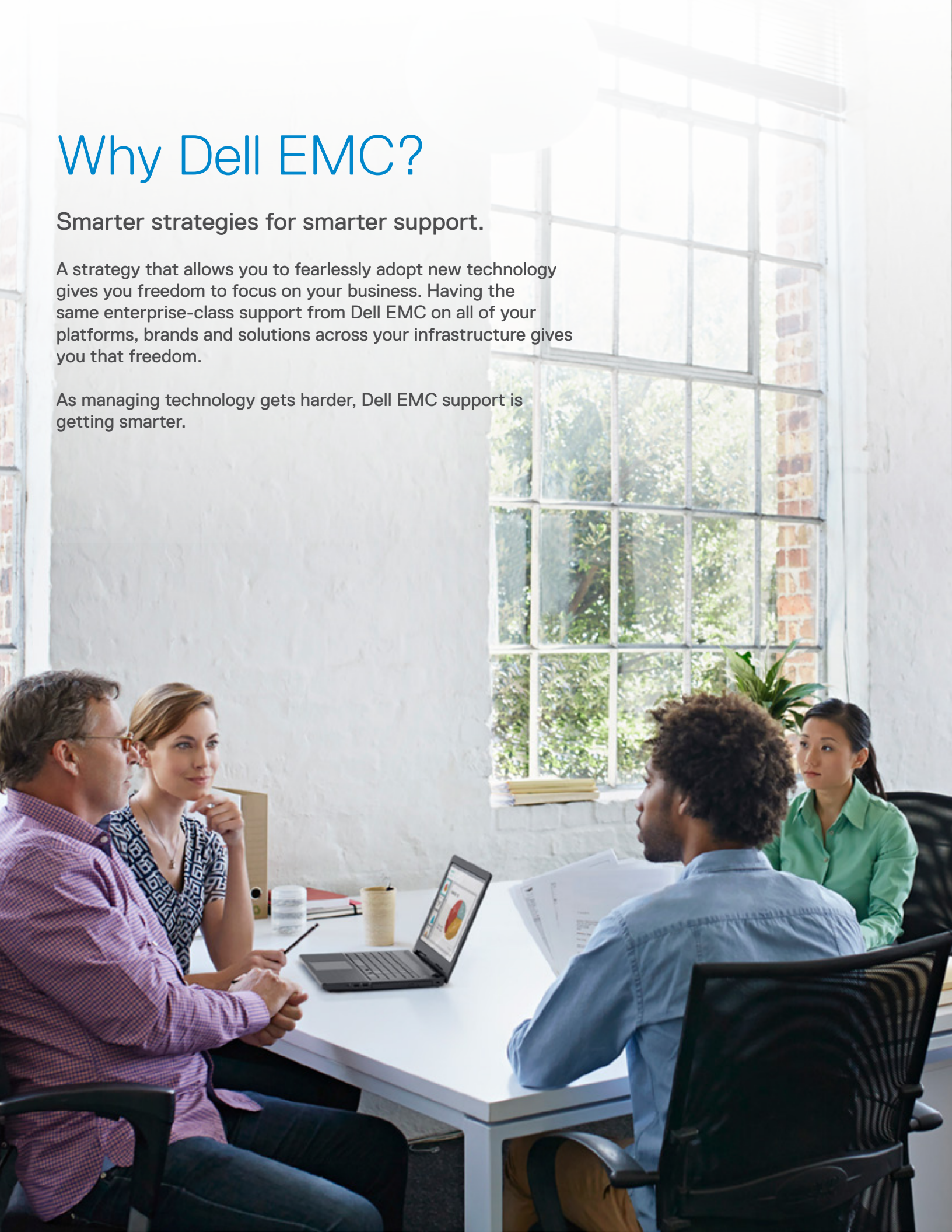

Accelerate
with
experts

Focus on your business while Dell EMC experts reduce IT complexity.

- 55,000+ Dell EMC & partner professionals
- 10,000+ certifications in industry-leading hardware, software and solutions
- Deep knowledge of complex, emerging technologies and multivendor environments
- Collaborative assistance with 3rd party technology vendors

Accelerate
with
insights

Improve performance and stability with deep insight and intelligent data.

- SupportAssist and Secure Remote Services (ESRS) automated monitoring and predictive* analysis for issue prevention and optimization
- Personalized relationship with a designated Technology Service Manager with deep knowledge of your business and environment
- Six Command Centers** to proactively monitor field service events
- Twelve Centers of Excellence and Joint Solution Centers deliver in-house collaboration leveraging our alliances with leading application providers

Accelerate
with
ease

Increase productivity with always accessible tailored support.

- Support offered in 160+ countries and 50+ languages
- 24x7*** phone, chat, email and social media support
- Consistent single-source support across hardware and software
- 94% customer satisfaction for Dell EMC Support & Deployment services

*SupportAssist predictive analysis failure detection includes server hard drives and backplanes. ESRS enables predictive capabilities and failure detection for enterprise storage, networking and converged infrastructure.

**Command Centers monitor only Dell-branded products.

***Availability and terms of Dell EMC Services vary by region and by product. For more information, contact your Dell EMC sales representative.

ProSupport Enterprise Suite

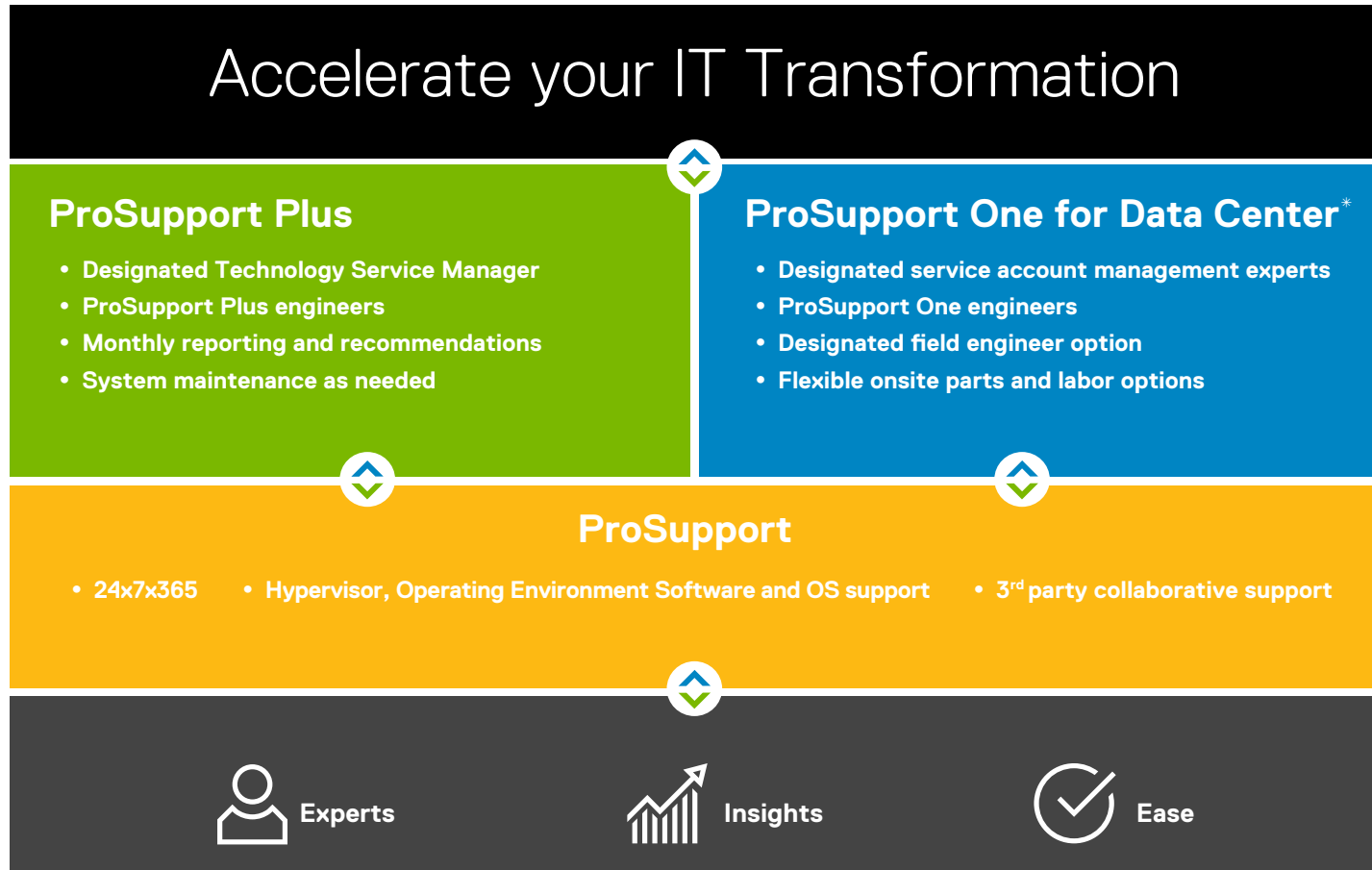

*ProSupport One is available for legacy Dell-warranted products only.

Enterprise-class support realized.

Built on a foundation of experts, insights and customer ease, our ProSupport Enterprise Suite has the enterprise-class support your organization needs. Select the service that aligns with the criticality of your systems, complexity of your environment and how you allocate your IT resources.

Technology Service Manager:

Your designated Dell EMC support advocate.

- Highly skilled service account management expert who understands the specific IT needs and objectives of your business
- Central point of contact to facilitate service management and escalation resolution
- Personalized recommendations based on your environment, best practices and support trends across all of our customers to help improve productivity and stability

Command Centers*:

Proactive monitoring of field service events across the globe.

- Real-time dispatch monitoring efficiently routes engineers and service parts to your site to speed problem resolution
- Proactive planning and ongoing communication during major events to preempt anything that may affect rapid response
- Crisis management for critical situations ranging from natural disasters to power outages or virus attacks to mobilize and route emergency resources

**Command Centers monitor only Dell-branded products.

“We get mini-storage reports every week, plus our monthly conference calls to review everything in detail. I’ve even received text messages. This is why Dell EMC Storage is the standard for Intuit’s data warehouse workloads. It’s a no-brainer.”

— Alex Lancaster,
Data Engineering Manager,
Intuit, United States



ProSupport



You need unwavering support for hardware and software and a smart way to manage the mix of vendors in your environment. Dell EMC offers a single source with the expertise, know-how and capabilities to make supporting your IT easier.

When you choose ProSupport*, highly trained experts are there around the clock and around the globe to address your IT needs. ProSupport helps you minimize disruptions and maintain a high level of productivity.

When you choose ProSupport, you'll get:

- 24x7x365 access to certified hardware and software experts
- Collaborative support with 3rd party vendors
- Hypervisor, Operating Environment Software and OS support
- Consistent level of support available for Dell EMC hardware, software and solutions
- Onsite parts and labor response options including next business day or four-hour mission critical

“If there’s a problem, each vendor blames the other. We have one point of contact with Dell, and we know that Dell will work with us to fix whatever comes up.”

— Chris Hele,
Senior Technical Support Officer,
North Norfolk District Council, United Kingdom

*Availability and terms of Dell EMC Services vary by region and by product. For more information, contact your Dell EMC sales representative.

A recognized services innovator!



5 Temkin Group
Customer Experience
Excellence Awards



30 TSIA STAR
Awards for
customer service



ProSupport Plus

Critical workloads and applications require constant availability and the systems supporting them need more than break/fix support – they need proactive and predictive measures to get ahead of problems before they happen.

ProSupport Plus* proactively improves the performance and stability of your critical systems through automated support, analytics and the right expertise for your organization. ProSupport Plus not only gets you back up and running quickly, but also helps you get ahead of problems before they happen. You'll have the freedom to adopt complex technologies with confidence, knowing Dell EMC has the expertise and insight to help you be more productive and focus on your goals.

When you choose ProSupport Plus, you'll get:

- A designated Technology Service Manager who knows your business and your environment
- Access to senior ProSupport Plus engineers for faster issue resolution
- Personalized, preventive recommendations based on analysis of support trends and best practices from across the Dell EMC customer base to reduce support issues and improve performance
- Predictive analysis for issue prevention and optimization enabled by SupportAssist and Secure Remote Service
- Proactive monitoring, issue detection, notification and automated case creation for accelerated issue resolution enabled by SupportAssist and Secure Remote Services
- Support that extends up to seven years*

ProSupport Plus with SupportAssist significantly reduces IT effort:⁵

Up to
90%
less IT effort to
resolve issues⁵

“We've found that Dell support is excellent. We like the proactivity that has helped identify potential issues before they become problems.”

— Chris Westwell,
IT Technical Specialist,
Blackpool Teaching Hospitals,
United Kingdom

*Availability and terms of Dell EMC Services vary by region and by product. For more information, contact your Dell EMC sales representative.

⁵Based on Sep 2015 Principled Technologies Test Report commissioned by Dell EMC. Actual results will vary. [Read full report.](#)

ProSupport One for Data Center

Large data centers are complex and unique. That's why you need a support solution that complements your internal resources and can evolve to fit your changing technology landscape.

ProSupport One for Data Center* offers flexible site-wide support for hyperscale data centers with more than 1,000 assets. This offering is built on standard ProSupport components that leverage our global scale but are tailored to your company's needs. While not for everyone, it offers a truly unique solution for Dell EMC's biggest customers with the most complex environments.

When you choose ProSupport One for Data Center, you'll get:

- Enterprise-wide support that covers your entire data center
- Designated service account management expert with remote, on-site, part-time and full-time options
- Designated ProSupport One technical and field engineers who are trained on your environment and configurations
- Flexible on-site support and parts options that fit your operational model
- A tailored support plan and training for your operations staff

“We appreciate everything about the offering: the service, flexibility, collaboration and quality of hardware.”

— Jürgen Hausmann,
CEO, EVISCO, Germany

*ProSupport One is available for legacy Dell-warranted products only.



Tools and technologies* that power your support experience

As demand for self-support, peer collaboration and automated support options rise, we continue to invest in and expand these technologies. With a goal of enhancing support and minimizing customer effort along the way, we have developed a portfolio of proactive, predictive tools and technologies that put you in control, drive productivity, avoid issues and improve the wellness of your IT environment.

Get connected

SupportAssist and Secure Remote Services (ESRS)

Avoid issues and get faster resolution with automated proactive and predictive** support. Leave manual routines behind with remote monitoring, automated issue detection and case creation, and remote resolution.

Get insight

MyService360

Gain insight, take action and save time managing your support experience and improving the health of your global environment with personalized, data-driven dashboards.

TechDirect

Boost productivity with this flexible, time-saving portal that streamlines support and makes it easy to manage technology, train staff and support your systems.

*MyService360 and ESRS are available for legacy EMC-warranted products. SupportAssist and TechDirect are available for legacy Dell-warranted products.
**SupportAssist predictive analysis failure detection includes server hard drives and backplanes. ESRS enables predictive capabilities and failure detection for enterprise storage, networking and converged infrastructure.

“Using Dell SupportAssist is a no-brainer for us. There are issues that could come up where the tool can notify us ahead of time, and that will be a huge benefit for us.”

— Service King Collision Repair Centers, United States

“Besides simplifying day-to-day support, the MyService360 dashboard will help [us] make good business decisions about our future. It's very cool!”

— Open Line, B.V., Netherlands

The right support for you

Enterprise Support Services Feature Comparison

	ProSupport	ProSupport Plus	ProSupport One for Data Center
Remote technical support	24x7	24x7	24x7
Onsite support	Next Business Day or Mission Critical	Next Business Day* or Mission Critical	Flexible
Automated issue detection and case creation	●	●	●
Self-service case initiation and management	●	●	●
Hypervisor, Operating Environment Software and OS support	●	●	●
Priority access to specialized support experts		●	●
Designated service account management expert		●	●
Periodic assessment and recommendations		●	●
Monthly contract renewal and support history reporting		●	Monthly or Quarterly
Systems Maintenance guidance		Semiannually	Optional
Designated technical and field support teams			●

*Next Business Day option available only on applicable legacy Dell products.

Availability and terms of Dell EMC Services vary by region and by product. For more information, contact your Dell EMC sales representative.



The Dell EMC difference

World-class companies all over the globe trust us to support their Dell EMC and multivendor enterprise systems efficiently and keep them running all day, every day. That's a responsibility that Dell EMC is proud to have — and proud to do well.

Improve performance and stability of critical systems, increase productivity and reduce downtime. With the experts, insights, and ease you get from the ProSupport Enterprise Suite, you'll always be prepared for whatever comes next — no matter what.



Go to Dell.com/prosupport for more information or contact your Dell EMC sales representative.

Copyright © 2017 Dell Inc. or its subsidiaries. All Rights Reserved. Dell, EMC, and other trademarks are trademarks of Dell Inc. or its subsidiaries. Other trademarks may be trademarks of their respective owners.
July 2017 | ProSupport Enterprise Suite brochure v4



QUESTION 65 – CORPORATE PROFILE

EMC Corporation History

EMC was founded in Newton, Massachusetts, in 1979 by Dick Egan and Roger Marino. By the late 1980s, EMC sold advanced storage subsystems for minicomputers and solid-state mainframe storage. In 1986 EMC went public on NASDAQ. And then in March 1988, after eight years of profitability, EMC's stock began trading on the New York Stock Exchange.

In late 1990, EMC introduced Symmetrix Integrated Cached Disk Array, which would become the most popular high-end storage system ever developed. EMC created a new storage industry segment, network attached storage (NAS), redefining the market for file servers. With the arrival of SANs in 1998, EMC's approach helped to speed up the conversion of NAS and SAN into the fast-growing market for networked storage. In 1999, EMC seized an opportunity to enlarge its target market while still concentrating on storage by acquiring Data General and its acclaimed CLARiON line. EMC could now help customers consolidate and manage more information.

In 2002, EMC created a new storage category and introduced the first information storage solution designed specifically for fixed, or unchanging, content. In 2003, EMC focused on helping customers get the maximum from their information, at the lowest total cost, at every point in the information life cycle. EMC's ILM strategy became its primary way of assisting customers in solving real-life information management challenges. Through scores of acquisitions during this decade, EMC has taken bold steps into opportunity-rich software markets in backup, archiving, and recovery management; content management; network systems management; and server and desktop virtualization. EMC's acquisition of VMware, the global leader in virtualization solutions from the desktop to the data center, gives EMC, by far, the strongest virtualization portfolio in the IT industry.

EMC's information infrastructure strategy could not be more relevant in a world where digital information has become one of the most important assets in nearly all organizations and where its growth is rapid and relentless. To fully extend the power of information infrastructure, EMC greatly expanded its portfolio of services by building out a 13,000-person-strong global services organization that helps customers deploy and maintain their EMC technologies and solve their information infrastructure challenges.

September 7, 2016 marked a milestone in EMC history. On that day, Dell Technologies announced completion of the acquisition of EMC Corporation, creating a unique family of businesses that provides the essential infrastructure for organizations to build their digital future, transform IT and protect their most important asset, information. This combination creates a \$74 billion market leader with an expansive technology portfolio that solves complex problems for customers in the industry's fast-growing areas of hybrid cloud, software-defined data center, converged infrastructure, platform-as-a-service, data analytics, mobility and cybersecurity.

Dell Technologies serves 98 percent of the Fortune 500 and comprises several market leading businesses. The two largest, and most well-known, are the Dell client solutions business and the Dell EMC infrastructure solutions business – both of which are supported by Dell EMC Services. In addition, Dell Technologies contains Boomi, Pivotal, RSA, SecureWorks, Virtustream and VMware. This unique structure combines the focus and innovation of a startup with the global scale and service of a large enterprise. Dell Technologies' scale will enable it to deliver more innovation and investment in R&D, sales and marketing, services and support and deliver more efficient and cost-effective solutions for customers. Furthermore, while the company will publically report its financial results, it is privately controlled, enabling it to better focus investments on its customer and partner ecosystem over the long term.

Dell Technologies blends Dell's go-to-market strength with small business and mid-market customers and EMC's strength with large enterprises and stands as a market leader in many of the most important and high-growth areas of the \$2 trillion information technology market, including positions as a "Leader" in 20 Gartner Magic Quadrants and a portfolio of more than 20,000 patents and applications.

Market Rankings

The historic acquisition of EMC Corporation on September 7, 2016 created a unique family of businesses that provides the essential infrastructure for organizations to build their digital future, transform IT and protect their most important asset, information. Dell Technologies becomes the world’s largest privately controlled tech company. The unique corporate structure gives us the flexibility to innovate like a startup and invest in R&D for the long term while offering the trust, service and global scale of a large enterprise.

Dell Technologies, Inc. comprises a unique family of businesses including Dell, Dell EMC, Pivotal, Boomi, RSA, SecureWorks, Virtustream and VMware. Dell Technologies blends Dell’s go-to-market strength with small business and mid-market customers and EMC’s strength with large enterprises. We are the technology leader in 20 Gartner Magic Quadrants.

Organizational Structure

Dell Technologies is a collective force of innovative capabilities trusted all over the world to provide technology solutions and services that accelerate digital transformation. Dell Technologies is the largest privately controlled technology company in the world, which enables it to focus on customers first and foremost. It also gives us the freedom both to invest in R&D for the long term and to incubate high-growth businesses in emerging areas. Our unique structure enables us to be agile and innovate like a start-up while offering the trust, service and global scale of a large enterprise.

The figure that follows illustrates the organizational structure of Dell Technologies family of companies.

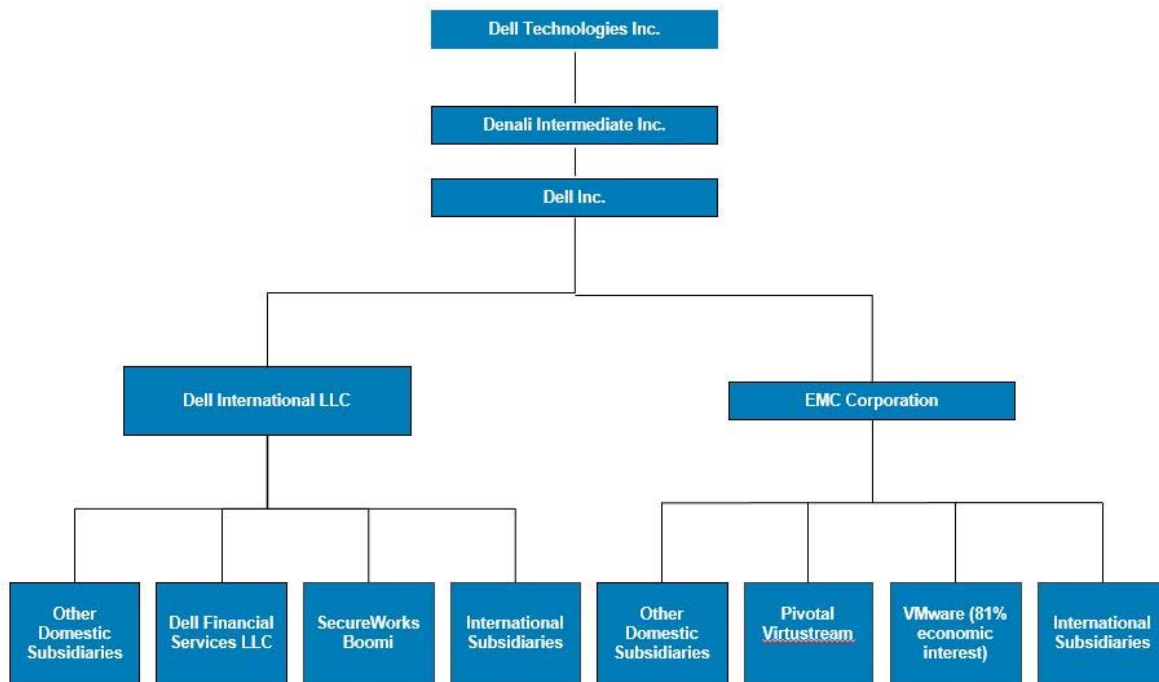

Leadership Team

Reporting to Michael Dell, Chairman and CEO of Dell Technologies, are:

- **Jeremy Burton**, Chief Marketing Officer, responsible for brand, events, marketing analytics, digital and communications.
- **Jeff Clarke**, Vice Chairman, Products & Operations.
- **Mike Cote**, President and CEO, SecureWorks.
- **Allison Dew**, Chief Marketing Officer
- **Howard Elias**, President, Dell Services, Digital and IT, supporting customers across the Client Solutions and Infrastructure Solutions Groups. He oversees technology and deployment services, consulting services, global support services, education services, global Centers of Excellence, the IT organization, Dell Commerce Services, and Virtustream.
- **Pat Gelsinger**, CEO, VMware
- **Marius Haas**, President & Chief Commercial Officer, Dell EMC He is responsible for the global go-to-market organization, delivering innovative and practical solutions to commercial customers, and has responsibility for Dell channel partners, as well as public and federal institutions worldwide.
- **Rob Mee**, CEO, Pivotal
- **Steve Price**, Chief Human Resources Officer.
- **Karen Quintos**, Chief Customer Officer
- **Rory Read**, Chief Operating Executive, Dell. In this role, Rory applies his executive leadership strength and operational expertise to critical areas of our business driving key transformational objectives. This includes our strategic go-to-market transformation, operations planning and execution for our Infrastructure Solutions Group (ISG), the integration of the historic combination of Dell and EMC, and Dell Boomi's hyper-growth expansion phase.
- **Rich Rothberg**, General Counsel.
- **Bill Scannell**, President, Global Enterprise Sales & Customer Operations, Dell EMC
- **Tom Sweet**, Chief Financial Officer.
- **Bask Iyer**, Chief Information Officer, Dell and VMware

EMC Corporation (AKA “Dell EMC”)

EMC Corporation, which brands itself as Dell EMC, is part of a unique family of businesses that provides the essential infrastructure for organizations to build their digital future, transform IT and protect their most important asset, information. The combination created the #1 market leader with an expansive technology portfolio that solves complex problems for customers in the industry's fast-growing areas of hybrid cloud, software defined data center, converged infrastructure, platform-as-a-service, data analytics, mobility and cybersecurity.

Dell EMC serves a key role in providing the essential infrastructure for organizations to build their digital future, transform IT, and protect their most important asset - information. Dell EMC enables our enterprise customers' IT and digital business transformation. Specifically, we enable our

Our Differentiators

- Market Share Leader in 20 Gartner Magic Quadrants
- Unique Family of Businesses gives customers choice
- Technology Innovator & Leader
- World's largest privately controlled tech company
- Unique, agile business structure

customers through trusted hybrid cloud and big-data solutions, built upon a modern data center infrastructure that incorporates industry-leading converged infrastructure, servers, storage, and cybersecurity technologies.

With over 30 years of experience, our value is in offering solutions that map to the government customers, which includes the U.S. Federal government and foreign government (both civilian and defense agencies) and state and local governments, provinces, counties, cities, as well as educational institutions around the world. EMC solutions help customers ensure that information is managed efficiently, effectively, and securely. EMC's understanding of government priorities enables us to work as a strategic partner—delivering value, and helping achieve critical objectives for our customers.

We empower agencies to meet today's challenges head on. Our tactical storage, data protection, and trust solutions are proven, scalable, secure, and easy to deploy and own. Today, our storage solutions are helping State and Local Governments and Education (SLED) agencies ensure long-term sustainability, with the potential for reducing cost of ownership.

DELL EMC CLIENT BASE

Dell EMC does not divulge the total number of customers; however, our customers include:

- 86% of the Forbes 2000 Companies
- 90% of the Business Week 50 Companies
- 97% of the S&P Global 100 Companies
- 95% of Fortune 500 Financial Services Companies
- 95% of the Top 25 U.S. Banks
- 98% of the Top 500 ranked of the Forbes 2000 index
- 99% of the Top 200 ranked of the Forbes 2000 index
- 100% of the Top 100 ranked of the Forbes 2000 index
- The World's Top 10 Telecommunications Companies
- The World's Top 10 Pharmaceutical Companies
- Manufacturers
- Healthcare Institutions
- Life Sciences Organizations
- Airlines
- Transportation Companies
- Educational Institutions
- Regional and National Government Agencies

Below is a list of some of our largest public agency customers:

- State of New York
- New York City
- State of Texas
- State of California
- State of Florida
- State of Michigan
- Commonwealth of Massachusetts

- State of North Carolina
- State of South Carolina
- State of Arizona

DELL EMC PUBLIC SECTOR

Dell EMC helps a wide range of public sector organizations—local and national, small and large, around the world—transform government with innovative information infrastructure services and technology.

Dell EMC helps customers leverage information assets, improve interfaces with constituencies, increase operational efficiency, reduce costs, ensure data security and regulatory compliance, and strengthen functional capabilities. Some of the public sector solutions we offer include:



- **Defense, Civilian and Intelligence Solutions** - Leverage Dell EMC's information storage and management systems to deploy solutions that can be configured to meet requirements for the highest government levels for security, reliability, and scalability.
- **Education Solutions** - Leverage affordable and effective information management capabilities for colleges, universities, K-12 education, e-Learning, students, faculty, and research institutions.
- **Public Health Solutions** - Deliver public health services in a timely, efficient, and cost-effective manner—serving more citizens despite increasingly complex delivery systems.
- **Public Safety and Justice Solutions** - Integrate, modernize, and automate your operations to improve citizen services. Respond quickly to any information-related public safety or judicial challenge.
- **Revenue, Finance, and Taxation Solutions** - Protect and share financial data, and optimize the design and implementation of your organization's tax, treasury, assessor, and other finance systems.
- **Social/Human Services and Benefits Solutions** - Deliver high-quality and citizen-based responsiveness in a cost-effective manner. Consolidate, modernize, and streamline important functions to effectively transform your IT infrastructure.
- **Transportation, Planning, and the Environment Solutions** - Establish and enforce clear policies and efficient processes for addressing data-intensive challenges related to transportation systems, government planning requirements, and environmental management.

GLOBAL PRESENCE

Dell EMC employs approximately 72,000 people worldwide. EMC employee retention rates specific for employees that may be associated with the services related to the RFP over the last two (2) years are approximately 85% 2016 and 2017.

We are represented by approximately 400 sales offices and scores of partners in 86 countries around the world. We have the world's largest sales and service force focused on information infrastructure, and we work closely with a global network of technology, outsourcing, systems integration, service, and distribution partners.



DELL EMC

EMC Corporation Marketing Plan For PEPPM 2019

EMC will market the PEPPM contract via a series of communications and activities throughout the year, including:

- Press Release to announce the Award
- PEPPM will be included in all contracts presentations and marketing material.
- PEPPM will be promoted on signage at Pennsylvania Public Sector events:
 - Pennsylvania Digital Government Summit
 - NASTD East
 - We will promote PEPPM in any/all other events that we do in Pennsylvania
- Train EMC Resellers on the contract
- Post information about the PEPPM contract onto EMC's Internal SLED Portal for employee reference

Social media promotion: www.dell EMC.com/slg and <https://www.facebook.com/DellEMC/>



Boomi Inc.
1400 Liberty Ridge Drive
Chesterbrook, PA 19087
Office: +1 800 732 3602
www.boomi.com
www.dell.com

September 17, 2018

Kern County Superintendent of Schools (KCSOS)
1300 17th Street
Bakersfield, California 93301

RE: *EMC as Authorized Dell Boomi reseller/dealer*

Dear PEPPM,

Boomi, Inc. is pleased to be part of the PEPPM 2019 Product Line Bid. This letter certifies that EMC Corporation, a Dell subsidiary, is an authorized Boomi, Inc. education reseller/dealer in good standing for the state(s) of any of the United States and its territories. I understand that PEPPM is a national technology bidding and purchasing program.

Dell and its subsidiaries have been successfully marketing and selling the Boomi line of integration services in the state(s) of any of the United States and its territories for over five years. I am confident that EMC Corporation will do an excellent job of representing and marketing the Boomi services as defined in our PEPPM bid proposal.

As an officer of Boomi, Inc. I have the authority to write this letter. I look forward to a mutually successful relationship working with PEPPM through EMC Corporation.

If you have any questions, please do not hesitate to let me know. Christopher_Port@Dell.com

Sincerely,

Christopher Port

Chris Port, Chief Operating Officer
Boomi, Inc.



RSA Security LLC T 781 515 5000
74 Middlesex Turnpike F 781 515 5450
Bedford, MA 01730 www.rsa.com

Bedford, MA 01730 www.rsasecurity.com

01 October 2018

Central Susquehanna Intermediate Unit
PEPPM 2019 Product Line Bid
90 Lawton Lane
Milton, PA 17847
Attn: Jared Lehman, Supervising Manager

Dear Mr. Lehman,

RSA Security LLC (RSA) is pleased to be part of the PEPPM 2019 Product Line Bid. This letter certifies that Dell EMC is an RSA authorized education reseller/dealer in good standing for the state of California. I understand that PEPPM is a national technology bidding and purchasing program.

Dell EMC is a partner of RSA and has been successfully marketing and selling the RSA line of IT Security products and services in the state of California for over 8 years now. I am confident that Dell EMC will do an excellent job of representing and marketing the RSA IT Security products as defined in our PEPPM bid proposal.

As the Director of Public Sector Programs for RSA, I have the authority to write this letter. My direct supervisor is Joe Welsh, Vice President of Public Sector Sales, and he can be reached at (301) 938-7608.

RSA looks forward to a mutually successful relationship working with PEPPM through Dell EMC. If you have any questions, please do not hesitate to contact me at (469) 855-5658.

Sincerely,



Jon L. Goodwin
Director, Programs
RSA Public Sector Sales

September 14, 2018

PEPPM
PEPPM 2019 Product Line Bid

ATTN: PEPPM

Ref: PEPPM 2019 Product Line Request for Bids.
Subject: Authorization of EMC Corporation

Dear PEPPM,

Virtustream, Inc., a wholly-owned subsidiary of EMC Corporation (“EMC”), is pleased to be part of the PEPPM 2019 Product Line Bid of EMC. EMC will be including Virtustream’s cloud services in the Request to Bid that will be submitted to PEPPM. This letter certifies that EMC is authorized to resell the Virtustream’s cloud services identified in the Request to Bid throughout the United States. I understand that PEPPM is a national technology bidding and purchasing program that Virtustream is pleased to participate in through EMC.

EMC is in the unique position to market and sell Virtustream’s cloud services, as set forth in and defined in our portion of the PEPPM bid proposal.

As Senior Legal Director of Virtustream, Inc., I have the authority to write this letter. My direct supervisor is Ryan Fitzgerald, Senior Managing Legal Director, phone: 774.803.5629.

We look forward to a mutually successful relationship working with PEPPM through EMC. If you have any questions, please do not hesitate to call.

Sincerely,

Wayne Arden

Wayne Arden
Senior Legal Director

PEPPM Ancillary Services Form

PEPPM 2019 Product Line Bid - California

Vendor Name: EMC CORPORATION

Product Line: RSA SECURITY

Type of Services Provided	Services Provided: Direct	Services Provided: Indirect	Standard Price	PEPPM Discount %	PEPPM Price or See Attachment
Suggested Services:					
ANCILARY SERVICES ARE LISTED ON THE PEPPM RSA PRICE LIST TEMPLATE					
Analysis and Design					
Application Certification					
Asset Management					
Asset Tag Services					
Cabling					
Configuration and Integration					
Consulting					
Data Backup Assessment, Design & Implement.					
Data Storage Assessment, Design & Implement.					
Deployment Services					
Desktop Services					
Disaster Recovery					
Disposal/Recycling Services					
Document Management					
Engineering					
Hard Drive Removal & Retention by the Buyer					
Help Desk Support					
Image Loading					
Inspection and Maintenance Services					
Installation					
IT Staff Augmentation					
Lan/Wan Infrastructure Services					
Managed Services(Firewall Monitoring, Intrusion Detection)					
Network Design & Management					
Network Operating Systems Engineering					
Regulatory Compliance Implementation Svcs.					
Security Assessment and Consulting					
Server Assessment, Consolidation, Implement.					
Software Upgrades and Data Migration					
Technical Support					
Training, Customer Education					
Wireless Infrastructure Assessment					
Wireless Network Implementation					
Wireless Network Management					
Other Services:					

In order to provide bid protection for your ancillary services (i.e. installation), provided directly and/or indirectly, you must provide specific information (i.e. price rates, published price list, etc.) for us to be able to determine a "bid price" for your services. Stating prices will be negotiated is not acceptable, and those services will not be considered bid protected. Additional optional information regarding services can be attached to this Form with the Product Line you are bidding.

EMC Corporation

Warranty Statement for **Boomi Services**

Per ebid Question no. 76, this document states the warranty for Boom SaaS services and Professional Services.

WARRANTY

A. Evaluation Use. If an Order indicates that the Boomi Services are to be used by Customer for evaluation purposes, or if access to the Boomi Services is otherwise obtained from Boomi for evaluation purposes, such as a free trial or a proof of concept, Customer will be granted a right to use the Boomi Services solely for Customer’s own non-production, internal evaluation purposes (an “Evaluation Right”). Each Evaluation Right will be granted for an evaluation period of up to thirty (30) days (subject to Boomi’s right to terminate the Evaluation Right in Boomi’s sole discretion at any time) from the date of delivery of the credentials need to access the applicable Boomi Services, plus any extensions granted by Boomi in writing (the "Evaluation Period"). There is no fee for an Evaluation Right during the Evaluation Period, however, Customer is responsible for any fees which may be associated with usage beyond the scope permitted herein. Notwithstanding anything otherwise set forth in this Agreement, Customer understands and agrees that Evaluation Rights are provided “AS IS” and that Boomi does not provide warranties or Support Services for Evaluation Rights.

B. Warranties and Remedies. (a) Warranties & Remedies. Boomi warrants that, during the term of an Order, the applicable Boomi Services will (i) substantially conform to the applicable Documentation (the “Operational Warranty”); and (ii) be available twenty-four hours a day, seven days a week as described in the Boomi SLA at www.boomi.com/sla except for scheduled maintenance, the installation of updates, and factors beyond the reasonable control of Boomi (the “Availability Warranty”). Customer’s sole and exclusive remedy and Boomi’s sole obligation for any breach of the Operational Warranty or Availability Warranty will be for Boomi to provide a fix or reasonably accepted workaround for the Boomi Services and for Boomi to provide Service Level Credits as defined at www.boomi.com/sla.

Boomi will process the Personal Data for the purposes of performing its obligations and complying with its rights under this Agreement and any applicable Orders, subject to the following: Customer hereby confirms that it has the right to transfer the Personal Data to Boomi, and (ii) agrees that Personal Data may be sent to Boomi’s third-party service providers and therefore authorizes Boomi to appoint and use Subprocessors where necessary for the provision of the Boomi Services. Customer understands that when Customer configures Boomi Services to move data from one point to another, that Customer is responsible to ensure that Customer is rightfully integrating data among connected systems, whether Customer transmits data outside of a particular cloud or system, outside of a particular geography, or otherwise. Customers are responsible to set applicable purge data settings and to configure Boomi Services in a manner that best fits Customer’s security needs. “Personal Data” means any information or data that is submitted by Customer to the Boomi Services during this Agreement, and relates to an identified or identifiable natural person or data considered to be personal data as defined under Privacy Laws, and which is received, accessed and/or processed by Boomi in the capacity of “processor” acting on behalf of Customer, as “controller”, in connection with the performance of the Boomi Services under this Agreement. “Privacy Laws” means any applicable law, statute, directive or regulation regarding privacy, data protection, and/or the processing of Personal Data to which Boomi and/or the Customer are subject and which is applicable to the parties’ data protection obligations under this Agreement.

(b) Warranty Disclaimer. THE EXPRESS WARRANTIES AND REMEDIES SET FORTH IN THIS SECTION ARE THE ONLY WARRANTIES AND REMEDIES RECOVERABLE. TO THE MAXIMUM EXTENT PERMITTED BY APPLICABLE LAW, ALL OTHER WARRANTIES OR REMEDIES ARE EXCLUDED, WHETHER EXPRESS OR IMPLIED, ORAL OR WRITTEN, INCLUDING ANY IMPLIED WARRANTIES OF MERCHANTABILITY, FITNESS FOR ANY PARTICULAR PURPOSE, NON-INFRINGEMENT, SATISFACTORY QUALITY, AND ANY WARRANTIES ARISING FROM USAGE OF TRADE OR COURSE OF DEALING OR PERFORMANCE. BOOMI DOES NOT WARRANT THAT THE BOOMI SERVICES WILL BE UNINTERRUPTED, MALWARE FREE, OR ERROR-FREE.

(c) High-Risk Disclaimer. CUSTOMER UNDERSTANDS AND AGREES THAT THE BOOMI SERVICES ARE NOT FAULTTOLERANT AND ARE NOT DESIGNED OR INTENDED FOR USE IN ANY HIGH-RISK OR HAZARDOUS ENVIRONMENT, INCLUDING WITHOUT LIMITATION, THE OPERATION OF NUCLEAR FACILITIES, AIRCRAFT NAVIGATION, AIR TRAFFIC CONTROL, LIFE SUPPORT MACHINES, WEAPONS SYSTEMS, OR ANY OTHER APPLICATION WHERE THE FAILURE OR MALFUNCTION OF ANY PRODUCT CAN REASONABLY BE EXPECTED TO RESULT IN DEATH, PERSONAL INJURY, SEVERE PROPERTY DAMAGE OR SEVERE ENVIRONMENTAL

HARM (A “HIGH RISK ENVIRONMENT”). ACCORDINGLY, (I) CUSTOMER SHOULD NOT USE THE BOOMI SERVICES IN A HIGH-RISK ENVIRONMENT, (II) ANY USE OF THE BOOMI SERVICES BY CUSTOMER IN A HIGH-RISK ENVIRONMENT IS AT CUSTOMER’S OWN RISK, (III) BOOMI, ITS AFFILIATES AND SUPPLIERS WILL NOT BE LIABLE TO CUSTOMER IN ANY WAY FOR USE OF THE BOOMI SERVICES IN A HIGH-RISK ENVIRONMENT, AND (IV) BOOMI MAKES NO WARRANTIES OR ASSURANCES, EXPRESS OR IMPLIED, REGARDING USE OF THE BOOMI SERVICES IN A HIGH-RISK ENVIRONMENT.

C. Professional Services Warranty. For any consulting, training, or configuration services rather than SaaS or cloud services, or Boomi, the following warranty shall apply: **(a) Performance.** Boomi warrants that the Professional Services shall be performed in a workmanlike, manner and with professional diligence and skill and that the Project Deliverables shall substantially conform to their descriptions in the Fixed Price SO and shall be consistent with applicable Boomi product manuals or Documentation. As Customer’s exclusive remedy and Boomi’s sole obligation for any and all breaches of the foregoing warranty, Boomi shall, at its option and expense, either re-perform any nonconforming Professional Services reported to Boomi, in writing, by Customer within thirty (30) days of the performance of the Professional Services or refund the fees paid for such nonconforming Professional Services. **(b) Right to Perform.** Boomi warrants that it has all necessary licenses and permits required to perform the Professional Services., Customer’s sole and exclusive remedy, and Boomi’s entire liability for any breach of the warranty in the preceding sentence, shall be for Boomi to perform its obligations under the INFRINGEMENT INDEMNITY Section of the Agreement. THE EXPRESS WARRANTIES AND REMEDIES IN THIS SECTION 5 ARE THE ONLY WARRANTIES AND REMEDIES PROVIDED IN CONNECTION WITH THE SERVICES, DELIVERABLES AND ACTIVITIES COVERED BY THIS ADDENDUM. TO THE MAXIMUM EXTENT PERMITTED BY APPLICABLE LAW, ALL OTHER WARRANTIES OR REMEDIES ARE EXCLUDED, WHETHER EXPRESS OR IMPLIED, ORAL OR WRITTEN, INCLUDING ANY IMPLIED WARRANTY OF MERCHANTABILITY, FITNESS FOR PARTICULAR PURPOSE, OR ANY WARRANTY ARISING FROM TRADE USAGE OR COURSE OF DEALING OR PERFORMANCE.

EMC Corporation

Warranty Statement for Dell EMC

*Per *ibid* Question no. 76, this document contains the warranty statement for Dell EMC products and related services.*

WARRANTY

A. Equipment and Software Media. EMC warrants that (i) Equipment, and Equipment upgrades installed into Equipment, when purchased from EMC and operated with normal usage and regular recommended service; and (ii) the physical media, if any, on which software is provided by EMC, shall be free from material defects in materials and workmanship, and perform substantially in accordance with Documentation provided for Equipment or the physical media until the expiration of the warranty period. Unless otherwise noted on the Product Notice or EMC quote, the warranty coverage for the microcode, firmware or operating system software that enables Equipment to perform as described in its Documentation shall be no less than that which applies to such Equipment. To the extent specified in the Product Notice (as defined in Section J below), Support Services in the form of the Support Option noted on the Product Notice are included free of charge during the Equipment warranty period. EMC reserves the right to charge for Support Services performed outside the time frames of the applicable Support Option as a Time and Materials Service. In some cases, a Support Option upgrade during the Equipment warranty period may also be available by separate purchase.

B. Equipment and Software Media Warranty Duration. Unless otherwise stated on the EMC quote, the warranty period from EMC for Products shall be as set forth at the Product Notice. Equipment warranty commences upon Delivery. Equipment upgrades are warranted in the same manner as the Equipment in which the upgrades are installed from Delivery of the upgrade until the end of the warranty period for the Equipment into which the upgrades are installed. The warranty for physical media for Software provided by EMC, if any, is ninety (90) days and commences upon Delivery. Support Services (including Support Option upgrades, if applicable) for Equipment are provided during the warranty period. Renewals of Equipment related Support Services shall commence and expire in accordance with the dates on the applicable EMC quote. Support Services for hardware upgrades installed into Equipment are coterminous with the Support Services that are then in effect for the Equipment into which such upgrades are installed.

C. Equipment and Software Media Warranty Remedies. EMC's entire liability and Customer's exclusive remedies under the Equipment and physical media for Software warranties described in this Section shall be for EMC, at its option, to remedy the non-compliance or to replace the affected Product, and if EMC is unable to effect such within a reasonable time, then EMC shall refund the amount paid by Customer for the affected Product as depreciated on a straight-line basis over a five (5) year period, upon return of such Product to EMC. All replaced Products or portions thereof shall be returned to and become the property of EMC. If such replacement is not so returned, Customer shall pay EMC's then current spare parts price therefore. EMC shall have no liability hereunder after expiration of the applicable warranty period.

D. Software Warranty, Duration and Remedy. EMC warrants to Customer that the Software will, for a period of ninety (90) days following Delivery or notice of availability for electronic download ("Warranty Period"), substantially conform to the applicable Documentation, provided that the Software: (i) has been properly installed and used at all times in accordance with the applicable Documentation; and (ii) has not been modified or added to by persons other than EMC or its authorized representative. EMC will, at its own expense and as its sole obligation and Customer's exclusive remedy for any breach of this warranty, either replace that Software or correct any reproducible error in that Software reported to EMC by Customer in writing during the Warranty Period. If EMC determines that it is unable to correct the error or replace the Software, EMC will refund to Customer the amount paid by Customer for that Software, in which case the license for that Software will terminate. The foregoing warranty is predicated on EMC's license terms which are provided with the Product in the form of a shrink-wrap or click-wrap agreement. Software related Support Services that are ordered at the same time as the license for such Software shall commence on the date of shipment of the physical media or electronic availability of the Software and continue for the period specified on the EMC quote. Renewals of Software related Support Services shall commence and expire in accordance with the dates on the applicable EMC quote.

E. Professional Services Warranty and Remedy. EMC shall perform Professional Services in a workmanlike manner in accordance with generally accepted industry standards. Customer must notify EMC of any failure to so perform within ten (10) days after the performance of the applicable portion of Professional Services. EMC's entire liability and Customer's sole remedy for EMC's failure to so perform shall be for EMC to, at its option, (i) correct such failure; and/or (ii) terminate the applicable

SOW and refund that portion of any fees received that correspond to such failure to perform. The foregoing warranty is predicated on EMC's reservation of all intellectual property rights in the Professional Services that it has not expressly granted to Customer pursuant to a statement of work, and any work product associated with the Professional Services shall not be a "work made for hire" under applicable law.

F. Support Services Warranty and Remedy. EMC shall perform the labor portion of Support Services in a workmanlike manner in accordance with generally accepted industry standards. Customer shall notify EMC of any failure to so perform as soon as reasonably possible, and in no event more than ten (10) days after the date on which such failure first occurs. A replacement part receives the remainder of the warranty or Support Services coverage applicable to the Product containing the replacement part. Customer's exclusive remedy and EMC's entire liability under the foregoing warranties for Support Services shall be for EMC to, at its option, (i) use reasonable efforts to (a) re-perform the deficient labor services within a reasonable time, or (b) replace any replacement parts which become defective during the remainder of the warranty or Support Services coverage applicable to the Product containing the replacement part, or sixty (60) days after installation thereof, whichever occurs later; and (ii) if, after reasonable efforts, EMC is not able correct such deficiencies, then Customer has the right to terminate for breach. If Customer terminates for EMC's breach, Customer's sole and exclusive remedy and EMC's sole and exclusive obligation shall be to either issue a credit for use against current or future purchases of Products or Support Services or grant a refund (as selected by Customer) for that portion of any pre-paid Support Service fee that corresponds to the period between the effective date of the termination for breach and the end of the then current Support Services period. If Customer wishes to re-instate Support Services for a Product that is not then currently covered thereby, such re-instatement shall be subject to a certification at EMC's then current Time and Materials Service rates and conditions. Once so certified, Support Services shall commence upon payment to EMC of (i) the charge for the above described Time and Materials Service; (ii) the amount EMC would have normally charged had Support Services been in effect during the period of the lapse or discontinuation; and (iii) the charge for the next twelve (12) months of the newly commenced Support Services.

G. Exclusions. Warranty does not cover problems that arise from (i) accident or neglect by Customer or any third party; (ii) any third party items or services with which the Product is used or other causes beyond EMC's control; (iii) installation, operation or use not in accordance with EMC's instructions or the applicable Documentation; (iv) use in an environment, in a manner or for a purpose for which the Product was not designed; (v) modification, alteration or repair by anyone other than EMC or its authorized representatives; or (vi) in case of Equipment only, causes not attributable to normal wear and tear. EMC has no obligation whatsoever for Software installed or used beyond the licensed use, for Equipment which was moved from the Installation Site without EMC's consent or whose original identification marks have been altered or removed. Except to the extent that Support Services are independent of the Equipment's location, EMC will have no obligation to provide Support Services with respect to Equipment that is outside the EMC Service Area. Support Services are subject to EMC's then-current "End-of-Service-Life" policy for the respective Product. Support Services do not apply to any Software other than the current and the immediately prior Software Release. EMC shall have no obligation to provide Support Services for Software problems that cannot be reproduced at EMC's facility or via remote access to Customer's facility. Support Services do not include the supply of Equipment upgrades, if any, needed to utilize new features or functionality in a Software Release.

H. Disclaimer of Warranty. EXCEPT AS EXPRESSLY STATED HEREIN, AND TO THE MAXIMUM EXTENT PERMITTED BY APPLICABLE LAW, WITH REGARD TO PRODUCTS, SERVICES OR ANY OTHER ITEMS OR MATTERS ARISING HEREUNDER, EMC (INCLUDING ITS SUPPLIERS) MAKES NO OTHER EXPRESS WARRANTIES, WRITTEN OR ORAL, AND DISCLAIMS ALL IMPLIED WARRANTIES. INsofar AS PERMITTED UNDER APPLICABLE LAW, ALL OTHER WARRANTIES ARE SPECIFICALLY EXCLUDED, INCLUDING, BUT NOT LIMITED TO, THE IMPLIED WARRANTIES OF MERCHANTABILITY, FITNESS FOR A PARTICULAR PURPOSE, TITLE AND NON-INFRINGEMENT, AND ANY WARRANTY ARISING BY STATUTE, OPERATION OF LAW, COURSE OF DEALING OR PERFORMANCE, OR USAGE OF TRADE. EMC AND ITS SUPPLIERS DO NOT WARRANT THAT THE SOFTWARE WILL OPERATE UNINTERRUPTED OR THAT IT WILL BE FREE FROM DEFECTS OR THAT IT WILL MEET CUSTOMER'S REQUIREMENTS.

I. Warranty Dependencies. The foregoing warranties are predicated upon the following Support Services requirements:

(i) Change of Equipment Location or Configuration. Customer may change the Installation Site or configuration of a Product under Support Services by EMC only after written notice to EMC. If the new location is in a different country, such move is subject to EMC's prior written approval. Customer shall promptly notify EMC of any changes to the configuration, or movement of Equipment by anyone other than EMC. EMC reserves the right to inspect and evaluate the changes in configuration or location of affected Equipment at EMC's then current Time and Materials Service terms, conditions and rates. Additional charges, if any, related to changes in configuration or location of Equipment shall apply from the date the change took place.

(ii) Data Security. Customer is fully responsible for the permanent erasure, of all information, including without limitation all personally identifiable and other protected information placed on, and by use of a method that does not cause damage to, any replaced parts or any other items that Customer provides to EMC for repair, trade-in, or disposal, before such items are returned

to EMC, and for all costs associated with such erasure (descriptions and charges associated with EMC's then currently offered data erasure services are available on request). EMC is not responsible for any information contained on such items notwithstanding anything to the contrary herein.

J. Product Notice. References herein to the "Product Notice" shall mean the Product and Services related information posted at the applicable EMC website at the time of the EMC quote, currently located at http://www.emc.com/products/warranty_maintenance/index.jsp. The Product Notice informs Customer of product-specific use rights and restrictions, unit of measure (if any), warranty periods, warranty upgrades and maintenance (support) terms. The terms of the Product Notice shall be deemed to be incorporated into and made a part of the EMC quote and related Customer purchase order. Each Product Notice is dated and is archived when it is superseded by a newer version. EMC shall not change any Product Notice retroactively with regard to any Products listed on an EMC quote issued prior to the date of the applicable Product Notice. Upon request, EMC shall, without undue delay provide a copy of the applicable Product Notice and/or attach it to the relevant EMC quote. For informational purposes, excerpts of the Product Notice have been included on the following pages.



EMC LIMITED WARRANTY

The following chart lists the service features of Limited Warranty provided under EMC’s standard warranty and/or maintenance terms.

Limited Warranty is available for EMC® Equipment which is identified on [the EMC Product Warranty and Maintenance Table](#) as including Limited Warranty during the applicable warranty period.

SERVICE FEATURE	DESCRIPTION	LIMITED SUPPORT—COVERAGE DETAILS
GLOBAL TECHNICAL SUPPORT	<p>Customer may contact EMC by telephone or web interface on a 24X7 basis to report an Equipment or Software problem and provide input for initial assessment of Severity Level*.</p> <p>EMC provides (i) a response by remote means based on the Severity Level of the problem; or, (ii) when deemed necessary by EMC Onsite Response as described below.</p>	<p>Included for Equipment only.</p> <p>Initial response objective, based upon Severity Level, within the following time period after receipt of Customer contact:</p> <p>Severity Level 1: Two local business hours; on a 9x5 basis</p> <p>Severity Level 2: Four local business hours; on a 9x5 basis</p> <p>Severity Level 3: Eight local business hours; on a 9x5 basis</p> <p>Severity Level 4: 12 local business hours; on a 9x5 basis</p>
ONSITE RESPONSE	<p>EMC sends authorized personnel to installation site to work on the problem after EMC has isolated the problem and deemed Onsite Response necessary.</p>	<p>Not included.</p> <p>Available for purchase under EMC's then-current, standard time and materials terms, conditions, and pricing.</p>
REPLACEMENT PARTS DELIVERY	<p>EMC provides replacement parts when deemed necessary by EMC.</p>	<p>Included.</p> <p>Replacement parts will be shipped to Customer for next local business day delivery of replacement parts.</p> <p>Local country shipment cut-off times may impact the same day/next local business day delivery of replacement parts.</p> <p>Installation of all replacement parts is the responsibility of the Customer.</p> <p>Customer is responsible for returning all replaced parts to a facility designated by EMC.</p>
RIGHTS TO NEW RELEASES OF SOFTWARE	<p>EMC provides the rights to new Software Releases as made generally available by EMC</p>	<p>Not included.</p>

INSTALLATION OF SOFTWARE RELEASES	EMC will perform the installation of new Software Releases.	Not included. Customer will perform the installation of new Software Releases (including, Software that is not classified by EMC as Equipment operating environment Software as well as Software which EMC determines is Equipment operating environment Software).
24X7 REMOTE MONITORING AND REPAIR	Certain EMC products will automatically and independently contact EMC to provide input to assist EMC in problem determination. EMC will remotely access products if necessary for additional diagnostics and to provide remote support.	Not included.
24X7 ACCESS TO ONLINE SUPPORT TOOLS	Customers who have properly registered have access on a 24x7 basis to EMC's web-based knowledge and self-help customer support tools via the EMC Online Support site.	Included.

*Severity Levels:

- **Severity 1—Critical:** a severe problem preventing customer or workgroup from performing critical business functions.
- **Severity 2—High:** the customer or workgroup able to perform job function, but performance of job function degraded or severely limited.
- **Severity 3—Medium:** the customer or workgroup performance of job function is largely unaffected.
- **Severity 4—Request:** minimal system impact; includes feature requests and other non-critical questions.

The warranty periods and support options (“EMC Support Information”) on this website apply (i) only between EMC and those organizations that procure the applicable products and/or maintenance under a contract directly with EMC (the “EMC Customer”); and (ii) only to those products or support options ordered by the EMC Customer at the time that the EMC Support Information is current. EMC may change the EMC Support Information at any time. The EMC Customer will be notified of any change in the EMC Support Information in the manner stated in the then current product ordering and/or maintenance related agreement between EMC and the EMC Customer, but any such change shall not apply to products or support options ordered by the EMC Customer prior to the date of such change.

EMC will have no obligation to provide Support Services with respect to Equipment that is outside the EMC Service Area. “EMC Service Area” means a location that is within (i) a one hundred (100) drivable miles radius of an EMC service location; and (ii) the same country as the EMC service location, unless otherwise defined in your governing agreement with EMC, in which case the definition in the governing agreement prevails.

Products or services obtained from any EMC reseller are governed solely by the agreement between the purchaser and the reseller. That agreement may provide terms that are the same as the EMC Support Information on this website. The

reseller may make arrangements with EMC to perform warranty and/or maintenance services for the purchaser on behalf of the reseller. Please contact the reseller or the local EMC sales representative for additional information on EMC's performance of warranty and maintenance services on Products obtained from a reseller.

CONTACT US

To learn more, contact your local representative or authorized reseller.



Copyright © 2010-2017 Dell Inc. or its subsidiaries. All Rights Reserved. Dell, EMC, Dell EMC and other trademarks are trademarks of Dell Inc. or its subsidiaries. Other trademarks may be the property of their respective owners. Published in the USA. H7358.7

EMC Corporation believes the information in this document is accurate as of its publication date. The information is subject to change without notice.

Rev. June 16, 2017

EMC PRODUCT WARRANTY AND MAINTENANCE TABLE

The table below sets forth EMC® product-specific warranty and maintenance terms and information. Each product identified as equipment also includes its related operating system, operating environment or microcode (also defined in many contracts as “Core Software”), if any, unless the table indicates that such operating system is licensed as a separate product. Any EMC software that is licensed as a separate product and is not specifically identified on this table is governed by the terms stated in the row entitled “software.”

EMC recommends that you locate products on the following table by simultaneously pressing the “Control” key and the letter “f” key to activate the “Find” feature, and then typing in the name of the applicable product.

Additional information about available Support Options as well as other important information can be found by clicking the link found [here](#).

Notice: In accordance with widely used business practices in the IT industry and in support of EMC’s worldwide sustainability and recycling initiatives, Equipment may contain components that are (i) previously unused; or (ii) re-manufactured to contain the most current updates, meet all relevant test specifications and be functionally equivalent to previously unused components. Spare, upgrade and/or replacement components may be re-manufactured. EMC warranty terms apply equally to all components. For information on EMC’s recycling and sustainability efforts please [click here](#).

Product	Standard Warranty	Available Support Options	Designated Customer-Replaceable Units (CRUs)*
AlphaStor Software	90 days; defective media replacement Support during warranty available with purchase of a maintenance support option	Premium, Enhanced	None
ApplicationXtender Family Software	90 days; defective media replacement Support during warranty available with purchase of a maintenance support option	Premium, Enhanced	None
AppSync	90 days; defective media replacement Support during warranty available with purchase of a maintenance support option	Premium ¹ , Enhanced ¹ , ProSupport Plus, ProSupport Mission Critical, ProSupport	None
Atmos Equipment	3 years; ProSupport	Premium ¹ , Enhanced ¹ , ProSupport Plus, ProSupport Mission Critical, ProSupport	None
Atmos Software	90 days; defective media replacement Support during warranty available with purchase of a maintenance support option	Premium ¹ , Enhanced ¹ ProSupport Plus, ProSupport Mission Critical, ProSupport	None
Autograph Family Software	90 days; defective media replacement Support during warranty available with purchase of a maintenance support option	Premium, Enhanced	None
Automated Failover Manager (AFM) Software	90 days; defective media replacement Support during warranty available with purchase of a RecoverPoint or MirrorView maintenance support option.	Premium	None The AFM is included with RecoverPoint or MirrorView software only

Product	Standard Warranty	Available Support Options	Designated Customer-Replaceable Units (CRUs)*
AutoStart Family Software	90 days; defective media replacement Support during warranty available with purchase of a maintenance support option	Premium, Enhanced	None
AutoSwap Software	90 days; defective media replacement Support during warranty available with purchase of a maintenance support option	Premium	None
AVALONidm Software	90 days; defective media replacement Support during warranty available with purchase of a maintenance support option	Premium, Enhanced	None
Avamar Data Store	2 years; ProSupport	Premium ¹ , Enhanced ¹ , ProSupport Plus, ProSupport Mission Critical, ProSupport	Power supply, disk drives
Avamar Software	90 days; defective media replacement Support during warranty available with purchase of a maintenance support option	Premium ¹ , Enhanced ¹ , ProSupport Plus, ProSupport Mission Critical, ProSupport	None
Backup Manager for SharePoint Software	90 days; defective media replacement Support during warranty available with purchase of a maintenance support option	Premium, Enhanced	None
Blade Logic Brand Software	No longer available for sale; maintenance only	Premium, Enhanced	None
Captiva Family Software (Except Pixtools and QuickScanPro products)	90 days; defective media replacement Support during warranty available with purchase of a maintenance support option	Premium, Enhanced	None
Celerra NS-120 and NS-480 Equipment	3 years; Enhanced	Premium, Enhanced	Power/cooling module (in processor enclosures), blade, management I/O module (in Storage Processor enclosure), SFP, standby power supply, and disk
Celerra NS20 Equipment	3 years; Enhanced	Premium, Enhanced	Power/cooling module (in processor enclosures), SFP module, disk
Celerra NS-960 and NS-G8 Equipment	3 years; Enhanced	Premium, Enhanced	SFP, X-Blade enclosure power supply, X-Blade enclosure fan, Storage Processor enclosure power supply, Storage Processor enclosure fan, and disk
Celerra NS-G2 Equipment	3 years; Enhanced	Premium, Enhanced	Power/cooling Module (in Processor Enclosures), fan blade, SFP, and disk
Celerra NX4 equipment	3 years; Enhanced	Premium, Enhanced	Power/cooling module (in processor enclosures, and in disk array enclosures), blade, Storage Processor (SP), SP DIMM memory, SP I/O module, SFP, standby Power supply, link control card, and disk
Celerra NX4 Core software	90 days; defective media replacement Support during warranty available with purchase of a maintenance support option	Premium, Enhanced	Not Applicable
Celerra VG2 and VG8 Equipment	3 years; Enhanced	Premium, Enhanced	Power/Cooling Module, SFP, UltraFlex I/O Module, Management Module
Centera Family Equipment	2 years, Enhanced	Premium, Enhanced	With Enhanced support option, Customer is responsible for resetting of modems and nodes
Centera Software	90 days; defective media replacement Support during warranty available with purchase of a maintenance support option	Premium	None

Product	Standard Warranty	Available Support Options	Designated Customer-Replaceable Units (CRUs)*
CLARiiON AX4 series equipment	3 years; Enhanced	Premium, Enhanced	All AX4-5 replacement parts are CRUs except for the chassis/midplane; Installation of AX4 Core software and system-based software releases
CLARiiON AX4 software	90 days; defective media replacement Support during warranty available with purchase of a maintenance support option	Premium, Enhanced,	Not Applicable
CLARiiON CX4-series Equipment	No longer available for sale; maintenance only	Premium, Enhanced	Power supply, cooling units, small form factor pluggable transceivers, disk drives per approval of Disk Replacement Utility (DRU) tool, DAE power supply, LCC; Installation of CX4-Series Core software and system-based software releases
CloudArray Software (Appliance and Virtual Edition)	90 days; defective media replacement Support during warranty available with purchase of a maintenance support option	Premium ¹ , ProSupport Plus, ProSupport Mission Critical	None
CloudArray Appliance Equipment	1 year; Limited	Premium ¹ , ProSupport Plus, ProSupport Mission Critical	Disk Drives, Power Supply
CloudBoost Software	90 days; defective media replacement Support during warranty available with purchase of a maintenance support option	Enhanced	None
CloudBoost Equipment	1 year (equipment only); Limited	Enhanced ¹ , ProSupport	Power Supply, disk drives, ES30, external fans, bezels, cables and rails
CloudLink Secure VM	90 days; defective media replacement Support during warranty available with purchase of a maintenance support option	Premium ¹ , ProSupport Plus, ProSupport Mission Critical	None
Cloud Tiering Appliance (CTA) Software	90 days; defective media replacement Support during warranty available with purchase of a maintenance support option	Premium, Enhanced	None
Cloud Tiering Appliance - Virtual Edition (CTA/VE) Software	90 days; defective media replacement Support during warranty available with purchase of a maintenance support option	Premium, Enhanced	None
Cloud Tiering Appliance (CTA) Equipment	1 year; Enhanced	Premium, Enhanced	Disk Drives, Power Supply
Connectrix Family of Directors	3 years; ProSupport	Enhanced ¹ , Premium ¹ , ProSupport Plus, ProSupport Mission Critical, ProSupport	Power supplies, fans, optics, cables
Connectrix Family of Switches (except Connectrix devices listed below)	3 years; ProSupport	Enhanced ¹ , Premium ¹ , ProSupport Plus, ProSupport Mission Critical, ProSupport	Power supplies, fans, SFP, cables and the complete switch when applicable
Connectrix Manager Software including CMDCE, CMCNE, Cisco Fabric Manager and Data Center Network Manager	90 days; defective media replacement Support during warranty available with purchase of a maintenance support option	Premium ¹ , ProSupport Plus ProSupport Mission Critical	None
Connectrix MP-7800B, MP-7840B	3 years; ProSupport Mission Critical	Premium ¹ , ProSupport Plus ProSupport Mission Critical	Power supplies, fans, SFP and cables

Product	Standard Warranty	Available Support Options	Designated Customer-Replaceable Units (CRUs)*
CopyPoint Software	90 days; defective media replacement Support during warranty available with purchase of a maintenance support option	Premium	None
Data Domain Cloud Disaster Recovery	90 day; defective media replacement Support during warranty available with purchase of a maintenance support option	Enhanced ¹ , Premium ¹ , ProSupport Plus, ProSupport Mission Critical ProSupport	None
Data Domain Software	90 day; defective media replacement Support during warranty available with purchase of a maintenance support option	Premium** ¹ , Enhanced** ¹ , ProSupport Plus** ProSupport Mission Critical** ProSupport**	None
Data Domain System	1 year hardware only; Limited Software (DDOS) 90 day; defective media replacement Support for DDOS during warranty available with purchase of a maintenance support option	Premium** ¹ , Enhanced** ¹ , ProSupport Plus***, ProSupport Mission Critical**, ProSupport**	Power supply, disk drives, SAS controller on ES20, external fans, bezels, cables and rails
Data Protection Advisor	90 days; defective media replacement Support during warranty available with purchase of a maintenance support option	Premium ¹ , Enhanced ¹ , ProSupport Plus, ProSupport Mission Critical, ProSupport	None
DatabaseXtender Software	90 days; defective media replacement Support during warranty available with purchase of a maintenance support option	Premium, Enhanced	None
Dell EMC Cloud for Microsoft Azure Stack Scale Unit Equipment	1 year; Limited	ProSupport Mission Critical, ProSupport	None
Dell EMC Cloud for Microsoft Azure Stack Platform Software	90 days; defective media replacement Support during warranty available with purchase of a maintenance support option	ProSupport Mission Critical, ProSupport	None
Disk Library DL1500, DL3000, and 3D 4000 Family Equipment	3 years; Enhanced	Premium, Enhanced	None
Disk Library Family Equipment (except for DL1500, DL3000, and 3D 4000)	2 years; Premium	Premium	None
Disk Library for Mainframe, DLm8000/6000/2000/1000, DLm8100 w/VMAX, DLm8100 w/VNX/DD, DLm8100 w/VNX/DD, DLm2100 w/DD DLm2100 w/VNX	2 years; ProSupport Mission Critical for DLm8100 w/VMAX, DLm8100 w/VNX/DD, DLm2100 w/DD, DLm2100 w/VNX 2 years; Premium for DLm8000/6000/2000/1000	Premium for DLm8000/6000/2000/1000 Premium ¹ , ProSupport Plus ProSupport Mission Critical for DLm8100 w/VMAX, DLm8100 w/VNX/DD, DLm2100 w/DD, DLm2100 w/VNX	None
DiskXtender Family Software	90 days; defective media replacement Support during warranty available with purchase of a maintenance support option	Premium, Enhanced	None
Documentum Family Software (except ApplicationXtender)	90 days; defective media replacement Support during warranty available with purchase of a maintenance support option	Premium, Enhanced	None
DSSD D5	1 year; Limited	Premium	None
ECS Appliance Equipment	Equipment: 1 year; Limited	Premium** ¹ , Enhanced** ¹ , ProSupport Plus**, ProSupport Mission Critical**, ProSupport**	None
ECS Appliance Software	90 days; defective media replacement. Support during warranty available with purchase of a maintenance support option	Premium ¹ , Enhanced ¹ , ProSupport Plus, ProSupport Mission Critical, ProSupport	None

Product	Standard Warranty	Available Support Options	Designated Customer-Replaceable Units (CRUs)*
Enterprise Hybrid Cloud Platform Software for VxRail	90 days; defective media replacement. Support during warranty available with purchase of a maintenance support option	Premium ¹ , ProSupport Mission Critical	None
eRoom Software	90 days; defective media replacement Support during warranty available with purchase of a maintenance support option	Premium, Enhanced	None
File Management Appliance Equipment	1 year; Enhanced	Premium, Enhanced	Disk drives, power supplies
File Management Appliance Software	90 days; defective media replacement Support during warranty available with purchase of a maintenance support option	Premium, Enhanced	None
Geographically Dispersed Disaster Restart Software	90 days; defective media replacement Support during warranty available with purchase of a maintenance support option	Premium	None
Greenplum Data Computing Appliance (DCA)	1 year hardware only; Limited	Premium ¹ , ProSupport Plus, ProSupport Mission Critical	None
Greenplum Data Integration Accelerator (DIA)	1 Year hardware only; Limited 90 days for software in the DIA; defective media replacement Support for software during warranty available with the purchase of a maintenance support option	Premium (covers both hardware and software portion of the DIA)	None
Greenplum DCA OE (operating environment Software)	90 days; defective media replacement Support during warranty available with purchase of a maintenance support option	Premium ¹ , ProSupport Plus, ProSupport Mission Critical,	None
Greenplum Family Standalone Production Software	90 days; defective media replacement Support during warranty available with purchase of a maintenance support option	Premium	None
HomeBase Software	90 days; defective media replacement Support during warranty available with purchase of a maintenance support option	Enhanced	None
InfoMover	90 days; defective media replacement Support during warranty available with purchase of a maintenance support option	Premium	None
Integrated Data Protection Appliance	1 year hardware only; Limited	ProSupport Mission Critical**	None
Integrated Data Protection Appliance Software	90 days; defective media replacement Support during warranty available with purchase of a maintenance support option	ProSupport Mission Critical**	None
Ionix ControlCenter Family Software	90 days; defective media replacement Support during warranty available with purchase of a maintenance support option	Premium ¹ , ProSupport Mission Critical ProSupport Plus	None
Ionix Family Software	90 days; defective media replacement Support during warranty available with purchase of a maintenance support option	Premium ¹ , Basic, ProSupport Mission Critical ProSupport Plus	None
Ionix for IT Operations Intelligence (formerly Smarts)	90 days; defective media replacement Support during warranty available with purchase of a maintenance support option	Premium ¹ , Basic, ProSupport Mission Critical, ProSupport Plus	None
Ionix Network Configuration Manager (formerly Voyence)	90 days; defective media replacement Support during warranty available with purchase of a maintenance support option	Premium ¹ , Basic, ProSupport Mission Critical, ProSupport Plus	None
Isilon Family Equipment	1 year hardware only; Limited	Premium** ¹ , Enhanced** ¹ , ProSupport Plus**, ProSupport Mission Critical**, ProSupport**	Power supplies, power cables, NVRAM batteries (only Gen4 or lower), Hard Disks, Rail kits, IB switches, IB cables, faceplates

Product	Standard Warranty	Available Support Options	Designated Customer-Replaceable Units (CRUs)*
Isilon Family Software	90 day; defective media replacement Support during warranty available with purchase of a maintenance support option	Premium** 1, Enhanced** 1, ProSupport Plus**, ProSupport Mission Critical**, ProSupport**	None
IT Compliance Analyzer Application Edition Software	90 days; defective media replacement Support during warranty available with purchase of a maintenance support option	Premium ¹ , Basic, ProSupport Plus**, ProSupport Mission Critical**	None
IT Performance Reporter Network Edition Software	90 days; defective media replacement Support during warranty available with purchase of a maintenance support option	Premium ¹ , Basic, ProSupport Plus**, ProSupport Mission Critical**	None
IT Process Centre Request Management Software	90 days; defective media replacement Support during warranty available with purchase of a maintenance support option	Premium ¹ , Basic, ProSupport Plus**, ProSupport Mission Critical**	None
Mainframe Disk Library (MDL) Equipment	1 year; Basic	Premium, Enhanced, Basic	Disk drives, power supplies
Mainframe Disk Library (MDL) Software	90 days; defective media replacement Support during warranty available with purchase of a maintenance support option	Premium, Enhanced, Basic	None
MirrorView Software (excluding AX4)	90 days; defective media replacement Support during warranty available with purchase of a maintenance support option	Premium	None
Native Hybrid Cloud (NHC) Software	90 days; defective media replacement Support during warranty available with purchase of a maintenance support option	Premium ¹ , ProSupport Plus, ProSupport Mission Critical	None
Navisphere Family Software (excluding AX4)	90 days; defective media replacement Support during warranty available with purchase of a maintenance support option	Premium	None
NetWorker Family Software (except for NetWorker Fast Start)	90 days; defective media replacement Support during warranty available with purchase of a maintenance support option	Premium ¹ , Enhanced ¹ , ProSupport Plus, ProSupport Mission Critical, ProSupport	None
Open Migrator/LM Software	90 days; defective media replacement Support during warranty available with purchase of a maintenance support option	Premium	None
Open Replicator For Symmetrix Software	90 days; defective media replacement Support during warranty available with purchase of a maintenance support option	Premium ¹ , ProSupport Plus, ProSupport Mission Critical	None
PowerExchange PWX Connector to Greenplum	90 days; defective media replacement Support during warranty available with purchase of a maintenance support option	Premium	None
PowerPath Family Software	90 days; defective media replacement Support during warranty available with purchase of a maintenance support option	Premium ¹ , ProSupport Plus, ProSupport Mission Critical	None
ProSphere Software	90 days; defective media replacement Support during warranty available with purchase of a maintenance support option	Premium, Basic	None
ProtectPoint Software	90 day; defective media replacement Support during warranty available with purchase of a maintenance support option	Premium ¹ , ProSupport Plus, ProSupport Mission Critical	None

Product	Standard Warranty	Available Support Options	Designated Customer-Replaceable Units (CRUs)*
Rainfinity Appliance Equipment	1 year; Enhanced	Premium (applies only to qualifying models specified by EMC in the maintenance quote), Enhanced	Disk drives and power supply
Rainfinity Appliance Software	90 days; defective media replacement Support during warranty available with purchase of a maintenance support option	Premium (applies only to qualifying models specified by EMC in the maintenance quote), Enhanced	None
Real Time Intelligence (RTI)	90 days; defective media replacement Support during warranty available with purchase of a maintenance support option	Premium ¹ ProSupport Mission Critical	None
RecoverPoint Equipment	3 years; ProSupport Mission Critical	Premium ¹ , ProSupport Plus, ProSupport Mission Critical	Drives and power supply for Gen 6 servers only.
RecoverPoint Software	90 days; defective media replacement Support during warranty available with purchase of a maintenance support option	Premium ¹ , ProSupport Plus, ProSupport Mission Critical	None
RecoverPoint for Virtual Machines	90 days; defective media replacement Support during warranty available with purchase of a maintenance support option	Enhanced ¹ ; Premium ¹ , ProSupport Plus, ProSupport Mission Critical ProSupport	None
Replication Manager Software	90 days; defective media replacement Support during warranty available with purchase of a maintenance support option	Premium ¹ , ProSupport Plus, ProSupport Mission Critical	None
RepliStor Software	No longer available for sale; maintenance only	Premium, Enhanced	None
SAN Copy Software (excluding AX4)	90 days; defective media replacement Support during warranty available with purchase of a maintenance support option	Premium	None
ScaleIO Software	90 days; defective media replacement Support during warranty available with purchase of a maintenance support option	Premium ¹ , Enhanced ¹ , Basic, ProSupport Plus, ProSupport Mission Critical, ProSupport	None
ScaleIO Ready Node	1 year, hardware only; Limited	Premium ¹ , Enhanced ¹ , ProSupport Plus, ProSupport Mission Critical	None
SnapView Software (excluding AX4)	90 days; defective media replacement Support during warranty available with purchase of a maintenance support option	Premium	None
Software (all other EMC Software products not listed separately in this table)	90 days; defective media replacement Support during warranty available with purchase of a maintenance support option	Basic	None
SourceOne eDiscovery Equipment	1 year; ProSupport	Premium ¹ , Enhanced ¹ , ProSupport Plus, ProSupport Mission Critical, ProSupport	Power supply, disk drives
SourceOne eDiscovery Software	90 days; defective media replacement Support during warranty available with purchase of a maintenance support option	Premium ¹ , Enhanced ¹ , ProSupport Plus, ProSupport Mission Critical, ProSupport	None
SourceOne Family Software (excluding SourceOne eDiscovery)	90 days; defective media replacement Support during warranty available with purchase of a maintenance support option	Premium ¹ , Enhanced ¹ , ProSupport Plus, ProSupport Mission Critical, ProSupport	None
SRDF Family Software	90 days; defective media replacement Support during warranty available with purchase of a maintenance support option	Premium ¹ , ProSupport Plus, ProSupport Mission Critical	None

Product	Standard Warranty	Available Support Options	Designated Customer-Replaceable Units (CRUs)*
Storage Analytics Software	90 days; defective media replacement Support during warranty available with purchase of a maintenance support option	Premium ¹ , Enhanced ¹ , ProSupport Plus, ProSupport Mission Critical, ProSupport	None
Storage Resource Management Suite	90 days; defective media replacement Support during warranty available with purchase of a maintenance support option	Premium ¹ , ProSupport Plus, ProSupport Mission Critical	None
Symmetrix DMX Enginuity (operating environment software)	3 years; Premium	Premium	None
Symmetrix DMX Family Equipment (excluding Symmetrix VMAX)	3 years; Premium	Premium	None
Symmetrix Management Console Software	90 days; defective media replacement Support during warranty available with purchase of a maintenance support option	Premium	None
Symmetrix Manager Software	90 days; defective media replacement Support during warranty available with purchase of a maintenance support option	Premium	None
Symmetrix Optimizer Software	90 days; defective media replacement Support during warranty available with purchase of a maintenance support option	Premium ¹ , ProSupport Plus, ProSupport Mission Critical	None
Symmetrix VMAX, VMAXe, VMAX 10K/20K/40K Enginuity (operating environment software)	90 days; defective media replacement Support during warranty available with purchase of a maintenance support option	Premium ¹ , ProSupport Plus, ProSupport Mission Critical	None
Symmetrix VMAX, VMAXe, VMAX 10K/20K/40K Family Equipment	3 years; ProSupport Mission Critical	Premium ¹ , ProSupport Plus, ProSupport Mission Critical	Disk drives
Symmetrix VMAX3 100K/200K/400K Family Equipment	3 years; ProSupport Mission Critical	Premium ¹ , ProSupport Plus, ProSupport Mission Critical	None
Symmetrix VMAX3 100K/200K/400K HyperMax OS (operating environment software)	90 days; defective media replacement Support during warranty available with purchase of a maintenance support option	Premium ¹ , ProSupport Plus, ProSupport Mission Critical	None
Telestream Flip Factory Software	90 days; defective media replacement Support during warranty available with purchase of a maintenance support option	Premium, Enhanced, Basic	None
TimeFinder Family Software	90 days; defective media replacement Support during warranty available with purchase of a maintenance support option	Premium ¹ , ProSupport Plus, ProSupport Mission Critical	None
Dell EMC Unity All Flash Family Equipment Dell EMC Unity 300F Dell EMC Unity 350F Dell EMC Unity 400F Dell EMC Unity 450F Dell EMC Unity 500F Dell EMC Unity 550F Dell EMC Unity 600F Dell EMC Unity 650F	1 year, hardware only; Limited Software (Dell EMC Unity OE) – see below	Premium** ¹ , Enhanced** ¹ , ProSupport Plus**, ProSupport Mission Critical**, ProSupport**	Drives, power supply, I/O card, storage processor, cables, memory, link control card, SSD, fan, SFP
Dell EMC Unity Hybrid Family Equipment Dell EMC Unity 300 Dell EMC Unity 400 Dell EMC Unity 500 Dell EMC Unity 600	1 year, hardware only; Limited Software (Dell EMC Unity OE) – see below	Premium** ¹ , Enhanced** ¹ , ProSupport Plus**, ProSupport Mission Critical**, ProSupport**	Drives, power supply, I/O card, storage processor, cables, memory, link control card, SSD, fan, SFP

Product	Standard Warranty	Available Support Options	Designated Customer-Replaceable Units (CRUs)*
Dell EMC UnityVSA Professional Edition	90 days; defective media replacement Support during warranty available with purchase of a maintenance support option	Enhanced ¹ , ProSupport	None
Dell EMC Unity OE (operating environment software)	90 days; defective media replacement Support during warranty available with purchase of a maintenance support option	Premium** ¹ , Enhanced** ¹ , ProSupport Plus**, ProSupport Mission Critical**, ProSupport**	None
Dell EMC Unity optional software products	90 days; defective media replacement Support during warranty available with purchase of a maintenance support option	Premium ¹ , Enhanced ¹ , ProSupport Plus, ProSupport Mission Critical, ProSupport	None
VFCache	3 years; Enhanced	Premium, Enhanced	VFCache PCIe card
VIPR	90 days; defective media replacement Support during warranty available with purchase of a maintenance support option	Premium ¹ , ProSupport Plus, ProSupport Mission Critical	None
VIPR SRM	90 days; defective media replacement Support during warranty available with purchase of a maintenance support option	Premium ¹ , ProSupport Plus, ProSupport Mission Critical	None
VMAX All Flash Family Equipment VMAX 250F, FX; VMAX 450F, FX; VMAX 850F, FX; VMAX 950F, FX	1 year; Limited	Premium** ¹ , ProSupport Mission Critical**, ProSupport Plus**	None
VMAX 10K File	3 years, Premium	Premium	Disk drives
VMAX NAS Gateway with VNX VG10 or VNX VG50 Data Movers	3 years, Enhanced	Premium, Enhanced	Power supply, UltraFlex I/O module, SFP, management module
VNX CA	3 years, ProSupport	Premium ¹ , Enhanced ¹ , ProSupport Plus, ProSupport Mission Critical, ProSupport	Disks, power supply, fan assembly, SFP, link control card, UltraFlex I/O module, management module
VNX F	1 year, hardware only; Limited Software (VNX OE) – see below	Premium ¹ , Enhanced ¹ , ProSupport Plus, ProSupport Mission Critical, ProSupport	Disks, power supply, fan assembly, SFP, link control card, UltraFlex I/O module, management module
VNX OE (operating environment software)	90 days; defective media replacement Support during warranty available with purchase of a maintenance support option	Premium ¹ , Enhanced ¹ , ProSupport Plus, ProSupport Mission Critical, ProSupport	None
VNX optional Software products	90 days; defective media replacement Support during warranty available with purchase of a maintenance support option	Premium ¹ , Enhanced ¹ , ProSupport Plus, ProSupport Mission Critical, ProSupport	None
VNX VG2 VNX VG8 VNX VG10 VNX VG50	3 years, Enhanced	Premium, Enhanced	Power supply, UltraFlex I/O module, SFP, management module
VNX5100	3 years, ProSupport	Premium ¹ , Enhanced ¹ , ProSupport Plus, ProSupport Mission Critical, ProSupport	Disks, power supply, standby power supply, SFP, link control card

Product	Standard Warranty	Available Support Options	Designated Customer-Replaceable Units (CRUs)*
VNX5150	3 years, Basic	Premium ¹ , Enhanced ¹ , ProSupport Plus, ProSupport Mission Critical, ProSupport	Disks, power supply, standby power supply, SFP, link control card
VNX5200 VNX5400 VNX5600 VNX5800 VNX7600 VNX8000	3 years, ProSupport	Premium ¹ , Enhanced ¹ , ProSupport Plus, ProSupport Mission Critical, ProSupport	Drive, power supply, fan assembly, SFP transceiver, link control card, UltraFlex I/O module, management module
VNX5300 VNX5500 VNX5700 VNX7500	3 years, ProSupport	Premium ¹ , Enhanced ¹ , ProSupport Plus, ProSupport Mission Critical, ProSupport	Disks, power supply, standby power supply, SFP, link control card, UltraFlex I/O module, management module
VNXe OE (operating environment software)	90 days; defective media replacement Support during warranty available with purchase of a maintenance support option	Premium ¹ , Enhanced ¹ , ProSupport Mission Critical, ProSupport (VNXe3300) Premium ¹ , Enhanced ¹ , Basic, ProSupport Mission Critical, ProSupport (VNXe3100, VNXe 3150 and VNXe3200)	None
VNXe optional Software products	90 days; defective media replacement Support during warranty available with purchase of a maintenance support option	Premium ¹ , Enhanced ¹ , ProSupport Mission Critical, ProSupport (VNXe3300) Premium ¹ , Enhanced ¹ , Basic, ProSupport Mission Critical, ProSupport (VNXe3100, VNXe 3150 and VNXe3200)	None
VNXe1600, VNXe3100, VNXe3150 and VNXe3200	3 years, Basic	Premium ¹ , Enhanced ¹ , Basic, ProSupport Mission Critical, ProSupport	Disk, power supplies (DAE and DPE), I/O card, storage processor, AC/Fibre cables, memory, link control cards (LCC), and SSD
VNXe3300	3 years, ProSupport	Premium ¹ , Enhanced ¹ , ProSupport Mission Critical, ProSupport	Disk, power supplies (DAE and DPE), I/O card, storage processor, AC/Fibre cables, memory, link control cards (LCC), and SSD
VNX-VSS OE (operating environment software for VNX-VSS)	90 days; defective media replacement Support during warranty available with purchase of a maintenance support option	Enhanced ¹ , Basic, ProSupport	None
VNX-VSS100	1 year, Limited	Enhanced ¹ , Basic, ProSupport	Disks, power supply, standby power supply, SFP, link control card, UltraFlex I/O module
VPLEX All Flash Family Equipment	3 years, hardware only; Limited Software (VPLEX OE) – see below	Premium ¹ , ProSupport Plus, ProSupport Mission Critical	None
VPLEX Family Equipment	3 years, hardware only; ProSupport Mission Critical Software (VPLEX OE) – see below	Premium ¹ , ProSupport Plus, ProSupport Mission Critical	None
VPLEX OE (operating environment software)	90 days; defective media replacement Support during warranty available with purchase of a maintenance support option	Premium ¹ , ProSupport Plus, ProSupport Mission Critical	None
VSPEX BLUE	1 year, hardware only; Limited	Premium, Enhanced, Basic	Power supply
VxRack Node	1 year; Limited	Premium ¹ , Enhanced ¹ , ProSupport Mission Critical, ProSupport	None
VxRail	1 year, hardware only; Limited	Premium ¹ , Enhanced ¹ , ProSupport Plus, ProSupport Mission Critical,	Disks, power supply

Product	Standard Warranty	Available Support Options	Designated Customer-Replaceable Units (CRUs)*
		ProSupport	
Watch4Net	90 days; defective media replacement Support during warranty available with purchase of a maintenance support option	Premium, Basic	None
Woodwing Smart Connection Enterprise Software	90 days; defective media replacement Support during warranty available with purchase of a maintenance support option	Premium, Enhanced, Basic	None
xPression Family Software	90 days; defective media replacement Support during warranty available with purchase of a maintenance support option	Premium, Enhanced	None
XtremIO Equipment	1 year; Limited	Premium** 1, ProSupport Plus**, ProSupport Mission Critical**	None
XtremIO SW Software	90 days; defective media replacement Support during warranty available with purchase of a maintenance support option	Premium ¹ , ProSupport Plus**, ProSupport Mission Critical**	None
XtremSF	3 years or maximum endurance reached, whichever occurs first; Basic. Replacement of server flash PCIe cards that have reached their maximum endurance is not included. Contact EMC or an authorized EMC partner to purchase a replacement when maximum endurance has been reached. Refer to the XtremSF user guide for additional information regarding maximum endurance.	Premium, Enhanced, Basic	XtremSF PCIe card
XtremSW Cache	90 days; defective media replacement Support during warranty available with purchase of a maintenance support option	Premium, Enhanced, Basic	None
XtremSW Suite	90 days; defective media replacement Support during warranty available with purchase of a maintenance support option	Premium, Enhanced	None
z/OS Storage Manager Software	90 days; defective media replacement Support during warranty available with purchase of a maintenance support option	Premium	None

*** Customer Replaceable Units (CRUs):**

CRUs are specific assemblies, components, or individual parts of designated EMC equipment that the Customer is authorized by EMC to self-replace. In the event of a failure or technical issue, the Customer may remove and replace a CRU by using EMC-provided diagnostic tools and/or documentation. Assemblies or components not designated as CRUs must be serviced and/or replaced by EMC or an EMC authorized service partner.

** Additional service features are included as part of a purchase of a renewal of an Enhanced, Premium, ProSupport, ProSupport Mission Critical and ProSupport Plus Support Option maintenance contract after May 31, 2018 for this Product; provided, that Customer has activated and maintains the currently supported version(s) of ESRS software during the applicable renewal term. These additional service features are specified in the applicable Support Option Service Description that can be found by clicking the link found [here](#).

¹ Enhanced and/or Premium Support Option, as applicable, is only available as part of a purchase of a renewal of an existing Enhanced and/or Premium Support Option maintenance contract.

RSA Security LLC

Warranty Statement for RSA Security LLC

Per ebid Question no. 76, this document contains the warranty statement for RSA Security products and related services.

WARRANTY

1. PRODUCTS

A. Equipment. RSA warrants that Equipment, and Equipment upgrades installed into Equipment, when purchased from RSA and operated with normal usage and regular recommended service, shall be free from material defects in materials and workmanship, and perform substantially in accordance with Documentation provided for Equipment until the expiration of the warranty period. Unless otherwise noted on the Product Notice or RSA quote, the warranty coverage for the microcode, firmware or operating system software that enables Equipment to perform as described in its Documentation shall be no less than that which applies to such Equipment. To the extent specified in the Product Notice, Support Services in the form of the Support Option noted on the Product Notice are included free of charge during the Equipment warranty period RSA reserves the right to charge for Support Services performed outside the time frames of the applicable Support Option as a Time and Materials Service. In some cases, a Support Option upgrade during the Equipment warranty period may be available separate purchase.

B. Software. RSA warrants that Software will substantially conform to the applicable Documentation for such Software and that any physical media provided by RSA will be free from manufacturing defects in materials and workmanship until the expiration of the warranty period. RSA does not warrant that the operation of Software shall be uninterrupted or error free, that all defects can be corrected, or that Software meets Customer's requirements, except if expressly warranted by RSA in its quote. Support Services for Software are available for separate purchase and the Support Options are identified at the Product Notice. The foregoing warranty is predicated on RSA's license terms which are provided with the Product in the form of a shrink-wrap or click-wrap agreement

C. Duration. Unless otherwise stated on the RSA quote, the warranty period from RSA for Products shall be as set forth at the Product Notice. Equipment warranty commences upon Delivery. Software warranty commences upon Delivery of the media or the date Customer is notified of electronic availability, as applicable. Equipment upgrades are warranted from Delivery until the end of the warranty period for the Equipment into which such upgrades are installed. Support Services (including Support Option upgrades, if applicable) for Equipment are provided during the warranty period. Renewals of Equipment related Support Services shall commence and expire in accordance with the dates on the applicable RSA quote. Support Services for hardware upgrades installed into Equipment and are coterminous with the Support Services that are then in effect for the Equipment into which such upgrades are installed.

Software related Support Services that are ordered at the same time as the license for such Software shall commence on the date of shipment of the physical media or electronic availability of the Software and continue for the period specified on the RSA quote. Renewals of Software related Support Services shall commence and expire in accordance with the dates on the applicable RSA quote.

D. Customer Remedies. RSA's entire liability and Customer's exclusive remedies under the warranties described in this Section shall be for RSA, at its option, to remedy the non-compliance or to replace the affected Product, and if RSA is unable to effect such within a reasonable time, then RSA shall refund the amount paid by Customer for the affected Product as depreciated on a straight line basis over a five (5) year period, upon return of such Product to RSA. All replaced Products or portions thereof shall be returned to and become the property of RSA. If such replacement is not so returned, Customer shall pay RSA's then current spare parts price therefore. RSA shall have no liability hereunder after expiration of the applicable warranty period.

E. Exclusions. Warranty does not cover problems that arise from (i) accident or neglect by Customer or any third party; (ii) any third party items or services with which the Product is used or other causes beyond RSA's control; (iii) installation, operation or use not in accordance with RSA's instructions or the applicable Documentation; (iv) use in an environment, in a manner or for a purpose for which the Product was not designed; (v) modification, alteration or repair by anyone other than RSA or its authorized representatives; or (vi) in case of Equipment only, causes not attributable to normal wear and tear. RSA has no obligation whatsoever for Software installed or used beyond the licensed use, for Equipment which was moved from the Installation Site without RSA's consent or whose original identification marks have been altered or removed.

KCSOS RFB 528899 for PEPPM 2019 Product Line Bid – California

prepared by RSA Security LLC

2. PROFESSIONAL SERVICES

A. Professional Services. RSA shall perform Professional Services in a workmanlike manner in accordance with generally accepted industry standards. Customer must notify RSA of any failure to so perform within ten (10) days after the performance of the applicable portion of Professional Services.

B. Customer Remedies. RSA's entire liability and Customer's sole remedy for RSA's failure to so perform shall be for RSA to, at its option, (i) correct such failure; and/or (ii) terminate the applicable SOW and refund that portion of any fees received that correspond to such failure to perform.

3. MAINTENANCE SERVICES

A. Maintenance Services Warranty. RSA warrants that Maintenance Services shall be performed in a workmanlike manner consistent with generally accepted industry standards. Customer must notify RSA of any such warranty failure within ten (10) days from the date of performance of such Maintenance Services. Notwithstanding anything to the contrary contained herein, RSA does not warrant or represent that all Errors, whether in Software or Hardware, can or will be corrected. RSA's entire liability and Customer's exclusive remedy under the foregoing warranty shall be for RSA to use reasonable efforts to (i) re-perform the deficient services within a reasonable time, or (ii) replace any replacement parts which become defective during a period in which the Product containing the replacement part is covered by warranty or Maintenance Services, or sixty (60) days after installation thereof, whichever occurs later. If, after reasonable efforts, RSA is not able to correct such deficiencies then Customer has the right to terminate for breach.

B. Warranty Exclusions. Maintenance Services specifically excludes support for any Errors caused by (i) operator error or use of the Software and/or Hardware in a manner not in accordance with the Product Documentation; (ii) use of the Software and/or Hardware with software and/or hardware other than that for which the Software and/or Hardware was originally licensed; (iii) Errors caused by any fault in the Customer's environment, hardware, or in any software used in conjunction with the Software or Hardware but not provided by or approved by RSA; (iv) any integration, modification, or repair of the Software and/or Hardware made by any person other than RSA; (v) installation of any appliance, firmware, or operating system on the Hardware other than that provided by RSA; (vi) unusual physical, electrical or electromagnetic stress, fluctuations in electrical power beyond Product specifications, or failure of air conditioning or humidity control; and (vii) accident, misuse, or neglect or causes not attributable to normal wear and tear. In addition, support excludes any Errors for which a correction is available in a subsequent Software Release than that currently operated by Customer and which has been made available to Customer by RSA. Maintenance Services also specifically **excludes** support for any version of the Software released by RSA which has reached its "end of primary support" (EOPS) date, as determined by RSA. Each Software Release will reach its EOPS date after a period of not less than thirty six (36) months following the date of that Software Release's "General Availability" (or "GA" release date, as this term is generally understood in the software industry), unless another EOPS date is set forth at <https://community.rsa.com/docs/DOC-40387>. This time period may be extended by RSA at its sole discretion. In order to continue to receive ongoing Maintenance Services hereunder for any Software Release which is beyond its EOPS date, Customers must upgrade to a currently supported Software Release. For certain Software Products, Customers may enter into an Extended Support agreement for a period of one or two years to obtain Maintenance Services for Software which has already reached its EOPS date. For additional information on Software EOPS dates and the availability of Extended Support agreements for such Software, please go to <https://community.rsa.com/docs/DOC-40387>. If the Maintenance Services expire or are terminated, and Customer subsequently seeks to reinstate Maintenance Services, Customer shall pay the cumulative Maintenance Services fees applicable for the period during which support lapsed in addition to then-current reinstatement fee. Support terms are also incorporated into the shrink-wrap and click-wrap agreements provided with software.

4. PRODUCT NOTICE. References herein to the "Product Notice" shall mean the Product and Services related information posted at the applicable RSA website at the time of the RSA quote, currently located at <http://www.emc.com/collateral/hardware/warranty-maintenance/rsa-warranty-replacement-parts.pdf> For informational purposes, the warranty related portions of the Product Notice have been included on the following pages.

5. NO FURTHER WARRANTIES. EXCEPT AS EXPRESSLY STATED HEREIN, AND TO THE MAXIMUM EXTENT PERMITTED BY APPLICABLE LAW, WITH REGARD TO PRODUCTS, SERVICES OR ANY OTHER ITEMS OR MATTERS ARISING HEREUNDER, RSA (INCLUDING ITS SUPPLIERS) MAKES NO OTHER EXPRESS WARRANTIES, WRITTEN OR ORAL, AND DISCLAIMS ALL IMPLIED WARRANTIES. IN SO FAR AS PERMITTED UNDER APPLICABLE LAW, ALL OTHER WARRANTIES ARE SPECIFICALLY EXCLUDED, INCLUDING, BUT NOT LIMITED TO, THE IMPLIED WARRANTIES OF MERCHANTABILITY, FITNESS FOR A PARTICULAR PURPOSE, TITLE AND NON-INFRINGEMENT, AND ANY WARRANTY ARISING BY STATUTE, OPERATION OF LAW, COURSE OF DEALING OR PERFORMANCE, OR USAGE OF TRADE.

Question 76 - Warranty Statement from Virtustream, Inc.

Virtustream represents and warrants that all Services shall be provided in a professional and workmanlike manner in accordance with generally accepted industry standards for the cloud hosting services industry.

Question 77 - Returned Good Statement from Boomi, Inc.

Boomi services are cloud services with no disks or hardware to be delivered. As a cloud service sold over time, there are no “returns” or shipping. An order can be terminated for material breach, but otherwise orders are not to be terminated for convenience of buyer.

EMC Corporation Returned Goods Statement for Dell EMC

Per ebid Question no. 77, this document contains the returned goods statement for Dell EMC products.

RETURNED GOODS POLICY

EMC strives to make sure the customer requirements are thoroughly understood prior to order execution. Should a Product be defective or damaged, the policy and procedures in EMC's Warranty Statement will govern. Please refer to question 76 attachment "EMC Corporation Warranty Statement for Dell EMC".

**RSA Security LLC (“RSA”)
Returned Goods Statement for RSA**

Per ebid Question no. 77, this document contains the returned goods statement for RSA products.

RETURNED GOODS POLICY

The policy and procedures related to performance of RSA’s Products and Services are set forth in the **RSA Warranty Statement** (question 76 attachment).

Question 77 - Returned Good Statement from Virtustream, Inc.

Virtustream services are cloud services only with no disks, software or hardware products to be delivered. As a cloud service sold over time, there are no “returns” or shipping that is associated with such services. An order can be terminated for material breach, but otherwise orders are not to be terminated for convenience of buyer.

State Selection Form

PEPPM 2019 Product Line Bid -- California

Bidding Company Name:

Product Line Being Bid:

STATE	K-14 Education	Local Gov.	Higher Ed.	STATE	K-14 Education	Local Gov.	Higher Ed.
ALL 50 States (including D.C.)	X	X	X	Montana			
ALL 47 Continental States (including D.C.)				Nebraska			
Alabama				Nevada			
Alaska				New Hampshire			
Arizona				New Jersey			
Arkansas				New Mexico			
Colorado				New York			
Connecticut				North Carolina			
Delaware				North Dakota			
District of Columbia				Ohio			
Florida				Oklahoma			
Georgia				Oregon			
Hawaii				Pennsylvania			
Idaho				Puerto Rico			
Illinois				Rhode Island			
Indiana				South Carolina			
Iowa				South Dakota			
Kansas				Tennessee			
Kentucky				Texas			
Louisiana				Utah			
Maine				Vermont			
Maryland				Virginia			
Massachusetts				Washington			
Michigan				West Virginia			
Minnesota				Wisconsin			
Mississippi				Wyoming			
Missouri							

Please indicate your willingness to extend California PEPPM Bid prices to other states by placing an "X" in the appropriate area of the spreadsheet. It will be necessary for you to complete a separate form for each Product Line you are bidding. After the form has been completed and thoroughly reviewed, it must be attached to your bid form. In California, no hard copy documents are being accepted. Please submit all documents as part of your electronic bid submission.

Signature: Tiffany Palcz Date: 10/11/18

State Selection Form

PEPPM 2019 Product Line Bid -- California

Bidding Company Name: EMC Corporation

Product Line Being Bid: Dell EMC

STATE	K-14 Education	Local Gov.	Higher Ed.	STATE	K-14 Education	Local Gov.	Higher Ed.
ALL 50 States (including D.C.)	X	X	X	Montana			
ALL 47 Continental States (including D.C.)				Nebraska			
Alabama				Nevada			
Alaska				New Hampshire			
Arizona				New Jersey			
Arkansas				New Mexico			
Colorado				New York			
Connecticut				North Carolina			
Delaware				North Dakota			
District of Columbia				Ohio			
Florida				Oklahoma			
Georgia				Oregon			
Hawaii				Pennsylvania			
Idaho				Puerto Rico			
Illinois				Rhode Island			
Indiana				South Carolina			
Iowa				South Dakota			
Kansas				Tennessee			
Kentucky				Texas			
Louisiana				Utah			
Maine				Vermont			
Maryland				Virginia			
Massachusetts				Washington			
Michigan				West Virginia			
Minnesota				Wisconsin			
Mississippi				Wyoming			
Missouri							

Please indicate your willingness to extend California PEPPM Bid prices to other states by placing an "X" in the appropriate area of the spreadsheet. It will be necessary for you to complete a separate form for each Product Line you are bidding. After the form has been completed and thoroughly reviewed, it must be attached to your bid form. In California, no hard copy documents are being accepted. Please submit all documents as part of your electronic bid submission.

 Signature				10/1/18 Date			
--	--	--	--	--	--	--	--

State Selection Form

PEPPM 2019 Product Line Bid -- California

Bidding Company Name:

Product Line Being Bid:

STATE	K-14 Education	Local Gov.	Higher Ed.	STATE	K-14 Education	Local Gov.	Higher Ed.
ALL 50 States (including D.C.)	X	X	X	Montana			
ALL 47 Continental States (including D.C.)				Nebraska			
Alabama				Nevada			
Alaska				New Hampshire			
Arizona				New Jersey			
Arkansas				New Mexico			
Colorado				New York			
Connecticut				North Carolina			
Delaware				North Dakota			
District of Columbia				Ohio			
Florida				Oklahoma			
Georgia				Oregon			
Hawaii				Pennsylvania			
Idaho				Puerto Rico			
Illinois				Rhode Island			
Indiana				South Carolina			
Iowa				South Dakota			
Kansas				Tennessee			
Kentucky				Texas			
Louisiana				Utah			
Maine				Vermont			
Maryland				Virginia			
Massachusetts				Washington			
Michigan				West Virginia			
Minnesota				Wisconsin			
Mississippi				Wyoming			
Missouri							

Please indicate your willingness to extend California PEPPM Bid prices to other states by placing an "X" in the appropriate area of the spreadsheet. It will be necessary for you to complete a separate form for each Product Line you are bidding. After the form has been completed and thoroughly reviewed, it must be attached to your bid form. In California, no hard copy documents are being accepted. Please submit all documents as part of your electronic bid submission.

Signature: Tiffany Pabst Date: 10/11/18

State Selection Form

PEPPM 2019 Product Line Bid -- California

Bidding Company Name:

Product Line Being Bid:

STATE	K-14 Education	Local Gov.	Higher Ed.	STATE	K-14 Education	Local Gov.	Higher Ed.
ALL 50 States (including D.C.)	X	X	X	Montana			
ALL 47 Continental States (including D.C.)				Nebraska			
Alabama				Nevada			
Alaska				New Hampshire			
Arizona				New Jersey			
Arkansas				New Mexico			
Colorado				New York			
Connecticut				North Carolina			
Delaware				North Dakota			
District of Columbia				Ohio			
Florida				Oklahoma			
Georgia				Oregon			
Hawaii				Pennsylvania			
Idaho				Puerto Rico			
Illinois				Rhode Island			
Indiana				South Carolina			
Iowa				South Dakota			
Kansas				Tennessee			
Kentucky				Texas			
Louisiana				Utah			
Maine				Vermont			
Maryland				Virginia			
Massachusetts				Washington			
Michigan				West Virginia			
Minnesota				Wisconsin			
Mississippi				Wyoming			
Missouri							

Please indicate your willingness to extend California PEPPM Bid prices to other states by placing an "X" in the appropriate area of the spreadsheet. It will be necessary for you to complete a separate form for each Product Line you are bidding. After the form has been completed and thoroughly reviewed, it must be attached to your bid form. In California, no hard copy documents are being accepted. Please submit all documents as part of your electronic bid submission.

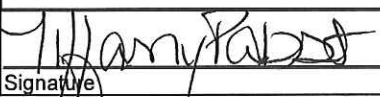
Signature:  Date: 10/11/18

PEPPM Bid Quote Sheet

My firm proposes -- after careful review, understanding and acceptance of all bid Terms and Conditions, plus instructions and specifications -- to supply the equipment and/or materials noted on Bid Response tab of this spreadsheet according to the bid price structure and at the final prices noted below (subject to further adjustments by manufacturers during the award period) to any eligible agency in any jurisdictions that are specified in the bid during the contract term specified in the bid Terms and Conditions.

Bidding Company Name > Submitted By and Attested to By>	EMC CORPORATION	A. Company
	Tiffany Pabst	B. Bid Signatory
	Sr. Contract Manager	C. Corporate Title
	(916) 221-0294	D. Phone Number
	Tiffany.Pabst@dell.com	E. E-Mail Address
	Oct. 1, 2018	F. Date

Product Line Being Bid>	Boomi, Inc.	G.
Description of Product Line>	Integration Platform as a Service	H.

Method Used for Calculation of Final Effective Bid Prices >	Variable	I.
---	----------	----

Note: Margin Over Cost Pricing Methods Are Not Acceptable; See Terms and Conditions

Percent Discount or Percent Mark-Up Over Cost >		J.
---	--	----

Note: No entry is necessary in box J, if bidding by variable discount or mark-up; instead, insert percentages starting at row 29

Name of the Catalog or Price List Used for Price Basis >	Boomi POR	K.
--	-----------	----

Effective Date of the Catalog or Price List >	August 31, 2018	L.
---	-----------------	----

NOTE: If certain subcategories of SKUs are being bid at variable percent mark-ups or discounts, you must clearly identify the subcategory grouping, the applicable percent and the method for determining the final effective bid price. If applicable, you may designate up to 30 subcategories in the spaces below. When completing the Bid Response Tab you must enter the same corresponding discounts in column H so that the final prices are correctly calculated.

	Clearly Defined Subcategories for Variable Mark-Up or	Percent	Mark-Up or Discount
Subcategory No. 1	Boomi License	20.0000%	Discount off list
Subcategory No. 2	Boomi Support	0.0000%	Discount off list
Subcategory No. 3	Boomi Services	0.0000%	Discount off list
Subcategory No. 4	Boomi Renewal	0.0000%	Discount off list
Subcategory No. 5			
Subcategory No. 6			
Subcategory No. 7			
Subcategory No. 8			
Subcategory No. 9			
Subcategory No. 10			
Subcategory No. 11			
Subcategory No. 12			
Subcategory No. 13			
Subcategory No. 14			
Subcategory No. 15			
Subcategory No. 16			
Subcategory No. 17			
Subcategory No. 18			
Subcategory No. 19			
Subcategory No. 20			
Subcategory No. 21			
Subcategory No. 22			
Subcategory No. 23			
Subcategory No. 24			
Subcategory No. 25			
Subcategory No. 26			
Subcategory No. 27			
Subcategory No. 28			
Subcategory No. 29			
Subcategory No. 30			

PEPPM Bid Quote Sheet

My firm proposes -- after careful review, understanding and acceptance of all bid Terms and Conditions, plus instructions and specifications -- to supply the equipment and/or materials noted on Bid Response tab of this spreadsheet according to the bid price structure and at the final prices noted below (subject to further adjustments by manufacturers during the award period) to any eligible agency in any jurisdictions that are specified in the bid during the contract term specified in the bid Terms and Conditions.

Bidding Company Name > Submitted By and Attested to By>	EMC CORPORATION	A. Company
	Tiffany Pabst	B. Bid Signatory
	Sr. Contract Manager	C. Corporate Title
	(916) 221-0294	D. Phone Number
	Tiffany.Pabst@dell.com	E. E-Mail Address
	Oct. 1, 2018	F. Date

Product Line Being Bid>	Dell EMC	G.
Description of Product Line>	Dell EMC storage systems, backup, software and services	H.

Method Used for Calculation of Final Effective Bid Prices >	Discount from List	I.
---	--------------------	----

Note: Margin Over Cost Pricing Methods Are Not Acceptable; See Terms and Conditions

Percent Discount or Percent Mark-Up Over Cost >		J.
---	--	----

Note: No entry is necessary in box J, if bidding by variable discount or mark-up; instead, insert percentages starting at row 29

Name of the Catalog or Price List Used for Price Basis >	EMC Commercial Price List	K.
--	---------------------------	----

Effective Date of the Catalog or Price List >	August 1, 2018	L.
---	----------------	----

NOTE: If certain subcategories of SKUs are being bid at variable percent mark-ups or discounts, you must clearly identify the subcategory grouping, the applicable percent and the method for determining the final effective bid price. If applicable, you may designate up to 30 subcategories in the spaces below. When completing the Bid Response Tab you must enter the same corresponding discounts in column H so that the final prices are correctly calculated.

	Clearly Defined Subcategories for Variable Mark-Up or	Percent	Mark-Up or Discount
Subcategory No. 1	Entry Systems	-10%	Discount off list
Subcategory No. 2	High-end Systems	-23%	Discount off list
Subcategory No. 3	Midrange Systems	-15%	Discount off list
Subcategory No. 4	Maintenance, Training, Services	0%	Discount off list
Subcategory No. 5	Software Systems	-33%	Discount off list
Subcategory No. 6	Specialty Systems	-21%	Discount off list
Subcategory No. 7	Connectrix	-44%	Discount off list
Subcategory No. 8	Symmetrix	-54%	Discount off list
Subcategory No. 9			
Subcategory No. 10			
Subcategory No. 11			
Subcategory No. 12			
Subcategory No. 13			
Subcategory No. 14			
Subcategory No. 15			
Subcategory No. 16			
Subcategory No. 17			
Subcategory No. 18			
Subcategory No. 19			
Subcategory No. 20			
Subcategory No. 21			
Subcategory No. 22			
Subcategory No. 23			
Subcategory No. 24			
Subcategory No. 25			
Subcategory No. 26			
Subcategory No. 27			
Subcategory No. 28			
Subcategory No. 29			
Subcategory No. 30			

PEPPM Bid Quote Sheet

My firm proposes -- after careful review, understanding and acceptance of all bid Terms and Conditions, plus instructions and specifications -- to supply the equipment and/or materials noted on Bid Response tab of this spreadsheet according to the bid price structure and at the final prices noted below (subject to further adjustments by manufacturers during the award period) to any eligible agency in any jurisdictions that are specified in the bid during the contract term specified in the bid Terms and Conditions.

Bidding Company Name > Submitted By and Attested to By>	EMC CORPORATION	A. Company
	Tiffany Pabst	B. Bid Signatory
	Sr. Contract Manager	C. Corporate Title
	(916) 221-0294	D. Phone Number
	Tiffany.Pabst@dell.com	E. E-Mail Address
	Oct. 1, 2018	F. Date

Product Line Being Bid>	RSA Security	G.
Description of Product Line>	IT Security Products & Services	H.

Method Used for Calculation of Final Effective Bid Prices >	Discount from List	I.
---	--------------------	----

Note: Margin Over Cost Pricing Methods Are Not Acceptable; See Terms and Conditions

Percent Discount or Percent Mark-Up Over Cost >	Variable	J.
---	----------	----

Note: No entry is necessary in box J, if bidding by variable discount or mark-up; instead, insert percentages starting at row 29

Name of the Catalog or Price List Used for Price Basis >	RSA Commercial Price Book	K.
--	---------------------------	----

Effective Date of the Catalog or Price List >	August 1, 2018	L.
---	----------------	----

NOTE: If certain subcategories of SKUs are being bid at variable percent mark-ups or discounts, you must clearly identify the subcategory grouping, the applicable percent and the method for determining the final effective bid price. If applicable, you may designate up to 30 subcategories in the spaces below. When completing the Bid Response Tab you must enter the same corresponding discounts in column H so that the final prices are correctly calculated.

	Clearly Defined Subcategories for Variable Mark-Up or	Percent	Mark-Up or Discount
Subcategory No. 1	Software	12.0000%	Discount off list
Subcategory No. 2	Hardware	0.0000%	Discount off list
Subcategory No. 3	Education/Training	0.0000%	Discount off list
Subcategory No. 4	Professional Services	0.0000%	Discount off list
Subcategory No. 5	Maintenance/Support	2.0000%	Discount off list
Subcategory No. 6			
Subcategory No. 7			
Subcategory No. 8			
Subcategory No. 9			
Subcategory No. 10			
Subcategory No. 11			
Subcategory No. 12			
Subcategory No. 13			
Subcategory No. 14			
Subcategory No. 15			
Subcategory No. 16			
Subcategory No. 17			
Subcategory No. 18			
Subcategory No. 19			
Subcategory No. 20			
Subcategory No. 21			
Subcategory No. 22			
Subcategory No. 23			
Subcategory No. 24			
Subcategory No. 25			
Subcategory No. 26			
Subcategory No. 27			
Subcategory No. 28			
Subcategory No. 29			
Subcategory No. 30			

PEPPM Bid Quote Sheet

My firm proposes -- after careful review, understanding and acceptance of all bid Terms and Conditions, plus instructions and specifications -- to supply the equipment and/or materials noted on Bid Response tab of this spreadsheet according to the bid price structure and at the final prices noted below (subject to further adjustments by manufacturers during the award period) to any eligible agency in any jurisdictions that are specified in the bid during the contract term specified in the bid Terms and Conditions.

Bidding Company Name >	EMC CORPORATION	A. Company
Submitted By and Attested to By>	Tiffany Pabst	B. Bid Signatory
	Sr. Contract Manager	C. Corporate Title
	(916) 221-0294	D. Phone Number
	Tiffany.Pabst@dell.com	E. E-Mail Address
	Oct. 1, 2018	F. Date

Product Line Being Bid>	Virtustream	G.
Description of Product Line>	Hosted managed infrastructure services	H.

Method Used for Calculation of Final Effective Bid Prices >	Discount from List	I.
---	--------------------	----

Note: Margin Over Cost Pricing Methods Are Not Acceptable; See Terms and Conditions

Percent Discount or Percent Mark-Up Over Cost >	7.0000%	J.
---	---------	----

Note: No entry is necessary in box J, if bidding by variable discount or mark-up; instead, insert percentages starting at row 29

Name of the Catalog or Price List Used for Price Basis >	Commercial List	K.
--	-----------------	----

Effective Date of the Catalog or Price List >	August 1, 2018	L.
---	----------------	----

NOTE: If certain subcategories of SKUs are being bid at variable percent mark-ups or discounts, you must clearly identify the subcategory grouping, the applicable percent and the method for determining the final effective bid price. If applicable, you may designate up to 30 subcategories in the spaces below. When completing the Bid Response Tab you must enter the same corresponding discounts in column H so that the final prices are correctly calculated.

	Clearly Defined Subcategories for Variable Mark-Up or	Percent	Mark-Up or Discount
Subcategory No. 1			
Subcategory No. 2			
Subcategory No. 3			
Subcategory No. 4			
Subcategory No. 5			
Subcategory No. 6			
Subcategory No. 7			
Subcategory No. 8			
Subcategory No. 9			
Subcategory No. 10			
Subcategory No. 11			
Subcategory No. 12			
Subcategory No. 13			
Subcategory No. 14			
Subcategory No. 15			
Subcategory No. 16			
Subcategory No. 17			
Subcategory No. 18			
Subcategory No. 19			
Subcategory No. 20			
Subcategory No. 21			
Subcategory No. 22			
Subcategory No. 23			
Subcategory No. 24			
Subcategory No. 25			
Subcategory No. 26			
Subcategory No. 27			
Subcategory No. 28			
Subcategory No. 29			
Subcategory No. 30			

Vendor:	Boomi	Vendor ID#	
Product:	Boomi		
Date:	8/31/2018		
Part Type (Hardware, Software, Services)	Model Number 16 Character Max	Description 40 Character Max (Must Start with SEL)	Vendor List Price
Services	BM-E-MS-LVL1	BOOMI EDI Mngd Services 1-10 (PPP)	\$1,000.00
Services	BM-E-MS-LVL2	BOOMI EDI Mngd Services 11-20 (PPP)	\$875.00
Services	BM-E-MS-LVL3	BOOMI EDI Mngd Services 21-35 (PPP)	\$750.00
Services	BM-E-MS-LVL4	BOOMI EDI Mngd Services 36-50 (PPP)	\$625.00
Services	BM-E-MS-LVL5	BOOMI EDI Mngd Services 51-100 (PPP)	\$500.00
Services	BM-E-MS-LVL6	BOOMI EDI Mngd Services >100 (PPP)	\$375.00
Services	BM-I-PS-DAP	BOOMI ProServ-Delivery Assurance Pgm	\$225.00
Services	BM-API-PS-R	BOOMI API ProServ-Hourly Remote	\$225.00
Services	BM-E-PS-CR	BOOMI EDI ProServ-Hourly Remote	\$225.00
Services	BM-F-PS-CR	BOOMI Flow ProServ-Hourly Remote	\$225.00
Services	BM-I-PS-IPSCR	BOOMI iPaaS ProServ-Hourly Remote	\$225.00
Services	BM-MDM-PS-CR	BOOMI MDM Proserv-Hourly Remote	\$225.00
Services	BM-I-PS-CR	BOOMI ProServ-Hourly Consult Remote	\$225.00
Services	BM-API-PS-O	BOOMI API ProServ Hourly Onsite	\$275.00
Services	BM-E-PS-CO	BOOMI EDI ProServ-Hourly Onsite	\$275.00
Services	BM-F-PS-CO	BOOMI Flow ProServ-Hourly Onsite	\$275.00
Services	BM-I-PS-IPSCO	BOOMI iPaaS ProServ-Hourly Onsite	\$275.00
Services	BM-MDM-PS-CO	BOOMI MDM ProServ-Hourly Onsite	\$275.00
Services	BM-I-PS-CO	BOOMI ProServ-Hourly Consult Onsite	\$275.00
Services	BM-I-PS-TACR	BOOMI TechArch-Hourly Consult Remote	\$275.00
Services	BM-I-PS-TACO	BOOMI TechArch-Hourly Consult Onsite	\$300.00
Services	BM-TR-PS-ADM1	BOOMI Administrator I Per Class	\$400.00
Services	BM-TR-PS-ADM2	BOOMI Administrator II Per Class	\$400.00
Services	BM-TR-PS-DEV3	BOOMI Developer III Per Class	\$600.00
Services	BM-TR-PS-BCE	BOOMI Int Developer EDI Per Class	\$700.00
Services	BM-TR-PS-ARC2	BOOMI Architect II Per Class	\$1,000.00
Services	BM-TR-PS-IA	BOOMI Architect I Per Class	\$1,200.00
Services	BM-TR-PS-ARC3	BOOMI Architect III Per Class	\$1,200.00
Services	BM-TR-PS-BCAR	BOOMI Developer II Per Class	\$1,200.00
Services	BM-TR-PS-BCM	BOOMI Master Data Mgmt I Per Class	\$1,600.00
Services	BM-TR-PS-BC-R	BOOMI Developer I Per Class	\$1,800.00
Services	BM-I-PS-JS	BOOMI ProServ-JumpStart - 8 hours	\$2,000.00
Services	BM-TR-PS-BC-L	BOOMI IntDev I & II Per Class	\$3,500.00
Services	BM-TR-PS-ID-R	BOOMI IntDev I & II Remote Per Class	\$3,500.00
Services	BM-I-PS-NSAS	BOOMI NS/SF Int Accl Service OT Fee	\$3,800.00
Services	BM-I-PS-IAW	BOOMI Int Accel Workday/WD OT Fee	\$17,500.00
Software Subscription	BM-F-LC-AL-1	BOOMI Flow Addtnl AppLaunches .01	\$0.01
Software Subscription	BM-F-LC-AL-2	BOOMI Flow Addtnl AppLaunches 1	\$1.00
Software Subscription	BM-F-LC-AL-3	BOOMI Flow Addtnl AppLaunches 100	\$100.00
Software Subscription	BM-F-LC-AL-4	BOOMI Flow Addtnl AppLaunches 1000	\$1,000.00
Software Subscription	BM-F-LC-FS-1	BOOMI Flow Addtnl Flows .01	\$0.01
Software Subscription	BM-F-LC-FS-2	BOOMI Flow Addtnl Flows 1	\$1.00
Software Subscription	BM-F-LC-FS-3	BOOMI Flow Addtnl Flows 100	\$100.00
Software Subscription	BM-F-LC-FS-4	BOOMI Flow Addtnl Flows 1000	\$1,000.00
Software Subscription	BM-F-LC-EG-1	BOOMI Flow Enterprise Gold .01	\$0.01
Software Subscription	BM-F-LC-EG-2	BOOMI Flow Enterprise Gold 1	\$1.00
Software Subscription	BM-F-LC-EG-3	BOOMI Flow Enterprise Gold 100	\$100.00
Software Subscription	BM-F-LC-EG-4	BOOMI Flow Enterprise Gold 1000	\$1,000.00
Software Subscription	BM-F-LC-HS-1	BOOMI Flow Hosting Services .01	\$0.01
Software Subscription	BM-F-LC-HS-2	BOOMI Flow Hosting Services 1	\$1.00
Software Subscription	BM-F-LC-HS-3	BOOMI Flow Hosting Services 100	\$100.00
Software Subscription	BM-F-LC-HS-4	BOOMI Flow Hosting Services 1000	\$1,000.00
Software Subscription	BM-MDM-CST-1	BOOMI MDM Ed (Custom Tier) .01	\$0.01
Software Subscription	BM-MDM-CST-2	BOOMI MDM Ed (Custom Tier) 1	\$1.00
Software Subscription	BM-MDM-CST-3	BOOMI MDM Ed (Custom Tier) 100	\$100.00
Software Subscription	BM-MDM-CST-4	BOOMI MDM Ed (Custom Tier) 1000	\$1,000.00
Software Subscription	BM-I-LC-RPI-1	BOOMI Renewal Price Increase .01	\$0.01
Software Subscription	BM-I-LC-RPI-2	BOOMI Renewal Price Increase 1	\$1.00
Software Subscription	BM-I-LC-RPI-3	BOOMI Renewal Price Increase 100	\$100.00
Software Subscription	BM-I-LC-RPI-4	BOOMI Renewal Price Increase 1000	\$1,000.00
Software Subscription	BM-I-LC-ASOAP	BOOMI Advanced Soap Processing	\$0.00
Software Subscription	BM-E-LC-BETA	BOOMI Beta EDI Features	\$0.00
Software Subscription	BM-I-LC-CLOUD	BOOMI Clouds	\$0.00
Software Subscription	BM-I-LC-CL	BOOMI Component Locking	\$0.00
Software Subscription	BM-E-LC-B2BF	BOOMI EDI/B2B Framework	\$0.00
Software Subscription	BM-I-LC-ENV	BOOMI Environments	\$0.00
Software Subscription	BM-I-LC-HL7	BOOMI HL7 Option	\$0.00
Software Subscription	BM-I-LC-PF	BOOMI Partner Account Features	\$0.00
Software Subscription	BM-I-LC-PR	BOOMI Process Route	\$0.00
Software Subscription	BM-I-LC-STO	BOOMI Session Timeout	\$0.00
Software Subscription	BM-I-LC-VC	BOOMI Version Control	\$0.00
Software Subscription	BM-F-LC-OCC	BOOMI Flow Occasional	\$10.00
Software Subscription	BM-E-CT100P1Y	BOOMI TradePartnerConnect > 100	\$22.50
Software Subscription	BM-F-LC-ESSNT	BOOMI Flow Essential	\$25.00
Software Subscription	BM-E-CT1001Y	BOOMI TradePartnerConnect (81-100)	\$30.00
Software Subscription	BM-I-LC-SMBTC	BOOMI SMB Test Connection	\$32.50
Software Subscription	BM-E-CT801Y	BOOMI TradePartnerConnect (61-80)	\$37.50
Software Subscription	BM-E-CTPTEST	BOOMI TradePartnerConnect Test	\$38.00
Software Subscription	BM-E-CTTCT-NS	BOOMI TradePartnerConnectTest NonSub	\$38.00

Vendor:	Boomi	Vendor ID#	
Product:	Boomi		
Date:	8/31/2018		
Part Type (Hardware, Software, Services)	Model Number 16 Character Max	Description 40 Character Max (Must Start with SEL)	Vendor List Price
Software Subscription	BM-F-LC-CONT	BOOMI Flow Continual	\$45.00
Software Subscription	BM-E-CT601Y	BOOMI TradePartnerConnect (41-60)	\$45.00
Software Subscription	BM-E-CT401Y	BOOMI TradePartnerConnect (21-40)	\$52.50
Software Subscription	BM-E-CT201Y	BOOMI TradePartnerConnect (11-20)	\$60.00
Software Subscription	BM-I-LC-SBC1Y	BOOMI Small Business Connection	\$65.00
Software Subscription	BM-E-CT101Y	BOOMI TradePartnerConnect (5-10)	\$67.50
Software Subscription	BM-E-C101-200	BOOMI TradePartnerConnect (101-200)	\$71.25
Software Subscription	BM-E-CT201P	BOOMI TradePartnerConnect (201 plus)	\$71.25
Software Subscription	BM-E-C41-100	BOOMI TradePartnerConnect (41-100)	\$71.25
Software Subscription	BM-E-CT6-40	BOOMI TradePartnerConnect (6-40)	\$71.25
Software Subscription	BM-E-CTP41Y	BOOMI TradePartnerConnect (1-4)	\$75.00
Software Subscription	BM-E-CTPCT-NS	BOOMI TradePartnerConnectProd NonSub	\$75.00
Software Subscription	BM-E-CTP	BOOMI Trading Partner Connection	\$75.00
Software Subscription	BM-I-LCS-SPC	BOOMI Support Case Per Case	\$95.00
Software Subscription	BM-I-LC-EDV	BOOMI Excess Data Volume-1Gb	\$100.00
Software Subscription	BM-I-LC-AW-T	BOOMI Atom Worker - Test	\$125.00
Software Subscription	BM-I-LC-ACA-T	BOOMI Atom Cloud Attachment - Test	\$150.00
Software Subscription	BM-I-LC-STCNS	BOOMI Standard Test Connect NonSub	\$150.00
Software Subscription	BM-I-LC-STC	BOOMI Standard Test Connection	\$150.00
Software Subscription	BM-I-LC-GCRM	BOOMI GearsCRM CSV to SFDC Bundle	\$225.00
Software Subscription	BM-I-LC-AW	BOOMI Atom Worker	\$250.00
Software Subscription	BM-I-LC-NS33	BOOMI NetSuite OpenAir SFDC 3300	\$275.00
Software Subscription	BM-I-LC-ACA-A	BOOMI ANZ Atom Cloud Attachment	\$300.00
Software Subscription	BM-MDM-LC-CAA	BOOMI ANZ MDM Cloud Attachment	\$300.00
Software Subscription	BM-I-LC-ACA	BOOMI Atom Cloud Attachment	\$300.00
Software Subscription	BM-I-LC-ACA-E	BOOMI EMEA Atom Cloud Attachment	\$300.00
Software Subscription	BM-I-LC-MCA-E	BOOMI EMEA MDM Cloud Attachment	\$300.00
Software Subscription	BM-MDM-LC-CA	BOOMI MDM Cloud Attachment	\$300.00
Software Subscription	BM-I-LC-SC1Y	BOOMI Standard Connection	\$300.00
Software Subscription	BM-I-LC-SPCNS	BOOMI Standard Prod Connect NonSub	\$300.00
Software Subscription	BM-MDM-LC-TR1	BOOMI MDM Ed (Tier 1 <10K GRecords)	\$355.00
Software Subscription	BM-I-LC-NS50	BOOMI NetSuite Salesforce Q2C 5000	\$416.67
Software Subscription	BM-I-LC-ETCNS	BOOMI Enterprise Test Connect NonSub	\$450.00
Software Subscription	BM-I-LC-ETC	BOOMI Enterprise Test Connection	\$450.00
Software Subscription	BM-I-LC-RAVIB	BOOMI Base Ed - NetSuite RAVI Bundle	\$467.00
Software Subscription	BM-E-LC-RAVI	BOOMI EDI Ed - NetSuite RAVI Bundle	\$467.00
Software Subscription	BM-I-LC-NSSIA	BOOMI NetSuite-SF Integration Accel	\$500.00
Software Subscription	BM-I-LC-BESMB	BOOMI Base Ed - SmallBiz Connection	\$550.00
Software Subscription	BM-I-LC-BESC	BOOMI Base Ed - Standard Connection	\$550.00
Software Subscription	BM-E-LC-FY18	BOOMI EDI Edition	\$550.00
Software Subscription	BM-E-LC-TRD1Y	BOOMI Trading Partner Edition	\$550.00
Software Subscription	BM-I-LC-NS72	BOOMI NetSuite OpenAir SFDC 7200	\$600.00
Software Subscription	BM-I-LC-AUC	BOOMI Advanced User Controls	\$650.00
Software Subscription	BM-I-LC-ADVW	BOOMI Advanced Workflow	\$650.00
Software Subscription	BM-API-LC-ADV	BOOMI API Publish Features	\$650.00
Software Subscription	BM-I-LC-ETM	BOOMI Enhanced Test Mode	\$650.00
Software Subscription	BM-I-LC-MQ	BOOMI Message Queuing	\$650.00
Software Subscription	BM-I-LC-PP	BOOMI Parallel Processing	\$650.00
Software Subscription	BM-I-LC-SWA	BOOMI Salesforce Wave Analytics Ed	\$833.33
Software Subscription	BM-I-LC-EC1Y	BOOMI Enterprise Connection	\$900.00
Software Subscription	BM-I-LC-EPCNS	BOOMI Enterprise Prod Connect NonSub	\$900.00
Software Subscription	BM-I-LC-RAVI2	BOOMI ProEd - 2 Connection NS RAVI	\$960.00
Software Subscription	BM-F-LC-ESTRT	BOOMI Flow Enterprise Starter	\$1,000.00
Software Subscription	BM-I-LC-PESB2	BOOMI ProEd-Spcl Bundle 2 connection	\$1,200.00
Software Subscription	BM-I-LC-MOL1Y	BOOMI Molecule	\$1,300.00
Software Subscription	BM-I-LC-SE	BOOMI Services Enablement	\$1,300.00
Software Subscription	BM-I-LC-RAVI3	BOOMI ProEd - 3 Connection NS RAVI	\$1,320.00
Software Subscription	BM-I-LC-RAVI4	BOOMI ProEd - 4 Connection NS RAVI	\$1,480.00
Software Subscription	BM-API-LC-T1	BOOMI API Mgmt Tier 1 Up to 100K T/D	\$1,500.00
Software Subscription	BM-I-LC-IAW	BOOMI Integration Accel Workday/AD	\$1,500.00
Software Subscription	BM-I-LC-RAVI5	BOOMI ProEd - 5 Connection NS RAVI	\$1,600.00
Software Subscription	BM-I-LC-PESB3	BOOMI ProEd-Spcl Bundle 3 connection	\$1,650.00
Software Subscription	BM-MDM-LC-TR2	BOOMI MDM Ed (Tier 2 <50K GRecords)	\$1,750.00
Software Subscription	BM-I-LC-PESB4	BOOMI ProEd-Spcl Bundle 4 connection	\$1,850.00
Software Subscription	BM-I-LC-PE1Y	BOOMI Professional Edition	\$2,000.00
Software Subscription	BM-F-LC-EBRNZ	BOOMI Flow Enterprise Bronze	\$2,250.00
Software Subscription	BM-API-LC-T2	BOOMI API Mgmt Tier 2 Up to 1M T/D	\$3,000.00
Software Subscription	BM-MDM-LC-TR3	BOOMI MDM Ed (Tier 3 <100K GRecords)	\$3,000.00
Software Subscription	BM-I-LC-PPE	BOOMI Pro Plus Edition	\$4,000.00
Software Subscription	BM-F-LC-ESLVR	BOOMI Flow Enterprise Silver	\$4,500.00
Software Subscription	BM-MDM-LC-B	BOOMI MDM Ed (Base Tier)	\$6,000.00
Software Subscription	BM-API-LC-T3	BOOMI API Mgmt Tier 3 Up to 10M T/D	\$8,000.00
Software Subscription	BM-I-LC-EE1Y	BOOMI Enterprise Edition	\$8,000.00
Software Subscription	BM-I-LC-EPE	BOOMI Enterprise Plus Edition	\$12,000.00
Software Subscription	BM-MDM-LC-PRO	BOOMI MDM Ed (Professional Tier)	\$12,000.00
Software Subscription	BM-API-LC-T4	BOOMI API Mgmt Tier 4 >10M T/D	\$15,000.00
Software Subscription	BM-MDM-LC-ENT	BOOMI MDM Ed (Enterprise Tier)	\$18,000.00
Support	BM-I-LC-PS-1	BOOMI Premier Support .01	\$0.01
Support	BM-I-LC-PS-2	BOOMI Premier Support 1	\$1.00

Vendor:	Boomi	Vendor ID#	
Product:	Boomi		
Date:	8/31/2018		
<u>Part Type (Hardware, Software, Services)</u>	<u>Model Number</u> <u>16 Character Max</u>	<u>Description</u> <u>40 Character Max</u> <u>(Must Start with SEL)</u>	<u>Vendor List Price</u>
Support	BM-I-LC-PS-3	BOOMI Premier Support 100	\$100.00
Support	BM-I-LC-PS-4	BOOMI Premier Support 1000	\$1,000.00
Support	BM-I-LC-PS-0	BOOMI Premier Support .00	\$0.00
Support	BM-I-LC-PPL-1	BOOMI Premier Plus .01	\$0.01
Support	BM-I-LC-PPL-2	BOOMI Premier Plus 1	\$1.00
Support	BM-I-LC-PPL-3	BOOMI Premier Plus 100	\$100.00
Support	BM-I-LC-PPL-4	BOOMI Premier Plus 1000	\$1,000.00
Support	BM-I-LC-PPA-1	BOOMI Premier Plus Adjustment .01	\$0.01
Support	BM-I-LC-PPA-2	BOOMI Premier Plus Adjustment 1	\$1.00
Support	BM-I-LC-PPA-3	BOOMI Premier Plus Adjustment 100	\$100.00
Support	BM-I-LC-PPA-4	BOOMI Premier Plus Adjustment 1000	\$1,000.00
Support	BM-I-LCS-SS	BOOMI Standard Support	\$0.00

Vendor:	Boomi	Vendor ID#	
Product:	Boomi		
Date:	8/31/2018		
Part Type (Hardware, Software, Services)	Model Number 16 Character Max	Description 40 Character Max (Must Start with SEL)	Vendor List Price
Services	BM-E-MS-LVL1	BOOMI EDI Mngd Services 1-10 (PPP)	\$1,000.00
Services	BM-E-MS-LVL2	BOOMI EDI Mngd Services 11-20 (PPP)	\$875.00
Services	BM-E-MS-LVL3	BOOMI EDI Mngd Services 21-35 (PPP)	\$750.00
Services	BM-E-MS-LVL4	BOOMI EDI Mngd Services 36-50 (PPP)	\$625.00
Services	BM-E-MS-LVL5	BOOMI EDI Mngd Services 51-100 (PPP)	\$500.00
Services	BM-E-MS-LVL6	BOOMI EDI Mngd Services >100 (PPP)	\$375.00
Services	BM-I-PS-DAP	BOOMI ProServ-Delivery Assurance Pgm	\$225.00
Services	BM-API-PS-R	BOOMI API ProServ-Hourly Remote	\$225.00
Services	BM-E-PS-CR	BOOMI EDI ProServ-Hourly Remote	\$225.00
Services	BM-F-PS-CR	BOOMI Flow ProServ-Hourly Remote	\$225.00
Services	BM-I-PS-IPSCR	BOOMI iPaaS ProServ-Hourly Remote	\$225.00
Services	BM-MDM-PS-CR	BOOMI MDM Proserv-Hourly Remote	\$225.00
Services	BM-I-PS-CR	BOOMI ProServ-Hourly Consult Remote	\$225.00
Services	BM-API-PS-O	BOOMI API ProServ Hourly Onsite	\$275.00
Services	BM-E-PS-CO	BOOMI EDI ProServ-Hourly Onsite	\$275.00
Services	BM-F-PS-CO	BOOMI Flow ProServ-Hourly Onsite	\$275.00
Services	BM-I-PS-IPSCO	BOOMI iPaaS ProServ-Hourly Onsite	\$275.00
Services	BM-MDM-PS-CO	BOOMI MDM ProServ-Hourly Onsite	\$275.00
Services	BM-I-PS-CO	BOOMI ProServ-Hourly Consult Onsite	\$275.00
Services	BM-I-PS-TACR	BOOMI TechArch-Hourly Consult Remote	\$275.00
Services	BM-I-PS-TACO	BOOMI TechArch-Hourly Consult Onsite	\$300.00
Services	BM-TR-PS-ADM1	BOOMI Administrator I Per Class	\$400.00
Services	BM-TR-PS-ADM2	BOOMI Administrator II Per Class	\$400.00
Services	BM-TR-PS-DEV3	BOOMI Developer III Per Class	\$600.00
Services	BM-TR-PS-BCE	BOOMI Int Developer EDI Per Class	\$700.00
Services	BM-TR-PS-ARC2	BOOMI Architect II Per Class	\$1,000.00
Services	BM-TR-PS-IA	BOOMI Architect I Per Class	\$1,200.00
Services	BM-TR-PS-ARC3	BOOMI Architect III Per Class	\$1,200.00
Services	BM-TR-PS-BCAR	BOOMI Developer II Per Class	\$1,200.00
Services	BM-TR-PS-BCM	BOOMI Master Data Mgmt I Per Class	\$1,600.00
Services	BM-TR-PS-BC-R	BOOMI Developer I Per Class	\$1,800.00
Services	BM-I-PS-JS	BOOMI ProServ-JumpStart - 8 hours	\$2,000.00
Services	BM-TR-PS-BC-L	BOOMI IntDev I & II Per Class	\$3,500.00
Services	BM-TR-PS-ID-R	BOOMI IntDev I & II Remote Per Class	\$3,500.00
Services	BM-I-PS-NSAS	BOOMI NS/SF Int Accl Service OT Fee	\$3,800.00
Services	BM-I-PS-IAW	BOOMI Int Accel Workday/WD OT Fee	\$17,500.00
Software Subscription	BM-F-LC-AL-1	BOOMI Flow Addtnl AppLaunches .01	\$0.01
Software Subscription	BM-F-LC-AL-2	BOOMI Flow Addtnl AppLaunches 1	\$1.00
Software Subscription	BM-F-LC-AL-3	BOOMI Flow Addtnl AppLaunches 100	\$100.00
Software Subscription	BM-F-LC-AL-4	BOOMI Flow Addtnl AppLaunches 1000	\$1,000.00
Software Subscription	BM-F-LC-FS-1	BOOMI Flow Addtnl Flows .01	\$0.01
Software Subscription	BM-F-LC-FS-2	BOOMI Flow Addtnl Flows 1	\$1.00
Software Subscription	BM-F-LC-FS-3	BOOMI Flow Addtnl Flows 100	\$100.00
Software Subscription	BM-F-LC-FS-4	BOOMI Flow Addtnl Flows 1000	\$1,000.00
Software Subscription	BM-F-LC-EG-1	BOOMI Flow Enterprise Gold .01	\$0.01
Software Subscription	BM-F-LC-EG-2	BOOMI Flow Enterprise Gold 1	\$1.00
Software Subscription	BM-F-LC-EG-3	BOOMI Flow Enterprise Gold 100	\$100.00
Software Subscription	BM-F-LC-EG-4	BOOMI Flow Enterprise Gold 1000	\$1,000.00
Software Subscription	BM-F-LC-HS-1	BOOMI Flow Hosting Services .01	\$0.01
Software Subscription	BM-F-LC-HS-2	BOOMI Flow Hosting Services 1	\$1.00
Software Subscription	BM-F-LC-HS-3	BOOMI Flow Hosting Services 100	\$100.00
Software Subscription	BM-F-LC-HS-4	BOOMI Flow Hosting Services 1000	\$1,000.00
Software Subscription	BM-MDM-CST-1	BOOMI MDM Ed (Custom Tier) .01	\$0.01
Software Subscription	BM-MDM-CST-2	BOOMI MDM Ed (Custom Tier) 1	\$1.00
Software Subscription	BM-MDM-CST-3	BOOMI MDM Ed (Custom Tier) 100	\$100.00
Software Subscription	BM-MDM-CST-4	BOOMI MDM Ed (Custom Tier) 1000	\$1,000.00
Software Subscription	BM-I-LC-RPI-1	BOOMI Renewal Price Increase .01	\$0.01
Software Subscription	BM-I-LC-RPI-2	BOOMI Renewal Price Increase 1	\$1.00
Software Subscription	BM-I-LC-RPI-3	BOOMI Renewal Price Increase 100	\$100.00
Software Subscription	BM-I-LC-RPI-4	BOOMI Renewal Price Increase 1000	\$1,000.00
Software Subscription	BM-I-LC-ASOAP	BOOMI Advanced Soap Processing	\$0.00
Software Subscription	BM-E-LC-BETA	BOOMI Beta EDI Features	\$0.00
Software Subscription	BM-I-LC-CLOUD	BOOMI Clouds	\$0.00
Software Subscription	BM-I-LC-CL	BOOMI Component Locking	\$0.00
Software Subscription	BM-E-LC-B2BF	BOOMI EDI/B2B Framework	\$0.00
Software Subscription	BM-I-LC-ENV	BOOMI Environments	\$0.00
Software Subscription	BM-I-LC-HL7	BOOMI HL7 Option	\$0.00
Software Subscription	BM-I-LC-PF	BOOMI Partner Account Features	\$0.00
Software Subscription	BM-I-LC-PR	BOOMI Process Route	\$0.00
Software Subscription	BM-I-LC-STO	BOOMI Session Timeout	\$0.00
Software Subscription	BM-I-LC-VC	BOOMI Version Control	\$0.00
Software Subscription	BM-F-LC-OCC	BOOMI Flow Occasional	\$10.00
Software Subscription	BM-E-CT100P1Y	BOOMI TradePartnerConnect > 100	\$22.50
Software Subscription	BM-F-LC-ESSNT	BOOMI Flow Essential	\$25.00
Software Subscription	BM-E-CT1001Y	BOOMI TradePartnerConnect (81-100)	\$30.00
Software Subscription	BM-I-LC-SMBTC	BOOMI SMB Test Connection	\$32.50
Software Subscription	BM-E-CT801Y	BOOMI TradePartnerConnect (61-80)	\$37.50
Software Subscription	BM-E-CTPTEST	BOOMI TradePartnerConnect Test	\$38.00
Software Subscription	BM-E-CTTCT-NS	BOOMI TradePartnerConnectTest NonSub	\$38.00

Vendor:	Boomi	Vendor ID#	
Product:	Boomi		
Date:	8/31/2018		
Part Type (Hardware, Software, Services)	Model Number 16 Character Max	Description 40 Character Max (Must Start with SEL)	Vendor List Price
Software Subscription	BM-F-LC-CONT	BOOMI Flow Continual	\$45.00
Software Subscription	BM-E-CT601Y	BOOMI TradePartnerConnect (41-60)	\$45.00
Software Subscription	BM-E-CT401Y	BOOMI TradePartnerConnect (21-40)	\$52.50
Software Subscription	BM-E-CT201Y	BOOMI TradePartnerConnect (11-20)	\$60.00
Software Subscription	BM-I-LC-SBC1Y	BOOMI Small Business Connection	\$65.00
Software Subscription	BM-E-CT101Y	BOOMI TradePartnerConnect (5-10)	\$67.50
Software Subscription	BM-E-C101-200	BOOMI TradePartnerConnect (101-200)	\$71.25
Software Subscription	BM-E-CT201P	BOOMI TradePartnerConnect (201 plus)	\$71.25
Software Subscription	BM-E-C41-100	BOOMI TradePartnerConnect (41-100)	\$71.25
Software Subscription	BM-E-CT6-40	BOOMI TradePartnerConnect (6-40)	\$71.25
Software Subscription	BM-E-CTP41Y	BOOMI TradePartnerConnect (1-4)	\$75.00
Software Subscription	BM-E-CTPCT-NS	BOOMI TradePartnerConnectProd NonSub	\$75.00
Software Subscription	BM-E-CTP	BOOMI Trading Partner Connection	\$75.00
Software Subscription	BM-I-LCS-SPC	BOOMI Support Case Per Case	\$95.00
Software Subscription	BM-I-LC-EDV	BOOMI Excess Data Volume-1Gb	\$100.00
Software Subscription	BM-I-LC-AW-T	BOOMI Atom Worker - Test	\$125.00
Software Subscription	BM-I-LC-ACA-T	BOOMI Atom Cloud Attachment - Test	\$150.00
Software Subscription	BM-I-LC-STCNS	BOOMI Standard Test Connect NonSub	\$150.00
Software Subscription	BM-I-LC-STC	BOOMI Standard Test Connection	\$150.00
Software Subscription	BM-I-LC-GCRM	BOOMI GearsCRM CSV to SFDC Bundle	\$225.00
Software Subscription	BM-I-LC-AW	BOOMI Atom Worker	\$250.00
Software Subscription	BM-I-LC-NS33	BOOMI NetSuite OpenAir SFDC 3300	\$275.00
Software Subscription	BM-I-LC-ACA-A	BOOMI ANZ Atom Cloud Attachment	\$300.00
Software Subscription	BM-MDM-LC-CAA	BOOMI ANZ MDM Cloud Attachment	\$300.00
Software Subscription	BM-I-LC-ACA	BOOMI Atom Cloud Attachment	\$300.00
Software Subscription	BM-I-LC-ACA-E	BOOMI EMEA Atom Cloud Attachment	\$300.00
Software Subscription	BM-I-LC-MCA-E	BOOMI EMEA MDM Cloud Attachment	\$300.00
Software Subscription	BM-MDM-LC-CA	BOOMI MDM Cloud Attachment	\$300.00
Software Subscription	BM-I-LC-SC1Y	BOOMI Standard Connection	\$300.00
Software Subscription	BM-I-LC-SPCNS	BOOMI Standard Prod Connect NonSub	\$300.00
Software Subscription	BM-MDM-LC-TR1	BOOMI MDM Ed (Tier 1 <10K GRecords)	\$355.00
Software Subscription	BM-I-LC-NS50	BOOMI NetSuite Salesforce Q2C 5000	\$416.67
Software Subscription	BM-I-LC-ETCNS	BOOMI Enterprise Test Connect NonSub	\$450.00
Software Subscription	BM-I-LC-ETC	BOOMI Enterprise Test Connection	\$450.00
Software Subscription	BM-I-LC-RAVIB	BOOMI Base Ed - NetSuite RAVI Bundle	\$467.00
Software Subscription	BM-E-LC-RAVI	BOOMI EDI Ed - NetSuite RAVI Bundle	\$467.00
Software Subscription	BM-I-LC-NSSIA	BOOMI NetSuite-SF Integration Accel	\$500.00
Software Subscription	BM-I-LC-BESMB	BOOMI Base Ed - SmallBiz Connection	\$550.00
Software Subscription	BM-I-LC-BESC	BOOMI Base Ed - Standard Connection	\$550.00
Software Subscription	BM-E-LC-FY18	BOOMI EDI Edition	\$550.00
Software Subscription	BM-E-LC-TRD1Y	BOOMI Trading Partner Edition	\$550.00
Software Subscription	BM-I-LC-NS72	BOOMI NetSuite OpenAir SFDC 7200	\$600.00
Software Subscription	BM-I-LC-AUC	BOOMI Advanced User Controls	\$650.00
Software Subscription	BM-I-LC-ADVW	BOOMI Advanced Workflow	\$650.00
Software Subscription	BM-API-LC-ADV	BOOMI API Publish Features	\$650.00
Software Subscription	BM-I-LC-ETM	BOOMI Enhanced Test Mode	\$650.00
Software Subscription	BM-I-LC-MQ	BOOMI Message Queuing	\$650.00
Software Subscription	BM-I-LC-PP	BOOMI Parallel Processing	\$650.00
Software Subscription	BM-I-LC-SWA	BOOMI Salesforce Wave Analytics Ed	\$833.33
Software Subscription	BM-I-LC-EC1Y	BOOMI Enterprise Connection	\$900.00
Software Subscription	BM-I-LC-EPCNS	BOOMI Enterprise Prod Connect NonSub	\$900.00
Software Subscription	BM-I-LC-RAVI2	BOOMI ProEd - 2 Connection NS RAVI	\$960.00
Software Subscription	BM-F-LC-ESTRT	BOOMI Flow Enterprise Starter	\$1,000.00
Software Subscription	BM-I-LC-PESB2	BOOMI ProEd-Spcl Bundle 2 connection	\$1,200.00
Software Subscription	BM-I-LC-MOL1Y	BOOMI Molecule	\$1,300.00
Software Subscription	BM-I-LC-SE	BOOMI Services Enablement	\$1,300.00
Software Subscription	BM-I-LC-RAVI3	BOOMI ProEd - 3 Connection NS RAVI	\$1,320.00
Software Subscription	BM-I-LC-RAVI4	BOOMI ProEd - 4 Connection NS RAVI	\$1,480.00
Software Subscription	BM-API-LC-T1	BOOMI API Mgmt Tier 1 Up to 100K T/D	\$1,500.00
Software Subscription	BM-I-LC-IAW	BOOMI Integration Accel Workday/AD	\$1,500.00
Software Subscription	BM-I-LC-RAVI5	BOOMI ProEd - 5 Connection NS RAVI	\$1,600.00
Software Subscription	BM-I-LC-PESB3	BOOMI ProEd-Spcl Bundle 3 connection	\$1,650.00
Software Subscription	BM-MDM-LC-TR2	BOOMI MDM Ed (Tier 2 <50K GRecords)	\$1,750.00
Software Subscription	BM-I-LC-PESB4	BOOMI ProEd-Spcl Bundle 4 connection	\$1,850.00
Software Subscription	BM-I-LC-PE1Y	BOOMI Professional Edition	\$2,000.00
Software Subscription	BM-F-LC-EBRNZ	BOOMI Flow Enterprise Bronze	\$2,250.00
Software Subscription	BM-API-LC-T2	BOOMI API Mgmt Tier 2 Up to 1M T/D	\$3,000.00
Software Subscription	BM-MDM-LC-TR3	BOOMI MDM Ed (Tier 3 <100K GRecords)	\$3,000.00
Software Subscription	BM-I-LC-PPE	BOOMI Pro Plus Edition	\$4,000.00
Software Subscription	BM-F-LC-ESLVR	BOOMI Flow Enterprise Silver	\$4,500.00
Software Subscription	BM-MDM-LC-B	BOOMI MDM Ed (Base Tier)	\$6,000.00
Software Subscription	BM-API-LC-T3	BOOMI API Mgmt Tier 3 Up to 10M T/D	\$8,000.00
Software Subscription	BM-I-LC-EE1Y	BOOMI Enterprise Edition	\$8,000.00
Software Subscription	BM-I-LC-EPE	BOOMI Enterprise Plus Edition	\$12,000.00
Software Subscription	BM-MDM-LC-PRO	BOOMI MDM Ed (Professional Tier)	\$12,000.00
Software Subscription	BM-API-LC-T4	BOOMI API Mgmt Tier 4 >10M T/D	\$15,000.00
Software Subscription	BM-MDM-LC-ENT	BOOMI MDM Ed (Enterprise Tier)	\$18,000.00
Support	BM-I-LC-PS-1	BOOMI Premier Support .01	\$0.01
Support	BM-I-LC-PS-2	BOOMI Premier Support 1	\$1.00

Vendor:	Boomi	Vendor ID#	
Product:	Boomi		
Date:	8/31/2018		
<u>Part Type (Hardware, Software, Services)</u>	<u>Model Number</u> <u>16 Character Max</u>	<u>Description</u> <u>40 Character Max</u> <u>(Must Start with SEL)</u>	<u>Vendor List Price</u>
Support	BM-I-LC-PS-3	BOOMI Premier Support 100	\$100.00
Support	BM-I-LC-PS-4	BOOMI Premier Support 1000	\$1,000.00
Support	BM-I-LC-PS-0	BOOMI Premier Support .00	\$0.00
Support	BM-I-LC-PPL-1	BOOMI Premier Plus .01	\$0.01
Support	BM-I-LC-PPL-2	BOOMI Premier Plus 1	\$1.00
Support	BM-I-LC-PPL-3	BOOMI Premier Plus 100	\$100.00
Support	BM-I-LC-PPL-4	BOOMI Premier Plus 1000	\$1,000.00
Support	BM-I-LC-PPA-1	BOOMI Premier Plus Adjustment .01	\$0.01
Support	BM-I-LC-PPA-2	BOOMI Premier Plus Adjustment 1	\$1.00
Support	BM-I-LC-PPA-3	BOOMI Premier Plus Adjustment 100	\$100.00
Support	BM-I-LC-PPA-4	BOOMI Premier Plus Adjustment 1000	\$1,000.00
Support	BM-I-LCS-SS	BOOMI Standard Support	\$0.00

Model	Description	Discount Class	List Price
40UC-SECURE1	CLRN 40UC ANTI-TIP KIT	A	\$2,500
8031-731AS	SYM 8031 68.8 GB AS4 SRDF	A	\$0
ACCONKIT-D	AC CONNECTOR KIT DOM 3BAY	A	\$0
ACKIT8230-D	AC LINE KIT DOM 8230	A	\$0
AC-LINE-EXT	AC LINE KIT EXT DOM 1BAY	A	\$0
ACLINKIT-D	AC LINE KIT DOM HALF BAY	A	\$0
ACLINKIT-I	AC LINE KIT INT HALF BAY	A	\$0
CNS-1200PS	1200W PS FOR CNS-14	A	\$0
DF41040016B	400GB 10K 5523.71GB 14+2	A	\$0
DF41040016C	400GB 10K 5595.5GB14+2 IBM-i(AS400)	A	\$0
DF4104001B	400GB10K 394.55GBONEDRV	A	\$0
DF4104001C	400GB10K 399.68GBONEDRV IBM-i(AS400)	A	\$0
DF4104002B	400GB 10K 394.55GBMIRR	A	\$0
DF4104002C	400GB 10K 399.68GBMIRR for IBM-i (AS400)	A	\$0
DF4104004B	400GB 10K 1183.65GB3+1	A	\$0
DF4104004C	400GB 10K 1199.05GB3+1 for IBM-i (AS400)	A	\$0
DF4104008B	400GB 10K 2761.86GB7+1	A	\$0
DF4104008C	400GB 10K 2797.77GB7+1 for IBM-i (AS400)	A	\$0
DF410400D8B	400GB 10K 2367.31GB 6+2	A	\$0
DF410400D8C	400GB 10K 2398.09GB6+2 IBM-i(AS400)	A	\$0
DL6100-SYS3D	DL6100 SYSTEM BAY WITH 3 PHASE DELTA PWR	A	\$104,830
DL6100-SYS3Y	DL6100 SYSTEM BAY WITH 3 PHASE WYE PWER	A	\$104,830
DL62G725001B	500GB 7.2K 493.19GB ONE DRV	A	\$2,710
DL62G725001BU	500GB7.2K493.19GB ONE DRV UPGRADE	A	\$3,795
DL62G725002B	500GB 7.2K 493.19GB MIRR	A	\$5,420
DL62G725002BU	500GB 7.2K 493.19GB MIRR UPGRADE	A	\$7,590
DL62G725008B	500GB 7.2K 3452.33GB 7+1	A	\$21,680
DL62G725008BU	500GB 7.2K 3452.33GB 7+1 UPGRADE	A	\$30,360
DL6300-SYS3D	DL6300 SYSTEM BAY WITH 3 PHASE DELTA PWR	A	\$104,830
DL6300-SYS3Y	DL6300 SYSTEM BAY WITH 3 PHASE WYE PWER	A	\$104,830
DL6ACON3P-50U	AC CONNECTOR 3PHASE UPGRADE	A	\$600
DL6DBDC-3DU	DL6000 Drive Bay DACHN 3D Upgrade	A	\$27,640
DL6DBDC-3YU	DL6000 Drive Bay DACHN 3Y Upgrade	A	\$27,640
DL6SB15-DCH-U	STORBAY 15 SLOT DR ENCL DCHN UPGRADE	A	\$5,200
DL6SB15-DCHUF	STORBAY 15 SLT DR ENCL DCH UPGRD FIELD	A	\$5,200
DL6SB-BBU-U	SB BATTERY BACKUP UPGRADE	A	\$3,400
DL6SB-BBU-UF	SB BATTERY BACKUP UPGRADE- FIELD	A	\$3,400
DL6SRVB-3D	DL6000 ServBay w 3D Pwr	A	\$27,640
DL6SRVB-3Y	DL6000 ServBay w 3Y Pwr	A	\$27,640
DMX-00004	DMX FICON DIR 4 PT MM	A	\$0
DMX-00004U	DMX FICON DIR 4PT MM UPG	A	\$52,300
DMX-0004	DMX FICON DIR 4 PT SM	A	\$0
DMX-0004U	DMX FICON DIR 4 PT SM-U	A	\$52,300
DMX-0013	DMX MPD 1MGE 3SF	A	\$0
DMX-0013U	DMX MPD 3SF 1MGE-U	A	\$61,075
DMX-0020	DMX GIGE DIR 2MGE	A	\$0
DMX-0020U	DMX GIGE DIR 2MGE-U	A	\$58,425

DMX-0022	DMX MPD 2MGE 2SF	A	\$0
DMX-0022U	DMX MPD 2SF 2MGE-U	A	\$69,730
DMX-0040	DMX GIGE DIR 4 PT MM	A	\$0
DMX-0040U	DMX GIGE DIR 4 PT MM-U	A	\$77,830
DMX1000	DMX HIGH PERF SBAY	A	\$0
DMX1000-P	DMX ULTRA PERF SBAY	A	\$0
DMX-1P-PWR	SINGLE PHASE PWR CONV	A	\$33,100
DMX2000	DMX HIGH PERF DBAY	A	\$0
DMX2-00004	DMX2 FICON DIR 4PT MM	A	\$0
DMX2-00004U	DMX2 FICON DIR 4PT MM UPG	A	\$52,300
DMX2000-3	DMX HIGH PERF DBAY 3PHASE	A	\$0
DMX2-0004	DMX-2 FICON DIR 4SF	A	\$0
DMX2-0004U	DMX-2 FICON DIR 4SF UPG	A	\$52,300
DMX2000-P	DMX ULTRA PERF DBAY	A	\$0
DMX2000-P3	DMX ULTRA PERF DBAY 3PHASE	A	\$0
DMX2-0013	DMX-2 MPCD DIR 1MGE 3SF	A	\$0
DMX2-0013U	DMX-2 MPCD 1MGE 3SF UPG	A	\$61,075
DMX2-0020	DMX-2 GIGE DIR 2MGE	A	\$0
DMX2-0020U	DMX-2 GIGE DIR 2MGE UPG	A	\$58,410
DMX2-0022	DMX2-MPCD DIR 2MGE 2SF	A	\$0
DMX2-0022U	DMX-2 MPCD 2MGE 2SF UPG	A	\$69,730
DMX2-0040	DMX2-GIGE DIR 4MGE	A	\$0
DMX2-0040U	DMX-2 GIGE DIR 4MGE UPG	A	\$77,870
DMX21030016B	300GB 10K 4139.89GB 14+2	A	\$0
DMX21030016C	300GB 10K 4088.37 14+2 A4	A	\$0
DMX210300D8B	300GB 10K 1774.24GB 6+2	A	\$0
DMX210300D8C	300GB 10K 1752.16 6+2 A4	A	\$0
DMX21514616B	146GB 15K 2027.41GB 14+2	A	\$0
DMX21514616C	146GB 15K 2039.28GB 14+2 A4	A	\$0
DMX215146D8B	146GB 15K 868.89GB 6+2	A	\$0
DMX215146D8C	146GB 15K 873.97GB 6+2 A4	A	\$0
DMX21530016B	300GB 15K 4139.89GB 14+2	A	\$0
DMX21530016C	300GB 15K 4088.37 14+2 A4	A	\$0
DMX215300D8B	300GB 15K 1774.24GB 6+2	A	\$0
DMX215300D8C	300GB 15K 1752.16 6+2 A4	A	\$0
DMX2157316B	73GB 15K 1013.69GB 14+2	A	\$0
DMX2157316C	73GB 15K 1019.59GB 14+2 IBM-i(AS400)	A	\$0
DMX21573D8B	73GB 15K 434.44GB 6+2	A	\$0
DMX21573D8C	73GB 15K 436.96GB 6+2 for IBM-i (AS400)	A	\$0
DMX2-2BE-CN	DMX-DMX-2 2 BE DIR CONV	A	\$82,350
DMX2-4BE-CN	DMX-DMX-2 4BE DIR CONV	A	\$164,700
DMX27250016B	500GB 7.2K 6901.76GB 14+2	A	\$0
DMX272500D8B	500GB 7.2K 2957.89GB 6+2	A	\$0
DMX2-8BE-CN	DMX-DMX-2 8BE DIR CONV	A	\$329,310
DMX2-8-F	DMX8 M2 2 PT FIC DIR	A	\$0
DMX2-8-FC	DMX8 M2 8PT FC DIR	A	\$0
DMX2-8-FC-CN	DMX800-DMX2 FC CON	A	\$0
DMX2-8-F-CN	DMX8-DMX2 FIC DIR CONV	A	\$0
DMX2-8-FC-UPG	DMX8 M2 8 PT FC DIR UPG	A	\$46,300
DMX2-8-F-UPG	DMX8 M2 2PT FIC DIR UPG	A	\$32,950

DMX2-8-G	DMX8 M2 2PT GIGE DIR	A	\$0
DMX2-8-G-CN	DMX800-DMX2 GE CON	A	\$0
DMX2-8-GF	DMX8 M2 2PT GE FIC DIR	A	\$0
DMX2-8-GF-CN	DMX800-DMX2 FIC-GE CON	A	\$0
DMX2-8-GF-UPG	DMX8 M2 2PT GE FIC DIR UP	A	\$49,825
DMX2-8-G-UPG	DMX8 M2 2PT GIGE DIR UPG	A	\$52,125
DMX2-FC0M8S	DMX-2 FC DIR 0MM 8SM	A	\$0
DMX2-FC4M4S	DMX-2 FC DIR 4MM 4SM	A	\$0
DMX2-FC6M2S	DMX-2 FC DIR 6MM 2SM	A	\$0
DMX2-FC6M2SU	DMX-2 FC DIR 6MM 2SM UPG	A	\$72,015
DMX2-FC7M1S	DMX-2 FC DIR 7MM 1SM	A	\$0
DMX2-FC7M1SU	DMX-2 FC DIR 7MM 1SM UPG	A	\$71,670
DMX2-FC8M0S	DMX-2 FC DIR 8MM	A	\$0
DMX2-FC8M0SU	DMX-2 FC DIR 8MM UPG	A	\$71,265
DMX2-FCD-CN	DMX-2 FC DIR CONV	A	\$41,175
DMX2G103001B	300GB 10K 296.91GB ONEDRV	A	\$0
DMX2G103001C	300GB10K 292.46GBONEDRVA4	A	\$0
DMX2G103002B	300GB 10K 296.91GB MIRR	A	\$0
DMX2G103002C	300GB 10K 292.46GBMIRRA4	A	\$0
DMX2G103004B	300GB 10K 890.73GB 3+1	A	\$0
DMX2G103004C	300GB 10K 877.38GB3+1A4	A	\$0
DMX2G103008B	300GB 10K 2078.37GB 7+1	A	\$0
DMX2G103008C	300GB 10K 2047.22GB7+1A4	A	\$0
DMX2G151461B	146GB 15K 144.81GB ONEDRV	A	\$0
DMX2G151461C	146GB 15K145.66GBONEDRVA4	A	\$0
DMX2G151462B	146GB 15K 144.81GB MIRR	A	\$0
DMX2G151462C	146GB 15K 145.66GBMIRRA4	A	\$0
DMX2G151464B	146GB 15K 434.43GB 3+1	A	\$0
DMX2G151464C	146GB 15K 436.98GB3+1A4	A	\$0
DMX2G151468B	146GB 15K 1013.67GB 7+1	A	\$0
DMX2G151468C	146GB 15K 1019.62GB7+1A4	A	\$0
DMX2G153001B	300GB 15K 296.91GB ONE DRV	A	\$0
DMX2G153001C	300GB 15K 292.46GB ONE DRV A4	A	\$0
DMX2G153002B	300GB 15K 296.91GB MIRR	A	\$0
DMX2G153002C	300GB 15K 292.46GB MIRR A4	A	\$0
DMX2G153004B	300GB 15K 890.73 GB 3+1	A	\$0
DMX2G153004C	300GB 15K 877.38GB 3+1 A4	A	\$0
DMX2G153008B	300GB 15K 2078.37GB 7+1	A	\$0
DMX2G153008C	300GB 15K 2047.22GB 7+1 A4	A	\$0
DMX2G15-731B	73GB 15K 72.40GB ONE DRV	A	\$0
DMX2G15-731C	73GB15K 72.8GBONEDRV IBM-i(AS400)	A	\$0
DMX2G15-732B	73GB 15K 72.40GB MIRR	A	\$0
DMX2G15-732C	73GB 15K 72.82GB MIRR for IBM-i (AS400)	A	\$0
DMX2G15-734B	73GB 15K 217.20GB 3+1	A	\$0
DMX2G15-734C	73GB 15K 218.46GB 3+1 for IBM-i (AS400)	A	\$0
DMX2G15-738B	73GB 15K 506.80GB 7+1	A	\$0
DMX2G15-738C	73GB 15K 509.74GB 7+1 for IBM-i (AS400)	A	\$0
DMX2G72-4001	400GB 7.2K394.34GB ONE DR	A	\$0
DMX2G724001B	400GB7.2K 394.55GBONEDRV	A	\$0
DMX2G725001B	500GB7.2K 493.19GBONEDRV	A	\$0

DMX2G725002B	500GB 7.2K 493.19GB MIRR	A	\$0
DMX2G725004B	500GB 7.2K 1479.57GB 3+1	A	\$0
DMX2G725008B	500GB 7.2K 3452.33GB 7+1	A	\$0
DMX-2GDAE	2GB DISK ARRAY ENCLOSURE	A	\$0
DMX-2GDAE-5M	5M DAE FC CABLE	A	\$800
DMX-2GDAE-FD	2GB DISK ARRAY ENC FIELD	A	\$12,300
DMX2-MPCD2-CN	DMX-2 2PT GIGE DIR CONV	A	\$33,750
DMX2-MPCD4-CN	DMX-2 4PT MPCD CONV	A	\$36,000
DMX3-00004	DMX3 4 PT FICON DIR 4S	A	\$0
DMX3-00004B	DMX3 4PT 4G FICON DIR 4S	A	\$0
DMX3000-3	DMX HIGH PERF 3PHASE 3BAY	A	\$0
DMX3-00040	DMX3-4PT FICON DIR 4M	A	\$0
DMX3-00040B	DMX3 4PT 4G FICON 4M	A	\$0
DMX3-00103	DMX3 4PT GE FICON 1M3S	A	\$0
DMX3-00103B	DMX3 4PT GEFICN DIR 1M3S	A	\$0
DMX3-00103BS	DMX3 4PT IPv4/6 GE 4M	A	\$0
DMX3-00400	DMX3 4PT GE DIR 4M	A	\$0
DMX3-00400B	DMX3 4PT GE DIR 4M	A	\$80,705
DMX3-00400BU	DMX3 4PT GE DIR 4MU	A	\$104,915
DMX3-00400S	DMX3 4PT IPv4/6 GE 4M	A	\$0
DMX3-08000	8PT FC DIR 0M8S	A	\$80,185
DMX3-08000B	DMX3 8PT 4G FC DIR 0M8S	A	\$80,185
DMX3-08000BU	DMX3 8PT 4G FC DIR 0M8SU	A	\$104,240
DMX3-08000U	8PT FC DIR 0M8S UPG	A	\$104,240
DMX3-120-DCH	DMX3 120 DRVSLT&BBU DCH	A	\$0
DMX3-120-DCHU	DMX3 120 DRVSLT&BBU DCHU	A	\$0
DMX3-120-DIR	DMX3 120 DRVSLT&BBU DCON	A	\$0
DMX3-120-DIRU	DMX3 120 DRVSLT&BBU DCONU	A	\$0
DMX3-1DAPAIR	DMX3 DISK DIR PAIR	A	\$0
DMX3-1DAPAIRU	DMX3 DISK DIR 1 PAIR UPG	A	\$101,535
DMX3-2DAPAIR	DMX3 DISK DIR 2 PAIR	A	\$0
DMX3-2DAPAIRU	DMX3 DISK DIR 2 PAIR UPG	A	\$203,070
DMX3-3DAPAIR	DMX3 DISK DIR 3 PAIR	A	\$0
DMX3-3DAPAIRU	DMX3 DISK DIR 3 PAIR UPG	A	\$304,605
DMX3-40002	DMX3 6PT FC FICON 4M2S	A	\$0
DMX3-40002B	DMX3 6PT 4G FC FICN 4M2S	A	\$0
DMX3-40200	DMX3 6PT FC GE 4M2M	A	\$0
DMX3-40200B	DMX3 6PT FC GE 4M2M	A	\$0
DMX3-40200BS	DMX3 6PT 4GFC IPv4/6 GE 6M	A	\$0
DMX3-4DAPAIR	DMX3 DISK DIR 4 PAIR	A	\$0
DMX3-60100	DMX3 7PT FC GE 6M1M	A	\$0
DMX3-60100B	DMX3 7PT FC GE 6M1M	A	\$0
DMX3-60100BS	DMX3 7PT 4GFC IPv4/6 GE 7M	A	\$0
DMX3-62000	DMX3 8PT FC DIR 6M2S	A	\$78,830
DMX3-62000B	DMX3 8PT 4G FC DIR 6M2S	A	\$0
DMX3-6-2FC1GB	DMX3 6SLOT 4G FCGE3PT DIR	A	\$29,470
DMX362FC1GBS	DMX3 6SLT 4GBFCIPv4/6GE 3PTDIR	A	\$31,825
DMX3-6-2GB	DMX3 6 SLOT GE 2PT DIR	A	\$29,785
DMX3-6-2GBS	DMX3 6 SLOT IPv4/6 GE 2PT DIR	A	\$32,165
DMX3-6-4FCB	DMX3-6 SLOT 4G FC 4PT DIR	A	\$27,640

DMX3-6-4GB	DMX3 6 SLOT GE 4PT DIR	A	\$0
DMX3-6-4GBU	DMX3 6 SLOT GE 4PT DIR UPG	A	\$0
DMX3-6-4GS	DMX3 6 SLOT IPv4/6 GE 4PT DIR	A	\$53,945
DMX3-6DBDC3D	DMX3 6 SLT DRV BAY DC 3D	A	\$0
DMX3-6DBDC3Y	DMX3 6 SLT DRV BAY DC 3Y	A	\$0
DMX3-71000	DMX3 8PT FC DIR 7M1S	A	\$78,495
DMX3-71000B	DMX3 8PT 4G FC DIR 7M1S	A	\$0
DMX3-80000	DMX3 8PT FC DIR 8M0S	A	\$78,105
DMX3-80000B	DMX3 8PT 4G FC DIR 8M0S	A	\$0
DMX3-CBL BRKT	DMX3 TOP CABLE ROUTE BRKT	A	\$100
DMX3-DB2402-D	DMX3 6SLTDBAY 240DR2DA 3D	A	\$27,640
DMX3-DBDC-3D	DMX3 DRV BAY DACHN 3D	A	\$0
DMX3-DBDC-3Y	DMX3 DRV BAY DACHN 3Y	A	\$0
DMX3-DBDCS-3D	DMX3 DRV BAY DACHN SEP 3D	A	\$0
DMX3-DBDCS-3Y	DMX3 DRV BAY DACHN SEP 3Y	A	\$0
DMX3-DBDR-3D	DMX3 DRV BAY DCON 3D	A	\$0
DMX3-DBDR-3Y	DMX3 DRV BAY DCON 3Y	A	\$0
DMX3-DCHCBL5M	DMX3 24 SLOT DCCHN 5M CBL	A	\$120
DMX3-DIRCBL6M	DMX3 24 SLOT DCON 6M CBL	A	\$160
DMX3-DOCKT	DMX3 PRINTED DOC KIT	A	\$0
DMX3-FB00200B	2X DMX3 2 PT GE FEBE 2M	A	\$17,450
DMX3-FB00400B	2X DMX3 4PT GE FEBE 4M	A	\$17,450
DMX3FB00400BU	2X DMX3 4PT GE FEBE 4MU	A	\$22,685
DMX3-FB08000B	2X DMX3 8PT 4G FC FEBE 8S	A	\$24,035
DMX3-FB20100B	2X DMX3 3PT FCGE FEBE 3M	A	\$17,450
DMX3-FB20300B	2XDMX3 5PT FCGE FEBE 5M	A	\$23,200
DMX3-FB20500B	2XDMX3 7PT 2FC5GE FEBE 7M	A	\$23,200
DMX3-FB40000B	2X DMX3 4PT 4G FC FEBE 4M	A	\$17,450
DMX3-FB40200B	2X DMX3 4M FC 2M GE FEBE	A	\$23,200
DMX3-FB60100B	2XDMX3 7PT 6FC1GE FEBE 7M	A	\$23,200
DMX3-FB62000B	2XDMX3 8PT 4G FC FEBE6M2S	A	\$21,945
DMX3-FB71000B	2X DMX3 8P 4G FC FEBE7M1S	A	\$21,215
DMX3-FB80000B	2X DMX3 8PT 4G FC FEBE 8M	A	\$20,480
DMX3-GE-ISCSI	DMX3 ISCSI PT	A	\$0
DMX3-GE-SRDF	DMX3 GERDF PT	A	\$0
DMX3-M9-16GB	DMX3 16GB MEM DIR	A	\$0
DMX3-M9-32GB	DMX3 32GB MEM DIR	A	\$0
DMX3-M9-64GB	DMX3 64GB MEM DIR	A	\$0
DMX3-M964GSUB	DMX3 64GB M9 ONLY SWAP	A	\$0
DMX3-M9-8GB	DMX3 8GB MEM DIR	A	\$0
DMX3-OPT-4M0S	DMX3 FEBE OPTICS UPG 4M0S	A	\$3,620
DMX3-OPT4M0SB	4GBC FEBE OPTICS UPGRADE KIT 4M0S	A	\$3,620
DMX3-OPT-4M4S	DMX3 FEBE OPTICS UPG 4M4S	A	\$10,735
DMX3-OPT4M4SB	4GBC FEBE OPTICS UPGRADE KIT 4M 4S	A	\$10,735
DMX3-OPT-6M0S	DMX3 FEBE OPTICS UPG 6M0S	A	\$13,725
DMX3-OPT6M0SB	4GBC FEBE OPTICS UPGRADE KIT	A	\$13,730
DMX3-OPT-6M2S	DMX3 FEBE OPTICS UPG 6M2S	A	\$8,985
DMX3-OPT6M2SB	4GBC FEBE OPTICS UPGRADE KIT 6M 2S	A	\$8,985
DMX-3PD-PWR	3PHASE DPWR CON	A	\$33,300
DMX-3PW-PWR	3PHASE WPWR CON	A	\$34,100

DMX3-PWRMOD	DMX3 PWR MOD 24 SYS	A	\$0
DMX3-SYS24-3D	DMX3 24 SLOT SYS BAY 3D	A	\$0
DMX3-SYS24-3Y	DMX3 24 SLOT SYS BAY 3Y	A	\$0
DMX4157316B	73GB 15K 1013.69GB 14+2	A	\$0
DMX4157316C	73GB 15K 1019.59GB14+2 IBM-i(AS400)	A	\$0
DMX415731B	73GB 15K 72.40GB ONE DRV	A	\$0
DMX415731C	73GB15K 72.8GBONEDRV IBM-i(AS400)	A	\$0
DMX415732B	73GB 15K 72.40GB MIRR	A	\$0
DMX415732C	73GB 15K 72.8GB MIR IBM-i(AS400)	A	\$0
DMX415734B	73GB 15K 217.20GB 3+1	A	\$0
DMX415734C	73GB 15K 218.46GB 3+1 IBM-i(AS400)	A	\$0
DMX415738B	73GB 15K 506.80GB 7+1	A	\$0
DMX415738C	73GB 15K 509.74GB 7+1 IBM-i(AS400)	A	\$0
DMX41573D8B	73GB 15K 434.44GB 6+2	A	\$0
DMX41573D8C	73GB 15K 436.96GB 6+2 IBM-i(AS400)	A	\$0
DMX4-6DBDC3DP	DMX4 6 SLT DRV BAY DCHAIN 3D PRD	A	\$26,745
DMX46DBDC3DPU	DMX4 6 SLT DRV BAY DCHAIN 3D U PRD	A	\$0
DMX4-6DBDC3YP	DMX4 6 SLT DRV BAY DCHAIN 3Y PRD	A	\$26,745
DMX46DBDC3YPU	DMX4 6 SLT DRV BAY DCHAIN 3Y U PRD	A	\$0
DMX4-6-DOCKT	DMX4 6 SLOT PRINTED DOC KIT	A	\$0
DMX47250016B	500GB 7.2K 6904. 66GB 14+2	A	\$0
DMX4725001B	500GB 7.2K 493.191GB ONEDRV	A	\$0
DMX4725002B	500GB 7.2K 493.191GB MIRR	A	\$0
DMX4725004B	500GB 7.2K 1479.57GB 3+1	A	\$0
DMX4725008B	500GB 7.2K 3452.33GB 7+1	A	\$0
DMX472500D8B	500GB 7.2K 2959. 14GB 6+2	A	\$0
DMX4-DBDC-3DP	DMX4 DRV BAY DCHAIN 3D REAR PERF'D DOOR	A	\$27,165
DMX4-DBDC3DPU	DMX4 DRVBAY DCHAIN 3D REAR PERF'D DOOR	A	\$27,165
DMX4-DBDC-3YP	DMX4 DRV BAY DCHAIN 3Y REAR PERF'D DOOR	A	\$27,165
DMX4-DBDC3YPU	DMX4 DRVBAY DCHAIN 3Y REAR PERF'D DOOR	A	\$27,165
DMX4-DBDCT3DP	DMX4 DRV BAY DACHN SEP 3D PRD	A	\$49,860
DMX4DBDCT3DPU	DMX4 DRV BAY DACHN SEP 3D U PRD	A	\$49,860
DMX4DBDCT3YP	DMX4 DRVBAY DACHN SEP3Y REAR PERF'D DOOR	A	\$49,860
DMX4-DBDCT3YP	DMX4 DRV BAY DACHN SEP 3Y PRD	A	\$49,860
DMX4DBDCT3YPU	DMX4 DRV BAY DACHN SEP 3Y U PRD	A	\$49,860
DMX4-DBDCTDP	DMX4 DRVBAY DACHN SEP3D REAR PERF'D DOOR	A	\$49,860
DMX4-DBDR-3DP	DMX4 DRV BAY DCON 3D REAR PERF'D DOOR	A	\$27,165
DMX4-DBDR3DPU	DMX4 DRVBAY DCON 3D REAR PERF'D DOOR U	A	\$27,165
DMX4-DBDR-3YP	DMX4 DRV BAY DCON 3Y REAR PERF'D DOOR	A	\$27,165
DMX4-DBDR3YPU	DMX4 DRVBAY DCON 3Y REAR PERF'D DOOR U	A	\$27,165
DMX4-DOCKT	DMX4 PRINTED DOC KIT	A	\$0
DMX4-GE-ISCSI	DMX4 GE ISCSI PT	A	\$0
DMX4-GE-SRDF	DMX4 GE SRDF PT	A	\$0
DMX4-OPT0M4SB	DMX4 4GB FEBE OPTICS UPG 0M4S	A	\$13,490
DMX4-OPT4M0SB	DMX4 4GB FEBE OPTICS UPG 4M0S	A	\$3,775
DMX4-OPT4M2SB	DMX4 4GB FEBE OPTICS UPG 4M2S	A	\$11,665
DMX4-OPT4M4SB	DMX4 4GB FEBE OPTICS UPG 4M4S	A	\$11,205
DMX4-OPT6M0SB	DMX4 4GB FEBE OPTICS UPG 6M0S	A	\$14,335
DMX4-OPT6M2SB	DMX4 4GB FEBE OPTICS UPG 6M2S	A	\$9,385
DMX4-SB-CBL6M	4GB FC SFP TO HSSDC2 6M	A	\$175

DMX800	DMX800 SPE FC 4 FC DIR	A	\$0
DMX800-FD	DMX800 SPE 4 FC DIR FIE	A	\$0
DMX800-M2	DMX800 M2 SPE 2/4 DIR	A	\$0
DMX800-M2-FD	DMX800 M2 SPE 2/4 DIR FIE	A	\$0
DMX801	DMX800 SPE 2 FC DIR	A	\$0
DMX801-FD	DMX800 SPE 2 FC DIR FIE	A	\$0
DMX8-3100	2XFEBE 3MFC1SFC 2-DIR SYS	A	\$0
DMX8-3102	2XFEBE 3MFC1SFC2SF	A	\$0
DMX8-3111	2XFEBE 3MFC 1SFC 1MGE 1SF	A	\$0
DMX8-3120	2XFEBE 3MFC1SMFC2MGE	A	\$0
DMX8-4000	2XFEBE 4MFC 2-FC DIR SYS	A	\$0
DMX8-4002	2XFEBE 4MFC2SF	A	\$0
DMX8-4011	2XFEBE 4MFC 1MGE 1SF	A	\$0
DMX8-4020	2XFEBE 4MFC2MGE	A	\$0
DMX8-DOCKT	DMX800 DOC KIT	A	\$0
DMX8-F	DMX8 FICON DIR	A	\$0
DMX8-FC	DMX8 FC DIR	A	\$0
DMX8-FC-UPG	DMX8 FC DIR-U	A	\$46,300
DMX8-F-UPG	DMX8 FICON DIR-U	A	\$54,865
DMX8-G	DMX8 GIGE DIR	A	\$0
DMX8-GF	DMX800 MPD-GF	A	\$0
DMX8-GF-UPG	DMX800 MPD GF DIR-U	A	\$54,865
DMX8-G-UPG	DMX8 GIGE DIR-U	A	\$59,140
DMX-ACL-3P-EU	10FT EXT PWR CORD 3P EU	A	\$2,545
DMX-ACL-EU	AC LINE CORD 10FT EXT EU	A	\$1,400
DMX-ACL-FL-EU	ACLIN 10FT W/FL LDS EU	A	\$760
DMX-ACLIN	AC LINE CORD 10FT EXTEN	A	\$1,400
DMX-ACLIN3P	10 FT EXT PWR CORD 3P	A	\$2,545
DMX-ACLIN-FL	AC LINE CORD (10FT) W/FLYING LEADS	A	\$760
DMX-ACONSP-60	AC MATING CONNECTOR 60 AMP	A	\$360
DMXDBDCT3DPU	DMX4 DRVBAY DACHN SEP3D REAR PERFD DR	A	\$49,860
DMXDBDCT3YPU	DMX4 DRVBAY DACHN SEP3Y REAR PERFD DR	A	\$49,860
DMX-DELTA	DELTA 3-PHASE POWER	A	\$0
DMX-DOCKT	DMX1000 2000 3000 DOC KIT	A	\$0
DMX-ESCD8	8 PT ESCON DIR	A	\$32,185
DMX-ESCD8U	8 PT ESCON DIR	A	\$52,300
DMX-FCD0M4S	4 PT FC DIR 0MM 4SM	A	\$0
DMX-FCD0M8S	8 PT FC DIR 0MM 8SM	A	\$0
DMX-FCD4M4S	8 PT FC DIR 4MM 4SM	A	\$0
DMX-FCD6M2S	8 PT FC DIR 6MM, 2SM	A	\$0
DMX-FCD6M2SU	8 PT FC DIR 6MM 2SM	A	\$72,015
DMX-FCD7M1S	8 PT FC DIR 7MM, 1SM	A	\$0
DMX-FCD7M1SU	8 PT FC DIR 7MM 1SM	A	\$71,655
DMX-FCD8M0S	8 PT FC DIR 8MM, 0SM	A	\$0
DMX-FCD8M0SU	8 PT FC DIR 8MM 0SM	A	\$71,270
DMX-FE-3M1S	2XFEBE 3MM,1SM EACH BOARD	A	\$0
DMX-FE-4M0S	2XFEBE 4MM,0SM EACH BOARD	A	\$0
DMX-FE-6M2S	2XFEBE 6MM,2SM EACH BOARD	A	\$0
DMX-FE-7M1S	2XFEBE 7MM,1SM EACH BOARD	A	\$0
DMX-FE-8M0S	2XFEBE 8MM,0SM EACH BOARD	A	\$0

DMX-GE-ISCSI	DMX GIGE ISCSI PORTS	A	\$0
DMX-GE-SRDF	DMX GIGE SRDF PORTS	A	\$0
DMX-KVM	KEYBOARD, VIDEO, MOUSE	A	\$0
DMX-KVM-FD	KEYBD, VIDEO, MOUSE-FIELD	A	\$6,760
DMX-M5-16384	16GB M5 CACHE DIRECTOR	A	\$0
DMX-M5-16384U	16GB M5 CACHE DIR UPG	A	\$58,240
DMX-M5-2048	2GB M5 CACHE DIRECTOR	A	\$0
DMX-M5-2048U	2GB M5 CACHE DIR UPG	A	\$38,625
DMX-M5-32768	32GB M5 CACHE DIR	A	\$0
DMX-M5-32768U	32GB M5 CACHE DIR UPG	A	\$123,710
DMX-M5-4096	4GB M5 CACHE DIRECTOR	A	\$0
DMX-M5-4096U	4GB M5 CACHE DIR UPG	A	\$40,350
DMX-M5-8192	8GB M5 CACHE DIRECTOR	A	\$0
DMX-M5-8192U	8GB M5 CACHE DIR UPG	A	\$46,410
DMX-OPT-1M1S	2X OPTICS KIT 1M1S	A	\$2,900
DMX-OPT-2M	2X OPTICS KIT 2M	A	\$1,900
DMX-OPT-2S	2X OPTICS KIT 2S	A	\$4,000
DMX-OPT-3M1S	2X OPTICS KIT 3M1S	A	\$4,420
DMX-OPT-4M0S	2X OPTICS KIT 4M0S	A	\$4,130
DMX-PWRMOD8	8 POWER MODULE	A	\$9,600
DMX-PWRMOD8U	8" POWER MODULE UPGRADE	A	\$12,500
DMX-RS232	RS232 SWITCH	A	\$0
DMX-RS23210FT	10 FT RS232 CABLE	A	\$30
DMX-RS232-FD	RS232 SWITCH FIELD INST	A	\$2,800
DMX-SECURE1	DMX1000 SEISMIC RESTRAINT	A	\$4,200
DMX-SECURE2	DMX2000 SEISMIC RESTRAINT	A	\$12,600
DMX-SECURE3	DMX3000 SEISMIC RESTRAINT	A	\$17,000
DMX-SERVER	DMX SERVER	A	\$0
DMX-SERVER-FD	DMX SERVER SERVER FIELD INST	A	\$9,620
DMX-SILENCER1	DMX1000 SOUND MUFFLER	A	\$1,700
DMX-SILENCER2	DMX2000 SOUND MUFFLER	A	\$2,400
DMX-SILENCER3	DMX3000 SOUND MUFFLER	A	\$3,800
DMX-SPS	2X850W STANDBY POWER SUP	A	\$0
DMX-SPS-FD	2X850W STANDBY PWR-FIELD	A	\$2,600
DMX-WYE	WYE 3-PHASE POWER	A	\$0
DP3-SCB1	12PORTB SYM FC SWITCH DIR	A	\$0
DP3-SCQ1	12PORTQ SYM FC SWITCH DIR	A	\$0
ENHCHN8430	RPL 10R2 CACHE BD W/CHNDR	A	\$0
FC100M-50M	FIBRE CHNL 100 MTR 50/125	A	\$950
FC100M-50MLC	FCHNL 100M 50/125 LC-LC	A	\$1,320
FC100M-50MSLC	FCHNL 100M 50/125 SC-LC	A	\$1,280
FC100M-62M	SC/SC 62.5 FC CABLE 100M	A	\$1,150
FC100M-62MLC	LC/LC 62.5 FC CABLE 100M	A	\$1,300
FC100M-62MSLC	SC/LC 62.5 FC CABLE 100M	A	\$1,630
FC100M-9M	FCHNL 100M 9/125 SC-SC	A	\$1,090
FC100M-9MLC	FCHNL 100M 9/125 LC-LC	A	\$1,090
FC100M-9MSLC	FCHNL 100M 9/125 SC-LC	A	\$1,090
FC10M-50M	FIBRE CHNL 10 MTR 50/125	A	\$300
FC10M-50MLC	FCHNL 10M 50/125 LC-LC	A	\$420
FC10M-50MSLC	FCHNL 10M 50/125 SC-LC	A	\$400

FC10M-62M	SC/SC 62.5 FC CABLE 10M	A	\$320
FC10M-62MLC	LC/LC 62.5 FC CABLE 10M	A	\$364
FC10M-62MSLC	SC/LC 62.5 FC CABLE 10M	A	\$475
FC10M-9M	FCHNL 10M 9/125 SC-SC	A	\$450
FC10M-9MLC	FCHNL 10M 9/125 LC-LC	A	\$450
FC10M-9MSLC	FCHNL 10M 9/125 SC-LC	A	\$450
FC1M-50MLC	FCHNL 1M 50/125 LC-LC	A	\$330
FC1M-50MSLC	FCHNL 1M 50/125 SC-LC	A	\$340
FC1M-62M	SC/SC 62.5 FC CABLE - 1M	A	\$210
FC1M-62MLC	LC/LC 62.5 FC CABLE 1M	A	\$282
FC1M-9MSLC	FCHNL 1M 9/125 SC-LC	A	\$420
FC30M-50M	FIBRE CHNL 30 MTR 50/125	A	\$430
FC30M-50MLC	FCHNL 30M 50/125 LC-LC	A	\$610
FC30M-50MSLC	FCHNL 30M 50/125 SC-LC	A	\$580
FC30M-62M	SC/SC 62.5 FC CABLE 30M	A	\$520
FC30M-62MLC	LC/LC 62.5 FC CABLE 30M	A	\$545
FC30M-62MSLC	SC/LC 62.5 FC CABLE 30M	A	\$710
FC30M-9M	FCHNL 30M 9/125 SC-SC	A	\$590
FC30M-9MLC	FCHNL 30M 9/125 LC-LC	A	\$580
FC30M-9MSLC	FCHNL 30M 9/125 SC-LC	A	\$590
FC3M-50MLC	FCHNL 3M 50/125 LC-LC	A	\$330
FC3M-50MSLC	FCHNL 3M 50/125 SC-LC	A	\$350
FC3M-62M	SC/SC 62.5 FC CABLE 3M	A	\$275
FC3M-62MLC	LC/LC 62.5 FC CABLE 3M	A	\$300
FC3M-62MSLC	SC/LC 62.5 3M W/SC CPLR	A	\$455
FC3M-9MSLC	FCHNL 3M 9/125 SC-LC	A	\$340
FC3M-LCESCADP	LC/ESCON W/ST CPLR 3M	A	\$400
FC3M-MTESCADP	MTRJ/ESCON W/ST CPLR 3M	A	\$500
FC3M-MTLCADP	MTRJ/LC W/LC CPLR 3M	A	\$600
FC50M-50M	FIBRE CHNL 50 MTR CABLE	A	\$560
FC50M-50MLC	FCHNL 50M 50/125 LC-LC	A	\$830
FC50M-50MSLC	FCHNL 50M 50/125 SC-LC	A	\$790
FC50M-62M	SC/SC 62.5 FC CABLE 50M	A	\$705
FC50M-62MLC	LC/LC 62.5 FC CABLE 50M	A	\$791
FC50M-62MSLC	SC/LC 62.5 FC CABLE 50M	A	\$1,030
FC50M-9M	FCHNL 50M 9/125 SC-SC	A	\$750
FC50M-9MLC	FCHNL 50M 9/125 LC-LC	A	\$750
FC50M-9MSLC	FCHNL 50M 9/125 SC-LC	A	\$750
FC5M-50M	FIBRE CHNL 5 METER 50/125	A	\$260
FC5M-50MLC	FCHNL 5M 50/125 LC-LC	A	\$380
FC5M-50MSLC	FCHNL 5M 50/125 SC-LC	A	\$350
FC5M-62M	SC/SC 62.5 FC CABLE 5M	A	\$275
FC5M-62MLC	LC/LC 62.5 FC CABLE 5M	A	\$318
FC5M-62MSLC	SC/LC 62.5 FC CABLE 5M	A	\$420
FC5M-9M	FCHNL 5M 9/125 SC-SC	A	\$410
FC5M-9MLC	FCHNL 5M 9/125 LC-LC	A	\$410
FC5M-9MSLC	FCHNL 5M 9/125 SC-LC	A	\$420
FIBER-107M	FBR JUMPER CBL FOR ESCON	A	\$1,200
FIBER-122M	FIBER OPTIC CBL 122METERS	A	\$1,300
FIBER-46M	FBR JUMPER CBL FOR ESCON	A	\$700

FIBER-61M	FIBER OPTIC CBL 61 METERS	A	\$900
FIBER-77M	FBR JUMPER CBL FOR ESCON	A	\$1,000
FIBER-92M	FBR JUMPER CBL FOR ESCON	A	\$1,100
FREE5TB	5TB FREE TIERED STORAGE	A	\$0
FREE5TB-SATA	5TB FREE TIERED STORAGE SATA	A	\$0
NA3F12001B	VMAX 4G FLASH 200GB DRV	A	\$0
NA3F12001BTU	VMAX 3G FLASH 200GB DRV UPG TAA	A	\$17,035
NA3F12001BU	VMAX 3G FLASH 200GB DRV UPG	A	\$0
NA3F12001C	VMAX 3G FLASH 200GB DRV FOR IBM-I(AS400)	A	\$0
NA3F12001CU	VMAX 3G FLASH 200GB DRV IBM-I(AS400)UPG	A	\$0
NA47210001B	VMAX 4G 7_2K1000GB DRV	A	\$0
NA47210001BTU	VMAX 4G 7_2K1000GB DRV UPG TAA	A	\$2,645
NA47210001BU	VMAX 4G 7_2K1000GB DRV UPG	A	\$0
NA47220001B	VMAX 4G 72K 2000GB DRV	A	\$0
NA47220001BTU	VMAX 4G 72K 2000GB DRV UPG TAA	A	\$4,185
NA47220001BU	VMAX 4G 72K 2000GB DRV UPG	A	\$0
NA47220001C	VMAX 4G 72K 2000GB DRVSI	A	\$0
NA47220001CTU	VMAX 4G 72K 2000GB DRVSI UPG TAA	A	\$4,185
NA47220001CU	VMAX 4G 72K 2000GB DRVSI UPGRADE	A	\$0
NF4103001B	VMAX 4G 10K300GB DRIVE	A	\$0
NF4103001BTU	VMAX 4G 10K300GB DRV UPG TAA	A	\$2,570
NF4103001BU	VMAX 4G 10K300GB DRV UPG	A	\$0
NF4103001C	VMAX 4G 10K300GB DRVsi	A	\$0
NF4103001CTU	VMAX 4G 10K300GB DRVSi UPG TAA	A	\$2,570
NF4103001CU	VMAX 4G 10K300GB DRVSi UPG	A	\$0
NF4104001B	VMAX 4G 10K400GB DRV	A	\$0
NF4104001BU	VMAX 4G 10K400GB DRV UPG	A	\$0
NF4104001C	VMAX 4G 10K400GB DRVSi	A	\$0
NF4104001CU	VMAX 4G 10K400GB DRVSi UPG	A	\$0
NF4104501B	VMAX 4G 10K450GB DRV	A	\$0
NF4104501BTU	VMAX 4G 10K450GB DRV UPG TAA	A	\$3,355
NF4104501BU	VMAX 4G 10K450GB DRV UPG	A	\$0
NF4104501C	VMAX 4G 10K450GB DRVSi	A	\$0
NF4104501CTU	VMAX 4G 10K450GB DRVSi UPG TAA	A	\$3,355
NF4104501CU	VMAX 4G 10K450GB DRVSi UPG	A	\$0
NF4106001B	VMAX 4G 10K600GB DRV	A	\$0
NF4106001BTU	VMAX 4G 10K600GB DRV UPG TAA	A	\$4,075
NF4106001BU	VMAX 4G 10K600GB DRV UPG	A	\$0
NF4106001C	V-MAX 4G 10K600GB DRVSi	A	\$0
NF4106001CTU	VMAX 4G 10K600GB DRVSi UPG TAA	A	\$4,075
NF4106001CU	VMAX 4G 10K600GB DRVSi UPG	A	\$0
NF4151461B	VMAX 4G 15K146GB DRV	A	\$0
NF4151461BTU	VMAX 4G 15K146GB DRV UPG TAA	A	\$3,435
NF4151461BU	VMAX 4G 15K146GB DRV UPG	A	\$0
NF4151461C	VMAX 4G 15K146GB DRVSi	A	\$0
NF4151461CTU	VMAX 4G 15K146GB DRVSi UPG TAA	A	\$3,435
NF4151461CU	VMAX 4G 15K146GB DRVSi UPG	A	\$0
NF4153001B	VMAX 4G 15K300GB DRV	A	\$0
NF4153001BTU	VMAX 4G 15K300GB DRV UPG TAA	A	\$3,235
NF4153001BU	VMAX 4G 15K300GB DRV UPG	A	\$0

NF4153001C	VMAX 4G 15K300GB DRVSi	A	\$0
NF4153001CTU	VMAX 4G 15K300GB DRVSi UPG TAA	A	\$3,235
NF4153001CU	VMAX 4G 15K300GB DRVSi UPG	A	\$0
NF4154501B	VMAX 4G 15K450GB DRV	A	\$0
NF4154501BTU	VMAX 4G 15K450GB DRV UPG TAA	A	\$4,240
NF4154501BU	VMAX 4G 15K450GB DRV UPG	A	\$0
NF4154501C	VMAX 4G 15K450GB DRVSi	A	\$0
NF4154501CTU	VMAX 4G 15K450GB DRVSi UPG TAA	A	\$4,240
NF4154501CU	VMAX 4G 15K450GB DRVSi UPG	A	\$0
NF4156001B	VMAX 4G 15K600GB DRV	A	\$0
NF4156001BTU	VMAX 4G 15K600GB DRV UPG TAA	A	\$5,235
NF4156001BU	VMAX 4G 15K600GB DRV UPG	A	\$0
NF4156001C	VMAX 4G 15K600GB DRVSi	A	\$0
NF4156001CTU	VMAX 4G 15K600GB DRVSi UPG TAA	A	\$5,235
NF4156001CU	VMAX 4G 15K600GB DRVSi UPG	A	\$0
NF4F11001B	VMAX 4G FLASH 100GB DRV	A	\$6,505
NF4F11001BU	VMAX 4G FLASH 100GB DRV UPG	A	\$0
NF4F11001C	VMAX 4G FLASH 100GB DRVSi	A	\$6,505
NF4F11001CU	VMAX 4G FLASH 100GB DRVSi UPG	A	\$0
NF4F12001B	VMAX 4G FLASH 200GB DRV	A	\$0
NF4F12001BTU	VMAX 200GB FLASH 4GB FC UPG TAA	A	\$17,035
NF4F12001BU	VMAX 200GB FLASH 4GB FC UPG	A	\$0
NF4F12001C	VMAX 4G FLASH 200GB DRVSi	A	\$0
NF4F12001CTU	VMAX 200GB FLASH 4GB FC Si UPG TAA	A	\$17,035
NF4F12001CU	VMAX 200GB FLASH 4GB FC Si UPG	A	\$0
NF4F14001B	VMAX 4G FLASH 400GB DRV	A	\$0
NF4F14001BTU	VMAX 400GB FLASH 4GB FC UPG TAA	A	\$32,320
NF4F14001BU	VMAX 400GB FLASH 4GB FC UPG	A	\$0
NF4F14001C	VMAX 4G FLASH 400GB DRVSi	A	\$0
NF4F14001CU	VMAX 400GB FLASH 4GB FC Si UPG	A	\$0
NF4F22001B	VMAX 4G FLASH 200GB DRV (STG2)	A	\$12,170
NF4F22001BU	VMAX 4G FLASH 200GB DRV UPG(STG2)	A	\$0
NF4F22001C	VMAX 4G FLASH 200GB DRVSi (STG2)	A	\$12,170
NF4F22001CU	VMAX 4G FLASH 200GB DRVSi UPG(STG2)	A	\$0
NF4F24001B	VMAX 4G FLASH 400GBS DRV	A	\$23,085
NF4F24001BU	VMAX 4G FLASH 400GBS DRV UPG	A	\$0
NF4F24001C	VMAX 4G FLASH 400GBS DRVSi	A	\$23,085
NF4F24001CU	VMAX 4G FLASH 400GBS DRVSi UPG	A	\$0
NS4103001B	VMAX 4G 10K 300GB SAS DRV	A	\$0
NS4103001BTU	VMAX 4G 10K 300GB SAS DRV UPG TAA	A	\$1,990
NS4103001BU	VMAX 4G 10K 300GB SAS DRV UPG	A	\$0
NS4103001C	VMAX 4G 10K 300GB SAS DRV FOR IBM-I	A	\$0
NS4103001CTU	VMAX 4G 10K 300GB SAS DRV IBM-I UPG TAA	A	\$1,990
NS4103001CU	VMAX 4G 10K 300GB SAS DRV FOR IBM-I UPG	A	\$0
NS4104501B	VMAX 4G 10K 450GB SAS DRV	A	\$0
NS4104501BTU	VMAX 4G 10K 450GB SAS DRV UPG TAA	A	\$2,835
NS4104501BU	VMAX 4G 10K 450GB SAS DRV UPG	A	\$0
NS4104501C	VMAX 4G 10K 450GB SAS DRV IBM-I	A	\$0
NS4104501CTU	VMAX 4G 10K 450GB SAS DRV IBM-I UPG TAA	A	\$2,835
NS4104501CU	VMAX 4G 10K 450GB SAS DRV IBM-I UPG	A	\$0

NS4106001B	VMAX 4G 10K 600GB SAS DRV	A	\$0
NS4106001BTU	VMAX 4G 10K 600GB SAS DRV UPG TAA	A	\$3,450
NS4106001BU	VMAX 4G 10K 600GB SAS DRV UPG	A	\$0
NS4106001C	VMAX 4G 10K 600GB SAS DRV IBM-I	A	\$0
NS4106001CTU	VMAX 4G 10K 600GB SAS DRV IBM-I UPG TAA	A	\$3,450
NS4106001CU	VMAX 4G 10K 600GB SAS DRV IBM-I UPG	A	\$0
NSXDM00-4A	NSX XBLADE60: 4GB,6CU+2OP	A	\$0
NSXDM00-4A-U	NSX XB60: 4GB,6CU+2OP-UPG	A	\$0
NSXDM01-4C	NSX XBLADE65 4GBMEM 6CU+2OP GIGE 1X10G	A	\$0
NSXDM01-4C-S	NSX XBLADE60 TO XBLADE 65 UPGRADE	A	\$0
NSXDM01-4C-U	XBLADE 4GBMEM 6CU+2OP GIGE 1X10GIGE UP	A	\$0
NSXDME00	NSX EXP CHASSIS: NO BLADE	A	\$0
NSXDME00-U	NSX EXP CHAS: NO BL-UPG	A	\$0
NSXRACKU	NSX BASE CAB: 2CS+UPS	A	\$0
NT47230001B	VMAX 4G 7_2K3000GB DRV	A	\$4,215
NT47230001BTU	VMAX 4G 7_2K3000GB DRV UPG TAA	A	\$5,900
NT47230001BU	VMAX 4G 7_2K3000GB DRV UPG	A	\$5,900
NT47230001C	VMAX 4G 7_2K3000GB DRV FOR IBM-I	A	\$4,215
NT47230001CTU	VMAX 4G 7_2K3000GB DRV FOR IBM-I UPG TAA	A	\$5,900
NT47230001CU	VMAX 4G 7_2K3000GB DRV FOR IBM-I UPG	A	\$5,900
PDP-1PHA-RC	QTY 2 SINGLE PH PDP ANDERSON-ROHS COMP	A	\$4,340
PDP-1PHTA-RC	QTY 2 SINGLE PH PDP TYCO/AMP-ROHS COMPL	A	\$4,340
PDP-3PHDELA-R	QTY 2 3-PH DELTA PDP ANDERSON-ROHS COM	A	\$4,340
PDP-3PHDEL-IN	QTY 2 3-PHASE DELTA PDP (INTL NON-ROHS)	A	\$4,340
PDP-3PHDEL-IR	QTY 2 3-PH DELTA PDP INTL-ROHS COMPLIANT	A	\$4,340
PDP-3PHDELT-R	QTY 2 3-PH DELTA PDP TYCO/AMP-ROHS COMP	A	\$4,340
PDP-3PHWYEA-R	QTY 2 3-PH WYE PDP ANDERSON-ROHS COMPL	A	\$4,340
PDP-3PHWYET-N	QTY 2 3-PH WYE PDP TYCO/AMP-NON ROHS CM	A	\$4,340
PDP-3PHWYET-R	QTY 2 3-PH WYE PDP TYCO/AMP-ROHS COMPLI	A	\$4,340
SB-00004-RET	VMAX 4Gb 4S FIC RETURN	A	\$0
SB-00040-RET	VMAX 4Gb 4M FIC RETURN	A	\$0
SB-00400-RET	VMAX 4M GIGE RETURN	A	\$0
SB-08000-RET	VMAX 4Gb 8S FC RETURN	A	\$0
SB-128A-BASE	VMAX SE BASE-128GB	A	\$0
SB-128A-BASEC	VMAX SE BASE-128GB-C	A	\$0
SB-128AD-BASC	VMAX SE BASE-128GB-C with Encryption	A	\$0
SB-128AD-BASE	VMAX SE BASE-128GB with Encryption	A	\$0
SB-128-BASE	VMAX BASE-128GB	A	\$0
SB-128-BASEC	VMAX BASE -128GB-C	A	\$0
SB-128D-BASE	VMAX BASE-128GB with Encryption	A	\$0
SB-128D-BASEC	VMAX BASE -128GB-C with Encryption	A	\$0
SB-128-RET	VMAX MEMORY RETURN 128GB	A	\$0
SB-15-DCH	STOR BAY 15SLT DR ENCL	A	\$0
SB-15-DCH-UFD	SB DCH 15SLT DR ENC UFD	A	\$5,200
SB-15-DIR	STOR BAY 15SLT DR ENCL	A	\$0
SB-15-DIR-UFD	SB DIR 15SLT DR ENC UFD	A	\$5,200
SB-1P	VMAX 1P INFRAS	A	\$0
SB-1P-A	VMAX SE 1P INFRAS	A	\$0
SB-32-128UFD	VMAX MEMCONV 2X16 to 2X64 GB	A	\$0
SB-32-64UFD	VMAX MEMCONV 2X16 to 2X32 GB	A	\$0

SB-32A-BASE	VMAX BASE SE-32GB	A	\$0
SB-32A-BASEC	VMAX SE BASE-32GB-C	A	\$0
SB-32AD-BASE	VMAX SE BASE-32GB with Encryption	A	\$0
SB-32AD-BASEC	VMAX SE BASE-32GB-C with Encryption	A	\$0
SB-32-BASE	VMAX BASE-32GB	A	\$0
SB-32-BASEC	VMAX BASE-32GB-C	A	\$0
SB-32D-BASE	VMAX BASE-32GB with Encryption	A	\$0
SB-32D-BASEC	VMAX BASE-32GB-C with Encryption	A	\$0
SB-32-RET	VMAX MEMORY RETURN 32GB	A	\$0
SB-3D	VMAX DELTA INFRAST	A	\$0
SB-3D-A	VMAX SE DELTA INFRAST	A	\$0
SB-3Y	VMAX WYE INFRAST	A	\$0
SB-3Y-A	VMAX SE WYE INFRAST	A	\$0
SB4-15DCH-UFD	DMX4 ST BAY 15SLT DR ENCL UFD	A	\$5,100
SB4-15DIR-UFD	DMX4 ST BAY 15SLT DR ENCL UFD	A	\$5,100
SB-44000-RET	VMAX 4Gb 4M4S FC RETURN	A	\$0
SB-62000-RET	VMAX 4Gb 6M2S FC RETURN	A	\$0
SB-64-128UFD	VMAX MEMCONV 2X32 to 2X64 GB	A	\$0
SB-64A-BASE	VMAX SE BASE-64GB	A	\$0
SB-64A-BASEC	VMAX SE BASE-64GB-C	A	\$0
SB-64AD-BASE	VMAX SE BASE-64GB with Encryption	A	\$0
SB-64AD-BASEC	VMAX SE BASE-64GB-C with Encryption	A	\$0
SB-64-BASE	VMAX BASE-64GB	A	\$0
SB-64-BASEC	VMAX BASE -64GB-C	A	\$0
SB-64D-BASE	VMAX BASE-64GB with Encryption	A	\$0
SB-64D-BASEC	VMAX BASE -64GB-C with Encryption	A	\$0
SB-64-RET	VMAX MEMORY RETURN 64GB	A	\$0
SB-80000-RET	VMAX 4Gb 8M FC RETURN	A	\$0
SBA-CNV-1PU	VMAX SE Conv to 1P infrastructure	A	\$4,340
SBA-CNV-3DU	VMAX SE Conv to 3D infrastructure	A	\$4,340
SBA-CNV-3YU	VMAX SE Conv to 3Y infrastructure	A	\$4,340
SBA-CNVDB-1PU	VMAX-SE EXPN BAY POWER CONVERSION 1P U	A	\$4,340
SB-AD128DNDCU	VMAX UPG ENGINE-128GB-C with Encryption	A	\$0
SB-AD128NDECU	VMAX UPG ENGINE-128GB-C	A	\$0
SB-ADD128DNDC	VMAX ADD ENGINE-128GB-C with Encryption	A	\$333,460
SB-ADD128DNDE	VMAX ADD ENGINE-128GB with Encryption	A	\$333,460
SB-ADD128DNDCU	VMAX UPG ENGINE-128GB with Encryption	A	\$0
SB-ADD128NDE	VMAX ADD ENGINE-128GB	A	\$0
SB-ADD128NDEC	VMAX ADD ENGINE-128GB-C	A	\$0
SB-ADD128NDEU	VMAX UPG ENGINE-128GB	A	\$0
SB-ADD32DNDCU	VMAX UPG ENGINE-32GB-C with Encryption	A	\$0
SB-ADD32DNDE	VMAX ADD ENGINE-32GB with Encryption	A	\$225,505
SB-ADD32DNDEC	VMAX ADD ENGINE-32GB-C with Encryption	A	\$225,505
SB-ADD32DNDCU	VMAX UPG ENGINE-32GB with Encryption	A	\$0
SB-ADD32NDE	VMAX ADD ENGINE-32GB	A	\$0
SB-ADD32NDEC	VMAX ADD ENGINE-32GB-C	A	\$0
SB-ADD32NDECU	VMAX UPG ENGINE-32GB-C	A	\$0
SB-ADD32NDEU	VMAX UPG ENGINE-32GB	A	\$0
SB-ADD64DNDCU	VMAX UPG ENGINE-64GB-C with Encryption	A	\$0
SB-ADD64DNDE	VMAX ADD ENGINE-64GB with Encryption	A	\$250,685

SB-ADD64DNDEC	VMAX ADD ENGINE-64GB-C with Encryption	A	\$250,685
SB-ADD64DNDEU	VMAX UPG ENGINE-64GB with Encryption	A	\$0
SB-ADD64NDE	VMAX ADD ENGINE-64GB	A	\$0
SB-ADD64NDEC	VMAX ADD ENGINE-64GB-C	A	\$0
SB-ADD64NDECU	VMAX UPG ENGINE-64GB-C	A	\$0
SB-ADD64NDEU	VMAX UPG ENGINE-64GB	A	\$0
SB-BBU-UFD	SB BATTERY BACK-UP UFD	A	\$3,400
SB-CNV-3DU	VMAX Conv to 3D infra/storage bay	A	\$4,340
SB-CNV-3YU	VMAX Conv to 3Y infra/storage bay	A	\$4,340
SB-CNVDB-1PU	VMAX Conv to 1P storage bay	A	\$4,340
SB-CNVINF-1PU	VMAX Conv to 1P infrastructure	A	\$4,340
SB-COMPRSUFD	VMAX UPG CMPR ENABLED	A	\$0
SB-DBA-DC-1P	VMAX SE SB DCH 1PHASE	A	\$0
SB-DBA-DC-3D	VMAX SE SB DCH DELTA	A	\$0
SB-DBA-DC-3Y	VMAX SE SB DCH WYE	A	\$0
SB-DBA-DCS-1P	VMAX SE SB SEPARATED DCH 1PHASE	A	\$49,730
SB-DBA-DCS1PU	VMAX SE SB SEPARATED DCH 1PHASE UPG	A	\$49,730
SB-DBA-DCS-3D	VMAX SE SB SEPARATED DCH DELTA	A	\$49,730
SB-DBA-DCS3DU	VMAX SE SB SEPARATED DCH DELTA UPG	A	\$49,730
SB-DBA-DCS-3Y	VMAX SE SB SEPARATED DCH WYE	A	\$49,730
SB-DBA-DCS3YU	VMAX SE SB SEPARATED DCH WYE UPG	A	\$49,730
SB-DB-DC-1P	VMAX SB DCH 1 PHASE	A	\$0
SB-DB-DC-1PU	VMAX SB DCH 1 PHASE UPG	A	\$0
SB-DB-DC-3D	VMAX SB DCH DELTA	A	\$0
SB-DB-DC-3DPU	VMAX SB DCH DELTA UPG PERF REAR DOOR	A	\$0
SB-DB-DC-3DU	VMAX SB DCH DELTA UPG	A	\$0
SB-DB-DC-3Y	VMAX SB DCH WYE	A	\$0
SB-DB-DC-3YP	VMAX SB DCH WYE WITH PERF REAR DOOR	A	\$0
SB-DB-DC-3YU	VMAX SB DCH WYE UPG	A	\$0
SB-DBDC-SPS	VMAX SB DCH SPS	A	\$0
SB-DBDC-SPS-U	VMAX SB DCH SPS UPG	A	\$0
SB-DBDCSPS-UF	VMAX SB DCH SPS UFD	A	\$0
SB-DB-DIR-1P	VMAX SB DIR 1 PHASE	A	\$0
SB-DB-DIR-1PU	VMAX SB DIR 1 PHASE UPG	A	\$0
SB-DB-DIR-3D	VMAX SB DIR DELTA	A	\$0
SB-DB-DIR-3DU	VMAX SB DIR DELTA UPG	A	\$0
SB-DB-DIR-3Y	VMAX SB DIR WYE	A	\$0
SB-DB-DIR-3YP	VMAX SB DIR WYE PERF REAR DOOR	A	\$0
SB-DB-DIR-3YU	VMAX SB DIR WYE UPG	A	\$0
SB-DB-SOLIDDR	VMAX Solid Rear Door-storage bay	A	\$1,400
SB-DB-SPS	VMAX SB SPS	A	\$0
SB-DB-SPS-U	VMAX SB SPS UPG	A	\$0
SB-DB-SPS-UFD	VMAX SB SPS UFD	A	\$0
SB-DDB-DC-1P	VMAX SEP SB 1PHASE	A	\$49,730
SB-DDB-DC-1PP	VMAX SEP SB 1PH PERF REAR DOOR	A	\$49,730
SB-DDB-DC1PPU	VMAX SEP SB 1PH PERF REAR DOOR UPG	A	\$49,730
SB-DDB-DC-1PU	VMAX SEP SB 1PHASE UPG	A	\$49,730
SB-DDB-DC-3D	VMAX SEP SB DELTA	A	\$49,730
SB-DDB-DC-3DP	VMAX SEP SB DELTA PERF REAR DOOR	A	\$49,730
SB-DDB-DC-3DU	VMAX SEP SB DELTA UPG	A	\$49,730

SB-DDB-DC-3Y	VMAX SEP SB WYE	A	\$49,730
SB-DDB-DC-3YP	VMAX SEP SB WYE PERF REAR DOOR	A	\$49,730
SB-DDB-DC-3YU	VMAX SEP SB WYE UPG	A	\$49,730
SB-DE15A-DIR	VMAX 15SLTA DRV ENCL	A	\$0
SB-DE15DCH	VMAX 15SLT DR ENCL	A	\$0
SB-DE15DCHU	VMAX 15SLT DR ENCL UPG	A	\$0
SB-DE15DCHUFD	VMAX 15SLT DR ENCL UFD	A	\$0
SB-DE15-DIR	VMAX 15SLT DR ENCL	A	\$0
SB-DE15-DIRU	VMAX 15SLT DR ENCL UPG	A	\$0
SB-DE15DIRUFD	VMAX 15SLT DR ENCL UFD	A	\$0
SB-FE00004	VMAX 4Gb 4S FIC	A	\$0
SB-FE00004E	VMAX 8Gb 4S FIC	A	\$0
SB-FE00004EU	VMAX 8Gb 4S FIC-UPG	A	\$0
SBFE00004EUF	VMAX 8Gb 4S FIC-CV	A	\$0
SB-FE00004U	VMAX 4Gb 4S FIC-UPG	A	\$0
SB-FE00004UFD	VMAX 4Gb 4S FIC-CV	A	\$0
SB-FE00040E	VMAX 8Gb 4M FIC	A	\$0
SB-FE00040EU	VMAX 8Gb 4M FIC-UPG	A	\$0
SBFE00040EUF	VMAX 8Gb 4M FIC-CV	A	\$0
SB-FE00040U	VMAX 4Gb 4M FIC-UPG	A	\$0
SB-FE00040UFD	VMAX 4Gb 4M FIC-CV	A	\$0
SB-FE00400T	VMAX 10Gb 4M GIGE	A	\$0
SB-FE00400TU	VMAX 10Gb 4M GIGE-UPG	A	\$0
SB-FE00400TUF	VMAX 10Gb 4M GIGE-CV	A	\$0
SB-FE00400U	VMAX 4M GIGE-UPG	A	\$0
SB-FE00400UFD	VMAX 4M GIGE-CV	A	\$0
SB-FE08000	VMAX 4Gb 8S FC	A	\$0
SB-FE08000E	VMAX 8Gb 8S FC	A	\$0
SB-FE08000EU	VMAX 8Gb 8S FC-UPG	A	\$0
SBFE08000EUF	VMAX 8Gb 8S FC-CV	A	\$0
SB-FE08000U	VMAX 4Gb 8S FC-UPG	A	\$0
SB-FE08000UFD	VMAX 4Gb 8S FC-CV	A	\$0
SB-FE44000	VMAX 4Gb 4M4S FC	A	\$0
SB-FE44000E	VMAX 8Gb 4M4S FC	A	\$0
SB-FE44000EU	VMAX 8Gb 4M4S FC-UPG	A	\$0
SBFE44000EUF	VMAX 8Gb 4M4S FC-CV	A	\$0
SB-FE44000U	VMAX 4Gb 4M4S FC-UPG	A	\$0
SB-FE44000UFD	VMAX 4Gb 4M4S FC-CV	A	\$0
SB-FE62000	VMAX 4Gb 6M2S FC	A	\$0
SB-FE62000E	VMAX 8Gb 6M2S FC	A	\$0
SB-FE62000EU	VMAX 8Gb 6M2S FC-UPG	A	\$0
SBFE62000EUF	VMAX 8Gb 6M2S FC-CV	A	\$0
SB-FE62000U	VMAX 4Gb 6M2S FC-UPG	A	\$0
SB-FE62000UFD	VMAX 4Gb 6M2S FC-CV	A	\$0
SB-FE80000	VMAX 4Gb 8M FC	A	\$0
SB-FE80000E	VMAX 8Gb 8M FC	A	\$0
SB-FE80000EU	VMAX 8Gb 8M FC-UPG	A	\$0
SB-FE80000EUF	VMAX 8Gb 8M FC-CV	A	\$0
SB-FE80000U	VMAX 4Gb 8M FC-UPG	A	\$0
SB-FE80000UFD	VMAX 4Gb 8M FC-CV	A	\$0

SB-GE-ISCSI	VMAX GIGE ISCSI PORTS	A	\$0
SB-GE-SRDF	VMAX GIGE SRDF PORTS	A	\$0
SB-INF-PERFDR	VMAX Perf Rear Door-infrastructure	A	\$1,400
SB-NOCMPRSRET	VMAX NON-CMPR RETURN	A	\$0
SB-SPSA	VMAX SE BAY SPS	A	\$0
SB-SYS-TOPKIT	VMAX SYSTEM BAY TOP ROUTING KIT	A	\$1,080
SB-VMAX-LOGO	VMAX/VMAX SE DOOR LOGO RETROFIT KIT	A	\$250
SYMMOD-115V	MODEM 115V	A	\$2,500
SYMMOD-230V	MODEM 230V	A	\$2,500
SYMMOD-ARTINA	MODEM ARGENTINA	A	\$2,500
SYMMOD-AST	MODEM AUSTRIA	A	\$2,500
SYMMOD-AUL	SYMII.5 MODEM AUSTRALIA	A	\$2,500
SYMMOD-BEL	SYMII.5 MODEM BELGIUM	A	\$2,500
SYMMOD-CZ	MODEM CZECH	A	\$2,500
SYMMOD-DEN	SYMII.5 MODEM DENMARK	A	\$2,500
SYMMOD-DMX3	MODEM FOR SYMMETRIX DMX3 SYSTEMS	A	\$2,500
SYMMOD-DMX4	MODEM FOR SYMMETRIX DMX4 SYSTEMS	A	\$2,500
SYMMOD-EUR	MODEM EURO	A	\$2,500
SYMMOD-FIN	MODEM FINLAND	A	\$2,500
SYMMOD-FRA	SYMII.5 MODEM FRANCE	A	\$2,500
SYMMOD-GER	SYMII.5 MODEM GERMANY	A	\$2,500
SYMMOD-HK	SYMII.5 MODEM HONG KONG	A	\$2,500
SYMMOD-IR1	SYMII.5 MODEM ICELAND	A	\$2,500
SYMMOD-IRL	MODEM IRELAND	A	\$2,500
SYMMOD-ISR	MODEM ISRAEL	A	\$2,500
SYMMOD-ITA	SYMII.5 MODEM ITALY	A	\$2,500
SYMMOD-JAP	SYMII.5 MODEM JAPAN	A	\$2,500
SYMMOD-KOR	SYMII.5 MODEM KOREA	A	\$2,500
SYMMOD-MOR	MODEM MOROCCO	A	\$2,500
SYMMOD-NET	SYMI.5 MODEM NETHERLANDS	A	\$2,500
SYMMOD-NOR	SYMII.5 MODEM NORWAY	A	\$2,500
SYMMOD-NZEA	MODEM NEW ZEALAND	A	\$2,500
SYMMOD-SA	SYMII.5 MODEM S.AFRICA	A	\$2,500
SYMMOD-SPA	MODEM SPAIN	A	\$2,500
SYMMOD-SWE	SYMII.5 MODEM SWEDEN	A	\$2,500
SYMMOD-SWI	SYMII.5 MODEM SWITZERLAND	A	\$2,500
SYMMOD-SWZ	SYMII.5 MODEM SWITZ INTER	A	\$2,500
SYMMOD-TAI	SYMII.5 MODEM TAIWAN	A	\$2,500
SYMMOD-UK	SYMMETRIXII.5 MODEM UK	A	\$2,500
SYMMOD-US	MODEM UNITED STATES	A	\$2,500
SYM-OM3-100M	OM3 50/125 MICRON OPTCL CABLE LC-LC 100M	A	\$1,620
SYM-OM3-10M	OM3 50/125 MICRON OPTCL CABLE LC-LC 10M	A	\$520
SYM-OM3-1M	OM3 50/125 MICRON OPTCL CABLE LC-LC 1M	A	\$410
SYM-OM3-30M	OM3 50/125 MICRON OPTCL CABLE LC-LC 30M	A	\$750
SYM-OM3-3M	OM3 50/125 MICRON OPTCL CABLE LC-LC 3M	A	\$410
SYM-OM3-50M	OM3 50/125 MICRON OPTCL CABLE LC-LC 50M	A	\$1,020
SYM-OM3-5M	OM3 50/125 MICRON OPTCL CABLE LC-LC 5M	A	\$470
SYM-SECURE1	HALF BAY SEISMIC KIT	A	\$2,600
SYM-SECURE2	1 BAY SEISMIC KIT	A	\$12,200
SYM-SECURE3	3 BAY SEISMIC KIT	A	\$12,200

TB-15-DIR-U	EQUIP BAY 15SLT DR ENCL U	A	\$5,200
TB-15-DIR-UFD	SYS BAY 15 SLT DR ENC FLD UPG	A	\$5,100
TB4-15-DIRUFD	SYS BAY 15 SLT DR ENC FLD UPG	A	\$5,100
TB-BBU-UFD	SYS BAY BATTERY BACK-UP FLD UPG	A	\$5,100
Z-SILENCER	SILENCER Z8530Z8830	A	\$770
40UC-SECURE2	CLRN 40UC ANTI-MOVE KIT	B	\$1,000
AUX-M1GI-A	CELERRA 2PORT GB ISCSI SLIC PAIR AUX FAC	B	\$0
AUX-M1GI-U	CEL 2PORTS GBISCSI SLIC PAIR FOR AUX UPG	B	\$7,000
AUX-M4GF-BE-A	CELERRA 4FC 4G BE SLIC PAIR FOR AUX FACT	B	\$0
AUX-M4GF-BE-U	CELERRA 4FC 4GB BE SLIC PAIR FOR AUX UPG	B	\$20,000
AUX-M4GF-FB-A	2 CELERRA 4FC 4GB FE/BE SLICS FOR AUXFAC	B	\$5,000
AUX-M4GF-FB-U	CELERRA 4FC 4GB FE/BE SLIC PAIR FOR AUX	B	\$7,000
AUX-M4GF-FE-A	CELERRA 4FC 4G FE SLIC PAIR FOR AUX FACT	B	\$0
AUX-M4GF-FE-U	CELERRA 4FC 4GB FE SLIC PAIR FOR AUX UPG	B	\$7,000
AUX-M4GF-XS-U	CEL 4GB FC 4PORT SLICPAIR NO SFP AUX UPG	B	\$12,500
AUX-M8GF-FB-A	2 CELERRA 4FC 8GB FE/BE SLICS FOR AUX FA	B	\$6,250
AUX-M8GF-FB-U	CELERRA 4FC 8GB FE/BE SLIC PAIR FOR AUX	B	\$8,750
AUX-M8GF-FE-A	CELERRA 4FC 8G FE SLIC PAIR FOR AUX FACT	B	\$0
AUX-M8GF-FE-U	CELERRA 4FC 8GB FE SLIC PAIR FOR AUX UPG	B	\$8,750
AUX-MXGFCEOPA	FCOE ONE PAIR OPTICAL 2 PORT FCOE IO MOD	B	\$0
AUX-MXGFCEOPU	FCOE 1 PAIR ADDON 2PORT OPT IO MODULE	B	\$8,100
AUX-MXGFCETWA	FCOE ONE PAIR 2 PORT IO MODULE TWIN AX	B	\$0
AUX-MXGFCETWU	FCOE 1 PAIR ADD-ON 2 PORT IO - ACT TWINA	B	\$5,670
AUX-MXGI-A	CEL 2 PORT 10GB ISCSI SLIC PAIR AUX FACT	B	\$0
AUX-MXGI-U	CEL 2PORT 10GB ISCSI SLIC PAIR AUXUPG	B	\$21,000
BSMI-PWR-CORD	POWER CORD - BSMI TAIWAN	B	\$1,150
C13-PWR-0	2 C13 PWRCORDS W/ SEV1011 PLUGS 250V 10A	B	\$0
C13-PWR-1	2 C13 PWRCORDS W/ NBR 14136 250V 10A	B	\$0
C13-PWR-10	2 C13 PWRCORDS W/ KSC8305 PLUGS 250V 10A	B	\$0
C13-PWR-11	2 C13 CORDS CNS690 125V 10A - NON DPE	B	\$0
C13-PWR-12	2 C13 CORDS NEMA 5-15 125V 10A - NON DPE	B	\$0
C13-PWR-13	2 C13 PWRCORDS W/ BS546 PLUGS 250V 10A	B	\$0
C13-PWR-14	2 C13 PWRCORDS W/ SI-32 PLUGS 250V 10A	B	\$0
C13-PWR-15	2 C13 POWER CORDS WITH IN6SA3 PLUGS	B	\$0
C13-PWR-2	2 C13 CORDS JISC8303 125V 10A - NON DPE	B	\$0
C13-PWR-3	2 C13 PWRCORDS W/ GB1002 PLUGS 250V 10A	B	\$0
C13-PWR-4	2 C13 PWRCORDS W/ IRAM 2073 250V 10A	B	\$0
C13-PWR-5	2 C13 PWRCORDS W/ BSI 1363 250V 10A	B	\$0
C13-PWR-6	2 C13 PWRCORDS w/ SAA/3 PLUGS 250V 10A	B	\$0
C13-PWR-7	2 C13 PWRCORDS W/ CEE7/7 PLUGS 250V 10A	B	\$0
C13-PWR-8	2 C13 PWRCORDS W/ CEI 23-16 250V 10A	B	\$0
C13-PWR-9	2 C13 CORDS W/ AFSNIT 107-2-D1 250V 10A	B	\$0
C4BCEX5	2.2TB4N MRDWIN LGT3YRMNT	B	\$0
C4BFSAW	2.2TB4N MRDWIN LGT2YRMNT	B	\$0
C4CEX1K	2.2TB4NOD LGTO1000MAILBX	B	\$0
C4NBRMS	4NODEMRRD MAIN3YR S/HMNT	B	\$0
C4NBRSS	4NODEMRRD CNTINSTL3YRMNT	B	\$0
C8BCEX5	4.4TB8NODE LGTO500MAILBXS	B	\$0
C8BFSAW	4.4TB8N MRDWIN LGT3YRMNT	B	\$0
C8CEX1K	4.4TB8NOD LGTO1000MAILBX	B	\$0

C8NBRMS	4.4TB8NODEMRD MAIN3YRMNT	B	\$0
C8NBRSS	4.4TB8NODE CNRIN STL3YRMNT	B	\$0
CLAR-RM-ARG	CLRN REM MAINT MODEM KIT	B	\$0
CLAR-RM-AUS	CLRN REM MAINT MODEM KIT	B	\$0
CLAR-RM-DEN	CLRN REM MAINT MODEM KIT	B	\$0
CLAR-RM-EUR	CLRN REM MAINT MODEM KIT	B	\$0
CLAR-RM-IND	CLRN REM MAINT MODEM KIT	B	\$0
CLAR-RM-ISR	CLRN REM MAINT MODEM KIT	B	\$0
CLAR-RM-ITA	CLRN REM MAINT MODEM KIT	B	\$0
CLAR-RM-JPN	CLRN REM MAINT MODEM KIT	B	\$0
CLAR-RM-KOR	CLRN REM MAINT MODEM KIT	B	\$0
CLAR-RM-SWI	CLRN REM MOINT MODEM KIT	B	\$0
CLAR-RM-TAI	CLRN REM MAINT MODEM KIT	B	\$0
CLAR-RM-UK	CLRN REM MAINT MODEM KIT	B	\$0
C-MODEM-US	CLARIION SERVICE MODEM-US	B	\$0
CN4NMBD	2.2TB 4NODECNTRA2YRS/HMNT	B	\$0
CNA2N1FUPG4LP	UNBUNDLED 2 NODE GEN4LP 1TB UPG FLD INS	B	\$0
CNA2N1MEXG4LP	BUNDLED 2 NODE GEN4LP 1TB UPG FACT INST	B	\$0
CNA2N2FUPG4LP	UNBUNDLED 2 NODE GEN4LP 2TB UPG FLD INS	B	\$0
CNA2N2MEXG4LP	BUNDLED 2 NODE GEN4LP 2TB UPG FACT INST	B	\$0
CNA2N3FUPG4LP	UNBUNDLED 2 NODE GEN4LP 3TB UPG FLD INS	B	\$0
CNA2N3MEXG4LP	BUNDLED 2 NODE GEN4LP 3TB UPG FACT INST	B	\$0
CNA3PHNAM	3 PHASE DELTA DUAL PDP NAM PWR RK FLD	B	\$0
CNA4N1FBAG4LP	UNBUNDLED 4 NODE GEN4LP 1TB FLD INST	B	\$0
CNA4N1MBAG4LP	BUNDLED 4 NODE GEN4LP 1TB FACTORY INST	B	\$0
CNA4N2FBAG4LP	UNBUNDLED 4 NODE GEN4LP 2TB FLD INST	B	\$0
CNA4N2MBAG4LP	BUNDLED 4 NODE GEN4LP 2TB FACTORY INST	B	\$0
CNA4N3FBAG4LP	UNBUNDLED 4 NODE GEN4LP 3TB FLD INST	B	\$0
CNA4N3MBAG4LP	BUNDLED 4 NODE GEN4LP 3TB FACTORY INST	B	\$0
CNACUA1NG4	SINGLE CUA NODE G4LP	B	\$0
CNR2N1FUPG4LP	UNBUNDLED 2 NODE GEN4LP WITH 1TB DRIVES	B	\$0
CNR2N1MEXG4LP	BUNDLED 2 NODE GEN4LP WITH 1TB DRIVES IN	B	\$0
CNR2N2FUPG4LP	Centera 2-node field upgrade model with	B	\$0
CNR2N2MEXG4LP	Centera 2-node manufacturing expansion m	B	\$0
CNR2N3FUPG4LP	UNBUNDLED 2 NODE CENTERA GEN4LP 3TB DR	B	\$0
CNR2N3MEXG4LP	BUNDLED 2 NODE CENTERA GEN4LP 3TB DRIVE	B	\$0
CNR3PHNAM	3P NAM PWR RK FLD	B	\$0
CNR4N1FBAG4LP	UNBUNDLED 4 NODE GEN4LP WITH 1TB DRIVES	B	\$0
CNR4N1MBAG4LP	BUNDLED 4 NODE GEN4LP WITH 1TB DRIVES W	B	\$0
CNR4N2FBAG4LP	Centera 4-node base field model with 2TB	B	\$0
CNR4N2MBAG4LP	Centera 4-node base manufacturing model	B	\$0
CNR4N3FBAG4LP	UNBUNDLED 4 NODE CENTERA GEN4LP 3TB DR	B	\$0
CNR4N3MBAG4LP	BUNDLED 4 NODE CENTERA GEN4LP 3TB DRIVE	B	\$0
CNR8TB	CNR 8TB RAW INCRE FAC INS	B	\$0
CNR8TBUP	CNR 8TB RAW INCRE FLD INS	B	\$0
CNRCUA1NG4	SINGLE CUA NODE G4	B	\$0
CNRGPLLICHW	CENTERA OPEN SOURCE LICENSES(RTU)	B	\$0
CNR RK4NG3	CNR GEN3 4NODE CHAN OFF	B	\$0
CNRRTSWCH	DI 8pt GbEth swtch inter	B	\$0
CR8NMBD	4.4TB 8NODECNTR3YRS/HMNT	B	\$0

CTA8-APL	CLOUD TIERING APPLIANCE	B	\$0
CTA8-HA-APL	CLOUD TIERING APL HIGH AVAIL	B	\$0
CTA-APL	CLOUD TIERING APPLIANCE	B	\$0
CTA-APL-HA	CLOUD TIERING APPLIANCE HIGH AVAILABILIT	B	\$0
CX200-CX600	CX200 TO CX600 UPGRADE	B	\$85,250
CX200LC-CX200	CX200LC-CX200 CONVERSION	B	\$0
CX200-R3610	CX200 WDRIVES FACT INST	B	\$23,250
CX200-R7310	CX200 BUNDLE FOR EMC RACK W/ 10 73GB 10K	B	\$26,800
CX2345-3-40C	CX2/3/4/5/300I/500I UPGRADE TO MODEL CX3	B	\$42,300
CX-2DDAE-70FD	2G DAE CX700 DC PWR FDINS	B	\$7,300
CX-2DDAE-FD	2G DAE W DC PWR FIELD INS	B	\$7,300
CX-2G10-146	146GB 10K 2GB FC	B	\$1,020
CX2G10-146-5	FC 146GB 10K 520B 2Gb 5PK	B	\$5,100
CX-2G10-146U	146GB 10K 2GB FC UPG	B	\$0
CX-2G10-300	300GB 10K 2GB FC	B	\$0
CX2G10-300-5	DRIVE BUNDLE W5 300GB 10K	B	\$0
CX-2G10-300U	300GB 10K 2GB FC UPG	B	\$0
CX-2G10-36	CHV 36Gb 10K 520BPS 12V 2Gb	B	\$1,140
CX-2G10-73	73GB 10K 2Gb FC	B	\$755
CX2G10-73-5	FC 73GB 10K 520B 2Gb 5PK	B	\$3,775
CX-2G10-73U	73GB 10K 2Gb FC UPG	B	\$0
CX-2G15-146	146GB 15K 2GB FC	B	\$1,330
CX2G15-146-5	DRIVE BUNDLE W5 146GB 15K 2Gb FC DRIVES	B	\$0
CX-2G15-146U	146GB 15K 2G FC UPG	B	\$1,800
CX-2G15-36	FC 36GB 15K 520B 2Gb	B	\$685
CX2G15-36-5	FC 36GB 15K 520B 2Gb 5PK	B	\$3,425
CX-2G15-36U	FC 36GB 15K 520B 2Gb UPG	B	\$925
CX-2G15-73	73GB 15K 2GB FC	B	\$1,030
CX2G15-73-5	FC 73GB 15K 520B 2Gb 5PK	B	\$5,150
CX-2G15-73U	73GB 15K 2GB FC UPG	B	\$0
CX-2G72-500	500GB 7200RPM 2GB FC DISK	B	\$0
CX-2G72-500U	500GB 7200RPM 2GB FC UPG	B	\$0
CX-2GDAE	DAE FC 2Gb EXPANS FOR CX	B	\$5,900
CX-2GDAE-70	CX700 DAE EXP W FLARE OS	B	\$5,900
CX-2GDAE-70FD	CX700 DAE W FLAR FLD INST	B	\$5,900
CX-2GDAE-FD	DAE FC 2Gb EXP FLD INSTAL	B	\$5,900
CX-2GDAE-OS	2Gb DAE EXP w/FLAREOS	B	\$6,200
CX-2GDAE-OSFD	2Gb DAE EXP wFLAREOS FIELD	B	\$6,200
CX-2GDAE-U	CUST INST FLD UPG FC DAE	B	\$0
CX-2PDAE	CX DAE FC 2GB EXPANSION	B	\$0
CX-2PDAE-70	CX700 2G FC DAE W/FLARE	B	\$5,900
CX-2PDAE-70FD	CX700 2G FC DAE W/FLARE	B	\$5,900
CX-2PDAE-FD	CX DAE FC 2GB EXPANSION	B	\$0
CX-2PDAE-U	2GB CUST INSTALL ULTRAPOINT DAE	B	\$0
CX300-412C	CONVERT CX300 / CX300I TO MODEL CX4-120C	B	\$0
CX300-412C8	CONVERT CX300/CX300I TO MODEL CX4-120C8	B	\$0
CX300-412C8X	CONVERT CX300/CX300I TO MODEL CX4-120C8X	B	\$0
CX300-412C-DC	DC CX4 CONV-KIT CX-2D300FD TO CX4-120CDC	B	\$17,750
CX300-BAS	CX300 FC BASIC SVC	B	\$11,040
CX300-BAS-FD	CX300 FC FLD BASIC SVC	B	\$11,040

CX300-BSP	CX300 FC BAS PLUS SVC	B	\$12,350
CX300-BSP-FD	CX300 FC FLD BAS PLUS SVC	B	\$12,350
CX314615-10	CX300 BUNDLE WITH 10 146GB-15K DRIVES	B	\$22,385
CX314615-10FD	CX300 BUNDLE WITH 10 146GB-15K	B	\$22,385
CX314615-5	CX300 BUNDLE W5 146GB 15K 2GB FC DRIVES	B	\$17,965
CX314615-5FD	CX300 BUNDLE W5 146GB 15K 2Gb FC DRIVES	B	\$17,965
CX3146-15FD	CX300 BUNDLE-15 146GB 10K	B	\$24,025
CX3-20CUST	CX3-20 CUSTOMER INSTALLABLE ARRAY	B	\$0
CX3-412C	CONVERT CX3-10C TO CX4-120C ARRAY	B	\$0
CX3-412C8	CONVERT CX3-10C TO CX4-120C8 ARRAY	B	\$0
CX3-412C8X	CONVERT CX3-10C TO CX4-120C8X ARRAY	B	\$0
CX3-424C	CONVERT CX3-10/20 TO CX4-240C	B	\$0
CX3-424C8	CONVERT CX3-10/20 MODEL TO CX4-240C8	B	\$0
CX3-424C8X	CONVERT CX3-10/20 MODEL TO CX4-240C8X	B	\$0
CX3-424C-DC	CONVERT CX3-20FDC TO CX4-240CDC	B	\$30,100
CX3-448C	CONVERT CX3-10/20/40 TO CX4-480C	B	\$0
CX3-448C8	CONVERT CX3-10/20/40 TO CX4-480C8	B	\$0
CX3-448C8X	CONVERT CX3-10/20/40 TO CX4-480C8X	B	\$0
CX3-448C-DC	CX4 CONV KIT CX3-20F/40FDC TO CX4-480CDC	B	\$80,100
CX3-496C	CONVERT CX3-10/20/40 TO CX4-960C	B	\$0
CX3-496C8	CONVERT CX3-10/20/40 TO CX4-960C8	B	\$0
CX3-496C8X	CONVERT CX3-10/20/40 TO CX4-960C8X ARRAY	B	\$0
CX35-424C	CONVERT CX300X/CX500X TO CX4-240C	B	\$0
CX35-424C8	CONVERT CX300X/CX500X TO CX4-240C8	B	\$0
CX35-424C8X	CONVERT CX300X/CX500X TO CX4-240C8X	B	\$0
CX35-424C-DC	DC CX4 CONVKIT CX-2D300/500 TO CX4-240CD	B	\$30,100
CX35-448C	CONVERT CX300X/CX500X TO CX4-480C	B	\$0
CX35-448C8	CONVERT CX300X/CX500X TO CX4-480C8	B	\$0
CX35-448C8X	CONVERT CX300X/CX500X TO CX4-480C8X	B	\$0
CX35-448C-DC	DC CX4 CONVKIT FOR CX-2D500 TO CX4-480CD	B	\$80,100
CX35-496C	CONVERT CX300X/CX500X TO CX4-960C	B	\$0
CX35-496C8	CONVERT CX300X/CX500X TO CX4-960C8	B	\$0
CX35-496C8X	CONVERT CX300X/CX500X TO CX4-960C8X	B	\$0
CX37315-15	CX300 BUNDLE-15 73GB 15K	B	\$24,150
CX37315-15FD	CX300 BUNDLE-15 73GB 15K	B	\$24,150
CX38-496C	CONVERT CX3-80 TO CX4-960C ARRAY	B	\$0
CX38-496C8	CONVERT CX3-80 TO CX4-960C8 ARRAY	B	\$0
CX38-496C8X	CONVERT CX3-80 TO CX4-960C8X ARRAY	B	\$0
CX3I7315-15FD	CX300I BNDL 15 73GB 15KFD	B	\$25,255
CX3-LP010-15	CX3 FACTORY DAE BNDL W/ 15 1TB SATA 5400	B	\$31,025
CX3LP010-15F	DAE BNDL W/ 15 1TB SATA 5400 RPM DRIVES	B	\$31,025
CX3-LP010-15U	CX3 UPGRADE DAE BNDL W/ 15 1TB SATA 5400	B	\$31,120
CX3-SPS	CX3-10 OPTIONAL SECOND SPS FACT INSTALL	B	\$900
CX3-SPS-FD	CX3-10 OPTIONAL SPS - FIELD INSTALL	B	\$0
CX4-120C	CX4-120C SPE WITH SINGLE SPS	B	\$0
CX4-120C8	CX4-120 COMBO (8GBFC- 1GBISCSI) W 1 SPS	B	\$0
CX4-120C8DC	CX4-120 DC SPE COMBO (8GFC - 1G ISCSI)	B	\$0
CX4-120C8X	CX4120C8X SPE (8 GBFC- 10GBISCSI) W1SPS	B	\$0
CX4-120C8XDC	CX4-120C8X DC (8GBFC-10GBISCSI)NO SPS	B	\$0
CX4-120CDC	CX4-120 DC SPE	B	\$0

CX4-120FCOEOP	CX4-120 (120 DRIVE) 8GFC-FCOE OPTICAL	B	\$0
CX4-120FCOETW	CX4120 SPE 120 DRIVE 8GFC-FCOE TWINAXACT	B	\$0
CX4-12-24-96C	CONVERT CX4-120C & 240C TO CX4-960C	B	\$0
CX412-24C	CONVERT CX4-120C TO CX4-240C	B	\$0
CX412-24C-DC	DC CX4 CONV CX4-120CDC TO CX4-240CDC	B	\$30,100
CX412-48C	CONVERT CX4-120C TO CX4-480C ARRAY	B	\$0
CX412-48C-DC	CONVERSION FOR CX4-120CDC TO CX4-480CDC	B	\$80,100
CX4-240C	CX4-240C SPE WITH REDUNDANT SPS	B	\$0
CX4-240C8	CX4-240 COMBO(8GBFC- 1GBISCSI) W 2 SPS	B	\$0
CX4-240C8DC	CX4-240 DC SPE COMBO (8G FC - 1 G ISCSI)	B	\$0
CX4-240C8X	CX4-240C8X SPE (8GBFC-10GBISCSI) W 2SPS	B	\$0
CX4-240C8XDC	CX4-240 DC PWR SPE(8GBFC-10GBISCSI)NO SP	B	\$0
CX4-240CDC	CX4-240C DC SPE	B	\$0
CX4-240C-ISW	CX4-240C IBM INFOSPHERE DATA WAREHOUSE	B	\$0
CX4-240FCOEOP	CX4-240 (240 DRIVE) 8GFC-FCOE OPTICAL	B	\$0
CX4-240FCOETW	CX4240 SPE (240 DRIVE)8GFC-FCOE TWINAX	B	\$0
CX424-48C	CONVERT CX4-240C TO CX4-480C ARRAY	B	\$0
CX424-48C-DC	DC CX4 CONV FOR CX4-240CDC TO 480CDC	B	\$80,100
CX4-480C	CX4-480C SPE	B	\$0
CX4-480C8	CX4480 SPE (8GBFC- 1GBISCSI) W 2 SPS	B	\$0
CX4-480C8DC	CX4-480 DC SPE COMBO (8G FC - 1G ISCSI)	B	\$0
CX4-480C8X	CX4-480C8X SPE (8GBFC-10GBISCSI) W 2SPS	B	\$0
CX4-480C8XDC	CX4-480C8X DC SPE 8GBFC 10GBISCSI NO SPS	B	\$0
CX4-480CDC	CX4-480C DC SPE	B	\$0
CX4-480FCOEOP	CX4-480 SPE COMBO 8GBFC-FCOE OPT	B	\$0
CX4-480FCOETW	CX4-480 (480 DRIVE) 8GBFC-FCOE TWINAX	B	\$0
CX448-96C	CONVERT CX4-480C TO CX4-960C ARRAY	B	\$0
CX4-4DDAE	CX4 ULTRAPPOINT DC ARRAY EXPANSION	B	\$0
CX4-4PDAE	4G DAE FACTORY OR FIELD INSTALL	B	\$0
CX4-960C	CX4-960C SPE	B	\$0
CX4-960C8	CX4-960 SPE 480 DRIVEREADY 8GBFC-1GBISCI	B	\$0
CX4-960C8X	CX4960C8X SPE 480 READY(8GBFC-10ISCSI)	B	\$0
CX4-960C-ISW	CX4-960C IBM INFOSPHERE DATA WAREHOUSE	B	\$0
CX4-960EXPIO	EXPANSION IO MODULES FOR CX4-960	B	\$0
CX4-960EXPIOU	UPGRADE EXPANSION IO MODULES FOR CX4-9	B	\$0
CX4-960FCOEOP	CX4960 SPE (480 READY) 8GBFC-FCOE OPT	B	\$0
CX4-960FCOETW	CX4960 SPE (480 READY)8GBFC-FCOE TWAX	B	\$0
CX4D-480C	MODEL-DATA PROCESSOR ENCLOSURE-NA-NA	B	\$0
CX4D-480C8	CX4-480C8 SPE IN CX DENSE RACK	B	\$0
CX4D-480C8X	CX4-480C8X SPE IN CX DENSE RACK	B	\$0
CX4D-960C	CX4-960C SPE IN CX DENSE RACK	B	\$0
CX4D-960C8	CX4-960C8 SPE IN CX DENSE RACK	B	\$0
CX4D-960C8X	CX4-960C8X SPE IN CX DENSE RACK	B	\$0
CX-4DDAE-10FD	CX3-10 DAE OS DC FIELD INSTALL	B	\$7,900
CX-4DDAE-20FD	CX3-20 DAE OS DC FIELD INSTALL	B	\$0
CX-4DDAE-40FD	CX3-40DAE OS DC FIELD	B	\$0
CX-4DDAE-FD	4G DAE DC FIELD INSTALL	B	\$0
CX-4G10-300	300GB 10K 4Gb FC	B	\$1,345
CX-4G10-300U	300GB 10K 4Gb FC UPG	B	\$0
CX-4G10-400	400GB 10K 4Gb FC	B	\$1,850

CX-4G10-400U	400GB 10K 4Gb FC UPG	B	\$0
CX-4G10-450	450GB 4GB 10K FIBRE CHANNEL DISK DRIVE	B	\$0
CX-4G10-450U	450GB 4GB FC 10K DISK DRIVE	B	\$0
CX-4G10-600	600GB 4GB FIBRE CHANNEL DISK DRIVE	B	\$0
CX-4G10-600U	600GB 10K 4GB FC DISK DRIVE	B	\$0
CX4G10S-600TU	600GB 10K SAS-FC UPGRADE DISK DRIVE CX	B	\$0
CX-4G10S-600U	600GB 10K SAS-FC UPGRADE DISK DRIVE CX	B	\$0
CX-4G15-146	146GB 15K 4GB FC	B	\$0
CX-4G15-146U	146GB 15K 4GB FC UPG	B	\$1,800
CX-4G15-300	300GB 15K 4GB FC	B	\$0
CX-4G15-300TU	300GB 4GB FC 15K DISK DRIVE	B	\$0
CX-4G15-300U	300GB 15K 4GB FC UPG	B	\$0
CX-4G15-450	450GB 15K 4GB 520BPS FC DISK DRIVE	B	\$0
CX-4G15-450TU	450GB 4GB FC 15K DISK DRIVE	B	\$0
CX-4G15-450U	450GB 15K 4GB FC UPGRADE DISK DRIVE	B	\$0
CX-4G15-600	600GB 15K 4GB FIBRE CHANNEL DISK DRIVE	B	\$0
CX-4G15-600TU	600GB 4GB FC 15K DISK DRIVE	B	\$0
CX-4G15-600U	600GB 15K 4GB FIBRE CHANNEL UPGRADE DISK DRIVE	B	\$0
CX-4G15-73	73GB 15K 4GB FC	B	\$1,030
CX-4G15-73U	73GB 15K 4GB FC UPG	B	\$0
CX4-LP010-15	DAE WITH 15 1 TB SATA 5400 RPM DRIVES	B	\$0
CX4-LP010-15U	DAE W/ 15 1TB SATA 5400RPM DRIVES U/G	B	\$25,650
CX-4PDAE	4G DAE FACTORY INSTALL	B	\$5,900
CX-4PDAE-20	CX3-20 DAE OS	B	\$5,900
CX-4PDAE-20FD	CX3-20 DAE OS FIELD INST	B	\$5,900
CX-4PDAE-40	CX3-40 DAE OS	B	\$5,900
CX-4PDAE40F	CX3-40 DAE OS FACTORY INSTALLED	B	\$5,900
CX-4PDAE-40FD	CX3-40 DAE OS FIELD INST	B	\$5,900
CX-4PDAE40FFD	CX3-40F DAE OS FIELD INSTALLE	B	\$5,900
CX-4PDAE-80	CX3-80 DAE OS FAC INSTALL	B	\$5,900
CX-4PDAE-80FD	CX3-80 DAE OS FLD INSTALL	B	\$5,900
CX-4PDAE-FD	4G DAE FIELD INSTALL	B	\$0
CX7-448C	CONVERT CX700 TO CX4-480C ARRAY	B	\$0
CX7-448C8	CONVERT CX700 TO CX4-480C8 ARRAY	B	\$0
CX7-448C8X	CONVERT CX700 TO CX4-480C8X ARRAY	B	\$0
CX7-496C	CONVERT CX700 TO CX4-960C ARRAY	B	\$0
CX7-496C8	CONVERT CX700 TO CX4-960C8 ARRAY	B	\$0
CX7-496C8X	CONVERT CX700 TO CX4-960C8X ARRAY	B	\$0
CX-AF04-100	100GB 3.5 520BPS FLASH DRIVE 4GB FC	B	\$0
CX-AF04-100U	100GB FLASH DRIVE UPG	B	\$0
CX-AF04-200	200GB 3.5 520BPS FLASH DRIVE 4GB FC	B	\$0
CX-AF04-200U	200GB FLASH DRIVE UPGRADE MODEL	B	\$0
CX-AT05-250	250GB PATA 5400RPM	B	\$950
CX-AT05-250U	250GB PATA 5400RPM	B	\$1,280
CX-AT05-320	ATA 320GB 5400RPM	B	\$950
CXAT05-320-5	ATA 320GB 5400RPM 5PK	B	\$4,750
CX-AT05-320U	ATA 320GB 5400RPM UPG	B	\$1,280
CX-AT07-010	1000GB 7200RPM SATA II	B	\$1,450
CX-AT07-010U	1000GB 7200RPM SATA II UPG	B	\$0
CX-AT07-250	250GB 7200RPM SATA Drive	B	\$950

CX-AT07-250U	250GB 7200RPM ATA DRIVE	B	\$1,280
CX-AT07-500	500GB 7200RPM SATA DISK	B	\$1,330
CX-AT07-500U	500GB 7200RPM SATA II UPG	B	\$1,795
CX-AT07-750	750GB 7200RPM SATA II	B	\$1,895
CX-AT07-750U	750GB 7200RPM SATA II UPG	B	\$2,558
CX-FC04-073	73GB 4GB FIBRE CHANNEL EFD	B	\$0
CX-FC04-073U	73GB 4GB FC EFD UPGRADE DRIVE	B	\$0
CX-FC04-200	200GB 4GB FIBRE CHANNEL EFD	B	\$0
CX-FC04-200U	200GB 4GB FC EFD UPG	B	\$0
CX-FC04-400	400GB 4GB FIBRE CHANNEL EFD	B	\$0
CX-FC04-400U	400GB 4GB FIBRE CHANNEL EFD UPGRADE	B	\$0
CX-FRAME-1UADJ	1U ADJUSTABLE RAIL KIT	B	\$160
CX-FRAME-4UADJ	4U ADJUSTABLE RAIL KIT	B	\$160
CX-FRAME-ADJ	CX DPEDAE ADJ RAIL KIT	B	\$160
CX-FRAME-PADJ	ADJUSTABLE RAILS 2PDAE	B	\$150
CX-LP05-010	1TB 5400RPM SATA II LOW POWER DISK DRIVE	B	\$0
CX-LP05-010U	1TB 5400RPM SATA 3GB LOW PWR UG DRIVE	B	\$0
CX-LP05-020	2TB 5400RPM SATA 4GB DISK DRIVE	B	\$0
CX-LP05-020U	2TB 5400RPM SATA 3GB DISK DRIVE UPGRADE	B	\$0
CX-M1GI-A	PAIR 1G ISCSI - TOTAL 4 FE PORTS	B	\$0
CX-M1GI-U	UPGRADE PAIR 1G ISCSI - TOTAL 4 FE PORTS	B	\$7,000
CX-M4GF-FE-A	ADDITIONAL PAIR 4G FC - TOTAL 8 FE PORTS	B	\$0
CX-M4GF-FE-U	UPGRADE PAIR 4G FC - TOTAL 8 FE PORTS	B	\$7,000
CX-M8GF-FE-A	8 GB FC FRONT END I/O MODULE PAIR	B	\$0
CX-M8GF-FE-U	UPGRADE PAIR 8 GB FC - TOTAL 8 FE PORTS	B	\$8,750
CX-MXGF-COEOPA	FCOE PAIR OPTICAL 2 PORT FCOE IO MODULE	B	\$0
CX-MXGF-COEOPU	FCOE 1 PAIR ADD-ON 2 PORT OPT IO MODULE	B	\$8,400
CX-MXGF-COETWA	FCOE 1 PAIR ADD-ON 2 PORT IO MOD TWIN AX	B	\$0
CX-MXGF-COETWU	FCOE 1 PAIR ADD-ON 2PORT IO ACTIVETWINAX	B	\$5,880
CX-MXGI-A	ADDON PAIR 10G ISCSI OPT 4 FE PORTS	B	\$0
CX-MXGI-U	UPGRADE PAIR 10G ISCSI OPTICAL IO MODS	B	\$21,000
CX-NEBS2-HWKT	CX LAN CABLE SURGE SUPPRESSOR KIT	B	\$0
CX-NEBS-HWKIT	AC NEBS CHASSIS MECH KIT	B	\$0
CX-OM3-100M	OM3 50/125 MICRON OPT CABLE LC- LC 100M	B	\$570
CX-OM3-10M	OM3 50/125 MICRON OPT CABLE LC- LC 10M	B	\$290
CX-OM3-1M	OM3 50/125 MICRON OPT CABLE LC- LC 1M	B	\$230
CX-OM3-30M	OM3 50/125 MICRON OPT CABLE LC- LC 30M	B	\$310
CX-OM3-3M	OM3 50/125 MICRON OPT CABLE LC- LC 3M	B	\$250
CX-OM3-50M	OM3 50/125 MICRON OPT CABLE LC- LC 50M	B	\$390
CX-OM3-5M	OM3 50/125 MICRON OPT CABLE LC- LC 5M	B	\$260
CX-PW40U-NIEC	40U CORD NA IEC 309-330P6	B	\$3,500
CX-SA07-010	1000GB 7200RPM SATA II	B	\$0
CX-SA07-010TU	1000GB 7200RPM SATA II UPG FOR 4G DAE	B	\$0
CX-SA07-010U	1000GB 7200RPM SATA II UPG FOR 4G DAE	B	\$0
CX-SA07-020	2TB 7200RPM SATA II DISK DRIVE	B	\$0
CX-SA07-020TU	2000GB 7200RPM SATA II UPG FOR 4G DAE	B	\$0
CX-SA07-020U	2TB 7200RPM 520BPS SATA	B	\$0
CX-SA07-030TU	3000GB 7200RPM SATA II UPG FOR 4G DAE	B	\$0
CX-SA07-030U	3TB 7200 RPM 4GB FC UPGRADE DISK DRIVE	B	\$0
CX-SA07-500	500GB SATA II DISK FOR 4G DAE	B	\$1,530

CX-SA07-500U	500GB 7200RPM SATA II UPG FOR 4G DAE	B	\$2,065
CX-SA07-750	750GB 7200RPM SATA II	B	\$1,895
CX-SA07-750U	750GB 7200RPM SATA II UPG FOR 4G DAE	B	\$2,558
DAE	ARRAY EXPANSION NEW SYS	B	\$5,400
DAEFLD	DAE FIELD UPGRADE	B	\$5,400
DCA2-10GBEXT	GP DCA EXP CBL KIT FOR DATADOMAIN OR EX	B	\$0
DL210BA-FD	PCDL BASE ARRAY FIELD INS	B	\$0
DL210EXP	DL210 EXPANSION ARRAY	B	\$23,000
DL210EXP-FD	FIELD DL210 EXP ARRAY	B	\$23,000
DL300-310_UPG	UGRD KIT DL300 TO DL310	B	\$60,000
DL4100	CX3-80 Array for Single Engine DL	B	\$0
DL4200	CX3-80 Array for Dual Engine DL	B	\$0
DL4400A	CX3-80 Array (1 of 2) for Dual Engine DL	B	\$0
DL4400B	CX3-80 Array (2 of 2) for Dual Engine DL	B	\$0
DL700-STBY	DL700 STANDBY SERVER	B	\$28,300
DL700-STBY-FD	FLD INST. DL700 STBY SVR	B	\$28,300
DL720	DL720 Array Module	B	\$0
DL740	DL740 Array Module	B	\$0
DL-750S-DAE	FULLY LOADED 4GB STILETTO DAE W/NORTHS	B	\$38,600
DL-750S-DAEFD	FIELD INSTALL DAE 4GB STILETTO W/750GB D	B	\$38,600
DL-ENGINE	DISK LIBRARY ENGINE	B	\$34,900
DS-16B-CRK	CLAR RAIL KIT FOR DS-16B	B	\$340
DS16M-CRKL	16PORT RAILKIT LO-P BEZEL	B	\$660
DS24M2RK39	DS24M MOUNT-CLAR 39U RACK	B	\$350
DS24M2RK40	DS24M MOUNT-CLAR 40U RACK	B	\$275
DS2-RK1U-T	TELCO RKT FOR 1U CL	B	\$360
DS32B2RK39	DS-32B2-0D RAIL KIT FOR THE 39U HIGH CAB	B	\$650
DS32B2RK40	DS-32B2-0D 40U RAIL KIT	B	\$230
DS32B2RK40-FD	DS 32B RK- VARIABLE	B	\$230
DS32B2RKEXT	DS32B2RK40 EXTENSION	B	\$0
DSB2RK40EXT	DSB2RK40 EXTENSION RAIL	B	\$280
DSB2RK40-FD	DS8B/16B RK-VARIABLE	B	\$275
FC1-HSSDC-2M	2M HSSDC to HSSDC2 bus cbl Qty 1	B	\$150
FC1-HSSDC-5M	5M HSSDC to HSSDC2 bus cbl Qty 1	B	\$275
FC1-HSSDC-8M	8M HSSDC to HSSDC2 bus cbl Qty 1	B	\$500
FC2-HSSDC-2M	2M HSSDC2 to HSSDC2 bus cbl Qty 1	B	\$250
FC2-HSSDC-8M	8M HSSDC2 to HSSDC2 bus cbl Qty 1	B	\$600
FC-31-146	146GB 10K 520BPS 1GB 12V	B	\$2,050
FC-31-146UPG	146GB 10K 1Gb 520BP UPG	B	\$1,835
FC-315-36	36GB 15K, 520BPS 1	B	\$950
FC-315-36U	36GB 15K, 520BPS Upgrade	B	\$960
FC-315-73UPG	73GB 15K 12V 520BPS 1GB UPGRADE	B	\$1,790
FC-31-73	FC 73GB DRIVE 10K	B	\$1,280
FC-31-73UP	FC73GB DRIVE UPG	B	\$1,095
FC-HS2-10M	10M HSSDC to HSSDC bus cbl Qty 1	B	\$230
FC-HS2-1M	1M HSSDC to HSSDC bus cbl Qty 1	B	\$80
FC-HS2-5M	5M HSSDC to HSSDC bus cbl Qty 1	B	\$160
FC-OPT100M	100M OPTICAL CABLE	B	\$570
FC-OPT10M	10M OPTICAL CABLE	B	\$120
FC-OPT250M	250M OPTICAL CABLE	B	\$1,300

FC-OPT500M	500M OPTICAL CABLE	B	\$2,500
FC-OPT50M	50M OPTICAL CABLE	B	\$290
FC-OPT5M	5M OPTICAL CABLE	B	\$110
FLCXAF04-100	100GB FLASH FOR CX4 FASTCACHE NEW	B	\$0
FLCXAF04-100U	100GB FLASH DRIVE FOR CX4 FAST CACHE U/G	B	\$0
FLCXAF04-200	200GB FLASH FOR CX4 FASTCACHE NEW	B	\$0
FLCXAF04-200U	200GB FLASH DRIVE FOR CX4 FAST CACHE U/G	B	\$0
FLCXFC04-073	73GB FLASH DRIVE FOR CX4 FAST CACHE NEW	B	\$0
FLCXFC04-073U	73GB FLASH DRIVE FOR CX4 FAST CACHE UPG	B	\$0
FLNSAF04-100	100GB DRIVE FOR NS FASTCACHE NEW INSTAL	B	\$0
FLNSAF04100HS	3.5IN 100GB FLASH HOTSPARE FOR NS SERIES	B	\$0
FLNSAF04-100U	100GB FLASH DRIVE FOR NS FAST CACHE U/G	B	\$0
FLNSAF04-200	200GB DRIVE FOR NS FASTCACHE NEW INSTAL	B	\$0
FLNSAF04200HS	200GB FLASH DRIVE FAST CACHE HOT SPARE	B	\$0
FLNSAF04-200U	200GB FLASH DRIVE FOR NS FAST CACHE U/G	B	\$0
FLNSFC04-073	73GB FLASH DRIVE FOR NS FAST CACHE NEW	B	\$0
FLNSFC04-073U	73GB FLASH DRIVE FOR NS FAST CACHE UPGR	B	\$0
FLNSFC04-200	200GB FLASH DRIVE FOR NS FAST CACHE NEW	B	\$0
FLNSFC04-200U	200GB FLASH DRIVE FOR NS FAST CACHE UPG	B	\$0
FMAVEBDL-120	Rainfinity BNDL 8 Drives 1TB 7200rpm SAT	B	\$15,160
FMAVEBDL-480	Rainfinity BNDL 8 Drives 1TB 7200rpm SAT	B	\$15,160
FMAVEBDL-960	Rainfinity BNDL 8 Drives 1TB 7200rpm SAT	B	\$15,160
FMAVEBDL-G2	Rainfinity BNDL 8 Drives 1TB 7200rpm SAT	B	\$15,160
FMAVEBDL-G8	Rainfinity BNDL 8 Drives 1TB 7200rpm SAT	B	\$15,160
FM-LL100MD	100M MM FIBRE CABLE LC-LC	B	\$570
FM-LL10MD	10M MM FIBRE CABLE LC-LC	B	\$290
FM-LL1MD	1M MM FIBRE CABLE LC-LC	B	\$230
FM-LL30MD	30M MM FIBRE CABLE LC-LC	B	\$310
FM-LL3MD	3M MM FIBRE CABLE LC-LC	B	\$250
FM-LL50MD	50M MM FIBRE CABLE LC-LC	B	\$390
FM-LL5MD	5M MM FIBRE CABLE LC-LC	B	\$260
FM-LS100MD	100M MM FIBRE CABLE LC-SC	B	\$570
FM-LS10MD	10M MM FIBRE CABLE LC-SC	B	\$290
FM-LS1MD	1M MM FIBRE CABLE LC-SC	B	\$230
FM-LS30MD	30M MM FIBRE CABLE LC-SC	B	\$310
FM-LS3MD	3M MM FIBRE CABLE LC-SC	B	\$250
FM-LS50MD	50M MM FIBRE CABLE LC-SC	B	\$390
FM-LS5MD	5M MM FIBRE CABLE LC-SC	B	\$260
FRAME-ADJ	ADJ RACK RAIL KIT-DAE/DPE	B	\$160
FRAME-T	TELCO RAILS FOR DAE/DPE	B	\$540
FRAME-T-CS	TELCO RAIL KIT FOR NS CS	B	\$565
FRAME-T-DAE2	TELCO RAIL KIT - DAE2	B	\$340
FRAME-T-PDAE	TELCO RAIL KIT	B	\$340
FRAME-T-SPE	TELCO RAIL KIT - SPE	B	\$340
HW-INT-CAB	FACTORY RACK INSTALL FLAG	B	\$0
INV-CTL	INV CONTROLLER	B	\$20,000
INV-CTL-FD	INV CONTROLLER FLD MNT	B	\$20,000
INV-STG	INV METADATA STORAGE	B	\$7,000
INV-STG-FD	INV METADATA STG FLD MNT	B	\$7,000
M4GB-CX600	4GB CACHE UPG CX600-F INS	B	\$6,200

MODEM-ARG	MODEM FOR ARGENTINA	B	\$0
MODEM-AUS	AUSTRALIA MODEM	B	\$0
MODEM-DEN	MODEM FOR DENMARK	B	\$0
MODEM-EUR	INTER EUROPE MODEM	B	\$0
MODEM-ITA	MODEM FOR ITALY	B	\$0
MODEM-JPN	MODEM FOR JAPAN	B	\$0
MODEM-KOR	MODEM FOR KOREA	B	\$0
MODEM-SWI	MODEM FOR SWITZERLAND	B	\$0
MODEM-TAI	MODEM FOR TAIWAN	B	\$0
MODEM-UK	UNITED KINGDOM MODEM	B	\$0
NB-2G10-146	NEBS system 146GB 10K 2Gb FC	B	\$1,020
NB-2G10-146U	NEBS 146GB 10K 2Gb FC UPG	B	\$0
NB-2G10-300	NEBS system 300GB 10K 2Gb FC	B	\$0
NB-2G10-300U	NEBS 300GB 10K 2Gb FC UPG	B	\$1,980
NB-2G10-73	NEBS system 73GB 10K 2Gb FC	B	\$755
NB-2G10-73U	NEBS 73GB 10K 2Gb FC UPG	B	\$0
NB-2G15-146	NEBS 146GB 15K 2Gb FC	B	\$0
NB-2G15-146U	NEBS 146GB 15K 2Gb FC UPG	B	\$0
NB-2G15-73	NEBS 73GB 15K 2Gb FC	B	\$0
NB-2G15-73U	NEBS 73GB 15K 2Gb FC UPG	B	\$0
NB-4G10-300	300GB 10K 4GB FC NEBS	B	\$1,345
NB-4G10-300U	300GB 10K 4GB FC NEBS UPGRADE DISK DRIVE	B	\$1,980
NB-4G10-400	400GB 10K 4GB FC NEBS DISK DRIVE	B	\$0
NB-4G10-400U	400GB 10K 4GB FC NEBS UPGRADE DISK DRIVE	B	\$0
NB-4G15-146	NEBS 146GB 15K 4GB FC	B	\$0
NB-4G15-146U	NEBS 146GB 15K 4GB FC UPG	B	\$1,800
NB-4G15-300	NEBS 300GB 15K 4Gb FC	B	\$0
NB-4G15-300U	NEBS 300GB 15K 4GB FC UPG	B	\$2,154
NB-4G15-450	450GB 15K 4GB 520BPS FC NEBS DISK DRIVE	B	\$0
NB-4G15-450U	450GB 15K 4GB FC NEBS UPGRADE DISK DRIVE	B	\$2,852
NB-4G15-73	NEBS 73GB 15K 4GB FC	B	\$1,030
NB-4G15-73U	NEBS 73GB 15K 4GB FC UPG	B	\$0
NS120-1-2-U	NS-120 1 TO 2 BLADE POST INSTALL UPGRADE	B	\$0
NS120-4PDAE	4GB DAE ONE MODEL FOR NS-120. FACTORY	B	\$0
NS120-4PDAE-F	4GB DAE ONE MODEL FOR NS-120 FIELD	B	\$0
NS120-AUX	NS-120 CAPTIVE ARRAY NO FC NO ISCSI	B	\$0
NS120-AUX-CR	NS120 ARRAY NO FC. NO ISCSI PORTS. FIELD	B	\$0
NS120-AUXF	NS-120 CAPTIVE ARRAY NO ISCSI 8 FC PORTS	B	\$0
NS120-AUXF8	NS-120 ARRAY NO ISCSI. 8 8GB FC PORTS	B	\$0
NS120-AUXF8CR	NS-120 ARRAY NO ISCSI 8 8GB FC PORTS FLD	B	\$0
NS120-AUXF-CR	NS120 ARRAY NO ISCSI. 8 FC PORTS. FIELD	B	\$0
NS120C-1-2-U	NS-120 10GBE 1 BLADE TO 2 BLADE UPGRADE	B	\$0
NS120-CS	NS-120 CONTROL STATION (FACTORY INSTALL)	B	\$0
NS120-CS-FD	NS-120 CONTROL STATION (FIELD INSTALLED)	B	\$0
NS120DAE-CR	4GB DAE MODEL FOR NS-120 FIELD VAULT DAE	B	\$0
NS120-FC-IS	ADD ISCSI IO TO NS-120 FC FOR MV/A ETC	B	\$7,000
NS120-NAS-FC	NS-120 NAS VARIANT TO FC VARIANT	B	\$7,000
NS120-NAS-MIS	NS-120 NAS VARIANT TO MPFS ISCSI VARIANT	B	\$0
NS120-SPS	NS-120 OPTIONAL SECOND SPS. FACT-INSTALL	B	\$0
NS120-SPS-U	NS-120 ADDITIONAL SPS FOR FIELD UPGRADE	B	\$0

NS121-A	NS-120 INT-1DM-4GB-4 CU GIGE PORTS FACT	B	\$0
NS121-A-FD	NS-120 INT-1DM-4GB-4 CU GIGE PORTS FLD	B	\$0
NS121-C	NS120 INT-1DM-4GB-2OP 10GE 2CU 1GE FACT	B	\$0
NS121-C-FD	NS-120 INT-1DM-4GB-2 OP 10GE 2CU 1GE FLD	B	\$0
NS122-A	NS-120 INT-2DM-4GB-4 CU GIGE PORTS FACT	B	\$0
NS122-A-FD	NS-120 INT-2DM-4GB-4 CU GIGE PORTS FLD	B	\$0
NS122-C	NS120 INT-2DM-4GB-2OP 10GE 2CU 1GE FACT	B	\$0
NS122-C-FD	NS-120 INT-2DM-4GB-2 OP 10GE 2CU 1GE FLD	B	\$0
NS12-480-AUXU	NS-1202 TO NS-480 CAPTIVE ARRAY UPG	B	\$0
NS20-CS	NS20 CONTROL STATION	B	\$4,700
NS20-CSB	NS20 CONTROL STATION - FACTORY INSTALLED	B	\$0
NS20-CSB-FD	NS20 CONTROL STATION - FIELD INSTALLED	B	\$0
NS20-CS-FD	NS20 CONTROL STATION (FLD INST)	B	\$4,700
NS20DAE0105	NS20 DAE OS W 5X1000GB DISKS-FAC INST	B	\$0
NS20DAE010F5	NS20 DAE OS W 5X1000GB DISKS-FIELD INST	B	\$0
NS20DAE1465	NS20 DAE OS W 5X146GB DISKS-FAC INST	B	\$0
NS20DAE146F5	NS20 DAE OS W 5X146GB DISKS-CUST RACK	B	\$0
NS20DAE146X5	NS20 DAE OS W 5X146GB 10K FC DISKS-FACT	B	\$0
NS20DAE146XF5	NS20 DAE OS W 5X146GB 10K FC DISKS-FIELD	B	\$0
NS20DAE3005	NS20 DAE OS W 5X300GB DISKS-FAC INST	B	\$0
NS20DAE300F5	NS20 DAE OS W 5X300GB DISKS-CUST RACK	B	\$0
NS20DAE300X5	NS20 DAE OS W 5X300GB 15K FC DISKS-FACT	B	\$0
NS20DAE300XF5	NS20 DAE OS W 5X300GB 15K FC DISKS-FIELD	B	\$0
NS20DAE4005	NS20 DAE OS W 5X400GB DISKS-FAC INST	B	\$0
NS20DAE400F5	NS20 DAE OS W 5X400GB DISKS-FIELD INST	B	\$0
NS20DAE4505	NS20 DAEOS W5X450GB 15K DISKS-FACTINSTA	B	\$0
NS20DAE450F5	NS20 DAEOS 5X450GB 15K DISKS-FLD INSTALL	B	\$0
NS20DAE5005	NS20 DAE OS W 5X500GB DISKS-FAC INST	B	\$0
NS20DAE500F5	NS20 DAE OS W 5X500GB DISKS-CUST RACK	B	\$0
NS20DAE7505	NS20 DAE OS W 5X750GB ATA DISKS-FAC INST	B	\$0
NS20DAE750F5	NS20 DAE OS W 5X750GB ATA DISKS-CUSTRAC	B	\$0
NS21-22-U	NS21 TO NS22 HW FIELD UPGRADE	B	\$0
NS21C-A	NS20 INT-1DM-4GB-4 CU GIGE PORTS	B	\$0
NS21C-A-FD	NS20 INT-1DM-4GB-4 CU GIGE PORTS FLD	B	\$0
NS22C-A	NS20 INT-2DM-4GB-4 CU GIGE PORTS	B	\$0
NS22C-A-FD	NS20 INT-2DM-4GB-4 CU GIGE PORTS FLD	B	\$0
NS2-40-AUXF-U	CONVERT NS20 TO NS40F	B	\$0
NS2-AUX	NS20 CAPTIVE ARRAY-EMC RACK-NO AVAIL FC	B	\$0
NS2-AUXBCR	NS20 CAPTIVE ARRAY XPE-CUST RACK-NEW GA	B	\$0
NS2-AUXF	NS20 CAPTIVE ARRAY XPE-EMC RACK-8 AVAIL	B	\$0
NS2-AUXFBCR	NS20 XPE-CUST RACK-8 FC-NEW GNG RAIL	B	\$0
NS2-AUXF-UPG	NS20 POST INSTALL UPG ADD 8 FC HOSTPORTS	B	\$0
NS-2G10-146	146GB 10K 520BPS 2GB 12V	B	\$1,020
NS2G10-146-HS	NS600 10K 146GB HOT SPARE	B	\$1,020
NS-2G10-146U	146GB 10K 520BPS 2GB 12V	B	\$1,375
NS-2G10-300	300GB FC 10K 2GB	B	\$0
NS2G10-300-HS	NS 10K 300GB HOT SPARE	B	\$0
NS-2G10-300U	300GB FC 10K 2GB UPG	B	\$0
NS-2G10-73	CHV 73GB 10K 520BPS 12V 2	B	\$0
NS2G10-73-HS	NS600 10K73GB HOT SPARE	B	\$0

NS-2G10-73U	CHV 73GB 10K 520BPS 12V 2	B	\$1,020
NS-2G15-146	146GB 15K 520BPS 2GB 12V	B	\$1,330
NS2G15-146-HS	NS HOT SPARE 146GB 15K FC	B	\$0
NS-2G15-146U	146GB FC 15K 2GB 520BPS	B	\$0
NS-2G15-36	X15-2 36GB 15K 520BPS 12V	B	\$685
NS2G15-36-HS	NS600 15K 36GB HOT SPARE	B	\$685
NS-2G15-36U	36GB 15K 520BPS 12V	B	\$925
NS-2G15-73	73GB 15K 12V 520BPS 2GB	B	\$1,030
NS2G15-73-HS	73GB 15K 12V 520BPS 2GB	B	\$0
NS-2G15-73U	73GB 15K 12V 520BPS 2GB U	B	\$0
NS-2G72-500	500GB 7200RPM 2GB FC DISK	B	\$0
NS-2G72-500HS	500GB 7200RPM 2GB FC HS	B	\$0
NS-2G72-500U	500GB 7200RPM 2GB FC UPG	B	\$0
NS-2GDAE	2GB DAE EXP FOR NS	B	\$5,900
NS-2GDAE-70	CX700 DAE EXP W FLARE OS	B	\$5,900
NS-2GDAE-70FD	CX700 DAE WFLAREOS FIELD	B	\$5,900
NS-2GDAE-FD	NS-DAE 2GB EXP-FLD INSTL	B	\$5,900
NS-2GDAE-OS	2GB DAE EXP WFLAREOS	B	\$5,900
NS-2GDAE-OSFD	2GB DAE EXP WFLAREOS FIEL	B	\$5,900
NS-2PDAE	CX DAE FC 2GB EXPANSION	B	\$0
NS-2PDAE-70	STILETTO DAE EXP W FLARE	B	\$0
NS-2PDAE-70FD	NS700-AUX 2G FC DAE W/FLA	B	\$0
NS-2PDAE-74	STILETTO DAE EXP W FLARE	B	\$0
NS-2PDAE-FD	CX DAE FC 2GB EXPANSION	B	\$0
NS351-352-UPG	NS350 UPGRADE FROM 1-2 DM	B	\$0
NS40-AUX	NS40 ARRAY RACK REQ	B	\$0
NS40-AUXC	NS40 COMBO ARRAY RACK REQ FOR MPFS	B	\$0
NS40-AUXC-FD	NS40 COMBO ARRAY FIELD INSTALL FOR MPFS	B	\$0
NS40-AUXDC-FD	NS40 ARRAY FLD INSTALL DC	B	\$11,420
NS40-AUXF	NS40F ARRAY 8 FC	B	\$0
NS40-AUXFB-CR	NS40 CAPTIVE ARRAY W SAN FC. CUST RACK.	B	\$0
NS40-AUX-FD	NS40 ARRAY FIELD INSTALL	B	\$0
NS40-CS	NS40 CONTROL STATION	B	\$4,700
NS40-CSB	NS40 CONTROL STATION - FACTORY INSTALLE	B	\$0
NS40-CSB-FD	NS40 CONTROL STATION - FIELD INSTALLED	B	\$0
NS40-CS-DC-FD	NS40 CTRL STATION FLD DC	B	\$5,370
NS40-CS-FD	NS CONTROL STATION FLD	B	\$4,700
NS40F-CS	NS40F CTRL STATION	B	\$4,700
NS40F-CSB	NS40F CONTROL STATION	B	\$0
NS40F-CSB-FD	NS40F CONTROL STATION - FIELD INSTALLED	B	\$0
NS40F-CS-FD	NS40F CTRL STATION FLD	B	\$4,700
NS40-NS40FC-U	NS40 AUX TO AUXF UPG	B	\$0
NS41-42-A-U	NS40 1-2 DM 4 IO UPG	B	\$0
NS41-42-B-U	NS40 1-2 DM 2/2 IO UPG	B	\$0
NS41C-A	NS40 INT-1DM-4GB-4-IO	B	\$0
NS41C-A-FD	NS40 FLD-1DM-4GB-4-IO	B	\$0
NS41C-B	NS40 INT-1DM-4GB-2/2-IO	B	\$0
NS41C-B-FD	NS40 FLD-1DM-4GB-2/2-IO	B	\$0
NS41C-DC-A-FD	NS40 FLD-1DM-4GB-4-IO DC	B	\$11,400
NS41C-DC-B-FD	NS40 FLD-1DM-4GB-2/2IO DC	B	\$11,400

NS41F-A	NS40 1DM-4GB-4-IO-8-FC	B	\$0
NS41F-A-FD	NS40 FLD-1DM-4GB-4-IO -8-FC	B	\$0
NS41F-B	NS40 1DM-4GB-2/2IO-8-FC	B	\$0
NS41F-B-FD	NS40 FLD-1DM-4GB-2/2IO-8-FC	B	\$0
NS41G-42G-A-U	NS40G 1-2 DM 4 IO UPG	B	\$0
NS41G-42G-B-U	NS40G 1-2 DM 2/2 IO UPG	B	\$0
NS41G-A	NS40G 1DM-4GB-4-IO	B	\$0
NS41G-A-FD	NS40G FLD-1DM-4GB-4-IO	B	\$0
NS41G-B	NS40G 1DM-4GB-2/2-IO	B	\$0
NS41G-B-FD	NS40G FLD-1DM-4GB-2/2IO	B	\$0
NS41G-DC-A-FD	NS40G FLD-1DM-4GB-4-IO DC	B	\$28,900
NS41G-DC-B-FD	NS40G FLD1DM-4GB-2/2IO DC	B	\$28,900
NS42C-A	NS40 INT-2DM-4GB-4-IO	B	\$0
NS42C-A-FD	NS40 FLD-2DM-4GB-4-IO	B	\$0
NS42C-B	NS40 INT-2DM-4GB-2/2-IO	B	\$0
NS42C-B-FD	NS40 FLD-2DM-4GB-2/2-IO	B	\$0
NS42C-DC-A-FD	NS40 FLD-2DM-4GB-4-IO DC	B	\$33,515
NS42C-DC-B-FD	NS40 FLD-2DM-4GB-2/2IO DC	B	\$33,515
NS42F-A	NS40 2DM-4GB-4-IO -8-FC	B	\$0
NS42F-A-FD	NS40 FLD-2DM-4GB-4-IO -8-FC	B	\$0
NS42F-B	NS40 2DM-4GB-2/2IO-8-FC	B	\$0
NS42F-B-FD	NS40 FLD-2DM-4GB-2/2IO-8-FC	B	\$0
NS42G-A	NS40G 2DM-4GB-4-IO	B	\$0
NS42G-A-FD	NS40G FLD-2DM-4GB-4-IO	B	\$0
NS42G-B	NS40G 2DM-4GB-2/2-IO	B	\$0
NS42G-B-FD	NS40G FLD-2DM-4GB-2/2IO	B	\$0
NS42G-DC-A-FD	NS40G FLD-2DM-4GB-4-IO DC	B	\$43,550
NS42G-DC-B-FD	NS40G FLD2DM-4GB-2/2IO DC	B	\$43,550
NS42U-DAEPAIR	TWO NS-4PDAE FOR USE WITH NS42U RACK	B	\$0
NS4-4PDAE	4G DAE FACTORY OR FIELD INSTALL	B	\$0
NS480-4PDAE	4GB DAE ONE MODEL FOR NS-480 FACTORY	B	\$0
NS480-4PDAE-F	4GB DAE ONE MODEL FOR NS-480 FIELD	B	\$0
NS480A-2-4-U	NS-480A 2 BLADE TO 4 BLADE UPGRADE	B	\$0
NS480-AUX	NS-480 CAPTIVE ARRAY NO FC/ISCSI. FACTOR	B	\$0
NS480-AUX-CR	NS-480 CAPTIVE ARRAY NO FC NO ISCSI FLD	B	\$0
NS480-AUXI-CR	NS480 ARRAY NO FC 12 ISCSI PORTS FL	B	\$26,950
NS480-AUX-U	NS-480 CAPTIVE ARRAY NO FC NO ISCSI UPG	B	\$0
NS480B-2-4-U	NS-480B 2 BLADE TO 4 BLADE UPGRADE	B	\$0
NS480C-2-4-U	NS480 2BLADE TO 4BLADE UPG FOR 10G BLADE	B	\$0
NS480-CS	NS-480 CONTROL STATION	B	\$0
NS480-CS-FD	NS-480 CONTROL STATION (FIELD INSTALLED)	B	\$0
NS480DAE-CR	4GB DAE MODEL FOR NS-480 FIELD VAULT DAE	B	\$0
NS480-FC-IS	ADD ISCSI IO TO NS-480 FC FOR MV/A ETC	B	\$0
NS480-NAS-FC	NS-480 NAS VARIANT TO FC VARIANT	B	\$0
NS480-NAS-MIS	NS-480 NAS VARIANT TO MPFS ISCSI VARIANT	B	\$0
NS4824-A	NS480 20F4DM-4GB-4CU GIGE PORTS FACT	B	\$0
NS4824-A-FD	NS480 20F4DM-4GB-4 CU GIGE PORTS FLD	B	\$0
NS4824-B	NS480 20F4DM-4GB-4 OPT/CU GIGE PORTSFAC	B	\$0
NS4824-B-FD	NS480 20F4DM-4GB-4 OPT/CU GIGE PORT FLD	B	\$0
NS4824-C	NS480 20F4DM-4GB-2OPT 10GE 2 CU 1GE FACT	B	\$0

NS4824-C-FD	NS480 20F4DM-4GB-2OPT 10GE 2CU 1GE FLD	B	\$0
NS482-A	NS-480 INT-2DM-4GB-4 CU GIGE PORTS FACT	B	\$0
NS482-A-FD	NS-480 INT-2DM-4GB-4 CU GIGE PORTS FLD	B	\$0
NS482-B	NS480 2DM-4GB-4 OPT/CU GIGE PORTS FACT	B	\$0
NS482-B-FD	NS480 INT-2DM-4GB-4 OPT/CU GIGE (FIELD)	B	\$0
NS482-C	NS480 INT-2DM-4GB-2OPT 10GE 2CU 1GE FACT	B	\$0
NS482-C-FD	NS-480 INT-2DM-4GB-2OPT 10GE 2CU 1GE FLD	B	\$0
NS484-A	NS480 INT-4DM-4GB-4 CU GIGE PORTS FACT	B	\$0
NS484-A-FD	NS-480 INT-4DM-4GB-4 CU GIGE PORTS FLD	B	\$0
NS484-B	NS480 4DM-4GB-4 OPT/CU GIGE PORTS FACT	B	\$0
NS484-B-FD	NS480 INT-4DM-4GB-4 OPT/CU GIGE (FIELD)	B	\$0
NS484-C	NS480 INT-4DM-4GB-2OPT 10GE 2CU 1GE FACT	B	\$0
NS484-C-FD	NS480 INT-4DM-4GB-2OPT 10GE 2 CU 1GE FLD	B	\$0
NS-4G10-300	300GB 10K 520BPS 5/12V 4GB FC 16MB -R	B	\$1,345
NS-4G10-300HS	300GB 10K 520BPS 5/12V 4GB FC 16MB -R HS	B	\$0
NS-4G10-300U	300GB 10K 520BPS 5/12V 4GB FC 16MB-R UPG	B	\$0
NS-4G10-400	DISK 400GB 10K 520BPS 12V 4GB FC 16MB	B	\$1,850
NS-4G10-400HS	ASSY 400GB10K 520BPS 12V 4GB FC 16MB HS	B	\$0
NS-4G10-400U	DISK 400GB10K 520BPS 12V 4GB FC 16MB UPG	B	\$0
NS-4G10-450	450GB 10K FC DRIVE 520BPS 5/12V 4GB 16MB	B	\$0
NS-4G10-450HS	450GB10KFC 520BPS 5/12V 4GB 16MB HOTSPR	B	\$0
NS-4G10-450U	450GB 10K RPM 4GB FC DRIVE	B	\$0
NS-4G10-600	600GB 10K FC DRIVE 520BPS 5/12V 4GB 16MB	B	\$0
NS-4G10-600HS	600GB10KFC 520BPS 5/12V 4GB 16MB HOTSPR	B	\$0
NS-4G10-600U	600GB 10K RPM 4GB FC DRIVE	B	\$0
NS4G10S-600TU	600GB 10K SAS-FC UPGRADE DISK DRIVE NS	B	\$0
NS-4G10S-600U	600GB 10K SAS-FC UPGRADE DISK DRIVE NS	B	\$0
NS-4G15-146	146GB 15K 520BPS 4GB	B	\$0
NS-4G15-146HS	146GB 15K 520BPS 4GB HS	B	\$0
NS-4G15-146U	146GB 15K 4GB FC DISK UPG	B	\$1,800
NS-4G15-300	300GB 15K 4GB FC 520BPS	B	\$0
NS-4G15-300HS	300GB 15K 4GB FC 520BPS HS	B	\$0
NS-4G15-300TU	300GB 15K 4GB FC 520BPS UPG	B	\$0
NS-4G15-300U	300GB 15K 4GB FC 520BPS UPG	B	\$0
NS-4G15-450	450GB 15K 520BPS 12V 4GB FC	B	\$0
NS-4G15-450HS	450GB 15K 520BPS 12V 4GB FC HS	B	\$0
NS-4G15-450TU	450GB 15K 4GB FC 520BPS UPG	B	\$0
NS-4G15-450U	450GB 15K 520BPS 12V 4GB FC UPG	B	\$0
NS-4G15-600	600GB 15K 4G FC NAS DISK DRIVE	B	\$0
NS-4G15-600HS	600GB 15K 4G FC NAS DISK DRIVE HOT SPARE	B	\$0
NS-4G15-600TU	600GB 15K 4GB FC 520BPS UPG	B	\$0
NS-4G15-600U	600GB 15K 4G FC NAS DISK DRIVE UPGRADE	B	\$0
NS-4G15-73	73GB 15K 520BPS 4GB	B	\$1,030
NS-4G15-73HS	73GB 15K 520BPS 4GB HS	B	\$0
NS-4G15-73U	73GB 15K 4GB FC DISK UPG	B	\$0
NS4-LP010-15	DAE WITH 15 1 TB SATA 5400 RPM DRIVES	B	\$0
NS4-LP010-15U	DAE WITH 15 1 TB SATA 5400 RPM DRIVE UPG	B	\$0
NS-4PDAE	NS INT EXP DAE	B	\$0
NS-4PDAE-40	NS40 INT VAULT DAE	B	\$0
NS-4PDAE-40FD	NS40 FLD VAULT DAE	B	\$0

NS-4PDAE-80	NS80 DAE OS FAC INSTALL	B	\$0
NS-4PDAE-80FD	NS80 DAE OS FLD INSTALL	B	\$0
NS-4PDAE-CR	4G DAE FIELD INSTALL	B	\$0
NS-4PDAE-FD	NS FLD EXP DAE	B	\$0
NS501-501G-U	1DM NS500 INT TO GTWY UPG	B	\$0
NS501-502-UPG	NS500 UPGRADE FROM 1-2 DM	B	\$0
NS501-701G-U	1DM NS500 TO 700/CX500 UP	B	\$0
NS501G-502G-U	NS500 GTWY 1-2 DM UPGR	B	\$0
NS501G-701G-U	1DM NS500G TO NS700G UPG	B	\$0
NS502-502G-U	2DM NS500 INT TO GTWY UPG	B	\$0
NS502-702G-U	2DM NS500 TO 700/CX500 UP	B	\$0
NS502G-42G-U	2DM NS500G TO NS40G UPG	B	\$0
NS502G-702G-U	2DM NS500G TO NS700G UPG	B	\$0
NS601-601G-U	NS601 UPG TO GATEWAY	B	\$0
NS601-602-UPG	NS600 UPGRADE FROM 1-2 DM	B	\$0
NS601G-602G-U	NS600G UPGRADE FROM 1-2 D	B	\$0
NS601G-701G-U	1DM UPG NS600 TO NS70	B	\$0
NS602-602G-U	NS602 UPG TO GATEWAY	B	\$0
NS602-702-UPG	NS600-NS700 UPG - 2 DM	B	\$0
NS602G-702G-U	2DM UPG NS600 TO NS700	B	\$0
NS701-2-A-UPG	NS700 1-2 DM NEW UPGR	B	\$0
NS701-701G-U	NS701 INT TO GTWY CONVERT	B	\$0
NS701-702-UPG	NS700 UPGRADE FROM 1-2 DM	B	\$0
NS701-CA-U	NS700 1DM-UPG TO 6/2 IO	B	\$0
NS701G-2G-A-U	NS700 GTWY 1-2 DM NEW UPG	B	\$0
NS701G-702G-U	NS700G UPG FROM 1-2 DMS	B	\$0
NS701G-GA-U	NS700G 1DM-UPG TO 6/2 IO	B	\$0
NS702-702G-U	NS702 INT TO GTWY CONVERT	B	\$0
NS702-CA-U	NS700 2DM-UPG TO 6/2 IO	B	\$0
NS702G-GA-U	NS700G 2DM-UPG TO 6/2 IO	B	\$0
NS80-AUX	NS80 ARRAY RACK REQ	B	\$0
NS80-AUX-FC	NS80 ARRAY 2 FC	B	\$0
NS80-AUX-FD	NS80 ARRAY FLD INSTALL	B	\$0
NS80CDM0-4A	NS80 XB60: 4GB6CU+2OP INT FACT	B	\$0
NS80CDM0-4AFD	NS80 XB60: 4GB6CU+2OP INT FLD INST	B	\$0
NS80CDM0-4A-U	NS80 XB60: 4GB6CU+2OP INT UPG	B	\$0
NS80CDM1-4C	NS80 XB65: 4GB4GB MIM;6CU+2OP GIGE+1X10	B	\$0
NS80CDM1-4CFD	NS80 4GB4GB 6CU+2OP GIGE 1X10 GIGE FLD	B	\$0
NS80CDM1-4C-S	NS80 XBLADE60 TO XBLADE 65 UPGRADE	B	\$0
NS80CDM1-4C-U	NS80 4GB4GB 6CU+2OP GIGE 1X10 GIGE UG	B	\$0
NS80CDME60	NS80 INT ENCL WITH 2 XB60 FACTORY	B	\$0
NS80CDME60-FD	NS80 INT ENCL WITH 2 XB60 FLD INST	B	\$0
NS80CDME65	NS80 INT ENCL WITH 2 XB65 FACTORY	B	\$0
NS80CDME65-FD	NS80 INT ENCL WITH 2 XB65 FLD INST	B	\$0
NS80-CS	NS80 CONTROL STATION FACTORY PRIMARY	B	\$0
NS80-CS2	NS80 CONTROL STATION FACTORY 2ND	B	\$0
NS80-CS2-FD	NS80 CONTROL STATION FLD 2ND	B	\$0
NS80-CS-FD	NS80 CONTROL STATION FLD PRIMARY	B	\$0
NS80-DME0	NS80 ENCLOSURE FACTORY	B	\$0
NS80-DME0-FD	NS80 ENCLOSURE FLD INSTALL	B	\$0

NS80GDM0-4A	NS80 XB60: 4GB6CU+2OP GW FACT	B	\$0
NS80GDM0-4AFD	NS80 XB60: 4GB6CU+2OP GW FLD INST	B	\$0
NS80GDM0-4A-U	NS80 XB60: 4GB6CU+2OP GW UPG	B	\$0
NS80GDM1-4C	NS80 XB65: 4GB4GB MIM;6CU+2OP GIGE+1X10	B	\$0
NS80GDM1-4CFD	NS80 4GB4GB 6CU+2OP GIGE 1X10 GIGE FLD	B	\$0
NS80GDM1-4C-S	NS80G XBLADE60 TO XBLADE 65 UPGRADE	B	\$0
NS80GDM1-4C-U	NS80 4GB4GB 6CU+2OP GIGE 1X10 GIGE UG	B	\$0
NS80GDME60	NS80 GW ENCL WITH 2 XB60 FACTORY	B	\$0
NS80GDME60-FD	NS80 GW ENCL WITH 2 XB60 FLD INST	B	\$0
NS80GDME65	NS80 GW ENCL WITH 2 XB65 FACTORY	B	\$0
NS80GDME65-FD	NS80 GW ENCL WITH 2 XB65 FLD INST	B	\$0
NS-8GFC-SFP	SINGLE 8G FC SFP	B	\$0
NS960-AUX	NS-960 ARRAY 8FC	B	\$0
NS960-AUX8	NS-960 ARRAY 8 8GBFC	B	\$0
NS960-CSB	NS-960 CONTROL STATION FACTORY PRIMARY	B	\$0
NS960-CSB2	NS-960 CONTROL STATION FACTORY 2ND	B	\$0
NS960DM-8A	NS-960 A BLADE; 8GB MEM 8 GBE 4 FC	B	\$0
NS960DM-8A1	NS-960 A1 BLADE; 8GB MEM 16 GBE 4 FC	B	\$0
NS960DM-8A2	NS-960 A2 BLD 8GB MEM 4GBE ONE 10GBE OPT	B	\$0
NS960DM-8B	NS960 B BLD 8GB MEM 4GBE CU 4 GBE OP 4FC	B	\$0
NS960DM-8B1	NS-960B1 8GB MEM 8 GBE CU 8 GBE OP 4 FC	B	\$0
NS960DM-8C	NS-960 C BLADE; 8GB MEM 2 10GBE OP 4 FC	B	\$0
NS960DM-8C1	NS-960 C1 BLADE; 8GB MEM 4 10GBE OP 4 FC	B	\$0
NS960DM-8C3	NS960 8GBMEM 2 10GBEOP 4GBECU 4GBEOP 4	B	\$0
NS960DM-8C5	NS960 C5 8GB MEM 2 10GBE OP 8 GBE CU 4FC	B	\$0
NS960DM-8D	NS-960 D BLADE; 8GB MEM 8 GBE 4 8GBFC	B	\$0
NS960DM-8D1	NS-960 D1 BLADE; 8GB MEM 16 GBE 4 8GBFC	B	\$0
NS960DM-8E	NS960 8GB MEM 4 GBE CU 4 GBE OP 4 8GBFC	B	\$0
NS960DM-8E1	NS960 8GB MEM 8 GBE CU 8 GBE OP 4 8GBFC	B	\$0
NS960DM-8F	NS-960 F BLADE; 8GB MEM 2 10GBE OP 4 FC	B	\$0
NS960DM-8F1	NS-960 F1 BLADE; 8GB MEM 4 10GBE OP 4 FC	B	\$0
NS960DM-8F3	NS960 8GBMEM 2 10GBEOP 4GBECU 4GBEOP 4	B	\$0
NS960DM-8F5	NS960 F5 8GB MEM 2 10GBE OP 8 GBE CU 4FC	B	\$0
NS960-DME0	NS-960 INITIAL ENCLOSURE ONE REQUIRED	B	\$0
NS960-DME1	NS-960 ENCLOSURE	B	\$0
NS960-DM-F4	NS-960 BASE BLADE; 8GB MEM; 4 PORT 4G FC	B	\$0
NS960-DM-F4U	NS960 8GB MEM 4 PORTS 4GFC UPG	B	\$0
NS960-DM-F8	NS-960 BASE BLADE; 8GB MEM; 4 PORT 8G FC	B	\$0
NS960-DM-F8U	NS960 8GB MEM 4 PORTS 8GFC UPG	B	\$0
NS960I-DME0	NS-960 ISCSI INITIAL ENCL ONE REQUIRED	B	\$0
NS96-CSB2-U	NS-960 CONTROL STATION UPGRADE	B	\$0
NS96-DM-8A1-U	NS-960 A1 BLADE; 8GB MEM 4 GBE 16 FC	B	\$0
NS96-DM-8A2-U	NS960 A2 8GB MEM 4 GBE ONE 10GBE OPT UPG	B	\$0
NS96-DM-8A-U	NS-960 A BLADE; 8GB MEM 4GBE 8FC UPGRADE	B	\$0
NS96-DM-8B1-U	NS960 8GBMEM 8GBE CU 8 GBE OP 4 FC UPG	B	\$0
NS96-DM-8B-U	NS960 8GB MEM 4 GBECU 4 GBEOP 4 FC UPG	B	\$0
NS96-DM-8C1-U	NS-960 C1 BLADE; 8GB MEM 4 10GBE OP 4 FC	B	\$0
NS96-DM-8C3-U	NS960 8GB MEM 2 10GBEOP 4GBECU 4GBE OP4	B	\$0
NS96-DM-8C5-U	NS960 8GB MEM 2 10GBE OP 8 GBE CU 4 FC U	B	\$0
NS96-DM-8C-U	NS960 8GB MEM 2 10GBE OP 4FC U/G	B	\$0

NS96-DM-8D1-U	NS-960 D1 BLADE; 8GBMEM 16GBE 4 8GBFC UP	B	\$0
NS96-DM-8D-U	NS-960 D BLADE 8GB MEM 8 GBE 4 8GBFC UPG	B	\$0
NS96-DM-8E1-U	NS960 8GB MEM 8 GBECU 8 GBEOP 4 8GBFC U	B	\$0
NS96-DM-8E-U	NS960 8GB MEM 4 GBECU 4 GBEOP 4 8GBFC UP	B	\$0
NS96-DM-8F1-U	NS960 F1 BLADE 8GBMEM 4 10GBE OP 4FC UPG	B	\$0
NS96-DM-8F3-U	NS960 8GBMEM 2 10GBEOP 4GBECU 4GBEOP 4	B	\$0
NS96-DM-8F5-U	NS960 8GB MEM 2 10GBEOP 8 GBECU 4FC UPG	B	\$0
NS96-DM-8F-U	NS-960 F BLADE 8GBMEM 2 10GBE OP 4FC UPG	B	\$0
NS96-DME1-U	NS-960 ENCLOSURE UPG	B	\$0
NS-AF04-100	100GB 3.5 520BPS FLASH DRIVE 4GB FC	B	\$0
NS-AF04-100HS	100GB 3.5IN 4GB FLASH DRIVE HOT SPARE	B	\$0
NS-AF04-100U	100GB 3.5IN 520BPS FLASH 4GB FC U/G	B	\$0
NS-AF04-200	200GB 3.5 520BPS FLASH DRIVE 4GB FC	B	\$0
NS-AF04-200HS	200GB 520BPS DRIVE 4GB FC HOT SPARE	B	\$0
NS-AF04-200U	200GB 3.5IN 520BPS FLASH 4GB FC U/G	B	\$0
NS-AT05-250	250GB PATA 5400RPM	B	\$950
NS-AT05-250U	250GB PATA 5400RPM	B	\$1,280
NS-AT05-320	320GB 5400RPM PATA	B	\$950
NS-AT05-320U	320GB 5400RPM PATA UPG	B	\$1,280
NS-AT07-010	ASSY DISK 1000GB 7.2K 512BPS SATA 3GB 32	B	\$1,440
NS-AT07-010HS	ASSY DISK 1000GB 7.2K 512BPS SATA 3GB 32	B	\$1,440
NS-AT07-010U	ASSY DISK 1000GB 7.2K 512BPS SATA 3GB 32	B	\$1,790
NS-AT07-250	250GB 7200RPM ATA DRIVE	B	\$950
NS-AT07-250U	250GB 7200RPM ATA DRIVE	B	\$1,280
NS-AT07-500	500GB 7200RPM SATA DISK	B	\$1,330
NS-AT07-500U	500GB SATA UPGRADE	B	\$1,795
NS-AT07-750	750GB 7200RPM SATA II 512BPS KLONDIKE	B	\$1,895
NS-AT07-750HS	750GB 7200RPM SATA II 512BPS KLONDIKE HS	B	\$1,895
NS-AT07-750U	750GB 7200RPM SATA II 512BPS KLONDIKE UP	B	\$2,558
NSB2G10-146	NEBS 146GB 10K 2GB FC	B	\$1,020
NSB2G10-146HS	NEBS 146GB 10K 2GB FC HS	B	\$1,020
NSB2G10-146U	NEBS 146GB 10K 2GB FC UPG	B	\$0
NSB2G10-300	NEBS 300GB 10K 2GB FC	B	\$0
NSB2G10-300HS	NEBS 300GB 10K 2GB FC HS	B	\$0
NSB2G10-300U	NEBS 300GB 10K 2GB FC UPG	B	\$0
NSB4G15-146	NEBS 146GB 15K 4GB FC	B	\$1,330
NSB4G15-146HS	NEBS 146GB 15K 4GB FC HS	B	\$1,330
NSB4G15-146U	NEBS 146GB 15K 4GB FC UPG	B	\$1,800
NSB4G15-73	NEBS 73GB 15K 4GB FC	B	\$0
NSB4G15-73HS	NEBS 73GB 15K 4GB FC HS	B	\$0
NSB4G15-73U	NEBS 73GB 15K 4GB FC UPG	B	\$0
NS-CS	1 CS NS500/NS700 EMC Rack	B	\$0
NS-CS-2	2nd CS NS704 EMC Rack	B	\$0
NS-CS-2-FD	2nd CS NS704 Fld Inst	B	\$0
NS-CS-2-U	2nd CS add-on for NS704	B	\$0
NS-CSB	GATEWAY CONTROL STATION SERIES B	B	\$0
NS-CSB2	GATEWAY C-STATION SERIES B - SECONDARY	B	\$0
NS-CSB2-U	SECOND CONT-STATION ADD-ON FOR CELERR	B	\$0
NS-CSFD	1 CS NS500/NS700 Fld Inst	B	\$0
NSD480-AUX	NS-480 DENSE ARRAY NO FC/ISCSI FACT	B	\$0

NSD480-CS	NS-480 DENSE CONTROL STATION	B	\$0
NSD4824-A	NS480 DENSE 2OF4DM-4GB-4 CU GIGE FACT	B	\$0
NSD4824-B	NS480DENSE 2OF4DM-4GB-4 OPT/CU GIGE	B	\$0
NSD4824-C	NS480DENSE 2OF4DM-4GB-2OPT10GE2CU1GE	B	\$0
NSD482-A	NS480DENSE 2DM-4GB-4 CU GIGE PORTS	B	\$0
NSD482-B	NS480DENSE 2DM-4GB-4 OPT/CU GIGE FACT	B	\$0
NSD482-C	NS480DENSE 2DM-4GB-2OPT 10GE 2CU1GE	B	\$0
NSD484-A	NS480DENSE 4DM-4GB-4 CU GIGE PORTS	B	\$0
NSD484-B	NS480DENSE 4DM-4GB-4 OPT/CU GIGE FACT	B	\$0
NSD484-C	NS480DENSE 4DM-4GB-2OPT 10GE 2CU1GE	B	\$0
NSD4PDAE-40FD	NS40-FLD-VAULT-DAE DC	B	\$0
NSD4PDAE-FD	NS40-FLD-EXP-DAE DC	B	\$0
NSD960-AUX	NS-960 DENSE AUX CHASSIS	B	\$0
NSD960-AUX8	NS-960 DENSE AUX CHASSIS	B	\$0
NSD960-CSB	DENSE NS-960 PRIMARY CONTROL STATION	B	\$0
NSD960-CSB2	DENSE NS-960 CONTROL STATION 2	B	\$0
NSD960-DME0	NS960 DENSE INT INITIAL D-MOVER ENCL-0	B	\$0
NSD960-DME1	NS960 DENSE INT DATAMOVER ENCLOSURE 1	B	\$0
NSDAE10146OS	NS600 DAE W-OS 5-10K146GB	B	\$13,900
NSDAE10146OSF	NS600 DAE W-OS 5-10K146GB	B	\$13,900
NSDAE1073OS	NS600 DAE W-OS 5-10K73GB	B	\$10,550
NSDAE1073OSFD	NS600 DAE W-OS 5-10K73GB	B	\$10,550
NSDAE1536OS	NS600 DAE W-OS 5-15K36GB	B	\$9,750
NSDAE1536OSFD	NS600 DAE W-OS 5-15K36GB	B	\$9,750
NSDAE1573OS	NS600 DAE W-OS 5-15K73GB	B	\$13,700
NSDAE1573OSFD	NS600 DAE W-OS 5-15K73GB	B	\$13,700
NS-FC04-073	73GB 4GB FIBRE CHANNEL EFD	B	\$0
NS-FC04-073HS	73GB 4GB FIBRE CHANNEL EFD HS	B	\$0
NS-FC04-073U	73GB 4GB FIBRE CHANNEL EFD UPGRADE	B	\$0
NS-FC04-200	200GB 4GB FIBRE CHANNEL EFD	B	\$0
NS-FC04-200HS	200GB 4GB FIBRE CHANNEL EFD HS	B	\$0
NS-FC04-200U	200GB 4GB FIBRE CHANNEL EFD UPG	B	\$0
NS-FC04-400	400GB 4GB FIBRE CHANNEL EFD	B	\$0
NS-FC04-400HS	400GB 4GB FIBRE CHANNEL EFD HS	B	\$0
NS-FC04-400U	400GB 4GB FIBRE CHANNEL EFD UPG	B	\$0
NSG2-1-2-A-U	NS-G2 1 TO 2 BLADE UPG 4 PORT 1GBE CU	B	\$0
NSG2-1-2-B-U	NSG2 1TO2 BLADE UPG 2X 1GBECU 2X 1GBEOF	B	\$0
NSG2-1-2-C-U	NS-G2 1TO2 BLADE UG 2X1GBE CU 2X10GBE OF	B	\$0
NSG2-1A	NS-G2 1DM 4GB 4 IO	B	\$0
NSG2-1A-FD	NS-G2 1DM 4GB 4 IO FLD	B	\$0
NSG2-1B	NS-G2 1DM 4GB 4 IO FLD	B	\$0
NSG2-1B-FD	NS-G2 1DM 4GB 2/2 1GIO FLD	B	\$0
NSG2-1C	NS-G2 1DM 4GB 2X10G OP / 2X1G CU IO	B	\$0
NSG2-1C-FD	NS-G2 1DM 4GB 2X10G OP / 2X1G CU IO FLD	B	\$0
NSG2-2A	NS-G2 2DM 4GB 4X1G CU IO	B	\$0
NSG2-2A-FD	NS-G2 2DM 4GB 4X1G CU IO FLD	B	\$0
NSG2-2B	NS-G2 2DM 4GB 2X1G OP / 2X1G CU IO	B	\$0
NSG2-2B-FD	NS-G2 2DM 4GB 2X1G OP / 2X1G CU IO FLD	B	\$0
NSG2-2C	NS-G2 2DM 4GB 2X10G OP / 2X1G CU IO	B	\$0
NSG2-2C-FD	NS-G2 2DM 4GB 2X10G OP / 2X1G CU IO FLD	B	\$0

NSG2-CS	NS-G2 CONTROL STATION	B	\$0
NSG2-CS-FD	NS-G2 CONTROL STATION (FIELD INSTALL)	B	\$0
NSG2-VG2-UPG	NSG2 TO VG2 CONVERSION	B	\$0
NSG41-2-DC-AU	NS40G DC 1-2 DM 4 IO UPG	B	\$0
NSG41-2-DC-BU	NS40G DC 1-2 DM 2/2 IO UPG	B	\$0
NSG8-CSB	NS-G8 CONTROL STATION FACTORY PRIMARY	B	\$0
NSG8-CSB2	NS-G8 CONTROL STATION FACTORY 2ND	B	\$0
NSG8-CSB2-U	NS-G8 CONTROL STATION UPGRADE	B	\$0
NSG8-DM-8A	NS-G8 A BLADE; 8GB MEM 8 GBE 4 FC	B	\$0
NSG8-DM-8A1	NS-G8 A1 BLADE; 8GB MEM 16 GBE 4 FC	B	\$0
NSG8-DM-8A1-U	NS-G8 A1 BLADE; 8GB MEM 16 GBE 4 FC	B	\$0
NSG8-DM-8A2	NS-G8 A2 BLD 8GB MEM 4 GBE ONE 10GBE OPT	B	\$0
NSG8-DM-8A2-U	NS-G8 A2 8GB MEM 4 GBE ONE 10GBE OPT UG	B	\$0
NSG8-DM-8A-U	NS-G8 A BLADE; 8GB MEM 8 GBE 4 FC UPG	B	\$0
NSG8-DM-8B	NS-G8 B BLADE 8GBMEM 4GBE CU 4GBE OP 4FC	B	\$0
NSG8-DM-8B1	NSG8 B1 BLD 8GB MEM 8GBE CU 8 GBE OP 4FC	B	\$0
NSG8-DM-8B1-U	NSG8 8GB MEM 8 GBE CU 8 GBE OP 4 FC UPG	B	\$0
NSG8-DM-8B-U	G8 BLADE 8GBMEM 4 GBECU 4 GBEOP 4 FC UG	B	\$0
NSG8-DM-8C	NS-G8 C BLADE; 8GB MEM 2 10GBE OP 4 FC	B	\$0
NSG8-DM-8C1	NS-G8 C1 BLADE; 8GB MEM 4 10GBE OP 4 FC	B	\$0
NSG8-DM-8C1-U	NS-G8 C1 BLADE 8GBMEM 4 10GBE OP 4FC UPG	B	\$0
NSG8-DM-8C3	NSG8 8GBMEM 2 10GBEOP 4GBECU 4GBEOP 4FC	B	\$0
NSG8-DM-8C3-U	NSG8 8GB 2 10GBEOP 4 GBECU 4 GBEOP 4FC U	B	\$0
NSG8-DM-8C5	NSG8 8GBMEM 2 10GBEOP 8GBECU 4 FC	B	\$0
NSG8-DM-8C5-U	NSG8 C5 8GB MEM 2 10GBE OP 8 GBE CU 4 FC	B	\$0
NSG8-DM-8C-U	NS-G8 C BLADE; 8GB MEM 2 10GBE OP 4FC UG	B	\$0
NSG8-DM-8D	NS-G8 D BLADE; 8GB MEM 8 GBE 4 8GBFC	B	\$0
NSG8-DM-8D1	NS-G8 D1 BLADE; 8GB MEM 16 GBE 4 8GBFC	B	\$0
NSG8-DM-8D1-U	NS-G8 D1 BLADE; 8GB MEM 16GBE 4 8GBFC UG	B	\$0
NSG8-DM-8D-U	NS-G8 D BLADE; 8GB MEM 8 GBE 4 8GBFC UPG	B	\$0
NSG8-DM-8E	NSG8 E 8GB MEM 4 GBE CU 4 GBE OP 4 8GBF	B	\$0
NSG8-DM-8E1	NS-G8 8GB MEM 8GBE CU 8GBE OP 4 8GBFC	B	\$0
NSG8-DM-8E1-U	NSG8 8GB 8 GBECU 8 GBEOP 4 8GBFC UG	B	\$0
NSG8-DM-8E-U	NSG8 8GB 4 GBECU 4 GBEOP 4 8GBFC UG	B	\$0
NSG8-DM-8F	NS-G8 F BLADE; 8GB MEM 2 10GBE OP 4 FC	B	\$0
NSG8-DM-8F1	NS-G8 F1 BLADE; 8GB MEM 4 10GBE OP 4 FC	B	\$0
NSG8-DM-8F1-U	NS-G8 F1 BLADE 8GBMEM 4 10GBE OP 4FC UPG	B	\$0
NSG8-DM-8F3	NSG8 8GBMEM 2 10GBEOP 4GBECU 4GBEOP 4FC	B	\$0
NSG8-DM-8F3-U	NSG8 F3 8GB 2 10GBEOP 4GBECU 4GBE OP 4FC	B	\$0
NSG8-DM-8F5	NS-G8 F5 8GBMEM 2 10GBE OP 8 GBECU 4FC	B	\$0
NSG8-DM-8F5-U	G8 BLADE 8GBMEM 2 10GBEOP 8 GBECU 4FC U	B	\$0
NSG8-DM-8F-U	NS-G8 F BLADE 8GB MEM 2 10GBE OP 4 FC UG	B	\$0
NSG8-DME0	NS-G8 INITIAL ENCLOSURE ONE REQUIRED	B	\$0
NSG8-DME1	NS-G8 ENCLOSURE	B	\$0
NSG8-DME1-U	NS-G8 ENCLOSURE UPG	B	\$0
NSG8-DM-F4	NS-G8 BASE BLADE; 8GB MEM; 4 PORTS 4G FC	B	\$0
NSG8-DM-F4U	G8 BLADE 8GBMEM 4 4G FC UPG	B	\$0
NSG8-DM-F8	NS-G8 BASE BLADE; 8GB MEM; 4 PORTS 8G FC	B	\$0
NSG8-DM-F8U	NSG8 BASE BLADE 8GB MEM 4 PORTS 8GFC UG	B	\$0
NSG8-VG8-UPG	NSG8 TO VG8 CONVERSION	B	\$0

NS-M1GCU-A	4 GBE CU PORTS FACTORY	B	\$0
NS-M1GCUOP-A	2 GBE CU PORTS AND 2 GBE OPT PORTS FACT	B	\$0
NS-M1GCUOP-U	2 GBE CU PORTS AND 2 GBE OPT PORTS UPG	B	\$0
NS-M1GCU-U	4 GBE CU PORTS UPG	B	\$0
NS-M4GF-A	4 FC 4GB PORTS FACTORY	B	\$0
NS-M4GF-U	4 FC 4GB PORTS UPG	B	\$0
NS-M8GF3-A	4 FC 8GB PORTS W 3 SFP FACTORY	B	\$0
NS-M8GF3-U	4 FC 8GB PORTS W 3 SFP UPG	B	\$0
NS-M8GF-A	4FC 8GB PORTS FACTORY	B	\$0
NS-M8GF-U	4FC 8GB PORTS UPG	B	\$0
NS-MXG20-A	10GBE OPT DUAL PORT FACT	B	\$0
NS-MXG20PBA	VNX GTWY 2-PORT 10GBE OPT DM MODULE	B	\$0
NS-MXG20PBU	VNX GTWY 2-PORT 10GBE OPT DM MODULE-UP	B	\$0
NS-MXG20-U	10GBE OPT DUAL PORT UPG	B	\$0
NS-MXG2TWBA	VNX GTWY 2-PORT 10GBE TWINAX DM MODULE	B	\$0
NS-MXG2TWBU	VNX GTWY 2-PT 10GBE TWINAX DM MODULE-UP	B	\$0
NS-MXGO-A	10GBE OPT PORT FACTORY	B	\$0
NS-MXGO-U	10GBE OPT PORT UPG	B	\$0
NS-MXGTA	VNX GTWY 2-PORT 10GBASE-T DM MODULE	B	\$0
NS-MXGTU	VNX GTWY 2-PORT 10GBASE-T DM MODULE-UP	B	\$0
NS-PXG202GC-U	CEL 2PORT 10GBE OPT 2PORT GBE CU UPG	B	\$0
NS-SA05-020	2TB 5400RPM SATA II DISK W/4GB FC	B	\$0
NS-SA05-020HS	2TB 5400RPM DISK W/4GB FC HOT SPARE	B	\$0
NS-SA05-020U	2TB 5400RPM SATAII DISK W/4GB FC UPGRADE	B	\$0
NS-SA07-010	DISK 1000GB 7.2K 512BPS SATA 3GB 32MB -R	B	\$0
NS-SA07-010HS	1000GB 7.2K 512BPS SATA 3GB 32MB -R HS	B	\$0
NS-SA07-010TU	1000GB 7.2K 512BPS SATA 3GB 32MB -R UPG	B	\$0
NS-SA07-010U	1000GB 7.2K 512BPS SATA 3GB 32MB -R UPG	B	\$0
NS-SA07-020	2TB 7200RPM SATA II DISK W/4GB FC	B	\$0
NS-SA07-020HS	2TB 7200RPM DISK W/4GB FC HOT SPARE	B	\$0
NS-SA07-020TU	2000GB 7.2K 512BPS SATA 3GB 32MB -R UPG	B	\$0
NS-SA07-020U	2TB 7200RPM SATAII DISK W/4GB FC UPGRADE	B	\$0
NS-SA07-030TU	3000GB 7.2K 512BPS SATA 3GB 32MB -R UPG	B	\$0
NS-SA07-030U	3TB 7200 RPM 4GB FC UPGRADE DISK DRIVE	B	\$0
NS-SA07-500	500GB SATA II DISK FOR 4G DAE	B	\$1,530
NS-SA07-500HS	500GB SATA FOR 4G DAE HS	B	\$1,530
NS-SA07-500U	500GB SATA UPG FOR 4G DAE	B	\$2,065
NS-SA07-750	750GB 7200RPM SATA II 512BPS NSTAR	B	\$1,895
NS-SA07-750HS	750GB 7200RPM SATA II 512BPS NSTAR HS	B	\$0
NS-SA07-750U	750GB 7200RPM SATA II 512BPS NSTAR UPG	B	\$2,558
NW200F14610FD	NETW CX200 NORACK 10 146G	B	\$31,000
NW200F7305FD	NETW CX200 NORACK 5 73G	B	\$20,460
NW200F7310FD	NETW CX200 NORACK 10 73G	B	\$26,820
NW-2G10-146	146GB 10K 520BPS 2GB 12V	B	\$1,540
NW-2G10-146-U	146GB 10K 520BPS 2GB UPGD	B	\$2,080
NW-2G10-300	300GB FIBRE DRIVE	B	\$2,700
NW-2G10-300U	300 GB FOBRE DRIVE UPG	B	\$3,645
NW-2G10-73	73GB 10K 520BPS 2GB 12V	B	\$870
NW-2G10-73-U	73GB 10K 520BPS 2GB 12V U	B	\$1,175
NW-2G15-36	36GB 15K 520BPS 2GB 12V	B	\$710

NW-2G15-36-U	36GB 15K 520BPS 2GB 12V U	B	\$960
NW-2G15-73	NETWIN 15K 73G FIBR DRIVE	B	\$1,500
NW-2G15-73U	NETWIN 15K 73GB FBRDR UPG	B	\$2,025
NW-2GDAE-FD	DAE NO RACK FOR NETWIN	B	\$6,200
NW30014610FD	NW CX300 W 10 146GB DRIVE	B	\$29,500
NW30073-10FD	NW CX300 BUNDL 10 73G FLD	B	\$23,600
NW-AT05-250	NETWIN ATA 250GB DRIVE	B	\$1,160
NW-AT05-250U	NETWIN 250GB ATA DR UPGD	B	\$1,510
NW-AT05-320	NETWIN ATA 320GB DRIVE	B	\$1,030
NW-AT05-320U	NETWIN 320GB 5400 ATA DR	B	\$1,390
NW-AT07-250	NETWIN 250GB ATA DR 7200	B	\$1,030
NW-AT07-250U	NETWIN 250GB ATA DR 7200	B	\$1,390
NW-CX200-FD	CX200 DPE NO RACK	B	\$15,500
NW-CX300-FD	NETWIN CX300 FIELD INSTAL	B	\$14,450
NW-CX500-FD	NETWIN CX500 FIELD INSTAL	B	\$38,000
PW25U-AZP	PDU FOR AUSTRALIA AND NZ	B	\$0
PW25U-EUP	PDU FOR EUROPE	B	\$0
PW25U-NAP	PDU FOR NORTH AMERICA	B	\$0
PW40U-60-ASTL	RACK-40U-60 PWR CORD ASTL	B	\$2,200
PW40U-60-IEC3	RACK-40U-60 PWR CORD IEC3	B	\$1,150
PW40U-60-RS	RACK-40U-60 PWR CORD	B	\$2,200
PW40U-60-US	RACK-40U-60 PWR CORD US	B	\$1,150
PW40U-C-ASTL	40U-C PWR CORD - AUST	B	\$1,150
PW40U-C-IEC3	40U-C PWR CORD - IEC309	B	\$1,150
PW40U-C-RS	40U-C PWR CORD - RS	B	\$1,150
PW40U-C-US	40U-C PWR CORD - US	B	\$1,150
PW40UD-ASTL	40U DEEP RACK PWR CORD ASTL LP-57 QTY 2	B	\$3,130
PW40UD-IEC3	40U DEEP RACK PWR CORD IEC309 - QTY 2	B	\$1,326
PW40UD-RS	40U DEEP RACK PWR CORD R&S PLUG - QTY 2	B	\$4,529
PWCAB-ASTL	DUAL PWR RACK AUSTRALIA	B	\$1,200
PWCAB-IEC3	DUAL PWR RACK IEC309	B	\$1,200
PWCAB-INTL	DUAL PWR RACK INTL TWIST	B	\$850
PWCAB-USL	DUAL PWR RACK US TWIST	B	\$670
RACK-40U-C	40U COMMON RACK	B	\$4,200
RAIN-SMT	EMC RAINFINITY SERVER MAINTENANCE TRIGG	B	\$1
RAIN-SMT-CL	EMC RAINFINITY SERVER MAINTENANCE TRIGG	B	\$1
RCK40U-SECURE	ANTI-TIP BRACKET, 40U CAB	B	\$160
SFP-HSSDC-10M	10M SFP to HSSDC encl-0 bus cbl Qty 1	B	\$550
SFP-HSSDC-2.5M	2.5M SFP to HSSDC encl-0 bus cbl Qty 1	B	\$130
SFP-HSSDC2-2M	2M SFP to HSSDC2 encl-0 bus cbl Qty 1	B	\$150
SFP-HSSDC2-5M	5M SFP to HSSDC2 encl-0 bus cbl Qty 1	B	\$275
SFP-HSSDC-6M	6M SFP to HSSDC encl-0 bus cbl Qty 1	B	\$275
SFP-TWNACT-1M	SFP+ TO SFP+ 1M ACTIVE 10G CABLE - PAIR	B	\$750
SFP-TWNACT-3M	SFP+ TO SFP+ 3M ACTIVE 10G CABLE	B	\$900
SFP-TWNACT-5M	SFP+ TO SFP+ 5M ACTIVE 10G CABLE	B	\$1,100
SOLIDPANEL-1U	1U SOLID FILLER FOR USE BEHIND 1U FILLER	B	\$40
SOLIDPANEL-2U	2U SOLID FILLER FOR USE BEHIND 2U FILLER	B	\$45
SOLIDPANEL-3U	3U SOLID FILLER FOR USE BEHIND 3U FILLER	B	\$50
SPE-TELCO-2U	CX4 TELCO ADJUSTABLE RAIL KIT FOR 2U SPE	B	\$750
SPS-ADJ	ADJ RACK RAIL KIT FOR SPS	B	\$420

SPST	TELCO RAILS FOR SPS	B	\$600
SPST-2GB	TELCO RAIL KIT - 2GB SPS	B	\$420
SP-TELCO-1U	1U STORAGE PROCESSOR TELCO RAIL KIT	B	\$500
SP-TELCO-2U	2U STORAGE PROCESSOR TELCO RAIL KIT	B	\$750
SP-TELCO-4U	4U STORAGE PROCESSOR TELCO RAIL KIT	B	\$1,500
V-CX2014610K	VAULT PACK CX3-20 146GB 10K 2GB DRIVES Q	B	\$5,100
V-CX2014610KN	VAULT PACK CX3-20 146GB 10K 2GB NEBS DRI	B	\$5,100
V-CX2014615K	VAULT PACK CX3-20 146GB 15K 4GB DRIVES Q	B	\$6,665
V-CX2014615KN	VAULT PACK CX3-20 146GB 15K 4GB NEBS DRI	B	\$6,665
V-CX2030010K	VAULT PACK CX3-20 300GB 10K 4GB DRIVES Q	B	\$6,715
V-CX2030010KN	VAULT PACK CX3-20 300GB 10K 4GB NEBS DRI	B	\$6,715
V-CX2030015K	VAULT PACK CX3-20 300GB 15K 4GB DRIVES Q	B	\$8,400
V-CX2030015KN	VAULT PACK CX3-20 300GB 15K 4GB NEBS DRI	B	\$8,400
V-CX2040010K	VAULT PACK CX3-20 400GB 10K 4GB DRIVES Q	B	\$9,240
V-CX2040010KN	VAULT PACK CX3-20 400GB 10K 4GB NEBS DRI	B	\$9,240
V-CX2045015K	VAULT PACK CX3-20 450GB 15K 4GB DRIVES Q	B	\$11,125
V-CX2045015KN	VAULT PACK CX3-20 450GB 15K 4GB NEBS DRI	B	\$11,125
V-CX207310K	VAULT PACK CX3-20 73GB 10K 2GB DRIVES QT	B	\$3,775
V-CX207310KN	VAULT PACK CX3-20 73GB 10K 2GB NEBS DRIV	B	\$3,775
V-CX207315K	VAULT PACK CX3-20 73GB 15K 4GB DRIVES QT	B	\$5,150
V-CX207315KN	VAULT PACK CX3-20 73GB 15K 4GB NEBS DRIV	B	\$5,150
V-CX4014610K	VAULT PACK CX3-40 146GB 10K 2GB DRIVES Q	B	\$5,100
V-CX4014610KN	VAULT PACK CX3-40 146GB 10K 2GB NEBS DRI	B	\$5,100
V-CX4014615K	VAULT PACK CX3-40 146GB 15K 4GB DRIVES Q	B	\$6,665
V-CX4014615KN	VAULT PACK CX3-40 146GB 15K 4GB NEBS DRI	B	\$6,665
V-CX4030010K	VAULT PACK CX3-40 300GB 10K 4GB DRIVES Q	B	\$6,715
V-CX4030010KN	VAULT PACK CX3-40 300GB 10K 4GB NEBS DRI	B	\$6,715
V-CX4030015K	VAULT PACK CX3-40 300GB 15K 4GB DRIVES Q	B	\$8,400
V-CX4030015KN	VAULT PACK CX3-40 300GB 15K 4GB NEBS DRI	B	\$8,400
V-CX4040010K	VAULT PACK CX3-40 400GB 10K 4GB DRIVES Q	B	\$9,240
V-CX4040010KN	VAULT PACK CX3-40 400GB 10K 4GB NEBS DRI	B	\$9,240
V-CX4045015K	VAULT PACK CX3-40 450GB 15K 4GB DRIVES Q	B	\$11,125
V-CX4045015KN	VAULT PACK CX3-40 450GB 15K 4GB NEBS DRI	B	\$11,125
V-CX407310K	VAULT PACK CX3-40 73GB 10K 2GB DRIVES QT	B	\$3,775
V-CX407310KN	VAULT PACK CX3-40 73GB 10K 2GB NEBS DRIV	B	\$3,775
V-CX407315K	VAULT PACK CX3-40 73GB 15K 4GB DRIVES QT	B	\$5,150
V-CX407315KN	VAULT PACK CX3-40 73GB 15K 4GB NEBS DRIV	B	\$5,150
V-CX4-14615K	CX4 VAULT PACK 146GB 15K 4G DRIVES QTY 5	B	\$0
V-CX4-14615KN	CX4 VAULT PACK 146GB 4G NEBS DRIVES QTY5	B	\$0
V-CX4-1K72K	Vault CX4-120 1TB 7.2K SATA Drives Qty 5	B	\$0
V-CX4-2K72K	VAULT PACK CX4-120 2TB 7.2K DRIVE QTY 5	B	\$0
V-CX4-30010K	CX4 VAULT PACK 300GB 10K 4G DRIVES QTY 5	B	\$6,725
V-CX4-30010KN	VAULT W/300GB 10K 4GB DRIVES NEBS	B	\$6,725
V-CX4-30015K	VAULT PACK 300GB 15K 4G DRIVES QTY 5	B	\$0
V-CX4-30015KN	CX4 VAULT 300GB 15K 4G NEBS DRIVES QTY 5	B	\$0
V-CX4-40010K	CX4 VAULT PACK 400GB 10K 4G DRIVES QTY 5	B	\$9,240
V-CX4-40010KN	VAULT PACK 400GB 10K 4G NEBS DRIVES QTY5	B	\$9,240
V-CX4-45010K	VAULT CX4 SERIES 450GB10K 4G DRIVES QTY5	B	\$0
V-CX4-45015K	VAULT PACK 450GB 15K 4G DRIVES QTY 5	B	\$0
V-CX4-45015KN	CX4 VAULT 450GB 15K 4G NEBS DRIVES QTY 5	B	\$0

V-CX4-60010K	VAULT CX4 SERIES 600-10K 4GB DRIVES QTY5	B	\$0
V-CX4-60015K	VAULT CX4 SERIES 600GB15K 4G DRIVES QTY	B	\$0
V-CX4-AF04100	100GB FLASH DRIVE VAULT CX4 SERIES ARRAY	B	\$0
V-CX4-AF04200	200GB FLASH DRIVE VAULT CX4 SERIES ARRAY	B	\$0
V-CX4-EFD-073	73GB EFD VAULT PACK FOR CX4 SERIES	B	\$0
V-CX4-EFD-200	200GB EFD VAULT PACK FOR CX4 SERIES	B	\$0
V-CX4-EFD-400	400GB FC EFD VAULT PACK FOR CX4 SYSTEMS	B	\$0
V-CX8014610K	VAULT PACK CX3-80 146GB 10K 2GB DRIVES	B	\$5,100
V-CX8014610KN	VAULT PACK CX3-80 146GB 10K 2GB NEBS DRI	B	\$5,100
V-CX8014615K	VAULT PACK CX3-80 146GB 15K 4GB DRIVES Q	B	\$6,665
V-CX8014615KN	VAULT PACK CX3-80 146GB 15K 4GB NEBS DRI	B	\$6,665
V-CX8030010K	VAULT PACK CX3-80 300GB 10K 4GB DRIVES Q	B	\$6,715
V-CX8030010KN	VAULT PACK CX3-80 300GB 10K 4GB NEBS DRI	B	\$6,715
V-CX8030015K	VAULT PACK CX3-80 300GB 15K 4GB DRIVES Q	B	\$8,400
V-CX8030015KN	VAULT PACK CX3-80 300GB 15K 4GB NEBS DRI	B	\$8,400
V-CX8040010K	VAULT PACK CX3-80 400GB 10K 4GB DRIVES Q	B	\$9,240
V-CX8040010KN	VAULT PACK CX3-80 400GB 10K 4GB NEBS DRI	B	\$9,240
V-CX8045015K	VAULT PACK CX3-80 450GB 15K 4GB DRIVES Q	B	\$11,125
V-CX8045015KN	VAULT PACK CX3-80 450GB 15K 4GB NEBS DRI	B	\$11,125
V-CX807310K	VAULT PACK CX3-80 73GB 10K 2GB DRIVES QT	B	\$3,775
V-CX807310KN	VAULT PACK CX3-80 73GB 10K 2GB NEBS DRIV	B	\$3,775
V-CX807315K	VAULT PACK CX3-80 73GB 15K 4GB DRIVES QT	B	\$5,150
V-CX807315KN	VAULT PACK CX3-80 73GB 15K 4GB NEBS DRIV	B	\$5,150
VDMMXG2FCOOPA	VNX VG 2 PT FCOE IO MOD-SFP	B	\$0
VDMMXG2FCOOPU	VNX VG 2 PT FCOE IO MOD-SFP ADD-ON	B	\$8,400
VDMMXG2FCOTWA	VNX VG 2 PT FCOE IO MOD-TWINAX	B	\$0
VDMMXG2FCOTWU	VNX VG 2 PT FCOE IO MOD-TWINAX ADD-ON	B	\$5,880
VG2-DM	VG2 GATEWAY SINGLE DATA MOVER	B	\$0
VG2-DME0	VG2 GATEWAY ENCLOSURE WITH 1 DATA MOV	B	\$0
VG2-DM-U	VG2 GATEWAY SINGLE DATA MOVER ADD-ON	B	\$13,000
VG8-DM	VG8 GATEWAY SINGLE DATA MOVER	B	\$0
VG8-DME0	VG8 G-WAY DM ENCLOSURE WITH 2 DATAMOVE	B	\$0
VG8-DMEX	VG8 GATEWAY EMPTY DATA MOVER ENCLOSURE	B	\$0
VG8-DMEX-U	VG8 G-WAY EMPTY DATAMOVER ENCLOSURE U	B	\$45,500
VG8-DM-U	VG8 GATEWAY SINGLE DATA MOVER ADD-ON	B	\$71,500
V-NS4014610K	VAULTPACK NS40 146GB10K 2GB DRIVES QTY 5	B	\$0
V-NS4014610KN	VAULT NS40 146GB 10K 2GB NEBS DRIVES QT	B	\$0
V-NS4014615KN	VAULT NS40 146GB 15K 4GB NEBS DRIVES QT	B	\$6,665
V-NS4030010K	Vault Pack NS40 300GB10K 4Gb Qty 5	B	\$0
V-NS4030010KN	VAULT NS40 300GB 10K 2GB NEBS DRIVES QT	B	\$0
V-NS4030015K	VAULTPACK NS40 300GB15K 4GB DRIVES QTY 5	B	\$0
V-NS4030015KN	VAULT NS40 300GB 15K 4GB NEBS DRIVES QT	B	\$0
V-NS4040010K	VAULTPACK NS40 400GB10K 4GB DRIVES QTY 5	B	\$0
V-NS4040010KN	VAULT NS40 400GB 10K 4GB NEBS DRIVES QT	B	\$9,240
V-NS4045015K	VAULTPACK NS40 450GB15K 4GB DRIVES QTY 5	B	\$0
V-NS407315K	VAULT PACK NS40 73GB 15K 4GB DRIVES QTY5	B	\$0
V-NS407315KN	VAULT NS40 73GB15K 4GB NEBS DRIVES QTY 5	B	\$0
V-NS4-14615K	CX4 VAULT 146GB 15K 4GB DRIVES	B	\$0
V-NS4-1K72K	VAULT CX4 SERIES 1TB 7200 DRIVES QTY 5	B	\$0
V-NS4-2K72K	VAULT CX4 SERIES 2TB 7200 DRIVES QTY 5	B	\$0

V-NS4-30010K	VAULT WITH 300GB 10K 4GB FC DRIVES QTY	B	\$0
V-NS4-30015K	CX4 VAULT 300GB 15K 4GB DRIVES	B	\$0
V-NS4-40010K	CX4 VAULT 400GB 10K 4GB DRIVES	B	\$9,240
V-NS4-45010K	VAULT WITH 450GB 10K 4GB FC DRIVES QTY	B	\$0
V-NS4-45015K	CX4 VAULT 450GB 15K 4GB DRIVES	B	\$0
V-NS4-60010K	VAULT WITH 600GB 10K 4GB FC DRIVES QTY	B	\$0
V-NS4-60015K	VAULT PACK 600GB 15K 4GB FC DRIVES 5PACK	B	\$0
V-NS8014610K	VAULT PACK NS80 146GB 10K 2GB DRIVES QTY	B	\$0
V-NS8014610KN	VAULT PACK NS80 146GB 10K 2GB NEBS DRIVE	B	\$0
V-NS8014615KN	VAULT PACK NS80 146GB 15K 4GB NEBS DRIVE	B	\$6,665
V-NS8030010K	Vault Pack NS80 300GB 10K 4Gb Drives, Qt	B	\$0
V-NS8030010KN	VAULT PACK NS80 300GB 10K 2GB NEBS DRIVE	B	\$0
V-NS8030015K	VAULT PACK NS80 300GB 15K 4GB DRIVES QTY	B	\$0
V-NS8030015KN	VAULT PACK NS80 300GB 15K 4GB NEBS DRIVE	B	\$0
V-NS8040010K	VAULT PACK NS80 400GB 10K 4GB DRIVES QTY	B	\$0
V-NS8045015K	VAULT PACK NS80 450GB 15K 4GB DRIVES QTY	B	\$0
V-NS807315K	VAULT PACK NS80 73GB 15K 4GB DRIVES QTY	B	\$0
V-NS807315KN	VAULT PACK NS80 73GB 15K 4GB NEBS DRIVES	B	\$0
2KMICL 1-QSFP	DCX8510 ICL 2KM QSFP 1 Pack	C	\$12,390
BR-10G40K-XFP	10GB 40KM LONG WAVE XFP-BR	C	\$0
BR-10G80K-XFP	10GB 80KM LONG WAVE XFP-BR	C	\$0
BRQSFP100G-SR4	BRQSFP 100GbE SW QSFP28 1PACK	C	\$9,140
BRQSFP40GE-10GBO	BRQSFP 40GbE W10GBE BRKOUT SW QSFP 1PA	C	\$3,680
BRQSFP40GE-BIDI	BRQSFP 40GbE BIDI SW QSFP 1PACK	C	\$4,050
BRQSFP-4X16G	BRCD LBL 4X16GB SHORT WAVE QSFP 1PACK	C	\$2,820
BRQSFP-4X32G	BRCD LBL 4X32GB SHORT WAVE QSFP 1PACK	C	\$7,460
BRQSFP-4X32G-BRKOD	BRCD DIR 4X32GB SW BREAKOUT QSFP 1PACK	C	\$11,340
BRSFP16G10K8P	BRCD LBL 16GB 10KM LONG WAVE SFPS 8PACK	C	\$34,640
BRSFP16G10KLW	BRCD LBL 16GB 10KM LONG WAVE SFP	C	\$5,030
BRSFP16G25KLW	BRCD LBL 16GB 25KM LONG WAVE SFP	C	\$12,810
BRSFP-16GSW	BRCD LBL 16GB SHORT WAVE SFP	C	\$1,140
BRSFP-16GSW8P	BRCD LBL 16GB SHORT WAVE SFPS 8PACK	C	\$7,950
BRSFP32G10K8P	BRCD LBL 32GB 10KM LONG WAVE SFPs 8PACK	C	\$44,840
BRSFP32G10KLW	BRCD LBL 32GB 10KM LONG WAVE SFP	C	\$6,510
BRSFP-32GSW	BRCD LBL 32GB SHORT WAVE SFP	C	\$1,700
BRSFP-32GSW8P	BRCD LBL 32GB SHORT WAVE SFPs 8PACK	C	\$11,700
BRSFP-4G10KLW	BRCD LBL 4GB 10KM LONG WAVE SFP	C	\$2,300
BRSFP-4G30KLW	BRCD LBL 4GB 30KM LONG WAVE SFP	C	\$4,550
BRSFP-4G4KLW	BRCD LBL 4GB 4KM LONG WAVE SFP	C	\$1,320
BRSFP-4GSW	BRCD LBL 4GB SHORT WAVE SFP	C	\$240
BRSFP-4GSW128	BRCD LBL 4GB SHORT WAVE SFPS 128PACK	C	\$21,180
BRSFP-4GSW8P	BRCD LBL 4GB SHORT WAVE SFPS 8PACK	C	\$1,450
BRSFP-8G10K8P	BRCD LBL 8GB 10KM LONG WAVE SFPS 8PACK	C	\$16,910
BRSFP-8G10KLW	BRCD LBL 8GB 10KM LONG WAVE SFP	C	\$2,360
BRSFP-8G25KLW	BRCD LBL 8GB 25KM LONG WAVE SFP	C	\$10,100
BRSFP-8GSW128	BRCD LBL 8GB SHORT WAVE SFPS 128PACK	C	\$58,770
BRSFP-N8GSW	BRCD NEW 8GB SHORT WAVE SFP	C	\$240
BRSFP-N8GSW8P	BRCD NEW 8GB SHORT WAVE SFPS 8PACK	C	\$1,490
CP-24000-UPG	UPG 12K CPs TO ED-24000B	C	\$0
DCX2PS-PWRCRD	CNX CAB DCX8510-8 2PS UPG PWR CORDS	C	\$50

DCX-2PS-UPG	DCX DUAL POWER SUPPLY UPGRADE KIT	C	\$19,300
DCX4S-GENKIT	DCX4S GENERIC CABINET RACK MOUNT KIT	C	\$3,190
DCX6-4 NPE 2PS KIT	DCX6-4 NON PORT EXHAUST 2 PWR SUP KIT	C	\$18,250
DCX6-4 NPE FAN KIT	DCX6-4 NON PORT EXHAUST 2 FAN KIT	C	\$15,910
DCX6-4 NPI 2PS KIT	DCX6-4 NON PORT INTAKE 2 PWR SUP KIT	C	\$18,250
DCX6-4 NPI FAN KIT	DCX6-4 NON PORT INTAKE 2 FAN KIT	C	\$15,910
DCX6-4-16G ICL100	DCX6-4 16GB ICL POD W 8 16G QSFPS 100M	C	\$69,840
DCX6-4-16G ICL2KM	DCX6-4 2KM ICL POD W 8 2KM 16G QSFPS	C	\$138,560
DCX6-4-32G BRKIOICL	DCX6-4 BRKOUT ICL POD W 8 32G B0-QSFPS	C	\$86,050
DCX6-4-32G ICL100	DCX6-4 32GB ICL POD W 8 32G QSFPS 100M	C	\$86,050
DCX6-4-32G ICL2KM	DCX6-4 2KM ICL POD W 8 2KM 32G QSFPS	C	\$171,370
DCX-64PTCHPNL	DCX 1U LC-TO-LC PTCH PNL FOR 64Port Card	C	\$0
DCX6-8 NPE 4PS KIT	DCX6-8 NON PORT EXHAUST 4 PWR SUP KIT	C	\$36,490
DCX6-8 NPE FAN KIT	DCX6-8 NON PORT EXHAUST 3FAN KIT	C	\$23,870
DCX6-8 NPI 4PS KIT	DCX6-8 NON PORT INTAKE 4 PWR SUP KIT	C	\$36,490
DCX6-8 NPI FAN KIT	DCX6-8 NON PORT INTAKE 3 FAN KIT	C	\$23,870
DCX6-8-16G ICL100	DCX6-8 16GB ICL POD W 16 16G QSFPS 100M	C	\$139,680
DCX6-8-16G ICL2KM	DCX6-8 2KM ICL POD W 8 2KM 16G QSFPS	C	\$199,270
DCX6-8-32G BRKIOICL	DCX6-8 BRKOUT ICL POD W 16 32G B0-QSFPS	C	\$166,400
DCX6-8-32G ICL100	DCX6-8 32GB ICL POD W 16 32G QSFPS 100M	C	\$166,400
DCX6-8-32G ICL2KM	DCX6-8 2KM ICL POD W 8 2KM 32G QSFPS	C	\$231,290
DCX8510CL100M	CNX DCX8510 ICL Cable 100 Meter	C	\$2,730
DCX8510ICL100	DCX8510 100M ICL POD Kit w 16 QSFPS	C	\$107,770
DCX8510ICL15M	CNX DCX8510 ICL CABLE 15 METER	C	\$630
DCX8510ICL2KM	DCX8510 2KM ICL POD Kit w8 2KM QSFPS	C	\$149,760
DCX8510ICL50M	CNX DCX8510 ICL CABLE 50 METER	C	\$1,300
DCX8510ICL5M	CNX DCX8510 ICL CABLE 5 METER	C	\$410
DCX854-ENTICL	DCX8510-4 ENTERPRISE ICL 1PER CHASSIS	C	\$190,760
DCX858-ENTICL	DCX8510-8 ENTERPRISE ICL 1PER CHASSIS	C	\$381,520
DCX-GENRLKT	DCX GENERIC CAB RACK MOUNT KIT	C	\$570
DCX-LCMPO100M	CNX DCX8510 4LC-1MPO Cable 100 Meter	C	\$2,800
DCX-LC-MPO15M	CNX DCX8510 4LC-1MPO Cable 15 Meter	C	\$670
DCX-LC-MPO50M	CNX DCX8510 4LC-1MPO Cable 50 Meter	C	\$1,530
DCX-LC-MPO5M	CNX DCX8510 4LC-1MPO Cable 5 Meter	C	\$420
DS-4400M-SHLF	DS-4400MRK MNT TRAY	C	\$0
DS-B-PC07	DEPT SWITCH INTL PWR CORD	C	\$0
DSBRK40-FD-B	DSB SWITCH CLAR FIELD RCK KIT -B	C	\$290
DSBRLKT-B	DSB SW GEN RCK KIT -B	C	\$600
DSED-LWKT35	LW OPTIC KIT-35 KM	C	\$1,200
DSED-LWKT4G10	4GB 10KM LW SFP OPTIC MCD	C	\$3,500
DSED-LWKT4G4	4GB 4KM LW SFP OPTIC BRCD	C	\$1,275
DSED-LWKT-XG1	XFP 10 GBPS L/W	C	\$3,600
DSED-LWKT-XG4	XFP 10GBPS LONGWAVE 40 KM OPTIC KIT	C	\$10,200
DSED-SWKT-XG	XFP 10 GBPS S/W	C	\$1,600
EC-1200	CONNECTRIX CABINET	C	\$0
EC-1230B	CABINET ED-12000B	C	\$0
EC-1500-B	CONNECTRIX B-SERIES CAB	C	\$0
EC1500BRLKT	MOUNT ED-XXB IN EC-1500B	C	\$305
EC-1500-M	CONNECTRIX M CABINET	C	\$0
EC-1500-PC1	PWR CRD 1PHS-L630P	C	\$0

EC-1500-PC2	PWR CRD 1PHS-IP66	C	\$0
EC-1500-PC3	PWR CRD 1PHS-IEC	C	\$0
EC-1500-PC4	PWR CRD 1PHS-IEC	C	\$0
EC-1700-B	CONNECTRIX B SERIES CABINET	C	\$9,400
EC-1700-C	CONNECTRIX MDS SERIES CABINET	C	\$9,400
ED-10000M	Chassis 2 SWMs 0/256 ports Director	C	\$0
ED-10KM-164L	I10K 16X2GB&4X10GB LW LIM	C	\$0
ED-10KM-164LU	10KM LIM 16-2G&4-10G LW	C	\$0
ED-10KM-164S	I10K 16X2GB & 4X10GB LIM	C	\$0
ED-10KM-164SU	10KM LIM 16-2G&4-10G SW	C	\$0
ED-10KM-242L	I10K 24X2GB&2X10GB LW LIM	C	\$0
ED-10KM-242LU	10KM LIM 24-2G&2-10G LW	C	\$0
ED-10KM-242S	I10K 24X2GB & 2X10GB LIM	C	\$0
ED-10KM-242SU	10KM LIM 24-2G&2-10G SW	C	\$0
ED-10KM-320L	I10K 32X2GB LW LIM	C	\$0
ED-10KM-320LU	ED-10K LIM 32 2GB L/W UPG	C	\$0
ED-10KM-320S	I10K 32X2GB LIM	C	\$0
ED-10KM-320SU	ED-10KM LIM 32 2GB S/W	C	\$0
ED-10KM432L4	I10K 4G LMQ W 4KM LONG WAVE OPTICS	C	\$0
ED-10KM432L4U	I10K 4G LMQ W 4KM LONG WAVE OPTICS	C	\$0
ED-10KM432LX	I10K 4G LMQ W 10KM LONG WAVE OPTICS	C	\$0
ED-10KM432LXU	I10K 4G LMQ W 10KM LONG WAVE OPTICS	C	\$0
ED-10KM432SW	I10K 4G LMQ W SHORT WAVE OPTICS	C	\$0
ED-10KM432SWU	I10K 4G LMQ W SHORT WAVE OPTICS	C	\$0
ED-10KM-CBLDOM	DOM CABLE MNT PLUG	C	\$0
ED-10KM-CBLINT	INT CABMNT PLUG INSTALLED	C	\$0
ED-10KM-SWM	I10k switching module	C	\$0
ED-10KM-SWX	I10K SWX CARD	C	\$0
ED-12000B-32	32-PORT FIBRE CHANNEL DIRECTOR	C	\$0
ED-12000B-32U	32-PORT FIBRE CHANNEL DIRECTOR UPG	C	\$0
ED-12000B-64	64-PORT FIBRE CHANNEL DIRECTOR	C	\$0
ED-12000B-64U	ED-12000B UPG	C	\$0
ED-12000B-CNV	12K/24K - NEMA RACK KIT	C	\$1,745
ED-140M	Chassis 0/140 ports FC Director	C	\$0
ED-140MCUP	140 PORT DIRECTOR WCUP	C	\$0
ED-140MCUP-U	140 PORT DRCTR UPGRADE	C	\$0
ED-140M-UPG	Chassis 0/140 ports Director UPG	C	\$0
ED-24000B	ED-24000B CHASSIS-NO PORT	C	\$0
ED-24000B-U	ED-24000B CHASSIS-NO PORT	C	\$0
ED-48000B	Chassis 0 Ports director	C	\$0
ED-6064-UPG	64 Port FICON Dirctr Upgrade	C	\$0
ED-64M	64-PORT FC DIRECTOR	C	\$0
ED-64MCUP	64-PT FICON CUP DIRCTOR	C	\$0
ED-64MCUP-UPG	64 PRT FICON CUP DRCT UPG	C	\$0
ED-64M-UPG	64-PORT FC DIRECTOR UPG	C	\$0
ED-CTP2-UPG	2Gb CTP UPG Kit/ED-64M	C	\$0
ED-DCX-4S-B	ED-DCX-4S BASE CHASSIS - 0 PORTS	C	\$0
ED-DCX6-4B	ED-DCX6-4B Base Chassis, 0 Ports	C	\$142,540
ED-DCX6-8B	ED-DCX6-8B Base Chassis, 0 Ports	C	\$214,560
ED-DCX8510-4B	ED-8510-4-B BASE CHASSIS; 0 PORTS	C	\$107,690

ED-DCX8510-8B	ED-8510-8-B BASE CHASSIS; 0 PORTS	C	\$186,850
ED-DCX-B	BASE DCX CHASSIS W FW OPTIONS 0 PORTS	C	\$0
ED-MDS-RLKT-AD	ED-XX ADJUSTABLE RAILKIT	C	\$480
ED-QPM-04	4Gb 4FC shortwave QPM ED-64/140M	C	\$0
ED-QPM-04-U	4Gb 4FC shortwave QPM ED-64/140M UPG	C	\$0
ED-QPM-L04	4Gb 4FC 4km longwave QPM	C	\$0
ED-QPM-L04-U	4Gb 4FC 4km longwave QPM UPG	C	\$0
ED-QPM-L10	4GB 4FC 10km longwave QPM	C	\$0
ED-QPM-L10-U	4GB 4FC 10km longwave QPM UPG	C	\$0
ED-UPM-04	2Gb 4 port w/sw optics	C	\$0
ED-UPM-04-UPG	2Gb 4 port w/sw optics UPG	C	\$0
ED-UPMC-04	SHORT WAVE CARD CUP	C	\$0
ED-UPMC-04-U	SHORT WAVE CARD CUP UPGD	C	\$0
ED-UPMC-L10	4 PORT LW 10KM W/CUP	C	\$0
ED-UPMC-L10-U	4 PORT LW 10KM W/CUP UPGRADE	C	\$0
ED-UPM-L10	2Gb 4 port w/LW 10K optics	C	\$0
ED-UPM-L10UPG	2Gb 4 port w/LW 10K optics UPG	C	\$0
ED-XPM-01	10Gb 2 port FC card	C	\$0
ED-XPM-01-U	10Gb 2 port FC card UPG	C	\$0
ED-XPM-L10	10Gb 2 port L/W FC card	C	\$0
ED-XPM-L10-U	10Gb 2 port L/W FC card UPG	C	\$0
INTCABPWRCB-B	C14-TO-C13 1M INTERNAL CAB POWER CORDS-	C	\$6
INTCAB-PWRCRD	C14-TO-C13 1METER INTERNAL CAB PWR CORD	C	\$6
MDS-10G-LR	10GBASE-LR SFP+ MODULE	C	\$4,900
MDS-10G-SR	10GBASE-SR SFP+ MODULE	C	\$1,220
MDS-10GX2-LR	MDS 10GB X2 LONG RANGE OPTIC	C	\$0
MDS-10GX2-SR	MDS 10GB X2 SHORT RANGE OPTIC	C	\$0
MDS-48P-16GFC	MDS 9000 48-Port 16-Gbps FC Module	C	\$93,660
MDS-48P16GFCU	MDS 9000 48-Port 16-Gbps FC Module UPG	C	\$118,640
MDS-48P-32GFC	MDS 9700 48-Port 32Gbps FC Module	C	\$98,260
MDS-48P-32GFCU	MDS 9700 48-Port 32Gbps FC Module Upg	C	\$127,750
MDS-8G-ER	MDS 8G FC EXT Range Direcotr Optic	C	\$9,900
MDS-8G-LW	MDS 2/4/8-GBPS FC LONGWAVE SFP LC	C	\$2,700
MDS-8G-SW	MDS 2/4/8-GBPS FC SHORTWAVE SFP LC	C	\$240
MDS-92CAB-KIT	SWITCH INSTALL EC-1500	C	\$0
MDS-9506	Chassis SUP1 no ports Director	C	\$0
MDS-9506-V2	Chassis SUP2 no ports Director	C	\$0
MDS-9509	Chassis SUP1 no ports Director	C	\$0
MDS-9509-V2	Chassis SUP2 no ports Director	C	\$0
MDS-9513	Chassis SUP2 no ports Director	C	\$0
MDS-9513-FAB	MDS 9513 CROSSBAR SWITCHING FABRIC2 MO	C	\$0
MDS-9513-FAB2	CISCO MDS 9513 FABRIC2 MODULE	C	\$0
MDS-9513-FAB3	MDS 9513 CROSSBAR SWITCHING FABRIC3	C	\$0
MDS-95CAB-KIT	DIRECTOR CAB INSTALL KIT	C	\$0
MDS-9700-AUS	MDS 9700 Power cord Australia	C	\$0
MDS-9700-CAB	MDS 9700 Cabinet Jumper Power Cord	C	\$0
MDS9700-CABKIT	MDS-9710 EC-1700-C Adpt Brckts Kit	C	\$140
MDS-9700-EU	MDS 9700 Power cord Europe	C	\$0
MDS-9700-INT	MDS 9700 Power cord International	C	\$0
MDS-9700-ISR	MDS 9700 Power cord Israel	C	\$0

MDS-9700-KOR	MDS 9700 Power Cord Korea	C	\$0
MDS-9700-NA	MDS 9700 NEMA 5-20 North America/Japan	C	\$0
MDS-9700-SA	MDS 9700 Power cord South Africa	C	\$0
MDS-9700-SW	MDS 9700 Power cord Switzerland	C	\$0
MDS-9700-US1	MDS 9700 NEMA 6-20 United States/Japan	C	\$0
MDS-9700-US2	MDS 9700 NEMA L6-20 United States/Japan	C	\$0
MDS-9706	9706 Chassis w/ Sup1, 4-PS, 3-Fab Mods	C	\$123,120
MDS9706-CABKIT	MDS-9706 EC-1700-C Adpt Brckts Kit	C	\$230
MDS-9706-FAB1	MDS 9706 Crossbar	C	\$6,310
MDS-9710	Connectrix MDS-9710 Director	C	\$193,340
MDS-9710-FAB	MDS 9710 Fabric 1 module	C	\$22,880
MDS-9710-FABU	MDS 9710 Fabric 1 module UPG	C	\$28,980
MDS-9710-PS	MDS 9710 3K Watt Power Supply	C	\$2,100
MDS-9710-PSU	MDS 9710 3K Watt Power Supply UPG	C	\$2,660
MDS-9718	9718 Chassis 2 Sup1E 12-PS 6-Fab Mods	C	\$381,173
MDS9718-CABKIT	MDS-9718 EC-1700-C Adpt Brckts Kit	C	\$294
MDS-BAFL-KIT	EC-1700-C MDS BAFFLE KIT	C	\$400
MDS-FCIP-9700	MDS 9000 24/10-port FCIP Module	C	\$141,260
MDS-FCIP-9700U	MDS 9000 24/10-port FCIP Module UPG	C	\$178,850
MDS-FCOE-8	MDS 9500 10-GBPS 8-PORT FCOE MODULE	C	\$0
MDS-FCOE-8U	CISCO MDS9000 10-GBPS 8-PORT FCOE MODUL	C	\$31,980
MDS-FCOE-9700	Connectrix 48P 10Gb FCoE Module	C	\$84,800
MDS-FCOE9700U	Connectrix 48P 10-Gb FCoE Module, UPG	C	\$110,240
MDS-FCOE-9718	Connectrix 24P 40Gb FCoE Module	C	\$93,035
MDS-FCOE-9718U	Connectrix 24P 40Gb FCoE Module UPG	C	\$120,946
MDS-FLASH-512	512MB FLASH UPGRADE	C	\$3,500
MDS-PBF-12SW	4Gb 12-Port FC Module	C	\$0
MDS-PBF-12SWU	4Gb 12-Port FC Module UPG	C	\$0
MDS-PBF-16	2Gb 16-Port FC Module	C	\$0
MDS-PBF-16LW	2Gb 16-Port FC Module LW	C	\$0
MDS-PBF-16U	2Gb 16-Port FC Module UPG	C	\$0
MDS-PBF-24-8G	MDS 1/2/4/8-GBPS 24-PORT PERF FC MODULE	C	\$0
MDS-PBF24-8GU	MDS 1/2/4/8-GBPS 24-PORT PERF FC MOD UPG	C	\$0
MDS-PBF-24LR	24 PORT 4GB LONG RANGE PORT BLADE	C	\$0
MDS-PBF-24LRU	24 PORT LW 4GB RANGE BLADE UPG	C	\$0
MDS-PBF-24MR	24 PORT 4GB MED-RNGE PORT BLADE	C	\$0
MDS-PBF-24MRU	24 PORT 4GB MEDIUM RANGE PORT BLADE UPG	C	\$0
MDS-PBF-24SW	4Gb 24-Port FC Module	C	\$0
MDS-PBF-24SWU	4Gb 24-Port FC Module UPG	C	\$0
MDS-PBF-32	2Gb 32-Port FC Module	C	\$0
MDS-PBF-32U	2Gb 32-Port FC Module UPG	C	\$0
MDS-PBF-44-8G	1/2/4/8-GBPS 4/44 HOST FC MODULE	C	\$0
MDS-PBF44-8GU	MDS 1/2/4/8-GBPS 4/44 HOST FC MODULE	C	\$0
MDS-PBF-48-8G	MDS 1/2/4/8-GBPS 48-PORT PERF FC MODULE	C	\$0
MDS-PBF48-8GU	MDS 1/2/4/8-GBPS 48P PERF FC MODULE UPG	C	\$0
MDS-PBF-48SW	4Gb 48-Port FC Module UPG	C	\$0
MDS-PBF-48SWU	4Gb 48-Port FC Module UPG	C	\$0
MDS-PBF-4LR	10Gb 4-Port FC Module LW 10Km	C	\$0
MDS-PBF-4LRU	10Gb 4-Port FC Module LW 10Km UPG	C	\$0
MDS-PBF-4SR	10Gb 4-Port FC Module SW 500m	C	\$0

MDS-PBF-4SRU	10Gb 4-Port FC Module SW 500m UPG	C	\$0
MDS-PBF-ADV32	CISCO 32-PORT 8-GBPS FC PORT MODULE	C	\$0
MDS-PBFADV32U	CISCO 32-PORT 8-GBPS FC PORT MOD UPG	C	\$0
MDS-PBF-ADV48	CISCO 48-PORT 8-GBPS FC PORT MODULE	C	\$0
MDS-PBFADV48U	CISCO 48-PORT 8-GBPS FC PORT MOD UPG	C	\$0
MDS-PBFI-1402	2Gb 14-Port FC+ 2-Port IP Module	C	\$0
MDS-PBFI-1804	4 GB 18 FC/4 GE PORT MODULE	C	\$0
MDS-PBFI1804U	4 GB 18 FC/4 GE PORT MODULE	C	\$68,120
MDS-PBI-4	4 PORT IP BLADE MDS	C	\$0
MDS-PBI-4U	4 PORT IP BLADE UPGRADE	C	\$0
MDS-PBI-8	8-Port IP Module	C	\$0
MDS-PBI-8U	8-Port IP Module UPG	C	\$0
MDS-PFI-1402U	2Gb 14-Port FC+ 2-Port IP Module UPG	C	\$0
MDS-PW19-EU	Qty 2 9506 Power Cord Europe	C	\$0
MDS-PW19-INT	Qty 2 9506 Power Cord International	C	\$0
MDS-PW19-KR	KOREA POWER CORDS FOR 9506 DIRECTOR	C	\$0
MDS-PW19-SA	Qty 2 9506 Power Cord South America	C	\$0
MDS-PW19-SW	Qty 2 9506 Power Cord Switzerland	C	\$0
MDS-PW19-TWST	Qty 2 9506 Twist Lock Power Cord US	C	\$0
MDS-PW19-UK	Qty 2 9506 Power Cord UK	C	\$0
MDS-PW19-US	Qty 2 9506 Power Cord US	C	\$0
MDS-PW2-AUS	CISCO POWER CABLE FOR MDS-9509 AUSTRAL	C	\$0
MDS-PW2-CAB	CAB PC DIRECTOR EC-1500	C	\$0
MDS-PW2-KR	KOREA POWER CORDS FOR 9509 DIRECTOR	C	\$0
MDS-PW8-CAB	Qty 2 Cabinet Power Cord	C	\$0
MDS-PW8-KR	Qty 2 9100 9200 Power Cord KOREA	C	\$0
MDS-PW8-SW	Qty 2 9100 9200 Power Cord Switzerland	C	\$0
MDS-PW8-TW	Qty 2 9100 9200 Power Cord TAIWAN	C	\$0
MDS-PW9513-AU	CISCO POWER CABLE FOR MDS-9513 AUSTRAL	C	\$0
MDS-PW9513-EU	Qty 4 9513 Power Cord Europe	C	\$0
MDS-PW9513-INT	Qty 4 9513 Power Cord International	C	\$0
MDS-PW9513-ISR	Qty 4 9513 Power Cord Israel	C	\$0
MDS-PW9513-KR	KOREA POWER CORDS FOR 9513 DIRECTOR	C	\$0
MDS-PW9513-SA	Qty 4 9513 Power Cord South Africa	C	\$0
MDS-PW9513-SW	Qty 4 9513 Power Cord Switzerland	C	\$0
MDS-PW9513-TWS	Qty 4 9513 Twist Lock Power Cord US/Japn	C	\$0
MDS-PW9513-US	Qty 4 9513 Power Cord US/Japan	C	\$0
MDS-PWQ-ARGIN	Qty 1 9Q20 & 9124 Power Cord Argentina	C	\$0
MDS-PWQ-AUS	Qty 1 9Q20 & 9124 Power Cord Australia	C	\$0
MDS-PWQ-ITALY	Qty 1 9Q20 & 9124 Power Cord Italy	C	\$0
MDS-PWQ-SA	Qty 1 9Q20 & 9124 Power Cord S Africa	C	\$0
MDS-PWQ-SW	Qty 1 9Q20 & 9124 Power Cord Switzerland	C	\$0
MDS-QSFP-40G-CSR4	MDS 40G CSR Optic QSFP+	C	\$3,668
MDS-QSFP-40G-SR4	MDS 40G SR Optic QSFP+	C	\$3,668
MDS-QSFP-40G-SR-BD	MDS 40G QSFP BiDi	C	\$1,342
MDS-QSFP-H40G-10M	MDS 40G Active Optical Cable Assy 10M	C	\$1,224
MDS-QSFP-H40G-3M	MDS 40G Active Optical Cable Assy 3M	C	\$1,039
MDS-QSFP-H40G-5M	MDS 40G Active Optical Cable Assy 5M	C	\$1,224
MDS-SC	OPTIONAL SMART CARD FOR SME FEATURE	C	\$470
MDS-SCR	OPTIONAL SMART CARD READER FOR SME	C	\$1,100

MDS-SFP-16GLW	MDS 16GB FC LW Optic	C	\$4,560
MDS-SFP-16GSW	MDS 16GB FC SW Optic	C	\$408
MDS-SFP-32GLW	MDS 32G LW Optic SFP+	C	\$7,370
MDS-SFP-32GSW	MDS 32G SW Optic SFP+	C	\$1,230
MDS-SSM-32	2Gb 32-Port FC Storage Sol Module	C	\$0
MDS-SSM-32F	MDS 9000 32-PORT 1 / 2 GBPS FC STORAGE S	C	\$0
MDS-SSM-32U	2Gb 32-Port FC Stg Sol Mod UPG	C	\$0
MDS-SSM-32UF	SSM UPGRADE BLADE 32 PORT	C	\$0
MDS-SSN-16	MDS 16P STORAGE SERVICES NO OPTICS	C	\$0
MDS-SSN-16U	MDS 16P STORAGE SERVICES NO OPTICS UPG	C	\$0
MDS-SUP-V2U	Supervisor2 Card UPG	C	\$0
MDS-TRI-LW	1-Gb Ethernet 2-Gb FC Tri-mode Longwave	C	\$1,700
MDS-TRI-SW	1-Gb Ethernet 2-Gb FC Tri-mode Shortwave	C	\$300
MDS-TWNX-10M	10G BASE COPPER ACTIVE TWINAX CABLE; 10M	C	\$510
MDS-TWNX-1M	10G BASE COPPER PASSIVE TWINAX CABLE; 1M	C	\$185
MDS-TWNX-3M	10G BASE COPPER PASSIVE TWINAX CABLE, 3M	C	\$265
MDS-TWNX-5M	10G BASE COPPER PASSIVE TWINAX CABLE; 5M	C	\$325
MDS-TWNX-7M	10G BASE COPPER ACTIVE TWINAX CABLE, 7M	C	\$450
PB-12000B-16	16-Port CARD ED-12000B	C	\$0
PB-12000B-16U	16-Port CARD ED-12000B	C	\$0
PB-24000-16	16-Port CARD ED-24000B	C	\$0
PB-24000-16U	2Gb 16 FC port blade/ED-24000B	C	\$0
PB-48000B-16	4Gb 16 FC port blade/ED-48000B	C	\$0
PB-48000B-16U	4Gb 16 FC port blade/ED-48000B UPG	C	\$0
PB-48000B-32	4Gb 32 FC port blade/ED-48000B	C	\$0
PB-48000B-32U	4Gb 32 FC port blade/ED-48000B UPG	C	\$0
PB-48K-10G-6	10GB 6 FC PORT BLADE/ED-48K	C	\$0
PB-48K-10G-6U	10GB 6 FC PORT BLADE/ED-48K-UPG	C	\$0
PB-48K-16IP	4GB 8-PORT FC+ 8-PORT IP CARD	C	\$0
PB-48K-16IPU	4GB 8-PORT FC+ 8-PORT IP CARD (UPGRADE)	C	\$0
PB-48K-18I	BROCADE FC4-18I IP-BLADE	C	\$0
PB-48K-18IU	BROCADE FC4-18I IP-BLADE UPGRADE	C	\$0
PB-48K-48	4GB 48-PORT FC CARD	C	\$0
PB-48K-48U	4GB 48-PORT FC CARD (UPGRADE)	C	\$0
PB-48K-AP4-18	AP4-18 ED-48000B APPLICATION BLADE	C	\$0
PB48K-AP4-18U	AP4-18 ED-48000B APPLICATION BLADE UPG	C	\$0
PB-DCX-16EB	ED-DCX-B 16P ENCRYPTION BLADE	C	\$0
PB-DCX-16EBU	ED-DCX-B 16P ENCRYPTION BLADE UPGRADE	C	\$0
PB-DCX-16P-4G	DCX PORT BLADE 16P 16 4G SFPS	C	\$0
PB-DCX-16P4GU	DCX UPGRADE PORT BLADE 16P 16 4G SFPS	C	\$0
PB-DCX-16P-8G	DCX PORT BLADE 16P 16 8G SFPS	C	\$0
PB-DCX-16P8GU	DCX UPGRADE PORT BLADE 16P 16 8G SFPS	C	\$0
PB-DCX-16P-E	DCX PORT BLADE 16P 0 SFPS	C	\$0
PB-DCX-32P16G	DCX PORT BLADE 32P 32 16G SFPS	C	\$84,880
PB-DCX32P16GE	DCX 16G PORT BLADE 32P 0 SFPS	C	\$65,910
PBDCX32P16GEU	DCX 16G PORT BLADE 32P 0 SFPS UPG	C	\$85,680
PB-DCX32P16GU	DCX UPGRADE PORT BLADE 32P 32 16G SFPS	C	\$110,340
PB-DCX-32P-4G	DCX PORT BLADE 32P 32 4G SFPS	C	\$0
PB-DCX-32P4GU	DCX UPGRADE PORT BLADE 32P 32 4G SFPS	C	\$0
PB-DCX-32P-8G	DCX PORT BLADE 32P 32 8G SFPS	C	\$0

PB-DCX-32P8GM	X8510 8G MAX 32P BLADE W/ 32 8G SFPS	C	\$0
PB-DCX32P8GME	DCX8510 8G MAX 32P BLADE W/ 0 SFPS	C	\$0
PB-DCX32P8GMU	DCX UPG 8G MAX 32P BLADE W/ 32 8G SFPS	C	\$0
PB-DCX-32P8GU	DCX UPGRADE PORT BLADE 32P 32 8G SFPS	C	\$0
PB-DCX-32P-E	DCX PORT BLADE 32P 0 SFPS	C	\$0
PB-DCX-48P16G	DCX PORT BLADE 48P 48 16G SFPS	C	\$118,950
PB-DCX48P16GE	DCX 16G PORT BLADE 48P 0 SFPS	C	\$91,670
PBDCX48P16GEU	DCX 16G PORT BLADE 48P 0 SFPS UPG	C	\$119,170
PB-DCX48P16GU	DCX UPGRADE PORT BLADE 48P 48 16G SFPS	C	\$154,640
PB-DCX-48P-4G	DCX PORT BLADE 48P 48 4G SFPS	C	\$0
PB-DCX-48P4GU	DCX UPGRADE PORT BLADE 48P 48 4G SFPS	C	\$0
PB-DCX-48P-8G	DCX PORT BLADE 48P 48 8G SFPS	C	\$0
PB-DCX-48P8GM	DCX8510 8G MAX 48P BLADE W/ 48 8G SFPS	C	\$0
PB-DCX48P8GME	DCX8510 8G MAX 48P BLADE W/ 0 SFPS	C	\$0
PB-DCX48P8GMU	DCX UPG 8G MAX 48P BLADE W/ 48 8G SFPS	C	\$0
PB-DCX-48P8GU	DCX UPGRADE PORT BLADE 48P 48 8G SFPS	C	\$0
PB-DCX-48P-E	DCX PORT BLADE 48P 0 SFPS	C	\$0
PB-DCX6-48P32G	DCX6 32G PORT BLADE 48P 48 SW 32G SFPS	C	\$185,500
PB-DCX6-48P32GE	DCX6 32G PORT BLADE 48P 0 SFPS	C	\$131,930
PB-DCX6-48P32GEU	DCX6 32G PORT BLADE 48P 0 SFPS UPG	C	\$171,510
PB-DCX6-48P32GU	DCX6 32G PORT BLADE 48P 48 SW SFPS UPG	C	\$241,150
PBDCX-64P-16G	DCX8510 16G 64P PORT BLADE 16-QSFPS	C	\$158,610
PBDCX-64P16GU	DCX8510 16G 64P UPG PORT BLADE 16-QSFPS	C	\$206,190
PB-DCX-64P-8G	DCX PORT BLADE 64P 64 8G MSFPS	C	\$0
PB-DCX-64P8GU	DCX UPGRADE PORT BLADE 64P 64 8G MSFPS	C	\$0
PB-DCX6-64P32G	DCX6 32G PORT BLADE 64P W 8-4X32G QSFPS	C	\$196,830
PB-DCX6-64P32GU	DCX6 32G UPG PRT BLD 64P W 8-4X32G QSFPS	C	\$255,880
PB-DCX6-SX6-LW	DCX6 SX6 16 32G LW SFP 0 IP SFP	C	\$453,250
PB-DCX6-SX6-SW	DCX6 SX6 16 32G SW SFP 0 IP SFP	C	\$321,530
PWRC-DCX-AU	DCX AUSTRALIA/NZ 250V PWR CRD KIT - 2PER	C	\$400
PWRC-DCX-EU	DCX EU CEE7/7 PWR CRD KIT - 2PER	C	\$400
PWRC-DCX-NA	DCX NORTHAM 250V PWR CRD KIT - 2PER	C	\$400
PWRC-DCX-NALV	DCX NORTHAM 110V PWR CRD KIT - 2PER	C	\$400
PWRC-DCX-OT	DCX NON-EU 230V PWR CRD KIT - 2PER	C	\$400
SP-1004	SRVCE PROCSSR FOR EC1200	C	\$0
SP-1010	CTX SRVC PROCSR-1U SRVR	C	\$0
SP-1020	CTX SERVICE PROCESSOR WINDOWS 2003	C	\$0
SP-HUB-ETH	CONNECTRIX ETHERNET HUB	C	\$1,300
SP-KVM	CTX KVM UNIT	C	\$0
SAS-458-000-066	CloudSnapshotManager Tier 1 PP=IB	CL-E	\$144
SAS-458-000-067	CloudSnapshotManager Tier 1 MB=IB	CL-E	\$158
SAS-458-000-068	CloudSnapshotManager Tier 2 PP=IB	CL-E	\$120
SAS-458-000-069	CloudSnapshotManager Tier 3 PP=IB	CL-E	\$102
SAS-458-000-070	CloudSnapshotManager Tier 4 PP=IB	CL-E	\$90
SAS-458-000-071	CloudSnapshotManager Tier 5 PP=IB	CL-E	\$84
SAS-458-000-072	CloudSnapshotManager Tier 2 MB=IB	CL-E	\$132
SAS-458-000-073	CloudSnapshotManager Tier 3 MB=IB	CL-E	\$112
SAS-458-000-074	CloudSnapshotManager Tier 4 MB=IB	CL-E	\$99
SAS-458-000-075	CloudSnapshotManager Tier 5 MB=IB	CL-E	\$92
SAS-458-000-077	CloudSnapshotManager 36M Tier1 AN=IB	CL-E	\$393

SAS-458-000-078	CloudSnapshotManager 36M Tier2 AN=IB	CL-E	\$327
SAS-458-000-079	CloudSnapshotManager 36M Tier3 AN=IB	CL-E	\$278
SAS-458-000-080	CloudSnapshotManager 36M Tier4 AN=IB	CL-E	\$245
SAS-458-000-081	CloudSnapshotManager 36M Tier5 AN=IB	CL-E	\$229
SAS-458-000-082	CloudSnapshotManager 36M Tier1 PP=IB	CL-E	\$353
SAS-458-000-083	CloudSnapshotManager 36M Tier2 PP=IB	CL-E	\$295
SAS-458-000-084	CloudSnapshotManager 36M Tier3 PP=IB	CL-E	\$250
SAS-458-000-085	CloudSnapshotManager 36M Tier4 PP=IB	CL-E	\$221
SAS-458-000-086	CloudSnapshotManager 36M Tier5 PP=IB	CL-E	\$206
456-000-521	SYMM MGMT SUITE SATA 0-14TB	D1	\$0
456-000-522	SYMM MGMT SUITE SATA 15-25TB	D1	\$0
456-000-523	SYMM MGMT SUITE SATA 26-40TB	D1	\$0
456-000-524	SYMM MGMT SUITE SATA 41-60TB	D1	\$0
456-000-525	SYMM MGMT SUITE SATA 61-100TB	D1	\$0
456-000-526	SYMM MGMT SUITE SATA 101-150TB	D1	\$0
456-000-527	SYMM MGMT SUITE SATA 151-250TB	D1	\$0
456-000-528	SYMM MGMT SUITE SATA 251-400TB	D1	\$0
456-000-529	SYMM MGMT SUITE SATA 401-600TB	D1	\$0
456-000-530	SYMM MGMT SUITE SATA 601-1000TB	D1	\$0
456-000-531	SYMM MGMT SUITE SATA 1000TB +	D1	\$0
456-000-532	SYMM MGMT SUITE NON-SATA 0-14TB	D1	\$0
456-000-533	SYMM MGMT SUITE NON-SATA 15-25TB	D1	\$0
456-000-534	SYMM MGMT SUITE NON-SATA 26-40TB	D1	\$0
456-000-535	SYMM MGMT SUITE NON-SATA 41-60TB	D1	\$0
456-000-536	SYMM MGMT SUITE NON-SATA 61-100TB	D1	\$0
456-000-537	SYMM MGMT SUITE NON-SATA 101-150TB	D1	\$0
456-000-538	SYMM MGMT SUITE NON-SATA 151-250TB	D1	\$0
456-000-539	SYMM MGMT SUITE NON-SATA 251-400TB	D1	\$0
456-000-540	SYMM MGMT SUITE NON-SATA 401-600TB	D1	\$0
456-000-541	SYMM MGMT SUITE NON-SATA 601-1000TB	D1	\$0
456-000-542	SYMM MGMT SUITE NON-SATA 1000TB +	D1	\$0
456-005-541	ADV FAST SUITE FTS 0-14TB	D1	\$0
456-005-542	ADV FAST SUITE FTS 15-25TB	D1	\$0
456-005-543	ADV FAST SUITE FTS 26-40TB	D1	\$0
456-005-544	ADV FAST SUITE FTS 41-60TB	D1	\$0
456-005-545	ADV FAST SUITE FTS 61-100TB	D1	\$0
456-005-546	ADV FAST SUITE FTS 101-150TB	D1	\$0
456-005-547	ADV FAST SUITE FTS 151-250TB	D1	\$0
456-005-548	ADV FAST SUITE FTS 251-400TB	D1	\$0
456-005-549	ADV FAST SUITE FTS 401-600TB	D1	\$0
456-005-550	ADV FAST SUITE FTS 601-1000TB	D1	\$0
456-005-551	ADV FAST SUITE FTS 1001TB+	D1	\$0
456-005-552	SRDF-A FTS 0 - 14TB	D1	\$0
456-005-553	SRDF-A FTS 15-25TB	D1	\$0
456-005-554	SRDF-A FTS 26-40TB	D1	\$0
456-005-555	SRDF-A FTS 41-60TB	D1	\$0
456-005-556	SRDF-A FTS 61-100TB	D1	\$0
456-005-557	SRDF-A FTS 101-150TB	D1	\$0
456-005-558	SRDF-A FTS 151-250TB	D1	\$0
456-005-559	SRDF-A FTS 251-400TB	D1	\$0

456-005-560	SRDF-A FTS 401-600TB	D1	\$0
456-005-561	SRDF-A FTS 601-1000TB	D1	\$0
456-005-562	SRDF-A FTS 1000TB+	D1	\$0
456-005-563	SRDF-S FTS 0 - 14TB	D1	\$0
456-005-564	SRDF-S FTS 15-25TB	D1	\$0
456-005-565	SRDF-S FTS 26-40TB	D1	\$0
456-005-566	SRDF-S FTS 41-60TB	D1	\$0
456-005-567	SRDF-S FTS 61-100TB	D1	\$0
456-005-568	SRDF-S FTS 101-150TB	D1	\$0
456-005-569	SRDF-S FTS 151-250TB	D1	\$0
456-005-570	SRDF-S FTS 251-400TB	D1	\$0
456-005-571	SRDF-S FTS 401-600TB	D1	\$0
456-005-572	SRDF-S FTS 601-1000TB	D1	\$0
456-005-573	SRDF-S FTS 1001TB+	D1	\$0
456-005-574	SRDF-STAR FTS 0 - 14TB	D1	\$0
456-005-575	SRDF-STAR FTS 15-25TB	D1	\$0
456-005-576	SRDF-STAR FTS 26-40TB	D1	\$0
456-005-577	SRDF-STAR FTS 41-60TB	D1	\$0
456-005-578	SRDF-STAR FTS 61-100TB	D1	\$0
456-005-579	SRDF-STAR FTS 101-150TB	D1	\$0
456-005-580	SRDF-STAR FTS 151-250TB	D1	\$0
456-005-581	SRDF-STAR FTS 251-400TB	D1	\$0
456-005-582	SRDF-STAR FTS 401-600TB	D1	\$0
456-005-583	SRDF-STAR FTS 601-1000TB	D1	\$0
456-005-584	SRDF-STAR FTS 1001TB+	D1	\$0
456-005-585	TF-CLONE FTS 0-14TB	D1	\$0
456-005-586	TF-CLONE FTS 15-25TB	D1	\$0
456-005-587	TF-CLONE FTS 26-40TB	D1	\$0
456-005-588	TF-CLONE FTS 41-60TB	D1	\$0
456-005-589	TF-CLONE FTS 61-100TB	D1	\$0
456-005-590	TF-CLONE FTS 101-150TB	D1	\$0
456-005-591	TF-CLONE FTS 151-250TB	D1	\$0
456-005-592	TF-CLONE FTS 251-400TB	D1	\$0
456-005-593	TF-CLONE FTS 401-600TB	D1	\$0
456-005-594	TF-CLONE FTS 601-1000TB	D1	\$0
456-005-595	TF-CLONE FTS 1001TB+	D1	\$0
456-005-596	TF-SNAP FTS 0 - 14TB	D1	\$0
456-005-597	TF-SNAP FTS 15-25TB	D1	\$0
456-005-598	TF-SNAP FTS 26-40TB	D1	\$0
456-005-599	TF-SNAP FTS 41-60TB	D1	\$0
456-005-600	TF-SNAP FTS 61-100TB	D1	\$0
456-005-601	TF-SNAP FTS 101-150TB	D1	\$0
456-005-602	TF-SNAP FTS 151-250TB	D1	\$0
456-005-603	TF-SNAP FTS 251-400TB	D1	\$0
456-005-604	TF-SNAP FTS 401-600TB	D1	\$0
456-005-605	TF-SNAP FTS 601-1000TB	D1	\$0
456-005-606	TF-SNAP FTS 1001TB+	D1	\$0
456-005-731	OR-DM NON-SATA 0-14TB	D1	\$0
456-005-732	OR-DM NON-SATA 15-25TB	D1	\$0
456-005-733	OR-DM NON-SATA 26-40TB	D1	\$0

456-005-734	OR-DM NON-SATA 41-60TB	D1	\$0
456-005-735	OR-DM NON-SATA 61-100TB	D1	\$0
456-005-736	OR-DM NON-SATA 101-150TB	D1	\$0
456-005-737	OR-DM NON-SATA 151-250TB	D1	\$0
456-005-738	OR-DM NON-SATA 251-400TB	D1	\$0
456-005-739	OR-DM NON-SATA 401-600TB	D1	\$0
456-005-740	OR-DM NON-SATA 601-1000TB	D1	\$0
456-005-741	OR-DM NON-SATA 1001TB+	D1	\$0
456-005-742	OR-DM SATA 0-14TB	D1	\$0
456-005-743	OR-DM SATA 15-25TB	D1	\$0
456-005-744	OR-DM SATA 26-40TB	D1	\$0
456-005-745	OR-DM SATA 41-60TB	D1	\$0
456-005-746	OR-DM SATA 61-100TB	D1	\$0
456-005-747	OR-DM SATA 101-150TB	D1	\$0
456-005-748	OR-DM SATA 151-250TB	D1	\$0
456-005-749	OR-DM SATA 251-400TB	D1	\$0
456-005-750	OR-DM SATA 401-600TB	D1	\$0
456-005-751	OR-DM SATA 601-1000TB	D1	\$0
456-005-752	OR-DM SATA 1001TB+	D1	\$0
456-011-711	FAST REGISTERED 0-14TB	D1	\$0
456-011-712	FAST REGISTERED 1001+	D1	\$0
456-011-713	FAST REGISTERED 101-150TB	D1	\$0
456-011-714	FAST REGISTERED 151-250TB	D1	\$0
456-011-715	FAST REGISTERED 15-25TB	D1	\$0
456-011-716	FAST REGISTERED 251-400TB	D1	\$0
456-011-717	FAST REGISTERED 26-40TB	D1	\$0
456-011-718	FAST REGISTERED 401-600TB	D1	\$0
456-011-719	FAST REGISTERED 41-60TB	D1	\$0
456-011-720	FAST REGISTERED 601-1000TB	D1	\$0
456-011-721	FAST REGISTERED 61-100TB	D1	\$0
456-011-733	FAST VP REGISTERED 0-14TB	D1	\$0
456-011-734	FAST VP REGISTERED 1001+	D1	\$0
456-011-735	FAST VP REGISTERED 101-150TB	D1	\$0
456-011-736	FAST VP REGISTERED 151-250TB	D1	\$0
456-011-737	FAST VP REGISTERED 15-25TB	D1	\$0
456-011-738	FAST VP REGISTERED 251-400TB	D1	\$0
456-011-739	FAST VP REGISTERED 26-40TB	D1	\$0
456-011-740	FAST VP REGISTERED 401-600TB	D1	\$0
456-011-741	FAST VP REGISTERED 41-60TB	D1	\$0
456-011-742	FAST VP REGISTERED 601-1000TB	D1	\$0
456-011-743	FAST VP REGISTERED 61-100TB	D1	\$0
456-101-739	SPA 1TB NON-SATA 0-14TB	D1	\$0
456-101-740	SPA 1TB NON-SATA 15-25TB	D1	\$0
456-101-741	SPA 1TB NON-SATA 26-40TB	D1	\$0
456-101-742	SPA 1TB NON-SATA 41-60TB	D1	\$0
456-101-743	SPA 1TB NON-SATA 61-100TB	D1	\$0
456-101-744	SPA 1TB NON-SATA 101-150TB	D1	\$0
456-101-745	SPA 1TB NON-SATA 151-250TB	D1	\$0
456-101-746	SPA 1TB NON-SATA 251-400TB	D1	\$0
456-101-747	SPA 1TB NON-SATA 401-600TB	D1	\$0

456-101-748	SPA 1TB NON-SATA 601-1000TB	D1	\$0
456-101-749	SPA 1TB NON-SATA 1001TB+	D1	\$0
456-101-750	SPA 1TB SATA 0-14TB	D1	\$0
456-101-751	SPA 1TB SATA 15-25TB	D1	\$0
456-101-752	SPA 1TB SATA 26-40TB	D1	\$0
456-101-753	SPA 1TB SATA 41-60TB	D1	\$0
456-101-754	SPA 1TB SATA 61-100TB	D1	\$0
456-101-755	SPA 1TB SATA 101-150TB	D1	\$0
456-101-756	SPA 1TB SATA 151-250TB	D1	\$0
456-101-757	SPA 1TB SATA 251-400TB	D1	\$0
456-101-758	SPA 1TB SATA 401-600TB	D1	\$0
456-101-759	SPA 1TB SATA 601-1000TB	D1	\$0
456-101-760	SPA 1TB SATA 1001TB+	D1	\$0
456-102-542	ENGINUIY NON-SATA 0-14TB (TCF0100)	D1	\$2,020
456-102-543	ENGINUIY NON-SATA 15-25TB (TCF0200)	D1	\$1,940
456-102-544	ENGINUIY NON-SATA 26-40TB (TCF0300)	D1	\$1,860
456-102-545	ENGINUIY NON-SATA 41-60TB (TCF0400)	D1	\$1,790
456-102-546	ENGINUIY NON-SATA 61-100TB (TCF0500)	D1	\$1,710
456-102-547	ENGINUIY NON-SATA 101-150TB (TCF0600)	D1	\$1,650
456-102-548	ENGINUIY NON-SATA 151-250TB (TCF0700)	D1	\$1,580
456-102-549	ENGINUIY NON-SATA 251-400TB (TCF0800)	D1	\$1,520
456-102-550	ENGINUIY NON-SATA 401-600TB (TCF0900)	D1	\$1,460
456-102-551	ENGINUIY NON-SATA 601-1000TB (TCF1000)	D1	\$1,400
456-102-552	ENGINUIY NON-SATA 1001+ (TCF1100)	D1	\$1,340
456-102-553	ENGINUIY SATA 0-14TB (TCS0100)	D1	\$910
456-102-554	ENGINUIY SATA 15-25TB (TCS0200)	D1	\$870
456-102-555	ENGINUIY SATA 26-40TB (TCS0300)	D1	\$840
456-102-556	ENGINUIY SATA 41-60TB (TCS0400)	D1	\$800
456-102-557	ENGINUIY SATA 61-100TB (TCS0500)	D1	\$770
456-102-558	ENGINUIY SATA 101-150TB (TCS0600)	D1	\$740
456-102-559	ENGINUIY SATA 151-250TB (TCS0700)	D1	\$710
456-102-560	ENGINUIY SATA 251-400TB (TCS0800)	D1	\$680
456-102-561	ENGINUIY SATA 401-600TB (TCS0900)	D1	\$660
456-102-562	ENGINUIY SATA 601-1000TB (TCS1000)	D1	\$630
456-102-563	ENGINUIY SATA 1001+ (TCS1100)	D1	\$600
456-102-565	OPTIMIZER NON-SATA 0-14TB (TCF0100)	D1	\$0
456-102-566	OPTIMIZER NON-SATA 15-25TB (TCF0200)	D1	\$0
456-102-567	OPTIMIZER NON-SATA 26-40TB (TCF0300)	D1	\$0
456-102-568	OPTIMIZER NON-SATA 41-60TB (TCF0400)	D1	\$0
456-102-569	OPTIMIZER NON-SATA 61-100TB (TCF0500)	D1	\$0
456-102-570	OPTIMIZER NON-SATA 101-150TB (TCF0600)	D1	\$0
456-102-571	OPTIMIZER NON-SATA 151-250TB (TCF0700)	D1	\$0
456-102-572	OPTIMIZER NON-SATA 251-400TB (TCF0800)	D1	\$0
456-102-573	OPTIMIZER NON-SATA 401-600TB (TCF0900)	D1	\$0
456-102-574	OPTIMIZER NON-SATA 601-1000TB (TCF1000)	D1	\$0
456-102-575	OPTIMIZER NON-SATA 1001+ (TCF1100)	D1	\$0
456-102-576	OPTIMIZER SATA 0-14TB (TCS0100)	D1	\$0
456-102-577	OPTIMIZER SATA 15-25TB (TCS0200)	D1	\$0
456-102-578	OPTIMIZER SATA 26-40TB (TCS0300)	D1	\$0
456-102-579	OPTIMIZER SATA 41-60TB (TCS0400)	D1	\$0

456-102-580	OPTIMIZER SATA 61-100TB (TCS0500)	D1	\$0
456-102-581	OPTIMIZER SATA 101-150TB (TCS0600)	D1	\$0
456-102-582	OPTIMIZER SATA 151-250TB (TCS0700)	D1	\$0
456-102-583	OPTIMIZER SATA 251-400TB (TCS0800)	D1	\$0
456-102-584	OPTIMIZER SATA 401-600TB (TCS0900)	D1	\$0
456-102-585	OPTIMIZER SATA 601-1000TB (TCS1000)	D1	\$0
456-102-586	OPTIMIZER SATA 1001+ (TCS1100)	D1	\$0
456-102-588	ATSM NON-SATA 0-14TB (TCF0100)	D1	\$0
456-102-589	ATSM NON-SATA 15-25TB (TCF0200)	D1	\$0
456-102-590	ATSM NON-SATA 26-40TB (TCF0300)	D1	\$0
456-102-591	ATSM NON-SATA 41-60TB (TCF0400)	D1	\$0
456-102-592	ATSM NON-SATA 61-100TB (TCF0500)	D1	\$0
456-102-593	ATSM NON-SATA 101-150TB (TCF0600)	D1	\$0
456-102-594	ATSM NON-SATA 151-250TB (TCF0700)	D1	\$0
456-102-595	ATSM NON-SATA 251-400TB (TCF0800)	D1	\$0
456-102-596	ATSM NON-SATA 401-600TB (TCF0900)	D1	\$0
456-102-597	ATSM NON-SATA 601-1000TB (TCF1000)	D1	\$0
456-102-598	ATSM NON-SATA 1001+ (TCF1100)	D1	\$0
456-102-599	ATSM SATA 0-14TB (TCS0100)	D1	\$0
456-102-600	ATSM SATA 15-25TB (TCS0200)	D1	\$0
456-102-601	ATSM SATA 26-40TB (TCS0300)	D1	\$0
456-102-602	ATSM SATA 41-60TB (TCS0400)	D1	\$0
456-102-603	ATSM SATA 61-100TB (TCS0500)	D1	\$0
456-102-604	ATSM SATA 101-150TB (TCS0600)	D1	\$0
456-102-605	ATSM SATA 151-250TB (TCS0700)	D1	\$0
456-102-606	ATSM SATA 251-400TB (TCS0800)	D1	\$0
456-102-607	ATSM SATA 401-600TB (TCS0900)	D1	\$0
456-102-608	ATSM SATA 601-1000TB (TCS1000)	D1	\$0
456-102-609	ATSM SATA 1001+ (TCS1100)	D1	\$0
456-102-611	TSM NON-SATA 0-14TB (TCF0100)	D1	\$0
456-102-612	TSM NON-SATA 15-25TB (TCF0200)	D1	\$0
456-102-613	TSM NON-SATA 26-40TB (TCF0300)	D1	\$0
456-102-614	TSM NON-SATA 41-60TB (TCF0400)	D1	\$0
456-102-615	TSM NON-SATA 61-100TB (TCF0500)	D1	\$0
456-102-616	TSM NON-SATA 101-150TB (TCF0600)	D1	\$0
456-102-617	TSM NON-SATA 151-250TB (TCF0700)	D1	\$0
456-102-618	TSM NON-SATA 251-400TB (TCF0800)	D1	\$0
456-102-619	TSM NON-SATA 401-600TB (TCF0900)	D1	\$0
456-102-620	TSM NON-SATA 601-1000TB (TCF1000)	D1	\$0
456-102-621	TSM NON-SATA 1001+ (TCF1100)	D1	\$0
456-102-622	TSM SATA 0-14TB (TCS0100)	D1	\$0
456-102-623	TSM SATA 15-25TB (TCS0200)	D1	\$0
456-102-624	TSM SATA 26-40TB (TCS0300)	D1	\$0
456-102-625	TSM SATA 41-60TB (TCS0400)	D1	\$0
456-102-626	TSM SATA 61-100TB (TCS0500)	D1	\$0
456-102-627	TSM SATA 101-150TB (TCS0600)	D1	\$0
456-102-628	TSM SATA 151-250TB (TCS0700)	D1	\$0
456-102-629	TSM SATA 251-400TB (TCS0800)	D1	\$0
456-102-630	TSM SATA 401-600TB (TCS0900)	D1	\$0
456-102-631	TSM SATA 601-1000TB (TCS1000)	D1	\$0

456-102-632	TSM SATA 1001+ (TCS1100)	D1	\$0
456-102-634	FAST SUITE NON-SATA 0-14TB (TCF0100)	D1	\$0
456-102-635	FAST SUITE NON-SATA 15-25TB (TCF0200)	D1	\$0
456-102-636	FAST SUITE NON-SATA 26-40TB (TCF0300)	D1	\$0
456-102-637	FAST SUITE NON-SATA 41-60TB (TCF0400)	D1	\$0
456-102-638	FAST SUITE NON-SATA 61-100TB (TCF0500)	D1	\$0
456-102-639	FAST SUITE NON-SATA 101-150TB (TCF0600)	D1	\$0
456-102-640	FAST SUITE NON-SATA 151-250TB (TCF0700)	D1	\$0
456-102-641	FAST SUITE NON-SATA 251-400TB (TCF0800)	D1	\$0
456-102-642	FAST SUITE NON-SATA 401-600TB (TCF0900)	D1	\$0
456-102-643	FAST SUITE NON-SATA 601-1000TB (TCF1000)	D1	\$0
456-102-644	FAST SUITE NON-SATA 1001+ (TCF1100)	D1	\$0
456-102-645	FAST SUITE SATA 0-14TB (TCS0100)	D1	\$0
456-102-646	FAST SUITE SATA 15-25TB (TCS0200)	D1	\$0
456-102-647	FAST SUITE SATA 26-40TB (TCS0300)	D1	\$0
456-102-648	FAST SUITE SATA 41-60TB (TCS0400)	D1	\$0
456-102-649	FAST SUITE SATA 61-100TB (TCS0500)	D1	\$0
456-102-650	FAST SUITE SATA 101-150TB (TCS0600)	D1	\$0
456-102-651	FAST SUITE SATA 151-250TB (TCS0700)	D1	\$0
456-102-652	FAST SUITE SATA 251-400TB (TCS0800)	D1	\$0
456-102-653	FAST SUITE SATA 401-600TB (TCS0900)	D1	\$0
456-102-654	FAST SUITE SATA 601-1000TB (TCS1000)	D1	\$0
456-102-655	FAST SUITE SATA 1001+ (TCS1100)	D1	\$0
456-102-657	FAST ADD ON NON-SATA 0-14TB (TCF0100)	D1	\$0
456-102-658	FAST ADD ON NON-SATA 15-25TB (TCF0200)	D1	\$0
456-102-659	FAST ADD ON NON-SATA 26-40TB (TCF0300)	D1	\$0
456-102-660	FAST ADD ON NON-SATA 41-60TB (TCF0400)	D1	\$0
456-102-661	FAST ADD ON NON-SATA 61-100TB (TCF0500)	D1	\$0
456-102-662	FAST ADD ON NON-SATA 101-150TB (TCF0600)	D1	\$0
456-102-663	FAST ADD ON NON-SATA 151-250TB (TCF0700)	D1	\$0
456-102-664	FAST ADD ON NON-SATA 251-400TB (TCF0800)	D1	\$0
456-102-665	FAST ADD ON NON-SATA 401-600TB (TCF0900)	D1	\$0
456-102-666	FAST ADD ON NON-SATA 601-1000TB	D1	\$0
456-102-667	FAST ADD ON NON-SATA 1001+ (TCF1100)	D1	\$0
456-102-668	FAST ADD ON SATA 0-14TB (TCS0100)	D1	\$0
456-102-669	FAST ADD ON SATA 15-25TB (TCS0200)	D1	\$0
456-102-670	FAST ADD ON SATA 26-40TB (TCS0300)	D1	\$0
456-102-671	FAST ADD ON SATA 41-60TB (TCS0400)	D1	\$0
456-102-672	FAST ADD ON SATA 61-100TB (TCS0500)	D1	\$0
456-102-673	FAST ADD ON SATA 101-150TB (TCS0600)	D1	\$0
456-102-674	FAST ADD ON SATA 151-250TB (TCS0700)	D1	\$0
456-102-675	FAST ADD ON SATA 251-400TB (TCS0800)	D1	\$0
456-102-676	FAST ADD ON SATA 401-600TB (TCS0900)	D1	\$0
456-102-677	FAST ADD ON SATA 601-1000TB (TCS1000)	D1	\$0
456-102-678	FAST ADD ON SATA 1001+ (TCS1100)	D1	\$0
456-102-680	ADV FAST SUITE NON-SATA 0-14TB	D1	\$2,054
456-102-681	ADV FAST SUITE NON-SATA 15-25TB	D1	\$1,926
456-102-682	ADV FAST SUITE NON-SATA 26-40TB	D1	\$1,696
456-102-683	ADV FAST SUITE NON-SATA 41-60TB	D1	\$1,578
456-102-684	ADV FAST SUITE NON-SATA 61-100TB	D1	\$1,509

456-102-685	ADV FAST SUITE NON-SATA 101-150TB	D1	\$1,358
456-102-686	ADV FAST SUITE NON-SATA 151-250TB	D1	\$1,220
456-102-687	ADV FAST SUITE NON-SATA 251-400TB	D1	\$1,056
456-102-688	ADV FAST SUITE NON-SATA 401-600TB	D1	\$906
456-102-689	ADV FAST SUITE NON-SATA 601-1000TB	D1	\$800
456-102-690	ADV FAST SUITE NON-SATA 1001TB+	D1	\$695
456-102-691	ADV FAST SUITE SATA 0-14TB (TCS0100)	D1	\$1,026
456-102-692	ADV FAST SUITE SATA 15-25TB (TCS0200)	D1	\$964
456-102-693	ADV FAST SUITE SATA 26-40TB (TCS0300)	D1	\$846
456-102-694	ADV FAST SUITE SATA 41-60TB (TCS0400)	D1	\$787
456-102-695	ADV FAST SUITE SATA 61-100TB (TCS0500)	D1	\$754
456-102-696	ADV FAST SUITE SATA 101-150TB (TCS0600)	D1	\$679
456-102-697	ADV FAST SUITE SATA 151-250TB (TCS0700)	D1	\$610
456-102-698	ADV FAST SUITE SATA 251-400TB (TCS0800)	D1	\$528
456-102-699	ADV FAST SUITE SATA 401-600TB (TCS0900)	D1	\$453
456-102-700	ADV FAST SUITE SATA 601-1000TB (TCS1000)	D1	\$400
456-102-701	ADV FAST SUITE SATA 1001TB+ (TCS1100)	D1	\$348
456-102-703	FAST VP ADD ON NON-SATA 0-14TB (TCF0100)	D1	\$0
456-102-704	FAST VP ADD ON NON-SATA 15-25TB	D1	\$0
456-102-705	FAST VP ADD ON NON-SATA 26-40TB	D1	\$0
456-102-706	FAST VP ADD ON NON-SATA 41-60TB	D1	\$0
456-102-707	FAST VP ADD ON NON-SATA 61-100TB	D1	\$0
456-102-708	FAST VP ADD ON NON-SATA 101-150TB	D1	\$0
456-102-709	FAST VP ADD ON NON-SATA 151-250TB	D1	\$0
456-102-710	FAST VP ADD ON NON-SATA 251-400TB	D1	\$0
456-102-711	FAST VP ADD ON NON-SATA 401-600TB	D1	\$0
456-102-712	FAST VP ADD ON NON-SATA 601-1000TB	D1	\$0
456-102-713	FAST VP ADD ON NON-SATA 1001+ (TCF1100)	D1	\$0
456-102-714	FAST VP ADD ON SATA 0-14TB (TCS0100)	D1	\$0
456-102-715	FAST VP ADD ON SATA 15-25TB (TCS0200)	D1	\$0
456-102-716	FAST VP ADD ON SATA 26-40TB (TCS0300)	D1	\$0
456-102-717	FAST VP ADD ON SATA 41-60TB (TCS0400)	D1	\$0
456-102-718	FAST VP ADD ON SATA 61-100TB (TCS0500)	D1	\$0
456-102-719	FAST VP ADD ON SATA 101-150TB (TCS0600)	D1	\$0
456-102-720	FAST VP ADD ON SATA 151-250TB (TCS0700)	D1	\$0
456-102-721	FAST VP ADD ON SATA 251-400TB (TCS0800)	D1	\$0
456-102-722	FAST VP ADD ON SATA 401-600TB (TCS0900)	D1	\$0
456-102-723	FAST VP ADD ON SATA 601-1000TB (TCS1000)	D1	\$0
456-102-724	FAST VP ADD ON SATA 1001+ (TCS1100)	D1	\$0
456-102-726	ADV FAST ADD ON NON-SATA 0-14TB	D1	\$0
456-102-727	ADV FAST ADD ON NON-SATA 15-25TB	D1	\$0
456-102-728	ADV FAST ADD ON NON-SATA 26-40TB	D1	\$0
456-102-729	ADV FAST ADD ON NON-SATA 41-60TB	D1	\$0
456-102-730	ADV FAST ADD ON NON-SATA 61-100TB	D1	\$0
456-102-731	ADV FAST ADD ON NON-SATA 101-150TB	D1	\$0
456-102-732	ADV FAST ADD ON NON-SATA 151-250TB	D1	\$0
456-102-733	ADV FAST ADD ON NON-SATA 251-400TB	D1	\$0
456-102-734	ADV FAST ADD ON NON-SATA 401-600TB	D1	\$0
456-102-735	ADV FAST ADD ON NON-SATA 601-1000TB	D1	\$0
456-102-736	ADV FAST ADD ON NON-SATA 1001+ (TCF1100)	D1	\$0

456-102-737	ADV FAST ADD ON SATA 0-14TB (TCS0100)	D1	\$0
456-102-738	ADV FAST ADD ON SATA 15-25TB (TCS0200)	D1	\$0
456-102-739	ADV FAST ADD ON SATA 26-40TB (TCS0300)	D1	\$0
456-102-740	ADV FAST ADD ON SATA 41-60TB (TCS0400)	D1	\$0
456-102-741	ADV FAST ADD ON SATA 61-100TB (TCS0500)	D1	\$0
456-102-742	ADV FAST ADD ON SATA 101-150TB (TCS0600)	D1	\$0
456-102-743	ADV FAST ADD ON SATA 151-250TB (TCS0700)	D1	\$0
456-102-744	ADV FAST ADD ON SATA 251-400TB (TCS0800)	D1	\$0
456-102-745	ADV FAST ADD ON SATA 401-600TB (TCS0900)	D1	\$0
456-102-746	ADV FAST ADD ON SATA 601-1000TB	D1	\$0
456-102-747	ADV FAST ADD ON SATA 1001+ (TCS1100)	D1	\$0
456-102-749	DCP NON-SATA 0-14TB (TCF0100)	D1	\$0
456-102-750	DCP NON-SATA 15-25TB (TCF0200)	D1	\$0
456-102-751	DCP NON-SATA 26-40TB (TCF0300)	D1	\$0
456-102-752	DCP NON-SATA 41-60TB (TCF0400)	D1	\$0
456-102-753	DCP NON-SATA 61-100TB (TCF0500)	D1	\$0
456-102-754	DCP NON-SATA 101-150TB (TCF0600)	D1	\$0
456-102-755	DCP NON-SATA 151-250TB (TCF0700)	D1	\$0
456-102-756	DCP NON-SATA 251-400TB (TCF0800)	D1	\$0
456-102-757	DCP NON-SATA 401-600TB (TCF0900)	D1	\$0
456-102-758	DCP NON-SATA 601-1000TB (TCF1000)	D1	\$0
456-102-759	DCP NON-SATA 1001TB + (TCF1100)	D1	\$0
456-102-760	DCP SATA 0-14TB (TCS0100)	D1	\$0
456-102-761	DCP SATA 15-25TB (TCS0200)	D1	\$0
456-102-762	DCP SATA 26-40TB (TCS0300)	D1	\$0
456-102-763	DCP SATA 41-60TB (TCS0400)	D1	\$0
456-102-764	DCP SATA 61-100TB (TCS0500)	D1	\$0
456-102-765	DCP SATA 101-150TB (TCS0600)	D1	\$0
456-102-766	DCP SATA 151-250TB (TCS0700)	D1	\$0
456-102-767	DCP SATA 251-400TB (TCS0800)	D1	\$0
456-102-768	DCP SATA 401-600TB (TCS0900)	D1	\$0
456-102-769	DCP SATA 601-1000TB (TCS1000)	D1	\$0
456-102-770	DCP SATA 1001TB + (TCS1100)	D1	\$0
456-102-773	SPC NON-SATA 15-25TB (TCF0200)	D1	\$0
456-102-774	SPC NON-SATA 26-40TB (TCF0300)	D1	\$0
456-102-775	SPC NON-SATA 41-60TB (TCF0400)	D1	\$0
456-102-776	SPC NON-SATA 61-100TB (TCF0500)	D1	\$0
456-102-777	SPC NON-SATA 101-150TB (TCF0600)	D1	\$0
456-102-778	SPC NON-SATA 151-250TB (TCF0700)	D1	\$0
456-102-779	SPC NON-SATA 251-400TB (TCF0800)	D1	\$0
456-102-780	SPC NON-SATA 401-600TB (TCF0900)	D1	\$0
456-102-781	SPC NON-SATA 601-1000TB (TCF1000)	D1	\$0
456-102-782	SPC NON-SATA 1001TB + (TCF1100)	D1	\$0
456-102-783	SPC SATA 0-14TB (TCS0100)	D1	\$0
456-102-784	SPC SATA 15-25TB (TCS0200)	D1	\$0
456-102-785	SPC SATA 26-40TB (TCS0300)	D1	\$0
456-102-786	SPC SATA 41-60TB (TCS0400)	D1	\$0
456-102-787	SPC SATA 61-100TB (TCS0500)	D1	\$0
456-102-788	SPC SATA 101-150TB (TCS0600)	D1	\$0
456-102-789	SPC SATA 151-250TB (TCS0700)	D1	\$0

456-102-790	SPC SATA 251-400TB (TCS0800)	D1	\$0
456-102-791	SPC SATA 401-600TB (TCS0900)	D1	\$0
456-102-792	SPC SATA 601-1000TB (TCS1000)	D1	\$0
456-102-793	SPC SATA 1001TB + (TCS1100)	D1	\$0
456-102-795	RMT SYNC-SRDFS CMPPEER REG 0-14 TB	D1	\$4,395
456-102-796	RMT SYNC-SRDFS CMPPEER REG 15-25 TB	D1	\$3,647
456-102-797	RMT SYNC-SRDFS CMPPEER REG 26-40 TB	D1	\$3,660
456-102-798	RMT SYNC-SRDFS CMPPEER REG 41-60 TB	D1	\$2,990
456-102-799	RMT SYNC-SRDFS CMPPEER REG 61-100 TB	D1	\$2,595
456-102-800	RMT SYNC-SRDFS CMPPEER REG 101-150 TB	D1	\$2,205
456-102-801	RMT SYNC-SRDFS CMPPEER REG 151-250 TB	D1	\$2,090
456-102-802	RMT SYNC-SRDFS CMPPEER REG 251-400 TB	D1	\$1,915
456-102-803	RMT SYNC-SRDFS CMPPEER REG 401-600 TB	D1	\$1,715
456-102-804	RMT SYNC-SRDFS CMPPEER REG 601-1000TB	D1	\$1,505
456-102-805	RMT SYNC-SRDFS CMPPEER REG 1001+ TB	D1	\$975
456-102-806	RMT SYNC-SRDFS CMPPEER NON-SATA 0-14 TB	D1	\$4,380
456-102-807	RMT SYNC-SRDFS CMPPEER NON-SATA 15-25 TB	D1	\$4,120
456-102-808	RMT SYNC-SRDFS CMPPEER NON-SATA 26-40 TB	D1	\$3,630
456-102-809	RMT SYNC-SRDFS CMPPEER NON-SATA 41-60 TB	D1	\$3,240
456-102-810	RMT SYNC-SRDFS CMPPEER NON-SATA 61-100 TB	D1	\$2,890
456-102-811	RMT SYNC-SRDFS CMPPEER NON-SATA 101-150 TB	D1	\$2,560
456-102-812	RMT SYNC-SRDFS CMPPEER NON-SATA 151-250 TB	D1	\$2,200
456-102-813	RMT SYNC-SRDFS CMPPEER NON-SATA 251-400 TB	D1	\$1,880
456-102-814	RMT SYNC-SRDFS CMPPEER NON-SATA 401-600 TB	D1	\$1,620
456-102-815	RMT SYNC-SRDFS CMPPEER NON-SATA 601-1000 TB	D1	\$1,390
456-102-816	RMT SYNC-SRDFS CMPPEER NON-SATA 1001+ TB	D1	\$1,190
456-102-817	RMT SYNC-SRDFS CMPPEER SATA 0-14 TB	D1	\$2,190
456-102-818	RMT SYNC-SRDFS CMPPEER SATA 15-25 TB	D1	\$2,060
456-102-819	RMT SYNC-SRDFS CMPPEER SATA 26-40 TB	D1	\$1,810
456-102-820	RMT SYNC-SRDFS CMPPEER SATA 41-60 TB	D1	\$1,620
456-102-821	RMT SYNC-SRDFS CMPPEER SATA 61-100 TB	D1	\$1,450
456-102-822	RMT SYNC-SRDFS CMPPEER SATA 101-150 TB	D1	\$1,280
456-102-823	RMT SYNC-SRDFS CMPPEER SATA 151-250 TB	D1	\$1,100
456-102-824	RMT SYNC-SRDFS CMPPEER SATA 251-400 TB	D1	\$940
456-102-825	RMT SYNC-SRDFS CMPPEER SATA 401-600 TB	D1	\$810
456-102-826	RMT SYNC-SRDFS CMPPEER SATA 601-1000 TB	D1	\$690
456-102-827	RMT SYNC-SRDFS CMPPEER SATA 1001+ TB	D1	\$600
456-102-828	RMT SYNC-SATA-OPTOUT-TR-SRDFS CMPPEER	D1	\$0
456-102-830	RMT SYNC-ADD-SRDFSCMPPEER NONSATA 0-14 TB	D1	\$0
456-102-831	RMT SYNC-ADD-SRDFSCMPPEER NONSATA 15-25 TB	D1	\$0
456-102-832	RMT SYNC-ADD-SRDFSCMPPEER NONSATA 26-40 TB	D1	\$0
456-102-833	RMT SYNC-ADD-SRDFSCMPPEER NONSATA 41-60 TB	D1	\$0
456-102-834	RMT SYNC-ADD-SRDFSCMPPEER NONSATA61-100 TB	D1	\$0
456-102-835	RMT SYNC-ADD-SRDFSCMPPEER NOSATA101-150 TB	D1	\$0
456-102-836	RMT SYNC-ADD-SRDFSCMPPEER NOSATA151-250 TB	D1	\$0
456-102-837	RMT SYNC-ADD-SRDFSCMPPEER NOSATA251-400 TB	D1	\$0
456-102-838	RMT SYNC-ADD-SRDFSCMPPEER NOSATA401-600 TB	D1	\$0
456-102-839	RMT SYNC-ADD-SRDFSCMPPEER NOSATA601-1000 TB	D1	\$0
456-102-840	RMT SYNC-ADD-SRDFSCMPPEER NONSATA1001+ TB	D1	\$0
456-102-841	RMT SYNC-ADD-SRDFS CMPPEER SATA 0-14 TB	D1	\$0

456-102-842	RMT SYNC-ADD-SRDFS CMPPEER SATA 15-25 T	D1	\$0
456-102-843	RMT SYNC-ADD-SRDFS CMPPEER SATA 26-40 T	D1	\$0
456-102-844	RMT SYNC-ADD-SRDFS CMPPEER SATA 41-60 T	D1	\$0
456-102-845	RMT SYNC-ADD-SRDFS CMPPEER SATA 61-100	D1	\$0
456-102-846	RMT SYNC-ADD-SRDFS CMPPEER SATA 101-150	D1	\$0
456-102-847	RMT SYNC-ADD-SRDFS CMPPEER SATA 151-250	D1	\$0
456-102-848	RMT SYNC-ADD-SRDFS CMPPEER SATA 251-400	D1	\$0
456-102-849	RMT SYNC-ADD-SRDFS CMPPEER SATA 401-600	D1	\$0
456-102-850	RMT SYNC-ADD-SRDFS CMPPEER SATA 601-1000	D1	\$0
456-102-851	RMT SYNC-ADD-SRDFS CMPPEER SATA1001+ T	D1	\$0
456-102-852	RMT SYNC-ADD-OPT OUT-SRDFSCMPPEERSAT	D1	\$0
456-102-854	RMT ASYNC-SRDFA CMPEXT REG 0-14 TB	D1	\$4,395
456-102-855	RMT ASYNC-SRDFA CMPEXT REG 15-25 TB	D1	\$3,647
456-102-856	RMT ASYNC-SRDFA CMPEXT REG 26-40 TB	D1	\$3,660
456-102-857	RMT ASYNC-SRDFA CMPEXT REG 41-60 TB	D1	\$2,990
456-102-858	RMT ASYNC-SRDFA CMPEXT REG 61-100 TB	D1	\$2,595
456-102-859	RMT ASYNC-SRDFA CMPEXT REG 101-150 TB	D1	\$2,205
456-102-860	RMT ASYNC-SRDFA CMPEXT REG 151-250 TB	D1	\$2,090
456-102-861	RMT ASYNC-SRDFA CMPEXT REG 251-400 TB	D1	\$1,915
456-102-862	RMT ASYNC-SRDFA CMPEXT REG 401-600 TB	D1	\$1,715
456-102-863	RMT ASYNC-SRDFA CMPEXT REG 601-1000TB	D1	\$1,505
456-102-864	RMT ASYNC-SRDFA CMPEXT REG 1001+ TB	D1	\$975
456-102-865	RMT ASYNC-SRDFA CMPEXT NON-SATA 0-14 TB	D1	\$4,380
456-102-866	RMT ASYNC-SRDFA CMPEXT NON-SATA 15-25 T	D1	\$4,120
456-102-867	RMT ASYNC-SRDFA CMPEXT NON-SATA 26-40 T	D1	\$3,630
456-102-868	RMT ASYNC-SRDFA CMPEXT NON-SATA 41-60 T	D1	\$3,240
456-102-869	RMT ASYNC-SRDFA CMPEXT NON-SATA 61-100	D1	\$2,890
456-102-870	RMT ASYNC-SRDFA CMPEXT NON-SATA 101-150	D1	\$2,560
456-102-871	RMT ASYNC-SRDFA CMPEXT NON-SATA 151-250	D1	\$2,200
456-102-872	RMT ASYNC-SRDFA CMPEXT NON-SATA 251-400	D1	\$1,880
456-102-873	RMT ASYNC-SRDFA CMPEXT NON-SATA 401-600	D1	\$1,620
456-102-874	RMT ASYNC-SRDFA CMPEXT NON-SATA 601-1000	D1	\$1,390
456-102-875	RMT ASYNC-SRDFA CMPEXT NON-SATA 1001+ T	D1	\$1,190
456-102-876	RMT ASYNC-SRDFA CMPEXT SATA 0-14 TB	D1	\$2,190
456-102-877	RMT ASYNC-SRDFA CMPEXT SATA 15-25 TB	D1	\$2,060
456-102-878	RMT ASYNC-SRDFA CMPEXT SATA 26-40 TB	D1	\$1,810
456-102-879	RMT ASYNC-SRDFA CMPEXT SATA 41-60 TB	D1	\$1,620
456-102-880	RMT ASYNC-SRDFA CMPEXT SATA 61-100 TB	D1	\$1,450
456-102-881	RMT ASYNC-SRDFA CMPEXT SATA 101-150 TB	D1	\$1,280
456-102-882	RMT ASYNC-SRDFA CMPEXT SATA 151-250 TB	D1	\$1,100
456-102-883	RMT ASYNC-SRDFA CMPEXT SATA 251-400 TB	D1	\$940
456-102-884	RMT ASYNC-SRDFA CMPEXT SATA 401-600 TB	D1	\$810
456-102-885	RMT ASYNC-SRDFA CMPEXT SATA 601-1000 TB	D1	\$690
456-102-886	RMT ASYNC-SRDFA CMPEXT SATA 1001+ TB	D1	\$600
456-102-887	RMT ASYNC-SATA-OPTOUT-TR-SRDFA CMPEXT	D1	\$0
456-102-889	RMT ASYNC-ADD-SRDFACMPEXT NONSATA 0-14	D1	\$0
456-102-890	RMT ASYNC-ADD-SRDFACMPEXT NONSATA 15-	D1	\$0
456-102-891	RMT ASYNC-ADD-SRDFACMPEXT NONSATA 26-	D1	\$0
456-102-892	RMT ASYNC-ADD-SRDFACMPEXT NONSATA 41-	D1	\$0
456-102-893	RMT ASYNC-ADD-SRDFACMPEXT NONSATA61-1	D1	\$0

456-102-894	RMT ASYNC-ADD-SRDFACMPEXT NOSATA101-1	D1	\$0
456-102-895	RMT ASYNC-ADD-SRDFACMPEXT NOSATA151-2	D1	\$0
456-102-896	RMT ASYNC-ADD-SRDFACMPEXT NOSATA251-4	D1	\$0
456-102-897	RMT ASYNC-ADD-SRDFACMPEXT NOSATA401-6	D1	\$0
456-102-898	RMT ASYNC-ADD-SRDFACMPEXT NOSATA601-1	D1	\$0
456-102-899	RMT ASYNC-ADD-SRDFACMPEXT NONSATA100	D1	\$0
456-102-900	RMT ASYNC-ADD-SRDFA CMPEXT SATA 0-14 TB	D1	\$0
456-102-901	RMT ASYNC-ADD-SRDFA CMPEXT SATA 15-25 T	D1	\$0
456-102-902	RMT ASYNC-ADD-SRDFA CMPEXT SATA 26-40 T	D1	\$0
456-102-903	RMT ASYNC-ADD-SRDFA CMPEXT SATA 41-60 T	D1	\$0
456-102-904	RMT ASYNC-ADD-SRDFA CMPEXT SATA 61-100T	D1	\$0
456-102-905	RMT ASYNC-ADD-SRDFA CMPEXT SATA 101-150	D1	\$0
456-102-906	RMT ASYNC-ADD-SRDFA CMPEXT SATA 151-250	D1	\$0
456-102-907	RMT ASYNC-ADD-SRDFA CMPEXT SATA 251-400	D1	\$0
456-102-908	RMT ASYNC-ADD-SRDFA CMPEXT SATA 401-600	D1	\$0
456-102-909	RMT ASYNC-ADD-SRDFA CMPEXT SATA 601-1000	D1	\$0
456-102-910	RMT ASYNC-ADD-SRDFA CMPEXT SATA1001+ T	D1	\$0
456-102-911	RMT ASYNC-ADD-SATAOPT OUT-TR-SRDFACMF	D1	\$0
456-102-913	SRDF-STAR REGISTERED 0-14TB (TR00100)	D1	\$1,425
456-102-914	SRDF-STAR REGISTERED 15-25TB (TR00200)	D1	\$1,155
456-102-915	SRDF-STAR REGISTERED 26-40TB (TR00300)	D1	\$1,203
456-102-916	SRDF-STAR REGISTERED 41-60TB (TR00400)	D1	\$1,073
456-102-917	SRDF-STAR REGISTERED 61-100TB (TR00500)	D1	\$917
456-102-918	SRDF-STAR REGISTERED 101-150TB (TR00600)	D1	\$850
456-102-919	SRDF-STAR REGISTERED 151-250TB (TR00700)	D1	\$749
456-102-920	SRDF-STAR REGISTERED 251-400TB (TR00800)	D1	\$668
456-102-921	SRDF-STAR REGISTERED 401-600TB (TR00900)	D1	\$555
456-102-922	SRDF-STAR REGISTER 601-1000TB (TR01000)	D1	\$449
456-102-923	SRDF-STAR REGISTERED 1001+ (TR01100)	D1	\$285
456-102-924	SRDF-STAR NON-SATA 0-14TB (TCF0100)	D1	\$3,460
456-102-925	SRDF-STAR NON-SATA 15-25TB (TCF0200)	D1	\$3,250
456-102-926	SRDF-STAR NON-SATA 26-40TB (TCF0300)	D1	\$2,865
456-102-927	SRDF-STAR NON-SATA 41-60TB (TCF0400)	D1	\$2,560
456-102-928	SRDF-STAR NON-SATA 61-100TB (TCF0500)	D1	\$2,275
456-102-929	SRDF-STAR NON-SATA 101-150TB (TCF0600)	D1	\$2,020
456-102-930	SRDF-STAR NON-SATA 151-250TB (TCF0700)	D1	\$1,740
456-102-931	SRDF-STAR NON-SATA 251-400TB (TCF0800)	D1	\$1,490
456-102-932	SRDF-STAR NON-SATA 401-600TB (TCF0900)	D1	\$1,280
456-102-933	SRDF-STAR NON-SATA 601-1000TB (TCF1000)	D1	\$1,095
456-102-934	SRDF-STAR NON-SATA 1001+ (TCF1100)	D1	\$935
456-102-935	SRDF-STAR SATA 0-14TB (TCS0100)	D1	\$1,725
456-102-936	SRDF-STAR SATA 15-25TB (TCS0200)	D1	\$1,630
456-102-937	SRDF-STAR SATA 26-40TB (TCS0300)	D1	\$1,435
456-102-938	SRDF-STAR SATA 41-60TB (TCS0400)	D1	\$1,280
456-102-939	SRDF-STAR SATA 61-100TB (TCS0500)	D1	\$1,145
456-102-940	SRDF-STAR SATA 101-150TB (TCS0600)	D1	\$1,010
456-102-941	SRDF-STAR SATA 151-250TB (TCS0700)	D1	\$870
456-102-942	SRDF-STAR SATA 251-400TB (TCS0800)	D1	\$740
456-102-943	SRDF-STAR SATA 401-600TB (TCS0900)	D1	\$635
456-102-944	SRDF-STAR SATA 601-1000TB (TCS1000)	D1	\$545

456-102-945	SRDF-STAR SATA 1001+ (TCS1100)	D1	\$470
456-102-946	SRDF-STAR ADD SATA OPT OUT TR (TN00000)	D1	\$0
456-102-948	LOCL REP-TFCLONE CNFLASH REG 0-14 TB	D1	\$4,425
456-102-949	LOCL REP-TFCLONE CNFLASH REG 15-25 TB	D1	\$3,850
456-102-950	LOCL REP-TFCLONE CNFLASH REG 26-40 TB	D1	\$3,350
456-102-951	LOCL REP-TFCLONE CNFLASH REG 41-60 TB	D1	\$2,730
456-102-952	LOCL REP-TFCLONE CNFLASH REG 61-100 TB	D1	\$2,290
456-102-953	LOCL REP-TFCLONE CNFLASH REG 101-150 TB	D1	\$2,135
456-102-954	LOCL REP-TFCLONE CNFLASH REG 151-250 TB	D1	\$1,985
456-102-955	LOCL REP-TFCLONE CNFLASH REG 251-400 TB	D1	\$1,840
456-102-956	TF-LOCL REP-TFCLONE CNFLASH REG 401-600	D1	\$1,675
456-102-957	LOCL REP-TFCLONE CNFLASH REG 601-1000TB	D1	\$1,560
456-102-958	LOCL REP-TFCLONE CNFLASH REG 1001+ TB	D1	\$1,100
456-102-959	LOCL REP-TFCLN CNFLASH NON-SATA 0-14 TB	D1	\$2,540
456-102-960	LOCL REP-TFCLN CNFLASH NON-SATA 15-25 TB	D1	\$2,385
456-102-961	LOCL REP-TFCLN CNFLASH NON-SATA 26-40 TB	D1	\$2,100
456-102-962	LOCL REP-TFCLN CNFLASH NON-SATA 41-60 TB	D1	\$1,955
456-102-963	LOCL REP-TFCLN CNFLASH NON-SATA 61-100TB	D1	\$1,880
456-102-964	LOCL REP-TFCLN CNFLASH NON-SATA 101-150T	D1	\$1,690
456-102-965	LOCL REP-TFCLN CNFLASH NON-SATA 151-250T	D1	\$1,500
456-102-966	LOCL REP-TFCLN CNFLASH NON-SATA 251-400T	D1	\$1,300
456-102-967	LOCL REP-TFCLN CNFLASH NON-SATA 401-600T	D1	\$1,135
456-102-968	LOCL REP-TFCLN CNFLASH NON-SATA 601-1000	D1	\$985
456-102-969	LOCL REP-TFCLN CNFLASH NON-SATA 1001+ TB	D1	\$860
456-102-970	LOCL REP-TFCLONE CNFLASH SATA 0-14 TB	D1	\$1,270
456-102-971	LOCL REP-TFCLONE CNFLASH SATA 15-25 TB	D1	\$1,185
456-102-972	LOCL REP-TFCLONE CNFLASH SATA 26-40 TB	D1	\$1,050
456-102-973	LOCL REP-TFCLONE CNFLASH SATA 41-60 TB	D1	\$975
456-102-974	LOCL REP-TFCLONE CNFLASH SATA 61-100 TB	D1	\$935
456-102-975	LOCL REP-TFCLONE CNFLASH SATA 101-150 TB	D1	\$850
456-102-976	LOCL REP-TFCLONE CNFLASH SATA 151-250 TB	D1	\$745
456-102-977	LOCL REP-TFCLONE CNFLASH SATA 251-400 TB	D1	\$650
456-102-978	LOCL REP-TFCLONE CNFLASH SATA 401-600 TB	D1	\$565
456-102-979	LOCL REP-TFCLN CNFLASH SATA 601-1000 TB	D1	\$495
456-102-980	LOCL REP-TFCLONE CNFLASH SATA 1001+ TB	D1	\$430
456-102-981	LOCL REP-SATA-OPTOUT-TR-TFCLONE CNFLAS	D1	\$0
456-102-983	LOCL REP-ADD-TFCLN CNFLASH NONSATA 0-14T	D1	\$0
456-102-984	LOCL REP-ADD-TFCLN CNFLASH NONSATA 15-2T	D1	\$0
456-102-985	LOCL REP-ADD-TFCLN CNFLASH NONSATA 26-4T	D1	\$0
456-102-986	LOCL REP-ADD-TFCLN CNFLASH NONSATA 41-6T	D1	\$0
456-102-987	LOCL REP-ADD-TFCLN CNFLASH NONSATA61-10T	D1	\$0
456-102-988	LOCL REP-ADD-TFCLN CNFLASH NOSATA101-15T	D1	\$0
456-102-989	LOCL REP-ADD-TFCLN CNFLASH NOSATA151-25T	D1	\$0
456-102-990	LOCL REP-ADD-TFCLN CNFLASH NOSATA251-40T	D1	\$0
456-102-991	LOCL REP-ADD-TFCLN CNFLASH NOSATA401-60T	D1	\$0
456-102-992	LOCL REP-ADD-TFCLN CNFLASH NOSATA601-10T	D1	\$0
456-102-993	LOCL REP-ADD-TFCLN CNFLASH NONSATA1001-	D1	\$0
456-102-994	LOCL REP-ADD-TFCLN CNFLASH SATA 0-14 TB	D1	\$0
456-102-995	LOCL REP-ADD-TFCLN CNFLASH SATA 15-25 TB	D1	\$0
456-102-996	LOCL REP-ADD-TFCLN CNFLASH SATA 26-40 TB	D1	\$0

456-102-997	LOCL REP-ADD-TFCLN CNFLASH SATA 41-60 TB	D1	\$0
456-102-998	LOCL REP-ADD-TFCLN CNFLASH SATA 61-100TB	D1	\$0
456-102-999	LOCL REP-ADD-TFCLN CNFLASH SATA 101-150T	D1	\$0
456-103-001	LOCL REP-ADD-TFCLN CNFLASH SATA 151-250T	D1	\$0
456-103-002	LOCL REP-ADD-TFCLN CNFLASH SATA 251-400T	D1	\$0
456-103-003	LOCL REP-ADD-TFCLN CNFLASH SATA 401-600T	D1	\$0
456-103-004	LOCL REP-ADD-TFCLN CNFLASH SATA 601-1000	D1	\$0
456-103-005	LOCL REP-ADD-TFCLN CNFLASH SATA1001+ TB	D1	\$0
456-103-006	LOCL REP-ADD-SATA-OPTOUT-TR-TFCLNCNFLA	D1	\$0
456-103-008	TF-SNAP REGISTERED 0-14TB (TR00100)	D1	\$4,425
456-103-009	TF-SNAP REGISTERED 15-25TB (TR00200)	D1	\$3,850
456-103-010	TF-SNAP REGISTERED 26-40TB (TR00300)	D1	\$3,350
456-103-011	TF-SNAP REGISTERED 41-60TB (TR00400)	D1	\$2,730
456-103-012	TF-SNAP REGISTERED 61-100TB (TR00500)	D1	\$2,290
456-103-013	TF-SNAP REGISTERED 101-150TB (TR00600)	D1	\$2,135
456-103-014	TF-SNAP REGISTERED 151-250TB (TR00700)	D1	\$1,985
456-103-015	TF-SNAP REGISTERED 251-400TB (TR00800)	D1	\$1,840
456-103-016	TF-SNAP REGISTERED 401-600TB (TR00900)	D1	\$1,675
456-103-017	TF-SNAP REGISTERED 601-1000TB (TR01000)	D1	\$1,560
456-103-018	TF-SNAP REGISTERED 1001+ (TR01100)	D1	\$1,100
456-103-019	TF-SNAP NON-SATA 0-14TB (TCF0100)	D1	\$2,420
456-103-020	TF-SNAP NON-SATA 15-25TB (TCF0200)	D1	\$2,270
456-103-021	TF-SNAP NON-SATA 26-40TB (TCF0300)	D1	\$2,000
456-103-022	TF-SNAP NON-SATA 41-60TB (TCF0400)	D1	\$1,860
456-103-023	TF-SNAP NON-SATA 61-100TB (TCF0500)	D1	\$1,790
456-103-024	TF-SNAP NON-SATA 101-150TB (TCF0600)	D1	\$1,610
456-103-025	TF-SNAP NON-SATA 151-250TB (TCF0700)	D1	\$1,430
456-103-026	TF-SNAP NON-SATA 251-400TB (TCF0800)	D1	\$1,240
456-103-027	TF-SNAP NON-SATA 401-600TB (TCF0900)	D1	\$1,080
456-103-028	TF-SNAP NON-SATA 601-1000TB (TCF1000)	D1	\$940
456-103-029	TF-SNAP NON-SATA 1001+ (TCF1100)	D1	\$820
456-103-030	TF-SNAP SATA 0-14TB (TCS0100)	D1	\$1,210
456-103-031	TF-SNAP SATA 15-25TB (TCS0200)	D1	\$1,130
456-103-032	TF-SNAP SATA 26-40TB (TCS0300)	D1	\$1,000
456-103-033	TF-SNAP SATA 41-60TB (TCS0400)	D1	\$930
456-103-034	TF-SNAP SATA 61-100TB (TCS0500)	D1	\$890
456-103-035	TF-SNAP SATA 101-150TB (TCS0600)	D1	\$810
456-103-036	TF-SNAP SATA 151-250TB (TCS0700)	D1	\$710
456-103-037	TF-SNAP SATA 251-400TB (TCS0800)	D1	\$620
456-103-038	TF-SNAP SATA 401-600TB (TCS0900)	D1	\$540
456-103-039	TF-SNAP SATA 601-1000TB (TCS1000)	D1	\$470
456-103-040	TF-SNAP SATA 1001+ (TCS1100)	D1	\$410
456-103-041	TF-SNAP SATA OPT OUT TIER (TN00000)	D1	\$0
456-103-043	TF-SNAP ADD NON-SATA 0-14TB (TCF0100)	D1	\$0
456-103-044	TF-SNAP ADD NON-SATA 15-25TB (TCF0200)	D1	\$0
456-103-045	TF-SNAP ADD NON-SATA 26-40TB (TCF0300)	D1	\$0
456-103-046	TF-SNAP ADD NON-SATA 41-60TB (TCF0400)	D1	\$0
456-103-047	TF-SNAP ADD NON-SATA 61-100TB (TCF0500)	D1	\$0
456-103-048	TF-SNAP ADD NON-SATA 101-150TB (TCF0600)	D1	\$0
456-103-049	TF-SNAP ADD NON-SATA 151-250TB (TCF0700)	D1	\$0

456-103-050	TF-SNAP ADD NON-SATA 251-400TB (TCF0800)	D1	\$0
456-103-051	TF-SNAP ADD NON-SATA 401-600TB (TCF0900)	D1	\$0
456-103-052	TF-SNAP ADD NO-SATA 601-1000TB	D1	\$0
456-103-053	TF-SNAP ADD NON-SATA 1001+ (TCF1100)	D1	\$0
456-103-054	TF-SNAP ADD SATA 0-14TB (TCS0100)	D1	\$0
456-103-055	TF-SNAP ADD SATA 15-25TB (TCS0200)	D1	\$0
456-103-056	TF-SNAP ADD SATA 26-40TB (TCS0300)	D1	\$0
456-103-057	TF-SNAP ADD SATA 41-60TB (TCS0400)	D1	\$0
456-103-058	TF-SNAP ADD SATA 61-100TB (TCS0500)	D1	\$0
456-103-059	TF-SNAP ADD SATA 101-150TB (TCS0600)	D1	\$0
456-103-060	TF-SNAP ADD SATA 151-250TB (TCS0700)	D1	\$0
456-103-061	TF-SNAP ADD SATA 251-400TB (TCS0800)	D1	\$0
456-103-062	TF-SNAP ADD SATA 401-600TB (TCS0900)	D1	\$0
456-103-063	TF-SNAP ADD SATA 601-1000TB (TCS1000)	D1	\$0
456-103-064	TF-SNAP ADD SATA 1001+ (TCS1100)	D1	\$0
456-103-065	TF-SNAP ADD SATA OPT OUT TIER (TN00000)	D1	\$0
456-103-676	PROSPHERE MGMT SYMM DMX 1TB	D1	\$0
456-103-886	PROSPHERE-CC ADD ON NON-SATA 0-14TB	D1	\$0
456-103-887	PROSPHERE-CC ADD ON NON-SATA 15-25TB	D1	\$0
456-103-888	PROSPHERE-CC ADD ON NON-SATA 26-40TB	D1	\$0
456-103-889	PROSPHERE-CC ADD ON NON-SATA 41-60TB	D1	\$0
456-103-890	PROSPHERE-CC ADD ON NON-SATA 61-100TB	D1	\$0
456-103-891	PROSPHERE-CC ADD ON NON-SATA 101-150TB	D1	\$0
456-103-892	PROSPHERE-CC ADD ON NON-SATA 151-250TB	D1	\$0
456-103-893	PROSPHERE-CC ADD ON NON-SATA 251-400TB	D1	\$0
456-103-894	PROSPHERE-CC ADD ON NON-SATA 401-600TB	D1	\$0
456-103-895	PROSPHERE-CC ADD ON NON-SATA 601-1000TB	D1	\$0
456-103-896	PROSPHERE-CC ADD ON NON-SATA 1001TB+	D1	\$0
456-103-897	PROSPHERE-CC ADD ON SATA 0-14TB	D1	\$0
456-103-898	PROSPHERE-CC ADD ON SATA 15-25TB	D1	\$0
456-103-899	PROSPHERE-CC ADD ON SATA 26-40TB	D1	\$0
456-103-900	PROSPHERE-CC ADD ON SATA 41-60TB	D1	\$0
456-103-901	PROSPHERE-CC ADD ON SATA 61-100TB	D1	\$0
456-103-902	PROSPHERE-CC ADD ON SATA 101-150TB	D1	\$0
456-103-903	PROSPHERE-CC ADD ON SATA 151-250TB	D1	\$0
456-103-904	PROSPHERE-CC ADD ON SATA 251-400TB	D1	\$0
456-103-905	PROSPHERE-CC ADD ON SATA 401-600TB	D1	\$0
456-103-906	PROSPHERE-CC ADD ON SATA 601-1000TB	D1	\$0
456-103-907	PROSPHERE-CC ADD ON SATA 1001TB+	D1	\$0
456-104-038	ENGINUIY SATA 0-14TB	D1	\$910
456-104-039	ENGINUIY SATA 15-25TB	D1	\$870
456-104-040	ENGINUIY SATA 26-40TB	D1	\$840
456-104-041	ENGINUIY SATA 41-60TB	D1	\$800
456-104-042	ENGINUIY SATA 61-100TB	D1	\$770
456-104-043	ENGINUIY SATA 101-150TB	D1	\$740
456-104-044	ENGINUIY SATA 151-250TB	D1	\$710
456-104-045	ENGINUIY SATA 251-400TB	D1	\$680
456-104-046	ENGINUIY SATA 401-600TB	D1	\$660
456-104-047	ENGINUIY SATA 601-1000TB	D1	\$630
456-104-048	ENGINUIY SATA 1000TB +	D1	\$600

456-104-049	ENGINUIITY NON-SATA 0-14TB	D1	\$2,020
456-104-050	ENGINUIITY NON-SATA 15-25TB	D1	\$1,940
456-104-051	ENGINUIITY NON-SATA 26-40TB	D1	\$1,860
456-104-052	ENGINUIITY NON-SATA 41-60TB	D1	\$1,790
456-104-053	ENGINUIITY NON-SATA 61-100TB	D1	\$1,710
456-104-054	ENGINUIITY NON-SATA 101-150TB	D1	\$1,650
456-104-055	ENGINUIITY NON-SATA 151-250TB	D1	\$1,580
456-104-056	ENGINUIITY NON-SATA 251-400TB	D1	\$1,520
456-104-057	ENGINUIITY NON-SATA 401-600TB	D1	\$1,460
456-104-058	ENGINUIITY NON-SATA 601-1000TB	D1	\$1,400
456-104-059	ENGINUIITY NON-SATA 1000TB +	D1	\$1,340
456-104-180	ATSM NON-SATA FOR REG FAST 0-14TB	D1	\$0
456-104-181	ATSM NON-SATA FOR REG FAST 15-25TB	D1	\$0
456-104-182	ATSM NON-SATA FOR REG FAST 26-40TB	D1	\$0
456-104-183	ATSM NON-SATA FOR REG FAST 41-60TB	D1	\$0
456-104-184	ATSM NON-SATA FOR REG FAST 61-100TB	D1	\$0
456-104-185	ATSM NON-SATA FOR REG FAST 101-150TB	D1	\$0
456-104-186	ATSM NON-SATA FOR REG FAST 151-250TB	D1	\$0
456-104-187	ATSM NON-SATA FOR REG FAST 251-400TB	D1	\$0
456-104-188	ATSM NON-SATA FOR REG FAST 401-600TB	D1	\$0
456-104-189	ATSM NON-SATA FOR REG FAST 601-1000TB	D1	\$0
456-104-190	ATSM NON-SATA FOR REG FAST 1001+	D1	\$0
456-104-191	ATSM SATA FOR REG FAST 0-14TB	D1	\$0
456-104-192	ATSM SATA FOR REG FAST 15-25TB	D1	\$0
456-104-193	ATSM SATA FOR REG FAST 26-40TB	D1	\$0
456-104-194	ATSM SATA FOR REG FAST 41-60TB	D1	\$0
456-104-195	ATSM SATA FOR REG FAST 61-100TB	D1	\$0
456-104-196	ATSM SATA FOR REG FAST 101-150TB	D1	\$0
456-104-197	ATSM SATA FOR REG FAST 151-250TB	D1	\$0
456-104-198	ATSM SATA FOR REG FAST 251-400TB	D1	\$0
456-104-199	ATSM SATA FOR REG FAST 401-600TB	D1	\$0
456-104-200	ATSM SATA FOR REG FAST 601-1000TB	D1	\$0
456-104-201	ATSM SATA FOR REG FAST 1001+	D1	\$0
456-104-517	RP/EX LOC REG CAP VMAX (0-14TB)	D1	\$3,800
456-104-518	RP/EX LOC REG CAP VMAX (15-25TB) =CA	D1	\$3,370
456-104-519	RP/EX LOC REG CAP VMAX (26-40TB) =CA	D1	\$3,200
456-104-520	RP/EX LOC REG CAP VMAX (41-60TB) =CA	D1	\$2,800
456-104-521	RP/EX LOC REG CAP VMAX (61-100TB) =CA	D1	\$2,575
456-104-522	RP/EX LOC REG CAP VMAX (101-150TB) =CA	D1	\$2,125
456-104-523	RP/EX LOC REG CAP VMAX (151-250TB) =CA	D1	\$1,970
456-104-524	RP/EX LOC REG CAP VMAX (251-400TB) =CA	D1	\$1,835
456-104-525	RP/EX LOC REG CAP VMAX (401-600TB) =CA	D1	\$1,700
456-104-526	RP/EX LOC REG CAP VMAX (601-1000TB) =CA	D1	\$1,430
456-104-527	RP/EX LOC REG CAP VMAX (1001TB+) =CA	D1	\$1,050
456-104-528	RP/EX REM REG CAP VMAX (0-14TB) =CA	D1	\$3,800
456-104-529	RP/EX REM REG CAP VMAX (15-25TB) =CA	D1	\$3,370
456-104-530	RP/EX REM REG CAP VMAX (26-40TB) =CA	D1	\$3,200
456-104-531	RP/EX REM REG CAP VMAX (41-60TB) =CA	D1	\$2,800
456-104-532	RP/EX REM REG CAP VMAX (61-100TB) =CA	D1	\$2,575
456-104-533	RP/EX REM REG CAP VMAX (101-150TB) =CA	D1	\$2,125

456-104-534	RP/EX REM REG CAP VMAX (151-250TB) =CA	D1	\$1,970
456-104-535	RP/EX REM REG CAP VMAX (251-400TB) =CA	D1	\$1,835
456-104-536	RP/EX REM REG CAP VMAX (401-600TB) =CA	D1	\$1,700
456-104-537	RP/EX REM REG CAP VMAX (601-1000TB) =CA	D1	\$1,430
456-104-538	RP/EX REM REG CAP VMAX (1001TB+) =CA	D1	\$1,050
456-105-156	1TB LOCAL RECOVERPOINT/EX FOR VMEE=CA	D1	\$0
456-105-298	SRMSUITE VMAX 0-14TB S =CB	D1	\$0
456-105-299	SRMSUITE VMAX 15-25TB S =CB	D1	\$0
456-105-300	SRMSUITE VMAX 26-40TB S =CB	D1	\$0
456-105-301	SRMSUITE VMAX 41-60TB S =CB	D1	\$0
456-105-302	SRMSUITE VMAX 61-100TB S =CB	D1	\$0
456-105-303	SRMSUITE VMAX 101-150TB S =CB	D1	\$0
456-105-304	SRMSUITE VMAX 151-250TB S =CB	D1	\$0
456-105-305	SRMSUITE VMAX 251-400TB S =CB	D1	\$0
456-105-306	SRMSUITE VMAX 401-600TB S =CB	D1	\$0
456-105-307	SRMSUITE VMAX 601-1PB S =CB	D1	\$0
456-105-308	SRMSUITE VMAX 1001TB+ S =CB	D1	\$0
456-105-309	SRMSUITE VMAX 0-14TB =CB	D1	\$0
456-105-310	SRMSUITE VMAX 15-25TB =CB	D1	\$0
456-105-311	SRMSUITE VMAX 26-40TB =CB	D1	\$0
456-105-312	SRMSUITE VMAX 41-60TB =CB	D1	\$0
456-105-313	SRMSUITE VMAX 61-100TB =CB	D1	\$0
456-105-314	SRMSUITE VMAX 101-150TB =CB	D1	\$0
456-105-315	SRMSUITE VMAX 151-250TB =CB	D1	\$0
456-105-316	SRMSUITE VMAX 251-400TB =CB	D1	\$0
456-105-317	SRMSUITE VMAX 401-600TB =CB	D1	\$0
456-105-318	SRMSUITE VMAX 601-1PB =CB	D1	\$0
456-105-319	SRMSUITE VMAX 1001TB+ =CB	D1	\$0
456-105-365	SRMSUITE DMX 1TB =CB	D1	\$0
456-105-399	SRMSUITE UPG VMAX 0-14TB S =CB	D1	\$0
456-105-400	SRMSUITE UPG VMAX 15-25TB S =CB	D1	\$0
456-105-401	SRMSUITE UPG VMAX 26-40TB S =CB	D1	\$0
456-105-402	SRMSUITE UPG VMAX 41-60TB S =CB	D1	\$0
456-105-403	SRMSUITE UPG VMAX 61-100TB S =CB	D1	\$0
456-105-404	SRMSUITE UPG VMAX 101-150TB S =CB	D1	\$0
456-105-405	SRMSUITE UPG VMAX 151-250TB S =CB	D1	\$0
456-105-406	SRMSUITE UPG VMAX 251-400TB S =CB	D1	\$0
456-105-407	SRMSUITE UPG VMAX 401-600TB S =CB	D1	\$0
456-105-408	SRMSUITE UPG VMAX 601-1PB S =CB	D1	\$0
456-105-409	SRMSUITE UPG VMAX 1001TB+ S =CB	D1	\$0
456-105-410	SRMSUITE UPG VMAX 0-14TB =CB	D1	\$0
456-105-411	SRMSUITE UPG VMAX 15-25TB =CB	D1	\$0
456-105-412	SRMSUITE UPG VMAX 26-40TB =CB	D1	\$0
456-105-413	SRMSUITE UPG VMAX 41-60TB =CB	D1	\$0
456-105-414	SRMSUITE UPG VMAX 61-100TB =CB	D1	\$0
456-105-415	SRMSUITE UPG VMAX 101-150TB =CB	D1	\$0
456-105-416	SRMSUITE UPG VMAX 151-250TB =CB	D1	\$0
456-105-417	SRMSUITE UPG VMAX 251-400TB =CB	D1	\$0
456-105-418	SRMSUITE UPG VMAX 401-600TB =CB	D1	\$0
456-105-419	SRMSUITE UPG VMAX 601-1PB =CB	D1	\$0

456-105-420	SRMSUITE UPG VMAX 1001TB+ =CB	D1	\$0
456-106-204	APPSYNC VMAX 0-14TB SATA =CB	D1	\$1,150
456-106-205	APPSYNC VMAX 15-25TB SATA =CB	D1	\$1,070
456-106-206	APPSYNC VMAX 26-40TB SATA =CB	D1	\$950
456-106-207	APPSYNC VMAX 41-60TB SATA =CB	D1	\$880
456-106-208	APPSYNC VMAX 61-100TB SATA =CB	D1	\$850
456-106-209	APPSYNC VMAX 101-150TB SATA =CB	D1	\$770
456-106-210	APPSYNC VMAX 151-250TB SATA =CB	D1	\$680
456-106-211	APPSYNC VMAX 251-400TB SATA =CB	D1	\$590
456-106-212	APPSYNC VMAX 401-600TB SATA =CB	D1	\$510
456-106-213	APPSYNC VMAX 601-1PB SATA =CB	D1	\$450
456-106-214	APPSYNC VMAX 1001TB+ SATA =CB	D1	\$390
456-106-215	APPSYNC VMAX 0-14TB NOSATA =CB	D1	\$2,290
456-106-216	APPSYNC VMAX 15-25TB NOSATA =CB	D1	\$2,150
456-106-217	APPSYNC VMAX 26-40TB NOSATA =CB	D1	\$1,890
456-106-218	APPSYNC VMAX 41-60TB NOSATA =CB	D1	\$1,760
456-106-219	APPSYNC VMAX 61-100TB NOSATA =CB	D1	\$1,700
456-106-220	APPSYNC VMAX 101-150TB NOSATA =CB	D1	\$1,530
456-106-221	APPSYNC VMAX 151-250TB NOSATA =CB	D1	\$1,350
456-106-222	APPSYNC VMAX 251-400TB NOSATA =CB	D1	\$1,170
456-106-223	APPSYNC VMAX 401-600TB NOSATA =CB	D1	\$1,030
456-106-224	APPSYNC VMAX 601-1PB NOSATA =CB	D1	\$890
456-106-225	APPSYNC VMAX 1001TB+ NOSATA =CB	D1	\$780
456-106-271	APPSYNC VMAX CAP UPG 0-14TB S=CB	D1	\$0
456-106-272	APPSYNC VMAX CAP UPG 15-25TB S=CB	D1	\$0
456-106-273	APPSYNC VMAX CAP UPG 26-40TB S=CB	D1	\$0
456-106-274	APPSYNC VMAX CAP UPG 41-60TB S=CB	D1	\$0
456-106-275	APPSYNC VMAX CAP UPG 61-100TB S=CB	D1	\$0
456-106-276	APPSYNC VMAX CAP UPG 101-150TB S=CB	D1	\$0
456-106-277	APPSYNC VMAX CAP UPG 151-250TB S=CB	D1	\$0
456-106-278	APPSYNC VMAX CAP UPG 251-400TB S=CB	D1	\$0
456-106-279	APPSYNC VMAX CAP UPG 401-600TB S=CB	D1	\$0
456-106-280	APPSYNC VMAX CAP UPG 601-1PB S=CB	D1	\$0
456-106-281	APPSYNC VMAX CAP UPG 1001TB+ S=CB	D1	\$0
456-106-282	APPSYNC VMAX CAP UPG 0-14TB NS=CB	D1	\$0
456-106-283	APPSYNC VMAX CAP UPG 15-25TB NS=CB	D1	\$0
456-106-284	APPSYNC VMAX CAP UPG 26-40TB NS=CB	D1	\$0
456-106-285	APPSYNC VMAX CAP UPG 41-60TB NS=CB	D1	\$0
456-106-286	APPSYNC VMAX CAP UPG 61-100TB NS=CB	D1	\$0
456-106-287	APPSYNC VMAX CAP UPG 101-150TB NS =CB	D1	\$0
456-106-288	APPSYNC VMAX CAP UPG 151-250TB NS=CB	D1	\$0
456-106-289	APPSYNC VMAX CAP UPG 251-400TB NS=CB	D1	\$0
456-106-290	APPSYNC VMAX CAP UPG 401-600TB NS=CB	D1	\$0
456-106-291	APPSYNC VMAX CAP UPG 601-1PB NS=CB	D1	\$0
456-106-292	APPSYNC VMAX CAP UPG 1001TB+ NS=CB	D1	\$0
456-106-338	APPSYNC VMAX 0-14TB REG CAP =CA	D1	\$3,990
456-106-339	APPSYNC VMAX 15-25TB REG CAP =CA	D1	\$3,470
456-106-340	APPSYNC VMAX 26-40TB REG CAP =CA	D1	\$3,020
456-106-341	APPSYNC VMAX 41-60TB REG CAP =CA	D1	\$2,460
456-106-342	APPSYNC VMAX 61-100TB REG CAP =CA	D1	\$2,070

456-106-343	APPSYNC VMAX 101-150TB REG CAP =CA	D1	\$1,930
456-106-344	APPSYNC VMAX 151-250TB REG CAP =CA	D1	\$1,790
456-106-345	APPSYNC VMAX 251-400TB REG CAP =CA	D1	\$1,660
456-106-346	APPSYNC VMAX 401-600TB REG CAP =CA	D1	\$1,510
456-106-347	APPSYNC VMAX 601-1PB REG CAP =CA	D1	\$1,410
456-106-348	APPSYNC VMAX 1001TB+ REG CAP =CA	D1	\$990
456-106-372	APPSYNC VMAX CAP UPG 0-14TB R=CA	D1	\$0
456-106-373	APPSYNC VMAX CAP UPG 15-25TB R=CA	D1	\$0
456-106-374	APPSYNC VMAX CAP UPG 26-40TB R=CA	D1	\$0
456-106-375	APPSYNC VMAX CAP UPG 41-60TB R=CA	D1	\$0
456-106-376	APPSYNC VMAX CAP UPG 61-100TB R=CA	D1	\$0
456-106-377	APPSYNC VMAX CAP UPG 101-150TB R=CA	D1	\$0
456-106-378	APPSYNC VMAX CAP UPG 151-250TB R=CA	D1	\$0
456-106-379	APPSYNC VMAX CAP UPG 251-400TB R=CA	D1	\$0
456-106-380	APPSYNC VMAX CAP UPG 401-600TB R=CA	D1	\$0
456-106-381	APPSYNC VMAX CAP UPG 601-1PB R=CA	D1	\$0
456-106-382	APPSYNC VMAX CAP UPG 1001TB+ R=CA	D1	\$0
456-107-195	ESA FOR VMAX NON-SATA 0-14TB=CB	D1	\$0
456-107-196	ESA FOR VMAX NON-SATA 15-25TB=CB	D1	\$0
456-107-197	ESA FOR VMAX NON-SATA 26-40TB=CB	D1	\$0
456-107-198	ESA FOR VMAX NON-SATA 41-60TB=CB	D1	\$0
456-107-199	ESA FOR VMAX NON-SATA 61-100TB=CB	D1	\$0
456-107-200	ESA FOR VMAX NON-SATA 101-150TB=CB	D1	\$0
456-107-201	ESA FOR VMAX NON-SATA 151-250TB=CB	D1	\$0
456-107-202	ESA FOR VMAX NON-SATA 251-400TB=CB	D1	\$0
456-107-203	ESA FOR VMAX NON-SATA 401-600TB=CB	D1	\$0
456-107-204	ESA FOR VMAX NON-SATA 601-1000TB=CB	D1	\$0
456-107-205	ESA FOR VMAX NON-SATA 1001TB-PLUS=CB	D1	\$0
456-107-206	ESA FOR VMAX SATA 0-14TB=CB	D1	\$0
456-107-207	ESA FOR VMAX SATA 15-25TB=CB	D1	\$0
456-107-208	ESA FOR VMAX SATA 26-40TB=CB	D1	\$0
456-107-209	ESA FOR VMAX SATA 41-60TB=CB	D1	\$0
456-107-210	ESA FOR VMAX SATA 61-100TB=CB	D1	\$0
456-107-211	ESA FOR VMAX SATA 101-150TB=CB	D1	\$0
456-107-212	ESA FOR VMAX SATA 151-250TB=CB	D1	\$0
456-107-213	ESA FOR VMAX SATA 251-400TB=CB	D1	\$0
456-107-214	ESA FOR VMAX SATA 401-600TB=CB	D1	\$0
456-107-215	ESA FOR VMAX SATA 601-1000TB=CB	D1	\$0
456-107-216	ESA FOR VMAX SATA 1001TB-PLUS=CB	D1	\$0
456-108-126	RP/EX LOC BASE CAP VMAX LIC=IC	D1	\$24,300
456-108-127	RP/EX REM BASE FOR VMAX LIC=IC	D1	\$24,300
456-108-145	VIPR SRM DMX BASE =IC	D1	\$20,980
456-108-789	APPSYNC VMAX BASE =IC	D1	\$19,240
456-109-267	SRM DMX BASE =IC	D1	\$20,980
456-109-306	SRM VMAX BASE =IC	D1	\$17,890
456-109-307	ADV FAST SUITE BASE NEW LICENSE=IC	D1	\$18,394
456-109-308	SYMM MGMT SUITE BASE NEW LICENSE=IC	D1	\$11,405
456-109-309	RMT ASYNC PROT-SRDFA CMPEXT-BASE=IC	D1	\$20,760
456-109-310	RMT ASYNC PROT-SRDFA CMPEXT-BASE REG=	D1	\$22,120
456-109-311	RMT SYNC PROT-SRDFS CMPPEER BASE=IC	D1	\$20,760

456-109-312	RMT SYNC PROT-SRDFS CMPPEER BASE REG=	D1	\$22,120
456-109-313	SRDF-STAR BASE NEW LICENSE=IC	D1	\$16,370
456-109-314	SRDF-STAR BASE NEW REG LICENSE=IC	D1	\$9,820
456-109-315	LOCL REP PROT-TFCLONE CNFLASH BASE=IC	D1	\$21,368
456-109-316	LOCL REP PROT-TFCLN CNFLASH BASE REG=IC	D1	\$13,890
456-109-317	TF-SNAP BASE NEW LICENSE=IC	D1	\$20,350
456-109-318	TF-SNAP BASE NEW REG LICENSE=IC	D1	\$13,230
456-110-697	SRM VMAX 1-14TB S =CB	D1	\$2,240
456-110-698	SRM VMAX 15-25TB S =CB	D1	\$2,100
456-110-699	SRM VMAX 26-40TB S =CB	D1	\$1,880
456-110-700	SRM VMAX 41-60TB S =CB	D1	\$1,620
456-110-701	SRM VMAX 61-100TB S =CB	D1	\$1,380
456-110-702	SRM VMAX 101-150TB S =CB	D1	\$1,230
456-110-703	SRM VMAX 151-250TB S =CB	D1	\$1,040
456-110-704	SRM VMAX 251-400TB S =CB	D1	\$880
456-110-705	SRM VMAX 401-600TB S =CB	D1	\$720
456-110-706	SRM VMAX 601-1PB S =CB	D1	\$590
456-110-707	SRM VMAX 1001TB+ S =CB	D1	\$510
456-110-708	SRM VMAX 1-14TB =CB	D1	\$4,470
456-110-709	SRM VMAX 15-25TB =CB	D1	\$4,190
456-110-710	SRM VMAX 26-40TB =CB	D1	\$3,750
456-110-711	SRM VMAX 41-60TB =CB	D1	\$3,230
456-110-712	SRM VMAX 61-100TB =CB	D1	\$2,760
456-110-713	SRM VMAX 101-150TB =CB	D1	\$2,460
456-110-714	SRM VMAX 151-250TB =CB	D1	\$2,070
456-110-715	SRM VMAX 251-400TB =CB	D1	\$1,750
456-110-716	SRM VMAX 401-600TB =CB	D1	\$1,420
456-110-717	SRM VMAX 601-1PB =CB	D1	\$1,180
456-110-718	SRM VMAX 1001TB+ =CB	D1	\$1,030
456-110-764	SRM DMX 1TB =CB	D1	\$1,710
457-000-160	SYMM MGMT SUITE BASE NEW LICENSE	D1	\$0
457-100-485	ADV FAST SUITE BASE NEW LICENSE	D1	\$0
457-100-505	RMT SYNC PROT-SRDFS CMPPEER-BASE	D1	\$0
457-100-509	RMT SYNC PROT-SRDFS CMPPEER-BASE REG	D1	\$0
457-100-519	RMT ASYNC PROT-SRDFA CMPEXT-BASE	D1	\$0
457-100-523	RMT ASYNC PROT-SRDFA CMPEXT-BASE REG	D1	\$0
457-100-533	SRDF-STAR BASE NEW LICENSE	D1	\$0
457-100-537	SRDF-STAR BASE REGISTERED NEW LICENSE	D1	\$0
457-100-541	LOCL REP PROT-TFCLONE CNFLASH-BASE	D1	\$0
457-100-545	LOCL REP PROT-TFCLONE CNFLASH-BASE REG	D1	\$0
457-100-555	TF-SNAP BASE NEW LICENSE	D1	\$0
457-100-559	TF-SNAP BASE REGISTERED NEW LICENSE	D1	\$0
457-101-144	RP/EX LOC BASE FOR VMAX =CA	D1	\$0
457-101-146	RP/EX REM BASE FOR VMAX =CA	D1	\$0
457-101-375	SRMSUITE VMAX BASE =IC	D1	\$0
457-101-376	SRMSUITE VMAX CAP UPG =IC	D1	\$0
457-101-383	SRMSUITE DMX BASE =IC	D1	\$0
457-101-384	SRMSUITE DMX CAP UPG =IC	D1	\$0
457-101-403	SRMSUITE UPG VMAX BASE =IC	D1	\$0
457-101-407	SRMSUITE UPG DMX BASE =IC	D1	\$0

457-101-643	APPSYNC VMAX BASE =IC	D1	\$0
457-102-641	VIPR SRM VMAX BASE =IC	D1	\$0
457-102-649	VIPR SRM DMX BASE =IC	D1	\$0
458-000-171	RP FOR CAPITAL ONE PRODUCT	D1	\$0
458-000-198	SRM for DMX	D1	\$0
458-001-244	VMAX ENGINUITY PRODUCT	D1	\$0
458-001-245	ADV FAST SUITE PRODUCT	D1	\$0
458-001-246	VMAX SYMM MGMT SUITE PRODUCT	D1	\$0
458-001-247	VMAX RMT ASYNC PROT-SRDFA CMPEXT PROD	D1	\$0
458-001-248	RMT SYNC PROT-SRDFA CMPPEER PRODUCT	D1	\$0
458-001-249	VMAX SRDF-STAR PRODUCT	D1	\$0
458-001-250	VMAX LOCL REP PROT-TFCLONE CNFLASH PRO	D1	\$0
458-001-251	VMAX TF-SNAP PRODUCT	D1	\$0
458-001-271	APPSYNC VMAX	D1	\$0
458-001-272	VIPR SRM for VMAX	D1	\$0
458-001-305	RP/EX REMOTE FOR VMAX PRODUCT	D1	\$0
458-001-308	RP/EX LOCAL FOR VMAX PRODUCT	D1	\$0
ACLILD01	DMX-LITE BUNDLE FOR DEAL	D1	\$49,287
ARMSYM-T1-5U	ARM SYM T1-T5UPG	D1	\$0
ARMSYM-T6-30U	ARM-SYM T6-T35UPG	D1	\$0
ARMSYM-T6-35U	CC SYM ARM T6-35 UPG	D1	\$0
AS400-STM	AS400 SRDF TF MANAGER	D1	\$0
AS-MSU-T0-3U	AUTOSWAP UPG MSU 0-3	D1	\$0
AS-MSU-T4-14U	AUTOSWAP UPG MSU 4-14	D1	\$0
AUTOS-MSUBASE	AUTOSWAP FOR MF BASE-3MSU	D1	\$86,800
AUTOS-MSU-M00	AUTOSWAP FOR MF 4-45 MSU	D1	\$190
AUTOS-MSU-M01	AUTOSWAP FOR MF 46-175MSU	D1	\$120
AUTOS-MSU-M02	AUTOSWAP MF 176-315 MSU	D1	\$90
AUTOS-MSU-M03	AUTOSWAP MF 316-575 MSU	D1	\$70
AUTOS-MSU-M04	AUTOSWAP MF 576-875 MSU	D1	\$50
AUTOS-MSU-M05	AUTOSWAP MF 876-1315 MSU	D1	\$35
AUTOS-MSU-M06	AUTOSWAP MF 1316-1975 MSU	D1	\$18
AUTOS-MSU-M07	AUTOSWAP MF 1976 & UP MSU	D1	\$4
AUTOS-MSU-UPG	AUTOSWAP FOR MF UPG	D1	\$0
AUTOSWAPMSU00	AUTOSWAP BASE-3 MSU	D1	\$124,560
AUTOSWAPMSU01	AUTOSWAP 4-25 MSU	D1	\$131,110
AUTOSWAPMSU02	AUTOSWAP 26-50 MSU	D1	\$137,660
AUTOSWAPMSU03	AUTOSWAP 51-75 MSU	D1	\$144,220
AUTOSWAPMSU04	AUTOSWAP 76-100 MSU	D1	\$150,770
AUTOSWAPMSU05	AUTOSWAP 101-150 MSU	D1	\$157,320
AUTOSWAPMSU06	AUTOSWAP 151-200 MSU	D1	\$163,870
AUTOSWAPMSU07	AUTOSWAP 201-250 MSU	D1	\$170,420
AUTOSWAPMSU08	AUTOSWAP 251-300 MSU	D1	\$176,980
AUTOSWAPMSU09	AUTOSWAP 301-350 MSU	D1	\$183,530
AUTOSWAPMSU10	AUTOSWAP 351-400 MSU	D1	\$190,080
AUTOSWAPMSU11	AUTOSWAP 401-450 MSU	D1	\$196,630
AUTOSWAPMSU12	AUTOSWAP 451-500 MSU	D1	\$203,180
AUTOSWAPMSU13	AUTOSWAP 501-550 MSU	D1	\$209,740
AUTOSWAPMSU14	AUTOSWAP 551-600 MSU	D1	\$216,290
AUTOS-ZVMBASE	AUTOSWAP FOR ZVM BASE	D1	\$0

CAM-KEY	CAM ICM LIC KEY	D1	\$0
CC-AM-SYM-T1	AUTO RES MGR 0-.250	D1	\$0
CC-AM-SYM-T10	AUTO RES MGR 10.01-12.00	D1	\$0
CC-AM-SYM-T11	AUTO RES MGR 12.01-14.00	D1	\$0
CC-AM-SYM-T12	AUTO RES MGR 14.01-17.00	D1	\$0
CC-AM-SYM-T13	AUTO RES MGR 17.01-20.00	D1	\$0
CC-AM-SYM-T14	AUTO RES MGR 20.01-23.00	D1	\$0
CC-AM-SYM-T15	AUTO RES MGR 23.01-26.00	D1	\$0
CC-AM-SYM-T16	AUTO RES MGR 26.01-29.00	D1	\$0
CC-AM-SYM-T17	AUTO RES MGR 29.01-32.00	D1	\$0
CC-AM-SYM-T18	AUTO RES MGR 32.01-35.00	D1	\$0
CC-AM-SYM-T19	AUTO RES MGR 35.01-38.00	D1	\$0
CC-AM-SYM-T2	AUTO RES MGR .251-.500	D1	\$0
CC-AM-SYM-T20	AUTO RES MGR 38.01-41.00	D1	\$0
CC-AM-SYM-T21	AUTO RES MGR 41.01-44.00	D1	\$0
CC-AM-SYM-T22	AUTO RES MGR 44.01-47.00	D1	\$0
CC-AM-SYM-T23	AUTO RES MGR 47.01-50.00	D1	\$0
CC-AM-SYM-T24	AUTO RES MGR 50.01-53.00	D1	\$0
CC-AM-SYM-T25	AUTO RES MGR 53.01-56.00	D1	\$0
CC-AM-SYM-T26	AUTO RES MGR 56.01-59.00	D1	\$0
CC-AM-SYM-T27	AUTO RES MGR 59.01-62.00	D1	\$0
CC-AM-SYM-T28	AUTO RES MGR 62.01-65.00	D1	\$0
CC-AM-SYM-T29	AUTO RES MGR 65.01-68.00	D1	\$0
CC-AM-SYM-T3	AUTO RES MGR .501-.750	D1	\$0
CC-AM-SYM-T30	AUTO RES MGR 68.01-71.00	D1	\$0
CC-AM-SYM-T31	AUTO RES MGR 71.01-74.00	D1	\$0
CC-AM-SYM-T32	AUTO RES MGR 74.01-77.00	D1	\$0
CC-AM-SYM-T33	AUTO RES MGR 77.01-80.00	D1	\$0
CC-AM-SYM-T34	AUTO RES MGR 80.01-83.00	D1	\$0
CC-AM-SYM-T35	AUTO RES MGR 83.01-86.00	D1	\$0
CC-AM-SYM-T4	AUTO RES MGR .751-1.00	D1	\$0
CC-AM-SYM-T5	AUTO RES MGR 1.01-2.00	D1	\$0
CC-AM-SYM-T6	AUTO RES MGR 2.01-4.00	D1	\$0
CC-AM-SYM-T7	AUTO RES MGR 4.01-6.00	D1	\$0
CC-AM-SYM-T8	AUTO RES MGR 6.01-8.00	D1	\$0
CC-AM-SYM-T9	AUTO RES MGR 8.01-10.00	D1	\$0
CC-ARC-T1	SAN ARC 1YR 0-.250	D1	\$0
CC-ARC-T10	SAN ARC 1YR 10.01-12.00	D1	\$0
CC-ARC-T11	SAN ARC 1YR 12.01-14.00	D1	\$0
CC-ARC-T12	SAN ARC 1YR 14.01-16.00	D1	\$0
CC-ARC-T13	SAN ARC 1YR 16.01-19.00	D1	\$0
CC-ARC-T14	SAN ARC 1YR 19.01-22.00	D1	\$0
CC-ARC-T15	SAN ARC 1YR 22.01-25.00	D1	\$0
CC-ARC-T16	SAN ARC 1YR 25.01-28.00	D1	\$0
CC-ARC-T17	SAN ARC 1YR 28.01-31.00	D1	\$0
CC-ARC-T18	SAN ARC 1YR 31.01-34.00	D1	\$0
CC-ARC-T19	SAN ARC 1YR 34.01-37.00	D1	\$0
CC-ARC-T1-T4	CC-SAN ARC 1YR T1-T4UP	D1	\$0
CC-ARC-T2	SAN ARC 1YR .251-.500	D1	\$0
CC-ARC-T20	SAN ARC 1YR 37.01-40.00	D1	\$0

CC-ARC-T21	SAN ARC 1YR 40.01-43.00	D1	\$0
CC-ARC-T22	SAN ARC 1YR 43.01-46.00	D1	\$0
CC-ARC-T23	SAN ARC 1YR 46.01-49.00	D1	\$0
CC-ARC-T24	SAN ARC 1YR 49.01-52.00	D1	\$0
CC-ARC-T25	SAN ARC 1YR 52.01-55.00	D1	\$0
CC-ARC-T26	SAN ARC 1YR 55.01-58.00	D1	\$0
CC-ARC-T27	SAN ARC 1YR 58.01-61.00	D1	\$0
CC-ARC-T28	SAN ARC 1YR 61.01-64.00	D1	\$0
CC-ARC-T29	SAN ARC 1YR 64.01-67.00	D1	\$0
CC-ARC-T3	SAN ARC 1YR .501-.750	D1	\$0
CC-ARC-T30	SAN ARC 1YR 67.01-70.00	D1	\$0
CC-ARC-T4	SAN ARC 1YR .751-1.0	D1	\$0
CC-ARC-T5	SAN ARC 1YR 1.01-2.00	D1	\$0
CC-ARC-T5-T30	CC-SAN ARC 1YR T5-T30UP	D1	\$0
CC-ARC-T6	SAN ARC 1YR 2.01-4.00	D1	\$0
CC-ARC-T7	SAN ARC 1YR 4.01-6.00	D1	\$0
CC-ARC-T8	SAN ARC 1YR 6.01-8.00	D1	\$0
CC-ARC-T9	SAN ARC 1YR 8.01-10.00	D1	\$0
CCBAS-T1-4UP	ECC BASE T1-T4 UPGRADE	D1	\$0
CCBAS-T5-12UP	ECC BASE T5-T12 UPGRADE	D1	\$0
CC-OIC-KIT	CC5.X OPN INTG CMPNTS KIT	D1	\$0
CC-OIC-KITPRV	PREVIOUS VERSION OIC KIT	D1	\$0
CC-OICMF-KIT	CC5.X OIC MAINFRAME KIT	D1	\$0
CC-OPTIM-BASE	SYMM OPT BASE LICENSE	D1	\$0
CC-OPTIM-C01	SYMM OPT 1TB (0-14TB)	D1	\$0
CC-OPTIM-C02	SYMM OPT 1TB (15-25TB)	D1	\$0
CC-OPTIM-C03	SYMM OPT 1TB (26-40TB)	D1	\$0
CC-OPTIM-C04	SYMM OPT 1TB (41-60TB)	D1	\$0
CC-OPTIM-C05	SYMM OPT 1TB (61-100TB)	D1	\$0
CC-OPTIM-C06	SYMM OPT 1TB (101-150TB)	D1	\$0
CC-OPTIM-C07	SYMM OPT 1TB (151-250TB)	D1	\$0
CC-OPTIM-C08	SYMM OPT 1TB (251-400TB)	D1	\$0
CC-OPTIM-C09	SYMM OPT 1TB (401-600TB)	D1	\$0
CC-OPTIM-C10	SYMM OPT 1TB (601-1000TB)	D1	\$0
CC-OPTIM-C11	SYMM OPT 1TB(1001TB or greater)	D1	\$0
CC-OPTIM-N01	SYMM OPT 1TB (0-14TB) NLT3	D1	\$0
CC-OPTIM-N02	SYMM OPT 1TB (15-25TB) NLT3	D1	\$0
CC-OPTIM-N03	SYMM OPT 1TB (26-40TB) NLT3	D1	\$0
CC-OPTIM-N04	SYMM OPT 1TB (41-60TB) NLT3	D1	\$0
CC-OPTIM-N05	SYMM OPT 1TB (61-100TB) NLT3	D1	\$0
CC-OPTIM-N06	SYMM OPT 1TB (101-150TB) NLT3	D1	\$0
CC-OPTIM-N07	SYMM OPT 1TB (151-250TB) NLT3	D1	\$0
CC-OPTIM-N08	SYMM OPT 1TB (251-400TB) NLT3	D1	\$0
CC-OPTIM-N09	SYMM OPT 1TB (401-600TB) NLT3	D1	\$0
CC-OPTIM-N10	SYMM OPT 1TB (601-1000TB) NLT3	D1	\$0
CC-OPTIM-N11	SYMM OPT 1TB(1001TB or greater) NLT3	D1	\$0
CC-OPTIM-T1	SYM OPTIM 0-.250	D1	\$0
CC-OPTIM-T10	SYM OPTIM 10.01-12.	D1	\$0
CC-OPTIM-T11	SYM OPTIM 12.01-14.	D1	\$0
CC-OPTIM-T12	SYM OPTIM 14.01-17.	D1	\$0

CC-OPTIM-T13	SYM OPTIM 17.01-20.00	D1	\$0
CC-OPTIM-T14	SYM OPTIM 20.01-23.00	D1	\$0
CC-OPTIM-T15	SYM OPTIM 23.01-26.00	D1	\$0
CC-OPTIM-T16	SYM OPTIM 26.01-29.00	D1	\$0
CC-OPTIM-T17	SYM OPTIM 29.01-32.00	D1	\$0
CC-OPTIM-T18	SYM OPTIM 32.01-35.00	D1	\$0
CC-OPTIM-T19	SYM OPTIM 35.01-38.00	D1	\$0
CC-OPTIM-T2	SYM OPTIM .251-.500	D1	\$0
CC-OPTIM-T20	SYM OPTIM 38.01-41.00	D1	\$0
CC-OPTIM-T21	SYM OPTIM 41.01-44.00	D1	\$0
CC-OPTIM-T22	SYM OPTIM 44.01-47.00	D1	\$0
CC-OPTIM-T23	SYM OPTIM 47.01-50.00	D1	\$0
CC-OPTIM-T24	SYM OPTIM 50.01-53.00	D1	\$0
CC-OPTIM-T25	SYM OPTIM 53.01-56.00	D1	\$0
CC-OPTIM-T26	SYM OPTIM 56.01-59.00	D1	\$0
CC-OPTIM-T27	SYM OPTIM 59.01-62.00	D1	\$0
CC-OPTIM-T28	SYM OPTIM 62.01-65.00	D1	\$0
CC-OPTIM-T29	SYM OPTIM 65.01-68.00	D1	\$0
CC-OPTIM-T3	SYM OPTIM .501-.750	D1	\$0
CC-OPTIM-T30	SYM OPTIM 68.01-71.00	D1	\$0
CC-OPTIM-T31	SYM OPTIM 71.01-74.00	D1	\$0
CC-OPTIM-T32	SYM OPTIM 74.01-77.00	D1	\$0
CC-OPTIM-T33	SYM OPTIM 77.01-80.00	D1	\$0
CC-OPTIM-T34	SYM OPTIM 80.01-83.00	D1	\$0
CC-OPTIM-T35	SYM OPTIM 83.01-86.00	D1	\$0
CC-OPTIM-T4	SYM OPTIM .751-1.00	D1	\$0
CC-OPTIM-T5	SYM OPTIM 1.01-2.00	D1	\$0
CC-OPTIM-T6	SYM OPTIM 2.01-4.00	D1	\$0
CC-OPTIM-T7	SYM OPTIM 4.01-6.00	D1	\$0
CC-OPTIM-T8	SYM OPTIM 6.01-8.00	D1	\$0
CC-OPTIM-T9	SYM OPTIM 8.01-10.0	D1	\$0
CC-OPTIMZ-BAS	VMAX OPTIMIZER BASE LICENSE	D1	\$0
CC-OPTIMZ-C01	VMAX OPTIMIZER 1TB (0-14TB)	D1	\$0
CC-OPTIMZ-C02	VMAX OPTIMIZER 1TB (15-25TB)	D1	\$0
CC-OPTIMZ-C03	VMAX OPTIMIZER 1TB (26-40TB)	D1	\$0
CC-OPTIMZ-C04	VMAX OPTIMIZER 1TB (41-60TB)	D1	\$0
CC-OPTIMZ-C05	VMAX OPTIMIZER 1TB (61-100TB)	D1	\$0
CC-OPTIMZ-C06	VMAX OPTIMIZER 1TB (101-150TB)	D1	\$0
CC-OPTIMZ-C07	VMAX OPTIMIZER 1TB (151-250TB)	D1	\$0
CC-OPTIMZ-C08	VMAX OPTIMIZER 1TB (251-400TB)	D1	\$0
CC-OPTIMZ-C09	VMAX OPTIMIZER 1TB (401-600TB)	D1	\$0
CC-OPTIMZ-C10	VMAX OPTIMIZER 1TB(601-1000TB)	D1	\$0
CC-OPTIMZ-C11	VMAX OPTIMIZER 1TB(1001TB or greater)	D1	\$0
CC-OPTIMZ-N01	VMAX OPTIMIZER 1TB (0-14TB) NLT3	D1	\$0
CC-OPTIMZ-N02	VMAX OPTIMIZER 1TB (15-25TB) NLT3	D1	\$0
CC-OPTIMZ-N03	VMAX OPTIMIZER 1TB (26-40TB) NLT3	D1	\$0
CC-OPTIMZ-N04	VMAX OPTIMIZER 1TB (41-60TB) NLT3	D1	\$0
CC-OPTIMZ-N05	VMAX OPTIMIZER 1TB (61-100TB) NLT3	D1	\$0
CC-OPTIMZ-N06	VMAX OPTIMIZER 1TB (101-150TB) NLT3	D1	\$0
CC-OPTIMZ-N07	VMAX OPTIMIZER 1TB (151-250TB) NLT3	D1	\$0

CC-OPTIMZ-N08	VMAX OPTIMIZER 1TB (251-400TB) NLT3	D1	\$0
CC-OPTIMZ-N09	VMAX OPTIMIZER 1TB (401-600TB) NLT3	D1	\$0
CC-OPTIMZ-N10	VMAX OPTIMIZER 1TB(601-1000TB) NLT3	D1	\$0
CC-OPTIMZ-N11	VMAX OPTIMIZER 1TB(1001TB or >) NLT3	D1	\$0
CC-OPTM6-BASE	EMC ControlCenter 6.1 Symmetrix Optimize	D1	\$0
CC-OPTM6-UPG	EMC ControlCenter 6.1 Symmetrix Optimize	D1	\$0
CC-OPT-PRV	PREVIOUS VERSION OPTIM	D1	\$0
CCOPT-T1-4UP	ECC OPTIMIZER T1-T4 UPG	D1	\$0
CCOPT-T5-12UP	ECC OPTIMIZER T5-T12 UPG	D1	\$0
CC-PFM-PRV	PREVIOUS VERSION PERFMGR	D1	\$0
CC-PFM-SY-T01	PERF MGR-SYM0-.250	D1	\$0
CC-PFM-SY-T02	PERF MGR-SYM.251-.500	D1	\$0
CC-PFM-SY-T03	PERF MGR-SYM.501-.750	D1	\$0
CC-PFM-SY-T04	PERF MGR-SYM.751-1.00	D1	\$0
CC-PFM-SY-T05	PERF MGR-SYM1.01-2.00	D1	\$0
CC-PFM-SY-T06	PERF MGR-SYM2.01-4.00	D1	\$0
CC-PFM-SY-T07	PERF MGR-SYM4.01-6.00	D1	\$0
CC-PFM-SY-T08	PERF MGR-SYM6.01-8.00	D1	\$0
CC-PFM-SY-T09	PERF MGR-SYM8.01-10.00	D1	\$0
CC-PFM-SY-T10	PERF MGR-SYM10.01-12.00	D1	\$0
CC-PFM-SY-T11	PERF MGR-SYM12.01-14.00	D1	\$0
CC-PFM-SY-T12	PERF MGR-SYM14.01-17.00	D1	\$0
CC-PFM-SY-T13	PERF MGR-SYM17.01-20.00	D1	\$0
CC-PFM-SY-T14	PERF MGR-SYM20.01-23.00	D1	\$0
CC-PFM-SY-T15	PERF MGR-SYM23.01-26.00	D1	\$0
CC-PFM-SY-T16	PERF MGR-SYM26.01-29.00	D1	\$0
CC-PFM-SY-T17	PERF MGR-SYM29.01-32.00	D1	\$0
CC-PFM-SY-T18	PERF MGR-SYM32.01-35.00	D1	\$0
CC-PFM-SY-T19	PERF MGR-SYM35.01-38.00	D1	\$0
CC-PFM-SY-T20	PERF MGR-SYM38.01-41.00	D1	\$0
CC-PFM-SY-T21	PERF MGR-SYM41.01-44.00	D1	\$0
CC-PFM-SY-T22	PERF MGR-SYM44.01-47.00	D1	\$0
CC-PFM-SY-T23	PERF MGR-SYM47.01-50.00	D1	\$0
CC-PFM-SY-T24	PERF MGR-SYM50.01-53.00	D1	\$0
CC-PFM-SY-T25	PERF MGR-SYM53.01-56.00	D1	\$0
CC-PFM-SY-T26	PERF MGR-SYM56.01-59.00	D1	\$0
CC-PFM-SY-T27	PERF MGR-SYM59.01-62.00	D1	\$0
CC-PFM-SY-T28	PERF MGR-SYM62.01-65.00	D1	\$0
CC-PFM-SY-T29	PERF MGR-SYM65.01-68.00	D1	\$0
CC-PFM-SY-T30	PERF MGR-SYM68.01-71.00	D1	\$0
CC-PFM-SY-T31	PERF MGR-SYM71.01-74.00	D1	\$0
CC-PFM-SY-T32	PERF MGR-SYM74.01-77.00	D1	\$0
CC-PFM-SY-T33	PERF MGR-SYM77.01-80.00	D1	\$0
CC-PFM-SY-T34	PERF MGR-SYM80.01-83.00	D1	\$0
CC-PFM-SY-T35	PERF MGR-SYM83.01-86.00	D1	\$0
CCPKG-T1-4UP	ECC PACKAGE T1-T4 UPGRADE	D1	\$0
CCPKG-T5-12UP	ECC PACKAGE T5-T12 UPGRAD	D1	\$0
CC-SARC-SYT1	SMGR SARC 1YR 0-.250	D1	\$0
CC-SARC-SYT10	SMGR SARC 1YR 10.01-12.00	D1	\$0
CC-SARC-SYT11	SMGR SARC 1YR 12.01-14.00	D1	\$0

CC-SARC-SYT12	SMGR SARC 1YR 14.01-16.00	D1	\$0
CC-SARC-SYT13	SMGR SARC 1YR 16.01-19.00	D1	\$0
CC-SARC-SYT14	SMGR SARC 1YR 19.01-22.00	D1	\$0
CC-SARC-SYT15	SMGR SARC 1YR 22.01-25.00	D1	\$0
CC-SARC-SYT16	SMGR SARC 1YR 25.01-28.00	D1	\$0
CC-SARC-SYT17	SMGR SARC 1YR 28.01-31.00	D1	\$0
CC-SARC-SYT18	SMGR SARC 1YR 31.01-34.00	D1	\$0
CC-SARC-SYT19	SMGR SARC 1YR 34.01-37.00	D1	\$0
CC-SARC-SYT2	SMGR SARC 1YR .251-.500	D1	\$0
CC-SARC-SYT20	SMGR SARC 1YR 37.01-40.00	D1	\$0
CC-SARC-SYT21	SMGR SARC 1YR 40.01-43.00	D1	\$0
CC-SARC-SYT22	SMGR SARC 1YR 43.01-46.00	D1	\$0
CC-SARC-SYT23	SMGR SARC 1YR 46.01-49.00	D1	\$0
CC-SARC-SYT24	SMGR SARC 1YR 49.01-52.00	D1	\$0
CC-SARC-SYT25	SMGR SARC 1YR 52.01-55.00	D1	\$0
CC-SARC-SYT26	SMGR SARC 1YR 55.01-58.00	D1	\$0
CC-SARC-SYT27	SMGR SARC 1YR 58.01-61.00	D1	\$0
CC-SARC-SYT28	SMGR SARC 1YR 61.01-64.00	D1	\$0
CC-SARC-SYT29	SMGR SARC 1YR 64.01-67.00	D1	\$0
CC-SARC-SYT3	SMGR SARC 1YR .501-.750	D1	\$0
CC-SARC-SYT30	SMGR SARC 1YR 67.01-70.00	D1	\$0
CC-SARC-SYT4	SMGR SARC 1YR .751-1.0	D1	\$0
CC-SARC-SYT5	SMGR SARC 1YR 1.01-2.00	D1	\$0
CC-SARC-SYT6	SMGR SARC 1YR 2.01-4.00	D1	\$0
CC-SARC-SYT7	SMGR SARC 1YR 4.01-6.00	D1	\$0
CC-SARC-SYT8	SMGR SARC 1YR 6.01-8.00	D1	\$0
CC-SARC-SYT9	SMGR SARC 1YR 8.01-10.00	D1	\$0
CCSDR-T1-4UP	ECC SDR T1-T4 UPGRADE	D1	\$0
CCSDR-T5-12UP	ECC SDR T5-T12 UPGRADE	D1	\$0
CC-SMPKLT-T01	CC SYM PKG LITE T1	D1	\$0
CC-SMPKLT-T02	CC SYM PKG LITE T2	D1	\$0
CC-SMPKLT-T03	CC SYM PKG LITE T3	D1	\$0
CC-SMPKLT-T04	CC SYM PKG LITE T4	D1	\$0
CC-SMPKLT-T05	CC SYM PKG LITE T5	D1	\$0
CC-SMPKLT-T06	CC SYM PKG LITE T6	D1	\$0
CC-SMPKLT-T07	CC SYM PKG LITE T7	D1	\$0
CC-SMPKLT-T08	CC SYM PKG LITE T8	D1	\$0
CC-SMPKLT-T09	CC SYM PKG LITE T9	D1	\$0
CC-SMPKLT-T10	CC SYM PKG LITE T10	D1	\$0
CC-SMPKLT-T11	CC SYM PKG LITE T11	D1	\$0
CC-SMPKLT-T12	CC SYM PKG LITE T12	D1	\$0
CC-SMPKLT-T13	CC SYM PKG LITE T13	D1	\$0
CC-SMPKLT-T14	CC SYM PKG LITE T14	D1	\$0
CC-SMPKLT-T15	CC SYM PKG LITE T15	D1	\$0
CC-SMPKLT-T16	CC SYM PKG LITE T16	D1	\$0
CC-SMPKLT-T17	CC SYM PKG LITE T17	D1	\$0
CC-SMPKLT-T18	CC SYM PKG LITE T18	D1	\$0
CC-SMPKLT-T19	CC SYM PKG LITE T19	D1	\$0
CC-SMPKLT-T20	CC SYM PKG LITE T20	D1	\$0
CC-SMPKLT-T21	CC SYM PKG LITE T21	D1	\$0

CC-SMPKLT-T22	CC SYM PKG LITE T22	D1	\$0
CC-SMPKLT-T23	CC SYM PKG LITE T23	D1	\$0
CC-SMPKLT-T24	CC SYM PKG LITE T24	D1	\$0
CC-SMPKLT-T25	CC SYM PKG LITE T25	D1	\$0
CC-SMPKLT-T26	CC SYM PKG LITE T26	D1	\$0
CC-SMPKLT-T27	CC SYM PKG LITE T27	D1	\$0
CC-SMPKLT-T28	CC SYM PKG LITE T28	D1	\$0
CC-SMPKLT-T29	CC SYM PKG LITE T29	D1	\$0
CC-SMPKLT-T30	CC SYM PKG LITE T30	D1	\$0
CC-SM-SYM-T1	SYM SANMGR 0-.250	D1	\$0
CC-SM-SYM-T10	SYM SANMGR 10.01-12.	D1	\$0
CC-SM-SYM-T11	SYM SANMGR 12.01-14.	D1	\$0
CC-SM-SYM-T12	SYM SANMGR 14.01-17.	D1	\$0
CC-SM-SYM-T13	SYM SANMGR 17.01-20.00	D1	\$0
CC-SM-SYM-T14	SYM SANMGR 20.01-23.00	D1	\$0
CC-SM-SYM-T15	SYM SANMGR 23.01-26.00	D1	\$0
CC-SM-SYM-T16	SYM SANMGR 26.01-29.00	D1	\$0
CC-SM-SYM-T17	SYM SANMGR 29.01-32.00	D1	\$0
CC-SM-SYM-T18	SYM SANMGR 32.01-35.00	D1	\$0
CC-SM-SYM-T19	SYM SANMGR 35.01-38.00	D1	\$0
CC-SM-SYM-T2	SYM SANMGR .251-.500	D1	\$0
CC-SM-SYM-T20	SYM SANMGR 38.01-41.00	D1	\$0
CC-SM-SYM-T21	SYM SANMGR 41.01-44.00	D1	\$0
CC-SM-SYM-T22	SYM SANMGR 44.01-47.00	D1	\$0
CC-SM-SYM-T23	SYM SANMGR 47.01-50.00	D1	\$0
CC-SM-SYM-T24	SYM SANMGR 50.01-53.00	D1	\$0
CC-SM-SYM-T25	SYM SANMGR 53.01-56.00	D1	\$0
CC-SM-SYM-T26	SYM SANMGR 56.01-59.00	D1	\$0
CC-SM-SYM-T27	SYM SANMGR 59.01-62.00	D1	\$0
CC-SM-SYM-T28	SYM SANMGR 62.01-65.00	D1	\$0
CC-SM-SYM-T29	SYM SANMGR 65.01-68.00	D1	\$0
CC-SM-SYM-T3	SYM SANMGR .501-.750	D1	\$0
CC-SM-SYM-T30	SYM SANMGR 68.01-71.00	D1	\$0
CC-SM-SYM-T31	SYM SANMGR 71.01-74.00	D1	\$0
CC-SM-SYM-T32	SYM SANMGR 74.01-77.00	D1	\$0
CC-SM-SYM-T33	SYM SANMGR 77.01-80.00	D1	\$0
CC-SM-SYM-T34	SYM SANMGR 80.01-83.00	D1	\$0
CC-SM-SYM-T35	SYM SANMGR 83.01-86.00	D1	\$0
CC-SM-SYM-T4	SYM SANMGR .751-1.00	D1	\$0
CC-SM-SYM-T5	SYM SANMGR 1.01-2.00	D1	\$0
CC-SM-SYM-T6	SYM SANMGR 2.01-4.00	D1	\$0
CC-SM-SYM-T7	SYM SANMGR 4.01-6.00	D1	\$0
CC-SM-SYM-T8	SYM SANMGR 6.01-8.00	D1	\$0
CC-SM-SYM-T9	SYM SANMGR 8.01-10.0	D1	\$0
CCSTM-T1-4UP	ECC STM T1-T4 UPGRADE	D1	\$0
CCSTM-T5-12UP	ECC STM T5-T12 UPGRADE	D1	\$0
CC-SYMGR6-BAS	EMC SYMMETRIX MANAGEMENT BASE LICENSE	D1	\$10,610
CC-SYMGR6-R	EMC SYMMETRIX MANAGEMENT REFRESH	D1	\$0
CC-SYMGR6-UPG	EMC SYMMETRIX MANAGEMENT UPGRADE	D1	\$0
CC-SYMGR-BASE	SYMM MGR BASE LICENSE	D1	\$10,610

CC-SYMGR-C01	SYMM MGR 1TB (0-14TB)	D1	\$1,870
CC-SYMGR-C02	SYMM MGR 1TB (15-25TB)	D1	\$1,760
CC-SYMGR-C03	SYMM MGR 1TB (26-40TB)	D1	\$1,550
CC-SYMGR-C04	SYMM MGR 1TB (41-60TB)	D1	\$1,440
CC-SYMGR-C05	SYMM MGR 1TB (61-100TB)	D1	\$1,380
CC-SYMGR-C06	SYMM MGR 1TB (101-150TB)	D1	\$1,240
CC-SYMGR-C07	SYMM MGR 1TB (151-250TB)	D1	\$1,100
CC-SYMGR-C08	SYMM MGR 1TB (251-400TB)	D1	\$950
CC-SYMGR-C09	SYMM MGR 1TB (401-600TB)	D1	\$830
CC-SYMGR-C10	SYMM MGR 1TB (601-1000TB)	D1	\$720
CC-SYMGR-C11	SYMM MGR 1TB(1001TB or greater)	D1	\$620
CC-SYMGR-N01	SYMM MGR 1TB (0-14TB) NLT3	D1	\$930
CC-SYMGR-N02	SYMM MGR 1TB (15-25TB) NLT3	D1	\$880
CC-SYMGR-N03	SYMM MGR 1TB (26-40TB) NLT3	D1	\$770
CC-SYMGR-N04	SYMM MGR 1TB (41-60TB) NLT3	D1	\$720
CC-SYMGR-N05	SYMM MGR 1TB (61-100TB) NLT3	D1	\$690
CC-SYMGR-N06	SYMM MGR 1TB (101-150TB) NLT3	D1	\$620
CC-SYMGR-N07	SYMM MGR 1TB (151-250TB) NLT3	D1	\$550
CC-SYMGR-N08	SYMM MGR 1TB (251-400TB) NLT3	D1	\$480
CC-SYMGR-N09	SYMM MGR 1TB (401-600TB) NLT3	D1	\$420
CC-SYMGR-N10	SYMM MGR 1TB (601-1000TB) NLT3	D1	\$360
CC-SYMGR-N11	SYMM MGR 1TB(1001TB or greater) NLT3	D1	\$310
CC-SYMGR-PRV	PREVIOUS VERSION SYMMGR	D1	\$0
CC-SYMGR-T1	CC5x SYMMETRIX MGR T1	D1	\$0
CC-SYMGR-T10	CC5x SYMMETRIX MGR T10	D1	\$0
CC-SYMGR-T11	CC5x SYMMETRIX MGR T11	D1	\$0
CC-SYMGR-T12	CC5x SYMMETRIX MGR T12	D1	\$0
CC-SYMGR-T13	CC5x SYMMETRIX MGR T13	D1	\$0
CC-SYMGR-T14	CC5x SYMMETRIX MGR T14	D1	\$0
CC-SYMGR-T15	CC5x SYMMETRIX MGR T15	D1	\$0
CC-SYMGR-T16	CC5x SYMMETRIX MGR T16	D1	\$0
CC-SYMGR-T17	CC5x SYMMETRIX MGR T17	D1	\$0
CC-SYMGR-T18	CC5x SYMMETRIX MGR T18	D1	\$0
CC-SYMGR-T19	CC5x SYMMETRIX MGR T19	D1	\$0
CC-SYMGR-T2	CC5x SYMMETRIX MGR T2	D1	\$0
CC-SYMGR-T20	CC5x SYMMETRIX MGR T20	D1	\$0
CC-SYMGR-T21	CC5x SYMMETRIX MGR T21	D1	\$0
CC-SYMGR-T22	CC5x SYMMETRIX MGR T22	D1	\$0
CC-SYMGR-T23	CC5x SYMMETRIX MGR T23	D1	\$0
CC-SYMGR-T24	CC5x SYMMETRIX MGR T24	D1	\$0
CC-SYMGR-T25	CC5x SYMMETRIX MGR T25	D1	\$0
CC-SYMGR-T26	CC5x SYMMETRIX MGR T26	D1	\$0
CC-SYMGR-T27	CC5x SYMMETRIX MGR T27	D1	\$0
CC-SYMGR-T28	CC5x SYMMETRIX MGR T28	D1	\$0
CC-SYMGR-T29	CC5x SYMMETRIX MGR T29	D1	\$0
CC-SYMGR-T3	CC5x SYMMETRIX MGR T3	D1	\$0
CC-SYMGR-T30	CC5x SYMMETRIX MGR T30	D1	\$0
CC-SYMGR-T31	CC SYMMETRIX MGR 71.01-74	D1	\$0
CC-SYMGR-T32	CC SYMMETRIX MGR 74.01-77	D1	\$0
CC-SYMGR-T33	CC SYMMETRIX MGR 77.01-80	D1	\$0

CC-SYMGR-T34	CC SYMMETRIX MGR 80.01-83	D1	\$0
CC-SYMGR-T35	CC SYMMETRIX MGR 83.01-86	D1	\$0
CC-SYMGR-T4	CC5x SYMMETRIX MGR T4	D1	\$0
CC-SYMGR-T5	CC5x SYMMETRIX MGR T5	D1	\$0
CC-SYMGR-T6	CC5x SYMMETRIX MGR T6	D1	\$0
CC-SYMGR-T7	CC5x SYMMETRIX MGR T7	D1	\$0
CC-SYMGR-T8	CC5x SYMMETRIX MGR T8	D1	\$0
CC-SYMGR-T9	CC5x SYMMETRIX MGR T9	D1	\$0
CC-SYMGR-UPG	SYMM MGR BASE UPGRADE	D1	\$0
CC-SYMPK6-BAS	EMC CONTROLCENTER 6.0 SYMMETRIX PACKA	D1	\$0
CC-SYMPK6-R	EMC CONTROLCENTER 6.0 SYMMETRIX PACKA	D1	\$0
CC-SYMPK6-UPG	EMC CONTROLCENTER 6.0 SYMMETRIX PACKA	D1	\$0
CC-SYMPK-BASE	SYMM PKG BASE LICENSE	D1	\$15,390
CC-SYMPK-C01	SYMM PKG 1TB (0-14TB)	D1	\$3,770
CC-SYMPK-C02	SYMM PKG 1TB (15-25TB)	D1	\$3,540
CC-SYMPK-C03	SYMM PKG 1TB (26-40TB)	D1	\$3,110
CC-SYMPK-C04	SYMM PKG 1TB (41-60TB)	D1	\$2,890
CC-SYMPK-C05	SYMM PKG 1TB (61-100TB)	D1	\$2,770
CC-SYMPK-C06	SYMM PKG 1TB (101-150TB)	D1	\$2,490
CC-SYMPK-C07	SYMM PKG 1TB (151-250TB)	D1	\$2,210
CC-SYMPK-C08	SYMM PKG 1TB (251-400TB)	D1	\$1,930
CC-SYMPK-C09	SYMM PKG 1TB (401-600TB)	D1	\$1,670
CC-SYMPK-C10	SYMM PKG 1TB (601-1000TB)	D1	\$1,460
CC-SYMPK-C11	SYMM PKG 1TB(1001TB or greater)	D1	\$1,270
CC-SYMPKE-BAS	EMC CC 6.1 SYM PKG ENHANCED WITH SANMG	D1	\$0
CC-SYMPKE-UPG	EMC CC 6.1 SYM PKG ENHANCED WITH SANMG	D1	\$0
CC-SYMPKGEC01	NEW SYMM PKG 1TB (0-14TB)	D1	\$0
CC-SYMPKGEC02	NEW SYMM PKG 1TB (15-25TB)	D1	\$0
CC-SYMPKGEC03	NEW SYMM PKG 1TB (26-40TB)	D1	\$0
CC-SYMPKGEC04	NEW SYMM PKG 1TB (41-60TB)	D1	\$0
CC-SYMPKGEC05	NEW SYMM PKG 1TB (61-100TB)	D1	\$0
CC-SYMPKGEC06	NEW SYMM PKG 1TB (101-150TB)	D1	\$0
CC-SYMPKGEC07	NEW SYMM PKG 1TB (151-250TB)	D1	\$0
CC-SYMPKGEC08	NEW SYMM PKG 1TB (251-400TB)	D1	\$0
CC-SYMPKGEC09	NEW SYMM PKG 1TB (401-600TB)	D1	\$0
CC-SYMPKGEC10	NEW SYMM PKG 1TB (601-1000TB)	D1	\$0
CC-SYMPKGEC11	NEW SYMM PKG 1TB(1001-1500TB)	D1	\$0
CC-SYMPKGEN01	NEW SYMM PKG 1TB (0-14TB) NLT3	D1	\$0
CC-SYMPKGEN02	NEW SYMM PKG 1TB (15-25TB) NLT3	D1	\$0
CC-SYMPKGEN03	NEW SYMM PKG 1TB (26-40TB) NLT3	D1	\$0
CC-SYMPKGEN04	NEW SYMM PKG 1TB (41-60TB) NLT3	D1	\$0
CC-SYMPKGEN05	NEW SYMM PKG 1TB (61-100TB) NLT3	D1	\$0
CC-SYMPKGEN06	NEW SYMM PKG 1TB (101-150TB) NLT3	D1	\$0
CC-SYMPKGEN07	NEW SYMM PKG 1TB (151-250TB) NLT3	D1	\$0
CC-SYMPKGEN08	NEW SYMM PKG 1TB (251-400TB) NLT3	D1	\$0
CC-SYMPKGEN09	NEW SYMM PKG 1TB (401-600TB) NLT3	D1	\$0
CC-SYMPKGEN10	NEW SYMM PKG 1TB (601-1000TB) NLT3	D1	\$0
CC-SYMPKGEN11	NEW SYMM PKG 1TB(1001-1500TB) NLT3	D1	\$0
CC-SYMPK-N01	SYMM PKG 1TB (0-14TB) NLT3	D1	\$1,880
CC-SYMPK-N02	SYMM PKG 1TB (15-25TB) NLT3	D1	\$1,770

CC-SYMPK-N03	SYMM PKG 1TB (26-40TB) NLT3	D1	\$1,550
CC-SYMPK-N04	SYMM PKG 1TB (41-60TB) NLT3	D1	\$1,450
CC-SYMPK-N05	SYMM PKG 1TB (61-100TB) NLT3	D1	\$1,390
CC-SYMPK-N06	SYMM PKG 1TB (101-150TB) NLT3	D1	\$1,250
CC-SYMPK-N07	SYMM PKG 1TB (151-250TB) NLT3	D1	\$1,110
CC-SYMPK-N08	SYMM PKG 1TB (251-400TB) NLT3	D1	\$970
CC-SYMPK-N09	SYMM PKG 1TB (401-600TB) NLT3	D1	\$840
CC-SYMPK-N10	SYMM PKG 1TB (601-1000TB) NLT3	D1	\$730
CC-SYMPK-N11	SYMM PKG 1TB(1001TB or greater) NLT3	D1	\$640
CC-SYMPK-T1	SYM PKG 0-.250	D1	\$0
CC-SYMPK-T10	SYM PKG 10.01-12.	D1	\$0
CC-SYMPK-T11	SYM PKG 12.01-14.	D1	\$0
CC-SYMPK-T12	SYM PKG 14.01-17.	D1	\$0
CC-SYMPK-T13	SYM PKG 17.01-20.00	D1	\$0
CC-SYMPK-T14	SYM PKG 20.01-23.00	D1	\$0
CC-SYMPK-T15	SYM PKG 23.01-26.00	D1	\$0
CC-SYMPK-T16	SYM PKG 26.01-29.00	D1	\$0
CC-SYMPK-T17	SYM PKG 29.01-32.00	D1	\$0
CC-SYMPK-T18	SYM PKG 32.01-35.00	D1	\$0
CC-SYMPK-T19	SYM PKG 35.01-38.00	D1	\$0
CC-SYMPK-T2	SYM PKG .251-.500	D1	\$0
CC-SYMPK-T20	SYM PKG 38.01-41.00	D1	\$0
CC-SYMPK-T21	SYM PKG 41.01-44.00	D1	\$0
CC-SYMPK-T22	SYM PKG 44.01-47.00	D1	\$0
CC-SYMPK-T23	SYM PKG 47.01-50.00	D1	\$0
CC-SYMPK-T24	SYM PKG 50.01-53.00	D1	\$0
CC-SYMPK-T25	SYM PKG 53.01-56.00	D1	\$0
CC-SYMPK-T26	SYM PKG 56.01-59.00	D1	\$0
CC-SYMPK-T27	SYM PKG 59.01-62.00	D1	\$0
CC-SYMPK-T28	SYM PKG 62.01-65.00	D1	\$0
CC-SYMPK-T29	SYM PKG 65.01-68.00	D1	\$0
CC-SYMPK-T3	SYM PKG .501-.750	D1	\$0
CC-SYMPK-T30	SYM PKG 68.01-71.00	D1	\$0
CC-SYMPK-T31	SYM PKG 71.01-74.00	D1	\$0
CC-SYMPK-T32	SYM PKG 74.01-77.00	D1	\$0
CC-SYMPK-T33	SYM PKG 77.01-80.00	D1	\$0
CC-SYMPK-T34	SYM PKG 80.01-83.00	D1	\$0
CC-SYMPK-T35	SYM PKG 83.01-86.00	D1	\$0
CC-SYMPK-T4	SYM PKG .751-1.00	D1	\$0
CC-SYMPK-T5	SYM PKG 1.01-2.00	D1	\$0
CC-SYMPK-T6	SYM PKG 2.01-4.00	D1	\$0
CC-SYMPK-T7	SYM PKG 4.01-6.00	D1	\$0
CC-SYMPK-T8	SYM PKG 6.01-8.00	D1	\$0
CC-SYMPK-T9	SYM PKG 8.01-10.0	D1	\$0
CC-WLA-SY-T1	CC5.x WLA-SYM T1	D1	\$0
CC-WLA-SY-T10	CC5.x WLA-SYM T10	D1	\$0
CC-WLA-SY-T11	CC5.x WLA-SYM T11	D1	\$0
CC-WLA-SY-T12	CC5.x WLA-SYM T12	D1	\$0
CC-WLA-SY-T13	CC5.x WLA-SYM T13	D1	\$0
CC-WLA-SY-T14	CC5.x WLA-SYM T14	D1	\$0

CC-WLA-SY-T15	CC5.x WLA-SYM T15	D1	\$0
CC-WLA-SY-T16	CC5.x WLA-SYM T16	D1	\$0
CC-WLA-SY-T17	CC5.x WLA-SYM T17	D1	\$0
CC-WLA-SY-T18	CC5.x WLA-SYM T18	D1	\$0
CC-WLA-SY-T19	CC5.x WLA-SYM T19	D1	\$0
CC-WLA-SY-T2	CC5.x WLA-SYM T2	D1	\$0
CC-WLA-SY-T20	CC5.x WLA-SYM T20	D1	\$0
CC-WLA-SY-T21	CC5.x WLA-SYM T21	D1	\$0
CC-WLA-SY-T22	CC5.x WLA-SYM T22	D1	\$0
CC-WLA-SY-T23	CC5.x WLA-SYM T23	D1	\$0
CC-WLA-SY-T24	CC5.x WLA-SYM T24	D1	\$0
CC-WLA-SY-T25	CC5.x WLA-SYM T25	D1	\$0
CC-WLA-SY-T26	CC5.x WLA-SYM T26	D1	\$0
CC-WLA-SY-T27	CC5.x WLA-SYM T27	D1	\$0
CC-WLA-SY-T28	CC5.x WLA-SYM T28	D1	\$0
CC-WLA-SY-T29	CC5.x WLA-SYM T29	D1	\$0
CC-WLA-SY-T3	CC5.x WLA-SYM T3	D1	\$0
CC-WLA-SY-T30	CC5.x WLA-SYM T30	D1	\$0
CC-WLA-SY-T31	CC5.X WLA-SYM T31	D1	\$0
CC-WLA-SY-T32	CC5.X WLA-SYM T32	D1	\$0
CC-WLA-SY-T33	CC5.X WLA-SYM T33	D1	\$0
CC-WLA-SY-T34	CC5.X WLA-SYM T34	D1	\$0
CC-WLA-SY-T35	CC5.X WLA-SYM T35	D1	\$0
CC-WLA-SY-T4	CC5.x WLA-SYM T4	D1	\$0
CC-WLA-SY-T5	CC5.x WLA-SYM T5	D1	\$0
CC-WLA-SY-T6	CC5.x WLA-SYM T6	D1	\$0
CC-WLA-SY-T7	CC5.x WLA-SYM T7	D1	\$0
CC-WLA-SY-T8	CC5.x WLA-SYM T8	D1	\$0
CC-WLA-SY-T9	CC5.x WLA-SYM T9	D1	\$0
CCWLA-T1-4UP	ECC WLA T1-T4 UPGRADE	D1	\$0
CCWLA-T5-12UP	ECC WLA T5-T12 UPGRADE	D1	\$0
CEXT-T1-4UP	CMPEXT T1-T4 UPGRADE	D1	\$0
CEXT-T5-35UP	CMPEXT T5-T35 UPGRADE	D1	\$0
CMPEXT-BASE	CMPEXT BASE LICENSE	D1	\$15,180
CMPEXT-C01	CMPEXT 1TB (0-14TB)	D1	\$3,400
CMPEXT-C02	CMPEXT 1TB (15-25TB)	D1	\$3,200
CMPEXT-C03	CMPEXT 1TB (26-40TB)	D1	\$2,810
CMPEXT-C04	CMPEXT 1TB (41-60TB)	D1	\$2,620
CMPEXT-C05	CMPEXT 1TB (61-100TB)	D1	\$2,510
CMPEXT-C06	CMPEXT 1TB (101-150TB)	D1	\$2,260
CMPEXT-C07	CMPEXT 1TB (151-250TB)	D1	\$2,020
CMPEXT-C08	CMPEXT 1TB (251-400TB)	D1	\$1,750
CMPEXT-C09	CMPEXT 1TB (401-600TB)	D1	\$1,530
CMPEXT-C10	CMPEXT 1TB (601-1000TB)	D1	\$1,330
CMPEXT-C11	CMPEXT1TB(1001TB or greater)	D1	\$1,160
CMPEXT-N01	CMPEXT 1TB (0-14TB) NLT3	D1	\$1,700
CMPEXT-N02	CMPEXT 1TB (15-25TB) NLT3	D1	\$1,600
CMPEXT-N03	CMPEXT 1TB (26-40TB) NLT3	D1	\$1,410
CMPEXT-N04	CMPEXT 1TB (41-60TB) NLT3	D1	\$1,310
CMPEXT-N05	CMPEXT 1TB (61-100TB) NLT3	D1	\$1,260

CMPEXT-N06	CMPEXT 1TB (101-150TB) NLT3	D1	\$1,130
CMPEXT-N07	CMPEXT 1TB (151-250TB) NLT3	D1	\$1,010
CMPEXT-N08	CMPEXT 1TB (251-400TB) NLT3	D1	\$880
CMPEXT-N09	CMPEXT 1TB (401-600TB) NLT3	D1	\$760
CMPEXT-N10	CMPEXT 1TB (601-1000TB) NLT3	D1	\$670
CMPEXT-N11	CMPEXT1TB(1001TB or greater) NLT3	D1	\$580
CMPEXTRMZ-BAS	CMPEXTRMZ BASE LICENSE	D1	\$2,580
CMPEXTRMZ-C01	COMPEXTRMZ 1 TB (0-14 TB)	D1	\$550
CMPEXTRMZ-C02	COMPEXTRMZ 1 TB (15-25 TB)	D1	\$525
CMPEXTRMZ-C03	COMPEXTRMZ 1 TB (26-40 TB)	D1	\$495
CMPEXTRMZ-C04	COMPEXTRMZ 1 TB (41-60 TB)	D1	\$470
CMPEXTRMZ-C05	COMPEXTRMZ 1 TB (61-100 TB)	D1	\$450
CMPEXTRMZ-C06	COMPEXTRMZ 1 TB (101-150 TB)	D1	\$425
CMPEXTRMZ-C07	COMPEXTRMZ 1 TB (151-250 TB)	D1	\$405
CMPEXTRMZ-C08	COMPEXTRMZ 1 TB (251-400 TB)	D1	\$385
CMPEXTRMZ-C09	COMPEXTRMZ 1 TB (401-600 TB)	D1	\$365
CMPEXTRMZ-C10	COMPEXTRMZ 1 TB (601-1000 TB)	D1	\$345
CMPEXTRMZ-C11	COMPEXTRMZ 1 TB (1001 TB OR GREATER)	D1	\$330
CMPEXTRMZ-N01	CMPEXTRMZ 1 TB (0-14TB) NLT3	D1	\$275
CMPEXTRMZ-N02	CMPEXTRMZ 1 TB (15-25TB) NLT3	D1	\$260
CMPEXTRMZ-N03	CMPEXTRMZ 1 TB (26-40TB) NLT3	D1	\$250
CMPEXTRMZ-N04	CMPEXTRMZ 1 TB (41-60TB) NLT3	D1	\$235
CMPEXTRMZ-N05	CMPEXTRMZ 1 TB (61-100TB) NLT3	D1	\$225
CMPEXTRMZ-N06	CMPEXTRMZ 1 TB (101-150TB) NLT3	D1	\$215
CMPEXTRMZ-N07	CMPEXTRMZ 1 TB (151-250TB) NLT3	D1	\$200
CMPEXTRMZ-N08	CMPEXTRMZ 1 TB (251-400TB) NLT3	D1	\$190
CMPEXTRMZ-N09	CMPEXTRMZ 1 TB (401-600TB) NLT3	D1	\$180
CMPEXTRMZ-N10	CMPEXTRMZ 1 TB (601-1000TB) NLT3	D1	\$175
CMPEXTRMZ-N11	CMPEXTRMZ 1 TB (1001 TB OR GREATER) NLT3	D1	\$165
CMPEXTRMZ-UPG	CMPEXTRMZ BASE UPGRADE	D1	\$0
CMPEXT-T01	COMP EXT CPTY 0-.250	D1	\$0
CMPEXT-T02	COMP EXT CPTY .251-.500	D1	\$0
CMPEXT-T03	COMP EXT CPTY .501-.750	D1	\$0
CMPEXT-T04	COMP EXT CPTY .751-1.00	D1	\$0
CMPEXT-T05	COMP EXT CPTY 1.01-2.00	D1	\$0
CMPEXT-T06	COMP EXT CPTY 2.01-4.00	D1	\$0
CMPEXT-T07	COMP EXT CPTY 4.01-6.00	D1	\$0
CMPEXT-T08	COMP EXT CPTY 6.01-8.00	D1	\$0
CMPEXT-T09	COMP EXT CPTY 8.01-10.00	D1	\$0
CMPEXT-T10	COMP EXT CPTY 10.01-12.00	D1	\$0
CMPEXT-T11	COMP EXT CPTY 12.01-14.00	D1	\$0
CMPEXT-T12	COMP EXT CPTY 14.01-17.00	D1	\$0
CMPEXT-T13	COMP EXT CPTY 17.01-20.00	D1	\$0
CMPEXT-T14	COMP EXT CPTY 20.01-23.00	D1	\$0
CMPEXT-T15	COMP EXT CPTY 23.01-26.00	D1	\$0
CMPEXT-T16	COMP EXT CPTY 26.01-29.00	D1	\$0
CMPEXT-T17	COMP EXT CPTY 29.01-32.00	D1	\$0
CMPEXT-T18	COMP EXT CPTY 32.01-35.00	D1	\$0
CMPEXT-T19	COMP EXT CPTY 35.01-38.00	D1	\$0
CMPEXT-T20	COMP EXT CPTY 38.01-41.00	D1	\$0

CMPEXT-T21	COMP EXT CPTY 41.01-44.00	D1	\$0
CMPEXT-T22	COMP EXT CPTY 44.01-47.00	D1	\$0
CMPEXT-T23	COMP EXT CPTY 47.01-50.00	D1	\$0
CMPEXT-T24	COMP EXT CPTY 50.01-53.00	D1	\$0
CMPEXT-T25	COMP EXT CPTY 53.01-56.00	D1	\$0
CMPEXT-T26	COMP EXT CPTY 56.01-59.00	D1	\$0
CMPEXT-T27	COMP EXT CPTY 59.01-62.00	D1	\$0
CMPEXT-T28	COMP EXT CPTY 62.01-65.00	D1	\$0
CMPEXT-T29	COMP EXT CPTY 62.01-68.00	D1	\$0
CMPEXT-T30	COMP EXT CPTY 68.01-71.00	D1	\$0
CMPEXT-T31	COMP EXT CPTY 71.01-74.00	D1	\$0
CMPEXT-T32	COMP EXT CPTY74.01-77.00	D1	\$0
CMPEXT-T33	COMP EXT CPTY 77.01-80.00	D1	\$0
CMPEXT-T34	COMP EXT CPTY 80.01-83.00	D1	\$0
CMPEXT-T35	COMP EXT CPTY 83.01-86.00	D1	\$0
CMPEXT-UPG	CMPEXT BASE UPGRADE	D1	\$0
CMPFLASHBASE	CMPFLASH BASE LICENSE	D1	\$7,000
CMPFLASH-C01	CMPFLASH 1TB (0-14TB)	D1	\$4,200
CMPFLASH-C02	CMPFLASH 1TB (15-25TB)	D1	\$4,030
CMPFLASH-C03	CMPFLASH 1TB (26-40TB)	D1	\$3,870
CMPFLASH-C04	CMPFLASH 1TB (41-60TB)	D1	\$3,720
CMPFLASH-C05	CMPFLASH 1TB (61-100TB)	D1	\$3,570
CMPFLASH-C06	CMPFLASH 1TB (101-150TB)	D1	\$3,430
CMPFLASH-C07	CMPFLASH 1TB (151-250TB)	D1	\$3,290
CMPFLASH-C08	CMPFLASH 1TB (251-400TB)	D1	\$3,160
CMPFLASH-C09	CMPFLASH 1TB (401-600TB)	D1	\$3,030
CMPFLASH-C10	CMPFLASH 1TB (601-1000TB)	D1	\$2,910
CMPFLASH-C11	CMPFLASH1TB(1001TB or greater)	D1	\$2,790
CMPFLASH-N01	CMPFLASH 1TB (0-14TB) NLT3	D1	\$2,100
CMPFLASH-N02	CMPFLASH 1TB (15-25TB) NLT3	D1	\$2,020
CMPFLASH-N03	CMPFLASH 1TB (26-40TB) NLT3	D1	\$1,940
CMPFLASH-N04	CMPFLASH 1TB (41-60TB) NLT3	D1	\$1,860
CMPFLASH-N05	CMPFLASH 1TB (61-100TB) NLT3	D1	\$1,790
CMPFLASH-N06	CMPFLASH 1TB (101-150TB) NLT3	D1	\$1,720
CMPFLASH-N07	CMPFLASH 1TB (151-250TB) NLT3	D1	\$1,650
CMPFLASH-N08	CMPFLASH 1TB (251-400TB) NLT3	D1	\$1,580
CMPFLASH-N09	CMPFLASH 1TB (401-600TB) NLT3	D1	\$1,520
CMPFLASH-N10	CMPFLASH 1TB (601-1000TB) NLT3	D1	\$1,460
CMPFLASH-N11	CMPFLASH1TB(1001TB or greater) NLT3	D1	\$1,400
CMPFLASH-UPG	CMPFLASH BASE UPGRADE	D1	\$0
CMPNFLASHBASE	CMP NATIVE FLASH BASE LICENSE	D1	\$7,000
CMPNFLASH-C01	CMPNFLASH 1TB (0-14TB)	D1	\$4,200
CMPNFLASH-C02	CMPNFLASH 1TB (15-25TB)	D1	\$4,030
CMPNFLASH-C03	CMPNFLASH 1TB (26-40TB)	D1	\$3,870
CMPNFLASH-C04	CMPNFLASH 1TB (41-60TB)	D1	\$3,720
CMPNFLASH-C05	CMPNFLASH 1TB (61-100TB)	D1	\$3,570
CMPNFLASH-C06	CMPNFLASH 1TB (101-150TB)	D1	\$3,430
CMPNFLASH-C07	CMPNFLASH 1TB (151-250TB)	D1	\$3,290
CMPNFLASH-C08	CMPNFLASH 1TB (251-400TB)	D1	\$3,160
CMPNFLASH-C09	CMPNFLASH 1TB (401-600TB)	D1	\$3,030

CMPNFLASH-C10	CMPNFLASH 1TB (601-1000TB)	D1	\$2,910
CMPNFLASH-C11	CMPNFLASH1TB(1001TB or greater)	D1	\$2,790
CMPNFLASH-N01	CMPNFLASH 1TB (0-14TB) NLT3	D1	\$2,100
CMPNFLASH-N02	CMPNFLASH 1TB (15-25TB) NLT3	D1	\$2,020
CMPNFLASH-N03	CMPNFLASH 1TB (26-40TB) NLT3	D1	\$1,940
CMPNFLASH-N04	CMPNFLASH 1TB (41-60TB) NLT3	D1	\$1,860
CMPNFLASH-N05	CMPNFLASH 1TB (61-100TB) NLT3	D1	\$1,790
CMPNFLASH-N06	CMPNFLASH 1TB (101-150TB) NLT3	D1	\$1,720
CMPNFLASH-N07	CMPNFLASH 1TB (151-250TB) NLT3	D1	\$1,650
CMPNFLASH-N08	CMPNFLASH 1TB (251-400TB) NLT3	D1	\$1,580
CMPNFLASH-N09	CMPNFLASH 1TB (401-600TB) NLT3	D1	\$1,520
CMPNFLASH-N10	CMPNFLASH 1TB (601-1000TB) NLT3	D1	\$1,460
CMPNFLASH-N11	CMPNFLASH1TB(1001TB or greater) NLT3	D1	\$1,400
CMPNFLASH-UPG	CMPNFLASH BASE UPGRADE	D1	\$0
CMPPEER-BASE	CMPPEER BASE LICENSE	D1	\$23,060
CMPPEER-C01	CMPPEER 1TB (0-14TB)	D1	\$4,870
CMPPEER-C02	CMPPEER 1TB (15-25TB)	D1	\$4,570
CMPPEER-C03	CMPPEER 1TB (26-40TB)	D1	\$4,030
CMPPEER-C04	CMPPEER 1TB (41-60TB)	D1	\$3,750
CMPPEER-C05	CMPPEER 1TB (61-100TB)	D1	\$3,590
CMPPEER-C06	CMPPEER 1TB (101-150TB)	D1	\$3,230
CMPPEER-C07	CMPPEER 1TB (151-250TB)	D1	\$2,880
CMPPEER-C08	CMPPEER 1TB (251-400TB)	D1	\$2,510
CMPPEER-C09	CMPPEER 1TB (401-600TB)	D1	\$2,180
CMPPEER-C10	CMPPEER 1TB (601-1000TB)	D1	\$1,900
CMPPEER-C11	CMPPEER1TB(1001TB or greater)	D1	\$1,650
CMPPEER-N01	CMPPEER 1TB (0-14TB) NLT3	D1	\$2,430
CMPPEER-N02	CMPPEER 1TB (15-25TB) NLT3	D1	\$2,290
CMPPEER-N03	CMPPEER 1TB (26-40TB) NLT3	D1	\$2,010
CMPPEER-N04	CMPPEER 1TB (41-60TB) NLT3	D1	\$1,870
CMPPEER-N05	CMPPEER 1TB (61-100TB) NLT3	D1	\$1,800
CMPPEER-N06	CMPPEER 1TB (101-150TB) NLT3	D1	\$1,620
CMPPEER-N07	CMPPEER 1TB (151-250TB) NLT3	D1	\$1,440
CMPPEER-N08	CMPPEER 1TB (251-400TB) NLT3	D1	\$1,250
CMPPEER-N09	CMPPEER 1TB (401-600TB) NLT3	D1	\$1,090
CMPPEER-N10	CMPPEER 1TB (601-1000TB) NLT3	D1	\$950
CMPPEER-N11	CMPPEER1TB(1001TB or greater) NLT3	D1	\$830
CMPPEER-T01	COMPPEER CPTY 0-.250	D1	\$0
CMPPEER-T02	COMPPEER CPTY .251-.500	D1	\$0
CMPPEER-T03	COMPPEER CPTY .501-.750	D1	\$0
CMPPEER-T04	COMPPEER CPTY .751-1.00	D1	\$0
CMPPEER-T05	COMPPEER CPTY 1.01-2.00	D1	\$0
CMPPEER-T06	COMPPEER CPTY 2.01-4.00	D1	\$0
CMPPEER-T07	COMPPEER CPTY 4.01-6.00	D1	\$0
CMPPEER-T08	COMPPEERCPTY 6.01-8.00	D1	\$0
CMPPEER-T09	COMPPEER CPTY 8.01-10.00	D1	\$0
CMPPEER-T10	COMPPEER CPTY 10.01-12.00	D1	\$0
CMPPEER-T11	COMPPEER CPTY 12.01-14.00	D1	\$0
CMPPEER-T12	COMPPEER CPTY 14.01-17.00	D1	\$0
CMPPEER-T13	COMPPEER CPTY 17.01-20.00	D1	\$0

CMPPEER-T14	COMPPEER CPTY 20.01-23.00	D1	\$0
CMPPEER-T15	COMPPEER CPTY 23.01-26.00	D1	\$0
CMPPEER-T16	COMPPEER CPTY 26.01-29.00	D1	\$0
CMPPEER-T17	COMPPEER CPTY 29.01-32.00	D1	\$0
CMPPEER-T18	COMPPEER CPTY 32.01-35.00	D1	\$0
CMPPEER-T19	COMPPEER CPTY 35.01-38.00	D1	\$0
CMPPEER-T20	COMPPEER CPTY 38.01-41.00	D1	\$0
CMPPEER-T21	COMPPEER CPTY 41.01-44.00	D1	\$0
CMPPEER-T22	COMPPEER CPTY44.01-47.00	D1	\$0
CMPPEER-T23	COMPPEER CPTY 47.01-50.00	D1	\$0
CMPPEER-T24	COMPPEER CPTY 50.01-53.00	D1	\$0
CMPPEER-T25	COMPPEER CPTY 53.01-56.00	D1	\$0
CMPPEER-T26	COMPPEER CPTY 56.01-59.00	D1	\$0
CMPPEER-T27	COMPPEER CPTY 59.01-62.00	D1	\$0
CMPPEER-T28	COMPPEER CPTY 62.01-65.00	D1	\$0
CMPPEER-T29	COMPPEER CPTY 65.01-68.00	D1	\$0
CMPPEER-T30	COMPPEER CPTY 68.01-71.00	D1	\$0
CMPPEER-T31	COMPPEER CPTY 71.01-74.00	D1	\$0
CMPPEER-T32	COMPPEER CPTY74.01-77.00	D1	\$0
CMPPEER-T33	COMPPEER CPTY 77.01-80.00	D1	\$0
CMPPEER-T34	COMPPEER CPTY 80.01-83.00	D1	\$0
CMPPEER-T35	COMPPEER CPTY 83.01-86.00	D1	\$0
CMPPEER-UPG	CMPPEER BASE UPGRADE	D1	\$0
CMPZHPF-BAS	CMP HIGH PERFORMANCE FICON BASE LICENS	D1	\$10,000
CNFMGR-T1-4U	ECC CNFMGR T1-T4 UPGRADE	D1	\$0
CNFMGR-T5-12U	ECC CNFMGR T5-T12 UPGRADE	D1	\$0
COM-PAV/MAT1	COMPAV CPCTY 0-.250	D1	\$4,820
COM-PAV/MAT10	COMPAV CPCTY 10.01-12.00	D1	\$56,450
COM-PAV/MAT11	COMPAV CPCTY 12.01-14.00	D1	\$63,580
COM-PAV/MAT12	COMPAV CPCTY 14.01-17.00	D1	\$70,710
COM-PAV/MAT13	COMPAV CPCTY 17.01-20.00	D1	\$77,840
COM-PAV/MAT14	COMPAV CPCTY 20.01-23.00	D1	\$84,970
COM-PAV/MAT15	COMPAV CPCTY 23.01-26.00	D1	\$92,100
COM-PAV/MAT16	COMPAV CPCTY 26.01-29.00	D1	\$99,230
COM-PAV/MAT17	COMPAV CPCTY 29.01-32.00	D1	\$106,360
COM-PAV/MAT18	COMPAV CPCTY 32.01-35.00	D1	\$113,490
COM-PAV/MAT19	COMPAV CPCTY 35.01-38.00	D1	\$120,620
COM-PAV/MAT2	COMPAV .251-.500	D1	\$7,770
COM-PAV/MAT20	COMPAV CPCTY 38.01-41.00	D1	\$127,750
COM-PAV/MAT21	COMPAV CPCTY 41.01-44.00	D1	\$134,880
COM-PAV/MAT22	COMPAV CPCTY 44.01-47.00	D1	\$142,010
COM-PAV/MAT23	COMPAV CPCTY 47.01-50.00	D1	\$149,140
COM-PAV/MAT24	COMPAV CPCTY 50.01-53.00	D1	\$156,270
COM-PAV/MAT25	COMPAV CPCTY 53.01-56.00	D1	\$163,400
COM-PAV/MAT26	COMPAV CPCTY 56.01-59.00	D1	\$170,530
COM-PAV/MAT27	COMPAV CPCTY 59.01-62.00	D1	\$177,660
COM-PAV/MAT28	COMPAV CPCTY 62.01-65.00	D1	\$184,790
COM-PAV/MAT29	COMPAV CPCTY 65.01-68.00	D1	\$191,920
COM-PAV/MAT3	COMPAV CPCTY .501-.750	D1	\$10,720
COM-PAV/MAT30	COMPAV CPCTY 68.01-71.00	D1	\$199,050

COM-PAV/MAT4	COMPAV CPCTY .751-1.00	D1	\$13,670
COM-PAV/MAT5	COMPAV CPCTY 1.01-2.00	D1	\$20,800
COM-PAV/MAT6	COMPAV CPCTY 2.01-4.00	D1	\$27,930
COM-PAV/MAT7	COMPAV CPCTY 4.01-6.00	D1	\$35,060
COM-PAV/MAT8	COMPAV CPCTY 6.01-8.00	D1	\$42,190
COM-PAV/MAT9	COMPAV CPCTY 8.01-10.00	D1	\$49,320
COM-PAV/MBASE	COM-PAV/M BASE LICENSE	D1	\$9,510
COM-PAV/M-C01	COM-PAV/M 1TB (0-14TB)	D1	\$2,250
COM-PAV/M-C02	COM-PAV/M 1TB (15-25TB)	D1	\$2,110
COM-PAV/M-C03	COM-PAV/M 1TB (26-40TB)	D1	\$1,860
COM-PAV/M-C04	COM-PAV/M 1TB (41-60TB)	D1	\$1,730
COM-PAV/M-C05	COM-PAV/M 1TB (61-100TB)	D1	\$1,660
COM-PAV/M-C06	COM-PAV/M 1TB (101-150TB)	D1	\$1,490
COM-PAV/M-C07	COM-PAV/M 1TB (151-250TB)	D1	\$1,330
COM-PAV/M-C08	COM-PAV/M 1TB (251-400TB)	D1	\$1,160
COM-PAV/M-C09	COM-PAV/M 1TB (401-600TB)	D1	\$1,010
COM-PAV/M-C10	COM-PAV/M 1TB(601-1000TB)	D1	\$880
COM-PAV/M-C11	COMPAV/M 1TB(1001TB or greater)	D1	\$760
COM-PAV/M-N01	COM-PAV/M 1TB (0-14TB) NLT3	D1	\$1,120
COM-PAV/M-N02	COM-PAV/M 1TB (15-25TB) NLT3	D1	\$1,060
COM-PAV/M-N03	COM-PAV/M 1TB (26-40TB) NLT3	D1	\$930
COM-PAV/M-N04	COM-PAV/M 1TB (41-60TB) NLT3	D1	\$860
COM-PAV/M-N05	COM-PAV/M 1TB (61-100TB) NLT3	D1	\$830
COM-PAV/M-N06	COM-PAV/M 1TB (101-150TB) NLT3	D1	\$750
COM-PAV/M-N07	COM-PAV/M 1TB (151-250TB) NLT3	D1	\$670
COM-PAV/M-N08	COM-PAV/M 1TB (251-400TB) NLT3	D1	\$580
COM-PAV/M-N09	COM-PAV/M 1TB (401-600TB) NLT3	D1	\$500
COM-PAV/M-N10	COM-PAV/M 1TB(601-1000TB) NLT3	D1	\$440
COM-PAV/M-N11	COMPAV/M 1TB(1001TB or greater) NLT3	D1	\$380
COM-PAV/M-UPG	COM-PAV/M BASE UPGRADE	D1	\$0
COM-PAVM-R01	COM-PAV/M REG 1TB (0-14TB)	D1	\$2,250
COM-PAVM-R02	COM-PAV/M REG 1TB (15-25TB)	D1	\$2,110
COM-PAVM-R03	COM-PAV/M REG 1TB (26-40TB)	D1	\$1,860
COM-PAVM-R04	COM-PAV/M REG 1TB (41-60TB)	D1	\$1,730
COM-PAVM-R05	COM-PAV/M REG 1TB (61-100TB)	D1	\$1,660
COM-PAVM-R06	COM-PAV/M REG 1TB (101-150TB)	D1	\$1,490
COM-PAVM-R07	COM-PAV/M REG 1TB (151-250TB)	D1	\$1,330
COM-PAVM-R08	COM-PAV/M REG 1TB (251-400TB)	D1	\$1,160
COM-PAVM-R09	COM-PAV/M REG 1TB (401-600TB)	D1	\$1,010
COM-PAVM-R10	COM-PAV/M REG 1TB (601-1000TB)	D1	\$880
COM-PAVM-R11	COMPAV/M REG 1TB (1001 TB+)	D1	\$760
COM-PAVM-RBAS	COM-PAV/M REG BASE LICENSE	D1	\$9,510
COM-PAVM-RUP	COM-PAV/M REG BASE UPGRADE	D1	\$0
CONENB-T1	CON ENBL CPTY 0-.250	D1	\$0
CONENB-T10	CON ENBL CPTY 10.01-12.00	D1	\$0
CONENB-T11	CON ENBL CPTY 12.01-14.00	D1	\$0
CONENB-T12	CON ENBL CPTY 14.01-17.00	D1	\$0
CONENB-T13	CON ENBL CPTY 17.01-20.00	D1	\$0
CONENB-T14	CON ENBL CPTY 20.01-23.00	D1	\$0
CONENB-T15	CON ENBL CPTY 23.01-26.00	D1	\$0

CONENB-T16	CON ENBL CPTY 26.01-29.00	D1	\$0
CONENB-T17	CON ENBL CPTY 29.01-32.00	D1	\$0
CONENB-T18	CON ENBL CPTY 32.01-35.00	D1	\$0
CONENB-T19	CON ENBL CPTY 35.01-38.00	D1	\$0
CONENB-T2	CON ENBL CPTY .251-.500	D1	\$0
CONENB-T20	CON ENBL CPTY 38.01-41.00	D1	\$0
CONENB-T21	CON ENBL CPTY 41.01-44.00	D1	\$0
CONENB-T22	CON ENBL CPTY 44.01-47.00	D1	\$0
CONENB-T23	CON ENBL CPTY 47.01-50.00	D1	\$0
CONENB-T24	CON ENBL CPTY 50.01-53.00	D1	\$0
CONENB-T25	CON ENBL CPTY 53.01-56.00	D1	\$0
CONENB-T26	CON ENBL CPTY 56.01-59.00	D1	\$0
CONENB-T27	CON ENBL CPTY 59.01-62.00	D1	\$0
CONENB-T28	CON ENBL CPTY 62.01-65.00	D1	\$0
CONENB-T29	CON ENBL CPTY 65.01-68.00	D1	\$0
CONENB-T3	CON ENBL CPTY .501-.750	D1	\$0
CONENB-T30	CON ENBL CPTY 68.01-71.00	D1	\$0
CONENB-T4	CON ENBL CPTY .751-1.00	D1	\$0
CONENB-T5	CON ENBL CPTY 1.01-2.00	D1	\$0
CONENB-T6	CON ENBL CPTY 2.01-4.00	D1	\$0
CONENB-T7	CON ENBL CPTY 4.01-6.00	D1	\$0
CONENB-T8	CON ENBL CPTY 6.01-8.00	D1	\$0
CONENB-T9	CON ENBL CPTY 8.01-10.00	D1	\$0
CPAV-T1-T4UP	COM PAV T1-T4 UPG	D1	\$0
CPAV-T5-30UP	COMPAV T5-T30 UPG	D1	\$0
CPEER-T1-4UP	COMPPEER T1-T4 UPGRADE	D1	\$0
CPEER-T5-35UP	COMPPEER T5-T35 UPGRADE	D1	\$0
CSL-MSU-BASE	CATALOG S BASE-3 MSU	D1	\$2,050
CSL-MSU-M00	CATALOG S 4-45 MSU	D1	\$410
CSL-MSU-M01	CATALOG S 46-175 MSU	D1	\$290
CSL-MSU-M02	CATALOG S 176-315 MSU	D1	\$270
CSL-MSU-M03	CATALOG S 316-575 MSU	D1	\$250
CSL-MSU-M04	CATALOG S 576-875 MSU	D1	\$230
CSL-MSU-M05	CATALOG S 876-1315 MSU	D1	\$210
CSL-MSU-M06	CATALOG S 1316-1975 MSU	D1	\$180
CSL-MSU-M07	CATALOG S 1976 & UP MSU	D1	\$160
CSL-MSU-UPG	CATALOG S UPG	D1	\$0
CSL-MVS-MIP1	CAT SOL MVS, 1-200 MIPS	D1	\$14,400
CSL-MVS-MIP10	CAT COL MVS, 1801-2000 MIPS	D1	\$273,600
CSL-MVS-MIP11	CAT SOL MVS 2001+ MIPS	D1	\$302,400
CSL-MVS-MIP2	CAT SOL MVS, 201-400 MIPS	D1	\$43,200
CSL-MVS-MIP3	CAT SOL MVS, 401-600 MIPS	D1	\$72,000
CSL-MVS-MIP4	CAT SOL MVS, 601-800 MIPS	D1	\$100,800
CSL-MVS-MIP5	CSL-MVS-MIP5	D1	\$129,600
CSL-MVS-MIP6	CAT SOL MVS, 1000+ MIPS	D1	\$158,400
CSL-MVS-MIP7	CAT SOL MVS, 1201-1400 MIPS	D1	\$187,200
CSL-MVS-MIP8	CAT SOL MVS, 1401-1600 MIPS	D1	\$216,000
CSL-MVS-MIP9	CAT SOL MVS, 1601-1800 MIPS	D1	\$244,800
CSL-MVS-UPG	CAT SOL MVS, UPGRADE	D1	\$28,800
CTLM-T1-T4UP	CTL MSP T1-T4UP	D1	\$0

CTLM-T5-12UP	CTL MSP T5-T12UP	D1	\$0
CTLV-T1-T4UP	CTL VOS T1-T4UP	D1	\$0
CTLV-T5-12UP	CTL VOS T5-T12UP	D1	\$0
CUCJ-ENB	SPECIAL PKG SW TITLES CUC JIANGXI FULL	D1	\$86,655
CUCJ-LTD	SPECIAL PKG SW TITLES CUC JIANGXI LTD	D1	\$37,140
CUCX-ENB	SPECIAL PKG SW TITLES CUC XINJIANG FULL	D1	\$320,625
CUCX-LTD	SPECIAL PKG SW TITLES CUC XINJIANG DMX	D1	\$137,425
D-ATSM-BAS	ADV TIERED STORAGE MGMT BUNDLE FOR DM	D1	\$0
D-ATSM-C01	DMX ADV TIER MGMT SW 1TB (0-14TB)	D1	\$0
D-ATSM-C02	DMX ADV TIER MGMT SW 1TB (15-25TB)	D1	\$0
D-ATSM-C03	DMX ADV TIER MGMT SW 1TB (26-40TB)	D1	\$0
D-ATSM-C04	DMX ADV TIER MGMT SW 1TB (41-60TB)	D1	\$0
D-ATSM-C05	DMX ADV TIER MGMT SW 1TB (61-100TB)	D1	\$0
D-ATSM-C06	DMX ADV TIER MGMT SW 1TB (101-150TB)	D1	\$0
D-ATSM-C07	DMX ADV TIER MGMT SW 1TB (151-250TB)	D1	\$0
D-ATSM-C08	DMX ADV TIER MGMT SW 1TB (251-400TB)	D1	\$0
D-ATSM-C09	DMX ADV TIER MGMT SW 1TB (401-600TB)	D1	\$0
D-ATSM-C10	DMX ADV TIER MGMT SW 1TB (601-1000TB)	D1	\$0
D-ATSM-C11	DMX ADV TIER MGMT SW 1TB (1001TB OR GR)	D1	\$0
D-ATSM-N01	DMX ADV TIER MGMT SW 1TB (0-14TB) NLT3	D1	\$0
D-ATSM-N02	DMX ADV TIER MGMT SW 1TB (15-25TB) NLT3	D1	\$0
D-ATSM-N03	DMX ADV TIER MGMT SW 1TB (26-40TB) NLT3	D1	\$0
D-ATSM-N04	DMX ADV TIER MGMT SW 1TB (41-60TB) NLT3	D1	\$0
D-ATSM-N05	DMX ADV TIER MGMT SW 1TB (61-100TB) NLT3	D1	\$0
D-ATSM-N06	DMX ADV TIER MGMT SW 1TB (101-150TB) NLT	D1	\$0
D-ATSM-N07	DMX ADV TIER MGMT SW 1TB (151-250TB) NLT	D1	\$0
D-ATSM-N08	DMX ADV TIER MGMT SW 1TB (251-400TB) NLT	D1	\$0
D-ATSM-N09	DMX ADV TIER MGMT SW 1TB (401-600TB) NLT	D1	\$0
D-ATSM-N10	DMX ADV TIER MGMT SW 1TB (601-1000TB) NL	D1	\$0
D-ATSM-N11	DMX ADV TIER MGMT SW 1TB (1001TB OR GR)N	D1	\$0
DCP-PC-BASE	DCP-PC BUNDLE BASE LICENSE	D1	\$0
DCP-PC-C01	DCP AND PC BUNDLE 1TB (0-14TB)	D1	\$0
DCP-PC-C02	DCP AND PC BUNDLE 1TB (15-25TB)	D1	\$0
DCP-PC-C03	DCP AND PC BUNDLE 1TB (26-40TB)	D1	\$0
DCP-PC-C04	DCP AND PC BUNDLE 1TB (41-60TB)	D1	\$0
DCP-PC-C05	DCP AND PC BUNDLE 1TB (61-100TB)	D1	\$0
DCP-PC-C06	DCP AND PC BUNDLE 1TB (101-150TB)	D1	\$0
DCP-PC-C07	DCP AND PC BUNDLE 1TB (151-250TB)	D1	\$0
DCP-PC-C08	DCP AND PC BUNDLE 1TB (251-400TB)	D1	\$0
DCP-PC-C09	DCP AND PC BUNDLE 1TB (401-600TB)	D1	\$0
DCP-PC-C10	DCP AND PC BUNDLE 1TB (601-1000TB)	D1	\$0
DCP-PC-C11	DCP & PC BUNDLE 1TB(1001TB or greater)	D1	\$0
DCP-PC-N01	DCP AND PC BUNDLE 1TB (0-14TB) NLT3	D1	\$0
DCP-PC-N02	DCP AND PC BUNDLE 1TB (15-25TB) NLT3	D1	\$0
DCP-PC-N03	DCP AND PC BUNDLE 1TB (26-40TB) NLT3	D1	\$0
DCP-PC-N04	DCP AND PC BUNDLE 1TB (41-60TB) NLT3	D1	\$0
DCP-PC-N05	DCP AND PC BUNDLE 1TB (61-100TB) NLT3	D1	\$0
DCP-PC-N06	DCP AND PC BUNDLE 1TB (101-150TB) NLT3	D1	\$0
DCP-PC-N07	DCP AND PC BUNDLE 1TB (151-250TB) NLT3	D1	\$0
DCP-PC-N08	DCP AND PC BUNDLE 1TB (251-400TB) NLT3	D1	\$0

DCP-PC-N09	DCP AND PC BUNDLE 1TB (401-600TB) NLT3	D1	\$0
DCP-PC-N10	DCP AND PC BUNDLE 1TB (601-1000TB) NLT3	D1	\$0
DCP-PC-N11	DCP & PC BNDL 1TB(1001TB or greater)NLT3	D1	\$0
D-MF-BAS	DMX MAINFRAME PKG BASE	D1	\$0
D-MF-C01	DMX MAINFRAME PKG SOFTWARE 1TB (15-25TB)	D1	\$0
D-MF-C02	DMX MAINFRAME PKG SOFTWARE 1TB (15-25TB)	D1	\$0
D-MF-C03	DMX MAINFRAME PKG SOFTWARE 1TB (26-40TB)	D1	\$0
D-MF-C04	DMX MAINFRAME PKG SOFTWARE 1TB (41-60TB)	D1	\$0
D-MF-C05	DMX MNFRM PKG SWR 1TB (61-100TB)	D1	\$0
D-MF-C06	DMX MNFRM PKG SWR 1TB (101-150TB)	D1	\$0
D-MF-C07	DMX MNFRM PKG SWR 1TB (151-250TB)	D1	\$0
D-MF-C08	DMX MNFRM PKG SWR 1TB (401-600TB)	D1	\$0
D-MF-C09	DMX MNFRM PKG SWR 1TB (401-600TB)	D1	\$0
D-MF-C10	DMX MNFRM PKG SWR 1TB (601-1000TB)	D1	\$0
D-MF-C11	DMX MNFRM PKG SWR 1TB (1001TB OR GRTR)	D1	\$0
D-MF-N01	DMX MNFRM PKG SOFTWARE 1TB (0-14TB)NLT3	D1	\$0
D-MF-N02	DMX MNFRM PKG SWR 1TB (15-25TB) NLT3	D1	\$0
D-MF-N03	DMX MNFRM PKG SWR 1TB (26-40TB) NLT3	D1	\$0
D-MF-N04	DMX MNFRM PKG SWR 1TB (41-60TB) NLT3	D1	\$0
D-MF-R01	DMX MNFRM PKG SWR REG 1TB (0-14TB)	D1	\$0
D-MF-R02	DMX MNFRM PKG SWR REG 1TB (15-25TB)	D1	\$0
D-MF-R03	DMX MNFRM PKG SWR REG 1TB (26-40TB)	D1	\$0
D-MF-R04	DMX MNFRM PKG SWR REG 1TB (41-60TB)	D1	\$0
D-MF-R05	DMX MNFRM PKG SWR REG 1TB (61-100TB)	D1	\$0
D-MF-R06	DMX MNFRM PKG SWR REG 1TB (101-150TB)	D1	\$0
D-MF-R07	DMX MNFRM PKG SWR REG 1TB (151-250TB)	D1	\$0
D-MF-R08	DMX MNFRM PKG SWR REG 1TB (251-400TB)	D1	\$0
D-MF-R09	DMX MNFRM PKG SWR REG 1TB (401-600TB)	D1	\$0
D-MF-R10	DMX MNFRM PKG SWR REG 1TB (601-1000TB)	D1	\$0
D-MF-R11	DMX MNFRM PKG SWR REG 1TB (1001 TB+)	D1	\$0
D-MF-RBAS	DMX MNFRM PKG SWR BASE LICENSE	D1	\$0
D-MF-RUP	DMX MNFRM PKG SWR BASE UPGRADE	D1	\$0
DM-T1-4UP	SRDF-DM-T1-T4UPGRADE	D1	\$0
DM-T5-30UP	SRDF-DM-T5-30UPGRADE	D1	\$0
DM-T5-35UP	SRDF-DM T5-T35 UPGRADE	D1	\$0
DRU-BASE	DRU BASE LICENSE	D1	\$7,700
DRU-C01	DRU 1TB (0-14TB)	D1	\$1,900
DRU-C02	DRU 1TB (15-25TB)	D1	\$1,790
DRU-C03	DRU 1TB (26-40TB)	D1	\$1,580
DRU-C04	DRU 1TB (41-60TB)	D1	\$1,470
DRU-C05	DRU 1TB (61-100TB)	D1	\$1,410
DRU-C06	DRU 1TB (101-150TB)	D1	\$1,270
DRU-C07	DRU 1TB (151-250TB)	D1	\$1,130
DRU-C08	DRU 1TB (251-400TB)	D1	\$980
DRU-C09	DRU 1TB (401-600TB)	D1	\$850
DRU-C10	DRU 1TB (601-1000TB)	D1	\$740
DRU-C11	DRU1TB(1001-1500TB)	D1	\$640
DRU-T01	DATA RELO 0-.250	D1	\$0
DRU-T02	DATA RELO .251-.500	D1	\$0
DRU-T03	DATA RELO .501-.750	D1	\$0

DRU-T04	DATA RELO .751-1.00	D1	\$0
DRU-T05	DATA RELO 1.01-2.00	D1	\$0
DRU-T06	DATA RELO 2.01-4.00	D1	\$0
DRU-T07	DATA RELO 4.01-6.00	D1	\$0
DRU-T08	DATA RELO 6.01-8.00	D1	\$0
DRU-T09	DATA RELO 8.01-10.00	D1	\$0
DRU-T10	DATA RELO 10.01-12.00	D1	\$0
DRU-T11	DATA RELO 12.01-14.00	D1	\$0
DRU-T12	DATA RELO 14.01-17.00	D1	\$0
DRU-T13	DATA RELO 17.01-20.00	D1	\$0
DRU-T14	DATA RELO 20.01-23.00	D1	\$0
DRU-T1-4U	DATA RELO T1-T4UPG	D1	\$0
DRU-T15	DATA RELO 23.01-26.00	D1	\$0
DRU-T16	DATA RELO 26.01-29.00	D1	\$0
DRU-T17	DATA RELO 29.01-32.00	D1	\$0
DRU-T18	DATA RELO 32.01-35.00	D1	\$0
DRU-T19	DATA RELO 35.01-38.00	D1	\$0
DRU-T20	DATA RELO 38.01-41.00	D1	\$0
DRU-T21	DATA RELO 41.01-44.00	D1	\$0
DRU-T22	DATA RELO 44.01-47.00	D1	\$0
DRU-T23	DATA RELO 47.01-50.00	D1	\$0
DRU-T24	DATA RELO 50.01-53.00	D1	\$0
DRU-T25	DATA RELO 53.01-56.00	D1	\$0
DRU-T26	DATA RELO 56.01-59.00	D1	\$0
DRU-T27	DATA RELO 59.01-62.00	D1	\$0
DRU-T28	DATA RELO 62.01-65.00	D1	\$0
DRU-T29	DATA RELO 65.01-68.00	D1	\$0
DRU-T30	DATA RELO 68.01-71.00	D1	\$0
DRU-T31	DATA RELO 71.01-74.00	D1	\$0
DRU-T32	DATA RELO 74.01-77.00	D1	\$0
DRU-T33	DATA RELO 77.01-80.00	D1	\$0
DRU-T34	DATA RELO 80.01-83.00	D1	\$0
DRU-T35	DATA RELO 83.01-86.00	D1	\$0
DRU-T5-35U	DATA RELO T5-T35UPG	D1	\$0
DRU-UPG	DRU BASE UPGRADE	D1	\$0
D-TIERADD-BAS	DMX FAST ADD BASE LICENSE	D1	\$0
D-TIERADD-C01	DMX FAST ADD SOFTWARE 1TB (0-14TB)	D1	\$0
D-TIERADD-C02	DMX FAST ADD SOFTWARE 1TB (15-25TB)	D1	\$0
D-TIERADD-C03	DMX FAST ADD SOFTWARE 1TB (26-40TB)	D1	\$0
D-TIERADD-C04	DMX FAST ADD SOFTWARE 1TB (41-60TB)	D1	\$0
D-TIERADD-C05	DMX FAST ADD SOFTWARE 1TB (61-100TB)	D1	\$0
D-TIERADD-C06	DMX FAST ADD SOFTWARE 1TB (101-150TB)	D1	\$0
D-TIERADD-C07	DMX FAST ADD SOFTWARE 1TB (151-250TB)	D1	\$0
D-TIERADD-C08	DMX FAST ADD SOFTWARE 1TB (251-400TB)	D1	\$0
D-TIERADD-C09	DMX FAST ADD SOFTWARE 1TB (401-600TB)	D1	\$0
D-TIERADD-C10	DMX FAST ADD SOFTWARE 1TB (601-1000TB)	D1	\$0
D-TIERADD-C11	DMX FAST ADD 1TB (1001TB or greater)	D1	\$0
D-TIERADD-N01	DMX FAST ADD SOFTWARE 1TB (0-14TB) NLT3	D1	\$0
D-TIERADD-N02	DMX FAST ADD SOFTWARE 1TB (15-25TB) NLT3	D1	\$0
D-TIERADD-N03	DMX FAST ADD SOFTWARE 1TB (26-40TB) NLT3	D1	\$0

D-TIERADD-N04	DMX FAST ADD SOFTWARE 1TB (41-60TB) NLT3	D1	\$0
D-TIERADD-N05	DMX FAST ADD 1TB (61-100TB) NLT3	D1	\$0
D-TIERADD-N06	DMX FAST ADD 1TB (101-150TB) NLT3	D1	\$0
D-TIERADD-N07	DMX FAST ADD 1TB (151-250TB) NLT3	D1	\$0
D-TIERADD-N08	DMX FAST ADD 1TB (251-400TB) NLT3	D1	\$0
D-TIERADD-N09	DMX FAST ADD 1TB (401-600TB) NLT3	D1	\$0
D-TIERADD-N10	DMX FAST ADD 1TB (601-1000TB) NLT3	D1	\$0
D-TIERADD-N11	DMX FAST ADD 1TB (1001TB or >) NLT3	D1	\$0
D-TIERPKG-BAS	DMX FAST PKG BASE LICENSE	D1	\$0
D-TIERPKG-C01	DMX FAST PKG SOFTWARE 1TB (0-14TB)	D1	\$0
D-TIERPKG-C02	DMX FAST PKG SOFTWARE 1TB (15-25TB)	D1	\$0
D-TIERPKG-C03	DMX FAST PKG SOFTWARE 1TB (26-40TB)	D1	\$0
D-TIERPKG-C04	DMX FAST PKG SOFTWARE 1TB (41-60TB)	D1	\$0
D-TIERPKG-C05	DMX FAST PKG SOFTWARE 1TB (61-100TB)	D1	\$0
D-TIERPKG-C06	DMX FAST PKG SOFTWARE 1TB (101-150TB)	D1	\$0
D-TIERPKG-C07	DMX FAST PKG SOFTWARE 1TB (151-250TB)	D1	\$0
D-TIERPKG-C08	DMX FAST PKG SOFTWARE 1TB (251-400TB)	D1	\$0
D-TIERPKG-C09	DMX FAST PKG SOFTWARE 1TB (401-600TB)	D1	\$0
D-TIERPKG-C10	DMX FAST PKG SOFTWARE 1TB (601-1000TB)	D1	\$0
D-TIERPKG-C11	DMX FAST PKG 1TB (1001TB or greater)	D1	\$0
D-TIERPKG-N01	DMX FAST PKG SOFTWARE 1TB (0-14TB) NLT3	D1	\$0
D-TIERPKG-N02	DMX FAST PKG SOFTWARE 1TB (15-25TB) NLT3	D1	\$0
D-TIERPKG-N03	DMX FAST PKG SOFTWARE 1TB (26-40TB) NLT3	D1	\$0
D-TIERPKG-N04	DMX FAST PKG SOFTWARE 1TB (41-60TB) NLT3	D1	\$0
D-TIERPKG-N05	DMX FAST PKG 1TB (61-100TB) NLT3	D1	\$0
D-TIERPKG-N06	DMX FAST PKG 1TB (101-150TB) NLT3	D1	\$0
D-TIERPKG-N07	DMX FAST PKG 1TB (151-250TB) NLT3	D1	\$0
D-TIERPKG-N08	DMX FAST PKG 1TB (251-400TB) NLT3	D1	\$0
D-TIERPKG-N09	DMX FAST PKG 1TB (401-600TB) NLT3	D1	\$0
D-TIERPKG-N10	DMX FAST PKG 1TB (601-1000TB) NLT3	D1	\$0
D-TIERPKG-N11	DMX FAST PKG 1TB (1001TB or >) NLT3	D1	\$0
DYNCP-BASE	DYNAMIC CACHE PARTITIONING BASE LICENSE	D1	\$0
DYNCP-C01	DYNAMIC CACHE PARTITIONING 1TB (0-14TB)	D1	\$0
DYNCP-C02	DYNAMIC CACHE PARTITIONING 1TB (15-25TB)	D1	\$0
DYNCP-C03	DYNAMIC CACHE PARTITIONING 1TB (26-40TB)	D1	\$0
DYNCP-C04	DYNAMIC CACHE PARTITIONING 1TB (41-60TB)	D1	\$0
DYNCP-C05	DCP 1TB (61-100TB)	D1	\$0
DYNCP-C06	DCP 1TB (101-150TB)	D1	\$0
DYNCP-C07	DCP 1TB (151-250TB)	D1	\$0
DYNCP-C08	DCP 1TB (251-400TB)	D1	\$0
DYNCP-C09	DCP 1TB (401-600TB)	D1	\$0
DYNCP-C10	DCP 1TB (601-1000TB)	D1	\$0
DYNCP-C11	DCP 1TB (1001TB or greater)	D1	\$0
DYNCP-N01	DCP 1TB (0-14TB) NLT3	D1	\$0
DYNCP-N02	DCP 1TB (15-25TB) NLT3	D1	\$0
DYNCP-N03	DCP 1TB (26-40TB) NLT3	D1	\$0
DYNCP-N04	DCP 1TB (41-60TB) NLT3	D1	\$0
DYNCP-N05	DCP 1TB (61-100TB) NLT3	D1	\$0
DYNCP-N06	DCP 1TB (101-150TB) NLT3	D1	\$0
DYNCP-N07	DCP 1TB (151-250TB) NLT3	D1	\$0

DYNCP-N08	DCP 1TB (251-400TB) NLT3	D1	\$0
DYNCP-N09	DCP 1TB (401-600TB) NLT3	D1	\$0
DYNCP-N10	DCP 1TB (601-1000TB) NLT3	D1	\$0
DYNCP-N11	DCP 1TB (1001TB or greater) NLT3	D1	\$0
ECRC-T01	ECRC CAPACITY 0-.250	D1	\$0
ECRC-T02	ECRC CAPACITY .251-.500	D1	\$0
ECRC-T03	ECRC CAPACITY .501-.750	D1	\$0
ECRC-T04	ECRC CAPACITY .751-1.00	D1	\$0
ECRC-T05	ECRC CAPACITY 1.01-2.00	D1	\$0
ECRC-T06	ECRC CAPACITY 2.01-4.00	D1	\$0
ECRC-T07	ECRC CAPACITY 4.01-6.00	D1	\$0
ECRC-T08	ECRC CAPACITY 6.01-8.00	D1	\$0
ECRC-T09	ECRC CAPACITY 8.01-10.00	D1	\$0
ECRC-T10	ECRC CAPACITY 10.01-12.00	D1	\$0
ECRC-T11	ECRC CAPACITY 12.01-14.00	D1	\$0
ECRC-T12	ECRC CAPACITY 14.01-17.00	D1	\$0
ECRC-T13	ECRC CPCTY 17.01-20.00	D1	\$0
ECRC-T14	ECRC CPCTY 20.01-23.00	D1	\$0
ECRC-T1-4UP	ECRC T1-T4 UPGRADE	D1	\$0
ECRC-T15	ECRC CPCTY 23.01-26.00	D1	\$0
ECRC-T16	ECRC CPCTY 26.01-29.00	D1	\$0
ECRC-T17	ECRC CPCTY 29.01-32.00	D1	\$0
ECRC-T18	ECRC CPCTY 32.01-35.00	D1	\$0
ECRC-T19	ECRC CPCTY 35.01-38.00	D1	\$0
ECRC-T20	ECRC CPCTY 38.01-41.00	D1	\$0
ECRC-T21	ECRC CPCTY 41.01-44.00	D1	\$0
ECRC-T22	ECRC CPCTY 44.01-47.00	D1	\$0
ECRC-T23	ECRC CPCTY 47.01-50.00	D1	\$0
ECRC-T24	ECRC CPCTY 50.01-53.00	D1	\$0
ECRC-T25	ECRC CPCTY 53.01-56.00	D1	\$0
ECRC-T26	ECRC CPCTY 56.01-59.00	D1	\$0
ECRC-T27	ECRC CPCTY 59.01-62.00	D1	\$0
ECRC-T28	ECRC CPCTY 62.01-65.00	D1	\$0
ECRC-T29	ECRC CPCTY 65.01-68.00	D1	\$0
ECRC-T30	ECRC CPCTY 68.01-71.00	D1	\$0
ECRC-T31	ECRC CPCTY 71.01-74.00	D1	\$0
ECRC-T32	ECRC CPCTY 74.01-77.00	D1	\$0
ECRC-T33	ECRC CPCTY 77.01-80.00	D1	\$0
ECRC-T34	ECRC CPCTY 80.01-83.00	D1	\$0
ECRC-T35	ECRC CPCTY 83.01-86.00	D1	\$0
ECRC-T5-30UP	ECRC T5-T30 UPGRADE	D1	\$0
ECRC-T5-35UP	ECRC T5-T35 UPGRADE	D1	\$0
E-DCHK-NTDEP	EMC DBLCHECK NT DEPT	D1	\$4,750
E-DCHK-NTENT	EMC DBLCHECK NT ENTER	D1	\$6,910
E-DCHK-NTWG	EMC DBLCHECK NT WKGRP	D1	\$1,940
E-DCHK-UDEP	EMC DBLCHECK UNIX DEPT	D1	\$0
E-DCHK-UENT	EMC DBLCHECK UNIX ENTER	D1	\$0
E-DCHK-UGLOB	EMC DBLCHECK UNIX GLOBL	D1	\$0
E-DCHK-UWG	EMC DBLCHECK UNIX WKGRP	D1	\$0
ENPTY-SB-BAS	VMAX ENGINUITY BASE LICENSE	D1	\$8,080

ENPTY-SB-C01	VMAX ENGINUITY 1TB (0-14TB)	D1	\$2,020
ENPTY-SB-C02	VMAX ENGINUITY 1TB (15-25TB)	D1	\$1,940
ENPTY-SB-C03	VMAX ENGINUITY 1TB (26-40TB)	D1	\$1,860
ENPTY-SB-C04	VMAX ENGINUITY 1TB (41-60TB)	D1	\$1,790
ENPTY-SB-C05	VMAX ENGINUITY 1TB (61-100TB)	D1	\$1,710
ENPTY-SB-C06	VMAX ENGINUITY 1TB (101-150TB)	D1	\$1,650
ENPTY-SB-C07	VMAX ENGINUITY 1TB (151-250TB)	D1	\$1,580
ENPTY-SB-C08	VMAX ENGINUITY 1TB (251-400TB)	D1	\$1,520
ENPTY-SB-C09	VMAX ENGINUITY 1TB (401-600TB)	D1	\$1,460
ENPTY-SB-C10	VMAX ENGINUITY 1TB (601-1000TB)	D1	\$1,400
ENPTY-SB-C11	VMAX ENGINUITY 1TB (1001TB or greater)	D1	\$1,340
ENPTY-SB-N01	VMAX ENGINUITY 1TB (0-14TB) NLT3	D1	\$910
ENPTY-SB-N02	VMAX ENGINUITY 1TB (15-25TB) NLT3	D1	\$870
ENPTY-SB-N03	VMAX ENGINUITY 1TB (26-40TB) NLT3	D1	\$840
ENPTY-SB-N04	VMAX ENGINUITY 1TB (41-60TB) NLT3	D1	\$800
ENPTY-SB-N05	VMAX ENGINUITY 1TB (61-100TB) NLT3	D1	\$770
ENPTY-SB-N06	VMAX ENGINUITY 1TB (101-150TB) NLT3	D1	\$740
ENPTY-SB-N07	VMAX ENGINUITY 1TB (151-250TB) NLT3	D1	\$710
ENPTY-SB-N08	VMAX ENGINUITY 1TB (251-400TB) NLT3	D1	\$680
ENPTY-SB-N09	VMAX ENGINUITY 1TB (401-600TB) NLT3	D1	\$660
ENPTY-SB-N10	VMAX ENGINUITY 1TB (601-1000TB) NLT3	D1	\$630
ENPTY-SB-N11	VMAX ENGINTY 1TB (1001TB or >)NLT3	D1	\$600
ENPTY-SB-UPG	VMAX ENGINUITY BASE UPGRADE	D1	\$0
ESA-VMX-BASE	ESA FOR VMAX BASE NEW LICENSE=CB	D1	\$0
ESA-VMX-C-UPG	ESA FOR VMAX CAPACITY UPGRADE LICENSE=	D1	\$0
ESA-VMX-NON1	ESA FOR VMAX NON-SATA 0-14TB=CB	D1	\$0
ESA-VMX-NON10	ESA FOR VMAX NON-SATA 601-1000TB=CB	D1	\$0
ESA-VMX-NON11	ESA FOR VMAX NON-SATA 1001TB-PLUS=CB	D1	\$0
ESA-VMX-NON2	ESA FOR VMAX NON-SATA 15-25TB=CB	D1	\$0
ESA-VMX-NON3	ESA FOR VMAX NON-SATA 26-40TB=CB	D1	\$0
ESA-VMX-NON4	ESA FOR VMAX NON-SATA 41-60TB=CB	D1	\$0
ESA-VMX-NON5	ESA FOR VMAX NON-SATA 61-100TB=CB	D1	\$0
ESA-VMX-NON6	ESA FOR VMAX NON-SATA 101-150TB=CB	D1	\$0
ESA-VMX-NON7	ESA FOR VMAX NON-SATA 151-250TB=CB	D1	\$0
ESA-VMX-NON8	ESA FOR VMAX NON-SATA 251-400TB=CB	D1	\$0
ESA-VMX-NON9	ESA FOR VMAX NON-SATA 401-600TB=CB	D1	\$0
ESA-VMX-SAT1	ESA FOR VMAX SATA 0-14TB=CB	D1	\$0
ESA-VMX-SAT10	ESA FOR VMAX SATA 601-1000TB=CB	D1	\$0
ESA-VMX-SAT11	ESA FOR VMAX SATA 1001TB-PLUS=CB	D1	\$0
ESA-VMX-SAT2	ESA FOR VMAX SATA 15-25TB=CB	D1	\$0
ESA-VMX-SAT3	ESA FOR VMAX SATA 26-40TB=CB	D1	\$0
ESA-VMX-SAT4	ESA FOR VMAX SATA 41-60TB=CB	D1	\$0
ESA-VMX-SAT5	ESA FOR VMAX SATA 61-100TB=CB	D1	\$0
ESA-VMX-SAT6	ESA FOR VMAX SATA 101-150TB=CB	D1	\$0
ESA-VMX-SAT7	ESA FOR VMAX SATA 151-250TB=CB	D1	\$0
ESA-VMX-SAT8	ESA FOR VMAX SATA 251-400TB=CB	D1	\$0
ESA-VMX-SAT9	ESA FOR VMAX SATA 401-600TB=CB	D1	\$0
ESN-T5-30UP	ESNM UPGRADE T5-T30	D1	\$0
ESP-BASE	ESP BASE LICENSE	D1	\$0
ESP-C01	ESP 1TB (0-14TB)	D1	\$0

ESP-C02	ESP 1TB (15-25TB)	D1	\$0
ESP-C03	ESP 1TB (26-40TB)	D1	\$0
ESP-C04	ESP 1TB (41-60TB)	D1	\$0
ESP-C05	ESP 1TB (61-100TB)	D1	\$0
ESP-C06	ESP 1TB (101-150TB)	D1	\$0
ESP-C07	ESP 1TB (151-250TB)	D1	\$0
ESP-C08	ESP 1TB (251-400TB)	D1	\$0
ESP-C09	ESP 1TB (401-600TB)	D1	\$0
ESP-C10	ESP 1TB (601-1000TB)	D1	\$0
ESP-C11	ESP 1TB (1001TB or greater)	D1	\$0
ESP-N01	ESP 1TB (0-14TB) NLT3	D1	\$0
ESP-N02	ESP 1TB (15-25TB) NLT3	D1	\$0
ESP-N03	ESP 1TB (26-40TB) NLT3	D1	\$0
ESP-N04	ESP 1TB (41-60TB) NLT3	D1	\$0
ESP-N05	ESP 1TB (61-100TB) NLT3	D1	\$0
ESP-N06	ESP 1TB (101-150TB) NLT3	D1	\$0
ESP-N07	ESP 1TB (151-250TB) NLT3	D1	\$0
ESP-N08	ESP 1TB (251-400TB) NLT3	D1	\$0
ESP-N09	ESP 1TB (401-600TB) NLT3	D1	\$0
ESP-N10	ESP 1TB (601-1000TB) NLT3	D1	\$0
ESP-N11	ESP 1TB (1001TB or greater) NLT3	D1	\$0
ESP-T1	ESP CAPACITY 0-.250	D1	\$0
ESP-T10	ESP CAPACITY 10.01-12.00	D1	\$0
ESP-T11	ESP CAPACITY 12.01-14.00	D1	\$0
ESP-T12	ESP CPTY 14.01-17.00	D1	\$0
ESP-T13	ESP CAPACITY 17.01-20.00	D1	\$0
ESP-T14	ESP CAPACITY 20.01-23.00	D1	\$0
ESP-T1-4UP	ESP T1-T4 UPGRADE	D1	\$0
ESP-T15	ESP CAPACITY 23.01-26.00	D1	\$0
ESP-T16	ESP CAPACITY 26.01-29.00	D1	\$0
ESP-T17	ESP CAPACITY 29.01-32.00	D1	\$0
ESP-T18	ESP CAPACITY 32.01-35.00	D1	\$0
ESP-T19	ESP CAPACITY 35.01-38.00	D1	\$0
ESP-T2	ESP CAPACITY .251-.500	D1	\$0
ESP-T20	ESP CAPACITY 38.01-41.00	D1	\$0
ESP-T21	ESP CAPACITY 41.01-44.00	D1	\$0
ESP-T22	ESP CAPACITY 44.01-47.00	D1	\$0
ESP-T23	ESP CAPACITY 47.01-50.00	D1	\$0
ESP-T24	ESP CAPACITY 50.01-53.00	D1	\$0
ESP-T25	ESP CAPACITY 53.01-56.00	D1	\$0
ESP-T26	ESP CAPACITY 56.01-59.00	D1	\$0
ESP-T27	ESP CAPACITY 59.01-62.00	D1	\$0
ESP-T28	ESP CAPACITY 62.01-65.00	D1	\$0
ESP-T29	ESP CAPACITY 65.01-68.00	D1	\$0
ESP-T3	ESP CAPACITY .501-.750	D1	\$0
ESP-T30	ESP CAPACITY 68.01-71.00	D1	\$0
ESP-T31	ESP CPCTY 71.01-74.00	D1	\$0
ESP-T32	ESP CPCTY 74.01-77.00	D1	\$0
ESP-T33	ESP CPCTY 77.01-80.00	D1	\$0
ESP-T34	ESP CPCTY 80.01-83.00	D1	\$0

ESP-T35	ESP CPCTY 83.01-86.00	D1	\$0
ESP-T4	ESP CAPACITY .751-1.00	D1	\$0
ESP-T5	ESP CAPACITY 1.01-2.00	D1	\$0
ESP-T5-30UP	ESP T5-T30 UPGRADE	D1	\$0
ESP-T5-35UP	ESP T5-T35 UPGRADE	D1	\$0
ESP-T6	ESP CAPACITY 2.01-4.00	D1	\$0
ESP-T7	ESP CAPACITY 4.01-6.00	D1	\$0
ESP-T8	ESP CAPACITY 6.01-8.00	D1	\$0
ESP-T9	ESP CAPACITY 8.01-10.00	D1	\$0
ESP-UPG	ESP BASE UPGRADE	D1	\$0
GDDR-CAOPSMVS	EMC GDDR W/ CAOPSMVS LIC	D1	\$210,000
GDDR-SITELIC	EMC GDDR SITE LICENSE	D1	\$175,000
GEO-MSCS-DEP	GEOSPAN-MSCS-DEP	D1	\$3,600
GEO-MSCS-ENT	GEOSPAN-MSCS-ENT	D1	\$7,200
GEO-MSCS-WG	GEOSPAN-MSCS-WG	D1	\$1,800
GEO-VCS-DEP	GEOSPAN FOR VCS DEP	D1	\$4,320
GEO-VCS-ENT	GEOSPAN FOR VCS ENT	D1	\$8,060
GEO-VCS-GLB	GEOSPAN FOR VCS GLB	D1	\$13,540
GEO-VCS-WG	GEOSPAN FOR VCS-WG	D1	\$2,880
IBMI-STM	SRDF TIMEFINDER MANAGER FOR IBM I =IC	D1	\$0
IFSAGENT-MSP	IFS FOR MSP	D1	\$0
INFOMOV-LXENT	INFOMOVER LINUX ENTERPRISE	D1	\$0
INFOMOV-LXWG	INFOMOVER LINUX WORKGROUP	D1	\$0
INFOMOV-NTDEP	INFOMOVER WINDOWS DEPARTMENT	D1	\$0
INFOMOV-NTENT	INFOMOVER WINDOWS ENTERPRISE	D1	\$0
INFOMOV-NTWG	INFOMOVER WINDOWS WORKGROUP	D1	\$0
INFOMOV-UDEP	INFOMOVER UNIX DEPARTMENT	D1	\$0
INFOMOV-UENT	INFOMOVER UNIX ENTERPRISE	D1	\$0
INFOMOV-UGLO	INFOMOVER UNIX GLOBAL	D1	\$0
INFOMOV-UWG	INFOMOVER UNIX WORKGROUP	D1	\$0
IPSEC-RN-ENT	SYMMETRIX IPSEC RUNTIME KIT	D1	\$0
MFE-SW-KIT	MAINFRAME ENABLERS RT KIT FOR ZOS	D1	\$0
MPFS-CPU-T1	MPFS: LESS THAN 100 CPUS	D1	\$0
MPFS-CPU-T2	MPFS: 100 TO 149 CPUS	D1	\$0
MPFS-CPU-T3	MPFS: MORE THAN 149 CPUS	D1	\$0
MPFSI-CPU-LIC	SERIALIZED MPFSI RTU LIC	D1	\$0
MPFSI-CPU-T1	MPFSI: LESS THAN 100 CPUS	D1	\$0
MPFSI-CPU-T10	MPFSI: 4000 TO 5999 CPUS	D1	\$0
MPFSI-CPU-T11	MPFSI: 6000 TO 9999 CPUS	D1	\$0
MPFSI-CPU-T12	MPFSI: 10000 OR MORE CPUS	D1	\$0
MPFSI-CPU-T2	MPFSI: 100 TO 149 CPUS	D1	\$0
MPFSI-CPU-T3	MPFSI: 150 TO 249 CPUS	D1	\$0
MPFSI-CPU-T4	MPFSI: 250 TO 399 CPUS	D1	\$0
MPFSI-CPU-T5	MPFSI: 400 TO 599 CPUS	D1	\$0
MPFSI-CPU-T6	MPFSI: 600 TO 999 CPUS	D1	\$0
MPFSI-CPU-T7	MPFSI: 1000 TO 1499 CPUS	D1	\$0
MPFSI-CPU-T8	MPFSI: 1500 TO 2499 CPUS	D1	\$0
MPFSI-CPU-T9	MPFSI: 2500 TO 3999 CPUS	D1	\$0
MPFSI-LNX-DCD	MPFSI LINUX DOC AND CD	D1	\$0
MPFS-LNXDEP	MPFS LINUX DEPARTMENTAL LIC	D1	\$0

MPFS-LNXENT	MPFS LINUX ENTERPRISE LIC	D1	\$0
MPFS-LNXWG	MPFS LINUX WORKGROUP LIC	D1	\$0
MPFS-NT-DCD	MPFS NT DOC, CD	D1	\$0
MPFS-NTDEP	MPFS NT DEPARTMENTAL	D1	\$0
MPFS-NTENT	MPFS NT ENTERPRISE	D1	\$0
MPFS-NTWG	MPFS NT WORK GROUP	D1	\$0
MPFS-UNIX-DCD	MPFS UNIX DOC, CD	D1	\$0
MPFS-UNIXDEP	MPFS UNIX DEPARTMENTAL	D1	\$0
MPFS-UNIXENT	MPFS UNIX ENTERPRISE	D1	\$0
MPFS-UNIXGLO	MPFS UNIX GLOBAL	D1	\$0
MPFS-UNIXWG	MPFS UNIX WORK GROUP	D1	\$0
MPLF-BASE	MPLF BASE LICENSE	D1	\$48,000
MPLF-C01	MPLF 1TB (0-14TB)	D1	\$11,520
MPLF-C02	MPLF 1TB (15-25TB)	D1	\$10,830
MPLF-C03	MPLF 1TB (26-40TB)	D1	\$9,530
MPLF-C04	MPLF 1TB (41-60TB)	D1	\$8,860
MPLF-C05	MPLF 1TB (61-100TB)	D1	\$8,510
MPLF-C06	MPLF 1TB (101-150TB)	D1	\$7,660
MPLF-C07	MPLF 1TB (151-250TB)	D1	\$6,820
MPLF-C08	MPLF 1TB (251-400TB)	D1	\$5,930
MPLF-C09	MPLF 1TB (401-600TB)	D1	\$5,160
MPLF-C10	MPLF 1TB (601-1000TB)	D1	\$4,490
MPLF-C11	MPLF1TB (1001-1500TB)	D1	\$3,910
MPLF-T1	MPLF CAPACITY 0-.250	D1	\$0
MPLF-T10	MPLF CAPACITY 10.01-12.00	D1	\$0
MPLF-T11	MPLF CAPACITY 12.01-14.00	D1	\$0
MPLF-T12	MPLF CPTY 14.01-AND ABOVE	D1	\$0
MPLF-T2	MPLF CAPACITY .251-.500	D1	\$0
MPLF-T3	MPLF CAPACITY .501-.750	D1	\$0
MPLF-T4	MPLF CAPACITY .751-1.00	D1	\$0
MPLF-T5	MPLF CAPACITY 1.01-2.00	D1	\$0
MPLF-T6	MPLF CAPACITY 2.01-4.00	D1	\$0
MPLF-T7	MPLF CAPACITY 4.01-6.00	D1	\$0
MPLF-T8	MPLF CAPACITY 6.01-8.00	D1	\$0
MPLF-T9	MPLF CAPACITY 8.01-10.00	D1	\$0
MPLF-UPG	MPLF BASE UPGRADE	D1	\$0
MSC-RUN-ZOS	LIC FEAT CODE MSC ON ZOS	D1	\$0
NS-SIM-EXT-L	CELERRA SIM ISV LIC	D1	\$0
NS-SIM-EXT-UL	Celerra SIM ISV UPG LIC	D1	\$0
NS-SIM-INT-L	CELERRA SIMULATOR LICENSE	D1	\$0
NS-SIM-INT-UL	CELERRA SIM UPG LIC	D1	\$0
NSX-CAVA-LIC	CAVA WIN LIC: NSX	D1	\$0
NSX-CAVA-L-U	CAVA WIN LIC: NSX-UPG	D1	\$0
NSX-CEE2-L	NSX EVENT ENABLER-2	D1	\$0
NSX-CEE-LIC	NSX EVENT ENABLER	D1	\$0
NSX-CIFS-L	CIFS LIC:1DM NSX	D1	\$0
NSX-CIFS-L-U	CIFS LIC:1DM NSX	D1	\$0
NSX-CIFS-UL	UPG CIFS TO CIFS AND UNIX	D1	\$0
NSX-ENT-L	ENT LIC:1DM NSX	D1	\$0
NSX-ENT-L-U	ENT LIC:1DM NSX	D1	\$0

NSX-FLR-L-U	NSX FLR UPGRADE LICENSE	D1	\$0
NSX-ISCSI-L	ISCSI LIC:1DM NSX	D1	\$0
NSX-ISCSI-L-U	ISCSI LIC:1DM NSX	D1	\$0
NSX-IS-EN-L	NSX ISCSI WITH ENT LIC	D1	\$0
NSX-REP-LIC	1DM REPLICATOR LIC: NSX	D1	\$0
NSX-REP-L-U	1DM REPLICATR LIC:NSX-UPG	D1	\$0
NSX-REPV2-L	NSX REPLICATOR V2 LICENSE	D1	\$0
NSX-REPV2-LU	NSX REPLICATOR V2 UPG LIC	D1	\$0
NSX-SNAP-LIC	1DM SNAPSURE LIC:NSX	D1	\$0
NSX-SNAP-L-U	1DM SNAPSURE LIC:NSX-UPG	D1	\$0
NSX-UNIX-L	NFS LIC:1DM NSX	D1	\$0
NSX-UNIX-L-U	NFS LIC:1DM NSX	D1	\$0
NSX-UNIX-UL	UPG UNIX TO CIFS AND UNIX	D1	\$0
OM-LM-DEP-UNX	OPEN MIGRATOR DEP UNIX	D1	\$6,050
OM-LM-ENT-UNX	OPEN MIGRATOR ENT UNIX	D1	\$12,450
OM-LM-WRK-UNX	OPEN MIGRATOR WRK UNIX	D1	\$2,500
OPTIMZ-RN-OPN	OPTIMIZER RUN TIME KIT FOR OPEN SYSTEMS	D1	\$0
OPT-T1-4U	SYM OPT T1-4UPG	D1	\$0
OPT-T5-30U	SYM OPT T5-35UPG	D1	\$0
OPT-T5-35U	CC OPT T5-35 UPG	D1	\$0
OPTUPT1-4	ECC OPT UPGRADE T1-T4	D1	\$1,010
OPTUPT5-12	ECC OPT UPGRADE T5-T12	D1	\$4,820
OR-DM-BASE	OR-DM BASE LICENSE	D1	\$0
OR-DM-C01	OR-DM 1TB (0-14TB)	D1	\$0
OR-DM-C02	OR-DM 1TB (15-25TB)	D1	\$0
OR-DM-C03	OR-DM 1TB (26-40TB)	D1	\$0
OR-DM-C04	OR-DM 1TB (41-60TB)	D1	\$0
OR-DM-C05	OR-DM 1TB (61-100TB)	D1	\$0
OR-DM-C06	OR-DM 1TB (101-150TB)	D1	\$0
OR-DM-C07	OR-DM 1TB (151-250TB)	D1	\$0
OR-DM-C08	OR-DM 1TB (251-400TB)	D1	\$0
OR-DM-C09	OR-DM 1TB (401-600TB)	D1	\$0
OR-DM-C10	OR-DM 1TB (601-1000TB)	D1	\$0
OR-DM-C11	OR-DM1TB(1001TB or greater)	D1	\$0
OR-DM-N01	OR-DM 1TB (0-14TB) NLT3	D1	\$0
OR-DM-N02	OR-DM 1TB (15-25TB) NLT3	D1	\$0
OR-DM-N03	OR-DM 1TB (26-40TB) NLT3	D1	\$0
OR-DM-N04	OR-DM 1TB (41-60TB) NLT3	D1	\$0
OR-DM-N05	OR-DM 1TB (61-100TB) NLT3	D1	\$0
OR-DM-N06	OR-DM 1TB (101-150TB) NLT3	D1	\$0
OR-DM-N07	OR-DM 1TB (151-250TB) NLT3	D1	\$0
OR-DM-N08	OR-DM 1TB (251-400TB) NLT3	D1	\$0
OR-DM-N09	OR-DM 1TB (401-600TB) NLT3	D1	\$0
OR-DM-N10	OR-DM 1TB (601-1000TB) NLT3	D1	\$0
OR-DM-N11	OR-DM1TB(1001TB or greater) NLT3	D1	\$0
OR-DM-T01	OR-DM CPCTY 0-.250	D1	\$0
OR-DM-T02	OR-DM CPCTY .251-.500	D1	\$0
OR-DM-T03	OR-DM CPCTY .501-.750	D1	\$0
OR-DM-T04	OR-DM CPCTY .751-1.00	D1	\$0
OR-DM-T05	OR-DM CPCTY 1.01-2.00	D1	\$0

OR-DM-T06	OR-DM CPCTY 2.01-4.00	D1	\$0
OR-DM-T07	OR-DM CPCTY 4.01-6.00	D1	\$0
OR-DM-T08	OR-DM CPCTY 6.01-8.00	D1	\$0
OR-DM-T09	OR-DM CPCTY 8.01-10.00	D1	\$0
OR-DM-T10	OR-DM CPTY 10.01-12.00	D1	\$0
OR-DM-T11	OR-DM CPTY 12.01-14.00	D1	\$0
OR-DM-T12	OR-DM CPTY 14.01-17.00	D1	\$0
OR-DM-T13	OR-DM CPTY 17.01-20.00	D1	\$0
OR-DM-T14	OR-DM CPTY 20.01-23.00	D1	\$0
OR-DM-T1-4U	OR-DM T1-T4 UPGRADE	D1	\$0
OR-DM-T15	OR-DM CPTY 23.01-26.00	D1	\$0
OR-DM-T16	OR-DM CPTY 26.01-29.00	D1	\$0
OR-DM-T17	OR-DM CPTY 29.01-32.00	D1	\$0
OR-DM-T18	OR-DM CPTY 32.01-35.00	D1	\$0
OR-DM-T19	OR-DM CPTY 35.01-38.00	D1	\$0
OR-DM-T20	OR-DM CPTY 38.01-41.00	D1	\$0
OR-DM-T21	OR-DM CPTY 41.01-44.00	D1	\$0
OR-DM-T22	OR-DM CPTY 44.01-47.00	D1	\$0
OR-DM-T23	OR-DM CPTY 47.01-50.00	D1	\$0
OR-DM-T24	OR-DM CPTY 50.01-53.00	D1	\$0
OR-DM-T25	OR-DM CPTY 53.01-56.00	D1	\$0
OR-DM-T26	OR-DM CPTY 56.01-59.00	D1	\$0
OR-DM-T27	OR-DM CPTY 59.01-62.00	D1	\$0
OR-DM-T28	OR-DM CPTY 62.01-65.00	D1	\$0
OR-DM-T29	OR-DM CPTY 65.01-68.00	D1	\$0
OR-DM-T30	OR-DM CPTY 68.01-71.00	D1	\$0
OR-DM-T31	OR-DM CPTY 71.01-74.00	D1	\$0
OR-DM-T32	OR-DM CPTY 74.01-77.00	D1	\$0
OR-DM-T33	OR-DM CPTY 77.01-80.00	D1	\$0
OR-DM-T34	OR-DM CPTY 80.01-83.00	D1	\$0
OR-DM-T35	OR-DM CPTY 83.01-86.00	D1	\$0
OR-DM-T5-35U	OR-DM T5-T35 UPGRADE	D1	\$0
OR-LM-BASE	OR-LM BASE LICENSE	D1	\$0
OR-LM-C01	OR-LM 1TB (0-14TB)	D1	\$0
OR-LM-C02	OR-LM 1TB (15-25TB)	D1	\$0
OR-LM-C03	OR-LM 1TB (26-40TB)	D1	\$0
OR-LM-C04	OR-LM 1TB (41-60TB)	D1	\$0
OR-LM-C05	OR-LM 1TB (61-100TB)	D1	\$0
OR-LM-C06	OR-LM 1TB (101-150TB)	D1	\$0
OR-LM-C07	OR-LM 1TB (151-250TB)	D1	\$0
OR-LM-C08	OR-LM 1TB (251-400TB)	D1	\$0
OR-LM-C09	OR-LM 1TB (401-600TB)	D1	\$0
OR-LM-C10	OR-LM 1TB (601-1000TB)	D1	\$0
OR-LM-C11	OR-LM1TB(1001TB or greater)	D1	\$0
OR-LM-N01	OR-LM 1TB (0-14TB) NLT3	D1	\$0
OR-LM-N02	OR-LM 1TB (15-25TB) NLT3	D1	\$0
OR-LM-N03	OR-LM 1TB (26-40TB) NLT3	D1	\$0
OR-LM-N04	OR-LM 1TB (41-60TB) NLT3	D1	\$0
OR-LM-N05	OR-LM 1TB (61-100TB) NLT3	D1	\$0
OR-LM-N06	OR-LM 1TB (101-150TB) NLT3	D1	\$0

OR-LM-N07	OR-LM 1TB (151-250TB) NLT3	D1	\$0
OR-LM-N08	OR-LM 1TB (251-400TB) NLT3	D1	\$0
OR-LM-N09	OR-LM 1TB (401-600TB) NLT3	D1	\$0
OR-LM-N10	OR-LM 1TB (601-1000TB) NLT3	D1	\$0
OR-LM-N11	OR-LM1TB(1001TB or greater) NLT3	D1	\$0
OR-LM-T01	OR-LM CPCTY 0-.250	D1	\$0
OR-LM-T02	OR-LM CPCTY .251-.500	D1	\$0
OR-LM-T03	OR-LM CPCTY .501-.750	D1	\$0
OR-LM-T04	OR-LM CPCTY .751-1.00	D1	\$0
OR-LM-T05	OR-LM CPCTY 1.01-2.00	D1	\$0
OR-LM-T06	OR-LM CPCTY 2.01-4.00	D1	\$0
OR-LM-T07	OR-LM CPCTY 4.01-6.00	D1	\$0
OR-LM-T08	OR-LM CPCTY 6.01-8.00	D1	\$0
OR-LM-T09	OR-LM CPCTY 8.01-10.00	D1	\$0
OR-LM-T10	OR-LM CPTY 10.01-12.00	D1	\$0
OR-LM-T11	OR-LM CPTY 12.01-14.00	D1	\$0
OR-LM-T12	OR-LM CPTY 14.01-17.00	D1	\$0
OR-LM-T13	OR-LM CPTY 17.01-20.00	D1	\$0
OR-LM-T14	OR-LM CPTY 20.01-23.00	D1	\$0
OR-LM-T1-4U	OR-LM T1-T4 UPGRADE	D1	\$0
OR-LM-T15	OR-LM CPTY 23.01-26.00	D1	\$0
OR-LM-T16	OR-LM CPTY 26.01-29.00	D1	\$0
OR-LM-T17	OR-LM CPTY 29.01-32.00	D1	\$0
OR-LM-T18	OR-LM CPTY 32.01-35.00	D1	\$0
OR-LM-T19	OR-LM CPTY 35.01-38.00	D1	\$0
OR-LM-T20	OR-LM CPTY 38.01-41.00	D1	\$0
OR-LM-T21	OR-LM CPTY 41.01-44.00	D1	\$0
OR-LM-T22	OR-LM CPTY 44.01-47.00	D1	\$0
OR-LM-T23	OR-LM CPTY 47.01-50.00	D1	\$0
OR-LM-T24	OR-LM CPTY 50.01-53.00	D1	\$0
OR-LM-T25	OR-LM CPTY 53.01-56.00	D1	\$0
OR-LM-T26	OR-LM CPTY 56.01-59.00	D1	\$0
OR-LM-T27	OR-LM CPTY 59.01-62.00	D1	\$0
OR-LM-T28	OR-LM CPTY 62.01-65.00	D1	\$0
OR-LM-T29	OR-LM CPTY 65.01-68.00	D1	\$0
OR-LM-T30	OR-LM CPTY 68.01-71.00	D1	\$0
OR-LM-T31	OR-LM CPTY 71.01-74.00	D1	\$0
OR-LM-T32	OR-LM CPTY 74.01-77.00	D1	\$0
OR-LM-T33	OR-LM CPTY 77.01-80.00	D1	\$0
OR-LM-T34	OR-LM CPTY 80.01-83.00	D1	\$0
OR-LM-T35	OR-LM CPTY 83.01-86.00	D1	\$0
OR-LM-T5-35U	OR-LM T5-T35 UPGRADE	D1	\$0
OR-LM-UPG	OR-LM BASE UPGRADE	D1	\$0
PERE-MSU-BASE	PERF ESS BASE-3 MSU	D1	\$15,900
PERE-MSU-M00	PERF ESS 4-45 MSU	D1	\$1,110
PERE-MSU-M01	PERF ESS 46-175 MSU	D1	\$800
PERE-MSU-M02	PERF ESS 176-315 MSU	D1	\$640
PERE-MSU-M03	PERF ESS 316-575 MSU	D1	\$480
PERE-MSU-M04	PERF ESS 576-875 MSU	D1	\$430
PERE-MSU-M05	PERF ESS 876-1315 MSU	D1	\$380

PERE-MSU-M06	PERF ESS 1316-1975 MSU	D1	\$240
PERE-MSU-M07	PERF ESS 1976 & UP MSU	D1	\$160
PERE-MSU-UPG	PERF ESS UPG	D1	\$0
PFM-SY-T1-4U	PERF MGR-SYM1-4 UPG	D1	\$0
PFM-SY-T5-35U	PERF MGR-SYM5-T35UPG	D1	\$0
PKG-SY-T1-4U	SYM PKG T1-4UPG	D1	\$0
PKG-SY-T5-30U	SYM PKG T5-35UPG	D1	\$0
PKG-SY-T5-35U	CC PKG SY T5-35UPG	D1	\$0
PKG-T1-4U	CC5.1 PKG T1-4 UPG	D1	\$0
PKG-T5-30U	CC5.1 PKG T5-30 UPG	D1	\$0
PKGUP1-4	ECC PKG UPGRADE T1-T4	D1	\$3,890
PKGUP5-12	ECC PKG UPGRADE T5-T12	D1	\$10,510
PKL-SY-T1-4U	CC SY PKG LT T1-4U	D1	\$0
PKL-SY-T5-30U	CC SY PKG LT T5-30U	D1	\$0
PP-AIX-DPF	PPATH AIX DEP FENB	D1	\$5,043
PP-AIX-DPL	PPATH AIX DEP LITE	D1	\$890
PPEP-DP-EN	PP ENT PLUS DEP-ENT	D1	\$4,610
PPEP-LX-DP	PPATH EN PLUS LINUX DEP	D1	\$2,520
PPEP-LX-EN	PPATH EN PLUS LINUX ENT	D1	\$7,130
PPEP-LX-WG	PPATH EN PLUS LINUX WGR	D1	\$1,440
PPEP-UX-DP	PPATH EN PLUS UNIX DEP	D1	\$6,980
PPEP-UX-DP-EN	PP ENT PLUS UNIX DEP-ENT	D1	\$7,420
PPEP-UX-EN	PPATH EN PLUS UNIX ENT	D1	\$14,400
PPEP-UX-EN-GB	PP ENT PLUS UNIX ENT-GLB	D1	\$25,200
PPEP-UX-GB	PPATH EN PLUS UNIX GLB	D1	\$39,600
PPEP-UX-WG	PPATH EN PLUS UNIX WGR	D1	\$2,880
PPEP-UX-WG-DP	PP ENT PLUS UNIX WGR-DEP	D1	\$4,100
PPEP-WG-DP	PP ENT PLUS WGR-DEP	D1	\$1,080
PPEP-WN-DP	PPATH EN PLUS WINDOWS DEP	D1	\$2,520
PPEP-WN-EN	PPATH EN PLUS WINDOWS ENT	D1	\$7,130
PPEP-WN-WG	PPATH EN PLUS WINDOWS WGR	D1	\$1,440
PP-HP-DPF	PPATH HP DEP FENB	D1	\$5,043
PP-HP-DPL	PPATH HP DEP LITE	D1	\$890
PP-LX-DPF	PPATH LINUX DEP FENB	D1	\$1,812
PP-LX-DPL	PPATH LINUX DEP LITE	D1	\$330
PP-SUN-DPF	PPATH SUN DEP FENB	D1	\$5,043
PP-SUN-DPL	PPATH SUN DEP LITE	D1	\$890
PP-WN-DPF	PPATH WINDOWS DEP FENB	D1	\$1,812
PP-WN-DPL	PPATH WINDOWS DEP LITE	D1	\$330
RCCBENB01	DMX-LITE FULLY ENABLED SW PACKAGE	D1	\$316,176
RCCBLTD01	DMX-LITE BASE LIMITED SW PACKAGE	D1	\$135,504
REPLI-MON-T6	REPLICARE MONITORING T6	D1	\$0
REPLIM-T5-T30U	REPLICAREMONITOR T5-30 UP	D1	\$0
RPE-MSP	RESOURCEPAK EXT FOR MSP	D1	\$10,500
RPEXM-CDP-BAS	RP LOC REG CAP BASE LIC FOR VMAX	D1	\$0
RPEXM-CDP-T1	RP LOC REG CAP T1 - VMAX (0-14TB)	D1	\$0
RPEXM-CDP-T10	RP LOC REG CAP T10 -VMAX (601-1PB)	D1	\$0
RPEXM-CDP-T11	RP LOC REG CAP T11 -VMAX (1PB+)	D1	\$0
RPEXM-CDP-T2	RP LOC REG CAP T2 - VMAX (15-25TB)	D1	\$0
RPEXM-CDP-T3	RP LOC REG CAP T3 - VMAX (26-40TB)	D1	\$0

RPEXM-CDP-T4	RP LOC REG CAP T4 - VMAX (41-60TB)	D1	\$0
RPEXM-CDP-T5	RP LOC REG CAP T5 - VMAX (61-100TB)	D1	\$0
RPEXM-CDP-T6	RP LOC REG CAP T6 - VMAX (101-150TB)	D1	\$0
RPEXM-CDP-T7	RP LOC REG CAP T7 - VMAX (151-250TB)	D1	\$0
RPEXM-CDP-T8	RP LOC REG CAP T8 - VMAX (251-400TB)	D1	\$0
RPEXM-CDP-T9	RP LOC REG CAP T9 - VMAX (401-600TB)	D1	\$0
RPEXM-CDP-UG	RP LOC REG CAP UG FOR VMAX	D1	\$0
RPEXM-CRR-BAS	RP REM REG CAP BASE FOR VMAX	D1	\$0
RPEXM-CRR-T1	RP REM REG CAP T1 -VMAX (0-14TB)	D1	\$0
RPEXM-CRR-T10	RP REM REG CAP T10 -VMAX (601-1PB)	D1	\$0
RPEXM-CRR-T11	RP REM REG CAP T11 -VMAX (1PB+)	D1	\$0
RPEXM-CRR-T2	RP REM REG CAP T2 - VMAX (15-25TB)	D1	\$0
RPEXM-CRR-T3	RP REM REG CAP T3 - VMAX (26-40TB)	D1	\$0
RPEXM-CRR-T4	RP REM REG CAP T4 - VMAX (41-60TB)	D1	\$0
RPEXM-CRR-T5	RP REM REG CAP T5 - VMAX (61-100TB)	D1	\$0
RPEXM-CRR-T6	RP REM REG CAP T6 - VMAX (101-150TB)	D1	\$0
RPEXM-CRR-T7	RP REM REG CAP T7 - VMAX (151-250TB)	D1	\$0
RPEXM-CRR-T8	RP REM REG CAP T8 -VMAX (251-400TB)	D1	\$0
RPEXM-CRR-T9	RP REM REG CAP T9 - VMAX (401-600TB)	D1	\$0
RPEXM-CRR-UG	RP REM REG CAP UG FOR VMAX	D1	\$0
RPEXT-MSUBASE	RESPKEXT BASE-3 MSU	D1	\$0
RPEXT-MSU-M00	RESPKEXT 4-45 MSU	D1	\$0
RPEXT-MSU-M01	RESPKEXT 46-175 MSU	D1	\$0
RPEXT-MSU-M02	RESPKEXT 176-315 MSU	D1	\$0
RPEXT-MSU-M03	RESPKEXT 316-575 MSU	D1	\$0
RPEXT-MSU-M04	RESPKEXT 576-875 MSU	D1	\$0
RPEXT-MSU-M05	RESPKEXT 876-1315 MSU	D1	\$0
RPEXT-MSU-M06	RESPKEXT 1316-1975 MSU	D1	\$0
RPEXT-MSU-M07	RESPKEXT 1976 & UP MSU	D1	\$0
RPEXT-MSU-T0	RESPKEXT BASE-3 MSU	D1	\$0
RPEXT-MSU-T1	RESPKEXT 4-25 MSU	D1	\$0
RPEXT-MSU-T10	RESPKEXT 351-400 MSU	D1	\$0
RPEXT-MSU-T11	RESPKEXT 401-450 MSU	D1	\$0
RPEXT-MSU-T12	RESPKEXT 451-500 MSU	D1	\$0
RPEXT-MSU-T13	RESPKEXT 501-550 MSU	D1	\$0
RPEXT-MSU-T14	RESPKEXT 551-600 MSU	D1	\$0
RPEXT-MSU-T2	RESPKEXT 26-50 MSU	D1	\$0
RPEXT-MSU-T3	RESPKEXT 51-75 MSU	D1	\$0
RPEXT-MSU-T4	RESPKEXT 76-100 MSU	D1	\$0
RPEXT-MSU-T5	RESPKEXT 101-150 MSU	D1	\$0
RPEXT-MSU-T6	RESPKEXT 151-200 MSU	D1	\$0
RPEXT-MSU-T7	RESPKEXT 201-250 MSU	D1	\$0
RPEXT-MSU-T8	RESPKEXT 251-300 MSU	D1	\$0
RPEXT-MSU-T9	RESPKEXT 301-350 MSU	D1	\$0
RPEXT-T0-T3U	RESPK EXT UPG T0-T3U	D1	\$0
RPEXT-T4-T14U	RESPK EXT UPG T4-T14	D1	\$0
RPKTPF-MSUBSE	RPTPF BASE-3 MSU	D1	\$0
RPKTPF-MSUM00	RPTPF 4-45 MSU	D1	\$0
RPKTPF-MSUM01	RPTPF 46-175 MSU	D1	\$0
RPKTPF-MSUM02	RPTPF 176-315 MSU	D1	\$0

RPKTPF-MSUM03	RPTPF 316-575 MSU	D1	\$0
RPKTPF-MSUM04	RPTPF 576-875 MSU	D1	\$0
RPKTPF-MSUM05	RPTPF 876-1315 MSU	D1	\$0
RPKTPF-MSUM06	RPTPF 1316-1975 MSU	D1	\$0
RPKTPF-MSUM07	RRTPF 1976 & UP MSU	D1	\$0
RPTPF-MSU-T0	RESPK TPF BASE-3 MSU	D1	\$0
RPTPF-MSU-T1	RESPK TPF 4-25 MSU	D1	\$0
RPTPF-MSU-T10	RESPK TPF 351-400 MSU	D1	\$0
RPTPF-MSU-T11	RESPK TPF 401-450 MSU	D1	\$0
RPTPF-MSU-T12	RESPK TPF 451-500 MSU	D1	\$0
RPTPF-MSU-T13	RESPK TPF 501-550 MSU	D1	\$0
RPTPF-MSU-T14	RESPK TPF 551-600 MSU	D1	\$0
RPTPF-MSU-T2	RESPK TPF 26-50 MSU	D1	\$0
RPTPF-MSU-T3	RESPK TPF 51-75 MSU	D1	\$0
RPTPF-MSU-T4	RESPK TPF 76-100 MSU	D1	\$0
RPTPF-MSU-T5	RESPK TPF 101-150 MSU	D1	\$0
RPTPF-MSU-T6	RESPK TPF 151-200 MSU	D1	\$0
RPTPF-MSU-T7	RESPK TPF 201-250 MSU	D1	\$0
RPTPF-MSU-T8	RESPK TPF 251-300 MSU	D1	\$0
RPTPF-MSU-T9	RESPK TPF 301-350 MSU	D1	\$0
RPTPF-T0-T3U	RESPK TPF UPG T0 THRU T3	D1	\$0
RPTPF-T4-T14U	RESPK UPG T4-T14	D1	\$0
RSPEX-MSU-T00	RESPKEXT BASE-3 MSU	D1	\$0
RSPEX-MSU-T01	RESPKEXT 4-25 MSU	D1	\$0
RSPEX-MSU-T02	RESPKEXT 26-50 MSU	D1	\$0
RSPEX-MSU-T03	RESPKEXT 51-75 MSU	D1	\$0
RSPEX-MSU-T04	RESPKEXT 76-100 MSU	D1	\$0
RSPEX-MSU-T05	RESPKEXT 101-150 MSU	D1	\$0
RSPEX-MSU-T06	RESPKEXT 151-200 MSU	D1	\$0
RSPEX-MSU-T07	RESPKEXT 201-250 MSU	D1	\$0
RSPEX-MSU-T08	RESPKEXT 251-300 MSU	D1	\$0
RSPEX-MSU-T09	RESPKEXT 301-350 MSU	D1	\$0
RSPEX-MSU-T10	RESPKEXT 351-400 MSU	D1	\$0
RSPEX-MSU-T11	RESPKEXT 401-450 MSU	D1	\$0
RSPEX-MSU-T12	RESPKEXT 451-500 MSU	D1	\$0
RSPEX-MSU-T13	RESPKEXT 501-550 MSU	D1	\$0
RSPEX-MSU-T14	RESPKEXT 551-600 MSU	D1	\$0
SAAM-4HOSTADD	SAAM 4 HOST ADD-ON	D1	\$18,000
SAAM-T11-T30U	SAAM T11-T30 PER TIER UP	D1	\$0
SAAM-T11-T35U	SAAM T11-T35 PER TIER UP	D1	\$0
SACENB01	DXM LITE FULLY ENABLED FOR SAC	D1	\$295,421
SACLTD01	DMX-LITE MODEL FOR BUNDLE DEAL	D1	\$126,610
SDMM-DP	SDMM DP LICENSE	D1	\$7,560
SDMM-DP-EN	DP TO EN UPG	D1	\$10,440
SDMM-EN	SDMM EN LICENSE	D1	\$18,000
SDMM-EN-GB	SDMM EN TO GB UPG	D1	\$7,220
SDMM-GB	SDMM GB LICENSE	D1	\$25,200
SDMM-KIT	SDMM SVR CLIENT KIT	D1	\$0
SDMM-T1	SDMM T1 CAP 0-.250	D1	\$0
SDMM-T10	SDMM T10 CAP 10.01-12.00	D1	\$0

SDMM-T11	SDMM T11 CAP 12.01-14.00	D1	\$0
SDMM-T12	SDMM T12 CAP 14.01-17.00	D1	\$0
SDMM-T13	SDMM T13 CAP 17.01-20.00	D1	\$0
SDMM-T14	SDMM T14 CAP 20.01-23.00	D1	\$0
SDMM-T1-4UP	SDMM T1-T4 UPGRADE	D1	\$0
SDMM-T15	SDMM T15 CAP 23.01-26.00	D1	\$0
SDMM-T16	SDMM T16 CAP 26.01-29.00	D1	\$0
SDMM-T17	SDMM T17 CAP 29.01-32.00	D1	\$0
SDMM-T18	SDMM T18 CAP 32.01-35.00	D1	\$0
SDMM-T19	SDMM T19 CAP 35.01-38.00	D1	\$0
SDMM-T2	SDMM T2 CAP .251-.500	D1	\$0
SDMM-T20	SDMM T20 CAP 38.01-41.00	D1	\$0
SDMM-T21	SDMM T21 CAP 41.01-44.00	D1	\$0
SDMM-T22	SDMM T22 CAP 44.01-47.00	D1	\$0
SDMM-T23	SDMM T23 CAP 47.01-50.00	D1	\$0
SDMM-T24	SDMM T24 CAP 50.01-53.00	D1	\$0
SDMM-T25	SDMM T25 CAP 53.01-56.00	D1	\$0
SDMM-T26	SDMM T26 CAP 56.01-59.00	D1	\$0
SDMM-T27	SDMM T27 CAP 59.01-62.00	D1	\$0
SDMM-T28	SDMM T28 CAP 62.01-65.00	D1	\$0
SDMM-T29	SDMM T29 CAP 65.01-68.00	D1	\$0
SDMM-T3	SDMM T3 CAP .501-.750	D1	\$0
SDMM-T30	SDMM T30 CAP 68.01-71.00	D1	\$0
SDMM-T4	SDMM T4 CAP .751-1.00	D1	\$0
SDMM-T5	SDMM T5 CAP 1.01-2.00	D1	\$0
SDMM-T5-T30UP	SDMM T5-T30 UPGRADE	D1	\$0
SDMM-T6	SDMM T6 CAP 2.01-4.00	D1	\$0
SDMM-T7	SDMM T7 CAP 4.01-6.00	D1	\$0
SDMM-T8	SDMM T8 CAP 6.01-8.00	D1	\$0
SDMM-T9	SDMM T9 CAP 8.01-10.00	D1	\$0
SDMM-WG	SDMM WG LICENSE	D1	\$3,740
SDMM-WG-DP	SDMM WG TO DP UPG	D1	\$3,820
SE-BMC-BACKUP	BACKUP ENABLER: BMC	D1	\$0
SE-CA-BACKUP	BACKUP ENABLER: CA	D1	\$0
SE-CMG-BACKUP	BACKUP ENABLER: COMVAULT	D1	\$0
SE-HP-BACKUP	BACKUP ENABLER: HP	D1	\$0
SE-LGT-BACKUP	LEGATO NETWORKER	D1	\$0
SE-QRT-BACKUP	BACKUP ENABLER: QUADRATEC	D1	\$0
SE-TSM-BACKUP	BACKUP ENABLER: TIVOLI	D1	\$0
SE-VRT-BACKUP	BACKUP ENABLER: VERITAS	D1	\$0
SGRUPT1-4	ECC SGR UPGRADE T1-T4	D1	\$1,870
SGRUPT5-12	ECC SGR UPGRADE T5-T12	D1	\$6,770
SHANG-ENB	SPECIAL PKG SE TITLES FOR SHANGHI UPG	D1	\$78,925
SHANG-LTD	SPECIAL PKG SW TITLES FOR SHANGHI MOBILE	D1	\$33,825
SM-ARC-T1-T4	SAN MGR SARC1YR T1-T4 UP	D1	\$0
SM-ARC-T5-T30	SAN MGR SARC1YR T5-T30 UP	D1	\$0
SMC-ADD-BASE	SMC ADD BASE LICENSE	D1	\$6,885
SMC-ADD-C01	SMC-ADD 1TB (0-14TB)	D1	\$1,215
SMC-ADD-C02	SMC-ADD 1TB (15-25TB)	D1	\$1,140
SMC-ADD-C03	SMC-ADD 1TB (26-40TB)	D1	\$1,005

SMC-ADD-C04	SMC-ADD 1TB (41-60TB)	D1	\$930
SMC-ADD-C05	SMC-ADD 1TB (61-100TB)	D1	\$895
SMC-ADD-C06	SMC-ADD 1TB (101-150TB)	D1	\$805
SMC-ADD-C07	SMC-ADD 1TB (151-250TB)	D1	\$715
SMC-ADD-C08	SMC-ADD 1TB (251-400TB)	D1	\$620
SMC-ADD-C09	SMC-ADD 1TB (401-600TB)	D1	\$540
SMC-ADD-C10	SMC-ADD 1TB(601-1000TB)	D1	\$470
SMC-ADD-C11	SMC-ADD1TB(1001-1500TB)	D1	\$405
SMC-ADD-N01	SMC-ADD 1TB (0-14TB) NLT3	D1	\$608
SMC-ADD-N02	SMC-ADD 1TB (15-25TB) NLT3	D1	\$570
SMC-ADD-N03	SMC-ADD 1TB (26-40TB) NLT3	D1	\$505
SMC-ADD-N04	SMC-ADD 1TB (41-60TB) NLT3	D1	\$465
SMC-ADD-N05	SMC-ADD 1TB (61-100TB) NLT3	D1	\$448
SMC-ADD-N06	SMC-ADD 1TB (101-150TB) NLT3	D1	\$405
SMC-ADD-N07	SMC-ADD 1TB (151-250TB) NLT3	D1	\$358
SMC-ADD-N08	SMC-ADD 1TB (251-400TB) NLT3	D1	\$310
SMC-ADD-N09	SMC-ADD 1TB (401-600TB) NLT3	D1	\$270
SMC-ADD-N10	SMC-ADD 1TB(601-1000TB) NLT3	D1	\$235
SMC-ADD-N11	SMC-ADD1TB(1001-1500TB) NLT3	D1	\$205
SMC-ADD-UPG	SMCADD BASE UPGRADE	D1	\$0
SMC-BASE	SMC BASE LICENSE	D1	\$13,770
SMC-BASE-ADD	SMC-ADD BASE LICENSE	D1	\$6,885
SMC-C01	SMC 1TB (0-14TB)	D1	\$2,430
SMC-C01-ADD	SMC-ADD 1TB (0-14TB)	D1	\$1,215
SMC-C02	SMC 1TB (15-25TB)	D1	\$2,280
SMC-C02-ADD	SMC-ADD 1TB (15-25TB)	D1	\$1,140
SMC-C03	SMC 1TB (26-40TB)	D1	\$2,010
SMC-C03-ADD	SMC-ADD 1TB (26-40TB)	D1	\$1,005
SMC-C04	SMC 1TB (41-60TB)	D1	\$1,860
SMC-C04-ADD	SMC-ADD 1TB (41-60TB)	D1	\$930
SMC-C05	SMC 1TB (61-100TB)	D1	\$1,790
SMC-C05-ADD	SMC-ADD 1TB (61-100TB)	D1	\$895
SMC-C06	SMC 1TB (101-150TB)	D1	\$1,610
SMC-C06-ADD	SMC-ADD 1TB (101-150TB)	D1	\$805
SMC-C07	SMC 1TB (151-250TB)	D1	\$1,430
SMC-C07-ADD	SMC-ADD 1TB (151-250TB)	D1	\$715
SMC-C08	SMC 1TB (251-400TB)	D1	\$1,240
SMC-C08-ADD	SMC-ADD 1TB (251-400TB)	D1	\$620
SMC-C09	SMC 1TB (401-600TB)	D1	\$1,080
SMC-C09-ADD	SMC-ADD 1TB (401-600TB)	D1	\$540
SMC-C10	SMC 1TB (601-1000TB)	D1	\$940
SMC-C10-ADD	SMC-ADD 1TB(601-1000TB)	D1	\$470
SMC-C11	SMC 1TB(1001-1500TB)	D1	\$810
SMC-C11-ADD	SMC-ADD1TB(1001-1500TB)	D1	\$405
SMC-N01	SMC 1TB (0-14TB) NLT3	D1	\$1,215
SMC-N02	SMC 1TB (15-25TB) NLT3	D1	\$1,140
SMC-N03	SMC 1TB (26-40TB) NLT3	D1	\$1,005
SMC-N04	SMC 1TB (41-60TB) NLT3	D1	\$930
SMC-N05	SMC 1TB (61-100TB) NLT3	D1	\$895
SMC-N06	SMC 1TB (101-150TB) NLT3	D1	\$805

SMC-N07	SMC 1TB (151-250TB) NLT3	D1	\$715
SMC-N08	SMC 1TB (251-400TB) NLT3	D1	\$620
SMC-N09	SMC 1TB (401-600TB) NLT3	D1	\$540
SMC-N10	SMC 1TB (601-1000TB) NLT3	D1	\$470
SMC-N11	SMC 1TB(1001-1500TB) NLT3	D1	\$405
SMC-UPG	SMC BASE UPGRADE	D1	\$0
SMC-UPG-ADD	SMCADD BASE UPGRADE	D1	\$0
SM-SYM-T1-4U	SM SYM T1-T4UPG	D1	\$0
SM-SYM-T5-30U	CC5.x SM SYM T5-30 UPG	D1	\$0
SM-SYM-T5-35U	SM SYM T5-T35UPG	D1	\$0
SNAPADD-T1	SNAP ADD CPTY 0-.250	D1	\$0
SNAPADD-T10	SNAP ADD CPTY 10.01-12.00	D1	\$0
SNAPADD-T11	SNAP ADD CPTY 12.01-14.00	D1	\$0
SNAPADD-T12	SNAP ADD CPTY 14.01-17.00	D1	\$0
SNAPADD-T13	SNAP ADD CPTY 17.01-20.00	D1	\$0
SNAPADD-T14	SNAP ADD CPTY 20.01-23.00	D1	\$0
SNAPADDT1-4UPG	SNAP ADD T1-T4 UPGRADE	D1	\$2,020
SNAPADD-T15	SNAP ADD CPTY 23.01-26.00	D1	\$0
SNAPADD-T16	SNAP ADD CPTY 26.01-29.00	D1	\$0
SNAPADD-T17	SNAP ADD CPTY 29.01-32.00	D1	\$0
SNAPADD-T18	SNAP ADD CPTY 32.01-35.00	D1	\$0
SNAPADD-T19	SNAP ADD CPTY 35.01-38.00	D1	\$0
SNAPADD-T2	SNAP ADD CPTY .251-.500	D1	\$0
SNAPADD-T20	SNAP ADD CPTY 38.01-41.00	D1	\$0
SNAPADD-T21	SNAP ADD CPTY 41.01-44.00	D1	\$0
SNAPADD-T22	SNAP ADD CPTY 44.01-47.00	D1	\$0
SNAPADD-T23	SNAP ADD CPTY 47.01-50.00	D1	\$0
SNAPADD-T24	SNAP ADD CPTY 50.01-53.00	D1	\$0
SNAPADD-T25	SNAP ADD CPTY 53.01-56.00	D1	\$0
SNAPADD-T26	SNAP ADD CPTY 56.01-59.00	D1	\$0
SNAPADD-T27	SNAP ADD CPTY 59.01-62.00	D1	\$0
SNAPADD-T28	SNAP ADD CPTY 62.01-65.00	D1	\$0
SNAPADD-T29	SNAP ADD CPTY 65.01-68.00	D1	\$0
SNAPADD-T3	SNAP ADD CPTY .501-.750	D1	\$0
SNAPADD-T30	SNAP ADD CPTY 68.01-71.00	D1	\$0
SNAPADD-T31	SNAP ADD CPTY 71.01-74.00	D1	\$0
SNAPADD-T32	SNAP ADD CPTY 74.01-77.00	D1	\$0
SNAPADD-T33	SNAP ADD CPTY 77.01-80.00	D1	\$0
SNAPADD-T34	SNAP ADD CPTY 80.01-83.00	D1	\$0
SNAPADD-T35	SNAP ADD CPTY 83.01-86.00	D1	\$0
SNAPADD-T4	SNAP ADD CPTY .751-1.00	D1	\$0
SNAPADD-T5	SNAP ADD CPTY 1.01-2.00	D1	\$0
SNAPADDT5-35U	SNAP ADD T5-T35 UPGRADE	D1	\$3,830
SNAPADD-T6	SNAP ADD CPTY 2.01-4.00	D1	\$0
SNAPADD-T7	SNAP ADD CPTY 4.01-6.00	D1	\$0
SNAPADD-T8	SNAP ADD CPTY 6.01-8.00	D1	\$0
SNAPADD-T9	SNAP ADD CPTY 8.01-10.00	D1	\$0
SNAPCD-RN-ZOS	MF SNAP CODE FOR ZOS	D1	\$0
SNAP-DOC-MF	MEDIAMANUALS MF VSNAP	D1	\$0
SNAP-RUN-OPN	EMC SNAP OPEN RUNTIME KIT	D1	\$0

SNAP-RUN-ZOS	MF LIC FEAT FOR VSNAP	D1	\$0
SNAP-T1	SNAP CAPACITY 0-.250	D1	\$0
SNAP-T10	SNAP CAPACITY 10.01-12.00	D1	\$0
SNAP-T11	SNAP CAPACITY 12.01-14.00	D1	\$0
SNAP-T12	SNAP CAPACITY 14.01-17.00	D1	\$0
SNAP-T13	SNAP CAPACITY 17.01-20.00	D1	\$0
SNAP-T14	SNAP CAPACITY 20.01-23.00	D1	\$0
SNAP-T15	SNAP CAPACITY 23.01-26.00	D1	\$0
SNAP-T16	SNAP CAPACITY 26.01-29.00	D1	\$0
SNAP-T17	SNAP CAPACITY 29.01-32.00	D1	\$0
SNAP-T18	SNAP CAPACITY 32.01-35.00	D1	\$0
SNAP-T19	SNAP CAPACITY 35.01-38.00	D1	\$0
SNAPT1-T4UPG	SNAP T1-T4 UPGRADE	D1	\$0
SNAP-T2	SNAP CAPACITY .251-.500	D1	\$0
SNAP-T20	SNAP CAPACITY 38.01-41.00	D1	\$0
SNAP-T21	SNAP CAPACITY 41.01-44.00	D1	\$0
SNAP-T22	SNAP CAPACITY 44.01-47.00	D1	\$0
SNAP-T23	SNAP CAPACITY 47.01-50.00	D1	\$0
SNAP-T24	SNAP CAPACITY 50.01-53.00	D1	\$0
SNAP-T25	SNAP CAPACITY 53.01-56.00	D1	\$0
SNAP-T26	SNAP CAPACITY 56.01-59.00	D1	\$0
SNAP-T27	SNAP CAPACITY 59.01-62.00	D1	\$0
SNAP-T28	SNAP CAPACITY 62.01-65.00	D1	\$0
SNAP-T29	SNAP CAPACITY 65.01-68.00	D1	\$0
SNAP-T3	SNAP CAPACITY .501-.750	D1	\$0
SNAP-T30	SNAP CAPACITY 68.01-71.00	D1	\$0
SNAP-T31	SNAP CPCTY 71.01-74.00	D1	\$0
SNAP-T32	SNAP CPCTY 74.01-77.00	D1	\$0
SNAP-T33	SNAP CPCTY 77.01-80.00	D1	\$0
SNAP-T34	SNAP CPCTY 80.01-83.00	D1	\$0
SNAP-T35	SNAP CPCTY 83.01-86.00	D1	\$0
SNAP-T4	SNAP CAPACITY .751-1.00	D1	\$0
SNAP-T5	SNAP CAPACITY 1.01-2.00	D1	\$0
SNAP-T5-35U	SNAP T5-T35 UPGRADE	D1	\$0
SNAP-T6	SNAP CAPACITY 2.01-4.00	D1	\$0
SNAP-T7	SNAP CAPACITY 4.01-6.00	D1	\$0
SNAP-T8	SNAP CAPACITY 6.01-8.00	D1	\$0
SNAP-T9	SNAP CAPACITY 8.01-10.00	D1	\$0
SPA-LICSOL	SPA LICENSE SOLUTION	D1	\$0
SPA-PHYS-KIT	SPA SOFTWARE - OPTIONAL PHYS MEDIA KIT	D1	\$0
SPA-RDF-BASE	RT KIT OS HOSTS DMX W/ SPA SOFTWARE FOR	D1	\$0
SPA-RDF-C01	SPA SOFTWARE 1TB (0-14TB)	D1	\$0
SPA-RDF-C02	SPA SOFTWARE 1TB (15-25TB)	D1	\$0
SPA-RDF-C03	SPA SOFTWARE 1TB (26-40TB)	D1	\$0
SPA-RDF-C04	SPA SOFTWARE 1TB (41-60TB)	D1	\$0
SPA-RDF-C05	SPA SOFTWARE 1TB (61-100TB)	D1	\$0
SPA-RDF-C06	SPA SOFTWARE 1TB (101-150TB)	D1	\$0
SPA-RDF-C07	SPA SOFTWARE 1TB (151-250TB)	D1	\$0
SPA-RDF-C08	SPA SOFTWARE 1TB (251-400TB)	D1	\$0
SPA-RDF-C09	SPA SOFTWARE 1TB (401-600TB)	D1	\$0

SPA-RDF-C10	SPA SOFTWARE 1TB (601-1000TB)	D1	\$0
SPA-RDF-C11	SPA SOFTWARE 1TB (1001-1500TB)	D1	\$0
SPA-RDF-N01	SPA SOFTWARE 1TB (0-14TB) NLT3	D1	\$0
SPA-RDF-N02	SPA SOFTWARE 1TB (15-25TB) NLT3	D1	\$0
SPA-RDF-N03	SPA SOFTWARE 1TB (26-40TB) NLT3	D1	\$0
SPA-RDF-N04	SPA SOFTWARE 1TB (41-60TB) NLT3	D1	\$0
SPA-RDF-N05	SPA SOFTWARE 1TB (61-100TB) NLT3	D1	\$0
SPA-RDF-N06	SPA SOFTWARE 1TB (101-150TB) NLT3	D1	\$0
SPA-RDF-N07	SPA SOFTWARE 1TB (151-250TB)	D1	\$0
SPA-RDF-N08	SPA SOFTWARE 1TB (251-400TB)	D1	\$0
SPA-RDF-N09	SPA SOFTWARE 1TB (401-600TB)	D1	\$0
SPA-RDF-N10	SPA SOFTWARE 1TB (601-1000TB)	D1	\$0
SPA-RDF-N11	SPA SOFTWARE 1TB (1001-1500TB)	D1	\$0
SPA-RDF-UPG	SPA BASE UPGRADE	D1	\$0
SPA-SRDFA-BAS	RT KIT OS HOSTS DMX W/ SPA SOFTWARE FOR	D1	\$0
SPA-SRDFA-C01	SPA SOFTWARE 1TB (0-14TB)	D1	\$0
SPA-SRDFA-C02	SPA SOFTWARE 1TB (15-25TB)	D1	\$0
SPA-SRDFA-C03	SPA SOFTWARE 1TB (26-40TB)	D1	\$0
SPA-SRDFA-C04	SPA SOFTWARE 1TB (41-60TB)	D1	\$0
SPA-SRDFA-C05	SPA SOFTWARE 1TB (61-100)	D1	\$0
SPA-SRDFA-C06	SPA SOFTWARE 1TB (101-150TB)	D1	\$0
SPA-SRDFA-C07	SPA SOFTWARE 1TB (151-250TB)	D1	\$0
SPA-SRDFA-C08	SPA SOFTWARE 1TB (251-400TB)	D1	\$0
SPA-SRDFA-C09	SPA SOFTWARE 1TB (401-600TB)	D1	\$0
SPA-SRDFA-C10	SPA SOFTWARE 1TB (601-1000TB)	D1	\$0
SPA-SRDFA-C11	SPA SOFTWARE 1TB (1001-1	D1	\$0
SPA-SRDFA-N01	SPA SOFTWARE 1TB (0-14TB) NLT3	D1	\$0
SPA-SRDFA-N02	SPA SOFTWARE 1TB (15-25TB) NLT3	D1	\$0
SPA-SRDFA-N03	SPA SOFTWARE 1TB (26-40TB) NLT3	D1	\$0
SPA-SRDFA-N04	SPA SOFTWARE 1TB (41-60TB) NLT3	D1	\$0
SPA-SRDFA-N05	SPA SOFTWARE 1TB (61-100TB) NLT3	D1	\$0
SPA-SRDFA-N06	SPA SOFTWARE 1TB (101-150TB) NLT3	D1	\$0
SPA-SRDFA-N07	SPA SOFTWARE 1TB (151-250TB)	D1	\$0
SPA-SRDFA-N08	SPA SOFTWARE 1TB (251-400TB)	D1	\$0
SPA-SRDFA-N09	SPA SOFTWARE 1TB (401-600TB)	D1	\$0
SPA-SRDFA-N10	SPA SOFTWARE 1TB (601-1000TB)	D1	\$0
SPA-SRDFA-N11	SPA SOFTWARE 1TB (1001TB or greater)	D1	\$0
SPA-SRDFA-UPG	SPA BASE UPGRADE	D1	\$0
SPA-SW-BASE	RT KIT OS HOSTS DMX W/ SPA SOFTWARE AND	D1	\$0
SPA-SW-C01	SPA SOFTWARE 1TB (0-14TB)	D1	\$0
SPA-SW-C02	SPA SOFTWARE 1TB (15-25TB)	D1	\$0
SPA-SW-C03	SPA SOFTWARE 1TB (26-40TB)	D1	\$0
SPA-SW-C04	SPA SOFTWARE 1TB (41-60TB)	D1	\$0
SPA-SW-C05	SPA SOFTWARE 1TB (61-100TB)	D1	\$0
SPA-SW-C06	SPA SOFTWARE 1TB (101-150TB)	D1	\$0
SPA-SW-C07	SPA SOFTWARE 1TB (151-250TB)	D1	\$0
SPA-SW-C08	SPA SOFTWARE 1TB (251-400TB)	D1	\$0
SPA-SW-C09	SPA SOFTWARE 1TB (401-600TB)	D1	\$0
SPA-SW-C10	SPA SOFTWARE 1TB (601-1000TB)	D1	\$0
SPA-SW-C11	SPA SOFTWARE 1TB (1001TB or greater)	D1	\$0

SPA-SW-N01	SPA SOFTWARE 1TB (0-14TB) NLT3	D1	\$0
SPA-SW-N02	SPA SOFTWARE 1TB (15-25TB) NLT3	D1	\$0
SPA-SW-N03	SPA SOFTWARE 1TB (26-40TB) NLT3	D1	\$0
SPA-SW-N04	SPA SOFTWARE 1TB (41-60TB) NLT3	D1	\$0
SPA-SW-N05	SPA SOFTWARE 1TB (61-100TB) NLT3	D1	\$0
SPA-SW-N06	SPA SOFTWARE 1TB (101-150TB) NLT3	D1	\$0
SPA-SW-N07	SPA SOFTWARE 1TB (151-250TB) NLT3	D1	\$0
SPA-SW-N08	SPA SOFTWARE 1TB (251-400TB) NLT3	D1	\$0
SPA-SW-N09	SPA SOFTWARE 1TB (401-600TB) NLT3	D1	\$0
SPA-SW-N10	SPA SOFTWARE 1TB (601-1000TB) NLT3	D1	\$0
SPA-SW-N11	SPA SOFTWARE 1TB (1001TB OR GR) NLT3	D1	\$0
SPA-SW-UPG	SPA BASE UPGRADE	D1	\$0
SRDFA-ADDBASE	RMT ASYNC-ADD ON-SRDFA CMPEXT-BASE	D1	\$0
SRDFA-ADD-C01	RMT ASYNC-ADD-SRDFACMPEXT NONSATA 0-1	D1	\$0
SRDFA-ADD-C02	RMT ASYNC-ADD-SRDFACMPEXT NONSATA 15-	D1	\$0
SRDFA-ADD-C03	RMT ASYNC-ADD-SRDFACMPEXT NONSATA 26-	D1	\$0
SRDFA-ADD-C04	RMT ASYNC-ADD-SRDFACMPEXT NONSATA 41-	D1	\$0
SRDFA-ADD-C05	RMT ASYNC-ADD-SRDFACMPEXT NONSATA61-1	D1	\$0
SRDFA-ADD-C06	RMT ASYNC-ADD-SRDFACMPEXT NOSATA101-1	D1	\$0
SRDFA-ADD-C07	RMT ASYNC-ADD-SRDFACMPEXT NOSATA151-2	D1	\$0
SRDFA-ADD-C08	RMT ASYNC-ADD-SRDFACMPEXT NOSATA251-4	D1	\$0
SRDFA-ADD-C09	RMT ASYNC-ADD-SRDFACMPEXT NOSATA401-6	D1	\$0
SRDFA-ADD-C10	RMT ASYNC-ADD-SRDFACMPEXT NOSATA601-1	D1	\$0
SRDFA-ADD-C11	RMT ASYNC-ADD-SRDFACMPEXT NONSATA100	D1	\$0
SRDFA-ADD-N01	RMT ASYNC-ADD-SRDFA CMPEXT SATA 0-14 TB	D1	\$0
SRDFA-ADD-N02	RMT ASYNC-ADD-SRDFA CMPEXT SATA 15-25 T	D1	\$0
SRDFA-ADD-N03	RMT ASYNC-ADD-SRDFA CMPEXT SATA 26-40 T	D1	\$0
SRDFA-ADD-N04	RMT ASYNC-ADD-SRDFA CMPEXT SATA 41-60 T	D1	\$0
SRDFA-ADD-N05	RMT ASYNC-ADD-SRDFA CMPEXT SATA 61-100T	D1	\$0
SRDFA-ADD-N06	RMT ASYNC-ADD-SRDFA CMPEXT SATA 101-150	D1	\$0
SRDFA-ADD-N07	RMT ASYNC-ADD-SRDFA CMPEXT SATA 151-250	D1	\$0
SRDFA-ADD-N08	RMT ASYNC-ADD-SRDFA CMPEXT SATA 251-400	D1	\$0
SRDFA-ADD-N09	RMT ASYNC-ADD-SRDFA CMPEXT SATA 401-600	D1	\$0
SRDFA-ADD-N10	RMT ASYNC-ADD-SRDFA CMPEXT SATA 601-100	D1	\$0
SRDFA-ADD-N11	RMT ASYNC-ADD-SRDFA CMPEXT SATA1001+ T	D1	\$0
SRDFA-ADDOBAS	RMT ASYNC-ADD-OPT OUT-SRDFA CMPEXT-BA	D1	\$0
SRDFA-ADD-OPT	RMT ASYNC-ADD-OPT OUT-SRDFA CMPEXT-UP	D1	\$0
SRDFA-ADD-OUP	RMT ASYNC-ADD-SATAOPT OUT-TR-SRDFACMF	D1	\$0
SRDFA-ADD-T01	SRDFA ADD CTY 0-.250	D1	\$0
SRDFA-ADD-T02	SRDFA ADD CTY .251-.500	D1	\$0
SRDFA-ADD-T03	SRDFA ADD CTY .501-.750	D1	\$0
SRDFA-ADD-T04	SRDFA ADD CTY .751-1.00	D1	\$0
SRDFA-ADD-T05	SRDFA ADD CTY 1.01-2.00	D1	\$0
SRDFA-ADD-T06	SRDFA ADD CTY 2.01-4.00	D1	\$0
SRDFA-ADD-T07	SRDFA ADD CTY 4.01-6.00	D1	\$0
SRDFA-ADD-T08	SRDFA ADD CTY 6.01-8.00	D1	\$0
SRDFA-ADD-T09	SRDFA ADD CTY 8.01-10.00	D1	\$0
SRDFA-ADD-T10	SRDFA ADD CTY 10.01-12.00	D1	\$0
SRDFA-ADD-T11	SRDFA ADD CTY 12.01-14.00	D1	\$0
SRDFA-ADD-T12	SRDFA ADD CTY 14.01-17.00	D1	\$0

SRDFA-ADD-T13	SRDFA ADD CTY 17.01-20.00	D1	\$0
SRDFA-ADD-T14	SRDFA ADD CTY 20.01-23.00	D1	\$0
SRDFAADDT1-4U	SRDFA ADD CTY T1-T4 UPG	D1	\$3,740
SRDFA-ADD-T15	SRDFA ADD CTY 23.01-26.00	D1	\$0
SRDFA-ADD-T16	SRDFA ADD CTY 26.01-29.00	D1	\$0
SRDFA-ADD-T17	SRDFA ADD CTY 29.01-32.00	D1	\$0
SRDFA-ADD-T18	SRDFA ADD CTY 32.01-35.00	D1	\$0
SRDFA-ADD-T19	SRDFA ADD CTY 35.01-38.00	D1	\$0
SRDFA-ADD-T20	SRDFA ADD CTY 38.01-41.00	D1	\$0
SRDFA-ADD-T21	SRDFA ADD CTY 41.01-44.00	D1	\$0
SRDFA-ADD-T22	SRDFA ADD CTY 44.01-47.00	D1	\$0
SRDFA-ADD-T23	SRDFA ADD CTY 47.01-50.00	D1	\$0
SRDFA-ADD-T24	SRDFA ADD CTY 50.01-53.00	D1	\$0
SRDFA-ADD-T25	SRDFA ADD CTY 53.01-56.00	D1	\$0
SRDFA-ADD-T26	SRDFA ADD CTY 56.01-59.00	D1	\$0
SRDFA-ADD-T27	SRDFA ADD CTY 59.01-62.00	D1	\$0
SRDFA-ADD-T28	SRDFA ADD CTY 62.01-65.00	D1	\$0
SRDFA-ADD-T29	SRDFA ADD CTY 65.01-68.00	D1	\$0
SRDFA-ADD-T30	SRDFA ADD CTY 68.01-71.00	D1	\$0
SRDFA-ADD-T31	SRDFA ADD CTY 71.01-74.00	D1	\$0
SRDFA-ADD-T32	SRDFA ADD CTY 74.01-77.00	D1	\$0
SRDFA-ADD-T33	SRDFA ADD CTY 77.01-80.00	D1	\$0
SRDFA-ADD-T34	SRDFA ADD CTY 80.01-83.00	D1	\$0
SRDFA-ADD-T35	SRDFA ADD CTY 83.01-86.00	D1	\$0
SRDFA-ADD-UPG	RMT ASYNC-ADD ON-SRDFA CMPEXT-UPG	D1	\$0
SRDFAADT5-35U	SRDFA ADD CTY T5-35 UPG	D1	\$9,650
SRDF-AAM-KIT	SAAM MEDIA KIT	D1	\$0
SRDF-AAM-T01	SAAM CAP0-.25 LT21HOST	D1	\$0
SRDF-AAM-T02	SAAM CAP.251-.5 LT21HOST	D1	\$0
SRDF-AAM-T03	SAAM CAP.501-.75 LT21HOST	D1	\$0
SRDF-AAM-T04	SAAM CAP.751-1 LT21HOST	D1	\$0
SRDF-AAM-T05	SAAM CAP1.01-2 LT21HOST	D1	\$0
SRDF-AAM-T06	SAAM CAP2.01-4 LT21HOST	D1	\$0
SRDF-AAM-T07	SAAM CAP4.01-6 LT21HOST	D1	\$0
SRDF-AAM-T08	SAAM CAP6.01-8 LT21HOST	D1	\$0
SRDF-AAM-T09	SAAM CAP8.01-10 LT21HOST	D1	\$0
SRDF-AAM-T10	SAAM CAP10.01-12 LT21HOST	D1	\$0
SRDF-AAM-T11	SAAM CAP12.01-14 LT23HOST	D1	\$0
SRDF-AAM-T12	SAAM CAP14.01-17 LT25HOST	D1	\$0
SRDF-AAM-T13	SAAM CAP17.01-20 LT27HOST	D1	\$0
SRDF-AAM-T14	SAAM CAP20.01-23 LT29HOST	D1	\$0
SRDF-AAM-T15	SAAM CAP23.01-26 LT31HOST	D1	\$0
SRDF-AAM-T16	SAAM CAP26.01-29 LT33HOST	D1	\$0
SRDF-AAM-T17	SAAM CAP29.01-32 LT35HOST	D1	\$0
SRDF-AAM-T18	SAAM CAP32.01-35 LT37HOST	D1	\$0
SRDF-AAM-T19	SAAM CAP35.01-38 LT39HOST	D1	\$0
SRDF-AAM-T20	SAAM CAP38.01-41 LT41HOST	D1	\$0
SRDF-AAM-T21	SAAM CAP41.01-44 LT43HOST	D1	\$0
SRDF-AAM-T22	SAAM CAP44.01-47 LT45HOST	D1	\$0
SRDF-AAM-T23	SAAM CAP47.01-50 LT47HOST	D1	\$0

SRDF-AAM-T24	SAAM CAP50.01-53 LT49HOST	D1	\$0
SRDF-AAM-T25	SAAM CAP53.01-56 LT51HOST	D1	\$0
SRDF-AAM-T26	SAAM CAP56.01-59 LT53HOST	D1	\$0
SRDF-AAM-T27	SAAM CAP59.01-62 LT55HOST	D1	\$0
SRDF-AAM-T28	SAAM CAP62.01-65 LT57HOST	D1	\$0
SRDF-AAM-T29	SAAM CAP65.01-68 LT59HOST	D1	\$0
SRDF-AAM-T30	SAAM CAP68.01-71 LT61HOST	D1	\$0
SRDF-AAM-T31	SAAM CAP71.01-74 LT63HOST	D1	\$0
SRDF-AAM-T32	SAAM CAP74.01-77 LT65HOST	D1	\$0
SRDF-AAM-T33	SAAM CAP77.01-80 LT67HOST	D1	\$0
SRDF-AAM-T34	SAAM CAP80.01-83 LT69HOST	D1	\$0
SRDF-AAM-T35	SAAM CAP83.01-86 LT71HOST	D1	\$0
SRDF-A-BASE	RMT ASYNC PROT-SRDFA CMPEXT-BASE	D1	\$20,760
SRDF-A-BASEF	SRDF-A FENB BASE LICENSE	D1	\$17,640
SRDF-A-BASEL	SRDF-A LITE BASE LICENSE	D1	\$3,120
SRDF-A-C01	RMT ASYNC-SRDFA CMPEXT NON-SATA 0-14 TB	D1	\$4,380
SRDF-A-C02	RMT ASYNC-SRDFA CMPEXT NON-SATA 15-25 TB	D1	\$4,120
SRDF-A-C03	RMT ASYNC-SRDFA CMPEXT NON-SATA 26-40 TB	D1	\$3,630
SRDF-A-C04	RMT ASYNC-SRDFA CMPEXT NON-SATA 41-60 TB	D1	\$3,240
SRDF-A-C05	RMT ASYNC-SRDFA CMPEXT NON-SATA 61-100TB	D1	\$2,890
SRDF-A-C06	RMT ASYNC-SRDFA CMPEXT NON-SATA 101-150TB	D1	\$2,560
SRDF-A-C07	RMT ASYNC-SRDFA CMPEXT NON-SATA 151-250TB	D1	\$2,200
SRDF-A-C08	RMT ASYNC-SRDFA CMPEXT NON-SATA 251-400TB	D1	\$1,880
SRDF-A-C09	RMT ASYNC-SRDFA CMPEXT NON-SATA 401-600TB	D1	\$1,620
SRDF-A-C10	RMT ASYNC-SRDFA CMPEXT NON-SATA 601-1000TB	D1	\$1,390
SRDF-A-C11	RMT ASYNC-SRDFA CMPEXT NON-SATA 1001+ TB	D1	\$1,190
SRDF-A-CF01	SRDF-A FENB 1TB (0-14TB)	D1	\$3,720
SRDF-A-CF02	SRDF-A FENB 1TB (15-25TB)	D1	\$3,500
SRDF-A-CF03	SRDF-A FENB 1TB (26-40TB)	D1	\$3,080
SRDF-A-CF04	SRDF-A FENB 1TB (41-60TB)	D1	\$2,750
SRDF-A-CF05	SRDF-A FENB 1TB (61-100TB)	D1	\$2,450
SRDF-A-CF06	SRDF-A FENB 1TB (101-150TB)	D1	\$2,170
SRDF-A-CF07	SRDF-A FENB 1TB (151-250TB)	D1	\$1,870
SRDF-A-CF08	SRDF-A FENB 1TB (251-400TB)	D1	\$1,590
SRDF-A-CF09	SRDF-A FENB 1TB (401-600TB)	D1	\$1,370
SRDF-A-CF10	SRDF-A FENB 1TB (601-1000TB)	D1	\$1,180
SRDF-A-CF11	SRDF-A FENB 1TB(1001TB OR GREATER)	D1	\$1,010
SRDF-A-CL01	SRDF-A LITE 1TB (0-14TB)	D1	\$660
SRDF-A-CL02	SRDF-A LITE 1TB (15-25TB)	D1	\$620
SRDF-A-CL03	SRDF-A LITE 1TB (26-40TB)	D1	\$550
SRDF-A-CL04	SRDF-A LITE 1TB (41-60TB)	D1	\$490
SRDF-A-CL05	SRDF-A LITE 1TB (61-100TB)	D1	\$440
SRDF-A-CL06	SRDF-A LITE 1TB (101-150TB)	D1	\$390
SRDF-A-CL07	SRDF-A LITE 1TB (151-250TB)	D1	\$330
SRDF-A-CL08	SRDF-A LITE 1TB (251-400TB)	D1	\$290
SRDF-A-CL09	SRDF-A LITE 1TB (401-600TB)	D1	\$250
SRDF-A-CL10	SRDF-A LITE 1TB (601-1000TB)	D1	\$210
SRDF-A-CL11	SRDF-A LITE 1TB(1001TB OR GREATER)	D1	\$180
SRDFADD-T01	SRDF ADD CTY 0-.250	D1	\$0
SRDFADD-T02	SRDF ADD CTY .251-.500	D1	\$0

SRDFADD-T03	SRDF ADD CTY .501-.750	D1	\$0
SRDFADD-T04	SRDF ADD CTY .751-1.00	D1	\$0
SRDFADD-T05	SRDF ADD CTY 1.01-2.00	D1	\$0
SRDFADD-T06	SRDF ADD CTY 2.01-4.00	D1	\$0
SRDFADD-T07	SRDF ADD CTY 4.01-6.00	D1	\$0
SRDFADD-T08	SRDF ADD CTY 6.01-8.00	D1	\$0
SRDFADD-T09	SRDF ADD CTY 8.01-10.00	D1	\$0
SRDFADD-T10	SRDF ADD CTY 10.01-12.00	D1	\$0
SRDFADD-T11	SRDF ADD CTY 12.01-14.00	D1	\$0
SRDFADD-T12	SRDF ADD CTY 14.01-17.00	D1	\$0
SRDFADD-T13	SRDF ADD CTY 17.01-20.00	D1	\$0
SRDFADD-T14	SRDF ADD CTY 20.01-23.00	D1	\$0
SRDFADDT1-4U	SRDF ADD CTY T1-T4 UPG	D1	\$3,740
SRDFADD-T15	SRDF ADD CTY 23.01-26.00	D1	\$0
SRDFADD-T16	SRDF ADD CTY 26.01-29.00	D1	\$0
SRDFADD-T17	SRDF ADD CTY 29.01-32.00	D1	\$0
SRDFADD-T18	SRDF ADD CTY 32.01-35.00	D1	\$0
SRDFADD-T19	SRDF ADD CTY 35.01-38.00	D1	\$0
SRDFADD-T20	SRDF ADD CTY 38.01-41.00	D1	\$0
SRDFADD-T21	SRDF ADD CTY 41.01-44.00	D1	\$0
SRDFADD-T22	SRDF ADD CTY 44.01-47.00	D1	\$0
SRDFADD-T23	SRDF ADD CTY 47.01-50.00	D1	\$0
SRDFADD-T24	SRDF ADD CTY 50.01-53.00	D1	\$0
SRDFADD-T25	SRDF ADD CTY 53.01-56.00	D1	\$0
SRDFADD-T26	SRDF ADD CTY 56.01-59.00	D1	\$0
SRDFADD-T27	SRDF ADD CTY 59.01-62.00	D1	\$0
SRDFADD-T28	SRDF ADD CTY 62.01-65.00	D1	\$0
SRDFADD-T29	SRDF ADD CTY 65.01-68.00	D1	\$0
SRDFADD-T30	SRDF ADD CTY 68.01-71.00	D1	\$0
SRDFADD-T31	SRDF ADD CTY 71.01-74.00	D1	\$0
SRDFADD-T32	SRDF ADD CTY 74.01-77.00	D1	\$0
SRDFADD-T33	SRDF ADD CTY 77.01-80.00	D1	\$0
SRDFADD-T34	SRDF ADD CTY 80.01-83.00	D1	\$0
SRDFADD-T35	SRDF ADD CTY 83.01-86.00	D1	\$0
SRDFADDT5-30U	SRDF ADD CTY T5-30 UPG	D1	\$7,720
SRDFADDT5-35U	SRDF ADD CTY T5-35 UPG	D1	\$7,720
SRDF-A-N01	RMT ASYNC-SRDFA CMPEXT SATA 0-14 TB	D1	\$2,190
SRDF-A-N02	RMT ASYNC-SRDFA CMPEXT SATA 15-25 TB	D1	\$2,060
SRDF-A-N03	RMT ASYNC-SRDFA CMPEXT SATA 26-40 TB	D1	\$1,810
SRDF-A-N04	RMT ASYNC-SRDFA CMPEXT SATA 41-60 TB	D1	\$1,620
SRDF-A-N05	RMT ASYNC-SRDFA CMPEXT SATA 61-100 TB	D1	\$1,450
SRDF-A-N06	RMT ASYNC-SRDFA CMPEXT SATA 101-150 TB	D1	\$1,280
SRDF-A-N07	RMT ASYNC-SRDFA CMPEXT SATA 151-250 TB	D1	\$1,100
SRDF-A-N08	RMT ASYNC-SRDFA CMPEXT SATA 251-400 TB	D1	\$940
SRDF-A-N09	RMT ASYNC-SRDFA CMPEXT SATA 401-600 TB	D1	\$810
SRDF-A-N10	RMT ASYNC-SRDFA CMPEXT SATA 601-1000 TB	D1	\$690
SRDF-A-N11	RMT ASYNC-SRDFA CMPEXT SATA 1001+ TB	D1	\$600
SRDF-A-NF01	SRDF-A FENB 1TB (0-14TB) NLT3	D1	\$1,860
SRDF-A-NF02	SRDF-A FENB 1TB (15-25TB) NLT3	D1	\$1,750
SRDF-A-NF03	SRDF-A FENB 1TB (26-40TB) NLT3	D1	\$1,530

SRDF-A-NF04	SRDF-A FENB 1TB (41-60TB) NLT3	D1	\$1,370
SRDF-A-NF05	SRDF-A FENB 1TB (61-100TB) NLT3	D1	\$1,230
SRDF-A-NF06	SRDF-A FENB 1TB (101-150TB) NLT3	D1	\$1,080
SRDF-A-NF07	SRDF-A FENB 1TB (151-250TB) NLT3	D1	\$930
SRDF-A-NF08	SRDF-A FENB 1TB (251-400TB) NLT3	D1	\$790
SRDF-A-NF09	SRDF-A FENB 1TB (401-600TB) NLT3	D1	\$680
SRDF-A-NF10	SRDF-A FENB 1TB (601-1000TB) NLT3	D1	\$580
SRDF-A-NF11	SRDF-A FENB 1TB(1001TB OR GREATER) NLT3	D1	\$510
SRDF-A-NL01	SRDF-A LITE 1TB (0-14TB) NLT3	D1	\$330
SRDF-A-NL02	SRDF-A LITE 1TB (15-25TB) NLT3	D1	\$310
SRDF-A-NL03	SRDF-A LITE 1TB (26-40TB) NLT3	D1	\$280
SRDF-A-NL04	SRDF-A LITE 1TB (41-60TB) NLT3	D1	\$250
SRDF-A-NL05	SRDF-A LITE 1TB (61-100TB) NLT3	D1	\$220
SRDF-A-NL06	SRDF-A LITE 1TB (101-150TB) NLT3	D1	\$200
SRDF-A-NL07	SRDF-A LITE 1TB (151-250TB) NLT3	D1	\$170
SRDF-A-NL08	SRDF-A LITE 1TB (251-400TB) NLT3	D1	\$150
SRDF-A-NL09	SRDF-A LITE 1TB (401-600TB) NLT3	D1	\$130
SRDF-A-NL10	SRDF-A LITE 1TB (601-1000TB) NLT3	D1	\$110
SRDF-A-NL11	SRDF-A LITE 1TB(1001TB OR GREATER) NLT3	D1	\$90
SRDF-A-OBAS	RMT ASYNC-OPT OUT-SRDFA CMPEXT-BASE	D1	\$0
SRDF-A-OPT	RMT ASYNC-OPT OUT-SRDFA CMPEXT-UPG	D1	\$0
SRDF-A-OUP	RMT ASYNC-SATA-OPTOUT-TR-SRDFA CMPEXT	D1	\$0
SRDF-A-R01	RMT ASYNC-SRDFA CMPEXT REG 0-14 TB	D1	\$4,395
SRDF-A-R02	RMT ASYNC-SRDFA CMPEXT REG 15-25 TB	D1	\$3,647
SRDF-A-R03	RMT ASYNC-SRDFA CMPEXT REG 26-40 TB	D1	\$3,660
SRDF-A-R04	RMT ASYNC-SRDFA CMPEXT REG 41-60 TB	D1	\$2,990
SRDF-A-R05	RMT ASYNC-SRDFA CMPEXT REG 61-100 TB	D1	\$2,595
SRDF-A-R06	RMT ASYNC-SRDFA CMPEXT REG 101-150 TB	D1	\$2,205
SRDF-A-R07	RMT ASYNC-SRDFA CMPEXT REG 151-250 TB	D1	\$2,090
SRDF-A-R08	RMT ASYNC-SRDFA CMPEXT REG 251-400 TB	D1	\$1,915
SRDF-A-R09	RMT ASYNC-SRDFA CMPEXT REG 401-600 TB	D1	\$1,715
SRDF-A-R10	RMT ASYNC-SRDFA CMPEXT REG 601-1000TB	D1	\$1,505
SRDF-A-R11	RMT ASYNC-SRDFA CMPEXT REG 1001+ TB	D1	\$975
SRDF-A-RBAS	RMT ASYNC PROT-SRDFA CMPEXT-BASE REG	D1	\$22,120
SRDFAR-BASE	SRDFAR BASE LICENSE	D1	\$0
SRDF-A-RBASF	SRDF-A FENB REPL BASE LICENSE	D1	\$12,740
SRDF-A-RBASL	SRDF-A LITE REPL BASE LICENSE	D1	\$2,250
SRDFAR-C01	SRDFAR 1TB (0-14TB)	D1	\$0
SRDFAR-C02	SRDFAR 1TB (15-25TB)	D1	\$0
SRDFAR-C03	SRDFAR 1TB (26-40TB)	D1	\$0
SRDFAR-C04	SRDFAR 1TB (41-60TB)	D1	\$0
SRDFAR-C05	SRDFAR 1TB (61-100TB)	D1	\$0
SRDFAR-C06	SRDFAR 1TB (101-150TB)	D1	\$0
SRDFAR-C07	SRDFAR 1TB (151-250TB)	D1	\$0
SRDFAR-C08	SRDFAR 1TB (251-400TB)	D1	\$0
SRDFAR-C09	SRDFAR 1TB (401-600TB)	D1	\$0
SRDFAR-C10	SRDFAR 1TB (601-1000TB)	D1	\$0
SRDFAR-C11	SRDFAR1TB(1001TB or greater)	D1	\$0
SRDF-A-RF01	SRDF-A FENB REPL 1TB(0-14TB)	D1	\$8,270
SRDF-A-RF02	SRDF-A FENB REPL 1TB(15-25TB)	D1	\$6,870

SRDF-A-RF03	SRDF-A FENB REPL 1TB(26-40TB)	D1	\$5,830
SRDF-A-RF04	SRDF-A FENB REPL 1TB(41-60TB)	D1	\$5,180
SRDF-A-RF05	SRDF-A FENB REPL 1TB(61-100TB)	D1	\$4,600
SRDF-A-RF06	SRDF-A FENB REPL 1TB(101-150TB)	D1	\$4,090
SRDF-A-RF07	SRDF-A FENB REPL 1TB(151-250TB)	D1	\$3,630
SRDF-A-RF08	SRDF-A FENB REPL 1TB(251-400TB)	D1	\$3,220
SRDF-A-RF09	SRDF-A FENB REPL 1TB(401-600TB)	D1	\$2,860
SRDF-A-RF10	SRDF-A FENB REPL 1TB(601-1000TB)	D1	\$2,550
SRDF-A-RF11	SRDF-A FENB REPL 1TB(1001TB OR GREATER)	D1	\$2,250
SRDF-A-RL01	SRDF-A LITE REPL 1TB(0-14TB)	D1	\$1,470
SRDF-A-RL02	SRDF-A LITE REPL 1TB(15-25TB)	D1	\$1,220
SRDF-A-RL03	SRDF-A LITE REPL 1TB(26-40TB)	D1	\$1,040
SRDF-A-RL04	SRDF-A LITE REPL 1TB(41-60TB)	D1	\$920
SRDF-A-RL05	SRDF-A LITE REPL 1TB(61-100TB)	D1	\$820
SRDF-A-RL06	SRDF-A LITE REPL 1TB(101-150TB)	D1	\$730
SRDF-A-RL07	SRDF-A LITE REPL 1TB(151-250TB)	D1	\$650
SRDF-A-RL08	SRDF-A LITE REPL 1TB(251-400TB)	D1	\$570
SRDF-A-RL09	SRDF-A LITE REPL 1TB(401-600TB)	D1	\$510
SRDF-A-RL10	SRDF-A LITE REPL 1TB(601-1000TB)	D1	\$450
SRDF-A-RL11	SRDF-A LITE REPL 1TB(1001TB OR GREATER)	D1	\$400
SRDFAR-N01	SRDFAR 1TB (0-14TB) NLT3	D1	\$0
SRDFAR-N02	SRDFAR 1TB (15-25TB) NLT3	D1	\$0
SRDFAR-N03	SRDFAR 1TB (26-40TB) NLT3	D1	\$0
SRDFAR-N04	SRDFAR 1TB (41-60TB) NLT3	D1	\$0
SRDFAR-N05	SRDFAR 1TB (61-100TB) NLT3	D1	\$0
SRDFAR-N06	SRDFAR 1TB (101-150TB) NLT3	D1	\$0
SRDFAR-N07	SRDFAR 1TB (151-250TB) NLT3	D1	\$0
SRDFAR-N08	SRDFAR 1TB (251-400TB) NLT3	D1	\$0
SRDFAR-N09	SRDFAR 1TB (401-600TB) NLT3	D1	\$0
SRDFAR-N10	SRDFAR 1TB (601-1000TB) NLT3	D1	\$0
SRDFAR-N11	SRDFAR1TB(1001TB or greater) NLT3	D1	\$0
SRDFAR-OBAS	SRDFAR OPT OUT BASE LICENSE	D1	\$0
SRDFAR-OPT	SRDFAR OPT OUT TB	D1	\$0
SRDFAR-OUP	SRDFAR OPT OUT BASE UPGRADE	D1	\$0
SRDF-AR-R01	SRDFAR REPL 1TB (0-14TB)	D1	\$0
SRDF-AR-R02	SRDFAR REPL 1TB (15-25TB)	D1	\$0
SRDF-AR-R03	SRDFAR REPL 1TB (26-40TB)	D1	\$0
SRDF-AR-R04	SRDFAR REPL 1TB (41-60TB)	D1	\$0
SRDF-AR-R05	SRDFAR REPL 1TB (61-100TB)	D1	\$0
SRDF-AR-R06	SRDFAR REPL 1TB (101-150TB)	D1	\$0
SRDF-AR-R07	SRDFAR REPL 1TB (151-250TB)	D1	\$0
SRDF-AR-R08	SRDFAR REPL 1TB (251-400TB)	D1	\$0
SRDF-AR-R09	SRDFAR REPL 1TB (401-600TB)	D1	\$0
SRDF-AR-R10	SRDFAR REPL 1TB (601-1000TB)	D1	\$0
SRDF-AR-R11	SRDFAR REPL 1TB(1001TB or greater)	D1	\$0
SRDF-AR-RBAS	SRDFAR REPL BASE LICENSE	D1	\$0
SRDFAR-RN-ZOS	LIC FEAT CODE MF SRDFAR	D1	\$0
SRDF-AR-RUP	SRDFAR REPL BASE UPGRADE	D1	\$0
SRDFAR-T01	AUTO REPLI 0-.250	D1	\$0
SRDFAR-T02	AUTO REPLI .251-.500	D1	\$0

SRDFAR-T03	AUTO REPLI .501-.750	D1	\$0
SRDFAR-T04	AUTO REPLI .751-1.00	D1	\$0
SRDFAR-T05	AUTO REPLI 1.01-2.00	D1	\$0
SRDFAR-T06	AUTO REPLI 2.01-4.00	D1	\$0
SRDFAR-T07	AUTO REPLI 4.01-6.00	D1	\$0
SRDFAR-T08	AUTO REPLI 6.01-8.00	D1	\$0
SRDFAR-T09	AUTO REPLI 8.01-10.0	D1	\$0
SRDFAR-T10	AUTO REPLI 10.01-12.	D1	\$0
SRDFAR-T11	AUTO REPLI 12.01-14.	D1	\$0
SRDFAR-T12	AUTO REPLI 14.01-17.	D1	\$0
SRDFAR-T13	AUTO REPLI 17.01-20.00	D1	\$0
SRDFAR-T14	AUTO REPLI 20.01-23.00	D1	\$0
SRDFAR-T1-4U	AUTO REP T1-T4UPG	D1	\$0
SRDFAR-T15	AUTO REPLI 23.01-26.00	D1	\$0
SRDFAR-T16	AUTO REPLI 26.01-29.00	D1	\$0
SRDFAR-T17	AUTO REPLI 29.01-32.00	D1	\$0
SRDFAR-T18	AUTO REPLI 32.01-35.00	D1	\$0
SRDFAR-T19	AUTO REPLI 35.01-38.00	D1	\$0
SRDFAR-T20	AUTO REPLI 38.01-41.00	D1	\$0
SRDFAR-T21	AUTO REPLI 41.01-44.00	D1	\$0
SRDFAR-T22	AUTO REPLI 44.01-47.00	D1	\$0
SRDFAR-T23	AUTO REPLI 47.01-50.00	D1	\$0
SRDFAR-T24	AUTO REPLI 50.01-53.00	D1	\$0
SRDFAR-T25	AUTO REPLI 53.01-56.00	D1	\$0
SRDFAR-T26	AUTO REPLI 56.01-59.00	D1	\$0
SRDFAR-T27	AUTO REPLI 59.01-62.00	D1	\$0
SRDFAR-T28	AUTO REPLI 62.01-65.00	D1	\$0
SRDFAR-T29	AUTO REPLI 65.01-68.00	D1	\$0
SRDFAR-T30	AUTO REPLI 68.01-71.00	D1	\$0
SRDFAR-T31	AUTO REPLI 71.01-74.00	D1	\$0
SRDF-AR-T31	SRDF-AR CPCTY 71.01-74.00	D1	\$0
SRDFAR-T32	AUTO REPLI 74.01-77.00	D1	\$0
SRDF-AR-T32	SRDF-AR CPCTY 74.01-77.00	D1	\$0
SRDFAR-T33	AUTO REPLI 77.01-80.00	D1	\$0
SRDF-AR-T33	SRDF-AR CPCTY 77.01-80.00	D1	\$0
SRDFAR-T34	AUTO REPLI 80.01-83.00	D1	\$0
SRDF-AR-T34	SRDF-AR CPCTY 80.01-83.00	D1	\$0
SRDFAR-T35	AUTO REPLI 83.01-86.00	D1	\$0
SRDF-AR-T35	SRDF-AR CPCTY 83.01-86.00	D1	\$0
SRDFAR-T5-35U	AUTO REP T5-T35UPG	D1	\$0
SRDF-A-RUP	RMT ASYNC PROT-SRDF A CMPEXT-UPG REG	D1	\$0
SRDFAR-UPG	SRDFAR BASE UPGRADE	D1	\$0
SRDF-A-RUPL	SRDF-A LITE REPL BASE UPGRADE	D1	\$0
SRDF-A-T01	SRDF-A CTY 0-.250	D1	\$0
SRDF-A-T02	SRDF-A CTY .251-.500	D1	\$0
SRDF-A-T03	SRDF-A CTY .501-.750	D1	\$0
SRDF-A-T04	SRDF-A CTY .751-1.00	D1	\$0
SRDF-A-T05	SRDF-A CTY 1.01-2.00	D1	\$0
SRDF-A-T06	SRDF-A CTY 2.01-4.00	D1	\$0
SRDF-A-T07	SRDF-A CTY 4.01-6.00	D1	\$0

SRDF-A-T08	SRDF-A CTY 6.01-8.00	D1	\$0
SRDF-A-T09	SRDF-A CTY 8.01-10.00	D1	\$0
SRDF-A-T10	SRDF-A CTY 10.01-12.00	D1	\$0
SRDF-A-T11	SRDF-A CTY 12.01-14.00	D1	\$0
SRDF-A-T12	SRDF-A CTY 14.01-17.00	D1	\$0
SRDF-A-T13	SRDF-A CTY 17.01-20.00	D1	\$0
SRDF-A-T14	SRDF-A CTY 20.01-23.00	D1	\$0
SRDF-A-T15	SRDF-A CTY 23.01-26.00	D1	\$0
SRDF-A-T16	SRDF-A CTY26.01-29.00	D1	\$0
SRDF-A-T17	SRDF-A CTY 29.01-32.00	D1	\$0
SRDF-A-T18	SRDF-A CTY 32.01-35.00	D1	\$0
SRDF-A-T19	SRDF-A CTY 35.01-38.00	D1	\$0
SRDF-AT1-T4UP	SRDF-A T1-T4 UPGRADE	D1	\$0
SRDF-A-T20	SRDF-A CTY 38.01-41.00	D1	\$0
SRDF-A-T21	SRDF-A CTY 41.01-44.00	D1	\$0
SRDF-A-T22	SRDF-A CTY 44.01-47.00	D1	\$0
SRDF-A-T23	SRDF-A CTY47.01-50.00	D1	\$0
SRDF-A-T24	SRDF-A CTY 50.01-53.00	D1	\$0
SRDF-A-T25	SRDF-A CTY 53.01-56.00	D1	\$0
SRDF-A-T26	SRDF-A CTY56.01-59.00	D1	\$0
SRDF-A-T27	SRDF-A CTY 59.01-62.00	D1	\$0
SRDF-A-T28	SRDF-A CTY 62.01-65.00	D1	\$0
SRDF-A-T29	SRDF-A CTY 65.01-68.00	D1	\$0
SRDF-A-T30	SRDF-A CTY 68.01-71.00	D1	\$0
SRDF-A-T31	SRDF-A CPCTY 71.01-74.00	D1	\$0
SRDF-A-T32	SRDF-A CPCTY 74.01-77.00	D1	\$0
SRDF-A-T33	SRDF-A CPCTY 77.01-80.00	D1	\$0
SRDF-A-T34	SRDF-A CPCTY 80.01-83.00	D1	\$0
SRDF-A-T35	SRDF-A CPCTY 83.01-86.00	D1	\$0
SRDF-A-T5-35U	SRDF-A T5-T35 UPGRADE	D1	\$0
SRDF-A-UPG	RMT ASYNC PROT-SRDF A CMPEXT-UPG	D1	\$0
SRDF-A-UPGL	SRDF-A LITE BASE UPGRADE	D1	\$0
SRDF-CEM-BASE	SRDF-CEM BASE LICENSE	D1	\$0
SRDF-CEM-C01	SRDF-CEM 1TB (0-14TB)	D1	\$0
SRDF-CEM-C02	SRDF-CEM 1TB (15-25TB)	D1	\$0
SRDF-CEM-C03	SRDF-CEM 1TB (26-40TB)	D1	\$0
SRDF-CEM-C04	SRDF-CEM 1TB (41-60TB)	D1	\$0
SRDF-CEM-C05	SRDF-CEM 1TB (61-100TB)	D1	\$0
SRDF-CEM-C06	SRDF-CEM 1TB (101-150TB)	D1	\$0
SRDF-CEM-C07	SRDF-CEM 1TB (151-250TB)	D1	\$0
SRDF-CEM-C08	SRDF-CEM 1TB (251-400TB)	D1	\$0
SRDF-CEM-C09	SRDF-CEM 1TB (401-600TB)	D1	\$0
SRDF-CEM-C10	SRDF-CEM 1TB (601-1000TB)	D1	\$0
SRDF-CEM-C11	SRDF-CEM1TB(1001TB or greater)	D1	\$0
SRDF-CEM-N01	SRDF-CEM 1TB (0-14TB) NLT3	D1	\$0
SRDF-CEM-N02	SRDF-CEM 1TB (15-25TB) NLT3	D1	\$0
SRDF-CEM-N03	SRDF-CEM 1TB (26-40TB) NLT3	D1	\$0
SRDF-CEM-N04	SRDF-CEM 1TB (41-60TB) NLT3	D1	\$0
SRDF-CEM-N05	SRDF-CEM 1TB (61-100TB) NLT3	D1	\$0
SRDF-CEM-N06	SRDF-CEM 1TB (101-150TB) NLT3	D1	\$0

SRDF-CEM-N07	SRDF-CEM 1TB (151-250TB) NLT3	D1	\$0
SRDF-CEM-N08	SRDF-CEM 1TB (251-400TB) NLT3	D1	\$0
SRDF-CEM-N09	SRDF-CEM 1TB (401-600TB) NLT3	D1	\$0
SRDF-CEM-N10	SRDF-CEM 1TB (601-1000TB) NLT3	D1	\$0
SRDF-CEM-N11	SRDF-CEM1TB(1001TB or greater) NLT3	D1	\$0
SRDF-CEM-OBAS	SRDF-CEM OPT OUT BASE LICENSE	D1	\$0
SRDF-CEM-OPT	SRDF-CEM OPT OUT TB	D1	\$0
SRDF-CEM-OUP	SRDF-CEM OPT OUT BASE UPGRADE	D1	\$0
SRDF-CEM-R01	SRDF-CEM REPL 1TB (0-14TB)	D1	\$0
SRDF-CEM-R02	SRDF-CEM REPL 1TB (15-25TB)	D1	\$0
SRDF-CEM-R03	SRDF-CEM REPL 1TB (26-40TB)	D1	\$0
SRDF-CEM-R04	SRDF-CEM REPL 1TB (41-60TB)	D1	\$0
SRDF-CEM-R05	SRDF-CEM REPL 1TB (61-100TB)	D1	\$0
SRDF-CEM-R06	SRDF-CEM REPL 1TB (101-150TB)	D1	\$0
SRDF-CEM-R07	SRDF-CEM REPL 1TB (151-250TB)	D1	\$0
SRDF-CEM-R08	SRDF-CEM REPL 1TB (251-400TB)	D1	\$0
SRDF-CEM-R09	SRDF-CEM REPL 1TB (401-600TB)	D1	\$0
SRDF-CEM-R10	SRDF-CEM REPL 1TB (601-1000TB)	D1	\$0
SRDF-CEM-R11	SRDF-CEM REPL 1TB(1001TB or greater)	D1	\$0
SRDF-CEM-RBAS	SRDF-CEM REPL BASE LICENSE	D1	\$0
SRDF-CEM-RUP	SRDF-CEM REPL BASE UPGRADE	D1	\$0
SRDF-CEM-T01	SRDFCEM CPCTY 0-.250	D1	\$0
SRDF-CEM-T02	SRDFCEM CPCTY .251-.500	D1	\$0
SRDF-CEM-T03	SRDFCEM CPCTY .501-.750	D1	\$0
SRDF-CEM-T04	SRDFCEM CPCTY .751-1.00	D1	\$0
SRDF-CEM-T05	SRDFCEM CPCTY 1.01-2.00	D1	\$0
SRDF-CEM-T06	SRDFCEM CPCTY 2.01-4.00	D1	\$0
SRDF-CEM-T07	SRDFCEM CPCTY 4.01-6.00	D1	\$0
SRDF-CEM-T08	SRDFCEM CPCTY 6.01-8.00	D1	\$0
SRDF-CEM-T09	SRDFCEM CPCTY 8.01-10.00	D1	\$0
SRDF-CEM-T10	SRDFCEM CPCTY 10.01-12.00	D1	\$0
SRDF-CEM-T11	SRDFCEM CPCTY 12.01-14.00	D1	\$0
SRDF-CEM-T12	SRDFCEM CPCTY 14.01-17.00	D1	\$0
SRDF-CEM-T13	SRDFCEM CPCTY 17.01-20.00	D1	\$0
SRDF-CEM-T14	SRDFCEM CPCTY 20.01-23.00	D1	\$0
SRDF-CEM-T15	SRDFCEM CPCTY 23.01-26.00	D1	\$0
SRDF-CEM-T16	SRDFCEM CPCTY 26.01-29.00	D1	\$0
SRDF-CEM-T17	SRDFCEM CPCTY 29.01-32.00	D1	\$0
SRDF-CEM-T18	SRDFCEM CPCTY 32.01-35.00	D1	\$0
SRDF-CEM-T19	SRDFCEM CPCTY 35.01-38.00	D1	\$0
SRDF-CEM-T20	SRDFCEM CPCTY 38.01-41.00	D1	\$0
SRDF-CEM-T21	SRDFCEM CPCTY 41.01-44.00	D1	\$0
SRDF-CEM-T22	SRDFCEM CPCTY 44.01-47.00	D1	\$0
SRDF-CEM-T23	SRDFCEM CPCTY 47.01-50.00	D1	\$0
SRDF-CEM-T24	SRDFCEM CPCTY 50.01-53.00	D1	\$0
SRDF-CEM-T25	SRDFCEM CPCTY 53.01-56.00	D1	\$0
SRDF-CEM-T26	SRDFCEM CPCTY 56.01-59.00	D1	\$0
SRDF-CEM-T27	SRDFCEM CPCTY 59.01-62.00	D1	\$0
SRDF-CEM-T28	SRDFCEM CPCTY 62.01-65.00	D1	\$0
SRDF-CEM-T29	SRDFCEM CPCTY 65.01-68.00	D1	\$0

SRDF-CEM-T30	SRDFCEM CPCTY 68.01-71.00	D1	\$0
SRDF-CEM-T31	SRDFCEM CPCTY 71.01-74.00	D1	\$0
SRDF-CEM-T32	SRDFCEM CPCTY 74.01-77.00	D1	\$0
SRDF-CEM-T33	SRDFCEM CPCTY 77.01-80.00	D1	\$0
SRDF-CEM-T34	SRDFCEM CPCTY 80.01-83.00	D1	\$0
SRDF-CEM-T35	SRDFCEM CPCTY 83.01-86.00	D1	\$0
SRDF-CEM-UPG	SRDF-CEM BASE UPGRADE	D1	\$0
SRDF-CG-BASE	SRDF-CG BASE LICENSE	D1	\$0
SRDF-CG-C01	SRDF-CG 1TB (0-14TB)	D1	\$0
SRDF-CG-C02	SRDF-CG 1TB (15-25TB)	D1	\$0
SRDF-CG-C03	SRDF-CG 1TB (26-40TB)	D1	\$0
SRDF-CG-C04	SRDF-CG 1TB (41-60TB)	D1	\$0
SRDF-CG-C05	SRDF-CG 1TB (61-100TB)	D1	\$0
SRDF-CG-C06	SRDF-CG 1TB (101-150TB)	D1	\$0
SRDF-CG-C07	SRDF-CG 1TB (151-250TB)	D1	\$0
SRDF-CG-C08	SRDF-CG 1TB (251-400TB)	D1	\$0
SRDF-CG-C09	SRDF-CG 1TB (401-600TB)	D1	\$0
SRDF-CG-C10	SRDF-CG 1TB (601-1000TB)	D1	\$0
SRDF-CG-C11	SRDF-CG1TB(1001TB or greater)	D1	\$0
SRDF-CG-N01	SRDF-CG 1TB (0-14TB) NLT3	D1	\$0
SRDF-CG-N02	SRDF-CG 1TB (15-25TB) NLT3	D1	\$0
SRDF-CG-N03	SRDF-CG 1TB (26-40TB) NLT3	D1	\$0
SRDF-CG-N04	SRDF-CG 1TB (41-60TB) NLT3	D1	\$0
SRDF-CG-N05	SRDF-CG 1TB (61-100TB) NLT3	D1	\$0
SRDF-CG-N06	SRDF-CG 1TB (101-150TB) NLT3	D1	\$0
SRDF-CG-N07	SRDF-CG 1TB (151-250TB) NLT3	D1	\$0
SRDF-CG-N08	SRDF-CG 1TB (251-400TB) NLT3	D1	\$0
SRDF-CG-N09	SRDF-CG 1TB (401-600TB) NLT3	D1	\$0
SRDF-CG-N10	SRDF-CG 1TB (601-1000TB) NLT3	D1	\$0
SRDF-CG-N11	SRDF-CG1TB(1001TB or greater) NLT3	D1	\$0
SRDF-CG-OBAS	SRDF-CG OPT OUT BASE LICENSE	D1	\$0
SRDF-CG-OPT	SRDF-CG OPT OUT TB	D1	\$0
SRDF-CG-OUP	SRDF-CG OPT OUT BASE UPGRADE	D1	\$0
SRDF-CG-R01	SRDF-CG REPL 1TB (0-14TB)	D1	\$0
SRDF-CG-R02	SRDF-CG REPL 1TB (15-25TB)	D1	\$0
SRDF-CG-R03	SRDF-CG REPL 1TB (26-40TB)	D1	\$0
SRDF-CG-R04	SRDF-CG REPL 1TB (41-60TB)	D1	\$0
SRDF-CG-R05	SRDF-CG REPL 1TB (61-100TB)	D1	\$0
SRDF-CG-R06	SRDF-CG REPL 1TB (101-150TB)	D1	\$0
SRDF-CG-R07	SRDF-CG REPL 1TB (151-250TB)	D1	\$0
SRDF-CG-R08	SRDF-CG REPL 1TB (251-400TB)	D1	\$0
SRDF-CG-R09	SRDF-CG REPL 1TB (401-600TB)	D1	\$0
SRDF-CG-R10	SRDF-CG REPL 1TB (601-1000TB)	D1	\$0
SRDF-CG-R11	SRDF-CG REPL 1TB(1001TB or greater)	D1	\$0
SRDF-CG-RBAS	SRDF-CG REPL BASE LICENS	D1	\$0
SRDF-CG-RUP	SRDF-CG REPL BASE UPGRADE	D1	\$0
SRDFCG-T01	SRDFCG CAPACITY 0-.250	D1	\$0
SRDFCG-T02	SRDFCG CAPACITY .251-.500	D1	\$0
SRDFCG-T03	SRDFCG CAPACITY .501-.750	D1	\$0
SRDFCG-T04	SRDFCG CAPACITY .751-1.00	D1	\$0

SRDFCG-T05	SRDFCG CAPACITY 1.01-2.00	D1	\$0
SRDFCG-T06	SRDFCG CAPACITY 2.01-4.00	D1	\$0
SRDFCG-T07	SRDFCG CAPACTY 4.01-6.00	D1	\$0
SRDFCG-T08	SRDFCG CAPACITY 6.01-8.00	D1	\$0
SRDFCG-T09	SRDFCG CAPACITY 8.01-10.0	D1	\$0
SRDFCG-T10	SRDFCG CAPACITY 10.01-12.	D1	\$0
SRDFCG-T11	SRDFCG CAPACITY 12.01-14.	D1	\$0
SRDFCG-T12	SRDFCG CAPACITY 14.01-17.	D1	\$0
SRDFCG-T13	SRDFCG CPCTY 17.01-20.00	D1	\$0
SRDFCG-T14	SRDFCG CPCTY 20.01-23.00	D1	\$0
SRDFCG-T1-4U	SRDFCG T1-T4 UPGRADE	D1	\$0
SRDFCG-T15	SRDFCG CPCTY 23.01-26.00	D1	\$0
SRDFCG-T16	SRDFCG CPCTY 26.01-29.00	D1	\$0
SRDFCG-T17	SRDFCG CPCTY 29.01-32.00	D1	\$0
SRDFCG-T18	SRDFCG CPCTY 32.01-35.00	D1	\$0
SRDFCG-T19	SRDFCG CPCTY 35.01-38.00	D1	\$0
SRDFCG-T20	SRDFCG CPCTY 38.01-41.00	D1	\$0
SRDFCG-T21	SRDFCG CPCTY 41.01-44.00	D1	\$0
SRDFCG-T22	SRDFCG CPCTY 44.01-47.00	D1	\$0
SRDFCG-T23	SRDFCG CPCTY 47.01-50.00	D1	\$0
SRDFCG-T24	SRDFCG CPCTY 50.01-53.00	D1	\$0
SRDFCG-T25	SRDFCG CPCTY 53.01-56.00	D1	\$0
SRDFCG-T26	SRDFCG CPCTY 56.01-59.00	D1	\$0
SRDFCG-T27	SRDFCG CPCTY 59.01-62.00	D1	\$0
SRDFCG-T28	SRDFCG CPCTY 62.01-65.00	D1	\$0
SRDFCG-T29	SRDFCG CPCTY 65.01-68.00	D1	\$0
SRDFCG-T30	SRDFCG CPCTY 68.01-71.00	D1	\$0
SRDFCG-T31	SRDFCG CPCTY 71.01-74.00	D1	\$0
SRDFCG-T32	SRDFCG CPCTY 74.01-77.00	D1	\$0
SRDFCG-T33	SRDFCG CPCTY 77.01-80.00	D1	\$0
SRDFCG-T34	SRDFCG CPCTY 80.01-83.00	D1	\$0
SRDFCG-T35	SRDFCG CPCTY 83.01-86.00	D1	\$0
SRDFCG-T5-35U	SRDFCG T5-T35 UPGRADE	D1	\$0
SRDF-CG-UPG	SRDF-CG BASE UPGRADE	D1	\$0
SRDFCM-T1-4U	SRDFCEM T1-T4 UPGRADE	D1	\$0
SRDFCM-T5-35U	SRDFCEM T5-T35 UPGR	D1	\$0
SRDF-CR-BASE	CASCADED SRDF BASE LICENSE	D1	\$0
SRDF-CR-C01	CASCADED SRDF 1TB (0-14TB)	D1	\$0
SRDF-CR-C02	CASCADED SRDF 1TB (15-25TB)	D1	\$0
SRDF-CR-C03	CASCADED SRDF 1TB (26-40TB)	D1	\$0
SRDF-CR-C04	CASCADED SRDF 1TB (41-60TB)	D1	\$0
SRDF-CR-C05	CASCADED SRDF 1TB (61-100TB)	D1	\$0
SRDF-CR-C06	CASCADED SRDF 1TB (101-150TB)	D1	\$0
SRDF-CR-C07	CASCADED SRDF 1TB (151-250TB)	D1	\$0
SRDF-CR-C08	CASCADED SRDF 1TB (251-400TB)	D1	\$0
SRDF-CR-C09	CASCADED SRDF 1TB (401-600TB)	D1	\$0
SRDF-CR-C10	CASCADED SRDF 1TB (601-1000TB)	D1	\$0
SRDF-CR-C11	CASCADED SRDF 1TB(1001-1500TB)	D1	\$0
SRDF-CR-N01	CASCADED SRDF 1TB(0-14TB) NLT3	D1	\$0
SRDF-CR-N02	CASCADED SRDF 1TB(15-25TB) NLT3	D1	\$0

SRDF-CR-N03	CASCADED SRDF 1TB(26-40TB) NLT3	D1	\$0
SRDF-CR-N04	CASCADED SRDF 1TB(41-60TB) NLT3	D1	\$0
SRDF-CR-N05	CASCADED SRDF 1TB(61-100TB) NLT3	D1	\$0
SRDF-CR-N06	CASCADED SRDF 1TB(101-150TB) NLT3	D1	\$0
SRDF-CR-N07	CASCADED SRDF 1TB(151-250TB) NLT3	D1	\$0
SRDF-CR-N08	CASCADED SRDF 1TB(251-400TB) NLT3	D1	\$0
SRDF-CR-N09	CASCADED SRDF 1TB(401-600TB) NLT3	D1	\$0
SRDF-CR-N10	CASCADED SRDF 1TB(601-1000TB) NLT3	D1	\$0
SRDF-CR-N11	CASCADED SRDF 1TB(1001-1500TB) NLT3	D1	\$0
SRDF-CR-OPN	RT FOR CASCADED SRDF OPEN SYSTEMS	D1	\$0
SRDF-CR-R01	CASCADED SRDF REPL 1TB (0-14TB)	D1	\$0
SRDF-CR-R02	CASCADED SRDF REPL 1TB (15-25TB)	D1	\$0
SRDF-CR-R03	CASCADED SRDF REPL 1TB (26-40TB)	D1	\$0
SRDF-CR-R04	CASCADED SRDF REPL 1TB (41-60TB)	D1	\$0
SRDF-CR-R05	CASCADED SRDF REPL 1TB (61-100TB)	D1	\$0
SRDF-CR-R06	CASCADED SRDF REPL 1TB (101-150TB)	D1	\$0
SRDF-CR-R07	CASCADED SRDF REPL 1TB (151-250TB)	D1	\$0
SRDF-CR-R08	CASCADED SRDF REPL 1TB (251-400TB)	D1	\$0
SRDF-CR-R09	CASCADED SRDF REPL 1TB (401-600TB)	D1	\$0
SRDF-CR-R10	CASCADED SRDF REPL 1TB (601-1000TB)	D1	\$0
SRDF-CR-R11	CASCADED SRDF REPL 1TB(1001-1500TB)	D1	\$0
SRDF-CR-RBAS	CASCADED SRDF REPL BASE LICENSE	D1	\$0
SRDF-CR-RUP	CASCADED SRDF REPL BASE UPGRADE	D1	\$0
SRDF-CR-UPG	CASCADED SRDF BASE UPGRADE	D1	\$0
SRDF-CR-ZOS	RT FOR CASCADED SRDF MAINFRAME	D1	\$0
SRDFCV-T1-4U	SRDFCEV T5-T35 UPGRADE	D1	\$0
SRDFCV-T5-35U	SRDFCEV T5-T35 UPGR	D1	\$0
SRDF-DM-BASE	SRDF-DM BASE LICENSE	D1	\$0
SRDF-DM-C01	SRDF-DM 1TB (0-14TB)	D1	\$0
SRDF-DM-C02	SRDF-DM 1TB (15-25TB)	D1	\$0
SRDF-DM-C03	SRDF-DM 1TB (26-40TB)	D1	\$0
SRDF-DM-C04	SRDF-DM 1TB (41-60TB)	D1	\$0
SRDF-DM-C05	SRDF-DM 1TB (61-100TB)	D1	\$0
SRDF-DM-C06	SRDF-DM 1TB (101-150TB)	D1	\$0
SRDF-DM-C07	SRDF-DM 1TB (151-250TB)	D1	\$0
SRDF-DM-C08	SRDF-DM 1TB (251-400TB)	D1	\$0
SRDF-DM-C09	SRDF-DM 1TB (401-600TB)	D1	\$0
SRDF-DM-C10	SRDF-DM 1TB (601-1000TB)	D1	\$0
SRDF-DM-C11	SRDF-DM1TB(1001TB or greater)	D1	\$0
SRDF-DM-N01	SRDF-DM 1TB (0-14TB) NLT3	D1	\$0
SRDF-DM-N02	SRDF-DM 1TB (15-25TB) NLT3	D1	\$0
SRDF-DM-N03	SRDF-DM 1TB (26-40TB) NLT3	D1	\$0
SRDF-DM-N04	SRDF-DM 1TB (26-40TB) NLT3	D1	\$0
SRDF-DM-N05	SRDF-DM 1TB (61-100TB) NLT3	D1	\$0
SRDF-DM-N06	SRDF-DM 1TB (101-150TB) NLT3	D1	\$0
SRDF-DM-N07	SRDF-DM 1TB (151-250TB) NLT3	D1	\$0
SRDF-DM-N08	SRDF-DM 1TB (251-400TB) NLT3	D1	\$0
SRDF-DM-N09	SRDF-DM 1TB (401-600TB) NLT3	D1	\$0
SRDF-DM-N10	SRDF-DM 1TB (601-1000TB) NLT3	D1	\$0
SRDF-DM-N11	SRDF-DM1TB(1001TB or greater) NLT3	D1	\$0

SRDF-DM-OBAS	SRDF-DM OPT OUT BASE LICENSE	D1	\$0
SRDF-DM-OPT	SRDF-DM OPT OUT TB	D1	\$0
SRDF-DM-OUP	SRDF-DM OPT OUT BASE UPGRADE	D1	\$0
SRDF-DM-R01	SRDF-DM REPL 1TB (0-14TB)	D1	\$0
SRDF-DM-R02	SRDF-DM REPL 1TB (15-25TB)	D1	\$0
SRDF-DM-R03	SRDF-DM REPL 1TB (26-40TB)	D1	\$0
SRDF-DM-R04	SRDF-DM REPL 1TB (41-60TB)	D1	\$0
SRDF-DM-R05	SRDF-DM REPL 1TB (61-100TB)	D1	\$0
SRDF-DM-R06	SRDF-DM REPL 1TB (101-150TB)	D1	\$0
SRDF-DM-R07	SRDF-DM REPL 1TB (151-250TB)	D1	\$0
SRDF-DM-R08	SRDF-DM REPL 1TB (251-400TB)	D1	\$0
SRDF-DM-R09	SRDF-DM REPL 1TB (401-600TB)	D1	\$0
SRDF-DM-R10	SRDF-DM REPL 1TB (601-1000TB)	D1	\$0
SRDF-DM-R11	SRDF-DM REPL 1TB (1001TB or greater)	D1	\$0
SRDF-DM-RBAS	SRDF-DM REPL BASE LICENSE	D1	\$0
SRDF-DM-RUP	SRDF-DM REPL BASE UPGRADE	D1	\$0
SRDF-DM-T1	DM CPCTY 0-.250	D1	\$0
SRDF-DM-T10	DM CPCTY 10.01-12.00	D1	\$0
SRDF-DM-T11	DM CPCTY 12.01-14.00	D1	\$0
SRDF-DM-T12	DM CPCTY 14.01-17.00	D1	\$0
SRDF-DM-T13	DM CPCTY 17.01-20.00	D1	\$0
SRDF-DM-T14	DM CPCTY 20.01-23.00	D1	\$0
SRDF-DM-T15	DM CPCTY 23.01-26.00	D1	\$0
SRDF-DM-T16	DM CPCTY 26.01-29.00	D1	\$0
SRDF-DM-T17	DM CPCTY 29.01-32.00	D1	\$0
SRDF-DM-T18	DM CPCTY 32.01-35.00	D1	\$0
SRDF-DM-T19	DM CPCTY 35.01-38.00	D1	\$0
SRDF-DM-T2	DM CPCTY .251-.500	D1	\$0
SRDF-DM-T20	DM CPCTY 38.01-41.00	D1	\$0
SRDF-DM-T21	DM CPCTY 41.01-44.00	D1	\$0
SRDF-DM-T22	DM CPCTY 44.01-47.00	D1	\$0
SRDF-DM-T23	DM CPCTY 47.01-50.00	D1	\$0
SRDF-DM-T24	DM CPCTY 50.01-53.00	D1	\$0
SRDF-DM-T25	DM CPCTY 53.01-56.00	D1	\$0
SRDF-DM-T26	DM CPCTY 56.01-59.00	D1	\$0
SRDF-DM-T27	DM CPCTY 59.01-62.00	D1	\$0
SRDF-DM-T28	DM CPCTY 62.01-65.00	D1	\$0
SRDF-DM-T29	DM CPCTY 65.01-68.00	D1	\$0
SRDF-DM-T3	DM CPCTY .501-.750	D1	\$0
SRDF-DM-T30	DM CPCTY 68.01-71.00	D1	\$0
SRDF-DM-T31	SRDF-DM CPCTY 71.01-74.00	D1	\$0
SRDF-DM-T32	SRDF-DM CPCTY 74.01-77.00	D1	\$0
SRDF-DM-T33	SRDF-DM CPCTY 77.01-80.00	D1	\$0
SRDF-DM-T34	SRDF-DM CPCTY 80.01-83.00	D1	\$0
SRDF-DM-T35	SRDF-DM CPCTY 83.01-86.00	D1	\$0
SRDF-DM-T4	DM CPCTY .751-1.00	D1	\$0
SRDF-DM-T5	DM CPCTY 1.01-2.00	D1	\$0
SRDF-DM-T6	DM CPCTY 2.01-4.00	D1	\$0
SRDF-DM-T7	DM CPCTY 4.01-6.00	D1	\$0
SRDF-DM-T8	DM CPCTY 6.01-8.00	D1	\$0

SRDF-DM-T9	DM CPCTY 8.01-10.00	D1	\$0
SRDF-DM-UPG	SRDF-DM BASE UPGRADE	D1	\$0
SRDF-EDP-OBAS	SRDF-EDP OPT OUT BASE LICENSE	D1	\$0
SRDF-EDP-OPT	SRDF-EDP OPT OUT TB	D1	\$0
SRDF-EDP-OUP	SRDF-EDP OPT OUT BASE UPGRADE	D1	\$0
SRDF-HP-MC	SRDF HP METRO CLUST 3X	D1	\$0
SRDF-RUN-AS4	SRDF AS4 RUNTIME NO CHRG	D1	\$0
SRDF-RUN-MFCG	SRDF MFCG RUNTIME NO CHRG	D1	\$0
SRDF-RUN-OPEN	SRDF OPEN RUNTIME NO CHRG	D1	\$0
SRDF-RUN-S390	SRDF S390 RUNTIME NO CHRG	D1	\$0
SRDF-RUN-TPF	SRDF TPF RUNTIME NO CHRG	D1	\$0
SRDF-RUN-VOS	SRDF VOS RUNTIME NO CHRG	D1	\$0
SRDFSADD-BASE	RMT SYNC-ADD ON-SRDFS CMPPEER-BASE	D1	\$0
SRDFS-ADD-C01	RMT SYNC-ADD-SRDFSCMPPEER NONSATA 0-1	D1	\$0
SRDFS-ADD-C02	RMT SYNC-ADD-SRDFSCMPPEER NONSATA 15-	D1	\$0
SRDFS-ADD-C03	RMT SYNC-ADD-SRDFSCMPPEER NONSATA 26-	D1	\$0
SRDFS-ADD-C04	RMT SYNC-ADD-SRDFSCMPPEER NONSATA 41-	D1	\$0
SRDFS-ADD-C05	RMT SYNC-ADD-SRDFSCMPPEER NONSATA61-1	D1	\$0
SRDFS-ADD-C06	RMT SYNC-ADD-SRDFSCMPPEER NOSATA101-1	D1	\$0
SRDFS-ADD-C07	RMT SYNC-ADD-SRDFSCMPPEER NOSATA151-2	D1	\$0
SRDFS-ADD-C08	RMT SYNC-ADD-SRDFSCMPPEER NOSATA251-4	D1	\$0
SRDFS-ADD-C09	RMT SYNC-ADD-SRDFSCMPPEER NOSATA401-6	D1	\$0
SRDFS-ADD-C10	RMT SYNC-ADD-SRDFSCMPPEER NOSATA601-1	D1	\$0
SRDFS-ADD-C11	RMT SYNC-ADD-SRDFSCMPPEER NONSATA100	D1	\$0
SRDFS-ADD-N01	RMT SYNC-ADD-SRDFS CMPPEER SATA 0-14 TB	D1	\$0
SRDFS-ADD-N02	RMT SYNC-ADD-SRDFS CMPPEER SATA 15-25 T	D1	\$0
SRDFS-ADD-N03	RMT SYNC-ADD-SRDFS CMPPEER SATA 26-40 T	D1	\$0
SRDFS-ADD-N04	RMT SYNC-ADD-SRDFS CMPPEER SATA 41-60 T	D1	\$0
SRDFS-ADD-N05	RMT SYNC-ADD-SRDFS CMPPEER SATA 61-100	D1	\$0
SRDFS-ADD-N06	RMT SYNC-ADD-SRDFS CMPPEER SATA 101-150	D1	\$0
SRDFS-ADD-N07	RMT SYNC-ADD-SRDFS CMPPEER SATA 151-250	D1	\$0
SRDFS-ADD-N08	RMT SYNC-ADD-SRDFS CMPPEER SATA 251-400	D1	\$0
SRDFS-ADD-N09	RMT SYNC-ADD-SRDFS CMPPEER SATA 401-600	D1	\$0
SRDFS-ADD-N10	RMT SYNC-ADD-SRDFS CMPPEER SATA 601-100	D1	\$0
SRDFS-ADD-N11	RMT SYNC-ADD-SRDFS CMPPEER SATA1001+ T	D1	\$0
SRDFSADD-OBAS	RMT SYNC-ADD-OPT OUT-SRDFS CMPPEER-BA	D1	\$0
SRDFS-ADD-OPT	RMT SYNC-ADD-OPT OUT-SRDFS CMPPEER-UP	D1	\$0
SRDFSADD-OUP	RMT SYNC-ADD-OPT OUT-SRDFSCMPPEERSAT	D1	\$0
SRDFS-ADD-T01	SRDFS ADD 0-.250 TB	D1	\$0
SRDFS-ADD-T02	SRDFS ADD .251-.500 TB	D1	\$0
SRDFS-ADD-T03	SRDFS ADD .501-.750 TB	D1	\$0
SRDFS-ADD-T04	SRDFS ADD .751-1.00 TB	D1	\$0
SRDFS-ADD-T05	SRDFS ADD 1.01-2.00 TB	D1	\$0
SRDFS-ADD-T06	SRDFS ADD 2.01-4.00 TB	D1	\$0
SRDFS-ADD-T07	SRDFS ADD 4.01-6.00 TB	D1	\$0
SRDFS-ADD-T08	SRDFS ADD 6.01-8.00 TB	D1	\$0
SRDFS-ADD-T09	SRDFS ADD 8.01-10.00 TB	D1	\$0
SRDFS-ADD-T10	SRDFS ADD 10.01-12.00 TB	D1	\$0
SRDFS-ADD-T11	SRDFS ADD 12.01-14.00 TB	D1	\$0
SRDFS-ADD-T12	SRDFS ADD 14.01-17.00 TB	D1	\$0

SRDFS-ADD-T13	SRDFS ADD 17.01-20.00 TB	D1	\$0
SRDFS-ADD-T14	SRDFS ADD 20.01-23.00 TB	D1	\$0
SRDFS-ADD-T15	SRDFS ADD 23.01-26.00 TB	D1	\$0
SRDFS-ADD-T16	SRDFS ADD 26.01-29.00 TB	D1	\$0
SRDFS-ADD-T17	SRDFS ADD 29.01-32.00 TB	D1	\$0
SRDFS-ADD-T18	SRDFS ADD 32.01-35.00 TB	D1	\$0
SRDFS-ADD-T19	SRDFS ADD 35.01-38.00 TB	D1	\$0
SRDFS-ADD-T20	SRDFS ADD 38.01-41.00 TB	D1	\$0
SRDFS-ADD-T21	SRDFS ADD 41.01-44.00 TB	D1	\$0
SRDFS-ADD-T22	SRDFS ADD 44.01-47.00 TB	D1	\$0
SRDFS-ADD-T23	SRDFS ADD 47.01-50.00 TB	D1	\$0
SRDFS-ADD-T24	SRDFS ADD 50.01-53.00 TB	D1	\$0
SRDFS-ADD-T25	SRDFS ADD 53.01-56.00 TB	D1	\$0
SRDFS-ADD-T26	SRDFS ADD 56.01-59.00 TB	D1	\$0
SRDFS-ADD-T27	SRDFS ADD 59.01-62.00 TB	D1	\$0
SRDFS-ADD-T28	SRDFS ADD 62.01-65.00 TB	D1	\$0
SRDFS-ADD-T29	SRDFS ADD 65.01-68.00 TB	D1	\$0
SRDFS-ADD-T30	SRDFS ADD 68.01-71.00 TB	D1	\$0
SRDFS-ADD-T31	SRDFS ADD 71.01-74.00 TB	D1	\$0
SRDFS-ADD-T32	SRDFS ADD 74.01-77.00 TB	D1	\$0
SRDFS-ADD-T33	SRDFS ADD 77.01-80.00 TB	D1	\$0
SRDFS-ADD-T34	SRDFS ADD 80.01-83.00 TB	D1	\$0
SRDFS-ADD-T35	SRDFS ADD 83.01-86.00 TB	D1	\$0
SRDFSADD-UPG	RMT SYNC-ADD ON-SRDFS CMPPEER-UPG	D1	\$0
SRDFS-ADT1-4U	SRDFS ADD T1-T4 UPG	D1	\$3,740
SRDFS-ADT5-35	SRDFS ADD T5-35 UPG	D1	\$7,720
SRDF-S-BASE	RMT SYNC PROT-SRDFS CMPPEER-BASE	D1	\$20,760
SRDF-S-BASEF	SRDF-S FENB BASE LICENSE	D1	\$17,640
SRDF-S-BASEL	SRDF-S LITE BASE LICENSE	D1	\$3,120
SRDF-S-C01	RMT SYNC-SRDFS CMPPEER NON-SATA 0-14 TB	D1	\$4,380
SRDF-S-C02	RMT SYNC-SRDFS CMPPEER NON-SATA 15-25 TB	D1	\$4,120
SRDF-S-C03	RMT SYNC-SRDFS CMPPEER NON-SATA 26-40 TB	D1	\$3,630
SRDF-S-C04	RMT SYNC-SRDFS CMPPEER NON-SATA 41-60 TB	D1	\$3,240
SRDF-S-C05	RMT SYNC-SRDFS CMPPEER NON-SATA 61-100 TB	D1	\$2,890
SRDF-S-C06	RMT SYNC-SRDFS CMPPEER NON-SATA 101-150 TB	D1	\$2,560
SRDF-S-C07	RMT SYNC-SRDFS CMPPEER NON-SATA 151-250 TB	D1	\$2,200
SRDF-S-C08	RMT SYNC-SRDFS CMPPEER NON-SATA 251-400 TB	D1	\$1,880
SRDF-S-C09	RMT SYNC-SRDFS CMPPEER NON-SATA 401-600 TB	D1	\$1,620
SRDF-S-C10	RMT SYNC-SRDFS CMPPEER NON-SATA 601-1000 TB	D1	\$1,390
SRDF-S-C11	RMT SYNC-SRDFS CMPPEER NON-SATA 1001+ TB	D1	\$1,190
SRDF-S-CF01	SRDF-S FENB 1TB (0-14TB)	D1	\$3,720
SRDF-S-CF02	SRDF-S FENB 1TB (15-25TB)	D1	\$3,500
SRDF-S-CF03	SRDF-S FENB 1TB (26-40TB)	D1	\$3,080
SRDF-S-CF04	SRDF-S FENB 1TB (41-60TB)	D1	\$2,750
SRDF-S-CF05	SRDF-S FENB 1TB (61-100TB)	D1	\$2,450
SRDF-S-CF06	SRDF-S FENB 1TB (101-150TB)	D1	\$2,170
SRDF-S-CF07	SRDF-S FENB 1TB (151-250TB)	D1	\$1,870
SRDF-S-CF08	SRDF-S FENB 1TB (251-400TB)	D1	\$1,590
SRDF-S-CF09	SRDF-S FENB 1TB (401-600TB)	D1	\$1,370
SRDF-S-CF10	SRDF-S FENB 1TB (601-1000TB)	D1	\$1,180

SRDF-S-CF11	SRDF-S FENB 1TB(1001TB OR GREATER)	D1	\$1,010
SRDF-S-CL01	SRDF-S LITE 1TB (0-14TB)	D1	\$660
SRDF-S-CL02	SRDF-S LITE 1TB (15-25TB)	D1	\$620
SRDF-S-CL03	SRDF-S LITE 1TB (26-40TB)	D1	\$550
SRDF-S-CL04	SRDF-S LITE 1TB (41-60TB)	D1	\$490
SRDF-S-CL05	SRDF-S LITE 1TB (61-100TB)	D1	\$440
SRDF-S-CL06	SRDF-S LITE 1TB (101-150TB)	D1	\$390
SRDF-S-CL07	SRDF-S LITE 1TB (151-250TB)	D1	\$330
SRDF-S-CL08	SRDF-S LITE 1TB (251-400TB)	D1	\$290
SRDF-S-CL09	SRDF-S LITE 1TB (401-600TB)	D1	\$250
SRDF-S-CL10	SRDF-S LITE 1TB (601-1000TB)	D1	\$210
SRDF-S-CL11	SRDF-S LITE 1TB(1001TB OR GREATER)	D1	\$180
SRDF-S-N01	RMT SYNC-SRDFS CMPPEER SATA 0-14 TB	D1	\$2,190
SRDF-S-N02	RMT SYNC-SRDFS CMPPEER SATA 15-25 TB	D1	\$2,060
SRDF-S-N03	RMT SYNC-SRDFS CMPPEER SATA 26-40 TB	D1	\$1,810
SRDF-S-N04	RMT SYNC-SRDFS CMPPEER SATA 41-60 TB	D1	\$1,620
SRDF-S-N05	RMT SYNC-SRDFS CMPPEER SATA 61-100 TB	D1	\$1,450
SRDF-S-N06	RMT SYNC-SRDFS CMPPEER SATA 101-150 TB	D1	\$1,280
SRDF-S-N07	RMT SYNC-SRDFS CMPPEER SATA 151-250 TB	D1	\$1,100
SRDF-S-N08	RMT SYNC-SRDFS CMPPEER SATA 251-400 TB	D1	\$940
SRDF-S-N09	RMT SYNC-SRDFS CMPPEER SATA 401-600 TB	D1	\$810
SRDF-S-N10	RMT SYNC-SRDFS CMPPEER SATA 601-1000 TB	D1	\$690
SRDF-S-N11	RMT SYNC-SRDFS CMPPEER SATA 1001+ TB	D1	\$600
SRDF-S-NF01	SRDF-S FENB 1TB (0-14TB) NLT3	D1	\$1,860
SRDF-S-NF02	SRDF-S FENB 1TB (15-25TB) NLT3	D1	\$1,750
SRDF-S-NF03	SRDF-S FENB 1TB (26-40TB) NLT3	D1	\$1,530
SRDF-S-NF04	SRDF-S FENB 1TB (41-60TB) NLT3	D1	\$1,370
SRDF-S-NF05	SRDF-S FENB 1TB (61-100TB) NLT3	D1	\$1,230
SRDF-S-NF06	SRDF-S FENB 1TB (101-150TB) NLT3	D1	\$1,080
SRDF-S-NF07	SRDF-S FENB 1TB (151-250TB) NLT3	D1	\$930
SRDF-S-NF08	SRDF-S FENB 1TB (251-400TB) NLT3	D1	\$790
SRDF-S-NF09	SRDF-S FENB 1TB (401-600TB) NLT3	D1	\$680
SRDF-S-NF10	SRDF-S FENB 1TB (601-1000TB) NLT3	D1	\$580
SRDF-S-NF11	SRDF-S FENB 1TB(1001TB OR GREATER) NLT3	D1	\$510
SRDF-S-NL01	SRDF-S LITE 1TB (0-14TB) NLT3	D1	\$330
SRDF-S-NL02	SRDF-S LITE 1TB (15-25TB) NLT3	D1	\$310
SRDF-S-NL03	SRDF-S LITE 1TB (26-40TB) NLT3	D1	\$280
SRDF-S-NL04	SRDF-S LITE 1TB (41-60TB) NLT3	D1	\$250
SRDF-S-NL05	SRDF-S LITE 1TB (61-100TB) NLT3	D1	\$220
SRDF-S-NL06	SRDF-S LITE 1TB (101-150TB) NLT3	D1	\$200
SRDF-S-NL07	SRDF-S LITE 1TB (151-250TB) NLT3	D1	\$170
SRDF-S-NL08	SRDF-S LITE 1TB (251-400TB) NLT3	D1	\$150
SRDF-S-NL09	SRDF-S LITE 1TB (401-600TB) NLT3	D1	\$130
SRDF-S-NL10	SRDF-S LITE 1TB (601-1000TB) NLT3	D1	\$110
SRDF-S-NL11	SRDF-S LITE 1TB(1001TB OR GREATER) NLT3	D1	\$90
SRDF-S-OBAS	RMT SYNC-OPT OUT-SRDFS CMPPEER-BASE	D1	\$0
SRDF-S-OPT	RMT SYNC-OPT OUT-SRDFS CMPPEER-UPG	D1	\$0
SRDF-S-OUP	RMT SYNC-SATA-OPTOUT-TR-SRDFS CMPPEER	D1	\$0
SRDF-S-R01	RMT SYNC-SRDFS CMPPEER REG 0-14 TB	D1	\$4,395
SRDF-S-R02	RMT SYNC-SRDFS CMPPEER REG 15-25 TB	D1	\$3,647

SRDF-S-R03	RMT SYNC-SRDFS CMPPEER REG 26-40 TB	D1	\$3,660
SRDF-S-R04	RMT SYNC-SRDFS CMPPEER REG 41-60 TB	D1	\$2,990
SRDF-S-R05	RMT SYNC-SRDFS CMPPEER REG 61-100 TB	D1	\$2,595
SRDF-S-R06	RMT SYNC-SRDFS CMPPEER REG 101-150 TB	D1	\$2,205
SRDF-S-R07	RMT SYNC-SRDFS CMPPEER REG 151-250 TB	D1	\$2,090
SRDF-S-R08	RMT SYNC-SRDFS CMPPEER REG 251-400 TB	D1	\$1,915
SRDF-S-R09	RMT SYNC-SRDFS CMPPEER REG 401-600 TB	D1	\$1,715
SRDF-S-R10	RMT SYNC-SRDFS CMPPEER REG 601-1000TB	D1	\$1,505
SRDF-S-R11	RMT SYNC-SRDFS CMPPEER REG 1001+ TB	D1	\$975
SRDF-S-RBAS	RMT SYNC PROT-SRDFS CMPPEER-BASE REG	D1	\$22,120
SRDF-S-RBASF	SRDF-S FENB REPL BASE LICENSE	D1	\$12,740
SRDF-S-RBASL	SRDF-S LITE REPL BASE LICENSE	D1	\$2,250
SRDF-S-RF01	SRDF-S FENB REPL 1TB (0-14TB)	D1	\$8,270
SRDF-S-RF02	SRDF-S FENB REPL 1TB (15-25TB)	D1	\$6,870
SRDF-S-RF03	SRDF-S FENB REPL 1TB (26-40TB)	D1	\$5,830
SRDF-S-RF04	SRDF-S FENB REPL 1TB (41-60TB)	D1	\$5,180
SRDF-S-RF05	SRDF-S FENB REPL 1TB (61-100TB)	D1	\$4,600
SRDF-S-RF06	SRDF-S FENB REPL 1TB (101-150TB)	D1	\$4,090
SRDF-S-RF07	SRDF-S FENB REPL 1TB (151-250TB)	D1	\$3,630
SRDF-S-RF08	SRDF-S FENB REPL 1TB (251-400TB)	D1	\$3,220
SRDF-S-RF09	SRDF-S FENB REPL 1TB (401-600TB)	D1	\$2,860
SRDF-S-RF10	SRDF-S FENB REPL 1TB (601-1000TB)	D1	\$2,550
SRDF-S-RF11	SRDF-S FENB REPL 1TB (1001TB OR GREATER)	D1	\$2,250
SRDF-S-RL01	SRDF-S LITE REPL 1TB (0-14TB)	D1	\$1,470
SRDF-S-RL02	SRDF-S LITE REPL 1TB (15-25TB)	D1	\$1,220
SRDF-S-RL03	SRDF-S LITE REPL 1TB (26-40TB)	D1	\$1,040
SRDF-S-RL04	SRDF-S LITE REPL 1TB (41-60TB)	D1	\$920
SRDF-S-RL05	SRDF-S LITE REPL 1TB (61-100TB)	D1	\$820
SRDF-S-RL06	SRDF-S LITE REPL 1TB (101-150TB)	D1	\$730
SRDF-S-RL07	SRDF-S LITE REPL 1TB (151-250TB)	D1	\$650
SRDF-S-RL08	SRDF-S LITE REPL 1TB (251-400TB)	D1	\$570
SRDF-S-RL09	SRDF-S LITE REPL 1TB (401-600TB)	D1	\$510
SRDF-S-RL10	SRDF-S LITE REPL 1TB (601-1000TB)	D1	\$450
SRDF-S-RL11	SRDF-S LITE REPL 1TB (1001TB OR GREATER)	D1	\$400
SRDF-S-RN-OPN	RT FOR SRDF-S ON OPEN SYS	D1	\$0
SRDFS-RN-ZOS	SRDF/S RUNTIME FOR ZOS	D1	\$0
SRDF-S-RUP	RMT SYNC PROT-SRDFS CMPPEER-UPG REG	D1	\$0
SRDF-S-RUPL	SRDF-S LITE REPL BASE UPGRADE	D1	\$0
SRDF-S-T01	SRDF-S CAPACITY 0-.250	D1	\$0
SRDF-S-T02	SRDF-S CAPACITY .251-.500	D1	\$0
SRDF-S-T03	SRDF-S CAPACITY .501-.750	D1	\$0
SRDF-S-T04	SRDF-S CAPACITY .751-1.00	D1	\$0
SRDF-S-T05	SRDF-S CAPACITY 1.01-2.00	D1	\$0
SRDF-S-T06	SRDF-S CAPACITY 2.01-4.00	D1	\$0
SRDF-S-T07	SRDF-S CAPACTY 4.01-6.00	D1	\$0
SRDF-S-T08	SRDF-S CAPACITY 6.01-8.00	D1	\$0
SRDF-S-T09	SRDF-S CAPACITY 8.01-10.0	D1	\$0
SRDF-S-T10	SRDF-S CAPACITY 10.01-12.	D1	\$0
SRDF-S-T11	SRDF-S CAPACITY 12.01-14.	D1	\$0
SRDF-S-T12	SRDF-S CAPACITY 14.01-17.	D1	\$0

SRDF-S-T13	SRDF-S CPCTY 17.01-20.00	D1	\$0
SRDF-S-T14	SRDF-S CPCTY 20.01-23.00	D1	\$0
SRDF-S-T1-4U	SRDF-S T1-T4 UPGRADE	D1	\$0
SRDF-S-T15	SRDF-S CPCTY 23.01-26.00	D1	\$0
SRDF-S-T16	SRDF-S CPCTY 26.01-29.00	D1	\$0
SRDF-S-T17	SRDF-S CPCTY 29.01-32.00	D1	\$0
SRDF-S-T18	SRDF-S CPCTY 32.01-35.00	D1	\$0
SRDF-S-T19	SRDF-S CPCTY 35.01-38.00	D1	\$0
SRDF-S-T20	SRDF-S CPCTY 38.01-41.00	D1	\$0
SRDF-S-T21	SRDF-S CPCTY 41.01-44.00	D1	\$0
SRDF-S-T22	SRDF-S CPCTY 44.01-47.00	D1	\$0
SRDF-S-T23	SRDF-S CPCTY 47.01-50.00	D1	\$0
SRDF-S-T24	SRDF-S CPCTY 50.01-53.00	D1	\$0
SRDF-S-T25	SRDF-S CPCTY 53.01-56.00	D1	\$0
SRDF-S-T26	SRDF-S CPCTY 56.01-59.00	D1	\$0
SRDF-S-T27	SRDF-S CPCTY 59.01-62.00	D1	\$0
SRDF-S-T28	SRDF-S CPCTY 62.01-65.00	D1	\$0
SRDF-S-T29	SRDF-S CPCTY 65.01-68.00	D1	\$0
SRDF-S-T30	SRDF-S CPCTY 68.01-71.00	D1	\$0
SRDF-S-T31	SRDF-S CPCTY 71.01-74.00	D1	\$0
SRDF-S-T32	SRDF-S CPCTY 74.01-77.00	D1	\$0
SRDF-S-T33	SRDF-S CPCTY 77.01-80.00	D1	\$0
SRDF-S-T34	SRDF-S CPCTY 80.01-83.00	D1	\$0
SRDF-S-T35	SRDF-S CPCTY 83.01-86.00	D1	\$0
SRDF-S-T5-35U	SRDF-S T5-T35 UPGRADE	D1	\$0
SRDFSTAR OPT	SRDFSTAR OPT OUT BASE UPGRADE	D1	\$0
SRDFSTAR-BASE	SRDFSTAR BASE LICENSE	D1	\$0
SRDFSTAR-C01	SRDFSTAR 1TB (0-14TB)	D1	\$0
SRDFSTAR-C02	SRDFSTAR 1TB (15-25TB)	D1	\$0
SRDFSTAR-C03	SRDFSTAR 1TB (26-40TB)	D1	\$0
SRDFSTAR-C04	SRDFSTAR 1TB (41-60TB)	D1	\$0
SRDFSTAR-C05	SRDFSTAR 1TB (61-100TB)	D1	\$0
SRDFSTAR-C06	SRDFSTAR 1TB (101-150TB)	D1	\$0
SRDFSTAR-C07	SRDFSTAR 1TB (151-250TB)	D1	\$0
SRDFSTAR-C08	SRDFSTAR 1TB (251-400TB)	D1	\$0
SRDFSTAR-C09	SRDFSTAR 1TB (401-600TB)	D1	\$0
SRDFSTAR-C10	SRDFSTAR 1TB (601-1000TB)	D1	\$0
SRDFSTAR-C11	SRDFSTAR1TB(1001TB or greater)	D1	\$0
SRDFSTAR-N01	SRDFSTAR 1TB (0-14TB) NLT3	D1	\$0
SRDFSTAR-N02	SRDFSTAR 1TB (15-25TB) NLT3	D1	\$0
SRDFSTAR-N03	SRDFSTAR 1TB (26-40TB) NLT3	D1	\$0
SRDFSTAR-N04	SRDFSTAR 1TB (41-60TB) NLT3	D1	\$0
SRDFSTAR-N05	SRDFSTAR 1TB (61-100TB) NLT3	D1	\$0
SRDFSTAR-N06	SRDFSTAR 1TB (101-150TB) NLT3	D1	\$0
SRDFSTAR-N07	SRDFSTAR 1TB (151-250TB) NLT3	D1	\$0
SRDFSTAR-N08	SRDFSTAR 1TB (251-400TB) NLT3	D1	\$0
SRDFSTAR-N09	SRDFSTAR 1TB (401-600TB) NLT3	D1	\$0
SRDFSTAR-N10	SRDFSTAR 1TB (601-1000TB) NLT3	D1	\$0
SRDFSTAR-N11	SRDFSTAR1TB(1001TB or greater) NLT3	D1	\$0
SRDFSTAR-OBAS	SRDFSTAR OPT OUT BASE LICENSE	D1	\$0

SRDFSTAR-OPT	SRDFSTAR OPT OUT TB	D1	\$0
SRDFSTAR-OUP	SRDFSTAR OPT OUT BASE UPGRADE	D1	\$0
SRDFSTAR-R01	SRDFSTAR REPL 1TB (0-14TB)	D1	\$0
SRDFSTAR-R02	SRDFSTAR REPL 1TB (15-25TB)	D1	\$0
SRDFSTAR-R03	SRDFSTAR REPL 1TB (26-40TB)	D1	\$0
SRDFSTAR-R04	SRDFSTAR REPL 1TB (41-60TB)	D1	\$0
SRDFSTAR-R05	SRDFSTAR REPL 1TB (61-100TB)	D1	\$0
SRDFSTAR-R06	SRDFSTAR REPL 1TB (101-150TB)	D1	\$0
SRDFSTAR-R07	SRDFSTAR REPL 1TB (151-250TB)	D1	\$0
SRDFSTAR-R08	SRDFSTAR REPL 1TB (251-400TB)	D1	\$0
SRDFSTAR-R09	SRDFSTAR REPL 1TB (401-600TB)	D1	\$0
SRDFSTAR-R10	SRDFSTAR REPL 1TB (601-1000TB)	D1	\$0
SRDFSTAR-R11	SRDFSTAR REPL 1TB(1001TB or greater)	D1	\$0
SRDFSTAR-RBAS	SRDFSTAR REPL BASE LICENSE	D1	\$0
SRDFSTAR-RN-Z	SRDFSTAR RUNTIME FOR ZOS	D1	\$0
SRDFSTAR-RUP	SRDFSTAR REPL BASE UPGRADE	D1	\$0
SRDFSTAR-T01	SRDFSTAR CPCTY 0-.250	D1	\$0
SRDFSTAR-T02	SRDFSTAR CPCTY .251-.500	D1	\$0
SRDFSTAR-T03	SRDFSTAR CPCTY .501-.750	D1	\$0
SRDFSTAR-T04	SRDFSTAR CPCTY .751-1.00	D1	\$0
SRDFSTAR-T05	SRDFSTAR CPCTY 1.01-2.00	D1	\$0
SRDFSTAR-T06	SRDFSTAR CPCTY 2.01-4.00	D1	\$0
SRDFSTAR-T07	SRDFSTAR CPCTY 4.01-6.00	D1	\$0
SRDFSTAR-T08	SRDFSTAR CPCTY 6.01-8.00	D1	\$0
SRDFSTAR-T09	SRDFSTAR CPCTY 8.01-10.00	D1	\$0
SRDFSTAR-T10	SRDFSTAR CPTY 10.01-12.00	D1	\$0
SRDFSTAR-T11	SRDFSTAR CPTY 12.01-14.00	D1	\$0
SRDFSTAR-T12	SRDFSTAR CPTY 14.01-17.00	D1	\$0
SRDFSTAR-T13	SRDFSTAR CPTY 17.01-20.00	D1	\$0
SRDFSTAR-T14	SRDFSTAR CPTY 20.01-23.00	D1	\$0
SRDFSTAR-T15	SRDFSTAR CPTY 23.01-26.00	D1	\$0
SRDFSTAR-T16	SRDFSTAR CPTY 26.01-29.00	D1	\$0
SRDFSTAR-T17	SRDFSTAR CPTY 29.01-32.00	D1	\$0
SRDFSTAR-T18	SRDFSTAR CPTY 32.01-35.00	D1	\$0
SRDFSTAR-T19	SRDFSTAR CPTY 35.01-38.00	D1	\$0
SRDFSTAR-T20	SRDFSTAR CPTY 38.01-41.00	D1	\$0
SRDFSTAR-T21	SRDFSTAR CPTY 41.01-44.00	D1	\$0
SRDFSTAR-T22	SRDFSTAR CPTY 44.01-47.00	D1	\$0
SRDFSTAR-T23	SRDFSTAR CPTY 47.01-50.00	D1	\$0
SRDFSTAR-T24	SRDFSTAR CPTY 50.01-53.00	D1	\$0
SRDFSTAR-T25	SRDFSTAR CPTY 53.01-56.00	D1	\$0
SRDFSTAR-T26	SRDFSTAR CPTY 56.01-59.00	D1	\$0
SRDFSTAR-T27	SRDFSTAR CPTY 59.01-62.00	D1	\$0
SRDFSTAR-T28	SRDFSTAR CPTY 62.01-65.00	D1	\$0
SRDFSTAR-T29	SRDFSTAR CPTY 65.01-68.00	D1	\$0
SRDFSTAR-T30	SRDFSTAR CPTY 68.01-71.00	D1	\$0
SRDFSTAR-T31	SRDFSTAR CPTY 71.01-74.00	D1	\$0
SRDFSTAR-T32	SRDFSTAR CPTY 74.01-77.00	D1	\$0
SRDFSTAR-T33	SRDFSTAR CPTY 77.01-80.00	D1	\$0
SRDFSTAR-T34	SRDFSTAR CPTY 80.01-83.00	D1	\$0

SRDFSTAR-T35	SRDFSTAR CPTY 83.01-86.00	D1	\$0
SRDFSTAR-UPG	SRDFSTAR BASE UPGRADE	D1	\$0
SRDFSTR-T1-4U	SRDFSTAR T1-T4 UPGRADE	D1	\$0
SRDFSTRT5-35U	SRDFSTAR T5-T35 UPGRADE	D1	\$2,490
SRDF-S-UPG	RMT SYNC PROT-SRDFS CMPPEER-UPG	D1	\$0
SRDF-S-UPGL	SRDF-S LITE BASE UPGRADE	D1	\$0
SRDF-T1	SRDF CAPACITY 0-.250	D1	\$0
SRDF-T10	SRDF CAPACITY 10.01-12.00	D1	\$0
SRDF-T11	SRDF CAPACITY 12.01-14.00	D1	\$0
SRDF-T12	SRDF CPTY 14.01-17.00	D1	\$0
SRDF-T13	SRDF CPCTY 17.01-20.00	D1	\$0
SRDF-T14	SRDF CPCTY 20.01-23.00	D1	\$0
SRDF-T1-4UP	SRDF T1-T4 UPGRADE	D1	\$0
SRDF-T15	SRDF CPCTY 23.01-26.00	D1	\$0
SRDF-T16	SRDF CPCTY 26.01-29.00	D1	\$0
SRDF-T17	SRDF CPCTY 29.01-32.00	D1	\$0
SRDF-T18	SRDF CPCTY 32.01-35.00	D1	\$0
SRDF-T19	SRDF CPCTY 35.01-38.00	D1	\$0
SRDF-T2	SRDF CAPACITY .251-.500	D1	\$0
SRDF-T20	SRDF CPCTY 38.01-41.00	D1	\$0
SRDF-T21	SRDF CPCTY 41.01-44.00	D1	\$0
SRDF-T22	SRDF CPCTY 44.01-47.00	D1	\$0
SRDF-T23	SRDF CPCTY 47.01-50.00	D1	\$0
SRDF-T24	SRDF CPCTY 50.01-53.00	D1	\$0
SRDF-T25	SRDF CPCTY 53.01-56.00	D1	\$0
SRDF-T26	SRDF CPCTY 56.01-59.00	D1	\$0
SRDF-T27	SRDF CPCTY 59.01-62.00	D1	\$0
SRDF-T28	SRDF CPCTY 62.01-65.00	D1	\$0
SRDF-T29	SRDF CPCTY 65.01-68.00	D1	\$0
SRDF-T3	SRDF CAPACITY .501-.750	D1	\$0
SRDF-T30	SRDF CPCTY 68.01-71.00	D1	\$0
SRDF-T31	SRDF CPCTY 71.01-74.00	D1	\$0
SRDF-T32	SRDF CPCTY 74.01-77.00	D1	\$0
SRDF-T33	SRDF CPCTY 77.01-80.00	D1	\$0
SRDF-T34	SRDF CPCTY 80.01-83.00	D1	\$0
SRDF-T35	SRDF CPCTY 83.01-86.00	D1	\$0
SRDF-T4	SRDF CAPACITY .751-1.00	D1	\$0
SRDF-T5	SRDF CAPACITY 1.01-2.00	D1	\$0
SRDF-T5-30UP	SRDF T5-T30 UPGRADE	D1	\$0
SRDF-T5-35U	SRDF T5-T35 UPGRADE	D1	\$0
SRDF-T6	SRDF CAPACITY 2.01-4.00	D1	\$0
SRDF-T7	SRDF CAPACITY 4.01-6.00	D1	\$0
SRDF-T8	SRDF CAPACITY 6.01-8.00	D1	\$0
SRDF-T9	SRDF CAPACITY 8.01-10.00	D1	\$0
SRM-ENABLER	SRM ENABLER MODEL	D1	\$0
SRMENB-T1	SRM CPTY 0-.250	D1	\$0
SRMENB-T10	SRM CPTY 10.01-12.00	D1	\$0
SRMENB-T11	SRM CPTY 12.01-14.00	D1	\$0
SRMENB-T12	ESP CPTY 14.01-17.00	D1	\$0
SRMENB-T13	SRM CPTY 17.01-20.00	D1	\$0

SRMENB-T14	SRM CPTY 20.01-23.00	D1	\$0
SRMENB-T15	SRM CPTY 23.01-26.00	D1	\$0
SRMENB-T16	SRM CPTY 26.01-29.00	D1	\$0
SRMENB-T17	SRM CPTY 29.01-32.00	D1	\$0
SRMENB-T18	SRM CPTY 32.01-35.00	D1	\$0
SRMENB-T19	SRM CPTY 35.01-38.00	D1	\$0
SRMENB-T2	SRM CPTY .251-.500	D1	\$0
SRMENB-T20	SRM CPTY 38.01-41.00	D1	\$0
SRMENB-T21	SRM CPTY 41.01-44.00	D1	\$0
SRMENB-T22	SRM CPTY 44.01-47.00	D1	\$0
SRMENB-T23	SRM CPTY 47.01-50.00	D1	\$0
SRMENB-T24	SRM CPTY 50.01-53.00	D1	\$0
SRMENB-T25	SRM CPTY 53.01-56.00	D1	\$0
SRMENB-T26	SRM CPTY 56.01-59.00	D1	\$0
SRMENB-T27	SRM CPTY 59.01-62.00	D1	\$0
SRMENB-T28	SRM CPTY 62.01-65.00	D1	\$0
SRMENB-T29	SRM CPTY 65.01-68.00	D1	\$0
SRMENB-T3	SRM CPTY .501-.750	D1	\$0
SRMENB-T30	SRM CPTY 68.01-71.00	D1	\$0
SRMENB-T4	SRM CPTY .751-1.00	D1	\$0
SRMENB-T5	SRM CPTY 1.01-2.00	D1	\$0
SRMENB-T6	SRM CPTY 2.01-4.00	D1	\$0
SRMENB-T7	SRM CPTY 4.01-6.00	D1	\$0
SRMENB-T8	SRM CPTY 6.01-8.00	D1	\$0
SRMENB-T9	SRM CPTY 8.01-10.00	D1	\$0
STM-T1-4U	CC5.1 STM T1-4 UPG	D1	\$0
STM-T5-30U	CC5.1 STM T5-30 UPG	D1	\$0
STMUPT1-4	ECC STM UPGRADE T1-T4	D1	\$1,010
STMUPT5-12	ECC STM UPGRADE T5-T12	D1	\$3,820
SYMADVMGT-BAS	VMAX ADV TIER STOR MGT BASE LICENSE	D1	\$0
SYMADVMGT-C01	VMAX ADV TIER STOR MGT 1TB (0-14TB)	D1	\$0
SYMADVMGT-C02	VMAX ADV TIER STOR MGT 1TB (14-25TB)	D1	\$0
SYMADVMGT-C03	VMAX ADV TIER STOR MGT 1TB (26-40TB)	D1	\$0
SYMADVMGT-C04	VMAX ADV TIER STOR MGT 1TB (41-60TB)	D1	\$0
SYMADVMGT-C05	VMAX ADV TIER STOR MGT 1TB (61-100TB)	D1	\$0
SYMADVMGT-C06	VMAX ADV TIER STOR MGT 1TB (101-150TB)	D1	\$0
SYMADVMGT-C07	VMAX ADV TIER STOR MGT 1TB (151-250TB)	D1	\$0
SYMADVMGT-C08	VMAX ADV TIER STOR MGT 1TB (251-400TB)	D1	\$0
SYMADVMGT-C09	VMAX ADV TIER STOR MGT 1TB (401-600TB)	D1	\$0
SYMADVMGT-C10	VMAX ADV TIER STOR MGT 1TB (601-1000TB)	D1	\$0
SYMADVMGT-C11	VMAX ADV TIER STOR MGT 1TB (1001TB or gr	D1	\$0
SYMADVMGT-N01	VMAX ADV TIER STOR MGT 1TB (0-14TB) NLT3	D1	\$0
SYMADVMGT-N02	VMAX ADV TIER MGMT SW 1TB (15-25TB) NLT3	D1	\$0
SYMADVMGT-N03	VMAX ADV TIER STOR MGT 1TB (26-40) NLT3	D1	\$0
SYMADVMGT-N04	VMAX ADV TIER MGMT SW 1TB (41-60TB) NLT3	D1	\$0
SYMADVMGT-N05	VMAX ADV TIER MGMT SW 1TB (61-100TB) NLT	D1	\$0
SYMADVMGT-N06	VMAX ADV TIER MGMT SW 1TB (101-150TB) NL	D1	\$0
SYMADVMGT-N07	VMAX ADV TIER MGMT SW 1TB (151-250TB) NL	D1	\$0
SYMADVMGT-N08	VMAX ADV TIER MGMT SW 1TB (251-400TB) NL	D1	\$0
SYMADVMGT-N09	VMAX ADV TIER MGMT SW 1TB (401-600TB) NL	D1	\$0

SYMADVMGT-N10	VMAX ADV TIER MGMT SW 1TB (601-1000TB) N	D1	\$0
SYMADVMGT-N11	VMAX ADV TIER MGMT SW 1TB (1001TB GR) NL	D1	\$0
SYMADVMGT-UPG	VMAX ADV TIER STOR MGT BASE UPGRADE	D1	\$0
SYM-ERAS-BASE	SYM-DISK-ERASE BASE LICENSE	D1	\$3,500
SYM-ERAS-C01	SYM-DISK-ERASE 1TB (0-14TB)	D1	\$260
SYM-ERAS-C02	SYM-DISK-ERASE 1TB (15-25TB)	D1	\$250
SYM-ERAS-C03	SYM-DISK-ERASE 1TB (26-40TB)	D1	\$240
SYM-ERAS-C04	SYM-DISK-ERASE 1TB (41-60TB)	D1	\$230
SYM-ERAS-C05	SYM-DISK-ERASE 1TB (61-100TB)	D1	\$210
SYM-ERAS-C06	SYM-DISK-ERASE 1TB (101-150TB)	D1	\$200
SYM-ERAS-C07	SYM-DISK-ERASE 1TB (151-250TB)	D1	\$190
SYM-ERAS-C08	SYM-DISK-ERASE 1TB (251-400TB)	D1	\$190
SYM-ERAS-C09	SYM-DISK-ERASE 1TB (401-600TB)	D1	\$180
SYM-ERAS-C10	SYM-DISK-ERASE 1TB (601-1000TB)	D1	\$170
SYM-ERAS-C11	SYM-DISK-ERASE 1TB (1001TB or greater)	D1	\$160
SYM-ERAS-N01	SYM-DISK-ERASE 1TB (0-14TB) NLT3	D1	\$130
SYM-ERAS-N02	SYM-DISK-ERASE 1TB (15-25TB) NLT3	D1	\$130
SYM-ERAS-N03	SYM-DISK-ERASE 1TB (26-40TB) NLT3	D1	\$120
SYM-ERAS-N04	SYM-DISK-ERASE 1TB (41-60TB) NLT3	D1	\$110
SYM-ERAS-N05	SYM-DISK-ERASE 1TB (61-100TB) NLT3	D1	\$110
SYM-ERAS-N06	SYM-DISK-ERASE 1TB (101-150TB) NLT3	D1	\$100
SYM-ERAS-N07	SYM-DISK-ERASE 1TB (151-250TB) NLT3	D1	\$90
SYM-ERAS-N08	SYM-DISK-ERASE 1TB (251-400TB) NLT3	D1	\$90
SYM-ERAS-N09	SYM-DISK-ERASE 1TB (401-600TB) NLT3	D1	\$90
SYM-ERAS-N10	SYM-DISK-ERASE 1TB (601-1000TB) NLT3	D1	\$80
SYM-ERAS-N11	SYM-DISK-ERASE 1TB (1001TB or >) NLT3	D1	\$80
SYM-ERAS-UPG	SYM-DISK-ERASE BASE UPGRADE	D1	\$0
SYMGR-T1-4U	CC5x SYMGR T1-4 UPG	D1	\$0
SYMGR-T5-30U	CC5x SYMGR T5-30 UPG	D1	\$0
SYMGR-T5-35U	CC SYMGR T5-35 UPG	D1	\$0
SYM-HYPERPAV	HYPERPAV BASE LICENSE	D1	\$28,000
SYM-IPSEC-SW	SYMMETRIX IPSEC SINGLE-PORT LICENSE	D1	\$7,000
SYMMGT-KIT	SYMMETRIX MANAGEMENT PHYSICAL FULFILL	D1	\$0
SYM-MIGR-BAS	SYMMETRIX MIGRATION PKG BASE LICENSE	D1	\$0
SYMMIP	REMOTE MAINTENANCE S/W	D1	\$0
SYMPCNT-BASE	SYMM PRIORITY CONTROLS BASE LICENSE	D1	\$0
SYMPCNT-C01	SYMM PRIORITY CONTROLS 1TB (0-14TB)	D1	\$0
SYMPCNT-C02	SYMM PRIORITY CONTROLS 1TB (15-25TB)	D1	\$0
SYMPCNT-C03	SYMM PRIORITY CONTROLS 1TB (26-40TB)	D1	\$0
SYMPCNT-C04	SYMM PRIORITY CONTROLS 1TB (41-60TB)	D1	\$0
SYMPCNT-C05	SYMM PRIORITY CONTROLS 1TB (61-100TB)	D1	\$0
SYMPCNT-C06	SYMM PRIORITY CONTROLS 1TB (101-150TB)	D1	\$0
SYMPCNT-C07	SYMM PRIORITY CONTROLS 1TB (151-250TB)	D1	\$0
SYMPCNT-C08	SYMM PRIORITY CONTROLS 1TB (251-400TB)	D1	\$0
SYMPCNT-C09	SYMM PRIORITY CONTROLS 1TB (401-600TB)	D1	\$0
SYMPCNT-C10	SYMM PRIORITY CONTROLS 1TB (601-1000TB)	D1	\$0
SYMPCNT-C11	SPC 1TB (1001TB or greater)	D1	\$0
SYMPCNT-N01	SYMM PRIORITY CONTROLS 1TB (0-14TB) NLT3	D1	\$0
SYMPCNT-N02	SPC 1TB (15-25TB) NLT3	D1	\$0
SYMPCNT-N03	SPC 1TB (26-40TB) NLT3	D1	\$0

SYMPCNT-N04	SPC 1TB (41-60TB) NLT3	D1	\$0
SYMPCNT-N05	SPC 1TB (61-100TB) NLT3	D1	\$0
SYMPCNT-N06	SPC 1TB (101-150TB) NLT3	D1	\$0
SYMPCNT-N07	SPC 1TB (151-250TB) NLT3	D1	\$0
SYMPCNT-N08	SPC 1TB (251-400TB) NLT3	D1	\$0
SYMPCNT-N09	SPC 1TB (401-600TB) NLT3	D1	\$0
SYMPCNT-N10	SPC 1TB (601-1000TB) NLT3	D1	\$0
SYMPCNT-N11	SPC 1TB (1001TB or greater) NLT3	D1	\$0
SYMPCNT-RN-M	SYMMETRIX PRIORITY CONTROLS RUNTIME FC	D1	\$0
SYMPCNT-UPG	SYMM PRIORITY CONTROLS BASE UPGRADE	D1	\$0
SYMVP-RN-OPN	SYMM VIRTUAL PROV RUNTIME	D1	\$0
SYMVPROV-BAS	SYMM VIRTUAL PROVISIONING BASE LICENSE	D1	\$0
SYMVPROV-R01	SYMM VIRTUAL PROV STD 1TB(0-14TB)	D1	\$0
SYMVPROV-R02	SYMM VIRTUAL PROV STD 1TB(15-25TB)	D1	\$0
SYMVPROV-R03	SYMM VIRTUAL PROV STD 1TB(26-40TB)	D1	\$0
SYMVPROV-R04	SYMM VIRTUAL PROV STD 1TB(41-60TB)	D1	\$0
SYMVPROV-R05	SYMM VIRTUAL PROV STD 1TB(61-100TB)	D1	\$0
SYMVPROV-R06	SYMM VIRTUAL PROV STD 1TB(101-150TB)	D1	\$0
SYMVPROV-R07	SYMM VIRTUAL PROV STD 1TB(151-250TB)	D1	\$0
SYMVPROV-R08	SYMM VIRTUAL PROV STD 1TB(251-400TB)	D1	\$0
SYMVPROV-R09	SYMM VIRTUAL PROV STD 1TB(401-600TB)	D1	\$0
SYMVPROV-R10	SYMM VIRTUAL PROV STD 1TB(601-1000TB)	D1	\$0
SYMVPROV-R11	SYMM VIRTUAL PROV STD 1TB(1001TB & grtr)	D1	\$0
SYMVPROV-S01	SYMM VIRTUAL PROV LCD 1TB(0-14TB)	D1	\$0
SYMVPROV-S02	SYMM VIRTUAL PROV LCD 1TB(15-25TB)	D1	\$0
SYMVPROV-S03	SYMM VIRTUAL PROV LCD 1TB(26-40TB)	D1	\$0
SYMVPROV-S04	SYMM VIRTUAL PROV LCD 1TB(41-60TB)	D1	\$0
SYMVPROV-S05	SYMM VIRTUAL PROV LCD 1TB(61-100TB)	D1	\$0
SYMVPROV-S06	SYMM VIRTUAL PROV LCD 1TB(101-150TB)	D1	\$0
SYMVPROV-S07	SYMM VIRTUAL PROV LCD 1TB(151-250TB)	D1	\$0
SYMVPROV-S08	SYMM VIRTUAL PROV LCD 1TB(251-400TB)	D1	\$0
SYMVPROV-S09	SYMM VIRTUAL PROV LCD 1TB(401-600TB)	D1	\$0
SYMVPROV-S10	SYMM VIRTUAL PROV LCD 1TB(601-1000TB)	D1	\$0
SYMVPROV-S11	SYMM VIRTUAL PROV LCD 1TB(1001TB & grtr)	D1	\$0
SYMVPROV-UPG	SYMM VIRTUAL PROV BASE UPGRADE	D1	\$0
TERA-MSUBASE	TERASAM BASE-3 MSU	D1	\$26,620
TERA-MSU-M00	TERASAM 4-45 MSU	D1	\$1,060
TERA-MSU-M01	TERASAM 46-175 MSU	D1	\$990
TERA-MSU-M02	TERASAM 176-315 MSU	D1	\$530
TERA-MSU-M03	TERASAM 316-575 MSU	D1	\$470
TERA-MSU-M04	TERASAM 576-875 MSU	D1	\$430
TERA-MSU-M05	TERASAM 876-1315 MSU	D1	\$350
TERA-MSU-M06	TERASAM 1316-1975 MSU	D1	\$320
TERA-MSU-M07	TERASAM 1976 & UP MSU	D1	\$290
TERA-MSU-UPG	TERASAM UPG	D1	\$0
TFADD-T1	TF ADDL CPCTY 0-.25	D1	\$0
TFADD-T10	TF ADDL CPCTY 10.01-12.00	D1	\$0
TFADD-T11	TF ADDL CPCTY 12.01-14.00	D1	\$0
TFADD-T12	TF ADDL CPCTY 14.01-17.00	D1	\$0
TFADD-T13	TF ADDL CPCTY 17.01-20.00	D1	\$0

TFADD-T14	TF ADDL CPCTY 20.01-23.00	D1	\$0
TFADDT1-4UPG	TF ADD T1-T4 UPGRADE	D1	\$2,020
TFADD-T15	TF ADDL CPCTY 23.01-26.00	D1	\$0
TFADD-T16	TF ADDL CPCTY 26.01-29.00	D1	\$0
TFADD-T17	TF ADDL CPCTY 29.01-32.00	D1	\$0
TFADD-T18	TF ADDL CPCTY 32.01-35.00	D1	\$0
TFADD-T19	TF ADDL CPCTY 35.01-38.00	D1	\$0
TFADD-T2	TF ADDL CPCTY .251-.500	D1	\$0
TFADD-T20	TF ADDL CPCTY 38.01-41.00	D1	\$0
TFADD-T21	TF ADDL CPCTY 41.01-44.00	D1	\$0
TFADD-T22	TF ADDL CPCTY 44.01-47.00	D1	\$0
TFADD-T23	TF ADDL CPCTY 47.01-50.00	D1	\$0
TFADD-T24	TF ADDL CPCTY 50.01-53.00	D1	\$0
TFADD-T25	TF ADDL CPCTY 53.01-56.00	D1	\$0
TFADD-T26	TF ADDL CPCTY 56.01-59.00	D1	\$0
TFADD-T27	TF ADDL CPCTY 59.01-62.00	D1	\$0
TFADD-T28	TF ADDL CPCTY 62.01-65.00	D1	\$0
TFADD-T29	TF ADDL CPCTY 65.01-68.00	D1	\$0
TFADD-T3	TF ADDL CPCTY .501-.750	D1	\$0
TFADD-T30	TF ADDL CPCTY 68.01-71.00	D1	\$0
TFADD-T31	TF ADDL CPCTY 71.01-74.00	D1	\$0
TFADD-T32	TF ADDL CPCTY 74.01-77.00	D1	\$0
TFADD-T33	TF ADDL CPCTY 77.01-80.00	D1	\$0
TFADD-T34	TF ADDL CPCTY 80.01-83.00	D1	\$0
TFADD-T35	TF ADDL CPCTY 83.01-86.00	D1	\$0
TFADD-T4	TF ADDL CPCTY .751-1.00	D1	\$0
TFADD-T5	TF ADDL CPCTY 1.01-2.00	D1	\$0
TFADDT5-35UPG	TF ADD T5-35 UPGRADE	D1	\$3,830
TFADD-T6	TF ADDL CPCTY 2.01-4.00	D1	\$0
TFADD-T7	TF ADDL CPCTY 4.01-6.00	D1	\$0
TFADD-T8	TF ADDL CPCTY 6.01-8.00	D1	\$0
TFADD-T9	TF ADDL CPCTY 8.01-10.00	D1	\$0
TF-CG-BASE	TF-CG BASE LICENSE	D1	\$0
TF-CG-C01	TF-CG 1TB (0-14TB)	D1	\$0
TF-CG-C02	TF-CG 1TB (15-25TB)	D1	\$0
TF-CG-C03	TF-CG 1TB (26-40TB)	D1	\$0
TF-CG-C04	TF-CG 1TB (41-60TB)	D1	\$0
TF-CG-C05	TF-CG 1TB (61-100TB)	D1	\$0
TF-CG-C06	TF-CG 1TB (101-150TB)	D1	\$0
TF-CG-C07	TF-CG 1TB (151-250TB)	D1	\$0
TF-CG-C08	TF-CG 1TB (251-400TB)	D1	\$0
TF-CG-C09	TF-CG 1TB (401-600TB)	D1	\$0
TF-CG-C10	TF-CG 1TB (601-1000TB)	D1	\$0
TF-CG-C11	TF-CG1TB(1001TB or greater)	D1	\$0
TF-CG-N01	TF-CG 1TB (0-14TB) NLT3	D1	\$0
TF-CG-N02	TF-CG 1TB (15-25TB) NLT3	D1	\$0
TF-CG-N03	TF-CG 1TB (26-40TB) NLT3	D1	\$0
TF-CG-N04	TF-CG 1TB (41-60TB) NLT3	D1	\$0
TF-CG-N05	TF-CG 1TB (61-100TB) NLT3	D1	\$0
TF-CG-N06	TF-CG 1TB (101-150TB) NLT3	D1	\$0

TF-CG-N07	TF-CG 1TB (151-250TB) NLT3	D1	\$0
TF-CG-N08	TF-CG 1TB (251-400TB) NLT3	D1	\$0
TF-CG-N09	TF-CG 1TB (401-600TB) NLT3	D1	\$0
TF-CG-N10	TF-CG 1TB (601-1000TB) NLT3	D1	\$0
TF-CG-N11	TF-CG1TB(1001TB or greater) NLT3	D1	\$0
TF-CG-OBAS	TF-CG OPT OUT BASE LICENSE	D1	\$0
TF-CG-OPT	TF-CG OPT OUT TB	D1	\$0
TF-CG-OUP	TF-CG OPT OUT BASE UPGRADE	D1	\$0
TF-CG-R01	TF-CG REPL 1TB (0-14TB)	D1	\$0
TF-CG-R02	TF-CG REPL 1TB (15-25TB)	D1	\$0
TF-CG-R03	TF-CG REPL 1TB (26-40TB)	D1	\$0
TF-CG-R04	TF-CG REPL 1TB (41-60TB)	D1	\$0
TF-CG-R05	TF-CG REPL 1TB (61-100TB)	D1	\$0
TF-CG-R06	TF-CG REPL 1TB (101-150TB)	D1	\$0
TF-CG-R07	TF-CG REPL 1TB (151-250TB)	D1	\$0
TF-CG-R08	TF-CG REPL 1TB (251-400TB)	D1	\$0
TF-CG-R09	TF-CG REPL 1TB (401-600TB)	D1	\$0
TF-CG-R10	TF-CG REPL 1TB (601-1000TB)	D1	\$0
TF-CG-R11	TF-CG REPL 1TB(1001TB or greater)	D1	\$0
TF-CG-RBAS	TF-CG REPL BASE LICENSE	D1	\$0
TF-CG-RUN-MSP	TIMEFINDER CONSISTENCY LFC FOR MSP	D1	\$0
TF-CG-RUP	TF-CG REPL BASE UPGRADE	D1	\$0
TF-CG-T01	TF-CG CAPACITY 0-.250	D1	\$0
TF-CG-T02	TF-CG CAPACITY .251-.500	D1	\$0
TF-CG-T03	TF-CG CAPACITY .501-.750	D1	\$0
TF-CG-T04	TF-CG CAPACITY .751-1.00	D1	\$0
TF-CG-T05	TF-CG CAPACITY 1.01-2.00	D1	\$0
TF-CG-T06	TF-CG CAPACITY 2.01-4.00	D1	\$0
TF-CG-T07	TF-CG CAPACTY 4.01-6.00	D1	\$0
TF-CG-T08	TF-CG CAPACITY 6.01-8.00	D1	\$0
TF-CG-T09	TF-CG CAPACITY 8.01-10.00	D1	\$0
TF-CG-T10	TF-CG CAPACITY 10.01-12.0	D1	\$0
TF-CG-T11	TF-CG CAPACITY 12.01-14.0	D1	\$0
TF-CG-T12	TF-CG CAPACITY 14.01-17.0	D1	\$0
TF-CG-T13	TF-CG CPCTY 17.01-20.00	D1	\$0
TF-CG-T14	TF-CG CPCTY 20.01-23.00	D1	\$0
TF-CG-T1-4U	TF-CG T1-T4 UPGRADE	D1	\$0
TF-CG-T15	TF-CG CPCTY 23.01-26.00	D1	\$0
TF-CG-T16	TF-CG CPCTY 26.01-29.00	D1	\$0
TF-CG-T17	TF-CG CPCTY 29.01-32.00	D1	\$0
TF-CG-T18	TF-CG CPCTY 32.01-35.00	D1	\$0
TF-CG-T19	TF-CG CPCTY 35.01-38.00	D1	\$0
TF-CG-T20	TF-CG CPCTY 38.01-41.00	D1	\$0
TF-CG-T21	TF-CG CPCTY 41.01-44.00	D1	\$0
TF-CG-T22	TF-CG CPCTY 44.01-47.00	D1	\$0
TF-CG-T23	TF-CG CPCTY 47.01-50.00	D1	\$0
TF-CG-T24	TF-CG CPCTY 50.01-53.00	D1	\$0
TF-CG-T25	TF-CG CPCTY 53.01-56.00	D1	\$0
TF-CG-T26	TF-CG CPCTY 56.01-59.00	D1	\$0
TF-CG-T27	TF-CG CPCTY 59.01-62.00	D1	\$0

TF-CG-T28	TF-CG CPCTY 62.01-65.00	D1	\$0
TF-CG-T29	TF-CG CPCTY 65.01-68.00	D1	\$0
TF-CG-T30	TF-CG CPCTY 68.01-71.00	D1	\$0
TF-CG-T31	TF-CG CPCTY 71.01-74.00	D1	\$0
TF-CG-T32	TF-CG CPCTY 74.01-77.00	D1	\$0
TF-CG-T33	TF-CG CPCTY 77.01-80.00	D1	\$0
TF-CG-T34	TF-CG CPCTY 80.01-83.00	D1	\$0
TF-CG-T35	TF-CG CPCTY 83.01-86.00	D1	\$0
TF-CG-T5-35U	TF-CG T5-T35 UPGRADE	D1	\$0
TF-CG-UPG	TF-CG BASE UPGRADE	D1	\$0
TFCLNADD-BASE	TF-CLNADD BASE LICENSE	D1	\$0
TF-CLNADD-C01	TF-CLNADD 1TB (0-14TB)	D1	\$0
TF-CLNADD-C02	TF-CLNADD 1TB (15-25TB)	D1	\$0
TF-CLNADD-C03	TF-CLNADD 1TB (26-40TB)	D1	\$0
TF-CLNADD-C04	TF-CLNADD 1TB (41-60TB)	D1	\$0
TF-CLNADD-C05	TF-CLNADD 1TB (61-100TB)	D1	\$0
TF-CLNADD-C06	TF-CLNADD 1TB (101-150TB)	D1	\$0
TF-CLNADD-C07	TF-CLNADD 1TB (151-250TB)	D1	\$0
TF-CLNADD-C08	TF-CLNADD 1TB (251-400TB)	D1	\$0
TF-CLNADD-C09	TF-CLNADD 1TB (401-600TB)	D1	\$0
TF-CLNADD-C10	TF-CLNADD 1TB(601-1000TB)	D1	\$0
TF-CLNADD-C11	TF-CLNADD1TB(1001TB or greater)	D1	\$0
TF-CLNADD-N01	TF-CLNADD 1TB (0-14TB) NLT3	D1	\$0
TF-CLNADD-N02	TF-CLNADD 1TB (15-25TB) NLT3	D1	\$0
TF-CLNADD-N03	TF-CLNADD 1TB (26-40TB) NLT3	D1	\$0
TF-CLNADD-N04	TF-CLNADD 1TB (41-60TB) NLT3	D1	\$0
TF-CLNADD-N05	TF-CLNADD 1TB (61-100TB) NLT3	D1	\$0
TF-CLNADD-N06	TF-CLNADD 1TB (101-150TB) NLT3	D1	\$0
TF-CLNADD-N07	TF-CLNADD 1TB (151-250TB) NLT3	D1	\$0
TF-CLNADD-N08	TF-CLNADD 1TB (251-400TB) NLT3	D1	\$0
TF-CLNADD-N09	TF-CLNADD 1TB (401-600TB) NLT3	D1	\$0
TF-CLNADD-N10	TF-CLNADD 1TB(601-1000TB) NLT3	D1	\$0
TF-CLNADD-N11	TF-CLNADD1TB(1001TB or greater) NLT3	D1	\$0
TFCLNADD-OBAS	LOCL REP-ADD-OPT OUT-TFCLONECNFLASH-B/	D1	\$0
TF-CLNADD-OPT	LOCL REP-ADD-OPT OUT-TFCLONECNFLASH-UF	D1	\$0
TFCLNADD-OUP	LOCL REP-ADD-SATA-OPTOUT-TR-TFCLNCNFLA	D1	\$0
TFCLNADD-UPG	TF-CLNADD BASE UPGRADE	D1	\$0
TFCLNADP-BASE	LOCL REP-ADD ON-TFCLONE CNFLASH-BASE	D1	\$0
TF-CLNADP-C01	LOCL REP-ADD-TFCLNCNFLASH NONSATA 0-14	D1	\$0
TF-CLNADP-C02	LOCL REP-ADD-TFCLNCNFLASH NONSATA 15-2	D1	\$0
TF-CLNADP-C03	LOCL REP-ADD-TFCLNCNFLASH NONSATA 26-4	D1	\$0
TF-CLNADP-C04	LOCL REP-ADD-TFCLNCNFLASH NONSATA 41-6	D1	\$0
TF-CLNADP-C05	LOCL REP-ADD-TFCLNCNFLASH NONSATA61-10	D1	\$0
TF-CLNADP-C06	LOCL REP-ADD-TFCLNCNFLASH NOSATA101-15	D1	\$0
TF-CLNADP-C07	LOCL REP-ADD-TFCLNCNFLASH NOSATA151-25	D1	\$0
TF-CLNADP-C08	LOCL REP-ADD-TFCLNCNFLASH NOSATA251-40	D1	\$0
TF-CLNADP-C09	LOCL REP-ADD-TFCLNCNFLASH NOSATA401-60	D1	\$0
TF-CLNADP-C10	LOCL REP-ADD-TFCLNCNFLASH NOSATA601-10	D1	\$0
TF-CLNADP-C11	LOCL REP-ADD-TFCLNCNFLASH NONSATA1001-	D1	\$0
TF-CLNADP-N01	LOCL REP-ADD-TFCLN CNFLASH SATA 0-14 TB	D1	\$0

TF-CLNADP-N02	LOCL REP-ADD-TFCLN CNFLASH SATA 15-25 TB	D1	\$0
TF-CLNADP-N03	LOCL REP-ADD-TFCLN CNFLASH SATA 26-40 TB	D1	\$0
TF-CLNADP-N04	LOCL REP-ADD-TFCLN CNFLASH SATA 41-60 TB	D1	\$0
TF-CLNADP-N05	LOCL REP-ADD-TFCLN CNFLASH SATA 61-100TB	D1	\$0
TF-CLNADP-N06	LOCL REP-ADD-TFCLN CNFLASH SATA 101-150T	D1	\$0
TF-CLNADP-N07	LOCL REP-ADD-TFCLN CNFLASH SATA 151-250T	D1	\$0
TF-CLNADP-N08	LOCL REP-ADD-TFCLN CNFLASH SATA 251-400T	D1	\$0
TF-CLNADP-N09	LOCL REP-ADD-TFCLN CNFLASH SATA 401-600T	D1	\$0
TF-CLNADP-N10	LOCL REP-ADD-TFCLN CNFLASH SATA 601-1000	D1	\$0
TF-CLNADP-N11	LOCL REP-ADD-TFCLN CNFLASH SATA1001+ TB	D1	\$0
TFCLNADP-OBAS	TF-CLONE OPT OUT BASE LICENSE	D1	\$0
TF-CLNADP-OPT	TF-CLONE OPT OUT TB	D1	\$0
TF-CLNADP-OUP	TF-CLONE OPT OUT BASE UPGRADE	D1	\$0
TF-CLNADP-RBA	TF/CLONE PREMIUM REGISTERED BASE LICENS	D1	\$0
TF-CLNADP-UPG	LOCL REP-ADD ON-TFCLONE CNFLASH-UPG	D1	\$0
TF-CLNAD-T01	TFCLNADD CPCTY 0-.250	D1	\$0
TF-CLNAD-T02	TFCLNADD CPCTY .251-.500	D1	\$0
TF-CLNAD-T03	TFCLNADD CPCTY .501-.750	D1	\$0
TF-CLNAD-T04	TFCLNADD CPCTY .751-1.00	D1	\$0
TF-CLNAD-T05	TFCLNADD CPCTY 1.01-2.00	D1	\$0
TF-CLNAD-T06	TFCLNADD CPCTY 2.01-4.00	D1	\$0
TF-CLNAD-T07	TFCLNADD CPCTY 4.01-6.00	D1	\$0
TF-CLNAD-T08	TFCLNADD CPCTY 6.01-8.00	D1	\$0
TF-CLNAD-T09	TFCLNADD CPCTY 8.01-10.00	D1	\$0
TF-CLNAD-T10	TFCLNADD CPTY 10.01-12.00	D1	\$0
TF-CLNAD-T11	TFCLNADD CPTY 12.01-14.00	D1	\$0
TF-CLNAD-T12	TFCLNADD CPTY 14.01-17.00	D1	\$0
TF-CLNAD-T13	TFCLNADD CPTY 17.01-20.00	D1	\$0
TF-CLNAD-T14	TFCLNADD CPTY 20.01-23.00	D1	\$0
TFCLNAD-T1-4U	TFCLNADD T1-T4 UPGRADE	D1	\$0
TF-CLNAD-T15	TFCLNADD CPTY 23.01-26.00	D1	\$0
TF-CLNAD-T16	TFCLNADD CPTY 26.01-29.00	D1	\$0
TF-CLNAD-T17	TFCLNADD CPTY 29.01-32.00	D1	\$0
TF-CLNAD-T18	TFCLNADD CPTY 32.01-35.00	D1	\$0
TF-CLNAD-T19	TFCLNADD CPTY 35.01-38.00	D1	\$0
TF-CLNAD-T20	TFCLNADD CPTY 38.01-41.00	D1	\$0
TF-CLNAD-T21	TFCLNADD CPTY 41.01-44.00	D1	\$0
TF-CLNAD-T22	TFCLNADD CPTY 44.01-47.00	D1	\$0
TF-CLNAD-T23	TFCLNADD CPTY 47.01-50.00	D1	\$0
TF-CLNAD-T24	TFCLNADD CPTY 50.01-53.00	D1	\$0
TF-CLNAD-T25	TFCLNADD CPTY 53.01-56.00	D1	\$0
TF-CLNAD-T26	TFCLNADD CPTY 56.01-59.00	D1	\$0
TF-CLNAD-T27	TFCLNADD CPTY 59.01-62.00	D1	\$0
TF-CLNAD-T28	TFCLNADD CPTY 62.01-65.00	D1	\$0
TF-CLNAD-T29	TFCLNADD CPTY 65.01-68.00	D1	\$0
TF-CLNAD-T30	TFCLNADD CPTY 68.01-71.00	D1	\$0
TF-CLNAD-T31	TFCLNADD CPTY 71.01-74.00	D1	\$0
TF-CLNAD-T32	TFCLNADD CPTY 74.01-77.00	D1	\$0
TF-CLNAD-T33	TFCLNADD CPTY 77.01-80.00	D1	\$0
TF-CLNAD-T34	TFCLNADD CPTY 80.01-83.0	D1	\$0

TF-CLNAD-T35	TFCLNADD CPTY 83.01-86.00	D1	\$0
TFCLNADT5-35U	TFCLNADD T5-T35 UPGRADE	D1	\$3,830
TF-CLNP-BAS	LOCL REP PROT-TFCLONE CNFLASH-BASE	D1	\$21,368
TF-CLNP-BASF	TF-CLONEP FENB BASE LICENSE	D1	\$18,158
TF-CLNP-BASL	TF-CLONEP LITE BASE LICENSE	D1	\$3,210
TF-CLNP-C01	LOCL REP-TFCLN CNFLASH NON-SATA 0-14 TB	D1	\$2,540
TF-CLNP-C02	LOCL REP-TFCLN CNFLASH NON-SATA 15-25 TB	D1	\$2,385
TF-CLNP-C03	LOCL REP-TFCLN CNFLASH NON-SATA 26-40 TB	D1	\$2,100
TF-CLNP-C04	LOCL REP-TFCLN CNFLASH NON-SATA 41-60 TB	D1	\$1,955
TF-CLNP-C05	LOCL REP-TFCLN CNFLASH NON-SATA 61-100TB	D1	\$1,880
TF-CLNP-C06	LOCL REP-TFCLN CNFLASH NON-SATA 101-150T	D1	\$1,690
TF-CLNP-C07	LOCL REP-TFCLN CNFLASH NON-SATA 151-250T	D1	\$1,500
TF-CLNP-C08	LOCL REP-TFCLN CNFLASH NON-SATA 251-400T	D1	\$1,300
TF-CLNP-C09	LOCL REP-TFCLN CNFLASH NON-SATA 401-600T	D1	\$1,135
TF-CLNP-C10	LOCL REP-TFCLN CNFLASH NON-SATA 601-1000	D1	\$985
TF-CLNP-C11	LOCL REP-TFCLN CNFLASH NON-SATA 1001+ TB	D1	\$860
TF-CLNP-CF01	TF-CLONEP FENB 1TB (0-14TB)	D1	\$2,150
TF-CLNP-CF02	TF-CLONEP FENB 1TB (15-25TB)	D1	\$2,025
TF-CLNP-CF03	TF-CLONEP FENB 1TB (26-40TB)	D1	\$1,780
TF-CLNP-CF04	TF-CLONEP FENB 1TB (41-60TB)	D1	\$1,655
TF-CLNP-CF05	TF-CLONEP FENB 1TB (61-100TB)	D1	\$1,590
TF-CLNP-CF06	TF-CLONEP FENB 1TB (101-150TB)	D1	\$1,430
TF-CLNP-CF07	TF-CLONEP FENB 1TB (151-250TB)	D1	\$1,270
TF-CLNP-CF08	TF-CLONEP FENB 1TB (251-400TB)	D1	\$1,100
TF-CLNP-CF09	TF-CLONEP FENB 1TB (401-600TB)	D1	\$955
TF-CLNP-CF10	TF-CLONEP FENB 1TB (601-1000TB)	D1	\$835
TF-CLNP-CF11	TF-CLONEP FENB 1TB (1001TB OR GREATER)	D1	\$730
TF-CLNP-CL01	TF-CLONEP LITE 1TB (0-14TB)	D1	\$390
TF-CLNP-CL02	TF-CLONEP LITE 1TB (15-25TB)	D1	\$360
TF-CLNP-CL03	TF-CLONEP LITE 1TB (26-40TB)	D1	\$320
TF-CLNP-CL04	TF-CLONEP LITE 1TB (41-60TB)	D1	\$300
TF-CLNP-CL05	TF-CLONEP LITE 1TB (61-100TB)	D1	\$290
TF-CLNP-CL06	TF-CLONEP LITE 1TB (101-150TB)	D1	\$260
TF-CLNP-CL07	TF-CLONEP LITE 1TB (151-250TB)	D1	\$230
TF-CLNP-CL08	TF-CLONEP LITE 1TB (251-400TB)	D1	\$200
TF-CLNP-CL09	TF-CLONEP LITE 1TB (401-600TB)	D1	\$180
TF-CLNP-CL10	TF-CLONEP LITE 1TB (601-1000TB)	D1	\$150
TF-CLNP-CL11	TF-CLONEP LITE 1TB (1001TB OR GREATER)	D1	\$130
TF-CLNP-N01	LOCL REP-TFCLONE CNFLASH SATA 0-14 TB	D1	\$1,270
TF-CLNP-N02	LOCL REP-TFCLONE CNFLASH SATA 15-25 TB	D1	\$1,185
TF-CLNP-N03	LOCL REP-TFCLONE CNFLASH SATA 26-40 TB	D1	\$1,050
TF-CLNP-N04	LOCL REP-TFCLONE CNFLASH SATA 41-60 TB	D1	\$975
TF-CLNP-N05	LOCL REP-TFCLONE CNFLASH SATA 61-100 TB	D1	\$935
TF-CLNP-N06	LOCL REP-TFCLONE CNFLASH SATA 101-150 TB	D1	\$850
TF-CLNP-N07	LOCL REP-TFCLONE CNFLASH SATA 151-250 TB	D1	\$745
TF-CLNP-N08	LOCL REP-TFCLONE CNFLASH SATA 251-400 TB	D1	\$650
TF-CLNP-N09	LOCL REP-TFCLONE CNFLASH SATA 401-600 TB	D1	\$565
TF-CLNP-N10	LOCL REP-TFCLN CNFLASH SATA 601-1000 TB	D1	\$495
TF-CLNP-N11	LOCL REP-TFCLONE CNFLASH SATA 1001+ TB	D1	\$430
TF-CLNP-NF01	TF-CLONEP FENB 1TB (0-14TB) NLT3	D1	\$1,070

TF-CLNP-NF02	TF-CLONEP FENB 1TB (15-25TB) NLT3	D1	\$1,005
TF-CLNP-NF03	TF-CLONEP FENB 1TB (26-40TB) NLT3	D1	\$890
TF-CLNP-NF04	TF-CLONEP FENB 1TB (41-60TB) NLT3	D1	\$825
TF-CLNP-NF05	TF-CLONEP FENB 1TB (61-100TB) NLT3	D1	\$785
TF-CLNP-NF06	TF-CLONEP FENB 1TB (101-150TB) NLT3	D1	\$720
TF-CLNP-NF07	TF-CLONEP FENB 1TB (151-250TB) NLT3	D1	\$625
TF-CLNP-NF08	TF-CLONEP FENB 1TB (251-400TB) NLT3	D1	\$550
TF-CLNP-NF09	TF-CLONEP FENB 1TB (401-600TB) NLT3	D1	\$475
TF-CLNP-NF10	TF-CLONEP FENB 1TB (601-1000TB) NLT3	D1	\$415
TF-CLNP-NF11	TF-CLONEP FENB 1TB (>=1001TB) NLT3	D1	\$360
TF-CLNP-NL01	TF-CLONEP LITE 1TB (0-14TB) NLT3	D1	\$200
TF-CLNP-NL02	TF-CLONEP LITE 1TB (15-25TB) NLT3	D1	\$180
TF-CLNP-NL03	TF-CLONEP LITE 1TB (26-40TB) NLT3	D1	\$160
TF-CLNP-NL04	TF-CLONEP LITE 1TB (41-60TB) NLT3	D1	\$150
TF-CLNP-NL05	TF-CLONEP LITE 1TB (61-100TB) NLT3	D1	\$150
TF-CLNP-NL06	TF-CLONEP LITE 1TB (101-150TB) NLT3	D1	\$130
TF-CLNP-NL07	TF-CLONEP LITE 1TB (151-250TB) NLT3	D1	\$120
TF-CLNP-NL08	TF-CLONEP LITE 1TB (251-400TB) NLT3	D1	\$100
TF-CLNP-NL09	TF-CLONEP LITE 1TB (401-600TB) NLT3	D1	\$90
TF-CLNP-NL10	TF-CLONEP LITE 1TB (601-1000TB) NLT3	D1	\$80
TF-CLNP-NL11	TF-CLONEP LITE 1TB (>= 1001TB) NLT3	D1	\$70
TF-CLNP-OBAS	VMAX TF-CLONE OPT OUT BASE LICENSE	D1	\$0
TF-CLNP-OPT	VMAX TF-CLONE OPT OUT TB	D1	\$0
TF-CLNP-OUP	VMAX TF-CLONE OPT OUT BASE UPGRADE	D1	\$0
TF-CLNP-R01	LOCL REP-TFCLONE CNFLASH REG 0-14 TB	D1	\$4,425
TF-CLNP-R02	LOCL REP-TFCLONE CNFLASH REG 15-25 TB	D1	\$3,850
TF-CLNP-R03	LOCL REP-TFCLONE CNFLASH REG 26-40 TB	D1	\$3,350
TF-CLNP-R04	LOCL REP-TFCLONE CNFLASH REG 41-60 TB	D1	\$2,730
TF-CLNP-R05	LOCL REP-TFCLONE CNFLASH REG 61-100 TB	D1	\$2,290
TF-CLNP-R06	LOCL REP-TFCLONE CNFLASH REG 101-150 TB	D1	\$2,135
TF-CLNP-R07	LOCL REP-TFCLONE CNFLASH REG 151-250 TB	D1	\$1,985
TF-CLNP-R08	LOCL REP-TFCLONE CNFLASH REG 251-400 TB	D1	\$1,840
TF-CLNP-R09	LOCL REP-TFCLONE CNFLASH REG 401-600 TB	D1	\$1,675
TF-CLNP-R10	LOCL REP-TFCLONE CNFLASH REG 601-1000TB	D1	\$1,560
TF-CLNP-R11	LOCL REP-TFCLONE CNFLASH REG 1001+ TB	D1	\$1,100
TF-CLNP-RBAS	LOCL REP PROT-TFCLONE CNFLASH-BASE REG	D1	\$13,890
TF-CLNP-RBASF	TF-CLONEP FENB LITE REG'D BASE LICENSE	D1	\$11,800
TF-CLNP-RBASL	TF-CLONEP LITE REGISTERED BASE LICENSE	D1	\$2,090
TF-CLNP-RF01	TF-CLONEP FENB REGISTERED 1TB (0-14TB)	D1	\$6,135
TF-CLNP-RF02	TF-CLONEP FENB REGISTERED 1TB (15-25TB)	D1	\$5,340
TF-CLNP-RF03	TF-CLONEP FENB REGISTERED 1TB (26-40TB)	D1	\$4,640
TF-CLNP-RF04	TF-CLONEP FENB REGISTERED 1TB (41-60TB)	D1	\$4,130
TF-CLNP-RF05	TF-CLONEP FENB REGISTERED 1TB (61-100TB)	D1	\$3,720
TF-CLNP-RF06	TF-CLONEP FENB REG'D 1TB (101-150TB)	D1	\$3,455
TF-CLNP-RF07	TF-CLONEP FENB REG'D 1TB (151-250TB)	D1	\$3,220
TF-CLNP-RF08	TF-CLONEP FENB REG'D 1TB (251-400TB)	D1	\$2,985
TF-CLNP-RF09	TF-CLONEP FENB REG'D 1TB (401-600TB)	D1	\$2,775
TF-CLNP-RF10	TF-CLONEP FENB REG'D 1TB (601-1000TB)	D1	\$2,585
TF-CLNP-RF11	TF-CLONEP FENB REG'D 1TB (>=1001TB)	D1	\$2,405
TF-CLNP-RL01	TF-CLONEP LITE REGISTERED 1TB (0-14TB)	D1	\$1,090

TF-CLNP-RL02	TF-CLONEP LITE REGISTERED 1TB (15-25TB)	D1	\$950
TF-CLNP-RL03	TF-CLONEP LITE REGISTERED 1TB (26-40TB)	D1	\$830
TF-CLNP-RL04	TF-CLONEP LITE REGISTERED 1TB (41-60TB)	D1	\$730
TF-CLNP-RL05	TF-CLONEP LITE REGISTERED 1TB (61-100TB)	D1	\$660
TF-CLNP-RL06	TF-CLONEP LITE REG'D 1TB (101-150TB)	D1	\$620
TF-CLNP-RL07	TF-CLONEP LITE REG'D 1TB (151-250TB)	D1	\$570
TF-CLNP-RL08	TF-CLONEP LITE REG'D 1TB (251-400TB)	D1	\$530
TF-CLNP-RL09	TF-CLONEP LITE REG'D 1TB (401-600TB)	D1	\$500
TF-CLNP-RL10	TF-CLONEP LITE REG'D 1TB (601-1000TB)	D1	\$460
TF-CLNP-RL11	TF-CLONEP LITE REG'D 1TB (>=1001TB)	D1	\$430
TFCLNP-RN-OPN	RT VMAX TF-CLONE ON OPEN SYSTEM	D1	\$0
TFCLNP-RN-ZOS	RT VMAX TF-CLONE ON MAINFRAME	D1	\$0
TF-CLNP-RUP	LOCL REP PROT-TFCLONE CNFLASH-UPG REG	D1	\$0
TF-CLNP-RUPL	TF-CLONEP LITE REGISTERED BASE UPGRADE	D1	\$0
TF-CLNP-UPG	LOCL REP PROT-TFCLONE CNFLASH-UPG	D1	\$0
TF-CLNP-UPGL	TF-CLONEP LITE BASE UPGRADE	D1	\$0
TF-CLN-RN-OPN	RT FOR TFCLONE ON OPEN SY	D1	\$0
TF-CLONE-BASE	TF-CLONE BASE LICENSE	D1	\$20,350
TF-CLONE-BASF	TF-CLONE FENB BASE LICENSE	D1	\$17,290
TF-CLONE-BASL	TF-CLONE LITE BASE LICENSE	D1	\$3,060
TF-CLONE-C01	TF-CLONE 1TB (0-14TB)	D1	\$2,420
TF-CLONE-C02	TF-CLONE 1TB (15-25TB)	D1	\$2,270
TF-CLONE-C03	TF-CLONE 1TB (26-40TB)	D1	\$2,000
TF-CLONE-C04	TF-CLONE 1TB (41-60TB)	D1	\$1,860
TF-CLONE-C05	TF-CLONE 1TB (61-100TB)	D1	\$1,790
TF-CLONE-C06	TF-CLONE 1TB (101-150TB)	D1	\$1,610
TF-CLONE-C07	TF-CLONE 1TB (151-250TB)	D1	\$1,430
TF-CLONE-C08	TF-CLONE 1TB (251-400TB)	D1	\$1,240
TF-CLONE-C09	TF-CLONE 1TB (401-600TB)	D1	\$1,080
TF-CLONE-C10	TF-CLONE 1TB (601-1000TB)	D1	\$940
TF-CLONE-C11	TF-CLONE 1TB(1001TB or greater)	D1	\$820
TF-CLONE-CF01	TF-CLONE FENB 1TB (0-14TB)	D1	\$2,050
TF-CLONE-CF02	TF-CLONE FENB 1TB (15-25TB)	D1	\$1,920
TF-CLONE-CF03	TF-CLONE FENB 1TB (26-40TB)	D1	\$1,700
TF-CLONE-CF04	TF-CLONE FENB 1TB (41-60TB)	D1	\$1,580
TF-CLONE-CF05	TF-CLONE FENB 1TB (61-100TB)	D1	\$1,520
TF-CLONE-CF06	TF-CLONE FENB 1TB (101-150TB)	D1	\$1,360
TF-CLONE-CF07	TF-CLONE FENB 1TB (151-250TB)	D1	\$1,210
TF-CLONE-CF08	TF-CLONE FENB 1TB (251-400TB)	D1	\$1,050
TF-CLONE-CF09	TF-CLONE FENB 1TB (401-600TB)	D1	\$910
TF-CLONE-CF10	TF-CLONE FENB 1TB (601-1000TB)	D1	\$790
TF-CLONE-CF11	TF-CLONE FENB 1TB(1001TB OR GREATER)	D1	\$690
TF-CLONE-CL01	TF-CLONE LITE 1TB (0-14TB)	D1	\$370
TF-CLONE-CL02	TF-CLONE LITE 1TB (15-25TB)	D1	\$350
TF-CLONE-CL03	TF-CLONE LITE 1TB (26-40TB)	D1	\$300
TF-CLONE-CL04	TF-CLONE LITE 1TB (41-60TB)	D1	\$280
TF-CLONE-CL05	TF-CLONE LITE 1TB (61-100TB)	D1	\$270
TF-CLONE-CL06	TF-CLONE LITE 1TB (101-150TB)	D1	\$250
TF-CLONE-CL07	TF-CLONE LITE 1TB (151-250TB)	D1	\$220
TF-CLONE-CL08	TF-CLONE LITE 1TB (251-400TB)	D1	\$190

TF-CLONE-CL09	TF-CLONE LITE 1TB (401-600TB)	D1	\$170
TF-CLONE-CL10	TF-CLONE LITE 1TB (601-1000TB)	D1	\$150
TF-CLONE-CL11	TF-CLONE LITE 1TB(1001TB OR GREATER)	D1	\$130
TF-CLONE-N01	TF-CLONE 1TB (0-14TB) NLT3	D1	\$1,210
TF-CLONE-N02	TF-CLONE 1TB (15-25TB) NLT3	D1	\$1,130
TF-CLONE-N03	TF-CLONE 1TB (26-40TB) NLT3	D1	\$1,000
TF-CLONE-N04	TF-CLONE 1TB (41-60TB) NLT3	D1	\$930
TF-CLONE-N05	TF-CLONE 1TB (61-100TB) NLT3	D1	\$890
TF-CLONE-N06	TF-CLONE 1TB (101-150TB) NLT3	D1	\$810
TF-CLONE-N07	TF-CLONE 1TB (151-250TB) NLT3	D1	\$710
TF-CLONE-N08	TF-CLONE 1TB (251-400TB) NLT3	D1	\$620
TF-CLONE-N09	TF-CLONE 1TB (401-600TB) NLT3	D1	\$540
TF-CLONE-N10	TF-CLONE 1TB (601-1000TB) NLT3	D1	\$470
TF-CLONE-N11	TF-CLONE 1TB(1001TB or greater) NLT3	D1	\$410
TF-CLONE-NF01	TF-CLONE FENB 1TB (0-14TB) NLT3	D1	\$1,020
TF-CLONE-NF02	TF-CLONE FENB 1TB (15-25TB) NLT3	D1	\$960
TF-CLONE-NF03	TF-CLONE FENB 1TB (26-40TB) NLT3	D1	\$850
TF-CLONE-NF04	TF-CLONE FENB 1TB (41-60TB) NLT3	D1	\$790
TF-CLONE-NF05	TF-CLONE FENB 1TB (61-100TB) NLT3	D1	\$750
TF-CLONE-NF06	TF-CLONE FENB 1TB (101-150TB) NLT3	D1	\$680
TF-CLONE-NF07	TF-CLONE FENB 1TB (151-250TB) NLT3	D1	\$600
TF-CLONE-NF08	TF-CLONE FENB 1TB (251-400TB) NLT3	D1	\$520
TF-CLONE-NF09	TF-CLONE FENB 1TB (401-600TB) NLT3	D1	\$450
TF-CLONE-NF10	TF-CLONE FENB 1TB (601-1000TB) NLT3	D1	\$390
TF-CLONE-NF11	TF-CLONE FENB 1TB(>=1001TB) NLT3	D1	\$340
TF-CLONE-NL01	TF-CLONE LITE 1TB (0-14TB) NLT3	D1	\$190
TF-CLONE-NL02	TF-CLONE LITE 1TB (15-25TB) NLT3	D1	\$170
TF-CLONE-NL03	TF-CLONE LITE 1TB (26-40TB) NLT3	D1	\$150
TF-CLONE-NL04	TF-CLONE LITE 1TB (41-60TB) NLT3	D1	\$140
TF-CLONE-NL05	TF-CLONE LITE 1TB (61-100TB) NLT3	D1	\$140
TF-CLONE-NL06	TF-CLONE LITE 1TB (101-150TB) NLT3	D1	\$130
TF-CLONE-NL07	TF-CLONE LITE 1TB (151-250TB) NLT3	D1	\$110
TF-CLONE-NL08	TF-CLONE LITE 1TB (251-400TB) NLT3	D1	\$100
TF-CLONE-NL09	TF-CLONE LITE 1TB (401-600TB) NLT3	D1	\$90
TF-CLONE-NL10	TF-CLONE LITE 1TB (601-1000TB) NLT3	D1	\$80
TF-CLONE-NL11	TF-CLONE LITE 1TB(>=1001TB) NLT3	D1	\$70
TF-CLONE-OBAS	LOCL REP-OPT OUT-TFCLONE CNFLASH-BASE	D1	\$0
TF-CLONE-OPT	LOCL REP-OPT OUT-TFCLONE CNFLASH-UPG	D1	\$0
TF-CLONE-OUP	LOCL REP-SATA-OPTOUT-TR-TFCLONE CNFLAS	D1	\$0
TF-CLONE-R01	TF-CLONE REPL 1TB(0-14TB)	D1	\$4,425
TF-CLONE-R02	TF-CLONE REPL 1TB(15-25TB)	D1	\$3,850
TF-CLONE-R03	TF-CLONE REPL 1TB(26-40TB)	D1	\$3,350
TF-CLONE-R04	TF-CLONE REPL 1TB(41-60TB)	D1	\$2,730
TF-CLONE-R05	TF-CLONE REPL 1TB(61-100TB)	D1	\$2,290
TF-CLONE-R06	TF-CLONE REPL 1TB(101-150TB)	D1	\$2,135
TF-CLONE-R07	TF-CLONE REPL 1TB(151-250TB)	D1	\$1,985
TF-CLONE-R08	TF-CLONE REPL 1TB(251-400TB)	D1	\$1,840
TF-CLONE-R09	TF-CLONE REPL 1TB(401-600TB)	D1	\$1,675
TF-CLONE-R10	TF-CLONE REPL 1TB(601-1000TB)	D1	\$1,560
TF-CLONE-R11	TF-CLONE REPL 1TB(1001TB or greater)	D1	\$1,100

TF-CLONE-RBAS	TF-CLONE REPL BASE LICENSE	D1	\$13,230
TF-CLONERBASF	TF-CLONE FENB REPL BASE LICENSE	D1	\$11,240
TF-CLONERBASL	TF-CLONE LITE REPL BASE LICENSE	D1	\$1,990
TF-CLONE-RF01	TF-CLONE FENB REPL 1TB(0-14TB)	D1	\$5,840
TF-CLONE-RF02	TF-CLONE FENB REPL 1TB(15-25TB)	D1	\$5,090
TF-CLONE-RF03	TF-CLONE FENB REPL 1TB(26-40TB)	D1	\$4,420
TF-CLONE-RF04	TF-CLONE FENB REPL 1TB(41-60TB)	D1	\$3,930
TF-CLONE-RF05	TF-CLONE FENB REPL 1TB(61-100TB)	D1	\$3,540
TF-CLONE-RF06	TF-CLONE FENB REPL 1TB(101-150TB)	D1	\$3,290
TF-CLONE-RF07	TF-CLONE FENB REPL 1TB(151-250TB)	D1	\$3,060
TF-CLONE-RF08	TF-CLONE FENB REPL 1TB(251-400TB)	D1	\$2,840
TF-CLONE-RF09	TF-CLONE FENB REPL 1TB(401-600TB)	D1	\$2,650
TF-CLONE-RF10	TF-CLONE FENB REPL 1TB(601-1000TB)	D1	\$2,460
TF-CLONE-RF11	TF-CLONE FENB REPL 1TB(>=1001TB)	D1	\$2,290
TF-CLONE-RL01	TF-CLONE LITE REPL 1TB(0-14TB)	D1	\$1,040
TF-CLONE-RL02	TF-CLONE LITE REPL 1TB(15-25TB)	D1	\$900
TF-CLONE-RL03	TF-CLONE LITE REPL 1TB(26-40TB)	D1	\$790
TF-CLONE-RL04	TF-CLONE LITE REPL 1TB(41-60TB)	D1	\$700
TF-CLONE-RL05	TF-CLONE LITE REPL 1TB(61-100TB)	D1	\$630
TF-CLONE-RL06	TF-CLONE LITE REPL 1TB(101-150TB)	D1	\$590
TF-CLONE-RL07	TF-CLONE LITE REPL 1TB(151-250TB)	D1	\$550
TF-CLONE-RL08	TF-CLONE LITE REPL 1TB(251-400TB)	D1	\$510
TF-CLONE-RL09	TF-CLONE LITE REPL 1TB(401-600TB)	D1	\$470
TF-CLONE-RL10	TF-CLONE LITE REPL 1TB(601-1000TB)	D1	\$440
TF-CLONE-RL11	TF-CLONE LITE REPL 1TB(>=1001TB)	D1	\$410
TF-CLONE-RUP	TF-CLONE REPL BASE UPGRADE	D1	\$0
TF-CLONE-RUPL	TF-CLONE LITE REPL BASE UPGRADE	D1	\$0
TF-CLONE-T01	TF-CLONE CPCTY 0-.250	D1	\$0
TF-CLONE-T02	TF-CLONE CPCTY .251-.500	D1	\$0
TF-CLONE-T03	TF-CLONE CPCTY .501-.750	D1	\$0
TF-CLONE-T04	TF-CLONE CPCTY .751-1.00	D1	\$0
TF-CLONE-T05	TF-CLONE CPCTY 1.01-2.00	D1	\$0
TF-CLONE-T06	TF-CLONE CPCTY 2.01-4.00	D1	\$0
TF-CLONE-T07	TF-CLONE CPCTY 4.01-6.00	D1	\$0
TF-CLONE-T08	TF-CLONE CPCTY 6.01-8.00	D1	\$0
TF-CLONE-T09	TF-CLONE CPCTY 8.01-10.00	D1	\$0
TF-CLONE-T10	TF-CLONE CPTY 10.01-12.00	D1	\$0
TF-CLONE-T11	TF-CLONE CPTY 12.01-14.00	D1	\$0
TF-CLONE-T12	TF-CLONE CPTY 14.01-17.00	D1	\$0
TF-CLONE-T13	TF-CLONE CPTY 17.01-20.00	D1	\$0
TF-CLONE-T14	TF-CLONE CPTY 20.01-23.00	D1	\$0
TFCLONE-T1-4U	TF-CLONE T1-T4 UPGRADE	D1	\$0
TF-CLONE-T15	TF-CLONE CPTY 23.01-26.00	D1	\$0
TF-CLONE-T16	TF-CLONE CPTY 26.01-29.00	D1	\$0
TF-CLONE-T17	TF-CLONE CPTY 29.01-32.00	D1	\$0
TF-CLONE-T18	TF-CLONE CPTY 32.01-35.00	D1	\$0
TF-CLONE-T19	TF-CLONE CPTY 35.01-38.00	D1	\$0
TF-CLONE-T20	TF-CLONE CPTY 38.01-41.00	D1	\$0
TF-CLONE-T21	TF-CLONE CPTY 41.01-44.00	D1	\$0
TF-CLONE-T22	TF-CLONE CPTY 44.01-47.00	D1	\$0

TF-CLONE-T23	TF-CLONE CPTY 47.01-50.00	D1	\$0
TF-CLONE-T24	TF-CLONE CPTY 50.01-53.00	D1	\$0
TF-CLONE-T25	TF-CLONE CPTY 53.01-56.00	D1	\$0
TF-CLONE-T26	TF-CLONE CPTY 56.01-59.00	D1	\$0
TF-CLONE-T27	TF-CLONE CPTY 59.01-62.00	D1	\$0
TF-CLONE-T28	TF-CLONE CPTY 62.01-65.00	D1	\$0
TF-CLONE-T29	TF-CLONE CPTY 65.01-68.00	D1	\$0
TF-CLONE-T30	TF-CLONE CPTY 68.01-71.00	D1	\$0
TF-CLONE-T31	TF-CLONE CPTY 71.01-74.00	D1	\$0
TF-CLONE-T32	TF-CLONE CPTY 74.01-77.00	D1	\$0
TF-CLONE-T33	TF-CLONE CPTY 77.01-80.00	D1	\$0
TF-CLONE-T34	TF-CLONE CPTY 80.01-83.00	D1	\$0
TF-CLONE-T35	TF-CLONE CPTY 83.01-86.00	D1	\$0
TF-CLONE-UPG	TF-CLONE BASE UPGRADE	D1	\$0
TF-CLONE-UPGL	TF-CLONE LITE BASE UPGRADE	D1	\$0
TFCLON-T5-35U	TF-CLONE T5-T35 UPGRADE	D1	\$0
TF-C-RN-ZOS	TFCLONE RUNTIME ZOS TGT	D1	\$0
TF-EIM-C01	TF-EIM 1TB (0-14TB)	D1	\$0
TF-EIM-C02	TF-EIM 1TB (15-25TB)	D1	\$0
TF-EIM-C03	TF-EIM 1TB (26-40TB)	D1	\$0
TF-EIM-C04	TF-EIM 1TB (41-60TB)	D1	\$0
TF-EIM-C05	TF-EIM 1TB (61-100TB)	D1	\$0
TF-EIM-C06	TF-EIM 1TB (101-150TB)	D1	\$0
TF-EIM-C07	TF-EIM 1TB (151-250TB)	D1	\$0
TF-EIM-C08	TF-EIM 1TB (251-400TB)	D1	\$0
TF-EIM-C09	TF-EIM 1TB (401-600TB)	D1	\$0
TF-EIM-C10	TF-EIM 1TB (601-1000TB)	D1	\$0
TF-EIM-C11	TF-EIM1TB(1001TB or greater)	D1	\$0
TF-EIM-N01	TF-EIM 1TB (0-14TB) NLT3	D1	\$0
TF-EIM-N02	TF-EIM 1TB (15-25TB) NLT3	D1	\$0
TF-EIM-N03	TF-EIM 1TB (26-40TB) NLT3	D1	\$0
TF-EIM-N04	TF-EIM 1TB (41-60TB) NLT3	D1	\$0
TF-EIM-N05	TF-EIM 1TB (61-100TB) NLT3	D1	\$0
TF-EIM-N06	TF-EIM 1TB (101-150TB) NLT3	D1	\$0
TF-EIM-N07	TF-EIM 1TB (151-250TB) NLT3	D1	\$0
TF-EIM-N08	TF-EIM 1TB (251-400TB) NLT3	D1	\$0
TF-EIM-N09	TF-EIM 1TB (401-600TB) NLT3	D1	\$0
TF-EIM-N10	TF-EIM 1TB (601-1000TB) NLT3	D1	\$0
TF-EIM-N11	TF-EIM1TB(1001TB or greater) NLT3	D1	\$0
TF-EIM-R01	TF-EIM REPL 1TB (0-14TB)	D1	\$0
TF-EIM-R02	TF-EIM REPL 1TB (15-25TB)	D1	\$0
TF-EIM-R03	TF-EIM REPL 1TB (26-40TB)	D1	\$0
TF-EIM-R04	TF-EIM REPL 1TB (41-60TB)	D1	\$0
TF-EIM-R05	TF-EIM REPL 1TB (61-100TB)	D1	\$0
TF-EIM-R06	TF-EIM REPL 1TB (101-150TB)	D1	\$0
TF-EIM-R07	TF-EIM REPL 1TB (151-250TB)	D1	\$0
TF-EIM-R08	TF-EIM REPL 1TB (251-400TB)	D1	\$0
TF-EIM-R09	TF-EIM REPL 1TB (401-600TB)	D1	\$0
TF-EIM-R10	TF-EIM REPL 1TB (601-1000TB)	D1	\$0
TF-EIM-R11	TF-EIM REPL 1TB(1001TB or greater)	D1	\$0

TFEIM-T01	TF EIM CPCTY 0-.250	D1	\$0
TFEIM-T02	TF EIM CPCTY .251-.500	D1	\$0
TFEIM-T03	TF EIM CPCTY .501-.750	D1	\$0
TFEIM-T04	TF EIM CPCTY .751-1.00	D1	\$0
TFEIM-T05	TF EIM CPCTY 1.01-2.00	D1	\$0
TFEIM-T06	TF EIM CPCTY 2.01-4.00	D1	\$0
TFEIM-T07	TF EIM CPCTY 4.01-6.00	D1	\$0
TFEIM-T08	TF EIM CPCTY 6.01-8.00	D1	\$0
TFEIM-T09	TF EIM CPCTY 8.01-10.00	D1	\$0
TFEIM-T10	TF EIM CPCTY 10.01-12.00	D1	\$0
TFEIM-T11	TF EIM CPCTY 12.01-14.00	D1	\$0
TFEIM-T12	TF EIM CPCTY 14.01-17.00	D1	\$0
TFEIM-T13	TF EIM CPCTY 17.01-20.00	D1	\$0
TFEIM-T14	TF EIM CPCTY 20.01-23.00	D1	\$0
TFEIM-T1-4U	TF EIM T1-T4 UPGRADE	D1	\$0
TFEIM-T15	TF EIM CPCTY 23.01-26.00	D1	\$0
TFEIM-T16	TF EIM CPCTY 26.01-29.00	D1	\$0
TFEIM-T17	TF EIM CPCTY 29.01-32.00	D1	\$0
TFEIM-T18	TF EIM CPCTY 32.01-35.00	D1	\$0
TFEIM-T19	TF EIM CPCTY 35.01-38.00	D1	\$0
TFEIM-T20	TF EIM CPCTY 38.01-41.00	D1	\$0
TFEIM-T21	TF EIM CPCTY 41.01-44.00	D1	\$0
TFEIM-T22	TF EIM CPCTY 44.01-47.00	D1	\$0
TFEIM-T23	TF EIM CPCTY 47.01-50.00	D1	\$0
TFEIM-T24	TF EIM CPCTY 50.01-53.00	D1	\$0
TFEIM-T25	TF EIM CPCTY 53.01-56.00	D1	\$0
TFEIM-T26	TF EIM CPCTY 56.01-59.00	D1	\$0
TFEIM-T27	TF EIM CPCTY 59.01-62.00	D1	\$0
TFEIM-T28	TF EIM CPCTY 62.01-65.00	D1	\$0
TFEIM-T29	TF EIM CPCTY 65.01-68.00	D1	\$0
TFEIM-T30	TF EIM CPCTY 68.01-71.00	D1	\$0
TFEIM-T31	TFEIM CPCTY 71.01-74.00	D1	\$0
TFEIM-T32	TFEIM CPCTY 74.01-77.00	D1	\$0
TFEIM-T33	TFEIM CPCTY 77.01-80.00	D1	\$0
TFEIM-T34	TFEIM CPCTY 80.01-83.00	D1	\$0
TFEIM-T35	TFEIM CPCTY 83.01-86.00	D1	\$0
TFEIM-T5-35U	TFEIM T5-T35 UPGRADE	D1	\$0
TF-EIM-UPG	TF-EIM BASE UPGRADE	D1	\$0
TF-M-ADD-BASE	TF-M-ADD BASE LICENSE	D1	\$16,200
TF-M-ADD-C01	TF-M-ADD 1TB (0-14TB)	D1	\$1,915
TF-M-ADD-C02	TF-M-ADD 1TB (15-25TB)	D1	\$1,800
TF-M-ADD-C03	TF-M-ADD 1TB (26-40TB)	D1	\$1,580
TF-M-ADD-C04	TF-M-ADD 1TB (41-60TB)	D1	\$1,470
TF-M-ADD-C05	TF-M-ADD 1TB (61-100TB)	D1	\$1,410
TF-M-ADD-C06	TF-M-ADD 1TB (101-150TB)	D1	\$1,270
TF-M-ADD-C07	TF-M-ADD 1TB (151-250TB)	D1	\$1,130
TF-M-ADD-C08	TF-M-ADD 1TB (251-400TB)	D1	\$980
TF-M-ADD-C09	TF-M-ADD 1TB (401-600TB)	D1	\$850
TF-M-ADD-C10	TF-M-ADD 1TB (601-1000TB)	D1	\$740
TF-M-ADD-C11	TF-M-ADD1TB(1001-1500TB)	D1	\$640

TF-M-ADD-T01	TF-M ADD 0-.250 TB	D1	\$0
TF-M-ADD-T02	TF-M ADD .251-.500 TB	D1	\$0
TF-M-ADD-T03	TF-M ADD .501-.750 TB	D1	\$0
TF-M-ADD-T04	TF-M ADD .751-1.00 TB	D1	\$0
TF-M-ADD-T05	TF-M ADD 1.01-2.00 TB	D1	\$0
TF-M-ADD-T06	TF-M ADD 2.01-4.00 TB	D1	\$0
TF-M-ADD-T07	TF-M ADD 4.01-6.00 TB	D1	\$0
TF-M-ADD-T08	TF-M ADD 6.01-8.00 TB	D1	\$0
TF-M-ADD-T09	TF-M ADD 8.01-10.00 TB	D1	\$0
TF-M-ADD-T10	TF-M ADD 10.01-12.00 TB	D1	\$0
TF-M-ADD-T11	TF-M ADD 12.01-14.00 TB	D1	\$0
TF-M-ADD-T12	TF-M ADD 14.01-17.00 TB	D1	\$0
TF-M-ADD-T13	TF-M ADD 17.01-20.00 TB	D1	\$0
TF-M-ADD-T14	TF-M ADD 20.01-23.00 TB	D1	\$0
TF-M-ADD-T15	TF-M ADD 23.01-26.00 TB	D1	\$0
TF-M-ADD-T16	TF-M ADD 26.01-29.00 TB	D1	\$0
TF-M-ADD-T17	TF-M ADD 29.01-32.00 TB	D1	\$0
TF-M-ADD-T18	TF-M ADD 32.01-35.00 TB	D1	\$0
TF-M-ADD-T19	TF-M ADD 35.01-38.00 TB	D1	\$0
TF-M-ADD-T20	TF-M ADD 38.01-41.00 TB	D1	\$0
TF-M-ADD-T21	TF-M ADD 41.01-44.00 TB	D1	\$0
TF-M-ADD-T22	TF-M ADD 44.01-47.00 TB	D1	\$0
TF-M-ADD-T23	TF-M ADD 47.01-50.00 TB	D1	\$0
TF-M-ADD-T24	TF-M ADD 50.01-53.00 TB	D1	\$0
TF-M-ADD-T25	TF-M ADD 53.01-56.00 TB	D1	\$0
TF-M-ADD-T26	TF-M ADD 56.01-59.00 TB	D1	\$0
TF-M-ADD-T27	TF-M ADD 59.01-62.00 TB	D1	\$0
TF-M-ADD-T28	TF-M ADD 62.01-65.00 TB	D1	\$0
TF-M-ADD-T29	TF-M ADD 65.01-68.00 TB	D1	\$0
TF-M-ADD-T30	TF-M ADD 68.01-71.00 TB	D1	\$0
TF-M-ADD-T31	TF-M ADD 71.01-74.00 TB	D1	\$0
TF-M-ADD-T32	TF-M ADD 74.01-77.00 TB	D1	\$0
TF-M-ADD-T33	TF-M ADD 77.01-80.00 TB	D1	\$0
TF-M-ADD-T34	TF-M ADD 80.01-83.00 TB	D1	\$0
TF-M-ADD-T35	TF-M ADD 83.01-86.00 TB	D1	\$0
TF-M-ADD-UPG	TF-M-ADD BASE UPGRADE	D1	\$0
TF-M-ADT1-4U	TF-M ADD T1-T4 UPG	D1	\$2,020
TF-M-ADT5-35	TF-M ADD T5-35 UPG	D1	\$3,830
TF-M-BASE	TF-M BASE LICENSE	D1	\$0
TF-M-C01	TF-M 1TB (0-14TB)	D1	\$0
TF-M-C02	TF-M 1TB (15-25TB)	D1	\$0
TF-M-C03	TF-M 1TB (26-40TB)	D1	\$0
TF-M-C04	TF-M 1TB (41-60TB)	D1	\$0
TF-M-C05	TF-M 1TB (61-100TB)	D1	\$0
TF-M-C06	TF-M 1TB (101-150TB)	D1	\$0
TF-M-C07	TF-M 1TB (151-250TB)	D1	\$0
TF-M-C08	TF-M 1TB (251-400TB)	D1	\$0
TF-M-C09	TF-M 1TB (401-600TB)	D1	\$0
TF-M-C10	TF-M 1TB (601-1000TB)	D1	\$0
TF-M-C11	TF-M1TB(1001TB or greater)	D1	\$0

TF-MIR-BASE	TF-MIR BASE LICENSE	D1	\$32,300
TF-MIR-C01	TF-MIR 1TB (0-14TB)	D1	\$0
TF-MIR-C02	TF-MIR 1TB (15-25TB)	D1	\$0
TF-MIR-C03	TF-MIR 1TB (26-40TB)	D1	\$0
TF-MIR-C04	TF-MIR 1TB (41-60TB)	D1	\$0
TF-MIR-C05	TF-MIR 1TB (61-100TB)	D1	\$0
TF-MIR-C06	TF-MIR 1TB (101-150TB)	D1	\$0
TF-MIR-C07	TF-MIR 1TB (151-250TB)	D1	\$0
TF-MIR-C08	TF-MIR 1TB (251-400TB)	D1	\$0
TF-MIR-C09	TF-MIR 1TB (401-600TB)	D1	\$0
TF-MIR-C10	TF-MIR 1TB (601-1000TB)	D1	\$0
TF-MIR-C11	TF-MIR 1TB(1001TB or greater)	D1	\$0
TF-MIR-N01	TF-MIR 1TB (0-14TB) NLT3	D1	\$0
TF-MIR-N02	TF-MIR 1TB (15-25TB) NLT3	D1	\$0
TF-MIR-N03	TF-MIR 1TB (26-40TB) NLT3	D1	\$0
TF-MIR-N04	TF-MIR 1TB (41-60TB) NLT3	D1	\$0
TF-MIR-N05	TF-MIR 1TB (61-100TB) NLT3	D1	\$0
TF-MIR-N06	TF-MIR 1TB (101-150TB) NLT3	D1	\$0
TF-MIR-N07	TF-MIR 1TB (151-250TB) NLT3	D1	\$0
TF-MIR-N08	TF-MIR 1TB (251-400TB) NLT3	D1	\$0
TF-MIR-N09	TF-MIR 1TB (401-600TB) NLT3	D1	\$0
TF-MIR-N10	TF-MIR 1TB (601-1000TB) NLT3	D1	\$0
TF-MIR-N11	TF-MIR 1TB(1001TB or greater) NLT3	D1	\$0
TF-MIR-UPG	TF-MIR BASE UPGRADE	D1	\$0
TF-M-N01	TF-M 1TB (0-14TB) NLT3	D1	\$0
TF-M-N02	TF-M 1TB (15-25TB) NLT3	D1	\$0
TF-M-N03	TF-M 1TB (26-40TB) NLT3	D1	\$0
TF-M-N04	TF-M 1TB (41-60TB) NLT3	D1	\$0
TF-M-N05	TF-M 1TB (61-100TB) NLT3	D1	\$0
TF-M-N06	TF-M 1TB (101-150TB) NLT3	D1	\$0
TF-M-N07	TF-M 1TB (151-250TB) NLT3	D1	\$0
TF-M-N08	TF-M 1TB (251-400TB) NLT3	D1	\$0
TF-M-N09	TF-M 1TB (401-600TB) NLT3	D1	\$0
TF-M-N10	TF-M 1TB (601-1000TB) NLT3	D1	\$0
TF-M-N11	TF-M1TB(1001TB or greater) NLT3	D1	\$0
TF-M-OBAS	TF-M OPT OUT BASE LICENSE	D1	\$0
TF-M-OPT	TF-M OPT OUT TB	D1	\$0
TF-M-OUP	TF-M OPT OUT BASE UPGRADE	D1	\$0
TF-M-R01	TF-M REPL 1TB (0-14TB)	D1	\$0
TF-M-R02	TF-M REPL 1TB (15-25TB)	D1	\$0
TF-M-R03	TF-M REPL 1TB (26-40TB)	D1	\$0
TF-M-R04	TF-M REPL 1TB (41-60TB)	D1	\$0
TF-M-R05	TF-M REPL 1TB (61-100TB)	D1	\$0
TF-M-R06	TF-M REPL 1TB (101-150TB)	D1	\$0
TF-M-R07	TF-M REPL 1TB (151-250TB)	D1	\$0
TF-M-R08	TF-M REPL 1TB (251-400TB)	D1	\$0
TF-M-R09	TF-M REPL 1TB (401-600TB)	D1	\$0
TF-M-R10	TF-M REPL 1TB (601-1000TB)	D1	\$0
TF-M-R11	TF-M REPL 1TB(1001TB or greater)	D1	\$0
TF-M-RBAS	TF-M REPL BASE LICENSE	D1	\$0

TF-M-RUP	TF-M REPL BASE UPGRADE	D1	\$0
TF-M-T01	TF-M CAPACITY 0-.250	D1	\$0
TF-M-T02	TF-M CAPACITY .251-.500	D1	\$0
TF-M-T03	TF-M CAPACITY .501-.750	D1	\$0
TF-M-T04	TF-M CAPACITY .751-1.00	D1	\$0
TF-M-T05	TF-M CAPACITY 1.01-2.00	D1	\$0
TF-M-T06	TF-M CAPACITY 2.01-4.00	D1	\$0
TF-M-T07	TF-M CAPACITY 4.01-6.00	D1	\$0
TF-M-T08	TF-M CAPACITY 6.01-8.00	D1	\$0
TF-M-T09	TF-M CAPACITY 8.01-10.00	D1	\$0
TF-M-T10	TF-M CAPACITY 10.01-12.00	D1	\$0
TF-M-T11	TF-M CAPACITY 12.01-14.00	D1	\$0
TF-M-T12	TF-M CAPACITY 14.01-17.00	D1	\$0
TF-M-T13	TF-M CPCTY 17.01-20.00	D1	\$0
TF-M-T14	TF-M CPCTY 20.01-23.00	D1	\$0
TF-M-T1-4U	TF-M T1-T4 UPGRADE	D1	\$0
TF-M-T15	TF-M CPCTY 23.01-26.00	D1	\$0
TF-M-T16	TF-M CPCTY 26.01-29.00	D1	\$0
TF-M-T17	TF-M CPCTY 29.01-32.00	D1	\$0
TF-M-T18	TF-M CPCTY 32.01-35.00	D1	\$0
TF-M-T19	TF-M CPCTY 35.01-38.00	D1	\$0
TF-M-T20	TF-M CPCTY 38.01-41.00	D1	\$0
TF-M-T21	TF-M CPCTY 41.01-44.00	D1	\$0
TF-M-T22	TF-M CPCTY 44.01-47.00	D1	\$0
TF-M-T23	TF-M CPCTY 47.01-50.00	D1	\$0
TF-M-T24	TF-M CPCTY 50.01-53.00	D1	\$0
TF-M-T25	TF-M CPCTY 53.01-56.00	D1	\$0
TF-M-T26	TF-M CPCTY 56.01-59.00	D1	\$0
TF-M-T27	TF-M CPCTY 59.01-62.00	D1	\$0
TF-M-T28	TF-M CPCTY 62.01-65.00	D1	\$0
TF-M-T29	TF-M CPCTY 65.01-68.00	D1	\$0
TF-M-T30	TF-M CPCTY 68.01-71.00	D1	\$0
TF-M-T31	TF-M CPCTY 71.01-74.00	D1	\$0
TF-M-T32	TF-M CPCTY 74.01-77.00	D1	\$0
TF-M-T33	TF-M CPCTY 77.01-80.00	D1	\$0
TF-M-T34	TF-M CPCTY 80.01-83.00	D1	\$0
TF-M-T35	TF-M CPCTY 83.01-86.00	D1	\$0
TF-M-T5-35U	TF-M T5-T35 UPGRADE	D1	\$0
TF-M-UPG	TF-M BASE UPGRADE	D1	\$0
TF-RUN-AS4	RUNTIME-NO CHARGE-AS4	D1	\$0
TF-RUN-MSP	RUNTIME-NO CHARGE-MSP	D1	\$0
TF-RUN-OPEN	RUNTIME NO CHARGE-OPEN	D1	\$0
TF-RUN-S390	RUNTIME-NO CHARGE-S390	D1	\$0
TF-RUN-TPF	RUNTIME-NO CHARGE-TPF	D1	\$0
TF-SIM-C01	TF-SIM 1TB (0-14TB)	D1	\$0
TF-SIM-C02	TF-SIM 1TB (15-25TB)	D1	\$0
TF-SIM-C03	TF-SIM 1TB (26-40TB)	D1	\$0
TF-SIM-C04	TF-SIM 1TB (41-60TB)	D1	\$0
TF-SIM-C05	TF-SIM 1TB (61-100TB)	D1	\$0
TF-SIM-C06	TF-SIM 1TB (101-150TB)	D1	\$0

TF-SIM-C07	TF-SIM 1TB (151-250TB)	D1	\$0
TF-SIM-C08	TF-SIM 1TB (251-400TB)	D1	\$0
TF-SIM-C09	TF-SIM 1TB (401-600TB)	D1	\$0
TF-SIM-C10	TF-SIM 1TB (601-1000TB)	D1	\$0
TF-SIM-C11	TF-SIM1TB (1001TB or greater)	D1	\$0
TF-SIM-N01	TF-SIM 1TB (0-14TB) NLT3	D1	\$0
TF-SIM-N02	TF-SIM 1TB (15-25TB) NLT3	D1	\$0
TF-SIM-N03	TF-SIM 1TB (26-40TB) NLT3	D1	\$0
TF-SIM-N04	TF-SIM 1TB (41-60TB) NLT3	D1	\$0
TF-SIM-N05	TF-SIM 1TB (61-100TB) NLT3	D1	\$0
TF-SIM-N06	TF-SIM 1TB (101-150TB) NLT3	D1	\$0
TF-SIM-N07	TF-SIM 1TB (151-250TB) NLT3	D1	\$0
TF-SIM-N08	TF-SIM 1TB (251-400TB) NLT3	D1	\$0
TF-SIM-N09	TF-SIM 1TB (401-600TB) NLT3	D1	\$0
TF-SIM-N10	TF-SIM 1TB (601-1000TB) NLT3	D1	\$0
TF-SIM-N11	TF-SIM1TB (1001TB or greater) NLT3	D1	\$0
TF-SIM-R01	TF-SIM REPL 1TB (0-14TB)	D1	\$0
TF-SIM-R02	TF-SIM REPL 1TB (15-25TB)	D1	\$0
TF-SIM-R03	TF-SIM REPL 1TB (26-40TB)	D1	\$0
TF-SIM-R04	TF-SIM REPL 1TB (41-60TB)	D1	\$0
TF-SIM-R05	TF-SIM REPL 1TB (61-100TB)	D1	\$0
TF-SIM-R06	TF-SIM REPL 1TB (101-150TB)	D1	\$0
TF-SIM-R07	TF-SIM REPL 1TB (151-250TB)	D1	\$0
TF-SIM-R08	TF-SIM REPL 1TB (251-400TB)	D1	\$0
TF-SIM-R09	TF-SIM REPL 1TB (401-600TB)	D1	\$0
TF-SIM-R10	TF-SIM REPL 1TB (601-1000TB)	D1	\$0
TF-SIM-R11	TF-SIM REPL 1TB (1001TB or greater)	D1	\$0
TFSIM-T01	TF SIM CPCTY 0-.250	D1	\$0
TFSIM-T02	TF SIM CPCTY 0-.250	D1	\$0
TFSIM-T03	TF SIM CPCTY .501-.750	D1	\$0
TFSIM-T04	TF SIM CPCTY .751-1.00	D1	\$0
TFSIM-T05	TF SIM CPCTY 1.01-2.00	D1	\$0
TFSIM-T06	TF SIM CPCTY 2.01-4.00	D1	\$0
TFSIM-T07	TF SIM CPCTY 4.01-6.00	D1	\$0
TFSIM-T08	TF SIM CPCTY 6.01-8.00	D1	\$0
TFSIM-T09	TF SIM CPCTY 8.01-10.00	D1	\$0
TFSIM-T10	TF SIM CPCTY 10.01-12.00	D1	\$0
TFSIM-T11	TF SIM CPCTY 12.01-14.00	D1	\$0
TFSIM-T12	TF SIM CPCTY 14.01-17.00	D1	\$0
TFSIM-T13	TF SIM CPCTY 17.01-20.00	D1	\$0
TFSIM-T14	TF SIM CPCTY 20.01-23.00	D1	\$0
TFSIM-T1-4U	TF SIM T1-T4 UPGRADE	D1	\$0
TFSIM-T15	TF SIM CPCTY 23.01-26.00	D1	\$0
TFSIM-T16	TF SIM CPCTY 26.01-29.00	D1	\$0
TFSIM-T17	TF SIM CPCTY 29.01-32.00	D1	\$0
TFSIM-T18	TF SIM CPCTY 32.01-35.00	D1	\$0
TFSIM-T19	TF SIM CPCTY 35.01-38.00	D1	\$0
TFSIM-T20	TF SIM CPCTY 38.01-41.00	D1	\$0
TFSIM-T21	TF SIM CPCTY 41.01-44.00	D1	\$0
TFSIM-T22	TF SIM CPCTY 44.01-47.00	D1	\$0

TFSIM-T23	TF SIM CPCTY 47.01-50.00	D1	\$0
TFSIM-T24	TF SIM CPCTY 50.01-53.00	D1	\$0
TFSIM-T25	TF SIM CPCTY 53.01-56.00	D1	\$0
TFSIM-T26	TF SIM CPCTY 56.01-59.00	D1	\$0
TFSIM-T27	TF SIM CPCTY 59.01-62.00	D1	\$0
TFSIM-T28	TF SIM CPCTY 62.01-65.00	D1	\$0
TFSIM-T29	TF SIM CPCTY 65.01-68.00	D1	\$0
TFSIM-T30	TF SIM CPCTY 68.01-71.00	D1	\$0
TFSIM-T31	TFSIM CPCTY 71.01-74.00	D1	\$0
TFSIM-T32	TFSIM CPCTY 74.01-77.00	D1	\$0
TFSIM-T33	TFSIM CPCTY 77.01-80.00	D1	\$0
TFSIM-T34	TFSIM CPCTY 80.01-83.00	D1	\$0
TFSIM-T35	TFSIM CPCTY 83.01-86.00	D1	\$0
TFSIM-T5-35U	TFSIM T5-T35 UPGRADE	D1	\$0
TF-SIM-UPG	TF-SIM BASE UPGRADE	D1	\$0
TFSNAPADDBASE	TFSNAP-ADD BASE LICENSE	D1	\$0
TFSNAPADD-C01	TFSNAP-ADD 1TB (0-14TB)	D1	\$0
TFSNAPADD-C02	TFSNAP-ADD 1TB (15-25TB)	D1	\$0
TFSNAPADD-C03	TFSNAP-ADD 1TB (26-40TB)	D1	\$0
TFSNAPADD-C04	TFSNAP-ADD 1TB (41-60TB)	D1	\$0
TFSNAPADD-C05	TFSNAP-ADD 1TB (61-100TB)	D1	\$0
TFSNAPADD-C06	TFSNAPADD 1TB (101-150TB)	D1	\$0
TFSNAPADD-C07	TFSNAPADD 1TB (151-250TB)	D1	\$0
TFSNAPADD-C08	TFSNAPADD 1TB (251-400TB)	D1	\$0
TFSNAPADD-C09	TFSNAPADD 1TB (401-600TB)	D1	\$0
TFSNAPADD-C10	TFSNAPADD 1TB(601-1000TB)	D1	\$0
TFSNAPADD-C11	TFSNAPADD1TB(1001TB or greater)	D1	\$0
TFSNAPADD-N01	TFSNAP-ADD 1TB (0-14TB) NLT3	D1	\$0
TFSNAPADD-N02	TFSNAP-ADD 1TB (15-25TB) NLT3	D1	\$0
TFSNAPADD-N03	TFSNAP-ADD 1TB (26-40TB) NLT3	D1	\$0
TFSNAPADD-N04	TFSNAP-ADD 1TB (41-60TB) NLT3	D1	\$0
TFSNAPADD-N05	TFSNAP-ADD 1TB (61-100TB) NLT3	D1	\$0
TFSNAPADD-N06	TFSNAPADD 1TB (101-150TB) NLT3	D1	\$0
TFSNAPADD-N07	TFSNAPADD 1TB (151-250TB) NLT3	D1	\$0
TFSNAPADD-N08	TFSNAPADD 1TB (251-400TB) NLT3	D1	\$0
TFSNAPADD-N09	TFSNAPADD 1TB (401-600TB) NLT3	D1	\$0
TFSNAPADD-N10	TFSNAPADD 1TB(601-1000TB) NLT3	D1	\$0
TFSNAPADD-N11	TFSNAPADD1TB(1001TB or greater) NLT3	D1	\$0
TFSNAPADDOBAS	TFSNAP-ADD OPT OUT BASE LICENSE	D1	\$0
TFSNAPADD-OPT	TFSNAP-ADD OPT OUT TB	D1	\$0
TFSNAPADD-OUP	TFSNAP-ADD OPT OUT BASE UPGRADE	D1	\$0
TF-SNAP-BASE	TF-SNAP BASE LICENSE	D1	\$0
TF-SNAP-BASEF	TF-SNAP FENB BASE LICENSE	D1	\$17,290
TF-SNAP-BASEL	TF-SNAP LITE BASE LICENSE	D1	\$3,060
TF-SNAP-C01	TF-SNAP 1TB (0-14TB)	D1	\$0
TF-SNAP-C02	TF-SNAP 1TB (15-25TB)	D1	\$0
TF-SNAP-C03	TF-SNAP 1TB (26-40TB)	D1	\$0
TF-SNAP-C04	TF-SNAP 1TB (41-60TB)	D1	\$0
TF-SNAP-C05	TF-SNAP 1TB (61-100TB)	D1	\$0
TF-SNAP-C06	TF-SNAP 1TB (101-150TB)	D1	\$0

TF-SNAP-C07	TF-SNAP 1TB (151-250TB)	D1	\$0
TF-SNAP-C08	TF-SNAP 1TB (251-400TB)	D1	\$0
TF-SNAP-C09	TF-SNAP 1TB (401-600TB)	D1	\$0
TF-SNAP-C10	TF-SNAP 1TB (601-1000TB)	D1	\$0
TF-SNAP-C11	TF-SNAP1TB(1001TB or greater)	D1	\$0
TF-SNAP-CF01	TF-SNAP FENB 1TB (0-14TB)	D1	\$2,050
TF-SNAP-CF02	TF-SNAP FENB 1TB (15-25TB)	D1	\$1,920
TF-SNAP-CF03	TF-SNAP FENB 1TB (26-40TB)	D1	\$1,700
TF-SNAP-CF04	TF-SNAP FENB 1TB (41-60TB)	D1	\$1,580
TF-SNAP-CF05	TF-SNAP FENB 1TB (61-100TB)	D1	\$1,520
TF-SNAP-CF06	TF-SNAP FENB 1TB (101-150TB)	D1	\$1,360
TF-SNAP-CF07	TF-SNAP FENB 1TB (151-250TB)	D1	\$1,210
TF-SNAP-CF08	TF-SNAP FENB 1TB (251-400TB)	D1	\$1,050
TF-SNAP-CF09	TF-SNAP FENB 1TB (401-600TB)	D1	\$910
TF-SNAP-CF10	TF-SNAP FENB 1TB (601-1000TB)	D1	\$790
TF-SNAP-CF11	TF-SNAP FENB1TB(1001TB OR GREATER)	D1	\$690
TF-SNAP-CL01	TF-SNAP LITE 1TB (0-14TB)	D1	\$370
TF-SNAP-CL02	TF-SNAP LITE 1TB (15-25TB)	D1	\$350
TF-SNAP-CL03	TF-SNAP LITE 1TB (26-40TB)	D1	\$300
TF-SNAP-CL04	TF-SNAP LITE 1TB (41-60TB)	D1	\$280
TF-SNAP-CL05	TF-SNAP LITE 1TB (61-100TB)	D1	\$270
TF-SNAP-CL06	TF-SNAP LITE 1TB (101-150TB)	D1	\$250
TF-SNAP-CL07	TF-SNAP LITE 1TB (151-250TB)	D1	\$220
TF-SNAP-CL08	TF-SNAP LITE 1TB (251-400TB)	D1	\$190
TF-SNAP-CL09	TF-SNAP LITE 1TB (401-600TB)	D1	\$170
TF-SNAP-CL10	TF-SNAP LITE 1TB (601-1000TB)	D1	\$150
TF-SNAP-CL11	TF-SNAP LITE1TB(1001TB OR GREATER)	D1	\$130
TF-SNAP-N01	TF-SNAP 1TB (0-14TB) NLT3	D1	\$0
TF-SNAP-N02	TF-SNAP 1TB (15-25TB) NLT3	D1	\$0
TF-SNAP-N03	TF-SNAP 1TB (26-40TB) NLT3	D1	\$0
TF-SNAP-N04	TF-SNAP 1TB (41-60TB) NLT3	D1	\$0
TF-SNAP-N05	TF-SNAP 1TB (61-100TB) NLT3	D1	\$0
TF-SNAP-N06	TF-SNAP 1TB (101-150TB) NLT3	D1	\$0
TF-SNAP-N07	TF-SNAP 1TB (151-250TB) NLT3	D1	\$0
TF-SNAP-N08	TF-SNAP 1TB (251-400TB) NLT3	D1	\$0
TF-SNAP-N09	TF-SNAP 1TB (401-600TB) NLT3	D1	\$0
TF-SNAP-N10	TF-SNAP 1TB (601-1000TB) NLT3	D1	\$0
TF-SNAP-N11	TF-SNAP1TB(1001TB or greater) NLT3	D1	\$0
TF-SNAP-NF01	TF-SNAP FENB 1TB (0-14TB) NLT3	D1	\$1,020
TF-SNAP-NF02	TF-SNAP FENB 1TB (15-25TB) NLT3	D1	\$960
TF-SNAP-NF03	TF-SNAP FENB 1TB (26-40TB) NLT3	D1	\$850
TF-SNAP-NF04	TF-SNAP FENB 1TB (41-60TB) NLT3	D1	\$790
TF-SNAP-NF05	TF-SNAP FENB 1TB (61-100TB) NLT3	D1	\$750
TF-SNAP-NF06	TF-SNAP FENB 1TB (101-150TB) NLT3	D1	\$680
TF-SNAP-NF07	TF-SNAP FENB 1TB (151-250TB) NLT3	D1	\$600
TF-SNAP-NF08	TF-SNAP FENB 1TB (251-400TB) NLT3	D1	\$520
TF-SNAP-NF09	TF-SNAP FENB 1TB (401-600TB) NLT3	D1	\$450
TF-SNAP-NF10	TF-SNAP FENB 1TB (601-1000TB) NLT3	D1	\$390
TF-SNAP-NF11	TF-SNAP FENB1TB(1001TB OR GREATER) NLT3	D1	\$340
TF-SNAP-NL01	TF-SNAP LITE 1TB (0-14TB) NLT3	D1	\$190

TF-SNAP-NL02	TF-SNAP LITE 1TB (15-25TB) NLT3	D1	\$170
TF-SNAP-NL03	TF-SNAP LITE 1TB (26-40TB) NLT3	D1	\$150
TF-SNAP-NL04	TF-SNAP LITE 1TB (41-60TB) NLT3	D1	\$140
TF-SNAP-NL05	TF-SNAP LITE 1TB (61-100TB) NLT3	D1	\$140
TF-SNAP-NL06	TF-SNAP LITE 1TB (101-150TB) NLT3	D1	\$130
TF-SNAP-NL07	TF-SNAP LITE 1TB (151-250TB) NLT3	D1	\$110
TF-SNAP-NL08	TF-SNAP LITE 1TB (251-400TB) NLT3	D1	\$100
TF-SNAP-NL09	TF-SNAP LITE 1TB (401-600TB) NLT3	D1	\$90
TF-SNAP-NL10	TF-SNAP LITE 1TB (601-1000TB) NLT3	D1	\$80
TF-SNAP-NL11	TF-SNAP LITE 1TB(1001TB OR GREATER) NLT3	D1	\$70
TF-SNAP-OBAS	TF-SNAP OPT OUT BASE LICENSE	D1	\$0
TF-SNAP-OPT	TF-SNAP OPT OUT TB	D1	\$0
TF-SNAP-OUP	TF-SNAP OPT OUT BASE UPGRADE	D1	\$0
TF-SNAP-R01	TF-SNAP REPL 1TB (0-14TB)	D1	\$0
TF-SNAP-R02	TF-SNAP REPL 1TB (15-25TB)	D1	\$0
TF-SNAP-R03	TF-SNAP REPL 1TB (26-40TB)	D1	\$0
TF-SNAP-R04	TF-SNAP REPL 1TB (41-60TB)	D1	\$0
TF-SNAP-R05	TF-SNAP REPL 1TB (61-100TB)	D1	\$0
TF-SNAP-R06	TF-SNAP REPL 1TB (101-150TB)	D1	\$0
TF-SNAP-R07	TF-SNAP REPL 1TB (151-250TB)	D1	\$0
TF-SNAP-R08	TF-SNAP REPL 1TB (251-400TB)	D1	\$0
TF-SNAP-R09	TF-SNAP REPL 1TB (401-600TB)	D1	\$0
TF-SNAP-R10	TF-SNAP REPL 1TB (601-1000TB)	D1	\$0
TF-SNAP-R11	TF-SNAP REPL 1TB(1001TB or greater)	D1	\$0
TF-SNAP-RBAS	TF-SNAP REPL BASE LICENSE	D1	\$0
TF-SNAP-RBASF	TF-SNAP FENB REPL BASE LICENSE	D1	\$11,240
TF-SNAP-RBASL	TF-SNAP LITE REPL BASE LICENSE	D1	\$1,990
TF-SNAP-RF01	TF-SNAP FENB REPL 1TB (0-14TB)	D1	\$5,840
TF-SNAP-RF02	TF-SNAP FENB REPL 1TB (15-25TB)	D1	\$5,090
TF-SNAP-RF03	TF-SNAP FENB REPL 1TB (26-40TB)	D1	\$4,420
TF-SNAP-RF04	TF-SNAP FENB REPL 1TB (41-60TB)	D1	\$3,930
TF-SNAP-RF05	TF-SNAP FENB REPL 1TB (61-100TB)	D1	\$3,540
TF-SNAP-RF06	TF-SNAP FENB REPL 1TB (101-150TB)	D1	\$3,290
TF-SNAP-RF07	TF-SNAP FENB REPL 1TB (151-250TB)	D1	\$3,060
TF-SNAP-RF08	TF-SNAP FENB REPL 1TB (251-400TB)	D1	\$2,840
TF-SNAP-RF09	TF-SNAP FENB REPL 1TB (401-600TB)	D1	\$2,650
TF-SNAP-RF10	TF-SNAP FENB REPL 1TB (601-1000TB)	D1	\$2,460
TF-SNAP-RF11	TF-SNAP FENB REPL 1TB(1001TB OR GREATER)	D1	\$2,290
TF-SNAP-RL01	TF-SNAP LITE REPL 1TB (0-14TB)	D1	\$1,040
TF-SNAP-RL02	TF-SNAP LITE REPL 1TB (15-25TB)	D1	\$900
TF-SNAP-RL03	TF-SNAP LITE REPL 1TB (26-40TB)	D1	\$790
TF-SNAP-RL04	TF-SNAP LITE REPL 1TB (41-60TB)	D1	\$700
TF-SNAP-RL05	TF-SNAP LITE REPL 1TB (61-100TB)	D1	\$630
TF-SNAP-RL06	TF-SNAP LITE REPL 1TB (101-150TB)	D1	\$590
TF-SNAP-RL07	TF-SNAP LITE REPL 1TB (151-250TB)	D1	\$550
TF-SNAP-RL08	TF-SNAP LITE REPL 1TB (251-400TB)	D1	\$510
TF-SNAP-RL09	TF-SNAP LITE REPL 1TB (401-600TB)	D1	\$470
TF-SNAP-RL10	TF-SNAP LITE REPL 1TB (601-1000TB)	D1	\$440
TF-SNAP-RL11	TF-SNAP LITE REPL 1TB(1001TB OR GREATER)	D1	\$410
TF-SNAP-RUPL	TF-SNAP LITE REPL BASE UPGRADE	D1	\$0

TFSNAP-T01	TFSNAP CAPACITY 0-.250	D1	\$0
TFSNAP-T02	TFSNAP CAPACITY .251-.500	D1	\$0
TFSNAP-T03	TFSNAP CAPACITY .501-.750	D1	\$0
TFSNAP-T04	TFSNAP CAPACITY .751-1.00	D1	\$0
TFSNAP-T05	TFSNAP CAPACITY 1.01-2.00	D1	\$0
TFSNAP-T06	TFSNAP CAPACITY 2.01-4.00	D1	\$0
TFSNAP-T07	TFSNAP CAPACTY 4.01-6.00	D1	\$0
TFSNAP-T08	TFSNAP CAPACITY 6.01-8.00	D1	\$0
TFSNAP-T09	TFSNAP CAPACITY 8.01-10.0	D1	\$0
TFSNAP-T10	TFSNAP CAPACITY 10.01-12.	D1	\$0
TFSNAP-T11	TFSNAP CAPACITY 12.01-14.	D1	\$0
TFSNAP-T12	TFSNAP CAPACITY 14.01-17.	D1	\$0
TFSNAP-T13	TFSNAP CPCTY 17.01-20.00	D1	\$0
TFSNAP-T14	TFSNAP CPCTY 20.01-23.00	D1	\$0
TFSNAP-T1-4U	TFSNAP T1-T4 UPGRADE	D1	\$0
TFSNAP-T15	TFSNAP CPCTY 23.01-26.00	D1	\$0
TFSNAP-T16	TFSNAP CPCTY 26.01-29.00	D1	\$0
TFSNAP-T17	TFSNAP CPCTY 29.01-32.00	D1	\$0
TFSNAP-T18	TFSNAP CPCTY 32.01-35.00	D1	\$0
TFSNAP-T19	TFSNAP CPCTY 35.01-38.00	D1	\$0
TFSNAP-T20	TFSNAP CPCTY 38.01-41.00	D1	\$0
TFSNAP-T21	TFSNAP CPCTY 41.01-44.00	D1	\$0
TFSNAP-T22	TFSNAP CPCTY 44.01-47.00	D1	\$0
TFSNAP-T23	TFSNAP CPCTY 47.01-50.00	D1	\$0
TFSNAP-T24	TFSNAP CPCTY 50.01-53.00	D1	\$0
TFSNAP-T25	TFSNAP CPCTY 53.01-56.00	D1	\$0
TFSNAP-T26	TFSNAP CPCTY 56.01-59.00	D1	\$0
TFSNAP-T27	TFSNAP CPCTY 59.01-62.00	D1	\$0
TFSNAP-T28	TFSNAP CPCTY 62.01-65.00	D1	\$0
TFSNAP-T29	TFSNAP CPCTY 65.01-68.00	D1	\$0
TFSNAP-T30	TFSNAP CPCTY 68.01-71.00	D1	\$0
TFSNAP-T31	TFSNAP CPCTY 71.01-74.00	D1	\$0
TFSNAP-T32	TFSNAP CPCTY 74.01-77.00	D1	\$0
TFSNAP-T33	TFSNAP CPCTY 77.01-80.00	D1	\$0
TFSNAP-T34	TFSNAP CPCTY 80.01-83.00	D1	\$0
TFSNAP-T35	TFSNAP CPCTY 83.01-86.00	D1	\$0
TFSNAP-T5-35U	TFSNAP T5-T35 UPGRADE	D1	\$0
TF-SNAP-UPGL	TF-SNAP LITE BASE UPGRADE	D1	\$0
TFSNPAD-T1-4U	TF-SNAP ADD T1-T4 UPG	D1	\$0
TF-T1	TF CAPACITY 0-.250	D1	\$0
TF-T10	TF CAPACITY 10.01-12.00	D1	\$0
TF-T11	TF CAPACITY 12.01-14.00	D1	\$0
TF-T12	TF CAPACITY 14.01-16.00	D1	\$0
TF-T13	TF CPCTY 17.01-20.00	D1	\$0
TF-T14	TF CPCTY 20.01-23.00	D1	\$0
TF-T1-4UP	TF T1-T4 UPGRADE	D1	\$0
TF-T15	TF CPCTY 23.01-26.00	D1	\$0
TF-T16	TF CPCTY 26.01-29.00	D1	\$0
TF-T17	TF CPCTY 29.01-32.00	D1	\$0
TF-T18	TF CPCTY 32.01-35.00	D1	\$0

TF-T19	TF CPCTY 35.01-38.00	D1	\$0
TF-T2	TF CAPACITY .251-.500	D1	\$0
TF-T20	TF CPCTY 38.01-41.00	D1	\$0
TF-T21	TF CPCTY 41.01-44.00	D1	\$0
TF-T22	TF CPCTY 44.01-47.00	D1	\$0
TF-T23	TF CPCTY 47.01-50.00	D1	\$0
TF-T24	TF CPCTY 50.01-53.00	D1	\$0
TF-T25	TF CPCTY 53.01-56.00	D1	\$0
TF-T26	TF CPCTY 56.01-59.00	D1	\$0
TF-T27	TF CPCTY 59.01-62.00	D1	\$0
TF-T28	TF CPCTY 62.01-65.00	D1	\$0
TF-T29	TF CPCTY 65.01-68.00	D1	\$0
TF-T3	TF CAPACITY .501-.750	D1	\$0
TF-T30	TF CPCTY 68.01-71.00	D1	\$0
TF-T31	TF CPCTY 71.01-74.00	D1	\$0
TF-T32	TF CPCTY 74.01-77.00	D1	\$0
TF-T33	TF CPCTY 77.01-80.00	D1	\$0
TF-T34	TF CPCTY 80.01-83.00	D1	\$0
TF-T35	TF CPCTY 83.01-86.00	D1	\$0
TF-T4	TF CAPACITY .751-1.00	D1	\$0
TF-T5	TF CAPACITY 1.01-2.00	D1	\$0
TF-T5-30UP	TF T5-T30 UPGRADE	D1	\$0
TF-T5-35U	TF T5-T35 UPGRADE	D1	\$0
TF-T6	TF CAPACITY 2.01-4.00	D1	\$0
TF-T7	TF CAPACTY 4.01-6.00	D1	\$0
TF-T8	TF CAPACITY 6.01-8.00	D1	\$0
TF-T9	TF CAPACITY 8.01-10.00	D1	\$0
TSNAPADD-T01	TF-SNAP ADD 0-.250TB	D1	\$0
TSNAPADD-T02	TF-SNAP ADD .251-.500TB	D1	\$0
TSNAPADD-T03	TF-SNAP ADD .501-.750TB	D1	\$0
TSNAPADD-T04	TF-SNAP ADD .751-1.00TB	D1	\$0
TSNAPADD-T05	TF-SNAP ADD 1.01-2.00TB	D1	\$0
TSNAPADD-T06	TF-SNAP ADD 2.01-4.00TB	D1	\$0
TSNAPADD-T07	TF-SNAP ADD 4.01-6.00TB	D1	\$0
TSNAPADD-T08	TF-SNAP ADD 6.01-8.00TB	D1	\$0
TSNAPADD-T09	TF-SNAP ADD 8.01-10.00TB	D1	\$0
TSNAPADD-T10	TF-SNAP ADD 10.01-12.00TB	D1	\$0
TSNAPADD-T11	TF-SNAP ADD 12.01-14.00TB	D1	\$0
TSNAPADD-T12	TF-SNAP ADD 14.01-17.00TB	D1	\$0
TSNAPADD-T13	TF-SNAP ADD 17.01-20.00TB	D1	\$0
TSNAPADD-T14	TF-SNAP ADD 20.01-23.00TB	D1	\$0
TSNAPADD-T15	TF-SNAP ADD 23.01-26.00TB	D1	\$0
TSNAPADD-T16	TF-SNAP ADD 26.01-29.00TB	D1	\$0
TSNAPADD-T17	TF-SNAP ADD 29.01-32.00TB	D1	\$0
TSNAPADD-T18	TF-SNAP ADD 32.01-35.00TB	D1	\$0
TSNAPADD-T19	TF-SNAP ADD 35.01-38.00TB	D1	\$0
TSNAPADD-T20	TF-SNAP ADD 38.01-41.00TB	D1	\$0
TSNAPADD-T21	TF-SNAP ADD 41.01-44.00TB	D1	\$0
TSNAPADD-T22	TF-SNAP ADD 44.01-47.00TB	D1	\$0
TSNAPADD-T23	TF-SNAP ADD 47.01-50.00TB	D1	\$0

TSNAPADD-T24	TF-SNAP ADD 50.01-53.00TB	D1	\$0
TSNAPADD-T25	TF-SNAP ADD 53.01-56.00TB	D1	\$0
TSNAPADD-T26	TF-SNAP ADD 56.01-59.00TB	D1	\$0
TSNAPADD-T27	TF-SNAP ADD 59.01-62.00TB	D1	\$0
TSNAPADD-T28	TF-SNAP ADD 62.01-65.00TB	D1	\$0
TSNAPADD-T29	TF-SNAP ADD 65.01-68.00TB	D1	\$0
TSNAPADD-T30	TF-SNAP ADD 68.01-71.00TB	D1	\$0
TSNAPADD-T31	TF-SNAP ADD 71.01-74.00TB	D1	\$0
TSNAPADD-T32	TF-SNAP ADD 74.01-77.00TB	D1	\$0
TSNAPADD-T33	TF-SNAP ADD 77.01-80.00TB	D1	\$0
TSNAPADD-T34	TF-SNAP ADD 80.01-83.00TB	D1	\$0
TSNAPADD-T35	TF-SNAP ADD 83.01-86.00TB	D1	\$0
TSNPAD-T5-35U	TF-SNAP ADD T5-35 UPG	D1	\$0
V-FASTADD-BAS	VMAX FAST ADD BASE LICENSE	D1	\$5,510
V-FASTADD-C01	VMAX FAST ADD SOFTWARE 1TB (0-14TB)	D1	\$615
V-FASTADD-C02	VMAX FAST ADD SOFTWARE 1TB (15-25TB)	D1	\$578
V-FASTADD-C03	VMAX FAST ADD SOFTWARE 1TB (26-40TB)	D1	\$508
V-FASTADD-C04	VMAX FAST ADD SOFTWARE 1TB (41-60TB)	D1	\$473
V-FASTADD-C05	VMAX FAST ADD SOFTWARE 1TB (61-100TB)	D1	\$452
V-FASTADD-C06	VMAX FAST ADD SOFTWARE 1TB (101-150TB)	D1	\$406
V-FASTADD-C07	VMAX FAST ADD SOFTWARE 1TB (151-250TB)	D1	\$365
V-FASTADD-C08	VMAX FAST ADD SOFTWARE 1TB (251-400TB)	D1	\$316
V-FASTADD-C09	VMAX FAST ADD SOFTWARE 1TB (401-600TB)	D1	\$271
V-FASTADD-C10	VMAX FAST ADD SOFTWARE 1TB (601-1000TB)	D1	\$240
V-FASTADD-C11	VMAX FAST ADD 1TB (1001TB OR GREATER)	D1	\$209
V-FASTADD-N01	VMAX FAST ADD SOFTWARE 1TB (0-14TB) NLT3	D1	\$308
V-FASTADD-N02	VMAX FAST ADD 1TB (15-25TB) NLT3	D1	\$289
V-FASTADD-N03	VMAX FAST ADD 1TB (26-40TB) NLT3	D1	\$254
V-FASTADD-N04	VMAX FAST ADD 1TB (41-60TB) NLT3	D1	\$236
V-FASTADD-N05	VMAX FAST ADD 1TB (61-100TB) NLT3	D1	\$226
V-FASTADD-N06	VMAX FAST ADD 1TB (101-150TB) NLT3	D1	\$203
V-FASTADD-N07	VMAX FAST ADD 1TB (151-250TB) NLT3	D1	\$182
V-FASTADD-N08	VMAX FAST ADD 1TB (251-400TB) NLT3	D1	\$158
V-FASTADD-N09	VMAX FAST ADD 1TB (401-600TB) NLT3	D1	\$136
V-FASTADD-N10	VMAX FAST ADD 1TB (601-1000TB) NLT3	D1	\$120
V-FASTADD-N11	VMAX FAST ADD 1TB (1001TB OR GREATER) NL	D1	\$104
V-FASTADD-UPG	VMAX FAST ADD UPGRADE LICENSE	D1	\$0
V-FASTPKG-BAS	VMAX FAST PKG BASE LICENSE	D1	\$13,829
V-FASTPKG-C01	VMAX FAST PKG SOFTWARE 1TB (0-14TB)	D1	\$1,544
V-FASTPKG-C02	VMAX FAST PKG SOFTWARE 1TB (15-25TB)	D1	\$1,449
V-FASTPKG-C03	VMAX FAST PKG SOFTWARE 1TB (26-40TB)	D1	\$1,274
V-FASTPKG-C04	VMAX FAST PKG SOFTWARE 1TB (41-60TB)	D1	\$1,186
V-FASTPKG-C05	VMAX FAST PKG SOFTWARE 1TB (61-100TB)	D1	\$1,134
V-FASTPKG-C06	VMAX FAST PKG SOFTWARE 1TB (101-150TB)	D1	\$1,021
V-FASTPKG-C07	VMAX FAST PKG SOFTWARE 1TB (151-250TB)	D1	\$917
V-FASTPKG-C08	VMAX FAST PKG SOFTWARE 1TB (251-400TB)	D1	\$794
V-FASTPKG-C09	VMAX FAST PKG SOFTWARE 1TB (401-600TB)	D1	\$680
V-FASTPKG-C10	VMAX FAST PKG SOFTWARE 1TB (601-1000TB)	D1	\$602
V-FASTPKG-C11	VMAX FAST PKG 1TB (1001TB OR GREATER)	D1	\$523
V-FASTPKG-N01	VMAX FAST PKG SOFTWARE 1TB (0-14TB) NLT3	D1	\$772

V-FASTPKG-N02	VMAX FAST PKG 1TB (15-25TB) NLT3	D1	\$724
V-FASTPKG-N03	VMAX FAST PKG 1TB (26-40TB) NLT3	D1	\$637
V-FASTPKG-N04	VMAX FAST PKG 1TB (41-60TB) NLT3	D1	\$593
V-FASTPKG-N05	VMAX FAST PKG 1TB (61-100TB) NLT3	D1	\$567
V-FASTPKG-N06	VMAX FAST PKG 1TB (101-150TB) NLT3	D1	\$510
V-FASTPKG-N07	VMAX FAST PKG 1TB (151-250TB) NLT3	D1	\$458
V-FASTPKG-N08	VMAX FAST PKG 1TB (251-400TB) NLT3	D1	\$397
V-FASTPKG-N09	VMAX FAST PKG 1TB (401-600TB) NLT3	D1	\$341
V-FASTPKG-N10	VMAX FAST PKG 1TB (601-1000TB) NLT3	D1	\$301
V-FASTPKG-N11	VMAX FAST PKG 1TB (1001TB OR GREATER) NL	D1	\$262
V-FASTPKG-UPG	VMAX FAST PKG UPGRADE LICENSE	D1	\$0
VLGX-ESN-UPG	VOL LOGIX TO ESN MGR UPG	D1	\$7,200
VLGX-SM-UPG	VLX TO SAN MGR UP	D1	\$6,480
VLGX-T1-4UP	VLGX MGR T1-T4 UPGRADE	D1	\$0
VLGX-T5-12UP	VLGX MGR T5-T12 UPGRADE	D1	\$0
V-MF-BAS	VMAX MAINFRAME PKG BASE	D1	\$30,650
V-MF-C01	VMAX MAINFRAME PKG SOFTWARE 1TB (0-14TB)	D1	\$2,565
V-MF-C02	VMAX MNFRM PKG SWR 1TB (15-25TB)	D1	\$2,415
V-MF-C03	VMAX MNFRM PKG SWR 1TB (26-40TB)	D1	\$2,125
V-MF-C04	VMAX MNFRM PKG SWR 1TB (41-60TB)	D1	\$1,970
V-MF-C05	VMAX MNFRM PKG SWR 1TB (61-100TB)	D1	\$1,895
V-MF-C06	VMAX MNFRM PKG SWR 1TB (101-150TB)	D1	\$1,700
V-MF-C07	VMAX MNFRM PKG SWR 1TB (151-250TB)	D1	\$1,515
V-MF-C08	VMAX MNFRM PKG SWR 1TB (251-400TB)	D1	\$1,320
V-MF-C09	VMAX MNFRM PKG SWR 1TB (401-600TB)	D1	\$1,145
V-MF-C10	VMAX MNFRM PKG SWR 1TB (601-1000TB)	D1	\$995
V-MF-C11	VMAX MNFRM PKG SWR 1TB (1001TB OR GRTR)	D1	\$865
V-MF-N01	VMAX MNFRM PKG SWR 1TB (0-14TB) NLT3	D1	\$1,285
V-MF-N02	VMAX MNFRM PKG SWR 1TB (15-25TB) NLT3	D1	\$1,205
V-MF-N03	VMAX MNFRM PKG SWR 1TB (26-40TB) NLT3	D1	\$1,065
V-MF-N04	VMAX MNFRM PKG SWR 1TB (41-60TB) NLT3	D1	\$985
V-MF-N05	VMAX MNFRM PKG SWR 1TB (61-100TB) NLT3	D1	\$945
V-MF-N06	VMAX MNFRM PKG SWR 1TB (101-150TB) NLT3	D1	\$850
V-MF-N07	VMAX MNFRM PKG SWR 1TB (151-250TB) NLT3	D1	\$755
V-MF-N08	VMAX MNFRM PKG SWR 1TB (251-400TB) NLT3	D1	\$660
V-MF-N09	VMAX MNFRM PKG SWR 1TB (401-600TB) NLT3	D1	\$575
V-MF-N10	VMAX MNFRM PKG SWR 1TB (601-1000TB) NLT3	D1	\$500
V-MF-N11	VMAX MNFRM PKG SWR 1TB (1001TB OR GRTR)	D1	\$435
V-MF-R01	VMAX MNFRM PKG SWR REG 1TB (0-14TB)	D1	\$2,565
V-MF-R02	VMAX MNFRM PKG SWR REG 1TB (15-25TB)	D1	\$2,415
V-MF-R03	VMAX MNFRM PKG SWR REG 1TB (26-40TB)	D1	\$2,125
V-MF-R04	VMAX MNFRM PKG SWR REG 1TB (41-60TB)	D1	\$1,970
V-MF-R05	VMAX MNFRM PKG SWR REG 1TB (61-100TB)	D1	\$1,895
V-MF-R06	VMAX MNFRM PKG SWR REG 1TB (101-150TB)	D1	\$1,700
V-MF-R07	VMAX MNFRM PKG SWR REG 1TB (151-250TB)	D1	\$1,515
V-MF-R08	VMAX MNFRM PKG SWR REG 1TB (251-400TB)	D1	\$1,320
V-MF-R09	VMAX MNFRM PKG SWR REG 1TB (401-600TB)	D1	\$1,145
V-MF-R10	VMAX MNFRM PKG SWR REG 1TB (601-1000TB)	D1	\$995
V-MF-R11	VMAX MNFRM PKG SWR REG 1TB (1001 TB+)	D1	\$865
V-MF-RBAS	VMAX MNFRM PKG SWR BASE LICENSE	D1	\$30,650

V-MF-RUP	VMAX MNFRM PKG SWR BASE UPGRADE	D1	\$0
V-MF-UPG	VMAX MAINFRAME PKG UPGRADE LICENSE	D1	\$0
VSA-MSUBASE	VSAM A BASE-3 MSU	D1	\$2,370
VSA-MSU-M00	VSAM A 4-45 MSU	D1	\$470
VSA-MSU-M01	VSAM A 46-175 MSU	D1	\$240
VSA-MSU-M02	VSAM A 176-315 MSU	D1	\$170
VSA-MSU-M03	VSAM A 316-575 MSU	D1	\$120
VSA-MSU-M04	VSAM A 576-875 MSU	D1	\$100
VSA-MSU-M05	VSAM A 876-1315 MSU	D1	\$70
VSA-MSU-M06	VSAM A 1316-1975 MSU	D1	\$50
VSA-MSU-M07	VSAM A 1976 & UP MSU	D1	\$20
VSA-MSU-UPG	VSAM A UPG	D1	\$0
VSQI-MSUBASE	VSAM QI BASE-3 MSU	D1	\$2,370
VSQI-MSU-M00	VSAM QI 4-45 MSU	D1	\$360
VSQI-MSU-M01	VSAM QI 46-175 MSU	D1	\$180
VSQI-MSU-M02	VSAM QI 176-315 MSU	D1	\$120
VSQI-MSU-M03	VSAM QI 316-575 MSU	D1	\$90
VSQI-MSU-M04	VSAM QI 576-875 MSU	D1	\$70
VSQI-MSU-M05	VSAM QI 876-1315 MSU	D1	\$50
VSQI-MSU-M06	VSAM QI 1316-1975 MSU	D1	\$40
VSQI-MSU-M07	VSAM QI 1976 & UP MSU	D1	\$20
VSQI-MSU-UPG	VSAM QI UPG	D1	\$0
VSS-STDS	PROVIDES VSS SUPPORT	D1	\$0
WLA-SY-T1-4U	CC5.x WLA SYM T1-4 UPG	D1	\$0
WLA-SY-T5-30U	CC5.x WLA SYM T5-30 UPG	D1	\$0
WLA-SY-T5-35U	CC WLA SYM T5-35 UPG	D1	\$0
WLAUPT1-4	ECC WLA UPGRADE T1-T4	D1	\$1,010
WLAUPT5-12	ECC WLA UPGRADE T5-T12	D1	\$3,820
YMAX-ENB	SPECIAL PKG SW TITLES FOR YMAX UPGRADE	D1	\$256,850
YMAX-LTD	SPECIAL PKG SW TITLES FOR DMX-LITE DEAL	D1	\$110,080
Z-COMPAV	Z8PAVMA- NO CHRGE	D1	\$0
456-103-728	CC / PROSPHERE PKG CLAR CX3-10/CX4-120	D2	\$0
456-103-729	CC / PROSPHERE PKG CLAR CX3-20/CX4-240	D2	\$0
456-103-730	CC / PROSPHERE PKG CLAR CX3-40/CX4-480	D2	\$0
456-103-731	CC / PROSPHERE PKG CLAR CX3-80/CX4-960	D2	\$0
456-104-647	RPSE LOC ARRY LIC - CX1 & CX2 = IC	D2	\$0
456-104-648	RPSE LOC ARRY LIC - CX3-10, AX4-5 = IC	D2	\$0
456-104-649	RPSE LOC ARRY LIC - CX3-20, CX4-120 = IC	D2	\$0
456-104-650	RPSE LOC ARRY LIC- CX3-40, CX4-240 = IC	D2	\$0
456-104-651	RPSE LOC ARRY LIC - CX3-80, CX4-480 = IC	D2	\$0
456-104-652	RPSE LOC ARRY LIC - CX4-960 = IC	D2	\$0
456-104-653	RPSE REM ARRY LIC- CX1 & CX2 = IC	D2	\$0
456-104-654	RPSE REM ARRY LIC - CX3-10, AX4-5 = IC	D2	\$0
456-104-655	RPSE REM ARRY LIC - CX3-20, CX4-120 = IC	D2	\$0
456-104-656	RPSE REM ARRY LIC - CX3-40, CX4-240 = IC	D2	\$0
456-104-657	RPSE REM ARRY LIC - CX3-80, CX4-480 = IC	D2	\$0
456-104-658	RPSE REM ARRY LIC - CX4-960 = IC	D2	\$0
456-104-659	RP/SE REM UG FOR CX1 & CX2 = IC	D2	\$0
456-104-660	RP/SE REM UG FOR CX3-10, AX4-5 = IC	D2	\$0
456-104-661	RP/SE REM UG FOR CX3-20,CX4-120 = IC	D2	\$0

456-104-662	RP/SE REM UG FOR CX3-40, CX4-240 = IC	D2	\$0
456-104-663	RP/SE REM UG FOR CX3-80 CX4-480 = IC	D2	\$0
456-104-664	RP/SE REM UG FOR CX4-960 = IC	D2	\$0
456-104-665	RP/SE LOC UG FOR CX1 & CX2 = IC	D2	\$0
456-104-666	RP/SE LOC UG FOR CX3-10, AX4-5 = IC	D2	\$0
456-104-667	RP/SE LOC UG FOR CX3-20, CX4-120 = IC	D2	\$0
456-104-668	RP/SE LOC UG FOR CX3-40, CX4-240 = IC	D2	\$0
456-104-669	RP/SE LOC UG FOR CX3-80 CX4-480 = IC	D2	\$0
456-104-670	RPSE LOC UG FOR CX4-960 = IC	D2	\$0
456-104-671	RP/SE REM UPGRADE TO LOC & REM = IC	D2	\$0
456-104-672	RP/SE LOC UPGRADE TO REM = IC	D2	\$0
456-105-382	SRMSUITE CENTERA (NODE PAIR) =ID	D2	\$0
456-105-483	SRMSUITE UPG CENTERA (NODE PAIR) =ID	D2	\$0
456-110-777	SRM CENTERA (NODE PAIR) =ID	D2	\$0
ACLG45-T1	ACCESSLOGIX,FC4500,T1	D2	\$0
ACLG45-T10	ACCESSLOGIX,FC4500,T10	D2	\$0
ACLG45-T11	ACCESSLOGIX,FC4500,T11	D2	\$0
ACLG45-T12	ACCESSLOGIX,FC4500,T12	D2	\$0
ACLG45-T2	ACCESSLOGIX,FC4500,T2	D2	\$0
ACLG45-T3	ACCESSLOGIX,FC4500,T3	D2	\$0
ACLG45-T4	ACCESSLOGIX,FC4500,T4	D2	\$0
ACLG45-T5	ACCESSLOGIX,FC4500,T5	D2	\$0
ACLG45-T6	ACCESSLOGIX,FC4500,T6	D2	\$0
ACLG45-T7	ACCESSLOGIX,FC4500,T7	D2	\$0
ACLG45-T8	ACCESSLOGIX,FC4500,T8	D2	\$0
ACLG45-T9	ACCESSLOGIX,FC4500,T9	D2	\$0
ACLG47-T1	ACCESS LOGIX, FC4700, T1	D2	\$0
ACLG47-T10	ACCESSLOGIX,FC4700,T10	D2	\$0
ACLG47-T11	ACCESSLOGIX,FC4700,T11	D2	\$0
ACLG47-T12	ACCESSLOGIX,FC4700,T12	D2	\$0
ACLG47-T2	ACCESSLOGIX,FC4700,T2	D2	\$0
ACLG47-T3	ACCESSLOGIX,FC4700,T3	D2	\$0
ACLG47-T4	ACCESSLOGIX,FC4700,T4	D2	\$0
ACLG47-T5	ACCESS LOGIX, FC4700, T5	D2	\$0
ACLG47-T6	ACCESSLOGIX,FC4700,T6	D2	\$0
ACLG47-T7	ACCESSLOGIX, FC4700,T7	D2	\$0
ACLG47-T8	ACCESSLOGIX,FC4700,T8	D2	\$0
ACLG47-T9	ACCESSLOGIX,FC4700,T9	D2	\$0
AFS-120	ADVANCED FAST SUITE FOR THE CX4/NS-120	D2	\$0
AFS-240	EMC ADVANCED FAST SUITE FOR THE CX4-240	D2	\$0
AFS-240UPG	FAST SUITE- UPGRADE TO CX4-240 PLATFORM	D2	\$0
AFS-480	ADVANCED FAST SUITE FOR THE CX4/NS-480	D2	\$0
AFS-480UPG	FAST SUITE - UPGRADE TO CX4-480 PLATFORM	D2	\$0
AFS-960	ADVANCED FAST SUITE FOR THE CX4/NS-960	D2	\$0
AFS-960UPG	FAST SUITE - UPGRADE TO CX4-960 PLATFORM	D2	\$0
AL200-KIT	CX200 ACCESS LOGIX MEDIA	D2	\$0
AL200-KIT303	CX200 ACC LGX V2.04 MEDIA	D2	\$0
AL200-KIT308	CX200 ACC LGX V2.05 MEDIA	D2	\$0
AL400-KIT	CX400 ACCESS LOGIX MEDIA	D2	\$0
AL400-KIT303	CX400 ACC LGX V2.04 MEDIA	D2	\$0

AL400-KIT308	CX400 ACC LGX V2.05 MEDIA	D2	\$0
AL400-NAS	CX400 ACCESSLOGIX FOR NAS	D2	\$0
AL400-T1	CX400 ACCESS LOGIX TIER 1	D2	\$0
AL400-T10	CX400 ACCESS LOGIX TIER 10	D2	\$0
AL400-T11	CX400 ACCESS LOGIX TIER 11	D2	\$0
AL400-T12	CX400 ACCESS LOGIX TIER 12	D2	\$0
AL400T1-T4	CX400 ACCESS-LGX UPG	D2	\$0
AL400-T2	CX400 ACCESS LOGIX TIER 2	D2	\$0
AL400-T3	CX400 ACCESS LOGIX TIER 3	D2	\$0
AL400-T4	CX400 ACCESS LOGIX TIER 4	D2	\$0
AL400-T5	CX400 ACCESS LOGIX TIER 5	D2	\$0
AL400T5-T12	CX400 ACCESS-LGX UPG	D2	\$0
AL400T5-T8	CX400 ACCESS-LGX UPG	D2	\$0
AL400-T6	CX400 ACCESS LOGIX TIER 6	D2	\$0
AL400-T7	CX400 ACCESS LOGIX TIER 7	D2	\$0
AL400-T8	CX400 ACCESS LOGIX TIER 8	D2	\$0
AL400-T9	CX400 ACCESS LOGIX TIER 9	D2	\$0
AL400T9-T12	CX400 ACCESS-LGX UPG	D2	\$0
AL45T1-T4	ACCESSLOGIX,FC4500,T1-T4	D2	\$0
AL45T5-T12	ACCESSLOGIX,FC4500,T5-T12	D2	\$0
AL600-KIT	CX600 ACCESS LOGIX MEDIA	D2	\$0
AL600-KIT303	CX600 ACC LGX V2.04 MEDIA	D2	\$0
AL600-KIT308	CX600 ACC LGX V2.05 MEDIA	D2	\$0
AL600-NAS	CX600 ACCESSLOGIX FOR NAS	D2	\$0
AL600-T1	CX600 ACCESS LOGIX TIER 1	D2	\$0
AL600-T10	CX600 ACCESS LOGIX TIER 10	D2	\$0
AL600-T11	CX600 ACCESS LOGIX TIER 11	D2	\$0
AL600-T12	CX600 ACCESS LOGIX TIER 12	D2	\$0
AL600-T19	CX600 ACCESS LOGIX T19	D2	\$0
AL600-T2	CX600 ACCESS LOGIX TIER 2	D2	\$0
AL600-T20	CX600 ACCESS LOGIX T20	D2	\$0
AL600-T21	CX600 ACCESS LOGIX T21	D2	\$0
AL600-T22	CX600 ACCESS LOGIX T22	D2	\$0
AL600-T23	CX600 ACCESS LOGIX T23	D2	\$0
AL600-T24	CX600 ACCESS LOGIX T24	D2	\$0
AL600-T25	CX600 ACCESS LOGIX T25	D2	\$0
AL600-T26	CX600 ACCESS LOGIX T26	D2	\$0
AL600-T27	CX600 ACCESS LOGIX T27	D2	\$0
AL600-T28	CX600 ACCESS LOGIX T28	D2	\$0
AL600-T29	CX600 ACCESS LOGIX T29	D2	\$0
AL600-T3	CX600 ACCESS LOGIX TIER 3	D2	\$0
AL600-T30	CX600 ACCESS LOGIX T30	D2	\$0
AL600-T31	CX600 ACCESS LOGIX T31	D2	\$0
AL600-T4	CX600 ACCESS LOGIX TIER 4	D2	\$0
AL600-T5	CX600 ACCESS LOGIX TIER 5	D2	\$0
AL600-T6	CX600 ACCESS LOGIX TIER 6	D2	\$0
AL600-T7	CX600 ACCESS LOGIX TIER 7	D2	\$0
AL600-T8	CX600 ACCESS LOGIX TIER 8	D2	\$0
AL600-T9	CX600 ACCESS LOGIX TIER 9	D2	\$0
ALGX-ESNUP	Access Logix to ESN Mgr. Upgrade	D2	\$7,750

AL-NAS	ACCESS LOGIX FOR NAS	D2	\$0
ARMCL-T1-5U	CC5.1 CL ARM T1-5 UPG	D2	\$0
ARMCL-T6-T31U	CC5.1 CL ARM T6-31 UPG	D2	\$0
ATFPP-UX-U	ATF-PPATH UNIX UPGRADE	D2	\$0
ATFPP-WN-U	ATF-PPATH WINDOWS UPGRADE	D2	\$0
AYZ4-120UPG	NAVI/Uni ANALYZER Upg CX4-120	D2	\$0
AYZ4-240UPG	NAVI/Uni ANALYZER Upg CX4-240	D2	\$0
AYZ4-480UPG	NAVI/Uni ANALYZER Upg CX4-480	D2	\$0
AYZ4-960UPG	NAVI/Uni ANALYZER Upg CX4-960	D2	\$0
CC-AM-CL-T1	CC5.x ARM-CLAR T1	D2	\$0
CC-AM-CL-T10	CC5.x ARM-CLAR T10	D2	\$0
CC-AM-CL-T11	CC5.x ARM-CLAR T11	D2	\$0
CC-AM-CL-T12	CC5.x ARM-CLAR T12	D2	\$0
CC-AM-CL-T13	CC5.x ARM-CLAR T13	D2	\$0
CC-AM-CL-T14	CC5.x ARM-CLAR T14	D2	\$0
CC-AM-CL-T15	CC5.x ARM-CLAR T15	D2	\$0
CC-AM-CL-T16	CC5.x ARM-CLAR T16	D2	\$0
CC-AM-CL-T17	CC5.x ARM-CLAR T17	D2	\$0
CC-AM-CL-T18	CC5.x ARM-CLAR T18	D2	\$0
CC-AM-CL-T19	CC5.x ARM-CLAR T19	D2	\$0
CC-AM-CL-T2	CC5.x ARM-CLAR T2	D2	\$0
CC-AM-CL-T20	CC5.x ARM-CLAR T20	D2	\$0
CC-AM-CL-T21	CC5.x ARM-CLAR T21	D2	\$0
CC-AM-CL-T22	CC5.x ARM-CLAR T22	D2	\$0
CC-AM-CL-T23	CC5.x ARM-CLAR T23	D2	\$0
CC-AM-CL-T24	CC5.x ARM-CLAR T24	D2	\$0
CC-AM-CL-T25	CC5.x ARM-CLAR T25	D2	\$0
CC-AM-CL-T26	CC5.x ARM-CLAR T26	D2	\$0
CC-AM-CL-T27	CC5.x ARM-CLAR T27	D2	\$0
CC-AM-CL-T28	CC5.x ARM-CLAR T28	D2	\$0
CC-AM-CL-T29	CC5.x ARM-CLAR T29	D2	\$0
CC-AM-CL-T3	CC5.x ARM-CLAR T3	D2	\$0
CC-AM-CL-T30	CC5.x ARM-CLAR T30	D2	\$0
CC-AM-CL-T31	CC5.x ARM-CLAR T31	D2	\$0
CC-AM-CL-T4	CC5.x ARM-CLAR T4	D2	\$0
CC-AM-CL-T5	CC5.x ARM-CLAR T5	D2	\$0
CC-AM-CL-T6	CC5.x ARM-CLAR T6	D2	\$0
CC-AM-CL-T7	CC5.x ARM-CLAR T7	D2	\$0
CC-AM-CL-T8	CC5.x ARM-CLAR T8	D2	\$0
CC-AM-CL-T9	CC5.x ARM-CLAR T9	D2	\$0
CC-CLKEY	CC CLARIION KEY	D2	\$0
CC-CLPKLT-T01	CC CLARIION PKG LITE T01	D2	\$0
CC-CLPKLT-T02	CC CLARIION PKG LITE T02	D2	\$0
CC-CLPKLT-T03	CC CLARIION PKG LITE T03	D2	\$0
CC-CLPKLT-T04	CC CLARIION PKG LITE T04	D2	\$0
CC-CLPKLT-T05	CC CLARIION PKG LITE T05	D2	\$0
CC-CLPKLT-T06	CC CLARIION PKG LITE T06	D2	\$0
CC-CLPKLT-T07	CC CLARIION PKG LITE T07	D2	\$0
CC-CLPKLT-T08	CC CLARIION PKG LITE T08	D2	\$0
CC-CLPKLT-T09	CC CLARIION PKG LITE T09	D2	\$0

CC-CLPKLT-T10	CC CLARIION PKG LITE T10	D2	\$0
CC-CLPKLT-T11	CC CLARIION PKG LITE T11	D2	\$0
CC-CLPKLT-T12	CC CLARIION PKG LITE T12	D2	\$0
CC-CLPKLT-T13	CC CLARIION PKG LITE T13	D2	\$0
CC-CLPKLT-T14	CC CLARIION PKG LITE T14	D2	\$0
CC-CLPKLT-T15	CC CLARIION PKG LITE T15	D2	\$0
CC-CLPKLT-T16	CC CLARIION PKG LITE T16	D2	\$0
CC-CLPKLT-T17	CC CLARIION PKG LITE T17	D2	\$0
CC-CLPKLT-T18	CC CLARIION PKG LITE T18	D2	\$0
CC-CLPKLT-T19	CC CLARIION PKG LITE T19	D2	\$0
CC-CLPKLT-T20	CC CLARIION PKG LITE T20	D2	\$0
CC-CLPKLT-T21	CC CLARIION PKG LITE T21	D2	\$0
CC-CLPKLT-T22	CC CLARIION PKG LITE T22	D2	\$0
CC-CLPKLT-T23	CC CLARIION PKG LITE T23	D2	\$0
CC-CLPKLT-T24	CC CLARIION PKG LITE T24	D2	\$0
CC-CLPKLT-T25	CC CLARIION PKG LITE T25	D2	\$0
CC-CLPKLT-T26	CC CLARIION PKG LITE T26	D2	\$0
CC-CLPKLT-T27	CC CLARIION PKG LITE T27	D2	\$0
CC-CLPKLT-T28	CC CLARIION PKG LITE T28	D2	\$0
CC-CLPKLT-T29	CC CLARIION PKG LITE T29	D2	\$0
CC-CLPKLT-T30	CC CLARIION PKG LITE T30	D2	\$0
CC-CLPKLT-T31	CC CLARIION PKG LITE T31	D2	\$0
CC-CLPK-T1	CC511 CLARIION PKG T1	D2	\$0
CC-CLPK-T10	CC511 CLARIION PKG T10	D2	\$0
CC-CLPK-T11	CC511 CLARIION PKG T11	D2	\$0
CC-CLPK-T12	CC511 CLARIION PKG T12	D2	\$0
CC-CLPK-T13	CC511 CLARIION PKG T13	D2	\$0
CC-CLPK-T14	CC511 CLARIION PKG T14	D2	\$0
CC-CLPK-T15	CC511 CLARIION PKG T15	D2	\$0
CC-CLPK-T16	CC511 CLARIION PKG T16	D2	\$0
CC-CLPK-T17	CC511 CLARIION PKG T17	D2	\$0
CC-CLPK-T18	CC511 CLARIION PKG T18	D2	\$0
CC-CLPK-T19	CC511 CLARIION PKG T19	D2	\$0
CC-CLPK-T2	CC511 CLARIION PKG T2	D2	\$0
CC-CLPK-T20	CC511 CLARIION PKG T20	D2	\$0
CC-CLPK-T21	CC511 CLARIION PKG T21	D2	\$0
CC-CLPK-T22	CC511 CLARIION PKG T22	D2	\$0
CC-CLPK-T23	CC511 CLARIION PKG T23	D2	\$0
CC-CLPK-T24	CC511 CLARIION PKG T24	D2	\$0
CC-CLPK-T25	CC511 CLARIION PKG T25	D2	\$0
CC-CLPK-T26	CC511 CLARIION PKG T26	D2	\$0
CC-CLPK-T27	CC511 CLARIION PKG T27	D2	\$0
CC-CLPK-T28	CC511 CLARIION PKG T28	D2	\$0
CC-CLPK-T29	CC511 CLARIION PKG T29	D2	\$0
CC-CLPK-T3	CC511 CLARIION PKG T3	D2	\$0
CC-CLPK-T30	CC511 CLARIION PKG T30	D2	\$0
CC-CLPK-T31	CC511 CLARIION PKG T31	D2	\$0
CC-CLPK-T4	CC511 CLARIION PKG T4	D2	\$0
CC-CLPK-T5	CC511 CLARIION PKG T5	D2	\$0
CC-CLPK-T6	CC511 CLARIION PKG T6	D2	\$0

CC-CLPK-T7	CC511 CLARIION PKG T7	D2	\$0
CC-CLPK-T8	CC511 CLARIION PKG T8	D2	\$0
CC-CLPK-T9	CC511 CLARIION PKG T9	D2	\$0
CC-PFM-CL-T01	PERF MGR CL 0-.250	D2	\$0
CC-PFM-CL-T02	PERF MGR CL .251-.500	D2	\$0
CC-PFM-CL-T03	PERF MGR CL .501-.750	D2	\$0
CC-PFM-CL-T04	PERF MGR CL .751-1.00	D2	\$0
CC-PFM-CL-T05	PERF MGR CL 1.01-2.00	D2	\$0
CC-PFM-CL-T06	PERF MGR CL 2.01-4.00	D2	\$0
CC-PFM-CL-T07	PERF MGR CL 4.01-6.00	D2	\$0
CC-PFM-CL-T08	PERF MGR CL 6.01-8.00	D2	\$0
CC-PFM-CL-T09	PERF MGR CL 8.01-10.00	D2	\$0
CC-PFM-CL-T10	PERF MGR CL 10.01-12.00	D2	\$0
CC-PFM-CL-T11	PERF MGR CL 12.01-14.00	D2	\$0
CC-PFM-CL-T12	PERF MGR CL 14.01-17.00	D2	\$0
CC-PFM-CL-T13	PERF MGR CL 17.01-20.00	D2	\$0
CC-PFM-CL-T14	PERF MGR CL 20.01-23.00	D2	\$0
CC-PFM-CL-T15	PERF MGR CL 23.01-26.00	D2	\$0
CC-PFM-CL-T16	PERF MGR CL 26.01-29.00	D2	\$0
CC-PFM-CL-T17	PERF MGR CL 29.01-32.00	D2	\$0
CC-PFM-CL-T18	PERF MGR CL 32.01-35.00	D2	\$0
CC-PFM-CL-T19	PERF MGR CL 35.01-38.00	D2	\$0
CC-PFM-CL-T20	PERF MGR CL 38.01-41.00	D2	\$0
CC-PFM-CL-T21	PERF MGR CL 41.01-44.00	D2	\$0
CC-PFM-CL-T22	PERF MGR CL 44.01-47.00	D2	\$0
CC-PFM-CL-T23	PERF MGR CL 47.01-50.00	D2	\$0
CC-PFM-CL-T24	PERF MGR CL 50.01-53.00	D2	\$0
CC-PFM-CL-T25	PERF MGR CL 53.01-56.00	D2	\$0
CC-PFM-CL-T26	PERF MGR CL 56.01-59.00	D2	\$0
CC-PFM-CL-T27	PERF MGR CL 59.01-62.00	D2	\$0
CC-PFM-CL-T28	PERF MGR CL 62.01-65.00	D2	\$0
CC-PFM-CL-T29	PERF MGR CL 65.01-68.00	D2	\$0
CC-PFM-CL-T30	PERF MGR CL 68.01-71.00	D2	\$0
CC-PFM-CL-T31	PERF MGR CL 71.00 - +	D2	\$0
CC-SM-AL5-T1	CC5.1 SAN MGR-CLAR 45 T1	D2	\$0
CC-SM-AL5-T10	CC5.1 SAN MGR-CLAR 45 T10	D2	\$0
CC-SM-AL5-T11	CC5.1 SAN MGR-CLAR 45 T11	D2	\$0
CC-SM-AL5-T12	CC5.1 SAN MGR-CLAR 45 T12	D2	\$0
CC-SM-AL5-T13	CC5.1 SAN MGR-CLAR 45 T13	D2	\$0
CC-SM-AL5-T14	CC5.1 SAN MGR-CLAR 45 T14	D2	\$0
CC-SM-AL5-T15	CC5.1 SAN MGR-CLAR 45 T15	D2	\$0
CC-SM-AL5-T16	CC5.1 SAN MGR-CLAR 45 T16	D2	\$0
CC-SM-AL5-T17	CC5.1 SAN MGR-CLAR 45 T17	D2	\$0
CC-SM-AL5-T18	CC5.1 SAN MGR-CLAR 45 T18	D2	\$0
CC-SM-AL5-T2	CC5.1 SAN MGR-CLAR 45 T2	D2	\$0
CC-SM-AL5-T3	CC5.1 SAN MGR-CLAR 45 T3	D2	\$0
CC-SM-AL5-T4	CC5.1 SAN MGR-CLAR 45 T4	D2	\$0
CC-SM-AL5-T5	CC5.1 SAN MGR-CLAR 45 T5	D2	\$0
CC-SM-AL5-T6	CC5.1 SAN MGR-CLAR 45 T6	D2	\$0
CC-SM-AL5-T7	CC5.1 SAN MGR-CLAR 45 T7	D2	\$0

CC-SM-AL5-T8	CC5.1 SAN MGR-CLAR 45 T8	D2	\$0
CC-SM-AL5-T9	CC5.1 SAN MGR-CLAR 45 T9	D2	\$0
CC-SM-AL7-T1	CC5.1 SAN MGR-CLAR 47 T1	D2	\$0
CC-SM-AL7-T10	CC5.1 SAN MGR-CLAR 47 T10	D2	\$0
CC-SM-AL7-T11	CC5.1 SAN MGR-CLAR 47 T11	D2	\$0
CC-SM-AL7-T12	CC5.1 SAN MGR-CLAR 47 T12	D2	\$0
CC-SM-AL7-T13	CC5.1 SAN MGR -CLAR 47 T13	D2	\$0
CC-SM-AL7-T14	CC5.1 SAN MGR -CLAR 47 T14	D2	\$0
CC-SM-AL7-T15	CC5.1 SAN MGR -CLAR 47 T15	D2	\$0
CC-SM-AL7-T16	CC5.1 SAN MGR -CLAR 47 T16	D2	\$0
CC-SM-AL7-T17	CC5.1 SAN MGR -CLAR 47 T17	D2	\$0
CC-SM-AL7-T18	CC5.1 SAN MGR -CLAR 47 T18	D2	\$0
CC-SM-AL7-T2	CC5.1 SAN MGR-CLAR 47 T2	D2	\$0
CC-SM-AL7-T3	CC5.1 SAN MGR-CLAR 47 T3	D2	\$0
CC-SM-AL7-T4	CC5.1 SAN MGR-CLAR 47 T4	D2	\$0
CC-SM-AL7-T5	CC5.1 SAN MGR-CLAR 47 T5	D2	\$0
CC-SM-AL7-T6	CC5.1 SAN MGR-CLAR 47 T6	D2	\$0
CC-SM-AL7-T7	CC5.1 SAN MGR-CLAR 47 T7	D2	\$0
CC-SM-AL7-T8	CC5.1 SAN MGR-CLAR 47 T8	D2	\$0
CC-SM-AL7-T9	CC5.1 SAN MGR-CLAR 47 T9	D2	\$0
CC-SM-CL-T01	CC SANMGR-CLARIION T01	D2	\$0
CC-SM-CL-T02	CC SANMGR-CLARIION T02	D2	\$0
CC-SM-CL-T03	CC SANMGR-CLARIION T03	D2	\$0
CC-SM-CL-T04	CC SANMGR-CLARIION T04	D2	\$0
CC-SM-CL-T05	CC SANMGR-CLARIION T05	D2	\$0
CC-SM-CL-T06	CC SANMGR-CLARIION T06	D2	\$0
CC-SM-CL-T07	CC SANMGR-CLARIION T07	D2	\$0
CC-SM-CL-T08	CC SANMGR-CLARIION T08	D2	\$0
CC-SM-CL-T09	CC SANMGR-CLARIION T09	D2	\$0
CC-SM-CL-T10	CC SANMGR-CLARIION T10	D2	\$0
CC-SM-CL-T11	CC SANMGR-CLARIION T11	D2	\$0
CC-SM-CL-T12	CC SANMGR-CLARIION T12	D2	\$0
CC-SM-CL-T13	CC SANMGR-CLARIION T13	D2	\$0
CC-SM-CL-T14	CC SANMGR-CLARIION T14	D2	\$0
CC-SM-CL-T15	CC SANMGR-CLARIION T15	D2	\$0
CC-SM-CL-T16	CC SANMGR-CLARIION T16	D2	\$0
CC-SM-CL-T17	CC SANMGR-CLARIION T17	D2	\$0
CC-SM-CL-T18	CC SANMGR-CLARIION T18	D2	\$0
CC-SM-CL-T19	CC SANMGR-CLARIION T19	D2	\$0
CC-SM-CL-T20	CC SANMGR-CLARIION T20	D2	\$0
CC-SM-CL-T21	CC SANMGR-CLARIION T21	D2	\$0
CC-SM-CL-T22	CC SANMGR-CLARIION T22	D2	\$0
CC-SM-CL-T23	CC SANMGR-CLARIION T23	D2	\$0
CC-SM-CL-T24	CC SANMGR-CLARIION T24	D2	\$0
CC-SM-CL-T25	CC SANMGR-CLARIION T25	D2	\$0
CC-SM-CL-T26	CC SANMGR-CLARIION T26	D2	\$0
CC-SM-CL-T27	CC SANMGR-CLARIION T27	D2	\$0
CC-SM-CL-T28	CC SANMGR-CLARIION T28	D2	\$0
CC-SM-CL-T29	CC SANMGR-CLARIION T29	D2	\$0
CC-SM-CL-T30	CC SANMGR-CLARIION T30	D2	\$0

CC-SM-CL-T31	CC SANMGR-CLARIION T31	D2	\$0
CC-SM-CX2-T01	CC SM CL CX2 0.00-.25	D2	\$0
CC-SM-CX2-T02	CC SM CL CX2 .251-.50	D2	\$0
CC-SM-CX2-T03	CC SM CL CX2 .501-.75	D2	\$0
CC-SM-CX2-T04	CC SM CL CX2 .751-1.0	D2	\$0
CC-SM-CX2-T05	CC SM CL CX2 1.01-2.0	D2	\$0
CC-SM-CX2-T06	CC SM CL CX2 2.01-4.0	D2	\$0
CC-SM-CX2-T07	CC SM CL CX2 4.01-6.0	D2	\$0
CC-SM-CX2-T08	CC SM CL CX2 6.01-8.00	D2	\$0
CC-SM-CX2-T09	CC SM CL CX2 8.01-10.0	D2	\$0
CC-SM-CX2-T10	CC SM CL CX2 10.01-12.0	D2	\$0
CC-SM-CX2-T11	CC SM CL CX2 12.01-14.00	D2	\$0
CC-SM-CX2-T12	CC SM CL CX2 14.01-17.0	D2	\$0
CC-SM-CX4-T1	SAN MGR CX400 0-.250	D2	\$0
CC-SM-CX4-T10	SAN MGR CX400 10.01-12.00	D2	\$0
CC-SM-CX4-T11	SAN MGR CX400 12.01-14.00	D2	\$0
CC-SM-CX4-T12	SAN MGR CX400 14.01-17.00	D2	\$0
CC-SM-CX4-T13	SAN MGR CX400 17.01-20.00	D2	\$0
CC-SM-CX4-T14	SAN MGR CX400 20.01-23.00	D2	\$0
CC-SM-CX4-T15	SAN MGR CX400 23.01-26.00	D2	\$0
CC-SM-CX4-T16	SAN MGR CX400 26.01-29.00	D2	\$0
CC-SM-CX4-T17	SAN MGR CX400 29.01-32.00	D2	\$0
CC-SM-CX4-T18	SAN MGR CX400 32.01-35.00	D2	\$0
CC-SM-CX4-T2	SAN MGR CX400 .251-.500	D2	\$0
CC-SM-CX4-T3	SAN MGR CX400 .501-.750	D2	\$0
CC-SM-CX4-T4	SAN MGR CX400 .751-1.00	D2	\$0
CC-SM-CX4-T5	SAN MGR CX400 1.01-2.00	D2	\$0
CC-SM-CX4-T6	SAN MGR CX400 2.01-4.00	D2	\$0
CC-SM-CX4-T7	SAN MGR CX400 4.01-6.00	D2	\$0
CC-SM-CX4-T8	SAN MGR CX400 6.01-8.00	D2	\$0
CC-SM-CX4-T9	SAN MGR CX400 8.01-10.00	D2	\$0
CC-SM-CX6-T1	CC5.1 SAN MGR-CL CX6 T1	D2	\$0
CC-SM-CX6-T10	CC5.1 SAN MGR-CL CX6 T10	D2	\$0
CC-SM-CX6-T11	CC5.1 SAN MGR-CL CX6 T11	D2	\$0
CC-SM-CX6-T12	CC5.1 SAN MGR-CL CX6 T12	D2	\$0
CC-SM-CX6-T13	CC5.1 SAN MGR-CL CX6 T13	D2	\$0
CC-SM-CX6-T14	CC5.1 SAN MGR-CL CX6 T14	D2	\$0
CC-SM-CX6-T15	CC5.1 SAN MGR-CL CX6 T15	D2	\$0
CC-SM-CX6-T16	CC5.1 SAN MGR-CL CX6 T16	D2	\$0
CC-SM-CX6-T17	CC5.1 SAN MGR-CL CX6 T17	D2	\$0
CC-SM-CX6-T18	CC5.1 SAN MGR-CL CX6 T18	D2	\$0
CC-SM-CX6-T19	CC5.1 SAN MGR-CL CX6 T19	D2	\$0
CC-SM-CX6-T2	CC5.1 SAN MGR-CL CX6 T2	D2	\$0
CC-SM-CX6-T20	CC5.1 SAN MGR-CL CX6 T20	D2	\$0
CC-SM-CX6-T21	CC5.1 SAN MGR-CL CX6 T21	D2	\$0
CC-SM-CX6-T22	CC5.1 SAN MGR-CL CX6 T22	D2	\$0
CC-SM-CX6-T23	CC5.1 SAN MGR-CL CX6 T23	D2	\$0
CC-SM-CX6-T24	CC5.1 SAN MGR-CL CX6 T24	D2	\$0
CC-SM-CX6-T25	CC5.1 SAN MGR-CL CX6 T25	D2	\$0
CC-SM-CX6-T26	CC5.1 SAN MGR-CL CX6 T26	D2	\$0

CC-SM-CX6-T27	CC5.1 SAN MGR-CL-CX6 T27	D2	\$0
CC-SM-CX6-T28	CC5.1 SAN MGR-CL-CX6 T28	D2	\$0
CC-SM-CX6-T29	CC5.1 SAN MGR-CL-CX6 T29	D2	\$0
CC-SM-CX6-T3	CC5.1 SAN MGR-CL CX6 T3	D2	\$0
CC-SM-CX6-T30	CC5.1 SAN MGR-CL-CX6 T30	D2	\$0
CC-SM-CX6-T31	CC5.1 SAN MGR-CL-CX6 T31	D2	\$0
CC-SM-CX6-T4	CC5.1 SAN MGR-CL CX6 T4	D2	\$0
CC-SM-CX6-T5	CC5.1 SAN MGR-CL CX6 T5	D2	\$0
CC-SM-CX6-T6	CC5.1 SAN MGR-CL CX6 T6	D2	\$0
CC-SM-CX6-T7	CC5.1 SAN MGR-CL CX6 T7	D2	\$0
CC-SM-CX6-T8	CC5.1 SAN MGR-CL CX6 T8	D2	\$0
CC-SM-CX6-T9	CC5.1 SAN MGR-CL CX6 T9	D2	\$0
CC-WLA-CL-T1	CC5.x WLA-CLAR T1	D2	\$0
CC-WLA-CL-T10	CC5.x WLA-CLAR T10	D2	\$0
CC-WLA-CL-T11	CC5.x WLA-CLAR T11	D2	\$0
CC-WLA-CL-T12	CC5.x WLA-CLAR T12	D2	\$0
CC-WLA-CL-T13	CC5.x WLA-CLAR T13	D2	\$0
CC-WLA-CL-T14	CC5.x WLA-CLAR T14	D2	\$0
CC-WLA-CL-T15	CC5.x WLA-CLAR T15	D2	\$0
CC-WLA-CL-T16	CC5.x WLA-CLAR T16	D2	\$0
CC-WLA-CL-T17	CC5.x WLA-CLAR T17	D2	\$0
CC-WLA-CL-T18	CC5.x WLA-CLAR T18	D2	\$0
CC-WLA-CL-T19	CC5.x WLA-CLAR T19	D2	\$0
CC-WLA-CL-T2	CC5.x WLA-CLAR T2	D2	\$0
CC-WLA-CL-T20	CC5.x WLA-CLAR T20	D2	\$0
CC-WLA-CL-T21	CC5.x WLA-CLAR T21	D2	\$0
CC-WLA-CL-T22	CC5.x WLA-CLAR T22	D2	\$0
CC-WLA-CL-T23	CC5.x WLA-CLAR T23	D2	\$0
CC-WLA-CL-T24	CC5.x WLA-CLAR T24	D2	\$0
CC-WLA-CL-T25	CC5.x WLA-CLAR T25	D2	\$0
CC-WLA-CL-T26	CC5.x WLA-CLAR T26	D2	\$0
CC-WLA-CL-T27	CC5.x WLA-CLAR T27	D2	\$0
CC-WLA-CL-T28	CC5.x WLA-CLAR T28	D2	\$0
CC-WLA-CL-T29	CC5.x WLA-CLAR T29	D2	\$0
CC-WLA-CL-T3	CC5.x WLA-CLAR T3	D2	\$0
CC-WLA-CL-T30	CC5.x WLA-CLAR T30	D2	\$0
CC-WLA-CL-T31	CC5.x WLA-CLAR T31	D2	\$0
CC-WLA-CL-T4	CC5.x WLA-CLAR T4	D2	\$0
CC-WLA-CL-T5	CC5.x WLA-CLAR T5	D2	\$0
CC-WLA-CL-T6	CC5.x WLA-CLAR T6	D2	\$0
CC-WLA-CL-T7	CC5.x WLA-CLAR T7	D2	\$0
CC-WLA-CL-T8	CC5.x WLA-CLAR T8	D2	\$0
CC-WLA-CL-T9	CC5.x WLA-CLAR T9	D2	\$0
CN514-REP2-LU	CNS 514 DM REPLICATOR V2 UPGRADE LICENS	D2	\$0
CNACUAIW	CENTERA INTERNAL BOX CUA SW	D2	\$0
CNR2CHBKLIC	EMC CENTERA CHARGEBACK REPORTER BASE	D2	\$0
CNR2NADVRMLIC	EMC CENTERA ADVANCED RETENTION MANAG	D2	\$0
CNR2NCEPLSLIC	EMC CENTERA CE+ 2-NODE RIGHT-TO-USE-LIC	D2	\$0
CNR2NGOVEDLIC	EMC CENTERA GOVERNANCE 2-NODE RIGHT-T	D2	\$0
CNR2NMSWG4	EMC CENTERA BASIC - MIRRORED 2-NODE RIG	D2	\$0

CNR2NPSWG4	RTU CENTERA BASIC - PARITY 2-NODE RIGHT-	D2	\$0
CNR2NPUPG4	EMC CENTERA GEN 4 - PARITY (UPGRADE) 2-N	D2	\$0
CNR2NREPLIC	EMC CENTERA GEN 4 REPLICATION 2-NODE RI	D2	\$0
CNR2SEEKLIC	EMC CENTERA SEEK BASE 2-NODE RIGHT-TO-U	D2	\$0
CNR2SKCBLIC	EMC CENTERA SEEK & CHARGEBACK REPORT	D2	\$0
CNR4NADVRMLIC	4NODE ADVRETN MGMT SW LIC	D2	\$0
CNR4NCEPLSLIC	NODE COMP PLUS SW LIC	D2	\$0
CNR4NGOVEDLIC	4NODE GOV EDITION SW LIC	D2	\$0
CNR4NMSWG3	CNR GEN3 \$NODE MIRR SW	D2	\$0
CNR4NMSWG4	MIRR SW RTU LIC	D2	\$0
CNR4NPSWG4	PAR SW RTU LIC	D2	\$0
CNR4NPUPG4	SW RTU LIC	D2	\$0
CNR4NREPLIC	4NODE REPLICATION SW LIC	D2	\$0
CNR50VPOOLLIC	50 VIRTUAL POOLS SW LIC	D2	\$0
CNR8NECCLIC	EMC CONTROL CENTER LIC KE	D2	\$0
CNR8NPANSW	3 CNR ACCESSNODE PTY SW	D2	\$0
CNRAN2SNLIC	ACCS NODE 2 STRG NODE LIC	D2	\$0
CNRANPUPG3	1 ACSNODE PTY UPGRADE	D2	\$0
CNRCAPEX	CNR 4N CAP EXPAN SW	D2	\$0
CNRCBRMBSW	CNR BACKUP AND REC MOD	D2	\$0
CNRCBRMLIC	BACKUP & RECVRY RTU LIC	D2	\$0
CNRCELIC	CENTERA COMP ED RTU	D2	\$0
CNRCELICG4	CE SW RTU LIC	D2	\$0
CNRCEPLUSG4	CE SW RTU LIC	D2	\$0
CNRCEPLUSLIC	CENTERA COMP ED PLUS RTU	D2	\$0
CNRCHBKLIC	4 NODE CHARGEBACK RTU LIC	D2	\$0
CNRCONSOLESW	CONSOLE SW LICENSE	D2	\$0
CNRCUAESW	CNR EXT DELL CUA SW	D2	\$0
CNRCUAISW	CNR INT BOX CUA SW	D2	\$0
CNRFMA6HASW	RAINFINITY FMA HA APPLIANCE	D2	\$0
CNRFMA6SW	RAINFINITY FMA APPLIANCE	D2	\$0
CNRFMA7HASW	FMA HA APPLIANCE	D2	\$20,000
CNRFMA7SW	FMA APPLIANCE	D2	\$42,500
CNRGTWYPROG	UNIV ACCESS PROGRAM	D2	\$0
CNRSDK	CNR ENT SW DV KIT	D2	\$0
CNRSEEKLIC	4 NODE RTU CNR SEEK LIC	D2	\$0
CNRSKCBLIC	4N SEEK & CHBK RTU LIC	D2	\$0
CNRSWRK2RK	CNR RACK TO RACK ENT SW	D2	\$0
CNRVASRV	EMC CENTERA VIRTUAL ARCHIVE BASE SOFTW	D2	\$0
COMP-120	EMC COMPRESSION FOR THE CX4-120 / NS-120	D2	\$0
COMP-240	EMC COMPRESSION FOR THE CX4-240	D2	\$0
COMP-240UPG	COMPRESSION - UPGRADE TO CX4-240 PLATFC	D2	\$0
COMP-480	EMC COMPRESSION FOR THE CX4-480 / NS-480	D2	\$0
COMP-480UPG	COMPRESSION - UPGRADE TO CX4-480 PLATFC	D2	\$0
COMP-960	EMC COMPRESSION FOR THE CX4-960 / NS-960	D2	\$0
COMP-960UPG	COMPRESSION - UPGRADE TO CX4-960 PLATFC	D2	\$0
CTA-APL-HA-SW	CLOUD TIERING APPLIANCE HA SOFTWARE	D2	\$0
CTA-APL-SW	CLOUD TIERING APPLIANCE SOFTWARE	D2	\$0
CTA-P2V	CLOUD TIERING APP TO VE UPGRADE	D2	\$14,700
CTA-VE	CLOUD TIERING APPLIANCE VIRTUAL EDITION	D2	\$0

CTA-VE-HA	CLOUD TIERING APPLIANCE VIRTUAL ED - HA	D2	\$0
CX20015-FL303	FLARE OS UPDATE 303	D2	\$0
CX20015-FL308	FLARE OS UPDATE 02.05	D2	\$0
CX20015-FL402	BACK REV FLARE RELEASE 13	D2	\$0
CX200-FL303	FLARE OS UPDATE 303	D2	\$0
CX200-FL308	FLARE OS UPDATE 02.05	D2	\$0
CX200-FL402	BACK REV FLARE RELEASE 13	D2	\$0
CX200LC-FL303	FLARE OS UPDATE 303	D2	\$0
CX200LC-FL308	FLARE OS UPDATE 02.05	D2	\$0
CX200LC-FL402	BACK REV FLARE RELEASE 13	D2	\$0
CX204080DP	CX3-20/40 TO CX3-80 NAVI DP Upg Lic	D2	\$29,400
CX204080EN	CX3-20/40 TO CX3-80 NAVI EN Upg Lic	D2	\$43,560
CX204080MVA	CX3-20 OR CX3-40 TO CX3-80 MV/A UPGRADE	D2	\$19,800
CX204080MVAL	CX3-20/40 TO CX3-80 MIRRORVIEW BOTH UPG	D2	\$34,560
CX204080MVS	CX3-20 OR CX3-40 TO CX3-80 MV/S UPGRADE	D2	\$26,250
CX204080SC	CX3-20/40 TO CX3-80 SAN COPY UPG LICENSE	D2	\$0
CX204080SV	CX3-20 OR CX3-40 TO CX3-80 SV UPGRADE LI	D2	\$0
CX204080WG	CX3-20/40 TO CX3-80 NAVI WG Upg Lic	D2	\$16,140
CX2-3-20EN	CX2/300 TO CX3-20 NAVI Ent Upg Lic	D2	\$18,600
CX2-3-20WG	CX2/300 TO CX3-20 NAVI WORKGROUP UPGRAD	D2	\$4,500
CX2345-40DP	CX2/3/4/500 TO CX3-40 NAVI Dept Upg	D2	\$26,100
CX2345-40EN	CX2/3/4/500 TO CX3-40 NAVI Ent Upg LIC	D2	\$38,700
CX2345-40WG	CX2/3/4/500 TO CX3-40 NAVI Wkg Upg	D2	\$12,900
CX2345-80DP	CX2/3/4/500 TO CX3-80 NAVI Dept Upg	D2	\$32,640
CX2345-80EN	CX2/3/4/500 TO CX3-80 NAVI Ent Upg LIC	D2	\$48,360
CX2345-80WG	CX2/3/4/500 TO CX3-80 NAVI Wkg Upg	D2	\$26,900
CX30015-FL402	BACK REV FLARE RELEASE 13	D2	\$0
CX30030-FL407	BACK REV FLARE 02.07.300	D2	\$0
CX30030-FL-501	BACK REV FLARE OE 02.16	D2	\$0
CX300-612KIT	BACK REV DOC KIT 02.24	D2	\$0
CX300DC-FL612	BACK REV FLARE OE 02.24	D2	\$0
CX300-FL402	BACK REV FLARE RELEASE 13	D2	\$0
CX300-FL407	BACK REV FLARE 02.07.300	D2	\$0
CX300-FL501	BACK REV FLARE OE 02.16	D2	\$0
CX300-FL508	BACK REV FLARE OE 2.19	D2	\$0
CX300-FL612	BACK REV FLARE OE 02.24	D2	\$0
CX3-10-20DP	CX3-10 TO CX3-20 NAVI Dept Lic Upg	D2	\$12,360
CX3-10-20EN	CX3-10 TO CX3-20 NAVI Ent Lic Upg	D2	\$18,600
CX3-10-20MVA	CX3-10 TO CX3-20 MIRRORVIEW/A LICENSE UP	D2	\$9,000
CX3-10-20MVAL	CX310 TO CX320 MVIEW BUNDLE LICENSE UPG	D2	\$15,720
CX3-10-20MVS	CX3-10 TO CX3-20 MIRRORVIEW/S LICENSE UP	D2	\$11,940
CX3-10-20NQM	CX3-10 TO CX3-20 NQM LICENSE UPGRADE	D2	\$6,000
CX3-10-20SC	CX3-10 TO CX3-20 SANCOPY LICENSE UPGRAD	D2	\$0
CX3-10-20SV	CX3-10 TO CX3-20 SNAPVIEW LIC UPGRADE	D2	\$0
CX3-10-20WG	CX3-10 TO CX3-20 NAVI Wkg Lic Upg	D2	\$0
CX3-10-40DP	CX3-10 TO CX3-40 NAVI Dept Lic Upg	D2	\$23,520
CX3-10-40EN	CX3-10 TO CX3-40 NAVI Ent Lic Upg	D2	\$34,800
CX3-10-40MVA	CX3-10 TO CX3-40 MIRRORVIEW/A LICENSE UP	D2	\$15,840
CX3-10-40MVAL	CX310 TO CX340 MVIEW BUNDLE LICENSE UPG	D2	\$27,600
CX3-10-40MVS	CX3-10 TO CX3-40 MIRRORVIEW/S LICENSE UP	D2	\$21,000

CX3-10-40NQM	CX3-10 TO CX3-40 NQM LICENSE UPGRADE	D2	\$13,800
CX3-10-40SC	CX3-10 TO CX3-40 SANCOPY LICENSE UPGRAD	D2	\$0
CX3-10-40SV	CX3-10 TO CX3-40 SNAPVIEW LIC UPGRADE	D2	\$0
CX3-10-40WG	CX3-10 TO CX3-40 NAVI Wkg Lic Upg	D2	\$0
CX31-612KIT	BACK REV DOC KIT 03.24	D2	\$0
CX31C-FL612	BACK REV FLARE 03.24 FOR CX3-10C	D2	\$0
CX31DC-FL612	BACK REV FLARE OE 3.24	D2	\$0
CX3204080N	NQM Upg CX3-20/40 TO CX3-80	D2	\$19,800
CX3-20-40DP	CX3-20 TO CX3-40 NAVI Dept Lic Upg	D2	\$23,520
CX3-20-40EN	CX3-20 TO CX3-40 NAVI Ent Upg Lic	D2	\$34,800
CX3-20-40MVA	CX3-20 TO CX3-40 MIRRORVIEW A UPGRADE LI	D2	\$15,840
CX3-20-40MVAL	CX3-20 TO CX3-40 MIRRORVIEW UPG LIC	D2	\$27,600
CX3-20-40MVS	CX3-20 TO CX3-40 MV/S UPGRADE LICENSE	D2	\$21,000
CX3-20-40NQM	NQM Upg CX3-20 TO CX3-40	D2	\$13,800
CX3-20-40SC	CX3-20 TO CX3-40 SC UPGRADE LICENSE	D2	\$0
CX3-20-40SV	CX3-20 TO CX3-40 SV UPGRADE LICENSE	D2	\$0
CX3-20-40WG	CX3-20 TO CX3-40 NAVI WORKGROUP UPGRAD	D2	\$12,900
CX3-20NQM	NQM Upg CX300 TO CX3-20	D2	\$6,000
CX3-20SV	CX300 TO CX3-20 SV UPGRADE LICENSE	D2	\$0
CX32-612KIT	BACK REV DOC KIT 03.24	D2	\$0
CX32C-508KIT	CX3-20C FOE 03.22 DOC KIT	D2	\$0
CX32C-FL508	BACK REV FLARE OE 03.22	D2	\$0
CX32C-FL612	BACK REV FLARE OE 03.24	D2	\$0
CX32FDC-FL612	BACK REV FLARE OE 03.24	D2	\$0
CX32F-FL612	BACK REV FLARE OE 03.24	D2	\$0
CX32-FL508	BACK REV FLARE OE 03.22	D2	\$0
CX345-40SV	CX3/4/500 TO CX3-40 SV UPGRADE LICENSE	D2	\$0
CX345-80SV	CX3/4/500 TO CX3-80 SV UPGRADE LICENSE	D2	\$0
CX34-612KIT	BACK REV DOC KIT 03.24	D2	\$0
CX34C-508KIT	CX3-40C FOE 03.22 DOC KIT	D2	\$0
CX34C-FL508	BACK REV FLARE OE 03.22	D2	\$0
CX34C-FL612	BACK REV FLARE OE 03.24	D2	\$0
CX34FDC-FL612	BACK REV FLARE OE 03.24	D2	\$0
CX34F-FL612	BACK REV FLARE OE 3.24	D2	\$0
CX34F-KIT	CX3-40F DOCS AND RTU KIT	D2	\$0
CX34-FL508	BACK REV FLARE OE 03.22	D2	\$0
CX35-40NQM	NQM Upg CX300/500 TO CX3-40	D2	\$13,800
CX38-612KIT	BACK REV DOC KIT 03.24	D2	\$0
CX38-FL508	BACK REV FLARE OE 03.22	D2	\$0
CX38-FL612	BACK REV FLARE OE 03.24	D2	\$0
CX400-FL303	FLARE OS UPDATE 303	D2	\$0
CX400-FL308	FLARE OS UPDATE 02.05	D2	\$0
CX400-FL402	BACK REV FLARE RELEASE 13	D2	\$0
CX45-40MVA	CX4/500 TO CX3-40 MV/A UPGRADE LICENSE	D2	\$15,840
CX45-40MVAL	CX4/500 TO CX340 MVIEW BUNDLE UPG LIC	D2	\$27,600
CX45-40MVS	CX4/500 TO CX3-40 MV/S UPGRADE LICENSE	D2	\$21,000
CX45-40SC	CX4/500 TO CX3-40 SC UPGRADE LICENSE	D2	\$0
CX45-80MVA	CX4/500 TO CX3-80 MV/A UPGRADE LICENSE	D2	\$19,800
CX45-80MVAL	CX4/500 TO CX3-80 MVIEW UPGRADE LICENSE	D2	\$34,560
CX45-80MVS	CX4/500 TO CX3-80 MV/S UPGRADE LICENSE	D2	\$26,250

CX45-80SC	CX4/500 TO CX3-80 SAN COPY U/G LICENSE	D2	\$0
CX4-960EXPSW	EXPANSION SW PACK FOR CX4-960	D2	\$0
CX4-FL808	Manufacturing flag FL 4.28 install	D2	\$0
CX4-FL908	Manufacturing flag FL 4.29 install	D2	\$0
CX600-40DP	CX600 TO CX3-40 NAVI Dept Upg	D2	\$26,100
CX600-40EN	CX600 TO CX3-40 NAVI Ent Upg Lic	D2	\$38,700
CX600-40MVA	CX600 TO CX3-40 MV/A UPGRADE LICENSE	D2	\$15,840
CX600-40MVAL	CX600 TO CX3-40 MIRRORVIEW BOTH UPGRADE	D2	\$27,600
CX600-40MVS	CX600 TO CX3-40 MV/S UPGRADE LICENSE	D2	\$21,000
CX600-40SC	CX600 TO CX3-40 SC UPGRADE LICENSE	D2	\$0
CX600-40SV	CX600 TO CX3-40 SV UPGRADE LICENSE	D2	\$0
CX600-40WG	CX600 TO CX3-40 NAVI WORKGROUP UPGRADE	D2	\$12,900
CX600-FL303	FLARE OS UPDATE 303	D2	\$0
CX600-FL308	FLARE OS UPDATE 02.05	D2	\$0
CX600-FL402	BACK REV FLARE RELEASE 13	D2	\$0
CX6-7-80DP	CX6/700 TO CX3-80 NAVI Dept Upg	D2	\$32,640
CX6-7-80EN	CX6/700 TO CX3-80 NAVI Ent Upg Lic	D2	\$48,360
CX6-7-80MVA	CX6/700 TO CX3-80 MV/A UPGRADE LICENSE	D2	\$19,800
CX6-7-80MVAL	CX6/700 TO CX3-80 MIRRORVIEW BOTH UPGRADE	D2	\$34,560
CX6-7-80MVS	CX6/700 TO CX3-80 MV/S UPGRADE LICENSE	D2	\$26,250
CX6-7-80SC	CX6/700 TO CX3-80 SC UPGRADE LICENSE	D2	\$0
CX6-7-80SV	CX6/700 TO CX3-80 SV UPGRADE LICENSE	D2	\$0
CX6-7-80WG	CX6/700 TO CX3-80 NAVI WORKGROUP UPGRADE	D2	\$16,140
CX7-40DP	CX700 TO CX3-40 NAVI Dept Lic Upg	D2	\$23,520
CX7-40EN	CX700 TO CX3-40 NAVI Ent Lic Upg	D2	\$34,800
CX7-40MVA	CX700 TO CX3-40 MIRRORVIEW/A LICENSE UPG	D2	\$15,840
CX7-40MVAL	CX700 TO CX3-40 MIRRORVIEW BUNDLE LICENS	D2	\$27,600
CX7-40MVS	CX700 TO CX3-40 MIRRORVIEW/S LICENSE UPG	D2	\$21,000
CX7-40NQM	CX700 TO CX3-40 NQM LICENSE UPGRADE	D2	\$13,800
CX7-40SC	CX700 TO CX3-40 SAN COPY LICENSE UPGRADE	D2	\$0
CX7-40SV	CX700 TO CX3-40 SNAPVIEW LICENSE UPGRADE	D2	\$0
CX7-40WG	CX700 TO CX3-40 NAVI Wkg Lic Upg	D2	\$0
CX7-80NQM	NQM UPGRADE CX700 TO CX3-80	D2	\$19,800
ESA-CX4120	EMC Storage Analytics for CX4-120 = IC	D2	\$0
ESA-CX4240	EMC Storage Analytics for CX4-240 = IC	D2	\$0
ESA-CX4480	EMC Storage Analytics for CX4-480 = IC	D2	\$0
ESA-CX4960	EMC Storage Analytics for CX4-960 = IC	D2	\$0
ESA-NS120	EMC Storage Analytics for NS-120 = IC	D2	\$0
ESA-NS480	EMC Storage Analytics for NS-480 = IC	D2	\$0
ESA-NS960	EMC Storage Analytics for NS-960 = IC	D2	\$0
ESA-SWKIT	EMC Storage Analytics Media Kit = IC	D2	\$0
ESA-VG2	EMC Storage Analytics for VG2 = IC	D2	\$7,000
ESA-VG8	EMC Storage Analytics for VG8 = IC	D2	\$35,000
ESNAL7-T1	ESN MGR & ACCESS LOGIX 0-.250	D2	\$0
ESNAL7-T10	ESN MGR & ACCESS LOGIX 10.01-12.00	D2	\$0
ESNAL7-T11	ESN MGR & ACCESS LOGIX 12.01-14.00	D2	\$0
ESNAL7-T12	ESN MGR & ACCESS LOGIX 14.01-ABOVE	D2	\$0
ESNAL7-T13	ESN FOR 4700 17.01-20.00	D2	\$0
ESNAL7-T14	ESN FOR 4700 20.01-23.00	D2	\$0
ESNAL7-T15	ESN FOR 4700 23.01-26.00	D2	\$0

ESNAL7-T16	ESN FOR 4700 26.01-29.00	D2	\$0
ESNAL7-T17	ESN FOR 4700 29.01-32.00	D2	\$0
ESNAL7-T18	ESN FOR 4700 32.01-35.00	D2	\$0
ESNAL7-T2	ESN MGR & ACCESS LOGIX .251-.500	D2	\$0
ESNAL7-T3	ESN MGR & ACCESS LOGIX .501-.750	D2	\$0
ESNAL7-T4	ESN MGR & ACCESS LOGIX .751-1.00	D2	\$0
ESNAL7-T5	ESN MGR & ACCESS LOGIX 1.01-2.00	D2	\$0
ESNAL7-T6	ESN MGR & ACCESS LOGIX 2.01-4.00	D2	\$0
ESNAL7-T7	ESN MGR & ACCESS LOGIX 4.01-6.00	D2	\$0
ESNAL7-T8	ESN MGR & ACCESS LOGIX 6.01-8.00	D2	\$0
ESNAL7-T9	ESN MGR & ACCESS LOGIX 8.01-10.00	D2	\$0
ESNCX4-T1	ESNM FOR CX400-0-.250	D2	\$0
ESNCX4-T10	ESNM FOR CX400-10.01-12.00	D2	\$0
ESNCX4-T11	ESNM FOR CX400-12.01-14.00	D2	\$0
ESNCX4-T12	ESNM FOR CX400-14.01-ABOV	D2	\$0
ESNCX4-T13	ESN FOR CX400 17.01-20.00	D2	\$0
ESNCX4-T14	ESN FOR CX400 20.01-23.00	D2	\$0
ESNCX4-T15	ESN FOR CX400 23.01-26.00	D2	\$0
ESNCX4-T16	ESN FOR CX400 26.01-29.00	D2	\$0
ESNCX4-T17	ESN FOR CX400 29.01-32.00	D2	\$0
ESNCX4-T18	ESN FOR CX400 32.01-35.00	D2	\$0
ESNCX4T1-T4	ESN MGR UPGRADE T1-T4	D2	\$0
ESNCX4-T2	ESNM FOR CX400-.251-.500	D2	\$0
ESNCX4-T3	ESNM FOR CX400-.501-.750	D2	\$0
ESNCX4-T4	ESNM FOR CX400-.751-1.00	D2	\$0
ESNCX4-T5	ESNM FOR CX400-1.01-2.00	D2	\$0
ESNCX4-T6	ESNM FOR CX400-2.01-4.00	D2	\$0
ESNCX4-T7	ESNM FOR CX400-4.01-6.00	D2	\$0
ESNCX4-T8	ESNM FOR CX400-6.01-8.00	D2	\$0
ESNCX4-T9	ESNM FOR CX400-8.01-10.00	D2	\$0
ESNCX6-T1	ESN MGR FOR CX600-0-.250	D2	\$0
ESNCX6-T10	ESNM FOR CX600-10.01-12.0	D2	\$0
ESNCX6-T11	ESNM FOR CX600-12.01-14.0	D2	\$0
ESNCX6-T12	ESNM FOR CX600-14.01-ABOV	D2	\$0
ESNCX6-T13	ESN FOR CX600 17.01-20.00	D2	\$0
ESNCX6-T14	ESN FOR CX600 20.01-23.00	D2	\$0
ESNCX6-T15	ESN FOR CX600 23.01-26.00	D2	\$0
ESNCX6-T16	ESN FOR CX600 26.01-29.00	D2	\$0
ESNCX6-T17	ESN FOR CX600 29.01-32.00	D2	\$0
ESNCX6-T18	ESN FOR CX600 32.01-35.00	D2	\$0
ESNCX6-T19	ESN FOR CX600 35.01-38.00	D2	\$0
ESNCX6T1-T4	UPGRADE FOR ESN T1-T4	D2	\$0
ESNCX6-T2	ESN MGR FOR CX600-.251-.5	D2	\$0
ESNCX6-T20	ESN FOR CX600 38.01-41.00	D2	\$0
ESNCX6-T21	ESN FOR CX600 41.01-44.00	D2	\$0
ESNCX6-T22	ESN FOR CX600 44.01-47.00	D2	\$0
ESNCX6-T23	ESN FOR CX600 47.01-50.00	D2	\$0
ESNCX6-T24	ESN FOR CX600 50.01-53.00	D2	\$0
ESNCX6-T25	ESN FOR CX600 53.01-56.00	D2	\$0
ESNCX6-T26	ESN FOR CX600 56.01-59.00	D2	\$0

ESNCX6-T27	ESN FOR CX600 59.01-62.00	D2	\$0
ESNCX6-T28	ESN FOR CX600 62.01-65.00	D2	\$0
ESNCX6-T29	ESN FOR CX600 65.01-68.00	D2	\$0
ESNCX6-T3	ESNM FOR CX600-.501-.750	D2	\$0
ESNCX6-T30	ESN FOR CX600 68.01-71.00	D2	\$0
ESNCX6-T31	ESN FOR CX600 71.01-74.00	D2	\$0
ESNCX6-T4	ESNM FOR CX600-.751-1.0	D2	\$0
ESNCX6-T5	ESNM FOR CX600-1.01-2.0	D2	\$0
ESNCX6-T6	ESNM FOR CX600-2.01-4.0	D2	\$0
ESNCX6-T7	ESNM FOR CX600-4.01-6.0	D2	\$0
ESNCX6-T8	ESNM FOR CX600-6.01-8.0	D2	\$0
ESNCX6-T9	ESNM FOR CX600-8.01-10.0	D2	\$0
ESNT1-4UP	ESN Mgr & Access Logix Tier 1 to Tier 4	D2	\$1,090
FAST-120	EMC FAST FOR THE CX4-120 OR NS-120	D2	\$0
FAST-240	EMC FAST FOR THE CX4-240	D2	\$0
FAST-240UPG	FAST - UPGRADE TO CX4-240 PLATFORM	D2	\$0
FAST-480	EMC FAST FOR THE CX4-480 OR NS-480	D2	\$0
FAST-480UPG	FAST - UPGRADE TO CX4-480 PLATFORM	D2	\$0
FAST-960	EMC FAST FOR THE CX4-960 OR NS-960	D2	\$0
FAST-960UPG	FAST - UPGRADE TO CX4-960 PLATFORM	D2	\$0
FASTUP-120	EMC FAST UPGRADE FOR THE CX4-120/NS-120	D2	\$0
FASTUP-240	EMC FAST UPGRADE FOR THE CX4-240	D2	\$0
FASTUP-480	EMC FAST UPGRADE FOR THE CX4-480/NS-480	D2	\$0
FASTUP-960	EMC FAST UPGRADE FOR THE CX4-960/NS-960	D2	\$0
FL-120	EMC FAST CACHE FOR CX4-120 OR NS-120	D2	\$0
FL-240	EMC FAST CACHE FOR CX4-240	D2	\$0
FL-240UPG	FAST CACHE - UPGRADE TO CX4-240 PLATFORM	D2	\$0
FL-480	EMC FAST CACHE FOR CX4-480 OR NS-480	D2	\$0
FL-480UPG	FAST CACHE - UPGRADE TO CX4-480 PLATFORM	D2	\$0
FL-960	EMC FAST CACHE FOR CX4-960 OR NS-960	D2	\$0
FL-960UPG	FAST CACHE - UPGRADE TO CX4-960 PLATFORM	D2	\$0
FLMA4-120	FAST ADD ON FOR THE CX4-120	D2	\$0
FLMA4-240	FAST ADD ON FOR THE CX4-240	D2	\$0
FLMA4-480	FAST ADD ON FOR THE CX4-480	D2	\$0
FLMA4-960	FAST ADD ON FOR THE CX4-960	D2	\$0
FLMS4-120	FAST SUITE CX4-120	D2	\$0
FLMS4-240	FAST SUITE FOR THE CX4-240	D2	\$0
FLMS4-240UPG	FAST SUITE UPGRADE FOR THE CX4-240	D2	\$15,000
FLMS4-480	FAST SUITE FOR THE CX4-480	D2	\$0
FLMS4-480UPG	FAST SUITE UPGRADE FOR THE CX4-480	D2	\$39,000
FLMS4-960	FAST SUITE FOR THE CX4-960	D2	\$0
FLMS4-960UPG	FAST SUITE UPGRADE FOR THE CX4-960	D2	\$63,000
FMA6-APL	RAINFINITY FMA APPLIANCE	D2	\$42,500
FMA6-HA-APL	RAINFINITY FMA HA APPLIANCE	D2	\$0
FMA7-APL	FMA APPLIANCE	D2	\$0
FMA7-HA-APL	FMA HA APPLIANCE	D2	\$0
FMA-APL	FMA APPLIANCE	D2	\$0
FMA-CTA-CONV	CONVERT FROM FMA/VE TO CTA/VE	D2	\$0
FMA-DCD-F	FULL FMA LICENSE DCD	D2	\$0
FMA-HA	FMA HA APPLIANCE	D2	\$0

FMAVE	FMA VIRTUAL EDITION	D2	\$0
FMA-VE	FMA VIRTUAL EDITION	D2	\$0
FMAVE-120	FMA/VE FOR CELERRA NS-120	D2	\$26,500
FMAVE-480	FMA/VE FOR CELERRA NS-480	D2	\$31,500
FMAVE-960	FMA/VE FOR CELERRA NS-960	D2	\$36,500
FMAVE-G2	FMA VIRTUAL EDITION FOR THE G2 PLATFORM	D2	\$31,500
FMAVE-G8	FMA/VE FOR CELERRA NS-G8	D2	\$36,500
FMA-VE-HA	FMA VIRTUAL EDITION HA	D2	\$0
FMA-VE-MIG	FMA APPLIANCE TO VE UPGRADE	D2	\$0
FMAVE-NX4	FMA/VE FOR CELERRA NX4	D2	\$21,500
FVA7-1216C-C	FVA7 12-COP 16G CIFS	D2	\$0
FVA71216CCCL1	FVA 12-COP 16G CIFS CL NODE 1 OF 2	D2	\$0
FVA71216CCCL2	FVA 12-COP 16G CIFS CL NODE 2 OF 2	D2	\$0
FVA7-1216C-HU	FVA7 12-COP 16G HW ONLY UPG	D2	\$0
FVA7-1216C-M	FVA7 12-COP 16G MULTI PROTOCOL	D2	\$0
FVA71216CMCL1	FVA 12-COP 16G MULTI CL NODE 1 OF 2	D2	\$0
FVA71216CMCL2	FVA 12-COP 16G MULTI CL NODE 2 OF 2	D2	\$0
FVA7-1216C-N	FVA7 12-COP 16G NFS	D2	\$0
FVA71216CNCL1	FVA 12-COP 16G NFS CLUSTER NODE 1 OF 2	D2	\$0
FVA71216CNCL2	FVA 12-COP 16G NFS CLUSTER NODE 2 OF 2	D2	\$0
FVA-DCD-FCM	FVA FULL CIFS SA	D2	\$0
FVA-DCD-FCMCL	FVA FULL CIFS CL	D2	\$0
FVA-DCD-FEM	FVA FULL MULTI SA	D2	\$0
FVA-DCD-FNM	FVA FULL NFS SA	D2	\$0
FVA-DCD-FNMCL	FVA FULL NFS CL	D2	\$0
FVA-DCD-TCM	FVA TRY CIFS SA	D2	\$0
FVA-DCD-TCMCL	FVA TRY CIFS CL	D2	\$0
FVA-DCD-TEM	FVA TRY MULTI SA	D2	\$0
FVA-DCD-TEMCL	FVA TRY MULTI CL	D2	\$0
FVA-DCD-TNM	FVA TRY NFS SA	D2	\$0
FVA-DCD-TNMCL	FVA TRY NFS CL	D2	\$0
FVA-SWU-C-M	LICENSE UPGRADE FROM CIFS TO MULTI-PROT	D2	\$0
FVA-SWU-N-M	LICENSE UPGRADE FROM NFS TO MULTI-PROT	D2	\$0
FVASWU-SC-CL	FVA SW UPG-SINGLE TO CL-CIFS	D2	\$0
FVASWU-SM-CL	FVA SW UPG-SINGLE TO CL-MULTI	D2	\$0
FVASWU-SN-CL	FVA SW UPG-SINGLE TO CL-NFS	D2	\$0
GFV6-1216C-C	GFV6 12-COP 16G CIFS	D2	\$0
GFV6-1216CCCL	GFV6 12-COP 16G CIFS CL	D2	\$0
GFV6-1216C-E	GFV6 12-COP 16G ENTERPRISE	D2	\$0
GFV6-1216CECL	GFV6 12-COP 16G ENT CL	D2	\$0
GFV6-1216C-HU	GFV6 12X16 SA-CL UPGRADE	D2	\$0
GFV6-1216C-N	GFV6 12-COP 16G NFS	D2	\$0
GFV6-1216CNCL	GFV6 12-COP 16G NFS CL	D2	\$0
GFV6-1232C-C	GFV6 12-COPPER 32G CIFS	D2	\$0
GFV6-1232CCCL	GFV6 12-COPPER 32G CIFS CLUSTER	D2	\$0
GFV6-1232C-E	GFV6 12-COPPER 32G ENTERPRISE	D2	\$0
GFV6-1232CECL	GFV6 12-COP 32G ENT CL	D2	\$0
GFV6-1232C-N	GFV6 12-COPPER 32G NFS	D2	\$0
GFV6-1232CNCL	GFV6 12-COPPER 32G NFS CLUSTER	D2	\$0
GFV6-441216HU	GFV6 HW UPGRADE FROM 4X4 TO 12X16	D2	\$0

GFV6-44C-C	GFV6 4-COP 4G CIFS	D2	\$0
GFV6-44C-CCL	GFV6 4-COP 4G CIFS CL	D2	\$0
GFV6-44C-HU	GFV6 4X4 SA-CL UPGRADE	D2	\$0
GFV6-616F-C	GFV6 6-OPTICAL 16G CIFS	D2	\$0
GFV6-616F-CCL	GFV6 6-OPTICAL 16G CIFS CLUSTER	D2	\$0
GFV6-616F-E	GFV6 6-OPTICAL 16G ENTERPRISE	D2	\$0
GFV6-616F-ECL	GFV6 6-OPTICAL 16G ENTERPRISE CLUSTER	D2	\$0
GFV6-616F-HU	GFV6 6X16 SA-CL UPGRADE	D2	\$0
GFV6-616F-N	GFV6 6-OPTICAL 16G NFS	D2	\$0
GFV6-616F-NCL	GFV6 6-OPTICAL 16G NFS CLUSTER	D2	\$0
GFV6-C-S	4-PORT COPPER CARD - GFV6	D2	\$0
GFV6-F-S	2-PORT FIBER CARD FOR GFV6	D2	\$0
GFV-SWU-FVA	GFV TO FVA SOFTWARE UPGRADE	D2	\$0
GNA6-12C-N1	GNA6 12-COP NODE 1 OF 2	D2	\$0
GNA6-12C-N2	GNA6 12-COP NODE 2 OF 2	D2	\$0
GNA6-4C-N1	GNA6 4-COP NODE 1 OF 2	D2	\$0
GNA6-4C-N2	GNA6 4-COP NODE 2 OF 2	D2	\$0
GNA7-4C-N1	GNA7 4-COP NODE 1 OF 2	D2	\$32,500
GNA7-4C-N2	GNA7 4-COP NODE 2 OF 2	D2	\$32,500
GNA-DCD-F	GNA FULL LIC	D2	\$0
GNA-DCD-T	GNA TRY LIC	D2	\$0
INV-BNDL1	MUST BE ORDERED WITH RP-BNDL1	D2	\$37,500
INV-BNDL2	MUST BE ORDERED WITH RP-BNDL2	D2	\$40,000
INV-BNDL3	MUST BE ORDERED WITH RP-BNDL3	D2	\$45,000
INV-BSV-BASE	INV-BSV BASE LICENSE	D2	\$0
INV-BSV-BASEF	INV-BSV BASE LICENSE FOR CISCO PROMOTIO	D2	\$5,000
INV-BSV-DPC	INVISTA BASE LICENSE KIT	D2	\$0
INV-BSVT10LIC	INV-BSV 1TB(601-1000TB)	D2	\$0
INV-BSVT11LIC	INV-BSV 1TB(1001-1500 TB)	D2	\$2,350
INV-BSV-T1LIC	INV-BSV 1TB (0-14 TB)	D2	\$0
INV-BSV-T2LIC	INV-BSV 1TB (15-25 TB)	D2	\$0
INV-BSV-T3LIC	INV-BSV 1TB (26-40 TB)	D2	\$0
INV-BSV-T4LIC	INV-BSV 1TB (41-60 TB)	D2	\$0
INV-BSV-T5LIC	INV-BSV 1TB (61-100 TB)	D2	\$0
INV-BSV-T6LIC	INV-BSV 1TB (101-150 TB)	D2	\$0
INV-BSV-T7LIC	INV-BSV 1TB (151-250 TB)	D2	\$0
INV-BSV-T8LIC	INV-BSV 1TB (251-400 TB)	D2	\$0
INV-BSV-T9LIC	INV-BSV 1TB(401-600 TB)	D2	\$0
INV-CL-BASE	INV-CL BASE LICENSE	D2	\$0
INV-CL-DPC	INVISTA CLONE LICENSE KIT	D2	\$0
INV-CL-T10LIC	INV-CL 1TB(601-1000TB)	D2	\$0
INV-CL-T11LIC	INV-CL 1TB(1001-1500 TB)	D2	\$990
INV-CL-T1LIC	INV-CL 1TB (0-14 TB)	D2	\$0
INV-CL-T2LIC	INV-CL 1TB (15-25 TB)	D2	\$0
INV-CL-T3LIC	INV-CL 1TB (26-40 TB)	D2	\$0
INV-CL-T4LIC	INV-CL 1TB (41-60 TB)	D2	\$0
INV-CL-T5LIC	INV-CL 1TB (61-100 TB)	D2	\$0
INV-CL-T6LIC	INV-CL 1TB (101-150 TB)	D2	\$0
INV-CL-T7LIC	INV-CL 1TB (151-250 TB)	D2	\$0
INV-CL-T8LIC	INV-CL 1TB (251-400 TB)	D2	\$0

INV-CL-T9LIC	INV-CL 1TB(401-600 TB)	D2	\$0
INV-MGMT-SW	INV MANAGEMENT SOFTWARE	D2	\$0
INV-T1B1B2UP	INV BASE LIC UPG 1-2 T-1	D2	\$0
INV-T1B1LIC	INV BASE LIC 1 T-1 DPC	D2	\$120,000
INV-T1B2B4UP	INV BASE LIC UPG 2-4 T-1	D2	\$0
INV-T1B2LIC	INV BASE LIC 2 T-1 DPC	D2	\$240,000
INV-T1B4LIC	INV BASE LIC 4 T-1 DPC	D2	\$480,000
INV-T1C1C2UP	INV CLONE LIC UPG 1-2 T-1	D2	\$0
INV-T1C1LIC	INV CLONE LIC 1 T-1 DPC	D2	\$40,000
INV-T1C2C4UP	INV CLONE LIC UPG 2-4 T-1	D2	\$0
INV-T1C2LIC	INV CLONE LIC 2 T-1 DPC	D2	\$80,000
INV-T1C4LIC	INV CLONE LIC 4 T-1 DPC	D2	\$160,000
IPCFT1-T4	CIFS, IP4700, T1-T4 UPG	D2	\$0
IPCFT5-T12	CIFS, IP4700, T5-T12 UPG	D2	\$0
IPFPT1-T4	IP4700 FTP ENBR UPG T1-T4	D2	\$0
IPFPT5-T12	IP4700 FTP UPG T5-T12	D2	\$0
IPNDT1-T4	NDMP, IP4700, T1-T4 UPG	D2	\$0
IPNDT5-T12	NDMP, IP4700, T5-T12 UPG	D2	\$0
IPNFT1-T4	NFS, IP4700, T1-T4 UPG	D2	\$0
IPNFT5-T12	NFS, IP4700, T5-512 UPG	D2	\$0
IPSVT1-T4	SNPVW/IP,IP4700,T1-T4 UPG	D2	\$0
IPSVT5-T12	SNPVW/IP,IP4700,T5-T12UPG	D2	\$0
MGRB200-KIT	NAVI MGR BASE MEDIA	D2	\$0
MGRBASEKIT303	MANAGER BASE V6.4 MEDIA	D2	\$0
MGRBASEKIT308	MANAGER BASE V6.5 MEDIA	D2	\$0
MGRBASEKIT402	MANAGER BASE V6.6 MEDIA	D2	\$0
MGRBASEKIT407	MANAGER BASE MEDIA V6.7	D2	\$0
MGRBASEKIT501	NAVI MANAGER BASE MEDIA	D2	\$0
MV400-KIT	MV/S CX400 MEDIA	D2	\$0
MV400-KIT303	CX400 MV V1.7 MEDIA	D2	\$0
MV400-KIT308	CX400 MV V1.8 MEDIA	D2	\$0
MV400-T1	MV/S CX400 TIER 1	D2	\$0
MV400-T10	MV/S CX400 TIER 10	D2	\$0
MV400-T11	MV/S CX400 TIER 11	D2	\$0
MV400-T12	MV/S CX400 TIER 12	D2	\$0
MV400T1-T4	MIRMV/S CX400 UPG T1-T4	D2	\$0
MV400-T2	MV/S CX400 TIER 2	D2	\$0
MV400-T3	MV/S CX400 TIER 3	D2	\$0
MV400-T4	MV/S CX400 TIER 4	D2	\$0
MV400-T5	MV/S CX400 TIER 5	D2	\$0
MV400T5-T12	MIRRORVIEW CX400 UPG T5-T12	D2	\$0
MV400T5-T8	MV/S CX400 UPG T5-T8	D2	\$0
MV400-T6	MV/S CX400 TIER 6	D2	\$0
MV400-T7	MV/S CX400 TIER 7	D2	\$0
MV400-T8	MV/S CX400 TIER 8	D2	\$0
MV400-T9	MV/S CX400 TIER 9	D2	\$0
MV47-T01	MV/S FC4700 TIER 01	D2	\$0
MV47-T02	MV/S FC4700 TIER 02	D2	\$0
MV47-T03	MV/S FC4700 TIER 03	D2	\$0
MV47-T04	MV/S FC4700 TIER 04	D2	\$0

MV47-T05	MV/S FC4700 TIER 05	D2	\$0
MV47-T06	MV/S FC4700 TIER 06	D2	\$0
MV47-T07	MV/S FC4700 TIER 07	D2	\$0
MV47-T08	MV/S FC4700 TIER 08	D2	\$0
MV47-T09	MV/S FC4700 TIER 09	D2	\$0
MV47-T10	MV/S FC4700 TIER 10	D2	\$0
MV47-T11	MV/S FC4700 TIER 11	D2	\$0
MV47-T12	MV/S FC4700 TIER 12	D2	\$0
MVA31	MIRRORVIEW A (ASYNC) FOR THE CX3-10	D2	\$0
MVA32	MIRRORVIEW/A CX3-20	D2	\$0
MVA34	MIRRORVIEW/A CX3-40	D2	\$0
MVA38	MIRRORVIEW/A CX3-80	D2	\$0
MVA3-KIT	MIRRORVIEW A MEDIA KIT	D2	\$0
MVA400-T1	CX400 MIRRORVIEW/A TIER 1	D2	\$0
MVA400-T10	CX400 MIRRORVIEW/A TIER 10	D2	\$0
MVA400-T11	CX400 MIRRORVIEW/A TIER 11	D2	\$0
MVA400-T12	CX400 MIRRORVIEW/A TIER 12	D2	\$0
MVA400T1-T4	MV/A CX400 UPG T1-T4	D2	\$0
MVA400-T2	CX400 MIRRORVIEW/A TIER 2	D2	\$0
MVA400-T3	CX400 MIRRORVIEW/A TIER 3	D2	\$0
MVA400-T4	CX400 MIRRORVIEW/A TIER 4	D2	\$0
MVA400-T5	CX400 MIRRORVIEW/A TIER 5	D2	\$0
MVA400T5-T8	MV/A CX400 UPG T5-T8	D2	\$0
MVA400-T6	CX400 MIRRORVIEW/A TIER 6	D2	\$0
MVA400-T7	CX400 MIRRORVIEW/A TIER 7	D2	\$0
MVA400-T8	CX400 MIRRORVIEW/A TIER 8	D2	\$0
MVA400-T9	CX400 MIRRORVIEW/A TIER 9	D2	\$0
MVA4-120	MIRRORVIEW/A FOR CX4-120	D2	\$0
MVA4-120UPG	MIRRORVIEW/A UPGRADE TO CX4-120C	D2	\$0
MVA4-240	MIRRORVIEW/A FOR CX4-240	D2	\$0
MVA4-240UPG	MIRRORVIEW/A UPGRADE TO CX4-240C	D2	\$0
MVA4-480	MIRRORVIEW/A FOR CX4-480	D2	\$0
MVA4-480UPG	MIRRORVIEW/A UPGRADE TO CX4-480C	D2	\$0
MVA4-960	MIRRORVIEW/A FOR CX4-960	D2	\$0
MVA4-960UPG	MIRRORVIEW/A UPGRADE TO CX4-960C	D2	\$0
MVA600-T1	CX600 MIRRORVIEW/A TIER 1	D2	\$0
MVA600-T10	CX600 MIRRORVIEW/A TIER10	D2	\$0
MVA600-T11	CX600 MIRRORVIEW/A TIER11	D2	\$0
MVA600-T12	CX600 MIRRORVIEW/A TIER12	D2	\$0
MVA600-T13	CX600 MIRRORVIEW/A TIER13	D2	\$0
MVA600-T14	CX600 MIRRORVIEW/A TIER14	D2	\$0
MVA600-T15	CX600 MIRRORVIEW/A TIER15	D2	\$0
MVA600-T16	CX600 MIRRORVIEW/A TIER16	D2	\$0
MVA600-T17	CX600 MIRRORVIEW/A TIER17	D2	\$0
MVA600-T18	CX600 MIRRORVIEW/A TIER18	D2	\$0
MVA600-T19	CX600 MIRRORVIEW/A TIER19	D2	\$0
MVA600T1-T4	MV/A CX600 UPG T1-T4	D2	\$0
MVA600-T2	CX600 MIRRORVIEW/A TIER 2	D2	\$0
MVA600-T20	CX600 MIRRORVIEW/A TIER20	D2	\$0
MVA600-T21	CX600 MIRRORVIEW/A TIER21	D2	\$0

MVA600-T22	CX600 MIRRORVIEW/A TIER22	D2	\$0
MVA600-T23	CX600 MIRRORVIEW/A TIER23	D2	\$0
MVA600-T24	CX600 MIRRORVIEW/A TIER24	D2	\$0
MVA600-T25	CX600 MIRRORVIEW/A TIER25	D2	\$0
MVA600-T26	CX600 MIRRORVIEW/A TIER26	D2	\$0
MVA600-T27	CX600 MIRRORVIEW/A TIER27	D2	\$0
MVA600-T28	CX600 MIRRORVIEW/A TIER28	D2	\$0
MVA600-T29	CX600 MIRRORVIEW/A TIER29	D2	\$0
MVA600-T3	CX600 MIRRORVIEW/A TIER 3	D2	\$0
MVA600-T30	CX600 MIRRORVIEW/A TIER30	D2	\$0
MVA600-T31	CX600 MIRRORVIEW/A TIER31	D2	\$0
MVA600-T4	CX600 MIRRORVIEW/A TIER 4	D2	\$0
MVA600-T5	CX600 MIRRORVIEW/A TIER 5	D2	\$0
MVA600T5-T12	MV/A CX600 UPG T5-T12	D2	\$0
MVA600-T6	CX600 MIRRORVIEW/A TIER 6	D2	\$0
MVA600-T7	CX600 MIRRORVIEW/A TIER 7	D2	\$0
MVA600-T8	CX600 MIRRORVIEW/A TIER 8	D2	\$0
MVA600-T9	CX600 MIRRORVIEW/A TIER 9	D2	\$0
MVAL31	MIRRORVIEW BUNDLE FOR THE CX3-10	D2	\$0
MVAL32	MIRRORVW A/S BNDL CX3-20	D2	\$0
MVAL34	MIRRORVW A/S BNDL CX3-40	D2	\$0
MVAL38	MIRRORVW A/S BNDL CX3-80	D2	\$0
MVAL400-T1	CX400 MVS+MVA BUNDLE T1	D2	\$0
MVAL400-T10	CX400 MVS+MVA BUNDLE T10	D2	\$0
MVAL400-T11	CX400 MVS+MVA BUNDLE T11	D2	\$0
MVAL400-T12	CX400 MVS+MVA BUNDLE T12	D2	\$0
MVAL400-T2	CX400 MVS+MVA BUNDLE T2	D2	\$0
MVAL400-T3	CX400 MVS+MVA BUNDLE T3	D2	\$0
MVAL400-T4	CX400 MVS+MVA BUNDLE T4	D2	\$0
MVAL400-T5	CX400 MVS+MVA BUNDLE T5	D2	\$0
MVAL400-T6	CX400 MVS+MVA BUNDLE T6	D2	\$0
MVAL400-T7	CX400 MVS+MVA BUNDLE T7	D2	\$0
MVAL400-T8	CX400 MVS+MVA BUNDLE T8	D2	\$0
MVAL400-T9	CX400 MVS+MVA BUNDLE T9	D2	\$0
MVAL4-120	MIRRORVIEW BUNDLE FOR CX4-120	D2	\$0
MVAL4-120UPG	MIRRORVIEW BUNDLE UPGRADE TO CX4-120C	D2	\$0
MVAL4-240	MIRRORVIEW BUNDLE FOR CX4-240	D2	\$0
MVAL4-240UPG	MIRRORVIEW BUNDLE UPGRADE TO CX4-240C	D2	\$0
MVAL4-480	MIRRORVIEW BUNDLE FOR CX4-480	D2	\$0
MVAL4-480UPG	MIRRORVIEW BUNDLE UPGRADE TO CX4-480C	D2	\$0
MVAL4-5UP	CX4-CX5 MVS+MVA BUNDL UPG	D2	\$0
MVAL4-7UP	CX4-CX7 MVS+MVA BUNDL UPG	D2	\$0
MVAL4-960	MIRRORVIEW BUNDLE FOR CX4-960	D2	\$0
MVAL4-960UPG	MIRRORVIEW BUNDLE UPGRADE TO CX4-960C	D2	\$0
MVAL4T1-T4	CX4 MVS+MVA BUND UP T1-T4	D2	\$0
MVAL4T5-T8	CX4 MVS+MVA BUND UP T5-T8	D2	\$0
MVAL5-7UP	CX5-CX7 MVS+MVA BUNDL UPG	D2	\$0
MVAL600-T1	CX600 MVS+MVA BUNDLE T1	D2	\$0
MVAL600-T10	CX600 MVS+MVA BUNDLE T10	D2	\$0
MVAL600-T11	CX600 MVS+MVA BUNDLE T11	D2	\$0

MVAL600-T12	CX600 MVS+MVA BUNDLE T12	D2	\$0
MVAL600-T13	CX600 MVS+MVA BUNDLE T13	D2	\$0
MVAL600-T14	CX600 MVS+MVA BUNDLE T14	D2	\$0
MVAL600-T15	CX600 MVS+MVA BUNDLE T15	D2	\$0
MVAL600-T16	CX600 MVS+MVA BUNDLE T16	D2	\$0
MVAL600-T17	CX600 MVS+MVA BUNDLE T17	D2	\$0
MVAL600-T18	CX600 MVS+MVA BUNDLE T18	D2	\$0
MVAL600-T19	CX600 MVS+MVA BUNDLE T19	D2	\$0
MVAL600-T2	CX600 MVS+MVA BUNDLE T2	D2	\$0
MVAL600-T20	CX600 MVS+MVA BUNDLE T20	D2	\$0
MVAL600-T21	CX600 MVS+MVA BUNDLE T21	D2	\$0
MVAL600-T22	CX600 MVS+MVA BUNDLE T22	D2	\$0
MVAL600-T23	CX600 MVS+MVA BUNDLE T23	D2	\$0
MVAL600-T24	CX600 MVS+MVA BUNDLE T24	D2	\$0
MVAL600-T25	CX600 MVS+MVA BUNDLE T25	D2	\$0
MVAL600-T26	CX600 MVS+MVA BUNDLE T26	D2	\$0
MVAL600-T27	CX600 MVS+MVA BUNDLE T27	D2	\$0
MVAL600-T28	CX600 MVS+MVA BUNDLE T28	D2	\$0
MVAL600-T29	CX600 MVS+MVA BUNDLE T29	D2	\$0
MVAL600-T3	CX600 MVS+MVA BUNDLE T3	D2	\$0
MVAL600-T30	CX600 MVS+MVA BUNDLE T30	D2	\$0
MVAL600-T31	CX600 MVS+MVA BUNDLE T31	D2	\$0
MVAL600-T4	CX600 MVS+MVA BUNDLE T4	D2	\$0
MVAL600-T5	CX600 MVS+MVA BUNDLE T5	D2	\$0
MVAL600-T6	CX600 MVS+MVA BUNDLE T6	D2	\$0
MVAL600-T7	CX600 MVS+MVA BUNDLE T7	D2	\$0
MVAL600-T8	CX600 MVS+MVA BUNDLE T8	D2	\$0
MVAL600-T9	CX600 MVS+MVA BUNDLE T9	D2	\$0
MVAL6-7UP	CX6-CX7 MVS+MVA BUNDL UPG	D2	\$0
MVAL6T1-T4	CX6 MVS+MVA BUND UP T1-T4	D2	\$0
MVAL6T5-T12	CX6 MVS+MVA BND UP T5-T12	D2	\$0
MV-CEM-31	MIRRORVIEW/CE (MS CLUSTERS) FOR CX3-10	D2	\$0
MV-CEM-32	MIRRORVIEW/CE (MS CLUSTERS) FOR CX3-20	D2	\$0
MV-CEM-34	MIRRORVIEW/CE (MS CLUSTERSS) FOR CX3-40	D2	\$0
MV-CEM-38	MIRRORVIEW/CE (MS CLUSTERS) FOR CX3-80	D2	\$0
MV-CEM4-120	MIRRORVIEW/CE SW APPLICATION FOR CX4-12	D2	\$0
MVCEM4-120UPG	MIRRORVIEW/CE UPGRADE TO CX4-120C	D2	\$0
MV-CEM4-240	MIRRORVIEW/CE SW APPLICATION FOR CX4-24	D2	\$0
MVCEM4-240UPG	MIRRORVIEW/CE UPGRADE TO CX4-240C	D2	\$0
MV-CEM4-480	MIRRORVIEW/CE SW APPLICATION FOR CX4-48	D2	\$0
MVCEM4-480UPG	MIRRORVIEW/CE UPGRADE TO CX4-480C	D2	\$0
MV-CEM4-960	MIRRORVIEW/CE SW APPLICATION FOR CX4-96	D2	\$0
MVCEM4-960UPG	MIRRORVIEW/CE UPGRADE TO CX4-960C	D2	\$0
MV-KIT	MV/S CX600 MEDIA	D2	\$0
MV-KIT303	MIRRORVIEW MEDIA 1.7	D2	\$0
MV-KIT308	MIRRORVIEW V1.8 MEDIA	D2	\$0
MVS31	MIRRORVIEW SYNC FOR THE CX3-10	D2	\$0
MVS32	MIRRORVIEW SYNC CX3-20	D2	\$0
MVS34	MIRRORVIEW SYNC CX3-40	D2	\$0
MVS38	MIRRORVIEW SYNC CX3-80	D2	\$0

MVS4-120	MIRRORVIEW/S FOR CX4-120	D2	\$0
MVS4-120UPG	MIRRORVIEW/S UPGRADE TO CX4-120C	D2	\$0
MVS4-240	MIRRORVIEW/S FOR CX4-240	D2	\$0
MVS4-240UPG	MIRRORVIEW/S UPGRADE TO CX4-240C	D2	\$0
MVS4-480	MIRRORVIEW/S FOR CX4-480	D2	\$0
MVS4-480UPG	MIRRORVIEW/S UPGRADE TO CX4-480C	D2	\$0
MVS4-960	MIRRORVIEW/S FOR CX4-960	D2	\$0
MVS4-960UPG	MIRRORVIEW/S UPGRADE TO CX4-960C	D2	\$0
MVS4-AL-T1	CX400 MVS TO BDLE UPG T1	D2	\$0
MVS4-AL-T10	CX400 MVS TO BDLE UPG T10	D2	\$0
MVS4-AL-T11	CX400 MVS TO BDLE UPG T11	D2	\$0
MVS4-AL-T12	CX400 MVS TO BDLE UPG T12	D2	\$0
MVS4-AL-T2	CX400 MVS TO BDLE UPG T2	D2	\$0
MVS4-AL-T3	CX400 MVS TO BDLE UPG T3	D2	\$0
MVS4-AL-T4	CX400 MVS TO BDLE UPG T4	D2	\$0
MVS4-AL-T5	CX400 MVS TO BDLE UPG T5	D2	\$0
MVS4-AL-T6	CX400 MVS TO BDLE UPG T6	D2	\$0
MVS4-AL-T7	CX400 MVS TO BDLE UPG T7	D2	\$0
MVS4-AL-T8	CX400 MVS TO BDLE UPG T8	D2	\$0
MVS4-AL-T9	CX400 MVS TO BDLE UPG T9	D2	\$0
MVS6-AL-T1	CX600 MVS TO BDLE UPG T1	D2	\$0
MVS6-AL-T10	CX600 MVS TO BDLE UPG T10	D2	\$0
MVS6-AL-T11	CX600 MVS TO BDLE UPG T11	D2	\$0
MVS6-AL-T12	CX600 MVS TO BDLE UPG T12	D2	\$0
MVS6-AL-T13	CX600 MVS TO BDLE UPG T13	D2	\$0
MVS6-AL-T14	CX600 MVS TO BDLE UPG T14	D2	\$0
MVS6-AL-T15	CX600 MVS TO BDLE UPG T15	D2	\$0
MVS6-AL-T16	CX600 MVS TO BDLE UPG T16	D2	\$0
MVS6-AL-T17	CX600 MVS TO BDLE UPG T17	D2	\$0
MVS6-AL-T18	CX600 MVS TO BDLE UPG T18	D2	\$0
MVS6-AL-T19	CX600 MVS TO BDLE UPG T19	D2	\$0
MVS6-AL-T2	CX600 MVS TO BDLE UPG T2	D2	\$0
MVS6-AL-T20	CX600 MVS TO BDLE UPG T20	D2	\$0
MVS6-AL-T21	CX600 MVS TO BDLE UPG T21	D2	\$0
MVS6-AL-T22	CX600 MVS TO BDLE UPG T22	D2	\$0
MVS6-AL-T23	CX600 MVS TO BDLE UPG T23	D2	\$0
MVS6-AL-T24	CX600 MVS TO BDLE UPG T24	D2	\$0
MVS6-AL-T25	CX600 MVS TO BDLE UPG T25	D2	\$0
MVS6-AL-T26	CX600 MVS TO BDLE UPG T26	D2	\$0
MVS6-AL-T27	CX600 MVS TO BDLE UPG T27	D2	\$0
MVS6-AL-T28	CX600 MVS TO BDLE UPG T28	D2	\$0
MVS6-AL-T29	CX600 MVS TO BDLE UPG T29	D2	\$0
MVS6-AL-T3	CX600 MVS TO BDLE UPG T3	D2	\$0
MVS6-AL-T30	CX600 MVS TO BDLE UPG T30	D2	\$0
MVS6-AL-T31	CX600 MVS TO BDLE UPG T31	D2	\$0
MVS6-AL-T4	CX600 MVS TO BDLE UPG T4	D2	\$0
MVS6-AL-T5	CX600 MVS TO BDLE UPG T5	D2	\$0
MVS6-AL-T6	CX600 MVS TO BDLE UPG T6	D2	\$0
MVS6-AL-T7	CX600 MVS TO BDLE UPG T7	D2	\$0
MVS6-AL-T8	CX600 MVS TO BDLE UPG T8	D2	\$0

MVS6-AL-T9	CX600 MVS TO BDLE UPG T9	D2	\$0
MV-T1	MV/S CX600 TIER1	D2	\$0
MV-T10	MV/S CX600 TIER10	D2	\$0
MV-T11	MV/S CX600 TIER11	D2	\$0
MV-T12	MV/S CX600 TIER12	D2	\$0
MV-T19	MV/S CX600 TIER 19	D2	\$0
MVT1-T4	MV/S CX600 UPG T1-T4	D2	\$0
MV-T2	MV/S CX600 TIER2	D2	\$0
MV-T20	MV/S CX600 TIER 20	D2	\$0
MV-T21	MV/S CX600 TIER 21	D2	\$0
MV-T22	MV/S CX600 TIER 22	D2	\$0
MV-T23	MV/S CX600 TIER 23	D2	\$0
MV-T24	MV/S CX600 TIER 24	D2	\$0
MV-T25	MV/S CX600 TIER 25	D2	\$0
MV-T26	MV/S CX600 TIER 26	D2	\$0
MV-T27	MV/S CX600 TIER 27	D2	\$0
MV-T28	MV/S CX600 TIER 28	D2	\$0
MV-T29	MV/S CX600 TIER 29	D2	\$0
MV-T3	MV/S CX600 TIER3	D2	\$0
MV-T30	MV/S CX600 TIER 30	D2	\$0
MV-T31	MV/S CX600 TIER 31	D2	\$0
MV-T4	MV/S CX600 TIER4	D2	\$0
MV-T5	MV/S CX600 TIER5	D2	\$0
MVT5-T12	MV/S CX600 UPG T5-T12	D2	\$0
MV-T6	MV/S CX600 TIER6	D2	\$0
MV-T7	MV/S CX600 TIER7	D2	\$0
MV-T8	MV/S CX600 TIER8	D2	\$0
MV-T9	MV/S CX600 TIER9	D2	\$0
MVX4-X6UP-T1	MIRRORVIEW CX400-CX600 UPG TIER 1	D2	\$0
MVX4-X6UP-T10	MIRRORVIEW CX400-CX600 UPG TIER 10	D2	\$0
MVX4-X6UP-T11	MIRRORVIEW CX400-CX600 UPG TIER 11	D2	\$0
MVX4-X6UP-T12	MIRRORVIEW CX400-CX600 UPG TIER 12	D2	\$0
MVX4-X6UP-T2	MIRRORVIEW CX400-CX600 UPG TIER 2	D2	\$0
MVX4-X6UP-T3	MIRRORVIEW CX400-CX600 UPG TIER 3	D2	\$0
MVX4-X6UP-T4	MIRRORVIEW CX400-CX600 UPG TIER 4	D2	\$0
MVX4-X6UP-T5	MIRRORVIEW CX400-CX600 UPG TIER 5	D2	\$0
MVX4-X6UP-T6	MIRRORVIEW CX400-CX600 UPG TIER 6	D2	\$0
MVX4-X6UP-T7	MIRRORVIEW CX400-CX600 UPG TIER 7	D2	\$0
MVX4-X6UP-T8	MIRRORVIEW CX400-CX600 UPG TIER 8	D2	\$0
MVX4-X6UP-T9	MIRRORVIEW CX400-CX600 UPG TIER 9	D2	\$0
NAS-MGR-L	MANAGER ADVANCED EDITION	D2	\$11,600
NAS-MGR-L-U	MANAGER ADVANCED EDITION	D2	\$11,600
NAS-MGR-PKG	NAS MGR ADD NAVI DISC PKG	D2	\$9,300
NAV31-DP-EN	NAVI MGR DP TO EN Lic Upg CX3-10	D2	\$3,000
NAV31-WG-DP	NAVI MGR WG TO DP UPGD LIC FOR CX3-10	D2	\$0
NAV31-WG-EN	NAVI MGR WG TO EN Lic Upg CX3-10	D2	\$0
NAV32-DP-EN	NAVI CX3-20 DP TO EN UPGR	D2	\$0
NAV32-WG-DP	NAVI CX3-20 WG TO DP UPG	D2	\$0
NAV32-WG-EN	NAVI CX3-20 WG TO EN UPGR	D2	\$0
NAV34-DP-EN	NAVI CX3-40 DP TO EN UPGR	D2	\$0

NAV34-WG-DP	NAVI CX3-40 WG TO DP UPG	D2	\$0
NAV34-WG-EN	NAVI CX3-40 WG TO EN UPGR	D2	\$0
NAV38-DP-EN	NAVI CX3-80 DP TO EN UPGR	D2	\$0
NAV38-WG-DP	NAVI CX3-80 WG TO DP UPG	D2	\$0
NAV38-WG-EN	NAVI CX3-80 WG TO EN UPGR	D2	\$0
NAV4-120	Navi/Uni CX4-120	D2	\$0
NAV4-120UPG	NAVI/Uni BLOCK Upg CX4-120	D2	\$0
NAV4-240	Navi/Uni CX4-240	D2	\$0
NAV4-240UPG	NAVI/Uni BLOCK Upg CX4-240	D2	\$0
NAV4-480	Navi/Uni CX4-480	D2	\$0
NAV4-480UPG	NAVI/Uni BLOCK Upg CX4-480	D2	\$0
NAV4-960	Navi/Uni CX4-960	D2	\$0
NAV4-960UPG	NAVI/Uni BLOCK Upg CX4-960	D2	\$0
NAVAGT-AIX	NAVISPHERE AGENT AIX	D2	\$1,200
NAVAGT-AIX303	AIX AGENT V6.4 MEDIA	D2	\$0
NAVAGT-AIX308	AIX AGENT V6.5 MEDIA	D2	\$0
NAVAGT-AIX402	AIX AGENT V6.6 MEDIA	D2	\$0
NAVAGT-AIX407	AIX AGENT V6.7 MEDIA	D2	\$0
NAVAGT-AIX501	AIX AGENT V6.16 MEDIA	D2	\$0
NAVAGT-AIXKIT	NAVI AGENT AIX MEDIA	D2	\$0
NAVAGT-HP	NAVISPHERE AGENT HPUX	D2	\$1,200
NAVAGT-HP303	HPUX AGENT V6.4 MEDIA	D2	\$0
NAVAGT-HP308	HPUX AGENT V6.5 MEDIA	D2	\$0
NAVAGT-HP402	HP AGENT V6.6 MEDIA	D2	\$0
NAVAGT-HP407	HPUX AGENT V6.7 MEDIA	D2	\$0
NAVAGT-HP501	HPUX AGENT V6.16 MEDIA	D2	\$0
NAVAGT-HPKIT	NAVI AGENT HPUX MEDIA	D2	\$0
NAVAGT-IRX	NAVISPHERE AGENT IRIX	D2	\$1,200
NAVAGT-IRX303	IRIX AGENT V6.4 MEDIA	D2	\$0
NAVAGT-IRX308	IRIX AGENT V6.5 MEDIA	D2	\$0
NAVAGT-IRX402	IRIX AGENT V6.6 MEDIA	D2	\$0
NAVAGT-IRX407	IRIX AGENT V6.7 MEDIA	D2	\$0
NAVAGT-IRX501	IRIX AGENT V6.16 MEDIA	D2	\$0
NAVAGT-IRXKIT	NAVI AGENT IRIX MEDIA	D2	\$0
NAVAGT-LNX	NAVISPHERE AGENT LINUX	D2	\$550
NAVAGT-LNX303	LINUX AGENT V6.4 MEDIA	D2	\$0
NAVAGT-LNX308	LINUX AGENT V6.5 MEDIA	D2	\$0
NAVAGT-LNX402	LINUX AGENT V6.6 MEDIA	D2	\$0
NAVAGT-LNX407	LINUX AGENT V6.7 MEDIA	D2	\$0
NAVAGT-LNX501	LINUX AGENT V6.16 MEDIA	D2	\$0
NAVAGT-LNXKIT	NAVI AGENT LINUX MEDIA	D2	\$0
NAVAGT-NW	NAVISPHERE AGENT NETWARE	D2	\$550
NAVAGT-NW303	NETWARE AGENT V6.4 MEDIA	D2	\$0
NAVAGT-NW308	NETWARE AGENT V6.5 MEDIA	D2	\$0
NAVAGT-NW402	NETWARE AGENT V6.6 MEDIA	D2	\$0
NAVAGT-NW407	NETWARE AGENT V6.7 MEDIA	D2	\$0
NAVAGT-NW501	NETWARE AGENT V6.16 MEDIA	D2	\$0
NAVAGT-NWKIT	NAVI AGENT NETWARE MEDIA	D2	\$0
NAVAGT-SUN	NAVISPHERE AGENT SUN	D2	\$1,200
NAVAGT-SUN303	SUN AGENT V6.4 MEDIA	D2	\$0

NAVAGT-SUN308	SUN AGENT V6.5 MEDIA	D2	\$0
NAVAGT-SUN402	SUN AGENT V6.6 MEDIA	D2	\$0
NAVAGT-SUN407	SUN AGENT V6.7 MEDIA	D2	\$0
NAVAGT-SUN501	SUN AGENT V6.16 MEDIA	D2	\$0
NAVAGT-SUNKIT	NAVI AGENT SUN MEDIA	D2	\$0
NAVAGT-VMW	NAVI AGENT VMWARE	D2	\$550
NAVAGT-VMWKIT	NAVI AGENT VMWARE MEDIA	D2	\$0
NAVAGT-WIN	NAVISPHERE AGENT NT/W2K	D2	\$550
NAVAGT-WIN303	WINDOWS AGENT V6.4 MEDIA	D2	\$0
NAVAGT-WIN308	WINDOWS AGENT V6.5 MEDIA	D2	\$0
NAVAGT-WIN402	WINDOWS AGENT V6.6 MEDIA	D2	\$0
NAVAGT-WIN407	WINDOWS AGENT V6.7 MEDIA	D2	\$0
NAVAGT-WIN501	WINDOWS AGENT V6.16 MEDIA	D2	\$0
NAVAGT-WINKIT	NAVI AGENT WINDOWS MEDIA	D2	\$0
NAVAG-WINIKIT	NAVI AGENT WINDOWS MEDIA	D2	\$0
NAVATF-AIX	NAVISPHERE ATF FOR AIX	D2	\$1,940
NAVAYZ2-3UP	ANALYZER CX2 TO CX3 UPG	D2	\$1,600
NAVAYZ2-5UP	ANALYZER CX2 TO CX5 UPG	D2	\$14,650
NAVAYZ2-7UP	ANALYZER CX2 TO CX7 UPG	D2	\$30,900
NAVAYZ-31	NAVISPHERE ANALYZER LICENSE FOR CX3-10	D2	\$0
NAVAYZ-32	NAVI ANALYZER CX3-20	D2	\$0
NAVAYZ-34	NAVI ANALYZER CX3-40	D2	\$0
NAVAYZ3-5UP	ANALYZER CX3 TO CX5 UPG	D2	\$13,000
NAVAYZ3-7UP	ANALYZER CX3 TO CX7 UPG	D2	\$29,300
NAVAYZ-38	NAVI ANALYZER CX3-80	D2	\$0
NAVAYZ4-120	Navi/Uni ANALYZER CX4-120	D2	\$0
NAVAYZ4-240	Navi/Uni ANALYZER CX4-240	D2	\$0
NAVAYZ4-480	Navi/Uni ANALYZER CX4-480	D2	\$0
NAVAYZ4-5UP	ANALYZER CX4 TO CX5 UPG	D2	\$8,100
NAVAYZ47-T01	4700 ANALYZER - TIER 1	D2	\$0
NAVAYZ47-T02	4700 ANALYZER - TIER 2	D2	\$0
NAVAYZ47-T03	4700 ANALYZER - TIER 3	D2	\$0
NAVAYZ47-T04	4700 ANALYZER - TIER 4	D2	\$0
NAVAYZ47-T05	4700 ANALYZER - TIER 5	D2	\$0
NAVAYZ47-T06	4700 ANALYZER - TIER 6	D2	\$0
NAVAYZ47-T07	4700 ANALYZER - TIER 7	D2	\$0
NAVAYZ47-T08	4700 ANALYZER - TIER 8	D2	\$0
NAVAYZ47-T09	4700 ANALYZER - TIER 9	D2	\$0
NAVAYZ47-T10	4700 ANALYZER - TIER 10	D2	\$0
NAVAYZ47-T11	4700 ANALYZER - TIER 11	D2	\$0
NAVAYZ47-T12	4700 ANALYZER - TIER 12	D2	\$0
NAVAYZ47-T13	4700 ANALYZER - TIER 13	D2	\$0
NAVAYZ47-T14	4700 ANALYZER - TIER 14	D2	\$0
NAVAYZ47-T15	4700 ANALYZER - TIER 15	D2	\$0
NAVAYZ47-T16	4700 ANALYZER - TIER 16	D2	\$0
NAVAYZ47-T17	4700 ANALYZER - TIER 17	D2	\$0
NAVAYZ47-T18	4700 ANALYZER - TIER 18	D2	\$0
NAVAYZ47-T19	4700 ANALYZER - TIER 19	D2	\$0
NAVAYZ47-T20	4700 ANALYZER - TIER 20	D2	\$0
NAVAYZ47-T21	4700 ANALYZER - TIER 21	D2	\$0

NAVAYZ47-T22	4700 ANALYZER - TIER 22	D2	\$0
NAVAYZ47-T23	4700 ANALYZER - TIER 23	D2	\$0
NAVAYZ47-T24	4700 ANALYZER - TIER 24	D2	\$0
NAVAYZ47-T25	4700 ANALYZER - TIER 25	D2	\$0
NAVAYZ47-T26	4700 ANALYZER - TIER 26	D2	\$0
NAVAYZ47-T27	4700 ANALYZER - TIER 27	D2	\$0
NAVAYZ47-T28	4700 ANALYZER - TIER 28	D2	\$0
NAVAYZ47-T29	4700 ANALYZER - TIER 29	D2	\$0
NAVAYZ47-T30	4700 ANALYZER - TIER 30	D2	\$0
NAVAYZ47-T31	4700 ANALYZER - TIER 31	D2	\$0
NAVAYZ4-960	Navi/Uni ANALYZER CX4-960	D2	\$0
NAVAYZ4-KIT	NAVI/UNISPHERE ANALYZER CX4 MEDIA KIT	D2	\$0
NAVAYZ5-7UP	ANALYZER CX5 TO CX7 UPG	D2	\$16,300
NAVAYZ6-7UP	ANALYZER CX6 TO CX7 UPG	D2	\$16,300
NAVAYZ-IKIT	NAVI ANALYZER MEDIA KIT	D2	\$0
NAVAYZ-KIT	NAVI ANALYZER MEDIA	D2	\$0
NAVAYZ-KIT303	NAVI ANALYZER V6.4 MEDIA	D2	\$0
NAVAYZ-KIT308	NAVI ANALYZER V6.5 MEDIA	D2	\$0
NAVAYZ-KIT402	NAVI ANALYZER V6.6 MEDIA	D2	\$0
NAVAYZKIT-407	ANALYZER MEDIA V6.7	D2	\$0
NAVAYZ-KIT501	NAVI ANALYZER MEDIA	D2	\$0
NAVAYZ-WLA	ANALYZER FOR WLA-CLARIION	D2	\$0
NAV-DPKIT	NAVI DEPARTMENTAL MEDIA	D2	\$0
NAV-DPKIT402	NAVI DP SUITE V6.6 MEDIA	D2	\$0
NAV-DPKIT407	NAVI DEPT MEDIA V6.7	D2	\$0
NAV-DPKIT501	DEPART. KIT CX3/5/700	D2	\$0
NAV-ENKIT	NAVI ENTERPRISE MEDIA	D2	\$0
NAV-ENKIT402	NAVI ENT SUITE V6.6 MEDIA	D2	\$0
NAV-ENKIT407	ENTERPRISE MEDIA V6.7	D2	\$0
NAV-ENKIT501	ENTRPR KIT V6.16 MEDIA	D2	\$0
NAV-IKIT	NAVI SUITE MEDIA CX-XXXI	D2	\$0
NAVMGR47-T01	4700 NAVI MGR - TIER 1	D2	\$0
NAVMGR47-T02	4700 NAVI MGR - TIER 2	D2	\$0
NAVMGR47-T03	4700 NAVI MGR - TIER 3	D2	\$0
NAVMGR47-T04	4700 NAVI MGR - TIER 4	D2	\$0
NAVMGR47-T05	4700 NAVI MGR - TIER 5	D2	\$0
NAVMGR47-T06	4700 NAVI MGR - TIER 6	D2	\$0
NAVMGR47-T07	4700 NAVI MGR - TIER 7	D2	\$0
NAVMGR47-T08	4700 NAVI MGR - TIER 8	D2	\$0
NAVMGR47-T09	4700 NAVI MGR - TIER 9	D2	\$0
NAVMGR47-T10	4700 NAVI MGR - TIER 10	D2	\$0
NAVMGR47-T11	4700 NAVI MGR - TIER 11	D2	\$0
NAVMGR47-T12	4700 NAVI MGR - TIER 12	D2	\$0
NAVMGR47-T13	4700 NAVI MGR - TIER 13	D2	\$0
NAVMGR47-T14	4700 NAVI MGR - TIER 14	D2	\$0
NAVMGR47-T15	4700 NAVI MGR - TIER 15	D2	\$0
NAVMGR47-T16	4700 NAVI MGR - TIER 16	D2	\$0
NAVMGR47-T17	4700 NAVI MGR - TIER 17	D2	\$0
NAVMGR47-T18	4700 NAVI MGR - TIER 18	D2	\$0
NAVMGR47-T19	4700 NAVI MGR - TIER 19	D2	\$0

NAVMGR47-T20	4700 NAVI MGR - TIER 20	D2	\$0
NAVMGR47-T21	4700 NAVI MGR - TIER 21	D2	\$0
NAVMGR47-T22	4700 NAVI MGR - TIER 22	D2	\$0
NAVMGR47-T23	4700 NAVI MGR - TIER 23	D2	\$0
NAVMGR47-T24	4700 NAVI MGR - TIER 24	D2	\$0
NAVMGR47-T25	4700 NAVI MGR - TIER 25	D2	\$0
NAVMGR47-T26	4700 NAVI MGR - TIER 26	D2	\$0
NAVMGR47-T27	4700 NAVI MGR - TIER 27	D2	\$0
NAVMGR47-T28	4700 NAVI MGR - TIER 28	D2	\$0
NAVMGR47-T29	4700 NAVI MGR - TIER 29	D2	\$0
NAVMGR47-T30	4700 NAVI MGR - TIER 30	D2	\$0
NAVMGR47-T31	4700 NAVI MGR - TIER 31	D2	\$0
NAVMGR-KIT303	NAVI MANAGER V6.4 MEDIA	D2	\$0
NAVMGR-KIT308	NAVI MANAGER V6.5 MEDIA	D2	\$0
NAVMGR-KIT402	NAVI MANAGER V6.6 MEDIA	D2	\$0
NAVMGRKIT-407	MANAGER MEDIA V6.7	D2	\$0
NAVMGR-KIT501	NAV MGR CX246 BK RV 16	D2	\$0
NAVMGR-T1	NAVI MGR T1	D2	\$0
NAVMGR-T10	NAVI MGR T10	D2	\$0
NAVMGR-T11	NAVI MGR T11	D2	\$0
NAVMGR-T12	NAVI MGR T12	D2	\$0
NAVMGR-T13	NAVI MGR T13	D2	\$0
NAVMGR-T14	NAVI MGR T14	D2	\$0
NAVMGR-T15	NAVI MGR T15	D2	\$0
NAVMGR-T16	NAVI MGR T16	D2	\$0
NAVMGR-T17	NAVI MGR T17	D2	\$0
NAVMGR-T18	NAVI MGR T18	D2	\$0
NAVMGR-T19	NAVI MGR T19	D2	\$0
NAVMGR-T2	NAVI MGR T2	D2	\$0
NAVMGR-T20	NAVI MGR T20	D2	\$0
NAVMGR-T21	NAVI MGR T21	D2	\$0
NAVMGR-T22	NAVI MGR T22	D2	\$0
NAVMGR-T23	NAVI MGR T23	D2	\$0
NAVMGR-T24	NAVI MGR T24	D2	\$0
NAVMGR-T25	NAVI MGR T25	D2	\$0
NAVMGR-T26	NAVI MGR T26	D2	\$0
NAVMGR-T27	NAVI MGR T27	D2	\$0
NAVMGR-T28	NAVI MGR T28	D2	\$0
NAVMGR-T29	NAVI MGR T29	D2	\$0
NAVMGR-T3	NAVI MGR T3	D2	\$0
NAVMGR-T30	NAVI MGR T30	D2	\$0
NAVMGR-T31	NAVI MGR T31	D2	\$0
NAVMGR-T4	NAVI MGR T4	D2	\$0
NAVMGR-T5	NAVI MGR T5	D2	\$0
NAVMGR-T6	NAVI MGR T6	D2	\$0
NAVMGR-T7	NAVI MGR T7	D2	\$0
NAVMGR-T8	NAVI MGR T8	D2	\$0
NAVMGR-T9	NAVI MGR T9	D2	\$0
NAV-NS120	NAVI MGR LICENSE FOR FC ENABLED NS-120	D2	\$0
NAV-NS480	NAVI MANAGER LICENSE NS-480 240 DRIVES	D2	\$0

NAV-NS480A	NAVI MANAGER LICENSE NS-480 480 DRIVES	D2	\$0
NAV-NS480-UL	Navi Mgr Upg FROM 240 TO 480 DRIVES	D2	\$0
NAV-WGKIT	NAVI WORKGROUP MEDIA	D2	\$0
NAV-WGKIT402	NAVI WG SUITE V6.6 MEDIA	D2	\$0
NAV-WGKIT407	NAVI WORKGROUP MEDIA V6.7	D2	\$0
NAV-WGKIT501	WORK GROUP KIT CX3/5/700	D2	\$0
NQM31	NAVISPHERE QOS MANAGER FOR CX3-10	D2	\$0
NQM32	NAVISPHERE QOS MANAGER FOR ANY CX3-20	D2	\$0
NQM34	NAVISPHERE QOS MANAGER FOR ANY CX3-40	D2	\$0
NQM38	NAVISPHERE QOS MANAGER FOR CX3-80	D2	\$0
NQM4-120	NAVI/UNISPHERE QOS MNGR FOR THE CX4-120	D2	\$0
NQM4-120UPG	NAVI/Uni QOS Mgr Upg CX4-120	D2	\$0
NQM4-240	NAVI/UNISPHERE QOS MNGR FOR THE CX4-240	D2	\$0
NQM4-240UPG	NAVI/Uni QOS Mgr Upg CX4-240	D2	\$0
NQM4-480	NAVI/UNISPHERE QOS MNGR FOR THE CX4-480	D2	\$0
NQM4-480UPG	NAVI/Uni QOS Mgr Upg CX4-480	D2	\$0
NQM4-960	NAVI/UNISPHERE QOS MNGR FOR THE CX4-960	D2	\$0
NQM4-960UPG	NAVI/Uni QOS Mgr Upg CX4-960	D2	\$0
NQM-KIT	NAVISPHERE QOS MANAGER MEDIA KIT	D2	\$0
NS120-CEE2-L	NS CEE-ANTI-VIRUS	D2	\$0
NS120-CEE-L	NS-120 CELERRA EVENT ENABLER LICENSE	D2	\$0
NS120-CIFS-L	CELERRA NS-120 CIFS LICENSE	D2	\$0
NS120-DCD	CELERRA NS-120 DOCUMENT AND CD	D2	\$0
NS120-FASTVE	FAST FMA/VE FOR NS-120	D2	\$26,500
NS120-FCOPT-L	CELERRA NS-120 BE ENABLEMENT LICENSE	D2	\$2,200
NS120-FCOPTUL	NS-120 BE PORT OPTION ENABLED LICENSE U/	D2	\$2,200
NS120-FLR-L	NS-120 FLR LICENSE	D2	\$0
NS120-IS-AL	NS120 ACCOMPANYING ISCSI LIC	D2	\$0
NS120-IS-CI-L	NS-120 ADD ISCSI LICENSE TO CIFS LICENSE	D2	\$0
NS120-ISCSI-L	CELERRA NS-120 ISCSI LICENSE	D2	\$0
NS120-IS-DCD	NS-120 ISCSI DOC AND CD SOFTWARE KIT	D2	\$0
NS120-IS-NF-L	NS-120 ADD ISCSI LICENSE TO UNIX NFS LIC	D2	\$0
NS120-NBOPT-L	NS-120 NATIVE BLOCK ENBL UP TO 120 DRVS	D2	\$0
NS120-NBOPTUL	NS-120 NATIVE BLOCK ENBL TO 120 DRVS UPG	D2	\$0
NS120-NFS-UL	NS-120 NFS LICENSE ADD TO EXISTING SYS	D2	\$0
NS120-REPV2-L	NS-120 CELERRA REPLICATOR V2 LICENSE	D2	\$0
NS120-REPV2LU	NS-120 CELERRA REPLICATOR V2 ADD-ON LIC	D2	\$0
NS120-UNIX-L	CELERRA NS-120 UNIX NFS LICENSE	D2	\$0
NS20-40-CEE-L	NS20 TO 40 LICENSE U/G FOR CEE AND CAVA	D2	\$0
NS20-40-FLR-L	UPGRADE NS20 FLR LICENSE TO NS40 FLR	D2	\$5,000
NS20-40-IS-LU	U/G NS20 ISCSI LIC TO NS40 ISCSI LIC	D2	\$0
NS20-40-RV2-L	U/G NS20 REPV2 LIC TO NS40 REPV2 LIC	D2	\$0
NS20-CAVA2-L	NS20 2 FOR 1 CAVA LICENSE	D2	\$2,000
NS20-CAVA-L	NS20 CAVA LICENSE	D2	\$2,000
NS20-C-DCD	DOC AND CD: NS20 WITH CLARIION	D2	\$0
NS20-CEE2-L	NS EVENT ENABLER-2	D2	\$0
NS20-CEE-L	NS EVENT ENABLER	D2	\$0
NS20-CI-UL	NS20 ADD CIFS POST INSTALL	D2	\$0
NS20-FCOPT-L	NS20 FC PORT OPTION ENABLED LICENSE	D2	\$0
NS20-FCOPT-UL	NS20 FC PORT OPTION ENABLED LICENSE - U/	D2	\$0

NS20-FLR-L	NS20 FLR LICENSE	D2	\$0
NS20-FLR-L-U	NS20 FLR UPGRADE LICENSE	D2	\$5,000
NS20-FLR-U	NS20 FLR UPGRADE	D2	\$0
NS20-IS-CI-L	NS20 ADD ISCSI LICENSE TO CIFS LICENSE	D2	\$0
NS20-IS-CI-UL	NS20 UPG ADD CIFS LIC TO ISCSI LIC	D2	\$0
NS20-ISCSI-L	NS20 ISCSI LICENSE	D2	\$0
NS20-ISCSI-UL	NS20 ISCSI LICENSE ADD-ON	D2	\$0
NS20-IS-DCD	NS20 ISCSI APP DCD	D2	\$0
NS20-IS-NF-L	NS20 ISCSI LICENSE TO UNIX NFS LICENSE	D2	\$0
NS20-IS-NF-UL	NS20 ISCSI LICENSE TO UNIX NFS LICENSE	D2	\$0
NS20-NF-UL	NS20 ADD NFS POST INSTALL	D2	\$0
NS20-REP-L	NS20 REPLICATOR LICENSE	D2	\$5,000
NS20-REPV2-L	NS20 REPLICATOR V2 LICENSE	D2	\$0
NS20-REPV2-LU	NS20 REPLICATOR V2 UPG LIC	D2	\$0
NS21-2-CIRYLT	NS21 TO NS22 CIFS FIELD UPGRADE	D2	\$0
NS21-2-NFUL	NS21 TO NS22 NFS FIELD UPGRADE	D2	\$0
NS21-41-CI-LU	U/G NS21 CIFS LICENSE TO NS41	D2	\$0
NS21-41-UN-LU	UPGRADE NS21 NFS LICENSE TO NS41 NFS	D2	\$0
NS21-CI-RYLT	NS20 CIFS ROYALTY FOR 1 BLADE	D2	\$0
NS21C-UNIX-L	CELERRA NS21C UNIX NFS LICENSE	D2	\$0
NS22-42-CI-LU	UPGRADE NS22 CIFS LICENSE TO NS42 CIFS	D2	\$0
NS22-42-UN-LU	UPGRADE NS22 NFS LICENSE TO NS42 NFS	D2	\$0
NS22-CI-RYLT	NS20 CIFS ROYALTY FOR 2 BLADES	D2	\$0
NS22C-UNIX-L	CELERRA NS22C UNIX NFS LICENSE	D2	\$0
NS350-CEE2-L	NS EVENT ENABLER-2	D2	\$0
NS350-CEE-L	NS EVENT ENABLER	D2	\$0
NS350-CIFS-UL	UPG CIFS TO CIFS AND UNIX	D2	\$0
NS350-ISCSI-UL	NS350 ISCSI LICENSE ADD ON	D2	\$0
NS350-REP2-LU	NS350 REPLICATOR V2 UPGRADE LICENSE	D2	\$0
NS350-UNIX-UL	UPG UNIX TO CIFS AND UNIX	D2	\$0
NS351C-2-CIUL	NS351 TO NS352 CIFS LIC ADD ON	D2	\$0
NS351C-2-ENUL	NS351 TO NS352 ENTERPRISE LICENSE ADD ON	D2	\$0
NS351C-ENT-L	NS351 ENTERPRISE LICENSE	D2	\$10,000
NS351-C-RYLT	NS351 CIFS ROYALTY	D2	\$1
NS351C-UNIX-L	NS351 UNIX LICENSE	D2	\$5,000
NS352C-ENT-L	NS352 ENTERPRISE LICENSE	D2	\$10,000
NS352-C-RYLT	NS352 CIFS ROYALTY	D2	\$1
NS352C-UNIX-L	NS352 UNIX LICENSE	D2	\$5,000
NS35-IS-CI-L	NS350 ISCSI WITH CIFS LIC	D2	\$0
NS35-IS-CI-UL	NS350 UPG CIFS WITH ISCSI	D2	\$0
NS35-ISCSI-DCD	NS350 ISCSI APP DCD	D2	\$0
NS35-IS-EN-L	NS350 ISCSI WITH ENT LIC	D2	\$0
NS35-IS-EN-UL	NS350 UPG ENT WITH ISCSI	D2	\$0
NS35-IS-NF-L	NS350 ISCSI WITH UNIX LIC	D2	\$0
NS35-IS-NF-UL	NS350 UPG NFS WITH ISCSI	D2	\$0
NS40-CAVA2-L	NS40 2 FOR 1 CAVA LICENSE	D2	\$0
NS40-CAVA-L	NS40 CAVA LICENSE	D2	\$0
NS40-C-DCD	DOC & CD: NS40+CLAR	D2	\$0
NS40-CEE2-L	NS EVENT ENABLER-2	D2	\$0
NS40-CEE-L	NS EVENT ENABLER	D2	\$0

NS40-CI-EN-L	UPG CIFS TO CIFS AND UNIX	D2	\$0
NS40-FCOPT-L	NS40 FC PORT OPTION ENABLED LICENSE	D2	\$0
NS40-FCOPT-UL	NS40 FC PORT OPTION ENABLED U/G LICENSE	D2	\$0
NS40-FLR24	BACK REV FLARE OE V03.24.040.5.011 NS40	D2	\$0
NS40-FLR-L	NS40 FLR BASE LICENSE (2 BLADES)	D2	\$0
NS40G-FLR-L	NS40G FLR BASE LICENSE (2 BLADES)	D2	\$0
NS40-IS-CI-L	NS40 ISCSI WITH CIFS	D2	\$0
NS40-IS-CI-UL	NS40 UPG CIFS WITH ISCSI	D2	\$0
NS40-ISCSI-L	CELERRA NS40 ISCSI LIC	D2	\$0
NS40-ISCSI-UL	NS40 ISCSI LICENSE ADD ON	D2	\$0
NS40-IS-DCD	NS40 ISCSI APP DCD	D2	\$0
NS40-IS-EN-L	NS40 ISCSI WITH ENT	D2	\$0
NS40-IS-EN-UL	NS40 UPG ENT WITH ISCSI	D2	\$0
NS40-IS-NF-L	NS40 ISCSI WITH NFS	D2	\$0
NS40-IS-NF-UL	NS40 UPG NFS WITH ISCSI	D2	\$0
NS40-NF-EN-L	UPG UNIX TO CIFS AND UNIX	D2	\$0
NS40-REP-L	NS40 REPLICATOR LIC	D2	\$0
NS40-REP-L-U	NS40 REPLICATOR UPG LIC	D2	\$0
NS40-REPV2-L	NS40 REPLICATOR V2 LICENSE	D2	\$0
NS40-REPV2-LU	NS40 REPLICATOR V2 UPG LIC	D2	\$0
NS40-S-DCD	DOC & CD: NS40+SYMM	D2	\$0
NS41-2-CI-U-L	NS41-2 CIFS UPG LIC	D2	\$0
NS41-2-EN-U	NS41-2 ENT UPG LIC	D2	\$0
NS41-2-NF-U	NS41-2 NFS UPG LIC	D2	\$0
NS41C-CIFS-L	CELERRA NS41C CIFS LIC	D2	\$0
NS41C-ENT-L	CELERRA NS41C ENT LIC	D2	\$0
NS41C-UNIX-L	CELERRA NS41C UNIX LIC	D2	\$0
NS41G-CIFS-L	CELERRA NS41G CIFS LIC	D2	\$0
NS41G-ENT-L	CELERRA NS41G ENT LIC	D2	\$0
NS41G-UNIX-L	CELERRA NS41G UNIX LIC	D2	\$0
NS42C-CIFS-L	CELERRA NS42C CIFS LIC	D2	\$0
NS42C-ENT-L	CELERRA NS42C ENT LIC	D2	\$0
NS42C-UNIX-L	CELERRA NS42C UNIX LIC	D2	\$0
NS42G-CIFS-L	CELERRA NS42G CIFS LIC	D2	\$0
NS42G-ENT-L	CELERRA NS42G ENT LIC	D2	\$0
NS42G-UNIX-L	CELERRA NS42G UNIX LIC	D2	\$0
NS480-CEE2-L	NS CEE-ANTI-VIRUS	D2	\$0
NS480-CEE-L	NS-480 CELERRA EVENT ENABLER LICENSE	D2	\$0
NS480-CIFS-L	CELERRA NS-480 CIFS LICENSE	D2	\$0
NS480-CIFS-UL	NS-480 CIFS LICENSE ADD TO EXISTING SYS	D2	\$0
NS480-CIU	CELERRA CIFS LIC UPG TO NS-480	D2	\$0
NS480-DCD	CELERRA NS-480 DOCUMENT AND CD	D2	\$0
NS480-FASTVE	FAST FMA/VE FOR NS480	D2	\$31,500
NS480-FCOPT-L	CELERRA NS-480 BE ENABLEMENT LICENSE	D2	\$11,700
NS480-FCOPTUL	NS480 BE PORT OPTION ENABLED LIC U/G	D2	\$11,700
NS480-FLR-L	NS480 FLR BASE LICENSE (2 BLADES)	D2	\$0
NS480-IS-AL	NS480 ACCOMPANYING ISCSI LICENSE	D2	\$0
NS480-ISCSI-L	CELERRA NS-480 ISCSI LICENSE	D2	\$0
NS480-IS-DCD	NS-480 ISCIS DOC AND CD SOFTWARE KIT	D2	\$0
NS480-ISU	CELERRA ISCSI LIC UPG TO NS-480	D2	\$0

NS480-NBOPT-L	NS-480 NATIVE BLOCK ENBL UP TO 480 DRVS	D2	\$0
NS480-NBOPTUL	NS-480 NATIVE BLOCK ENBL TO 480 DRVS UPG	D2	\$0
NS480-NBOPU	NS480 BLOCK ENBL UPG	D2	\$0
NS480-NFS-UL	NS-480 NFS LICENSE ADD TO EXIST-SYSTEM	D2	\$0
NS480-NFU	CELERRA NFS LIC UPG TO NS-480	D2	\$0
NS480-REP2U	CELERRA REPV2 UPG LIC FOR NS-480	D2	\$0
NS480-REPV2-L	NS-480 CELERRA REPLICATOR V2 LICENSE	D2	\$0
NS480-REPV2LU	NS-480 CELERRA REPLICATOR V2 ADD-ON LIC	D2	\$0
NS480-RPU	CELERRA RECOVERPOINT BUNDLE UPG TO NS	D2	\$24,000
NS480-UNIX-L	CELERRA NS-480 UNIX NFS LICENSE	D2	\$0
NS500-CAVA2-L	NS500 2 FOR 1 CAVA LICENSE	D2	\$0
NS500-CAVA-L	NS500 CAVA LICENSE	D2	\$0
NS500-CEE2-L	NS EVENT ENABLER-2	D2	\$0
NS500-CEE-L	NS EVENT ENABLER	D2	\$0
NS500-CIFS-UL	UPG CIFS TO CIFS AND UNIX	D2	\$0
NS500-REP2-LU	NS500 REPLICATOR V2 UPGRADE LICENSE	D2	\$0
NS500-REP-L	NS500 REPLICATOR LICENSE	D2	\$0
NS500-UNIX-UL	UPG UNIX TO CIFS AND UNIX	D2	\$0
NS501C-2-CIUL	NS501-2 CIFS UPG LIC	D2	\$0
NS501C-2-ENUL	NS501-2 ENT UPG LIC	D2	\$0
NS501C-CIFS-L	NS501 CIFS LICENSE	D2	\$0
NS501C-ENT-L	NS500 ENTERPRISE LICENSE	D2	\$0
NS501C-UNIX-L	NS500 NFS LICENSE	D2	\$0
NS501G-2-CIUL	NS501-2 CIFS UPG LIC	D2	\$0
NS501G-2-ENUL	NS501-2 ENT UPG LIC	D2	\$0
NS501G-CIFS-L	NS501G CIFS LICENSE	D2	\$0
NS501G-ENT-L	NS500 ENTERPRISE LICENSE	D2	\$0
NS501G-UNIX-L	NS500 NFS LICENSE	D2	\$0
NS502C-CIFS-L	NS500 CIFS LICENSE	D2	\$0
NS502C-ENT-L	NS502C ENTERPRISE LICENSE	D2	\$0
NS502C-UNIX-L	NS502C NFS LICENSE	D2	\$0
NS502G-CIFS-L	NS500 CIFS LICENSE	D2	\$0
NS502G-ENT-L	NS502G ENTERPRISE LICENSE	D2	\$0
NS502G-UNIX-L	NS502G NFS LICENSE	D2	\$0
NS5-C-DCD	DOC & CD: NS500+CLAR	D2	\$0
NS5-EXC2K-L	SNAPSURE FOR EXCHANGE	D2	\$0
NS5-EXC2K-UL	NS500 EXCHANGE 2000 UPG	D2	\$0
NS5-IS-CI-L	NS500 ISCSI WITH CIFS LIC	D2	\$0
NS5-IS-CI-UL	NS500 UPG CIFS WITH ISCSI	D2	\$0
NS5-ISCSI-L	NS500 ISCSI	D2	\$0
NS5-ISCSI-UL	NS500 ISCSI UPGRADE LIC	D2	\$0
NS5-IS-EN-L	NS500 ISCSI WITH ENT LIC	D2	\$0
NS5-IS-EN-UL	NS500 UPG ENT WITH ISCSI	D2	\$0
NS5-ISNAP-DP	NS500 SNAP MGR DEP	D2	\$0
NS5ISNAPDP-EN	NS500 SNAP MGR DEP TO ENT	D2	\$0
NS5-ISNAP-DPU	NS500 ISCSI SNAP FOR DEPT	D2	\$0
NS5-ISNAP-EN	NS500 SNAP MGR ENT	D2	\$0
NS5-ISNAP-ENU	NS500 ISCSI SNAP FOR ENT	D2	\$0
NS5-ISNAP-WG	NS500 ISNAP WKGRP	D2	\$0
NS5ISNAPWG-DP	NS500 ISNAP WKGRP TO DEP	D2	\$0

NS5ISNAPWG-EN	NS500 ISNAP WKGRP TO ENT	D2	\$0
NS5-ISNAP-WGU	NS500 ISCSI SNAP WORK GRP	D2	\$0
NS5-IS-NF-L	NS500 ISCSI WITH NFS LIC	D2	\$0
NS5-IS-NF-UL	NS500 UPG NFS WITH ISCSI	D2	\$0
NS5-S-DCD	DOC & CD: NS500+SYMM	D2	\$0
NS600-CIFS-UL	NS600 CIFS TO ENT UPGRADE	D2	\$0
NS600-CM-L	MONITOR FOR CELERRA NS600 SERIES	D2	\$0
NS600-CM-L-U	NS600 UPG MONITOR	D2	\$0
NS600-CNM-L	CELERRA NATIVE MANAGER FOR NS600 SERIES	D2	\$0
NS600-CNM-L-U	NS600 UPG NATIVE MGR	D2	\$0
NS600-DCD	CELERRA NS600 DOCS & CD	D2	\$0
NS600-ENT-L	CELERRA NS600 ENT LIC	D2	\$0
NS600-REP-L	CELERRA NS600 REPLICATOR LIC	D2	\$0
NS600-REP-L-U	NS600 REPLICATOR UPG LIC	D2	\$0
NS600-UNIX-L	CELERRA NS600 NFS LIC	D2	\$0
NS600-UNIX-UL	NS600 UNIX TO ENT UPGRADE	D2	\$0
NS700-CEE2-L	NS EVENT ENABLER-2	D2	\$0
NS700-REP2-LU	NS700 REPLICATOR V2 UPGRADE LICENSE	D2	\$0
NS701C-2-CIUL	NS701-2 CIFS UPG LIC	D2	\$0
NS701C-2-ENUL	NS701-2 ENT UPG LIC	D2	\$0
NS701G-2-CIUL	NS701-2 CIFS UPG LIC	D2	\$0
NS701G-2-ENUL	NS701-2 ENT UPG LIC	D2	\$0
NS704C-CIFS-UL	UPG CIFS TO CIFS AND UNIX	D2	\$0
NS704-CIFS-UL	PNS704 CIFS UPGRADE LIC	D2	\$0
NS704C-UNIX-UL	UPG UNIX TO CIFS AND UNIX	D2	\$0
NS704-ENT-UL	NS702 TO 704 ENT UPG LIC	D2	\$0
NS704G-CIFS-UL	UPG CIFS TO CIFS AND UNIX	D2	\$0
NS704G-UNIX-UL	UPG UNIX TO CIFS AND UNIX	D2	\$0
NS704-UNIX-UL	UNIX UPG NS700 TO 704	D2	\$0
NS7-IS-CI-UL	NS700 UPG CIFS WITH ISCSI	D2	\$0
NS7-ISCSI-UL	NS700 ISCSI UPGRADE LIC	D2	\$0
NS7-IS-EN-UL	NS700 UPG ENT WITH ISCSI	D2	\$0
NS7-IS-NF-UL	NS700 UPG NFS WITH ISCSI	D2	\$0
NS80-CAVA2-L	NS80 2 FOR 1 CAVA LICENSE	D2	\$3,000
NS80-CAVA-L	NS80 CAVA LICENSE	D2	\$3,000
NS80C-CIFS-L	CELERRA NS80C CIFS LIC	D2	\$0
NS80-CEE2-L	NS EVENT ENABLER-2	D2	\$0
NS80-CEE-L	NS EVENT ENABLER	D2	\$0
NS80-CIFS-U-L	Upg CIFS to CIFS and NFS	D2	\$0
NS80C-UNIX-L	CELERRA NS80C UNIX LIC	D2	\$0
NS80-FCOPT-L	NS80 FC PORT OPTION ENABLED LICENSE	D2	\$0
NS80-FLR24	BACK REV FLARE OE V03 24 080 5 011	D2	\$0
NS80-FLR-L	NS80 FLR BASE LICENSE (2 BLADES)	D2	\$0
NS80G-CIFS-L	CELERRA NS80G CIFS LIC	D2	\$0
NS80G-ENT-L	CELERRA NS80G ENT LIC	D2	\$37,200
NS80G-FLR-L	NS80G FLR BASE LICENSE (2 BLADES)	D2	\$0
NS80G-UNIX-L	CELERRA NS80G UNIX LIC	D2	\$0
NS80-IS-CI-L	NS80 ISCSI WITH CIFS	D2	\$0
NS80-IS-CI-UL	NS80 UPG CIFS WITH ISCSI	D2	\$0
NS80-ISCSI-L	CELERRA NS80 ISCSI LIC	D2	\$0

NS80-ISCSI-UL	NS80 ISCSI UPGRADE LIC	D2	\$0
NS80-IS-EN-L	NS80 ISCSI WITH ENT	D2	\$0
NS80-IS-NF-L	NS80 ISCSI WITH NFS	D2	\$0
NS80-IS-NF-UL	NS80 UPG NFS WITH ISCSI	D2	\$0
NS80-NFS-U-L	NS80 NFS UPGRADE TO ADD CIFS LIC	D2	\$0
NS80-REP-L	NS80 REPLICATOR LIC	D2	\$18,600
NS80-REPV2-L	NS80 REPLICATOR V2 LICENSE	D2	\$0
NS80-REPV2-LU	NS80 REPLICATOR V2 UPG LIC	D2	\$0
NS960-CEE2-L	NS CEE-ANTI-VIRUS	D2	\$0
NS960-CEE-L	NS-960 AV LICENSE	D2	\$0
NS960-CIFS-L	CELERRA NS-960 CIFS LIC	D2	\$0
NS960-CIFS-UL	CELERRA NS-960 CIFS UPG LIC	D2	\$0
NS960-CIU	CELERRA CIFS LIC UPG TO NS-960	D2	\$0
NS960-DCD	CELERRA NS-960 DOCS & CD	D2	\$0
NS960-EXPSW	SW CHARGE FOR 960 DRIVES ON NS960	D2	\$0
NS960-FASTVE	FAST FMA/VE FOR NS-960	D2	\$36,500
NS960-FCOPT-U	CELERRA NS-960 FC ENABLEMENT LIC UPG	D2	\$0
NS960-FLR-L	NS960 FLR BASE LICENSE (2 BLADES)	D2	\$0
NS960-ISCSI-L	CELERRA NS-960 ISCSI LIC	D2	\$0
NS960-ISU	CELERRA ISCSI LIC UPG TO NS-960	D2	\$0
NS960-NFS-UL	CELERRA NS-960 NFS UPG LIC	D2	\$0
NS960-NFU	CELERRA NFS LIC UPG TO NS-960	D2	\$0
NS960-REP2U	CELERRA REPV2 UPG LIC FOR NS-960	D2	\$0
NS960-REPV2-L	NS-960 CELERRA REPLICATOR V2 LICENSE	D2	\$0
NS960-REPV2LU	NS-960 CELERRA REPLICATOR V2 ADD-ON LIC	D2	\$0
NS960-RPU	CELERRA RECOVERPOINT BUNDLE UPG TO NS	D2	\$43,200
NS960-UNIX-L	CELERRA NS-960 UNIX LIC	D2	\$0
NS96-FCNV480L	NS960 BE ENBL Navi UP TO 480 DRIVES	D2	\$96,500
NS96-FCNV480U	NS960 BE ENABLE Navi UPG UP TO 480 DR	D2	\$96,500
NS96-FCNV960A	NS960 BE ENABLE Navi UPG 480 TO 960 DR	D2	\$33,500
NS96-FCNV960L	NS960 BE ENABLE Navi UP TO 960 DRIVES	D2	\$130,000
NS96-FCNV960U	NS960 BE ENABLE Navi UPG UP TO 960 DR	D2	\$130,000
NS96-NBNV480L	NS960 BLOCK ENBL W NAVI UP TO 480 DRVS	D2	\$0
NS96-NBNV480U	NS960 BLOCK ENBL W NAV TO 480 DRVS UPG	D2	\$0
NS96-NBNV960A	NS960 NATIV BLOCK ENBL 480TO960 UPG	D2	\$0
NS96-NBNV960L	NS960 BLOCK ENBL W NAVI UP TO 960 DRVS	D2	\$0
NS96-NBNV960U	NS960 BLOCK ENBL W NAV TO 960 DRVS UPG	D2	\$0
NS-CAVA-L-U	CELERRA NS600 AV UPG LIC	D2	\$0
NS-CIFS-UL	UPG CIFS TO CIFS AND UNIX	D2	\$0
NS-DART-54	BACK REV DART V5.4.27.2	D2	\$0
NS-DART-55	BACK REV DART V5 5	D2	\$0
NS-DART-5537	BACK REV DART V5 5 37	D2	\$0
NS-DCD-56	NS MEDIA AND DOC KIT FOR DART V 5 6 44	D2	\$0
NS-FAST-APL	CELERRA FAST FMA APPLIANCE	D2	\$0
NS-FAST-HAAPL	CELERRA FAST FMA HA APPLIANCE	D2	\$0
NS-FAST-VE	CELERRA FAST FMA/VE	D2	\$0
NS-FLR-LIC	NS FLR LICENSE	D2	\$10,000
NS-FLR-L-U	NS FLR UPGRADE LICENSE	D2	\$10,000
NS-FLR-U	NS FLR ADDITIONAL BLADE	D2	\$0
NSG2-C-DCD	DOC & CD: NS-G2 + CLARIION	D2	\$0

NSG2-CEE2-L	NS CEE-ANTI-VIRUS	D2	\$0
NSG2-CEE-L	NS EVENT ENABLER LICENSE	D2	\$0
NSG2-CIFS-L	CELERRA NS-G2 CIFS LICENSE	D2	\$0
NSG2-CIFS-UL	NS-G2 CIFS LICENSE ADD TO EXISTING SYS	D2	\$0
NSG2-FASTVE	FAST FMA/VE FOR NS-G2	D2	\$31,500
NSG2-FLR-L	NS-G2 FLR BASE LICENSE (2 BLADES)	D2	\$0
NSG2-IS-AL	ISCSI LICENSE WITH EXISTING NFS OR CIFS	D2	\$0
NSG2-ISCSI-L	CELERRA NS-G2 ISCSI LICENSE	D2	\$0
NSG2-IS-UL	NS-G2 ISCSI LICENSE ADD TO EXISTING SYS	D2	\$0
NSG2-NFS-L	CELERRA NS-G2 UNIX NFS LICENSE	D2	\$0
NSG2-NFS-UL	NS-G2 NFS LICENSE ADD TO EXISTING SYSTEM	D2	\$0
NSG2-REPV2-L	NS-G2 REPLICATOR V2 LICENSE	D2	\$0
NSG2-REPV2-LU	CELERRA REPLICATOR V2 RTU	D2	\$0
NSG2-S-DCD	DOC & CD: NS-G2 + SYMMETRIX	D2	\$0
NSG41-2-CI-U	NS41G-2G CIFS UPG LIC	D2	\$0
NSG41-2-NF-U	NS41G-2G NFS UPG LIC	D2	\$0
NSG8-C-DCD	CELERRA NS-G8 WITH CLARIION DOCS CD	D2	\$0
NSG8-CEE2-L	NS CEE-ANTI-VIRUS	D2	\$0
NSG8-CEE-L	NS-G8 AV LICENSE	D2	\$0
NSG8-CIFS-L	CELERRA NS-G8 CIFS LIC	D2	\$0
NSG8-CIFS-UL	CELERRA NS-G8 CIFS UPG LIC	D2	\$0
NSG8-CIU	CELERRA CIFS LIC UPG TO NS-G8	D2	\$0
NSG8-FASTVE	FAST FMA/VE FOR NS-G8	D2	\$36,500
NSG8-FLR-L	NSG8 FLR BASE LICENSE (2 BLADES)	D2	\$0
NSG8-ISCSI-AL	CELERRA NS-G8 ADD ISCSI LIC	D2	\$0
NSG8-ISCSI-L	CELERRA NS-G8 ISCSI LIC	D2	\$0
NSG8-ISU	CELERRA ISCSI LIC UPG TO NS-G8	D2	\$0
NSG8-NFS-UL	CELERRA NS-G8 NFS UPG LIC	D2	\$0
NSG8-NFU	CELERRA NFS LIC UPG TO NS-G8	D2	\$0
NSG8-REP2U	CELERRA REPV2 UPG LIC FOR NS-G8	D2	\$0
NSG8-REPV2-L	NS-G8 CELERRA REPLICATOR V2 LICENSE	D2	\$0
NSG8-REPV2-LU	NS-G8 CELERRA REPLICATOR V2 ADD-ON LIC	D2	\$0
NSG8-S-DCD	CELERRA NS-G8 WITH SYMM DOCS CD	D2	\$0
NSG8-UNIX-L	CELERRA NS-G8 UNIX LIC	D2	\$0
NS-ISCSI-DCD	CELERRA ISCSI APP DCD	D2	\$0
NS-REP-L	NS REPLICATOR LICENSE	D2	\$18,600
NS-REP-PKG	NS REP PLUG-IN PKG	D2	\$14,000
NS-REPV1V2-U	REPLICATOR V1 TO V2 UPGRADE LICENSE	D2	\$0
NS-UNIX-UL	UPG UNIX TO CIFS AND UNIX	D2	\$0
NS-WIN-CAVA-L	CELERRA NS700 AV LIC	D2	\$0
NS-WIN-CEE2-L	NS EVENT ENABLER-2	D2	\$0
NS-WIN-CEE-L	NS EVENT ENABLER	D2	\$0
NSX-FLR-L	NSX FLR BASE LICENSE (2 BLADES)	D2	\$0
NWMGRB200-DAE	NAVI MGR BASE FOR NW DAE	D2	\$6,280
NWMGRB200-DPE	NAVI MGR BASE FOR NETWIN	D2	\$1,260
NW-UTIL-WIN	WINDOWS UTILS FOR NETWIN	D2	\$40
OM-CLR-DB-UNX	OM CLARIION UNIX DEPT	D2	\$6,050
OM-CLR-EN-UNX	OM CLARIION UNIX ENT	D2	\$12,450
OM-CLR-WG-UNX	OM CLARIION UNIX WRKGP	D2	\$2,500
PFM-CL-T1-4U	PFM CL T1-4 UPG	D2	\$0

PFM-CL-T5-31U	PFM CL T5-31 UPG	D2	\$0
PKG-CL-T1-4U	CC5.1 PKG CL T1-4 UPG	D2	\$0
PKG-CL-T5-31U	CC5.1 PKG CL T5-31 UPG	D2	\$0
PKL-CL-T1-4U	CC CL PKG LT T1-4U	D2	\$0
PKL-CL-T5-31U	CC CL PKG LT T5-31U	D2	\$0
PP-AIX-BR405	BACK-REV FOR PP 4.2 AIX	D2	\$0
PP-AIX-BR501	POWERPATH 4.3 AIX	D2	\$0
PP-DPU	PPATH DEP UPGRADE	D2	\$0
PP-ENU	PPATH ENT UPGRADE	D2	\$0
PPEN-UX-DP	PPATH ENT UNIX DEP	D2	\$7,520
PPEN-UX-EN	PPATH ENT UNIX ENT	D2	\$15,500
PPEN-UX-GB	PPATH ENT UNIX GLB	D2	\$42,630
PPEN-UX-WG	PPATH ENT UNIX WGR	D2	\$3,100
PP-HP-BR312	POWERPATH 4.1 FOR HP-UX	D2	\$0
PP-HP-BR403	POWERPATH 4.2 HP-UX	D2	\$0
PP-LX-BR212	PP LINUX BACK REV	D2	\$0
PP-LX-BR402	POWERPATH LINUX 3.0.5	D2	\$0
PP-LX-BR410	POWERPATH 4.3 LINUX	D2	\$0
PPMEINV-B1B2U	PPME-INVISTA UPGRADE 1 TO 2 DPC LIC	D2	\$18,000
PPMEINV-B2B4U	PPME-INVISTA UPGRADE 2 TO 4 DPC LIC	D2	\$36,000
PPME-INV-T1	PPME-INV T1 (0- 14 TB)	D2	\$0
PPME-INV-T10	PPME-INV-T10 (601-1000TB)	D2	\$0
PPME-INV-T1B1	PPME-INVISTA BASE LIC FOR 1 TIER 1 DPC	D2	\$0
PPME-INV-T1B2	PPME-INVISTA BASE LIC FOR 2 TIER 1 DPC	D2	\$0
PPME-INV-T1B4	PPME-INVISTA BASE LIC FOR 4 TIER 1 DPC	D2	\$0
PPME-INV-T2	PPME-INV T2(15-25 TB)	D2	\$0
PPME-INV-T3	PPME-INV T3 (26-40 TB)	D2	\$0
PPME-INV-T4	PPME-INV T4 (41-60 TB)	D2	\$0
PPME-INV-T5	PPME-INV T5 (61-100 TB)	D2	\$0
PPME-INV-T6	PPME-INV T6 (101-150 TB)	D2	\$0
PPME-INV-T7	PPME-INV T7 (151-250 TB)	D2	\$0
PPME-INV-T8	PPME-INV T8 (251-400 TB)	D2	\$0
PPME-INV-T9	PPME-INV-T9 (401-600TB)	D2	\$0
PPME-INV-UPG	PPME INVISTA UPGRADE LICENSE	D2	\$0
PP-SUN-BR307	POWERPATH 4.0.2 SUN BR	D2	\$0
PP-SUN-BR312	INACTIVE PP 4.1 for Solaris	D2	\$0
PP-SUN-BR403	POWERPATH 4.2 SOLARIS	D2	\$0
PP-SUN-BR407	POWERPATH SOLARIS 4.3	D2	\$0
PP-UX-DPU	PPATH UNIX DEP UPGRADE	D2	\$0
PP-UX-ENU	PPATH UNIX ENT UPGRADE	D2	\$0
PP-UX-GBU	PPATH UNIX GLB UPGRADE	D2	\$0
PP-UX-WGU	PPATH UNIX WGR UPGRADE	D2	\$0
PP-WGU	PPATH WGR UPGRADE	D2	\$0
PP-WN-BR205	PP WINDOWS BACK REV	D2	\$0
PP-WN-BR308	POWERPATH WIN 3.0.5 BR	D2	\$0
PP-WN-BR401	POWERPATH 3.0.6 FOR WINDO	D2	\$0
PP-WN-BR411	POWERPATH WINDOWS 4.3.1	D2	\$0
RM-IN-U31PLUS	RM FOR INVISTA / UNIX 31 HOSTS & UP	D2	\$0
RM-INV-LINUX	RM FOR INVISTA CLONES / LINUX HST	D2	\$0
RM-INV-U16-30	RM FOR INVISTA CLONES / UNIX 16-30 HOSTS	D2	\$0

RM-INV-UNIX	RM FOR INVISTA CLONES / UNIX HST	D2	\$0
RM-INV-W16-30	RM FOR INVISTA CLONES / WINDOWS 16-30 HO	D2	\$0
RM-INV-WIN	RM FOR INVISTA CLONES / WINDOWS HST	D2	\$0
RM-IN-W31PLUS	RM FOR INVISTA / WINDOWS 31 HOSTS & UP	D2	\$0
ROAM-DCD	ROAM DOCUMENTATION & CD	D2	\$0
RP-CDP-CX1	CX3-10 CDP	D2	\$20,000
RP-CDP-CX1-2U	CDP CX3-10 CX3-20 UPGRD	D2	\$20,250
RP-CDP-CX1-4U	CDP CX3-10 CX3-40 UPGRD	D2	\$54,750
RP-CDP-CX1-8U	CDP CX3-10 CX3-80 UPGRD	D2	\$95,000
RP-CDP-CX2	CX3-20 CDP	D2	\$35,000
RP-CDP-CX2-4U	CDP CX3-20 CX3-40 UPGRD	D2	\$39,750
RP-CDP-CX2-8U	CDP CX3-20 CX3-80 UPGRD	D2	\$80,000
RP-CDP-CX4	CX3-40 CDP	D2	\$65,000
RP-CDP-CX4-8U	CDP CX3-40 CX3-80 UPGRD	D2	\$50,000
RP-CDP-CX8	CX3-80 CDP	D2	\$100,000
RP-CLR-CX1	CX3-10 CLR	D2	\$20,000
RP-CLR-CX1-2U	CLR CX1 CX2 UPGD	D2	\$15,500
RP-CLR-CX1-4U	CLR CX1 CX4 UPGD	D2	\$57,500
RP-CLR-CX1-8U	CLR CX1 CX8 UPGD	D2	\$100,000
RP-CLR-CX2	CX3-20 CLR	D2	\$35,500
RP-CLR-CX2-4U	CLR CX2 CX4 UPGD	D2	\$42,000
RP-CLR-CX2-8U	CLR CX2 CX8 UPGD	D2	\$84,500
RP-CLR-CX4	CX3-40 CLR	D2	\$77,500
RP-CLR-CX4-8U	CLR CX4 CX8 UPGD	D2	\$42,500
RP-CLR-CX8	CX3-80 CLR	D2	\$120,000
RP-CP-UG-CLR1	CDP CX1 CLR CX1 UPGD	D2	\$0
RP-CP-UG-CLR2	CDP CX2 CLR CX2 UPGD	D2	\$500
RP-CP-UG-CLR4	CDP CX4 CLR CX4 UPGD	D2	\$12,500
RP-CP-UG-CLR8	CDP CX8 CLR CX8 UPGD	D2	\$20,000
RPCP-UG-CPCX1	CDP BASE 4TB UG CX1 CDP	D2	\$134,100
RPCP-UG-CPCX2	CDP BASE 4TB UG CX2 CDP	D2	\$119,100
RPCP-UG-CPCX4	CDP BASE 4TB UG CX4 CDP	D2	\$89,100
RPCP-UG-CPCX8	CDP BASE 4TB UG CX8 CDP	D2	\$54,100
RPLR-UG-LRCX1	CLR CX1 RP CLR 8TB UPGD	D2	\$168,000
RPLR-UG-LRCX2	CLR CX2 RP CLR 8TB UPGD	D2	\$152,500
RPLR-UG-LRCX4	CLR CX4 RP CLR 8TB UPGD	D2	\$110,500
RPLR-UG-LRCX8	CLR CX8 RP CLR 8TB UPGD	D2	\$68,000
RP-RR-CX1	CX3-10 CRR	D2	\$10,000
RP-RR-CX1-2U	CRR CX3-10 CX3-20 UPGRD	D2	\$10,700
RP-RR-CX1-4U	CRR CX3-10 CX3-40 UPGRD	D2	\$41,750
RP-RR-CX1-8U	CRR CX3-10 CX3-80 UPGRD	D2	\$70,500
RP-RR-CX2	CX3-20 CRR	D2	\$18,000
RP-RR-CX2-4U	CRR CX3-20 CX3-40 UPGRD	D2	\$33,750
RP-RR-CX2-8U	CRR CX3-20 CX3-80 UPGRD	D2	\$62,500
RP-RR-CX4	CX3-40 CRR	D2	\$45,000
RP-RR-CX4-8U	CRR CX3-40 CX3-80 UPGRD	D2	\$35,500
RP-RR-CX8	CX3-80 CRR	D2	\$70,000
RP-RR-CXBW	CX BW REDUCTION OPTION	D2	\$30,000
RP-RR-NS120	RECOVERPOINT FOR NS-120 LIC BUNDLE	D2	\$20,000
RP-RR-NS20	RP/NS BUNDLE FOR CELERRA	D2	\$10,000

RP-RR-NS40	RP/NS 40 BUNDLE FOR CELERRA	D2	\$45,000
RP-RR-NS480	RECOVERPOINT FOR NS-480 LIC BUNDLE	D2	\$40,000
RP-RR-NS80	RP/NS 80 BUNDLE FOR CELERRA	D2	\$70,000
RP-RR-NS960	CELERRA NS-960 RECOVERPOINT BUNDLE	D2	\$72,000
RP-RR-NSG2	RP/NS-G2 BUNDLE FOR CELERRA	D2	\$40,000
RP-RR-UG-CLR1	CRR CX1 CLR CX1 UPGD	D2	\$10,000
RP-RR-UG-CLR2	CRR CX2 CLR CX2 UPGD	D2	\$17,500
RP-RR-UG-CLR4	CRR CX4 CLR CX4 UPGD	D2	\$32,500
RP-RR-UG-CLR8	CRR CX8 CLR CX8 UPGD	D2	\$50,000
RPRR-UG-RRCX1	CRR BASE 8TB UG CX1 CRRR	D2	\$114,150
RPRR-UG-RRCX2	CRR BASE 8TB UG CX2 CRR	D2	\$106,150
RPRR-UG-RRCX4	CRR BASE 8TB UG CX4 CRR	D2	\$79,150
RPRR-UG-RRCX8	CRR BASE 8TB UG CX8 CRR	D2	\$54,150
RPSE-CDP-16	RP/SE CDP 16TB	D2	\$0
RPSE-CDP-1TB	RP/SE CDP 1TB	D2	\$0
RPSE-CDP-24	RP/SE CDP 24TB	D2	\$0
RPSE-CDP-32	RP/SE CDP 32TB	D2	\$0
RPSE-CDP-4	RP/SE CDP 4TB	D2	\$0
RPSE-CDP-4-16	RP/SE 4TB TO 16TB CDP CAPACITY UPGRADE	D2	\$0
RPSE-CDP-4-24	RP/SE CDP 4TB TO 24TB CAPACITY UPGRADE	D2	\$0
RPSE-CDP-4-32	RP/SE CDP 4TB TO 32TB CAPACITY UPGRADE	D2	\$0
RPSE-CDP-4-8	RP/SE 4TB TO 8TB CDP CAPACITY UPGRADE	D2	\$0
RPSE-CDP-8	RP/SE CDP 8TB	D2	\$0
RPSE-CDP-8-16	RP/SE 8TB TO 16TB CDP CAPACITY UPGRADE	D2	\$0
RPSE-CDP-8-24	RP/SE CDP 8TB TO 24TB CAPACITY UPGRADE	D2	\$0
RPSE-CDP-8-32	RP/SE CDP 8TB TO 32TB CAPACITY UPGRADE	D2	\$0
RPSE-CDP-L2	RP/SE CDP 300TB ARRAY LICENSE FOR CX	D2	\$0
RPSE-CDP-L23U	RP/SE CDP UPGRADE LICENSE L2 TO L3	D2	\$0
RPSE-CDP-L24U	RP/SE CDP UPGRADE LICENSE L2 TO L4	D2	\$0
RPSE-CDP-L25U	RP/SE CDP UPGRADE LICENSE L2 TO L5	D2	\$0
RPSE-CDP-L26U	RP/SE CDP UPGRADE LICENSE L2 TO L6	D2	\$0
RPSE-CDP-L27U	RP/SE CDP UPGRADE LICENSE L2 TO L7	D2	\$0
RPSE-CDP-L2C	RP/SE CDP ARRAY UPGRADE LICENSE FOR CX	D2	\$0
RPSE-CDP-L3	RP/SE CDP 300TB LIC FOR AX4-5	D2	\$0
RPSE-CDP-L34U	RP/SE CDP UPGRADE LICENSE L3 TO L4	D2	\$0
RPSE-CDP-L35U	RP/SE CDP UPGRADE LICENSE L3 TO L5	D2	\$0
RPSE-CDP-L36U	RP/SE CDP UPGRADE LICENSE L3 TO L6	D2	\$0
RPSE-CDP-L37U	RP/SE CDP UPGRADE LICENSE L3 TO L7	D2	\$0
RPSE-CDP-L3C	RP/SE CDP U/G LIC FOR AX4-5	D2	\$0
RPSE-CDP-L4	RP/SE CDP 300TB LIC CX4-120; NS-120	D2	\$0
RPSE-CDP-L45U	RP/SE CDP UPGRADE LICENSE L4 TO L5	D2	\$0
RPSE-CDP-L46U	RP/SE CDP UPGRADE LICENSE L4 TO L6	D2	\$0
RPSE-CDP-L47U	RP/SE CDP UPGRADE LICENSE L4 TO L7	D2	\$0
RPSE-CDP-L4C	RP/SE CDP U/G LIC CX4-120; NS-120	D2	\$0
RPSE-CDP-L5	RP/SE CDP 300TB LIC NS40; CX4-240	D2	\$0
RPSE-CDP-L56U	RP/SE CDP UPGRADE LICENSE L5 TO L6	D2	\$0
RPSE-CDP-L57U	RP/SE CDP UPGRADE LICENSE L5 TO L7	D2	\$0
RPSE-CDP-L5C	RP/SE CDP U/G LIC CX4-240	D2	\$0
RPSE-CDP-L6	RPSE CDP 300TB LIC CX4-480 NS-480	D2	\$0
RPSE-CDP-L67U	RP/SE CDP UPGRADE LICENSE L6 TO L7	D2	\$0

RPSE-CDP-L6C	RPSE CDP U/G LIC CX4-480 NS-480	D2	\$0
RPSE-CDP-L7	RP/SE CDP 300TB LICENSE CX4-960; NS-960	D2	\$0
RPSE-CDP-L7C	RP/SE CDP U/G LIC FOR CX4-960; NS-960	D2	\$0
RPSE-CDP-UPG	RPSE CDP CAPACITY UPGRADE	D2	\$0
RPSE-CE-16	RP CE FOR RP/SE: MS CLUSTERS 16TB	D2	\$0
RPSE-CE-16-24	RP CE FOR RP/SE: UG 16 TO 24TB	D2	\$0
RPSE-CE-16-32	RP CE FOR RP/SE: UG 16 TO 32TB	D2	\$0
RPSE-CE-1TB	RP CE FOR RP/SE: MS CLUSTERS 1TB	D2	\$0
RPSE-CE-24	RP CE FOR RP/SE: MS CLUSTERS 24TB	D2	\$0
RPSE-CE-24-32	RP CE FOR RP/SE: UG 24 TO 32TB	D2	\$0
RPSE-CE-32	RP CE FOR RP/SE: MS CLUSTERS 32TB	D2	\$0
RPSE-CE-4	RP CE FOR RP/SE: MS CLUSTERS 4TB	D2	\$0
RPSE-CE-4-16	RP CE FOR RP/SE: UG 4 TO 16TB	D2	\$0
RPSE-CE-4-24	RP CE FOR RP/SE: UG 4 TO 24TB	D2	\$0
RPSE-CE-4-32	RP CE FOR RP/SE:UG 4 TO 32TB	D2	\$0
RPSE-CE-4-8	RP CE FOR RP/SE: UG 4 TO 8TB	D2	\$0
RPSE-CE-8	RP CE FOR RP/SE: MS CLUSTERS 8TB	D2	\$0
RPSE-CE-8-16	RP CE FOR RP/SE: UG 8 TO 16TB	D2	\$0
RPSE-CE-8-24	RP CE FOR RP/SE: UG 8 TO 24TB	D2	\$0
RPSE-CE-8-32	RP CE FOR RP/SE: UG 8 TO 32TB	D2	\$0
RPSE-CP-16-24	RP/SE CDP 16TB TO 24TB CAPACITY UPGRADE	D2	\$0
RPSE-CP-16-32	RP/SE CDP 16TB TO 32TB CAPACITY UPGRADE	D2	\$0
RPSE-CP-24-32	RP/SE CDP 24TB TO 32TB CAPACITY UPGRADE	D2	\$0
RPSE-CRR	RP/SE CRR HOLDER FOR SERIAL NUMBER	D2	\$0
RPSE-CRR-16	RP/SE CRR 16TB	D2	\$0
RPSE-CRR-1TB	RP/SE CRR 1TB	D2	\$0
RPSE-CRR-24	RP/SE CRR 24TB	D2	\$0
RPSE-CRR-32	RP/SE CRR 32TB	D2	\$0
RPSE-CRR-4	RP/SE CRR 4TB	D2	\$0
RPSE-CRR-4-16	RP/SE 4TB TO 16TB CRR CAPACITY UPGRADE	D2	\$0
RPSE-CRR-4-24	RP/SE CRR 4TB TO 24TB CAPACITY UPGRADE	D2	\$0
RPSE-CRR-4-32	RP/SE CRR 4TB TO 32TB CAPACITY UPGRADE	D2	\$0
RPSE-CRR-4-8	RP/SE 4TB TO 8TB CRR CAPACITY UPGRADE	D2	\$0
RPSE-CRR-8	RP/SE CRR 8TB	D2	\$0
RPSE-CRR-8-16	RP/SE 8TB TO 16TB CRR CAPACITY UPGRADE	D2	\$0
RPSE-CRR-8-24	RP/SE CRR 8TB TO 24TB CAPACITY UPGRADE	D2	\$0
RPSE-CRR-8-32	RP/SE CRR 8TB TO 32TB CAPACITY UPGRADE	D2	\$0
RPSE-CRR-L2	RP/SE CRR 300TB ARRAY LICENSE FOR CX	D2	\$0
RPSE-CRR-L23U	RP/SE CRR UPGRADE LICENSE L2 TO L3	D2	\$0
RPSE-CRR-L24U	RP/SE CRR UPGRADE LICENSE L2 TO L4	D2	\$0
RPSE-CRR-L25U	RP/SE CRR UPGRADE LICENSE L2 TO L5	D2	\$0
RPSE-CRR-L26U	RP/SE CRR UPGRADE LICENSE L2 TO L6	D2	\$0
RPSE-CRR-L27U	RP/SE CRR UPGRADE LICENSE L2 TO L7	D2	\$0
RPSE-CRR-L2C	RP/SE CRR ARRAY UPGRADE LICENSE FOR CX	D2	\$0
RPSE-CRR-L3	RP/SE CRR 300TB LIC FOR AX	D2	\$0
RPSE-CRR-L34U	RP/SE CRR UPGRADE LICENSE L3 TO L4	D2	\$0
RPSE-CRR-L35U	RP/SE CRR UPGRADE LICENSE L3 TO L5	D2	\$0
RPSE-CRR-L36U	RP/SE CRR UPGRADE LICENSE L3 TO L6	D2	\$0
RPSE-CRR-L37U	RP/SE CRR UPGRADE LICENSE L3 TO L7	D2	\$0
RPSE-CRR-L3C	RP/SE CRR UPGRADE LIC FOR AX4-5	D2	\$0

RPSE-CRR-L4	RP/SE CRR 300TB LIC CX4-120; NS-120	D2	\$0
RPSE-CRR-L45U	RP/SE CRR UPGRADE LICENSE L4 TO L5	D2	\$0
RPSE-CRR-L46U	RP/SE CRR UPGRADE LICENSE L4 TO L6	D2	\$0
RPSE-CRR-L47U	RP/SE CRR UPGRADE LICENSE L4 TO L7	D2	\$0
RPSE-CRR-L4C	RP/SE CRR UPGRADE LIC CX4-120; NS-120	D2	\$0
RPSE-CRR-L5	RP/SE CRR 300TB LIC NS40; CX4-240	D2	\$0
RPSE-CRR-L56U	RP/SE CRR UPGRADE LICENSE L5 TO L6	D2	\$0
RPSE-CRR-L57U	RP/SE CRR UPGRADE LICENSE L5 TO L7	D2	\$0
RPSE-CRR-L5C	RP/SE CRR UPGRADE LIC NS40; CX4-240	D2	\$0
RPSE-CRR-L6	RPSE CRR 300TB LIC CX4-480 NS-480	D2	\$0
RPSE-CRR-L67U	RP/SE CRR UPGRADE LICENSE L6 TO L7	D2	\$0
RPSE-CRR-L6C	RPSE CRR UPGRD LIC CX4-480 NS-480	D2	\$0
RPSE-CRR-L7	RP/SE CRR 300TB LIC CX4-960; NS-960	D2	\$0
RPSE-CRR-L7C	RP/SE CRR U/G LIC FOR CX4-960; NS-960	D2	\$0
RPSE-CRR-UPG	RPSE CRR CAPACITY UPGRADE	D2	\$0
RPSE-RR-16-24	RP/SE CRR 16TB TO 24TB CAPACITY UPGRADE	D2	\$0
RPSE-RR-16-32	RP/SE CRR 16TB TO 32TB CAPACITY UPGRADE	D2	\$0
RPSE-RR-24-32	RP/SE CRR 24TB TO 32TB CAPACITY UPGRADE	D2	\$0
SC31	SANCOPY FOR THE CX3-10	D2	\$0
SC32	SAN COPY CX3-20	D2	\$0
SC34	SAN COPY CX3-40	D2	\$0
SC38	SAN COPY CX3-80	D2	\$0
SC4-120	SAN COPY FOR CX4-120	D2	\$0
SC4-120UPG	SAN COPY UPGRADE TO CX4-120C	D2	\$0
SC4-240	SAN COPY FOR CX4-240	D2	\$0
SC4-240UPG	SAN COPY UPGRADE TO CX4-240C	D2	\$0
SC4-480	SAN COPY FOR CX4-480	D2	\$0
SC4-480UPG	SAN COPY UPGRADE TO CX4-480C	D2	\$0
SC47-T01	SANCOPY FC4700 TIER 01	D2	\$0
SC47-T02	SANCOPY FC4700 TIER 02	D2	\$0
SC47-T03	SANCOPY FC4700 TIER 03	D2	\$0
SC47-T04	SANCOPY FC4700 TIER 04	D2	\$0
SC47-T05	SANCOPY FC4700 TIER 05	D2	\$0
SC47-T06	SANCOPY FC4700 TIER 06	D2	\$0
SC47-T07	SANCOPY FC4700 TIER 07	D2	\$0
SC47-T08	SANCOPY FC4700 TIER 08	D2	\$0
SC47-T09	SANCOPY FC4700 TIER 09	D2	\$0
SC47-T10	SANCOPY FC4700 TIER 10	D2	\$0
SC47-T11	SANCOPY FC4700 TIER 11	D2	\$0
SC47-T12	SANCOPY FC4700 TIER 12	D2	\$0
SC4-960	SAN COPY FOR CX4-960	D2	\$0
SC4-960UPG	SAN COPY UPGRADE TO CX4-960C	D2	\$0
SCE300	SAN COPY/E CX300	D2	\$0
SCE300-KIT	SAN COPY/E MEDIA CX300	D2	\$0
SC-KIT	SAN COPY MEDIA	D2	\$0
SC-KIT303	SAN COPY V1.0 MEDIA	D2	\$0
SC-KIT308	SAN COPY V1.1 MEDIA	D2	\$0
SC-KIT402	SANCOPY MEDIA V2.0	D2	\$0
SC-KIT-407	SANCOPY MEDIA	D2	\$0
SC-ORCL CX500	SAN COPY FOR ORACLE	D2	\$0

SC-ORCL CX700	SAN COPY FOR ORACLE	D2	\$0
SCT1-T4	SAN COPY UPG T1-T4	D2	\$0
SCT5-T12	SAN COPY UPG T5-T12	D2	\$0
SE-CL-BAS	SOL ENABLER FOR CL	D2	\$0
SIMS	SNAPVIEW INT MOD FOR SQL	D2	\$800
SM-AL5-T1-4U	CC5.x SM AL5 T1-4 UPG	D2	\$0
SM-AL5-T5-18U	CC5.x SM AL5 T5-18 UPG	D2	\$0
SM-AL7-T1-4U	CC5.x SM AL7 T1-4 UPG	D2	\$0
SM-AL7-T5-18U	CC5.x SM AL7 T5-18 UPG	D2	\$0
SM-CL-T1-4U	CC SANMGR-CLARIION T1-T4U	D2	\$0
SM-CL-T5-31U	CC SANMGR-CLARIION T5-T31	D2	\$0
SM-CX4-T1-4U	SAN MGR CX400 T1-4 UPG	D2	\$0
SM-CX4-T5-18U	SAN MGR CX400 UPG T5-18	D2	\$0
SM-CX6-T1-4U	CC5.x SM CX6 T1-4 UPG	D2	\$0
SM-CX6-T5-31U	CC5.x SM CX6 T5-31 UPG	D2	\$0
SV300	CX300 SNAPVIEW	D2	\$0
SV300-KIT-407	SNAPVIEW CX300 MEDIA	D2	\$0
SV31	SNAPVIEW FOR THE CX3-10	D2	\$0
SV31-RM	SNAPVIEW/REPLICATION MANAGER BUNDLE FO	D2	\$0
SV32	SNAPVIEW CX3-20	D2	\$0
SV34	SNAPVIEW CX3-40	D2	\$0
SV38	SNAPVIEW CX3-80	D2	\$0
SV400-KIT	SNAPVIEW CX400 MEDIA	D2	\$0
SV400-KIT303	CX400 SV V2.1 MEDIA	D2	\$1
SV400-KIT308	CX400 SV V1.8 MEDIA	D2	\$1
SV400-KIT-407	SNAPVIEW CX400 MEDIA	D2	\$0
SV400T1-T4	SNAPVIEW CX400 UPG T1-T4	D2	\$0
SV400T5-T8	SNAPVIEW CX400 UPG T5-T8	D2	\$0
SV4-120	SNAPVIEW FOR CX4-120	D2	\$0
SV4120-RM	BUNDLE FOR SV + RM FOR CX4-120	D2	\$4,175
SV4-120UPG	SNAPVIEW UPGRADE TO CX4-120C	D2	\$0
SV4-240	SNAPVIEW FOR CX4-240	D2	\$0
SV4240-RM	BUNDLE FOR SV + RM FOR CX4-240	D2	\$9,035
SV4-240UPG	SNAPVIEW UPGRADE TO CX4-240C	D2	\$0
SV4-480	SNAPVIEW FOR CX4-480	D2	\$0
SV4-480UPG	SNAPVIEW UPGRADE TO CX4-480C	D2	\$0
SV4-960	SNAPVIEW FOR CX4-960	D2	\$0
SV4-960UPG	SNAPVIEW UPGRADE TO CX4-960C	D2	\$0
SV-KIT	SNAPVIEW CX600 MEDIA	D2	\$0
SV-KIT303	SNAPVIEW V2.1 MEDIA	D2	\$0
SV-KIT308	SNAPVIEW V1.8 MEDIA	D2	\$0
SV-KIT-407	SNAPVIEW MEDIA	D2	\$0
SV-ORCL CX500	SNAPVIEW FOR ORACLE	D2	\$0
SV-ORCL CX700	SNAPVIEW FOR ORACLE	D2	\$0
SVT1-T4	SNAPVIEW CX600 UPG T1-T4	D2	\$0
SVT5-T12	SNAPVIEW CX600 UPG T5-T12	D2	\$0
SWBDL-160TB	CX4 BUNDLE CONFIG - S1 (160TB; NO REPLN)	D2	\$0
SWBDL-160TBMS	CX4 BUNDLE-SERIES1 (160TB; MV-SV REPLN)	D2	\$0
SWBDL-27TB	CX4 BUNDLE - SERIES 1 (27 TB; NO REPLN)	D2	\$0
SWBDL-27TBMS	CX4 BUNDLE SERIES 1 (27 TB; MV-SV REPLN	D2	\$0

SWBDL-56TB	CX4 BUNDLE - SERIES 1 (56 TB; NO REPLN)	D2	\$0
SWBDL-56TBMS	CX4 BUNDLE SERIES 1 (56TB MV-SV REPLN)	D2	\$0
SWBDL-79TB	CX4 BUNDLE - SERIES 1 (79 TB; NO REPLN)	D2	\$0
SWBDL-79TBMS	CX4 BUNDLE SERIES 1 (79TB MV-SV REPLN)	D2	\$0
TP-240	EMC THIN PROVISIONING FOR THE CX4-240	D2	\$0
UNIF4-120	UNISPHERE FOR FILE ON NS120	D2	\$0
UNIF4-120U	UNISPHERE UNIFIED Upg NS120	D2	\$0
UNIF4-480	UNISPHERE FOR FILE ON NS480	D2	\$0
UNIF4-480AU	UNISPHERE UNIFIED UPG NS480 (480 DRIVE)	D2	\$0
UNIF4-480U	UNISPHERE UNIFIED UPG NS480 (240 DRIVE)	D2	\$0
UNIF4-960	UNISPHERE FOR FILE ON NS960	D2	\$0
UNIF4-960U	UNISPHERE UNIFIED Upg NS960	D2	\$0
UNIF-G2	UNISPHERE FOR FILE ON G2	D2	\$1,000
UNIF-G8	UNISPHERE FOR FILE ON G8	D2	\$4,000
UNIF-VG2	UNISPHERE FOR FILE ON V-G2=IC	D2	\$0
UNIF-VG8	UNISPHERE FOR FILE ON V-G8=IC	D2	\$0
UNIU4-120	UNISPHERE FOR UNIFIED ON NS120	D2	\$0
UNIU4-480	UNISPHERE UNIFIED NS480 (240 DRIVES)	D2	\$0
UNIU4-480A	UNISPHERE UNIFIED NS480 (480 DRIVES)	D2	\$0
UNIU4-480AU	UNISPHERE UNIFIED 240+ DRIVE FIELD Upg	D2	\$0
UNIU4-960	UNISPHERE FOR UNIFIED ON NS960	D2	\$0
UTIL-AIX305	AIX UTILITIES W-PP3.0.0	D2	\$0
UTIL-AIX407	AIX 4.2 UTILITIES	D2	\$0
UTIL-AIX501	AIX PP 4.3 UTILITIES	D2	\$0
UTIL-HP306	HP UTILITIES W-PP3.0.0	D2	\$0
UTIL-HPUX312	HPUX 4.1 UTILITIES	D2	\$0
UTIL-HPUX407	HPUX 4.3 UTILITIES	D2	\$0
UTIL-LNX306	LINUX 3.0.3 UTILITIES	D2	\$0
UTIL-LNX410	LINUX PP 4.3 UTILITIES	D2	\$0
UTIL-LNX504	LINUX 4.3.2 UTILITIES	D2	\$0
UTIL-LNX507	LINUX 4.4UTILITIES	D2	\$0
UTIL-NW405	NETWARE 3.0.3 UTILITIES	D2	\$0
UTIL-SUN303	SUN UTILITIES W-PP3.0.0	D2	\$0
UTIL-SUN307	SUN UTILITIES W-PP4.0.2	D2	\$0
UTIL-SUN407	SOLARIS PP 4.3 UTILITIES	D2	\$0
UTIL-WIN303	WIN UTILITIES W-PP3.0.0	D2	\$0
UTIL-WIN308	WIN UTILITIES W-PP3.0.5	D2	\$0
UTIL-WIN411	WINDOW PP 4.3.1 UTILITIES	D2	\$0
VG2-ADV-L	VG2 ADV FILE LIC (NFS; MPFS & PNFS)=IC	D2	\$0
VG2-C-DCD	VG2 DOCUMENT CD KIT FOR CLARIION=IC	D2	\$0
VG2-CEE2-L	VG2 AV 2-FOR-1 LICENSE=IC	D2	\$2,000
VG2-CEE-L	VG2 AV LICENSE	D2	\$2,000
VG2-CU-DCD	VNX OE FOR FILE SOFTWARE KIT=IC	D2	\$0
VG2-FLR-L	VG2 FLR BASE LICENSE (2 BLADES)=IC	D2	\$10,000
VG2-REP2-L	VG2 REPLICATOR V2 LICENSE=IC	D2	\$18,750
VG2-REP2-LU	VG2 REPLICATOR V2 UPG LICENSE	D2	\$18,750
VG2-S-DCD	VG2 DOCUMENT CD KIT FOR SYMMETRIX	D2	\$0
VG2-SU-DCD	VNX OE FOR FILE SOFTWARE KIT=IC	D2	\$0
VG8-ADV-L	VG8 ADV FILE LIC (NFS; MPFS & PNFS)=IC	D2	\$0
VG8-C-DCD	VG8 DOCUMENT CD KIT FOR CLARIION=IC	D2	\$0

VG8-CEE2-L	VG8 AV 2-FOR-1 LICENSE=IC	D2	\$3,000
VG8-CEE-L	VG8 AV LICENSE	D2	\$3,000
VG8-CU-DCD	VNX OE FOR FILE SOFTWARE KIT=IC	D2	\$0
VG8-FLR-L	VG8 FLR BASE LICENSE (2 BLADES)=IC	D2	\$10,000
VG8-REPV2-L	VG8 REPLICATOR V2 LICENSE=IC	D2	\$31,100
VG8-REPV2-LU	VG8 REPLICATOR V2 UPG LICENSE	D2	\$31,100
VG8-S-DCD	VG8 DOCUMENT CD KIT FOR SYMMETRIX	D2	\$0
VG8-SU-DCD	VNX OE FOR FILE SOFTWARE KIT=IC	D2	\$0
VP4-120	VIRTUAL PROVISIONING FOR THE CX4-120	D2	\$0
VP4-240	VIRTUAL PROVISIONING FOR THE CX4-240	D2	\$0
VP4-240UPG	VIRTUAL PROVISIONING FOR THE CX4-240	D2	\$0
VP4-480	VIRTUAL PROVISIONING FOR THE CX4-480	D2	\$0
VP4-480UPG	VIRTUAL PROVISIONING FOR THE CX4-480	D2	\$0
VP4-960	VIRTUAL PROVISIONING FOR THE CX4-960	D2	\$0
VP4-960UPG	VIRTUAL PROVISIONING FOR THE CX4-960	D2	\$0
VP4-KIT	VIRTUAL PROVISIONING CX4 MEDIA KIT	D2	\$0
WLA-CL-T1-4U	CC5.1 WLA CL T1-4 UPG	D2	\$0
WLA-CL-T5-31U	CC5.1 WLA CL T5-31 UPG	D2	\$0
450-001-514	ViPR SUITE SIO Tier 0=CB	D3	\$450
450-001-515	ViPR SUITE SIO Tier 1=CB	D3	\$340
450-001-516	ViPR SUITE SIO Tier 2=CB	D3	\$270
450-001-517	ViPR SUITE SIO Tier 3=CB	D3	\$240
450-001-518	ViPR SUITE SIO Tier 4=CB	D3	\$190
450-001-519	ViPR SUITE SIO Tier 5=CB	D3	\$160
450-001-520	ViPR SUITE SIO Tier 6=CB	D3	\$150
450-001-534	ViPR SUITE Ent 1-50TB=CB	D3	\$1,600
450-001-535	ViPR SUITE Ent 51-150TB=CB	D3	\$1,590
450-001-536	ViPR SUITE Ent 151-300TB=CB	D3	\$1,580
450-001-537	ViPR SUITE Ent 301-450TB=CB	D3	\$1,570
450-001-538	ViPR SUITE Ent 451-750TB=CB	D3	\$1,460
450-001-539	ViPR SUITE Ent 751-1500TB=CB	D3	\$1,230
450-001-540	ViPR SUITE Ent 1501-3000TB=CB	D3	\$1,170
450-001-541	ViPR SUITE Ent 3001-5000TB=CB	D3	\$1,060
450-001-542	ViPR SUITE Ent 5001-10000TB=CB	D3	\$810
450-001-543	ViPR SUITE Ent 10001TB+=CB	D3	\$690
450-001-544	ViPR SUITE Mid 1-50TB=CB	D3	\$975
450-001-545	ViPR SUITE Mid 51-150TB=CB	D3	\$970
450-001-546	ViPR SUITE Mid 151-300TB=CB	D3	\$900
450-001-547	ViPR SUITE Mid 301-450TB=CB	D3	\$830
450-001-548	ViPR SUITE Mid 451-750TB=CB	D3	\$760
450-001-549	ViPR SUITE Mid 751-1500TB=CB	D3	\$580
450-001-550	ViPR SUITE Mid 1501-3000TB=CB	D3	\$540
450-001-551	ViPR SUITE Mid 3001-5000TB=CB	D3	\$500
450-001-552	ViPR SUITE Mid 5001-10000TB=CB	D3	\$470
450-001-553	ViPR SUITE Mid 10001TB+=CB	D3	\$440
450-001-554	ViPR SUITE Cloud 1-50TB=CB	D3	\$700
450-001-555	ViPR SUITE Cloud 51-150TB=CB	D3	\$660
450-001-556	ViPR SUITE Cloud 151-300TB=CB	D3	\$610
450-001-557	ViPR SUITE Cloud 301-450TB=CB	D3	\$560
450-001-558	ViPR SUITE Cloud 451-750TB=CB	D3	\$520

450-001-559	ViPR SUITE Cloud 751-1500TB=CB	D3	\$470
450-001-560	ViPR SUITE Cloud 1501-3000TB=CB	D3	\$430
450-001-561	ViPR SUITE Cloud 3001-5000TB=CB	D3	\$380
450-001-562	ViPR SUITE Cloud 5001-10000TB=CB	D3	\$350
450-001-563	ViPR SUITE Cloud 10001TB+=CB	D3	\$320
456-000-054	RETROSPECT ADVANCED TAPE SUPPORT	D3	\$0
456-000-055	RETROSPECT DISASTER RECOVERY	D3	\$0
456-000-056	RETROSPECT EXCHANGE SERVER AGENT	D3	\$0
456-000-057	RETROSPECT MACINTOSH CLIENT 50-PACK	D3	\$0
456-000-058	RETROSPECT FOR WINDOWS MULTI SERVER	D3	\$0
456-000-059	RETROSPECT OPEN FILE OPTION	D3	\$0
456-000-060	RETROSPECT SERVER CLIENT 1-PACK	D3	\$0
456-000-061	RETROSPECT FOR MACINTOSH SERVER	D3	\$0
456-000-062	RETROSPECT FOR WINDOWS SINGLE SERVER	D3	\$0
456-000-063	RETROSPECT SQL SERVER AGENT	D3	\$0
456-000-065	RETROSPECT PROFESSIONAL - QTY 100	D3	\$0
456-000-066	SRDF/AUTOSTART	D3	\$0
456-000-067	SRDF/AUTOSTART FOR EXCHANGE 2000	D3	\$0
456-000-069	SRDF/AUTOSTART FOR EXCHANGE 5.5	D3	\$0
456-000-070	SRDF/AUTOSTART FOR ORACLE ON SOLARIS	D3	\$0
456-000-073	SRDF/AUTOSTART FOR SRDF DATA SOURCE	D3	\$0
456-000-240	RETROSPECT MULTI SERVER (CU)	D3	\$0
456-000-241	RETROSPECT SMALL BUS SVR-PREMIUM (CU)	D3	\$0
456-000-242	RETROSPECT SINGLE SERVER (CU)	D3	\$0
456-000-243	RETROSPECT DISK-TO-DISK (CU)	D3	\$0
456-000-244	RETROSPECT PROFESSIONAL (CU)	D3	\$0
456-000-245	RETROSPECT ADD-ON VALUE PACKAGE (CU)	D3	\$0
456-000-246	RETROSPECT OPEN FILE BACKUP (CU)	D3	\$0
456-000-247	RETROSPECT DISASTER RECOVERY (CU)	D3	\$0
456-000-248	RETROSPECT ADVANCED TAPE SUPPORT (CU)	D3	\$0
456-000-249	RETROSPECT SQL SERVER AGENT (CU)	D3	\$0
456-000-250	RETROSPECT EXCHANGE SERVER AGENT (CU)	D3	\$0
456-000-251	RETROSPECT SMALL BUSINESS SVR - PREMIUM	D3	\$0
456-000-252	RETROSPECT SMALL BUSINESS SVR - STANDAL	D3	\$0
456-000-253	RETROSPECT DISK-TO-DISK SERVERS	D3	\$0
456-000-254	RETROSPECT PROFESSIONAL SERVERS	D3	\$0
456-000-255	RETROSPECT ADD-ON VALUE PACKAGE	D3	\$0
456-000-278	BACKUP ADVISOR (UP TO 50 CLIENTS)	D3	\$0
456-000-279	BACKUP ADVISOR (UP TO 100 CLIENTS)	D3	\$0
456-000-280	BACKUP ADVISOR (UP TO 250 CLIENTS)	D3	\$0
456-000-281	BACKUP ADVISOR (UP TO 500 CLIENTS)	D3	\$0
456-000-282	BACKUP ADVISOR (UP TO 800 CLIENTS)	D3	\$0
456-000-283	BACKUP ADVISOR (MORE THAN 800 CLIENTS)	D3	\$0
456-000-362	DISKXTENDER UNIX STORAGE MANAGER SERV	D3	\$0
456-000-368	DISKXTENDER LINUX STORAGE MGR SERVER	D3	\$0
456-000-390	DISKXTENDER FILE SYSTEM MGR UNIX	D3	\$0
456-000-391	DISKXTENDER FOR UNIX/LINUX CAPACITY 1TB	D3	\$0
456-000-397	DISKXTENDER FOR UNIX/LINUX CAPACITY 20TE	D3	\$0
456-000-400	DISKXTENDER FOR UNIX/LINUX CAPACITY 32TE	D3	\$0
456-000-403	DSKXTNDR FOR UX/LX CAP 100TB	D3	\$0

456-000-404	DSKXTNDR FOR UX/LX CAP 200TB	D3	\$0
456-000-405	DSKXTNDR FOR UX/LX CAP 300TB	D3	\$0
456-000-406	DSKXTNDR FOR UX/LX CAP 400TB	D3	\$0
456-000-407	DSKXTNDR FOR UX/LX CAP 500TB	D3	\$0
456-000-409	DISXTENDER-U/L CAP 1000TB (1 PETABYTE)	D3	\$0
456-000-411	DISXTENDER FOR U/L CAP 2KTB (2 PETABYTE)	D3	\$0
456-000-413	DISXTENDER-U/L CAP 3000TB (3 PETABYTE)	D3	\$0
456-000-415	DISXTENDER-U/L CAP 4000TB (4 PETABYTE)	D3	\$0
456-000-417	DISXTENDER-U/L CAP 5000TB (5 PETABYTE)	D3	\$0
456-000-418	DISKXTENDER FILE SYSTEM MANAGER LINUX	D3	\$0
456-000-420	DISKXTENDER FOR UNIX/LINUX CAPACITY 2TB	D3	\$0
456-000-421	DISKXTENDER FOR UNIX/LINUX CAPACITY 5TB	D3	\$0
456-000-422	DISKXTENDER FOR UNIX/LINUX CAPACITY 10TB	D3	\$0
456-000-423	DISKXTENDER FOR UNIX/LINUX CAPACITY 15TB	D3	\$0
456-000-424	DISKXTENDER FOR UNIX/LINUX CAPACITY 64TB	D3	\$0
456-000-425	DSKXTNDR FOR UX/LX CAP 600TB	D3	\$0
456-000-426	DSKXTNDR FOR UX/LX CAP 700TB	D3	\$0
456-000-427	DSKXTNDR FOR UX/LX CAP 800TB	D3	\$0
456-000-428	DSKXTNDR FOR UX/LX CAP 900TB	D3	\$0
456-000-429	DSKXTNDR FOR U/L CAP 6000TB (6 PETABYTE)	D3	\$0
456-000-430	DSKXTNDR FOR U/L CAP 7000TB (7 PETABYTE)	D3	\$0
456-000-431	DSKXTNDR FOR U/L CAP 8000TB (8 PETABYTE)	D3	\$0
456-000-432	DSKXTNDR FOR U/L CAP 9000TB (9 PETABYTE)	D3	\$0
456-000-433	DSKXTNDR FOR U/L CAP 10000TB(10PETABYTE)	D3	\$0
456-001-755	INA REPLISTOR FOR WINDOWS	D3	\$0
456-001-756	INA REPLISTOR FOR WINDOWS ADVANCED SVF	D3	\$0
456-001-757	INA REPLISTOR FOR WINDOWS STORAGE SERV	D3	\$0
456-001-758	INA REPLISTOR FOR WINDOWS DATA CENTER	D3	\$0
456-001-881	ARCHXTNDR WIN MO/WORM/UDO LEVEL A	D3	\$0
456-001-882	ARCHXTNDR WIN MO/WORM/UDO LEVEL B	D3	\$0
456-001-883	ARCHXTNDR WIN MO/WORM/UDO LEVEL C	D3	\$0
456-001-884	ARCHXTNDR WIN MO/WORM/UDO LEVEL D	D3	\$0
456-001-885	ARCHXTNDR WIN MO/WORM/UDO LEVEL E	D3	\$0
456-001-886	ARCHXTNDR WIN MO/WORM/UDO LEVEL F	D3	\$0
456-001-887	ARCHXTNDR WIN MO/WORM/UDO LEVEL G	D3	\$0
456-001-888	ARCHXTNDR WIN MO/WORM/UDO LEVEL H	D3	\$0
456-001-889	ARCHXTNDR WIN MO/WORM/UDO LEVEL I	D3	\$0
456-001-890	ARCHXTNDR WIN MO/WORM/UDO LEVEL J	D3	\$0
456-001-891	ARCHXTNDR WIN MO/WORM/UDO LEVEL K	D3	\$0
456-001-892	ARCHXTNDR WIN MO/WORM/UDO LEVEL L	D3	\$0
456-001-893	ARCHXTNDR WIN MO/WORM/UDO LEVEL M	D3	\$0
456-001-894	ARCHXTNDR WIN MO/WORM/UDO LEVEL N	D3	\$0
456-001-895	ARCHXTNDR WIN MO/WORM/UDO LEVEL O	D3	\$0
456-001-896	ARCHXTNDR WIN MO/WORM/UDO LEVEL P	D3	\$0
456-001-897	ARCHXTNDR WIN MO/WORM/UDO LEVEL Q	D3	\$0
456-001-898	ARCHXTNDR WIN MO/WORM/UDO LEVEL R	D3	\$0
456-001-944	ARCHIVEXTENDER API TOOLKIT FOR WINDOWS	D3	\$0
456-001-989	ARCHIVEXTENDER FOR WINDOWS CD-R LEVEL	D3	\$0
456-001-990	ARCHIVEXTENDER FOR WINDOWS CD-R LEVEL	D3	\$0
456-001-991	ARCHXTNDR WIN PRODATA LEVEL A	D3	\$0

456-001-992	ARCHIVEXTENDER FOR WINDOWS CD-R LEVEL	D3	\$0
456-001-993	ARCHXTNDR WIN PRODATA LEVEL D	D3	\$0
456-001-994	ARCHIVEXTENDER FOR WINDOWS CD-R LEVEL	D3	\$0
456-001-995	ARCHXTNDR WIN PRODATA LEVEL G	D3	\$0
456-001-996	ARCHIVEXTENDER FOR WINDOWS CD-R LEVEL	D3	\$0
456-001-997	ARCHXTNDR WIN PRODATA LEVEL J	D3	\$0
456-001-998	ARCHIVEXTENDER FOR WINDOWS CD-R LEVEL	D3	\$0
456-001-999	ARCHXTNDR WIN PRODATA LEVEL M	D3	\$0
456-002-000	ARCHIVEXTENDER FOR WINDOWS CD-R LEVEL	D3	\$0
456-002-001	ARCHIVEXTENDER FOR WINDOWS CD-R LEVEL	D3	\$0
456-002-002	ARCHIVEXTENDER FOR WINDOWS CD-R LEVEL	D3	\$0
456-002-003	ARCHIVEXTENDER FOR WINDOWS CD-R LEVEL	D3	\$0
456-002-004	ARCHIVEXTENDER FOR WINDOWS CD-R LEVEL	D3	\$0
456-002-005	ARCHIVEXTENDER FOR WINDOWS CD-R LEVEL	D3	\$0
456-002-006	ARCHIVEXTENDER FOR WINDOWS CD-R LEVEL	D3	\$0
456-002-007	ARCHIVEXTENDER FOR WINDOWS CD-R LEVEL	D3	\$0
456-002-008	ARCHIVEXTENDER FOR WINDOWS CD-R LEVEL	D3	\$0
456-002-009	ARCHIVEXTENDER FOR WINDOWS CD-R LEVEL	D3	\$0
456-002-010	ARCHIVEXTENDER FOR WINDOWS CD-R LEVEL	D3	\$0
456-002-011	ARCHIVEXTENDER FOR WINDOWS CD-R LEVEL	D3	\$0
456-002-012	ARCHIVEXTENDER FOR WINDOWS CD-R LEVEL	D3	\$0
456-002-013	ARCHIVEXTENDER FOR WINDOWS DVD-R LEVE	D3	\$0
456-002-014	ARCHIVEXTENDER FOR WINDOWS DVD-R LEVE	D3	\$0
456-002-015	ARCHIVEXTENDER FOR WINDOWS DVD-R LEVE	D3	\$0
456-002-016	ARCHIVEXTENDER FOR WINDOWS DVD-R LEVE	D3	\$0
456-002-017	ARCHIVEXTENDER FOR WINDOWS DVD-R LEVE	D3	\$0
456-002-018	ARCHIVEXTENDER FOR WINDOWS DVD-R LEVE	D3	\$0
456-002-019	ARCHIVEXTENDER FOR WINDOWS DVD-R LEVE	D3	\$0
456-002-020	ARCHIVEXTENDER FOR WINDOWS DVD-R LEVE	D3	\$0
456-002-021	ARCHIVEXTENDER FOR WINDOWS DVD-R LEVE	D3	\$0
456-002-022	ARCHIVEXTENDER FOR WINDOWS DVD-R LEVE	D3	\$0
456-002-023	ARCHIVEXTENDER FOR WINDOWS DVD-R LEVE	D3	\$0
456-002-024	ARCHIVEXTENDER FOR WINDOWS DVD-R LEVE	D3	\$0
456-002-025	ARCHXTNDR WIN DVD-RAM LEVEL A	D3	\$0
456-002-026	ARCHXTNDR WIN DVD-RAM LEVEL B	D3	\$0
456-002-027	ARCHXTNDR WIN DVD-RAM LEVEL C	D3	\$0
456-002-028	ARCHXTNDR WIN DVD-RAM LEVEL D	D3	\$0
456-002-029	ARCHXTNDR WIN DVD-RAM LEVEL E	D3	\$0
456-002-030	ARCHXTNDR WIN DVD-RAM LEVEL F	D3	\$0
456-002-031	ARCHXTNDR WIN DVD-RAM LEVEL G	D3	\$0
456-002-032	ARCHXTNDR WIN DVD-RAM LEVEL H	D3	\$0
456-002-033	ARCHXTNDR WIN DVD-RAM LEVEL I	D3	\$0
456-002-034	ARCHXTNDR WIN DVD-RAM LEVEL J	D3	\$0
456-002-035	ARCHXTNDR WIN DVD-RAM LEVEL K	D3	\$0
456-002-036	ARCHXTNDR WIN DVD-RAM LEVEL L	D3	\$0
456-002-037	ARCHXTNDR WIN DVD-RAM LEVEL M	D3	\$0
456-002-038	ARCHXTNDR WIN DVD-RAM LEVEL N	D3	\$0
456-002-039	ARCHXTNDR WIN DVD-RAM LEVEL O	D3	\$0
456-002-040	ARCHXTNDR WIN DVD-RAM LEVEL P	D3	\$0
456-002-041	ARCHXTNDR WIN DVD-RAM LEVEL Q	D3	\$0

456-002-042	ARCHXTNDR WIN DVD-RAM LEVEL R	D3	\$0
456-002-043	ARCHX WIN ROM LV A MIN CHGR 0- 7 SLTS	D3	\$0
456-002-044	ARCHX WIN ROM LV A 0- 16 CD/DVD ROM	D3	\$0
456-002-045	ARCHX WIN ROM LEVEL A UP TO 16 CHANGER	D3	\$0
456-002-046	ARCHX WIN ROM LV A 0- 32 CD/DVD ROM	D3	\$0
456-002-047	ARCHX WIN ROM LEVEL A UP TO 32 CHANGER	D3	\$0
456-002-048	ARCHX WIN ROM LV A 0- 64 CD/DVD ROM	D3	\$0
456-002-049	ARCHX WIN ROM LEVEL A UP TO 64 CHANGER	D3	\$0
456-002-050	ARCHX WIN ROM LEVEL A UP TO 8 CD/DVD ROM	D3	\$0
456-002-051	ARCHX WIN ROM LEVEL A UP TO 8 CHANGER	D3	\$0
456-002-052	ARCHIVEXTENDER FOR WINDOWS ROM LEVEL	D3	\$0
456-002-053	ARCHIVEXTENDER FOR WINDOWS ROM LEVEL	D3	\$0
456-002-054	ARCHIVEXTENDER FOR WINDOWS ROM LEVEL	D3	\$0
456-002-055	ARCHIVEXTENDER FOR WINDOWS ROM LEVEL	D3	\$0
456-002-056	ARCHIVEXTENDER FOR WINDOWS ROM LEVEL	D3	\$0
456-002-057	ARCHIVEXTENDER FOR WINDOWS ROM LEVEL	D3	\$0
456-002-058	ARCHIVEXTENDER FOR WINDOWS ROM LEVEL	D3	\$0
456-002-059	ARCHIVEXTENDER FOR WINDOWS ROM LEVEL	D3	\$0
456-002-060	ARCHIVEXTENDER FOR WINDOWS ROM LEVEL	D3	\$0
456-002-061	ARCHIVEXTENDER FOR WINDOWS ROM LEVEL	D3	\$0
456-002-062	ARCHIVEXTENDER FOR WINDOWS ROM LEVEL	D3	\$0
456-002-063	ARCHIVEXTENDER FOR WINDOWS ROM LEVEL	D3	\$0
456-002-064	ARCHIVEXTENDER FOR WINDOWS ROM LEVEL	D3	\$0
456-002-065	ARCHIVEXTENDER FOR WINDOWS ROM LEVEL	D3	\$0
456-002-066	ARCHIVEXTENDER FOR WINDOWS ROM LEVEL	D3	\$0
456-002-067	ARCHIVEXTENDER FOR WINDOWS ROM LEVEL	D3	\$0
456-002-068	ARCHIVEXTENDER FOR WINDOWS ROM LEVEL	D3	\$0
456-002-069	ARCHIVEXTENDER FOR WINDOWS ROM LEVEL	D3	\$0
456-002-070	ARCHIVEXTENDER FOR WINDOWS ROM LEVEL	D3	\$0
456-004-760	INA NETWORKER MODULE FOR IANYWHERE CL	D3	\$0
456-004-765	INA NETWORKER MOD FOR IANYWHERE WIN C	D3	\$0
456-004-766	INA NETWORKER MOD FOR IANYWHERE WIN C	D3	\$0
456-004-767	INA NETWORKER MOD FOR IANYWHERE WIN C	D3	\$0
456-004-768	INA NETWORKER MOD FOR IANYWHERE WIN C	D3	\$0
456-005-143	AUTOSTART FOR LINUX	D3	\$0
456-005-147	AUTOSTART FOR UNIX WG	D3	\$0
456-005-148	AUTOSTART FOR UNIX DP	D3	\$0
456-005-149	AUTOSTART FOR UNIX EN	D3	\$0
456-005-151	AUTOSTART FOR WINDOWS WG	D3	\$0
456-005-189	AUTOSTART DS SRDF WG	D3	\$0
456-005-190	AUTOSTART DS SRDF DP	D3	\$0
456-005-191	AUTOSTART DS SRDF EN	D3	\$0
456-005-198	AUTOSTART FOR WINDOWS DP	D3	\$0
456-005-199	AUTOSTART FOR WINDOWS EN	D3	\$0
456-005-205	AUTOSTART DS SRDF INTEL	D3	\$0
456-005-209	AUTOSTART MOD FOR MS SQL SERVER	D3	\$0
456-005-210	AUTOSTART DS MV WG	D3	\$0
456-005-211	AUTOSTART DS MV DP	D3	\$0
456-005-212	AUTOSTART DS MV EN	D3	\$0
456-005-213	AUTOSTART DS MV INTEL	D3	\$0

456-005-242	AUTOSTART MOD FOR EXCH2K3	D3	\$0
456-005-413	AUTOSTART MOD FOR ORA WG	D3	\$0
456-005-414	AUTOSTART MOD FOR ORA DP	D3	\$0
456-005-415	AUTOSTART MOD FOR ORA EN	D3	\$0
456-005-416	AUTOSTART MOD FOR ORA WN	D3	\$0
456-010-503	DISKXTENDER FOR NAS UNIX	D3	\$0
456-010-547	RETROSPECT USER INITIATED RESTORE	D3	\$0
456-010-548	RETROSPECT OPEN FILE BACKUP - 3 SERVERS	D3	\$0
456-010-549	RETROSPECT SMALL BUSINESS SVR-STD (CU)	D3	\$0
456-010-550	RETROSPECT ADD-ON VALUE PKAGE-SBS (CU)	D3	\$0
456-010-551	RETROSPECT OPEN FILE BACKUP 3 SVRS (CU)	D3	\$0
456-010-552	RETROSPECT USER INITIATED RESTORE (CU)	D3	\$0
456-010-553	RETROSPECT SERVER CLIENT 1-PACK (CU)	D3	\$0
456-010-554	RETROSPECT ADD-ON VALUE PACKAGE FOR S	D3	\$0
456-100-012	INA REPLISTOR WORKGROUP	D3	\$0
456-100-013	INA REPLISTOR DEPARTMENT/ENTERPRISE	D3	\$0
456-100-014	INA REPLISTOR WORKGROUP VIRTUAL	D3	\$0
456-100-015	INA REPLISTOR DEPARTMENT/ENTERPRISE VIF	D3	\$0
456-100-016	INA REPLISTOR WG TO DP/EN	D3	\$0
456-100-017	INA REPLISTOR WG TO WG_VIRTUAL	D3	\$0
456-100-018	INA REPLISTOR WG TO DP/EN_VIRTUAL	D3	\$0
456-100-019	INA REPLISTOR DP/EN TO DP/EN_VIRTUAL	D3	\$0
456-100-020	INA REPLISTOR WG_VIRTUAL 2 DP/EN_VIRTUAL	D3	\$0
456-100-038	DATA PROTECTION ADVISOR 50 CLNTS UPGRA	D3	\$0
456-100-116	DX SEARCH MODULE FOR ONE DXW SERVER=I	D3	\$0
456-100-117	DX SEARCH MOD 2-5 DXW SVR (PER SVR)=IA	D3	\$0
456-100-118	DX SEARCH MOD 6-10 DXW SVR(PER SVR)=IA	D3	\$0
456-100-145	DX FOR NAS - LINUX	D3	\$0
456-100-151	DX FOR NAS - UNIX	D3	\$0
456-100-156	HOMEBASE SERVER	D3	\$0
456-100-157	HOMEBASE AGENT FOR AIX	D3	\$0
456-100-158	HomeBase Agent for HP/UX	D3	\$0
456-100-159	HOMEBASE AGENT FOR SOLARIS	D3	\$0
456-100-160	HOMEBASE AGENT FOR WINDOWS	D3	\$0
456-100-161	HOMEBASE AGENT FOR LINUX	D3	\$0
456-100-162	HOMEBASE DISCOVERY AGENT FOR AIX	D3	\$0
456-100-163	HomeBase Discovery Agent for HP/UX	D3	\$0
456-100-164	HOMEBASE DISCOVERY AGENT FOR SOLARIS	D3	\$0
456-100-165	HOMEBASE DISCOVERY AGENT FOR WINDOWS	D3	\$0
456-100-166	HOMEBASE DISCOVERY AGENT FOR LINUX	D3	\$0
456-100-168	HOMEBASE PROXY SERVER	D3	\$0
456-100-485	HOMEBASE SE	D3	\$0
456-100-598	DX FOR UX/LX CAP UPGR FROM 1 TB TO 2 TB	D3	\$0
456-100-599	DX FOR UX/LX CAP UPGR FROM 2 TB TO 5 TB	D3	\$0
456-100-600	DX FOR UX/LX CAP UPGR FROM 5 TB TO 10 TB	D3	\$0
456-100-601	DX FOR UX/LX CAP UPGR FROM 10TB TO 15TB	D3	\$0
456-100-602	DX FOR UX/LX CAP UPGR FROM 15TB TO 20TB	D3	\$0
456-100-603	DX FOR UX/LX CAP UPGR FROM 20TB TO 32TB	D3	\$0
456-100-604	DX FOR UX/LX CAP UPGR FROM 32TB TO 64TB	D3	\$0
456-100-605	DX FOR UX/LX CAP UPGR FROM 64TB TO 100TB	D3	\$0

456-100-607	DATA PROTECTION ADVISOR 0-50 CLNTS UPG	D3	\$0
456-100-608	Data Protection Advisor UP TO 50 CLIENTS	D3	\$0
456-100-609	DATA PROTECTION ADVISOR 0- 100 CLIENTS	D3	\$0
456-100-610	DATA PROTECTION ADVISOR 0- 250 CLIENTS	D3	\$0
456-100-611	DATA PROTECTION ADVISOR 0- 500 CLIENTS	D3	\$0
456-100-612	DATA PROTECTION ADVISOR 0- 800 CLIENTS	D3	\$0
456-100-613	DATA PROTECTION ADVISOR 800+ CLNTS(EACH	D3	\$0
456-100-636	INA REPLISTOR AX4 VIRT WKGRP 2 ESX SVRS	D3	\$0
456-100-647	HomeBase SE Base Package	D3	\$0
456-100-648	HOMEBASE BMR ADDITIONAL AIX AGENT	D3	\$0
456-100-649	HOMEBASE BMR ADDITIONAL HP/UX AGENT	D3	\$0
456-100-650	HOMEBASE BMR ADDITIONAL SOLARIS AGENT	D3	\$0
456-100-651	HOMEBASE BMR ADDITIONAL WINDOWS AGEN	D3	\$0
456-100-652	HOMEBASE BMR ADDITIONAL SERVER	D3	\$0
456-100-653	HOMEBASE BMR ADDITIONAL LINUX AGENT	D3	\$0
456-100-654	AUTOSTART MOD FOR SQL2005 and 2008	D3	\$0
456-100-663	DPA: single disk array	D3	\$0
456-100-665	DPA: SINGLE DB SERVER	D3	\$0
456-100-670	HOMEBASE SERVER FOR ESR	D3	\$0
456-100-671	HOMEBASE PROXY SERVER FOR ESR	D3	\$0
456-100-708	AUTOSTART MOD FOR ORA LINUX	D3	\$0
456-100-709	AUTOSTART MOD FOR EXCH2K7	D3	\$0
456-101-254	STANDALONE DPA LICENSE FOR DISK LIBRARY	D3	\$0
456-101-268	HOMEBASE FOR ESR: AIX/SOLARIS-20 CLIENTS	D3	\$0
456-101-269	HOMEBASE FOR ESR:WINDOWS -20 CLIENTS	D3	\$0
456-101-270	HOMEBASE FOR ESR:REDHAT-LINUX-20 CLIENT	D3	\$0
456-101-271	PROMO: DPA 1TB AVAMAR CAP	D3	\$0
456-101-598	DPA SINGLE-USE ASSMNT LIC-ALL OPT-30 DYS	D3	\$0
456-101-599	DPA MULTI-USE ASSMNT LIC-ALL OPT-12 MOS	D3	\$0
456-101-600	PPATH COUNT OF HYPER-V HOSTS=IC	D3	\$0
456-101-620	RM for SnapView on Windows License	D3	\$0
456-101-621	RM for SnapView on Linux License	D3	\$0
456-101-622	RM for SnapView on Unix License	D3	\$0
456-101-623	RM for TimeFinder on Windows License	D3	\$0
456-101-624	RM for TimeFinder on Linux License	D3	\$0
456-101-625	RM for TimeFinder on Unix License	D3	\$0
456-101-628	RM Server License=IA	D3	\$0
456-101-629	RM for SANCopy on Windows License	D3	\$0
456-101-630	RM for SANCopy on Linux License	D3	\$0
456-101-631	RM for SANCopy on Unix License	D3	\$0
456-101-632	RM for iSCSI Celerra on Windows 2 Licens	D3	\$0
456-101-663	RM for RecoverPoint Windows	D3	\$0
456-101-664	RM VMWARE Proxy Host License=IA	D3	\$0
456-101-666	RM Agent License=ID	D3	\$0
456-101-667	RM Agent License 15 + hosts	D3	\$0
456-101-782	DPA: RA 1TB RECOVERPOINT CAPACITY	D3	\$0
456-101-783	DPA: 1TB RECOVERPOINT SE CAPACITY	D3	\$0
456-101-784	DPA: RA FOR CLARIION CX-120	D3	\$0
456-101-785	DPA: RA FOR CLARIION CX-240	D3	\$0
456-101-787	DPA: RA FOR CLARIION CX-960	D3	\$0

456-101-788	DPA: REPLICATION ANALYSIS BASE SERVER	D3	\$0
456-101-789	DPA: RA 1TB(0-14TB) RAW HI PERF	D3	\$0
456-101-790	DPA: RA 1TB (15-25TB) RAW HI PERF	D3	\$0
456-101-791	DPA: RA 1TB (26-40TB) HI PERF	D3	\$0
456-101-792	DPA: RA 1TB (41-60TB) HI PERF	D3	\$0
456-101-793	DPA: RA 1TB(61-100TB) HI PERF	D3	\$0
456-101-794	DPA: RA 1TB(101-150TB) HI PERF	D3	\$0
456-101-795	DPA: RA 1TB(151-250TB) HI PERF	D3	\$0
456-101-796	DPA: RA 1TB(251-400TB) HI PERF	D3	\$0
456-101-797	DPA: RA 1TB (401-600TB) HI PERF	D3	\$0
456-101-798	DPA: RA 1TB (601-1000TB) HI PERF	D3	\$0
456-101-799	DPA: RA 1TB (1001TB OR MORE) HI PERF	D3	\$0
456-101-867	DPA: RA 1TB (0-14TB) HIGH DENSITY	D3	\$0
456-101-868	DPA: RA 1TB (15-25TB) HIGH DENSITY	D3	\$0
456-101-869	DPA: RA 1TB (26-40TB) HIGH DENSITY	D3	\$0
456-101-870	DPA: RA 1TB (41-60TB) HIGH DENSITY	D3	\$0
456-101-871	DPA: RA 1TB (61-100TB) HIGH DENSITY	D3	\$0
456-101-872	DPA: RA 1TB (101-150TB) HIGH DENSITY	D3	\$0
456-101-873	DPA: RA 1TB (151-250TB) HIGH DENSITY	D3	\$0
456-101-874	DPA: RA 1TB (251-400TB) HIGH DENSITY	D3	\$0
456-101-875	DPA: RA 1TB (401-600TB) HIGH DENSITY	D3	\$0
456-101-876	DPA VNX/File: VNX 5100, VNX 5300	D3	\$0
456-101-878	DPA VNX/File: VNX 7500	D3	\$0
456-101-970	DPA: RA 1TB (601-1000TB) HIGH DENSITY	D3	\$0
456-101-971	DPA: RA 1TB (1001TB OR MORE)	D3	\$0
456-101-972	DPA: RA 1TB (0-14TB) REPLICATED CAP	D3	\$0
456-101-973	DPA: RA 1TB (15-25TB) REPLICATED CAP	D3	\$0
456-101-974	DPA: RA 1TB (26-40TB) REPLICATED CAP	D3	\$0
456-101-975	DPA:Replic. Analysis 1TB (41-60TB) Repl	D3	\$0
456-101-976	DPA:Replic. Analysis 1TB (61-100TB) Repl	D3	\$0
456-101-977	DPA: Replic. Analysis 1TB (101-150TB) Re	D3	\$0
456-101-978	DPA: RA 1TB (151-250TB) REPLICATED CAP	D3	\$0
456-101-979	DPA: RA 1TB (251-400TB) REPLICATED CAP	D3	\$0
456-101-980	DPA: REPLIC. ANALYSIS 1TB (401 TO 600TB)	D3	\$0
456-101-981	DPA: RA 1TB (601-1000TB)REPLICATED CAP	D3	\$0
456-101-982	DPA: RA 1TB (1001TB PLUS)REPLICATED CAP	D3	\$0
456-102-219	AUTOSTART MOD FOR EXCH2010	D3	\$0
456-102-251	RM Server - RP/SE Adv Prot	D3	\$0
456-102-252	RM Agent - RP/SE Adv Prot	D3	\$0
456-102-253	RM for VMware Datastore - RP/SE Adv Prot	D3	\$0
456-103-630	DPA RA Upg: CX4-120 to CX4-960	D3	\$0
456-103-632	DPA RA UPG: CX4-240 TO CX4-960	D3	\$0
456-103-633	DPA RA UPG: CX4-480 TO CX4-960	D3	\$0
456-103-657	POWERPATH PME-HC-BDL	D3	\$0
456-103-741	Greenplum DCA DB Client and Server SW	D3	\$0
456-104-495	RP/CL LOC REP CAP (0-14 TB)= CA	D3	\$4,700
456-104-496	RP/CL LOC REP CAP (15-25 TB) =CA	D3	\$3,595
456-104-497	RP/CL LOC REP CAP (26-40 TB) = CA	D3	\$3,330
456-104-498	RP/CL LOC REP CAP (41-60 TB) =CA	D3	\$2,820
456-104-499	RP/CL LOC REP CAP (61-100 TB) =CA	D3	\$2,640

456-104-500	RP/CL LOC REP CAP (101-150 TB) =CA	D3	\$2,400
456-104-501	RP/CL LOC REP CAP (151-250 TB) =CA	D3	\$2,255
456-104-502	RP/CL LOC REP CAP (251-400 TB) =CA	D3	\$2,100
456-104-503	RP/CL LOC REP CAP (401-600 TB) =CA	D3	\$1,840
456-104-504	RP/CL LOC REP CAP (601-1000TB) =CA	D3	\$1,545
456-104-505	RP/CL LOC REP CAP (1001TB+) =CA	D3	\$1,175
456-104-506	RP/CL REM REP CAP (0-14 TB) =CA	D3	\$4,700
456-104-507	RP/CL REM REP CAP (15-25 TB) =CA	D3	\$3,595
456-104-508	RP/CL REM REP CAP (26-40 TB) =CA	D3	\$3,330
456-104-509	RP/CL REM REP CAP (41-60 TB) =CA	D3	\$2,820
456-104-510	RP/CL REM REP CAP (61-100 TB) =CA	D3	\$2,640
456-104-511	RP/CL REM REP CAP (101-150 TB) =CA	D3	\$2,400
456-104-512	RP/CL REM REP CAP (151-250 TB) =CA	D3	\$2,255
456-104-513	RP/CL REM REP CAP (251-400 TB) =CA	D3	\$2,100
456-104-514	RP/CL REM REP CAP (401-600 TB) =CA	D3	\$1,840
456-104-515	RP/CL REM REP CAP (601-1000TB) =CA	D3	\$1,545
456-104-516	RP/CL REM REP CAP (1001TB+) =CA	D3	\$1,175
456-104-751	DISKXTENDER_FOR_WINDOWS_100GB=CA	D3	\$0
456-104-752	DISKXTENDER_FOR_WINDOWS_500GB=CA	D3	\$0
456-104-753	DISKXTENDER_FOR_WINDOWS_1TB=CA	D3	\$0
456-104-754	DISKXTENDER_FOR_WINDOWS_2TB=CA	D3	\$0
456-104-755	DISKXTENDER_FOR_WINDOWS_5TB=CA	D3	\$0
456-104-756	DISKXTENDER_FOR_WINDOWS_10TB=CA	D3	\$0
456-104-757	DISKXTENDER_FOR_WINDOWS_15TB=CA	D3	\$0
456-104-758	DISKXTENDER_FOR_WINDOWS_20TB=CA	D3	\$0
456-104-759	DISKXTENDER_FOR_WINDOWS_32TB=CA	D3	\$0
456-104-760	DISKXTENDER_FOR_WINDOWS_64TB=CA	D3	\$0
456-104-761	DISKXTENDER_FOR_WINDOWS_100TB=CA	D3	\$0
456-104-762	DISKXTENDER_FOR_WINDOWS_200TB=CA	D3	\$0
456-104-763	DISKXTENDER_FOR_WINDOWS_300TB=CA	D3	\$0
456-104-764	DISKXTENDER_FOR_WINDOWS_400TB=CA	D3	\$0
456-104-765	DISKXTENDER_FOR_WINDOWS_500TB=CA	D3	\$0
456-104-766	DISKXTENDER_FOR_WINDOWS_600TB=CA	D3	\$0
456-104-767	DISKXTENDER_FOR_WINDOWS_700TB=CA	D3	\$0
456-104-768	DISKXTENDER_FOR_WINDOWS_800TB=CA	D3	\$0
456-104-769	DISKXTENDER_FOR_WINDOWS_900TB=CA	D3	\$0
456-104-770	DISKXTENDER_FOR_WINDOWS_1PB=CA	D3	\$0
456-104-771	DX_WIN_UPGR_0.1TB_TO_0.5TB=CA	D3	\$0
456-104-772	DX_WIN_UPGR_0.5TB_TO_1TB=CA	D3	\$0
456-104-773	DX_WIN_UPGR_1TB_TO_2TB=CA	D3	\$0
456-104-774	DX_WIN_UPGR_2TB_TO_5TB=CA	D3	\$0
456-104-775	DX_WIN_UPGR_5TB_TO_10TB=CA	D3	\$0
456-104-776	DX_WIN_UPGR_10TB_TO_15TB=CA	D3	\$0
456-104-777	DX_WIN_UPGR_15TB_TO_20TB=CA	D3	\$0
456-104-778	DX_WIN_UPGR_20TB_TO_32TB=CA	D3	\$0
456-104-779	DX_WIN_UPGR_32TB_TO_64TB=CA	D3	\$0
456-104-780	DX_WIN_UPGR_64TB_TO_100TB=CA	D3	\$0
456-104-781	DX_WIN_FSM_SERVER=IA	D3	\$0
456-104-782	DX_WIN_FSM_CLUSTER=IA	D3	\$0
456-104-783	DX_WINDOWS_SDK_TOOLKIT=IA	D3	\$0

456-104-863	DPA RA: VNX5200 (BLOCK)=IC	D3	\$0
456-104-864	DPA RA: VNX5400 (BLOCK)=IC	D3	\$0
456-104-865	DPA RA: VNX5600 (BLOCK)=IC	D3	\$0
456-104-866	DPA RA: VNX5800 (BLOCK)=IC	D3	\$0
456-104-867	DPA RA: VNX7600 (BLOCK)=IC	D3	\$0
456-104-868	DPA RA: VNX8000 (BLOCK)=IC	D3	\$0
456-105-287	SRMSUITE AX TIER 1 =IC	D3	\$0
456-105-288	SRMSUITE CX/NS TIER 2 =IC	D3	\$0
456-105-289	SRMSUITE CX TIER 3 =IC	D3	\$0
456-105-290	SRMSUITE CX/NS TIER 4 =IC	D3	\$0
456-105-291	SRMSUITE CX/NS TIER 5 =IC	D3	\$0
456-105-369	SRMSUITE Vblock TIER 1 =IC	D3	\$0
456-105-370	SRMSUITE Vblock TIER 2 =IC	D3	\$0
456-105-371	SRMSUITE Vblock TIER 3 =IC	D3	\$0
456-105-372	SRMSUITE Vblock TIER 4 =IC	D3	\$0
456-105-373	SRMSUITE 3PTY TB =CB	D3	\$0
456-105-374	SRMSUITE HDS TB =CB	D3	\$0
456-105-375	SRMSUITE IBM DS TB =CB	D3	\$0
456-105-376	SRMSUITE XIV TB =CB	D3	\$0
456-105-377	SRMSUITE 3Par TB =CB	D3	\$0
456-105-378	SRMSUITE HP EVA TB =CB	D3	\$0
456-105-379	SRMSUITE NTAP TB =CB	D3	\$0
456-105-380	SRMSUITE Compellent TB =CB	D3	\$0
456-105-381	SRMSUITE 3PTY2 TB =CB	D3	\$0
456-105-388	SRMSUITE UPG AX TIER 1 =IC	D3	\$0
456-105-389	SRMSUITE UPG CX/NS TIER 2 =IC	D3	\$0
456-105-390	SRMSUITE UPG CX TIER 3 =IC	D3	\$0
456-105-391	SRMSUITE UPG CX/NS TIER 4 =IC	D3	\$0
456-105-392	SRMSUITE UPG CX/NS TIER 5 =IC	D3	\$0
456-105-466	SRMSUITE UPG DMX 1TB =CB	D3	\$0
456-105-474	SRMSUITE UPG 3PTY TB =CB	D3	\$0
456-105-475	SRMSUITE UPG HDS TB =CB	D3	\$0
456-105-476	SRMSUITE UPG IBM DS TB =CB	D3	\$0
456-105-477	SRMSUITE UPG XIV TB =CB	D3	\$0
456-105-478	SRMSUITE UPG 3Par TB =CB	D3	\$0
456-105-479	SRMSUITE UPG HP EVA TB =CB	D3	\$0
456-105-480	SRMSUITE UPG NTAP TB =CB	D3	\$0
456-105-481	SRMSUITE UPG Compellent TB =CB	D3	\$0
456-105-482	SRMSUITE UPG 3PTY2 TB =CB	D3	\$0
456-105-741	SRMSUITE STD HP XP/P9500 TB =CB	D3	\$0
456-105-742	SRM HP XP/P9500 TB =CB	D3	\$390
456-105-743	SRMSUITE UPG HP XP/P9500 TB =CB	D3	\$0
456-105-947	SRMSUITE VG GATEWAY =ID	D3	\$0
456-105-948	EMC SCALEIO SOFTWARE CAPACITY=CB	D3	\$0
456-105-949	EMC SCALEIO ENTERPRISE FEATURES=CB	D3	\$0
456-105-984	KZN LEGAL HOLD MGR=IA	D3	\$0
456-106-000	KZN EDSC FED ROE LICENSE=IA	D3	\$0
456-106-002	KZN EDSC FED NODE LICENSE=IA	D3	\$0
456-106-008	KZN EDSC SW (PER TB)=CA	D3	\$0
456-106-012	KZN FILE INT ENT-EDSC UPGRADE=IA	D3	\$0

456-106-127	RecoverPoint - VM REM 1(1-99 VM)=IB	D3	\$0
456-106-128	RecoverPoint - VM REM 1(100-249 VM)=IB	D3	\$0
456-106-129	RecoverPoint - VM REM 1(250-499 VM)=IB	D3	\$0
456-106-130	RecoverPoint - VM REM 1(500-999 VM)=IB	D3	\$0
456-106-131	RecoverPoint -VM REM 1(1000-1999 VM)=IB	D3	\$0
456-106-132	RecoverPoint - VM REM 1(2000+ VM)=IB	D3	\$0
456-106-133	RecoverPoint - VM REM 2 (1-99 VM) =IB	D3	\$0
456-106-134	RecoverPoint - VM REM 2(100-249 VM) =IB	D3	\$0
456-106-154	EMC SCALEIO SOFTWARE CAPACITY=CB	D3	\$0
456-106-155	EMC SCALEIO ENTERPRISE FEATURES=CB	D3	\$0
456-106-439	RP VIRTUAL APPLIANCE FOR V5200/V5300=IB	D3	\$860
456-106-440	RP VIRTUAL APPLIANCE v54-v80 & VNX-F=IB	D3	\$8,570
456-106-491	RecoverPoint - VM REM 2(250-499) VM) =IB	D3	\$0
456-106-492	RecoverPoint - VM REM 2 (500-999) VM=IB	D3	\$0
456-106-493	RecoverPoint - VM REM 2(1000-1999) VM=IB	D3	\$0
456-106-494	RecoverPoint - VM REM 2 (2000+) VM) =IB	D3	\$0
456-106-495	RecoverPoint - VM LOC (1-99 VM) =IB	D3	\$1,240
456-106-496	RecoverPoint - VM LOC(100-249 VM) =IB	D3	\$1,175
456-106-497	RecoverPoint - VM LOC (250-499) VM) =IB	D3	\$1,120
456-106-498	RecoverPoint - VM LOC (500-999) VM) =IB	D3	\$1,060
456-106-499	RecoverPoint - VM LOC (1000-1999) VM=IB	D3	\$1,010
456-106-500	RecoverPoint - VM LOC (2000+) VM) =IB	D3	\$955
456-106-648	EMC Ent HCP SW - VMware = IC	D3	\$0
456-106-703	RecoverPoint Remote-SIO (12-100 TB)=CA	D3	\$0
456-106-704	RecoverPoint Remote-SIO (101-250 TB)=CA	D3	\$0
456-106-705	RecoverPoint Remote-SIO (251-500 TB)=CA	D3	\$0
456-106-706	RecoverPoint Remote-SIO(501-1000 TB)=CA	D3	\$0
456-106-707	RecoverPoint Remote-SIO(1001-5000 TB)=CA	D3	\$0
456-106-708	RecoverPoint Remote-SIO(5001 -10K TB)=CA	D3	\$0
456-106-709	RecoverPoint Remote-SIO (10001+ TB)=CA	D3	\$0
456-106-710	RecoverPoint Remote SIO Upgrade=CA	D3	\$0
456-106-711	VIRTUAL RPA FOR SIO =IB	D3	\$0
456-106-720	RecoverPoint for VM (15-99 VM)=IB	D3	\$1,240
456-106-721	RecoverPoint for VM (100-249 VM)=IB	D3	\$1,175
456-106-722	RecoverPoint for VM (250-499 VM)=IB	D3	\$1,120
456-106-723	RecoverPoint for VM (500-999 VM)=IB	D3	\$1,060
456-106-724	RecoverPoint for VM (1000-1999 VM)=IB	D3	\$1,010
456-106-725	RecoverPoint for VM (2000+ VM)=IB	D3	\$955
456-106-727	RecoverPoint for VM VSPEX Blue REM 1=IB	D3	\$0
456-106-728	RecoverPoint for VM VSPEX Blue REM 2=IB	D3	\$0
456-106-729	RecoverPoint for VM VSPEX Blue LOC=IB	D3	\$0
456-106-736	RecoverPoint-VM Storage Analytics UG=IB	D3	\$0
456-106-740	RTI PERP=ZC	D3	\$0
456-106-741	REAL TIME INTELLIGENCE MONTHLY SUBSC=ZC	D3	\$0
456-106-742	RTI 2yr Sub=ZC	D3	\$0
456-106-743	RTI 3yr Sub=ZC	D3	\$0
456-106-929	EMC SIO SW Basic Starter Pack 12TB=CB	D3	\$0
456-106-930	EMC SIO Ent Starter Pack 12 TB=CB	D3	\$0
456-106-931	EMC SIO SW Basic Tier 1=CB	D3	\$0
456-106-932	EMC SIO SW Basic Tier 2=CB	D3	\$0

456-106-933	EMC SIO SW Basic Tier 3=CB	D3	\$0
456-106-934	EMC SIO SW Basic Tier 4=CB	D3	\$0
456-106-935	EMC SIO SW Basic Tier 5=CB	D3	\$0
456-106-936	EMC SIO SW Basic Tier 6=CB	D3	\$0
456-106-937	EMC SIO SW Basic Tier 7=CB	D3	\$0
456-106-938	EMC SIO Ent Tier 1=CB	D3	\$850
456-106-939	EMC SIO Ent Tier 2=CB	D3	\$770
456-106-940	EMC SIO Ent Tier 3=CB	D3	\$690
456-106-941	EMC SIO Ent Tier 4=CB	D3	\$620
456-106-942	EMC SIO Ent Tier 5=CB	D3	\$560
456-106-943	EMC SIO Ent Tier 6=CB	D3	\$490
456-106-944	EMC SIO Ent Tier 7=CB	D3	\$440
456-106-957	IONIX ITOPS OPTICAL TRANSPORT MGR KIT=MA	D3	\$175,000
456-106-958	IONIX IT OPS OTM MANAGED DEVICE L11=MA	D3	\$2,300
456-106-959	IONIX IT OPS OTM MANAGED DEVICE L21=MA	D3	\$1,725
456-106-960	IONIX IT OPS OTM MANAGED DEVICE L31=MA	D3	\$1,334
456-106-961	IONIX IT OPS OTM MANAGED DEVICE L41=MA	D3	\$1,081
456-106-962	ACM MANAGED SYSTEM=MA	D3	\$90
456-106-963	ACM Prod RTU Lic=MA	D3	\$36,000
456-106-964	AL5620 SAM ADP-P/PER SERV=MA	D3	\$75,000
456-106-965	BMC Patrol ADP - P=MA	D3	\$9,000
456-106-966	Concord eHealth ADP - P=MA	D3	\$9,000
456-106-967	CONCORD SYSEGE ADP - P=MA	D3	\$9,000
456-106-968	CIENA C.D TMF 814 ADP - P=MA	D3	\$75,000
456-106-969	CISCO CTM TMF 814 ADP - P=MA	D3	\$75,000
456-106-970	E-Mail ADP - P=MA	D3	\$4,500
456-106-971	ISC Adp - Production Lic=MA	D3	\$22,500
456-106-972	InfoVista Server ADP - P=MA	D3	\$9,000
456-106-973	Log File ADP - P=MA	D3	\$4,500
456-106-974	NetIQ ADP - P=MA	D3	\$9,000
456-106-975	OUTBOUND SNMP ADP - P=MA	D3	\$4,500
456-106-976	ADP MICROSOFT SYS CTR OPS MGR 2007 PRO=M	D3	\$18,000
456-106-977	Remedy ADP - P=MA	D3	\$9,000
456-106-978	Script ADP - P=MA	D3	\$4,500
456-106-979	CLAR-CEL-SYM ADP SITE LIC=MA	D3	\$18,000
456-106-980	SQL Unix ADP(p/server)-P=MA	D3	\$4,500
456-106-981	SQL Windows ADP - P=MA	D3	\$4,500
456-106-982	Syslog ADP - P=MA	D3	\$0
456-106-983	SNMP Trap ADP - P=MA	D3	\$0
456-106-984	XML ADP - P=MA	D3	\$4,500
456-106-985	AM Mgd High End Device=MA	D3	\$13
456-106-986	IP AM - NAS EXTENSION (2)=MA	D3	\$90
456-106-987	IP AM - NAS EXTENSION (1)=MA	D3	\$90
456-106-988	AM Production License=MA	D3	\$22,500
456-106-989	ITOI C API LICENSE=MA	D3	\$0
456-106-990	ITOI JAVA API LICENSE=MA	D3	\$0
456-106-991	ITOI PERL API LICENSE=MA	D3	\$0
456-106-992	ITOI BUSINESS IMPACT MANAGER=MA	D3	\$31,500
456-106-993	DM Static Ent License=MA	D3	\$9,000
456-106-994	DM Static SP License=MA	D3	\$9,000

456-106-995	DM Traveling License=MA	D3	\$90,000
456-106-996	ITOI BUSNS DASHBRD 1 CONCURRENT USER=	D3	\$900
456-106-997	ITOI BUSNS DASHBRD 2500 CONCURRNT USR=	D3	\$152,280
456-106-998	ITOI BUSNS DASHBRD 5 CONCURRENT USERS=	D3	\$2,835
456-106-999	ITOI BUSNS DASHBRD 10 CONCURRNT USERS=	D3	\$4,050
456-107-000	ITOI BUSNS DASHBRD 25 CONCURRENT USER=	D3	\$8,100
456-107-001	ITOI BUSNS DASHBRD 50 CONCURRNT USERS=	D3	\$13,770
456-107-002	ITOI BUSNS DASHBRD 100 CONCURRNT USRS=	D3	\$20,250
456-107-003	ITOI BUSNS DASHBRD 250 CONCURRNT USRS=	D3	\$40,500
456-107-004	ITOI BUSNS DASHBRD 500 CONCURRNT USRS=	D3	\$60,750
456-107-005	ITOI BUSNS DASHBRD 1000 CONCURRNT USR=	D3	\$81,000
456-107-006	ITOI BUSINESS DASHBOARD PRODUCTION=MA	D3	\$13,500
456-107-007	ITOI SRVR MGR-APP PROCESS MGMT MODULE=	D3	\$13,500
456-107-008	ITOI SRVR MGR-CLUSTER MGT MOD- SITE=MA	D3	\$13,500
456-107-009	F5 LOAD BALANCER MGMT MODULE=MA	D3	\$13,500
456-107-010	MICROSOFT HYPER-V MGMT MODULE=MA	D3	\$13,500
456-107-011	EMC SERVER MANAGER - PROD LICENSE=MA	D3	\$13,500
456-107-012	ITOI SERVER MGR - VM MODULE- SITE=MA	D3	\$13,500
456-107-013	ACM EXP PACK UPG 1=MA	D3	\$24,300
456-107-014	ACM EXP PACK UPG 2=MA	D3	\$100,800
456-107-015	ACM EXP PACK UPG 3=MA	D3	\$76,500
456-107-016	ASM Express Pack Upg 1=MA	D3	\$17,000
456-107-017	ASM Express Pack Upg 2=MA	D3	\$65,875
456-107-018	ASM Express Pack Upg 3=MA	D3	\$48,875
456-107-019	BI Express Pack Upg 1=MA	D3	\$37,000
456-107-020	BI Express Pack Upg 2=MA	D3	\$145,875
456-107-021	BI Express Pack Upg 3=MA	D3	\$108,875
456-107-022	NAS EXPRESS PACK 50 to 100 UPG - P=MA	D3	\$14,400
456-107-023	NAS EXPRESS PACK 100 to 200 UPG - P=MA	D3	\$57,600
456-107-024	NAS EXPRESS PACK 100 to 250 UPG - P=MA	D3	\$43,200
456-107-025	Express Pack Upg 1=MA	D3	\$18,000
456-107-026	Express Pack Upg 2=MA	D3	\$72,000
456-107-027	Express Pack Upg 3=MA	D3	\$54,000
456-107-028	GLOBAL CONSOLE 100=MA	D3	\$72,000
456-107-029	GLOBAL CONSOLE 10=MA	D3	\$22,500
456-107-030	GLOBAL CONSOLE 1=MA	D3	\$4,500
456-107-031	GLOBAL CONSOLE 25=MA	D3	\$36,000
456-107-032	GLOBAL CONSOLE 3=MA	D3	\$10,800
456-107-033	GLOBAL CONSOLE 50=MA	D3	\$54,000
456-107-034	IP AM Mgd Tier 1 Lic=MA	D3	\$225
456-107-035	IP AM Mgd Tier 1: 501-1000 Lic=MA	D3	\$216
456-107-036	IP AM MGD TIER 1 DEVICES: 1001-1500=MA	D3	\$198
456-107-037	IP AM MGD TIER 1 DEVICES: 1501-2500=MA	D3	\$180
456-107-038	IP AM MGD TIER 1 DEVICES: 2501-5000=MA	D3	\$149
456-107-039	IP AM MGD TIER 1 DEVICES: 5001-10000=MA	D3	\$122
456-107-040	IP AM Mgd Tier 1: 10,001+ =MA	D3	\$90
456-107-041	IP AM Mgd Tier 2 Lic=MA	D3	\$18
456-107-042	IP AM Mgd Tier 2: 501-1000=MA	D3	\$17
456-107-043	IP AM MGD TIER 2 DEVICES: 1001-1500=MA	D3	\$16
456-107-044	IP AM MGD TIER 2 DEVICES: 1501-2500=MA	D3	\$15

456-107-045	IP AM MGD TIER 2 DEVICES: 2501-5000=MA	D3	\$14
456-107-046	IP AM MGD TIER 2 DEVICES: 5001-10000=MA	D3	\$12
456-107-047	IP AM Mgd Tier 2: 10,001+ =MA	D3	\$10
456-107-048	IP AM Mgd Tier 3 Lic=MA	D3	\$54
456-107-049	IP AM Mgd Tier 3: 501-1000=MA	D3	\$50
456-107-050	IP AM MGD TIER 3 DEVICES: 1001-1500=MA	D3	\$45
456-107-051	IP AM MGD TIER 3 DEVICES: 1501-2500=MA	D3	\$41
456-107-052	IP AM MGD TIER 3 DEVICES: 2501-5000=MA	D3	\$36
456-107-053	IP AM MGD TIER 3 DEVICES: 5001-10000=MA	D3	\$32
456-107-054	IP AM Mgd Tier 3: 10,001+=MA	D3	\$23
456-107-055	IP AM Mgd Tier 4 NAS Lic=MA	D3	\$32
456-107-056	IP AM MGD TIER 4 NAS DEVICES:101-250=MA	D3	\$27
456-107-057	IP AM MGD TIER 4 NAS DEVICES:251+UP=MA	D3	\$23
456-107-059	MULTICAST MGD DEV LIC=MA	D3	\$125
456-107-060	MULTICAST MGD DEV: 501-1,000 =MA	D3	\$120
456-107-061	MULTICAST MGR DEVICES: 1001-1500=MA	D3	\$110
456-107-062	MULTICAST MGR DEVICES: 1501-2500=MA	D3	\$100
456-107-063	MULTICAST MGR DEVICES: 2501-5000=MA	D3	\$85
456-107-064	MULTICAST MGR DEVICES: 5001-10000=MA	D3	\$70
456-107-065	MULTICAST MGD DEV: 10,000+ =MA	D3	\$50
456-107-066	MULTICAST MGR: MULTICST VPN FEATURE=MA	D3	\$35,000
456-107-067	MULTICAST PRODUCTION LIC=MA	D3	\$25,000
456-107-068	MPLSMGD LAY3 CE DEV LIC=MA	D3	\$150
456-107-069	MPLS MGD LAY3 CE DEVICES: 2501-5000=MA	D3	\$144
456-107-070	MPLS MGD LAY3 CE DEVICES: 5001-10000=MA	D3	\$132
456-107-071	MPLS MGD LAY3 CE DEVICES: 10001-25000=MA	D3	\$126
456-107-072	MPLS MGD LAY3 CE DEVICES: 25001-50000=MA	D3	\$120
456-107-073	MPLS MGD LAY3 CE DEVICES: 50001+UP=MA	D3	\$105
456-107-074	MPLSMGD LAY2 FWD INTF LIC=MA	D3	\$75
456-107-075	MPLS MGD LAY2 FRWRDR INTFC:201-1000=MA	D3	\$72
456-107-076	MPLS MGD LAY2 FRWRDR INTFC:1001-4000=MA	D3	\$66
456-107-077	MPLS MGD LAY2 FRWRDR INTFC:4001-20000=M	D3	\$63
456-107-078	MPLS MGD LAY2 FRWRDR INTFC:20001-100K=M	D3	\$60
456-107-079	MPLS MGD LAY2 FRWRDR INTFC:100K+UP=MA	D3	\$53
456-107-080	MPLS PRODUCTION LICENSE=MA	D3	\$100,000
456-107-081	MPLSMGD LAY3 VRF INTF LIC=MA	D3	\$50
456-107-082	MPLS MGD LAY3 VRF INTFC: 2501-5000=MA	D3	\$48
456-107-083	MPLS MGD LAY3 VRF INTFC: 5001-10000=MA	D3	\$44
456-107-084	MPLS MGD LAY3 VRF INTFC: 10001-25000=MA	D3	\$42
456-107-085	MPLS MGD LAY3 VRF INTFC: 25001-50000=MA	D3	\$40
456-107-086	MPLS MGD LAY3 VRF INTFC: 50001+UP=MA	D3	\$35
456-107-087	IPV6 AVAILABILITY MGR - PRODUCTION=MA	D3	\$26,100
456-107-088	EMC NOTIFICATION MANAGER=MA	D3	\$67,500
456-107-089	NPM MGD DEVICES LIC=MA	D3	\$113
456-107-090	NPM MGD DEVICES: 501-1,000=MA	D3	\$108
456-107-091	NPM MGD DEVICES: 1,001-1,500=MA	D3	\$99
456-107-092	NPM MGD DEVICES: 1,501-2,500=MA	D3	\$90
456-107-093	NPM MGD DEVICES: 2,501-5,000=MA	D3	\$77
456-107-094	NPM MGD DEVICES: 5,001-10,000=MA	D3	\$63
456-107-095	NPM MGD DEVICES: 10,001+=MA	D3	\$45

456-107-096	NPM PRODUCTION LICENSE=MA	D3	\$22,500
456-107-097	OLIP Production License=MA	D3	\$18,000
456-107-098	IP AM Mgd P&I Lic=MA	D3	\$1,080
456-107-099	IP AM MGD PORTS&INTRFCS: 5001-10000=MA	D3	\$990
456-107-100	IP AM MGD PORTS&INTRFCS: 10001-25000=MA	D3	\$900
456-107-101	IP AM MGD PORTS&INTRFCS: 25001-50000=MA	D3	\$810
456-107-102	IP AM MGD PORTS&INTRFCS: 50001-100K=MA	D3	\$720
456-107-103	IP AM MGD PORTS&INTRFCS: 100001-250K=MA	D3	\$540
456-107-104	IP AM MGD PORTS&INTRFCS: 250001-500K=MA	D3	\$450
456-107-105	IP AM MGD PORTS&INTRFCS: 500001-1M=MA	D3	\$360
456-107-106	IP AM MGD PORTS&INTRFCS: 1000001-1.5M=MA	D3	\$270
456-107-107	IP AM MGD PORTS&INTRFCS: 1500001-2M=MA	D3	\$180
456-107-108	IP AM Mgd P&I: 2MM + Lic 91.7% Disc=MA	D3	\$90
456-107-109	PM Production License=MA	D3	\$9,000
456-107-110	RCA Upgrade License=MA	D3	\$18,000
456-107-111	SERVICE ASSURANCE MGR - PRODUCTION=MA	D3	\$36,000
456-107-112	ITOPS DYNAMIC MODEL COMPILER LICENSE=M	D3	\$10,000
456-107-113	SMARTS DYNAMIC MODEL=MA	D3	\$0
456-107-114	ITOI ITOPS DYNAMIC MODEL LOADER LIC=MA	D3	\$0
456-107-115	SPM PRODUCTION LICENSE=MA	D3	\$10,000
456-107-116	SDN SR for Smarts=MA=MA	D3	\$0
456-107-117	EMC SMARTS VOIP ENBLMNT PACK FOR AVAY=	D3	\$25,000
456-107-118	VOIP - CISCO IP MODULE=MA	D3	\$25,000
456-107-119	EMC SMARTS VOIP AM PRODUCTION LICENSE=	D3	\$40,000
456-107-120	VOIP MGMT SUITE PROD RTU PER DCTR/NOC=I	D3	\$50,000
456-107-121	WIFI ACCESS POINTS LICENSE 1-1000=MA	D3	\$38
456-107-122	WIFI ACCESS POINTS LICENSE 1001-5000=MA	D3	\$33
456-107-123	WIFI ACCESS POINTS LICENSE 5001-10000=MA	D3	\$25
456-107-124	WIFI CONTROLLER LICENSE COUNT=MA	D3	\$200
456-107-125	WIRELESS MANAGER - FAILOVER LICENSE=MA	D3	\$7,500
456-107-126	WIRELESS MANAGER - PRODUCTION LICENSE=	D3	\$15,000
456-107-194	SRMSUITE IBM V7000 TB=CB	D3	\$0
456-107-281	PowerPath VE Bundle =IC	D3	\$0
456-107-805	RP4VM for VNXe3200 STARTER PACK =IB	D3	\$0
456-108-124	RP/CL LOC BASE LIC=IC	D3	\$26,400
456-108-125	RP/CL REM BASE LIC=IC	D3	\$26,400
456-108-162	VIPR SRM UPG IBM DS BASE =IC	D3	\$4,820
456-108-164	VIPR SRM UPG HP XP/P9500 BASE =IC	D3	\$4,820
456-108-165	VIPR SRM UPG NTAP BASE =IC	D3	\$4,820
456-108-167	POWERPATH PP-NON-X86-T1 =ZC	D3	\$1,400
456-108-168	POWERPATH PP-NON-X86-T2 =ZC	D3	\$1,335
456-108-169	POWERPATH PP-NON-X86-V1 =ZC	D3	\$1,200
456-108-170	POWERPATH PP-NON-X86-V2 =ZC	D3	\$1,100
456-108-171	POWERPATH PP-X86-T1 =ZC	D3	\$595
456-108-172	POWERPATH PP-X86-T2 =ZC	D3	\$550
456-108-173	POWERPATH PP-X86-V1 =ZC	D3	\$500
456-108-174	POWERPATH PP-X86-V2 =ZC	D3	\$450
456-108-175	POWERPATH/VE STD. VOLUME (1,000+)=ZC	D3	\$1,050
456-108-177	POWERPATH/VE STD. VOLUME (3,000+)=ZC	D3	\$900
456-108-179	POWERPATH/VE STD. VOLUME (500+)=ZC	D3	\$1,200

456-108-180	POWERPATH/VE? ADD-ON VOL (200+ CPU)=ZC	D3	\$900
456-108-181	POWERPATH/VE ADD-ON VOL (100-199 CPU)=ZC	D3	\$1,000
456-108-182	POWERPATH/VE STD. VOL (100-199 CPU)=ZC	D3	\$1,500
456-108-183	POWERPATH/VE STD. VOL (200+ CPU)=ZC	D3	\$1,350
456-108-188	POWERPATH/VE ADD-ON X86 T1 (1-7 CPU)=ZC	D3	\$1,200
456-108-189	POWERPATH/VE ADD-ON X86 T2 (8+ CPUS)=ZC	D3	\$1,100
456-108-190	POWERPATH/VE STD. X86 T1 (1-7 CPUS)=ZC	D3	\$1,785
456-108-191	POWERPATH/VE STD. X86 T2 (8+ CPUS)=ZC	D3	\$1,645
456-108-654	DX FOR WIN FILE SYS MGR=IA	D3	\$0
456-108-782	SRMSUITE IBM V7000 BASE=IC	D3	\$7,920
456-109-268	SRM 3PTY BASE =IC	D3	\$7,920
456-109-269	SRM HDS BASE =IC	D3	\$7,920
456-109-270	SRM IBM DS BASE =IC	D3	\$7,920
456-109-271	SRM XIV BASE =IC	D3	\$7,920
456-109-272	SRM 3Par BASE =IC	D3	\$7,920
456-109-273	VIPR SRM HP EVA BASE =IC	D3	\$7,920
456-109-274	SRM HP XP/P9500 BASE =IC	D3	\$4,820
456-109-275	SRM NTAP BASE =IC	D3	\$7,920
456-109-276	VIPR SRM Compellent BASE =IC	D3	\$7,920
456-109-277	SRM 3PTY2 BASE =IC	D3	\$7,920
456-109-278	SRM IBM V7000 BASE=IC	D3	\$7,920
456-109-371	CLOUDARRAY SW FC AP 20TBU - 40TBU UPG=IC	D3	\$53,360
456-109-562	RP4VM Starter Pack for VxFLEX OS=IB	D3	\$0
456-110-063	EMC SIO SW Tier 1=CB	D3	\$1,250
456-110-064	EMC SIO SW Tier 2=CB	D3	\$1,130
456-110-065	EMC SIO SW Tier 3=CB	D3	\$1,020
456-110-066	EMC SIO SW Tier 4=CB	D3	\$920
456-110-067	EMC SIO SW Tier 5=CB	D3	\$830
456-110-068	EMC SIO SW Tier 6=CB	D3	\$740
456-110-069	EMC SIO SW Tier 7=CB	D3	\$670
456-110-121	RecoverPoint Local - SIO(12 -100 TB)=CA	D3	\$0
456-110-122	RecoverPoint Local - SIO(101-250 TB)=CA	D3	\$0
456-110-123	RecoverPoint Local - SIO(251-500 TB)=CA	D3	\$0
456-110-124	RecoverPoint Local - SIO(501-1000 TB)=CA	D3	\$0
456-110-125	RecoverPoint Local - SIO(1001-5K TB)=CA	D3	\$0
456-110-126	RecoverPoint Local - SIO(5001-10K TB)=CA	D3	\$0
456-110-127	RecoverPoint Local - SIO(10,001+ TB)=CA	D3	\$0
456-110-159	EMC Storage Analytics for SIO Tier 1=CB	D3	\$0
456-110-160	EMC Storage Analytics for SIO Tier 2=CB	D3	\$0
456-110-161	EMC Storage Analytics for SIO Tier 3=CB	D3	\$0
456-110-162	EMC Storage Analytics for SIO Tier 4=CB	D3	\$0
456-110-163	EMC Storage Analytics for SIO Tier 5=CB	D3	\$0
456-110-164	EMC Storage Analytics for SIO Tier 6=CB	D3	\$0
456-110-165	EMC Storage Analytics for SIO Tier 7=CB	D3	\$0
456-110-224	CLOUDARRAY SW FOR FC APPLIANCE 40TBU=IC	D3	\$100,000
456-110-229	EMC SIO SW lic key delivery=CB	D3	\$0
456-110-230	VCE ESRs ENABLER=IA	D3	\$0
456-110-300	VS T1 NPSUITE SRM LICENSE=CB	D3	\$0
456-110-301	VS T2 NPSUITE SRM LICENSE=CB	D3	\$0
456-110-302	VS T3 NPSUITE SRM LICENSE=CB	D3	\$0

456-110-303	T1 SRM SA 1-50TB=CB	D3	\$1,070
456-110-304	T1 SRM SA 51-150TB=CB	D3	\$1,060
456-110-305	T1 SRM SA 151-300TB=CB	D3	\$1,060
456-110-306	T1 SRM SA 301-450TB=CB	D3	\$1,050
456-110-307	T1 SRM SA 451-750TB=CB	D3	\$980
456-110-308	T1 SRM SA 751-1500TB=CB	D3	\$820
456-110-309	T1 SRM SA 1501-3000TB=CB	D3	\$780
456-110-310	T1 SRM SA 3001-5000TB=CB	D3	\$700
456-110-311	T1 SRM SA 5001-10000TB=CB	D3	\$540
456-110-312	T1 SRM SA 10001+TB=CB	D3	\$460
456-110-313	T2 SRM SA 1-50TB=CB	D3	\$660
456-110-314	T2 SRM SA 51-150TB=CB	D3	\$620
456-110-315	T2 SRM SA 151-300TB=CB	D3	\$580
456-110-316	T2 SRM SA 301-450TB=CB	D3	\$530
456-110-317	T2 SRM SA 451-750TB=CB	D3	\$480
456-110-318	T2 SRM SA 751-1500TB=CB	D3	\$340
456-110-319	T2 SRM SA 1501-3000TB=CB	D3	\$320
456-110-320	T2 SRM SA 3001-5000TB=CB	D3	\$300
456-110-321	T2 SRM SA 5001-10000TB=CB	D3	\$280
456-110-322	T2 SRM SA 10001+TB=CB	D3	\$260
456-110-323	T3 SRM SA 1-50TB=CB	D3	\$420
456-110-324	T3 SRM SA 51-150TB=CB	D3	\$390
456-110-325	T3 SRM SA 151-300TB=CB	D3	\$370
456-110-326	T3 SRM SA 301-450TB=CB	D3	\$340
456-110-327	T3 SRM SA 451-750TB=CB	D3	\$310
456-110-328	T3 SRM SA 751-1500TB=CB	D3	\$280
456-110-329	T3 SRM SA 1501-3000TB=CB	D3	\$260
456-110-348	VS T1 NPSUITE VIPRC LICENSE=CB	D3	\$0
456-110-349	VS T2 NPSUITE VIPRC LICENSE=CB	D3	\$0
456-110-350	VS T3 NPSUITE VIPRC LICENSE=CB	D3	\$0
456-110-351	T1 VIPRC SA 1-50TB=CB	D3	\$555
456-110-352	T1 VIPRC SA 51-150TB=CB	D3	\$550
456-110-353	T1 VIPRC SA 151-300TB=CB	D3	\$544
456-110-354	T1 VIPRC SA 301-450TB=CB	D3	\$540
456-110-355	T1 VIPRC SA 451-750TB=CB	D3	\$510
456-110-356	T1 VIPRC SA 751-1500TB=CB	D3	\$430
456-110-357	T1 VIPRC SA 1501-3000TB=CB	D3	\$410
456-110-358	T1 VIPRC SA 3001-5000TB=CB	D3	\$370
456-110-359	T1 VIPRC SA 5001-10000TB=CB	D3	\$280
456-110-360	T1 VIPRC SA 10001+TB=CB	D3	\$240
456-110-361	T2 VIPRC SA 1-50TB=CB	D3	\$375
456-110-362	T2 VIPRC SA 51-150TB=CB	D3	\$370
456-110-363	T2 VIPRC SA 151-300TB=CB	D3	\$340
456-110-364	T2 VIPRC SA 301-450TB=CB	D3	\$320
456-110-365	T2 VIPRC SA 451-750TB=CB	D3	\$290
456-110-366	T2 VIPRC SA 751-1500TB=CB	D3	\$250
456-110-367	T2 VIPRC SA 1501-3000TB=CB	D3	\$230
456-110-368	T2 VIPRC SA 3001-5000TB=CB	D3	\$220
456-110-369	T2 VIPRC SA 5001-10000TB=CB	D3	\$210
456-110-370	T2 VIPRC SA 10001+TB=CB	D3	\$200

456-110-371	T3 VIPRC SA 1-50TB=CB	D3	\$300
456-110-372	T3 VIPRC SA 51-150TB=CB	D3	\$0
456-110-373	T3 VIPRC SA 151-300TB=CB	D3	\$0
456-110-374	T3 VIPRC SA 301-450TB=CB	D3	\$0
456-110-375	T3 VIPRC SA 451-750TB=CB	D3	\$0
456-110-376	T3 VIPRC SA 751-1500TB=CB	D3	\$0
456-110-377	T3 VIPRC SA 1501-3000TB=CB	D3	\$0
456-110-421	T3 SRM SA 3001-5000TB=CB	D3	\$230
456-110-422	T3 SRM SA 5001-10000TB=CB	D3	\$210
456-110-423	T3 SRM SA 10001TB+=CB	D3	\$190
456-110-424	T3 VIPRC SA 3001-5000TB=CB	D3	\$0
456-110-425	T3 VIPRC SA 5001-10000TB=CB	D3	\$0
456-110-426	T3 VIPRC SA 10001TB+=CB	D3	\$0
456-110-456	POWERPATH VE HOST LICENSES SRV/USRV=IA	D3	\$0
456-110-457	POWERPATH VE BUNDLE=IC	D3	\$8,554
456-110-510	FEHC-Master-Order-Agreement=ID	D3	\$0
456-110-539	VS SRM SIO Tier 0 TB=CB	D3	\$450
456-110-553	VS VIPRC SIO LIC=CB	D3	\$0
456-110-555	CLOUDARRAY SW FOR FC APPLIANCE 20TBU=IC	D3	\$66,700
456-110-686	SRM AX TIER 1 =IC	D3	\$4,830
456-110-687	SRM CX/NS TIER 2 =IC	D3	\$13,480
456-110-688	SRM CX TIER 3 =IC	D3	\$33,030
456-110-689	SRM CX/NS TIER 4 =IC	D3	\$61,460
456-110-690	SRM CX/NS TIER 5 =IC	D3	\$105,990
456-110-768	SRM 3PTY TB =CB	D3	\$700
456-110-769	SRM HDS TB =CB	D3	\$700
456-110-770	SRM IBM DS TB =CB	D3	\$700
456-110-771	SRM XIV TB =CB	D3	\$700
456-110-772	SRM 3Par TB =CB	D3	\$700
456-110-773	VIPR SRM HP EVA TB =CB	D3	\$700
456-110-774	SRM NTAP TB =CB	D3	\$700
456-110-775	VIPR SRM Compellent TB =CB	D3	\$700
456-110-776	SRM 3PTY2 TB =CB	D3	\$700
456-110-782	SRM VG GATEWAY =ID	D3	\$5,000
456-110-808	SRM VxFlex OS Tier 1 TB=CB	D3	\$310
456-110-809	SRM VxFlex OS Tier 2 TB=CB	D3	\$240
456-110-810	SRM VxFlex OS Tier 3 TB=CB	D3	\$180
456-110-811	SRM VxFlex OS Tier 4 TB=CB	D3	\$170
456-110-812	SRM VxFlex OS Tier 5 TB=CB	D3	\$130
456-110-813	SRM VxFlex OS Tier 6 TB=CB	D3	\$110
456-110-814	SRM VxFlex OS Tier 7 TB=CB	D3	\$100
456-110-824	SRM IBM V7000 TB=CB	D3	\$700
456-110-891	VIPR SRM Vblock TIER 1 =IC	D3	\$0
456-110-892	VIPR SRM Vblock TIER 2 =IC	D3	\$0
456-110-893	VIPR SRM Vblock TIER 3 =IC	D3	\$0
456-110-894	VIPR SRM Vblock TIER 4 =IC	D3	\$0
456-110-895	VIPR SRM DMX CAP UPG =IC	D3	\$0
456-110-937	CLOUDARRAY VIRT EDTN SW <118TB=CC	D3	\$23,810
456-110-938	CLOUDARRAY VIRT EDTN SW 118-499TB=CC	D3	\$205
456-110-939	CLOUDARRAY VIRT EDTN SW 500-999TB=CC	D3	\$175

456-110-940	CLOUDARRAY VIRT EDTN SW 1000-4999TB=CC	D3	\$155
456-110-941	CLOUDARRAY VIRT EDTN SW >5000TB=CC	D3	\$135
456-110-955	SVR SAN STE VMWARE 5TB SCALEIO=CB	D3	\$3,750
456-110-956	SVR SAN STE 5TB SIO OR 1CPU VSANAD=CB	D3	\$0
456-110-969	SDS BUNDLE 1 CPU VSAN ADV=ZC	D3	\$0
456-110-970	SDS BUNDLE 5TB ScaleIO=CB	D3	\$0
456-111-156	CloudLink for ScaleIO DARE Tier 1=CB	D3	\$0
456-111-157	CloudLink for ScaleIO DARE Tier 2=CB	D3	\$0
456-111-158	CloudLink for ScaleIO DARE Tier 3=CB	D3	\$0
456-111-159	CloudLink for ScaleIO DARE Tier 4=CB	D3	\$0
456-111-160	CloudLink for ScaleIO DARE Tier 5=CB	D3	\$0
456-111-161	CloudLink for ScaleIO DARE Tier 6=CB	D3	\$0
456-111-162	CloudLink for ScaleIO DARE Tier 7=CB	D3	\$0
456-111-231	CLOUDARRAY VMAXFX SW FOR FC APP 40TBU=	D3	\$0
456-111-359	EMC SIO SW Tier 8=CB	D3	\$603
456-111-360	EMC SIO SW Tier 9=CB	D3	\$543
456-111-361	CloudLink for ScaleIO DARE Tier 8=CB	D3	\$0
456-111-362	CloudLink for ScaleIO DARE Tier 9=CB	D3	\$0
456-111-497	EMC SIO SW Tier 10=CB	D3	\$488
456-111-498	EMC SIO SW Tier 11=CB	D3	\$440
456-111-499	CloudLink for ScaleIO DARE Tier 10=CB	D3	\$0
456-111-500	CloudLink for ScaleIO DARE Tier 11=CB	D3	\$0
456-111-672	VS SRM SIO LIC=CB	D3	\$0
456-111-673	VS SRM ECS LIC=CB	D3	\$0
456-111-816	RP/EX VPLX V2 LC DL SCV2000/3000/3020=IC	D3	\$3,320
456-111-817	RP/EX VPLX V2 LC DL SC4020=IC	D3	\$4,610
456-111-818	RP/EX VPLEX LOCAL DELL COMPLT SC8000=IC	D3	\$14,000
456-111-819	RP/EX VPLX V2 LC DL SC8000/9000=IC	D3	\$19,000
456-111-820	RP/EX VPLX V2 RM DL SCV2000/3000/3020=IC	D3	\$8,550
456-111-821	RP/EX VPLX V2 RM DL SC4020=IC	D3	\$11,890
456-111-822	RP/EX VPLEX REM DELL COMPLT SC8000=IC	D3	\$33,070
456-111-823	RP/EX VPLX V2 RM DL SC8000/9000=IC	D3	\$47,490
456-111-824	RP/EX VPLX V6 LC DL SCV2000/3000/3020=IC	D3	\$3,320
456-111-825	RP/EX VPLX V6 LC DL SC4020=IC	D3	\$4,610
456-111-826	RP/EX VPLX V6 LOC DELL COMPLT SC8000=IC	D3	\$14,000
456-111-827	RP/EX VPLX V6 LC DL SC8000/9000=IC	D3	\$19,000
456-111-828	RP/EX VPLX V6 RM DL SCV2000/3000/3020=IC	D3	\$8,550
456-111-829	RP/EX VPLX V6 RM DL SC4020=IC	D3	\$11,890
456-111-830	RP/EX VPLX V6 REM DELL COMPLT SC8000=IC	D3	\$33,070
456-111-831	RP/EX VPLX V6 RM DL SC8000/9000=IC	D3	\$47,490
456-111-886	RTI BASIC PLATFORM PERPETUAL=ZC	D3	\$23,000
456-111-889	RTI MIGRATION PLATFORM PERPETUAL=ZC	D3	\$0
456-111-909	EMC Native Hybrid Cloud VMware = MC	D3	\$0
456-111-916	RP/EX LOC BASE FOR V OS=IC	D3	\$0
456-111-917	RP/EX LOC FOR V OS (12-100TB)=CA	D3	\$1,030
456-111-918	RP/EX LOC FOR V OS (101-250TB)=CA	D3	\$931
456-111-919	RP/EX LOC FOR V OS (251-500TB)=CA	D3	\$840
456-111-920	RP/EX LOC FOR V OS (501-1,000TB)=CA	D3	\$758
456-111-921	RP/EX LOC FOR V OS (1,001-5,000TB)=CA	D3	\$650
456-111-922	RP/EX LOC FOR V OS (5,001-10,000TB)=CA	D3	\$540

456-111-923	RP/EX LOC FOR V OS (10,001-20,000TB)=CA	D3	\$475
456-111-924	RP/EX LOC FOR V OS (20,001-40,000TB)=CA	D3	\$450
456-111-925	RP/EX LOC FOR V OS (40,001-60,000TB)=CA	D3	\$425
456-111-926	RP/EX LOC FOR V OS (60,001-100,000TB)=CA	D3	\$400
456-111-927	RP/EX LOC FOR V OS (100,001TB+)=CA	D3	\$363
456-111-928	RP/EX REM BASE FOR V OS=IC	D3	\$0
456-111-929	RP/EX REM FOR V OS (12-100TB)=CA	D3	\$1,030
456-111-930	RP/EX REM FOR V OS (101-250TB)=CA	D3	\$931
456-111-931	RP/EX REM FOR V OS (251-500TB)=CA	D3	\$840
456-111-932	RP/EX REM FOR V OS (501-1,000TB)=CA	D3	\$758
456-111-933	RP/EX REM FOR V OS (1,001-5,000TB)=CA	D3	\$650
456-111-934	RP/EX REM FOR V OS (5,001-10,000TB)=CA	D3	\$540
456-111-935	RP/EX REM FOR V OS (10,001-20,000TB)=CA	D3	\$475
456-111-936	RP/EX REM FOR V OS (20,001-40,000TB)=CA	D3	\$450
456-111-937	RP/EX REM FOR V OS (40,001-60,000TB)=CA	D3	\$425
456-111-938	RP/EX REM FOR V OS (60,001-100,000TB)=CA	D3	\$400
456-111-939	RP/EX REM FOR V OS (100,001TB+)=CA	D3	\$363
456-111-959	RECOVERPOINT FOR VM FOR 1-NODE HCIA =IB	D3	\$0
456-112-135	SRM for Dell SC2000=IC	D3	\$5,460
456-112-136	SRM for Dell SC4000=IC	D3	\$13,100
456-112-137	SRM for Dell SC7000=IC	D3	\$26,190
456-112-139	SRM for Dell SC9000=IC	D3	\$38,190
456-112-969	RP/EX VPLX V2 LC DL SC5000/5020/F=IC	D3	\$7,820
456-112-970	RP/EX VPLX V2 RM DL SC5000/5020/F=IC	D3	\$20,140
456-112-971	RP/EX VPLX V2 LC DL SC7020/F=IC	D3	\$13,320
456-112-972	RP/EX VPLX V2 RM DL SC7020/F=IC	D3	\$29,730
456-112-973	RP/EX VPLX V6 LC DL SC5000/5020/F=IC	D3	\$7,820
456-112-974	RP/EX VPLX V6 RM DL SC5000/5020/F=IC	D3	\$20,140
456-112-975	RP/EX VPLX V6 LC DL SC7020/F=IC	D3	\$13,320
456-112-976	RP/EX VPLX V6 RM DL SC7020/F=IC	D3	\$29,730
456-113-102	RP4VM Midrange Pack 100 =IB	D3	\$500
456-113-103	RP4VM Midrange Pack 300 =IB	D3	\$400
456-113-407	Appsync ADV for Dell SCv2K-v3K series=IC	D3	\$6,030
456-113-408	Appsync ADV for Dell SC4K-5K series=IC	D3	\$13,560
456-113-409	Appsync ADV for Dell SC7K series=IC	D3	\$27,910
456-113-410	Appsync ADV for Dell SC9K series=IC	D3	\$53,725
456-113-425	SRM for Dell SC5020=IC	D3	\$12,890
456-113-426	SRM for Dell SC3000 series=IC	D3	\$7,475
456-113-487	VxFlex OS CloudLink SW Enc Tier 1=CB	D3	\$0
456-113-488	VxFlex OS CloudLink SW Enc Tier 2=CB	D3	\$0
456-113-489	VxFlex OS CloudLink SW Enc Tier 3=CB	D3	\$0
456-113-490	VxFlex OS CloudLink SW Enc Tier 4=CB	D3	\$0
456-113-491	VxFlex OS CloudLink SW Enc Tier 5=CB	D3	\$0
456-113-492	VxFlex OS CloudLink SW Enc Tier 6=CB	D3	\$0
456-113-493	VxFlex OS CloudLink SW Enc Tier 7=CB	D3	\$0
456-113-494	VxFlex OS CloudLink SW Enc Tier 8=CB	D3	\$0
456-113-495	VxFlex OS CloudLink SW Enc Tier 9=CB	D3	\$0
456-113-496	VxFlex OS CloudLink SW Enc Tier 10=CB	D3	\$0
456-113-497	VxFlex OS CloudLink SW Enc Tier 11=CB	D3	\$0
456-113-575	CloudLink: VxFlex OS SW Enc Tier 1=CB	D3	\$113

456-113-576	CloudLink: VxFlex OS SW Enc Tier 2=CB	D3	\$102
456-113-577	CloudLink: VxFlex OS SW Enc Tier 3=CB	D3	\$92
456-113-578	CloudLink: VxFlex OS SW Enc Tier 4=CB	D3	\$83
456-113-579	CloudLink: VxFlex OS SW Enc Tier 5=CB	D3	\$75
456-113-580	CloudLink: VxFlex OS SW Enc Tier 6=CB	D3	\$67
456-113-581	CloudLink: VxFlex OS SW Enc Tier 7=CB	D3	\$61
456-113-582	CloudLink: VxFlex OS SW Enc Tier 8=CB	D3	\$55
456-113-583	CloudLink: VxFlex OS SW Enc Tier 9=CB	D3	\$50
456-113-584	CloudLink: VxFlex OS SW Enc Tier 10=CB	D3	\$45
456-113-585	CloudLink: VxFlex OS SW Enc Tier 11=CB	D3	\$41
456-113-592	VxFlex OS SW Tier 1=CB	D3	\$1,250
456-113-593	VxFlex OS SW Tier 2=CB	D3	\$1,130
456-113-594	VxFlex OS SW Tier 3=CB	D3	\$1,020
456-113-595	VxFlex OS SW Tier 4=CB	D3	\$920
456-113-596	VxFlex OS SW Tier 5=CB	D3	\$830
456-113-597	VxFlex OS SW Tier 6=CB	D3	\$740
456-113-598	VxFlex OS SW Tier 7=CB	D3	\$670
456-113-599	VxFlex OS SW Tier 8=CB	D3	\$603
456-113-600	VxFlex OS SW Tier 9=CB	D3	\$543
456-113-601	VxFlex OS SW Tier 10=CB	D3	\$488
456-113-602	VxFlex OS SW Tier 11=CB	D3	\$440
457-000-038	EMC BACKUP ADVISOR (UP TO 100 CLIENTS)	D3	\$0
457-000-039	EMC BACKUP ADVISOR (UP TO 250 CLIENTS)	D3	\$0
457-000-040	EMC BACKUP ADVISOR (UP TO 500 CLIENTS)	D3	\$0
457-000-041	EMC BACKUP ADVISOR (UP TO 800 CLIENTS)	D3	\$0
457-000-042	EMC BACKUP ADVISOR (MORE THAN 800 CLNTS)	D3	\$0
457-000-256	DISKXTENDER FOR WINDOWS FILE SYS MGR	D3	\$0
457-000-272	ARCHXTNDR PLACE HOLDER-ORDERS FROM IC	D3	\$0
457-000-276	ARCHIVEXTENDER FOR WINDOWS	D3	\$0
457-000-481	DISKXTENDER FOR NAS AND UNIX	D3	\$0
457-100-182	POWERPATH VE STD X86 T1 (2-7 CPUs)	D3	\$0
457-100-183	POWERPATH VE STD X86 T2 (8+ CPUs)	D3	\$0
457-100-184	POWERPATH VE STD. VOL (100-199 CPU)	D3	\$0
457-100-185	POWERPATH VE STD. VOLUME 2 (200+ CPUs)	D3	\$0
457-100-186	POWERPATH VE ADD-ON X86 T1 (2-7 CPUs)	D3	\$0
457-100-187	POWERPATH VE ADD-ON X86 T2 (8+ CPUs)	D3	\$0
457-100-188	PPOWERPATH VEADDON VOL (100 - 199 CPU)	D3	\$0
457-100-189	POWERPATH VE ADDON VOL 2 (200+ CPUs)	D3	\$0
457-100-696	PP IND LIC X86 (1-7 CPUs)	D3	\$0
457-100-697	PP IND LIC X86 (8+ CPUs)	D3	\$0
457-100-698	PP VOL X86 (100-199 CPUS)	D3	\$0
457-100-699	PP VOL X86 (200+ CPUS)	D3	\$0
457-100-700	PP IND LIC NX86 (1-7 CPUs)	D3	\$0
457-100-701	PP IND LIC NX86 (8+ CPUs)	D3	\$0
457-100-702	PP VOL NX86 (100-199 CPUS)	D3	\$0
457-100-703	PP VOL NX86 (200+ CPUS)	D3	\$0
457-101-046	POWERPATH/VE STD. VOLUME (500+)	D3	\$0
457-101-047	POWERPATH/VE STD. VOLUME (1,000+)	D3	\$0
457-101-048	POWERPATH/VE STD. VOLUME (3,000+)	D3	\$0
457-101-141	RP/CL LOC BASE = CA	D3	\$0

457-101-143	RP/CL REM BASE =CA	D3	\$0
457-101-181	DX_FOR_WIN_FILE_SYS_MGR_S=IA	D3	\$0
457-101-182	DX_FOR_WIN_FILE_SYS_MGR_C=IA	D3	\$0
457-101-385	SRMSUITE 3PTY BASE =IC	D3	\$0
457-101-387	SRMSUITE HDS BASE =IC	D3	\$0
457-101-389	SRMSUITE IBM DS BASE =IC	D3	\$0
457-101-391	SRMSUITE XIV BASE =IC	D3	\$0
457-101-393	SRMSUITE 3Par BASE =IC	D3	\$0
457-101-395	SRMSUITE HP EVA BASE =IC	D3	\$0
457-101-397	SRMSUITE NTAP BASE =IC	D3	\$0
457-101-399	SRMSUITE Compellent BASE =IC	D3	\$0
457-101-401	SRMSUITE 3PTY2 BASE =IC	D3	\$0
457-101-408	SRMSUITE UPG 3PTY BASE =IC	D3	\$0
457-101-409	SRMSUITE UPG HDS BASE =IC	D3	\$0
457-101-410	SRMSUITE UPG IBM DS BASE =IC	D3	\$0
457-101-411	SRMSUITE UPG XIV BASE =IC	D3	\$0
457-101-412	SRMSUITE UPG 3Par BASE =IC	D3	\$0
457-101-413	SRMSUITE UPG HP EVA BASE =IC	D3	\$0
457-101-414	SRMSUITE UPG NTAP BASE =IC	D3	\$0
457-101-415	SRMSUITE UPG Compellent BASE =IC	D3	\$0
457-101-525	SRMSUITE HP XP/P9500 BASE =IC	D3	\$0
457-101-526	SRMSUITE HP XP/P9500 CAP UPG =IC	D3	\$0
457-101-527	SRMSUITE UPG HP XP/P9500 BASE =IC	D3	\$0
457-101-888	SRMSUITE IBM V7000 BASE=IC	D3	\$0
457-102-089	VS T1 NPSUITE 1-50TB=CB	D3	\$0
457-102-090	VS T1 NPSUITE 51-150TB=CB	D3	\$0
457-102-091	VS T1 NPSUITE 151-300TB=CB	D3	\$0
457-102-092	VS T1 NPSUITE 301-450TB=CB	D3	\$0
457-102-093	VS T1 NPSUITE 451-750TB=CB	D3	\$0
457-102-094	VS T1 NPSUITE 751-1500TB=CB	D3	\$0
457-102-095	VS T1 NPSUITE 1501-3000TB=CB	D3	\$0
457-102-096	VS T1 NPSUITE 3001-5000TB=CB	D3	\$0
457-102-097	VS T1 NPSUITE 5001-10000TB=CB	D3	\$0
457-102-098	VS T1 NPSUITE 10001TB+=CB	D3	\$0
457-102-099	VS T2 NPSUITE 1-50TB=CB	D3	\$0
457-102-100	VS T2 NPSUITE 51-150TB=CB	D3	\$0
457-102-101	VS T2 NPSUITE 151-300TB=CB	D3	\$0
457-102-102	VS T2 NPSUITE 301-450TB=CB	D3	\$0
457-102-103	VS T2 NPSUITE 451-750TB=CB	D3	\$0
457-102-104	VS T2 NPSUITE 751-1500TB=CB	D3	\$0
457-102-105	VS T2 NPSUITE 1501-3000TB=CB	D3	\$0
457-102-106	VS T2 NPSUITE 3001-5000TB=CB	D3	\$0
457-102-107	VS T2 NPSUITE 5001-10000TB=CB	D3	\$0
457-102-108	VS T2 NPSUITE 10001TB+=CB	D3	\$0
457-102-109	VS T3 NPSUITE 1-50TB=CB	D3	\$0
457-102-110	VS T3 NPSUITE 51-150TB=CB	D3	\$0
457-102-111	VS T3 NPSUITE 151-300TB=CB	D3	\$0
457-102-112	VS T3 NPSUITE 301-450TB=CB	D3	\$0
457-102-113	VS T3 NPSUITE 451-750TB=CB	D3	\$0
457-102-114	VS T3 NPSUITE 751-1500TB=CB	D3	\$0

457-102-115	VS T3 NPSUITE 1501-3000TB=CB	D3	\$0
457-102-124	VS T3 NPSUITE 3001-5000TB=CB	D3	\$0
457-102-125	VS T3 NPSUITE 5001-10000TB=CB	D3	\$0
457-102-126	VS T3 NPSUITE 10001TB+=CB	D3	\$0
457-102-650	VIPR SRM 3PTY BASE =IC	D3	\$0
457-102-651	VIPR SRM HDS BASE =IC	D3	\$0
457-102-652	VIPR SRM IBM DS BASE =IC	D3	\$0
457-102-653	VIPR SRM XIV BASE =IC	D3	\$0
457-102-654	VIPR SRM 3Par BASE =IC	D3	\$0
457-102-655	VIPR SRM HP EVA BASE =IC	D3	\$0
457-102-656	VIPR SRM NTAP BASE =IC	D3	\$0
457-102-657	VIPR SRM Compellent BASE =IC	D3	\$0
457-102-658	VIPR SRM 3PTY2 BASE =IC	D3	\$0
457-102-659	VIPR SRM HP XP/P9500 BASE =IC	D3	\$0
457-102-667	VIPR SRM IBM V7000 BASE=IC	D3	\$0
458-000-150	RP/CL LOCAL CLASSIC PRODUCT	D3	\$0
458-000-151	RP/CL REMOTE CLASSIC PRODUCT	D3	\$0
458-000-170	RP FOR HCA PRODUCT	D3	\$0
458-000-192	SRM for VG Gateway	D3	\$0
458-000-201	SRM for 3rd Party	D3	\$0
458-000-212	VIPR SRM UPG for 3PTY =IC	D3	\$0
458-000-217	POWERPATH Physical Edition	D3	\$0
458-000-218	POWERPATH Virtual Edition	D3	\$0
458-000-226	RP VIRTUAL APPLIANCE FOR VNX PRODUCT	D3	\$0
458-000-228	RECOVERPOINT FOR VM PRODUCT	D3	\$0
458-000-405	ScaleIO Software	D3	\$0
458-000-464	RP/EX REMOTE FOR SCALE IO PRODUCT	D3	\$0
458-000-526	DISKXTENDER SOFTWARE	D3	\$0
458-000-586	EMC Ent HCP SW - VMware	D3	\$0
458-000-836	PowerPath VE Bundle	D3	\$0
458-000-840	PPTH PHYSICAL	D3	\$0
458-000-841	PPVE	D3	\$0
458-000-884	SMARTS	D3	\$0
458-000-955	ECS Promotion	D3	\$0
458-000-956	RecoverPoint LOCAL SIO PRODUCT	D3	\$0
458-000-991	CLOUDARRAY SW PRODUCT	D3	\$0
458-000-992	CLOUDARRAY VIRT EDITION SW PRODUCT	D3	\$0
458-000-996	EMC Storage Analytics for SIO	D3	\$0
458-000-997	VCE HYP OE Software	D3	\$0
458-001-114	ScaleIO Node SW	D3	\$0
458-001-121	RecoverPoint for VM for HCIA	D3	\$0
458-001-124	CLOUDARRAY FOR FC APPL PRODUCT	D3	\$0
458-001-161	ViPR Controller Open	D3	\$0
458-001-196	CLOUDARRAY SW FOR SA APPL PRODUCT	D3	\$0
458-001-197	CLOUDARRAY VIRT EDN BULK SW PROD	D3	\$0
458-001-314	ViPR Controller Promo	D3	\$0
458-001-328	REAL TIME INTELLIGENCE-PERPETUAL=ZC	D3	\$0
458-001-336	Server SAN Suite	D3	\$0
458-001-440	RecoverPoint for VM Starter Packs	D3	\$0
458-001-587	RP VIRTUAL APPLIANCE FOR VNX PRODUCT	D3	\$0

458-001-639	VS SRM SIO=CB	D3	\$0
458-001-640	VS VIPRC SIO=CB	D3	\$0
458-001-644	VS VIPRC ECS=CB	D3	\$0
458-001-645	VS SRM Ent=CB	D3	\$0
458-001-646	VS VIPRC Ent=CB	D3	\$0
458-001-647	VS SRM Mid=CB	D3	\$0
458-001-648	VS VIPRC Mid=CB	D3	\$0
458-001-649	VS SRM Cloud=CB	D3	\$0
458-001-650	VS VIPRC Cloud=CB	D3	\$0
458-001-706	VIPR Controller Promo	D3	\$0
458-001-815	PROTECTPOINT RP ENABLER	D3	\$0
458-001-855	RP/EX VPLEX VS2 Local Dell=IC	D3	\$0
458-001-856	RP/EX VPLEX VS2 Remote Dell=IC	D3	\$0
458-001-857	RP/EX VPLEX VS6 Local Dell=IC	D3	\$0
458-001-858	RP/EX VPLEX VS6 Remote Dell=IC	D3	\$0
458-001-873	RTI BASIC PLATFORM PERPETUAL=ZC	D3	\$0
458-001-876	RTI MIGRATION PLATFORM PERPETUAL=ZC	D3	\$0
458-001-889	CPD Native Hybrid Cloud	D3	\$0
458-001-898	RP/EX LOCAL FOR VxFlex OS	D3	\$0
458-001-899	RP/EX REMOTE FOR VxFlex OS	D3	\$0
458-001-937	RECOVERPOINT FOR VM FOR 1-NODE HCIA	D3	\$0
458-002-195	RP4VM Midrange Pack	D3	\$0
458-002-342	Appsync ADV for Dell SC series=IC	D3	\$0
458-002-352	Dell EMC ESA for vROps=IC	D3	\$0
458-002-432	CloudLink: VxFlex OS SW Encryption	D3	\$0
458-002-440	VxFlex OS Software	D3	\$0
ADV-CAPM-T01	ADV ICM UP TO 14TB	D3	\$0
ADV-CAPM-T02	ADV ICM AT LEAST 15TB	D3	\$0
ADV-CAPM-T03	ADV ICM AT LEAST 25TB	D3	\$0
ADV-CAPM-T04	ADV ICM AT LEAST 40TB	D3	\$0
ADV-CAPM-T05	ADV ICM AT LEAST 60TB	D3	\$0
ADV-CAPM-T06	ADV ICM AT LEAST 100TB	D3	\$0
ADV-CAPM-T07	ADV ICM AT LEAST 150TB	D3	\$0
ADV-CAPM-T08	ADV ICM AT LEAST 250TB	D3	\$0
ADV-CAPM-T09	ADV ICM AT LEAST 400TB	D3	\$0
ADV-CAPM-T10	ADV ICM AT LEAST 600TB	D3	\$0
ADV-CAPM-T11	ADV ICM AT LEAST 1000TB	D3	\$0
ADV-CAPM-T12	ADV ICM AT LEAST 1500TB	D3	\$0
ADV-CAPM-T13	ADV ICM AT LEAST 2500TB	D3	\$0
ADV-CAPM-T14	ADV ICM AT LEAST 4000TB	D3	\$0
ADV-KEY	ADV ICM LIC KEY	D3	\$0
ADV-UPG-T01	ADV UP PP TO 14TB	D3	\$0
ADV-UPG-T02	ADV UP PP AT LEAST 15TB	D3	\$0
ADV-UPG-T03	ADV UP PP AT LEAST 25TB	D3	\$0
ADV-UPG-T04	ADV UP PP AT LEAST 40TB	D3	\$0
ADV-UPG-T05	ADV UP PP AT LEAST 60TB	D3	\$0
ADV-UPG-T06	ADV UP PP AT LEAST 100TB	D3	\$0
ADV-UPG-T07	ADV UP PP AT LEAST 150TB	D3	\$0
ADV-UPG-T08	ADV UP PP AT LEAST 250TB	D3	\$0
ADV-UPG-T09	ADV UP PP AT LEAST 400TB	D3	\$0

ADV-UPG-T10	ADV UP PP AT LEAST 600TB	D3	\$0
ADV-UPG-T11	ADV UP PP AT LEAST 1000TB	D3	\$0
ADV-UPG-T12	ADV UP PP AT LEAST 1500TB	D3	\$0
ADV-UPG-T13	ADV UP PP AT LEAST 2500TB	D3	\$0
ADV-UPG-T14	ADV UP PP AT LEAST 4000TB	D3	\$0
ARC-CAPM-T01	ARC 1YRICM UP TO 14TB	D3	\$0
ARC-CAPM-T02	ARC 1YRICM UP TO 15TB	D3	\$0
ARC-CAPM-T03	ARC 1YRICM UP TO 25TB	D3	\$0
ARC-CAPM-T04	ARC 1YRICM UP TO 40TB	D3	\$0
ARC-CAPM-T05	ARC 1YRICM UP TO 60TB	D3	\$0
ARC-CAPM-T06	ARC 1YRICM UP TO 100TB	D3	\$0
ARC-CAPM-T07	ARC 1YRICM UP TO 150TB	D3	\$0
ARC-CAPM-T08	ARC 1YRICM UP TO 250TB	D3	\$0
ARC-CAPM-T09	ARC 1YRICM UP TO 400TB	D3	\$0
ARC-CAPM-T10	ARC 1YRICM UP TO 600TB	D3	\$0
ARC-CAPM-T11	ARC 1YRICM UP TO 1000TB	D3	\$0
ARC-CAPM-T12	ARC 1YRICM UP TO 1500TB	D3	\$0
ARC-CAPM-T13	ARC 1YRICM UP TO 2500TB	D3	\$0
ARC-CAPM-T14	ARC 1YRICM UP TO 4000TB	D3	\$0
ARCHX-PLACE	ARCHIVEXTENDER PLACE HOLDER - ORDERS F	D3	\$0
ARCHX-WINDOW	ARCHIVEXTENDER FOR WINDOWS	D3	\$0
ARC-KEY	ARC ICM LIC KEY	D3	\$0
ARC-UPG-T01	ARC UP PP TO 14TB	D3	\$0
ARC-UPG-T02	ARC UP PP AT LEAST 15TB	D3	\$0
ARC-UPG-T03	ARC UP PP AT LEAST 25TB	D3	\$0
ARC-UPG-T04	ARC UP PP AT LEAST 40TB	D3	\$0
ARC-UPG-T05	ARC UP PP AT LEAST 60TB	D3	\$0
ARC-UPG-T06	ARC UP PP AT LEAST 100TB	D3	\$0
ARC-UPG-T07	ARC UP PP AT LEAST 150TB	D3	\$0
ARC-UPG-T08	ARC UP PP AT LEAST 250TB	D3	\$0
ARC-UPG-T09	ARC UP PP AT LEAST 400TB	D3	\$0
ARC-UPG-T10	ARC UP PP AT LEAST 600TB	D3	\$0
ARC-UPG-T11	ARC UP PP AT LEAST 1000TB	D3	\$0
ARC-UPG-T12	ARC UP PP AT LEAST 1500TB	D3	\$0
ARC-UPG-T13	ARC UP PP AT LEAST 2500TB	D3	\$0
ARC-UPG-T14	ARC UP PP AT LEAST 4000TB	D3	\$0
ARM6-CAPM-T01	EMC CONTROLCENTER 6.0 ARM PPA TIER 1	D3	\$0
ARM6-CAPM-T02	EMC CONTROLCENTER 6.0 ARM PPA TIER 2	D3	\$0
ARM6-CAPM-T03	EMC CONTROLCENTER 6.0 ARM PPA TIER 3	D3	\$0
ARM6-CAPM-T04	EMC CONTROLCENTER 6.0 ARM PPA TIER 4	D3	\$0
ARM6-CAPM-T05	EMC CONTROLCENTER 6.0 ARM PPA TIER 5	D3	\$0
ARM6-CAPM-T06	EMC CONTROLCENTER 6.0 ARM PPA TIER 6	D3	\$0
ARM6-CAPM-T07	EMC CONTROLCENTER 6.0 ARM PPA TIER 7	D3	\$0
ARM6-CAPM-T08	EMC CONTROLCENTER 6.0 ARM PPA TIER 8	D3	\$0
ARM6-CAPM-T09	EMC CONTROLCENTER 6.0 ARM PPA TIER 9	D3	\$0
ARM6-CAPM-T10	EMC CONTROLCENTER 6.0 ARM PPA TIER 10	D3	\$0
ARM6-CAPM-T11	EMC CONTROLCENTER 6.0 ARM PPA TIER 11	D3	\$0
ARM6-CAPM-T12	EMC CONTROLCENTER 6.0 ARM PPA TIER 12	D3	\$0
ARM6-CAPM-T13	EMC CONTROLCENTER 6.0 ARM PPA TIER 13	D3	\$0
ARM6-CAPM-T14	EMC CONTROLCENTER 6.0 ARM PPA TIER 14	D3	\$0

ARM6-UPG-T01	EMC CONTROLCENTER 6.0 ARM PPA TIER 1	D3	\$0
ARM6-UPG-T02	EMC CONTROLCENTER 6.0 ARM PPA TIER 2	D3	\$0
ARM6-UPG-T03	EMC CONTROLCENTER 6.0 ARM PPA TIER 3	D3	\$0
ARM6-UPG-T04	EMC CONTROLCENTER 6.0 ARM PPA TIER 4	D3	\$0
ARM6-UPG-T05	EMC CONTROLCENTER 6.0 ARM PPA TIER 5	D3	\$0
ARM6-UPG-T06	EMC CONTROLCENTER 6.0 ARM PPA TIER 6	D3	\$0
ARM6-UPG-T07	EMC CONTROLCENTER 6.0 ARM PPA TIER 7	D3	\$0
ARM6-UPG-T08	EMC CONTROLCENTER 6.0 ARM PPA TIER 8	D3	\$0
ARM6-UPG-T09	EMC CONTROLCENTER 6.0 ARM PPA TIER 9	D3	\$0
ARM6-UPG-T10	EMC CONTROLCENTER 6.0 ARM PPA TIER 10	D3	\$0
ARM6-UPG-T11	EMC CONTROLCENTER 6.0 ARM PPA TIER 11	D3	\$0
ARM6-UPG-T12	EMC CONTROLCENTER 6.0 ARM PPA TIER 12	D3	\$0
ARM6-UPG-T13	EMC CONTROLCENTER 6.0 ARM PPA TIER 13	D3	\$0
ARM6-UPG-T14	EMC CONTROLCENTER 6.0 ARM PPA TIER 14	D3	\$0
ARM-CAPM-T01	ARM ICM UP TO 14TB	D3	\$0
ARM-CAPM-T02	ARM ICM AT LEAST 15TB	D3	\$0
ARM-CAPM-T03	ARM ICM AT LEAST 25TB	D3	\$0
ARM-CAPM-T04	ARM ICM AT LEAST 40TB	D3	\$0
ARM-CAPM-T05	ARM ICM AT LEAST 60TB	D3	\$0
ARM-CAPM-T06	ARM ICM AT LEAST 100TB	D3	\$0
ARM-CAPM-T07	ARM ICM AT LEAST 150TB	D3	\$0
ARM-CAPM-T08	ARM ICM AT LEAST 250TB	D3	\$0
ARM-CAPM-T09	ARM ICM AT LEAST 400TB	D3	\$0
ARM-CAPM-T10	ARM ICM AT LEAST 600TB	D3	\$0
ARM-CAPM-T11	ARM ICM AT LEAST 1000TB	D3	\$0
ARM-CAPM-T12	ARM ICM AT LEAST 1500TB	D3	\$0
ARM-CAPM-T13	ARM ICM AT LEAST 2500TB	D3	\$0
ARM-CAPM-T14	ARM ICM AT LEAST 4000TB	D3	\$0
ARMHP-T1-5U	ARM HP T1-T5UPG	D3	\$0
ARMHP-T6-30U	ARM HP T6-T30UPG	D3	\$0
ARM-KEY	ARM ICM LIC KEY	D3	\$0
ARMOTH-T1-5U	OTH ARM T1-5 UPG	D3	\$0
ARMOTH-T6-30U	OTH ARM T6-30 UPG	D3	\$0
ARM-UPG-T01	ARM UP PP TO 14TB	D3	\$0
ARM-UPG-T02	ARM UP PP AT LEAST 15TB	D3	\$0
ARM-UPG-T03	ARM UP PP AT LEAST 25TB	D3	\$0
ARM-UPG-T04	ARM UP PP AT LEAST 40TB	D3	\$0
ARM-UPG-T05	ARM UP PP AT LEAST 60TB	D3	\$0
ARM-UPG-T06	ARM UP PP AT LEAST 100TB	D3	\$0
ARM-UPG-T07	ARM UP PP AT LEAST 150TB	D3	\$0
ARM-UPG-T08	ARM UP PP AT LEAST 250TB	D3	\$0
ARM-UPG-T09	ARM UP PP AT LEAST 400TB	D3	\$0
ARM-UPG-T10	ARM UP PP AT LEAST 600TB	D3	\$0
ARM-UPG-T11	ARM UP PP AT LEAST 1000TB	D3	\$0
ARM-UPG-T12	ARM UP PP AT LEAST 1500TB	D3	\$0
ARM-UPG-T13	ARM UP PP AT LEAST 2500TB	D3	\$0
ARM-UPG-T14	ARM UP PP AT LEAST 4000TB	D3	\$0
AUTOSTART-KIT	EMC AVAILABILITY MEDIA KIT	D3	\$0
AVACLIENT10	ADDL CLIENTS 10+	D3	\$0
AX-DEV-PROG	APPLICATIONXTENDER DEVELOPER PROGRAM	D3	\$0

AX-DEV-PRUPD	APPLICATIONXTENDER DEVELOPER PROGRAM	D3	\$0
BKP-4TBLNX-NS7	NS700700S BUNDLE 4TB LNX	D3	\$0
BKP-DBO-INC	NW TIER 5 - 1TB INCREMENT	D3	\$0
BKP-KIT	BKP TO DISK KIT	D3	\$0
BKP-RS-KIT	RETROSPECT MEDIA KIT	D3	\$0
BKP-RS-OPEN-3	RETROSPECT OPEN FILE 3 SV	D3	\$0
BKP-RS-UIR	RETROSPECT USER INIT REST	D3	\$0
BUAD-MT800CI	EMC Data Protection Advisor (MORE THAN 8	D3	\$0
BUAD-UPGR50	DATA PROTECTION ADVISOR 50 CLIENT UPGRA	D3	\$0
CC-ADV-BASE	SAN ADV BASE LICENSE	D3	\$0
CC-ADV-C01	SAN ADV 1TB (0-14TB)	D3	\$0
CC-ADV-C02	SAN ADV 1TB (15-25TB)	D3	\$0
CC-ADV-C03	SAN ADV 1TB (26-40TB)	D3	\$0
CC-ADV-C04	SAN ADV 1TB (41-60TB)	D3	\$0
CC-ADV-C05	SAN ADV 1TB (61-100TB)	D3	\$0
CC-ADV-C06	SAN ADV 1TB (101-150TB)	D3	\$0
CC-ADV-C07	SAN ADV 1TB (151-250TB)	D3	\$0
CC-ADV-C08	SAN ADV 1TB (251-400TB)	D3	\$0
CC-ADV-C09	SAN ADV 1TB (401-600TB)	D3	\$0
CC-ADV-C10	SAN ADV 1TB (601-1000TB)	D3	\$0
CC-ADV-C11	SAN ADV 1TB (1001TB or greater)	D3	\$0
CC-ADV-N01	SAN ADV 1TB (0-14TB) NLT3	D3	\$0
CC-ADV-N02	SAN ADV 1TB (15-25TB) NLT3	D3	\$0
CC-ADV-N03	SAN ADV 1TB (26-40TB) NLT3	D3	\$0
CC-ADV-N04	SAN ADV 1TB (41-60TB) NLT3	D3	\$0
CC-ADV-N05	SAN ADV 1TB (61-100TB) NLT3	D3	\$0
CC-ADV-N06	SAN ADV 1TB (101-150TB) NLT3	D3	\$0
CC-ADV-N07	SAN ADV 1TB (151-250TB) NLT3	D3	\$0
CC-ADV-N08	SAN ADV 1TB (251-400TB) NLT3	D3	\$0
CC-ADV-N09	SAN ADV 1TB (401-600TB) NLT3	D3	\$0
CC-ADV-N10	SAN ADV 1TB (601-1000TB) NLT3	D3	\$0
CC-ADV-N11	SAN ADV 1TB (1001TB or greater) NLT3	D3	\$0
CC-ADV-UPG	SAN ADV BASE UPGRADE	D3	\$0
CC-ARM6-BASE	EMC CC 6.1 Automated Resource Mgr Base	D3	\$0
CC-ARM6-R	EMC CONTROLCENTER 6.0 AUTOMATED RESRC	D3	\$0
CC-ARM-BASE	CC ARM BASE LICENSE	D3	\$0
CC-ARM-C01	CC ARM 1TB (0-14TB)	D3	\$0
CC-ARM-C02	CC ARM 1TB (15-25TB)	D3	\$0
CC-ARM-C03	CC ARM 1TB (26-40TB)	D3	\$0
CC-ARM-C04	CC ARM 1TB (41-60TB)	D3	\$0
CC-ARM-C05	CC ARM 1TB (61-100TB)	D3	\$0
CC-ARM-C06	CC ARM 1TB (101-150TB)	D3	\$0
CC-ARM-C07	CC ARM 1TB (151-250TB)	D3	\$0
CC-ARM-C08	CC ARM 1TB (251-400TB)	D3	\$0
CC-ARM-C09	CC ARM 1TB (401-600TB)	D3	\$0
CC-ARM-C10	CC ARM 1TB (601-1000TB)	D3	\$0
CC-ARM-C11	CC ARM 1TB(1001TB or greater)	D3	\$0
CC-ARM-N01	CC ARM 1TB (0-14TB) NLT3	D3	\$0
CC-ARM-N02	CC ARM 1TB (15-25TB) NLT3	D3	\$0
CC-ARM-N03	CC ARM 1TB (26-40TB) NLT3	D3	\$0

CC-ARM-N04	CC ARM 1TB (41-60TB) NLT3	D3	\$0
CC-ARM-N05	CC ARM 1TB (61-100TB) NLT3	D3	\$0
CC-ARM-N06	CC ARM 1TB (101-150TB) NLT3	D3	\$0
CC-ARM-N07	CC ARM 1TB (151-250TB) NLT3	D3	\$0
CC-ARM-N08	CC ARM 1TB (251-400TB) NLT3	D3	\$0
CC-ARM-N09	CC ARM 1TB (401-600TB) NLT3	D3	\$0
CC-ARM-N10	CC ARM 1TB (601-1000TB) NLT3	D3	\$0
CC-ARM-N11	CC ARM 1TB(1001TB or greater) NLT3	D3	\$0
CC-ARM-PRV	PREVIOUS VERSION ARM	D3	\$0
CC-CENT-2NODE	ECC 6.1 LIC FOR CENTERA PER 2 NODE	D3	\$0
CC-CENT-NODE	EMC CC 6.1 MGMT PKG LICENSE FOR CENTERA	D3	\$0
CC-CNRKEY6-B	CC 6.0 STORAGE AGENT CENTERA RTU CARD	D3	\$0
CC-CX200/300	CC 6.1 MGMT PKG LIC CLARIIION CX200/300	D3	\$0
CC-FLR6-BASE	EMC ControlCenter 6.1 File Level Reporte	D3	\$0
CC-FLR6-UPG	EMC ControlCenter 6.1 File Level Reporte	D3	\$0
CC-FLR-C01	FLR 1TB (0-14TB)	D3	\$0
CC-FLR-C02	FLR 1TB (15-25TB)	D3	\$0
CC-FLR-C03	FLR 1TB (26-40TB)	D3	\$0
CC-FLR-C04	FLR 1TB (41-60TB)	D3	\$0
CC-FLR-C05	FLR 1TB (61-100TB)	D3	\$0
CC-FLR-C06	FLR 1TB (101-150TB)	D3	\$0
CC-FLR-C07	FLR 1TB (151-250TB)	D3	\$0
CC-FLR-C08	FLR 1TB (251-400TB)	D3	\$0
CC-FLR-C09	FLR 1TB (401-600TB)	D3	\$0
CC-FLR-C10	FLR 1TB (601-1000TB)	D3	\$0
CC-FLR-C11	FLR 1TB (1001TB or greater)	D3	\$0
CC-FLR-KIT	CC FILE LEVEL REPORTER KI	D3	\$0
CC-FLR-N01	FLR 1TB (0-14TB) NLT3	D3	\$0
CC-FLR-N02	FLR 1TB (15-25TB) NLT3	D3	\$0
CC-FLR-N03	FLR 1TB (26-40TB) NLT3	D3	\$0
CC-FLR-N04	FLR 1TB (41-60TB) NLT3	D3	\$0
CC-FLR-N05	FLR 1TB (61-100TB) NLT3	D3	\$0
CC-FLR-N06	FLR 1TB (101-150TB) NLT3	D3	\$0
CC-FLR-N07	FLR 1TB (151-250TB) NLT3	D3	\$0
CC-FLR-N08	FLR 1TB (251-400TB) NLT3	D3	\$0
CC-FLR-N09	FLR 1TB (401-600TB) NLT3	D3	\$0
CC-FLR-N10	FLR 1TB (601-1000TB) NLT3	D3	\$0
CC-FLR-N11	FLR 1TB (1001TB or greater) NLT3	D3	\$0
CCFLR-T01-04U	FILE LVL RPT T1-T5UPG	D3	\$0
CC-MR6-BASE	EMC CONTROLCENTER 6.0 SRM MONITORING/F	D3	\$0
CC-MR6-R	EMC CONTROLCENTER 6.0 SRM MONITORING/F	D3	\$0
CC-MR6-UPG	EMC CONTROLCENTER 6.0 SRM MONITORING/F	D3	\$0
CC-NASKEY6-B	CC 6.0 STORAGE AGENT FOR NAS RTU CARD	D3	\$0
CC-NS-20	EMC CC 6.1 MGMT PKG LICENSE FOR CELERRA	D3	\$0
CC-NS350	EMC CC 6.1 MGMT PKG LICENSE FOR CELERRA	D3	\$0
CC-NS-40	EMC CC 6.1 MGMT PKG LICENSE FOR CELERRA	D3	\$0
CC-NS-80	EMC CC 6.1 MGMT PKG LICENSE FOR CELERRA	D3	\$0
CC-NS-OTHER	EMC CC 6.1 MGMT PKG LICENSE FOR CELERRA	D3	\$0
CC-OPTM6-R	EMC CONTROLCENTER 6.0 SYMM OPTIMIZER R	D3	\$0
CC-PFM6-R	EMC CONTROLCENTER 6.0 PERFORMANCE MG	D3	\$0

CC-PP6-BASE	EMC CONTROLCENTER 6.0 SRM PLANNING/PRC	D3	\$0
CC-PP6-R	EMC CONTROLCENTER 6.0 SRM PLANNING/PRC	D3	\$0
CC-PP6-UPG	EMC CONTROLCENTER 6.0 SRM PLANNING/PRC	D3	\$0
CC-SAMGR-PRV	PREVIOUS VERSION SANMGR	D3	\$0
CC-SM6-R	EMC CONTROLCENTER 6.0 SAN MGR REFRESH	D3	\$0
CC-ST6-R	EMC CONTROLCENTER 6.0 STORAGE SCOPE R	D3	\$0
CC-ST6-C01	STS 1TB (0-14TB)	D3	\$0
CC-ST6-C11	STS 1TB (1001TB or greater)	D3	\$0
CC-ST6FLR-KIT	STS+FLR KIT	D3	\$0
CC-ST6-N01	STS 1TB (0-14TB) NLT3	D3	\$0
CC-ST6-N11	STS 1TB (1001TB or greater) NLT3	D3	\$0
CC-ST6-PRV	PREVIOUS VERSION STS	D3	\$0
CC-UPG-KIT6	EMC CC 6.1 UPGRADE KIT	D3	\$0
CHE-AIX	CLARIION HOST ENCRYPTION FOR AIX	D3	\$0
CHE-LNX	CLARIION HOST ENCRYPTION FOR LINUX	D3	\$0
CHE-SOL	CLARIION HOST ENCRYPTION FOR SOLARIS	D3	\$0
CHE-WIN	CLARIION HOST ENCRYPTION FOR WINDOWS	D3	\$0
CLA-CLDARRSW-12TBU	CLOUDARRAY SW FOR 12TBU=IA	D3	\$0
CLA-CLDARRSW-18TBU	CLOUDARRAY SW FOR 18TBU=IA	D3	\$0
CLA-CLDARRSW-40TBU	CLOUDARRAY SW FOR 40TBU=IA	D3	\$0
CLA-CLDARRSW-60TBU	CLOUDARRAY SW FOR 60TBU=IA	D3	\$0
CLA-FCSAHW-18TBU	CLOUDARRAY SA HW FC APPLIANCE 40TBU	D3	\$0
CLA-FCSAHW20-40TBU	CLOUDARRAY SA HW FC APPLIANCE 20-40TBU	D3	\$24,000
CLA-FCSAHW-40TBU	CLOUDARRAY SA HW FC APPLIANCE 40TBU	D3	\$24,000
CLA-HWVMAXFX-40TBU	CLOUDARRAY VMAXFX HW FC APPLIANCE 40TBU	D3	\$24,000
CLA-VRTED12-NEW	CLOUDARRAY VIRT EDITION 12 SW NEW=IA	D3	\$0
CLA-VRTED3-NEW	CLOUDARRAY VIRT EDITION 3 SW NEW=IA	D3	\$0
CLA-VRTED6-NEW	CLOUDARRAY VIRT EDITION 6 SW NEW=IA	D3	\$0
CX300-KIT	ARRAY DOCS & RTU	D3	\$0
CX31C-KIT	CX3-10C DOCS RTU KIT AND POWERPATH FOR	D3	\$0
CX412CDC-KIT	CX4-120CDC DOCS & RTU & PPATH FOR DC	D3	\$0
CX412C-KIT	CX4-120 DOCS COMMON RTU & POWERPATH	D3	\$0
DBIDM-DE-KIT	DBIDM DVLP EDITION SW KIT	D3	\$0
DBIDM-DE-T1	DBIDM DVLP EDITION TIER 1	D3	\$0
DBIDM-DE-T2	DBIDM DVLP EDITION TIER 2	D3	\$0
DBIDM-DE-T3	DBIDM DVLP EDITION TIER 3	D3	\$0
DBIDM-DE-T4	DBIDM DVLP EDITION TIER 4	D3	\$0
DBIDM-DE-T5	DBIDM DVLP EDITION TIER 5	D3	\$0
DBIDM-DE-T6	DBIDM DVLP EDITION TIER 6	D3	\$0
DBIDM-DE-T7	DBIDM DVLP EDITION TIER 7	D3	\$0
DBIDM-DE-T8	DBIDM DVLP EDITION TIER 8	D3	\$0
DBIDM-IG-KIT	DBIDM INSTANCE GEN SW KIT	D3	\$0
DBIDM-IG-T1	DBIDM INSTANCE GEN TIER 1	D3	\$0
DBIDM-IG-T2	DBIDM INSTANCE GEN TIER 2	D3	\$0
DBIDM-IG-T3	DBIDM INSTANCE GEN TIER 3	D3	\$0
DBIDM-IG-T4	DBIDM INSTANCE GEN TIER 4	D3	\$0
DBIDM-IG-T5	DBIDM INSTANCE GEN TIER 5	D3	\$0
DBIDM-IG-T6	DBIDM INSTANCE GEN TIER 6	D3	\$0
DBIDM-IG-T7	DBIDM INSTANCE GEN TIER 7	D3	\$0
DBIDM-IG-T8	DBIDM INSTANCE GEN TIER 8	D3	\$0

DBIDM-KIT	DBIDM SOFTWARE KIT	D3	\$0
DBIDM-MOD-KIT	DBIDM MODULE SOFTWARE KIT	D3	\$0
DBIDM-MOD-T1	DB IDM APP MODULES TIER 1	D3	\$0
DBIDM-MOD-T2	DB IDM APP MODULES TIER 2	D3	\$0
DBIDM-MOD-T3	DB IDM APP MODULES TIER 3	D3	\$0
DBIDM-MOD-T4	DB IDM APP MODULES TIER 4	D3	\$0
DBIDM-MOD-T5	DB IDM APP MODULES TIER 5	D3	\$0
DBIDM-MOD-T6	DB IDM APP MODULES TIER 6	D3	\$0
DBIDM-MOD-T7	DB IDM APP MODULES TIER 7	D3	\$0
DBIDM-MOD-T8	DB IDM APP MODULES TIER 8	D3	\$0
DBIDM-T1	DATABASE IDM TIER 1	D3	\$0
DBIDM-T2	DATABASE IDM TIER 2	D3	\$0
DBIDM-T3	DATABASE IDM TIER 3	D3	\$0
DBIDM-T4	DATABASE IDM TIER 4	D3	\$0
DBIDM-T5	DATABASE IDM TIER 5	D3	\$0
DBIDM-T6	DATABASE IDM TIER 6	D3	\$0
DBIDM-T7	DATABASE IDM TIER 7	D3	\$0
DBIDM-T8	DATABASE IDM TIER 8	D3	\$0
DBX-OPT-KIT	DBX OPT SW KIT	D3	\$0
DBX-SS-KIT	DBX SUBSETTER SW KIT	D3	\$0
DCA1-DBSW-BAS	DCA-GREENPLUM APPLIANCE	D3	\$1,100,000
DCA1-DBSW-TB	DCA-MODEL NOT USED	D3	\$0
DCA1-DBSW-UPG	DCA - GREENPLUM APPLIANCE UPG	D3	\$1,100,000
DCA1-GP0	DCA - Greenplum Appliance Half Rack Bala	D3	\$0
DCA1GP0-2TBT	DCA - GREENPLUM APPLIANCE HALF RACK HIG	D3	\$0
DCA1GP0-2TBTU	DCA - GREENPLUM APPLIANCE HALF RACK HIG	D3	\$0
DCA1-GP1	DCA - Greenplum Appliance Full Rack Bala	D3	\$0
DCA1GP1-2TBT	DCA - GREENPLUM APPLIANCE FULL RACK HIG	D3	\$0
DCA1GP1-2TBTU	DCA - GREENPLUM APPLIANCE FULL RACK HIG	D3	\$0
DCA1-GP1U	DCA - Greenplum Appliance Full Rack Bala	D3	\$0
DCA1-GP2	DCA - Greenplum Appliance Two Rack Balan	D3	\$0
DCA1GP2-2TBT	DCA - GREENPLUM APPLIANCE TWO RACK HIG	D3	\$0
DCA1GP2-2TBTU	DCA - GREENPLUM APPLIANCE TWO RACK HIG	D3	\$0
DCA1-GP2U	DCA - Greenplum Appliance Two Rack Balan	D3	\$0
DCA1-GP3	DCA - Greenplum Appliance Three Rack Bal	D3	\$0
DCA1GP3-2TBT	DCA - GREENPLUM APPLIANCE THREE RACK HI	D3	\$0
DCA1GP3-2TBTU	DCA - GREENPLUM APPLIANCE THREE RACK HI	D3	\$0
DCA1-GP3U	DCA - Greenplum Appliance Three Rack Bal	D3	\$0
DCA2-DIA02A	GP DIA MOD 64GB MEM 300GBHDD UPG FCT	D3	\$0
DCA2-DIA02DA	GP DIA SVR 64GB MEM 12x3TB HDD UPG FCT	D3	\$0
DCA2-DIA02DU	GP DIA SVR 64GB MEM 12x3TB HDD UPG FLD	D3	\$0
DCA2-DIA02U	GP DIA MOD 64GB MEM 300GBHDD UPG FLD	D3	\$0
DCA2-GP04CH	GPDB UAP STD MOD ALL INCLSV HI DEN RACK	D3	\$0
DCA2-GP04CH2	GPDB UAP STD MOD ALL INCLSV HI DEN MS2	D3	\$0
DCA2-GP04H	GPDB COM MOD ALL INCLSV HI DEN RACK	D3	\$0
DCA2-GP04H2	GPDB COM MOD ALL INCLSV HI DEN MS2 RACK	D3	\$0
DCA2-GP04MH	GPDB STD MEM MOD AL INCLSV HI DEN RACK	D3	\$0
DCA2-GP04MH2	GPDB STD MEM MOD AL INCLSV HI DEN MS2	D3	\$0
DCA2GP04-SCA	GPDB UAPSTD MOD ALL INCLSV UPG FCT	D3	\$0
DCA2GP04-SCU	GPDB UAP STD MOD ALL INCLSV UPG FLD	D3	\$0

DCA2GP04-SMA	GPDB 256GB MEM MOD ALL INCLSV UPG FCT	D3	\$0
DCA2GP04-SMU	GPDB 256GB MEM MOD ALL INCLSV UPG FLD	D3	\$0
DCA2GP04-SU	GPDB COM MOD ALL INCLSV UPG FLD	D3	\$0
DCA2GP04-SUA	GPDB COM MOD ALL INCLSV UPG FCT	D3	\$0
DCA2-HD04A	GP HD MOD UPG FCT	D3	\$0
DCA2-HD04H	GPHD DATA MOD ALL INCLSV HI DEN RACK	D3	\$0
DCA2-HD04H2	GPHD DATA MOD ALL INCLSV HI DEN MS2	D3	\$0
DCA2-HD04U	GP HD MOD UPG FLD	D3	\$0
DCA2-HDC02A	GP HD COMPUTE MOD UPG FCT	D3	\$0
DCA2-HDC02H	GPHD COMPUTE MOD ALL INCLSV MOD HI DEN	D3	\$0
DCA2-HDC02H2	GPHD COMPUTE MOD ALL INCLSV MOD MS2	D3	\$0
DCA2-HDC02U	GP HD COMPUTE MOD UPG FLD	D3	\$0
DCO-013-00	IONIX ITOPS OPTICAL TRANSPORT MGR KIT	D3	\$0
DCO-OTM-11	IONIX IT OPS OTM MANAGED DEVICE L11	D3	\$0
DCO-OTM-21	IONIX IT OPS OTM MANAGED DEVICE L21	D3	\$0
DCO-OTM-31	IONIX IT OPS OTM MANAGED DEVICE L31	D3	\$0
DCO-OTM-41	IONIX IT OPS OTM MANAGED DEVICE L41	D3	\$0
DCO-OTM-LIC	IONIX IT OPS OPTICAL TRANSPORT MGR LICEN	D3	\$0
DXFMSOLARIS	DISKXTENDER FSM FOR SOLARIS MEDIA KIT	D3	\$0
EBA-QUOTE	EMC BACKUP ADVISOR (>800)	D3	\$0
EBA-UP-1.5K-2K	EBA UPGRADE(1.5K-2K)	D3	\$0
EBA-UP-100-250	EBA UPGRADE(100-250)	D3	\$0
EBA-UP-1K-1.5K	EBA UPGRADE(1K-1.5K)	D3	\$0
EBA-UP-250-500	EBA UPGRADE(250-500)	D3	\$0
EBA-UP-500-800	EBA UPGRADE(500-800)	D3	\$0
EBA-UP-800-1K	EBA UPGRADE(800-1K)	D3	\$0
ERM-EXCH-DP	ERM EXCHANGE 2K CLIENT	D3	\$0
ERM-EXCH-EN	ERM EXCHANGE 2K CLIENT	D3	\$0
ERM-EXCH-WG	ERM EXCHANGE 2K CLIENT	D3	\$0
ERM-ORAUNX-DP	ORACLE UNIX FS CLIENT	D3	\$0
ERM-ORAUNX-EN	ORACLE UNIX FS CLIENT	D3	\$0
ERM-ORAUNX-GB	ORACLE UNIX FS CLIENT	D3	\$0
ERM-ORAUNX-WG	ORACLE UNIX FS CLIENT	D3	\$0
ERM-ORAW2K-DP	ORACLE-NTFS: W2K CLIENT	D3	\$0
ERM-ORAW2K-EN	ORACLE-NTFS: W2K CLIENT	D3	\$0
ERM-ORAW2K-WG	ORACLE-NTFS: W2K CLIENT	D3	\$0
ERM-SQLS-DP	ERM SQL 2K CLIENT	D3	\$0
ERM-SQLS-EN	ERM SQL 2K CLIENT	D3	\$0
ERM-SQLS-WG	ERM SQL 2K CLIENT	D3	\$0
ERM-SRVSUN-DP	ERM SERVER ON SOLARIS	D3	\$0
ERM-SRVSUN-EN	ERM SERVER ON SOLARIS	D3	\$0
ERM-SRVSUN-GB	ERM SERVER ON SOLARIS	D3	\$0
ERM-SRVSUN-WG	ERM SERVER ON SOLARIS	D3	\$0
ERM-SRVW2K-DP	ERM SERVER ON W2K	D3	\$0
ERM-SRVW2K-EN	ERM SERVER ON W2K	D3	\$0
ERM-SRVW2K-WG	ERM SERVER ON W2K	D3	\$0
ERM-UDBUNX-DP	ERM UDB UNIX FS CLIENT	D3	\$0
ERM-UDBUNX-EN	ERM UDB UNIX FS CLIENT	D3	\$0
ERM-UDBUNX-GB	ERM UDB UNIX FS CLIENT	D3	\$0
ERM-UDBUNX-WG	ERM UDB UNIX FS CLIENT	D3	\$0

FLR6-CAPM-T01	EMC CONTRLCTR 6.0 FILE LEVEL REPORTER PF	D3	\$0
FLR6-CAPM-T02	EMC CONTRLCTR 6.0 FILE LEVEL REPORTER PF	D3	\$0
FLR6-CAPM-T03	EMC CONTRLCTR 6.0 FILE LEVEL REPORTER PF	D3	\$0
FLR6-CAPM-T04	EMC CONTRLCTR 6.0 FILE LEVEL REPORTER PF	D3	\$0
FLR6-CAPM-T05	EMC CONTRLCTR 6.0 FILE LEVEL REPORTER PF	D3	\$0
FLR6-CAPM-T06	EMC CONTRLCTR 6.0 FILE LEVEL REPORTER PF	D3	\$0
FLR6-CAPM-T07	EMC CONTRLCTR 6.0 FILE LEVEL REPORTER PF	D3	\$0
FLR6-CAPM-T08	EMC CONTRLCTR 6.0 FILE LEVEL REPORTER PF	D3	\$0
FLR6-CAPM-T09	EMC CONTRLCTR 6.0 FILE LEVEL REPORTER PF	D3	\$0
FLR6-CAPM-T10	EMC CONTRLCTR 6.0 FILE LEVEL REPORTER PF	D3	\$0
FLR6-CAPM-T11	EMC CONTRLCTR 6.0 FILE LEVEL REPORTER PF	D3	\$0
FLR6-CAPM-T12	EMC CONTRLCTR 6.0 FILE LEVEL REPORTER PF	D3	\$0
FLR6-CAPM-T13	EMC CONTRLCTR 6.0 FILE LEVEL REPORTER PF	D3	\$0
FLR6-CAPM-T14	EMC CONTRLCTR 6.0 FILE LEVEL REPORTER PF	D3	\$0
FLR6-UPG-T01	EMC CNTRLCTR 6.0 FILE LEVEL REPORTER MR	D3	\$0
FLR6-UPG-T02	EMC CNTRLCTR 6.0 FILE LEVEL REPORTER MR	D3	\$0
FLR6-UPG-T03	EMC CNTRLCTR 6.0 FILE LEVEL REPORTER MR	D3	\$0
FLR6-UPG-T04	EMC CNTRLCTR 6.0 FILE LEVEL REPORTER MR	D3	\$0
FLR6-UPG-T05	EMC CNTRLCTR 6.0 FILE LEVEL REPORTER MR	D3	\$0
FLR6-UPG-T06	EMC CNTRLCTR 6.0 FILE LEVEL REPORTER MR	D3	\$0
FLR6-UPG-T07	EMC CNTRLCTR 6.0 FILE LEVEL REPORTER MR	D3	\$0
FLR6-UPG-T08	EMC CNTRLCTR 6.0 FILE LEVEL REPORTER MR	D3	\$0
FLR6-UPG-T09	EMC CNTRLCTR 6.0 FILE LEVEL REPORTER MR	D3	\$0
FLR6-UPG-T10	EMC CNTRLCTR 6.0 FILE LEVEL REPORTER MR	D3	\$0
FLR6-UPG-T11	EMC CNTRLCTR 6.0 FILE LEVEL REPORTER MR	D3	\$0
FLR6-UPG-T12	EMC CNTRLCTR 6.0 FILE LEVEL REPORTER MR	D3	\$0
FLR6-UPG-T13	EMC CNTRLCTR 6.0 FILE LEVEL REPORTER MR	D3	\$0
FLR6-UPG-T14	EMC CNTRLCTR 6.0 FILE LEVEL REPORTER MR	D3	\$0
FLR-KEY	STS FLR ICM LIC KEY	D3	\$0
ITEMPT-EX-500	ITEMPOINT EXCHANGE QTY 500 MAILBOXES	D3	\$0
ITPC-PL-G1	EMC ITPC Base Platform User Seats 1-15	D3	\$0
ITPC-PL-UG2	EMC ITPC Platform User Seats 16-64	D3	\$0
ITPC-PL-UG3	EMC ITPC Platform User Seats 65-515	D3	\$0
ITPC-PL-UG4	EMC ITPC Platform User Seats 516 and up	D3	\$0
ITPC-RMM-G2	ITPC REQUEST MANAGEMENT MODULE SEATS	D3	\$0
ITPC-RMM-G3	ITPC REQUEST MANAGEMENT MODULE SEATS	D3	\$0
ITPC-RMM-G4	ITPC REQUEST MANAGEMENT MODULE SEATS	D3	\$0
LIC-ARMAGNT	ARM AGENT	D3	\$0
LIC-ARMBASE1	APP REL MGR 1 (1-20)	D3	\$0
LIC-ARMBASE2	APP REL MGR 2 (21-150)	D3	\$0
LIC-ARMBASE3	APP REL MGR 3 (151-600)	D3	\$0
LIC-ARMBASE4	APP REL MGR 4 (600)	D3	\$0
LIC-ARMCOMP	TARGET APP MODEL	D3	\$0
LIC-OPSCFG	CONFIGURATION MODULE	D3	\$0
LIC-OPSCMP	COMPLIANCE MODULE	D3	\$0
LIC-OPSDSC	DISCOVERY MODULE	D3	\$0
LIC-OPSMGR	OPERATIONS MANAGER SUITE	D3	\$0
LIC-ORCAPAD	ORCH MGR APP ADAPT	D3	\$0
LIC-ORCBASE	ORCH MGR BP	D3	\$0
LIC-ORCBSAD	ORCH MGR ADD BASE ADAPT	D3	\$0

LIC-ORCWFS	SECONDARY WF SERV	D3	\$0
LIC-RPTMGR	REPORTING ANALYTICS MGR	D3	\$0
LIC-VRMMGR	VIRTUALIZATION MANAGER	D3	\$0
L-SIO-7010-E	Enhanced L3 License - 7010	D3	\$0
L-SIO-7010-E-CF	Enhanced L3 License - 7010	D3	\$9,263
L-SIO-7010-V	Virtualization License - 7010	D3	\$0
L-SIO-7010-V-CF	Virtualization License - 7010	D3	\$4,638
L-SIO-7050-E	Enhanced L3 License - 7050	D3	\$0
L-SIO-7050-E-CF	Enhanced L3 License - 7050	D3	\$20,394
L-SIO-7050-V	Virtualization License - 7050	D3	\$0
L-SIO-7050-V-CF	Virtualization License - 7050	D3	\$9,276
MPKG-CAPM-T01	EMC CC 6.1 SRM MANAGEMENT PACKAGE PPA	D3	\$0
MPKG-CAPM-T02	EMC CC 6.1 SRM MANAGEMENT PACKAGE PPA	D3	\$0
MPKG-CAPM-T03	EMC CC 6.1 SRM MANAGEMENT PACKAGE PPA	D3	\$0
MPKG-CAPM-T04	EMC CC 6.1 SRM MANAGEMENT PACKAGE PPA	D3	\$0
MPKG-CAPM-T05	EMC CC 6.1 SRM MANAGEMENT PACKAGE PPA	D3	\$0
MPKG-CAPM-T06	EMC CC 6.1 SRM MANAGEMENT PACKAGE PPA	D3	\$0
MPKG-CAPM-T07	EMC CC 6.1 SRM MANAGEMENT PACKAGE PPA	D3	\$0
MPKG-CAPM-T08	EMC CC 6.1 SRM MANAGEMENT PACKAGE PPA	D3	\$0
MPKG-CAPM-T09	6.1 SRM MANAGEMENT PACKAGE PPA TIER 09	D3	\$0
MPKG-CAPM-T10	6.1 SRM MANAGEMENT PACKAGE PPA TIER 10	D3	\$0
MPKG-CAPM-T11	6.1 SRM MANAGEMENT PACKAGE PPA TIER 11	D3	\$0
MPKG-CAPM-T12	6.1 SRM MANAGEMENT PACKAGE PPA TIER 12	D3	\$0
MPKG-CAPM-T13	6.1 SRM MANAGEMENT PACKAGE PPA TIER 13	D3	\$0
MPKG-CAPM-T14	6.1 SRM MANAGEMENT PACKAGE PPA TIER 14	D3	\$0
MPKG-KEY	EMC CONTROLCENTER 6.1 SRM MANAGEMENT	D3	\$0
MR-CAPM-T01	SMR ICM UP TO 14TB	D3	\$0
MR-CAPM-T02	SMR ICM AT LEAST 15TB	D3	\$0
MR-CAPM-T03	SMR ICM AT LEAST 25TB	D3	\$0
MR-CAPM-T04	SMR ICM AT LEAST 40TB	D3	\$0
MR-CAPM-T05	SMR ICM AT LEAST 60TB	D3	\$0
MR-CAPM-T06	SMR ICM AT LEAST 100TB	D3	\$0
MR-CAPM-T07	SMR ICM AT LEAST 150TB	D3	\$0
MR-CAPM-T08	SMR ICM AT LEAST 250TB	D3	\$0
MR-CAPM-T09	SMR ICM AT LEAST 400TB	D3	\$0
MR-CAPM-T10	SMR ICM AT LEAST 600TB	D3	\$0
MR-CAPM-T11	SMR ICM AT LEAST 1000TB	D3	\$0
MR-CAPM-T12	SMR ICM AT LEAST 1500TB	D3	\$0
MR-CAPM-T13	SMR ICM AT LEAST 2500TB	D3	\$0
MR-CAPM-T14	SMR ICM AT LEAST 4000TB	D3	\$0
MR-KEY	SMR ICM LIC KEY	D3	\$0
MSG-KIT	MESSAGING MEDIA KIT	D3	\$0
NCM-001-00	ITOI NCM FOUNDATION LICENSE	D3	\$0
NCM-001-00A	ITOI NCM FOUNDATION LICENSE=MA	D3	\$10,000
NCM-KIT-001	EMC NETWORK CONFIGURATION MANAGER	D3	\$0
NL-AD-HPOV	SMARTS HPOV INTEGRATION ADAPTER FOR AD	D3	\$31,500
NODE-OPTICS-0001	VxRack Node 2U4N Optics Kit 16x SFP+ SR	D3	\$16,124
NODE-OPTICS-0002	VxRack Node 2U1N Optics Kit 4x SFP+ SR	D3	\$4,031
NODE-OPTICS-0003	VxRack Node 1U1N Optics Kit 4x SFP+ SR	D3	\$4,031
NODE-OPTICS-0004	VxRack Node 2U4N Optics Kit 16x SFP+ LR	D3	\$50,672

NODE-OPTICS-0005	VxRack Node 1U1N Optics Kit 4x SFP+ LR	D3	\$12,664
NODE-OPTICS-0006	VxRack Node 2U1N Optics Kit 4x SFP+ LR	D3	\$12,664
NW200-RS-STG	NETWIN200 REPLISTOR STORAGE	D3	\$0
OPT-BW BASE	DBX OPT FOR SAP BW BASE	D3	\$0
OPT-BW-ADD ON	DBX OPT FOR SAP BW ADD ON	D3	\$0
OPTICS-CBL-0001	VxRack Node Optical Cable - 1m	D3	\$31
OPTICS-CBL-0002	VxRack Node Optical Cable - 3m	D3	\$42
OPTICS-CBL-0003	VxRack Node Optical Cable - 10m	D3	\$59
PFM6-CAPM-T01	EMC CONTROLCENTER 6.0 PERFORMANCE MG	D3	\$0
PFM6-CAPM-T02	EMC CONTROLCENTER 6.0 PERFORMANCE MG	D3	\$0
PFM6-CAPM-T03	EMC CONTROLCENTER 6.0 PERFORMANCE MG	D3	\$0
PFM6-CAPM-T04	EMC CONTROLCENTER 6.0 PERFORMANCE MG	D3	\$0
PFM6-CAPM-T05	EMC CONTROLCENTER 6.0 PERFORMANCE MG	D3	\$0
PFM6-CAPM-T06	EMC CONTROLCENTER 6.0 PERFORMANCE MG	D3	\$0
PFM6-CAPM-T07	EMC CONTROLCENTER 6.0 PERFORMANCE MG	D3	\$0
PFM6-CAPM-T08	EMC CONTROLCENTER 6.0 PERFORMANCE MG	D3	\$0
PFM6-CAPM-T09	EMC CONTROLCENTER 6.0 PERFORMANCE MG	D3	\$0
PFM6-CAPM-T10	EMC CONTROLCENTER 6.0 PERFORMANCE MG	D3	\$0
PFM6-CAPM-T11	EMC CONTROLCENTER 6.0 PERFORMANCE MG	D3	\$0
PFM6-CAPM-T12	EMC CONTROLCENTER 6.0 PERFORMANCE MG	D3	\$0
PFM6-CAPM-T13	EMC CONTROLCENTER 6.0 PERFORMANCE MG	D3	\$0
PFM6-CAPM-T14	EMC CONTROLCENTER 6.0 PERFORMANCE MG	D3	\$0
PFM6-UPG-T01	EMC CONTROLCENTER 6.0 PERFORMCE MGR M	D3	\$0
PFM6-UPG-T02	EMC CONTROLCENTER 6.0 PERFORMCE MGR M	D3	\$0
PFM6-UPG-T03	EMC CONTROLCENTER 6.0 PERFORMCE MGR M	D3	\$0
PFM6-UPG-T04	EMC CONTROLCENTER 6.0 PERFORMCE MGR M	D3	\$0
PFM6-UPG-T05	EMC CONTROLCENTER 6.0 PERFORMCE MGR M	D3	\$0
PFM6-UPG-T06	EMC CONTROLCENTER 6.0 PERFORMCE MGR M	D3	\$0
PFM6-UPG-T07	EMC CONTROLCENTER 6.0 PERFORMCE MGR M	D3	\$0
PFM6-UPG-T08	EMC CONTROLCENTER 6.0 PERFORMCE MGR M	D3	\$0
PFM6-UPG-T09	EMC CONTROLCENTER 6.0 PERFORMCE MGR M	D3	\$0
PFM6-UPG-T10	EMC CONTROLCENTER 6.0 PERFORMCE MGR M	D3	\$0
PFM6-UPG-T11	EMC CONTROLCENTER 6.0 PERFORMCE MGR M	D3	\$0
PFM6-UPG-T12	EMC CONTROLCENTER 6.0 PERFORMCE MGR M	D3	\$0
PFM6-UPG-T13	EMC CONTROLCENTER 6.0 PERFORMCE MGR M	D3	\$0
PFM6-UPG-T14	EMC CONTROLCENTER 6.0 PERFORMCE MGR M	D3	\$0
PFM-CAPM-T01	PFM ICM UP TO 14TB	D3	\$0
PFM-CAPM-T02	PFM ICM AT LEAST 15TB	D3	\$0
PFM-CAPM-T03	PFM ICM AT LEAST 25TB	D3	\$0
PFM-CAPM-T04	PFM ICM AT LEAST 40TB	D3	\$0
PFM-CAPM-T05	PFM ICM AT LEAST 60TB	D3	\$0
PFM-CAPM-T06	PFM ICM AT LEAST 100TB	D3	\$0
PFM-CAPM-T07	PFM ICM AT LEAST 150TB	D3	\$0
PFM-CAPM-T08	PFM ICM AT LEAST 250TB	D3	\$0
PFM-CAPM-T09	PFM ICM AT LEAST 400TB	D3	\$0
PFM-CAPM-T10	PFM ICM AT LEAST 600TB	D3	\$0
PFM-CAPM-T11	PFM ICM AT LEAST 1000TB	D3	\$0
PFM-CAPM-T12	PFM ICM AT LEAST 1500TB	D3	\$0
PFM-CAPM-T13	PFM ICM AT LEAST 2500TB	D3	\$0
PFM-CAPM-T14	PFM ICM AT LEAST 4000TB	D3	\$0

PFM-HD-T1-4U	PERF MGR HD T1-T4UPG	D3	\$0
PFM-HD-T5-31U	PERF MGR HD T5-T31UPG	D3	\$0
PFM-KEY	PFM ICM LIC KEY	D3	\$0
PFM-UPG-T01	PFM UP MR TO 14TB	D3	\$0
PFM-UPG-T02	PFM UP MR AT LEAST 15TB	D3	\$0
PFM-UPG-T03	PFM UP MR AT LEAST 25TB	D3	\$0
PFM-UPG-T04	PFM UP MR AT LEAST 40TB	D3	\$0
PFM-UPG-T05	PFM UP MR AT LEAST 60TB	D3	\$0
PFM-UPG-T06	PFM UP MR AT LEAST 100TB	D3	\$0
PFM-UPG-T07	PFM UP MR AT LEAST 150TB	D3	\$0
PFM-UPG-T08	PFM UP MR AT LEAST 250TB	D3	\$0
PFM-UPG-T09	PFM UP MR AT LEAST 400TB	D3	\$0
PFM-UPG-T10	PFM UP MR AT LEAST 600TB	D3	\$0
PFM-UPG-T11	PFM UP MR AT LEAST 1000TB	D3	\$0
PFM-UPG-T12	PFM UP MR AT LEAST 1500TB	D3	\$0
PFM-UPG-T13	PFM UP MR AT LEAST 2500TB	D3	\$0
PFM-UPG-T14	PFM UP MR AT LEAST 4000TB	D3	\$0
PKG-HP-T1-4U	CC5.1 PKG HP T1-4 UPG	D3	\$0
PKG-HP-T5-30U	CC5.1 PKG HP T5-30 UPG	D3	\$0
POWERPATH-VE	PowerPath/VE License Solution	D3	\$0
PP6-CAPM-T01	EMC CTRLCTR 6.0 SRM PLANNING-PROVISIONII	D3	\$0
PP6-CAPM-T02	EMC CTRLCTR 6.0 SRM PLANNING-PROVISIONII	D3	\$0
PP6-CAPM-T03	EMC CTRLCTR 6.0 SRM PLANNING-PROVISIONII	D3	\$0
PP6-CAPM-T04	EMC CTRLCTR 6.0 SRM PLANNING-PROVISIONII	D3	\$0
PP6-CAPM-T05	EMC CTRLCTR 6.0 SRM PLANNING-PROVISIONII	D3	\$0
PP6-CAPM-T06	EMC CTRLCTR 6.0 SRM PLANNING-PROVISIONII	D3	\$0
PP6-CAPM-T07	EMC CTRLCTR 6.0 SRM PLANNING-PROVISIONII	D3	\$0
PP6-CAPM-T08	EMC CTRLCTR 6.0 SRM PLANNING-PROVISIONII	D3	\$0
PP6-CAPM-T09	EMC CTRLCTR 6.0 SRM PLANNING-PROVISIONII	D3	\$0
PP6-CAPM-T10	EMC CTRLCTR 6.0 SRM PLANNING-PROVISIONII	D3	\$0
PP6-CAPM-T11	EMC CTRLCTR 6.0 SRM PLANNING-PROVISIONII	D3	\$0
PP6-CAPM-T12	EMC CTRLCTR 6.0 SRM PLANNING-PROVISIONII	D3	\$0
PP6-CAPM-T13	EMC CTRLCTR 6.0 SRM PLANNING-PROVISIONII	D3	\$0
PP6-CAPM-T14	EMC CTRLCTR 6.0 SRM PLANNING-PROVISIONII	D3	\$0
PP-AIX-COUNTR	COUNTS # OF POWERPATH AIX HOSTS	D3	\$0
PP-AIX-DP	PPATH AIX DEP	D3	\$0
PP-AIX-EN	PPATH AIX ENT	D3	\$0
PP-AIX-GB	PPATH AIX GLB	D3	\$0
PP-AIX-KIT	POWERPATH PP-AIX-KIT	D3	\$50
PP-AIX-SYMC	INACTIVE PP SYMC L KEY CARD FOR AIX	D3	\$0
PP-AIX-WG	PPATH AIX WGR	D3	\$0
PPB-EN-WGU	PPATH BASE-ENT WGR UPG	D3	\$0
PPB-LX	PPATH BASE LINUX	D3	\$0
PPB-WN	PPATH BASE WINDOWS	D3	\$0
PP-CPU-KEY	PP ICM LIC KEY	D3	\$0
PP-CPU-T01	PP ICM AT LEAST 100 CPUS	D3	\$0
PP-CPU-T02	PP ICM AT LEAST 150 CPUS	D3	\$0
PP-CPU-T03	PP ICM AT LEAST 250 CPUS	D3	\$0
PP-CPU-T04	PP ICM AT LEAST 400 CPUS	D3	\$0
PP-CPU-T05	PP ICM AT LEAST 600 CPUS	D3	\$0

PP-CPU-T06	PP ICM AT LEAST 1000 CPUS	D3	\$0
PP-CPU-T07	PP ICM AT LEAST 1500 CPUS	D3	\$0
PP-CPU-T08	PP ICM AT LEAST 2500 CPUS	D3	\$0
PP-CPU-T09	PP ICM AT LEAST 4000 CPUS	D3	\$0
PP-CPUWL-T01	PPA WL AT LEAST 100 CPUS	D3	\$0
PP-CPUWL-T02	PPA WL AT LEAST 150 CPUS	D3	\$0
PP-CPUWL-T03	PPA WL AT LEAST 250 CPUS	D3	\$0
PP-CPUWL-T04	PPA WL AT LEAST 400 CPUS	D3	\$0
PP-CPUWL-T05	PPA WL AT LEAST 600 CPUS	D3	\$0
PP-CPUWL-T06	PPA WL AT LEAST 1000 CPUS	D3	\$0
PP-CPUWL-T07	PPA WL AT LEAST 1500 CPUS	D3	\$0
PP-CPUWL-T08	PPA WL AT LEAST 2500 CPUS	D3	\$0
PP-CPUWL-T09	PPA WL AT LEAST 4000 CPUS	D3	\$0
PP-DP-EN-U	PP ENT DEP-ENT	D3	\$0
PPE-AIX	POWERPATH ENCRYPTION FOR AIX	D3	\$0
PP-HP-COUNTR	COUNTS # OF POWERPATH HP-UX HOSTS	D3	\$0
PP-HP-DP	PPATH HP DEP	D3	\$0
PP-HP-EN	PPATH HP ENT	D3	\$0
PP-HP-GB	PPATH HP GLB	D3	\$0
PP-HP-KIT	POWERPATH PP-HP-KIT	D3	\$50
PP-HP-WG	PPATH HP WGR	D3	\$0
PP-HPX-SYMC	INACTIVE PP SYMC L KEY CARD FOR HP-UX	D3	\$0
PP-ISCSI-LX	POWERPATH ISCSI - LINUX	D3	\$0
PP-ISCSI-WN	POWERPATH ISCSI - WINDOWS	D3	\$0
PP-LNX-SYMC	INACTIVE PP SYMC L KEY CARD FOR LINUX	D3	\$0
PP-LX-COUNTR	COUNTS # OF POWERPATH LINUX HOSTS	D3	\$0
PP-LX-DP	PPATH LINUX DEP	D3	\$0
PP-LX-EN	PPATH LINUX ENT	D3	\$0
PP-LX-KIT	POWERPATH PP-LX-KIT	D3	\$50
PP-LX-WG	PPATH LINUX WGR	D3	\$0
PPME-HC-AIX	POWERPATH MIGRATION ENABLER HOST COPY	D3	\$0
PPME-HC-BDL	PPME HOST COPY BUNDLE	D3	\$0
PPME-HC-LNX	POWERPATH MIGRATION ENABLER HOST COPY	D3	\$0
PPME-HC-SUN	POWERPATH MIGRATION ENABLER HOST COPY	D3	\$0
PPME-HC-WIN	POWERPATH MIGRATION ENABLER HOST COPY	D3	\$0
PPME-INV-BDL	PPME INVISTA BUNDLE	D3	\$0
PPME-OR-BDL	PPME OPEN REPLICATOR BUNDLE	D3	\$0
PPME-OR-C01	PPME-OR 1TB (0-14TB)	D3	\$0
PPME-OR-C02	PPME-OR 1TB (15-25TB)	D3	\$0
PPME-OR-C03	PPME-OR 1TB (26-40TB)	D3	\$0
PPME-OR-C04	PPME-OR 1TB (41-60TB)	D3	\$0
PPME-OR-C05	PPME-OR 1TB (61-100TB)	D3	\$0
PPME-OR-C06	PPME-OR 1TB (101-150TB)	D3	\$0
PPME-OR-C07	PPME-OR 1TB (151-250TB)	D3	\$0
PPME-OR-C08	PPME-OR 1TB (251-400TB)	D3	\$0
PPME-OR-C09	PPME-OR 1TB (401-600TB)	D3	\$0
PPME-OR-C10	PPME-OR 1TB (601-1000TB)	D3	\$0
PPME-OR-C11	PPME-OR 1TB (1001TB or greater)	D3	\$0
PPME-OR-N01	PPME-OR 1TB (0-14TB) NLT3	D3	\$0
PPME-OR-N02	PPME-OR 1TB (15-25TB) NLT3	D3	\$0

PPME-OR-N03	PPME-OR 1TB (16-40TB) NLT3	D3	\$0
PPME-OR-N04	PPME-OR 1TB (41-60TB) NLT3	D3	\$0
PPME-OR-N05	PPME-OR 1TB (61-100TB) NLT3	D3	\$0
PPME-OR-N06	PPME-OR 1TB (101-150TB) NLT3	D3	\$0
PPME-OR-N07	PPME-OR 1TB (151-250TB) NLT3	D3	\$0
PPME-OR-N08	PPME-OR 1TB (251-400TB) NLT3	D3	\$0
PPME-OR-N09	PPME-OR 1TB (401-600TB) NLT3	D3	\$0
PPME-OR-N10	PPME-OR 1TB (601-1000TB) NLT3	D3	\$0
PPME-OR-N11	PPME-OR 1TB (1001TB or greater) NLT3	D3	\$0
PPME-OR-UPG	PPME-OR BASE UPGRADE	D3	\$0
PPME-TFC-BDL	PPME TF/CLONE BUNDLE	D3	\$0
PP-NON-X86-T1	PP IND LIC NON-X86 1-7 CPUS	D3	\$0
PP-NON-X86-T2	PP IND LIC NON-X86 8+ CPUS	D3	\$0
PP-NON-X86-V1	PP VOL NON-X86 100-199 CPUS	D3	\$0
PP-NON-X86-V2	PP VOL NON-X86 200+ CPUS	D3	\$0
PP-NW-DP	PPATH NETWORKARE DEP	D3	\$0
PP-NW-EN	PPATH NETWORKARE ENT	D3	\$0
PP-NW-KIT	POWERPATH NETWORKARE KIT	D3	\$0
PP-NW-WG	PPATH NETWORKARE WGR	D3	\$0
PP-SE-SPC	PPATH FABRIC FAILOVER SYM - Q407 SPECIAL	D3	\$0
PP-SOL-COUNTR	COUNTS # OF POWERPATH SOLARIS HOSTS	D3	\$0
PP-SOL-SYMC	INACTIVE PP SYMC L KEY CARD FOR SOLARIS	D3	\$0
PP-SUN-DP	PPATH SUN DEP	D3	\$0
PP-SUN-EN	PPATH SUN ENT	D3	\$0
PP-SUN-GB	PPATH SUN GLB	D3	\$0
PP-SUN-KIT	POWERPATH PP-SOL-KIT	D3	\$50
PP-SUN-WG	PPATH SUN WGR	D3	\$0
PPUX-DP-EN-U	PP ENT UNIX DEP-ENT	D3	\$0
PPUX-EN-GB-U	PP ENT UNIX ENT-GLB	D3	\$0
PP-UX-KIT	POWERPATH UNIX KIT	D3	\$0
PPUX-WG-DP-U	PP ENT UNIX WGR-DEP	D3	\$0
PPVE-VM-KIT	POWERPATH PP-VMW-KIT	D3	\$50
PP-WG-DP-U	PP ENT WGR-DEP	D3	\$0
PP-WIN-SYMC	INACTIVE PP SYMC L KEY CARD FOR WINDOWS	D3	\$0
PP-WN43-KIT	POWERPATH FOR WINDOWS 4.3	D3	\$0
PP-WN-COUNTR	COUNTS # OF POWERPATH WINDOWS HOSTS	D3	\$0
PP-WN-DP	PPATH WINDOWS DEP	D3	\$0
PP-WN-EN	PPATH WINDOWS ENT	D3	\$0
PP-WN-KIT	POWERPATH PP-WN-KIT	D3	\$50
PP-WNMPIO-KIT	PP MPIO	D3	\$0
PP-WN-WG	PPATH WINDOWS WGR	D3	\$0
PP-X86-T1	PP IND LIC X86 1-7 CPUS	D3	\$0
PP-X86-T2	PP IND LIC X86 8+ CPUS	D3	\$0
PP-X86-V1	PP VOL X86 100-199 CPUS	D3	\$0
PP-X86-V2	PP VOL X86 200+ CPUS	D3	\$0
PWR-1PH-01	PWR CORD 24A SP 15FT 56PA332	D3	\$2,485
PWR-1PH-02	PWR CORD 24A SP 15FT IEC309P	D3	\$1,468
PWR-1PH-03	PWR CORD 24A SP 15FT L6-30P	D3	\$470
PWR-1PH-04	PWR CORD 24A SP 15FT 3750DP	D3	\$2,194
PWR-1PH-F-01	FAC PWR CORD 24A SP 15FT 56PA332	D3	\$2,485

PWR-1PH-F-02	FAC PWR CORD 24A SP 15FT IEC309P	D3	\$1,468
PWR-1PH-F-03	FAC PWR CORD 24A SP 15FT L6-30P	D3	\$470
PWR-1PH-F-04	FAC PWR CORD 24A SP 15FT 3750DP	D3	\$2,194
PWR-3PH-DELTA-01	PWR CORD 3-PH DELTA, 40A, 15FT, Int'l	D3	\$2,426
PWR-3PH-DELTA-02	PWR CORD 3-PH DELTA, 40A, 15FT, N. Am.	D3	\$1,754
PWR-3PH-DELTA-03	PWR CORD 3-PH DELTA, 40A/RS 15FT, N. Am.	D3	\$3,175
PWR-3PH-DELTA-F-01	FAC PWR CORD 3PH DELTA 40A 15FT INT'L	D3	\$2,426
PWR-3PH-DELTA-F-02	FAC PWR CORD 3PH DELTA 40A 15FT N. AM	D3	\$1,754
PWR-3PH-DELTA-F-03	FAC PWR CORD 3PH DELTA 40A/RS 15FT N. AM	D3	\$3,175
PWR-3PH-JUMP-01	3-PHASE DELTA, 40A, PDU JUMPER CABLE	D3	\$493
PWR-3PH-JUMP-F-01	FAC 3-PHASE DELTA 40A PDU JUMPER CABLE	D3	\$493
PWR-3PH-WYE-01	PWR CORD 3-PH WYE, 32A, 15FT, INT'L	D3	\$838
PWR-3PH-WYE-02	PWR CORD 3-PH WYE, 32A, 15FT, UNIV (FL)	D3	\$749
PWR-3PH-WYE-03	PWR CORD 3-PH WYE, 32A, 15FT, N. AM	D3	\$1,855
PWR-3PH-WYE-F-01	FAC PWR CORD 3PH WYE 32A 15FT INT'L	D3	\$838
PWR-3PH-WYE-F-02	FAC PWR CORD 3PH WYE 32A 15FT UNIV (FL)	D3	\$749
PWR-3PH-WYE-F-03	FAC PWR CORD 3PH WYE 32A 15FT N. AM	D3	\$1,855
RECOVERPNT-VM-KIT	RECOVERPOINT FOR VM MEDIA KIT=UA	D3	\$0
RECOVERPNT-KIT	RECOVERPOINT MEDIA KIT=UA	D3	\$0
RML-DP-EN	RM LOCAL DP TO EN UPG	D3	\$0
RML-EN-GB	RM LOCAL EN TO GB UPG	D3	\$0
RML-EXCHANGE	RM LOCAL EXCHANGE KIT	D3	\$0
RML-LINUX	RMLOCAL LINUX CL KIT	D3	\$0
RM-LOCAL-DP	RM LOCAL DP LIC	D3	\$0
RM-LOCAL-EN	RM LOCAL EN LIC	D3	\$0
RM-LOCAL-GB	RM LOCAL GB LIC	D3	\$0
RM-LOCAL-WG	RM LOCAL WG LIC	D3	\$0
RML-ORACLE	RM LOCAL ORACLE KIT	D3	\$0
RML-SQL	RM LOCAL SQL KIT	D3	\$0
RML-SVR-SUN	RM LOCAL SUN SVR KIT	D3	\$0
RML-SVR-WIN	RM LOCAL WIN SVR KIT	D3	\$0
RML-UDB	RM LOCAL UDB KIT	D3	\$0
RML-WG-DP	RM LOCAL WG TO DP UPG	D3	\$0
RM-NS20	RM FOR CELERRA ISCSI NS20 NO VSS SUPPORT	D3	\$0
RM-NSWIN02	RM FOR ISCSI CELERRA / WINDOWS 2	D3	\$0
RM-NSWIN03	RM FOR ISCSI CELERRA / WINDOWS 3	D3	\$0
RM-NSWIN05	RM FOR ISCSI CELERRA / WINDOWS 5	D3	\$0
RM-NSWIN08	RM FOR ISCSI CELERRA / WINDOWS 8	D3	\$0
RM-NSWIN12	RM FOR ISCSI CELERRA / WINDOWS 12	D3	\$0
RM-RP	RM FOR RECOVERPOINT	D3	\$0
RM-SC-L16-30	RM FOR SANCOPY / LINUX 16-30 HOSTS	D3	\$0
RM-SC-L31PLUS	RM FOR SANCOPY / LINUX 31 HOSTS & UP	D3	\$0
RM-SC-LINUX	RM FOR SANCOPY / LINUX HST	D3	\$0
RM-SC-U16-30	RM FOR SANCOPY/UNIX 16-30 HOSTS	D3	\$0
RM-SC-U31PLUS	RM FOR SANCOPY / UNIX 31 HOSTS & UP	D3	\$0
RM-SC-UNIX	RM FOR SANCOPY / UNIX HST	D3	\$0
RM-SC-W16-30	RM FOR SANCOPY / WINDOWS 16-30 HOSTS	D3	\$0
RM-SC-W31PLUS	RM FOR SANCOPY / WINDOWS 31 HOSTS & UP	D3	\$0
RM-SC-WIN	RM FOR SANCOPY / WINDOWS HST	D3	\$0
RMSE-NSKIT	RMSE-CELERRA MEDIA KIT	D3	\$0

RM-SERVER-DR	RM SERVER HST - DR	D3	\$0
RM-SV-L16-30	RM FOR SNAPVIEW / LINUX 16-30 HOSTS	D3	\$0
RM-SV-L31PLUS	RM FOR SNAPVIEW / LINUX 31 HOSTS & UP	D3	\$0
RM-SV-LINUX	RM FOR SNAPVIEW / LINUX HST	D3	\$0
RM-SV-U16-30	RM FOR SNAPVIEW / UNIX 16-30 HOSTS	D3	\$0
RM-SV-U31PLUS	RM FOR SNAPVIEW / UNIX 31 HOSTS & UP	D3	\$0
RM-SV-UNIX	RM FOR SNAPVIEW / UNIX HST	D3	\$0
RM-SV-W16-30	RM FOR SNAPVIEW / WINDOWS 16-30 HOSTS	D3	\$0
RM-SV-W31PLUS	RM FOR SNAPVIEW / WINDOWS 31 HOSTS & UP	D3	\$0
RM-SV-WIN	RM FOR SNAPVIEW / WINDOWS HST	D3	\$0
RM-TF-L16-30	RM FOR TIMEFINDER / LINUX 16-30 HOSTS	D3	\$0
RM-TF-L31PLUS	RM FOR TIMEFINDER / LINUX 31 HOSTS & UP	D3	\$0
RM-TF-LINUX	RM FOR TIMEFINDER / LINUX HST	D3	\$0
RM-TF-U16-30	RM FOR TIMEFINDER / UNIX 16-30 HOSTS	D3	\$0
RM-TF-U31PLUS	RM FOR TIMEFINDER / UNIX 31 HOSTS & UP	D3	\$0
RM-TF-UNIX	RM FOR TIMEFINDER / UNIX HST	D3	\$0
RM-TF-W16-30	RM FOR TIMEFINDER / WINDOWS 16-30 HOSTS	D3	\$0
RM-TF-W31PLUS	RM FOR TIMEFINDER / WINDOWS 31 HOSTS & U	D3	\$0
RM-TF-WIN	RM FOR TIMEFINDER / WINDOWS HST	D3	\$0
RM-WG	RM WORKGROUP LICENSE	D3	\$0
RP-BNDL1	MUST BE ORDERED WITH INV-BNDL1	D3	\$0
RP-BNDL2	MUST BE ORDERED WITH INV-BNDL2	D3	\$0
RP-BNDL3	MUST BE ORDERED WITH INV-BNDL3	D3	\$0
RP-BROCADE	RP BROCADE SPLITTER (CONFIG)	D3	\$0
RP-CDP-BASE	RP CDP BASE LICENSE	D3	\$0
RP-CDP-BASEF	RP CDP BASE PROMO LIC	D3	\$0
RP-CDP-BASEP	RP CDP BASE PROMO LIC	D3	\$0
RP-CDP-R01	RP-CDP 1TB (0-14 TB)	D3	\$0
RP-CDP-R01P	RP-CDP 1TB (0-14 TB) PROMO	D3	\$0
RP-CDP-R02	RP-CDP 1TB (15-25 TB)	D3	\$0
RP-CDP-R02P	RP-CDP 1TB (15-25 TB) PROMO	D3	\$0
RP-CDP-R03	RP-CDP 1TB (26-40 TB)	D3	\$0
RP-CDP-R03P	RP-CDP 1TB (26-40 TB) PROMO	D3	\$0
RP-CDP-R04	RP-CDP 1TB (41-60 TB)	D3	\$0
RP-CDP-R04P	RP-CDP 1TB (41-60 TB) PROMO	D3	\$0
RP-CDP-R05	RP-CDP 1TB (61-100 TB)	D3	\$0
RP-CDP-R05P	RP-CDP 1TB (61-100 TB) PROMO	D3	\$0
RP-CDP-R06	RP-CDP 1TB (101-150 TB)	D3	\$0
RP-CDP-R06P	RP-CDP 1TB (101-150 TB) PROMO	D3	\$0
RP-CDP-R07	RP-CDP 1TB (151-250 TB)	D3	\$0
RP-CDP-R08	RP-CDP 1TB (251-400 TB)	D3	\$0
RP-CDP-R09	RP-CDP 1TB(401-600 TB)	D3	\$0
RP-CDP-R10	RP-CDP 1TB (601-1000TB)	D3	\$0
RP-CDP-R11	RP-CDP 1TB (1001+ TB)	D3	\$0
RP-CE-01	RP CE FOR RP: MS CLUSTERS (0-14TB)	D3	\$0
RP-CE-02	RP CE FOR RP: MS CLUSTERS (15-25TB)	D3	\$0
RP-CE-03	RP CE FOR RP: MS CLUSTERS (26-40TB)	D3	\$0
RP-CE-04	RP CE FOR RP: MS CLUSTERS (41-60TB)	D3	\$0
RP-CE-05	RP CE FOR RP: MS CLUSTERS (61-100TB)	D3	\$0
RP-CE-06	RP CE FOR RP: MS CLUSTERS (101-150TB)	D3	\$0

RP-CE-07	RP CE FOR RP: MS CLUSTERS (151-250TB)	D3	\$0
RP-CE-08	RP CE FOR RP: MS CLUSTERS (251-400TB)	D3	\$0
RP-CE-09	RP CE FOR RP: MS CLUSTERS (401-600TB)	D3	\$0
RP-CE-BASE	RP CE FOR RP: MS CLUSTERS BASE	D3	\$0
RP-CLARIION	RP CLARIION SPLITTER (CONFIG)	D3	\$0
RP-KDRIVER	RP KDRIVER SPLITTER (CONFIG)	D3	\$0
RP-LNX-GPL	RECOVERPOINT LINUX GPLV3 DISTRIBUTION	D3	\$0
RP-LS	RECOVERPOINT LICENSE SOLUTION	D3	\$0
RP-RR-BASE	RP RR BASE LICENSE	D3	\$0
RP-RR-BASEF	RP RR BASE PROMO LIC	D3	\$0
RP-RR-CP-BASE	CDP AND CRR BASE LICENSE	D3	\$0
RP-RRCP-BASEF	RP RR CDP BASE PROMO LIC	D3	\$0
RP-RRCP-BASEP	RP RR CDP BASE PROMO	D3	\$0
RP-RR-R01	RP-RR 1TB (0-14 TB)	D3	\$0
RP-RR-R02	RP-RR 1TB (15-25 TB)	D3	\$0
RP-RR-R03	RP-RR 1TB (26-40 TB)	D3	\$0
RP-RR-R04	RP-RR 1TB (41-60 TB)	D3	\$0
RP-RR-R05	RP-RR 1TB (61-100 TB)	D3	\$0
RP-RR-R06	RP-RR 1TB (101-150 TB)	D3	\$0
RP-RR-R07	RP-RR 1TB (151-250 TB)	D3	\$0
RP-RR-R08	RP-RR 1TB (251-400 TB)	D3	\$0
RP-RR-R09	RP-RR 1TB (401-600 TB)	D3	\$0
RP-RR-R10	RECOVERPOINT CDP TIERED LICENSE	D3	\$0
RP-RR-R11	RP-RR 1TB (1001+ TB)	D3	\$0
RP-SANTAP	RP SANTAP SPLITTER (CONFIG)	D3	\$0
RPSE-RPCP-03U	RPSE CDP TO RPCL CDP T3 1TB UG	D3	\$0
RPSE-RPCP-04U	RPSE CDP TO RPCL CDP T4 1TB UG	D3	\$0
RPSE-RPCP-05U	RPSE CDP TO RPCL CDP T5 1TB UG	D3	\$0
RPSE-RPCP-06U	RPSE CDP TO RPCL CDP T6 1TB UG	D3	\$0
RPSE-RPCP-16U	RP/SE CDP 16TB TO RP CLASSIC CDP 16TB UG	D3	\$0
RPSE-RPCP-24U	RR/SE CDP 24TB TO RP CLASSIC CDP 24TB UG	D3	\$0
RPSE-RPCP-32U	RP/SE CDP 32TB TO RP CLASSIC CDP 32TB UG	D3	\$0
RPSE-RPCP-4U	RP/SE CDP 4TB TO RP CLASSIC CDP 4TB UG	D3	\$0
RPSE-RPCP-8U	RP/SE CDP 8TB TO RP CLASSIC CDP 8TB UG	D3	\$0
RPSE-RPRR-03U	RPSE CRR TO RPCL CRR T3 1TB UG	D3	\$0
RPSE-RPRR-04U	RPSE CRR TO RPCL CRR T4 1TB UG	D3	\$0
RPSE-RPRR-05U	RPSE CRR TO RPCL CRR T5 1TB UG	D3	\$0
RPSE-RPRR-06U	RPSE CRR TO RPCL CRR T6 1TB UG	D3	\$0
RPSE-RPRR-16U	RP/SE CRR 16TB TO RP CLASSIC CRR 16TB UG	D3	\$0
RPSE-RPRR-24U	RP/SE CRR 24TB TO RP CLASSIC CRR 24TB UG	D3	\$0
RPSE-RPRR-32U	RP/SE CRR 32TB TO RP CLASSIC CRR 32TB UG	D3	\$0
RPSE-RPRR-4U	RP/SE CRR 4TB TO RP CLASSIC CRR 4TB UG	D3	\$0
RPSE-RPRR-8U	RP/SE CRR 8TB TO RP CLASSIC CRR 8TB UG	D3	\$0
RP-SYNC	RP SYNCHRONOUS REPLICATION (CONFIG)	D3	\$0
RS-MEDIA-KIT	REPLISTOR MEDIA KIT	D3	\$0
RS-WIN-ADSV	REPLISTOR FOR WINDOWS ADVANCED SERVER	D3	\$0
RS-WIN-ADVSV	REPLISTOR ADVANCED SERVER	D3	\$0
RS-WIN-DC	REPLISTOR FOR WINDOWS DATA CENTER	D3	\$0
RS-WIN-SERV	REPLISTOR FOR WINDOWS SERVER	D3	\$0
RS-WIN-STGSV	REPLISTOR FOR WINDOWS STORAGE SERVER	D3	\$0

RS-WIN-SV	REPLISTOR FOR WINDOWS SERVER	D3	\$0
SAE-EX-RTU	RTU CARD FOR SAFE	D3	\$0
SANARC-ADVUPG	\$0 UPG SAN-ARC TO SAN-ADV	D3	\$0
SANM-CAPM-T01	SANM ICM UP TO 14TB	D3	\$0
SANM-CAPM-T02	SANM ICM AT LEAST 15TB	D3	\$0
SANM-CAPM-T03	SANM ICM AT LEAST 25TB	D3	\$0
SANM-CAPM-T04	SANM ICM AT LEAST 40TB	D3	\$0
SANM-CAPM-T05	SANM ICM AT LEAST 60TB	D3	\$0
SANM-CAPM-T06	SANM ICM AT LEAST 100TB	D3	\$0
SANM-CAPM-T07	SANM ICM AT LEAST 150TB	D3	\$0
SANM-CAPM-T08	SANM ICM AT LEAST 250TB	D3	\$0
SANM-CAPM-T09	SANM ICM AT LEAST 400TB	D3	\$0
SANM-CAPM-T10	SANM ICM AT LEAST 600TB	D3	\$0
SANM-CAPM-T11	SANM ICM AT LEAST 1000TB	D3	\$0
SANM-CAPM-T12	SANM ICM AT LEAST 1500TB	D3	\$0
SANM-CAPM-T13	SANM ICM AT LEAST 2500TB	D3	\$0
SANM-CAPM-T14	SANM ICM AT LEAST 4000TB	D3	\$0
SANM-KEY	SANM ICM LIC KEY	D3	\$0
SAS-ADV-AE	SA SUITE ADVANCED EDITION=MA	D3	\$0
SAS-ADV-AEA	SA SUITE ADVANCED EDITION ADD=MA	D3	\$0
SAS-ADV-AEU	SA SUITE UPGRADE TO ADVANCED=MA	D3	\$0
SAS-ADV-AEU-CF	SA SUITE UPGRADE TO ADVANCED=MA	D3	\$100
SAS-ADV-SDN	SDN for SA Suite Advanced Edition=MA	D3	\$0
SAS-ADV-SDN-CF	SDN FOR SA SUITE ADVANCED EDITION=MA	D3	\$140
SAS-ADV-T1	SA SUITE ADVANCED EDITION TIER 1=MA	D3	\$231
SAS-ADV-T2	SA SUITE ADVANCED EDITION TIER 2=MA	D3	\$180
SAS-ADV-T3	SA SUITE ADVANCED EDITION TIER 3=MA	D3	\$141
SAS-ADV-T4	SA SUITE ADVANCED EDITION TIER 4=MA	D3	\$141
SAS-ADV-T5	SA SUITE ADVANCED EDITION TIER 5=MA	D3	\$110
SAS-ADV-T6	SA SUITE ADVANCED EDITION TIER 6=MA	D3	\$110
SAS-ADV-T7	SA SUITE ADVANCED EDITION TIER 7=MA	D3	\$86
SAS-ADV-T8	SA SUITE ADVANCED EDITION TIER 8=MA	D3	\$86
SAS-MOB-CR1	Mobile Core Edition from 1 to 49=MA	D3	\$0
SAS-MOB-CR1-CF	Mobile Core Edition from 1 to 49=MA	D3	\$3,650
SAS-MOB-CR2	Mobile Core Edition from 50 to 99=MA	D3	\$0
SAS-MOB-CR2-CF	Mobile Core Edition from 50 to 99=MA	D3	\$2,920
SAS-MOB-CR3	Mobile Core Edition from 100+=MA	D3	\$0
SAS-MOB-CR3-CF	Mobile Core Edition from 100+=MA	D3	\$2,340
SAS-MOB-IM1	Mobile IMS Edition from 1 to 49=MA	D3	\$0
SAS-MOB-IM1-CF	Mobile IMS Edition from 1 to 49=MA	D3	\$11,080
SAS-MOB-IM2	Mobile IMS Edition from 50 to 99=MA	D3	\$0
SAS-MOB-IM2-CF	Mobile IMS Edition from 50 to 99=MA	D3	\$8,870
SAS-MOB-IM3	Mobile IMS Edition from 100+=MA	D3	\$0
SAS-MOB-IM3-CF	Mobile IMS Edition from 100+=MA	D3	\$7,090
SAS-MOB-RN1	Mobile RAN Edition from 1 to 4999=MA	D3	\$0
SAS-MOB-RN1-CF	Mobile RAN Edition from 1 to 4999=MA	D3	\$140
SAS-MOB-RN2	Mobile RAN Edition from 5000 to 9999=MA	D3	\$0
SAS-MOB-RN2-CF	Mobile RAN Edition from 5000 to 9999=MA	D3	\$120
SAS-MOB-RN3	Mobile RAN Edition from 10000+=MA	D3	\$0
SAS-MOB-RN3-CF	Mobile RAN Edition from 10000+=MA	D3	\$90

SASN-AE	SA SUITE N ADVANCED ED=MA	D3	\$0
SASN-SE	SA SUITE N STANDARD ED=MA	D3	\$0
SASN-SER	SA SUITE NR STANDARD ED=MA	D3	\$0
SASN-SERA	SA SUITE NR STANDARD ED=MA	D3	\$0
SASN-SERA-CF	SA SUITE NR STANDARD ED=MA	D3	\$0
SASN-SEV	SA SUITE NV STANDARD ED=MA	D3	\$0
SASN-SEV-CF	SA SUITE NV STANDARD ED=MA	D3	\$0
SASS-AE	SA SUITE S ADVANCED ED=MA	D3	\$0
SASS-AER	SA SUITE SR ADVANCED ED=MA	D3	\$0
SASS-AER-CF	SA SUITE SR ADVANCED ED=MA	D3	\$0
SASS-AEV	SA SUITE SV ADVANCED ED=MA	D3	\$0
SASS-AEV50	SA SUITE SV50 ADVANCED ED=MA	D3	\$0
SASS-AEV50-CF	SA SUITE SV50 ADVANCED ED=MA	D3	\$0
SASS-AEV-CF	SA SUITE SV ADVANCED ED=MA	D3	\$0
SAS-SP-E2E	SolutionPack for Transaction=MA	D3	\$0
SAS-SP-E2E-CF	SOLUTIONPACK FOR TRANSACTION=MA	D3	\$50,000
SAS-SP-MSSQL	SolutionPack for Microsoft SQL Server=MA	D3	\$0
SAS-SP-MSSQL-CF	SOLUTIONPACK FOR MICROSOFT SQLSERVER=	D3	\$120
SAS-SP-OMYSQL	SolutionPack for ORA MySQL Database=MA	D3	\$0
SAS-SP-OMYSQL-CF	SOLUTIONPACK FOR ORA MYSQL DATABASE=M	D3	\$120
SASS-SDR	SDN SR for SA Suite=MA	D3	\$0
SASS-SDR-CF	SDN SR FOR SA SUITE=MA	D3	\$0
SASS-SDV	SDN SV for SA Suite=MA	D3	\$0
SASS-SDV50	SDN SV50 for SA Suite=MA	D3	\$0
SASS-SDV50-CF	SDN SV50 FOR SA SUITE=MA	D3	\$0
SASS-SDV-CF	SDN SV FOR SA SUITE=MA	D3	\$0
SASS-SE	SA SUITE S STANDARD ED=MA	D3	\$0
SASS-SER	SA SUITE SR STANDARD ED=MA	D3	\$0
SASS-SER-CF	SA SUITE SR STANDARD ED=MA	D3	\$0
SASS-SEV	SA SUITE SV STANDARD ED=MA	D3	\$0
SASS-SEV50	SA SUITE SV50 STANDARD ED=MA	D3	\$0
SASS-SEV50-CF	SA SUITE SV50 STANDARD ED=MA	D3	\$0
SASS-SEV-CF	SA SUITE SV STANDARD ED=MA	D3	\$0
SAS-STD-SDN	SDN for SA Suite Standard Edition=MA	D3	\$0
SAS-STD-SDN-CF	SDN FOR SA SUITE STANDARD EDITION=MA	D3	\$140
SAS-STND-SE	SA SUITE STANDARD EDITION=MA	D3	\$0
SAS-STND-SEA	SA SUITE STANDARD EDITION ADD=MA	D3	\$0
SAS-STND-SEA-CF	SA SUITE STANDARD EDITION ADD=MA	D3	\$225
SAS-STND-SE-CF	SA SUITE STANDARD EDITION=MA	D3	\$225
SASW-AE	SA SUITE W ADVANCED ED; SERVER BASE=IA	D3	\$0
SASW-LER	SA SUITE WR LITE ED=MA	D3	\$0
SASW-LER-CF	SA SUITE WR LITE ED=MA	D3	\$0
SASW-LEV	SA SUITE WV LITE ED=MA	D3	\$0
SASW-LEV-CF	SA SUITE WV LITE ED=MA	D3	\$0
SASW-SDNR	SDN WR for SA Suite=MA	D3	\$0
SASW-SDNR-CF	SDN WR FOR SA SUITE=MA	D3	\$0
SASW-SDNV	SDN WV for SA Suite=MA	D3	\$0
SASW-SDNV-CF	SDN WV FOR SA SUITE=MA	D3	\$0
SASW-SE	SA SUITE W STANDARD ED; SERVER BASE=IA	D3	\$0
SH-458-000-130	REAL TIME INTELLIGENCE - SUBSC=ZC	D3	\$0

SIO-CBLKIT-0001	NETWORK KIT FOR SCALEIO 2U4N	D3	\$3,829
SIO-CBLKIT-0002	NETWORK KIT FOR SCALEIO 2U1N	D3	\$957
SIO-CBLKIT-0003	NETWORK KIT FOR SCALEIO 1U1N	D3	\$1,197
SIO-CBLKIT-1U1N	Ready 4x 3m Twinax Cable Kit - 1U1N	D3	\$690
SIO-CBLKIT-2U1N	Ready 4x 3m Twinax Cable Kit - 2U1N	D3	\$690
SIO-CBLKIT-F-0001	FAC NETWORK KIT FOR SCALEIO 2U4N	D3	\$3,829
SIO-CBLKIT-F-0002	FAC NETWORK KIT FOR SCALEIO 2U1N	D3	\$957
SIO-CBLKIT-F-0003	FAC NETWORK KIT FOR SCALEIO 1U1N	D3	\$1,197
SIO-CBL-LBL-1U1N	SIO 1U1N SERVERS CABLE LABEL SHEET	D3	\$0
SIO-CBL-LBL-2U1N	SIO 2U1N SERVERS CABLE LABEL SHEET	D3	\$0
SIO-CBL-LBL-2U4N	SIO 2U4N SERVERS CABLE LABEL SHEET	D3	\$0
SIO-HO-0001	HO 2U4N-280/512G/4.8T SSD	D3	\$526,048
SIO-HO-0002	HO 2U4N-280/256G/4.8T SSD	D3	\$426,941
SIO-HO-0003	HO 2U4N-280/256G/400G SSD/6T/CC	D3	\$267,810
SIO-HO-0004	HO 2U4N-250/256G/400G SSD/6T/CC	D3	\$237,650
SIO-HO-0005	HO 2U4N-280/512G/400G SSD/6T/CC	D3	\$357,007
SIO-HO-0006	HO 2U4N-250/512G/400G SSD/6T/CC	D3	\$326,847
SIO-HO-0007	HO 2U1N-250/256G/28.8T	D3	\$59,833
SIO-HO-0008	HO 2U1N-280/256G/4.8T SSD/21.6T	D3	\$90,578
SIO-HO-0009	HO 2U1N-250/256G/800G SSD/26.4T/CC	D3	\$63,893
SIO-HO-0010	HO 2U1N-250/512G/800G SSD/26.4T/CC	D3	\$78,030
SIO-HO-0011	HO 2U1N-280/256G/800G SSD/26.4T/CC	D3	\$69,204
SIO-HO-0012	HO 2U1N-280/512G/800G SSD/26.4T/CC	D3	\$83,341
SIO-HO-0013	HO 2U1N-150/64G/28.8T	D3	\$43,880
SIO-HO-0014	HO 2U1N-150/64G/4.8T SSD/21.6T	D3	\$68,732
SIO-HO-0015	HO 2U1N-150/64G/800G SSD/26.4T/CC	D3	\$47,940
SIO-HO-0016	HO 2U4N-280/128G/400G SSD/6T/CC	D3	\$223,265
SIO-HO-0017	HO 2U4N-250/128G/400G SSD/6T/CC	D3	\$193,109
SIO-HO-0018	HO 2U1N-250/256G/4T SSD/21.6T/CC	D3	\$80,461
SIO-HO-0019	HO 2U1N-250/512G/4T SSD/21.6T/CC	D3	\$99,428
SIO-HO-0020	HO 2U1N-250/128G/4T SSD/21.6T/CC	D3	\$71,626
SIO-HO-0021	HO 2U1N-250/128G/800G SSD/26.4T/CC	D3	\$55,058
SIO-HO-0022	HO 2U1N-280/256G/4T SSD/21.6T/CC	D3	\$85,779
SIO-HO-0023	HO 2U1N-280/512G/4T SSD/21.6T/CC	D3	\$106,397
SIO-HO-0024	HO 2U1N-280/128G/4T SSD/21.6T/CC	D3	\$76,937
SIO-HO-0025	HO 2U1N-280/128G/800G SSD/26.4T/CC	D3	\$60,369
SIO-HO-0026	HO 2U1N-120/64G/28.8T	D3	\$40,444
SIO-HO-0028	HO 2U1N-120/64G/800G SSD/26.4T/CC	D3	\$44,504
SIO-HO-0029	HO 1U1N-280/512G/800GB SSD/9.6T/CC	D3	\$72,937
SIO-HO-0030	HO 1U1N-280/512G/16T SSD	D3	\$178,206
SIO-HO-0031	HO 1U1N-150/64G/16T SSD	D3	\$130,980
SIO-HO-0032	HO 1U1N-120/64G/12T	D3	\$32,845
SIO-HO-0035	HO 1U1N-280/768G/800GB SSD/9.6T/CC	D3	\$89,211
SIO-HO-0036	HO 1U1N-250/256G/800G SSD/9.6T/CC	D3	\$54,895
SIO-HO-0037	HO 1U1N-150/128G/400G SSD/10.8T/CC	D3	\$37,149
SIO-HO-0039	HO 1U1N-250/256G/4T SSD /6T/CC	D3	\$78,157
SIO-MGMT-0001	MGMT 1U1N-120/16G/1.8T	D3	\$22,211
SIO-NETCNCT-F-001	FAC ARISTA 10GBASE-SRL SFP+ OPTIC	D3	\$2,063
SIO-NETCNCT-F-002	FAC ARISTA 40GBASE-SR4 QSFP+ OPTIC	D3	\$8,662
SIO-NETCNCT-F-003	FAC SIO Intel Ethernet SFP+ SR Optics	D3	\$815

SIO-NETCONNECT-001	ARISTA 10GBASE-SRL SFP+ OPTICAL MODULE	D3	\$2,063
SIO-NETCONNECT-002	ARISTA 40GBASE-SR4 QSFP+ OPTICAL MODULE	D3	\$8,662
SIO-NETCONNECT-003	SIO Intel Ethernet SFP+ SR Optics	D3	\$815
SIO-OPTIC-1U1N-LR	Ready Node Optics Kit - 1U1N 4x SFP+ LR	D3	\$10,077
SIO-OPTIC-1U1N-SR	Ready Node Optics Kit - 1U1N 4x SFP+ SR	D3	\$4,379
SIO-OPTIC-2U1N-LR	Ready Node Optics Kit - 2U1N 4x SFP+ LR	D3	\$10,077
SIO-OPTIC-2U1N-SR	Ready Node Optics Kit - 2U1N 4x SFP+ SR	D3	\$4,379
SIO-RACK-1PH	SCALEIO RACK 40U SINGLE PHASE	D3	\$12,759
SIO-RACK-3PH-DELTA	SCALEIO RACK 40U 3-PHASE DELTA	D3	\$17,093
SIO-RACK-3PH-F-DLT	FAC SCALEIO RACK 40U 3-PHASE DELTA	D3	\$17,093
SIO-RACK-3PH-F-WYE	FAC SCALEIO RACK 40U 3-PHASE WYE	D3	\$16,914
SIO-RACK-3PH-WYE	SCALEIO RACK 40U 3-PHASE WYE	D3	\$16,914
SIO-RACK-F-1PH	FAC SCALEIO RACK 40U SINGLE PHASE	D3	\$12,759
SIO-RAILKIT-1U1N	Ready 1U1N Rail Mounting Kit (Titan)	D3	\$166
SIO-RAILKIT-2U1N	Ready 2U1N Rail Mounting Kit (Titan)	D3	\$166
SIO-SWITCH-0001	ARISTA 7010T-48-R 48xRJ45 4xSFP+	D3	\$30,637
SIO-SWITCH-0002	ARISTA 7050SX-64-R 48xSFP+ 4xQSFP+	D3	\$67,519
SIO-SWITCH-0003	ARISTA 7050SX-128-R 96xSFP+ 8xQSFP+	D3	\$131,900
SIO-SWITCH-0004	ARISTA 7280SE-64-R 48xSFP+ 4xQSFP+	D3	\$123,870
SM6-CAPM-T12	EMC CONTROLCENTER 6.0 SAN MANAGER PPA	D3	\$0
SM6-CAPM-T13	EMC CONTROLCENTER 6.0 SAN MANAGER PPA	D3	\$0
SM6-CAPM-T14	EMC CONTROLCENTER 6.0 SAN MANAGER PPA	D3	\$0
SM6-UPG-T01	EMC CONTROLCENTER 6.0 SAN MGR PP UPGR	D3	\$0
SM6-UPG-T02	EMC CONTROLCENTER 6.0 SAN MGR PP UPGR	D3	\$0
SM6-UPG-T03	EMC CONTROLCENTER 6.0 SAN MGR PP UPGR	D3	\$0
SM6-UPG-T04	EMC CONTROLCENTER 6.0 SAN MGR PP UPGR	D3	\$0
SM6-UPG-T05	EMC CONTROLCENTER 6.0 SAN MGR PP UPGR	D3	\$0
SM6-UPG-T06	EMC CONTROLCENTER 6.0 SAN MGR PP UPGR	D3	\$0
SM6-UPG-T07	EMC CONTROLCENTER 6.0 SAN MGR PP UPGR	D3	\$0
SM6-UPG-T08	EMC CONTROLCENTER 6.0 SAN MGR PP UPGR	D3	\$0
SM6-UPG-T09	EMC CONTROLCENTER 6.0 SAN MGR PP UPGR	D3	\$0
SM6-UPG-T10	EMC CONTROLCENTER 6.0 SAN MGR PP UPGR	D3	\$0
SM6-UPG-T11	EMC CONTROLCENTER 6.0 SAN MGR PP UPGR	D3	\$0
SM6-UPG-T12	EMC CONTROLCENTER 6.0 SAN MGR PP UPGR	D3	\$0
SM6-UPG-T13	EMC CONTROLCENTER 6.0 SAN MGR PP UPGR	D3	\$0
SM6-UPG-T14	EMC CONTROLCENTER 6.0 SAN MGR PP UPGR	D3	\$0
SMA-ACM-F	ACM FAILOVER & TEST RTU LIC	D3	\$18,000
SMA-ACM-MS	ACM MANAGED SYSTEM	D3	\$0
SMA-ACM-P	ACM Prod RTU Lic	D3	\$0
SMA-ACM-UPG	ACM VOLUME LIC UPG CARD	D3	\$0
SMA-AD-ALS-F	AL5620 SAM ADAPTER-FAILOVER & TEST	D3	\$37,500
SMA-AD-ALS-P	AL5620 SAM ADP-P/PER SERV	D3	\$0
SMA-AD-BMC-F	BMC PATROL ADAPTER-FAILOVER & TEST	D3	\$4,500
SMA-AD-BMC-P	BMC Patrol ADP - P	D3	\$0
SMA-AD-BOX	ITOI ADAPTERS BOX	D3	\$0
SMA-AD-CEH-F	CONCORD EHEALTH ADAPTR - FAILOVER & TES	D3	\$4,500
SMA-AD-CEH-P	Concord eHealth ADP - P	D3	\$0
SMA-AD-CSE-F	CONCORD SYSEGE ADAPTR - FAILOVER & TES	D3	\$0
SMA-AD-CSE-P	CONCORD SYSEGE ADP - P	D3	\$0
SMA-AD-CTC-P	CIENA C.D TMF 814 ADP - P	D3	\$0

SMA-AD-CTM-P	CISCO CTM TMF 814 ADP - P	D3	\$0
SMA-AD-EML-F	EMAIL ADAPTER - FAILOVER & TEST	D3	\$2,250
SMA-AD-EML-P	E-Mail ADP - P	D3	\$0
SMA-AD-ISC-F	ISC ADAPTER - FAILOVER & TEST	D3	\$11,250
SMA-AD-ISC-P	ISC Adp - Production Lic	D3	\$0
SMA-AD-IVS-F	INFOVISTA SRVR ADAPTER - FAILOVER & TEST	D3	\$4,500
SMA-AD-IVS-P	InfoVista Server ADP - P	D3	\$0
SMA-AD-LGF-F	LOG FILE NOTIFICTN ADPTR - FAILOVER&TEST	D3	\$2,250
SMA-AD-LGF-P	Log File ADP - P	D3	\$0
SMA-AD-LIC	ITOI ADAPTERS LIC CARD	D3	\$0
SMA-AD-MOM-F	MOM TO SAM ADAPTER - FAILOVER & TEST	D3	\$0
SMA-AD-MOM-P	MOM TO SAM ADAPTER - P	D3	\$0
SMA-AD-NIQ-F	NETIQ ADAPTER - FAILOVER & TEST	D3	\$4,500
SMA-AD-NIQ-P	NetIQ ADP - P	D3	\$0
SMA-AD-NOTF-F	OUTBOUND SNMP ADAPTER - FAILOVER & TES	D3	\$2,250
SMA-AD-NOTF-P	OUTBOUND SNMP ADP - P	D3	\$0
SMA-AD-NV-F	IBM TIVOLI NETVW ADPTR - FAILOVER & TEST	D3	\$0
SMA-AD-NV-P	IBM Netview ADP - P	D3	\$0
SMA-AD-OPS-F	ADP MICROSOFT SYS CTR OPS MGR 2007 - F&T	D3	\$9,000
SMA-AD-OPS-P	ADP MICROSOFT SYS CTR OPS MGR 2007 - PRO	D3	\$0
SMA-AD-OVN-F	HP OPNVW NOTIFICTN ADPTR-FAILOVER & TST	D3	\$0
SMA-AD-OVN-P	HPOV Notification ADP - P	D3	\$0
SMA-AD-OVO-F	SAM ADAPTER HP OVO/U - FAILOVER & TEST	D3	\$0
SMA-AD-OVO-P	HPOV Ops Unix ADP - P	D3	\$0
SMA-AD-REM-F	BMC REMEDY ARS ADAPTER - FAILOVER & TES	D3	\$4,500
SMA-AD-REM-P	Remedy ADP - P	D3	\$0
SMA-AD-SCR-F	SCRIPT ADAPTER - FAILOVER & TEST	D3	\$2,250
SMA-AD-SCR-P	Script ADP - P	D3	\$0
SMA-AD-SIA-S	CLAR-CEL-SYM ADP SITE LIC	D3	\$0
SMA-AD-SQU-F	SQL UNIX ADPTR-P/SRVR - FAILOVER & TEST	D3	\$2,250
SMA-AD-SQU-P	SQL Unix ADP(p/server)-P	D3	\$0
SMA-AD-SQW-F	SQL WIN ADAPTER - FAILOVER & TEST	D3	\$2,250
SMA-AD-SQW-P	SQL Windows ADP - P	D3	\$0
SMA-AD-SSC-F	SAM ADPTR FOR SITESCOPE - FAIL OVER LIC	D3	\$4,500
SMA-AD-SSC-P	SAM ADAPTER FOR SITESCOPE - PROD LIC	D3	\$9,000
SMA-AD-SYS-F	SYSLOG ADAPTER - FAILOVER & TEST	D3	\$0
SMA-AD-SYS-P	Syslog ADP - P	D3	\$0
SMA-AD-TRP-F	SNMP TRAP ADAPTER - FAILOVER & TEST	D3	\$0
SMA-AD-TRP-P	SNMP Trap ADP - P	D3	\$0
SMA-ADVSOL	EMC SMARTS ADVANCED SOLUTIONS	D3	\$0
SMA-AD-XML-F	XML ADAPTER - FAILOVER & TEST	D3	\$2,250
SMA-AD-XML-P	XML ADP - P	D3	\$0
SMA-AM-HED	AM Mgd High End Device	D3	\$0
SMA-AM-LIC	IP AVAIL MGR LICENSE CARD	D3	\$0
SMA-AM-NAS-N	IP AM - NAS EXTENSION (1)	D3	\$0
SMA-AM-P	AM Production License	D3	\$0
SMA-API-C	ITOI C API LICENSE	D3	\$0
SMA-API-JAVA	ITOI JAVA API LICENSE	D3	\$0
SMA-API-PERL	ITOI PERL API LICENSE	D3	\$0
SMA-ATT-NGP	ATT NGP - AM DEVICES	D3	\$0

SMA-BIM-F	BIM MGR - FAILOVER & TEST	D3	\$15,750
SMA-BIM-LIC	BUS IMPACT MGR LIC CARD	D3	\$0
SMA-BIM-P	ITOI BUSINESS IMPACT MANAGER	D3	\$0
SMA-DMS-E	DM Static Ent License	D3	\$0
SMA-DMS-SP	DM Static SP License	D3	\$0
SMA-DMT-UD	DM Traveling License	D3	\$0
SMA-DSB-1	ITOI BUSNS DASHBRD - 1 CONCURRENT USER	D3	\$0
SMA-DSB-10	ITOI BUSNS DASHBRD - 2500 CONCURRNT USR	D3	\$0
SMA-DSB-2	ITOI BUSNS DASHBRD - 5 CONCURRENT USERS	D3	\$0
SMA-DSB-3	ITOI BUSNS DASHBRD - 10 CONCURRNT USERS	D3	\$0
SMA-DSB-4	ITOI BUSNS DASHBRD - 25 CONCURRENT USER	D3	\$0
SMA-DSB-5	ITOI BUSNS DASHBRD - 50 CONCURRNT USERS	D3	\$0
SMA-DSB-6	ITOI BUSNS DASHBRD - 100 CONCURRNT USRS	D3	\$0
SMA-DSB-7	ITOI BUSNS DASHBRD - 250 CONCURRNT USRS	D3	\$0
SMA-DSB-8	ITOI BUSNS DASHBRD - 500 CONCURRNT USRS	D3	\$0
SMA-DSB-9	ITOI BUSNS DASHBRD - 1000 CONCURRNT USR	D3	\$0
SMA-DSB-F	ITOI BUSINESS DASHBRD - FAILOVER & TEST	D3	\$6,750
SMA-DSB-LIC	EMC BUSINESS DASHBOARD LICENSE CARD	D3	\$0
SMA-DSB-P	ITOI BUSINESS DASHBOARD PRODUCTION LIC	D3	\$0
SMA-ESM-A1	ITOI SRVR MGR-APP PROCESS SRVR 1-9	D3	\$106
SMA-ESM-A2	ITOI SRVR MGR-APP PROCESS SRVR 10-49	D3	\$96
SMA-ESM-A3	ITOI SRVR MGR-APP PROCESS SRVR 50-99	D3	\$85
SMA-ESM-A4	ITOI SRVR MGR-APP PROCESS SRVR 100-249	D3	\$74
SMA-ESM-A5	ITOI SRVR MGR-APP PROCESS SRVR 250-599	D3	\$64
SMA-ESM-A6	ITOI SRVR MGR-APP PROCESS SRVR 600-999	D3	\$58
SMA-ESM-A7	ITOI SRVR MGR-APP PROCESS SRVR 1000-199	D3	\$53
SMA-ESM-A8	ITOI SRVR MGR-APP PROCESS SRVR 2000+	D3	\$45
SMA-ESM-APM	ITOI SRVR MGR-APP PROCESS MGMT MODULE	D3	\$0
SMA-ESM-APM-1	ITOI SRVR MGR-APP PROCESS MGMT PER HOS	D3	\$113
SMA-ESM-BOX	EMC SERVER MONITOR KIT	D3	\$0
SMA-ESM-CMM	ITOI SRVR MGR-CLUSTER MGT MOD- SITE LIC	D3	\$0
SMA-ESM-CMM-1	ITOI SERVER MGR - PER SERVER IN CLUSTER	D3	\$113
SMA-ESM-F	ITOI SERVER MGR - FAILOVER & TEST	D3	\$6,750
SMA-ESM-F5	F5 LOAD BALANCER MGMT MODULE	D3	\$0
SMA-ESM-F51	F5 LOAD BALANCER PER SERVER LICENSE	D3	\$133
SMA-ESM-H1	ITOI SERVER MGR - HYPER-V SERVER 1-9	D3	\$1,912
SMA-ESM-H2	ITOI SERVER MGR - HYPER-V SERVER 10-49	D3	\$1,721
SMA-ESM-H3	ITOI SERVER MGR - HYPER-V SERVER 50-99	D3	\$1,530
SMA-ESM-H4	ITOI SERVER MGR - HYPER-V SERVER 100-249	D3	\$1,338
SMA-ESM-H5	ITOI SERVER MGR - HYPER-V SERVER 250-599	D3	\$1,147
SMA-ESM-H6	ITOI SERVER MGR - HYPER-V SERVER 600-999	D3	\$1,052
SMA-ESM-H7	ITOI SERVER MGR - HYPER-V SRVR 1000-1999	D3	\$956
SMA-ESM-H8	ITOI SERVER MGR - HYPER-V SERVER 2000+	D3	\$812
SMA-ESM-HPV	MICROSOFT HYPER-V MGMT MODULE	D3	\$0
SMA-ESM-LIC	EMC SERVER MANAGER LICENSE CARD	D3	\$0
SMA-ESM-N1	ESX-NSX Servers 1 to 9=IA	D3	\$1,912
SMA-ESM-N2	ESX-NSX Servers 10 to 49=IA	D3	\$1,721
SMA-ESM-N3	ESX-NSX Servers 50 to 99=IA	D3	\$1,530
SMA-ESM-N4	ESX-NSX Servers 100 to 249=IA	D3	\$1,338
SMA-ESM-N5	ESX-NSX Servers 250 to 599=IA	D3	\$1,147

SMA-ESM-N6	ESX-NSX Servers 600 to 999=IA	D3	\$1,052
SMA-ESM-N7	ESX-NSX Servers 1000 to 1999=IA	D3	\$956
SMA-ESM-N8	ESX-NSX Servers 2000+=IA	D3	\$812
SMA-ESM-O1	Opn Src KVM,XEN Servers 1-9=IA	D3	\$1,243
SMA-ESM-O2	Opn Src KVM,XEN Servers 10-49=IA	D3	\$1,119
SMA-ESM-O3	Opn Src KVM,XEN Servers 50-99=IA	D3	\$995
SMA-ESM-O4	Opn Src KVM,XEN Servers 100-249=IA	D3	\$870
SMA-ESM-O5	Opn Src KVM,XEN Servers 250-599=IA	D3	\$746
SMA-ESM-O6	Opn Src KVM,XEN Servers 600-999=IA	D3	\$684
SMA-ESM-O7	Opn Src KVM,XEN Servers 1000-1999=IA	D3	\$622
SMA-ESM-O8	Opn Src KVM,XEN Servers 2000+=IA	D3	\$528
SMA-ESM-P	EMC SERVER MANAGER - PROD LICENSE	D3	\$0
SMA-ESM-SDN	SDN for Smarts=MA	D3	\$17,200
SMA-ESM-V1	ITOI SERVER MGR - VMWARE ESX SRVR 1-9	D3	\$1,912
SMA-ESM-V2	ITOI SERVER MGR - VMWARE ESX SRVR 10-49	D3	\$1,721
SMA-ESM-V3	ITOI SERVER MGR - VMWARE ESX SRVR 50-99	D3	\$1,530
SMA-ESM-V4	ITOI SERVER MGR - VMWARE ESX SVR 100-249	D3	\$1,338
SMA-ESM-V5	ITOI SERVER MGR - VMWARE ESX SVR 250-599	D3	\$1,147
SMA-ESM-V6	ITOI SERVER MGR - VMWARE ESX SVR 600-999	D3	\$1,052
SMA-ESM-V7	ITOI SERVER MGR - VMW ESX SVR 1000-1999	D3	\$956
SMA-ESM-V8	ITOI SERVER MGR - VMWARE ESX SRVR 2000+	D3	\$812
SMA-ESM-VMM	ITOI SERVER MGR - VM MODULE (SITE LIC)	D3	\$0
SMA-ESM-VMM-1	EMC SERVER MANAGER - MANAGED VM HOSTS	D3	\$2,250
SMA-EX-100	Express Pack 100	D3	\$45,000
SMA-EX-250	Express Pack 250	D3	\$99,000
SMA-EX-250F	EXPRESS PACK 250 - FAILOVER & TEST	D3	\$29,250
SMA-EX-50	Express Pack 50	D3	\$27,000
SMA-EX-A100	ASM Express Pack 100	D3	\$0
SMA-EX-A250	ASM Express Pack 250	D3	\$0
SMA-EX-A50	ASM Express Pack 50	D3	\$0
SMA-EX-AC100	ACM EXPRESS 100 PROD LIC	D3	\$65,250
SMA-EX-AC100F	ACM EXPRESS PACK 100 - FAILOVER & TEST	D3	\$32,625
SMA-EX-AC250	ACM EXPRESS 250 PROD LIC	D3	\$141,750
SMA-EX-AC250F	ACM EXPRESS PACK 250 - FAILOVER & TEST	D3	\$47,250
SMA-EX-AC50	ACM EXPRESS 50 PROD LIC	D3	\$40,950
SMA-EX-AC50F	ACM EXPRESS PACK 50 - FAILOVER & TEST	D3	\$20,475
SMA-EX-ACUP1	ACM EXP PACK UPG 1	D3	\$0
SMA-EX-ACUP1F	ACM EXPRESS PACK 50 UPG-FAILOVER & TEST	D3	\$12,150
SMA-EX-ACUP2	ACM EXP PACK UPG 2	D3	\$0
SMA-EX-ACUP2F	ACM EXPRESS PACK 200 UPG-FAILOVER & TES	D3	\$26,775
SMA-EX-ACUP3	ACM EXP PACK UPG 3	D3	\$0
SMA-EX-ACUP3F	ACM EXPRESS PACK 100 UPG-FAILOVER & TES	D3	\$14,625
SMA-EX-AC-UPG	ACM EXP UPG LIC CARD	D3	\$0
SMA-EX-AUP1	ASM Express Pack Upg 1	D3	\$0
SMA-EX-AUP2	ASM Express Pack Upg 2	D3	\$0
SMA-EX-AUP3	ASM Express Pack Upg 3	D3	\$0
SMA-EX-BUP1	BI Express Pack Upg 1	D3	\$0
SMA-EX-BUP2	BI Express Pack Upg 2	D3	\$0
SMA-EX-BUP3	BI Express Pack Upg 3	D3	\$0
SMA-EX-BUPG	BI EXP UPGRADE CARD	D3	\$0

SMA-EX-CM250	SMARTS EXPRESS PACK COMMERCIAL 250	D3	\$15,000
SMA-EX-CM250U	SMARTS EXPRESS PACK COMMERCIAL 250 UPG	D3	\$45,000
SMA-EX-EME-F	EMER MRKTS EXPRS PKG EXT-FAILOVER & TEST	D3	\$42,300
SMA-EX-EME-P	EMER MRKTS EXPRS PKG EXT-PRODUCTION	D3	\$84,600
SMA-EX-EM-F	EMERGING MRKTS EXP PKG - FAILOVER & TEST	D3	\$58,500
SMA-EX-EM-P	EMERGING MRKTS EXP PKG - PRODUCTION	D3	\$140,400
SMA-EX-M100	MPLS EXPRESS PACK 100	D3	\$112,500
SMA-EX-M100F	MPLS EXPRESS PACK 100 - FAILOVER & TEST	D3	\$49,500
SMA-EX-M250	MPLS EXPRESS PACK 250	D3	\$186,750
SMA-EX-M250F	MPLS EXPRESS PACK 250 - FAILOVER & TEST	D3	\$55,800
SMA-EX-M50	MPLS EXPRESS PACK 50	D3	\$87,750
SMA-EX-M50F	MPLS EXPRESS PACK 50 - FAILOVER & TEST	D3	\$40,500
SMA-EX-MUP1	MPLS EXP PACK UPG 1	D3	\$24,750
SMA-EX-MUP1F	MPLS EXP PACK 50 UPG - FAILOVER & TEST	D3	\$9,000
SMA-EX-MUP2	MPLS EXP PACK UPG 2	D3	\$99,000
SMA-EX-MUP2F	MPLS EXP PACK 200 UPG - FAILOVER & TEST	D3	\$15,300
SMA-EX-MUP3	MPLS EXP PACK UPG 3	D3	\$74,250
SMA-EX-MUP3F	MPLS EXP PACK 100 UPG - FAILOVER & TEST	D3	\$6,300
SMA-EX-MUPG	MPLS EXP UPGRADE CARD	D3	\$0
SMA-EX-NA100	NAS EXPRESS PACK 100 PRODUCTION LICENSE	D3	\$37,260
SMA-EX-NA100F	NAS EXPRESS PACK 100 - FAILOVER & TEST	D3	\$18,630
SMA-EX-NA250	NAS EXPRESS PACK 250 PRODUCTION LICNESH	D3	\$80,460
SMA-EX-NA250F	NAS EXPRESS PACK 250 - FAILOVER & TEST	D3	\$29,250
SMA-EX-NA50	NAS EXPRESS PACK 50 PRODUCTION LICENSE	D3	\$22,860
SMA-EX-NA50F	NAS EXPRESS PACK 50 - FAILOVER & TEST	D3	\$11,430
SMA-EX-NAUP1	NAS EXPRESS PACK 50 UPGRADE - PRODUCTION	D3	\$0
SMA-EX-NAUP1F	NAS EXP PACK 50 UPG - FAILOVER & TEST	D3	\$7,200
SMA-EX-NAUP2	NAS EXPRESS PACK 50 UPGRADE - PRODUCTION	D3	\$0
SMA-EX-NAUP2F	NAS EXP PACK 50 UPG - FAILOVER & TEST	D3	\$17,820
SMA-EX-NAUP3	UPG-NAS EXP PKG 100 TO NAS EXP 250 PROD	D3	\$0
SMA-EX-NAUP3F	NAS EXP PACK 100 UPG - FAILOVER & TEST	D3	\$10,620
SMA-EX-NAUPG	NAS EXPRESS PACKAGE UPGRADE LICENSE	D3	\$0
SMA-EX-OP100F	MS SCOM 2007 EXP PACK 100- FAILOVER&TEST	D3	\$10,000
SMA-EX-OP100P	MS SCOM 2007 EXP PACK 100 - PRODUCTION	D3	\$20,000
SMA-EXP-100F	ITOI EXPRESS PACK 100 - FAILOVER & TEST	D3	\$22,500
SMA-EXP-50F	ITOI EXPRESS PACK 50 - FAILOVER & TEST	D3	\$13,500
SMA-EX-UP1	Express Pack Upg 1	D3	\$0
SMA-EX-UP1F	ITOI EXP PCK 50 UPG-100 -FAILOVER&TEST	D3	\$9,000
SMA-EX-UP2	Express Pack Upg 2	D3	\$0
SMA-EX-UP2F	ITOI EXP PCK 50 UPG-250 -FAILOVERs&TEST	D3	\$15,750
SMA-EX-UP3	Express Pack Upg 3	D3	\$0
SMA-EX-UP3F	ITOI EXP PCK 100 UPG-250 -FAILOVER&TEST	D3	\$6,750
SMA-EX-UPG	EXPRESS PACK UPGRADE CARD	D3	\$0
SMA-EXVC-100	ITOI NCM EXPRESS PACKAGE 100 PRODUCTION	D3	\$0
SMA-EXVC-100A	ITOI NCM EXPRESS PACKAGE 100 PRODUCTION	D3	\$30,000
SMA-EXVC-100F	ITOI NCM EXP PACK 100 - FAILOVER & TEST	D3	\$9,500
SMA-EXVC-250	ITOI NCM EXPRESS PACKAGE 250 PRODUCTION	D3	\$0
SMA-EXVC-250A	ITOI NCM EXPRESS PACKAGE 250 PRODUCTION	D3	\$75,000
SMA-EXVC-250F	ITOI NCM EXP PACK 250 - FAILOVER & TEST	D3	\$12,500
SMA-EXVC-50	ITOI NCM EXPRESS PACKAGE 50 PRODUCTION	D3	\$0

SMA-EXVC-50A	ITOI NCM EXPRESS PACKAGE 50 PRODUCTION	D3	\$15,000
SMA-EXVC-50F	ITOI NCM EXP PACK 50 - FAILOVER & TEST	D3	\$5,500
SMA-EXVC-UP1	ITOI NCM EXP PACK 50 UPG- PRODUCTION	D3	\$15,000
SMA-EXVC-UP1F	ITOI NCM EXP PACK 50 UPG- FAILOVER&TEST	D3	\$4,000
SMA-EXVC-UP2	ITOI NCM EXP PACK 50 UPG-250 - PRODCNTN	D3	\$60,000
SMA-EXVC-UP2F	ITOI NCM EXP PAK 50 UPG-250-FAILOVR&TST	D3	\$7,000
SMA-EXVC-UP3	ITOI NCM EXP PACK 100 UPG-250 - PRODCNTN	D3	\$45,000
SMA-EXVC-UP3F	ITOI NCM EXPPAK 100 UPG-250-FAILOVR&TST	D3	\$3,000
SMA-EXVS-100	ITOI NCM&ITOI EXP PACK 100 - PRODCNTN	D3	\$0
SMA-EXVS-100A	ITOI NCM&ITOI EXP PACK 100 - PRODCNTN=MA	D3	\$85,000
SMA-EXVS-100F	ITOI NCM&ITOI EXP PAK 100-FAILOVER&TST	D3	\$32,500
SMA-EXVS-250	ITOI NCM&ITOI EXP PACK 250 - PRODCNTN	D3	\$0
SMA-EXVS-250A	ITOI NCM&ITOI EXP PACK 250 - PRODCNTN=MA	D3	\$195,000
SMA-EXVS-250F	ITOI NCM&ITOI EXP PAK 250-FAILOVER&TST	D3	\$45,000
SMA-EXVS-50	ITOI NCM&ITOI EXP PACK 50 - PRODCNTN	D3	\$0
SMA-EXVS-50A	ITOI NCM&ITOI EXP PACK 50 - PRODCNTN=MA	D3	\$50,000
SMA-EXVS-50F	ITOI NCM&ITOI EXP PACK 50-FAILOVER&TST	D3	\$20,000
SMA-EXVS-UP1	ITOI NCM&ITOI EXP PAK 50 UPG-PRODCNTN	D3	\$35,000
SMA-EXVS-UP1F	ITOI NCM&ITOI EXPPAK 50UPG-FAILOVR&TST	D3	\$12,500
SMA-EXVS-UP2	ITOI NCM&ITOI EXP PAK200 UPG-PRODCNTN	D3	\$140,000
SMA-EXVS-UP2F	ITOI NCM&ITOI EXPAK 200UPG-FAILOVR&TST	D3	\$25,000
SMA-EXVS-UP3	ITOI NCM&ITOI EXP PAK100 UPG-PRODCNTN	D3	\$105,000
SMA-EXVS-UP3F	ITOI NCM&ITOI EXPAK 100UPG-FAILOVR&TST	D3	\$12,500
SMA-GC-100P	GLOBAL CONSOLE 100	D3	\$0
SMA-GC-10P	GLOBAL CONSOLE 10	D3	\$0
SMA-GC-1P	GLOBAL CONSOLE 1	D3	\$0
SMA-GC-25P	GLOBAL CONSOLE 25	D3	\$0
SMA-GC-3P	GLOBAL CONSOLE 3	D3	\$0
SMA-GC-50P	GLOBAL CONSOLE 50	D3	\$0
SMA-IP-BOX	IP MANAGEMENT SUITE KIT	D3	\$0
SMA-MD1-001	IP AM Mgd Tier 1 Lic	D3	\$0
SMA-MD1-002	IP AM Mgd Tier 1: 501-1000 Lic 4% Disc	D3	\$0
SMA-MD1-003	IP AM MANAGED TIER 1 DEVICES: 1001-1500	D3	\$0
SMA-MD1-004	IP AM MANAGED TIER 1 DEVICES: 1501-2500	D3	\$0
SMA-MD1-005	IP AM MANAGED TIER 1 DEVICES: 2501-5000	D3	\$0
SMA-MD1-006	IP AM MANAGED TIER 1 DEVICES: 5001-10000	D3	\$0
SMA-MD1-007	IP AM Mgd Tier 1: 10,001+ Lic 60% Disc	D3	\$0
SMA-MD2-001	IP AM Mgd Tier 2 Lic	D3	\$0
SMA-MD2-002	IP AM Mgd Tier 2: 501-1000 Lic 5% Disc	D3	\$0
SMA-MD2-003	IP AM MANAGED TIER 2 DEVICES: 1001-1500	D3	\$0
SMA-MD2-004	IP AM MANAGED TIER 2 DEVICES: 1501-2500	D3	\$0
SMA-MD2-005	IP AM MANAGED TIER 2 DEVICES: 2501-5000	D3	\$0
SMA-MD2-006	IP AM MANAGED TIER 2 DEVICES: 5001-10000	D3	\$0
SMA-MD2-007	IP AM Mgd Tier 2: 10,001+ Lic 45% Disc	D3	\$0
SMA-MD3-001	IP AM Mgd Tier 3 Lic	D3	\$0
SMA-MD3-002	IP AM Mgd Tier 3: 501-1000 Lic 8.3% Disc	D3	\$0
SMA-MD3-003	IP AM MANAGED TIER 3 DEVICES: 1001-1500	D3	\$0
SMA-MD3-004	IP AM MANAGED TIER 3 DEVICES: 1501-2500	D3	\$0
SMA-MD3-005	IP AM MANAGED TIER 3 DEVICES: 2501-5000	D3	\$0
SMA-MD3-006	IP AM MANAGED TIER 3 DEVICES: 5001-10000	D3	\$0

SMA-MD3-007	IP AM Mgd Tier 3: 10,001+ Lic 58.3% Disc	D3	\$0
SMA-MD4-001	IP AM Mgd Tier 4 NAS Lic	D3	\$0
SMA-MD4-002	IP AM MANGD TIER 4 NAS DEVICES:101-250	D3	\$0
SMA-MD4-003	IP AM MANGD TIER 4 NAS DEVICES:251+UP	D3	\$0
SMA-MMD-BOX	MULTICAST MGMT SUITE KIT	D3	\$0
SMA-MMD-F	MULTICAST MGR RTU:DC-NOC - FAILOVER&TES	D3	\$12,500
SMA-MMD-MD1	MULTICAST MGD DEV LIC	D3	\$0
SMA-MMD-MD2	MULTICAST MGD DEV: 501-1,000 LIC 4% DISC	D3	\$0
SMA-MMD-MD3	MULTICAST MGR DEVICES: 1001-1500	D3	\$0
SMA-MMD-MD4	MULTICAST MGR DEVICES: 1501-2500	D3	\$0
SMA-MMD-MD5	MULTICAST MGR DEVICES: 2501-5000	D3	\$0
SMA-MMD-MD6	MULTICAST MGR DEVICES: 5001-10000	D3	\$0
SMA-MMD-MD7	MULTICAST MGD DEV: 10,000+ LIC 60% DISC	D3	\$0
SMA-MMD-MVPN	MULTICAST MGR: MULTICST VPN FEATURE LIC	D3	\$0
SMA-MMD-P	MULTICAST PRODUCTION LIC	D3	\$0
SMA-MMD-UPG	MULTICAST VOLUME LIC CARD	D3	\$0
SMA-MPLS-BOX	EMC ITOI MPLS MANAGER KIT	D3	\$0
SMA-MPLS-CE1	MPLSMGD LAY3 CE DEV LIC	D3	\$0
SMA-MPLS-CE2	MPLS MGD LAY3 CE DEVICES: 2501-5000	D3	\$0
SMA-MPLS-CE3	MPLS MGD LAY3 CE DEVICES: 5001-10000	D3	\$0
SMA-MPLS-CE4	MPLS MGD LAY3 CE DEVICES: 10001-25000	D3	\$0
SMA-MPLS-CE5	MPLS MGD LAY3 CE DEVICES: 25001-50000	D3	\$0
SMA-MPLS-CE6	MPLS MGD LAY3 CE DEVICES: 50001+UP	D3	\$0
SMA-MPLS-FI1	MPLSMGD LAY2 FWD INTF LIC	D3	\$0
SMA-MPLS-FI2	MPLS MGD LAY2 FRWRDR INTFC: 201-1000	D3	\$0
SMA-MPLS-FI3	MPLS MGD LAY2 FRWRDR INTFC: 1001-4000	D3	\$0
SMA-MPLS-FI4	MPLS MGD LAY2 FRWRDR INTFC: 4001-20000	D3	\$0
SMA-MPLS-FI5	MPLS MGD LAY2 FRWRDR INTFC: 20001-100K	D3	\$0
SMA-MPLS-FI6	MPLS MGD LAY2 FRWRDR INTFC: 100K+UP	D3	\$0
SMA-MPLS-P	MPLS PRODUCTION LICENSE	D3	\$0
SMA-MPLS-UPG	MPLS UPGRADE CARD	D3	\$0
SMA-MPLS-VR1	MPLSMGD LAY3 VRF INTF LIC	D3	\$0
SMA-MPLS-VR2	MPLS MGD LAY3 VRF INTFC: 2501-5000	D3	\$0
SMA-MPLS-VR3	MPLS MGD LAY3 VRF INTFC: 5001-10000	D3	\$0
SMA-MPLS-VR4	MPLS MGD LAY3 VRF INTFC: 10001-25000	D3	\$0
SMA-MPLS-VR5	MPLS MGD LAY3 VRF INTFC: 25001-50000	D3	\$0
SMA-MPLS-VR6	MPLS MGD LAY3 VRF INTFC: 50001+UP	D3	\$0
SMA-MULTI-UPG	MULTICAST UPGRADE CARD	D3	\$0
SMA-NIPV61-01	IPV6 AM MNGD TIER 1 DEVICES: 1-500	D3	\$261
SMA-NIPV61-02	IPV6 AM MNGD TIER 1 DEVICES: 501-1000	D3	\$248
SMA-NIPV61-03	IPV6 AM MNGD TIER 1 DEVICES: 1001-1500	D3	\$230
SMA-NIPV61-04	IPV6 AM MNGD TIER 1 DEVICES: 1501-2500	D3	\$207
SMA-NIPV61-05	IPV6 AM MNGD TIER 1 DEVICES: 2501+UP	D3	\$171
SMA-NIPV61-U1	IPV6 AM MNGD TR1 V4-V6 UPG-DEV: 1-500	D3	\$36
SMA-NIPV61-U2	IPV6 AM MNGD TR1 V4-V6 UPG-DEV: 501-1000	D3	\$32
SMA-NIPV61-U3	IPV6 AM MNGD TR1 V4-V6 UPG-DEV:1001-1500	D3	\$32
SMA-NIPV61-U4	IPV6 AM MNGD TR1 V4-V6 UPG-DEV:1501-2500	D3	\$27
SMA-NIPV61-U5	IPV6 AM MNGD TR1 V4-V6 UPG-DEV: 2501+UP	D3	\$9
SMA-NIPV62-01	NATIVE IPV6 AM MGD TIER 2 DEV: 1-500	D3	\$21
SMA-NIPV62-02	NATIVE IPV6 AM MGD TIER 2 DEV: 501-1000	D3	\$20

SMA-NIPV62-03	NATIVE IPV6 AM MGD TIER 2 DEV: 1001-1500	D3	\$19
SMA-NIPV62-04	NATIVE IPV6 AM MGD TIER 2 DEV: 1501-2500	D3	\$18
SMA-NIPV62-05	NATIVE IPV6 AM MGD TIER 2 DEV: 2501+UP	D3	\$16
SMA-NIPV62-U1	IPV6 AM MNGD TR2 V4-V6 UPG-DEV:1-500	D3	\$3
SMA-NIPV62-U2	IPV6 AM MNGD TR2 V4-V6 UPG-DEV:501-1000	D3	\$3
SMA-NIPV62-U3	IPV6 AM MNGD TR2 V4-V6 UPG-DEV:1001-1500	D3	\$3
SMA-NIPV62-U4	IPV6 AM MGD TR2 V4-V6 UPG-DEV: 1501-2500	D3	\$3
SMA-NIPV62-U5	IPV6 AM MGD TR2 V4-V6 UPG-DEV: 2501+UP	D3	\$3
SMA-NIPV63-01	NATIVE IPV6 AM MGD TIER 3 DEV: 1-500	D3	\$63
SMA-NIPV63-02	NATIVE IPV6 AM MGD TIER 3 DEV: 501-1000	D3	\$58
SMA-NIPV63-03	NATIVE IPV6 AM MGD TIER 3 DEV: 1001-1500	D3	\$52
SMA-NIPV63-04	NATIVE IPV6 AM MGD TIER 3 DEV: 1501-2500	D3	\$47
SMA-NIPV63-05	NATIVE IPV6 AM MGD TIER 3 DEV: 2501+UP	D3	\$41
SMA-NIPV63-U1	IPV6 AM MNGD TR3 V4-V6 UPG-DEV:1-500	D3	\$9
SMA-NIPV63-U2	IPV6 AM MNGD TR3 V4-V6 UPG-DEV:501-1000	D3	\$8
SMA-NIPV63-U3	IPV6 AM MNGD TR3 V4-V6 UPG-DEV:1001-1500	D3	\$7
SMA-NIPV63-U4	IPV6 AM MGD TR3 V4-V6 UPG-DEV: 1501-2500	D3	\$6
SMA-NIPV63-U5	IPV6 AM MGD TR3 V4-V6 UPG-DEV: 2501+UP	D3	\$5
SMA-NIPV6-BOX	EMC ITOI NATIVE IPV6 AM KIT	D3	\$0
SMA-NIPV6-F	IPV6 AM MGR RTU LIC - FAILOVER & TEST	D3	\$13,050
SMA-NIPV6-LIC	EMC ITOI NATIVE IPV6 AM LICENSE CARD	D3	\$0
SMA-NIPV6-P	IPV6 AVAILABILITY MGR - PRODUCTION	D3	\$0
SMA-NIPV6-UF	IPV6 AM - V4 TO V6 UPG - FAILOVER & TEST	D3	\$1,800
SMA-NIPV6-UP	EMC IPV6 AM PRODUCTION - V4 TO V6 UPG	D3	\$3,600
SMA-NIPV6-UPG	IPV6 AM - VOLUME LICENSE CARD	D3	\$0
SMA-NOTIF-BOX	EMC NOTIFICATION MANAGER KIT	D3	\$0
SMA-NOTIF-F	EMC NOTIFICATION MANAGER	D3	\$33,750
SMA-NOTIF-P	EMC NOTIFICATION MANAGER	D3	\$0
SMA-NPM-BOX	EMC ITOI NPM KIT	D3	\$0
SMA-NPM-F	NPM FAIL OVER LICENSE	D3	\$11,250
SMA-NPM-MD1	NPM MGD DEVICES LIC	D3	\$0
SMA-NPM-MD2	NPM MGD DEVICES: 501-1,000 LIC 4% DISC	D3	\$0
SMA-NPM-MD3	NPM MGD DEVICES: 1,001-1,500	D3	\$0
SMA-NPM-MD4	NPM MGD DEVICES: 1,501-2,500	D3	\$0
SMA-NPM-MD5	NPM MGD DEVICES: 2,501-5,000	D3	\$0
SMA-NPM-MD6	NPM MGD DEVICES: 5,001-10,000	D3	\$0
SMA-NPM-MD7	NPM MGD DEVICES: 10,001+ LIC 60% DISC	D3	\$0
SMA-NPM-P	NPM PRODUCTION LICENSE	D3	\$0
SMA-NPM-UPG	NPM UPGRADE CARD	D3	\$0
SMA-OLIP-F	OLIP Fail Over License	D3	\$9,000
SMA-OLIP-LIC	OVERLAPPING IP LIC CARD	D3	\$0
SMA-OLIP-P	OLIP Production License	D3	\$0
SMA-PI-001	IP AM Mgd P&I Lic	D3	\$0
SMA-PI-002	IP AM MNGD PORTS & INTRFCS: 5001-10000	D3	\$0
SMA-PI-003	IP AM MNGD PORTS & INTRFCS: 10001-25000	D3	\$0
SMA-PI-004	IP AM MNGD PORTS & INTRFCS: 25001-50000	D3	\$0
SMA-PI-005	IP AM MNGD PORTS & INTRFCS: 50001-100K	D3	\$0
SMA-PI-006	IP AM MNGD PORTS & INTRFCS: 100001-250K	D3	\$0
SMA-PI-007	IP AM MNGD PORTS & INTRFCS: 250001-500K	D3	\$0
SMA-PI-008	IP AM MNGD PORTS & INTRFCS: 500001-1M	D3	\$0

SMA-PI-009	IP AM MNGD PORTS & INTRFCS: 1000001-1.5M	D3	\$0
SMA-PI-010	IP AM MNGD PORTS & INTRFCS: 1500001-2M	D3	\$0
SMA-PI-011	IP AM Mgd P&I: 2MM + Lic 91.7% Disc	D3	\$0
SMA-PM-F	PM Fail Over License	D3	\$4,500
SMA-PM-LIC	IP PERF MGR LICENSE CARD	D3	\$0
SMA-PM-P	PM Production License	D3	\$0
SMA-RCA	RCA Upgrade License	D3	\$0
SMA-RM-UPG	RM UPGRADE CARD	D3	\$0
SMA-SAM-BOX	ITOI SERVICE ASSURANCE MGR KIT	D3	\$0
SMA-SAM-F	SERVICE ASSURANCE MGR - FAILOVER & TEST	D3	\$18,000
SMA-SAM-LIC	ITOI SERVICE ASSURANCE MRG LIC CARD	D3	\$0
SMA-SAM-P	SERVICE ASSURANCE MGR - PRODUCTION	D3	\$0
SMA-SCM-ADLIC	EMC SCM ACTIVE DIRECTORY LICENSE CARD	D3	\$0
SMA-SDM-C	ITOPS DYNAMIC MODEL COMPILER LICENSE	D3	\$0
SMA-SDM-F	SMARTS DYNAMIC MODEL	D3	\$0
SMA-SDM-L	ITOI ITOPS DYNAMIC MODEL LOADER LICENSE	D3	\$0
SMA-SIA-C10TB	EMC SIA EXPRESS PACKAGE 10 TB SIA	D3	\$0
SMA-SIA-NP001	SIA PPA: up to 14TB NLT3	D3	\$1,452
SMA-SIA-NP002	SIA PPA: Least 15TB NLT3	D3	\$1,236
SMA-SIA-NP003	SIA PPA: Least 25TB NLT3	D3	\$989
SMA-SIA-NP004	SIA PPA: Least 40TB NLT3	D3	\$807
SMA-SIA-NP005	SIA PPA: Least 60TB NLT3	D3	\$686
SMA-SIA-NP006	SIA PPA: Least 100TB NLT3	D3	\$578
SMA-SIA-NP007	SIA PPA: Least 150TB NLT3	D3	\$503
SMA-SIA-NP008	SIA PPA: Least 250TB NLT3	D3	\$426
SMA-SIA-NP009	SIA PPA: Least 400TB NLT3	D3	\$389
SMA-SIA-NP010	SIA PPA: Least 600TB NLT3	D3	\$338
SMA-SIA-NP011	SIA PPA: Least 1000TB NLT3	D3	\$284
SMA-SIA-NP012	SIA PPA: Least 1500TB NLT3	D3	\$248
SMA-SIA-NP013	SIA PPA: Least 2500TB NLT3	D3	\$209
SMA-SIA-NP014	SIA PPA: Least 4000TB NLT3	D3	\$180
SMA-SIA-P001	SIA PPA: UP TO 14TB	D3	\$2,903
SMA-SIA-P002	SIA PPA: LEAST 15TB	D3	\$2,471
SMA-SIA-P003	SIA PPA: LEAST 25TB	D3	\$1,978
SMA-SIA-P004	SIA PPA: LEAST 40TB	D3	\$1,614
SMA-SIA-P005	SIA PPA: LEAST 60TB	D3	\$1,371
SMA-SIA-P006	SIA PPA: LEAST 100TB	D3	\$1,155
SMA-SIA-P007	SIA PPA: LEAST 150TB	D3	\$1,006
SMA-SIA-P008	SIA PPA: LEAST 250TB	D3	\$851
SMA-SIA-P009	SIA PPA: LEAST 400TB	D3	\$778
SMA-SIA-P010	SIA PPA: LEAST 600TB	D3	\$677
SMA-SIA-P011	SIA PPA: LEAST 1000TB	D3	\$569
SMA-SIA-P012	SIA PPA: LEAST 1500TB	D3	\$497
SMA-SIA-P013	SMA PPA: LEAST 2500TB	D3	\$418
SMA-SIA-P014	SMA PPA: LEAST 4000TB	D3	\$360
SMA-SPM-F	IP SPM - FAILOVER & TEST	D3	\$5,000
SMA-SPM-LIC	SERVER PERF MGR LIC CARD	D3	\$0
SMA-SPM-P	SPM PRODUCTION LICENSE	D3	\$0
SMAS-SDR	SDN SR for Smarts=MA	D3	\$0
SMAS-SDV	SDN SV for Smarts=MA	D3	\$0

SMA-SDV50	SDN SV50 for Smarts=MA	D3	\$0
SMA-VCB-LIC	ITOI NCM INTEGRATION TOOL KIT LIC CARD	D3	\$0
SMA-VC-BOX	VC SOFTWARE KIT	D3	\$0
SMA-VCB-SDK	ITOI NCM INTEGRATION TOOL KIT	D3	\$10,000
SMA-VCIM-BOX	EMC VOYENCE CONTROL INTEGRATION MODU	D3	\$0
SMA-VC-LIC	NCM LICENSE CARD	D3	\$0
SMA-VCM-ADB2	ITOI NCM BMC ATRIUM INTEGRATION MODULE	D3	\$0
SMA-VCM-BRT	ITOI NCM BMC REMEDY INTEGRATION MODULE	D3	\$0
SMA-VCM-BSIM	ITOI NCM BMC SIM INTEGRATION MODULE	D3	\$0
SMA-VCM-CRME	ITOI NCM CISCOWORKS RME INT MODULE	D3	\$0
SMA-VCMD1-01	NCM TIER 1 MNGD DEVICES: 1-500	D3	\$250
SMA-VCMD1-02	NCM TIER 1 MNGD DEVICES: 501-1000	D3	\$240
SMA-VCMD1-03	NCM TIER 1 MNGD DEVICES: 1001-1500	D3	\$220
SMA-VCMD1-04	NCM TIER 1 MNGD DEVICES: 1501-2500	D3	\$200
SMA-VCMD1-05	NCM TIER 1 MNGD DEVICES: 2501-5000	D3	\$165
SMA-VCMD1-06	NCM TIER 1 MNGD DEVICES: 5001-10000	D3	\$135
SMA-VCMD1-07	NCM TIER 1 MNGD DEVICES: 10000+ UP	D3	\$100
SMA-VCMD2-01	NCM TIER 2 MNGD DEVICES: 1-500	D3	\$20
SMA-VCMD2-02	NCM TIER 2 MNGD DEVICES: 501-1000	D3	\$19
SMA-VCMD2-03	NCM TIER 2 MNGD DEVICES: 1001-1500	D3	\$18
SMA-VCMD2-04	NCM TIER 2 MNGD DEVICES: 1501-2500	D3	\$17
SMA-VCMD2-05	NCM TIER 2 MNGD DEVICES: 2501-5000	D3	\$15
SMA-VCMD2-06	NCM TIER 2 MNGD DEVICES: 5001-10000	D3	\$13
SMA-VCMD2-07	NCM TIER 2 MNGD DEVICES: 10000+ UP	D3	\$11
SMA-VCMD3-01	NCM TIER 3 MNGD DEVICES: 1-500	D3	\$60
SMA-VCMD3-02	NCM TIER 3 MNGD DEVICES: 501-1000	D3	\$55
SMA-VCMD3-03	NCM TIER 3 MNGD DEVICES: 1001-1500	D3	\$50
SMA-VCMD3-04	NCM TIER 3 MNGD DEVICES: 1501-2500	D3	\$45
SMA-VCMD3-05	NCM TIER 3 MNGD DEVICES: 2501-5000	D3	\$40
SMA-VCMD3-06	NCM TIER 3 MNGD DEVICES: 5001-10000	D3	\$35
SMA-VCMD3-07	NCM TIER 3 MNGD DEVICES: 10000+ UP	D3	\$25
SMA-VCMD-F	ITOI NCM FAIL OVER LICENSE	D3	\$12,500
SMA-VCMD-P	ITOI NCM PRODUCTION LICENSE	D3	\$0
SMA-VCMD-PA	ITOI NCM PRODUCTION LICENSE=MA	D3	\$25,000
SMA-VCMD-T	ITOI NCM TEST LAB LICENSE	D3	\$12,500
SMA-VCM-HPNM	ITOI NCM HP OPENVIEW NNM INT MODULE	D3	\$0
SMA-VCM-LIC	ITOI NCM INT MODULES LICENSE CARD	D3	\$0
SMA-VCM-MNC	ITOI NCM IBM TIVOLI NETCOOL INT MODULE	D3	\$0
SMA-VCM-SIC	ITOI NCM IT OPS INTEGRATION MODULE	D3	\$0
SMA-VCO-BOX	EMC VOYENCE CONTROL OPTIONAL COMPONE	D3	\$0
SMA-VCO-LIC	ITOI NCM PCI ADVISOR LICENSE CARD	D3	\$0
SMA-VCO-NA01	NCM NETWORK ADVISOR - LESS THAN 1K DEVS	D3	\$0
SMA-VCO-NA02	NCM NETWORK ADVISOR - 1K TO 10K DEVS	D3	\$0
SMA-VCO-NA03	NCM NETWORK ADVISOR - 10K TO 100K DEVS	D3	\$0
SMA-VCO-NA04	NCM NETWORK ADVISOR - 100K+UP DEVICES	D3	\$0
SMA-VCO-NALIC	ITOI NCM NETWORK ADVISOR LICENSE CARD	D3	\$0
SMA-VC-ROY	EMC VOYENCE NEW CUSTOMER	D3	\$0
SMA-VOIP-AYA	EMC SMARTS VOIP ENABLEMENT PACK FOR AV	D3	\$0
SMA-VOIP-CS	VOIP - CISCO IP MODULE	D3	\$0
SMA-VOIP-P	EMC SMARTS VOIP AM PRODUCTION LICENSE	D3	\$0

SMA-VOIPS-P	VOIP MGMT SUITE PROD RTU PER DCTR/NOC	D3	\$0
SMA-WAP-01	WIFI ACCESS POINTS LICENSE 1-1000	D3	\$0
SMA-WAP-02	WIFI ACCESS POINTS LICENSE 1001-5000	D3	\$0
SMA-WAP-03	WIFI ACCESS POINTS LICENSE 5001-10;000	D3	\$0
SMA-WCTL-01	WIFI CONTROLLER LICENSE COUNT	D3	\$0
SMA-WIFI-F	WIRELESS MANAGER - FAILOVER LICENSE	D3	\$0
SMA-WIFI-P	WIRELESS MANAGER - PRODUCTION LICENSE	D3	\$0
SMAW-SDNR	SDN WR for Smarts=MA	D3	\$0
SMAW-SDNV	SDN WV for Smarts=MA	D3	\$0
SMC-SW-KIT	SYMMETRIX MANAGEMENT CONSOLE KIT	D3	\$0
SMG-UPG-T01	SMG UP PP TO 14TB	D3	\$0
SMG-UPG-T02	SMG UP PP AT LEAST 15TB	D3	\$0
SMG-UPG-T03	SMG UP PP AT LEAST 25TB	D3	\$0
SMG-UPG-T04	SMG UP PP AT LEAST 40TB	D3	\$0
SMG-UPG-T05	SMG UP PP AT LEAST 60TB	D3	\$0
SMG-UPG-T06	SMG UP PP AT LEAST 100TB	D3	\$0
SMG-UPG-T07	SMG UP PP AT LEAST 150TB	D3	\$0
SMG-UPG-T08	SMG UP PP AT LEAST 250TB	D3	\$0
SMG-UPG-T09	SMG UP PP AT LEAST 400TB	D3	\$0
SMG-UPG-T10	SMG UP PP AT LEAST 600TB	D3	\$0
SMG-UPG-T11	SMG UP PP AT LEAST 1000TB	D3	\$0
SMG-UPG-T12	SMG UP PP AT LEAST 1500TB	D3	\$0
SMG-UPG-T13	SMG UP PP AT LEAST 2500TB	D3	\$0
SMG-UPG-T14	SMG UP PP AT LEAST 4000TB	D3	\$0
SM-HD-T1-4U	SAN MGR HDS T1-T5UPG	D3	\$0
SM-HD-T5-30U	SAN MGR HDS T6-T30UPG	D3	\$0
SM-HP-T1-4U	CC5.x SM HP T1-4 UPG	D3	\$0
SM-HP-T5-30U	CC5.x SM HP T5-30 UPG	D3	\$0
SOM-ESM-DA	Storage Ops - Smarts Lite DA only	D3	\$0
SPP-CAPM-T01	SPP ICM UP TO 14TB	D3	\$0
SPP-CAPM-T02	SPP ICM AT LEAST 15TB	D3	\$0
SPP-CAPM-T03	SPP ICM AT LEAST 25TB	D3	\$0
SPP-CAPM-T04	SPP ICM AT LEAST 40TB	D3	\$0
SPP-CAPM-T05	SPP ICM AT LEAST 60TB	D3	\$0
SPP-CAPM-T06	SPP ICM AT LEAST 100TB	D3	\$0
SPP-CAPM-T07	SPP ICM AT LEAST 150TB	D3	\$0
SPP-CAPM-T08	SPP ICM AT LEAST 250TB	D3	\$0
SPP-CAPM-T09	SPP ICM AT LEAST 400TB	D3	\$0
SPP-CAPM-T10	SPP ICM AT LEAST 600TB	D3	\$0
SPP-CAPM-T11	SPP ICM AT LEAST 1000TB	D3	\$0
SPP-CAPM-T12	SPP ICM AT LEAST 1500TB	D3	\$0
SPP-CAPM-T13	SPP ICM AT LEAST 2500TB	D3	\$0
SPP-CAPM-T14	SPP ICM AT LEAST 4000TB	D3	\$0
SPP-KEY	SPP ICM LIC KEY	D3	\$0
SRM3-SW-KIT	SRM 3.0 MEDIA KIT	D3	\$0
SRMST-SITE	SRST SITE; SERVER BASE =IA	D3	\$0
SRSTW-DX3P-BN	SRSTW DMX/VMAX10K/3PTY BASE =IC	D3	\$0
SRSTW-DX3P-N	SRSTW DMX/VMAX10K/3PTY 1TB =IC	D3	\$0
SRSTW-VMAX-B	SRSTW VMAX BASE =IC	D3	\$0
SRSTW-VMX1	SRSTW VMAX (0-14TB) NONSATA =CB	D3	\$0

SRSTW-VMX10	SRSTW VMAX (601-1000TB) NONSATA =CB	D3	\$0
SRSTW-VMX11	SRSTW VMAX (1001TB+) NONSATA =CB	D3	\$0
SRSTW-VMX2	SRSTW VMAX (15-25TB) NONSATA =CB	D3	\$0
SRSTW-VMX3	SRSTW VMAX (26-40TB) NONSATA =CB	D3	\$0
SRSTW-VMX4	SRSTW VMAX (41-60TB) NONSATA =CB	D3	\$0
SRSTW-VMX5	SRSTW VMAX (61-100TB) NONSATA =CB	D3	\$0
SRSTW-VMX6	SRSTW VMAX (101-150TB) NONSATA =CB	D3	\$0
SRSTW-VMX7	SRSTW VMAX (151-250TB) NONSATA =CB	D3	\$0
SRSTW-VMX8	SRSTW VMAX (251-400TB) NONSATA =CB	D3	\$0
SRSTW-VMX9	SRSTW VMAX (401-600TB) NONSATA =CB	D3	\$0
SRSTW-VMXS1	SRSTW VMAX (0-14TB) SATA =CB	D3	\$0
SRSTW-VMXS10	SRSTW VMAX (601-1000TB) SATA =CB	D3	\$0
SRSTW-VMXS11	SRSTW VMAX (1001TB+) SATA =CB	D3	\$0
SRSTW-VMXS2	SRSTW VMAX (15-25TB) SATA =CB	D3	\$0
SRSTW-VMXS3	SRSTW VMAX (26-40TB) SATA =CB	D3	\$0
SRSTW-VMXS4	SRSTW VMAX (41-60TB) SATA =CB	D3	\$0
SRSTW-VMXS5	SRSTW VMAX (61-100TB) SATA =CB	D3	\$0
SRSTW-VMXS6	SRSTW VMAX (101-150TB) SATA =CB	D3	\$0
SRSTW-VMXS7	SRSTW VMAX (151-250TB) SATA =CB	D3	\$0
SRSTW-VMXS8	SRSTW VMAX (251-400TB) SATA =CB	D3	\$0
SRSTW-VMXS9	SRSTW VMAX (401-600TB) SATA =CB	D3	\$0
STS6-CAPM-T01	EMC CONTROLCENTER 6.0 STORAGESCOPE PF	D3	\$0
STS6-CAPM-T02	EMC CONTROLCENTER 6.0 STORAGESCOPE PF	D3	\$0
STS6-CAPM-T03	EMC CONTROLCENTER 6.0 STORAGESCOPE PF	D3	\$0
STS6-CAPM-T04	EMC CONTROLCENTER 6.0 STORAGESCOPE PF	D3	\$0
STS6-CAPM-T05	EMC CONTROLCENTER 6.0 STORAGESCOPE PF	D3	\$0
STS6-CAPM-T06	EMC CONTROLCENTER 6.0 STORAGESCOPE PF	D3	\$0
STS6-CAPM-T07	EMC CONTROLCENTER 6.0 STORAGESCOPE PF	D3	\$0
STS6-CAPM-T08	EMC CONTROLCENTER 6.0 STORAGESCOPE PF	D3	\$0
STS6-CAPM-T09	EMC CONTROLCENTER 6.0 STORAGESCOPE PF	D3	\$0
STS6-CAPM-T10	EMC CONTROLCENTER 6.0 STORAGESCOPE PF	D3	\$0
STS6-CAPM-T11	EMC CONTROLCENTER 6.0 STORAGESCOPE PF	D3	\$0
STS6-CAPM-T12	EMC CONTROLCENTER 6.0 STORAGESCOPE PF	D3	\$0
STS6-CAPM-T13	EMC CONTROLCENTER 6.0 STORAGESCOPE PF	D3	\$0
STS6-CAPM-T14	EMC CONTROLCENTER 6.0 STORAGESCOPE PF	D3	\$0
STS6-UPG-T01	EMC CONTROLCENTER 6.0 STORAGESCOPE MI	D3	\$0
STS6-UPG-T02	EMC CONTROLCENTER 6.0 STORAGESCOPE MI	D3	\$0
STS6-UPG-T03	EMC CONTROLCENTER 6.0 STORAGESCOPE MI	D3	\$0
STS6-UPG-T04	EMC CONTROLCENTER 6.0 STORAGESCOPE MI	D3	\$0
STS6-UPG-T05	EMC CONTROLCENTER 6.0 STORAGESCOPE MI	D3	\$0
STS6-UPG-T06	EMC CONTROLCENTER 6.0 STORAGESCOPE MI	D3	\$0
STS6-UPG-T07	EMC CONTROLCENTER 6.0 STORAGESCOPE MI	D3	\$0
STS6-UPG-T08	EMC CONTROLCENTER 6.0 STORAGESCOPE MI	D3	\$0
STS6-UPG-T09	EMC CONTROLCENTER 6.0 STORAGESCOPE MI	D3	\$0
STS6-UPG-T10	EMC CONTROLCENTER 6.0 STORAGESCOPE MI	D3	\$0
STS6-UPG-T11	EMC CONTROLCENTER 6.0 STORAGESCOPE MI	D3	\$0
STS6-UPG-T12	EMC CONTROLCENTER 6.0 STORAGESCOPE MI	D3	\$0
STS6-UPG-T13	EMC CONTROLCENTER 6.0 STORAGESCOPE MI	D3	\$0
STS6-UPG-T14	EMC CONTROLCENTER 6.0 STORAGESCOPE MI	D3	\$0
STS-CAPM-T01	STS ICM UP TO 14TB	D3	\$0

STS-CAPM-T02	STS ICM AT LEAST 15TB	D3	\$0
STS-CAPM-T03	STS ICM AT LEAST 25TB	D3	\$0
STS-CAPM-T04	STS ICM AT LEAST 40TB	D3	\$0
STS-CAPM-T05	STS ICM AT LEAST 60TB	D3	\$0
STS-CAPM-T06	STS ICM AT LEAST 100TB	D3	\$0
STS-CAPM-T07	STS ICM AT LEAST 150TB	D3	\$0
STS-CAPM-T08	STS ICM AT LEAST 250TB	D3	\$0
STS-CAPM-T09	STS ICM AT LEAST 400TB	D3	\$0
STS-CAPM-T10	STS ICM AT LEAST 600TB	D3	\$0
STS-CAPM-T11	STS ICM AT LEAST 1000TB	D3	\$0
STS-CAPM-T12	STS ICM AT LEAST 1500TB	D3	\$0
STS-CAPM-T13	STS ICM AT LEAST 2500TB	D3	\$0
STS-CAPM-T14	STS ICM AT LEAST 4000TB	D3	\$0
STS-KEY	STS ICM LIC KEY	D3	\$0
STS-UPG-T01	STS UP MR TO 14TB	D3	\$0
STS-UPG-T02	STS UP MR AT LEAST 15TB	D3	\$0
STS-UPG-T03	STS UP MR AT LEAST 25TB	D3	\$0
STS-UPG-T04	STS UP MR AT LEAST 40TB	D3	\$0
STS-UPG-T05	STS UP MR AT LEAST 60TB	D3	\$0
STS-UPG-T06	STS UP MR AT LEAST 100TB	D3	\$0
STS-UPG-T07	STS UP MR AT LEAST 150TB	D3	\$0
STS-UPG-T08	STS UP MR AT LEAST 250TB	D3	\$0
STS-UPG-T09	STS UP MR AT LEAST 400TB	D3	\$0
STS-UPG-T10	STS UP MR AT LEAST 600TB	D3	\$0
STS-UPG-T11	STS UP MR AT LEAST 1000TB	D3	\$0
STS-UPG-T12	STS UP MR AT LEAST 1500TB	D3	\$0
STS-UPG-T13	STS UP MR AT LEAST 2500TB	D3	\$0
STS-UPG-T14	STS UP MR AT LEAST 4000TB	D3	\$0
SU-458-000-255	RTI BASIC PLATFORM MONTHLY SUBSC=ZC	D3	\$1,083
SU-458-000-297	SRM SUB 12Mo Ent 1-50TB=CB	D3	\$55
SU-458-000-298	SRM SUB 12Mo Mid 1-50TB=CB	D3	\$34
SU-458-000-299	SRM SUB 12Mo Cloud 1-50TB=CB	D3	\$22
SU-458-000-335	SRM SUB 36Mo+ Ent 1-50TB=CB	D3	\$45
SU-458-000-336	SRM SUB 36Mo+ Mid 1-50TB=CB	D3	\$28
SU-458-000-337	SRM SUB 36Mo+ Cloud 1-50TB=CB	D3	\$18
SU-458-000-371	SRM SUB 36Mo+AIP ENT 1-50TB=CB	D3	\$50
SU-458-000-372	SRM SUB 36Mo+AIP Mid 1-50TB=CB	D3	\$31
SU-458-000-373	SRM SUB 36Mo+AIP CLOUD 1-50TB=CB	D3	\$20
SU-458-000-407	SRM SUB 12Mo Ent 51-150TB=CB	D3	\$55
SU-458-000-408	SRM SUB 12Mo Ent 151-300TB=CB	D3	\$55
SU-458-000-409	SRM SUB 12Mo Ent 301-450TB=CB	D3	\$54
SU-458-000-410	SRM SUB 12Mo Ent 451-750TB=CB	D3	\$51
SU-458-000-411	SRM SUB 12Mo Ent 751-1500TB=CB	D3	\$42
SU-458-000-412	SRM SUB 12Mo Ent 1501-3000TB=CB	D3	\$40
SU-458-000-413	SRM SUB 12Mo Ent 3001-5000TB=CB	D3	\$36
SU-458-000-414	SRM SUB 12Mo Ent 5001-10000TB=CB	D3	\$28
SU-458-000-415	SRM SUB 12Mo Ent 10001+TB=CB	D3	\$24
SU-458-000-416	SRM SUB 12Mo Mid 51-150TB=CB	D3	\$32
SU-458-000-417	SRM SUB 12Mo Mid 151-300TB=CB	D3	\$30
SU-458-000-418	SRM SUB 12Mo Mid 301-450TB=CB	D3	\$27

SU-458-000-419	SRM SUB 12Mo Mid 451-750TB=CB	D3	\$25
SU-458-000-420	SRM SUB 12Mo Mid 751-1500TB=CB	D3	\$18
SU-458-000-421	SRM SUB 12Mo Mid 1501-3000TB=CB	D3	\$17
SU-458-000-422	SRM SUB 12Mo Mid 3001-5000TB=CB	D3	\$16
SU-458-000-423	SRM SUB 12Mo Mid 5001-10000TB=CB	D3	\$14
SU-458-000-424	SRM SUB 12Mo Mid 10001+TB=CB	D3	\$13
SU-458-000-425	SRM SUB 12Mo Cloud 51-150TB=CB	D3	\$20
SU-458-000-426	SRM SUB 12Mo Cloud 151-300TB=CB	D3	\$19
SU-458-000-427	SRM SUB 12Mo Cloud 301-450TB=CB	D3	\$18
SU-458-000-428	SRM SUB 12Mo Cloud 451-750TB=CB	D3	\$16
SU-458-000-429	SRM SUB 12Mo Cloud 751-1500TB=CB	D3	\$14
SU-458-000-430	SRM SUB 12Mo Cloud 1501-3000TB=CB	D3	\$13
SU-458-000-431	SRM SUB 12Mo Cloud 3001-5000TB=CB	D3	\$12
SU-458-000-432	SRM SUB 12Mo Cloud 5001-10000TB=CB	D3	\$11
SU-458-000-433	SRM SUB 12Mo Cloud 10001+TB=CB	D3	\$10
SU-458-000-434	SRM SUB 36Mo+ Ent 51-150TB=CB	D3	\$45
SU-458-000-435	SRM SUB 36Mo+ Ent 151-300TB=CB	D3	\$45
SU-458-000-436	SRM SUB 36Mo+ Ent 301-450TB=CB	D3	\$44
SU-458-000-437	SRM SUB 36Mo+ Ent 451-750TB=CB	D3	\$41
SU-458-000-438	SRM SUB 36Mo+ Ent 751-1500TB=CB	D3	\$35
SU-458-000-439	SRM SUB 36Mo+ Ent 1501-3000TB=CB	D3	\$33
SU-458-000-440	SRM SUB 36Mo+ Ent 3001-5000TB=CB	D3	\$30
SU-458-000-441	SRM SUB 36Mo+ Ent 5001-10000TB=CB	D3	\$23
SU-458-000-442	SRM SUB 36Mo+ Ent 10001+TB=CB	D3	\$19
SU-458-000-443	SRM SUB 36Mo+ Mid 51-150TB=CB	D3	\$26
SU-458-000-444	SRM SUB 36Mo+ Mid 151-300TB=CB	D3	\$25
SU-458-000-445	SRM SUB 36Mo+ Mid 301-450TB=CB	D3	\$22
SU-458-000-446	SRM SUB 36Mo+ Mid 451-750TB=CB	D3	\$20
SU-458-000-447	SRM SUB 36Mo+ Mid 751-1500TB=CB	D3	\$14
SU-458-000-448	SRM SUB 36Mo+ Mid 1501-3000TB=CB	D3	\$14
SU-458-000-449	SRM SUB 36Mo+ Mid 3001-5000TB=CB	D3	\$13
SU-458-000-450	SRM SUB 36Mo+ Mid 5001-10000TB=CB	D3	\$12
SU-458-000-451	SRM SUB 36Mo+ Mid 10001+TB=CB	D3	\$11
SU-458-000-452	SRM SUB 36Mo+ Cloud 51-150TB=CB	D3	\$17
SU-458-000-453	SRM SUB 36Mo+ Cloud 151-300TB=CB	D3	\$16
SU-458-000-454	SRM SUB 36Mo+ Cloud 301-450TB=CB	D3	\$14
SU-458-000-455	SRM SUB 36Mo+ Cloud 451-750TB=CB	D3	\$13
SU-458-000-456	SRM SUB 36Mo+ Cloud 751-1500TB=CB	D3	\$12
SU-458-000-457	SRM SUB 36Mo+ Cloud 1501-3000TB=CB	D3	\$11
SU-458-000-458	SRM SUB 36Mo+ Cloud 3001-5000TB=CB	D3	\$10
SU-458-000-459	SRM SUB 36Mo+ Cloud 5001-10000TB=CB	D3	\$9
SU-458-000-460	SRM SUB 36Mo+ Cloud 10001+TB=CB	D3	\$8
SU-458-000-461	SRM SUB 36Mo+AIP ENT 51-150TB=CB	D3	\$50
SU-458-000-462	SRM SUB 36Mo+AIP ENT 151-300TB=CB	D3	\$50
SU-458-000-463	SRM SUB 36Mo+AIP ENT 301-450TB=CB	D3	\$49
SU-458-000-464	SRM SUB 36Mo+AIP ENT 451-750TB=CB	D3	\$46
SU-458-000-465	SRM SUB 36Mo+AIP ENT 751-1500TB=CB	D3	\$38
SU-458-000-466	SRM SUB 36Mo+AIP ENT 1501-3000TB=CB	D3	\$37
SU-458-000-467	SRM SUB 36Mo+AIP ENT 3001-5000TB=CB	D3	\$33
SU-458-000-468	SRM SUB 36Mo+AIP ENT 5001-10000TB=CB	D3	\$25

SU-458-000-469	SRM SUB 36Mo+AIP ENT 10001+TB=CB	D3	\$22
SU-458-000-470	SRM SUB 36Mo+AIP Mid 51-150TB=CB	D3	\$29
SU-458-000-471	SRM SUB 36Mo+AIP Mid 151-300TB=CB	D3	\$27
SU-458-000-472	SRM SUB 36Mo+AIP Mid 301-450TB=CB	D3	\$25
SU-458-000-473	SRM SUB 36Mo+AIP Mid 451-750TB=CB	D3	\$23
SU-458-000-474	SRM SUB 36Mo+AIP Mid 751-1500TB=CB	D3	\$16
SU-458-000-475	SRM SUB 36Mo+AIP Mid 1501-3000TB=CB	D3	\$15
SU-458-000-476	SRM SUB 36Mo+AIP Mid 3001-5000TB=CB	D3	\$14
SU-458-000-477	SRM SUB 36Mo+AIP Mid 5001-10000TB=CB	D3	\$13
SU-458-000-478	SRM SUB 36Mo+AIP Mid 10001+TB=CB	D3	\$12
SU-458-000-479	SRM SUB 36Mo+AIP CLOUD 51-150TB=CB	D3	\$18
SU-458-000-480	SRM SUB 36Mo+AIP CLOUD 151-300TB=CB	D3	\$17
SU-458-000-481	SRM SUB 36Mo+AIP CLOUD 301-450TB=CB	D3	\$16
SU-458-000-482	SRM SUB 36Mo+AIP CLOUD 451-750TB=CB	D3	\$15
SU-458-000-483	SRM SUB 36Mo+AIP CLOUD 751-1500TB=CB	D3	\$13
SU-458-000-484	SRM SUB 36Mo+AIP CLOUD 1501-3000TB=CB	D3	\$12
SU-458-000-485	SRM SUB 36Mo+AIP CLOUD 3001-5000TB=CB	D3	\$11
SU-458-000-486	SRM SUB 36Mo+AIP CLOUD 5001-10000TB=CB	D3	\$10
SU-458-000-487	SRM SUB 36Mo+AIP CLOUD 10001+TB=CB	D3	\$9
SU-458-000-649	PP SUB 12Mo Phys non-X86 1-7=ZC	D3	\$31
SU-458-000-650	PP SUB 12Mo Phys non-X86 8-99=ZC	D3	\$28
SU-458-000-651	PP SUB 12Mo Phys non-X86 100-199=ZC	D3	\$26
SU-458-000-652	PP SUB 12Mo Phys non-X86 200-499=ZC	D3	\$23
SU-458-000-653	PP SUB 12Mo Phys X86 1-7=ZC	D3	\$72
SU-458-000-654	PP SUB 12Mo Phys X86 8-99=ZC	D3	\$69
SU-458-000-655	PP SUB 12Mo Phys X86 100-199=ZC	D3	\$62
SU-458-000-656	PP SUB 12Mo Phys X86 200-499=ZC	D3	\$57
SU-458-000-657	PP SUB 12Mo VE STD 1-7=ZC	D3	\$92
SU-458-000-658	PP SUB 12Mo VE STD 8-99=ZC	D3	\$85
SU-458-000-659	PP SUB 12Mo VE STD 100-199=ZC	D3	\$77
SU-458-000-660	PP SUB 12Mo VE STD 200-499=ZC	D3	\$70
SU-458-000-661	PP SUB 12Mo VE STD 500-999=ZC	D3	\$62
SU-458-000-662	PP SUB 12Mo VE STD 1000-2999=ZC	D3	\$54
SU-458-000-663	PP SUB 12Mo VE STD 3000+=ZC	D3	\$46
SU-458-000-664	PP SUB 36Mo+ Phys non-X86 1-7=ZC	D3	\$25
SU-458-000-665	PP SUB 36Mo+ Phys non-X86 8-99=ZC	D3	\$23
SU-458-000-666	PP SUB 36Mo+ Phys non-X86 100-199=ZC	D3	\$21
SU-458-000-667	PP SUB 36Mo+ Phys non-X86 200-499=ZC	D3	\$19
SU-458-000-668	PP SUB 36Mo+ Phys X86 1-7=ZC	D3	\$59
SU-458-000-669	PP SUB 36Mo+ Phys X86 8-99=ZC	D3	\$56
SU-458-000-670	PP SUB 36Mo+ Phys X86 100-199=ZC	D3	\$51
SU-458-000-671	PP SUB 36Mo+ Phys X86 200-499=ZC	D3	\$46
SU-458-000-672	PP SUB 36Mo+ VE STD 1-7=ZC	D3	\$75
SU-458-000-673	PP SUB 36Mo+ VE STD 8-99=ZC	D3	\$70
SU-458-000-674	PP SUB 36Mo+ VE STD 100-199=ZC	D3	\$63
SU-458-000-675	PP SUB 36Mo+ VE STD 200-499=ZC	D3	\$57
SU-458-000-676	PP SUB 36Mo+ VE STD 500-999=ZC	D3	\$51
SU-458-000-677	PP SUB 36Mo+ VE STD 1000-2999=ZC	D3	\$44
SU-458-000-678	PP SUB 36Mo+ VE STD 3000+=ZC	D3	\$38
SU-458-000-679	PP SUB 36Mo+AIP Phys non-X86 1-7=ZC	D3	\$28

SU-458-000-680	PP SUB 36Mo+AIP Phys non-X86 8-99=ZC	D3	\$26
SU-458-000-681	PP SUB 36Mo+AIP Phys non-X86 100-199=ZC	D3	\$23
SU-458-000-682	PP SUB 36Mo+AIP Phys non-X86 200-499=ZC	D3	\$21
SU-458-000-683	PP SUB 36Mo+AIP Phys X86 1-7=ZC	D3	\$66
SU-458-000-684	PP SUB 36Mo+AIP Phys X86 8-99=ZC	D3	\$63
SU-458-000-685	PP SUB 36Mo+AIP Phys X86 100-199=ZC	D3	\$56
SU-458-000-686	PP SUB 36Mo+AIP Phys X86 200-499=ZC	D3	\$52
SU-458-000-687	PP SUB 36Mo+AIP VE STD 1-7=ZC	D3	\$84
SU-458-000-688	PP SUB 36Mo+AIP VE STD 8-99=ZC	D3	\$77
SU-458-000-689	PP SUB 36Mo+AIP VE STD 100-199=ZC	D3	\$70
SU-458-000-690	PP SUB 36Mo+AIP VE STD 200-499=ZC	D3	\$63
SU-458-000-691	PP SUB 36Mo+AIP VE STD 500-999=ZC	D3	\$56
SU-458-000-692	PP SUB 36Mo+AIP VE STD 1000-2999=ZC	D3	\$49
SU-458-000-693	PP SUB 36Mo+AIP VE STD 3000+=ZC	D3	\$42
SU-458-001-045	RP4VM (1000-1999 VMs) 12Mo Sub=IB	D3	\$52
SU-458-001-046	RP4VM (1000-1999 VMs) 36Mo+ PP Sub=IB	D3	\$43
SU-458-001-047	RP4VM (1000-1999 VMs) 36Mo+ AIP Sub=IB	D3	\$47
SU-458-001-048	RP4VM (100-249 VMs) 12Mo Sub=IB	D3	\$61
SU-458-001-049	RP4VM (100-249 VMs) 36Mo+ PP Sub=IB	D3	\$50
SU-458-001-050	RP4VM (100-249 VMs) 36Mo+ AIP Sub=IB	D3	\$55
SU-458-001-051	RP4VM (1-99 VMs) 12Mo Sub=IB	D3	\$64
SU-458-001-052	RP4VM (1-99 VMs) 36Mo+ PP Sub=IB	D3	\$52
SU-458-001-053	RP4VM (1-99 VMs) 36Mo+ AIP Sub=IB	D3	\$58
SU-458-001-054	RP4VM (2000+ VMs) 12Mo Sub=IB	D3	\$49
SU-458-001-055	RP4VM (2000+ VMs) 36Mo+ PP Sub=IB	D3	\$40
SU-458-001-056	RP4VM (2000+ VMs) 36Mo+ AIP Sub=IB	D3	\$45
SU-458-001-057	RP4VM (250-499 VMs) 12Mo Sub=IB	D3	\$58
SU-458-001-058	RP4VM (250-499 VMs) 36Mo+ PP Sub=IB	D3	\$47
SU-458-001-059	RP4VM (250-499 VMs) 36Mo+ AIP Sub=IB	D3	\$53
SU-458-001-060	RP4VM (500-999 VMs) 12Mo Sub=IB	D3	\$55
SU-458-001-061	RP4VM (500-999 VMs) 36Mo+ PP Sub=IB	D3	\$45
SU-458-001-062	RP4VM (500-999 VMs) 36Mo+ AIP Sub=IB	D3	\$50
SU-458-001-064	RP4VM MdRng Pk 100 12Mo Sub=IB	D3	\$26
SU-458-001-065	RP4VM MdRng Pk 100 36Mo+ PP Sub=IB	D3	\$21
SU-458-001-066	RP4VM MdRng Pk 100 36Mo+ AIP Sub=IB	D3	\$23
SU-458-001-067	RP4VM MdRng Pk 300 12Mo Sub=IB	D3	\$21
SU-458-001-068	RP4VM MdRng Pk 300 36Mo+ AIP Sub=IB	D3	\$19
SU-458-001-069	RP4VM MdRng Pk 300 36Mo+ PP Sub=IB	D3	\$17
TSL-CLOUDARRAY-BAS	CloudArray SW 1TB=IA	D3	\$0
TSL-CLOUDARRAY-T1	CloudArray SW 5TB=IA	D3	\$0
TSL-CLOUDARRAY-T2	CloudArray SW 10TB=IA	D3	\$0
TSL-CLOUDARRAY-T3	CloudArray SW 25TB=IA	D3	\$0
TSL-CLOUDARRAY-T4	CloudArray SW 50TB=IA	D3	\$0
TSL-CLOUDARRAY-T5	CloudArray SW Unlimited=IA	D3	\$0
VBK-MGM1-720A	INACTIVE VBK 700a INFRA MGMT 10K=MA	D3	\$0
VBK-MGM2-720A	INACTIVE VBK 700a INFRA MGMT 20K=MA	D3	\$0
VBK-MGM4-720A	INACTIVE VBK 700a INFRA MGMT 40K=MA	D3	\$0
VBK-MGMT-320A	INACTIVE VBK 300a INFRA MGMT=MA	D3	\$0
VBK-MTR1-700	VBLOCK 700 MONITORING VMAX 10K=MA	D3	\$0
VBK-MTR2-700	INACTIVE VBK 700 MONT VMAX 20K=MA	D3	\$0

VBK-MTR-300	INACTIVE VBK 300 MONT=MA	D3	\$0
VBK-MTR4-700	INACTIVE VBK 700 MONT VMAX 40K=MA	D3	\$0
VBK-PRV1-700	VBLOCK 700 PROVISIONING VMAX 10K=MA	D3	\$0
VBK-PRV2-700	INACTIVE VBK 700 PROV VMAX 20K=MA	D3	\$0
VBK-PRV4-700	INACTIVE VBK 700 PROV VMAX 40K=MA	D3	\$0
VBK-UIM-200	VBLOCK 200 UIM=MA	D3	\$0
VBK-UIM-320	VBLOCK 300/320 UIM = MA	D3	\$0
VBK-UIM-720	VBLOCK 700/720 UIM = MA	D3	\$0
VBK-UIM-LIC	VBLOCK UIM LICENSE CARD	D3	\$0
VSX-UIM-LG	VSPEX UIM LARGE = MA	D3	\$0
VSX-UIM-MD	VSPEX UIM MEDIUM = MA	D3	\$0
VSX-UIM-SM	VSPEX UIM SMALL = MA	D3	\$0
W4N5620SAM	SOLUTIONPACK FOR ALCATEL 5620SAM	D3	\$30,000
W4NAVAYA	SOLUTIONPACK FOR AVAYA VOIP	D3	\$10,000
W4NBROADSOFT	SOLUTIONPACK FOR BROADSOFT VOIP	D3	\$0
W4NC-JMS	COLLECTOR FOR JMS	D3	\$20,000
W4NC-JMX	COLLECTOR FOR JMX	D3	\$20,000
W4NC-SNMP	COLLECTOR FOR SNMP/ICMP	D3	\$10,000
W4NC-SQL	COLLECTOR FOR SQL	D3	\$20,000
W4NC-SSH	COLLECTOR FOR SSH/TELNET	D3	\$20,000
W4NC-TEXT	COLLECTOR FOR CSV/TEXT	D3	\$20,000
W4NCUCM	SOLUTIONPACK FOR CISCO VOIP	D3	\$10,000
W4NC-WMI	COLLECTOR FOR WMI/POWERSHELL	D3	\$10,000
W4NC-XML	COLLECTOR FOR XML/SOAP	D3	\$20,000
W4NE2E	SOLUTIONPACK FOR TRANSACTIONS	D3	\$50,000
W4NFAIL-LAB	W4N FAILOVER/LAB LICENSE	D3	\$15,000
W4NFlows	SOLUTIONPACK FOR TRAFFIC FLOWS	D3	\$20,000
W4NGEOMAPS	GEOMAPS MODULE	D3	\$30,000
W4NHPOVO	SOLUTIONPACK FOR HP OPENVIEW	D3	\$30,000
W4NHUAWEI	SOLUTIONPACK FOR HUAWEI IMANAGER	D3	\$30,000
W4NIPH-50	IPHONE INTEGRATION (50NAMEDUSERS)	D3	\$7,500
W4NITOI	SOLUTIONPACK FOR EMC ITOI IP/ACM/ESM	D3	\$10,000
W4NITOI-BAS	ITOI BASIC REPORTING	D3	\$21,000
W4NITOI-BAS-1	ITOI BASIC RPTG MGD DEVICES 1 TO 1499	D3	\$12
W4NITOI-BAS-2	ITOI BASIC RPTG MGD DEVICES 1500 TO 3499	D3	\$10
W4NITOI-BAS-3	ITOI BASIC RPTG MGD DEVICES 3500 TO 9999	D3	\$8
W4NITOI-BAS-4	ITOI BASIC RPTG MGD DEVICES 10,000 PLUS	D3	\$6
W4N-KIT	EMC Watch4Net Physical Media	D3	\$0
W4NMD-ACC-1	MGD DEVICES: ACCESS; 1 TO 1,499	D3	\$20
W4NMD-ACC-2	MGD DEVICES: ACCESS; 1500 TO 3499	D3	\$15
W4NMD-ACC-3	MGD DEVICES: ACCESS; 3500 TO 9999	D3	\$12
W4NMD-ACC-4	MGD DEVICES: ACCESS; 10,000PLUS	D3	\$8
W4NMD-FLOW-1	MGD FLOW-ENABLED ROUTERS: 1 TO 10	D3	\$800
W4NMD-FLOW-2	MGD FLOW-ENABLED ROUTERS: 11 TO 50	D3	\$600
W4NMD-FLOW-3	MGD FLOW-ENABLED ROUTERS: 51 TO 200	D3	\$460
W4NMD-FLOW-4	MGD FLOW-ENABLED ROUTERS: 201 TO 500	D3	\$350
W4NMD-FLOW-5	MGD FLOW-ENABLED ROUTERS: 500PLUS	D3	\$270
W4NMD-HE-1	MGD DEVICES: NETWORK HE; 1 TO 1499	D3	\$750
W4NMD-HE-2	MGD DEVICES: NETWORK HE; 1500 TO 3499	D3	\$570

W4NMD-HE-3	MGD DEVICES: NETWORK HE; 3500 TO 9999	D3	\$430
W4NMD-HE-4	MGD DEVICES: NETWORK HE; 10000PLUS	D3	\$330
W4NMD-NET-1	MGD DEVICES: NETWORK; 1 TO 1499	D3	\$150
W4NMD-NET-2	MGD DEVICES: NETWORK; 1500 TO 3499	D3	\$115
W4NMD-NET-3	MGD DEVICES: NETWORK; 3500 TO 9999	D3	\$85
W4NMD-NET-4	MGD DEVICES: NETWORK; 10;000PLUS	D3	\$65
W4NMD-SVR-1	MGD DEVICES: SERVERS; 1 TO 1499	D3	\$70
W4NMD-SVR-2	MGD DEVICES: SERVERS 1500 TO 3499	D3	\$55
W4NMD-SVR-3	MGD DEVICES: SERVERS; 3500 TO 9999	D3	\$40
W4NMD-SVR-4	MGD DEVICES: SERVERS; 10;000PLUS	D3	\$30
W4NMD-TB-1	MGD TERABYTES: 1 TO 25TB	D3	\$3,560
W4NMD-TB-2	MGD TERABYTES: 26 TO 100TB	D3	\$2,983
W4NMD-TB-3	MGD TERABYTES: 101 TO 400TB	D3	\$1,956
W4NMD-TB-4	MGD TERABYTES: 401 TO 1;000TB	D3	\$1,385
W4NMD-TB-5	MGD TERABYTES: 1;000TBPLUS	D3	\$1,385
W4NMD-VOIP-1	MGD IP PHONES: 1 TO 10000	D3	\$6
W4NMD-VOIP-2	MGD IP PHONES: 10001 TO 20000	D3	\$5
W4NMD-VOIP-3	MGD IP PHONES: 20001 TO 40000	D3	\$4
W4NMD-VOIP-4	MGD IP PHONES: 40000PLUS	D3	\$3
W4NNETACT	SOLUTIONPACK FOR NOKIA NETACT	D3	\$30,000
W4NR-ACME	REPORTPACK FOR ACME PACKET SBC	D3	\$10,000
W4NR-BCOAT	REPORTPACK FOR BLUECOAT SG SERIES	D3	\$10,000
W4NR-BGP	REPORTPACK FOR BGP	D3	\$10,000
W4NR-BIGIP	REPORTPACK FOR F5 BIGIP	D3	\$10,000
W4NR-CABLE	REPORTPACK FOR CABLE DOCSIS	D3	\$30,000
W4NR-CHKPT	REPORTPACK FOR CHECKPOINT FIREWALL	D3	\$10,000
W4NR-CISFW	REPORTPACK FOR CISCO FIREWALL	D3	\$10,000
W4NR-CLAR	REPORTPACK FOR EMC CLARIION	D3	\$50,000
W4NR-CWIFI	REPORTPACK FOR CISCO WIFI	D3	\$10,000
W4NR-DB2	REPORTPACK FOR IBM DB2	D3	\$10,000
W4NR-DSLAM	REPORTPACK FOR DSLAM	D3	\$20,000
W4NR-FC	REPORTPACK FIBRE-CHANNEL FABRICS	D3	\$50,000
W4NR-HPEVA	REPORTPACK FOR HP EVA	D3	\$50,000
W4NR-IBMDS	REPORTPACK FOR IBM DS SERIES	D3	\$50,000
W4NR-IBMSV	REPORTPACK FOR IBM SVC	D3	\$50,000
W4NR-IPSLA	REPORTPACK FOR CISCO IP-SLA	D3	\$20,000
W4NR-JUNFW	REPORTPACK FOR JUNIPER FIREWALL	D3	\$10,000
W4NR-JUNQOS	REPORTPACK FOR JUNIPER QOS	D3	\$15,000
W4NR-MPLS	REPORTPACK FOR MPLS	D3	\$20,000
W4NR-MSSQL	REPORTPACK FOR MICROSOFT SQLSERVER	D3	\$10,000
W4NR-MYSQL	REPORTPACK FOR MYSQL	D3	\$10,000
W4NR-NETAP	REPORTPACK FOR NETAPP FILERS	D3	\$75,000
W4NR-NGGSN	REPORTPACK FOR NSN GGSN	D3	\$10,000
W4NR-NSCA	REPORTPACK FOR CITRIX NETSCALER	D3	\$20,000
W4NR-ORA	REPORTPACK FOR ORACLE	D3	\$10,000
W4NR-QOS	REPORTPACK FOR CISCO CLASS-BASED QOS	D3	\$10,000
W4NR-RIM	REPORTPACK RIM BLACKBERRY SERVER	D3	\$10,000
W4NR-RPM	REPORTPACK FOR JUNIPER RPM	D3	\$20,000
W4NR-SYMM	REPORTPACK FOR EMC SYMMETRIX	D3	\$75,000
W4NR-UPS	REPORTPACK FOR UPS	D3	\$10,000

W4NSCOM	SOLUTIONPACK FOR MICROSOFT SCOM	D3	\$20,000
W4NSERVER	W4N PRODUCTION SERVER LICENSE	D3	\$30,000
W4NSTORAGE	SOLUTIONPACK FOR STORAGE	D3	\$75,000
W4NTR-OS	TRAINING ON CUSTOMER SITE (5 DAY)	D3	\$20,000
W4NTR-P5	TRAINING AT MONTREAL FACILITY (5 DAY)	D3	\$4,500
W4NUCS	SOLUTIONPACK FOR CISCO UCS MANAGER	D3	\$10,000
W4NVBLOCK-1	Solution Pack for Vblock Series 300	D3	\$98,000
W4NVBLOCK-2	Solution Pack for Vblock Series 700	D3	\$380,000
W4NVMWARE	SOLUTIONPACK FOR VMWARE VSPHERE	D3	\$10,000
WEBX-SOFTWR	WEBXTENDER	D3	\$0
WLA-KEY	WLA ICM LIC KEY	D3	\$0
WN-MPIO-KIT	EMC WINDOWS MPIO KIT	D3	\$0
456-113-609	VxFlex Manager License=ID	DC1	\$0
458-002-447	VxFlex Manager	DC1	\$0
FLEX-SYS-6415	1U1N-268/384G/38.4T SSD	DC1	\$110,615
FLEX-SYS-6416	1U1N-268/576G/38.4T SSD	DC1	\$117,455
FLEX-SYS-6417	1U1N-242/768G/1.92T SSD	DC1	\$50,695
SD14G1U-P3104-768F	SD1U1N 3104 768(12X64GB)1.92SSD 8DRV F	DC1	\$74,464
SD14G1U-P3104768FU	SD1U1N 3104 768(12X64GB)1.92SSD 8DRV FU	DC1	\$75,602
SD14G1U-P3104-768M	SD1U1N 3104 768(12X64GB)1.92SSD 8DRV MF	DC1	\$74,464
SD14G1U-P3106-768F	SD1U1N 3106 768(12X64GB)1.92SSD 8DRV F	DC1	\$74,796
SD14G1UP3106-768FU	SD1U1N 3106 768(12X64GB)1.92SSD 8DRV FU	DC1	\$75,934
SD14G1U-P3106-768M	SD1U1N 3106 768(12X64GB)1.92SSD 8DRV MF	DC1	\$74,796
SD14G1UP6142-768FU	SD1U1N 6142 768(12X64GB)1.92SSD 8DRV FU	DC1	\$84,479
SD14G1UP8180-1.5FU	SD1U1N 8180 1.5TB(24X64GB)3.84SSD 8DR FU	DC1	\$170,703
SD14G1UPR6142-768F	SD1U1N 6142 768(12X64GB)1.92SSD 8DRV F	DC1	\$83,341
SD14G1UPR6142-768M	SD1U1N 6142 768(12X64GB)1.92SSD 8DRV MF	DC1	\$83,341
SD14G1UPR8180-1.5F	SD1U1N 8180 1.5TB(24X64GB)3.84SSD 8DR F	DC1	\$169,565
SD14G-P3104-768H-M	SD2U1N 3104 1S 768(12X64GB)2HDD 20DRV MH	DC1	\$74,074
SD14G-P6130-768-GF	SD2U1N 6130 M10GPU 768GB(12X64GB)192SSD	DC1	\$132,412
SD14G-P6130-768GFU	SD2U1N 6130 M10GPU 768GB(12X64GB)192SSD	DC1	\$133,550
SD14G-P6138-768-GF	SD2U1N 6138 M10GPU 768GB(12X64GB)192SSD	DC1	\$134,691
SD14G-P6138-768GFU	SD2U1N 6138 M10GPU 768GB(12X64GB)192SSD	DC1	\$135,829
SD14G-P8160-768-GF	SD2U1N 8160 M60GPU 768GB(12X64GB)384SSD	DC1	\$211,345
SD14G-P8160-768GFU	SD2U1N 8160 M60GPU 768GB(12X64GB)384SSD	DC1	\$212,483
SD14G-P8176-768-GF	SD2U1N 8176 M60GPU 768GB(12X64GB)384SSD	DC1	\$224,612
SD14G-P8176-768GFU	SD2U1N 8176 M60GPU 768GB(12X64GB)384SSD	DC1	\$225,750
SD14G-PR3104-192-H	SD1U1N 3104 192(12X16GB)2HDD 8DRV H	DC1	\$28,433
SD14G-PR3104-192HU	SD1U1N 3104 192(12X16GB)2HDD 8DRV HU	DC1	\$29,571
SD14G-PR3104-192-M	SD1U1N 3104 192(12X16GB)2HDD 8DRV MH	DC1	\$28,433
SD14G-PR3104-768-H	SD2U1N 3104 1S 768(12X64GB)2HDD 20DRV H	DC1	\$74,074
SD14G-PR3104-768HU	SD2U1N 3104 1S 768(12X64GB)2HDD 20DRV HU	DC1	\$75,212
SD14G-PR3106-192-H	SD1U1N 3106 192(12X16GB)2HDD 8DRV H	DC1	\$28,766
SD14G-PR3106-192HU	SD1U1N 3106 192(12X16GB)2HDD 8DRV HU	DC1	\$29,904
SD14G-PR3106-192-M	SD1U1N 3106 192(12X16GB)2HDD 8DRV MH	DC1	\$28,766
SD14G-PR3106-768-H	SD2U1N 3106 1S 768(12X64GB)2HDD 20DRV H	DC1	\$74,240
SD14G-PR3106-768HU	SD2U1N 3106 1S 768(12X64GB)2HDD 20DRV HU	DC1	\$75,378
SD14G-PR3106-768-M	SD2U1N 3106 1S 768(12X64GB)2HDD 20DRV MH	DC1	\$74,240
SD14G-PR4108-768-F	SD2U1N 4108 768(12X64GB)1.92SSD 20DRV F	DC1	\$122,662
SD14G-PR4108-768FU	SD2U1N 4108 768(12X64GB)1.92SSD 20DRV FU	DC1	\$123,800

SD14G-PR4108-768-M	SD2U1N 4108 768(12X64GB)192SSD 20DRV MF	DC1	\$122,662
SD14G-PR4110-768-F	SD1U1N 4110 768(12X64GB)1.92SSD 8DRV F	DC1	\$75,296
SD14G-PR4110-768FU	SD1U1N 4110 768(12X64GB)1.92SSD 8DRV FU	DC1	\$76,434
SD14G-PR4110-768-M	SD1U1N 4110 768(12X64GB)1.92SSD 8DRV MF	DC1	\$75,296
SD14G-PR4114-384-F	SD1U1N 4114 384(12X32GB)1.92SSD 8DRV F	DC1	\$55,620
SD14G-PR4114-384FU	SD1U1N 4114 384(12X32GB)1.92SSD 8DRV FU	DC1	\$56,758
SD14G-PR4114-384-M	SD1U1N 4114 384(12X32GB)1.92SSD 8DRV MF	DC1	\$55,620
SD14G-PR4114-768-F	SD1U1N 4114 768(12X64GB)1.92SSD 8DRV F	DC1	\$75,899
SD14G-PR4114-768FU	SD1U1N 4114 768(12X64GB)1.92SSD 8DRV FU	DC1	\$77,037
SD14G-PR4114-768-M	SD1U1N 4114 768(12X64GB)1.92SSD 8DRV MF	DC1	\$75,899
SD14G-PR5118-768-F	SD2U1N 5118 768(12X64GB)1.92SSD 20DRV F	DC1	\$125,137
SD14G-PR5118-768FU	SD2U1N 5118 768(12X64GB)1.92SSD 20DRV FU	DC1	\$126,275
SD14G-PR5118-768-M	SD2U1N 5118 768(12X64GB)192SSD 20DRV MF	DC1	\$125,137
SD14G-PR6126-768-F	SD1U1N 6126 768(12X64GB)1.92SSD 8DRV F	DC1	\$79,537
SD14G-PR6126-768FU	SD1U1N 6126 768(12X64GB)1.92SSD 8DRV FU	DC1	\$80,675
SD14G-PR6126-768-M	SD1U1N 6126 768(12X64GB)1.92SSD 8DRV MF	DC1	\$79,537
SD14G-PR6130-768-F	SD2U1N 6130 768(12X64GB)1.92SSD 20DRV F	DC1	\$127,177
SD14G-PR6130-768FU	SD2U1N 6130 768(12X64GB)1.92SSD 20DRV FU	DC1	\$128,315
SD14G-PR6130-768-M	SD2U1N 6130 768(12X64GB)192SSD 20DRV MF	DC1	\$127,177
SD14G-PR6132-768-F	SD1U1N 6132 768(12X64GB)1.92SSD 8DRV F	DC1	\$80,498
SD14G-PR6132-768FU	SD1U1N 6132 768(12X64GB)1.92SSD 8DRV FU	DC1	\$81,636
SD14G-PR6132-768-M	SD1U1N 6132 768(12X64GB)1.92SSD 8DRV MF	DC1	\$80,498
SD14G-PR6136-384-F	SD1U1N 6136 384(12X32GB)3.84SSD 8DRV F	DC1	\$87,866
SD14G-PR6136-384FU	SD1U1N 6136 384(12X32GB)3.84SSD 8DRV FU	DC1	\$89,004
SD14G-PR6136-384-M	SD1U1N 6136 384(12X32GB)3.84SSD 8DRV MF	DC1	\$87,866
SD14G-PR6140-768-F	SD2U1N 6140 768(24X32GB)1.92SSD 20DRV F	DC1	\$123,042
SD14G-PR6140-768FU	SD2U1N 6140 768(24X32GB)1.92SSD 20DRV FU	DC1	\$124,180
SD14G-PR6142-768-F	SD2U1N 6142 768(12X64GB)1.92SSD 20DRV F	DC1	\$130,753
SD14G-PR6142-768FU	SD2U1N 6142 768(12X64GB)1.92SSD 20DRV FU	DC1	\$131,891
SD14G-PR6142-768-M	SD2U1N 6142 768(12X64GB)192SSD 20DRV MF	DC1	\$130,753
SD14G-PR6150-1.5-F	SD2U1N 6150 1.5T(24X64GB)3.84SSD 20DRV F	DC1	\$231,854
SD14G-PR6150-1.5FU	SD2U1N 6150 1.5T(24X64GB)3.84SSD 20DV FU	DC1	\$232,992
SD14G-PR6150-768-F	SD1U1N 6150 768(12X64GB)1.92SSD 8DRV F	DC1	\$85,420
SD14G-PR6150-768FU	SD1U1N 6150 768(12X64GB)1.92SSD 8DRV FU	DC1	\$86,558
SD14G-PR6152-1.5-F	SD2U1N 6152 1.5T(24X64GB)3.84SSD 20DRV F	DC1	\$232,431
SD14G-PR6152-1.5FU	SD2U1N 6152 1.5T(24X64GB)3.84SSD 20DV FU	DC1	\$233,569
SD14G-PR6152-768-F	SD1U1N 6152 768(12X64GB)3.84SSD 8DRV F	DC1	\$111,650
SD14G-PR6152-768FU	SD1U1N 6152 768(12X64GB)3.84SSD 8DRV FU	DC1	\$112,788
SD14G-PR8153-768-F	SD2U1N 8153 768(24x32GB)1.92SSD 20DRV F	DC1	\$125,665
SD14G-PR8153-768FU	SD2U1N 8153 768(24x32GB)1.92SSD 20DRV FU	DC1	\$126,803
SD14G-PR8153-768-M	SD2U1N 8153 768(24x32GB)192SSD 20DRV MF	DC1	\$125,665
SD14G-PR8160-1.5-F	SD1U1N 8160 1.5TB(24X64GB)3.84SSD 8DR F	DC1	\$150,118
SD14G-PR8160-1.5FU	SD1U1N 8160 1.5TB(24X64GB)3.84SSD 8DR FU	DC1	\$151,256
SD14G-PR8168-1.5-F	SD2U1N 8168 1.5TB(24X64GB)3.84SSD 20DR F	DC1	\$240,278
SD14G-PR8168-1.5FU	SD2U1N 8168 1.5TB(24X64GB)3.84SSD20DR FU	DC1	\$241,416
SD14G-PR8168-384-F	SD2U1N 8168 384(12X32GB)1.92SSD 20DRV F	DC1	\$120,835
SD14G-PR8168-384FU	SD2U1N 8168 384(12X32GB)1.92SSD 20DRV FU	DC1	\$121,973
SD14G-PR8180-1.5-F	SD2U1N 8180 1.5TB(24X64GB)3.84SSD 20DR F	DC1	\$255,504
SD14G-PR8180-1.5FU	SD2U1N 8180 1.5TB(24X64GB)3.84SSD20DV FU	DC1	\$256,642
SD14P8168-768-192F	SD2U1N 8168 768(24x32GB)1.92SSD 20DRV F	DC1	\$135,239

SD14P8168768-192FU	SD2U1N 8168 768(24x32GB)1.92SSD 20DRV FU	DC1	\$136,377
SD14P8168-768-384F	SD2U1N 8168 768(24X32GB) 3.84SSD 20DRV F	DC1	\$199,719
SD14P8168768-384FU	SD2U1N 8168 768(24X32GB) 3.84SSD 20DV FU	DC1	\$200,857
SD1S5STDFN165L	SDDC 1S 5 STD Fan Less Than 165W	DC1	\$0
SD1S8HPFN165GR	SDDC 1S 8 HIGH PERF Fan 165W/GRT	DC1	\$207
SD1SHSDM125GR	SDDC 1S 125GR HTK Dimm BLNK	DC1	\$91
SD1SHSDM125OL	SDDC 1S 125WL HTK Dimm BLNK	DC1	\$49
SD1SHSKDM165G	SDDC 1S 165WGR HTKDimm CPUBLNK	DC1	\$70
SD1SHSKDM165OL	SDDC 1S 165WL HTK Dimm BLNK	DC1	\$40
SD1SHSKDMBLKFN	SDDC 1S HSK Dimm CPU BLK Fan	DC1	\$1,181
SD2S5STDFN165L	SDDC 2S 8 STD Fan LESS THAN 165W	DC1	\$0
SD2S8HPFN165GR	SDDC 2S 8 HIGH PERF Fan 165W/GRT	DC1	\$207
SD2SHSDM125GR	SDDC 2S 125GR HTK Dimm BLNK	DC1	\$82
SD2SHSDM125OL	SDDC 2S 125WL HTK Dimm BLNK	DC1	\$40
SD2SHSKDM165GR	SDDC 2S 165GR HTK Dimm BLNK	DC1	\$61
SD2SHSKDM165OL	SDDC 2S 165WL HTK Dimm BLNK	DC1	\$40
SD2SS570HSKDMFN	SDDC 2S HSK Dimm CPU BLK Fan	DC1	\$1,172
SD2U1N24CHASSIS1SF	SDDC 1S 2U1N 24X2.5 Chassis F	DC1	\$260
SD2U1N24CHASSIS1SH	SDDC 1S 2U1N 24X2.5 Chassis	DC1	\$260
SD2U1N24CHASSIS2SF	SDDC 2S 2U1N 24X2.5 Chassis F	DC1	\$260
SD2U1N24CHASSIS2SH	SDDC 2S 2U1N 24X2.5 Chassis	DC1	\$260
SDCAPHDD12TB10K25	SDDC HDD SAS 1.2TB 10K RPM 2.5Inch	DC1	\$779
SDCAPHDD20TB72K25	SDDC HDD SAS 2TB 7.2K RPM 2.5inch	DC1	\$1,071
SDCAPHDD40TB72K35	SDDC HDD SAS 4TB 7.2K RPM 2.5inch	DC1	\$831
SDCAPSATASSD192TB	SDDC Capacity SATA SSD 1.92TB1WPD	DC1	\$2,131
SDCAPSATASSD384TB	SDDC Capacity SATA SSD 3.84TB1WPD	DC1	\$4,263
SDCAPSSD192TB1WPD	SDDC Capacity SAS SSD 1.92TB1WPD	DC1	\$3,431
SDCAPSSD384TB1WPD	SDDC Capacity SAS SSD 3.84TB1WPD	DC1	\$6,655
SDDC-1P-RACK1	VxRack SDDC 1 Phase 42U Cabinet Rack 1	DC1	\$52,620
SDDC-1P-RACK2	VxRack SDDC 1 Phase 42U Cabinet Rack 2	DC1	\$52,620
SDDC-1P-RACK2U	VxRack SDDC 1 Phase 42U Cabinet Rack 2U	DC1	\$52,620
SDDC-1P-RACK3	VxRack SDDC 1 Phase 42U Cabinet Rack 3	DC1	\$52,620
SDDC-1P-RACK3U	VxRack SDDC 1 Phase 42U Cabinet Rack 3U	DC1	\$52,620
SDDC-1P-RACK4	VxRack SDDC 1 Phase 42U Cabinet Rack 4	DC1	\$52,620
SDDC-1P-RACK4U	VxRack SDDC 1 Phase 42U Cabinet Rack 4U	DC1	\$52,620
SDDC-1P-RACK5	VxRack SDDC 1 Phase 42U Cabinet Rack 5	DC1	\$52,620
SDDC-1P-RACK5U	VxRack SDDC 1 Phase 42U Cabinet Rack 5U	DC1	\$52,620
SDDC-1P-RACK6	VxRack SDDC 1 Phase 42U Cabinet Rack 6	DC1	\$52,620
SDDC-1P-RACK6U	VxRack SDDC 1 Phase 42U Cabinet Rack 6U	DC1	\$52,620
SDDC-1P-RACK7	VxRack SDDC 1 Phase 42U Cabinet Rack 7	DC1	\$52,620
SDDC-1P-RACK7U	VxRack SDDC 1 Phase 42U Cabinet Rack 7U	DC1	\$52,620
SDDC-1P-RACK8	VxRack SDDC 1 Phase 42U Cabinet Rack 8	DC1	\$52,620
SDDC-1P-RACK8U	VxRack SDDC 1 Phase 42U Cabinet Rack 8U	DC1	\$52,620
SDDC-3PDELTA-RACK1	VxRack SDDC 3P 42U Delta2 Cabinet Rack 1	DC1	\$49,882
SDDC-3PDELTA-RACK2	VxRack SDDC 3P 42U Delta2 Cabinet Rack 2	DC1	\$49,882
SDDC-3PDELTA-RACK3	VxRack SDDC 3P 42U Delta2 Cabinet Rack 3	DC1	\$49,882
SDDC-3PDELTA-RACK4	VxRack SDDC 3P 42U Delta2 Cabinet Rack 4	DC1	\$49,882
SDDC-3PDELTA-RACK5	VxRack SDDC 3P 42U Delta2 Cabinet Rack 5	DC1	\$49,882
SDDC-3PDELTA-RACK6	VxRack SDDC 3P 42U Delta2 Cabinet Rack 6	DC1	\$49,882
SDDC-3PDELTA-RACK7	VxRack SDDC 3P 42U Delta2 Cabinet Rack 7	DC1	\$49,882

SDDC-3PDELTA-RACK8	VxRack SDDC 3P 42U Delta2 Cabinet Rack 8	DC1	\$49,882
SDDC-3PDELTA-RCK2U	VxRack SDDC 3P 42U Delta2 Cabinet Rck 2U	DC1	\$49,882
SDDC-3PDELTA-RCK3U	VxRack SDDC 3P 42U Delta2 Cabinet Rck 3U	DC1	\$49,882
SDDC-3PDELTA-RCK4U	VxRack SDDC 3P 42U Delta2 Cabinet Rck 4U	DC1	\$49,882
SDDC-3PDELTA-RCK5U	VxRack SDDC 3P 42U Delta2 Cabinet Rck 5U	DC1	\$49,882
SDDC-3PDELTA-RCK6U	VxRack SDDC 3P 42U Delta2 Cabinet Rck 6U	DC1	\$49,882
SDDC-3PDELTA-RCK7U	VxRack SDDC 3P 42U Delta2 Cabinet Rck 7U	DC1	\$49,882
SDDC-3PDELTA-RCK8U	VxRack SDDC 3P 42U Delta2 Cabinet Rck 8U	DC1	\$49,882
SDDC-3P-WYE-RACK1	VxRack SDDC 3P WYE 42U Cabinet Rack 1	DC1	\$45,882
SDDC-3P-WYE-RACK2	VxRack SDDC 3P WYE 42U Cabinet Rack 2	DC1	\$45,882
SDDC-3P-WYE-RACK2U	VxRack SDDC 3P WYE 42U Cabinet Rack 2U	DC1	\$45,882
SDDC-3P-WYE-RACK3	VxRack SDDC 3P WYE 42U Cabinet Rack 3	DC1	\$45,882
SDDC-3P-WYE-RACK3U	VxRack SDDC 3P WYE 42U Cabinet Rack 3U	DC1	\$45,882
SDDC-3P-WYE-RACK4	VxRack SDDC 3P WYE 42U Cabinet Rack 4	DC1	\$45,882
SDDC-3P-WYE-RACK4U	VxRack SDDC 3P WYE 42U Cabinet Rack 4U	DC1	\$45,882
SDDC-3P-WYE-RACK5	VxRack SDDC 3P WYE 42U Cabinet Rack 5	DC1	\$45,882
SDDC-3P-WYE-RACK5U	VxRack SDDC 3P WYE 42U Cabinet Rack 5U	DC1	\$45,882
SDDC-3P-WYE-RACK6	VxRack SDDC 3P WYE 42U Cabinet Rack 6	DC1	\$45,882
SDDC-3P-WYE-RACK6U	VxRack SDDC 3P WYE 42U Cabinet Rack 6U	DC1	\$45,882
SDDC-3P-WYE-RACK7	VxRack SDDC 3P WYE 42U Cabinet Rack 7	DC1	\$45,882
SDDC-3P-WYE-RACK7U	VxRack SDDC 3P WYE 42U Cabinet Rack 7U	DC1	\$45,882
SDDC-3P-WYE-RACK8	VxRack SDDC 3P WYE 42U Cabinet Rack 8	DC1	\$45,882
SDDC-3P-WYE-RACK8U	VxRack SDDC 3P WYE 42U Cabinet Rack 8U	DC1	\$45,882
SDDCCIS9332SW1YMC	VXRACK SDDC CISCO 9332 SWIT 1Y MC U	DC1	\$37,950
SDDCCIS9332SW1YPP	VXRACK SDDC CISCO 9332 SWIT 1Y PP U	DC1	\$37,950
SDDCCIS9332SW2YMC	VXRACK SDDC CISCO 9332 SWIT 2Y MC U	DC1	\$37,950
SDDCCIS9332SW2YPP	VXRACK SDDC CISCO 9332 SWIT 2Y PP U	DC1	\$37,950
SDDCCIS9332SW3YMC	VxRack SDDC Cisco 9332 Switch 3Y MC	DC1	\$37,950
SDDCCIS9332SW3YMCV	VxRack SDDC Cisco 9332 Switch 3Y MCV	DC1	\$37,950
SDDCCIS9332SW3YPP	VxRack SDDC Cisco 9332 Switch 3Y PP	DC1	\$37,950
SDDCCIS9332SW3YPPV	VxRack SDDC Cisco 9332 Switch 3Y PPV	DC1	\$37,950
SDDCCIS9332SW4YMC	VxRack SDDC Cisco 9332 Switch 4Y MC	DC1	\$37,950
SDDCCIS9332SW4YMCV	VxRack SDDC Cisco 9332 Switch 4Y MCV	DC1	\$37,950
SDDCCIS9332SW4YPP	VxRack SDDC Cisco 9332 Switch 4Y PP	DC1	\$37,950
SDDCCIS9332SW4YPPV	VxRack SDDC Cisco 9332 Switch 4Y PPV	DC1	\$37,950
SDDCCIS9332SW5YMC	VxRack SDDC Cisco 9332 Switch 5Y MC	DC1	\$37,950
SDDCCIS9332SW5YMCV	VxRack SDDC Cisco 9332 Switch 5Y MCV	DC1	\$37,950
SDDCCIS9332SW5YPP	VxRack SDDC Cisco 9332 Switch 5Y PP	DC1	\$37,950
SDDCCIS9332SW5YPPV	VxRack SDDC Cisco 9332 Switch 5Y PPV	DC1	\$37,950
SDDCCISCO93180KIT	VxRack SDDC Cisco 93180 Switch Kit	DC1	\$2,149
SDDCCISCO9332KIT1	VxRack SDDC Cisco 9332 Switch Kit 1	DC1	\$2,172
SDDCCISCO9332KIT2	VxRack SDDC Cisco 9332 Switch Kit 2	DC1	\$12,391
SDDCDELLMGMTSW	VxRack SDDC DELL MANAGEMENT SWITCH	DC1	\$5,976
SDDCDELLMGMTSWKIT	VxRack SDDC Dell Management Switch Kit	DC1	\$2,097
SDDCFIBERCBL10M	VxRack SDDC 10M Fiber Cable	DC1	\$323
SDDCFIBERCBL30M	VxRack SDDC 30M LC-LC Fiber Cable	DC1	\$975
SDDCHBA330CTRL1SF	SDDC PercHBA330RAIDCTR MINI12Gb1SF	DC1	\$228
SDDCHBA330CTRL2SF	SDDC PercHBA330+RAIDCTR12Gb 2SLP F	DC1	\$291
SDDCISCOTORSW	VxRack SDDC CISCO ToR 93180 SWITCH	DC1	\$28,538
SDDCISCOTORSW1YMC	VXRACK SDDC CISCO TOR 93180 SWIT 1Y MC U	DC1	\$28,538

SDDCISCOTORSW1YPP	VXRACK SDDC CISCO TOR 93180 SWIT 1Y PP U	DC1	\$28,538
SDDCISCOTORSW2YMC	VXRACK SDDC CISCO TOR 93180 SWIT 2Y MC U	DC1	\$28,538
SDDCISCOTORSW2YPP	VXRACK SDDC CISCO TOR 93180 SWIT 2Y PP U	DC1	\$28,538
SDDCISCOTORSW3YMC	VxRack SDDC CISCO ToR 93180 SWITCH 3Y MC	DC1	\$28,538
SDDCISCOTORSW3YMC	VxRack SDDC CISCO ToR 93180 SWIT 3Y MCV	DC1	\$28,538
SDDCISCOTORSW3YPP	VxRack SDDC CISCO ToR 93180 SWITCH 3Y PP	DC1	\$28,538
SDDCISCOTORSW3YPP	VxRack SDDC CISCO ToR 93180 SWIT 3Y PPV	DC1	\$28,538
SDDCISCOTORSW4YMC	VxRack SDDC CISCO ToR 93180 SWITCH 4Y MC	DC1	\$28,538
SDDCISCOTORSW4YMC	VxRack SDDC CISCO ToR 93180 SWIT 4Y MCV	DC1	\$28,538
SDDCISCOTORSW4YPP	VxRack SDDC CISCO ToR 93180 SWITCH 4Y PP	DC1	\$28,538
SDDCISCOTORSW4YPP	VxRack SDDC CISCO ToR 93180 SWIT 4Y PPV	DC1	\$28,538
SDDCISCOTORSW5YMC	VxRack SDDC CISCO ToR 93180 SWITCH 5Y MC	DC1	\$28,538
SDDCISCOTORSW5YMC	VxRack SDDC CISCO ToR 93180 SWIT 5Y MCV	DC1	\$28,538
SDDCISCOTORSW5YPP	VxRack SDDC CISCO ToR 93180 SWITCH 5Y PP	DC1	\$28,538
SDDCISCOTORSW5YPP	VxRack SDDC CISCO ToR 93180 SWIT 5Y PPV	DC1	\$28,538
SDDCISCOTORSWKIT	VxRack SDDC CISCO ToR 93180 SWITCH KIT	DC1	\$2,149
SDDCMSWINSERV	VxRack SDDC MS Windows Srvr Std-2VM=IB	DC1	\$1,745
SDDCNS9300LI	SDDC Nexus 9300 LAN Enterprise=MA	DC1	\$8,000
SDDCPR3104BN6C17	SDDC Intel CPU 3104 6C 1.7GHz H	DC1	\$457
SDDCPR3104BN6C17-2	SDDC INTEL CPU 3104 6C 1.7GHz 2ndH	DC1	\$457
SDDCPR3106BN8C17	SDDC Intel CPU 3106 8C 1.7 GHz H	DC1	\$623
SDDCPR3106BN8C17-2	SDDC Intel CPU 3106 8C 1.7 GHz2ndH	DC1	\$623
SDDCPR4108SV8C18	SDDC Intel CPU 4108 8C 1.8 GHz H	DC1	\$821
SDDCPR4108SV8C18-2	SDDC Intel CPU 4108 8C 1.8 GHz2ndH	DC1	\$821
SDDCPR4109TSV8C20	SDDC Intel CPU 4109T 8C 2.0 GHz H	DC1	\$935
SDDCPR4110SV8C21	SDDC Intel CPU 4110 8C 2.1 GHz H	DC1	\$873
SDDCPR4110SV8C21-2	SDDC Intel CPU 4110 8C 2.1GHz2ndH	DC1	\$873
SDDCPR4112SV4C26	SDDC Intel CPU 4112 4C 2.6 GHz H	DC1	\$837
SDDCPR4112SV4C26-2	SDDC Intel CPU 4112 4C 2.6GHz 2ndH	DC1	\$837
SDDCPR4114SV10C22	SDDC Intel CPU 4114 10C 2.2 GHz H	DC1	\$1,175
SDDCPR4116SV12C21	SDDC Intel CPU 4116 12C 2.1 GHz H	DC1	\$1,663
SDDCPR5115GD10C24	SDDC Intel CPU 5115 10C 2.4 GHz H	DC1	\$2,059
SDDCPR5118GD12C23	SDDC Intel CPU 5118 12C 2.3 GHz H	DC1	\$2,059
SDDCPR5120GD14C22	SDDC Intel CPU 5120 14C 2.2 GHz H	DC1	\$2,532
SDDCPR5122GD4C35	SDDC Intel CPU 5122 4C 3.5 GHz H	DC1	\$2,038
SDDCPR5122GD4C35-2	SDDC Intel CPU 5122 4C 3.5 GHz2ndH	DC1	\$2,038
SDDCPR6126GD12C26	SDDC Intel CPU 6126 12C 2.6 GHz H	DC1	\$2,944
SDDCPR6128GD6C34	SDDC Intel CPU 6128 6C 3.4 GHz H	DC1	\$2,776
SDDCPR6128GD6C34-2	SDDC Intel CPU 6128 6C 3.4 GHz2ndH	DC1	\$2,776
SDDCPR6130GD16C21	SDDC Intel CPU 6130 16C 2.1 GHz H	DC1	\$3,079
SDDCPR6132GD14C26	SDDC Intel CPU 6132 14C 2.6 GHz H	DC1	\$3,424
SDDCPR6134GD8C32	SDDC Intel CPU 6134 8C 3.2 GHz H	DC1	\$3,608
SDDCPR6134GD8C32-2	SDDC Intel CPU 6134 8C 3.2 GHz2ndH	DC1	\$3,608
SDDCPR6134MGD8C32	SDDC Intel CPU 6134M 8C 3.2 GHz H	DC1	\$7,935
SDDCPR6136GD12C30	SDDC Intel CPU 6136 12C 3.0 GHz H	DC1	\$3,993
SDDCPR6138GD20C20	SDDC Intel CPU 6138 20C 2.0 GHz H	DC1	\$4,219
SDDCPR6140GD18C23	SDDC Intel CPU 6140 18C 2.3 GHz H	DC1	\$3,930
SDDCPR6140MGD18C23	SDDC Intel CPU 6140M 18C 2.3 GHz H	DC1	\$8,371
SDDCPR6142GD16C26	SDDC Intel CPU 6142 16C 2.6 GHz H	DC1	\$4,846
SDDCPR6142MGD16C26	SDDC Intel CPU 6142M 16C 2.6 GHz H	DC1	\$9,203

SDDCPR6148GD20C24	SDDC Intel CPU 6148 20C 2.4 GHz H	DC1	\$5,012
SDDCPR6150GD18C27	SDDC Intel CPU 6150 18C 2.7 GHz H	DC1	\$5,782
SDDCPR6152GD22C21	SDDC Intel CPU 6152 22C 2.1 GHz H	DC1	\$6,104
SDDCPR6154GD18C30	SDDC Intel CPU 6154 18C 3.0 GHz H	DC1	\$5,875
SDDCPR8153PT16C20	SDDC Intel CPU 8153 16C 2.0 GHz H	DC1	\$5,262
SDDCPR8160MPT24C21	SDDC Intel CPU 8160M 24C 2.1 GHz H	DC1	\$11,907
SDDCPR8160PT24C21	SDDC Intel CPU 8160 24C 2.1 GHz H	DC1	\$7,997
SDDCPR8164PT26C20	SDDC Intel CPU 8164 26C 2.0 GHz H	DC1	\$10,285
SDDCPR8168PT24C27	SDDC Intel CPU 8168 24C 2.7 GHz H	DC1	\$9,994
SDDCPR8170MPT26C21	SDDC Intel CPU 8170M 26C 2.1 GHz H	DC1	\$16,327
SDDCPR8170PT26C21	SDDC Intel CPU 8170 26C 2.1 GHz H	DC1	\$12,427
SDDCPR8176M28C21	SDDC Intel CPU 8176M 28C 2.1 GHz H	DC1	\$18,283
SDDCPR8176PT28C21	SDDC Intel CPU 8176 28C 2.1 GHz H	DC1	\$14,630
SDDCPR8180M28C25-2	SDDC Intel CPU 8180M 28C 2.5GHz2ndH	DC1	\$20,695
SDDCPR8180MPT28C25	SDDC Intel CPU 8180M 28C 2.5 GHz H	DC1	\$20,695
SDDCPR8180PT28C25	SDDC Intel CPU 8180 28C 2.5 GHz H	DC1	\$17,607
SDDCPR-NO-2ND-PROC	SDDC No Second Processor	DC1	\$0
SDDC-PWR-SINGLE-US	VxRack SDDC 1P Power NA & Japan	DC1	\$3,095
SDDC-PWR-SNGL-IEC3	VxRack SDDC 1P Power International	DC1	\$3,734
SDDC-PWR-WYE-INT	VxRack SDDC 3P Power WYE INT	DC1	\$3,771
SDDC-PWR-WYE-US	VxRack SDDC 3P Power WYE NA	DC1	\$4,976
SDDC-R640SERVR-KIT	VxRack SDDC R640 SERVER KIT	DC1	\$855
SDDC-R740GPUSVRKIT	VxRack SDDC R740XD SERVER KIT WITH GPU	DC1	\$956
SDDC-R740SVRKIT	VxRack SDDC R740XD SERVER KIT W/O GPU	DC1	\$866
SDDCSY7402U1NG24DF	SDDC 2U1N GPU 24x2.5 Disk Slts AF	DC1	\$2,233
SDDCSYS6401U10DBF	SDDC 1U1N 10x2.5 Disk Slts BR AF	DC1	\$3,478
SDDCSYS6401U1N10D	SDDC 1U1N 10x2.5 Disk Slts H	DC1	\$3,478
SDDCSYS6401U1N10DF	SDDC 1U1N 10x2.5 Disk Slts AF	DC1	\$3,478
SDDCSYS7402U1N14D	SDDC 2U1N 14x3.5 Disk Slts H	DC1	\$1,539
SDDCSYS7402U1N24D	SDDC 2U1N 24x2.5 Disk Slts H	DC1	\$1,683
SDDCSYS7402U1N24DF	SDDC 2U1N 24x2.5 Disk Slts AF	DC1	\$1,683
SDDCSYS7402U1NG24D	SDDC 2U1N GPU 24x2.5 Disk Slts H	DC1	\$2,233
SDDCSYS7402U24DBF	SDDC 2U1N 24x2.5 Disk Slts BR AF	DC1	\$1,683
SDDCSYS7402UG24DBF	SDDC 2U1N GPU 24x2.5 Disk Slts BR AF	DC1	\$2,233
SDDCTRANSCEIVER10G	VxRack SDDC 10G Transceiver	DC1	\$7,704
SDDCTRANSCEIVER40G	VxRack SDDC 40G Transceiver	DC1	\$10,395
SDDINTERCONNSW	VxRack SDDC CISCO9332 INTERCONNECT SWT	DC1	\$37,950
SDDINTERCONNSWKIT1	VxRack SDDC Cisco9332 INTRCONN SWTC KIT1	DC1	\$2,172
SDDINTERCONNSWKIT2	VxRack SDDC Cisco9332 INTRCONN SWTC KIT2	DC1	\$12,391
SDDPR4109TSV8C20-2	SDDC IntelCPU 4109T 8C 2.0 GHz2ndH	DC1	\$935
SDDPR4114SV10C22-2	SDDC Intel CPU 4114 10C 2.2GHz2ndH	DC1	\$1,175
SDDPR4116SV12C21-2	SDDC Intel CPU 4116 12C 2.1GHz2ndH	DC1	\$1,663
SDDPR5115GD10C24-2	SDDC Intel CPU 5115 10C 2.4GHz2ndH	DC1	\$2,059
SDDPR5118GD12C23-2	SDDC Intel CPU 5118 12C 2.3GHz2ndH	DC1	\$2,059
SDDPR5120GD14C22-2	SDDC Intel CPU 5120 14C 2.2GHz2ndH	DC1	\$2,532
SDDPR6126GD12C26-2	SDDC Intel CPU 6126 12C 2.6GHz2ndH	DC1	\$2,944
SDDPR6130GD16C21-2	SDDC Intel CPU 6130 16C 2.1GHz2ndH	DC1	\$3,079
SDDPR6132GD14C26-2	SDDC Intel CPU 6132 14C 2.6GHz2ndH	DC1	\$3,424
SDDPR6134MGD8C32-2	SDDC Intel CPU 6134M 8C 3.2GHz2ndH	DC1	\$7,935
SDDPR6136GD12C30-2	SDDC Intel CPU 6136 12C 3.0GHz2ndH	DC1	\$3,993

SDDPR6138GD20C20-2	SDDC Intel CPU 6138 20C 2.0GHz2ndH	DC1	\$4,219
SDDPR6140GD18C23-2	SDDC Intel CPU 6140 18C 2.3GHz2ndH	DC1	\$3,930
SDDPR6142GD16C26-2	SDDC Intel CPU 6142 16C 2.6GHz2ndH	DC1	\$4,846
SDDPR6148GD20C24-2	SDDC Intel CPU 6148 20C 2.4GHz2ndH	DC1	\$5,012
SDDPR6150GD18C27-2	SDDC Intel CPU 6150 18C 2.7GHz2ndH	DC1	\$5,782
SDDPR6152GD22C21-2	SDDC Intel CPU 6152 22C 2.1GHz2ndH	DC1	\$6,104
SDDPR6154GD18C30-2	SDDC Intel CPU 6154 18C 3.0GHz2ndH	DC1	\$5,875
SDDPR8153PT16C20-2	SDDC Intel CPU 8153 16C 2.0GHz2ndH	DC1	\$5,262
SDDPR8160PT24C21-2	SDDC Intel CPU 8160 24C 2.1GHz2ndH	DC1	\$7,997
SDDPR8164PT26C20-2	SDDC Intel CPU 8164 26C 2.0GHz2ndH	DC1	\$10,285
SDDPR8168PT24C27-2	SDDC Intel CPU 8168 24C 2.7GHz2ndH	DC1	\$9,994
SDDPR8170PT26C21-2	SDDC Intel CPU 8170 26C 2.1GHz2ndH	DC1	\$12,427
SDDPR8176PT28C21-2	SDDC Intel CPU 8176 28C 2.1GHz2ndH	DC1	\$14,630
SDDPR8180PT28C25-2	SDDC Intel CPU 8180 28C 2.5GHz2ndH	DC1	\$17,607
SDGPU6PERFFAN	SDDC GPU 6 PERF Fan	DC1	\$207
SDGPUNVDIATESLAM10	SDDC Gpu NVIDIA TESLA M10 H	DC1	\$4,700
SDGPUNVDIATESLAM60	SDDC Gpu NVIDIA TESLA M60 H	DC1	\$9,359
SDHBA330CTRL1SH	SDDC PercHBA330RAIDCTR MINI12Gb 1S	DC1	\$228
SDHBA330CTRL2SH	SDDC PercHBA330+ RAIDCTR 12Gb 2SLP	DC1	\$291
SDINSTALLKITGPUM10	SDDC GPU Install Kit M10	DC1	\$145
SDINSTALLKITGPUM60	SDDC GPU Install Kit M60	DC1	\$103
SDINSTALLKITNOGPU	SDDC NO GPU INSTALL KIT	DC1	\$103
SDINSTGR13AFGR740	VxRack SDDC AFGANISTAN SHIPMOD GR1300	DC1	\$102
SDINSTGR13ARER740	VxRack SDDC UAE SHIPMOD GR1300	DC1	\$102
SDINSTGR13ARGR740	VxRack SDDC ARGENTINA SHIPMOD GR1300	DC1	\$102
SDINSTGR13AUSR740	VxRack SDDC AUSTRALIA SHIPMOD GR1300	DC1	\$102
SDINSTGR13AUTR740	VxRack SDDC AUSTRIA SHIPMOD GR1300	DC1	\$102
SDINSTGR13BELR740	VxRack SDDC BELGIUM SHIPMOD GR1300	DC1	\$102
SDINSTGR13BGDR740	VxRack SDDC BANGLADESH SHIPMOD GR1300	DC1	\$102
SDINSTGR13BOLR740	VxRack SDDC BOLIVIA SHIPMOD GR1300	DC1	\$102
SDINSTGR13BRNR740	VxRack SDDC BRUNEI SHIPMOD GR1300	DC1	\$102
SDINSTGR13BTNR740	VxRack SDDC BHUTAN SHIPMOD GR1300	DC1	\$102
SDINSTGR13CANR740	VxRack SDDC CANADA SHIPMOD GR1300	DC1	\$102
SDINSTGR13CHER740	VxRack SDDC SWITZERLAND SHIPMOD GR1300	DC1	\$102
SDINSTGR13CHLR740	VxRack SDDC CHILE SHIPMOD GR1300	DC1	\$102
SDINSTGR13COLR740	VxRack SDDC COLOMBIA SHIPMOD GR1300	DC1	\$102
SDINSTGR13CZER740	VxRack SDDC CZECH REP SHIPMOD GR1300	DC1	\$102
SDINSTGR13DEUR740	VxRack SDDC GERMANY SHIPMOD GR1300	DC1	\$102
SDINSTGR13DNKR740	VxRack SDDC DENMARK SHIPMOD GR1300	DC1	\$102
SDINSTGR13ECUR740	VxRack SDDC ECUADOR SHIPMOD GR1300	DC1	\$102
SDINSTGR13EGYR740	VxRack SDDC EGYPT SHIPMOD GR1300	DC1	\$102
SDINSTGR13ESPR740	VxRack SDDC SPAIN SHIPMOD GR1300	DC1	\$102
SDINSTGR13FINR740	VxRack SDDC FINLAND SHIPMOD GR1300	DC1	\$102
SDINSTGR13FJIR740	VxRack SDDC FIJI SHIPMOD GR1300	DC1	\$102
SDINSTGR13FRAR740	VxRack SDDC FRANCE SHIPMOD GR1300	DC1	\$102
SDINSTGR13GBRR740	VxRack SDDC UNITED KING SHIPMOD GR1300	DC1	\$102
SDINSTGR13GRCR740	VxRack SDDC GREECE SHIPMOD GR1300	DC1	\$102
SDINSTGR13GUMR740	VxRack SDDC GUAM SHIPMOD GR1300	DC1	\$102
SDINSTGR13HKGR740	VxRack SDDC HONG KONG SHIPMOD GR1300	DC1	\$102
SDINSTGR13HUNR740	VxRack SDDC HUNGARY SHIPMOD GR1300	DC1	\$102

SDINSTGR13IDNR740	VxRack SDDC INDONESIA SHIPMOD GR1300	DC1	\$102
SDINSTGR13INDR740	VxRack SDDC INDIA SHIPMOD GR1300	DC1	\$102
SDINSTGR13IRLR740	VxRack SDDC IRELAND SHIPMOD GR1300	DC1	\$102
SDINSTGR13ISRR740	VxRack SDDC ISRAEL SHIPMOD GR1300	DC1	\$102
SDINSTGR13ITAR740	VxRack SDDC ITALY SHIPMOD GR1300	DC1	\$102
SDINSTGR13JPNR740	VxRack SDDC JAPAN SHIPMOD GR1300	DC1	\$102
SDINSTGR13KAZR740	VxRack SDDC KAZAKHSTAN SHIPMOD GR1300	DC1	\$102
SDINSTGR13KENR740	VxRack SDDC KENYA SHIPMOD GR1300	DC1	\$102
SDINSTGR13KHMR740	VxRack SDDC CAMBODIA SHIPMOD GR1300	DC1	\$102
SDINSTGR13KIRR740	VxRack SDDC KIRIBATI SHIPMOD GR1300	DC1	\$102
SDINSTGR13KORR740	VxRack SDDC SOUTH KOREA SHIPMOD GR1300	DC1	\$102
SDINSTGR13LAOR740	VxRack SDDC LAOS SHIPMOD GR1300	DC1	\$102
SDINSTGR13LKAR740	VxRack SDDC SRI LANKA SHIPMOD GR1300	DC1	\$102
SDINSTGR13LTUR740	VxRack SDDC LITHUANIA SHIPMOD GR1300	DC1	\$102
SDINSTGR13LUXR740	VxRack SDDC LUXEMBOURG SHIPMOD GR1300	DC1	\$102
SDINSTGR13MACR740	VxRack SDDC MACAU SHIPMOD GR1300	DC1	\$102
SDINSTGR13MARR740	VxRack SDDC MOROCCO SHIPMOD GR1300	DC1	\$102
SDINSTGR13MEXR740	VxRack SDDC MEXICO SHIPMOD GR1300	DC1	\$102
SDINSTGR13MNGR740	VxRack SDDC MONGOLIA SHIPMOD GR1300	DC1	\$102
SDINSTGR13MNPR740	VxRack SDDC N. MARIANAS SHIPMOD GR1300	DC1	\$102
SDINSTGR13MYSR740	VxRack SDDC MALAYSIA SHIPMOD GR1300	DC1	\$102
SDINSTGR13NCLR740	VxRack SDDC NEW CALEDONIA SHIPMOD GR13	DC1	\$102
SDINSTGR13NGAR740	VxRack SDDC NIGERIA SHIPMOD GR1300	DC1	\$102
SDINSTGR13NLDR740	VxRack SDDC NETHERLANDS SHIPMOD GR1300	DC1	\$102
SDINSTGR13NORR740	VxRack SDDC NORWAY SHIPMOD GR1300	DC1	\$102
SDINSTGR13NPLR740	VxRack SDDC NEPAL SHIPMOD GR1300	DC1	\$102
SDINSTGR13NZLR740	VxRack SDDC NEW ZEALAND SHIPMOD GR1300	DC1	\$102
SDINSTGR13PAKR740	VxRack SDDC PAKISTAN SHIPMOD GR1300	DC1	\$102
SDINSTGR13PERR740	VxRack SDDC PERU SHIPMOD GR1300	DC1	\$102
SDINSTGR13PHLR740	VxRack SDDC PHILIPPINES SHIPMOD GR1300	DC1	\$102
SDINSTGR13PLWR740	VxRack SDDC PALAU SHIPMOD GR1300	DC1	\$102
SDINSTGR13PNGR740	VxRack SDDC PAPUA N GUINEA SHIPM GR1300	DC1	\$102
SDINSTGR13POLR740	VxRack SDDC POLAND SHIPMOD GR1300	DC1	\$102
SDINSTGR13PRIR740	VxRack SDDC PUERTO RICO SHIPMOD GR1300	DC1	\$102
SDINSTGR13PRTR740	VxRack SDDC PORTUGAL SHIPMOD GR1300	DC1	\$102
SDINSTGR13PRYR740	VxRack SDDC PARAGUAY SHIPMOD GR1300	DC1	\$102
SDINSTGR13QATR740	VxRack SDDC QATAR SHIPMOD GR1300	DC1	\$102
SDINSTGR13ROUR740	VxRack SDDC ROMANIA SHIPMOD GR1300	DC1	\$102
SDINSTGR13SAUR740	VxRack SDDC SAUDI ARABIA SHIPMOD GR1300	DC1	\$102
SDINSTGR13SGPR740	VxRack SDDC SINGAPORE SHIPMOD GR1300	DC1	\$102
SDINSTGR13SLBR740	VxRack SDDC SOLOMON ISL SHIPMOD GR1300	DC1	\$102
SDINSTGR13SVKR740	VxRack SDDC SLOVAKIA SHIPMOD GR1300	DC1	\$102
SDINSTGR13SVNR740	VxRack SDDC SLOVENIA SHIPMOD GR1300	DC1	\$102
SDINSTGR13SWER740	VxRack SDDC SWEDEN SHIPMOD GR1300	DC1	\$102
SDINSTGR13THAR740	VxRack SDDC THAILAND SHIPMOD GR1300	DC1	\$102
SDINSTGR13TONR740	VxRack SDDC TONGA SHIPMOD GR1300	DC1	\$102
SDINSTGR13TURR740	VxRack SDDC TURKEY SHIPMOD GR1300	DC1	\$102
SDINSTGR13TWNR740	VxRack SDDC TAIWAN SHIPMOD GR1300	DC1	\$102
SDINSTGR13UKRR740	VxRack SDDC UKRAINE SHIPMOD GR1300	DC1	\$102
SDINSTGR13URYR740	VxRack SDDC URUGUAY SHIPMOD GR1300	DC1	\$102

SDINSTGR13USAR740	VxRack SDDC USA SHIPMOD GR1300	DC1	\$102
SDINSTGR13VENR740	VxRack SDDC VENEZUELA SHIPMOD GR1300	DC1	\$102
SDINSTGR13VMYR740	VxRack SDDC MYANMAR SHIPMOD GR1300	DC1	\$102
SDINSTGR13VNM740	VxRack SDDC VIETNAM SHIPMOD GR1300	DC1	\$102
SDINSTGR13VUTR740	VxRack SDDC VANUATU SHIPMOD GR1300	DC1	\$102
SDINSTGR13WSMR740	VxRack SDDC SAMOA SHIPMOD GR1300	DC1	\$102
SDINSTGR13ZAFR740	VxRack SDDC SOUTH AFRICA SHIPMOD GR1300	DC1	\$102
SDINSTLCTRYAFGR740	VxRack SDDC AFGANISTAN SHIPMOD	DC1	\$102
SDINSTLCTRYARER740	VxRack SDDC UAE SHIPMOD	DC1	\$102
SDINSTLCTRYARGR740	VxRack SDDC ARGENTINA SHIPMOD	DC1	\$88
SDINSTLCTRYAUSR740	VxRack SDDC AUSTRALIA SHIPMOD	DC1	\$83
SDINSTLCTRYAUTR740	VxRack SDDC AUSTRIA SHIPMOD	DC1	\$102
SDINSTLCTRYBELR740	VxRack SDDC BELGIUM SHIPMOD	DC1	\$102
SDINSTLCTRYBGDR740	VxRack SDDC BANGLADESH SHIPMOD	DC1	\$83
SDINSTLCTRYBOLR740	VxRack SDDC BOLIVIA SHIPMOD	DC1	\$88
SDINSTLCTRYBRNR740	VxRack SDDC BRUNEI SHIPMOD	DC1	\$83
SDINSTLCTRYBTNR740	VxRack SDDC BHUTAN SHIPMOD	DC1	\$83
SDINSTLCTRYCANR740	VxRack SDDC CANADA SHIPMOD	DC1	\$83
SDINSTLCTRYCHER740	VxRack SDDC SWITZERLAND SHIPMOD	DC1	\$102
SDINSTLCTRYCHLR740	VxRack SDDC CHILE SHIPMOD	DC1	\$88
SDINSTLCTRYCOLR740	VxRack SDDC COLOMBIA SHIPMOD	DC1	\$88
SDINSTLCTRYCZER740	VxRack SDDC CZECH REPUBLIC SHIPMOD	DC1	\$102
SDINSTLCTRYDEUR740	VxRack SDDC GERMANY SHIPMOD	DC1	\$102
SDINSTLCTRYDNKR740	VxRack SDDC DENMARK SHIPMOD	DC1	\$102
SDINSTLCTRYECUR740	VxRack SDDC ECUADOR SHIPMOD	DC1	\$88
SDINSTLCTRYEGYR740	VxRack SDDC EGYPT SHIPMOD	DC1	\$102
SDINSTLCTRYESPR740	VxRack SDDC SPAIN SHIPMOD	DC1	\$102
SDINSTLCTRYFINR740	VxRack SDDC FINLAND SHIPMOD	DC1	\$102
SDINSTLCTRYFJIR740	VxRack SDDC FIJI SHIPMOD	DC1	\$83
SDINSTLCTRYFRAR740	VxRack SDDC FRANCE SHIPMOD	DC1	\$102
SDINSTLCTRYGBRR740	VxRack SDDC UNITED KINGDOM SHIPMOD	DC1	\$102
SDINSTLCTRYGR740	VxRack SDDC GREECE SHIPMOD	DC1	\$102
SDINSTLCTRYGUMR740	VxRack SDDC GUAM SHIPMOD	DC1	\$83
SDINSTLCTRYHKGR740	VxRack SDDC HONG KONG SHIPMOD	DC1	\$83
SDINSTLCTRYHUNR740	VxRack SDDC HUNGARY SHIPMOD	DC1	\$102
SDINSTLCTRYIDNR740	VxRack SDDC INDONESIA SHIPMOD	DC1	\$83
SDINSTLCTRYINDR740	VxRack SDDC INDIA SHIPMOD	DC1	\$83
SDINSTLCTRYIRLR740	VxRack SDDC IRELAND SHIPMOD	DC1	\$102
SDINSTLCTRYISRR740	VxRack SDDC ISRAEL SHIPMOD	DC1	\$102
SDINSTLCTRYITAR740	VxRack SDDC ITALY SHIPMOD	DC1	\$102
SDINSTLCTRYJPNR740	VxRack SDDC JAPAN SHIPMOD	DC1	\$83
SDINSTLCTRYKAZR740	VxRack SDDC KAZAKHSTAN SHIPMOD	DC1	\$102
SDINSTLCTRYKENR740	VxRack SDDC KENYA SHIPMOD	DC1	\$102
SDINSTLCTRYKHMR740	VxRack SDDC CAMBODIA SHIPMOD	DC1	\$83
SDINSTLCTRYKIRR740	VxRack SDDC KIRIBATI SHIPMOD	DC1	\$83
SDINSTLCTRYKORR740	VxRack SDDC SOUTH KOREA SHIPMOD	DC1	\$83
SDINSTLCTRYLAOR740	VxRack SDDC LAOS SHIPMOD	DC1	\$83
SDINSTLCTRYLKAR740	VxRack SDDC SRI LANKA SHIPMOD	DC1	\$83
SDINSTLCTRYLTUR740	VxRack SDDC LITHUANIA SHIPMOD	DC1	\$102
SDINSTLCTRYLUXR740	VxRack SDDC LUXEMBOURG SHIPMOD	DC1	\$102

SDINSTLCTRYMACR740	VxRack SDDC MACAU SHIPMOD	DC1	\$83
SDINSTLCTRYMARR740	VxRack SDDC MOROCCO SHIPMOD	DC1	\$102
SDINSTLCTRYMEXR740	VxRack SDDC MEXICO SHIPMOD	DC1	\$83
SDINSTLCTRYMNGR740	VxRack SDDC MONGOLIA SHIPMOD	DC1	\$83
SDINSTLCTRYMNPR740	VxRack SDDC N. MARIANAS ISLANDS SHIPMOD	DC1	\$83
SDINSTLCTRYMYSR740	VxRack SDDC MALAYSIA SHIPMOD	DC1	\$83
SDINSTLCTRYNCLR740	VxRack SDDC NEW CALEDONIA SHIPMOD	DC1	\$83
SDINSTLCTRYNGAR740	VxRack SDDC NIGERIA SHIPMOD	DC1	\$102
SDINSTLCTRYNLDL740	VxRack SDDC NETHERLANDS SHIPMOD	DC1	\$102
SDINSTLCTRYNORR740	VxRack SDDC NORWAY SHIPMOD	DC1	\$102
SDINSTLCTRYNPLR740	VxRack SDDC NEPAL SHIPMOD	DC1	\$83
SDINSTLCTRYNZLR740	VxRack SDDC NEW ZEALAND SHIPMOD	DC1	\$83
SDINSTLCTRYPAKR740	VxRack SDDC PAKISTAN SHIPMOD	DC1	\$83
SDINSTLCTRYPERR740	VxRack SDDC PERU SHIPMOD	DC1	\$88
SDINSTLCTRYPHLR740	VxRack SDDC PHILIPPINES SHIPMOD	DC1	\$83
SDINSTLCTRYPLWR740	VxRack SDDC PALAU SHIPMOD	DC1	\$83
SDINSTLCTRYPNGR740	VxRack SDDC PAPUA NEW GUINEA SHIPMOD	DC1	\$83
SDINSTLCTRYPOLR740	VxRack SDDC POLAND SHIPMOD	DC1	\$102
SDINSTLCTRYPRIR740	VxRack SDDC PUERTO RICO SHIPMOD	DC1	\$83
SDINSTLCTRYPRTR740	VxRack SDDC PORTUGAL SHIPMOD	DC1	\$102
SDINSTLCTRYPRYR740	VxRack SDDC PARAGUAY SHIPMOD	DC1	\$79
SDINSTLCTRYQATR740	VxRack SDDC QATAR SHIPMOD	DC1	\$102
SDINSTLCTRYROUR740	VxRack SDDC ROMANIA SHIPMOD	DC1	\$102
SDINSTLCTRYSAUR740	VxRack SDDC SAUDI ARABIA SHIPMOD	DC1	\$102
SDINSTLCTRYSGPR740	VxRack SDDC SINGAPORE SHIPMOD	DC1	\$83
SDINSTLCTRYSLBR740	VxRack SDDC SOLOMON ISLAND SHIPMOD	DC1	\$83
SDINSTLCTRYSVKR740	VxRack SDDC SLOVAKIA SHIPMOD	DC1	\$102
SDINSTLCTRYSVNR740	VxRack SDDC SLOVENIA SHIPMOD	DC1	\$102
SDINSTLCTRYSWER740	VxRack SDDC SWEDEN SHIPMOD	DC1	\$102
SDINSTLCTRYTHAR740	VxRack SDDC THAILAND SHIPMOD	DC1	\$83
SDINSTLCTRYTONR740	VxRack SDDC TONGA SHIPMOD	DC1	\$83
SDINSTLCTRYTURR740	VxRack SDDC TURKEY SHIPMOD	DC1	\$102
SDINSTLCTRYTWR740	VxRack SDDC TAIWAN SHIPMOD	DC1	\$83
SDINSTLCTRYUKRR740	VxRack SDDC UKRAINE SHIPMOD	DC1	\$102
SDINSTLCTRYURYR740	VxRack SDDC URUGUAY SHIPMOD	DC1	\$88
SDINSTLCTRYUSAR740	VxRack SDDC USA SHIPMOD	DC1	\$83
SDINSTLCTRYVENR740	VxRack SDDC VENEZUELA SHIPMOD	DC1	\$88
SDINSTLCTRYVMYR740	VxRack SDDC MYANMAR SHIPMOD	DC1	\$83
SDINSTLCTRYVNMR740	VxRack SDDC VIETNAM SHIPMOD	DC1	\$83
SDINSTLCTRYVUTR740	VxRack SDDC VANUATU SHIPMOD	DC1	\$83
SDINSTLCTRYWSMR740	VxRack SDDC SAMOA SHIPMOD	DC1	\$83
SDINSTLCTRYZAFR740	VxRack SDDC SOUTH AFRICA SHIPMOD	DC1	\$102
SDLRDIMM2666INFO	SDDC FactoryOrd Rq 2666Mhz LRDIMMs	DC1	\$0
SDMEMLDIMM16GBAF	SDDC Memory 16GB RDIMM AF	DC1	\$665
SDMEMLDIMM16GBBCC	SDDC Memory 16GB RDIMM BCC F	DC1	\$977
SDMEMLDIMM16GBBH	SDDC Memory 16GB RDIMM BCC H	DC1	\$977
SDMEMLDIMM16GBH	SDDC Memory 16GB RDIMM H	DC1	\$665
SDMEMLDIMM32GBAF	SDDC Memory 32GB RDIMM AF	DC1	\$1,258
SDMEMLDIMM32GBBCC	SDDC Memory 32GB RDIMM BCC F	DC1	\$1,765
SDMEMLDIMM32GBBH	SDDC Memory 32GB RDIMM BCC H	DC1	\$1,765

SDMEMLRDIMM32GBH	SDDC Memory 32GB RDIMM H	DC1	\$1,258
SDMEMLRDIMM64GBAF	SDDC Memory 64GB LRDIMM AF	DC1	\$2,891
SDMEMLRDIMM64GBBF	SDDC Memory 64GB LRDIMM BCC F	DC1	\$3,979
SDMEMLRDIMM64GBBH	SDDC Memory 64GB LRDIMM BCC H	DC1	\$3,979
SDMEMLRDIMM64GBH	SDDC Memory 64GB LRDIMM H	DC1	\$2,891
SDNDCX710QP10GBSFH	SDDC NDC Intel X710 QP 10Gb SFP+ H	DC1	\$883
SDNO-TPMMOD	SDDC NO TPM module	DC1	\$0
SDPR3106BN8C17F	SDDC Intel CPU 3106 8C 1.7 GHz AF	DC1	\$623
SDPR3106BN8C17F-2	SDDC Intel CPU 3106 8C 1.7GHz 2nd AF	DC1	\$623
SDPR4108SV8C18F	SDDC Intel CPU 4108 8C 1.8 GHz AF	DC1	\$821
SDPR4108SV8C18F-2	SDDC Intel CPU 4108 8C 1.8GHz 2nd AF	DC1	\$821
SDPR4109TSV8C20F	SDDC Intel CPU 4109T 8C 2.0 GHzAF	DC1	\$935
SDPR4109TSV8C20F-2	SDDC Intel CPU 4109T 8C 2.0 GHz 2nd AF	DC1	\$935
SDPR4110SV8C21F	SDDC Intel CPU 4110 8C 2.1 GHz AF	DC1	\$873
SDPR4110SV8C21F-2	SDDC Intel CPU 4110 8C 2.1 GHz 2nd AF	DC1	\$873
SDPR4112SV4C26F	SDDC Intel CPU 4112 4C 2.6 GHz AF	DC1	\$837
SDPR4112SV4C26F-2	SDDC Intel CPU 4112 4C 2.6 GHz 2nd AF	DC1	\$837
SDPR4114SV10C22F	SDDC Intel CPU 4114 10C 2.2 GHz AF	DC1	\$1,175
SDPR4114SV10C22F-2	SDDC Intel CPU 4114 10 C2.2 GHz 2nd AF	DC1	\$1,175
SDPR4116SV12C21F	SDDC Intel CPU 4116 12C 2.1 GHz AF	DC1	\$1,663
SDPR4116SV12C21F-2	SDDC Intel CPU 4116 12C 2.1 GHz 2nd AF	DC1	\$1,663
SDPR5115GD10C24F	SDDC Intel CPU 5115 10C 2.4 GHz AF	DC1	\$2,059
SDPR5115GD10C24F-2	SDDC Intel CPU 5115 10C 2.4 GHz 2nd AF	DC1	\$2,059
SDPR5118GD12C23F	SDDC Intel CPU 5118 12C 2.3 GHz AF	DC1	\$2,059
SDPR5118GD12C23F-2	SDDC Intel CPU 5118 12C 2.3 GHz 2nd AF	DC1	\$2,059
SDPR5120GD14C22F	SDDC Intel CPU 5120 14C 2.2 GHz AF	DC1	\$2,532
SDPR5120GD14C22F-2	SDDC Intel CPU 5120 14C 2.2 GHz 2nd AF	DC1	\$2,532
SDPR5122GD4C35F	SDDC Intel CPU 5122 4C 3.5 GHz AF	DC1	\$2,038
SDPR5122GD4C35F-2	SDDC Intel CPU 5122 4C 3.5 GHz 2nd AF	DC1	\$2,038
SDPR6126GD12C26F	SDDC Intel CPU 6126 12C 2.6 GHz AF	DC1	\$2,944
SDPR6126GD12C26F-2	SDDC Intel CPU 6126 12C 2.6 GHz 2nd AF	DC1	\$2,944
SDPR6128GD6C34F	SDDC Intel CPU 6128 6C 3.4 GHz AF	DC1	\$2,776
SDPR6128GD6C34F-2	SDDC Intel CPU 6128 6C 3.4 GHz 2nd AF	DC1	\$2,776
SDPR6130GD16C21F	SDDC Intel CPU 6130 16C 2.1 GHz AF	DC1	\$3,079
SDPR6130GD16C21F-2	SDDC Intel CPU 6130 16C 2.1 GHz 2nd AF	DC1	\$3,079
SDPR6132GD14C26F	SDDC Intel CPU 6132 14C 2.6 GHz AF	DC1	\$3,424
SDPR6132GD14C26F-2	SDDC Intel CPU 6132 14C 2.6 GHz 2nd AF	DC1	\$3,424
SDPR6134GD8C32F	SDDC Intel CPU 6134 8C 3.2 GHz AF	DC1	\$3,608
SDPR6134GD8C32F-2	SDDC Intel CPU 6134 8C 3.2 GHz 2nd AF	DC1	\$3,608
SDPR6134MGD8C32F	SDDC Intel CPU 6134M 8C 3.2 GHz AF	DC1	\$7,935
SDPR6136GD12C30F	SDDC Intel CPU 6136 12C 3.0 GHz AF	DC1	\$3,993
SDPR6136GD12C30F-2	SDDC Intel CPU 6136 12C 3.0 GHz 2nd AF	DC1	\$3,993
SDPR6138GD20C20F	SDDC Intel CPU 6138 20C 2.0 GHz AF	DC1	\$4,219
SDPR6138GD20C20F-2	SDDC Intel CPU 6138 20C 2.0 GHz 2nd AF	DC1	\$4,219
SDPR6140GD18C23F	SDDC Intel CPU 6140 18C 2.3 GHz AF	DC1	\$3,930
SDPR6140GD18C23F-2	SDDC Intel CPU 6140 18C 2.3 GHz 2nd AF	DC1	\$3,930
SDPR6140MGD18C23-2	SDDC Intel CPU 6140M 18C2.3GHz2ndH	DC1	\$8,371
SDPR6140MGD18C23F	SDDC Intel CPU 6140M 18C 2.3 GHzAF	DC1	\$8,371
SDPR6142GD16C26F	SDDC Intel CPU 6142 16C 2.6 GHz AF	DC1	\$4,846
SDPR6142GD16C26F-2	SDDC Intel CPU 6142 16C 2.6 GHz 2nd AF	DC1	\$4,846

SDPR6142MGD16C26-2	SDDC IntelCPU 6142M 16C 2.6GHz2ndH	DC1	\$9,203
SDPR6142MGD16C26F	SDDC Intel CPU 6142M 16C 2.6 GHzAF	DC1	\$9,203
SDPR6146GD12C32F	SDDC Intel CPU 6146 12C 3.2 GHz AF	DC1	\$5,459
SDPR6146GD12C32F-2	SDDC Intel CPU 6146 12C 3.2 GHz 2nd AF	DC1	\$5,459
SDPR6148GD20C24F	SDDC Intel CPU 6148 20C 2.4 GHz AF	DC1	\$5,012
SDPR6148GD20C24F-2	SDDC Intel CPU 6148 20C 2.4 GHz 2nd AF	DC1	\$5,012
SDPR6150GD18C27F	SDDC Intel CPU 6150 18C 2.7 GHz AF	DC1	\$5,782
SDPR6150GD18C27F-2	SDDC Intel CPU 6150 18C 2.7 GHz 2nd AF	DC1	\$5,782
SDPR6152GD22C21F	SDDC Intel CPU 6152 22C 2.1 GHz AF	DC1	\$6,104
SDPR6152GD22C21F-2	SDDC Intel CPU 6152 22C 2.1 GHz 2nd AF	DC1	\$6,104
SDPR6154GD18C30F	SDDC Intel CPU 6154 18C 3.0 GHz AF	DC1	\$5,875
SDPR6154GD18C30F-2	SDDC Intel CPU 6154 18C 3.0 GHz 2nd AF	DC1	\$5,875
SDPR8153PT16C20F	SDDC Intel CPU 8153 16C 2.0 GHz AF	DC1	\$5,262
SDPR8153PT16C20F-2	SDDC Intel CPU 8153 16C 2.0 GHz 2nd AF	DC1	\$5,262
SDPR8160MPT24C21F	SDDC Intel CPU 8160M 24C2.1 GHz AF	DC1	\$11,907
SDPR8160PT24C21F	SDDC Intel CPU 8160 24C 2.1 GHz AF	DC1	\$7,997
SDPR8160PT24C21F-2	SDDC Intel CPU 8160 24C 2.1 GHz 2nd AF	DC1	\$7,997
SDPR8164PT26C20F	SDDC Intel CPU 8164 26C 2.0 GHz AF	DC1	\$10,285
SDPR8164PT26C20F-2	SDDC Intel CPU 8164 26C 2.0 GHz 2nd AF	DC1	\$10,285
SDPR8168PT24C27F	SDDC Intel CPU 8168 24C 2.7 GHz AF	DC1	\$9,994
SDPR8168PT24C27F-2	SDDC Intel CPU 8168 24C 2.7 GHz 2nd AF	DC1	\$9,994
SDPR8170MPT26C21F	SDDC Intel CPU 8170M 26C 2.1 GHz AF	DC1	\$16,327
SDPR8170PT26C21F	SDDC Intel CPU 8170 26C 2.1 GHz AF	DC1	\$12,427
SDPR8170PT26C21F-2	SDDC Intel CPU 8170 26C 2.1 GHz 2nd AF	DC1	\$12,427
SDPR8176M28C21F	SDDC Intel CPU 8176M 28C 2.1 GHz AF	DC1	\$18,283
SDPR8176PT28C21F	SDDC Intel CPU 8176 28C 2.1 GHz AF	DC1	\$14,630
SDPR8176PT28C21F-2	SDDC Intel CPU 8176 28C 2.1 GHz 2nd AF	DC1	\$14,630
SDPR8180M28C25F-2	SDDC Intel CPU 8180M 28C 2.5 GHz 2nd AF	DC1	\$20,695
SDPR8180MPT28C25F	SDDC Intel CPU 8180M28C 2.5 GHz AF	DC1	\$20,695
SDPR8180PT28C25F	SDDC Intel CPU 8180 28C 2.5 GHz AF	DC1	\$17,607
SDPR8180PT28C25F-2	SDDC Intel CPU 8180 28C 2.5 GHz 2nd AF	DC1	\$17,607
SDPS1100WPSF	SDDC Dual Hotplg 1100W PS F	DC1	\$817
SDPS1100WPSH	SDDC Dual Hotplg 1100W PS H	DC1	\$817
SDPS1600W-250VACF	SDDC Dual Hotplg 1600W PS-250VAC F	DC1	\$884
SDPS1600W-250VACH	SDDC Dual Hotplg 1600W PS-250VAC H	DC1	\$884
SDPS2000W-240VACF	SDDC Dual Hotplg 2000W PS 240V AC F	DC1	\$1,039
SDPS2000W-240VACH	SDDC Dual Hotplg 2000W PS 240V AC H	DC1	\$1,039
SDPS750WPSF	SDDC Dual Hotplg 750W PS F	DC1	\$717
SDPS750WPSH	SDDC Dual Hotplg 750W PS H	DC1	\$717
SDRDIMM2666INFO	SDDC FactoryOrd Rq 2666Mhz RDIMMs	DC1	\$0
SDRISERR740S570	SDDC Riser R740 S570 1B 2B	DC1	\$72
SDRSER640CNFG2DUAL	SDDC Riser R640 CONFIG2 LP	DC1	\$20
SDRSER640CNFG4SNGI	SDDC Riser R640 CONFIG4 LP	DC1	\$20
SDRSER740CNFG1SNGI	SDDC Riser R740 CONFIG1	DC1	\$976
SDRSER740CNFG4DUAL	SDDC Riser R740 CONFIG4	DC1	\$686
SDSSD800GB10WPD25	SDDC Cache SSD 800GB 10WPD 2.5INCH	DC1	\$3,140
SDSSD800GB10WPD25F	SDDC CACHE SSD 800GB 10WPD 2.5Inch F	DC1	\$3,140
SDSSD800GB25S570	SDDC CacheSSD S570 800GB 10WPD 2.5I	DC1	\$3,140
SDSYS6401U1N10DBRH	SDDC 1U1N 10x2.5 Disk Slts BR H	DC1	\$3,478
SDSYS7402U1N14DBRH	SDDC 2U1N 14x3.5 Disk Slts BR H	DC1	\$1,539

SDSYS7402U1N24DBRH	SDDC 2U1N 24x2.5 Disk Slts BR H	DC1	\$1,683
SDSYS7402U1NG24DBH	SDDC 2U1N GPU 24x2.5 Disk Slts BR H	DC1	\$2,733
SDTPM1.2MODULEF	SDDC TPM 1.2 Module AF	DC1	\$62
SDTPM1.2MODULEH	SDDC TPM 1.2 module H	DC1	\$62
SDTPM2.0MODULE-CF	SDDC TPM 2.0 Module FOR C AF	DC1	\$103
SDTPM2.0MODULE-CH	SDDC TPM 2.0 module FOR C H	DC1	\$103
SDTPM2.0MODULEF	SDDC TPM 2.0 Module AF	DC1	\$103
SDTPM2.0MODULEH	SDDC TPM 2.0 module H	DC1	\$103
SGPUNVDIATESLAM10F	SDDC Gpu NVIDIA TESLA M10 AF	DC1	\$4,700
SGPUNVDIATESLAM60F	SDDC Gpu NVIDIA TESLA M60 AF	DC1	\$9,359
SINSLCTRYAFGFR640	VxRack SDDC AFGANISTAN SHIPMOD	DC1	\$84
SINSLCTRYAREFR640	VxRack SDDC UAE SHIPMOD	DC1	\$84
SINSLCTRYARGFR640	VxRack SDDC ARGENTINA SHIPMOD	DC1	\$82
SINSLCTRYAUSFR640	VxRack SDDC AUSTRALIA SHIPMOD	DC1	\$85
SINSLCTRYAUTFR640	VxRack SDDC AUSTRIA SHIPMOD	DC1	\$84
SINSLCTRYBELFR640	VxRack SDDC BELGIUM SHIPMOD	DC1	\$84
SINSLCTRYBGDFR640	VxRack SDDC BANGLADESH SHIPMOD	DC1	\$85
SINSLCTRYBOLFR640	VxRack SDDC BOLIVIA SHIPMOD	DC1	\$82
SINSLCTRYBRNFR640	VxRack SDDC BRUNEI SHIPMOD	DC1	\$85
SINSLCTRYBTNFR640	VxRack SDDC BHUTAN SHIPMOD	DC1	\$85
SINSLCTRYCANFR640	VxRack SDDC CANADA SHIPMOD	DC1	\$81
SINSLCTRYCHEFR640	VxRack SDDC SWITZERLAND SHIPMOD	DC1	\$84
SINSLCTRYCHLFR640	VxRack SDDC CHILE SHIPMOD	DC1	\$82
SINSLCTRYCOLFR640	VxRack SDDC COLOMBIA SHIPMOD	DC1	\$82
SINSLCTRYCZEFR640	VxRack SDDC CZECH REPUBLIC SHIPMOD	DC1	\$84
SINSLCTRYDEUFR640	VxRack SDDC GERMANY SHIPMOD	DC1	\$84
SINSLCTRYDNKFR640	VxRack SDDC DENMARK SHIPMOD	DC1	\$84
SINSLCTRYECUFR640	VxRack SDDC ECUADOR SHIPMOD	DC1	\$82
SINSLCTRYEGYFR640	VxRack SDDC EGYPT SHIPMOD	DC1	\$84
SINSLCTRYESPFR640	VxRack SDDC SPAIN SHIPMOD	DC1	\$84
SINSLCTRYFINFR640	VxRack SDDC FINLAND SHIPMOD	DC1	\$84
SINSLCTRYFJIFR640	VxRack SDDC FIJI SHIPMOD	DC1	\$85
SINSLCTRYFRAFR640	VxRack SDDC FRANCE SHIPMOD	DC1	\$84
SINSLCTRYGBRFR640	VxRack SDDC UNITED KINGDOM SHIPMOD	DC1	\$84
SINSLCTRYGRCFR640	VxRack SDDC GREECE SHIPMOD	DC1	\$84
SINSLCTRYGUMFR640	VxRack SDDC GUAM SHIPMOD	DC1	\$85
SINSLCTRYHKGFR640	VxRack SDDC HONG KONG SHIPMOD	DC1	\$86
SINSLCTRYHUNFR640	VxRack SDDC HUNGARY SHIPMOD	DC1	\$84
SINSLCTRYIDNFR640	VxRack SDDC INDONESIA SHIPMOD	DC1	\$85
SINSLCTRYINDFR640	VxRack SDDC INDIA SHIPMOD	DC1	\$85
SINSLCTRYIRLFR640	VxRack SDDC IRELAND SHIPMOD	DC1	\$84
SINSLCTRYISRFR640	VxRack SDDC ISRAEL SHIPMOD	DC1	\$84
SINSLCTRYITAFR640	VxRack SDDC ITALY SHIPMOD	DC1	\$84
SINSLCTRYJPNFR640	VxRack SDDC JAPAN SHIPMOD	DC1	\$85
SINSLCTRYKAZFR640	VxRack SDDC KAZAKHSTAN SHIPMOD	DC1	\$84
SINSLCTRYKENFR640	VxRack SDDC KENYA SHIPMOD	DC1	\$84
SINSLCTRYKHMFR640	VxRack SDDC CAMBODIA SHIPMOD	DC1	\$85
SINSLCTRYKIRFR640	VxRack SDDC KIRIBATI SHIPMOD	DC1	\$85
SINSLCTRYKORFR640	VxRack SDDC SOUTH KOREA SHIPMOD	DC1	\$86
SINSLCTRYLAOFR640	VxRack SDDC LAOS SHIPMOD	DC1	\$85

SINSLCTRYLKAFR640	VxRack SDDC SRI LANKA SHIPMOD	DC1	\$85
SINSLCTRYLTUFR640	VxRack SDDC LITHUANIA SHIPMOD	DC1	\$84
SINSLCTRYLUXFR640	VxRack SDDC LUXEMBOURG SHIPMOD	DC1	\$84
SINSLCTRYMACFR640	VxRack SDDC MACAU SHIPMOD	DC1	\$86
SINSLCTRYMARFR640	VxRack SDDC MOROCCO SHIPMOD	DC1	\$84
SINSLCTRYMEXFR640	VxRack SDDC MEXICO SHIPMOD	DC1	\$81
SINSLCTRYMNGFR640	VxRack SDDC MONGOLIA SHIPMOD	DC1	\$85
SINSLCTRYMNPFR640	VxRack SDDC N. MARIANAS ISL SHIPMOD	DC1	\$85
SINSLCTRYMYSFR640	VxRack SDDC MALAYSIA SHIPMOD	DC1	\$85
SINSLCTRYNCLFR640	VxRack SDDC NEW CALEDONIA SHIPMOD	DC1	\$85
SINSLCTRYNGAFR640	VxRack SDDC NIGERIA SHIPMOD	DC1	\$84
SINSLCTRYNLDFR640	VxRack SDDC NETHERLANDS SHIPMOD	DC1	\$84
SINSLCTRYNORFR640	VxRack SDDC NORWAY SHIPMOD	DC1	\$84
SINSLCTRYNPLFR640	VxRack SDDC NEPAL SHIPMOD	DC1	\$85
SINSLCTRYNZLFR640	VxRack SDDC NEW ZEALAND SHIPMOD	DC1	\$85
SINSLCTRYPAKFR640	VxRack SDDC PAKISTAN SHIPMOD	DC1	\$85
SINSLCTRYPERFR640	VxRack SDDC PERU SHIPMOD	DC1	\$82
SINSLCTRYPHLFR640	VxRack SDDC PHILIPPINES SHIPMOD	DC1	\$85
SINSLCTRYPLWFR640	VxRack SDDC PALAU SHIPMOD	DC1	\$85
SINSLCTRYPNGFR640	VxRack SDDC PAPUA NEW GUINEA SHIPMOD	DC1	\$85
SINSLCTRYPOLFR640	VxRack SDDC POLAND SHIPMOD	DC1	\$84
SINSLCTRYPRIFR640	VxRack SDDC PUERTO RICO SHIPMOD	DC1	\$81
SINSLCTRYPRTFR640	VxRack SDDC PORTUGAL SHIPMOD	DC1	\$84
SINSLCTRYPRYFR640	VxRack SDDC PARAGUAY SHIPMOD	DC1	\$82
SINSLCTRYQATFR640	VxRack SDDC QATAR SHIPMOD	DC1	\$84
SINSLCTRYROUFR640	VxRack SDDC ROMANIA SHIPMOD	DC1	\$84
SINSLCTRYSAUFR640	VxRack SDDC SAUDI ARABIA SHIPMOD	DC1	\$84
SINSLCTRYSGPFR640	VxRack SDDC SINGAPORE SHIPMOD	DC1	\$85
SINSLCTRYSLBFR640	VxRack SDDC SOLOMON ISLAND SHIPMOD	DC1	\$85
SINSLCTRYSVKFR640	VxRack SDDC SLOVAKIA SHIPMOD	DC1	\$84
SINSLCTRYSVNFR640	VxRack SDDC SLOVENIA SHIPMOD	DC1	\$84
SINSLCTRYSWEFR640	VxRack SDDC SWEDEN SHIPMOD	DC1	\$84
SINSLCTRYTHAFR640	VxRack SDDC THAILAND SHIPMOD	DC1	\$85
SINSLCTRYTONFR640	VxRack SDDC TONGA SHIPMOD	DC1	\$85
SINSLCTRYTURFR640	VxRack SDDC TURKEY SHIPMOD	DC1	\$84
SINSLCTRYTWNFR640	VxRack SDDC TAIWAN SHIPMOD	DC1	\$86
SINSLCTRYUKRFR640	VxRack SDDC UKRAINE SHIPMOD	DC1	\$84
SINSLCTRYURYFR640	VxRack SDDC URUGUAY SHIPMOD	DC1	\$82
SINSLCTRYUSAFR640	VxRack SDDC USA SHIPMOD	DC1	\$81
SINSLCTRYVENFR640	VxRack SDDC VENEZUELA SHIPMOD	DC1	\$82
SINSLCTRYVMYR640	VxRack SDDC MYANMAR SHIPMOD	DC1	\$85
SINSLCTRYVNMFR640	VxRack SDDC VIETNAM SHIPMOD	DC1	\$85
SINSLCTRYVUTFR640	VxRack SDDC VANUATU SHIPMOD	DC1	\$85
SINSLCTRYWSMFR640	VxRack SDDC SAMOA SHIPMOD	DC1	\$85
SINSLCTRYZAFFR640	VxRack SDDC SOUTH AFRICA SHIPMOD	DC1	\$84
SNDCX710QP10GBSFPF	SDDC NDC IntelX710 QP 10Gb SFP+ AF	DC1	\$883
VXRKSDDCSW5_1	SDDC Automation&ServiceabilityExt 5.1=MA	DC1	\$5,500
VXRKSDDCSW5_2	SDDC Automation&ServiceabilityExt 5.2=MA	DC1	\$5,500
VXSDDCDLIMG	VxRack SDDC Dell Node Image=MA	DC1	\$0
456-107-989	DD VE PERPETUAL CAP NF 1TB=CA	DD-1	\$1,355

456-107-990	LIC;CLD TIER DDVE SW CAP NF;1TB=CC	DD-1	\$400
456-109-399	LICENSE EXT RETENTION SW OPT DD6300=IA	DD-1	\$0
456-109-409	LICENSE EXTD RETN SW OPT DD6300 UPG=IA	DD-1	\$0
456-109-417	LIC DD6300 CAPACITY AIO 14TB=IA	DD-1	\$0
456-109-418	LIC DD6300 CAPACITY AIO 34TB=IA	DD-1	\$0
456-109-419	LIC DD6300 CAP AIO 14TB to 34TB UPG=IA	DD-1	\$0
456-109-424	LICENSE BASE DD OE DD6300=IA	DD-1	\$16,200
456-109-433	LICENSE BASE DD OE DD9800=IA	DD-1	\$16,200
456-109-435	LICENSE DD9800 HIGH AVAILABILITY=IA	DD-1	\$0
456-109-438	LICENSE EXT RETENTION SW OPT DD9800=IA	DD-1	\$0
456-109-446	LICENSE DD9800 HIGH AVAIL UPGRADE=IA	DD-1	\$0
456-109-449	LICENSE EXT RETENT SW OPT DD9800 UPG=IA	DD-1	\$0
456-109-724	LICENSE BASE DD OE DD6800=IA	DD-1	\$16,200
456-109-726	LICENSE DD6800 HIGH AVAILABILITY=IA	DD-1	\$0
456-109-729	LICENSE EXT RETENTION SW OPT DD6800=IA	DD-1	\$0
456-109-737	LICENSE DD6800 HIGH AVAIL UPGRADE=IA	DD-1	\$0
456-109-740	LIC EXT RETENT SW OPT DD6800 UPGRADE=IA	DD-1	\$0
456-109-751	LICENSE BASE DD OE DD9300=IA	DD-1	\$16,200
456-109-753	LICENSE DD9300 HIGH AVAILABILITY=IA	DD-1	\$0
456-109-756	LICENSE EXT RETENTION SW OPT DD9300=IA	DD-1	\$0
456-109-764	LICENSE DD9300 HIGH AVAIL UPGRADE=IA	DD-1	\$0
456-109-767	LICENSE EXT RETENT SW OPT DD9300 UPG=IA	DD-1	\$0
456-111-297	FS 800GB 6.4TB RAW=CF	DD-1	\$0
456-111-298	FS 800GB 12TB RAW=CF	DD-1	\$0
456-111-299	FS 800GB 1.6TB RAW=CF	DD-1	\$0
456-111-300	FS 800GB 4.0TB RAW=CF	DD-1	\$0
456-111-321	FS 800GB 3.2TB RAW=CF	DD-1	\$0
456-111-330	FS 800GB 0.8TB RAW=CF	DD-1	\$0
456-111-693	DD OE license 1TB RAW ENABLER=CB	DD-1	\$0
456-111-694	DD Encryption enabler=CB	DD-1	\$0
456-111-695	DD VTL enabler=CB	DD-1	\$0
456-111-696	DD VTL IBMI enabler=CB	DD-1	\$0
456-111-697	DD RLC enabler=CB	DD-1	\$0
456-111-698	DD RLG enabler=CB	DD-1	\$0
456-111-699	DD XCAP enabler=CB	DD-1	\$0
456-111-700	DD Boost 1TB RAW ENABLER=CB	DD-1	\$0
456-111-701	DD Replication 1TB RAW ENABLER=CB	DD-1	\$0
456-111-740	DD BOOST 1TB RAW ENABLER UPG=CB	DD-1	\$0
456-111-741	DD REPLICATION 1TB RAW ENABLER UPG=CB	DD-1	\$0
456-111-742	DD OE LICENSE 1TB RAW ENABLER UPG=CB	DD-1	\$0
456-111-743	DD ENCRYPTION 1TB RAW ENABLER UPG=CB	DD-1	\$0
456-111-744	DD VTL 1TB RAW ENABLER UPG=CB	DD-1	\$0
456-111-745	DD VTL IBMI 1TB RAW ENABLER UPG=CB	DD-1	\$0
456-111-746	DD RLC 1TB RAW ENABLER UPG=CB	DD-1	\$0
456-111-747	DD RLG 1TB RAW ENABLER UPG=CB	DD-1	\$0
456-111-793	DD Encryption enabler=CB	DD-1	\$0
456-111-794	DD VTL enabler=CB	DD-1	\$0
456-111-795	DD VTL IBMI enabler=CB	DD-1	\$0
456-111-796	DD RLC enabler=CB	DD-1	\$0
456-111-797	DD RLG enabler=CB	DD-1	\$0

456-111-798	DD XCAP enabler=CB	DD-1	\$0
456-111-799	DD VTL enabler=CB	DD-1	\$0
456-111-800	DD VTL IBMI enabler=CB	DD-1	\$0
456-111-801	DD RLC enabler=CB	DD-1	\$0
456-111-802	DD RLG enabler=CB	DD-1	\$0
456-111-803	DD XCAP enabler=CB	DD-1	\$0
456-111-940	LIC REPLICATOR DD160, UPGRADE=IA	DD-1	\$0
456-111-941	LICENSE;EXPSTOR;DD670;UPGRADE=IA	DD-1	\$0
456-111-942	LIC;VTL;670INCL:1XPCIE CARD;DP;4G;UPG=IA	DD-1	\$0
456-111-960	ES30 3TB ACT 45TB RAW=CB	DD-1	\$0
456-111-961	ES30 4TB ACT 60TB RAW=CB	DD-1	\$0
456-111-962	DS60 3TB ACT 45TB RAW=CB	DD-1	\$0
456-111-963	DS60 4TB ACT 60TB RAW=CB	DD-1	\$0
456-111-964	ES30 3TB ER 45TB RAW=CB	DD-1	\$0
456-111-965	ES30 4TB ER 60TB RAW=CB	DD-1	\$0
456-111-966	DS60 3TB ER 45TB RAW=CB	DD-1	\$0
456-111-967	DS60 4TB ER 60TB RAW=CB	DD-1	\$0
456-111-968	LIC;CLD TIER; 1TB;SW CAP=CC	DD-1	\$400
456-111-969	LIC DD STORAGE MIGRATION=IA	DD-1	\$0
456-111-970	LIC DD STORAGE MIGRATION UPG=IA	DD-1	\$0
456-111-971	ES30 1TB RAW ACT=CB	DD-1	\$0
456-111-972	DS60 1TB RAW ACT=CB	DD-1	\$0
456-111-973	ES30 1TB RAW ER=CB	DD-1	\$0
456-111-974	DS60 1TB RAW ER=CB	DD-1	\$0
456-111-975	ES20 1TB RAW ACT=CB	DD-1	\$0
456-111-976	ES20 1TB RAW ER=CB	DD-1	\$0
456-111-977	LICENSE ES30 1TB ER TO ACTIVE UPGRADE=IA	DD-1	\$11,016
456-111-978	LICENSE ES30 2TB ER TO ACTIVE UPGRADE=IA	DD-1	\$18,630
456-111-979	LICENSE ES30 3TB ER TO ACTIVE UPGRADE=IA	DD-1	\$30,375
456-111-980	LICENSE DS60 3TB ER TO ACTIVE UPGRADE=IA	DD-1	\$30,375
456-111-981	LICENSE ES30 4TB ER TO ACTIVE UPGRADE=IA	DD-1	\$40,419
456-111-982	LICENSE DS60 4TB ER TO ACTIVE UPGRADE=IA	DD-1	\$40,419
456-111-984	LICENSE DD OE PER TB CAPACITY ER=CB	DD-1	\$0
456-111-985	LICENSE DD OE PER TB UPG ER=CB	DD-1	\$741
456-112-160	DD AIO Boost Software enabler=CB	DD-1	\$0
456-112-161	DD AIO Replication Software enabler=CB	DD-1	\$0
456-112-162	DD Boost 1TB RAW enabler=CB	DD-1	\$0
456-112-163	DD Replication 1TB RAW enabler=CB	DD-1	\$0
456-112-164	DD Encryption enabler=CB	DD-1	\$0
456-112-165	DD VTL enabler=CB	DD-1	\$0
456-112-166	DD VTL IBMI enabler=CB	DD-1	\$0
456-112-167	DD RLC enabler=CB	DD-1	\$0
456-112-168	DD RLG enabler=CB	DD-1	\$0
456-112-169	DD XCAP enabler=CB	DD-1	\$0
456-112-239	SRM for Data Domain MID=IC	DD-1	\$16,160
456-112-240	SRM for Data Domain ENT=IC	DD-1	\$32,320
456-112-950	Lic Cloud Tier Bundle 1TB SW Cap=CC	DD-1	\$0
456-112-951	Lic Base DDOE DD6800 CT Bundle=IA	DD-1	\$0
456-113-112	DD VE Perpetual Cap Channel 1TB=CA	DD-1	\$0
456-113-293	IDPA DP5300 Base OE=IA	DD-1	\$0

456-113-294	IDPA DP5300 Boost Software Enabler=CB	DD-1	\$0
456-113-295	IDPA DP5300 Repl Software Enabler=CB	DD-1	\$0
456-113-300	IDPA CTRL FS 800GB 0.8TB RAW =CF	DD-1	\$0
456-113-301	IDPA BU App Enabler=IA	DD-1	\$0
456-113-302	IDPA Single Fed Reporting Server=IA	DD-1	\$0
456-113-303	IDPA BU Search Enabler=CA	DD-1	\$0
456-113-304	IDPA Backup G Enabler=CC	DD-1	\$0
456-113-305	IDPA Target Protocol Enabler=CA	DD-1	\$0
456-113-306	IDPA Analytics Enabler=CB	DD-1	\$0
456-113-307	IDPA MSM Enabler=IA	DD-1	\$0
456-113-308	IDPA vRealize Enabler=IA	DD-1	\$0
456-113-309	Plugin for IDPA vRealize Automation=IA	DD-1	\$0
456-113-315	DD OE license 1TB RAW Enabler =CB	DD-1	\$0
456-113-320	DD OE license 1TB RAW Enablr EDP=CB	DD-1	\$0
456-113-324	IDPA DP5800 Base OE=IA	DD-1	\$0
456-113-325	IDPA Target Boost 1TB RAW Enabler=CB	DD-1	\$0
456-113-326	IDPA Target Repl 1TB RAW Enabler=CB	DD-1	\$0
456-113-327	IDPA DP8300 Base OE=IA	DD-1	\$0
456-113-328	IDPA DP8800 Base OE=IA	DD-1	\$0
456-113-337	LIC;CLD TIER; 1TB;SW CAP=CC	DD-1	\$400
456-113-352	DD VE Channel 1TB Capacity License=CA	DD-1	\$0
456-113-429	DLm5 VTEOS Storage Group 1=IE	DD-1	\$37,630
456-113-430	DLm5 VTEOS Storage Group 2=IE	DD-1	\$37,630
456-113-431	DLm5 VTEOS Storage Group 3=IE	DD-1	\$37,630
456-113-434	DLm5 VTEOS Storage Group 6=IE	DD-1	\$37,630
456-113-435	DLm5 VTEOS Storage Group 7=IE	DD-1	\$37,630
456-113-436	DLm5 VTEOS Storage Group 8=IE	DD-1	\$37,630
456-113-437	DLm5 VTEOS Storage Group 9=IE	DD-1	\$37,630
456-113-438	DLm5 Capacity Storage Group 1=CC	DD-1	\$190
456-113-439	DLm5 Capacity Storage Group 2=CC	DD-1	\$235
456-113-440	DLm5 Capacity Storage Group 3=CC	DD-1	\$435
456-113-443	DLm5 Capacity Storage Group 6=CC	DD-1	\$570
456-113-444	DLm5 Capacity Storage Group 7=CC	DD-1	\$1,225
456-113-445	DLm5 Capacity Storage Group 8=CC	DD-1	\$0
456-113-446	DLm5 Capacity Storage Group 9=CC	DD-1	\$855
458-001-330	DD6300 OE APPLICATION SOFTWARE	DD-1	\$0
458-001-335	DD6300 OPERATING ENVIRONMENT SOFTWARE	DD-1	\$0
458-001-343	DD9800 OPERATING ENVIRONMENT SOFTWARE	DD-1	\$0
458-001-344	DD9800 OE APPLICATION SOFTWARE	DD-1	\$0
458-001-415	DD6800 OPERATING ENVIRONMENT SOFTWARE	DD-1	\$0
458-001-416	DD6800 OE APPLICATION SOFTWARE	DD-1	\$0
458-001-417	DD6800 OE APPLICATION SOFTWARE UPGRADE	DD-1	\$0
458-001-418	DD9300 OPERATING ENVIRONMENT SOFTWARE	DD-1	\$0
458-001-419	DD9300 OE APPLICATION SOFTWARE	DD-1	\$0
458-001-420	DD9300 OE APPLICATION SOFTWARE UPGRADE	DD-1	\$0
458-001-448	DD6300 OE APPLICATION SOFTWARE UPGRADE	DD-1	\$0
458-001-460	DD9800 OE APPLICATION SOFTWARE UPGRADE	DD-1	\$0
458-001-603	DD SSD CAPACITY LICENSE	DD-1	\$0
458-001-708	DD ENABLER DDBEA PROTECTPOINT	DD-1	\$0
458-001-800	DD Software=CB	DD-1	\$1,215

458-001-801	DD Boost Software Option=CB	DD-1	\$60
458-001-802	DD Replication Software Option=CB	DD-1	\$80
458-001-823	DD Software EDP=CB	DD-1	\$1,215
458-001-824	DD Boost Software Option UPG=CB	DD-1	\$75
458-001-825	DD REPLICATION SOFTWARE OPT UPG=CB	DD-1	\$100
458-001-826	DD SOFTWARE UPG=CB	DD-1	\$1,520
458-001-827	DD SOFTWARE EDP UPG=CB	DD-1	\$1,520
458-001-836	DD6300 SOFTWARE=CB	DD-1	\$0
458-001-890	DD STORAGE MIGRATION LICENSE	DD-1	\$0
458-001-891	DD OE CAPACITY LICENSE	DD-1	\$0
458-001-904	DD9800 RAW SHELF CAPACITY LICENSE	DD-1	\$0
458-001-905	DD9800 SSD CAPACITY LICENSE	DD-1	\$0
458-001-906	DD9800 CLOUD TIER LICENSE	DD-1	\$0
458-001-907	DD9800 STORAGE MIGRATION LICENSE	DD-1	\$0
458-001-908	DD9800 1TB CAPACITY LICENSE	DD-1	\$0
458-001-909	DD9800 ER TO ACT RAW SHELF CAPACITY LIC	DD-1	\$0
458-001-911	DD9800 OE ER CAPACITY LICENSE	DD-1	\$0
458-001-912	DD9300 RAW SHELF CAPACITY LICENSE	DD-1	\$0
458-001-913	DD9300 SSD CAPACITY LICENSE	DD-1	\$0
458-001-914	DD9300 CLOUD TIER LICENSE	DD-1	\$0
458-001-915	DD9300 STORAGE MIGRATION LICENSE	DD-1	\$0
458-001-916	DD9300 1TB CAPACITY LICENSE	DD-1	\$0
458-001-917	DD9300 ER TO ACT RAW SHELF CAPACITY LIC	DD-1	\$0
458-001-919	DD9300 OE ER CAPACITY LICENSE	DD-1	\$0
458-001-920	DD6800 RAW SHELF CAPACITY LICENSE	DD-1	\$0
458-001-921	DD6800 SSD CAPACITY LICENSE	DD-1	\$0
458-001-922	DD6800 CLOUD TIER LICENSE	DD-1	\$0
458-001-923	DD6800 STORAGE MIGRATION LICENSE	DD-1	\$0
458-001-924	DD6800 1TB CAPACITY LICENSE	DD-1	\$0
458-001-925	DD6800 ER TO ACT RAW SHELF CAPACITY LIC	DD-1	\$0
458-001-927	DD6800 OE ER CAPACITY LICENSE	DD-1	\$0
458-001-928	DD6300 RAW SHELF CAPACITY LICENSE	DD-1	\$0
458-001-929	DD6300 SSD CAPACITY LICENSE	DD-1	\$0
458-001-930	DD6300 STORAGE MIGRATION LICENSE	DD-1	\$0
458-001-931	DD6300 1TB CAPACITY LICENSE	DD-1	\$0
458-001-932	DD6300 ER TO ACT RAW SHELF CAPACITY LIC	DD-1	\$0
458-002-006	DD Boost/Replication AIO enabler=CB	DD-1	\$0
458-002-007	DD SW Enablers	DD-1	\$0
458-002-162	DD6800 Cloud Tier Bundle	DD-1	\$0
458-002-163	DD Software 6800 CT Bundle=CB	DD-1	\$0
458-002-167	DD Replication Controller Upg Enabler=CB	DD-1	\$1
458-002-168	DD Boost Controller Upgrade Enabler=CB	DD-1	\$1
458-002-186	Data Domain Cloud DR Essentials 1TB=CC	DD-1	\$800
458-002-193	DD VE Cloud DR Essentials 1TB=CC	DD-1	\$800
458-002-198	DD VE Channel Capacity 4TB	DD-1	\$4,800
458-002-255	IDPA DP5300 AIO Env Config	DD-1	\$0
458-002-256	IDPA DP5300 Env Config	DD-1	\$0
458-002-257	IDPA DP5300 Env Config EDP	DD-1	\$0
458-002-258	IDPA DP5800 Env Config	DD-1	\$0
458-002-259	IDPA DP5800 Env Config EDP	DD-1	\$0

458-002-260	IDPA DP8300 Env Config	DD-1	\$0
458-002-261	IDPA DP8300 Env Config EDP	DD-1	\$0
458-002-262	IDPA DP8800 Env Config	DD-1	\$0
458-002-263	IDPA DP8800 Env Config EDP	DD-1	\$0
458-002-264	IDPA Capacity Enabler=CB	DD-1	\$0
458-002-265	IDPA DP5300 AIO Env Config EDP	DD-1	\$0
458-002-284	DP5800 CLOUD TIER LICENSE	DD-1	\$0
458-002-285	DP8300 CLOUD TIER LICENSE=CC	DD-1	\$0
458-002-286	DP8800 CLOUD TIER LICENSE=CC	DD-1	\$0
458-002-305	DD VE Channel 4TB Base=IA	DD-1	\$4,800
458-002-306	DD VE Channel 1TB Capacity	DD-1	\$0
458-002-343	IDPA DD Cloud DR Essentials 1TB=CC	DD-1	\$800
458-002-368	DLM5 VETOS Storage Groups	DD-1	\$0
458-002-369	DLM5 Capacity Storage Groups	DD-1	\$0
458-002-370	DLM5 GDDR Tape=IF	DD-1	\$81,850
458-002-374	DLM Long-Term Retention=IC	DD-1	\$0
458-002-375	DLM Encryption=IC	DD-1	\$0
458-002-376	DLM File-Lock Retention=IC	DD-1	\$0
458-002-377	DLM Guarantee Replication=IC	DD-1	\$0
458-002-378	DLM KMIP Encryption=IC	DD-1	\$0
458-002-379	DLM DD Retention Lock=IC	DD-1	\$0
458-002-380	DLM Physical Tape SCSI=IC	DD-1	\$0
C-10GBTM4P-NF	DD 10GBASE T IO MODULE 4PORT	DD-1	\$4,050
C-10GBTM4P-NF-B	DD 10GBASE T IO MODULE 4PORT BUND	DD-1	\$0
C-10GMCU4P-NF	DD 10GBE IO MOD CU TWINAX 4PORT OPTION	DD-1	\$4,860
C-10GMOP4P-NF	DD 10GBE IO MOD OPTICAL SFP 4PORT OPTION	DD-1	\$4,860
C-16GFC-M2P-NF	DD 16GBIT FC IO MOD LC 2PORT OPTION	DD-1	\$4,860
C-6300-SAS-SLIC-G2	ADD ES EXP KIT,DUAL PATH,DD6300,UPG	DD-1	\$3,000
C-6300-SASSLICG2-B	ADD ES EXP KIT,DUAL PATH,DD6300,UPG B	DD-1	\$0
C-9800-BEZEL-FIELD	OPT DD9800 BEZEL FIELD INSTL G3	DD-1	\$0
C-9800-MEM256	MEMKIT ADD 256GB DD9800 16X16GB OPTION	DD-1	\$0
C-9800-MEM512	MEMKIT ADD 512GB DD9800 32X16GB OPTION	DD-1	\$29,250
C-A16E30-CT	OPT ADD9TO16ES30 2X2M2X3M CBLKT FLDIN C	DD-1	\$0
C-A16E30-H-NF	OPTION,ADD 9TO16 ES30 SAS,CABLE KIT	DD-1	\$486
C-A24E30-CT	OPT ADD 17TO24 ES30 4X3M CBLKIT FLDIN CT	DD-1	\$0
C-A24E30-H-NF	OPTION,ADD 17TO24 ES30 SAS CABLE KIT	DD-1	\$486
C-A8E30-HN-NF	OPTION ADD 1TO8 ES30 SAS CABLE KIT	DD-1	\$486
C-DD6300EXPKIT	DD6300 OPTION - EXPANSION KIT DIMM SSD	DD-1	\$8,550
C-DD6300EXPKIT-B	DD6300 OPTION - EXPANSION KIT DIMM SSD B	DD-1	\$0
C-DD6800EXPKIT	DD6800 OPTION - EXPANSION KIT SSD	DD-1	\$22,050
C-DD6800SSDBASEKIT	DD6800 BASE KIT -SSD	DD-1	\$0
C-DD9300EXPKIT	DD9300 OPTION - EXPANSION KIT DIMM	DD-1	\$22,050
C-DD9300SSDBASEKIT	DD9300 BASE KIT -SSD	DD-1	\$0
C-DD9300SSDEXPKIT	DD9300 OPTION - EXPANSION KIT SSD	DD-1	\$0
C-DD-CBLCAT6A1M	CAT6A CBL HA CTRLR INTERCONNECT 1M	DD-1	\$405
C-DD-EOS-CMA	DD MID-TIER CABLE MNGMNT ASSY - FIELD	DD-1	\$167
C-DD-EOS-RAILKIT	DD MID-TIER RAILKIT - FIELD	DD-1	\$179
C-DS60-3-135S-G3	OPT DS60 SHELF 45X3TB SAS HDD G3	DD-1	\$98,637
C-DS60-3-135SR-G3	OPT DS60 SHELF 45X3TB SAS HDD RETN G3	DD-1	\$0
C-DS60-3-180S-G3	OPT DS60 SHELF 60X3TB SAS HDD G3	DD-1	\$131,098

C-DS60-3-180SR-G3	OPT DS60 SHELF 60X3TB SAS HDD RETN G3	DD-1	\$0
C-DS60-3-45S-G3	OPT DS60 SHELF 15X3TB SAS HDD G3	DD-1	\$35,096
C-DS60-3-45SR-G3	OPT DS60 SHELF 15X3TB SAS HDD RETN G3	DD-1	\$0
C-DS60-3-90S-G3	OPT DS60 SHELF 30X3TB SAS HDD G3	DD-1	\$65,831
C-DS60-3-90SR-G3	OPT DS60 SHELF 30X3TB SAS HDD RETN G3	DD-1	\$0
C-DS60-4-120S-G3	OPT DS60 SHELF 30X4TB SAS HDD G3	DD-1	\$79,787
C-DS60-4-120SR-G3	OPT DS60 SHELF 30X4TB SAS HDD RETN G3	DD-1	\$0
C-DS60-4-180S-G3	OPT DS60 SHELF 45X4TB SAS HDD G3	DD-1	\$119,556
C-DS60-4-180SR-G3	OPT DS60 SHELF 45X4TB SAS HDD RETN G3	DD-1	\$0
C-DS60-4-240S-G3	OPT DS60 SHELF 60X4TB SAS HDD G3	DD-1	\$158,885
C-DS60-4-240SG3-CT	OPT DS60 SHELF 60X4TB SAS HDD G3 CT	DD-1	\$1
C-DS60-4-240SG3CTB	OPT DS60 SHELF 60X4TB SAS HDD G3 CT BUND	DD-1	\$0
C-DS60-4-240SR-G3	OPT DS60 SHELF 60X4TB SAS HDD RETN G3	DD-1	\$0
C-DS60-4-60S-G3	OPT DS60 SHELF 15X4TB SAS HDD G3	DD-1	\$42,560
C-DS60-4-60SR-G3	OPT DS60 SHELF 15X4TB SAS HDD RETN G3	DD-1	\$0
C-DS60-SAS-4M	4M 12G MINI-HDX4 TO MINI-HDX4 CABLE	DD-1	\$250
C-DS60-SAS-5M	5M X4 TO X4 MINI-SAS HD FLEX 12G	DD-1	\$310
C-DS60-SAS-5M-CT	5M X4 TO X4 MINI-SAS HD FLEX 12G	DD-1	\$0
C-ES30-45S-G3	OPT,ES30 SHELF,15X3TB SAS HDD,FIELD G3	DD-1	\$33,339
C-ES30-45S-G3-B	OPT,ES30 SHELF,15X3TB SAS HDD,FIELD G3 B	DD-1	\$0
C-ES30-45S-G3-CT	OPT,ES30 SHELF,15X3TB SAS HDD,FIELD CT	DD-1	\$1
C-ES30-45SR-G3	OPT,ES30 SHELF,15X3TB SAS,FIELD RETN G3	DD-1	\$0
C-ES30-60S-G3	OPT,ES30 SHELF,15X4TB SAS HDD,FIELD G3	DD-1	\$40,019
C-ES30-60S-G3-B	OPT,ES30 SHELF,15X4TB SAS HDD,FIELD G3 B	DD-1	\$0
C-ES30-60S-G3-CT	OPT,ES30 SHELF,15X4TB SAS HDD,FIELD CT	DD-1	\$1
C-ES30-60SR-G3	OPT,ES30 SHELF,15X4TB SAS,FIELD RETN G3	DD-1	\$0
C-FLDIN6300	DD6300 OPTION - FIELD INSTALL KIT	DD-1	\$0
C-FLDIN6300E	OPTION FIELD INSTALL KIT DD6300 EMC	DD-1	\$0
C-FLDIN6800	DD6800 OPTION - FIELD INSTALL KIT	DD-1	\$0
C-FLDIN6800E	OPTION FIELD INSTALL KIT DD6800 EMC	DD-1	\$0
C-FLDIN9300	DD9300 OPTION - FIELD INSTALL KIT	DD-1	\$0
C-FLDIN9300E	OPTION FIELD INSTALL KIT DD9300 EMC	DD-1	\$0
C-FLDIN9800	OPTION FIELD INSTALL KIT DD9800	DD-1	\$0
C-FLDIN9800E	OPT DD9800 BEZEL FIELD INSTL EMC	DD-1	\$0
C-FS15-15X800G-SSD	OPT - FLASH SHELF 15x800GB SSD FLD INSTL	DD-1	\$0
C-FS15-2X800G-SSD	OPT - FLASH SHELF 2x800GB SSD FLD INSTL	DD-1	\$0
C-FS15-4X800G-SSD	OPT - FLASH SHELF 4x800GB SSD FLD INSTL	DD-1	\$0
C-FS15-5X800G-SSD	OPT - FLASH SHELF 5x800GB SSD FLD INSTL	DD-1	\$0
C-FS15-8X800G-SSD	OPT - FLASH SHELF 8x800GB SSD FLD INSTL	DD-1	\$0
C-HA-DS60-SAS3-CT	CABLE HA INTERCONNECT DS60 3M CT	DD-1	\$0
C-HA-DS60-SAS-3-NF	CABLE HA INTERCONNECT DS60 3M;	DD-1	\$261
C-HA-ES30-SAS-2-NF	CABLE HA INTERCONNECT ES30 2M	DD-1	\$122
C-HA-ES30-SAS5-CT	CABLE HA INTERCONNECT ES30 5M CT	DD-1	\$0
C-HA-ES30-SAS-5-NF	CABLE HA INTERCONNECT ES30 5M	DD-1	\$308
C-HA-INTER-1-NF	CABLE HA INTERCONNECT CTRLR 1M	DD-1	\$405
C-SAS-HDMS2	C CABLE,DD,SASMINISAS HD-MINISAS,2 METER	DD-1	\$150
C-SAS-HDMS2-CT	C CABLE,DD,SASMINISAS HD-MINISAS,2M CT	DD-1	\$0
C-SAS-HDMS5	5M MINI-HDX4 TO MINI-SASX4 CABLE	DD-1	\$380
C-SAS-HDMS5-CT	5M MINI-HDX4 TO MINI-SASX4 CABLE CT	DD-1	\$0
C-SAS-M4P-CT	OPTION,DD 6G SAS,CT,IO MOD,4PORT	DD-1	\$0

C-SAS-M4PMC-CT	DD 6GBIT SAS IO MOD 4PORT CT OPTION	DD-1	\$0
C-SAS-M4PMC-NF	DD 6GBIT SAS IO MOD 4PORT ER OPTION	DD-1	\$4,050
C-SAS-MSMS3	3M M-SAS TO M-SAS CABLE	DD-1	\$200
C-SAS-MSMS3-CT	3M M-SAS TO M-SAS CABLE CT	DD-1	\$0
DD6300	SYSTEM DD6300 NFS CIFS	DD-1	\$0
DD6300-14TB	SYSTEM DD6300-7x4 14TB NFS CIFS	DD-1	\$21,060
DD6300-1E45	SYSTEM DD6300+1ES45	DD-1	\$54,080
DD6300-1E60	SYSTEM DD6300+1ES60	DD-1	\$63,290
DD6300-2E45	SYSTEM DD6300+2ES45	DD-1	\$71,910
DD6300-2E60	SYSTEM DD6300+2ES60	DD-1	\$77,270
DD6300-34TB	SYSTEM DD6300-12x4 34TB NFS CIFS	DD-1	\$49,410
DD6300-34TB-B	SYSTEM DD6300-12x4 34TB NFS CIFS B	DD-1	\$0
DD6300-3E45	SYSTEM DD6300+3ES45	DD-1	\$84,320
DD6300-3E60	SYSTEM DD6300+3ES60	DD-1	\$105,610
DD6300-4E45	SYSTEM DD6300+4ES45	DD-1	\$105,570
DD6800	SYSTEM DD6800 NFS CIFS	DD-1	\$0
DD6800-CT-BUNDLE	SYSTEM DD6800 DS60 120 CLOUDTIER 100	DD-1	\$237,473
DD6800-CTL	SYSTEM DD6800 CTL NFS CIFS	DD-1	\$36,828
DD6800-CTL-B	SYSTEM DD6800 CTL NFS CIFS CT BUNDLE	DD-1	\$0
DD6800HA-CTL	SYSTEM DD6800 CTL FOR HA - NFS CIFS	DD-1	\$36,828
DD9300	SYSTEM DD9300 NFS CIFS	DD-1	\$0
DD9300-CTL	SYSTEM DD9300 CTL NFS CIFS	DD-1	\$153,900
DD9300HA-CTL	SYSTEM DD9300 CTL FOR HA - NFS CIFS	DD-1	\$153,900
DD9800	SYSTEM DD9800 NFS CIFS	DD-1	\$0
DD9800-CTL	SYSTEM DD9800 CTL 256GB NFS CIFS	DD-1	\$231,255
DD9800HA-CTL	SYSTEM DD9800 CTL FOR HA 256GB NFS CIFS	DD-1	\$231,255
DDOS-60	DOCS DD OS DOC 6=IA	DD-1	\$0
DDOS-60-X	DOCS DD OS DOC 6X LATEST FACTORY REL=IA	DD-1	\$0
DDOS-61-DP	DD OS 61X IDPA=IA	DD-1	\$0
DDRACK-1PH-3	RACK DATA DOMAIN 40U SNGL PHASE RK-BEZE	DD-1	\$3,400
DDRACK-1PH-3E	RACK DATA DOMAIN 40U SNG PH RK-BEZEL EM	DD-1	\$3,400
DDRACK-1PH-DR3	RACK DATA DOMAIN 40U SNGL PHASE;DOOR D	DD-1	\$3,400
DDRACK-3PD-3	RACK DATA DOMAIN 40U 3P DELTA RK-BEZEL	DD-1	\$3,400
DDRACK-3PD-3E	RACK DATA DOMAIN 40U 3P DELT RK-BEZE EM	DD-1	\$3,400
DDRACK-3PD-DR3	RACK DATA DOMAIN 40U 3P DELTA;DOOR DE	DD-1	\$3,400
DDRACK-3PY-3	RACK DATA DOMAIN 40U 3P WYE RK-BEZEL	DD-1	\$3,400
DDRACK-3PY-3E	RACK DATA DOMAIN 40U 3P WYE RK-BEZEL EM	DD-1	\$3,400
DDRACK-3PY-DR3	RACK DATA DOMAIN 40U 3P WYE;DOOR DE	DD-1	\$3,400
DLM5-10GB4048	DLM8500 Dell4048 10GbE Switch Mfg Inst	DD-1	\$15,050
DLM5-10GB4048-MPG	DLM8500 Dell 4048 10GbE Switch UPG Mfg	DD-1	\$15,050
DLM5-10GB4048-UPG	DLM8500 Dell4048 10GbE Switch Fld Inst	DD-1	\$20,315
DLM5-1GB3048	DLM8500 Dell 3048 GbE Switch Mfg Inst	DD-1	\$7,175
DLM5-1GB3048-MPG	DLM8500 Dell3048 GbE Switch Upg Mfg Inst	DD-1	\$7,175
DLM5-1GB3048-UPG	DLM8500 Dell3048 GbE Switch Fld Inst	DD-1	\$9,685
DLM5-DD-BASE	DLM5 Generic DD base kit	DD-1	\$4,705
DLM5-DOOR-DELL	Factory-install rack door (DellEMC)	DD-1	\$0
DLM5-FMM-KIT	DLM G5 FICON Multi Mode Gbic Mfg Inst	DD-1	\$0
DLM5-FMM-KIT-UPG	DLM G5 FICON Multi Mode Gbic Fld Inst	DD-1	\$0
DLM5-RACK	DLM 5 40U Titan Rack skins/doors/blue	DD-1	\$11,290
DLM5SDD6300PSNT	DLM Gen5 Single Rack DD6300 PSNT Label	DD-1	\$0

DLM5SDD6800PSNT	DLm Gen5 Single Rack DD6800 PSNT Label	DD-1	\$0
DLM5SDD9300PSNT	DLm Gen5 Single Rack DD9300 PSNT Label	DD-1	\$0
DLM5SDD9800PSNT	DLm Gen5 Single Rack DD9800 PSNT Label	DD-1	\$0
DLM5-SMM-KIT	DLm G5 FICON Single Mode Gbic Mfg Inst	DD-1	\$0
DLM5-SMM-KIT-UPG	DLm G5 FICON Single Mode Gbic Fld Inst	DD-1	\$0
DLM5VDD6800PSNT	DLm Gen5 VTEC Rack DD6800 PSNT Label	DD-1	\$0
DLM5VDD9300PSNT	DLm Gen5 VTEC Rack DD9300 PSNT Label	DD-1	\$0
DLM5VDD9800PSNT	DLm Gen5 VTEC Rack DD9800 PSNT Label	DD-1	\$0
DLM5-VTE	DLm8500 Vte G5 Mfg Installed	DD-1	\$96,900
DLM5VTECBASE	DLm8500 VTEC rack base kit	DD-1	\$6,395
DLM5VTECSINGLE	DLm8500 VTEC Single Rack Base	DD-1	\$6,395
DLM5-VTEUPG	DLm8500 Vte G5 Upg Fld Installed	DD-1	\$130,820
DP5300CTL-EDP-DP	DP5300 BASE APPL CONTROLLER EDP	DD-1	\$0
DP5800CTL-EDP-DP	DP5800 BASE APPL CONTROLLER EDP	DD-1	\$0
DP8300CTL-EDP-DP	DP8300 BASE APPL CONTROLLER EDP	DD-1	\$0
DP8800CTL-EDP-DP	DP8800 BASE APPL CONTROLLER EDP	DD-1	\$0
DPACCELG4T-DP	DP APPL ACCELERATOR G4T 10GB	DD-1	\$14,000
DPCBL-40G-MTP-10M	IDPA Cable 40Gb MTP Crossover 10M	DD-1	\$740
DPCBL-40G-MTP-25M	IDPA Cable 40Gb MTP Crossover 25M	DD-1	\$1,285
DPCBL-40G-MTP-3M	IDPA Cable 40Gb MTP Crossover 3M	DD-1	\$495
DPCBL-40GMTP4LC-7M	IDPA Cable 40Gb MTP Breakout 4xLC 7M	DD-1	\$670
DPCBL-40G-MTP-7M	IDPA Cable 40Gb MTP Crossover 7M	DD-1	\$630
DPCBL-LC-OM4-10M	10 M LC to LC Cable Kit	DD-1	\$61
DPCBL-QSFP-QSFP-5M	5 M QSFP to QSFP Cable Kit	DD-1	\$720
DPCBL-QSFP-QSFP-7M	7 M QSFP to QSFP Cable Kit	DD-1	\$860
DPCBL-QSFP-RJ45-1M	1 M QSFP to RJ45 Breakout Kit	DD-1	\$1,350
DPCBL-QSFP-SFP-10M	10 M QSFP to SFP Cable Kit	DD-1	\$1,000
DPCBL-QSFP-SFP-30M	30 M QSFP to SFP Cable Kit	DD-1	\$1,150
DPCBL-QSFP-SFP-5M	5 M QSFP to SFP Cable Kit	DD-1	\$860
DPCB-QSFP-QSFP-10M	10 M QSFP to QSFP Cable Kit	DD-1	\$1,800
DPCB-QSFP-QSFP-50M	50 M QSFP to QSFP Cable Kit	DD-1	\$2,000
DPLG-FAKIT-DP	DP Appl Accelerator FacKit LG	DD-1	\$0
DPXCVR-QSFP-100M	XCVR 100 M QSFP Optics	DD-1	\$2,500
DPXCVR-QSFP-400M	XCVR 400 M QSFP Optics	DD-1	\$3,100
DPXCVR-QSFP-40GBE	XCVR 100 M QSFP Optics	DD-1	\$934
DPXCVR-SFP-10GBE	XCVR 300 M SFP Optics	DD-1	\$947
DPXL-FAKIT-DP	DP Appl Accelerator FacKit XL	DD-1	\$0
IDPA_2-0	Integrated Data Protection App V2_0=IA	DD-1	\$0
IDPA_2-1	Integrated Data Protection App V2_1=IA	DD-1	\$0
IDPA_2-2	Integrated Data Protection App V2_2=IA	DD-1	\$0
IDPA_CAP_PK_60TB	IDPA 60TB Capacity Expansion Pack	DD-1	\$197,368
IDPA_DP5300_CUBE	IDPA DP5300 Base Cube	DD-1	\$168,421
IDPA_DP5800_CUBE	IDPA DP5800 Base Cube	DD-1	\$457,895
IDPA_DP8300_CUBE	IDPA DP8300 Base Cube	DD-1	\$1,157,895
IDPA_DP8800_CUBE	IDPA DP8800 Base Cube	DD-1	\$3,157,895
R-9800-BEZEL-FAC	OPT DD9800 BEZEL FACTORY RACK G3	DD-1	\$0
R-A16E30-H-NF	OPTION,ADD 9TO16 ES30 SAS,CABLE KIT	DD-1	\$486
R-A24E30-H-NF	OPTION,ADD 17TO24 ES30 SAS,CABLE KIT	DD-1	\$486
R-DD-EMI-SHLDEOS	DD MID-TIER EMI SHIELD EOS - FAC W-DOOR	DD-1	\$89
R-DS60-3-135S-G3	OPT DS60 SHELF 45X3TB SAS HDD RACK G3	DD-1	\$98,637

R-DS60-3-135SR-G3	OPT DS60 SHELF 45X3TB SAS RACK RETN G3	DD-1	\$0
R-DS60-3-180S-G3	OPT DS60 SHELF 60X3TB SAS HDD RACK G3	DD-1	\$131,098
R-DS60-3-180SR-G3	OPT DS60 SHELF 60X3TB SAS RACK RETN G3	DD-1	\$0
R-DS60-3-45S-G3	OPT DS60 SHELF 15X3TB SAS HDD RACK G3	DD-1	\$35,096
R-DS60-3-45SR-G3	OPT DS60 SHELF 15X3TB SAS HDD RETN G3	DD-1	\$0
R-DS60-3-90S-G3	OPT DS60 SHELF 30X3TB SAS HDD RACK G3	DD-1	\$65,831
R-DS60-3-90SR-G3	OPT DS60 SHELF 30X3TB SAS RACK RETN G3	DD-1	\$0
R-DS60-4-120S-G3	OPT DS60 SHELF 30X4TB SAS HDD RACK G3	DD-1	\$79,787
R-DS60-4-120SR-G3	OPT DS60 SHELF 30X4TB SAS RACK RETN G3	DD-1	\$0
R-DS60-4-180S-G3	OPT DS60 SHELF 45X4TB SAS HDD RACK G3	DD-1	\$119,556
R-DS60-4-180SR-G3	OPT DS60 SHELF 45X4TB SAS RACK RETN G3	DD-1	\$0
R-DS60-4-240S-G3	OPT DS60 SHELF 60X4TB SAS HDD RACK G3	DD-1	\$158,885
R-DS60-4-240SG3-CT	OPT DS60 SHELF 60X4TB SAS HDD RACK G3 CT	DD-1	\$1
R-DS60-4-240SG3CTB	DS60 SHELF 60X4TB SASHDD RACK G3 CT BUN	DD-1	\$0
R-DS60-4-240SR-G3	OPT DS60 SHELF 60X4TB SAS RACK RETN G3	DD-1	\$0
R-DS60-4-60S-G3	OPT DS60 SHELF 15X4TB SAS HDD RACK G3	DD-1	\$42,560
R-DS60-4-60SR-G3	OPT DS60 SHELF 15X4TB SAS RACK RETN G3	DD-1	\$0
R-DS60-SAS-4M	4M 12G MINI-HDX4 TO MINI-HDX4 CABLE	DD-1	\$492
R-DS60-SAS-5M	5M X4 TO X4 MINI-SAS HD FLEX 12G	DD-1	\$592
R-DS60-SAS-5M-CT	5M X4 TO X4 MINI-SAS HD FLEX 12G	DD-1	\$0
R-DS60-SAS-5M-DP	5M X4 TO X4 MINI-SAS HD FLEX 12G	DD-1	\$0
R-EMISHIELD-3U	EMI Shield for 3U Shelf	DD-1	\$83
R-ES30-45S-G3	OPT,ES30 SHELF,15X3TB SAS HDD,RACK G3	DD-1	\$33,339
R-ES30-45S-G3-B	OPT,ES30 SHELF,15X3TB SAS HDD,RACK G3 B	DD-1	\$0
R-ES30-45S-G3-CT	OPT,ES30 SHELF,15X3TB SAS HDD,RACK CT	DD-1	\$1
R-ES30-45SR-G3	OPT,ES30 SHELF,15X3TB SAS,RACK RETN G3	DD-1	\$0
R-ES30-60S-G3	OPT,ES30 SHELF,15X4TB SAS HDD,RACK G3	DD-1	\$40,019
R-ES30-60S-G3-B	OPT,ES30 SHELF,15X4TB SAS HDD,RACK G3 B	DD-1	\$0
R-ES30-60S-G3-CT	OPT,ES30 SHELF,15X4TB SAS HDD,RACK CT	DD-1	\$1
R-ES30-60SR-G3	OPT,ES30 SHELF,15X4TB SAS,RACK RETN G3	DD-1	\$0
R-FACIN6300-BZ	DD6300 OPTION - FACT INSTALL BEZEL	DD-1	\$0
R-FACIN6300-BZE	DD6300 OPTION - FACT INSTALL BEZEL EMC	DD-1	\$0
R-FACIN6800-BZ	DD6800 OPTION - FACT INSTALL BEZEL	DD-1	\$0
R-FACIN6800-BZE	DD6800 OPTION - FACT INSTALL BEZEL EMC	DD-1	\$0
R-FACIN9300-BZ	DD9300 OPTION - FACT INSTALL BEZEL	DD-1	\$0
R-FACIN9300-BZE	DD9300 OPTION - FACT INSTALL BEZEL EMC	DD-1	\$0
R-FACIN9800	OPTION FACTORY INSTALL KIT DD9800	DD-1	\$0
R-FACIN9800-BZ	DD9800 OPTION - FACT INSTALL BEZEL	DD-1	\$0
R-FACIN9800-BZE	DD9800 OPTION - FACT INSTALL BEZEL EMC	DD-1	\$0
R-FACIN-DS60-BZ3	DS60 OPTION - FACT INSTALL BEZEL G3	DD-1	\$0
R-FACIN-ES30-BZ3	ES30 OPTION - FACT INSTALL BEZEL G3	DD-1	\$0
R-FACIN-FS15-BZ	FS15 OPTION - FACT INSTALL BEZEL	DD-1	\$0
R-FACINSTL6300	DD6300 OPTION - FACTORY INSTALL KIT	DD-1	\$0
R-FACINSTL6800	DD6800 OPTION - FACTORY INSTALL KIT	DD-1	\$0
R-FACINSTL9300	DD9300 OPTION - FACTORY INSTALL KIT	DD-1	\$0
R-FS15-15X800G-SSD	OPT - FLASH SHELF 15x800GB SSD FACT INSTL	DD-1	\$0
R-FS15-2X800G-SSD	OPT - FLASH SHELF 2x800GB SSD FACT INSTL	DD-1	\$0
R-FS15-4X800G-SSD	OPT - FLASH SHELF 4x800GB SSD FACT INSTL	DD-1	\$0
R-FS15-5X800G-SSD	OPT - FLASH SHELF 5x800GB SSD FACT INSTL	DD-1	\$0
R-FS15-8X800G-SSD	OPT - FLASH SHELF 8x800GB SSD FACT INSTL	DD-1	\$0

R-HA-DS60-SAS-3-NF	CABLE HA INTERCONNECT DS60 3M;RACK	DD-1	\$261
R-HA-ES30-SAS2-CT	CABLE HA INTERCONNECT ES30 2M,RACK CT	DD-1	\$0
R-HA-ES30-SAS-2-NF	CABLE HA INTERCONNECT ES30 2M,RACK	DD-1	\$122
R-HA-ES30-SAS5-CT	CABLE HA INTERCONNECT ES30 5M; RACK CT	DD-1	\$0
R-HA-ES30-SAS-5-NF	CABLE HA INTERCONNECT ES30 5M; RACK	DD-1	\$308
R-HA-INTER-1-NF	CABLE HA INTERCONNECT CTRLR 1M;RACK	DD-1	\$405
R-SAS-HDMS2	R CABLE,DD,SASMINISAS HD-MINISAS,2 METER	DD-1	\$150
R-SAS-HDMS2-CT	R CABLE,DD,SASMINISAS HD-MINISAS,2M CT	DD-1	\$0
R-SAS-HDMS5	5M MINI-HDX4 TO MINI-SASX4 CABLE	DD-1	\$380
R-SAS-HDMS5-CT	5M MINI-HDX4 TO MINI-SASX4 CABLE CT	DD-1	\$0
R-SAS-MSMS3	3M M-SAS TO M-SAS CABLE	DD-1	\$200
R-SAS-MSMS3-CT	3M M-SAS TO M-SAS CABLE CT	DD-1	\$0
SU-458-000-569	DD VE Capacity 12 Mo Subscp=CA	DD-1	\$70
SU-458-000-570	DD VE Cloud Tier 12 Mo Subscp =CC	DD-1	\$21
SU-458-000-571	DD VE Channel 4TB Cap 12 Mo Subscp=CA	DD-1	\$248
SU-458-000-572	DD VE Capacity 36 Mo+AIP Subscp=CA	DD-1	\$64
SU-458-000-573	DD VE Cloud Tier 36 Mo+AIP Subscp=CC	DD-1	\$19
SU-458-000-574	DD VE Channel 4TB Cap 36 Mo+AIP Sub=CA	DD-1	\$225
SU-458-000-575	DD VE Capacity 36 Mo+ PP Subscp=CA	DD-1	\$57
SU-458-000-576	DD VE Cloud Tier 36 Mo+ PP Subscp=CC	DD-1	\$17
SU-458-000-577	DD VE Channel 4TB Cap 36 Mo+ PP Sub=CA	DD-1	\$203
U-10GBTM4P-NF	DD 10GBASE T IO MODULE 4PORT UPGRADE	DD-1	\$4,050
U-10GMCU4P-NF	DD 10GBE IO MOD CU TWINAX 4PORT UPG	DD-1	\$4,860
U-10GMOP4P-NF	DD 10GBE IO MOD OPTICAL SFP 4PORT UPG	DD-1	\$4,860
U-16GFC-M2P-NF	DD 16GBIT FC IO MOD LC 2PORT UPG	DD-1	\$4,860
U-6300-SAS-SLIC-G2	ADD ES EXP KIT,DUAL PATH,DD6300,UPG	DD-1	\$3,000
U-9800-MEM256	MEMKIT ADD 256GB DD9800 16X16GB UPG	DD-1	\$0
U-9800-MEM512	MEMKIT ADD 512GB DD9800 32X16GB UPG	DD-1	\$29,250
U-A16E30-CT	DD 9TO16 ES30;2X2M2X5M;CBLKIT;40U;UPG CT	DD-1	\$0
U-A16E30-H-NF	ADD 9TO16 ES30;2X2M;2X5M;CBLKIT;40U;UPG	DD-1	\$486
U-A24E30-CT	ADD 17TO24 ES30;4X5M CBLKIT;40U;UPG CT	DD-1	\$0
U-A24E30-H-NF	ADD 17TO24 ES30;4X5M CBLKIT;40U;UPGRADE	DD-1	\$486
U-DD6300DISKEXPKIT	DD6300 OPTION - EXPANSION KIT 5HDD	DD-1	\$31,500
U-DD6300EXPKIT	UPGD DD6300 EXPANSION KIT DIMM SSD FIELD	DD-1	\$8,550
U-DD6800EXPKIT	UPGD DD6800 EXPANSION KIT SSD FIELD	DD-1	\$22,050
U-DD6800HA-CTL	SYSTEM DD6800 HA CTL NFS CIFS UPGRADE	DD-1	\$45,936
U-DD6800SSDBASEKIT	DD6800 BASE KIT -SSD	DD-1	\$0
U-DD9300EXPKIT	UPGD DD9300 EXPANSION KIT DIMM FIELD	DD-1	\$22,050
U-DD9300HA-CTL	SYSTEM DD9300 HA CTL NFS CIFS UPGRADE	DD-1	\$192,496
U-DD9300SSDBASEKIT	DD9300 BASE KIT -SSD	DD-1	\$0
U-DD9300SSDEXPKIT	DD9300 OPTION - EXPANSION KIT SSD	DD-1	\$0
U-DD9800HA-CTL	UPG SYSTEM DD9800 CTL HA 256GB NFS CIFS	DD-1	\$289,170
U-DD-CBLCAT6A1M	CAT6A CBL HA CTRLR INTERCONNECT 1M UPG	DD-1	\$405
U-DS60-3-135S-G3	DS60 SHELF 45X3TB SAS HDD UPGRD G3	DD-1	\$123,288
U-DS60-3-135SR-G3	DS60 SHELF 45X3TB SAS HDD RETN UPGRD G3	DD-1	\$123,288
U-DS60-3-180S-G3	DS60 SHELF 60X3TB SAS HDD UPGRD G3	DD-1	\$163,841
U-DS60-3-180SR-G3	DS60 SHELF 60X3TB SAS HDD RETN UPGRD G3	DD-1	\$163,841
U-DS60-3-45S-G3	DS60 SHELF 15X3TB SAS HDD UPGRD G3	DD-1	\$43,877
U-DS60-3-45SR-G3	DS60 SHELF 15X3TB SAS HDD RETN UPGRD G3	DD-1	\$43,877
U-DS60-3-90S-G3	DS60 SHELF 30X3TB SAS HDD UPGRD G3	DD-1	\$82,265

U-DS60-3-90SR-G3	DS60 SHELF 30X3TB SAS HDD RETN UPGRD G3	DD-1	\$82,265
U-DS60-3HDD-15-NF	HDD EXP PK 15X3TB SAS W/ DS60 CR - NF	DD-1	\$40,615
U-DS60-3HDD-15R-NF	HDD EXP PK 15X3TB SAS W/ DS60 CR RET- NF	DD-1	\$40,615
U-DS60-3HDD-CT-NF	HDD EXP PK 15X3TB SAS W/ DS60 CR CT- NF	DD-1	\$1
U-DS60-4-120S-G3	DS60 SHELF 30X4TB SAS HDD UPGRD G3	DD-1	\$99,734
U-DS60-4-120SR-G3	DS60 SHELF 30X4TB SAS HDD RETN UPGRD G3	DD-1	\$99,734
U-DS60-4-180S-G3	DS60 SHELF 45X4TB SAS HDD UPGRD G3	DD-1	\$149,414
U-DS60-4-180SR-G3	DS60 SHELF 45X4TB SAS HDD RETN UPGRD G3	DD-1	\$149,414
U-DS60-4-240S-G3	DS60 SHELF 60X4TB SAS HDD UPGRD G3	DD-1	\$198,591
U-DS60-4-240SG3-CT	DS60 SHELF 60X4TB SAS HDD UPGRD G3 CT	DD-1	\$1
U-DS60-4-240SR-G3	DS60 SHELF 60X4TB SAS HDD RETN UPGRD G3	DD-1	\$198,591
U-DS60-4-60S-G3	DS60 SHELF 15X4TB SAS HDD UPGRD G3	DD-1	\$53,191
U-DS60-4-60SR-G3	DS60 SHELF 15X4TB SAS HDD RETN UPGRD G3	DD-1	\$53,191
U-DS60-4HDD-15-NF	HDD EXP PK 15X4TB SAS W/ DS60 CR- NF	DD-1	\$50,024
U-DS60-4HDD-15R-NF	HDD EXP PK 15X4TB SAS W/ DS60 CR RET- NF	DD-1	\$50,024
U-DS60-4HDD-CT-NF	HDD EXP PK 15X4TB SAS W/ DS60 CR CT- NF	DD-1	\$1
U-DS60-SAS-4M	4M 12G MINI-HDX4 TO MINI-HDX4 CABLE	DD-1	\$492
U-DS60-SAS-5M	5M X4 TO X4 MINI-SAS HD FLEX 12G	DD-1	\$592
U-DS60-SAS-5M-CT	5M X4 TO X4 MINI-SAS HD FLEX 12G	DD-1	\$0
U-ES30-45S-G3	OPT,ES30 SHELF, 15X3TB SAS HDD,UPGRD G3	DD-1	\$43,376
U-ES30-45S-G3-CT	OPT,ES30 SHELF, 15X3TB SAS HDD,UPGRD CT	DD-1	\$1
U-ES30-45SR-G3	OPT,ES30 SHELF, 15X3TB SAS,UPGRD RETN G3	DD-1	\$43,376
U-ES30-60S-G3	OPT,ES30 SHELF, 15X4TB SAS HDD,UPGRD G3	DD-1	\$50,024
U-ES30-60S-G3-CT	OPT,ES30 SHELF 15X4TB SAS HDDUPGRD G3 CT	DD-1	\$1
U-ES30-60SR-G3	OPT,ES30 SHELF, 15X4TB SAS,UPGRD RETN G3	DD-1	\$50,024
U-FS15-2X800G-SSD	UPGRD - FS15 2x800GB SSD FIELD INSTL	DD-1	\$0
U-FS15-4X800G-SSD	UPGRD - FS15 4x800GB SSD FIELD INSTL	DD-1	\$0
U-FS15-5X800G-SSD	UPGRD - FS15 5x800GB SSD FIELD INSTL	DD-1	\$0
U-HA-DS60-SAS-3-NF	CABLE HA INTERCONNECT DS60 3M;UPGRADE	DD-1	\$261
U-HA-ES30-SAS2-CT	CABLE HA INTERCONNECT ES30 2M;UPG CT	DD-1	\$0
U-HA-ES30-SAS-2-NF	CABLE HA INTERCONNECT ES30 2M;UPGRADE	DD-1	\$122
U-HA-ES30-SAS5-CT	CABLE HA INTERCONNECT ES30 5M;UPG CT	DD-1	\$0
U-HA-ES30-SAS-5-NF	CABLE HA INTERCONNECT ES30 5M;UPGRADE	DD-1	\$308
U-HA-INTER-1-NF	CABLE HA INTERCONNECT CTRLR 1M;UPGRADE	DD-1	\$405
U-IDPA_CAP_PK_60TB	IDPA 60TB Capacity Exp Pack Upgrade	DD-1	\$246,710
U-IDPA-15HDD	IDPA HDD EXP PACK 15X4TB SAS W/ DS60 CAR	DD-1	\$0
U-IDPA-DS60-15	IDPA DS60 Shelf 15X4TB SAS HDD Upgrd G3	DD-1	\$0
U-IDPA-DS60-30	IDPA DS60 Shelf 30X4TB SAS HDD Upgrd G3	DD-1	\$0
U-IDPA-DS60-45	IDPA DS60 Shelf 45X4TB SAS HDD Upgrd G3	DD-1	\$0
U-IDPA-DS60-60	IDPA DS60 Shelf 60X4TB SAS HDD Upgrd G3	DD-1	\$0
U-SAS-HDMS2	U CABLE,DD,SASMINISAS HD-MINISAS,2 METER	DD-1	\$150
U-SAS-HDMS2-CT	U CABLE,DD,SASMINISAS HD-MINISAS,2M CT	DD-1	\$0
U-SAS-HDMS5	5M MINI-HDX4 TO MINI-SASX4 CABLE	DD-1	\$380
U-SAS-HDMS5-CT	5M MINI-HDX4 TO MINI-SASX4 CABLE CT	DD-1	\$0
U-SAS-MSMS3	3M M-SAS TO M-SAS CABLE	DD-1	\$200
U-SAS-MSMS3-CT	3M M-SAS TO M-SAS CABLE CT	DD-1	\$0
U-SSD-3X800G-FS15	UPGRD - SSD 3-PACK 800GB FOR FS15 FIELD	DD-1	\$0
U-SSD-7X800G-FS15	UPGRD - SSD 7-PACK 800GB FOR FS15 FIELD	DD-1	\$0
X-10GBTM4P-NF	SPARE DD 10GBASE T IO MODULE 4PORT	DD-1	\$4,050
X-10GMCU4P-NF	DD 10GBE IO MOD CU TWINAX 4PORT SPARE	DD-1	\$4,860

X-10GMOP4P-NF	DD 10GBE IO MOD OPTICAL SFP 4PORT SPARE	DD-1	\$4,860
X-16GB-DIMM-NF	SPARE 16GB DDR3-1600 RDIMM DD9500	DD-1	\$1,296
X-16GFC-M2P-NF	DD 16GBIT FC IO MOD LC 2PORT SPARE	DD-1	\$4,860
X-16G-XDRAM	16G DIMM REVENUE SPARE	DD-1	\$562
X-2UC-4TBS	HDD REVENUE SPARE	DD-1	\$780
X-32G-XDRAM	32G DIMM REVENUE SPARE	DD-1	\$1,192
X-6300-SAS-SLIC-G2	ADD ES EXP KIT,DUAL PATH,DD6300,UPG	DD-1	\$3,000
X-6300SPMOD	T2 PACK SP REVENUE SPARE	DD-1	\$19,703
X-6800SPMOD	T3 PACK SP REVENUE SPARE	DD-1	\$26,542
X-8G-XDRAM	8G DIMM REVENUE SPARE	DD-1	\$351
X-9300SPMOD	T4 PACK SP REVENUE SPARE	DD-1	\$43,130
XC-10GBT15M-NF	CABLE 10GBASE-T 15 METER	DD-1	\$182
XC-10GBT5M-NF	CABLE 10GBASE-T 5 METER	DD-1	\$61
XC-10GCX-15-NF	CABLE;10GBE;CX4;COPPER;15 METER	DD-1	\$527
XC-10GCX-5-NF	SPARE; CABLE; 10GBE;CX4;COPPER;5 METER	DD-1	\$263
XC-10GOP-15-NF	CABLE;10GBE;LC;OPTICAL;15 METER	DD-1	\$263
XC-10GOP-30-NF	SPARE,CABLE,10GBE,LC,IO MOD,OPTICAL,30M	DD-1	\$263
XC-10GSFP10-NF	CABLE;10GBE;SFP+;COPPER;10 METER	DD-1	\$324
XC-10GSFP5M-NF	SPARE,CABLE,10GBE,SFP+,IO MOD,COPPER,5M	DD-1	\$263
XC-10GSFP-5-NF	CABLE;10GBE;SFP+;COPPER;5 METER	DD-1	\$263
XC-CBLJUMP-1-NF	CABLE SINGLE PHASE PDU JUMPER	DD-1	\$1,661
XC-CBLJUMP-2-NF	CABLE 3PHASE PDU JUMPER	DD-1	\$1,661
XC-CBLKT-11-CT	CABLE:EXT RTN,SAS MSHDMS,KIT,25TO36ES C	DD-1	\$0
XC-CBLKT-11-NF	CABLE:EXTD RETN,SAS MSHD-MS,KIT,25TO36ES	DD-1	\$1,661
XC-CBLKT-12-NF	CABLE:EXTD RETN,SAS MSHD-MS,KIT,37TO56ES	DD-1	\$1,215
XC-DS60-CBL160I-NF	SPARE 160IN CABLE RA CONN	DD-1	\$46
XC-DS60-CBL66IN-NF	SPARE 66IN CABLE RA CONN	DD-1	\$25
XC-DS60-SAS-3M-NF	3M 12G MINI-HDX4 TO MINI-HDX4 CABLE	DD-1	\$261
XC-DS60-SAS-4M-NF	4M 12G MINI-HDX4 TO MINI-HDX4 CABLE	DD-1	\$492
XC-DS60-SAS-5M-NF	5M 12G MINI-HDX4 TO MINI-HDX4 CABLE	DD-1	\$592
XC-DS60-SAS-7M-NF	7M 12G MINI-HDX4 TO MINI-HDX4 CABLE	DD-1	\$681
XC-RKPDP3DU-NF	PDP 3PHASE DELTA N AMER JAPAN DD RACK	DD-1	\$2,171
XC-RKPDP3YU-NF	PDP,3PHASE,WYE,N.AMER&INTL,DD RACK	DD-1	\$2,171
XC-SECUR-40N-NF	SPARE,SECURE,STABILIZING KIT,40U DDRACK	DD-1	\$810
XC-SECUREBAR-NF	SECURING BAR KIT	DD-1	\$810
X-DD-CBLCAT6A1M	CAT6A CBL 1M SPARE	DD-1	\$29
X-DD-EOS-CHASS	PACK CHASS REVENUE SPARE	DD-1	\$2,140
X-DD-EOS-CMA	CMA REVENUE SPARE	DD-1	\$167
X-DD-EOS-FAN	FAN REVENUE SPARE	DD-1	\$493
X-DD-EOS-PS	PSU REVENUE SPARE	DD-1	\$546
X-DD-EOS-RAILKIT	RAILKIT REVENUE SPARE	DD-1	\$179
X-DS60-3TBS-NF	SPARE DD HDD 3TB SAS W/DS60 CARR	DD-1	\$3,807
X-DS60-4TBS-NF	SPARE DD HDD 4TB SAS W/DS60 CARR	DD-1	\$4,617
X-DS60-BEZ-1U-NF	SPARE CMA 1U BEZEL	DD-1	\$42
X-DS60-BEZ-4U-NF	SPARE DS60 4U BEZEL	DD-1	\$58
X-DS60-CHAS-NF	SPARE DS60 CHASSIS	DD-1	\$14,471
X-DS60-CMA-1U-NF	SPARE CMA 1U	DD-1	\$1,564
X-DS60-CMA-REAR-NF	SPARE CMA REAR	DD-1	\$1,454
X-DS60-CTL-NF	SPARE DS60 CONTROLLER	DD-1	\$3,504
X-DS60-FAN-NF	SPARE DS60 FAN	DD-1	\$187

X-DS60-PS-NF	SPARE DS60 PSU	DD-1	\$1,852
X-DS60-RAIL-NF	SPARE RAIL DS60 (PAIR)	DD-1	\$1,162
X-ES30-3TB-NF	SPARE;DISK DRIVE;3TB SATA;ES30 CARRIER	DD-1	\$2,835
X-ES30-3TBS-NF	SPARE,DD,HDD,3TB SAS,W/ES30 CARRIER	DD-1	\$2,835
X-ES30-4TBS-NF	SPARE DD HDD 4TB SAS W/ES30 CARRIER	DD-1	\$873
X-ES30-BEZL-NF	SPARE;BEZEL;ES30	DD-1	\$81
X-ES30-CHAS-NF	SPARE;CHASSIS W/O HDD & 2XLCC;ES30	DD-1	\$8,181
X-ES30-CTL-NF	SPARE;SHELF CONTROLLER;LCC;ES30	DD-1	\$2,430
X-ES30-PS-NF	SPARE;POWER SUPPLY AND FAN;ES30	DD-1	\$1,620
X-ES30-RAIL-NF	SSPARE;UNIV RAILKIT;ES30	DD-1	\$97
X-HA-DS60-SAS-3-NF	CABLE HA INTERCONNECT DS60 3M;SPARE	DD-1	\$261
X-HA-ES30-SAS2-CT	CABLE HA INTERCONNECT ES30 2M; SPARE CT	DD-1	\$0
X-HA-ES30-SAS-2-NF	CABLE HA INTERCONNECT ES30 2M; SPARE	DD-1	\$122
X-HAES30-SAS5-CTNF	CABLE HA INTERCONNECT ES30 5M;SPARE	DD-1	\$0
X-HA-ES30-SAS-5-NF	CABLE HA INTERCONNECT ES30 5M;SPARE	DD-1	\$308
X-HA-INTER-1-NF	CABLE HA INTERCONNECT CTLR 1M;SPARE	DD-1	\$101
X-HA-INTER-5-NF	CABLE HA INTERCONNECT CTLR 5M;SPARE	DD-1	\$101
X-NVRAM-8G-NF	DD NVRAM IO MOD 8G SPARE	DD-1	\$4,860
X-RAIL-XTND-NF	SPARE; RAIL EXTENDER	DD-1	\$146
X-RKFRONTDOOR-3	SPARE,FRONT DOOR KIT,40U DDRACK DE	DD-1	\$810
X-RK-PDP-SP-NF	SPARE;PDP;SINGLE PHASE;L6-30;DDRACK	DD-1	\$365
X-RKPDU3D-1-NF	SPARE PDU 3PH DELTA N AMER JAPAN DDRACK	DD-1	\$2,171
X-RKPDU3Y-1-NF	SPARE PDU 3PH WYE N AMER INTL DDRACK	DD-1	\$2,171
X-RK-PDU-NF	SPARE;PDU;C13;DDRACK	DD-1	\$365
X-RKPDUSP-1-NF	SPARE PDU SINGLE PHASE DDRACK	DD-1	\$365
X-RRDOOR-40-NF	SPARE;REAR DOOR;40U DDRACK	DD-1	\$1,458
X-SAS-HDMS1-NF	CABLE,DD,SAS,MINISAS HD-MINISAS,1 METER	DD-1	\$122
X-SAS-HDMS2-NF	CABLE,DD,SAS,MINISAS HD-MINISAS,2 METER	DD-1	\$122
X-SAS-HDMS3-NF	CABLE,DD,SAS,MINISAS HD-MINISAS,3 METER	DD-1	\$162
X-SAS-HDMS5-NF	CABLE,DD,SAS,MINISAS HD-MINISAS,5 METER	DD-1	\$308
X-SAS-M4PMC-NF	DD 6GBIT SAS IO MOD 4PORT ER UPG	DD-1	\$3,645
X-SAS-MSMS1-NF	CABLE;SAS;MINISAS-MINISAS;1 METER	DD-1	\$97
X-SAS-MSMS2-NF	CABLE;SAS;MINISAS-MINISAS;2 METER	DD-1	\$122
X-SAS-MSMS3-CT	SPARE;CBL;SAS;MINISAS-MINISAS;3 METER CT	DD-1	\$0
X-SAS-MSMS3-NF	SPARE;CBL;SAS;MINISAS-MINISAS;3 METER	DD-1	\$162
X-SAS-MSMS4-NF	SPARE;CBL;SAS;MINISAS-MINISAS;4 METER	DD-1	\$251
X-SAS-MSMS5-NF	CABLE;SAS;MINISAS-MINISAS;5 METER	DD-1	\$308
X-SSDF-800GBS	FRONT 3,5 SSD REVENUE SPARE	DD-1	\$3,650
X-SSDR-800GBS	REAR 2,5 SSD REVENUE SPARE	DD-1	\$3,100
456-104-750	Avamar S2400 1/2 Capacity License	DE	\$24,000
456-107-983	LIC; Cloud Tier DP4400 Base TB=CC	DE	\$0
456-107-987	DP4400 Capacity Enabler DDVE 12TB=CC	DE	\$0
456-109-596	LICENSE BASE DD OE DD2200-14=IA	DE	\$5,896
456-109-597	LICENSE BASE DD OE DD2200-24=IA	DE	\$10,736
456-109-598	LICENSE BASE DD OE DD2200-4=IA	DE	\$3,168
456-109-599	LICENSE,ARCHIVE STORE=IA	DE	\$0
456-109-600	LIC BOOST DD2200=IA	DE	\$1,500
456-109-601	LICENSE ENCRYPTION DD2200=IA	DE	\$1,500
456-109-602	LIC REPLICATOR DD2200=IA	DE	\$2,540
456-109-603	LIC REPLICATOR 4TB DD2200=IA	DE	\$0

456-109-604	LICENSE RETENTION LOCK COMPL DD2200=IA	DE	\$1,500
456-109-605	LICENSE RETENTION LOCK GOVERN DD2200=IA	DE	\$1,500
456-109-606	LIC VTL OPEN SYSTEMS DD2200=IA	DE	\$1,500
456-109-607	LIC VTL NDMP TAPE SVR ETH DD2200=IA	DE	\$1,500
456-109-608	LIC VTL IBM IOS DD2200=IA	DE	\$2,250
456-109-609	LICENSE EXPSTOR DD2200=IA	DE	\$8,500
456-109-610	LICENSE EXPSTOR DD2200 (B)=IA	DE	\$0
456-109-611	UPG BOOST 2200=IA	DE	\$1,500
456-109-612	LICENSE ENCRYPTION 2200 UPGRADE=IA	DE	\$1,500
456-109-613	LIC REPLICATOR 2200,UPGRADE=IA	DE	\$2,540
456-109-614	LIC RTN LOCK COMPL EDTN DD2200 UPG=IA	DE	\$1,500
456-109-615	LIC RTN LOCK GOV EDTN DD2200 UPG=IA	DE	\$1,500
456-109-616	LIC VTL OPEN SYSTEMS DD2200 UPGRADE=IA	DE	\$1,500
456-109-617	LIC VTL NDMP TAPE SVR ETH DD2200 UPG=IA	DE	\$1,500
456-109-618	LIC VTL IBM IOS DD2200 UPGRADE=IA	DE	\$2,250
456-109-619	LIC VTL OPEN SYS TO IBM IOS 2200 UPG=IA	DE	\$750
456-109-620	LICENSE EXPSTOR 2200 UPG=IA	DE	\$8,500
456-109-621	LICENSE CAP ON DEMAND 2200 4TB UPG=IA	DE	\$11,500
456-109-817	UPG BOOST;DD160=IA	DE	\$0
456-109-818	LICENSE;ENCRYPTION;DD160;UPGRADE=IA	DE	\$0
456-109-819	LIC;RETENTION LOCK COMPL; DD160;UPG=IA	DE	\$0
456-109-820	LIC;RETENTION LOCK GOV; DD160;UPG=IA	DE	\$0
456-109-821	LIC;VTL;160INCL:1XPCIE CARD;DP;4G;UPG=IA	DE	\$0
456-109-822	LIC;VTL;NDMP TAPE SVR;ETH;DD160;UPG=IA	DE	\$0
456-109-823	LIC;VTL;IBM I/OS;FC;DD160;1XDP;4G;UPG=IA	DE	\$0
456-109-824	LIC VTL;OPEN SYS TO IBM I/OS;DD160=IA	DE	\$0
456-109-825	UPGRADE;DD160; LICENSE;5 HDD(2.5TB)=IA	DE	\$0
456-110-081	AVAMAR E S2400 1/2 CAPACITY=IA	DE	\$24,000
456-110-232	CloudBoost VM Appliance 2TB ENABLER=CA	DE	\$6,000
456-110-233	CloudBoost VM Appliance 6TB ENABLER=CA	DE	\$15,000
456-110-234	CloudBoost Client ENABLER=CA	DE	\$0
456-110-455	CloudBoost SW for HW ENABLER=CA	DE	\$0
456-110-504	AVAMAR F S2400 1/2 CAPACITY=IA	DE	\$24,000
456-111-635	CLOUDBOOST Amazon Image=CA	DE	\$15,000
456-112-184	AVAMAR G S2400 1/2 Capacity=IA	DE	\$24,000
456-112-197	CLOUDBOOST Azure Image=CA	DE	\$15,000
456-113-358	DD3300 SW License 1TB=CC	DE	\$0
456-113-361	DD3300 Upgrade License 1TB=CC	DE	\$0
456-113-363	DD3300 Cloud Tier 1TB=CC	DE	\$285
456-113-545	Commercial DPS DDVE Bundle Sockets=IA	DE	\$1,521
456-113-568	DPS 2TB AVE Enabler ENTRY=CA	DE	\$0
456-113-569	DPS RP4VM Enabler ENTRY=IB	DE	\$0
456-113-570	DPS DP Search Enabler ENTRY=CA	DE	\$0
456-113-571	EMC DPA Enabler-B ENTRY=CB	DE	\$0
456-113-572	DPA Single Fed Reporting Server ENTRY=IA	DE	\$0
456-113-573	DD VE Perpetual Cap Chnl ENTRY 1TB=CA	DE	\$0
456-113-589	RP4VM 5VM Starter Pack for DP4400=IB	DE	\$0
456-113-591	DP4400 Upg Capacity Enabler 12TB=CC	DE	\$0
456-113-620	Federated Reporting Server ENTRY=IA	DE	\$0
456-113-621	IDPA BU App Enabler ENTRY=IA	DE	\$0

456-113-622	vRealize Enabler ENTRY=IA	DE	\$0
456-113-623	Analytics Enabler ENTRY=CB	DE	\$0
456-113-624	IDPA BU Search Enabler ENTRY=CA	DE	\$0
456-113-625	LIC;CLD TIER; 1TB;SW CAP ENTRY=CC	DE	\$285
456-113-660	Plugin IDPA vRealize Automation ENTRY=IA	DE	\$0
456-113-661	IDPA Target Protocol Enabler ENTRY=CA	DE	\$0
458-001-195	Cloudboost VM SW Option	DE	\$0
458-001-400	DD2200 OPERATING ENVIRONMENT SOFTWARE	DE	\$0
458-001-401	DD2200 OE APPLICATION SOFTWARE	DE	\$0
458-001-402	DD2200 OE APPLICATION SOFTWARE UPGRADE	DE	\$0
458-001-430	DD160 OE APPLICATION SOFTWARE UPGRADE	DE	\$0
458-001-768	CLOUDBOOST Amazon Image	DE	\$0
458-002-013	CLOUDBOOST Azure Image	DE	\$0
458-002-266	DD2200 OE SW	DE	\$0
458-002-267	DD2200 OE App SW	DE	\$0
458-002-268	DD2200 OE App SW Upg	DE	\$0
458-002-313	DD3300 Appliance SW License	DE	\$0
458-002-314	DD3300 Upgrade License	DE	\$0
458-002-315	DD3300 Cloud Tier	DE	\$0
458-002-337	CloudBoost VM SW Option	DE	\$0
458-002-338	CloudBoost Amazon Image	DE	\$0
458-002-339	CloudBoost Azure Image	DE	\$0
458-002-387	DD3300 Cloud DR Essentials 1TB=CC	DE	\$569
458-002-398	Commercial DPS DDVE Bundle	DE	\$0
458-002-414	Data Protection Central ENTRY=CA	DE	\$0
458-002-436	IDPA DP4400 ENV CONFIG	DE	\$0
458-002-437	DP4400 Cloud Tier License	DE	\$0
458-002-438	DP4400 DD Cloud DR Essentials 1TB=CC	DE	\$569
458-002-439	IDPA Upg DP4400 ENV CONFIG	DE	\$0
458-002-482	DP4400 DD Cloud DR Essentials 5TB=CC	DE	\$0
CB-APPLIANCE-SW	CLOUDBOOST APPLIANCE SW=IA	DE	\$0
DD2200-14TB-S-CF	License Base DD OE DD2200-14=IA	DE	\$4,796
DDOS_VE_61	DD3300 Operating System=IA	DE	\$0
IDPA_DDVE_61	IDPA DDOS 6.1 Virtual Edition=IA	DE	\$0
L-BST-2200	LICENSE BOOST DD2200=IA	DE	\$1,500
L-BST-2200-CF	License Boost DD2200=IA	DE	\$1,500
L-DDOE-DD160	LICENSE BASE DD OE DD160=IA	DE	\$0
L-DDOE-DD2200-14	LICENSE BASE DD OE DD2200-14=IA	DE	\$5,896
L-DDOE-DD2200-14CF	License Base DD OE DD2200-14=IA	DE	\$5,896
L-DDOE-DD2200-24	LICENSE BASE DD OE DD2200-24=IA	DE	\$10,736
L-DDOE-DD2200-24CF	License Base DD OE DD2200-24=IA	DE	\$10,736
L-DDOE-DD2200-4	LICENSE BASE DD OE DD2200-4=IA	DE	\$3,168
L-DDOE-DD2200-4CF	License Base DD OE DD2200-4=IA	DE	\$3,168
L-ENC-2200	LICENSE ENCRYPTION DD2200=IA	DE	\$1,500
L-ENC-2200-CF	License Encryption DD2200=IA	DE	\$1,500
L-REP-2200	LICENSE REPLICATOR DD2200=IA	DE	\$2,540
L-REP-2200-B	LICENSE REPLICATOR 4TB DD2200=IA	DE	\$0
L-REP-2200-B-CF	License Replicator 4TB DD2200=IA	DE	\$0
L-REP-2200-CF	License Replicator DD2200=IA	DE	\$2,540
L-RLC-2200	LICENSE RETENTION LOCK COMPL DD2200=IA	DE	\$1,500

L-RLC-2200-CF	Lic Retention Lock Compliance DD2200=IA	DE	\$1,500
L-RLG-2200	LICENSE RETENTION LOCK GOVERN DD2200=IA	DE	\$1,500
L-RLG-2200-CF	Lic Retention Lock Governance DD2200=IA	DE	\$1,500
L-VTL-2200	LICENSE VTL OPEN SYSTEMS DD2200=IA	DE	\$1,500
L-VTL-2200-CF	License VTL Open Systems DD2200=IA	DE	\$1,500
L-VTL-2200E	LICENSE VTL NDMP TAPE SVR ETH DD2200=IA	DE	\$1,500
L-VTL-2200E-CF	License VTL NdmP Tape Svr Eth DD2200=IA	DE	\$1,500
L-VTL-2200F	LICENSE VTL IBM IOS DD2200=IA	DE	\$2,250
L-VTL-2200F-CF	License VTL IBM IOS DD2200=IA	DE	\$2,250
L-XCAP2200	LICENSE EXPSTOR DD2200=IA	DE	\$8,500
L-XCAP2200-B	LICENSE EXPSTOR DD2200=IA	DE	\$0
L-XCAP2200-B-CF	License Expstor DD2200=IA	DE	\$0
L-XCAP2200-CF	License Expstor DD2200=IA	DE	\$8,500
U-BST-120	UPGRADE;LICENSE;BOOST;DD120	DE	\$0
U-BST-160	LICENSE;BOOST;DD160;UPGRADE	DE	\$0
U-BST-2200	LICENSE BOOST 2200 UPGRADE=IA	DE	\$1,500
U-BST-2200-CF	License Boost DD2200 Upgrade=IA	DE	\$1,500
U-ENC-120	UPGRADE;LICENSE;ENCRYPTION;DD120	DE	\$0
U-ENC-160	LICENSE;ENCRYPTION;DD160;UPGRADE	DE	\$0
U-ENC-2200	LICENSE ENCRYPTION 2200 UPGRADE=IA	DE	\$1,500
U-ENC-2200-CF	License Encryption DD2200 Upgrade=IA	DE	\$1,500
U-IOSUP160	LIC;VTL;OPEN SYS TO IBM I/OS;DD160;UPG	DE	\$0
U-IOSUP2200	LIC VTL OPEN SYS TO IBM IOS 2200 UPG=IA	DE	\$750
U-IOSUP2200-CF	Lic Vtl Open Sys IBM IOS DD2200 Upg=IA	DE	\$750
U-OST-120	UPGRADE;LICENSE;OPENSTORAGE(OST);DD120	DE	\$0
U-REP-2200	LICENSE REPLICATOR 2200 UPGRADE=IA	DE	\$2,540
U-REP-2200-CF	License Replicator DD2200 Upgrade=IA	DE	\$2,540
U-RL-120	LIC;RETENTION LOCK GOV EDITION;DD120;UPG	DE	\$0
U-RL-160	LIC;RETENTION LOCK GOV EDITION;DD160;UPG	DE	\$0
U-RLC-120	LIC;RETENTION LOCK COMPL EDITN;DD120;UPG	DE	\$0
U-RLC-160	LIC;RETENTION LOCK COMPL EDITN;DD160;UPG	DE	\$0
U-RLC-2200	LIC RTN LOCK COMPL EDTN DD2200 UPG=IA	DE	\$1,500
U-RLC-2200-CF	Lic Retention Lock Compl DD2200 Upg=IA	DE	\$1,500
U-RLG-2200	LIC RTN LOCK GOV EDTN DD2200 UPG=IA	DE	\$1,500
U-RLG-2200-CF	Lic Retention Lock Gov Edt DD2200 Upg=IA	DE	\$1,500
U-VTL120-E	LIC;VTL;NDMP TAPE SVR;ETH;DD120;UPG	DE	\$0
U-VTL-160-1	LIC;VTL;160.INCL:1XPCIE CARD;DP;4G;UPG	DE	\$0
U-VTL160-E	LIC;VTL;NDMP TAPE SVR;ETH;DD160;UPG	DE	\$0
U-VTL160-F1	LIC;VTL;IBM I/OS;FC;DD160;1XDP;4G;UPG	DE	\$0
U-VTL-2200	LIC VTL OPEN SYSTEMS DD2200 UPGRADE=IA	DE	\$1,500
U-VTL-2200-CF	Lic Vtl Open Systems DD2200 Upgrade=IA	DE	\$1,500
U-VTL-2200E	LIC VTL NDMP TAPE SRVR ETH DD2200 UPG=IA	DE	\$1,500
U-VTL-2200E-CF	Lic Vtl NdmP Tape Srv Eth DD2200 Upgr=IA	DE	\$1,500
U-VTL-2200F	LIC VTL IBM IOS DD2200 UPGRADE=IA	DE	\$2,250
U-VTL-2200F-CF	Lic Vtl IBM IOS DD2200 Upgrade=IA	DE	\$2,250
U-XCAP2200	LICENSE EXPSTOR 2200 UPG=IA	DE	\$8,500
U-XCAP2200-1	LICENSE CAP ON DEMAND 2200 4TB UPG=IA	DE	\$11,500
U-XCAP2200-1-CF	License Cap On Demand 2200 4TB Upg=IA	DE	\$11,500
U-XCAP2200-CF	Lic Expstor DD2200 Upg=IA	DE	\$8,500
450-000-598	NW 3RD-PRTY VRTL TAPE LIBRARY BNDLE=CC	DH	\$10,000

450-000-599	NW DATA DOMAIN BUNDLE 10TB CAP=CC	DH	\$20,000
450-000-601	NW DATA DOMAIN DEV TYPE ENABLER +7TB=C	DH	\$9,590
450-000-602	NW OPENVMS STG NODE ALPHA TIER 1=CC	DH	\$0
450-000-603	NW OPENVMS STG NODE ALPHA TIER 2=CC	DH	\$0
450-000-604	NW OPENVMS STG NODE ALPHA TIER 3=CC	DH	\$0
450-000-605	NW OPENVMS STG NODE INTEGRITY SGL PRO=	DH	\$0
456-000-268	CENTERA BKUP & RCVRY MOD 8 NODES OR LE	DH	\$0
456-000-269	CENTERA BKUP & RCVRY MOD 9 TO 16 NODES	DH	\$0
456-000-270	CENTERA BKUP & RCVRY MOD 17 TO 24 NODES	DH	\$0
456-000-271	CENTERA BKUP & RCVRY MOD 25 TO 32 NODES	DH	\$0
456-001-624	NW AUTOCH SW MOD 1-20 SLOTS=IA	DH	\$5,500
456-001-633	NW AUTOCH SW MOD 1-40 SLOTS=IA	DH	\$7,700
456-001-665	NW NETWORK ED STG NODE QTY 5 UNIX	DH	\$0
456-001-737	NetWorker VSS Client For Windows	DH	\$0
456-001-738	NetWorker VSS Client For Windows QTY 5	DH	\$0
456-001-739	NetWorker VSS Client For Windows QTY 25	DH	\$0
456-001-740	NetWorker VSS Client for Windows Qty 500	DH	\$0
456-001-741	NetWorker VSS Client for Windows Qty 500	DH	\$0
456-001-742	NW VSS CLIENT WIN QTY 1000	DH	\$0
456-001-743	NETWORKER CLIENTPAK FOR WINDOWS QTY 5	DH	\$0
456-001-744	NETWORKER CLIENTPAK FOR WINDOWS QTY 2	DH	\$0
456-004-536	NW OPENVMS CLNT ALPHA TIER 1 QTY 1=IA	DH	\$0
456-004-537	NW OPENVMS CLNT ALPHA TIER 1 QTY 5=IA	DH	\$0
456-004-539	NW OPENVMS CLNT ALPHA TIER 2 QTY 1=IA	DH	\$0
456-004-540	NW OPENVMS CLIENT FOR ALPHA TIER 2 QTY 5	DH	\$0
456-004-541	NW OPENVMS CLIENT FOR ALPHA TIER2 QTY 2	DH	\$0
456-004-542	NW OPENVMS CLNT ALPHA TIER 3 QTY 1=IA	DH	\$0
456-004-543	NW OPENVMS CLIENT FOR ALPHA TIER 3 QTY 5	DH	\$0
456-004-544	NW OPENVMS CLIENT FOR ALPHA TIER 3 QTY2	DH	\$0
456-004-562	NETWORKER CLIENT CONNECTIONS	DH	\$0
456-004-563	NW ORACLE ON OPENVMS ALPHA CL TIER 1=IA	DH	\$0
456-004-564	NW ORACLE ON OPENVMS ALPHA CL TIER 2=IA	DH	\$0
456-004-565	NW ORACLE ON OPENVMS ALPHA CL TIER 3=IA	DH	\$0
456-004-602	NW AUTOCH SOFTWARE 1-32 SLOTS=IA	DH	\$6,900
456-004-603	NW AUTOCH SOFTWARE 1-9 SLOTS=IA	DH	\$2,400
456-004-606	NW AUTOCH SOFTWARE 1-16 SLOTS=IA	DH	\$4,830
456-004-607	NW AUTOCH SOFTWARE 1-64 SLOTS=IA	DH	\$11,000
456-004-613	NETWORKER CLIENT CONNECTIONS QTY 5	DH	\$0
456-004-614	NETWORKER CLIENT CONNECTIONS QTY 25	DH	\$0
456-004-615	NETWORKER CLIENT CONNECTIONS QTY 100	DH	\$0
456-004-617	NW SNMP MOD=IA	DH	\$2,000
456-004-622	NW ARCHIVE MOD UNIX=IA	DH	\$5,000
456-004-632	NW SILO SOFTWARE MOD 1-128 VOLUMES	DH	\$0
456-004-633	NW SILO SOFTWARE MOD UNLIMITED VOLUMES	DH	\$0
456-004-634	NETWORKER SILO SOFTWARE MOD 1-64 VOLU	DH	\$0
456-004-635	NW AUTOCH SOFTWARE MOD 1-128 SLOTS=IA	DH	\$14,500
456-004-636	NW AUTOCH SOFTWARE MOD 1-256 SLOTS=IA	DH	\$20,480
456-004-638	NW AUTOCH SOFTWARE MOD UNLMTD SLOTS=	DH	\$39,000
456-004-639	NW SILO SOFTWARE MOD 1-256 VOLUMES	DH	\$0
456-004-640	NW SILO SOFTWARE MOD 1-512 VOLUMES	DH	\$0

456-004-659	NW NETWORK ED STG NODE UNIX	DH	\$0
456-004-660	NW NETWORK ED STG NODE WIN	DH	\$0
456-004-663	NW MOD FOR MS SQL SVR CLIENT TIER 1	DH	\$0
456-004-664	NW MOD FOR MS SQL SVR CLIENT TIER 2	DH	\$0
456-004-665	NW MOD FOR MS SQL SVR CLIENT TIER 3	DH	\$0
456-004-666	NW MOD FOR MS SQL SVR CLIENT TIER 4	DH	\$0
456-004-676	NW SVR NETWORK ED UNIX	DH	\$0
456-004-677	NW SVR WORKGROUP ED UNIX	DH	\$0
456-004-678	NW DYNAMIC DRIVE SHARING OPTION=IA	DH	\$2,000
456-004-681	NW CLUSTER CLNT CON WIN	DH	\$0
456-004-682	NW CLUSTER CLNT CON WIN QTY 5	DH	\$0
456-004-685	NW CLUSTER CLNT CON UNIX	DH	\$0
456-004-686	NW CLUSTER CLNT CON QTY 5 UNIX	DH	\$0
456-004-689	NW NDMP CLNT CON - TIER 1=IC	DH	\$2,995
456-004-690	NW NDMP CLNT CON - TIER 2=IC	DH	\$4,995
456-004-691	NW NDMP CLNT CON - TIER 3=IC	DH	\$11,995
456-004-692	NW NDMP CLNT CON - TIER 4=IC	DH	\$17,995
456-004-714	NETWORKER MOD FOR INFORMIX CLIENT Linux	DH	\$0
456-004-716	NETWORKER MOD FOR INFORMIX CLIENT UNIX	DH	\$0
456-004-717	NETWORKER MOD FOR SYBASE CLIENT UNIX	DH	\$0
456-004-718	NW MOD FOR ORACLE CLT ORACLE8 & LATER U	DH	\$0
456-004-720	NETWORKER MOD FOR ORACLE ON LINUX	DH	\$0
456-004-725	NW MOD SAP UNIX CLNT=IA	DH	\$15,500
456-004-726	NW MOD SAP LIN CLNT=IA	DH	\$4,000
456-004-754	NETWORKER MODULE FOR DB2 CLIENT LINUX	DH	\$0
456-004-755	NW MOD FOR DB2 UNIVERSAL DB CLIENT UX	DH	\$0
456-004-756	NW MOD FOR LOTUS NOTES CLIENT UX	DH	\$0
456-004-758	NW MOD FOR LOTUS NOTES CLIENT LX	DH	\$0
456-004-762	NW AUTOCH SOFTWARE MOD 1-400 SLOTS=IA	DH	\$26,500
456-004-763	NW AUTOCH SOFTWARE MOD 1-512 SLOTS=IA	DH	\$30,000
456-004-764	NW AUTOCH SOFTWARE MOD 1-700 SLOTS=IA	DH	\$34,500
456-004-770	NETWORKER MODULE FOR SYBASE CLIENT LIN	DH	\$0
456-004-821	NDMP TAPESERVER FOR WINDOWS	DH	\$0
456-004-822	NETWORKER RESTORE NODE FOR EDM	DH	\$0
456-004-824	NW NETWORK ED DED STG NODE WIN V7	DH	\$0
456-004-825	NW PWR ED DED STG NODE WIN V7	DH	\$0
456-004-826	NW NETWORK ED DED STG NODE UNIX V7	DH	\$0
456-004-827	NW PWR ED DED STG NODE UNIX V7	DH	\$0
456-004-828	NW NETWORK ED DED STG NODE LIN V7	DH	\$0
456-004-829	NW PWR ED DED STG NODE LIN V7	DH	\$0
456-004-960	NW ARCHIVE MOD NETWARE	DH	\$0
456-004-976	OPEN FILE MGR 5 CLIENT WORKSTATION WIN	DH	\$0
456-004-977	OPEN FILE MGR 25 CLIENT WORKSTATION WIN	DH	\$0
456-004-984	NW SVR NETWORK ED WIN	DH	\$0
456-004-987	NW SVR WORKGROUP ED WIN	DH	\$0
456-005-006	NW ARCHIVE MOD WIN=IA	DH	\$1,000
456-005-031	NW MOD SAP WIN CLNT=IA	DH	\$4,000
456-005-032	OPEN FILE MGR 5 CLIENT SVR WIN NETWARE	DH	\$0
456-005-033	OPEN FILE MGR 25 CLIENT SVR WIN NETWARE	DH	\$0
456-005-041	OPEN FILE MGR CLIENT SVR WIN NETWARE	DH	\$0

456-005-083	NW CLNTPAK UNIX	DH	\$0
456-005-085	NW CLNTPAK PC DESKTOPS	DH	\$0
456-005-087	NW CLNTPAK WIN	DH	\$0
456-005-101	NW CLNTPAK LIN	DH	\$0
456-005-102	NW CLNTPAK MAC OS-X	DH	\$0
456-005-123	NW PWR ED STG NODE UNIX	DH	\$0
456-005-124	NW PWR ED STG NODE WIN	DH	\$0
456-005-126	NW SVR PWR ED UNIX	DH	\$0
456-005-139	NW SVR PWR ED WIN	DH	\$0
456-005-404	NW PWRSNAP MOD 500GB CAP	DH	\$0
456-005-405	NW PWRSNAP MOD 1TB CAP	DH	\$0
456-005-406	NW PWRSNAP MOD 2TB CAP	DH	\$0
456-005-407	NW PWRSNAP MOD 5TB CAP	DH	\$0
456-005-408	NW PWRSNAP MOD 10TB CAP	DH	\$0
456-005-409	NW PWRSNAP MOD 25TB CAP	DH	\$0
456-005-410	NW PWRSNAP MOD 50TB CAP	DH	\$0
456-005-411	NW PWRSNAP MOD 100TB CAP	DH	\$0
456-005-471	NW SVR WORKGROUP ED LIN	DH	\$0
456-005-472	NW SVR NETWORK ED LIN	DH	\$0
456-005-473	NW SVR PWR ED LIN	DH	\$0
456-005-474	NW NETWORK ED STG NODE LIN	DH	\$0
456-005-475	NW PWR ED STG NODE FOR LIN	DH	\$0
456-005-476	NW ARCHIVE MOD LIN=IA	DH	\$1,000
456-005-477	NW CLUSTER CLNT CON LIN	DH	\$0
456-005-478	NW CLUSTER CLNT CON LIN QTY5	DH	\$0
456-010-504	NW CLNT OPENVMS ON INTEGRITY SGL PRO=IA	DH	\$0
456-010-506	NW ORACLE ON OPENVMS INTEGRITY SVR=IA	DH	\$0
456-010-507	NW SVR WORKGROUP ED SOLARIS X64/X86	DH	\$0
456-010-509	NW SVR NETWORK ED SOLARIS X64/X86	DH	\$0
456-010-510	NW SVR PWR ED SOLARIS X64/X86	DH	\$0
456-010-511	NW NETWORK ED STG NODE SOLARIS X64/X86	DH	\$0
456-010-512	NW PWR ED STG NODE SOLARIS X64/X86	DH	\$0
456-010-513	NW ED DED STG NODE SOLARIS X64/X86	DH	\$0
456-010-514	NW PWR ED DED STG ND SOLARIS X64/X86	DH	\$0
456-100-042	NW VIRT TAPE LIBRARY 10TB CAP ADDON=CC	DH	\$7,495
456-100-043	NW VIRT TAPE LIBRARY 25TB CAP ADDON=CC	DH	\$16,100
456-100-136	CBRM LICENSE FOR NW - 4 CENTERA NODES	DH	\$0
456-100-137	CBRM LICENSE-SYMANTEC NBU-4 CTRA NODES	DH	\$0
456-100-138	CBRM LICENSE-IBM TSM - 4 CENTERA NODES	DH	\$0
456-100-309	AVAMAR 1 TB INCR CAPACITY LICENSE	DH	\$12,000
456-100-318	AVAMAR OPEN FILE SOLN WINNT, WIN2K CLNTS	DH	\$100
456-100-484	NW AGENT DATA DEDUP=IA	DH	\$0
456-100-578	CBRM LICENSE-IBM TSM - 2 CENTERA NODES	DH	\$0
456-100-591	NW MOD FOR DB2 UNV DB CLIENT WIN	DH	\$0
456-100-592	NW MOD FOR INFORMIX CLIENT WIN	DH	\$0
456-100-593	NW MOD FOR LOTUS NOTES CLIENT WIN	DH	\$0
456-100-594	NW MOD FOR MS EXCG SVR CLIENT WIN	DH	\$0
456-100-595	NW MOD MS SQL SVR CLNT WIN	DH	\$0
456-100-596	NW MOD FOR ORACLE CLIENT WIN	DH	\$0
456-100-597	NETWORKER MOD FOR SYBASE CLIENT WINDC	DH	\$0

456-100-606	NW AUTOCH SILO FEATURE PRE NW 7.4=IC	DH	\$95
456-100-629	NW SVR UPG NETWORK TO PWR ED WIN	DH	\$0
456-100-630	NW SVR UPG NETWORK TO PWR ED UNIX	DH	\$0
456-100-631	NW SVR UPG NETWORK TO PWR ED LIN	DH	\$0
456-100-632	NW MOD MEDITECH LIC=IA	DH	\$4,950
456-100-633	NW MOD MICROSOFT APPS=IA	DH	\$1,595
456-100-635	NW CONVERT AUTOCH TO EDL NW 7.4=IC	DH	\$0
456-100-676	NETWORKER VIRTUAL EDITION CLIENT=IA	DH	\$1,995
456-100-690	NW CLNT=IA	DH	\$500
456-100-691	NW CLNT QTY 5=IA	DH	\$2,500
456-100-692	NW CLNT QTY 25=IA	DH	\$11,500
456-100-693	NW CLNT QTY 100=IA	DH	\$42,500
456-100-697	NW DISKBACKUP OPT TIER 1: 1TB=CC	DH	\$1,495
456-100-698	NW DISKBACKUP OPT TIER 2: 5TB=CC	DH	\$4,160
456-100-699	NW DISKBACKUP OPT TIER 3: 10TB=CC	DH	\$7,495
456-100-700	NW DISKBACKUP OPT TIER 4: 25TB=CC	DH	\$16,100
456-100-701	NW DISKBACKUP OPT TIER 5: 50TB=CC	DH	\$26,960
456-100-703	NW VIRT TAPE LIBRARY 1TB CAP ADDON=CC	DH	\$1,495
456-100-704	NW VIRT TAPE LIBRARY 5TB CAP ADDON=CC	DH	\$4,160
456-100-705	NW VIRT TAPE LIBRARY 50TB CAP ADDON=CC	DH	\$29,960
456-101-213	DATA PROTECTION ADVISOR: SGL VMWARE SV	DH	\$0
456-101-235	NW SVR NETWORK ED UNIX (E)	DH	\$0
456-101-236	NW SVR NETWORK ED WIN (E)	DH	\$0
456-101-237	NW SVR NETWORK ED LIN (E)	DH	\$0
456-101-238	NW SVR WORKGROUP ED UNIX (E)	DH	\$0
456-101-239	NW SVR WORKGROUP ED WIN (E)	DH	\$0
456-101-240	NW SVR WORKGROUP ED LIN (E)	DH	\$0
456-101-241	NW SVR PWR ED UNIX (E)	DH	\$0
456-101-242	NW SVR PWR ED WIN (E)	DH	\$0
456-101-243	NW SVR PWR ED LIN (E)	DH	\$0
456-101-253	DATA PROTECTION ADVISOR: 20 BACKUP CLNT	DH	\$0
456-101-264	DPA-Avamar 1TB CAP=CB	DH	\$0
456-101-595	NW CLNT DATA DEDUP QTY 25=IA	DH	\$575
456-101-596	NW CLNT DATA DEDUP QTY 100=IA	DH	\$2,225
456-101-597	NW VIRTUAL ED CLNT DATA DEDUP=IA	DH	\$225
456-101-708	NW PUBLIC CLOUD BACKUP OPTION=IA	DH	\$1,495
456-101-709	NW PRIVATE CLOUD BACKUP OPTION: 1TB=CC	DH	\$1,495
456-101-710	NW PRIVATE CLOUD BACKUP OPTION: 5TB=CC	DH	\$4,160
456-101-711	NW PRIVATE CLOUD BACKUP OPTION: 10TB=CC	DH	\$7,495
456-101-712	NW PRIVATE CLOUD BACKUP OPTION: 25TB=CC	DH	\$16,100
456-101-713	NW PRIVATE CLOUD BACKUP OPTION: 50TB=CC	DH	\$26,960
456-101-761	NW SVR NETWORK ED WIN/LIN	DH	\$2,300
456-101-762	NW SVR NETWORK ED UNIX	DH	\$8,280
456-101-763	NW SVR WORKGROUP ED WIN/LIN	DH	\$1,150
456-101-764	NW SVR WORKGROUP ED UNIX	DH	\$4,140
456-101-765	NW SVR PWR ED WIN/LIN	DH	\$7,500
456-101-766	NW SVR PWR ED UNIX	DH	\$22,500
456-101-767	NW NETWORK ED STG NODE WIN/LIN=IA	DH	\$2,300
456-101-768	NW NETWORK ED STG NODE UNIX=IA	DH	\$8,280
456-101-769	NW PWR ED STG NODE WIN/LIN=IA	DH	\$7,500

456-101-770	NW PWR ED STG NODE UNIX=IA	DH	\$22,500
456-101-771	NW NETWORK ED DED STG NODE WIN/LIN=IA	DH	\$1,250
456-101-772	NW NETWORK ED DED STG NODE UNIX=IA	DH	\$3,000
456-101-773	NW PWR ED DED STG NODE WIN/LIN=IA	DH	\$2,500
456-101-774	NW PWR ED DED STG NODE UNIX=IA	DH	\$5,000
456-101-775	NW ARCHIVE MOD WIN/LIN=IA	DH	\$1,000
456-101-776	NW ARCHIVE MOD UNIX=IA	DH	\$5,000
456-101-779	NW MOD DATABASES AND APPS WIN/LIN=IA	DH	\$1,595
456-101-780	NW MOD DATABASES AND APPS UNIX=IA	DH	\$7,750
456-102-028	NW MOD MICROSOFT VSS HW PROVIDER=IA	DH	\$1,595
456-102-247	S1 EMAIL MGMT-NOTES/DOMINO 1-5000USER=M	DH	\$29
456-102-248	S1 EMAIL MGMT-NOTES/DOMINO 5001+ USER=M	DH	\$25
456-102-249	S1 EMAIL MGMT-MS EXCH 1-5000 USER=MB	DH	\$29
456-102-250	S1 EMAIL MGMT-MS EXCH 5001+ USER=MB	DH	\$25
456-102-321	S1 FOR MS SHAREPOINT-TIER1 STDAL=MB	DH	\$40
456-102-322	S1 FOR MS SHAREPOINT-TIER2 STDAL=MB	DH	\$35
456-102-323	SOURCEONE FOR MS SHAREPOINT-TIER1 ADD-	DH	\$31
456-102-324	SOURCEONE FOR MS SHAREPOINT-TIER2 ADD-	DH	\$26
456-102-513	NW DATA DOMAIN DEV TYPE ENABLER=IA	DH	\$4,250
456-102-514	NW DATA DOMAIN DEV TYPE: 1TB CAP=CC	DH	\$2,540
456-102-515	NW DATA DOMAIN DEV TYPE: 5TB CAP=CC	DH	\$7,075
456-102-516	NW DATA DOMAIN DEV TYPE: 10TB CAP=CC	DH	\$12,740
456-102-517	NW DATA DOMAIN DEV TYPE: 25TB CAP=CC	DH	\$27,370
456-102-518	NW DATA DOMAIN DEV TYPE: 50TB CAP=CC	DH	\$45,830
456-102-536	S1-FILE SYSTEMS,TIER 1, ADD-ON=MB	DH	\$26
456-102-537	S1 FOR FILE SYSTEMS,TIER 2, ADD-ON=MB	DH	\$23
456-103-439	NW SOURCE CAP 1TB LICENSE TIER 6=CA	DH	\$0
456-103-718	Avamar 1 TB Replication Capacity Lic=CB	DH	\$0
456-103-719	AVAMAR 1TB DATA DOMAIN CAPACITY LICENSE	DH	\$9,000
456-103-732	DPA FOR NETWORKER 1TB CAPACITY	DH	\$0
456-103-794	S1 FOR MS SPT STOR MGMT, PREM=MB	DH	\$10
456-103-874	S1 IPM, BASE, TIER 1 (1-10TB)	DH	\$2,500
456-103-875	S1 IPM, STOR, TIER 1 (1-10TB)	DH	\$2,500
456-103-876	S1 IPM, BASE, TIER 2 (11-50TB)	DH	\$7,500
456-103-877	S1 IPM, STOR, TIER 2 (11-50TB)	DH	\$2,000
456-103-878	S1 IPM, BASE, TIER 3 (51TB OR MORE)=CA	DH	\$15,000
456-103-879	S1 IPM, STOR, TIER 3 (51TB OR MORE)=CA	DH	\$1,800
456-103-913	AVAMAR EXTENDED RETENTION	DH	\$0
456-103-951	Backup and Recovery Manager - NetWorker	DH	\$0
456-103-970	CONCEPT MGR 1TB - BRS S1 EDISC	DH	\$0
456-103-971	EMC CENTERA 1TB - BRS S1 EDISC	DH	\$0
456-103-972	LEGAL HOLD MGR - BRS S1 EDISC	DH	\$0
456-103-973	LAPTOP/DESKTOP 1TB - BRS S1 EDISC	DH	\$0
456-103-974	EMC DCTM 1TB - BRS S1 EDISC	DH	\$0
456-103-975	CONCEPT MGR ROE 500GB BRS S1 EDISC	DH	\$0
456-103-976	EMC CENTERA ROE 500GB - BRS S1 EDISC	DH	\$0
456-103-977	EMC CELERRA FLR 1TB - BRS S1 EDISC	DH	\$0
456-103-978	NETAPP SNAPLOCK 1TB - BRS S1 EDISC	DH	\$0
456-103-979	IBM LOTUS DOMINO 1TB - BRS S1 EDISC	DH	\$0
456-103-981	NETAPP SNAPSHOTS 1TB - BRS S1 EDISC	DH	\$0

456-103-982	LT/DT ROE500GB - BRS S1 EDISC	DH	\$0
456-103-983	EMC DCTM ROE 500GB - BRS S1 EDISC	DH	\$0
456-103-984	MS EXCH 1TB - BRS S1 EDISC	DH	\$0
456-103-985	CELERRA FLR ROE 500GB - BRS S1 EDISC	DH	\$0
456-103-986	LOTUS DOMINO ROE 500GB BRS S1 EDISC	DH	\$0
456-103-988	MS SP 1TB - BRS S1 EDISC	DH	\$0
456-103-989	INFOCTR ECS ROE LICENSE BRS S1 EDISC	DH	\$0
456-103-990	INFOCTR ECS NODE LICENSE BRS S1 EDISC	DH	\$0
456-103-991	MS EXCH ROE500GB BRS S1 EDISC	DH	\$0
456-103-992	MS SP ROE 500GB BRS S1 EDISC	DH	\$0
456-103-993	SYMANTEC EV 1TB - BRS S1 EDISC	DH	\$0
456-103-994	SYMANTEC EV ROE 500GB BRS S1 EDISC	DH	\$0
456-103-995	ECS SW (PER TB) - BRS S1 EDISC	DH	\$0
456-103-996	ECS ROE 500GB - BRS S1 EDISC	DH	\$0
456-103-998	INFOCTR ECS SWARE - BRS S1 EDISC	DH	\$0
456-104-324	NW SVR NETWORK ED WIN/LIN - G=IA	DH	\$2,300
456-104-325	NW SVR NETWORK ED UNIX - G=IA	DH	\$8,280
456-104-326	NW SVR WORKGROUP ED WIN/LIN - G=IA	DH	\$1,150
456-104-327	NW SVR WORKGROUP ED UNIX - G=IA	DH	\$4,140
456-104-328	NW SVR POWER ED WIN/LIN - G=IA	DH	\$7,500
456-104-329	NW SVR POWER ED UNIX - G=IA	DH	\$22,500
456-104-439	CONCEPT MGR 1TB - BRS S1 EDISC=CA	DH	\$0
456-104-440	EMC CENTERA 1TB - BRS S1 EDISC=CA	DH	\$0
456-104-441	LEGAL HOLD MGR - BRS S1 EDISC=IA	DH	\$0
456-104-442	LAPTOP/DESKTOP 1TB - BRS S1 EDISC=CA	DH	\$0
456-104-443	EMC DCTM 1TB - BRS S1 EDISC=CA	DH	\$0
456-104-444	CONCEPT MGR ROE 500GB BRS S1 EDISC=CA	DH	\$0
456-104-445	EMC CENTERA ROE 500GB - BRS S1 EDISC=CA	DH	\$0
456-104-446	EMC CELERRA FLR 1TB - BRS S1 EDISC=CA	DH	\$0
456-104-447	NETAPP SNAPLOCK 1TB - BRS S1 EDISC=CA	DH	\$0
456-104-448	IBM LOTUS DOMINO 1TB - BRS S1 EDISC=CA	DH	\$0
456-104-450	NETAPP SNAPSHOTS 1TB - BRS S1 EDISC=CA	DH	\$0
456-104-451	LT/DT ROE500GB - BRS S1 EDISC=CA	DH	\$0
456-104-452	EMC DCTM ROE 500GB - BRS S1 EDISC=CA	DH	\$0
456-104-453	MS EXCH 1TB - BRS S1 EDISC=CA	DH	\$0
456-104-454	CELERRA FLR ROE 500GB - BRS S1 EDISC=CA	DH	\$0
456-104-455	LOTUS DOMINO ROE 500GB BRS S1 EDISC=CA	DH	\$0
456-104-457	MS SP 1TB - BRS S1 EDISC=CA	DH	\$0
456-104-458	INFOCTR ECS ROE LICENSE BRS S1 EDISC=IA	DH	\$0
456-104-459	INFOCTR ECS NODE LICENSE BRS S1 EDISC=IA	DH	\$0
456-104-460	MS EXCH ROE500GB BRS S1 EDISC=CA	DH	\$0
456-104-461	MS SP ROE 500GB BRS S1 EDISC=CA	DH	\$0
456-104-462	SYMANTEC EV 1TB - BRS S1 EDISC=CA	DH	\$0
456-104-463	SYMANTEC EV ROE 500GB BRS S1 EDISC=CA	DH	\$0
456-104-464	ECS SW (PER TB) - BRS S1 EDISC=CA	DH	\$0
456-104-465	ECS ROE 500GB - BRS S1 EDISC=CA	DH	\$0
456-104-467	INFOCTR ECS SWARE - BRS S1 EDISC=IA	DH	\$0
456-105-038	NW VMWARE PROTECTION TIER 1 QTY 1=ZA	DH	\$1,400
456-105-039	NW VMWARE PROTECTION TIER 2 QTY 1=ZA	DH	\$1,300
456-105-040	NW VMWARE PROTECTION TIER 3 QTY 1=ZA	DH	\$1,200

456-105-041	NW VMWARE PROTECTION TIER 4 QTY 1=ZA	DH	\$1,100
456-105-042	NW VMWARE PROTECTION TIER 5 QTY 1=ZA	DH	\$1,000
456-105-043	NW VMWARE PROTECTION TIER 1 QTY 5=ZA	DH	\$7,000
456-105-044	NW VMWARE PROTECTION TIER 2 QTY 5=ZA	DH	\$6,500
456-105-045	NW VMWARE PROTECTION TIER 3 QTY 5=ZA	DH	\$6,000
456-105-046	NW VMWARE PROTECTION TIER 4 QTY 5=ZA	DH	\$5,500
456-105-047	NW VMWARE PROTECTION TIER 5 QTY 5=ZA	DH	\$5,000
456-105-048	NW SNAPSHOT MANAGEMENT 1TB CAP=CA	DH	\$4,495
456-105-049	NW SNAPSHOT MANAGEMENT 2TB CAP=CA	DH	\$7,995
456-105-050	NW SNAPSHOT MANAGEMENT 5TB CAP=CA	DH	\$17,495
456-105-051	NW SNAPSHOT MANAGEMENT 10TB CAP=CA	DH	\$29,995
456-105-052	NW SNAPSHOT MANAGEMENT 25TB CAP=CA	DH	\$63,495
456-105-053	NW SNAPSHOT MANAGEMENT 50TB CAP=CA	DH	\$102,495
456-105-054	NW SNAPSHOT MANAGEMENT 100TB CAP=CA	DH	\$174,495
456-105-055	NW SERVER FAST START ED 10 CLIENTS=IA	DH	\$9,475
456-105-056	NW SERVER FAST START ED 20 CLIENTS=IA	DH	\$17,900
456-105-057	NW SERVER WORKGROUP ED WIN/LIN=IA	DH	\$1,150
456-105-058	NW SERVER WORKGROUP ED UNIX=IA	DH	\$4,140
456-105-059	NW SERVER NETWORK ED WIN/LIN=IA	DH	\$2,300
456-105-060	NW SERVER NETWORK ED UNIX=IA	DH	\$8,280
456-105-061	NW SERVER POWER ED WIN/LIN=IA	DH	\$7,500
456-105-062	NW SERVER POWER ED UNIX=IA	DH	\$22,500
456-105-081	AVAMAR VIRTUAL EDITION .5TB LICENSE=CA	DH	\$6,800
456-105-082	AVAMAR VIRTUAL EDITION 1TB LICENSE=CA	DH	\$13,600
456-105-083	AVAMAR VIRTUAL EDITION 2TB LICENSE=CA	DH	\$27,200
456-105-084	AVAMAR VIRTUAL EDITION 4TB LICENSE=CA	DH	\$54,400
456-105-085	AVAMAR VIRTUAL NDMP ACCELERATOR=IA	DH	\$0
456-105-086	S1 CPTY FILES 11 TO 50 TB=CA	DH	\$0
456-105-087	S1 CPTY FILES 51 TO 150 TB=CA	DH	\$0
456-105-088	S1 CPTY FILES 151 TO 250 TB=CA	DH	\$0
456-105-089	S1 CPTY FILES 251 TO 400 TB=CA	DH	\$0
456-105-090	S1 CPTY FILES 401 TO 600 TB=CA	DH	\$0
456-105-091	S1 CPTY FILES 601 TO 1000 TB=CA	DH	\$0
456-105-092	S1 CPTY FILES 1001+ TB=CA	DH	\$0
456-105-093	S1 CPTY SP 11 TO 50 TB=CA	DH	\$0
456-105-094	S1 CPTY SP 51 TO 150 TB=CA	DH	\$0
456-105-095	S1 CPTY SP 151 TO 250 TB=CA	DH	\$0
456-105-096	S1 CPTY SP 251 TO 400 TB=CA	DH	\$0
456-105-097	S1 CPTY SP 401 TO 600 TB=CA	DH	\$0
456-105-098	S1 CPTY SP 601 TO 1000 TB=CA	DH	\$0
456-105-099	S1 CPTY SP 1001+ TB=CA	DH	\$0
456-105-100	S1 CPTYBDL EM_EXCH=UA	DH	\$0
456-105-101	S1 CPTYBDL EM_LTDM=UA	DH	\$0
456-105-102	S1 CPTYBDL MS SP STORMGT PREM=UA	DH	\$0
456-105-103	S1_DISKXTENDER_FOR_WINDOWS_1TB=CA	DH	\$0
456-105-104	S1_DISKXTENDER_FOR_WINDOWS_2TB=CA	DH	\$0
456-105-105	S1_DISKXTENDER_FOR_WINDOWS_5TB=CA	DH	\$0
456-105-106	S1_DISKXTENDER_FOR_WINDOWS_10TB=CA	DH	\$0
456-105-107	S1_DISKXTENDER_FOR_WINDOWS_15TB=CA	DH	\$0
456-105-108	S1_DISKXTENDER_FOR_WINDOWS_20TB=CA	DH	\$0

456-105-109	S1_DISKXTENDER_FOR_WINDOWS_32TB=CA	DH	\$0
456-105-110	S1_DISKXTENDER_FOR_WINDOWS_64TB=CA	DH	\$0
456-105-111	S1_DISKXTENDER_FOR_WINDOWS_100TB=CA	DH	\$0
456-105-112	S1_DISKXTENDER_FOR_WINDOWS_200TB=CA	DH	\$0
456-105-113	S1_DISKXTENDER_FOR_WINDOWS_300TB=CA	DH	\$0
456-105-114	S1_DISKXTENDER_FOR_WINDOWS_400TB=CA	DH	\$0
456-105-115	S1_DISKXTENDER_FOR_WINDOWS_500TB=CA	DH	\$0
456-105-116	S1_DISKXTENDER_FOR_WINDOWS_600TB=CA	DH	\$0
456-105-117	S1_DISKXTENDER_FOR_WINDOWS_700TB=CA	DH	\$0
456-105-118	S1_DISKXTENDER_FOR_WINDOWS_800TB=CA	DH	\$0
456-105-119	S1_DISKXTENDER_FOR_WINDOWS_900TB=CA	DH	\$0
456-105-120	S1_DISKXTENDER_FOR_WINDOWS_1PB=CA	DH	\$0
456-105-129	S1_DX_WIN_FSM_SERVER=IA	DH	\$0
456-105-130	S1_DSKXTNDR WIN FILE SYS MGR CLUSTER=IA	DH	\$0
456-105-131	S1_DX_WIN_FSM_CLUSTER=IA	DH	\$0
456-105-132	S1_DX_WINDOWS_SDK_TOOLKIT=IA	DH	\$0
456-105-181	S1_CPTYBDL EM=CA	DH	\$0
456-105-733	SRMSUITE DATA DOM TIER 3 =IC	DH	\$0
456-105-734	SRMSUITE DATA DOM TIER 4 =IC	DH	\$0
456-105-943	S1_CPTY FILES 1 TO 10TB = CA	DH	\$0
456-105-944	S1_CPTY SP 1 TO 10TB = CA	DH	\$0
456-107-744	NW SOURCE CAP 1TB ENTITLEMENT TIER 1=CA	DH	\$9,500
456-107-745	NW SOURCE CAP 1TB ENTITLEMENT TIER 2=CA	DH	\$8,750
456-107-746	NW SOURCE CAP 1TB ENTITLEMENT TIER 3=CA	DH	\$8,250
456-107-747	NW SOURCE CAP 1TB ENTITLEMENT TIER 4=CA	DH	\$7,500
456-107-748	NW SOURCE CAP 1TB ENTITLEMENT TIER 5=CA	DH	\$6,500
456-107-749	NW SOURCE CAP 1TB ENTITLEMENT TIER 6=CA	DH	\$6,000
456-107-750	NW 9.0 UPGRADE ENTITLEMENT=EA	DH	\$0
456-108-317	NW AUTOCH UPGRD FROM 1-9 TO 1-16=IA	DH	\$2,650
456-108-318	NW AUTOCH UPGRD FROM 1-16 TO 1-20=IA	DH	\$750
456-108-319	NW AUTOCH UPGRD FROM 1-20 TO 1-32=IA	DH	\$1,550
456-108-320	NW AUTOCH UPGRD FROM 1-32 TO 1-40=IA	DH	\$850
456-108-321	NW AUTOCH UPGRD FROM 1-40 TO 1-64=IA	DH	\$3,650
456-108-322	NW AUTOCH UPGRD FROM 1-64 TO 1-128=IA	DH	\$3,850
456-108-323	NW AUTOCH UPGRD FROM 1-128 TO 1-256=IA	DH	\$6,600
456-108-324	NW AUTOCH UPGRD FROM 1-256 TO 1-512=IA	DH	\$10,450
456-108-325	NW AUTOCH UPGRD FROM 1-512 TO UNLMTD=I	DH	\$9,900
456-108-326	NW AUTOCH UPGRD FROM 1-256 TO 1-400=IA	DH	\$6,020
456-108-327	NW AUTOCH UPGRD FROM 1-400 TO 1-512=IA	DH	\$3,500
456-108-328	NW AUTOCH UPGRD FROM 1-512 TO 1-700=IA	DH	\$4,500
456-108-329	NW AUTOCH UPGRD FROM 1-700 to 1-UNLIM=IA	DH	\$4,500
456-108-670	NW AUTOCHANGER SW MOD UNLMTD SLOTS=C	DH	\$10,000
456-108-671	NW VIRT TAPE LIBRARY 10TB CAP ADDON=CC	DH	\$10,000
456-108-675	NW Disk backup Opt Tier 3: 10TB=CC	DH	\$10,000
456-108-679	DD STORAGE SYSTEM ENABLER UPG=CC	DH	\$9,590
456-108-680	DD DEVICE TYPE: 1TB CAP ENTITLEMENT=CC	DH	\$9,590
456-108-681	DD DEVICE TYPE: 5TB CAP ENTITLEMENT=CC	DH	\$10,000
456-108-995	Data Prot Suite Archive 1001TB+=CA	DH	\$2,575
456-108-997	EMC SOURCEONE DISCOVERY MANAGER=MC	DH	\$30
456-108-998	EMC SOURCEONE EMAIL SUPERVISOR=UA	DH	\$30

456-109-007	DATA PROT SUITE ARCHIVE 11-50TB=CA	DH	\$5,100
456-109-008	DATA PROT SUITE ARCHIVE 51-150TB=CA	DH	\$4,125
456-109-009	DATA PROT SUITE ARCHIVE 151-250TB=CA	DH	\$3,875
456-109-010	DATA PROT SUITE ARCHIVE 251-400TB=CA	DH	\$3,575
456-109-011	DATA PROT SUITE ARCHIVE 401-600TB=CA	DH	\$3,250
456-109-012	DATA PROT SUITE ARCHIVE 601-1000TB=CA	DH	\$2,900
456-109-013	DATA PROT SUITE ARCHIVE 1001TB+=CA	DH	\$2,575
456-109-015	DATA PROT SUITE ARCHIVE 1-10TB=CA	DH	\$6,050
456-109-420	vREALIZE DATA PROTECTION EXTENSION = IA	DH	\$0
456-109-423	LICENSE DD OE PER TB CAPACITY ER=CB	DH	\$785
456-109-427	LICENSE DD OE PER TB UPG ACTIVE=CB	DH	\$1,750
456-109-428	LICENSE DD OE PER TB UPG ER=CB	DH	\$915
456-109-432	LICENSE DD OE PER TB HI CAPACITY ACT=CB	DH	\$1,450
456-109-690	LICENSE BASE DD OE DD7200=IA	DH	\$20,000
456-109-691	LIC BOOST,DD7200=IA	DH	\$38,000
456-109-692	LICENSE,ENCRYPTION,DD7200=IA	DH	\$38,000
456-109-693	LICENSE;EXTD RETN SW OPT;DD7200=IA	DH	\$0
456-109-694	LIC REPLICATOR,DD7200=IA	DH	\$60,000
456-109-695	LICENSE,RETENTION LOCK COMPL,DD7200=IA	DH	\$38,000
456-109-696	LICENSE,RETENTION LOCK GOV,DD7200=IA	DH	\$38,000
456-109-697	LIC VTL,OPEN SYSTEMS,DD7200=IA	DH	\$38,000
456-109-698	LIC VTL,NDMP TAPE SVR,ETH,DD7200=IA	DH	\$38,000
456-109-699	LIC VTL,IBM IOS,DD7200=IA	DH	\$57,000
456-109-700	LICENSE,EXP CAP,DD7200,ABOVE 360TB=IA	DH	\$40,000
456-109-701	LICENSE,EXP CAP,DD7200,ABOVE 360TB(B)=IA	DH	\$0
456-109-706	UPG BOOST,DD7200=IA	DH	\$38,000
456-109-707	LICENSE,ENCRYPTION,DD7200,UPGRADE=IA	DH	\$38,000
456-109-708	LICENSE;ER SW OPT;DD7200;UPGRADE=IA	DH	\$0
456-109-709	LIC REPLICATOR, DD7200,UPGRADE=IA	DH	\$60,000
456-109-710	LIC,RETENTION LOCK COMPL ;DD7200,UPG=IA	DH	\$38,000
456-109-711	LIC,RETENTION LOCK GOV ,DD7200,UPG=IA	DH	\$38,000
456-109-712	LIC,VTL,OPEN SYSTEMS,DD7200,UPG=IA	DH	\$38,000
456-109-713	LIC,VTL,NDMP TAPE SVR,ETH,DD7200,UPG=IA	DH	\$38,000
456-109-714	LIC,VTL,IBM IOS,DD7200,UPG=IA	DH	\$57,000
456-109-715	LIC,VTL,OPEN SYS TO IBM IOS,DD7200=IA	DH	\$19,000
456-109-716	LICENSE,EXPCAP,DD7200,ABOVE 360TB,UPG=IA	DH	\$40,000
456-109-775	LICENSE BASE DD OE DD9500=IA	DH	\$20,000
456-109-776	LIC BOOST DD9500=IA	DH	\$45,000
456-109-777	LIC ENCRYPTION DD9500=IA	DH	\$45,000
456-109-778	LIC;EXTD RETN SW OPT;DD9500=IA	DH	\$0
456-109-779	LIC REPLICATOR DD9500=IA	DH	\$70,000
456-109-780	LIC RETENTION LOCK COMPLIANCE DD9500=IA	DH	\$90,000
456-109-781	LIC RETENTION LOCK GOVERNANCE DD9500=IA	DH	\$45,000
456-109-782	LIC VTL OPEN SYSTEMS DD9500=IA	DH	\$45,000
456-109-783	LIC VTL NDMP TAPE SVR ETH DD9500=IA	DH	\$45,000
456-109-784	LIC VTL IBM IOS DD9500=IA	DH	\$72,000
456-109-785	LIC EXP CAP DD9500 MORE THAN 540TB=IA	DH	\$50,000
456-109-786	LIC DD STORAGE MIGRATION=IA	DH	\$0
456-109-787	LIC HA OPEN A-P SYSTEMS DD9500=IA	DH	\$0
456-109-788	UPG BOOST;DD9500=IA	DH	\$45,000

456-109-789	LIC ENCRYPTION DD9500 UPG=IA	DH	\$45,000
456-109-790	LIC;EXTD RETN SW OPT;DD9500;UPGRADE=IA	DH	\$0
456-109-791	LIC REPLICATOR DD9500 UPG=IA	DH	\$70,000
456-109-792	LIC RETN LOCK COMPL EDTN DD9500 UPG=IA	DH	\$90,000
456-109-793	LIC RETN LOCK GOV EDTION DD9500 UPG=IA	DH	\$45,000
456-109-794	LIC VTL OPEN SYSTEMS DD9500 UPG=IA	DH	\$45,000
456-109-795	LIC VTL NDMP TAPE SERV ETH DD9500 UPG=IA	DH	\$45,000
456-109-796	LIC VTL IBM IOS DD9500 UPG=IA	DH	\$72,000
456-109-797	LIC VTL OPEN SYS IBM IOS DD9500 UPG=IA	DH	\$72,000
456-109-798	LIC EXPCAP DD9500 ABOVE 540TB UPG=IA	DH	\$50,000
456-109-799	LIC DD STORAGE MIGRATION UPG=IA	DH	\$0
456-109-800	LIC HA A-P DD9500 UPG=IA	DH	\$0
456-109-889	UPG BOOST;DD860=IA	DH	\$0
456-109-890	LICENSE;ENCRYPTION;DD860;UPGRADE=IA	DH	\$0
456-109-892	LIC REPLICATOR DD860,UPGRADE=IA	DH	\$0
456-109-893	LIC;RETENTION LOCK COMPL; DD860;UPG=IA	DH	\$0
456-109-894	LIC;RETENTION LOCK GOV; DD860;UPG=IA	DH	\$0
456-109-895	LIC;VTL;860INCL 1XPCIE CARD;DP;8G;UPG=IA	DH	\$0
456-109-896	LIC;VTL;860INCL 2XPCIE CARD;DP;8G;UPG=IA	DH	\$0
456-109-897	LIC;VTL;NDMP TAPE SVR;ETH;DD860;UPG=IA	DH	\$0
456-109-898	LIC;VTL;IBM I/OS;FC;DD860;1XDP;8G;UPG=IA	DH	\$0
456-109-899	LIC;VTL;IBM I/OS;FC;DD860;2XDP;8G;UPG=IA	DH	\$0
456-109-900	LIC;VTL;OPEN SYS TO IBM I/OS;DD860=IA	DH	\$0
456-109-901	LICENSE;DD860 CAP EXP;ABOVE 60TB;UPG=IA	DH	\$0
456-109-902	UPG BOOST;DD890=IA	DH	\$0
456-109-903	UPG BOOST;DD890;CTL2=IA	DH	\$0
456-109-904	LICENSE;ENCRYPTION;DD890;UPGRADE=IA	DH	\$0
456-109-905	LIC REPLICATOR DD890,UPGRADE=IA	DH	\$0
456-109-906	LIC REPLICATOR DD890;CTL2;UPG=IA	DH	\$0
456-109-907	LIC;RETENTION LOCK COMPL; DD890;UPG=IA	DH	\$0
456-109-908	LIC;RETENTION LOCK GOV; DD890;UPG=IA	DH	\$0
456-109-909	LIC;VTL;890INCL 1XPCIE CARD;DP;8G;UPG=IA	DH	\$0
456-109-910	LIC;VTL;890INCL 2XPCIE CARD;DP;8G;UPG=IA	DH	\$0
456-109-911	LIC;VTL;NDMP TAPE SVR;ETH;DD890;UPG=IA	DH	\$0
456-109-912	LIC;VTL;IBM I/OS;FC;DD890;1XDP;8G;UPG=IA	DH	\$0
456-109-913	LIC;VTL;IBM I/OS;FC;DD890;2XDP;8G;UPG=IA	DH	\$0
456-109-914	LIC;VTL;890INCL 1XPCIE;DP;8G;CTL2;UPG=IA	DH	\$0
456-109-915	LIC;VTL;OPEN SYS TO IBM I/OS;DD890=IA	DH	\$0
456-109-916	LICENSE;DD890;EXPCAP180T TO 384T;UPG=IA	DH	\$0
456-109-917	UPG BOOST;DD990=IA	DH	\$45,000
456-109-918	LICENSE; ENCRYPTION;DD990;UPGRADE=IA	DH	\$45,000
456-109-919	LICENSE;EXTD RETN;DD990;UPGRADE=IA	DH	\$0
456-109-920	LIC REPLICATOR DD990,UPGRADE=IA	DH	\$70,000
456-109-921	LIC;RETENTION LOCK COMPL; DD990;UPG=IA	DH	\$45,000
456-109-922	LIC;RETENTION LOCK GOV; DD990;UPG=IA	DH	\$45,000
456-109-923	LIC;VTL;990INCL 1XPCIE CARD;DP;8G;UPG=IA	DH	\$49,500
456-109-924	LIC;VTL;990INCL 2XPCIE CARD;DP;8G;UPG=IA	DH	\$54,000
456-109-925	LIC;VTL;990INCL 3XPCIE CARD;DP;8G;UPG=IA	DH	\$58,500
456-109-926	LIC;VTL;NDMP TAPE SVR;ETH;DD990;UPG=IA	DH	\$45,000
456-109-927	LIC;VTL;IBM I/OS;FC;DD990;1XDP;8G;UPG=IA	DH	\$72,000

456-109-928	LIC;VTL;IBM I/OS;FC;DD990;2XDP;8G;UPG=IA	DH	\$76,500
456-109-929	LIC;VTL;IBM I/OS;FC;DD990;3XDP;8G;UPG=IA	DH	\$81,000
456-109-930	LIC;VTL;OPEN SYS TO IBM I/OS;DD990=IA	DH	\$22,500
456-109-931	LICENSE;EXPCAP;DD990; ABOVE 360TB;UPG=IA	DH	\$50,000
456-109-966	vRealize Data Protection Extn for AV=IA	DH	\$0
456-110-030	CloudBoost for NetWorker=CA	DH	\$1,500
456-110-070	AVAMAR E 1 TB BACKEND CAPACITY=CA	DH	\$12,000
456-110-071	AVAMAR E DATA TRANSPORT SINGLE VM=IA	DH	\$0
456-110-072	AVAMAR E 1TB REPLICATION CAPACITY=CA	DH	\$0
456-110-073	AVAMAR E 1TB DATA DOMAIN CAPACITY=CA	DH	\$9,000
456-110-074	AVAMAR E EXTENDED RETENTION=IA	DH	\$0
456-110-075	AVAMAR E VIRTUAL EDITION .5TB=CA	DH	\$6,800
456-110-076	AVAMAR E VIRTUAL EDITION 1TB=CA	DH	\$13,600
456-110-077	AVAMAR E VIRTUAL EDITION 2TB=CA	DH	\$27,200
456-110-078	AVAMAR E VIRTUAL EDITION 4TB=CA	DH	\$54,400
456-110-079	AVAMAR E VIRTUAL NDMP ACCELERATOR=IA	DH	\$0
456-110-082	AVAMAR E DESKTOP/LAPTOP=IA	DH	\$0
456-110-203	Plugin for vRealize Automation=IA	DH	\$0
456-110-231	Avamar Plugin for vCloud Director=IA	DH	\$0
456-110-493	AVAMAR F 1 TB BACKEND CAPACITY=CA	DH	\$12,000
456-110-495	AVAMAR F 1TB REPLICATION CAPACITY=CA	DH	\$0
456-110-496	AVAMAR F 1TB DATA DOMAIN CAPACITY=CA	DH	\$9,000
456-110-498	AVAMAR F VIRTUAL EDITION .5TB=CA	DH	\$6,800
456-110-499	AVAMAR F VIRTUAL EDITION 1TB=CA	DH	\$13,600
456-110-500	AVAMAR F VIRTUAL EDITION 2TB=CA	DH	\$27,200
456-110-501	AVAMAR F VIRTUAL EDITION 4TB=CA	DH	\$54,400
456-110-502	AVAMAR F VIRTUAL NDMP ACCELERATOR=IA	DH	\$0
456-110-505	AVAMAR F DESKTOP/LAPTOP=IA	DH	\$0
456-110-778	SRM DATA DOM TIER 3 =IC	DH	\$20,000
456-110-779	SRM DATA DOM TIER 4 =IC	DH	\$40,000
456-111-111	ES30 3TB ACT 45TB RAW=CB	DH	\$0
456-111-112	ES30 4TB ACT 60TB RAW=CB	DH	\$0
456-111-113	DS60 3TB ACT 45TB RAW=CB	DH	\$0
456-111-114	DS60 4TB ACT 60TB RAW=CB	DH	\$0
456-111-115	ES30 3TB ER 45TB RAW=CB	DH	\$0
456-111-116	ES30 4TB ER 60TB RAW=CB	DH	\$0
456-111-117	DS60 3TB ER 45TB RAW=CB	DH	\$0
456-111-118	DS60 4TB ER 60TB RAW=CB	DH	\$0
456-111-143	EMC GLR for MS Apps Enabler=CA	DH	\$0
456-111-152	ES30 1TB RAW ACT=CB	DH	\$0
456-111-153	DS60 1TB RAW ACT=CB	DH	\$0
456-111-154	ES30 1TB RAW ER=CB	DH	\$0
456-111-155	DS60 1TB RAW ER=CB	DH	\$0
456-111-203	ES20 1TB RAW ACT=CB	DH	\$0
456-111-204	ES20 1TB RAW ER=CB	DH	\$0
456-111-205	LIC;CLD TIER; 1TB HIGH;SW CAP=CC	DH	\$500
456-111-302	LIC DLM 9500 Enabler =IA	DH	\$50,000
456-111-636	OpenStack DP Extn for AV=IA	DH	\$0
456-111-702	vRealize Data Protection Extn for AV=IA	DH	\$0
456-111-898	DLm8100 VTE OS Storage Group 1=IE	DH	\$0

456-111-899	DLm8100 VTE OS Storage Group 2=IE	DH	\$0
456-111-900	DLm8100 Global Virtual Library=IF	DH	\$50,000
456-111-905	DLm8100 VTE OS Storage Group 3=IE	DH	\$0
456-112-100	DLm8100 VTE OS Storage Group 1 UPG=IE	DH	\$195,000
456-112-101	DLm8100 VTE OS Storage Group 2 UPG=IE	DH	\$98,000
456-112-102	DLm8100 VTE OS Storage Group 3 UPG=IE	DH	\$47,500
456-112-103	LIC;CLD TIER DR; 1TB;SW CAP=CC	DH	\$1
456-112-124	AVAMAR G 1 TB BACKEND CAPACITY=CA	DH	\$12,000
456-112-125	AVAMAR G 1TB REPLICATION CAPACITY=CA	DH	\$0
456-112-126	AVAMAR G 1TB DATA DOMAIN CAPACITY=CA	DH	\$9,000
456-112-127	AVAMAR G VIRTUAL EDITION .5TB=CA	DH	\$6,800
456-112-128	AVAMAR G VIRTUAL EDITION 1TB=CA	DH	\$13,600
456-112-129	AVAMAR G VIRTUAL EDITION 2TB=CA	DH	\$27,200
456-112-130	AVAMAR G VIRTUAL EDITION 4TB=CA	DH	\$54,400
456-112-131	AVAMAR G DESKTOP/LAPTOP=IA	DH	\$0
456-112-133	vRealize DP Extension 4.0=IA	DH	\$0
456-112-134	vCloud Director DP Extension=IA	DH	\$0
456-112-149	NW 9.1 UPGRADE ENTITLEMENT=EA	DH	\$0
456-112-151	NW 9.1 SRC CAP 1TB ENTLMNT; 0-10TB=CA	DH	\$9,500
456-112-152	NW 9.1 SRC CAP 1TB ENTLMNT; 11-50TB=CA	DH	\$8,750
456-112-153	NW 9.1 SRC CAP 1TB ENTLMNT; 51-100TB=CA	DH	\$8,250
456-112-154	NW 9.1 SRC CAP 1TB ENTLMNT;101-250TB=CA	DH	\$7,500
456-112-155	NW 9.1 SRC CAP 1TB ENTLMNT; 251-500TB=CA	DH	\$6,500
456-112-156	NW 9.1 SRC CAP 1TB ENTLMNT; 501TB+=CA	DH	\$6,000
456-112-157	vRealize DP Ext 4.0 for NetWorker=IA	DH	\$0
456-112-185	Avamar US Federal CAC Implementation=IA	DH	\$0
456-112-201	Multiple Systems Management=CC	DH	\$0
456-112-493	AVE G VDP Promotion=CA	DH	\$1
456-112-960	Avamar H S2400 1/2 Capacity=IA	DH	\$24,000
456-112-961	Avamar H 1 TB Backend Capacity=CA	DH	\$12,000
456-112-962	Avamar H 1TB Replication Capacity=CA	DH	\$0
456-112-963	Avamar H 1TB Data Domain Capacity=CA	DH	\$9,000
456-112-964	Avamar H Virtual Edition .5TB=CA	DH	\$6,800
456-112-965	Avamar H Virtual Edition 1TB=CA	DH	\$13,600
456-112-966	Avamar H Virtual Edition 2TB=CA	DH	\$27,200
456-112-967	Avamar H Virtual Edition 4TB=CA	DH	\$54,400
456-112-968	Avamar H Desktop/Laptop=IA	DH	\$0
456-112-981	NW 9.2+ Source Cap 1TB Lic; 0-10TB=CA	DH	\$9,500
456-112-982	NW 9.2+ Source Cap 1TB Lic; 11-50TB=CA	DH	\$8,750
456-112-983	NW 9.2+ Source Cap 1TB Lic; 51-100TB=CA	DH	\$8,250
456-112-984	NW 9.2+ Source Cap 1TB Lic;101-250TB=CA	DH	\$7,500
456-112-985	NW 9.2+ Source Cap 1TB Lic;251-500TB=CA	DH	\$6,500
456-112-986	NW 9.2+ Source Cap 1TB Lic; 501TB+=CA	DH	\$6,000
456-112-987	NW 9.2+ Upgrade Entitlement=EA	DH	\$0
457-000-119	NW OPENVMS STG NODE ALPHA TIER 1 QTY 1	DH	\$0
457-000-120	NW OPENVMS STG NODE ALPHA TIER 1 QTY 5	DH	\$0
457-000-121	NW OPENVMS STG NODE ALPHA TIER 1 QTY 25	DH	\$0
457-000-122	NW OPENVMS STG NODE ALPHA TIER 2 QTY 1	DH	\$0
457-000-123	NW OPENVMS STG NODE ALPHA TIER 2 QTY 5	DH	\$0
457-000-124	NW OPENVMS STG NODE ALPHA TIER 2 QTY 25	DH	\$0

457-000-125	NW OPENVMS STG NODE ALPHA TIER 3 QTY 1	DH	\$0
457-000-126	NW OPENVMS STG NODE ALPHA TIER 3 QTY 5	DH	\$0
457-000-127	NW OPENVMS STG NODE ALPHA TIER 3 QTY 25	DH	\$0
457-000-128	NW OPENVMS CLNT VAX TIER 1	DH	\$0
457-000-129	NW FOR OPENVMS FOR VAX TIER 1 QTY 5	DH	\$0
457-000-130	NW FOR OPENVMS FOR VAX TIER 1 QTY 25	DH	\$0
457-000-131	NW OPENVMS CLNT VAX TIER 2	DH	\$0
457-000-132	NW FOR OPENVMS FOR VAX TIER 2 QTY 5	DH	\$0
457-000-133	NW FOR OPENVMS FOR VAX TIER 2 QTY 25	DH	\$0
457-000-134	NW OPENVMS CLNT VAX TIER 3	DH	\$0
457-000-135	NW FOR OPENVMS FOR VAX TIER 3 QTY 5	DH	\$0
457-000-136	NW FOR OPENVMS FOR VAX TIER 3 QTY 25	DH	\$0
457-000-206	NW PWRSNAP MOD EMC SYMMETRIX 5TB LIC	DH	\$0
457-000-208	NW PWRSNAP MOD EMC SYMMETRIX DMX 5TB	DH	\$0
457-000-209	NW PWRSNAP MOD EMC CLARiiON 2TB LIC	DH	\$0
457-000-502	NW OPENVMS STG NODE INTEGRITY SGL PRO	DH	\$0
457-100-004	NW AUTOCH UPGRD FROM 1-9 TO 1-16	DH	\$0
457-100-005	NW AUTOCH UPGRD FROM 1-16 TO 1-20	DH	\$0
457-100-006	NW AUTOCH UPGRD FROM 1-20 TO 1-32	DH	\$0
457-100-007	NW AUTOCH UPGRD FROM 1-32 TO 1-40	DH	\$0
457-100-008	NW AUTOCH UPGRD FROM 1-40 TO 1-64	DH	\$0
457-100-009	NW AUTOCH UPGRD FROM 1-64 TO 1-128	DH	\$0
457-100-010	NW AUTOCH UPGRD FROM 1-128 TO 1-256	DH	\$0
457-100-011	NW AUTOCH UPGRD FROM 1-256 TO 1-512	DH	\$0
457-100-012	NW AUTOCH UPGRD FROM 1-512 TO UNLMTD	DH	\$0
457-100-013	NW AUTOCH BUNDLE VTL 10TB	DH	\$0
457-100-014	NW EMBEDDED STG NODE EDL	DH	\$0
457-100-038	NW EMC DISK LIBRARY 10TB CAP	DH	\$0
457-100-053	NW PWRSNAP MOD EMC RECOVERPOINT CDP	DH	\$0
457-100-075	NW AUTOCH UPGRD FROM 1-256 TO 1-400	DH	\$0
457-100-076	NW AUTOCH UPGRD FROM 1-400 TO 1-512	DH	\$0
457-100-077	NW AUTOCH UPGRD FROM 1-512 TO 1-700	DH	\$0
457-100-078	NW AUTOCH UPGRD FROM 1-700 to 1-UNLMTD	DH	\$0
457-100-084	NWR 20 CT 10TB B2D VTL5 APP MD AC32 HBSE	DH	\$0
457-100-130	EMC SOURCEONE DISCOVERY MANAGER	DH	\$0
457-100-133	EMC SOURCEONE DISCOVERY MANAGER - FRE	DH	\$0
457-100-135	EMC SOURCEONE DISCOVERY MANAGER - GEF	DH	\$0
457-100-136	EMC SOURCEONE DISCOVERY MGR - ITALIAN	DH	\$0
457-100-139	EMC SOURCEONE DISCOVERY MGR - SPANISH	DH	\$0
457-100-140	EMC SOURCEONE EMAIL SUPERVISOR	DH	\$0
457-100-147	NW BUNDLE EMC DL3D MODELS 10TB CAP	DH	\$0
457-100-222	NW PWRSNAP MOD EMC SYMMETRIX VMAX 5TB	DH	\$0
457-100-227	NW LICENSING BUNDLE DATA DOMAIN 10TB CA	DH	\$0
457-100-439	NW DATA DOMAIN DEV TYPE ENABLER 7TB CAP	DH	\$0
457-101-192	S1 BUNDLE EXCH_SP_FILES TIER1=UA	DH	\$0
457-101-193	S1 BUNDLE LTDM_SP_FILES TIER1=UA	DH	\$0
457-101-194	S1 BUNDLE EXCH_SP_FILES TIER2=UA	DH	\$0
457-101-195	S1 BUNDLE LTDM_SP_FILES TIER2=UA	DH	\$0
457-101-196	S1 SIDECAR EX_SP_FILES_DM_SUP TIER1=UA	DH	\$0
457-101-197	S1 SIDECAR LTDM_SP_FILES_DM_SUP TIER1=U	DH	\$0

457-101-198	S1 SIDECAR EX_SP_FILES_DM_SUP TIER2=UA	DH	\$0
457-101-199	S1 SIDECAR LTDM_SP_FILES_DM_SUP TIER2=U	DH	\$0
457-101-279	Data Prot Suite Archive 11-50TB=CA	DH	\$0
457-101-280	DATA PROT SUITE ARCHIVE 51-150TB=CA	DH	\$0
457-101-281	Data Prot Suite Archive 151-250TB=CA	DH	\$0
457-101-282	Data Prot Suite Archive 251-400TB=CA	DH	\$0
457-101-283	Data Prot Suite Archive 401-600TB=CA	DH	\$0
457-101-284	Data Prot Suite Archive 601-1000TB=CA	DH	\$0
457-101-285	Data Prot Suite Archive 1001TB+=CA	DH	\$0
457-101-286	S1_DX_FOR_WIN_FILE_SYS_MGR_S=IA	DH	\$0
457-101-287	S1_DX_FOR_WIN_FILE_SYS_MGR_C=IA	DH	\$0
457-101-547	DATA PROT SUITE ARCHIVE 1-10TB=CA	DH	\$0
458-000-189	AVAMAR BACKUP AND RECOVERY SW	DH	\$0
458-000-203	SRM for DATA DOM	DH	\$0
458-000-396	NW Family of Capacity Licenses	DH	\$0
458-000-850	SOURCEONE CAPACITY BUNDLES	DH	\$0
458-000-851	SOURCEONE ARCHIVING PRODUCTS	DH	\$0
458-000-883	EMC DATA PROTECTION SUITE FOR ARCHIVE	DH	\$0
458-000-961	CloudBoost for NetWorker	DH	\$0
458-000-976	AVAMAR VCD PLUGIN	DH	\$0
458-001-302	NW SOURCE CAP 1TB LICENSE TIER 6=CA	DH	\$6,000
458-001-334	vREALIZE DATA PROTECTION EXTENSION	DH	\$0
458-001-412	DD7200 OPERATING ENVIRONMENT SOFTWARE	DH	\$0
458-001-413	DD7200 OE APPLICATION SOFTWARE	DH	\$0
458-001-414	DD7200 OE APPLICATION SOFTWARE UPGRADE	DH	\$0
458-001-421	DD9500 OPERATING ENVIRONMENT SOFTWARE	DH	\$0
458-001-422	DD9500 OE APPLICATION SOFTWARE	DH	\$0
458-001-423	DD9500 OE APPLICATION SOFTWARE UPGRADE	DH	\$0
458-001-437	DD860 OE APPLICATION SOFTWARE UPGRADE	DH	\$0
458-001-438	DD890 OE APPLICATION SOFTWARE UPGRADE	DH	\$0
458-001-439	DD990 OE APPLICATION SOFTWARE UPGRADE	DH	\$0
458-001-446	vRealize Data Protection Extn for AV=IA	DH	\$0
458-001-480	DD990 OE APPLICATION SOFTWARE	DH	\$0
458-001-481	EMC Granular Recovery for Microsoft=IC	DH	\$0
458-001-522	DD RAW SHELF CAPACITY LICENSE	DH	\$0
458-001-523	DD 1TB CAPACITY LICENSE	DH	\$0
458-001-673	DD SHELF CAPACITY LICENSE	DH	\$0
458-001-769	OpenStack DP Extn	DH	\$0
458-001-803	vRealize Data Protection Extn for AV	DH	\$0
458-001-878	DD CLOUD TIER LICENSE	DH	\$0
458-001-991	AVAMAR G BACKUP AND RECOVERY SW	DH	\$0
458-001-993	vRealize DP Extension 4.0	DH	\$0
458-001-994	vCloud Director	DH	\$0
458-002-002	NW 9.1 UPGRADE ENTITLEMENT	DH	\$0
458-002-004	NW 9.1 SOURCE CAPACITY	DH	\$0
458-002-005	vRealize DP Ext 4.0 for NetWorker	DH	\$0
458-002-015	Multiple Systems Management	DH	\$0
458-002-061	AVE G VDP Promotion	DH	\$0
458-002-170	Avamar H Backup and Recovery SW	DH	\$0
458-002-173	NW 9.2 Source Capacity Qty 1=CA	DH	\$0

458-002-174	NW 9.2 Upgrade Entitlement=EA	DH	\$0
458-002-183	DD7200 OE Application Software Upgrade	DH	\$0
458-002-187	DD Raw Shelf Capacity License	DH	\$0
458-002-188	DD 1TB Capacity License	DH	\$0
458-002-189	DD ER To ACT Raw Shelf Capacity License	DH	\$0
458-002-329	SourceOne for Email Management	DH	\$0
458-002-330	SourceOne for Discovery Manager	DH	\$0
458-002-331	SourceOne For Microsoft SharePoint	DH	\$0
458-002-332	SourceOne File Systems	DH	\$0
458-002-333	SourceOne for MS SharePoint Stor Mgmt	DH	\$0
458-002-334	SourceOne for InPlace Migration	DH	\$0
458-002-335	SourceOne for Email Supervisor	DH	\$0
458-002-336	SourceOne for MS SharePoint Add-On	DH	\$0
458-002-385	Data Protection Central HIGH=CA	DH	\$0
458-002-484	EMC Granular Recovery Microsoft HIGH=CA	DH	\$0
ADS-OPT-DD	DATA DOMAIN BACKUP TARGET	DH	\$0
D-BST-DOCS2N	DOCS, LICENSE, BOOST, S2	DH	\$0
DD-BST-DOCS3N	DOCS, LICENSE, BOOST, S3N	DH	\$0
DDOS-DOC-A4N	DOCS,DD OS DOC,A4	DH	\$0
DDOS-DOC-A4N-X	DOCS DD OS DOC A4 LATEST FACTORY REL=IA	DH	\$0
DL3D-15OST-L	DL3D 1500 OST SOFTWARE LICENSE	DH	\$0
DL3D-3KOST-L	DL3D 3000 OST SOFTWARE LICENSE	DH	\$0
DL-3DP2T	DIRECT PATH TO TAPE OPTION FOR NBU 6.5 a	DH	\$0
DL-3DREP1500	DL3D 1500 REPLICATION OPTION	DH	\$0
DL-3DREP3000	DL3D 3000 REPLICATION OPTION	DH	\$0
DL-3DREP4000	3D4000 REPLICATION OPTION	DH	\$0
DL-3DVTL1500	DL3D 1500 VTL OPTION	DH	\$0
DL-3DVTL3000	DL3D 3000 VTL OPTION	DH	\$0
DL-A/ACTIVE	ACTIVE ENGINE FAILOVER SFTW OPT	DH	\$0
DL-IPCOPY	REMOTE COPY SOFTWARE OPITON	DH	\$0
DLM120-REP2-L	DLM120 REPLICATOR V2 LICENSE	DH	\$0
DLM120-SC-L	DLM120 UNIX NFS LICENSE	DH	\$0
DLM3-CAPTBL-L	DLM3 VNX STORAGE CAPACITY LICENSE	DH	\$0
DLM3-CAPTBL-L-CF	DLM3 VNX STORAGE CAPACITY LICENSE	DH	\$806
DLM3-REPL	DLM3 VNX REPLICATOR LICENSE	DH	\$0
DLM3-REPL-CF	DLM3 VNX REPLICATOR LICENSE	DH	\$72,881
DLM3-VNX-L	DLM3 VNX USAGE LICENSE	DH	\$0
DLM3-VNX-L-CF	DLM3 VNX USAGE LICENSE	DH	\$72,692
DLM3-VTEOS	DLM GEN3 OPERATING SYSTEM LICENSE	DH	\$97,500
DLM3-WORM	DLM3 VNX FLR LICENSE	DH	\$4,972
DLM4-8KVTEOS	DLm8100 - VTE Operating System license	DH	\$0
DLM4-8KVTEOS-CF	DLM8100 - VTE OPERATING SYSTEM LICENSE	DH	\$98,000
DLM4-8KVTEOSU	DLm8100 - VTE OS license Upgrade	DH	\$0
DLM4-8KVTEOSU-CF	DLM8100 - VTE OS LICENSE UPGRADE	DH	\$98,000
DLM4-GVL	DLm Global Virtual Library License =MA	DH	\$50,000
DLM8K-VTEOS	DLM GEN3 - VTE OPERATING SYSTEM LICENSE	DH	\$97,500
DLM-8P10G6740	DLm Brocade VDX6740 8-port 10G upg =MA	DH	\$4,400
DLM960-REPV2	DLM960 REPLICATOR V2 LICENSE	DH	\$0
DL-MEDIAMGR	NetBackup Media Mgr Software Option	DH	\$0
DLM-MGR-L	DLM MANAGER ADVANCED LICENSE	DH	\$11,600

DL-NODEMGR	NETWORKER NODE MGR SFTW OPT	DH	\$0
DL-STKACSLs	STK ACsLS SOFTWARE OPTION	DH	\$0
DL-TAPECACHE	TAPE CACHING OPTION FOR EDL	DH	\$0
L-860-XCAP	LICENSE;DD860 CAP EXP;MORE THAN 60TB	DH	\$0
L-890AU384T	LICENSE;DD890 CAP EXP KIT;MORE THAN 180T	DH	\$0
L-ASN	LICENSE,ARCHIVE STORE,4500,6200	DH	\$0
L-BST-690	LICENSE; BOOST; DD690	DH	\$0
L-BST-690G	LICENSE; BOOST; DD690G	DH	\$0
L-BST-7200	LICENSE,BOOST,DD7200	DH	\$38,000
L-BST-860	LICENSE; BOOST; DD860	DH	\$0
L-BST-880G	LICENSE; BOOST; DD880G	DH	\$0
L-BST-890	LICENSE; BOOST; DD890	DH	\$0
L-BST-9500	LIC BOOST DD9500=IA	DH	\$45,000
L-BST-990	LICENSE;BOOST;DD990	DH	\$0
L-DDOE-CAP-ER	LICENSE DD OE PER TB CAPACITY ER=CB	DH	\$785
L-DDOE-CAP-ER-NC	LICENSE DD OE PER TB CAPACITY ER=CB	DH	\$785
L-DDOE-DD7200	LICENSE BASE DD OE DD7200=IA	DH	\$20,000
L-DDOE-DD9500	LICENSE BASE DD OE DD9500=IA	DH	\$20,000
L-DDOE-DD990	LICENSE BASE DD OE DD990=IA	DH	\$0
L-DDOE-HICAP-ACT	LICENSE DD OE PER TB HI CAPACITY ACT=CB	DH	\$1,450
L-DDOE-HICAP-ACTNC	LICENSE DD OE PER TB HI CAPACITY ACT=CB	DH	\$1,450
L-DD-SMIG	LIC DD STORAGE MIGRATION=IA	DH	\$0
L-DLM6000	LICENSE; DEDUPE STORAGE FOR DLM; DD890	DH	\$0
L-DLM8100	LICENSE DLM8100 DEDUPE STORAGE =IA	DH	\$50,000
L-DLM8100N-CF	LICENSE DLM8100 DEDUPE STORAGE =IA	DH	\$50,000
L-ENC-690	LICENSE;ENCRYPTION;DD690	DH	\$0
L-ENC-690G	LICENSE;ENCRYPTION;DD690G	DH	\$0
L-ENC-7200	LICENSE,ENCRYPTION,DD7200	DH	\$38,000
L-ENC-860	LICENSE; ENCRYPTION; DD860	DH	\$0
L-ENC-880G	LICENSE;ENCRYPTION;DD880G	DH	\$0
L-ENC-890	LICENSE;ENCRYPTION;DD890	DH	\$0
L-ENC-9500	LIC ENCRYPTION DD9500=IA	DH	\$45,000
L-ENC-990	LICENSE;ENCRYPTION;DD990	DH	\$0
L-ER-7200	LICENSE,EXTENDED RETENTION SW OPT,DD72	DH	\$0
L-ER-9500	LIC EXTENDED RETENTION SW OPT DD9500=IA	DH	\$0
L-GWSTOR-3	LICENSE; GATEWAY STORAGE; LEVEL 3; 143TB	DH	\$0
L-GWSTOR-L2	LICENSE; GATEWAY STORAGE; LEVEL 2;71TB	DH	\$0
L-HA-9500	LIC HA OPEN A-P SYSTEMS DD9500=IA	DH	\$0
L-MC-10	LICENSE;DDMC-10;ADDITIONAL SYSTEMS	DH	\$0
L-MC-5	LICENSE;DDMC-5;ADDITIONAL SYSTEMS	DH	\$0
L-MC-BASE	LICENSE DDMC-BASE	DH	\$0
L-MC-BASE-CF	LICENSE;DDMC-BASE	DH	\$0
L-OST-690	LICENSE; OPENSTORAGE (OST); DD690	DH	\$0
L-OST-690G	LICENSE; OPENSTORAGE (OST); DD690G	DH	\$0
L-OST-880	LICENSE; OPENSTORAGE (OST); DD880	DH	\$0
L-OST-880G	LICENSE; OPENSTORAGE (OST); DD880G	DH	\$0
L-OSTC2-880	LICENSE; OPENSTORAGE (OST); DD880;CTRL 2	DH	\$0
L-REP-690	LICENSE; REPLICATOR; DD690	DH	\$0
L-REP-690G	LICENSE; REPLICATOR; DD690G	DH	\$0
L-REP-7200	LICENSE,REPLICATOR,DD7200	DH	\$60,000

L-REP-860	LICENSE; REPLICATOR; DD860	DH	\$0
L-REP-880G	LICENSE; REPLICATOR; DD880G	DH	\$0
L-REP-890	LICENSE;REPLICATOR;DD890	DH	\$0
L-REP-9500	LIC REPLICATOR DD9500=IA	DH	\$70,000
L-REP-990	LICENSE;REPLICATOR;DD990	DH	\$0
L-RL-690	LICENSE; RETENTION LOCK; DD690	DH	\$0
L-RL-690G	LICENSE; RETENTION LOCK; DD690G	DH	\$0
L-RL-860	LIC;RETENTION LOCK GOV EDITION;DD860	DH	\$0
L-RL-880G	LICENSE; RETENTION LOCK; DD880G	DH	\$0
L-RL-890	LIC;RETENTION LOCK GOV EDITION;DD890	DH	\$0
L-RL-990	LIC;RETENTION LOCK GOV EDITION;DD990	DH	\$0
L-RLC-7200	LICENSE,RETENTION LOCK COMPLIANCE,DD720	DH	\$38,000
L-RLC-860	LIC;RETENTION LOCK COMPL EDITN;DD860	DH	\$0
L-RLC-890	LIC;RETENTION LOCK COMPL EDITN;DD890	DH	\$0
L-RLC-9500	LIC RETENTION LOCK COMPLIANCE DD9500=IA	DH	\$45,000
L-RLC-990	LIC;RETENTION LOCK COMPL EDITN;DD990	DH	\$0
L-RLG-7200	LICENSE,RETENTION LOCK GOVERNANCE,DD720	DH	\$38,000
L-RLG-9500	LIC RETENTION LOCK GOVERNANCE DD9500=IA	DH	\$45,000
L-VTL-690-1	LIC;VTL;690. INCL:1XPCIE CARD;DP;4G	DH	\$0
L-VTL-690-2	LIC;VTL;690. INCL:2XPCIE CARD;DP;4G	DH	\$0
L-VTL690-E	LIC;VTL;NDMP TAPE SVR;ETH;DD690	DH	\$0
L-VTL690-F1	LIC;VTL;IBM I/OS;FC;DD690;1XPCIE;DP;4G	DH	\$0
L-VTL690-F2	LIC;VTL;IBM I/OS;FC;DD690;2XPCIE;DP;4G	DH	\$0
L-VTL-690G1	LIC;VTL;690G. INCL:1XPCIE CARD;DP;4G	DH	\$0
L-VTL-690G2	LIC;VTL;690G. INCL:2XPCIE CARD;DP;4G	DH	\$0
L-VTL-7200	LICENSE,VTL,OPEN SYSTEMS,DD7200	DH	\$38,000
L-VTL-7200E	LICENSE,VTL,NDMP TAPE SVR,ETH,DD7200	DH	\$38,000
L-VTL-7200F	LICENSE,VTL,IBM IOS,DD7200	DH	\$57,000
L-VTL-860-1	LIC;VTL;860; INCL 1XPCIE CARD;DP;8G	DH	\$0
L-VTL-860-2	LIC;VTL;860; INCL 2XPCIE CARD;DP;8G	DH	\$0
L-VTL860-E	LIC;VTL;NDMP TAPE SVR;ETH;DD860	DH	\$0
L-VTL860-F1	LIC;VTL;IBM I/OS;FC;DD860;1XPCIE;DP;8G	DH	\$0
L-VTL860-F2	LIC;VTL;IBM I/OS;FC;DD860;2XPCIE;DP;8G	DH	\$0
L-VTL-880G1	LIC;VTL;880G. INCL:1XPCIE CARD;DP;4G	DH	\$0
L-VTL-880G2	LIC;VTL;880G. INCL:2XPCIE CARD;DP;4G	DH	\$0
L-VTL880G81	LIC;VTL;880G; INCL 1XPCIE CARD;DP;8G	DH	\$0
L-VTL880G82	LIC;VTL;880G; INCL 2XPCIE CARD;DP;8G	DH	\$0
L-VTL-890-1	LICENSE;VTL;DD890;INCL1X PCIE CARD;DP;8G	DH	\$0
L-VTL-890-2	LICENSE;VTL;DD890;INCL2X PCIE CARD;DP;8G	DH	\$0
L-VTL890-E	LIC;VTL;NDMP TAPE SVR;ETH;DD890	DH	\$0
L-VTL890-F1	LIC;VTL;IBM I/OS;FC;DD890;1XPCIE;DP;8G	DH	\$0
L-VTL890-F2	LIC;VTL;IBM I/OS;FC;DD890;2XPCIE;DP;8G	DH	\$0
L-VTL-9500	LIC VTL OPEN SYSTEMS DD9500=IA	DH	\$45,000
L-VTL-9500E	LIC VTL NDMP TAPE SVR ETH DD9500=IA	DH	\$45,000
L-VTL-9500F	LIC VTL IBM IOS DD9500=IA	DH	\$72,000
L-VTL-990-1	LIC;VTL;990; INCL 1XPCIE CARD;DP;8G	DH	\$0
L-VTL-990-2	LIC;VTL;990; INCL 2XPCIE CARD;DP;8G	DH	\$0
L-VTL-990-3	LIC;VTL;990; INCL 3XPCIE CARD;DP;8G	DH	\$0
L-VTL990-E	LIC;VTL;NDMP TAPE SVR;ETH;DD990	DH	\$0
L-VTL990-F1	LIC;VTL;IBM I/OS;FC;DD990;1XPCIE;DP;8G	DH	\$0

L-VTL990-F2	LIC;VTL;IBM I/OS;FC;DD990;2XPCIE;DP;8G	DH	\$0
L-VTL990-F3	LIC;VTL;IBM I/OS;FC;DD990;3XPCIE;DP;8G	DH	\$0
L-XCAP7200	LICENSE,EXP CAP,DD7200,MORE THAN 360TB	DH	\$40,000
L-XCAP7200-B	LICENSE,EXP CAP,DD7200,MORE THAN 360TB	DH	\$0
L-XCAP9500	LIC EXP CAP DD9500 MORE THAN 540TB=IA	DH	\$50,000
L-XCAP9500-B	LIC EXP CAP DD9500 MORE THAN 570TB=IA	DH	\$0
L-XCAP990	LICENSE;EXP CAP;DD990;MORE THAN 360TB	DH	\$0
S1-CTA-VE	S1 CPCTY BDL CTA-VE	DH	\$0
S1-CTA-VE-HA	S1 CPCTY BDL CTA-VE-HA	DH	\$0
S1-LS	S1 LIC SOL	DH	\$0
U-1TB-ER-ACT	LICENSE ES30 1TB ER TO ACTIVE UPGRADE=IA	DH	\$0
U-2TB-ER-ACT	LICENSE ES30 2TB ER TO ACTIVE UPGRADE=IA	DH	\$0
U-3TB-ER-ACT	LICENSE ES30 3TB ER TO ACTIVE UPGRADE=IA	DH	\$0
U-3TB-ER-ACT-DS60	LICENSE DS60 3TB ER TO ACTIVE UPGRADE=IA	DH	\$37,500
U-4TB-ER-ACT	LICENSE ES30 4TB ER TO ACTIVE UPGRADE=IA	DH	\$49,900
U-4TB-ER-ACT-DS60	LICENSE DS60 4TB ER TO ACTIVE UPGRADE=IA	DH	\$49,900
U-860-XCAP	LICENSE;DD860 CAP EXP;MORE THAN 60TB;UPG	DH	\$0
U-880U192T	UPGRADE;LIC; DD880 EXP CAP 97T TO 192T	DH	\$50,000
U-890AU384T	LICENSE;DD890;EXPCAP180T TO 384T;UPGRAD	DH	\$0
U-BST-690	UPGRADE;LICENSE;BOOST;DD690	DH	\$0
U-BST-690G	UPGRADE;LICENSE;BOOST;DD690G	DH	\$0
U-BST-7200	LICENSE,BOOST,DD7200,UPGRADE	DH	\$38,000
U-BST-7200-CF	License,Boost,DD7200,Upgrade=IA	DH	\$38,000
U-BST-860	UPGRADE;LICENSE;BOOST;DD860	DH	\$0
U-BST-880	UPGRADE;LICENSE;BOOST;DD880	DH	\$0
U-BST-880G	UPGRADE;LICENSE;BOOST;DD880G	DH	\$0
U-BST-890	UPGRADE;LICENSE;BOOST;DD890	DH	\$0
U-BST-9500	LIC BOOST DD9500 UPG=IA	DH	\$45,000
U-BST-990	LICENSE;BOOST;DD990;UPGRADE	DH	\$45,000
U-DDOE-ACT	LICENSE DD OE PER TB UPG ACTIVE=CB	DH	\$1,750
U-DDOE-ACT-MCAP	License DD OE Per TB UPG Active=CB	DH	\$1,750
U-DDOE-ACT-NC	LICENSE DD OE PER TB UPG ACTIVE=CB	DH	\$1,750
U-DDOE-ER	LICENSE DD OE PER TB UPG ER=CB	DH	\$915
U-DDOE-ER-CF	LICENSE DD OE PER TB UPG ER=CB	DH	\$915
U-DD-SMIG	LIC DD STORAGE MIGRATION UPG=IA	DH	\$0
U-DD-SMIG-NC	LICENSE DD STORAGE MIGRATION UPG=IA	DH	\$0
U-DLM960	UPG;LIC;DEDUPE STORAGE FOR DLM;DD880	DH	\$0
U-ENC-690	UPGRADE;LICENSE;ENCRYPTION;DD690	DH	\$0
U-ENC-690G	UPGRADE;LICENSE;ENCRYPTION;DD690G	DH	\$0
U-ENC-7200	LICENSE,ENCRYPTION,DD7200,UPGRADE	DH	\$38,000
U-ENC-7200-CF	License,Encryption,DD7200,Upgrade=IA	DH	\$38,000
U-ENC-860	LICENSE;ENCRYPTION;DD860;UPGRADE	DH	\$0
U-ENC-880	UPGRADE;LICENSE;ENCRYPTION;DD880	DH	\$0
U-ENC-880G	UPGRADE;LICENSE;ENCRYPTION;DD880G	DH	\$0
U-ENC-890	LICENSE;ENCRYPTION;DD890;UPGRADE	DH	\$0
U-ENC-9500	LIC ENCRYPTION DD9500 UPG=IA	DH	\$45,000
U-ENC-990	LICENSE; ENCRYPTION;DD990;UPGRADE	DH	\$45,000
U-ER-7200	LICENSE,EXTD RETN SW OPT,DD7200,UPGRAD	DH	\$0
U-ER-7200-CF	License,Extd Retn SW Opt,DD7200,Upg=IA	DH	\$0
U-ER-9500-CF	LIC;EXTD RETN SW OPT;DD9500;UPGRADE=IA	DH	\$0

U-GW-L2TOL3	UPG;LIC;GWAYSTOR;71TB LEV2 TO 143TB LEV3	DH	\$0
U-GWSTOR-3	UPG;LICENSE;GATEWAYSTORAGE;LEVEL 3-143	DH	\$0
U-GWSTOR-L2	UPG;LICENSE;GATEWAYSTORAGE;LEVEL 2;71T	DH	\$0
U-HA-9500	LIC HA A-P DD9500 UPG=IA	DH	\$0
U-HA-9500-CF	LIC HA A-P DD9500 UPG=IA	DH	\$0
U-IOSUP690	LIC;VTL;OPEN SYS TO IBM I/OS;DD690;UPG	DH	\$0
U-IOSUP690G	LIC;VTL;OPEN SYS TO IBM I/OS;DD690G;UPG	DH	\$0
U-IOSUP7200	LIC,VTL,OPEN SYS TO IBM IOS,DD7200,UPG	DH	\$19,000
U-IOSUP7200-CF	Lic Vtl Open Sys IBM IOS DD7200 Upg=IA	DH	\$19,000
U-IOSUP860	LIC;VTL;OPEN SYS TO IBM I/OS;DD860;UPG	DH	\$0
U-IOSUP880	LIC;VTL;OPEN SYS TO IBM I/OS;DD880;UPG	DH	\$0
U-IOSUP880G	LIC;VTL;OPEN SYS TO IBM I/OS;DD880G;UPG	DH	\$0
U-IOSUP890	LIC;VTL;OPEN SYS TO IBM I/OS;DD890;UPG	DH	\$0
U-IOSUP9500	LIC VTL OPEN SYS IBM IOS DD9500 UPG=IA	DH	\$0
U-IOSUP9500-CF	LIC VTL OPEN SYS IBM IOS DD9500 UPG=IA	DH	\$27,000
U-IOSUP990	LIC;VTL;OPEN SYS TO IBM I/OS;DD990;UPG	DH	\$22,500
U-MC-10	LICENSE;DDMC-10;ADDITIONAL SYSTEMS,UPGF	DH	\$0
U-MC-5	LICENSE;DDMC-5;ADDITIONAL SYSTEMS,UPGR	DH	\$0
U-OST-690	UPGRADE;LICENSE;OPENSTORAGE(OST);DD69	DH	\$0
U-OST-690G	UPGRADE;LICENSE;OPENSTORAGE(OST);DD69	DH	\$0
U-OST-880	UPGRADE;LICENSE;OPENSTORAGE(OST);DD88	DH	\$0
U-OST-880G	UPGRADE;LICENSE;OPENSTORAGE(OST);DD88	DH	\$0
U-OSTC2-880	UPG;LIC;OPENSTORAGE(OST); DD880;CTRL 2	DH	\$0
U-REP-690	UPGRADE; LICENSE; REPLICATOR; DD690	DH	\$0
U-REP-690G	UPGRADE; LICENSE; REPLICATOR; DD690G	DH	\$0
U-REP-7200	LICENSE, REPLICATOR, DD7200,UPGRADE	DH	\$60,000
U-REP-7200-CF	License,Replicator,DD7200,Upgrade=IA	DH	\$60,000
U-REP-860	LICENSE; REPLICATOR; DD860;UPGRADE	DH	\$0
U-REP-880	UPGRADE; LICENSE; REPLICATOR; DD880	DH	\$0
U-REP-880G	UPGRADE; LICENSE; REPLICATOR; DD880G	DH	\$0
U-REP-890	LICENSE;REPLICATOR;DD890;UPGRADE	DH	\$0
U-REP-9500	LIC REPLICATOR DD9500 UPG=IA	DH	\$70,000
U-REP-990	LICENSE; REPLICATOR; DD990;UPGRADE	DH	\$70,000
U-RL-690	LIC;RETENTION LOCK GOV EDITION;DD690;UPG	DH	\$0
U-RL-690G	LIC;RETENTION LOCKGOV EDITION;DD690G;UP	DH	\$0
U-RL-860	LIC;RETENTION LOCK GOV EDITION;DD860;UPG	DH	\$0
U-RL-880	LIC;RETENTION LOCK GOV EDITION;DD880;UPG	DH	\$0
U-RL-880G	LIC;RETENTION LOCKGOV EDITION;DD880G;UP	DH	\$0
U-RL-890	LIC;RETENTION LOCK GOV EDITION;DD890;UPG	DH	\$0
U-RL-990	LIC;RETENTION LOCK GOV EDITION;DD990;UPG	DH	\$45,000
U-RLC-690	LIC;RETENTION LOCK COMPL EDITN;DD690;UPC	DH	\$24,000
U-RLC-7200	LIC,RETENTION LOCK COMPL EDTN,DD7200,UP	DH	\$38,000
U-RLC-7200-CF	Lic,Retention Lock Compl,DD7200,Upg=IA	DH	\$38,000
U-RLC-860	LIC;RETENTION LOCK COMPL EDITN;DD860;UPC	DH	\$0
U-RLC-880	LIC;RETENTION LOCK COMPL EDITN;DD880;UPC	DH	\$0
U-RLC-890	LIC;RETENTION LOCK COMPL EDITN;DD890;UPC	DH	\$0
U-RLC-9500	LIC RETN LOCK COMPL EDTN DD9500 UPG=IA	DH	\$90,000
U-RLC-990	LIC;RETENTION LOCK COMPL EDITN;DD990;UPC	DH	\$45,000
U-RLG-7200	LIC,RETENTION LOCK GOV EDTION,DD7200,UPC	DH	\$38,000
U-RLG-7200-CF	Lic,Retention Lock Gov Edt,DD7200,Upg=IA	DH	\$38,000

U-RLG-9500	LIC RETN LOCK GOV EDTION DD9500 UPG=IA	DH	\$45,000
U-VTL-690-1	UPG;LIC;VTL;690. INCL:1XPCIE CARD;DP;4G	DH	\$0
U-VTL-690-2	UPG;LIC;VTL;690. INCL:2XPCIE CARD;DP;4G	DH	\$0
U-VTL690-E	LIC;VTL;NDMP TAPE SVR;ETH;DD690;UPG	DH	\$0
U-VTL690-F1	LIC;VTL;IBM I/OS;FC;DD690;1XDP;4G;UPG	DH	\$0
U-VTL690-F2	LIC;VTL;IBM I/OS;FC;DD690;2XDP;4G;UPG	DH	\$0
U-VTL-690G1	UPG;LIC;VTL;690G. INCL:1XPCIE CARD;DP;4G	DH	\$0
U-VTL-690G2	UPG;LIC;VTL;690G. INCL:2XPCIE CARD;DP;4G	DH	\$0
U-VTL690G-E	LIC;VTL;NDMP TAPE SVR;ETH;DD690G;UPG	DH	\$0
U-VTL690GF1	LIC;VTL;IBM I/OS;FC;DD690G;1XDP;4G;UPG	DH	\$0
U-VTL690GF2	LIC;VTL;IBM I/OS;FC;DD690G;2XDP;4G;UPG	DH	\$0
U-VTL-7200	LIC,VTL,OPEN SYSTEMS,DD7200,UPGRADE	DH	\$38,000
U-VTL-7200-CF	Lic,Vtl,Open Systems,DD7200,Upgrade=IA	DH	\$38,000
U-VTL-7200E	LIC,VTL,NDMP TAPE SERVER,ETH,DD7200,UPGF	DH	\$38,000
U-VTL-7200E-CF	Lic,Vtl,Ndmp Tape Srv,Eth,DD7200,Upgr=IA	DH	\$38,000
U-VTL-7200F	LIC,VTL,IBM IOS,DD7200,UPGRADE	DH	\$57,000
U-VTL-7200F-CF	Lic,Vtl,IBM IOS,DD7200,Upgrade=IA	DH	\$57,000
U-VTL-860-1	LIC;VTL;860; INCL 1XPCIE CARD;DP;8G;UPG	DH	\$0
U-VTL-860-2	LIC;VTL;860; INCL 2XPCIE CARD;DP;8G;UPG	DH	\$0
U-VTL860-E	LIC;VTL;NDMP TAPE SVR;ETH;DD860;UPG	DH	\$0
U-VTL860-F1	LIC;VTL;IBM I/OS;FC;DD860;1XDP;8G;UPG	DH	\$0
U-VTL860-F2	LIC;VTL;IBM I/OS;FC;DD860;2XDP;8G;UPG	DH	\$0
U-VTL-880-1	UPG;LIC;VTL;880. INCL:1XPCIE CARD;DP;4G	DH	\$0
U-VTL-880-2	UPG;LIC;VTL;880. INCL:2XPCIE CARD;DP;4G	DH	\$0
U-VTL880G1	UPG;LIC;VTL;880; INCL 1XPCIE CARD;DP;8G	DH	\$0
U-VTL880G2	UPG;LIC;VTL;880; INCL 2XPCIE CARD;DP;8G	DH	\$0
U-VTL880-E	LIC;VTL;NDMP TAPE SVR;ETH;DD880;UPG	DH	\$0
U-VTL880-F1	LIC;VTL;IBM I/OS;FC;DD880;1XDP;8G;UPG	DH	\$0
U-VTL880-F2	LIC;VTL;IBM I/OS;FC;DD880;2XDP;8G;UPG	DH	\$0
U-VTL-880G1	UPG;LIC;VTL;880G. INCL:1XPCIE CARD;DP;4G	DH	\$0
U-VTL-880G2	UPG;LIC;VTL;880G. INCL:2XPCIE CARD;DP;4G	DH	\$0
U-VTL880G81	UPG;LIC;VTL;880G; INCL 1XPCIE CARD;DP;8G	DH	\$0
U-VTL880G82	UPG;LIC;VTL;880G; INCL 2XPCIE CARD;DP;8G	DH	\$0
U-VTL880G-E	LIC;VTL;NDMP TAPE SVR;ETH;DD880G;UPG	DH	\$0
U-VTL880GF1	LIC;VTL;IBM I/OS;FC;DD880G;1XDP;8G;UPG	DH	\$0
U-VTL880GF2	LIC;VTL;IBM I/OS;FC;DD880G;2XDP;8G;UPG	DH	\$0
U-VTL-890-1	LIC;VTL;890; INCL 1XPCIE CARD;DP;8G;UPG	DH	\$0
U-VTL-890-2	LIC;VTL;890; INCL 2XPCIE CARD;DP;8G;UPG	DH	\$0
U-VTL890-E	LIC;VTL;NDMP TAPE SVR;ETH;DD890;UPG	DH	\$0
U-VTL890-F1	LIC;VTL;IBM I/OS;FC;DD890;1XDP;8G;UPG	DH	\$0
U-VTL890-F2	LIC;VTL;IBM I/OS;FC;DD890;2XDP;8G;UPG	DH	\$0
U-VTL-9500	LIC VTL OPEN SYSTEMS DD9500 UPG=IA	DH	\$45,000
U-VTL-9500E	LIC VTL NDMP TAPE SERV ETH DD9500 UPG=IA	DH	\$45,000
U-VTL-9500F	LIC VTL IBM IOS DD9500 UPG=IA	DH	\$72,000
U-VTL-990-1	LIC;VTL;990; INCL 1XPCIE CARD;DP;8G;UPG	DH	\$49,500
U-VTL-990-2	LIC;VTL;990; INCL 2XPCIE CARD;DP;8G;UPG	DH	\$54,000
U-VTL-990-3	LIC;VTL;990; INCL 3XPCIE CARD;DP;8G;UPG	DH	\$58,500
U-VTL990-E	LIC;VTL;NDMP TAPE SVR;ETH;DD990;UPG	DH	\$45,000
U-VTL990-F1	LIC;VTL;IBM I/OS;FC;DD990;1XDP;8G;UPG	DH	\$72,000
U-VTL990-F2	LIC;VTL;IBM I/OS;FC;DD990;2XDP;8G;UPG	DH	\$76,500

U-VTL990-F3	LIC;VTL;IBM I/OS;FC;DD990;3XDP;8G;UPG	DH	\$81,000
U-VTLC2-890	LIC;VTL;890;INCL 1XPCIE;DP;8G;CTL2;UPG	DH	\$27,000
U-VTLC2-892	LIC;VTL;890;INCL 2XPCIE;DP;8G;CTL2;UPG	DH	\$31,500
U-XCAP7200	LICENSE,EXPCAP,DD7200,MORETHAN 360TB,UF	DH	\$40,000
U-XCAP7200-CF	Lic Expcap DD7200 Above 360TB Upg=IA	DH	\$40,000
U-XCAP9500	LIC EXPCAP DD9500 MORETHAN 540TB UPG=IA	DH	\$0
U-XCAP9500-CF	LIC EXPCAP DD9500 ABOVE 540TB UPG=IA	DH	\$50,000
U-XCAP990	LICENSE;EXPCAP;DD990;MORE THAN 360TB;UP	DH	\$50,000
456-100-664	DPA: NetApp Single Fileserver	DM	\$0
456-101-786	DR Basic Metering for RecoverPoint.	DM	\$0
456-101-877	DPA: VNX File: VNX 5500, VNX 5700	DM	\$0
456-102-254	DPA - RECOVERPOINT/SE BUNDLE - 1TB CAP	DM	\$0
456-104-123	Data Prot Suite Backup 51-150TB=CA	DM	\$8,250
456-104-124	Data Prot Suite Backup 151-250TB=CA	DM	\$7,750
456-104-147	Data Prot Suite Backup 251-400TB=CA	DM	\$7,150
456-104-148	Data Prot Suite Backup 401-600TB=CA	DM	\$6,500
456-104-149	Data Prot Suite Backup 601-1000TB=CA	DM	\$5,800
456-104-150	Data Prot Suite Backup 1001TB+=CA	DM	\$5,150
456-104-151	EMC BACKUP SUITE (2001-3000TB)	DM	\$0
456-104-152	EMC BACKUP SUITE (3001-4000TB)	DM	\$0
456-104-153	EMC BACKUP SUITE (4001TB OR MORE)	DM	\$0
456-104-247	EMC BACKUP SUITE AVAMAR ENABLER=CA	DM	\$0
456-104-274	EMC BACKUP SUITE NETWORKER ENABLER	DM	\$0
456-104-857	DPA: 20 backup clients=IA	DM	\$3,000
456-104-858	DPA: 1TB Avamar capacity=CB	DM	\$1,995
456-104-859	DPA: single VMware server=IA	DM	\$570
456-104-860	DPA: NetWorker Source Capacity 1TB=CB	DM	\$595
456-105-080	Data Prot Suite Backup 11-50TB=CA	DM	\$10,200
456-105-958	Data Prot Suite Backup 1-10TB=CA	DM	\$12,100
456-106-013	DPA: PRIMARY STORAGE REPLICATION=IC	DM	\$0
456-106-107	DPA-20 Backup Clients-B=IA	DM	\$3,000
456-106-108	DPA-1TB Avamar Capacity-B=CB	DM	\$1,995
456-106-109	DPA-Single VMware Server-B=IA	DM	\$570
456-106-110	DPA-NetWorker Source Capacity 1TB-B=CB	DM	\$595
456-106-111	DPA-Primary Storage Replication-B=IC	DM	\$0
456-106-112	EMC BACKUP SUITE DPA ENABLER-B=CB	DM	\$0
456-106-137	SRMSUITE ATMOS 1TB =CB	DM	\$0
456-106-138	DD Boost for Apps 1-10TB=CA	DM	\$0
456-106-139	DD Boost for Apps 11-50TB=CA	DM	\$0
456-106-140	DD Boost for Apps 51-150TB=CA	DM	\$0
456-106-141	DD Boost for Apps 151-250TB=CA	DM	\$0
456-106-142	DD Boost for Apps 251-400TB=CA	DM	\$0
456-106-143	DD Boost for Apps 401-600TB=CA	DM	\$0
456-106-144	DD Boost for Apps 601-1000TB=CA	DM	\$0
456-106-145	DD Boost for Apps 1001TB+=CA	DM	\$0
456-106-146	DD Boost App to DPS BU UPG 1-10TB=CA	DM	\$7,260
456-106-147	DD Boost App to DPS BU UPG 11-50TB=CA	DM	\$6,130
456-106-148	DD Boost App to DPS BU UPG 51-150TB=CA	DM	\$4,959
456-106-149	DD Boost App to DPS BU UPG 151-250TB=CA	DM	\$4,652
456-106-150	DD Boost App to DPS BU UPG 251-400TB=CA	DM	\$4,294

456-106-151	DD Boost App to DPS BU UPG 401-600TB=CA	DM	\$3,886
456-106-152	DD Boost App to DPS BU UPG 601-1000TB=CA	DM	\$3,477
456-106-153	DD Boost App to DPS BU UPG 1001TB+=CA	DM	\$3,069
456-106-406	DPS for BU DDBOOST for Apps ENABLER=CA	DM	\$0
456-106-407	DPA ENABLER FOR DDBEA=CA	DM	\$0
456-106-676	DPSAPPS 0-10TB=CC	DM	\$0
456-106-677	DPSAPPS 11-50TB=CC	DM	\$0
456-106-678	DPSAPPS 51-150TB=CC	DM	\$0
456-106-679	DPSAPPS 151-250TB=CC	DM	\$0
456-106-680	DPSAPPS 251-400TB=CC	DM	\$0
456-106-681	DPSAPPS 401-600TB=CC	DM	\$0
456-106-682	DPSAPPS 601-1000TB=CC	DM	\$0
456-106-683	DPSAPPS 1001+TB=CC	DM	\$0
456-106-802	DPA-Enterprise Applications-B=CB	DM	\$200
456-106-803	DPA: Symmetrix/RecoverPoint-B=CB	DM	\$0
456-106-804	DR Basic Metering for RecoverPoint-B=CB	DM	\$0
456-107-278	CloudBoost ENABLER=CA	DM	\$0
456-107-280	DPS for BU DP Search ENABLER=CA	DM	\$0
456-107-330	CloudBoost Client (AV) ENABLER=CA	DM	\$0
456-107-773	Upgrade to DPSAPPS 0-10TB=CC	DM	\$0
456-107-774	Upgrade to DPSAPPS 11-50TB=CC	DM	\$0
456-107-775	Upgrade to DPSAPPS 51-150TB=CC	DM	\$0
456-107-776	Upgrade to DPSAPPS 151-250TB=CC	DM	\$0
456-107-777	Upgrade to DPSAPPS 251-400TB=CC	DM	\$0
456-107-778	Upgrade to DPSAPPS 401-600TB=CC	DM	\$0
456-107-779	Upgrade to DPSAPPS 601-1000TB=CC	DM	\$0
456-107-780	Upgrade to DPSAPPS 1001+TB=CC	DM	\$0
456-107-804	DPS for VMWare RP4VM Enabler=IB	DM	\$0
456-107-988	DD VE PERPETUAL CAP 1TB=CA	DM	\$1,675
456-109-385	DPS Ent Edition 151-250TB=CA	DM	\$8,500
456-109-386	DPS Ent Edition 251-400TB=CA	DM	\$7,900
456-109-387	DPS Ent Edition 401-600TB=CA	DM	\$7,200
456-109-388	DPS Ent Edition 601-999TB=CA	DM	\$6,400
456-109-389	DPS Ent Edition 1PB-1.999PB=CA	DM	\$5,700
456-109-390	DPS Ent Edition 2PB-2.999PB=CA	DM	\$5,000
456-109-391	DPS Ent Edition 4PB+=CA	DM	\$3,500
456-109-392	DPS Ent Edition 1-10TB=CA	DM	\$13,300
456-109-393	DPS Ent Edition 11-50TB=CA	DM	\$11,200
456-109-394	DPS Ent Edition 51-150TB=CA	DM	\$9,100
456-109-396	DPS ENTERPRISE EDITION RP4VM ENABLER=IB	DM	\$0
456-109-422	LICENSE DD OE PER TB MID CAPACITY ACT=CB	DM	\$1,450
456-109-564	DPS Upg Ent Edition 1-10TB=CA	DM	\$1,200
456-109-565	DPS Upg Ent Edition 11-50TB=CA	DM	\$1,000
456-109-566	DPS Upg Ent Edition 51-150TB=CA	DM	\$850
456-109-567	DPS Upg Ent Edition 151-250TB=CA	DM	\$750
456-109-568	DPS Upg Ent Edition 251-400TB=CA	DM	\$750
456-109-569	DPS Upg Ent Edition 401-600TB=CA	DM	\$700
456-109-570	DPS Upg Ent Edition 601-999TB=CA	DM	\$600
456-109-571	DPS Upg Ent Edition 1PB+=CA	DM	\$550
456-109-622	LICENSE BASE DD OE DD2500-21=IA	DM	\$15,000

456-109-623	LICENSE BASE DD OE DD2500-36=IA	DM	\$15,000
456-109-624	LIC BOOST,DD2500=IA	DM	\$4,000
456-109-625	LICENSE,ENCRYPTION,DD2500=IA	DM	\$4,000
456-109-626	LIC REPLICATOR,DD2500=IA	DM	\$5,000
456-109-627	LICENSE,RETENTION LOCK COMPL,DD2500=IA	DM	\$4,000
456-109-628	LICENSE,RETENTION LOCK GOV,DD2500=IA	DM	\$4,000
456-109-629	LIC VTL,OPEN SYSTEMS,DD2500=IA	DM	\$4,000
456-109-630	LIC VTL,NDMP TAPE SERVER,ETH,DD2500=IA	DM	\$4,000
456-109-631	LIC VTL,IBM IOS,DD2500=IA	DM	\$6,000
456-109-632	LICENSE,DD2500 EXP CAP,ABOVE 66TB=IA	DM	\$0
456-109-634	UPG BOOST,2500=IA	DM	\$4,000
456-109-635	LICENSE,ENCRYPTION,2500,UPGRADE=IA	DM	\$4,000
456-109-636	LIC REPLICATOR, 2500,UPGRADE=IA	DM	\$5,000
456-109-637	LIC,RETENTION LOCK COMPL ,DD2500,UPG=IA	DM	\$4,000
456-109-638	LIC,RETENTION LOCK GOV ,DD2500,UPG=IA	DM	\$4,000
456-109-639	LIC,VTL,OPEN SYSTEMS,DD2500,UPG=IA	DM	\$4,000
456-109-640	LIC,VTL,NDMP TAPE SVR,ETH,DD2500,UPG=IA	DM	\$4,000
456-109-641	LIC,VTL,IBM IOS,DD2500,UPG=IA	DM	\$6,000
456-109-642	LIC VTL,OPEN SYS TO IBM IOS,2500=IA	DM	\$2,000
456-109-643	LICENSE,EXPSTOR,2500,UPG=IA	DM	\$0
456-109-644	LICENSE BASE DD OE DD4200=IA	DM	\$15,000
456-109-645	LIC BOOST,DD4200=IA	DM	\$9,000
456-109-646	LICENSE,ENCRYPTION,DD4200=IA	DM	\$9,000
456-109-647	LICENSE,EXTD RETN SW OPT;DD4200=IA	DM	\$0
456-109-648	LIC REPLICATOR,DD4200=IA	DM	\$10,000
456-109-649	LICENSE,RETENTION LOCK COMPL,DD4200=IA	DM	\$7,000
456-109-650	LICENSE,RETENTION LOCK GOV,DD4200=IA	DM	\$7,000
456-109-651	LIC VTL,OPEN SYSTEMS,DD4200=IA	DM	\$9,000
456-109-652	LIC VTL,NDMP TAPE SERVER,ETH,DD4200=IA	DM	\$9,000
456-109-653	LIC VTL,IBM IOS,DD4200=IA	DM	\$13,500
456-109-654	LICENSE,EXP CAP,DD4200,ABOVE 120TB=IA	DM	\$20,000
456-109-656	UPG BOOST,DD4200=IA	DM	\$9,000
456-109-657	LICENSE,ENCRYPTION,DD4200,UPGRADE=IA	DM	\$9,000
456-109-658	LICENSE;ER SW OPT;DD4200,UPGRADE=IA	DM	\$0
456-109-659	LIC REPLICATOR DD4200,UPGRADE=IA	DM	\$10,000
456-109-660	LIC,RETENTION LOCK COMPL ,DD4200,UPG=IA	DM	\$7,000
456-109-661	LIC,RETENTION LOCK GOV ,DD4200,UPG=IA	DM	\$7,000
456-109-662	LIC,VTL,OPEN SYSTEMS,DD4200,UPG=IA	DM	\$9,000
456-109-663	LIC,VTL,NDMP TAPE SVR,ETH,DD4200,UPG=IA	DM	\$9,000
456-109-664	LIC,VTL,IBM IOS,DD4200,UPG=IA	DM	\$13,500
456-109-665	LIC,VTL,OPEN SYS TO IBM IOS,DD4200=IA	DM	\$4,500
456-109-666	LICENSE,EXPCAP,DD4200,ABOVE 120TB,UPG=IA	DM	\$20,000
456-109-667	LICENSE BASE DD OE DD4500=IA	DM	\$15,000
456-109-668	LIC BOOST,DD4500=IA	DM	\$19,000
456-109-669	LICENSE,ENCRYPTION,DD4500=IA	DM	\$19,000
456-109-670	LICENSE;EXTD RETN SW OPT;DD4500=IA	DM	\$0
456-109-671	LIC REPLICATOR,DD4500=IA	DM	\$30,000
456-109-672	LICENSE,RETENTION LOCK COMPL,DD4500=IA	DM	\$20,400
456-109-673	LICENSE,RETENTION LOCK GOV,DD4500=IA	DM	\$20,400
456-109-674	LIC VTL,OPEN SYSTEMS,DD4500=IA	DM	\$19,000

456-109-675	LIC VTL,NDMP TAPE SERVER,ETH,DD4500=IA	DM	\$19,000
456-109-676	LIC VTL,IBM IOS,DD4500=IA	DM	\$28,500
456-109-677	LICENSE,EXP CAP,DD4500,ABOVE 180TB=IA	DM	\$30,000
456-109-679	UPG BOOST,DD4500=IA	DM	\$19,000
456-109-680	LICENSE,ENCRYPTION,DD4500,UPGRADE=IA	DM	\$19,000
456-109-681	LICENSE;ER SW OPT;DD4500;UPGRADE=IA	DM	\$0
456-109-682	LIC REPLICATOR, DD4500,UPGRADE=IA	DM	\$30,000
456-109-683	LIC,RETENTION LOCK COMPL ,DD4500,UPG=IA	DM	\$20,400
456-109-684	LIC,RETENTION LOCK GOV ,DD4500,UPG=IA	DM	\$20,400
456-109-685	LIC,VTL,OPEN SYSTEMS,DD4500,UPG=IA	DM	\$19,000
456-109-686	LIC,VTL,NDMP TAPE SVR,ETH,DD4500,UPG=IA	DM	\$19,000
456-109-687	LIC,VTL,IBM IOS,DD4500,UPG=IA	DM	\$28,500
456-109-688	LIC,VTL,OPEN SYS TO IBM IOS,DD4500=IA	DM	\$9,500
456-109-689	LICENSE,EXPCAP,DD4500,ABOVE 180TB,UPG=IA	DM	\$30,000
456-109-723	NW 9+DPS CAP ENABLER=CA	DM	\$0
456-109-801	Enterprise Copy Data Management BASE=CA	DM	\$0
456-109-839	UPG BOOST;DD620=IA	DM	\$0
456-109-840	LICENSE;ENCRYPTION;DD620;UPGRADE=IA	DM	\$0
456-109-841	LIC REPLICATOR DD620,UPGRADE=IA	DM	\$0
456-109-842	LIC;RETENTION LOCK COMPL; DD620;UPG=IA	DM	\$0
456-109-843	LIC;RETENTION LOCK GOV; DD620;UPG=IA	DM	\$0
456-109-844	LIC;VTL;620INCL:1XPCIE CARD;DP;4G;UPG=IA	DM	\$0
456-109-845	LIC;VTL;NDMP TAPE SVR;ETH;DD620;UPG=IA	DM	\$0
456-109-846	LIC;VTL;IBM I/OS;FC;DD620;1XDP;4G;UPG=IA	DM	\$0
456-109-847	LIC;VTL;OPEN SYS TO IBM I/OS;DD620=IA	DM	\$0
456-109-848	UPGRADE;DD620;INCL LICENSE;5 HDD(5TB)=IA	DM	\$0
456-109-862	UPG BOOST;DD640=IA	DM	\$0
456-109-863	LICENSE;ENCRYPTION;DD640;UPGRADE=IA	DM	\$0
456-109-864	LIC REPLICATOR DD640,UPGRADE=IA	DM	\$0
456-109-865	LIC;RETENTION LOCK COMPL; DD640;UPG=IA	DM	\$0
456-109-866	LIC;RETENTION LOCK GOV; DD640;UPG=IA	DM	\$0
456-109-867	LIC;VTL;640INCL 1XPCIE CARD;DP;8G;UPG=IA	DM	\$0
456-109-868	LIC;VTL;640INCL 2XPCIE CARD;DP;8G;UPG=IA	DM	\$0
456-109-869	LIC;VTL;OPEN SYS TO IBM I/OS;DD640=IA	DM	\$0
456-109-870	LICENSE;EXPSTOR;DD640;UPGRADE=IA	DM	\$0
456-109-874	UPGRADE; LICENSE; ENCRYPTION; DD670=IA	DM	\$0
456-109-875	LIC REPLICATOR DD670,UPGRADE=IA	DM	\$0
456-109-877	LIC;RETENTION LOCK GOV; DD670;UPG=IA	DM	\$0
456-109-878	LIC;VTL;IBM I/OS;FC;DD670;1XDP;8G;UPG=IA	DM	\$0
456-109-879	LIC;VTL;IBM I/OS;FC;DD670;2XDP;8G;UPG=IA	DM	\$0
456-109-880	LIC;VTL;OPEN SYS TO IBM I/OS;DD670=IA	DM	\$0
456-109-974	DPS for VMware 2TB AVE Enabler=CA	DM	\$0
456-110-080	AVAMAR E DPS BACKUP ENABLER=IA	DM	\$0
456-110-128	DPSAPPS RP ENABLER BASE=CA	DM	\$0
456-110-129	DPSAPPS RP ENABLER UPG=CA	DM	\$0
456-110-330	DDBEA 1-10TB only w/ DD in same cart=CA	DM	\$3,872
456-110-331	Upgrade to DPSAPPS 0-10TB=CC	DM	\$0
456-110-332	Upgrade to DPSAPPS 11-50TB=CC	DM	\$0
456-110-333	Upgrade to DPSAPPS 51-150TB=CC	DM	\$0
456-110-334	Upgrade to DPSAPPS 151-250TB=CC	DM	\$0

456-110-335	Upgrade to DPSAPPS 251-400TB=CC	DM	\$0
456-110-336	Upgrade to DPSAPPS 401-600TB=CC	DM	\$0
456-110-337	Upgrade to DPSAPPS 601-1000TB=CC	DM	\$0
456-110-338	Upgrade to DPSAPPS 1001+TB=CC	DM	\$0
456-110-503	AVAMAR F DPS BACKUP ENABLER=IA	DM	\$0
456-110-556	CloudBoost v2 VM 2TB for DPS ENABLER=CA	DM	\$0
456-110-557	CloudBoost v2 Client for DPS ENABLER=CA	DM	\$0
456-110-793	SRM ATMOS 1TB =CB	DM	\$0
456-110-832	DPS for VMWare Sockets=IA	DM	\$2,100
456-110-833	DPS for VMWare AVAMAR ENABLER=CA	DM	\$0
456-110-834	DPS for VMWare DPA ENABLER-C=CB	DM	\$0
456-110-835	DPS for VMWare DPSearch ENABLER=CA	DM	\$0
456-111-206	LIC;CLD TIER DDVE SW CAP;1TB=CC	DM	\$500
456-111-207	LIC;CLD TIER; 1TB MID;SW CAP=CC	DM	\$500
456-111-235	DPS for VMware Avamar F Enabler=IA	DM	\$0
456-111-237	Hadoop Application Agent=CA	DM	\$0
456-111-273	APPSYNC 3.0 ULTD DPS ENT ED ENABLER=CB	DM	\$0
456-111-301	LIC DLM 7200 Enabler =IA	DM	\$50,000
456-111-304	DPS Ent Edition 3PB-3.999PB=CA	DM	\$4,200
456-111-332	Upgrade to DPS for APPS=CC	DM	\$0
456-111-350	DPS APPS to Ent Edition UPG 1-10TB=CA	DM	\$8,460
456-111-351	DPS APPS to Ent Edition UPG 11-50TB=CA	DM	\$7,130
456-111-352	DPS APPS to Ent Edition UPG 51-150TB=CA	DM	\$5,809
456-111-353	DPS APPS to Ent Edition UPG 151-250TB=CA	DM	\$5,402
456-111-354	DPS APPS to Ent Edition UPG 251-400TB=CA	DM	\$5,044
456-111-355	DPS APPS to Ent Edition UPG 401-600TB=CA	DM	\$4,586
456-111-356	DPS APPS to Ent Edition UPG 601-999TB=CA	DM	\$4,077
456-111-357	DPS APPS to Ent Edition UPG 1PB+=CA	DM	\$3,619
456-111-358	LIC DD ENABLER DBEA PROTECTPOINT=IA	DM	\$0
456-111-901	DLm2100 VTE OS Single Channel=IE	DM	\$13,200
456-111-902	DLm2100 VTE OS Two Channel=IE	DM	\$26,400
456-112-106	DLm GDDR Tape=IF	DM	\$87,000
456-112-170	Microsoft Application Agent=CA	DM	\$0
456-112-171	Database Application Agent=CA	DM	\$0
456-112-172	File System Agent=CA	DM	\$0
456-112-183	AVAMAR G DPS Backup Enabler=IA	DM	\$0
456-112-186	DPS for APPS 0-10TB=CC	DM	\$4,840
456-112-187	DPS for APPS 11-50TB=CC	DM	\$4,070
456-112-188	DPS for APPS 51-150TB=CC	DM	\$3,291
456-112-189	DPS for APPS 151-250TB=CC	DM	\$3,098
456-112-190	DPS for APPS 251-400TB=CC	DM	\$2,856
456-112-191	DPS for APPS 401-600TB=CC	DM	\$2,614
456-112-192	DPS for APPS 601-1000TB=CC	DM	\$2,323
456-112-193	DPS for APPS 1001+TB=CC	DM	\$2,081
456-112-195	AVAMAR G DPS Backup Enabler=IA	DM	\$0
456-112-196	NW 9.1 DPS CAP ENABLER=CA	DM	\$0
456-112-408	DPA Single Fed Reporting Server=IA	DM	\$0
456-112-494	DPS4VM VDP Promotion=IA	DM	\$2,100
456-112-957	AVAMAR H DPS Backup Enabler=IA	DM	\$0
456-112-958	DPS for VMware Avamar H Enabler=IA	DM	\$0

456-112-959	DPS for VMware 2TB AVE H Enabler=CA	DM	\$0
456-113-086	NW 9.2+ DPS Cap Enabler=CA	DM	\$0
456-113-089	Oracle RMAN agent=CA	DM	\$0
456-113-090	Oracle RMAN agent 10G_RESTRICTED=CA	DM	\$0
456-113-291	CloudBoost AWS DPS Enabler=CA	DM	\$0
456-113-605	CloudBoost Azure DPS Enabler=CA	DM	\$0
456-113-606	ProtectPoint PowerMax Enabler=CA	DM	\$0
456-113-618	DD BoostFS Enabler=CA	DM	\$0
457-101-601	DPSAPPS BASE NEW 100K=IC	DM	\$0
457-101-602	DPSAPPS BASE NEW 200K=IC	DM	\$0
457-101-603	DPSAPPS BASE NEW 400K=IC	DM	\$0
457-101-604	DPSAPPS CAP UPG 100K=IC	DM	\$0
457-101-605	DPSAPPS CAP UPG 200K=IC	DM	\$0
457-101-606	DPSAPPS CAP UPG 400K=IC	DM	\$0
458-000-167	SRM for ATMOS	DM	\$0
458-000-325	DATA PROTECTION ADVISOR 6.1 PRODUCT	DM	\$0
458-000-588	DATA PROTECTION ADVISOR 6.2 PRODUCT	DM	\$0
458-000-837	DPA ENABLER PRODUCT	DM	\$0
458-000-846	VMAX3 DPSAPPS PRODUCT	DM	\$0
458-000-880	DD Boost for Apps	DM	\$0
458-000-952	DPSAPPS CAPACITY	DM	\$0
458-000-953	DPSAPPS CAPACITY UPGRADE	DM	\$0
458-000-959	DPSAPPS CAPACITY	DM	\$0
458-000-960	DPSAPPS CAPACITY UPGRADE	DM	\$0
458-001-156	DPSAPPS RP ENABLER	DM	\$0
458-001-162	DPSAPPS RP ENABLER	DM	\$0
458-001-191	CLOUDBOOST CONNECTORS	DM	\$0
458-001-192	DPS for VMWARE	DM	\$0
458-001-329	DPS ENTERPRISE EDITION	DM	\$0
458-001-403	DD2500 OPERATING ENVIRONMENT SOFTWARE	DM	\$0
458-001-404	DD2500 OE APPLICATION SOFTWARE	DM	\$0
458-001-405	DD2500 OE APPLICATION SOFTWARE UPGRADE	DM	\$0
458-001-406	DD4200 OPERATING ENVIRONMENT SOFTWARE	DM	\$0
458-001-407	DD4200 OE APPLICATION SOFTWARE	DM	\$0
458-001-408	DD4200 OE APPLICATION SOFTWARE UPGRADE	DM	\$0
458-001-409	DD4500 OPERATING ENVIRONMENT SOFTWARE	DM	\$0
458-001-410	DD4500 OE APPLICATION SOFTWARE	DM	\$0
458-001-411	DD4500 OE APPLICATION SOFTWARE UPGRADE	DM	\$0
458-001-432	DD620 OE APPLICATION SOFTWARE UPGRADE	DM	\$0
458-001-434	DD640 OE APPLICATION SOFTWARE UPGRADE	DM	\$0
458-001-435	DD670 OE APPLICATION SOFTWARE UPGRADE	DM	\$0
458-001-675	DPS for APPS PRODUCT CAPACITY UPGRADE	DM	\$0
458-001-697	Hadoop Application Agent	DM	\$0
458-001-707	DPS APPS to Ent Edition UPG	DM	\$0
458-001-729	DD ER TO ACT RAW SHELF CAPACITY LICENSE	DM	\$0
458-001-811	DPA ENABLER PRODUCT	DM	\$0
458-001-812	DPS for APPS PRODUCT CAPACITY UPGRADE	DM	\$0
458-001-813	DPS for APPS PRODUCT CAPACITY	DM	\$0
458-001-814	ProtectPoint for VMAX ENABLER	DM	\$0
458-001-816	COPY DATA MANAGEMENT	DM	\$0

458-002-008	DPS for Apps Software	DM	\$0
458-002-060	DPA Single Federated Reporting Server	DM	\$0
458-002-062	DPS4VM VDP Promotion	DM	\$0
458-002-122	DPS for APPS PRODUCT CAPACITY	DM	\$0
458-002-180	DD2500 OE Application Software Upgrade	DM	\$0
458-002-181	DD4200 OE Application Software Upgrade	DM	\$0
458-002-182	DD4500 OE Application Software Upgrade	DM	\$0
458-002-386	Data Protection Central MID=CA	DM	\$0
458-002-441	Data Protection Suite for Backup	DM	\$0
458-002-483	EMC Granular Recovery Microsoft MID=CA	DM	\$0
A-ACE-C-1TB	ATMOS CE CAPACITY PER TB	DM	\$0
A-ACE-L-RTU	ATMOS CE RIGHT TO USE LIC	DM	\$0
A-ACE-ULE-1TB	ATMOS LE TO CE UPGRADE PER TB	DM	\$0
A-ALE-C-1TB	ATMOS LE CAPACITY PER TB	DM	\$0
A-ALE-L-RTU	ATMOS LE RIGHT TO USE LIC	DM	\$0
A-AOS-C-1TB	ATMOS OS CAPACITY PER TB	DM	\$0
A-AVE-C-1TB	ATMOS VE CAPACITY PER TB	DM	\$0
A-AVE-L-ENTL	ATMOS VE ENTITLEMENT KEY	DM	\$0
A-CDP-C-1TB	ATMOS CDP CAPACITY PER TB	DM	\$0
A-CDP-L-ENTL	ATMOS CDP ENTITLEMENT KEY	DM	\$0
CDP-SW-B-T00	ATMOS CDP CAP 1TB (101-500TB)	DM	\$0
CDP-SW-B-T01	ATMOS CDP CAP 1TB (501-1500TB)	DM	\$0
CDP-SW-B-T02	ATMOS CDP CAP 1TB (1501-4500TB)	DM	\$0
CDP-SW-B-T03	ATMOS CDP CAP 1TB (4501-9500TB)	DM	\$0
CDP-SW-B-T04	ATMOS CDP CAP 1TB (9500TB+)	DM	\$0
CDP-SW-SOL-S	ATMOS CDP BASE & CAP 100TB	DM	\$0
COS-SW-B-SOL	ATMOS SW BASE & CAP 500TB	DM	\$0
COS-SW-C-T01	ATMOS SW CAP 1TB (501-1500TB)	DM	\$0
COS-SW-C-T02	ATMOS SW CAP 1TB (1501-4500TB)	DM	\$0
COS-SW-C-T03	ATMOS SW CAP 1TB (4501-9500TB)	DM	\$0
COS-SW-C-T04	ATMOS SW CAP 1TB (9500TB+)	DM	\$0
COS-SW-ENTL	ATMOS SW LICENSE KEY	DM	\$0
COS-SW-SOL	ATMOS SW BASE 1TB (1-500TB)	DM	\$0
DDOS-DOCDL4	DOCS DD OS DOC DL4 = IA	DM	\$0
DLM1010-LIC	DLM1000 WITH 1 FICON VTEOS LICENSE	DM	\$13,200
DLM1020-LIC	DLM1000 WITH 2 FICON VTEOS LICENSE	DM	\$26,400
DLM2K-REPL	DLM2000 VNX REPLICATOR LICENSE	DM	\$0
DLM2K-REPL-CF	DLM2000 VNX REPLICATOR LICENSE	DM	\$10,000
DLM2K-VNX-L	DLM2000 VNX5300 USAGE LICENSE	DM	\$0
DLM2K-VNX-L-CF	DLM2000 VNX5300 USAGE LICENSE	DM	\$7,838
DLM2K-VTEOS	DLM2000 VTE OPERATING SYSTEM LICENSE	DM	\$48,750
DLM4-2KVTEOS	DLm2100 - VTE Operating System license	DM	\$0
DLM42KVTEOS1	DLM2100 - VTE DD OS LICENSE 1 CHANNEL	DM	\$0
DLM42KVTEOS1-CF	DLM2100 - VTE DD OS LICENSE 1 CHANNEL	DM	\$13,200
DLM42KVTEOS2	DLM2100 - VTE DD OS LICENSE 2 CHANNEL	DM	\$0
DLM42KVTEOS2-CF	DLM2100 - VTE DD OS LICENSE 2 CHANNEL	DM	\$26,400
DLM4-2KVTEOS-CF	DLM2100 - VTE OPERATING SYSTEM LICENSE	DM	\$47,500
DLM4-2KVTEOSU	DLm2100 - VTE OS license Upgrade	DM	\$0
DLM4-2KVTEOSU-CF	DLM2100 - VTE OS LICENSE UPGRADE	DM	\$47,500
DLM4-8KXVTEOS	DLM8100 VMAX - VTE OS LICENSE =ID	DM	\$0

DLM4-8KXVTEOS-CF	DLM8100 VMAX - VTE OS LICENSE =ID	DM	\$195,000
DLM48KXVTEOSU	DLM8100 VMAX - VTE OS LICENSE UPGRADE=ID	DM	\$0
DLM48KXVTEOSU-CF	DLM8100 VMAX - VTE OS LICENSE UPGRADE=ID	DM	\$195,000
DLM-5400-REPL	DLm VNX5400 Replicator License =MA	DM	\$0
DLM-5400-REPL-CF	DLM VNX5400 REPLICATOR LICENSE =MA	DM	\$15,313
DLM-5400-REPU	DLm VNX5400 Replicator Upg License =MA	DM	\$0
DLM-5400-REPU-CF	DLM VNX5400 REPLICATOR UPG LICENSE =MA	DM	\$15,313
DLM-7600-REPL	DLm VNX7600 Replicator License =MA	DM	\$0
DLM-7600-REPL-CF	DLM VNX7600 REPLICATOR LICENSE =MA	DM	\$67,051
DLM-7600REPU	DLm VNX7600 Replicator Upg License =MA	DM	\$0
DLM-7600REPU-CF	DLM VNX7600 REPLICATOR UPG LICENSE =MA	DM	\$67,051
DLM8K-UNIFVG8	DLm8000 Unisphere Software License	DM	\$0
DLM8K-UNIFVG8-CF	DLM8000 UNISPHERE SOFTWARE LICENSE	DM	\$20,000
DLM8K-VG8ADVL	DLm8000 VG8 Advanced Protocol License	DM	\$0
DLM8K-VG8ADVL-CF	DLM8000 VG8 ADVANCED PROTOCOL LICENSE	DM	\$30,000
DLM8K-VG8BASL	DLm8000 VG8 Base Protocol License	DM	\$0
DLM8K-VG8SDCD	DLm8000 VG8 Symm (VMAX) Support	DM	\$0
DLM-FSTVP5400	DLm Fast VP for VNX5400 License =MA	DM	\$0
DLM-FSTVP5400-CF	DLM FAST VP FOR VNX5400 LICENSE =MA	DM	\$8,543
DLM-FSTVP7600	DLm Fast VP for VNX7600 License =MA	DM	\$0
DLM-FSTVP7600-CF	DLM FAST VP FOR VNX7600 LICENSE =MA	DM	\$21,358
DLM-V54CAPTBL	DLm VNX5400 Storage Cap License =CB	DM	\$0
DLM-V54CAPTBL-CF	DLM VNX5400 STORAGE CAP LICENSE=CB	DM	\$400
DLM-V54CAPTBU	DLm VNX5400 Storage Cap Upg License =CB	DM	\$0
DLM-V54CAPTBU-CF	DLM VNX5400 STORAGE CAP UPG LICENSE=CB	DM	\$400
DLM-V76CAPTBL	DLm VNX7600 Storage Cap License =CB	DM	\$0
DLM-V76CAPTBL-CF	DLM VNX7600 STORAGE CAP LICENSE=CB	DM	\$400
DLM-V76CAPTBU	DLm VNX7600 Storage Cap Upg License =CB	DM	\$0
DLM-V76CAPTBU-CF	DLM VNX7600 STORAGE CAP UPG LICENSE=CB	DM	\$400
DLM-VNX5400L	DLm VNX5400 Usage License =MA	DM	\$0
DLM-VNX5400L-CF	DLM VNX5400 USAGE LICENSE =MA	DM	\$10,744
DLM-VNX7600L	DLm VNX7600 Usage License =MA	DM	\$0
DLM-VNX7600L-CF	DLM VNX7600 USAGE LICENSE =MA	DM	\$89,567
DLM-VNX7600LU	DLm VNX7600 Usage Upg License =MA	DM	\$0
DLM-VNX7600LU-CF	DLM VNX7600 USAGE UPG LICENSE =MA	DM	\$89,567
L-640-XCAP	LICENSE;EXPSTOR;DD640	DM	\$0
L-640XCAP-B	LICENSE;EXPSTOR;DD640	DM	\$0
L-BLCK-2200	BLOCK SERVICE DPSAPPS DD2200=IA	DM	\$0
L-BLCK-2500	BLOCK SERVICE DPSAPPS DD2500=IA	DM	\$0
L-BLCK-4200	BLOCK SERVICE DPSAPPS DD4200=IA	DM	\$0
L-BLCK-4500	BLOCK SERVICE DPSAPPS DD4500=IA	DM	\$0
L-BLCK-7200	BLOCK SERVICE DPSAPPS DD7200=IA	DM	\$0
L-BLCK-9500	LIC BLOCK SVCS DPSAPPS 9500=IA	DM	\$0
L-BLCK-990	BLOCK SERVICE DPSAPPS DD990=IA	DM	\$0
L-BST-2500	LICENSE,BOOST,DD2500	DM	\$4,000
L-BST-4200	LICENSE,BOOST,DD4200	DM	\$9,000
L-BST-4500	LICENSE,BOOST,DD4500	DM	\$19,000
L-BST-620	LICENSE; BOOST; DD620	DM	\$1,500
L-BST-640	LICENSE;BOOST;DD640	DM	\$0
L-BST-660	LICENSE; BOOST; DD660	DM	\$0

L-BST-670	LICENSE; BOOST; DD670	DM	\$0
L-DDOE-DD2500-21	LICENSE BASE DD OE DD2500-21=IA	DM	\$15,000
L-DDOE-DD2500-36	LICENSE BASE DD OE DD2500-36=IA	DM	\$15,000
L-DDOE-DD4200	LICENSE BASE DD OE DD4200=IA	DM	\$15,000
L-DDOE-DD4500	LICENSE BASE DD OE DD4500=IA	DM	\$15,000
L-DDOE-MCAP-ACT	LICENSE DD OE PER TB MID CAPACITY ACT=CB	DM	\$1,450
L-DDOE-MCAP-ACT-N	LICENSE DD OE PER TB MID CAPACITY ACT=CB	DM	\$1,450
L-ENC-2500	LICENSE, ENCRYPTION, DD2500	DM	\$4,000
L-ENC-4200	LICENSE, ENCRYPTION, DD4200	DM	\$9,000
L-ENC-4500	LICENSE, ENCRYPTION, DD4500	DM	\$19,000
L-ENC-620	LICENSE; ENCRYPTION; DD620	DM	\$1,500
L-ENC-640	LICENSE; ENCRYPTION; DD640	DM	\$0
L-ENC-660	LICENSE; ENCRYPTION; DD660	DM	\$0
L-ENC-670	LICENSE; ENCRYPTION; DD670	DM	\$0
L-ER-4200	LICENSE, EXTENDED RETENTION SW OPT, DD42	DM	\$0
L-ER-4500	LICENSE, EXTENDED RETENTION SW OPT, DD45	DM	\$0
L-OST-565	LICENSE; OPENSTORAGE (OST); DD565	DM	\$0
L-OST-660	LICENSE; OPENSTORAGE (OST); DD660	DM	\$0
L-REP-2500	LICENSE, REPLICATOR, DD2500	DM	\$5,000
L-REP-4200	LICENSE, REPLICATOR, DD4200	DM	\$10,000
L-REP-4500	LICENSE, REPLICATOR, DD4500	DM	\$30,000
L-REP-565	LICENSE; REPLICATOR; DD565	DM	\$0
L-REP-620	LICENSE; REPLICATOR; DD620	DM	\$2,540
L-REP-640	LICENSE; REPLICATOR; DD640	DM	\$0
L-REP-660	LICENSE; REPLICATOR; DD660	DM	\$0
L-REP-670	LICENSE; REPLICATOR; DD670	DM	\$0
L-RL-565	LICENSE; RETENTION LOCK; DD565	DM	\$0
L-RL-620	LIC; RETENTION LOCK GOV EDITION; DD620	DM	\$1,500
L-RL-640	LIC; RETENTION LOCK GOV EDITION; DD640	DM	\$0
L-RL-660	LIC; RETENTION LOCK GOV EDITION; DD660	DM	\$0
L-RL-670	LIC; RETENTION LOCK GOV EDITION; DD670	DM	\$0
L-RLC-2500	LICENSE, RETENTION LOCK COMPLIANCE, DD25	DM	\$4,000
L-RLC-4200	LICENSE, RETENTION LOCK COMPLIANCE, DD42	DM	\$7,000
L-RLC-4500	LICENSE, RETENTION LOCK COMPLIANCE, DD45	DM	\$20,400
L-RLC-620	LIC; RETENTION LOCK COMPL EDITN; DD620	DM	\$1,500
L-RLC-640	LIC; RETENTION LOCK COMPL EDITN; DD640	DM	\$0
L-RLC-670	LIC; RETENTION LOCK COMPL EDITN; DD670	DM	\$0
L-RLG-2500	LICENSE, RETENTION LOCK GOVERNANCE, DD250	DM	\$4,000
L-RLG-4200	LICENSE, RETENTION LOCK GOVERNANCE, DD420	DM	\$7,000
L-RLG-4500	LICENSE, RETENTION LOCK GOVERNANCE, DD450	DM	\$20,400
L-VTL-2500	LICENSE, VTL, OPEN SYSTEMS, DD2500	DM	\$4,000
L-VTL-2500E	LICENSE, VTL, NDMP TAPE SERVER, ETH, DD2500	DM	\$4,000
L-VTL-2500F	LICENSE, VTL, IBM IOS, DD2500	DM	\$6,000
L-VTL-4200	LICENSE, VTL, OPEN SYSTEMS, DD4200	DM	\$9,000
L-VTL-4200E	LICENSE, VTL, NDMP TAPE SERVER, ETH, DD4200	DM	\$9,000
L-VTL-4200F	LICENSE, VTL, IBM IOS, DD4200	DM	\$13,500
L-VTL-4500	LICENSE, VTL, OPEN SYSTEMS, DD4500	DM	\$19,000
L-VTL-4500E	LICENSE, VTL, NDMP TAPE SERVER, ETH, DD4500	DM	\$19,000
L-VTL-4500F	LICENSE, VTL, IBM IOS, DD4500	DM	\$28,500
L-VTL-565-1	LIC; VTL; 565. INCL: 1XPCIE CARD; DP; 4G	DM	\$0

L-VTL-565-2	LIC;VTL;565. INCL:2XPCIE CARD;DP;4G	DM	\$0
L-VTL-620-1	LIC;VTL;620. INCL:1XPCIE CARD;DP;4G	DM	\$6,000
L-VTL620-E	LIC;VTL;NDMP TAPE SVR;ETH;DD620	DM	\$1,500
L-VTL620-F1	LIC;VTL;IBM I/OS;FC;DD620;1XPCIE;DP;4G	DM	\$6,750
L-VTL-640-1	LIC;VTL;640; INCL 1XPCIE CARD;DP;8G	DM	\$0
L-VTL-640-2	LIC;VTL;640; INCL 2XPCIE CARD;DP;8G	DM	\$0
L-VTL640-E	LIC;VTL;NDMP TAPE SVR;ETH;DD640	DM	\$0
L-VTL640-F1	LIC;VTL;IBM I/OS;FC;DD640;1XPCIE;DP;8G	DM	\$0
L-VTL640-F2	LIC;VTL;IBM I/OS;FC;DD640;2XPCIE;DP;8G	DM	\$0
L-VTL-660-1	LIC;VTL;660. INCL:1XPCIE CARD;DP;4G	DM	\$0
L-VTL-660-2	LIC;VTL;660. INCL:2XPCIE CARD;DP;4G	DM	\$0
L-VTL-670-1	LIC;VTL;670; INCL 1XPCIE CARD;DP;8G	DM	\$0
L-VTL-670-2	LIC;VTL;670; INCL 2XPCIE CARD;DP;8G	DM	\$0
L-VTL670-E	LIC;VTL;NDMP TAPE SVR;ETH;DD670	DM	\$0
L-VTL670-F1	LIC;VTL;IBM I/OS;FC;DD670;1XPCIE;DP;8G	DM	\$0
L-VTL670-F2	LIC;VTL;IBM I/OS;FC;DD670;2XPCIE;DP;8G	DM	\$0
L-XCAP2500	LICENSE,DD2500 EXP CAP,MORE THAN 66TB	DM	\$0
L-XCAP2500-B	LICENSE,DD2500 EXP CAP,MORE THAN 66TB	DM	\$0
L-XCAP4200	LICENSE,EXP CAP,DD4200,MORE THAN 120TB	DM	\$20,000
L-XCAP4200-B	LICENSE,EXP CAP,DD4200,MORE THAN 120TB	DM	\$0
L-XCAP4500	LICENSE,EXP CAP,DD4500,MORE THAN 180TB	DM	\$30,000
L-XCAP4500-B	LICENSE,EXP CAP,DD4500,MORE THAN 180TB	DM	\$0
MDL-1000-LIC	MDL-1000 FOR DD SOFTWARE LICENSE	DM	\$0
MDL-2000-LIC	MDL-2000 FOR DD SOFTWARE LICENSE	DM	\$0
MDL-VIR-BKUP	MDL-2000/1000/100 VIRTUENT BACKUP	DM	\$0
MDL-VIR-REPL	MDL-2000/1000/100 VIRTUENT REPLICATOR	DM	\$0
OMSA-TOOL-SET	GPLV3 DELL OMSA TOOLSET VARIOUS PRODU	DM	\$0
SAMBA GPLV3	SAMBA GPLV3 TOOLSET VARIOUS PRODUCTS	DM	\$0
SU-458-000-296	DPS Backup 12Mo Sub Tier 1=CC	DM	\$625
SU-458-000-334	DPS VMWare 12Mo Sub=IA	DM	\$108
SU-458-000-581	DPS Backup 12Mo Sub Tier 4=CC	DM	\$400
SU-458-000-582	DPS Backup 12Mo Sub Tier 5=CC	DM	\$369
SU-458-000-583	DPS Backup 12Mo Sub Tier 6=CC	DM	\$336
SU-458-000-584	DPS Backup 12Mo Sub Tier 7=CC	DM	\$300
SU-458-000-585	DPS Backup 12Mo Sub Tier 8=CC	DM	\$266
SU-458-000-586	DPS Backup 36Mo+ PP Sub Tier 1=CC	DM	\$511
SU-458-000-587	DPS Backup 36Mo+ PP Sub Tier 2=CC	DM	\$431
SU-458-000-588	DPS Backup 36Mo+ PP Sub Tier 3=CC	DM	\$349
SU-458-000-589	DPS Backup 36Mo+ PP Sub Tier 4=CC	DM	\$327
SU-458-000-590	DPS Backup 36Mo+ PP Sub Tier 5=CC	DM	\$302
SU-458-000-591	DPS Backup 36Mo+ PP Sub Tier 6=CC	DM	\$275
SU-458-000-592	DPS Backup 36Mo+ PP Sub Tier 7=CC	DM	\$245
SU-458-000-593	DPS Backup 36Mo+ PP Sub Tier 8=CC	DM	\$218
SU-458-000-594	DPS Backup 36Mo+AIP Sub Tier 1=CC	DM	\$568
SU-458-000-595	DPS Backup 36Mo+AIP Sub Tier 2=CC	DM	\$479
SU-458-000-596	DPS Backup 36Mo+AIP Sub Tier 3=CC	DM	\$387
SU-458-000-597	DPS Backup 36Mo+AIP Sub Tier 4=CC	DM	\$364
SU-458-000-598	DPS Backup 36Mo+AIP Sub Tier 5=CC	DM	\$336
SU-458-000-599	DPS Backup 36Mo+AIP Sub Tier 6=CC	DM	\$305
SU-458-000-600	DPS Backup 36Mo+AIP Sub Tier 7=CC	DM	\$272

SU-458-000-601	DPS Backup 36Mo+AIP Sub Tier 8=CC	DM	\$242
SU-458-000-602	DPS VMWare 36Mo+AIP Sub=IA	DM	\$99
SU-458-000-603	DPS VMWare 36Mo+ PP Sub=IA	DM	\$89
SU-458-000-604	DPS for VMWare RPVM Subscription=IB	DM	\$0
SU-458-000-605	DPS for VMWare Avamar Rep Sub=CA	DM	\$0
SU-458-000-606	DPS Enterprise 12Mo Sub Tier 1=CC	DM	\$687
SU-458-000-607	DPS Enterprise 12Mo Sub Tier 2=CC	DM	\$578
SU-458-000-608	DPS Enterprise 12Mo Sub Tier 3=CC	DM	\$470
SU-458-000-609	DPS Enterprise 12Mo Sub Tier 4=CC	DM	\$439
SU-458-000-610	DPS Enterprise 12Mo Sub Tier 5=CC	DM	\$408
SU-458-000-611	DPS Enterprise 12Mo Sub Tier 6=CC	DM	\$372
SU-458-000-612	DPS Enterprise 12Mo Sub Tier 7=CC	DM	\$330
SU-458-000-613	DPS Enterprise 12Mo Sub Tier 8=CC	DM	\$294
SU-458-000-614	DPS Enterprise 12Mo Sub Tier 9=CC	DM	\$258
SU-458-000-615	DPS Enterprise 12Mo Sub Tier 10=CC	DM	\$217
SU-458-000-616	DPS Enterprise 12Mo Sub Tier 11=CC	DM	\$181
SU-458-000-617	DPS Enterprise 36Mo+AIP Sub Tier 1=CC	DM	\$624
SU-458-000-618	DPS Enterprise 36Mo+AIP Sub Tier 2=CC	DM	\$526
SU-458-000-619	DPS Enterprise 36Mo+AIP Sub Tier 3=CC	DM	\$427
SU-458-000-620	DPS Enterprise 36Mo+AIP Sub Tier 4=CC	DM	\$399
SU-458-000-621	DPS Enterprise 36Mo+AIP Sub Tier 5=CC	DM	\$371
SU-458-000-622	DPS Enterprise 36Mo+AIP Sub Tier 6=CC	DM	\$338
SU-458-000-623	DPS Enterprise 36Mo+AIP Sub Tier 7=CC	DM	\$300
SU-458-000-624	DPS Enterprise 36Mo+AIP Sub Tier 8=CC	DM	\$268
SU-458-000-625	DPS Enterprise 36Mo+AIP Sub Tier 9=CC	DM	\$235
SU-458-000-626	DPS Enterprise 36Mo+AIP Sub Tier 10=CC	DM	\$197
SU-458-000-627	DPS Enterprise 36Mo+AIP Sub Tier 11=CC	DM	\$164
SU-458-000-628	DPS Enterprise 36Mo+ PP Sub Tier 1=CC	DM	\$562
SU-458-000-629	DPS Enterprise 36Mo+ PP Sub Tier 2=CC	DM	\$473
SU-458-000-630	DPS Enterprise 36Mo+ PP Sub Tier 3=CC	DM	\$384
SU-458-000-631	DPS Enterprise 36Mo+ PP Sub Tier 4=CC	DM	\$359
SU-458-000-632	DPS Enterprise 36Mo+ PP Sub Tier 5=CC	DM	\$334
SU-458-000-633	DPS Enterprise 36Mo+ PP Sub Tier 6=CC	DM	\$304
SU-458-000-634	DPS Enterprise 36Mo+ PP Sub Tier 7=CC	DM	\$270
SU-458-000-635	DPS Enterprise 36Mo+ PP Sub Tier 8=CC	DM	\$241
SU-458-000-636	DPS Enterprise 36Mo+ PP Sub Tier 9=CC	DM	\$211
SU-458-000-637	DPS Enterprise 36Mo+ PP Sub Tier 10=CC	DM	\$177
SU-458-000-638	DPS Enterprise 36Mo+ PP Sub Tier 11=CC	DM	\$148
SU-458-000-639	DPS Backup 12Mo Sub Tier 2=CC	DM	\$527
SU-458-000-640	DPS Backup 12Mo Sub Tier 3=CC	DM	\$426
SU-458-000-641	DPS Enterprise Sub DDBEA PROTECTPOINT=IA	DM	\$0
SU-458-000-642	DPS Subscription Primary Storage=IA	DM	\$0
SU-458-000-643	DPS Enterprise RPVM Subscription=IB	DM	\$0
SU-458-000-644	DPS Subscription Primary Storage=IA	DM	\$0
SU-458-000-645	DPS Suite for BackUp Sub Enablers=IA	DM	\$0
SU-458-000-646	DPS for VMWare Avamar Subscription=CA	DM	\$0
SU-458-000-647	DPS Suite for VMWare Sub Enablers=CC	DM	\$0
SU-458-000-648	DPS Enterprise Subscription Enablers=IA	DM	\$0
SU-458-000-926	VMware Cloud DP 12Mo Subscr=IA	DM	\$1,103
SU-458-000-927	VMware Cloud DP 36 Mo+ PP Subscr=IA	DM	\$902

SU-458-000-928	VMware Cloud DP 36 Mo+AIP Subscr=IA	DM	\$1,003
SU-458-000-929	Cloudboost Amazon Image=CA	DM	\$0
SU-458-000-954	VMWare Cloud DDVE Enabler=CA	DM	\$0
SU-458-001-003	Cloudboost Azure Image=CA	DM	\$0
U-640-XCAP	LICENSE;EXPSTOR;DD640;UPGRADE	DM	\$0
U-BLCK-2200	UPG BLOCK SERVICE DPSAPPS DD2200=IA	DM	\$0
U-BLCK-2500	UPG BLOCK SERVICE DPSAPPS DD2500=IA	DM	\$0
U-BLCK-4200	UPG BLOCK SERVICE DPSAPPS DD4200=IA	DM	\$0
U-BLCK-4500	UPG BLOCK SERVICE DPSAPPS DD4500=IA	DM	\$0
U-BLCK-4500V	UPG BLOCK SERVICE DPSAPPS DD4500=IA	DM	\$0
U-BLCK-7200	UPG BLOCK SERVICE DPSAPPS DD7200=IA	DM	\$0
U-BLCK-7200V	UPG BLOCK SERVICE DPSAPPS DD7200=IA	DM	\$0
U-BLCK-9500	UPG BLOCK SERVICE DPSAPPS DD9500=IA	DM	\$0
U-BLCK-9500V	UPG BLOCK SERVICE DPSAPPS DD4500=IA	DM	\$0
U-BLCK-990	UPG BLOCK SERVICE DPSAPPS DD990=IA	DM	\$0
U-BLCK-990V	UPG BLOCK SERVICE DPSAPPS DD990=IA	DM	\$0
U-BST-2500	LICENSE,BOOST,2500,UPGRADE	DM	\$4,000
U-BST-2500-CF	License,Boost,DD2500,Upgrade=IA	DM	\$4,000
U-BST-4200	LICENSE,BOOST,DD4200,UPGRADE	DM	\$9,000
U-BST-4200-CF	License,Boost,DD4200,Upgrade=IA	DM	\$9,000
U-BST-4500	LICENSE,BOOST,DD4500,UPGRADE	DM	\$19,000
U-BST-4500-CF	License,Boost,DD4500,Upgrade=IA	DM	\$19,000
U-BST-510	UPGRADE;LICENSE;BOOST;DD510	DM	\$0
U-BST-530	UPGRADE;LICENSE;BOOST;DD530	DM	\$0
U-BST-560	UPGRADE;LICENSE;BOOST;DD560	DM	\$0
U-BST-560G	UPGRADE;LICENSE;BOOST;DD560G	DM	\$0
U-BST-565	UPGRADE;LICENSE;BOOST;DD565	DM	\$0
U-BST-580	UPGRADE;LICENSE;BOOST;DD580	DM	\$0
U-BST-580G	UPGRADE;LICENSE;BOOST;DD580G	DM	\$0
U-BST-620	LICENSE;BOOST;DD620;UPGRADE	DM	\$0
U-BST-640	LICENSE;BOOST;DD640;UPGRADE	DM	\$0
U-BST-660	UPGRADE;LICENSE;BOOST;DD660	DM	\$0
U-BST-670	UPGRADE;LICENSE;BOOST;DD670	DM	\$0
U-DDOE-ER-MCAP	License DD OE Per TB UPG ER=CB	DM	\$915
U-DD-SMIG-MCAP	Lic DD Storage Migration UPG=IA	DM	\$0
U-ENC-2500	LICENSE,ENCRYPTION,2500,UPGRADE	DM	\$4,000
U-ENC-2500-CF	License,Encryption,DD2500,Upgrade=IA	DM	\$4,000
U-ENC-4200	LICENSE,ENCRYPTION,DD4200,UPGRADE	DM	\$9,000
U-ENC-4200-CF	License,Encryption,DD4200,Upgrade=IA	DM	\$9,000
U-ENC-4500	LICENSE,ENCRYPTION,DD4500,UPGRADE	DM	\$19,000
U-ENC-4500-CF	License,Encryption,DD4500,Upgrade=IA	DM	\$19,000
U-ENC-510	UPGRADE;LICENSE;ENCRYPTION;DD510	DM	\$0
U-ENC-530	UPGRADE;LICENSE;ENCRYPTION;DD530	DM	\$0
U-ENC-565	UPGRADE;LICENSE;ENCRYPTION;DD565	DM	\$0
U-ENC-580	UPGRADE;LICENSE;ENCRYPTION;DD580	DM	\$0
U-ENC-580G	UPGRADE;LICENSE;ENCRYPTION;DD580G	DM	\$0
U-ENC-620	LICENSE;ENCRYPTION;DD620;UPGRADE	DM	\$0
U-ENC-640	LICENSE;ENCRYPTION;DD640;UPGRADE	DM	\$0
U-ENC-660	UPGRADE;LICENSE;ENCRYPTION;DD660	DM	\$0
U-ENC-670	UPGRADE; LICENSE; ENCRYPTION; DD670	DM	\$0

U-ER-4200	LICENSE,EXTD RETN SW OPT,DD4200,UPGRAD	DM	\$0
U-ER-4200-CF	License,Extd Retn SW Opt,DD4200,Upg=IA	DM	\$0
U-ER-4500	LICENSE,EXTD RETN SW OPT,DD4500,UPGRAD	DM	\$0
U-ER-4500-CF	License,Extd Retn SW Opt,DD4500,Upg=IA	DM	\$0
U-IOSUP2500	LIC,VTL,OPEN SYS TO IBM IOS,2500,UPG	DM	\$2,000
U-IOSUP2500-CF	Lic Vtl Open Sys IBM IOS DD2500 Upg=IA	DM	\$2,000
U-IOSUP4200	LIC,VTL,OPEN SYS TO IBM IOS,DD4200,UPG	DM	\$4,500
U-IOSUP4200-CF	Lic Vtl Open Sys IBM IOS DD4200 Upg=IA	DM	\$4,500
U-IOSUP4500	LIC,VTL,OPEN SYS TO IBM IOS,DD4500,UPG	DM	\$9,500
U-IOSUP4500-CF	Lic Vtl Open Sys IBM IOS DD4500 Upg=IA	DM	\$9,500
U-IOSUP510	LIC;VTL;OPEN SYS TO IBM I/OS;DD510;UPG	DM	\$0
U-IOSUP530	LIC;VTL;OPEN SYS TO IBM I/OS;DD530;UPG	DM	\$0
U-IOSUP565	LIC;VTL;OPEN SYS TO IBM I/OS;DD565;UPG	DM	\$0
U-IOSUP580	LIC;VTL;OPEN SYS TO IBM I/OS;DD580;UPG	DM	\$0
U-IOSUP580G	LIC;VTL;OPEN SYS TO IBM I/OS;DD580G;UPG	DM	\$0
U-IOSUP620	LIC;VTL;OPEN SYS TO IBM I/OS;DD620;UPG	DM	\$0
U-IOSUP640	LIC;VTL;OPEN SYS TO IBM I/OS;DD640;UPG	DM	\$0
U-IOSUP660	LIC;VTL;OPEN SYS TO IBM I/OS;DD660;UPG	DM	\$7,500
U-IOSUP670	LIC;VTL;OPEN SYS TO IBM I/OS;DD670;UPG	DM	\$0
U-OST-510	UPGRADE;LICENSE;OPENSTORAGE(OST);DD51	DM	\$0
U-OST-530	UPGRADE;LICENSE;OPENSTORAGE(OST);DD53	DM	\$0
U-OST-565	UPGRADE;LICENSE;OPENSTORAGE(OST);DD56	DM	\$0
U-OST-580	UPGRADE;LICENSE;OPENSTORAGE(OST);DD58	DM	\$0
U-OST-580G	UPGRADE;LICENSE;OPENSTORAGE(OST);DD58	DM	\$0
U-OST-660	UPGRADE;LICENSE;OPENSTORAGE(OST);DD66	DM	\$0
U-REP-2500	LICENSE, REPLICATOR, 2500,UPGRADE	DM	\$5,000
U-REP-2500-CF	License,Replicator,DD2500,Upgrade=IA	DM	\$5,000
U-REP-410	UPGRADE; LICENSE; REPLICATOR; DD410	DM	\$0
U-REP-4200	LICENSE, REPLICATOR, DD4200,UPGRADE	DM	\$10,000
U-REP-4200-CF	License,Replicator,DD4200,Upgrade=IA	DM	\$10,000
U-REP-430	UPGRADE; LICENSE; REPLICATOR; DD430	DM	\$0
U-REP-4500	LICENSE, REPLICATOR, DD4500,UPGRADE	DM	\$30,000
U-REP-4500-CF	License,Replicator,DD4500,Upgrade=IA	DM	\$30,000
U-REP-460	UPGRADE; LICENSE; REPLICATOR; DD460	DM	\$0
U-REP-460G	UPGRADE; LICENSE; REPLICATOR; DD460G	DM	\$0
U-REP-510	UPGRADE; LICENSE; REPLICATOR; DD510	DM	\$0
U-REP-530	UPGRADE; LICENSE; REPLICATOR; DD530	DM	\$0
U-REP-560	UPGRADE; LICENSE; REPLICATOR; DD560	DM	\$0
U-REP-560G	UPGRADE; LICENSE; REPLICATOR; DD560G	DM	\$0
U-REP-565	UPGRADE; LICENSE; REPLICATOR; DD565	DM	\$0
U-REP-580	UPGRADE; LICENSE; REPLICATOR; DD580	DM	\$0
U-REP-580G	UPGRADE; LICENSE; REPLICATOR; DD580G	DM	\$0
U-REP-620	LICENSE;REPLICATOR; DD620;UPGRADE	DM	\$0
U-REP-640	LICENSE; REPLICATOR; DD640;UPGRADE	DM	\$0
U-REP-660	UPGRADE; LICENSE; REPLICATOR; DD660	DM	\$25,000
U-REP-670	UPGRADE; LICENSE; REPLICATOR; DD670	DM	\$0
U-RL-510	LIC;RETENTION LOCK GOV EDITION;DD510;UPG	DM	\$0
U-RL-530	LIC;RETENTION LOCK GOV EDITION;DD530;UPG	DM	\$0
U-RL-565	LIC;RETENTION LOCK GOV EDITION;DD565;UPG	DM	\$0
U-RL-580	LIC;RETENTION LOCK GOV EDITION;DD580;UPG	DM	\$0

U-RL-580G	LIC;RETENTION LOCKGOV EDITION;DD580G;UPG	DM	\$0
U-RL-620	LIC;RETENTION LOCK GOV EDITION;DD620;UPG	DM	\$0
U-RL-640	LIC;RETENTION LOCK GOV EDITION;DD640;UPG	DM	\$0
U-RL-660	LIC;RETENTION LOCK GOV EDITION;DD660;UPG	DM	\$20,000
U-RL-670	LIC;RETENTION LOCK GOV EDITION;DD670;UPG	DM	\$0
U-RLC-2500	LIC,RETENTION LOCK COMPL EDTN,DD2500,UPG	DM	\$4,000
U-RLC-2500-CF	Lic,Retention Lock Compl,DD2500,Upgr=IA	DM	\$4,000
U-RLC-4200	LIC,RETENTION LOCK COMPL EDTN,DD4200,UPG	DM	\$7,000
U-RLC-4200-CF	Lic,Retention Lock Compl,DD4200,Upgr=IA	DM	\$7,000
U-RLC-4500	LIC,RETENTION LOCK COMPL EDTN,DD4500,UPG	DM	\$20,400
U-RLC-4500-CF	Lic,Retention Lock Compl,DD4500,Upgr=IA	DM	\$20,400
U-RLC-510	LIC;RETENTION LOCK COMPL EDITN;DD510;UPG	DM	\$0
U-RLC-530	LIC;RETENTION LOCK COMPL EDITN;DD530;UPG	DM	\$0
U-RLC-565	LIC;RETENTION LOCK COMPL EDITN;DD565;UPG	DM	\$0
U-RLC-580	LIC;RETENTION LOCK COMPL EDITN;DD580;UPG	DM	\$0
U-RLC-620	LIC;RETENTION LOCK COMPL EDITN;DD620;UPG	DM	\$0
U-RLC-640	LIC;RETENTION LOCK COMPL EDITN;DD640;UPG	DM	\$0
U-RLC-660	LIC;RETENTION LOCK COMPL EDITN;DD660;UPG	DM	\$20,000
U-RLC-670	LIC;RETENTION LOCK COMPL EDITN;DD670;UPG	DM	\$0
U-RLG-2500	LIC,RETENTION LOCK GOV EDTN,DD2500,UPG	DM	\$4,000
U-RLG-2500-CF	Lic,Retention Lock Gov Edt,DD2500,Upgr=IA	DM	\$4,000
U-RLG-4200	LIC,RETENTION LOCK GOV EDTION,DD4200,UPG	DM	\$7,000
U-RLG-4200-CF	Lic,Retention Lock Gov Edt,DD4200,Upgr=IA	DM	\$7,000
U-RLG-4500	LIC,RETENTION LOCK GOV EDTION,DD4500,UPG	DM	\$20,400
U-RLG-4500-CF	Lic,Retention Lock Gov Edt,DD4500,Upgr=IA	DM	\$20,400
U-VTL-2500	LIC,VTL,OPEN SYSTEMS,DD2500,UPGRADE	DM	\$4,000
U-VTL-2500-CF	Lic,Vtl,Open Systems,DD2500,Upgrade=IA	DM	\$4,000
U-VTL-2500E	LIC,VTL,NDMP TAPE SERVER,ETH,DD2500,UPG	DM	\$4,000
U-VTL-2500E-CF	Lic,Vtl,Ndmp Tape Srv,Eth,DD2500,Upgr=IA	DM	\$4,000
U-VTL-2500F	LIC,VTL,IBM IOS,DD2500,UPGRADE	DM	\$6,000
U-VTL-2500F-CF	Lic,Vtl,IBM IOS,DD2500,Upgrade=IA	DM	\$6,000
U-VTL-410	UPG;LIC;VTL;410.INCL:1XPCIX CARD;1P;2G	DM	\$0
U-VTL-4200	LIC,VTL,OPEN SYSTEMS,DD4200,UPGRADE	DM	\$9,000
U-VTL-4200-CF	Lic,Vtl,Open Systems,DD4200,Upgrade=IA	DM	\$9,000
U-VTL-4200E	LIC,VTL,NDMP TAPE SERVER,ETH,DD4200,UPG	DM	\$9,000
U-VTL-4200E-CF	Lic,Vtl,Ndmp Tape Srv,Eth,DD4200,Upgr=IA	DM	\$9,000
U-VTL-4200F	LIC,VTL,IBM IOS,DD4200,UPGRADE	DM	\$13,500
U-VTL-4200F-CF	Lic,Vtl,IBM IOS,DD4200,Upgrade=IA	DM	\$13,500
U-VTL-430	UPG;LIC;VTL;430.INCL:1XPCIX CARD;1P;2G	DM	\$0
U-VTL-4500	LIC,VTL,OPEN SYSTEMS,DD4500,UPGRADE	DM	\$19,000
U-VTL-4500-CF	Lic,Vtl,Open Systems,DD4500,Upgrade=IA	DM	\$19,000
U-VTL-4500E	LIC,VTL,NDMP TAPE SERVER,ETH,DD4500,UPG	DM	\$19,000
U-VTL-4500E-CF	Lic,Vtl,Ndmp Tape Srv,Eth,DD4500,Upgr=IA	DM	\$19,000
U-VTL-4500F	LIC,VTL,IBM IOS,DD4500,UPGRADE	DM	\$28,500
U-VTL-4500F-CF	Lic,Vtl,IBM IOS,DD4500,Upgrade=IA	DM	\$28,500
U-VTL-460	UPG;LIC;VTL;460.INCL:1XPCIX CARD;1P;2G	DM	\$0
U-VTL-460G	UPG;LIC;VTL;460G.INCL:1XPCIX CARD;1P;2G	DM	\$0
U-VTL-510	UPG;LIC;VTL;510.INCL:1XPCIE CARD;DP;4G	DM	\$0
U-VTL510-E	LIC;VTL;NDMP TAPE SVR;ETH;DD510;UPG	DM	\$0
U-VTL510-F1	LIC;VTL;IBM I/OS;FC;DD510;1XDP;4G;UPG	DM	\$0

U-VTL-530	UPG;LIC;VTL;530.INCL:1XPCIE CARD;DP;4G	DM	\$0
U-VTL530-E	LIC;VTL;NDMP TAPE SVR;ETH;DD530;UPG	DM	\$0
U-VTL530-F1	LIC;VTL;IBM I/OS;FC;DD530;1XDP;4G;UPG	DM	\$0
U-VTL-560	UPG;LIC;VTL;560.INCL:1XPCIX CARD;1P;2G	DM	\$0
U-VTL-560G	UPG;LIC;VTL;560G.INCL:1XPCIX CARD;1P;2G	DM	\$0
U-VTL-565-1	UPG;LIC;VTL;565.INCL:1XPCIE CARD;DP;4G	DM	\$0
U-VTL-565-2	UPG;LIC;VTL;565.INCL:2XPCIE CARD;DP;4G	DM	\$0
U-VTL565-E	LIC;VTL;NDMP TAPE SVR;ETH;DD565;UPG	DM	\$0
U-VTL565-F1	LIC;VTL;IBM I/OS;FC;DD565;1XDP;4G;UPG	DM	\$0
U-VTL565-F2	LIC;VTL;IBM I/OS;FC;DD565;2XDP;4G;UPG	DM	\$0
U-VTL-580-1	UPG;LIC;VTL;580.INCL:1XPCIE CARD;DP;4G	DM	\$0
U-VTL-580-2	UPG;LIC;VTL;580.INCL:2XPCIE CARD;DP;4G	DM	\$0
U-VTL580-E	LIC;VTL;NDMP TAPE SVR;ETH;DD580;UPG	DM	\$0
U-VTL580-F1	LIC;VTL;IBM I/OS;FC;DD580;1XDP;4G;UPG	DM	\$0
U-VTL580-F2	LIC;VTL;IBM I/OS;FC;DD580;2XDP;4G;UPG	DM	\$0
U-VTL-580G1	UPG;LIC;VTL;580G.INCL:1XPCIE CARD;DP;4G	DM	\$0
U-VTL-580G2	UPG;LIC;VTL;580G.INCL:2XPCIE CARD;DP;4G	DM	\$0
U-VTL580G-E	LIC;VTL;NDMP TAPE SVR;ETH;DD580G;UPG	DM	\$0
U-VTL580GF1	LIC;VTL;IBM I/OS;FC;DD580G;1XDP;4G;UPG	DM	\$0
U-VTL580GF2	LIC;VTL;IBM I/OS;FC;DD580G;2XDP;4G;UPG	DM	\$0
U-VTL-620-1	LIC;VTL;620.INCL:1XPCIE CARD;DP;4G;UPG	DM	\$0
U-VTL620-E	LIC;VTL;NDMP TAPE SVR;ETH;DD620;UPG	DM	\$0
U-VTL620-F1	LIC;VTL;IBM I/OS;FC;DD620;1XDP;4G;UPG	DM	\$0
U-VTL-640-1	LIC;VTL;640; INCL 1XPCIE CARD;DP;8G;UPG	DM	\$0
U-VTL-640-2	LIC;VTL;640; INCL 2XPCIE CARD;DP;8G;UPG	DM	\$0
U-VTL640-E	VTL;NDMP TAPE SVR;ETH;DD640;UPG	DM	\$4,000
U-VTL640-F1	VTL;IBM I/OS;FC;DD640;1XPCIE;DP;8G;UPG	DM	\$10,500
U-VTL640-F2	VTL;IBM I/OS;FC;DD640;2XPCIE;DP;8G;UPG	DM	\$15,000
U-VTL-660-1	UPG;LIC;VTL;660. INCL:1XPCIE CARD;DP;4G	DM	\$19,500
U-VTL-660-2	UPG;LIC;VTL;660. INCL:2XPCIE CARD;DP;4G	DM	\$24,000
U-VTL660-E	LIC;VTL;NDMP TAPE SVR;ETH;DD660;UPG	DM	\$15,000
U-VTL660-F1	LIC;VTL;IBM I/OS;FC;DD660;1XDP;4G;UPG	DM	\$27,000
U-VTL660-F2	LIC;VTL;IBM I/OS;FC;DD660;2XDP;4G;UPG	DM	\$31,500
U-VTL-670-1	UPG;LIC;VTL;670; INCL 1XPCIE CARD;DP;8G	DM	\$13,500
U-VTL-670-2	UPG;LIC;VTL;670; INCL 2XPCIE CARD;DP;8G	DM	\$18,000
U-VTL670-E	LIC;VTL;NDMP TAPE SVR;ETH;DD670;UPG	DM	\$9,000
U-VTL670-F1	LIC;VTL;IBM I/OS;FC;DD670;1XDP;8G;UPG	DM	\$0
U-VTL670-F2	LIC;VTL;IBM I/OS;FC;DD670;2XDP;8G;UPG	DM	\$0
U-XCAP2500	LICENSE,EXPSTOR,2500,UPG	DM	\$0
U-XCAP2500-CF	License Expstor DD2500 Upg=IA	DM	\$0
U-XCAP4200	LICENSE,EXPCAP,DD4200,MORETHAN 120TB,UF	DM	\$20,000
U-XCAP4200-CF	Lic Expcap DD4200 Above 120TB Upg=IA	DM	\$20,000
U-XCAP4500	LICENSE,EXPCAP,DD4500,MORETHAN 180TB,UF	DM	\$30,000
U-XCAP4500-CF	Lic Expcap DD4500 Above 180TB Upg=IA	DM	\$30,000
VE-COS-C-T01	ATMOS VE CAP 1TB (501-1500TB)	DM	\$0
VE-COS-C-T02	ATMOS VE CAP 1TB (1501-4500TB)	DM	\$0
VE-COS-C-T03	ATMOS VE CAP 1TB (4501-9500TB)	DM	\$0
VE-COS-C-T04	ATMOS VE CAP 1TB (9500TB+)	DM	\$0
VE-COS-SW-SOL	ATMOS VE BASE 1TB (1-500TB)	DM	\$0
VE-SW-B-SOL	ATMOS VE BASE & CAP 500TB	DM	\$0

VE-SW-ENTL	ATMOS VE SW LICENSE KEY	DM	\$0
0010200	RSA RKM APPLIANCE	E	\$0
6740-7840RCKT	VDX-6740 MP-7840 EMC UNIV RACK KIT	E	\$600
850-0029	CABLE, IB DDR, CX4-CX4, 3M	E	\$224
850-0030	CABLE, IB DDR, CX4-CX4, 5M	E	\$296
850-0031	1 METER SAS CABLE	E	\$250
850-0032	3 METER SAS CABLE	E	\$328
850-0033	1U; 24 PORT DDR IB SWITCH	E	\$0
850-0035	CABLE, IB DDR, CX4-CX4, 1M	E	\$176
851-0077	1U; 24 PORT DDR IB SWITCH	E	\$0
851-0083	FLEXTRONICS 24-PORT DDR SWITCH	E	\$0
851-0149	Switch Intel IB QDR 48 Port 2PS 5U - 040	E	\$141,431
851-0150	Switch Intel IB QDR 24 Port Upgrade Leaf	E	\$28,134
851-0151	Switch Intel IB QDR 48 Port 2PS 10U -120	E	\$216,100
851-0153	CABLE, IB HYBRID, QSFP-CX4, 1M	E	\$164
851-0154	CABLE, IB HYBRID, QSFP-CX4, 3M	E	\$206
851-0155	CABLE, IB HYBRID, QSFP-CX4, 5M	E	\$319
851-0156	CABLE, IB HYBRID, QSFP-CX4, 6M	E	\$343
851-0167	MELLANOX 8 PORT QDR SWITCH	E	\$5,634
851-0168	Switch IB QDR 18 Port 1PS 1U Mellanox	E	\$11,168
851-0169	MELLANOX 36 PORT QDR SWITCH	E	\$0
851-0170	Switch IB QDR 18 Port 1PS 1U Intel	E	\$11,168
851-0173	CABLE, IB HYBRID, QSFP-CX4, 10M	E	\$745
851-0179	MELLANOX 36 PORT QDR SWITCH WITH 2 PS	E	\$0
851-0201	CABLE, IB DDR, CX4-CX4, 8M	E	\$560
851-0208	CABLE, IB QDR, QSFP-QSFP, 1M	E	\$155
851-0209	CABLE, IB QDR, QSFP-QSFP, 3M	E	\$225
851-0210	CABLE, IB QDR, QSFP-QSFP, 5M	E	\$428
851-0211	CABLE-IB QDR-QSFP/QSFP-ACT OPT-10M	E	\$1,043
851-0214	SWITCH IB QDR 36 PORT 2PS 1U INTEL	E	\$23,489
851-0257	SWITCH 10GBE 48P 2PS Celestica	E	\$10,950
851-0258	SWITCH 10GBE 24P 2PS Celestica	E	\$7,280
851-0259	SWITCH 40GBE 32P 2PS Celestica	E	\$13,433
851-0260	SWITCH CHASSIS 96P x 10GBE SFP+ Arista	E	\$195,770
851-0261	SWITCH CHASSIS 64P x 40GBE QSFP+ Arista	E	\$275,127
851-0282	Switch 40GBE 32 Port Upgrade Leaf Arista	E	\$29,852
851-0283	Switch 10GBE 48 Port Upgrade Leaf Arista	E	\$66,333
851-0284	Switch IB QDR 36 Port, 2PS, 1U, Mellanox	E	\$23,489
851-0311	SWITCH IB 18 Port Upgrade Leaf Mellanox	E	\$21,310
851-0312	SWITCH CHASSIS IB QDR 54P 10U MELLANOX	E	\$249,430
851-0313	SWITCH CHASSIS IB QDR 54P 7U MELLANOX	E	\$168,760
AP-7420B-00	2Gb 16 port FC Application Switch	E	\$0
AP-7420B-F	16-PORT INVISTA-RCVRPNT PROMO APP SWITC	E	\$0
AP7420B-IP	LIC FCIP TUNNELING	E	\$0
AP7420B-MPR	ROUTER/FCIP BUNDLE	E	\$0
AP7420B-RTR	LIC AP7420B FABRIC ROUTER	E	\$0
AP7420B-SAS	SAS LICENSE FOR AP-7420B	E	\$0
AP7420B-SAS-F	SAS LIC FOR AP7420B RECOVERPOINT PROMO	E	\$0
AP-7600B	AP-7600B FABRIC APPLICATION SWITCH	E	\$0
BRCD-FREE-TRN	CX3 SAN-B TRAINING OFFER	E	\$0

BRDCX-8GSW8P	BRCD LBL DCX 8GB SHORT WAVE SFPS 8PACK	E	\$2,280
BRQSFP40GDA5M	BRCD QSFP 40G DIRECT ATTACH 5 METER	E	\$870
BRQSFP-4X32G-2KM	BRCD LBL 4X32GB 2KM QSFP 1PACK	E	\$12,250
BRQSFP-4X32G-BRKOT	BRCD LBL 4X32GB SW BREAKOUT QSFP 1PACK	E	\$7,460
BRSFP-10G10K	BRCD 10GBE SFP+ 10K LONG WAVE 1PACK	E	\$2,280
BRSFP-10G10K8	BRCD 10GBE SFP+ 10K LONG WAVE 8PACK	E	\$15,640
BRSFP-10GE1PK	BRCD LBL SFP 10GbE SW USR OPTIC 1PACK	E	\$460
BRSFP-10GE8PK	BRCD LBL SFP 10GbE SW USR OPTIC 8PACK	E	\$3,310
BRSFP-10GFCLW	BRCD LBL 10GB FC 10KM LONG WAVE SFP	E	\$1,980
BRSFP-10GFCSW	BRCD LBL 10GB FC SHORT WAVE SFP	E	\$620
BRSFP-10GSW1P	BRCD 10GBE SFP+ SHORT WAVE 1PACK	E	\$800
BRSFP-10GSW8P	BRCD 10GBE SFP+ SHORT WAVE 8PACK	E	\$4,510
BRSFP-1GBE-OP	BRCD LBL 1GbE Optical SFP for 7840	E	\$940
BRSFP-1GECOPR	BRSFP 1GBE COP SFP FOR MP-7800B & FX8-24	E	\$460
BRSFP-1GELX1P	BRCD LBL SFP 1GbE LX OPTIC 1PACK	E	\$1,089
BRSFP-1GELX8P	BRCD LBL SFP 1GbE LX OPTIC 8PACK	E	\$8,195
BRSFP-1GESX8P	BRCD LBL SFP 1GbE SX OPTIC 8PACK	E	\$3,740
BRSFP40GQSFLP	BRCD LBL QSFP 40GbE LW OPTIC 1PACK	E	\$24,900
BRSFP40GQSFPS	BRCD LBL QSFP 40GbE SW OPTIC 1PACK	E	\$5,330
CBFM-04	FM 4 DOMAINS SEAT LIC	E	\$0
CBFM-04-10	FM 4 TO 10 DOMAIN UPG	E	\$0
CBFM-04-99	FM 4 TO 99 DOMAIN UPG	E	\$0
CBFM-10	FM 10 DOMAINS SEAT LIC	E	\$0
CBFM-10-99	FM 10 DOM TO 99 DOM UPG	E	\$0
CBFM-3X-4X	FM 3.X TO 4.X SITE UPGRAD	E	\$0
CBFM-99	FM 99 DOMAINS SITE LIC	E	\$0
CC-DTU-UDEPHU	DBTUNER DB2UDB WG-DEP UP	E	\$14,710
CC-DTU-UENTHU	DBTUNER DB2UDB DEP-ENT UP	E	\$9,780
CC-DTU-UGLOHU	DBTUNER DB2UDB ENT-GLO UP	E	\$9,780
CLS-RPHW-G5	RPA GEN5 NON-TAA FOR RP CLASSIC	E	\$0
CLS-RPHW-G5T	RPA GEN5-TAA FOR RP CLASSIC	E	\$0
CLS-RPHW-G6T	RPA CLASSIC	E	\$19,250
CLS-RPHW-G6T-D	Dell RPA Classic	E	\$19,250
CMCNE-SAN-ENT	CTX MGR CNE SAN Enterprise	E	\$0
CMCNE-SAN-ENT-CF	CTX MGR CNE SAN Enterprise	E	\$37,600
CMCNE-SAN-PLU	CTX MGR CNE SAN Pro Plus	E	\$0
CMCNE-SAN-PLU-CF	CTX MGR CNE SAN Pro Plus	E	\$15,000
CMCNE-SW-KIT-CF	CMCNE SOFTWARE MEDIA KIT NO LICENSE =IA	E	\$0
CNE-IPADV100	CTX MGR CNE - ADD IP DATA CTR TO IP BASE	E	\$0
CNE-IPADV100-CF	CTX MGR CNE - ADD IP DATA CTR TO IP BASE	E	\$0
CNE-IPB-150	CTX MGR CNE IP Data Center	E	\$0
CNE-IPB-50	CTX MGR CNE IP BASE	E	\$0
CNE-IPB-50-CF	CTX MGR CNE IP BASE	E	\$0
CNE-IPSANPLUE	CTX MGR CNE - IP ADD ENT TO PLUS LIC	E	\$0
CNE-IPSANPLUE-CF	CTX MGR CNE - ADD 100 IP DEV UPG LIC	E	\$0
CNE-IPU100	CTX MGR CNE - ADD 100 IP DEV UPG LIC	E	\$0
CNE-IPU1000	CTX MGR CNE - ADD 1000 IP DEV UPG LIC	E	\$0
CNE-IPU1000-CF	CTX MGR CNE - ADD 1000 IP DEV UPG LIC	E	\$0
CNE-IPU100-CF	CTX MGR CNE - ADD 100 IP DEV UPG LIC	E	\$0
CNE-IPU2500	CTX MGR CNE - ADD 2500 IP DEV UPG LIC	E	\$0

CNE-IPU2500-CF	CTX MGR CNE - ADD 2500 IP DEV UPG LIC	E	\$0
CNE-IPU500	CTX MGR CNE - ADD 500 IP DEV UPG LIC	E	\$0
CNE-IPU500-CF	CTX MGR CNE - ADD 500 IP DEV UPG LIC	E	\$0
CNE-IPUSANENT	CTX MGR CNE - IP ADD SAN ENT UPG LIC	E	\$0
CNE-IPUSANENT-CF	CTX MGR CNE - IP ADD SAN ENT UPG LIC	E	\$0
CNE-IPUSANPLU	CTX MGR CNE - IP ADD SAN PLUS UPG LIC	E	\$0
CNE-IPUSANPLU-CF	CTX MGR CNE - IP ADD SAN PLUS UPG LIC	E	\$0
CNE-MPLS10	CTX MGR CNE - ADD 10 MPLS IP DEV UPG LIC	E	\$0
CNE-MPLS10-CF	CTX MGR CNE - ADD 10 MPLS IP DEV UPG LIC	E	\$0
CNE-MPLS25	CTX MGR CNE - ADD 25 MPLS IP DEV UPG LIC	E	\$0
CNE-MPLS25-CF	CTX MGR CNE - ADD 25 MPLS IP DEV UPG LIC	E	\$0
CNE-MPLS50	CTX MGR CNE - ADD 50 MPLS IP DEV UPG LIC	E	\$0
CNE-MPLS50-CF	CTX MGR CNE - ADD 50 MPLS IP DEV UPG LIC	E	\$0
CNE-SAN-IP150	CTX MGR CNE SAN ADD IP BASE LIC	E	\$0
CNE-SAN-IP150-CF	CTX MGR CNE SAN ADD IP BASE LIC	E	\$0
CNE-SANIP-ENT	CTX MGR CNE SAN-IP Enterprise	E	\$0
CNE-SANIP-ENT-CF	CTX MGR CNE SAN-IP Enterprise	E	\$0
CNE-SANIP-PLU	CTX MGR CNE SAN-IP Pro Plus	E	\$0
CNE-SANIP-PLU-CF	CTX MGR CNE SAN-IP Pro Plus	E	\$0
CNE-SANIPUPLS	CTX MGR CNE - PLUS SAN-IP TO ENT UPG LIC	E	\$0
CNE-SANIPUPLS-CF	CTX MGR CNE - PLUS SAN-IP TO ENT UPG LIC	E	\$0
CNESANPLUSUPG	CTX MGR CNE SAN PRO PLUS TO ENT UPG LIC	E	\$0
CNESANPLUSUPG-CF	CTX MGR CNE SAN PRO PLUS TO ENT UPG LIC	E	\$24,800
CNRSEEKSVR	CNR SEEK APPLIANCE SERVER	E	\$0
CNX-DNQSFP-40GDA1M	CNX DN QSFP 40G DIRECT ATTACH 1 METER	E	\$400
CNX-DNQSFP-40GDA5M	CNX DN QSFP 40G DIRECT ATTACH 5 METER	E	\$675
CNX-DNQSFP-40GSR1P	CNX DN QSFP 40GbE SR OPTIC 1PACK	E	\$2,250
CNX-DN-SFP-1GCOP1P	CNX DN 1GbE SR COPPER SFP 1PACK	E	\$275
CNX-DN-SFP-1GOPT1P	CNX DN 1GbE SR OPTICAL SFP 1PACK	E	\$300
CNX-DN-SFP-TX1M1P	CNX DN 10GbE DAC TWINAX COPPER 1M 1PACK	E	\$120
CNX-DN-SFP-TX3M1P	CNX DN 10GbE DAC TWINAX COPPER 3M 1PACK	E	\$160
CNX-DN-SFP-TX5M1P	CNX DN 10GbE DAC TWINAX COPPER 5M 1PACK	E	\$200
CNX-S4048-DN-48R	CNX DN S4048 48PORT 10GbE Switch RTF AIR	E	\$12,450
CNXSFP-10G-SR	CNX SFP 10GbE SR OPTIC 1 PACK	E	\$650
CNXSFP-10GSR8	CNX SFP 10GbE SR OPTIC 8 PACK	E	\$3,200
CPCY-T0-T3-U	COPYCROSS UPG T0 THRU T3	E	\$0
CPCY-T4-T14-U	COPYCROSS UPG T4-T14	E	\$0
CPYC-MSUBASE	COPYCROSS BASE-3 MSU	E	\$6,800
CPYC-MSU-M00	COPYCROSS 4-45 MSU	E	\$715
CPYC-MSU-M01	COPYCROSS 46-175 MSU	E	\$440
CPYC-MSU-M02	COPYCROSS 176-315 MSU	E	\$340
CPYC-MSU-M03	COPYCROSS 316-575 MSU	E	\$205
CPYC-MSU-M04	COPYCROSS 576-875 MSU	E	\$70
CPYC-MSU-M05	COPYCROSS 876-1315 MSU	E	\$55
CPYC-MSU-M06	COPYCROSS 1316-1975 MSU	E	\$30
CPYC-MSU-M07	COPYCROSS 1976 & UP MSU	E	\$15
CPYC-MSU-T13	COPYCROSS 501-550 MSU	E	\$0
CPYC-MSU-T8	COPYCROSS 251-300 MSU	E	\$0
CSL-MSU-T00	CATALOG S BASE-3 MSU	E	\$0
CSL-MSU-T01	CATALOG S 004-025 MSU	E	\$0

CSL-MSU-T02	CATALOG S 026-050 MSU	E	\$0
CSL-MSU-T03	CATALOG S 051-075 MSU	E	\$0
CSL-MSU-T04	CATALOG S 076-100 MSU	E	\$0
CSL-MSU-T05	CATALOG S 101-150 MSU	E	\$0
CSL-MSU-T06	CATALOG S 150-200 MSU	E	\$0
CSL-MSU-T07	CATALOG S 201-250 MSU	E	\$0
CSL-MSU-T08	CATALOG S 251-300 MSU	E	\$0
CSL-MSU-T09	CATALOG S 301-350 MSU	E	\$0
CSL-MSU-T10	CATALOG S 351-400 MSU	E	\$0
CSL-MSU-T11	CATALOG S 401-450 MSU	E	\$0
CSL-MSU-T12	CATALOG S 451-500 MSU	E	\$0
CSL-MSU-T13	CATALOG S 501-550 MSU	E	\$0
CSL-MSU-T14	CATALOG S 551-600 MSU	E	\$0
CSL-T00-T03-U	CATALOG S UPG T00 - T03	E	\$0
CSL-T04-T14-U	CATALOG S UPG T04-T14	E	\$0
CTX-OM3-100M	OM3 50/125 FIBER CABLE LC- LC 100 METER	E	\$570
CTX-OM3-10M	OM3 50/125 FIBER CABLE LC- LC 10 METER	E	\$290
CTX-OM3-1M	OM3 50/125 FIBER CABLE LC- LC 1 METER	E	\$230
CTX-OM3-30M	OM3 50/125 FIBER CABLE LC- LC 30 METER	E	\$310
CTX-OM3-3M	OM3 50/125 FIBER CABLE LC- LC 3 METER	E	\$250
CTX-OM3-50M	OM3 50/125 FIBER CABLE LC- LC 50 METER	E	\$390
CTX-OM3-5M	OM3 50/125 FIBER CABLE LC- LC 5 METER	E	\$260
CTX-OM4-100M	OM4 50/125 MICRON OPTICL CBL LC-LC 100M	E	\$1,000
CTX-OM4-10M	OM4 50/125 MICRON OPTICAL CBL LC-LC 10M	E	\$320
CTX-OM4-1M	OM4 50/125 MICRON OPTICAL CBL LC-LC 1M	E	\$255
CTX-OM4-30M	OM4 50/125 MICRON OPTICAL CBL LC-LC 30M	E	\$465
CTX-OM4-3M	OM4 50/125 MICRON OPTICAL CBL LC-LC 3M	E	\$255
CTX-OM4-50M	OM4 50/125 MICRON OPTICAL CBL LC-LC 50M	E	\$630
CTX-OM4-5M	OM4 50/125 MICRON OPTICAL CBL LC-LC 5M	E	\$290
DCA1-EXPRCKA	DCA-40U EXPANSION RACK (INCLUDED)	E	\$0
DCA1-EXPRCKAU	DCA-40U EXPANSION RACK UPG (INCLUDED)	E	\$0
DCA1-EXPRCKB	DCA-40U EXPANSION RACK (INCLUDED)	E	\$0
DCA1-EXPRCKBU	DCA-40U EXPANSION RACK UPG (INCLUDED)	E	\$0
DCA2-AGGREGL	GP DCA 30ULIM AGGREGATION RACK	E	\$0
DCA2-AGGREGLU	GP DCA 30LIM AGGREGATION RACK UPG	E	\$0
DCA2-AGGREGM	DCA 3ZONE AGGREGATION RACK	E	\$0
DCA2-AGGREGMU	DCA 3ZONE AGGREGATION RACK UPG	E	\$0
DCA2-ASTL-15	GP DCA-1P 30A BTTM RK CLPSL 56PA332 INCL	E	\$0
DCA2-CBL10	GP DCA EXPANSION RACK CABLE 10M	E	\$0
DCA2-CBL30	GP DCA EXPANSION RACK CABLE 30M	E	\$0
DCA2-CSF-HD	GP DCA HD FLD SVR 64GB MEM 300GB HDD	E	\$0
DCA2-CSFHDBDL	GP DCA HD FLD SVR 64GB MEM 300G HDD CBL	E	\$0
DCA2-CSFHDBDU	GP DCA HD FLD SVR 64GB MEM 300G HDD CBL	E	\$0
DCA2-CSF-HD-U	GP DCA HD FLD SVR 64GB MEM 300GB HDD	E	\$0
DCA2-CS-HD	GP DCA HD COMPUTE SVR 64GB MEM 300GB H	E	\$0
DCA2-CS-HDBDL	GP DCA HD COMP SVR 64GB MEM 300G HDD CE	E	\$0
DCA2-CSHDBDLU	GP DCA HD COMP SVR 64GB MEM 300G HDD CE	E	\$0
DCA2-CS-HD-U	GP DCA HD COMPUTE SVR 64GB MEM 300GB H	E	\$0
DCA2-DIA02MA	GP DIA 256GBMEM MOD 300GB HD UPG FCT	E	\$0
DCA2-DIA02MU	GP DIA 256GBMEM MOD 300GB HD UPG FLD	E	\$0

DCA2-DS-HD	GP DCA HD SVR 64GB MEM 3TB HDD	E	\$0
DCA2-DS-HDBDL	GP DCA HD SVR 64GB MEM 3TB HDD CBL	E	\$0
DCA2-DSHDBDLU	GP DCA HD SVR 64GB MEM 3TB HDD CBL	E	\$0
DCA2-DS-HD-U	GP DCA HD SVR 64GB MEM 3TB HDD	E	\$0
DCA2-EXPANDL	GP DCA 30ULIM EXPANSION RACK	E	\$0
DCA2-EXPANDLU	GP DCA 30ULIM EXPANSION RACK UPG	E	\$0
DCA2-EXPANDM	DCA 3ZONE EXPANSION RACK	E	\$0
DCA2-EXPANDMU	DCA 3ZONE EXPANSION RACK UPG	E	\$0
DCA2-MS	GP DCA MSTR SRVR 8X8 MEM; 300GB HDD	E	\$0
DCA2-MS2	GP DCA 2CNA MASTER SERVER	E	\$0
DCA2-RUS-15	GP DCA-1P 30A BTM RK RUSS 3750DP INCL	E	\$0
DCA2-SS	GP DCA GPDB COM SVR 64GB MEM 300GB HDD	E	\$0
DCA2-SS-BDL	GP DCA GPDB COM SV 64GB MEM 300GBHDD C	E	\$0
DCA2-SS-BDLU	GP DCA GPDB COM SVR 64G MEM 300G HDD C	E	\$0
DCA2-SS-C	GP DCA GPDB UAP STD SVR 64G MEM 900G HD	E	\$0
DCA2-SSC-BDL	GP DCA GPDB UAPSTD SV 64GMEM 900GHDD C	E	\$0
DCA2-SSC-BDLU	GP DCA GPDB UAPSTD SV 64GMEM 900GHDD C	E	\$0
DCA2-SS-CU	GP DCA GPDB UAP STD SVR 64G MEM 900G HD	E	\$0
DCA2-SSM	GP GPDB SVR 256GB MEM 24X300GB HDD	E	\$0
DCA2-SSM-BDL	GP GPDB SVR 256GB MEM 24X300GB HDD CBL	E	\$0
DCA2-SSM-BDLU	GP GPDB SVR 256GB MEM 24X300GB HDD CBL	E	\$0
DCA2-SSM-U	GP GPDB SVR 256GB MEM 24X300GB HDD	E	\$0
DCA2-SS-U	GP DCA GPDB COM SVR 64GB MEM 300GB HDD	E	\$0
DCA2-SWADM	GP DCA ADMIN SWITCH	E	\$0
DCA2-SWADM-U	GP DCA ADMIN SWITCH	E	\$0
DCA2-SWAGG	GP DCA INTERCONNECT SWITCH AGGREGATIO	E	\$0
DCAETL-SS2TBT	GP DCA DIA SERVER (2TB)	E	\$0
DCX-16EB48G	ED-DCX-B-16EB 48G ENCRYPTION BW UPG LIC	E	\$0
DCX-16EB48G-CF	ED-DCX-B-16EB 48G ENCRYPTION BW UPG LIC	E	\$127,800
DCX4S-FIC-CUP	DCX-4S FICON CUP LICENSE	E	\$0
DCX4S-FIC-CUP-CF	DCX-4S FICON CUP LICENSE	E	\$24,800
DCX-4S-IR	DCX-4S INTEGRATED ROUTING LICENSE	E	\$0
DCX-4S-IR-CF	DCX-4S INTEGRATED ROUTING LICENSE	E	\$32,700
DCX-CUP-LIC	DCX FICON CUP LICENSE	E	\$0
DCX-CUP-LIC-CF	DCX FICON CUP LICENSE	E	\$33,800
DCX-FCIP-LIC	DCX+48K 18I HI-PERF FCIP/FC EXT LICENSE	E	\$0
DCX-FCIP-LIC-CF	DCX+48K 18I HI-PERF FCIP/FC EXT LICENSE	E	\$23,500
DIA2-CS	GP DIA COMP SVR 64GB MEM 300GB HDD	E	\$0
DIA2-CS-BDL	GP DIA COMP SVR 64GB MEM 300GB HDD CBL	E	\$0
DIA2-CS-BDLU	GP DIA COMP SVR 64GB MEM 300GB HDD CBL	E	\$0
DIA2-CSF	GP DIA FLD SVR 64GB MEM 300GB HDD	E	\$0
DIA2-CSF-BDL	GP DIA FLD SVR 64GB MEM 300GB HDD CBL	E	\$0
DIA2-CSF-BDLU	GP DIA FLD SVR 64GB MEM 300GB HDD CBL	E	\$0
DIA2-CSF-U	GP DIA FLD SVR 64GB MEM 300GB HDD	E	\$0
DIA2-CSM	GP DIA SVR 256GB MEM 24X300GB HDD	E	\$0
DIA2-CSM-BDL	GP DIA SVR 256GB MEM 24X300GB HDD CBL	E	\$0
DIA2-CSM-BDLU	GP GPDB SVR 256GB MEM 24X300GB HDD CBL	E	\$0
DIA2-CSM-U	GP GPDB SVR 256GB MEM 24X300GB HDD	E	\$0
DIA2-CS-U	GP DIA COMP SVR 64GB MEM 300GB HDD	E	\$0
DIA2-DS	GP DIA SVR 64GB MEM 12x3TB HDD	E	\$0

DIA2-DS-BDL	GP DIA SVR 64GB MEM 12x3TB HDD CBL	E	\$0
DIA2-DS-BDLU	GP DIA SVR 64GB MEM 12x3TB HDD CBL	E	\$0
DIA2-DS-U	GP DIA SVR 64GB MEM 12x3TB HDD	E	\$0
DL6-A/ACTIVE	DL6000 A/Active Failover	E	\$40,000
DL6-IPCOPY	DL6000 DL Copy	E	\$20,000
DL6-MEDIAMGR	DL6000 NetBackupMedia	E	\$7,500
DL6-NODEMGR	DL6000 NetworkerNode	E	\$7,500
DL6-STKACSLs	DL6000 STK-ACSLs	E	\$15,000
DS-16B2-00	DS-16B2 2G SWL Switch	E	\$0
DS-16B3-FF-0	DS16B3 16-PORT FULL FAB	E	\$0
DS-16B3-FF-0U	DS16B3US 16-PORT FULL FAB	E	\$0
DS16B-ENT	ENT SW BNDL - DS-16B2/3	E	\$0
DS16B-FW	FAB WATCH FOR DS-16B2/3	E	\$0
DS16B-PM	PERF MON FOR DS-16B2/3	E	\$0
DS16B-QL	QLOOP LIC-2GB DS PROD	E	\$0
DS16B-TR	TRUNKING FOR DS-16B2/3	E	\$0
DS16B-XF	EXT FABRIC FOR DS-16B2/3	E	\$0
DS-16M-STG	SANTEGRITY LIC 16M	E	\$0
DS-16M-TRK	OPEN TRNK SW LIC DS-16M	E	\$0
DS200B-4U-00	4Gb 4FC ports Upgrade Kit	E	\$0
DS200B-FW	FABRIC WATCH FOR DS-2X0B	E	\$0
DS200B-PM	PERF. MONITOR FOR DS-2X0B	E	\$0
DS200B-TR	TRUNKING FOR DS-2X0B	E	\$0
DS-220B-FF-0	4GB 8/16 port FC Switch	E	\$0
DS-220B-XF	SW32XX/38XX/2X0E EXT FABRIC LIC	E	\$0
DS-24M2-08	2GB 8 FC port base kit	E	\$0
DS-24M2-AUT	SANTEGRITY AUTH DS-24M2	E	\$0
DS-24M-KT8	2Gb 8 FC port expansion kit	E	\$0
DS-24M-KT8-U	2Gb 8 FC port upgrade kit	E	\$0
DS-24M-STG	SANTEGRITY LIC DS24M	E	\$0
DS-24M-TRK	OPEN TRNK SW LIC DS-24M	E	\$0
DS-300B	DS-300B 8/24P BASE SWITCH	E	\$0
DS300B-4G8PU	DS-300B 4G 8PORT UPGRADE KIT	E	\$0
DS-300B-8G	DS-300B 8/24P 8G BASE SWITCH	E	\$4,290
DS300B-8G8PU	DS-300B 8G 8PORT UPGRADE KIT	E	\$3,010
DS-300B-AN	DS-300B ADAPTIVE NETWORKING LICENSE	E	\$0
DS-300B-AN-CF	DS-300B ADAPTIVE NETWORKING LICENSE	E	\$3,040
DS-300B-EGM	DS-300B ENHANCED GROUP MANAGEMENT LIC	E	\$590
DS-300B-ENT	DS-300B ENTERPRISE SW BUNDLE	E	\$0
DS-300B-ENT-CF	DS-300B ENTERPRISE SW BUNDLE	E	\$5,780
DS-300B-ENTEPEP	DS-300B ENTERPRIS SW BNDL FOR ENT SWITC	E	\$0
DS-300B-ENTEPEP-CF	DS-300B ENTERPRIS SW BNDL FOR ENT SWITC	E	\$5,000
DS-300B-EP	DS-300B 8G 24/24P ENTERPRISE SWITCH	E	\$10,100
DS-300B-FV	DS-300B FABRIC VISION LICENSE =MA	E	\$0
DS-300B-FV-CF	DS-300B FABRIC VISION LICENSE =MA	E	\$5,600
DS-300B-FW	DS-300B FABRIC WATCH LICENSE	E	\$0
DS-300B-FW-CF	DS-300B FABRIC WATCH LICENSE	E	\$2,400
DS-300B-PM	DS-300B PERFORMANCE MONITOR LICENSE	E	\$0
DS-300B-PM-CF	DS-300B PERFORMANCE MONITOR LICENSE	E	\$2,500
DS-300B-TR	DS-300B TRUNKING LICENSE	E	\$0

DS-300B-TR-CF	DS-300B TRUNKING LICENSE	E	\$4,800
DS-300B-XF	DS-300B EXTENDED FABRIC LICENSE	E	\$0
DS-300B-XF-CF	DS-300B EXTENDED FABRIC LICENSE	E	\$1,200
DS-32B2-00	32-PORT 2GB DEPARTMENTAL SWITCH	E	\$0
DS32B-CU	FICON/CUP - DS32B	E	\$0
DS32B-ENT	ENT SW BNDL FOR DS-32B2	E	\$0
DS32B-FW	FABRIC WATCH FOR DS-32B2	E	\$0
DS32B-PM	PERF MONITOR FOR DS-32B2	E	\$0
DS32B-TR	TRUNKING FOR DS-32B2	E	\$0
DS32B-XF	EXT FABRIC FOR DS-32B2	E	\$0
DS-32M2-00	32-port Switch w/optics	E	\$0
DS-32M-AUT	SANTERGRITY AUTH DS-32M	E	\$0
DS-32M-STG	SANTEGRITY LIC 32M	E	\$0
DS-32M-TRK	OPEN TRNK SW LIC	E	\$0
DS-4100B-00	4GB 16/32 port FC Switch	E	\$0
DS4100B-8U-00	4Gb 8 FC port upgrade Kit	E	\$0
DS4100B-CU	FICON CUP-32B2 & 4100B	E	\$0
DS4100B-ENT	ENTERPRISE BUNDLE - 4100B	E	\$0
DS4100B-FW	FABRIC WATCH - 4100B	E	\$0
DS4100B-PM	PERFORM MONITOR - 4100B	E	\$0
DS4100B-TR	TRUNKING - 4100B	E	\$0
DS4100B-XF	EXTENDED FABRIC - 4100B	E	\$0
DS-4400M-08	4Gb 8/16 FC port shortwave	E	\$0
DS-4400M-FLV	FULL VOLATILITY KEYI	E	\$0
DS-4400M-KT4	4Gb 4 port UPG Kit	E	\$0
DS-4400M-SUI	DS-4400M SECURITY BUNDLE	E	\$0
DS-4400M-TRK	DS-4400M OPEN TRK LIC	E	\$0
DS-4700M-16	4Gb 16/32 FC port shortwave	E	\$0
DS-4700M-KT8	4Gb 8 port flex kit	E	\$0
DS-4700M-KT8U	DS-4700 8PORT UPKIT	E	\$0
DS-4900B-00	4Gb 32/64 port FC Switch	E	\$0
DS4900B-16U-0	4Gb 16 FC port upgrade Kit	E	\$0
DS-4900B-CU	DS-4900B FICON CUP LICENSE	E	\$0
DS4900B-ENT	ENT BUNDLE FOR DS-4900B	E	\$0
DS4900B-FW	FABRIC WATCH FOR DS-4900B	E	\$0
DS4900B-PM	PERF MONITOR FOR DS-4900B	E	\$0
DS4900B-TR	TRUNKING FOR DS-4900B	E	\$0
DS4900B-XF	EXT FABRIC FOR DS-4900B	E	\$0
DS-5000B-00	BRCD 32-PORTS W/16 ACTIVE	E	\$0
DS5000B-8U-00	5000B 8-PORT UPGRADE	E	\$0
DS-5000B-CU	DS-5000B FICON CUP LICENSE	E	\$0
DS5000B-ENT	DS-5000B ENTERPRISE SOFTWARE BUNDLE LIC	E	\$0
DS5000B-FW	DS-5000B FABRIC WATCH LICENSE	E	\$0
DS5000B-PM	DS-5000B PERFORMANCE MONITOR LICENSE	E	\$0
DS5000B-TR	DS-5000B ISL TRUNKING LICENSE	E	\$0
DS5000B-XF	DS-5000B EXTENDED FABRIC LICENSE	E	\$0
DS-5100B	DS-5100B 24P/40P BASE SWITCH	E	\$0
DS5100B-4G8PU	DS-5100B 4G 8PORT UPGRADE KIT	E	\$0
DS-5100B-AN	DS-5100B ADAPTIVE NETWORKING LICENSE	E	\$0
DS-5100B-CU	DS-5100B FICON CUP LICENSE	E	\$0

DS-5100B-ENT	DS-5100B ENTERPRISE SW BUNDLE	E	\$0
DS-5100B-ENTE	DS-5100B ENTERPRS SW BNDL FOR ENT SWITC	E	\$0
DS-5100B-ENTE-CF	DS-5100B ENTERPRS SW BNDL FOR ENT SWITC	E	\$8,600
DS-5100B-EP	DS-5100B 8G 40P/40P ENTERPRISE SWITCH	E	\$0
DS-5100B-FV	DS-5100B FABRIC VISION LICENSE =MA	E	\$0
DS-5100B-FW	DS-5100B FABRIC WATCH LICENSE	E	\$0
DS-5100B-IR	DS-5100B INTERGRATED ROUTING LICENSE	E	\$0
DS-5100B-PM	DS-5100B PERFORMANCE MONITOR LICENSE	E	\$0
DS-5100B-TR	DS-5100B TRUNKING LICENSE	E	\$0
DS-5100B-XF	DS-5100B EXTENDED FABRIC LICENSE	E	\$0
DS-5300B	DS-5300B 48P/80P BASE SWITCH	E	\$0
DS5300B4G16PU	DS-5300B 4G 16PORT UPGRADE KIT	E	\$0
DS-5300B-8G	DS-5300B 48P/80P 8G BASE SWITCH	E	\$0
DS-5300B-AN	DS-5300B ADAPTIVE NETWORKING LICENSE	E	\$0
DS-5300B-AN-CF	DS-5300B ADAPTIVE NETWORKING LICENSE	E	\$8,230
DS-5300B-CU	DS-5300B FICON CUP LICENSE	E	\$0
DS-5300B-CU-CF	DS-5300B FICON CUP LICENSE	E	\$11,800
DS-5300B-EGM	DS-5300B ENHANCED GROUP MANAGMENT LIC	E	\$3,135
DS-5300B-ENT	DS-5300B ENTERPRISE SW BUNDLE	E	\$0
DS-5300B-ENT-CF	DS-5300B ENTERPRISE SW BUNDLE	E	\$19,010
DS-5300B-ENTE	DS-5300B ENTERPRS SW BNDL FOR ENT SWITC	E	\$0
DS-5300B-ENTE-CF	DS-5300B ENTERPRS SW BNDL FOR ENT SWITC	E	\$16,800
DS-5300B-EP	DS-5300B 8G 80P/80P ENTERPRISE SWITCH	E	\$0
DS-5300B-FV	DS-5300B FABRIC VISION LICENSE =MA	E	\$0
DS-5300B-FV-CF	DS-5300B FABRIC VISION LICENSE =MA	E	\$15,720
DS-5300B-FW	DS-5300B FABRIC WATCH LICENSE	E	\$0
DS-5300B-FW-CF	DS-5300B FABRIC WATCH LICENSE	E	\$7,300
DS-5300B-IR	DS-5300B INTERGRATED ROUTING LICENSE	E	\$0
DS-5300B-IR-CF	DS-5300B INTERGRATED ROUTING LICENSE	E	\$23,715
DS-5300B-PM	DS-5300B PERFORMANCE MONITOR LICENSE	E	\$0
DS-5300B-PM-CF	DS-5300B PERFORMANCE MONITOR LICENSE	E	\$7,300
DS-5300B-TR	DS-5300B TRUNKING LICENSE	E	\$0
DS-5300B-TR-CF	DS-5300B TRUNKING LICENSE	E	\$8,800
DS-5300B-XF	DS-5300B EXTENDED FABRIC LICENSE	E	\$0
DS-5300B-XF-CF	DS-5300B EXTENDED FABRIC LICENSE	E	\$5,800
DS6505-16G12P	DS-6505B 16G 12PORT UPGRADE KIT	E	\$6,700
DS-6505B-AN	DS-6505B ADAPTIVE NETWORKING LICENSE	E	\$0
DS-6505B-AN-CF	DS-6505B ADAPTIVE NETWORKING LICENSE	E	\$3,600
DS-6505B-ENT	DS-6505B ENTERPRISE SW BUNDLE	E	\$0
DS-6505B-ENT-CF	DS-6505B ENTERPRISE SW BUNDLE	E	\$6,800
DS-6505B-FV	DS-6505B FABRIC VISION LICENSE =MA	E	\$0
DS-6505B-FV-CF	DS-6505B FABRIC VISION LICENSE =MA	E	\$5,600
DS-6505B-FW	DS-6505B FABRIC WATCH LICENSE	E	\$0
DS-6505B-FW-CF	DS-6505B FABRIC WATCH LICENSE	E	\$2,900
DS-6505B-PM	DS-6505B PERFORMANCE MONITOR LICENSE	E	\$0
DS-6505B-PM-CF	DS-6505B PERFORMANCE MONITOR LICENSE	E	\$3,000
DS-6505B-TR	DS-6505B TRUNKING LICENSE	E	\$0
DS-6505B-TR-CF	DS-6505B TRUNKING LICENSE	E	\$5,700
DS-6505B-XF	DS-6505B EXTENDED FABRIC LICENSE	E	\$0
DS-6505B-XF-CF	DS-6505B EXTENDED FABRIC LICENSE	E	\$1,500

DS-6505R-B	DS-6505R-B 12P/24P 16GB RTF BASE SWITCH	E	\$8,170
DS-6505R-B-EP	DS-6505R-B 24P/24P 16GB RTF ENT SWITCH	E	\$19,910
DS6510-16G8PU	DS-6510B 16G 12PORT UPGRADE KIT	E	\$10,130
DS-6510B-10G	DS-6510B 10G FC LICENSE	E	\$0
DS-6510B-10G-CF	DS-6510B 10G FC LICENSE	E	\$20,400
DS-6510B-AN	DS-6510B ADAPTIVE NETWORKING LICENSE	E	\$0
DS-6510B-AN-CF	DS-6510B ADAPTIVE NETWORKING LICENSE	E	\$5,600
DS-6510B-CU	DS-6510B FICON CUP LICENSE	E	\$0
DS-6510B-ENT	DS-6510B ENTERPRISE SW BUNDLE	E	\$0
DS-6510B-ENT-CF	DS-6510B ENTERPRISE SW BUNDLE	E	\$11,000
DS-6510B-FV	DS-6510B FABRIC VISION LICENSE =MA	E	\$0
DS-6510B-FV-CF	DS-6510B FABRIC VISION LICENSE =MA	E	\$8,970
DS-6510B-FW	DS-6510B FABRIC WATCH LICENSE	E	\$0
DS-6510B-FW-CF	DS-6510B FABRIC WATCH LICENSE	E	\$4,200
DS-6510B-IR	DS-6510B INTERGRATED ROUTING LICENSE	E	\$0
DS-6510B-IR-CF	DS-6510B INTERGRATED ROUTING LICENSE	E	\$17,700
DS-6510B-PM	DS-6510B PERFORMANCE MONITOR LICENSE	E	\$0
DS-6510B-PM-CF	DS-6510B PERFORMANCE MONITOR LICENSE	E	\$4,700
DS-6510B-SAO	DS-6510B SERVER APPL OPT LICENSE	E	\$0
DS-6510B-SAO-CF	DS-6510B SERVER APPL OPT LICENSE	E	\$2,200
DS-6510B-TR	DS-6510B TRUNKING LICENSE	E	\$0
DS-6510B-TR-CF	DS-6510B TRUNKING LICENSE	E	\$5,900
DS-6510B-XF	DS-6510B EXTENDED FABRIC LICENSE	E	\$0
DS-6510B-XF-CF	DS-6510B EXTENDED FABRIC LICENSE	E	\$4,700
DS-6510R8G-DC	DS-6510R-B 24P/48P 8GB RTF DC PWR Switch	E	\$19,870
DS-6510R-B	DS-6510R-B 24P/48P 16GB RTF BASE SWITCH	E	\$20,720
DS-6510R-B-EP	DS-6510R-B 48P/48P 16GB RTF ENT SWITCH	E	\$49,230
DS6510-RCKMNT	DS-6510-B RACK MOUNT KIT	E	\$600
DS6520-16G24P	DS-6520B 16G 24Port Upgrade Kit	E	\$24,550
DS-6520B-10G	DS-6520B 10G FC License	E	\$0
DS-6520B-10G-CF	DS-6520B 10G FC License	E	\$21,200
DS-6520B-ENT	DS-6520B Enterprise SW Bundle	E	\$0
DS-6520B-ENT-CF	DS-6520B Enterprise SW Bundle	E	\$18,320
DS-6520B-FV	DS-6520B FABRIC VISION LICENSE =MA	E	\$0
DS-6520B-FV-CF	DS-6520B FABRIC VISION LICENSE =MA	E	\$15,720
DS-6520B-FW	DS-6520B Fabric Watch License	E	\$0
DS-6520B-FW-CF	DS-6520B Fabric Watch License	E	\$7,560
DS-6520B-IR	DS-6520B Intergrated Routing License	E	\$0
DS-6520B-IR-CF	DS-6520B Intergrated Routing License	E	\$25,520
DS-6520B-PM	DS-6520B Performance Monitor License	E	\$0
DS-6520B-PM-CF	DS-6520B Performance Monitor License	E	\$7,560
DS-6520B-TR	DS-6520B Trunking License	E	\$0
DS-6520B-TR-CF	DS-6520B Trunking License	E	\$9,070
DS-6520B-XF	DS-6520B Extended Fabric License	E	\$0
DS-6520B-XF-CF	DS-6520B Extended Fabric License	E	\$6,050
DS-6520R-B	DS-6520R-B 48P/96P 16GB RTF Base Switch	E	\$58,860
DS-6520R-B-EP	DS-6520R-B 96P/96P 16GB RTF Ent Switch	E	\$115,620
DS-65XXPWRSUP	DS-6505R ADD ON PWR SUPPLY	E	\$2,550
DS6610-16G8PU	DS-6610B 8Port 16G SFP Upgrade Kit	E	\$4,590
DS-6610B-8PODLIC	DS-6610B 8Port SFP POD Lic - 0 SFPs =MA	E	\$4,560

DS-6610B-ENT	DS-6610B Enterprise SW Bundle =MA	E	\$5,490
DS-6610R-B-0	DS-6610R-B 8/24P RTF 0 SFP Switch	E	\$5,480
DS-6610R-B-8	DS-6610R-B 8/24P RTF W/8 16G SFP Swch	E	\$5,950
DS-6610R-B-EP	DS-6610R-B 24/24P W/16GB RTF ENT Switch	E	\$18,300
DS6620-12PODLIC	DS-6620B 12Port SFP POD Lic - 0 SFPs =MA	E	\$10,560
DS6620-16QSFP LIC	DS-6620B 16Port QSFP POD Lic 0 QSFPs =MA	E	\$14,080
DS6620-32G12PU	DS-6620B 32G 12Port 32G SFP Upgrade Kit	E	\$11,820
DS6620-32GX4QSFP	DS-6620B 16Port 4X32G QSFP Upg Kit	E	\$23,640
DS6620-32QSFP-BRKO	DS-6620B 16P-4X32G BRKOUT QSFP POD KIT	E	\$23,610
DS-6620B-ENT	DS-6620B ENTERPRISE SW BUNDLE=MA	E	\$12,134
DS-6620B-IR	DS-6620B INTEGRATED ROUTING LICENSE=MA	E	\$17,700
DS-6620B-MF	DS-6620B Main Frame Enterprise Lic =MA	E	\$17,770
DS-6620F-B-0	DS-6620F-B 24P/48P 32GB FTR 0 SFP Switch	E	\$21,570
DS-6620F-B-24	DS-6620F-B 24P/48P 32GB FTR 24SFP Switch	E	\$25,280
DS-6620F-B-EP	DS-6620F-B 48P/48P 32GB FTR Ent Switch	E	\$55,130
DS-6620R-B-0	DS-6620R-B 24P/48P 32GB RTF 0 SFP Switch	E	\$21,570
DS-6620R-B-24	DS-6620R-B 24P/48P 32GB RTF 24SFP Switch	E	\$25,280
DS-6620R-B-EP	DS-6620R-B 48P/48P 32GB RTF Ent Switch	E	\$55,130
DS6630-24PODLIC	DS-6630B 24Port SFP POD Lic 0 SFPs =MA	E	\$42,210
DS6630-32G24PU	DS-6630B 32G 24Port 32G SFP Upgrade Kit	E	\$40,740
DS6630-32GX8QSFP	DS-6630B 32Port 8 32G QSFP Upgrade Kit	E	\$81,480
DS6630-32QSFP LIC	DS-6630B 32Port QSFP POD Lic 0 QSFPs =MA	E	\$84,420
DS-6630B-ENT	DS-6630B Enterprise SW Bundle =MA	E	\$35,530
DS-6630B-IR	DS-6630B Intergrated Routing License =MA	E	\$41,130
DS-6630F-B-0	DS-6630F-B 48P/96P 32GB FTR 0 SFP Switch	E	\$90,570
DS-6630F-B-24	DS-6630F-B 48P/96P 32GB FTR 48SFP Switch	E	\$98,720
DS-6630R-B-0	DS-6630R-B 48P/96P 32GB RTF 0 SFP Switch	E	\$91,330
DS-6630R-B-24	DS-6630R-B 48P/96P 32GB RTF 48SFP Switch	E	\$98,720
DS-6630R-B-EP	DS-6630R-B 96P/96P 32GB RTF Ent Switch	E	\$191,700
DS-8B2-00	8 PORT 2GB FC SWITCH	E	\$0
DS-8B2-00L	8 PORT SWITCH W SINGLE E	E	\$0
DS-8B3-FF-0	DS8B3 8-PORT FULL FAB	E	\$0
DS-8B3-FF-0U	DS8B3US 8-PORT FULL FAB	E	\$0
DS8B-ENT	ENT SW BNDL FOR DS-8B2/3	E	\$0
DS8B-EP8	FW Lic E-Port Expansion	E	\$0
DS8B-FW	FABRIC WATCH FOR DS-8B2/3	E	\$0
DS8B-PM	PERF MONITOR FOR DS8B2/3	E	\$0
DS8B-QL	QUICKLOOP FOR DS-8B2	E	\$0
DS8B-TR	TRUNKING FOR DS-8B2/3	E	\$0
DS8B-XF	EXT FABRIC DS-8B2/3	E	\$0
DSBQLP-0D	QLOOP LIC FOR DSB	E	\$2,900
DS-CUPSW-32M2	CUP LIC DS32M2	E	\$0
DS-CUPSW-4700	CUP LIC FOR THE DS-4700M	E	\$5,200
ED-10KM-AUT	SANTEGRITY AUTH ED-10000M	E	\$0
ED-10KM-CUP	I10K FICON LIC KEY	E	\$0
ED-10KM-TRK	ED-10K OPEN TRUNKING LICENSE	E	\$0
ED-140M-AUT	SANTEGRITY AUTH ED-140M	E	\$0
ED-140M-STG	SANTEGRITY LIC ED140M	E	\$0
ED-140M-TRK	OPEN TRNK SW LIC	E	\$0
ED-64M-AUT	SANTEGRITY AUTH ED-64M	E	\$0

ED-64M-FCZ	FICON CUP ZONING ED-64M	E	\$0
ED-64M-STG	SANTEGRITY LIC ED64M	E	\$0
ED-64M-TRK	OPEN TRNK SW LICENSE	E	\$0
ED-CUPSW-140M	CUP LIC ED140M	E	\$0
ED-CUPSW-64M	CUP LIC ED64M	E	\$0
ED-DCX6-IR-LIC	ED-DCX6 INTEGRATED ROUTING LICENSE =MA	E	\$38,452
ED-DCX-B-IR	ED-DCX-B INTEGRATED ROUTING LICENSE	E	\$0
ED-DCX-B-IR-CF	ED-DCX-B INTEGRATED ROUTING LICENSE	E	\$38,810
EM-1007	CTX MGR VERSION 7	E	\$0
EM-1007-UPG	CTX MGR V 7.X UPGRADE	E	\$0
EM-1009-ENT	CTX MGR ENTERPRISE BASE	E	\$0
EM-1009-STD	CTX MGR STANDARD	E	\$0
EM-1010-ENT	CTX MGR 10;X DATACTRED ENTERPRISE	E	\$0
EM-1010-PLUS	CTX MGR 10.X DATACTRED - PRO PLUS	E	\$0
EM1010PLUSUPG	CTX MGR 10.X CMDCE PRO PLUS TO ENT UPG	E	\$0
EM-10KM-ENT	ENTERPRISE OS SW PACKAGED-10000	E	\$0
EM-10KM-FIC	ENTERPRISE FICON SW PACKAGED-10000	E	\$0
EM-10KM-OPT	OPTIMIZER SW PACKAGED-10000	E	\$0
EM-10KM-SEC	SECURITY SW PACKAGED-10000	E	\$0
EM-140M-ENT	ED-140M ENT SW+FW BNDL	E	\$0
EM-140M-FIC	FICON BUNDLE LICENSE ED-140M	E	\$0
EM-140M-OPT	ED-140M OPT SW+FW BNDL	E	\$0
EM-140M-SEC	EM-140M SEC BUNDLE	E	\$0
EM-16M2-ENT	DS-16M2 ENT SW+FW BNDL	E	\$0
EM-16M2-OPT	ED-16M2 OPT SW+FW BNDL	E	\$0
EM-16M2-SEC	EM-16M2 SEC BNDL	E	\$0
EM-24M2-ENT	DS-24M2- ENT SW+FW BNDL	E	\$0
EM-24M2-OPT	EM-24M2-OPT	E	\$0
EM-24M2-SEC	EM-24M2 SEC BNDL	E	\$0
EM-32M2-ENT	DS-32M2 ENT SW+FW BNDL	E	\$0
EM-32M2-FIC	FICON BUNDLE LICENSE DS-32M2	E	\$0
EM-32M2-OPT	ED-32M2 OPT SW+FW BNDL	E	\$0
EM-32M2-SEC	EM-32M2 SECY BNDL	E	\$0
EM-4400M-ENT	DS-4400M ENT SW&FW BLD	E	\$0
EM-4400M-OPT	DS-4400M OPT SW+FW BNDL	E	\$0
EM-4400M-SEC	DS-4400M SEC BNDL	E	\$0
EM-4700M-ENT	DS-4700M ENT SW&FW BLD	E	\$0
EM-4700M-FIC	FICON BUNDLE LICENSE ED-140M	E	\$0
EM-4700M-OPT	DS-4700M OPT SW+FW BNDL	E	\$0
EM-4700M-SEC	DS-4700 SEC BNDL	E	\$0
EM-64M-ENT	ED-64M ENT SW+FW BND	E	\$0
EM-64M-FIC	FICON BUNDLE LICENSE ED-64M	E	\$0
EM-64M-OPT	ED-64M OPTSW+FW BNDL	E	\$0
EM-64M-SEC	EM-64M SECURITY BUNDLE	E	\$0
EM-ADVMOD-256	CTX MGR ADVANCED MODULE - 256 PORTS	E	\$0
EM-ADVMOD-32	CTX MGR ADVANCED MODULE - 32 PORTS	E	\$0
EM-ADVMOD-512	CTX MGR ADVANCED MODULE - 512 PORTS	E	\$0
EM-ADVMOD-64	CTX MGR ADVANCED MODULE - 64 PORTS	E	\$0
EM-ADVSAVRTG	CTX MGR ADVANCED SAN ROUTING	E	\$0
EM-CMS-CME-U	CTX MGR ENTERPRISE BASE UPGR	E	\$0

EM-EVTMGR-512	EVENT MGR LICENSE 512 PORTS P/O CTX MGR	E	\$0
EM-EVTMGR-64	EVENT MGR LICENSE 64 PORTS P/O CTX MGR	E	\$0
EM-PRFEVT-512	PERFRMNCE-EVENT 512 PRT BUNDL LICNSE P/O	E	\$0
EM-PRFEVT-64	PERFRMNCE-EVENT 64 PRT BUNDL LICNSE P/O	E	\$0
EM-PRFMON-512	PERF MNTR 512 PORTS	E	\$0
EM-PRFMON-64	PERF MNTR 64 PORTS	E	\$0
EM-SECCTL-512	SANTEG SEC CM 512 PORTS	E	\$0
EM-SECCTL-64	SANTEG SEC CM 64 PORTS	E	\$0
EM-STD-ENT-U	CTX MGR STANDARD TO ENTERPRISE UPGRAD	E	\$0
EM-SVGE-CME-U	SANV ENT/CTX MGR TO CTX MGR ENT UPGR	E	\$0
EM-SVGE-CMS-U	SANVERGENCE ENT TO CTX MGR STAN UPGR	E	\$0
EM-SVGS-CMS-U	SANVERGENCE STAND TO CTX MGR STAN UPG	E	\$0
ENCSMRTCARDS	ES-5832B + PB-DCX-16EB SMART CARDS10-PK	E	\$393
EOC-AIX-DEP	TRANSFER AGENT AIX DEPT	E	\$0
EOC-AIX-ENT	TRANSFER AGENT AIX ENT	E	\$0
EOC-AIX-GLBL	TRANSFER AGENT AIX GLB	E	\$0
EOC-AIX-WGP	TRANSFER AGENT AIX WKGP	E	\$0
EOC-HPUX-DEP	EMC ONCOURSE TA HPUX DEP	E	\$0
EOC-HPUX-ENT	EMC ONCOURSE TA HPUX ENT	E	\$0
EOC-HPUX-GLBL	EMC ONCOURSE TA HPUX GLB	E	\$0
EOC-HPUX-WGP	EMC ONCOURSE TA HPUX WGR	E	\$0
EOC-LNX-DEP	EMC ONCOURSE TA LNX DEP	E	\$0
EOC-LNX-ENT	EMC ONCOURSE TA LNX ENT	E	\$0
EOC-LNX-TMGR	EMC ONCOURSE LNX TRAN MGR	E	\$0
EOC-LNX-WGP	EMC ONCOURSE TA LNX WGR	E	\$0
EOC-SLNX-DEP	TRANSFER AGENT SUSE DPT	E	\$0
EOC-SLNX-ENT	TRANSFER AGENT SUSE ENT	E	\$0
EOC-SLNX-WGP	TRANSFER AGNT SUSE WKGP	E	\$0
EOC-SUNUX-DEP	EMC ONCOURSE TA SUN DEP	E	\$0
EOC-SUNUX-ENT	EMC ONCOURSE TA SUN ENT	E	\$0
EOC-SUNUX-GBL	EMC ONCOURSE TA SUN GLB	E	\$0
EOC-SUNUX-WGP	EMC ONCOURSE TA SUN WGR	E	\$0
EOC-WIN-DEP	EMC ONCOURSE TA WIN DEP	E	\$0
EOC-WIN-ENT	EMC ONCOURSE TA WIN ENT	E	\$0
EOC-WIN-TMGR	EMC ONCOURSE WIN TRAN MGR	E	\$0
EOC-WIN-WGP	EMC ONCOURSE TA WIN WGP	E	\$0
ES-5832B	ES-5832B 32P ENCRYPT SWITCH BASE 48G EB	E	\$0
ES5832B-48GBW	ES-5832B 48G ENCRYPTBW UPGRADE LICENSE	E	\$0
ES5832B-48GBW-CF	ES-5832B 48G ENCRYPTBW UPGRADE LICENSE	E	\$93,200
ES-5832B-AN	ES-5832B ADAPTIVE NETWORKING LICENSE	E	\$0
ES-5832B-AN-CF	ES-5832B ADAPTIVE NETWORKING LICENSE	E	\$0
ES-5832B-ENT	ES-5832B ENTERPRISE SW BUNDLE	E	\$0
ES-5832B-ENT-CF	ES-5832B ENTERPRISE SW BUNDLE	E	\$0
ES-5832B-FV	ES-5823B FABRIC VISION LICENSE =MA	E	\$0
ES-5832B-FV-CF	ES-5823B FABRIC VISION LICENSE =MA	E	\$0
ES-5832B-FW	ES-5832B FABRIC WATCH LICENSE	E	\$0
ES-5832B-FW-CF	ES-5832B FABRIC WATCH LICENSE	E	\$0
ES-5832B-IR	ES-5832B INTERGRATED ROUTING LICENSE	E	\$0
ES-5832B-IR-CF	ES-5832B INTERGRATED ROUTING LICENSE	E	\$0
ES-5832B-PM	ES-5832B PERFORMANCE MONITOR LICENSE	E	\$0

ES-5832B-PM-CF	ES-5832B PERFORMANCE MONITOR LICENSE	E	\$0
ES-5832B-TR	ES-5832B TRUNKING LICENSE	E	\$0
ES-5832B-TR-CF	ES-5832B TRUNKING LICENSE	E	\$0
ES-5832B-XF	ES-5832B EXTENDED FABRIC LICENSE	E	\$0
ES-5832B-XF-CF	ES-5832B EXTENDED FABRIC LICENSE	E	\$0
FX8-24-10GBE	ED-DCX FX8-24 2P 10GBE LICENSE	E	\$0
FX8-24-10GBE-CF	ED-DCX FX8-24 2P 10GBE LICENSE	E	\$30,800
FX8-24-ADVEXT	ED-DCX FX8-24 ADVANCED EXTENSION LICENS	E	\$0
FX8-24-ADVEXT-CF	ED-DCX FX8-24 ADVANCED EXTENSION LICENS	E	\$14,100
GEN6-10GBE-CO	10GBE COPPER SLIC (ROCKSLIDE)	E	\$1,250
GEN6-10GBE-CO-U	10GB COPPER SLIC (ROCKSLIDE) UPG	E	\$1,250
GEN6-10GBE-FI	10GBE OPTICAL SLIC (LANDSLIDE)	E	\$750
GEN6-10GBE-FI-U	10GB OPTICAL SLIC (LANDSLIDE) UPG	E	\$750
GEN6-10GB-SFP	10GBE OPTICAL SFP (MULTI-MODE)	E	\$375
GEN6-16GBFC	6GB FC 4-PORT SLIC (VORTEX-Q)	E	\$0
GEN6-16GBSFP	16GB SFP	E	\$750
GEN6-8GBSFC	8GB SFP	E	\$250
KAZ-ECS	KAZ ECS SERVER NODE (INTL)	E	\$0
KAZ-FI	KAZ FI SERVER NODE (INTL)	E	\$0
KAZ-FIE	KAZ FIE SERVER NODE (INTL)	E	\$0
KAZ-IC-ECS	KAZ ECS INFOCNTR SERVER NODE (INTL)	E	\$0
KAZ-IC-FI	KAZ FI INFOCNTR SERVER NODE (INTL)	E	\$0
KAZ-IC-FIE	KAZ FIE INFOCNTR SERVER NODE (INTL)	E	\$0
MDS-10GE-SFPL	MDS 10GbE LW Switch Optic	E	\$3,230
MDS-10GE-SFPS	MDS 10GbE SW Switch Optic	E	\$800
MDS-16FC-SFPL	MDS 16Gb FC LW Switch Optic	E	\$2,990
MDS-16FC-SFPS	MDS 16Gb FC SW Switch Optic	E	\$268
MDS-32G-LW	MDS 32G Switch LW Optics SFP+	E	\$4,850
MDS-32G-SW	MDS 32G Switch SW Optics SFP+	E	\$810
MDS-9120-00	2Gb 20-port FC Switch	E	\$0
MDS-9124	4GB 8-PORT FC SWITCH	E	\$0
MDS-9124-0D	24 PORT 4GB SWITCH W/8 ACTIVE PORTS	E	\$5,200
MDS-9124-8	4GB 8-PORT FC OPTIC KIT	E	\$0
MDS-9124-8D	4GB 8-PORT FC OPTIC KIT	E	\$3,000
MDS-9132T-24E-16	MDS-9132T Switch 24 16G SFPs PSE ENT LIC	E	\$15,400
MDS-9132T-24E-32	MDS-9132T Switch w/24 32G SFPs PSE	E	\$25,040
MDS-9132T-24I-16	MDS-9132T Switch 24 16G SFPs PSI ENT LIC	E	\$15,400
MDS-9132T-24I-32	MDS-9132T Switch w/24 32G SFPs PSI	E	\$25,040
MDS-9132T-8E-16	MDS-9132T Switch w/8 16G SFPs PSE	E	\$5,490
MDS-9132T-8E-32	MDS-9132T Switch w/8 32G SFPs PSE	E	\$9,130
MDS-9132T-8I-16	MDS-9132T Switch w/8 16G SFPs PSI	E	\$5,490
MDS-9132T-8I-32	MDS-9132T Switch w/8 32G SFPs PSI	E	\$9,130
MDS-9132T-E	MDS-9132T Base Switch no SFPs PSE	E	\$4,690
MDS-9132T-EXP	MDS-9132T Expansion Module	E	\$9,690
MDS-9132T-I	MDS-9132T Base Switch no SFPs PSI	E	\$4,690
MDS-9132T-POD-CF	MDS-9132T 32G FC 8 Port Upg Lic=MA	E	\$5,140
MDS-9132T-PSU-E	MDS-9132T Power Supply PSE	E	\$670
MDS-9132T-PSU-I	MDS-9132T Power Supply PSI	E	\$670
MDS-9132T-UPG-16G	MDS-9132T Port Upg Kit w/8 16G SFPs	E	\$4,540
MDS-9134	4 GB 32 FC/2 10GB PORT SWITCH	E	\$0

MDS-9134-2	2-PORT 10GB ACTIVATION LICENSE	E	\$0
MDS-9134-2-CF	2-PORT 10GB ACTIVATION LICENSE	E	\$1,600
MDS-9134-8	8-PORT 4GB ACTIVATION LICENSE	E	\$0
MDS-9134-8-CF	8-PORT 4GB ACTIVATION LICENSE	E	\$3,100
MDS-9140-00	2Gb 40-port FC Switch	E	\$0
MDS-9148-POD	CISCO 9148 8-PORT POD LICENSE	E	\$6,400
MDS-9148S-12	MDS-9148S 16Gb Switch - 12 active ports	E	\$4,580
MDS-9148S-POD	Connectrix 9148S 16G FC 12P Upg Lic=MA	E	\$4,500
MDS-9148S-POD-CF	CONNECTRIX 9148S 16G FC 12P UPG LIC=MA	E	\$4,500
MDS-9216-00	CISCO DEPARTMENTAL SWITCH	E	\$0
MDS-9216A-00	2Gb 16-Port FC Switch	E	\$0
MDS-9216I-00	2Gb 14-Port FC+ 2-Port IP Switch	E	\$0
MDS-9222I	4 GB 18 FC/4 GE PORT SWITCH	E	\$0
MDS-9250I	16Gb, 50-Port 9250i, 20 active ports	E	\$53,900
MDS-9250I-20	16Gb, 20-Port 9250i port upg license=MA	E	\$0
MDS-9250I-20-CF	16Gb, 20-Port 9250i port upg license=MA	E	\$15,710
MDS-9250I-IOA	MDS IOA License for 9250i=MA	E	\$47,720
MDS-9250I-IOA-CF	MDS IOA LICENSE FOR 9250I=MA	E	\$47,720
MDS-9396S-48	MDS-9396S 16Gb Switch - 48 active ports	E	\$36,941
MDS-9396S-48-I	MDS-9396S 16Gb Switch 48 act ports PSI	E	\$37,210
MDS-9396S-POD	Connectrix 9396S 16G FC 12P Upg Lic=MA	E	\$0
MDS-9396S-POD-CF	CONNECTRIX 9396S 16G FC 12P UPG LIC=MA	E	\$7,621
MDS-9Q20-00	4Gb 20-Port FC Switch	E	\$0
MDS-DCNM-91	DCNM SAN LICENSE FOR MDS 9100	E	\$0
MDS-DCNM-91-CF	DCNM SAN LICENSE FOR MDS 9100	E	\$7,012
MDS-DCNM-91X	DCNM SAN Lic MDS 9100 Switch based=MA	E	\$0
MDS-DCNM-91X-CF	DCNM SAN LIC MDS 9100 SWITCH BASED=MA	E	\$7,012
MDS-DCNM-92	DCNM SAN LICENSE FOR MDS 9200	E	\$0
MDS-DCNM-92-CF	DCNM SAN LICENSE FOR MDS 9200	E	\$7,012
MDS-DCNM-92X	DCNM SAN Lic MDS 9200 Switch based=MA	E	\$0
MDS-DCNM-92X-CF	DCNM SAN LIC MDS 9200 SWITCH BASED=MA	E	\$7,012
MDS-DCNM-93	DCNM 9300 SAN License Server based=MA	E	\$0
MDS-DCNM-93-CF	DCNM 9300 SAN LICENSE SERVER BASED=MA	E	\$7,014
MDS-DCNM-93X	DCNM 9300 SAN License Switch based=MA	E	\$0
MDS-DCNM-93X-CF	DCNM 9300 SAN LICENSE SWITCH BASED=MA	E	\$7,014
MDS-DCNM-95	DCNM SAN LICENSE FOR MDS 9500	E	\$0
MDS-DCNM-95-CF	DCNM SAN LICENSE FOR MDS 9500	E	\$21,032
MDS-DCNM-95X	DCNM SAN Lic MDS 9500 Switch based=MA	E	\$0
MDS-DCNM-95X-CF	DCNM SAN LIC MDS 9500 SWITCH BASED=MA	E	\$21,032
MDS-DCNM-97	DCNM SAN License for MDS 9700	E	\$0
MDS-DCNM-97-CF	DCNM SAN License for MDS 9700	E	\$21,032
MDS-DCNM-97X	DCNM SAN Lic MDS 9700 Switch based=MA	E	\$0
MDS-DCNM-97X-CF	DCNM SAN LIC MDS 9700 SWITCH BASED=MA	E	\$21,032
MDS-DCNM-SAN-AXK9	MDS DCNM SAN Analytics M97 3 yr Lic=MA	E	\$20,720
MDS-EDCNM-93	Ent + DCNM MDS 9300 Lic Server based=MA	E	\$0
MDS-EDCNM-93-CF	ENT + DCNM MDS 9300 LIC SERVER BASED=MA	E	\$9,198
MDS-EDCNM-93X	Ent + DCNM MDS 9300 Lic Switch based=MA	E	\$0
MDS-EDCNM-93X-CF	ENT + DCNM MDS 9300 LIC SWITCH BASED=MA	E	\$9,198
MDS-ENT-9100	ENTERPRISE LIC KEY 9100	E	\$0
MDS-ENT-9100-CF	ENTERPRISE LIC KEY 9100	E	\$7,300

MDS-ENT-9200	ENTERPRISE LIC KEY 9200	E	\$0
MDS-ENT-9200-CF	ENTERPRISE LIC KEY 9200	E	\$8,100
MDS-ENT-9300	MDS 9300 Enterprise License=MA	E	\$0
MDS-ENT-9300-CF	MDS 9300 ENTERPRISE LICENSE=MA	E	\$6,610
MDS-ENT-9500	ENTERPRISE LIC KEY 9500	E	\$0
MDS-ENT-9500-CF	ENTERPRISE LIC KEY 9500	E	\$27,800
MDS-ENT-97	Enterprise License for MDS 9700	E	\$0
MDS-ENT-97-CF	Enterprise License for MDS 9700	E	\$27,250
MDS-EXT92-SSN	SAN EXT LIC (1 ENGINE) FOR THE SSN-16 MO	E	\$0
MDS-EXT92-SSN-CF	SAN EXT LIC (1 ENGINE) FOR THE SSN-16 MO	E	\$23,900
MDS-EXT95-SSN	SAN EXT LIC (1 ENGINE) FOR THE SSN-16 MO	E	\$0
MDS-EXT95-SSN-CF	SAN EXT LIC (1 ENGINE) FOR THE SSN-16 MO	E	\$23,900
MDS-FCIP2-9200	2 PT FCIP LIC KEY BLADES	E	\$0
MDS-FCIP2-9500	LICENSE KEY FOR 2 PT FCIP	E	\$0
MDS-FCIP4-9200	SAN EXT LIC 4PORT IP 92xx	E	\$0
MDS-FCIP4-9500	SAN EXT LIC 4PORT IP 95xx	E	\$0
MDS-FCIP-9200	SAN EXT LIC 8PORT IP 92xx	E	\$0
MDS-FCIP92-4	MDS 9200 SAN EXT FOR 18/4 MSM M	E	\$0
MDS-FCIP92-4-CF	MDS 9200 SAN EXT FOR 18/4 MSM M	E	\$15,600
MDS-FCIP-9500	SAN EXT LIC 8PORT IP 95xx	E	\$0
MDS-FCIP95-4	MDS 9500 SAN EXT FOR ONE 18/4 MSM	E	\$0
MDS-FCIP95-4-CF	MDS 9500 SAN EXT FOR ONE 18/4 MSM	E	\$15,600
MDS-FMS-9100	FABRIC MGR SVR LIC 91xx	E	\$0
MDS-FMS-9100-CF	FABRIC MGR SVR LIC 91xx	E	\$6,800
MDS-FMS-9200	FABRIC MGR SVR LIC 92xx	E	\$0
MDS-FMS-9200-CF	FABRIC MGR SVR LIC 92xx	E	\$7,100
MDS-FMS-9500	FABRIC MGR SVR LIC 95xx	E	\$0
MDS-FMS-9500-CF	FABRIC MGR SVR LIC 95xx	E	\$21,200
MDS-IO92I-MSM	IOA LICENSE FOR THE MSM 18/4 MODULE IN	E	\$0
MDS-IO92I-MSM-CF	IOA LICENSE FOR THE MSM 18/4 MODULE IN	E	\$55,000
MDS-IOA92-MSM	IOA LICENSE FOR THE MSM 18/4 MODULE IN	E	\$0
MDS-IOA92-MSM-CF	IOA LICENSE FOR THE MSM 18/4 MODULE IN	E	\$55,000
MDS-IOA92-SSN	IOA LICENSE (1 ENGINE) FOR THE SSN-16	E	\$0
MDS-IOA92-SSN-CF	IOA LICENSE (1 ENGINE) FOR THE SSN-16	E	\$54,600
MDS-IOA95-MSM	IOA LICENSE FOR THE MSM 18/4 MODULE IN	E	\$0
MDS-IOA95-MSM-CF	IOA LICENSE FOR THE MSM 18/4 MODULE IN	E	\$55,000
MDS-IOA95-SSN	IOA LICENSE (1 ENGINE) FOR THE SSN-16	E	\$0
MDS-IOA95-SSN-CF	IOA LICENSE (1 ENGINE) FOR THE SSN-16	E	\$54,600
MDS-IOA97-2410	MDS IOA 24/10 Module 1 Engine Lic=MA	E	\$54,670
MDS-IOA97-24102X	MDS IOA 24/10 Module 2 Engine Lic=MA	E	\$102,540
MDS-MAIN-9100	MAINFRAME LIC KEY 9100	E	\$12,600
MDS-MAIN-9200	MAINFRAME LIC KEY 9200	E	\$0
MDS-MAIN-9200-CF	MAINFRAME LIC KEY 9200	E	\$12,000
MDS-MAIN-9500	MAINFRAME LIC KEY 9500	E	\$0
MDS-MAIN-9500-CF	MAINFRAME LIC KEY 9500	E	\$25,000
MDS-MAIN-9700	Connectrix MDS Mainframe Lic Key 9700=MA	E	\$0
MDS-MAIN-9700-CF	Connectrix MDS Mainframe Lic Key 9700=MA	E	\$25,130
MDS-PW2-EU	Qty 2 9509 Power Cord Europe	E	\$0
MDS-PW2-INT	Qty 2 9509 Power Cord International	E	\$0
MDS-PW2-SA	Qty 2 9509 Power Cord South Africa	E	\$0

MDS-PW2-SW	Qty 2 9509 Power Cord Switzerland	E	\$0
MDS-PW2-TWST	Qty 2 9509 Twist Lock Power Cord US	E	\$0
MDS-PW2-US	Qty 2 9509 Power Cord US	E	\$0
MDS-PW8-ARGIN	Qty 2 9100 9200 Power Cord Argentina	E	\$0
MDS-PW8-AUS	Qty 2 9100 9200 Power Cord Australia	E	\$0
MDS-PW8-EU	Qty 2 9100 9200 Power Cord Europe	E	\$0
MDS-PW8-ISR	Israel Power Cord for 9200/9100 switch	E	\$0
MDS-PW8-ITALY	Qty 2 9100 9200 Power Cord Italy	E	\$0
MDS-PW8-SA	Qty 2 9100 9200 Power Cord S Africa	E	\$0
MDS-PW8-UK	Qty 2 9216 9120 9124 9140 Power Cord UK	E	\$0
MDS-PW8-US	Qty 2 9216 9120 9124 9140 Power Cord US	E	\$0
MDS-SAN-M97S-AXK9	MDS SAN Analytics M9700 3 yr Lic=MA	E	\$15,540
MDS-SFP-8GER	MDS 8G FC EXT Range Switch Optic	E	\$6,500
MDS-SFP-8GLW	2/4/8-GBPS FC LONGWAVE SWITCH SFP LC	E	\$1,800
MDS-SFP-8GSW	2/4/8-GBPS FC SHORTWAVE SWITCH SFP LC	E	\$158
MDS-SFP-GE-T	MDS-9250i 1Gb Copper SFP	E	\$324
MDS-SME-9200	MDS 9200 SME LICENSE FOR MDS-	E	\$0
MDS-SME-9200-CF	MDS 9200 SME LICENSE FOR MDS-	E	\$15,900
MDS-SME-9200E	SME LIC FOR EXPANSION SLOT IN MDS-9222I	E	\$0
MDS-SME-9200E-CF	SME LIC FOR EXPANSION SLOT IN MDS-9222I	E	\$15,900
MDS-SME92-SSN	SME LICENSE (1 ENGINE) FOR TH	E	\$0
MDS-SME92-SSN-CF	SME LICENSE (1 ENGINE) FOR TH	E	\$17,900
MDS-SME-9500	DIRECTOR SME LICENSE FOR MDS-PBFI-1804	E	\$0
MDS-SME-9500-CF	DIRECTOR SME LICENSE FOR MDS-PBFI-1804	E	\$15,900
MDS-SME95-SSN	SME LIC (1 ENGINE) FOR T	E	\$0
MDS-SME95-SSN-CF	SME LIC (1 ENGINE) FOR T	E	\$17,900
MDS-SSE-9200	SOT SOL ENABLER LIC 9200	E	\$0
MDS-SSE-9200F	MDS 9200 STORAGE SERVICES ENABLER LICEN	E	\$0
MDS-SSE-9222I	CISCO SSE LICENSE ON MDS 9222I	E	\$0
MDS-SSE-92MSM	CISCO SSE LICENSE FOR 18/4 ON MDS 9200	E	\$0
MDS-SSE-9500	STOR SOL ENABLRLIC 9500	E	\$0
MDS-SSE-9500F	MDS 9500 STORAGE SERVICES ENABLER LICEN	E	\$0
MDS-SSE-95MSM	CISCO SSE LICENSE FOR 18/4 ON MDS 9500	E	\$0
MP-1620M	1Gb 2 FC 2 GE MP Router	E	\$0
MP-1620M-EN	ENT EXPANDED FUNCT	E	\$0
MP-1620M-IF	IFCP SW MP-1620M	E	\$0
MP-1620M-MGR	ENT MGR SW MP-1620M	E	\$0
MP-2211	CWDM 1610NM 100K	E	\$0
MP-2212	CWDM 1590NM 100K	E	\$0
MP-2213	CWDM 1570NM 100K	E	\$0
MP-2214	CWDM 1550NM 100K	E	\$0
MP-2640M	2Gb 8 FC 4GE MP Router	E	\$0
MP-7500B	MP-7500B FC/IP SAN ROUTER	E	\$0
MP7500B-FCIP	MP-7500B FCIP IPSEC & HW COMPRESSION LIC	E	\$0
MP7500B-FCIP-CF	MP-7500B FCIP IPSEC & HW COMPRESSION LIC	E	\$0
MP7500B-FW	MP-7500B FABRIC WATCH LICENSE	E	\$0
MP7500B-FW-CF	MP-7500B FABRIC WATCH LICENSE	E	\$0
MP7500B-PM	MP-7500B PERFORMANCE MONITOR LICENSE	E	\$0
MP7500B-PM-CF	MP-7500B PERFORMANCE MONITOR LICENSE	E	\$0
MP7500B-TR	MP-7500B ISL TRUNKING LICENSE	E	\$0

MP7500B-TR-CF	MP-7500B ISL TRUNKING LICENSE	E	\$0
MP-7800B	MP-7800B BASE 4P FC 2P 1GBE MP SWITCH	E	\$14,340
MP-7800B-ADVX	MP-7800B ADVANCED EXTENSION LICENSE	E	\$0
MP-7800B-ADVX-CF	MP-7800B ADVANCED EXTENSION LICENSE	E	\$9,505
MP-7800B-AN	MP-7800B ADAPTIVE NETWORKING LICENSE	E	\$0
MP-7800B-AN-CF	MP-7800B ADAPTIVE NETWORKING LICENSE	E	\$4,215
MP-7800B-ENT	MP-7800B ENTERPRISE SW BUNDLE	E	\$0
MP-7800B-ENT-CF	MP-7800B ENTERPRISE SW BUNDLE	E	\$11,565
MP7800B-ENTFC	MP-7800B ENTERPRISE UPG W/12 8GB FC SFPS	E	\$44,700
MP-7800B-FIC	MP-7800B FICON CUP LICENSE	E	\$0
MP-7800B-FIC-CF	MP-7800B FICON CUP LICENSE	E	\$5,195
MP-7800B-FV	MP-7800B FABRIC VISION LICENSE =MA	E	\$0
MP-7800B-FV-CF	MP-7800B FABRIC VISION LICENSE =MA	E	\$5,820
MP-7800B-FW	MP-7800B FABRIC WATCH LICENSE	E	\$0
MP-7800B-FW-CF	MP-7800B FABRIC WATCH LICENSE	E	\$2,550
MP-7800B-IR	MP-7800B INTERGRATED ROUTING LICENSE	E	\$0
MP-7800B-IR-CF	MP-7800B INTERGRATED ROUTING LICENSE	E	\$12,350
MP-7800B-PM	MP-7800B PERFORMANCE MONITOR LICENSE	E	\$0
MP-7800B-PM-CF	MP-7800B PERFORMANCE MONITOR LICENSE	E	\$2,845
MP-7800B-SAO	MP-7800B SERVER APPLICATION OPTIMIZA LIC	E	\$0
MP-7800B-SAO-CF	MP-7800B SERVER APPLICATION OPTIMIZA LIC	E	\$1,375
MP-7800B-TR	MP-7800B TRUNKING LICENSE	E	\$0
MP-7800B-TR-CF	MP-7800B TRUNKING LICENSE	E	\$4,215
MP-7800B-XF	MP-7800B EXTENDED FABRIC LICENSE	E	\$0
MP-7800B-XF-CF	MP-7800B EXTENDED FABRIC LICENSE	E	\$2,845
MP-7840B	MP-7840B Base 24P FC 2P 1GbE MP Switch	E	\$91,800
MP-7840B-CU	MP-7840B FICON CUP Lic=MA	E	\$7,800
MP-7840B-CU-CF	MP-7840B FICON CUP Lic=MA	E	\$7,800
MP-7840B-IR	MP-7840B Intergrated Routing Lic=MA	E	\$17,700
MP-7840B-IR-CF	MP-7840B Intergrated Routing Lic=MA	E	\$17,700
MP-7840B-WU1	MP-7840B Wan Upgrade1 Lic=MA	E	\$36,580
MP-7840B-WU1-CF	MP-7840B Wan Upgrade1 Lic=MA	E	\$36,580
MP-7840B-WU2	MP-7840B Wan Upgrade2 Lic=MA	E	\$59,030
MP-7840B-WU2-CF	MP-7840B Wan Upgrade2 Lic=MA	E	\$59,030
MP-CWDM-2114	CWDM 8 STARTER PCK 4/100KM	E	\$0
MP-CWDM-2118	CWDM 8 STARTER PAK 8/100K	E	\$0
MP-CWDM-2215	SFP PAIR 1530NM DD 100KM	E	\$0
MP-CWDM-2216	SFP PAIR 1510NM DD 100KM	E	\$0
MP-CWDM-2217	SFP PAIR 1490NM DD 100KM	E	\$0
MP-CWDM-2218	SFP PAIR 1470NM DD 100KM	E	\$0
MP-CWDM-2220	PRISM MODULE 1 SLOT PASSI	E	\$0
MP-CWDM-2229	MP-CWDM CARRIER 4 SLOT 1U	E	\$0
MP-CWDM-2230	CWDM CABLE PAIR MU TO LC	E	\$0
NEX-5010	NEXUS 5010 1RU CHASSIS STORAGE SERVICES	E	\$0
NEX-5020	NEXUS 5020 2RU CHASSIS INCLUDES STORAGE	E	\$0
NEX-5K-4E4FC	4-PORT 10GE / 4-PORT FC MODULE	E	\$0
NEX-5K-4E4FCU	4-PORT 10GE / 4-PORT FC MODULE	E	\$0
NEX-5K-4GSW	4GB 4 SW OPTICS	E	\$0
NEX-5K-6E	6-PORT 10GB ENET MODULE	E	\$0
NEX-5K-6EU	6-PORT 10GB ENET MODULE	E	\$0

NEX-5K-6FC-8G	NEXUS 5000 6-PORT 8GB FC MODULE	E	\$0
NEX-5K-6FC8GU	NEXUS 5000 6-PORT 8GB FC MODULE UPGRADE	E	\$0
NEX-5K-8FC	8-PORT 4GB FC MODULE	E	\$0
NEX-5K-8FCU	8-PORT 4GB FC MODULE	E	\$0
NEX-8G-LW	NEXUS 2/4/8-GBPS FC LONGWAVE SFP LC	E	\$0
NEX-8G-SW	NEXUS 2/4/8-GBPS FC SHORTWAVE SFP LC	E	\$0
NEX-FMS-5000	NEXUS 5000 FABRIC MANAGER SERVER	E	\$0
NS2-AREPALL-L	NS20FC REPLICATION BUNDLE WITH MV/A	E	\$0
NS2-SREPALL-L	NS20FC REPLICATION BUNDLE WITH MV/S	E	\$0
NS-CX-ES01	NS-CNX ENCRYPTION SOLUTION	E	\$0
OBN-RPHW3-G6T	RPA GEN 6 FOR UNITY	E	\$19,250
OBN-RPHW3-G6T-D	Dell RPA GEN6 for Unity	E	\$19,250
PERE-MSU-T00	PERF ESS BASE-3 MSU	E	\$0
PERE-MSU-T01	PERF ESS 4-25 MSU	E	\$0
PERE-MSU-T02	PERF ESS 26-50 MSU	E	\$0
PERE-MSU-T03	PERF ESS 51-75 MSU	E	\$0
PERE-MSU-T04	PERF ESS 76-100 MSU	E	\$0
PERE-MSU-T05	PERF ESS 101-150 MSU	E	\$0
PERE-MSU-T06	PERF ESS 151-200 MSU	E	\$0
PERE-MSU-T07	PERF ESS 201-250 MSU	E	\$0
PERE-MSU-T08	PERF ESS 251-300 MSU	E	\$0
PERE-MSU-T09	PERF ESS 301-350 MSU	E	\$0
PERE-MSU-T10	PERF ESS 351-400 MSU	E	\$0
PERE-MSU-T11	PERF ESS 401-450 MSU	E	\$0
PERE-MSU-T12	PERF ESS 451-500 MSU	E	\$0
PERE-MSU-T13	PERF ESS 501-550 MSU	E	\$0
PERE-MSU-T14	PERF ESS 551-600 MSU	E	\$0
PERE-T0-T03-U	PERF ESS UPG T00 - T03	E	\$0
PERE-T4-T14-U	PERF ESS UPG T04-T14	E	\$0
PM-4400M	DS-4400M ELEMENT MANAGER	E	\$0
PMAX2-RPHW-G6T	RPA FOR POWERMAX 2000	E	\$19,250
PMAX2-RPHW-G6T-D	DELL RPA FOR POWERMAX 2000	E	\$19,250
PMAX8-RPHW-G6T	RPA FOR POWERMAX 8000	E	\$19,250
PMAX8-RPHW-G6T-D	DELL RPA FOR POWERMAX 8000	E	\$19,250
PM-DS24M	PRODUCT MANAGER - DS-24M2	E	\$0
PM-DS32M	PROD MNGR SW LIC DS32M	E	\$0
PM-ED140M	PRODUCT MGR FOR ED-140M	E	\$0
PM-ED64M	PROD MGR SW LIC ED64M	E	\$0
PP-RPHWP-G5T	RPA GEN5-TAA FOR PROTECTPOINT-RP	E	\$0
PP-RPHWP-G6T	RPA FOR PROTECTPOINT	E	\$19,250
PP-RPHWP-G6T-D	Dell RPA for ProtectPoint	E	\$19,250
PP-RSAE-AIX	POWERPATH ENCRYPTION WITH RSA FOR AIX	E	\$0
PP-RSAE-SUN	POWERPATH ENCRYPTION BY RSA FOR SUN	E	\$0
RKM-SWITCH18	RKM LICENSE UP TO 18 ENCRYPTED PORTS	E	\$0
RKM-SWITCH4	RKM LIC 1-4 ENCRYPT DEVICES 1PER DEV	E	\$0
RKM-SWITCH5	RKM LIC 5-99 ENCRYPT DEVICES 1PER DEV	E	\$0
RKM-SWITCH54	RKM LICENSE UP TO 54 ENCRYPTED PORTS	E	\$0
RKM-SWITCH55	RKM LICENSE UNLIMITED PORTS	E	\$0
ROAM-1TB	ROAM MIGRATION LIC - 1TB	E	\$6,800
ROAM-30DAYEXT	ROAM 30 DAY TIME EXTENSION	E	\$0

ROAM-3TB	ROAM MIGRATION LIC 3TB	E	\$18,400
ROAM-5TB	ROAM MIGRATION LIC 5TB	E	\$27,290
ROAM-ASM	ROAM ASSESSMENT LICENSE	E	\$9,100
RP-DR	RECOVERPOINT 1.2TB DRIVE	E	\$1,165
RP-HW-G5	GEN5 RPA FOR RP	E	\$0
RP-PS	RECOVERPOINT POWER SUPPLY	E	\$385
S1-ECS	ECS SERVER FOR SOURCEONE EDISCOVERY	E	\$0
S1-FI	FILE INTELLIGENCE SERVER FOR S1	E	\$0
S1-FIE	S1-FI-ENT SERVER	E	\$0
S1-IC-ECS	INFOCTR ECS SERVER FOR SOURCEONE EDISCOVERY	E	\$0
S1-IC-FI	INFOCTR FILE INT ENT SERVER S1 KAZEON	E	\$0
S1-IC-FIE	S1-IC-FI-ENT SERVER	E	\$0
SCAP-APPL	SCA SERVER	E	\$0
SIO-RPHW-G6T	RPA FOR SCALEIO	E	\$19,250
SIO-RPHW-G6T-D	DELL VxFlex OS-RP APPLIANCE GEN6	E	\$19,250
SMA-VCO-PCI	ITOI NCM PCI ADVISOR	E	\$0
SP811-0320	R-SPR KIT-SWITCH RAIL KIT D2060/4040 CLS	E	\$350
SP811-0321	R-SPR KIT-SWITCH PSU 460W 90-264V CLS	E	\$530
SP811-0322	R-SPR KIT-SWITCH FAN MODULE D2060/4040	E	\$100
SP811-0323	R-SPR KIT-SWITCH RAIL KIT D2024 CLS	E	\$340
SP811-0324	R-SPR KIT-SWITCH FAN MODULE D2024 CLS	E	\$70
SP811-0325	R-SPR KIT-Switch 1670 220VAC PSU MSX65XX	E	\$84,730
SP811-0326	R-SPR KIT-Switch Fan Unit MSX65XX	E	\$3,530
SP811-0327	R-SPR KIT-Switch 36P QDR Spine MSX65XX	E	\$17,200
SP811-0328	R-SPR KIT-Switch Spine Fan Unit MSX65XX	E	\$17,200
SP811-0329	R-SPR KIT-Switch Mgt Module MSX65XX	E	\$17,800
SP811-0330	R-SPR KIT-Switch Fabric-X INT Fan AR7304	E	\$15,750
SP811-0331	R-SPR KIT-Switch 3kW AC PSU ARS	E	\$9,900
SP811-0332	R-SPR KIT-Switch Fabric-X INT Fan AR7308	E	\$28,650
SP811-0333	R-SPR KIT-Switch Spare Fan Module ARS	E	\$400
SP811-0334	R-SPR KIT-Switch Supervisor Module AR73x	E	\$44,970
SP811-0335	R-SPR KIT-Switch NEPTUNE-X MTEF-FANF-A	E	\$1,260
SP811-0336	R-SPR KIT-Switch NEPTUNE-X MTEF-PSF-AC-A	E	\$2,330
SW-12000B-CU	FICON/CUP - SW12000B	E	\$0
SW-12000B-PM	PERF MONITOR ED-12000B	E	\$0
SW-12000B-TR	TRUNKING ED-12000B	E	\$0
SW-12000B-XF	EXT FABRIC LIC ED-12000B	E	\$0
SW-24000B-CU	FICON/CUP - SW24000B	E	\$0
SW-24000B-FW	FABRIC WATCH FOR ED-24000	E	\$0
SW-24000B-TR	TRUNKING FOR ED-24000B	E	\$0
SW-48000B-CU	FICON CUP-ED-48000B	E	\$0
SW-48000B-ENT	ENT SW BNDL FOR ED-48000B	E	\$0
SW-48000B-FW	FAB WATCH FOR ED-48000B	E	\$0
SW-48000B-IP	FCIP LICENSE FOR THE 18I BLADE	E	\$0
SW-48000B-PM	PERF MONITOR ED-48000B	E	\$0
SW-48000B-TR	TRUNKING FOR ED-48000B	E	\$0
SW-48000B-XF	EXT FABRIC FOR ED-48000B	E	\$0
VDX6740-2P40G	VDX-6740 2X40GBE POD Upgrade Lic=MA	E	\$0
VDX6740-8P10G	VDX-6740 8X10GBE POD Upgrade Lic=MA	E	\$0
VDX6740-FCOE	VDX-6740 FCoE Lic=MA	E	\$0

VM2-RPHW-G6T	RPA FOR VMAX AF250	E	\$19,250
VM2-RPHW-G6T-D	Dell RPA for VMAX AF250	E	\$19,250
VM4-RPHW-G6T	RPA for VMAX AF450/850/950	E	\$19,250
VM4-RPHW-G6T-D	Dell RPA for VMAX AF450/850/950	E	\$19,250
VMAX3-RPHW-G6T	RPA FOR VMAX3	E	\$19,250
VMAX3-RPHW-G6T-D	Dell RPA for VMAX3	E	\$19,250
VME-RPHW-G5	RPA GEN5-Non TAA FOR VMAX10K	E	\$0
VME-RPHW-G5T	RPA GEN5-TAA FOR VMAX10K	E	\$0
VME-RPHW-G6T	RPA FOR VMAX10K	E	\$19,250
VMX-RPHW-G5	RPA GEN5-Non TAA FOR VMAX20K & VMAX40K	E	\$0
VMX-RPHW-G5T	RPA GEN5-TAA FOR VMAX 20K & VMAX 40K	E	\$0
VMX-RPHW-G6T	RPA FOR VMAX20K/VMAX40K	E	\$19,250
VNX-RPHW7-G5T	RPA GEN5-TAA FOR VNX UM DC	E	\$0
VNX-RPHW7-G6T	RPA FOR VNX2, VNXe3200	E	\$19,250
VPLX-RPHW-G5T	RPA GEN5-TAA FOR VPLEX	E	\$0
VPLX-RPHW-G6T	RPA FOR VPLEX	E	\$23,750
VPLX-RPHW-G6T-D	Dell RPA for VPLEX	E	\$23,750
VPX-RPHW-G5	RPA GEN5 FOR VPLEX	E	\$0
VPX-RPHW-G5T	RPA GEN5 TAA FOR RP VPLEX	E	\$0
VSA-MSU-T00	VSAM A BASE-3-MSU	E	\$0
VSA-MSU-T01	VSAM A 4-25 MSU	E	\$0
VSA-MSU-T02	VSAM A 26-50 MSU	E	\$0
VSA-MSU-T03	VSAM A 51-75 MSU	E	\$0
VSA-MSU-T04	VSAM A 76-100 MSU	E	\$0
VSA-MSU-T05	VSAM A 101-150 MSU	E	\$0
VSA-MSU-T06	VSAM A 151-200 MSU	E	\$0
VSA-MSU-T07	VSAM A 201-250 MSU	E	\$0
VSA-MSU-T08	VSAM A 251-300 MSU	E	\$0
VSA-MSU-T09	VSAM A 301-350 MSU	E	\$0
VSA-MSU-T10	VSAM A 351-400 MSU	E	\$0
VSA-MSU-T11	VSAM A 401-450 MSU	E	\$0
VSA-MSU-T12	VSAM A 451-500 MSU	E	\$0
VSA-MSU-T13	VSAM A 501-550 MSU	E	\$0
VSA-MSU-T14	VSAM A 551-600 MSU	E	\$0
VSA-T00-T03-U	VSAM A UPG T00 - T03	E	\$0
VSA-T04-T14-U	VSAM A UPG T04-T14	E	\$0
VSCP-MSUBASE	VSAM CP BASE-3 MSU	E	\$21,600
VSCP-MSU-M00	VSAM CP 4-45 MSU	E	\$430
VSCP-MSU-M01	VSAM CP 46-175 MSU	E	\$260
VSCP-MSU-M02	VSAM CP 176-315 MSU	E	\$175
VSCP-MSU-M03	VSAM CP 316-575 MSU	E	\$110
VSCP-MSU-M04	VSAM CP 576-875 MSU	E	\$85
VSCP-MSU-M05	VSAM CP 876-1315 MSU	E	\$65
VSCP-MSU-M06	VSAM CP 1316-1975 MSU	E	\$45
VSCP-MSU-M07	VSAM CP 1976 & UP MSU	E	\$20
VSCP-MSU-T00	VSAM CP BASE-3 MSU	E	\$0
VSCP-MSU-T01	VSAM CP 4-25 MSU	E	\$0
VSCP-MSU-T02	VSAM CP 26-50 MSU	E	\$0
VSCP-MSU-T03	VSAM CP 51-75 MSU	E	\$0
VSCP-MSU-T04	VSAM CP 76-100 MSU	E	\$0

VSCP-MSU-T05	VSAM CP 101-150 MSU	E	\$0
VSCP-MSU-T06	VSAM CP 151-200 MSU	E	\$0
VSCP-MSU-T07	VSAM CP 201-250 MSU	E	\$0
VSCP-MSU-T08	VSAM CP 251-300 MSU	E	\$0
VSCP-MSU-T09	VSAM CP 301-350 MSU	E	\$0
VSCP-MSU-T10	VSAM CP 351-400 MSU	E	\$0
VSCP-MSU-T11	VSAM CP 401-450 MSU	E	\$0
VSCP-MSU-T12	VSAM CP 451-500 MSU	E	\$0
VSCP-MSU-T13	VSAM CP 501-550 MSU	E	\$0
VSCP-MSU-T14	VSAM CP 551-600 MSU	E	\$0
VSCP-MSU-UPG	VSAM CP UPG	E	\$0
VSCP-T00-T03	VSAM CP UPG T00 - T03	E	\$0
VSCP-T04-T14	VSAM CP UPG T04-T14	E	\$0
VSQI-MSU-T00	VSAM QI BASE-3 MSU	E	\$0
VSQI-MSU-T01	VSAM QI 4-25 MSU	E	\$0
VSQI-MSU-T02	VSAM QI 26-50 MSU	E	\$0
VSQI-MSU-T03	VSAM QI 51-75 MSU	E	\$0
VSQI-MSU-T04	VSAM QI 76-100 MSU	E	\$0
VSQI-MSU-T05	VSAM QI 101-150 MSU	E	\$0
VSQI-MSU-T06	VSAM QI 151-200 MSU	E	\$0
VSQI-MSU-T07	VSAM QI 201-250 MSU	E	\$0
VSQI-MSU-T08	VSAM QI 251-300 MSU	E	\$0
VSQI-MSU-T09	VSAM QI 301-350 MSU	E	\$0
VSQI-MSU-T10	VSAM QI 351-400 MSU	E	\$0
VSQI-MSU-T11	VSAM QI 401-450 MSU	E	\$0
VSQI-MSU-T12	VSAM QI 451-500 MSU	E	\$0
VSQI-MSU-T13	VSAM QI 501-550 MSU	E	\$0
VSQI-MSU-T14	VSAM QI 551-600 MSU	E	\$0
VSQI-T00-T03	VSAM QI UPG T00 - T03	E	\$0
VSQI-T04-T14	VSAM QI UPG T04-T14	E	\$0
X01-IBSW-36F	XtremIO - 36 PORT IB SWITCH -FLD	E	\$0
X02-FC-10M	XtremIO - FC Cable 10m	E	\$202
X02-FC-1M	XtremIO - FC Cable 1m	E	\$160
X02-FC-3M	XtremIO - FC Cable 3m	E	\$174
X02-IBSW	XtremIO - IB SWITCH	E	\$20,900
X02-IBSW-F	XtremIO - IB SWITCH -FLD	E	\$20,900
X02-IBSW-U	XTREMIO - IB SWITCH UPG	E	\$20,900
X02-ISCSI-10M	XtremIO - iSCSI Cable 10m	E	\$202
X02-ISCSI-1M	XtremIO - iSCSI Cable 1m	E	\$160
X02-ISCSI-3M	XtremIO - iSCSI Cable 3m	E	\$174
X2-HD-SWITCH	XtremIO X2-R InfiniBand Switch Fac	E	\$30,000
X2-HD-SWITCH-FD	XtremIO X2-R InfiniBand Switch Fld	E	\$30,000
X2-HD-SWITCH-KIT	XtremIO X2-R InfiniBand Switch Kit Fac	E	\$0
X2-HD-SWITCH-KIT-U	XtremIO X2-R InfiniBand Switch Kit FD/UG	E	\$0
X2-HD-SWITCH-U	XtremIO X2-R InfiniBand Switch UG	E	\$13,500
X2-IB-SINGLE	X2-Single X-Brick IB Cbl Kit-Fact Inst	E	\$0
X2-IB-SINGLE-U	X2-Single X-Brick IB Cbl Kit-Upgrade	E	\$0
X2-IB-XB1	X2 - X-Brick 1 IB Cable Kit-Fact Inst	E	\$0
X2-IB-XB1-U	X2 - X-Brick 1 IB Cable Kit - Field/Upg	E	\$0
X2-IB-XB2	X2 - X-Brick 2 IB Cable Kit-Fact Inst	E	\$0

X2-IB-XB2-U	X2 - X-Brick 2 IB Cable Kit - Field/Upg	E	\$0
X2-IB-XB3	X2 - X-Brick 3 IB Cable Kit-Fact Inst	E	\$0
X2-IB-XB3-U	X2 - X-Brick 3 IB Cable Kit - Field/Upg	E	\$0
X2-IB-XB4	X2 - X-Brick 4 IB Cable Kit-Fact Inst	E	\$0
X2-IB-XB4-U	X2 - X-Brick 4 IB Cable Kit - Field/Upg	E	\$0
X2-SD-SWITCH	XtremIO X2-S InfiniBand Switch Fac	E	\$13,500
X2-SD-SWITCH-FD	XtremIO X2-S InfiniBand Switch Fld	E	\$13,500
X2-SD-SWITCH-KIT	XtremIO X2-S InfiniBand Switch Kit Fac	E	\$0
X2-SD-SWITCH-KIT-U	XtremIO X2-S InfiniBand Switch Kit FD/UG	E	\$0
X2-SD-SWITCH-U	XtremIO X2-S InfiniBand Switch UG	E	\$30,000
XELOR32E	ROLEX ENGINE	E	\$0
XELORDTS	ROLEX DATA TAP SOLARIS	E	\$0
XELORDTW	ROLEX DATA TAP WINDOWS	E	\$0
XIO-RP-HW-G6T-D	Dell XIO-RP Appliance GEN6-TAA	E	\$19,250
XIO-RPHWX-G5T	RPA GEN5-TAA FOR XtremIO XT DC	E	\$0
XIO-RPHWX-G6T	RPA FOR XTREMIO	E	\$19,250
XIOX2-RPHW-G6T	RPA for XtremIO-X2	E	\$19,250
XIOX2-RPHW-G6T-D	Dell RPA for XtremIO-X2	E	\$19,250
AA47220001B	VMAX 10K 4Gb 7_2K 2000GB DRIVE	EN-H	\$1,665
AA47220001BTU	VMAX 10K 4Gb 7_2K 2000GB DRIVE UPG	EN-H	\$2,330
AA47220001BU	VMAX 10K 4Gb 7_2K 2000GB DRIVE UPG	EN-H	\$2,330
AA47220005B	VMAX 10K 4Gb 7_2K 2000GB DRIVE R5(3+1)	EN-H	\$1,665
AA47220005BTU	VMAX 10K 4Gb 7_2K 2000GB DRV R5(3+1) UPG	EN-H	\$2,330
AA47220005BU	VMAX 10K 4Gb 7_2K 2000GB DRV R5(3+1) UPG	EN-H	\$2,330
AA47220006B	VMAX 10K 4Gb 7_2K 2000GB DRIVE R6(6+2)	EN-H	\$1,665
AA47220006BTU	VMAX 10K 4Gb 7_2K 2000GB DRV R6(6+2) UPG	EN-H	\$2,330
AA47220006BU	VMAX 10K 4Gb 7_2K 2000GB DRV R6(6+2) UPG	EN-H	\$2,330
AA47220007B	VMAX 10K 4Gb 7_2K 2000GB DRIVE R5(7+1)	EN-H	\$1,665
AA47220007BTU	VMAX 10K 4Gb 7_2K 2000GB DRV R5(7+1) UPG	EN-H	\$2,330
AA47220007BU	VMAX 10K 4Gb 7_2K 2000GB DRV R5(7+1) UPG	EN-H	\$2,330
AA4722000FB	VMAX 10K 4Gb 7_2K 2000GB DRIVE R6(14+2)	EN-H	\$1,665
AA4722000FBTU	VMAX 10K 4Gb 7_2K 2000GB DRV R6(14+2)UPG	EN-H	\$2,330
AA4722000FBU	VMAX 10K 4Gb 7_2K 2000GB DRV R6(14+2)UPG	EN-H	\$2,330
AA4722000SB	VMAX 10K 4Gb 7_2K 2000GB DRIVE SPARE	EN-H	\$1,665
AA4722000SBTU	VMAX 10K 4Gb 7_2K 2000GB DRIVE SPARE UPG	EN-H	\$2,330
AA4722000SBU	VMAX 10K 4Gb 7_2K 2000GB DRIVE SPARE UPG	EN-H	\$2,330
AF4106001B	VMAX 10K 4Gb 10K 600 DRIVE	EN-H	\$0
AF4106001BTU	VMAX 10K 4Gb 10K 600 DRIVE UPG	EN-H	\$2,395
AF4106001BU	VMAX 10K 4Gb 10K 600 DRIVE UPG	EN-H	\$2,395
AF4106005B	VMAX 10K 4Gb 10K 600 GB DRIVE R5(3+1)	EN-H	\$0
AF4106005BTU	VMAX 10K 4Gb 10K 600 GB DRIVE R5(3+1)UPG	EN-H	\$2,395
AF4106005BU	VMAX 10K 4Gb 10K 600 GB DRIVE R5(3+1)UPG	EN-H	\$2,395
AF4106006B	VMAX 10K 4Gb 10K 600 GB DRIVE R6(6+2)	EN-H	\$0
AF4106006BTU	VMAX 10K 4Gb 10K 600 GB DRIVE R6(6+2)UPG	EN-H	\$2,395
AF4106006BU	VMAX 10K 4Gb 10K 600 GB DRIVE R6(6+2)UPG	EN-H	\$2,395
AF4106007B	VMAX 10K 4Gb 10K 600 GB DRIVE R5(7+1)	EN-H	\$0
AF4106007BTU	VMAX 10K 4Gb 10K 600 GB DRIVE R5(7+1)UPG	EN-H	\$2,395
AF4106007BU	VMAX 10K 4Gb 10K 600 GB DRIVE R5(7+1)UPG	EN-H	\$2,395
AF410600FB	VMAX 10K 4Gb 10K 600 GB DRIVE R6(14+2)	EN-H	\$0
AF410600FBTU	VMAX 10K 4Gb 10K 600 GB DRV R6(14+2) UPG	EN-H	\$2,395

AF410600FBU	VMAX 10K 4Gb 10K 600 GB DRV R6(14+2) UPG	EN-H	\$2,395
AF410600SB	VMAX 10K 4Gb 10K 600 GB DRIVE SPARE	EN-H	\$0
AF410600SBTU	VMAX 10K 4Gb 10K 600 GB DRIVE SPARE UPG	EN-H	\$2,395
AF410600SBU	VMAX 10K 4Gb 10K 600 GB DRIVE SPARE UPG	EN-H	\$2,395
AF4153001B	VMAX 10K 4GB 15K 300 GB DRIVE R1	EN-H	\$0
AF4153001BTU	VMAX 10K 4GB 15K 300 GB DRIVE R1 UPG	EN-H	\$1,935
AF4153001BU	VMAX 10K 4GB 15K 300 GB DRIVE R1 UPG	EN-H	\$1,935
AF4153005B	VMAX 10K 4GB 15K 300 GB DRIVE R5(3+1)	EN-H	\$0
AF4153005BTU	VMAX 10K 4GB 15K 300 GB DRV R5(3+1) UPG	EN-H	\$1,935
AF4153005BU	VMAX 10K 4GB 15K 300 GB DRV R5(3+1) UPG	EN-H	\$1,935
AF4153006B	VMAX 10K 4GB 15K 300 GB DRIVE R6(6+2)	EN-H	\$0
AF4153006BTU	VMAX 10K 4GB 15K 300 GB DRV R6(6+2) UPG	EN-H	\$1,935
AF4153006BU	VMAX 10K 4GB 15K 300 GB DRV R6(6+2) UPG	EN-H	\$1,935
AF4153007B	VMAX 10K 4GB 15K 300 GB DRIVE R5(7+1)	EN-H	\$0
AF4153007BTU	VMAX 10K 4GB 15K 300 GB DRV R5(7+1) UPG	EN-H	\$1,935
AF4153007BU	VMAX 10K 4GB 15K 300 GB DRV R5(7+1) UPG	EN-H	\$1,935
AF415300FB	VMAX 10K 4GB 15K 300 GB DRIVE R6(14+2)	EN-H	\$0
AF415300FBTU	VMAX 10K 4GB 15K 300 GB DRV R6(14+2) UPG	EN-H	\$1,935
AF415300FBU	VMAX 10K 4GB 15K 300 GB DRV R6(14+2) UPG	EN-H	\$1,935
AF415300SB	VMAX 10K 4GB 15K 300 GB DRIVE SPARE	EN-H	\$0
AF415300SBTU	VMAX 10K 4GB 15K 300 GB DRIVE SPARE UPG	EN-H	\$1,935
AF415300SBU	VMAX 10K 4GB 15K 300 GB DRIVE SPARE UPG	EN-H	\$1,935
AF4154501B	VMAX 10K 4Gb 15K 450GB DRIVE	EN-H	\$0
AF4154501BTU	VMAX 10K 4Gb 15K 450GB DRIVE UPG	EN-H	\$2,540
AF4154501BU	VMAX 10K 4Gb 15K 450GB DRIVE UPG	EN-H	\$2,540
AF4154505B	VMAX 10K 4Gb 15K 450GB DRIVE R5(3+1)	EN-H	\$0
AF4154505BTU	VMAX 10K 4Gb 15K 450GB DRIVE R5(3+1) UPG	EN-H	\$2,540
AF4154505BU	VMAX 10K 4Gb 15K 450GB DRIVE R5(3+1) UPG	EN-H	\$2,540
AF4154506B	VMAX 10K 4Gb 15K 450GB DRIVE R6(6+2)	EN-H	\$0
AF4154506BU	VMAX 10K 4Gb 15K 450GB DRIVE R6(6+2) UPG	EN-H	\$2,540
AF4154506TBU	VMAX 10K 4Gb 15K 450GB DRIVE R6(6+2) UPG	EN-H	\$2,540
AF4154507B	VMAX 10K 4Gb 15K 450GB DRIVE R5(7+1)	EN-H	\$0
AF4154507BTU	VMAX 10K 4Gb 15K 450GB DRIVE R5(7+1) UPG	EN-H	\$2,540
AF4154507BU	VMAX 10K 4Gb 15K 450GB DRIVE R5(7+1) UPG	EN-H	\$2,540
AF415450FB	VMAX 10K 4Gb 15K 450GB DRIVE R6(14+2)	EN-H	\$0
AF415450FBTU	VMAX 10K 4Gb 15K 450GB DRV R6(14+2) UPG	EN-H	\$2,540
AF415450FBU	VMAX 10K 4Gb 15K 450GB DRV R6(14+2) UPG	EN-H	\$2,540
AF415450SB	VMAX 10K 4Gb 15K 450GB DRIVE SPARE	EN-H	\$0
AF415450SBTU	VMAX 10K 4Gb 15K 450GB DRIVE SPARE UPG	EN-H	\$2,540
AF415450SBU	VMAX 10K 4Gb 15K 450GB DRIVE SPARE UPG	EN-H	\$2,540
AF4156001B	VMAX 10K 4GB 15K 600 GB DRIVE R1	EN-H	\$0
AF4156001BTU	VMAX 10K 4GB 15K 600 GB DRIVE R1 UPG	EN-H	\$3,145
AF4156001BU	VMAX 10K 4GB 15K 600 GB DRIVE R1 UPG	EN-H	\$3,145
AF4156005B	VMAX 10K 4GB 15K 600 GB DRIVE R5(3+1)	EN-H	\$0
AF4156005BTU	VMAX 10K 4GB 15K 600 GB DRIVE R5(3+1)UPG	EN-H	\$3,145
AF4156005BU	VMAX 10K 4GB 15K 600 GB DRIVE R5(3+1)UPG	EN-H	\$3,145
AF4156006B	VMAX 10K 4GB 15K 600 GB DRIVE R6(6+2)	EN-H	\$0
AF4156006BTU	VMAX 10K 4GB 15K 600 GB DRIVE R6(6+2)UPG	EN-H	\$3,145
AF4156006BU	VMAX 10K 4GB 15K 600 GB DRIVE R6(6+2)UPG	EN-H	\$3,145
AF4156007B	VMAX 10K 4GB 15K 600 GB DRIVE R5(7+1)	EN-H	\$0

AF4156007BTU	VMAX 10K 4GB 15K 600 GB DRIVE R5(7+1)UPG	EN-H	\$3,145
AF4156007BU	VMAX 10K 4GB 15K 600 GB DRIVE R5(7+1)UPG	EN-H	\$3,145
AF415600FB	VMAX 10K 4GB 15K 600 GB DRIVE R6(14+2)	EN-H	\$0
AF415600FBTU	VMAX 10K 4GB 15K 600 GB DRV R6(14+2)UPG	EN-H	\$3,145
AF415600FBU	VMAX 10K 4GB 15K 600 GB DRV R6(14+2)UPG	EN-H	\$3,145
AF415600SB	VMAX 10K 4GB 15K 600 GB DRIVE SPARE	EN-H	\$0
AF415600SBTU	VMAX 10K 4GB 15K 600 GB DRIVE SPARE UPG	EN-H	\$3,145
AF415600SBU	VMAX 10K 4GB 15K 600 GB DRIVE SPARE UPG	EN-H	\$3,145
AF4F11001B	VMAX 10K 4GB FLASH 100GB DRIVE R1	EN-H	\$0
AF4F11001BFP	VMAX 10K 4G FLASH 100GB DRV R1 FP	EN-H	\$0
AF4F11001BP	VMAX 10K 4GB FLASH 100GB DRIVE R1 PROM	EN-H	\$0
AF4F11001BTU	VMAX 10K 4GB FLASH 100GB DRIVE R1 UPG	EN-H	\$4,355
AF4F11001BU	VMAX 10K 4GB FLASH 100GB DRIVE R1 UPG	EN-H	\$4,355
AF4F11005B	VMAX 10K 4GB FLASH 100GB DRIVE R5(3+1)	EN-H	\$0
AF4F11005BFP	VMAX 10K 4G FLASH 100GB DRV R5(3+1) FP	EN-H	\$0
AF4F11005BP	VMAX 10K 4GB FLASH 100GB DRV R5(3+1)PROM	EN-H	\$0
AF4F11005BTU	VMAX 10K 4GB FLASH 100GB DRV R5(3+1)UPG	EN-H	\$4,355
AF4F11005BU	VMAX 10K 4GB FLASH 100GB DRV R5(3+1)UPG	EN-H	\$4,355
AF4F11007B	VMAX 10K 4GB FLASH 100GB DRIVE R5(7+1)	EN-H	\$0
AF4F11007BFP	VMAX 10K 4G FLASH 100GB DRV R5(7+1) FP	EN-H	\$0
AF4F11007BP	VMAX 10K 4GB FLASH 100GB DRV R5(7+1)PROM	EN-H	\$0
AF4F11007BTU	VMAX 10K 4GB FLASH 100GB DRV R5(7+1)UPG	EN-H	\$4,355
AF4F11007BU	VMAX 10K 4GB FLASH 100GB DRV R5(7+1)UPG	EN-H	\$4,355
AF4F1100SB	VMAX 10K 4GB FLASH 100GB DRIVE SPARE	EN-H	\$0
AF4F1100SBP	VMAX 10K 4GB FLASH 100GB DRV SPARE PROM	EN-H	\$0
AF4F1100SBTU	VMAX 10K 4GB FLASH 100GB DRIVE SPARE UPG	EN-H	\$4,355
AF4F1100SBU	VMAX 10K 4GB FLASH 100GB DRIVE SPARE UPG	EN-H	\$4,355
AF4F12001B	VMAX 10K 4Gb FLASH 200GB DRIVE	EN-H	\$5,595
AF4F12001BTU	VMAX 10K 4Gb FLASH 200GB DRIVE UPG	EN-H	\$7,830
AF4F12001BU	VMAX 10K 4Gb FLASH 200GB DRIVE UPG	EN-H	\$7,830
AF4F12005B	VMAX 10K 4Gb FLASH 200GB DRIVE R5(3+1)	EN-H	\$5,595
AF4F12005BTU	VMAX 10K 4Gb FLASH 200GB DRV R5(3+1)UPG	EN-H	\$7,830
AF4F12005BU	VMAX 10K 4Gb FLASH 200GB DRV R5(3+1)UPG	EN-H	\$7,830
AF4F12007B	VMAX 10K 4Gb FLASH 200GB DRIVE R5(7+1)	EN-H	\$5,595
AF4F12007BTU	VMAX 10K 4Gb FLASH 200GB DRV R5(7+1)UPG	EN-H	\$7,830
AF4F12007BU	VMAX 10K 4Gb FLASH 200GB DRV R5(7+1)UPG	EN-H	\$7,830
AF4F1200SB	VMAX 10K 4Gb FLASH 200GB DRIVE SPARE	EN-H	\$5,595
AF4F1200SBTU	VMAX 10K 4Gb FLASH 200GB DRIVE SPARE UPG	EN-H	\$7,830
AF4F1200SBU	VMAX 10K 4Gb FLASH 200GB DRIVE SPARE UPG	EN-H	\$7,830
AF4F14001B	VMAX 10K 4GB FLASH 400GB DRIVE R1	EN-H	\$10,615
AF4F14001BU	VMAX 10K 4GB FLASH 400GB DRIVE R1 UPG	EN-H	\$14,855
AF4F14005B	VMAX 10K 4GB FLASH 400GB DRIVE R5(3+1)	EN-H	\$10,615
AF4F14005BU	VMAX 10K 4GB FLASH 400GB DRV R5(3+1)UPG	EN-H	\$14,855
AF4F1400SB	VMAX 10K 4GB FLASH 400GB DRIVE SPARE	EN-H	\$10,615
AF4F1400SBU	VMAX 10K 4GB FLASH 400GB DRIVE SPARE UPG	EN-H	\$14,855
AL41012001B	VMAX 10K 1200GB 10K SAS DRV R1	EN-H	\$2,130
AL41012001BTU	VMAX 10K 1200GB 10K SAS DRV R1 UPG	EN-H	\$2,980
AL41012001BU	VMAX 10K 1200GB 10K SAS DRV R1 UPG	EN-H	\$2,980
AL41012005B	VMAX 10K 1200GB 10K SAS DRV R5(3+1)	EN-H	\$2,130
AL41012005BTU	VMAX 10K 1200GB 10K SAS DRV R5(3+1) UPG	EN-H	\$2,980

AL41012005BU	VMAX 10K 1200GB 10K SAS DRV R5(3+1) UPG	EN-H	\$2,980
AL41012006B	VMAX 10K 1200GB 10K SAS DRV R6(6+2)	EN-H	\$2,130
AL41012006BTU	VMAX 10K 1200GB 10K SAS DRV R6(6+2) UPG	EN-H	\$2,980
AL41012006BU	VMAX 10K 1200GB 10K SAS DRV R6(6+2) UPG	EN-H	\$2,980
AL41012007B	VMAX 10K 1200GB 10K SAS DRV R5(7+1)	EN-H	\$2,130
AL41012007BTU	VMAX 10K 1200GB 10K SAS DRV R5(7+1) UPG	EN-H	\$2,980
AL41012007BU	VMAX 10K 1200GB 10K SAS DRV R5(7+1) UPG	EN-H	\$2,980
AL4101200FB	VMAX 10K 1200GB 10K SAS DRV R6(14+2)	EN-H	\$2,130
AL4101200FBTU	VMAX 10K 1200GB 10K SAS DRV R6(14+2) UPG	EN-H	\$2,980
AL4101200FBU	VMAX 10K 1200GB 10K SAS DRV R6(14+2) UPG	EN-H	\$2,980
AL4101200SB	VMAX 10K 1200GB 10K SAS DRV SPARE	EN-H	\$2,130
AL4101200SBTU	VMAX 10K 1200GB 10K SAS DRV SPARE UPG	EN-H	\$2,980
AL4101200SBU	VMAX 10K 1200GB 10K SAS DRV SPARE UPG	EN-H	\$2,980
AL4103001B	VMAX 10K 300GB 10K SAS DRV R1	EN-H	\$0
AL4103001BTU	VMAX 10K 300GB 10K SAS DRV R1 UPG	EN-H	\$1,170
AL4103001BU	VMAX 10K 300GB 10K SAS DRV R1 UPG	EN-H	\$1,170
AL4103005B	VMAX 10K 300GB 10K SAS DRV R5(3+1)	EN-H	\$0
AL4103005BTU	VMAX 10K 300GB 10K SAS DRV R5(3+1) UPG	EN-H	\$1,170
AL4103005BU	VMAX 10K 300GB 10K SAS DRV R5(3+1) UPG	EN-H	\$1,170
AL4103006B	VMAX 10K 300GB 10K SAS DRV R6(6+2)	EN-H	\$0
AL4103006BTU	VMAX 10K 300GB 10K SAS DRV R6(6+2) UPG	EN-H	\$1,170
AL4103006BU	VMAX 10K 300GB 10K SAS DRV R6(6+2) UPG	EN-H	\$1,170
AL4103007B	VMAX 10K 300GB 10K SAS DRV R5(7+1)	EN-H	\$0
AL4103007BTU	VMAX 10K 300GB 10K SAS DRV R5(7+1) UPG	EN-H	\$1,170
AL4103007BU	VMAX 10K 300GB 10K SAS DRV R5(7+1) UPG	EN-H	\$1,170
AL410300FB	VMAX 10K 300GB 10K SAS DRV R6(14+2)	EN-H	\$0
AL410300FBTU	VMAX 10K 300GB 10K SAS DRV R6(14+2) UPG	EN-H	\$1,170
AL410300FBU	VMAX 10K 300GB 10K SAS DRV R6(14+2) UPG	EN-H	\$1,170
AL410300SB	VMAX 10K 300GB 10K SAS DRV SPARE	EN-H	\$0
AL410300SBTU	VMAX 10K 300GB 10K SAS DRV SPARE UPG	EN-H	\$1,170
AL410300SBU	VMAX 10K 300GB 10K SAS DRV SPARE UPG	EN-H	\$1,170
AL4106001B	VMAX 10K 600GB 10K SAS DRV R1	EN-H	\$0
AL4106001BTU	VMAX 10K 600GB 10K SAS DRV R1 UPG	EN-H	\$2,025
AL4106001BU	VMAX 10K 600GB 10K SAS DRV R1 UPG	EN-H	\$2,025
AL4106005B	VMAX 10K 600GB 10K SAS DRV R5(3+1)	EN-H	\$0
AL4106005BTU	VMAX 10K 600GB 10K SAS DRV R5(3+1) UPG	EN-H	\$2,025
AL4106005BU	VMAX 10K 600GB 10K SAS DRV R5(3+1) UPG	EN-H	\$2,025
AL4106006B	VMAX 10K 600GB 10K SAS DRV R6(6+2)	EN-H	\$0
AL4106006BTU	VMAX 10K 600GB 10K SAS DRV R6(6+2) UPG	EN-H	\$2,025
AL4106006BU	VMAX 10K 600GB 10K SAS DRV R6(6+2) UPG	EN-H	\$2,025
AL4106007B	VMAX 10K 600GB 10K SAS DRV R5(7+1)	EN-H	\$0
AL4106007BTU	VMAX 10K 600GB 10K SAS DRV R5(7+1) UPG	EN-H	\$2,025
AL4106007BU	VMAX 10K 600GB 10K SAS DRV R5(7+1) UPG	EN-H	\$2,025
AL410600FB	VMAX 10K 600GB 10K SAS DRV R6(14+2)	EN-H	\$0
AL410600FBTU	VMAX 10K 600GB 10K SAS DRV R6(14+2) UPG	EN-H	\$2,025
AL410600FBU	VMAX 10K 600GB 10K SAS DRV R6(14+2) UPG	EN-H	\$2,025
AL410600SB	VMAX 10K 600GB 10K SAS DRV SPARE	EN-H	\$0
AL410600SBTU	VMAX 10K 600GB 10K SAS DRV SPARE UPG	EN-H	\$2,025
AL410600SBU	VMAX 10K 600GB 10K SAS DRV SPARE UPG	EN-H	\$2,025
AL4109001B	VMAX 10K 900GB 10K SAS DRV R1	EN-H	\$0

AL4109001BTU	VMAX 10K 900GB 10K SAS DRV R1 UPG	EN-H	\$2,660
AL4109001BU	VMAX 10K 900GB 10K SAS DRV R1 UPG	EN-H	\$2,660
AL4109005B	VMAX 10K 900GB 10K SAS DRV R5(3+1)	EN-H	\$0
AL4109005BTU	VMAX 10K 900GB 10K SAS DRV R5(3+1) UPG	EN-H	\$2,660
AL4109005BU	VMAX 10K 900GB 10K SAS DRV R5(3+1) UPG	EN-H	\$2,660
AL4109006B	VMAX 10K 900GB 10K SAS DRV R6(6+2)	EN-H	\$0
AL4109006BTU	VMAX 10K 900GB 10K SAS DRV R6(6+2) UPG	EN-H	\$2,660
AL4109006BU	VMAX 10K 900GB 10K SAS DRV R6(6+2) UPG	EN-H	\$2,660
AL4109007B	VMAX 10K 900GB 10K SAS DRV R5(7+1)	EN-H	\$0
AL4109007BTU	VMAX 10K 900GB 10K SAS DRV R5(7+1) UPG	EN-H	\$2,660
AL4109007BU	VMAX 10K 900GB 10K SAS DRV R5(7+1) UPG	EN-H	\$2,660
AL410900FB	VMAX 10K 900GB 10K SAS DRV R6(14+2)	EN-H	\$0
AL410900FBTU	VMAX 10K 900GB 10K SAS DRV R6(14+2) UPG	EN-H	\$2,660
AL410900FBU	VMAX 10K 900GB 10K SAS DRV R6(14+2) UPG	EN-H	\$2,660
AL410900SB	VMAX 10K 900GB 10K SAS DRV SPARE	EN-H	\$0
AL410900SBTU	VMAX 10K 900GB 10K SAS DRV SPARE UPG	EN-H	\$2,660
AL410900SBU	VMAX 10K 900GB 10K SAS DRV SPARE UPG	EN-H	\$2,660
AL4153001B	VMAX 10K 300GB 15K SAS DRV R1	EN-H	\$0
AL4153001BTU	VMAX 10K 300GB 15K SAS DRV R1 UPG	EN-H	\$3,010
AL4153001BU	VMAX 10K 300GB 15K SAS DRV R1 UPG	EN-H	\$3,010
AL4153005B	VMAX 10K 300GB 15K SAS DRV R5(3+1)	EN-H	\$0
AL4153005BTU	VMAX 10K 300GB 15K SAS DRV R5(3+1) UPG	EN-H	\$3,010
AL4153005BU	VMAX 10K 300GB 15K SAS DRV R5(3+1) UPG	EN-H	\$3,010
AL4153006B	VMAX 10K 300GB 15K SAS DRV R6(6+2)	EN-H	\$0
AL4153006BTU	VMAX 10K 300GB 15K SAS DRV R6(6+2) UPG	EN-H	\$3,010
AL4153006BU	VMAX 10K 300GB 15K SAS DRV R6(6+2) UPG	EN-H	\$3,010
AL4153007B	VMAX 10K 300GB 15K SAS DRV R5(7+1)	EN-H	\$0
AL4153007BTU	VMAX 10K 300GB 15K SAS DRV R5(7+1) UPG	EN-H	\$3,010
AL4153007BU	VMAX 10K 300GB 15K SAS DRV R5(7+1) UPG	EN-H	\$3,010
AL415300FB	VMAX 10K 300GB 15K SAS DRV R6(14+2)	EN-H	\$0
AL415300FBTU	VMAX 10K 300GB 15K SAS DRV R6(14+2) UPG	EN-H	\$3,010
AL415300FBU	VMAX 10K 300GB 15K SAS DRV R6(14+2) UPG	EN-H	\$3,010
AL415300SB	VMAX 10K 300GB 15K SAS DRV SPARE	EN-H	\$0
AL415300SBTU	VMAX 10K 300GB 15K SAS DRV SPARE UPG	EN-H	\$3,010
AL415300SBU	VMAX 10K 300GB 15K SAS DRV SPARE UPG	EN-H	\$3,010
AL4156001B	VMAX 10K 600GB 15K SAS DRV R1	EN-H	\$3,806
AL4156001BTU	VMAX 10K 600GB 15K SAS DRV R1 UPG	EN-H	\$5,328
AL4156001BU	VMAX 10K 600GB 15K SAS DRV R1 UPG	EN-H	\$5,328
AL4156005B	VMAX 10K 600GB 15K SAS DRV R5(3+1)	EN-H	\$3,806
AL4156005BTU	VMAX 10K 600GB 15K SAS DRV R5(3+1) UPG	EN-H	\$5,328
AL4156005BU	VMAX 10K 600GB 15K SAS DRV R5(3+1) UPG	EN-H	\$5,328
AL4156006B	VMAX 10K 600GB 15K SAS DRV R5(7+1)	EN-H	\$3,806
AL4156006BTU	VMAX 10K 600GB 15K SAS DRV R6(6+2) UPG	EN-H	\$5,328
AL4156006BU	VMAX 10K 600GB 15K SAS DRV R5(7+1) UPG	EN-H	\$5,328
AL4156007B	VMAX 10K 600GB 15K SAS DRV R6(6+2)	EN-H	\$3,806
AL4156007BTU	VMAX 10K 600GB 15K SAS DRV R5(7+1) UPG	EN-H	\$5,328
AL4156007BU	VMAX 10K 600GB 15K SAS DRV R6(6+2) UPG	EN-H	\$5,328
AL415600FB	VMAX 10K 600GB 15K SAS DRV R6(14+2)	EN-H	\$3,806
AL415600FBTU	VMAX 10K 600GB 15K SAS DRV R6(14+2) UPG	EN-H	\$5,328
AL415600FBU	VMAX 10K 600GB 15K SAS DRV R6(14+2) UPG	EN-H	\$5,328

AL415600SB	VMAX 10K 600GB 15K SAS DRV SPARE	EN-H	\$3,806
AL415600SBTU	VMAX 10K 600GB 15K SAS DRV SPARE UPG	EN-H	\$5,328
AL415600SBU	VMAX 10K 600GB 15K SAS DRV SPARE UPG	EN-H	\$5,328
AL47210001B	VMAX 10K 1000GB 7_2K DRIVE R1	EN-H	\$0
AL47210001BTU	VMAX 10K 1000GB 7_2K DRIVE R1 UPG	EN-H	\$2,215
AL47210001BU	VMAX 10K 1000GB 7_2K DRIVE R1 UPG	EN-H	\$2,215
AL47210005B	VMAX 10K 1000GB 7_2K DRIVE R5(3+1)	EN-H	\$0
AL47210005BTU	VMAX 10K 1000GB 7_2K DRIVE R5(3+1) UPG	EN-H	\$2,215
AL47210005BU	VMAX 10K 1000GB 7_2K DRIVE R5(3+1) UPG	EN-H	\$2,215
AL47210006B	VMAX 10K 1000GB 7_2K DRIVE R6(6+2)	EN-H	\$0
AL47210006BTU	VMAX 10K 1000GB 7_2K DRIVE R6(6+2) UPG	EN-H	\$2,215
AL47210006BU	VMAX 10K 1000GB 7_2K DRIVE R6(6+2) UPG	EN-H	\$2,215
AL47210007B	VMAX 10K 1000GB 7_2K DRIVE R5(7+1)	EN-H	\$0
AL47210007BTU	VMAX 10K 1000GB 7_2K DRIVE R5(7+1) UPG	EN-H	\$2,215
AL47210007BU	VMAX 10K 1000GB 7_2K DRIVE R5(7+1) UPG	EN-H	\$2,215
AL4721000FB	VMAX 10K 1000GB 7_2K DRIVE R6(14+2)	EN-H	\$0
AL4721000FBTU	VMAX 10K 1000GB 7_2K DRIVE R6(14+2) UPG	EN-H	\$2,215
AL4721000FBU	VMAX 10K 1000GB 7_2K DRIVE R6(14+2) UPG	EN-H	\$2,215
AL4721000SB	VMAX 10K 1000GB 7_2K DRIVE SPARE	EN-H	\$0
AL4721000SBTU	VMAX 10K 1000GB 7_2K DRIVE SPARE UPG	EN-H	\$2,215
AL4721000SBU	VMAX 10K 1000GB 7_2K DRIVE SPARE UPG	EN-H	\$2,215
AL4F11001B	VMAX 10K 100GB FLASH DRIVE R1	EN-H	\$0
AL4F11001BFP	VMAX 10K 4G FLASH 100GB DRV RIVE R1 FP	EN-H	\$0
AL4F11001BTU	VMAX 10K 100GB FLASH DRIVE R1 UPG	EN-H	\$4,355
AL4F11001BU	VMAX 10K 100GB FLASH DRIVE R1 UPG	EN-H	\$4,355
AL4F11005B	VMAX 10K 100GB FLASH DRIVE R5(3+1)	EN-H	\$0
AL4F11005BFP	VMAX 10K 4G FLASH 100GB DRV R5(3+1) FP	EN-H	\$0
AL4F11005BTU	VMAX 10K 100GB FLASH DRIVE R5(3+1) UPG	EN-H	\$4,355
AL4F11005BU	VMAX 10K 100GB FLASH DRIVE R5(3+1) UPG	EN-H	\$4,355
AL4F11007B	VMAX 10K 100GB FLASH DRIVE R5(7+1)	EN-H	\$0
AL4F11007BFP	VMAX 10K 4G FLASH 100GB DRV R5(7+1) FP	EN-H	\$0
AL4F11007BTU	VMAX 10K 100GB FLASH DRIVE R5(7+1) UPG	EN-H	\$4,355
AL4F11007BU	VMAX 10K 100GB FLASH DRIVE R5(7+1) UPG	EN-H	\$4,355
AL4F1100SB	VMAX 10K 100GB FLASH DRIVE SPARE	EN-H	\$0
AL4F1100SBTU	VMAX 10K 100GB FLASH DRIVE SPARE UPG	EN-H	\$4,355
AL4F1100SBU	VMAX 10K 100GB FLASH DRIVE SPARE UPG	EN-H	\$4,355
AL4FM2001B	VMAX 10K 200GB FLASH DRIVE R1	EN-H	\$0
AL4FM2001BFP	VMAX 10K 4G FLASH 200GB DRV RIVE R1 FP	EN-H	\$0
AL4FM2001BTU	VMAX 10K 200GB FLASH DRIVE R1 UPG	EN-H	\$7,830
AL4FM2001BU	VMAX 10K 200GB FLASH DRIVE R1 UPG	EN-H	\$7,830
AL4FM2005B	VMAX 10K 200GB FLASH DRIVE R5(3+1)	EN-H	\$0
AL4FM2005BFP	VMAX 10K 4G FLASH 200GB DRV R5(3+1) FP	EN-H	\$0
AL4FM2005BTU	VMAX 10K 200GB FLASH DRIVE R5(3+1) UPG	EN-H	\$7,830
AL4FM2005BU	VMAX 10K 200GB FLASH DRIVE R5(3+1) UPG	EN-H	\$7,830
AL4FM2007B	VMAX 10K 200GB FLASH DRIVE R5(7+1)	EN-H	\$0
AL4FM2007BFP	VMAX 10K 4G FLASH 200GB DRV R5(7+1) FP	EN-H	\$0
AL4FM2007BTU	VMAX 10K 200GB FLASH DRIVE R5(7+1) UPG	EN-H	\$7,830
AL4FM2007BU	VMAX 10K 200GB FLASH DRIVE R5(7+1) UPG	EN-H	\$7,830
AL4FM200SB	VMAX 10K 200GB FLASH DRIVE SPARE	EN-H	\$0
AL4FM200SBTU	VMAX 10K 200GB FLASH DRIVE SPARE UPG	EN-H	\$7,830

AL4FM200SBU	VMAX 10K 200GB FLASH DRIVE SPARE UPG	EN-H	\$7,830
AL4FM4001B	VMAX 10K 400GB FLASH DRIVE R1	EN-H	\$0
AL4FM4001BFP	VMAX 10K 4G FLASH 400GB DRV RIVE R1 FP	EN-H	\$0
AL4FM4001BTU	VMAX 10K 400GB FLASH DRIVE R1 UPG	EN-H	\$14,855
AL4FM4001BU	VMAX 10K 400GB FLASH DRIVE R1 UPG	EN-H	\$14,855
AL4FM4005B	VMAX 10K 400GB FLASH DRIVE R5(3+1)	EN-H	\$0
AL4FM4005BFP	VMAX 10K 4G FLASH 400GB DRV R5(3+1) FP	EN-H	\$0
AL4FM4005BTU	VMAX 10K 400GB FLASH DRIVE R5(3+1) UPG	EN-H	\$14,855
AL4FM4005BU	VMAX 10K 400GB FLASH DRIVE R5(3+1) UPG	EN-H	\$14,855
AL4FM4007B	VMAX 10K 400GB FLASH DRIVE R5(7+1)	EN-H	\$0
AL4FM4007BFP	VMAX 10K 4G FLASH 400GB DRV R5(7+1) FP	EN-H	\$0
AL4FM4007BTU	VMAX 10K 400GB FLASH DRIVE R5(7+1)UPG	EN-H	\$14,855
AL4FM4007BU	VMAX 10K 400GB FLASH DRIVE R5(7+1)UPG	EN-H	\$14,855
AL4FM400SB	VMAX 10K 400GB FLASH DRIVE SPARE	EN-H	\$0
AL4FM400SBTU	VMAX 10K 400GB FLASH DRIVE SPARE UPG	EN-H	\$14,855
AL4FM400SBU	VMAX 10K 400GB FLASH DRIVE SPARE UPG	EN-H	\$14,855
AL4FM8001B	VMAX 10K 800GB FLASH DRIVE R1	EN-H	\$18,750
AL4FM8001BFP	VMAX 10K 800GB FLASH DRIVE R1 FP	EN-H	\$0
AL4FM8001BTU	VMAX 10K 800GB FLASH DRIVE R1 UPG	EN-H	\$26,250
AL4FM8001BU	VMAX 10K 800GB FLASH DRIVE R1 UPG	EN-H	\$26,250
AL4FM8005B	VMAX 10K 800GB FLASH DRIVE R5(3+1)	EN-H	\$18,750
AL4FM8005BFP	VMAX 10K 800GB FLASH DRIVE R5(3+1) FP	EN-H	\$0
AL4FM8005BTU	VMAX 10K 800GB FLASH DRIVE R5(3+1) UPG	EN-H	\$26,250
AL4FM8005BU	VMAX 10K 800GB FLASH DRIVE R5(3+1) UPG	EN-H	\$26,250
AL4FM8007B	VMAX 10K 800GB FLASH DRIVE R5(7+1)	EN-H	\$18,750
AL4FM8007BFP	VMAX 10K 800GB FLASH DRIVE R5(7+1) FP	EN-H	\$0
AL4FM8007BTU	VMAX 10K 800GB FLASH DRIVE R5(7+1) UPG	EN-H	\$26,250
AL4FM8007BU	VMAX 10K 800GB FLASH DRIVE R5(7+1) UPG	EN-H	\$26,250
AL4FM800SB	VMAX 10K 800GB FLASH DRIVE SPARE	EN-H	\$18,750
AL4FM800SBTU	VMAX 10K 800GB FLASH DRIVE SPARE UPG	EN-H	\$26,250
AL4FM800SBU	VMAX 10K 800GB FLASH DRIVE SPARE UPG	EN-H	\$26,250
AS41012001B	VMAX 10K 1200GB 10K SAS DRV R1	EN-H	\$2,130
AS41012001BTU	VMAX 10K 1200GB 10K SAS DRV R1 UPG	EN-H	\$2,980
AS41012001BU	VMAX 10K 1200GB 10K SAS DRV R1 UPG	EN-H	\$2,980
AS41012005B	VMAX 10K 1200GB 10K SAS DRV R5(3+1)	EN-H	\$2,130
AS41012005BTU	VMAX 10K 1200GB 10K SAS DRV R5(3+1) UPG	EN-H	\$2,980
AS41012005BU	VMAX 10K 1200GB 10K SAS DRV R5(3+1) UPG	EN-H	\$2,980
AS41012006B	VMAX 10K 1200GB 10K SAS DRV R6(6+2)	EN-H	\$2,130
AS41012006BTU	VMAX 10K 1200GB 10K SAS DRV R6(6+2) UPG	EN-H	\$2,980
AS41012006BU	VMAX 10K 1200GB 10K SAS DRV R6(6+2) UPG	EN-H	\$2,980
AS41012007B	VMAX 10K 1200GB 10K SAS DRV R5(7+1)	EN-H	\$2,130
AS41012007BTU	VMAX 10K 1200GB 10K SAS DRV R5(7+1) UPG	EN-H	\$2,980
AS41012007BU	VMAX 10K 1200GB 10K SAS DRV R5(7+1) UPG	EN-H	\$2,980
AS4101200FB	VMAX 10K 1200GB 10K SAS DRV R6(14+2)	EN-H	\$2,130
AS4101200FBTU	VMAX 10K 1200GB 10K SAS DRV R6(14+2) UPG	EN-H	\$2,980
AS4101200FBU	VMAX 10K 1200GB 10K SAS DRV R6(14+2) UPG	EN-H	\$2,980
AS4101200SB	VMAX 10K 1200GB 10K SAS DRV SPARE	EN-H	\$2,130
AS4101200SBTU	VMAX 10K 1200GB 10K SAS DRV SPARE UPG	EN-H	\$2,980
AS4101200SBU	VMAX 10K 1200GB 10K SAS DRV SPARE UPG	EN-H	\$2,980
AS4103001B	VMAX 10K 4G 10K 300GB SAS DRV R1	EN-H	\$0

AS4103001BTU	VMAX 10K 4G 10K 300GB SAS DRV R1 UPG	EN-H	\$1,170
AS4103001BU	VMAX 10K 4G 10K 300GB SAS DRV R1 UPG	EN-H	\$1,170
AS4103005B	VMAX 10K 4G 10K 300GB SAS DRV R5(3+1)	EN-H	\$0
AS4103005BTU	VMAX 10K 4G 10K 300GB SAS DRV R5(3+1)UPG	EN-H	\$1,170
AS4103005BU	VMAX 10K 4G 10K 300GB SAS DRV R5(3+1)UPG	EN-H	\$1,170
AS4103006B	VMAX 10K 4G 10K 300GB SAS DRV R6(6+2)	EN-H	\$0
AS4103006BTU	VMAX 10K 4G 10K 300GB SAS DRV R6(6+2)UPG	EN-H	\$1,170
AS4103006BU	VMAX 10K 4G 10K 300GB SAS DRV R6(6+2)UPG	EN-H	\$1,170
AS4103007B	VMAX 10K 4G 10K 300GB SAS DRV R5(7+1)	EN-H	\$0
AS4103007BTU	VMAX 10K 4G 10K 300GB SAS DRV R5(7+1)UPG	EN-H	\$1,170
AS4103007BU	VMAX 10K 4G 10K 300GB SAS DRV R5(7+1)UPG	EN-H	\$1,170
AS410300FB	VMAX 10K 4G 10K 300GB SAS DRV R6(14+2)	EN-H	\$0
AS410300FBTU	VMAX 10K 4G 10K 300GB SAS DR R6(14+2)UPG	EN-H	\$1,170
AS410300FBU	VMAX 10K 4G 10K 300GB SAS DR R6(14+2)UPG	EN-H	\$1,170
AS410300SB	VMAX 10K 4G 10K 300GB SAS DRV SPARE	EN-H	\$0
AS410300SBTU	VMAX 10K 4G 10K 300GB SAS DRV SPARE UPG	EN-H	\$1,170
AS410300SBU	VMAX 10K 4G 10K 300GB SAS DRV SPARE UPG	EN-H	\$1,170
AS4106001B	VMAX 10K 4G 10K 600GB SAS DRV R1	EN-H	\$0
AS4106001BTU	VMAX 10K 4G 10K 600GB SAS DRV R1 UPG	EN-H	\$2,025
AS4106001BU	VMAX 10K 4G 10K 600GB SAS DRV R1 UPG	EN-H	\$2,025
AS4106005B	VMAX 10K 4G 10K 600GB SAS DRV R5(3+1)	EN-H	\$0
AS4106005BTU	VMAX 10K 4G 10K 600GB SAS DRV R5(3+1)UPG	EN-H	\$2,025
AS4106005BU	VMAX 10K 4G 10K 600GB SAS DRV R5(3+1)UPG	EN-H	\$2,025
AS4106006B	VMAX 10K 4G 10K 600GB SAS DRV R6(6+2)	EN-H	\$0
AS4106006BTU	VMAX 10K 4G 10K 600GB SAS DRV R6(6+2)UPG	EN-H	\$2,025
AS4106006BU	VMAX 10K 4G 10K 600GB SAS DRV R6(6+2)UPG	EN-H	\$2,025
AS4106007B	VMAX 10K 4G 10K 600GB SAS DRV R5(7+1)	EN-H	\$0
AS4106007BTU	VMAX 10K 4G 10K 600GB SAS DRV R5(7+1)UPG	EN-H	\$2,025
AS4106007BU	VMAX 10K 4G 10K 600GB SAS DRV R5(7+1)UPG	EN-H	\$2,025
AS410600FB	VMAX 10K 4G 10K 600GB SAS DRV R6(14+2)	EN-H	\$0
AS410600FBTU	VMAX 10K 4G 10K 600GB SAS R6(14+2)UPG	EN-H	\$2,025
AS410600FBU	VMAX 10K 4G 10K 600GB SAS R6(14+2)UPG	EN-H	\$2,025
AS410600SB	VMAX 10K 4G 10K 600GB SAS DRV SPARE	EN-H	\$0
AS410600SBTU	VMAX 10K 4G 10K 600GB SAS DRV SPARE UPG	EN-H	\$2,025
AS410600SBU	VMAX 10K 4G 10K 600GB SAS DRV SPARE UPG	EN-H	\$2,025
AS4109001B	VMAX 10K 900GB 10K SAS DRV R1	EN-H	\$0
AS4109001BTU	VMAX 10K 900GB 10K SAS DRV R1 UPG	EN-H	\$2,660
AS4109001BU	VMAX 10K 900GB 10K SAS DRV R1 UPG	EN-H	\$2,660
AS4109005B	VMAX 10K 900GB 10K SAS DRV R5(3+1)	EN-H	\$0
AS4109005BTU	VMAX 10K 900GB 10K SAS DRV R5(3+1) UPG	EN-H	\$2,660
AS4109005BU	VMAX 10K 900GB 10K SAS DRV R5(3+1) UPG	EN-H	\$2,660
AS4109006B	VMAX 10K 900GB 10K SAS DRV R6(6+2)	EN-H	\$0
AS4109006BTU	VMAX 10K 900GB 10K SAS DRV R6(6+2) UPG	EN-H	\$2,660
AS4109006BU	VMAX 10K 900GB 10K SAS DRV R6(6+2) UPG	EN-H	\$2,660
AS4109007B	VMAX 10K 900GB 10K SAS DRV R5(7+1)	EN-H	\$0
AS4109007BTU	VMAX 10K 900GB 10K SAS DRV R5(7+1) UPG	EN-H	\$2,660
AS4109007BU	VMAX 10K 900GB 10K SAS DRV R5(7+1) UPG	EN-H	\$2,660
AS410900FB	VMAX 10K 900GB 10K SAS DRV R6(14+2)	EN-H	\$0
AS410900FBTU	VMAX 10K 900GB 10K SAS DRV R6(14+2) UPG	EN-H	\$2,660
AS410900FBU	VMAX 10K 900GB 10K SAS DRV R6(14+2) UPG	EN-H	\$2,660

AS410900SB	VMAX 10K 900GB 10K SAS DRV SPARE	EN-H	\$0
AS410900SBTU	VMAX 10K 900GB 10K SAS DRV SPARE UPG	EN-H	\$2,660
AS410900SBU	VMAX 10K 900GB 10K SAS DRV SPARE UPG	EN-H	\$2,660
AS4156001B	VMAX 10K 600GB 15K SAS DRV R1	EN-H	\$3,806
AS4156001BTU	VMAX 10K 600GB 15K SAS DRV R1 UPG	EN-H	\$5,328
AS4156001BU	VMAX 10K 600GB 15K SAS DRV R1 UPG	EN-H	\$5,328
AS4156005B	VMAX 10K 600GB 15K SAS DRV R5(3+1)	EN-H	\$3,806
AS4156005BTU	VMAX 10K 600GB 15K SAS DRV R5(3+1) UPG	EN-H	\$5,328
AS4156005BU	VMAX 10K 600GB 15K SAS DRV R5(3+1) UPG	EN-H	\$5,328
AS4156006B	VMAX 10K 600GB 15K SAS DRV R5(7+1)	EN-H	\$3,806
AS4156006BTU	VMAX 10K 600GB 15K SAS DRV R6(6+2) UPG	EN-H	\$5,328
AS4156006BU	VMAX 10K 600GB 15K SAS DRV R5(7+1) UPG	EN-H	\$5,328
AS4156007B	VMAX 10K 600GB 15K SAS DRV R6(6+2)	EN-H	\$3,806
AS4156007BTU	VMAX 10K 600GB 15K SAS DRV R5(7+1) UPG	EN-H	\$5,328
AS4156007BU	VMAX 10K 600GB 15K SAS DRV R6(6+2) UPG	EN-H	\$5,328
AS415600FB	VMAX 10K 600GB 15K SAS DRV R6(14+2)	EN-H	\$3,806
AS415600FBTU	VMAX 10K 600GB 15K SAS DRV R6(14+2) UPG	EN-H	\$5,328
AS415600FBU	VMAX 10K 600GB 15K SAS DRV R6(14+2) UPG	EN-H	\$5,328
AS415600SB	VMAX 10K 600GB 15K SAS DRV SPARE	EN-H	\$3,806
AS415600SBTU	VMAX 10K 600GB 15K SAS DRV SPARE UPG	EN-H	\$5,328
AS415600SBU	VMAX 10K 600GB 15K SAS DRV SPARE UPG	EN-H	\$5,328
AS4FM2001B	VMAX 10K 200GB FLASH DRIVE R1	EN-H	\$0
AS4FM2001BFP	VMAX 10K 4G FLASH 200GB DRV RIVE R1 FP	EN-H	\$0
AS4FM2001BTU	VMAX 10K 200GB FLASH DRIVE R1 UPG	EN-H	\$7,830
AS4FM2001BU	VMAX 10K 200GB FLASH DRIVE R1 UPG	EN-H	\$7,830
AS4FM2005B	VMAX 10K 200GB FLASH DRIVE R5(3+1)	EN-H	\$0
AS4FM2005BFP	VMAX 10K 4G FLASH 200GB DRV R5(3+1) FP	EN-H	\$0
AS4FM2005BTU	VMAX 10K 200GB FLASH DRIVE R5(3+1) UPG	EN-H	\$7,830
AS4FM2005BU	VMAX 10K 200GB FLASH DRIVE R5(3+1) UPG	EN-H	\$7,830
AS4FM2007B	VMAX 10K 200GB FLASH DRIVE R5(7+1)	EN-H	\$0
AS4FM2007BFP	VMAX 10K 4G FLASH 200GB DRV R5(7+1) FP	EN-H	\$0
AS4FM2007BTU	VMAX 10K 200GB FLASH DRIVE R5(7+1) UPG	EN-H	\$7,830
AS4FM2007BU	VMAX 10K 200GB FLASH DRIVE R5(7+1) UPG	EN-H	\$7,830
AS4FM200SB	VMAX 10K 200GB FLASH DRIVE SPARE	EN-H	\$0
AS4FM200SBTU	VMAX 10K 200GB FLASH DRIVE SPARE UPG	EN-H	\$7,830
AS4FM200SBU	VMAX 10K 200GB FLASH DRIVE SPARE UPG	EN-H	\$7,830
AS4FM4001B	VMAX 10K 400GB FLASH DRIVE R1	EN-H	\$0
AS4FM4001BFP	VMAX 10K 4G FLASH 400GB DRV RIVE R1 FP	EN-H	\$0
AS4FM4001BTU	VMAX 10K 400GB FLASH DRIVE R1 UPG	EN-H	\$14,855
AS4FM4001BU	VMAX 10K 400GB FLASH DRIVE R1 UPG	EN-H	\$14,855
AS4FM4005B	VMAX 10K 400GB FLASH DRIVE R5(3+1)	EN-H	\$0
AS4FM4005BFP	VMAX 10K 4G FLASH 400GB DRV R5(3+1) FP	EN-H	\$0
AS4FM4005BTU	VMAX 10K 400GB FLASH DRIVE R5(3+1) UPG	EN-H	\$14,855
AS4FM4005BU	VMAX 10K 400GB FLASH DRIVE R5(3+1) UPG	EN-H	\$14,855
AS4FM4007B	VMAX 10K 400GB FLASH DRIVE R5(7+1)	EN-H	\$0
AS4FM4007BFP	VMAX 10K 4G FLASH 400GB DRV R5(7+1) FP	EN-H	\$0
AS4FM4007BTU	VMAX 10K 400GB FLASH DRIVE R5(7+1) UPG	EN-H	\$14,855
AS4FM4007BU	VMAX 10K 400GB FLASH DRIVE R5(7+1) UPG	EN-H	\$14,855
AS4FM400SB	VMAX 10K 400GB FLASH DRIVE SPARE	EN-H	\$0
AS4FM400SBTU	VMAX 10K 400GB FLASH DRIVE SPARE UPG	EN-H	\$14,855

AS4FM400SBU	VMAX 10K 400GB FLASH DRIVE SPARE UPG	EN-H	\$14,855
AS4FM8001B	VMAX 10K 800GB FLASH DRIVE R1	EN-H	\$18,750
AS4FM8001BFP	VMAX 10K 800GB FLASH DRIVE R1 FP	EN-H	\$20,470
AS4FM8001BTU	VMAX 10K 800GB FLASH DRIVE R1 UPG	EN-H	\$26,250
AS4FM8001BU	VMAX 10K 800GB FLASH DRIVE R1 UPG	EN-H	\$26,250
AS4FM8005B	VMAX 10K 800GB FLASH DRIVE R5(3+1)	EN-H	\$18,750
AS4FM8005BFP	VMAX 10K 800GB FLASH DRIVE R5(3+1) FP	EN-H	\$20,470
AS4FM8005BTU	VMAX 10K 800GB FLASH DRIVE R5(3+1) UPG	EN-H	\$26,250
AS4FM8005BU	VMAX 10K 800GB FLASH DRIVE R5(3+1) UPG	EN-H	\$26,250
AS4FM8007B	VMAX 10K 800GB FLASH DRIVE R5(7+1)	EN-H	\$18,750
AS4FM8007BFP	VMAX 10K 800GB FLASH DRIVE R5(7+1) FP	EN-H	\$20,470
AS4FM8007BTU	VMAX 10K 800GB FLASH DRIVE R5(7+1) UPG	EN-H	\$26,250
AS4FM8007BU	VMAX 10K 800GB FLASH DRIVE R5(7+1) UPG	EN-H	\$26,250
AS4FM800SB	VMAX 10K 800GB FLASH DRIVE SPARE	EN-H	\$18,750
AS4FM800SBTU	VMAX 10K 800GB FLASH DRIVE SPARE UPG	EN-H	\$26,250
AS4FM800SBU	VMAX 10K 800GB FLASH DRIVE SPARE UPG	EN-H	\$26,250
AT47220001B	VMAX 10K 2000GB 7_2K DRIVE R1	EN-H	\$0
AT47220001BTU	VMAX 10K 2000GB 7_2K DRIVE R1 UPG	EN-H	\$2,330
AT47220001BU	VMAX 10K 2000GB 7_2K DRIVE R1 UPG	EN-H	\$2,330
AT47220005B	VMAX 10K 2000GB 7_2K DRIVE R5(3+1)	EN-H	\$0
AT47220005BTU	VMAX 10K 2000GB 7_2K DRIVE R5(3+1) UPG	EN-H	\$2,330
AT47220005BU	VMAX 10K 2000GB 7_2K DRIVE R5(3+1) UPG	EN-H	\$2,330
AT47220006B	VMAX 10K 2000GB 7_2K DRIVE R6(6+2)	EN-H	\$0
AT47220006BTU	VMAX 10K 2000GB 7_2K DRIVE R6(6+2) UPG	EN-H	\$2,330
AT47220006BU	VMAX 10K 2000GB 7_2K DRIVE R6(6+2) UPG	EN-H	\$2,330
AT47220007B	VMAX 10K 2000GB 7_2K DRIVE R5(7+1)	EN-H	\$0
AT47220007BTU	VMAX 10K 2000GB 7_2K DRIVE R5(7+1) UPG	EN-H	\$2,330
AT47220007BU	VMAX 10K 2000GB 7_2K DRIVE R5(7+1) UPG	EN-H	\$2,330
AT4722000FB	VMAX 10K 2000GB 7_2K DRIVE R6(14+2)	EN-H	\$0
AT4722000FBTU	VMAX 10K 2000GB 7_2K DRIVE R6(14+2) UPG	EN-H	\$2,330
AT4722000FBU	VMAX 10K 2000GB 7_2K DRIVE R6(14+2) UPG	EN-H	\$2,330
AT4722000SB	VMAX 10K 2000GB 7_2K DRIVE SPARE	EN-H	\$0
AT4722000SBTU	VMAX 10K 2000GB 7_2K DRIVE SPARE UPG	EN-H	\$2,330
AT4722000SBU	VMAX 10K 2000GB 7_2K DRIVE SPARE UPG	EN-H	\$2,330
AT47230001B	VMAX 10K 4G 7_2K 3000GB SAS DRV R1	EN-H	\$0
AT47230001BTU	VMAX 10K 4G 7_2K 3000GB SAS DRV R1 UPG	EN-H	\$3,285
AT47230001BU	VMAX 10K 4G 7_2K 3000GB SAS DRV R1 UPG	EN-H	\$3,285
AT47230005B	VMAX 10K 4G 7_2K 3000GB SAS DRV R5(3+1)	EN-H	\$0
AT47230005BTU	VMAX 10K 4G 7_2K 3000GB SAS R5(3+1)UPG	EN-H	\$3,285
AT47230005BU	VMAX 10K 4G 7_2K 3000GB SAS R5(3+1)UPG	EN-H	\$3,285
AT47230006B	VMAX 10K 4G 7_2K 3000GB SAS DRV R6(6+2)	EN-H	\$0
AT47230006BTU	VMAX 10K 4G 7_2K 3000GB SAS R6(6+2)UPG	EN-H	\$3,285
AT47230006BU	VMAX 10K 4G 7_2K 3000GB SAS R6(6+2)UPG	EN-H	\$3,285
AT47230007B	VMAX 10K 4G 7_2K 3000GB SAS DRV R5(7+1)	EN-H	\$0
AT47230007BTU	VMAX 10K 4G 7_2K 3000GB SAS R5(7+1)UPG	EN-H	\$3,285
AT47230007BU	VMAX 10K 4G 7_2K 3000GB SAS R5(7+1)UPG	EN-H	\$3,285
AT4723000FB	VMAX 10K 4G 7_2K 3000GB SAS DRV R6(14+2)	EN-H	\$0
AT4723000FBTU	VMAX 10K 4G 7_2K 3000GB SAS R6(14+2)UPG	EN-H	\$3,285
AT4723000FBU	VMAX 10K 4G 7_2K 3000GB SAS R6(14+2)UPG	EN-H	\$3,285
AT4723000SB	VMAX 10K 4G 7_2K 3000GB SAS DRV SPARE	EN-H	\$0

AT4723000SBTU	VMAX 10K 4G 7_2K 3000GB SAS SPARE UPG	EN-H	\$3,285
AT4723000SBU	VMAX 10K 4G 7_2K 3000GB SAS SPARE UPG	EN-H	\$3,285
AT47240001B	VMAX 10K 4G 7.2K 4000GB DRV R1	EN-H	\$0
AT47240001BTU	VMAX 10K 4G 7_2K 4000GB SAS DRV R1 TAAUP	EN-H	\$4,045
AT47240001BU	VMAX 10K 4G 7.2K 4000GB DRV R1 UPG	EN-H	\$4,045
AT47240005B	VMAX 10K 4G 7.2K 4000GB DRV R5(3+1)	EN-H	\$0
AT47240005BTU	VMAX 10K 4G 7_2K 4000GB SAS R5(3+1)TAAUP	EN-H	\$4,045
AT47240005BU	VMAX 10K 4G 7.2K 4000GB DRV R5(3+1) UPG	EN-H	\$4,045
AT47240006B	VMAX 10K 4G 7.2K 4000GB DRV R6(6+2)	EN-H	\$0
AT47240006BTU	VMAX 10K 4G 7_2K 4000GB SAS R6(6+2)TAAUP	EN-H	\$4,045
AT47240006BU	VMAX 10K 4G 7.2K 4000GB DRV R6(6+2) UPG	EN-H	\$4,045
AT47240007B	VMAX 10K 4G 7.2K 4000GB DRV R5(7+1)	EN-H	\$0
AT47240007BTU	VMAX 10K 4G 7_2K 4000GB SAS R5(7+1)TAAUP	EN-H	\$4,045
AT47240007BU	VMAX 10K 4G 7.2K 4000GB DRV R5(7+1) UPG	EN-H	\$4,045
AT4724000FB	VMAX 10K 4G 7.2K 4000GB DRV R6(14+2)	EN-H	\$0
AT4724000FBTU	VMAX 10K 4G 7_2K 4000GB SASR6(14+2)TAAUP	EN-H	\$4,045
AT4724000FBU	VMAX 10K 4G 7.2K 4000GB DRV R6(14+2) UPG	EN-H	\$4,045
AT4724000SB	VMAX 10K 4G 7.2K 4000GB DRV SPARE	EN-H	\$0
AT4724000SBTU	VMAX 10K 4G 7_2K 4000GB SAS SPARE TAA UP	EN-H	\$4,045
AT4724000SBU	VMAX 10K 4G 7.2K 4000GB DRV SPARE UPG	EN-H	\$4,045
BA-10GE-FCOE	VMAX 10K 10Gb FCOE PORTS	EN-H	\$0
BA-128ED-ENG	VMAX 10K ENGINE 128GB 2.8GHZ ENCRYPT	EN-H	\$0
BA-128ED-ENGU	VMAX 10K ENGINE 128GB 2.8GHZ ENCRYPT UPG	EN-H	\$196,300
BA-128E-ENG	VMAX 10K ENGINE 128GB 2.8GHZ	EN-H	\$0
BA-128E-ENGU	VMAX 10K ENGINE 128GB 2.8GHZ UPG	EN-H	\$163,800
BA-128-ENG	VMAX 10K ENGINE - 128GB	EN-H	\$0
BA-128-ENGU	VMAX 10K UPG ENGINE - 128GB	EN-H	\$0
BA-128GB-E	VMAX 10K MEMCONV TO 128GB 2.8GHZ	EN-H	\$70,255
BA-1UF-3PUFD	VMAX 10K 3RD PARTY 1-1U FILLER KIT	EN-H	\$75
BA-2UF-3PUFD	VMAX 10K 3RD PARTY 2-2U FILLER KIT	EN-H	\$75
BA-2UR-3P-UFD	VMAX 10K 3RD PARTY KIT; 2.5 DAE RAIL	EN-H	\$240
BA-2UR-RET	VMAX 10K 3P FAC KIT; 2.5 DAE RAIL RETURN	EN-H	\$0
BA-2UR-UFD	VMAX 10K FIELD UPG KIT; 2.5 DAE RAIL	EN-H	\$240
BA-2UR-UPG	VMAX 10K FACTORY UPG KIT; 2.5 DAE RAIL	EN-H	\$240
BA-3PDB-RET	VMAX 10K 3P SHIPPING RACK RETURN DB	EN-H	\$0
BA-3P-SB	VMAX 10K 3RD PARTY DRIVE BAY	EN-H	\$0
BA-3PSB1-RET	VMAX 10K 3P SHIPPING RACK RETURN SB1	EN-H	\$0
BA-3PSB2-RET	VMAX 10K 3P SHIPPING RACK RETURN SB1	EN-H	\$0
BA-3PSB34-RET	VMAX 10K 3P SHIPPING RACK RETURN SB34	EN-H	\$0
BA-3P-SBU	VMAX 10K 3RD PARTY DRIVE BAY UPG	EN-H	\$16,870
BA-3PSR-SYS1	VMAX 10K 3RD PARTY SHIPPING RACK SB1	EN-H	\$0
BA-3PSR-SYS2	VMAX 10K 3RD PARTY SHIPPING RACK SB2	EN-H	\$0
BA-3PSR-SYS34	VMAX 10K 3RD PARTY SHIPPING RACK SB34	EN-H	\$0
BA-3P-SYS1	VMAX 10K 3RD PARTY SB1	EN-H	\$0
BA-3P-SYS2	VMAX 10K 3RD PARTY SB2	EN-H	\$0
BA-3P-SYS2U	VMAX 10K 3RD PARTY SB2 UPG	EN-H	\$30,880
BA-3P-SYS3	VMAX 10K 3RD PARTY SB3	EN-H	\$0
BA-3P-SYS3SEP	VMAX 10K 3RD PARTY SB3 SEPARATED	EN-H	\$0
BA-3PSYS3SEPU	VMAX 10K 3RD PARTY SB3 SEPARATED UPG	EN-H	\$30,880
BA-3P-SYS3U	VMAX 10K 3RD PARTY SB3 UPG	EN-H	\$30,880

BA-3P-SYS4	VMAX 10K 3RD PARTY SB4	EN-H	\$0
BA-3P-SYS4SEP	VMAX 10K 3RD PARTY SB4 SEPARATED	EN-H	\$0
BA-3PSYS4SEPU	VMAX 10K 3RD PARTY SB4 SEPARATED UPG	EN-H	\$30,880
BA-3P-SYS4U	VMAX 10K 3RD PARTY SB4 UPG	EN-H	\$30,880
BA-3UR-3P-UFD	VMAX 10K 3RD PARTY KIT; 3.5 DAE RAIL	EN-H	\$240
BA-3UR-RET	VMAX 10K 3P FAC KIT; 3.5 DAE RAIL RETURN	EN-H	\$0
BA-3UR-UFD	VMAX 10K FIELD UPG KIT; 3.5 DAE RAIL	EN-H	\$240
BA-3UR-UPG	VMAX 10K FACTORY UPG KIT; 3.5 DAE RAIL	EN-H	\$240
BA-8GB-MM-OPT	8GB MM OPTIC	EN-H	\$470
BA-8GB-SM-OPT	8GB SM OPTIC	EN-H	\$940
BA-96ED-ENG	VMAX 10K ENGINE 96GB 2.8GHZ ENCRYPT	EN-H	\$0
BA-96ED-ENGU	VMAX 10K ENGINE 96GB 2.8GHZ ENCRYPT UPG	EN-H	\$169,000
BA-96E-ENG	VMAX 10K ENGINE 96GB 2.8GHZ	EN-H	\$0
BA-96E-ENGU	VMAX 10K ENGINE 96GB 2.8GHZ UPG	EN-H	\$136,500
BA-96-ENG	VMAX 10K ENGINE - 96GB	EN-H	\$0
BA-96-ENGU	VMAX 10K ENGINE - 96GB UPG	EN-H	\$0
BA-96GB-E-RET	VMAX 10K 96GB MEMORY RETURN 2.8GHZ	EN-H	\$0
BA-ACON3P-50	VMAX 10K AC 3PH 50A W3-4IN CONDUIT ADPTR	EN-H	\$455
BA-BC-VFP1-10K	PROMO 100GB VFP10K 32	EN-H	\$0
BA-BC-VFP1-10KU	PROMO 100GB VFP10K 32U	EN-H	\$0
BA-BC-VFP2-10K	PROMO 100GB VFP10K 48	EN-H	\$0
BA-BC-VFP2-10KU	PROMO 100GB VFP10K 48U	EN-H	\$0
BA-BC-VFP3-10K	PROMO 200GB VFP10K 32	EN-H	\$0
BA-BC-VFP3-10KU	PROMO 200GB VFP10K 32U	EN-H	\$0
BA-BC-VFP4-10K	PROMO 200GB VFP10K 48	EN-H	\$0
BA-BC-VFP4-10KU	PROMO 200GB VFP10K 48U	EN-H	\$0
BA-BC-VFP5-10K	PROMO 400GB VFP10K 32	EN-H	\$0
BA-BC-VFP5-10KU	PROMO 400GB VFP10K 32U	EN-H	\$0
BA-BC-VFP6-10K	PROMO 400GB VFP10K 48	EN-H	\$0
BA-BC-VFP6-10KU	PROMO 400GB VFP10K 48U	EN-H	\$0
BA-CONFIG	VMAX 10K CONFIGURATION	EN-H	\$0
BA-DCH1-3PUFD	VMAX 10K 3RD PARTY KIT; DAISY 1 METER	EN-H	\$740
BA-DCH4-3PUFD	VMAX 10K 3RD PARTY KIT; DAISY 4 METER	EN-H	\$770
BA-DCHKIT1E	VMAX 10K FACTORY KIT; 2 DAE DAISY 1M	EN-H	\$740
BA-DCHKIT4E	VMAX 10K FACTORY KIT; 2 DAE DAISY 4M	EN-H	\$770
BA-DCHKITU1E	VMAX 10K FACTORY KIT; 2 DAE DAISY 1M	EN-H	\$740
BA-DCHKITU4E	VMAX 10K FACTORY KIT; 2 DAE DAISY 4M	EN-H	\$770
BA-DCHUFD1E	VMAX 10K FIELD UPG KIT; 2 DAE DAISY 1M	EN-H	\$960
BA-DCHUFD4E	VMAX 10K FIELD UPG KIT; 2 DAE DAISY 4M	EN-H	\$1,000
BA-DE15-3P	VMAX 10K 15 SLOT DAE HE 3RD PARTY	EN-H	\$0
BA-DE15-3PUFD	VMAX 10K 15 SLOT DAE HE UFD 3RD PARTY	EN-H	\$3,150
BA-DE15-3PUPG	VMAX 10K 15 SLOT DAE HE UPG 3RD PARTY	EN-H	\$3,150
BA-DE15DCHE	VMAX 10K 15 SLOT DAE W/HIGH EFF PS	EN-H	\$0
BA-DE15DIRE	VMAX 10K 15 SLOT DAE W/HIGH EFF PS	EN-H	\$0
BA-DE15E	VMAX 10K 15 SLOT DAE W/HIGH EFF PS	EN-H	\$0
BA-DE15EUFD	VMAX 10K 15 SLOT DAE W/HIGH EFF PS UFD	EN-H	\$3,150
BA-DE15EUPG	VMAX 10K 15 SLOT DAE W/HIGH EFF PS UPG	EN-H	\$3,150
BA-DE25	VMAX 10K 25 SLOT DAE	EN-H	\$0
BA-DE25-3P	VMAX 10K 25 SLOT DAE 3RD PARTY	EN-H	\$0
BA-DE25-3PUFD	VMAX 10K 25 SLOT DAE UFD 3RD PARTY	EN-H	\$5,930

BA-DE25-3PUPG	VMAX 10K 25 SLOT DAE UPG 3RD PARTY	EN-H	\$5,930
BA-DE25UFD	VMAX 10K 25 SLOT DAE UFD	EN-H	\$5,930
BA-DE25UPG	VMAX 10K 25 SLOT DAE UPG	EN-H	\$5,930
BA-FABE-UFD	VMAX 10K FABRIC CONNECTION - E	EN-H	\$0
BA-FC-FTS	VMAX 10K FTS TRACKING	EN-H	\$0
BA-FE00400	VMAX 10K 1Gb 4MM GIGE PORTS	EN-H	\$0
BA-FE00400T	VMAX 10K 10Gb 4MM GIGE PORTS	EN-H	\$0
BA-FE00400TU	VMAX 10K 10Gb 4MM GIGE PORTS-UPG	EN-H	\$4,880
BA-FE00400TUF	VMAX 10K 10Gb 4MM GIGE PORTS-CONVERSION	EN-H	\$11,735
BA-FE00400U	VMAX 10K 1Gb 4MM GIGE PORTS-UPG	EN-H	\$0
BA-FE00400UFD	VMAX 10K 1Gb 4MM GIGE PORTS-CONVERSION	EN-H	\$11,735
BA-FE08000E	VMAX 10K 8GB 8SM FC PORTS	EN-H	\$0
BA-FE08000EU	VMAX 10K 8GB 8SM FC PORTS-UPG	EN-H	\$9,765
BAFE08000EUF	VMAX 10K 8Gb 8SM FC PORTS-CONVERSION	EN-H	\$11,735
BA-FE40000S	VMAX 10K 16GB 4MM FC PORTS	EN-H	\$0
BA-FE40000SU	VMAX 10K 16GB 4MM FC PORTS-UPG	EN-H	\$7,787
BA-FE40000SUF	VMAX 10K 16GB 4MM FC PORTS-CONVERSION	EN-H	\$12,980
BA-FE44000E	VMAX 10K 8GB 4MM 4SM FC PORTS	EN-H	\$0
BA-FE44000EU	VMAX 10K 8GB 4MM 4SM FC PORTS-UPG	EN-H	\$7,320
BAFE44000EUF	VMAX 10K 8GB 4MM 4SM FC PORTS-CONVERSION	EN-H	\$11,735
BA-FE62000E	VMAX 10K 8GB 6MM 2SM FC PORTS	EN-H	\$0
BA-FE62000EU	VMAX 10K 8GB 6MM 2SM FC PORTS-UPG	EN-H	\$6,100
BAFE62000EUF	VMAX 10K 8GB 6MM 2SM FC PORTS-CONVERSION	EN-H	\$11,735
BA-FE80000E	VMAX 10K 8Gb 8MM FC PORTS	EN-H	\$0
BA-FE80000EU	VMAX 10K 8Gb 8MM FC PORTS-UPG	EN-H	\$4,880
BA-FE80000EUF	VMAX 10K 8Gb 8MM FC PORTS-CONVERSION	EN-H	\$11,735
BA-ISERIES	VMAX 10K ISERIES TRACKING MODEL	EN-H	\$0
BA-ISERIESU	VMAX 10K ISERIES UPG TRACKING MODEL	EN-H	\$0
BA-MODEM	VMAX 10K ZBA MODEM LEAD FREE	EN-H	\$1,545
BA-PC3YAFLA	VMAX 10K 32A 3P WYE CORD SET IEC309-AMER	EN-H	\$2,255
BA-PC3YAFLE	VMAX 10K 32A 3P WYE CRD SET FLY LEAD EUR	EN-H	\$3,920
BA-PCBL3DHH	VMAX 10K PWR CBL HBL-HBL 3D	EN-H	\$2,255
BA-PCBL3DHR	VMAX 10K PWR CBL HBL-RSTOL 3D	EN-H	\$2,255
BA-PCBL3YAG	VMAX 10K INTL 3P 32 AMP IEC309 TO GARO	EN-H	\$3,920
BA-PCBL3YL23P	VMAX 10K 24A 3PH WYE L22-30P	EN-H	\$3,920
BA-PW40UASTLE	VMAX 10K 30A 1PH CLIPSAL 56PA332 AUS - E	EN-H	\$1,410
BA-PW40UIEC3E	VMAX 10K 30A 1PH IEC309-332P6 INTL - E	EN-H	\$270
BA-PW40URUSE	VMAX 10K 30A 1PH RUSSELLSTOLL 3750DP - E	EN-H	\$1,670
BA-PW40U-USE	VMAX 10K 30A 1PH L6-30P NA; JAPAN - E	EN-H	\$270
BA-SB	VMAX 10K STORAGE BAY	EN-H	\$0
BA-SBE	VMAX 10K STORAGE BAY - E 1P	EN-H	\$0
BA-SBE-3D	VMAX 10K STORAGE BAY - E 3D	EN-H	\$16,870
BA-SBE-3Y	VMAX 10K STORAGE BAY - E 3Y	EN-H	\$16,870
BA-SBEU	VMAX 10K STORAGE BAY - E 1P UPG	EN-H	\$16,875
BA-SBEU-3D	VMAX 10K STORAGE BAY - E 3D UPG	EN-H	\$16,870
BA-SBEU-3Y	VMAX 10K STORAGE BAY - E 3Y UPG	EN-H	\$16,870
BA-SBU	VMAX 10K STORAGE BAY UPG	EN-H	\$0
BA-SECURE	VMAX 10K SECURE BRACK KIT SYS & STOR BAY	EN-H	\$5,015
BA-SECUREJK	VMAX 10K SECURE BRKT JNG KIT	EN-H	\$2,050
BA-SPSR-DB	VMAX 10K 3RD PARTY SHIPPING RACK DB	EN-H	\$0

BA-SYS1	VMAX 10K BASE INFRASTRUCTURE 1	EN-H	\$0
BA-SYS1E	VMAX 10K BASE INFRASTRUCTURE 1E 1P	EN-H	\$0
BA-SYS1E-3D	VMAX 10K BASE INFRASTRUCTURE 1E 3D	EN-H	\$30,880
BA-SYS1E-3Y	VMAX 10K BASE INFRASTRUCTURE 1E 3Y	EN-H	\$30,880
BA-SYS2	VMAX 10K SCALE INFRASTRUCTURE 2	EN-H	\$0
BA-SYS2E	VMAX 10K SCALE INFRASTRUCTURE 2E 1P	EN-H	\$0
BA-SYS2E-3D	VMAX 10K SCALE INFRASTRUCTURE 2E 3D	EN-H	\$30,880
BA-SYS2E-3Y	VMAX 10K SCALE INFRASTRUCTURE 2E 3Y	EN-H	\$30,880
BA-SYS2EU	VMAX 10K SCALE INFRASTRUCTURE 2E 1P UPG	EN-H	\$30,880
BA-SYS2EU-3D	VMAX 10K SCALE INFRASTRUCTURE 2E 3D UPG	EN-H	\$30,880
BA-SYS2EU-3Y	VMAX 10K SCALE INFRASTRUCTURE 2E 3Y UPG	EN-H	\$30,880
BA-SYS3	VMAX 10K SCALE INFRASTRUCTURE 3	EN-H	\$0
BA-SYS3COPKIT	VMAX 10K SCALE INFRSTRCTRE 3 COP CNV KIT	EN-H	\$940
BA-SYS3E	VMAX 10K SCALE INFRASTRUCTURE 3E 1P	EN-H	\$0
BA-SYS3E-3D	VMAX 10K SCALE INFRASTRUCTURE 3E 3D	EN-H	\$30,880
BA-SYS3E-3Y	VMAX 10K SCALE INFRASTRUCTURE 3E 3Y	EN-H	\$30,880
BA-SYS3E-SEP	VMAX 10K SCALE INFRASTRUCTURE 3E 1P SEP	EN-H	\$0
BA-SYS3E-SEP-3D	VMAX 10K SCALE INFRASTRUCTURE 3E 3D SEP	EN-H	\$30,880
BA-SYS3E-SEP-3Y	VMAX 10K SCALE INFRASTRUCTURE 3E 3Y SEP	EN-H	\$30,880
BA-SYS3E-SEPU	VMAX 10K SCALE INFRSTRCTRE 3E 1P SEP UPG	EN-H	\$30,880
BA-SYS3E-SEPU-3D	VMAX 10K SCALE INFRSTRCTRE 3E 3D SEP UPG	EN-H	\$30,880
BA-SYS3E-SEPU-3Y	VMAX 10K SCALE INFRSTRCTRE 3E 3Y SEP UPG	EN-H	\$30,880
BA-SYS3EU	VMAX 10K SCALE INFRASTRUCTURE 3E 1P UPG	EN-H	\$30,880
BA-SYS3EU-3D	VMAX 10K SCALE INFRASTRUCTURE 3E 3D UPG	EN-H	\$30,880
BA-SYS3EU-3Y	VMAX 10K SCALE INFRASTRUCTURE 3E 3Y UPG	EN-H	\$30,880
BA-SYS3OPTKIT	VMAX 10K SCALE INFRSTRCTRE 3 OPT CNV KIT	EN-H	\$12,355
BA-SYS3-SEP	VMAX 10K SCALE INFRASTRUCTURE 3 SEP	EN-H	\$0
BA-SYS4	VMAX 10K SCALE INFRASTRUCTURE 4	EN-H	\$0
BA-SYS4COPKIT	VMAX 10K SCALE INFRSTRCTRE 4 COP CNV KIT	EN-H	\$850
BA-SYS4E	VMAX 10K SCALE INFRASTRUCTURE 4E 1P	EN-H	\$0
BA-SYS4E-3D	VMAX 10K SCALE INFRASTRUCTURE 4E 3D	EN-H	\$30,880
BA-SYS4E-3Y	VMAX 10K SCALE INFRASTRUCTURE 4E 3Y	EN-H	\$30,880
BA-SYS4E-SEP	VMAX 10K SCALE INFRASTRUCTURE 4E 1P SEP	EN-H	\$0
BA-SYS4E-SEP-3D	VMAX 10K SCALE INFRASTRUCTURE 4E 3D SEP	EN-H	\$30,880
BA-SYS4E-SEP-3Y	VMAX 10K SCALE INFRASTRUCTURE 4E 3Y SEP	EN-H	\$30,880
BA-SYS4E-SEPU	VMAX 10K SCALE INFRSTRCTRE 4E 1P SEP UPG	EN-H	\$30,880
BA-SYS4E-SEPU-3D	VMAX 10K SCALE INFRSTRCTRE 4E 3D SEP UPG	EN-H	\$30,880
BA-SYS4E-SEPU-3Y	VMAX 10K SCALE INFRSTRCTRE 4E 3Y SEP UPG	EN-H	\$30,880
BA-SYS4EU	VMAX 10K SCALE INFRASTRUCTURE 4E 1P UPG	EN-H	\$30,880
BA-SYS4EU-3D	VMAX 10K SCALE INFRASTRUCTURE 4E 3D UPG	EN-H	\$30,880
BA-SYS4EU-3Y	VMAX 10K SCALE INFRASTRUCTURE 4E 3Y UPG	EN-H	\$30,880
BA-SYS4OPTKIT	VMAX 10K SCALE INFRSTRCTRE 4 OPT CNV KIT	EN-H	\$12,355
BA-SYS4-SEP	VMAX 10K SCALE INFRASTRUCTURE 4 SEP	EN-H	\$0
BA-TELCO	VMAX 10K ZBA INTL TELCO KIT	EN-H	\$85
BA-TOP-KIT	VMAX 10K TOP ROUTING KIT	EN-H	\$665
BC-128-ENG	VMAX 10K ENGINE - 128GB	EN-H	\$0
BC-24-ENG	VMAX 10K ENGINE - 24GB	EN-H	\$0
BC-96-ENG	VMAX 10K ENGINE - 96GB	EN-H	\$0
BC-DE15DCH	VMAX 10K 15 SLOT DAE	EN-H	\$0
BC-DE15DCHE	VMAX 10K 15 SLOT DAE W/HIGH EFF PS	EN-H	\$0

BC-DE15DIR	VMAX 10K 15 SLOT DAE	EN-H	\$0
BC-DE15DIRE	VMAX 10K 15 SLOT DAE W/HIGH EFF PS	EN-H	\$0
BC-SB	VMAX 10K STORAGE BAY	EN-H	\$0
BC-SYS1	VMAX 10K BASE INFRASTRUCTURE 1	EN-H	\$0
BC-SYS2	VMAX 10K SCALE INFRASTRUCTURE 2	EN-H	\$0
BC-SYS3	VMAX 10K SCALE INFRASTRUCTURE 3	EN-H	\$0
BC-SYS3-SEP	VMAX 10K SCALE INFRASTRUCTURE 3 SEP	EN-H	\$0
BC-SYS4	VMAX 10K SCALE INFRASTRUCTURE 4	EN-H	\$0
BC-SYS4-SEP	VMAX 10K SCALE INFRASTRUCTURE 4 SEP	EN-H	\$0
DRIVEPACK-240	DRIVE BULK PACK 2.5 AND 3.5 240	EN-H	\$0
DRIVEPACK-420	DRIVE BULK PACK 2.5 420	EN-H	\$0
MA3F12001B	VMAX 20K 4G FLASH 200GB DRV	EN-H	\$0
MA3F12001BTU	VMAX 20K 3G FLASH 200GB DRV UPG TAA	EN-H	\$8,075
MA3F12001BU	VMAX 20K 3G FLASH 200GB DRV UPG	EN-H	\$0
MA3F12001C	VMAX 20K 3G FLASH 200GB DRV FOR IBM-I	EN-H	\$5,765
MA3F12001CU	VMAX 20K 3G FLASH 200GB DRV IBM-IUPG	EN-H	\$8,075
MA3F12002BFP	VMAX 20K 4G FLASH 200GB DRV FP	EN-H	\$0
MA47210001B	VMAX 20K 4G 7_2K1000GB DRV	EN-H	\$0
MA47210001BTU	VMAX 20K 4G 7_2K1000GB DRV UPG TAA	EN-H	\$1,545
MA47210001BU	VMAX 20K 4G 7_2K1000GB DRV UPG	EN-H	\$0
MA47220001B	VMAX 20K 4G 72K 2000GB DRV	EN-H	\$0
MA47220001BTU	VMAX 20K 4G 72K 2000GB DRV UPG TAA	EN-H	\$2,400
MA47220001BU	VMAX 20K 4G 72K 2000GB DRV UPG	EN-H	\$0
MA47220001C	VMAX 20K 4G 72K 2000GB DRVSI	EN-H	\$0
MA47220001CTU	VMAX 20K 4G 72K 2000GB DRVSI UPG TAA	EN-H	\$2,400
MA47220001CU	VMAX 20K 4G 72K 2000GB DRVSI UPGRADE	EN-H	\$0
MF4103001B	VMAX 20K 4G 10K300GB DRIVE	EN-H	\$0
MF4103001BTU	VMAX 20K 4G 10K300GB DRV UPG TAA	EN-H	\$1,580
MF4103001BU	VMAX 20K 4G 10K300GB DRV UPG	EN-H	\$0
MF4103001C	VMAX 20K 4G 10K300GB DRVsi	EN-H	\$0
MF4103001CTU	VMAX 20K 4G 10K300GB DRVSi UPG TAA	EN-H	\$1,580
MF4103001CU	VMAX 20K 4G 10K300GB DRVSi UPG	EN-H	\$0
MF4104001B	VMAX 20K 4G 10K400GB DRV	EN-H	\$1,860
MF4104001BU	VMAX 20K 4G 10K400GB DRV UPG	EN-H	\$0
MF4104001C	VMAX 20K 4G 10K400GB DRVSi	EN-H	\$1,860
MF4104001CU	VMAX 20K 4G 10K400GB DRVSi UPG	EN-H	\$0
MF4104501B	VMAX 20K 4G 10K450GB DRV	EN-H	\$0
MF4104501BTU	VMAX 20K 4G 10K450GB DRV UPG TAA	EN-H	\$2,070
MF4104501BU	VMAX 20K 4G 10K450GB DRV UPG	EN-H	\$0
MF4104501C	VMAX 20K 4G 10K450GB DRVSi	EN-H	\$0
MF4104501CTU	VMAX 20K 4G 10K450GB DRVSi UPG TAA	EN-H	\$2,070
MF4104501CU	VMAX 20K 4G 10K450GB DRVSi UPG	EN-H	\$0
MF4106001B	VMAX 20K 4G 10K600GB DRV	EN-H	\$0
MF4106001BTU	VMAX 20K 4G 10K600GB DRV UPG TAA	EN-H	\$2,515
MF4106001BU	VMAX 20K 4G 10K600GB DRV UPG	EN-H	\$0
MF4106001C	VMAX 20K 4G 10K600GB DRVSi	EN-H	\$0
MF4106001CTU	VMAX 20K 4G 10K600GB DRVSi UPG TAA	EN-H	\$2,515
MF4106001CU	VMAX 20K 4G 10K600GB DRVSi UPG	EN-H	\$0
MF4151461B	VMAX 20K 4G 15K146GB DRV	EN-H	\$0
MF4151461BTU	VMAX 20K 4G 15K146GB DRV UPG TAA	EN-H	\$2,120

MF4151461BU	VMAX 20K 4G 15K146GB DRV UPG	EN-H	\$0
MF4151461C	VMAX 20K 4G 15K146GB DRVSi	EN-H	\$0
MF4151461CTU	VMAX 20K 4G 15K146GB DRVSi UPG TAA	EN-H	\$2,120
MF4151461CU	VMAX 20K 4G 15K146GB DRVSi UPG	EN-H	\$0
MF4153001B	VMAX 20K 4G 15K300GB DRV	EN-H	\$0
MF4153001BTU	VMAX 20K 4G 15K300GB DRV UPG TAA	EN-H	\$1,995
MF4153001BU	VMAX 20K 4G 15K300GB DRV UPG	EN-H	\$0
MF4153001C	VMAX 20K 4G 15K300GB DRVSi	EN-H	\$0
MF4153001CTU	VMAX 20K 4G 15K300GB DRVSi UPG TAA	EN-H	\$1,995
MF4153001CU	VMAX 20K 4G 15K300GB DRVSi UPG	EN-H	\$0
MF4154501B	VMAX 20K 4G 15K450GB DRV	EN-H	\$0
MF4154501BTU	VMAX 20K 4G 15K450GB DRV UPG TAA	EN-H	\$2,620
MF4154501BU	VMAX 20K 4G 15K450GB DRV UPG	EN-H	\$0
MF4154501C	VMAX 20K 4G 15K450GB DRVSi	EN-H	\$0
MF4154501CTU	VMAX 20K 4G 15K450GB DRVSi UPG TAA	EN-H	\$2,620
MF4154501CU	VMAX 20K 4G 15K450GB DRVSi UPG	EN-H	\$0
MF4156001B	VMAX 20K 4G 15K600GB DRV	EN-H	\$0
MF4156001BTU	VMAX 20K 4G 15K600GB DRV UPG TAA	EN-H	\$3,240
MF4156001BU	VMAX 20K 4G 15K600GB DRV UPG	EN-H	\$0
MF4156001C	VMAX 20K 4G 15K600GB DRVSI	EN-H	\$0
MF4156001CTU	VMAX 20K 4G 15K600GB DRVSI UPG TAA	EN-H	\$3,240
MF4156001CU	VMAX 20K 4G 15K600GB DRVSI UPG	EN-H	\$0
MF4F11001B	VMAX 20K 4G FLASH 100GB DRV	EN-H	\$3,255
MF4F11001BU	VMAX 20K 4G FLASH 100GB DRV UPG	EN-H	\$4,480
MF4F11001C	VMAX 20K 4G FLASH 100GB drive IBM-I	EN-H	\$3,255
MF4F11001CU	VMAX 20K 4G FLASH 100GB drive IBM-I UPG	EN-H	\$4,480
MF4F11002BFP	VMAX 20K 4G FLASH 100GB DRV FP	EN-H	\$0
MF4F11002CFP	VMAX 20K 4G FLASH 100GB DRV FP	EN-H	\$0
MF4F1100ABP	1 of 10X100GB EFD FOR VMAX 20K FF PROMO	EN-H	\$0
MF4F12001B	VMAX 20K 4G FLASH 200GB DRV	EN-H	\$0
MF4F12001BU	VMAX 20K 200GB FLASH 4GB FC UPG	EN-H	\$0
MF4F12001C	VMAX 20K 4G FLASH 200GB DRVSi	EN-H	\$0
MF4F12001CU	VMAX 20K 200GB FLASH 4GB FC Si UPG	EN-H	\$0
MF4F12005BP	1 of 5x200GB EFD FOR VMAX 20K FF PROMO	EN-H	\$5,765
MF4F14001B	VMAX 20K 4G FLASH 400GB DRV	EN-H	\$0
MF4F14001BU	VMAX 20K 400GB FLASH 4GB FC UPG	EN-H	\$0
MF4F14001C	VMAX 20K 4G FLASH 400GB DRVSi	EN-H	\$0
MF4F14001CU	VMAX 20K 400GB FLASH 4GB FC Si UPG	EN-H	\$0
MF4F22001B	VMAX 20K 4G FLASH 200GBS DRV	EN-H	\$5,765
MF4F22001BTU	VMAX 20K 200GB FLASH 4GB FC UPG TAA	EN-H	\$8,075
MF4F22001BU	VMAX 20K 4G FLASH 200GBS DRV UPG	EN-H	\$8,075
MF4F22001C	VMAX 20K 4G FLASH 200GBS drive IBM-i	EN-H	\$5,765
MF4F22001CTU	VMAX 20K 200GB FLASH 4GB FC Si UPG TAA	EN-H	\$8,075
MF4F22001CU	VMAX 20K 4G FLASH 200GBS drv IBM-i UPG	EN-H	\$8,075
MF4F22002BFP	VMAX 20K 4G FLASH 200GB DRV FP	EN-H	\$0
MF4F22002CFP	VMAX 20K 4G FLASH 200GB DRV FP	EN-H	\$0
MF4F24001B	VMAX 20K 4G FLASH 400GBS DRV	EN-H	\$10,940
MF4F24001BTU	VMAX 20K 400GB FLASH 4GB FC UPG TAA	EN-H	\$15,310
MF4F24001BU	VMAX 20K 4G FLASH 400GBS DRV UPG	EN-H	\$15,310
MF4F24001C	VMAX 20K 4G FLASH 400GBS drive IBM-i	EN-H	\$10,940

MF4F24001CTU	VMAX 20K 400GB FLASH 4GB FC Si UPG TAA	EN-H	\$15,310
MF4F24001CU	VMAX 20K 4G FLASH 400GBS drive IBM-i UPG	EN-H	\$15,310
MF4F24002BFP	VMAX 20K 4G FLASH 400GB DRV FP	EN-H	\$0
MF4F24002CFP	VMAX 20K 4G FLASH 400GB DRV FP	EN-H	\$0
ML4103001B	VMAX 20K 4G 10K 300GB SAS DRIVE	EN-H	\$0
ML4103001BTU	VMAX 20K 4G 10K 300GB SAS DRIVE UPG TAA	EN-H	\$1,205
ML4103001BU	VMAX 20K 4G 10K 300GB SAS DRIVE UPG	EN-H	\$0
ML4103001C	VMAX 20K 4G 10K 300GB SAS DRIVE IBM-I	EN-H	\$0
ML4103001CTU	VMAX 20K4G 10K 300GB SAS DRVIBMI UPGTAA	EN-H	\$1,205
ML4103001CU	VMAX 20K 4G 10K 300GB SAS DRIVE IBM-IUPG	EN-H	\$0
ML4106001B	VMAX 20K 4G 10K 600GB SAS DRIVE	EN-H	\$0
ML4106001BTU	VMAX 20K 4G 10K 600GB SAS DRIVE UPG TAA	EN-H	\$2,085
ML4106001BU	VMAX 20K 4G 10K 600GB SAS DRIVE UPG	EN-H	\$0
ML4106001C	VMAX 20K 4G 10K 600GB SAS DRIVE IBM-I	EN-H	\$0
ML4106001CTU	VMAX 20K4G 10K 600GB SAS DRV IBMIUPGTAA	EN-H	\$2,085
ML4106001CU	VMAX 20K 4G 10K 600GB SAS DRIVE IBM-IUPG	EN-H	\$0
ML4109001B	VMAX 20K 4G 10K 900GB SAS DRIVE	EN-H	\$0
ML4109001BTU	VMAX 20K 4G 10K 900GB SAS DRIVE UPG TAA	EN-H	\$2,745
ML4109001BU	VMAX 20K 4G 10K 900GB SAS DRIVE UPG	EN-H	\$2,745
ML4109001C	VMAX 20K 4G 10K 900GB SAS DRIVE IBM-I	EN-H	\$0
ML4109001CTU	VMAX 20K4G 10K 900GB SAS DRVIBMI UPGTAA	EN-H	\$2,745
ML4109001CU	VMAX 20K 4G 10K 900GB SAS DRIVE IBM-IUPG	EN-H	\$2,745
ML4151461B	VMAX 20K 4G 15K 146GB SAS DRIVE	EN-H	\$0
ML4151461BTU	VMAX 20K 4G 15k 146GB SAS DRVUPG TAA	EN-H	\$2,120
ML4151461BU	VMAX 20K 4G 15K 146GB SAS DRIVE	EN-H	\$0
ML4151461C	VMAX 20K 4G 15K 146GB SAS DRIVE IBM-i	EN-H	\$0
ML4151461CTU	VMAX 20K4G 15K 146GB SAS DRVIBMI UPGTAA	EN-H	\$2,120
ML4151461CU	VMAX 20K 4G 15K 146GB SAS DRV IBM-I UPG	EN-H	\$0
ML4153001B	VMAX 20K 4G 15K 300GB SAS DRIVE	EN-H	\$0
ML4153001BTU	VMAX 20K 4G 15K 300GB SAS DRIVE TAA	EN-H	\$3,100
ML4153001BU	VMAX 20K 4G 15K 300GB SAS DRIVE	EN-H	\$0
ML4153001C	VMAX 20K 4G 15K 300GB SAS DRIVE IBM-i	EN-H	\$0
ML4153001CTU	VMAX 20K4G 15K 300GB SAS DRVIBMI UPGTAA	EN-H	\$3,100
ML4153001CU	VMAX 20K 4G 15K 300GB SAS DRV IBM-I UPG	EN-H	\$0
ML47210001B	VMAX 20K 4G 7_2K 1000GB SAS DRIVE	EN-H	\$0
ML47210001BTU	VMAX 20K 4G 7_2K 1000GB SAS DRIVEUPGTAA	EN-H	\$2,280
ML47210001BU	VMAX 20K 4G 7_2K 1000GB SAS DRIVE	EN-H	\$2,280
ML47210001C	VMAX 20K 4G 7_2K 1000GB SAS DRIVE IBM-i	EN-H	\$0
ML47210001CTU	VMAX20K4G 7_2K 1000GB SASDRV IBMIUPGTAA	EN-H	\$2,280
ML47210001CU	VMAX 20K 4G 7_2K 1000GB SAS DRV IBMI UPG	EN-H	\$2,280
ML4F11001B	VMAX 20K 4G SSD 100GB SAS DRIVE	EN-H	\$0
ML4F11001BU	VMAX 20K 4G SSD 100GB SAS DRIVE UPG	EN-H	\$0
ML4F11001C	VMAX 20K 4G SSD 100GB SAS DRIVE IBM-i	EN-H	\$0
ML4F11001CU	VMAX 20K 4G SSD 100GB SAS DRV IBM-i UPG	EN-H	\$0
ML4F11002BFP	VMAX 20K 4G FLASH 100GB DRV FP	EN-H	\$0
ML4F11002CFP	VMAX 20K 4G FLASH 100GB DRV FP	EN-H	\$0
ML4F12001B	VMAX 20K 4G SSD 200GB SAS DRIVE	EN-H	\$0
ML4F12001BU	VMAX 20K 4G SSD 200GB SAS DRIVE UPG	EN-H	\$0
ML4F12001C	VMAX 20K 4G SSD 200GB SAS DRV IBM-i	EN-H	\$0
ML4F12001CU	VMAX 20K 4G SSD 200GB SAS DRV UPG IBM-i	EN-H	\$0

ML4F12002BFP	VMAX 20K 4G FLASH 200GB DRV FP	EN-H	\$0
ML4F12002CFP	VMAX 20K 4G FLASH 200GB DRV FP	EN-H	\$0
ML4F14001B	VMAX 20K 4G SSD 400GB SAS DRIVE	EN-H	\$0
ML4F14001BU	VMAX 20K 4G SSD 400GB SAS DRIVE UPG	EN-H	\$0
ML4F14001C	VMAX 20K 4G SSD 400GB SAS DRIVE IBM-i	EN-H	\$0
ML4F14001CU	VMAX 20K 4G SSD 400GB SAS DRV UPG IBM-i	EN-H	\$0
ML4F14002BFP	VMAX 20K 4G FLASH 400GB DRV FP	EN-H	\$0
ML4F14002CFP	VMAX 20K 4G FLASH 400GB DRV FP	EN-H	\$0
MS4103001B	VMAX 20K 4G 10K 300GB SAS DRV	EN-H	\$0
MS4103001BTU	VMAX 20K 4G 10K 300GB SAS DRV UPG TAA	EN-H	\$1,205
MS4103001BU	VMAX 20K 4G 10K 300GB SAS DRV UPG	EN-H	\$0
MS4103001C	VMAX 20K 4G 10k 300GB SAS drive IBM-i	EN-H	\$0
MS4103001CTU	VMAX 20K4G 10k 300GB SAS drv IBMi UPGTAA	EN-H	\$1,205
MS4103001CU	VMAX 20K 4G 10k 300GB SAS drv IBM-i UPG	EN-H	\$0
MS4104501B	VMAX 20K 4G 10K 450GB SAS DRV	EN-H	\$0
MS4104501BTU	VMAX 20K 4G 10K 450GB SAS DRV UPG TAA	EN-H	\$1,750
MS4104501BU	VMAX 20K 4G 10K 450GB SAS DRV UPG	EN-H	\$0
MS4104501C	VMAX 20K 4G 10k 450GB SAS drive IBM-i	EN-H	\$0
MS4104501CTU	VMAX 20K4G 10k 450GB SAS drv IBMi UPGTAA	EN-H	\$1,750
MS4104501CU	VMAX 20K 4G 10k 450GB SAS drv IBM-i UPG	EN-H	\$0
MS4106001B	VMAX 20K 4G 10K 600GB SAS DRV	EN-H	\$0
MS4106001BTU	VMAX 20K 4G 10K 600GB SAS DRV UPG TAA	EN-H	\$2,085
MS4106001BU	VMAX 20K 4G 10K 600GB SAS DRV UPG	EN-H	\$0
MS4106001C	VMAX 20K 4G 10k 600GB SAS drive IBM-i	EN-H	\$0
MS4106001CTU	VMAX 20K4G 10k 600GB SAS drv IBMi UPGTAA	EN-H	\$2,085
MS4106001CU	VMAX 20K 4G 10k 600GB SAS drv IBM-i UPG	EN-H	\$0
MS4109001B	VMAX 20K 4G 10K 900GB SAS DRIVE	EN-H	\$0
MS4109001BTU	VMAX 20K 4G 10K 900GB SAS DRIVEUPGTAA	EN-H	\$2,745
MS4109001BU	VMAX 20K 4G 10K 900GB SAS DRIVEUPG	EN-H	\$2,745
MS4109001C	VMAX 20K 4G 10K 900GB SAS DRIVE IBM-I	EN-H	\$0
MS4109001CTU	VMAX 20K 4G 10K 900GB SAS DRIVESIUPGTAA	EN-H	\$2,745
MS4109001CU	VMAX 20K 4G 10K 900GB SAS DRIVE IBM-IUPG	EN-H	\$2,745
MT47230001B	VMAX 20K 4G 72K 3000GB DRV	EN-H	\$0
MT47230001BTU	VMAX 20K 4G 72K 3000GB DRV UPG TAA	EN-H	\$3,390
MT47230001BU	VMAX 20K 4G 72K 3000GB DRV UPG	EN-H	\$0
MT47230001C	VMAX 20K 4G 72K 3000GB DRVSI	EN-H	\$0
MT47230001CTU	VMAX 20K 4G 7_2K3000GB DRV UPG TAA	EN-H	\$3,390
MT47230001CU	VMAX 20K 4G 72K 3000GB DRVSI UPGRADE	EN-H	\$0
S2-00004-RET	VMAX 20K 4Gb 4S FIC RETURN	EN-H	\$0
S2-00040-RET	VMAX 20K 4Gb 4M FIC RETURN	EN-H	\$0
S2-00400-RET	VMAX 20K 4M GIGE RETURN	EN-H	\$0
S2-08000-RET	VMAX 20K 4Gb 8S FC RETURN	EN-H	\$0
S2-128-BASE	VMAX 20K BASE-128GB	EN-H	\$0
S2-128-BASEC	VMAX 20K BASE -128GB-C	EN-H	\$0
S2-128D-BASE	VMAX 20K BASE-128GB with Encryption	EN-H	\$0
S2-128D-BASEC	VMAX 20K BASE -128GB-C with Encryption	EN-H	\$0
S2-128-RET	VMAX 20K MEMORY RETURN 128GB	EN-H	\$0
S2-1P	VMAX 20K 1P INFRAST	EN-H	\$0
S2-32-128UFD	VMAX 20K MEMCONV 2X16 to 2X64 GB	EN-H	\$0
S2-32-64UFD	VMAX 20K MEMCONV 2X16 to 2X32 GB	EN-H	\$0

S2-32-BASE	VMAX 20K BASE-32GB	EN-H	\$0
S2-32-BASEC	VMAX 20K BASE-32GB-C	EN-H	\$0
S2-32D-BASE	VMAX 20K BASE-32GB with Encryption	EN-H	\$0
S2-32D-BASEC	VMAX 20K BASE-32GB-C with Encryption	EN-H	\$0
S2-32-RET	VMAX 20K MEMORY RETURN 32GB	EN-H	\$0
S2-3D	VMAX 20K DELTA INFRAST	EN-H	\$0
S2-3Y	VMAX 20K WYE INFRAST	EN-H	\$0
S2-44000-RET	VMAX 20K 4Gb 4M4S FC RETURN	EN-H	\$0
S2-62000-RET	VMAX 20K 4Gb 6M2S FC RETURN	EN-H	\$0
S2-64-128UFD	VMAX 20K MEMCONV 2X32 to 2X64 GB	EN-H	\$0
S2-64-BASE	VMAX 20K BASE-64GB	EN-H	\$0
S2-64-BASEC	VMAX 20K BASE -64GB-C	EN-H	\$0
S2-64D-BASE	VMAX 20K BASE-64GB with Encryption	EN-H	\$0
S2-64D-BASEC	VMAX 20K BASE -64GB-C with Encryption	EN-H	\$0
S2-64-RET	VMAX 20K MEMORY RETURN 64GB	EN-H	\$0
S2-80000-RET	VMAX 20K 4Gb 8M FC RETURN	EN-H	\$0
S2-AD128DNDCU	VMAX 20K UPG ENGINE-128GB-C with Encryp	EN-H	\$0
S2-AD128NDECU	VMAX 20K UPG ENGINE-128GB-C	EN-H	\$0
S2-ADD128DNDC	VMAX 20K ADD ENGINE-128GB-C with Encryp	EN-H	\$205,960
S2-ADD128DNDE	VMAX 20K ADD ENGINE-128GB with Encryp	EN-H	\$205,960
S2-ADD128DNDCU	VMAX 20K UPG ENGINE-128GB with Encryp	EN-H	\$0
S2-ADD128NDE	VMAX 20K ADD ENGINE-128GB	EN-H	\$0
S2-ADD128NDEC	VMAX 20K ADD ENGINE-128GB-C	EN-H	\$0
S2-ADD128NDEU	VMAX 20K UPG ENGINE-128GB	EN-H	\$0
S2-ADD32DNDCU	VMAX 20K UPG ENGINE-32GB-C with Encryp	EN-H	\$0
S2-ADD32DNDE	VMAX 20K ADD ENGINE-32GB with Encryption	EN-H	\$139,280
S2-ADD32DNDEC	VMAX 20K ADD ENGINE-32GB-C with Encryp	EN-H	\$139,280
S2-ADD32DNDEU	VMAX 20K UPG ENGINE-32GB with Encryption	EN-H	\$0
S2-ADD32NDE	VMAX 20K ADD ENGINE-32GB	EN-H	\$0
S2-ADD32NDEC	VMAX 20K ADD ENGINE-32GB-C	EN-H	\$0
S2-ADD32NDECU	VMAX 20K UPG ENGINE-32GB-C	EN-H	\$0
S2-ADD32NDEU	VMAX 20K UPG ENGINE-32GB	EN-H	\$0
S2-ADD64DNDCU	VMAX 20K UPG ENGINE-64GB-C with Encryp	EN-H	\$0
S2-ADD64DNDE	VMAX 20K ADD ENGINE-64GB with Encryption	EN-H	\$154,835
S2-ADD64DNDEC	VMAX 20K ADD ENGINE-64GB-C with Encryp	EN-H	\$154,835
S2-ADD64DNDEU	VMAX 20K UPG ENGINE-64GB with Encryption	EN-H	\$0
S2-ADD64NDE	VMAX 20K ADD ENGINE-64GB	EN-H	\$0
S2-ADD64NDEC	VMAX 20K ADD ENGINE-64GB-C	EN-H	\$0
S2-ADD64NDECU	VMAX 20K UPG ENGINE-64GB-C	EN-H	\$0
S2-ADD64NDEU	VMAX 20K UPG ENGINE-64GB	EN-H	\$0
S2-ASSETTG-MS	CUSTOMER SPECIFD ASSET TAG - MICROSOFT	EN-H	\$0
S2-CNV-3DU	VMAX 20K CONV TO 3D INFRA/STOR BAY MISC	EN-H	\$2,680
S2-CNV-3YU	VMAX 20K CONV TO 3Y INFRA/STOR BAY MISC	EN-H	\$2,680
S2-CNVDB-1PU	VMAX 20K CONV TO 1P STORAGE BAY MISC	EN-H	\$2,680
S2-CNVINF-1PU	VMAX 20K CONV TO 1P INFRASTRUCTURE MISC	EN-H	\$2,680
S2-COMPRSUF	VMAX 20K UPG CMPR ENABLED	EN-H	\$0
S2-CONFIG03	VMAX 20K CONFIG 03	EN-H	\$0
S2-CONFIG04	VMAX 20K CONFIG 04	EN-H	\$0
S2-CONFIG19-2	VMAX 20K CONFIG 19-2	EN-H	\$0
S2-CONFIG22-2	VMAX 20K CONFIG 22-2	EN-H	\$0

S2-CONFIG32-2	VMAX 20K CONFIG 32-2	EN-H	\$0
S2-CONFIG36-2	VMAX 20K CONFIG 36-2	EN-H	\$0
S2-CONFIG39-2	VMAX 20K CONFIG 39-2	EN-H	\$0
S2-CONFIG40-2	VMAX 20K CONFIG 40-2	EN-H	\$0
S2-CONFIG41-2	VMAX 20K CONFIG 41-2	EN-H	\$0
S2-DB-DC-1P	VMAX 20K SB DCH 1 PHASE	EN-H	\$0
S2-DB-DC-1PP	VMAX 20K SB DCH 1 PHASE PERF REAR DOOR	EN-H	\$0
S2-DB-DC-1PPU	VMAX 20K DCH 1 PHASE UPG PERF REAR DOOR	EN-H	\$0
S2-DB-DC-1PU	VMAX 20K SB DCH 1 PHASE UPG	EN-H	\$0
S2-DB-DC-3D	VMAX 20K SB DCH DELTA	EN-H	\$0
S2-DB-DC-3DP	VMAX 20K SB DCH DELTA PERF REAR DOOR	EN-H	\$0
S2-DB-DC-3DPU	VMAX 20K SB DCH DELTA UPG PERF REAR DOOR	EN-H	\$0
S2-DB-DC-3DU	VMAX 20K SB DCH DELTA UPG	EN-H	\$0
S2-DB-DC-3PY	VMAX 20K SB DCH WYE PERF REAR DOOR	EN-H	\$0
S2-DB-DC-3Y	VMAX 20K SB DCH WYE	EN-H	\$0
S2-DB-DC-3YPU	VMAX 20K SB DCH WYE UPG PERF REAR DOOR	EN-H	\$0
S2-DB-DC-3YU	VMAX 20K SB DCH WYE UPG	EN-H	\$0
S2-DBDC-SPS	VMAX 20K SB DCH SPS	EN-H	\$0
S2-DBDC-SPS-U	VMAX 20K SB DCH SPS UPG	EN-H	\$0
S2-DBDCSPS-UF	VMAX 20K SB DCH SPS UFD	EN-H	\$0
S2-DBDCV-SPS	VMAX 20K SPSV DCH	EN-H	\$0
S2-DBDCVSPS-U	VMAX 20K SPSV DCH UPG	EN-H	\$0
S2DBDCVSPS-UF	VMAX 20K SPSV DCH UPGFD	EN-H	\$2,100
S2-DB-DIR-1P	VMAX 20K SB DIR 1 PHASE	EN-H	\$0
S2-DB-DIR-1PP	VMAX 20K SB DIR 1 PHASE PERF REAR DOOR	EN-H	\$0
S2-DB-DIR1PPU	VMAX 20K DIR 1 PHASE UPG PERF REAR DOOR	EN-H	\$0
S2-DB-DIR-1PU	VMAX 20K SB DIR 1 PHASE UPG	EN-H	\$0
S2-DB-DIR-3D	VMAX 20K SB DIR DELTA	EN-H	\$0
S2-DB-DIR-3DP	VMAX 20K SB DIR DELTA PERF REAR DOOR	EN-H	\$0
S2-DB-DIR3DPU	VMAX 20K SB DIR DELTA UPG PERF REAR DOOR	EN-H	\$0
S2-DB-DIR-3DU	VMAX 20K SB DIR DELTA UPG	EN-H	\$0
S2-DB-DIR-3Y	VMAX 20K SB DIR WYE	EN-H	\$0
S2-DB-DIR-3YP	VMAX 20K SB DIR WYE PERF REAR DOOR	EN-H	\$0
S2-DB-DIR3YPU	VMAX 20K SB DIR WYE UPG PERF REAR DOOR	EN-H	\$0
S2-DB-DIR-3YU	VMAX 20K SB DIR WYE UPG	EN-H	\$0
S2-DB-SPS	VMAX 20K SB SPS	EN-H	\$0
S2-DB-SPS-U	VMAX 20K SB SPS UPG	EN-H	\$0
S2-DB-SPS-UFD	VMAX 20K SB SPS UFD	EN-H	\$0
S2-DBV-DC-1P	VMAX 20K DBV DIR 1 PHASE	EN-H	\$16,255
S2-DBV-DC-1PU	VMAX 20K DBV DIR 1 PHASE UPG	EN-H	\$0
S2-DBV-DC-3D	VMAX 20K DBV DCH DELTA	EN-H	\$0
S2-DBV-DC-3DU	VMAX 20K DBV DCH DELTA UPG	EN-H	\$0
S2-DBV-DC-3Y	VMAX 20K DBV DCH WYE	EN-H	\$0
S2-DBV-DC-3YU	VMAX 20K DBV DCH WYE UPG	EN-H	\$0
S2-DBV-DIR-1P	VMAX 20K DBV DIR 1 PHASE	EN-H	\$0
S2-DBV-DIR1PU	VMAX 20K DBV DIR 1 PHASE UPG	EN-H	\$0
S2-DBV-DIR-3D	VMAX 20K DBV DIR DELTA	EN-H	\$0
S2-DBV-DIR3DU	VMAX 20K DBV DIR DELTA UPG	EN-H	\$0
S2-DBV-DIR-3Y	VMAX 20K DBV DIR WYE	EN-H	\$0
S2-DBV-DIR3YU	VMAX 20K DBV DIR WYE UPG	EN-H	\$0

S2-DBV-SPS	VMAX 20K SPSV	EN-H	\$0
S2-DBV-SPS-U	VMAX 20K SPSV-UPG	EN-H	\$0
S2-DBVSPS-UF	VMAX 20K SPSV UPGFD	EN-H	\$0
S2-DDB-DC-1P	VMAX 20K SEP SB 1PHASE	EN-H	\$30,715
S2-DDB-DC-1PP	VMAX 20K SEP SB 1PH PERF REAR DOOR	EN-H	\$30,715
S2-DDB-DC1PPU	VMAX 20K SEP SB 1PH PERF REAR DOOR UPG	EN-H	\$30,715
S2-DDB-DC-1PU	VMAX 20K SEP SB 1PHASE UPG	EN-H	\$30,715
S2-DDB-DC-3D	VMAX 20K SEP SB DELTA	EN-H	\$30,715
S2-DDB-DC-3DP	VMAX 20K SEP SB DELTA PERF REAR DOOR	EN-H	\$30,715
S2-DDB-DC3DPU	VMAX 20K SEP SB DELTA UPG PERF REAR DOC	EN-H	\$30,715
S2-DDB-DC-3DU	VMAX 20K SEP SB DELTA UPG	EN-H	\$30,715
S2-DDB-DC-3Y	VMAX 20K SEP SB WYE	EN-H	\$30,715
S2-DDB-DC-3YP	VMAX 20K SEP SB WYE PERF REAR DOOR	EN-H	\$30,715
S2-DDB-DC3YPU	VMAX 20K SEP SB WYE UPG PERF REAR DOOR	EN-H	\$30,715
S2-DDB-DC-3YU	VMAX 20K SEP SB WYE UPG	EN-H	\$30,715
S2-DDBV-DC-1P	VMAX 20K DDBV DCH 1 PHASE	EN-H	\$30,100
S2-DDBVDC-1PU	VMAX 20K DDBV DCH 1 PHASE UPG	EN-H	\$30,100
S2-DDBV-DC-3D	VMAX 20K DDBV DCH DELTA	EN-H	\$30,100
S2-DDBVDC-3DU	VMAX 20K DDBV DCH DELTA UPG	EN-H	\$30,100
S2-DDBV-DC-3Y	VMAX 20K DDBV DCH WYE	EN-H	\$30,100
S2-DDBVDC-3YU	VMAX 20K DDBV DCH WYE UPG	EN-H	\$30,100
S2-DE15DCH	VMAX 20K 15SLT DR ENCL	EN-H	\$0
S2-DE15DCHU	VMAX 20K 15SLT DR ENCL UPG	EN-H	\$0
S2-DE15DCHUFD	VMAX 20K 15SLT DR ENCL UFD	EN-H	\$0
S2-DE15-DIR	VMAX 20K 15SLT DR ENCL	EN-H	\$0
S2-DE15-DIRU	VMAX 20K 15SLT DR ENCL UPG	EN-H	\$0
S2-DE15DIRUFD	VMAX 20K 15SLT DR ENCL UFD	EN-H	\$0
S2-DE25-DCH	VMAX 20K 25SLT DR ENCL	EN-H	\$0
S2-DE25-DCHU	VMAX 20K 25SLT DR ENCL UPG	EN-H	\$5,930
S2-DE25DCHUFD	VMAX 20K 25SLT DR ENCL UFD	EN-H	\$0
S2-DE25-DIR	VMAX 20K 25SLT DR ENCL	EN-H	\$0
S2-DE25-DIRU	VMAX 20K 25SLT DR ENCL UPG	EN-H	\$0
S2-DE25DIRUFD	VMAX 20K 25SLT DR ENCL UFD	EN-H	\$0
S2-FC-FTS	VMAX 20K FED TRD STRG PORT TRACKING	EN-H	\$0
S2-FE00004	VMAX 20K 4Gb 4S FIC	EN-H	\$0
S2-FE00004E	VMAX 20K 8Gb 4S FIC	EN-H	\$0
S2-FE00004EU	VMAX 20K 8Gb 4S FIC-UPG	EN-H	\$0
S2FE00004EUF	VMAX 20K 8Gb 4S FIC-CV	EN-H	\$0
S2-FE00004U	VMAX 20K 4Gb 4S FIC-UPG	EN-H	\$0
S2-FE00004UFD	VMAX 20K 4Gb 4S FIC-CV	EN-H	\$0
S2-FE00040	VMAX 20K 4Gb 4M FIC	EN-H	\$0
S2-FE00040E	VMAX 20K 8Gb 4M FIC	EN-H	\$0
S2-FE00040EU	VMAX 20K 8Gb 4M FIC-UPG	EN-H	\$0
S2FE00040EUF	VMAX 20K 8Gb 4M FIC-CV	EN-H	\$0
S2-FE00040U	VMAX 20K 4Gb 4M FIC-UPG	EN-H	\$0
S2-FE00040UFD	VMAX 20K 4Gb 4M FIC-CV	EN-H	\$0
S2-FE00400	VMAX 20K 4M GIGE	EN-H	\$0
S2-FE00400T	VMAX 20K 10Gb 4M GIGE	EN-H	\$0
S2-FE00400TU	VMAX 20K 10Gb 4M GIGE-UPG	EN-H	\$0
S2-FE00400TUF	VMAX 20K 10Gb 4M GIGE-CV	EN-H	\$0

S2-FE00400U	VMAX 20K 4M GIGE-UPG	EN-H	\$0
S2-FE00400UFD	VMAX 20K 4M GIGE-CV	EN-H	\$0
S2-FE08000	VMAX 20K 4Gb 8S FC	EN-H	\$0
S2-FE08000E	VMAX 20K 8Gb 8S FC	EN-H	\$0
S2-FE08000EU	VMAX 20K 8Gb 8S FC-UPG	EN-H	\$0
S2FE08000EUF	VMAX 20K 8Gb 8S FC-CV	EN-H	\$0
S2-FE08000U	VMAX 20K 4Gb 8S FC-UPG	EN-H	\$0
S2-FE08000UFD	VMAX 20K 4Gb 8S FC-CV	EN-H	\$0
S2-FE44000	VMAX 20K 4Gb 4M4S FC	EN-H	\$0
S2-FE44000E	VMAX 20K 8Gb 4M4S FC	EN-H	\$0
S2-FE44000EU	VMAX 20K 8Gb 4M4S FC-UPG	EN-H	\$0
S2FE44000EUF	VMAX 20K 8Gb 4M4S FC-CV	EN-H	\$0
S2-FE44000U	VMAX 20K 4Gb 4M4S FC-UPG	EN-H	\$0
S2-FE44000UFD	VMAX 20K 4Gb 4M4S FC-CV	EN-H	\$0
S2-FE62000	VMAX 20K 4Gb 6M2S FC	EN-H	\$0
S2-FE62000E	VMAX 20K 8Gb 6M2S FC	EN-H	\$0
S2-FE62000EU	VMAX 20K 8Gb 6M2S FC-UPG	EN-H	\$0
S2FE62000EUF	VMAX 20K 8Gb 6M2S FC-CV	EN-H	\$0
S2-FE62000U	VMAX 20K 4Gb 6M2S FC-UPG	EN-H	\$0
S2-FE62000UFD	VMAX 20K 4Gb 6M2S FC-CV	EN-H	\$0
S2-FE80000	VMAX 20K 4Gb 8M FC	EN-H	\$0
S2-FE80000E	VMAX 20K 8Gb 8M FC	EN-H	\$0
S2-FE80000EU	VMAX 20K 8Gb 8M FC-UPG	EN-H	\$0
S2-FE80000EUF	VMAX 20K 8Gb 8M FC-CV	EN-H	\$0
S2-FE80000U	VMAX 20K 4Gb 8M FC-UPG	EN-H	\$0
S2-FE80000UFD	VMAX 20K 4Gb 8M FC-CV	EN-H	\$0
S2-GE-FCOE	VMAX 20K GIGE FCOE PORTS	EN-H	\$0
S2-GE-ISCSI	VMAX 20K GIGE ISCSI PORTS	EN-H	\$0
S2-GE-SRDF	VMAX 20K GIGE SRDF PORTS	EN-H	\$0
S2-INTBKVKIT	VMAX 20K INTERNAL CABLE BRACKET TITAN	EN-H	\$310
S2-ISERIESU	VMAX 20K ISERIES UPG TRACKING MODEL	EN-H	\$0
S2-MAINFRAMEU	VMAX 20K MAINFRAME UPG TRACKING MODEL	EN-H	\$0
S2-NOCMPRSRET	VMAX 20K NON-CMPR RETURN	EN-H	\$0
S2-OM3-100M	OM3 50/125 MICRON OPTCL CABLE LC-LC 100M	EN-H	\$1,000
S2-OM3-10M	OM3 50/125 MICRON OPTCL CABLE LC-LC 10M	EN-H	\$320
S2-OM3-1M	OM3 50/125 MICRON OPTCL CABLE LC-LC 1M	EN-H	\$255
S2-OM3-30M	OM3 50/125 MICRON OPTCL CABLE LC-LC 30M	EN-H	\$465
S2-OM3-3M	OM3 50/125 MICRON OPTCL CABLE LC-LC 3M	EN-H	\$255
S2-OM3-50M	OM3 50/125 MICRON OPTCL CABLE LC-LC 50M	EN-H	\$630
S2-OM3-5M	OM3 50/125 MICRON OPTCL CABLE LC-LC 5M	EN-H	\$290
S2-PERFREARDR	VMAX 20K STORAGE BAY PERFORATED REARD	EN-H	\$865
S2-SECURETDB	VMAX 20K SEISMIC BRKT STORBAY TITAN	EN-H	\$665
S2-SECURETM	VMAX 20K SEIS BRKT JNG KIT	EN-H	\$665
S2VDBPERDOR1P	VMAX 20K DRIVE BAY PERF DOOR 1P	EN-H	\$620
S2VDBPERFDOOR	VMAX 20K DRIVE BAY PERF DOOR	EN-H	\$620
S2VDBSOLDOOR	VMAX 20K DRIVE BAY SOLID DOOR	EN-H	\$620
S2VDBSOLDOR1P	37.3220K DRIVE BAY SOLID DOOR 1P	EN-H	\$620
S2-VFP1-20K	PROMO 100GB VFP20K 96	EN-H	\$0
S2-VFP1-20KU	PROMO 100GB VFP20K 32U	EN-H	\$0
S2-VFP2-20K	PROMO 100GB VFP20K 192	EN-H	\$0

S2-VFP2-20KU	PROMO 100GB VFP20K 48U	EN-H	\$0
S2-VFP3-20K	PROMO 200GB VFP20K 96	EN-H	\$0
S2-VFP3-20KU	PROMO 100GB VFP20K 96U	EN-H	\$0
S2-VFP4-20K	PROMO 200GB VFP20K 192	EN-H	\$0
S2-VFP4-20KU	PROMO 200GB VFP20K 32U	EN-H	\$0
S2-VFP5-20K	PROMO 400GB VFP20K 96	EN-H	\$0
S2-VFP5-20KU	PROMO 200GB VFP20K 48U	EN-H	\$0
S2-VFP6-20K	PROMO 400GB VFP20K 192	EN-H	\$0
S2-VFP6-20KU	PROMO 200GB VFP20K 96U	EN-H	\$0
S2-VFP7-20KU	PROMO 400GB VFP20K 32U	EN-H	\$0
S2-VFP8-20KU	PROMO 400GB VFP20K 48U	EN-H	\$0
S2-VFP9-20KU	PROMO 400GB VFP20K 96U	EN-H	\$0
SD-0004-RET	VMAX 40K 4SM 8G FIC RETURN	EN-H	\$0
SD-0040-RET	VMAX 40K 4MM 8G FIC RETURN	EN-H	\$0
SD-00400-RET	VMAX 40K 4MM GIGE RETURN	EN-H	\$0
SD-00400T-RET	VMAX 40K 4MM 10 GIGE RETURN	EN-H	\$0
SD-08000E-RET	VMAX 40K 8SM 8G FC RETURN	EN-H	\$0
SD-192-256UFD	VMAX 40K MEMCONV 2X96 to 2X128 GB	EN-H	\$238,590
SD-192-BASE	VMAX 40K BASE-192GB	EN-H	\$0
SD-192-BASEC	VMAX 40K BASE-192GB-C	EN-H	\$0
SD-192DBASECE	VMAX 40K BASE-192GB-C with Encryption	EN-H	\$0
SD-192D-BASEE	VMAX 40K BASE-192GB with Encryption	EN-H	\$0
SD-192-RET	VMAX 40K MEMORY RETURN 192GB	EN-H	\$0
SD-1P	VMAX 40K 1P INFRAST	EN-H	\$0
SD-1P-D	VMAX 40K 1P INFRAST DISP	EN-H	\$0
SD-1P-DU	VMAX 40K 1P INFRAST DISP UPG	EN-H	\$46,325
SD-256-BASE	VMAX 40K BASE-256GB	EN-H	\$0
SD-256-BASEC	VMAX 40K BASE-256GB-C	EN-H	\$0
SD-256DBASECE	VMAX 40K BASE-256GB-C WITH ENCRYPTION	EN-H	\$0
SD-256D-BASEE	VMAX 40K BASE-256GB WITH ENCRYPTION	EN-H	\$0
SD-3D	VMAX 40K 3D INFRAST	EN-H	\$0
SD-3D-D	VMAX 40K 3D INFRAST DISP	EN-H	\$0
SD-3D-DU	VMAX 40K 3D INFRAST DISP UPG	EN-H	\$46,325
SD-3Y	VMAX 40K 3Y INFRAST	EN-H	\$0
SD-3Y-D	VMAX 40K 3Y INFRAST DISP	EN-H	\$0
SD-3Y-DU	VMAX 40K 3Y INFRAST DISP UPG	EN-H	\$46,325
SD-40000S-RET	VMAX 40K 4MM 16G FC RETURN	EN-H	\$0
SD-44000E-RET	VMAX 40K 4MM4SS 8G FC RETURN	EN-H	\$0
SD-48-192UFD	VMAX 40K MEMCONV 2X24 TO 2X96 GB	EN-H	\$198,610
SD-48-256UFD	VMAX 40K MEMCONV 2X24 to 2X128 GB	EN-H	\$333,190
SD-48-96UFD	VMAX 40K MEMCONV 2X24 to 2X48 GB	EN-H	\$56,470
SD-48-BASE	VMAX 40K BASE-48GB	EN-H	\$0
SD-48-BASEC	VMAX 40K BASE-48GB-C	EN-H	\$0
SD-48D-BASECE	VMAX 40K BASE-48GB-C with Encryption	EN-H	\$0
SD-48D-BASEE	VMAX 40K BASE-48GB with Encryption	EN-H	\$0
SD-48-RET	VMAX 40K MEMORY RETURN 48GB	EN-H	\$0
SD-62000E-RET	VMAX 40K 6MM2SM 8G FC RETURN	EN-H	\$0
SD-80000E-RET	VMAX 40K 8MM 8G FC RETURN	EN-H	\$0
SD-96-192UFD	VMAX 40K MEMCONV 2X48 to 2X96 GB	EN-H	\$176,175
SD-96-256UFD	VMAX 40K MEMCONV 2X48 to 2X128 GB	EN-H	\$310,755

SD-96-BASE	VMAX 40K BASE-96GB	EN-H	\$0
SD-96-BASEC	VMAX 40K BASE-96GB-C	EN-H	\$0
SD-96D-BASECE	VMAX 40K BASE-96GB-C with Encryption	EN-H	\$0
SD-96D-BASEEE	VMAX 40K BASE-96GB with Encryption	EN-H	\$0
SD-96-RET	VMAX 40K MEMORY RETURN 96GB	EN-H	\$0
SD-ACON3P-50	ADPTR AC 3PH 50A W3-4IN CONDUIT ADPTR	EN-H	\$455
SD-ADD192	VMAX 40K ADD ENGINE-192GB	EN-H	\$0
SD-ADD192C	VMAX 40K ADD ENGINE-192GB-C	EN-H	\$0
SD-ADD192CU	VMAX 40K UPG ENGINE-192GB-C	EN-H	\$324,285
SD-ADD192CUF	VMAX 40K UPG ENGINE-192GB-C	EN-H	\$324,285
SD-ADD192DCE	VMAX 40K ADD ENGINE-192GB-C with Encryp	EN-H	\$0
SD-ADD192DCEU	VMAX 40K UPG ENGINE-192GB-C with Encryp	EN-H	\$356,800
SDADD192DCEUF	VMAX 40K UPG ENGINE-192GB-C with Encryp	EN-H	\$356,800
SD-ADD192DE	VMAX 40K ADD ENGINE-192GB with Encryp	EN-H	\$0
SD-ADD192DEU	VMAX 40K UPG ENGINE-192GB with Encryp	EN-H	\$356,800
SD-ADD192DEUF	VMAX 40K UPG ENGINE-192GB with Encryp	EN-H	\$356,800
SD-ADD192U	VMAX 40K UPG ENGINE-192GB	EN-H	\$324,285
SD-ADD192UF	VMAX 40K UPG ENGINE-192GB	EN-H	\$324,285
SD-ADD256	VMAX 40K ADD ENGINE-256GB	EN-H	\$0
SD-ADD256C	VMAX 40K ADD ENGINE-256GB-C	EN-H	\$0
SD-ADD256CU	VMAX 40K UPG ENGINE-256GB-C	EN-H	\$510,060
SD-ADD256CUF	VMAX 40K UPG ENGINE-256GB-C	EN-H	\$510,060
SD-ADD256DCE	VMAX 40K ADD ENGINE-256GB-C with Encryp	EN-H	\$0
SD-ADD256DCEU	VMAX 40K UPG ENGINE-256GB-C with Encryp	EN-H	\$542,580
SDADD256DCEUF	VMAX 40K UPG ENGINE-256GB-C with Encryp	EN-H	\$542,580
SD-ADD256DE	VMAX 40K ADD ENGINE-256GB with Encryp	EN-H	\$0
SD-ADD256DEU	VMAX 40K UPG ENGINE-256GB with Encryp	EN-H	\$542,580
SD-ADD256DEUF	VMAX 40K UPG ENGINE-256GB with Encryp	EN-H	\$542,580
SD-ADD256U	VMAX 40K UPG ENGINE-256GB	EN-H	\$510,060
SD-ADD256UF	VMAX 40K UPG ENGINE-256GB	EN-H	\$510,060
SD-ADD48	VMAX 40K ADD ENGINE-48GB	EN-H	\$0
SD-ADD48C	VMAX 40K ADD ENGINE-48GB-C	EN-H	\$0
SD-ADD48CU	VMAX 40K UPG ENGINE-48GB-C	EN-H	\$221,245
SD-ADD48CUF	VMAX 40K UPG ENGINE-48GB-C	EN-H	\$221,245
SD-ADD48DCE	VMAX 40K ADD ENGINE-48GB-C with Encryp	EN-H	\$0
SD-ADD48DCEU	VMAX 40K UPG ENGINE-48GB-C with Encryp	EN-H	\$253,765
SD-ADD48DCEUF	VMAX 40K UPG ENGINE-48GB-C with Encryp	EN-H	\$253,765
SD-ADD48DE	VMAX 40K ADD ENGINE-48GB with Encryp	EN-H	\$0
SD-ADD48DEU	VMAX 40K UPG ENGINE-48GB with Encryp	EN-H	\$253,765
SD-ADD48DEUF	VMAX 40K UPG ENGINE-48GB with Encryp	EN-H	\$253,765
SD-ADD48U	VMAX 40K UPG ENGINE-48GB	EN-H	\$221,245
SD-ADD48UF	VMAX 40K UPG ENGINE-48GB	EN-H	\$221,245
SD-ADD96	VMAX 40K ADD ENGINE-96GB	EN-H	\$0
SD-ADD96C	VMAX 40K ADD ENGINE-96GB-C	EN-H	\$0
SD-ADD96CU	VMAX 40K UPG ENGINE-96GB-C	EN-H	\$261,020
SD-ADD96CUF	VMAX 40K UPG ENGINE-96GB-C	EN-H	\$261,020
SD-ADD96DCE	VMAX 40K ADD ENGINE-96GB-C with Encryp	EN-H	\$0
SD-ADD96DCEU	VMAX 40K UPG ENGINE-96GB-C with Encryp	EN-H	\$293,540
SD-ADD96DCEUF	VMAX 40K UPG ENGINE-96GB-C with Encryp	EN-H	\$293,540
SD-ADD96DE	VMAX 40K ADD ENGINE-96GB with Encryp	EN-H	\$0

SD-ADD96DEU	VMAX 40K UPG ENGINE-96GB with Encryp	EN-H	\$293,540
SD-ADD96DEUF	VMAX 40K UPG ENGINE-96GB with Encryp	EN-H	\$293,540
SD-ADD96U	VMAX 40K UPG ENGINE-96GB	EN-H	\$261,020
SD-ADD96UF	VMAX 40K UPG ENGINE-96GB	EN-H	\$261,020
SD-ASSETTG-MS	CUST SPECIFD ASSET TAG - MICROSOFT IT	EN-H	\$0
SD-CNV-3DU	VMAX 40K CONV TO 3D INFRA/STORAGE BAY	EN-H	\$2,680
SD-CNV-3YU	VMAX 40K CONV TO 3Y INFRA/STORAGE BAY	EN-H	\$2,680
SD-CNVDB-1PU	VMAX 40K CONV TO 1P STORAGE BAY	EN-H	\$2,680
SD-CNVINF-1PU	VMAX 40K CONV TO 1P INFRASTRUCTURE	EN-H	\$2,680
SD-COMPRSUFD	VMAX 40K UPG CMPRESSION ENABLED	EN-H	\$10,165
SD-CONFIG01	VMAX 40K CONFIG 01	EN-H	\$0
SD-CONFIG02	VMAX 40K CONFIG 02	EN-H	\$0
SD-CONFIG03	VMAX 40K CONFIG 03	EN-H	\$0
SD-CONFIG04	VMAX 40K CONFIG 04	EN-H	\$0
SD-CONFIG05	VMAX 40K CONFIG 05	EN-H	\$0
SD-CONFIG06	VMAX 40K CONFIG 06	EN-H	\$0
SD-CONFIG07	VMAX 40K CONFIG 07	EN-H	\$0
SD-CONFIG08	VMAX 40K CONFIG 08	EN-H	\$0
SD-CONFIG09	VMAX 40K CONFIG 09	EN-H	\$0
SD-CONFIG10	VMAX 40K CONFIG 10	EN-H	\$0
SD-CONFIG11	VMAX 40K CONFIG 11	EN-H	\$0
SD-CONFIG12	VMAX 40K CONFIG 12	EN-H	\$0
SD-CONFIG13	VMAX 40K CONFIG 13	EN-H	\$0
SD-CONFIG14	VMAX 40K CONFIG 14	EN-H	\$0
SD-CONFIG15	VMAX 40K CONFIG 15	EN-H	\$0
SD-CONFIG16	VMAX 40K CONFIG 16	EN-H	\$0
SD-CONFIG17	VMAX 40K CONFIG 17	EN-H	\$0
SD-CONFIG18	VMAX 40K CONFIG 18	EN-H	\$0
SD-CONFIG19	VMAX 40K CONFIG 19	EN-H	\$0
SD-CONFIG19-2	VMAX 40K CONFIG 19-2	EN-H	\$0
SD-CONFIG20	VMAX 40K CONFIG 20	EN-H	\$0
SD-CONFIG21	VMAX 40K CONFIG 21	EN-H	\$0
SD-CONFIG22	VMAX 40K CONFIG 22	EN-H	\$0
SD-CONFIG22-2	VMAX 40K CONFIG 22-2	EN-H	\$0
SD-CONFIG23	VMAX 40K CONFIG 23	EN-H	\$0
SD-CONFIG24	VMAX 40K CONFIG 24	EN-H	\$0
SD-CONFIG25	VMAX 40K CONFIG 25	EN-H	\$0
SD-CONFIG26	VMAX 40K CONFIG 26	EN-H	\$0
SD-CONFIG27	VMAX 40K CONFIG 27	EN-H	\$0
SD-CONFIG28	VMAX 40K CONFIG 28	EN-H	\$0
SD-CONFIG29	VMAX 40K CONFIG 29	EN-H	\$0
SD-CONFIG30	VMAX 40K CONFIG 30	EN-H	\$0
SD-CONFIG31	VMAX 40K CONFIG 31	EN-H	\$0
SD-CONFIG32	VMAX 40K CONFIG 32	EN-H	\$0
SD-CONFIG32-2	VMAX 40K CONFIG 32-2	EN-H	\$0
SD-CONFIG33	VMAX 40K CONFIG 33	EN-H	\$0
SD-CONFIG34	VMAX 40K CONFIG 34	EN-H	\$0
SD-CONFIG35	VMAX 40K CONFIG 35	EN-H	\$0
SD-CONFIG36	VMAX 40K CONFIG 36	EN-H	\$0
SD-CONFIG36-2	VMAX 40K CONFIG 36-2	EN-H	\$0

SD-CONFIG37	VMAX 40K CONFIG 37	EN-H	\$0
SD-CONFIG38	VMAX 40K CONFIG 38	EN-H	\$0
SD-CONFIG39	VMAX 40K CONFIG 39	EN-H	\$0
SD-CONFIG39-2	VMAX 40K CONFIG 39-2	EN-H	\$0
SD-CONFIG40	VMAX 40K CONFIG 40	EN-H	\$0
SD-CONFIG40-2	VMAX 40K CONFIG 40-2	EN-H	\$0
SD-CONFIG41	VMAX 40K CONFIG 41	EN-H	\$0
SD-CONFIG41-2	VMAX 40K CONFIG 41-2	EN-H	\$0
SD-CONFIG42	VMAX 40K CONFIG 42	EN-H	\$0
SD-CONFIG43	VMAX 40K CONFIG 43	EN-H	\$0
SD-CONFIG44	VMAX 40K CONFIG 44	EN-H	\$0
SD-DB-DC-1P	VMAX 40K DB DCH 1 PHASE	EN-H	\$0
SD-DB-DC-1PU	VMAX 40K DB DCH 1 PHASE UPG	EN-H	\$16,255
SD-DB-DC-3D	VMAX 40K DB DCH DELTA	EN-H	\$0
SD-DB-DC-3DU	VMAX 40K DB DCH DELTA UPG	EN-H	\$16,255
SD-DB-DC-3Y	VMAX 40K DB DCH WYE	EN-H	\$0
SD-DB-DC-3YU	VMAX 40K DB DCH WYE UPG	EN-H	\$16,255
SD-DBDC-SPS	VMAX 40K SPS DCH SPS	EN-H	\$0
SD-DBDC-SPS-U	VMAX 40K SPS DCH -UPG	EN-H	\$2,100
SD-DBDCSPS-UF	VMAX 40K SPS DCH-UPGFD	EN-H	\$2,100
SD-DBDCV-SPS	VMAX 40K SPSV DCH	EN-H	\$0
SD-DBDCVSPS-U	VMAX 40K SPSV DCH UPG	EN-H	\$2,100
SDDBDCVSPS-UF	VMAX 40K SPSV DCH UPGFD	EN-H	\$2,100
SD-DB-DIR-1P	VMAX 40K DB DIR 1 PHASE	EN-H	\$0
SD-DB-DIR-1PU	VMAX 40K DB DIR 1 PHASE UPG	EN-H	\$16,255
SD-DB-DIR-3D	VMAX 40K DB DIR DELTA	EN-H	\$0
SD-DB-DIR-3DU	VMAX 40K DB DIR DELTA UPG	EN-H	\$16,255
SD-DB-DIR-3Y	VMAX 40K DB DIR WYE	EN-H	\$0
SD-DB-DIR-3YU	VMAX 40K DB DIR WYE UPG	EN-H	\$16,255
SDDBPRFDOOR	VMAX 40K DRIVE BAY PERF DOOR	EN-H	\$620
SDDBPRFDOR1P	VMAX 40K DRIVE BAY PERF DOOR 1P	EN-H	\$620
SDDBSOLIDOOR	VMAX 40K DRIVE BAY SOLID DOOR	EN-H	\$620
SDDBSOLIDOR1P	VMAX 40K DRIVE BAY SOLID DOOR 1P	EN-H	\$620
SD-DB-SPS	VMAX 40K SPS	EN-H	\$0
SD-DB-SPS-U	VMAX 40K SPS UPG	EN-H	\$2,100
SD-DBSPS-UF	VMAX 40K SPS UPGFD	EN-H	\$2,100
SD-DB-TOP-KIT	VMAX 40K TOP ROUTING KIT	EN-H	\$665
SD-DBTTOPKIT	VMAX 40K DENSE TOP ROUTING KIT	EN-H	\$665
SD-DBV-DC-1P	VMAX 40K DBV DIR 1 PHASE	EN-H	\$0
SD-DBV-DC-1PU	VMAX 40K DBV DIR 1 PHASE UPG	EN-H	\$16,255
SD-DBV-DC-3D	VMAX 40K DBV DCH DELTA	EN-H	\$0
SD-DBV-DC-3DU	VMAX 40K DBV DCH DELTA UPG	EN-H	\$16,255
SD-DBV-DC-3Y	VMAX 40K DBV DCH WYE	EN-H	\$0
SD-DBV-DC-3YU	VMAX 40K DBV DCH WYE UPG	EN-H	\$16,255
SD-DBV-DIR-1P	VMAX 40K DBV DIR 1 PHASE	EN-H	\$0
SD-DBV-DIR1PU	VMAX 40K DBV DIR 1 PHASE UPG	EN-H	\$16,255
SD-DBV-DIR-3D	VMAX 40K DBV DIR DELTA	EN-H	\$0
SD-DBV-DIR3DU	VMAX 40K DBV DIR DELTA UPG	EN-H	\$16,255
SD-DBV-DIR-3Y	VMAX 40K DBV DIR WYE	EN-H	\$0
SD-DBV-DIR3YU	VMAX 40K DBV DIR WYE UPG	EN-H	\$16,255

SD-DBV-SPS	VMAX 40K SPSV	EN-H	\$0
SD-DBV-SPS-U	VMAX 40K SPSV-UPG	EN-H	\$2,100
SD-DBVSPS-UF	VMAX 40K SPSV UPGFD	EN-H	\$2,100
SD-DDB-DC-1P	VMAX 40K DDB DCH 1 PHASE	EN-H	\$0
SD-DDB-DC-1PU	VMAX 40K DDB DCH 1 PHASE UPG	EN-H	\$30,100
SD-DDB-DC-3D	VMAX 40K DDB DCH DELTA	EN-H	\$0
SD-DDB-DC-3DU	VMAX 40K DDB DCH DELTA UPG	EN-H	\$30,100
SD-DDB-DC-3Y	VMAX 40K DDB DCH WYE	EN-H	\$0
SD-DDB-DC-3YU	VMAX 40K DDB DCH WYE UPG	EN-H	\$30,100
SD-DDBV-DC-1P	VMAX 40K DDBV DCH 1 PHASE	EN-H	\$0
SD-DDBVDC-1PU	VMAX 40K DDBV DCH 1 PHASE UPG	EN-H	\$30,100
SD-DDBV-DC-3D	VMAX 40K DDBV DCH DELTA	EN-H	\$0
SD-DDBVDC-3DU	VMAX 40K DDBV DCH DELTA UPG	EN-H	\$30,100
SD-DDBV-DC-3Y	VMAX 40K DDBV DCH WYE	EN-H	\$0
SD-DDBVDC-3YU	VMAX 40K DDBV DCH WYE UPG	EN-H	\$30,100
SD-DE15-DCH	VMAX 40K 15SLT DR ENCL	EN-H	\$0
SD-DE15-DCHU	VMAX 40K 15SLT DR ENCL UPG	EN-H	\$3,150
SD-DE15DCHUFD	VMAX 40K 15SLT DR ENCL UFD	EN-H	\$3,150
SD-DE15-DIR	VMAX 40K 15SLT DR ENCL	EN-H	\$0
SD-DE15-DIRU	VMAX 40K 15SLT DR ENCL UPG	EN-H	\$3,150
SD-DE15DIRUFD	VMAX 40K 15SLT DR ENCL UFD	EN-H	\$3,150
SD-DE25-DCH	VMAX 40K 25SLT DR ENCL	EN-H	\$0
SD-DE25-DCHU	VMAX 40K 25SLT DR ENCL UPG	EN-H	\$5,930
SD-DE25DCHUFD	VMAX 40K 25SLT DR ENCL UFD	EN-H	\$5,930
SD-DE25-DIR	VMAX 40K 25SLT DR ENCL	EN-H	\$0
SD-DE25-DIRU	VMAX 40K 25SLT DR ENCL UPG	EN-H	\$5,930
SD-DE25DIRUFD	VMAX 40K 25SLT DR ENCL UFD	EN-H	\$5,930
SD-DSP 2-1	VMAX 40K DISPERSED CONFIG DSP 2-1	EN-H	\$0
SD-DSP 2-2	VMAX 40K DISPERSED CONFIG DSP 2-2	EN-H	\$0
SD-DSP 2-3	VMAX 40K DISPERSED CONFIG DSP 2-3	EN-H	\$0
SD-DSP 2-4	VMAX 40K DISPERSED CONFIG DSP 2-4	EN-H	\$0
SD-DSP 2-5	VMAX 40K DISPERSED CONFIG DSP 2-5	EN-H	\$0
SD-DSP 2-6	VMAX 40K DISPERSED CONFIG DSP 2-6	EN-H	\$0
SD-DSP 4-1	VMAX 40K DISPERSED CONFIG DSP 4-1	EN-H	\$0
SD-DSP 4-2	VMAX 40K DISPERSED CONFIG DSP 4-2	EN-H	\$0
SD-DSP 4-3	VMAX 40K DISPERSED CONFIG DSP 4-3	EN-H	\$0
SD-DSP 4-4	VMAX 40K DISPERSED CONFIG DSP 4-4	EN-H	\$0
SD-DSP 6-1	VMAX 40K DISPERSED CONFIG DSP 6-1	EN-H	\$0
SD-DSP 6-2	VMAX 40K DISPERSED CONFIG DSP 6-2	EN-H	\$0
SD-DSP-3	VMAX 40K DSP ENG LOCATION 3	EN-H	\$0
SD-DSP-3U	VMAX 40K DSP ENG LOCATION 3 UPG	EN-H	\$0
SD-DSP-5	VMAX 40K DSP ENG LOCATION 5	EN-H	\$0
SD-DSP-5U	VMAX 40K DSP ENG LOCATION 5 UPG	EN-H	\$0
SD-DSP-7	VMAX 40K DSP ENG LOCATION 7	EN-H	\$0
SD-DSP-7U	VMAX 40K DSP ENG LOCATION 7 UPG	EN-H	\$0
SD-FC-FTS	VMAX 40K FED TRD STRG PORT TRACKING	EN-H	\$0
SD-FE00004E	VMAX 40K 4SM 8G FICON	EN-H	\$0
SD-FE00004EU	VMAX 40K 4SM 8G FICON-UPG	EN-H	\$3,210
SD-FE00004EUF	VMAX 40K 4SM 8G FICON-CONV	EN-H	\$11,120
SD-FE000040E	VMAX 40K 4MM 8G FICON	EN-H	\$0

SD-FE00040EU	VMAX 40K 4MM 8G FICON -UPG	EN-H	\$0
SD-FE00040EUF	VMAX 40K 4MM 8G FICON-CONV	EN-H	\$7,905
SD-FE00400	VMAX 40K 4M GIGE	EN-H	\$0
SD-FE00400T	VMAX 40K 4MM 10 GIGE	EN-H	\$0
SD-FE00400TU	VMAX 40K 4MM 10 GIGE-UPG	EN-H	\$1,605
SD-FE00400TUF	VMAX 40K- 4MM 10 GIGE-CONV	EN-H	\$8,830
SD-FE00400U	VMAX 40K 4M GIGE-UPG	EN-H	\$0
SD-FE00400UFD	VMAX40K 4M GIGE-CONV	EN-H	\$7,905
SD-FE080000E	VMAX 40K 8SM 8G FIBRE	EN-H	\$0
SD-FE080000EU	VMAX 40K 8SM 8G FIBRE-UPG	EN-H	\$6,425
SD-FE080000EUF	VMAX 40K 8SM 8G FIBRE-CONV	EN-H	\$14,330
SD-FE40000S	VMAX 40K 4MM? 16G FC?	EN-H	\$0
SD-FE40000SU	VMAX 40K 4MM 16G FC -UPG	EN-H	\$2,906
SD-FE40000SUF	VMAX 40K 4MM 16G FC -CONV	EN-H	\$8,205
SD-FE44000E	VMAX 40K 4MM4SM 8G FIBRE	EN-H	\$0
SD-FE44000EU	VMAX 40K 4MM4SM 8G FIBRE-UPG	EN-H	\$3,210
SD-FE44000EUF	VMAX 40K 4MM4SM 8G FIBRE-CONV	EN-H	\$11,120
SD-FE62000E	VMAX 40K 6MM2SM 8G FIBRE	EN-H	\$0
SD-FE62000EU	VMAX 40K 6MM2SM 8G FIBRE-UPG	EN-H	\$1,605
SD-FE62000UF	VMAX 40K 6MM2SM 8G FIBRE-CONV	EN-H	\$9,510
SD-FE80000E	VMAX 40K 8MM 8G FIBRE	EN-H	\$0
SD-FE80000EU	VMAX 40K 8MM 8G FIBRE-UPG	EN-H	\$0
SD-FE80000EUF	VMAX 40K 8MM 8G FIBRE-CONV	EN-H	\$7,905
SD-GE-FCOE	VMAX 40K FCOE PORTS	EN-H	\$0
SD-GE-ISCSI	VMAX 40K GIGE ISCSI PORTS	EN-H	\$0
SD-GE-SRDF	VMAX 40K GIGE SRDF PORTS	EN-H	\$0
SD-INTBKVKIT	VMAX 40K INTERNAL CABLE BRACKET TITAN	EN-H	\$310
SD-INTBRK-KIT	VMAX 40K INTERNAL CABLE BRKT	EN-H	\$310
SD-ISERIESU	VMAX 40K ISERIES UPG TRACKING MODEL	EN-H	\$0
SD-MAINFRAMEU	VMAX 40K MAINFRAME UPG TRACKING MODEL	EN-H	\$0
SD-MDCONFIG01	VMAX 40K MIXED CONFIG M01	EN-H	\$0
SD-MDCONFIG02	VMAX 40K MIXED CONFIG M02	EN-H	\$0
SD-MDCONFIG03	VMAX 40K MIXED CONFIG M03	EN-H	\$0
SD-MDCONFIG04	VMAX 40K MIXED CONFIG M04	EN-H	\$0
SD-MDCONFIG05	VMAX 40K MIXED CONFIG M05	EN-H	\$0
SD-MDCONFIG06	VMAX 40K MIXED CONFIG M06	EN-H	\$0
SD-MDCONFIG07	VMAX 40K MIXED CONFIG M07	EN-H	\$0
SD-MDCONFIG08	VMAX 40K MIXED CONFIG M08	EN-H	\$0
SD-MDCONFIG09	VMAX 40K MIXED CONFIG M09	EN-H	\$0
SD-MDCONFIG10	VMAX 40K MIXED CONFIG M10	EN-H	\$0
SD-MDCONFIG11	VMAX 40K MIXED CONFIG M11	EN-H	\$0
SD-MDCONFIG12	VMAX 40K MIXED CONFIG M12	EN-H	\$0
SD-MDCONFIG13	VMAX 40K MIXED CONFIG M13	EN-H	\$0
SD-MDCONFIG14	VMAX 40K MIXED CONFIG M14	EN-H	\$0
SD-MDCONFIG15	VMAX 40K MIXED CONFIG M15	EN-H	\$0
SD-MDCONFIG16	VMAX 40K MIXED CONFIG M16	EN-H	\$0
SD-MDCONFIG17	VMAX 40K MIXED CONFIG M17	EN-H	\$0
SD-MDCONFIG18	VMAX 40K MIXED CONFIG M18	EN-H	\$0
SD-MDCONFIGA4	VMAX 40K MIXED CONFIG MDA4	EN-H	\$0
SD-MDCONFIGA6	VMAX 40K MIXED CONFIG MDA6	EN-H	\$0

SD-MDCONFIGD6	VMAX 40K MIXED CONFIG MD6	EN-H	\$0
SD-MDCONFIGD8	VMAX 40K MIXED CONFIG MD8	EN-H	\$0
SD-MODEM	VMAX 40K ZBA MODEM LEAD FREE	EN-H	\$1,545
SD-MVCONFIG01	VMAX 40K MIXED CONFIG V01	EN-H	\$0
SD-MVCONFIG02	VMAX 40K MIXED CONFIG V02	EN-H	\$0
SD-MVCONFIG03	VMAX 40K MIXED CONFIG V03	EN-H	\$0
SD-MVCONFIG04	VMAX 40K MIXED CONFIG V04	EN-H	\$0
SD-MVCONFIG05	VMAX 40K MIXED CONFIG V05	EN-H	\$0
SD-MVCONFIG06	VMAX 40K MIXED CONFIG V06	EN-H	\$0
SD-MVCONFIG07	VMAX 40K MIXED CONFIG V07	EN-H	\$0
SD-MVCONFIG08	VMAX 40K MIXED CONFIG V08	EN-H	\$0
SD-MVCONFIG09	VMAX 40K MIXED CONFIG V09	EN-H	\$0
SD-MVCONFIG10	VMAX 40K MIXED CONFIG V10	EN-H	\$0
SD-MVCONFIG11	VMAX 40K MIXED CONFIG V11	EN-H	\$0
SD-MVCONFIG12	VMAX 40K MIXED CONFIG V12	EN-H	\$0
SD-MVCONFIG13	VMAX 40K MIXED CONFIG V13	EN-H	\$0
SD-MVCONFIG14	VMAX 40K MIXED CONFIG V14	EN-H	\$0
SD-MVCONFIG15	VMAX 40K MIXED CONFIG V15	EN-H	\$0
SD-MVCONFIG16	VMAX 40K MIXED CONFIG V16	EN-H	\$0
SD-MVCONFIG17	VMAX 40K MIXED CONFIG V17	EN-H	\$0
SD-MVCONFIG18	VMAX 40K MIXED CONFIG V18	EN-H	\$0
SD-MVCONFIGA4	VMAX 40K MIXED CONFIG MVA4	EN-H	\$0
SD-MVCONFIGA6	VMAX 40K MIXED CONFIG MVA6	EN-H	\$0
SD-MVCONFIGD6	VMAX 40K MIXED CONFIG MV6	EN-H	\$0
SD-MVCONFIGD8	VMAX 40K MIXED CONFIG MV8	EN-H	\$0
SD-NOCMPRSRET	VMAX 40K NON-COMPRESSION RETURN	EN-H	\$0
SD-PC3YAFLA	32A 3PHASE WYE CORD SET IEC309-AMER	EN-H	\$2,255
SD-PC3YAFLE	32A 3PHASE WYE CRD SET FLY LEAD EUROPE	EN-H	\$3,920
SD-PCBL3DHH	PWR CBL HBL-HBL 3D	EN-H	\$2,255
SD-PCBL3DHR	PWR CBL HBL-RSTOL 3D	EN-H	\$2,255
SD-PCBL3YAG	INTL 3PHASE 32 AMP IEC309 TO GARO	EN-H	\$3,920
SD-PW40UASTL	30A 1PHASE AUSIP57 CLIPSAL 56PA332	EN-H	\$1,410
SD-PW40UIEC3	30A 1PHASE INTERNATNL IEC309-332P6	EN-H	\$270
SD-PW40URUS	30A 1PH RUSSELLSTOLL 3750DP	EN-H	\$1,670
SD-PW40U-US	30A 1PHASE NAMER JAPAN I6-30P	EN-H	\$270
SD-SECURE	VMAX 40K SEISMIC BRKT SYSBAY	EN-H	\$5,015
SD-SECUREA	VMAX 40K SE SEISMIC BRKT KIT	EN-H	\$5,015
SD-SECUREDB	VMAX 40K SEISMIC BRKT STORBAY	EN-H	\$1,975
SD-SECUREJK	VMAX 40K SEIS BRKT JNG KIT	EN-H	\$2,050
SD-SECURETDB	VMAX 40K SEISMIC BRKT STORBAY TITAN	EN-H	\$665
SD-SECURETM	VMAX 40K SEIS BRKT JNG KIT	EN-H	\$665
SD-SILENCERM	VMAX 40K SILENCER KIT SYS/STOR 3.5" BAY	EN-H	\$1,235
SD-SILENCERT	VMAX 40K SILENCER KIT STOR DENSE BAY	EN-H	\$1,235
SD-TELCO	ZBA WW TELCO KIT (INTERNATIONAL)	EN-H	\$85
SD-VCONFG19-2	VMAX 40K VCONFIG 19-2	EN-H	\$0
SD-VCONFIG01	VMAX 40K VCONFIG 01	EN-H	\$0
SD-VCONFIG02	VMAX 40K VCONFIG 02	EN-H	\$0
SD-VCONFIG05	VMAX 40K VCONFIG 05	EN-H	\$0
SD-VCONFIG06	VMAX 40K VCONFIG 06	EN-H	\$0
SD-VCONFIG07	VMAX 40K VCONFIG 07	EN-H	\$0

SD-VCONFIG08	VMAX 40K VCONFIG 08	EN-H	\$0
SD-VCONFIG09	VMAX 40K VCONFIG 09	EN-H	\$0
SD-VCONFIG10	VMAX 40K VCONFIG 10	EN-H	\$0
SD-VCONFIG11	VMAX 40K VCONFIG 11	EN-H	\$0
SD-VCONFIG12	VMAX 40K VCONFIG 12	EN-H	\$0
SD-VCONFIG13	VMAX 40K VCONFIG 13	EN-H	\$0
SD-VCONFIG14	VMAX 40K VCONFIG 14	EN-H	\$0
SD-VCONFIG15	VMAX 40K VCONFIG 15	EN-H	\$0
SD-VCONFIG16	VMAX 40K VCONFIG 16	EN-H	\$0
SD-VCONFIG17	VMAX 40K VCONFIG 17	EN-H	\$0
SD-VCONFIG18	VMAX 40K VCONFIG 18	EN-H	\$0
SD-VCONFIG19	VMAX 40K VCONFIG 19	EN-H	\$0
SD-VCONFIG20	VMAX 40K VCONFIG 20	EN-H	\$0
SD-VCONFIG21	VMAX 40K VCONFIG 21	EN-H	\$0
SD-VCONFIG22	VMAX 40K VCONFIG 22	EN-H	\$0
SD-VCONFIG23	VMAX 40K VCONFIG 23	EN-H	\$0
SD-VCONFIG24	VMAX 40K VCONFIG 24	EN-H	\$0
SD-VCONFIG25	VMAX 40K VCONFIG 25	EN-H	\$0
SD-VCONFIG26	VMAX 40K VCONFIG 26	EN-H	\$0
SD-VCONFIG27	VMAX 40K VCONFIG 27	EN-H	\$0
SD-VCONFIG28	VMAX 40K VCONFIG 28	EN-H	\$0
SD-VCONFIG29	VMAX 40K VCONFIG 29	EN-H	\$0
SD-VCONFIG30	VMAX 40K VCONFIG 30	EN-H	\$0
SD-VCONFIG31	VMAX 40K VCONFIG 31	EN-H	\$0
SD-VCONFIG32	VMAX 40K VCONFIG 32	EN-H	\$0
SD-VCONFIG33	VMAX 40K VCONFIG 33	EN-H	\$0
SD-VCONFIG34	VMAX 40K VCONFIG 34	EN-H	\$0
SD-VCONFIG35	VMAX 40K VCONFIG 35	EN-H	\$0
SD-VCONFIG36	VMAX 40K VCONFIG 36	EN-H	\$0
SD-VDSP 2-1	VMAX 40K DISPERSED CONFIG VDSP 2-1	EN-H	\$0
SD-VDSP 2-2	VMAX 40K DISPERSED CONFIG VDSP 2-2	EN-H	\$0
SD-VDSP 2-3	VMAX 40K DISPERSED CONFIG VDSP 2-3	EN-H	\$0
SD-VDSP 2-4	VMAX 40K DISPERSED CONFIG VDSP 2-4	EN-H	\$0
SD-VDSP 2-5	VMAX 40K DISPERSED CONFIG VDSP 2-5	EN-H	\$0
SD-VDSP 2-6	VMAX 40K DISPERSED CONFIG VDSP 2-6	EN-H	\$0
SD-VDSP 4-1	VMAX 40K DISPERSED CONFIG VDSP 4-1	EN-H	\$0
SD-VDSP 4-2	VMAX 40K DISPERSED CONFIG VDSP 4-2	EN-H	\$0
SD-VDSP 4-3	VMAX 40K DISPERSED CONFIG VDSP 4-3	EN-H	\$0
SD-VDSP 4-4	VMAX 40K DISPERSED CONFIG VDSP 4-4	EN-H	\$0
SD-VDSP 6-1	VMAX 40K DISPERSED CONFIG VDSP 6-1	EN-H	\$0
SD-VDSP 6-2	VMAX 40K DISPERSED CONFIG VDSP 6-2	EN-H	\$0
SD-VFP1-40K	PROMO 100GB VFP40K 96	EN-H	\$0
SD-VFP1-40KU	PROMO 100GB VFP40K 32U	EN-H	\$0
SD-VFP2-40K	PROMO 100GB VFP40K 192	EN-H	\$0
SD-VFP2-40KU	PROMO 100GB VFP40K 48U	EN-H	\$0
SD-VFP3-40K	PROMO 200GB VFP40K 96	EN-H	\$0
SD-VFP3-40KU	PROMO 100GB VFP40K 96U	EN-H	\$0
SD-VFP4-40K	PROMO 200GB VFP40K 192	EN-H	\$0
SD-VFP4-40KU	PROMO 200GB VFP40K 32U	EN-H	\$0
SD-VFP5-40K	PROMO 400GB VFP40K 96	EN-H	\$0

SD-VFP5-40KU	PROMO 200GB VFP40K 48U	EN-H	\$0
SD-VFP6-40K	PROMO 400GB VFP40K 192	EN-H	\$0
SD-VFP6-40KU	PROMO 200GB VFP40K 96U	EN-H	\$0
SD-VFP7-40KU	PROMO 400GB VFP40K 32U	EN-H	\$0
SD-VFP8-40KU	PROMO 400GB VFP40K 48U	EN-H	\$0
SD-VFP9-40KU	PROMO 400GB VFP40K 96U	EN-H	\$0
SVDBPERDOR1P	VMAX 40K DRIVE BAY PERF DOOR 1P	EN-H	\$620
SVDBPERFDOOR	VMAX 40K DRIVE BAY PERF DOOR	EN-H	\$620
SVDBSOLDOOR	VMAX 40K DRIVE BAY SOLID DOOR	EN-H	\$620
SVDBSOLDOR1P	VMAX 40K DRIVE BAY SOLID DOOR 1P	EN-H	\$620
SYM-OM4-100M	OM4 50/125 MICRON OPTICAL CABLE; LC- LC;	EN-H	\$1,000
SYM-OM4-10M	OM4 50/125 MICRON OPTICAL CABLE; LC- LC;	EN-H	\$320
SYM-OM4-1M	OM4 50/125 MICRON OPTICAL CABLE; LC- LC;	EN-H	\$255
SYM-OM4-30M	OM4 50/125 MICRON OPTICAL CABLE; LC- LC;	EN-H	\$465
SYM-OM4-3M	OM4 50/125 MICRON OPTICAL CABLE; LC- LC;	EN-H	\$255
SYM-OM4-50M	OM4 50/125 MICRON OPTICAL CABLE; LC- LC;	EN-H	\$630
SYM-OM4-5M	OM4 50/125 MICRON OPTICAL CABLE; LC- LC;	EN-H	\$290
VF4103001B	VMAX 40K 4G 10K 300GB DRIVE	EN-H	\$1,130
VF4103001BTU	VMAX 40K 4G 10K 300GB DRIVE UPG TAA	EN-H	\$1,580
VF4103001BU	VMAX 40K 4G 10K 300GB DRIVE UPG	EN-H	\$1,580
VF4103001C	VMAX 40K 4G 10K 300GB DRIVE IBM-i	EN-H	\$1,130
VF4103001CTU	VMAX 40K 4G 10K 300GB DRIVE IBMi UPG TAA	EN-H	\$1,580
VF4103001CU	VMAX 40K 4G 10K 300GB DRIVE IBM-i UPG	EN-H	\$1,580
VF4106001B	VMAX 40K 4G 10K 600GB DRIVE	EN-H	\$0
VF4106001BTU	VMAX 40K 4G 10K 600GB DRIVE UPG TAA	EN-H	\$2,470
VF4106001BU	VMAX 40K 4G 10K 600GB DRIVE UPG	EN-H	\$2,470
VF4106001C	VMAX 40K 4G 10K 600GB DRIVE IBM-i	EN-H	\$0
VF4106001CTU	VMAX 40K 4G 10K 600GB DRIVE IBMi UPG TAA	EN-H	\$2,470
VF4106001CU	VMAX 40K 4G 10K 600GB DRIVE IBM-i UPG	EN-H	\$2,470
VF4153001B	VMAX 40K 4G 15K 300GB DRIVE	EN-H	\$0
VF4153001BTU	VMAX 40K 4G 15K 300GB DRIVE UPG TAA	EN-H	\$1,995
VF4153001BU	VMAX 40K 4G 15K 300GB DRIVE UPG	EN-H	\$1,995
VF4153001C	VMAX 40K 4G 15K 300GB DRIVE IBM-i	EN-H	\$0
VF4153001CTU	VMAX 40K 4G 15K 300GB DRIVE IBMi UPG TAA	EN-H	\$1,995
VF4153001CU	VMAX 40K 4G 15K 300GB DRIVE IBM-i UPG	EN-H	\$1,995
VF4156001B	VMAX 40K 4G 15K 600GB DRIVE	EN-H	\$0
VF4156001BTU	VMAX 40K 4G 15K 600GB DRIVE UPG TAA	EN-H	\$3,240
VF4156001BU	VMAX 40K 4G 15K 600GB DRIVE UPG	EN-H	\$3,240
VF4156001C	VMAX 40K 4G 15K 600GB DRIVE IBM-i	EN-H	\$0
VF4156001CTU	VMAX 40K 4G 15K 600GB DRIVE IBMi UPG TAA	EN-H	\$3,240
VF4156001CU	VMAX 40K 4G 15K 600GB DRIVE IBM-i UPG	EN-H	\$3,240
VF4F11001B	VMAX 40K 4G FLASH 100GBDRIVE	EN-H	\$0
VF4F11001BU	VMAX 40K 4G FLASH 100GBDRIVE UPG	EN-H	\$4,480
VF4F11001C	VMAX 40K 4G FLASH 100GBDRIVE IBM-i	EN-H	\$0
VF4F11001CU	VMAX 40K 4G FLASH 100GBDRIVE IBM-I UPG	EN-H	\$4,480
VF4F11002BFP	VMAX 40K 4G FLASH 100GB DRV FP	EN-H	\$0
VF4F11002CFP	VMAX 40K 4G FLASH 100GB DRV FP	EN-H	\$0
VF4F12001B	VMAX 40K 4G FLASH 200GBDRIVE	EN-H	\$0
VF4F12001BU	VMAX 40K 4G FLASH 200GBDRIVE UPG	EN-H	\$8,075
VF4F12001C	VMAX 40K 4G FLASH 200GBDRIVE IBM-i	EN-H	\$0

VF4F12001CU	VMAX 40K 4G FLASH 200GBDRIVE IBM-i UPG	EN-H	\$8,075
VF4F12002BFP	VMAX 40K 4G FLASH 200GB DRV FP	EN-H	\$0
VF4F12002CFP	VMAX 40K 4G FLASH 200GB DRV FP	EN-H	\$0
VF4F14001B	VMAX 40K 4G FLASH 400GB DRIVE	EN-H	\$0
VF4F14001BU	VMAX 40K 4G FLASH 400GB DRIVE UPG	EN-H	\$15,310
VF4F14001C	VMAX 40K 4G FLASH 400GB DRIVE IBM-i	EN-H	\$0
VF4F14001CU	VMAX 40K 4G FLASH 400GB DRIVE IBM-iUPG	EN-H	\$15,310
VF4F14002BFP	VMAX 40K 4G FLASH 400GB DRV FP	EN-H	\$0
VF4F14002CFP	VMAX 40K 4G FLASH 400GB DRV FP	EN-H	\$0
VF4FM8001B	VMAX 40K 4G FLASH 800GB DRIVE	EN-H	\$19,330
VF4FM8001BTU	VMAX 40K 4G FLASH 800GB DRIVE UPG	EN-H	\$27,060
VF4FM8001BU	VMAX 40K 4G FLASH 800GB DRIVE UPG	EN-H	\$27,060
VF4FM8002BFP	VMAX 40K 4G FLASH 800GB DRIVE FP	EN-H	\$29,540
VG10-DCD-10	VNX File and Software for VG10=IC	EN-H	\$0
VG10-DCD-20	VNX File and Software for VG10=IC	EN-H	\$0
VG10-DCD-40	VNX File and Software for VG10=IC	EN-H	\$0
VG10-DM	VNX NAS GATEWAY 1 VG10 DATA MOVER	EN-H	\$0
VG10-DME	VNX NAS GATEWAY ENCL 1 VG10 DATA MOVER	EN-H	\$17,030
VG10-DM-U	VNX NAS GATEWAY 1 VG10 DATA MOVER-UPG	EN-H	\$17,030
VG50-DCD-10	VNX File and Software for VG50=IC	EN-H	\$0
VG50-DCD-20	VNX File and Software for VG50=IC	EN-H	\$0
VG50-DCD-40	VNX File and Software for VG50=IC	EN-H	\$0
VG50-DM	VNX NAS GATEWAY 1 VG50 DATA MOVER	EN-H	\$0
VG50-DME0	VNX NAS GATEWAY ENCL 2 VG50 DATA MOVER	EN-H	\$0
VG50-DMEX	VNX NAS GATEWAY EMPTY ENCLOSURE	EN-H	\$0
VG50-DMEX-U	VNX NAS GATEWAY EMPTY ENCLOSURE-UPG	EN-H	\$58,500
VG50-DM-U	VNX NAS GATEWAY VG50 DATA MOVER-UPG	EN-H	\$71,500
VG-CS	Gateway Control Station 8GB MEM	EN-H	\$8,695
VG-CS2	2nd Gateway Control Station 8 GB MEM	EN-H	\$0
VG-CS2-U	2nd Gateway Control Station 8 GB MEM-UPG	EN-H	\$11,305
VG-FCOE-OP	2 port FCoE optical IO module	EN-H	\$0
VG-FCOE-TW	2 port FCoE Twinax IO module	EN-H	\$0
VG-M1GCU-A	4 port 1GbE CU Factory	EN-H	\$0
VG-M1GCU-U	4 port 1GbE CU Upgrade	EN-H	\$2,360
VG-M8GF-A	4 port 8G FC W/4 SFPs Factory	EN-H	\$0
VG-MXG2OP-A	2 port 10GbE Opt Factory	EN-H	\$0
VG-MXG2OP-U	2 port 10GbE Opt Upgrade	EN-H	\$13,325
VG-MXG2TW-A	2 port 10GbE Twin Ax Factory	EN-H	\$0
VG-MXG2TW-U	2 port 10GbE Twin Ax Upgrade	EN-H	\$2,360
VG-MXGT-A	2 port 10GBaseT Factory	EN-H	\$0
VG-MXGT-U	2 port 10GBaseT Upgrade	EN-H	\$13,325
VL41012001B	VMAX 40K 4G 10K 1200GB 2.5" DRIVE	EN-H	\$2,195
VL41012001BTU	VMAX 40K 4G 10K 1200GB 2.5" DRV TAA UPG	EN-H	\$3,075
VL41012001BU	VMAX 40K 4G 10K 1200GB 2.5" DRIVE UPG	EN-H	\$3,075
VL4103001B	VMAX 40K 4G 10K 300GB SAS DRIVE	EN-H	\$0
VL4103001BTU	VMAX 40K 4G 10K 300GB SAS DRIVE UPG TAA	EN-H	\$1,205
VL4103001BU	VMAX 40K 4G 10K 300GB SAS DRIVE UPG	EN-H	\$1,205
VL4103001C	VMAX 40K 4G 10K 300GB SAS DRIVE IBM-I	EN-H	\$0
VL4103001CTU	VMAX 40K4G 10K 300GB SAS DRV IBMI UPGTAA	EN-H	\$1,205
VL4103001CU	VMAX 40K 4G 10K 300GB SAS DRIVE IBM-IUPG	EN-H	\$1,205

VL4106001B	VMAX 40K 4G 10K 600GB SAS DRIVE	EN-H	\$0
VL4106001BTU	VMAX 40K 4G 10K 600GB SAS DRIVE UPG TAA	EN-H	\$2,085
VL4106001BU	VMAX 40K 4G 10K 600GB SAS DRIVE UPG	EN-H	\$2,085
VL4106001C	VMAX 40K 4G 10K 600GB SAS DRIVE IBM-I	EN-H	\$0
VL4106001CTU	VMAX 40K4G 10K 600GB SAS DRV IBMI UPGTAA	EN-H	\$2,085
VL4106001CU	VMAX 40K 4G 10K 600GB SAS DRIVE IBM-IUPG	EN-H	\$2,085
VL4109001B	VMAX 40K 4G 10K 900GB SAS DRIVE	EN-H	\$0
VL4109001BTU	VMAX 40K 4G 10K 900GB SAS DRIVE UPG TAA	EN-H	\$2,745
VL4109001BU	VMAX 40K 4G 10K 900GB SAS DRIVE UPG	EN-H	\$2,745
VL4109001C	VMAX 40K 4G 10K 900GB SAS DRIVE IBM-I	EN-H	\$0
VL4109001CTU	VMAX 40 4G 10K 900GB SAS DRV IBMI UPGTAA	EN-H	\$2,745
VL4109001CU	VMAX 40K 4G 10K 900GB SAS DRIVE IBM-IUPG	EN-H	\$2,745
VL4151461B	VMAX 40K 4G 15K 146GB SAS DRIVE	EN-H	\$0
VL4151461BTU	VMAX 40K 4G 15k 146GB SAS DRV UPG TAA	EN-H	\$2,120
VL4151461BU	VMAX 40K 4G 15K 146GB SAS DRIVE	EN-H	\$2,120
VL4151461C	VMAX 40K 4G 15K 146GB SAS DRIVE IBM-i	EN-H	\$0
VL4151461CTU	VMAX 40K4G 15K 146GB SAS DRV IBMI UPGTAA	EN-H	\$2,120
VL4151461CU	VMAX 40K 4G 15K 146GB SAS DRV IBM-I UPG	EN-H	\$2,120
VL4153001B	VMAX 40K 4G 15K 300GB SAS DRIVE	EN-H	\$0
VL4153001BTU	VMAX 40K 4G 15K 300GB SAS DRIVE	EN-H	\$3,100
VL4153001BU	VMAX 40K 4G 15K 300GB SAS DRIVE	EN-H	\$3,100
VL4153001C	VMAX 40K 4G 15K 300GB SAS DRIVE IBM-i	EN-H	\$0
VL4153001CTU	VMAX 40K4G 15K 300GB SAS DRV IBMI UPGTAA	EN-H	\$3,100
VL4153001CU	VMAX 40K 4G 15K 300GB SAS DRV IBM-I UPG	EN-H	\$3,100
VL4156001B	VMAX 40K 600GB 15K SAS DRV	EN-H	\$3,924
VL4156001BTU	VMAX 40K 600GB 15K SAS DRV TAA UPG	EN-H	\$5,493
VL4156001BU	VMAX 40K 600GB 15K SAS DRV UPG	EN-H	\$5,493
VL47210001B	VMAX 40K 4G 7_2K 1000GB SAS DRIVE	EN-H	\$0
VL47210001BTU	VMAX 40K 4G 7_2K 1000GB SAS DRIVE	EN-H	\$2,280
VL47210001BU	VMAX 40K 4G 7_2K 1000GB SAS DRIVE	EN-H	\$2,280
VL47210001C	VMAX 40K 4G 7_2K 1000GB SAS DRIVE IBM-i	EN-H	\$0
VL47210001CTU	VMAX40K4G 7_2K 1000GB SASDRV IBMI UPGTAA	EN-H	\$2,280
VL47210001CU	VMAX 40K 4G 7_2K 1000GB SASDRV IBM-I UPG	EN-H	\$2,280
VL4FM1001B	VMAX 40K 4G FLASH 100GB DRIVE	EN-H	\$0
VL4FM1001BU	VMAX 40K 4G FLASH 100GB DRIVE UPG	EN-H	\$4,480
VL4FM1001C	VMAX 40K 4G FLASH 100GB DRIVE IBM-I	EN-H	\$0
VL4FM1001CTU	VMAX 40K 4G FLASH 100GB DRV IBMI UPG TAA	EN-H	\$4,480
VL4FM1001CU	VMAX 40K 4G FLASH 100GB DRIVE IBM-I UPG	EN-H	\$4,480
VL4FM1002BFP	VMAX 40K 4G FLASH 100GB DRV FP	EN-H	\$0
VL4FM1002CFP	VMAX 40K 4G FLASH 100GB DRV FP	EN-H	\$0
VL4FM2001B	VMAX 40K 4G FLASH 200GB DRIVE	EN-H	\$0
VL4FM2001BU	VMAX 40K 4G FLASH 200GB DRIVE UPG	EN-H	\$8,075
VL4FM2001C	VMAX 40K 4G FLASH 200GB DRIVE IBM-I	EN-H	\$0
VL4FM2001CU	VMAX 40K 4G FLASH 200GB DRIVE IBM-I UPG	EN-H	\$8,075
VL4FM2002BFP	VMAX 40K 4G FLASH 200GB DRV FP	EN-H	\$0
VL4FM2002CFP	VMAX 40K 4G FLASH 200GB DRV FP	EN-H	\$0
VL4FM4001B	VMAX 40K 4G FLASH 400GB DRIVE	EN-H	\$0
VL4FM4001BU	VMAX 40K 4G FLASH 400GB DRIVE UPG	EN-H	\$15,310
VL4FM4001C	VMAX 40K 4G FLASH 400GB DRIVE IBM-I	EN-H	\$0
VL4FM4001CU	VMAX 40K 4G FLASH 400GB DRIVE IBM-I-UPG	EN-H	\$15,310

VL4FM4002BFP	VMAX 40K 4G FLASH 400GB DRV FP	EN-H	\$0
VL4FM4002CFP	VMAX 40K 4G FLASH 400GB DRV FP	EN-H	\$0
VL4FM8001B	VMAX 40K 4G FLASH 800GB DRIVE	EN-H	\$0
VL4FM8001BTU	VMAX 40K 4G FLASH 800GB DRIVE PG	EN-H	\$27,060
VL4FM8001BU	VMAX 40K 4G FLASH 800GB DRIVE UPG	EN-H	\$27,060
VL4FM8002BFP	VMAX 40K 4G FLASH 800GB DRIVE FP	EN-H	\$0
VMAX2SP-UPGRADE	V2 SERVICE PROCESSOR UPG WIN 7	EN-H	\$600
VS41012001B	VMAX 40K 4G 10K 1200GB 3.5" DRIVE	EN-H	\$2,195
VS41012001BTU	VMAX 40K 4G 10K 1200GB 3.5" DRV TAA UPG	EN-H	\$3,075
VS41012001BU	VMAX 40K 4G 10K 1200GB 3.5" DRV UPG	EN-H	\$3,075
VS4103001B	VMAX 40K 4G 10K 300GB SAS DRIVE	EN-H	\$0
VS4103001BTU	VMAX 40K 4G 10K 300GB SAS DRIVE UPG TAA	EN-H	\$1,205
VS4103001BU	VMAX 40K 4G 10K 300GB SAS DRIVE UPG	EN-H	\$1,205
VS4103001C	VMAX 40K 4G 10K 300GB SAS DRIVE IBM-I	EN-H	\$0
VS4103001CTU	VMAX 40K4G 10K 300GB SAS DRV IBMI UPGTAA	EN-H	\$1,205
VS4103001CU	VMAX 40K 4G 10K 300GB SAS DRIVE IBM-IUPG	EN-H	\$1,205
VS4106001B	VMAX 40K 4G 10K 600GB SAS DRIVE	EN-H	\$0
VS4106001BTU	VMAX 40K 4G 10K 600GB SAS DRIVE UPG TAA	EN-H	\$2,085
VS4106001BU	VMAX 40K 4G 10K 600GB SAS DRIVE UPG	EN-H	\$2,085
VS4106001C	VMAX 40K 4G 10K 600GB SAS DRIVE IBM-I	EN-H	\$0
VS4106001CTU	VMAX 40K4G 10K 600GB SAS DRV IBMI UPGTAA	EN-H	\$2,085
VS4106001CU	VMAX 40K 4G 10K 600GB SAS DRIVE IBM-IUPG	EN-H	\$2,085
VS4109001B	VMAX 40K 4G 10K 900GB SAS Drive	EN-H	\$0
VS4109001BTU	VMAX 40K 4G 10K 900GB SAS Drive UPG TAA	EN-H	\$2,745
VS4109001BU	VMAX 40K 4G 10K 900GB SAS Drive UPG	EN-H	\$2,745
VS4109001C	VMAX 40K 4G 10K 900GB SAS Drive IBM-I	EN-H	\$0
VS4109001CTU	VMAX 40K 4G 10K 900GB SASDRV IBMI UPGTAA	EN-H	\$2,745
VS4109001CU	VMAX 40K 4G 10K 900GB SASDrive IBM-I UPG	EN-H	\$2,745
VS4156001B	VMAX 40K 600GB 15K SAS DRV	EN-H	\$3,924
VS4156001BTU	VMAX 40K 600GB 15K SAS DRV TAA UPG	EN-H	\$5,493
VS4156001BU	VMAX 40K 600GB 15K SAS DRV UPG	EN-H	\$5,493
VT47220001B	VMAX 40K 4G 7.2K 2000GB DRIVE	EN-H	\$0
VT47220001BTU	VMAX 40K 4G 7.2K 2000GB DRIVE UPG TAA	EN-H	\$2,400
VT47220001BU	VMAX 40K 4G 7.2K 2000GB DRIVE UPG	EN-H	\$2,400
VT47220001C	VMAX 40K 4G 7.2K 2000GB DRIVE IBM-I	EN-H	\$0
VT47220001CTU	VMAX 40 4G 7.2K 2000GB DRIVE IBMI UPGTAA	EN-H	\$2,400
VT47220001CU	VMAX 40K 4G 7.2K 2000GB DRIVE IBM-I UPG	EN-H	\$2,400
VT47230001B	VMAX 40K 4G 7_2K 3000GB DRIVE	EN-H	\$0
VT47230001BTU	VMAX 40K 4G 7_2K 3000GB DRIVE UPG TAA	EN-H	\$3,390
VT47230001BU	VMAX 40K 4G 7_2K 3000GB DRIVE UPG	EN-H	\$3,390
VT47230001C	VMAX 40K 4G 7_2K 3000GB DRIVE IBM-I	EN-H	\$0
VT47230001CTU	VMAX 40K 4G 7_2K 3000GB DRV IBMI UPGTAA	EN-H	\$3,390
VT47230001CU	VMAX 40K 4G 7_2K 3000GB DRIVE I-IBMUPG	EN-H	\$3,390
VT47240001B	VMAX 40K 4G 7.2K 4000GB DRIVE	EN-H	\$0
VT47240001BTU	VMAX 40K 4G 7.2K 4000GB DRIVE TAA UPG	EN-H	\$4,170
VT47240001BU	VMAX 40K 4G 7.2K 4000GB DRIVE UPG	EN-H	\$4,175
VT47240001C	VMAX 40K 4G 7.2K 4000GB DRIVE IBM-I	EN-H	\$0
VT47240001CTU	VMAX 40K 4G 7.2K 4000GB IBM-i TAA UPG	EN-H	\$4,170
VT47240001CU	VMAX 40K 4G 7.2K 4000GB DRIVE IBM-I UPG	EN-H	\$4,175
VX10-M1GCU-A	4 port 1GbE CU Factory	EN-H	\$0

VX10-M1GCU-U	4 port 1GbE CU Upgrade	EN-H	\$2,360
VX10-M8GF-A	4 port 8G FC W/4 SFPs Factory	EN-H	\$0
VX10-MXG2OP-A	2 port 10GbE Opt Factory	EN-H	\$0
VX10-MXG2OP-U	2 port 10GbE Opt Upgrade	EN-H	\$13,330
VX10-MXGT-A	2 port 10GBaseT Factory	EN-H	\$0
VX10-MXGT-U	2 port 10GBaseT Upgrade	EN-H	\$13,330
VX10VG50-DM	VMAX10K NAS GTWY 1 VG50 DM	EN-H	\$0
VX10VG50DME0	VMAX10K NAS GTWY ENCL 2 VG50 DM	EN-H	\$0
VX10VG50DMEX	VMAX10K NAS GTWY EMPTY ENCLOSURE	EN-H	\$0
VX10VG50DMEXU	VMAX10K NAS GTWY EMPTY ENCLOSURE-UPG	EN-H	\$58,500
VX10VG50-DMU	VMAX10K NAS GTWY VG50 DM-UPG	EN-H	\$71,500
VX10VG50-KIT	VMAX10K PDU-PDP AND CABLE KIT FOR NAS 1F	EN-H	\$0
VX10VG50-KIT-3D	VMAX10K PDU-PDP AND CABLE KIT FOR NAS 3D	EN-H	\$0
VX10VG50-KIT-3Y	VMAX10K PDU-PDP AND CABLE KIT FOR NAS 3Y	EN-H	\$0
VX10VG-CS	VMAX10k NAS GTWY CS 8GB MEM	EN-H	\$0
VX10VG-CS2	VMAX10k NAS GTWY 2nd CS 8GB MEM	EN-H	\$0
450-000-023	VMAX10K BASE SW SATA CAP 1TB=CB	EN-S	\$740
450-000-024	VMAX10K BASE SW NON-SATA CAP 1TB=CB	EN-S	\$1,485
450-000-025	VMAX10K ADV SW SATA CAP 1TB=CB	EN-S	\$1,035
450-000-026	VMAX10K ADV SW NON-SATA CAP 1TB=CB	EN-S	\$2,070
450-000-029	VMAX10K ENGNTY PKG SATA CAP 1TB=CB	EN-S	\$555
450-000-030	VMAX10K ENGNTY PKG NON-SATA CAP 1TB=CB	EN-S	\$1,230
450-000-033	VMAX10K BASIC SRDF NON-SATA CAP 1TB=CB	EN-S	\$1,650
450-000-034	VMAX10K BASIC SRDF SATA CAP 1TB=CB	EN-S	\$825
450-000-035	VMAX10K BASIC SRDF REG CAP 1TB=CA	EN-S	\$1,905
450-000-036	VMAX10K BASIC SRDF XTRN CAP 1TB=CB	EN-S	\$825
450-000-041	VMAX10K BASE SW II SATA CAP 1TB=CB	EN-S	\$740
450-000-042	VMAX10K BASE SW II NON-SATA CAP 1TB=CB	EN-S	\$1,484
450-000-044	VMAX40K MGMT PKG SATA 1001TB+=CB	EN-S	\$335
450-000-045	VMAX40K MGMT PKG NON-SATA 1000TB+=CB	EN-S	\$665
450-000-053	VMAX10K ADVANCED SW NON-SATA CAP 1TB=CB	EN-S	\$2,192
450-000-054	VMAX10K ADVANCED SW SATA CAP 1TB=CB	EN-S	\$1,096
450-000-059	VMAX10K REMPROT F+B N-SATA CAP 1TB=CB	EN-S	\$1,650
450-000-060	VMAX10K REMPROT F+B SATA CAP 1TB=CB	EN-S	\$825
450-000-061	VMAX10K REMPROT F+B REG CAP 1TB=CA	EN-S	\$1,905
450-000-062	VMAX10K REMPROT F+B XTRN CAP 1TB=CB	EN-S	\$825
450-000-070	VMAX40K ADV SW PKG N-SATA 0-14TB=CB	EN-S	\$5,880
450-000-071	VMAX40K ADV SW PKG N-SATA 15-25TB=CB	EN-S	\$5,520
450-000-072	VMAX40K ADV SW PKG N-SATA 26-40TB=CB	EN-S	\$4,860
450-000-073	VMAX40K ADV SW PKG N-SATA 41-60TB=CB	EN-S	\$4,520
450-000-074	VMAX40K ADV SW PKG N-SATA 61-100TB=CB	EN-S	\$4,340
450-000-075	VMAX40K ADV SW PKG N-SATA 101-150TB=CB	EN-S	\$3,900
450-000-076	VMAX40K ADV SW PKG N-SATA 151-250TB=CB	EN-S	\$3,480
450-000-077	VMAX40K ADV SW PKG N-SATA 251-400TB=CB	EN-S	\$3,010
450-000-078	VMAX40K ADV SW PKG N-SATA 401-600TB=CB	EN-S	\$2,610
450-000-079	VMAX40K ADV SW PKG N-SATA 601-1000TB=CB	EN-S	\$2,280
450-000-080	VMAX40K ADV SW PKG N-SATA 1001+TB=CB	EN-S	\$1,980
450-000-081	VMAX40K ADV SW PKG SATA 0-14TB=CB	EN-S	\$2,930
450-000-082	VMAX40K ADV SW PKG SATA 15-25TB=CB	EN-S	\$2,750
450-000-083	VMAX40K ADV SW PKG SATA 26-40TB=CB	EN-S	\$2,430

450-000-084	VMAX40K ADV SW PKG SATA 41-60TB=CB	EN-S	\$2,260
450-000-085	VMAX40K ADV SW PKG SATA 61-100TB=CB	EN-S	\$2,160
450-000-086	VMAX40K ADV SW PKG SATA 101-150TB=CB	EN-S	\$1,950
450-000-087	VMAX40K ADV SW PKG SATA 151-250TB=CB	EN-S	\$1,730
450-000-088	VMAX40K ADV SW PKG SATA 251-400TB=CB	EN-S	\$1,510
450-000-089	VMAX40K ADV SW PKG SATA 401-600TB=CB	EN-S	\$1,310
450-000-090	VMAX40K ADV SW PKG SATA 601-1000TB=CB	EN-S	\$1,140
450-000-091	VMAX40K ADV SW PKG SATA 1001+TB=CB	EN-S	\$990
450-000-180	VMAX40K MGMT PKG NON-SATA 0-14TB=CB	EN-S	\$2,010
450-000-181	VMAX40K MGMT PKG NON-SATA 15-25TB=CB	EN-S	\$1,890
450-000-182	VMAX40K MGMT PKG N-SATA 26-40TB=CB	EN-S	\$1,665
450-000-183	VMAX40K MGMT PKG NON-SATA 41-60TB=CB	EN-S	\$1,550
450-000-184	VMAX40K MGMT PKG NON-SATA 61-100TB=CB	EN-S	\$1,485
450-000-185	VMAX40K MGMT PKG NON-SATA 101-150TB=CB	EN-S	\$1,335
450-000-186	VMAX40K MGMT PKG NON-SATA 151-250TB=CB	EN-S	\$1,185
450-000-187	VMAX40K MGMT PKG NON-SATA 251-400TB=CB	EN-S	\$1,020
450-000-188	VMAX40K MGMT PKG NON-SATA 401-600TB=CB	EN-S	\$890
450-000-189	VMAX40K MGMT PKG NON-SATA 601-1000TB=CB	EN-S	\$775
450-000-190	VMAX40K MGMT PKG SATA 0-14TB=CB	EN-S	\$1,000
450-000-191	VMAX40K MGMT PKG SATA 15-25TB=CB	EN-S	\$945
450-000-192	VMAX40K MGMT PKG SATA 26-40TB=CB	EN-S	\$830
450-000-193	VMAX40K MGMT PKG SATA 41-60TB=CB	EN-S	\$775
450-000-194	VMAX40K MGMT PKG SATA 61-100TB=CB	EN-S	\$740
450-000-195	VMAX40K MGMT PKG SATA 101-150TB=CB	EN-S	\$665
450-000-196	VMAX40K MGMT PKG SATA 151-250TB=CB	EN-S	\$590
450-000-197	VMAX40K MGMT PKG SATA 251-400TB=CB	EN-S	\$515
450-000-198	VMAX40K MGMT PKG SATA 401-600TB=CB	EN-S	\$450
450-000-199	VMAX40K MGMT PKG SATA 601-1000TB=CB	EN-S	\$385
450-000-290	VMAX20K ENGNTY PKG N-SATA 0-14TB=CB	EN-S	\$2,020
450-000-291	VMAX20K ENGNTY PKG N-SATA 15-25TB=CB	EN-S	\$1,940
450-000-292	VMAX20K ENGNTY PKG N-SATA 26-40TB=CB	EN-S	\$1,860
450-000-293	VMAX20K ENGNTY PKG N-SATA 41-60TB=CB	EN-S	\$1,790
450-000-294	VMAX20K ENGNTY PKG N-SATA 61-100TB=CB	EN-S	\$1,710
450-000-295	VMAX20K ENGNTY PKG N-SATA 101-150TB=CB	EN-S	\$1,650
450-000-296	VMAX20K ENGNTY PKG N-SATA 151-250TB=CB	EN-S	\$1,580
450-000-297	VMAX20K ENGNTY PKG N-SATA 251-400TB=CB	EN-S	\$1,520
450-000-298	VMAX20K ENGNTY PKG N-SATA 401-600TB=CB	EN-S	\$1,460
450-000-299	VMAX20K ENGNTY PKG N-SATA 601-1000TB=CB	EN-S	\$1,400
450-000-300	VMAX20K ENGNTY PKG N-SATA 1001+TB=CB	EN-S	\$1,340
450-000-301	VMAX20K ENGNTY PKG SATA 0-14TB=CB	EN-S	\$910
450-000-302	VMAX20K ENGNTY PKG SATA 15-25TB=CB	EN-S	\$870
450-000-303	VMAX20K ENGNTY PKG SATA 26-40TB=CB	EN-S	\$840
450-000-304	VMAX20K ENGNTY PKG SATA 41-60TB=CB	EN-S	\$800
450-000-305	VMAX20K ENGNTY PKG SATA 61-100TB=CB	EN-S	\$770
450-000-306	VMAX20K ENGNTY PKG SATA 101-150TB=CB	EN-S	\$740
450-000-307	VMAX20K ENGNTY PKG SATA 151-250TB=CB	EN-S	\$710
450-000-308	VMAX20K ENGNTY PKG SATA 251-400TB=CB	EN-S	\$680
450-000-309	VMAX20K ENGNTY PKG SATA 401-600TB=CB	EN-S	\$660
450-000-310	VMAX20K ENGNTY PKG SATA 601-1000TB=CB	EN-S	\$630
450-000-311	VMAX20K ENGNTY PKG SATA 1001+TB=CB	EN-S	\$600

450-000-312	VMAX20K SRDF PKG N-SATA 0-14TB=CB	EN-S	\$4,380
450-000-313	VMAX20K SRDF PKG N-SATA 15-25TB=CB	EN-S	\$4,120
450-000-314	VMAX20K SRDF PKG N-SATA 26-40TB=CB	EN-S	\$3,630
450-000-315	VMAX20K SRDF PKG N-SATA 41-60TB=CB	EN-S	\$3,240
450-000-316	VMAX20K SRDF PKG N-SATA 61-100TB=CB	EN-S	\$2,890
450-000-317	VMAX20K SRDF PKG N-SATA 101-150TB=CB	EN-S	\$2,560
450-000-318	VMAX20K SRDF PKG N-SATA 151-250TB=CB	EN-S	\$2,200
450-000-319	VMAX20K SRDF PKG N-SATA 251-400TB=CB	EN-S	\$1,880
450-000-320	VMAX20K SRDF PKG N-SATA 401-600TB=CB	EN-S	\$1,620
450-000-321	VMAX20K SRDF PKG N-SATA 601-1000TB=CB	EN-S	\$1,390
450-000-322	VMAX20K SRDF PKG N-SATA 1001+TB=CB	EN-S	\$1,190
450-000-323	VMAX20K SRDF PKG SATA 0-14TB=CB	EN-S	\$2,190
450-000-324	VMAX20K SRDF PKG SATA 15-25TB=CB	EN-S	\$2,060
450-000-325	VMAX20K SRDF PKG SATA 26-40TB=CB	EN-S	\$1,810
450-000-326	VMAX20K SRDF PKG SATA 41-60TB=CB	EN-S	\$1,620
450-000-327	VMAX20K SRDF PKG SATA 61-100TB=CB	EN-S	\$1,450
450-000-328	VMAX20K SRDF PKG SATA 101-150TB=CB	EN-S	\$1,280
450-000-329	VMAX20K SRDF PKG SATA 151-250TB=CB	EN-S	\$1,100
450-000-330	VMAX20K SRDF PKG SATA 251-400TB=CB	EN-S	\$940
450-000-331	VMAX20K SRDF PKG SATA 401-600TB=CB	EN-S	\$810
450-000-332	VMAX20K SRDF PKG SATA 601-1000TB=CB	EN-S	\$690
450-000-333	VMAX20K SRDF PKG SATA 1001+TB=CB	EN-S	\$600
450-000-334	VMAX20K SRDF PKG REG 0-14TB=CA	EN-S	\$4,395
450-000-335	VMAX20K SRDF PKG REG 15-25TB=CA	EN-S	\$3,647
450-000-336	VMAX20K SRDF PKG REG 26-40TB=CA	EN-S	\$3,660
450-000-337	VMAX20K SRDF PKG REG 41-60TB=CA	EN-S	\$2,990
450-000-338	VMAX20K SRDF PKG REG 61-100TB=CA	EN-S	\$2,595
450-000-339	VMAX20K SRDF PKG REG 101-150TB=CA	EN-S	\$2,205
450-000-340	VMAX20K SRDF PKG REG 151-250TB=CA	EN-S	\$2,090
450-000-341	VMAX20K SRDF PKG REG 251-400TB=CA	EN-S	\$1,915
450-000-342	VMAX20K SRDF PKG REG 401-600TB=CA	EN-S	\$1,715
450-000-343	VMAX20K SRDF PKG REG 601-1000TB=CA	EN-S	\$1,505
450-000-344	VMAX20K SRDF PKG REG 1001+TB=CA	EN-S	\$975
450-000-345	VMAX20K SRDF PKG XTRN 0-14TB=CB	EN-S	\$2,190
450-000-346	VMAX20K SRDF PKG XTRN 15-25TB=CB	EN-S	\$2,060
450-000-347	VMAX20K SRDF PKG XTRN 26-40TB=CB	EN-S	\$1,810
450-000-348	VMAX20K SRDF PKG XTRN 41-60TB=CB	EN-S	\$1,620
450-000-349	VMAX20K SRDF PKG XTRN 61-100TB=CB	EN-S	\$1,450
450-000-350	VMAX20K SRDF PKG XTRN 101-150TB=CB	EN-S	\$1,280
450-000-351	VMAX20K SRDF PKG XTRN 151-250TB=CB	EN-S	\$1,100
450-000-352	VMAX20K SRDF PKG XTRN 251-400TB=CB	EN-S	\$940
450-000-353	VMAX20K SRDF PKG XTRN 401-600TB=CB	EN-S	\$810
450-000-354	VMAX20K SRDF PKG XTRN 601-1000TB=CB	EN-S	\$690
450-000-355	VMAX20K SRDF PKG XTRN 1001+TB=CB	EN-S	\$600
450-000-400	VMAX20K MGMT PKG NON-SATA 0-14TB=CB	EN-S	\$2,010
450-000-401	VMAX20K MGMT PKG NON-SATA 15-25TB=CB	EN-S	\$1,890
450-000-402	VMAX20K MGMT PKG NON-SATA 26-40TB=CB	EN-S	\$1,665
450-000-403	VMAX20K MGMT PKG NON-SATA 41-60TB=CB	EN-S	\$1,550
450-000-404	VMAX20K MGMT PKG NON-SATA 61-100TB=CB	EN-S	\$1,485
450-000-405	VMAX20K MGMT PKG NON-SATA 101-150TB=CB	EN-S	\$1,335

450-000-406	VMAX20K MGMT PKG NON-SATA 151-250TB=CB	EN-S	\$1,185
450-000-407	VMAX20K MGMT PKG NON-SATA 251-400TB=CB	EN-S	\$1,020
450-000-408	VMAX20K MGMT PKG NON-SATA 401-600TB=CB	EN-S	\$890
450-000-409	VMAX20K MGMT PKG NON-SATA 601-1000TB=CB	EN-S	\$775
450-000-410	VMAX20K MGMT PKG NON-SATA 1001+TB=CB	EN-S	\$665
450-000-411	VMAX20K MGMT PKG SATA 0-14TB=CB	EN-S	\$1,000
450-000-412	VMAX20K MGMT PKG SATA 15-25TB=CB	EN-S	\$945
450-000-413	VMAX20K MGMT PKG SATA 26-40TB=CB	EN-S	\$830
450-000-414	VMAX20K MGMT PKG SATA 41-60TB=CB	EN-S	\$775
450-000-415	VMAX20K MGMT PKG SATA 61-100TB=CB	EN-S	\$740
450-000-416	VMAX20K MGMT PKG SATA 101-150TB=CB	EN-S	\$665
450-000-417	VMAX20K MGMT PKG SATA 151-250TB=CB	EN-S	\$590
450-000-418	VMAX20K MGMT PKG SATA 251-400TB=CB	EN-S	\$515
450-000-419	VMAX20K MGMT PKG SATA 401-600TB=CB	EN-S	\$450
450-000-420	VMAX20K MGMT PKG SATA 601-1000TB=CB	EN-S	\$385
450-000-421	VMAX20K MGMT PKG SATA 1001+TB=CB	EN-S	\$335
450-000-422	VMAX20K TF PKG NON-SATA 0-14TB=CB	EN-S	\$2,540
450-000-423	VMAX20K TF PKG NON-SATA 15-25TB=CB	EN-S	\$2,385
450-000-424	VMAX20K TF PKG NON-SATA 26-40TB=CB	EN-S	\$2,100
450-000-425	VMAX20K TF PKG NON-SATA 41-60TB=CB	EN-S	\$1,955
450-000-426	VMAX20K TF PKG NON-SATA 61-100TB=CB	EN-S	\$1,880
450-000-427	VMAX20K TF PKG NON-SATA 101-150TB=CB	EN-S	\$1,690
450-000-428	VMAX20K TF PKG NON-SATA 151-250TB=CB	EN-S	\$1,500
450-000-429	VMAX20K TF PKG NON-SATA 251-400TB=CB	EN-S	\$1,300
450-000-430	VMAX20K TF PKG NON-SATA 401-600TB=CB	EN-S	\$1,135
450-000-431	VMAX20K TF PKG NON-SATA 601-1000TB=CB	EN-S	\$985
450-000-432	VMAX20K TF PKG NON-SATA 1001+TB=CB	EN-S	\$860
450-000-433	VMAX20K TF PKG SATA 0-14TB=CB	EN-S	\$1,270
450-000-434	VMAX20K TF PKG SATA 15-25TB=CB	EN-S	\$1,185
450-000-435	VMAX20K TF PKG SATA 26-40TB=CB	EN-S	\$1,050
450-000-436	VMAX20K TF PKG SATA 41-60TB=CB	EN-S	\$975
450-000-437	VMAX20K TF PKG SATA 61-100TB=CB	EN-S	\$935
450-000-438	VMAX20K TF PKG SATA 101-150TB=CB	EN-S	\$850
450-000-439	VMAX20K TF PKG SATA 151-250TB=CB	EN-S	\$745
450-000-440	VMAX20K TF PKG SATA 251-400TB=CB	EN-S	\$650
450-000-441	VMAX20K TF PKG SATA 401-600TB=CB	EN-S	\$565
450-000-442	VMAX20K TF PKG SATA 601-1000TB=CB	EN-S	\$495
450-000-443	VMAX20K TF PKG SATA 1001+TB=CB	EN-S	\$430
450-000-444	VMAX20K TF PKG REG 0-14TB=CA	EN-S	\$4,425
450-000-445	VMAX20K TF PKG REG 15-25TB=CA	EN-S	\$3,850
450-000-446	VMAX20K TF PKG REG 26-40TB=CA	EN-S	\$3,350
450-000-447	VMAX20K TF PKG REG 41-60TB=CA	EN-S	\$2,730
450-000-448	VMAX20K TF PKG REG 61-100TB=CA	EN-S	\$2,290
450-000-449	VMAX20K TF PKG REG 101-150TB=CA	EN-S	\$2,135
450-000-450	VMAX20K TF PKG REG 151-250TB=CA	EN-S	\$1,985
450-000-451	VMAX20K TF PKG REG 251-400TB=CA	EN-S	\$1,840
450-000-452	VMAX20K TF PKG REG 401-600TB=CA	EN-S	\$1,675
450-000-453	VMAX20K TF PKG REG 601-1000TB=CA	EN-S	\$1,560
450-000-454	VMAX20K TF PKG REG 1001+TB=CA	EN-S	\$1,100
450-000-455	VMAX20K TF PKG XTRN 0-14TB=CB	EN-S	\$1,270

450-000-456	VMAX20K TF PKG XTRN 15-25TB=CB	EN-S	\$1,185
450-000-457	VMAX20K TF PKG XTRN 26-40TB=CB	EN-S	\$1,050
450-000-458	VMAX20K TF PKG XTRN 41-60TB=CB	EN-S	\$975
450-000-459	VMAX20K TF PKG XTRN 61-100TB=CB	EN-S	\$935
450-000-460	VMAX20K TF PKG XTRN 101-150TB=CB	EN-S	\$850
450-000-461	VMAX20K TF PKG XTRN 151-250TB=CB	EN-S	\$745
450-000-462	VMAX20K TF PKG XTRN 251-400TB=CB	EN-S	\$650
450-000-463	VMAX20K TF PKG XTRN 401-600TB=CB	EN-S	\$565
450-000-464	VMAX20K TF PKG XTRN 601-1000TB=CB	EN-S	\$495
450-000-465	VMAX20K TF PKG XTRN 1001+TB=CB	EN-S	\$430
450-000-466	VMAX20K FASTTR PKG N-SATA 0-14TB=CB	EN-S	\$2,054
450-000-467	VMAX20K FASTTR PKG N-SATA 15-25TB=CB	EN-S	\$1,926
450-000-468	VMAX20K FASTTR PKG N-SATA 26-40TB=CB	EN-S	\$1,696
450-000-469	VMAX20K FASTTR PKG N-SATA 41-60TB=CB	EN-S	\$1,578
450-000-470	VMAX20K FASTTR PKG N-SATA 61-100TB=CB	EN-S	\$1,509
450-000-471	VMAX20K FASTTR PKG N-SATA 101-150TB=CB	EN-S	\$1,358
450-000-472	VMAX20K FASTTR PKG N-SATA 151-250TB=CB	EN-S	\$1,220
450-000-473	VMAX20K FASTTR PKG N-SATA 251-400TB=CB	EN-S	\$1,056
450-000-474	VMAX20K FASTTR PKG N-SATA 401-600TB=CB	EN-S	\$906
450-000-475	VMAX20K FASTTR PKG N-SATA 601-1000TB=CB	EN-S	\$800
450-000-476	VMAX20K FASTTR PKG N-SATA 1001+TB=CB	EN-S	\$695
450-000-477	VMAX20K FASTTR PKG SATA 0-14TB=CB	EN-S	\$1,026
450-000-478	VMAX20K FASTTR PKG SATA 15-25TB=CB	EN-S	\$964
450-000-479	VMAX20K FASTTR PKG SATA 26-40TB=CB	EN-S	\$846
450-000-480	VMAX20K FASTTR PKG SATA 41-60TB=CB	EN-S	\$787
450-000-481	VMAX20K FASTTR PKG SATA 61-100TB=CB	EN-S	\$754
450-000-482	VMAX20K FASTTR PKG SATA 101-150TB=CB	EN-S	\$679
450-000-483	VMAX20K FASTTR PKG SATA 151-250TB=CB	EN-S	\$610
450-000-484	VMAX20K FASTTR PKG SATA 251-400TB=CB	EN-S	\$528
450-000-485	VMAX20K FASTTR PKG SATA 401-600TB=CB	EN-S	\$453
450-000-486	VMAX20K FASTTR PKG SATA 601-1000TB=CB	EN-S	\$400
450-000-487	VMAX20K FASTTR PKG SATA 1001+TB=CB	EN-S	\$348
450-000-488	VMAX20K FASTTR PKG REG 0-14TB=CA	EN-S	\$2,474
450-000-489	VMAX20K FASTTR PKG REG 15-25TB=CA	EN-S	\$2,186
450-000-490	VMAX20K FASTTR PKG REG 26-40TB=CA	EN-S	\$1,908
450-000-491	VMAX20K FASTTR PKG REG 41-60TB=CA	EN-S	\$1,656
450-000-492	VMAX20K FASTTR PKG REG 61-100TB=CA	EN-S	\$1,455
450-000-493	VMAX20K FASTTR PKG REG 101-150TB=CA	EN-S	\$1,358
450-000-494	VMAX20K FASTTR PKG REG 151-250TB=CA	EN-S	\$1,253
450-000-495	VMAX20K FASTTR PKG REG 251-400TB=CA	EN-S	\$1,148
450-000-496	VMAX20K FASTTR PKG REG 401-600TB=CA	EN-S	\$1,093
450-000-497	VMAX20K FASTTR PKG REG 601-1000TB=CA	EN-S	\$1,014
450-000-498	VMAX20K FASTTR PKG REG 1001+TB=CA	EN-S	\$923
450-000-499	VMAX20K FASTTR PKG XTRN 0-14TB=CB	EN-S	\$1,028
450-000-500	VMAX20K FASTTR PKG XTRN 15-25TB=CB	EN-S	\$964
450-000-501	VMAX20K FASTTR PKG XTRN 26-40TB=CB	EN-S	\$848
450-000-502	VMAX20K FASTTR PKG XTRN 41-60TB=CB	EN-S	\$788
450-000-503	VMAX20K FASTTR PKG XTRN 61-100TB=CB	EN-S	\$756
450-000-504	VMAX20K FASTTR PKG XTRN 101-150TB=CB	EN-S	\$680
450-000-505	VMAX20K FASTTR PKG XTRN 151-250TB=CB	EN-S	\$612

450-000-506	VMAX20K FASTTR PKG XTRN 251-400TB=CB	EN-S	\$528
450-000-507	VMAX20K FASTTR PKG XTRN 401-600TB=CB	EN-S	\$452
450-000-508	VMAX20K FASTTR PKG XTRN 601-1000TB=CB	EN-S	\$400
450-000-509	VMAX20K FASTTR PKG XTRN 1001+TB=CB	EN-S	\$348
450-000-510	VMAX20K ADV SW PKG N-SATA 0-14TB=CB	EN-S	\$5,880
450-000-511	VMAX20K ADV SW PKG N-SATA 15-25TB=CB	EN-S	\$5,520
450-000-512	VMAX20K ADV SW PKG N-SATA 26-40TB=CB	EN-S	\$4,860
450-000-513	VMAX20K ADV SW PKG N-SATA 41-60TB=CB	EN-S	\$4,520
450-000-514	VMAX20K ADV SW PKG N-SATA 61-100TB=CB	EN-S	\$4,340
450-000-515	VMAX20K ADV SW PKG N-SATA 101-150TB=CB	EN-S	\$3,900
450-000-516	VMAX20K ADV SW PKG N-SATA 151-250TB=CB	EN-S	\$3,480
450-000-517	VMAX20K ADV SW PKG N-SATA 251-400TB=CB	EN-S	\$3,010
450-000-518	VMAX20K ADV SW PKG N-SATA 401-600TB=CB	EN-S	\$2,610
450-000-519	VMAX20K ADV SW PKG N-SATA 601-1000TB=CB	EN-S	\$2,280
450-000-520	VMAX20K ADV SW PKG N-SATA 1001+TB=CB	EN-S	\$1,980
450-000-521	VMAX20K ADV SW PKG SATA 0-14TB=CB	EN-S	\$2,930
450-000-522	VMAX20K ADV SW PKG SATA 15-25TB=CB	EN-S	\$2,750
450-000-523	VMAX20K ADV SW PKG SATA 26-40TB=CB	EN-S	\$2,430
450-000-524	VMAX20K ADV SW PKG SATA 41-60TB=CB	EN-S	\$2,260
450-000-525	VMAX20K ADV SW PKG SATA 61-100TB=CB	EN-S	\$2,160
450-000-526	VMAX20K ADV SW PKG SATA 101-150TB=CB	EN-S	\$1,950
450-000-527	VMAX20K ADV SW PKG SATA 151-250TB=CB	EN-S	\$1,730
450-000-528	VMAX20K ADV SW PKG SATA 251-400TB=CB	EN-S	\$1,510
450-000-529	VMAX20K ADV SW PKG SATA 401-600TB=CB	EN-S	\$1,310
450-000-530	VMAX20K ADV SW PKG SATA 601-1000TB=CB	EN-S	\$1,140
450-000-531	VMAX20K ADV SW PKG SATA 1001+TB=CB	EN-S	\$990
450-000-942	RP/EX FOR VMAX10K SATA CAP=CB	EN-S	\$800
450-000-943	RP/EX FOR VMAX10K N-SATA CAP=CB	EN-S	\$1,600
450-000-944	RP/EX FOR VMAX10K EXTRN CAP=CB	EN-S	\$800
450-001-191	VMAX 10K ADV SW SUITE NON-SATA 1TB	EN-S	\$2,070
450-001-192	VMAX 10K ADV SW SUITE SATA 1TB	EN-S	\$1,035
456-000-623	VMAX40K ENGINUITY SATA 0-14TB=CB	EN-S	\$910
456-000-624	VMAX40K ENGINUITY SATA 15-25TB=CB	EN-S	\$870
456-000-625	VMAX40K ENGINUITY SATA 26-40TB=CB	EN-S	\$840
456-000-626	VMAX40K ENGINUITY SATA 41-60TB=CB	EN-S	\$800
456-000-627	VMAX40K ENGINUITY SATA 61-100TB=CB	EN-S	\$770
456-000-628	VMAX40K ENGINUITY SATA 101-150TB=CB	EN-S	\$740
456-000-629	VMAX40K ENGINUITY SATA 151-250TB=CB	EN-S	\$710
456-000-630	VMAX40K ENGINUITY SATA 251-400TB=CB	EN-S	\$680
456-000-631	VMAX40K ENGINUITY SATA 401-600TB=CB	EN-S	\$660
456-000-632	VMAX40K ENGINUITY SATA 601-1000TB=CB	EN-S	\$630
456-000-633	VMAX40K ENGINUITY SATA 1001+TB=CB	EN-S	\$600
456-000-634	VMAX40K ENGINUITY N-SATA 0-14TB=CB	EN-S	\$2,020
456-000-635	VMAX40K ENGINUITY N-SATA 15-25TB=CB	EN-S	\$1,940
456-000-636	VMAX40K ENGINUITY N-SATA 26-40TB=CB	EN-S	\$1,860
456-000-637	VMAX40K ENGINUITY N-SATA 41-60TB=CB	EN-S	\$1,790
456-000-638	VMAX40K ENGINUITY N-SATA 61-100TB=CB	EN-S	\$1,710
456-000-639	VMAX40K ENGINUITY N-SATA 101-150TB=CB	EN-S	\$1,650
456-000-640	VMAX40K ENGINUITY N-SATA 151-250TB=CB	EN-S	\$1,580
456-000-641	VMAX40K ENGINUITY N-SATA 251-400TB=CB	EN-S	\$1,520

456-000-642	VMAX40K ENGINUITY N-SATA 401-600TB=CB	EN-S	\$1,460
456-000-643	VMAX40K ENGINUITY N-SATA 601-1000TB=CB	EN-S	\$1,400
456-000-644	VMAX40K ENGINUITY N-SATA 1001+TB=CB	EN-S	\$1,340
456-000-656	SYMM MGMT SUITE FOR 40K SATA 0-14TB	EN-S	\$0
456-000-657	SYMM MGMT SUITE FOR 40K SATA 15-25TB	EN-S	\$0
456-000-658	SYMM MGMT SUITE FOR 40K SATA 26-40TB	EN-S	\$0
456-000-659	SYMM MGMT SUITE FOR 40K SATA 41-60TB	EN-S	\$0
456-000-660	SYMM MGMT SUITE FOR 40K SATA 61-100TB	EN-S	\$0
456-000-661	SYMM MGMT SUITE FOR 40K SATA 101-150TB	EN-S	\$0
456-000-662	SYMM MGMT SUITE FOR 40K SATA 151-250TB	EN-S	\$0
456-000-663	SYMM MGMT SUITE FOR 40K SATA 251-400TB	EN-S	\$0
456-000-664	SYMM MGMT SUITE FOR 40K SATA 401-600TB	EN-S	\$0
456-000-665	SYMM MGMT SUITE FOR 40K SATA 601-1000TB	EN-S	\$0
456-000-666	SYMM MGMT SUITE FOR 40K SATA 1000TB +	EN-S	\$0
456-000-667	SYMM MGMT SUITE FOR 40K NON-SATA 0-14TB	EN-S	\$0
456-000-668	SYMM MGMT SUITE FOR 40K NON-SATA 15-25TB	EN-S	\$0
456-000-669	SYMM MGMT SUITE FOR 40K NON-SATA 26-40TB	EN-S	\$0
456-000-670	SYMM MGMT SUITE FOR 40K NON-SATA 41-60TB	EN-S	\$0
456-000-671	SYMM MGMT SUITE 40K NON-SATA 61-100TB	EN-S	\$0
456-000-672	SYMM MGMT SUITE 40K NON-SATA 101-150TB	EN-S	\$0
456-000-673	SYMM MGMT SUITE 40K NON-SATA 151-250TB	EN-S	\$0
456-000-674	SYMM MGMT SUITE 40K NON-SATA 251-400TB	EN-S	\$0
456-000-675	SYMM MGMT SUITE 40K NON-SATA 401-600TB	EN-S	\$0
456-000-676	SYMM MGMT SUITE 40K NON-SATA 601-1000TB	EN-S	\$0
456-000-677	SYMM MGMT SUITE FOR 40K NON-SATA 1000TB	EN-S	\$0
456-000-680	SYMM MGMT Q2 FAST COMBO TIER VMAX40K	EN-S	\$226,505
456-000-689	VMAX40K TIMEFINDR SATA 0-14TB=CB	EN-S	\$1,270
456-000-690	VMAX40K TIMEFINDR SATA 15-25TB=CB	EN-S	\$1,185
456-000-691	VMAX40K TIMEFINDR SATA 26-40TB=CB	EN-S	\$1,050
456-000-692	VMAX40K TIMEFINDR SATA 41-60TB=CB	EN-S	\$975
456-000-693	VMAX40K TIMEFINDR SATA 61-100TB=CB	EN-S	\$935
456-000-694	VMAX40K TIMEFINDR SATA 101-150TB=CB	EN-S	\$850
456-000-695	VMAX40K TIMEFINDR SATA 151-250TB=CB	EN-S	\$745
456-000-696	VMAX40K TIMEFINDR SATA 251-400TB=CB	EN-S	\$650
456-000-697	VMAX40K TIMEFINDR SATA 401-600TB=CB	EN-S	\$565
456-000-698	VMAX40K TIMEFINDR SATA 601-1000TB=CB	EN-S	\$495
456-000-699	VMAX40K TIMEFINDR SATA 1001+TB=CB	EN-S	\$430
456-000-700	VMAX40K TIMEFINDR N-SATA 0-14TB=CB	EN-S	\$2,540
456-000-701	VMAX40K TIMEFINDR N-SATA 15-25TB=CB	EN-S	\$2,385
456-000-702	VMAX40K TIMEFINDR N-SATA 26-40TB=CB	EN-S	\$2,100
456-000-703	VMAX40K TIMEFINDR N-SATA 41-60TB=CB	EN-S	\$1,955
456-000-704	VMAX40K TIMEFINDR N-SATA 61-100TB=CB	EN-S	\$1,880
456-000-705	VMAX40K TIMEFINDR N-SATA 101-150TB=CB	EN-S	\$1,690
456-000-706	VMAX40K TIMEFINDR N-SATA 151-250TB=CB	EN-S	\$1,500
456-000-707	VMAX40K TIMEFINDR N-SATA 251-400TB=CB	EN-S	\$1,300
456-000-708	VMAX40K TIMEFINDR N-SATA 401-600TB=CB	EN-S	\$1,135
456-000-709	VMAX40K TIMEFINDR N-SATA 601-1000TB=CB	EN-S	\$985
456-000-710	VMAX40K TIMEFINDR N-SATA 1001+TB=CB	EN-S	\$860
456-000-711	VMAX40K TIMEFINDR XTRN 0-14TB=CB	EN-S	\$1,270
456-000-712	VMAX40K TIMEFINDR XTRN 15-25TB=CB	EN-S	\$1,185

456-000-713	VMAX40K TIMEFINDR XTRN 26-40TB=CB	EN-S	\$1,050
456-000-714	VMAX40K TIMEFINDR XTRN 41-60TB=CB	EN-S	\$975
456-000-715	VMAX40K TIMEFINDR XTRN 61-100TB=CB	EN-S	\$935
456-000-716	VMAX40K TIMEFINDR XTRN 101-150TB=CB	EN-S	\$850
456-000-717	VMAX40K TIMEFINDR XTRN 151-250TB=CB	EN-S	\$745
456-000-718	VMAX40K TIMEFINDR XTRN 251-400TB=CB	EN-S	\$650
456-000-719	VMAX40K TIMEFINDR XTRN 401-600TB=CB	EN-S	\$565
456-000-720	VMAX40K TIMEFINDR XTRN 601-1000TB=CB	EN-S	\$495
456-000-721	VMAX40K TIMEFINDR XTRN 1001+TB=CB	EN-S	\$430
456-000-722	VMAX40K TIMEFINDR REG 0-14TB=CA	EN-S	\$4,425
456-000-723	VMAX40K TIMEFINDR REG 15-25TB=CA	EN-S	\$3,850
456-000-724	VMAX40K TIMEFINDR REG 26-40TB=CA	EN-S	\$3,350
456-000-725	VMAX40K TIMEFINDR REG 41-60TB=CA	EN-S	\$2,730
456-000-726	VMAX40K TIMEFINDR REG 61-100TB=CA	EN-S	\$2,290
456-000-727	VMAX40K TIMEFINDR REG 101-150TB=CA	EN-S	\$2,135
456-000-728	VMAX40K TIMEFINDR REG 151-250TB=CA	EN-S	\$1,985
456-000-729	VMAX40K TIMEFINDR REG 251-400TB=CA	EN-S	\$1,840
456-000-730	VMAX40K TIMEFINDR REG 401-600TB=CA	EN-S	\$1,675
456-000-731	VMAX40K TIMEFINDR REG 601-1000TB=CA	EN-S	\$1,560
456-000-732	VMAX40K TIMEFINDR REG 1001+TB=CA	EN-S	\$1,100
456-000-733	VMAX40K FAST_TIER SATA 0-14TB=CB	EN-S	\$1,026
456-000-734	VMAX40K FAST_TIER SATA 15-25TB=CB	EN-S	\$964
456-000-735	VMAX40K FAST_TIER SATA 26-40TB=CB	EN-S	\$846
456-000-736	VMAX40K FAST_TIER SATA 41-60TB=CB	EN-S	\$787
456-000-737	VMAX40K FAST_TIER SATA 61-100TB=CB	EN-S	\$754
456-000-738	VMAX40K FAST_TIER SATA 101-150TB=CB	EN-S	\$679
456-000-739	VMAX40K FAST_TIER SATA 151-250TB=CB	EN-S	\$610
456-000-740	VMAX40K FAST_TIER SATA 251-400TB=CB	EN-S	\$528
456-000-741	VMAX40K FAST_TIER SATA 401-600TB=CB	EN-S	\$453
456-000-742	VMAX40K FAST_TIER SATA 601-1000TB=CB	EN-S	\$400
456-000-743	VMAX40K FAST_TIER SATA 1001+TB=CB	EN-S	\$348
456-000-744	VMAX40K FAST_TIER N-SATA 0-14TB=CB	EN-S	\$2,054
456-000-745	VMAX40K FAST_TIER N-SATA 15-25TB=CB	EN-S	\$1,926
456-000-746	VMAX40K FAST_TIER N-SATA 26-40TB=CB	EN-S	\$1,696
456-000-747	VMAX40K FAST_TIER N-SATA 41-60TB=CB	EN-S	\$1,578
456-000-748	VMAX40K FAST_TIER N-SATA 61-100TB=CB	EN-S	\$1,509
456-000-749	VMAX40K FAST_TIER N-SATA 101-150TB=CB	EN-S	\$1,358
456-000-750	VMAX40K FAST_TIER N-SATA 151-250TB=CB	EN-S	\$1,220
456-000-751	VMAX40K FAST_TIER N-SATA 251-400TB=CB	EN-S	\$1,056
456-000-752	VMAX40K FAST_TIER N-SATA 401-600TB=CB	EN-S	\$906
456-000-753	VMAX40K FAST_TIER N-SATA 601-1000TB=CB	EN-S	\$800
456-000-754	VMAX40K FAST_TIER N-SATA 1001TB+=CB	EN-S	\$695
456-000-755	VMAX40K FAST_TIER XTRN 0-14TB=CB	EN-S	\$1,028
456-000-756	VMAX40K FAST_TIER XTRN 15-25TB=CB	EN-S	\$964
456-000-757	VMAX40K FAST_TIER XTRN 26-40TB=CB	EN-S	\$848
456-000-758	VMAX40K FAST_TIER XTRN 41-60TB=CB	EN-S	\$788
456-000-759	FAST SUITE FOR 40K FTS 61-100TB	EN-S	\$756
456-000-760	VMAX40K FAST_TIER XTRN 101-150TB=CB	EN-S	\$680
456-000-761	FAST SUITE FOR 40K FTS 151-250TB	EN-S	\$612
456-000-762	VMAX40K FAST_TIER XTRN 251-400TB=CB	EN-S	\$528

456-000-763	VMAX40K FAST_TIER XTRN 401-600TB=CB	EN-S	\$452
456-000-764	VMAX40K FAST_TIER XTRN 601-1000TB=CB	EN-S	\$400
456-000-765	VMAX40K FAST_TIER XTRN 1001+TB=CB	EN-S	\$348
456-000-766	VMAX40K FAST_TIER REG 0-14TB=CA	EN-S	\$2,474
456-000-767	VMAX40K FAST_TIER REG 15-25TB=CA	EN-S	\$2,186
456-000-768	VMAX40K FAST_TIER REG 26-40TB=CA	EN-S	\$1,908
456-000-769	VMAX40K FAST_TIER REG 41-60TB=CA	EN-S	\$1,656
456-000-770	VMAX40K FAST_TIER REG 61-100TB=CA	EN-S	\$1,455
456-000-771	VMAX40K FAST_TIER REG 101-150TB=CA	EN-S	\$1,358
456-000-772	VMAX40K FAST_TIER REG 151-250TB=CA	EN-S	\$1,253
456-000-773	VMAX40K FAST_TIER REG 251-400TB=CA	EN-S	\$1,148
456-000-774	VMAX40K FAST_TIER REG 401-600TB=CA	EN-S	\$1,093
456-000-775	VMAX40K FAST_TIER REG 601-1000TB=CA	EN-S	\$1,014
456-000-776	VMAX40K FAST_TIER REG 1001+TB=CA	EN-S	\$923
456-000-777	VMAX40K SRDF REP SATA 0-14TB=CB	EN-S	\$2,190
456-000-778	VMAX40K SRDF REP SATA 15-25TB=CB	EN-S	\$2,060
456-000-779	VMAX40K SRDF REP SATA 26-40TB=CB	EN-S	\$1,810
456-000-780	VMAX40K SRDF REP SATA 41-60TB=CB	EN-S	\$1,620
456-000-781	VMAX40K SRDF REP SATA 61-100TB=CB	EN-S	\$1,450
456-000-782	VMAX40K SRDF REP SATA 101-150TB=CB	EN-S	\$1,280
456-000-783	VMAX40K SRDF REP SATA 151-250TB=CB	EN-S	\$1,100
456-000-784	VMAX40K SRDF REP SATA 251-400TB=CB	EN-S	\$940
456-000-785	VMAX40K SRDF REP SATA 401-600TB=CB	EN-S	\$810
456-000-786	VMAX40K SRDF REP SATA 601-1000TB=CB	EN-S	\$690
456-000-787	VMAX40K SRDF REP SATA 1001+TB=CB	EN-S	\$600
456-000-788	VMAX40K SRDF REP N-SATA 0-14TB=CB	EN-S	\$4,380
456-000-789	VMAX40K SRDF REP N-SATA 15-25TB=CB	EN-S	\$4,120
456-000-790	VMAX40K SRDF REP N-SATA 26-40TB=CB	EN-S	\$3,630
456-000-791	VMAX40K SRDF REP N-SATA 41-60TB=CB	EN-S	\$3,240
456-000-792	VMAX40K SRDF REP N-SATA 61-100TB=CB	EN-S	\$2,890
456-000-793	VMAX40K SRDF REP N-SATA 101-150TB=CB	EN-S	\$2,560
456-000-794	VMAX40K SRDF REP N-SATA 151-250TB=CB	EN-S	\$2,200
456-000-795	VMAX40K SRDF REP N-SATA 251-400TB=CB	EN-S	\$1,880
456-000-796	VMAX40K SRDF REP N-SATA 401-600TB=CB	EN-S	\$1,620
456-000-797	VMAX40K SRDF REP N-SATA 601-1000TB=CB	EN-S	\$1,390
456-000-798	VMAX40K SRDF REP N-SATA 1001+TB=CB	EN-S	\$1,190
456-000-799	VMAX40K SRDF REP XTRN 0-14TB=CB	EN-S	\$2,190
456-000-800	VMAX40K SRDF REP XTRN 15-25TB=CB	EN-S	\$2,060
456-000-801	VMAX40K SRDF REP XTRN 26-40TB=CB	EN-S	\$1,810
456-000-802	VMAX40K SRDF REP XTRN 41-60TB=CB	EN-S	\$1,620
456-000-803	VMAX40K SRDF REP XTRN 61-100TB=CB	EN-S	\$1,450
456-000-804	VMAX40K SRDF REP XTRN 101-150TB=CB	EN-S	\$1,280
456-000-805	VMAX40K SRDF REP XTRN 151-250TB=CB	EN-S	\$1,100
456-000-806	VMAX40K SRDF REP XTRN 251-400TB=CB	EN-S	\$940
456-000-807	VMAX40K SRDF REP XTRN 401-600TB=CB	EN-S	\$810
456-000-808	VMAX40K SRDF REP XTRN 601-1000TB=CB	EN-S	\$690
456-000-809	VMAX40K SRDF REP XTRN 1001+TB=CB	EN-S	\$600
456-000-810	VMAX40K SRDF REP REG 0-14TB=CA	EN-S	\$4,395
456-000-811	VMAX40K SRDF REP REG 15-25TB=CA	EN-S	\$3,647
456-000-812	VMAX40K SRDF REP REG 26-40TB=CA	EN-S	\$3,660

456-000-813	SRDF SUITE FOR 40K REG 41-60TB	EN-S	\$2,990
456-000-814	VMAX40K SRDF REP REG 61-100TB=CA	EN-S	\$2,595
456-000-815	VMAX40K SRDF REP REG 101-150TB=CA	EN-S	\$2,205
456-000-816	VMAX40K SRDF REP REG 151-250TB=CA	EN-S	\$2,090
456-000-817	VMAX40K SRDF REP REG 251-400TB=CA	EN-S	\$1,915
456-000-818	VMAX40K SRDF REP REG 401-600TB=CA	EN-S	\$1,715
456-000-819	VMAX40K SRDF REP REG 601-1000TB=CA	EN-S	\$1,505
456-000-820	VMAX40K SRDF REP REG 1001+TB=CA	EN-S	\$975
456-000-821	VMAX40K ADV SRDF SATA 0-14TB=CB	EN-S	\$1,725
456-000-822	VMAX40K ADV SRDF SATA 15-25TB=CB	EN-S	\$1,630
456-000-823	VMAX40K ADV SRDF SATA 26-40TB=CB	EN-S	\$1,435
456-000-824	VMAX40K ADV SRDF SATA 41-60TB=CB	EN-S	\$1,280
456-000-825	VMAX40K ADV SRDF SATA 61-100TB=CB	EN-S	\$1,145
456-000-826	VMAX40K ADV SRDF SATA 101-150TB=CB	EN-S	\$1,010
456-000-827	VMAX40K ADV SRDF SATA 151-250TB=CB	EN-S	\$870
456-000-828	VMAX40K ADV SRDF SATA 251-400TB=CB	EN-S	\$740
456-000-829	VMAX40K ADV SRDF SATA 401-600TB=CB	EN-S	\$635
456-000-830	VMAX40K ADV SRDF SATA 601-1000TB=CB	EN-S	\$545
456-000-831	VMAX40K ADV SRDF SATA 1001+TB=CB	EN-S	\$470
456-000-832	VMAX40K ADV SRDF N-SATA 0-14TB=CB	EN-S	\$3,460
456-000-833	VMAX40K ADV SRDF N-SATA 15-25TB=CB	EN-S	\$3,250
456-000-834	VMAX40K ADV SRDF N-SATA 26-40TB=CB	EN-S	\$2,865
456-000-835	VMAX40K ADV SRDF N-SATA 41-60TB=CB	EN-S	\$2,560
456-000-836	VMAX40K ADV SRDF N-SATA 61-100TB=CB	EN-S	\$2,275
456-000-837	VMAX40K ADV SRDF N-SATA 101-150TB=CB	EN-S	\$2,020
456-000-838	VMAX40K ADV SRDF N-SATA 151-250TB=CB	EN-S	\$1,740
456-000-839	VMAX40K ADV SRDF N-SATA 251-400TB=CB	EN-S	\$1,490
456-000-840	VMAX40K ADV SRDF N-SATA 401-600TB=CB	EN-S	\$1,280
456-000-841	VMAX40K ADV SRDF N-SATA 601-1000TB=CB	EN-S	\$1,095
456-000-842	VMAX40K ADV SRDF N-SATA 1001+TB=CB	EN-S	\$935
456-000-843	VMAX40K ADV SRDF XTRN 0-14TB=CB	EN-S	\$1,725
456-000-844	VMAX40K ADV SRDF XTRN 15-25TB=CB	EN-S	\$1,630
456-000-845	VMAX40K ADV SRDF XTRN 26-40TB=CB	EN-S	\$1,435
456-000-846	VMAX40K ADV SRDF XTRN 41-60TB=CB	EN-S	\$1,280
456-000-847	VMAX40K ADV SRDF XTRN 61-100TB=CB	EN-S	\$1,145
456-000-848	VMAX40K ADV SRDF XTRN 101-150TB=CB	EN-S	\$1,010
456-000-849	VMAX40K ADV SRDF XTRN 151-250TB=CB	EN-S	\$870
456-000-850	VMAX40K ADV SRDF XTRN 251-400TB=CB	EN-S	\$740
456-000-851	VMAX40K ADV SRDF XTRN 401-600TB=CB	EN-S	\$635
456-000-852	VMAX40K ADV SRDF XTRN 601-1000TB=CB	EN-S	\$545
456-000-853	VMAX40K ADV SRDF XTRN 1001+TB=CB	EN-S	\$470
456-000-854	VMAX40K ADV SRDF REG 0-14TB=CB=CA	EN-S	\$1,425
456-000-855	VMAX40K ADV SRDF REG 15-25TB=CA	EN-S	\$1,155
456-000-856	VMAX40K ADV SRDF REG 26-40TB=CA	EN-S	\$1,203
456-000-857	VMAX40K ADV SRDF REG 41-60TB=CA	EN-S	\$1,073
456-000-858	VMAX40K ADV SRDF REG 61-100TB=CA	EN-S	\$917
456-000-859	VMAX40K ADV SRDF REG 101-150TB=CA	EN-S	\$850
456-000-860	VMAX40K ADV SRDF REG 151-250TB=CA	EN-S	\$749
456-000-861	VMAX40K ADV SRDF REG 251-400TB=CA	EN-S	\$668
456-000-862	VMAX40K ADV SRDF REG 401-600TB=CA	EN-S	\$555

456-000-863	VMAX40K ADV SRDF REG 601-1000TB=CA	EN-S	\$449
456-000-864	VMAX40K ADV SRDF REG 1001+TB=CA	EN-S	\$285
456-000-865	PROSPHERE-CC 40K SATA 0-14TB	EN-S	\$0
456-000-866	PROSPHERE-CC 40K SATA 15-25TB	EN-S	\$0
456-000-867	PROSPHERE-CC 40K SATA 26-40TB	EN-S	\$0
456-000-868	PROSPHERE-CC 40K SATA 41-60TB	EN-S	\$0
456-000-869	PROSPHERE-CC 40K SATA 61-100TB	EN-S	\$0
456-000-870	PROSPHERE-CC 40K SATA 101-150TB	EN-S	\$0
456-000-871	PROSPHERE-CC 40K SATA 151-250TB	EN-S	\$0
456-000-872	PROSPHERE-CC 40K SATA 251-400TB	EN-S	\$0
456-000-873	PROSPHERE-CC 40K SATA 401-600TB	EN-S	\$0
456-000-874	PROSPHERE-CC 40K SATA 601-1000TB	EN-S	\$0
456-000-875	PROSPHERE-CC 40K SATA 1000TB +	EN-S	\$0
456-000-876	PROSPHERE-CC 40K NON-SATA 0-14TB	EN-S	\$0
456-000-877	PROSPHERE-CC 40K NON-SATA 15-25TB	EN-S	\$0
456-000-878	PROSPHERE-CC 40K NON-SATA 26-40TB	EN-S	\$0
456-000-879	PROSPHERE-CC 40K NON-SATA 41-60TB	EN-S	\$0
456-000-880	PROSPHERE-CC 40K NON-SATA 61-100TB	EN-S	\$0
456-000-881	PROSPHERE-CC 40K NON-SATA 101-150TB	EN-S	\$0
456-000-882	PROSPHERE-CC 40K NON-SATA 151-250TB	EN-S	\$0
456-000-883	PROSPHERE-CC 40K NON-SATA 251-400TB	EN-S	\$0
456-000-884	PROSPHERE-CC 40K NON-SATA 401-600TB	EN-S	\$0
456-000-885	PROSPHERE-CC 40K NON-SATA 601-1000TB	EN-S	\$0
456-000-886	PROSPHERE-CC 40K NON-SATA 1000TB +	EN-S	\$0
456-000-898	VMAX40K OR-DM SATA 0-14TB=CB	EN-S	\$1,971
456-000-899	VMAX40K OR-DM SATA 15-25TB=CB	EN-S	\$1,854
456-000-900	VMAX40K OR-DM SATA 26-40TB=CB	EN-S	\$1,629
456-000-901	VMAX40K OR-DM SATA 41-60TB=CB	EN-S	\$1,458
456-000-902	VMAX40K OR-DM SATA 61-100TB=CB	EN-S	\$1,305
456-000-903	VMAX40K OR-DM SATA 101-150TB=CB	EN-S	\$1,152
456-000-904	VMAX40K OR-DM SATA 151-250TB=CB	EN-S	\$990
456-000-905	VMAX40K OR-DM SATA 251-400TB=CB	EN-S	\$846
456-000-906	VMAX40K OR-DM SATA 401-600TB=CB	EN-S	\$729
456-000-907	VMAX40K OR-DM SATA 601-1000TB=CB	EN-S	\$621
456-000-908	VMAX40K OR-DM SATA 1001+TB=CB	EN-S	\$540
456-000-909	VMAX40K OR-DM N-SATA 0-14TB=CB	EN-S	\$3,942
456-000-910	VMAX40K OR-DM N-SATA 15-25TB=CB	EN-S	\$3,708
456-000-911	VMAX40K OR-DM N-SATA 26-40TB=CB	EN-S	\$3,267
456-000-912	VMAX40K OR-DM N-SATA 41-60TB=CB	EN-S	\$2,916
456-000-913	VMAX40K OR-DM N-SATA 61-100TB=CB	EN-S	\$2,601
456-000-914	VMAX40K OR-DM N-SATA 101-150TB=CB	EN-S	\$2,304
456-000-915	VMAX40K OR-DM N-SATA 151-250TB=CB	EN-S	\$1,980
456-000-916	VMAX40K OR-DM N-SATA 251-400TB=CB	EN-S	\$1,692
456-000-917	VMAX40K OR-DM N-SATA 401-600TB=CB	EN-S	\$1,458
456-000-918	VMAX40K OR-DM N-SATA 601-1000TB=CB	EN-S	\$1,251
456-000-919	VMAX40K OR-DM N-SATA 1001+TB=CB	EN-S	\$1,071
456-005-500	VMAX 10K ADV SW SUITE NON-SATA 1TB	EN-S	\$0
456-005-501	VMAX 10K ADV SW SUITE SATA 1TB	EN-S	\$0
456-005-502	VMAX 10K ENGINUITY NON-SATA 1TB	EN-S	\$1,230
456-005-503	VMAX 10K ENGINUITY SATA 1TB	EN-S	\$555

456-005-753	VMAX10K OR-DM NON-SATA 1TB=CB	EN-S	\$2,580
456-005-754	VMAX10K OR-DM SATA 1TB=CB	EN-S	\$1,290
456-005-759	AFS Q2 FAST COMBO TIER VMAX 40K	EN-S	\$240,155
456-005-901	VMAX10K FAST VP FTS EXT 1TB=CB	EN-S	\$530
456-005-903	VMAX10K TIMEFINDER FTS EXT 1TB=CB	EN-S	\$1,380
456-005-906	VMAX 10K SRDF-A FTS EXT 1TB	EN-S	\$825
456-005-907	VMAX10K SRDF-A FTS EXT AP 1TB=CB	EN-S	\$825
456-005-909	VMAX10K SRDF-S FTS EXT 1TB=CB	EN-S	\$825
456-005-910	VMAX10K SRDF-S FTS EXT AP 1TB=CB	EN-S	\$825
456-005-912	VMAX10K SRDF-STAR FTS EXT 1TB=CB	EN-S	\$330
456-005-913	VMAX10K SRDF-STAR FTS EXT AP 1TB=CB	EN-S	\$330
456-005-914	VMAX10K ADV SRDF REG CAP 1TB=CA	EN-S	\$1,600
456-005-915	VMAX10K ADV SRDF SATA CAP 1TB=CB	EN-S	\$660
456-005-916	VMAX10K ADV SRDF NON-SATA CAP 1TB=CB	EN-S	\$1,320
456-005-917	VMAX10K ADV SRDF XTRN CAP 1TB=CB	EN-S	\$660
456-006-020	VMAX20K ADV SRDF XTRN 0-14TB=CB	EN-S	\$1,725
456-006-021	VMAX20K ADV SRDF XTRN 15-25TB=CB	EN-S	\$1,630
456-006-022	VMAX20K ADV SRDF XTRN 26-40TB=CB	EN-S	\$1,435
456-006-023	VMAX20K ADV SRDF XTRN 41-60TB=CB	EN-S	\$1,280
456-006-024	VMAX20K ADV SRDF XTRN 61-100TB=CB	EN-S	\$1,145
456-006-025	VMAX20K ADV SRDF XTRN 101-150TB=CB	EN-S	\$1,010
456-006-026	VMAX20K ADV SRDF XTRN 151-250TB=CB	EN-S	\$870
456-006-027	VMAX20K ADV SRDF XTRN 251-400TB=CB	EN-S	\$740
456-006-028	VMAX20K ADV SRDF XTRN 401-600TB=CB	EN-S	\$635
456-006-029	VMAX20K ADV SRDF XTRN 601-1000TB=CB	EN-S	\$545
456-006-030	VMAX20K ADV SRDF XTRN 1001+TB=CB	EN-S	\$470
456-006-031	VMAX20K ADV SRDF N-SATA 0-14TB=CB	EN-S	\$3,460
456-006-032	VMAX20K ADV SRDF N-SATA 15-25TB=CB	EN-S	\$3,250
456-006-033	VMAX20K ADV SRDF N-SATA 26-40TB=CB	EN-S	\$2,865
456-006-034	VMAX20K ADV SRDF N-SATA 41-60TB=CB	EN-S	\$2,560
456-006-035	VMAX20K ADV SRDF N-SATA 61-100TB=CB	EN-S	\$2,275
456-006-036	VMAX20K ADV SRDF N-SATA 101-150TB=CB	EN-S	\$2,020
456-006-037	VMAX20K ADV SRDF N-SATA 151-250TB=CB	EN-S	\$1,740
456-006-038	VMAX20K ADV SRDF N-SATA 251-400TB=CB	EN-S	\$1,490
456-006-039	VMAX20K ADV SRDF N-SATA 401-600TB=CB	EN-S	\$1,280
456-006-040	VMAX20K ADV SRDF N-SATA 601-1000TB=CB	EN-S	\$1,095
456-006-041	VMAX20K ADV SRDF N-SATA 1001+TB=CB	EN-S	\$935
456-006-042	VMAX20K ADV SRDF SATA 0-14TB=CB	EN-S	\$1,725
456-006-043	VMAX20K ADV SRDF SATA 15-25TB=CB	EN-S	\$1,630
456-006-044	VMAX20K ADV SRDF SATA 26-40TB=CB	EN-S	\$1,435
456-006-045	VMAX20K ADV SRDF SATA 41-60TB=CB	EN-S	\$1,280
456-006-046	VMAX20K ADV SRDF SATA 61-100TB=CB	EN-S	\$1,145
456-006-047	VMAX20K ADV SRDF SATA 101-150TB=CB	EN-S	\$1,010
456-006-048	VMAX20K ADV SRDF SATA 151-250TB=CB	EN-S	\$870
456-006-049	VMAX20K ADV SRDF SATA 251-400TB=CB	EN-S	\$740
456-006-050	VMAX20K ADV SRDF SATA 401-600TB=CB	EN-S	\$635
456-006-051	VMAX20K ADV SRDF SATA 601-1000TB=CB	EN-S	\$545
456-006-052	VMAX20K ADV SRDF SATA 1001+TB=CB	EN-S	\$470
456-006-053	VMAX20K ADV SRDF REG 0-14TB=CA	EN-S	\$1,425
456-006-054	VMAX20K ADV SRDF REG 15-25TB=CA	EN-S	\$1,155

456-006-055	VMAX20K ADV SRDF REG 26-40TB=CA	EN-S	\$1,203
456-006-056	VMAX20K ADV SRDF REG 41-60TB=CB	EN-S	\$1,073
456-006-057	VMAX20K ADV SRDF REG 61-100TB=CA	EN-S	\$917
456-006-058	VMAX20K ADV SRDF REG 101-150TB=CA	EN-S	\$850
456-006-059	VMAX20K ADV SRDF REG 151-250TB=CA	EN-S	\$749
456-006-060	VMAX20K ADV SRDF REG 251-400TB=CA	EN-S	\$668
456-006-061	VMAX20K ADV SRDF REG 401-600TB=CA	EN-S	\$555
456-006-062	VMAX20K ADV SRDF REG 601-1000TB=CA	EN-S	\$449
456-006-063	VMAX20K ADV SRDF REG 1001+TB=CA	EN-S	\$285
456-006-064	ENGINUIY FOR VMAX 20K N-S 0-14TB	EN-S	\$0
456-006-065	ENGINUIY FOR VMAX 20K N-S 15-25TB	EN-S	\$0
456-006-066	ENGINUIY FOR VMAX 20K N-S 26-40TB	EN-S	\$0
456-006-067	ENGINUIY FOR VMAX 20K N-S 41-60TB	EN-S	\$0
456-006-068	ENGINUIY FOR VMAX 20K N-S 61-100TB	EN-S	\$0
456-006-069	ENGINUIY FOR VMAX 20K N-S 101-150TB	EN-S	\$0
456-006-070	ENGINUIY FOR VMAX 20K N-S 151-250TB	EN-S	\$0
456-006-071	ENGINUIY FOR VMAX 20K N-S 251-400TB	EN-S	\$0
456-006-072	ENGINUIY FOR VMAX 20K N-S 401-600TB	EN-S	\$0
456-006-073	ENGINUIY FOR VMAX 20K N-S 601-1000TB	EN-S	\$0
456-006-074	ENGINUIY FOR VMAX 20K N-S 1000TB+	EN-S	\$0
456-006-075	ENGINUIY FOR VMAX 20K SATA 0-14TB	EN-S	\$0
456-006-076	ENGINUIY FOR VMAX 20K SATA 15-25TB	EN-S	\$0
456-006-077	ENGINUIY FOR VMAX 20K SATA 26-40TB	EN-S	\$0
456-006-078	ENGINUIY FOR VMAX 20K SATA 41-60TB	EN-S	\$0
456-006-079	ENGINUIY FOR VMAX 20K SATA 61-100TB	EN-S	\$0
456-006-080	ENGINUIY FOR VMAX 20K SATA 101-150TB	EN-S	\$0
456-006-081	ENGINUIY FOR VMAX 20K SATA 151-250TB	EN-S	\$0
456-006-082	ENGINUIY FOR VMAX 20K SATA 251-400TB	EN-S	\$0
456-006-083	ENGINUIY FOR VMAX 20K SATA 401-600TB	EN-S	\$0
456-006-084	ENGINUIY FOR VMAX 20K SATA 601-1000TB	EN-S	\$0
456-006-085	ENGINUIY FOR VMAX 20K SATA 1000TB+	EN-S	\$0
456-006-086	FAST TIERING SUITE 20K SATA 0-14TB	EN-S	\$0
456-006-087	FAST TIERING SUITE 20K SATA 15-25TB	EN-S	\$0
456-006-088	FAST TIERING SUITE 20K SATA 26-40TB	EN-S	\$0
456-006-089	FAST TIERING SUITE 20K SATA 41-60TB	EN-S	\$0
456-006-090	FAST TIERING SUITE 20K SATA 61-100TB	EN-S	\$0
456-006-091	FAST TIERING SUITE 20K SATA 101-150TB	EN-S	\$0
456-006-092	FAST TIERING SUITE 20K SATA 151-250TB	EN-S	\$0
456-006-093	FAST TIERING SUITE 20K SATA 251-400TB	EN-S	\$0
456-006-094	FAST TIERING SUITE 20K SATA 401-600TB	EN-S	\$0
456-006-095	FAST TIERING SUITE 20K SATA 601-1000TB	EN-S	\$0
456-006-096	FAST TIERING SUITE 20K SATA 1000TB+	EN-S	\$0
456-006-097	FAST TIERING SUITE 20K N-S 0-14TB	EN-S	\$0
456-006-098	FAST TIERING SUITE 20K N-S 15-25TB	EN-S	\$0
456-006-099	FAST TIERING SUITE 20K N-S 26-40TB	EN-S	\$0
456-006-100	FAST TIERING SUITE 20K N-S 41-60TB	EN-S	\$0
456-006-101	FAST TIERING SUITE 20K N-S 61-100TB	EN-S	\$0
456-006-102	FAST TIERING SUITE 20K N-S 101-150TB	EN-S	\$0
456-006-103	FAST TIERING SUITE 20K N-S 151-250TB	EN-S	\$0
456-006-104	FAST TIERING SUITE 20K N-S 251-400TB	EN-S	\$0

456-006-105	FAST TIERING SUITE 20K N-S 401-600TB	EN-S	\$0
456-006-106	FAST TIERING SUITE 20K N-S 601-1000TB	EN-S	\$0
456-006-107	FAST TIERING SUITE 20K N-S 1000TB+	EN-S	\$0
456-006-108	FAST TIERING SUITE 20K FTS EXT 0-14TB	EN-S	\$0
456-006-109	FAST TIERING SUITE 20K FTS EXT 15-25TB	EN-S	\$0
456-006-110	FAST TIERING SUITE 20K FTS EXT 26-40TB	EN-S	\$0
456-006-111	FAST TIERING SUITE 20K FTS EXT 41-60TB	EN-S	\$0
456-006-112	FAST TIERING SUITE 20K FTS EXT 61-100TB	EN-S	\$0
456-006-113	FAST TIERING SUITE 20K FTS EXT 101-150TB	EN-S	\$0
456-006-114	FAST TIERING SUITE 20K FTS EXT 151-250TB	EN-S	\$0
456-006-115	FAST TIERING SUITE 20K FTS EXT 251-400TB	EN-S	\$0
456-006-116	FAST TIERING SUITE 20K FTS EXT 401-600TB	EN-S	\$0
456-006-117	FAST TIERING SUITE 20K FTSEXT 601-1000TB	EN-S	\$0
456-006-118	FAST TIERING SUITE 20K FTS EXT 1000TB+	EN-S	\$0
456-006-119	FAST TIERING REG 20K 0-14TB	EN-S	\$0
456-006-120	FAST TIERING REG 20K 15-25TB	EN-S	\$0
456-006-121	FAST TIERING REG 20K 26-40TB	EN-S	\$0
456-006-122	FAST TIERING REG 20K 41-60TB	EN-S	\$0
456-006-123	FAST TIERING REG 20K 61-100TB	EN-S	\$0
456-006-124	FAST TIERING REG 20K 101-150TB	EN-S	\$0
456-006-125	FAST TIERING REG 20K 151-250TB	EN-S	\$0
456-006-126	FAST TIERING REG 20K 251-400TB	EN-S	\$0
456-006-127	FAST TIERING REG 20K 401-600TB	EN-S	\$0
456-006-128	FAST TIERING REG 20K 601-1000TB	EN-S	\$0
456-006-129	FAST TIERING REG 20K 1000TB+	EN-S	\$0
456-006-130	VMAX20K OR-DM REG 0-14TB=CA	EN-S	\$3,516
456-006-131	VMAX20K OR-DM REG 15-25TB=CA	EN-S	\$2,917
456-006-132	VMAX20K OR-DM REG 26-40TB=CA	EN-S	\$2,928
456-006-133	VMAX20K OR-DM REG 41-60TB=CA	EN-S	\$2,392
456-006-134	VMAX20K OR-DM REG 61-100TB=CA	EN-S	\$2,076
456-006-135	VMAX20K OR-DM REG 101-150TB=CA	EN-S	\$1,764
456-006-136	VMAX20K OR-DM REG 151-250TB=CA	EN-S	\$1,672
456-006-137	VMAX20K OR-DM REG 251-400TB=CA	EN-S	\$1,532
456-006-138	VMAX20K OR-DM REG 401-600TB=CA	EN-S	\$1,372
456-006-139	VMAX20K OR-DM REG 601-1000TB=CA	EN-S	\$1,204
456-006-140	VMAX20K OR-DM REG 1001TB+=CA	EN-S	\$780
456-006-141	VMAX40K OR-DM REG 0-14TB=CA	EN-S	\$3,956
456-006-142	VMAX40K OR-DM REG 15-25TB=CA	EN-S	\$3,282
456-006-143	VMAX40K OR-DM REG 26-40TB=CA	EN-S	\$3,294
456-006-144	VMAX40K OR-DM REG 41-60TB=CA	EN-S	\$2,691
456-006-145	VMAX40K OR-DM REG 61-100TB=CA	EN-S	\$2,336
456-006-146	VMAX40K OR-DM REG 101-150TB=CA	EN-S	\$1,985
456-006-147	VMAX40K OR-DM REG 151-250TB=CA	EN-S	\$1,881
456-006-148	VMAX40K OR-DM REG 251-400TB=CA	EN-S	\$1,724
456-006-149	VMAX40K OR-DM REG 401-600TB=CA	EN-S	\$1,544
456-006-150	VMAX40K OR-DM REG 601-1000TB=CA	EN-S	\$1,355
456-006-151	VMAX40K OR-DM REG 1001+TB=CA	EN-S	\$878
456-006-152	PROSPHERE VMAX 20K SATA 0-14TB	EN-S	\$0
456-006-153	PROSPHERE VMAX 20K SATA 15-25TB	EN-S	\$0
456-006-154	PROSPHERE VMAX 20K SATA 26-40TB	EN-S	\$0

456-006-155	PROSPHERE VMAX 20K SATA 41-60TB	EN-S	\$0
456-006-156	PROSPHERE VMAX 20K SATA 61-100TB	EN-S	\$0
456-006-157	PROSPHERE VMAX 20K SATA 101-150TB	EN-S	\$0
456-006-158	PROSPHERE VMAX 20K SATA 151-250TB	EN-S	\$0
456-006-159	PROSPHERE VMAX 20K SATA 251-400TB	EN-S	\$0
456-006-160	PROSPHERE VMAX 20K SATA 401-600TB	EN-S	\$0
456-006-161	PROSPHERE VMAX 20K SATA 601-1000TB	EN-S	\$0
456-006-162	PROSPHERE VMAX 20K SATA 1000TB+	EN-S	\$0
456-006-163	PROSPHERE VMAX 20K NON-SATA 0-14TB	EN-S	\$0
456-006-164	PROSPHERE VMAX 20K NON-SATA 15-25TB	EN-S	\$0
456-006-165	PROSPHERE VMAX 20K NON-SATA 26-40TB	EN-S	\$0
456-006-166	PROSPHERE VMAX 20K NON-SATA 41-60TB	EN-S	\$0
456-006-167	PROSPHERE VMAX 20K NON-SATA 61-100TB	EN-S	\$0
456-006-168	PROSPHERE VMAX 20K NON-SATA 101-150TB	EN-S	\$0
456-006-169	PROSPHERE VMAX 20K NON-SATA 151-250TB	EN-S	\$0
456-006-170	PROSPHERE VMAX 20K NON-SATA 251-400TB	EN-S	\$0
456-006-171	PROSPHERE VMAX 20K NON-SATA 401-600TB	EN-S	\$0
456-006-172	PROSPHERE VMAX 20K NON-SATA 601-1000TB	EN-S	\$0
456-006-173	PROSPHERE VMAX 20K NON-SATA 1000TB+	EN-S	\$0
456-006-174	SRDF REP SUITE VMAX 20K SATA 0-14TB	EN-S	\$0
456-006-175	SRDF REP SUITE VMAX 20K SATA 15-25TB	EN-S	\$0
456-006-176	SRDF REP SUITE VMAX 20K SATA 26-40TB	EN-S	\$0
456-006-177	SRDF REP SUITE VMAX 20K SATA 41-60TB	EN-S	\$0
456-006-178	SRDF REP SUITE VMAX 20K SATA 61-100TB	EN-S	\$0
456-006-179	SRDF REP SUITE VMAX 20K SATA 101-150TB	EN-S	\$0
456-006-180	SRDF REP SUITE VMAX 20K SATA 151-250TB	EN-S	\$0
456-006-181	SRDF REP SUITE VMAX 20K SATA 251-400TB	EN-S	\$0
456-006-182	SRDF REP SUITE VMAX 20K SATA 401-600TB	EN-S	\$0
456-006-183	SRDF REP SUITE VMAX 20K SATA 601-1000TB	EN-S	\$0
456-006-184	SRDF REP SUITE VMAX 20K SATA 1000TB+	EN-S	\$0
456-006-185	SRDF REP SUITE VMAX 20K N-S 0-14TB	EN-S	\$0
456-006-186	SRDF REP SUITE VMAX 20K N-S 15-25TB	EN-S	\$0
456-006-187	SRDF REP SUITE VMAX 20K N-S 26-40TB	EN-S	\$0
456-006-188	SRDF REP SUITE VMAX 20K N-S 41-60TB	EN-S	\$0
456-006-189	SRDF REP SUITE VMAX 20K N-S 61-100TB	EN-S	\$0
456-006-190	SRDF REP SUITE VMAX 20K N-S 101-150TB	EN-S	\$0
456-006-191	SRDF REP SUITE VMAX 20K N-S 151-250TB	EN-S	\$0
456-006-192	SRDF REP SUITE VMAX 20K N-S 251-400TB	EN-S	\$0
456-006-193	SRDF REP SUITE VMAX 20K N-S 401-600TB	EN-S	\$0
456-006-194	SRDF REP SUITE VMAX 20K N-S 601-1000TB	EN-S	\$0
456-006-195	SRDF REP SUITE VMAX 20K N-S 1000TB+	EN-S	\$0
456-006-196	SRDF REP SUITE VMAX 20K FTS EXT 0-14TB	EN-S	\$0
456-006-197	SRDF REP SUITE VMAX 20K FTS EXT 15-25TB	EN-S	\$0
456-006-198	SRDF REP SUITE VMAX 20K FTS EXT 26-40TB	EN-S	\$0
456-006-199	SRDF REP SUITE VMAX 20K FTS EXT 41-60TB	EN-S	\$0
456-006-200	SRDF REP SUITE VMAX 20K FTS EXT 61-100TB	EN-S	\$0
456-006-201	SRDF REP SUITE VMAX 20K FTSEXT 101-150TB	EN-S	\$0
456-006-202	SRDF REP SUITE VMAX 20K FTSEXT 151-250TB	EN-S	\$0
456-006-203	SRDF REP SUITE VMAX 20K FTSEXT 251-400TB	EN-S	\$0
456-006-204	SRDF REP SUITE VMAX 20K FTSEXT 401-600TB	EN-S	\$0

456-006-205	SRDF REP SUITE VMAX20K FTSEXT 601-1000TB	EN-S	\$0
456-006-206	SRDF REP SUITE VMAX 20K FTS EXT 1000TB+	EN-S	\$0
456-006-207	SRDF REP SUITE VMAX 20K REG 0-14TB	EN-S	\$0
456-006-208	SRDF REP SUITE VMAX 20K REG 15-25TB	EN-S	\$0
456-006-209	SRDF REP SUITE VMAX 20K REG 26-40TB	EN-S	\$0
456-006-210	SRDF REP SUITE VMAX 20K REG 41-60TB	EN-S	\$0
456-006-211	SRDF REP SUITE VMAX 20K REG 61-100TB	EN-S	\$0
456-006-212	SRDF REP SUITE VMAX 20K REG 101-150TB	EN-S	\$0
456-006-213	SRDF REP SUITE VMAX 20K REG 151-250TB	EN-S	\$0
456-006-214	SRDF REP SUITE VMAX 20K REG 251-400TB	EN-S	\$0
456-006-215	SRDF REP SUITE VMAX 20K REG 401-600TB	EN-S	\$0
456-006-216	SRDF REP SUITE VMAX 20K REG 601-1000TB	EN-S	\$0
456-006-217	SRDF REP SUITE VMAX 20K REG 1000TB+	EN-S	\$0
456-006-218	SYMM MGMT SUITE VMAX 20K SATA 0-14TB	EN-S	\$0
456-006-219	SYMM MGMT SUITE VMAX 20K SATA 15-25TB	EN-S	\$0
456-006-220	SYMM MGMT SUITE VMAX 20K SATA 26-40TB	EN-S	\$0
456-006-221	SYMM MGMT SUITE VMAX 20K SATA 41-60TB	EN-S	\$0
456-006-222	SYMM MGMT SUITE VMAX 20K SATA 61-100TB	EN-S	\$0
456-006-223	SYMM MGMT SUITE VMAX 20K SATA 101-150TB	EN-S	\$0
456-006-224	SYMM MGMT SUITE VMAX 20K SATA 151-250TB	EN-S	\$0
456-006-225	SYMM MGMT SUITE VMAX 20K SATA 251-400TB	EN-S	\$0
456-006-226	SYMM MGMT SUITE VMAX 20K SATA 401-600TB	EN-S	\$0
456-006-227	SYMM MGMT SUITE VMAX 20K SATA 601-1000TB	EN-S	\$0
456-006-228	SYMM MGMT SUITE VMAX 20K SATA 1000TB+	EN-S	\$0
456-006-229	SYMM MGMT SUITE VMAX 20K N-S 0-14TB	EN-S	\$0
456-006-230	SYMM MGMT SUITE VMAX 20K N-S 15-25TB	EN-S	\$0
456-006-231	SYMM MGMT SUITE VMAX 20K N-S 26-40TB	EN-S	\$0
456-006-232	SYMM MGMT SUITE VMAX 20K N-S 41-60TB	EN-S	\$0
456-006-233	SYMM MGMT SUITE VMAX 20K N-S 61-100TB	EN-S	\$0
456-006-234	SYMM MGMT SUITE VMAX 20K N-S 101-150TB	EN-S	\$0
456-006-235	SYMM MGMT SUITE VMAX 20K N-S 151-250TB	EN-S	\$0
456-006-236	SYMM MGMT SUITE VMAX 20K N-S 251-400TB	EN-S	\$0
456-006-237	SYMM MGMT SUITE VMAX 20K N-S 401-600TB	EN-S	\$0
456-006-238	SYMM MGMT SUITE VMAX 20K N-S 601-1000TB	EN-S	\$0
456-006-239	SYMM MGMT SUITE VMAX 20K N-S 1000TB+	EN-S	\$0
456-006-240	TIMEFINDER SUITE VMAX 20K SATA 0-14TB	EN-S	\$0
456-006-241	TIMEFINDER SUITE VMAX 20K SATA 15-25TB	EN-S	\$0
456-006-242	TIMEFINDER SUITE VMAX 20K SATA 26-40TB	EN-S	\$0
456-006-243	TIMEFINDER SUITE VMAX 20K SATA 41-60TB	EN-S	\$0
456-006-244	TIMEFINDER SUITE VMAX 20K SATA 61-100TB	EN-S	\$0
456-006-245	TIMEFINDER SUITE VMAX 20K SATA 101-150TB	EN-S	\$0
456-006-246	TIMEFINDER SUITE VMAX 20K SATA 151-250TB	EN-S	\$0
456-006-247	TIMEFINDER SUITE VMAX 20K SATA 251-400TB	EN-S	\$0
456-006-248	TIMEFINDER SUITE VMAX 20K SATA 401-600TB	EN-S	\$0
456-006-249	TIMEFINDER SUITE VMAX 20K SATA601-1000TB	EN-S	\$0
456-006-250	TIMEFINDER SUITE VMAX 20K SATA 1000TB+	EN-S	\$0
456-006-251	TIMEFINDER SUITE VMAX 20K N-S 0-14TB	EN-S	\$0
456-006-252	TIMEFINDER SUITE VMAX 20K N-S 15-25TB	EN-S	\$0
456-006-253	TIMEFINDER SUITE VMAX 20K N-S 26-40TB	EN-S	\$0
456-006-254	TIMEFINDER SUITE VMAX 20K N-S 41-60TB	EN-S	\$0

456-006-255	TIMEFINDER SUITE VMAX 20K N-S 61-100TB	EN-S	\$0
456-006-256	TIMEFINDER SUITE VMAX 20K N-S 101-150TB	EN-S	\$0
456-006-257	TIMEFINDER SUITE VMAX 20K N-S 151-250TB	EN-S	\$0
456-006-258	TIMEFINDER SUITE VMAX 20K N-S 251-400TB	EN-S	\$0
456-006-259	TIMEFINDER SUITE VMAX 20K N-S 401-600TB	EN-S	\$0
456-006-260	TIMEFINDER SUITE VMAX 20K N-S 601-1000TB	EN-S	\$0
456-006-261	TIMEFINDER SUITE VMAX 20K N-S 1000TB+	EN-S	\$0
456-006-262	TIMEFINDER SUITE VMAX 20K FTS 0-14TB	EN-S	\$0
456-006-263	TIMEFINDER SUITE VMAX 20K FTS 15-25TB	EN-S	\$0
456-006-264	TIMEFINDER SUITE VMAX 20K FTS 26-40TB	EN-S	\$0
456-006-265	TIMEFINDER SUITE VMAX 20K FTS 41-60TB	EN-S	\$0
456-006-266	TIMEFINDER SUITE VMAX 20K FTS 61-100TB	EN-S	\$0
456-006-267	TIMEFINDER SUITE VMAX 20K FTS 101-150TB	EN-S	\$0
456-006-268	TIMEFINDER SUITE VMAX 20K FTS 151-250TB	EN-S	\$0
456-006-269	TIMEFINDER SUITE VMAX 20K FTS 251-400TB	EN-S	\$0
456-006-270	TIMEFINDER SUITE VMAX 20K FTS 401-600TB	EN-S	\$0
456-006-271	TIMEFINDER SUITE VMAX 20K FTS 601-1000TB	EN-S	\$0
456-006-272	TIMEFINDER SUITE VMAX 20K FTS 1000TB+	EN-S	\$0
456-006-273	TIMEFINDER SUITE VMAX 20K REG 0-14TB	EN-S	\$0
456-006-274	TIMEFINDER SUITE VMAX 20K REG 15-25TB	EN-S	\$0
456-006-275	TIMEFINDER SUITE VMAX 20K REG 26-40TB	EN-S	\$0
456-006-276	TIMEFINDER SUITE VMAX 20K REG 41-60TB	EN-S	\$0
456-006-277	TIMEFINDER SUITE VMAX 20K REG 61-100TB	EN-S	\$0
456-006-278	TIMEFINDER SUITE VMAX 20K REG 101-150TB	EN-S	\$0
456-006-279	TIMEFINDER SUITE VMAX 20K REG 151-250TB	EN-S	\$0
456-006-280	TIMEFINDER SUITE VMAX 20K REG 251-400TB	EN-S	\$0
456-006-281	TIMEFINDER SUITE VMAX 20K REG 401-600TB	EN-S	\$0
456-006-282	TIMEFINDER SUITE VMAX 20K REG 601-1000TB	EN-S	\$0
456-006-283	TIMEFINDER SUITE VMAX 20K REG 1000TB+	EN-S	\$0
456-007-000	SYMM MGMT SUITE 20K SATA 0-14TB	EN-S	\$0
456-007-001	SYMM MGMT SUITE 20K SATA 15-25TB	EN-S	\$0
456-007-002	SYMM MGMT SUITE 20K SATA 26-40TB	EN-S	\$0
456-007-003	SYMM MGMT SUITE 20K SATA 41-60TB	EN-S	\$0
456-007-004	SYMM MGMT SUITE 20K SATA 61-100TB	EN-S	\$0
456-007-005	SYMM MGMT SUITE 20K SATA 101-150TB	EN-S	\$0
456-007-006	SYMM MGMT SUITE 20K SATA 151-250TB	EN-S	\$0
456-007-007	SYMM MGMT SUITE 20K SATA 251-400TB	EN-S	\$0
456-007-008	SYMM MGMT SUITE 20K SATA 401-600TB	EN-S	\$0
456-007-009	SYMM MGMT SUITE 20K SATA 601-1000TB	EN-S	\$0
456-007-010	SYMM MGMT SUITE 20K SATA 1000TB +	EN-S	\$0
456-007-011	SYMM MGMT SUITE 20K NON-SATA 0-14TB	EN-S	\$0
456-007-012	SYMM MGMT SUITE 20K NON-SATA 15-25TB	EN-S	\$0
456-007-013	SYMM MGMT SUITE 20K NON-SATA 26-40TB	EN-S	\$0
456-007-014	SYMM MGMT SUITE 20K NON-SATA 41-60TB	EN-S	\$0
456-007-015	SYMM MGMT SUITE 20K NON-SATA 61-100TB	EN-S	\$0
456-007-016	SYMM MGMT SUITE 20K NON-SATA 101-150TB	EN-S	\$0
456-007-017	SYMM MGMT SUITE 20K NON-SATA 151-250TB	EN-S	\$0
456-007-018	SYMM MGMT SUITE 20K NON-SATA 251-400TB	EN-S	\$0
456-007-019	SYMM MGMT SUITE 20K NON-SATA 401-600TB	EN-S	\$0
456-007-020	SYMM MGMT SUITE 20K NON-SATA 601-1000TB	EN-S	\$0

456-007-021	SYMM MGMT SUITE 20K NON-SATA 1000TB +	EN-S	\$0
456-007-022	SYMM PACK ENH VMAX 20K SATA 0-14TB	EN-S	\$0
456-007-023	SYMM PACK ENH VMAX 20K SATA 15-25TB	EN-S	\$0
456-007-024	SYMM PACK ENH VMAX 20K SATA 26-40TB	EN-S	\$0
456-007-025	SYMM PACK ENH VMAX 20K SATA 41-60TB	EN-S	\$0
456-007-026	SYMM PACK ENH VMAX 20K SATA 61-100TB	EN-S	\$0
456-007-027	SYMM PACK ENH VMAX 20K SATA 101-150TB	EN-S	\$0
456-007-028	SYMM PACK ENH VMAX 20K SATA 151-250TB	EN-S	\$0
456-007-029	SYMM PACK ENH VMAX 20K SATA 251-400TB	EN-S	\$0
456-007-030	SYMM PACK ENH VMAX 20K SATA 401-600TB	EN-S	\$0
456-007-031	SYMM PACK ENH VMAX 20K SATA 601-1000TB	EN-S	\$0
456-007-032	SYMM PACK ENH VMAX 20K SATA 1000TB +	EN-S	\$0
456-007-033	SYMM PACK ENH VMAX 20K N-S 0-14TB	EN-S	\$0
456-007-034	SYMM PACK ENH VMAX 20K N-S 15-25TB	EN-S	\$0
456-007-035	SYMM PACK ENH VMAX 20K N-S 26-40TB	EN-S	\$0
456-007-036	SYMM PACK ENH VMAX 20K N-S 41-60TB	EN-S	\$0
456-007-037	SYMM PACK ENH VMAX 20K N-S 61-100TB	EN-S	\$0
456-007-038	SYMM PACK ENH VMAX 20K N-S 101-150TB	EN-S	\$0
456-007-039	SYMM PACK ENH VMAX 20K N-S 151-250TB	EN-S	\$0
456-007-040	SYMM PACK ENH VMAX 20K N-S 251-400TB	EN-S	\$0
456-007-041	SYMM PACK ENH VMAX 20K N-S 401-600TB	EN-S	\$0
456-007-042	SYMM PACK ENH VMAX 20K N-S 601-1000TB	EN-S	\$0
456-007-043	SYMM PACK ENH VMAX 20K N-S 1000TB +	EN-S	\$0
456-007-044	ADV FAST SUITE VMAX 20K EXT 0-14TB	EN-S	\$0
456-007-045	ADV FAST SUITE VMAX 20K EXT 15-25TB	EN-S	\$0
456-007-046	ADV FAST SUITE VMAX 20K EXT 26-40TB	EN-S	\$0
456-007-047	ADV FAST SUITE VMAX 20K EXT 41-60TB	EN-S	\$0
456-007-048	ADV FAST SUITE VMAX 20K EXT 61-100TB	EN-S	\$0
456-007-049	ADV FAST SUITE VMAX 20K EXT 101-150TB	EN-S	\$0
456-007-050	ADV FAST SUITE VMAX 20K EXT 151-250TB	EN-S	\$0
456-007-051	ADV FAST SUITE VMAX 20K EXT 251-400TB	EN-S	\$0
456-007-052	ADV FAST SUITE VMAX 20K EXT 401-600TB	EN-S	\$0
456-007-053	ADV FAST SUITE VMAX 20K EXT 601-1000TB	EN-S	\$0
456-007-054	ADV FAST SUITE VMAX 20K EXT 1001TB+	EN-S	\$0
456-007-055	SRDF-A VMAX 20K EXTERNAL 0 - 14TB	EN-S	\$0
456-007-056	SRDF-A VMAX 20K EXTERNAL 15-25TB	EN-S	\$0
456-007-057	SRDF-A VMAX 20K EXTERNAL 26-40TB	EN-S	\$0
456-007-058	SRDF-A VMAX 20K EXTERNAL 41-60TB	EN-S	\$0
456-007-059	SRDF-A VMAX 20K EXTERNAL 61-100TB	EN-S	\$0
456-007-060	SRDF-A VMAX 20K EXTERNAL 101-150TB	EN-S	\$0
456-007-061	SRDF-A VMAX 20K EXTERNAL 151-250TB	EN-S	\$0
456-007-062	SRDF-A VMAX 20K EXTERNAL 251-400TB	EN-S	\$0
456-007-063	SRDF-A VMAX 20K EXTERNAL 401-600TB	EN-S	\$0
456-007-064	SRDF-A VMAX 20K EXTERNAL 601-1000TB	EN-S	\$0
456-007-065	SRDF-A VMAX 20K EXTERNAL 1001TB+	EN-S	\$0
456-007-066	SRDF-S VMAX 20K EXTERNAL 0 - 14TB	EN-S	\$0
456-007-067	SRDF-S VMAX 20K EXTERNAL 15-25TB	EN-S	\$0
456-007-068	SRDF-S VMAX 20K EXTERNAL 26-40TB	EN-S	\$0
456-007-069	SRDF-S VMAX 20K EXTERNAL 41-60TB	EN-S	\$0
456-007-070	SRDF-S VMAX 20K EXTERNAL 61-100TB	EN-S	\$0

456-007-071	SRDF-S VMAX 20K EXTERNAL 101-150TB	EN-S	\$0
456-007-072	SRDF-S VMAX 20K EXTERNAL 151-250TB	EN-S	\$0
456-007-073	SRDF-S VMAX 20K EXTERNAL 251-400TB	EN-S	\$0
456-007-074	SRDF-S VMAX 20K EXTERNAL 401-600TB	EN-S	\$0
456-007-075	SRDF-S VMAX 20K EXTERNAL 601-1000TB	EN-S	\$0
456-007-076	SRDF-S VMAX 20K EXTERNAL 1001TB+	EN-S	\$0
456-007-077	SRDF-STAR VMAX 20K EXTERNAL 0 - 14TB	EN-S	\$0
456-007-078	SRDF-STAR VMAX 20K EXTERNAL 15-25TB	EN-S	\$0
456-007-079	SRDF-STAR VMAX 20K EXTERNAL 26-40TB	EN-S	\$0
456-007-080	SRDF-STAR VMAX 20K EXTERNAL 41-60TB	EN-S	\$0
456-007-081	SRDF-STAR VMAX 20K EXTERNAL 61-100TB	EN-S	\$0
456-007-082	SRDF-STAR VMAX 20K EXTERNAL 101-150TB	EN-S	\$0
456-007-083	SRDF-STAR VMAX 20K EXTERNAL 151-250TB	EN-S	\$0
456-007-084	SRDF-STAR VMAX 20K EXTERNAL 251-400TB	EN-S	\$0
456-007-085	SRDF-STAR VMAX 20K EXTERNAL 401-600TB	EN-S	\$0
456-007-086	SRDF-STAR VMAX 20K EXTERNAL 601-1000TB	EN-S	\$0
456-007-087	SRDF-STAR VMAX 20K EXTERNAL 1001TB+	EN-S	\$0
456-007-088	TF-CLONE VMAX 20K EXTERNAL 0-14TB	EN-S	\$0
456-007-089	TF-CLONE VMAX 20K EXTERNAL 15-25TB	EN-S	\$0
456-007-090	TF-CLONE VMAX 20K EXTERNAL 26-40TB	EN-S	\$0
456-007-091	TF-CLONE VMAX 20K EXTERNAL 41-60TB	EN-S	\$0
456-007-092	TF-CLONE VMAX 20K EXTERNAL 61-100TB	EN-S	\$0
456-007-093	TF-CLONE VMAX 20K EXTERNAL 101-150TB	EN-S	\$0
456-007-094	TF-CLONE VMAX 20K EXTERNAL 151-250TB	EN-S	\$0
456-007-095	TF-CLONE VMAX 20K EXTERNAL 251-400TB	EN-S	\$0
456-007-096	TF-CLONE VMAX 20K EXTERNAL 401-600TB	EN-S	\$0
456-007-097	TF-CLONE VMAX 20K EXTERNAL 601-1000TB	EN-S	\$0
456-007-098	TF-CLONE VMAX 20K EXTERNAL 1001TB+	EN-S	\$0
456-007-099	TF-SNAP VMAX 20K EXTERNAL 0 - 14TB	EN-S	\$0
456-007-100	TF-SNAP VMAX 20K EXTERNAL 15-25TB	EN-S	\$0
456-007-101	TF-SNAP VMAX 20K EXTERNAL 26-40TB	EN-S	\$0
456-007-102	TF-SNAP VMAX 20K EXTERNAL 41-60TB	EN-S	\$0
456-007-103	TF-SNAP VMAX 20K EXTERNAL 61-100TB	EN-S	\$0
456-007-104	TF-SNAP VMAX 20K EXTERNAL 101-150TB	EN-S	\$0
456-007-105	TF-SNAP VMAX 20K EXTERNAL 151-250TB	EN-S	\$0
456-007-106	TF-SNAP VMAX 20K EXTERNAL 251-400TB	EN-S	\$0
456-007-107	TF-SNAP VMAX 20K EXTERNAL 401-600TB	EN-S	\$0
456-007-108	TF-SNAP VMAX 20K EXTERNAL 601-1000TB	EN-S	\$0
456-007-109	TF-SNAP VMAX 20K EXTERNAL 1001TB+	EN-S	\$0
456-007-132	VMAX20K OR-DM N-SATA 0-14TB=CB	EN-S	\$3,942
456-007-133	VMAX20K OR-DM N-SATA 15-25TB=CB	EN-S	\$3,708
456-007-134	VMAX20K OR-DM N-SATA 26-40TB=CB	EN-S	\$3,267
456-007-135	VMAX20K OR-DM N-SATA 41-60TB=CB	EN-S	\$2,916
456-007-136	VMAX20K OR-DM N-SATA 61-100TB=CB	EN-S	\$2,601
456-007-137	VMAX20K OR-DM N-SATA 101-150TB=CB	EN-S	\$2,304
456-007-138	VMAX20K OR-DM N-SATA 151-250TB=CB	EN-S	\$1,980
456-007-139	VMAX20K OR-DM N-SATA 251-400TB=CB	EN-S	\$1,692
456-007-140	VMAX20K OR-DM N-SATA 401-600TB=CB	EN-S	\$1,458
456-007-141	VMAX20K OR-DM N-SATA 601-1000TB=CB	EN-S	\$1,251
456-007-142	VMAX20K OR-DM N-SATA 1001TB+=CB	EN-S	\$1,071

456-007-143	VMAX20K OR-DM SATA 0-14TB=CB	EN-S	\$1,971
456-007-144	VMAX20K OR-DM SATA 15-25TB=CB	EN-S	\$1,854
456-007-145	VMAX20K OR-DM SATA 26-40TB=CB	EN-S	\$1,629
456-007-146	VMAX20K OR-DM SATA 41-60TB=CB	EN-S	\$1,458
456-007-147	VMAX20K OR-DM SATA 61-100TB=CB	EN-S	\$1,305
456-007-148	VMAX20K OR-DM SATA 101-150TB=CB	EN-S	\$1,152
456-007-149	VMAX20K OR-DM SATA 151-250TB=CB	EN-S	\$990
456-007-150	VMAX20K OR-DM SATA 251-400TB=CB	EN-S	\$846
456-007-151	VMAX20K OR-DM SATA 401-600TB=CB	EN-S	\$729
456-007-152	VMAX20K OR-DM SATA 601-1000TB=CB	EN-S	\$621
456-007-153	VMAX20K OR-DM SATA 1001TB+=CB	EN-S	\$540
456-007-176	FAST VMAX 20K REGISTERED 0-14TB	EN-S	\$0
456-007-177	FAST VMAX 20K REGISTERED 15-25TB	EN-S	\$0
456-007-178	FAST VMAX 20K REGISTERED 26-40TB	EN-S	\$0
456-007-179	FAST VMAX 20K REGISTERED 41-60TB	EN-S	\$0
456-007-180	FAST VMAX 20K REGISTERED 61-100TB	EN-S	\$0
456-007-181	FAST VMAX 20K REGISTERED 101-150TB	EN-S	\$0
456-007-182	FAST VMAX 20K REGISTERED 151-250TB	EN-S	\$0
456-007-183	FAST VMAX 20K REGISTERED 251-400TB	EN-S	\$0
456-007-184	FAST VMAX 20K REGISTERED 401-600TB	EN-S	\$0
456-007-185	FAST VMAX 20K REGISTERED 601-1000TB	EN-S	\$0
456-007-186	FAST VMAX 20K REGISTERED 1001+	EN-S	\$0
456-007-187	VMAX20K FAST VP REG 0-14TB=CA	EN-S	\$2,474
456-007-188	VMAX20K FAST VP REG 15-25TB=CA	EN-S	\$2,186
456-007-189	VMAX20K FAST VP REG 26-40TB=CA	EN-S	\$1,908
456-007-190	VMAX20K FAST VP REG 41-60TB=CA	EN-S	\$1,656
456-007-191	VMAX20K FAST VP REG 61-100TB=CA	EN-S	\$1,455
456-007-192	VMAX20K FAST VP REG 101-150TB=CA	EN-S	\$1,358
456-007-193	VMAX20K FAST VP REG 151-250TB=CA	EN-S	\$1,253
456-007-194	VMAX20K FAST VP REG 251-400TB=CA	EN-S	\$1,148
456-007-195	VMAX20K FAST VP REG 401-600TB=CA	EN-S	\$1,093
456-007-196	VMAX20K FAST VP REG 601-1000TB=CA	EN-S	\$1,014
456-007-197	VMAX20K FAST VP REG 1001+=CA	EN-S	\$923
456-007-198	VMAX20K OPTIMIZER N-SATA 0-14TB=CB	EN-S	\$0
456-007-199	VMAX20K OPTIMIZER N-SATA 15-25TB=CB	EN-S	\$0
456-007-200	VMAX20K OPTIMIZER N-SATA 26-40TB=CB	EN-S	\$0
456-007-201	VMAX20K OPTIMIZER N-SATA 41-60TB=CB	EN-S	\$0
456-007-202	VMAX20K OPTIMIZER N-SATA 61-100TB=CB	EN-S	\$0
456-007-203	VMAX20K OPTIMIZER N-SATA 101-150TB=CB	EN-S	\$0
456-007-204	VMAX20K OPTIMIZER N-SATA 151-250TB=CB	EN-S	\$0
456-007-205	VMAX20K OPTIMIZER N-SATA 251-400TB=CB	EN-S	\$0
456-007-206	VMAX20K OPTIMIZER N-SATA 401-600TB=CB	EN-S	\$0
456-007-207	VMAX20K OPTIMIZER N-SATA 601-1000TB=CB	EN-S	\$0
456-007-208	VMAX20K OPTIMIZER N-SATA 1001TB+=CB	EN-S	\$0
456-007-209	VMAX20K OPTIMIZER SATA 0-14TB=CB	EN-S	\$0
456-007-210	VMAX20K OPTIMIZER SATA 15-25TB=CB	EN-S	\$0
456-007-211	VMAX20K OPTIMIZER SATA 26-40TB=CB	EN-S	\$0
456-007-212	VMAX20K OPTIMIZER SATA 41-60TB=CB	EN-S	\$0
456-007-213	VMAX20K OPTIMIZER SATA 61-100TB=CB	EN-S	\$0
456-007-214	VMAX20K OPTIMIZER SATA 101-150TB=CB	EN-S	\$0

456-007-215	VMAX20K OPTIMIZER SATA 151-250TB=CB	EN-S	\$0
456-007-216	VMAX20K OPTIMIZER SATA 251-400TB=CB	EN-S	\$0
456-007-217	VMAX20K OPTIMIZER SATA 401-600TB=CB	EN-S	\$0
456-007-218	VMAX20K OPTIMIZER SATA 601-1000TB=CB	EN-S	\$0
456-007-219	VMAX20K OPTIMIZER SATA 1001TB+=CB	EN-S	\$0
456-007-220	ATSM VMAX 20K NON-SATA 0-14TB	EN-S	\$0
456-007-221	ATSM VMAX 20K NON-SATA 15-25TB	EN-S	\$0
456-007-222	ATSM VMAX 20K NON-SATA 26-40TB	EN-S	\$0
456-007-223	ATSM VMAX 20K NON-SATA 41-60TB	EN-S	\$0
456-007-224	ATSM VMAX 20K NON-SATA 61-100TB	EN-S	\$0
456-007-225	ATSM VMAX 20K NON-SATA 101-150TB	EN-S	\$0
456-007-226	ATSM VMAX 20K NON-SATA 151-250TB	EN-S	\$0
456-007-227	ATSM VMAX 20K NON-SATA 251-400TB	EN-S	\$0
456-007-228	ATSM VMAX 20K NON-SATA 401-600TB	EN-S	\$0
456-007-229	ATSM VMAX 20K NON-SATA 601-1000TB	EN-S	\$0
456-007-230	ATSM VMAX 20K NON-SATA 1001+	EN-S	\$0
456-007-231	ATSM VMAX 20K SATA 0-14TB	EN-S	\$0
456-007-232	ATSM VMAX 20K SATA 15-25TB	EN-S	\$0
456-007-233	ATSM VMAX 20K SATA 26-40TB	EN-S	\$0
456-007-234	ATSM VMAX 20K SATA 41-60TB	EN-S	\$0
456-007-235	ATSM VMAX 20K SATA 61-100TB	EN-S	\$0
456-007-236	ATSM VMAX 20K SATA 101-150TB	EN-S	\$0
456-007-237	ATSM VMAX 20K SATA 151-250TB	EN-S	\$0
456-007-238	ATSM VMAX 20K SATA 251-400TB	EN-S	\$0
456-007-239	ATSM VMAX 20K SATA 401-600TB	EN-S	\$0
456-007-240	ATSM VMAX 20K SATA 601-1000TB	EN-S	\$0
456-007-241	ATSM VMAX 20K SATA 1001+	EN-S	\$0
456-007-242	TSM VMAX 20K NON-SATA 0-14TB	EN-S	\$0
456-007-243	TSM VMAX 20K NON-SATA 15-25TB	EN-S	\$0
456-007-244	TSM VMAX 20K NON-SATA 26-40TB	EN-S	\$0
456-007-245	TSM VMAX 20K NON-SATA 41-60TB	EN-S	\$0
456-007-246	TSM VMAX 20K NON-SATA 61-100TB	EN-S	\$0
456-007-247	TSM VMAX 20K NON-SATA 101-150TB	EN-S	\$0
456-007-248	TSM VMAX 20K NON-SATA 151-250TB	EN-S	\$0
456-007-249	TSM VMAX 20K NON-SATA 251-400TB	EN-S	\$0
456-007-250	TSM VMAX 20K NON-SATA 401-600TB	EN-S	\$0
456-007-251	TSM VMAX 20K NON-SATA 601-1000TB	EN-S	\$0
456-007-252	TSM VMAX 20K NON-SATA 1001+	EN-S	\$0
456-007-253	TSM VMAX 20K SATA 0-14TB	EN-S	\$0
456-007-254	TSM VMAX 20K SATA 15-25TB	EN-S	\$0
456-007-255	TSM VMAX 20K SATA 26-40TB	EN-S	\$0
456-007-256	TSM VMAX 20K SATA 41-60TB	EN-S	\$0
456-007-257	TSM VMAX 20K SATA 61-100TB	EN-S	\$0
456-007-258	TSM VMAX 20K SATA 101-150TB	EN-S	\$0
456-007-259	TSM VMAX 20K SATA 151-250TB	EN-S	\$0
456-007-260	TSM VMAX 20K SATA 251-400TB	EN-S	\$0
456-007-261	TSM VMAX 20K SATA 401-600TB	EN-S	\$0
456-007-262	TSM VMAX 20K SATA 601-1000TB	EN-S	\$0
456-007-263	TSM VMAX 20K SATA 1001+	EN-S	\$0
456-007-264	FAST SUITE VMAX 20K NON-SATA 0-14TB	EN-S	\$0

456-007-265	FAST SUITE VMAX 20K NON-SATA 15-25TB	EN-S	\$0
456-007-266	FAST SUITE VMAX 20K NON-SATA 26-40TB	EN-S	\$0
456-007-267	FAST SUITE VMAX 20K NON-SATA 41-60TB	EN-S	\$0
456-007-268	FAST SUITE VMAX 20K NON-SATA 61-100TB	EN-S	\$0
456-007-269	FAST SUITE VMAX 20K NON-SATA 101-150TB	EN-S	\$0
456-007-270	FAST SUITE VMAX 20K NON-SATA 151-250TB	EN-S	\$0
456-007-271	FAST SUITE VMAX 20K NON-SATA 251-400TB	EN-S	\$0
456-007-272	FAST SUITE VMAX 20K NON-SATA 401-600TB	EN-S	\$0
456-007-273	FAST SUITE VMAX 20K NON-SATA 601-1000TB	EN-S	\$0
456-007-274	FAST SUITE VMAX 20K NON-SATA 1001+	EN-S	\$0
456-007-275	FAST SUITE VMAX 20K SATA 0-14TB	EN-S	\$0
456-007-276	FAST SUITE VMAX 20K SATA 15-25TB	EN-S	\$0
456-007-277	FAST SUITE VMAX 20K SATA 26-40TB	EN-S	\$0
456-007-278	FAST SUITE VMAX 20K SATA 41-60TB	EN-S	\$0
456-007-279	FAST SUITE VMAX 20K SATA 61-100TB	EN-S	\$0
456-007-280	FAST SUITE VMAX 20K SATA 101-150TB	EN-S	\$0
456-007-281	FAST SUITE VMAX 20K SATA 151-250TB	EN-S	\$0
456-007-282	FAST SUITE VMAX 20K SATA 251-400TB	EN-S	\$0
456-007-283	FAST SUITE VMAX 20K SATA 401-600TB	EN-S	\$0
456-007-284	FAST SUITE VMAX 20K SATA 601-1000TB	EN-S	\$0
456-007-285	FAST SUITE VMAX 20K SATA 1001+	EN-S	\$0
456-007-286	FAST VMAX 20K ADD ON NON-SATA 0-14TB	EN-S	\$0
456-007-287	FAST VMAX 20K ADD ON NON-SATA 15-25TB	EN-S	\$0
456-007-288	FAST VMAX 20K ADD ON NON-SATA 26-40TB	EN-S	\$0
456-007-289	FAST VMAX 20K ADD ON NON-SATA 41-60TB	EN-S	\$0
456-007-290	FAST VMAX 20K ADD ON NON-SATA 61-100TB	EN-S	\$0
456-007-291	FAST VMAX 20K ADD ON NON-SATA 101-150TB	EN-S	\$0
456-007-292	FAST VMAX 20K ADD ON NON-SATA 151-250TB	EN-S	\$0
456-007-293	FAST VMAX 20K ADD ON NON-SATA 251-400TB	EN-S	\$0
456-007-294	FAST VMAX 20K ADD ON NON-SATA 401-600TB	EN-S	\$0
456-007-295	FAST VMAX 20K ADD ON NON-SATA 601-1000TB	EN-S	\$0
456-007-296	FAST VMAX 20K ADD ON NON-SATA 1001+	EN-S	\$0
456-007-297	FAST VMAX 20K ADD ON SATA 0-14TB	EN-S	\$0
456-007-298	FAST VMAX 20K ADD ON SATA 15-25TB	EN-S	\$0
456-007-299	FAST VMAX 20K ADD ON SATA 26-40TB	EN-S	\$0
456-007-300	FAST VMAX 20K ADD ON SATA 41-60TB	EN-S	\$0
456-007-301	FAST VMAX 20K ADD ON SATA 61-100TB	EN-S	\$0
456-007-302	FAST VMAX 20K ADD ON SATA 101-150TB	EN-S	\$0
456-007-303	FAST VMAX 20K ADD ON SATA 151-250TB	EN-S	\$0
456-007-304	FAST VMAX 20K ADD ON SATA 251-400TB	EN-S	\$0
456-007-305	FAST VMAX 20K ADD ON SATA 401-600TB	EN-S	\$0
456-007-306	FAST VMAX 20K ADD ON SATA 601-1000TB	EN-S	\$0
456-007-307	FAST VMAX 20K ADD ON SATA 1001+	EN-S	\$0
456-007-308	ADV FAST SUITE VMAX 20K NON-SATA 0-14TB	EN-S	\$0
456-007-309	ADV FAST SUITE VMAX 20K NON-SATA 15-25TB	EN-S	\$0
456-007-310	ADV FAST SUITE VMAX 20K NON-SATA 26-40TB	EN-S	\$0
456-007-311	ADV FAST SUITE VMAX 20K NON-SATA 41-60TB	EN-S	\$0
456-007-312	ADV FAST SUITE VMAX 20K N-S 61-100TB	EN-S	\$0
456-007-313	ADV FAST SUITE VMAX 20K N-S 101-150TB	EN-S	\$0
456-007-314	ADV FAST SUITE VMAX 20K N-S 151-250TB	EN-S	\$0

456-007-315	ADV FAST SUITE VMAX 20K N-S 251-400TB	EN-S	\$0
456-007-316	ADV FAST SUITE VMAX 20K N-S 401-600TB	EN-S	\$0
456-007-317	ADV FAST SUITE VMAX 20K N-S 601-1000TB	EN-S	\$0
456-007-318	ADV FAST SUITE VMAX 20K NON-SATA 1001TB+	EN-S	\$0
456-007-319	ADV FAST SUITE VMAX 20K SATA 0-14TB	EN-S	\$0
456-007-320	ADV FAST SUITE VMAX 20K SATA 15-25TB	EN-S	\$0
456-007-321	ADV FAST SUITE VMAX 20K SATA 26-40TB	EN-S	\$0
456-007-322	ADV FAST SUITE VMAX 20K SATA 41-60TB	EN-S	\$0
456-007-323	ADV FAST SUITE VMAX 20K SATA 61-100TB	EN-S	\$0
456-007-324	ADV FAST SUITE VMAX 20K SATA 101-150TB	EN-S	\$0
456-007-325	ADV FAST SUITE VMAX 20K SATA 151-250TB	EN-S	\$0
456-007-326	ADV FAST SUITE VMAX 20K SATA 251-400TB	EN-S	\$0
456-007-327	ADV FAST SUITE VMAX 20K SATA 401-600TB	EN-S	\$0
456-007-328	ADV FAST SUITE VMAX 20K SATA 601-1000TB	EN-S	\$0
456-007-329	ADV FAST SUITE VMAX 20K SATA 1001TB+	EN-S	\$0
456-007-330	VMAX20K FAST VP AO N-SATA 0-14TB=CB	EN-S	\$509
456-007-331	VMAX20K FAST VP AO N-SATA 15-25TB=CB	EN-S	\$479
456-007-332	VMAX20K FAST VP AO N-SATA 26-40TB=CB	EN-S	\$420
456-007-333	VMAX20K FAST VP AO N-SATA 41-60TB=CB	EN-S	\$390
456-007-334	VMAX20K FAST VP AO N-SATA 61-100TB=CB	EN-S	\$374
456-007-335	VMAX20K FAST VP AO N-SATA 101-150TB=CB	EN-S	\$338
456-007-336	VMAX20K FAST VP AO N-SATA 151-250TB=CB	EN-S	\$302
456-007-337	VMAX20K FAST VP AO N-SATA 251-400TB=CB	EN-S	\$262
456-007-338	VMAX20K FAST VP AO N-SATA 401-600TB=CB	EN-S	\$223
456-007-339	VMAX20K FAST VP AO N-SATA 601-1000TB=CB	EN-S	\$200
456-007-340	VMAX20K FAST VP AO N-SATA 1001+=CB	EN-S	\$174
456-007-341	VMAX20K FAST VP AO SATA 0-14TB=CB	EN-S	\$256
456-007-342	VMAX20K FAST VP AO SATA 15-25TB=CB	EN-S	\$239
456-007-343	VMAX20K FAST VP AO SATA 26-40TB=CB	EN-S	\$210
456-007-344	VMAX20K FAST VP AO SATA 41-60TB=CB	EN-S	\$197
456-007-345	VMAX20K FAST VP AO SATA 61-100TB=CB	EN-S	\$187
456-007-346	VMAX20K FAST VP AO SATA 101-150TB=CB	EN-S	\$167
456-007-347	VMAX20K FAST VP AO SATA 151-250TB=CB	EN-S	\$151
456-007-348	VMAX20K FAST VP AO SATA 251-400TB=CB	EN-S	\$131
456-007-349	VMAX20K FAST VP AO SATA 401-600TB=CB	EN-S	\$111
456-007-350	VMAX20K FAST VP AO SATA 601-1000TB=CB	EN-S	\$98
456-007-351	VMAX20K FAST VP AO SATA 1001+=CB	EN-S	\$86
456-007-352	ADV FAST VMAX 20K AO NON-SATA 0-14TB	EN-S	\$0
456-007-353	ADV FAST VMAX 20K AO NON-SATA 15-25TB	EN-S	\$0
456-007-354	ADV FAST VMAX 20K AO NON-SATA 26-40TB	EN-S	\$0
456-007-355	ADV FAST VMAX 20K AO NON-SATA 41-60TB	EN-S	\$0
456-007-356	ADV FAST VMAX 20K AO NON-SATA 61-100TB	EN-S	\$0
456-007-357	ADV FAST VMAX 20K AO NON-SATA 101-150TB	EN-S	\$0
456-007-358	ADV FAST VMAX 20K AO NON-SATA 151-250TB	EN-S	\$0
456-007-359	ADV FAST VMAX 20K AO NON-SATA 251-400TB	EN-S	\$0
456-007-360	ADV FAST VMAX 20K AO NON-SATA 401-600TB	EN-S	\$0
456-007-361	ADV FAST VMAX 20K AO NON-SATA 601-1000TB	EN-S	\$0
456-007-362	ADV FAST VMAX 20K AO NON-SATA 1001+	EN-S	\$0
456-007-363	ADV FAST VMAX 20K ADD ON SATA 0-14TB	EN-S	\$0
456-007-364	ADV FAST VMAX 20K ADD ON SATA 15-25TB	EN-S	\$0

456-007-365	ADV FAST VMAX 20K ADD ON SATA 26-40TB	EN-S	\$0
456-007-366	ADV FAST VMAX 20K ADD ON SATA 41-60TB	EN-S	\$0
456-007-367	ADV FAST VMAX 20K ADD ON SATA 61-100TB	EN-S	\$0
456-007-368	ADV FAST VMAX 20K ADD ON SATA 101-150TB	EN-S	\$0
456-007-369	ADV FAST VMAX 20K ADD ON SATA 151-250TB	EN-S	\$0
456-007-370	ADV FAST VMAX 20K ADD ON SATA 251-400TB	EN-S	\$0
456-007-371	ADV FAST VMAX 20K ADD ON SATA 401-600TB	EN-S	\$0
456-007-372	ADV FAST VMAX 20K ADD ON SATA 601-1000TB	EN-S	\$0
456-007-373	ADV FAST VMAX 20K ADD ON SATA 1001+	EN-S	\$0
456-007-374	VMAX20K DCP N-SATA 0-14TB=CB	EN-S	\$0
456-007-375	VMAX20K DCP N-SATA 15-25TB=CB	EN-S	\$0
456-007-376	VMAX20K DCP N-SATA 26-40TB=CB	EN-S	\$0
456-007-377	VMAX20K DCP N-SATA 41-60TB=CB	EN-S	\$0
456-007-378	VMAX20K DCP N-SATA 61-100TB=CB	EN-S	\$0
456-007-379	VMAX20K DCP N-SATA 101-150TB=CB	EN-S	\$0
456-007-380	VMAX20K DCP N-SATA 151-250TB=CB	EN-S	\$0
456-007-381	VMAX20K DCP N-SATA 251-400TB=CB	EN-S	\$0
456-007-382	VMAX20K DCP N-SATA 401-600TB=CB	EN-S	\$0
456-007-383	VMAX20K DCP N-SATA 601-1000TB=CB	EN-S	\$0
456-007-384	VMAX20K DCP N-SATA 1001TB+=CB	EN-S	\$0
456-007-385	VMAX20K DCP SATA 0-14TB=CB	EN-S	\$0
456-007-386	VMAX20K DCP SATA 15-25TB=CB	EN-S	\$0
456-007-387	VMAX20K DCP SATA 26-40TB=CB	EN-S	\$0
456-007-388	VMAX20K DCP SATA 41-60TB=CB	EN-S	\$0
456-007-389	VMAX20K DCP SATA 61-100TB=CB	EN-S	\$0
456-007-390	VMAX20K DCP SATA 101-150TB=CB	EN-S	\$0
456-007-391	VMAX20K DCP SATA 151-250TB=CB	EN-S	\$0
456-007-392	VMAX20K DCP SATA 251-400TB=CB	EN-S	\$0
456-007-393	VMAX20K DCP SATA 401-600TB=CB	EN-S	\$0
456-007-394	VMAX20K DCP SATA 601-1000TB=CB	EN-S	\$0
456-007-395	VMAX20K DCP SATA 1001TB+=CB	EN-S	\$0
456-007-396	SPC VMAX 20K NON-SATA 0-14TB	EN-S	\$0
456-007-397	SPC VMAX 20K NON-SATA 15-25TB	EN-S	\$0
456-007-398	SPC VMAX 20K NON-SATA 26-40TB	EN-S	\$0
456-007-399	SPC VMAX 20K NON-SATA 41-60TB	EN-S	\$0
456-007-400	SPC VMAX 20K NON-SATA 61-100TB	EN-S	\$0
456-007-401	SPC VMAX 20K NON-SATA 101-150TB	EN-S	\$0
456-007-402	SPC VMAX 20K NON-SATA 151-250TB	EN-S	\$0
456-007-403	SPC VMAX 20K NON-SATA 251-400TB	EN-S	\$0
456-007-404	SPC VMAX 20K NON-SATA 401-600TB	EN-S	\$0
456-007-405	SPC VMAX 20K NON-SATA 601-1000TB	EN-S	\$0
456-007-406	SPC VMAX 20K NON-SATA 1001TB+	EN-S	\$0
456-007-407	SPC VMAX 20K SATA 0-14TB	EN-S	\$0
456-007-408	SPC VMAX 20K SATA 15-25TB	EN-S	\$0
456-007-409	SPC VMAX 20K SATA 26-40TB	EN-S	\$0
456-007-410	SPC VMAX 20K SATA 41-60TB	EN-S	\$0
456-007-411	SPC VMAX 20K SATA 61-100TB	EN-S	\$0
456-007-412	SPC VMAX 20K SATA 101-150TB	EN-S	\$0
456-007-413	SPC VMAX 20K SATA 151-250TB	EN-S	\$0
456-007-414	SPC VMAX 20K SATA 251-400TB	EN-S	\$0

456-007-415	SPC VMAX 20K SATA 401-600TB	EN-S	\$0
456-007-416	SPC VMAX 20K SATA 601-1000TB	EN-S	\$0
456-007-417	SPC VMAX 20K SATA 1001TB+	EN-S	\$0
456-007-418	RMT SYNC 20K-SRDFS CMPPEER REG 0-14 TB	EN-S	\$0
456-007-419	RMT SYNC 20K-SRDFS CMPPEER REG 15-25 TB	EN-S	\$0
456-007-420	RMT SYNC 20K-SRDFS CMPPEER REG 26-40 TB	EN-S	\$0
456-007-421	RMT SYNC 20K-SRDFS CMPPEER REG 41-60 TB	EN-S	\$0
456-007-422	RMT SYNC 20K-SRDFS CMPPEER REG 61-100 TB	EN-S	\$0
456-007-423	RMT SYNC 20K-SRDFS CMPPEER REG101-150 TB	EN-S	\$0
456-007-424	RMT SYNC 20K-SRDFS CMPPEER REG151-250 TB	EN-S	\$0
456-007-425	RMT SYNC 20K-SRDFS CMPPEER REG251-400 TB	EN-S	\$0
456-007-426	RMT SYNC 20K-SRDFS CMPPEER REG401-600 TB	EN-S	\$0
456-007-427	RMT SYNC 20K-SRDFS CMPPEER REG601-1000 TB	EN-S	\$0
456-007-428	RMT SYNC 20K-SRDFS CMPPEER REG 1001+ TB	EN-S	\$0
456-007-429	RMT SYNC 20K-SRDFS CMPPEER N-S 0-14 TB	EN-S	\$0
456-007-430	RMT SYNC 20K-SRDFS CMPPEER N-S 15-25 TB	EN-S	\$0
456-007-431	RMT SYNC 20K-SRDFS CMPPEER N-S 26-40 TB	EN-S	\$0
456-007-432	RMT SYNC 20K-SRDFS CMPPEER N-S 41-60 TB	EN-S	\$0
456-007-433	RMT SYNC 20K-SRDFS CMPPEER N-S 61-100TB	EN-S	\$0
456-007-434	RMT SYNC 20K-SRDFS CMPPEER N-S 101-150TB	EN-S	\$0
456-007-435	RMT SYNC 20K-SRDFS CMPPEER N-S 151-250TB	EN-S	\$0
456-007-436	RMT SYNC 20K-SRDFS CMPPEER N-S 251-400TB	EN-S	\$0
456-007-437	RMT SYNC 20K-SRDFS CMPPEER N-S 401-600TB	EN-S	\$0
456-007-438	RMT SYNC 20K-SRDFS CMPPEER N-S 601-1000 TB	EN-S	\$0
456-007-439	RMT SYNC 20K-SRDFS CMPPEER N-S 1001+ TB	EN-S	\$0
456-007-440	RMT SYNC 20K-SRDFS CMPPEER SATA 0-14 TB	EN-S	\$0
456-007-441	RMT SYNC 20K-SRDFS CMPPEER SATA 15-25 TB	EN-S	\$0
456-007-442	RMT SYNC 20K-SRDFS CMPPEER SATA 26-40 TB	EN-S	\$0
456-007-443	RMT SYNC 20K-SRDFS CMPPEER SATA 41-60 TB	EN-S	\$0
456-007-444	RMT SYNC 20K-SRDFS CMPPEER SATA 61-100TB	EN-S	\$0
456-007-445	RMT SYNC 20K-SRDFS CMPPEER SATA101-150TB	EN-S	\$0
456-007-446	RMT SYNC 20K-SRDFS CMPPEER SATA151-250TB	EN-S	\$0
456-007-447	RMT SYNC 20K-SRDFS CMPPEER SATA251-400TB	EN-S	\$0
456-007-448	RMT SYNC 20K-SRDFS CMPPEER SATA401-600TB	EN-S	\$0
456-007-449	RMT SYNC 20KSRDFS CMPPEER SATA601-1000TB	EN-S	\$0
456-007-450	RMT SYNC 20K-SRDFS CMPPEER SATA 1001+ TB	EN-S	\$0
456-007-451	RMT SYNC 20K-SATA-OPTOUT-TRSRDFS CMPPEER	EN-S	\$0
456-007-452	RMT SYNC 20K-ADD-SRDFSCMPPEER N-S 0-14TB	EN-S	\$0
456-007-453	RMT SYNC 20K-ADD-SRDFSCMPPEER N-S 15-25 TB	EN-S	\$0
456-007-454	RMT SYNC 20K-ADD-SRDFSCMPPEER N-S 26-40 TB	EN-S	\$0
456-007-455	RMT SYNC 20K-ADD-SRDFSCMPPEER N-S 41-60 TB	EN-S	\$0
456-007-456	RMT SYNC 20K-ADD-SRDFSCMPPEER N-S61-100TB	EN-S	\$0
456-007-457	RMT SYNC 20K-ADDSRDFSCMPPEER N-S101-150TB	EN-S	\$0
456-007-458	RMT SYNC 20K-ADDSRDFSCMPPEER N-S151-250TB	EN-S	\$0
456-007-459	RMT SYNC 20K-ADDSRDFSCMPPEER N-S251-400TB	EN-S	\$0
456-007-460	RMT SYNC 20K-ADDSRDFSCMPPEER N-S401-600TB	EN-S	\$0
456-007-461	RMT SYNC 20K-ADDSRDFSCMPPEER N-S601-1000TB	EN-S	\$0
456-007-462	RMT SYNC 20K-ADD-SRDFSCMPPEER N-S1001+ TB	EN-S	\$0
456-007-463	RMT SYNC 20K-ADD-SRDFSCMPPEER SATA0-14TB	EN-S	\$0
456-007-464	RMT SYNC 20K-ADDSRDFSCMPPEER SATA15-25TB	EN-S	\$0

456-007-465	RMTSYNC 20KADDSRDFSCMPPEER SATA 26-40	EN-S	\$0
456-007-466	RMTSYNC 20KADDSRDFSCMPPEER SATA 41-60	EN-S	\$0
456-007-467	RMTSYNC 20KADDSRDFSCMPPEER SATA 61-10	EN-S	\$0
456-007-468	RMTSYNC 20KADDSRDFSCMPPEER SATA 101-1	EN-S	\$0
456-007-469	RMTSYNC 20KADDSRDFSCMPPEER SATA 151-2	EN-S	\$0
456-007-470	RMTSYNC 20KADDSRDFSCMPPEER SATA 251-4	EN-S	\$0
456-007-471	RMTSYNC 20KADDSRDFSCMPPEER SATA 401-6	EN-S	\$0
456-007-472	RMTSYNC 20KADDSRDFSCMPPEER SATA 601-1	EN-S	\$0
456-007-473	RMTSYNC 20KADDSRDFSCMPPEER SATA1001+	EN-S	\$0
456-007-474	RMTSYNC 20K-ADDOPT OUTSRDFSCMPPEERSA	EN-S	\$0
456-007-475	RMT ASYNC 20K-SRDFA CMPEXT REG 0-14 TB	EN-S	\$0
456-007-476	RMT ASYNC 20K-SRDFA CMPEXT REG 15-25 TB	EN-S	\$0
456-007-477	RMT ASYNC 20K-SRDFA CMPEXT REG 26-40 TB	EN-S	\$0
456-007-478	RMT ASYNC 20K-SRDFA CMPEXT REG 41-60 TB	EN-S	\$0
456-007-479	RMT ASYNC 20K-SRDFA CMPEXT REG 61-100 TB	EN-S	\$0
456-007-480	RMT ASYNC 20K-SRDFA CMPEXT REG 101-150T	EN-S	\$0
456-007-481	RMT ASYNC 20K-SRDFA CMPEXT REG 151-250T	EN-S	\$0
456-007-482	RMT ASYNC 20K-SRDFA CMPEXT REG 251-400T	EN-S	\$0
456-007-483	RMT ASYNC 20K-SRDFA CMPEXT REG 401-600T	EN-S	\$0
456-007-484	RMT ASYNC 20KSRDFA CMPEXT REG 601-1000T	EN-S	\$0
456-007-485	RMT ASYNC 20K-SRDFA CMPEXT REG 1001+ TB	EN-S	\$0
456-007-486	RMT ASYNC 20K-SRDFA CMPEXT N-S 0-14 TB	EN-S	\$0
456-007-487	RMT ASYNC 20K-SRDFA CMPEXT N-S 15-25 TB	EN-S	\$0
456-007-488	RMT ASYNC 20K-SRDFA CMPEXT N-S 26-40 TB	EN-S	\$0
456-007-489	RMT ASYNC 20K-SRDFA CMPEXT N-S 41-60 TB	EN-S	\$0
456-007-490	RMT ASYNC 20K-SRDFA CMPEXT N-S 61-100TB	EN-S	\$0
456-007-491	RMT ASYNC 20K-SRDFA CMPEXT N-S 101-150TE	EN-S	\$0
456-007-492	RMT ASYNC 20K-SRDFA CMPEXT N-S 151-250TE	EN-S	\$0
456-007-493	RMT ASYNC 20K-SRDFA CMPEXT N-S 251-400TE	EN-S	\$0
456-007-494	RMT ASYNC 20K-SRDFA CMPEXT N-S 401-600TE	EN-S	\$0
456-007-495	RMT ASYNC 20K-SRDFA CMPEXT N-S601-1000TE	EN-S	\$0
456-007-496	RMT ASYNC 20K-SRDFA CMPEXT N-S 1001+ TB	EN-S	\$0
456-007-497	RMT ASYNC 20K-SRDFA CMPEXT SATA 0-14 TB	EN-S	\$0
456-007-498	RMT ASYNC 20K-SRDFA CMPEXT SATA 15-25 TE	EN-S	\$0
456-007-499	RMT ASYNC 20K-SRDFA CMPEXT SATA 26-40 TE	EN-S	\$0
456-007-500	RMT ASYNC 20K-SRDFA CMPEXT SATA 41-60 TE	EN-S	\$0
456-007-501	RMT ASYNC 20K-SRDFA CMPEXT SATA 61-100T	EN-S	\$0
456-007-502	RMT ASYNC 20K-SRDFACMPEXT SATA 101-150T	EN-S	\$0
456-007-503	RMT ASYNC 20K-SRDFACMPEXT SATA 151-250T	EN-S	\$0
456-007-504	RMT ASYNC 20K-SRDFACMPEXT SATA 251-400T	EN-S	\$0
456-007-505	RMT ASYNC 20K-SRDFACMPEXT SATA 401-600T	EN-S	\$0
456-007-506	RMT ASYNC 20K-SRDFACMPEXT SATA 601-1000	EN-S	\$0
456-007-507	RMT ASYNC 20K-SRDFA CMPEXT SATA 1001+ T	EN-S	\$0
456-007-508	RMT ASYNC 20K-SATA-OPTOUTTR-SRDFA CMPI	EN-S	\$0
456-007-509	RMT ASYNC 20K-ADD-SRDFACMPEXT N-S 0-14T	EN-S	\$0
456-007-510	RMT ASYNC 20K-ADD-SRDFACMPEXT N-S 15-25	EN-S	\$0
456-007-511	RMT ASYNC 20K-ADD-SRDFACMPEXT N-S 26-40	EN-S	\$0
456-007-512	RMT ASYNC 20K-ADD-SRDFACMPEXT N-S 41-60	EN-S	\$0
456-007-513	RMT ASYNC 20K-ADD-SRDFACMPEXT N-S61-100	EN-S	\$0
456-007-514	RMT ASYNC 20K-ADDSRDFACMPEXT N-S101-15	EN-S	\$0

456-007-515	RMT ASYNC 20K-ADDSRDFACMPEXT N-S151-25	EN-S	\$0
456-007-516	RMT ASYNC 20K-ADDSRDFACMPEXT N-S251-40	EN-S	\$0
456-007-517	RMT ASYNC 20K-ADDSRDFACMPEXT N-S401-60	EN-S	\$0
456-007-518	RMT ASYNC 20K-ADDSRDFACMPEXT N-S601-10	EN-S	\$0
456-007-519	RMT ASYNC 20K-ADD-SRDFACMPEXT N-S1001+	EN-S	\$0
456-007-520	RMT ASYNC20KADD-SRDFACMPEXT SATA 0-14	EN-S	\$0
456-007-521	RMT ASYNC20KADD-SRDFACMPEXT SATA 15-25	EN-S	\$0
456-007-522	RMT ASYNC20KADD-SRDFACMPEXT SATA 26-40	EN-S	\$0
456-007-523	RMT ASYNC20KADD-SRDFACMPEXT SATA 41-60	EN-S	\$0
456-007-524	RMT ASYNC20KADD-SRDFACMPEXT SATA61-10	EN-S	\$0
456-007-525	RMT ASYNC20KADD-SRDFACMPEXT SATA101-1	EN-S	\$0
456-007-526	RMT ASYNC20KADD-SRDFACMPEXT SATA151-2	EN-S	\$0
456-007-527	RMT ASYNC20KADD-SRDFACMPEXT SATA251-4	EN-S	\$0
456-007-528	RMT ASYNC20KADD-SRDFACMPEXT SATA401-6	EN-S	\$0
456-007-529	RMT ASYNC20KADD-SRDFACMPEXT SATA601-1	EN-S	\$0
456-007-530	RMT ASYNC20KADD-SRDFACMPEXT SATA1001+	EN-S	\$0
456-007-531	RMT ASYNC20KADD-SATAOPT OUTTRSDFACM	EN-S	\$0
456-007-532	SRDF-STAR VMAX 20K REGISTERED 0-14TB	EN-S	\$1,425
456-007-533	SRDF-STAR VMAX 20K REGISTERED 15-25TB	EN-S	\$1,155
456-007-534	SRDF-STAR VMAX 20K REGISTERED 26-40TB	EN-S	\$1,203
456-007-535	SRDF-STAR VMAX 20K REGISTERED 41-60TB	EN-S	\$1,073
456-007-536	SRDF-STAR VMAX 20K REGISTERED 61-100TB	EN-S	\$917
456-007-537	SRDF-STAR VMAX 20K REGISTERED 101-150TB	EN-S	\$850
456-007-538	SRDF-STAR VMAX 20K REGISTERED 151-250TB	EN-S	\$749
456-007-539	SRDF-STAR VMAX 20K REGISTERED 251-400TB	EN-S	\$668
456-007-540	SRDF-STAR VMAX 20K REGISTERED 401-600TB	EN-S	\$555
456-007-541	SRDF-STAR VMAX 20K REGISTER 601-1000TB	EN-S	\$449
456-007-542	SRDF-STAR VMAX 20K REGISTERED 1001+	EN-S	\$285
456-007-543	SRDF-STAR VMAX 20K NON-SATA 0-14TB	EN-S	\$3,460
456-007-544	SRDF-STAR VMAX 20K NON-SATA 15-25TB	EN-S	\$3,250
456-007-545	SRDF-STAR VMAX 20K NON-SATA 26-40TB	EN-S	\$2,865
456-007-546	SRDF-STAR VMAX 20K NON-SATA 41-60TB	EN-S	\$2,560
456-007-547	SRDF-STAR VMAX 20K NON-SATA 61-100TB	EN-S	\$2,275
456-007-548	SRDF-STAR VMAX 20K NON-SATA 101-150TB	EN-S	\$2,020
456-007-549	SRDF-STAR VMAX 20K NON-SATA 151-250TB	EN-S	\$1,740
456-007-550	SRDF-STAR VMAX 20K NON-SATA 251-400TB	EN-S	\$1,490
456-007-551	SRDF-STAR VMAX 20K NON-SATA 401-600TB	EN-S	\$1,280
456-007-552	SRDF-STAR VMAX 20K NON-SATA 601-1000TB	EN-S	\$1,095
456-007-553	SRDF-STAR VMAX 20K NON-SATA 1001+	EN-S	\$935
456-007-554	SRDF-STAR VMAX 20K SATA 0-14TB	EN-S	\$1,725
456-007-555	SRDF-STAR VMAX 20K SATA 15-25TB	EN-S	\$1,630
456-007-556	SRDF-STAR VMAX 20K SATA 26-40TB	EN-S	\$1,435
456-007-557	SRDF-STAR VMAX 20K SATA 41-60TB	EN-S	\$1,280
456-007-558	SRDF-STAR VMAX 20K SATA 61-100TB	EN-S	\$1,145
456-007-559	SRDF-STAR VMAX 20K SATA 101-150TB	EN-S	\$1,010
456-007-560	SRDF-STAR VMAX 20K SATA 151-250TB	EN-S	\$870
456-007-561	SRDF-STAR VMAX 20K SATA 251-400TB	EN-S	\$740
456-007-562	SRDF-STAR VMAX 20K SATA 401-600TB	EN-S	\$635
456-007-563	SRDF-STAR VMAX 20K SATA 601-1000TB	EN-S	\$545
456-007-564	SRDF-STAR VMAX 20K SATA 1001+	EN-S	\$470

456-007-565	SRDF-STAR ADD SATA OPT OUT VMAX 20K TIEF	EN-S	\$0
456-007-566	LCL REP 20K-TFCLONECNFLASH REG 0-14 TB	EN-S	\$0
456-007-567	LCL REP 20K-TFCLONECNFLASH REG 15-25 TB	EN-S	\$0
456-007-568	LCL REP 20K-TFCLONECNFLASH REG 26-40 TB	EN-S	\$0
456-007-569	LCL REP 20K-TFCLONECNFLASH REG 41-60 TB	EN-S	\$0
456-007-570	LCL REP 20K-TFCLONECNFLASH REG 61-100 TB	EN-S	\$0
456-007-571	LCL REP 20K-TFCLONECNFLASH REG 101-150TB	EN-S	\$0
456-007-572	LCL REP 20K-TFCLONECNFLASH REG 151-250TB	EN-S	\$0
456-007-573	LCL REP 20K-TFCLONECNFLASH REG 251-400TB	EN-S	\$0
456-007-574	LCL REP 20K-TFCLONECNFLASH REG 401-600TB	EN-S	\$0
456-007-575	LCL REP 20K-TFCLONECNFLASH REG601-1000T	EN-S	\$0
456-007-576	LCL REP 20K-TFCLONECNFLASH REG 1001+ TB	EN-S	\$0
456-007-577	LCL REP 20K-TFCLN CNFLASH N-S 0-14 TB	EN-S	\$0
456-007-578	LCL REP 20K-TFCLN CNFLASH N-S 15-25 TB	EN-S	\$0
456-007-579	LCL REP 20K-TFCLN CNFLASH N-S 26-40 TB	EN-S	\$0
456-007-580	LCL REP 20K-TFCLN CNFLASH N-S 41-60 TB	EN-S	\$0
456-007-581	LCL REP 20K-TFCLN CNFLASH N-S 61-100TB	EN-S	\$0
456-007-582	LCL REP 20K-TFCLN CNFLASH N-S 101-150T	EN-S	\$0
456-007-583	LCL REP 20K-TFCLN CNFLASH N-S 151-250T	EN-S	\$0
456-007-584	LCL REP 20K-TFCLN CNFLASH N-S 251-400T	EN-S	\$0
456-007-585	LCL REP 20K-TFCLN CNFLASH N-S 401-600T	EN-S	\$0
456-007-586	LCL REP 20K-TFCLN CNFLASH N-S 601-1000TB	EN-S	\$0
456-007-587	LCL REP 20K-TFCLN CNFLASH N-S 1001+ TB	EN-S	\$0
456-007-588	LCL REP 20K-TFCLONECNFLASH SATA 0-14 TB	EN-S	\$0
456-007-589	LCL REP 20K-TFCLONECNFLASH SATA 15-25 TB	EN-S	\$0
456-007-590	LCL REP 20K-TFCLONECNFLASH SATA 26-40 TB	EN-S	\$0
456-007-591	LCL REP 20K-TFCLONECNFLASH SATA 41-60 TB	EN-S	\$0
456-007-592	LCL REP 20K-TFCLONECNFLASH SATA 61-100TB	EN-S	\$0
456-007-593	LCL REP 20K-TFCLONECNFLASH SATA101-150T	EN-S	\$0
456-007-594	LCL REP 20K-TFCLONECNFLASH SATA151-250T	EN-S	\$0
456-007-595	LCL REP 20K-TFCLONECNFLASHSATA 251-400T	EN-S	\$0
456-007-596	LCL REP 20K-TFCLONECNFLASH SATA401-600T	EN-S	\$0
456-007-597	LCL REP 20K-TFCLN CNFLASH SATA601-1000TB	EN-S	\$0
456-007-598	LCL REP 20K-TFCLONECNFLASH SATA 1001+ TB	EN-S	\$0
456-007-599	LCL REP 20K-SATA-OPTOUTTR-TFCLONECNFLA	EN-S	\$0
456-007-600	LCL REP 20K-ADD-TFCLN CNFLASH N-S 0-14TB	EN-S	\$0
456-007-601	LCL REP 20K-ADD-TFCLN CNFLASH N-S 15-25T	EN-S	\$0
456-007-602	LCL REP 20K-ADD-TFCLN CNFLASH N-S 26-40T	EN-S	\$0
456-007-603	LCL REP 20K-ADD-TFCLN CNFLASH N-S 41-60T	EN-S	\$0
456-007-604	LCL REP 20K-ADD-TFCLN CNFLASH N-S61-100T	EN-S	\$0
456-007-605	LCL REP 20K-ADD-TFCLN CNFLASH N-S101-150T	EN-S	\$0
456-007-606	LCL REP 20K-ADD-TFCLN CNFLASH N-S151-250T	EN-S	\$0
456-007-607	LCL REP 20K-ADD-TFCLN CNFLASH N-S251-400T	EN-S	\$0
456-007-608	LCL REP 20K-ADD-TFCLN CNFLASH N-S401-600T	EN-S	\$0
456-007-609	LCL REP 20K-ADD-TFCLN CNFLASH N-S601-1000	EN-S	\$0
456-007-610	LCL REP 20K-ADD-TFCLN CNFLASH N-S 1001+TB	EN-S	\$0
456-007-611	LCL REP 20K-ADD-TFCLN CNFLASH SATA0-14TB	EN-S	\$0
456-007-612	LCL REP 20K-ADD-TFCLN CNFLASH SATA15-25TB	EN-S	\$0
456-007-613	LCL REP 20K-ADD-TFCLN CNFLASH SATA26-40TB	EN-S	\$0
456-007-614	LCL REP 20K-ADD-TFCLN CNFLASH SATA41-60TB	EN-S	\$0

456-007-615	LCL REP 20K-ADDTFCLNCNFLASH SATA61-100T	EN-S	\$0
456-007-616	LCL REP 20K-ADDTFCLNCNFLASH SATA101-150	EN-S	\$0
456-007-617	LCL REP 20K-ADDTFCLNCNFLASH SATA151-250	EN-S	\$0
456-007-618	LCL REP 20K-ADDTFCLNCNFLASH SATA251-400	EN-S	\$0
456-007-619	LCL REP 20K-ADDTFCLNCNFLASH SATA401-600	EN-S	\$0
456-007-620	LCL REP 20K-ADDTFCLNCNFLASHSATA 601-100	EN-S	\$0
456-007-621	LCL REP 20K-ADDTFCLNCNFLASH SATA1001+ T	EN-S	\$0
456-007-622	LCL REP 20K-ADDSATAOPTOUT-TRTFCLNCNFL	EN-S	\$0
456-007-623	TF-SNAP VMAX 20K REGISTERED 0-14TB	EN-S	\$0
456-007-624	TF-SNAP VMAX 20K REGISTERED 15-25TB	EN-S	\$0
456-007-625	TF-SNAP VMAX 20K REGISTERED 26-40TB	EN-S	\$0
456-007-626	TF-SNAP VMAX 20K REGISTERED 41-60TB	EN-S	\$0
456-007-627	TF-SNAP VMAX 20K REGISTERED 61-100TB	EN-S	\$0
456-007-628	TF-SNAP VMAX 20K REGISTERED 101-150TB	EN-S	\$0
456-007-629	TF-SNAP VMAX 20K REGISTERED 151-250TB	EN-S	\$0
456-007-630	TF-SNAP VMAX 20K REGISTERED 251-400TB	EN-S	\$0
456-007-631	TF-SNAP VMAX 20K REGISTERED 401-600TB	EN-S	\$0
456-007-632	TF-SNAP VMAX 20K REGISTERED 601-1000TB	EN-S	\$0
456-007-633	TF-SNAP VMAX 20K REGISTERED 1001+	EN-S	\$0
456-007-634	TF-SNAP VMAX 20K NON-SATA 0-14TB	EN-S	\$0
456-007-635	TF-SNAP VMAX 20K NON-SATA 15-25TB	EN-S	\$0
456-007-636	TF-SNAP VMAX 20K NON-SATA 26-40TB	EN-S	\$0
456-007-637	TF-SNAP VMAX 20K NON-SATA 41-60TB	EN-S	\$0
456-007-638	TF-SNAP VMAX 20K NON-SATA 61-100TB	EN-S	\$0
456-007-639	TF-SNAP VMAX 20K NON-SATA 101-150TB	EN-S	\$0
456-007-640	TF-SNAP VMAX 20K NON-SATA 151-250TB	EN-S	\$0
456-007-641	TF-SNAP VMAX 20K NON-SATA 251-400TB	EN-S	\$0
456-007-642	TF-SNAP VMAX 20K NON-SATA 401-600TB	EN-S	\$0
456-007-643	TF-SNAP VMAX 20K NON-SATA 601-1000TB	EN-S	\$0
456-007-644	TF-SNAP VMAX 20K NON-SATA 1001+	EN-S	\$0
456-007-645	TF-SNAP VMAX 20K SATA 0-14TB	EN-S	\$0
456-007-646	TF-SNAP VMAX 20K SATA 15-25TB	EN-S	\$0
456-007-647	TF-SNAP VMAX 20K SATA 26-40TB	EN-S	\$0
456-007-648	TF-SNAP VMAX 20K SATA 41-60TB	EN-S	\$0
456-007-649	TF-SNAP VMAX 20K SATA 61-100TB	EN-S	\$0
456-007-650	TF-SNAP VMAX 20K SATA 101-150TB	EN-S	\$0
456-007-651	TF-SNAP VMAX 20K SATA 151-250TB	EN-S	\$0
456-007-652	TF-SNAP VMAX 20K SATA 251-400TB	EN-S	\$0
456-007-653	TF-SNAP VMAX 20K SATA 401-600TB	EN-S	\$0
456-007-654	TF-SNAP VMAX 20K SATA 601-1000TB	EN-S	\$0
456-007-655	TF-SNAP VMAX 20K SATA 1001+	EN-S	\$0
456-007-656	TF-SNAP VMAX 20K SATA OPT OUT TIER	EN-S	\$0
456-007-657	TF-SNAP ADD VMAX 20K NON-SATA 0-14TB	EN-S	\$0
456-007-658	TF-SNAP ADD VMAX 20K NON-SATA 15-25TB	EN-S	\$0
456-007-659	TF-SNAP ADD VMAX 20K NON-SATA 26-40TB	EN-S	\$0
456-007-660	TF-SNAP ADD VMAX 20K NON-SATA 41-60TB	EN-S	\$0
456-007-661	TF-SNAP ADD VMAX 20K NON-SATA 61-100TB	EN-S	\$0
456-007-662	TF-SNAP ADD VMAX 20K NON-SATA 101-150TB	EN-S	\$0
456-007-663	TF-SNAP ADD VMAX 20K NON-SATA 151-250TB	EN-S	\$0
456-007-664	TF-SNAP ADD VMAX 20K NON-SATA 251-400TB	EN-S	\$0

456-007-665	TF-SNAP ADD VMAX 20K NON-SATA 401-600TB	EN-S	\$0
456-007-666	TF-SNAP ADD VMAX 20K NO-SATA 601-1000TB	EN-S	\$0
456-007-667	TF-SNAP ADD VMAX 20K NON-SATA 1001+	EN-S	\$0
456-007-668	TF-SNAP ADD VMAX 20K SATA 0-14TB	EN-S	\$0
456-007-669	TF-SNAP ADD VMAX 20K SATA 15-25TB	EN-S	\$0
456-007-670	TF-SNAP ADD VMAX 20K SATA 26-40TB	EN-S	\$0
456-007-671	TF-SNAP ADD VMAX 20K SATA 41-60TB	EN-S	\$0
456-007-672	TF-SNAP ADD VMAX 20K SATA 61-100TB	EN-S	\$0
456-007-673	TF-SNAP ADD VMAX 20K SATA 101-150TB	EN-S	\$0
456-007-674	TF-SNAP ADD VMAX 20K SATA 151-250TB	EN-S	\$0
456-007-675	TF-SNAP ADD VMAX 20K SATA 251-400TB	EN-S	\$0
456-007-676	TF-SNAP ADD VMAX 20K SATA 401-600TB	EN-S	\$0
456-007-677	TF-SNAP ADD VMAX 20K SATA 601-1000TB	EN-S	\$0
456-007-678	TF-SNAP ADD VMAX 20K SATA 1001+	EN-S	\$0
456-007-679	TF-SNAP ADD VMAX 20K SATA OPT OUT TIER	EN-S	\$0
456-007-680	PROSPHERE-CC 20K AO NON-SATA 0-14TB	EN-S	\$0
456-007-681	PROSPHERE-CC 20K AO NON-SATA 15-25TB	EN-S	\$0
456-007-682	PROSPHERE-CC 20K AO NON-SATA 26-40TB	EN-S	\$0
456-007-683	PROSPHERE-CC 20K AO NON-SATA 41-60TB	EN-S	\$0
456-007-684	PROSPHERE-CC 20K AO NON-SATA 61-100TB	EN-S	\$0
456-007-685	PROSPHERE-CC 20K AO NON-SATA 101-150TB	EN-S	\$0
456-007-686	PROSPHERE-CC 20K AO NON-SATA 151-250TB	EN-S	\$0
456-007-687	PROSPHERE-CC 20K AO NON-SATA 251-400TB	EN-S	\$0
456-007-688	PROSPHERE-CC 20K AO NON-SATA 401-600TB	EN-S	\$0
456-007-689	PROSPHERE-CC 20K AO NON-SATA 601-1000TB	EN-S	\$0
456-007-690	PROSPHERE-CC 20K AO NON-SATA 1001TB+	EN-S	\$0
456-007-691	PROSPHERE-CC 20K AO SATA 0-14TB	EN-S	\$0
456-007-692	PROSPHERE-CC 20K AO SATA 15-25TB	EN-S	\$0
456-007-694	PROSPHERE-CC 20K AO SATA 41-60TB	EN-S	\$0
456-007-695	PROSPHERE-CC 20K AO SATA 61-100TB	EN-S	\$0
456-007-696	PROSPHERE-CC 20K AO SATA 101-150TB	EN-S	\$0
456-007-697	PROSPHERE-CC 20K AO SATA 151-250TB	EN-S	\$0
456-007-698	PROSPHERE-CC 20K AO SATA 251-400TB	EN-S	\$0
456-007-699	PROSPHERE-CC 20K AO SATA 401-600TB	EN-S	\$0
456-007-700	PROSPHERE-CC 20K AO SATA 601-1000TB	EN-S	\$0
456-007-701	PROSPHERE-CC 20K AO SATA 1001TB+	EN-S	\$0
456-007-702	ENGINUIY VMAX 20K SATA 0-14TB	EN-S	\$0
456-007-703	ENGINUIY VMAX 20K SATA 15-25TB	EN-S	\$0
456-007-704	ENGINUIY VMAX 20K SATA 26-40TB	EN-S	\$0
456-007-705	ENGINUIY VMAX 20K SATA 41-60TB	EN-S	\$0
456-007-706	ENGINUIY VMAX 20K SATA 61-100TB	EN-S	\$0
456-007-707	ENGINUIY VMAX 20K SATA 101-150TB	EN-S	\$0
456-007-708	ENGINUIY VMAX 20K SATA 151-250TB	EN-S	\$0
456-007-709	ENGINUIY VMAX 20K SATA 251-400TB	EN-S	\$0
456-007-710	ENGINUIY VMAX 20K SATA 401-600TB	EN-S	\$0
456-007-711	ENGINUIY VMAX 20K SATA 601-1000TB	EN-S	\$0
456-007-712	ENGINUIY VMAX 20K SATA 1000TB +	EN-S	\$0
456-007-713	ENGINUIY VMAX 20K NON-SATA 0-14TB	EN-S	\$0
456-007-714	ENGINUIY VMAX 20K NON-SATA 15-25TB	EN-S	\$0
456-007-715	ENGINUIY VMAX 20K NON-SATA 26-40TB	EN-S	\$0

456-007-716	ENGINUIITY VMAX 20K NON-SATA 41-60TB	EN-S	\$0
456-007-717	ENGINUIITY VMAX 20K NON-SATA 61-100TB	EN-S	\$0
456-007-718	ENGINUIITY VMAX 20K NON-SATA 101-150TB	EN-S	\$0
456-007-719	ENGINUIITY VMAX 20K NON-SATA 151-250TB	EN-S	\$0
456-007-720	ENGINUIITY VMAX 20K NON-SATA 251-400TB	EN-S	\$0
456-007-721	ENGINUIITY VMAX 20K NON-SATA 401-600TB	EN-S	\$0
456-007-722	ENGINUIITY VMAX 20K NON-SATA 601-1000TB	EN-S	\$0
456-007-723	ENGINUIITY VMAX 20K NON-SATA 1000TB +	EN-S	\$0
456-007-724	ATSM 20K NON-SATA FOR REG FAST 0-14TB	EN-S	\$0
456-007-725	ATSM 20K NON-SATA FOR REG FAST 15-25TB	EN-S	\$0
456-007-726	ATSM 20K NON-SATA FOR REG FAST 26-40TB	EN-S	\$0
456-007-727	ATSM 20K NON-SATA FOR REG FAST 41-60TB	EN-S	\$0
456-007-728	ATSM 20K NON-SATA FOR REG FAST 61-100TB	EN-S	\$0
456-007-729	ATSM 20K NON-SATA FOR REG FAST 101-150TB	EN-S	\$0
456-007-730	ATSM 20K NON-SATA FOR REG FAST 151-250TB	EN-S	\$0
456-007-731	ATSM 20K NON-SATA FOR REG FAST 251-400TB	EN-S	\$0
456-007-732	ATSM 20K NON-SATA FOR REG FAST 401-600TB	EN-S	\$0
456-007-733	ATSM 20K NON-SATA FOR REG FAST601-1000TB	EN-S	\$0
456-007-734	ATSM 20K NON-SATA FOR REG FAST 1001+	EN-S	\$0
456-007-735	ATSM 20K SATA FOR REG FAST 0-14TB	EN-S	\$0
456-007-736	ATSM 20K SATA FOR REG FAST 15-25TB	EN-S	\$0
456-007-737	ATSM 20K SATA FOR REG FAST 26-40TB	EN-S	\$0
456-007-738	ATSM 20K SATA FOR REG FAST 41-60TB	EN-S	\$0
456-007-739	ATSM 20K SATA FOR REG FAST 61-100TB	EN-S	\$0
456-007-740	ATSM 20K SATA FOR REG FAST 101-150TB	EN-S	\$0
456-007-741	ATSM 20K SATA FOR REG FAST 151-250TB	EN-S	\$0
456-007-742	ATSM 20K SATA FOR REG FAST 251-400TB	EN-S	\$0
456-007-743	ATSM 20K SATA FOR REG FAST 401-600TB	EN-S	\$0
456-007-744	ATSM 20K SATA FOR REG FAST 601-1000TB	EN-S	\$0
456-007-745	ATSM 20K SATA FOR REG FAST 1001+	EN-S	\$0
456-103-685	VMAX 10K CC / PROSPHERE PKG 1TB SATA	EN-S	\$1,690
456-103-686	VMAX 10K CC / PROSPHERE PKG 1TB NON-SATA	EN-S	\$1,690
456-103-756	VMAX10K FAST VP NON-SATA 1TB=CB	EN-S	\$1,056
456-103-757	VMAX10K FAST VP SATA 1TB=CB	EN-S	\$528
456-103-764	VMAX10K FAST and SYMM MGMT PROMO TIER	EN-S	\$290,455
456-103-765	VMAX10K FAST and SYMM MGMT PROMO TIER /	EN-S	\$290,455
456-103-772	VMAX 10K BASE SW SUITE NON-SATA 1TB	EN-S	\$0
456-103-773	VMAX 10K BASE SW SUITE SATA 1TB	EN-S	\$0
456-103-776	VMAX 10K TF SNAP NON-SATA 1TB	EN-S	\$1,000
456-103-777	VMAX 10K TF SNAP SATA FULL 1TB	EN-S	\$500
456-103-833	VMAX10K SRDF-A NON-SATA 1TB=CB	EN-S	\$1,650
456-103-834	VMAX10K SRDF-A REG 1TB=CA	EN-S	\$1,905
456-103-835	VMAX10K SRDF-A SATA 1TB=CB	EN-S	\$825
456-103-836	VMAX10K SRDF-S NON-SATA 1TB=CB	EN-S	\$1,650
456-103-837	VMAX10K SRDF-S REG 1TB=CA	EN-S	\$1,905
456-103-838	VMAX10K SRDF-S SATA 1TB=CB	EN-S	\$825
456-103-964	VMAX 10K SPA 2.2 SATA FULL 1TB	EN-S	\$0
456-104-036	VMAX 10K ENGINUIITY NON-SATA 1TB	EN-S	\$1,230
456-104-037	VMAX 10K ENGINUIITY SATA 1TB	EN-S	\$555
456-104-102	VMAX 10K SYMM MGT SUITE NON SATA 1TB	EN-S	\$0

456-104-103	VMAX10K SYMM MGT SUITE SATA 1TB=CB	EN-S	\$0
456-104-109	VMAX10K TIMEFINDER REG 1TB=CA	EN-S	\$1,895
456-104-112	VMAX10K FAST VP SL NON SATA 1TB=CB	EN-S	\$1,056
456-104-113	VMAX10K FAST VP SL SATA 1TB=CB	EN-S	\$528
456-104-115	VMAX10K FAST VP SL REG 1TB=CA	EN-S	\$1,584
456-104-118	VMAX10K SRDF-STAR NON-SATA 1TB=CB	EN-S	\$660
456-104-119	VMAX10K SRDF-STAR SATA 1TB=CB	EN-S	\$330
456-104-121	VMAX10K SRDF-STAR REG 1TB=CA	EN-S	\$840
456-104-349	VMAX 10K BAS SRDF SUITE REG 1TB	EN-S	\$0
456-104-350	VMAX 10K BAS SRDF SUITE SATA 1TB	EN-S	\$0
456-104-351	VMAX 10K BAS SRDF SUITE NON-SATA 1TB	EN-S	\$0
456-104-352	VMAX 10K BAS SRDF SUITE FTS EXT 1 TB	EN-S	\$0
456-104-372	VMAX 10K ENGINUITY SUITE SATA 1TB	EN-S	\$0
456-104-373	VMAX 10K ENGINUITY SUITE NON-SATA 1TB	EN-S	\$0
456-104-376	VMAX 10K ADV SW SUITE II SATA 1TB	EN-S	\$0
456-104-377	VMAX 10K ADV SW SUITE II NON-SATA 1TB	EN-S	\$0
456-104-378	VMAX 10K BASE SW SUITE II SATA 1TB	EN-S	\$0
456-104-379	VMAX 10K BASE SW SUITE II NON-SATA 1TB	EN-S	\$0
456-104-380	VMAX10K SYMM MGT II PKG SATA 1TB=CB	EN-S	\$415
456-104-381	VMAX10K SYMM MGT II PKG NON-SATA 1TB=CB	EN-S	\$830
456-104-386	VMAX10K OR-DM REG 1TB=CA	EN-S	\$1,715
456-104-394	VMAX10K SRDF-A REG ADDON 1TB=CA	EN-S	\$0
456-104-395	VMAX10K SRDF-A SATA ADDON 1TB=CB	EN-S	\$0
456-104-396	VMAX10K SRDF-A NON-SATA ADDON 1TB=CB	EN-S	\$0
456-104-397	VMAX10K SRDF-S REG ADDON 1TB=CA	EN-S	\$0
456-104-398	VMAX10K SRDF-S SATA ADDON 1TB=CA	EN-S	\$0
456-104-399	VMAX10K SRDF-S NON-SATA ADDON 1TB=CA	EN-S	\$0
456-104-539	RP/EX LOC REG CAP VMAX20 (0-14TB) =CA	EN-S	\$3,800
456-104-540	RP/EX LOC REG CAP VMAX20 (15-25TB) =CA	EN-S	\$3,370
456-104-541	RP/EX LOC REG CAP VMAX20 (26-40TB) =CA	EN-S	\$3,200
456-104-542	RP/EX LOC REG CAP VMAX20 (41-60TB) =CA	EN-S	\$2,800
456-104-543	RP/EX LOC REG CAP VMAX20 (61-100TB) =CA	EN-S	\$2,575
456-104-544	RP/EX LOC REG CAP VMAX20 (101-150TB) =CA	EN-S	\$2,125
456-104-545	RP/EX LOC REG CAP VMAX20 (151-250TB) =CA	EN-S	\$1,970
456-104-546	RP/EX LOC REG CAP VMAX20(251-400TB) =CA	EN-S	\$1,835
456-104-547	RP/EX LOC REG CAP VMAX20 (401-600TB) =CA	EN-S	\$1,700
456-104-548	RP/EX LOC REG CAP VMAX20 (601-1000TB)=CA	EN-S	\$1,430
456-104-549	RP/EX LOC REG CAP VMAX20 (1001TB+) =CA	EN-S	\$1,050
456-104-550	RP/EX REM REG CAP VMAX20 (0-14TB) =CA	EN-S	\$3,800
456-104-551	RP/EX REM REG CAP VMAX20 (15-25TB) =CA	EN-S	\$3,370
456-104-552	RP/EX REM REG CAP VMAX20 (26-40TB) =CA	EN-S	\$3,200
456-104-553	RP/EX REM REG CAP VMAX20 (41-60TB) =CA	EN-S	\$2,800
456-104-554	RP/EX REM REG CAP VMAX20 (61-100TB) =CA	EN-S	\$2,575
456-104-555	RP/EX REM REG CAP VMAX20 (101-150TB) =CA	EN-S	\$2,125
456-104-556	RP/EX REM REG CAP VMAX20 (151-250TB) =CA	EN-S	\$1,970
456-104-557	RP/EX REM REG CAP VMAX20 (251-400TB) =CA	EN-S	\$1,835
456-104-558	RP/EX REM REG CAP VMAX20 (401-600TB) =CA	EN-S	\$1,700
456-104-559	RP/EX REM REG CAP VMAX20 (601-1000TB)=CA	EN-S	\$1,430
456-104-560	RP/EX REM REG CAP VMAX20 (1001TB+) =CA	EN-S	\$1,050
456-104-561	RP/EX LOC REG CAP VMAX40 (0-14TB) =CA	EN-S	\$3,800

456-104-562	RP/EX LOC REG CAP VMAX40 (15-25TB) =CA	EN-S	\$3,370
456-104-563	RP/EX LOC REG CAP VMAX40 (26-40TB) =CA	EN-S	\$3,200
456-104-564	RP/EX LOC REG CAP VMAX40 (41-60TB) =CA	EN-S	\$2,800
456-104-565	RP/EX LOC REG CAP VMAX40 (61-100TB) =CA	EN-S	\$2,575
456-104-566	RP/EX LOC REG CAP VMAX40 (101-150TB) =CA	EN-S	\$2,125
456-104-567	RP/EX LOC REG CAP VMAX40 (151-250TB) =CA	EN-S	\$1,970
456-104-568	RP/EX LOC REG CAP VMAX40 (251-400TB) =CA	EN-S	\$1,835
456-104-569	RP/EX LOC REG CAP VMAX40 (401-600TB) =CA	EN-S	\$1,700
456-104-570	RP/EX LOC REG CAP VMAX40 (601-1000TB)=CA	EN-S	\$1,430
456-104-571	RP/EX LOC REG CAP VMAX40(1001TB+) =CA	EN-S	\$1,050
456-104-572	RP/EX REM REG CAP VMAX40 (0-14TB) =CA	EN-S	\$3,800
456-104-573	RP/EX REM REG CAP VMAX40 (15-25TB) =CA	EN-S	\$3,370
456-104-574	RP/EX REM REG CAP VMAX40 (26-40TB) =CA	EN-S	\$3,200
456-104-575	RP/EX REM REG CAP VMAX40 (41-60TB) =CA	EN-S	\$2,800
456-104-576	RP/EX REM REG CAP VMAX40 (61-100TB) =CA	EN-S	\$2,575
456-104-577	RP/EX REM REG CAP VMAX40 (101-150TB) =CA	EN-S	\$2,125
456-104-578	RP/EX REM REG CAP VMAX40 (151-250TB) =CA	EN-S	\$1,970
456-104-579	RP/EX REM REG CAP VMAX40 (251-400TB) =CA	EN-S	\$1,835
456-104-580	RP/EX REM REG CAP VMAX40 (401-600TB)=CA	EN-S	\$1,700
456-104-581	RP/EX REM REG CAP VMAX40 (601-1000TB)=CA	EN-S	\$1,430
456-104-582	RP/EX REM REG CAP VMAX40 (1001TB+) =CA	EN-S	\$1,050
456-104-583	RP/EX LOC REG CAP 1TB VMAX10 =CA	EN-S	\$1,500
456-104-584	RP/EX LOC REG CAP UG VMAX10 =CA	EN-S	\$0
456-104-585	RP/EX REM REG CAP 1TB VMAX10 =CA	EN-S	\$1,500
456-104-586	RP/EX REM REG CAP UG VMAX10=CA	EN-S	\$0
456-104-587	RP/EX RAW 1TB SATA VMAX10=CB	EN-S	\$0
456-104-589	RP/EX RAW 1TB NSATA VMAX10=CB	EN-S	\$0
456-104-591	RP/EX FTS EXT CAP 1TB VMAX10 = CB	EN-S	\$0
456-104-844	VMAX 10K SRDF-A FTS ADD ON	EN-S	\$0
456-104-845	VMAX 10K SRDF-S FTS ADD ON	EN-S	\$0
456-104-875	AppSync: VG10 / VG50 = IC	EN-S	\$0
456-104-901	Replication Manager: VG10 / VG50 = IC	EN-S	\$0
456-104-962	VMAX10K FILE BLK UNI SATA CAP 1TB=CB	EN-S	\$530
456-104-963	VMAX10K FILE BLK UNI NON-SATA CAP 1TB=CB	EN-S	\$1,070
456-104-964	VMAX10K FILE BLOC UNISPHERE FTSEXT1TB=C	EN-S	\$530
456-104-968	VMAX10K FILE BLOC LOCAL UNL TB=CB	EN-S	\$0
456-104-969	VMAX10K LOCPROT F+B REG 1TB=CA	EN-S	\$0
456-104-970	VMAX10K FILE BLOC ADV SW SATA 1TB=CB	EN-S	\$0
456-104-971	VMAX10K FILE BLOC ADV SW NON SATA 1TB=C	EN-S	\$0
456-104-972	VMAX10K FILE BLOC ADV SW UNL TB=CB	EN-S	\$0
456-104-973	VMAX10K FILE BLOC REMOTE SATA 1TB=CB	EN-S	\$0
456-104-974	VMAX10K FILE BLOC REMOTE NON SATA 1TB=C	EN-S	\$0
456-104-975	VMAX10K FILE BLOC REMOTE FTS EXT 1TB=CB	EN-S	\$0
456-104-976	VMAX10K FILE BLOC REMOTE UNL TB=CB	EN-S	\$0
456-104-977	VMAX10K FILE BLOC REMOTE REG 1TB=CA	EN-S	\$0
456-105-320	SRMSUITE 10K 1TB =CB	EN-S	\$0
456-105-321	SRMSUITE 20K 0-14TB S =CB	EN-S	\$0
456-105-322	SRMSUITE 20K 15-25TB S =CB	EN-S	\$0
456-105-323	SRMSUITE 20K 26-40TB S =CB	EN-S	\$0
456-105-324	SRMSUITE 20K 41-60TB S =CB	EN-S	\$0

456-105-325	SRMSUITE 20K 61-100TB S =CB	EN-S	\$0
456-105-326	SRMSUITE 20K 101-150TB S =CB	EN-S	\$0
456-105-327	SRMSUITE 20K 151-250TB S =CB	EN-S	\$0
456-105-328	SRMSUITE 20K 251-400TB S =CB	EN-S	\$0
456-105-329	SRMSUITE 20K 401-600TB S =CB	EN-S	\$0
456-105-330	SRMSUITE 20K 601-1PB S =CB	EN-S	\$0
456-105-331	SRMSUITE 20K 1001TB+ S =CB	EN-S	\$0
456-105-332	SRMSUITE 20K 0-14TB =CB	EN-S	\$0
456-105-333	SRMSUITE 20K 15-25TB =CB	EN-S	\$0
456-105-334	SRMSUITE 20K 26-40TB =CB	EN-S	\$0
456-105-335	SRMSUITE 20K 41-60TB =CB	EN-S	\$0
456-105-336	SRMSUITE 20K 61-100TB =CB	EN-S	\$0
456-105-337	SRMSUITE 20K 101-150TB =CB	EN-S	\$0
456-105-338	SRMSUITE 20K 151-250TB =CB	EN-S	\$0
456-105-339	SRMSUITE 20K 251-400TB =CB	EN-S	\$0
456-105-340	SRMSUITE 20K 401-600TB =CB	EN-S	\$0
456-105-341	SRMSUITE 20K 601-1PB =CB	EN-S	\$0
456-105-342	SRMSUITE 20K 1001TB+ =CB	EN-S	\$0
456-105-343	SRMSUITE 40K 0-14TB S =CB	EN-S	\$0
456-105-344	SRMSUITE 40K 15-25TB S =CB	EN-S	\$0
456-105-345	SRMSUITE 40K 26-40TB S =CB	EN-S	\$0
456-105-346	SRMSUITE 40K 41-60TB S =CB	EN-S	\$0
456-105-347	SRMSUITE 40K 61-100TB S =CB	EN-S	\$0
456-105-348	SRMSUITE 40K 101-150TB S =CB	EN-S	\$0
456-105-349	SRMSUITE 40K 151-250TB S =CB	EN-S	\$0
456-105-350	SRMSUITE 40K 251-400TB S =CB	EN-S	\$0
456-105-351	SRMSUITE 40K 401-600TB S =CB	EN-S	\$0
456-105-352	SRMSUITE 40K 601-1PB S =CB	EN-S	\$0
456-105-353	SRMSUITE 40K 1001TB+ S =CB	EN-S	\$0
456-105-354	SRMSUITE 40K 0-14TB =CB	EN-S	\$0
456-105-355	SRMSUITE 40K 15-25TB =CB	EN-S	\$0
456-105-356	SRMSUITE 40K 26-40TB =CB	EN-S	\$0
456-105-357	SRMSUITE 40K 41-60TB =CB	EN-S	\$0
456-105-358	SRMSUITE 40K 61-100TB =CB	EN-S	\$0
456-105-359	SRMSUITE 40K 101-150TB =CB	EN-S	\$0
456-105-360	SRMSUITE 40K 151-250TB =CB	EN-S	\$0
456-105-361	SRMSUITE 40K 251-400TB =CB	EN-S	\$0
456-105-362	SRMSUITE 40K 401-600TB =CB	EN-S	\$0
456-105-363	SRMSUITE 40K 601-1PB =CB	EN-S	\$0
456-105-364	SRMSUITE 40K 1001TB+ =CB	EN-S	\$0
456-105-421	SRMSUITE UPG 10K 1TB =CB	EN-S	\$0
456-105-422	SRMSUITE UPG 20K 0-14TB S =CB	EN-S	\$0
456-105-423	SRMSUITE UPG 20K 15-25TB S =CB	EN-S	\$0
456-105-424	SRMSUITE UPG 20K 26-40TB S =CB	EN-S	\$0
456-105-425	SRMSUITE UPG 20K 41-60TB S =CB	EN-S	\$0
456-105-426	SRMSUITE UPG 20K 61-100TB S =CB	EN-S	\$0
456-105-427	SRMSUITE UPG 20K 101-150TB S =CB	EN-S	\$0
456-105-428	SRMSUITE UPG 20K 151-250TB S =CB	EN-S	\$0
456-105-429	SRMSUITE UPG 20K 251-400TB S =CB	EN-S	\$0
456-105-430	SRMSUITE UPG 20K 401-600TB S =CB	EN-S	\$0

456-105-431	SRMSUITE UPG 20K 601-1PB S =CB	EN-S	\$0
456-105-432	SRMSUITE UPG 20K 1001TB+ S =CB	EN-S	\$0
456-105-433	SRMSUITE UPG 20K 0-14TB =CB	EN-S	\$0
456-105-434	SRMSUITE UPG 20K 15-25TB =CB	EN-S	\$0
456-105-435	SRMSUITE UPG 20K 26-40TB =CB	EN-S	\$0
456-105-436	SRMSUITE UPG 20K 41-60TB =CB	EN-S	\$0
456-105-437	SRMSUITE UPG 20K 61-100TB =CB	EN-S	\$0
456-105-438	SRMSUITE UPG 20K 101-150TB =CB	EN-S	\$0
456-105-439	SRMSUITE UPG 20K 151-250TB =CB	EN-S	\$0
456-105-440	SRMSUITE UPG 20K 251-400TB =CB	EN-S	\$0
456-105-441	SRMSUITE UPG 20K 401-600TB =CB	EN-S	\$0
456-105-442	SRMSUITE UPG 20K 601-1PB =CB	EN-S	\$0
456-105-443	SRMSUITE UPG 20K 1001TB+ =CB	EN-S	\$0
456-105-444	SRMSUITE UPG 40K 0-14TB S =CB	EN-S	\$0
456-105-445	SRMSUITE UPG 40K 15-25TB S =CB	EN-S	\$0
456-105-446	SRMSUITE UPG 40K 26-40TB S =CB	EN-S	\$0
456-105-447	SRMSUITE UPG 40K 41-60TB S =CB	EN-S	\$0
456-105-448	SRMSUITE UPG 40K 61-100TB S =CB	EN-S	\$0
456-105-449	SRMSUITE UPG 40K 101-150TB S =CB	EN-S	\$0
456-105-450	SRMSUITE UPG 40K 151-250TB S =CB	EN-S	\$0
456-105-451	SRMSUITE UPG 40K 251-400TB S =CB	EN-S	\$0
456-105-452	SRMSUITE UPG 40K 401-600TB S =CB	EN-S	\$0
456-105-453	SRMSUITE UPG 40K 601-1PB S =CB	EN-S	\$0
456-105-454	SRMSUITE UPG 40K 1001TB+ S =CB	EN-S	\$0
456-105-455	SRMSUITE UPG 40K 0-14TB =CB	EN-S	\$0
456-105-456	SRMSUITE UPG 40K 15-25TB =CB	EN-S	\$0
456-105-457	SRMSUITE UPG 40K 26-40TB =CB	EN-S	\$0
456-105-458	SRMSUITE UPG 40K 41-60TB =CB	EN-S	\$0
456-105-459	SRMSUITE UPG 40K 61-100TB =CB	EN-S	\$0
456-105-460	SRMSUITE UPG 40K 101-150TB =CB	EN-S	\$0
456-105-461	SRMSUITE UPG 40K 151-250TB =CB	EN-S	\$0
456-105-462	SRMSUITE UPG 40K 251-400TB =CB	EN-S	\$0
456-105-463	SRMSUITE UPG 40K 401-600TB =CB	EN-S	\$0
456-105-464	SRMSUITE UPG 40K 601-1PB =CB	EN-S	\$0
456-105-465	SRMSUITE UPG 40K 1001TB+ =CB	EN-S	\$0
456-106-226	APPSYNC VMAX 10K 1TB =CB	EN-S	\$1,250
456-106-227	APPSYNC VMAX 20K 0-14TB SATA =CB	EN-S	\$1,150
456-106-228	APPSYNC VMAX 20K 15-25TB SATA =CB	EN-S	\$1,070
456-106-229	APPSYNC VMAX 20K 26-40TB SATA =CB	EN-S	\$950
456-106-230	APPSYNC VMAX 20K 41-60TB SATA =CB	EN-S	\$880
456-106-231	APPSYNC VMAX 20K 61-100TB SATA =CB	EN-S	\$850
456-106-232	APPSYNC VMAX 20K 101-150TB SATA =CB	EN-S	\$770
456-106-233	APPSYNC VMAX 20K 151-250TB SATA =CB	EN-S	\$680
456-106-234	APPSYNC VMAX 20K 251-400TB SATA =CB	EN-S	\$590
456-106-235	APPSYNC VMAX 20K 401-600TB SATA =CB	EN-S	\$510
456-106-236	APPSYNC VMAX 20K 601-1PB SATA =CB	EN-S	\$450
456-106-237	APPSYNC VMAX 20K 1001TB+ SATA =CB	EN-S	\$390
456-106-238	APPSYNC VMAX 20K 0-14TB NOSATA =CB	EN-S	\$2,290
456-106-239	APPSYNC VMAX 20K 15-25TB NOSATA =CB	EN-S	\$2,150
456-106-240	APPSYNC VMAX 20K 26-40TB NOSATA =CB	EN-S	\$1,890

456-106-241	APPSYNC VMAX 20K 41-60TB NOSATA =CB	EN-S	\$1,760
456-106-242	APPSYNC VMAX 20K 61-100TB NOSATA =CB	EN-S	\$1,700
456-106-243	APPSYNC VMAX 20K 101-150TB NOSATA =CB	EN-S	\$1,530
456-106-244	APPSYNC VMAX 20K 151-250TB NOSATA =CB	EN-S	\$1,350
456-106-245	APPSYNC VMAX 20K 251-400TB NOSATA =CB	EN-S	\$1,170
456-106-246	APPSYNC VMAX 20K 401-600TB NOSATA =CB	EN-S	\$1,030
456-106-247	APPSYNC VMAX 20K 601-1PB NOSATA =CB	EN-S	\$890
456-106-248	APPSYNC VMAX 20K 1001TB+ NOSATA =CB	EN-S	\$780
456-106-249	APPSYNC VMAX 40K 0-14TB SATA =CB	EN-S	\$1,150
456-106-250	APPSYNC VMAX 40K 15-25TB SATA =CB	EN-S	\$1,070
456-106-251	APPSYNC VMAX 40K 26-40TB SATA =CB	EN-S	\$950
456-106-252	APPSYNC VMAX 40K 41-60TB SATA =CB	EN-S	\$880
456-106-253	APPSYNC VMAX 40K 61-100TB SATA =CB	EN-S	\$850
456-106-254	APPSYNC VMAX 40K 101-150TB SATA =CB	EN-S	\$770
456-106-255	APPSYNC VMAX 40K 151-250TB SATA =CB	EN-S	\$680
456-106-256	APPSYNC VMAX 40K 251-400TB SATA =CB	EN-S	\$590
456-106-257	APPSYNC VMAX 40K 401-600TB SATA =CB	EN-S	\$510
456-106-258	APPSYNC VMAX 40K 601-1PB SATA =CB	EN-S	\$450
456-106-259	APPSYNC VMAX 40K 1001TB+ SATA =CB	EN-S	\$390
456-106-260	APPSYNC VMAX 40K 0-14TB NOSATA =CB	EN-S	\$2,290
456-106-261	APPSYNC VMAX 40K 15-25TB NOSATA =CB	EN-S	\$2,150
456-106-262	APPSYNC VMAX 40K 26-40TB NOSATA =CB	EN-S	\$1,890
456-106-263	APPSYNC VMAX 40K 41-60TB NOSATA =CB	EN-S	\$1,760
456-106-264	APPSYNC VMAX 40K 61-100TB NOSATA =CB	EN-S	\$1,700
456-106-265	APPSYNC VMAX 40K 101-150TB NOSATA =CB	EN-S	\$1,530
456-106-266	APPSYNC VMAX 40K 151-250TB NOSATA =CB	EN-S	\$1,350
456-106-267	APPSYNC VMAX 40K 251-400TB NOSATA =CB	EN-S	\$1,170
456-106-268	APPSYNC VMAX 40K 401-600TB NOSATA =CB	EN-S	\$1,030
456-106-269	APPSYNC VMAX 40K 601-1PB NOSATA =CB	EN-S	\$890
456-106-270	APPSYNC VMAX 40K 1001TB+ NOSATA =CB	EN-S	\$780
456-106-293	APPSYNC VMAX 10K CAP UPG 1TB=CB	EN-S	\$1,250
456-106-316	APPSYNC VMAX 40K CAP UPG 0-14TB S=CB	EN-S	\$0
456-106-317	APPSYNC VMAX 40K CAP UPG 15-25TB S=CB	EN-S	\$0
456-106-318	APPSYNC VMAX 40K CAP UPG 26-40TB S=CB	EN-S	\$0
456-106-319	APPSYNC VMAX 40K CAP UPG 41-60TB S=CB	EN-S	\$0
456-106-320	APPSYNC VMAX 40K CAP UPG 61-100TB S=CB	EN-S	\$0
456-106-321	APPSYNC VMAX 40K CAP UPG 101-150TB S=CB	EN-S	\$0
456-106-322	APPSYNC VMAX 40K CAP UPG 151-250TB S=CB	EN-S	\$0
456-106-323	APPSYNC VMAX 40K CAP UPG 251-400TB S=CB	EN-S	\$0
456-106-324	APPSYNC VMAX 40K CAP UPG 401-600TB S=CB	EN-S	\$0
456-106-325	APPSYNC VMAX 40K CAP UPG 601-1PB S=CB	EN-S	\$0
456-106-326	APPSYNC VMAX 40K CAP UPG 1001TB+ S=CB	EN-S	\$0
456-106-327	APPSYNC VMAX 40K CAP UPG 0-14TB NS=CB	EN-S	\$0
456-106-328	APPSYNC VMAX 40K CAP UPG 15-25TB NS=CB	EN-S	\$0
456-106-329	APPSYNC VMAX 40K CAP UPG 26-40TB NS=CB	EN-S	\$0
456-106-330	APPSYNC VMAX 40K CAP UPG 41-60TB NS=CB	EN-S	\$0
456-106-331	APPSYNC VMAX 40K CAP UPG 61-100TB NS=CB	EN-S	\$0
456-106-332	APPSYNC VMAX 40K CAP UPG 101-150TB NS=CB	EN-S	\$0
456-106-333	APPSYNC VMAX 40K CAP UPG 151-250TB NS=CB	EN-S	\$0
456-106-334	APPSYNC VMAX 40K CAP UPG 251-400TB NS=CB	EN-S	\$0

456-106-335	APPSYNC VMAX 40K CAP UPG 401-600TB NS=CB	EN-S	\$0
456-106-336	APPSYNC VMAX 40K CAP UPG 601-1PB NS=CB	EN-S	\$0
456-106-337	APPSYNC VMAX 40K CAP UPG 1001TB+ NS=CB	EN-S	\$0
456-106-349	APPSYNC VMAX 10K 1TB =CA	EN-S	\$1,710
456-106-350	APPSYNC VMAX 20K 0-14TB REG CAP =CA	EN-S	\$3,990
456-106-351	APPSYNC VMAX 20K 15-25TB REG CAP =CA	EN-S	\$3,470
456-106-352	APPSYNC VMAX 20K 26-40TB REG CAP =CA	EN-S	\$3,020
456-106-353	APPSYNC VMAX 20K 41-60TB REG CAP =CA	EN-S	\$2,460
456-106-354	APPSYNC VMAX 20K 61-100TB REG CAP =CA	EN-S	\$2,070
456-106-355	APPSYNC VMAX 20K 101-150TB REG CAP =CA	EN-S	\$1,930
456-106-356	APPSYNC VMAX 20K 151-250TB REG CAP =CA	EN-S	\$1,790
456-106-357	APPSYNC VMAX 20K 251-400TB REG CAP =CA	EN-S	\$1,660
456-106-358	APPSYNC VMAX 20K 401-600TB REG CAP =CA	EN-S	\$1,510
456-106-359	APPSYNC VMAX 20K 601-1PB REG CAP =CA	EN-S	\$1,410
456-106-360	APPSYNC VMAX 20K 1001TB+ REG CAP =CA	EN-S	\$990
456-106-361	APPSYNC VMAX 40K 0-14TB REG CAP =CA	EN-S	\$3,990
456-106-362	APPSYNC VMAX 40K 15-25TB REG CAP =CA	EN-S	\$3,470
456-106-363	APPSYNC VMAX 40K 26-40TB REG CAP =CA	EN-S	\$3,020
456-106-364	APPSYNC VMAX 40K 41-60TB REG CAP =CA	EN-S	\$2,460
456-106-365	APPSYNC VMAX 40K 61-100TB REG CAP =CA	EN-S	\$2,070
456-106-366	APPSYNC VMAX 40K 101-150TB REG CAP =CA	EN-S	\$1,930
456-106-367	APPSYNC VMAX 40K 151-250TB REG CAP =CA	EN-S	\$1,790
456-106-368	APPSYNC VMAX 40K 251-400TB REG CAP =CA	EN-S	\$1,660
456-106-369	APPSYNC VMAX 40K 401-600TB REG CAP =CA	EN-S	\$1,510
456-106-370	APPSYNC VMAX 40K 601-1PB REG CAP =CA	EN-S	\$1,410
456-106-371	APPSYNC VMAX 40K 1001TB+ REG CAP =CA	EN-S	\$990
456-106-383	APPSYNC VMAX 10K CAP UPG 1TB=CA	EN-S	\$1,710
456-106-395	APPSYNC VMAX 40K CAP UPG 0-14TB R=CA	EN-S	\$0
456-106-396	APPSYNC VMAX 40K CAP UPG 15-25TB R=CA	EN-S	\$0
456-106-397	APPSYNC VMAX 40K CAP UPG 26-40TB R=CA	EN-S	\$0
456-106-398	APPSYNC VMAX 40K CAP UPG 41-60TB R=CA	EN-S	\$0
456-106-399	APPSYNC VMAX 40K CAP UPG 61-100TB R=CA	EN-S	\$0
456-106-400	APPSYNC VMAX 40K CAP UPG 101-150TB R=CA	EN-S	\$0
456-106-401	APPSYNC VMAX 40K CAP UPG 151-250TB R=CA	EN-S	\$0
456-106-402	APPSYNC VMAX 40K CAP UPG 251-400TB R=CA	EN-S	\$0
456-106-403	APPSYNC VMAX 40K CAP UPG 401-600TB R=CA	EN-S	\$0
456-106-404	APPSYNC VMAX 40K CAP UPG 601-1PB R=CA	EN-S	\$0
456-106-405	APPSYNC VMAX 40K CAP UPG 1001TB+ R=CA	EN-S	\$0
456-106-446	ADV SW SUITE 40K SATA 0-14TB=CB	EN-S	\$0
456-106-447	ADV SW SUITE 40K SATA 15-25TB=CB	EN-S	\$0
456-106-448	ADV SW SUITE 40K SATA 26-40TB=CB	EN-S	\$0
456-106-449	ADV SW SUITE 40K SATA 41-60TB=CB	EN-S	\$0
456-106-450	ADV SW SUITE 40K SATA 61-100TB=CB	EN-S	\$0
456-106-451	ADV SW SUITE 40K SATA 101-150TB=CB	EN-S	\$0
456-106-452	ADV SW SUITE 40K SATA 151-250TB=CB	EN-S	\$0
456-106-453	ADV SW SUITE 40K SATA 251-400TB=CB	EN-S	\$0
456-106-454	ADV SW SUITE 40K SATA 401-600TB=CB	EN-S	\$0
456-106-455	ADV SW SUITE 40K SATA 601-1000TB=CB	EN-S	\$0
456-106-456	ADV SW SUITE 40K SATA 1001TB+=CB	EN-S	\$0
456-106-457	ADV SW SUITE 40K NON-SATA 0-14TB=CB	EN-S	\$0

456-106-458	ADV SW SUITE 40K NON-SATA 15-25TB=CB	EN-S	\$0
456-106-459	ADV SW SUITE 40K NON-SATA 26-40TB=CB	EN-S	\$0
456-106-460	ADV SW SUITE 40K NON-SATA 41-60TB=CB	EN-S	\$0
456-106-461	ADV SW SUITE 40K NON-SATA 61-100TB=CB	EN-S	\$0
456-106-462	ADV SW SUITE 40K NON-SATA 101-150TB=CB	EN-S	\$0
456-106-463	ADV SW SUITE 40K NON-SATA 151-250TB=CB	EN-S	\$0
456-106-464	ADV SW SUITE 40K NON-SATA 251-400TB=CB	EN-S	\$0
456-106-465	ADV SW SUITE 40K NON-SATA 401-600TB=CB	EN-S	\$0
456-106-466	ADV SW SUITE 40K NON-SATA 601-1000TB=CB	EN-S	\$0
456-106-467	ADV SW SUITE 40K NON-SATA 1001TB+=CB	EN-S	\$0
456-106-468	ADV SW SUITE 20K SATA 0-14TB=CB	EN-S	\$0
456-106-469	ADV SW SUITE 20K SATA 15-25TB=CB	EN-S	\$0
456-106-470	ADV SW SUITE 20K SATA 26-40TB=CB	EN-S	\$0
456-106-471	ADV SW SUITE 20K SATA 41-60TB=CB	EN-S	\$0
456-106-472	ADV SW SUITE 20K SATA 61-100TB=CB	EN-S	\$0
456-106-473	ADV SW SUITE 20K SATA 101-150TB=CB	EN-S	\$0
456-106-474	ADV SW SUITE 20K SATA 151-250TB=CB	EN-S	\$0
456-106-475	ADV SW SUITE 20K SATA 251-400TB=CB	EN-S	\$0
456-106-476	ADV SW SUITE 20K SATA 401-600TB=CB	EN-S	\$0
456-106-477	ADV SW SUITE 20K SATA 601-1000TB=CB	EN-S	\$0
456-106-478	ADV SW SUITE 20K SATA 1001TB+=CB	EN-S	\$0
456-106-479	ADV SW SUITE 20K NON-SATA 0-14TB=CB	EN-S	\$0
456-106-480	ADV SW SUITE 20K NON-SATA 15-25TB=CB	EN-S	\$0
456-106-481	ADV SW SUITE 20K NON-SATA 26-40TB=CB	EN-S	\$0
456-106-482	ADV SW SUITE 20K NON-SATA 41-60TB=CB	EN-S	\$0
456-106-483	ADV SW SUITE 20K NON-SATA 61-100TB=CB	EN-S	\$0
456-106-484	ADV SW SUITE 20K NON-SATA 101-150TB=CB	EN-S	\$0
456-106-485	ADV SW SUITE 20K NON-SATA 151-250TB=CB	EN-S	\$0
456-106-486	ADV SW SUITE 20K NON-SATA 251-400TB=CB	EN-S	\$0
456-106-487	ADV SW SUITE 20K NON-SATA 401-600TB=CB	EN-S	\$0
456-106-488	ADV SW SUITE 20K NON-SATA 601-1000TB=CB	EN-S	\$0
456-106-489	ADV SW SUITE 20K NON-SATA 1001TB+=CB	EN-S	\$0
456-106-901	APPSYNC 10K SW Suite SATA 1TB=CB	EN-S	\$370
456-106-902	APPSYNC 10K SW Suite Non-SATA 1TB=CB	EN-S	\$740
456-106-903	APPSYNC 10K SW CAP UPG Suite SATA=CB	EN-S	\$370
456-106-904	APPSYNC 10K SW Suite CAP UPG Non-SATA=CB	EN-S	\$740
456-107-217	ESA FOR 10K NON-SATA - PER TB AP=CB	EN-S	\$0
456-107-218	ESA FOR 10K SATA - PER TB AP=CB	EN-S	\$0
456-107-219	ESA FOR 10K NON-SATA - PER TB WW=CB	EN-S	\$0
456-107-220	ESA FOR 10K SATA - PER TB WW=CB	EN-S	\$0
456-107-221	ESA FOR 20K NON-SATA 0-14TB=CB	EN-S	\$0
456-107-222	ESA FOR 20K NON-SATA 15-25TB=CB	EN-S	\$0
456-107-223	ESA FOR 20K NON-SATA 26-40TB=CB	EN-S	\$0
456-107-224	ESA FOR 20K NON-SATA 41-60TB=CB	EN-S	\$0
456-107-225	ESA FOR 20K NON-SATA 61-100TB=CB	EN-S	\$0
456-107-226	ESA FOR 20K NON-SATA 101-150TB=CB	EN-S	\$0
456-107-227	ESA FOR 20K NON-SATA 151-250TB=CB	EN-S	\$0
456-107-228	ESA FOR 20K NON-SATA 251-400TB=CB	EN-S	\$0
456-107-229	ESA FOR 20K NON-SATA 401-600TB=CB	EN-S	\$0
456-107-230	ESA FOR 20K NON-SATA 601-1000TB=CB	EN-S	\$0

456-107-231	ESA FOR 20K NON-SATA 1001TB-PLUS=CB	EN-S	\$0
456-107-232	ESA FOR 20K SATA 0-14TB=CB	EN-S	\$0
456-107-233	ESA FOR 20K SATA 15-25TB=CB	EN-S	\$0
456-107-234	ESA FOR 20K SATA 26-40TB=CB	EN-S	\$0
456-107-235	ESA FOR 20K SATA 41-60TB=CB	EN-S	\$0
456-107-236	ESA FOR 20K SATA 61-100TB=CB	EN-S	\$0
456-107-237	ESA FOR 20K SATA 101-150TB=CB	EN-S	\$0
456-107-238	ESA FOR 20K SATA 151-250TB=CB	EN-S	\$0
456-107-239	ESA FOR 20K SATA 251-400TB=CB	EN-S	\$0
456-107-240	ESA FOR 20K SATA 401-600TB=CB	EN-S	\$0
456-107-241	ESA FOR 20K SATA 601-1000TB=CB	EN-S	\$0
456-107-242	ESA FOR 20K SATA 1001TB-PLUS=CB	EN-S	\$0
456-107-243	ESA FOR 40K NON-SATA 0-14TB=CB	EN-S	\$0
456-107-244	ESA FOR 40K NON-SATA 15-25TB=CB	EN-S	\$0
456-107-245	ESA FOR 40K NON-SATA 26-40TB=CB	EN-S	\$0
456-107-246	ESA FOR 40K NON-SATA 41-60TB=CB	EN-S	\$0
456-107-247	ESA FOR 40K NON-SATA 61-100TB=CB	EN-S	\$0
456-107-248	ESA FOR 40K NON-SATA 101-150TB=CB	EN-S	\$0
456-107-249	ESA FOR 40K NON-SATA 151-250TB=CB	EN-S	\$0
456-107-250	ESA FOR 40K NON-SATA 251-400TB=CB	EN-S	\$0
456-107-251	ESA FOR 40K NON-SATA 401-600TB=CB	EN-S	\$0
456-107-252	ESA FOR 40K NON-SATA 601-1000TB=CB	EN-S	\$0
456-107-253	ESA FOR 40K NON-SATA 1001TB-PLUS=CB	EN-S	\$0
456-107-254	ESA FOR 40K SATA 0-14TB=CB	EN-S	\$0
456-107-255	ESA FOR 40K SATA 15-25TB=CB	EN-S	\$0
456-107-256	ESA FOR 40K SATA 26-40TB=CB	EN-S	\$0
456-107-257	ESA FOR 40K SATA 41-60TB=CB	EN-S	\$0
456-107-258	ESA FOR 40K SATA 61-100TB=CB	EN-S	\$0
456-107-259	ESA FOR 40K SATA 101-150TB=CB	EN-S	\$0
456-107-260	ESA FOR 40K SATA 151-250TB=CB	EN-S	\$0
456-107-261	ESA FOR 40K SATA 251-400TB=CB	EN-S	\$0
456-107-262	ESA FOR 40K SATA 401-600TB=CB	EN-S	\$0
456-107-263	ESA FOR 40K SATA 601-1000TB=CB	EN-S	\$0
456-107-264	ESA FOR 40K SATA 1001TB-PLUS=CB	EN-S	\$0
456-107-753	ESA VMAX 10K WW N-S 1TB MPO=CB	EN-S	\$0
456-107-754	ESA VMAX 10K WW S 1TB MPO=CB	EN-S	\$0
456-107-755	ESA FOR VMAX 40K N-S 0-14TB MPO=CB	EN-S	\$0
456-107-756	ESA FOR VMAX 40K N-S 15-25TB MPO=CB	EN-S	\$0
456-107-757	ESA FOR VMAX 40K N-S 26-40TB MPO=CB	EN-S	\$0
456-107-758	ESA FOR VMAX 40K N-S 41-60TB MPO=CB	EN-S	\$0
456-107-759	ESA FOR VMAX 40K N-S 61-100TB MPO=CB	EN-S	\$0
456-107-760	ESA FOR VMAX 40K N-S 101-150TB MPO=CB	EN-S	\$0
456-107-761	ESA FOR VMAX 40K N-S 151-250TB MPO=CB	EN-S	\$0
456-107-762	ESA FOR VMAX 40K N-S 251-400TB MPO=CB	EN-S	\$0
456-107-763	ESA FOR VMAX 40K N-S 401-600TB MPO=CB	EN-S	\$0
456-107-764	ESA FOR VMAX 40K N-S 601-1000TB MPO=CB	EN-S	\$0
456-107-765	ESA FOR VMAX 40K N-S 1001TB+ MPO=CB	EN-S	\$0
456-107-766	ESA FOR VMAX 40K SATA 0-14TB MPO=CB	EN-S	\$0
456-107-767	ESA FOR VMAX 40K SATA 15-25TB MPO=CB	EN-S	\$0
456-107-768	ESA FOR VMAX 40K SATA 26-40TB MPO=CB	EN-S	\$0

456-107-769	ESA FOR VMAX 40K SATA 41-60TB MPO=CB	EN-S	\$0
456-107-770	ESA FOR VMAX 40K SATA 61-100TB MPO=CB	EN-S	\$0
456-107-771	ESA FOR VMAX 40K SATA 101-150TB MPO=CB	EN-S	\$0
456-107-772	ESA FOR VMAX 40K SATA 151-250TB MPO=CB	EN-S	\$0
456-108-015	VMAX10K OR-DM BASE NEW LIC=IC	EN-S	\$23,060
456-108-016	VMAX10K OR-DM BASE REG NEW LIC=IC	EN-S	\$19,910
456-108-027	VMAX10K TIMEFINDER REG NEW=IC	EN-S	\$13,890
456-108-032	VMAX10K FAST VP BASE NEW LIC=IC	EN-S	\$18,394
456-108-034	VMAX10K FAST VP SL REG NEW LIC=IC	EN-S	\$22,570
456-108-035	VMAX10K FAST VP REG NEW AP=IC	EN-S	\$22,570
456-108-036	VMAX10K FAST VP SL NEW LIC=IC	EN-S	\$18,394
456-108-060	VMAX10K SRDF-A BASE NEW LIC=IC	EN-S	\$10,000
456-108-061	VMAX10K SRDF-A BASE REG NEW LIC=IC	EN-S	\$22,120
456-108-062	VMAX10K SRDF-A BASE NEW ADDON=IC	EN-S	\$0
456-108-063	VMAX10K SRDF-A REG BASE NEW ADDON=IC	EN-S	\$0
456-108-084	VMAX10K SRDF-S BASE NEW LIC=IC	EN-S	\$10,000
456-108-085	VMAX10K SRDF-S BASE REG NEW LIC=IC	EN-S	\$22,120
456-108-086	VMAX10K SRDF-S BASE NEW ADDON=IC	EN-S	\$0
456-108-087	VMAX10K SRDF-S REG BASE NEW ADDON=IC	EN-S	\$0
456-108-094	VMAX10K SRDF-STAR REG BASE LIC=IC	EN-S	\$9,000
456-108-096	VMAX10K SRDF-STAR BASE LIC=IC	EN-S	\$5,000
456-108-102	VMAX10K BASE SW PKG BASE NEW LIC=IC	EN-S	\$44,150
456-108-103	VMAX10K ADV SW PKG BASE NEW LIC=IC	EN-S	\$57,545
456-108-105	VMAX10K ENGNTY PKG BASE NEW LIC=IC	EN-S	\$8,080
456-108-107	VMAX10K BASIC SRDF PKG BASE LIC=IC	EN-S	\$10,000
456-108-109	VMAX10K ADV SRDF PKG BASE LIC=IC	EN-S	\$9,000
456-108-111	VMAX10K SYMM MGMT II PKG BASE LIC=IC	EN-S	\$11,405
456-108-128	RP/EX LOC BASE FOR VMAX20K LIC=IC	EN-S	\$24,300
456-108-129	RP/EX REM BASE FOR VMAX20K LIC=IC	EN-S	\$24,300
456-108-130	RP/EX LOC BASE FOR VMAX40K LIC=IC	EN-S	\$24,300
456-108-131	RP/EX REM BASE FOR VMAX40K LIC=IC	EN-S	\$24,300
456-108-132	RP/EX BASE LOC FOR VMAX10K LIC=IC	EN-S	\$27,000
456-108-133	RP/EX BASE REM FOR VMAX10K LIC=IC	EN-S	\$27,000
456-108-142	VIPR SRM VMAX10K BASE =IC	EN-S	\$24,700
456-108-143	VIPR SRM VMAX20K BASE =IC	EN-S	\$21,060
456-108-144	VIPR SRM VMAX40K BASE =IC	EN-S	\$21,060
456-108-157	VIPR SRM UPG VMAX10K BASE =IC	EN-S	\$6,410
456-108-158	VIPR SRM UPG VMAX20K BASE =IC	EN-S	\$5,460
456-108-159	VIPR SRM UPG VMAX40K BASE =IC	EN-S	\$5,460
456-108-196	VMAX40K ENGINUITY BASE NEW LIC=IC	EN-S	\$8,080
456-108-217	VMAX40K OR-DM REG BASE LIC=IC	EN-S	\$19,908
456-108-218	VMAX40K OR-DM BASE NEW LIC=IC	EN-S	\$18,684
456-108-225	VMAX40K ADV SW PKG BASE LIC=IC	EN-S	\$45,540
456-108-226	VMAX40K ADV SRDF PKG REG BASE LIC=IC	EN-S	\$9,820
456-108-227	VMAX40K ADV SRDF PKG BASE LIC=IC	EN-S	\$16,370
456-108-228	VMAX40K SRDF REP PKG REG BASE LIC=IC	EN-S	\$20,760
456-108-229	VMAX40K SRDF REP PKG BASE LIC=IC	EN-S	\$22,120
456-108-230	VMAX40K SYMM MGMT PKG BASE LIC	EN-S	\$0
456-108-231	VMAX40K FAST_TIER REG BASE LIC=IC	EN-S	\$16,928
456-108-232	VMAX40K FAST_TIER BASE LIC=IC	EN-S	\$18,394

456-108-233	VMAX40K TIMEFINDER REP PKG REG BASE LIC	EN-S	\$13,890
456-108-234	VMAX40K TIMEFINDER BASE LIC=IC	EN-S	\$21,368
456-108-254	VMAX10K BASIC SRDF PKG REG BASE LIC=IC	EN-S	\$22,120
456-108-256	VMAX10K ADV SRDF PKG REG BASE LIC=IC	EN-S	\$9,000
456-108-272	VMAX20K FAST VP BASE NEW LIC=IC	EN-S	\$4,562
456-108-273	VMAX20K OPTIMIZER BASE NEW LIC=IC	EN-S	\$0
456-108-280	VMAX20K DCP BASE NEW LIC=IC	EN-S	\$0
456-108-283	VMAX20K OR-DM BASE NEW LIC=IC	EN-S	\$18,684
456-108-302	VMAX20K ENGINUITY PKG BASE LIC=IC	EN-S	\$8,080
456-108-303	VMAX20K SRDF PKG REG BASE LIC=IC	EN-S	\$22,120
456-108-304	VMAX20K SRDF PKG BASE LIC=IC	EN-S	\$20,760
456-108-305	VMAX20K ADV SRDF PKG REG BASE LIC=IC	EN-S	\$16,370
456-108-306	VMAX20K ADV SRDF PKG BASE LIC=IC	EN-S	\$9,820
456-108-307	VMAX20K SYMM MGMT PKG BASE LIC=IC	EN-S	\$0
456-108-308	VMAX20K TIMEFINDER PKG BASE LIC=IC	EN-S	\$21,368
456-108-309	VMAX20K TIMEFINDER PKG REG BASE LIC=IC	EN-S	\$13,890
456-108-310	VMAX20K FAST TIERING PKG BASE LIC=IC	EN-S	\$18,394
456-108-311	VMAX20K FAST TIERING PKG REG BASE LIC=IC	EN-S	\$16,928
456-108-312	VMAX20K ADV SW PKG BASE LIC=IC	EN-S	\$45,540
456-108-316	VMAX20K OR-DM BASE REG NEW LIC=IC	EN-S	\$20,754
456-108-360	ESA FOR 20K BASE NEW LICENSE=IC	EN-S	\$0
456-108-653	VMAX10K ESA BASE LIC E=IC	EN-S	\$0
456-108-660	VMAX10K BASE SW II PKG BASE NEW LIC=IC	EN-S	\$44,150
456-108-678	ESA FOR 40K BASE NEW LICENSE=IC	EN-S	\$7,200
456-108-824	VMAX10K ESA BASE AP LIC=IC	EN-S	\$0
456-108-994	RP/EX FOR VMAX10K RAW BASE LIC=IC	EN-S	\$1,000
456-108-999	APPSYNC 10K SW Suite Base=IC	EN-S	\$21,860
456-109-000	APPSYNC VMAX20K BASE =IC	EN-S	\$19,240
456-109-001	APPSYNC VMAX40K BASE =IC	EN-S	\$19,240
456-109-002	APPSYNC 10K BASE =IC	EN-S	\$12,510
456-109-030	VMAX20K FAST VP BASE REG NEW LIC=IC	EN-S	\$16,928
456-109-036	VMAX10K ESA BASE NEW LIC MP ONLY WW=IC	EN-S	\$0
456-109-098	VMS VMAX10K BASE=IC	EN-S	\$0
456-109-099	VMS VMAX40K BASE=IC	EN-S	\$0
456-109-264	VIPR SRM 10K BASE =IC	EN-S	\$24,700
456-109-265	VIPR SRM 20K BASE =IC	EN-S	\$21,060
456-109-266	VIPR SRM 40K BASE =IC	EN-S	\$21,060
456-110-031	ESA FOR VMAX 40K SATA 251-400TB MPO=CB	EN-S	\$0
456-110-032	ESA FOR VMAX 40K SATA 401-600TB MPO=CB	EN-S	\$0
456-110-033	ESA FOR VMAX 40K SATA 601-1000TB MPO=CB	EN-S	\$0
456-110-034	ESA FOR VMAX 40K SATA 1001TB+ MPO=CB	EN-S	\$0
456-110-378	VS VMAX 40K 1-14TB S=CB	EN-S	\$0
456-110-379	VS VMAX 40K 15-25TB S=CB	EN-S	\$0
456-110-380	VS VMAX 40K 26-40TB S=CB	EN-S	\$0
456-110-381	VS VMAX 40K 41-60TB S=CB	EN-S	\$1,310
456-110-382	VS VMAX 40K 61-100TB S=CB	EN-S	\$1,280
456-110-383	VS VMAX 40K 101-150TB S=CB	EN-S	\$1,250
456-110-384	VS VMAX 40K 151-250TB S=CB	EN-S	\$1,240
456-110-385	VS VMAX 40K 251-400TB S=CB	EN-S	\$1,030
456-110-386	VS VMAX 40K 401-600TB S=CB	EN-S	\$850

456-110-387	VS VMAX 40K 601-1PBS S=CB	EN-S	\$780
456-110-388	VS VMAX 40K 1001TB+ S=CB	EN-S	\$760
456-110-389	VS VMAX 40K 1-14TB NS=CB	EN-S	\$2,840
456-110-390	VS VMAX 40K 15-25TB NS=CB	EN-S	\$2,760
456-110-391	VS VMAX 40K 26-40TB NS=CB	EN-S	\$2,680
456-110-392	VS VMAX 40K 41-60TB NS=CB	EN-S	\$2,620
456-110-393	VS VMAX 40K 61-100TB NS=CB	EN-S	\$2,550
456-110-394	VS VMAX 40K 101-150TB NS=CB	EN-S	\$2,500
456-110-395	VS VMAX 40K 151-250TB NS=CB	EN-S	\$2,480
456-110-396	VS VMAX 40K 251-400TB NS=CB	EN-S	\$2,050
456-110-397	VS VMAX 40K 401-600TB NS=CB	EN-S	\$1,690
456-110-398	VS VMAX 40K 601-1PBS NS=CB	EN-S	\$1,550
456-110-399	VS VMAX 40K 1001TB+ NS=CB	EN-S	\$1,520
456-110-400	VS VMAX 10K CAPACITY=CB	EN-S	\$0
456-110-432	VS VMAX 10K VIPRC LICENSE=CB	EN-S	\$0
456-110-433	VS VMAX 40K VIPRC LICENSE=CB	EN-S	\$0
456-110-593	VMAX 20K UNISPHERE360 BASE NEW=IC	EN-S	\$0
456-110-594	VMAX 10K UNISPHERE360 BASE NEW WW=IC	EN-S	\$55,000
456-110-606	VMAX 40K UNISPHERE360 BASE NEW=IC	EN-S	\$0
456-110-719	VIPR SRM 10K 1TB =CB	EN-S	\$1,440
456-110-720	VIPR SRM 20K 1-14TB S =CB	EN-S	\$2,640
456-110-721	VIPR SRM 20K 15-25TB S =CB	EN-S	\$2,470
456-110-722	VIPR SRM 20K 26-40TB S =CB	EN-S	\$2,210
456-110-723	VIPR SRM 20K 41-60TB S =CB	EN-S	\$1,900
456-110-724	VIPR SRM 20K 61-100TB S =CB	EN-S	\$1,630
456-110-725	VIPR SRM 20K 101-150TB S =CB	EN-S	\$1,450
456-110-726	VIPR SRM 20K 151-250TB S =CB	EN-S	\$1,220
456-110-727	VIPR SRM 20K 251-400TB S =CB	EN-S	\$1,030
456-110-728	VIPR SRM 20K 401-600TB S =CB	EN-S	\$840
456-110-729	VIPR SRM 20K 601-1PB S =CB	EN-S	\$700
456-110-730	VIPR SRM 20K 1001TB+ S =CB	EN-S	\$600
456-110-731	VIPR SRM 20K 1-14TB =CB	EN-S	\$5,270
456-110-732	VIPR SRM 20K 15-25TB =CB	EN-S	\$4,930
456-110-733	VIPR SRM 20K 26-40TB =CB	EN-S	\$4,410
456-110-734	VIPR SRM 20K 41-60TB =CB	EN-S	\$3,800
456-110-735	VIPR SRM 20K 61-100TB =CB	EN-S	\$3,240
456-110-736	VIPR SRM 20K 101-150TB =CB	EN-S	\$2,900
456-110-737	VIPR SRM 20K 151-250TB =CB	EN-S	\$2,440
456-110-738	VIPR SRM 20K 251-400TB =CB	EN-S	\$2,050
456-110-739	VIPR SRM 20K 401-600TB =CB	EN-S	\$1,670
456-110-740	VIPR SRM 20K 601-1PB =CB	EN-S	\$1,390
456-110-741	VIPR SRM 20K 1001TB+ =CB	EN-S	\$1,210
456-110-742	VIPR SRM 40K 1-14TB S =CB	EN-S	\$1,120
456-110-743	VIPR SRM 40K 15-25TB S =CB	EN-S	\$1,090
456-110-744	VIPR SRM 40K 26-40TB S =CB	EN-S	\$1,050
456-110-745	VIPR SRM 40K 41-60TB S =CB	EN-S	\$1,030
456-110-746	VIPR SRM 40K 61-100TB S =CB	EN-S	\$1,000
456-110-747	VIPR SRM 40K 101-150TB S =CB	EN-S	\$980
456-110-748	VIPR SRM 40K 151-250TB S =CB	EN-S	\$970
456-110-749	VIPR SRM 40K 251-400TB S =CB	EN-S	\$810

456-110-750	VIPR SRM 40K 401-600TB S =CB	EN-S	\$660
456-110-751	VIPR SRM 40K 601-1PB S =CB	EN-S	\$610
456-110-752	VIPR SRM 40K 1001TB+ S =CB	EN-S	\$600
456-110-753	VIPR SRM 40K 1-14TB =CB	EN-S	\$2,230
456-110-754	VIPR SRM 40K 15-25TB =CB	EN-S	\$2,170
456-110-755	VIPR SRM 40K 26-40TB =CB	EN-S	\$2,100
456-110-756	VIPR SRM 40K 41-60TB =CB	EN-S	\$2,050
456-110-757	VIPR SRM 40K 61-100TB =CB	EN-S	\$2,000
456-110-758	VIPR SRM 40K 101-150TB =CB	EN-S	\$1,960
456-110-759	VIPR SRM 40K 151-250TB =CB	EN-S	\$1,940
456-110-760	VIPR SRM 40K 251-400TB =CB	EN-S	\$1,610
456-110-761	VIPR SRM 40K 401-600TB =CB	EN-S	\$1,320
456-110-762	VIPR SRM 40K 601-1PB =CB	EN-S	\$1,220
456-110-763	VIPR SRM 40K 1001TB+ =CB	EN-S	\$1,190
456-110-781	SRM LIC ENABLE VMAX =IA	EN-S	\$0
456-111-596	ESA FOR VMAX BASE NEW LIC 40K MPO=IC	EN-S	\$5,040
457-000-668	VMAX 10K OR-DM BASE NEW LICENSE	EN-S	\$0
457-001-013	OR-DM VMAX 20K BASE NEW LICENSE	EN-S	\$0
457-001-027	FAST VP VMAX 20K REG BASE NEW LICENSE	EN-S	\$0
457-001-031	OPTIMIZER VMAX 20K BASE NEW LICENSE	EN-S	\$0
457-001-055	FAST VP VMAX 20K ADD ON BASE NEW LIC	EN-S	\$0
457-001-063	DCP VMAX 20K BASE NEW LICENSE	EN-S	\$0
457-001-229	VMAX 10K ADV SRDF SUITE REG BASE NEW	EN-S	\$0
457-001-231	VMAX 10K ADV SRDF SUITE BASE NEW	EN-S	\$0
457-002-001	ADV SRDF REP SUITE 20K BASE LICENSE	EN-S	\$0
457-002-007	ADV SRDF REP SUITE 20K REG BASE LIC	EN-S	\$0
457-002-011	ENGINUITY FOR VMAX 20K BASE LICENSE	EN-S	\$0
457-002-015	FAST TIERING SUITE 20K BASE LICENSE	EN-S	\$0
457-002-020	FAST TIERING REG 20K BASE LICENSE	EN-S	\$0
457-002-023	OR-DM VMAX 20K REG BASE LICENSE	EN-S	\$0
457-002-026	OR-DM VMAX 40K REG BASE LICENSE	EN-S	\$0
457-002-033	SRDF REP SUITE VMAX 20K BASE LICENSE	EN-S	\$0
457-002-039	SRDF REP SUITE VMAX 20K REG BASE LIC	EN-S	\$0
457-002-043	SYMM MGMT SUITE VMAX 20K BASE LICENSE	EN-S	\$0
457-002-047	TIMEFINDER SUITE VMAX 20K BASE LICENSE	EN-S	\$0
457-002-053	TIMEFINDER SUITE VMAX 20K REG BASE LIC	EN-S	\$0
457-100-760	VMAX 10K FAST VP BASE NEW LIC	EN-S	\$0
457-100-773	VMAX 10K BASE SW SUITE BASE NEW LIC	EN-S	\$0
457-100-777	VMAX 10K TF SNAP CAP UPG	EN-S	\$0
457-100-796	AFS Q2 FAST COMBO VMAX 40K	EN-S	\$0
457-100-823	VMAX 10K SRDF-A BASE NEW LICENSE	EN-S	\$0
457-100-824	VMAX 10K SRDF-A BASE REGISTERED NEW LIC	EN-S	\$0
457-100-830	VMAX 10K SRDF-S BASE NEW LICENSE	EN-S	\$0
457-100-831	VMAX 10K SRDF-S BASE REGISTERED NEW LIC	EN-S	\$0
457-100-901	SYMM MGMT Q2 FAST COMBO VMAX 40K	EN-S	\$0
457-100-903	ENGINUITY FOR VMAX 40K BASE NEW LICENSE	EN-S	\$0
457-100-908	SYMM MGMT SUITE FOR VMAX 40K BASE LIC	EN-S	\$0
457-100-913	TF REP SUITE FOR VMAX 40K BASE LICENSE	EN-S	\$0
457-100-919	TF REP SUITE FOR VMAX 40K REG BASE LIC	EN-S	\$0
457-100-923	FAST SUITE FOR VMAX 40K BASE LICENSE	EN-S	\$0

457-100-928	FAST SUITE FOR VMAX 40K REG BASE LICENSE	EN-S	\$0
457-100-931	SRDF REP SUITE FOR VMAX 40K BASE LIC	EN-S	\$0
457-100-937	SRDF REP SUITE FOR VMAX 40K REG BASE LIC	EN-S	\$0
457-100-941	ADV SRDF REP SUITE VMAX 40K BASE LIC	EN-S	\$0
457-100-947	ADV SRDF REP SUITE 40K REG BASE LIC	EN-S	\$0
457-100-957	OR-DM VMAX 40K BASE NEW LICENSE	EN-S	\$0
457-100-988	VMAX 10K TIMEFINDER REG NEW	EN-S	\$0
457-100-990	VMAX 10K FAST VP SL NEW	EN-S	\$0
457-100-992	VMAX 10K FAST VP SL REG NEW	EN-S	\$0
457-100-993	VMAX 10K FAST VP SL REG CAP UPG	EN-S	\$0
457-100-994	VMAX 10K SRDF-STAR BASE NEW LICENSE	EN-S	\$0
457-100-996	VMAX 10K SRDF-STAR REG BASE NEW LICENSE	EN-S	\$0
457-101-029	VMAX 10K BAS SRDF SUITE REG BASE NEW	EN-S	\$0
457-101-031	VMAX 10K BAS SRDF SUITE BASE NEW	EN-S	\$0
457-101-051	VMAX 10K ENGINUITY SUITE BASE NEW LIC	EN-S	\$0
457-101-059	VMAX 10K ADV SW SUITE II BASE NEW LIC	EN-S	\$0
457-101-063	VMAX 10K BASE SW SUITE II BASE NEW LIC	EN-S	\$0
457-101-067	VMAX 10K SYMM MGT SUITE II NEW	EN-S	\$0
457-101-079	VMAX 10K OR-DM BASE REGISTERED NEW LIC	EN-S	\$0
457-101-148	RP/EX LOC BASE FOR VMAX 20 =CA	EN-S	\$0
457-101-150	RP/EX REM BASE FOR VMAX20 =CA	EN-S	\$0
457-101-152	RP/EX LOC BASE FOR VMAX40=CA	EN-S	\$0
457-101-154	RP/EX REM BASE FOR VMAX40 =CA	EN-S	\$0
457-101-156	RP/EX BASE LOC FOR VMAX10 =CA	EN-S	\$0
457-101-157	RP/EX BASE REM FOR VMAX10 =CA	EN-S	\$0
457-101-158	RP/EX RAW BASE VMAX10 = CB	EN-S	\$0
457-101-190	VG10 Application Protection=IA	EN-S	\$0
457-101-191	VG50 Application Protection=IA	EN-S	\$0
457-101-298	VMAX 10K SRDF-A BASE NEW ADD ON=CB	EN-S	\$0
457-101-299	VMAX 10K SRDF-A REG BASE NEW ADD ON=CA	EN-S	\$0
457-101-300	VMAX 10K SRDF-S BASE NEW ADD ON=CB	EN-S	\$0
457-101-301	VMAX 10K SRDF-S REG BASE NEW ADD ON=CA	EN-S	\$0
457-101-306	Application Protection Suite for VG50=IA	EN-S	\$0
457-101-311	VMAX10K FILE BLOC UNISPHERE BASE=CB	EN-S	\$0
457-101-322	VMAX10K FILE BLOC LOCAL REG BASE=CA	EN-S	\$0
457-101-325	VMAX10K FILE BLOC ADV SW BASE=CB	EN-S	\$0
457-101-331	VMAX10K FILE BLOC REMOTE BASE=CB	EN-S	\$0
457-101-337	VMAX10K FILE BLOC REMOTE REG BASE=CA	EN-S	\$0
457-101-377	SRMSUITE 10K BASE =IC	EN-S	\$0
457-101-378	SRMSUITE 10K CAP UPG =IC	EN-S	\$0
457-101-379	SRMSUITE 20K BASE =IC	EN-S	\$0
457-101-380	SRMSUITE 20K CAP UPG =IC	EN-S	\$0
457-101-381	SRMSUITE 40K BASE =IC	EN-S	\$0
457-101-382	SRMSUITE 40K CAP UPG =IC	EN-S	\$0
457-101-404	SRMSUITE UPG 10K BASE =IC	EN-S	\$0
457-101-405	SRMSUITE UPG 20K BASE =IC	EN-S	\$0
457-101-406	SRMSUITE UPG 40K BASE =IC	EN-S	\$0
457-101-644	APPSYNC 10K BASE =IC	EN-S	\$0
457-101-645	APPSYNC 20K BASE =IC	EN-S	\$0
457-101-646	APPSYNC 40K BASE =IC	EN-S	\$0

457-101-697	ADV SW SUITE VMAX 40K BASE LICENSE=CB	EN-S	\$0
457-101-701	ADV SW SUITE VMAX 20K BASE LICENSE=CB	EN-S	\$0
457-101-841	APPSYNC 10K SW Suite Base=IC	EN-S	\$0
457-101-891	ESA FOR 10K BASE NEW LICENSE AP=CB	EN-S	\$0
457-101-893	ESA FOR 10K BASE NEW LICENSE WW=CB	EN-S	\$0
457-101-895	ESA FOR 20K BASE NEW LICENSE=CB	EN-S	\$0
457-101-897	ESA FOR 40K BASE NEW LICENSE=CB	EN-S	\$0
457-102-005	ESA VMAX BASE NEW LIC 10K WW MP ONLY=IC	EN-S	\$0
457-102-116	VS VMAX 40K BASE=IC	EN-S	\$0
457-102-643	VIPR SRM 10K BASE =IC	EN-S	\$0
457-102-645	VIPR SRM 20K BASE =IC	EN-S	\$0
457-102-647	VIPR SRM 40K BASE =IC	EN-S	\$0
458-000-052	VMAX10K OR-DM PRODUCT	EN-S	\$0
458-000-053	VMAX10K TIMEFINDER PRODUCT	EN-S	\$0
458-000-058	VMAX10K FAST VP	EN-S	\$0
458-000-072	VMAX10K SRDF-A PRODUCT	EN-S	\$0
458-000-084	VMAX10K SRDF-S PRODUCT	EN-S	\$0
458-000-089	VMAX10K SRDF-STAR PRODUCT	EN-S	\$0
458-000-094	VMAX10K BASE SW PKG BASE NEW LIC=IC	EN-S	\$0
458-000-095	VMAX10K ADV SW PKG BASE NEW LIC=IC	EN-S	\$0
458-000-096	VMAX10K ADV FAST PKG BASE NEW AP LIC=IC	EN-S	\$0
458-000-097	VMAX10K ENGNTY PKG BASE NEW LIC=IC	EN-S	\$0
458-000-098	VMAX10K ENGINUITY PKG BASE AP LIC=IC	EN-S	\$0
458-000-099	VMAX10K BASIC SRDF PKG BASE LIC=IC	EN-S	\$0
458-000-100	VMAX10K BASIC SRDF PKG BASE AP LIC=IC	EN-S	\$0
458-000-102	VMAX10K ADV SRDF PKG	EN-S	\$0
458-000-103	VMAX10K SYMM MAN/AGEMENT II PACKAGE	EN-S	\$0
458-000-118	VG10 Application Protection=IA	EN-S	\$0
458-000-119	VG50 Application Protection=IA	EN-S	\$33,970
458-000-120	VG50 Application Protection 10K Suite=IA	EN-S	\$33,970
458-000-157	RP/EX REM VMAX40K PRODUCT	EN-S	\$0
458-000-250	VMAX40K ENGINUITY PRODUCT	EN-S	\$0
458-000-252	VMAX10K SYMM MAN/AGEMENT PACKAGE AP	EN-S	\$0
458-000-271	VMAX40K OR-DM PRODUCT	EN-S	\$0
458-000-278	VMAX40K ADV SW PKG BASE LIC=IC	EN-S	\$0
458-000-279	VMAX40K ADV SRDF REPLICATION PKG (STAR)	EN-S	\$0
458-000-281	VMAX40K SRDF REPLICATION PKG	EN-S	\$0
458-000-283	VMAX40K SYMM MGMT PKG BASE LIC	EN-S	\$0
458-000-284	VMAX40K FAST TIERING PKG	EN-S	\$0
458-000-286	VMAX40K TIMEFINDER REPLICATION PKG	EN-S	\$0
458-000-312	VMAX10K ADV SRDF PACKAGE (STAR)	EN-S	\$0
458-000-334	VMAX10K BASIC SRDF PKG REG BASE LIC=IC	EN-S	\$0
458-000-335	VMAX10K BASIC SRDF PKG REG BASE AP=IC	EN-S	\$0
458-000-352	VMAX20K FAST VP PRODUCT	EN-S	\$0
458-000-353	VMAX20K OPTIMIZER PRODUCT	EN-S	\$0
458-000-356	VMAX10K SRDF-A PRODUCT AP	EN-S	\$0
458-000-357	VMAX10K SRDF-S PRODUCT AP	EN-S	\$0
458-000-358	VMAX10K SRDF-STAR PRODUCT AP	EN-S	\$0
458-000-360	VMAX20K DCP PRODUCT	EN-S	\$0
458-000-363	VMAX20K OR-DM PRODUCT	EN-S	\$0

458-000-382	VMAX20K ENGINUITY PKG BASE LIC=IC	EN-S	\$0
458-000-383	VMAX20K SRDF PKG REG BASE LIC=IC	EN-S	\$0
458-000-384	VMAX20K SRDF PKG BASE LIC=IC	EN-S	\$0
458-000-385	VMAX20K ADV SRDF REPLICATION PKG (STAR)	EN-S	\$0
458-000-387	VMAX20K SYMM MGMT PKG BASE LIC=IC	EN-S	\$0
458-000-388	VMAX20K TIMEFINDER PKG BASE LIC=IC	EN-S	\$0
458-000-389	VMAX20K TIMEFINDER PKG REG BASE LIC=IC	EN-S	\$0
458-000-390	VMAX20K FAST TIERING PKG BASE LIC=IC	EN-S	\$0
458-000-391	VMAX20K FAST TIERING PKG REG BASE LIC=IC	EN-S	\$0
458-000-392	VMAX20K ADV SW PKG BASE LIC=IC	EN-S	\$0
458-000-393	VMAX10K OR-DM PRODUCT AP	EN-S	\$0
458-000-394	VMAX10K TIMEFINDER PRODUCT AP	EN-S	\$0
458-000-395	VMAX10K FAST VP AP	EN-S	\$0
458-000-433	VMAX10K LOCPROT F+B NON-SATA 1TB=CB	EN-S	\$0
458-000-434	VMAX10K LOCPROT F+B SATA 1TB=CB	EN-S	\$0
458-000-444	VMAX10K LOCPROT F+B XTRN 1TB=CB	EN-S	\$0
458-000-446	VMAX10K LOCPROT F+B REG 1TB=CA	EN-S	\$1,895
458-000-455	VMAX10K FILE BLK UNI NON-SATA CAP 1TB=CB	EN-S	\$0
458-000-547	VMAX10K ESA PRODUCT	EN-S	\$0
458-000-548	VMAX20K ESA PRODUCT	EN-S	\$0
458-000-549	VMAX40K ESA PRODUCT	EN-S	\$0
458-000-550	VMAX10K BASE SW II PKG BASE NEW LIC=IC	EN-S	\$0
458-000-847	RP/EX LOCAL FOR VMAX10K PRODUCT	EN-S	\$0
458-000-848	RP/EX REMOTE FOR VMAX10K PRODUCT	EN-S	\$0
458-000-849	RP/EX FOR VMAX10K PRODUCT	EN-S	\$0
458-000-854	RP/EX LOCAL FOR VMAX20K PRODUCT	EN-S	\$0
458-000-855	RP/EX REMOTE FOR VMAX20K PRODUCT	EN-S	\$0
458-000-856	RP/EX LOCAL FOR VMAX40K PRODUCT	EN-S	\$0
458-000-857	RP/EX REM FOR VMAX40K PRODUCT	EN-S	\$0
458-000-858	VIPR SRM for VMAX10K	EN-S	\$0
458-000-859	VIPR SRM for VMAX20K	EN-S	\$0
458-000-860	VIPR SRM for VMAX40K	EN-S	\$0
458-000-862	VIPR SRM UPG for VMAX20K	EN-S	\$0
458-000-863	VIPR SRM UPG for VMAX40K	EN-S	\$0
458-000-864	APPSYNC VMAX10K	EN-S	\$0
458-000-865	APPSYNC VMAX10K Suite	EN-S	\$0
458-000-866	APPSYNC VMAX20K	EN-S	\$0
458-000-867	APPSYNC VMAX 40K	EN-S	\$0
458-000-993	VMS VMAX10K SUITE	EN-S	\$0
458-000-994	VIPR Suite for VMAX40K PRODUCT	EN-S	\$0
458-001-037	VIPR SRM LIC ENABLE VMAX	EN-S	\$0
458-001-038	ESA FOR VMAX10K NON-SATA =CB	EN-S	\$340
458-001-039	ESA FOR VMAX10K SATA=CB	EN-S	\$170
458-001-040	ESA FOR VMAX10K NON-SATA AP=CB	EN-S	\$0
458-001-041	ESA FOR VMAX10K SATA AP=CB	EN-S	\$170
458-001-042	ESA FOR 20K NON-SATA 0-14TB=CB	EN-S	\$730
458-001-043	ESA FOR 20K NON-SATA 15-25TB=CB	EN-S	\$685
458-001-044	ESA FOR 20K NON-SATA 26-40TB=CB	EN-S	\$610
458-001-045	ESA FOR 20K NON-SATA 41-60TB=CB	EN-S	\$535
458-001-046	ESA FOR 20K NON-SATA 61-100TB=CB	EN-S	\$465

458-001-047	ESA FOR 20K NON-SATA 101-150TB=CB	EN-S	\$405
458-001-048	ESA FOR 20K NON-SATA 151-250TB=CB	EN-S	\$345
458-001-049	ESA FOR 20K NON-SATA 251-400TB=CB	EN-S	\$295
458-001-050	ESA FOR 20K NON-SATA 401-600TB=CB	EN-S	\$255
458-001-051	ESA FOR 20K NON-SATA 601-1000TB=CB	EN-S	\$220
458-001-052	ESA FOR 20K NON-SATA 1001TB+=CB	EN-S	\$185
458-001-053	ESA FOR 20K SATA 0-14TB=CB	EN-S	\$365
458-001-054	ESA FOR 20K SATA 15-25TB=CB	EN-S	\$340
458-001-055	ESA FOR 20K SATA 26-40TB=CB	EN-S	\$305
458-001-056	ESA FOR 20K SATA 41-60TB=CB	EN-S	\$265
458-001-057	ESA FOR 20K SATA 61-100TB=CB	EN-S	\$235
458-001-058	ESA FOR 20K SATA 101-150TB=CB	EN-S	\$200
458-001-059	ESA FOR 20K SATA 151-250TB=CB	EN-S	\$175
458-001-060	ESA FOR 20K SATA 251-400TB=CB	EN-S	\$150
458-001-061	ESA FOR 20K SATA 401-600TB=CB	EN-S	\$125
458-001-062	ESA FOR 20K SATA 601-1000TB=CB	EN-S	\$110
458-001-063	ESA FOR 20K SATA 1001TB+=CB	EN-S	\$95
458-001-064	ESA FOR 40K NON-SATA 0-14TB=CB	EN-S	\$730
458-001-065	ESA FOR 40K NON-SATA 15-25TB=CB	EN-S	\$685
458-001-066	ESA FOR 40K NON-SATA 26-40TB=CB	EN-S	\$610
458-001-067	ESA FOR 40K NON-SATA 41-60TB=CB	EN-S	\$535
458-001-068	ESA FOR 40K NON-SATA 61-100TB=CB	EN-S	\$465
458-001-069	ESA FOR 40K NON-SATA 101-150TB=CB	EN-S	\$405
458-001-070	ESA FOR 40K NON-SATA 151-250TB=CB	EN-S	\$345
458-001-071	ESA FOR 40K NON-SATA 251-400TB=CB	EN-S	\$295
458-001-072	ESA FOR 40K NON-SATA 401-600TB=CB	EN-S	\$255
458-001-073	ESA FOR 40K NON-SATA 601-1000TB=CB	EN-S	\$220
458-001-074	ESA FOR 40K NON-SATA 1001TB+=CB	EN-S	\$185
458-001-075	ESA FOR 40K SATA 0-14TB=CB	EN-S	\$365
458-001-076	ESA FOR 40K SATA 15-25TB=CB	EN-S	\$340
458-001-077	ESA FOR 40K SATA 26-40TB=CB	EN-S	\$305
458-001-078	ESA FOR 40K SATA 41-60TB=CB	EN-S	\$265
458-001-079	ESA FOR 40K SATA 61-100TB=CB	EN-S	\$235
458-001-080	ESA FOR 40K SATA 101-150TB=CB	EN-S	\$200
458-001-081	ESA FOR 40K SATA 151-250TB=CB	EN-S	\$175
458-001-082	ESA FOR 40K SATA 251-400TB=CB	EN-S	\$150
458-001-083	ESA FOR 40K SATA 401-600TB=CB	EN-S	\$125
458-001-084	ESA FOR 40K SATA 601-1000TB=CB	EN-S	\$110
458-001-085	ESA FOR 40K SATA 1001TB+=CB	EN-S	\$95
458-001-119	VMAX40K ENGINUITY CAPACITY	EN-S	\$0
458-001-123	VMAX10K FILE BLK UNI SATA CAP 1TB=CB	EN-S	\$0
458-001-168	VMAX10K ESA MGMT PACK ONLY WW PRODUCT	EN-S	\$0
458-001-169	VMAX10K ESA MGMT PACK ONLY AP PRODUCT	EN-S	\$0
458-001-170	VMAX10K ESA AP PRODUCT	EN-S	\$0
458-001-203	VMAX10K ENGINUITY PRODUCT	EN-S	\$0
458-001-303	VG50 Application Protection 10K Suite=IA	EN-S	\$33,970
458-001-310	VMAX10K UNISPHERE360 PRODUCT=IC	EN-S	\$0
458-001-312	VMAX20K UNISPHERE360 PRODUCT=IC	EN-S	\$55,000
458-001-313	VMAX40K UNISPHERE360 PRODUCT=IC	EN-S	\$55,000
458-001-494	AFS FAST COMBO VMAX V1/20K/40K =IC	EN-S	\$0

458-001-495	SYMM MGMT FAST COMBO VMAX V1/20K/40K =I	EN-S	\$0
458-001-496	SRMSUITE FAST COMBO VMAX V1/20K/40K =IC	EN-S	\$0
458-001-497	SRDF FAST COMBO VMAX V1/20K/40K =IC	EN-S	\$0
458-001-498	TF FAST COMBO VMAX V1/20K/40K =IC	EN-S	\$0
458-001-499	SRMSUITE FAST COMBO VMAX10K =IC	EN-S	\$0
458-001-500	SRMSUITE FAST COMBO VMAX10K CN =IC	EN-S	\$0
458-001-501	VMAX10K FAST AND SYMM MGMT PROMO =IC	EN-S	\$0
458-001-502	VMAX10K FAST AND SYMM MGMT PROMO AP =	EN-S	\$0
458-001-503	VMAX 10K SRDF FAST COMBO =IC	EN-S	\$0
458-001-504	VMAX 10K TF FAST COMBO =IC	EN-S	\$0
458-001-505	VMAX 10K SRDF FAST COMBO AP =IC	EN-S	\$0
458-001-506	VMAX 10K TF FAST COMBO AP =IC	EN-S	\$0
458-001-759	ESA FOR VMAX 40K MPO PRODUCT	EN-S	\$0
AUTOS1MSUBASE	AUTOSWAP 20K FOR MF BASE-3MSU	EN-S	\$86,800
AUTOS1MSU-M00	AUTOSWAP 20K FOR MF 4-45 MSU	EN-S	\$190
AUTOS1MSU-M01	AUTOSWAP 20K FOR MF 46-175MSU	EN-S	\$120
AUTOS1MSU-M02	AUTOSWAP 20K MF 176-315 MSU	EN-S	\$90
AUTOS1MSU-M03	AUTOSWAP 20K MF 316-575 MSU	EN-S	\$70
AUTOS1MSU-M04	AUTOSWAP 20K MF 576-875 MSU	EN-S	\$50
AUTOS1MSU-M05	AUTOSWAP 20K MF 876-1315 MSU	EN-S	\$35
AUTOS1MSU-M06	AUTOSWAP 20K MF 1316-1975 MSU	EN-S	\$18
AUTOS1MSU-M07	AUTOSWAP 20K MF 1976 & UP MSU	EN-S	\$4
AUTOS1MSU-UPG	AUTOSWAP 20K FOR MF UPG	EN-S	\$0
AUTOS1ZVMBASE	AUTOSWAP 20K FOR ZVM BASE	EN-S	\$0
AUTOS2MSUBASE	AUTOSWAP 40K FOR MF BASE-3MSU	EN-S	\$86,800
AUTOS2MSU-M00	AUTOSWAP 40K FOR MF 4-45 MSU	EN-S	\$190
AUTOS2MSU-M01	AUTOSWAP 40K FOR MF 46-175MSU	EN-S	\$120
AUTOS2MSU-M02	AUTOSWAP 40K MF 176-315 MSU	EN-S	\$90
AUTOS2MSU-M03	AUTOSWAP 40K MF 316-575 MSU	EN-S	\$70
AUTOS2MSU-M04	AUTOSWAP 40K MF 576-875 MSU	EN-S	\$50
AUTOS2MSU-M05	AUTOSWAP 40K MF 876-1315 MSU	EN-S	\$35
AUTOS2MSU-M06	AUTOSWAP 40K MF 1316-1975 MSU	EN-S	\$18
AUTOS2MSU-M07	AUTOSWAP 40K MF 1976 & UP MSU	EN-S	\$4
AUTOS2MSU-UPG	AUTOSWAP 40K FOR MF UPG	EN-S	\$0
AUTOS2ZVMBASE	AUTOSWAP 40K FOR ZVM BASE	EN-S	\$0
BA-CC-1TBC	VMAX 10K IONIX CTRLCTR PKG NON-SATA 1TB	EN-S	\$0
BA-CC-1TBN	VMAX 10K IONIX CTRLCTR PKG SATA 1TB	EN-S	\$0
BA-CC-BASE	VMAX 10K IONIX CTRLCTR PKG BASE LIC	EN-S	\$0
CC-LS	CC/ PROSPHERE CAP UPG LIC SOLUTION	EN-S	\$0
CC-LS-CAP	CC / PROSPHERE CAP LIC SOLUTION	EN-S	\$0
CMPEXT-1R01	CMPEXT REG 20K 1TB (0-14TB)	EN-S	\$3,400
CMPEXT-1R02	CMPEXT REG 20K 1TB (15-25TB)	EN-S	\$3,200
CMPEXT-1R03	CMPEXT REG 20K 1TB (26-40TB)	EN-S	\$2,810
CMPEXT-1R04	CMPEXT REG 20K 1TB (41-60TB)	EN-S	\$2,620
CMPEXT-1R05	CMPEXT REG 20K 1TB (61-100TB)	EN-S	\$2,510
CMPEXT-1R06	CMPEXT REG 20K 1TB (101-150TB)	EN-S	\$2,260
CMPEXT-1R07	CMPEXT REG 20K 1TB (151-250TB)	EN-S	\$2,020
CMPEXT-1R08	CMPEXT REG 20K 1TB (251-400TB)	EN-S	\$1,750
CMPEXT-1R09	CMPEXT REG 20K 1TB (401-600TB)	EN-S	\$1,530
CMPEXT-1R10	CMPEXT REG 20K 1TB (601-1000TB)	EN-S	\$1,330

CMPEXT-1R11	CMPEXT REG 20K1TB(1001TB or greater)	EN-S	\$1,160
CMPEXT-1RBASE	CMPEXT REG 20K BASE LICENSE	EN-S	\$18,215
CMPEXT-1RUPG	CMPEXT REG 20K BASE UPGRADE	EN-S	\$0
CMPEXT-2BASE	CMPEXT 40K BASE LICENSE	EN-S	\$15,180
CMPEXT-2C01	CMPEXT 40K 1TB (0-14TB)	EN-S	\$3,400
CMPEXT-2C02	CMPEXT 40K 1TB (15-25TB)	EN-S	\$3,200
CMPEXT-2C03	CMPEXT 40K 1TB (26-40TB)	EN-S	\$2,810
CMPEXT-2C04	CMPEXT 40K 1TB (41-60TB)	EN-S	\$2,620
CMPEXT-2C05	CMPEXT 40K 1TB (61-100TB)	EN-S	\$2,510
CMPEXT-2C06	CMPEXT 40K 1TB (101-150TB)	EN-S	\$2,260
CMPEXT-2C07	CMPEXT 40K 1TB (151-250TB)	EN-S	\$2,020
CMPEXT-2C08	CMPEXT 40K 1TB (251-400TB)	EN-S	\$1,750
CMPEXT-2C09	CMPEXT 40K 1TB (401-600TB)	EN-S	\$1,530
CMPEXT-2C10	CMPEXT 40K 1TB (601-1000TB)	EN-S	\$1,330
CMPEXT-2C11	CMPEXT 40K1TB(1001TB or greater)	EN-S	\$1,160
CMPEXT-2N01	CMPEXT 40K 1TB (0-14TB) NLT3	EN-S	\$1,700
CMPEXT-2N02	CMPEXT 40K 1TB (15-25TB) NLT3	EN-S	\$1,600
CMPEXT-2N03	CMPEXT 40K 1TB (26-40TB) NLT3	EN-S	\$1,410
CMPEXT-2N04	CMPEXT 40K 1TB (41-60TB) NLT3	EN-S	\$1,310
CMPEXT-2N05	CMPEXT 40K 1TB (61-100TB) NLT3	EN-S	\$1,260
CMPEXT-2N06	CMPEXT 40K 1TB (101-150TB) NLT3	EN-S	\$1,130
CMPEXT-2N07	CMPEXT 40K 1TB (151-250TB) NLT3	EN-S	\$1,010
CMPEXT-2N08	CMPEXT 40K 1TB (251-400TB) NLT3	EN-S	\$880
CMPEXT-2N09	CMPEXT 40K 1TB (401-600TB) NLT3	EN-S	\$760
CMPEXT-2N10	CMPEXT 40K 1TB (601-1000TB) NLT3	EN-S	\$670
CMPEXT-2N11	CMPEXT 40K1TB(1001TB or greater) NLT3	EN-S	\$580
CMPEXT-2R01	CMPEXT REG 40K 1TB (0-14TB)	EN-S	\$3,400
CMPEXT-2R02	CMPEXT REG 40K 1TB (15-25TB)	EN-S	\$3,200
CMPEXT-2R03	CMPEXT REG 40K 1TB (26-40TB)	EN-S	\$2,810
CMPEXT-2R04	CMPEXT REG 40K 1TB (41-60TB)	EN-S	\$2,620
CMPEXT-2R05	CMPEXT REG 40K 1TB (61-100TB)	EN-S	\$2,510
CMPEXT-2R06	CMPEXT REG 40K 1TB (101-150TB)	EN-S	\$2,260
CMPEXT-2R07	CMPEXT REG 40K 1TB (151-250TB)	EN-S	\$2,020
CMPEXT-2R08	CMPEXT REG 40K 1TB (251-400TB)	EN-S	\$1,750
CMPEXT-2R09	CMPEXT REG 40K 1TB (401-600TB)	EN-S	\$1,530
CMPEXT-2R10	CMPEXT REG 40K 1TB (601-1000TB)	EN-S	\$1,330
CMPEXT-2R11	CMPEXT REG 40K1TB(1001TB or greater)	EN-S	\$1,160
CMPEXT-2RBASE	CMPEXT REG 40K BASE LICENSE	EN-S	\$18,215
CMPEXT-2RUPG	CMPEXT REG 40K BASE UPGRADE	EN-S	\$0
CMPEXT-2UPG	CMPEXT 40K BASE UPGRADE	EN-S	\$0
CMPEXTRMZ1BAS	CMPEXT 20KRMZ BASE LICENSE	EN-S	\$2,580
CMPEXTRMZ1C01	COMPEXTRMZ 20K 1 TB (0-14 TB)	EN-S	\$550
CMPEXTRMZ1C02	COMPEXTRMZ 20K 1 TB (15-25 TB)	EN-S	\$525
CMPEXTRMZ1C03	COMPEXTRMZ 20K 1 TB (26-40 TB)	EN-S	\$495
CMPEXTRMZ1C04	COMPEXTRMZ 20K 1 TB (41-60 TB)	EN-S	\$470
CMPEXTRMZ1C05	COMPEXTRMZ 20K 1 TB (61-100 TB)	EN-S	\$450
CMPEXTRMZ1C06	COMPEXTRMZ 20K 1 TB (101-150 TB)	EN-S	\$425
CMPEXTRMZ1C07	COMPEXTRMZ 20K 1 TB (151-250 TB)	EN-S	\$405
CMPEXTRMZ1C08	COMPEXTRMZ 20K 1 TB (251-400 TB)	EN-S	\$385
CMPEXTRMZ1C09	COMPEXTRMZ 20K 1 TB (401-600 TB)	EN-S	\$365

CMPEXTRMZ1C10	COMPEXTRMZ 20K 1 TB (601-1000 TB)	EN-S	\$345
CMPEXTRMZ1C11	COMPEXTRMZ 20K 1 TB (1001 TB OR GREATER)	EN-S	\$330
CMPEXTRMZ1N01	CMPEXTRMZ 20K 1 TB (0-14TB) NLT3	EN-S	\$275
CMPEXTRMZ1N02	CMPEXTRMZ 20K 1 TB (15-25TB) NLT3	EN-S	\$260
CMPEXTRMZ1N03	CMPEXTRMZ 20K 1 TB (26-40TB) NLT3	EN-S	\$250
CMPEXTRMZ1N04	CMPEXTRMZ 20K 1 TB (41-60TB) NLT3	EN-S	\$235
CMPEXTRMZ1N05	CMPEXTRMZ 20K 1 TB (61-100TB) NLT3	EN-S	\$225
CMPEXTRMZ1N06	CMPEXTRMZ 20K 1 TB (101-150TB) NLT3	EN-S	\$215
CMPEXTRMZ1N07	CMPEXTRMZ 20K 1 TB (151-250TB) NLT3	EN-S	\$200
CMPEXTRMZ1N08	CMPEXTRMZ 20K 1 TB (251-400TB) NLT3	EN-S	\$190
CMPEXTRMZ1N09	CMPEXTRMZ 20K 1 TB (401-600TB) NLT3	EN-S	\$180
CMPEXTRMZ1N10	CMPEXTRMZ 20K 1 TB (601-1000TB) NLT3	EN-S	\$175
CMPEXTRMZ1N11	CMPEXTRMZ 20K 1 TB 1001 TB OR GRTR NLT3	EN-S	\$165
CMPEXTRMZ1R01	COMPEXTRMZ REG 20K 1 TB (0-14 TB)	EN-S	\$550
CMPEXTRMZ1R02	COMPEXTRMZ REG 20K 1 TB (15-25 TB)	EN-S	\$525
CMPEXTRMZ1R03	COMPEXTRMZ REG 20K 1 TB (26-40 TB)	EN-S	\$495
CMPEXTRMZ1R04	COMPEXTRMZ REG 20K 1 TB (41-60 TB)	EN-S	\$470
CMPEXTRMZ1R05	COMPEXTRMZ REG 20K 1 TB (61-100 TB)	EN-S	\$450
CMPEXTRMZ1R06	COMPEXTRMZ REG 20K 1 TB (101-150 TB)	EN-S	\$425
CMPEXTRMZ1R07	COMPEXTRMZ REG 20K 1 TB (151-250 TB)	EN-S	\$405
CMPEXTRMZ1R08	COMPEXTRMZ REG 20K 1 TB (251-400 TB)	EN-S	\$385
CMPEXTRMZ1R09	COMPEXTRMZ REG 20K 1 TB (401-600 TB)	EN-S	\$365
CMPEXTRMZ1R10	COMPEXTRMZ REG 20K 1 TB (601-1000 TB)	EN-S	\$345
CMPEXTRMZ1R11	COMPEXTRMZ REG 20K 1 TB 1001 TB OR GRTR	EN-S	\$330
CMPEXTRMZ1RBS	CMPEXTRMZ REG 20K BASE LICENSE	EN-S	\$3,095
CMPEXTRMZ1RUP	CMPEXTRMZ REG BASE UPGRADE	EN-S	\$0
CMPEXTRMZ1UPG	CMPEXTRMZ 20K BASE UPGRADE	EN-S	\$0
CMPEXTRMZ2BAS	CMPEXT 40KRMZ BASE LICENSE	EN-S	\$2,580
CMPEXTRMZ2C01	COMPEXTRMZ 40K 1 TB (0-14 TB)	EN-S	\$550
CMPEXTRMZ2C02	COMPEXTRMZ 40K 1 TB (15-25 TB)	EN-S	\$525
CMPEXTRMZ2C03	COMPEXTRMZ 40K 1 TB (26-40 TB)	EN-S	\$495
CMPEXTRMZ2C04	COMPEXTRMZ 40K 1 TB (41-60 TB)	EN-S	\$470
CMPEXTRMZ2C05	COMPEXTRMZ 40K 1 TB (61-100 TB)	EN-S	\$450
CMPEXTRMZ2C06	COMPEXTRMZ 40K 1 TB (101-150 TB)	EN-S	\$425
CMPEXTRMZ2C07	COMPEXTRMZ 40K 1 TB (151-250 TB)	EN-S	\$405
CMPEXTRMZ2C08	COMPEXTRMZ 40K 1 TB (251-400 TB)	EN-S	\$385
CMPEXTRMZ2C09	COMPEXTRMZ 40K 1 TB (401-600 TB)	EN-S	\$365
CMPEXTRMZ2C10	COMPEXTRMZ 40K 1 TB (601-1000 TB)	EN-S	\$345
CMPEXTRMZ2C11	COMPEXTRMZ 40K 1 TB (1001 TB OR GREATER)	EN-S	\$330
CMPEXTRMZ2N01	CMPEXTRMZ 40K 1 TB (0-14TB) NLT3	EN-S	\$275
CMPEXTRMZ2N02	CMPEXTRMZ 40K 1 TB (15-25TB) NLT3	EN-S	\$260
CMPEXTRMZ2N03	CMPEXTRMZ 40K 1 TB (26-40TB) NLT3	EN-S	\$250
CMPEXTRMZ2N04	CMPEXTRMZ 40K 1 TB (41-60TB) NLT3	EN-S	\$235
CMPEXTRMZ2N05	CMPEXTRMZ 40K 1 TB (61-100TB) NLT3	EN-S	\$225
CMPEXTRMZ2N06	CMPEXTRMZ 40K 1 TB (101-150TB) NLT3	EN-S	\$215
CMPEXTRMZ2N07	CMPEXTRMZ 40K 1 TB (151-250TB) NLT3	EN-S	\$200
CMPEXTRMZ2N08	CMPEXTRMZ 40K 1 TB (251-400TB) NLT3	EN-S	\$190
CMPEXTRMZ2N09	CMPEXTRMZ 40K 1 TB (401-600TB) NLT3	EN-S	\$180
CMPEXTRMZ2N10	CMPEXTRMZ 40K 1 TB (601-1000TB) NLT3	EN-S	\$175
CMPEXTRMZ2N11	CMPEXTRMZ 40K 1 TB 1001 TB OR GRTR NLT3	EN-S	\$165

CMPEXTRMZ2R01	COMPEXTRMZ REG 40K 1 TB (0-14 TB)	EN-S	\$550
CMPEXTRMZ2R02	COMPEXTRMZ REG 40K 1 TB (15-25 TB)	EN-S	\$525
CMPEXTRMZ2R03	COMPEXTRMZ REG 40K 1 TB (26-40 TB)	EN-S	\$495
CMPEXTRMZ2R04	COMPEXTRMZ REG 40K 1 TB (41-60 TB)	EN-S	\$470
CMPEXTRMZ2R05	COMPEXTRMZ REG 40K 1 TB (61-100 TB)	EN-S	\$450
CMPEXTRMZ2R06	COMPEXTRMZ REG 40K 1 TB (101-150 TB)	EN-S	\$425
CMPEXTRMZ2R07	COMPEXTRMZ REG 40K 1 TB (151-250 TB)	EN-S	\$405
CMPEXTRMZ2R08	COMPEXTRMZ REG 40K 1 TB (251-400 TB)	EN-S	\$385
CMPEXTRMZ2R09	COMPEXTRMZ REG 40K 1 TB (401-600 TB)	EN-S	\$365
CMPEXTRMZ2R10	COMPEXTRMZ REG 40K 1 TB (601-1000 TB)	EN-S	\$345
CMPEXTRMZ2R11	COMPEXTRMZ REG 40K 1 TB 1001 TB OR GRTR	EN-S	\$330
CMPEXTRMZ2RBS	CMPEXTRMZ REG 40K BASE LICENSE	EN-S	\$3,095
CMPEXTRMZ2RUP	CMPEXTRMZ REG BASE UPGRADE	EN-S	\$0
CMPEXTRMZ2UPG	CMPEXTRMZ 40K BASE UPGRADE	EN-S	\$0
CMZHPF-1BAS	CMP HIGH PERFORMANCE FICON 20K BASE LIC	EN-S	\$10,000
COMPAV/M1BASE	COM-PAV/M 20K BASE LICENSE	EN-S	\$9,510
COMPAV/M-1C01	COM-PAV/M 20K 1TB (0-14TB)	EN-S	\$2,250
COMPAV/M-1C02	COM-PAV/M 20K 1TB (15-25TB)	EN-S	\$2,110
COMPAV/M-1C03	COM-PAV/M 20K 1TB (26-40TB)	EN-S	\$1,860
COMPAV/M-1C04	COM-PAV/M 20K 1TB (41-60TB)	EN-S	\$1,730
COMPAV/M-1C05	COM-PAV/M 20K 1TB (61-100TB)	EN-S	\$1,660
COMPAV/M-1C06	COM-PAV/M 20K 1TB (101-150TB)	EN-S	\$1,490
COMPAV/M-1C07	COM-PAV/M 20K 1TB (151-250TB)	EN-S	\$1,330
COMPAV/M-1C08	COM-PAV/M 20K 1TB (251-400TB)	EN-S	\$1,160
COMPAV/M-1C09	COM-PAV/M 20K 1TB (401-600TB)	EN-S	\$1,010
COMPAV/M-1C10	COM-PAV/M 20K 1TB(601-1000TB)	EN-S	\$880
COMPAV/M-1C11	COMPAV/M 20K 1TB(1001TB OR GREATER)	EN-S	\$760
COMPAV/M-1N01	COM-PAV/M 20K 1TB (0-14TB) NLT3	EN-S	\$1,120
COMPAV/M-1N02	COM-PAV/M 20K 1TB (15-25TB) NLT3	EN-S	\$1,060
COMPAV/M-1N03	COM-PAV/M 20K 1TB (26-40TB) NLT3	EN-S	\$930
COMPAV/M-1N04	COM-PAV/M 20K 1TB (41-60TB) NLT3	EN-S	\$860
COMPAV/M-1N05	COM-PAV/M 20K 1TB (61-100TB) NLT3	EN-S	\$830
COMPAV/M-1N06	COM-PAV/M 20K 1TB (101-150TB) NLT3	EN-S	\$750
COMPAV/M-1N07	COM-PAV/M 20K 1TB (151-250TB) NLT3	EN-S	\$670
COMPAV/M-1N08	COM-PAV/M 20K 1TB (251-400TB) NLT3	EN-S	\$580
COMPAV/M-1N09	COM-PAV/M 20K 1TB (401-600TB) NLT3	EN-S	\$500
COMPAV/M-1N10	COM-PAV/M 20K 1TB(601-1000TB) NLT3	EN-S	\$440
COMPAV/M-1N11	COMPAV/M 20K 1TB(1001TB OR GREATER) NLT3	EN-S	\$380
COMPAV/M-1UPG	COM-PAV/M 20K BASE UPGRADE	EN-S	\$0
COM-PAV-1R01	COM-PAV/M 20K REG 1TB (0-14TB)	EN-S	\$2,250
COM-PAV-1R02	COM-PAV/M 20K REG 1TB (15-25TB)	EN-S	\$2,110
COM-PAV-1R03	COM-PAV/M 20K REG 1TB (26-40TB)	EN-S	\$1,860
COM-PAV-1R04	COM-PAV/M 20K REG 1TB (41-60TB)	EN-S	\$1,730
COM-PAV-1R05	COM-PAV/M 20K REG 1TB (61-100TB)	EN-S	\$1,660
COM-PAV-1R06	COM-PAV/M 20K REG 1TB (101-150TB)	EN-S	\$1,490
COM-PAV-1R07	COM-PAV/M 20K REG 1TB (151-250TB)	EN-S	\$1,330
COM-PAV-1R08	COM-PAV/M 20K REG 1TB (251-400TB)	EN-S	\$1,160
COM-PAV-1R09	COM-PAV/M 20K REG 1TB (401-600TB)	EN-S	\$1,010
COM-PAV-1R10	COM-PAV/M 20K REG 1TB (601-1000TB)	EN-S	\$880
COM-PAV-1R11	COMPAV/M 20K REG 1TB (1001 TB+)	EN-S	\$760

COM-PAV-1RBAS	COM-PAV/M 20K REG BASE LICENSE	EN-S	\$9,510
COM-PAV-1RUP	COM-PAV/M 20K REG BASE UPGRADE	EN-S	\$0
COM-PAV-2R01	COM-PAV/M 40K REG 1TB (0-14TB)	EN-S	\$2,250
COM-PAV-2R02	COM-PAV/M 40K REG 1TB (15-25TB)	EN-S	\$2,110
COM-PAV-2R03	COM-PAV/M 40K REG 1TB (26-40TB)	EN-S	\$1,860
COM-PAV-2R04	COM-PAV/M 40K REG 1TB (41-60TB)	EN-S	\$1,730
COM-PAV-2R05	COM-PAV/M 40K REG 1TB (61-100TB)	EN-S	\$1,660
COM-PAV-2R06	COM-PAV/M 40K REG 1TB (101-150TB)	EN-S	\$1,490
COM-PAV-2R07	COM-PAV/M 40K REG 1TB (151-250TB)	EN-S	\$1,330
COM-PAV-2R08	COM-PAV/M 40K REG 1TB (251-400TB)	EN-S	\$1,160
COM-PAV-2R09	COM-PAV/M 40K REG 1TB (401-600TB)	EN-S	\$1,010
COM-PAV-2R10	COM-PAV/M 40K REG 1TB (601-1000TB)	EN-S	\$880
COM-PAV-2R11	COMPAV/M 40K REG 1TB (1001 TB+)	EN-S	\$760
COM-PAV-2RBAS	COM-PAV/M 40K REG BASE LICENSE	EN-S	\$9,510
COM-PAV-2RUP	COM-PAV/M 40K REG BASE UPGRADE	EN-S	\$0
ESA-10K-BASE	ESA FOR 10K BASE NEW LICENSE=CB	EN-S	\$0
ESA-10K-C-UPG	ESA FOR 10K CAPACITY UPGRADE LICENSE=CB	EN-S	\$0
ESA-10K-N-S	ESA FOR 10K NON-SATA - PER TB=CB	EN-S	\$0
ESA-10K-SATA	ESA FOR 10K SATA - PER TB=CB	EN-S	\$0
ESA-20K-BASE	ESA FOR 20K BASE NEW LICENSE=CB	EN-S	\$0
ESA-20K-C-UPG	ESA FOR 20K CAPACITY UPGRADE LICENSE=CB	EN-S	\$0
ESA-20K-NON1	ESA FOR 20K NON-SATA 0-14TB=CB	EN-S	\$0
ESA-20K-NON10	ESA FOR 20K NON-SATA 601-1000TB=CB	EN-S	\$0
ESA-20K-NON11	ESA FOR 20K NON-SATA 1001TB-PLUS=CB	EN-S	\$0
ESA-20K-NON2	ESA FOR 20K NON-SATA 15-25TB=CB	EN-S	\$0
ESA-20K-NON3	ESA FOR 20K NON-SATA 26-40TB=CB	EN-S	\$0
ESA-20K-NON4	ESA FOR 20K NON-SATA 41-60TB=CB	EN-S	\$0
ESA-20K-NON5	ESA FOR 20K NON-SATA 61-100TB=CB	EN-S	\$0
ESA-20K-NON6	ESA FOR 20K NON-SATA 101-150TB=CB	EN-S	\$0
ESA-20K-NON7	ESA FOR 20K NON-SATA 151-250TB=CB	EN-S	\$0
ESA-20K-NON8	ESA FOR 20K NON-SATA 251-400TB=CB	EN-S	\$0
ESA-20K-NON9	ESA FOR 20K NON-SATA 401-600TB=CB	EN-S	\$0
ESA-20K-SAT1	ESA FOR 20K SATA 0-14TB=CB	EN-S	\$0
ESA-20K-SAT10	ESA FOR 20K SATA 601-1000TB=CB	EN-S	\$0
ESA-20K-SAT11	ESA FOR 20K SATA 1001TB-PLUS=CB	EN-S	\$0
ESA-20K-SAT2	ESA FOR 20K SATA 15-25TB=CB	EN-S	\$0
ESA-20K-SAT3	ESA FOR 20K SATA 26-40TB=CB	EN-S	\$0
ESA-20K-SAT4	ESA FOR 20K SATA 41-60TB=CB	EN-S	\$0
ESA-20K-SAT5	ESA FOR 20K SATA 61-100TB=CB	EN-S	\$0
ESA-20K-SAT6	ESA FOR 20K SATA 101-150TB=CB	EN-S	\$0
ESA-20K-SAT7	ESA FOR 20K SATA 151-250TB=CB	EN-S	\$0
ESA-20K-SAT8	ESA FOR 20K SATA 251-400TB=CB	EN-S	\$0
ESA-20K-SAT9	ESA FOR 20K SATA 401-600TB=CB	EN-S	\$0
ESA-40K-BASE	ESA FOR 40K BASE NEW LICENSE=CB	EN-S	\$0
ESA-40K-C-UPG	ESA FOR 40K CAPACITY UPGRADE LICENSE=CB	EN-S	\$0
ESA-40K-NON1	ESA FOR 40K NON-SATA 0-14TB=CB	EN-S	\$0
ESA-40K-NON10	ESA FOR 40K NON-SATA 601-1000TB=CB	EN-S	\$0
ESA-40K-NON11	ESA FOR 40K NON-SATA 1001TB-PLUS=CB	EN-S	\$0
ESA-40K-NON2	ESA FOR 40K NON-SATA 15-25TB=CB	EN-S	\$0
ESA-40K-NON3	ESA FOR 40K NON-SATA 26-40TB=CB	EN-S	\$0

ESA-40K-NON4	ESA FOR 40K NON-SATA 41-60TB=CB	EN-S	\$0
ESA-40K-NON5	ESA FOR 40K NON-SATA 61-100TB=CB	EN-S	\$0
ESA-40K-NON6	ESA FOR 40K NON-SATA 101-150TB=CB	EN-S	\$0
ESA-40K-NON7	ESA FOR 40K NON-SATA 151-250TB=CB	EN-S	\$0
ESA-40K-NON8	ESA FOR 40K NON-SATA 251-400TB=CB	EN-S	\$0
ESA-40K-NON9	ESA FOR 40K NON-SATA 401-600TB=CB	EN-S	\$0
ESA-40K-SAT1	ESA FOR 40K SATA 0-14TB=CB	EN-S	\$0
ESA-40K-SAT10	ESA FOR 40K SATA 601-1000TB=CB	EN-S	\$0
ESA-40K-SAT11	ESA FOR 40K SATA 1001TB-PLUS=CB	EN-S	\$0
ESA-40K-SAT2	ESA FOR 40K SATA 15-25TB=CB	EN-S	\$0
ESA-40K-SAT3	ESA FOR 40K SATA 26-40TB=CB	EN-S	\$0
ESA-40K-SAT4	ESA FOR 40K SATA 41-60TB=CB	EN-S	\$0
ESA-40K-SAT5	ESA FOR 40K SATA 61-100TB=CB	EN-S	\$0
ESA-40K-SAT6	ESA FOR 40K SATA 101-150TB=CB	EN-S	\$0
ESA-40K-SAT7	ESA FOR 40K SATA 151-250TB=CB	EN-S	\$0
ESA-40K-SAT8	ESA FOR 40K SATA 251-400TB=CB	EN-S	\$0
ESA-40K-SAT9	ESA FOR 40K SATA 401-600TB=CB	EN-S	\$0
ESP-1BASE	ESP 20K BASE LICENSE	EN-S	\$0
ESP-1C01	ESP 20K 1TB (0-14TB)	EN-S	\$0
ESP-1C02	ESP 20K 1TB (15-25TB)	EN-S	\$0
ESP-1C03	ESP 20K 1TB (26-40TB)	EN-S	\$0
ESP-1C04	ESP 20K 1TB (41-60TB)	EN-S	\$0
ESP-1C05	ESP 20K 1TB (61-100TB)	EN-S	\$0
ESP-1C06	ESP 20K 1TB (101-150TB)	EN-S	\$0
ESP-1C07	ESP 20K 1TB (151-250TB)	EN-S	\$0
ESP-1C08	ESP 20K 1TB (251-400TB)	EN-S	\$0
ESP-1C09	ESP 20K 1TB (401-600TB)	EN-S	\$0
ESP-1C10	ESP 20K 1TB (601-1000TB)	EN-S	\$0
ESP-1C11	ESP 20K 1TB (1001TB OR GREATER)	EN-S	\$0
ESP-1N01	ESP 20K 1TB (0-14TB) NLT3	EN-S	\$0
ESP-1N02	ESP 20K 1TB (15-25TB) NLT3	EN-S	\$0
ESP-1N03	ESP 20K 1TB (26-40TB) NLT3	EN-S	\$0
ESP-1N04	ESP 20K 1TB (41-60TB) NLT3	EN-S	\$0
ESP-1N05	ESP 20K 1TB (61-100TB) NLT3	EN-S	\$0
ESP-1N06	ESP 20K 1TB (101-150TB) NLT3	EN-S	\$0
ESP-1N07	ESP 20K 1TB (151-250TB) NLT3	EN-S	\$0
ESP-1N08	ESP 20K 1TB (251-400TB) NLT3	EN-S	\$0
ESP-1N09	ESP 20K 1TB (401-600TB) NLT3	EN-S	\$0
ESP-1N10	ESP 20K 1TB (601-1000TB) NLT3	EN-S	\$0
ESP-1N11	ESP 20K 1TB (1001TB OR GREATER) NLT3	EN-S	\$0
ESP-1UPG	ESP 20K BASE UPGRADE	EN-S	\$0
GDDR1CAOPSMVS	EMC GDDR 20K W/ CAOPSMVS LIC	EN-S	\$210,000
GDDR-1SITELIC	EMC GDDR 20K SITE LICENSE	EN-S	\$175,000
GDDR2CAOPSMVS	EMC GDDR 40K W/ CAOPSMVS LIC	EN-S	\$0
GDDR-2SITELIC	EMC GDDR 40K SITE LICENSE	EN-S	\$0
LPS-VG10	VG10 Local Protection Suite=IC	EN-S	\$0
LPS-VG50	VG50 Local Protection Suite=IC	EN-S	\$0
LPS-VG50-10K	VG50 Local Protection 10k Suite=IC	EN-S	\$0
MFE-1SW-KIT	MAINFRAME ENABLERS 20K RT KIT FOR ZOS	EN-S	\$0
PPAK-VG50-10K	VG50 Total Protection 10k Pack=IC	EN-S	\$80,880

RPAKS390-1BAS	RESPAK FOR S/390 20K BASE	EN-S	\$0
RPBA-CDP-1TB	RPEX CDP 1TB PER CLUSTER	EN-S	\$0
RPBA-CDP-BASE	RPEX CDP BASE LICENSE PER CLUSTER	EN-S	\$0
RPBA-CDP-R01U	RPEX TO RPCL TIER 1 CDP UPGD 1TB	EN-S	\$0
RPBA-CDP-R02U	RPEX TO RPCL TIER 2 CDP UPGD 1TB	EN-S	\$0
RPBA-CDP-R03U	RPEX TO RPCL TIER 3 CDP UPGD 1TB	EN-S	\$0
RPBA-CDP-R04U	RPEX TO RPCL TIER 4 CDP UPGD 1TB	EN-S	\$0
RPBA-CDP-UPGD	RPEX CDP BASE TO RPCL CDP BASE UPGD	EN-S	\$0
RPBA-CLR-BASE	RPEX CLR BASE LICENSE PER CLUSTER	EN-S	\$0
RPBA-CLR-UPGD	RPEX CLR BASE TO RPCL CLR BASE UPGD	EN-S	\$0
RPBA-CRR-1TB	RPEX CRR 1TB PER CLUSTER	EN-S	\$0
RPBA-CRR-BASE	RPEX CRR BASE LICENSE PER CLUSTER	EN-S	\$0
RPBA-CRR-R01U	RPEX TO RPCL TIER 1 CRR UPGD 1TB	EN-S	\$0
RPBA-CRR-R02U	RPEX TO RPCL TIER 2 CRR UPGD 1TB	EN-S	\$0
RPBA-CRR-R03U	RPEX TO RPCL TIER 3 CRR UPGD 1TB	EN-S	\$0
RPEX-1TBN	RECOVERPOINT EX 1TB NON-SATA	EN-S	\$0
RPEX-1TBS	RECOVERPOINT/EX 1TB SATA	EN-S	\$0
RPEX2-CDP-BAS	RP LOC REG CAP BASE LIC FOR VMAX 20K	EN-S	\$0
RPEX2-CDP-T1	RP LOC REG CAP T1 - VMAX 20K (0-14TB)	EN-S	\$0
RPEX2-CDP-T10	RP LOC REG CAP T10 -VMAX 20K (601-1PB)	EN-S	\$0
RPEX2-CDP-T11	RP LOC REG CAP T11 -VMAX 20K (1PB+)	EN-S	\$0
RPEX2-CDP-T2	RP LOC REG CAP T2 - VMAX 20K (15-25TB)	EN-S	\$0
RPEX2-CDP-T3	RP LOC REG CAP T3 - VMAX 20K (26-40TB)	EN-S	\$0
RPEX2-CDP-T4	RP LOC REG CAP T4 - VMAX 20K (41-60TB)	EN-S	\$0
RPEX2-CDP-T5	RP LOC REG CAP T5 - VMAX 20K (61-100TB)	EN-S	\$0
RPEX2-CDP-T6	RP LOC REG CAP T6 - VMAX 20K (101-150TB)	EN-S	\$0
RPEX2-CDP-T7	RP LOC REG CAP T7 - VMAX 20K (151-250TB)	EN-S	\$0
RPEX2-CDP-T8	RP LOC REG CAP T8 - VMAX 20K (251-400TB)	EN-S	\$0
RPEX2-CDP-T9	RP LOC REG CAP T9 - VMAX 20K (401-600TB)	EN-S	\$0
RPEX2-CDP-UG	RP LOC REG CAP UG FOR VMAX 20K	EN-S	\$0
RPEX2-CRR-BAS	RP REM REG CAP BASE FOR VMAX 20K	EN-S	\$0
RPEX2-CRR-T1	RP REM REG CAP T1 -VMAX 20K (0-14TB)	EN-S	\$0
RPEX2-CRR-T10	RP REM REG CAP T10 -VMAX 20K (601-1PB)	EN-S	\$0
RPEX2-CRR-T11	RP REM REG CAP T11 -VMAX 20K (1PB+)	EN-S	\$0
RPEX2-CRR-T2	RP REM REG CAP T2 - VMAX 20K (15-25TB)	EN-S	\$0
RPEX2-CRR-T3	RP REM REG CAP T3 - VMAX 20K (26-40TB)	EN-S	\$0
RPEX2-CRR-T4	RP REM REG CAP T4 - VMAX 20K (41-60TB)	EN-S	\$0
RPEX2-CRR-T5	RP REM REG CAP T5 - VMAX 20K (61-100TB)	EN-S	\$0
RPEX2-CRR-T6	RP REM REG CAP T6 - VMAX 20K (101-150TB)	EN-S	\$0
RPEX2-CRR-T7	RP REM REG CAP T7 - VMAX 20K (151-250TB)	EN-S	\$0
RPEX2-CRR-T8	RP REM REG CAP T8 -VMAX 20K (251-400TB)	EN-S	\$0
RPEX2-CRR-T9	RP REM REG CAP T9 - VMAX 20K (401-600TB)	EN-S	\$0
RPEX2-CRR-UG	RP REM REG CAP UG FOR VMAX 20K	EN-S	\$0
RPEX-BASE	RECOVERPOINT/EX BASE	EN-S	\$0
RPEXE-CDP-1TB	VMAX 10K RP LOCAL REG CAP 1TB	EN-S	\$0
RPEXE-CDP-BAS	VMAX 10K RP LOCAL REG CAP BASE	EN-S	\$0
RPEXE-CDP-UG	VMAX 10K RP LOCAL REG CAP 1TB UPGRADE	EN-S	\$0
RPEXE-CRR-1TB	VMAX 10K RP REMOTE REG CAP 1TB	EN-S	\$0
RPEXE-CRR-BAS	VMAX 10K RP REMOTE REG CAP BASE	EN-S	\$0
RPEXE-CRR-UG	VMAX 10K RP REMOTE REG CAP 1TB UPGRADE	EN-S	\$0

RPEXM2-CDP-BA	RP LOC REG CAP BASE LIC FOR VMAX 40K	EN-S	\$0
RPEXM2-CDP-T1	RP LOC REG CAP T1 - VMAX 40K (0-14TB)	EN-S	\$0
RPEXM2-CDP-T2	RP LOC REG CAP T2 - VMAX 40K (15-25TB)	EN-S	\$0
RPEXM2-CDP-T3	RP LOC REG CAP T3 - VMAX 40K (26-40TB)	EN-S	\$0
RPEXM2-CDP-T4	RP LOC REG CAP T4 - VMAX 40K (41-60TB)	EN-S	\$0
RPEXM2-CDP-T5	RP LOC REG CAP T5 - VMAX 40K (61-100TB)	EN-S	\$0
RPEXM2-CDP-T6	RP LOC REG CAP T6 - VMAX 40K (101-150TB)	EN-S	\$0
RPEXM2-CDP-T7	RP LOC REG CAP T7 - VMAX 40K (151-250TB)	EN-S	\$0
RPEXM2-CDP-T8	RP LOC REG CAP T8 - VMAX 40K (251-400TB)	EN-S	\$0
RPEXM2-CDP-T9	RP LOC REG CAP T9 - VMAX 40K (401-600TB)	EN-S	\$0
RPEXM2-CDP-UG	RP LOC REG CAP UPGRADE - VMAX 40K	EN-S	\$0
RPEXM2-CD-T10	RP LOC REG CAP T10 - VMAX 40K (601-1PTB)	EN-S	\$0
RPEXM2-CD-T11	RP LOC REG CAP T11 - VMAX 40K (1PB+)	EN-S	\$0
RPEXM2-CRR-BA	RP REM REG CAP BASE - VMAX 40K	EN-S	\$0
RPEXM2-CRR-T1	RP REM REG CAP T1 - VMAX 40K (0-14TB)	EN-S	\$0
RPEXM2-CRR-T2	RP REM REG CAP T2 - VMAX 40K (15-25TB)	EN-S	\$0
RPEXM2-CRR-T3	RP REM REG CAP T3 - VMAX 40K (26-40TB)	EN-S	\$0
RPEXM2-CRR-T4	RP REM REG CAP T4 - VMAX 40K (41-60TB)	EN-S	\$0
RPEXM2-CRR-T5	RP REM REG CAP T5 - VMAX 40K (61-100TB)	EN-S	\$0
RPEXM2-CRR-T6	RP REM REG CAP T6 - VMAX 40K (101-150TB)	EN-S	\$0
RPEXM2-CRR-T7	RP REM REG CAP T7 - VMAX 40K (151-250TB)	EN-S	\$0
RPEXM2-CRR-T8	RP REM REG CAP T8 - VMAX 40K (251-400TB)	EN-S	\$0
RPEXM2-CRR-T9	RP REM REG CAP T9 - VMAX 40K (401-600TB)	EN-S	\$0
RPEXM2-CRR-UG	RP REM REG CAP UPGRADE- VMAX 40K	EN-S	\$0
RPEXM2-CR-T10	RP REM REG CAP T10 - VMAX 40K (601-1PB)	EN-S	\$0
RPEXM2-CR-T11	RP REM REG CAP T11 - VMAX 40K (1PB+)	EN-S	\$0
RPEX-UPG	RECOVERPOINT/EX CAPACITY UPGRADE	EN-S	\$0
RP-FTS-EXT	VMAX 10K RP FTS EXT CAP 1TB	EN-S	\$0
RPS-VG10	VG10 Remote Protection Suite=IC	EN-S	\$0
RPS-VG50	VG50 Remote Protection Suite=IC	EN-S	\$0
RPS-VG50-10K	VG50 Remote Protection 10k Suite=IC	EN-S	\$0
SCS-VG10	VG10 Events and Retention Suite=IC	EN-S	\$0
SCS-VG50	VG50 Events and Retention Suite=IC	EN-S	\$0
SCS-VG50-10K	VG50 Events and Retention 10k Suite=IC	EN-S	\$12,940
SRDF20KRNMFCG	SRDF MFCG RUNTIME NO CHRG	EN-S	\$0
SRDF20KRNS390	SRDF S390 RUNTIME NO CHRG	EN-S	\$0
SRDF20KRNVOS	SRDF VOS RUNTIME NO CHRG	EN-S	\$0
SRDF20KRUNAS4	SRDF AS4 RUNTIME NO CHRG	EN-S	\$0
SRDF20KRUNMSP	SRDF MSP RUNTIM NO CHRG	EN-S	\$0
SRDF20KRUNOPN	SRDF OPEN RUNTIME NO CHRG	EN-S	\$0
SRDF20KRUNTPF	SRDF TPF RUNTIME NO CHRG	EN-S	\$0
SRDFA20KRNZOS	SRDF/A 20K RUNTIME FOR ZOS	EN-S	\$0
SRDFAR20K-C01	SRDFAR20K 1TB (0-14TB)	EN-S	\$0
SRDFAR20K-C02	SRDFAR20K 1TB (15-25TB)	EN-S	\$0
SRDFAR20K-C03	SRDFAR20K 1TB (26-40TB)	EN-S	\$0
SRDFAR20K-C04	SRDFAR20K 1TB (41-60TB)	EN-S	\$0
SRDFAR20K-C05	SRDFAR20K 1TB (61-100TB)	EN-S	\$0
SRDFAR20K-C06	SRDFAR20K 1TB (101-150TB)	EN-S	\$0
SRDFAR20K-C07	SRDFAR20K 1TB (151-250TB)	EN-S	\$0
SRDFAR20K-C08	SRDFAR20K 1TB (251-400TB)	EN-S	\$0

SRDFAR20K-C09	SRDFAR20K 1TB (401-600TB)	EN-S	\$0
SRDFAR20K-C10	SRDFAR20K 1TB (601-1000TB)	EN-S	\$0
SRDFAR20K-C11	SRDFAR20K1TB(1001TB OR GREATER)	EN-S	\$0
SRDFAR20K-N01	SRDFAR20K 1TB (0-14TB) NLT3	EN-S	\$0
SRDFAR20K-N02	SRDFAR20K 1TB (15-25TB) NLT3	EN-S	\$0
SRDFAR20K-N03	SRDFAR20K 1TB (26-40TB) NLT3	EN-S	\$0
SRDFAR20K-N04	SRDFAR20K 1TB (41-60TB) NLT3	EN-S	\$0
SRDFAR20K-N05	SRDFAR20K 1TB (61-100TB) NLT3	EN-S	\$0
SRDFAR20K-N06	SRDFAR20K 1TB (101-150TB) NLT3	EN-S	\$0
SRDFAR20K-N07	SRDFAR20K 1TB (151-250TB) NLT3	EN-S	\$0
SRDFAR20K-N08	SRDFAR20K 1TB (251-400TB) NLT3	EN-S	\$0
SRDFAR20K-N09	SRDFAR20K 1TB (401-600TB) NLT3	EN-S	\$0
SRDFAR20K-N10	SRDFAR20K 1TB (601-1000TB) NLT3	EN-S	\$0
SRDFAR20K-N11	SRDFAR20K1TB(1001TB OR GREATER) NLT3	EN-S	\$0
SRDFAR20K-OBA	SRDFAR20K OPT OUT BASE LICENSE	EN-S	\$0
SRDFAR20K-OPT	SRDFAR20K OPT OUT TB	EN-S	\$0
SRDFAR20K-OUP	SRDFAR20K OPT OUT BASE UPGRADE	EN-S	\$0
SRDFAR20K-R01	SRDFAR20K REPL 1TB (0-14TB)	EN-S	\$0
SRDFAR20K-R02	SRDFAR20K REPL 1TB (15-25TB)	EN-S	\$0
SRDFAR20K-R03	SRDFAR20K REPL 1TB (26-40TB)	EN-S	\$0
SRDFAR20K-R04	SRDFAR20K REPL 1TB (41-60TB)	EN-S	\$0
SRDFAR20K-R05	SRDFAR20K REPL 1TB (61-100TB)	EN-S	\$0
SRDFAR20K-R06	SRDFAR20K REPL 1TB (101-150TB)	EN-S	\$0
SRDFAR20K-R07	SRDFAR20K REPL 1TB (151-250TB)	EN-S	\$0
SRDFAR20K-R08	SRDFAR20K REPL 1TB (251-400TB)	EN-S	\$0
SRDFAR20K-R09	SRDFAR20K REPL 1TB (401-600TB)	EN-S	\$0
SRDFAR20K-R10	SRDFAR20K REPL 1TB (601-1000TB)	EN-S	\$0
SRDFAR20K-R11	SRDFAR20K REPL 1TB(1001TB OR GREATER)	EN-S	\$0
SRDFAR20K-RBA	SRDFAR20K REPL BASE LICENSE	EN-S	\$0
SRDFAR20KRNZO	LIC FEAT CODE MF SRDFAR20K	EN-S	\$0
SRDFAR20K-RUP	SRDFAR20K REPL BASE UPGRADE	EN-S	\$0
SRDFCE20KBASE	SRDF-CE 20K BASE LICENSE	EN-S	\$0
SRDFCE20KC01	SRDF-CE 20K 1TB (0-14TB)	EN-S	\$0
SRDFCE20KC02	SRDF-CE 20K 1TB (15-25TB)	EN-S	\$0
SRDFCE20KC03	SRDF-CE 20K 1TB (26-40TB)	EN-S	\$0
SRDFCE20KC04	SRDF-CE 20K 1TB (41-60TB)	EN-S	\$0
SRDFCE20KC05	SRDF-CE 20K 1TB (61-100TB)	EN-S	\$0
SRDFCE20KC06	SRDF-CE 20K 1TB (101-150TB)	EN-S	\$0
SRDFCE20KC07	SRDF-CE 20K 1TB (151-250TB)	EN-S	\$0
SRDFCE20KC08	SRDF-CE 20K 1TB (251-400TB)	EN-S	\$0
SRDFCE20KC09	SRDF-CE 20K 1TB (401-600TB)	EN-S	\$0
SRDFCE20KC10	SRDF-CE 20K 1TB (601-1000TB)	EN-S	\$0
SRDFCE20KC11	SRDF-CE 20K1TB(1001TB OR GREATER)	EN-S	\$0
SRDFCE20KN01	SRDF-CE 20K 1TB (0-14TB) NLT3	EN-S	\$0
SRDFCE20KN02	SRDF-CE 20K 1TB (15-25TB) NLT3	EN-S	\$0
SRDFCE20KN03	SRDF-CE 20K 1TB (26-40TB) NLT3	EN-S	\$0
SRDFCE20KN04	SRDF-CE 20K 1TB (41-60TB) NLT3	EN-S	\$0
SRDFCE20KN05	SRDF-CE 20K 1TB (61-100TB) NLT3	EN-S	\$0
SRDFCE20KN06	SRDF-CE 20K 1TB (101-150TB) NLT3	EN-S	\$0
SRDFCE20KN07	SRDF-CE 20K 1TB (151-250TB) NLT3	EN-S	\$0

SRDFCE20KN08	SRDF-CE 20K 1TB (251-400TB) NLT3	EN-S	\$0
SRDFCE20KN09	SRDF-CE 20K 1TB (401-600TB) NLT3	EN-S	\$0
SRDFCE20KN10	SRDF-CE 20K 1TB (601-1000TB) NLT3	EN-S	\$0
SRDFCE20KN11	SRDF-CE 20K 1TB(1001TB OR GREATER) NLT3	EN-S	\$0
SRDFCE20KOBAS	SRDF-CE 20K OPT OUT BASE LICENSE	EN-S	\$0
SRDFCE20KOPT	SRDF-CE 20K OPT OUT TB	EN-S	\$0
SRDFCE20KOUP	SRDF-CE 20K OPT OUT BASE UPGRADE	EN-S	\$0
SRDFCE20KR01	SRDF-CE 20K REPL 1TB (0-14TB)	EN-S	\$0
SRDFCE20KR02	SRDF-CE 20K REPL 1TB (15-25TB)	EN-S	\$0
SRDFCE20KR03	SRDF-CE 20K REPL 1TB (26-40TB)	EN-S	\$0
SRDFCE20KR04	SRDF-CE 20K REPL 1TB (41-60TB)	EN-S	\$0
SRDFCE20KR05	SRDF-CE 20K REPL 1TB (61-100TB)	EN-S	\$0
SRDFCE20KR06	SRDF-CE 20K REPL 1TB (101-150TB)	EN-S	\$0
SRDFCE20KR07	SRDF-CE 20K REPL 1TB (151-250TB)	EN-S	\$0
SRDFCE20KR08	SRDF-CE 20K REPL 1TB (251-400TB)	EN-S	\$0
SRDFCE20KR09	SRDF-CE 20K REPL 1TB (401-600TB)	EN-S	\$0
SRDFCE20KR10	SRDF-CE 20K REPL 1TB (601-1000TB)	EN-S	\$0
SRDFCE20KR11	SRDF-CE 20K REPL 1TB(1001TB OR GREATER)	EN-S	\$0
SRDFCE20KRBAS	SRDF-CE 20K REPL BASE LICENSE	EN-S	\$0
SRDFCE20KRUP	SRDF-CE 20K REPL BASE UPGRADE	EN-S	\$0
SRDFCE20KUPG	SRDF-CE 20K BASE UPGRADE	EN-S	\$0
SRDF-CEM-2BAS	SRDF-CE 40K BASE LICENSE	EN-S	\$0
SRDF-CEM-2C01	SRDF-CE 40K 1TB (0-14TB)	EN-S	\$0
SRDF-CEM-2C02	SRDF-CE 40K 1TB (15-25TB)	EN-S	\$0
SRDF-CEM-2C03	SRDF-CE 40K 1TB (26-40TB)	EN-S	\$0
SRDF-CEM-2C04	SRDF-CE 40K 1TB (41-60TB)	EN-S	\$0
SRDF-CEM-2C05	SRDF-CE 40K 1TB (61-100TB)	EN-S	\$0
SRDF-CEM-2C06	SRDF-CE 40K 1TB (101-150TB)	EN-S	\$0
SRDF-CEM-2C07	SRDF-CE 40K 1TB (151-250TB)	EN-S	\$0
SRDF-CEM-2C08	SRDF-CE 40K 1TB (251-400TB)	EN-S	\$0
SRDF-CEM-2C09	SRDF-CE 40K 1TB (401-600TB)	EN-S	\$0
SRDF-CEM-2C10	SRDF-CE 40K 1TB (601-1000TB)	EN-S	\$0
SRDF-CEM-2C11	SRDF-CE 40K 1TB(1001TB or greater)	EN-S	\$0
SRDF-CEM-2N01	SRDF-CE 40K 1TB (0-14TB) NLT3	EN-S	\$0
SRDF-CEM-2N02	SRDF-CE 40K 1TB (15-25TB) NLT3	EN-S	\$0
SRDF-CEM-2N03	SRDF-CE 40K 1TB (26-40TB) NLT3	EN-S	\$0
SRDF-CEM-2N04	SRDF-CE 40K 1TB (41-60TB) NLT3	EN-S	\$0
SRDF-CEM-2N05	SRDF-CE 40K 1TB (61-100TB) NLT3	EN-S	\$0
SRDF-CEM-2N06	SRDF-CE 40K 1TB (101-150TB) NLT3	EN-S	\$0
SRDF-CEM-2N07	SRDF-CE 40K 1TB (151-250TB) NLT3	EN-S	\$0
SRDF-CEM-2N08	SRDF-CE 40K 1TB (251-400TB) NLT3	EN-S	\$0
SRDF-CEM-2N09	SRDF-CE 40K 1TB (401-600TB) NLT3	EN-S	\$0
SRDF-CEM-2N10	SRDF-CE 40K 1TB (601-1000TB) NLT3	EN-S	\$0
SRDF-CEM-2N11	SRDF-CE 40K 1TB(1001TB or greater) NLT3	EN-S	\$0
SRDF-CEM-2R01	SRDF-CE 40K REPL 1TB (0-14TB)	EN-S	\$0
SRDF-CEM-2R02	SRDF-CE 40K REPL 1TB (15-25TB)	EN-S	\$0
SRDF-CEM-2R03	SRDF-CE 40K REPL 1TB (26-40TB)	EN-S	\$0
SRDF-CEM-2R04	SRDF-CE 40K REPL 1TB (41-60TB)	EN-S	\$0
SRDF-CEM-2R05	SRDF-CE 40K REPL 1TB (61-100TB)	EN-S	\$0
SRDF-CEM-2R06	SRDF-CE 40K REPL 1TB (101-150TB)	EN-S	\$0

SRDF-CEM-2R07	SRDF-CE 40K REPL 1TB (151-250TB)	EN-S	\$0
SRDF-CEM-2R08	SRDF-CE 40K REPL 1TB (251-400TB)	EN-S	\$0
SRDF-CEM-2R09	SRDF-CE 40K REPL 1TB (401-600TB)	EN-S	\$0
SRDF-CEM-2R10	SRDF-CE 40K REPL 1TB (601-1000TB)	EN-S	\$0
SRDF-CEM-2R11	SRDF-CE 40K REPL 1TB(1001TB or greater)	EN-S	\$0
SRDF-CEM-2RBA	SRDF-CE 40K REPL BASE LICENSE	EN-S	\$0
SRDF-CEM-2RUP	SRDF-CE 40K REPL BASE UPGRADE	EN-S	\$0
SRDF-CEM-2UPG	SRDF-CE 40K BASE UPGRADE	EN-S	\$0
SRDFSTR20KRNZ	SRDFSTAR RUNTIME FOR ZOS	EN-S	\$0
SYM-HYPERPAV1	HYPERPAV 20K BASE LICENSE	EN-S	\$28,000
SYM2-MIGRBAS	SYMMETRIX 40K MIGRATION BUNDLE	EN-S	\$0
TF-EIM-20KC01	TF-EIM 20K 1TB 0-14TB	EN-S	\$0
TF-EIM-20KC02	TF-EIM 20K 1TB 15-25TB	EN-S	\$0
TF-EIM-20KC03	TF-EIM 20K 1TB 26-40TB	EN-S	\$0
TF-EIM-20KC04	TF-EIM 20K 1TB 41-60TB	EN-S	\$0
TF-EIM-20KC05	TF-EIM 20K 1TB 61-100TB	EN-S	\$0
TF-EIM-20KC06	TF-EIM 20K 1TB 101-150TB	EN-S	\$0
TF-EIM-20KC07	TF-EIM 20K 1TB 151-250TB	EN-S	\$0
TF-EIM-20KC08	TF-EIM 20K 1TB 251-400TB	EN-S	\$0
TF-EIM-20KC09	TF-EIM 20K 1TB 401-600TB	EN-S	\$0
TF-EIM-20KC10	TF-EIM 20K 1TB 601-1000TB	EN-S	\$0
TF-EIM-20KC11	TF-EIM 20K 1TB 1001TB OR GREATER	EN-S	\$0
TF-EIM-20KN01	TF-EIM 20K 1TB 0-14TB NLT3	EN-S	\$0
TF-EIM-20KN02	TF-EIM 20K 1TB 15-25TB NLT3	EN-S	\$0
TF-EIM-20KN03	TF-EIM 20K 1TB 26-40TB NLT3	EN-S	\$0
TF-EIM-20KN04	TF-EIM 20K 1TB 41-60TB NLT3	EN-S	\$0
TF-EIM-20KN05	TF-EIM 20K 1TB 61-100TB NLT3	EN-S	\$0
TF-EIM-20KN06	TF-EIM 20K 1TB 101-150TB NLT3	EN-S	\$0
TF-EIM-20KN07	TF-EIM 20K 1TB 151-250TB NLT3	EN-S	\$0
TF-EIM-20KN08	TF-EIM 20K 1TB 251-400TB NLT3	EN-S	\$0
TF-EIM-20KN09	TF-EIM 20K 1TB 401-600TB NLT3	EN-S	\$0
TF-EIM-20KN10	TF-EIM 20K 1TB 601-1000TB NLT3	EN-S	\$0
TF-EIM-20KN11	TF-EIM 20K 1TB 1001TB OR GREATER NLT3	EN-S	\$0
TF-EIM-20KR01	TF-EIM 20K REG 1TB 0-14TB	EN-S	\$0
TF-EIM-20KR02	TF-EIM 20K REG 1TB 15-25TB	EN-S	\$0
TF-EIM-20KR03	TF-EIM 20K REG 1TB 26-40TB	EN-S	\$0
TF-EIM-20KR04	TF-EIM 20K REG 1TB 41-60TB	EN-S	\$0
TF-EIM-20KR05	TF-EIM 20K REG 1TB 61-100TB	EN-S	\$0
TF-EIM-20KR06	TF-EIM 20K REG 1TB 101-150TB	EN-S	\$0
TF-EIM-20KR07	TF-EIM 20K REG 1TB 151-250TB	EN-S	\$0
TF-EIM-20KR08	TF-EIM 20K REG 1TB 251-400TB	EN-S	\$0
TF-EIM-20KR09	TF-EIM 20K REG 1TB 401-600TB	EN-S	\$0
TF-EIM-20KR10	TF-EIM 20K REG 1TB 601-1000TB	EN-S	\$0
TF-EIM-20KR11	TF-EIM 20K REG 1TB 1001TB OR GREATER	EN-S	\$0
TF-EIM-2C01	TF-EIM 40K 1TB 0-14TB	EN-S	\$0
TF-EIM-2C02	TF-EIM 40K 1TB 15-25TB	EN-S	\$0
TF-EIM-2C03	TF-EIM 40K 1TB 26-40TB	EN-S	\$0
TF-EIM-2C04	TF-EIM 40K 1TB 41-60TB	EN-S	\$0
TF-EIM-2C05	TF-EIM 40K 1TB 61-100TB	EN-S	\$0
TF-EIM-2C06	TF-EIM 40K 1TB 101-150TB	EN-S	\$0

TF-EIM-2C07	TF-EIM 40K 1TB 151-250TB	EN-S	\$0
TF-EIM-2C08	TF-EIM 40K 1TB 251-400TB	EN-S	\$0
TF-EIM-2C09	TF-EIM 40K 1TB 401-600TB	EN-S	\$0
TF-EIM-2C10	TF-EIM 40K 1TB 601-1000TB	EN-S	\$0
TF-EIM-2C11	TF-EIM 40K 1TB 1001TB OR GREATER	EN-S	\$0
TF-EIM-2N01	TF-EIM 40K 1TB 0-14TB NLT3	EN-S	\$0
TF-EIM-2N02	TF-EIM 40K 1TB 15-25TB NLT3	EN-S	\$0
TF-EIM-2N03	TF-EIM 40K 1TB 26-40TB NLT3	EN-S	\$0
TF-EIM-2N04	TF-EIM 40K 1TB 41-60TB NLT3	EN-S	\$0
TF-EIM-2N05	TF-EIM 40K 1TB 61-100TB NLT3	EN-S	\$0
TF-EIM-2N06	TF-EIM 40K 1TB 101-150TB NLT3	EN-S	\$0
TF-EIM-2N07	TF-EIM 40K 1TB 151-250TB NLT3	EN-S	\$0
TF-EIM-2N08	TF-EIM 40K 1TB 251-400TB NLT3	EN-S	\$0
TF-EIM-2N09	TF-EIM 40K 1TB 401-600TB NLT3	EN-S	\$0
TF-EIM-2N10	TF-EIM 40K 1TB 601-1000TB NLT3	EN-S	\$0
TF-EIM-2N11	TF-EIM 40K 1TB 1001TB NLT3 OR GREATER	EN-S	\$0
TF-EIM-2R01	TF-EIM 40K REG 1TB 0-14TB	EN-S	\$0
TF-EIM-2R02	TF-EIM 40K REG 1TB 15-25TB	EN-S	\$0
TF-EIM-2R03	TF-EIM 40K REG 1TB 26-40TB	EN-S	\$0
TF-EIM-2R04	TF-EIM 40K REG 1TB 41-60TB	EN-S	\$0
TF-EIM-2R05	TF-EIM 40K REG 1TB 61-100TB	EN-S	\$0
TF-EIM-2R06	TF-EIM 40K REG 1TB 101-150TB	EN-S	\$0
TF-EIM-2R07	TF-EIM 40K REG 1TB 151-250TB	EN-S	\$0
TF-EIM-2R08	TF-EIM 40K REG 1TB 251-400TB	EN-S	\$0
TF-EIM-2R09	TF-EIM 40K REG 1TB 401-600TB	EN-S	\$0
TF-EIM-2R10	TF-EIM 40K REG 1TB 601-1000TB	EN-S	\$0
TF-EIM-2R11	TF-EIM 40K REG 1TB 1001TB OR GREATER	EN-S	\$0
TF-SIM-20KC01	TF-SIM 20K 1TB 0-14TB	EN-S	\$0
TF-SIM-20KC02	TF-SIM 20K 1TB 15-25TB	EN-S	\$0
TF-SIM-20KC03	TF-SIM 20K 1TB 26-40TB	EN-S	\$0
TF-SIM-20KC04	TF-SIM 20K 1TB 41-60TB	EN-S	\$0
TF-SIM-20KC05	TF-SIM 20K 1TB 61-100TB	EN-S	\$0
TF-SIM-20KC06	TF-SIM 20K 1TB 101-150TB	EN-S	\$0
TF-SIM-20KC07	TF-SIM 20K 1TB 151-250TB	EN-S	\$0
TF-SIM-20KC08	TF-SIM 20K 1TB 251-400TB	EN-S	\$0
TF-SIM-20KC09	TF-SIM 20K 1TB 401-600TB	EN-S	\$0
TF-SIM-20KC10	TF-SIM 20K 1TB 601-1000TB	EN-S	\$0
TF-SIM-20KC11	TF-SIM 20K 1TB 1001TB OR GREATER	EN-S	\$0
TF-SIM-20KN01	TF-SIM 20K 1TB 0-14TB NLT3	EN-S	\$0
TF-SIM-20KN02	TF-SIM 20K 1TB 15-25TB NLT3	EN-S	\$0
TF-SIM-20KN03	TF-SIM 20K 1TB 26-40TB NLT3	EN-S	\$0
TF-SIM-20KN04	TF-SIM 20K 1TB 41-60TB NLT3	EN-S	\$0
TF-SIM-20KN05	TF-SIM 20K 1TB 61-100TB NLT3	EN-S	\$0
TF-SIM-20KN06	TF-SIM 20K 1TB 101-150TB NLT3	EN-S	\$0
TF-SIM-20KN07	TF-SIM 20K 1TB 151-250TB NLT3	EN-S	\$0
TF-SIM-20KN08	TF-SIM 20K 1TB 251-400TB NLT3	EN-S	\$0
TF-SIM-20KN09	TF-SIM 20K 1TB 401-600TB NLT3	EN-S	\$0
TF-SIM-20KN10	TF-SIM 20K 1TB 601-1000TB NLT3	EN-S	\$0
TF-SIM-20KN11	TF-SIM 20K 1TB 1001TB OR GREATER NLT3	EN-S	\$0
TF-SIM-20KOBA	TF-SIM 20K OPT OUT BASE LICENSE	EN-S	\$0

TF-SIM-20KOPT	TF-SIM 20K OPT OUT TB	EN-S	\$0
TF-SIM-20KROUP	TF-SIM 20K OPT OUT BASE UPGRADE	EN-S	\$0
TF-SIM-20KR01	TF-SIM 20K REG 1TB 0-14TB	EN-S	\$0
TF-SIM-20KR02	TF-SIM 20K REG 1TB 15-25TB	EN-S	\$0
TF-SIM-20KR03	TF-SIM 20K REG 1TB 26-40TB	EN-S	\$0
TF-SIM-20KR04	TF-SIM 20K REG 1TB 41-60TB	EN-S	\$0
TF-SIM-20KR05	TF-SIM 20K REG 1TB 61-100TB	EN-S	\$0
TF-SIM-20KR06	TF-SIM 20K REG 1TB 101-150TB	EN-S	\$0
TF-SIM-20KR07	TF-SIM 20K REG 1TB 151-250TB	EN-S	\$0
TF-SIM-20KR08	TF-SIM 20K REG 1TB 251-400TB	EN-S	\$0
TF-SIM-20KR09	TF-SIM 20K REG 1TB 401-600TB	EN-S	\$0
TF-SIM-20KR10	TF-SIM 20K REG 1TB 601-1000TB	EN-S	\$0
TF-SIM-20KR11	TF-SIM 20K REG 1TB 1001TB OR GREATER	EN-S	\$0
TF-SIM-2C01	TF-SIM 40K 1TB 0-14TB	EN-S	\$0
TF-SIM-2C02	TF-SIM 40K 1TB 15-25TB	EN-S	\$0
TF-SIM-2C03	TF-SIM 40K 1TB 26-40TB	EN-S	\$0
TF-SIM-2C04	TF-SIM 40K 1TB 41-60TB	EN-S	\$0
TF-SIM-2C05	TF-SIM 40K 1TB 61-100TB	EN-S	\$0
TF-SIM-2C06	TF-SIM 40K 1TB 101-150TB	EN-S	\$0
TF-SIM-2C07	TF-SIM 40K 1TB 151-250TB	EN-S	\$0
TF-SIM-2C08	TF-SIM 40K 1TB 251-400TB	EN-S	\$0
TF-SIM-2C09	TF-SIM 40K 1TB 401-600TB	EN-S	\$0
TF-SIM-2C10	TF-SIM 40K 1TB 601-1000TB	EN-S	\$0
TF-SIM-2C11	TF-SIM 40K 1TB 1001TB OR GREATER	EN-S	\$0
TF-SIM-2N01	TF-SIM 40K 1TB 0-14TB NLT3	EN-S	\$0
TF-SIM-2N02	TF-SIM 40K 1TB 15-25TB NLT3	EN-S	\$0
TF-SIM-2N03	TF-SIM 40K 1TB 26-40TB NLT3	EN-S	\$0
TF-SIM-2N04	TF-SIM 40K 1TB 41-60TB NLT3	EN-S	\$0
TF-SIM-2N05	TF-SIM 40K 1TB 61-100TB NLT3	EN-S	\$0
TF-SIM-2N06	TF-SIM 40K 1TB 101-150TB NLT3	EN-S	\$0
TF-SIM-2N07	TF-SIM 40K 1TB 151-250TB NLT3	EN-S	\$0
TF-SIM-2N08	TF-SIM 40K 1TB 251-400TB NLT3	EN-S	\$0
TF-SIM-2N09	TF-SIM 40K 1TB 401-600TB NLT3	EN-S	\$0
TF-SIM-2N10	TF-SIM 40K 1TB 601-1000TB NLT3	EN-S	\$0
TF-SIM-2N11	TF-SIM 40K 1TB 1001TB NLT3 OR GREATER	EN-S	\$0
TF-SIM-2R01	TF-SIM 40K REG 1TB 0-14TB	EN-S	\$0
TF-SIM-2R02	TF-SIM 40K REG 1TB 15-25TB	EN-S	\$0
TF-SIM-2R03	TF-SIM 40K REG 1TB 26-40TB	EN-S	\$0
TF-SIM-2R04	TF-SIM 40K REG 1TB 41-60TB	EN-S	\$0
TF-SIM-2R05	TF-SIM 40K REG 1TB 61-100TB	EN-S	\$0
TF-SIM-2R06	TF-SIM 40K REG 1TB 101-150TB	EN-S	\$0
TF-SIM-2R07	TF-SIM 40K REG 1TB 151-250TB	EN-S	\$0
TF-SIM-2R08	TF-SIM 40K REG 1TB 251-400TB	EN-S	\$0
TF-SIM-2R09	TF-SIM 40K REG 1TB 401-600TB	EN-S	\$0
TF-SIM-2R10	TF-SIM 40K REG 1TB 601-1000TB	EN-S	\$0
TF-SIM-2R11	TF-SIM 40K REG 1TB 1001TB OR GREATER	EN-S	\$0
UNISF-VG10	VG10 Unisphere File Suite=IC	EN-S	\$0
UNISF-VG50	VG50 Unisphere File Suite=IC	EN-S	\$0
UNISF-VG50-10K	VG50 Unisphere File 10k Suite=IC	EN-S	\$0
V20K-MIGRBAS	VMAX 20K MIGRATION BUNDLE	EN-S	\$0

VG10-LPS	VG10 Local Protection Suite=IC	EN-S	\$0
VG10-PPAK	VG10 Total Protection Pack=IC	EN-S	\$0
VG10-RPS	VG10 REMOTE Protection Suite=IC	EN-S	\$0
VG10-SCS	VG10 Events and Retention Suite=IC	EN-S	\$5,660
VG10-UNISF	VG10 Unisphere File Suite=IC	EN-S	\$1,620
VG50-LPS	VG50 Local Protection Suite=IC	EN-S	\$0
VG50-PPAK	VG50 Total Protection Pack=IC	EN-S	\$56,295
VG50-RPS	VG50 REMOTE Protection Suite=IC	EN-S	\$0
VG50-SCS	VG50 Events and Retention Suite=IC	EN-S	\$11,325
VG50-UNISF	VG50 Unisphere File Suite=IC	EN-S	\$16,175
VMAX10K-ADVFB-PPAK	VMAX10K ADVANCED SW FILE BLK PPAK=IC	EN-S	\$80,560
VMAX10K-FBUNI-PPAK	VMAX10K FILE BLK UNISPHERE PPAK=IC	EN-S	\$13,570
VMAX10K-LOCPRGPPAK	VMAX10K LOCAL PROT FILE BLK REG PPAK=IC	EN-S	\$13,890
VMAX10K-REMPRGPPAK	VMAX10K REM PROT FILE BLK REG PPAK=IC	EN-S	\$22,120
VMAX10K-REMPRWPPAK	VMAX10K REM PROT FILE BLK RAW PPAK=IC	EN-S	\$10,000
V-MF-1BAS	VMAX MNFRM PKG 20K SWR BASE LICENSE	EN-S	\$30,650
V-MF-1C01	VMAX MNFRM PKG 20K SWR 1TB 0-14TB	EN-S	\$2,565
V-MF-1C02	VMAX MNFRM PKG 20K SWR 1TB 15-25TB	EN-S	\$2,415
V-MF-1C03	VMAX MNFRM PKG 20K SWR 1TB 26-40TB	EN-S	\$2,125
V-MF-1C04	VMAX MNFRM PKG 20K SWR 1TB 41-60TB	EN-S	\$1,970
V-MF-1C05	VMAX MNFRM PKG 20K SWR 1TB 61-100TB	EN-S	\$1,895
V-MF-1C06	VMAX MNFRM PKG 20K SWR 1TB 101-150TB	EN-S	\$1,700
V-MF-1C07	VMAX MNFRM PKG 20K SWR 1TB 151-250TB	EN-S	\$1,515
V-MF-1C08	VMAX MNFRM PKG 20K SWR 1TB 251-400TB	EN-S	\$1,320
V-MF-1C09	VMAX MNFRM PKG 20K SWR 1TB 401-600TB	EN-S	\$1,145
V-MF-1C10	VMAX MNFRM PKG 20K SWR 1TB 601-1000TB	EN-S	\$995
V-MF-1C11	VMAX MNFRM PKG 20K SWR 1TB 1001 TB+	EN-S	\$865
V-MF-1LBAS	VMAX MNFRM PKGL 20K SWR BASE LICENSE	EN-S	\$30,650
V-MF-1LC01	VMAX MNFRM PKGL 20K SWR 1TB 0-14TB	EN-S	\$2,565
V-MF-1LC02	VMAX MNFRM PKGL 20K SWR 1TB 15-25TB	EN-S	\$2,415
V-MF-1LC03	VMAX MNFRM PKGL 20K SWR 1TB 26-40TB	EN-S	\$2,125
V-MF-1LC04	VMAX MNFRM PKGL 20K SWR 1TB 41-60TB	EN-S	\$1,970
V-MF-1LC05	VMAX MNFRM PKGL 20K SWR 1TB 61-100TB	EN-S	\$1,895
V-MF-1LC06	VMAX MNFRM PKGL 20K SWR 1TB 101-150TB	EN-S	\$1,700
V-MF-1LC07	VMAX MNFRM PKGL 20K SWR 1TB 151-250TB	EN-S	\$1,515
V-MF-1LC08	VMAX MNFRM PKGL 20K SWR 1TB 251-400TB	EN-S	\$1,320
V-MF-1LC09	VMAX MNFRM PKGL 20K SWR 1TB 401-600TB	EN-S	\$1,145
V-MF-1LC10	VMAX MNFRM PKGL 20K SWR 1TB 601-1000TB	EN-S	\$995
V-MF-1LC11	VMAX MNFRM PKGL 20K SWR 1TB 1001 TB+	EN-S	\$865
V-MF-1LN01	VMAX MNFRM PKGL 20K SWR 1TB 0-14TB NLT3	EN-S	\$1,285
V-MF-1LN02	VMAX MNFRM PKGL 20K SWR 1TB 15-25TB NLT3	EN-S	\$1,205
V-MF-1LN03	VMAX MNFRM PKGL 20K SWR 1TB 26-40TB NLT3	EN-S	\$1,065
V-MF-1LN04	VMAX MNFRM PKGL 20K SWR 1TB 41-60TB NLT3	EN-S	\$985
V-MF-1LN05	VMAX MNFRM PKGL 20K SW 1TB 61-100TB NLT3	EN-S	\$945
V-MF-1LN06	VMAX MFRM PKGL 20K SW 1TB 101-150TB NLT3	EN-S	\$850
V-MF-1LN07	VMAX MFRM PKGL 20K SW 1TB 151-250TB NLT3	EN-S	\$755
V-MF-1LN08	VMAX MFRM PKGL 20K SW 1TB 251-400TB NLT3	EN-S	\$660
V-MF-1LN09	VMAX MFRM PKGL 20K SW 1TB 401-600TB NLT3	EN-S	\$575
V-MF-1LN10	VMAX MFRM PKGL 20K SW 1TB 601-1000TB NLT3	EN-S	\$500
V-MF-1LN11	VMAX MFRM PKGL 20K SW 1TB 1001TB OR GRT	EN-S	\$435

V-MF-1LR01	VMAX MNFRM PKGL 20K SWR REG 1TB 0-14TB	EN-S	\$2,565
V-MF-1LR02	VMAX MNFRM PKGL 20K SWR REG 1TB 15-25TB	EN-S	\$2,415
V-MF-1LR03	VMAX MNFRM PKGL 20K SWR REG 1TB 26-40TB	EN-S	\$2,125
V-MF-1LR04	VMAX MNFRM PKGL 20K SWR REG 1TB 41-60TB	EN-S	\$1,970
V-MF-1LR05	VMAX MNFRM PKGL 20K SWR REG 1TB 61-100TB	EN-S	\$1,895
V-MF-1LR06	VMAX MNFRM PKGL 20K SW REG 1TB 101-150TB	EN-S	\$1,700
V-MF-1LR07	VMAX MNFRM PKGL 20K SW REG 1TB 151-250TB	EN-S	\$1,515
V-MF-1LR08	VMAX MNFRM PKGL 20K SW REG 1TB 251-400TB	EN-S	\$1,320
V-MF-1LR09	VMAX MNFRM PKGL 20K SW REG 1TB 401-600TB	EN-S	\$1,145
V-MF-1LR10	VMAX MFRM PKGL 20K SW REG 1TB 601-1000TB	EN-S	\$995
V-MF-1LR11	VMAX MNFRM PKGL 20K SWR REG 1TB 1001 TB	EN-S	\$865
V-MF-1LRBAS	VMAX MNFRM PKGL 20K SWR BASE LICENSE	EN-S	\$30,650
V-MF-1LRUP	VMAX MNFRM PKGL 20K SWR BASE UPGRADE	EN-S	\$0
V-MF-1LUP	VMAX MNFRM PKGL 20K SWR BASE UPGRADE	EN-S	\$0
V-MF-1N01	VMAX MNFRM PKG 20K SWR 1TB 0-14TB NLT3	EN-S	\$1,285
V-MF-1N02	VMAX MNFRM PKG 20K SWR 1TB 15-25TB NLT3	EN-S	\$1,205
V-MF-1N03	VMAX MNFRM PKG 20K SWR 1TB 26-40TB NLT3	EN-S	\$1,065
V-MF-1N04	VMAX MNFRM PKG 20K SWR 1TB 41-60TB NLT3	EN-S	\$985
V-MF-1N05	VMAX MNFRM PKG 20K SWR 1TB 61-100TB NLT3	EN-S	\$945
V-MF-1N06	VMAX MNFRM PKG 20K SW 1TB 101-150TB NLT3	EN-S	\$850
V-MF-1N07	VMAX MNFRM PKG 20K SW 1TB 151-250TB NLT3	EN-S	\$755
V-MF-1N08	VMAX MNFRM PKG 20K SW 1TB 251-400TB NLT3	EN-S	\$660
V-MF-1N09	VMAX MNFRM PKG 20K SW 1TB 401-600TB NLT3	EN-S	\$575
V-MF-1N10	VMAX MNFRM PKG 20K SW 1TB 601-1000TB NLT3	EN-S	\$500
V-MF-1N11	VMAX MNFRM PKG 20K SW 1TB 1001TB OR GRT	EN-S	\$435
V-MF-1R01	VMAX MNFRM PKG 20K SWR REG 1TB 0-14TB	EN-S	\$2,565
V-MF-1R02	VMAX MNFRM PKG 20K SWR REG 1TB 15-25TB	EN-S	\$2,415
V-MF-1R03	VMAX MNFRM PKG 20K SWR REG 1TB 26-40TB	EN-S	\$2,125
V-MF-1R04	VMAX MNFRM PKG 20K SWR REG 1TB 41-60TB	EN-S	\$1,970
V-MF-1R05	VMAX MNFRM PKG 20K SWR REG 1TB 61-100TB	EN-S	\$1,895
V-MF-1R06	VMAX MNFRM PKG 20K SWR REG 1TB 101-150TB	EN-S	\$1,700
V-MF-1R07	VMAX MNFRM PKG 20K SWR REG 1TB 151-250TB	EN-S	\$1,515
V-MF-1R08	VMAX MNFRM PKG 20K SWR REG 1TB 251-400TB	EN-S	\$1,320
V-MF-1R09	VMAX MNFRM PKG 20K SWR REG 1TB 401-600TB	EN-S	\$1,145
V-MF-1R10	VMAX MNFRM PKG 20K SW REG 1TB 601-1000TB	EN-S	\$995
V-MF-1R11	VMAX MNFRM PKG 20K SWR REG 1TB 1001 TB+	EN-S	\$865
V-MF-1RBAS	VMAX MNFRM PKG 20K SWR BASE LICENSE	EN-S	\$30,650
V-MF-1RUP	VMAX MNFRM PKG 20K SWR BASE UPGRADE	EN-S	\$0
V-MF-1UP	VMAX MNFRM PKG 20K SWR BASE UPGRADE	EN-S	\$0
V-MF-2BAS	VMAX MNFRM PKG 40K SWR BASE LICENSE	EN-S	\$27,585
V-MF-2C01	VMAX MNFRM PKG 40K SWR 1TB 0-14TB	EN-S	\$2,310
V-MF-2C02	VMAX MNFRM PKG 40K SWR 1TB 15-25TB	EN-S	\$2,175
V-MF-2C03	VMAX MNFRM PKG 40K SWR 1TB 26-40TB	EN-S	\$1,915
V-MF-2C04	VMAX MNFRM PKG 40K SWR 1TB 41-60TB	EN-S	\$1,775
V-MF-2C05	VMAX MNFRM PKG 40K SWR 1TB 61-100TB	EN-S	\$1,705
V-MF-2C06	VMAX MNFRM PKG 40K SWR 1TB 101-150TB	EN-S	\$1,530
V-MF-2C07	VMAX MNFRM PKG 40K SWR 1TB 151-250TB	EN-S	\$1,365
V-MF-2C08	VMAX MNFRM PKG 40K SWR 1TB 251-400TB	EN-S	\$1,190
V-MF-2C09	VMAX MNFRM PKG 40K SWR 1TB 401-600TB	EN-S	\$1,030
V-MF-2C10	VMAX MNFRM PKG 40K SWR 1TB 601-1000TB	EN-S	\$895

V-MF-2C11	VMAX MNFRM PKG 40K SWR 1TB 1001 TB+	EN-S	\$780
V-MF-2N01	VMAX MNFRM PKG 40K SWR 1TB 0-14TB NLT3	EN-S	\$1,155
V-MF-2N02	VMAX MNFRM PKG 40K SWR 1TB 15-25TB NLT3	EN-S	\$1,085
V-MF-2N03	VMAX MNFRM PKG 40K SWR 1TB 26-40TB NLT3	EN-S	\$960
V-MF-2N04	VMAX MNFRM PKG 40K SWR 1TB 41-60TB NLT3	EN-S	\$885
V-MF-2N05	VMAX MNFRM PKG 40K SWR 1TB 61-100TB NLT3	EN-S	\$850
V-MF-2N06	VMAX MNFRM PKG 40K SW 1TB 101-150TB NLT3	EN-S	\$765
V-MF-2N07	VMAX MNFRM PKG 40K SW 1TB 151-250TB NLT3	EN-S	\$680
V-MF-2N08	VMAX MNFRM PKG 40K SW 1TB 251-400TB NLT3	EN-S	\$595
V-MF-2N09	VMAX MNFRM PKG 40K SW 1TB 401-600TB NLT3	EN-S	\$520
V-MF-2N10	VMAX MNFRM PKG 40K SW 1TB 601-1000TB NLT3	EN-S	\$450
V-MF-2N11	VMAX MNFRM PKG 40K SW 1TB 1001TB OR GRT	EN-S	\$390
V-MF-2R01	VMAX MNFRM PKG 40K SWR REG 1TB 0-14TB	EN-S	\$2,310
V-MF-2R02	VMAX MNFRM PKG 40K SWR REG 1TB 15-25TB	EN-S	\$2,175
V-MF-2R03	VMAX MNFRM PKG 40K SWR REG 1TB 26-40TB	EN-S	\$1,915
V-MF-2R04	VMAX MNFRM PKG 40K SWR REG 1TB 41-60TB	EN-S	\$1,775
V-MF-2R05	VMAX MNFRM PKG 40K SWR REG 1TB 61-100TB	EN-S	\$1,705
V-MF-2R06	VMAX MNFRM PKG 40K SWR REG 1TB 101-150TB	EN-S	\$1,530
V-MF-2R07	VMAX MNFRM PKG 40K SWR REG 1TB 151-250TB	EN-S	\$1,365
V-MF-2R08	VMAX MNFRM PKG 40K SWR REG 1TB 251-400TB	EN-S	\$1,190
V-MF-2R09	VMAX MNFRM PKG 40K SWR REG 1TB 401-600TB	EN-S	\$1,030
V-MF-2R10	VMAX MNFRM PKG 40K SW REG 1TB 601-1000TB	EN-S	\$895
V-MF-2R11	VMAX MNFRM PKG 40K SWR REG 1TB 1001 TB+	EN-S	\$780
V-MF-2RBAS	VMAX MNFRM PKG 40K SWR BASE LICENSE	EN-S	\$27,585
V-MF-2RUP	VMAX MNFRM PKG 40K SWR BASE UPGRADE	EN-S	\$0
V-MF-2UP	VMAX MNFRM PKG 40K SWR BASE UPGRADE	EN-S	\$0
V-MF-4AOBAS	VMAX MNFRM ESS PLUS AO 40K SWR BASE=IC	EN-S	\$20,690
V-MF-4AOC01	VMAX MF ESS PLUS AO 40K SW 0-14TB=CB	EN-S	\$1,735
V-MF-4AOC02	VMAX MF ESS PLUS AO 40K SW 15-25TB=CB	EN-S	\$1,630
V-MF-4AOC03	VMAX MF ESS PLUS AO 40K SW 26-40TB=CB	EN-S	\$1,435
V-MF-4AOC04	VMAX MF ESS PLUS AO 40K SW 41-60TB=CB	EN-S	\$1,330
V-MF-4AOC05	VMAX MF ESS PLUS AO 40K SW 61-100TB=CB	EN-S	\$1,280
V-MF-4AOC06	VMAX MF ESS PLUS AO 40K SW 101-150TB=CB	EN-S	\$1,150
V-MF-4AOC07	VMAX MF ESS PLUS AO 40K SW 151-250TB=CB	EN-S	\$1,025
V-MF-4AOC08	VMAX MF ESS PLUS AO 40K SW 251-400TB=CB	EN-S	\$895
V-MF-4AOC09	VMAX MF ESS PLUS AO 40K SW 401-600TB=CB	EN-S	\$775
V-MF-4AOC10	VMAX MF ESS PLUS AO 40K SW 601-1000TB=CB	EN-S	\$670
V-MF-4AOC11	VMAX MF ESS PLUS AO 40K SW 1001 TB+=CB	EN-S	\$585
V-MF-4AOUP	VMAX MF ESS PLUS AO 40K SW BASE UPG=IC	EN-S	\$0
V-MF-4BAS	VMAX MNFRM ESSENTLS PLUS 40K SWR BASE=	EN-S	\$48,275
V-MF-4C01	VMAX MF ESS PLUS 40K SW 0-14TB=CB	EN-S	\$4,045
V-MF-4C02	VMAX MF ESS PLUS 40K SW 15-25TB=CB	EN-S	\$3,805
V-MF-4C03	VMAX MF ESS PLUS 40K SW 26-40TB=CB	EN-S	\$3,350
V-MF-4C04	VMAX MF ESS PLUS 40K SW 41-60TB=CB	EN-S	\$3,105
V-MF-4C05	VMAX MF ESS PLUS 40K SW 61-100TB=CB	EN-S	\$2,985
V-MF-4C06	VMAX MF ESS PLUS 40K SW 101-150TB=CB	EN-S	\$2,680
V-MF-4C07	VMAX MF ESS PLUS 40K SW 151-250TB=CB	EN-S	\$2,390
V-MF-4C08	VMAX MF ESS PLUS 40K SW 251-400TB=CB	EN-S	\$2,085
V-MF-4C09	VMAX MF ESS PLUS 40K SW 401-600TB=CB	EN-S	\$1,805
V-MF-4C10	VMAX MF ESS PLUS 40K SW 601-1000TB=CB	EN-S	\$1,565

V-MF-4C11	VMAX MF ESS PLUS 40K SW 1001 TB+=CB	EN-S	\$1,365
V-MF-4N01	VMAX MF ESS PLUS 40K NLT3 0-14TB=CB	EN-S	\$2,020
V-MF-4N02	VMAX MF ESS PLUS 40K NLT3 15-25TB=CB	EN-S	\$1,900
V-MF-4N03	VMAX MF ESS PLUS 40K NLT3 26-40TB=CB	EN-S	\$1,680
V-MF-4N04	VMAX MF ESS PLUS 40K NLT3 41-60TB=CB	EN-S	\$1,550
V-MF-4N05	VMAX MF ESS PLUS 40K NLT3 61-100TB=CB	EN-S	\$1,490
V-MF-4N06	VMAX MF ESS PLUS 40K NLT3 101-150TB=CB	EN-S	\$1,340
V-MF-4N07	VMAX MF ESS PLUS 40K NLT3 151-250TB=CB	EN-S	\$1,190
V-MF-4N08	VMAX MF ESS PLUS 40K NLT3 251-400TB=CB	EN-S	\$1,040
V-MF-4N09	VMAX MF ESS PLUS 40K NLT3 401-600TB=CB	EN-S	\$910
V-MF-4N10	VMAX MF ESS PLUS 40K NLT3 601-1000TB=CB	EN-S	\$790
V-MF-4N11	VMAX MF ESS PLUS 40K NLT3 1000TB+=CB	EN-S	\$685
V-MF-4R01	VMAX MF ESS PLUS 40K REG 0-14TB=CA	EN-S	\$4,045
V-MF-4R02	VMAX MF ESS PLUS 40K REG 15-25TB=CA	EN-S	\$3,805
V-MF-4R03	VMAX MF ESS PLUS 40K REG 26-40TB=CA	EN-S	\$3,350
V-MF-4R04	VMAX MF ESS PLUS 40K REG 41-60TB=CA	EN-S	\$3,105
V-MF-4R05	VMAX MF ESS PLUS 40K REG 61-100TB=CA	EN-S	\$2,985
V-MF-4R06	VMAX MF ESS PLUS 40K REG 101-150TB=CA	EN-S	\$2,680
V-MF-4R07	VMAX MF ESS PLUS 40K REG 151-250TB=CA	EN-S	\$2,390
V-MF-4R08	VMAX MF ESS PLUS 40K REG 251-400TB=CA	EN-S	\$2,085
V-MF-4R09	VMAX MF ESS PLUS 40K REG 401-600TB=CA	EN-S	\$1,805
V-MF-4R10	VMAX MF ESS PLUS 40K REG 601-1000TB=CA	EN-S	\$1,565
V-MF-4R11	VMAX MF ESS PLUS 40K REG 1000TB+=CA	EN-S	\$1,365
V-MF-4RBAS	VMAX MNFRM ESSENTLS PLUS 40K REG BASE=	EN-S	\$48,275
V-MF-4RUP	VMAX MNFRM ESSENTLS PLUS 40K REG UPG=I	EN-S	\$0
V-MF-4UP	VMAX MF ESS PLUS 40K SW BASE UPGRADE=IC	EN-S	\$0
Z-1COMPAV	Z8PAVMA 20K- NO CHRGE	EN-S	\$0
450-000-694	V100K ADVANCED UPG 0-50TB=CC	ES-1	\$2,345
450-000-695	V100K ADVANCED UPG 51-150TB=CC	ES-1	\$1,855
450-000-696	V100K ADVANCED UPG 151-300TB=CC	ES-1	\$1,605
450-000-697	V100K ADVANCED UPG 301-450TB=CC	ES-1	\$1,545
450-000-698	V100K ADVANCED UPG 451-750TB=CC	ES-1	\$1,120
450-000-699	V100K ADVANCED UPG 751-1500TB=CC	ES-1	\$845
450-000-700	V100K ADVANCED UPG 1501+TB=CC	ES-1	\$640
450-000-701	V200K ADVANCED UPG 0-50TB=CC	ES-1	\$2,345
450-000-702	V200K ADVANCED UPG 51-150TB=CC	ES-1	\$1,855
450-000-703	V200K ADVANCED UPG 151-300TB=CC	ES-1	\$1,605
450-000-704	V200K ADVANCED UPG 301-450TB=CC	ES-1	\$1,545
450-000-705	V200K ADVANCED UPG 451-750TB=CC	ES-1	\$1,120
450-000-706	V200K ADVANCED UPG 751-1500TB=CC	ES-1	\$845
450-000-707	V200K ADVANCED UPG 1501+TB=CC	ES-1	\$640
450-000-708	V400K ADVANCED UPG 0-50TB=CC	ES-1	\$2,345
450-000-709	V400K ADVANCED UPG 51-150TB=CC	ES-1	\$1,855
450-000-710	V400K ADVANCED UPG 151-300TB=CC	ES-1	\$1,605
450-000-711	V400K ADVANCED UPG 301-450TB=CC	ES-1	\$1,545
450-000-712	V400K ADVANCED UPG 451-750TB=CC	ES-1	\$1,120
450-000-713	V400K ADVANCED UPG 751-1500TB=CC	ES-1	\$845
450-000-714	V400K ADVANCED UPG 1501+TB=CC	ES-1	\$640
450-000-715	V100K FOUNDATION UPG 0-50TB=CC	ES-1	\$2,095
450-000-716	V100K FOUNDATION UPG 51-150TB=CC	ES-1	\$1,680

450-000-717	V100K FOUNDATION UPG 151-300TB=CC	ES-1	\$1,320
450-000-718	V100K FOUNDATION UPG 301-450TB=CC	ES-1	\$1,280
450-000-719	V100K FOUNDATION UPG 451-750TB=CC	ES-1	\$930
450-000-720	V100K FOUNDATION UPG 751-1500TB=CC	ES-1	\$700
450-000-721	V100K FOUNDATION UPG 1501+TB=CC	ES-1	\$530
450-000-722	V200K FOUNDATION UPG 0-50TB=CC	ES-1	\$2,095
450-000-723	V200K FOUNDATION UPG 51-150TB=CC	ES-1	\$1,680
450-000-724	V200K FOUNDATION UPG 151-300TB=CC	ES-1	\$1,320
450-000-725	V200K FOUNDATION UPG 301-450TB=CC	ES-1	\$1,280
450-000-726	V200K FOUNDATION UPG 451-750TB=CC	ES-1	\$930
450-000-727	V200K FOUNDATION UPG 751-1500TB=CC	ES-1	\$700
450-000-728	V200K FOUNDATION UPG 1501+TB=CC	ES-1	\$530
450-000-729	V400K FOUNDATION UPG 0-50TB=CC	ES-1	\$2,095
450-000-730	V400K FOUNDATION UPG 51-150TB=CC	ES-1	\$1,680
450-000-731	V400K FOUNDATION UPG 151-300TB=CC	ES-1	\$1,320
450-000-732	V400K FOUNDATION UPG 301-450TB=CC	ES-1	\$1,280
450-000-733	V400K FOUNDATION UPG 451-750TB=CC	ES-1	\$930
450-000-734	V400K FOUNDATION UPG 751-1500TB=CC	ES-1	\$700
450-000-735	V400K FOUNDATION UPG 1501+TB=CC	ES-1	\$530
450-000-770	V100K UNISPHERE PACKAGE=IC	ES-1	\$5,715
450-000-771	V200K UNISPHERE PACKAGE=IC	ES-1	\$17,145
450-000-772	V400K UNISPHERE PACKAGE=IC	ES-1	\$42,855
450-000-780	V100K LOC REP PACKAGE=IC	ES-1	\$22,500
450-000-781	V200K LOC REP PACKAGE=IC	ES-1	\$22,500
450-000-782	V400K LOC REP PACKAGE=IC	ES-1	\$22,500
450-000-790	V100K ADVANCED PACKAGE=IC	ES-1	\$10,715
450-000-791	V200K ADVANCED PACKAGE=IC	ES-1	\$32,145
450-000-792	V400K ADVANCED PACKAGE=IC	ES-1	\$78,570
450-000-793	VMAX3 ADVANCED PKG 0-50TB=CC	ES-1	\$2,345
450-000-794	VMAX3 ADVANCED PKG 51-150TB=CC	ES-1	\$1,855
450-000-795	VMAX3 ADVANCED PKG 151-300TB=CC	ES-1	\$1,605
450-000-796	VMAX3 ADVANCED PKG 301-450TB=CC	ES-1	\$1,545
450-000-797	VMAX3 ADVANCED PKG 451-750TB=CC	ES-1	\$1,120
450-000-798	VMAX3 ADVANCED PKG 751-1500TB=CC	ES-1	\$845
450-000-799	VMAX3 ADVANCED PKG 1501+TB=CC	ES-1	\$640
450-000-810	V100K TOTAL PROD PACK=IC	ES-1	\$53,735
450-000-811	V200K TOTAL PROD PACK=IC	ES-1	\$71,950
450-000-812	V400K TOTAL PROD PACK=IC	ES-1	\$111,410
450-000-813	VMAX3 TOTAL PROD PACK 0-50TB=CC	ES-1	\$4,425
450-000-814	VMAX3 TOTAL PROD PACK 51-150TB=CC	ES-1	\$3,385
450-000-815	VMAX3 TOTAL PROD PACK 151-300TB=CC	ES-1	\$2,595
450-000-816	VMAX3 TOTAL PROD PACK 301-450TB=CC	ES-1	\$2,300
450-000-817	VMAX3 TOTAL PROD PACK 451-750TB=CC	ES-1	\$1,800
450-000-818	VMAX3 TOTAL PROD PACK 751-1500TB=CC	ES-1	\$1,455
450-000-819	VMAX3 TOTAL PROD PACK 1501+TB=CC	ES-1	\$1,170
450-000-820	VMAX3 ADV UPG FROM FOUND 0-50TB=CC	ES-1	\$250
450-000-821	VMAX3 ADV UPG FROM FOUND 51-150TB=CC	ES-1	\$175
450-000-822	VMAX3 ADV UPG FROM FOUND 151-300TB=CC	ES-1	\$285
450-000-823	VMAX3 ADV UPG FROM FOUND 301-450TB=CC	ES-1	\$265
450-000-824	VMAX3 ADV UPG FROM FOUND 451-750TB=CC	ES-1	\$190

450-000-825	VMAX3 ADV UPG FROM FOUND 751-1500TB=CC	ES-1	\$145
450-000-826	VMAX3 ADV UPG FROM FOUND 1501+TB=CC	ES-1	\$110
450-000-827	VMAX3 ADV FROM FOUND DLTA 0-50TB=CC	ES-1	\$2,345
450-000-828	VMAX3 ADV FROM FOUND DLTA 51-150TB=CC	ES-1	\$1,855
450-000-829	VMAX3 ADV FROM FOUND DLTA 151-300TB=CC	ES-1	\$1,605
450-000-830	VMAX3 ADV FROM FOUND DLTA 301-450TB=CC	ES-1	\$1,545
450-000-831	VMAX3 ADV FROM FOUND DLTA 451-750TB=CC	ES-1	\$1,120
450-000-832	VMAX3 ADV FROM FOUND DLTA 751-1500TB=CC	ES-1	\$845
450-000-833	VMAX3 ADV FROM FOUND DLTA 1501+TB=CC	ES-1	\$640
450-000-841	VMAX3 ADV UPG FROM UNI 0-50TB=CC	ES-1	\$850
450-000-842	VMAX3 ADV UPG FROM UNI 51-150TB=CC	ES-1	\$640
450-000-843	VMAX3 ADV UPG FROM UNI 151-300TB=CC	ES-1	\$500
450-000-844	VMAX3 ADV UPG FROM UNI 301-450TB=CC	ES-1	\$590
450-000-845	VMAX3 ADV UPG FROM UNI 451-750TB=CC	ES-1	\$420
450-000-846	VMAX3 ADV UPG FROM UNI 751-1500TB=CC	ES-1	\$315
450-000-847	VMAX3 ADV UPG FROM UNI 1501+TB=CC	ES-1	\$235
450-000-848	VMAX3 ADV FROM UNI DLTA 0-50TB=CC	ES-1	\$2,345
450-000-849	VMAX3 ADV FROM UNI DLTA 51-150TB=CC	ES-1	\$1,855
450-000-850	VMAX3 ADV FROM UNI DLTA 151-300TB=CC	ES-1	\$1,605
450-000-851	VMAX3 ADV FROM UNI DLTA 301-450TB=CC	ES-1	\$1,545
450-000-852	VMAX3 ADV FROM UNI DLTA 451-750TB=CC	ES-1	\$1,120
450-000-853	VMAX3 ADV FROM UNI DLTA 751-1500TB=CC	ES-1	\$845
450-000-854	VMAX3 ADV FROM UNI DLTA 1501+TB=CC	ES-1	\$640
450-000-855	VMAX3 ADV UPG FROM BASE 0-50TB=CC	ES-1	\$890
450-000-856	VMAX3 ADV UPG FROM BASE 51-150TB=CC	ES-1	\$660
450-000-857	VMAX3 ADV UPG FROM BASE 151-300TB=CC	ES-1	\$685
450-000-858	VMAX3 ADV UPG FROM BASE 301-450TB=CC	ES-1	\$675
450-000-859	VMAX3 ADV UPG FROM BASE 451-750TB=CC	ES-1	\$475
450-000-860	VMAX3 ADV UPG FROM BASE 751-1500TB=CC	ES-1	\$355
450-000-861	VMAX3 ADV UPG FROM BASE 1501+TB=CC	ES-1	\$245
450-000-862	VMAX3 ADV FROM BASE DLTA 0-50TB=CC	ES-1	\$2,345
450-000-863	VMAX3 ADV FROM BASE DLTA 51-150TB=CC	ES-1	\$1,855
450-000-864	VMAX3 ADV FROM BASE DLTA 151-300TB=CC	ES-1	\$1,605
450-000-865	VMAX3 ADV FROM BASE DLTA 301-450TB=CC	ES-1	\$1,545
450-000-866	VMAX3 ADV FROM BASE DLTA 451-750TB=CC	ES-1	\$1,120
450-000-867	VMAX3 ADV FROM BASE DLTA 751-1500TB=CC	ES-1	\$845
450-000-868	VMAX3 ADV FROM BASE DLTA 1501+TB=CC	ES-1	\$640
450-000-898	VMAX3 ADVANCED FAST COMBO TIER=CC	ES-1	\$0
450-000-920	V100K SRDF REPLICATION FILE REG PKG=IC	ES-1	\$45,575
450-000-921	V200K SRDF REPLICATION FILE REG PKG=IC	ES-1	\$45,575
450-000-922	V400K SRDF REPLICATION FILE REG PKG=IC	ES-1	\$45,575
450-000-923	V100K TIMEFINDER SNAPSURE REG PKG=IC	ES-1	\$25,140
450-000-924	V200K TIMEFINDER SNAPSURE REG PKG=IC	ES-1	\$25,140
450-000-925	V400K TIMEFINDER SNAPSURE REG PKG=IC	ES-1	\$25,140
450-000-945	V100K ADV FROM BASE 0-50TB=CC	ES-1	\$890
450-000-946	V100K ADV FROM BASE 51-150TB=CC	ES-1	\$660
450-000-947	V100K ADV FROM BASE 151-300TB=CC	ES-1	\$685
450-000-948	V100K ADV FROM BASE 301-450TB=CC	ES-1	\$675
450-000-949	V100K ADV FROM BASE 451-750TB=CC	ES-1	\$475
450-000-950	V100K ADV FROM BASE 751-1500TB=CC	ES-1	\$355

450-000-951	V100K ADV FROM BASE 1501+TB=CC	ES-1	\$245
450-000-952	V200K ADV FROM BASE 0-50TB=CC	ES-1	\$890
450-000-953	V200K ADV FROM BASE 51-150TB=CC	ES-1	\$660
450-000-954	V200K ADV FROM BASE 151-300TB=CC	ES-1	\$685
450-000-955	V200K ADV FROM BASE 301-450TB=CC	ES-1	\$675
450-000-956	V200K ADV FROM BASE 451-750TB=CC	ES-1	\$475
450-000-957	V200K ADV FROM BASE 751-1500TB=CC	ES-1	\$355
450-000-958	V200K ADV FROM BASE 1501+TB=CC	ES-1	\$245
450-000-959	V400K ADV FROM BASE 0-50TB=CC	ES-1	\$890
450-000-960	V400K ADV FROM BASE 51-150TB=CC	ES-1	\$660
450-000-961	V400K ADV FROM BASE 151-300TB=CC	ES-1	\$685
450-000-962	V400K ADV FROM BASE 301-450TB=CC	ES-1	\$675
450-000-963	V400K ADV FROM BASE 451-750TB=CC	ES-1	\$475
450-000-964	V400K ADV FROM BASE 751-1500TB=CC	ES-1	\$355
450-000-965	V400K ADV FROM BASE 1501+TB=CC	ES-1	\$245
450-000-987	V100K ADV FROM UNI 0-50TB=CC	ES-1	\$850
450-000-988	V100K ADV FROM UNI 51-150TB=CC	ES-1	\$640
450-000-989	V100K ADV FROM UNI 151-300TB=CC	ES-1	\$500
450-000-990	V100K ADV FROM UNI 301-450TB=CC	ES-1	\$590
450-000-991	V100K ADV FROM UNI 451-750TB=CC	ES-1	\$420
450-000-992	V100K ADV FROM UNI 751-1500TB=CC	ES-1	\$315
450-000-993	V100K ADV FROM UNI 1501+TB=CC	ES-1	\$235
450-000-994	V200K ADV FROM UNI 0-50TB=CC	ES-1	\$850
450-000-995	V200K ADV FROM UNI 51-150TB=CC	ES-1	\$640
450-000-996	V200K ADV FROM UNI 151-300TB=CC	ES-1	\$500
450-000-997	V200K ADV FROM UNI 301-450TB=CC	ES-1	\$590
450-000-998	V200K ADV FROM UNI 451-750TB=CC	ES-1	\$420
450-000-999	V200K ADV FROM UNI 751-1500TB=CC	ES-1	\$315
450-001-000	V200K ADV FROM UNI 1501+TB=CC	ES-1	\$235
450-001-001	V400K ADV FROM UNI 0-50TB=CC	ES-1	\$850
450-001-002	V400K ADV FROM UNI 51-150TB=CC	ES-1	\$640
450-001-003	V400K ADV FROM UNI 151-300TB=CC	ES-1	\$500
450-001-004	V400K ADV FROM UNI 301-450TB=CC	ES-1	\$590
450-001-005	V400K ADV FROM UNI 451-750TB=CC	ES-1	\$420
450-001-006	V400K ADV FROM UNI 751-1500TB=CC	ES-1	\$315
450-001-007	V400K ADV FROM UNI 1501+TB=CC	ES-1	\$235
450-001-008	V100K ADV FROM BASE DLTA 0-50TB=CC	ES-1	\$2,345
450-001-009	V100K ADV FROM BASE DLTA 51-150TB=CC	ES-1	\$1,855
450-001-010	V100K ADV FROM BASE DLTA 151-300TB=CC	ES-1	\$1,605
450-001-011	V100K ADV FROM BASE DLTA 301-450TB=CC	ES-1	\$1,545
450-001-012	V100K ADV FROM BASE DLTA 451-750TB=CC	ES-1	\$1,120
450-001-013	V100K ADV FROM BASE DLTA 751-1500TB=CC	ES-1	\$845
450-001-014	V100K ADV FROM BASE DLTA 1501+TB=CC	ES-1	\$640
450-001-015	V200K ADV FROM BASE DLTA 0-50TB=CC	ES-1	\$2,345
450-001-016	V200K ADV FROM BASE DLTA 51-150TB=CC	ES-1	\$1,855
450-001-017	V200K ADV FROM BASE DLTA 151-300TB=CC	ES-1	\$1,605
450-001-018	V200K ADV FROM BASE DLTA 301-450TB=CC	ES-1	\$1,545
450-001-019	V200K ADV FROM BASE DLTA 451-750TB=CC	ES-1	\$1,120
450-001-020	V200K ADV FROM BASE DLTA 751-1500TB=CC	ES-1	\$845
450-001-021	V200K ADV FROM BASE DLTA 1501+TB=CC	ES-1	\$640

450-001-022	V400K ADV FROM BASE DLTA 0-50TB=CC	ES-1	\$2,345
450-001-023	V400K ADV FROM BASE DLTA 51-150TB=CC	ES-1	\$1,855
450-001-024	V400K ADV FROM BASE DLTA 151-300TB=CC	ES-1	\$1,605
450-001-025	V400K ADV FROM BASE DLTA 301-450TB=CC	ES-1	\$1,545
450-001-026	V400K ADV FROM BASE DLTA 451-750TB=CC	ES-1	\$1,120
450-001-027	V400K ADV FROM BASE DLTA 751-1500TB=CC	ES-1	\$845
450-001-028	V400K ADV FROM BASE DLTA 1501+TB=CC	ES-1	\$640
450-001-029	V100K ADV FROM UNI DLTA 0-50TB=CC	ES-1	\$2,345
450-001-030	V100K ADV FROM UNI DLTA 51-150TB=CC	ES-1	\$1,855
450-001-031	V100K ADV FROM UNI DLTA 151-300TB=CC	ES-1	\$1,605
450-001-032	V100K ADV FROM UNI DLTA 301-450TB=CC	ES-1	\$1,545
450-001-033	V100K ADV FROM UNI DLTA 451-750TB=CC	ES-1	\$1,120
450-001-034	V100K ADV FROM UNI DLTA 751-1500TB=CC	ES-1	\$845
450-001-035	V100K ADV FROM UNI DLTA 1501+TB=CC	ES-1	\$640
450-001-036	V200K ADV FROM UNI DLTA 0-50TB=CC	ES-1	\$2,345
450-001-037	V200K ADV FROM UNI DLTA 51-150TB=CC	ES-1	\$1,855
450-001-038	V200K ADV FROM UNI DLTA 151-300TB=CC	ES-1	\$1,605
450-001-039	V200K ADV FROM UNI DLTA 301-450TB=CC	ES-1	\$1,545
450-001-040	V200K ADV FROM UNI DLTA 451-750TB=CC	ES-1	\$1,120
450-001-041	V200K ADV FROM UNI DLTA 751-1500TB=CC	ES-1	\$845
450-001-042	V200K ADV FROM UNI DLTA 1501+TB=CC	ES-1	\$640
450-001-043	V400K ADV FROM UNI DLTA 0-50TB=CC	ES-1	\$2,345
450-001-044	V400K ADV FROM UNI DLTA 51-150TB=CC	ES-1	\$1,855
450-001-045	V400K ADV FROM UNI DLTA 151-300TB=CC	ES-1	\$1,605
450-001-046	V400K ADV FROM UNI DLTA 301-450TB=CC	ES-1	\$1,545
450-001-047	V400K ADV FROM UNI DLTA 451-750TB=CC	ES-1	\$1,120
450-001-048	V400K ADV FROM UNI DLTA 751-1500TB=CC	ES-1	\$845
450-001-049	V400K ADV FROM UNI DLTA 1501+TB=CC	ES-1	\$640
450-001-067	V100K REMOTE REP BASE LIC=IC	ES-1	\$30,000
450-001-068	V200K REMOTE REP BASE LIC=IC	ES-1	\$30,000
450-001-069	V400K REMOTE REP BASE LIC=IC	ES-1	\$30,000
450-001-070	VMAX3 REMOTE REP PKG 0-50TB=CC	ES-1	\$1,760
450-001-071	VMAX3 REMOTE REP PKG 51-150TB=CC	ES-1	\$1,260
450-001-072	VMAX3 REMOTE REP PKG 151-300TB=CC	ES-1	\$890
450-001-073	VMAX3 REMOTE REP PKG 301-450TB=CC	ES-1	\$705
450-001-074	VMAX3 REMOTE REP PKG 451-750TB=CC	ES-1	\$605
450-001-075	VMAX3 REMOTE REP PKG 751-1500TB=CC	ES-1	\$520
450-001-076	VMAX3 REMOTE REP PKG 1501+TB=CC	ES-1	\$440
450-001-079	V100K REMOTE REP UPG 301-450TB=CC	ES-1	\$705
450-001-080	V100K REMOTE REP UPG 451-750TB=CC	ES-1	\$605
450-001-081	V100K REMOTE REP UPG 751-1500TB=CC	ES-1	\$520
450-001-082	V100K REMOTE REP UPG 1500+TB=CC	ES-1	\$440
450-001-083	V200K REMOTE REP UPG 0-50TB=CC	ES-1	\$1,760
450-001-084	V200K REMOTE REP UPG 51-150TB=CC	ES-1	\$1,260
450-001-085	V200K REMOTE REP UPG 151-300TB=CC	ES-1	\$890
450-001-086	V200K REMOTE REP UPG 301-450TB=CC	ES-1	\$705
450-001-087	V200K REMOTE REP UPG 451-750TB=CC	ES-1	\$605
450-001-088	V200K REMOTE REP UPG 751-1500TB=CC	ES-1	\$520
450-001-089	V200K REMOTE REP UPG 1500+TB=CC	ES-1	\$440
450-001-090	V400K REMOTE REP UPG 0-50TB=CC	ES-1	\$1,760

450-001-091	V400K REMOTE REP UPG 51-150TB=CC	ES-1	\$1,260
450-001-092	V400K REMOTE REP UPG 151-300TB=CC	ES-1	\$890
450-001-093	V400K REMOTE REP UPG 301-450TB=CC	ES-1	\$705
450-001-094	V400K REMOTE REP UPG 451-750TB=CC	ES-1	\$605
450-001-095	V400K REMOTE REP UPG 751-1500TB=CC	ES-1	\$520
450-001-096	V400K REMOTE REP UPG 1500+TB=CC	ES-1	\$440
450-001-097	V100K REMOTE REP UPG 0-50TB=CC	ES-1	\$1,760
450-001-098	V100K REMOTE REP UPG 51-150TB=CC	ES-1	\$1,260
450-001-099	V100K REMOTE REP UPG 151-300TB=CC	ES-1	\$890
450-001-121	V100K TOTAL PROD PACK UPG 0-50TB=CC	ES-1	\$4,425
450-001-122	V100K TOTAL PROD PACK UPG 51-150TB=CC	ES-1	\$3,385
450-001-123	V100K TOTAL PROD PACK UPG 151-300TB=CC	ES-1	\$2,595
450-001-124	V100K TOTAL PROD PACK UPG 301-450TB=CC	ES-1	\$2,300
450-001-125	V100K TOTAL PROD PACK UPG 451-750TB=CC	ES-1	\$1,800
450-001-126	V100K TOTAL PROD PACK UPG 751-1500TB=CC	ES-1	\$1,455
450-001-127	V100K TOTAL PROD PACK UPG 1500+TB=CC	ES-1	\$1,170
450-001-128	V200K TOTAL PROD PACK UPG 0-50TB=CC	ES-1	\$4,425
450-001-129	V200K TOTAL PROD PACK UPG 51-150TB=CC	ES-1	\$3,385
450-001-130	V200K TOTAL PROD PACK UPG 151-300TB=CC	ES-1	\$2,595
450-001-131	V200K TOTAL PROD PACK UPG 301-450TB=CC	ES-1	\$2,300
450-001-132	V200K TOTAL PROD PACK UPG 451-750TB=CC	ES-1	\$1,800
450-001-133	V200K TOTAL PROD PACK UPG 751-1500TB=CC	ES-1	\$1,455
450-001-134	V200K TOTAL PROD PACK UPG 1500+TB=CC	ES-1	\$1,170
450-001-135	V400K TOTAL PROD PACK UPG 0-50TB=CC	ES-1	\$4,425
450-001-136	V400K TOTAL PROD PACK UPG 51-150TB=CC	ES-1	\$3,385
450-001-137	V400K TOTAL PROD PACK UPG 151-300TB=CC	ES-1	\$2,595
450-001-138	V400K TOTAL PROD PACK UPG 301-450TB=CC	ES-1	\$2,300
450-001-139	V400K TOTAL PROD PACK UPG 451-750TB=CC	ES-1	\$1,800
450-001-140	V400K TOTAL PROD PACK UPG 751-1500TB=CC	ES-1	\$1,455
450-001-141	V400K TOTAL PROD PACK UPG 1500+TB=CC	ES-1	\$1,170
450-001-142	V100K ADV FROM FOUND DLTA 0-50TB=CC	ES-1	\$2,345
450-001-143	V100K ADV FROM FOUND DLTA 51-150TB=CC	ES-1	\$1,855
450-001-144	V100K ADV FROM FOUND DLTA 151-300TB=CC	ES-1	\$1,605
450-001-145	V100K ADV FROM FOUND DLTA 301-450TB=CC	ES-1	\$1,545
450-001-146	V100K ADV FROM FOUND DLTA 451-750TB=CC	ES-1	\$1,120
450-001-147	V100K ADV FROM FOUND DLTA 751-1500TB=CC	ES-1	\$845
450-001-148	V100K ADV FROM FOUND DLTA 1501+TB=CC	ES-1	\$640
450-001-149	V200K ADV FROM FOUND DLTA 0-50TB=CC	ES-1	\$2,345
450-001-150	V200K ADV FROM FOUND DLTA 51-150TB=CC	ES-1	\$1,855
450-001-151	V200K ADV FROM FOUND DLTA 151-300TB=CC	ES-1	\$1,605
450-001-152	V200K ADV FROM FOUND DLTA 301-450TB=CC	ES-1	\$1,545
450-001-153	V200K ADV FROM FOUND DLTA 451-750TB=CC	ES-1	\$1,120
450-001-154	V200K ADV FROM FOUND DLTA 751-1500TB=CC	ES-1	\$845
450-001-155	V200K ADV FROM FOUND DLTA 1501+TB=CC	ES-1	\$640
450-001-156	V400K ADV FROM FOUND DLTA 0-50TB=CC	ES-1	\$2,345
450-001-157	V400K ADV FROM FOUND DLTA 51-150TB=CC	ES-1	\$1,855
450-001-158	V400K ADV FROM FOUND DLTA 151-300TB=CC	ES-1	\$1,605
450-001-159	V400K ADV FROM FOUND DLTA 301-450TB=CC	ES-1	\$1,545
450-001-160	V400K ADV FROM FOUND DLTA 451-750TB=CC	ES-1	\$1,120
450-001-161	V400K ADV FROM FOUND DLTA 751-1500TB=CC	ES-1	\$845

450-001-162	V400K ADV FROM FOUND DLTA 1501+TB=CC	ES-1	\$640
450-001-163	V100K ADV FROM FOUND 0-50TB=CC	ES-1	\$250
450-001-164	V100K ADV FROM FOUND 51-150TB=CC	ES-1	\$175
450-001-165	V100K ADV FROM FOUND 151-300TB=CC	ES-1	\$285
450-001-166	V100K ADV FROM FOUND 301-450TB=CC	ES-1	\$265
450-001-167	V100K ADV FROM FOUND 451-750TB=CC	ES-1	\$190
450-001-168	V100K ADV FROM FOUND 751-1500TB=CC	ES-1	\$145
450-001-169	V100K ADV FROM FOUND 1501+TB=CC	ES-1	\$110
450-001-170	V200K ADV FROM FOUND 0-50TB=CC	ES-1	\$250
450-001-171	V200K ADV FROM FOUND 51-150TB=CC	ES-1	\$175
450-001-172	V200K ADV FROM FOUND 151-300TB=CC	ES-1	\$285
450-001-173	V200K ADV FROM FOUND 301-450TB=CC	ES-1	\$265
450-001-174	V200K ADV FROM FOUND 451-750TB=CC	ES-1	\$190
450-001-175	V200K ADV FROM FOUND 751-1500TB=CC	ES-1	\$145
450-001-176	V200K ADV FROM FOUND 1501+TB=CC	ES-1	\$110
450-001-177	V400K ADV FROM FOUND 0-50TB=CC	ES-1	\$250
450-001-178	V400K ADV FROM FOUND 51-150TB=CC	ES-1	\$175
450-001-179	V400K ADV FROM FOUND 151-300TB=CC	ES-1	\$285
450-001-180	V400K ADV FROM FOUND 301-450TB=CC	ES-1	\$265
450-001-181	V400K ADV FROM FOUND 451-750TB=CC	ES-1	\$190
450-001-182	V400K ADV FROM FOUND 751-1500TB=CC	ES-1	\$145
450-001-183	V400K ADV FROM FOUND 1501+TB=CC	ES-1	\$110
450-001-189	ESA FOR V200K BASE LIC=IA	ES-1	\$5,145
450-001-193	V100K LOC REP PACKAGE=IC	ES-1	\$22,500
450-001-194	V200K LOC REP PACKAGE=IC	ES-1	\$22,500
450-001-195	V400K LOC REP PACKAGE=IC	ES-1	\$22,500
450-001-196	V100K REMOTE REP BASE LIC=IC	ES-1	\$30,000
450-001-197	V200K REMOTE REP BASE LIC=IC	ES-1	\$30,000
450-001-198	V100K TOTAL PROD PACK=IC	ES-1	\$53,735
450-001-199	V200K TOTAL PROD PACK=IC	ES-1	\$71,950
450-001-200	V400K TOTAL PROD PACK=IC	ES-1	\$111,410
450-001-201	V400K REMOTE REP BASE LIC=IC	ES-1	\$30,000
450-001-211	V100K FOUNDATION UPG 0-50TB=CC	ES-1	\$2,095
450-001-212	V100K FOUNDATION UPG 51-150TB=CC	ES-1	\$1,680
450-001-213	V100K FOUNDATION UPG 151-300TB=CC	ES-1	\$1,320
450-001-214	V100K FOUNDATION UPG 301-450TB=CC	ES-1	\$1,280
450-001-215	V100K FOUNDATION UPG451-750TB=CC	ES-1	\$930
450-001-216	V100K FOUNDATION UPG 751-1500TB=CC	ES-1	\$700
450-001-217	V100K FOUNDATION UPG 1501+TB=CC	ES-1	\$530
450-001-218	V100K UNISPHERE PACKAGE=IC	ES-1	\$5,715
450-001-219	V100K LOC REP PACKAGE=IC	ES-1	\$22,500
450-001-220	V100K ADVANCED PACKAGE=IC	ES-1	\$10,715
450-001-221	VMAX3 ADVANCED PKG 0-50TB=CC	ES-1	\$2,345
450-001-222	VMAX3 ADVANCED PKG 51-150TB=CC	ES-1	\$1,855
450-001-223	VMAX3 ADVANCED PKG 151-300TB=CC	ES-1	\$1,605
450-001-224	VMAX3 ADVANCED PKG 301-450TB=CC	ES-1	\$1,545
450-001-225	VMAX3 ADVANCED PKG451-750TB=CC	ES-1	\$1,120
450-001-226	VMAX3 ADVANCED PKG 751-1500TB=CC	ES-1	\$845
450-001-227	VMAX3 ADVANCED PKG 1501+TB=CC	ES-1	\$640
450-001-228	V100K ADVANCED UPG 0-50TB=CC	ES-1	\$2,345

450-001-229	V100K ADVANCED UPG 51-150TB=CC	ES-1	\$1,855
450-001-230	V100K ADVANCED UPG 151-300TB=CC	ES-1	\$1,605
450-001-231	V100K ADVANCED UPG 301-450TB=CC	ES-1	\$1,545
450-001-232	V100K ADVANCED UPG451-750TB=CC	ES-1	\$1,120
450-001-233	V100K ADVANCED UPG 751-1500TB=CC	ES-1	\$845
450-001-234	V100K ADVANCED UPG 1501+TB=CC	ES-1	\$640
450-001-235	V100K REMOTE REP BASE LIC=IC	ES-1	\$30,000
450-001-236	VMAX3 REMOTE REP PKG 0-50TB=CC	ES-1	\$1,760
450-001-237	VMAX3 REMOTE REP PKG 51-150TB=CC	ES-1	\$1,260
450-001-238	VMAX3 REMOTE REP PKG 151-300TB=CC	ES-1	\$890
450-001-239	VMAX3 REMOTE REP PKG 301-450TB=CC	ES-1	\$705
450-001-240	VMAX3 REMOTE REP PKG451-750TB=CC	ES-1	\$605
450-001-241	VMAX3 REMOTE REP PKG 751-1500TB=CC	ES-1	\$520
450-001-242	VMAX3 REMOTE REP PKG 1501+TB=CC	ES-1	\$440
450-001-243	V100K REMOTE REP UPG 0-50TB=CC	ES-1	\$1,760
450-001-244	V100K REMOTE REP UPG 51-150TB=CC	ES-1	\$1,260
450-001-245	V100K REMOTE REP UPG 151-300TB=CC	ES-1	\$890
450-001-246	V100K REMOTE REP UPG 301-450TB=CC	ES-1	\$705
450-001-247	V100K REMOTE REP UPG451-750TB=CC	ES-1	\$605
450-001-248	V100K REMOTE REP UPG 751-1500TB=CC	ES-1	\$520
450-001-249	V100K REMOTE REP UPG 1500+TB=CC	ES-1	\$440
450-001-250	V100K TOTAL PROD PACK=IC	ES-1	\$53,735
450-001-251	VMAX3 TOTAL PROD PACK 0-50TB=CC	ES-1	\$4,425
450-001-252	VMAX3 TOTAL PROD PACK 51-150TB=CC	ES-1	\$3,385
450-001-253	VMAX3 TOTAL PROD PACK 151-300TB=CC	ES-1	\$2,595
450-001-254	VMAX3 TOTAL PROD PACK 301-450TB=CC	ES-1	\$2,300
450-001-255	VMAX3 TOTAL PROD PACK451-750TB=CC	ES-1	\$1,800
450-001-256	VMAX3 TOTAL PROD PACK 751-1500TB=CC	ES-1	\$1,455
450-001-257	VMAX3 TOTAL PROD PACK 1501+TB=CC	ES-1	\$1,170
450-001-258	V100K TOTAL PROD PACK UPG 0-50TB=CC	ES-1	\$4,425
450-001-259	V100K TOTAL PROD PACK UPG 51-150TB=CC	ES-1	\$3,385
450-001-260	V100K TOTAL PROD PACK UPG 151-300TB=CC	ES-1	\$2,595
450-001-261	V100K TOTAL PROD PACK UPG 301-450TB=CC	ES-1	\$2,300
450-001-262	V100K TOTAL PROD PACK UPG451-750TB=CC	ES-1	\$1,800
450-001-263	V100K TOTAL PROD PACK UPG 751-1500TB=CC	ES-1	\$1,455
450-001-264	V100K TOTAL PROD PACK UPG 1500+TB=CC	ES-1	\$1,170
450-001-265	VMAX3 ADV UPG FROM FOUND 0-50TB=CC	ES-1	\$250
450-001-266	VMAX3 ADV UPG FROM FOUND 51-150TB=CC	ES-1	\$175
450-001-267	VMAX3 ADV UPG FROM FOUND 151-300TB=CC	ES-1	\$285
450-001-268	VMAX3 ADV UPG FROM FOUND 301-450TB=CC	ES-1	\$265
450-001-269	VMAX3 ADV UPG FROM FOUND451-750TB=CC	ES-1	\$190
450-001-270	VMAX3 ADV UPG FROM FOUND 751-1500TB=CC	ES-1	\$145
450-001-271	VMAX3 ADV UPG FROM FOUND 1501+TB=CC	ES-1	\$110
450-001-272	VMAX3 ADV FROM FOUND DLTA 0-50TB=CC	ES-1	\$2,345
450-001-273	VMAX3 ADV FROM FOUND DLTA 51-150TB=CC	ES-1	\$1,855
450-001-274	VMAX3 ADV FROM FOUND DLTA 151-300TB=CC	ES-1	\$1,605
450-001-275	VMAX3 ADV FROM FOUND DLTA 301-450TB=CC	ES-1	\$1,545
450-001-276	VMAX3 ADV FROM FOUND DLTA451-750TB=CC	ES-1	\$1,120
450-001-277	VMAX3 ADV FROM FOUND DLTA 751-1500TB=CC	ES-1	\$845
450-001-278	VMAX3 ADV FROM FOUND DLTA 1501+TB=CC	ES-1	\$640

450-001-279	V100K ADV FROM FOUND DLTA 0-50TB=CC	ES-1	\$2,345
450-001-280	V100K ADV FROM FOUND DLTA 51-150TB=CC	ES-1	\$1,855
450-001-281	V100K ADV FROM FOUND DLTA 151-300TB=CC	ES-1	\$1,605
450-001-282	V100K ADV FROM FOUND DLTA 301-450TB=CC	ES-1	\$1,545
450-001-283	V100K ADV FROM FOUND DLTA451-750TB=CC	ES-1	\$1,120
450-001-284	V100K ADV FROM FOUND DLTA 751-1500TB=CC	ES-1	\$845
450-001-285	V100K ADV FROM FOUND DLTA 1501+TB=CC	ES-1	\$640
450-001-286	V100K ADV FROM FOUND 0-50TB=CC	ES-1	\$250
450-001-287	V100K ADV FROM FOUND 51-150TB=CC	ES-1	\$175
450-001-288	V100K ADV FROM FOUND 151-300TB=CC	ES-1	\$285
450-001-289	V100K ADV FROM FOUND 301-450TB=CC	ES-1	\$265
450-001-290	V100K ADV FROM FOUND451-750TB=CC	ES-1	\$190
450-001-291	V100K ADV FROM FOUND 751-1500TB=CC	ES-1	\$145
450-001-292	V100K ADV FROM FOUND 1501+TB=CC	ES-1	\$110
450-001-293	VMAX3 ADV UPG FROM UNI 0-50TB=CC	ES-1	\$850
450-001-294	VMAX3 ADV UPG FROM UNI 51-150TB=CC	ES-1	\$640
450-001-295	VMAX3 ADV UPG FROM UNI 151-300TB=CC	ES-1	\$500
450-001-296	VMAX3 ADV UPG FROM UNI 301-450TB=CC	ES-1	\$590
450-001-297	VMAX3 ADV UPG FROM UNI451-750TB=CC	ES-1	\$420
450-001-298	VMAX3 ADV UPG FROM UNI 751-1500TB=CC	ES-1	\$315
450-001-299	VMAX3 ADV UPG FROM UNI 1501+TB=CC	ES-1	\$235
450-001-300	VMAX3 ADV FROM UNI DLTA 0-50TB=CC	ES-1	\$2,345
450-001-301	VMAX3 ADV FROM UNI DLTA 51-150TB=CC	ES-1	\$1,855
450-001-302	VMAX3 ADV FROM UNI DLTA 151-300TB=CC	ES-1	\$1,605
450-001-303	VMAX3 ADV FROM UNI DLTA 301-450TB=CC	ES-1	\$1,545
450-001-304	VMAX3 ADV FROM UNI DLTA451-750TB=CC	ES-1	\$1,120
450-001-305	VMAX3 ADV FROM UNI DLTA 751-1500TB=CC	ES-1	\$845
450-001-306	VMAX3 ADV FROM UNI DLTA 1501+TB=CC	ES-1	\$640
450-001-307	VMAX3 ADV UPG FROM BASE 0-50TB=CC	ES-1	\$890
450-001-308	VMAX3 ADV UPG FROM BASE 51-150TB=CC	ES-1	\$660
450-001-309	VMAX3 ADV UPG FROM BASE 151-300TB=CC	ES-1	\$685
450-001-310	VMAX3 ADV UPG FROM BASE 301-450TB=CC	ES-1	\$675
450-001-311	VMAX3 ADV UPG FROM BASE451-750TB=CC	ES-1	\$475
450-001-312	VMAX3 ADV UPG FROM BASE 751-1500TB=CC	ES-1	\$355
450-001-313	VMAX3 ADV UPG FROM BASE 1501+TB=CC	ES-1	\$245
450-001-314	VMAX3 ADV FROM BASE DLTA 0-50TB=CC	ES-1	\$2,345
450-001-315	VMAX3 ADV FROM BASE DLTA 51-150TB=CC	ES-1	\$1,855
450-001-316	VMAX3 ADV FROM BASE DLTA 151-300TB=CC	ES-1	\$1,605
450-001-317	VMAX3 ADV FROM BASE DLTA 301-450TB=CC	ES-1	\$1,545
450-001-318	VMAX3 ADV FROM BASE DLTA451-750TB=CC	ES-1	\$1,120
450-001-319	VMAX3 ADV FROM BASE DLTA 751-1500TB=CC	ES-1	\$845
450-001-320	VMAX3 ADV FROM BASE DLTA 1501+TB=CC	ES-1	\$640
450-001-321	V100K ADV FROM BASE 0-50TB=CC	ES-1	\$890
450-001-322	V100K ADV FROM BASE 51-150TB=CC	ES-1	\$660
450-001-323	V100K ADV FROM BASE 151-300TB=CC	ES-1	\$685
450-001-324	V100K ADV FROM BASE 301-450TB=CC	ES-1	\$675
450-001-325	V100K ADV FROM BASE451-750TB=CC	ES-1	\$475
450-001-326	V100K ADV FROM BASE 751-1500TB=CC	ES-1	\$355
450-001-327	V100K ADV FROM BASE 1501+TB=CC	ES-1	\$245
450-001-328	V100K ADV FROM UNI 0-50TB=CC	ES-1	\$850

450-001-329	V100K ADV FROM UNI 51-150TB=CC	ES-1	\$640
450-001-330	V100K ADV FROM UNI 151-300TB=CC	ES-1	\$500
450-001-331	V100K ADV FROM UNI 301-450TB=CC	ES-1	\$590
450-001-332	V100K ADV FROM UNI451-750TB=CC	ES-1	\$420
450-001-333	V100K ADV FROM UNI 751-1500TB=CC	ES-1	\$315
450-001-334	V100K ADV FROM UNI 1501+TB=CC	ES-1	\$235
450-001-335	V100K ADV FROM BASE DLTA 0-50TB=CC	ES-1	\$2,345
450-001-336	V100K ADV FROM BASE DLTA 51-150TB=CC	ES-1	\$1,855
450-001-337	V100K ADV FROM BASE DLTA 151-300TB=CC	ES-1	\$1,605
450-001-338	V100K ADV FROM BASE DLTA 301-450TB=CC	ES-1	\$1,545
450-001-339	V100K ADV FROM BASE DLTA451-750TB=CC	ES-1	\$1,120
450-001-340	V100K ADV FROM BASE DLTA 751-1500TB=CC	ES-1	\$845
450-001-341	V100K ADV FROM BASE DLTA 1501+TB=CC	ES-1	\$640
450-001-342	V100K ADV FROM UNI DLTA 0-50TB=CC	ES-1	\$2,345
450-001-343	V100K ADV FROM UNI DLTA 51-150TB=CC	ES-1	\$1,855
450-001-344	V100K ADV FROM UNI DLTA 151-300TB=CC	ES-1	\$1,605
450-001-345	V100K ADV FROM UNI DLTA 301-450TB=CC	ES-1	\$1,545
450-001-346	V100K ADV FROM UNI DLTA451-750TB=CC	ES-1	\$1,120
450-001-347	V100K ADV FROM UNI DLTA 751-1500TB=CC	ES-1	\$845
450-001-348	V100K ADV FROM UNI DLTA 1501+TB=CC	ES-1	\$640
450-001-349	VMAX3 ADVANCED FAST COMBO TIER=CC	ES-1	\$0
450-001-350	V100K SRDF REPLICATION FILE REG PKG=IC	ES-1	\$45,575
450-001-351	V100K TIMEFINDER SNAPSURE REG PKG=IC	ES-1	\$25,140
450-001-353	V400K FOUNDATION UPG 0-50TB=CC	ES-1	\$2,095
450-001-354	V400K FOUNDATION UPG 51-150TB=CC	ES-1	\$1,680
450-001-355	V400K FOUNDATION UPG 151-300TB=CC	ES-1	\$1,320
450-001-356	V400K FOUNDATION UPG 301-450TB=CC	ES-1	\$1,280
450-001-357	V400K FOUNDATION UPG 451-750TB=CC	ES-1	\$930
450-001-358	V400K FOUNDATION UPG 751-1500TB=CC	ES-1	\$700
450-001-359	V400K FOUNDATION UPG 1501+TB=CC	ES-1	\$530
450-001-360	V400K UNISPHERE PACKAGE=IC	ES-1	\$42,855
450-001-361	V400K LOC REP PACKAGE=IC	ES-1	\$22,500
450-001-362	V400K ADVANCED PACKAGE=IC	ES-1	\$78,570
450-001-363	V400K ADVANCED UPG 0-50TB=CC	ES-1	\$2,345
450-001-364	V400K ADVANCED UPG 51-150TB=CC	ES-1	\$1,855
450-001-365	V400K ADVANCED UPG 151-300TB=CC	ES-1	\$1,605
450-001-366	V400K ADVANCED UPG 301-450TB=CC	ES-1	\$1,545
450-001-367	V400K ADVANCED UPG 451-750TB=CC	ES-1	\$1,120
450-001-368	V400K ADVANCED UPG 751-1500TB=CC	ES-1	\$845
450-001-369	V400K ADVANCED UPG 1501+TB=CC	ES-1	\$640
450-001-370	V400K REMOTE REP BASE LIC=IC	ES-1	\$30,000
450-001-371	V400K REMOTE REP UPG 0-50TB=CC	ES-1	\$1,760
450-001-372	V400K REMOTE REP UPG 51-150TB=CC	ES-1	\$1,260
450-001-373	V400K REMOTE REP UPG 151-300TB=CC	ES-1	\$890
450-001-374	V400K REMOTE REP UPG 301-450TB=CC	ES-1	\$705
450-001-375	V400K REMOTE REP UPG 451-750TB=CC	ES-1	\$605
450-001-376	V400K REMOTE REP UPG 751-1500TB=CC	ES-1	\$520
450-001-377	V400K REMOTE REP UPG 1500+TB=CC	ES-1	\$440
450-001-378	V400K TOTAL PROD PACK=IC	ES-1	\$111,410
450-001-379	V400K TOTAL PROD PACK UPG 0-50TB=CC	ES-1	\$4,425

450-001-380	V400K TOTAL PROD PACK UPG 51-150TB=CC	ES-1	\$3,385
450-001-381	V400K TOTAL PROD PACK UPG 151-300TB=CC	ES-1	\$2,595
450-001-382	V400K TOTAL PROD PACK UPG 301-450TB=CC	ES-1	\$2,300
450-001-383	V400K TOTAL PROD PACK UPG 451-750TB=CC	ES-1	\$1,800
450-001-384	V400K TOTAL PROD PACK UPG 751-1500TB=CC	ES-1	\$1,455
450-001-385	V400K TOTAL PROD PACK UPG 1500+TB=CC	ES-1	\$1,170
450-001-386	V400K ADV FROM FOUND DLTA 0-50TB=CC	ES-1	\$2,345
450-001-387	V400K ADV FROM FOUND DLTA 51-150TB=CC	ES-1	\$1,855
450-001-388	V400K ADV FROM FOUND DLTA 151-300TB=CC	ES-1	\$1,605
450-001-389	V400K ADV FROM FOUND DLTA 301-450TB=CC	ES-1	\$1,545
450-001-390	V400K ADV FROM FOUND DLTA 451-750TB=CC	ES-1	\$1,120
450-001-391	V400K ADV FROM FOUND DLTA 751-1500TB=CC	ES-1	\$845
450-001-392	V400K ADV FROM FOUND DLTA 1501+TB=CC	ES-1	\$640
450-001-393	V400K ADV FROM FOUND 0-50TB=CC	ES-1	\$250
450-001-394	V400K ADV FROM FOUND 51-150TB=CC	ES-1	\$175
450-001-395	V400K ADV FROM FOUND 151-300TB=CC	ES-1	\$285
450-001-396	V400K ADV FROM FOUND 301-450TB=CC	ES-1	\$265
450-001-397	V400K ADV FROM FOUND 451-750TB=CC	ES-1	\$190
450-001-398	V400K ADV FROM FOUND 751-1500TB=CC	ES-1	\$145
450-001-399	V400K ADV FROM FOUND 1501+TB=CC	ES-1	\$110
450-001-400	V400K ADV FROM BASE 0-50TB=CC	ES-1	\$890
450-001-401	V400K ADV FROM BASE 51-150TB=CC	ES-1	\$660
450-001-402	V400K ADV FROM BASE 151-300TB=CC	ES-1	\$685
450-001-403	V400K ADV FROM BASE 301-450TB=CC	ES-1	\$675
450-001-404	V400K ADV FROM BASE 451-750TB=CC	ES-1	\$475
450-001-405	V400K ADV FROM BASE 751-1500TB=CC	ES-1	\$355
450-001-406	V400K ADV FROM BASE 1501+TB=CC	ES-1	\$245
450-001-407	V400K ADV FROM UNI 0-50TB=CC	ES-1	\$850
450-001-408	V400K ADV FROM UNI 51-150TB=CC	ES-1	\$640
450-001-409	V400K ADV FROM UNI 151-300TB=CC	ES-1	\$500
450-001-410	V400K ADV FROM UNI 301-450TB=CC	ES-1	\$590
450-001-411	V400K ADV FROM UNI 451-750TB=CC	ES-1	\$420
450-001-412	V400K ADV FROM UNI 751-1500TB=CC	ES-1	\$315
450-001-413	V400K ADV FROM UNI 1501+TB=CC	ES-1	\$235
450-001-414	V400K ADV FROM BASE DLTA 0-50TB=CC	ES-1	\$2,345
450-001-415	V400K ADV FROM BASE DLTA 51-150TB=CC	ES-1	\$1,855
450-001-416	V400K ADV FROM BASE DLTA 151-300TB=CC	ES-1	\$1,605
450-001-417	V400K ADV FROM BASE DLTA 301-450TB=CC	ES-1	\$1,545
450-001-418	V400K ADV FROM BASE DLTA 451-750TB=CC	ES-1	\$1,120
450-001-419	V400K ADV FROM BASE DLTA 751-1500TB=CC	ES-1	\$845
450-001-420	V400K ADV FROM BASE DLTA 1501+TB=CC	ES-1	\$640
450-001-421	V400K ADV FROM UNI DLTA 0-50TB=CC	ES-1	\$2,345
450-001-422	V400K ADV FROM UNI DLTA 51-150TB=CC	ES-1	\$1,855
450-001-423	V400K ADV FROM UNI DLTA 151-300TB=CC	ES-1	\$1,605
450-001-424	V400K ADV FROM UNI DLTA 301-450TB=CC	ES-1	\$1,545
450-001-425	V400K ADV FROM UNI DLTA 451-750TB=CC	ES-1	\$1,120
450-001-426	V400K ADV FROM UNI DLTA 751-1500TB=CC	ES-1	\$845
450-001-427	V400K ADV FROM UNI DLTA 1501+TB=CC	ES-1	\$640
450-001-428	V400K SRDF REPLICATION FILE REG PKG=IC	ES-1	\$45,575
450-001-429	V400K TIMEFINDER SNAPSURE REG PKG=IC	ES-1	\$25,140

450-001-431	V200K FOUNDATION UPG 0-50TB=CC	ES-1	\$2,095
450-001-432	V200K FOUNDATION UPG 51-150TB=CC	ES-1	\$1,680
450-001-433	V200K FOUNDATION UPG 151-300TB=CC	ES-1	\$1,320
450-001-434	V200K FOUNDATION UPG 301-450TB=CC	ES-1	\$1,280
450-001-435	V200K FOUNDATION UPG 451-750TB=CC	ES-1	\$930
450-001-436	V200K FOUNDATION UPG 751-1500TB=CC	ES-1	\$700
450-001-437	V200K FOUNDATION UPG 1501+TB=CC	ES-1	\$530
450-001-438	V200K UNISPHERE PACKAGE=IC	ES-1	\$17,145
450-001-439	V200K LOC REP PACKAGE=IC	ES-1	\$22,500
450-001-440	V200K ADVANCED PACKAGE=IC	ES-1	\$32,145
450-001-441	V200K ADVANCED UPG 0-50TB=CC	ES-1	\$2,345
450-001-442	V200K ADVANCED UPG 51-150TB=CC	ES-1	\$1,855
450-001-443	V200K ADVANCED UPG 151-300TB=CC	ES-1	\$1,605
450-001-444	V200K ADVANCED UPG 301-450TB=CC	ES-1	\$1,545
450-001-445	V200K ADVANCED UPG 451-750TB=CC	ES-1	\$1,120
450-001-446	V200K ADVANCED UPG 751-1500TB=CC	ES-1	\$845
450-001-447	V200K ADVANCED UPG 1501+TB=CC	ES-1	\$640
450-001-448	V200K REMOTE REP BASE LIC=IC	ES-1	\$30,000
450-001-449	V200K REMOTE REP UPG 0-50TB=CC	ES-1	\$1,760
450-001-450	V200K REMOTE REP UPG 51-150TB=CC	ES-1	\$1,260
450-001-451	V200K REMOTE REP UPG 151-300TB=CC	ES-1	\$890
450-001-452	V200K REMOTE REP UPG 301-450TB=CC	ES-1	\$705
450-001-453	V200K REMOTE REP UPG 451-750TB=CC	ES-1	\$605
450-001-454	V200K REMOTE REP UPG 751-1500TB=CC	ES-1	\$520
450-001-455	V200K REMOTE REP UPG 1500+TB=CC	ES-1	\$440
450-001-456	V200K TOTAL PROD PACK=IC	ES-1	\$71,950
450-001-457	V200K TOTAL PROD PACK UPG 0-50TB=CC	ES-1	\$4,425
450-001-458	V200K TOTAL PROD PACK UPG 51-150TB=CC	ES-1	\$3,385
450-001-459	V200K TOTAL PROD PACK UPG 151-300TB=CC	ES-1	\$2,595
450-001-460	V200K TOTAL PROD PACK UPG 301-450TB=CC	ES-1	\$2,300
450-001-461	V200K TOTAL PROD PACK UPG 451-750TB=CC	ES-1	\$1,800
450-001-462	V200K TOTAL PROD PACK UPG 751-1500TB=CC	ES-1	\$1,455
450-001-463	V200K TOTAL PROD PACK UPG 1500+TB=CC	ES-1	\$1,170
450-001-464	V200K ADV FROM FOUND DLTA 0-50TB=CC	ES-1	\$2,345
450-001-465	V200K ADV FROM FOUND DLTA 51-150TB=CC	ES-1	\$1,855
450-001-466	V200K ADV FROM FOUND DLTA 151-300TB=CC	ES-1	\$1,605
450-001-467	V200K ADV FROM FOUND DLTA 301-450TB=CC	ES-1	\$1,545
450-001-468	V200K ADV FROM FOUND DLTA 451-750TB=CC	ES-1	\$1,120
450-001-469	V200K ADV FROM FOUND DLTA 751-1500TB=CC	ES-1	\$845
450-001-470	V200K ADV FROM FOUND DLTA 1501+TB=CC	ES-1	\$640
450-001-471	V200K ADV FROM FOUND 0-50TB=CC	ES-1	\$250
450-001-472	V200K ADV FROM FOUND 51-150TB=CC	ES-1	\$175
450-001-473	V200K ADV FROM FOUND 151-300TB=CC	ES-1	\$285
450-001-474	V200K ADV FROM FOUND 301-450TB=CC	ES-1	\$265
450-001-475	V200K ADV FROM FOUND 451-750TB=CC	ES-1	\$190
450-001-476	V200K ADV FROM FOUND 751-1500TB=CC	ES-1	\$145
450-001-477	V200K ADV FROM FOUND 1501+TB=CC	ES-1	\$110
450-001-478	V200K ADV FROM BASE 0-50TB=CC	ES-1	\$890
450-001-479	V200K ADV FROM BASE 51-150TB=CC	ES-1	\$660
450-001-480	V200K ADV FROM BASE 151-300TB=CC	ES-1	\$685

450-001-481	V200K ADV FROM BASE 301-450TB=CC	ES-1	\$675
450-001-482	V200K ADV FROM BASE 451-750TB=CC	ES-1	\$475
450-001-483	V200K ADV FROM BASE 751-1500TB=CC	ES-1	\$355
450-001-484	V200K ADV FROM BASE 1501+TB=CC	ES-1	\$245
450-001-485	V200K ADV FROM UNI 0-50TB=CC	ES-1	\$850
450-001-486	V200K ADV FROM UNI 51-150TB=CC	ES-1	\$640
450-001-487	V200K ADV FROM UNI 151-300TB=CC	ES-1	\$500
450-001-488	V200K ADV FROM UNI 301-450TB=CC	ES-1	\$590
450-001-489	V200K ADV FROM UNI 451-750TB=CC	ES-1	\$420
450-001-490	V200K ADV FROM UNI 751-1500TB=CC	ES-1	\$315
450-001-491	V200K ADV FROM UNI 1501+TB=CC	ES-1	\$235
450-001-492	V200K ADV FROM BASE DLTA 0-50TB=CC	ES-1	\$2,345
450-001-493	V200K ADV FROM BASE DLTA 51-150TB=CC	ES-1	\$1,855
450-001-494	V200K ADV FROM BASE DLTA 151-300TB=CC	ES-1	\$1,605
450-001-495	V200K ADV FROM BASE DLTA 301-450TB=CC	ES-1	\$1,545
450-001-496	V200K ADV FROM BASE DLTA 451-750TB=CC	ES-1	\$1,120
450-001-497	V200K ADV FROM BASE DLTA 751-1500TB=CC	ES-1	\$845
450-001-498	V200K ADV FROM BASE DLTA 1501+TB=CC	ES-1	\$640
450-001-499	V200K ADV FROM UNI DLTA 0-50TB=CC	ES-1	\$2,345
450-001-500	V200K ADV FROM UNI DLTA 51-150TB=CC	ES-1	\$1,855
450-001-501	V200K ADV FROM UNI DLTA 151-300TB=CC	ES-1	\$1,605
450-001-502	V200K ADV FROM UNI DLTA 301-450TB=CC	ES-1	\$1,545
450-001-503	V200K ADV FROM UNI DLTA 451-750TB=CC	ES-1	\$1,120
450-001-504	V200K ADV FROM UNI DLTA 751-1500TB=CC	ES-1	\$845
450-001-505	V200K ADV FROM UNI DLTA 1501+TB=CC	ES-1	\$640
450-001-506	V200K SRDF REPLICATION FILE REG PKG=IC	ES-1	\$45,575
450-001-507	V200K TIMEFINDER SNAPSURE REG PKG=IC	ES-1	\$25,140
450-001-508	ESA FOR V200K BASE LIC=IA	ES-1	\$5,145
450-001-564	ViPR SUITE VMAX3 100K Base=IC	ES-1	\$11,420
450-001-565	ViPR SUITE VMAX3 200K Base=IC	ES-1	\$25,390
450-001-566	ViPR SUITE VMAX3 400K Base=IC	ES-1	\$27,940
450-001-567	ViPR SUITE VMAX3 1-50TB=CC	ES-1	\$1,690
450-001-568	ViPR SUITE VMAX3 51-150TB=CC	ES-1	\$1,674
450-001-569	ViPR SUITE VMAX3 151-300TB=CC	ES-1	\$1,658
450-001-570	ViPR SUITE VMAX3 301-450TB=CC	ES-1	\$1,595
450-001-571	ViPR SUITE VMAX3 451-750TB=CC	ES-1	\$1,466
450-001-572	ViPR SUITE VMAX3 751-1500TB=CC	ES-1	\$1,340
450-001-573	ViPR SUITE VMAX3 1501TB+=CC	ES-1	\$1,274
456-105-633	VMAX3 BASE PKG 0-50TB=CC	ES-1	\$1,455
456-105-634	VMAX3 BASE PKG 51-150TB=CC	ES-1	\$1,195
456-105-635	VMAX3 BASE PKG 751-1500TB=CC	ES-1	\$490
456-105-636	VMAX3 BASE PKG 151-300TB=CC	ES-1	\$920
456-105-637	VMAX3 BASE PKG 1501+TB=CC	ES-1	\$395
456-105-638	VMAX3 BASE PKG 301-450TB=CC	ES-1	\$870
456-105-639	VMAX3 BASE PKG 451-750TB=CC	ES-1	\$645
456-105-647	Unisphere for FILE e-RTU Card	ES-1	\$0
456-105-649	SnapSure e-RTU Card	ES-1	\$0
456-105-651	Replication for FILE e-RTU Card	ES-1	\$0
456-105-654	VMAX FOUNDATION SUITE 0-50TB=CC	ES-1	\$0
456-105-655	VMAX FOUNDATION SUITE 51-150TB=CC	ES-1	\$0

456-105-656	VMAX FOUNDATION SUITE 751-1500TB=CC	ES-1	\$0
456-105-657	VMAX FOUNDATION SUITE 151-300TB=CC	ES-1	\$0
456-105-658	VMAX FOUNDATION SUITE 1501+TB=CC	ES-1	\$0
456-105-659	VMAX FOUNDATION SUITE 301-450TB=CC	ES-1	\$0
456-105-660	VMAX FOUNDATION SUITE 451-750TB=CC	ES-1	\$0
456-105-668	SRDF STAR REM REP 0-50TB=CC	ES-1	\$0
456-105-669	SRDF STAR REM REP 51-150TB=CC	ES-1	\$0
456-105-670	SRDF STAR REM REP 151-300TB=CC	ES-1	\$0
456-105-671	SRDF STAR REM REP 301-450TB=CC	ES-1	\$0
456-105-672	SRDF STAR REM REP 451-750TB=CC	ES-1	\$0
456-105-673	SRDF STAR REM REP 751-1500TB=CC	ES-1	\$0
456-105-674	SRDF STAR REM REP 1501+TB=CC	ES-1	\$0
456-105-675	SRDF REM REP 0-50TB=CC	ES-1	\$0
456-105-676	SRDF REM REP 51-150TB=CC	ES-1	\$0
456-105-677	SRDF REM REP 751-1500TB=CC	ES-1	\$0
456-105-678	SRDF REM REP 151-300TB=CC	ES-1	\$0
456-105-679	SRDF REM REP 1501+TB=CC	ES-1	\$0
456-105-680	SRDF REM REP 301-450TB=CC	ES-1	\$0
456-105-681	SRDF REM REP 451-750TB=CC	ES-1	\$0
456-105-682	SRDF TPP 0-50TB=CC	ES-1	\$0
456-105-683	SRDF TPP 51-150TB=CC	ES-1	\$0
456-105-684	SRDF TPP 751-1500TB=CC	ES-1	\$0
456-105-685	SRDF TPP 151-300TB=CC	ES-1	\$0
456-105-686	SRDF TPP 1501+TB=CC	ES-1	\$0
456-105-687	SRDF TPP 301-450TB=CC	ES-1	\$0
456-105-688	SRDF TPP 451-750TB=CC	ES-1	\$0
456-105-689	VMAX3 SRDF STAR 0-50TB=CC	ES-1	\$0
456-105-690	VMAX3 SRDF STAR 51-150TB=CC	ES-1	\$0
456-105-691	VMAX3 SRDF STAR 751-1500TB=CC	ES-1	\$0
456-105-692	VMAX3 SRDF STAR 151-300TB=CC	ES-1	\$0
456-105-693	VMAX3 SRDF STAR 1501+TB=CC	ES-1	\$0
456-105-694	VMAX3 SRDF STAR 301-450TB=CC	ES-1	\$0
456-105-695	VMAX3 SRDF STAR 451-750TB=CC	ES-1	\$0
456-105-696	TIMEFINDER LOC REP 0-50TB=CC	ES-1	\$0
456-105-697	TIMEFINDER LOC REP 51-150TB=CC	ES-1	\$0
456-105-698	TIMEFINDER LOC REP 751-1500TB=CC	ES-1	\$0
456-105-699	TIMEFINDER LOC REP 151-300TB=CC	ES-1	\$0
456-105-700	TIMEFINDER LOC REP 1501+TB=CC	ES-1	\$0
456-105-701	TIMEFINDER LOC REP 301-450TB=CC	ES-1	\$0
456-105-702	TIMEFINDER LOC REP 451-750TB=CC	ES-1	\$0
456-105-703	TIMEFINDER TPP 0-50TB=CC	ES-1	\$0
456-105-704	TIMEFINDER TPP 51-150TB=CC	ES-1	\$0
456-105-705	TIMEFINDER TPP 751-1500TB=CC	ES-1	\$0
456-105-706	TIMEFINDER TPP 151-300TB=CC	ES-1	\$0
456-105-707	TIMEFINDER TPP 1501+TB=CC	ES-1	\$0
456-105-708	TIMEFINDER TPP 301-450TB=CC	ES-1	\$0
456-105-709	TIMEFINDER TPP 451-750TB=CC	ES-1	\$0
456-105-710	VMAX ADVANCED SUITE 0-50TB=CC	ES-1	\$0
456-105-711	VMAX ADVANCED SUITE 51-150TB=CC	ES-1	\$0
456-105-712	VMAX ADVANCED SUITE 751-1500TB=CC	ES-1	\$0

456-105-713	VMAX ADVANCED SUITE 151-300TB=CC	ES-1	\$0
456-105-714	VMAX ADVANCED SUITE 1501+TB=CC	ES-1	\$0
456-105-715	VMAX ADVANCED SUITE 301-450TB=CC	ES-1	\$0
456-105-716	VMAX ADVANCED SUITE 451-750TB=CC	ES-1	\$0
456-105-717	VMAX ADVANCED SUITE TPP 0-50TB=CC	ES-1	\$0
456-105-718	VMAX ADVANCED SUITE TPP 51-150TB=CC	ES-1	\$0
456-105-719	VMAX ADVANCED SUITE TPP 751-1500TB=CC	ES-1	\$0
456-105-720	VMAX ADVANCED SUITE TPP 151-300TB=CC	ES-1	\$0
456-105-721	VMAX ADVANCED SUITE TPP 1501+TB=CC	ES-1	\$0
456-105-722	VMAX ADVANCED SUITE TPP 301-450TB=CC	ES-1	\$0
456-105-723	VMAX ADVANCED SUITE TPP 451-750TB=CC	ES-1	\$0
456-105-724	SRDF STAR TPP 0-50TB=CC	ES-1	\$0
456-105-725	SRDF STAR TPP 51-150TB=CC	ES-1	\$0
456-105-726	SRDF STAR TPP 151-300TB=CC	ES-1	\$0
456-105-727	SRDF STAR TPP 301-450TB=CC	ES-1	\$0
456-105-728	SRDF STAR TPP 451-750TB=CC	ES-1	\$0
456-105-729	SRDF STAR TPP 751-1500TB=CC	ES-1	\$0
456-105-730	SRDF STAR TPP 1501+TB=CC	ES-1	\$0
456-106-026	SRM VMAX3 0-50TB=CC	ES-1	\$0
456-106-027	SRM VMAX3 51-150TB =CC	ES-1	\$0
456-106-028	SRM VMAX3 151-300TB=CC	ES-1	\$0
456-106-029	SRM VMAX3 301-450TB=CC	ES-1	\$0
456-106-030	SRM VMAX3 451-750TB=CC	ES-1	\$0
456-106-031	SRM VMAX3 751-1500TB=CC	ES-1	\$0
456-106-032	SRM VMAX3 1500+TB =CC	ES-1	\$0
456-106-093	APPSYNC VMAX3 0-50TB=CC	ES-1	\$990
456-106-094	APPSYNC VMAX3 51-150TB=CC	ES-1	\$779
456-106-095	APPSYNC VMAX3 151-300TB=CC	ES-1	\$504
456-106-096	APPSYNC VMAX3 301-450TB=CC	ES-1	\$410
456-106-097	APPSYNC VMAX3 451-750TB=CC	ES-1	\$356
456-106-098	APPSYNC VMAX3 751-1500TB=CC	ES-1	\$315
456-106-099	APPSYNC VMAX3 1501+ =CC	ES-1	\$266
456-106-425	VMAX3 HYPERMAX OS BASE 0-50TB=CC	ES-1	\$1,425
456-106-426	VMAX3 HYPERMAX OS BASE 51-150TB=CC	ES-1	\$1,230
456-106-427	VMAX3 HYPERMAX OS BASE 151-300TB=CC	ES-1	\$950
456-106-428	VMAX3 HYPERMAX OS BASE 301-450TB=CC	ES-1	\$845
456-106-429	VMAX3 HYPERMAX OS BASE 451-750TB=CC	ES-1	\$670
456-106-430	VMAX3 HYPERMAX OS BASE 751-1500TB=CC	ES-1	\$555
456-106-431	VMAX3 HYPERMAX OS BASE 1501+TB=CC	ES-1	\$460
456-106-432	UNISPHERE SUITE 0-50TB=CC	ES-1	\$1,495
456-106-433	UNISPHERE SUITE 51-150TB=CC	ES-1	\$1,215
456-106-434	UNISPHERE SUITE 151-300TB=CC	ES-1	\$1,105
456-106-435	UNISPHERE SUITE 301-450TB=CC	ES-1	\$955
456-106-436	UNISPHERE SUITE 451-750TB=CC	ES-1	\$700
456-106-437	UNISPHERE SUITE 751-1500TB=CC	ES-1	\$530
456-106-438	UNISPHERE SUITE 1501+TB=CC	ES-1	\$405
456-106-684	VMAX3 TIMEFINDER LOC REG 0-50TB=CA	ES-1	\$2,130
456-106-685	VMAX3 TIMEFINDER LOC REG 51-150TB=CA	ES-1	\$1,650
456-106-686	VMAX3 TIMEFINDER LOC REG 751-1500TB=CA	ES-1	\$1,035
456-106-687	VMAX3 TIMEFINDER LOC REG 151-300TB=CA	ES-1	\$1,580

456-106-688	VMAX3 TIMEFINDER LOC REG 1501+TB=CA	ES-1	\$725
456-106-689	VMAX3 TIMEFINDER LOC REG 301-450TB=CA	ES-1	\$1,355
456-106-690	VMAX3 TIMEFINDER LOC REG 451-750TB=CA	ES-1	\$1,265
456-106-691	VMAX3 SRDF REG 0-50TB=CA	ES-1	\$2,665
456-106-692	VMAX3 SRDF REG 51-150TB=CA	ES-1	\$1,880
456-106-693	VMAX3 SRDF REG 751-1500TB=CA	ES-1	\$955
456-106-694	VMAX3 SRDF REG 151-300TB=CA	ES-1	\$1,605
456-106-695	VMAX3 SRDF REG 1501+TB=CA	ES-1	\$575
456-106-696	VMAX3 SRDF REG 301-450TB=CA	ES-1	\$1,510
456-106-697	VMAX3 SRDF REG 451-750TB=CA	ES-1	\$1,350
456-106-698	UNIS FAST COMBO TIER VMAX=CC	ES-1	\$0
456-106-699	FOUND FAST COMBO TIER VMAX=CC	ES-1	\$0
456-106-700	ADV SUITE FAST COMBO TIER VMAX=CC	ES-1	\$0
456-106-753	ESA FOR VMAX3 0-50TB=CC	ES-1	\$0
456-106-754	ESA FOR VMAX3 51-150TB=CC	ES-1	\$0
456-106-755	ESA FOR VMAX3 151-300TB=CC	ES-1	\$0
456-106-756	ESA FOR VMAX3 301-450TB=CC	ES-1	\$0
456-106-757	ESA FOR VMAX3 451-750TB=CC	ES-1	\$0
456-106-758	ESA FOR VMAX3 751-1500TB=CC	ES-1	\$0
456-106-759	ESA FOR VMAX3 1501+TB=CC	ES-1	\$0
456-106-761	ESA FOR 200K 0-50TB=CC	ES-1	\$0
456-106-762	ESA FOR 200K 51-150TB=CC	ES-1	\$0
456-106-763	ESA FOR 200K 151-300TB=CC	ES-1	\$0
456-106-764	ESA FOR 200K 301-450TB=CC	ES-1	\$0
456-106-765	ESA FOR 200K 451-750TB=CC	ES-1	\$0
456-106-766	ESA FOR 200K 751-1500TB=CC	ES-1	\$0
456-106-767	ESA FOR 200K 1501+TB=CC	ES-1	\$0
456-106-769	ESA FOR 400K 0-50TB=CC	ES-1	\$0
456-106-770	ESA FOR 400K 51-150TB=CC	ES-1	\$0
456-106-771	ESA FOR 400K 151-300TB=CC	ES-1	\$0
456-106-772	ESA FOR 400K 301-450TB=CC	ES-1	\$0
456-106-773	ESA FOR 400K 451-750TB=CC	ES-1	\$0
456-106-774	ESA FOR 400K 751-1500TB=CC	ES-1	\$0
456-106-775	ESA FOR 400K 1501+TB=CC	ES-1	\$0
456-106-805	TIMEFINDER FAST COMBO TIER VMAX=IC	ES-1	\$0
456-106-806	SRDF FAST COMBO TIER VMAX=CC	ES-1	\$0
456-106-831	FOUNDTN SUITE UPGFUS 0-50TB=CC	ES-1	\$600
456-106-832	FOUNDTN SUITE UPGFUS 51-150TB=CC	ES-1	\$465
456-106-833	FOUNDTN SUITE UPGFUS 151-300TB=CC	ES-1	\$215
456-106-834	FOUNDTN SUITE UPGFUS 301-450TB=CC	ES-1	\$325
456-106-835	FOUNDTN SUITE UPGFUS 451-750TB=CC	ES-1	\$230
456-106-836	FOUNDTN SUITE UPGFUS 751-1500TB=CC	ES-1	\$170
456-106-837	FOUNDTN SUITE UPGFUS 1501+TB=CC	ES-1	\$125
456-106-838	FOUNDTN SUITE UPGFUS DELTA 0-50TB=CC	ES-1	\$2,095
456-106-839	FOUNDTN SUITE UPGFUS DELTA 51-150TB=CC	ES-1	\$1,680
456-106-840	FOUNDTN SUITE UPGFUS DELTA 151-300TB=CC	ES-1	\$1,320
456-106-841	FOUNDTN SUITE UPGFUS DELTA 301-450TB=CC	ES-1	\$1,280
456-106-842	FOUNDTN SUITE UPGFUS DELTA 451-750TB=CC	ES-1	\$930
456-106-843	FOUNDTN SUITE UPGFUS DELTA 751-1500TB=C	ES-1	\$700
456-106-844	FOUNDTN SUITE UPGFUS DELTA 1501+TB=CC	ES-1	\$530

456-106-845	FOUNDTN SUITE UPGFB 0-50TB=CC	ES-1	\$640
456-106-846	FOUNDTN SUITE UPGFB 51-150TB=CC	ES-1	\$485
456-106-847	FOUNDTN SUITE UPGFB 151-300TB=CC	ES-1	\$400
456-106-848	FOUNDTN SUITE UPGFB 301-450TB=CC	ES-1	\$410
456-106-849	FOUNDTN SUITE UPGFB 451-750TB=CC	ES-1	\$285
456-106-850	FOUNDTN SUITE UPGFB 751-1500TB=CC	ES-1	\$210
456-106-851	FOUNDTN SUITE UPGFB 1501+TB=CC	ES-1	\$135
456-106-852	FOUNDTN SUITE UPGFB DELTA 0-50TB=CC	ES-1	\$2,095
456-106-853	FOUNDTN SUITE UPGFB DELTA 51-150TB=CC	ES-1	\$1,680
456-106-854	FOUNDTN SUITE UPGFB DELTA 151-300TB=CC	ES-1	\$1,320
456-106-855	FOUNDTN SUITE UPGFB DELTA 301-450TB=CC	ES-1	\$1,280
456-106-856	FOUNDTN SUITE UPGFB DELTA 451-750TB=CC	ES-1	\$930
456-106-857	FOUNDTN SUITE UPGFB DELTA 751-1500TB=CC	ES-1	\$700
456-106-858	FOUNDTN SUITE UPGFB DELTA 1501+TB=CC	ES-1	\$530
456-106-859	ADVANCED SUITE UPGFB 0-50TB=CC	ES-1	\$0
456-106-860	ADVANCED SUITE UPGFB 51-150TB=CC	ES-1	\$0
456-106-861	ADVANCED SUITE UPGFB 151-300TB=CC	ES-1	\$0
456-106-862	ADVANCED SUITE UPGFB 301-450TB=CC	ES-1	\$0
456-106-863	ADVANCED SUITE UPGFB 451-750TB=CC	ES-1	\$0
456-106-864	ADVANCED SUITE UPGFB 751-1500TB=CC	ES-1	\$0
456-106-865	ADVANCED SUITE UPGFB 1501+TB=CC	ES-1	\$0
456-106-866	ADVANCED SUITE UPGFB DELTA 0-50TB=CC	ES-1	\$0
456-106-867	ADVANCED SUITE UPGFB DELTA 51-150TB=CC	ES-1	\$0
456-106-868	ADVANCED SUITE UPGFB DELTA 151-300TB=CC	ES-1	\$0
456-106-869	ADVANCED SUITE UPGFB DELTA 301-450TB=CC	ES-1	\$0
456-106-870	ADVANCED SUITE UPGFB DELTA 451-750TB=CC	ES-1	\$0
456-106-871	ADVANCED SUITE UPGFB DELTA 751-1500TB=C	ES-1	\$0
456-106-872	ADVANCED SUITE UPGFB DELTA 1501+TB=CC	ES-1	\$0
456-106-873	ADVANCED SUITE UPGFF 0-50TB=CC	ES-1	\$0
456-106-874	ADVANCED SUITE UPGFF 51-150TB=CC	ES-1	\$0
456-106-875	ADVANCED SUITE UPGFF 151-300TB=CC	ES-1	\$0
456-106-876	ADVANCED SUITE UPGFF 301-450TB=CC	ES-1	\$0
456-106-877	ADVANCED SUITE UPGFF 451-750TB=CC	ES-1	\$0
456-106-878	ADVANCED SUITE UPGFF 751-1500TB=CC	ES-1	\$0
456-106-879	ADVANCED SUITE UPGFF 1501+TB=CC	ES-1	\$0
456-106-880	ADVANCED SUITE UPGFF DELTA 0-50TB=CC	ES-1	\$0
456-106-881	ADVANCED SUITE UPGFF DELTA 51-150TB=CC	ES-1	\$0
456-106-882	ADVANCED SUITE UPGFF DELTA 151-300TB=CC	ES-1	\$0
456-106-883	ADVANCED SUITE UPGFF DELTA 301-450TB=CC	ES-1	\$0
456-106-884	ADVANCED SUITE UPGFF DELTA 451-750TB=CC	ES-1	\$0
456-106-885	ADVANCED SUITE UPGFF DELTA 751-1500TB=C	ES-1	\$0
456-106-886	ADVANCED SUITE UPGFF DELTA 1501+TB=CC	ES-1	\$0
456-106-887	ADVANCED SUITE UPGFU 0-50TB=CC	ES-1	\$0
456-106-888	ADVANCED SUITE UPGFU 51-150TB=CC	ES-1	\$0
456-106-889	ADVANCED SUITE UPGFU 151-300TB=CC	ES-1	\$0
456-106-890	ADVANCED SUITE UPGFU 301-450TB=CC	ES-1	\$0
456-106-891	ADVANCED SUITE UPGFU 451-750TB=CC	ES-1	\$0
456-106-892	ADVANCED SUITE UPGFU 751-1500TB=CC	ES-1	\$0
456-106-893	ADVANCED SUITE UPGFU 1501+TB=CC	ES-1	\$0
456-106-894	ADVANCED SUITE UPGFU DELTA 0-50TB=CC	ES-1	\$0

456-106-895	ADVANCED SUITE UPGFU DELTA 51-150TB=CC	ES-1	\$0
456-106-896	ADVANCED SUITE UPGFU DELTA 151-300TB=CC	ES-1	\$0
456-106-897	ADVANCED SUITE UPGFU DELTA 301-450TB=CC	ES-1	\$0
456-106-898	ADVANCED SUITE UPGFU DELTA 451-750TB=CC	ES-1	\$0
456-106-899	ADVANCED SUITE UPGFU DELTA 751-1500TB=C	ES-1	\$0
456-106-900	ADVANCED SUITE UPGFU DELTA 1501+TB=CC	ES-1	\$0
456-106-915	APPSYNC VMAX3 0-50TB UPG=CC	ES-1	\$990
456-106-916	APPSYNC VMAX3 51-150TB UPG=CC	ES-1	\$779
456-106-917	APPSYNC VMAX3 151-300TB UPG=CC	ES-1	\$504
456-106-918	APPSYNC VMAX3 301-450TB UPG=CC	ES-1	\$410
456-106-919	APPSYNC VMAX3 451-750TB UPG=CC	ES-1	\$356
456-106-920	APPSYNC VMAX3 751-1500TB UPG=CC	ES-1	\$315
456-106-921	APPSYNC VMAX3 1501+ UPG=CC	ES-1	\$266
456-106-947	SRM VMAX3 0-50TB UPG=CC	ES-1	\$0
456-106-948	SRM VMAX3 51-150TB UPG=CC	ES-1	\$0
456-106-949	SRM VMAX3 151-300TB UPG=CC	ES-1	\$0
456-106-950	SRM VMAX3 301-450TB UPG=CC	ES-1	\$0
456-106-951	SRM VMAX3 451-750TB? UPG=CC	ES-1	\$0
456-106-952	SRM VMAX3 751-1500TB UPG=CC	ES-1	\$0
456-106-953	SRM VMAX3 1501+ UPG=CC	ES-1	\$0
456-107-128	VIPR SRM FAST COMBO VMAX3 TIER TB=CC	ES-1	\$0
456-107-149	APPSYNC VMAX3 Reg 0-50TB=CA	ES-1	\$1,917
456-107-150	APPSYNC VMAX3 Reg 51-150TB=CA	ES-1	\$1,485
456-107-151	APPSYNC VMAX3 Reg 151-300TB=CA	ES-1	\$1,422
456-107-152	APPSYNC VMAX3 Reg 301-450TB=CA	ES-1	\$1,220
456-107-153	APPSYNC VMAX3 Reg 451-750TB=CA	ES-1	\$1,139
456-107-154	APPSYNC VMAX3 Reg 751-1500TB=CA	ES-1	\$932
456-107-155	APPSYNC VMAX3 Reg 1501+ =CA	ES-1	\$653
456-107-156	APPSYNC VMAX3 Reg Upg 0-50TB=CA	ES-1	\$1,917
456-107-157	APPSYNC VMAX3 Reg Upg 51-150TB=CA	ES-1	\$1,485
456-107-158	APPSYNC VMAX3 Reg Upg 151-300TB=CA	ES-1	\$1,422
456-107-159	APPSYNC VMAX3 Reg Upg 301-450TB=CA	ES-1	\$1,220
456-107-160	APPSYNC VMAX3 Reg Upg 451-750TB=CA	ES-1	\$1,139
456-107-161	APPSYNC VMAX3 Reg Upg 751-1500TB=CA	ES-1	\$932
456-107-162	APPSYNC VMAX3 Reg Upg 1501+ =CA	ES-1	\$653
456-107-163	APPSYNC VMAX3 TPP 0-50TB=CC	ES-1	\$842
456-107-164	APPSYNC VMAX3 TPP 51-150TB=CC	ES-1	\$662
456-107-165	APPSYNC VMAX3 TPP 151-300TB=CC	ES-1	\$428
456-107-166	APPSYNC VMAX3 TPP 301-450TB=CC	ES-1	\$348
456-107-167	APPSYNC VMAX3 TPP 451-750TB=CC	ES-1	\$302
456-107-168	APPSYNC VMAX3 TPP 751-1500TB=CC	ES-1	\$268
456-107-169	APPSYNC VMAX3 TPP 1501+ =CC	ES-1	\$226
456-107-170	APPSYNC VMAX3 TPP Upg 0-50TB=CC	ES-1	\$842
456-107-171	APPSYNC VMAX3 TPP Upg 51-150TB=CC	ES-1	\$662
456-107-172	APPSYNC VMAX3 TPP Upg 151-300TB=CC	ES-1	\$428
456-107-173	APPSYNC VMAX3 TPP Upg 301-450TB=CC	ES-1	\$348
456-107-174	APPSYNC VMAX3 TPP Upg 451-750TB=CC	ES-1	\$302
456-107-175	APPSYNC VMAX3 TPP Upg 751-1500TB=CC	ES-1	\$268
456-107-176	APPSYNC VMAX3 TPP Upg 1501+ =CC	ES-1	\$226
456-107-293	VMAX3 LOCAL REP REG 0-50TB=CA	ES-1	\$2,130

456-107-294	VMAX3 LOCAL REP REG 51-150TB=CA	ES-1	\$1,650
456-107-295	VMAX3 LOCAL REP REG 151-300TB=CA	ES-1	\$1,580
456-107-296	VMAX3 LOCAL REP REG 301-450TB=CA	ES-1	\$1,355
456-107-297	VMAX3 LOCAL REP REG 451-750TB=CA	ES-1	\$1,265
456-107-298	VMAX3 LOCAL REP REG 751-1500TB=CA	ES-1	\$1,035
456-107-299	VMAX3 LOCAL REP REG 1500+TB=CA	ES-1	\$725
456-107-300	VMAX3 REG SNAPSURE ERTU CARD=IC	ES-1	\$0
456-107-301	VMAX3 REMOTE REP REG 0-50TB=CA	ES-1	\$2,665
456-107-302	VMAX3 REMOTE REP REG 51-150TB=CA	ES-1	\$1,880
456-107-303	VMAX3 REMOTE REP REG 151-300TB=CA	ES-1	\$1,605
456-107-304	VMAX3 REMOTE REP REG 301-450TB=CA	ES-1	\$1,510
456-107-305	VMAX3 REMOTE REP REG 451-750TB=CA	ES-1	\$1,350
456-107-306	VMAX3 REMOTE REP REG 751-1500TB=CA	ES-1	\$955
456-107-307	VMAX3 REMOTE REP REG 1500+TB=CA	ES-1	\$575
456-107-308	VMAX3 REG REPLICTN FOR FILE ERTU CARD=IC	ES-1	\$0
456-107-374	V100K HYPERMAX OS UPG 0-50TB=CC	ES-1	\$1,425
456-107-375	V100K HYPERMAX OS UPG 51-150TB=CC	ES-1	\$1,230
456-107-376	V100K HYPERMAX OS UPG 150-300TB=CC	ES-1	\$950
456-107-377	V100K HYPERMAX OS UPG 301-450TB=CC	ES-1	\$845
456-107-378	V100K HYPERMAX OS UPG 451-750TB=CC	ES-1	\$670
456-107-379	V100K HYPERMAX OS UPG 751-1500TB=CC	ES-1	\$555
456-107-380	V100K HYPERMAX OS UPG 1501+TB=CC	ES-1	\$460
456-107-381	V200K HYPERMAX OS UPG 0-50TB=CC	ES-1	\$1,425
456-107-382	V200K HYPERMAX OS UPG 51-150TB=CC	ES-1	\$1,230
456-107-383	V200K HYPERMAX OS UPG 150-300TB=CC	ES-1	\$950
456-107-384	V200K HYPERMAX OS UPG 301-450TB=CC	ES-1	\$845
456-107-385	V200K HYPERMAX OS UPG 451-750TB=CC	ES-1	\$670
456-107-386	V200K HYPERMAX OS UPG 751-1500TB=CC	ES-1	\$555
456-107-387	V200K HYPERMAX OS UPG 1501+TB=CC	ES-1	\$460
456-107-388	V400K HYPERMAX OS UPG 0-50TB=CC	ES-1	\$1,425
456-107-389	V400K HYPERMAX OS UPG 51-150TB=CC	ES-1	\$1,230
456-107-390	V400K HYPERMAX OS UPG 150-300TB=CC	ES-1	\$950
456-107-391	V400K HYPERMAX OS UPG 301-450TB=CC	ES-1	\$845
456-107-392	V400K HYPERMAX OS UPG 451-750TB=CC	ES-1	\$670
456-107-393	V400K HYPERMAX OS UPG 751-1500TB=CC	ES-1	\$555
456-107-394	V400K HYPERMAX OS UPG 1501+TB=CC	ES-1	\$460
456-107-395	V100K UNISPHERE UPG 0-50TB=CC	ES-1	\$1,495
456-107-396	V100K UNISPHERE UPG 51-150TB=CC	ES-1	\$1,215
456-107-397	V100K UNISPHERE UPG 151-300TB=CC	ES-1	\$1,105
456-107-398	V100K UNISPHERE UPG 301-450TB=CC	ES-1	\$955
456-107-399	V100K UNISPHERE UPG 451-750TB=CC	ES-1	\$700
456-107-400	V100K UNISPHERE UPG 751-1500TB=CC	ES-1	\$530
456-107-401	V100K UNISPHERE UPG 1501+TB=CC	ES-1	\$405
456-107-402	V200K UNISPHERE UPG 0-50TB=CC	ES-1	\$1,495
456-107-403	V200K UNISPHERE UPG 51-150TB=CC	ES-1	\$1,215
456-107-404	V200K UNISPHERE UPG 151-300TB=CC	ES-1	\$1,105
456-107-405	V200K UNISPHERE UPG 301-450TB=CC	ES-1	\$955
456-107-406	V200K UNISPHERE UPG 451-750TB=CC	ES-1	\$700
456-107-407	V200K UNISPHERE UPG 751-1500TB=CC	ES-1	\$530
456-107-408	V200K UNISPHERE UPG 1501+TB=CC	ES-1	\$405

456-107-409	V400K UNISPHERE UPG 0-50TB=CC	ES-1	\$1,495
456-107-410	V400K UNISPHERE UPG 51-150TB=CC	ES-1	\$1,215
456-107-411	V400K UNISPHERE UPG 151-300TB=CC	ES-1	\$1,105
456-107-412	V400K UNISPHERE UPG 301-450TB=CC	ES-1	\$955
456-107-413	V400K UNISPHERE UPG 451-750TB=CC	ES-1	\$700
456-107-414	V400K UNISPHERE UPG 751-1500TB=CC	ES-1	\$530
456-107-415	V400K UNISPHERE UPG 1501+TB=CC	ES-1	\$405
456-107-416	V100K BASE UPG 0-50TB=CC	ES-1	\$1,455
456-107-417	V100K BASE UPG 51-150TB=CC	ES-1	\$1,195
456-107-418	V100K BASE UPG 151-300TB=CC	ES-1	\$920
456-107-419	V100K BASE UPG 301-450TB=CC	ES-1	\$870
456-107-420	V100K BASE UPG 451-750TB=CC	ES-1	\$645
456-107-421	V100K BASE UPG 751-1500TB=CC	ES-1	\$490
456-107-422	V100K BASE UPG 1501+TB=CC	ES-1	\$395
456-107-423	V200K BASE UPG 0-50TB=CC	ES-1	\$1,455
456-107-424	V200K BASE UPG 51-150TB=CC	ES-1	\$1,195
456-107-425	V200K BASE UPG 151-300TB=CC	ES-1	\$920
456-107-426	V200K BASE UPG 301-450TB=CC	ES-1	\$870
456-107-427	V200K BASE UPG 451-750TB=CC	ES-1	\$645
456-107-428	V200K BASE UPG 751-1500TB=CC	ES-1	\$490
456-107-429	V200K BASE UPG 1501+TB=CC	ES-1	\$395
456-107-430	V400K BASE UPG 0-50TB=CC	ES-1	\$1,455
456-107-431	V400K BASE UPG 51-150TB=CC	ES-1	\$1,195
456-107-432	V400K BASE UPG 151-300TB=CC	ES-1	\$920
456-107-433	V400K BASE UPG 301-450TB=CC	ES-1	\$870
456-107-434	V400K BASE UPG 451-750TB=CC	ES-1	\$645
456-107-435	V400K BASE UPG 751-1500TB=CC	ES-1	\$490
456-107-436	V400K BASE UPG 1501+TB=CC	ES-1	\$395
456-107-437	V100K FOUNDATION UPG 0-50TB=CC	ES-1	\$0
456-107-438	V100K FOUNDATION UPG 51-150TB=CC	ES-1	\$0
456-107-439	V100K FOUNDATION UPG 151-300TB=CC	ES-1	\$0
456-107-440	V100K FOUNDATION UPG 301-450TB=CC	ES-1	\$0
456-107-441	V100K FOUNDATION UPG 451-750TB=CC	ES-1	\$0
456-107-442	V100K FOUNDATION UPG 751-1500TB=CC	ES-1	\$0
456-107-443	V100K FOUNDATION UPG 1501+TB=CC	ES-1	\$0
456-107-444	V200K FOUNDATION UPG 0-50TB=CC	ES-1	\$0
456-107-445	V200K FOUNDATION UPG 51-150TB=CC	ES-1	\$0
456-107-446	V200K FOUNDATION UPG 151-300TB=CC	ES-1	\$0
456-107-447	V200K FOUNDATION UPG 301-450TB=CC	ES-1	\$0
456-107-448	V200K FOUNDATION UPG 451-750TB=CC	ES-1	\$0
456-107-449	V200K FOUNDATION UPG 751-1500TB=CC	ES-1	\$0
456-107-450	V200K FOUNDATION UPG 1501+TB=CC	ES-1	\$0
456-107-451	V400K FOUNDATION UPG 0-50TB=CC	ES-1	\$0
456-107-452	V400K FOUNDATION UPG 51-150TB=CC	ES-1	\$0
456-107-453	V400K FOUNDATION UPG 151-300TB=CC	ES-1	\$0
456-107-454	V400K FOUNDATION UPG 301-450TB=CC	ES-1	\$0
456-107-455	V400K FOUNDATION UPG 451-750TB=CC	ES-1	\$0
456-107-456	V400K FOUNDATION UPG 751-1500TB=CC	ES-1	\$0
456-107-457	V400K FOUNDATION UPG 1501+TB=CC	ES-1	\$0
456-107-458	V100K FOUND FROM BASE 0-50TB=CC	ES-1	\$0

456-107-459	V100K FOUND FROM BASE 51-150TB=CC	ES-1	\$0
456-107-460	V100K FOUND FROM BASE 151-300TB=CC	ES-1	\$0
456-107-461	V100K FOUND FROM BASE 301-450TB=CC	ES-1	\$0
456-107-462	V100K FOUND FROM BASE 451-750TB=CC	ES-1	\$0
456-107-463	V100K FOUND FROM BASE 751-1500TB=CC	ES-1	\$0
456-107-464	V100K FOUND FROM BASE 1501+TB=CC	ES-1	\$0
456-107-465	V200K FOUND FROM BASE 0-50TB=CC	ES-1	\$0
456-107-466	V200K FOUND FROM BASE 51-150TB=CC	ES-1	\$0
456-107-467	V200K FOUND FROM BASE 151-300TB=CC	ES-1	\$0
456-107-468	V200K FOUND FROM BASE 301-450TB=CC	ES-1	\$0
456-107-469	V200K FOUND FROM BASE 451-750TB=CC	ES-1	\$0
456-107-470	V200K FOUND FROM BASE 751-1500TB=CC	ES-1	\$0
456-107-471	V200K FOUND FROM BASE 1501+TB=CC	ES-1	\$0
456-107-472	V400K FOUND FROM BASE 0-50TB=CC	ES-1	\$0
456-107-473	V400K FOUND FROM BASE 51-150TB=CC	ES-1	\$0
456-107-474	V400K FOUND FROM BASE 151-300TB=CC	ES-1	\$0
456-107-475	V400K FOUND FROM BASE 301-450TB=CC	ES-1	\$0
456-107-476	V400K FOUND FROM BASE 451-750TB=CC	ES-1	\$0
456-107-477	V400K FOUND FROM BASE 751-1500TB=CC	ES-1	\$0
456-107-478	V400K FOUND FROM BASE 1501+TB=CC	ES-1	\$0
456-107-479	V100K FOUND FROM UNI 0-50TB=CC	ES-1	\$0
456-107-480	V100K FOUND FROM UNI 51-150TB=CC	ES-1	\$0
456-107-481	V100K FOUND FROM UNI 151-300TB=CC	ES-1	\$0
456-107-482	V100K FOUND FROM UNI 301-450TB=CC	ES-1	\$0
456-107-483	V100K FOUND FROM UNI 451-750TB=CC	ES-1	\$0
456-107-484	V100K FOUND FROM UNI 751-1500TB=CC	ES-1	\$0
456-107-485	V100K FOUND FROM UNI 1501+TB=CC	ES-1	\$0
456-107-486	V200K FOUND FROM UNI 0-50TB=CC	ES-1	\$0
456-107-487	V200K FOUND FROM UNI 51-150TB=CC	ES-1	\$0
456-107-488	V200K FOUND FROM UNI 151-300TB=CC	ES-1	\$0
456-107-489	V200K FOUND FROM UNI 301-450TB=CC	ES-1	\$0
456-107-490	V200K FOUND FROM UNI 451-750TB=CC	ES-1	\$0
456-107-491	V200K FOUND FROM UNI 751-1500TB=CC	ES-1	\$0
456-107-492	V200K FOUND FROM UNI 1501+TB=CC	ES-1	\$0
456-107-493	V400K FOUND FROM UNI 0-50TB=CC	ES-1	\$0
456-107-494	V400K FOUND FROM UNI 51-150TB=CC	ES-1	\$0
456-107-495	V400K FOUND FROM UNI 151-300TB=CC	ES-1	\$0
456-107-496	V400K FOUND FROM UNI 301-450TB=CC	ES-1	\$0
456-107-497	V400K FOUND FROM UNI 451-750TB=CC	ES-1	\$0
456-107-498	V400K FOUND FROM UNI 751-1500TB=CC	ES-1	\$0
456-107-499	V400K FOUND FROM UNI 1501+TB=CC	ES-1	\$0
456-107-500	V100K FOUND FROM BASE DLTA 0-50TB=CC	ES-1	\$0
456-107-501	V100K FOUND FROM BASE DLTA 51-150TB=CC	ES-1	\$0
456-107-502	V100K FOUND FROM BASE DLTA 151-300TB=CC	ES-1	\$0
456-107-503	V100K FOUND FROM BASE DLTA 301-450TB=CC	ES-1	\$0
456-107-504	V100K FOUND FROM BASE DLTA 451-750TB=CC	ES-1	\$0
456-107-505	V100K FOUND FROM BASE DLTA 751-1500TB=CC	ES-1	\$0
456-107-506	V100K FOUND FROM BASE DLTA 1501+TB=CC	ES-1	\$0
456-107-507	V200K FOUND FROM BASE DLTA 0-50TB=CC	ES-1	\$0
456-107-508	V200K FOUND FROM BASE DLTA 51-150TB=CC	ES-1	\$0

456-107-509	V200K FOUND FROM BASE DLTA 151-300TB=CC	ES-1	\$0
456-107-510	V200K FOUND FROM BASE DLTA 301-450TB=CC	ES-1	\$0
456-107-511	V200K FOUND FROM BASE DLTA 451-750TB=CC	ES-1	\$0
456-107-512	V200K FOUND FROM BASE DLTA 751-1500TB=CC	ES-1	\$0
456-107-513	V200K FOUND FROM BASE DLTA 1501+TB=CC	ES-1	\$0
456-107-514	V400K FOUND FROM BASE DLTA 0-50TB=CC	ES-1	\$0
456-107-515	V400K FOUND FROM BASE DLTA 51-150TB=CC	ES-1	\$0
456-107-516	V400K FOUND FROM BASE DLTA 151-300TB=CC	ES-1	\$0
456-107-517	V400K FOUND FROM BASE DLTA 301-450TB=CC	ES-1	\$0
456-107-518	V400K FOUND FROM BASE DLTA 451-750TB=CC	ES-1	\$0
456-107-519	V400K FOUND FROM BASE DLTA 751-1500TB=CC	ES-1	\$0
456-107-520	V400K FOUND FROM BASE DLTA 1501+TB=CC	ES-1	\$0
456-107-521	V100K FOUND FROM UNI DLTA 0-50TB=CC	ES-1	\$0
456-107-522	V100K FOUND FROM UNI DLTA 51-150TB=CC	ES-1	\$0
456-107-523	V100K FOUND FROM UNI DLTA 151-300TB=CC	ES-1	\$0
456-107-524	V100K FOUND FROM UNI DLTA 301-450TB=CC	ES-1	\$0
456-107-525	V100K FOUND FROM UNI DLTA 451-750TB=CC	ES-1	\$0
456-107-526	V100K FOUND FROM UNI DLTA 751-1500TB=CC	ES-1	\$0
456-107-527	V100K FOUND FROM UNI DLTA 1501+TB=CC	ES-1	\$0
456-107-528	V200K FOUND FROM UNI DLTA 0-50TB=CC	ES-1	\$0
456-107-529	V200K FOUND FROM UNI DLTA 51-150TB=CC	ES-1	\$0
456-107-530	V200K FOUND FROM UNI DLTA 151-300TB=CC	ES-1	\$0
456-107-531	V200K FOUND FROM UNI DLTA 301-450TB=CC	ES-1	\$0
456-107-532	V200K FOUND FROM UNI DLTA 451-750TB=CC	ES-1	\$0
456-107-533	V200K FOUND FROM UNI DLTA 751-1500TB=CC	ES-1	\$0
456-107-534	V200K FOUND FROM UNI DLTA 1501+TB=CC	ES-1	\$0
456-107-535	V400K FOUND FROM UNI DLTA 0-50TB=CC	ES-1	\$0
456-107-536	V400K FOUND FROM UNI DLTA 51-150TB=CC	ES-1	\$0
456-107-537	V400K FOUND FROM UNI DLTA 151-300TB=CC	ES-1	\$0
456-107-538	V400K FOUND FROM UNI DLTA 301-450TB=CC	ES-1	\$0
456-107-539	V400K FOUND FROM UNI DLTA 451-750TB=CC	ES-1	\$0
456-107-540	V400K FOUND FROM UNI DLTA 751-1500TB=CC	ES-1	\$0
456-107-541	V400K FOUND FROM UNI DLTA 1501+TB=CC	ES-1	\$0
456-107-542	V100K ADVANCED UPG 0-50TB=CC	ES-1	\$0
456-107-543	V100K ADVANCED UPG 51-150TB=CC	ES-1	\$0
456-107-544	V100K ADVANCED UPG 151-300TB=CC	ES-1	\$0
456-107-545	V100K ADVANCED UPG 301-450TB=CC	ES-1	\$0
456-107-546	V100K ADVANCED UPG 451-750TB=CC	ES-1	\$0
456-107-547	V100K ADVANCED UPG 751-1500TB=CC	ES-1	\$0
456-107-548	V100K ADVANCED UPG 1501+TB=CC	ES-1	\$0
456-107-549	V200K ADVANCED UPG 0-50TB=CC	ES-1	\$0
456-107-550	V200K ADVANCED UPG 51-150TB=CC	ES-1	\$0
456-107-551	V200K ADVANCED UPG 151-300TB=CC	ES-1	\$0
456-107-552	V200K ADVANCED UPG 301-450TB=CC	ES-1	\$0
456-107-553	V200K ADVANCED UPG 451-750TB=CC	ES-1	\$0
456-107-554	V200K ADVANCED UPG 751-1500TB=CC	ES-1	\$0
456-107-555	V200K ADVANCED UPG 1501+TB=CC	ES-1	\$0
456-107-556	V400K ADVANCED UPG 0-50TB=CC	ES-1	\$0
456-107-557	V400K ADVANCED UPG 51-150TB=CC	ES-1	\$0
456-107-558	V400K ADVANCED UPG 151-300TB=CC	ES-1	\$0

456-107-559	V400K ADVANCED UPG 301-450TB=CC	ES-1	\$0
456-107-560	V400K ADVANCED UPG 451-750TB=CC	ES-1	\$0
456-107-561	V400K ADVANCED UPG 751-1500TB=CC	ES-1	\$0
456-107-562	V400K ADVANCED UPG 1501+TB=CC	ES-1	\$0
456-107-563	V100K ADV FROM BASE 0-50TB=CC	ES-1	\$0
456-107-564	V100K ADV FROM BASE 51-150TB=CC	ES-1	\$0
456-107-565	V100K ADV FROM BASE 151-300TB=CC	ES-1	\$0
456-107-566	V100K ADV FROM BASE 301-450TB=CC	ES-1	\$0
456-107-567	V100K ADV FROM BASE 451-750TB=CC	ES-1	\$0
456-107-568	V100K ADV FROM BASE 751-1500TB=CC	ES-1	\$0
456-107-569	V100K ADV FROM BASE 1501+TB=CC	ES-1	\$0
456-107-570	V200K ADV FROM BASE 0-50TB=CC	ES-1	\$0
456-107-571	V200K ADV FROM BASE 51-150TB=CC	ES-1	\$0
456-107-572	V200K ADV FROM BASE 151-300TB=CC	ES-1	\$0
456-107-573	V200K ADV FROM BASE 301-450TB=CC	ES-1	\$0
456-107-574	V200K ADV FROM BASE 451-750TB=CC	ES-1	\$0
456-107-575	V200K ADV FROM BASE 751-1500TB=CC	ES-1	\$0
456-107-576	V200K ADV FROM BASE 1501+TB=CC	ES-1	\$0
456-107-577	V400K ADV FROM BASE 0-50TB=CC	ES-1	\$0
456-107-578	V400K ADV FROM BASE 51-150TB=CC	ES-1	\$0
456-107-579	V400K ADV FROM BASE 151-300TB=CC	ES-1	\$0
456-107-580	V400K ADV FROM BASE 301-450TB=CC	ES-1	\$0
456-107-581	V400K ADV FROM BASE 451-750TB=CC	ES-1	\$0
456-107-582	V400K ADV FROM BASE 751-1500TB=CC	ES-1	\$0
456-107-583	V400K ADV FROM BASE 1501+TB=CC	ES-1	\$0
456-107-584	V100K ADV FROM FOUND 0-50TB=CC	ES-1	\$0
456-107-585	V100K ADV FROM FOUND 51-150TB=CC	ES-1	\$0
456-107-586	V100K ADV FROM FOUND 151-300TB=CC	ES-1	\$0
456-107-587	V100K ADV FROM FOUND 301-450TB=CC	ES-1	\$0
456-107-588	V100K ADV FROM FOUND 451-750TB=CC	ES-1	\$0
456-107-589	V100K ADV FROM FOUND 751-1500TB=CC	ES-1	\$0
456-107-590	V100K ADV FROM FOUND 1501+TB=CC	ES-1	\$0
456-107-591	V200K ADV FROM FOUND 0-50TB=CC	ES-1	\$0
456-107-592	V200K ADV FROM FOUND 51-150TB=CC	ES-1	\$0
456-107-593	V200K ADV FROM FOUND 151-300TB=CC	ES-1	\$0
456-107-594	V200K ADV FROM FOUND 301-450TB=CC	ES-1	\$0
456-107-595	V200K ADV FROM FOUND 451-750TB=CC	ES-1	\$0
456-107-596	V200K ADV FROM FOUND 751-1500TB=CC	ES-1	\$0
456-107-597	V200K ADV FROM FOUND 1501+TB=CC	ES-1	\$0
456-107-598	V400K ADV FROM FOUND 0-50TB=CC	ES-1	\$0
456-107-599	V400K ADV FROM FOUND 51-150TB=CC	ES-1	\$0
456-107-600	V400K ADV FROM FOUND 151-300TB=CC	ES-1	\$0
456-107-601	V400K ADV FROM FOUND 301-450TB=CC	ES-1	\$0
456-107-602	V400K ADV FROM FOUND 451-750TB=CC	ES-1	\$0
456-107-603	V400K ADV FROM FOUND 751-1500TB=CC	ES-1	\$0
456-107-604	V400K ADV FROM FOUND 1501+TB=CC	ES-1	\$0
456-107-605	V100K ADV FROM UNI 0-50TB=CC	ES-1	\$0
456-107-606	V100K ADV FROM UNI 51-150TB=CC	ES-1	\$0
456-107-607	V100K ADV FROM UNI 151-300TB=CC	ES-1	\$0
456-107-608	V100K ADV FROM UNI 301-450TB=CC	ES-1	\$0

456-107-609	V100K ADV FROM UNI 451-750TB=CC	ES-1	\$0
456-107-610	V100K ADV FROM UNI 751-1500TB=CC	ES-1	\$0
456-107-611	V100K ADV FROM UNI 1501+TB=CC	ES-1	\$0
456-107-612	V200K ADV FROM UNI 0-50TB=CC	ES-1	\$0
456-107-613	V200K ADV FROM UNI 51-150TB=CC	ES-1	\$0
456-107-614	V200K ADV FROM UNI 151-300TB=CC	ES-1	\$0
456-107-615	V200K ADV FROM UNI 301-450TB=CC	ES-1	\$0
456-107-616	V200K ADV FROM UNI 451-750TB=CC	ES-1	\$0
456-107-617	V200K ADV FROM UNI 751-1500TB=CC	ES-1	\$0
456-107-618	V200K ADV FROM UNI 1501+TB=CC	ES-1	\$0
456-107-619	V400K ADV FROM UNI 0-50TB=CC	ES-1	\$0
456-107-620	V400K ADV FROM UNI 51-150TB=CC	ES-1	\$0
456-107-621	V400K ADV FROM UNI 151-300TB=CC	ES-1	\$0
456-107-622	V400K ADV FROM UNI 301-450TB=CC	ES-1	\$0
456-107-623	V400K ADV FROM UNI 451-750TB=CC	ES-1	\$0
456-107-624	V400K ADV FROM UNI 751-1500TB=CC	ES-1	\$0
456-107-625	V400K ADV FROM UNI 1501+TB=CC	ES-1	\$0
456-107-626	V100K ADV FROM BASE DLTA 0-50TB=CC	ES-1	\$0
456-107-627	V100K ADV FROM BASE DLTA 51-150TB=CC	ES-1	\$0
456-107-628	V100K ADV FROM BASE DLTA 151-300TB=CC	ES-1	\$0
456-107-629	V100K ADV FROM BASE DLTA 301-450TB=CC	ES-1	\$0
456-107-630	V100K ADV FROM BASE DLTA 451-750TB=CC	ES-1	\$0
456-107-631	V100K ADV FROM BASE DLTA 751-1500TB=CC	ES-1	\$0
456-107-632	V100K ADV FROM BASE DLTA 1501+TB=CC	ES-1	\$0
456-107-633	V200K ADV FROM BASE DLTA 0-50TB=CC	ES-1	\$0
456-107-634	V200K ADV FROM BASE DLTA 51-150TB=CC	ES-1	\$0
456-107-635	V200K ADV FROM BASE DLTA 151-300TB=CC	ES-1	\$0
456-107-636	V200K ADV FROM BASE DLTA 301-450TB=CC	ES-1	\$0
456-107-637	V200K ADV FROM BASE DLTA 451-750TB=CC	ES-1	\$0
456-107-638	V200K ADV FROM BASE DLTA 751-1500TB=CC	ES-1	\$0
456-107-639	V200K ADV FROM BASE DLTA 1501+TB=CC	ES-1	\$0
456-107-640	V400K ADV FROM BASE DLTA 0-50TB=CC	ES-1	\$0
456-107-641	V400K ADV FROM BASE DLTA 51-150TB=CC	ES-1	\$0
456-107-642	V400K ADV FROM BASE DLTA 151-300TB=CC	ES-1	\$0
456-107-643	V400K ADV FROM BASE DLTA 301-450TB=CC	ES-1	\$0
456-107-644	V400K ADV FROM BASE DLTA 451-750TB=CC	ES-1	\$0
456-107-645	V400K ADV FROM BASE DLTA 751-1500TB=CC	ES-1	\$0
456-107-646	V400K ADV FROM BASE DLTA 1501+TB=CC	ES-1	\$0
456-107-647	V100K ADV FROM FOUND DLTA 0-50TB=CC	ES-1	\$0
456-107-648	V100K ADV FROM FOUND DLTA 51-150TB=CC	ES-1	\$0
456-107-649	V100K ADV FROM FOUND DLTA 151-300TB=CC	ES-1	\$0
456-107-650	V100K ADV FROM FOUND DLTA 301-450TB=CC	ES-1	\$0
456-107-651	V100K ADV FROM FOUND DLTA 451-750TB=CC	ES-1	\$0
456-107-652	V100K ADV FROM FOUND DLTA 751-1500TB=CC	ES-1	\$0
456-107-653	V100K ADV FROM FOUND DLTA 1501+TB=CC	ES-1	\$0
456-107-654	V200K ADV FROM FOUND DLTA 0-50TB=CC	ES-1	\$0
456-107-655	V200K ADV FROM FOUND DLTA 51-150TB=CC	ES-1	\$0
456-107-656	V200K ADV FROM FOUND DLTA 151-300TB=CC	ES-1	\$0
456-107-657	V200K ADV FROM FOUND DLTA 301-450TB=CC	ES-1	\$0
456-107-658	V200K ADV FROM FOUND DLTA 451-750TB=CC	ES-1	\$0

456-107-659	V200K ADV FROM FOUND DLTA 751-1500TB=CC	ES-1	\$0
456-107-660	V200K ADV FROM FOUND DLTA 1501+TB=CC	ES-1	\$0
456-107-661	V400K ADV FROM FOUND DLTA 0-50TB=CC	ES-1	\$0
456-107-662	V400K ADV FROM FOUND DLTA 51-150TB=CC	ES-1	\$0
456-107-663	V400K ADV FROM FOUND DLTA 151-300TB=CC	ES-1	\$0
456-107-664	V400K ADV FROM FOUND DLTA 301-450TB=CC	ES-1	\$0
456-107-665	V400K ADV FROM FOUND DLTA 451-750TB=CC	ES-1	\$0
456-107-666	V400K ADV FROM FOUND DLTA 751-1500TB=CC	ES-1	\$0
456-107-667	V400K ADV FROM FOUND DLTA 1501+TB=CC	ES-1	\$0
456-107-668	V100K ADV FROM UNI DLTA 0-50TB=CC	ES-1	\$0
456-107-669	V100K ADV FROM UNI DLTA 51-150TB=CC	ES-1	\$0
456-107-670	V100K ADV FROM UNI DLTA 151-300TB=CC	ES-1	\$0
456-107-671	V100K ADV FROM UNI DLTA 301-450TB=CC	ES-1	\$0
456-107-672	V100K ADV FROM UNI DLTA 451-750TB=CC	ES-1	\$0
456-107-673	V100K ADV FROM UNI DLTA 751-1500TB=CC	ES-1	\$0
456-107-674	V100K ADV FROM UNI DLTA 1501+TB=CC	ES-1	\$0
456-107-675	V200K ADV FROM UNI DLTA 0-50TB=CC	ES-1	\$0
456-107-676	V200K ADV FROM UNI DLTA 51-150TB=CC	ES-1	\$0
456-107-677	V200K ADV FROM UNI DLTA 151-300TB=CC	ES-1	\$0
456-107-678	V200K ADV FROM UNI DLTA 301-450TB=CC	ES-1	\$0
456-107-679	V200K ADV FROM UNI DLTA 451-750TB=CC	ES-1	\$0
456-107-680	V200K ADV FROM UNI DLTA 751-1500TB=CC	ES-1	\$0
456-107-681	V200K ADV FROM UNI DLTA 1501+TB=CC	ES-1	\$0
456-107-682	V400K ADV FROM UNI DLTA 0-50TB=CC	ES-1	\$0
456-107-683	V400K ADV FROM UNI DLTA 51-150TB=CC	ES-1	\$0
456-107-684	V400K ADV FROM UNI DLTA 151-300TB=CC	ES-1	\$0
456-107-685	V400K ADV FROM UNI DLTA 301-450TB=CC	ES-1	\$0
456-107-686	V400K ADV FROM UNI DLTA 451-750TB=CC	ES-1	\$0
456-107-687	V400K ADV FROM UNI DLTA 751-1500TB=CC	ES-1	\$0
456-107-688	V400K ADV FROM UNI DLTA 1501+TB=CC	ES-1	\$0
456-107-689	V100K LOCAL REP REG UPG 0-50TB=CA	ES-1	\$2,130
456-107-690	V100K LOCAL REP REG UPG 51-150TB=CA	ES-1	\$1,650
456-107-691	V100K LOCAL REP REG UPG 151-300TB=CA	ES-1	\$1,580
456-107-692	V100K LOCAL REP REG UPG 301-450TB=CA	ES-1	\$1,355
456-107-693	V100K LOCAL REP REG UPG 451-750TB=CA	ES-1	\$1,265
456-107-694	V100K LOCAL REP REG UPG 751-1500TB=CA	ES-1	\$1,035
456-107-695	V100K LOCAL REP REG UPG 1500+TB=CA	ES-1	\$725
456-107-696	V200K LOCAL REP REG UPG 0-50TB=CA	ES-1	\$2,130
456-107-697	V200K LOCAL REP REG UPG 51-150TB=CA	ES-1	\$1,650
456-107-698	V200K LOCAL REP REG UPG 151-300TB=CA	ES-1	\$1,580
456-107-699	V200K LOCAL REP REG UPG 301-450TB=CA	ES-1	\$1,355
456-107-700	V200K LOCAL REP REG UPG 451-750TB=CA	ES-1	\$1,265
456-107-701	V200K LOCAL REP REG UPG 751-1500TB=CA	ES-1	\$1,035
456-107-702	V200K LOCAL REP REG UPG 1500+TB=CA	ES-1	\$725
456-107-703	V400K LOCAL REP REG UPG 0-50TB=CA	ES-1	\$2,130
456-107-704	V400K LOCAL REP REG UPG 51-150TB=CA	ES-1	\$1,650
456-107-705	V400K LOCAL REP REG UPG 151-300TB=CA	ES-1	\$1,580
456-107-706	V400K LOCAL REP REG UPG 301-450TB=CA	ES-1	\$1,355
456-107-707	V400K LOCAL REP REG UPG 451-750TB=CA	ES-1	\$1,265
456-107-708	V400K LOCAL REP REG UPG 751-1500TB=CA	ES-1	\$1,035

456-107-709	V400K LOCAL REP REG UPG 1500+TB=CA	ES-1	\$725
456-107-710	V100K REMOTE REP REG UPG 0-50TB=CA	ES-1	\$2,665
456-107-711	V100K REMOTE REP REG UPG 51-150TB=CA	ES-1	\$1,880
456-107-712	V100K REMOTE REP REG UPG 151-300TB=CA	ES-1	\$1,605
456-107-713	V100K REMOTE REP REG UPG 301-450TB=CA	ES-1	\$1,510
456-107-714	V100K REMOTE REP REG UPG 451-750TB=CA	ES-1	\$1,350
456-107-715	V100K REMOTE REP REG UPG 751-1500TB=CA	ES-1	\$955
456-107-716	V100K REMOTE REP REG UPG 1500+TB=CA	ES-1	\$575
456-107-717	V200K REMOTE REP REG UPG 0-50TB=CA	ES-1	\$2,665
456-107-718	V200K REMOTE REP REG UPG 51-150TB=CA	ES-1	\$1,880
456-107-719	V200K REMOTE REP REG UPG 151-300TB=CA	ES-1	\$1,605
456-107-720	V200K REMOTE REP REG UPG 301-450TB=CA	ES-1	\$1,510
456-107-721	V200K REMOTE REP REG UPG 451-750TB=CA	ES-1	\$1,350
456-107-722	V200K REMOTE REP REG UPG 751-1500TB=CA	ES-1	\$955
456-107-723	V200K REMOTE REP REG UPG 1500+TB=CA	ES-1	\$575
456-107-724	V400K REMOTE REP REG UPG 0-50TB=CA	ES-1	\$2,665
456-107-725	V400K REMOTE REP REG UPG 51-150TB=CA	ES-1	\$1,880
456-107-726	V400K REMOTE REP REG UPG 151-300TB=CA	ES-1	\$1,605
456-107-727	V400K REMOTE REP REG UPG 301-450TB=CA	ES-1	\$1,510
456-107-728	V400K REMOTE REP REG UPG 451-750TB=CA	ES-1	\$1,350
456-107-729	V400K REMOTE REP REG UPG 751-1500TB=CA	ES-1	\$955
456-107-730	V400K REMOTE REP REG UPG 1500+TB=CA	ES-1	\$575
456-107-731	VMAX3 STAR TPP 0-50TB=CC	ES-1	\$0
456-107-732	VMAX3 STAR TPP 51-150TB=CC	ES-1	\$0
456-107-733	VMAX3 STAR TPP 151-300TB=CC	ES-1	\$0
456-107-734	VMAX3 STAR TPP 301-450TB=CC	ES-1	\$0
456-107-735	VMAX3 STAR TPP 451-750TB=CC	ES-1	\$0
456-107-736	VMAX3 STAR TPP 751-1500TB=CC	ES-1	\$0
456-107-737	VMAX3 STAR TPP 1501+TB=CC	ES-1	\$0
456-108-357	V100K HYPERMAX OS BASE LIC=IC	ES-1	\$2,855
456-108-358	V200K HYPERMAX OS BASE LIC=IC	ES-1	\$11,430
456-108-359	V400K HYPERMAX OS BASE LIC=IC	ES-1	\$28,570
456-108-378	V100K BASE PKG LIC=IC	ES-1	\$4,285
456-108-379	V200K BASE PKG LIC=IC	ES-1	\$12,855
456-108-380	V400K BASE PKG LIC=IC	ES-1	\$35,715
456-108-409	V100K ADVANCED FROM BASE PKG UPG=IC	ES-1	\$6,430
456-108-410	V200K ADVANCED FROM BASE PKG UPG=IC	ES-1	\$19,290
456-108-411	V400K ADVANCED FROM BASE PKG UPG=IC	ES-1	\$42,855
456-108-412	V100K ADVANCED FROM FNDATION PKG UPG=I	ES-1	\$2,145
456-108-413	V200K ADVANCED FROM FNDATION PKG UPG=I	ES-1	\$6,430
456-108-414	V400K ADVANCED FROM FNDATION PKG UPG=I	ES-1	\$21,425
456-108-418	V100K ADVANCED FROM UNISPHERE UPG=IC	ES-1	\$5,000
456-108-419	V200K ADVANCED FROM UNISPHERE UPG=IC	ES-1	\$15,000
456-108-420	V400K ADVANCED FROM UNISPHERE UPG=IC	ES-1	\$35,715
456-108-474	V100K UNISPHERE FAST COMBO LIC=IC	ES-1	\$467,715
456-108-475	V200K UNISPHERE FAST COMBO LIC=IC	ES-1	\$479,145
456-108-476	V400K UNISPHERE FAST COMBO LIC=IC	ES-1	\$504,855
456-108-480	V100K ADVANCED FAST COMBO LIC=IC	ES-1	\$749,915
456-108-481	V200K ADVANCED FAST COMBO LIC=IC	ES-1	\$771,345
456-108-482	V400K ADVANCED FAST COMBO LIC=IC	ES-1	\$817,770

456-108-483	V100K SRDF FAST COMBO LIC=IC	ES-1	\$277,810
456-108-484	V200K SRDF FAST COMBO LIC=IC	ES-1	\$277,810
456-108-485	V400K SRDF FAST COMBO LIC=IC	ES-1	\$277,810
456-108-486	V100K TIMEFINDER FAST COMBO LIC=IC	ES-1	\$183,015
456-108-487	V200K TIMEFINDER FAST COMBO LIC=IC	ES-1	\$183,015
456-108-488	V400K TIMEFINDER FAST COMBO LIC=IC	ES-1	\$183,015
456-108-621	V100K ESA BASE LIC=IC	ES-1	\$0
456-108-622	V200K ESA BASE LIC=IC	ES-1	\$0
456-108-623	V400K ESA BASE LIC=IC	ES-1	\$0
456-108-783	SRM VMAX3 BASE NEW 100K =CC	ES-1	\$8,950
456-108-784	SRM VMAX3 BASE NEW 200K =CC	ES-1	\$19,900
456-108-785	SRM VMAX3 BASE NEW 400K =CC	ES-1	\$21,900
456-108-985	AppSync Base New VMAX3 Local Rep=IC	ES-1	\$20,250
456-108-986	AppSync Base New 200K=IC	ES-1	\$20,250
456-108-987	AppSync Base New 400K=IC	ES-1	\$20,250
456-108-988	AppSync Base New VMAX3 Reg=IC	ES-1	\$22,626
456-108-989	AppSync Base Reg. New 200K=IC	ES-1	\$22,626
456-108-990	AppSync Base Reg. New 400K=IC	ES-1	\$22,626
456-108-991	AppSync Base New VMAX3 TPP=IC	ES-1	\$17,213
456-108-992	AppSync Base TPP New 200K=IC	ES-1	\$17,213
456-108-993	AppSync Base TPP New 400K=IC	ES-1	\$17,213
456-109-032	V100K DATA AT REST ENCRYPT OS LIC=IC	ES-1	\$35,000
456-109-033	V200K DATA AT REST ENCRYPT OS LIC=IC	ES-1	\$100,000
456-109-034	V400K DATA AT REST ENCRYPT OS LIC=IC	ES-1	\$192,000
456-109-074	V100K FAST.X CLOUDARRAY BASE NEW=IC	ES-1	\$35,000
456-109-075	V200K FAST.X CLOUDARRAY BASE NEW=IC	ES-1	\$0
456-109-076	V400K FAST.X CLOUDARRAY BASE NEW=IC	ES-1	\$0
456-109-077	V100K FAST.X BASE NEW=IC	ES-1	\$35,000
456-109-078	V200K FAST.X BASE NEW=IC	ES-1	\$62,500
456-109-079	V400K FAST.X BASE NEW=IC	ES-1	\$112,000
456-109-080	V100K SRDF METRO BASE NEW=IC	ES-1	\$37,500
456-109-081	V200K SRDF METRO BASE NEW=IC	ES-1	\$37,500
456-109-082	V400K SRDF METRO BASE NEW=IC	ES-1	\$37,500
456-109-083	V100K SRDF METRO REG BASE NEW=IC	ES-1	\$24,000
456-109-084	V200K SRDF METRO REG BASE NEW=IC	ES-1	\$24,000
456-109-085	V400K SRDF METRO REG BASE NEW=IC	ES-1	\$24,000
456-109-086	V100K SRDF METRO ADD ON BASE NEW=IC	ES-1	\$22,500
456-109-087	V200K SRDF METRO ADD ON BASE NEW=IC	ES-1	\$22,500
456-109-088	V400K SRDF METRO ADD ON BASE NEW=IC	ES-1	\$22,500
456-109-089	V100K SRDFM CNV BASE NEW=IC	ES-1	\$13,500
456-109-090	V200K SRDFM CNV BASE NEW=IC	ES-1	\$13,500
456-109-091	V400K SRDFM CNV BASE NEW=IC	ES-1	\$13,500
456-109-095	V100K SRDF METRO FAST COMBO=IC	ES-1	\$372,000
456-109-096	V200K SRDF METRO FAST COMBO=IC	ES-1	\$372,000
456-109-097	V400K SRDF METRO FAST COMBO=IC	ES-1	\$372,000
456-109-113	VMAX3 LOC REP PKG 0-50TB=CC	ES-1	\$1,100
456-109-114	VMAX3 LOC REP PKG 51-150TB=CC	ES-1	\$865
456-109-115	VMAX3 LOC REP PKG 151-300TB=CC	ES-1	\$560
456-109-116	VMAX3 LOC REP PKG 301-450TB=CC	ES-1	\$455
456-109-117	VMAX3 LOC REP PKG451-750TB=CC	ES-1	\$395

456-109-118	VMAX3 LOC REP PKG 751-1500TB=CC	ES-1	\$350
456-109-119	VMAX3 LOC REP PKG 1501+TB=CC	ES-1	\$295
456-109-120	V100K LOCAL REP UPG 0-50TB=CC	ES-1	\$1,100
456-109-121	V100K LOCAL REP UPG 51-150TB=CC	ES-1	\$865
456-109-122	V100K LOCAL REP UPG 151-300TB=CC	ES-1	\$560
456-109-123	V100K LOCAL REP UPG 301-450TB=CC	ES-1	\$455
456-109-124	V100K LOCAL REP UPG451-750TB=CC	ES-1	\$395
456-109-125	V100K LOCAL REP UPG 751-1500TB=CC	ES-1	\$350
456-109-126	V100K LOCAL REP UPG 1501+TB=CC	ES-1	\$295
456-109-127	V200K LOCAL REP UPG 0-50TB=CC	ES-1	\$1,100
456-109-128	V200K LOCAL REP UPG 51-150TB=CC	ES-1	\$865
456-109-129	V200K LOCAL REP UPG 151-300TB=CC	ES-1	\$560
456-109-130	V200K LOCAL REP UPG 301-450TB=CC	ES-1	\$455
456-109-131	V200K LOCAL REP UPG451-750TB=CC	ES-1	\$395
456-109-132	V200K LOCAL REP UPG 751-1500TB=CC	ES-1	\$350
456-109-133	V200K LOCAL REP UPG 1501+TB=CC	ES-1	\$295
456-109-134	V400K LOCAL REP UPG 0-50TB=CC	ES-1	\$1,100
456-109-135	V400K LOCAL REP UPG 51-150TB=CC	ES-1	\$865
456-109-136	V400K LOCAL REP UPG 151-300TB=CC	ES-1	\$560
456-109-137	V400K LOCAL REP UPG 301-450TB=CC	ES-1	\$455
456-109-138	V400K LOCAL REP UPG451-750TB=CC	ES-1	\$395
456-109-139	V400K LOCAL REP UPG 751-1500TB=CC	ES-1	\$350
456-109-140	V400K LOCAL REP UPG 1501+TB=CC	ES-1	\$295
456-109-206	VMWARE ESA FOR VMAX3 IN PKG=IA	ES-1	\$0
456-109-207	ESA FOR V100K IN PKG=IA	ES-1	\$0
456-109-209	ESA FOR V400K IN PKG=IA	ES-1	\$0
456-109-261	SRM VMAX3 BASE NEW 100K =IC	ES-1	\$8,950
456-109-262	SRM VMAX3 BASE NEW 200K =IC	ES-1	\$19,900
456-109-263	SRM VMAX3 BASE NEW 400K =IC	ES-1	\$21,900
456-109-367	V100K DATA AT REST ENCRYPT OS UPG LIC=IC	ES-1	\$35,000
456-109-368	V200K DATA AT REST ENCRYPT OS UOG LIC=IC	ES-1	\$100,000
456-109-369	V400K DATA AT REST ENCRYPT OS UPG LIC=IC	ES-1	\$192,000
456-110-000	FAST.X SYSTEM=IC	ES-1	\$0
456-110-035	VMAX SRDF METRO 0-50TB=CC	ES-1	\$2,200
456-110-036	VMAX SRDF METRO 51-150TB=CC	ES-1	\$1,575
456-110-037	VMAX SRDF METRO 151-300TB=CC	ES-1	\$1,115
456-110-038	VMAX SRDF METRO 301-450TB=CC	ES-1	\$880
456-110-039	VMAX SRDF METRO 451-750TB=CC	ES-1	\$755
456-110-040	VMAX SRDF METRO 751-1500TB=CC	ES-1	\$650
456-110-041	VMAX SRDF METRO 1501+TB=CC	ES-1	\$550
456-110-042	V100K SRDF METRO UPG 0-50TB=CC	ES-1	\$2,200
456-110-043	V100K SRDF METRO UPG 51-150TB=CC	ES-1	\$1,575
456-110-044	V100K SRDF METRO UPG 151-300TB=CC	ES-1	\$1,115
456-110-045	V100K SRDF METRO UPG 301-450TB=CC	ES-1	\$880
456-110-046	V100K SRDF METRO UPG 451-750TB=CC	ES-1	\$755
456-110-047	V100K SRDF METRO UPG 751-1500TB=CC	ES-1	\$650
456-110-048	V100K SRDF METRO UPG 1501+TB=CC	ES-1	\$550
456-110-049	V200K SRDF METRO UPG 0-50TB=CC	ES-1	\$2,200
456-110-050	V200K SRDF METRO UPG 51-150TB=CC	ES-1	\$1,575
456-110-051	V200K SRDF METRO UPG 151-300TB=CC	ES-1	\$1,115

456-110-052	V200K SRDF METRO UPG 301-450TB=CC	ES-1	\$880
456-110-053	V200K SRDF METRO UPG 451-750TB=CC	ES-1	\$755
456-110-054	V200K SRDF METRO UPG 751-1500TB=CC	ES-1	\$650
456-110-055	V200K SRDF METRO UPG 1501+TB=CC	ES-1	\$550
456-110-056	V400K SRDF METRO UPG 0-50TB=CC	ES-1	\$2,200
456-110-057	V400K SRDF METRO UPG 51-150TB=CC	ES-1	\$1,575
456-110-058	V400K SRDF METRO UPG 151-300TB=CC	ES-1	\$1,115
456-110-059	V400K SRDF METRO UPG 301-450TB=CC	ES-1	\$880
456-110-060	V400K SRDF METRO UPG 451-750TB=CC	ES-1	\$755
456-110-061	V400K SRDF METRO UPG 751-1500TB=CC	ES-1	\$650
456-110-062	V400K SRDF METRO UPG 1501+TB=CC	ES-1	\$550
456-110-210	FAST.X CLOUDARRAY TIER=IC	ES-1	\$0
456-110-235	VMAX3 SRDF METRO REG 0-50TB=CA	ES-1	\$1,800
456-110-236	VMAX3 SRDF METRO REG 51-150TB=CA	ES-1	\$2,340
456-110-237	VMAX3 SRDF METRO REG 151-300TB=CA	ES-1	\$2,270
456-110-238	VMAX3 SRDF METRO REG 301-450TB=CA	ES-1	\$2,190
456-110-239	VMAX3 SRDF METRO REG 451-750TB=CA	ES-1	\$1,860
456-110-240	VMAX3 SRDF METRO REG 751-1500TB=CA	ES-1	\$1,580
456-110-241	VMAX3 SRDF METRO REG 1501+TB=CA	ES-1	\$1,345
456-110-242	V100K SRDF METRO REG UPG 0-50TB=CA	ES-1	\$1,800
456-110-243	V100K SRDF METRO REG UPG 51-150TB=CA	ES-1	\$2,340
456-110-244	V100K SRDF METRO REG UPG 151-300TB=CA	ES-1	\$2,575
456-110-245	V100K SRDF METRO REG UPG 301-450TB=CA	ES-1	\$2,190
456-110-246	V100K SRDF METRO REG UPG 451-750TB=CA	ES-1	\$1,860
456-110-247	V100K SRDF METRO REG UPG 751-1500TB=CA	ES-1	\$1,580
456-110-248	V100K SRDF METRO REG UPG 1501+TB=CA	ES-1	\$1,345
456-110-249	V200K SRDF METRO REG UPG 0-50TB=CA	ES-1	\$1,800
456-110-250	V200K SRDF METRO REG UPG 51-150TB=CA	ES-1	\$2,340
456-110-251	V200K SRDF METRO REG UPG 151-300TB=CA	ES-1	\$2,575
456-110-252	V200K SRDF METRO REG UPG 301-450TB=CA	ES-1	\$2,190
456-110-253	V200K SRDF METRO REG UPG 451-750TB=CA	ES-1	\$1,860
456-110-254	V200K SRDF METRO REG UPG 751-1500TB=CA	ES-1	\$1,580
456-110-255	V200K SRDF METRO REG UPG 1501+TB=CA	ES-1	\$1,345
456-110-256	V400K SRDF METRO REG UPG 0-50TB=CA	ES-1	\$1,800
456-110-257	V400K SRDF METRO REG UPG 51-150TB=CA	ES-1	\$2,340
456-110-258	V400K SRDF METRO REG UPG 151-300TB=CA	ES-1	\$2,575
456-110-259	V400K SRDF METRO REG UPG 301-450TB=CA	ES-1	\$2,190
456-110-260	V400K SRDF METRO REG UPG 451-750TB=CA	ES-1	\$1,860
456-110-261	V400K SRDF METRO REG UPG 751-1500TB=CA	ES-1	\$1,580
456-110-262	V400K SRDF METRO REG UPG 1501+TB=CA	ES-1	\$1,345
456-110-263	VMAX3 SRDF METRO ADD ON 0-50TB=CC	ES-1	\$1,320
456-110-264	VMAX3 SRDF METRO ADD ON 51-150TB=CC	ES-1	\$945
456-110-265	VMAX3 SRDF METRO ADD ON 151-300TB=CC	ES-1	\$670
456-110-266	VMAX3 SRDF METRO ADD ON 301-450TB=CC	ES-1	\$530
456-110-267	VMAX3 SRDF METRO ADD ON 451-750TB=CC	ES-1	\$455
456-110-268	VMAX3 SRDF METRO ADD ON 751-1500TB=CC	ES-1	\$390
456-110-269	VMAX3 SRDF METRO ADD ON 1501+TB=CC	ES-1	\$330
456-110-270	V100K SRDF METRO ADD ON UPG 0-50TB=CC	ES-1	\$1,320
456-110-271	V100K SRDF METRO ADD ON UPG 51-150TB=CC	ES-1	\$945
456-110-272	V100K SRDF METRO ADD ON UPG 151-300TB=C	ES-1	\$670

456-110-273	V100K SRDF METRO ADD ON UPG 301-450TB=C	ES-1	\$530
456-110-274	V100K SRDF METRO ADD ON UPG 451-750TB=C	ES-1	\$455
456-110-275	V100K SRDF MET ADD ON UPG 751-1500TB=CC	ES-1	\$390
456-110-276	V100K SRDF METRO ADD ON UPG 1501+TB=CC	ES-1	\$330
456-110-277	V200K SRDF METRO ADD ON UPG 0-50TB=CC	ES-1	\$1,320
456-110-278	V200K SRDF METRO ADD ON UPG 51-150TB=CC	ES-1	\$945
456-110-279	V200K SRDF METRO ADD ON UPG 151-300TB=C	ES-1	\$670
456-110-280	V200K SRDF METRO ADD ON UPG 301-450TB=C	ES-1	\$530
456-110-281	V200K SRDF METRO ADD ON UPG 451-750TB=C	ES-1	\$455
456-110-282	V200K SRDF MET ADD ON UPG 751-1500TB=CC	ES-1	\$390
456-110-283	V200K SRDF METRO ADD ON UPG 1501+TB=CC	ES-1	\$330
456-110-284	V400K SRDF METRO ADD ON UPG 0-50TB=CC	ES-1	\$1,320
456-110-285	V400K SRDF METRO ADD ON UPG 51-150TB=CC	ES-1	\$945
456-110-286	V400K SRDF METRO ADD ON UPG 151-300TB=C	ES-1	\$670
456-110-287	V400K SRDF METRO ADD ON UPG 301-450TB=C	ES-1	\$530
456-110-288	V400K SRDF METRO ADD ON UPG 451-750TB=C	ES-1	\$455
456-110-289	V400K SRDF MET ADD ON UPG 751-1500TB=CC	ES-1	\$390
456-110-290	V400K SRDF METRO ADD ON UPG 1501+TB=CC	ES-1	\$330
456-110-291	SRDFM FAST COMBO TIER VMAX=CC	ES-1	\$0
456-110-434	V100K SRDFM CNV UPG 0-50TB=CC	ES-1	\$400
456-110-435	V100K SRDFM CNV UPG 51-150TB=CC	ES-1	\$350
456-110-436	V100K SRDFM CNV UPG 151-300TB=CC	ES-1	\$300
456-110-437	V100K SRDFM CNV UPG 301-450TB=CC	ES-1	\$275
456-110-438	V100K SRDFM CNV UPG 451-750TB=CC	ES-1	\$250
456-110-439	V100K SRDFM CNV UPG 751-1500TB=CC	ES-1	\$225
456-110-440	V100K SRDFM CNV UPG 1501TB+=CC	ES-1	\$200
456-110-441	V200K SRDFM CNV UPG 0-50TB=CC	ES-1	\$400
456-110-442	V200K SRDFM CNV UPG 51-150TB=CC	ES-1	\$350
456-110-443	V200K SRDFM CNV UPG 151-300TB=CC	ES-1	\$300
456-110-444	V200K SRDFM CNV UPG 301-450TB=CC	ES-1	\$275
456-110-445	V200K SRDFM CNV UPG 451-750TB=CC	ES-1	\$250
456-110-446	V200K SRDFM CNV UPG 751-1500TB=CC	ES-1	\$225
456-110-447	V200K SRDFM CNV UPG 1501TB+=CC	ES-1	\$200
456-110-448	V400K SRDFM CNV UPG 0-50TB=CC	ES-1	\$400
456-110-449	V400K SRDFM CNV UPG 51-150TB=CC	ES-1	\$350
456-110-450	V400K SRDFM CNV UPG 151-300TB=CC	ES-1	\$300
456-110-451	V400K SRDFM CNV UPG 301-450TB=CC	ES-1	\$275
456-110-452	V400K SRDFM CNV UPG 451-750TB=CC	ES-1	\$250
456-110-453	V400K SRDFM CNV UPG 751-1500TB=CC	ES-1	\$225
456-110-454	V400K SRDFM CNV UPG 1501TB+=CC	ES-1	\$200
456-110-514	VS SRM VMAX3 1-50TB=CC	ES-1	\$1,690
456-110-580	VMAX3UNISPHERE360 BASE NEW 100KPROMO=	ES-1	\$50,000
456-110-581	VMAX3UNISPHERE360 BASE NEW 200KPROMO=	ES-1	\$50,000
456-110-582	VMAX3UNISPHERE360 BASE NEW 400KPROMO=	ES-1	\$50,000
456-110-629	VMAX3 MF ESSENTIALS BASE NEW=IC	ES-1	\$27,585
456-110-631	VMAX3 MF ESSENTIALS 0-50TB=CA	ES-1	\$2,135
456-110-632	VMAX3 MF ESSENTIALS 51-150TB=CA	ES-1	\$1,670
456-110-633	VMAX3 MF ESSENTIALS 151-300TB=CA	ES-1	\$1,365
456-110-634	VMAX3 MF ESSENTIALS 301-450TB=CA	ES-1	\$1,190
456-110-635	VMAX3 MF ESSENTIALS 451-750TB=CA	ES-1	\$1,030

456-110-636	VMAX3 MF ESSENTIALS 751-1500TB=CA	ES-1	\$895
456-110-637	VMAX3 MF ESSENTIALS 1501+TB=CA	ES-1	\$780
456-110-638	VMAX3 MF ESSENTIALS PLUS BASE NEW=IC	ES-1	\$48,275
456-110-640	VMAX3 MF ESSENTIALS PLUS 0-50TB=CA	ES-1	\$3,735
456-110-641	VMAX3 MF ESSENTIALS PLUS 51-150TB=CA	ES-1	\$2,925
456-110-642	VMAX3 MF ESSENTIALS PLUS 151-300TB=CA	ES-1	\$2,390
456-110-643	VMAX3 MF ESSENTIALS PLUS 301-450TB=CA	ES-1	\$2,085
456-110-644	VMAX3 MF ESSENTIALS PLUS 451-750TB=CA	ES-1	\$1,805
456-110-645	VMAX3 MF ESSENTIALS PLUS 751-1500TB=CA	ES-1	\$1,565
456-110-646	VMAX3 MF ESSENTIALS PLUS 1501+TB=CA	ES-1	\$1,365
456-110-647	VMAX3 AUTOSWAP BASE NEW=ZD	ES-1	\$86,800
456-110-649	VMAX3 AUTOSWAP 1-45 MSU=ZD	ES-1	\$190
456-110-650	VMAX3 AUTOSWAP 46-175 MSU=ZD	ES-1	\$120
456-110-651	VMAX3 AUTOSWAP 176-315 MSU=ZD	ES-1	\$90
456-110-652	VMAX3 AUTOSWAP 316-575 MSU=ZD	ES-1	\$70
456-110-653	VMAX3 AUTOSWAP 576-875 MSU=ZD	ES-1	\$50
456-110-654	VMAX3 AUTOSWAP 876-1315 MSU=ZD	ES-1	\$35
456-110-655	VMAX3 AUTOSWAP 1316+ MSU=ZD	ES-1	\$18
456-110-656	VMAX3 ZDP FOR MF BASE NEW=IC	ES-1	\$12,570
456-110-658	VMAX3 ZDP FOR MF 0-50TB=CA	ES-1	\$1,065
456-110-659	VMAX3 ZDP FOR MF 51-150TB=CA	ES-1	\$825
456-110-660	VMAX3 ZDP FOR MF 151-300TB=CA	ES-1	\$790
456-110-661	VMAX3 ZDP FOR MF 301-450TB=CA	ES-1	\$680
456-110-662	VMAX3 ZDP FOR MF 451-750TB=CA	ES-1	\$635
456-110-663	VMAX3 ZDP FOR MF 751-1500TB=CA	ES-1	\$520
456-110-664	VMAX3 ZDP FOR MF 1501+TB=CA	ES-1	\$365
456-110-665	VMAX3 GDDR BASE NEW=MD	ES-1	\$0
456-110-667	VMAX3 GDDR TIER=MD	ES-1	\$175,000
456-110-784	SRM VMAX3 0-50TB=CC	ES-1	\$1,190
456-110-785	SRM VMAX3 51-150TB =CC	ES-1	\$1,180
456-110-786	SRM VMAX3 151-300TB=CC	ES-1	\$1,170
456-110-787	SRM VMAX3 301-450TB=CC	ES-1	\$1,125
456-110-788	SRM VMAX3 451-750TB=CC	ES-1	\$1,035
456-110-789	SRM VMAX3 751-1500TB=CC	ES-1	\$945
456-110-790	SRM VMAX3 1500+TB =CC	ES-1	\$900
456-111-315	VS VIPRC VMAX3 LIC=IC	ES-1	\$0
456-111-943	RP/EX LOC BASE FOR VMAX3=IC	ES-1	\$24,300
456-111-944	RP/EX LOC FOR VMAX3 (0-50TB)=CA	ES-1	\$3,090
456-111-945	RP/EX LOC FOR VMAX3 (51-150TB)=CA	ES-1	\$2,020
456-111-946	RP/EX LOC FOR VMAX3 (151-300TB)=CA	ES-1	\$1,675
456-111-947	RP/EX LOC FOR VMAX3 (301-450TB)=CA	ES-1	\$1,555
456-111-948	RP/EX LOC FOR VMAX3 (451-750TB)=CA	ES-1	\$1,380
456-111-949	RP/EX LOC FOR VMAX3 (751-1,500TB)=CA	ES-1	\$970
456-111-950	RP/EX LOC FOR VMAX3 (1,501TB+)=CA	ES-1	\$585
456-111-951	RP/EX REM BASE FOR VMAX3=IC	ES-1	\$24,300
456-111-952	RP/EX REM FOR VMAX3 (0-50TB)=CA	ES-1	\$3,090
456-111-953	RP/EX REM FOR VMAX3 (51-150TB)=CA	ES-1	\$2,020
456-111-954	RP/EX REM FOR VMAX3 (151-300TB)=CA	ES-1	\$1,675
456-111-955	RP/EX REM FOR VMAX3 (301-450TB)=CA	ES-1	\$1,555
456-111-956	RP/EX REM FOR VMAX3 (451-750TB)=CA	ES-1	\$1,380

456-111-957	RP/EX REM FOR VMAX3 (751-1,500TB)=CA	ES-1	\$970
456-111-958	RP/EX REM FOR VMAX3 (1,501TB+)=CA	ES-1	\$585
457-101-423	VMAX BASE SUITE NEW 100K=IC	ES-1	\$0
457-101-424	VMAX BASE SUITE NEW 200K=IC	ES-1	\$0
457-101-425	VMAX BASE SUITE NEW 400K=IC	ES-1	\$0
457-101-441	LOC REP SUITE 0-50TB=CC	ES-1	\$0
457-101-442	LOC REP SUITE 51-150TB=CC	ES-1	\$0
457-101-443	LOC REP SUITE 751-1500TB=CC	ES-1	\$0
457-101-444	LOC REP SUITE 151-300TB=CC	ES-1	\$0
457-101-445	LOC REP SUITE 1501+TB=CC	ES-1	\$0
457-101-446	LOC REP SUITE 301-450TB=CC	ES-1	\$0
457-101-447	LOC REP SUITE 451-750TB=CC	ES-1	\$0
457-101-448	LOC REP SUITE BASE NEW 100K=IC	ES-1	\$0
457-101-449	LOC REP SUITE BASE NEW 200K=IC	ES-1	\$0
457-101-450	LOC REP SUITE BASE NEW 400K=IC	ES-1	\$0
457-101-473	STAR BASE NEW 100K=IC	ES-1	\$0
457-101-474	STAR BASE NEW 200K=IC	ES-1	\$0
457-101-475	STAR BASE NEW 400K=IC	ES-1	\$0
457-101-476	STAR CAP UPGRADE 100K=IC	ES-1	\$0
457-101-477	STAR CAP UPGRADE 200K=IC	ES-1	\$0
457-101-478	STAR CAP UPGRADE 400K=IC	ES-1	\$0
457-101-498	VMAX ADVANCED SUITE BASE NEW 100K=IC	ES-1	\$0
457-101-499	VMAX ADVANCED SUITE BASE NEW 200K=IC	ES-1	\$0
457-101-500	VMAX ADVANCED SUITE BASE NEW 400K=IC	ES-1	\$0
457-101-507	V200K VMAX TOTAL PROD PAK BASE NEW =IC	ES-1	\$0
457-101-508	V400K VMAX TOTAL PROD PAK BASE NEW=IC	ES-1	\$0
457-101-511	TOTAL PROD PAK 0-50TB=CC	ES-1	\$0
457-101-512	TOTAL PROD PAK 51-150TB=CC	ES-1	\$0
457-101-513	TOTAL PROD PAK 151-300TB=CC	ES-1	\$0
457-101-521	TOTAL PROD PAK 301-450TB=CC	ES-1	\$0
457-101-522	TOTAL PROD PAK 451-750TB=CC	ES-1	\$0
457-101-573	VIPR SRM VMAX3 BASE NEW 100K =CC	ES-1	\$0
457-101-574	VIPR SRM VMAX3 BASE NEW 200K =CC	ES-1	\$0
457-101-575	VIPR SRM VMAX3 BASE NEW 400K =CC	ES-1	\$0
457-101-576	VIPR SRM VMAX3 CAP UPGRADE 100K =CC	ES-1	\$0
457-101-577	VIPR SRM VMAX3 CAP UPGRADE 200K =CC	ES-1	\$0
457-101-578	VIPR SRM VMAX3 CAP UPGRADE 400K =CC	ES-1	\$0
457-101-586	AppSync Base New 100K=IC	ES-1	\$0
457-101-588	AppSync Base New 200K=IC	ES-1	\$0
457-101-590	AppSync Base New 400K=IC	ES-1	\$0
457-101-616	V200K REM REP SUITE BASE NEW=IC	ES-1	\$0
457-101-617	V400K REM REP SUITE BASE NEW=IC	ES-1	\$0
457-101-620	REM REP SUITE 0-50TB=CC	ES-1	\$0
457-101-621	REM REP SUITE 51-150TB=CC	ES-1	\$0
457-101-622	REM REP SUITE 151-300TB=CC	ES-1	\$0
457-101-623	REM REP SUITE 301-450TB=CC	ES-1	\$0
457-101-624	REM REP SUITE 451-750TB=CC	ES-1	\$0
457-101-625	REM REP SUITE 751-1500TB=CC	ES-1	\$0
457-101-626	REM REP SUITE 1501+TB=CC	ES-1	\$0
457-101-627	V100 REM REP SUITE BASE NEW=IC	ES-1	\$0

457-101-631	V100K VMAX TOTAL PROD PAK BASE NEW=IC	ES-1	\$0
457-101-637	ADVANCED SUITE BASE UPG FBS 100K=IC	ES-1	\$0
457-101-638	ADVANCED SUITE BASE UPG FBS 200K=IC	ES-1	\$0
457-101-639	ADVANCED SUITE BASE UPG FBS 400K=IC	ES-1	\$0
457-101-640	ADVANCED SUITE BASE UPG FFS 100K=IC	ES-1	\$0
457-101-641	ADVANCED SUITE BASE UPG FFS 200K=IC	ES-1	\$0
457-101-642	ADVANCED SUITE BASE UPG FFS 400K=IC	ES-1	\$0
457-101-658	HYPERMAX OS BASE NEW 100K=IC	ES-1	\$0
457-101-659	HYPERMAX OS BASE NEW 200K=IC	ES-1	\$0
457-101-660	HYPERMAX OS BASE NEW 400K=IC	ES-1	\$0
457-101-667	UNISPHERE SUITE NEW 100K=IC	ES-1	\$0
457-101-669	UNISPHERE SUITE NEW 400K=IC	ES-1	\$0
457-101-676	TOTAL PROD PAK 751-1500TB=CC	ES-1	\$0
457-101-677	TOTAL PROD PAK 1501+TB=CC	ES-1	\$0
457-101-691	ADVANCED UPG FRM UNISPHERE 100K=CC	ES-1	\$0
457-101-692	ADVANCED UPG FRM UNISPHERE 200K=CC	ES-1	\$0
457-101-693	ADVANCED UPG FRM UNISPHERE 400K=CC	ES-1	\$0
457-101-810	UNIS FAST COMBO VMAX 100K=IC	ES-1	\$0
457-101-811	UNIS FAST COMBO VMAX 200K=IC	ES-1	\$0
457-101-812	UNIS FAST COMBO VMAX 400K=IC	ES-1	\$0
457-101-816	ADV SUITE FAST COMBO VMAX 100K=IC	ES-1	\$0
457-101-817	ADV SUITE FAST COMBO VMAX 200K=IC	ES-1	\$0
457-101-818	ADV SUITE FAST COMBO VMAX 400K=IC	ES-1	\$0
457-101-823	ESA FOR V100K BASE LIC=IA	ES-1	\$0
457-101-825	ESA FOR V200K BASE LIC=IA	ES-1	\$0
457-101-827	ESA FOR V400K BASE LIC=IA	ES-1	\$0
457-101-829	TIMEFINDER FAST COMBO VMAX 100K=IC	ES-1	\$0
457-101-830	TIMEFINDER FAST COMBO VMAX 200K=IC	ES-1	\$0
457-101-831	TIMEFINDER FAST COMBO VMAX 400K=IC	ES-1	\$0
457-101-832	SRDF FAST COMBO VMAX 100K=IC	ES-1	\$0
457-101-833	SRDF FAST COMBO VMAX 200K=IC	ES-1	\$0
457-101-834	SRDF FAST COMBO VMAX 400K=IC	ES-1	\$0
457-101-870	AppSync Base Reg New 100K=IC	ES-1	\$0
457-101-872	AppSync Base Reg New 200K=IC	ES-1	\$0
457-101-874	AppSync Base Reg New 400K=IC	ES-1	\$0
457-101-876	AppSync Base TPP New 100K=IC	ES-1	\$0
457-101-878	AppSync Base TPP New 200K=IC	ES-1	\$0
457-101-880	AppSync Base TPP New 400K=IC	ES-1	\$0
457-101-882	DATA AT REST ENCRYPT OS NEW LIC 100K=IC	ES-1	\$0
457-101-883	DATA AT REST ENCRYPT OS UPG 100K=IC	ES-1	\$0
457-101-884	DATA AT REST ENCRYPT OS NEW LIC 200K=IC	ES-1	\$0
457-101-885	DATA AT REST ENCRYPT OS UPG 200K=IC	ES-1	\$0
457-101-886	DATA AT REST ENCRYPT OS NEW LIC 400K=IC	ES-1	\$0
457-101-887	DATA AT REST ENCRYPT OS UPG 400K=IC	ES-1	\$0
457-101-914	V100K LOCAL REP REG BASE LIC=IC	ES-1	\$0
457-101-915	V200K LOCAL REP REG BASE LIC=IC	ES-1	\$0
457-101-916	V400K LOCAL REP REG BASE LIC=IC	ES-1	\$0
457-101-920	V100K REMOTE REP REG BASE LIC=IC	ES-1	\$0
457-101-921	V200K REMOTE REP REG BASE LIC=IC	ES-1	\$0
457-101-922	V400K REMOTE REP REG BASE LIC=IC	ES-1	\$0

457-101-926	ESA FOR 100K BASE NEW LICENSE MP ONLY=IC	ES-1	\$0
457-101-927	ESA FOR 200K BASE NEW LICENSE MP ONLY=IC	ES-1	\$0
457-101-928	ESA FOR 400K BASE NEW LICENSE MP ONLY=IC	ES-1	\$0
457-101-932	V100K REMOTE REP UPG 0-50TB=CC	ES-1	\$0
457-101-933	V100K REMOTE REP UPG 51-150TB=CC	ES-1	\$0
457-101-934	V100K REMOTE REP UPG 151-300TB=CC	ES-1	\$0
457-101-935	V100K REMOTE REP UPG 301-450TB=CC	ES-1	\$0
457-101-936	V100K REMOTE REP UPG 451-750TB=CC	ES-1	\$0
457-101-937	V100K REMOTE REP UPG 751-1500TB=CC	ES-1	\$0
457-101-938	V100K REMOTE REP UPG 1501+TB=CC	ES-1	\$0
457-101-939	V200K REMOTE REP UPG 0-50TB=CC	ES-1	\$0
457-101-940	V200K REMOTE REP UPG 51-150TB=CC	ES-1	\$0
457-101-941	V200K REMOTE REP UPG 151-300TB=CC	ES-1	\$0
457-101-942	V200K REMOTE REP UPG 301-450TB=CC	ES-1	\$0
457-101-943	V200K REMOTE REP UPG 451-750TB=CC	ES-1	\$0
457-101-944	V200K REMOTE REP UPG 751-1500TB=CC	ES-1	\$0
457-101-945	V200K REMOTE REP UPG 1501+TB=CC	ES-1	\$0
457-101-946	V400K REMOTE REP UPG 0-50TB=CC	ES-1	\$0
457-101-947	V400K REMOTE REP UPG 51-150TB=CC	ES-1	\$0
457-101-948	V400K REMOTE REP UPG 151-300TB=CC	ES-1	\$0
457-101-949	V400K REMOTE REP UPG 301-450TB=CC	ES-1	\$0
457-101-950	V400K REMOTE REP UPG 451-750TB=CC	ES-1	\$0
457-101-951	V400K REMOTE REP UPG 751-1500TB=CC	ES-1	\$0
457-101-952	V400K REMOTE REP UPG 1501+TB=CC	ES-1	\$0
457-101-953	V100K LOCAL REP UPG 0-50TB=CC	ES-1	\$0
457-101-954	V100K LOCAL REP UPG 51-150TB=CC	ES-1	\$0
457-101-955	V100K LOCAL REP UPG 151-300TB=CC	ES-1	\$0
457-101-956	V100K LOCAL REP UPG 301-450TB=CC	ES-1	\$0
457-101-957	V100K LOCAL REP UPG 451-750TB=CC	ES-1	\$0
457-101-958	V100K LOCAL REP UPG 751-1500TB=CC	ES-1	\$0
457-101-959	V100K LOCAL REP UPG 1501+TB=CC	ES-1	\$0
457-101-960	V200K LOCAL REP UPG 0-50TB=CC	ES-1	\$0
457-101-961	V200K LOCAL REP UPG 51-150TB=CC	ES-1	\$0
457-101-962	V200K LOCAL REP UPG 151-300TB=CC	ES-1	\$0
457-101-963	V200K LOCAL REP UPG 301-450TB=CC	ES-1	\$0
457-101-964	V200K LOCAL REP UPG 451-750TB=CC	ES-1	\$0
457-101-965	V200K LOCAL REP UPG 751-1500TB=CC	ES-1	\$0
457-101-966	V200K LOCAL REP UPG 1501+TB=CC	ES-1	\$0
457-101-967	V400K LOCAL REP UPG 0-50TB=CC	ES-1	\$0
457-101-968	V400K LOCAL REP UPG 51-150TB=CC	ES-1	\$0
457-101-969	V400K LOCAL REP UPG 151-300TB=CC	ES-1	\$0
457-101-970	V400K LOCAL REP UPG 301-450TB=CC	ES-1	\$0
457-101-971	V400K LOCAL REP UPG 451-750TB=CC	ES-1	\$0
457-101-972	V400K LOCAL REP UPG 751-1500TB=CC	ES-1	\$0
457-101-973	V400K LOCAL REP UPG 1501+TB=CC	ES-1	\$0
457-101-974	V100K TOTAL PROD PACK UPG 0-50TB=CC	ES-1	\$0
457-101-975	V100K TOTAL PROD PACK UPG 51-150TB=CC	ES-1	\$0
457-101-976	V100K TOTAL PROD PACK UPG 151-300TB=CC	ES-1	\$0
457-101-977	V100K TOTAL PROD PACK UPG 301-450TB=CC	ES-1	\$0
457-101-978	V100K TOTAL PROD PACK UPG 451-750TB=CC	ES-1	\$0

457-101-979	V100K TOTAL PROD PACK UPG 751-1500TB=CC	ES-1	\$0
457-101-980	V100K TOTAL PROD PACK UPG 1501+TB=CC	ES-1	\$0
457-101-981	V200K TOTAL PROD PACK UPG 0-50TB=CC	ES-1	\$0
457-101-982	V200K TOTAL PROD PACK UPG 51-150TB=CC	ES-1	\$0
457-101-983	V200K TOTAL PROD PACK UPG 151-300TB=CC	ES-1	\$0
457-101-984	V200K TOTAL PROD PACK UPG 301-450TB=CC	ES-1	\$0
457-101-985	V200K TOTAL PROD PACK UPG 451-750TB=CC	ES-1	\$0
457-101-986	V200K TOTAL PROD PACK UPG 751-1500TB=CC	ES-1	\$0
457-101-987	V200K TOTAL PROD PACK UPG 1501+TB=CC	ES-1	\$0
457-101-988	V400K TOTAL PROD PACK UPG 0-50TB=CC	ES-1	\$0
457-101-989	V400K TOTAL PROD PACK UPG 51-150TB=CC	ES-1	\$0
457-101-990	V400K TOTAL PROD PACK UPG 151-300TB=CC	ES-1	\$0
457-101-991	V400K TOTAL PROD PACK UPG 301-450TB=CC	ES-1	\$0
457-101-992	V400K TOTAL PROD PACK UPG 451-750TB=CC	ES-1	\$0
457-101-993	V400K TOTAL PROD PACK UPG 751-1500TB=CC	ES-1	\$0
457-101-994	V400K TOTAL PROD PACK UPG 1501+TB=CC	ES-1	\$0
457-102-018	FAST.X BASE NEW 100K=IC	ES-1	\$0
457-102-019	FAST.X BASE NEW 200K=IC	ES-1	\$0
457-102-020	FAST.X BASE NEW 400K=IC	ES-1	\$0
457-102-032	VMAX SRDF METRO BASE NEW 100K=IC	ES-1	\$0
457-102-033	VMAX SRDF METRO BASE NEW 200K=IC	ES-1	\$0
457-102-034	VMAX SRDF METRO BASE NEW 400K=IC	ES-1	\$0
457-102-046	V200K FAST.X CLOUDARRAY BASE NEW=IC	ES-1	\$0
457-102-047	V400K FAST.X CLOUDARRAY BASE NEW=IC	ES-1	\$0
457-102-074	VMAX3 SRDF METRO REG BASE NEW 100K=IC	ES-1	\$0
457-102-075	VMAX3 SRDF METRO REG BASE NEW 200K=IC	ES-1	\$0
457-102-076	VMAX3 SRDF METRO REG BASE NEW 400K=IC	ES-1	\$0
457-102-080	VMAX3 SRDF METRO ADD ON BASE NEW 100K=	ES-1	\$0
457-102-081	VMAX3 SRDF METRO ADD ON BASE NEW 200K=	ES-1	\$0
457-102-082	VMAX3 SRDF METRO ADD ON BASE NEW 400K=	ES-1	\$0
457-102-086	SRDFM FAST COMBO VMAX 100K=IC	ES-1	\$0
457-102-087	SRDFM FAST COMBO VMAX 200K=IC	ES-1	\$0
457-102-088	SRDFM FAST COMBO VMAX 400K=IC	ES-1	\$0
457-102-127	VMAX SRDFM CNV BASE NEW 100K=IC	ES-1	\$0
457-102-128	VMAX SRDFM CNV BASE NEW 200K=IC	ES-1	\$0
457-102-129	VMAX SRDFM CNV BASE NEW 400K=IC	ES-1	\$0
457-102-661	VIPR SRM VMAX3 BASE NEW 100K =IC	ES-1	\$0
457-102-662	VIPR SRM VMAX3 BASE NEW 200K =IC	ES-1	\$0
457-102-663	VIPR SRM VMAX3 BASE NEW 400K =IC	ES-1	\$0
458-000-785	VMAX3 HYPERMAX OS PRODUCT	ES-1	\$0
458-000-786	VMAX3 BASE PKG	ES-1	\$0
458-000-787	V100K ADVANCED FROM FNDATION PKG UPG=I	ES-1	\$0
458-000-789	V400K ADVANCED FROM FNDATION PKG UPG=I	ES-1	\$0
458-000-790	V100K ADVANCED FROM UNISPHERE UPG=IC	ES-1	\$0
458-000-792	V400K ADVANCED FROM UNISPHERE UPG=IC	ES-1	\$0
458-000-793	V100K ADVANCED FROM BASE PKG UPG=IC	ES-1	\$0
458-000-795	V400K ADVANCED FROM BASE PKG UPG=IC	ES-1	\$0
458-000-802	VMAX3 UNISPHERE FAST COMBO	ES-1	\$0
458-000-808	VMAX3 ADVANCED FAST COMBO	ES-1	\$0
458-000-811	VMAX3 SRDF FAST COMBO	ES-1	\$0

458-000-814	VMAX3 TIMEFINDER FAST COMBO	ES-1	\$0
458-000-817	V100K ESA PRODUCT	ES-1	\$0
458-000-819	V400K ESA PRODUCT	ES-1	\$0
458-000-823	VMAX3 SRDF REPFIL REG CAP=CA	ES-1	\$0
458-000-824	V100K SRDF REPFIL REG UPG CAP=CA	ES-1	\$0
458-000-825	V200K SRDF REPFIL REG UPG CAP=CA	ES-1	\$0
458-000-826	V400K SRDF REPFIL REG UPG CAP=CA	ES-1	\$0
458-000-830	VMAX3 TF SNAPSURE REG CAP=CA	ES-1	\$0
458-000-831	V100K TFSNAPSURE REG UPG CAP=CA	ES-1	\$0
458-000-832	V200K TFSNAPSURE REG UPG CAP=CA	ES-1	\$0
458-000-833	V400K TFSNAPSURE REG UPG CAP=CA	ES-1	\$0
458-000-839	VIPR SRM VMAX3 PRODUCT	ES-1	\$0
458-000-843	APPSYNC FOR VMAX3 PRODUCT	ES-1	\$0
458-000-844	APPSYNC FOR VMAX3 REG PRODUCT	ES-1	\$0
458-000-845	APPSYNC FOR VMAX3 TPP PRODUCT	ES-1	\$0
458-000-951	VMAX3 DATA AT REST ENCRYPTION PRODUCT	ES-1	\$0
458-000-965	V100K ESA MGMT PACK ONLY PRODUCT	ES-1	\$0
458-000-966	V200K ESA MGMT PACK ONLY PRODUCT	ES-1	\$0
458-000-967	V400K ESA MGMT PACK ONLY PRODUCT	ES-1	\$0
458-000-980	VMAX3 FAST.X CLOUDARRAY PRODUCT	ES-1	\$0
458-000-981	VMAX3 FAST.X PRODUCT	ES-1	\$0
458-000-982	VMAX3 SRDF METRO PRODUCT	ES-1	\$0
458-000-983	VMAX3 SRDF METRO REGISTERED PRODUCT	ES-1	\$0
458-000-984	VMAX3 SRDF METRO ADD ON PRODUCT	ES-1	\$0
458-000-985	VMAX3 SRDF METRO CONV REG TO FULL PROD	ES-1	\$0
458-000-990	VMAX3 SRDF METRO FAST COMBO PRODUCT	ES-1	\$0
458-001-086	V100K ESA 0-50TB=CC	ES-1	\$370
458-001-087	V100K ESA 51-150TB=CC	ES-1	\$275
458-001-088	V100K ESA 151-300TB=CC	ES-1	\$175
458-001-089	V100K ESA 301-450TB=CC	ES-1	\$150
458-001-090	V100K ESA 451-750TB=CC	ES-1	\$125
458-001-091	V100K ESA 751-1500TB=CC	ES-1	\$110
458-001-092	V100K ESA 1501+TB=CC	ES-1	\$100
458-001-093	V200K ESA 0-50TB=CC	ES-1	\$370
458-001-094	V200K ESA 51-150TB=CC	ES-1	\$275
458-001-095	V200K ESA 151-300TB=CC	ES-1	\$175
458-001-096	V200K ESA 301-450TB=CC	ES-1	\$150
458-001-097	V200K ESA 451-750TB=CC	ES-1	\$125
458-001-098	V200K ESA 751-1500TB=CC	ES-1	\$110
458-001-099	V200K ESA 1501+TB=CC	ES-1	\$100
458-001-100	V400K ESA 0-50TB=CC	ES-1	\$370
458-001-101	V400K ESA 51-150TB=CC	ES-1	\$275
458-001-102	V400K ESA 151-300TB=CC	ES-1	\$175
458-001-103	V400K ESA 301-450TB=CC	ES-1	\$150
458-001-104	V400K ESA 451-750TB=CC	ES-1	\$125
458-001-105	V400K ESA 751-1500TB=CC	ES-1	\$110
458-001-106	V400K ESA 1501+TB=CC	ES-1	\$100
458-001-115	VMAX3 LOC REPLICATION PKG CAPACITY	ES-1	\$0
458-001-116	VMAX3 UNISPHERE PKG CAPACITY	ES-1	\$0
458-001-117	VMAX3 HYPERMAX OS CAPACITY	ES-1	\$0

458-001-163	ESA FOR VMAX3 CAPACITY	ES-1	\$0
458-001-274	VMAX3 UNISPHERE360 PRODUCT	ES-1	\$0
458-001-275	VMAX3 MF ESSENTIALS PRODUCT	ES-1	\$0
458-001-276	VMAX3 MF ESSENTIALS PLUS PRODUCT	ES-1	\$0
458-001-277	VMAX3 AUTOSWAP PRODUCT	ES-1	\$0
458-001-279	VMAX3 GDDR PRODUCT	ES-1	\$0
458-001-331	ESA FOR V100K BASE LIC=IA	ES-1	\$5,145
458-001-332	ESA FOR V200K BASE LIC=IA	ES-1	\$5,145
458-001-333	ESA FOR V400K BASE LIC=IA	ES-1	\$5,145
458-001-534	VMAX3 HYPERMAX OS PRODUCT	ES-1	\$0
458-001-535	VMAX3 HYPERMAX OS CAPACITY	ES-1	\$0
458-001-536	VMAX3 BASE PKG	ES-1	\$0
458-001-537	VMAX3 UNISPHERE PKG CAPACITY	ES-1	\$0
458-001-538	VMAX3 LOC REPLICATION PKG CAPACITY	ES-1	\$0
458-001-539	V100K ADVANCED FROM FNDATION PKG UPG=I	ES-1	\$0
458-001-540	V100K ADVANCED FROM UNISPHERE UPG=IC	ES-1	\$0
458-001-541	V100K ADVANCED FROM BASE PKG UPG=IC	ES-1	\$0
458-001-542	VMAX3 UNISPHERE FAST COMBO	ES-1	\$0
458-001-543	VMAX3 ADVANCED FAST COMBO	ES-1	\$0
458-001-544	VMAX3 SRDF FAST COMBO	ES-1	\$0
458-001-545	VMAX3 TIMEFINDER FAST COMBO LIC=IC	ES-1	\$0
458-001-547	VMAX3 SRDF REPFIL REG CAP=CA	ES-1	\$0
458-001-548	V100K SRDF REPFIL REG UPG CAP=CA	ES-1	\$0
458-001-549	VMAX3 TF SNAPSURE REG CAP=CA	ES-1	\$0
458-001-550	V100K TFSNAPSURE REG UPG CAP=CA	ES-1	\$0
458-001-551	VMAX3 DATA AT REST ENCRYPTION PRODUCT	ES-1	\$0
458-001-552	VMAX3 FAST.X CLOUDARRAY PRODUCT	ES-1	\$0
458-001-553	VMAX3 FAST.X PRODUCT	ES-1	\$0
458-001-554	VMAX3 SRDF METRO PRODUCT	ES-1	\$0
458-001-555	VMAX3 SRDF METRO REGISTERED PRODUCT	ES-1	\$0
458-001-556	VMAX3 SRDF METRO ADD ON PRODUCT	ES-1	\$0
458-001-557	VMAX3 SRDF METRO FAST COMBO PRODUCT	ES-1	\$0
458-001-558	VMAX3 SRDF METRO CONV REG TO FULL PRO	ES-1	\$0
458-001-559	VMAX3 ESA CAPACITY	ES-1	\$0
458-001-560	VMAX3 UNISPHERE360 PRODUCT	ES-1	\$0
458-001-561	VMAX3 MF ESSENTIALS PRODUCT	ES-1	\$0
458-001-562	VMAX3 MF ESSENTIALS PLUS PRODUCT	ES-1	\$0
458-001-563	VMAX3 AUTOSWAP PRODUCT	ES-1	\$0
458-001-564	VMAX3 ZDP FOR MF PRODUCT	ES-1	\$0
458-001-565	VMAX3 GDDR PRODUCT	ES-1	\$0
458-001-611	V400K ADVANCED FROM FNDATION PKG UPG=I	ES-1	\$0
458-001-612	V400K ADVANCED FROM UNISPHERE UPG=IC	ES-1	\$0
458-001-613	V400K ADVANCED FROM BASE PKG UPG=IC	ES-1	\$0
458-001-615	V400K SRDF REPFIL REG UPG CAP=CA	ES-1	\$0
458-001-616	V400K TFSNAPSURE REG UPG CAP=CA	ES-1	\$0
458-001-617	V200K ADVANCED FROM FNDATION PKG UPG=I	ES-1	\$0
458-001-618	V200K ADVANCED FROM UNISPHERE UPG=IC	ES-1	\$0
458-001-619	V200K ADVANCED FROM BASE PKG UPG=IC	ES-1	\$0
458-001-621	V200K SRDF REPFIL REG UPG CAP=CA	ES-1	\$0
458-001-622	V200K TFSNAPSURE REG UPG CAP=CA	ES-1	\$0

458-001-651	VS SRM VMAX3 Base=IC	ES-1	\$0
458-001-652	VS VIPRC VMAX3 Base=IC	ES-1	\$0
458-001-653	VS SRM VMAX3 TBu=CC	ES-1	\$0
458-001-654	VS VIPRC VMAX3 TBu=CC	ES-1	\$0
458-001-753	VIPR SRM FAST COMBO VMAX3 PRODUCT=CC	ES-1	\$780,900
458-001-900	RP/EX LOCAL FOR VMAX3	ES-1	\$0
458-001-901	RP/EX REMOTE FOR VMAX3	ES-1	\$0
458-001-938	ESA FOR V200K BASE LIC=IA	ES-1	\$5,145
458-001-939	ESA FOR V400K BASE LIC=IA	ES-1	\$5,145
APPSYNC-3-LS	AppSync License Solution for VMAX3=CB	ES-1	\$0
E-100K-UPG	VMAX 100K UPGRADE TRACKING	ES-1	\$0
E-10GE-CSRDF	VMAX VG 10 GIGE COM SRDF PT TRKNG MODEL	ES-1	\$0
E-10GE-SRDF	VMAX VG 10 GIGE SRDF PORT TRACKING MODEL	ES-1	\$0
E-13UF-UFD-3P	VMAX VG 1U/3U FILLER PANEL KIT 3RD PARTY	ES-1	\$285
E-1400MOD	VMAX VG FLASH MOD 1400	ES-1	\$34,930
E-1400MODCONV	VMAX VG FLASH MOD 1400 CONVERSION	ES-1	\$34,930
E-1400MODU	VMAX VG FLASH MOD 1400 UPG	ES-1	\$34,930
E-1400MODUF	VMAX VG FLASH MOD 1400 FD UPG	ES-1	\$34,930
E-1600MODS	VMAX VG FLASH MODS 1600	ES-1	\$34,930
E-1600MODSCONV	VMAX VG FLASH MOD 1600 CONVERSION	ES-1	\$34,930
E-1600MODSU	VMAX VG FLASH MODS 1600 UPG	ES-1	\$34,930
E-1600MODSUF	VMAX VG FLASH MODS 1600 FD UPG	ES-1	\$34,930
E-16FC-CSRDF	VMAX VG 16G FC COM SRDF PT TRKNG MODEL	ES-1	\$0
E-16FC-FASTX	FASTX 16G PORTS TRACKING MODEL	ES-1	\$0
E-16FC-PTP	PROTECTPNT PORT TRACKING MODEL	ES-1	\$0
E-16FC-SRDF	VMAX VG 16G FC SRDF PORT TRACKING MODEL	ES-1	\$0
E-1ENG	VMAX VG SINGLE ENGINE SYS BAY	ES-1	\$0
E-1ENG-3P	VMAX VG SINGLE ENGINE SYS BAY	ES-1	\$0
E-1ENGU	VMAX VG SINGLE ENGINE SYS BAY UPG	ES-1	\$0
E-1ENGU-3P	VMAX VG SINGLE ENGINE SYS BAY UPG	ES-1	\$0
E-200K-UPG	VMAX 200K UPGRADE TRACKING	ES-1	\$0
E-2ENG	VMAX VG DUAL ENGINE SYS BAY	ES-1	\$0
E-2ENG-3P	VMAX VG DUAL ENGINE SYS BAY	ES-1	\$0
E-2ENGU	VMAX VG DUAL ENGINE SYS BAY UPG	ES-1	\$0
E-2ENGU-3P	VMAX VG DUAL ENGINE SYS BAY UPG	ES-1	\$0
E-2ME1-3PUFD	VMAX VG ENG 1 IB CABLE KIT FD UPG 3P	ES-1	\$1,250
E-2ME2DUAL-3P	VMAX VG ENG 2 IB/ETH CABLE KIT 2ENG 3P	ES-1	\$1,250
E-2MENG2CBLUF	VMAX VG 2 MTR 2ND ENG CONTIBÐ CBL UP	ES-1	\$1,250
E-2METERCBL	VMAX VG 2 METER CONTIGIB ETH CABLE	ES-1	\$1,250
E-2METERCBLU	VMAX VG 2 METER CONTIGIB ETH CABLE UPG	ES-1	\$1,250
E-2UF-UFD-3P	VMAX VG 2U FILLER PANEL KIT 3RD PARTY	ES-1	\$285
E-350MOD	VMAX VG FLASH MOD 350	ES-1	\$9,320
E-350MODRET	VMAX VG FLASH MOD 350	ES-1	\$0
E-350MODU	VMAX VG FLASH MOD 350 UPG	ES-1	\$9,320
E-350MODUF	VMAX VG FLASH MOD 350 FD UPG	ES-1	\$9,320
E-3ME2-3P	VMAX VG ENG 2 IB/ETH CABLE KIT 3RD PARTY	ES-1	\$1,250
E-3ME2-3PUFD	VMAX VG ENG 2 IB/ETH CABLE KIT FD UPG 3P	ES-1	\$1,250
E-3ME3-3P	VMAX VG ENG 3 IB/ETH CABLE KIT 3RD PARTY	ES-1	\$1,250
E-3ME3-3PUFD	VMAX VG ENG 3 IB/ETH CABLE KIT FD UPG 3P	ES-1	\$1,250
E-3ME4DUAL-3P	VMAX VG ENG 4 IB/ETH CABLE KIT 2ENG 3P	ES-1	\$1,250

E-3ME6DUAL-3P	VMAX VG ENG 6 IB/ETH CABLE KIT 2ENG 3P	ES-1	\$1,250
E-3MENG4CBLUF	VMAX VG 3 MTR 2ND ENG CONTIBÐ CBL UP	ES-1	\$1,250
E-3MENG6CBLUF	VMAX VG 3 MTR 2ND ENG CONTIBÐ CBL UP	ES-1	\$1,250
E-3METERCBL	VMAX VG 3 METER CONTIGIB ETH CABLE	ES-1	\$1,250
E-3METERCBLU	VMAX VG 3 METER CONTIGIB ETH CABLE UPG	ES-1	\$1,250
E-3MX1X2-3PU	VMAX VG 3MET IB/ETH CABLE KIT NEW/UPG 3P	ES-1	\$1,250
E-400K-UPG	VMAX 400K UPGRADE TRACKING	ES-1	\$0
E-5ME4-3P	VMAX VG ENG 4 IB/ETH CABLE KIT 3RD PARTY	ES-1	\$1,250
E-5ME4-3PUFD	VMAX VG ENG 4 IB/ETH CABLE KIT FD UPG 3P	ES-1	\$1,250
E-5ME5-3P	VMAX VG ENG 5 IB/ETH CABLE KIT 3RD PARTY	ES-1	\$1,250
E-5ME5-3PUFD	VMAX VG ENG 5 IB/ETH CABLE KIT FD UPG 3P	ES-1	\$1,250
E-5ME6DUAL-3P	VMAX VG ENG 6 IB/ETH CABLE KIT 2ENG 3P	ES-1	\$1,250
E-5ME8DUAL-3P	VMAX VG ENG 8 IB/ETH CABLE KIT 2ENG 3P	ES-1	\$1,250
E-5MENG6CBLUF	VMAX VG 5 MTR 2ND ENG CONTIBÐ CBL UP	ES-1	\$1,250
E-5MENG8CBLUF	VMAX VG 5 MTR 2ND ENG CONTIBÐ CBL UP	ES-1	\$1,250
E-5METERCBL	VMAX VG 5 METER CONTIGIB ETH CABLE	ES-1	\$1,250
E-5METERCBLU	VMAX VG 5 METER CONTIGIB ETH CABLE UPG	ES-1	\$1,250
E-5MX3X4-3PU	VMAX VG 5MET IB/ETH CABLE KIT NEW/UPG 3P	ES-1	\$1,250
E-700MOD	VMAX VG FLASH MOD 700	ES-1	\$17,860
E-700MODCONV	VMAX VG FLASH MOD 700 CONVERSION	ES-1	\$17,860
E-700MODRET	VMAX VG FLASH MOD 700	ES-1	\$0
E-700MODU	VMAX VG FLASH MOD 700 UPG	ES-1	\$17,860
E-700MODUF	VMAX VG FLASH MOD 700 FD UPG	ES-1	\$17,860
E-8FC-CSRDF	VMAX VG 8G FC COM SRDF PT TRKNG MODEL	ES-1	\$0
E-8FC-FASTX	FASTX 8G PORTS TRACKING MODEL	ES-1	\$0
E-8FC-FASTXCAP	FASTX CAPACITY TRACKING MODEL	ES-1	\$0
E-8FC-SRDF	VMAX VG 8G FC SRDF PORT TRACKING MODEL	ES-1	\$0
E-8ME6-3P	VMAX VG ENG 6 IB/ETH CABLE KIT 3RD PARTY	ES-1	\$1,250
E-8ME6-3PUFD	VMAX VG ENG 6 IB/ETH CABLE KIT FD UPG 3P	ES-1	\$1,250
E-8ME7-3P	VMAX VG ENG 7 IB/ETH CABLE KIT 3RD PARTY	ES-1	\$1,250
E-8ME7-3PUFD	VMAX VG ENG 7 IB/ETH CABLE KIT FD UPG 3P	ES-1	\$1,250
E-8ME8-3P	VMAX VG ENG 8 IB/ETH CABLE KIT 3RD PARTY	ES-1	\$1,250
E-8ME8-3PUFD	VMAX VG ENG 8 IB/ETH CABLE KIT FD UPG 3P	ES-1	\$1,250
E-8ME8DUAL-3P	VMAX VG ENG 8 IB/ETH CABLE KIT 2ENG 3P	ES-1	\$1,250
E-8MENG8CBLUF	VMAX VG 8 MTR 2ND ENG CONTIBÐ CBL UP	ES-1	\$1,250
E-8METERCBL	VMAX VG 8 METER CONTIGIB ETH CABLE	ES-1	\$1,250
E-8METERCBLU	VMAX VG 8 METER CONTIGIB ETH CABLE UPG	ES-1	\$1,250
E8MX5X6X7-3PU	VMAX VG 8MET IB/ETH CABLE KIT NEW/UPG 3P	ES-1	\$1,250
EA-1024-2048UFD	VMAX 200K MEMCONV 2X512 to 2X1024 GB	ES-1	\$348,215
EA-1024ADD	VMAX 200K ADD 1024GB	ES-1	\$324,570
EA-1024ADD3P	VMAX 200K ADD 1024GB 3RD PARTY	ES-1	\$324,570
EA-1024ADDU	VMAX 200K ADD 1024GB UPG	ES-1	\$421,940
EA-1024ADDU3P	VMAX 200K ADD 1024GB UPG 3RD PARTY	ES-1	\$421,940
EA-1024ADDUFD	VMAX 200K ADD 1024GB UPG FIELD	ES-1	\$421,940
EA1024ADUFD3P	VMAX 200K ADD 1024GB UPG FIELD 3RD PARTY	ES-1	\$421,940
EA-1024BASE	VMAX 200K BASE 1024GB	ES-1	\$324,570
EA-1024BASE3P	VMAX 200K BASE 1024GB 3RD PARTY	ES-1	\$324,570
EA-1024-RET	VMAX 200K 1024GB MEMORY RETURN	ES-1	\$0
EA-2048ADD	VMAX 200K ADD 2048GB	ES-1	\$617,210
EA-2048ADD3P	VMAX 200K ADD 2048GB 3RD PARTY	ES-1	\$617,210

EA-2048ADDU	VMAX 200K ADD 2048GB UPG	ES-1	\$802,375
EA-2048ADDU3P	VMAX 200K ADD 2048GB UPG 3RD PARTY	ES-1	\$802,375
EA-2048ADDUFD	VMAX 200K ADD 2048GB UPG FIELD	ES-1	\$802,375
EA2048ADUFD3P	VMAX 200K ADD 2048GB UPG FIELD 3RD PARTY	ES-1	\$802,375
EA-2048BASE	VMAX 200K BASE 2048GB	ES-1	\$617,210
EA-2048BASE3P	VMAX 200K BASE 2048GB 3RD PARTY	ES-1	\$617,210
EA-512-1024UFD	VMAX 200K MEMCONV 2X256 to 2X512 GB	ES-1	\$87,730
EA-512-2048UFD	VMAX 200K MEMCONV 2X256 to 2X1024 GB	ES-1	\$348,215
EA-512ADD	VMAX 200K ADD 512GB	ES-1	\$253,220
EA-512ADD3P	VMAX 200K ADD 512GB 3RD PARTY	ES-1	\$253,220
EA-512ADDU	VMAX 200K ADD 512GB UPG	ES-1	\$329,190
EA-512ADDU3P	VMAX 200K ADD 512GB UPG 3RD PARTY	ES-1	\$329,190
EA-512ADDUFD	VMAX 200K ADD 512GB UPG FIELD	ES-1	\$329,190
EA512ADDUFD3P	VMAX 200K ADD 512GB UPG FIELD 3RD PARTY	ES-1	\$329,190
EA-512BASE	VMAX 200K BASE 512GB	ES-1	\$253,220
EA-512BASE3P	VMAX 200K BASE 512GB 3RD PARTY	ES-1	\$253,220
EA-512-RET	VMAX 200K 256GB MEMORY RETURN	ES-1	\$0
EA-AFA200K	VMAX 200K All Flash	ES-1	\$0
E-ACON3P-50	ADPTR AC 3PH 50A W3-4IN CONDUIT ADPTR	ES-1	\$400
EA-DATAMOVER	VMAX 200K DATA MOVER FOR NAS	ES-1	\$0
EA-DATAMOVERU	VMAX 200K DATA MOVER FOR NAS UPG	ES-1	\$0
EA-ISERIES	VMAX 200K ISERIES TRACKING MODEL	ES-1	\$0
EA-NAS-SN	Embedded NAS Base OE for VMAX 200K	ES-1	\$115,000
EA-NAS-SNU	EMBEDDED NAS BASE OE FOR VMAX 200K UPG	ES-1	\$115,000
E-ASSETTG-MS	CUSTOMER SPECIFD ASSET TAG - MICROSOFT	ES-1	\$0
EA-VFP1-200K	PROMO 200GB VFP200K 96	ES-1	\$0
EA-VFP1-200KU	PROMO 200GB VFP200K 32U	ES-1	\$0
EA-VFP2-200K	PROMO 200GB VFP200K 192	ES-1	\$0
EA-VFP2-200KU	PROMO 200GB VFP200K 48U	ES-1	\$0
EA-VFP3-200K	PROMO 400GB VFP200K 96	ES-1	\$0
EA-VFP3-200KU	PROMO 400GB VFP200K 32U	ES-1	\$0
EA-VFP4-200K	PROMO 400GB VFP200K 192	ES-1	\$0
EA-VFP4-200KU	PROMO 400GB VFP200K 48U	ES-1	\$0
EA-VFP5-200K	PROMO 800GB VFP200K 48	ES-1	\$0
EA-VFP5-200KU	PROMO 800GB VFP200K 16U	ES-1	\$0
EA-VFP6-200K	PROMO 800GB VFP200K 96	ES-1	\$0
EA-VFP6-200KU	PROMO 800GB VFP200K 24U	ES-1	\$0
EA-VFP7-200K	PROMO 1600GB VFP200K 24 Tracking Model	ES-1	\$0
EA-VFP7-200KU	PROMO 1600GB VFP200K 8U	ES-1	\$0
EA-VFP8-200K	PROMO 1600GB VFP200K 48 Tracking Model	ES-1	\$0
EA-VFP8-200KU	PROMO 1600GB VFP200K 12U	ES-1	\$0
E-BK40000E	VMAX VG FC BACKUP I/O FOR NAS	ES-1	\$2,100
E-BK40000EU	VMAX VG FC BACKUP I/O FOR NAS UPG	ES-1	\$5,460
E-BK40000EUF	VMAX VG FC BACKUP I/O FOR NAS CONV	ES-1	\$19,110
E-BLNK-SKINS	VMAX VG SIDE PANELS BLANK	ES-1	\$645
E-BLNK-SKINSU	VMAX VG SIDE PANELS BLANK UPG	ES-1	\$645
E-CHANGERATELRP	VMAX CHANGE RATE LREP TRACKING	ES-1	\$0
E-CNVINF-1PU	VMAX VG SINGLE PHASE PDU CONVERSION	ES-1	\$3,000
E-CNVINF-3DU	VMAX VG 3 PHASE DELTA PDU CONVERSION	ES-1	\$3,000
E-CNVINF-3YU	VMAX VG 3 PHASE WYE PDU CONVERSION	ES-1	\$3,000

E-COMPRESS	HDW COMPRESSION	ES-1	\$8,095
E-COMPRESSU	HDW COMPRESSION UPG	ES-1	\$10,525
E-COMPRESSUF	HDW COMPRESSION FD UPG	ES-1	\$27,605
E-DCH3MCBL	VMAX VG DAISY CHAIN 3 METER	ES-1	\$1,285
E-DCH3MCBLU	VMAX VG DAISY CHAIN 3 METER UPG	ES-1	\$1,285
E-DCH3MCBLUF	VMAX VG DAISY CHAIN 3 METER FD UPG	ES-1	\$1,285
E-DE120	VMAX VG 120 SLT DR ENCL	ES-1	\$25,300
E-DE120-3P	VMAX VG 120 SLT DR ENCL 3RD PARTY	ES-1	\$25,300
E-DE120U	VMAX VG 120 SLT DR ENCL UPG	ES-1	\$25,300
E-DE120U-3P	VMAX VG 120 SLT DR ENCL UPG 3RD PARTY	ES-1	\$25,300
E-DE120UFD	VMAX VG 120 SLT DR ENCL UFD	ES-1	\$25,300
E-DE120UFD-3P	VMAX VG 120 SLT DR ENCL UFD 3RD PARTY	ES-1	\$25,300
E-DE60	VMAX VG 60 SLT DR ENCL	ES-1	\$18,920
E-DE60-3P	VMAX VG 60 SLT DR ENCL 3RD PARTY	ES-1	\$18,920
E-DE60U	VMAX VG 60 SLT DR ENCL UPG	ES-1	\$18,920
E-DE60U-3P	VMAX VG 60 SLT DR ENCL UPG 3RD PARTY	ES-1	\$18,920
E-DE60UFD	VMAX VG 60 SLT DR ENCL UFD	ES-1	\$18,920
E-DE60UFD-3P	VMAX VG 60 SLT DR ENCL UFD 3RD PARTY	ES-1	\$18,920
E-DIR3MCBL	VMAX VG DIRECT CONNECT 3 METER	ES-1	\$1,285
E-DIR3MCBLU	VMAX VG DIRECT CONNECT 3 METER UPG	ES-1	\$1,285
E-DIR3MCBLUF	DIRECT CONNECT 3 METER FD UPG	ES-1	\$1,285
E-DIR3MCBLUF1	VMAX VG DIRECT CONNECT 3 MTR DAE1 FD UP	ES-1	\$1,285
E-DIR3MCBLUF2	VMAX VG DIRECT CONNECT 3 MTR DAE2 FD UP	ES-1	\$1,285
E-DIR3MCBLUF3	VMAX VG Std 1 Eng DAE3 (Direct A) Upgr	ES-1	\$1,285
E-DIR3MCBLUF4	VMAX VG Std 1 Eng DAE 4 (Direct B) Upgr	ES-1	\$1,285
E-DSOPTICE2	VMAX VG SYS BAY 2 DSP CBLOPTICS KIT	ES-1	\$15,285
E-DSOPTICE2U	VMAX VG SYS BAY 2 DSP CBLOPTICS KIT UPG	ES-1	\$15,285
E-DSOPTICE3	VMAX VG SYS BAY 3 DSP CBLOPTICS KIT	ES-1	\$15,285
E-DSOPTICE3U	VMAX VG SYS BAY 3 DSP CBLOPTICS KIT UPG	ES-1	\$15,285
E-DSOPTICE4	VMAX VG SYS BAY 4 DSP CBLOPTICS KIT	ES-1	\$15,285
E-DSOPTICE4U	VMAX VG SYS BAY 4 DSP CBLOPTICS KIT UPG	ES-1	\$15,285
E-DSOPTICE5	VMAX VG SYS BAY 5 DSP CBLOPTICS KIT	ES-1	\$15,285
E-DSOPTICE5U	VMAX VG SYS BAY 5 DSP CBLOPTICS KIT UPG	ES-1	\$15,285
E-DSOPTICE6	VMAX VG SYS BAY 6 DSP CBLOPTICS KIT	ES-1	\$15,285
E-DSOPTICE6U	VMAX VG SYS BAY 6 DSP CBLOPTICS KIT UPG	ES-1	\$15,285
E-DSOPTICE7	VMAX VG SYS BAY 7 DSP CBLOPTICS KIT	ES-1	\$15,285
E-DSOPTICE7U	VMAX VG SYS BAY 7 DSP CBLOPTICS KIT UPG	ES-1	\$15,285
E-DSOPTICE8	VMAX VG SYS BAY 8 DSP CBLOPTICS KIT	ES-1	\$15,285
E-DSOPTICE8U	VMAX VG SYS BAY 8 DSP CBLOPTICS KIT UPG	ES-1	\$15,285
E-DSP-1U	VMAX VG DSP SINGLE ENG SYS BAY	ES-1	\$0
E-DSP-2U	VMAX VG DSP DUAL ENG SYS BAY	ES-1	\$0
E-FABLA	VMAX 100K/200K FABRIC	ES-1	\$27,350
E-FABLA-3P	VMAX 100K/200K FABRIC 3RD PARTY	ES-1	\$27,350
E-FABLA-UFD	VMAX 100K/200K FABRIC UPGRADE	ES-1	\$27,350
E-FABLAUFD-3P	VMAX 100K/200K FABRIC UPGRADE 3RD PARTY	ES-1	\$27,350
E-FABR	VMAX 400K FABRIC	ES-1	\$46,560
E-FABR-3P	VMAX 400K FABRIC 3RD PARTY	ES-1	\$46,560
E-FABR-UFD	VMAX 400K FABRIC UPGRADE	ES-1	\$46,560
E-FABR-UFD-3P	VMAX 400K FABRIC UPGRADE 3RD PARTY	ES-1	\$46,560
E-FC-FTS	FTS PORTS TRACKING MODEL	ES-1	\$0

E-FC-PTP	PROTECTPNT PORT TRACKING MODEL	ES-1	\$0
E-FDOORDB	VMAX VG Drive Bay Hex Door Pair	ES-1	\$3,000
E-FDOORDBKEY	VMAX VG Drive Bay Key Door Pair	ES-1	\$3,000
E-FDOORDBU	Drive Bay Hex Door Pair Upg	ES-1	\$3,000
E-FDOORS1DKEYE	SB1 DUAL ENGINE KEY DELL DOOR	ES-1	\$3,000
E-FDOORS1KEYE	SB1 SINGLE ENGINE KEY DELL DOOR	ES-1	\$3,000
E-FDOORS28DKEYE	SB2-8 DUAL ENGINE KEY DELL DOOR	ES-1	\$3,000
E-FDOORS28KEYE	SB2-8 SINGLE ENGINE KEY DELL DOOR	ES-1	\$3,000
E-FDOORSYS1	VMAX VG SB1 Single Engine Hex Door Pair	ES-1	\$3,000
E-FDOORSYS1D	VMAX VG SB1 Dual Engine Hex Door Pair	ES-1	\$3,000
E-FDOORSYS1DE	SB1 DUAL ENGINE HEX DELL DOOR	ES-1	\$3,000
E-FDOORSYS1E	SB1 SINGLE ENGINE HEX DELL DOOR	ES-1	\$3,000
E-FDOORSYS28	VMAX VG SB2-8 Single Engine Hex DoorPair	ES-1	\$3,000
E-FDOORSYS28D	VMAX VG SB2-8 Dual Engine Hex Door Pair	ES-1	\$3,000
E-FDOORSYS28DE	SB2-8 DUAL ENGINE HEX DELL DOOR	ES-1	\$3,000
E-FDOORSYS28DU	SB2-8 Dual Engine Hex Door Pair Upg	ES-1	\$3,000
E-FDOORSYS28DUE	SB2-8 DUAL ENGINE HEX DELL DOOR UPG	ES-1	\$3,000
E-FDOORSYS28E	SB2-8 SINGLE ENGINE HEX DELL DOOR	ES-1	\$3,000
E-FDOORSYS28U	SB2-8 Single Engine Hex Door Pair Upg	ES-1	\$3,000
E-FDOORSYS28UE	SB2-8 SINGLE ENGINE HEX DELL DOOR UPG	ES-1	\$3,000
E-FE00008S	VMAX VG 8SM 16G FICON	ES-1	\$15,575
E-FE00080S	VMAX VG 8MM 16G FICON	ES-1	\$7,150
E-FE00200TC	VMAX VG 2PT 10 GBE BASE T	ES-1	\$2,200
E-FE00200TCRT	VMAX VG 2PT 10 GBE BASE T RETURN	ES-1	\$0
E-FE00200TO	VMAX VG 2PT 10 GBE OPTICAL	ES-1	\$2,100
E-FE00200TORT	VMAX VG 2PT 10 GBE OPTICAL RETURN	ES-1	\$0
E-FE00200TOU	VMAX VG 2PT 10 GBE OPTICAL UPG	ES-1	\$5,460
E-FE00200TOUF	VMAX VG 2PT 10 GBE OPTICAL CONV	ES-1	\$9,555
E-FE00200TU	VMAX VG 2PT 10 GBE BASE T UPG	ES-1	\$5,720
E-FE00200TUF	VMAX VG 2PT 10 GBE BASE T CONV	ES-1	\$20,020
E-FE00400C	VMAX VG 4PT GBE BASE T	ES-1	\$2,000
E-FE00400C4	VMAX VG 4MM4 COPR GIGE	ES-1	\$1,980
E-FE00400C4U	VMAX VG 4MM4 COPR GIGE UPG	ES-1	\$2,575
E-FE00400C4UF	VMAX VG 4MM4 COPR GIGE CONV	ES-1	\$9,000
E-FE00400CU	VMAX VG 4PT GBE BASE T UPG	ES-1	\$5,200
E-FE00400CUF	VMAX VG 4PT GBE BASE T CONV	ES-1	\$18,200
E-FE00400T	VMAX VG 4MM 10 GIGE	ES-1	\$3,650
E-FE00400TOUF	VMAX VG 4MM 10 GIGE OPTICAL CONV	ES-1	\$19,110
E-FE00400TU	VMAX VG 4MM 10 GIGE UPG	ES-1	\$4,745
E-FE00400TUF	VMAX VG 4MM 10 GIGE CONV	ES-1	\$16,600
E-FE00800T	VMAX VG 8MM 10GIGE	ES-1	\$5,475
E-FE08000E	VMAX VG 8SM 8G FIBRE	ES-1	\$4,140
E-FE08000EU	VMAX VG 8SM 8G FIBRE UPG	ES-1	\$5,385
E-FE08000EUF	VMAX VG 8SM 8G FIBRE CONV	ES-1	\$18,250
E-FE08000S	VMAX VG 8SM 16G FC	ES-1	\$10,805
E-FE08000SUF	VMAX VG 8SM 16G FC CONV	ES-1	\$32,410
E-FE44000E	VMAX VG 4MM4SM 8G FIBRE	ES-1	\$3,315
E-FE44000EU	VMAX VG 4MM4SM 8G FIBRE UPG	ES-1	\$4,310
E-FE44000EUF	VMAX VG 4MM4SM 8G FIBRE CONV	ES-1	\$13,270
E-FE62000E	VMAX VG 6MM2SM 8G FIBRE	ES-1	\$2,395

E-FE62000EU	VMAX VG 6MM2SM 8G FIBRE UPG	ES-1	\$3,115
E-FE62000EUF	VMAX VG 6MM2SM 8G FIBRE CONV	ES-1	\$9,335
E-FE62000UF	VMAX VG 6MM2SM 8G FIBRE CONV	ES-1	\$9,335
E-FE80000E	VMAX VG 8MM 8G FIBRE	ES-1	\$2,070
E-FE80000EU	VMAX VG 8MM 8G FIBRE UPG	ES-1	\$2,690
E-FE80000EUF	VMAX VG 8MM 8G FIBRE CONV	ES-1	\$8,285
E-FE80000S	VMAX VG 8MM 16G FC	ES-1	\$5,400
E-FE80000SUF	VMAX VG 8MM 16G FC CONV	ES-1	\$21,645
E-GE-CSRDF	VMAX VG GIGE COM SRDF PT TRKNG MODEL	ES-1	\$0
E-GE-SRDF	VMAX VG GIGE SRDF PORT TRACKING MODEL	ES-1	\$0
EL-1024ADD	V100K ADD2 1024GB	ES-1	\$112,000
EL-1024ADD-3P	V100K ADD2 1024GB 3RD PARTY	ES-1	\$112,000
EL-1024ADDU	V100K ADD2 1024GB UPG	ES-1	\$145,600
EL-1024ADDU3P	V100K ADD2 1024GB UPG 3RD PARTY	ES-1	\$145,600
EL-1024ADDUFD	V100K ADD2 1024GB UPG FIELD	ES-1	\$145,600
EL1024ADUFD3P	V100K ADD2 1024GB UPG FIELD 3RD PARTY	ES-1	\$145,600
EL-1024BASE	VMAX 100K BASE 1024GB	ES-1	\$58,800
EL-1024BASE3P	VMAX 100K BASE 1024GB 3RD PARTY	ES-1	\$58,800
EL-512-1024UFD	VMAX 100K MEMCONV 2X256 to 2X512 GB	ES-1	\$42,275
EL-512ADD	V100K ADD2 512GB	ES-1	\$43,710
EL-512ADD-3P	V100K ADD2 512GB 3RD PARTY	ES-1	\$43,710
EL-512ADDU	V100K ADD2 512GB UPG	ES-1	\$56,825
EL-512ADDU-3P	V100K ADD2 512GB UPG 3RD PARTY	ES-1	\$56,825
EL-512ADDUFD	V100K ADD2 512GB UPG FIELD	ES-1	\$56,825
EL512ADDUFD3P	V100K ADD2 512GB UPG FIELD 3RD PARTY	ES-1	\$56,825
EL-512BASE	VMAX 100K BASE 512GB	ES-1	\$43,710
EL-512BASE-3P	VMAX 100K BASE 512GB 3RD PARTY	ES-1	\$43,710
EL-512-RET	VMAX 100K 512GB MEMORY RETURN	ES-1	\$0
EL61012001B	VMAX VG 1200GB 10K SAS DRV R1	ES-1	\$1,665
EL61012001BTU	VMAX VG 1200GB 10K SAS DRV R1 TAA UPG	ES-1	\$2,330
EL61012001BU	VMAX VG 1200GB 10K SAS DRV R1 UPG	ES-1	\$2,330
EL61012005B	VMAX VG 1200GB 10K SAS DRV R5(3+1)	ES-1	\$1,665
EL61012005BTU	VMAX VG 1200GB 10K SAS DRV R5(3+1)TAAUPG	ES-1	\$2,330
EL61012005BU	VMAX VG 1200GB 10K SAS DRV R5(3+1) UPG	ES-1	\$2,330
EL61012006B	VMAX VG 1200 10K SAS DRV R6(6+2)	ES-1	\$1,665
EL61012006BTU	VMAX VG 1200GB 10K SAS DRV R6(6+2)TAAUPG	ES-1	\$2,330
EL61012006BU	VMAX VG 1200GB 10K SAS DRV R6(6+2) UPG	ES-1	\$2,330
EL61012007B	VMAX VG 1200GB 10K SAS DRV R5(7+1)	ES-1	\$1,665
EL61012007BTU	VMAX VG 1200GB 10K SAS DRV R5(7+1)TAAUPG	ES-1	\$2,330
EL61012007BU	VMAX VG 1200GB 10K SAS DRV R5(7+1) UPG	ES-1	\$2,330
EL6101200FB	VMAX VG 1200GB 10K SAS DRV R6(14+2)	ES-1	\$1,665
EL6101200FBTU	VMAX VG 1200GB 10K SASDRV R6(14+2)TAAUPG	ES-1	\$2,330
EL6101200FBU	VMAX VG 1200GB 10K SAS DRV R6(14+2) UPG	ES-1	\$2,330
EL6101200SB	VMAX VG 1200GB 10K SAS DRV SPARE	ES-1	\$1,665
EL6101200SBTU	VMAX VG 1200GB 10K SAS DRV SPARE TAA UPG	ES-1	\$2,330
EL6101200SBU	VMAX VG 1200GB 10K SAS DRV SPARE UPG	ES-1	\$2,330
EL6103001B	VMAX VG 300GB 10K SAS DRV R1	ES-1	\$575
EL6103001BTU	VMAX VG 300GB 10K SAS DRV R1 TAA UPG	ES-1	\$805
EL6103001BU	VMAX VG 300GB 10K SAS DRV R1 UPG	ES-1	\$805
EL6103005B	VMAX VG 300GB 10K SAS DRV R5(3+1)	ES-1	\$575

EL6103005BTU	VMAX VG 300GB 10K SAS DRV R5(3+1)TAA UPG	ES-1	\$805
EL6103005BU	VMAX VG 300GB 10K SAS DRV R5(3+1) UPG	ES-1	\$805
EL6103006B	VMAX VG 300GB 10K SAS DRV R6(6+2)	ES-1	\$575
EL6103006BTU	VMAX VG 300GB 10K SAS DRV R6(6+2)TAA UPG	ES-1	\$805
EL6103006BU	VMAX VG 300GB 10K SAS DRV R6(6+2) UPG	ES-1	\$805
EL6103007B	VMAX VG 300GB 10K SAS DRV R5(7+1)	ES-1	\$575
EL6103007BTU	VMAX VG 300GB 10K SAS DRV R5(7+1)TAA UPG	ES-1	\$805
EL6103007BU	VMAX VG 300GB 10K SAS DRV R5(7+1) UPG	ES-1	\$805
EL610300FB	VMAX VG 300GB 10K SAS DRV R6(14+2)	ES-1	\$575
EL610300FBTU	VMAX VG 300GB 10K SAS DRV R6(14+2)TAAUPG	ES-1	\$805
EL610300FBU	VMAX VG 300GB 10K SAS DRV R6(14+2) UPG	ES-1	\$805
EL610300SB	VMAX VG 300GB 10K SAS DRV SPARE	ES-1	\$575
EL610300SBTU	VMAX VG 300GB 10K SAS DRV SPARE TAA UPG	ES-1	\$805
EL610300SBU	VMAX VG 300GB 10K SAS DRV SPARE UPG	ES-1	\$805
EL6106001B	VMAX VG 600GB 10K SAS DRV R1	ES-1	\$1,080
EL6106001BTU	VMAX VG 600GB 10K SAS DRV R1 TAA UPG	ES-1	\$1,510
EL6106001BU	VMAX VG 600GB 10K SAS DRV R1 UPG	ES-1	\$1,510
EL6106005B	VMAX VG 600GB 10K SAS DRV R5(3+1)	ES-1	\$1,080
EL6106005BTU	VMAX VG 600GB 10K SAS DRV R5(3+1)TAA UPG	ES-1	\$1,510
EL6106005BU	VMAX VG 600GB 10K SAS DRV R5(3+1) UPG	ES-1	\$1,510
EL6106006B	VMAX VG 600GB 10K SAS DRV R6(6+2)	ES-1	\$1,080
EL6106006BTU	VMAX VG 600GB 10K SAS DRV R6(6+2)TAA UPG	ES-1	\$1,510
EL6106006BU	VMAX VG 600GB 10K SAS DRV R6(6+2) UPG	ES-1	\$1,510
EL6106007B	VMAX VG 600GB 10K SAS DRV R5(7+1)	ES-1	\$1,080
EL6106007BTU	VMAX VG 600GB 10K SAS DRV R5(7+1)TAA UPG	ES-1	\$1,510
EL6106007BU	VMAX VG 600GB 10K SAS DRV R5(7+1) UPG	ES-1	\$1,510
EL610600FB	VMAX VG 600GB 10K SAS DRV R6(14+2)	ES-1	\$1,080
EL610600FBTU	VMAX VG 600GB 10K SAS DRV R6(14+2)TAAUPG	ES-1	\$1,510
EL610600FBU	VMAX VG 600GB 10K SAS DRV R6(14+2) UPG	ES-1	\$1,510
EL610600SB	VMAX VG 600GB 10K SAS DRV SPARE	ES-1	\$1,080
EL610600SBTU	VMAX VG 600GB 10K SAS DRV SPARE TAA UPG	ES-1	\$1,510
EL610600SBU	VMAX VG 600GB 10K SAS DRV SPARE UPG	ES-1	\$1,510
EL6153001BTU	VMAX VG 300GB 15K SAS DRV R1 TAA UPG	ES-1	\$2,065
EL6153001BU	VMAX VG 300GB 15K SAS DRV R1 UPG	ES-1	\$2,065
EL6153005BTU	VMAX VG 300GB 15K SAS DRV R5(3+1)TAA UPG	ES-1	\$2,065
EL6153005BU	VMAX VG 300GB 15K SAS DRV R5(3+1) UPG	ES-1	\$2,065
EL6153006BTU	VMAX VG 300GB 15K SAS DRV R6(6+2)TAA UPG	ES-1	\$2,065
EL6153006BU	VMAX VG 300GB 15K SAS DRV R6(6+2) UPG	ES-1	\$2,065
EL6153007BTU	VMAX VG 300GB 15K SAS DRV R5(7+1)TAA UPG	ES-1	\$2,065
EL6153007BU	VMAX VG 300GB 15K SAS DRV R5(7+1) UPG	ES-1	\$2,065
EL615300FBTU	VMAX VG 300GB 15K SAS DRV R6(14+2)TAAUPG	ES-1	\$2,065
EL615300FBU	VMAX VG 300GB 15K SAS DRV R6(14+2) UPG	ES-1	\$2,065
EL615300SBTU	VMAX VG 300GB 15K SAS DRV SPARE TAA UPG	ES-1	\$2,065
EL615300SBU	VMAX VG 300GB 15K SAS DRV SPARE UPG	ES-1	\$2,065
EL6F319201BT0	VMAX3 1920GB FLASH R1	ES-1	\$22,775
EL6F319201BT1	VMAX3 1920GB FLASH R1 1-31	ES-1	\$22,775
EL6F319201BT10	VMAX3 1920GB FLASH R1 128+	ES-1	\$16,465
EL6F319201BT2	VMAX3 1920GB FLASH R1 1-47	ES-1	\$22,775
EL6F319201BT3	VMAX3 1920GB FLASH R1 16-31	ES-1	\$19,935
EL6F319201BT4	VMAX3 1920GB FLASH R1 32-47	ES-1	\$18,400

EL6F319201BT5	VMAX3 1920GB FLASH R1 48+	ES-1	\$18,770
EL6F319201BT6	VMAX3 1920GB FLASH R1 48-95	ES-1	\$17,455
EL6F319201BT7	VMAX3 1920GB FLASH R1 48-63	ES-1	\$16,465
EL6F319201BT8	VMAX3 1920GB FLASH R1 64-95	ES-1	\$16,465
EL6F319201BT9	VMAX3 1920GB FLASH R1 96-127	ES-1	\$16,465
EL6F319205BT0	VMAX3 1920GB FLASH R5(3+1)	ES-1	\$22,775
EL6F319205BT1	VMAX3 1920GB FLASH R5(3+1) 1-31	ES-1	\$22,775
EL6F319205BT10	VMAX3 1920GB FLASH R5(3+1) 128+	ES-1	\$16,465
EL6F319205BT2	VMAX3 1920GB FLASH R5(3+1) 1-47	ES-1	\$22,775
EL6F319205BT3	VMAX3 1920GB FLASH R5(3+1) 16-31	ES-1	\$19,935
EL6F319205BT4	VMAX3 1920GB FLASH R5(3+1) 32-47	ES-1	\$18,400
EL6F319205BT5	VMAX3 1920GB FLASH R5(3+1) 48+	ES-1	\$18,770
EL6F319205BT6	VMAX3 1920GB FLASH R5(3+1) 48-95	ES-1	\$17,455
EL6F319205BT7	VMAX3 1920GB FLASH R5(3+1) 48-63	ES-1	\$16,465
EL6F319205BT8	VMAX3 1920GB FLASH R5(3+1) 64-95	ES-1	\$16,465
EL6F319205BT9	VMAX3 1920GB FLASH R5(3+1) 96-127	ES-1	\$16,465
EL6F319206BT0	VMAX3 1920GB FLASH R6(6+2)	ES-1	\$22,775
EL6F319206BT1	VMAX3 1920GB FLASH R6(6+2) 1-31	ES-1	\$22,775
EL6F319206BT10	VMAX3 1920GB FLASH R6(6+2) 128+	ES-1	\$16,465
EL6F319206BT2	VMAX3 1920GB FLASH R6(6+2) 1-47	ES-1	\$22,775
EL6F319206BT3	VMAX3 1920GB FLASH R6(6+2) 16-31	ES-1	\$19,935
EL6F319206BT4	VMAX3 1920GB FLASH R6(6+2) 32-47	ES-1	\$18,400
EL6F319206BT5	VMAX3 1920GB FLASH R6(6+2) 48+	ES-1	\$18,770
EL6F319206BT6	VMAX3 1920GB FLASH R6(6+2) 48-95	ES-1	\$17,455
EL6F319206BT7	VMAX3 1920GB FLASH R6(6+2) 48-63	ES-1	\$16,465
EL6F319206BT8	VMAX3 1920GB FLASH R6(6+2) 64-95	ES-1	\$16,465
EL6F319206BT9	VMAX3 1920GB FLASH R6(6+2) 96-127	ES-1	\$16,465
EL6F319207BT0	VMAX3 1920GB FLASH R5(7+1)	ES-1	\$22,775
EL6F319207BT1	VMAX3 1920GB FLASH R5(7+1) 1-31	ES-1	\$22,775
EL6F319207BT10	VMAX3 1920GB FLASH R5(7+1) 128+	ES-1	\$16,465
EL6F319207BT2	VMAX3 1920GB FLASH R5(7+1) 1-47	ES-1	\$22,775
EL6F319207BT3	VMAX3 1920GB FLASH R5(7+1) 16-31	ES-1	\$19,935
EL6F319207BT4	VMAX3 1920GB FLASH R5(7+1) 32-47	ES-1	\$18,400
EL6F319207BT5	VMAX3 1920GB FLASH R5(7+1) 48+	ES-1	\$18,770
EL6F319207BT6	VMAX3 1920GB FLASH R5(7+1) 48-95	ES-1	\$17,455
EL6F319207BT7	VMAX3 1920GB FLASH R5(7+1) 48-63	ES-1	\$16,465
EL6F319207BT8	VMAX3 1920GB FLASH R5(7+1) 64-95	ES-1	\$16,465
EL6F319207BT9	VMAX3 1920GB FLASH R5(7+1) 96-127	ES-1	\$16,465
EL6F31920FBT0	VMAX3 1920GB FLASH R6(14+2)	ES-1	\$22,775
EL6F31920FBT1	VMAX3 1920GB FLASH R6(14+2) 1-31	ES-1	\$22,775
EL6F31920FBT10	VMAX3 1920GB FLASH R6(14+2) 128+	ES-1	\$16,465
EL6F31920FBT2	VMAX3 1920GB FLASH R6(14+2) 1-47	ES-1	\$22,775
EL6F31920FBT3	VMAX3 1920GB FLASH R6(14+2) 16-31	ES-1	\$19,935
EL6F31920FBT4	VMAX3 1920GB FLASH R6(14+2) 32-47	ES-1	\$18,400
EL6F31920FBT5	VMAX3 1920GB FLASH R6(14+2) 48+	ES-1	\$18,770
EL6F31920FBT6	VMAX3 1920GB FLASH R6(14+2) 48-95	ES-1	\$17,455
EL6F31920FBT7	VMAX3 1920GB FLASH R6(14+2) 48-63	ES-1	\$16,465
EL6F31920FBT8	VMAX3 1920GB FLASH R6(14+2) 64-95	ES-1	\$16,465
EL6F31920FBT9	VMAX3 1920GB FLASH R6(14+2) 96-127	ES-1	\$16,465
EL6F31920SBT0	VMAX3 1920GB FLASH SPARE	ES-1	\$22,775

EL6F39601BT0	VMAX3 960GB FLASH R1	ES-1	\$13,195
EL6F39601BT1	VMAX3 960GB FLASH R1 1-63	ES-1	\$13,195
EL6F39601BT2	VMAX3 960GB FLASH R1 1-95	ES-1	\$13,195
EL6F39601BT3	VMAX3 960GB FLASH R1 32-63	ES-1	\$11,220
EL6F39601BT4	VMAX3 960GB FLASH R1 64-95	ES-1	\$10,660
EL6F39601BT5	VMAX3 960GB FLASH R1 96+	ES-1	\$10,660
EL6F39601BT6	VMAX3 960GB FLASH R1 96-127	ES-1	\$10,100
EL6F39601BT7	VMAX3 960GB FLASH R1 128-191	ES-1	\$9,540
EL6F39601BT8	VMAX3 960GB FLASH R1 192-255	ES-1	\$9,540
EL6F39601BT9	VMAX3 960GB FLASH R1 256+	ES-1	\$9,540
EL6F39605BT0	VMAX3 960GB FLASH R5(3+1)	ES-1	\$13,195
EL6F39605BT1	VMAX3 960GB FLASH R5(3+1) 1-63	ES-1	\$13,195
EL6F39605BT2	VMAX3 960GB FLASH R5(3+1) 1-95	ES-1	\$13,195
EL6F39605BT3	VMAX3 960GB FLASH R5(3+1) 32-63	ES-1	\$11,220
EL6F39605BT4	VMAX3 960GB FLASH R5(3+1) 64-95	ES-1	\$10,660
EL6F39605BT5	VMAX3 960GB FLASH R5(3+1) 96+	ES-1	\$10,660
EL6F39605BT6	VMAX3 960GB FLASH R5(3+1) 96-127	ES-1	\$10,100
EL6F39605BT7	VMAX3 960GB FLASH R5(3+1) 128-191	ES-1	\$9,540
EL6F39605BT8	VMAX3 960GB FLASH R5(3+1) 192-255	ES-1	\$9,540
EL6F39605BT9	VMAX3 960GB FLASH R5(3+1) 256+	ES-1	\$9,540
EL6F39606BT0	VMAX3 960GB FLASH R6(6+2)	ES-1	\$13,195
EL6F39606BT1	VMAX3 960GB FLASH R6(6+2) 1-63	ES-1	\$13,195
EL6F39606BT2	VMAX3 960GB FLASH R6(6+2) 1-95	ES-1	\$13,195
EL6F39606BT3	VMAX3 960GB FLASH R6(6+2) 32-63	ES-1	\$11,220
EL6F39606BT4	VMAX3 960GB FLASH R6(6+2) 64-95	ES-1	\$10,660
EL6F39606BT5	VMAX3 960GB FLASH R6(6+2) 96+	ES-1	\$10,660
EL6F39606BT6	VMAX3 960GB FLASH R6(6+2) 96-127	ES-1	\$10,100
EL6F39606BT7	VMAX3 960GB FLASH R6(6+2) 128-191	ES-1	\$9,540
EL6F39606BT8	VMAX3 960GB FLASH R6(6+2) 192-255	ES-1	\$9,540
EL6F39606BT9	VMAX3 960GB FLASH R6(6+2) 256+	ES-1	\$9,540
EL6F39607BT0	VMAX3 960GB FLASH R5(7+1)	ES-1	\$13,195
EL6F39607BT1	VMAX3 960GB FLASH R5(7+1) 1-63	ES-1	\$13,195
EL6F39607BT2	VMAX3 960GB FLASH R5(7+1) 1-95	ES-1	\$13,195
EL6F39607BT3	VMAX3 960GB FLASH R5(7+1) 32-63	ES-1	\$11,220
EL6F39607BT4	VMAX3 960GB FLASH R5(7+1) 64-95	ES-1	\$10,660
EL6F39607BT5	VMAX3 960GB FLASH R5(7+1) 96+	ES-1	\$10,660
EL6F39607BT6	VMAX3 960GB FLASH R5(7+1) 96-127	ES-1	\$10,100
EL6F39607BT7	VMAX3 960GB FLASH R5(7+1) 128-191	ES-1	\$9,540
EL6F39607BT8	VMAX3 960GB FLASH R5(7+1) 192-255	ES-1	\$9,540
EL6F39607BT9	VMAX3 960GB FLASH R5(7+1) 256+	ES-1	\$9,540
EL6F3960FBT0	VMAX3 960GB FLASH R6(14+2)	ES-1	\$13,195
EL6F3960FBT1	VMAX3 960GB FLASH R6(14+2) 1-63	ES-1	\$13,195
EL6F3960FBT2	VMAX3 960GB FLASH R6(14+2) 1-95	ES-1	\$13,195
EL6F3960FBT3	VMAX3 960GB FLASH R6(14+2) 32-63	ES-1	\$11,220
EL6F3960FBT4	VMAX3 960GB FLASH R6(14+2) 64-95	ES-1	\$10,660
EL6F3960FBT5	VMAX3 960GB FLASH R6(14+2) 96+	ES-1	\$10,660
EL6F3960FBT6	VMAX3 960GB FLASH R6(14+2) 96-127	ES-1	\$10,100
EL6F3960FBT7	VMAX3 960GB FLASH R6(14+2) 128-191	ES-1	\$9,540
EL6F3960FBT8	VMAX3 960GB FLASH R6(14+2) 192-255	ES-1	\$9,540
EL6F3960FBT9	VMAX3 960GB FLASH R6(14+2) 256+	ES-1	\$9,540

EL6F3960SBT0	VMAX3 960GB FLASH SPARE	ES-1	\$13,195
EL6FM16001B	VMAX 1600GB FLASH DRIVE R1	ES-1	\$22,600
EL6FM16001BFP	VMAX VG PROMO 1600GB FLASH DRIVE R1	ES-1	\$0
EL6FM16001BTU	VMAX 1600GB FLASH DRIVE R1 TAA UPG	ES-1	\$31,640
EL6FM16001BU	VMAX 1600GB FLASH DRIVE R1 UPG	ES-1	\$31,640
EL6FM16005B	VMAX 1600GB FLASH DRIVE R5(3+1)	ES-1	\$22,600
EL6FM16005BFP	VMAX VG PROMO 1600GB FLASH DRIVE R5(3+1)	ES-1	\$0
EL6FM16005BTU	VMAX 1600GB FLASH DRIVE R5(3+1) TAA UPG	ES-1	\$31,640
EL6FM16005BU	VMAX 1600GB FLASH DRIVE R5(3+1) UPG	ES-1	\$31,640
EL6FM16006B	VMAX VG 1600GB FLASH DRIVE R6(6+2)	ES-1	\$22,600
EL6FM16006BTU	VMAX VG 1600GB FLASH DRIVE R6(6+2)TAAUPG	ES-1	\$31,640
EL6FM16006BU	VMAX VG 1600GB FLASH DRIVE R6(6+2)UPG	ES-1	\$31,640
EL6FM16006FBTU	VMAX VG 1600GB FLASH DRV R6(14+2)TAAUPG	ES-1	\$31,640
EL6FM16007B	VMAX 1600GB FLASH DRIVE R5(7+1)	ES-1	\$22,600
EL6FM16007BFP	VMAX VG PROMO 1600GB FLASH DRIVE R5(7+1)	ES-1	\$0
EL6FM16007BTU	VMAX 1600GB FLASH DRIVE R5(7+1)TAAUPG	ES-1	\$31,640
EL6FM16007BU	VMAX 1600GB FLASH DRIVE R5(7+1)UPG	ES-1	\$31,640
EL6FM1600FB	VMAX VG 1600GB FLASH DRIVE R6(14+2)	ES-1	\$22,600
EL6FM1600FBU	VMAX VG 1600GB FLASH DRIVE R6(14+2)UPG	ES-1	\$31,640
EL6FM1600SB	VMAX 1600GB FLASH DRIVE SPARE	ES-1	\$22,600
EL6FM1600SBFP	VMAX VG PROMO 1600GB FLASH DRIVE SPARE	ES-1	\$0
EL6FM1600SBTU	VMAX 1600GB FLASH DRIVE SPARE TAA UPG	ES-1	\$31,640
EL6FM1600SBU	VMAX 1600GB FLASH DRIVE SPARE UPG	ES-1	\$31,640
EL6FM2001B	VMAX VG 200GB FLASH DRIVE R1	ES-1	\$3,905
EL6FM2001BFP	VMAX VG PROMO 200GB FLASH DRIVE R1	ES-1	\$0
EL6FM2001BTU	VMAX VG 200GB FLASH DRIVE R1 TAA UPG	ES-1	\$5,475
EL6FM2001BU	VMAX VG 200GB FLASH DRIVE R1 UPG	ES-1	\$5,475
EL6FM2005B	VMAX VG 200GB FLASH DRIVE R5(3+1)	ES-1	\$3,905
EL6FM2005BFP	VMAX VG PROMO 200GB FLASH DRIVE R5(3+1)	ES-1	\$0
EL6FM2005BTU	VMAX VG 200GB FLASH DRIVE R5(3+1)TAA UPG	ES-1	\$5,475
EL6FM2005BU	VMAX VG 200GB FLASH DRIVE R5(3+1) UPG	ES-1	\$5,475
EL6FM2006B	VMAX VG 200GB FLASH DRIVE R6(6+2)	ES-1	\$3,905
EL6FM2006BTU	VMAX VG 200GB FLASH DRIVE R6(6+2)TAAUPG	ES-1	\$5,475
EL6FM2006BU	VMAX VG 200GB FLASH DRIVE R6(6+2)UPG	ES-1	\$5,475
EL6FM2007B	VMAX VG 200GB FLASH DRIVE R5(7+1)	ES-1	\$3,905
EL6FM2007BFP	VMAX VG PROMO 200GB FLASH DRIVE R5(7+1)	ES-1	\$0
EL6FM2007BTU	VMAX VG 200GB FLASH DRIVE R5(7+1)TAA UPG	ES-1	\$5,475
EL6FM2007BU	VMAX VG 200GB FLASH DRIVE R5(7+1) UPG	ES-1	\$5,475
EL6FM200FB	VMAX VG 200GB FLASH DRIVE R6(14+2)	ES-1	\$3,905
EL6FM200FBTU	VMAX VG 200GB FLASH DRIVE R6(14+2)TAAUPG	ES-1	\$5,475
EL6FM200FBU	VMAX VG 200GB FLASH DRIVE R6(14+2)UPG	ES-1	\$5,475
EL6FM200SB	VMAX VG 200GB FLASH DRIVE SPARE	ES-1	\$3,905
EL6FM200SBFP	VMAX VG PROMO 200GB FLASH DRIVE SPARE	ES-1	\$0
EL6FM200SBTU	VMAX VG 200GB FLASH DRIVE SPARE TAA UPG	ES-1	\$5,475
EL6FM200SBU	VMAX VG 200GB FLASH DRIVE SPARE UPG	ES-1	\$5,475
EL6FM4001B	VMAX VG 400GB FLASH DRIVE R1	ES-1	\$7,425
EL6FM4001BFP	VMAX VG PROMO 400GB FLASH DRIVE R1	ES-1	\$0
EL6FM4001BTU	VMAX VG 400GB FLASH DRIVE R1 TAA UPG	ES-1	\$10,395
EL6FM4001BU	VMAX VG 400GB FLASH DRIVE R1 UPG	ES-1	\$10,395
EL6FM4005B	VMAX VG 400GB FLASH DRIVE R5(3+1)	ES-1	\$7,425

EL6FM4005BFP	VMAX VG PROMO 400GB FLASH DRIVE R5(3+1)	ES-1	\$0
EL6FM4005BTU	VMAX VG 400GB FLASH DRIVE R5(3+1)TAA UPG	ES-1	\$10,395
EL6FM4005BU	VMAX VG 400GB FLASH DRIVE R5(3+1) UPG	ES-1	\$10,395
EL6FM4006B	VMAX VG 400GB FLASH DRIVE R6(6+2)	ES-1	\$7,425
EL6FM4006BTU	VMAX VG 400GB FLASH DRIVE R6(6+2)TAAUPG	ES-1	\$10,395
EL6FM4006BU	VMAX VG 400GB FLASH DRIVE R6(6+2)UPG	ES-1	\$10,395
EL6FM4007B	VMAX VG 400GB FLASH DRIVE R5(7+1)	ES-1	\$7,425
EL6FM4007BFP	VMAX VG PROMO 400GB FLASH DRIVE R5(7+1)	ES-1	\$0
EL6FM4007BTU	VMAX VG 400GB FLASH DRIVE R5(7+1)TAAUPG	ES-1	\$10,395
EL6FM4007BU	VMAX VG 400GB FLASH DRIVE R5(7+1)UPG	ES-1	\$10,395
EL6FM400FB	VMAX VG 400GB FLASH DRIVE R6(14+2)	ES-1	\$7,425
EL6FM400FBTU	VMAX VG 400GB FLASH DRIVE R6(14+2)TAAUPG	ES-1	\$10,395
EL6FM400FBU	VMAX VG 400GB FLASH DRIVE R6(14+2)UPG	ES-1	\$10,395
EL6FM400SB	VMAX VG 400GB FLASH DRIVE SPARE	ES-1	\$7,425
EL6FM400SBFP	VMAX VG PROMO 400GB FLASH DRIVE SPARE	ES-1	\$0
EL6FM400SBTU	VMAX VG 400GB FLASH DRIVE SPARE TAA UPG	ES-1	\$10,395
EL6FM400SBU	VMAX VG 400GB FLASH DRIVE SPARE UPG	ES-1	\$10,395
EL6FM8001B	VMAX VG 800GB FLASH DRIVE R1	ES-1	\$13,095
EL6FM8001BFP	VMAX VG PROMO 800GB FLASH DRIVE R1	ES-1	\$0
EL6FM8001BTU	VMAX VG 800GB FLASH DRIVE R1 TAA UPG	ES-1	\$18,335
EL6FM8001BU	VMAX VG 800GB FLASH DRIVE R1 UPG	ES-1	\$18,335
EL6FM8005B	VMAX VG 800GB FLASH DRIVE R5(3+1)	ES-1	\$13,095
EL6FM8005BFP	VMAX VG PROMO 800GB FLASH DRIVE R5(3+1)	ES-1	\$0
EL6FM8005BTU	VMAX VG 800GB FLASH DRIVE R5(3+1)TAA UPG	ES-1	\$18,335
EL6FM8005BU	VMAX VG 800GB FLASH DRIVE R5(3+1) UPG	ES-1	\$18,335
EL6FM8006B	VMAX VG 800GB FLASH DRIVE R6(6+2)	ES-1	\$13,095
EL6FM8006BTU	VMAX VG 800GB FLASH DRIVE R6(6+2)TAAUPG	ES-1	\$18,335
EL6FM8006BU	VMAX VG 800GB FLASH DRIVE R6(6+2)UPG	ES-1	\$18,335
EL6FM8007B	VMAX VG 800GB FLASH DRIVE R5(7+1)	ES-1	\$13,095
EL6FM8007BFP	VMAX VG PROMO 800GB FLASH DRIVE R5(7+1)	ES-1	\$0
EL6FM8007BTU	VMAX VG 800GB FLASH DRIVE R5(7+1)TAAUPG	ES-1	\$18,335
EL6FM8007BU	VMAX VG 800GB FLASH DRIVE R5(7+1)UPG	ES-1	\$18,335
EL6FM800FB	VMAX VG 800GB FLASH DRIVE R6(14+2)	ES-1	\$13,095
EL6FM800FBTU	VMAX VG 800GB FLASH DRIVE R6(14+2)TAAUPG	ES-1	\$18,335
EL6FM800FBU	VMAX VG 800GB FLASH DRIVE R6(14+2)UPG	ES-1	\$18,335
EL6FM800SB	VMAX VG 800GB FLASH DRIVE SPARE	ES-1	\$13,095
EL6FM800SBFP	VMAX VG PROMO 800GB FLASH DRIVE SPARE	ES-1	\$0
EL6FM800SBTU	VMAX VG 800GB FLASH DRIVE SPARE TAA UPG	ES-1	\$18,335
EL6FM800SBU	VMAX VG 800GB FLASH DRIVE SPARE UPG	ES-1	\$18,335
EL-AFA100K	VMAX 100K All Flash	ES-1	\$0
EL-DATAMOVER	VMAX 100K DATA MOVER FOR NAS	ES-1	\$0
EL-DATAMOVERU	VMAX 100K DATA MOVER FOR NAS UPG	ES-1	\$0
EL-ISERIES	VMAX 100K ISERIES TRACKING MODEL	ES-1	\$0
EL-NAS-SN	Embedded NAS Base OE for VMAX 100K	ES-1	\$85,000
EL-NAS-SNU	EMBEDDED NAS BASE OE FOR VMAX 100K UPG	ES-1	\$85,000
E-LREPCCMCAP	LOCAL REP CCM TRACKING MODEL	ES-1	\$0
EL-VFP1-100K	PROMO 200GB VFP100K 32	ES-1	\$0
EL-VFP1-100KU	PROMO 200GB VFP100K 32U	ES-1	\$0
EL-VFP2-100K	PROMO 200GB VFP100K 48	ES-1	\$0
EL-VFP2-100KU	PROMO 200GB VFP100K 48U	ES-1	\$0

EL-VFP3-100K	PROMO 400GB VFP100K 32	ES-1	\$0
EL-VFP3-100KU	PROMO 400GB VFP100K 32U	ES-1	\$0
EL-VFP4-100K	PROMO 400GB VFP100K 48	ES-1	\$0
EL-VFP4-100KU	PROMO 400GB VFP100K 48U	ES-1	\$0
EL-VFP5-100K	PROMO 800GB VFP100K 16	ES-1	\$0
EL-VFP5-100KU	PROMO 800GB VFP100K 16U	ES-1	\$0
EL-VFP6-100K	PROMO 800GB VFP100K 24	ES-1	\$0
EL-VFP6-100KU	PROMO 800GB VFP100K 24U	ES-1	\$0
EL-VFP7-100K	PROMO 1600GB VFP100K 8 Tracking Model	ES-1	\$0
EL-VFP7-100KU	PROMO 1600GB VFP100K 8U	ES-1	\$0
EL-VFP8-100K	PROMO 1600GB VFP100K 12 Tracking Model	ES-1	\$0
EL-VFP8-100KU	PROMO 1600GB VFP100K 12U	ES-1	\$0
E-MANCONFIG	VMAX VG MANUAL CONFIG TRKNG MODEL	ES-1	\$0
E-MODEM	VMAX VG ZBA MODEM LEAD FREE	ES-1	\$1,105
E-MSRPTRACKING	VMAX VG MULT RESOURCE POOL TRACKING	ES-1	\$0
ENGINE2	VMAX VG FIRST UPGRADE ENGINE NUMBER 2	ES-1	\$0
ENGINE3	VMAX VG FIRST UPGRADE ENGINE NUMBER 3	ES-1	\$0
ENGINE4	VMAX VG FIRST UPGRADE ENGINE NUMBER 4	ES-1	\$0
ENGINE5	VMAX VG FIRST UPGRADE ENGINE NUMBER 5	ES-1	\$0
ENGINE6	VMAX VG FIRST UPGRADE ENGINE NUMBER 6	ES-1	\$0
ENGINE7	VMAX VG FIRST UPGRADE ENGINE NUMBER 7	ES-1	\$0
ENGINE8	VMAX VG FIRST UPGRADE ENGINE NUMBER 8	ES-1	\$0
E-OPROVISION	OPROVISION FACTOR TRACKING MODEL	ES-1	\$0
E-PC3YAFLA	32A 3PHASE WYE CORD SET IEC309-AMER	ES-1	\$1,155
E-PC3YAFLE	32A 3PHASE WYE CRD SET FLY LEAD EUROPE	ES-1	\$2,800
E-PCBL3DHH	PWR CBL HBL-HBL 3D	ES-1	\$1,155
E-PCBL3DHR	PWR CBL HBL-RSTOL 3D	ES-1	\$1,155
E-PCBL3YAG	INTL 3PHASE 32 AMP IEC309 TO GARO	ES-1	\$2,000
E-PCBL3YL23P	24A 3PH WYE L22-30P	ES-1	\$2,000
E-PDU1P	VMAX VG SINGLE PHASE PDU 3RD PARTY	ES-1	\$4,145
E-PDUDELTA	VMAX VG 3 PHASE DELTA PDU 3RD PARTY	ES-1	\$4,145
E-PDUWYE	VMAX VG 3 PHASE WYE PDU 3RD PARTY	ES-1	\$4,145
E-PTP-CAPACITY	PROTECTPOINT CAPACITY TRACKING MODEL	ES-1	\$0
E-PW40UASTL	30A 1PHASE AUSIP57 CLIPSAL 56PA332	ES-1	\$850
E-PW40UASTL-2	30A 1PHASE AUSIP57 CLIPSAL 56PA332 2FT	ES-1	\$850
E-PW40UIEC3	VMAX VG30A 1PHASE INTERNATNLIEC309-332P	ES-1	\$310
E-PW40URUS	30A 1PH RUSSELLSTOLL 3750DP	ES-1	\$1,240
E-PW40U-US	VMAX VG 30A 1PHASE NAMER JAPAN I6-30P	ES-1	\$350
E-PW40U-US-2	VMAX VG 30A 1PH NAMER JAPAN L6-30P 2FT	ES-1	\$350
ER-1024-2048UFD	VMAX 400K MEMCONV 2X512 to 2X1024 GB	ES-1	\$370,980
ER-1024ADD	VMAX 400K ADD 1024GB	ES-1	\$284,420
ER-1024ADD-3P	VMAX 400K ADD 1024GB 3RD PARTY	ES-1	\$284,420
ER-1024ADDU	VMAX 400K ADD 1024GB UPG	ES-1	\$369,750
ER-1024ADDU3P	VMAX 400K ADD 1024GB UPG 3RD PARTY	ES-1	\$369,750
ER-1024ADDUFD	VMAX 400K ADD 1024GB UPG FIELD	ES-1	\$369,750
ER1024ADUFD3P	VMAX 400K ADD 1024GB UPG FIELD 3RD PARTY	ES-1	\$369,750
ER-1024BASE	VMAX 400K BASE 1024GB	ES-1	\$592,545
ER-1024BASE3P	VMAX 400K BASE 1024GB 3RD PARTY	ES-1	\$592,545
ER-1024-RET	VMAX 400K 1024GB MEMORY RETURN	ES-1	\$0
ER-2048ADD	VMAX 400K ADD 2048GB	ES-1	\$422,380

ER-2048ADD-3P	VMAX 400K ADD 2048GB 3RD PARTY	ES-1	\$422,380
ER-2048ADDU	VMAX 400K ADD 2048GB UPG	ES-1	\$549,090
ER-2048ADDU3P	VMAX 400K ADD 2048GB UPG 3RD PARTY	ES-1	\$549,090
ER-2048ADDUFD	VMAX 400K ADD 2048GB UPG FIELD	ES-1	\$549,090
ER2048ADUFD3P	VMAX 400K ADD 2048GB UPG FIELD 3RD PARTY	ES-1	\$549,090
ER-2048BASE	VMAX 400K BASE 2048GB	ES-1	\$1,126,340
ER-2048BASE3P	VMAX 400K BASE 2048GB 3RD PARTY	ES-1	\$1,126,340
ER-512-1024UFD	VMAX 400K MEMCONV 2X256 to 2X512 GB	ES-1	\$111,985
ER-512-2048UFD	VMAX 400K MEMCONV 2X256 to 2X1024 GB	ES-1	\$370,980
ER-512ADD	VMAX 400K ADD 512GB	ES-1	\$256,130
ER-512ADD-3P	VMAX 400K ADD 512GB 3RD PARTY	ES-1	\$256,130
ER-512ADDU	VMAX 400K ADD 512GB UPG	ES-1	\$332,970
ER-512ADDU-3P	VMAX 400K ADD 512GB UPG 3RD PARTY	ES-1	\$332,970
ER-512ADDUFD	VMAX 400K ADD 512GB UPG FIELD	ES-1	\$332,970
ER512ADDUFD3P	VMAX 400K ADD 512GB UPG FIELD 3RD PARTY	ES-1	\$332,970
ER-512BASE	VMAX 400K BASE 512GB	ES-1	\$437,830
ER-512BASE-3P	VMAX 400K BASE 512GB 3RD PARTY	ES-1	\$437,830
ER-512-RET	VMAX 400K 128GB MEMORY RETURN	ES-1	\$0
ER-AFA400K	VMAX 400K All Flash	ES-1	\$0
ER-DATAMOVER	VMAX 400K DATA MOVER FOR NAS	ES-1	\$0
ER-DATAMOVERU	VMAX 400K DATA MOVER FOR NAS UPG	ES-1	\$0
E-RDFCAP	RDF ADDL MEM TRACKING MODEL	ES-1	\$0
ER-ISERIES	VMAX 400K ISERIES TRACKING MODEL	ES-1	\$0
ER-NAS-SN	Embedded NAS Base OE for VMAX 400K	ES-1	\$149,500
ER-NAS-SNU	EMBEDDED NAS BASE OE FOR VMAX 400K UPG	ES-1	\$149,500
ER-VFP1-400K	PROMO 200GB VFP400K 96	ES-1	\$0
ER-VFP1-400KU	PROMO 200GB VFP400K 32U	ES-1	\$0
ER-VFP2-400K	PROMO 200GB VFP400K 192	ES-1	\$0
ER-VFP2-400KU	PROMO 200GB VFP400K 48U	ES-1	\$0
ER-VFP3-400K	PROMO 400GB VFP400K 96	ES-1	\$0
ER-VFP3-400KU	PROMO 400GB VFP400K 32U	ES-1	\$0
ER-VFP4-400K	PROMO 400GB VFP400K 192	ES-1	\$0
ER-VFP4-400KU	PROMO 400GB VFP400K 48U	ES-1	\$0
ER-VFP5-400K	PROMO 800GB VFP400K 48	ES-1	\$0
ER-VFP5-400KU	PROMO 800GB VFP400K 16U	ES-1	\$0
ER-VFP6-400K	PROMO 800GB VFP400K 96	ES-1	\$0
ER-VFP6-400KU	PROMO 800GB VFP400K 24U	ES-1	\$0
ER-VFP7-400K	PROMO 1600GB VFP400K 24 Tracking Model	ES-1	\$0
ER-VFP7-400KU	PROMO 1600GB VFP400K 8U	ES-1	\$0
ER-VFP8-400K	PROMO 1600GB VFP400K 48 Tracking Model	ES-1	\$0
ER-VFP8-400KU	PROMO 1600GB VFP400K 12U	ES-1	\$0
ES61012001B	VMAX VG 1200GB 10K SAS DRV R1	ES-1	\$1,665
ES61012001BTU	VMAX VG 1200GB 10K SAS DRV R1 TAA UPG	ES-1	\$2,330
ES61012001BU	VMAX VG 1200GB 10K SAS DRV R1 UPG	ES-1	\$2,330
ES61012005B	VMAX VG 1200GB 10K SAS DRV R5(3+1)	ES-1	\$1,665
ES61012005BTU	VMAX VG 1200GB 10K SAS DRV R5(3+1)TAAUPG	ES-1	\$2,330
ES61012005BU	VMAX VG 1200GB 10K SAS DRV R5(3+1)UPG	ES-1	\$2,330
ES61012006B	VMAX VG 1200GB 10K SAS DRV R6(6+2)	ES-1	\$1,665
ES61012006BTU	VMAX VG 1200GB 10K SAS DRV R6(6+2)TAAUPG	ES-1	\$2,330
ES61012006BU	VMAX VG 1200GB 10K SAS DRV R6(6+2)UPG	ES-1	\$2,330

ES61012007B	VMAX VG 1200GB 10K SAS DRV R5(7+1)	ES-1	\$1,665
ES61012007BTU	VMAX VG 1200GB 10K SAS DRV R5(7+1)TAAUPG	ES-1	\$2,330
ES61012007BU	VMAX VG 1200GB 10K SAS DRV R5(7+1)UPG	ES-1	\$2,330
ES6101200FB	VMAX VG 1200GB 10K SAS DRV R6(14+2)	ES-1	\$1,665
ES6101200FBTU	VMAX VG 1200GB 10K SAS R6(14+2)TAAUPG	ES-1	\$2,330
ES6101200FBU	VMAX VG 1200GB 10K SAS R6(14+2)UPG	ES-1	\$2,330
ES6101200SB	VMAX VG 1200GB 10K SAS DRV SPARE	ES-1	\$1,665
ES6101200SBTU	VMAX VG 1200GB 10K SAS SPARE TAA UPG	ES-1	\$2,330
ES6101200SBU	VMAX VG 1200GB 10K SAS SPARE UPG	ES-1	\$2,330
ES6103001B	VMAX VG 300GB 10K SAS DRV R1	ES-1	\$575
ES6103001BTU	VMAX VG 300GB 10K SAS DRV R1 TAA UPG	ES-1	\$805
ES6103001BU	VMAX VG 300GB 10K SAS DRV R1 UPG	ES-1	\$805
ES6103005B	VMAX VG 300GB 10K SAS DRV R5(3+1)	ES-1	\$575
ES6103005BTU	VMAX VG 300GB 10K SAS DRV R5(3+1)TAAUPG	ES-1	\$805
ES6103005BU	VMAX VG 300GB 10K SAS DRV R5(3+1)UPG	ES-1	\$805
ES6103006B	VMAX VG 300GB 10K SAS DRV R6(6+2)	ES-1	\$575
ES6103006BTU	VMAX VG 300GB 10K SAS DRV R6(6+2)TAAUPG	ES-1	\$805
ES6103006BU	VMAX VG 300GB 10K SAS DRV R6(6+2)UPG	ES-1	\$805
ES6103007B	VMAX VG 300GB 10K SAS DRV R5(7+1)	ES-1	\$575
ES6103007BTU	VMAX VG 300GB 10K SAS DRV R5(7+1)TAAUPG	ES-1	\$805
ES6103007BU	VMAX VG 300GB 10K SAS DRV R5(7+1)UPG	ES-1	\$805
ES610300FB	VMAX VG 300GB 10K SAS DRV R6(14+2)	ES-1	\$575
ES610300FBTU	VMAX VG 300GB 10K SAS DR R6(14+2)TAAUPG	ES-1	\$805
ES610300FBU	VMAX VG 300GB 10K SAS DR R6(14+2)UPG	ES-1	\$805
ES610300SB	VMAX VG 300GB 10K SAS DRV SPARE	ES-1	\$575
ES610300SBTU	VMAX VG 300GB 10K SAS DR SPARE TAAUPG	ES-1	\$805
ES610300SBU	VMAX VG 300GB 10K SAS DR SPARE UPG	ES-1	\$805
ES6106001B	VMAX VG 600GB 10K SAS DRV R1	ES-1	\$1,080
ES6106001BTU	VMAX VG 600GB 10K SAS DRV R1 TAA UPG	ES-1	\$1,510
ES6106001BU	VMAX VG 600GB 10K SAS DRV R1 UPG	ES-1	\$1,510
ES6106005B	VMAX VG 600GB 10K SAS DRV R5(3+1)	ES-1	\$1,080
ES6106005BTU	VMAX VG 600GB 10K SAS DRV R5(3+1)TAA UPG	ES-1	\$1,510
ES6106005BU	VMAX VG 600GB 10K SAS DRV R5(3+1)UPG	ES-1	\$1,510
ES6106006B	VMAX VG 600GB 10K SAS DRV R6(6+2)	ES-1	\$1,080
ES6106006BTU	VMAX VG 600GB 10K SAS DRV R6(6+2)TAA UPG	ES-1	\$1,510
ES6106006BU	VMAX VG 600GB 10K SAS DRV R6(6+2)UPG	ES-1	\$1,510
ES6106007B	VMAX VG 600GB 10K SAS DRV R5(7+1)	ES-1	\$1,080
ES6106007BTU	VMAX VG 600GB 10K SAS DRV R5(7+1)TAA UPG	ES-1	\$1,510
ES6106007BU	VMAX VG 600GB 10K SAS DRV R5(7+1)UPG	ES-1	\$1,510
ES610600FB	VMAX VG 600GB 10K SAS DRV R6(14+2)	ES-1	\$1,080
ES610600FBTU	VMAX VG 600GB 10K SAS R6(14+2)TAA UPG	ES-1	\$1,510
ES610600FBU	VMAX VG 600GB 10K SAS R6(14+2)UPG	ES-1	\$1,510
ES610600SB	VMAX VG 600GB 10K SAS DRV SPARE	ES-1	\$1,080
ES610600SBTU	VMAX VG 600GB 10K SAS SPARE TAA UPG	ES-1	\$1,510
ES610600SBU	VMAX VG 600GB 10K SAS SPARE UPG	ES-1	\$1,510
ES6153001BTU	VMAX VG 300GB 15K SAS DRV R1 TAA UPG	ES-1	\$2,065
ES6153001BU	VMAX VG 300GB 15K SAS DRV R1 UPG	ES-1	\$2,065
ES6153005BTU	VMAX VG 300GB 15K SAS DRV R5(3+1)TAA UPG	ES-1	\$2,065
ES6153005BU	VMAX VG 300GB 15K SAS DRV R5(3+1) UPG	ES-1	\$2,065
ES6153006BTU	VMAX VG 300GB 15K SAS DRV R6(6+2)TAA UPG	ES-1	\$2,065

ES6153006BU	VMAX VG 300GB 15K SAS DRV R6(6+2) UPG	ES-1	\$2,065
ES6153007BTU	VMAX VG 300GB 15K SAS DRV R5(7+1)TAA UPG	ES-1	\$2,065
ES6153007BU	VMAX VG 300GB 15K SAS DRV R5(7+1) UPG	ES-1	\$2,065
ES615300FBTU	VMAX VG 300GB 15K SAS DRV R6(14+2)TAAUPG	ES-1	\$2,065
ES615300FBU	VMAX VG 300GB 15K SAS DRV R6(14+2) UPG	ES-1	\$2,065
ES615300SBTU	VMAX VG 300GB 15K SAS DRV SPARE TAA UPG	ES-1	\$2,065
ES615300SBU	VMAX VG 300GB 15K SAS DRV SPARE UPG	ES-1	\$2,065
ES6FM16001B	VMAX 1600GB FLASH DRIVE R1	ES-1	\$22,600
ES6FM16001BFP	VMAX VG PROMO 1600GB FLASH DRIVE R1	ES-1	\$0
ES6FM16001BTU	VMAX 1600GB FLASH DRIVE R1 TAA UPG	ES-1	\$31,640
ES6FM16001BU	VMAX 1600GB FLASH DRIVE R1 UPG	ES-1	\$31,640
ES6FM16005B	VMAX 1600GB FLASH DRIVE R5(3+1)	ES-1	\$22,600
ES6FM16005BFP	VMAX VG PROMO 1600GB FLASH DRIVE R5(3+1)	ES-1	\$0
ES6FM16005BTU	VMAX 1600GB FLASH DRIVE R5(3+1) TAA UPG	ES-1	\$31,640
ES6FM16005BU	VMAX 1600GB FLASH DRIVE R5(3+1) UPG	ES-1	\$31,640
ES6FM16006B	VMAX VG 1600GB FLASH DRIVE R6(6+2)	ES-1	\$22,600
ES6FM16006BTU	VMAX VG 1600GB FLASH DRV R6(6+2) TAA UPG	ES-1	\$31,640
ES6FM16006BU	VMAX VG 1600GB FLASH DRIVE R6(6+2) UPG	ES-1	\$31,640
ES6FM16007B	VMAX 1600GB FLASH DRIVE R5(7+1)	ES-1	\$22,600
ES6FM16007BFP	VMAX VG PROMO 1600GB FLASH DRIVE R5(7+1)	ES-1	\$0
ES6FM16007BTU	VMAX 1600GB FLASH DRIVE R5(7+1) TAA UPG	ES-1	\$31,640
ES6FM16007BU	VMAX 1600GB FLASH DRIVE R5(7+1) UPG	ES-1	\$31,640
ES6FM1600FB	VMAX VG 1600GB FLASH DRIVE R6(14+2)	ES-1	\$22,600
ES6FM1600FBTU	VMAX VG 1600GB FLASH DRV R6(14+2) TAAUPG	ES-1	\$31,640
ES6FM1600FBU	VMAX VG 1600GB FLASH DRIVE R6(14+2) UPG	ES-1	\$31,640
ES6FM1600SB	VMAX 1600GB FLASH DRIVE SPARE	ES-1	\$22,600
ES6FM1600SBFP	VMAX VG PROMO 1600GB FLASH DRIVE SPARE	ES-1	\$0
ES6FM1600SBTU	VMAX 1600GB FLASH DRIVE SPARE TAA UPG	ES-1	\$31,640
ES6FM1600SBU	VMAX 1600GB FLASH DRIVE SPARE UPG	ES-1	\$31,640
ES6FM2001B	VMAX VG 200GB FLASH DRIVE R1	ES-1	\$3,905
ES6FM2001BFP	VMAX VG PROMO 200GB FLASH DRIVE R1	ES-1	\$0
ES6FM2001BTU	VMAX VG 200GB FLASH DRIVE R1 TAA UPG	ES-1	\$5,475
ES6FM2001BU	VMAX VG 200GB FLASH DRIVE R1 UPG	ES-1	\$5,475
ES6FM2005B	VMAX VG 200GB FLASH DRIVE R5(3+1)	ES-1	\$3,905
ES6FM2005BFP	VMAX VG PROMO 200GB FLASH DRIVE R5(3+1)	ES-1	\$0
ES6FM2005BTU	VMAX VG 200GB FLASH DRIVE R5(3+1)TAA UPG	ES-1	\$5,475
ES6FM2005BU	VMAX VG 200GB FLASH DRIVE R5(3+1) UPG	ES-1	\$5,475
ES6FM2006B	VMAX VG 200GB FLASH DRIVE R6(6+2)	ES-1	\$3,905
ES6FM2006BTU	VMAX VG 200GB FLASH DRV R6(6+2) TAA UPG	ES-1	\$5,475
ES6FM2006BU	VMAX VG 200GB FLASH DRIVE R6(6+2) UPG	ES-1	\$5,475
ES6FM2007B	VMAX VG 200GB FLASH DRIVE R5(7+1)	ES-1	\$3,905
ES6FM2007BFP	VMAX VG PROMO 200GB FLASH DRIVE R5(7+1)	ES-1	\$0
ES6FM2007BTU	VMAX VG 200GB FLASH DRIVE R5(7+1)TAA UPG	ES-1	\$5,475
ES6FM2007BU	VMAX VG 200GB FLASH DRIVE R5(7+1) UPG	ES-1	\$5,475
ES6FM200FB	VMAX VG 200GB FLASH DRIVE R6(14+2)	ES-1	\$3,905
ES6FM200FBTU	VMAX VG 200GB FLASH DRV R6(14+2) TAA UPG	ES-1	\$5,475
ES6FM200FBU	VMAX VG 200GB FLASH DRIVE R6(14+2) UPG	ES-1	\$5,475
ES6FM200SB	VMAX VG 200GB FLASH DRIVE SPARE	ES-1	\$3,905
ES6FM200SBFP	VMAX VG PROMO 200GB FLASH DRIVE SPARE	ES-1	\$0
ES6FM200SBTU	VMAX VG 200GB FLASH DRIVE SPARE TAA UPG	ES-1	\$5,475

ES6FM200SBU	VMAX VG 200GB FLASH DRIVE SPARE UPG	ES-1	\$5,475
ES6FM4001B	VMAX VG 400GB FLASH DRIVE R1	ES-1	\$7,425
ES6FM4001BFP	VMAX VG PROMO 400GB FLASH DRIVE R1	ES-1	\$0
ES6FM4001BTU	VMAX VG 400GB FLASH DRIVE R1 TAA UPG	ES-1	\$10,395
ES6FM4001BU	VMAX VG 400GB FLASH DRIVE R1 UPG	ES-1	\$10,395
ES6FM4005B	VMAX VG 400GB FLASH DRIVE R5(3+1)	ES-1	\$7,425
ES6FM4005BFP	VMAX VG PROMO 400GB FLASH DRIVE R5(3+1)	ES-1	\$0
ES6FM4005BTU	VMAX VG 400GB FLASH DRIVE R5(3+1)TAA UPG	ES-1	\$10,395
ES6FM4005BU	VMAX VG 400GB FLASH DRIVE R5(3+1) UPG	ES-1	\$10,395
ES6FM4006B	VMAX VG 400GB FLASH DRIVE R6(6+2)	ES-1	\$7,425
ES6FM4006BTU	VMAX VG 400GB FLASH DRV R6(6+2) TAA UPG	ES-1	\$10,395
ES6FM4006BU	VMAX VG 400GB FLASH DRIVE R6(6+2) UPG	ES-1	\$10,395
ES6FM4007B	VMAX VG 400GB FLASH DRIVE R5(7+1)	ES-1	\$7,425
ES6FM4007BFP	VMAX VG PROMO 400GB FLASH DRIVE R5(7+1)	ES-1	\$0
ES6FM4007BTU	VMAX VG 400GB FLASH DRIVE R5(7+1)TAA UPG	ES-1	\$10,395
ES6FM4007BU	VMAX VG 400GB FLASH DRIVE R5(7+1) UPG	ES-1	\$10,395
ES6FM400FB	VMAX VG 400GB FLASH DRIVE R6(14+2)	ES-1	\$7,425
ES6FM400FBTU	VMAX VG 400GB FLASH DRV R6(14+2) TAA UPG	ES-1	\$10,395
ES6FM400FBU	VMAX VG 400GB FLASH DRIVE R6(14+2) UPG	ES-1	\$10,395
ES6FM400SB	VMAX VG 400GB FLASH DRIVE SPARE	ES-1	\$7,425
ES6FM400SBFP	VMAX VG PROMO 400GB FLASH DRIVE SPARE	ES-1	\$0
ES6FM400SBTU	VMAX VG 400GB FLASH DRIVE SPARE TAA UPG	ES-1	\$10,395
ES6FM400SBU	VMAX VG 400GB FLASH DRIVE SPARE UPG	ES-1	\$10,395
ES6FM8001B	VMAX VG 800GB FLASH DRIVE R1	ES-1	\$13,095
ES6FM8001BFP	VMAX VG PROMO 800GB FLASH DRIVE R1	ES-1	\$0
ES6FM8001BTU	VMAX VG 800GB FLASH DRIVE R1 TAA UPG	ES-1	\$18,335
ES6FM8001BU	VMAX VG 800GB FLASH DRIVE R1 UPG	ES-1	\$18,335
ES6FM8005B	VMAX VG 800GB FLASH DRIVE R5(3+1)	ES-1	\$13,095
ES6FM8005BFP	VMAX VG PROMO 800GB FLASH DRIVE R5(3+1)	ES-1	\$0
ES6FM8005BTU	VMAX VG 800GB FLASH DRIVE R5(3+1)TAA UPG	ES-1	\$18,335
ES6FM8005BU	VMAX VG 800GB FLASH DRIVE R5(3+1) UPG	ES-1	\$18,335
ES6FM8006B	VMAX VG 800GB FLASH DRIVE R6(6+2)	ES-1	\$13,095
ES6FM8006BTU	VMAX VG 800GB FLASH DRV R6(6+2) TAA UPG	ES-1	\$18,335
ES6FM8006BU	VMAX VG 800GB FLASH DRIVE R6(6+2) UPG	ES-1	\$18,335
ES6FM8007B	VMAX VG 800GB FLASH DRIVE R5(7+1)	ES-1	\$13,095
ES6FM8007BFP	VMAX VG PROMO 800GB FLASH DRIVE R5(7+1)	ES-1	\$0
ES6FM8007BTU	VMAX VG 800GB FLASH DRIVE R5(7+1)TAA UPG	ES-1	\$18,335
ES6FM8007BU	VMAX VG 800GB FLASH DRIVE R5(7+1) UPG	ES-1	\$18,335
ES6FM800FB	VMAX VG 800GB FLASH DRIVE R6(14+2)	ES-1	\$13,095
ES6FM800FBTU	VMAX VG 800GB FLASH DRV R6(14+2) TAA UPG	ES-1	\$18,335
ES6FM800FBU	VMAX VG 800GB FLASH DRIVE R6(14+2) UPG	ES-1	\$18,335
ES6FM800SB	VMAX VG 800GB FLASH DRIVE SPARE	ES-1	\$13,095
ES6FM800SBFP	VMAX VG PROMO 800GB FLASH DRIVE SPARE	ES-1	\$0
ES6FM800SBTU	VMAX VG 800GB FLASH DRIVE SPARE TAA UPG	ES-1	\$18,335
ES6FM800SBU	VMAX VG 800GB FLASH DRIVE SPARE UPG	ES-1	\$18,335
E-SECURE	VMAX VG SECURE KIT SINGLE BAY	ES-1	\$2,570
E-SECUREADD	VMAX VG SECURE JOINING KIT	ES-1	\$2,570
E-SKINS	VMAX VG SIDE PANELS	ES-1	\$645
E-SKINSU	VMAX VG SIDE PANELS UPG	ES-1	\$645
E-SMOD	SZR CONFIG TRACKING MODEL	ES-1	\$0

E-SOURCECAP	VMAX SOURCE CAPACITY TRACKING	ES-1	\$0
E-SYS13RDPT	VMAX VG 1ENG SYSTEM BAY SHIPPING RACK	ES-1	\$0
E-SYS1A-1P	VMAX 200K SYS BAY1 1P	ES-1	\$33,360
E-SYS1A-3D	VMAX 200K SYS BAY1 3D	ES-1	\$33,360
E-SYS1A-3P-1P	VMAX 200K SYS BAY1 1P 3RD PARTY	ES-1	\$33,360
E-SYS1A-3P-3D	VMAX 200K SYS BAY1 3D 3RD PARTY	ES-1	\$33,360
E-SYS1A-3P-3Y	VMAX 200K SYS BAY1 3Y 3RD PARTY	ES-1	\$33,360
E-SYS1A-3PE-1P	VMAX 200K DELL SYS BAY1 1P 3RD PARTY	ES-1	\$33,360
E-SYS1A-3PE-3D	VMAX 200K DELL SYS BAY1 3D 3RD PARTY	ES-1	\$33,360
E-SYS1A-3PE-3Y	VMAX 200K DELL SYS BAY1 3Y 3RD PARTY	ES-1	\$33,360
E-SYS1A-3Y	VMAX 200K SYS BAY1 3Y	ES-1	\$33,360
E-SYS1L-1P	VMAX 100K SYS BAY1 1P	ES-1	\$20,390
E-SYS1L-3D	VMAX 100K SYS BAY1 3D	ES-1	\$20,390
E-SYS1L-3P-1P	VMAX 100K SYS BAY1 1P 3RD PARTY	ES-1	\$20,390
E-SYS1L-3P-3D	VMAX 100K SYS BAY1 3D 3RD PARTY	ES-1	\$20,390
E-SYS1L-3P-3Y	VMAX 100K SYS BAY1 3Y 3RD PARTY	ES-1	\$20,390
E-SYS1L-3PE-1P	VMAX 100K DELL SYS BAY1 1P 3RD PARTY	ES-1	\$20,390
E-SYS1L-3PE-3D	VMAX 100K DELL SYS BAY1 3D 3RD PARTY	ES-1	\$20,390
E-SYS1L-3PE-3Y	VMAX 100K DELL SYS BAY1 3Y 3RD PARTY	ES-1	\$20,390
E-SYS1L-3Y	VMAX 100K SYS BAY1 3Y	ES-1	\$20,390
E-SYS1R-1P	VMAX 400K SYS BAY1 1P	ES-1	\$33,360
E-SYS1R-3D	VMAX 400K SYS BAY1 3D	ES-1	\$33,360
E-SYS1R-3P-1P	VMAX 400K SYS BAY1 1P 3RD PARTY	ES-1	\$33,360
E-SYS1R-3P-3D	VMAX 400K SYS BAY1 3D 3RD PARTY	ES-1	\$33,360
E-SYS1R-3P-3Y	VMAX 400K SYS BAY1 3Y 3RD PARTY	ES-1	\$33,360
E-SYS1R-3PE-1P	VMAX 400K DELL SYS BAY1 1P 3RD PARTY	ES-1	\$33,360
E-SYS1R-3PE-3D	VMAX 400K DELL SYS BAY1 3D 3RD PARTY	ES-1	\$33,360
E-SYS1R-3PE-3Y	VMAX 400K DELL SYS BAY1 3Y 3RD PARTY	ES-1	\$33,360
E-SYS1R-3Y	VMAX 400K SYS BAY1 3Y	ES-1	\$33,360
E-SYS23RDPT	VMAX VG 2ENG SYSTEM BAY SHIPPING RACK	ES-1	\$0
E-SYSADD1P	VMAX VG ADD SYS BAY 1P	ES-1	\$13,890
E-SYSADD1P-3P	VMAX VG ADD SYS BAY 1P 3RD PARTY	ES-1	\$13,890
E-SYSADD1P-3PE	VMAX VG ADD DELL SYS BAY 1P 3RD PARTY	ES-1	\$13,890
E-SYSADD1PU	VMAX VG ADD SYS BAY 1P UPG	ES-1	\$13,890
E-SYSADD1PU3P	VMAX VG ADD SYS BAY 1P UPG 3RD PARTY	ES-1	\$13,890
E-SYSADD1PU3PE	VMAX VG ADD DELL SYS BAY 1P UPG 3RD PART	ES-1	\$13,890
E-SYSADD3D	VMAX VG ADD SYS BAY 3D	ES-1	\$13,890
E-SYSADD3D-3P	VMAX VG ADD SYS BAY 3D 3RD PARTY	ES-1	\$13,890
E-SYSADD3D-3PE	VMAX VG ADD DELL SYS BAY 3D 3RD PARTY	ES-1	\$13,890
E-SYSADD3DU	VMAX VG ADD SYS BAY 3D UPG	ES-1	\$13,890
E-SYSADD3DU3P	VMAX VG ADD SYS BAY 3D UPG 3RD PARTY	ES-1	\$13,890
E-SYSADD3DU3PE	VMAX VG ADD DELL SYS BAY 3D UPG 3RD PAR	ES-1	\$13,890
E-SYSADD3Y	VMAX VG ADD SYS BAY 3Y	ES-1	\$13,890
E-SYSADD3Y-3P	VMAX VG ADD SYS BAY 3Y 3RD PARTY	ES-1	\$13,890
E-SYSADD3Y-3PE	VMAX VG ADD DELL SYS BAY 3Y 3RD PARTY	ES-1	\$13,890
E-SYSADD3YU	VMAX VG ADD SYS BAY 3Y UPG	ES-1	\$13,890
E-SYSADD3YU3P	VMAX VG ADD SYS BAY 3Y UPG 3RD PARTY	ES-1	\$13,890
E-SYSADD3YU3PE	VMAX VG ADD DELL SYS BAY 3Y UPG 3RD PAR	ES-1	\$13,890
ET67220001B	VMAX VG 2000GB 7_2K DRIVE R1	ES-1	\$1,140
ET67220001BTU	VMAX VG 2000GB 7_2K DRIVE R1 TAA UPG	ES-1	\$1,595

ET67220001BU	VMAX VG 2000GB 7_2K DRIVE R1 UPG	ES-1	\$1,595
ET67220005B	VMAX VG 2000GB 7_2K DRIVE R5(3+1)	ES-1	\$1,140
ET67220005BTU	VMAX VG 2000GB 7_2K DRIVE R5(3+1)TAA UPG	ES-1	\$1,595
ET67220005BU	VMAX VG 2000GB 7_2K DRIVE R5(3+1) UPG	ES-1	\$1,595
ET67220006B	VMAX VG 2000GB 7_2K DRIVE R6(6+2)	ES-1	\$1,140
ET67220006BTU	VMAX VG 2000GB 7_2K DRIVE R6(6+2)TAA UPG	ES-1	\$1,595
ET67220006BU	VMAX VG 2000GB 7_2K DRIVE R6(6+2) UPG	ES-1	\$1,595
ET67220007B	VMAX VG 2000GB 7_2K DRIVE R5(7+1)	ES-1	\$1,140
ET67220007BTU	VMAX VG 2000GB 7_2K DRIVE R5(7+1)TAA UPG	ES-1	\$1,595
ET67220007BU	VMAX VG 2000GB 7_2K DRIVE R5(7+1) UPG	ES-1	\$1,595
ET6722000FB	VMAX VG 2000GB 7_2K DRIVE R6(14+2)	ES-1	\$1,140
ET6722000FBTU	VMAX VG 2000GB 7_2K DRIVE R6(14+2)TAAUPG	ES-1	\$1,595
ET6722000FBU	VMAX VG 2000GB 7_2K DRIVE R6(14+2) UPG	ES-1	\$1,595
ET6722000SB	VMAX VG 2000GB 7_2K DRIVE SPARE	ES-1	\$1,140
ET6722000SBTU	VMAX VG 2000GB 7_2K DRIVE SPARE TAA UPG	ES-1	\$1,595
ET6722000SBU	VMAX VG 2000GB 7_2K DRIVE SPARE UPG	ES-1	\$1,595
ET67240001B	VMAX VG 4000GB 7_2K DRV R1	ES-1	\$1,990
ET67240001BTU	VMAX VG 4000GB 7_2K DRV R1 TAA UPG	ES-1	\$2,790
ET67240001BU	VMAX VG 4000GB 7_2K DRV R1 UPG	ES-1	\$2,790
ET67240005B	VMAX VG 4000GB 7_2K DRV R5(3+1)	ES-1	\$1,990
ET67240005BTU	VMAX VG 4000GB 7_2K DRV R5(3+1)TAAUPG	ES-1	\$2,790
ET67240005BU	VMAX VG 4000GB 7_2K DRV R5(3+1)UPG	ES-1	\$2,790
ET67240006B	VMAX VG 4000GB 7_2K DRV R6(6+2)	ES-1	\$1,990
ET67240006BTU	VMAX VG 4000GB 7_2K DRV R6(6+2)TAAUPG	ES-1	\$2,790
ET67240006BU	VMAX VG 4000GB 7_2K DRV R6(6+2)UPG	ES-1	\$2,790
ET67240007B	VMAX VG 4000GB 7_2K DRV R5(7+1)	ES-1	\$1,990
ET67240007BTU	VMAX VG 4000GB 7_2K DRV R5(7+1)TAAUPG	ES-1	\$2,790
ET67240007BU	VMAX VG 4000GB 7_2K DRV R5(7+1)UPG	ES-1	\$2,790
ET6724000FB	VMAX VG 4000GB 7_2K DRV R6(14+2)	ES-1	\$1,990
ET6724000FBTU	VMAX VG 4000GB 7_2K DRV R6(14+2)TAAUPG	ES-1	\$2,790
ET6724000FBU	VMAX VG 4000GB 7_2K DRV R6(14+2)UPG	ES-1	\$2,790
ET6724000SB	VMAX VG 4000GB 7_2K DRV SPARE	ES-1	\$1,990
ET6724000SBTU	VMAX VG 4000GB 7_2K DRV SPARE TAAUPG	ES-1	\$2,790
ET6724000SBU	VMAX VG 4000GB 7_2K DRV SPARE UPG	ES-1	\$2,790
E-TELCO	VMAX VG ZBA WW Telco Kit (International)	ES-1	\$70
E-TMC-RDY	E-TRACKINGC-RDY	ES-1	\$0
E-TMG10-RDY	E-TRACKINGG10-RDY	ES-1	\$0
E-TMG-RDY	E-TRACKINGG-RDY	ES-1	\$0
E-TM-RDY	E-TRACKING-RDY	ES-1	\$0
E-TOP-KIT	VMAX VG TOP ROUTING KIT	ES-1	\$500
E-TOP-POWER	VMAX3 TOP POWER ROUTING TRACKING MODE	ES-1	\$0
FFE00008SU	VMAX 100K 8SM 16G FICON UPG	ES-1	\$20,250
FFE00008SUF	VMAX 100K 8SM 16G FICON CONV	ES-1	\$68,660
FFE00080SU	VMAX 100K 8MM 16G FICON UPG	ES-1	\$9,295
FFE00080SUF	VMAX 100K 8MM 16G FICON CONV	ES-1	\$31,520
FFE00200TOU	VMAX 100K 2PT 10 GBE OPTICAL UPG	ES-1	\$2,730
FFE00200TU	VMAX 100K 2PT 10 GBE BASE T UPG	ES-1	\$2,860
FFE00400C4U	VMAX 100K 4MM4 COPR GIGE UPG	ES-1	\$2,575
FFE00400C4UF	VMAX 100K 4MM4 COPR GIGE CONV	ES-1	\$9,000
FFE00400CU	VMAX 100K 4PT GBE BASE T UPG	ES-1	\$2,600

FFE00400CUF	VMAX 100K 4M GIGE COPPER CONV	ES-1	\$9,100
FFE00400TOUF	VMAX 100K 4MM 10 GIGE OPTICAL CONV	ES-1	\$9,555
FFE00400TU	VMAX 100K 4MM 10 GIGE UPG	ES-1	\$4,745
FFE00400TUF	VMAX 100K 4MM 10 GIGE CONV	ES-1	\$16,600
FFE00800TU	VMAX 100K 8MM 10 GIGE UPG	ES-1	\$7,120
FFE00800TUF	VMAX 100K 8MM 10 GIGE CONV	ES-1	\$24,920
FFE08000EU	VMAX 100K 8SM 8G FIBRE UPG	ES-1	\$5,380
FFE08000EUF	VMAX 100K 8SM 8G FIBRE CONV	ES-1	\$18,250
FFE08000SU	VMAX 100K 8SM 16G FC UPG	ES-1	\$14,045
FFE08000SUF	VMAX 100K 8SM 16G FC CONV	ES-1	\$63,565
FFE44000EUF	VMAX 100K 4MM4SM 8G FIBRE CONV	ES-1	\$13,270
FFE62000EUF	VMAX 100K 6MM2SM 8G FIBRE CONV	ES-1	\$9,335
FFE80000EU	VMAX 100K 8MM 8G FIBRE UPG	ES-1	\$2,690
FFE80000EUF	VMAX 100K 8MM 8G FIBRE CONV	ES-1	\$8,285
FFE80000SU	VMAX 100K 8MM 16G FC UPG	ES-1	\$14,045
FFE80000SUF	VMAX 100K 8MM 16G FC CONV	ES-1	\$21,645
FL61012001BTU	VMAX 100K 1200GB 10K SAS DRV R1 TAA UPG	ES-1	\$2,330
FL61012001BU	VMAX 100K 1200GB 10K SAS DRV R1 UPG	ES-1	\$2,330
FL61012005BTU	VMAX 100K 1200GB 10K SAS DRR5(3+1)TAAUPG	ES-1	\$2,330
FL61012005BU	VMAX 100K 1200GB 10K SAS DRV R5(3+1) UPG	ES-1	\$2,330
FL61012006BTU	VMAX 100K 1200GB 10K SAS DRR6(6+2)TAAUPG	ES-1	\$2,330
FL61012006BU	VMAX 100K 1200GB 10K SAS DRV R6(6+2) UPG	ES-1	\$2,330
FL61012007BTU	VMAX 100K 1200GB 10K SAS DRR5(7+1)TAAUPG	ES-1	\$2,330
FL61012007BU	VMAX 100K 1200GB 10K SAS DRV R5(7+1) UPG	ES-1	\$2,330
FL6101200FBTU	VMAX 100K 1200GB 10K SASDRR6(14+2)TAAUPG	ES-1	\$2,330
FL6101200FBU	VMAX 100K 1200GB 10K SAS DRV R6(14+2)UPG	ES-1	\$2,330
FL6101200SBTU	VMAX 100K 1200GB 10K SAS DRV SPARETAAUP	ES-1	\$2,330
FL6101200SBU	VMAX 100K 1200GB 10K SAS DRV SPARE UPG	ES-1	\$2,330
FL6103001BTU	VMAX 100K 300GB 10K SAS DRV R1 TAA UPG	ES-1	\$805
FL6103001BU	VMAX 100K 300GB 10K SAS DRV R1 UPG	ES-1	\$805
FL6103005BTU	VMAX 100K 300GB 10K SAS DRVR5(3+1)TAAUPG	ES-1	\$805
FL6103005BU	VMAX 100K 300GB 10K SAS DRV R5(3+1) UPG	ES-1	\$805
FL6103006BTU	VMAX 100K 300GB 10K SAS DRVR6(6+2)TAAUPG	ES-1	\$805
FL6103006BU	VMAX 100K 300GB 10K SAS DRV R6(6+2) UPG	ES-1	\$805
FL6103007BTU	VMAX 100K 300GB 10K SAS DRVR5(7+1)TAAUPG	ES-1	\$805
FL6103007BU	VMAX 100K 300GB 10K SAS DRV R5(7+1) UPG	ES-1	\$805
FL610300FBTU	VMAX 100K 300GB 10K SAS DRR6(14+2)TAAUPG	ES-1	\$805
FL610300FBU	VMAX 100K 300GB 10K SAS DRV R6(14+2) UPG	ES-1	\$805
FL610300SBTU	VMAX 100K 300GB 10K SAS DRV SPARE TAAUPG	ES-1	\$805
FL610300SBU	VMAX 100K 300GB 10K SAS DRV SPARE UPG	ES-1	\$805
FL6106001BTU	VMAX 100K 600GB 10K SAS DRV R1 TAA UPG	ES-1	\$1,510
FL6106001BU	VMAX 100K 600GB 10K SAS DRV R1 UPG	ES-1	\$1,510
FL6106005BTU	VMAX 100K 600GB 10K SAS DRVR5(3+1)TAAUPG	ES-1	\$1,510
FL6106005BU	VMAX 100K 600GB 10K SAS DRV R5(3+1) UPG	ES-1	\$1,510
FL6106006BTU	VMAX 100K 600GB 10K SAS DRVR6(6+2)TAAUPG	ES-1	\$1,510
FL6106006BU	VMAX 100K 600GB 10K SAS DRV R6(6+2) UPG	ES-1	\$1,510
FL6106007BTU	VMAX 100K 600GB 10K SAS DRVR5(7+1)TAAUPG	ES-1	\$1,510
FL6106007BU	VMAX 100K 600GB 10K SAS DRV R5(7+1) UPG	ES-1	\$1,510
FL610600FBTU	VMAX 100K 600GB 10K SAS DRR6(14+2)TAAUPG	ES-1	\$1,510
FL610600FBU	VMAX 100K 600GB 10K SAS DRV R6(14+2) UPG	ES-1	\$1,510

FL610600SBTU	VMAX 100K 600GB 10K SAS DRV SPARE TAAUPG	ES-1	\$1,510
FL610600SBU	VMAX 100K 600GB 10K SAS DRV SPARE UPG	ES-1	\$1,510
FL6153001BTU	VMAX 100K 300GB 15K SAS DRV R1 TAA UPG	ES-1	\$2,065
FL6153001BU	VMAX 100K 300GB 15K SAS DRV R1 UPG	ES-1	\$2,065
FL6153005BTU	VMAX 100K 300GB 15K SAS DRVR5(3+1)TAAUPG	ES-1	\$2,065
FL6153005BU	VMAX 100K 300GB 15K SAS DRV R5(3+1) UPG	ES-1	\$2,065
FL6153006BTU	VMAX 100K 300GB 15K SAS DRVR6(6+2)TAAUPG	ES-1	\$2,065
FL6153006BU	VMAX 100K 300GB 15K SAS DRV R6(6+2) UPG	ES-1	\$2,065
FL6153007BTU	VMAX 100K 300GB 15K SAS DRVR5(7+1)TAAUPG	ES-1	\$2,065
FL6153007BU	VMAX 100K 300GB 15K SAS DRV R5(7+1) UPG	ES-1	\$2,065
FL615300FBTU	VMAX 100K 300GB 15K SAS DRR6(14+2)TAAUPG	ES-1	\$2,065
FL615300FBU	VMAX 100K 300GB 15K SAS DRV R6(14+2) UPG	ES-1	\$2,065
FL615300SBTU	VMAX 100K 300GB 15K SAS DRV SPARE TAAUPG	ES-1	\$2,065
FL615300SBU	VMAX 100K 300GB 15K SAS DRV SPARE UPG	ES-1	\$2,065
FL6F319201BTUT0	VMAX100K 1920GB FLASH R1 TAA UPG	ES-1	\$31,885
FL6F319201BTUT1	VMAX100K 1920GB FLASH R1 TAA UPG 8-11	ES-1	\$27,910
FL6F319201BTUT2	VMAX100K 1920GB FLASH R1 TAA UPG 12+	ES-1	\$25,760
FL6F319201BUT0	VMAX100K 1920GB FLASH R1 UPG	ES-1	\$31,885
FL6F319201BUT1	VMAX100K 1920GB FLASH R1 UPG 8-11	ES-1	\$27,910
FL6F319201BUT2	VMAX100K 1920GB FLASH R1 UPG 12+	ES-1	\$25,760
FL6F319205BTUT0	VMAX100K 1920GBFLASH R5(3+1)TAAUPG	ES-1	\$31,885
FL6F319205BTUT1	VMAX100K 1920GBFLASH R5(3+1)TAAUPG 8-11	ES-1	\$27,910
FL6F319205BTUT2	VMAX100K 1920GBFLASH R5(3+1)TAAUPG 12+	ES-1	\$25,760
FL6F319205BUT0	VMAX100K 1920GB FLASH R5(3+1) UPG	ES-1	\$31,885
FL6F319205BUT1	VMAX100K 1920GB FLASH R5(3+1) UPG 8-11	ES-1	\$27,910
FL6F319205BUT2	VMAX100K 1920GB FLASH R5(3+1) UPG 12+	ES-1	\$25,760
FL6F319206BTUT0	VMAX100K 1920GBFLASH R6(6+2)TAAUPG	ES-1	\$31,885
FL6F319206BTUT1	VMAX100K 1920GBFLASH R6(6+2)TAAUPG 8-11	ES-1	\$27,910
FL6F319206BTUT2	VMAX100K 1920GBFLASH R6(6+2)TAAUPG 12+	ES-1	\$25,760
FL6F319206BUT0	VMAX100K 1920GB FLASH R6(6+2)UPG	ES-1	\$31,885
FL6F319206BUT1	VMAX100K 1920GB FLASH R6(6+2)UPG 8-11	ES-1	\$27,910
FL6F319206BUT2	VMAX100K 1920GB FLASH R6(6+2)UPG 12+	ES-1	\$25,760
FL6F319207BTUT0	VMAX100K 1920GBFLASH R5(7+1)TAAUPG	ES-1	\$31,885
FL6F319207BTUT1	VMAX100K 1920GBFLASH R5(7+1)TAAUPG 8-11	ES-1	\$27,910
FL6F319207BTUT2	VMAX100K 1920GBFLASH R5(7+1)TAAUPG 12+	ES-1	\$25,760
FL6F319207BUT0	VMAX100K 1920GB FLASH R5(7+1) UPG	ES-1	\$31,885
FL6F319207BUT1	VMAX100K 1920GB FLASH R5(7+1) UPG 8-11	ES-1	\$27,910
FL6F319207BUT2	VMAX100K 1920GB FLASH R5(7+1) UPG 12+	ES-1	\$25,760
FL6F31920FBTUT0	VMAX100K 1920GB FLASH R6(14+2)TAAUPG	ES-1	\$31,885
FL6F31920FBTUT1	VMAX100K 1920GB FLASH R6(14+2)TAAUPG8-11	ES-1	\$27,910
FL6F31920FBTUT2	VMAX100K 1920GB FLASH R6(14+2)TAAUPG 12+	ES-1	\$25,760
FL6F31920FBUT0	VMAX100K 1920GB FLASH R6(14+2)UPG	ES-1	\$31,885
FL6F31920FBUT1	VMAX100K 1920GB FLASH R6(14+2)UPG 8-11	ES-1	\$27,910
FL6F31920FBUT2	VMAX100K 1920GB FLASH R6(14+2)UPG 12+	ES-1	\$25,760
FL6F31920SBTUT0	VMAX100K 1920GB FLASH SPARE TAAUPG	ES-1	\$31,885
FL6F31920SBUT0	VMAX100K 1920GB FLASH SAS DRV SPARE UPG	ES-1	\$31,885
FL6F39601BTUT0	VMAX100K 960GB FLASH R1 TAA UPG	ES-1	\$18,475
FL6F39601BTUT1	VMAX100K 960GB FLASH R1 TAA UPG 8-11	ES-1	\$15,710
FL6F39601BTUT2	VMAX100K 960GB FLASH R1 TAA UPG 12+	ES-1	\$14,925
FL6F39601BUT0	VMAX100K 960GB FLASH R1 UPG	ES-1	\$18,475

FL6F39601BUT1	VMAX100K 960GB FLASH R1 UPG 8-11	ES-1	\$15,710
FL6F39601BUT2	VMAX100K 960GB FLASH R1 UPG 12+	ES-1	\$14,925
FL6F39605BTUT0	VMAX100K 960GBFLASH R5(3+1)TAAUPG	ES-1	\$18,475
FL6F39605BTUT1	VMAX100K 960GBFLASH R5(3+1)TAAUPG 8-11	ES-1	\$15,710
FL6F39605BTUT2	VMAX100K 960GBFLASH R5(3+1)TAAUPG 12+	ES-1	\$14,925
FL6F39605BUT0	VMAX100K 960GB FLASH R5(3+1) UPG	ES-1	\$18,475
FL6F39605BUT1	VMAX100K 960GB FLASH R5(3+1) UPG 8-11	ES-1	\$15,710
FL6F39605BUT2	VMAX100K 960GB FLASH R5(3+1) UPG 12+	ES-1	\$14,925
FL6F39606BTUT0	VMAX100K 960GBFLASH R6(6+2)TAAUPG	ES-1	\$18,475
FL6F39606BTUT1	VMAX100K 960GBFLASH R6(6+2)TAAUPG 8-11	ES-1	\$15,710
FL6F39606BTUT2	VMAX100K 960GBFLASH R6(6+2)TAAUPG 12+	ES-1	\$14,925
FL6F39606BUT0	VMAX100K 960GB FLASH R6(6+2)UPG	ES-1	\$18,475
FL6F39606BUT1	VMAX100K 960GB FLASH R6(6+2)UPG 8-11	ES-1	\$15,710
FL6F39606BUT2	VMAX100K 960GB FLASH R6(6+2)UPG 12+	ES-1	\$14,925
FL6F39607BTUT0	VMAX100K 960GBFLASH R5(7+1)TAAUPG	ES-1	\$18,475
FL6F39607BTUT1	VMAX100K 960GBFLASH R5(7+1)TAAUPG 8-11	ES-1	\$15,710
FL6F39607BTUT2	VMAX100K 960GBFLASH R5(7+1)TAAUPG 12+	ES-1	\$14,925
FL6F39607BUT0	VMAX100K 960GB FLASH R5(7+1) UPG	ES-1	\$18,475
FL6F39607BUT1	VMAX100K 960GB FLASH R5(7+1) UPG 8-11	ES-1	\$15,710
FL6F39607BUT2	VMAX100K 960GB FLASH R5(7+1) UPG 12+	ES-1	\$14,925
FL6F3960FBTUT0	VMAX100K 960GB FLASH R6(14+2)TAAUPG	ES-1	\$18,475
FL6F3960FBTUT1	VMAX100K 960GB FLASH R6(14+2)TAAUPG8-11	ES-1	\$15,710
FL6F3960FBTUT2	VMAX100K 960GB FLASH R6(14+2)TAAUPG 12+	ES-1	\$14,925
FL6F3960FBUT0	VMAX100K 960GB FLASH R6(14+2)UPG	ES-1	\$18,475
FL6F3960FBUT1	VMAX100K 960GB FLASH R6(14+2)UPG 8-11	ES-1	\$15,710
FL6F3960FBUT2	VMAX100K 960GB FLASH R6(14+2)UPG 12+	ES-1	\$14,925
FL6F3960SBTUT0	VMAX100K 960GB FLASH SPARE TAAUPG	ES-1	\$18,475
FL6F3960SBUT0	VMAX100K 960GB FLASH SAS DRV SPARE UPG	ES-1	\$18,475
FL6FM16001BT0	VMAX100K 1600GB FLASH R1 1-7	ES-1	\$22,600
FL6FM16001BT1	VMAX100K 1600GB FLASH R1 8-15	ES-1	\$19,370
FL6FM16001BT2	VMAX100K 1600GB FLASH R1 16-23	ES-1	\$16,950
FL6FM16001BT3	VMAX100K 1600GB FLASH R1 24+	ES-1	\$16,140
FL6FM16001BTUT0	VMAX100K 1600GB FLASH R1 TAA UPG	ES-1	\$31,805
FL6FM16001BTUT1	VMAX100K 1600GB FLASH R1 TAA UPG 8-15	ES-1	\$20,600
FL6FM16001BTUT2	VMAX100K 1600GB FLASH R1 TAA UPG 16-23	ES-1	\$19,200
FL6FM16001BTUT3	VMAX100K 1600GB FLASH R1 TAA UPG 24+	ES-1	\$22,600
FL6FM16001BUT0	VMAX100K 1600GB FLASH R1 UPG	ES-1	\$31,805
FL6FM16001BUT1	VMAX100K 1600GB FLASH R1 UPG 8-15	ES-1	\$20,600
FL6FM16001BUT2	VMAX100K 1600GB FLASH R1 UPG 16-23	ES-1	\$19,200
FL6FM16001BUT3	VMAX100K 1600GB FLASH R1 UPG 24+	ES-1	\$19,200
FL6FM16005BT0	VMAX100K 1600GB FLASH R5(3+1) 1-7	ES-1	\$22,600
FL6FM16005BT1	VMAX100K 1600GB FLASH R5(3+1) 8-15	ES-1	\$19,370
FL6FM16005BT2	VMAX100K 1600GB FLASH R5(3+1) 16-23	ES-1	\$16,950
FL6FM16005BT3	VMAX100K 1600GB FLASH R5(3+1) 24+	ES-1	\$16,140
FL6FM16005BTUT0	VMAX100K 1600GB FLASH R5(3+1)TAA UPG	ES-1	\$31,805
FL6FM16005BTUT1	VMAX100K 1600GB FLASH R5(3+1)TAAUPG 8-15	ES-1	\$20,600
FL6FM16005BTUT2	VMAX100K 1600GBFLASH R5(3+1)TAAUPG 16-23	ES-1	\$19,200
FL6FM16005BTUT3	VMAX100K 1600GB FLASH R5(3+1)TAA UPG 24+	ES-1	\$22,600
FL6FM16005BUT0	VMAX100K 1600GB FLASH R5(3+1) UPG	ES-1	\$31,805
FL6FM16005BUT1	VMAX100K 1600GB FLASH R5(3+1) UPG 8-15	ES-1	\$20,600

FL6FM16005BUT2	VMAX100K 1600GB FLASH R5(3+1) UPG 16-23	ES-1	\$19,200
FL6FM16005BUT3	VMAX100K 1600GB FLASH R5(3+1) UPG 24+	ES-1	\$22,600
FL6FM16006BT0	VMAX100K 1600GB FLASH R6(6+2) 1-7	ES-1	\$22,600
FL6FM16006BT1	VMAX100K 1600GB FLASH R6(6+2) 8-15	ES-1	\$19,370
FL6FM16006BT2	VMAX100K 1600GB FLASH R6(6+2) 16-23	ES-1	\$16,950
FL6FM16006BT3	VMAX100K 1600GB FLASH R6(6+2) 24+	ES-1	\$16,140
FL6FM16006BTUT0	VMAX100K 1600GB FLASH R6(6+2)TAA UPG	ES-1	\$31,805
FL6FM16006BTUT1	VMAX100K 1600GBFLASH R6(6+2)TAA UPG 8-15	ES-1	\$27,120
FL6FM16006BTUT2	VMAX100K 1600GBFLASH R6(6+2)TAAUPG 16-23	ES-1	\$23,730
FL6FM16006BTUT3	VMAX100K 1600GB FLASH R6(6+2)TAA UPG 24+	ES-1	\$22,600
FL6FM16006BUT0	VMAX100K 1600GB FLASH R6(6+2) UPG	ES-1	\$31,805
FL6FM16006BUT1	VMAX100K 1600GB FLASH R6(6+2) UPG 8-15	ES-1	\$27,120
FL6FM16006BUT2	VMAX100K 1600GB FLASH R6(6+2) UPG 16-23	ES-1	\$23,730
FL6FM16006BUT3	VMAX100K 1600GB FLASH R6(6+2) UPG 24+	ES-1	\$22,600
FL6FM16007BT0	VMAX100K 1600GB FLASH R5(7+1) 1-7	ES-1	\$22,600
FL6FM16007BT1	VMAX100K 1600GB FLASH R5(7+1) 8-15	ES-1	\$19,370
FL6FM16007BT2	VMAX100K 1600GB FLASH R5(7+1) 16-23	ES-1	\$16,950
FL6FM16007BT3	VMAX100K 1600GB FLASH R5(7+1) 24+	ES-1	\$16,140
FL6FM16007BTUT0	VMAX100K 1600GB FLASH R5(7+1)TAA UPG	ES-1	\$31,805
FL6FM16007BTUT1	VMAX100K 1600GB FLASH R5(7+1)TAAUPG 8-15	ES-1	\$20,600
FL6FM16007BTUT2	VMAX100K 1600GBFLASH R5(7+1)TAAUPG 16-23	ES-1	\$19,200
FL6FM16007BTUT3	VMAX100K 1600GB FLASH R5(7+1)TAA UPG 24+	ES-1	\$22,600
FL6FM16007BUT0	VMAX100K 1600GB FLASH R5(7+1) UPG	ES-1	\$31,805
FL6FM16007BUT1	VMAX100K 1600GB FLASH R5(7+1) UPG 8-15	ES-1	\$20,600
FL6FM16007BUT2	VMAX100K 1600GB FLASH R5(7+1) UPG 16-23	ES-1	\$19,200
FL6FM16007BUT3	VMAX100K 1600GB FLASH R5(7+1) UPG 24+	ES-1	\$22,600
FL6FM1600FBT0	VMAX100K 1600GB FLASH R6(14+2) 1-7	ES-1	\$22,600
FL6FM1600FBT1	VMAX100K 1600GB FLASH R6(14+2) 8-15	ES-1	\$19,370
FL6FM1600FBT2	VMAX100K 1600GB FLASH R6(14+2) 16-23	ES-1	\$16,950
FL6FM1600FBT3	VMAX100K 1600GB FLASH R6(14+2) 24+	ES-1	\$16,140
FL6FM1600FBTUT0	VMAX100K 1600GB FLASH R6(14+2)TAA UPG	ES-1	\$31,805
FL6FM1600FBTUT1	VMAX100K 1600GB FLSHDRVR6(14+2)TAAUPG8-	ES-1	\$27,120
FL6FM1600FBTUT2	V100K 1600GB FLSHDRVR6(14+2)TAAUPG 16-23	ES-1	\$23,730
FL6FM1600FBTUT3	VMAX100K 1600GB FLSHDRVR6(14+2)TAAUPGA	ES-1	\$22,600
FL6FM1600FBUT0	VMAX100K 1600GB FLASH R6(14+2) UPG	ES-1	\$31,805
FL6FM1600FBUT1	VMAX100K 1600GB FLASH R6(14+2) UPG 8-15	ES-1	\$27,120
FL6FM1600FBUT2	VMAX100K 1600GB FLASH R6(14+2) UPG 16-23	ES-1	\$23,730
FL6FM1600FBUT3	VMAX100K 1600GB FLASH R6(14+2) UPG 24+	ES-1	\$22,600
FL6FM1600SB	VMAX100K 1600GB FLASH SPARE	ES-1	\$22,600
FL6FM1600SBU	VMAX 100K 1600GB FLASH DRIVE SPARE UPG	ES-1	\$31,805
FL6FM2001BT0	VMAX100K 200GB FLASH R1 1-63	ES-1	\$3,905
FL6FM2001BT1	VMAX100K 200GB FLASH R1 64-127	ES-1	\$3,625
FL6FM2001BT2	VMAX100K 200GB FLASH R1 128-191	ES-1	\$3,065
FL6FM2001BT3	VMAX100K 200GB FLASH R1192+	ES-1	\$2,930
FL6FM2001BTUT0	VMAX100K 200GB FLASH R1 TAA UPG	ES-1	\$5,475
FL6FM2001BTUT1	VMAX100K 200GB FLASH R1 TAA UPG 64-95	ES-1	\$5,106
FL6FM2001BTUT2	VMAX100K 200GB FLASH R1 TAA UPG 96+	ES-1	\$4,257
FL6FM2001BUT0	VMAX100K 200GB FLASH R1 UPG	ES-1	\$5,475
FL6FM2001BUT1	VMAX100K 200GB FLASH R1 UPG 64-95	ES-1	\$5,106
FL6FM2001BUT2	VMAX100K 200GB FLASH R1 UPG 96+	ES-1	\$4,257

FL6FM2005BT0	VMAX100K 200GB FLASH R5(3+1) 1-63	ES-1	\$3,905
FL6FM2005BT1	VMAX100K 200GB FLASH R5(3+1) 64-127	ES-1	\$3,625
FL6FM2005BT2	VMAX100K 200GB FLASH R5(3+1) 128-191	ES-1	\$3,065
FL6FM2005BT3	VMAX100K 200GB FLASH R5(3+1) 192+	ES-1	\$2,930
FL6FM2005BTUT0	VMAX100K 200GB FLASH R5(3+1)TAA UPG	ES-1	\$5,475
FL6FM2005BTUT1	VMAX100K 200GB FLASHR5(3+1)TAAUPG 64-95	ES-1	\$5,106
FL6FM2005BTUT2	VMAX100K 200GB FLASHR5(3+1)TAAUPG 96+	ES-1	\$4,257
FL6FM2005BUT0	VMAX100K 200GB FLASH R5(3+1) UPG	ES-1	\$5,475
FL6FM2005BUT1	VMAX100K 200GB FLASH R5(3+1) UPG 64-95	ES-1	\$5,106
FL6FM2005BUT2	VMAX100K 200GB FLASH R5(3+1) UPG 96+	ES-1	\$4,257
FL6FM2006BT0	VMAX100K 200GB FLASH R6(6+2) 1-63	ES-1	\$3,905
FL6FM2006BT1	VMAX100K 200GB FLASH R6(6+2) 64-127	ES-1	\$3,625
FL6FM2006BT2	VMAX100K 200GB FLASH R6(6+2) 128-191	ES-1	\$3,065
FL6FM2006BT3	VMAX100K 200GB FLASH R6(6+2)192+	ES-1	\$2,930
FL6FM2006BTUT0	VMAX100K 200GB FLASH R6(6+2)TAA UPG	ES-1	\$5,475
FL6FM2006BTUT1	VMAX100K 200GBFLASH R6(6+2)TAAUPG 64-95	ES-1	\$5,106
FL6FM2006BTUT2	VMAX100K 200GBFLASH R6(6+2)TAAUPG 96+	ES-1	\$4,257
FL6FM2006BUT0	VMAX100K 200GB FLASH R6(6+2) UPG	ES-1	\$5,475
FL6FM2006BUT1	VMAX100K 200GB FLASH R6(6+2)UPG 64-95	ES-1	\$5,106
FL6FM2006BUT2	VMAX100K 200GB FLASH R6(6+2)UPG 96+	ES-1	\$4,257
FL6FM2007BT0	VMAX100K 200GB FLASH R5(7+1) 1-63	ES-1	\$3,905
FL6FM2007BT1	VMAX100K 200GB FLASH R5(7+1) 64-127	ES-1	\$3,625
FL6FM2007BT2	VMAX100K 200GB FLASH R5(7+1) 128-191	ES-1	\$3,065
FL6FM2007BT3	VMAX100K 200GB FLASH R5(7+1) 192+	ES-1	\$2,930
FL6FM2007BTUT0	VMAX100K 200GB FLASH R5(7+1)TAA UPG	ES-1	\$5,475
FL6FM2007BTUT1	VMAX100K 200GB FLASHR5(7+1)TAAUPG 64-95	ES-1	\$5,106
FL6FM2007BTUT2	VMAX100K 200GB FLASHR5(7+1)TAAUPG 96+	ES-1	\$4,257
FL6FM2007BUT0	VMAX100K 200GB FLASH R5(7+1) UPG	ES-1	\$5,475
FL6FM2007BUT1	VMAX100K 200GB FLASH R5(7+1) UPG 64-95	ES-1	\$5,106
FL6FM2007BUT2	VMAX100K 200GB FLASH R5(7+1) UPG 96+	ES-1	\$4,257
FL6FM200FBT0	VMAX100K 200GB FLASH R6(14+2) 1-63	ES-1	\$3,905
FL6FM200FBT1	VMAX100K 200GB FLASH R6(14+2) 64-127	ES-1	\$3,625
FL6FM200FBT2	VMAX100K 200GB FLASH R6(14+2) 128-191	ES-1	\$3,065
FL6FM200FBT3	VMAX100K 200GB FLASH R6(14+2) 192+	ES-1	\$2,930
FL6FM200FBTUT0	VMAX100K 200GB FLASH R6(14+2)TAA UPG	ES-1	\$5,475
FL6FM200FBTUT1	VMAX100K200GBFLASH R6(14+2)TAAUPG 64-95	ES-1	\$5,106
FL6FM200FBTUT2	VMAX100K200GBFLASHR6(14+2)TAAUPG 96+	ES-1	\$4,257
FL6FM200FBUT0	VMAX100K 200GB FLASH R6(14+2) UPG	ES-1	\$5,475
FL6FM200FBUT1	VMAX100K 200GB FLASH R6(14+2)UPG 64-95	ES-1	\$5,106
FL6FM200FBUT2	VMAX100K 200GB FLASH R6(14+2)UPG 96+	ES-1	\$4,257
FL6FM200SB	VMAX100K 200GB FLASH SPARE	ES-1	\$3,905
FL6FM200SBU	VMAX 100K 200GB FLASH DRIVE SPARE UPG	ES-1	\$5,475
FL6FM4001BT0	VMAX100K 400GB FLASH R1 1-31	ES-1	\$7,425
FL6FM4001BT1	VMAX100K 400GB FLASH R1 32-63	ES-1	\$6,900
FL6FM4001BT2	VMAX100K 400GB FLASH R1 64-95	ES-1	\$5,565
FL6FM4001BT3	VMAX100K 400GB FLASH R1 96+	ES-1	\$5,305
FL6FM4001BTUT0	VMAX100K 400GB FLASH R1 TAA UPG	ES-1	\$10,395
FL6FM4001BTUT1	VMAX100K 400GB FLASH R1 TAA UPG 32-47	ES-1	\$9,660
FL6FM4001BTUT2	VMAX100K 400GB FLASH R1 TAA UPG 48+	ES-1	\$7,790
FL6FM4001BUT0	VMAX100K 400GB FLASH R1 UPG	ES-1	\$10,395

FL6FM4001BUT1	VMAX100K 400GB FLASH R1 UPG 32-47	ES-1	\$9,660
FL6FM4001BUT2	VMAX100K 400GB FLASH R1 UPG 48+	ES-1	\$7,790
FL6FM4005BT0	VMAX100K 400GB FLASH R5(3+1) 1-31	ES-1	\$7,425
FL6FM4005BT1	VMAX100K 400GB FLASH R5(3+1) 32-63	ES-1	\$6,900
FL6FM4005BT2	VMAX100K 400GB FLASH R5(3+1) 64-95	ES-1	\$5,565
FL6FM4005BT3	VMAX100K 400GB FLASH R5(3+1) 96+	ES-1	\$5,305
FL6FM4005BTUT0	VMAX100K 400GB FLASH R5(3+1)TAA UPG	ES-1	\$10,395
FL6FM4005BTUT1	VMAX100K 400GB FLASHR5(3+1)TAAUPG 32-47	ES-1	\$9,660
FL6FM4005BTUT2	VMAX100K 400GB FLASHR5(3+1)TAAUPG 48+	ES-1	\$7,790
FL6FM4005BUT0	VMAX100K 400GB FLASH R5(3+1) UPG	ES-1	\$10,395
FL6FM4005BUT1	VMAX100K 400GB FLASH R5(3+1) UPG 32-47	ES-1	\$9,660
FL6FM4005BUT2	VMAX100K 400GB FLASH R5(3+1) UPG 48+	ES-1	\$7,790
FL6FM4006BT0	VMAX100K 400GB FLASH R6(6+2) 1-31	ES-1	\$7,425
FL6FM4006BT1	VMAX100K 400GB FLASH R6(6+2) 32-63	ES-1	\$6,900
FL6FM4006BT2	VMAX100K 400GB FLASH R6(6+2) 64-95	ES-1	\$5,565
FL6FM4006BT3	VMAX100K 400GB FLASH R6(6+2) 96+	ES-1	\$5,305
FL6FM4006BTUT0	VMAX100K 400GB FLASH R6(6+2)TAA UPG	ES-1	\$10,395
FL6FM4006BTUT1	VMAX100K 400GB FLASHR6(6+2)TAAUPG 32-47	ES-1	\$9,660
FL6FM4006BTUT2	VMAX100K 400GB FLASHR6(6+2)TAAUPG 48+	ES-1	\$7,790
FL6FM4006BUT0	VMAX100K 400GB FLASH R6(6+2) UPG	ES-1	\$10,395
FL6FM4006BUT1	VMAX100K 400GB FLASH R6(6+2)UPG 32-47	ES-1	\$9,660
FL6FM4006BUT2	VMAX100K 400GB FLASH R6(6+2)UPG 48+	ES-1	\$7,790
FL6FM4007BT0	VMAX100K 400GB FLASH R5(7+1) 1-31	ES-1	\$7,425
FL6FM4007BT1	VMAX100K 400GB FLASH R5(7+1) 32-63	ES-1	\$6,900
FL6FM4007BT2	VMAX100K 400GB FLASH R5(7+1) 64-95	ES-1	\$5,565
FL6FM4007BT3	VMAX100K 400GB FLASH R5(7+1) 96+	ES-1	\$5,305
FL6FM4007BTUT0	VMAX100K 400GB FLASH R5(7+1)TAA UPG	ES-1	\$10,395
FL6FM4007BTUT1	VMAX100K 400GB FLASHR5(7+1)TAAUPG 32-47	ES-1	\$9,660
FL6FM4007BTUT2	VMAX100K 400GB FLASHR5(7+1)TAAUPG 48+	ES-1	\$7,790
FL6FM4007BUT0	VMAX100K 400GB FLASH R5(7+1) UPG	ES-1	\$10,395
FL6FM4007BUT1	VMAX100K 400GB FLASH R5(7+1) UPG 32-47	ES-1	\$9,660
FL6FM4007BUT2	VMAX100K 400GB FLASH R5(7+1) UPG 48+	ES-1	\$7,790
FL6FM400FBT0	VMAX100K 400GB FLASH R6(14+2) 1-31	ES-1	\$7,425
FL6FM400FBT1	VMAX100K 400GB FLASH R6(14+2) 32-63	ES-1	\$6,900
FL6FM400FBT2	VMAX100K 400GB FLASH R6(14+2) 64-95	ES-1	\$5,565
FL6FM400FBT3	VMAX100K 400GB FLASH R6(14+2) 96+	ES-1	\$5,305
FL6FM400FBTUT0	VMAX100K 400GB FLASH R6(14+2)TAA UPG	ES-1	\$10,395
FL6FM400FBTUT1	VMAX100K400GBFLASH R6(14+2)TAAUPG 32-47	ES-1	\$9,660
FL6FM400FBTUT2	VMAX100K400GBFLASHR6(14+2)TAAUPG 48+	ES-1	\$7,790
FL6FM400FBUT0	VMAX100K 400GB FLASH R6(14+2) UPG	ES-1	\$10,395
FL6FM400FBUT1	VMAX100K 400GB FLASH R6(14+2) UPG 32-47	ES-1	\$9,660
FL6FM400FBUT2	VMAX100K 400GB FLASH R6(14+2) UPG 48+	ES-1	\$7,790
FL6FM400SB	VMAX100K 400GB FLASH SPARE	ES-1	\$7,425
FL6FM400SBU	VMAX 100K 400GB FLASH DRIVE SPARE UPG	ES-1	\$10,395
FL6FM8001BT0	VMAX100K 800GB FLASH R1 1-15	ES-1	\$13,095
FL6FM8001BT1	VMAX100K 800GB FLASH R1 16-31	ES-1	\$11,220
FL6FM8001BT2	VMAX100K 800GB FLASH R1 32-47	ES-1	\$9,350
FL6FM8001BT3	VMAX100K 800GB FLASH R1 48+	ES-1	\$8,885
FL6FM8001BTUT0	VMAX100K 800GB FLASH R1 TAA UPG	ES-1	\$18,325
FL6FM8001BTUT1	VMAX100K 800GB FLASH R1 TAA UPG 16-23	ES-1	\$15,710

FL6FM8001BTUT2	VMAX100K 800GB FLASH R1 TAA UPG 24+	ES-1	\$12,986
FL6FM8001BUT0	VMAX100K 800GB FLASH R1 UPG	ES-1	\$18,325
FL6FM8001BUT1	VMAX100K 800GB FLASH R1 UPG 16-23	ES-1	\$15,710
FL6FM8001BUT2	VMAX100K 800GB FLASH R1 UPG 24+	ES-1	\$12,986
FL6FM8005BT0	VMAX100K 800GB FLASH R5(3+1) 1-15	ES-1	\$13,095
FL6FM8005BT1	VMAX100K 800GB FLASH R5(3+1) 16-31	ES-1	\$11,220
FL6FM8005BT2	VMAX100K 800GB FLASH R5(3+1) 32-47	ES-1	\$9,350
FL6FM8005BT3	VMAX100K 800GB FLASH R5(3+1) 48+	ES-1	\$8,885
FL6FM8005BTUT0	VMAX100K 800GB FLASH R5(3+1)TAA UPG	ES-1	\$18,325
FL6FM8005BTUT1	VMAX100K 800GB FLASHR5(3+1)TAAUPG 16-23	ES-1	\$15,710
FL6FM8005BTUT2	VMAX100K 800GB FLASHR5(3+1)TAAUPG 24+	ES-1	\$12,986
FL6FM8005BUT0	VMAX100K 800GB FLASH R5(3+1) UPG	ES-1	\$18,325
FL6FM8005BUT1	VMAX100K 800GB FLASH R5(3+1) UPG 16-23	ES-1	\$15,710
FL6FM8005BUT2	VMAX100K 800GB FLASH R5(3+1) UPG 24+	ES-1	\$12,986
FL6FM8006BT0	VMAX100K 800GB FLASH R6(6+2) 1-15	ES-1	\$13,095
FL6FM8006BT1	VMAX100K 800GB FLASH R6(6+2) 16-31	ES-1	\$11,220
FL6FM8006BT2	VMAX100K 800GB FLASH R6(6+2) 32-47	ES-1	\$9,350
FL6FM8006BT3	VMAX100K 800GB FLASH R6(6+2) 48+	ES-1	\$8,885
FL6FM8006BTUT0	VMAX100K 800GB FLASH R6(6+2)TAA UPG	ES-1	\$18,325
FL6FM8006BTUT1	VMAX100K 800GB FLASHR6(6+2)TAAUPG 16-23	ES-1	\$15,710
FL6FM8006BTUT2	VMAX100K 800GB FLASHR6(6+2)TAAUPG 24+	ES-1	\$12,986
FL6FM8006BUT0	VMAX100K 800GB FLASH R6(6+2) UPG	ES-1	\$18,325
FL6FM8006BUT1	VMAX100K 800GB FLASH R6(6+2)UPG 16-23	ES-1	\$15,710
FL6FM8006BUT2	VMAX100K 800GB FLASH R6(6+2)UPG 24+	ES-1	\$12,986
FL6FM8007BT0	VMAX100K 800GB FLASH R5(7+1) 1-15	ES-1	\$13,095
FL6FM8007BT1	VMAX100K 800GB FLASH R5(7+1) 16-31	ES-1	\$11,220
FL6FM8007BT2	VMAX100K 800GB FLASH R5(7+1) 32-47	ES-1	\$9,350
FL6FM8007BT3	VMAX100K 800GB FLASH R5(7+1)48+	ES-1	\$8,885
FL6FM8007BTUT0	VMAX100K 800GB FLASH R5(7+1)TAA UPG	ES-1	\$18,325
FL6FM8007BTUT1	VMAX100K 800GB FLASHR5(7+1)TAAUPG 16-23	ES-1	\$15,710
FL6FM8007BTUT2	VMAX100K 800GB FLASHR5(7+1)TAAUPG 24+	ES-1	\$12,986
FL6FM8007BUT0	VMAX100K 800GB FLASH R5(7+1) UPG	ES-1	\$18,325
FL6FM8007BUT1	VMAX100K 800GB FLASH R5(7+1)UPG 16-23	ES-1	\$15,710
FL6FM8007BUT2	VMAX100K 800GB FLASH R5(7+1)UPG 24+	ES-1	\$12,986
FL6FM800FBT0	VMAX100K 800GB FLASH R6(14+2) 1-15	ES-1	\$13,095
FL6FM800FBT1	VMAX100K 800GB FLASH R6(14+2) 16-31	ES-1	\$11,220
FL6FM800FBT2	VMAX100K 800GB FLASH R6(14+2) 32-47	ES-1	\$9,350
FL6FM800FBT3	VMAX100K 800GB FLASH R6(14+2) 48+	ES-1	\$8,885
FL6FM800FBTUT0	VMAX100K 800GB FLASH R6(14+2)TAA UPG	ES-1	\$18,325
FL6FM800FBTUT1	VMAX100K 800GBFLASH R6(14+2)TAAUPG 16-23	ES-1	\$15,710
FL6FM800FBTUT2	VMAX100K 800GBFLASH R6(14+2)TAAUPG 24+	ES-1	\$12,986
FL6FM800FBUT0	VMAX100K 800GB FLASH R6(14+2) UPG	ES-1	\$18,325
FL6FM800FBUT1	VMAX100K 800GB FLASH R6(14+2) UPG 16-23	ES-1	\$15,710
FL6FM800FBUT2	VMAX100K 800GB FLASH R6(14+2) UPG 24+	ES-1	\$12,986
FL6FM800SB	VMAX100K 800GB FLASH SPARE	ES-1	\$13,095
FL6FM800SBU	VMAX 100K 800GB FLASH DRIVE SPARE UPG	ES-1	\$18,325
FS61012001BTU	VMAX 100K 1200GB 10K SAS DRV R1 TAA UPG	ES-1	\$2,330
FS61012001BU	VMAX 100K 1200GB 10K SAS DRV R1 UPG	ES-1	\$2,330
FS61012005BTU	VMAX 100K 1200GB 10K SAS DRR5(3+1)TAAUPG	ES-1	\$2,330
FS61012005BU	VMAX 100K 1200GB 10K SAS DRV R5(3+1)UPG	ES-1	\$2,330

FS61012006BTU	VMAX 100K 1200GB 10K SAS DRR6(6+2)TAAUPG	ES-1	\$2,330
FS61012006BU	VMAX 100K 1200GB 10K SAS DRV R6(6+2)UPG	ES-1	\$2,330
FS61012007BTU	VMAX 100K 1200GB 10K SAS DRR5(7+1)TAAUPG	ES-1	\$2,330
FS61012007BU	VMAX 100K 1200GB 10K SAS DRV R5(7+1)UPG	ES-1	\$2,330
FS6101200FBTU	VMAX 100K 1200GB 10K SAS R6(14+2)TAAUPG	ES-1	\$2,330
FS6101200FBU	VMAX 100K 1200GB 10K SAS R6(14+2)UPG	ES-1	\$2,330
FS6101200SBTU	VMAX 100K 1200GB 10K SAS SPARE TAA UPG	ES-1	\$2,330
FS6101200SBU	VMAX 100K 1200GB 10K SAS SPARE UPG	ES-1	\$2,330
FS6103001BTU	VMAX 100K 300GB 10K SAS DRV R1 TAA UPG	ES-1	\$805
FS6103001BU	VMAX 100K 300GB 10K SAS DRV R1 UPG	ES-1	\$805
FS6103005BTU	VMAX 100K 300GB 10K SAS DRVR5(3+1)TAAUPG	ES-1	\$805
FS6103005BU	VMAX 100K 300GB 10K SAS DRV R5(3+1)UPG	ES-1	\$805
FS6103006BTU	VMAX 100K 300GB 10K SAS DRVR6(6+2)TAAUPG	ES-1	\$805
FS6103006BU	VMAX 100K 300GB 10K SAS DRV R6(6+2)UPG	ES-1	\$805
FS6103007BTU	VMAX 100K 300GB 10K SAS DRVR5(7+1)TAAUPG	ES-1	\$805
FS6103007BU	VMAX 100K 300GB 10K SAS DRV R5(7+1)UPG	ES-1	\$805
FS610300FBTU	VMAX 100K 300GB 10K SAS DRR6(14+2)TAAUPG	ES-1	\$805
FS610300FBU	VMAX 100K 300GB 10K SAS DR R6(14+2)UPG	ES-1	\$805
FS610300SBTU	VMAX 100K 300GB 10K SAS DR SPARE TAAUPG	ES-1	\$805
FS610300SBU	VMAX 100K 300GB 10K SAS DR SPARE UPG	ES-1	\$805
FS6106001BTU	VMAX 100K 600GB 10K SAS DRV R1 TAA UPG	ES-1	\$1,510
FS6106001BU	VMAX 100K 600GB 10K SAS DRV R1 UPG	ES-1	\$1,510
FS6106005BTU	VMAX 100K 600GB 10K SAS DRVR5(3+1)TAAUPG	ES-1	\$1,510
FS6106005BU	VMAX 100K 600GB 10K SAS DRV R5(3+1)UPG	ES-1	\$1,510
FS6106006BTU	VMAX 100K 600GB 10K SAS DRVR6(6+2)TAAUPG	ES-1	\$1,510
FS6106006BU	VMAX 100K 600GB 10K SAS DRV R6(6+2)UPG	ES-1	\$1,510
FS6106007BTU	VMAX 100K 600GB 10K SAS DRVR5(7+1)TAAUPG	ES-1	\$1,510
FS6106007BU	VMAX 100K 600GB 10K SAS DRV R5(7+1)UPG	ES-1	\$1,510
FS610600FBTU	VMAX 100K 600GB 10K SAS R6(14+2)TAA UPG	ES-1	\$1,510
FS610600FBU	VMAX 100K 600GB 10K SAS R6(14+2)UPG	ES-1	\$1,510
FS610600SBTU	VMAX 100K 600GB 10K SAS SPARE TAA UPG	ES-1	\$1,510
FS610600SBU	VMAX 100K 600GB 10K SAS SPARE UPG	ES-1	\$1,510
FS6153001BTU	VMAX 100K 300GB 15K SAS DRV R1 TAA UPG	ES-1	\$2,065
FS6153001BU	VMAX 100K 300GB 15K SAS DRV R1 UPG	ES-1	\$2,065
FS6153005BTU	VMAX 100K 300GB 15K SAS DRVR5(3+1)TAAUPG	ES-1	\$2,065
FS6153005BU	VMAX 100K 300GB 15K SAS DRV R5(3+1) UPG	ES-1	\$2,065
FS6153006BTU	VMAX 100K 300GB 15K SAS DRVR6(6+2)TAAUPG	ES-1	\$2,065
FS6153006BU	VMAX 100K 300GB 15K SAS DRV R6(6+2) UPG	ES-1	\$2,065
FS6153007BTU	VMAX 100K 300GB 15K SAS DRVR5(7+1)TAAUPG	ES-1	\$2,065
FS6153007BU	VMAX 100K 300GB 15K SAS DRV R5(7+1) UPG	ES-1	\$2,065
FS615300FBTU	VMAX 100K 300GB 15K SAS DRR6(14+2)TAAUPG	ES-1	\$2,065
FS615300FBU	VMAX 100K 300GB 15K SAS DRV R6(14+2) UPG	ES-1	\$2,065
FS615300SBTU	VMAX 100K 300GB 15K SAS DRV SPARE TAAUPG	ES-1	\$2,065
FS615300SBU	VMAX 100K 300GB 15K SAS DRV SPARE UPG	ES-1	\$2,065
FS6FM16001BT1	VMAX100K 1600GB FLASH R1 1-7	ES-1	\$22,600
FS6FM16001BT2	VMAX100K 1600GB FLASH R1 16-23	ES-1	\$16,950
FS6FM16001BT3	VMAX100K 1600GB FLASH R1 24+	ES-1	\$16,140
FS6FM16001BTUT0	VMAX100K 1600GB FLASH R1 TAA UPG	ES-1	\$31,805
FS6FM16001BTUT1	VMAX100K 1600GB FLASH R1 TAA UPG 8-15	ES-1	\$20,600
FS6FM16001BTUT2	VMAX100K 1600GB FLASH R1 TAA UPG 16-23	ES-1	\$19,200

FS6FM16001BTUT3	VMAX100K 1600GB FLASH R1 TAA UPG 24+	ES-1	\$22,600
FS6FM16001BUT0	VMAX100K 1600GB FLASH R1 UPG	ES-1	\$31,805
FS6FM16001BUT1	VMAX100K 1600GB FLASH R1 UPG 8-15	ES-1	\$20,600
FS6FM16001BUT2	VMAX100K 1600GB FLASH R1 UPG 16-23	ES-1	\$19,200
FS6FM16001BUT3	VMAX100K 1600GB FLASH R1 UPG 24+	ES-1	\$22,600
FS6FM16005BT0	VMAX100K 1600GB FLASH R5(3+1) 1-7	ES-1	\$22,600
FS6FM16005BT1	VMAX100K 1600GB FLASH R5(3+1) 8-15	ES-1	\$19,370
FS6FM16005BT2	VMAX100K 1600GB FLASH R5(3+1) 16-23	ES-1	\$16,950
FS6FM16005BT3	VMAX100K 1600GB FLASH R5(3+1) 24+	ES-1	\$16,140
FS6FM16005BTUT0	VMAX100K 1600GB FLASH R5(3+1)TAA UPG	ES-1	\$31,805
FS6FM16005BTUT1	VMAX100K 1600GBFLASH R5(3+1)TAAUPG 8-15	ES-1	\$20,600
FS6FM16005BTUT2	VMAX100K 1600GBFLASH R5(3+1)TAAUPG 16-23	ES-1	\$19,200
FS6FM16005BTUT3	VMAX100K 1600GB FLASH R5(3+1)TAA UPG 24+	ES-1	\$22,600
FS6FM16005BUT0	VMAX100K 1600GB FLASH R5(3+1) UPG	ES-1	\$31,805
FS6FM16005BUT1	VMAX100K 1600GB FLASH R5(3+1) UPG 8-15	ES-1	\$20,600
FS6FM16005BUT2	VMAX100K 1600GB FLASH R5(3+1) UPG 16-23	ES-1	\$19,200
FS6FM16005BUT3	VMAX100K 1600GB FLASH R5(3+1) UPG 24+	ES-1	\$22,600
FS6FM16006BT0	VMAX100K 1600GB FLASH R6(6+2) 1-7	ES-1	\$22,600
FS6FM16006BT1	VMAX100K 1600GB FLASH R6(6+2) 8-15	ES-1	\$19,370
FS6FM16006BT2	VMAX100K 1600GB FLASH R6(6+2) 16-23	ES-1	\$16,950
FS6FM16006BT3	VMAX100K 1600GB FLASH R6(6+2) 24+	ES-1	\$16,140
FS6FM16006BTUT0	VMAX100K 1600GB FLASH R6(6+2)TAA UPG	ES-1	\$31,805
FS6FM16006BTUT1	VMAX100K 1600GB FLASH R6(6+2)TAAUPG 8-15	ES-1	\$27,120
FS6FM16006BTUT2	VMAX100K 1600GBFLASH R6(6+2)TAAUPG 16-23	ES-1	\$23,730
FS6FM16006BTUT3	VMAX100K 1600GB FLASH R6(6+2)TAA UPG 24+	ES-1	\$22,600
FS6FM16006BUT0	VMAX100K 1600GB FLASH R6(6+2) UPG	ES-1	\$31,805
FS6FM16006BUT1	VMAX100K 1600GB FLASH R6(6+2) UPG 8-15	ES-1	\$27,120
FS6FM16006BUT2	VMAX100K 1600GB FLASH R6(6+2) UPG 16-23	ES-1	\$23,730
FS6FM16006BUT3	VMAX100K 1600GB FLASH R6(6+2) UPG 24+	ES-1	\$22,600
FS6FM16007BT0	VMAX100K 1600GB FLASH R5(7+1) 1-7	ES-1	\$22,600
FS6FM16007BT1	VMAX100K 1600GB FLASH R5(7+1) 8-15	ES-1	\$19,370
FS6FM16007BT2	VMAX100K 1600GB FLASH R5(7+1) 16-23	ES-1	\$16,950
FS6FM16007BT3	VMAX100K 1600GB FLASH R5(7+1) 24+	ES-1	\$16,140
FS6FM16007BTUT0	VMAX100K 1600GB FLASH R5(7+1)TAA UPG	ES-1	\$31,805
FS6FM16007BTUT1	VMAX100K 1600GB FLASH R5(7+1)TAAUPG 8-15	ES-1	\$20,600
FS6FM16007BTUT2	VMAX100K 1600GBFLASH R5(7+1)TAAUPG 16-23	ES-1	\$19,200
FS6FM16007BTUT3	VMAX100K 1600GB FLASH R5(7+1)TAA UPG 24+	ES-1	\$22,600
FS6FM16007BUT0	VMAX100K 1600GB FLASH R5(7+1) UPG	ES-1	\$31,805
FS6FM16007BUT1	VMAX100K 1600GB FLASH R5(7+1) UPG 8-15	ES-1	\$20,600
FS6FM16007BUT2	VMAX100K 1600GB FLASH R5(7+1) UPG 16-23	ES-1	\$19,200
FS6FM16007BUT3	VMAX100K 1600GB FLASH R5(7+1) UPG 24+	ES-1	\$22,600
FS6FM1600FBT0	VMAX100K 1600GB FLASH R6(14+2) 1-7	ES-1	\$22,600
FS6FM1600FBT1	VMAX100K 1600GB FLASH R6(14+2) 8-15	ES-1	\$19,370
FS6FM1600FBT2	VMAX100K 1600GB FLASH R6(14+2) 16-23	ES-1	\$16,950
FS6FM1600FBT3	VMAX100K 1600GB FLASH R6(14+2) 24+	ES-1	\$16,140
FS6FM1600FBTUT0	VMAX100K 1600GB FLASH R6(14+2)TAA UPG	ES-1	\$31,805
FS6FM1600FBTUT1	VMAX100K 1600GBFLASH R6(14+2)TAAUPG 8-15	ES-1	\$27,120
FS6FM1600FBTUT2	VMAX100K 1600GBFLASH R6(14+2)TAAUPG16-23	ES-1	\$23,730
FS6FM1600FBTUT3	VMAX100K 1600GB FLASH R6(14+2)TAAUPG 24+	ES-1	\$22,600
FS6FM1600FBUT0	VMAX100K 1600GB FLASH R6(14+2) UPG	ES-1	\$31,805

FS6FM1600FBUT1	VMAX100K 1600GB FLASH R6(14+2) UPG 8-15	ES-1	\$27,120
FS6FM1600FBUT2	VMAX100K 1600GB FLASH R6(14+2) UPG 16-23	ES-1	\$23,730
FS6FM1600FBUT3	VMAX100K 1600GB FLASH R6(14+2) UPG 24+	ES-1	\$22,600
FS6FM1600SB	VMAX100K 1600GB FLASH SPARE	ES-1	\$22,600
FS6FM1600SBU	VMAX 100K 1600GB FLASH DRIVE SPARE UPG	ES-1	\$31,805
FS6FM2001BT0	VMAX100K 200GB FLASH R1 1-63	ES-1	\$3,905
FS6FM2001BT1	VMAX100K 200GB FLASH R1 64-127	ES-1	\$3,625
FS6FM2001BT2	VMAX100K 200GB FLASH R1 128-191	ES-1	\$3,065
FS6FM2001BT3	VMAX100K 200GB FLASH R1192+	ES-1	\$2,930
FS6FM2001BTUT0	VMAX100K 200GB FLASH R1 TAA UPG	ES-1	\$5,475
FS6FM2001BTUT1	VMAX100K 200GB FLASH R1 TAA UPG 64-95	ES-1	\$5,106
FS6FM2001BTUT2	VMAX100K 200GB FLASH R1 TAA UPG 96+	ES-1	\$4,257
FS6FM2001BUT0	VMAX100K 200GB FLASH R1 UPG	ES-1	\$5,475
FS6FM2001BUT1	VMAX100K 200GB FLASH R1 UPG 64-95	ES-1	\$5,106
FS6FM2001BUT2	VMAX100K 200GB FLASH R1 UPG 96+	ES-1	\$4,257
FS6FM2005BT0	VMAX100K 200GB FLASH R5(3+1) 1-63	ES-1	\$3,905
FS6FM2005BT1	VMAX100K 200GB FLASH R5(3+1) 64-127	ES-1	\$3,625
FS6FM2005BT2	VMAX100K 200GB FLASH R5(3+1) 128-191	ES-1	\$3,065
FS6FM2005BT3	VMAX100K 200GB FLASH R5(3+1) 192+	ES-1	\$2,930
FS6FM2005BTUT0	VMAX100K 200GB FLASH R5(3+1)TAA UPG	ES-1	\$5,475
FS6FM2005BTUT1	VMAX100K 200GB FLASH R5(3+1)TAAUPG 64-95	ES-1	\$5,106
FS6FM2005BTUT2	VMAX100K 200GB FLASH R5(3+1)TAA UPG 96+	ES-1	\$4,257
FS6FM2005BUT0	VMAX100K 200GB FLASH R5(3+1) UPG	ES-1	\$5,475
FS6FM2005BUT1	VMAX100K 200GB FLASH R5(3+1) UPG 64-95	ES-1	\$5,106
FS6FM2005BUT2	VMAX100K 200GB FLASH R5(3+1) UPG 96+	ES-1	\$4,257
FS6FM2006BT0	VMAX100K 200GB FLASH R6(6+2) 1-63	ES-1	\$3,905
FS6FM2006BT1	VMAX100K 200GB FLASH R6(6+2) 64-127	ES-1	\$3,625
FS6FM2006BT2	VMAX100K 200GB FLASH R6(6+2) 128-191	ES-1	\$3,065
FS6FM2006BT3	VMAX100K 200GB FLASH R6(6+2)192+	ES-1	\$2,930
FS6FM2006BTUT0	VMAX100K 200GB FLASH R6(6+2)TAA UPG	ES-1	\$5,475
FS6FM2006BTUT1	VMAX100K 200GBFLASH R6(6+2)TAAUPG 64-95	ES-1	\$5,106
FS6FM2006BTUT2	VMAX100K 200GB FLASH R6(6+2)TAA UPG 96+	ES-1	\$4,257
FS6FM2006BUT0	VMAX100K 200GB FLASH R6(6+2) UPG	ES-1	\$5,475
FS6FM2006BUT1	VMAX100K 200GB FLASH R6(6+2) UPG 64-95	ES-1	\$5,106
FS6FM2006BUT2	VMAX100K 200GB FLASH R6(6+2) UPG 96+	ES-1	\$4,257
FS6FM2007BT0	VMAX100K 200GB FLASH R5(7+1) 1-63	ES-1	\$3,905
FS6FM2007BT1	VMAX100K 200GB FLASH R5(7+1) 64-127	ES-1	\$3,625
FS6FM2007BT2	VMAX100K 200GB FLASH R5(7+1) 128-191	ES-1	\$3,065
FS6FM2007BT3	VMAX100K 200GB FLASH R5(7+1) 192+	ES-1	\$2,930
FS6FM2007BTUT0	VMAX100K 200GB FLASH R5(7+1)TAA UPG	ES-1	\$5,475
FS6FM2007BTUT1	VMAX100K 200GB FLASH R5(7+1)TAAUPG 64-95	ES-1	\$5,106
FS6FM2007BTUT2	VMAX100K 200GB FLASH R5(7+1)TAA UPG 96+	ES-1	\$4,257
FS6FM2007BUT0	VMAX100K 200GB FLASH R5(7+1) UPG	ES-1	\$5,475
FS6FM2007BUT1	VMAX100K 200GB FLASH R5(7+1) UPG 64-95	ES-1	\$5,106
FS6FM2007BUT2	VMAX100K 200GB FLASH R5(7+1) UPG 96+	ES-1	\$4,257
FS6FM200FBT0	VMAX100K 200GB FLASH R6(14+2) 1-63	ES-1	\$3,905
FS6FM200FBT1	VMAX100K 200GB FLASH R6(14+2) 64-127	ES-1	\$3,625
FS6FM200FBT2	VMAX100K 200GB FLASH R6(14+2) 128-191	ES-1	\$3,065
FS6FM200FBT3	VMAX100K 200GB FLASH R6(14+2) 192+	ES-1	\$2,930
FS6FM200FBTUT0	VMAX100K 200GB FLASH R6(14+2)TAA UPG	ES-1	\$5,475

FS6FM200FBTUT1	VMAX100K 200GBFLASH R6(14+2)TAAUPG 64-95	ES-1	\$5,106
FS6FM200FBTUT2	VMAX100K 200GB FLASH R6(14+2TAA UPG 96+	ES-1	\$4,257
FS6FM200FBUT0	VMAX100K 200GB FLASH R6(14+2) UPG	ES-1	\$5,475
FS6FM200FBUT1	VMAX100K 200GB FLASH R6(14+2) UPG 64-95	ES-1	\$5,106
FS6FM200FBUT2	VMAX100K 200GB FLASH R6(14+2) UPG 96+	ES-1	\$4,257
FS6FM200SB	VMAX100K 200GB FLASH SPARE	ES-1	\$3,905
FS6FM200SBU	VMAX 100K 200GB FLASH DRIVE SPARE UPG	ES-1	\$5,475
FS6FM4001BT0	VMAX100K 400GB FLASH R1 1-31	ES-1	\$7,425
FS6FM4001BT1	VMAX100K 400GB FLASH R1 32-63	ES-1	\$6,900
FS6FM4001BT2	VMAX100K 400GB FLASH R1 64-95	ES-1	\$5,565
FS6FM4001BT3	VMAX100K 400GB FLASH R1 96+	ES-1	\$5,305
FS6FM4001BTUT0	VMAX100K 400GB FLASH R1 TAA UPG	ES-1	\$10,395
FS6FM4001BTUT1	VMAX100K 400GB FLASH R1 TAA UPG 32-47	ES-1	\$9,660
FS6FM4001BTUT2	VMAX100K 400GB FLASH R1 TAA UPG 48+	ES-1	\$7,790
FS6FM4001BUT0	VMAX100K 400GB FLASH R1 UPG	ES-1	\$10,395
FS6FM4001BUT1	VMAX100K 400GB FLASH R1 UPG 32-47	ES-1	\$9,660
FS6FM4001BUT2	VMAX100K 400GB FLASH R1 UPG 48+	ES-1	\$7,790
FS6FM4005BT0	VMAX100K 400GB FLASH R5(3+1) 1-31	ES-1	\$7,425
FS6FM4005BT1	VMAX100K 400GB FLASH R5(3+1) 32-63	ES-1	\$6,900
FS6FM4005BT2	VMAX100K 400GB FLASH R5(3+1) 64-95	ES-1	\$5,565
FS6FM4005BT3	VMAX100K 400GB FLASH R5(3+1) 96+	ES-1	\$5,305
FS6FM4005BTUT0	VMAX100K 400GB FLASH R5(3+1)TAA UPG	ES-1	\$10,395
FS6FM4005BTUT1	VMAX100K 400GB FLASHR5(3+1)TAAUPG 32-47	ES-1	\$9,660
FS6FM4005BTUT2	VMAX100K 400GB FLASHR5(3+1)TAAUPG 48+	ES-1	\$7,790
FS6FM4005BUT0	VMAX100K 400GB FLASH R5(3+1) UPG	ES-1	\$10,395
FS6FM4005BUT1	VMAX100K 400GB FLASH R5(3+1) UPG 32-47	ES-1	\$9,660
FS6FM4005BUT2	VMAX100K 400GB FLASH R5(3+1) UPG 48+	ES-1	\$7,790
FS6FM4006BT0	VMAX100K 400GB FLASH R6(6+2) 1-31	ES-1	\$7,425
FS6FM4006BT1	VMAX100K 400GB FLASH R6(6+2) 32-63	ES-1	\$6,900
FS6FM4006BT2	VMAX100K 400GB FLASH R6(6+2) 64-95	ES-1	\$5,565
FS6FM4006BT3	VMAX100K 400GB FLASH R6(6+2) 96+	ES-1	\$5,305
FS6FM4006BTUT0	VMAX100K 400GB FLASH R6(6+2)TAA UPG	ES-1	\$10,395
FS6FM4006BTUT1	VMAX100K 400GB FLASHR6(6+2)TAAUPG 32-47	ES-1	\$9,660
FS6FM4006BTUT2	VMAX100K 400GB FLASHR6(6+2)TAAUPG 48+	ES-1	\$7,790
FS6FM4006BUT0	VMAX100K 400GB FLASH R6(6+2) UPG	ES-1	\$10,395
FS6FM4006BUT1	VMAX100K 400GB FLASH R6(6+2)UPG 32-47	ES-1	\$9,660
FS6FM4006BUT2	VMAX100K 400GB FLASH R6(6+2)UPG 48+	ES-1	\$7,790
FS6FM4007BT0	VMAX100K 400GB FLASH R5(7+1) 1-31	ES-1	\$7,425
FS6FM4007BT1	VMAX100K 400GB FLASH R5(7+1) 32-63	ES-1	\$6,900
FS6FM4007BT2	VMAX100K 400GB FLASH R5(7+1) 64-95	ES-1	\$5,565
FS6FM4007BT3	VMAX100K 400GB FLASH R5(7+1) 96+	ES-1	\$5,305
FS6FM4007BTUT0	VMAX100K 400GB FLASH R5(7+1)TAA UPG	ES-1	\$10,395
FS6FM4007BTUT1	VMAX100K 400GB FLASHR5(7+1)TAAUPG 32-47	ES-1	\$9,660
FS6FM4007BTUT2	VMAX100K 400GB FLASHR5(7+1)TAAUPG 48+	ES-1	\$7,790
FS6FM4007BUT0	VMAX100K 400GB FLASH R5(7+1) UPG	ES-1	\$10,395
FS6FM4007BUT1	VMAX100K 400GB FLASH R5(7+1) UPG 32-47	ES-1	\$9,660
FS6FM4007BUT2	VMAX100K 400GB FLASH R5(7+1) UPG 48+	ES-1	\$7,790
FS6FM400FBT0	VMAX100K 400GB FLASH R6(14+2) 1-31	ES-1	\$7,425
FS6FM400FBT1	VMAX100K 400GB FLASH R6(14+2) 32-63	ES-1	\$6,900
FS6FM400FBT2	VMAX100K 400GB FLASH R6(14+2) 64-95	ES-1	\$5,565

FS6FM400FBT3	VMAX100K 400GB FLASH R6(14+2) 96+	ES-1	\$5,305
FS6FM400FBTUT0	VMAX100K 400GB FLASH R6(14+2)TAA UPG	ES-1	\$10,395
FS6FM400FBTUT1	VMAX100K400GBFLASH R6(14+2)TAAUPG 32-47	ES-1	\$9,660
FS6FM400FBTUT2	VMAX100K400GBFLASHR6(14+2)TAAUPG 48+	ES-1	\$7,790
FS6FM400FBUT0	VMAX100K 400GB FLASH R6(14+2) UPG	ES-1	\$10,395
FS6FM400FBUT1	VMAX100K 400GB FLASH R6(14+2) UPG 32-47	ES-1	\$9,660
FS6FM400FBUT2	VMAX100K 400GB FLASH R6(14+2) UPG 48+	ES-1	\$7,790
FS6FM400SB	VMAX100K 400GB FLASH SPARE	ES-1	\$7,425
FS6FM400SBU	VMAX 100K 400GB FLASH DRIVE SPARE UPG	ES-1	\$10,395
FS6FM8001BT0	VMAX100K 800GB FLASH R1 1-15	ES-1	\$13,095
FS6FM8001BT1	VMAX100K 800GB FLASH R1 16-31	ES-1	\$11,220
FS6FM8001BT2	VMAX100K 800GB FLASH R1 32-47	ES-1	\$9,350
FS6FM8001BT3	VMAX100K 800GB FLASH R1 48+	ES-1	\$8,885
FS6FM8001BTUT0	VMAX100K 800GB FLASH R1 TAA UPG	ES-1	\$18,325
FS6FM8001BTUT1	VMAX100K 800GB FLASH R1 TAA UPG 16-23	ES-1	\$15,710
FS6FM8001BTUT2	VMAX100K 800GB FLASH R1 TAA UPG 24+	ES-1	\$12,986
FS6FM8001BUT0	VMAX100K 800GB FLASH R1 UPG	ES-1	\$18,325
FS6FM8001BUT1	VMAX100K 800GB FLASH R1 UPG 16-23	ES-1	\$15,710
FS6FM8001BUT2	VMAX100K 800GB FLASH R1 UPG 24+	ES-1	\$12,986
FS6FM8005BT0	VMAX100K 800GB FLASH R5(3+1) 1-15	ES-1	\$13,095
FS6FM8005BT1	VMAX100K 800GB FLASH R5(3+1) 16-31	ES-1	\$11,220
FS6FM8005BT2	VMAX100K 800GB FLASH R5(3+1) 32-47	ES-1	\$9,350
FS6FM8005BT3	VMAX100K 800GB FLASH R5(3+1) 48+	ES-1	\$8,885
FS6FM8005BTUT0	VMAX100K 800GB FLASH R5(3+1)TAA UPG	ES-1	\$18,325
FS6FM8005BTUT1	VMAX100K 800GB FLASHR5(3+1)TAAUPG 16-23	ES-1	\$15,710
FS6FM8005BTUT2	VMAX100K 800GB FLASHR5(3+1)TAAUPG 24+	ES-1	\$12,986
FS6FM8005BUT0	VMAX100K 800GB FLASH R5(3+1) UPG	ES-1	\$18,325
FS6FM8005BUT1	VMAX100K 800GB FLASH R5(3+1) UPG 16-23	ES-1	\$15,710
FS6FM8005BUT2	VMAX100K 800GB FLASH R5(3+1) UPG 24+	ES-1	\$12,986
FS6FM8006BT0	VMAX100K 800GB FLASH R6(6+2) 1-15	ES-1	\$13,095
FS6FM8006BT1	VMAX100K 800GB FLASH R6(6+2) 16-31	ES-1	\$11,220
FS6FM8006BT2	VMAX100K 800GB FLASH R6(6+2) 32-47	ES-1	\$9,350
FS6FM8006BT3	VMAX100K 800GB FLASH R6(6+2) 48+	ES-1	\$8,885
FS6FM8006BTUT0	VMAX100K 800GB FLASH R6(6+2)TAA UPG	ES-1	\$18,325
FS6FM8006BTUT1	VMAX100K 800GB FLASHR6(6+2)TAAUPG 16-23	ES-1	\$15,710
FS6FM8006BTUT2	VMAX100K 800GB FLASHR6(6+2)TAAUPG 24+	ES-1	\$12,986
FS6FM8006BUT0	VMAX100K 800GB FLASH R6(6+2) UPG	ES-1	\$18,325
FS6FM8006BUT1	VMAX100K 800GB FLASH R6(6+2)UPG 16-23	ES-1	\$15,710
FS6FM8006BUT2	VMAX100K 800GB FLASH R6(6+2)UPG 24+	ES-1	\$12,986
FS6FM8007BT0	VMAX100K 800GB FLASH R5(7+1) 1-15	ES-1	\$13,095
FS6FM8007BT1	VMAX100K 800GB FLASH R5(7+1) 16-31	ES-1	\$11,220
FS6FM8007BT2	VMAX100K 800GB FLASH R5(7+1) 32-47	ES-1	\$9,350
FS6FM8007BT3	VMAX100K 800GB FLASH R5(7+1)48+	ES-1	\$8,885
FS6FM8007BTUT0	VMAX100K 800GB FLASH R5(7+1)TAA UPG	ES-1	\$18,325
FS6FM8007BTUT1	VMAX100K 800GB FLASHR5(7+1)TAAUPG 16-23	ES-1	\$15,710
FS6FM8007BTUT2	VMAX100K 800GB FLASHR5(7+1)TAAUPG 24+	ES-1	\$12,986
FS6FM8007BUT0	VMAX100K 800GB FLASH R5(7+1) UPG	ES-1	\$18,325
FS6FM8007BUT1	VMAX100K 800GB FLASH R5(7+1)UPG 16-23	ES-1	\$15,710
FS6FM8007BUT2	VMAX100K 800GB FLASH R5(7+1)UPG 24+	ES-1	\$12,986
FS6FM800FBT0	VMAX100K 800GB FLASH R6(14+2) 1-15	ES-1	\$13,095

FS6FM800FBT1	VMAX100K 800GB FLASH R6(14+2) 16-31	ES-1	\$11,220
FS6FM800FBT2	VMAX100K 800GB FLASH R6(14+2) 32-47	ES-1	\$9,350
FS6FM800FBT3	VMAX100K 800GB FLASH R6(14+2) 48+	ES-1	\$8,885
FS6FM800FBTUT0	VMAX100K 800GB FLASH R6(14+2)TAA UPG	ES-1	\$18,325
FS6FM800FBTUT1	VMAX100K 800GBFLASH R6(14+2)TAAUPG 16-23	ES-1	\$15,710
FS6FM800FBTUT2	VMAX100K 800GBFLASH R6(14+2)TAAUPG 24+	ES-1	\$12,986
FS6FM800FBUT0	VMAX100K 800GB FLASH R6(14+2) UPG	ES-1	\$18,325
FS6FM800FBUT1	VMAX100K 800GB FLASH R6(14+2) UPG 16-23	ES-1	\$15,710
FS6FM800FBUT2	VMAX100K 800GB FLASH R6(14+2) UPG 24+	ES-1	\$12,986
FS6FM800SB	VMAX100K 800GB FLASH SPARE	ES-1	\$13,095
FS6FM800SBU	VMAX 100K 800GB FLASH DRIVE SPARE UPG	ES-1	\$18,325
FT67220001BTU	VMAX 100K 2000GB 7_2K DRIVE R1 TAA UPG	ES-1	\$1,595
FT67220001BU	VMAX 100K 2000GB 7_2K DRIVE R1 UPG	ES-1	\$1,595
FT67220005BTU	VMAX 100K 2000GB 7_2K DRIVER5(3+1)TAAUPG	ES-1	\$1,595
FT67220005BU	VMAX 100K 2000GB 7_2K DRIVE R5(3+1) UPG	ES-1	\$1,595
FT67220006BTU	VMAX 100K 2000GB 7_2K DRIVER6(6+2)TAAUPG	ES-1	\$1,595
FT67220006BU	VMAX 100K 2000GB 7_2K DRIVE R6(6+2) UPG	ES-1	\$1,595
FT67220007BTU	VMAX 100K 2000GB 7_2K DRIVER5(7+1)TAAUPG	ES-1	\$1,595
FT67220007BU	VMAX 100K 2000GB 7_2K DRIVE R5(7+1) UPG	ES-1	\$1,595
FT6722000FBTU	VMAX 100K 2000GB 7_2K DRVR6(14+2)TAAUPG	ES-1	\$1,595
FT6722000FBU	VMAX 100K 2000GB 7_2K DRIVE R6(14+2) UPG	ES-1	\$1,595
FT6722000SBTU	VMAX 100K 2000GB 7_2K DRV SPARE TAAUPG	ES-1	\$1,595
FT6722000SBU	VMAX 100K 2000GB 7_2K DRIVE SPARE UPG	ES-1	\$1,595
FT67240001BTU	VMAX 100K 4000GB 7_2K DRV R1 TAA UPG	ES-1	\$2,790
FT67240001BU	VMAX 100K 4000GB 7_2K DRV R1 UPG	ES-1	\$2,790
FT67240005BTU	VMAX 100K 4000GB 7_2K DRV R5(3+1)TAAUPG	ES-1	\$2,790
FT67240005BU	VMAX 100K 4000GB 7_2K DRV R5(3+1)UPG	ES-1	\$2,790
FT67240006BTU	VMAX 100K 4000GB 7_2K DRV R6(6+2)TAAUPG	ES-1	\$2,790
FT67240006BU	VMAX 100K 4000GB 7_2K DRV R6(6+2)UPG	ES-1	\$2,790
FT67240007BTU	VMAX 100K 4000GB 7_2K DRV R5(7+1)TAAUPG	ES-1	\$2,790
FT67240007BU	VMAX 100K 4000GB 7_2K DRV R5(7+1)UPG	ES-1	\$2,790
FT6724000FBTU	VMAX 100K 4000GB 7_2K DRV R6(14+2)TAAUPG	ES-1	\$2,790
FT6724000FBU	VMAX 100K 4000GB 7_2K DRV R6(14+2)UPG	ES-1	\$2,790
FT6724000SBTU	VMAX 100K 4000GB 7_2K DRV SPARE TAAUPG	ES-1	\$2,790
FT6724000SBU	VMAX 100K 4000GB 7_2K DRV SPARE UPG	ES-1	\$2,790
G-FE00008SU	VMAX 200K 8SM 16G FICON UPG	ES-1	\$20,250
G-FE00008SUF	VMAX 200K 8SM 16G FICON CONV	ES-1	\$68,660
G-FE00080SU	VMAX 200K 8MM 16G FICON UPG	ES-1	\$9,295
G-FE00080SUF	VMAX 200K 8MM 16G FICON CONV	ES-1	\$31,520
G-FE00200TOU	VMAX 200K 2PT 10 GBE OPTICAL UPG	ES-1	\$5,460
G-FE00200TU	VMAX 200K 2PT 10 GBE BASE T UPG	ES-1	\$5,720
G-FE00400C4U	VMAX 200K 4MM4 COPR GIGE UPG	ES-1	\$2,575
G-FE00400C4UF	VMAX 200K 4MM4 COPR GIGE CONV	ES-1	\$9,000
G-FE00400CU	VMAX 200K 4PT GBE BASE T UPG	ES-1	\$5,200
G-FE00400CUF	VMAX 200K 4M GIGE COPPER CONV	ES-1	\$18,200
G-FE00400TOUF	VMAX 200K 4MM 10 GIGE OPTICAL CONV	ES-1	\$19,110
G-FE00400TU	VMAX 200K 4MM 10 GIGE UPG	ES-1	\$4,745
G-FE00400TUF	VMAX 200K 4MM 10 GIGE CONV	ES-1	\$16,600
G-FE00800TU	VMAX 200K 8MM 10 GIGE UPG	ES-1	\$7,120
G-FE00800TUF	VMAX 200K 8MM 10 GIGE CONV	ES-1	\$24,920

G-FE08000EU	VMAX 200K 8SM 8G FIBRE UPG	ES-1	\$5,380
G-FE08000EUF	VMAX 200K 8SM 8G FIBRE CONV	ES-1	\$18,250
G-FE08000SU	VMAX 200K 8SM 16G FC UPG	ES-1	\$14,045
G-FE08000SUF	VMAX 200K 8SM 16G FC CONV	ES-1	\$63,565
G-FE44000EUF	VMAX 200K 4MM4SM 8G FIBRE CONV	ES-1	\$13,270
G-FE62000EUF	VMAX 200K 6MM2SM 8G FIBRE CONV	ES-1	\$9,335
G-FE80000EU	VMAX 200K 8MM 8G FIBRE UPG	ES-1	\$2,690
G-FE80000EUF	VMAX 200K 8MM 8G FIBRE CONV	ES-1	\$8,285
G-FE80000SU	VMAX 200K 8MM 16G FC UPG	ES-1	\$14,045
G-FE80000SUF	VMAX 200K 8MM 16G FC CONV	ES-1	\$21,645
GL61012001BTU	VMAX 200K 1200GB 10K SAS DRV R1 TAA UPG	ES-1	\$2,330
GL61012001BU	VMAX 200K 1200GB 10K SAS DRV R1 UPG	ES-1	\$2,330
GL61012005BTU	VMAX 200K 1200GB 10K SAS DRR5(3+1)TAAUPG	ES-1	\$2,330
GL61012005BU	VMAX 200K 1200GB 10K SAS DRV R5(3+1) UPG	ES-1	\$2,330
GL61012006BTU	VMAX 200K 1200GB 10K SAS DRR6(6+2)TAAUPG	ES-1	\$2,330
GL61012006BU	VMAX 200K 1200GB 10K SAS DRV R6(6+2) UPG	ES-1	\$2,330
GL61012007BTU	VMAX 200K 1200GB 10K SAS DRR5(7+1)TAAUPG	ES-1	\$2,330
GL61012007BU	VMAX 200K 1200GB 10K SAS DRV R5(7+1) UPG	ES-1	\$2,330
GL6101200FBTU	VMAX 200K 1200GB 10K SAS DRR6(14+2)TAAUPG	ES-1	\$2,330
GL6101200FBU	VMAX 200K 1200GB 10K SAS DRV R6(14+2)UPG	ES-1	\$2,330
GL6101200SBTU	VMAX 200K 1200GB 10K SAS DRV SPARE TAAUP	ES-1	\$2,330
GL6101200SBU	VMAX 200K 1200GB 10K SAS DRV SPARE UPG	ES-1	\$2,330
GL6103001BTU	VMAX 200K 300GB 10K SAS DRV R1 TAA UPG	ES-1	\$805
GL6103001BU	VMAX 200K 300GB 10K SAS DRV R1 UPG	ES-1	\$805
GL6103005BTU	VMAX 200K 300GB 10K SAS DRVR5(3+1)TAAUPG	ES-1	\$805
GL6103005BU	VMAX 200K 300GB 10K SAS DRV R5(3+1) UPG	ES-1	\$805
GL6103006BTU	VMAX 200K 300GB 10K SAS DRVR6(6+2)TAAUPG	ES-1	\$805
GL6103006BU	VMAX 200K 300GB 10K SAS DRV R6(6+2) UPG	ES-1	\$805
GL6103007BTU	VMAX 200K 300GB 10K SAS DRVR5(7+1)TAAUPG	ES-1	\$805
GL6103007BU	VMAX 200K 300GB 10K SAS DRV R5(7+1) UPG	ES-1	\$805
GL610300FBTU	VMAX 200K 300GB 10K SAS DRR6(14+2)TAAUPG	ES-1	\$805
GL610300FBU	VMAX 200K 300GB 10K SAS DRV R6(14+2) UPG	ES-1	\$805
GL610300SBTU	VMAX 200K 300GB 10K SAS DRV SPARE TAAUPG	ES-1	\$805
GL610300SBU	VMAX 200K 300GB 10K SAS DRV SPARE UPG	ES-1	\$805
GL6106001BTU	VMAX 200K 600GB 10K SAS DRV R1 TAA UPG	ES-1	\$1,510
GL6106001BU	VMAX 200K 600GB 10K SAS DRV R1 UPG	ES-1	\$1,510
GL6106005BTU	VMAX 200K 600GB 10K SAS DRVR5(3+1)TAAUPG	ES-1	\$1,510
GL6106005BU	VMAX 200K 600GB 10K SAS DRV R5(3+1) UPG	ES-1	\$1,510
GL6106006BTU	VMAX 200K 600GB 10K SAS DRVR6(6+2)TAAUPG	ES-1	\$1,510
GL6106006BU	VMAX 200K 600GB 10K SAS DRV R6(6+2) UPG	ES-1	\$1,510
GL6106007BTU	VMAX 200K 600GB 10K SAS DRVR5(7+1)TAAUPG	ES-1	\$1,510
GL6106007BU	VMAX 200K 600GB 10K SAS DRV R5(7+1) UPG	ES-1	\$1,510
GL610600FBTU	VMAX 200K 600GB 10K SAS DRR6(14+2)TAAUPG	ES-1	\$1,510
GL610600FBU	VMAX 200K 600GB 10K SAS DRV R6(14+2) UPG	ES-1	\$1,510
GL610600SBTU	VMAX 200K 600GB 10K SAS DRV SPARE TAAUPG	ES-1	\$1,510
GL610600SBU	VMAX 200K 600GB 10K SAS DRV SPARE UPG	ES-1	\$1,510
GL6153001BTU	VMAX 200K 300GB 15K SAS DRV R1 TAA UPG	ES-1	\$2,065
GL6153001BU	VMAX 200K 300GB 15K SAS DRV R1 UPG	ES-1	\$2,065
GL6153005BTU	VMAX 200K 300GB 15K SAS DRVR5(3+1)TAAUPG	ES-1	\$2,065
GL6153005BU	VMAX 200K 300GB 15K SAS DRV R5(3+1) UPG	ES-1	\$2,065

GL6153006BTU	VMAX 200K 300GB 15K SAS DRVR6(6+2)TAAUPG	ES-1	\$2,065
GL6153006BU	VMAX 200K 300GB 15K SAS DRV R6(6+2) UPG	ES-1	\$2,065
GL6153007BTU	VMAX 200K 300GB 15K SAS DRVR5(7+1)TAAUPG	ES-1	\$2,065
GL6153007BU	VMAX 200K 300GB 15K SAS DRV R5(7+1) UPG	ES-1	\$2,065
GL615300FBTU	VMAX 200K 300GB 15K SAS DRR6(14+2)TAAUPG	ES-1	\$2,065
GL615300FBU	VMAX 200K 300GB 15K SAS DRV R6(14+2) UPG	ES-1	\$2,065
GL615300SBTU	VMAX 200K 300GB 15K SAS DRV SPARE TAAUPG	ES-1	\$2,065
GL615300SBU	VMAX 200K 300GB 15K SAS DRV SPARE UPG	ES-1	\$2,065
GL6F319201BTUT0	VMAX200K 1920GB FLASH R1 TAA UPG 1-7	ES-1	\$31,885
GL6F319201BTUT1	VMAX200K 1920GB FLASH R1 TAA UPG 8-11	ES-1	\$27,910
GL6F319201BTUT2	VMAX200K 1920GB FLASH R1 TAA UPG 12+	ES-1	\$25,760
GL6F319201BUT0	VMAX200K 1920GB FLASH R1 UPG 1-7	ES-1	\$31,885
GL6F319201BUT1	VMAX200K 1920GB FLASH R1 UPG 8-11	ES-1	\$27,910
GL6F319201BUT2	VMAX200K 1920GB FLASH R1 UPG 12+	ES-1	\$25,760
GL6F319205BTUT0	VMAX200K 1920GBFLASH R5(3+1)TAAUPG 1-7	ES-1	\$31,885
GL6F319205BTUT1	VMAX200K 1920GBFLASH R5(3+1)TAAUPG 8-11	ES-1	\$27,910
GL6F319205BTUT2	VMAX200K 1920GBFLASH R5(3+1)TAAUPG 12+	ES-1	\$25,760
GL6F319205BUT0	VMAX200K 1920GB FLASH R5(3+1) UPG 1-7	ES-1	\$31,885
GL6F319205BUT1	VMAX200K 1920GB FLASH R5(3+1) UPG 8-11	ES-1	\$27,910
GL6F319205BUT2	VMAX200K 1920GB FLASH R5(3+1) UPG 12+	ES-1	\$25,760
GL6F319206BTUT0	VMAX200K 1920GBFLASH R6(6+2)TAAUPG 1-7	ES-1	\$31,885
GL6F319206BTUT1	VMAX200K 1920GBFLASH R6(6+2)TAAUPG 8-11	ES-1	\$27,910
GL6F319206BTUT2	VMAX200K 1920GBFLASH R6(6+2)TAAUPG 12+	ES-1	\$25,760
GL6F319206BUT0	VMAX200K 1920GB FLASH R6(6+2)UPG 1-7	ES-1	\$31,885
GL6F319206BUT1	VMAX200K 1920GB FLASH R6(6+2)UPG 8-11	ES-1	\$27,910
GL6F319206BUT2	VMAX200K 1920GB FLASH R6(6+2)UPG 12+	ES-1	\$25,760
GL6F319207BTUT0	VMAX200K 1920GBFLASH R5(7+1)TAAUPG 1-7	ES-1	\$31,885
GL6F319207BTUT1	VMAX200K 1920GBFLASH R5(7+1)TAAUPG 8-11	ES-1	\$27,910
GL6F319207BTUT2	VMAX200K 1920GBFLASH R5(7+1)TAAUPG 12+	ES-1	\$25,760
GL6F319207BUT0	VMAX200K 1920GB FLASH R5(7+1) UPG 1-7	ES-1	\$31,885
GL6F319207BUT1	VMAX200K 1920GB FLASH R5(7+1) UPG 8-11	ES-1	\$27,910
GL6F319207BUT2	VMAX200K 1920GB FLASH R5(7+1) UPG 12+	ES-1	\$25,760
GL6F31920FBTUT0	VMAX200K 1920GB FLASH R6(14+2)TAAUPG 1-7	ES-1	\$31,885
GL6F31920FBTUT1	VMAX200K 1920GB FLASH R6(14+2)TAAUPG8-11	ES-1	\$27,910
GL6F31920FBTUT2	VMAX200K 1920GB FLASH R6(14+2)TAAUPG 12+	ES-1	\$25,760
GL6F31920FBUT0	VMAX200K 1920GB FLASH R6(14+2)UPG 1-7	ES-1	\$31,885
GL6F31920FBUT1	VMAX200K 1920GB FLASH R6(14+2)UPG 8-11	ES-1	\$27,910
GL6F31920FBUT2	VMAX200K 1920GB FLASH R6(14+2)UPG 12+	ES-1	\$25,760
GL6F31920SBTUT0	VMAX200K 1920GB FLASH SPARE TAA UPG	ES-1	\$31,885
GL6F31920SBUT0	VMAX200K 1920GB FLASH SAS DRV SPARE UPG	ES-1	\$31,885
GL6F39601BTUT0	VMAX200K 960GB FLASH R1 TAA UPG 1-7	ES-1	\$18,475
GL6F39601BTUT1	VMAX200K 960GB FLASH R1 TAA UPG 8-11	ES-1	\$15,710
GL6F39601BTUT2	VMAX200K 960GB FLASH R1 TAA UPG 12+	ES-1	\$14,925
GL6F39601BUT0	VMAX200K 960GB FLASH R1 UPG 1-7	ES-1	\$18,475
GL6F39601BUT1	VMAX200K 960GB FLASH R1 UPG 8-11	ES-1	\$15,710
GL6F39601BUT2	VMAX200K 960GB FLASH R1 UPG 12+	ES-1	\$14,925
GL6F39605BTUT0	VMAX200K 960GBFLASH R5(3+1)TAAUPG 1-7	ES-1	\$18,475
GL6F39605BTUT1	VMAX200K 960GBFLASH R5(3+1)TAAUPG 8-11	ES-1	\$15,710
GL6F39605BTUT2	VMAX200K 960GBFLASH R5(3+1)TAAUPG 12+	ES-1	\$14,925
GL6F39605BUT0	VMAX200K 960GB FLASH R5(3+1) UPG 1-7	ES-1	\$18,475

GL6F39605BUT1	VMAX200K 960GB FLASH R5(3+1) UPG 8-11	ES-1	\$15,710
GL6F39605BUT2	VMAX200K 960GB FLASH R5(3+1) UPG 12+	ES-1	\$14,925
GL6F39606BTUT0	VMAX200K 960GBFLASH R6(6+2)TAAUPG 1-7	ES-1	\$18,475
GL6F39606BTUT1	VMAX200K 960GBFLASH R6(6+2)TAAUPG 8-11	ES-1	\$15,710
GL6F39606BTUT2	VMAX200K 960GBFLASH R6(6+2)TAAUPG 12+	ES-1	\$14,925
GL6F39606BUT0	VMAX200K 960GB FLASH R6(6+2)UPG 1-7	ES-1	\$18,475
GL6F39606BUT1	VMAX200K 960GB FLASH R6(6+2)UPG 8-11	ES-1	\$15,710
GL6F39606BUT2	VMAX200K 960GB FLASH R6(6+2)UPG 12+	ES-1	\$14,925
GL6F39607BTUT0	VMAX200K 960GBFLASH R5(7+1)TAAUPG 1-7	ES-1	\$18,475
GL6F39607BTUT1	VMAX200K 960GBFLASH R5(7+1)TAAUPG 8-11	ES-1	\$15,710
GL6F39607BTUT2	VMAX200K 960GBFLASH R5(7+1)TAAUPG 12+	ES-1	\$14,925
GL6F39607BUT0	VMAX200K 960GB FLASH R5(7+1) UPG 1-7	ES-1	\$18,475
GL6F39607BUT1	VMAX200K 960GB FLASH R5(7+1) UPG 8-11	ES-1	\$15,710
GL6F39607BUT2	VMAX200K 960GB FLASH R5(7+1) UPG 12+	ES-1	\$14,925
GL6F3960FBTUT0	VMAX200K 960GB FLASH R6(14+2)TAAUPG 1-7	ES-1	\$18,475
GL6F3960FBTUT1	VMAX200K 960GB FLASH R6(14+2)TAAUPG8-11	ES-1	\$15,710
GL6F3960FBTUT2	VMAX200K 960GB FLASH R6(14+2)TAAUPG 12+	ES-1	\$14,925
GL6F3960FBUT0	VMAX200K 960GB FLASH R6(14+2)UPG 1-7	ES-1	\$18,475
GL6F3960FBUT1	VMAX200K 960GB FLASH R6(14+2)UPG 8-11	ES-1	\$15,710
GL6F3960FBUT2	VMAX200K 960GB FLASH R6(14+2)UPG 12+	ES-1	\$14,925
GL6F3960SBTUT0	VMAX200K 960GB FLASH SPARE TAA UPG	ES-1	\$18,475
GL6F3960SBUT0	VMAX200K 960GB FLASH SAS DRV SPARE UPG	ES-1	\$18,475
GL6FM16001BT0	VMAX200K 1600GB FLASH R1 1-15	ES-1	\$22,600
GL6FM16001BT1	VMAX200K 1600GB FLASH R1 16-23	ES-1	\$16,140
GL6FM16001BT2	VMAX200K 1600GB FLASH R1 24-31	ES-1	\$15,335
GL6FM16001BT3	VMAX200K 1600GB FLASH R1 32-63	ES-1	\$14,525
GL6FM16001BT4	VMAX200K 1600GB FLASH R1 64+	ES-1	\$13,720
GL6FM16001BTUT0	VMAX200K 1600GB FLASH R1 TAA UPG	ES-1	\$31,805
GL6FM16001BTUT1	VMAX200K 1600GB FLASH R1 TAA UPG 16-23	ES-1	\$20,600
GL6FM16001BTUT2	VMAX200K 1600GB FLASH R1 TAA UPG 24+	ES-1	\$19,200
GL6FM16001BUT0	VMAX200K 1600GB FLASH R1 UPG	ES-1	\$31,805
GL6FM16001BUT1	VMAX200K 1600GB FLASH R1 UPG 16-23	ES-1	\$20,600
GL6FM16001BUT2	VMAX200K 1600GB FLASH R1 UPG 24+	ES-1	\$19,200
GL6FM16005BT0	VMAX200K 1600GB FLASH R5(3+1) 1-15	ES-1	\$22,600
GL6FM16005BT1	VMAX200K 1600GB FLASH R5(3+1) 16-23	ES-1	\$16,140
GL6FM16005BT2	VMAX200K 1600GB FLASH R5(3+1) 24-31	ES-1	\$15,335
GL6FM16005BT3	VMAX200K 1600GB FLASH R5(3+1) 32-63	ES-1	\$14,525
GL6FM16005BT4	VMAX200K 1600GB FLASH R5(3+1) 64+	ES-1	\$13,720
GL6FM16005BTUT0	VMAX200K 1600GB FLASH R5(3+1)TAA UPG	ES-1	\$31,805
GL6FM16005BTUT1	VMAX200K 1600GBFLASH R5(3+1)TAAUPG 16-23	ES-1	\$20,600
GL6FM16005BTUT2	VMAX200K 1600GB FLASH R5(3+1)TAA UPG 24+	ES-1	\$19,200
GL6FM16005BUT0	VMAX200K 1600GB FLASH R5(3+1) UPG	ES-1	\$31,805
GL6FM16005BUT1	VMAX200K 1600GB FLASH R5(3+1) UPG 16-23	ES-1	\$20,600
GL6FM16005BUT2	VMAX200K 1600GB FLASH R5(3+1) UPG 24+	ES-1	\$19,200
GL6FM16006BT0	VMAX200K 1600GB FLASH R6(6+2) 1-15	ES-1	\$22,600
GL6FM16006BT1	VMAX200K 1600GB FLASH R6(6+2) 16-23	ES-1	\$16,140
GL6FM16006BT2	VMAX200K 1600GB FLASH R6(6+2) 24-31	ES-1	\$15,335
GL6FM16006BT3	VMAX200K 1600GB FLASH R6(6+2) 32-63	ES-1	\$14,525
GL6FM16006BT4	VMAX200K 1600GB FLASH R6(6+2) 64+	ES-1	\$13,720
GL6FM16006BTUT0	VMAX200K 1600GB FLASH R6(6+2)TAA UPG	ES-1	\$31,805

GL6FM16006BTUT1	VMAX200K 1600GBFLASH R6(6+2)TAAUPG 16-23	ES-1	\$22,595
GL6FM16006BTUT2	VMAX200K 1600GB FLASH R6(6+2)TAA UPG 24+	ES-1	\$21,470
GL6FM16006BUT0	VMAX200K 1600GB FLASH R6(6+2) UPG	ES-1	\$31,805
GL6FM16006BUT1	VMAX200K 1600GB FLASH R6(6+2) UPG 16-23	ES-1	\$22,595
GL6FM16006BUT2	VMAX200K 1600GB FLASH R6(6+2) UPG 24+	ES-1	\$21,470
GL6FM16007BT0	VMAX200K 1600GB FLASH R5(7+1) 1-15	ES-1	\$22,600
GL6FM16007BT1	VMAX200K 1600GB FLASH R5(7+1) 16-23	ES-1	\$16,140
GL6FM16007BT2	VMAX200K 1600GB FLASH R5(7+1) 24-31	ES-1	\$15,335
GL6FM16007BT3	VMAX200K 1600GB FLASH R5(7+1) 32-63	ES-1	\$14,525
GL6FM16007BT4	VMAX200K 1600GB FLASH R5(7+1) 64+	ES-1	\$13,720
GL6FM16007BTUT0	VMAX200K 1600GB FLASH R5(7+1)TAA UPG	ES-1	\$31,805
GL6FM16007BTUT1	VMAX200K 1600GBFLASH R5(7+1)TAAUPG 16-23	ES-1	\$20,600
GL6FM16007BTUT2	VMAX200K 1600GB FLASH R5(7+1)TAA UPG 24+	ES-1	\$19,200
GL6FM16007BUT0	VMAX200K 1600GB FLASH R5(7+1) UPG	ES-1	\$31,805
GL6FM16007BUT1	VMAX200K 1600GB FLASH R5(7+1) UPG 16-23	ES-1	\$20,600
GL6FM16007BUT2	VMAX200K 1600GB FLASH R5(7+1) UPG 24+	ES-1	\$19,200
GL6FM1600FBT0	VMAX200K 1600GB FLASH R6(14+2) 1-15	ES-1	\$22,600
GL6FM1600FBT1	VMAX200K 1600GB FLASH R6(14+2) 16-23	ES-1	\$16,140
GL6FM1600FBT2	VMAX200K 1600GB FLASH R6(14+2) 24-31	ES-1	\$15,335
GL6FM1600FBT3	VMAX200K 1600GB FLASH R6(14+2) 32-63	ES-1	\$14,525
GL6FM1600FBT4	VMAX200K 1600GB FLASH R6(14+2) 64+	ES-1	\$13,720
GL6FM1600FBTUT0	VMAX200K 1600GB FLASH R6(14+2)TAA UPG	ES-1	\$31,805
GL6FM1600FBTUT1	VMAX200K 1600GB FLSHDRVR6(14+2)TAAUPG8-	ES-1	\$22,595
GL6FM1600FBTUT2	V200K 1600GB FLSHDRVR6(14+2)TAAUPG 24+	ES-1	\$21,470
GL6FM1600FBUT0	VMAX200K 1600GB FLASH R6(14+2) UPG	ES-1	\$31,805
GL6FM1600FBUT1	VMAX200K 1600GB FLASH R6(14+2) UPG 16-23	ES-1	\$22,595
GL6FM1600FBUT2	VMAX200K 1600GB FLASH R6(14+2) UPG 24+	ES-1	\$21,470
GL6FM1600SB	VMAX200K 1600GB FLASH SPARE	ES-1	\$22,600
GL6FM1600SBU	VMAX 200K 1600GB FLASH DRIVE SPARE UPG	ES-1	\$31,805
GL6FM2001BT0	VMAX200K 200GB FLASH R1 1-127	ES-1	\$3,905
GL6FM2001BT1	VMAX200K 200GB FLASH R1 128-191	ES-1	\$3,625
GL6FM2001BT2	VMAX200K 200GB FLASH R1 192-255	ES-1	\$3,350
GL6FM2001BT3	VMAX200K 200GB FLASH R1 256-383	ES-1	\$3,210
GL6FM2001BT4	VMAX200K 200GB FLASH R1 384-511	ES-1	\$3,065
GL6FM2001BT5	VMAX200K 200GB FLASH R1 512+	ES-1	\$2,930
GL6FM2001BTUT0	VMAX200K 200GB FLASH R1 TAA UPG	ES-1	\$5,475
GL6FM2001BTUT1	VMAX200K 200GB FLASH R1 TAA UPG 64-95	ES-1	\$5,866
GL6FM2001BTUT2	VMAX200K 200GB FLASH R1 TAA UPG 96+	ES-1	\$5,514
GL6FM2001BUT0	VMAX200K 200GB FLASH R1 UPG	ES-1	\$5,475
GL6FM2001BUT1	VMAX200K 200GB FLASH R1 UPG 64-95	ES-1	\$5,866
GL6FM2001BUT2	VMAX200K 200GB FLASH R1 UPG 96+	ES-1	\$5,514
GL6FM2005BT0	VMAX200K 200GB FLASH R5(3+1) 1-127	ES-1	\$3,905
GL6FM2005BT1	VMAX200K 200GB FLASH R5(3+1) 128-191	ES-1	\$3,625
GL6FM2005BT2	VMAX200K 200GB FLASH R5(3+1) 192-255	ES-1	\$3,350
GL6FM2005BT3	VMAX200K 200GB FLASH R5(3+1) 256-383	ES-1	\$3,210
GL6FM2005BT4	VMAX200K 200GB FLASH R5(3+1) 384-511	ES-1	\$3,065
GL6FM2005BT5	VMAX200K 200GB FLASH R5(3+1) 512+	ES-1	\$2,930
GL6FM2005BTUT0	VMAX200K 200GB FLASH R5(3+1) TAA UPG	ES-1	\$5,475
GL6FM2005BTUT1	VMAX200K 200GB FLASH R5(3+1)TAAUPG 64-95	ES-1	\$5,866
GL6FM2005BTUT2	VMAX200K 200GB FLASH R5(3+1) TAA UPG 96+	ES-1	\$5,514

GL6FM2005BUT0	VMAX200K 200GB FLASH R5(3+1) UPG	ES-1	\$5,475
GL6FM2005BUT1	VMAX200K 200GB FLASH R5(3+1) UPG 64-95	ES-1	\$5,866
GL6FM2005BUT2	VMAX200K 200GB FLASH R5(3+1) UPG 96+	ES-1	\$5,514
GL6FM2006BT0	VMAX200K 200GB FLASH R6(6+2) 1-127	ES-1	\$3,905
GL6FM2006BT1	VMAX200K 200GB FLASH R6(6+2) 128-191	ES-1	\$3,625
GL6FM2006BT2	VMAX200K 200GB FLASH R6(6+2) 192-255	ES-1	\$3,350
GL6FM2006BT3	VMAX200K 200GB FLASH R6(6+2) 256-383	ES-1	\$3,210
GL6FM2006BT4	VMAX200K 200GB FLASH R6(6+2) 384-511	ES-1	\$3,065
GL6FM2006BT5	VMAX200K 200GB FLASH R6(6+2) 512+	ES-1	\$2,930
GL6FM2006BTUT0	VMAX200K 200GB FLASH R6(6+2) TAA UPG	ES-1	\$5,475
GL6FM2006BTUT1	VMAX200K 200GB FLASH R6(6+2)TAAUPG 64-95	ES-1	\$5,866
GL6FM2006BTUT2	VMAX200K 200GB FLASH R6(6+2)TAAUPG 96+	ES-1	\$5,514
GL6FM2006BUT0	VMAX200K 200GB FLASH R6(6+2) UPG	ES-1	\$5,475
GL6FM2006BUT1	VMAX200K 200GB FLASH R6(6+2)UPG 64-95	ES-1	\$5,866
GL6FM2006BUT2	VMAX200K 200GB FLASH R6(6+2)UPG 96+	ES-1	\$5,514
GL6FM2007BT0	VMAX200K 200GB FLASH R5(7+1) 1-127	ES-1	\$3,905
GL6FM2007BT1	VMAX200K 200GB FLASH R5(7+1) 128-191	ES-1	\$3,625
GL6FM2007BT2	VMAX200K 200GB FLASH R5(7+1) 192-255	ES-1	\$3,350
GL6FM2007BT3	VMAX200K 200GB FLASH R5(7+1) 256-383	ES-1	\$3,210
GL6FM2007BT4	VMAX200K 200GB FLASH R5(7+1) 384-511	ES-1	\$3,065
GL6FM2007BT5	VMAX200K 200GB FLASH R5(7+1) 512+	ES-1	\$2,930
GL6FM2007BTUT0	VMAX200K 200GB FLASH R5(7+1) TAA UPG	ES-1	\$5,475
GL6FM2007BTUT1	VMAX200K 200GB FLASH R5(7+1)TAAUPG 64-95	ES-1	\$5,866
GL6FM2007BTUT2	VMAX200K 200GB FLASH R5(7+1) TAA UPG 96+	ES-1	\$5,514
GL6FM2007BUT0	VMAX200K 200GB FLASH R5(7+1) UPG	ES-1	\$5,475
GL6FM2007BUT1	VMAX200K 200GB FLASH R5(7+1) UPG 64-95	ES-1	\$5,866
GL6FM2007BUT2	VMAX200K 200GB FLASH R5(7+1) UPG 96+	ES-1	\$5,514
GL6FM200FBT0	VMAX200K 200GB FLASH R6(14+2) 1-127	ES-1	\$3,905
GL6FM200FBT1	VMAX200K 200GB FLASH R6(14+2) 128-191	ES-1	\$3,625
GL6FM200FBT2	VMAX200K 200GB FLASH R6(14+2) 192-255	ES-1	\$3,350
GL6FM200FBT3	VMAX200K 200GB FLASH R6(14+2) 256-383	ES-1	\$3,210
GL6FM200FBT4	VMAX200K 200GB FLASH R6(14+2) 384-511	ES-1	\$3,065
GL6FM200FBT5	VMAX200K 200GB FLASH R6(14+2) 512+	ES-1	\$2,930
GL6FM200FBTUT0	VMAX200K 200GB FLASH R6(14+2)TAA UPG	ES-1	\$5,475
GL6FM200FBTUT1	VMAX200K 200GBFLASH R6(14+2)TAAUPG 64-95	ES-1	\$5,866
GL6FM200FBTUT2	VMAX200K 200GB FLASH R6(14+2)TAA UPG 96+	ES-1	\$5,514
GL6FM200FBUT0	VMAX200K 200GB FLASH R6(14+2) UPG	ES-1	\$5,475
GL6FM200FBUT1	VMAX200K 200GB FLASH R6(14+2)UPG 64-95	ES-1	\$5,866
GL6FM200FBUT2	VMAX200K 200GB FLASH R6(14+2)UPG 96+	ES-1	\$5,514
GL6FM200SB	VMAX200K 200GB FLASH SPARE	ES-1	\$3,905
GL6FM200SBU	VMAX 200K 200GB FLASH DRIVE SPARE UPG	ES-1	\$5,475
GL6FM4001BT0	VMAX200K 400GB FLASH R1 1-63	ES-1	\$7,425
GL6FM4001BT1	VMAX200K 400GB FLASH R1 64-95	ES-1	\$6,100
GL6FM4001BT2	VMAX200K 400GB FLASH R1 96-127	ES-1	\$5,830
GL6FM4001BT3	VMAX200K 400GB FLASH R1 128-191	ES-1	\$5,565
GL6FM4001BT4	VMAX200K 400GB FLASH R1 192-255	ES-1	\$5,305
GL6FM4001BT5	VMAX200K 400GB FLASH R1 256+	ES-1	\$5,040
GL6FM4001BTUT0	VMAX200K 400GB FLASH R1 TAA UPG	ES-1	\$10,395
GL6FM4001BTUT1	VMAX200K 400GB FLASH R1 TAA UPG 32-47	ES-1	\$8,472
GL6FM4001BTUT2	VMAX200K 400GB FLASH R1 TAA UPG 48+	ES-1	\$8,540

GL6FM4001BUT0	VMAX200K 400GB FLASH R1 UPG	ES-1	\$10,395
GL6FM4001BUT1	VMAX200K 400GB FLASH R1 UPG 32-47	ES-1	\$8,472
GL6FM4001BUT2	VMAX200K 400GB FLASH R1 UPG 48+	ES-1	\$8,540
GL6FM4005BT0	VMAX200K 400GB FLASH R5(3+1) 1-63	ES-1	\$7,425
GL6FM4005BT1	VMAX200K 400GB FLASH R5(3+1) 64-95	ES-1	\$6,100
GL6FM4005BT2	VMAX200K 400GB FLASH R5(3+1) 96-127	ES-1	\$5,830
GL6FM4005BT3	VMAX200K 400GB FLASH R5(3+1) 128-191	ES-1	\$5,565
GL6FM4005BT4	VMAX200K 400GB FLASH R5(3+1) 192-255	ES-1	\$5,305
GL6FM4005BT5	VMAX200K 400GB FLASH R5(3+1) 256+	ES-1	\$5,040
GL6FM4005BTUT0	VMAX200K 400GB FLASH R5(3+1) TAA UPG	ES-1	\$10,395
GL6FM4005BTUT1	VMAX200K 400GB FLASHR5(3+1)TAAUPG 32-47	ES-1	\$8,472
GL6FM4005BTUT2	VMAX200K 400GB FLASHR5(3+1)TAAUPG 48+	ES-1	\$8,540
GL6FM4005BUT0	VMAX200K 400GB FLASH R5(3+1) UPG	ES-1	\$10,395
GL6FM4005BUT1	VMAX200K 400GB FLASH R5(3+1) UPG 32-47	ES-1	\$8,472
GL6FM4005BUT2	VMAX200K 400GB FLASH R5(3+1) UPG 48+	ES-1	\$8,540
GL6FM4006BT0	VMAX200K 400GB FLASH R6(6+2) 1-63	ES-1	\$7,425
GL6FM4006BT1	VMAX200K 400GB FLASH R6(6+2) 64-95	ES-1	\$6,100
GL6FM4006BT2	VMAX200K 400GB FLASH R6(6+2) 96-127	ES-1	\$5,830
GL6FM4006BT3	VMAX200K 400GB FLASH R6(6+2) 128-191	ES-1	\$5,565
GL6FM4006BT4	VMAX200K 400GB FLASH R6(6+2) 192-255	ES-1	\$5,305
GL6FM4006BT5	VMAX200K 400GB FLASH R6(6+2) 256+	ES-1	\$5,040
GL6FM4006BTUT0	VMAX200K 400GB FLASH R6(6+2) TAA UPG	ES-1	\$10,395
GL6FM4006BTUT1	VMAX200K 400GB FLASHR6(6+2)TAAUPG 32-47	ES-1	\$8,472
GL6FM4006BTUT2	VMAX200K 400GB FLASHR6(6+2)TAAUPG 48+	ES-1	\$8,540
GL6FM4006BUT0	VMAX200K 400GB FLASH R6(6+2) UPG	ES-1	\$10,395
GL6FM4006BUT1	VMAX200K 400GB FLASH R6(6+2)UPG 32-47	ES-1	\$8,472
GL6FM4006BUT2	VMAX200K 400GB FLASH R6(6+2)UPG 48+	ES-1	\$8,540
GL6FM4007BT0	VMAX200K 400GB FLASH R5(7+1) 1-63	ES-1	\$7,425
GL6FM4007BT1	VMAX200K 400GB FLASH R5(7+1) 64-95	ES-1	\$6,100
GL6FM4007BT2	VMAX200K 400GB FLASH R5(7+1) 96-127	ES-1	\$5,830
GL6FM4007BT3	VMAX200K 400GB FLASH R5(7+1) 128-191	ES-1	\$5,565
GL6FM4007BT4	VMAX200K 400GB FLASH R5(7+1) 192-255	ES-1	\$5,305
GL6FM4007BT5	VMAX200K 400GB FLASH R5(7+1) 256+	ES-1	\$5,040
GL6FM4007BTUT0	VMAX200K 400GB FLASH R5(7+1) TAA UPG	ES-1	\$10,395
GL6FM4007BTUT1	VMAX200K 400GB FLASHR5(7+1)TAAUPG 32-47	ES-1	\$8,472
GL6FM4007BTUT2	VMAX200K 400GB FLASHR5(7+1)TAAUPG 48+	ES-1	\$8,540
GL6FM4007BUT0	VMAX200K 400GB FLASH R5(7+1) UPG	ES-1	\$10,395
GL6FM4007BUT1	VMAX200K 400GB FLASH R5(7+1) UPG 32-47	ES-1	\$8,472
GL6FM4007BUT2	VMAX200K 400GB FLASH R5(7+1) UPG 48+	ES-1	\$8,540
GL6FM400FBT0	VMAX200K 400GB FLASH R6(14+2) 1-63	ES-1	\$7,425
GL6FM400FBT1	VMAX200K 400GB FLASH R6(14+2) 64-95	ES-1	\$6,100
GL6FM400FBT2	VMAX200K 400GB FLASH R6(14+2) 96-127	ES-1	\$5,830
GL6FM400FBT3	VMAX200K 400GB FLASH R6(14+2) 128-191	ES-1	\$5,565
GL6FM400FBT4	VMAX200K 400GB FLASH R6(14+2) 192-255	ES-1	\$5,305
GL6FM400FBT5	VMAX200K 400GB FLASH R6(14+2) 256+	ES-1	\$5,040
GL6FM400FBTUT0	VMAX200K 400GB FLASH R6(14+2)TAA UPG	ES-1	\$10,395
GL6FM400FBTUT1	VMAX200K 400GBFLASH R6(14+2)TAAUPG 32-47	ES-1	\$8,472
GL6FM400FBTUT2	VMAX200K 400GBFLASH R6(14+2)TAAUPG 48+	ES-1	\$8,540
GL6FM400FBUT0	VMAX200K 400GB FLASH R6(14+2) UPG	ES-1	\$10,395
GL6FM400FBUT1	VMAX200K 400GB FLASH R6(14+2) UPG 32-47	ES-1	\$8,472

GL6FM400FBUT2	VMAX200K 400GB FLASH R6(14+2) UPG 48+	ES-1	\$8,540
GL6FM400SB	VMAX200K 400GB FLASH SPARE	ES-1	\$7,425
GL6FM400SBU	VMAX 200K 400GB FLASH DRIVE SPARE UPG	ES-1	\$10,395
GL6FM8001BT0	VMAX200K 800GB FLASH R1 1-31	ES-1	\$13,095
GL6FM8001BT1	VMAX200K 800GB FLASH R1 32-47	ES-1	\$9,350
GL6FM8001BT2	VMAX200K 800GB FLASH R1 48-95	ES-1	\$8,885
GL6FM8001BT3	VMAX200K 800GB FLASH R1 96-127	ES-1	\$8,415
GL6FM8001BT4	VMAX200K 800GB FLASH R1 128+	ES-1	\$7,950
GL6FM8001BTUT0	VMAX200K 800GB FLASH R1 TAA UPG	ES-1	\$18,325
GL6FM8001BTUT1	VMAX200K 800GB FLASH R1 TAA UPG 24-31	ES-1	\$13,090
GL6FM8001BTUT2	VMAX200K 800GB FLASH R1 TAA UPG 32+	ES-1	\$12,440
GL6FM8001BUT0	VMAX200K 800GB FLASH R1 UPG	ES-1	\$18,325
GL6FM8001BUT1	VMAX200K 800GB FLASH R1 UPG 24-31	ES-1	\$13,090
GL6FM8001BUT2	VMAX200K 800GB FLASH R1 UPG 32+	ES-1	\$12,440
GL6FM8005BT0	VMAX200K 800GB FLASH R5(3+1) 1-31	ES-1	\$13,095
GL6FM8005BT1	VMAX200K 800GB FLASH R5(3+1) 32-47	ES-1	\$9,350
GL6FM8005BT2	VMAX200K 800GB FLASH R5(3+1) 48-95	ES-1	\$8,885
GL6FM8005BT3	VMAX200K 800GB FLASH R5(3+1) 96-127	ES-1	\$8,415
GL6FM8005BT4	VMAX200K 800GB FLASH R5(3+1) 128+	ES-1	\$7,950
GL6FM8005BTUT0	VMAX200K 800GB FLASH R5(3+1) TAA UPG	ES-1	\$18,325
GL6FM8005BTUT1	VMAX200K 800GB FLASH R5(3+1)TAAUPG 24-31	ES-1	\$13,090
GL6FM8005BTUT2	VMAX200K 800GB FLASH R5(3+1) TAA UPG 32+	ES-1	\$12,440
GL6FM8005BUT0	VMAX200K 800GB FLASH R5(3+1) UPG	ES-1	\$18,325
GL6FM8005BUT1	VMAX200K 800GB FLASH R5(3+1) UPG 24-31	ES-1	\$13,090
GL6FM8005BUT2	VMAX200K 800GB FLASH R5(3+1) UPG 32+	ES-1	\$12,440
GL6FM8006BT0	VMAX200K 800GB FLASH R6(6+2) 1-31	ES-1	\$13,095
GL6FM8006BT1	VMAX200K 800GB FLASH R6(6+2) 32-47	ES-1	\$9,350
GL6FM8006BT2	VMAX200K 800GB FLASH R6(6+2) 48-95	ES-1	\$8,885
GL6FM8006BT3	VMAX200K 800GB FLASH R6(6+2) 96-127	ES-1	\$8,415
GL6FM8006BT4	VMAX200K 800GB FLASH R6(6+2) 128+	ES-1	\$7,950
GL6FM8006BTUT0	VMAX200K 800GB FLASH R6(6+2) TAA UPG	ES-1	\$18,325
GL6FM8006BTUT1	VMAX200K 800GB FLASH R6(6+2)TAAUPG 24-31	ES-1	\$13,090
GL6FM8006BTUT2	VMAX200K 800GB FLASH R6(6+2) TAA UPG 32+	ES-1	\$12,440
GL6FM8006BUT0	VMAX200K 800GB FLASH R6(6+2) UPG	ES-1	\$18,325
GL6FM8006BUT1	VMAX200K 800GB FLASH R6(6+2) UPG 24-31	ES-1	\$13,090
GL6FM8006BUT2	VMAX200K 800GB FLASH R6(6+2) UPG 32+	ES-1	\$12,440
GL6FM8007BT0	VMAX200K 800GB FLASH R5(7+1) 1-31	ES-1	\$13,095
GL6FM8007BT1	VMAX200K 800GB FLASH R5(7+1) 32-47	ES-1	\$9,350
GL6FM8007BT2	VMAX200K 800GB FLASH R5(7+1) 48-95	ES-1	\$8,885
GL6FM8007BT3	VMAX200K 800GB FLASH R5(7+1) 96-127	ES-1	\$8,415
GL6FM8007BT4	VMAX200K 800GB FLASH R5(7+1) 128+	ES-1	\$7,950
GL6FM8007BTUT0	VMAX200K 800GB FLASH R5(7+1) TAA UPG	ES-1	\$18,325
GL6FM8007BTUT1	VMAX200K 800GB FLASH R5(7+1)TAAUPG 24-31	ES-1	\$13,090
GL6FM8007BTUT2	VMAX200K 800GB FLASH R5(7+1) TAA UPG 32+	ES-1	\$12,440
GL6FM8007BUT0	VMAX200K 800GB FLASH R5(7+1) UPG	ES-1	\$18,325
GL6FM8007BUT1	VMAX200K 800GB FLASH R5(7+1) UPG 24-31	ES-1	\$13,090
GL6FM8007BUT2	VMAX200K 800GB FLASH R5(7+1) UPG 32+	ES-1	\$12,440
GL6FM800FBT0	VMAX200K 800GB FLASH R6(14+2) 1-31	ES-1	\$13,095
GL6FM800FBT1	VMAX200K 800GB FLASH R6(14+2) 32-47	ES-1	\$9,350
GL6FM800FBT2	VMAX200K 800GB FLASH R6(14+2) 48-95	ES-1	\$8,885

GL6FM800FBT3	VMAX200K 800GB FLASH R6(14+2) 96-127	ES-1	\$8,415
GL6FM800FBT4	VMAX200K 800GB FLASH R6(14+2) 128+	ES-1	\$7,950
GL6FM800FBTUT0	VMAX200K 800GB FLASH R6(14+2)TAA UPG	ES-1	\$18,325
GL6FM800FBTUT1	VMAX200K 800GBFLASH R6(14+2)TAAUPG 24-31	ES-1	\$13,090
GL6FM800FBTUT2	VMAX200K 800GB FLASH R6(14+2)TAA UPG 32+	ES-1	\$12,440
GL6FM800FBUT0	VMAX200K 800GB FLASH R6(14+2) UPG	ES-1	\$18,325
GL6FM800FBUT1	VMAX200K 800GB FLASH R6(14+2) UPG 24-31	ES-1	\$13,090
GL6FM800FBUT2	VMAX200K 800GB FLASH R6(14+2) UPG 32+	ES-1	\$12,440
GL6FM800SB	VMAX200K 800GB FLASH SPARE	ES-1	\$13,095
GL6FM800SBU	VMAX 200K 800GB FLASH DRIVE SPARE UPG	ES-1	\$18,325
GS61012001BTU	VMAX 200K 1200GB 10K SAS DRV R1 TAA UPG	ES-1	\$2,330
GS61012001BU	VMAX 200K 1200GB 10K SAS DRV R1 UPG	ES-1	\$2,330
GS61012005BTU	VMAX 200K 1200GB 10K SAS DRR5(3+1)TAAUPG	ES-1	\$2,330
GS61012005BU	VMAX 200K 1200GB 10K SAS DRV R5(3+1)UPG	ES-1	\$2,330
GS61012006BTU	VMAX 200K 1200GB 10K SAS DRR6(6+2)TAAUPG	ES-1	\$2,330
GS61012006BU	VMAX 200K 1200GB 10K SAS DRV R6(6+2)UPG	ES-1	\$2,330
GS61012007BTU	VMAX 200K 1200GB 10K SAS DRR5(7+1)TAAUPG	ES-1	\$2,330
GS61012007BU	VMAX 200K 1200GB 10K SAS DRV R5(7+1)UPG	ES-1	\$2,330
GS6101200FBTU	VMAX 200K 1200GB 10K SAS R6(14+2)TAAUPG	ES-1	\$2,330
GS6101200FBU	VMAX 200K 1200GB 10K SAS R6(14+2)UPG	ES-1	\$2,330
GS6101200SBTU	VMAX 200K 1200GB 10K SAS SPARE TAA UPG	ES-1	\$2,330
GS6101200SBU	VMAX 200K 1200GB 10K SAS SPARE UPG	ES-1	\$2,330
GS6103001BTU	VMAX 200K 300GB 10K SAS DRV R1 TAA UPG	ES-1	\$805
GS6103001BU	VMAX 200K 300GB 10K SAS DRV R1 UPG	ES-1	\$805
GS6103005BTU	VMAX 200K 300GB 10K SAS DRVR5(3+1)TAAUPG	ES-1	\$805
GS6103005BU	VMAX 200K 300GB 10K SAS DRV R5(3+1)UPG	ES-1	\$805
GS6103006BTU	VMAX 200K 300GB 10K SAS DRVR6(6+2)TAAUPG	ES-1	\$805
GS6103006BU	VMAX 200K 300GB 10K SAS DRV R6(6+2)UPG	ES-1	\$805
GS6103007BTU	VMAX 200K 300GB 10K SAS DRVR5(7+1)TAAUPG	ES-1	\$805
GS6103007BU	VMAX 200K 300GB 10K SAS DRV R5(7+1)UPG	ES-1	\$805
GS610300FBTU	VMAX 200K 300GB 10K SAS DRR6(14+2)TAAUPG	ES-1	\$805
GS610300FBU	VMAX 200K 300GB 10K SAS DR R6(14+2)UPG	ES-1	\$805
GS610300SBTU	VMAX 200K 300GB 10K SAS DR SPARE TAAUPG	ES-1	\$805
GS610300SBU	VMAX 200K 300GB 10K SAS DR SPARE UPG	ES-1	\$805
GS6106001BTU	VMAX 200K 600GB 10K SAS DRV R1 TAA UPG	ES-1	\$1,510
GS6106001BU	VMAX 200K 600GB 10K SAS DRV R1 UPG	ES-1	\$1,510
GS6106005BTU	VMAX 200K 600GB 10K SAS DRVR5(3+1)TAAUPG	ES-1	\$1,510
GS6106005BU	VMAX 200K 600GB 10K SAS DRV R5(3+1)UPG	ES-1	\$1,510
GS6106006BTU	VMAX 200K 600GB 10K SAS DRVR6(6+2)TAAUPG	ES-1	\$1,510
GS6106006BU	VMAX 200K 600GB 10K SAS DRV R6(6+2)UPG	ES-1	\$1,510
GS6106007BTU	VMAX 200K 600GB 10K SAS DRVR5(7+1)TAAUPG	ES-1	\$1,510
GS6106007BU	VMAX 200K 600GB 10K SAS DRV R5(7+1)UPG	ES-1	\$1,510
GS610600FBTU	VMAX 200K 600GB 10K SAS R6(14+2)TAA UPG	ES-1	\$1,510
GS610600FBU	VMAX 200K 600GB 10K SAS R6(14+2)UPG	ES-1	\$1,510
GS610600SBTU	VMAX 200K 600GB 10K SAS SPARE TAA UPG	ES-1	\$1,510
GS610600SBU	VMAX 200K 600GB 10K SAS SPARE UPG	ES-1	\$1,510
GS6153001BTU	VMAX 200K 300GB 15K SAS DRV R1 TAA UPG	ES-1	\$2,065
GS6153001BU	VMAX 200K 300GB 15K SAS DRV R1 UPG	ES-1	\$2,065
GS6153005BTU	VMAX 200K 300GB 15K SAS DRVR5(3+1)TAAUPG	ES-1	\$2,065
GS6153005BU	VMAX 200K 300GB 15K SAS DRV R5(3+1) UPG	ES-1	\$2,065

GS6153006BTU	VMAX 200K 300GB 15K SAS DRVR6(6+2)TAAUPG	ES-1	\$2,065
GS6153006BU	VMAX 200K 300GB 15K SAS DRV R6(6+2) UPG	ES-1	\$2,065
GS6153007BTU	VMAX 200K 300GB 15K SAS DRVR5(7+1)TAAUPG	ES-1	\$2,065
GS6153007BU	VMAX 200K 300GB 15K SAS DRV R5(7+1) UPG	ES-1	\$2,065
GS615300FBTU	VMAX 200K 300GB 15K SAS DRR6(14+2)TAAUPG	ES-1	\$2,065
GS615300FBU	VMAX 200K 300GB 15K SAS DRV R6(14+2) UPG	ES-1	\$2,065
GS615300SBTU	VMAX 200K 300GB 15K SAS DRV SPARE TAAUPG	ES-1	\$2,065
GS615300SBU	VMAX 200K 300GB 15K SAS DRV SPARE UPG	ES-1	\$2,065
GS6FM16001BT0	VMAX200K 1600GB FLASH R1 1-15	ES-1	\$22,600
GS6FM16001BT1	VMAX200K 1600GB FLASH R1 16-23	ES-1	\$16,140
GS6FM16001BT2	VMAX200K 1600GB FLASH R1 24-31	ES-1	\$15,335
GS6FM16001BT3	VMAX200K 1600GB FLASH R1 32-63	ES-1	\$14,525
GS6FM16001BT4	VMAX200K 1600GB FLASH R1 64+	ES-1	\$13,720
GS6FM16001BTUT0	VMAX200K 1600GB FLASH R1 TAA UPG	ES-1	\$31,805
GS6FM16001BTUT1	VMAX200K 1600GB FLASH R1 TAA UPG 16-23	ES-1	\$20,600
GS6FM16001BTUT2	VMAX200K 1600GB FLASH R1 TAA UPG 24+	ES-1	\$19,200
GS6FM16001BUT0	VMAX200K 1600GB FLASH R1 UPG	ES-1	\$31,805
GS6FM16001BUT1	VMAX200K 1600GB FLASH R1 UPG 16-23	ES-1	\$20,600
GS6FM16001BUT2	VMAX200K 1600GB FLASH R1 UPG 24+	ES-1	\$19,200
GS6FM16005BT0	VMAX200K 1600GB FLASH R5(3+1) 1-15	ES-1	\$22,600
GS6FM16005BT1	VMAX200K 1600GB FLASH R5(3+1) 16-23	ES-1	\$16,140
GS6FM16005BT2	VMAX200K 1600GB FLASH R5(3+1) 24-31	ES-1	\$15,335
GS6FM16005BT3	VMAX200K 1600GB FLASH R5(3+1) 32-63	ES-1	\$14,525
GS6FM16005BT4	VMAX200K 1600GB FLASH R5(3+1) 64+	ES-1	\$13,720
GS6FM16005BTUT0	VMAX200K 1600GB FLASH R5(3+1)TAA UPG	ES-1	\$31,805
GS6FM16005BTUT1	VMAX200K 1600GBFLASH R5(3+1)TAAUPG 16-23	ES-1	\$20,600
GS6FM16005BTUT2	VMAX200K 1600GB FLASH R5(3+1)TAA UPG 24+	ES-1	\$19,200
GS6FM16005BUT0	VMAX200K 1600GB FLASH R5(3+1) UPG	ES-1	\$31,805
GS6FM16005BUT1	VMAX200K 1600GB FLASH R5(3+1) UPG 16-23	ES-1	\$20,600
GS6FM16005BUT2	VMAX200K 1600GB FLASH R5(3+1) UPG 24+	ES-1	\$19,200
GS6FM16006BT0	VMAX200K 1600GB FLASH R6(6+2) 1-15	ES-1	\$22,600
GS6FM16006BT1	VMAX200K 1600GB FLASH R6(6+2) 16-23	ES-1	\$16,140
GS6FM16006BT2	VMAX200K 1600GB FLASH R6(6+2) 24-31	ES-1	\$15,335
GS6FM16006BT3	VMAX200K 1600GB FLASH R6(6+2) 32-63	ES-1	\$14,525
GS6FM16006BT4	VMAX200K 1600GB FLASH R6(6+2) 64+	ES-1	\$13,720
GS6FM16006BTUT0	VMAX200K 1600GB FLASH R6(6+2)TAA UPG	ES-1	\$31,805
GS6FM16006BTUT1	VMAX200K 1600GBFLASH R6(6+2)TAAUPG 16-23	ES-1	\$22,595
GS6FM16006BTUT2	VMAX200K 1600GB FLASH R6(6+2)TAA UPG 24+	ES-1	\$21,470
GS6FM16006BUT0	VMAX200K 1600GB FLASH R6(6+2) UPG	ES-1	\$31,805
GS6FM16006BUT1	VMAX200K 1600GB FLASH R6(6+2) UPG 16-23	ES-1	\$22,595
GS6FM16006BUT2	VMAX200K 1600GB FLASH R6(6+2) UPG 24+	ES-1	\$21,470
GS6FM16007BT0	VMAX200K 1600GB FLASH R5(7+1) 1-15	ES-1	\$22,600
GS6FM16007BT1	VMAX200K 1600GB FLASH R5(7+1) 16-23	ES-1	\$16,140
GS6FM16007BT2	VMAX200K 1600GB FLASH R5(7+1) 24-31	ES-1	\$15,335
GS6FM16007BT3	VMAX200K 1600GB FLASH R5(7+1) 32-63	ES-1	\$14,525
GS6FM16007BT4	VMAX200K 1600GB FLASH R5(7+1) 64+	ES-1	\$13,720
GS6FM16007BTUT0	VMAX200K 1600GB FLASH R5(7+1)TAA UPG	ES-1	\$31,805
GS6FM16007BTUT1	VMAX200K 1600GBFLASH R5(7+1)TAAUPG 16-23	ES-1	\$20,600
GS6FM16007BTUT2	VMAX200K 1600GB FLASH R5(7+1)TAA UPG 24+	ES-1	\$19,200
GS6FM16007BUT0	VMAX200K 1600GB FLASH R5(7+1) UPG	ES-1	\$31,805

GS6FM16007BUT1	VMAX200K 1600GB FLASH R5(7+1) UPG 16-23	ES-1	\$20,600
GS6FM16007BUT2	VMAX200K 1600GB FLASH R5(7+1) UPG 24+	ES-1	\$19,200
GS6FM1600FBT0	VMAX200K 1600GB FLASH R6(14+2) 1-15	ES-1	\$22,600
GS6FM1600FBT1	VMAX200K 1600GB FLASH R6(14+2) 16-23	ES-1	\$16,140
GS6FM1600FBT2	VMAX200K 1600GB FLASH R6(14+2) 24-31	ES-1	\$15,335
GS6FM1600FBT3	VMAX200K 1600GB FLASH R6(14+2) 32-63	ES-1	\$14,525
GS6FM1600FBT4	VMAX200K 1600GB FLASH R6(14+2) 64+	ES-1	\$13,720
GS6FM1600FBTUT0	VMAX200K 1600GB FLASH R6(14+2)TAA UPG	ES-1	\$31,805
GS6FM1600FBTUT1	VMAX200K 1600GBFLASH R6(14+2)TAAUPG16-23	ES-1	\$22,595
GS6FM1600FBTUT2	VMAX200K 1600GBFLASH R6(14+2)TAAUPG 24+	ES-1	\$21,470
GS6FM1600FBUT0	VMAX200K 1600GB FLASH R6(14+2) UPG	ES-1	\$31,805
GS6FM1600FBUT1	VMAX200K 1600GB FLASH R6(14+2) UPG 16-23	ES-1	\$22,595
GS6FM1600FBUT2	VMAX200K 1600GB FLASH R6(14+2) UPG 24+	ES-1	\$21,470
GS6FM1600SB	VMAX200K 1600GB FLASH SPARE	ES-1	\$22,600
GS6FM1600SBU	VMAX 200K 1600GB FLASH DRIVE SPARE UPG	ES-1	\$31,805
GS6FM2001BT0	VMAX200K 200GB FLASH R1 1-127	ES-1	\$3,905
GS6FM2001BT1	VMAX200K 200GB FLASH R1 128-191	ES-1	\$3,625
GS6FM2001BT2	VMAX200K 200GB FLASH R1 192-255	ES-1	\$3,350
GS6FM2001BT3	VMAX200K 200GB FLASH R1 256-383	ES-1	\$3,210
GS6FM2001BT4	VMAX200K 200GB FLASH R1 384-511	ES-1	\$3,065
GS6FM2001BT5	VMAX200K 200GB FLASH R1 512+	ES-1	\$2,930
GS6FM2001BTUT0	VMAX200K 200GB FLASH R1 TAA UPG	ES-1	\$5,475
GS6FM2001BTUT1	VMAX200K 200GB FLASH R1 TAA UPG 64-95	ES-1	\$5,866
GS6FM2001BTUT2	VMAX200K 200GB FLASH R1 TAA UPG 96+	ES-1	\$5,514
GS6FM2001BUT0	VMAX200K 200GB FLASH R1 UPG	ES-1	\$5,475
GS6FM2001BUT1	VMAX200K 200GB FLASH R1 UPG 64-95	ES-1	\$5,866
GS6FM2001BUT2	VMAX200K 200GB FLASH R1 UPG 96+	ES-1	\$5,514
GS6FM2005BT0	VMAX200K 200GB FLASH R5(3+1) 1-127	ES-1	\$3,905
GS6FM2005BT1	VMAX200K 200GB FLASH R5(3+1) 128-191	ES-1	\$3,625
GS6FM2005BT2	VMAX200K 200GB FLASH R5(3+1) 192-255	ES-1	\$3,350
GS6FM2005BT3	VMAX200K 200GB FLASH R5(3+1) 256-383	ES-1	\$3,210
GS6FM2005BT4	VMAX200K 200GB FLASH R5(3+1) 384-511	ES-1	\$3,065
GS6FM2005BT5	VMAX200K 200GB FLASH R5(3+1) 512+	ES-1	\$2,930
GS6FM2005BTUT0	VMAX200K 200GB FLASH R5(3+1) TAA UPG	ES-1	\$5,475
GS6FM2005BTUT1	VMAX200K 200GBFLASH R5(3+1)TAAUPG 64-95	ES-1	\$5,866
GS6FM2005BTUT2	VMAX200K 200GB FLASH R5(3+1) TAA UPG 96+	ES-1	\$5,514
GS6FM2005BUT0	VMAX200K 200GB FLASH R5(3+1) UPG	ES-1	\$5,475
GS6FM2005BUT1	VMAX200K 200GB FLASH R5(3+1) UPG 64-95	ES-1	\$5,866
GS6FM2005BUT2	VMAX200K 200GB FLASH R5(3+1) UPG 96+	ES-1	\$5,514
GS6FM2006BT0	VMAX200K 200GB FLASH R6(6+2) 1-127	ES-1	\$3,905
GS6FM2006BT1	VMAX200K 200GB FLASH R6(6+2) 128-191	ES-1	\$3,625
GS6FM2006BT2	VMAX200K 200GB FLASH R6(6+2) 192-255	ES-1	\$3,350
GS6FM2006BT3	VMAX200K 200GB FLASH R6(6+2) 256-383	ES-1	\$3,210
GS6FM2006BT4	VMAX200K 200GB FLASH R6(6+2) 384-511	ES-1	\$3,065
GS6FM2006BT5	VMAX200K 200GB FLASH R6(6+2) 512+	ES-1	\$2,930
GS6FM2006BTUT0	VMAX200K 200GB FLASH R6(6+2) TAA UPG	ES-1	\$5,475
GS6FM2006BTUT1	VMAX200K 200GB FLASH R6(6+2)TAAUPG 64-95	ES-1	\$5,866
GS6FM2006BTUT2	VMAX200K 200GB FLASH R6(6+2) TAA UPG 96+	ES-1	\$5,514
GS6FM2006BUT0	VMAX200K 200GB FLASH R6(6+2) UPG	ES-1	\$5,475
GS6FM2006BUT1	VMAX200K 200GB FLASH R6(6+2) UPG 64-95	ES-1	\$5,866

GS6FM2006BUT2	VMAX200K 200GB FLASH R6(6+2) UPG 96+	ES-1	\$5,514
GS6FM2007BT0	VMAX200K 200GB FLASH R5(7+1) 1-127	ES-1	\$3,905
GS6FM2007BT1	VMAX200K 200GB FLASH R5(7+1) 128-191	ES-1	\$3,625
GS6FM2007BT2	VMAX200K 200GB FLASH R5(7+1) 192-255	ES-1	\$3,350
GS6FM2007BT3	VMAX200K 200GB FLASH R5(7+1) 256-383	ES-1	\$3,210
GS6FM2007BT4	VMAX200K 200GB FLASH R5(7+1) 384-511	ES-1	\$3,065
GS6FM2007BT5	VMAX200K 200GB FLASH R5(7+1) 512+	ES-1	\$2,930
GS6FM2007BTUT0	VMAX200K 200GB FLASH R5(7+1) TAA UPG	ES-1	\$5,475
GS6FM2007BTUT1	VMAX200K 200GB FLASH R5(7+1)TAAUPG 64-95	ES-1	\$5,866
GS6FM2007BTUT2	VMAX200K 200GB FLASH R5(7+1) TAA UPG 96+	ES-1	\$5,514
GS6FM2007BUT0	VMAX200K 200GB FLASH R5(7+1) UPG	ES-1	\$5,475
GS6FM2007BUT1	VMAX200K 200GB FLASH R5(7+1) UPG 64-95	ES-1	\$5,866
GS6FM2007BUT2	VMAX200K 200GB FLASH R5(7+1) UPG 96+	ES-1	\$5,514
GS6FM200FBT0	VMAX200K 200GB FLASH R6(14+2) 1-127	ES-1	\$3,905
GS6FM200FBT1	VMAX200K 200GB FLASH R6(14+2) 128-191	ES-1	\$3,625
GS6FM200FBT2	VMAX200K 200GB FLASH R6(14+2) 192-255	ES-1	\$3,350
GS6FM200FBT3	VMAX200K 200GB FLASH R6(14+2) 256-383	ES-1	\$3,210
GS6FM200FBT4	VMAX200K 200GB FLASH R6(14+2) 384-511	ES-1	\$3,065
GS6FM200FBT5	VMAX200K 200GB FLASH R6(14+2) 512+	ES-1	\$2,930
GS6FM200FBTUT0	VMAX200K 200GB FLASH R6(14+2)TAA UPG	ES-1	\$5,475
GS6FM200FBTUT1	VMAX200K 200GBFLASH R6(14+2)TAAUPG 64-95	ES-1	\$5,866
GS6FM200FBTUT2	VMAX200K 200GB FLASH R6(14+2)TAA UPG 96+	ES-1	\$5,514
GS6FM200FBUT0	VMAX200K 200GB FLASH R6(14+2) UPG	ES-1	\$5,475
GS6FM200FBUT1	VMAX200K 200GB FLASH R6(14+2) UPG 64-95	ES-1	\$5,866
GS6FM200FBUT2	VMAX200K 200GB FLASH R6(14+2) UPG 96+	ES-1	\$5,514
GS6FM200SB	VMAX200K 200GB FLASH SPARE	ES-1	\$3,905
GS6FM200SBU	VMAX 200K 200GB FLASH DRIVE SPARE UPG	ES-1	\$5,475
GS6FM4001BT0	VMAX200K 400GB FLASH R1 1-63	ES-1	\$7,425
GS6FM4001BT1	VMAX200K 400GB FLASH R1 64-95	ES-1	\$6,100
GS6FM4001BT2	VMAX200K 400GB FLASH R1 96-127	ES-1	\$5,830
GS6FM4001BT3	VMAX200K 400GB FLASH R1 128-191	ES-1	\$5,565
GS6FM4001BT4	VMAX200K 400GB FLASH R1 192-255	ES-1	\$5,305
GS6FM4001BT5	VMAX200K 400GB FLASH R1 256+	ES-1	\$5,040
GS6FM4001BTUT0	VMAX200K 400GB FLASH R1 TAA UPG	ES-1	\$10,395
GS6FM4001BTUT1	VMAX200K 400GB FLASH R1 TAA UPG 32-47	ES-1	\$8,472
GS6FM4001BTUT2	VMAX200K 400GB FLASH R1 TAA UPG 48+	ES-1	\$8,160
GS6FM4001BUT0	VMAX200K 400GB FLASH R1 UPG	ES-1	\$10,395
GS6FM4001BUT1	VMAX200K 400GB FLASH R1 UPG 32-47	ES-1	\$8,472
GS6FM4001BUT2	VMAX200K 400GB FLASH R1 UPG 48+	ES-1	\$8,160
GS6FM4005BT0	VMAX200K 400GB FLASH R5(3+1) 1-63	ES-1	\$7,425
GS6FM4005BT1	VMAX200K 400GB FLASH R5(3+1) 64-95	ES-1	\$6,100
GS6FM4005BT2	VMAX200K 400GB FLASH R5(3+1) 96-127	ES-1	\$5,830
GS6FM4005BT3	VMAX200K 400GB FLASH R5(3+1) 128-191	ES-1	\$5,565
GS6FM4005BT4	VMAX200K 400GB FLASH R5(3+1) 192-255	ES-1	\$5,305
GS6FM4005BT5	VMAX200K 400GB FLASH R5(3+1) 256+	ES-1	\$5,040
GS6FM4005BTUT0	VMAX200K 400GB FLASH R5(3+1) TAA UPG	ES-1	\$10,395
GS6FM4005BTUT1	VMAX200K 400GB FLASHR5(3+1)TAAUPG 32-47	ES-1	\$8,472
GS6FM4005BTUT2	VMAX200K 400GB FLASHR5(3+1)TAAUPG 48+	ES-1	\$8,160
GS6FM4005BUT0	VMAX200K 400GB FLASH R5(3+1) UPG	ES-1	\$10,395
GS6FM4005BUT1	VMAX200K 400GB FLASH R5(3+1) UPG 32-47	ES-1	\$8,472

GS6FM4005BUT2	VMAX200K 400GB FLASH R5(3+1) UPG 48+	ES-1	\$8,160
GS6FM4006BT0	VMAX200K 400GB FLASH R6(6+2) 1-63	ES-1	\$7,425
GS6FM4006BT1	VMAX200K 400GB FLASH R6(6+2) 64-95	ES-1	\$6,100
GS6FM4006BT2	VMAX200K 400GB FLASH R6(6+2) 96-127	ES-1	\$5,830
GS6FM4006BT3	VMAX200K 400GB FLASH R6(6+2) 128-191	ES-1	\$5,565
GS6FM4006BT4	VMAX200K 400GB FLASH R6(6+2) 192-255	ES-1	\$5,305
GS6FM4006BT5	VMAX200K 400GB FLASH R6(6+2) 256+	ES-1	\$5,040
GS6FM4006BTUT0	VMAX200K 400GB FLASH R6(6+2) TAA UPG	ES-1	\$10,395
GS6FM4006BTUT1	VMAX200K 400GB FLASHR6(6+2)TAAUPG 32-47	ES-1	\$8,472
GS6FM4006BTUT2	VMAX200K 400GB FLASHR6(6+2)TAAUPG 48+	ES-1	\$8,160
GS6FM4006BUT0	VMAX200K 400GB FLASH R6(6+2) UPG	ES-1	\$10,395
GS6FM4006BUT1	VMAX200K 400GB FLASH R6(6+2)UPG 32-47	ES-1	\$8,472
GS6FM4006BUT2	VMAX200K 400GB FLASH R6(6+2)UPG 48+	ES-1	\$8,160
GS6FM4007BT0	VMAX200K 400GB FLASH R5(7+1) 1-63	ES-1	\$7,425
GS6FM4007BT1	VMAX200K 400GB FLASH R5(7+1) 64-95	ES-1	\$6,100
GS6FM4007BT2	VMAX200K 400GB FLASH R5(7+1) 96-127	ES-1	\$5,830
GS6FM4007BT3	VMAX200K 400GB FLASH R5(7+1) 128-191	ES-1	\$5,565
GS6FM4007BT4	VMAX200K 400GB FLASH R5(7+1) 192-255	ES-1	\$5,305
GS6FM4007BT5	VMAX200K 400GB FLASH R5(7+1) 256+	ES-1	\$5,040
GS6FM4007BTUT0	VMAX200K 400GB FLASH R5(7+1) TAA UPG	ES-1	\$10,395
GS6FM4007BTUT1	VMAX200K 400GB FLASHR5(7+1)TAAUPG 32-47	ES-1	\$8,472
GS6FM4007BTUT2	VMAX200K 400GB FLASHR5(7+1)TAAUPG 48+	ES-1	\$8,160
GS6FM4007BUT0	VMAX200K 400GB FLASH R5(7+1) UPG	ES-1	\$10,395
GS6FM4007BUT1	VMAX200K 400GB FLASH R5(7+1) UPG 32-47	ES-1	\$8,472
GS6FM4007BUT2	VMAX200K 400GB FLASH R5(7+1) UPG 48+	ES-1	\$8,160
GS6FM400FBT0	VMAX200K 400GB FLASH R6(14+2) 1-63	ES-1	\$7,425
GS6FM400FBT1	VMAX200K 400GB FLASH R6(14+2) 64-95	ES-1	\$6,100
GS6FM400FBT2	VMAX200K 400GB FLASH R6(14+2) 96-127	ES-1	\$5,830
GS6FM400FBT3	VMAX200K 400GB FLASH R6(14+2) 128-191	ES-1	\$5,565
GS6FM400FBT4	VMAX200K 400GB FLASH R6(14+2) 192-255	ES-1	\$5,305
GS6FM400FBT5	VMAX200K 400GB FLASH R6(14+2) 256+	ES-1	\$5,040
GS6FM400FBTUT0	VMAX200K 400GB FLASH R6(14+2)TAA UPG	ES-1	\$10,395
GS6FM400FBTUT1	VMAX200K 400GBFLASH R6(14+2)TAAUPG 32-47	ES-1	\$8,472
GS6FM400FBTUT2	VMAX200K 400GBFLASH R6(14+2)TAAUPG 48+	ES-1	\$8,160
GS6FM400FBUT0	VMAX200K 400GB FLASH R6(14+2) UPG	ES-1	\$10,395
GS6FM400FBUT1	VMAX200K 400GB FLASH R6(14+2) UPG 32-47	ES-1	\$8,472
GS6FM400FBUT2	VMAX200K 400GB FLASH R6(14+2) UPG 48+	ES-1	\$8,160
GS6FM400SB	VMAX200K 400GB FLASH SPARE	ES-1	\$7,425
GS6FM400SBU	VMAX 200K 400GB FLASH DRIVE SPARE UPG	ES-1	\$10,395
GS6FM8001BT0	VMAX200K 800GB FLASH R1 1-31	ES-1	\$13,095
GS6FM8001BT1	VMAX200K 800GB FLASH R1 32-47	ES-1	\$9,350
GS6FM8001BT2	VMAX200K 800GB FLASH R1 48-95	ES-1	\$8,885
GS6FM8001BT3	VMAX200K 800GB FLASH R1 96-127	ES-1	\$8,415
GS6FM8001BT4	VMAX200K 800GB FLASH R1 128+	ES-1	\$7,950
GS6FM8001BTUT0	VMAX200K 800GB FLASH R1 TAA UPG	ES-1	\$18,325
GS6FM8001BTUT1	VMAX200K 800GB FLASH R1 TAA UPG 24-31	ES-1	\$13,090
GS6FM8001BTUT2	VMAX200K 800GB FLASH R1 TAA UPG 32+	ES-1	\$12,440
GS6FM8001BUT0	VMAX200K 800GB FLASH R1 UPG	ES-1	\$18,325
GS6FM8001BUT1	VMAX200K 800GB FLASH R1 UPG 24-31	ES-1	\$13,090
GS6FM8001BUT2	VMAX200K 800GB FLASH R1 UPG 32+	ES-1	\$12,440

GS6FM8005BT0	VMAX200K 800GB FLASH R5(3+1) 1-31	ES-1	\$13,095
GS6FM8005BT1	VMAX200K 800GB FLASH R5(3+1) 32-47	ES-1	\$9,350
GS6FM8005BT2	VMAX200K 800GB FLASH R5(3+1) 48-95	ES-1	\$8,885
GS6FM8005BT3	VMAX200K 800GB FLASH R5(3+1) 96-127	ES-1	\$8,415
GS6FM8005BT4	VMAX200K 800GB FLASH R5(3+1) 128+	ES-1	\$7,950
GS6FM8005BTUT0	VMAX200K 800GB FLASH R5(3+1) TAA UPG	ES-1	\$18,325
GS6FM8005BTUT1	VMAX200K 800GB FLASH R5(3+1)TAAUPG 24-31	ES-1	\$13,090
GS6FM8005BTUT2	VMAX200K 800GB FLASH R5(3+1) TAA UPG 32+	ES-1	\$12,440
GS6FM8005BUT0	VMAX200K 800GB FLASH R5(3+1) UPG	ES-1	\$18,325
GS6FM8005BUT1	VMAX200K 800GB FLASH R5(3+1) UPG 24-31	ES-1	\$13,090
GS6FM8005BUT2	VMAX200K 800GB FLASH R5(3+1) UPG 32+	ES-1	\$12,440
GS6FM8006BT0	VMAX200K 800GB FLASH R6(6+2) 1-31	ES-1	\$13,095
GS6FM8006BT1	VMAX200K 800GB FLASH R6(6+2) 32-47	ES-1	\$9,350
GS6FM8006BT2	VMAX200K 800GB FLASH R6(6+2) 48-95	ES-1	\$8,885
GS6FM8006BT3	VMAX200K 800GB FLASH R6(6+2) 96-127	ES-1	\$8,415
GS6FM8006BT4	VMAX200K 800GB FLASH R6(6+2) 128+	ES-1	\$7,950
GS6FM8006BTUT0	VMAX200K 800GB FLASH R6(6+2) TAA UPG	ES-1	\$18,325
GS6FM8006BTUT1	VMAX200K 800GB FLASH R6(6+2)TAAUPG 24-31	ES-1	\$13,090
GS6FM8006BTUT2	VMAX200K 800GB FLASH R6(6+2) TAA UPG 32+	ES-1	\$12,440
GS6FM8006BUT0	VMAX200K 800GB FLASH R6(6+2) UPG	ES-1	\$18,325
GS6FM8006BUT1	VMAX200K 800GB FLASH R6(6+2) UPG 24-31	ES-1	\$13,090
GS6FM8006BUT2	VMAX200K 800GB FLASH R6(6+2) UPG 32+	ES-1	\$12,440
GS6FM8007BT0	VMAX200K 800GB FLASH R5(7+1) 1-31	ES-1	\$13,095
GS6FM8007BT1	VMAX200K 800GB FLASH R5(7+1) 32-47	ES-1	\$9,350
GS6FM8007BT2	VMAX200K 800GB FLASH R5(7+1) 48-95	ES-1	\$8,885
GS6FM8007BT3	VMAX200K 800GB FLASH R5(7+1) 96-127	ES-1	\$8,415
GS6FM8007BT4	VMAX200K 800GB FLASH R5(7+1) 128+	ES-1	\$7,950
GS6FM8007BTUT0	VMAX200K 800GB FLASH R5(7+1) TAA UPG	ES-1	\$18,325
GS6FM8007BTUT1	VMAX200K 800GBFLASH R5(7+1)TAAUPG 24-31	ES-1	\$13,090
GS6FM8007BTUT2	VMAX200K 800GB FLASH R5(7+1) TAA UPG 32+	ES-1	\$12,440
GS6FM8007BUT0	VMAX200K 800GB FLASH R5(7+1) UPG	ES-1	\$18,325
GS6FM8007BUT1	VMAX200K 800GB FLASH R5(7+1) UPG 24-31	ES-1	\$13,090
GS6FM8007BUT2	VMAX200K 800GB FLASH R5(7+1) UPG 32+	ES-1	\$12,440
GS6FM800FBT0	VMAX200K 800GB FLASH R6(14+2) 1-31	ES-1	\$13,095
GS6FM800FBT1	VMAX200K 800GB FLASH R6(14+2) 32-47	ES-1	\$9,350
GS6FM800FBT2	VMAX200K 800GB FLASH R6(14+2) 48-95	ES-1	\$8,885
GS6FM800FBT3	VMAX200K 800GB FLASH R6(14+2) 96-127	ES-1	\$8,415
GS6FM800FBT4	VMAX200K 800GB FLASH R6(14+2) 128+	ES-1	\$7,950
GS6FM800FBTUT0	VMAX200K 800GB FLASH R6(14+2)TAA UPG	ES-1	\$18,325
GS6FM800FBTUT1	VMAX200K 800GBFLASH R6(14+2)TAAUPG 24-31	ES-1	\$13,090
GS6FM800FBTUT2	VMAX200K 800GB FLASH R6(14+2)TAA UPG 32+	ES-1	\$12,440
GS6FM800FBUT0	VMAX200K 800GB FLASH R6(14+2) UPG	ES-1	\$18,325
GS6FM800FBUT1	VMAX200K 800GB FLASH R6(14+2) UPG 24-31	ES-1	\$13,090
GS6FM800FBUT2	VMAX200K 800GB FLASH R6(14+2) UPG 32+	ES-1	\$12,440
GS6FM800SB	VMAX200K 800GB FLASH SPARE	ES-1	\$13,095
GS6FM800SBU	VMAX 200K 800GB FLASH DRIVE SPARE UPG	ES-1	\$18,325
GT67220001BTU	VMAX 200K 2000GB 7_2K DRIVE R1 TAA UPG	ES-1	\$1,595
GT67220001BU	VMAX 200K 2000GB 7_2K DRIVE R1 UPG	ES-1	\$1,595
GT67220005BTU	VMAX 200K 2000GB 7_2K DRIVER5(3+1)TAAUPG	ES-1	\$1,595
GT67220005BU	VMAX 200K 2000GB 7_2K DRIVE R5(3+1) UPG	ES-1	\$1,595

GT67220006BTU	VMAX 200K 2000GB 7_2K DRIVER6(6+2)TAAUPG	ES-1	\$1,595
GT67220006BU	VMAX 200K 2000GB 7_2K DRIVE R6(6+2) UPG	ES-1	\$1,595
GT67220007BTU	VMAX 200K 2000GB 7_2K DRIVER5(7+1)TAAUPG	ES-1	\$1,595
GT67220007BU	VMAX 200K 2000GB 7_2K DRIVE R5(7+1) UPG	ES-1	\$1,595
GT6722000FBTU	VMAX 200K 2000GB 7_2K DRVR6(14+2)TAAUPG	ES-1	\$1,595
GT6722000FBU	VMAX 200K 2000GB 7_2K DRIVE R6(14+2) UPG	ES-1	\$1,595
GT6722000SBTU	VMAX 200K 2000GB 7_2K DRV SPARE TAAUPG	ES-1	\$1,595
GT6722000SBU	VMAX 200K 2000GB 7_2K DRIVE SPARE UPG	ES-1	\$1,595
GT67240001BTU	VMAX 200K 4000GB 7_2K DRV R1 TAA UPG	ES-1	\$2,790
GT67240001BU	VMAX 200K 4000GB 7_2K DRV R1 UPG	ES-1	\$2,790
GT67240005BTU	VMAX 200K 4000GB 7_2K DRV R5(3+1)TAAUPG	ES-1	\$2,790
GT67240005BU	VMAX 200K 4000GB 7_2K DRV R5(3+1)UPG	ES-1	\$2,790
GT67240006BTU	VMAX 200K 4000GB 7_2K DRV R6(6+2)TAAUPG	ES-1	\$2,790
GT67240006BU	VMAX 200K 4000GB 7_2K DRV R6(6+2)UPG	ES-1	\$2,790
GT67240007BTU	VMAX 200K 4000GB 7_2K DRV R5(7+1)TAAUPG	ES-1	\$2,790
GT67240007BU	VMAX 200K 4000GB 7_2K DRV R5(7+1)UPG	ES-1	\$2,790
GT6724000FBTU	VMAX 200K 4000GB 7_2K DRV R6(14+2)TAAUPG	ES-1	\$2,790
GT6724000FBU	VMAX 200K 4000GB 7_2K DRV R6(14+2)UPG	ES-1	\$2,790
GT6724000SBTU	VMAX 200K 4000GB 7_2K DRV SPARE TAAUPG	ES-1	\$2,790
GT6724000SBU	VMAX 200K 4000GB 7_2K DRV SPARE UPG	ES-1	\$2,790
H-FE00008SU	VMAX 400K 8SM 16G FICON UPG	ES-1	\$20,250
H-FE00008SUF	VMAX 400K 8SM 16G FICON CONV	ES-1	\$68,660
H-FE00080SU	VMAX 400K 8MM 16G FICON UPG	ES-1	\$9,295
H-FE00080SUF	VMAX 400K 8MM 16G FICON CONV	ES-1	\$31,520
H-FE00200TOU	VMAX 400K 2PT 10 GBE OPTICAL UPG	ES-1	\$5,460
H-FE00200TU	VMAX 400K 2PT 10 GBE BASE T UPG	ES-1	\$5,720
H-FE00400C4U	VMAX 400K 4MM4 COPR GIGE UPG	ES-1	\$2,575
H-FE00400C4UF	VMAX 400K 4MM4 COPR GIGE CONV	ES-1	\$9,000
H-FE00400CU	VMAX 400K 4PT GBE BASE T UPG	ES-1	\$5,200
H-FE00400CUF	VMAX 400K 4M GIGE COPPER CONV	ES-1	\$18,200
H-FE00400TOUF	VMAX 400K 4MM 10 GIGE OPTICAL CONV	ES-1	\$19,110
H-FE00400TU	VMAX 400K 4MM 10 GIGE UPG	ES-1	\$4,745
H-FE00400TUF	VMAX 400K 4MM 10 GIGE CONV	ES-1	\$16,600
H-FE00800TU	VMAX 400K 8MM 10 GIGE UPG	ES-1	\$7,120
H-FE00800TUF	VMAX 400K 8MM 10 GIGE CONV	ES-1	\$24,920
H-FE08000EU	VMAX 400K 8SM 8G FIBRE UPG	ES-1	\$5,380
H-FE08000EUF	VMAX 400K 8SM 8G FIBRE CONV	ES-1	\$18,250
H-FE08000SU	VMAX 400K 8SM 16G FC UPG	ES-1	\$14,045
H-FE08000SUF	VMAX 400K 8SM 16G FC CONV	ES-1	\$63,565
H-FE44000EUF	VMAX 400K 4MM4SM 8G FIBRE CONV	ES-1	\$13,270
H-FE62000EUF	VMAX 400K 6MM2SM 8G FIBRE CONV	ES-1	\$9,335
H-FE80000EU	VMAX 400K 8MM 8G FIBRE UPG	ES-1	\$2,690
H-FE80000EUF	VMAX 400K 8MM 8G FIBRE CONV	ES-1	\$8,285
H-FE80000SU	VMAX 400K 8MM 16G FC UPG	ES-1	\$14,045
H-FE80000SUF	VMAX 400K 8MM 16G FC CONV	ES-1	\$21,645
HL61012001BTU	VMAX 400K 1200GB 10K SAS DRV R1 TAA UPG	ES-1	\$2,330
HL61012001BU	VMAX 400K 1200GB 10K SAS DRV R1 UPG	ES-1	\$2,330
HL61012005BTU	VMAX 400K 1200GB 10K SAS DRR5(3+1)TAAUPG	ES-1	\$2,330
HL61012005BU	VMAX 400K 1200GB 10K SAS DRV R5(3+1) UPG	ES-1	\$2,330
HL61012006BTU	VMAX 400K 1200GB 10K SAS DRR6(6+2)TAAUPG	ES-1	\$2,330

HL61012006BU	VMAX 400K 1200GB 10K SAS DRV R6(6+2) UPG	ES-1	\$2,330
HL61012007BTU	VMAX 400K 1200GB 10K SAS DRR5(7+1)TAAUPG	ES-1	\$2,330
HL61012007BU	VMAX 400K 1200GB 10K SAS DRV R5(7+1) UPG	ES-1	\$2,330
HL6101200FBTU	VMAX 400K 1200GB 10K SASDRR6(14+2)TAAUPG	ES-1	\$2,330
HL6101200FBU	VMAX 400K 1200GB 10K SAS DRV R6(14+2)UPG	ES-1	\$2,330
HL6101200SBTU	VMAX 400K 1200GB 10K SAS DRV SPARETAAUP	ES-1	\$2,330
HL6101200SBU	VMAX 400K 1200GB 10K SAS DRV SPARE UPG	ES-1	\$2,330
HL6103001BTU	VMAX 400K 300GB 10K SAS DRV R1 TAA UPG	ES-1	\$805
HL6103001BU	VMAX 400K 300GB 10K SAS DRV R1 UPG	ES-1	\$805
HL6103005BTU	VMAX 400K 300GB 10K SAS DRVR5(3+1)TAAUPG	ES-1	\$805
HL6103005BU	VMAX 400K 300GB 10K SAS DRV R5(3+1) UPG	ES-1	\$805
HL6103006BTU	VMAX 400K 300GB 10K SAS DRVR6(6+2)TAAUPG	ES-1	\$805
HL6103006BU	VMAX 400K 300GB 10K SAS DRV R6(6+2) UPG	ES-1	\$805
HL6103007BTU	VMAX 400K 300GB 10K SAS DRVR5(7+1)TAAUPG	ES-1	\$805
HL6103007BU	VMAX 400K 300GB 10K SAS DRV R5(7+1) UPG	ES-1	\$805
HL610300FBTU	VMAX 400K 300GB 10K SAS DRR6(14+2)TAAUPG	ES-1	\$805
HL610300FBU	VMAX 400K 300GB 10K SAS DRV R6(14+2) UPG	ES-1	\$805
HL610300SBTU	VMAX 400K 300GB 10K SAS DRV SPARE TAAUPG	ES-1	\$805
HL610300SBU	VMAX 400K 300GB 10K SAS DRV SPARE UPG	ES-1	\$805
HL6106001BTU	VMAX 400K 600GB 10K SAS DRV R1 TAA UPG	ES-1	\$1,510
HL6106001BU	VMAX 400K 600GB 10K SAS DRV R1 UPG	ES-1	\$1,510
HL6106005BTU	VMAX 400K 600GB 10K SAS DRVR5(3+1)TAAUPG	ES-1	\$1,510
HL6106005BU	VMAX 400K 600GB 10K SAS DRV R5(3+1) UPG	ES-1	\$1,510
HL6106006BTU	VMAX 400K 600GB 10K SAS DRVR6(6+2)TAAUPG	ES-1	\$1,510
HL6106006BU	VMAX 400K 600GB 10K SAS DRV R6(6+2) UPG	ES-1	\$1,510
HL6106007BTU	VMAX 400K 600GB 10K SAS DRVR5(7+1)TAAUPG	ES-1	\$1,510
HL6106007BU	VMAX 400K 600GB 10K SAS DRV R5(7+1) UPG	ES-1	\$1,510
HL610600FBTU	VMAX 400K 600GB 10K SAS DRR6(14+2)TAAUPG	ES-1	\$1,510
HL610600FBU	VMAX 400K 600GB 10K SAS DRV R6(14+2) UPG	ES-1	\$1,510
HL610600SBTU	VMAX 400K 600GB 10K SAS DRV SPARE TAAUPG	ES-1	\$1,510
HL610600SBU	VMAX 400K 600GB 10K SAS DRV SPARE UPG	ES-1	\$1,510
HL6153001BTU	VMAX 400K 300GB 15K SAS DRV R1 TAA UPG	ES-1	\$2,065
HL6153001BU	VMAX 400K 300GB 15K SAS DRV R1 UPG	ES-1	\$2,065
HL6153005BTU	VMAX 400K 300GB 15K SAS DRVR5(3+1)TAAUPG	ES-1	\$2,065
HL6153005BU	VMAX 400K 300GB 15K SAS DRV R5(3+1) UPG	ES-1	\$2,065
HL6153006BTU	VMAX 400K 300GB 15K SAS DRVR6(6+2)TAAUPG	ES-1	\$2,065
HL6153006BU	VMAX 400K 300GB 15K SAS DRV R6(6+2) UPG	ES-1	\$2,065
HL6153007BTU	VMAX 400K 300GB 15K SAS DRVR5(7+1)TAAUPG	ES-1	\$2,065
HL6153007BU	VMAX 400K 300GB 15K SAS DRV R5(7+1) UPG	ES-1	\$2,065
HL615300FBTU	VMAX 400K 300GB 15K SAS DRR6(14+2)TAAUPG	ES-1	\$2,065
HL615300FBU	VMAX 400K 300GB 15K SAS DRV R6(14+2) UPG	ES-1	\$2,065
HL615300SBTU	VMAX 400K 300GB 15K SAS DRV SPARE TAAUPG	ES-1	\$2,065
HL615300SBU	VMAX 400K 300GB 15K SAS DRV SPARE UPG	ES-1	\$2,065
HL6F319201BTUT0	VMAX400K 1920GB FLASH R1 TAA UPG 1-7	ES-1	\$31,885
HL6F319201BTUT1	VMAX400K 1920GB FLASH R1 TAA UPG 8-11	ES-1	\$27,910
HL6F319201BTUT2	VMAX400K 1920GB FLASH R1 TAA UPG 12+	ES-1	\$25,760
HL6F319201BUT0	VMAX400K 1920GB FLASH R1 UPG 1-7	ES-1	\$31,885
HL6F319201BUT1	VMAX400K 1920GB FLASH R1 UPG 8-11	ES-1	\$27,910
HL6F319201BUT2	VMAX400K 1920GB FLASH R1 UPG 12+	ES-1	\$25,760
HL6F319205BTUT0	VMAX400K 1920GBFLASH R5(3+1)TAAUPG 1-7	ES-1	\$31,885

HL6F319205BTUT1	VMAX400K 1920GBFLASH R5(3+1)TAAUPG 8-11	ES-1	\$27,910
HL6F319205BTUT2	VMAX400K 1920GBFLASH R5(3+1)TAAUPG 12+	ES-1	\$25,760
HL6F319205BUT0	VMAX400K 1920GB FLASH R5(3+1) UPG 1-7	ES-1	\$31,885
HL6F319205BUT1	VMAX400K 1920GB FLASH R5(3+1) UPG 8-11	ES-1	\$27,910
HL6F319205BUT2	VMAX400K 1920GB FLASH R5(3+1) UPG 12+	ES-1	\$25,760
HL6F319206BTUT0	VMAX400K 1920GBFLASH R6(6+2)TAAUPG 1-7	ES-1	\$31,885
HL6F319206BTUT1	VMAX400K 1920GBFLASH R6(6+2)TAAUPG 8-11	ES-1	\$27,910
HL6F319206BTUT2	VMAX400K 1920GBFLASH R6(6+2)TAAUPG 12+	ES-1	\$25,760
HL6F319206BUT0	VMAX400K 1920GB FLASH R6(6+2)UPG 1-7	ES-1	\$31,885
HL6F319206BUT1	VMAX400K 1920GB FLASH R6(6+2)UPG 8-11	ES-1	\$27,910
HL6F319206BUT2	VMAX400K 1920GB FLASH R6(6+2)UPG 12+	ES-1	\$25,760
HL6F319207BTUT0	VMAX400K 1920GBFLASH 5(7+1)TAAUPG 1-7	ES-1	\$31,885
HL6F319207BTUT1	VMAX400K 1920GBFLASH 5(7+1)TAAUPG 8-11	ES-1	\$27,910
HL6F319207BTUT2	VMAX400K 1920GBFLASH 5(7+1)TAAUPG 12+	ES-1	\$25,760
HL6F319207BUT0	VMAX400K 1920GB FLASH R5(7+1) UPG 1-7	ES-1	\$31,885
HL6F319207BUT1	VMAX400K 1920GB FLASH R5(7+1) UPG 8-11	ES-1	\$27,910
HL6F319207BUT2	VMAX400K 1920GB FLASH R5(7+1) UPG 12+	ES-1	\$25,760
HL6F31920FBTUT0	VMAX400K 1920GB FLASH R6(14+2)TAAUPG 1-7	ES-1	\$31,885
HL6F31920FBTUT1	VMAX400K 1920GB FLASH R6(14+2)TAAUPG8-11	ES-1	\$27,910
HL6F31920FBTUT2	VMAX400K 1920GB FLASH R6(14+2)TAAUPG 12+	ES-1	\$25,760
HL6F31920FBUT0	VMAX400K 1920GB FLASH R6(14+2)UPG 1-7	ES-1	\$31,885
HL6F31920FBUT1	VMAX400K 1920GB FLASH R6(14+2)UPG 8-11	ES-1	\$27,910
HL6F31920FBUT2	VMAX400K 1920GB FLASH R6(14+2)UPG 12+	ES-1	\$25,760
HL6F31920SBTUT0	VMAX400K 1920GB FLASH SPARE TAA UPG	ES-1	\$31,885
HL6F31920SBUT0	VMAX400K 1920GB FLASH SAS DRV SPARE UPG	ES-1	\$31,885
HL6F39601BTUT0	VMAX400K 960GB FLASH R1 TAA UPG 1-7	ES-1	\$18,475
HL6F39601BTUT1	VMAX400K 960GB FLASH R1 TAA UPG 8-11	ES-1	\$15,710
HL6F39601BTUT2	VMAX400K 960GB FLASH R1 TAA UPG 12+	ES-1	\$14,925
HL6F39601BUT0	VMAX400K 960GB FLASH R1 UPG 1-7	ES-1	\$18,475
HL6F39601BUT1	VMAX400K 960GB FLASH R1 UPG 8-11	ES-1	\$15,710
HL6F39601BUT2	VMAX400K 960GB FLASH R1 UPG 12+	ES-1	\$14,925
HL6F39605BTUT0	VMAX400K 960GBFLASH R5(3+1)TAAUPG 1-7	ES-1	\$18,475
HL6F39605BTUT1	VMAX400K 960GBFLASH R5(3+1)TAAUPG 8-11	ES-1	\$15,710
HL6F39605BTUT2	VMAX400K 960GBFLASH R5(3+1)TAAUPG 12+	ES-1	\$14,925
HL6F39605BUT0	VMAX400K 960GB FLASH R5(3+1) UPG 1-7	ES-1	\$18,475
HL6F39605BUT1	VMAX400K 960GB FLASH R5(3+1) UPG 8-11	ES-1	\$15,710
HL6F39605BUT2	VMAX400K 960GB FLASH R5(3+1) UPG 12+	ES-1	\$14,925
HL6F39606BTUT0	VMAX400K 960GBFLASH R6(6+2)TAAUPG 1-7	ES-1	\$18,475
HL6F39606BTUT1	VMAX400K 960GBFLASH R6(6+2)TAAUPG 8-11	ES-1	\$15,710
HL6F39606BTUT2	VMAX400K 960GBFLASH R6(6+2)TAAUPG 12+	ES-1	\$14,925
HL6F39606BUT0	VMAX400K 960GB FLASH R6(6+2)UPG 1-7	ES-1	\$18,475
HL6F39606BUT1	VMAX400K 960GB FLASH R6(6+2)UPG 8-11	ES-1	\$15,710
HL6F39606BUT2	VMAX400K 960GB FLASH R6(6+2)UPG 12+	ES-1	\$14,925
HL6F39607BTUT0	VMAX400K 960GBFLASH 5(7+1)TAAUPG 1-7	ES-1	\$18,475
HL6F39607BTUT1	VMAX400K 960GBFLASH 5(7+1)TAAUPG 8-11	ES-1	\$15,710
HL6F39607BTUT2	VMAX400K 960GBFLASH 5(7+1)TAAUPG 12+	ES-1	\$14,925
HL6F39607BUT0	VMAX400K 960GB FLASH R5(7+1) UPG 1-7	ES-1	\$18,475
HL6F39607BUT1	VMAX400K 960GB FLASH R5(7+1) UPG 8-11	ES-1	\$15,710
HL6F39607BUT2	VMAX400K 960GB FLASH R5(7+1) UPG 12+	ES-1	\$14,925
HL6F3960FBTUT0	VMAX400K 960GB FLASH R6(14+2)TAAUPG 1-7	ES-1	\$18,475

HL6F3960FBTUT1	VMAX400K 960GB FLASH R6(14+2)TAAUPG8-11	ES-1	\$15,710
HL6F3960FBTUT2	VMAX400K 960GB FLASH R6(14+2)TAAUPG 12+	ES-1	\$14,925
HL6F3960FBUT0	VMAX400K 960GB FLASH R6(14+2)UPG 1-7	ES-1	\$18,475
HL6F3960FBUT1	VMAX400K 960GB FLASH R6(14+2)UPG 8-11	ES-1	\$15,710
HL6F3960FBUT2	VMAX400K 960GB FLASH R6(14+2)UPG 12+	ES-1	\$14,925
HL6F3960SBTUT0	VMAX400K 960GB FLASH SPARE TAA UPG	ES-1	\$18,475
HL6F3960SBUT0	VMAX400K 960GB FLASH SAS DRV SPARE UPG	ES-1	\$18,475
HL6FM16001BT0	VMAX400K 1600GB FLASH R1 1-23	ES-1	\$22,600
HL6FM16001BT1	VMAX400K 1600GB FLASH R1 24-31	ES-1	\$15,335
HL6FM16001BT2	VMAX400K 1600GB FLASH R1 32-47	ES-1	\$14,525
HL6FM16001BT3	VMAX400K 1600GB FLASH R1 48-63	ES-1	\$13,720
HL6FM16001BT4	VMAX400K 1600GB FLASH R1 64+	ES-1	\$12,915
HL6FM16001BTUT0	VMAX400K 1600GB FLASH R1 TAA UPG	ES-1	\$31,805
HL6FM16001BTUT1	VMAX400K 1600GB FLASH R1 TAA UPG 16-23	ES-1	\$20,600
HL6FM16001BTUT2	VMAX400K 1600GB FLASH R1 TAA UPG 24+	ES-1	\$19,200
HL6FM16001BUT0	VMAX400K 1600GB FLASH R1 UPG	ES-1	\$31,805
HL6FM16001BUT1	VMAX400K 1600GB FLASH R1 UPG 16-23	ES-1	\$20,600
HL6FM16001BUT2	VMAX400K 1600GB FLASH R1 UPG 24+	ES-1	\$19,200
HL6FM16005BT0	VMAX400K 1600GB FLASH R5(3+1) 1-23	ES-1	\$22,600
HL6FM16005BT1	VMAX400K 1600GB FLASH R5(3+1) 24-31	ES-1	\$15,335
HL6FM16005BT2	VMAX400K 1600GB FLASH R5(3+1) 32-47	ES-1	\$14,525
HL6FM16005BT3	VMAX400K 1600GB FLASH R5(3+1) 48-63	ES-1	\$13,720
HL6FM16005BT4	VMAX400K 1600GB FLASH R5(3+1) 64+	ES-1	\$12,915
HL6FM16005BTUT0	VMAX400K 1600GB FLASH R5(3+1)TAA UPG	ES-1	\$31,805
HL6FM16005BTUT1	VMAX400K 1600GBFLASH R5(3+1)TAAUPG 16-23	ES-1	\$20,600
HL6FM16005BTUT2	VMAX400K 1600GBFLASH R5(3+1)TAAUPG 24+	ES-1	\$19,200
HL6FM16005BUT0	VMAX400K 1600GB FLASH R5(3+1) UPG	ES-1	\$31,805
HL6FM16005BUT1	VMAX400K 1600GB FLASH R5(3+1) UPG 16-23	ES-1	\$20,600
HL6FM16005BUT2	VMAX400K 1600GB FLASH R5(3+1) UPG 24+	ES-1	\$19,200
HL6FM16006BT0	VMAX400K 1600GB FLASH R6(6+2) 1-23	ES-1	\$22,600
HL6FM16006BT1	VMAX400K 1600GB FLASH R6(6+2) 24-31	ES-1	\$15,335
HL6FM16006BT2	VMAX400K 1600GB FLASH R6(6+2) 32-47	ES-1	\$14,525
HL6FM16006BT3	VMAX400K 1600GB FLASH R6(6+2) 48-63	ES-1	\$13,720
HL6FM16006BT4	VMAX400K 1600GB FLASH R6(6+2) 64+	ES-1	\$12,915
HL6FM16006BTUT0	VMAX400K 1600GB FLASH R6(6+2)TAA UPG	ES-1	\$31,805
HL6FM16006BTUT1	VMAX400K 1600GBFLASH R6(6+2)TAAUPG 16-23	ES-1	\$21,599
HL6FM16006BTUT2	VMAX400K 1600GBFLASH R6(6+2)TAAUPG 24+	ES-1	\$20,174
HL6FM16006BUT0	VMAX400K 1600GB FLASH R6(6+2) UPG	ES-1	\$31,805
HL6FM16006BUT1	VMAX400K 1600GB FLASH R6(6+2)UPG 16-23	ES-1	\$21,599
HL6FM16006BUT2	VMAX400K 1600GB FLASH R6(6+2)UPG 24+	ES-1	\$20,174
HL6FM16007BT0	VMAX400K 1600GB FLASH R5(7+1) 1-23	ES-1	\$22,600
HL6FM16007BT1	VMAX400K 1600GB FLASH R5(7+1) 24-31	ES-1	\$15,335
HL6FM16007BT2	VMAX400K 1600GB FLASH R5(7+1) 32-47	ES-1	\$14,525
HL6FM16007BT3	VMAX400K 1600GB FLASH R5(7+1) 48-63	ES-1	\$13,720
HL6FM16007BT4	VMAX400K 1600GB FLASH R5(7+1) 64+	ES-1	\$12,915
HL6FM16007BTUT0	VMAX400K 1600GB FLASH R5(7+1)TAA UPG	ES-1	\$31,805
HL6FM16007BTUT1	VMAX400K 1600GBFLASH 5(7+1)TAAUPG 16-23	ES-1	\$20,600
HL6FM16007BTUT2	VMAX400K 1600GBFLASH 5(7+1)TAAUPG 24+	ES-1	\$19,200
HL6FM16007BUT0	VMAX400K 1600GB FLASH R5(7+1) UPG	ES-1	\$31,805
HL6FM16007BUT1	VMAX400K 1600GB FLASH R5(7+1) UPG 16-23	ES-1	\$20,600

HL6FM16007BUT2	VMAX400K 1600GB FLASH R5(7+1) UPG 24+	ES-1	\$19,200
HL6FM1600FBT0	VMAX400K 1600GB FLASH R6(14+2) 1-23	ES-1	\$22,600
HL6FM1600FBT1	VMAX400K 1600GB FLASH R6(14+2) 24-31	ES-1	\$15,335
HL6FM1600FBT2	VMAX400K 1600GB FLASH R6(14+2) 32-47	ES-1	\$14,525
HL6FM1600FBT3	VMAX400K 1600GB FLASH R6(14+2) 48-63	ES-1	\$13,720
HL6FM1600FBT4	VMAX400K 1600GB FLASH R6(14+2) 64+	ES-1	\$12,915
HL6FM1600FBTUT0	VMAX400K 1600GB FLASH R6(14+2TAA UPG	ES-1	\$31,805
HL6FM1600FBTUT1	V400K 1600GB FLSHDRVR6(14+2)TAAUPG 16-23	ES-1	\$21,599
HL6FM1600FBTUT2	V400K 1600GB FLSHDRVR6(14+2)TAAUPG 24+	ES-1	\$20,174
HL6FM1600FBUT0	VMAX400K 1600GB FLASH R6(14+2) UPG	ES-1	\$31,805
HL6FM1600FBUT1	VMAX400K 1600GB FLASH R6(14+2)UPG 16-23	ES-1	\$21,599
HL6FM1600FBUT2	VMAX400K 1600GB FLASH R6(14+2)UPG 24+	ES-1	\$20,174
HL6FM1600SB	VMAX400K 1600GB FLASH SPARE	ES-1	\$22,600
HL6FM1600SBU	VMAX 400K 1600GB FLASH DRIVE SPARE UPG	ES-1	\$31,805
HL6FM2001BT0	VMAX400K 200GB FLASH R1 1-191	ES-1	\$3,905
HL6FM2001BT1	VMAX400K 200GB FLASH R1 192-255	ES-1	\$3,350
HL6FM2001BT2	VMAX400K 200GB FLASH R1 256-383	ES-1	\$3,210
HL6FM2001BT3	VMAX400K 200GB FLASH R1 384-511	ES-1	\$3,065
HL6FM2001BT4	VMAX400K 200GB FLASH R1 512+	ES-1	\$2,930
HL6FM2001BTUT0	VMAX400K 200GB FLASH R1 TAA UPG	ES-1	\$5,475
HL6FM2001BTUT1	VMAX400K 200GB FLASH R1 TAA UPG 64-95	ES-1	\$4,718
HL6FM2001BTUT2	VMAX400K 200GB FLASH R1 TAA UPG 96+	ES-1	\$4,458
HL6FM2001BUT0	VMAX400K 200GB FLASH R1 UPG	ES-1	\$5,475
HL6FM2001BUT1	VMAX400K 200GB FLASH R1 UPG 64-95	ES-1	\$4,718
HL6FM2001BUT2	VMAX400K 200GB FLASH R1 UPG 96+	ES-1	\$4,458
HL6FM2005BT0	VMAX400K 200GB FLASH R5(3+1) 1-191	ES-1	\$3,905
HL6FM2005BT1	VMAX400K 200GB FLASH R5(3+1) 192-255	ES-1	\$3,350
HL6FM2005BT2	VMAX400K 200GB FLASH R5(3+1) 256-383	ES-1	\$3,210
HL6FM2005BT3	VMAX400K 200GB FLASH R5(3+1) 384-511	ES-1	\$3,065
HL6FM2005BT4	VMAX400K 200GB FLASH R5(3+1) 512+	ES-1	\$2,930
HL6FM2005BTUT0	VMAX400K 200GB FLASH R5(3+1) TAA UPG	ES-1	\$5,475
HL6FM2005BTUT1	VMAX400K 200GB FLASHR5(3+1)TAAUPG 64-95	ES-1	\$4,718
HL6FM2005BTUT2	VMAX400K 200GB FLASHR5(3+1)TAAUPG 96+	ES-1	\$4,458
HL6FM2005BUT0	VMAX400K 200GB FLASH R5(3+1) UPG	ES-1	\$5,475
HL6FM2005BUT1	VMAX400K 200GB FLASH R5(3+1) UPG 64-95	ES-1	\$4,718
HL6FM2005BUT2	VMAX400K 200GB FLASH R5(3+1) UPG 96+	ES-1	\$4,458
HL6FM2006BT0	VMAX400K 200GB FLASH R6(6+2) 1-191	ES-1	\$3,905
HL6FM2006BT1	VMAX400K 200GB FLASH R6(6+2) 192-255	ES-1	\$3,350
HL6FM2006BT2	VMAX400K 200GB FLASH R6(6+2) 256-383	ES-1	\$3,210
HL6FM2006BT3	VMAX400K 200GB FLASH R6(6+2) 384-511	ES-1	\$3,065
HL6FM2006BT4	VMAX400K 200GB FLASH R6(6+2) 512+	ES-1	\$2,930
HL6FM2006BTUT0	VMAX400K 200GB FLASH R6(6+2) TAA UPG	ES-1	\$5,475
HL6FM2006BTUT1	VMAX400K 200GB FLASHR6(6+2)TAAUPG 64-95	ES-1	\$4,718
HL6FM2006BTUT2	VMAX400K 200GB FLASHR6(6+2)TAAUPG 96+	ES-1	\$4,458
HL6FM2006BUT0	VMAX400K 200GB FLASH R6(6+2) UPG	ES-1	\$5,475
HL6FM2006BUT1	VMAX400K 200GB FLASH R6(6+2)UPG 64-95	ES-1	\$4,718
HL6FM2006BUT2	VMAX400K 200GB FLASH R6(6+2)UPG 96+	ES-1	\$4,458
HL6FM2007BT0	VMAX400K 200GB FLASH R5(7+1) 1-191	ES-1	\$3,905
HL6FM2007BT1	VMAX400K 200GB FLASH R5(7+1) 192-255	ES-1	\$3,350
HL6FM2007BT2	VMAX400K 200GB FLASH R5(7+1) 256-383	ES-1	\$3,210

HL6FM2007BT3	VMAX400K 200GB FLASH R5(7+1) 384-511	ES-1	\$3,065
HL6FM2007BT4	VMAX400K 200GB FLASH R5(7+1) 512+	ES-1	\$2,930
HL6FM2007BTUT0	VMAX400K 200GB FLASH R5(7+1) TAA UPG	ES-1	\$5,475
HL6FM2007BTUT1	VMAX400K 200GB FLASHR5(7+1)TAAUPG 64-95	ES-1	\$4,718
HL6FM2007BTUT2	VMAX400K 200GB FLASHR5(7+1)TAAUPG 96+	ES-1	\$4,458
HL6FM2007BUT0	VMAX400K 200GB FLASH R5(7+1) UPG	ES-1	\$5,475
HL6FM2007BUT1	VMAX400K 200GB FLASH R5(7+1) UPG 64-95	ES-1	\$4,718
HL6FM2007BUT2	VMAX400K 200GB FLASH R5(7+1) UPG 96+	ES-1	\$4,458
HL6FM200FBT0	VMAX400K 200GB FLASH R6(14+2) 1-191	ES-1	\$3,905
HL6FM200FBT1	VMAX400K 200GB FLASH R6(14+2) 192-255	ES-1	\$3,350
HL6FM200FBT2	VMAX400K 200GB FLASH R6(14+2) 256-383	ES-1	\$3,210
HL6FM200FBT3	VMAX400K 200GB FLASH R6(14+2) 394-511	ES-1	\$3,065
HL6FM200FBT4	VMAX400K 200GB FLASH R6(14+2) 512+	ES-1	\$2,930
HL6FM200FBTUT0	VMAX400K 200GB FLASH R6(14+2)TAA UPG	ES-1	\$5,475
HL6FM200FBTUT1	VMAX400K 200GBFLASH R6(14+2)TAAUPG 64-95	ES-1	\$4,718
HL6FM200FBTUT2	VMAX400K 200GBFLASH R6(14+2)TAAUPG 96+	ES-1	\$4,458
HL6FM200FBUT0	VMAX400K 200GB FLASH R6(14+2) UPG	ES-1	\$5,475
HL6FM200FBUT1	VMAX400K 200GB FLASH R6(14+2)UPG 64-95	ES-1	\$4,718
HL6FM200FBUT2	VMAX400K 200GB FLASH R6(14+2)UPG 96+	ES-1	\$4,458
HL6FM200SB	VMAX400K 200GB FLASH SPARE	ES-1	\$3,905
HL6FM200SBU	VMAX 400K 200GB FLASH DRIVE SPARE UPG	ES-1	\$5,475
HL6FM4001BT0	VMAX400K 400GB FLASH R1 1-95	ES-1	\$7,425
HL6FM4001BT1	VMAX400K 400GB FLASH R1 96-127	ES-1	\$5,830
HL6FM4001BT2	VMAX400K 400GB FLASH R1 128-191	ES-1	\$5,565
HL6FM4001BT3	VMAX400K 400GB FLASH R1 192-255	ES-1	\$5,305
HL6FM4001BT4	VMAX400K 400GB FLASH R1 256+	ES-1	\$5,040
HL6FM4001BTUT0	VMAX400K 400GB FLASH R1 TAA UPG	ES-1	\$10,395
HL6FM4001BTUT1	VMAX400K 400GB FLASH R1 TAA UPG 32-47	ES-1	\$7,300
HL6FM4001BTUT2	VMAX400K 400GB FLASH R1 TAA UPG 48+	ES-1	\$8,160
HL6FM4001BUT0	VMAX400K 400GB FLASH R1 UPG	ES-1	\$10,395
HL6FM4001BUT1	VMAX400K 400GB FLASH R1 UPG 32-47	ES-1	\$8,097
HL6FM4001BUT2	VMAX400K 400GB FLASH R1 UPG 48+	ES-1	\$8,160
HL6FM4005BT0	VMAX400K 400GB FLASH R5(3+1) 1-95	ES-1	\$7,425
HL6FM4005BT1	VMAX400K 400GB FLASH R5(3+1) 96-127	ES-1	\$5,830
HL6FM4005BT2	VMAX400K 400GB FLASH R5(3+1) 128-191	ES-1	\$5,565
HL6FM4005BT3	VMAX400K 400GB FLASH R5(3+1) 192-255	ES-1	\$5,305
HL6FM4005BT4	VMAX400K 400GB FLASH R5(3+1) 256+	ES-1	\$5,040
HL6FM4005BTUT0	VMAX400K 400GB FLASH R5(3+1) TAA UPG	ES-1	\$10,395
HL6FM4005BTUT1	VMAX400K 400GB FLASHR5(3+1)TAAUPG 32-47	ES-1	\$8,097
HL6FM4005BTUT2	VMAX400K 400GB FLASHR5(3+1)TAAUPG 48+	ES-1	\$7,790
HL6FM4005BUT0	VMAX400K 400GB FLASH R5(3+1) UPG	ES-1	\$10,395
HL6FM4005BUT1	VMAX400K 400GB FLASH R5(3+1) UPG 32-47	ES-1	\$8,097
HL6FM4005BUT2	VMAX400K 400GB FLASH R5(3+1) UPG 48+	ES-1	\$7,790
HL6FM4006BT0	VMAX400K 400GB FLASH R6(6+2) 1-95	ES-1	\$7,425
HL6FM4006BT1	VMAX400K 400GB FLASH R6(6+2) 96-127	ES-1	\$5,830
HL6FM4006BT2	VMAX400K 400GB FLASH R6(6+2) 128-191	ES-1	\$5,565
HL6FM4006BT3	VMAX400K 400GB FLASH R6(6+2) 192-255	ES-1	\$5,305
HL6FM4006BT4	VMAX400K 400GB FLASH R6(6+2) 256+	ES-1	\$5,040
HL6FM4006BTUT0	VMAX400K 400GB FLASH R6(6+2) TAA UPG	ES-1	\$10,395
HL6FM4006BTUT1	VMAX400K 400GB FLASHR6(6+2)TAAUPG 32-47	ES-1	\$8,097

HL6FM4006BTUT2	VMAX400K 400GB FLASH R6(6+2)TAAUPG 48+	ES-1	\$7,790
HL6FM4006BUT0	VMAX400K 400GB FLASH R6(6+2) UPG	ES-1	\$10,395
HL6FM4006BUT1	VMAX400K 400GB FLASH R6(6+2)UPG 32-47	ES-1	\$8,097
HL6FM4006BUT2	VMAX400K 400GB FLASH R6(6+2)UPG 48+	ES-1	\$7,790
HL6FM4007BT0	VMAX400K 400GB FLASH R5(7+1) 1-95	ES-1	\$7,425
HL6FM4007BT1	VMAX400K 400GB FLASH R5(7+1) 96-127	ES-1	\$5,830
HL6FM4007BT2	VMAX400K 400GB FLASH R5(7+1) 128-191	ES-1	\$5,565
HL6FM4007BT3	VMAX400K 400GB FLASH R5(7+1) 192-255	ES-1	\$5,305
HL6FM4007BT4	VMAX400K 400GB FLASH R5(7+1) 256+	ES-1	\$5,040
HL6FM4007BTUT0	VMAX400K 400GB FLASH R5(7+1) TAA UPG	ES-1	\$10,395
HL6FM4007BTUT1	VMAX400K 400GB FLASH R5(7+1)TAAUPG 32-47	ES-1	\$8,097
HL6FM4007BTUT2	VMAX400K 400GB FLASH R5(7+1)TAAUPG 48+	ES-1	\$7,790
HL6FM4007BUT0	VMAX400K 400GB FLASH R5(7+1) UPG	ES-1	\$10,395
HL6FM4007BUT1	VMAX400K 400GB FLASH R5(7+1) UPG 32-47	ES-1	\$8,097
HL6FM4007BUT2	VMAX400K 400GB FLASH R5(7+1) UPG 48+	ES-1	\$7,790
HL6FM400FBT0	VMAX400K 400GB FLASH R6(14+2) 1-95	ES-1	\$7,425
HL6FM400FBT1	VMAX400K 400GB FLASH R6(14+2) 96-127	ES-1	\$5,830
HL6FM400FBT2	VMAX400K 400GB FLASH R6(14+2) 128-191	ES-1	\$5,565
HL6FM400FBT3	VMAX400K 400GB FLASH R6(14+2) 192-255	ES-1	\$5,305
HL6FM400FBT4	VMAX400K 400GB FLASH R6(14+2) 256+	ES-1	\$5,040
HL6FM400FBTUT0	VMAX400K 400GB FLASH R6(14+2)TAA UPG	ES-1	\$10,395
HL6FM400FBTUT1	VMAX400K 400GBFLASH R6(14+2)TAAUPG 32-47	ES-1	\$8,097
HL6FM400FBTUT2	VMAX400K 400GBFLASH R6(14+2)TAAUPG 48+	ES-1	\$7,790
HL6FM400FBUT0	VMAX400K 400GB FLASH R6(14+2) UPG	ES-1	\$10,395
HL6FM400FBUT1	VMAX400K 400GB FLASH R6(14+2) UPG 32-47	ES-1	\$8,097
HL6FM400FBUT2	VMAX400K 400GB FLASH R6(14+2) UPG 48+	ES-1	\$7,790
HL6FM400SB	VMAX400K 400GB FLASH SPARE	ES-1	\$7,425
HL6FM400SBU	VMAX 400K 400GB FLASH DRIVE SPARE UPG	ES-1	\$10,395
HL6FM8001BT0	VMAX400K 800GB FLASH R1 1-47	ES-1	\$13,095
HL6FM8001BT1	VMAX400K 800GB FLASH R1 48-63	ES-1	\$8,885
HL6FM8001BT2	VMAX400K 800GB FLASH R1 64-95	ES-1	\$8,415
HL6FM8001BT3	VMAX400K 800GB FLASH R1 96-127	ES-1	\$7,950
HL6FM8001BT4	VMAX400K 800GB FLASH R1 128+	ES-1	\$7,950
HL6FM8001BTUT0	VMAX400K 800GB FLASH R1 TAA UPG	ES-1	\$18,325
HL6FM8001BTUT1	VMAX400K 800GB FLASH R1 TAA UPG 24-31	ES-1	\$12,340
HL6FM8001BTUT2	VMAX400K 800GB FLASH R1 TAA UPG 32+	ES-1	\$11,780
HL6FM8001BUT0	VMAX400K 800GB FLASH R1 UPG	ES-1	\$18,325
HL6FM8001BUT1	VMAX400K 800GB FLASH R1 UPG 24-31	ES-1	\$12,340
HL6FM8001BUT2	VMAX400K 800GB FLASH R1 UPG 32+	ES-1	\$11,780
HL6FM8005BT0	VMAX400K 800GB FLASH R5(3+1) 1-47	ES-1	\$13,095
HL6FM8005BT1	VMAX400K 800GB FLASH R5(3+1) 48-63	ES-1	\$8,885
HL6FM8005BT2	VMAX400K 800GB FLASH R5(3+1) 64-95	ES-1	\$8,415
HL6FM8005BT3	VMAX400K 800GB FLASH R5(3+1) 96-127	ES-1	\$7,950
HL6FM8005BT4	VMAX400K 800GB FLASH R5(3+1) 128+	ES-1	\$7,950
HL6FM8005BTUT0	VMAX400K 800GB FLASH R5(3+1) TAA UPG	ES-1	\$18,325
HL6FM8005BTUT1	VMAX400K 800GBFLASH R5(3+1) TAAUPG 24-31	ES-1	\$12,340
HL6FM8005BTUT2	VMAX400K 800GB FLASH R5(3+1) TAA UPG 32+	ES-1	\$11,780
HL6FM8005BUT0	VMAX400K 800GB FLASH R5(3+1) UPG	ES-1	\$18,325
HL6FM8005BUT1	VMAX400K 800GB FLASH R5(3+1) UPG 24-31	ES-1	\$12,340
HL6FM8005BUT2	VMAX400K 800GB FLASH R5(3+1) UPG 32+	ES-1	\$11,780

HL6FM8006BT0	VMAX400K 800GB FLASH R6(6+2) 1-47	ES-1	\$13,095
HL6FM8006BT1	VMAX400K 800GB FLASH R6(6+2) 48-63	ES-1	\$8,885
HL6FM8006BT2	VMAX400K 800GB FLASH R6(6+2) 64-95	ES-1	\$8,415
HL6FM8006BT3	VMAX400K 800GB FLASH R6(6+2) 96-127	ES-1	\$7,950
HL6FM8006BT4	VMAX400K 800GB FLASH R6(6+2) 128+	ES-1	\$7,950
HL6FM8006BTUT0	VMAX400K 800GB FLASH R6(6+2) TAA UPG	ES-1	\$18,325
HL6FM8006BTUT1	VMAX400K 800GBFLASH R6(6+2)TAAUPG 24-31	ES-1	\$12,340
HL6FM8006BTUT2	VMAX400K 800GB FLASH R6(6+2) TAA UPG 32+	ES-1	\$11,780
HL6FM8006BUT0	VMAX400K 800GB FLASH R6(6+2) UPG	ES-1	\$18,325
HL6FM8006BUT1	VMAX400K 800GB FLASH R6(6+2) UPG 24-31	ES-1	\$12,340
HL6FM8006BUT2	VMAX400K 800GB FLASH R6(6+2) UPG 32+	ES-1	\$11,780
HL6FM8007BT0	VMAX400K 800GB FLASH R5(7+1) 1-47	ES-1	\$13,095
HL6FM8007BT1	VMAX400K 800GB FLASH R5(7+1) 48-63	ES-1	\$8,885
HL6FM8007BT2	VMAX400K 800GB FLASH R5(7+1) 64-95	ES-1	\$8,415
HL6FM8007BT3	VMAX400K 800GB FLASH R5(7+1) 96-127	ES-1	\$7,950
HL6FM8007BT4	VMAX400K 800GB FLASH R5(7+1) 128+	ES-1	\$7,950
HL6FM8007BTUT0	VMAX400K 800GB FLASH R5(7+1) TAA UPG	ES-1	\$18,325
HL6FM8007BTUT1	VMAX400K 800GBFLASH R5(7+1) TAAUPG 24-31	ES-1	\$12,340
HL6FM8007BTUT2	VMAX400K 800GB FLASH R5(7+1) TAA UPG 32+	ES-1	\$11,780
HL6FM8007BUT0	VMAX400K 800GB FLASH R5(7+1) UPG	ES-1	\$18,325
HL6FM8007BUT1	VMAX400K 800GB FLASH R5(7+1) UPG 24-31	ES-1	\$12,340
HL6FM8007BUT2	VMAX400K 800GB FLASH R5(7+1) UPG 32+	ES-1	\$11,780
HL6FM800FBT0	VMAX400K 800GB FLASH R6(14+2) 1-47	ES-1	\$13,095
HL6FM800FBT1	VMAX400K 800GB FLASH R6(14+2) 48-63	ES-1	\$8,885
HL6FM800FBT2	VMAX400K 800GB FLASH R6(14+2) 64-95	ES-1	\$8,415
HL6FM800FBT3	VMAX400K 800GB FLASH R6(14+2) 96-127	ES-1	\$7,950
HL6FM800FBT4	VMAX400K 800GB FLASH R6(14+2) 128+	ES-1	\$7,950
HL6FM800FBTUT0	VMAX400K 800GB FLASH R6(14+2)TAA UPG	ES-1	\$18,325
HL6FM800FBTUT1	VMAX400K 800GBFLASH R6(14+2)TAAUPG 24-31	ES-1	\$12,340
HL6FM800FBTUT2	VMAX400K 800GB FLASH R6(14+2)TAA UPG 32+	ES-1	\$11,780
HL6FM800FBUT0	VMAX400K 800GB FLASH R6(14+2) UPG	ES-1	\$18,325
HL6FM800FBUT1	VMAX400K 800GB FLASH R6(14+2) UPG 24-31	ES-1	\$12,340
HL6FM800FBUT2	VMAX400K 800GB FLASH R6(14+2) UPG 32+	ES-1	\$11,780
HL6FM800SB	VMAX400K 800GB FLASH SPARE	ES-1	\$13,095
HL6FM800SBU	VMAX 400K 800GB FLASH DRIVE SPARE UPG	ES-1	\$18,325
HS61012001BTU	VMAX 400K 1200GB 10K SAS DRV R1 TAA UPG	ES-1	\$2,330
HS61012001BU	VMAX 400K 1200GB 10K SAS DRV R1 UPG	ES-1	\$2,330
HS61012005BTU	VMAX 400K 1200GB 10K SAS DRR5(3+1)TAAUPG	ES-1	\$2,330
HS61012005BU	VMAX 400K 1200GB 10K SAS DRV R5(3+1)UPG	ES-1	\$2,330
HS61012006BTU	VMAX 400K 1200GB 10K SAS DRR6(6+2)TAAUPG	ES-1	\$2,330
HS61012006BU	VMAX 400K 1200GB 10K SAS DRV R6(6+2)UPG	ES-1	\$2,330
HS61012007BTU	VMAX 400K 1200GB 10K SAS DRR5(7+1)TAAUPG	ES-1	\$2,330
HS61012007BU	VMAX 400K 1200GB 10K SAS DRV R5(7+1)UPG	ES-1	\$2,330
HS6101200FBTU	VMAX 400K 1200GB 10K SAS R6(14+2)TAAUPG	ES-1	\$2,330
HS6101200FBU	VMAX 400K 1200GB 10K SAS R6(14+2)UPG	ES-1	\$2,330
HS6101200SBTU	VMAX 400K 1200GB 10K SAS SPARE TAA UPG	ES-1	\$2,330
HS6101200SBU	VMAX 400K 1200GB 10K SAS SPARE UPG	ES-1	\$2,330
HS6103001BTU	VMAX 400K 300GB 10K SAS DRV R1 TAA UPG	ES-1	\$805
HS6103001BU	VMAX 400K 300GB 10K SAS DRV R1 UPG	ES-1	\$805
HS6103005BTU	VMAX 400K 300GB 10K SAS DRVR5(3+1)TAAUPG	ES-1	\$805

HS6103005BU	VMAX 400K 300GB 10K SAS DRV R5(3+1)UPG	ES-1	\$805
HS6103006BTU	VMAX 400K 300GB 10K SAS DRVR6(6+2)TAAUPG	ES-1	\$805
HS6103006BU	VMAX 400K 300GB 10K SAS DRV R6(6+2)UPG	ES-1	\$805
HS6103007BTU	VMAX 400K 300GB 10K SAS DRVR5(7+1)TAAUPG	ES-1	\$805
HS6103007BU	VMAX 400K 300GB 10K SAS DRV R5(7+1)UPG	ES-1	\$805
HS610300FBTU	VMAX 400K 300GB 10K SAS DRR6(14+2)TAAUPG	ES-1	\$805
HS610300FBU	VMAX 400K 300GB 10K SAS DR R6(14+2)UPG	ES-1	\$805
HS610300SBTU	VMAX 400K 300GB 10K SAS DR SPARE TAAUPG	ES-1	\$805
HS610300SBU	VMAX 400K 300GB 10K SAS DR SPARE UPG	ES-1	\$805
HS6106001BTU	VMAX 400K 600GB 10K SAS DRV R1 TAA UPG	ES-1	\$1,510
HS6106001BU	VMAX 400K 600GB 10K SAS DRV R1 UPG	ES-1	\$1,510
HS6106005BTU	VMAX 400K 600GB 10K SAS DRVR5(3+1)TAAUPG	ES-1	\$1,510
HS6106005BU	VMAX 400K 600GB 10K SAS DRV R5(3+1)UPG	ES-1	\$1,510
HS6106006BTU	VMAX 400K 600GB 10K SAS DRVR6(6+2)TAAUPG	ES-1	\$1,510
HS6106006BU	VMAX 400K 600GB 10K SAS DRV R6(6+2)UPG	ES-1	\$1,510
HS6106007BTU	VMAX 400K 600GB 10K SAS DRVR5(7+1)TAAUPG	ES-1	\$1,510
HS6106007BU	VMAX 400K 600GB 10K SAS DRV R5(7+1)UPG	ES-1	\$1,510
HS610600FBTU	VMAX 400K 600GB 10K SAS R6(14+2)TAA UPG	ES-1	\$1,510
HS610600FBU	VMAX 400K 600GB 10K SAS R6(14+2)UPG	ES-1	\$1,510
HS610600SBTU	VMAX 400K 600GB 10K SAS SPARE TAA UPG	ES-1	\$1,510
HS610600SBU	VMAX 400K 600GB 10K SAS SPARE UPG	ES-1	\$1,510
HS6153001BTU	VMAX 400K 300GB 15K SAS DRV R1 TAA UPG	ES-1	\$2,065
HS6153001BU	VMAX 400K 300GB 15K SAS DRV R1 UPG	ES-1	\$2,065
HS6153005BTU	VMAX 400K 300GB 15K SAS DRVR5(3+1)TAAUPG	ES-1	\$2,065
HS6153005BU	VMAX 400K 300GB 15K SAS DRV R5(3+1) UPG	ES-1	\$2,065
HS6153006BTU	VMAX 400K 300GB 15K SAS DRVR6(6+2)TAAUPG	ES-1	\$2,065
HS6153006BU	VMAX 400K 300GB 15K SAS DRV R6(6+2) UPG	ES-1	\$2,065
HS6153007BTU	VMAX 400K 300GB 15K SAS DRVR5(7+1)TAAUPG	ES-1	\$2,065
HS6153007BU	VMAX 400K 300GB 15K SAS DRV R5(7+1) UPG	ES-1	\$2,065
HS615300FBTU	VMAX 400K 300GB 15K SAS DRR6(14+2)TAAUPG	ES-1	\$2,065
HS615300FBU	VMAX 400K 300GB 15K SAS DRV R6(14+2) UPG	ES-1	\$2,065
HS615300SBTU	VMAX 400K 300GB 15K SAS DRV SPARE TAAUPG	ES-1	\$2,065
HS615300SBU	VMAX 400K 300GB 15K SAS DRV SPARE UPG	ES-1	\$2,065
HS6FM16001BT0	VMAX400K 1600GB FLASH R1 1-23	ES-1	\$22,600
HS6FM16001BT1	VMAX400K 1600GB FLASH R1 24-31	ES-1	\$15,335
HS6FM16001BT2	VMAX400K 1600GB FLASH R1 32-47	ES-1	\$14,525
HS6FM16001BT3	VMAX400K 1600GB FLASH R1 48-63	ES-1	\$13,720
HS6FM16001BT4	VMAX400K 1600GB FLASH R1 64+	ES-1	\$12,915
HS6FM16001BTUT0	VMAX400K 1600GB FLASH R1 TAA UPG	ES-1	\$31,805
HS6FM16001BTUT1	VMAX400K 1600GB FLASH R1 TAA PG 16-23	ES-1	\$20,600
HS6FM16001BTUT2	VMAX400K 1600GB FLASH R1 TAA UPG 24+	ES-1	\$19,200
HS6FM16001BUT0	VMAX400K 1600GB FLASH R1 UPG	ES-1	\$31,805
HS6FM16001BUT1	VMAX400K 1600GB FLASH R1 UPG 16-23	ES-1	\$20,600
HS6FM16001BUT2	VMAX400K 1600GB FLASH R1 UPG 24+	ES-1	\$19,200
HS6FM16005BT0	VMAX400K 1600GB FLASH R5(3+1) 1-23	ES-1	\$22,600
HS6FM16005BT1	VMAX400K 1600GB FLASH R5(3+1) 24-31	ES-1	\$15,335
HS6FM16005BT2	VMAX400K 1600GB FLASH R5(3+1) 32-47	ES-1	\$14,525
HS6FM16005BT3	VMAX400K 1600GB FLASH R5(3+1) 48-63	ES-1	\$13,720
HS6FM16005BT4	VMAX400K 1600GB FLASH R5(3+1) 64+	ES-1	\$12,915
HS6FM16005BTUT0	VMAX400K 1600GB FLASH R5(3+1)TAA UPG	ES-1	\$31,805

HS6FM16005BTUT1	VMAX400K 1600GBFLASH R5(3+1)TAAUPG16-23	ES-1	\$20,600
HS6FM16005BTUT2	VMAX400K 1600GB FLASH R5(3+1)TAAUPG 24+	ES-1	\$19,200
HS6FM16005BUT0	VMAX400K 1600GB FLASH R5(3+1) UPG	ES-1	\$31,805
HS6FM16005BUT1	VMAX400K 1600GB FLASH R5(3+1) UPG 16-23	ES-1	\$20,600
HS6FM16005BUT2	VMAX400K 1600GB FLASH R5(3+1) UPG 24+	ES-1	\$19,200
HS6FM16006BT0	VMAX400K 1600GB FLASH R6(6+2) 1-23	ES-1	\$22,600
HS6FM16006BT1	VMAX400K 1600GB FLASH R6(6+2) 24-31	ES-1	\$15,335
HS6FM16006BT2	VMAX400K 1600GB FLASH R6(6+2) 32-47	ES-1	\$14,525
HS6FM16006BT3	VMAX400K 1600GB FLASH R6(6+2) 48-63	ES-1	\$13,720
HS6FM16006BT4	VMAX400K 1600GB FLASH R6(6+2) 64+	ES-1	\$12,915
HS6FM16006BTUT0	VMAX400K 1600GB FLASH R6(6+2)TAA UPG	ES-1	\$31,805
HS6FM16006BTUT1	VMAX400K 1600GBFLASH R6(6+2)TAAUPG16-23	ES-1	\$21,599
HS6FM16006BTUT2	VMAX400K 1600GBFLASH R6(6+2)TAA UPG 24+	ES-1	\$20,174
HS6FM16006BUT0	VMAX400K 1600GB FLASH R6(6+2) UPG	ES-1	\$31,805
HS6FM16006BUT1	VMAX400K 1600GB FLASH R6(6+2) UPG 16-23	ES-1	\$21,599
HS6FM16006BUT2	VMAX400K 1600GB FLASH R6(6+2) UPG 24+	ES-1	\$20,174
HS6FM16007BT0	VMAX400K 1600GB FLASH R5(7+1) 1-23	ES-1	\$22,600
HS6FM16007BT1	VMAX400K 1600GB FLASH R5(7+1) 24-31	ES-1	\$15,335
HS6FM16007BT2	VMAX400K 1600GB FLASH R5(7+1) 32-47	ES-1	\$14,525
HS6FM16007BT3	VMAX400K 1600GB FLASH R5(7+1) 48-63	ES-1	\$13,720
HS6FM16007BT4	VMAX400K 1600GB FLASH R5(7+1) 64+	ES-1	\$12,915
HS6FM16007BTUT0	VMAX400K 1600GB FLASH R5(7+1)TAA UPG	ES-1	\$31,805
HS6FM16007BTUT1	VMAX400K 1600GBFLASH R5(7+1)TAAUPG16-23	ES-1	\$20,600
HS6FM16007BTUT2	VMAX400K 1600GBFLASH R5(7+1)TAA UPG 24+	ES-1	\$19,200
HS6FM16007BUT0	VMAX400K 1600GB FLASH R5(7+1) UPG	ES-1	\$31,805
HS6FM16007BUT1	VMAX400K 1600GB FLASH R5(7+1) UPG 16-23	ES-1	\$20,600
HS6FM16007BUT2	VMAX400K 1600GB FLASH R5(7+1) UPG 24+	ES-1	\$19,200
HS6FM1600FBT0	VMAX400K 1600GB FLASH R6(14+2) 1-23	ES-1	\$22,600
HS6FM1600FBT1	VMAX400K 1600GB FLASH R6(14+2) 24-31	ES-1	\$15,335
HS6FM1600FBT2	VMAX400K 1600GB FLASH R6(14+2) 32-47	ES-1	\$14,525
HS6FM1600FBT3	VMAX400K 1600GB FLASH R6(14+2) 48-63	ES-1	\$13,720
HS6FM1600FBT4	VMAX400K 1600GB FLASH R6(14+2) 64+	ES-1	\$12,915
HS6FM1600FBTUT0	VMAX400K 1600GB FLASH R6(14+2)TAA UPG	ES-1	\$31,805
HS6FM1600FBTUT1	VMAX400K 1600GBFLASH R6(14+2)TAAUPG16-23	ES-1	\$21,599
HS6FM1600FBTUT2	VMAX400K 1600GB FLASH R6(14+2)TAA UPG 24+	ES-1	\$20,174
HS6FM1600FBUT0	VMAX400K 1600GB FLASH R6(14+2) UPG	ES-1	\$31,805
HS6FM1600FBUT1	VMAX400K 1600GB FLASH R6(14+2)UPG 16-23	ES-1	\$21,599
HS6FM1600FBUT2	VMAX400K 1600GB FLASH R6(14+2) UPG 24+	ES-1	\$22,600
HS6FM1600SB	VMAX400K 1600GB FLASH SPARE	ES-1	\$22,600
HS6FM1600SBU	VMAX 400K 1600GB FLASH DRIVE SPARE UPG	ES-1	\$31,805
HS6FM2001BT0	VMAX400K 200GB FLASH R1 1-191	ES-1	\$3,905
HS6FM2001BT1	VMAX400K 200GB FLASH R1 192-255	ES-1	\$3,350
HS6FM2001BT2	VMAX400K 200GB FLASH R1 256-383	ES-1	\$3,210
HS6FM2001BT3	VMAX400K 200GB FLASH R1 384-511	ES-1	\$3,065
HS6FM2001BT4	VMAX400K 200GB FLASH R1 512+	ES-1	\$2,930
HS6FM2001BTUT0	VMAX400K 200GB FLASH R1 TAA UPG	ES-1	\$5,475
HS6FM2001BTUT1	VMAX400K 200GB FLASH R1 TAA UPG 64-95	ES-1	\$4,718
HS6FM2001BTUT2	VMAX400K 200GB FLASH R1 TAA UPG 96+	ES-1	\$4,458
HS6FM2001BUT0	VMAX400K 200GB FLASH R1 UPG	ES-1	\$5,475
HS6FM2001BUT1	VMAX400K 200GB FLASH R1 UPG 64-95	ES-1	\$4,718

HS6FM2001BUT2	VMAX400K 200GB FLASH R1 UPG 96+	ES-1	\$4,458
HS6FM2005BT0	VMAX400K 200GB FLASH R5(3+1) 1-191	ES-1	\$3,905
HS6FM2005BT1	VMAX400K 200GB FLASH R5(3+1) 192-255	ES-1	\$3,350
HS6FM2005BT2	VMAX400K 200GB FLASH R5(3+1) 256-383	ES-1	\$3,210
HS6FM2005BT3	VMAX400K 200GB FLASH R5(3+1) 384-511	ES-1	\$3,065
HS6FM2005BT4	VMAX400K 200GB FLASH R5(3+1) 512+	ES-1	\$2,930
HS6FM2005BTUT0	VMAX400K 200GB FLASH R5(3+1) TAA UPG	ES-1	\$5,475
HS6FM2005BTUT1	VMAX400K 200GBFLASH R5(3+1)TAAUPG 64-95	ES-1	\$4,718
HS6FM2005BTUT2	VMAX400K 200GB FLASH R5(3+1) TAAUPG 96+	ES-1	\$4,458
HS6FM2005BUT0	VMAX400K 200GB FLASH R5(3+1) UPG	ES-1	\$5,475
HS6FM2005BUT1	VMAX400K 200GB FLASH R5(3+1) UPG 64-95	ES-1	\$4,718
HS6FM2005BUT2	VMAX400K 200GB FLASH R5(3+1) UPG 96+	ES-1	\$4,458
HS6FM2006BT0	VMAX400K 200GB FLASH R6(6+2) 1-191	ES-1	\$3,905
HS6FM2006BT1	VMAX400K 200GB FLASH R6(6+2) 192-255	ES-1	\$3,350
HS6FM2006BT2	VMAX400K 200GB FLASH R6(6+2) 256-383	ES-1	\$3,210
HS6FM2006BT3	VMAX400K 200GB FLASH R6(6+2) 384-511	ES-1	\$3,065
HS6FM2006BT4	VMAX400K 200GB FLASH R6(6+2) 512+	ES-1	\$2,930
HS6FM2006BTUT0	VMAX400K 200GB FLASH R6(6+2) TAA UPG	ES-1	\$5,475
HS6FM2006BTUT1	VMAX400K 200GBFLASH R6(6+2) TAAUPG 64-95	ES-1	\$4,718
HS6FM2006BTUT2	VMAX400K 200GB FLASH R6(6+2) TAA UPG 96+	ES-1	\$4,458
HS6FM2006BUT0	VMAX400K 200GB FLASH R6(6+2) UPG	ES-1	\$5,475
HS6FM2006BUT1	VMAX400K 200GB FLASH R6(6+2) UPG 64-95	ES-1	\$4,718
HS6FM2006BUT2	VMAX400K 200GB FLASH R6(6+2) UPG 96+	ES-1	\$4,458
HS6FM2007BT0	VMAX400K 200GB FLASH R5(7+1) 1-191	ES-1	\$3,905
HS6FM2007BT1	VMAX400K 200GB FLASH R5(7+1) 192-255	ES-1	\$3,350
HS6FM2007BT2	VMAX400K 200GB FLASH R5(7+1) 256-383	ES-1	\$3,210
HS6FM2007BT3	VMAX400K 200GB FLASH R5(7+1) 384-511	ES-1	\$3,065
HS6FM2007BT4	VMAX400K 200GB FLASH R5(7+1) 512+	ES-1	\$2,930
HS6FM2007BTUT0	VMAX400K 200GB FLASH R5(7+1) TAA UPG	ES-1	\$5,475
HS6FM2007BTUT1	VMAX400K 200GBFLASH R5(7+1)TAAUPG 64-95	ES-1	\$4,718
HS6FM2007BTUT2	VMAX400K 200GBFLASH R5(7+1) TAA UPG 96+	ES-1	\$4,458
HS6FM2007BUT0	VMAX400K 200GB FLASH R5(7+1) UPG	ES-1	\$5,475
HS6FM2007BUT1	VMAX400K 200GB FLASH R5(7+1) UPG 64-95	ES-1	\$4,718
HS6FM2007BUT2	VMAX400K 200GB FLASH R5(7+1) UPG 96+	ES-1	\$4,458
HS6FM200FBT0	VMAX400K 200GB FLASH R6(14+2) 1-191	ES-1	\$3,905
HS6FM200FBT1	VMAX400K 200GB FLASH R6(14+2) 192-255	ES-1	\$3,350
HS6FM200FBT2	VMAX400K 200GB FLASH R6(14+2) 256-383	ES-1	\$3,210
HS6FM200FBT3	VMAX400K 200GB FLASH R6(14+2) 394-511	ES-1	\$3,065
HS6FM200FBT4	VMAX400K 200GB FLASH R6(14+2) 512+	ES-1	\$2,930
HS6FM200FBTUT0	VMAX400K 200GB FLASH R6(14+2)TAA UPG	ES-1	\$5,475
HS6FM200FBTUT1	VMAX400K 200GBFLASH R6(14+2)TAAUPG 64-95	ES-1	\$4,718
HS6FM200FBTUT2	VMAX400K 200GB FLASH R6(14+2)TAA UPG 96+	ES-1	\$4,458
HS6FM200FBUT0	VMAX400K 200GB FLASH R6(14+2) UPG	ES-1	\$5,475
HS6FM200FBUT1	VMAX400K 200GB FLASH R6(14+2) UPG 64-95	ES-1	\$4,718
HS6FM200FBUT2	VMAX400K 200GB FLASH R6(14+2) UPG 96+	ES-1	\$4,458
HS6FM200SB	VMAX400K 200GB FLASH SPARE	ES-1	\$3,905
HS6FM200SBU	VMAX 400K 200GB FLASH DRIVE SPARE UPG	ES-1	\$5,475
HS6FM4001BT0	VMAX400K 400GB FLASH R1 1-95	ES-1	\$7,425
HS6FM4001BT1	VMAX400K 400GB FLASH R1 96-127	ES-1	\$5,830
HS6FM4001BT2	VMAX400K 400GB FLASH R1 128-191	ES-1	\$5,565

HS6FM4001BT3	VMAX400K 400GB FLASH R1 192-255	ES-1	\$5,305
HS6FM4001BT4	VMAX400K 400GB FLASH R1 256+	ES-1	\$5,040
HS6FM4001BTUT0	VMAX400K 400GB FLASH R1 TAA UPG	ES-1	\$10,395
HS6FM4001BTUT1	VMAX400K 400GB FLASH R1 TAA UPG 32-47	ES-1	\$8,097
HS6FM4001BTUT2	VMAX400K 400GB FLASH R1 TAA UPG 48+	ES-1	\$7,790
HS6FM4001BUT0	VMAX400K 400GB FLASH R1 UPG	ES-1	\$10,395
HS6FM4001BUT1	VMAX400K 400GB FLASH R1 UPG 32-47	ES-1	\$8,097
HS6FM4001BUT2	VMAX400K 400GB FLASH R1 UPG 48+	ES-1	\$7,790
HS6FM4005BT0	VMAX400K 400GB FLASH R5(3+1) 1-95	ES-1	\$7,425
HS6FM4005BT1	VMAX400K 400GB FLASH R5(3+1) 96-127	ES-1	\$5,830
HS6FM4005BT2	VMAX400K 400GB FLASH R5(3+1) 128-191	ES-1	\$5,565
HS6FM4005BT3	VMAX400K 400GB FLASH R5(3+1) 192-255	ES-1	\$5,305
HS6FM4005BT4	VMAX400K 400GB FLASH R5(3+1) 256+	ES-1	\$5,040
HS6FM4005BTUT0	VMAX400K 400GB FLASH R5(3+1) TAA UPG	ES-1	\$10,395
HS6FM4005BTUT1	VMAX400K 400GB FLASH R5(3+1) TAA UPG 32-47	ES-1	\$8,097
HS6FM4005BTUT2	VMAX400K 400GB FLASH R5(3+1) TAA UPG 48+	ES-1	\$7,790
HS6FM4005BUT0	VMAX400K 400GB FLASH R5(3+1) UPG	ES-1	\$10,395
HS6FM4005BUT1	VMAX400K 400GB FLASH R5(3+1) UPG 32-47	ES-1	\$8,097
HS6FM4005BUT2	VMAX400K 400GB FLASH R5(3+1) UPG 48+	ES-1	\$7,790
HS6FM4006BT0	VMAX400K 400GB FLASH R6(6+2) 1-95	ES-1	\$7,425
HS6FM4006BT1	VMAX400K 400GB FLASH R6(6+2) 96-127	ES-1	\$5,830
HS6FM4006BT2	VMAX400K 400GB FLASH R6(6+2) 128-191	ES-1	\$5,565
HS6FM4006BT3	VMAX400K 400GB FLASH R6(6+2) 192-255	ES-1	\$5,305
HS6FM4006BT4	VMAX400K 400GB FLASH R6(6+2) 256+	ES-1	\$5,040
HS6FM4006BTUT0	VMAX400K 400GB FLASH R6(6+2) TAA UPG	ES-1	\$10,395
HS6FM4006BTUT1	VMAX400K 400GB FLASH R6(6+2) TAA UPG 32-47	ES-1	\$8,097
HS6FM4006BTUT2	VMAX400K 400GB FLASH R6(6+2) TAA UPG 48+	ES-1	\$7,790
HS6FM4006BUT0	VMAX400K 400GB FLASH R6(6+2) UPG	ES-1	\$10,395
HS6FM4006BUT1	VMAX400K 400GB FLASH R6(6+2) UPG 32-47	ES-1	\$8,097
HS6FM4006BUT2	VMAX400K 400GB FLASH R6(6+2) UPG 48+	ES-1	\$7,790
HS6FM4007BT0	VMAX400K 400GB FLASH R5(7+1) 1-95	ES-1	\$7,425
HS6FM4007BT1	VMAX400K 400GB FLASH R5(7+1) 96-127	ES-1	\$5,830
HS6FM4007BT2	VMAX400K 400GB FLASH R5(7+1) 128-191	ES-1	\$5,565
HS6FM4007BT3	VMAX400K 400GB FLASH R5(7+1) 192-255	ES-1	\$5,305
HS6FM4007BT4	VMAX400K 400GB FLASH R5(7+1) 256+	ES-1	\$5,040
HS6FM4007BTUT0	VMAX400K 400GB FLASH R5(7+1) TAA UPG	ES-1	\$10,395
HS6FM4007BTUT1	VMAX400K 400GB FLASH R5(7+1) TAA UPG 32-47	ES-1	\$8,097
HS6FM4007BTUT2	VMAX400K 400GB FLASH R5(7+1) TAA UPG 48+	ES-1	\$7,790
HS6FM4007BUT0	VMAX400K 400GB FLASH R5(7+1) UPG	ES-1	\$10,395
HS6FM4007BUT1	VMAX400K 400GB FLASH R5(7+1) UPG 32-47	ES-1	\$8,097
HS6FM4007BUT2	VMAX400K 400GB FLASH R5(7+1) UPG 48+	ES-1	\$7,790
HS6FM400FBT0	VMAX400K 400GB FLASH R6(14+2) 1-95	ES-1	\$7,425
HS6FM400FBT1	VMAX400K 400GB FLASH R6(14+2) 96-127	ES-1	\$5,830
HS6FM400FBT2	VMAX400K 400GB FLASH R6(14+2) 128-191	ES-1	\$5,565
HS6FM400FBT3	VMAX400K 400GB FLASH R6(14+2) 192-255	ES-1	\$5,305
HS6FM400FBT4	VMAX400K 400GB FLASH R6(14+2) 256+	ES-1	\$5,040
HS6FM400FBTUT0	VMAX400K 400GB FLASH R6(14+2) TAA UPG	ES-1	\$10,395
HS6FM400FBTUT1	VMAX400K 400GB FLASH R6(14+2) TAA UPG 32-47	ES-1	\$8,097
HS6FM400FBTUT2	VMAX400K 400GB FLASH R6(14+2) TAA UPG 48+	ES-1	\$7,790
HS6FM400FBUT0	VMAX400K 400GB FLASH R6(14+2) UPG	ES-1	\$10,395

HS6FM400FBUT1	VMAX400K 400GB FLASH R6(14+2) UPG 32-47	ES-1	\$8,097
HS6FM400FBUT2	VMAX400K 400GB FLASH R6(14+2) UPG 48+	ES-1	\$7,790
HS6FM400SB	VMAX400K 400GB FLASH SPARE	ES-1	\$7,425
HS6FM400SBU	VMAX 400K 400GB FLASH DRIVE SPARE UPG	ES-1	\$10,395
HS6FM8001BT0	VMAX400K 800GB FLASH R1 1-47	ES-1	\$13,095
HS6FM8001BT1	VMAX400K 800GB FLASH R1 48-63	ES-1	\$8,885
HS6FM8001BT2	VMAX400K 800GB FLASH R1 64-95	ES-1	\$8,415
HS6FM8001BT3	VMAX400K 800GB FLASH R1 96-127	ES-1	\$7,950
HS6FM8001BT4	VMAX400K 800GB FLASH R1 128+	ES-1	\$7,950
HS6FM8001BTUT0	VMAX400K 800GB FLASH R1 TAA UPG	ES-1	\$18,325
HS6FM8001BTUT1	VMAX400K 800GB FLASH R1 TAA UPG 24-31	ES-1	\$12,340
HS6FM8001BTUT2	VMAX400K 800GB FLASH R1 TAA UPG 32+	ES-1	\$11,780
HS6FM8001BUT0	VMAX400K 800GB FLASH R1 UPG	ES-1	\$18,325
HS6FM8001BUT1	VMAX400K 800GB FLASH R1 UPG 24-31	ES-1	\$12,340
HS6FM8001BUT2	VMAX400K 800GB FLASH R1 UPG 32+	ES-1	\$11,780
HS6FM8005BT0	VMAX400K 800GB FLASH R5(3+1) 1-47	ES-1	\$13,095
HS6FM8005BT1	VMAX400K 800GB FLASH R5(3+1) 48-63	ES-1	\$8,885
HS6FM8005BT2	VMAX400K 800GB FLASH R5(3+1) 64-95	ES-1	\$8,415
HS6FM8005BT3	VMAX400K 800GB FLASH R5(3+1) 96-127	ES-1	\$7,950
HS6FM8005BT4	VMAX400K 800GB FLASH R5(3+1) 128+	ES-1	\$7,950
HS6FM8005BTUT0	VMAX400K 800GB FLASH R5(3+1) TAA UPG	ES-1	\$18,325
HS6FM8005BTUT1	VMAX400K 800GBFLASH R5(3+1)TAAUPG 24-31	ES-1	\$12,340
HS6FM8005BTUT2	VMAX400K 800GBFLASH R5(3+1) TAA UPG 32+	ES-1	\$11,780
HS6FM8005BUT0	VMAX400K 800GB FLASH R5(3+1) UPG	ES-1	\$18,325
HS6FM8005BUT1	VMAX400K 800GB FLASH R5(3+1) UPG 24-31	ES-1	\$12,340
HS6FM8005BUT2	VMAX400K 800GB FLASH R5(3+1) UPG 32+	ES-1	\$11,780
HS6FM8006BT0	VMAX400K 800GB FLASH R6(6+2) 1-47	ES-1	\$13,095
HS6FM8006BT1	VMAX400K 800GB FLASH R6(6+2) 48-63	ES-1	\$8,885
HS6FM8006BT2	VMAX400K 800GB FLASH R6(6+2) 64-95	ES-1	\$8,415
HS6FM8006BT3	VMAX400K 800GB FLASH R6(6+2) 96-127	ES-1	\$7,950
HS6FM8006BT4	VMAX400K 800GB FLASH R6(6+2) 128+	ES-1	\$7,950
HS6FM8006BTUT0	VMAX400K 800GB FLASH R6(6+2) TAA UPG	ES-1	\$18,325
HS6FM8006BTUT1	VMAX400K 800GBFLASH R6(6+2) TAAUPG 24-31	ES-1	\$12,340
HS6FM8006BTUT2	VMAX400K 800GB FLASH R6(6+2) TAA UPG 32+	ES-1	\$11,780
HS6FM8006BUT0	VMAX400K 800GB FLASH R6(6+2) UPG	ES-1	\$18,325
HS6FM8006BUT1	VMAX400K 800GB FLASH R6(6+2) UPG 24-31	ES-1	\$12,340
HS6FM8006BUT2	VMAX400K 800GB FLASH R6(6+2) UPG 32+	ES-1	\$11,780
HS6FM8007BT0	VMAX400K 800GB FLASH R5(7+1) 1-47	ES-1	\$13,095
HS6FM8007BT1	VMAX400K 800GB FLASH R5(7+1) 48-63	ES-1	\$8,885
HS6FM8007BT2	VMAX400K 800GB FLASH R5(7+1) 64-95	ES-1	\$8,415
HS6FM8007BT3	VMAX400K 800GB FLASH R5(7+1) 96-127	ES-1	\$7,950
HS6FM8007BT4	VMAX400K 800GB FLASH R5(7+1) 128+	ES-1	\$7,950
HS6FM8007BTUT0	VMAX400K 800GB FLASH R5(7+1) TAA UPG	ES-1	\$18,325
HS6FM8007BTUT1	VMAX400K 800GBFLASH R5(7+1)TAAUPG 24-31	ES-1	\$12,340
HS6FM8007BTUT2	VMAX400K 800GBFLASH R5(7+1) TAAUPG 32+	ES-1	\$11,780
HS6FM8007BUT0	VMAX400K 800GB FLASH R5(7+1) UPG	ES-1	\$18,325
HS6FM8007BUT1	VMAX400K 800GB FLASH R5(7+1) UPG 24-31	ES-1	\$12,340
HS6FM8007BUT2	VMAX400K 800GB FLASH R5(7+1) UPG 32+	ES-1	\$11,780
HS6FM800FBT0	VMAX400K 800GB FLASH R6(14+2) 1-47	ES-1	\$13,095
HS6FM800FBT1	VMAX400K 800GB FLASH R6(14+2) 48-63	ES-1	\$8,885

HS6FM800FBT2	VMAX400K 800GB FLASH R6(14+2) 64-95	ES-1	\$8,415
HS6FM800FBT3	VMAX400K 800GB FLASH R6(14+2) 96-127	ES-1	\$7,950
HS6FM800FBT4	VMAX400K 800GB FLASH R6(14+2) 128+	ES-1	\$7,950
HS6FM800FBTUT0	VMAX400K 800GB FLASH R6(14+2)TAA UPG	ES-1	\$18,325
HS6FM800FBTUT1	VMAX400K 800GBFLASH R6(14+2)TAAUPG 24-31	ES-1	\$12,340
HS6FM800FBTUT2	VMAX400K 800GB FLASH R6(14+2)TAA UPG 32+	ES-1	\$11,780
HS6FM800FBUT0	VMAX400K 800GB FLASH R6(14+2) UPG	ES-1	\$18,325
HS6FM800FBUT1	VMAX400K 800GB FLASH R6(14+2) UPG 24-31	ES-1	\$12,340
HS6FM800FBUT2	VMAX400K 800GB FLASH R6(14+2) UPG 32+	ES-1	\$11,780
HS6FM800SB	VMAX400K 800GB FLASH SPARE	ES-1	\$13,095
HS6FM800SBU	VMAX 400K 800GB FLASH DRIVE SPARE UPG	ES-1	\$18,325
HT67220001BTU	VMAX 400K 2000GB 7_2K DRIVE R1 TAA UPG	ES-1	\$1,595
HT67220001BU	VMAX 400K 2000GB 7_2K DRIVE R1 UPG	ES-1	\$1,595
HT67220005BTU	VMAX 400K 2000GB 7_2K DRIVER5(3+1)TAAUPG	ES-1	\$1,595
HT67220005BU	VMAX 400K 2000GB 7_2K DRIVE R5(3+1) UPG	ES-1	\$1,595
HT67220006BTU	VMAX 400K 2000GB 7_2K DRIVER6(6+2)TAAUPG	ES-1	\$1,595
HT67220006BU	VMAX 400K 2000GB 7_2K DRIVE R6(6+2) UPG	ES-1	\$1,595
HT67220007BTU	VMAX 400K 2000GB 7_2K DRIVER5(7+1)TAAUPG	ES-1	\$1,595
HT67220007BU	VMAX 400K 2000GB 7_2K DRIVE R5(7+1) UPG	ES-1	\$1,595
HT6722000FBTU	VMAX 400K 2000GB 7_2K DRVR6(14+2)TAAUPG	ES-1	\$1,595
HT6722000FBU	VMAX 400K 2000GB 7_2K DRIVE R6(14+2) UPG	ES-1	\$1,595
HT6722000SBTU	VMAX 400K 2000GB 7_2K DRV SPARE TAAUPG	ES-1	\$1,595
HT6722000SBU	VMAX 400K 2000GB 7_2K DRIVE SPARE UPG	ES-1	\$1,595
HT67240001BTU	VMAX 400K 4000GB 7_2K DRV R1 TAA UPG	ES-1	\$2,790
HT67240001BU	VMAX 400K 4000GB 7_2K DRV R1 UPG	ES-1	\$2,790
HT67240005BTU	VMAX 400K 4000GB 7_2K DRV R5(3+1)TAAUPG	ES-1	\$2,790
HT67240005BU	VMAX 400K 4000GB 7_2K DRV R5(3+1)UPG	ES-1	\$2,790
HT67240006BTU	VMAX 400K 4000GB 7_2K DRV R6(6+2)TAAUPG	ES-1	\$2,790
HT67240006BU	VMAX 400K 4000GB 7_2K DRV R6(6+2)UPG	ES-1	\$2,790
HT67240007BTU	VMAX 400K 4000GB 7_2K DRV R5(7+1)TAAUPG	ES-1	\$2,790
HT67240007BU	VMAX 400K 4000GB 7_2K DRV R5(7+1)UPG	ES-1	\$2,790
HT6724000FBTU	VMAX 400K 4000GB 7_2K DRV R6(14+2)TAAUPG	ES-1	\$2,790
HT6724000FBU	VMAX 400K 4000GB 7_2K DRV R6(14+2)UPG	ES-1	\$2,790
HT6724000SBTU	VMAX 400K 4000GB 7_2K DRV SPARE TAAUPG	ES-1	\$2,790
HT6724000SBU	VMAX 400K 4000GB 7_2K DRV SPARE UPG	ES-1	\$2,790
IRS-200K-U	IRS - 200K Upg Tracking	ES-1	\$0
PCBL3YAG-T	INTL 3PHASE 32 AMP ABL TO GARO	ES-1	\$2,000
SCA-SUITE-RTU	Events and Retention Suite for File=CB	ES-1	\$15,000
SYMX-LS	SYMM LICENSE SOLUTION MODEL UPGRADES	ES-1	\$0
WKPROFILE-BAL	VMAX VG WORKPROFILE BALANCED	ES-1	\$0
WKPROFILE-BE	VMAX VG WORKPROFILE BACK-END	ES-1	\$0
WKPROFILE-FE	VMAX VG WORKPROFILE FRONT-END	ES-1	\$0
450-001-202	VMAX FX SUITE BASE=IC	ES-AF	\$0
450-001-204	VMAX FLASH FX SUITE ENABLER 1TB=CC	ES-AF	\$0
450-001-205	VMAX FLASH F SUITE ENABLER 1TB=CC	ES-AF	\$0
450-001-206	VMAX FLASH F SUITE ENABLER 1TB=CC	ES-AF	\$0
450-001-207	VMAX FLASH FX SUITE ENABLER 1TB=CC	ES-AF	\$0
450-001-208	VMAX FLASH FX SUITE BASE=IC	ES-AF	\$0
450-001-599	VIPR SUITE for VMAX 450 FLASH=CC	ES-AF	\$2,360
450-001-600	VIPR SUITE for VMAX 850 FLASH=CC	ES-AF	\$2,360

450-001-601	VIPR SUITE for VMAX 250 FLASH=CC	ES-AF	\$2,360
450-001-610	VMAX FLASH zF SUITE BASE=IC	ES-AF	\$0
450-001-611	VMAX FLASH zFX SUITE ENABLER 1TB=CC	ES-AF	\$0
450-001-612	VMAX FLASH zFX SUITE BASE=IC	ES-AF	\$0
450-001-623	VMAX FLASH zF SUITE BASE=IC	ES-AF	\$0
450-001-624	VMAX FLASH zFX SUITE BASE=IC	ES-AF	\$0
450-001-641	VMAX Flash zFX Suite Enabler 1TB=CC	ES-AF	\$0
450-001-642	VMAX Flash FX Suite Enabler Mixed 1TB=CC	ES-AF	\$0
450-001-651	VMAX All Flash zFX Suite Base=IC	ES-AF	\$0
450-001-656	VMAX All Flash FX Suite Base=IC	ES-AF	\$0
450-001-657	VMAX Flash FX Suite Enabler 1TB=CC	ES-AF	\$0
456-111-363	Powerpath 75 licenses=IC	ES-AF	\$0
456-112-107	RP/EX Local for VMAX 450/850/950 LIC=CC	ES-AF	\$2,700
456-112-108	RP/EX Rem for VMAX 450/850/950 LIC=CC	ES-AF	\$2,700
456-112-109	RP/EX LOCAL FOR VMAX 250 LIC=CC	ES-AF	\$2,700
456-112-110	RP/EX REMOTE FOR VMAX 250 LIC=CC	ES-AF	\$2,700
456-112-948	VMAX F to FX Conversion Add Cap=CC	ES-AF	\$4,255
456-112-949	VMAX zF to zFX Conversion Add Cap=CC	ES-AF	\$4,315
456-112-977	VMAX F to FX Existing Capacity =CC	ES-AF	\$5,660
456-112-978	VMAX zF to zFX Existing Capacity =CC	ES-AF	\$5,740
458-001-382	VMAX FLASH F SUITE OS 1TB=CC	ES-AF	\$0
458-001-384	VMAX F SUITE BASE=IC	ES-AF	\$0
458-001-385	VMAX FLASH LOCAL REP PRODUCT 1TB=CC	ES-AF	\$0
458-001-386	VMAX FLASH LOCAL REP BASE PRODUCT=IC	ES-AF	\$0
458-001-387	VMAX FLASH REM REP PRODUCT 1TB=CC	ES-AF	\$3,100
458-001-388	VMAXF FLASH REM REP BASE PRODUCT=IC	ES-AF	\$0
458-001-389	VMAX FLASH SRDF METRO PRODUCT 1TB=CC	ES-AF	\$3,275
458-001-390	VMAX FLASH ENCRYPTION PRODUCT 1TB=CC	ES-AF	\$1,475
458-001-391	VMAX FLASH UNISPHERE360 PRODUCT=IC	ES-AF	\$50,000
458-001-395	VMAX FLASH CLOUD.X PRODUCT 1TB=CC	ES-AF	\$0
458-001-397	VMAX FLASH FX SUITE OS 1TB=CC	ES-AF	\$0
458-001-441	APPSYNC STR PK FOR VMAX F SUITE=CC	ES-AF	\$0
458-001-442	APPSYNC STR PK FOR VMAX FX SUITE=CC	ES-AF	\$0
458-001-445	VMAX FLASH VIPR CONTROLLER PRODUCT=IC	ES-AF	\$0
458-001-508	VMAX FLASH F SUITE OS 1TB=CC	ES-AF	\$0
458-001-509	VMAX FLASH F SUITE BASE=IC	ES-AF	\$0
458-001-510	VMAX FLASH LOCAL REP BASE PRODUCT=IC	ES-AF	\$0
458-001-511	VMAX FLASH REM REP PRODUCT 1TB=CC	ES-AF	\$3,100
458-001-512	VMAX FLASH REM REP BASE PRODUCT=IC	ES-AF	\$0
458-001-513	VMAX FLASH SRDF METRO PRODUCT 1TB=CC	ES-AF	\$3,275
458-001-514	VMAX850 FLASH ENCRYPTION PRODUCT=IC	ES-AF	\$288,000
458-001-515	VMAX FLASH UNISPHERE360 PRODUCT=IC	ES-AF	\$50,000
458-001-516	VMAX FLASH FX SUITE OS 1TB=CC	ES-AF	\$0
458-001-517	VMAX FLASH CLOUDARRAY PRODUCT=IC	ES-AF	\$0
458-001-518	APPSYNC FOR VMAX F SUITE STR PK=CC	ES-AF	\$0
458-001-519	APPSYNC FOR VMAX FX SUITE STR PK=CC	ES-AF	\$0
458-001-525	APPSYNC FULL FOR VMAX 450/850F STE =CC	ES-AF	\$0
458-001-526	APPSYNC FULL FOR VMAX 450/850FX STE =CC	ES-AF	\$0
458-001-533	VMAX FLASH ESA PRODUCT=CC	ES-AF	\$0
458-001-598	VMAX850 FLASH ESA PRODUCT=CC	ES-AF	\$0

458-001-605	APPSYNC FOR VMAX F SUITE =CC	ES-AF	\$0
458-001-606	APPSYNC FOR VMAX FX SUITE =CC	ES-AF	\$0
458-001-608	VMAX850 FLASH ESA PRODUCT=CC	ES-AF	\$0
458-001-609	VMAX450 FLASH ENCRYPTION PRODUCT=IC	ES-AF	\$150,000
458-001-610	VMAX450 FLASH ENCRYPTION PRODUCT=IC	ES-AF	\$150,000
458-001-636	VMAX850 FLASH ENCRYPTION PRODUCT=IC	ES-AF	\$288,000
458-001-686	VMAX ALL FLASH EVENTS AND RET PROD=IC	ES-AF	\$15,000
458-001-690	APPSYNC STR PK FOR VMAX F SUITE =CC	ES-AF	\$0
458-001-691	APPSYNC STR PK FOR VMAX FX SUITE =CC	ES-AF	\$0
458-001-694	VMAX ALL FLASH EVENTS AND RET PROD=IC	ES-AF	\$15,000
458-001-711	VMAX FLASH FX POWERPATH PRODUCT=IC	ES-AF	\$0
458-001-765	VMAX FLASH REM REP MF ENABLER=IC	ES-AF	\$0
458-001-766	VMAX FLASH AUTOSWAP PRODUCT=IC	ES-AF	\$550,000
458-001-767	VMAX FLASH zDP PRODUCT 1TB=CC	ES-AF	\$950
458-001-770	VMAX FLASH GDDR PRODUCT=IC	ES-AF	\$175,000
458-001-771	ViPR SRM for VMAX 250 TB=CC	ES-AF	\$1,850
458-001-772	ViPR SRM for VMAX 450 TB=CC	ES-AF	\$1,850
458-001-773	ViPR SRM for VMAX 850 TB=CC	ES-AF	\$1,850
458-001-775	VMAX250 FLASH ENCRYPTION PRODUCT=IC	ES-AF	\$52,500
458-001-859	APPSYNC FULL FOR VMAX 250F SUITE =CC	ES-AF	\$595
458-001-860	APPSYNC FULL FOR VMAX 250FX SUITE =CC	ES-AF	\$595
458-001-871	VMAX FLASH F SUITE OS UPG 1TB=CC	ES-AF	\$0
458-001-872	VMAX FLASH FX SUITE OS UPG 1TB=CC	ES-AF	\$0
458-001-902	APPSYNC FULL FOR VMAX 450/850F SUITE=CC	ES-AF	\$595
458-001-903	APPSYNC FULL FOR VMAX 450/850FX SUITE=CC	ES-AF	\$595
458-001-978	VMAX FLASH MNFRM ESS PLUS PRODUCT=IC	ES-AF	\$0
458-001-979	VMAX FLASH MNFRM ESS PLUS CAP 1TB=CC	ES-AF	\$1,515
458-001-983	RP/EX Local for VMAX 450/850/950 F/FX=CC	ES-AF	\$0
458-001-984	RP/EX Rem for VMAX 450/850/950 F/FX=CC	ES-AF	\$0
458-001-985	RP/EX LOCAL FOR VMAX 250 F/FX=CC	ES-AF	\$0
458-001-986	RP/EX REMOTE FOR VMAX 250 F/FX=CC	ES-AF	\$0
458-002-158	VMAX950 Flash Encryption Product=IC	ES-AF	\$288,000
458-002-159	ViPR SRM For VMAX950 TB=CC	ES-AF	\$0
458-002-160	VMAX F to FX Conversion	ES-AF	\$0
458-002-161	VMAX zF to zFX Conversion	ES-AF	\$0
458-002-192	VMAX Flash zFX Suite Enab zDP Mix 1TB=CC	ES-AF	\$0
458-002-197	VMAX Flash FX Suite Enab OSO Mixd 1TB=CC	ES-AF	\$0
458-002-353	VMAX250 FX Flash Encryption Product=IC	ES-AF	\$0
458-002-354	VMAX450 FX Flash Encryption Product=IC	ES-AF	\$0
458-002-355	VMAX850 FX Flash Encryption Product=IC	ES-AF	\$0
458-002-356	VMAX950 FX Flash Encryption Product=IC	ES-AF	\$0
458-002-357	AppSync Adv for VMAX AF-FX=CC	ES-AF	\$0
458-002-359	SRM for VMAX AF-FX=CC	ES-AF	\$0
458-002-389	VMAX FLASH CloudArray FX Product 1TB=IC	ES-AF	\$0
458-002-390	PowerPath for VMAX AF-FX=IC	ES-AF	\$0
458-002-392	AppSync Str Pk for VMAX AF-F=CC	ES-AF	\$0
458-002-394	SRM for VMAX 250 TB=CC	ES-AF	\$1,850
458-002-395	SRM for VMAX 450 TB=CC	ES-AF	\$1,850
458-002-396	SRM for VMAX 850 TB=CC	ES-AF	\$1,850
458-002-397	SRM for VMAX 950 TB=CC	ES-AF	\$1,850

458-002-433	VMAX Flash FX Suite Enab OSO Mixd 1TB=CC	ES-AF	\$0
EAF-1024-2048UFD	VMAX 450 MEMCONV 2X512 to 2X1024 GB	ES-AF	\$1,080,000
EAF-1024ADD	VMAX 450 ADD 1024GB	ES-AF	\$0
EAF-1024ADD-3P	VMAX 450 ADD 1024GB 3RD PARTY	ES-AF	\$0
EAF-1024ADDU	VMAX 450 ADD 1024GB UPG	ES-AF	\$0
EAF-1024ADDU-3P	VMAX 450 ADD 1024GB UPG 3RD PARTY	ES-AF	\$0
EAF-1024ADDUFD	VMAX 450 ADD 1024GB UPG FIELD	ES-AF	\$0
EAF1024ADUFD3P	VMAX 450 ADD 1024GB FD UPG 3RD PARTY	ES-AF	\$0
EAF-1024BASE	VMAX 450 BASE 1024GB	ES-AF	\$0
EAF-1024BASE-3P	VMAX 450 BASE 1024GB 3RD PARTY	ES-AF	\$0
EAF-2048ADD	VMAX 450 ADD 2048GB	ES-AF	\$0
EAF-2048ADD-3P	VMAX 450 ADD 2048GB 3RD PARTY	ES-AF	\$0
EAF-2048ADDU	VMAX 450 ADD 2048GB UPG	ES-AF	\$0
EAF-2048ADDU-3P	VMAX 450 ADD 2048GB UPG 3RD PARTY	ES-AF	\$0
EAF-2048ADDUFD	VMAX 450 ADD 2048GB UPG FIELD	ES-AF	\$0
EAF2048ADUFD3P	VMAX 450 ADD 2048GB FD UPG 3RD PARTY	ES-AF	\$0
EAF-2048BASE	VMAX 450 BASE 2048GB	ES-AF	\$0
EAF-2048BASE-3P	VMAX 450 BASE 2048GB 3RD PARTY	ES-AF	\$0
EAF-512ADD	VMAX 450 ADD 512GB	ES-AF	\$0
EAF-512ADD-3P	VMAX 450 ADD 512GB 3RD PARTY	ES-AF	\$0
EAF-512ADDU	VMAX 450 ADD 512GB UPG	ES-AF	\$0
EAF-512ADDU-3P	VMAX 450 ADD 512GB UPG 3RD PARTY	ES-AF	\$0
EAF-512ADDUFD	VMAX 450 ADD 512GB UPG FIELD	ES-AF	\$0
EAF512ADDUFD3P	VMAX 450 ADD 512GB FD UPG 3RD PARTY	ES-AF	\$0
EAF-512BASE	VMAX 450 BASE 512GB	ES-AF	\$0
EAF-512BASE-3P	VMAX 450 BASE 512GB 3RD PARTY	ES-AF	\$0
EAF-DATAMOVER	VMAX 450 DATA MOVER FOR NAS	ES-AF	\$0
EAF-DATAMOVERU	VMAX 450 DATA MOVER FOR NAS UPG	ES-AF	\$0
EAF-NAS-SN	Embedded NAS Base OE for VMAX 450	ES-AF	\$115,000
EAF-NAS-SNU	Embedded NAS Base OE for VMAX 450 UPG	ES-AF	\$115,000
EAFX-NAS-SN	Embedded NAS Base OE for VMAX 450 FX	ES-AF	\$0
EAFX-NAS-SNU	Embedded NAS Base OE for VMAX 450 FX UPG	ES-AF	\$0
E-CONV-AENG-3P	VMAX EMC TO 3P ADD ENG CONV	ES-AF	\$5,735
E-CONV-BENG-3P	VMAX EMC TO 3P BASE ENG CONV	ES-AF	\$0
E-CONV-DAE-3P	VMAX EMC TO 3P DAE CONV	ES-AF	\$2,520
E-CONV-FABR-3P	VMAX EMC TO 3P FAB CONV	ES-AF	\$6,270
E-CONV-PDU-3P	VMAX EMC TO 3P PDU CONV	ES-AF	\$3,165
E-CONV-SYS1-3P	VMAX EMC TO 3P SYS1 CONV	ES-AF	\$36,605
E-CONV-SYS1-3PE	VMAX DELL EMC TO 3P SYS1 CONV	ES-AF	\$36,605
E-CONV-SYSA-3P	VMAX EMC TO 3P SYS ADD CONV	ES-AF	\$22,545
E-CONV-SYSA-3PE	VMAX DELL EMC TO 3P SYS ADD CONV	ES-AF	\$22,545
E-ENCRYPT 450	VMAX 450 DATA AT REST ENCRYPT OS NEW TM	ES-AF	\$0
EF-13UF-UFD-3P	VMAX AF 1U/3U FILLER PANEL KIT 3RD PARTY	ES-AF	\$0
EF-1400MOD	VMAX AF FLASH MOD 1400	ES-AF	\$0
EF-1400MODCONV	VMAX AF FLASH MOD 1400 CONVERSION	ES-AF	\$0
EF-1400MODS	VMAX AF FLASH MODS 1400	ES-AF	\$0
EF-1400MODSCONV	VMAX AF FLASH MODS 1400 CONVERSION	ES-AF	\$0
EF-1400MODSU	VMAX AF FLASH MODS 1400 UPG	ES-AF	\$0
EF-1400MODSUF	VMAX AF FLASH MODS 1400 FD UPG	ES-AF	\$0
EF-1400MODU	VMAX AF FLASH MOD 1400 UPG	ES-AF	\$0

EF-1400MODUF	VMAX AF FLASH MOD 1400 FD UPG	ES-AF	\$0
EF-1600MODS	VMAX AF FLASH MODS 1600	ES-AF	\$0
EF-1600MODSCONV	VMAX AF FLASH MODS 1600 CONVERSION	ES-AF	\$0
EF-1600MODSU	VMAX AF FLASH MODS 1600 UPG	ES-AF	\$0
EF-1600MODSUF	VMAX AF FLASH MODS 1600 FD UPG	ES-AF	\$0
EF-1UF-3PUFD	VMAX AF 3RD PARTY 1-1U FILLER KIT	ES-AF	\$0
EF-2ENGBEZ-3P	VMAX AF DUAL ENGINE BEZEL KIT 3RD PARTY	ES-AF	\$0
EF-2ME1-3P	VMAX AF ENG 1 IB CABLE KIT 3RD PARTY	ES-AF	\$0
EF-2ME1-3PUFD	VMAX AF ENG 1 IB CABLE KIT FD UPG 3P	ES-AF	\$0
EF-2ME2DUAL-3P	VMAX AF ENG 2 IB/ETH CABLE KIT 2ENG 3P	ES-AF	\$0
EF-2MENG2CBLUF	VMAX AF 2 MTR 2ND ENG CONTIBÐ CBL UP	ES-AF	\$0
EF-2METERCBL	VMAX AF 2 METER CONTIGIB ETH CABLE	ES-AF	\$0
EF-2METERCBLU	VMAX AF 2 METER CONTIGIB ETH CABLE UPG	ES-AF	\$0
EF-2UF-UFD-3P	VMAX AF 2U FILLER PANEL KIT 3RD PARTY	ES-AF	\$0
EF-350MOD	VMAX AF FLASH MOD 350	ES-AF	\$0
EF-350MODS	VMAX AF FLASH MODS 350	ES-AF	\$0
EF-350MODSCONV	VMAX AF FLASH MODSS 350 CONVERSION	ES-AF	\$0
EF-350MODSU	VMAX AF FLASH MODS 350 UPG	ES-AF	\$0
EF-350MODSUF	VMAX AF FLASH MODS 350 FD UPG	ES-AF	\$0
EF-350MODU	VMAX AF FLASH MOD 350 UPG	ES-AF	\$0
EF-350MODUF	VMAX AF FLASH MOD 350 FD UPG	ES-AF	\$0
EF-3ME2-3P	VMAX AF ENG 2 IB/ETH CABLE KIT 3RD PARTY	ES-AF	\$0
EF-3ME2-3PUFD	VMAX AF ENG 2 IB/ETH CABLE KIT FD UPG 3P	ES-AF	\$0
EF-3ME3-3P	VMAX AF ENG 3 IB/ETH CABLE KIT 3RD PARTY	ES-AF	\$0
EF-3ME3-3PUFD	VMAX AF ENG 3 IB/ETH CABLE KIT FD UPG 3P	ES-AF	\$0
EF-3ME4DUAL-3P	VMAX AF ENG 4 IB/ETH CABLE KIT 2ENG 3P	ES-AF	\$0
EF-3ME6DUAL-3P	VMAX AF ENG 6 IB/ETH CABLE KIT 2ENG 3P	ES-AF	\$0
EF-3MENG4CBLUF	VMAX AF 3 MTR 2ND ENG CONTIBÐ CBL UP	ES-AF	\$0
EF-3MENG6CBLUF	VMAX AF 3 MTR 2ND ENG CONTIBÐ CBL UP	ES-AF	\$0
EF-3METERCBL	VMAX AF 3 METER CONTIGIB ETH CABLE	ES-AF	\$0
EF-3METERCBLU	VMAX AF 3 METER CONTIGIB ETH CABLE UPG	ES-AF	\$0
EF-3MX1X2-3PU	VMAX AF 3MET IB/ETH CABLE KIT NEW/UPG 3P	ES-AF	\$0
EF-5ME4-3P	VMAX AF ENG 4 IB/ETH CABLE KIT 3RD PARTY	ES-AF	\$0
EF-5ME4-3PUFD	VMAX AF ENG 4 IB/ETH CABLE KIT FD UPG 3P	ES-AF	\$0
EF-5ME5-3P	VMAX AF ENG 5 IB/ETH CABLE KIT 3RD PARTY	ES-AF	\$0
EF-5ME5-3PUFD	VMAX AF ENG 5 IB/ETH CABLE KIT FD UPG 3P	ES-AF	\$0
EF-5ME6DUAL-3P	VMAX AF ENG 6 IB/ETH CABLE KIT 2ENG 3P	ES-AF	\$0
EF-5ME8DUAL-3P	VMAX AF ENG 8 IB/ETH CABLE KIT 2ENG 3P	ES-AF	\$0
EF-5MENG6CBLUF	VMAX AF 5 MTR 2ND ENG CONTIBÐ CBL UP	ES-AF	\$0
EF-5MENG8CBLUF	VMAX AF 5 MTR 2ND ENG CONTIBÐ CBL UP	ES-AF	\$0
EF-5METERCBL	VMAX AF 5 METER CONTIGIB ETH CABLE	ES-AF	\$0
EF-5METERCBLU	VMAX AF 5 METER CONTIGIB ETH CABLE UPG	ES-AF	\$0
EF-5MX3X4-3PU	VMAX AF 5MET IB/ETH CABLE KIT NEW/UPG 3P	ES-AF	\$0
EF-700MOD	VMAX AF FLASH MOD 700	ES-AF	\$0
EF-700MODCONV	VMAX AF FLASH MOD 700 CONVERSION	ES-AF	\$0
EF-700MODS	VMAX AF FLASH MODS 700	ES-AF	\$0
EF-700MODSCONV	VMAX AF FLASH MODS 700 CONVERSION	ES-AF	\$0
EF-700MODSU	VMAX AF FLASH MODS 700 UPG	ES-AF	\$0
EF-700MODSUF	VMAX AF FLASH MODS 700 FD UPG	ES-AF	\$0
EF-700MODU	VMAX AF FLASH MOD 700 UPG	ES-AF	\$0

EF-700MODUF	VMAX AF FLASH MOD 700 FD UPG	ES-AF	\$0
EF-8ME6-3P	VMAX AF ENG 6 IB/ETH CABLE KIT 3RD PARTY	ES-AF	\$0
EF-8ME6-3PUFD	VMAX AF ENG 6 IB/ETH CABLE KIT FD UPG 3P	ES-AF	\$0
EF-8ME7-3P	VMAX AF ENG 7 IB/ETH CABLE KIT 3RD PARTY	ES-AF	\$0
EF-8ME7-3PUFD	VMAX AF ENG 7 IB/ETH CABLE KIT FD UPG 3P	ES-AF	\$0
EF-8ME8-3P	VMAX AF ENG 8 IB/ETH CABLE KIT 3RD PARTY	ES-AF	\$0
EF-8ME8-3PUFD	VMAX AF ENG 8 IB/ETH CABLE KIT FD UPG 3P	ES-AF	\$0
EF-8ME8DUAL-3P	VMAX AF ENG 8 IB/ETH CABLE KIT 2ENG 3P	ES-AF	\$0
EF-8MENG8CBLUF	VMAX AF 8 MTR 2ND ENG CONTIBÐ CBL UP	ES-AF	\$0
EF-8METERCBL	VMAX AF 8 METER CONTIGIBÐ CABLE	ES-AF	\$0
EF-8METERCBLU	VMAX AF 8 METER CONTIGIBÐ CABLE UPG	ES-AF	\$0
EF-8MX5X6X7-3PU	VMAX AF 8MET IB/ETH CABLE KIT NEW/UPG 3P	ES-AF	\$0
EF-ACON3P-50	ADPTR AC 3PH 50A W3-4IN CONDUIT ADPTR	ES-AF	\$0
EF-BEDIR	VMAX AF DIR F	ES-AF	\$9,750
EF-BEDIRU	VMAX AF DIR F UPG	ES-AF	\$9,750
EF-BEDIRUFD	VMAX AF DIR F FD UPG	ES-AF	\$9,750
EF-BK40000E	VMAX AF FC BACKUP I/O FOR NAS	ES-AF	\$2,100
EF-BK80000E	VMAX AF FC BACKUP I/O FOR NAS	ES-AF	\$2,100
EF-BLNK-SKINS	VMAX AF SIDE PANELS BLANK	ES-AF	\$0
EF-BLNK-SKINSU	VMAX AF SIDE PANELS BLANK UPG	ES-AF	\$0
EF-CNVINF-1PU	VMAX AF SINGLE PHASE PDU CONVERSION	ES-AF	\$700
EF-CNVINF-3DU	VMAX AF 3 PHASE DELTA PDU CONVERSION	ES-AF	\$995
EF-CNVINF-3YU	VMAX AF 3 PHASE WYE PDU CONVERSION	ES-AF	\$1,085
EF-COMPRESS	VMAX AF HDW COMPRESSION	ES-AF	\$0
EF-COMPRESSF	VMAX AF HDW COMPRESSION FD UPG	ES-AF	\$0
EF-COMPRESSU	VMAX AF HDW COMPRESSION UPG	ES-AF	\$0
EF-CONV-FDOORSYS1D	SB1 Dual Engine Hex Front Door CONV	ES-AF	\$3,100
EF-CONV-SKINS	VMAX VG SIDE PANELS CONV	ES-AF	\$630
EF-CONV-SKINSU	VMAX VG SIDE PANELS CONV UPG	ES-AF	\$630
EF-CONV-SYS1-3P	VMAX AF EMC TO 3P SYS1 CONV	ES-AF	\$36,605
EF-CONV-SYS1-3PE	VMAX AF DELL EMC TO 3P SYS1 CONV	ES-AF	\$36,605
EF-CONV-SYS1A-1P	VMAX 450 3P TO EMC SYS BAY1 1P CONV	ES-AF	\$42,630
EF-CONV-SYS1A-3D	VMAX 450 3P TO EMC SYS BAY1 3D CONV	ES-AF	\$42,630
EF-CONV-SYS1A-3Y	VMAX 450 3P TO EMC SYS BAY1 3Y CONV	ES-AF	\$42,630
EF-CONV-SYS1R-1P	VMAX 850 3P TO EMC SYS BAY1 1P CONV	ES-AF	\$42,630
EF-CONV-SYS1R-3D	VMAX 850 3P TO EMC SYS BAY1 3D CONV	ES-AF	\$42,630
EF-CONV-SYS1R-3Y	VMAX 850 3P TO EMC SYS BAY1 3Y CONV	ES-AF	\$42,630
EF-CONV-SYSA-3P	VMAX AF EMC TO 3P SYS ADD CONV	ES-AF	\$22,545
EF-CONV-SYSA-3PE	VMAX AF DELL EMC TO 3P SYS ADD CONV	ES-AF	\$22,545
EF-CONV-SYSADD1P	VMAX VG ADD 3P TO EMC SYS BAY 1P CONV	ES-AF	\$42,630
EF-CONV-SYSADD1PU	VMAX VG ADD 3P TO EMC SYS BAY 1P CONV U	ES-AF	\$42,630
EF-CONV-SYSADD3D	VMAX VG ADD 3P TO EMC SYS BAY 3D CONV	ES-AF	\$42,630
EF-CONV-SYSADD3DU	VMAX VG ADD 3P TO EMC SYS BAY 3D CONV UP	ES-AF	\$42,630
EF-CONV-SYSADD3Y	VMAX VG ADD 3P TO EMC SYS BAY 3Y CONV	ES-AF	\$42,630
EF-CONV-SYSADD3YU	VMAX VG ADD 3P TO EMC SYS BAY 3Y CONV UP	ES-AF	\$42,630
EF-CV-FDOORSYS28D	SB2-8 Dual Engine Hex Front Door CONV	ES-AF	\$3,100
EF-CV-FDOORSYS28DU	SB2-8 Dual Engine Hex Door Pair Upg CONV	ES-AF	\$3,100
EF-DE120	VMAX AF 120 SLT DR ENCL	ES-AF	\$0
EF-DE120-3P	VMAX AF 120 SLT DR ENCL 3RD PARTY	ES-AF	\$0
EF-DE120U	VMAX AF 120 SLT DR ENCL UPG	ES-AF	\$0

EF-DE120U-3P	VMAX AF 120 SLT DR ENCL UPG 3RD PARTY	ES-AF	\$0
EF-DE120UFD	VMAX AF 120 SLT DR ENCL UFD	ES-AF	\$0
EF-DE120UFD-3P	VMAX AF 120 SLT DR ENCL UFD 3RD PARTY	ES-AF	\$0
EF-DIR3MCBL	VMAX AF DIRECT CONNECT 3 METER	ES-AF	\$0
EF-DIR3MCBLU	VMAX AF DIRECT CONNECT 3 METER UPG	ES-AF	\$0
EF-DIR3MCBLUF1	VMAX AF DIRECT CONNECT 3 MTR DAE1 FD UP	ES-AF	\$0
EF-DIR3MCBLUF2	VMAX AF DIRECT CONNECT 3 MTR DAE2 FD UP	ES-AF	\$0
EF-DIR3MCBLUF3	VMAX AF Std 1 Eng DAE3 (Direct A) Upgr	ES-AF	\$0
EF-DIR3MCBLUF4	VMAX AF Std 1 Eng DAE 4 (Direct B) Upgr	ES-AF	\$0
EF-DSOPTICE2	VMAX AF ENG 2 DSP CBLOPTICS KIT	ES-AF	\$15,285
EF-DSOPTICE2U	VMAX AF ENG 2 DSP CBLOPTICS KIT UPG	ES-AF	\$15,285
EF-DSOPTICE3	VMAX AF ENG 3 DSP CBLOPTICS KIT	ES-AF	\$15,285
EF-DSOPTICE3U	VMAX AF ENG 3 DSP CBLOPTICS KIT UPG	ES-AF	\$15,285
EF-DSOPTICE4	VMAX AF ENG 4 DSP CBLOPTICS KIT	ES-AF	\$15,285
EF-DSOPTICE4U	VMAX AF ENG 4 DSP CBLOPTICS KIT UPG	ES-AF	\$15,825
EF-DSOPTICE5	VMAX AF ENG 5 DSP CBLOPTICS KIT	ES-AF	\$15,285
EF-DSOPTICE5U	VMAX AF ENG 5 DSP CBLOPTICS KIT UPG	ES-AF	\$15,825
EF-DSOPTICE6	VMAX AF ENG 6 DSP CBLOPTICS KIT	ES-AF	\$15,285
EF-DSOPTICE6U	VMAX AF ENG 6 DSP CBLOPTICS KIT UPG	ES-AF	\$15,825
EF-DSOPTICE7	VMAX AF ENG 7 DSP CBLOPTICS KIT	ES-AF	\$15,285
EF-DSOPTICE7U	VMAX AF ENG 7 DSP CBLOPTICS KIT UPG	ES-AF	\$15,825
EF-DSOPTICE8	VMAX AF ENG 8 DSP CBLOPTICS KIT	ES-AF	\$15,285
EF-DSOPTICE8U	VMAX AF ENG 8 DSP CBLOPTICS KIT UPG	ES-AF	\$15,825
EF-FABLA	VMAX 450 FABRIC	ES-AF	\$0
EF-FABLA-3P	VMAX 450 FABRIC 3RD PARTY	ES-AF	\$0
EF-FABLA-UFD	VMAX 450 FABRIC UPGRADE	ES-AF	\$0
EF-FABLAUFD-3P	VMAX 450 FABRIC UPGRADE 3RD PARTY	ES-AF	\$0
EF-FABR	VMAX 850 FABRIC	ES-AF	\$0
EF-FABR-3P	VMAX 850 FABRIC 3RD PARTY	ES-AF	\$0
EF-FABR-UFD	VMAX 850 FABRIC UPGRADE	ES-AF	\$0
EF-FABR-UFD-3P	VMAX 850 FABRIC UPGRADE 3RD PARTY	ES-AF	\$0
EF-FDOORS1DKEY	SB1 DUAL ENGINE KEY DELL DOOR	ES-AF	\$0
EF-FDOORS1DKEYE	SB1 DUAL ENGINE KEY DELL DOOR	ES-AF	\$0
EF-FDOORS28DKEY	SB2-8 DUAL ENGINE KEY DELL DOOR	ES-AF	\$0
EF-FDOORS28DKEYE	SB2-8 DUAL ENGINE KEY DELL DOOR	ES-AF	\$0
EF-FDOORSYS1D	SB1 Dual Engine Hex Front Door	ES-AF	\$0
EF-FDOORSYS1DE	SB1 DUAL ENGINE HEX DELL DOOR	ES-AF	\$0
EF-FDOORSYS28D	SB2-8 Dual Engine Hex Front Door	ES-AF	\$0
EF-FDOORSYS28DE	SB2-8 DUAL ENGINE HEX DELL DOOR	ES-AF	\$0
EF-FDOORSYS28DU	SB2-8 Dual Engine Hex Door Pair Upg	ES-AF	\$0
EF-FDOORSYS28DUE	SB2-8 DUAL ENGINE HEX DELL DOOR UPG	ES-AF	\$0
EF-FE00008S	VMAX AF 8SM 16G FICON	ES-AF	\$15,575
EF-FE00080S	VMAX AF 8MM 16G FICON	ES-AF	\$7,150
EF-FE00200TC	VMAX AF 2PT 10 GBE BASE T	ES-AF	\$2,200
EF-FE00200TO	VMAX AF 2PT 10 GBE OPTICAL	ES-AF	\$2,100
EF-FE00400	VMAX AF 4M GIGE	ES-AF	\$5,310
EF-FE00400C	VMAX AF 4PT GBE BASE T	ES-AF	\$2,000
EF-FE00400C4	VMAX AF 4MM4 COPR GIGE	ES-AF	\$1,980
EF-FE00400C4UFX	VMAX VG 4MM4COPR FD UPG	ES-AF	\$0
EF-FE00400C4UX	VMAX VG 4MM4COPR UPG	ES-AF	\$0

EF-FE00400T	VMAX AF 4MM 10 GIGE	ES-AF	\$3,650
EF-FE00400TUFX	VMAX VG 4MM 10 GIGE FD UPG	ES-AF	\$0
EF-FE00400TUX	VMAX VG 4MM 10 GIGE UPG	ES-AF	\$0
EF-FE00800T	VMAX AF 8MM 10GIGE	ES-AF	\$5,475
EF-FE00800TUFX	VMAX VG 8MM 10 GIGE FD UPG	ES-AF	\$0
EF-FE00800TUX	VMAX VG 8MM 10 GIGE UPG	ES-AF	\$0
EF-FE08000E	VMAX AF 8SM 8G FIBRE	ES-AF	\$4,140
EF-FE08000S	VMAX AF 8SM 16G FC	ES-AF	\$10,805
EF-FE44000E	VMAX VG 4MM4SM 8G FIBRE	ES-AF	\$3,315
EF-FE62000E	VMAX AF 6MM2SM 8G FIBRE	ES-AF	\$2,395
EF-FE80000E	VMAX AF 8MM 8G FIBRE	ES-AF	\$2,070
EF-FE80000EUFX	VMAX VG 8MM 8G FIBRE FD UPG	ES-AF	\$0
EF-FE80000EUX	VMAX VG 8MM 8G FIBRE UPG	ES-AF	\$0
EF-FE80000S	VMAX AF 8MM 16G FC	ES-AF	\$5,400
EF-FE80000SUFX	VMAX VG 8MM 16G FIBRE FD UPG	ES-AF	\$0
EF-FE80000SUX	VMAX VG 8MM 16G FIBRE UPG	ES-AF	\$0
EF-PC3YAFLA	32A 3PHASE WYE CORD SET IEC309-AMER	ES-AF	\$0
EF-PC3YAFLE	32A 3PHASE WYE CRD SET FLY LEAD EUROPE	ES-AF	\$0
EF-PCBL3DHH	VMAX VG PWR CBL HBL-HBL 3D	ES-AF	\$0
EF-PCBL3DHR	VMAX VG PWR CBL HBL-RSTOL 3D	ES-AF	\$0
EF-PCBL3YAG	INTL 3PHASE 32 AMP IEC309 TO GARO	ES-AF	\$0
EF-PCBL3YL23P	24A 3PH WYE L22-30P	ES-AF	\$0
EF-PDU1P	VMAX AF SINGLE PHASE PDU 3RD PARTY	ES-AF	\$0
EF-PDUDELTA	VMAX AF 3 PHASE DELTA PDU 3RD PARTY	ES-AF	\$0
EF-PDUWYE	VMAX AF 3 PHASE WYE PDU 3RD PARTY	ES-AF	\$0
EF-PW40UASTL	30A 1PHASE AUSIP57 CLIPSAL 56PA332	ES-AF	\$0
EF-PW40UIEC3	VMAX VG30A 1PHASE INTERNATNLIIEC309-332P	ES-AF	\$0
EF-PW40URUS	30A 1PH RUSSELLSTOLL 3750DP	ES-AF	\$0
EF-PW40U-US	VMAX VG 30A 1PHASE NAMER JAPAN I6-30P	ES-AF	\$0
EF-SKINS	VMAX AF SIDE PANELS	ES-AF	\$0
EF-SKINSU	VMAX AF SIDE PANELS UPG	ES-AF	\$0
EF-SYS13RDPT	VMAX AF 1ENG SYSTEM BAY SHIPPING RACK	ES-AF	\$0
EF-SYS1A-1P	VMAX 450 SYS BAY1 1P	ES-AF	\$0
EF-SYS1A-3D	VMAX 450 SYS BAY1 3D	ES-AF	\$0
EF-SYS1A-3P-1P	VMAX 450 SYS BAY1 1P 3RD PARTY	ES-AF	\$0
EF-SYS1A-3P-3D	VMAX 450 SYS BAY1 3D 3RD PARTY	ES-AF	\$0
EF-SYS1A-3P-3Y	VMAX 450 SYS BAY1 3Y 3RD PARTY	ES-AF	\$0
EF-SYS1A-3PE-1P	VMAX 450 DELL SYS BAY1 1P 3RD PARTY	ES-AF	\$0
EF-SYS1A-3PE-3D	VMAX 450 DELL SYS BAY1 3D 3RD PARTY	ES-AF	\$0
EF-SYS1A-3PE-3Y	VMAX 450 DELL SYS BAY1 3Y 3RD PARTY	ES-AF	\$0
EF-SYS1A-3Y	VMAX 450 SYS BAY1 3Y	ES-AF	\$0
EF-SYS1R-1P	VMAX 850 SYS BAY1 1P	ES-AF	\$0
EF-SYS1R-3D	VMAX 850 SYS BAY1 3D	ES-AF	\$0
EF-SYS1R-3P-1P	VMAX 850 SYS BAY1 1P 3RD PARTY	ES-AF	\$0
EF-SYS1R-3P-3D	VMAX 850 SYS BAY1 3D 3RD PARTY	ES-AF	\$0
EF-SYS1R-3P-3Y	VMAX 850 SYS BAY1 3Y 3RD PARTY	ES-AF	\$0
EF-SYS1R-3PE-1P	VMAX 850 DELL SYS BAY1 1P 3RD PARTY	ES-AF	\$0
EF-SYS1R-3PE-3D	VMAX 850 DELL SYS BAY1 3D 3RD PARTY	ES-AF	\$0
EF-SYS1R-3PE-3Y	VMAX 850 DELL SYS BAY1 3Y 3RD PARTY	ES-AF	\$0
EF-SYS1R-3Y	VMAX 850 SYS BAY1 3Y	ES-AF	\$0

EF-SYS23RDPT	VMAX AF 2ENG SYSTEM BAY SHIPPING RACK	ES-AF	\$0
EF-SYSADD1P	VMAX AF ADD SYS BAY 1P	ES-AF	\$0
EF-SYSADD1P-3P	VMAX AF ADD SYS BAY 1P 3RD PARTY	ES-AF	\$0
EF-SYSADD1P-3PE	VMAX AF ADD DELL SYS BAY 1P 3RD PARTY	ES-AF	\$0
EF-SYSADD1PU	VMAX AF ADD SYS BAY 1P UPG	ES-AF	\$0
EF-SYSADD1PU3P	VMAX AF ADD SYS BAY 1P UPG 3RD PARTY	ES-AF	\$0
EF-SYSADD1PU3PE	VMAX AF ADD DELL SYS BAY 1P UPG 3RD PART	ES-AF	\$0
EF-SYSADD3D	VMAX AF ADD SYS BAY 3D	ES-AF	\$0
EF-SYSADD3D-3P	VMAX AF ADD SYS BAY 3D 3RD PARTY	ES-AF	\$0
EF-SYSADD3D-3PE	VMAX AF ADD DELL SYS BAY 3D 3RD PARTY	ES-AF	\$0
EF-SYSADD3DU	VMAX AF ADD SYS BAY 3D UPG	ES-AF	\$0
EF-SYSADD3DU3P	VMAX AF ADD SYS BAY 3D UPG 3RD PARTY	ES-AF	\$0
EF-SYSADD3DU3PE	VMAX AF ADD DELL SYS BAY 3D UPG 3RD PART	ES-AF	\$0
EF-SYSADD3Y	VMAX AF ADD SYS BAY 3Y	ES-AF	\$0
EF-SYSADD3Y-3P	VMAX AF ADD SYS BAY 3Y 3RD PARTY	ES-AF	\$0
EF-SYSADD3Y-3PE	VMAX AF ADD DELL SYS BAY 3Y 3RD PARTY	ES-AF	\$0
EF-SYSADD3YU	VMAX AF ADD SYS BAY 3Y UPG	ES-AF	\$0
EF-SYSADD3YU3P	VMAX AF ADD SYS BAY 3Y UPG 3RD PARTY	ES-AF	\$0
EF-SYSADD3YU3PE	VMAX AF ADD DELL SYS BAY 3Y UPG 3RD PART	ES-AF	\$0
EFX-BEDIR	VMAX AF DIR FX	ES-AF	\$0
EFX-BEDIRU	VMAX AF DIR FX UPG	ES-AF	\$0
EFX-BEDIRUFD	VMAX AF DIR FX FD UPG	ES-AF	\$0
EL6F33840SBT0	VMAX3 3840GB FLASH SPARE	ES-AF	\$0
E-PCBL3YAG-INTL-US	INTL_DOM 3Phse Wye VMAX3-AFA Pwr Ext Cbl	ES-AF	\$2,000
E-Q118E	Elm Tracking Model	ES-AF	\$0
ERF-1024-2048UFD	VMAX 850 MEMCONV 2X512 to 2X1024 GB	ES-AF	\$1,080,000
ERF-1024ADD	VMAX 850 ADD 1024GB	ES-AF	\$0
ERF-1024ADD-3P	VMAX 850 ADD 1024GB 3RD PARTY	ES-AF	\$0
ERF-1024ADDU	VMAX 850 ADD 1024GB UPG	ES-AF	\$0
ERF-1024ADDU3P	VMAX 850 ADD 1024GB UPG 3RD PARTY	ES-AF	\$0
ERF-1024ADDUFD	VMAX 850 ADD 1024GB UPG FIELD	ES-AF	\$0
ERF1024ADUFD3P	VMAX 850 ADD 1024GB FD UPG 3RD PARTY	ES-AF	\$0
ERF-1024BASE	VMAX 850 BASE 1024GB	ES-AF	\$0
ERF-1024BASE-3P	VMAX 850 BASE 1024GB 3RD PARTY	ES-AF	\$0
ERF-2048ADD	VMAX 850 ADD 2048GB	ES-AF	\$0
ERF-2048ADD-3P	VMAX 850 ADD 2048GB 3RD PARTY	ES-AF	\$0
ERF-2048ADDU	VMAX 850 ADD 2048GB UPG	ES-AF	\$0
ERF-2048ADDU3P	VMAX 850 ADD 2048GB UPG 3RD PARTY	ES-AF	\$0
ERF-2048ADDUFD	VMAX 850 ADD 2048GB UPG FIELD	ES-AF	\$0
ERF2048ADUFD3P	VMAX 850 ADD 2048GB FD UPG 3RD PARTY	ES-AF	\$0
ERF-2048BASE	VMAX 850 BASE 2048GB	ES-AF	\$0
ERF-2048BASE-3P	VMAX 850 BASE 2048GB 3RD PARTY	ES-AF	\$0
ERF-512ADD	VMAX 850 ADD 512GB	ES-AF	\$0
ERF-512ADD-3P	VMAX 850 ADD 512GB 3RD PARTY	ES-AF	\$0
ERF-512ADDU	VMAX 850 ADD 512GB UPG	ES-AF	\$0
ERF-512ADDU3P	VMAX 850 ADD 512GB UPG 3RD PARTY	ES-AF	\$0
ERF-512ADDUFD	VMAX 850 ADD 512GB UPG FIELD	ES-AF	\$0
ERF512ADDUFD3P	VMAX 850 ADD 512GB FD UPG 3RD PARTY	ES-AF	\$0
ERF-512BASE	VMAX 850 BASE 512GB	ES-AF	\$0
ERF-512BASE-3P	VMAX 850 BASE 512GB 3RD PARTY	ES-AF	\$0

ERF-DATAMOVER	VMAX 850 DATA MOVER FOR NAS	ES-AF	\$0
ERF-DATAMOVERU	VMAX 850 DATA MOVER FOR NAS UPG	ES-AF	\$0
ERF-NAS-SN	Embedded NAS Base OE for VMAX 850	ES-AF	\$150,000
ERF-NAS-SNU	Embedded NAS Base OE for VMAX 850 UPG	ES-AF	\$150,000
ERFX-NAS-SN	Embedded NAS Base OE for VMAX 850 FX	ES-AF	\$0
ERFX-NAS-SNU	Embedded NAS Base OE for VMAX 850 FXUPG	ES-AF	\$0
ERT-1024-2048UFD	VMAX 950 MEMCONV 2X512 to 2X1024 GB	ES-AF	\$878,760
ERT-1024ADD	VMAX 950 ADD 1024GB	ES-AF	\$0
ERT-1024ADD-3P	VMAX 950 ADD 1024GB 3RD PARTY	ES-AF	\$0
ERT-1024ADDU	VMAX 950 ADD 1024GB UPG	ES-AF	\$0
ERT-1024ADDU3P	VMAX 950 ADD 1024GB UPG 3RD PARTY	ES-AF	\$0
ERT-1024ADDUFD	VMAX 950 ADD 1024GB UPG FIELD	ES-AF	\$0
ERT-1024ADDUVCE	VMAX 950 ADD 1024GB UPG VXBLOCK 3P	ES-AF	\$0
ERT-1024ADD-VCE	VMAX 950 ADD 1024GB VXBLOCK 3P	ES-AF	\$0
ERT-1024ADUFD-3P	VMAX 950 ADD 1024GB FD UPG 3RD PARTY	ES-AF	\$0
ERT-1024ADUFD-VCE	VMAX 950 ADD 1024GB FD UPG VXBLOCK 3P	ES-AF	\$0
ERT-1024BASE	VMAX 950 BASE 1024GB	ES-AF	\$0
ERT-1024BASE-3P	VMAX 950 BASE 1024GB 3RD PARTY	ES-AF	\$0
ERT-1024BASE-VCE	VMAX 950 BASE 1024GB VXBLOCK 3P	ES-AF	\$0
ERT-2048ADD	VMAX 950 ADD 2048GB	ES-AF	\$0
ERT-2048ADD-3P	VMAX 950 ADD 2048GB 3RD PARTY	ES-AF	\$0
ERT-2048ADDU	VMAX 950 ADD 2048GB UPG	ES-AF	\$0
ERT-2048ADDU3P	VMAX 950 ADD 2048GB UPG 3RD PARTY	ES-AF	\$0
ERT-2048ADDUFD	VMAX 950 ADD 2048GB UPG FIELD	ES-AF	\$0
ERT-2048ADDUVCE	VMAX 950 ADD 2048GB UPG VXBLOCK 3P	ES-AF	\$0
ERT-2048ADD-VCE	VMAX 950 ADD 2048GB VXBLOCK 3P	ES-AF	\$0
ERT-2048ADUFD-3P	VMAX 950 ADD 2048GB FD UPG 3RD PARTY	ES-AF	\$0
ERT-2048ADUFD-VCE	VMAX 950 ADD 2048GB FD UPG VXBLOCK 3P	ES-AF	\$0
ERT-2048BASE	VMAX 950 BASE 2048GB	ES-AF	\$0
ERT-2048BASE-3P	VMAX 950 BASE 2048GB 3RD PARTY	ES-AF	\$0
ERT-2048BASE-VCE	VMAX 950 BASE 2048GB VXBLOCK 3P	ES-AF	\$0
ERT-DATAMOVER	VMAX 950 DATA MOVER FOR NAS	ES-AF	\$0
ERT-DATAMOVERU	VMAX 950 DATA MOVER FOR NAS UPG	ES-AF	\$0
ERT-NAS-SN	Embedded NAS Base OE for VMAX 950	ES-AF	\$150,000
ERT-NAS-SNU	Embedded NAS Base OE for VMAX 950 UPG	ES-AF	\$150,000
ERTX-NAS-SN	Embedded NAS Base OE for VMAX 950 FX	ES-AF	\$0
ERTX-NAS-SNU	Embedded NAS Base OE for VMAX 950 FX UPG	ES-AF	\$0
ES-1024-2048UFD	VMAX 250F MEMCONV 2X512 to 2X1024 GB	ES-AF	\$409,600
ES-1024ADD	VMAX 250F ADD 1024GB	ES-AF	\$0
ES-1024ADD-3P	VMAX 250F ADD 1024GB 3RD PARTY	ES-AF	\$0
ES-1024ADD-3PE	VMAX 250 DELL ADD 1024GB 3RD PARTY	ES-AF	\$0
ES-1024ADDE	VMAX 250 DELL ADD 1024GB	ES-AF	\$0
ES-1024ADDU	VMAX 250F ADD 1024GB UPG	ES-AF	\$0
ES-1024ADDU-3P	VMAX 250F ADD 1024GB 3RD PARTY UPG	ES-AF	\$0
ES-1024ADDU-3PE	VMAX 250 DELL ADD 1024GB 3RD PARTY UPG	ES-AF	\$0
ES-1024ADDUE	VMAX 250 DELL ADD 1024GB UPG	ES-AF	\$0
ES-1024ADDUFD	VMAX 250F ADD 1024GB UPG FIELD	ES-AF	\$0
ES-1024ADDUFD-3P	VMAX 250F ADD 1024GB 3RD PARTY UPG FIELD	ES-AF	\$0
ES-1024ADDUFD-3PE	VMAX 250 DELL ADD 1024GB 3RD PART UPG FD	ES-AF	\$0
ES-1024ADDUFDE	VMAX 250 DELL ADD 1024GB UPG FD	ES-AF	\$0

ES-1024BASE	VMAX 250F BASE 1024GB	ES-AF	\$0
ES-1024BASE-3P	VMAX 250F BASE 1024GB 3RD PARTY	ES-AF	\$0
ES-1024BASE-3PE	VMAX 250 DELL BASE 1024GB 3RD PARTY	ES-AF	\$0
ES-1024BASEEE	VMAX 250 DELL BASE 1024GB	ES-AF	\$0
ES-1024-RET	VMAX 250F 1024GB MEMORY RETURN	ES-AF	\$0
ES-1600MOD	VMAX 250F FLASH MOD 1600	ES-AF	\$0
ES-1600MODCONV	VMAX 250 FLASH MOD 1600 CONVERSION	ES-AF	\$0
ES-1600MODU	VMAX 250F FLASH MOD 1600 UPG	ES-AF	\$0
ES-1600MODUF	VMAX 250F FLASH MOD 1600 CONV	ES-AF	\$0
ES-2048ADD	VMAX 250F ADD 2048GB	ES-AF	\$0
ES-2048ADD-3P	VMAX 250F ADD 2048GB 3RD PARTY	ES-AF	\$0
ES-2048ADD-3PE	VMAX 250 DELL ADD 2048GB 3RD PARTY	ES-AF	\$0
ES-2048ADDE	VMAX 250 DELL ADD 2048GB	ES-AF	\$0
ES-2048ADDU	VMAX 250F ADD 2048GB UPG	ES-AF	\$0
ES-2048ADDU-3P	VMAX 250F ADD 2048GB 3RD PARTY UPG	ES-AF	\$0
ES-2048ADDU-3PE	VMAX 250 DELL ADD 2048GB 3RD PARTY UPG	ES-AF	\$0
ES-2048ADDUE	VMAX 250 DELL ADD 2048GB UPG	ES-AF	\$0
ES-2048ADDUFD	VMAX 250F ADD 2048GB UPG FIELD	ES-AF	\$0
ES-2048ADDUFD-3P	VMAX 250F ADD 2048GB 3RD PARTY UPG FIELD	ES-AF	\$0
ES-2048ADDUFD-3PE	VMAX 250 DELL ADD 2048GB 3RD PART UPG FD	ES-AF	\$0
ES-2048ADDUFDE	VMAX 250 DELL ADD 2048GB UPG FD	ES-AF	\$0
ES-2048BASE	VMAX 250F BASE 2048GB	ES-AF	\$0
ES-2048BASE-3P	VMAX 250F BASE 2048GB 3RD PARTY	ES-AF	\$0
ES-2048BASE-3PE	VMAX 250 DELL BASE 2048GB 3RD PARTY	ES-AF	\$0
ES-2048BASEEE	VMAX 250 DELL BASE 2048GB	ES-AF	\$0
ES-256ADD	VMAX 250F ADD 256GB	ES-AF	\$0
ES-256ADD-3P	VMAX 250F ADD 256GB 3RD PARTY	ES-AF	\$0
ES-256ADD-3PE	VMAX 250 DELL ADD 256GB 3RD PARTY	ES-AF	\$0
ES-256ADDE	VMAX 250 DELL ADD 256GB	ES-AF	\$0
ES-256ADDU	VMAX 250F ADD 256GB UPG	ES-AF	\$0
ES-256ADDU-3P	VMAX 250F ADD 256GB 3RD PARTY UPG	ES-AF	\$0
ES-256ADDU-3PE	VMAX 250 DELL ADD 256GB 3RD PARTY UPG	ES-AF	\$0
ES-256ADDUE	VMAX 250 DELL ADD 256GB UPG	ES-AF	\$0
ES-256ADDUFD	VMAX 250F ADD 256GB UPG FIELD	ES-AF	\$0
ES-256ADDUFD-3P	VMAX 250F ADD 256GB 3RD PARTY UPG FIELD	ES-AF	\$0
ES-256ADDUFD-3PE	VMAX 250 DELL ADD 256GB 3RD PARTY UPG FD	ES-AF	\$0
ES-256ADDUFDE	VMAX 250 DELL ADD 256GB UPG FD	ES-AF	\$0
ES-256BASE	VMAX 250F BASE 256GB	ES-AF	\$0
ES-256BASE-3P	VMAX 250F BASE 256GB 3RD PARTY	ES-AF	\$0
ES-256BASE-3PE	VMAX 250 DELL BASE 256GB 3RD PARTY	ES-AF	\$0
ES-256BASEEE	VMAX 250 DELL BASE 256GB	ES-AF	\$0
ES-256-RET	VMAX 250F 256GB MEMORY RETURN	ES-AF	\$0
ES-2METERCBL	VMAX 250F 2M CONTIGIB CABLE	ES-AF	\$0
ES-2METERCBL-3P	VMAX 250F 2M CONTIGIB CABLE 3RD PARTY	ES-AF	\$0
ES-2METERCBL-3PU	VMAX 250F 2M CONTIGIB CABLE 3RD PARTY UP	ES-AF	\$0
ES-2METERCBLUF	VMAX 250F 2M CONTIGIB CABLE FD UPG	ES-AF	\$0
ES-2UF-UFD-3P	VMAX 250 2U FILLER PANEL KIT 3RD PARTY	ES-AF	\$0
ES-512-1024UFD	VMAX 250F MEMCONV 2X256 to 2X512 GB	ES-AF	\$204,800
ES-512-2048UFD	VMAX 250F MEMCONV 2X256 to 2X1024 GB	ES-AF	\$614,400
ES-512ADD	VMAX 250F ADD 512GB	ES-AF	\$0

ES-512ADD-3P	VMAX 250F ADD 512GB 3RD PARTY	ES-AF	\$0
ES-512ADD-3PE	VMAX 250 DELL ADD 512GB 3RD PARTY	ES-AF	\$0
ES-512ADDE	VMAX 250 DELL ADD 512GB	ES-AF	\$0
ES-512ADDU	VMAX 250F ADD 512GB UPG	ES-AF	\$0
ES-512ADDU-3P	VMAX 250F ADD 512GB 3RD PARTY UPG	ES-AF	\$0
ES-512ADDU-3PE	VMAX 250 DELL ADD 512GB 3RD PARTY UPG	ES-AF	\$0
ES-512ADDUE	VMAX 250 DELL ADD 512GB UPG	ES-AF	\$0
ES-512ADDUFD	VMAX 250F ADD 512GB UPG FIELD	ES-AF	\$0
ES-512ADDUFD-3P	VMAX 250F ADD 512GB 3RD PARTY UPG FIELD	ES-AF	\$0
ES-512ADDUFD-3PE	VMAX 250 DELL ADD 512GB 3RD PARTY UPG FD	ES-AF	\$0
ES-512ADDUFDE	VMAX 250 DELL ADD 512GB UPG FD	ES-AF	\$0
ES-512BASE	VMAX 250F BASE 512GB	ES-AF	\$0
ES-512BASE-3P	VMAX 250F BASE 512GB 3RD PARTY	ES-AF	\$0
ES-512BASE-3PE	VMAX 250 DELL BASE 512GB 3RD PARTY	ES-AF	\$0
ES-512BASEE	VMAX 250 DELL BASE 512GB	ES-AF	\$0
ES-512-RET	VMAX 250F 512GB MEMORY RETURN	ES-AF	\$0
ES-800MOD	VMAX 250F FLASH MOD 800	ES-AF	\$0
ES-800MODU	VMAX 250F FLASH MOD 800 UPG	ES-AF	\$0
ES-800MODUF	VMAX 250F FLASH MOD 800 CONV	ES-AF	\$0
ES-ACON3P-50	ADPTR AC 3PH 50A W3-4IN CONDUIT ADPTR	ES-AF	\$0
ES-BK40000E	VMAX 250F FC BACKUP I/O FOR NAS	ES-AF	\$2,100
ES-BK40000EU	VMAX 250F FC BACKUP I/O FOR NAS UPG	ES-AF	\$5,460
ES-BK40000EUF	VMAX 250F FC BACKUP I/O FOR NAS CONV	ES-AF	\$19,110
ES-BLNK-SKINS	VMAX 250F SIDE PANELS BLANK	ES-AF	\$0
ES-BLNK-SKINSU	VMAX 250F SIDE PANELS BLANK UPG	ES-AF	\$0
ES-CAPF	VMAX 250F CAPACITY	ES-AF	\$12,990
ES-CAPFU	VMAX 250F CAPACITY UPG	ES-AF	\$15,590
ES-CAPX	VMAX 250FX CAPACITY	ES-AF	\$17,245
ES-CAPXU	VMAX 250FX CAPACITY UPG	ES-AF	\$20,695
ES-CNVINF-1PU	VMAX 250 SINGLE PHASE PDP CONVERSION	ES-AF	\$700
ES-CNVINF-3DU	VMAX 250 3P Delta PHASE PDP CONVERSION	ES-AF	\$995
ES-CNVINF-3YU	VMAX 250 3WYE PHASE PDP CONVERSION	ES-AF	\$1,085
ES-COMPRESS	VMAX 250F HDW COMPRESSION	ES-AF	\$0
ES-COMPRESSU	VMAX 250F HDW COMPRESSION UPG	ES-AF	\$0
ES-COMPRESSUF	VMAX 250F HDW COMPRESSION CONV	ES-AF	\$0
ES-CONV-AENG-3P	VMAX 250 EMC TO 3P ADD ENG CONV	ES-AF	\$10,915
ES-CONV-BENG-3P	VMAX 250 EMC TO 3P BASE ENG CONV	ES-AF	\$12,180
ES-CONV-SKINS	VMAX 250F SIDE PANELS CONV	ES-AF	\$1,295
ES-CONV-SKINSU	VMAX 250F SIDE PANELS CONV UPG	ES-AF	\$1,295
ES-CONV-SYS1-1P	VMAX 250F 3P TO EMC SYS BAY1 1P CONV	ES-AF	\$16,000
ES-CONV-SYS1-3D	VMAX 250F 3P TO EMC SYS BAY1 3D CONV	ES-AF	\$16,445
ES-CONV-SYS1-3Y	VMAX 250F 3P TO EMC SYS BAY1 3Y CONV	ES-AF	\$16,620
ES-DATAMOVER	VMAX 250 DATA MOVER FOR NAS	ES-AF	\$0
ES-DATAMOVERU	VMAX 250 DATA MOVER FOR NAS UPG	ES-AF	\$0
ES-DE25-3P	VMAX 250F DAISY 25 SLT DR ENCL 3RD PARTY	ES-AF	\$0
ES-DE25-DC	VMAX 250F DAISY 25 SLT DR ENCL	ES-AF	\$0
ES-DE25-DIR	VMAX 250F DIRECT 25 SLT DR ENCL	ES-AF	\$0
ES-DE25-DIR-3P	VMAX 250 DIRECT 25 SLT DR ENCL 3RD PARTY	ES-AF	\$0
ES-DE25-DIR-UFD	VMAX 250F 25 SLT DR ENCL FIELD UPG	ES-AF	\$0
ES-DE25-DIR-UFD-3P	VMAX 250 DIRECT 25 SLT DR ENCL 3RD P UPG	ES-AF	\$0

ES-DE25-UFD	VMAX 250F 25 SLT DR ENCL FIELD UPG	ES-AF	\$0
ESF-BEDIR	VMAX 250 DIR F	ES-AF	\$9,750
ESF-BEDIRU	VMAX 250 DIR F UPG	ES-AF	\$9,750
ESF-BEDIRUFD	VMAX 250 DIR F FD UPG	ES-AF	\$9,750
ES-FDOORS1DKEYE	VMAX 250 SB1 Dual Engine Key Dell Door	ES-AF	\$5,595
ES-FDOORSYS1DE	VMAX 250 SB1 Dual Engine Hex Dell Door	ES-AF	\$5,595
ES-FE00200TC	VMAX 250F 2PT 10 GBE BASE T	ES-AF	\$2,200
ES-FE00200TO	VMAX 250F 2PT 10 GBE OPTICAL	ES-AF	\$2,100
ES-FE00200TOU	VMAX 250F 2PT 10 GBE OPTICAL UPG	ES-AF	\$5,460
ES-FE00200TOUF	VMAX 250F 2PT 10 GBE OPTICAL CONV	ES-AF	\$9,555
ES-FE00200TU	VMAX 250F 2PT 10 GBE BASE T UPG	ES-AF	\$5,720
ES-FE00200TUF	VMAX 250F 2PT 10 GBE BASE T CONV	ES-AF	\$20,020
ES-FE00400C	VMAX 250 4PT GBE BASE T	ES-AF	\$2,000
ES-FE00400C4	VMAX 250 4MM4 COPR GIGE	ES-AF	\$1,980
ES-FE00400C4U	VMAX 250 4MM4 COPR GIGE UPG	ES-AF	\$2,575
ES-FE00400C4UF	VMAX 250 4MM4 COPR GIGE CONV	ES-AF	\$9,000
ES-FE00400C4UFX	VMAX VG2 4MM4COPR FD UPG	ES-AF	\$0
ES-FE00400CFUX	VMAX VG2 4MM4COPR UPG	ES-AF	\$0
ES-FE00400CU	VMAX 250 4PT GBE BASE T UPG	ES-AF	\$5,200
ES-FE00400CUF	VMAX 250 4PT GBE BASE T CONV	ES-AF	\$18,200
ES-FE00400T	VMAX 250 4MM 10 GIGE	ES-AF	\$3,650
ES-FE00400TOUF	VMAX 250F 4MM 10 GIGE OPTICAL CONV	ES-AF	\$19,110
ES-FE00400TU	VMAX 250 4MM 10 GIGE UPG	ES-AF	\$4,745
ES-FE00400TUF	VMAX 250 4MM 10 GIGE CONV	ES-AF	\$16,600
ES-FE00800T	VMAX 250F 8MM 10GIGE	ES-AF	\$5,475
ES-FE00800TU	VMAX 250F 8MM 10GIGE UPG	ES-AF	\$7,120
ES-FE00800TUF	VMAX 250F 8MM 10GIGE CONV	ES-AF	\$24,920
ES-FE00800TUFX	VMAX VG2 8MM 10 GIGE FD UPG	ES-AF	\$0
ES-FE00800TUX	VMAX VG2 8MM 10 GIGE UPG	ES-AF	\$0
ES-FE08000E	VMAX 250F 8SM 8G FIBRE	ES-AF	\$4,140
ES-FE08000EU	VMAX 250F 8SM 8G FIBRE UPG	ES-AF	\$5,385
ES-FE08000EUF	VMAX 250F 8SM 8G FIBRE CONV	ES-AF	\$18,250
ES-FE08000S	VMAX 250F 8SM 16G FC	ES-AF	\$10,805
ES-FE08000SU	VMAX 250F 8SM 16G FC UPG	ES-AF	\$14,045
ES-FE08000SUF	VMAX 250F 8SM 16G FC CONV	ES-AF	\$32,410
ES-FE44000E	VMAX 250F 4MM4SM 8G FIBRE	ES-AF	\$3,315
ES-FE44000EU	VMAX 250F 4MM4SM 8G FIBRE UPG	ES-AF	\$4,310
ES-FE44000EUF	VMAX 250F 4MM4SM 8G FIBRE CONV	ES-AF	\$13,270
ES-FE62000E	VMAX 250F 6MM2SM 8G FIBRE	ES-AF	\$2,395
ES-FE62000EU	VMAX 250F 6MM2SM 8G FIBRE UPG	ES-AF	\$3,115
ES-FE62000UF	VMAX 250F 6MM2SM 8G FIBRE CONV	ES-AF	\$9,335
ES-FE80000E	VMAX 250F 8MM 8G FIBRE	ES-AF	\$2,070
ES-FE80000EU	VMAX 250F 8MM 8G FIBRE UPG	ES-AF	\$2,690
ES-FE80000EUF	VMAX 250F 8MM 8G FIBRE CONV	ES-AF	\$8,285
ES-FE80000EUFX	VMAX VG2 8MM 8G FIBRE FD UPG	ES-AF	\$0
ES-FE80000EUX	VMAX VG2 8MM 8G FIBRE UPG	ES-AF	\$0
ES-FE80000S	VMAX 250F 8MM 16G FC	ES-AF	\$5,400
ES-FE80000SU	VMAX 250F 8MM 16G FC UPG	ES-AF	\$14,045
ES-FE80000SUF	VMAX 250F 8MM 16G FC CONV	ES-AF	\$21,645
ES-FE80000SUFX	VMAX VG2 8MM 16G FIBRE FD UPG	ES-AF	\$0

ES-FE80000SUX	VMAX VG2 8MM 16G FIBRE UPG	ES-AF	\$0
ESF-NAS-SN	Embedded NAS Base OE for VMAX 250F	ES-AF	\$85,000
ESF-NAS-SNU	Embedded NAS Base OE for VMAX 250F UPG	ES-AF	\$85,000
ES-IB	VMAX 250F FABRIC	ES-AF	\$0
ES-IBU	VMAX 250F FABRIC UPG	ES-AF	\$0
ES-IBUFD	VMAX 250F FABRIC CONV	ES-AF	\$0
ES-MODEM	VMAX 250 ZBA MODEM LEAD FREE	ES-AF	\$1,105
ES-PC3YAFLA	32A 3PHASE WYE CORD SET IEC309-AMER	ES-AF	\$0
ES-PC3YAFLE	32A 3PHASE WYE CRD SET FLY LEAD EUROPE	ES-AF	\$0
ES-PCBL3DHH	PWR CBL HBL-HBL 3D	ES-AF	\$0
ES-PCBL3DHR	PWR CBL HBL-RSTOL 3D	ES-AF	\$0
ES-PCBL3YAG	INTL 3PHASE 32 AMP IEC309 TO GARO	ES-AF	\$0
ES-PCBL3YL23P	24A 3PH WYE L22-30P	ES-AF	\$0
ES-PSNT-1P	VMAX 250F SYS BAY1 1P PSNT	ES-AF	\$0
ES-PSNT-3D	VMAX 250F SYS BAY1 3D PSNT	ES-AF	\$0
ES-PSNT-3P-1P	VMAX 250F SYS BAY1 1P 3RD PARTY PSNT	ES-AF	\$0
ES-PSNT-3P-3D	VMAX 250F SYS BAY1 3D 3RD PARTY PSNT	ES-AF	\$0
ES-PSNT-3P-3Y	VMAX 250F SYS BAY1 3Y 3RD PARTY PSNT	ES-AF	\$0
ES-PSNT-3Y	VMAX 250F SYS BAY1 3Y PSNT	ES-AF	\$0
ES-PW40UASTL	30A 1PHASE AUSIP57 CLIPSAL 56PA332	ES-AF	\$0
ES-PW40UIEC3	VMAX VG30A 1PHASE INTERNATNLIEC309-332P	ES-AF	\$0
ES-PW40URUS	30A 1PH RUSSELLSTOLL 3750DP	ES-AF	\$0
ES-PW40U-US	VMAX VG 30A 1PHASE NAMER JAPAN I6-30P	ES-AF	\$0
ES-PWRKIT-1P	SINGLE PHASE PDU/PDP KIT	ES-AF	\$1,575
ES-PWRKIT-1PU	SINGLE PHASE PDU/PDP KIT UPG	ES-AF	\$1,575
ES-PWRKIT-3D	3P DELTA PHASE PDU/PDP KIT	ES-AF	\$1,870
ES-PWRKIT-3DU	3P DELTA PHASE PDU/PDP KIT UPG	ES-AF	\$1,870
ES-PWRKIT-3Y	3WYE PHASE PDU/PDP KIT	ES-AF	\$1,960
ES-PWRKIT-3YU	3WYE PHASE PDU/PDP KIT UPG	ES-AF	\$1,960
ES-SECURE	SECURE KIT SINGLE BAY	ES-AF	\$2,570
ES-SECUREJK	SECURE JOINING KIT	ES-AF	\$1,685
ES-SKINS	VMAX 250F SIDE PANELS	ES-AF	\$0
ES-SKINSU	VMAX 250F SIDE PANELS UPG	ES-AF	\$0
ES-SYS1-1P	VMAX 250F SYS BAY1 1P	ES-AF	\$0
ES-SYS1-3D	VMAX 250F SYS BAY1 3D	ES-AF	\$0
ES-SYS1-3Y	VMAX 250F SYS BAY1 3Y	ES-AF	\$0
ES-TELCO	VMAX 250 ZBA INTL TELCO KIT	ES-AF	\$70
ES-TOP-KIT	TOP ROUTING KIT	ES-AF	\$500
ES-VBF-1024	VMAX 250F VBRCK BASE 1024GB	ES-AF	\$349,140
ES-VBF-1024-ADD	VMAX 250F VBRCK ADD 1024GB	ES-AF	\$349,140
ES-VBF-1024-ADDU	VMAX 250F VBRCK ADD 1024GB UPG	ES-AF	\$418,970
ES-VBF-1024-ADDUFD	VMAX 250F VBRCK ADD 1024GB UFD	ES-AF	\$418,970
ES-VBF-2048	VMAX 250F VBRCK BASE 2048GB	ES-AF	\$565,405
ES-VBF-2048-ADD	VMAX 250F VBRCK ADD 2048GB	ES-AF	\$565,405
ES-VBF-2048-ADDU	VMAX 250F VBRCK ADD 2048GB UPG	ES-AF	\$678,485
ES-VBF-2048-ADDUFD	VMAX 250F VBRCK ADD 2048GB UFD	ES-AF	\$678,485
ES-VBF-512	VMAX 250F VBRCK BASE 512GB	ES-AF	\$340,155
ES-VBF-512-ADD	VMAX 250F VBRCK ADD 512GB	ES-AF	\$340,155
ES-VBF-512-ADDU	VMAX 250F VBRCK ADD 512GB UPG	ES-AF	\$408,185
ES-VBF-512-ADDUFD	VMAX 250F VBRCK ADD 512GB UFD	ES-AF	\$408,185

ES-VBX-1024	VMAX 250FX VBRICK BASE 1024GB	ES-AF	\$395,945
ES-VBX-1024-ADD	VMAX 250FX VBRCK ADD 1024GB	ES-AF	\$395,945
ES-VBX-1024-ADDU	VMAX 250FX VBRCK ADD 1024GB UPG	ES-AF	\$475,135
ES-VBX-1024-ADDUFD	VMAX 250FX VBRCK ADD 1024GB UFD	ES-AF	\$475,135
ES-VBX-2048	VMAX 250FX VBRCK BASE 2048GB	ES-AF	\$612,210
ES-VBX-2048-ADD	VMAX 250FX VBRCK ADD 2048GB	ES-AF	\$612,210
ES-VBX-2048-ADDU	VMAX 250FX VBRCK ADD 2048GB UPG	ES-AF	\$734,650
ES-VBX-2048-ADDUFD	VMAX 250FX VBRCK ADD 2048GB UFD	ES-AF	\$734,650
ES-VBX-512	VMAX 250FX VBRCK BASE 512GB	ES-AF	\$386,960
ES-VBX-512-ADD	VMAX 250FX VBRCK ADD 512GB	ES-AF	\$386,960
ES-VBX-512-ADDU	VMAX 250FX VBRCK ADD 512GB UPG	ES-AF	\$464,350
ES-VBX-512-ADDUFD	VMAX 250FX VBRCK ADD 512GB UFD	ES-AF	\$464,350
ESX-BEDIR	VMAX 250 DIR FX	ES-AF	\$0
ESX-BEDIRU	VMAX 250 DIR FX UPG	ES-AF	\$0
ESX-BEDIRUFD	VMAX 250 DIR FX FD UPG	ES-AF	\$0
ESX-NAS-SN	Embedded NAS Base OE for VMAX 250X	ES-AF	\$0
ESX-NAS-SNU	Embedded NAS Base OE for VMAX 250X UPG	ES-AF	\$0
ET-13UF-UFD-3P	VMAX 950 1U3U FILLER PANEL KIT 3RD PARTY	ES-AF	\$0
ET-1600MOD	VMAX 950 FLASH MOD 1600	ES-AF	\$0
ET-1600MODU	VMAX 950 FLASH MOD 1600 UPG	ES-AF	\$0
ET-1600MODUF	VMAX 950 FLASH MOD 1600 FD UPG	ES-AF	\$0
ET-1UF-3PUFD	VMAX 950 3RD PARTY 1-1U FILLER KIT	ES-AF	\$0
ET-2ENGBEZ-3P	VMAX 950 DUAL ENGINE BEZEL KIT 3RD PARTY	ES-AF	\$0
ET-2ME2DUAL-3P	VMAX 950 ENG 2 IB/ETH 2M CBL KIT 2ENG 3P	ES-AF	\$0
ET-2MENG2CBLUF	VMAX 950 2 MTR 2ND ENG CONTIBÐ CBL UF	ES-AF	\$0
ET-2METERCBL	VMAX 950 2 METER CONTIGIB ETH CABLE	ES-AF	\$0
ET-2METERCBLU	VMAX 950 2 METER CONTIGIB ETH CABLE UPG	ES-AF	\$0
ET-2UF-UFD-3P	VMAX 950 2U FILLER PANEL KIT 3RD PARTY	ES-AF	\$0
ET-3ME3-3P	VMAX 950 ENG 3 IB/ETH 3M CBL KIT 3P	ES-AF	\$0
ET-3ME3-3PUFD	VMAX 950 ENG 3 IB/ETH 3M CBL KIT UPG 3P	ES-AF	\$0
ET-3ME4DUAL-3P	VMAX 950 ENG 4 IB/ETH 3M CBL KIT 2ENG 3P	ES-AF	\$0
ET-3ME5-3P	VMAX 950 ENG 5 IB/ETH 3M CBL KIT 3P	ES-AF	\$0
ET-3ME5-3PUFD	VMAX 950 ENG 5 IB/ETH 3M CBL KIT UPG 3P	ES-AF	\$0
ET-3ME6DUAL-3P	VMAX 950 ENG 6 IB/ETH 3M CBL KIT 2ENG 3P	ES-AF	\$0
ET-3MENG4CBLUF	VMAX 950 3 MTR 2ND ENG CONTIBÐ CBL UF	ES-AF	\$0
ET-3MENG6CBLUF	VMAX 950 3 MTR 2ND ENG CONTIBÐ CBL UF	ES-AF	\$0
ET-3METERCBL	VMAX 950 3 METER CONTIGIB ETH CABLE	ES-AF	\$0
ET-3METERCBLU	VMAX 950 3 METER CONTIGIB ETH CABLE UPG	ES-AF	\$0
ET-3MX2-X6-3PU	VMAX 950 3M IB/ETH CABLE KIT NEW/UPG 3P	ES-AF	\$0
ET-5ME7-3P	VMAX 950 ENG 7 IB/ETH 5M CBL KIT 3P	ES-AF	\$0
ET-5ME7-3PUFD	VMAX 950 ENG 7 IB/ETH 5M CBL KIT UPG 3P	ES-AF	\$0
ET-5ME8DUAL-3P	VMAX 950 ENG 8 IB/ETH 5M CBL KIT 2ENG 3P	ES-AF	\$0
ET-5MENG8CBLUF	VMAX 950 5 MTR 2ND ENG CONTIBÐ CBL UF	ES-AF	\$0
ET-5METERCBL	VMAX 950 5 METER CONTIGIB ETH CABLE	ES-AF	\$0
ET-5METERCBLU	VMAX 950 5 METER CONTIGIB ETH CABLE UPG	ES-AF	\$0
ET-5MX7X8-3PU	VMAX 950 5M IB/ETH CABLE KIT NEW/UPG 3P	ES-AF	\$0
ET-ACON3P-50	ADPTR AC 3PH 50A W3-4IN CONDUIT ADPTR	ES-AF	\$0
ET-BEDIR	VMAX 950 DIR F	ES-AF	\$9,750
ET-BEDIRU	VMAX 950 DIR F UPG	ES-AF	\$9,750
ET-BEDIRUFD	VMAX 950 DIR F FD UPG	ES-AF	\$9,750

ET-BK40000E	VMAX 950 FC BACKUP I/O FOR NAS	ES-AF	\$2,100
ET-BK40000EU	VMAX 950 FC BACKUP I/O FOR NAS UPG	ES-AF	\$5,460
ET-BK40000EUF	VMAX 950 FC BACKUP I/O FOR NAS CONV	ES-AF	\$19,110
ET-CAPF	VMAX 950F CAPACITY	ES-AF	\$13,090
ET-CAPFU	VMAX 950F CAPACITY UPG	ES-AF	\$15,710
ET-CAPX	VMAX 950X CAPACITY	ES-AF	\$18,390
ET-CAPXU	VMAX 950X CAPACITY UPG	ES-AF	\$22,070
ET-CNVINF-1PU	VMAX 950 SINGLE PHASE PDU CONVERSION	ES-AF	\$700
ET-CNVINF-3DU	VMAX 950 3 PHASE DELTA PDU CONVERSION	ES-AF	\$995
ET-CNVINF-3YU	VMAX 950 3 PHASE WYE PDU CONVERSION	ES-AF	\$1,085
ET-COMPRESS	VMAX 950 HDW COMPRESSION	ES-AF	\$0
ET-COMPRESSF	VMAX 950 HDW COMPRESSION FD UPG	ES-AF	\$0
ET-COMPRESSU	VMAX 950 HDW COMPRESSION UPG	ES-AF	\$0
ET-DE120	VMAX 950 120 SLT DR ENCL	ES-AF	\$0
ET-DE120-3P	VMAX 950 120 SLT DR ENCL 3RD PARTY	ES-AF	\$0
ET-DE120U	VMAX 950 120 SLT DR ENCL UPG	ES-AF	\$0
ET-DE120U-3P	VMAX 950 120 SLT DR ENCL UPG 3RD PARTY	ES-AF	\$0
ET-DE120UFD	VMAX 950 120 SLT DR ENCL UFD	ES-AF	\$0
ET-DE120UFD-3P	VMAX 950 120 SLT DR ENCL UFD 3RD PARTY	ES-AF	\$0
ET-DIR3MCBL	VMAX 950 DIRECT CONNECT 3 METER	ES-AF	\$0
ET-DIR3MCBLU	VMAX 950 DIRECT CONNECT 3 METER UPG	ES-AF	\$0
ET-DIR3MCBLUF1	VMAX 950 DC 3 METER DAE1 FD UPG	ES-AF	\$0
ET-DIR3MCBLUF2	VMAX 950 DC 3 METER DAE2 FD UPG	ES-AF	\$0
ET-DIR3MCBLUF3	VMAX 950 STD 1 ENG DAE3 (DIRECT A) UPG	ES-AF	\$0
ET-DIR3MCBLUF4	VMAX 950 STD 1 ENG DAE 4 (DIRECT B) UPG	ES-AF	\$0
ET-DSOPTICE2	VMAX 950 SYS BAY 2 DSP CBLOPTICS KIT	ES-AF	\$15,285
ET-DSOPTICE2U	VMAX 950 SYS BAY 2 DSP CBLOPTICS KIT UPG	ES-AF	\$15,285
ET-DSOPTICE3	VMAX 950 SYS BAY 2 DSP CBLOPTICS KIT	ES-AF	\$15,285
ET-DSOPTICE3U	VMAX 950 SYS BAY 2 DSP CBLOPTICS KIT UPG	ES-AF	\$15,285
ET-DSOPTICE4	VMAX 950 SYS BAY 2 DSP CBLOPTICS KIT	ES-AF	\$15,285
ET-DSOPTICE4U	VMAX 950 SYS BAY 2 DSP CBLOPTICS KIT UPG	ES-AF	\$15,825
ET-DSOPTICE5	VMAX 950 SYS BAY 3 DSP CBLOPTICS KIT	ES-AF	\$15,285
ET-DSOPTICE5U	VMAX 950 SYS BAY 3 DSP CBLOPTICS KIT UPG	ES-AF	\$15,825
ET-DSOPTICE6	VMAX 950 SYS BAY 3 DSP CBLOPTICS KIT	ES-AF	\$15,285
ET-DSOPTICE6U	VMAX 950 SYS BAY 3 DSP CBLOPTICS KIT UPG	ES-AF	\$15,825
ET-DSOPTICE7	VMAX 950 SYS BAY 4 DSP CBLOPTICS KIT	ES-AF	\$15,285
ET-DSOPTICE7U	VMAX 950 SYS BAY 4 DSP CBLOPTICS KIT UPG	ES-AF	\$15,825
ET-DSOPTICE8	VMAX 950 SYS BAY 4 DSP CBLOPTICS KIT	ES-AF	\$15,285
ET-DSOPTICE8U	VMAX 950 SYS BAY 4 DSP CBLOPTICS KIT UPG	ES-AF	\$15,825
ET-FABR	VMAX 950 FABRIC	ES-AF	\$0
ET-FABR-3P	VMAX 950 FABRIC 3RD PARTY	ES-AF	\$0
ET-FABR-UFD	VMAX 950 FABRIC UPGRADE	ES-AF	\$0
ET-FABR-UFD-3P	VMAX 950 FABRIC UPGRADE 3RD PARTY	ES-AF	\$0
ET-FDOORS1DKEY	SB1 950 Dual Engine Key Front Door	ES-AF	\$0
ET-FDOORS1DKEYE	SB1 Dual Engine Key Dell Door	ES-AF	\$0
ET-FDOORS28DKEY	SB2-8 950 Dual Engine Key Front Door	ES-AF	\$0
ET-FDOORS28DKEYE	SB2-8 Dual Engine Key Dell Door	ES-AF	\$0
ET-FDOORSYS1D	SB1 950 Dual Engine Hex Front Door	ES-AF	\$0
ET-FDOORSYS1DE	SB1 Dual Engine Hex Dell Door	ES-AF	\$0
ET-FDOORSYS28D	SB2-8 950 Dual Engine Hex Front Door	ES-AF	\$0

ET-FDOORSYS28DE	SB2-8 Dual Engine Hex Dell Door	ES-AF	\$0
ET-FDOORSYS28DU	SB2-8 950 Dual Engine Hex Door Pair Upg	ES-AF	\$0
ET-FDOORSYS28DUE	SB2-8 Dual Engine Hex Dell Door Upg	ES-AF	\$0
ET-FE00008S	VMAX 950 8SM 16G FICON	ES-AF	\$15,575
ET-FE00008SU	VMAX 950 8SM 16G FICON UPG	ES-AF	\$20,250
ET-FE00008SUF	VMAX 950 8SM 16G FICON CONV	ES-AF	\$18,250
ET-FE00080S	VMAX 950 8MM 16G FICON	ES-AF	\$7,150
ET-FE00080SU	VMAX 950 8MM 16G FICON UPG	ES-AF	\$9,295
ET-FE00080SUF	VMAX 950 8MM 16G FICON CONV	ES-AF	\$31,520
ET-FE00200TC	VMAX 950 2PT 10 GBE BASE T	ES-AF	\$2,200
ET-FE00200TCU	VMAX 950 2PT?10 GBE BASE T UPG	ES-AF	\$5,720
ET-FE00200TCUF	VMAX 950 2PT?10 GBE BASE T CONV	ES-AF	\$10,010
ET-FE00200TO	VMAX 950 2PT 10 GBE OPTICAL	ES-AF	\$2,100
ET-FE00200TOU	VMAX 950 2PT 10 GBE OPTICAL UPG	ES-AF	\$5,460
ET-FE00200TOUF	VMAX 950 4MM 10 GIGE OPTICAL CONV	ES-AF	\$9,555
ET-FE00400C4	VMAX 950 4MM4COPR	ES-AF	\$1,980
ET-FE00400C4U	VMAX 950 4MM4COPR UPG	ES-AF	\$2,575
ET-FE00400C4UF	VMAX 950 4MM4COPR CONV	ES-AF	\$9,000
ET-FE00400C4UFX	VMAX VGL 4MM4COPR FD UPG	ES-AF	\$0
ET-FE00400CFUX	VMAX VGL 4MM4COPR UPG	ES-AF	\$0
ET-FE00800T	VMAX 950 8MM 10GIGE	ES-AF	\$5,475
ET-FE00800TU	VMAX 950 8MM 10GIGE UPG	ES-AF	\$7,120
ET-FE00800TUF	VMAX 950 8MM 10GIGE CONV	ES-AF	\$24,920
ET-FE00800TUFX	VMAX VGL 8MM 10 GIGE FD UPG	ES-AF	\$0
ET-FE00800TUX	VMAX VGL 8MM 10 GIGE UPG	ES-AF	\$0
ET-FE08000E	VMAX 950 8SM 8G FIBRE	ES-AF	\$4,140
ET-FE08000EU	VMAX 950 8SM 8G FIBRE UPG	ES-AF	\$5,380
ET-FE08000EUF	VMAX 950 8SM 8G FIBRE CONV	ES-AF	\$18,950
ET-FE08000S	VMAX 950 8SM 16G FC	ES-AF	\$10,805
ET-FE08000SU	VMAX 950 8SM 16G FC UPG	ES-AF	\$14,045
ET-FE08000SUF	VMAX 950 8SM 16G FC CONV	ES-AF	\$32,410
ET-FE44000E	VMAX 950 4MM4SM 8G FIBRE	ES-AF	\$3,315
ET-FE44000EU	VMAX 950 4MM4SM 8G FIBRE UPG	ES-AF	\$4,310
ET-FE44000EUF	VMAX 950 4MM4SM 8G FIBRE CONV	ES-AF	\$13,270
ET-FE62000E	VMAX 950 6MM2SM 8G FIBRE	ES-AF	\$2,395
ET-FE62000EU	VMAX 950 6MM2SM 8G FIBRE UPG	ES-AF	\$3,115
ET-FE62000UF	VMAX 950 6MM2SM 8G FIBRE CONV	ES-AF	\$9,335
ET-FE80000E	VMAX 950 8MM 8G FIBRE	ES-AF	\$2,070
ET-FE80000EU	VMAX 950 8MM 8G FIBRE UPG	ES-AF	\$2,690
ET-FE80000EUF	VMAX 950 8MM 8G FIBRE CONV	ES-AF	\$8,285
ET-FE80000EUFX	VMAX VGL 8MM 8G FIBRE FD UPG	ES-AF	\$0
ET-FE80000EUX	VMAX VGL 8MM 8G FIBRE UPG	ES-AF	\$0
ET-FE80000S	VMAX 950 8MM 16G FC	ES-AF	\$5,400
ET-FE80000SU	VMAX 950 8MM 16G FC UPG	ES-AF	\$14,045
ET-FE80000SUF	VMAX 950 8MM 16G FC CONV	ES-AF	\$21,645
ET-FE80000SUFX	VMAX VGL 8MM 16G FIBRE FD UPG	ES-AF	\$0
ET-FE80000SUX	VMAX VGL 8MM 16G FIBRE UPG	ES-AF	\$0
ET-PC3YAFLA	32A 3PHASE WYE CORD SET IEC309-AMER	ES-AF	\$0
ET-PC3YAFLE	32A 3PHASE WYE CRD SET FLY LEAD EUROPE	ES-AF	\$0
ET-PCBL3DHH	VMAX 950 PWR CBL HBL-HBL 3D	ES-AF	\$0

ET-PCBL3DHR	VMAX 950 PWR CBL HBL-RSTOL 3D	ES-AF	\$0
ET-PCBL3YAG	INTL 3PHASE 32 AMP IEC309 TO GARO	ES-AF	\$0
ET-PCBL3YL23P	24A 3PH WYE L22-30P	ES-AF	\$0
ET-PDU1P	VMAX 950 SINGLE PHASE PDU 3RD PARTY	ES-AF	\$0
ET-PDUDELTA	VMAX 950 3 PHASE DELTA PDU 3RD PARTY	ES-AF	\$0
ET-PDUWYE	VMAX 950 3 PHASE WYE PDU 3RD PARTY	ES-AF	\$0
ET-PW40UASTL	30A 1PHASE AUSIP57 CLIPSAL 56PA332	ES-AF	\$0
ET-PW40UIEC3	VMAX 30A 1PHASE INTERNATNLIEC309-332P6	ES-AF	\$0
ET-PW40URUS	30A 1PH RUSSELLSTOLL 3750DP	ES-AF	\$0
ET-PW40U-US	VMAX 950 30A 1PHASE NAMER JAPAN I6-30P	ES-AF	\$0
ET-SKINS	VMAX 950 SIDE PANELS	ES-AF	\$0
ET-SKINSU	VMAX 950 SIDE PANELS UPG	ES-AF	\$0
ET-SYS13RDPT	VMAX 950 1ENG SYSTEM BAY SHIPPING RACK	ES-AF	\$0
ET-SYS1R-1P	VMAX 950 SYS BAY1 1P	ES-AF	\$0
ET-SYS1R-3D	VMAX 950 SYS BAY1 3D	ES-AF	\$0
ET-SYS1R-3P-1P	VMAX 950 SYS BAY1 1P 3RD PARTY	ES-AF	\$0
ET-SYS1R-3P-3D	VMAX 950 SYS BAY1 3D 3RD PARTY	ES-AF	\$0
ET-SYS1R-3P-3Y	VMAX 950 SYS BAY1 3Y 3RD PARTY	ES-AF	\$0
ET-SYS1R-3PE-1P	VMAX 950 SYS BAY1 1P 3RD PARTY	ES-AF	\$0
ET-SYS1R-3PE-3D	VMAX 950 SYS BAY1 3D 3RD PARTY	ES-AF	\$0
ET-SYS1R-3PE-3Y	VMAX 950 SYS BAY1 3Y 3RD PARTY	ES-AF	\$0
ET-SYS1R-3Y	VMAX 950 SYS BAY1 3Y	ES-AF	\$0
ET-SYS1R-VCE-1P	VMAX 950 SYS BAY1 1P VXBLOCK 3P	ES-AF	\$0
ET-SYS1R-VCE-3D	VMAX 950 SYS BAY1 3D VXBLOCK 3P	ES-AF	\$0
ET-SYS1R-VCE-3Y	VMAX 950 SYS BAY1 3Y VXBLOCK 3P	ES-AF	\$0
ET-SYS1R-VCEE-1P	VMAX 950 SYS BAY1 1P VXBLOCK 3P	ES-AF	\$0
ET-SYS1R-VCEE-3D	VMAX 950 SYS BAY1 3D VXBLOCK 3P	ES-AF	\$0
ET-SYS1R-VCEE-3Y	VMAX 950 SYS BAY1 3Y VXBLOCK 3P	ES-AF	\$0
ET-SYS23RDPT	VMAX 950 2ENG SYSTEM BAY SHIPPING RACK	ES-AF	\$0
ET-SYSADD1P	VMAX 950 ADD SYS BAY 1P	ES-AF	\$0
ET-SYSADD1P-3P	VMAX 950 ADD SYS BAY 1P 3RD PARTY	ES-AF	\$0
ET-SYSADD1P-3PE	VMAX 950 ADD SYS BAY 1P 3RD PARTY	ES-AF	\$0
ET-SYSADD1PU	VMAX 950 ADD SYS BAY 1P UPG	ES-AF	\$0
ET-SYSADD1PU3P	VMAX 950 ADD SYS BAY 1P UPG 3RD PARTY	ES-AF	\$0
ET-SYSADD1PU3PE	VMAX 950 ADD SYS BAY 1P UPG 3RD PARTY	ES-AF	\$0
ET-SYSADD1PUVCE	VMAX 950 ADD SYS BAY 1P UPG VXBLOCK 3P	ES-AF	\$0
ET-SYSADD1PUVCEE	VMAX 950 ADD SYS BAY 1P UPG VXBLOCK 3P	ES-AF	\$0
ET-SYSADD1P-VCE	VMAX 950 ADD SYS BAY 1P VXBLOCK 3P	ES-AF	\$0
ET-SYSADD1P-VCEE	VMAX 950 ADD SYS BAY 1P VXBLOCK 3P	ES-AF	\$0
ET-SYSADD3D	VMAX 950 ADD SYS BAY 3D	ES-AF	\$0
ET-SYSADD3D-3P	VMAX 950 ADD SYS BAY 3D 3RD PARTY	ES-AF	\$0
ET-SYSADD3D-3PE	VMAX 950 ADD SYS BAY 3D 3RD PARTY	ES-AF	\$0
ET-SYSADD3DU	VMAX 950 ADD SYS BAY 3D UPG	ES-AF	\$0
ET-SYSADD3DU3P	VMAX 950 ADD SYS BAY 3D UPG 3RD PARTY	ES-AF	\$0
ET-SYSADD3DU3PE	VMAX 950 ADD SYS BAY 3D UPG 3RD PARTY	ES-AF	\$0
ET-SYSADD3DUVCE	VMAX 950 ADD SYS BAY 3D UPG VXBLOCK 3P	ES-AF	\$0
ET-SYSADD3DUVCEE	VMAX 950 ADD SYS BAY 3D UPG VXBLOCK 3P	ES-AF	\$0
ET-SYSADD3D-VCE	VMAX 950 ADD SYS BAY 3D VXBLOCK 3P	ES-AF	\$0
ET-SYSADD3D-VCEE	VMAX 950 ADD SYS BAY 3D VXBLOCK 3P	ES-AF	\$0
ET-SYSADD3Y	VMAX 950 ADD SYS BAY 3Y	ES-AF	\$0

ET-SYSADD3Y-3P	VMAX 950 ADD SYS BAY 3Y 3RD PARTY	ES-AF	\$0
ET-SYSADD3Y-3PE	VMAX 950 ADD SYS BAY 3Y 3RD PARTY	ES-AF	\$0
ET-SYSADD3YU	VMAX 950 ADD SYS BAY 3Y UPG	ES-AF	\$0
ET-SYSADD3YU3P	VMAX 950 ADD SYS BAY 3Y UPG 3RD PARTY	ES-AF	\$0
ET-SYSADD3YU3PE	VMAX 950 ADD SYS BAY 3Y UPG 3RD PARTY	ES-AF	\$0
ET-SYSADD3YUVCE	VMAX 950 ADD SYS BAY 3Y UPG VXBLOCK 3P	ES-AF	\$0
ET-SYSADD3YUVCEE	VMAX 950 ADD SYS BAY 3Y UPG VXBLOCK 3P	ES-AF	\$0
ET-SYSADD3Y-VCE	VMAX 950 ADD SYS BAY 3Y VXBLOCK 3P	ES-AF	\$0
ET-SYSADD3Y-VCEE	VMAX 950 ADD SYS BAY 3Y VXBLOCK 3P	ES-AF	\$0
ET-VBF-1024	VMAX 950 VBRICK BASE 1024GB	ES-AF	\$1,159,120
ET-VBF-1024-ADD	VMAX 950 VBRICK ADD 1024GB	ES-AF	\$1,159,120
ET-VBF-1024-ADDU	VMAX 950 VBRICK ADD 1024GB UPG	ES-AF	\$1,390,945
ET-VBF-1024-ADDUFD	VMAX 950 VBRICK ADD 1024GB UFD	ES-AF	\$1,390,945
ET-VBF-2048	VMAX 950 VBRICK BASE 2048GB	ES-AF	\$1,702,280
ET-VBF-2048-ADD	VMAX 950 VBRICK ADD 2048GB	ES-AF	\$1,702,280
ET-VBF-2048-ADDU	VMAX 950 VBRICK ADD 2048GB UPG	ES-AF	\$2,042,735
ET-VBF-2048-ADDUFD	VMAX 950 VBRICK ADD 2048GB UFD	ES-AF	\$2,042,735
ET-VBX-1024	VMAX 950 VBRICK BASE 1024GB	ES-AF	\$1,384,635
ET-VBX-1024-ADD	VMAX 950 VBRICK ADD 1024GB	ES-AF	\$1,384,635
ET-VBX-1024-ADDU	VMAX 950 VBRICK ADD 1024GB UPG	ES-AF	\$1,661,560
ET-VBX-1024-ADDUFD	VMAX 950 VBRICK ADD 1024GB UFD	ES-AF	\$1,661,560
ET-VBX-2048	VMAX 950 VBRICK BASE 2048GB	ES-AF	\$1,927,795
ET-VBX-2048-ADD	VMAX 950 VBRICK ADD 2048GB	ES-AF	\$1,927,795
ET-VBX-2048-ADDU	VMAX 950 VBRICK ADD 2048GB UPG	ES-AF	\$2,313,355
ET-VBX-2048-ADDUFD	VMAX 950 VBRICK ADD 2048GB UFD	ES-AF	\$2,313,355
ETX-BEDIR	VMAX 950 DIR FX	ES-AF	\$0
ETX-BEDIRU	VMAX 950 DIR FX UPG	ES-AF	\$0
ETX-BEDIRUFD	VMAX 950 DIR FX FD UPG	ES-AF	\$0
ET-ZBF-1024	VMAX 950 MF VBRICK BASE 1024GB	ES-AF	\$796,035
ET-ZBF-1024-ADD	VMAX 950 MF VBRICK ADD 1024GB	ES-AF	\$796,035
ET-ZBF-1024-ADDU	VMAX 950 MF VBRICK ADD 1024GB UPG	ES-AF	\$955,240
ET-ZBF-1024-ADDUFD	VMAX 950 MF VBRICK ADD 1024GB UFD	ES-AF	\$955,240
ET-ZBF-2048	VMAX 950 MF VBRICK BASE 2048GB	ES-AF	\$1,375,500
ET-ZBF-2048-ADD	VMAX 950 MF VBRICK ADD 2048GB	ES-AF	\$1,375,500
ET-ZBF-2048-ADDU	VMAX 950 MF VBRICK ADD 2048GB UPG	ES-AF	\$1,650,600
ET-ZBF-2048-ADDUFD	VMAX 950 MF VBRICK ADD 2048GB UFD	ES-AF	\$1,650,600
ET-ZBX-1024	VMAX 950 MF VBRICK BASE 1024GB	ES-AF	\$852,140
ET-ZBX-1024-ADD	VMAX 950 MF VBRICK ADD 1024GB	ES-AF	\$852,140
ET-ZBX-1024-ADDU	VMAX 950 MF VBRICK ADD 1024GB UPG	ES-AF	\$1,022,570
ET-ZBX-1024-ADDUFD	VMAX 950 MF VBRICK ADD 1024GB UFD	ES-AF	\$1,022,570
ET-ZBX-2048	VMAX 950 MF VBRICK BASE 2048GB	ES-AF	\$1,431,595
ET-ZBX-2048-ADD	VMAX 950 MF VBRICK ADD 2048GB	ES-AF	\$1,431,595
ET-ZBX-2048-ADDU	VMAX 950 MF VBRICK ADD 2048GB UPG	ES-AF	\$1,717,915
ET-ZBX-2048-ADDUFD	VMAX 950 MF VBRICK ADD 2048GB UFD	ES-AF	\$1,717,915
ET-ZCAPF	VMAX 950F MF CAPACITY	ES-AF	\$12,810
ET-ZCAPFU	VMAX 950F MF CAPACITY UPG	ES-AF	\$15,370
ET-ZCAPX	VMAX 950X MF CAPACITY	ES-AF	\$17,970
ET-ZCAPXU	VMAX 950X MF CAPACITY UPG	ES-AF	\$21,565
F-2-FX-TRIM	FX TRIM UPGRADE	ES-AF	\$0
F-2-ZFX-TRIM	ZFX TRIM UPGRADE	ES-AF	\$0

GF-BK40000EU	VMAX 450 FC BACKUP I/O FOR NAS UPG	ES-AF	\$5,460
GF-BK40000EUF	VMAX 450 FC BACKUP I/O FOR NAS CONV	ES-AF	\$9,555
GF-BK80000EF	VMAX 450 FC BACKUP I/O FOR NAS CONV	ES-AF	\$9,555
GF-COMPRESSF	VMAX 450 HDW COMPRESSION FD UPG	ES-AF	\$0
GF-COMPRESSU	VMAX 450 HDW COMPRESSION UPG	ES-AF	\$0
GF-FE00008SU	VMAX 450 8SM 16G FICON UPG	ES-AF	\$20,250
GF-FE00008SUF	VMAX 450 8SM 16G FICON CONV	ES-AF	\$68,660
GF-FE00080SU	VMAX 450 8MM 16G FICON UPG	ES-AF	\$9,295
GF-FE00080SUF	VMAX 450 8MM 16G FICON CONV	ES-AF	\$31,520
GF-FE00200TCU	VMAX 450 2PT 10 GBE BASE T UPG	ES-AF	\$5,720
GF-FE00200TCUF	VMAX 450 2PT 10 GBE BASE T CONV	ES-AF	\$10,010
GF-FE00200TOU	VMAX 450 2PT 10 GBE OPTICAL UPG	ES-AF	\$5,460
GF-FE00200TOUF	VMAX 450 2PT 10 GIGE OPTICAL CONV	ES-AF	\$9,555
GF-FE00400C4U	VMAX 450 4MM4 COPR GIGE UPG	ES-AF	\$2,575
GF-FE00400C4UF	VMAX 450 4MM4 COPR GIGE CONV	ES-AF	\$9,000
GF-FE00400CU	VMAX 450 4PT GBE BASE T UPG	ES-AF	\$5,200
GF-FE00400CUF	VMAX 450 4M GIGE COPPER CONV	ES-AF	\$9,100
GF-FE00400TOUF	VMAX 450 4MM 10 GIGE OPTICAL CONV	ES-AF	\$9,555
GF-FE00400TU	VMAX 450 4MM 10 GIGE UPG	ES-AF	\$4,745
GF-FE00400TUF	VMAX 450 4MM 10 GIGE CONV	ES-AF	\$16,600
GF-FE00400UF	VMAX 450 4M GIGE CONV	ES-AF	\$24,161
GF-FE00800TU	VMAX 450 8MM 10GIGE UPG	ES-AF	\$7,120
GF-FE00800TUF	VMAX 450 8MM 10GIGE CONV	ES-AF	\$24,920
GF-FE08000EU	VMAX 450 8SM 8G FIBRE UPG	ES-AF	\$5,380
GF-FE08000EUF	VMAX 450 8SM 8G FIBRE CONV	ES-AF	\$18,250
GF-FE08000SU	VMAX 450 8SM 16G FC UPG	ES-AF	\$14,045
GF-FE08000SUF	VMAX 450 8SM 16G FC CONV	ES-AF	\$32,410
GF-FE44000EUF	VMAX 450 4MM4SM 8G FIBRE CONV	ES-AF	\$13,270
GF-FE62000UF	VMAX 450 6MM2SM 8G FIBRE CONV	ES-AF	\$9,335
GF-FE80000EU	VMAX 450 8MM 8G FIBRE UPG	ES-AF	\$2,690
GF-FE80000EUF	VMAX 450 8MM 8G FIBRE CONV	ES-AF	\$8,285
GF-FE80000SU	VMAX 450 8MM 16G FC UPG	ES-AF	\$14,045
GF-FE80000SUF	VMAX 450 8MM 16G FC CONV	ES-AF	\$21,645
HF-BK40000EU	VMAX 850 FC BACKUP I/O FOR NAS UPG	ES-AF	\$5,460
HF-BK40000EUF	VMAX 850 FC BACKUP I/O FOR NAS CONV	ES-AF	\$9,555
HF-BK80000EF	VMAX 850 FC BACKUP I/O FOR NAS CONV	ES-AF	\$9,555
HF-COMPRESSF	VMAX 850 HDW COMPRESSION FD UPG	ES-AF	\$0
HF-COMPRESSU	VMAX 850 HDW COMPRESSION UPG	ES-AF	\$0
HF-FE00008SU	VMAX 850 8SM 16G FICON UPG	ES-AF	\$20,250
HF-FE00008SUF	VMAX 850 8SM 16G FICON CONV	ES-AF	\$68,660
HF-FE00080SU	VMAX 850 8MM 16G FICON UPG	ES-AF	\$9,295
HF-FE00080SUF	VMAX 850 8MM 16G FICON CONV	ES-AF	\$31,520
HF-FE00200TCU	VMAX 850 2PT 10 GBE BASE T UPG	ES-AF	\$5,720
HF-FE00200TCUF	VMAX 850 2PT 10 GBE BASE T CONV	ES-AF	\$10,010
HF-FE00200TOU	VMAX 850 2PT 10 GBE OPTICAL UPG	ES-AF	\$5,460
HF-FE00200TOUF	VMAX 850 2PT 10 GIGE OPTICAL CONV	ES-AF	\$9,555
HF-FE00400C4U	VMAX 850 4MM4 COPR GIGE UPG	ES-AF	\$2,575
HF-FE00400C4UF	VMAX 850 4MM4 COPR GIGE CONV	ES-AF	\$9,000
HF-FE00400CU	VMAX 850 4PT GBE BASE T UPG	ES-AF	\$5,200
HF-FE00400CUF	VMAX 850 4M GIGE COPPER CONV	ES-AF	\$9,100

HF-FE00400TOUF	VMAX 850 4MM 10 GIGE OPTICAL CONV	ES-AF	\$9,555
HF-FE00400TU	VMAX 850 4MM 10 GIGE UPG	ES-AF	\$4,745
HF-FE00400TUF	VMAX 850 4MM 10 GIGE CONV	ES-AF	\$16,600
HF-FE00400UF	VMAX 850 4M GIGE CONV	ES-AF	\$24,161
HF-FE00800TU	VMAX 850 8MM 10GIGE UPG	ES-AF	\$7,120
HF-FE00800TUF	VMAX 850 8MM 10GIGE CONV	ES-AF	\$24,920
HF-FE08000EU	VMAX 850 8SM 8G FIBRE UPG	ES-AF	\$5,380
HF-FE08000EUF	VMAX 850 8SM 8G FIBRE CONV	ES-AF	\$18,250
HF-FE08000SU	VMAX 850 8SM 16G FC UPG	ES-AF	\$14,045
HF-FE08000SUF	VMAX 850 8SM 16G FC CONV	ES-AF	\$32,410
HF-FE44000EUF	VMAX 850 4MM4SM 8G FIBRE CONV	ES-AF	\$13,270
HF-FE62000UF	VMAX 850 6MM2SM 8G FIBRE CONV	ES-AF	\$9,335
HF-FE80000EU	VMAX 850 8MM 8G FIBRE UPG	ES-AF	\$2,690
HF-FE80000EUF	VMAX 850 8MM 8G FIBRE CONV	ES-AF	\$8,285
HF-FE80000SU	VMAX 850 8MM 16G FC UPG	ES-AF	\$14,045
HF-FE80000SUF	VMAX 850 8MM 16G FC CONV	ES-AF	\$21,645
JLCF3015T51	VMAX 250 RAID5(3+1) 15360GB	ES-AF	\$0
JLCF3015T51TU	VMAX 250 RAID5(3+1) 15360GB TAA UPG	ES-AF	\$0
JLCF3015T51U	VMAX 250 RAID5(3+1) 15360GB UPG	ES-AF	\$0
JLCF3015T61	VMAX 250 RAID6(6+2) 15360GB	ES-AF	\$0
JLCF3015T61TU	VMAX 250 RAID6(6+2) 15360GB TAA UPG	ES-AF	\$0
JLCF3015T61U	VMAX 250 RAID6(6+2) 15360GB UPG	ES-AF	\$0
JLCF3015T71	VMAX 250 RAID5(7+1) 15360GB	ES-AF	\$0
JLCF3015T71TU	VMAX 250 RAID5(7+1) 15360GB TAA UPG	ES-AF	\$0
JLCF3015T71U	VMAX 250 RAID5(7+1) 15360GB UPG	ES-AF	\$0
JLCF3015TR1	VMAX 250 15360GB FLASH ADD SPARE	ES-AF	\$259,120
JLCF3015TR1TU	VMAX 250 15360GB FLASH ADD SPARE TAA UPG	ES-AF	\$336,855
JLCF3015TR1U	VMAX 250 15360GB FLASH ADD SPARE UPG	ES-AF	\$336,855
JLCF3015TS1	VMAX 250 15360GB FLASH SPARE	ES-AF	\$0
JLCF3015TS1TU	VMAX 250 15360GB FLASH SPARE TAA UPG	ES-AF	\$0
JLCF3015TS1U	VMAX 250 15360GB FLASH SPARE UPG	ES-AF	\$0
JLCF3192051	VMAX 250 RAID5(3+1) 1920GB	ES-AF	\$0
JLCF3192051TU	VMAX 250 RAID5(3+1) 1920GB TAA UPG	ES-AF	\$0
JLCF3192051U	VMAX 250 RAID5(3+1) 1920GB UPG	ES-AF	\$0
JLCF3192061	VMAX 250 RAID6(6+2) 1920GB	ES-AF	\$0
JLCF3192061TU	VMAX 250 RAID6(6+2) 1920GB TAA UPG	ES-AF	\$0
JLCF3192061U	VMAX 250 RAID6(6+2) 1920GB UPG	ES-AF	\$0
JLCF3192071	VMAX 250 RAID5(7+1) 1920GB	ES-AF	\$0
JLCF3192071TU	VMAX 250 RAID5(7+1) 1920GB TAA UPG	ES-AF	\$0
JLCF3192071U	VMAX 250 RAID5(7+1) 1920GB UPG	ES-AF	\$0
JLCF31920R1	VMAX 250 1920GB FLASH ADD SPARE	ES-AF	\$32,390
JLCF31920R1TU	VMAX 250 1920GB FLASH ADD SPARE TAA UPG	ES-AF	\$42,105
JLCF31920R1U	VMAX 250 1920GB FLASH ADD SPARE UPG	ES-AF	\$42,105
JLCF31920S1	VMAX 250 1920GB FLASH SPARE	ES-AF	\$0
JLCF31920S1TU	VMAX 250 1920GB FLASH SPARE TAA UPG	ES-AF	\$0
JLCF31920S1U	VMAX 250 1920GB FLASH SPARE UPG	ES-AF	\$0
JLCF3384051	VMAX 250 RAID5(3+1) 3840GB	ES-AF	\$0
JLCF3384051TU	VMAX 250 RAID5(3+1) 3840GB TAA UPG	ES-AF	\$0
JLCF3384051U	VMAX 250 RAID5(3+1) 3840GB UPG	ES-AF	\$0
JLCF3384061	VMAX 250 RAID6(6+2) 3840GB	ES-AF	\$0

JLCF3384061TU	VMAX 250 RAID6(6+2) 3840GB TAA UPG	ES-AF	\$0
JLCF3384061U	VMAX 250 RAID6(6+2) 3840GB UPG	ES-AF	\$0
JLCF3384071	VMAX 250 RAID5(7+1) 3840GB	ES-AF	\$0
JLCF3384071TU	VMAX 250 RAID5(7+1) 3840GB TAA UPG	ES-AF	\$0
JLCF3384071U	VMAX 250 RAID5(7+1) 3840GB UPG	ES-AF	\$0
JLCF33840R1	VMAX 250 3840GB FLASH ADD SPARE	ES-AF	\$64,780
JLCF33840R1TU	VMAX 250 3840GB FLASH ADD SPARE TAA UPG	ES-AF	\$84,215
JLCF33840R1U	VMAX 250 3840GB FLASH ADD SPARE UPG	ES-AF	\$84,215
JLCF33840S1	VMAX 250 3840GB FLASH SPARE	ES-AF	\$0
JLCF33840S1TU	VMAX 250 3840GB FLASH SPARE TAA UPG	ES-AF	\$0
JLCF33840S1U	VMAX 250 3840GB FLASH SPARE UPG	ES-AF	\$0
JLCF3768051	VMAX 250 RAID5(3+1) 7680GB	ES-AF	\$0
JLCF3768051TU	VMAX 250 RAID5(3+1) 7680GB TAA UPG	ES-AF	\$0
JLCF3768051U	VMAX 250 RAID5(3+1) 7680GB UPG	ES-AF	\$0
JLCF3768061	VMAX 250 RAID6(6+2) 7680GB	ES-AF	\$0
JLCF3768061TU	VMAX 250 RAID6(6+2) 7680GB TAA UPG	ES-AF	\$0
JLCF3768061U	VMAX 250 RAID6(6+2) 7680GB UPG	ES-AF	\$0
JLCF3768071	VMAX 250 RAID5(7+1) 7680GB	ES-AF	\$0
JLCF3768071TU	VMAX 250 RAID5(7+1) 7680GB TAA UPG	ES-AF	\$0
JLCF3768071U	VMAX 250 RAID5(7+1) 7680GB UPG	ES-AF	\$0
JLCF37680R1	VMAX 250 7680GB FLASH ADD SPARE	ES-AF	\$129,560
JLCF37680R1TU	VMAX 250 7680GB FLASH ADD SPARE TAA UPG	ES-AF	\$168,430
JLCF37680R1U	VMAX 250 7680GB FLASH ADD SPARE UPG	ES-AF	\$168,430
JLCF37680S1	VMAX 250 7680GB FLASH SPARE	ES-AF	\$0
JLCF37680S1TU	VMAX 250 7680GB FLASH SPARE TAA UPG	ES-AF	\$0
JLCF37680S1U	VMAX 250 7680GB FLASH SPARE UPG	ES-AF	\$0
JLCF396051	VMAX 250 RAID5(3+1) 960GB	ES-AF	\$0
JLCF396051TU	VMAX 250 RAID5(3+1) 960GB TAA UPG	ES-AF	\$0
JLCF396051U	VMAX 250 RAID5(3+1) 960GB UPG	ES-AF	\$0
JLCF396061	VMAX 250 RAID6(6+2) 960GB	ES-AF	\$0
JLCF396061TU	VMAX 250 RAID6(6+2) 960GB TAA UPG	ES-AF	\$0
JLCF396061U	VMAX 250 RAID6(6+2) 960GB UPG	ES-AF	\$0
JLCF396071	VMAX 250 RAID5(7+1) 960GB	ES-AF	\$0
JLCF396071TU	VMAX 250 RAID5(7+1) 960GB TAA UPG	ES-AF	\$0
JLCF396071U	VMAX 250 RAID5(7+1) 960GB UPG	ES-AF	\$0
JLCF3960R1	VMAX 250 960GB FLASH ADD SPARE	ES-AF	\$16,195
JLCF3960R1TU	VMAX 250 960GB FLASH ADD SPARE TAA UPG	ES-AF	\$21,055
JLCF3960R1U	VMAX 250 960GB FLASH ADD SPARE UPG	ES-AF	\$21,055
JLCF3960S1	VMAX 250 960GB FLASH SPARE	ES-AF	\$0
JLCF3960S1TU	VMAX 250 960GB FLASH SPARE TAA UPG	ES-AF	\$0
JLCF3960S1U	VMAX 250 960GB FLASH SPARE UPG	ES-AF	\$0
KL6F3015TR1	VMAX AF 15360GB FLASH ADD SPARE	ES-AF	\$259,120
KL6F3015TR1TU	VMAX AF 15360GB FLASH ADD SPARE TAA UPG	ES-AF	\$336,855
KL6F3015TR1U	VMAX AF 15360GB FLASH ADD SPARE UPG	ES-AF	\$336,855
KL6F3192078	VMAX 450F RAID5(7+1) 1.92Q8 13TB	ES-AF	\$170,165
KL6F3192078TU	VMAX 450F RAID5(7+1) 1.92Q8 13TB TAA UPG	ES-AF	\$204,200
KL6F3192078U	VMAX 450F RAID5(7+1) 1.92Q8 13TB UPG	ES-AF	\$204,200
KL6F31920F16	VMAX 450F RAID6(14+2) 1.92Q16 26TB	ES-AF	\$340,330
KL6F31920F16TU	VMAX 450F RAID6(14+2) 1.92Q16 26TB TAAUP	ES-AF	\$408,395
KL6F31920F16U	VMAX 450F RAID6(14+2) 1.92Q16 26TB UPG	ES-AF	\$408,395

KL6F31920R1	VMAX AF 1920GB FLASH ADD SPARE	ES-AF	\$32,390
KL6F31920R1TU	VMAX AF 1920GB FLASH ADD SPARE TAA UPG	ES-AF	\$42,105
KL6F31920R1U	VMAX AF 1920GB FLASH ADD SPARE UPG	ES-AF	\$42,105
KL6F31920S1	VMAX AF 1920GB FLASH SPARE	ES-AF	\$0
KL6F31920S1TU	VMAX AF 1920GB FLASH SPARE TAA UPG	ES-AF	\$0
KL6F31920S1U	VMAX AF 1920GB FLASH SPARE UPG	ES-AF	\$0
KL6F3384078	VMAX 450F RAID5(7+1) 3.84Q8 26TB	ES-AF	\$340,330
KL6F3384078TU	VMAX 450F RAID5(7+1) 3.84Q8 26TB TAA UPG	ES-AF	\$408,395
KL6F3384078U	VMAX 450F RAID5(7+1) 3.84Q8 26TB UPG	ES-AF	\$408,395
KL6F33840F16	VMAX 450F RAID6(14+2) 3.84Q16 52TB	ES-AF	\$693,755
KL6F33840F16TU	VMAX 450F RAID6(14+2) 3.84Q16 52TB TAAUP	ES-AF	\$832,505
KL6F33840F16U	VMAX 450F RAID6(14+2) 3.84Q16 52TB UPG	ES-AF	\$832,505
KL6F33840R1	VMAX AF 3840GB FLASH ADD SPARE	ES-AF	\$64,780
KL6F33840R1TU	VMAX AF 3840GB FLASH ADD SPARE TAA UPG	ES-AF	\$84,215
KL6F33840R1U	VMAX AF 3840GB FLASH ADD SPARE UPG	ES-AF	\$84,215
KL6F33840S1	VMAX AF 3840GB FLASH SPARE	ES-AF	\$0
KL6F33840S1TU	VMAX AF 3840GB FLASH SPARE TAA UPG	ES-AF	\$0
KL6F33840S1U	VMAX AF 3840GB FLASH SPARE UPG	ES-AF	\$0
KL6F37680R1	VMAX AF 7680GB FLASH ADD SPARE	ES-AF	\$129,560
KL6F37680R1TU	VMAX AF 7680GB FLASH ADD SPARE TAA UPG	ES-AF	\$168,430
KL6F37680R1U	VMAX AF 7680GB FLASH ADD SPARE UPG	ES-AF	\$168,430
KL6F3960F16	VMAX 450F RAID6(14+2) .96Q16 13TB	ES-AF	\$170,165
KL6F3960F16TU	VMAX 450F RAID6(14+2) .96Q16 13TB TAA UP	ES-AF	\$204,200
KL6F3960F16U	VMAX 450F RAID6(14+2) .96Q16 13TB UPG	ES-AF	\$204,200
KL6F3960R1	VMAX AF 960GB FLASH ADD SPARE	ES-AF	\$16,195
KL6F3960R1TU	VMAX AF 960GB FLASH ADD SPARE TAA UPG	ES-AF	\$21,055
KL6F3960R1U	VMAX AF 960GB FLASH ADD SPARE UPG	ES-AF	\$21,055
KL6F3960S1	VMAX AF 960GB FLASH SPARE	ES-AF	\$0
KL6F3960S1TU	VMAX AF 960GB FLASH SPARE TAA UPG	ES-AF	\$0
KL6F3960S1U	VMAX AF 960GB FLASH SPARE UPG	ES-AF	\$0
KML6F3192078	VMAX MF 450F RAID5(7+1) 1.92Q8 13TB	ES-AF	\$166,500
KML6F3192078TU	VMAX MF450F R5(7+1) 1.92Q8 13TB TAA UPG	ES-AF	\$199,800
KML6F3192078U	VMAX MF 450F RAID5(7+1) 1.92Q8 13TB UPG	ES-AF	\$199,800
KML6F31920F16	VMAX MF 450F RAID6(14+2) 1.92Q16 26TB	ES-AF	\$333,000
KML6F31920F16TU	VMAX MF450F R6(14+2) 1.92Q16 26TB TAA UP	ES-AF	\$399,600
KML6F31920F16U	VMAX MF 450F RAID6(14+2) 1.92Q16 26TB UP	ES-AF	\$399,600
KML6F3384078	VMAX MF 450F RAID5(7+1) 3.84Q8 26TB	ES-AF	\$333,000
KML6F3384078TU	VMAX MF450F R5(7+1) 3.84Q8 26TB TAA UPG	ES-AF	\$399,600
KML6F3384078U	VMAX MF 450F RAID5(7+1) 3.84Q8 26TB UPG	ES-AF	\$399,600
KML6F33840F16	VMAX MF 450F RAID6(14+2) 3.84Q16 52TB	ES-AF	\$678,810
KML6F33840F16TU	VMAX MF450F R6(14+2) 3.84Q16 52TB TAA UP	ES-AF	\$814,570
KML6F33840F16U	VMAX MF 450F RAID6(14+2) 3.84Q16 52TB UP	ES-AF	\$814,570
KML6F3960F16	VMAX MF 450F RAID6(14+2) .96Q16 13TB	ES-AF	\$166,500
KML6F3960F16TU	VMAX MF450F R6(14+2) .96Q16 13TB TAA UP	ES-AF	\$199,800
KML6F3960F16U	VMAX MF 450F RAID6(14+2) .96Q16 13TB UPG	ES-AF	\$199,800
KMXL6F3192078	VMAX MF 450FX RAID5(7+1) 1.92Q8 13TB	ES-AF	\$233,630
KMXL6F3192078TU	VMAX MF450FX R5(7+1) 1.92Q8 13TB TAA UPG	ES-AF	\$280,355
KMXL6F3192078U	VMAX MF 450FX RAID5(7+1) 1.92Q8 13TB UPG	ES-AF	\$280,355
KMXL6F31920F16	VMAX MF 450FX RAID6(14+2) 1.92Q16 26TB	ES-AF	\$467,260
KMXL6F31920F16TU	VMAX MF450FX R6(14+2) 1.92Q16 26TB TA AU	ES-AF	\$560,710

KMXL6F31920F16U	VMAX MF 450FX RAID6(14+2) 1.92Q16 26TB U	ES-AF	\$560,710
KMXL6F3384078	VMAX MF 450FX RAID5(7+1) 3.84Q8 26TB	ES-AF	\$467,260
KMXL6F3384078TU	VMAX MF450FX R5(7+1) 3.84Q8 26TB TAA UPG	ES-AF	\$560,710
KMXL6F3384078U	VMAX MF 450FX RAID5(7+1) 3.84Q8 26TB UPG	ES-AF	\$560,710
KMXL6F33840F16	VMAX MF 450FX RAID6(14+2) 3.84Q16 52TB	ES-AF	\$962,940
KMXL6F33840F16TU	VMAX MF450FX R6(14+2) 3.84Q16 52TB TAA U	ES-AF	\$1,155,530
KMXL6F33840F16U	VMAX MF 450FX RAID6(14+2) 3.84Q16 52TB U	ES-AF	\$1,155,530
KMXL6F3960F16	VMAX MF 450FX RAID6(14+2) .96Q16 13TB	ES-AF	\$233,630
KMXL6F3960F16TU	VMAX MF450FX R6(14+2) .96Q16 13TB TAA UP	ES-AF	\$280,355
KMXL6F3960F16U	VMAX MF 450FX RAID6(14+2) .96Q16 13TB UP	ES-AF	\$280,355
KXL6F3192078	VMAX 450FX RAID5(7+1) 1.92Q8 13TB	ES-AF	\$239,065
KXL6F3192078TU	VMAX 450FX RAID5(7+1) 1.92Q8 13TB TAA UP	ES-AF	\$286,880
KXL6F3192078U	VMAX 450FX RAID5(7+1) 1.92Q8 13TB UPG	ES-AF	\$286,880
KXL6F31920F16	VMAX 450FX RAID6(14+2) 1.92Q16 26TB	ES-AF	\$478,130
KXL6F31920F16TU	VMAX 450FX RAID6(14+2) 1.92Q16 26TB TAAU	ES-AF	\$573,755
KXL6F31920F16U	VMAX 450FX RAID6(14+2) 1.92Q16 26TB UPG	ES-AF	\$573,755
KXL6F3384078	VMAX 450FX RAID5(7+1) 3.84Q8 26TB	ES-AF	\$478,130
KXL6F3384078TU	VMAX 450FX RAID5(7+1) 3.84Q8 26TB TAA UP	ES-AF	\$573,755
KXL6F3384078U	VMAX 450FX RAID5(7+1) 3.84Q8 26TB UPG	ES-AF	\$573,755
KXL6F33840F16	VMAX 450FX RAID6(14+2) 3.84Q16 52TB	ES-AF	\$974,655
KXL6F33840F16TU	VMAX 450FX RAID6(14+2) 3.84Q16 52TB TAAU	ES-AF	\$1,169,585
KXL6F33840F16U	VMAX 450FX RAID6(14+2) 3.84Q16 52TB UPG	ES-AF	\$1,169,585
KXL6F3960F16	VMAX 450FX RAID6(14+2) .96Q16 13TB	ES-AF	\$239,065
KXL6F3960F16TU	VMAX 450FX RAID6(14+2) .96Q16 13TB TAAUP	ES-AF	\$286,880
KXL6F3960F16U	VMAX 450FX RAID6(14+2) .96Q16 13TB UPG	ES-AF	\$286,880
LL6F3192078	VMAX 850F RAID5(7+1) 1.92Q8 13TB	ES-AF	\$170,165
LL6F3192078TU	VMAX 850F RAID5(7+1) 1.92Q8 13TB TAA UPG	ES-AF	\$204,200
LL6F3192078U	VMAX 850F RAID5(7+1) 1.92Q8 13TB UPG	ES-AF	\$204,200
LL6F31920F16	VMAX 850F RAID6(14+2) 1.92Q16 26TB	ES-AF	\$340,330
LL6F31920F16TU	VMAX 850F RAID6(14+2) 1.92Q16 26TB TAAUP	ES-AF	\$408,395
LL6F31920F16U	VMAX 850F RAID6(14+2) 1.92Q16 26TB UPG	ES-AF	\$408,395
LL6F3384078	VMAX 850F RAID5(7+1) 3.84Q8 26TB	ES-AF	\$340,330
LL6F3384078TU	VMAX 850F RAID5(7+1) 3.84Q8 26TB TAA UPG	ES-AF	\$408,395
LL6F3384078U	VMAX 850F RAID5(7+1) 3.84Q8 26TB UPG	ES-AF	\$408,395
LL6F33840F16	VMAX 850F RAID6(14+2) 3.84Q16 52TB	ES-AF	\$693,755
LL6F33840F16TU	VMAX 850F RAID6(14+2) 3.84Q16 52TB TAAUP	ES-AF	\$832,505
LL6F33840F16U	VMAX 850F RAID6(14+2) 3.84Q16 52TB UPG	ES-AF	\$832,505
LL6F3960F16	VMAX 850F RAID6(14+2) .96Q16 13TB	ES-AF	\$170,165
LL6F3960F16TU	VMAX 850F RAID6(14+2) .96Q16 13TB TAA UP	ES-AF	\$204,200
LL6F3960F16U	VMAX 850F RAID6(14+2) .96Q16 13TB UPG	ES-AF	\$204,200
LML6F3192078	VMAX MF 850F RAID5(7+1) 1.92Q8 13TB	ES-AF	\$166,500
LML6F3192078TU	VMAX MF850F R5(7+1) 1.92Q8 13TB TAA UPG	ES-AF	\$199,800
LML6F3192078U	VMAX MF 850F RAID5(7+1) 1.92Q8 13TB UPG	ES-AF	\$199,800
LML6F31920F16	VMAX MF 850F RAID6(14+2) 1.92Q16 26TB	ES-AF	\$333,000
LML6F31920F16TU	VMAX MF850F R6(14+2) 1.92Q16 26TB TAA UP	ES-AF	\$399,600
LML6F31920F16U	VMAX MF 850F RAID6(14+2) 1.92Q16 26TB UP	ES-AF	\$399,600
LML6F3384078	VMAX MF 850F RAID5(7+1) 3.84Q8 26TB	ES-AF	\$333,000
LML6F3384078TU	VMAX MF850F R5(7+1) 3.84Q8 26TB TAA UPG	ES-AF	\$399,600
LML6F3384078U	VMAX MF 850F RAID5(7+1) 3.84Q8 26TB UPG	ES-AF	\$399,600
LML6F33840F16	VMAX MF 850F RAID6(14+2) 3.84Q16 52TB	ES-AF	\$678,810

LML6F33840F16TU	VMAX MF850F R6(14+2) 3.84Q16 52TB TAA UP	ES-AF	\$814,570
LML6F33840F16U	VMAX MF 850F RAID6(14+2) 3.84Q16 52TB UP	ES-AF	\$814,570
LML6F3960F16	VMAX MF 850F RAID6(14+2) .96Q16 13TB	ES-AF	\$166,500
LML6F3960F16TU	VMAX MF850F R6(14+2) .96Q16 13TB TAA UP	ES-AF	\$199,800
LML6F3960F16U	VMAX MF 850F RAID6(14+2) .96Q16 13TB UPG	ES-AF	\$199,800
LMXL6F3192078	VMAX MF 850FX RAID5(7+1) 1.92Q8 13TB	ES-AF	\$233,630
LMXL6F3192078TU	VMAX MF850FX R5(7+1) 1.92Q8 13TB TAA UP	ES-AF	\$280,355
LMXL6F3192078U	VMAX MF 850FX RAID5(7+1) 1.92Q8 13TB UPG	ES-AF	\$280,355
LMXL6F31920F16	VMAX MF 850FX RAID6(14+2) 1.92Q16 26TB	ES-AF	\$467,260
LMXL6F31920F16TU	VMAX MF850FX R6(14+2) 1.92Q16 26TB TAA U	ES-AF	\$560,710
LMXL6F31920F16U	VMAX MF 850FX RAID6(14+2) 1.92Q16 26TB U	ES-AF	\$560,710
LMXL6F3384078	VMAX MF 850FX RAID5(7+1) 3.84Q8 26TB	ES-AF	\$467,260
LMXL6F3384078TU	VMAX MF850FX R5(7+1) 3.84Q8 26TB TAA UP	ES-AF	\$560,710
LMXL6F3384078U	VMAX MF 850FX RAID5(7+1) 3.82Q8 26TB UPG	ES-AF	\$560,710
LMXL6F33840F16	VMAX MF 850FX RAID6(14+2) 3.84Q16 52TB	ES-AF	\$962,940
LMXL6F33840F16TU	VMAX MF850FX R6(14+2) 3.84Q16 52TB TAA U	ES-AF	\$1,155,530
LMXL6F33840F16U	VMAX MF 850FX RAID6(14+2) 3.84Q16 52TB U	ES-AF	\$1,155,530
LMXL6F3960F16	VMAX MF 850FX RAID6(14+2) .96Q16 13TB	ES-AF	\$233,630
LMXL6F3960F16TU	VMAX MF850FX R6(14+2) .96Q16 13TB TAA UP	ES-AF	\$280,355
LMXL6F3960F16U	VMAX MF 850FX RAID6(14+2) .96Q16 13TB UP	ES-AF	\$280,355
LXL6F3192078	VMAX 850FX RAID5(7+1) 1.92Q8 13TB	ES-AF	\$239,065
LXL6F3192078TU	VMAX 850FX RAID5(7+1) 1.92Q8 13TB TAA UP	ES-AF	\$286,880
LXL6F3192078U	VMAX 850FX RAID5(7+1) 1.92Q8 13TB UPG	ES-AF	\$286,880
LXL6F31920F16	VMAX 850FX RAID6(14+2) 1.92Q16 26TB	ES-AF	\$478,130
LXL6F31920F16TU	VMAX 850FX RAID6(14+2) 1.92Q16 26TB TAAU	ES-AF	\$573,755
LXL6F31920F16U	VMAX 850FX RAID6(14+2) 1.92Q16 26TB UPG	ES-AF	\$573,755
LXL6F3384078	VMAX 850FX RAID5(7+1) 3.84Q8 26TB	ES-AF	\$478,130
LXL6F3384078TU	VMAX 850FX RAID5(7+1) 3.84Q8 26TB TAA UP	ES-AF	\$573,755
LXL6F3384078U	VMAX 850FX RAID5(7+1) 3.84Q8 26TB UPG	ES-AF	\$573,755
LXL6F33840F16	VMAX 850FX RAID6(14+2) 3.84Q16 52TB	ES-AF	\$974,655
LXL6F33840F16TU	VMAX 850FX RAID6(14+2) 3.84Q16 52TB TAAU	ES-AF	\$1,169,585
LXL6F33840F16U	VMAX 850FX RAID6(14+2) 3.84Q16 52TB UPG	ES-AF	\$1,169,585
LXL6F3960F16	VMAX 850FX RAID6(14+2) .96Q16 13TB	ES-AF	\$239,065
LXL6F3960F16TU	VMAX 850FX RAID6(14+2) .96Q16 13TB TAAUP	ES-AF	\$286,880
LXL6F3960F16U	VMAX 850FX RAID6(14+2) .96Q16 13TB UPG	ES-AF	\$286,880
PLCF3015T71	VMAX 950 RAID5(7+1) 15360GB	ES-AF	\$0
PLCF3015T71TU	VMAX 950 RAID5(7+1) 15360GB TAA UPG	ES-AF	\$0
PLCF3015T71U	VMAX 950 RAID5(7+1) 15360GB UPG	ES-AF	\$0
PLCF3015TF1	VMAX 950 RAID6(14+2) 15360GB	ES-AF	\$0
PLCF3015TF1TU	VMAX 950 RAID6(14+2) 15360GB TAA UPG	ES-AF	\$0
PLCF3015TF1U	VMAX 950 RAID6(14+2) 15360GB UPG	ES-AF	\$0
PLCF3015TR1	VMAX 950 15360GB FLASH ADD SPARE	ES-AF	\$259,120
PLCF3015TR1TU	VMAX 950 15360GB FLASH ADD SPARE TAA UPG	ES-AF	\$336,855
PLCF3015TR1U	VMAX 950 15360GB FLASH ADD SPARE UPG	ES-AF	\$336,855
PLCF3015TS1	VMAX 950 15360GB FLASH SPARE	ES-AF	\$0
PLCF3015TS1TU	VMAX 950 15360GB FLASH SPARE TAA UPG	ES-AF	\$0
PLCF3015TS1U	VMAX 950 15360GB FLASH SPARE UPG	ES-AF	\$0
PLCF3192071	VMAX 950 RAID5(7+1) 1920GB	ES-AF	\$0
PLCF3192071TU	VMAX 950 RAID5(7+1) 1920GB TAA UPG	ES-AF	\$0
PLCF3192071U	VMAX 950 RAID5(7+1) 1920GB UPG	ES-AF	\$0

PLCF31920F1	VMAX 950 RAID6(14+2) 1920GB	ES-AF	\$0
PLCF31920F1TU	VMAX 950 RAID6(14+2) 1920GB TAA UPG	ES-AF	\$0
PLCF31920F1U	VMAX 950 RAID6(14+2) 1920GB UPG	ES-AF	\$0
PLCF31920R1	VMAX 950 1920GB FLASH ADD SPARE	ES-AF	\$32,390
PLCF31920R1TU	VMAX 950 1920GB FLASH ADD SPARE TAA UPG	ES-AF	\$42,105
PLCF31920R1U	VMAX 950 1920GB FLASH ADD SPARE UPG	ES-AF	\$42,105
PLCF31920S1	VMAX 950 1920GB FLASH SPARE	ES-AF	\$0
PLCF31920S1TU	VMAX 950 1920GB FLASH SPARE TAA UPG	ES-AF	\$0
PLCF31920S1U	VMAX 950 1920GB FLASH SPARE UPG	ES-AF	\$0
PLCF3384071	VMAX 950 RAID5(7+1) 3840GB	ES-AF	\$0
PLCF3384071TU	VMAX 950 RAID5(7+1) 3840GB TAA UPG	ES-AF	\$0
PLCF3384071U	VMAX 950 RAID5(7+1) 3840GB UPG	ES-AF	\$0
PLCF33840F1	VMAX 950 RAID6(14+2) 3840GB	ES-AF	\$0
PLCF33840F1TU	VMAX 950 RAID6(14+2) 3840GB TAA UPG	ES-AF	\$0
PLCF33840F1U	VMAX 950 RAID6(14+2) 3840GB UPG	ES-AF	\$0
PLCF33840R1	VMAX 950 3840GB FLASH ADD SPARE	ES-AF	\$64,780
PLCF33840R1TU	VMAX 950 3840GB FLASH ADD SPARE TAA UPG	ES-AF	\$84,215
PLCF33840R1U	VMAX 950 3840GB FLASH ADD SPARE UPG	ES-AF	\$84,215
PLCF33840S1	VMAX 950 3840GB FLASH SPARE	ES-AF	\$0
PLCF33840S1TU	VMAX 950 3840GB FLASH SPARE TAA UPG	ES-AF	\$0
PLCF33840S1U	VMAX 950 3840GB FLASH SPARE UPG	ES-AF	\$0
PLCF3768071	VMAX 950 RAID5(7+1) 7680GB	ES-AF	\$0
PLCF3768071TU	VMAX 950 RAID5(7+1) 7680GB TAA UPG	ES-AF	\$0
PLCF3768071U	VMAX 950 RAID5(7+1) 7680GB UPG	ES-AF	\$0
PLCF37680F1	VMAX 950 RAID6(14+2) 7680GB	ES-AF	\$0
PLCF37680F1TU	VMAX 950 RAID6(14+2) 7680GB TAA UPG	ES-AF	\$0
PLCF37680F1U	VMAX 950 RAID6(14+2) 7680GB UPG	ES-AF	\$0
PLCF37680R1	VMAX 950 7680GB FLASH ADD SPARE	ES-AF	\$129,560
PLCF37680R1TU	VMAX 950 7680GB FLASH ADD SPARE TAA UPG	ES-AF	\$168,430
PLCF37680R1U	VMAX 950 7680GB FLASH ADD SPARE UPG	ES-AF	\$168,430
PLCF37680S1	VMAX 950 7680GB FLASH SPARE	ES-AF	\$0
PLCF37680S1TU	VMAX 950 7680GB FLASH SPARE TAA UPG	ES-AF	\$0
PLCF37680S1U	VMAX 950 7680GB FLASH SPARE UPG	ES-AF	\$0
PLCF396071	VMAX 950 RAID5(7+1) 960GB	ES-AF	\$0
PLCF396071TU	VMAX 950 RAID5(7+1) 960GB TAA UPG	ES-AF	\$0
PLCF396071U	VMAX 950 RAID5(7+1) 960GB UPG	ES-AF	\$0
PLCF3960F1	VMAX 950 RAID6(14+2) 960GB	ES-AF	\$0
PLCF3960F1TU	VMAX 950 RAID6(14+2) 960GB TAA UPG	ES-AF	\$0
PLCF3960F1U	VMAX 950 RAID6(14+2) 960GB UPG	ES-AF	\$0
PLCF3960R1	VMAX 950 960GB FLASH ADD SPARE	ES-AF	\$16,195
PLCF3960R1TU	VMAX 950 960GB FLASH ADD SPARE TAA UPG	ES-AF	\$21,055
PLCF3960R1U	VMAX 950 960GB FLASH ADD SPARE UPG	ES-AF	\$21,055
PLCF3960S1	VMAX 950 960GB FLASH SPARE	ES-AF	\$0
PLCF3960S1TU	VMAX 950 960GB FLASH SPARE TAA UPG	ES-AF	\$0
PLCF3960S1U	VMAX 950 960GB FLASH SPARE UPG	ES-AF	\$0
PMLCF3015T71	VMAX 950 MF RAID5(7+1) 15360GB	ES-AF	\$0
PMLCF3015T71TU	VMAX 950 MF RAID5(7+1) 15360GB TAA UPG	ES-AF	\$0
PMLCF3015T71U	VMAX 950 MF RAID5(7+1) 15360GB UPG	ES-AF	\$0
PMLCF3015TF1	VMAX 950 MF RAID6(14+2) 15360GB	ES-AF	\$0
PMLCF3015TF1TU	VMAX 950 MF RAID6(14+2) 15360GB TAA UPG	ES-AF	\$0

PMLCF3015TF1U	VMAX 950 MF RAID6(14+2) 15360GB UPG	ES-AF	\$0
PMLCF3015TR1	VMAX 950 MF 15360GB FLASH ADD SPARE	ES-AF	\$259,120
PMLCF3015TR1TU	VMAX 950 MF 15360GB FLASH ADD SPARE TA U	ES-AF	\$336,855
PMLCF3015TR1U	VMAX 950 MF 15360GB FLASH ADD SPARE UPG	ES-AF	\$336,855
PMLCF3015TS1	VMAX 950 MF 15360GB FLASH SPARE	ES-AF	\$0
PMLCF3015TS1TU	VMAX 950 MF 15360GB FLASH SPARE TAA UPG	ES-AF	\$0
PMLCF3015TS1U	VMAX 950 MF 15360GB FLASH SPARE UPG	ES-AF	\$0
PMLCF3192071	VMAX 950 MF RAID5(7+1) 1920GB	ES-AF	\$0
PMLCF3192071TU	VMAX 950 MF RAID5(7+1) 1920GB TAA UPG	ES-AF	\$0
PMLCF3192071U	VMAX 950 MF RAID5(7+1) 1920GB UPG	ES-AF	\$0
PMLCF31920F1	VMAX 950 MF RAID6(14+2) 1920GB	ES-AF	\$0
PMLCF31920F1TU	VMAX 950 MF RAID6(14+2) 1920GB TAA UPG	ES-AF	\$0
PMLCF31920F1U	VMAX 950 MF RAID6(14+2) 1920GB UPG	ES-AF	\$0
PMLCF31920R1	VMAX 950 MF 1920GB FLASH ADD SPARE	ES-AF	\$32,390
PMLCF31920R1TU	VMAX 950 MF 1920GB FLASH ADD SPARE TAA U	ES-AF	\$42,105
PMLCF31920R1U	VMAX 950 MF 1920GB FLASH ADD SPARE UPG	ES-AF	\$42,105
PMLCF31920S1	VMAX 950 MF 1920GB FLASH SPARE	ES-AF	\$0
PMLCF31920S1TU	VMAX 950 MF 1920GB FLASH SPARE TAA UPG	ES-AF	\$0
PMLCF31920S1U	VMAX 950 MF 1920GB FLASH SPARE UPG	ES-AF	\$0
PMLCF3384071	VMAX 950 MF RAID5(7+1) 3840GB	ES-AF	\$0
PMLCF3384071TU	VMAX 950 MF RAID5(7+1) 3840GB TAA UPG	ES-AF	\$0
PMLCF3384071U	VMAX 950 MF RAID5(7+1) 3840GB UPG	ES-AF	\$0
PMLCF33840F1	VMAX 950 MF RAID6(14+2) 3840GB	ES-AF	\$0
PMLCF33840F1TU	VMAX 950 MF RAID6(14+2) 3840GB TAA UPG	ES-AF	\$0
PMLCF33840F1U	VMAX 950 MF RAID6(14+2) 3840GB UPG	ES-AF	\$0
PMLCF33840R1	VMAX 950 MF 3840GB FLASH ADD SPARE	ES-AF	\$64,780
PMLCF33840R1TU	VMAX 950 MF 3840GB FLASH ADD SPARE TAA U	ES-AF	\$84,215
PMLCF33840R1U	VMAX 950 MF 3840GB FLASH ADD SPARE UPG	ES-AF	\$84,215
PMLCF33840S1	VMAX 950 MF 3840GB FLASH SPARE	ES-AF	\$0
PMLCF33840S1TU	VMAX 950 MF 3840GB FLASH SPARE TAA UPG	ES-AF	\$0
PMLCF33840S1U	VMAX 950 MF 3840GB FLASH SPARE UPG	ES-AF	\$0
PMLCF3768071	VMAX 950 MF RAID5(7+1) 7680GB	ES-AF	\$0
PMLCF3768071TU	VMAX 950 MF RAID5(7+1) 7680GB TAA UPG	ES-AF	\$0
PMLCF3768071U	VMAX 950 MF RAID5(7+1) 7680GB UPG	ES-AF	\$0
PMLCF37680F1	VMAX 950 MF RAID6(14+2) 7680GB	ES-AF	\$0
PMLCF37680F1TU	VMAX 950 MF RAID6(14+2) 7680GB TAA UPG	ES-AF	\$0
PMLCF37680F1U	VMAX 950 MF RAID6(14+2) 7680GB UPG	ES-AF	\$0
PMLCF37680R1	VMAX 950 MF 7680GB FLASH ADD SPARE	ES-AF	\$129,560
PMLCF37680R1TU	VMAX 950 MF 7680GB FLASH ADD SPARE TAA U	ES-AF	\$168,430
PMLCF37680R1U	VMAX 950 MF 7680GB FLASH ADD SPARE UPG	ES-AF	\$168,430
PMLCF37680S1	VMAX 950 MF 7680GB FLASH SPARE	ES-AF	\$0
PMLCF37680S1TU	VMAX 950 MF 7680GB FLASH SPARE TAA UPG	ES-AF	\$0
PMLCF37680S1U	VMAX 950 MF 7680GB FLASH SPARE UPG	ES-AF	\$0
PMLCF396071	VMAX 950 MF RAID5(7+1) 960GB	ES-AF	\$0
PMLCF396071TU	VMAX 950 MF RAID5(7+1) 960GB TAA UPG	ES-AF	\$0
PMLCF396071U	VMAX 950 MF RAID5(7+1) 960GB UPG	ES-AF	\$0
PMLCF3960F1	VMAX 950 MF RAID6(14+2) 960GB	ES-AF	\$0
PMLCF3960F1TU	VMAX 950 MF RAID6(14+2) 960GB TAA UPG	ES-AF	\$0
PMLCF3960F1U	VMAX 950 MF RAID6(14+2) 960GB UPG	ES-AF	\$0
PMLCF3960R1	VMAX 950 MF 960GB FLASH ADD SPARE	ES-AF	\$16,195

PMLCF3960R1TU	VMAX 950 MF 960GB FLASH ADD SPARE TAA UP	ES-AF	\$21,055
PMLCF3960R1U	VMAX 950 MF 960GB FLASH ADD SPARE UPG	ES-AF	\$21,055
PMLCF3960S1	VMAX 950 MF 960GB FLASH SPARE	ES-AF	\$0
PMLCF3960S1TU	VMAX 950 MF 960GB FLASH SPARE TAA UPG	ES-AF	\$0
PMLCF3960S1U	VMAX 950 MF 960GB FLASH SPARE UPG	ES-AF	\$0
VB1-450F-1TB-2R57	VBRICK1 450F 1TB RAID5(7+1)	ES-AF	\$1,084,350
VB1-450F-1TB-2R614	VBRICK1 450F 1TB RAID6(14+2)	ES-AF	\$1,084,350
VB1-450F-1TB-4R57	VBRICK1 450F 1TB 4RAID5(7+1)	ES-AF	\$1,084,350
VB1-450F-2TB-2R57	VBRICK1 450F 2TB RAID5(7+1)	ES-AF	\$1,984,350
VB1-450F-2TB-2R614	VBRICK1 450F 2TB RAID6(14+2)	ES-AF	\$1,984,350
VB1-450F-2TB-4R57	VBRICK1 450F 2TB 4RAID5(7+1)	ES-AF	\$1,984,350
VB1-450X-1TB-2R57	VBRICK1 450FX 1TB RAID5(7+1)	ES-AF	\$1,358,035
VB1-450X-1TB-2R614	VBRICK1 450FX 1TB RAID6(14+2)	ES-AF	\$1,358,035
VB1-450X-1TB-4R57	VBRICK1 450FX 1TB 4RAID5(7+1)	ES-AF	\$1,358,035
VB1-450X-2TB-2R57	VBRICK1 450FX 2TB RAID5(7+1)	ES-AF	\$2,258,035
VB1-450X-2TB-2R614	VBRICK1 450FX 2TB RAID6(14+2)	ES-AF	\$2,258,035
VB1-450X-2TB-4R57	VBRICK1 450FX 2TB 4RAID5(7+1)	ES-AF	\$2,258,035
VB1-850F-1TB-2R57	VBRICK1 850F 1TB RAID5(7+1)	ES-AF	\$1,214,330
VB1-850F-1TB-2R614	VBRICK1 850F 1TB RAID6(14+2)	ES-AF	\$1,214,330
VB1-850F-1TB-4R57	VBRICK1 850F 1TB 4RAID5(7+1)	ES-AF	\$1,214,330
VB1-850F-2TB-2R57	VBRICK1 850F 2TB RAID5(7+1)	ES-AF	\$2,114,330
VB1-850F-2TB-2R614	VBRICK1 850F 2TB RAID6(14+2)	ES-AF	\$2,114,330
VB1-850F-2TB-4R57	VBRICK1 850F 2TB 4RAID5(7+1)	ES-AF	\$2,114,330
VB1-850X-1TB-2R57	VBRICK1 850FX 1TB RAID5(7+1)	ES-AF	\$1,489,930
VB1-850X-1TB-2R614	VBRICK1 850FX 1TB RAID6(14+2)	ES-AF	\$1,489,930
VB1-850X-1TB-4R57	VBRICK1 850FX 1TB 4RAID5(7+1)	ES-AF	\$1,489,930
VB1-850X-2TB-2R57	VBRICK1 850FX 2TB RAID5(7+1)	ES-AF	\$2,389,930
VB1-850X-2TB-2R614	VBRICK1 850FX 2TB RAID6(14+2)	ES-AF	\$2,389,930
VB1-850X-2TB-4R57	VBRICK1 850FX 2TB 4RAID5(7+1)	ES-AF	\$2,389,930
VB2-450F-1TB-2R57	VBRICK2 450F 1TB RAID5(7+1)	ES-AF	\$1,084,350
VB2-450F-1TB-2R57U	VBRICK2 450F 1TB RAID5(7+1) UPG	ES-AF	\$1,301,220
VB2-450F-1TB-2R614	VBRICK2 450F 1TB RAID6(14+2)	ES-AF	\$1,084,350
VB2-450F-1TB-2R64U	VBRICK2 450F 1TB RAID6(14+2) UPG	ES-AF	\$1,301,220
VB2-450F-1TB-4R57	VBRICK2 450F 1TB 4RAID5(7+1)	ES-AF	\$1,084,350
VB2-450F-1TB-4R57U	VBRICK2 450F 1TB 4RAID5(7+1) UPG	ES-AF	\$1,301,220
VB2-450F-2TB-2R57	VBRICK2 450F 2TB RAID5(7+1)	ES-AF	\$1,984,350
VB2-450F-2TB-2R57U	VBRICK2 450F 2TB RAID5(7+1) UPG	ES-AF	\$2,381,220
VB2-450F-2TB-2R614	VBRICK2 450F 2TB RAID6(14+2)	ES-AF	\$1,984,350
VB2-450F-2TB-2R64U	VBRICK2 450F 2TB RAID6(14+2) UPG	ES-AF	\$2,381,220
VB2-450F-2TB-4R57	VBRICK2 450F 2TB 4RAID5(7+1)	ES-AF	\$1,984,350
VB2-450F-2TB-4R57U	VBRICK2 450F 2TB 4RAID5(7+1) UPG	ES-AF	\$2,381,220
VB2-450X-1TB-2R57	VBRICK2 450FX 1TB RAID5(7+1)	ES-AF	\$1,358,035
VB2-450X-1TB-2R57U	VBRICK2 450FX 1TB RAID5(7+1) UPG	ES-AF	\$1,629,640
VB2-450X-1TB-2R614	VBRICK2 450FX 1TB RAID6(14+2)	ES-AF	\$1,358,035
VB2-450X-1TB-2R64U	VBRICK2 450FX 1TB RAID6(14+2) UPG	ES-AF	\$1,629,640
VB2-450X-1TB-4R57	VBRICK2 450FX 1TB 4RAID5(7+1)	ES-AF	\$1,358,035
VB2-450X-1TB-4R57U	VBRICK2 450FX 1TB 4RAID5(7+1) UPG	ES-AF	\$1,629,640
VB2-450X-2TB-2R57	VBRICK2 450FX 2TB RAID5(7+1)	ES-AF	\$2,258,035
VB2-450X-2TB-2R57U	VBRICK2 450FX 2TB RAID5(7+1) UPG	ES-AF	\$2,709,640
VB2-450X-2TB-2R614	VBRICK2 450FX 2TB RAID6(14+2)	ES-AF	\$2,258,035

VB2-450X-2TB-2R64U	VBRICK2 450FX 2TB RAID6(14+2) UPG	ES-AF	\$2,709,640
VB2-450X-2TB-4R57	VBRICK2 450FX 2TB 4RAID5(7+1)	ES-AF	\$2,258,035
VB2-450X-2TB-4R57U	VBRICK2 450FX 2TB 4RAID5(7+1) UPG	ES-AF	\$2,709,640
VB2-45TF-1TB-2R57U	VBRICK2 450F 1TB RAID5(7+1) TAA UPG	ES-AF	\$1,301,220
VB2-45TF-1TB-2R64U	VBRICK2 450F 1TB RAID6(14+2) TAA UPG	ES-AF	\$1,301,220
VB2-45TF-1TB-4R57U	VBRICK2 450F 1TB 4RAID5(7+1) TAA UPG	ES-AF	\$1,301,220
VB2-45TF-2TB-2R57U	VBRICK2 450F 2TB RAID5(7+1) TAA UPG	ES-AF	\$2,381,220
VB2-45TF-2TB-2R64U	VBRICK2 450F 2TB RAID6(14+2) TAA UPG	ES-AF	\$2,381,220
VB2-45TF-2TB-4R57U	VBRICK2 450F 2TB 4RAID5(7+1) TAA UPG	ES-AF	\$2,381,220
VB2-45TX-1TB-2R57U	VBRICK2 450FX 1TB RAID5(7+1) TAA UPG	ES-AF	\$1,629,640
VB2-45TX-1TB-2R64U	VBRICK2 450FX 1TB RAID6(14+2) TAA UPG	ES-AF	\$1,629,640
VB2-45TX-1TB-4R57U	VBRICK2 450FX 1TB 4RAID5(7+1) TAA UPG	ES-AF	\$1,629,640
VB2-45TX-2TB-2R57U	VBRICK2 450FX 2TB RAID5(7+1) TAA UPG	ES-AF	\$2,709,640
VB2-45TX-2TB-2R64U	VBRICK2 450FX 2TB RAID6(14+2) TAA UPG	ES-AF	\$2,709,640
VB2-45TX-2TB-4R57U	VBRICK2 450FX 2TB 4RAID5(7+1) TAA UPG	ES-AF	\$2,709,640
VB2-850F-1TB-2R57	VBRICK2 850F 1TB RAID5(7+1)	ES-AF	\$1,214,330
VB2-850F-1TB-2R57U	VBRICK2 850F 1TB RAID5(7+1) UPG	ES-AF	\$1,457,195
VB2-850F-1TB-2R614	VBRICK2 850F 1TB RAID6(14+2)	ES-AF	\$1,214,330
VB2-850F-1TB-2R64U	VBRICK2 850F 1TB RAID6(14+2) UPG	ES-AF	\$1,457,195
VB2-850F-1TB-4R57	VBRICK2 850F 1TB 4RAID5(7+1)	ES-AF	\$1,214,330
VB2-850F-1TB-4R57U	VBRICK2 850F 1TB 4RAID5(7+1) UPG	ES-AF	\$1,457,195
VB2-850F-2TB-2R57	VBRICK2 850F 2TB RAID5(7+1)	ES-AF	\$2,114,330
VB2-850F-2TB-2R57U	VBRICK2 850F 2TB RAID5(7+1) UPG	ES-AF	\$2,537,195
VB2-850F-2TB-2R614	VBRICK2 850F 2TB RAID6(14+2)	ES-AF	\$2,114,330
VB2-850F-2TB-2R64U	VBRICK2 850F 2TB RAID6(14+2) UPG	ES-AF	\$2,537,195
VB2-850F-2TB-4R57	VBRICK2 850F 2TB 4RAID5(7+1)	ES-AF	\$2,114,330
VB2-850F-2TB-4R57U	VBRICK2 850F 2TB 4RAID5(7+1) UPG	ES-AF	\$2,537,195
VB2-850X-1TB-2R57	VBRICK2 850FX 1TB RAID5(7+1)	ES-AF	\$1,489,930
VB2-850X-1TB-2R57U	VBRICK2 850FX 1TB RAID5(7+1) UPG	ES-AF	\$1,787,915
VB2-850X-1TB-2R614	VBRICK2 850FX 1TB RAID6(14+2)	ES-AF	\$1,489,930
VB2-850X-1TB-2R64U	VBRICK2 850FX 1TB RAID6(14+2) UPG	ES-AF	\$1,787,915
VB2-850X-1TB-4R57	VBRICK2 850FX 1TB 4RAID5(7+1)	ES-AF	\$1,489,930
VB2-850X-1TB-4R57U	VBRICK2 850FX 1TB 4RAID5(7+1) UPG	ES-AF	\$1,787,915
VB2-850X-2TB-2R57	VBRICK2 850FX 2TB RAID5(7+1)	ES-AF	\$2,389,930
VB2-850X-2TB-2R57U	VBRICK2 850FX 2TB RAID5(7+1) UPG	ES-AF	\$2,867,915
VB2-850X-2TB-2R614	VBRICK2 850FX 2TB RAID6(14+2)	ES-AF	\$2,389,930
VB2-850X-2TB-2R64U	VBRICK2 850FX 2TB RAID6(14+2) UPG	ES-AF	\$2,867,915
VB2-850X-2TB-4R57	VBRICK2 850FX 2TB 4RAID5(7+1)	ES-AF	\$2,389,930
VB2-850X-2TB-4R57U	VBRICK2 850FX 2TB 4RAID5(7+1) UPG	ES-AF	\$2,867,915
VB2-85TF-1TB-2R57U	VBRICK2 850F 1TB RAID5(7+1) TAA UPG	ES-AF	\$1,457,195
VB2-85TF-1TB-2R64U	VBRICK2 850F 1TB RAID6(14+2) TAA UPG	ES-AF	\$1,457,195
VB2-85TF-1TB-4R57U	VBRICK2 850F 1TB 4RAID5(7+1) TAA UPG	ES-AF	\$1,457,195
VB2-85TF-2TB-2R57U	VBRICK2 850F 2TB RAID5(7+1) TAA UPG	ES-AF	\$2,537,195
VB2-85TF-2TB-2R64U	VBRICK2 850F 2TB RAID6(14+2) TAA UPG	ES-AF	\$2,537,195
VB2-85TF-2TB-4R57U	VBRICK2 850F 2TB 4RAID5(7+1) TAA UPG	ES-AF	\$2,537,195
VB2-85TX-1TB-2R57U	VBRICK2 850FX 1TB RAID5(7+1) TAA UPG	ES-AF	\$1,787,915
VB2-85TX-1TB-2R64U	VBRICK2 850FX 1TB RAID6(14+2) TAA UPG	ES-AF	\$1,787,915
VB2-85TX-1TB-4R57U	VBRICK2 850FX 1TB 4RAID5(7+1) TAA UPG	ES-AF	\$1,787,915
VB2-85TX-2TB-2R57U	VBRICK2 850FX 2TB RAID5(7+1) TAA UPG	ES-AF	\$2,867,915
VB2-85TX-2TB-2R64U	VBRICK2 850FX 2TB RAID6(14+2) TAA UPG	ES-AF	\$2,867,915

VB2-85TX-2TB-4R57U	VBRICK2 850FX 2TB 4RAID5(7+1) TAA UPG	ES-AF	\$2,867,915
VB3-450F-1TB-2R57	VBRICK3 450F 1TB RAID5(7+1)	ES-AF	\$1,084,350
VB3-450F-1TB-2R57U	VBRICK3 450F 1TB RAID5(7+1) UPG	ES-AF	\$1,301,220
VB3-450F-1TB-2R614	VBRICK3 450F 1TB RAID6(14+2)	ES-AF	\$1,084,350
VB3-450F-1TB-2R64U	VBRICK3 450F 1TB RAID6(14+2) UPG	ES-AF	\$1,301,220
VB3-450F-1TB-4R57	VBRICK3 450F 1TB 4RAID5(7+1)	ES-AF	\$1,084,350
VB3-450F-1TB-4R57U	VBRICK3 450F 1TB 4RAID5(7+1) UPG	ES-AF	\$1,301,220
VB3-450F-2TB-2R57	VBRICK3 450F 2TB RAID5(7+1)	ES-AF	\$1,984,350
VB3-450F-2TB-2R57U	VBRICK3 450F 2TB RAID5(7+1) UPG	ES-AF	\$2,381,220
VB3-450F-2TB-2R614	VBRICK3 450F 2TB RAID6(14+2)	ES-AF	\$1,984,350
VB3-450F-2TB-2R64U	VBRICK3 450F 2TB RAID6(14+2) UPG	ES-AF	\$2,381,220
VB3-450F-2TB-4R57	VBRICK3 450F 2TB 4RAID5(7+1)	ES-AF	\$1,984,350
VB3-450F-2TB-4R57U	VBRICK3 450F 2TB 4RAID5(7+1) UPG	ES-AF	\$2,381,220
VB3-450X-1TB-2R57	VBRICK3 450FX 1TB RAID5(7+1)	ES-AF	\$1,358,035
VB3-450X-1TB-2R57U	VBRICK3 450FX 1TB RAID5(7+1) UPG	ES-AF	\$1,629,640
VB3-450X-1TB-2R614	VBRICK3 450FX 1TB RAID6(14+2)	ES-AF	\$1,358,035
VB3-450X-1TB-2R64U	VBRICK3 450FX 1TB RAID6(14+2) UPG	ES-AF	\$1,629,640
VB3-450X-1TB-4R57	VBRICK3 450FX 1TB 4RAID5(7+1)	ES-AF	\$1,358,035
VB3-450X-1TB-4R57U	VBRICK3 450FX 1TB 4RAID5(7+1) UPG	ES-AF	\$1,629,640
VB3-450X-2TB-2R57	VBRICK3 450FX 2TB RAID5(7+1)	ES-AF	\$2,258,035
VB3-450X-2TB-2R57U	VBRICK3 450FX 2TB RAID5(7+1) UPG	ES-AF	\$2,709,640
VB3-450X-2TB-2R614	VBRICK3 450FX 2TB RAID6(14+2)	ES-AF	\$2,258,035
VB3-450X-2TB-2R64U	VBRICK3 450FX 2TB RAID6(14+2) UPG	ES-AF	\$2,709,640
VB3-450X-2TB-4R57	VBRICK3 450FX 2TB 4RAID5(7+1)	ES-AF	\$2,258,035
VB3-450X-2TB-4R57U	VBRICK3 450FX 2TB 4RAID5(7+1) UPG	ES-AF	\$2,709,640
VB3-45TF-1TB-2R57U	VBRICK3 450F 1TB RAID5(7+1) TAA UPG	ES-AF	\$1,301,220
VB3-45TF-1TB-2R64U	VBRICK3 450F 1TB RAID6(14+2) TAA UPG	ES-AF	\$1,301,220
VB3-45TF-1TB-4R57U	VBRICK3 450F 1TB 4RAID5(7+1) TAA UPG	ES-AF	\$1,301,220
VB3-45TF-2TB-2R57U	VBRICK3 450F 2TB RAID5(7+1) TAA UPG	ES-AF	\$2,381,220
VB3-45TF-2TB-2R64U	VBRICK3 450F 2TB RAID6(14+2) TAA UPG	ES-AF	\$2,381,220
VB3-45TF-2TB-4R57U	VBRICK3 450F 2TB 4RAID5(7+1) TAA UPG	ES-AF	\$2,381,220
VB3-45TX-1TB-2R57U	VBRICK3 450FX 1TB RAID5(7+1) TAA UPG	ES-AF	\$1,629,640
VB3-45TX-1TB-2R64U	VBRICK3 450FX 1TB RAID6(14+2) TAA UPG	ES-AF	\$1,629,640
VB3-45TX-1TB-4R57U	VBRICK3 450FX 1TB 4RAID5(7+1) TAA UPG	ES-AF	\$1,629,640
VB3-45TX-2TB-2R57U	VBRICK3 450FX 2TB RAID5(7+1) TAA UPG	ES-AF	\$2,709,640
VB3-45TX-2TB-2R64U	VBRICK3 450FX 2TB RAID6(14+2) TAA UPG	ES-AF	\$2,709,640
VB3-45TX-2TB-4R57U	VBRICK3 450FX 2TB 4RAID5(7+1) TAA UPG	ES-AF	\$2,709,640
VB3-850F-1TB-2R57	VBRICK3 850F 1TB RAID5(7+1)	ES-AF	\$1,214,330
VB3-850F-1TB-2R57U	VBRICK3 850F 1TB RAID5(7+1) UPG	ES-AF	\$1,457,195
VB3-850F-1TB-2R614	VBRICK3 850F 1TB RAID6(14+2)	ES-AF	\$1,214,330
VB3-850F-1TB-2R64U	VBRICK3 850F 1TB RAID6(14+2) UPG	ES-AF	\$1,457,195
VB3-850F-1TB-4R57	VBRICK3 850F 1TB 4RAID5(7+1)	ES-AF	\$1,214,330
VB3-850F-1TB-4R57U	VBRICK3 850F 1TB 4RAID5(7+1) UPG	ES-AF	\$1,457,195
VB3-850F-2TB-2R57	VBRICK3 850F 2TB RAID5(7+1)	ES-AF	\$2,114,330
VB3-850F-2TB-2R57U	VBRICK3 850F 2TB RAID5(7+1) UPG	ES-AF	\$2,537,195
VB3-850F-2TB-2R614	VBRICK3 850F 2TB RAID6(14+2)	ES-AF	\$2,114,330
VB3-850F-2TB-2R64U	VBRICK3 850F 2TB RAID6(14+2) UPG	ES-AF	\$2,537,195
VB3-850F-2TB-4R57	VBRICK3 850F 2TB 4RAID5(7+1)	ES-AF	\$2,114,330
VB3-850F-2TB-4R57U	VBRICK3 850F 2TB 4RAID5(7+1) UPG	ES-AF	\$2,537,195
VB3-850X-1TB-2R57	VBRICK3 850FX 1TB RAID5(7+1)	ES-AF	\$1,489,930

VB3-850X-1TB-2R57U	VBRICK3 850FX 1TB RAID5(7+1) UPG	ES-AF	\$1,787,915
VB3-850X-1TB-2R614	VBRICK3 850FX 1TB RAID6(14+2)	ES-AF	\$1,489,930
VB3-850X-1TB-2R64U	VBRICK3 850FX 1TB RAID6(14+2) UPG	ES-AF	\$1,787,915
VB3-850X-1TB-4R57	VBRICK3 850FX 1TB 4RAID5(7+1)	ES-AF	\$1,489,930
VB3-850X-1TB-4R57U	VBRICK3 850FX 1TB 4RAID5(7+1) UPG	ES-AF	\$1,787,915
VB3-850X-2TB-2R57	VBRICK3 850FX 2TB RAID5(7+1)	ES-AF	\$2,389,930
VB3-850X-2TB-2R57U	VBRICK3 850FX 2TB RAID5(7+1) UPG	ES-AF	\$2,867,915
VB3-850X-2TB-2R614	VBRICK3 850FX 2TB RAID6(14+2)	ES-AF	\$2,389,930
VB3-850X-2TB-2R64U	VBRICK3 850FX 2TB RAID6(14+2) UPG	ES-AF	\$2,867,915
VB3-850X-2TB-4R57	VBRICK3 850FX 2TB 4RAID5(7+1)	ES-AF	\$2,389,930
VB3-850X-2TB-4R57U	VBRICK3 850FX 2TB 4RAID5(7+1) UPG	ES-AF	\$2,867,915
VB3-85TF-1TB-2R57U	VBRICK3 850F 1TB RAID5(7+1) TAA UPG	ES-AF	\$1,457,195
VB3-85TF-1TB-2R64U	VBRICK3 850F 1TB RAID6(14+2) TAA UPG	ES-AF	\$1,457,195
VB3-85TF-1TB-4R57U	VBRICK3 850F 1TB 4RAID5(7+1) TAA UPG	ES-AF	\$1,457,195
VB3-85TF-2TB-2R57U	VBRICK3 850F 2TB RAID5(7+1) TAA UPG	ES-AF	\$2,537,195
VB3-85TF-2TB-2R64U	VBRICK3 850F 2TB RAID6(14+2) TAA UPG	ES-AF	\$2,537,195
VB3-85TF-2TB-4R57U	VBRICK3 850F 2TB 4RAID5(7+1) TAA UPG	ES-AF	\$2,537,195
VB3-85TX-1TB-2R57U	VBRICK3 850FX 1TB RAID5(7+1) TAA UPG	ES-AF	\$1,787,915
VB3-85TX-1TB-2R64U	VBRICK3 850FX 1TB RAID6(14+2) TAA UPG	ES-AF	\$1,787,915
VB3-85TX-1TB-4R57U	VBRICK3 850FX 1TB 4RAID5(7+1) TAA UPG	ES-AF	\$1,787,915
VB3-85TX-2TB-2R57U	VBRICK3 850FX 2TB RAID5(7+1) TAA UPG	ES-AF	\$2,867,915
VB3-85TX-2TB-2R64U	VBRICK3 850FX 2TB RAID6(14+2) TAA UPG	ES-AF	\$2,867,915
VB3-85TX-2TB-4R57U	VBRICK3 850FX 2TB 4RAID5(7+1) TAA UPG	ES-AF	\$2,867,915
VB4-450F-1TB-2R57	VBRICK4 450F 1TB RAID5(7+1)	ES-AF	\$1,084,350
VB4-450F-1TB-2R57U	VBRICK4 450F 1TB RAID5(7+1) UPG	ES-AF	\$1,301,220
VB4-450F-1TB-2R614	VBRICK4 450F 1TB RAID6(14+2)	ES-AF	\$1,084,350
VB4-450F-1TB-2R64U	VBRICK4 450F 1TB RAID6(14+2) UPG	ES-AF	\$1,301,220
VB4-450F-1TB-4R57	VBRICK4 450F 1TB 4RAID5(7+1)	ES-AF	\$1,084,350
VB4-450F-1TB-4R57U	VBRICK4 450F 1TB 4RAID5(7+1) UPG	ES-AF	\$1,301,220
VB4-450F-2TB-2R57	VBRICK4 450F 2TB RAID5(7+1)	ES-AF	\$1,984,350
VB4-450F-2TB-2R57U	VBRICK4 450F 2TB RAID5(7+1) UPG	ES-AF	\$2,381,220
VB4-450F-2TB-2R614	VBRICK4 450F 2TB RAID6(14+2)	ES-AF	\$1,984,350
VB4-450F-2TB-2R64U	VBRICK4 450F 2TB RAID6(14+2) UPG	ES-AF	\$2,381,220
VB4-450F-2TB-4R57	VBRICK4 450F 2TB 4RAID5(7+1)	ES-AF	\$1,984,350
VB4-450F-2TB-4R57U	VBRICK4 450F 2TB 4RAID5(7+1) UPG	ES-AF	\$2,381,220
VB4-450X-1TB-2R57	VBRICK4 450FX 1TB RAID5(7+1)	ES-AF	\$1,358,035
VB4-450X-1TB-2R57U	VBRICK4 450FX 1TB RAID5(7+1) UPG	ES-AF	\$1,629,640
VB4-450X-1TB-2R614	VBRICK4 450FX 1TB RAID6(14+2)	ES-AF	\$1,358,035
VB4-450X-1TB-2R64U	VBRICK4 450FX 1TB RAID6(14+2) UPG	ES-AF	\$1,629,640
VB4-450X-1TB-4R57	VBRICK4 450FX 1TB 4RAID5(7+1)	ES-AF	\$1,358,035
VB4-450X-1TB-4R57U	VBRICK4 450FX 1TB 4RAID5(7+1) UPG	ES-AF	\$1,629,640
VB4-450X-2TB-2R57	VBRICK4 450FX 2TB RAID5(7+1)	ES-AF	\$2,258,035
VB4-450X-2TB-2R57U	VBRICK4 450FX 2TB RAID5(7+1) UPG	ES-AF	\$2,709,640
VB4-450X-2TB-2R614	VBRICK4 450FX 2TB RAID6(14+2)	ES-AF	\$2,258,035
VB4-450X-2TB-2R64U	VBRICK4 450FX 2TB RAID6(14+2) UPG	ES-AF	\$2,709,640
VB4-450X-2TB-4R57	VBRICK4 450FX 2TB 4RAID5(7+1)	ES-AF	\$2,258,035
VB4-450X-2TB-4R57U	VBRICK4 450FX 2TB 4RAID5(7+1) UPG	ES-AF	\$2,709,640
VB4-45TF-1TB-2R57U	VBRICK4 450F 1TB RAID5(7+1) TAA UPG	ES-AF	\$1,301,220
VB4-45TF-1TB-2R64U	VBRICK4 450F 1TB RAID6(14+2) TAA UPG	ES-AF	\$1,301,220
VB4-45TF-1TB-4R57U	VBRICK4 450F 1TB 4RAID5(7+1) TAA UPG	ES-AF	\$1,301,220

VB4-45TF-2TB-2R57U	VBRICK4 450F 2TB RAID5(7+1) TAA UPG	ES-AF	\$2,381,220
VB4-45TF-2TB-2R64U	VBRICK4 450F 2TB RAID6(14+2) TAA UPG	ES-AF	\$2,381,220
VB4-45TF-2TB-4R57U	VBRICK4 450F 2TB 4RAID5(7+1) TAA UPG	ES-AF	\$2,381,220
VB4-45TX-1TB-2R57U	VBRICK4 450FX 1TB RAID5(7+1) TAA UPG	ES-AF	\$1,629,640
VB4-45TX-1TB-2R64U	VBRICK4 450FX 1TB RAID6(14+2) TAA UPG	ES-AF	\$1,629,640
VB4-45TX-1TB-4R57U	VBRICK4 450FX 1TB 4RAID5(7+1) TAA UPG	ES-AF	\$1,629,640
VB4-45TX-2TB-2R57U	VBRICK4 450FX 2TB RAID5(7+1) TAA UPG	ES-AF	\$2,709,640
VB4-45TX-2TB-2R64U	VBRICK4 450FX 2TB RAID6(14+2) TAA UPG	ES-AF	\$2,709,640
VB4-45TX-2TB-4R57U	VBRICK4 450FX 2TB 4RAID5(7+1) TAA UPG	ES-AF	\$2,709,640
VB4-850F-1TB-2R57	VBRICK4 850F 1TB RAID5(7+1)	ES-AF	\$1,214,330
VB4-850F-1TB-2R57U	VBRICK4 850F 1TB RAID5(7+1) UPG	ES-AF	\$1,457,195
VB4-850F-1TB-2R614	VBRICK4 850F 1TB RAID6(14+2)	ES-AF	\$1,214,330
VB4-850F-1TB-2R64U	VBRICK4 850F 1TB RAID6(14+2) UPG	ES-AF	\$1,457,195
VB4-850F-1TB-4R57	VBRICK4 850F 1TB 4RAID5(7+1)	ES-AF	\$1,214,330
VB4-850F-1TB-4R57U	VBRICK4 850F 1TB 4RAID5(7+1) UPG	ES-AF	\$1,457,195
VB4-850F-2TB-2R57	VBRICK4 850F 2TB RAID5(7+1)	ES-AF	\$2,114,330
VB4-850F-2TB-2R57U	VBRICK4 850F 2TB RAID5(7+1) UPG	ES-AF	\$2,537,195
VB4-850F-2TB-2R614	VBRICK4 850F 2TB RAID6(14+2)	ES-AF	\$2,114,330
VB4-850F-2TB-2R64U	VBRICK4 850F 2TB RAID6(14+2) UPG	ES-AF	\$2,537,195
VB4-850F-2TB-4R57	VBRICK4 850F 2TB 4RAID5(7+1)	ES-AF	\$2,114,330
VB4-850F-2TB-4R57U	VBRICK4 850F 2TB 4RAID5(7+1) UPG	ES-AF	\$2,537,195
VB4-850X-1TB-2R57	VBRICK4 850FX 1TB RAID5(7+1)	ES-AF	\$1,489,930
VB4-850X-1TB-2R57U	VBRICK4 850FX 1TB RAID5(7+1) UPG	ES-AF	\$1,787,915
VB4-850X-1TB-2R614	VBRICK4 850FX 1TB RAID6(14+2)	ES-AF	\$1,489,930
VB4-850X-1TB-2R64U	VBRICK4 850FX 1TB RAID6(14+2) UPG	ES-AF	\$1,787,915
VB4-850X-1TB-4R57	VBRICK4 850FX 1TB 4RAID5(7+1)	ES-AF	\$1,489,930
VB4-850X-1TB-4R57U	VBRICK4 850FX 1TB 4RAID5(7+1) UPG	ES-AF	\$1,787,915
VB4-850X-2TB-2R57	VBRICK4 850FX 2TB RAID5(7+1)	ES-AF	\$2,389,930
VB4-850X-2TB-2R57U	VBRICK4 850FX 2TB RAID5(7+1) UPG	ES-AF	\$2,867,915
VB4-850X-2TB-2R614	VBRICK4 850FX 2TB RAID6(14+2)	ES-AF	\$2,389,930
VB4-850X-2TB-2R64U	VBRICK4 850FX 2TB RAID6(14+2) UPG	ES-AF	\$2,867,915
VB4-850X-2TB-4R57	VBRICK4 850FX 2TB 4RAID5(7+1)	ES-AF	\$2,389,930
VB4-850X-2TB-4R57U	VBRICK4 850FX 2TB 4RAID5(7+1) UPG	ES-AF	\$2,867,915
VB4-85TF-1TB-2R57U	VBRICK4 850F 1TB RAID5(7+1) TAA UPG	ES-AF	\$1,457,195
VB4-85TF-1TB-2R64U	VBRICK4 850F 1TB RAID6(14+2) TAA UPG	ES-AF	\$1,457,195
VB4-85TF-1TB-4R57U	VBRICK4 850F 1TB 4RAID5(7+1) TAA UPG	ES-AF	\$1,457,195
VB4-85TF-2TB-2R57U	VBRICK4 850F 2TB RAID5(7+1) TAA UPG	ES-AF	\$2,537,195
VB4-85TF-2TB-2R64U	VBRICK4 850F 2TB RAID6(14+2) TAA UPG	ES-AF	\$2,537,195
VB4-85TF-2TB-4R57U	VBRICK4 850F 2TB 4RAID5(7+1) TAA UPG	ES-AF	\$2,537,195
VB4-85TX-1TB-2R57U	VBRICK4 850FX 1TB RAID5(7+1) TAA UPG	ES-AF	\$1,787,915
VB4-85TX-1TB-2R64U	VBRICK4 850FX 1TB RAID6(14+2) TAA UPG	ES-AF	\$1,787,915
VB4-85TX-1TB-4R57U	VBRICK4 850FX 1TB 4RAID5(7+1) TAA UPG	ES-AF	\$1,787,915
VB4-85TX-2TB-2R57U	VBRICK4 850FX 2TB RAID5(7+1) TAA UPG	ES-AF	\$2,867,915
VB4-85TX-2TB-2R64U	VBRICK4 850FX 2TB RAID6(14+2) TAA UPG	ES-AF	\$2,867,915
VB4-85TX-2TB-4R57U	VBRICK4 850FX 2TB 4RAID5(7+1) TAA UPG	ES-AF	\$2,867,915
VB5-850F-1TB-2R57	VBRICK5 850F 1TB RAID5(7+1)	ES-AF	\$1,214,330
VB5-850F-1TB-2R57U	VBRICK5 850F 1TB RAID5(7+1) UPG	ES-AF	\$1,457,195
VB5-850F-1TB-2R614	VBRICK5 850F 1TB RAID6(14+2)	ES-AF	\$1,214,330
VB5-850F-1TB-2R64U	VBRICK5 850F 1TB RAID6(14+2) UPG	ES-AF	\$1,457,195
VB5-850F-1TB-4R57	VBRICK5 850F 1TB 4RAID5(7+1)	ES-AF	\$1,214,330

VB5-850F-1TB-4R57U	VBRICK5 850F 1TB 4RAID5(7+1) UPG	ES-AF	\$1,457,195
VB5-850F-2TB-2R57	VBRICK5 850F 2TB RAID5(7+1)	ES-AF	\$2,114,330
VB5-850F-2TB-2R57U	VBRICK5 850F 2TB RAID5(7+1) UPG	ES-AF	\$2,537,195
VB5-850F-2TB-2R614	VBRICK5 850F 2TB RAID6(14+2)	ES-AF	\$2,114,330
VB5-850F-2TB-2R64U	VBRICK5 850F 2TB RAID6(14+2) UPG	ES-AF	\$2,537,195
VB5-850F-2TB-4R57	VBRICK5 850F 2TB 4RAID5(7+1)	ES-AF	\$2,114,330
VB5-850F-2TB-4R57U	VBRICK5 850F 2TB 4RAID5(7+1) UPG	ES-AF	\$2,537,195
VB5-850X-1TB-2R57	VBRICK5 850FX 1TB RAID5(7+1)	ES-AF	\$1,489,930
VB5-850X-1TB-2R57U	VBRICK5 850FX 1TB RAID5(7+1) UPG	ES-AF	\$1,787,915
VB5-850X-1TB-2R614	VBRICK5 850FX 1TB RAID6(14+2)	ES-AF	\$1,489,930
VB5-850X-1TB-2R64U	VBRICK5 850FX 1TB RAID6(14+2) UPG	ES-AF	\$1,787,915
VB5-850X-1TB-4R57	VBRICK5 850FX 1TB 4RAID5(7+1)	ES-AF	\$1,489,930
VB5-850X-1TB-4R57U	VBRICK5 850FX 1TB 4RAID5(7+1) UPG	ES-AF	\$1,787,915
VB5-850X-2TB-2R57	VBRICK5 850FX 2TB RAID5(7+1)	ES-AF	\$2,389,930
VB5-850X-2TB-2R57U	VBRICK5 850FX 2TB RAID5(7+1) UPG	ES-AF	\$2,867,915
VB5-850X-2TB-2R614	VBRICK5 850FX 2TB RAID6(14+2)	ES-AF	\$2,389,930
VB5-850X-2TB-2R64U	VBRICK5 850FX 2TB RAID6(14+2) UPG	ES-AF	\$2,867,915
VB5-850X-2TB-4R57	VBRICK5 850FX 2TB 4RAID5(7+1)	ES-AF	\$2,389,930
VB5-850X-2TB-4R57U	VBRICK5 850FX 2TB 4RAID5(7+1) UPG	ES-AF	\$2,867,915
VB5-85TF-1TB-2R57U	VBRICK5 850F 1TB RAID5(7+1) TAA UPG	ES-AF	\$1,457,195
VB5-85TF-1TB-2R64U	VBRICK5 850F 1TB RAID6(14+2) TAA UPG	ES-AF	\$1,457,195
VB5-85TF-1TB-4R57U	VBRICK5 850F 1TB 4RAID5(7+1) TAA UPG	ES-AF	\$1,457,195
VB5-85TF-2TB-2R57U	VBRICK5 850F 2TB RAID5(7+1) TAA UPG	ES-AF	\$2,537,195
VB5-85TF-2TB-2R64U	VBRICK5 850F 2TB RAID6(14+2) TAA UPG	ES-AF	\$2,537,195
VB5-85TF-2TB-4R57U	VBRICK5 850F 2TB 4RAID5(7+1) TAA UPG	ES-AF	\$2,537,195
VB5-85TX-1TB-2R57U	VBRICK5 850FX 1TB RAID5(7+1) TAA UPG	ES-AF	\$1,787,915
VB5-85TX-1TB-2R64U	VBRICK5 850FX 1TB RAID6(14+2) TAA UPG	ES-AF	\$1,787,915
VB5-85TX-1TB-4R57U	VBRICK5 850FX 1TB 4RAID5(7+1) TAA UPG	ES-AF	\$1,787,915
VB5-85TX-2TB-2R57U	VBRICK5 850FX 2TB RAID5(7+1) TAA UPG	ES-AF	\$2,867,915
VB5-85TX-2TB-2R64U	VBRICK5 850FX 2TB RAID6(14+2) TAA UPG	ES-AF	\$2,867,915
VB5-85TX-2TB-4R57U	VBRICK5 850FX 2TB 4RAID5(7+1) TAA UPG	ES-AF	\$2,867,915
VB6-850F-1TB-2R57	VBRICK6 850F 1TB RAID5(7+1)	ES-AF	\$1,214,330
VB6-850F-1TB-2R57U	VBRICK6 850F 1TB RAID5(7+1) UPG	ES-AF	\$1,457,195
VB6-850F-1TB-2R614	VBRICK6 850F 1TB RAID6(14+2)	ES-AF	\$1,214,330
VB6-850F-1TB-2R64U	VBRICK6 850F 1TB RAID6(14+2) UPG	ES-AF	\$1,457,195
VB6-850F-1TB-4R57	VBRICK6 850F 1TB 4RAID5(7+1)	ES-AF	\$1,214,330
VB6-850F-1TB-4R57U	VBRICK6 850F 1TB 4RAID5(7+1) UPG	ES-AF	\$1,457,195
VB6-850F-2TB-2R57	VBRICK6 850F 2TB RAID5(7+1)	ES-AF	\$2,114,330
VB6-850F-2TB-2R57U	VBRICK6 850F 2TB RAID5(7+1) UPG	ES-AF	\$2,537,195
VB6-850F-2TB-2R614	VBRICK6 850F 2TB RAID6(14+2)	ES-AF	\$2,114,330
VB6-850F-2TB-2R64U	VBRICK6 850F 2TB RAID6(14+2) UPG	ES-AF	\$2,537,195
VB6-850F-2TB-4R57	VBRICK6 850F 2TB 4RAID5(7+1)	ES-AF	\$2,114,330
VB6-850F-2TB-4R57U	VBRICK6 850F 2TB 4RAID5(7+1) UPG	ES-AF	\$2,537,195
VB6-850X-1TB-2R57	VBRICK6 850FX 1TB RAID5(7+1)	ES-AF	\$1,489,930
VB6-850X-1TB-2R57U	VBRICK6 850FX 1TB RAID5(7+1) UPG	ES-AF	\$1,787,915
VB6-850X-1TB-2R614	VBRICK6 850FX 1TB RAID6(14+2)	ES-AF	\$1,489,930
VB6-850X-1TB-2R64U	VBRICK6 850FX 1TB RAID6(14+2) UPG	ES-AF	\$1,787,915
VB6-850X-1TB-4R57	VBRICK6 850FX 1TB 4RAID5(7+1)	ES-AF	\$1,489,930
VB6-850X-1TB-4R57U	VBRICK6 850FX 1TB 4RAID5(7+1) UPG	ES-AF	\$1,787,915
VB6-850X-2TB-2R57	VBRICK6 850FX 2TB RAID5(7+1)	ES-AF	\$2,389,930

VB6-850X-2TB-2R57U	VBRICK6 850FX 2TB RAID5(7+1) UPG	ES-AF	\$2,867,915
VB6-850X-2TB-2R614	VBRICK6 850FX 2TB RAID6(14+2)	ES-AF	\$2,389,930
VB6-850X-2TB-2R64U	VBRICK6 850FX 2TB RAID6(14+2) UPG	ES-AF	\$2,867,915
VB6-850X-2TB-4R57	VBRICK6 850FX 2TB 4RAID5(7+1)	ES-AF	\$2,389,930
VB6-850X-2TB-4R57U	VBRICK6 850FX 2TB 4RAID5(7+1) UPG	ES-AF	\$2,867,915
VB6-85TF-1TB-2R57U	VBRICK6 850F 1TB RAID5(7+1) TAA UPG	ES-AF	\$1,457,195
VB6-85TF-1TB-2R64U	VBRICK6 850F 1TB RAID6(14+2) TAA UPG	ES-AF	\$1,457,195
VB6-85TF-1TB-4R57U	VBRICK6 850F 1TB 4RAID5(7+1) TAA UPG	ES-AF	\$1,457,195
VB6-85TF-2TB-2R57U	VBRICK6 850F 2TB RAID5(7+1) TAA UPG	ES-AF	\$2,537,195
VB6-85TF-2TB-2R64U	VBRICK6 850F 2TB RAID6(14+2) TAA UPG	ES-AF	\$2,537,195
VB6-85TF-2TB-4R57U	VBRICK6 850F 2TB 4RAID5(7+1) TAA UPG	ES-AF	\$2,537,195
VB6-85TX-1TB-2R57U	VBRICK6 850FX 1TB RAID5(7+1) TAA UPG	ES-AF	\$1,787,915
VB6-85TX-1TB-2R64U	VBRICK6 850FX 1TB RAID6(14+2) TAA UPG	ES-AF	\$1,787,915
VB6-85TX-1TB-4R57U	VBRICK6 850FX 1TB 4RAID5(7+1) TAA UPG	ES-AF	\$1,787,915
VB6-85TX-2TB-2R57U	VBRICK6 850FX 2TB RAID5(7+1) TAA UPG	ES-AF	\$2,867,915
VB6-85TX-2TB-2R64U	VBRICK6 850FX 2TB RAID6(14+2) TAA UPG	ES-AF	\$2,867,915
VB6-85TX-2TB-4R57U	VBRICK6 850FX 2TB 4RAID5(7+1) TAA UPG	ES-AF	\$2,867,915
VB7-850F-1TB-2R57	VBRICK7 850F 1TB RAID5(7+1)	ES-AF	\$1,214,330
VB7-850F-1TB-2R57U	VBRICK7 850F 1TB RAID5(7+1) UPG	ES-AF	\$1,457,195
VB7-850F-1TB-2R614	VBRICK7 850F 1TB RAID6(14+2)	ES-AF	\$1,214,330
VB7-850F-1TB-2R64U	VBRICK7 850F 1TB RAID6(14+2) UPG	ES-AF	\$1,457,195
VB7-850F-1TB-4R57	VBRICK7 850F 1TB 4RAID5(7+1)	ES-AF	\$1,214,330
VB7-850F-1TB-4R57U	VBRICK7 850F 1TB 4RAID5(7+1) UPG	ES-AF	\$1,457,195
VB7-850F-2TB-2R57	VBRICK7 850F 2TB RAID5(7+1)	ES-AF	\$2,114,330
VB7-850F-2TB-2R57U	VBRICK7 850F 2TB RAID5(7+1) UPG	ES-AF	\$2,537,195
VB7-850F-2TB-2R614	VBRICK7 850F 2TB RAID6(14+2)	ES-AF	\$2,114,330
VB7-850F-2TB-2R64U	VBRICK7 850F 2TB RAID6(14+2) UPG	ES-AF	\$2,537,195
VB7-850F-2TB-4R57	VBRICK7 850F 2TB 4RAID5(7+1)	ES-AF	\$2,114,330
VB7-850F-2TB-4R57U	VBRICK7 850F 2TB 4RAID5(7+1) UPG	ES-AF	\$2,537,195
VB7-850X-1TB-2R57	VBRICK7 850FX 1TB RAID5(7+1)	ES-AF	\$1,489,930
VB7-850X-1TB-2R57U	VBRICK7 850FX 1TB RAID5(7+1) UPG	ES-AF	\$1,787,915
VB7-850X-1TB-2R614	VBRICK7 850FX 1TB RAID6(14+2)	ES-AF	\$1,489,930
VB7-850X-1TB-2R64U	VBRICK7 850FX 1TB RAID6(14+2) UPG	ES-AF	\$1,787,915
VB7-850X-1TB-4R57	VBRICK7 850FX 1TB 4RAID5(7+1)	ES-AF	\$1,489,930
VB7-850X-1TB-4R57U	VBRICK7 850FX 1TB 4RAID5(7+1) UPG	ES-AF	\$1,787,915
VB7-850X-2TB-2R57	VBRICK7 850FX 2TB RAID5(7+1)	ES-AF	\$2,389,930
VB7-850X-2TB-2R57U	VBRICK7 850FX 2TB RAID5(7+1) UPG	ES-AF	\$2,867,915
VB7-850X-2TB-2R614	VBRICK7 850FX 2TB RAID6(14+2)	ES-AF	\$2,389,930
VB7-850X-2TB-2R64U	VBRICK7 850FX 2TB RAID6(14+2) UPG	ES-AF	\$2,867,915
VB7-850X-2TB-4R57	VBRICK7 850FX 2TB 4RAID5(7+1)	ES-AF	\$2,389,930
VB7-850X-2TB-4R57U	VBRICK7 850FX 2TB 4RAID5(7+1) UPG	ES-AF	\$2,867,915
VB7-85TF-1TB-2R57U	VBRICK7 850F 1TB RAID5(7+1) TAA UPG	ES-AF	\$1,457,195
VB7-85TF-1TB-2R64U	VBRICK7 850F 1TB RAID6(14+2) TAA UPG	ES-AF	\$1,457,195
VB7-85TF-1TB-4R57U	VBRICK7 850F 1TB 4RAID5(7+1) TAA UPG	ES-AF	\$1,457,195
VB7-85TF-2TB-2R57U	VBRICK7 850F 2TB RAID5(7+1) TAA UPG	ES-AF	\$2,537,195
VB7-85TF-2TB-2R64U	VBRICK7 850F 2TB RAID6(14+2) TAA UPG	ES-AF	\$2,537,195
VB7-85TF-2TB-4R57U	VBRICK7 850F 2TB 4RAID5(7+1) TAA UPG	ES-AF	\$2,537,195
VB7-85TX-1TB-2R57U	VBRICK7 850FX 1TB RAID5(7+1) TAA UPG	ES-AF	\$1,787,915
VB7-85TX-1TB-2R64U	VBRICK7 850FX 1TB RAID6(14+2) TAA UPG	ES-AF	\$1,787,915
VB7-85TX-1TB-4R57U	VBRICK7 850FX 1TB 4RAID5(7+1) TAA UPG	ES-AF	\$1,787,915

VB7-85TX-2TB-2R57U	VBRICK7 850FX 2TB RAID5(7+1) TAA UPG	ES-AF	\$2,867,915
VB7-85TX-2TB-2R64U	VBRICK7 850FX 2TB RAID6(14+2) TAA UPG	ES-AF	\$2,867,915
VB7-85TX-2TB-4R57U	VBRICK7 850FX 2TB 4RAID5(7+1) TAA UPG	ES-AF	\$2,867,915
VB8-850F-1TB-2R57	VBRICK8 850F 1TB RAID5(7+1)	ES-AF	\$1,214,330
VB8-850F-1TB-2R57U	VBRICK8 850F 1TB RAID5(7+1) UPG	ES-AF	\$1,457,195
VB8-850F-1TB-2R614	VBRICK8 850F 1TB RAID6(14+2)	ES-AF	\$1,214,330
VB8-850F-1TB-2R64U	VBRICK8 850F 1TB RAID6(14+2) UPG	ES-AF	\$1,457,195
VB8-850F-1TB-4R57	VBRICK8 850F 1TB 4RAID5(7+1)	ES-AF	\$1,214,330
VB8-850F-1TB-4R57U	VBRICK8 850F 1TB 4RAID5(7+1) UPG	ES-AF	\$1,457,195
VB8-850F-2TB-2R57	VBRICK8 850F 2TB RAID5(7+1)	ES-AF	\$2,114,330
VB8-850F-2TB-2R57U	VBRICK8 850F 2TB RAID5(7+1) UPG	ES-AF	\$2,537,195
VB8-850F-2TB-2R614	VBRICK8 850F 2TB RAID6(14+2)	ES-AF	\$2,114,330
VB8-850F-2TB-2R64U	VBRICK8 850F 2TB RAID6(14+2) UPG	ES-AF	\$2,537,195
VB8-850F-2TB-4R57	VBRICK8 850F 2TB 4RAID5(7+1)	ES-AF	\$2,114,330
VB8-850F-2TB-4R57U	VBRICK8 850F 2TB 4RAID5(7+1) UPG	ES-AF	\$2,537,195
VB8-850X-1TB-2R57	VBRICK8 850FX 1TB RAID5(7+1)	ES-AF	\$1,489,930
VB8-850X-1TB-2R57U	VBRICK8 850FX 1TB RAID5(7+1) UPG	ES-AF	\$1,787,915
VB8-850X-1TB-2R614	VBRICK8 850FX 1TB RAID6(14+2)	ES-AF	\$1,489,930
VB8-850X-1TB-2R64U	VBRICK8 850FX 1TB RAID6(14+2) UPG	ES-AF	\$1,787,915
VB8-850X-1TB-4R57	VBRICK8 850FX 1TB 4RAID5(7+1)	ES-AF	\$1,489,930
VB8-850X-1TB-4R57U	VBRICK8 850FX 1TB 4RAID5(7+1) UPG	ES-AF	\$1,787,915
VB8-850X-2TB-2R57	VBRICK8 850FX 2TB RAID5(7+1)	ES-AF	\$2,389,930
VB8-850X-2TB-2R57U	VBRICK8 850FX 2TB RAID5(7+1) UPG	ES-AF	\$2,867,915
VB8-850X-2TB-2R614	VBRICK8 850FX 2TB RAID6(14+2)	ES-AF	\$2,389,930
VB8-850X-2TB-2R64U	VBRICK8 850FX 2TB RAID6(14+2) UPG	ES-AF	\$2,867,915
VB8-850X-2TB-4R57	VBRICK8 850FX 2TB 4RAID5(7+1)	ES-AF	\$2,389,930
VB8-850X-2TB-4R57U	VBRICK8 850FX 2TB 4RAID5(7+1) UPG	ES-AF	\$2,867,915
VB8-85TF-1TB-2R57U	VBRICK8 850F 1TB RAID5(7+1) TAA UPG	ES-AF	\$1,457,195
VB8-85TF-1TB-2R64U	VBRICK8 850F 1TB RAID6(14+2) TAA UPG	ES-AF	\$1,457,195
VB8-85TF-1TB-4R57U	VBRICK8 850F 1TB 4RAID5(7+1) TAA UPG	ES-AF	\$1,457,195
VB8-85TF-2TB-2R57U	VBRICK8 850F 2TB RAID5(7+1) TAA UPG	ES-AF	\$2,537,195
VB8-85TF-2TB-2R64U	VBRICK8 850F 2TB RAID6(14+2) TAA UPG	ES-AF	\$2,537,195
VB8-85TF-2TB-4R57U	VBRICK8 850F 2TB 4RAID5(7+1) TAA UPG	ES-AF	\$2,537,195
VB8-85TX-1TB-2R57U	VBRICK8 850FX 1TB RAID5(7+1) TAA UPG	ES-AF	\$1,787,915
VB8-85TX-1TB-2R64U	VBRICK8 850FX 1TB RAID6(14+2) TAA UPG	ES-AF	\$1,787,915
VB8-85TX-1TB-4R57U	VBRICK8 850FX 1TB 4RAID5(7+1) TAA UPG	ES-AF	\$1,787,915
VB8-85TX-2TB-2R57U	VBRICK8 850FX 2TB RAID5(7+1) TAA UPG	ES-AF	\$2,867,915
VB8-85TX-2TB-2R64U	VBRICK8 850FX 2TB RAID6(14+2) TAA UPG	ES-AF	\$2,867,915
VB8-85TX-2TB-4R57U	VBRICK8 850FX 2TB 4RAID5(7+1) TAA UPG	ES-AF	\$2,867,915
ZB1-450F-1TB-2R57	ZBRICK1 450F 1TB RAID5(7+1)	ES-AF	\$1,192,035
ZB1-450F-1TB-2R614	ZBRICK1 450F 1TB RAID6(14+2)	ES-AF	\$1,192,035
ZB1-450F-1TB-4R57	ZBRICK1 450F 1TB 4RAID5(7+1)	ES-AF	\$1,192,035
ZB1-450F-2TB-2R57	ZBRICK1 450F 2TB RAID5(7+1)	ES-AF	\$2,092,035
ZB1-450F-2TB-2R614	ZBRICK1 450F 2TB RAID6(14+2)	ES-AF	\$2,092,035
ZB1-450F-2TB-4R57	ZBRICK1 450F 2TB 4RAID5(7+1)	ES-AF	\$2,092,035
ZB1-450X-1TB-2R57	ZBRICK1 450FX 1TB RAID5(7+1)	ES-AF	\$1,465,725
ZB1-450X-1TB-2R614	ZBRICK1 450FX 1TB RAID6(14+2)	ES-AF	\$1,465,725
ZB1-450X-1TB-4R57	ZBRICK1 450FX 1TB 4RAID5(7+1)	ES-AF	\$1,465,725
ZB1-450X-2TB-2R57	ZBRICK1 450FX 2TB RAID5(7+1)	ES-AF	\$2,365,725
ZB1-450X-2TB-2R614	ZBRICK1 450FX 2TB RAID6(14+2)	ES-AF	\$2,365,725

ZB1-450X-2TB-4R57	ZBRICK1 450FX 2TB 4RAID5(7+1)	ES-AF	\$2,365,725
ZB1-850F-1TB-2R57	ZBRICK1 850F 1TB RAID5(7+1)	ES-AF	\$1,338,220
ZB1-850F-1TB-2R614	ZBRICK1 850F 1TB RAID6(14+2)	ES-AF	\$1,338,220
ZB1-850F-1TB-4R57	ZBRICK1 850F 1TB 4RAID5(7+1)	ES-AF	\$1,338,220
ZB1-850F-2TB-2R57	ZBRICK1 850F 2TB RAID5(7+1)	ES-AF	\$2,238,220
ZB1-850F-2TB-2R614	ZBRICK1 850F 2TB RAID6(14+2)	ES-AF	\$2,238,220
ZB1-850F-2TB-4R57	ZBRICK1 850F 2TB 4RAID5(7+1)	ES-AF	\$2,238,220
ZB1-850X-1TB-2R57	ZBRICK1 850FX 1TB RAID5(7+1)	ES-AF	\$1,613,825
ZB1-850X-1TB-2R614	ZBRICK1 850FX 1TB RAID6(14+2)	ES-AF	\$1,613,825
ZB1-850X-1TB-4R57	ZBRICK1 850FX 1TB 4RAID5(7+1)	ES-AF	\$1,613,825
ZB1-850X-2TB-2R57	ZBRICK1 850FX 2TB RAID5(7+1)	ES-AF	\$2,513,825
ZB1-850X-2TB-2R614	ZBRICK1 850FX 2TB RAID6(14+2)	ES-AF	\$2,513,825
ZB1-850X-2TB-4R57	ZBRICK1 850FX 2TB 4RAID5(7+1)	ES-AF	\$2,513,825
ZB2-450F-1TB-2R57	ZBRICK2 450F 1TB RAID5(7+1)	ES-AF	\$1,192,035
ZB2-450F-1TB-2R57U	ZBRICK2 450F 1TB RAID5(7+1) UPG	ES-AF	\$1,430,440
ZB2-450F-1TB-2R614	ZBRICK2 450F 1TB RAID6(14+2)	ES-AF	\$1,192,035
ZB2-450F-1TB-2R64U	ZBRICK2 450F 1TB RAID6(14+2) UPG	ES-AF	\$1,430,440
ZB2-450F-1TB-4R57	ZBRICK2 450F 1TB 4RAID5(7+1)	ES-AF	\$1,192,035
ZB2-450F-1TB-4R57U	ZBRICK2 450F 1TB 4RAID5(7+1) UPG	ES-AF	\$1,430,440
ZB2-450F-2TB-2R57	ZBRICK2 450F 2TB RAID5(7+1)	ES-AF	\$2,092,035
ZB2-450F-2TB-2R57U	ZBRICK2 450F 2TB RAID5(7+1) UPG	ES-AF	\$2,510,440
ZB2-450F-2TB-2R614	ZBRICK2 450F 2TB RAID6(14+2)	ES-AF	\$2,092,035
ZB2-450F-2TB-2R64U	ZBRICK2 450F 2TB RAID6(14+2) UPG	ES-AF	\$2,510,440
ZB2-450F-2TB-4R57	ZBRICK2 450F 2TB 4RAID5(7+1)	ES-AF	\$2,092,035
ZB2-450F-2TB-4R57U	ZBRICK2 450F 2TB 4RAID5(7+1) UPG	ES-AF	\$2,510,440
ZB2-450X-1TB-2R57	ZBRICK2 450FX 1TB RAID5(7+1)	ES-AF	\$1,465,725
ZB2-450X-1TB-2R57U	ZBRICK2 450FX 1TB RAID5(7+1) UPG	ES-AF	\$1,758,870
ZB2-450X-1TB-2R614	ZBRICK2 450FX 1TB RAID6(14+2)	ES-AF	\$1,465,725
ZB2-450X-1TB-2R64U	ZBRICK2 450FX 1TB RAID6(14+2) UPG	ES-AF	\$1,758,870
ZB2-450X-1TB-4R57	ZBRICK2 450FX 1TB 4RAID5(7+1)	ES-AF	\$1,465,725
ZB2-450X-1TB-4R57U	ZBRICK2 450FX 1TB 4RAID5(7+1) UPG	ES-AF	\$1,758,870
ZB2-450X-2TB-2R57	ZBRICK2 450FX 2TB RAID5(7+1)	ES-AF	\$2,365,725
ZB2-450X-2TB-2R57U	ZBRICK2 450FX 2TB RAID5(7+1) UPG	ES-AF	\$2,838,870
ZB2-450X-2TB-2R614	ZBRICK2 450FX 2TB RAID6(14+2)	ES-AF	\$2,365,725
ZB2-450X-2TB-2R64U	ZBRICK2 450FX 2TB RAID6(14+2) UPG	ES-AF	\$2,838,870
ZB2-450X-2TB-4R57	ZBRICK2 450FX 2TB 4RAID5(7+1)	ES-AF	\$2,365,725
ZB2-450X-2TB-4R57U	ZBRICK2 450FX 2TB 4RAID5(7+1) UPG	ES-AF	\$2,838,870
ZB2-45TF-1TB-2R57U	ZBRICK2 450F 1TB RAID5(7+1) TAA UPG	ES-AF	\$1,430,440
ZB2-45TF-1TB-2R64U	ZBRICK2 450F 1TB RAID6(14+2) TAA UPG	ES-AF	\$1,430,440
ZB2-45TF-1TB-4R57U	ZBRICK2 450F 1TB 4RAID5(7+1) TAA UPG	ES-AF	\$1,430,440
ZB2-45TF-2TB-2R57U	ZBRICK2 450F 2TB RAID5(7+1) TAA UPG	ES-AF	\$2,510,440
ZB2-45TF-2TB-2R64U	ZBRICK2 450F 2TB RAID6(14+2) TAA UPG	ES-AF	\$2,510,440
ZB2-45TF-2TB-4R57U	ZBRICK2 450F 2TB 4RAID5(7+1) TAA UPG	ES-AF	\$2,510,440
ZB2-45TX-1TB-2R57U	ZBRICK2 450FX 1TB RAID5(7+1) TAA UPG	ES-AF	\$1,758,870
ZB2-45TX-1TB-2R64U	ZBRICK2 450FX 1TB RAID6(14+2) TAA UPG	ES-AF	\$1,758,870
ZB2-45TX-1TB-4R57U	ZBRICK2 450FX 1TB 4RAID5(7+1) TAA UPG	ES-AF	\$1,758,870
ZB2-45TX-2TB-2R57U	ZBRICK2 450FX 2TB RAID5(7+1) TAA UPG	ES-AF	\$2,838,870
ZB2-45TX-2TB-2R64U	ZBRICK2 450FX 2TB RAID6(14+2) TAA UPG	ES-AF	\$2,838,870
ZB2-45TX-2TB-4R57U	ZBRICK2 450FX 2TB 4RAID5(7+1) TAA UPG	ES-AF	\$2,838,870
ZB2-850F-1TB-2R57	ZBRICK2 850F 1TB RAID5(7+1)	ES-AF	\$1,338,220

ZB2-850F-1TB-2R57U	ZBRICK2 850F 1TB RAID5(7+1) UPG	ES-AF	\$1,605,865
ZB2-850F-1TB-2R614	ZBRICK2 850F 1TB RAID6(14+2)	ES-AF	\$1,338,220
ZB2-850F-1TB-2R64U	ZBRICK2 850F 1TB RAID6(14+2) UPG	ES-AF	\$1,605,865
ZB2-850F-1TB-4R57	ZBRICK2 850F 1TB 4RAID5(7+1)	ES-AF	\$1,338,220
ZB2-850F-1TB-4R57U	ZBRICK2 850F 1TB 4RAID5(7+1) UPG	ES-AF	\$1,605,865
ZB2-850F-2TB-2R57	ZBRICK2 850F 2TB RAID5(7+1)	ES-AF	\$2,238,220
ZB2-850F-2TB-2R57U	ZBRICK2 850F 2TB RAID5(7+1) UPG	ES-AF	\$2,685,865
ZB2-850F-2TB-2R614	ZBRICK2 850F 2TB RAID6(14+2)	ES-AF	\$2,238,220
ZB2-850F-2TB-2R64U	ZBRICK2 850F 2TB RAID6(14+2) UPG	ES-AF	\$2,685,865
ZB2-850F-2TB-4R57	ZBRICK2 850F 2TB 4RAID5(7+1)	ES-AF	\$2,238,220
ZB2-850F-2TB-4R57U	ZBRICK2 850F 2TB 4RAID5(7+1) UPG	ES-AF	\$2,685,865
ZB2-850X-1TB-2R57	ZBRICK2 850FX 1TB RAID5(7+1)	ES-AF	\$1,613,825
ZB2-850X-1TB-2R57U	ZBRICK2 850FX 1TB RAID5(7+1) UPG	ES-AF	\$1,936,590
ZB2-850X-1TB-2R614	ZBRICK2 850FX 1TB RAID6(14+2)	ES-AF	\$1,613,825
ZB2-850X-1TB-2R64U	ZBRICK2 850FX 1TB RAID6(14+2) UPG	ES-AF	\$1,936,590
ZB2-850X-1TB-4R57	ZBRICK2 850FX 1TB 4RAID5(7+1)	ES-AF	\$1,613,825
ZB2-850X-1TB-4R57U	ZBRICK2 850FX 1TB 4RAID5(7+1) UPG	ES-AF	\$1,936,590
ZB2-850X-2TB-2R57	ZBRICK2 850FX 2TB RAID5(7+1)	ES-AF	\$2,513,825
ZB2-850X-2TB-2R57U	ZBRICK2 850FX 2TB RAID5(7+1) UPG	ES-AF	\$3,016,590
ZB2-850X-2TB-2R614	ZBRICK2 850FX 2TB RAID6(14+2)	ES-AF	\$2,513,825
ZB2-850X-2TB-2R64U	ZBRICK2 850FX 2TB RAID6(14+2) UPG	ES-AF	\$3,016,590
ZB2-850X-2TB-4R57	ZBRICK2 850FX 2TB 4RAID5(7+1)	ES-AF	\$2,513,825
ZB2-850X-2TB-4R57U	ZBRICK2 850FX 2TB 4RAID5(7+1) UPG	ES-AF	\$3,016,590
ZB2-85TF-1TB-2R57U	ZBRICK2 850F 1TB RAID5(7+1) TAA UPG	ES-AF	\$1,605,865
ZB2-85TF-1TB-2R64U	ZBRICK2 850F 1TB RAID6(14+2) TAA UPG	ES-AF	\$1,605,865
ZB2-85TF-1TB-4R57U	ZBRICK2 850F 1TB 4RAID5(7+1) TAA UPG	ES-AF	\$1,605,865
ZB2-85TF-2TB-2R57U	ZBRICK2 850F 2TB RAID5(7+1) TAA UPG	ES-AF	\$2,685,865
ZB2-85TF-2TB-2R64U	ZBRICK2 850F 2TB RAID6(14+2) TAA UPG	ES-AF	\$2,685,865
ZB2-85TF-2TB-4R57U	ZBRICK2 850F 2TB 4RAID5(7+1) TAA UPG	ES-AF	\$2,685,865
ZB2-85TX-1TB-2R57U	ZBRICK2 850FX 1TB RAID5(7+1) TAA UPG	ES-AF	\$1,936,590
ZB2-85TX-1TB-2R64U	ZBRICK2 850FX 1TB RAID6(14+2) TAA UPG	ES-AF	\$1,936,590
ZB2-85TX-1TB-4R57U	ZBRICK2 850FX 1TB 4RAID5(7+1) TAA UPG	ES-AF	\$1,936,590
ZB2-85TX-2TB-2R57U	ZBRICK2 850FX 2TB RAID5(7+1) TAA UPG	ES-AF	\$3,016,590
ZB2-85TX-2TB-2R64U	ZBRICK2 850FX 2TB RAID6(14+2) TAA UPG	ES-AF	\$3,016,590
ZB2-85TX-2TB-4R57U	ZBRICK2 850FX 2TB 4RAID5(7+1) TAA UPG	ES-AF	\$3,016,590
ZB3-450F-1TB-2R57	ZBRICK3 450F 1TB RAID5(7+1)	ES-AF	\$1,192,035
ZB3-450F-1TB-2R57U	ZBRICK3 450F 1TB RAID5(7+1) UPG	ES-AF	\$1,430,440
ZB3-450F-1TB-2R614	ZBRICK3 450F 1TB RAID6(14+2)	ES-AF	\$1,192,035
ZB3-450F-1TB-2R64U	ZBRICK3 450F 1TB RAID6(14+2) UPG	ES-AF	\$1,430,440
ZB3-450F-1TB-4R57	ZBRICK3 450F 1TB 4RAID5(7+1)	ES-AF	\$1,192,035
ZB3-450F-1TB-4R57U	ZBRICK3 450F 1TB 4RAID5(7+1) UPG	ES-AF	\$1,430,440
ZB3-450F-2TB-2R57	ZBRICK3 450F 2TB RAID5(7+1)	ES-AF	\$2,092,035
ZB3-450F-2TB-2R57U	ZBRICK3 450F 2TB RAID5(7+1) UPG	ES-AF	\$2,510,440
ZB3-450F-2TB-2R614	ZBRICK3 450F 2TB RAID6(14+2)	ES-AF	\$2,092,035
ZB3-450F-2TB-2R64U	ZBRICK3 450F 2TB RAID6(14+2) UPG	ES-AF	\$2,510,440
ZB3-450F-2TB-4R57	ZBRICK3 450F 2TB 4RAID5(7+1)	ES-AF	\$2,092,035
ZB3-450F-2TB-4R57U	ZBRICK3 450F 2TB 4RAID5(7+1) UPG	ES-AF	\$2,510,440
ZB3-450X-1TB-2R57	ZBRICK3 450FX 1TB RAID5(7+1)	ES-AF	\$1,465,725
ZB3-450X-1TB-2R57U	ZBRICK3 450FX 1TB RAID5(7+1) UPG	ES-AF	\$1,758,870
ZB3-450X-1TB-2R614	ZBRICK3 450FX 1TB RAID6(14+2)	ES-AF	\$1,465,725

ZB3-450X-1TB-2R64U	ZBRICK3 450FX 1TB RAID6(14+2) UPG	ES-AF	\$1,758,870
ZB3-450X-1TB-4R57	ZBRICK3 450FX 1TB 4RAID5(7+1)	ES-AF	\$1,465,725
ZB3-450X-1TB-4R57U	ZBRICK3 450FX 1TB 4RAID5(7+1) UPG	ES-AF	\$1,758,870
ZB3-450X-2TB-2R57	ZBRICK3 450FX 2TB RAID5(7+1)	ES-AF	\$2,365,725
ZB3-450X-2TB-2R57U	ZBRICK3 450FX 2TB RAID5(7+1) UPG	ES-AF	\$2,838,870
ZB3-450X-2TB-2R614	ZBRICK3 450FX 2TB RAID6(14+2)	ES-AF	\$2,365,725
ZB3-450X-2TB-2R64U	ZBRICK3 450FX 2TB RAID6(14+2) UPG	ES-AF	\$2,838,870
ZB3-450X-2TB-4R57	ZBRICK3 450FX 2TB 4RAID5(7+1)	ES-AF	\$2,365,725
ZB3-450X-2TB-4R57U	ZBRICK3 450FX 2TB 4RAID5(7+1) UPG	ES-AF	\$2,838,870
ZB3-45TF-1TB-2R57U	ZBRICK3 450F 1TB RAID5(7+1) TAA UPG	ES-AF	\$1,430,440
ZB3-45TF-1TB-2R64U	ZBRICK3 450F 1TB RAID6(14+2) TAA UPG	ES-AF	\$1,430,440
ZB3-45TF-1TB-4R57U	ZBRICK3 450F 1TB 4RAID5(7+1) TAA UPG	ES-AF	\$1,430,440
ZB3-45TF-2TB-2R57U	ZBRICK3 450F 2TB RAID5(7+1) TAA UPG	ES-AF	\$2,510,440
ZB3-45TF-2TB-2R64U	ZBRICK3 450F 2TB RAID6(14+2) TAA UPG	ES-AF	\$2,510,440
ZB3-45TF-2TB-4R57U	ZBRICK3 450F 2TB 4RAID5(7+1) TAA UPG	ES-AF	\$2,510,440
ZB3-45TX-1TB-2R57U	ZBRICK3 450FX 1TB RAID5(7+1) TAA UPG	ES-AF	\$1,758,870
ZB3-45TX-1TB-2R64U	ZBRICK3 450FX 1TB RAID6(14+2) TAA UPG	ES-AF	\$1,758,870
ZB3-45TX-1TB-4R57U	ZBRICK3 450FX 1TB 4RAID5(7+1) TAA UPG	ES-AF	\$1,758,870
ZB3-45TX-2TB-2R57U	ZBRICK3 450FX 2TB RAID5(7+1) TAA UPG	ES-AF	\$2,838,870
ZB3-45TX-2TB-2R64U	ZBRICK3 450FX 2TB RAID6(14+2) TAA UPG	ES-AF	\$2,838,870
ZB3-45TX-2TB-4R57U	ZBRICK3 450FX 2TB 4RAID5(7+1) TAA UPG	ES-AF	\$2,838,870
ZB3-850F-1TB-2R57	ZBRICK3 850F 1TB RAID5(7+1)	ES-AF	\$1,338,220
ZB3-850F-1TB-2R57U	ZBRICK3 850F 1TB RAID5(7+1) UPG	ES-AF	\$1,605,865
ZB3-850F-1TB-2R614	ZBRICK3 850F 1TB RAID6(14+2)	ES-AF	\$1,338,220
ZB3-850F-1TB-2R64U	ZBRICK3 850F 1TB RAID6(14+2) UPG	ES-AF	\$1,605,865
ZB3-850F-1TB-4R57	ZBRICK3 850F 1TB 4RAID5(7+1)	ES-AF	\$1,338,220
ZB3-850F-1TB-4R57U	ZBRICK3 850F 1TB 4RAID5(7+1) UPG	ES-AF	\$1,605,865
ZB3-850F-2TB-2R57	ZBRICK3 850F 2TB RAID5(7+1)	ES-AF	\$2,238,220
ZB3-850F-2TB-2R57U	ZBRICK3 850F 2TB RAID5(7+1) UPG	ES-AF	\$2,685,865
ZB3-850F-2TB-2R614	ZBRICK3 850F 2TB RAID6(14+2)	ES-AF	\$2,238,220
ZB3-850F-2TB-2R64U	ZBRICK3 850F 2TB RAID6(14+2) UPG	ES-AF	\$2,685,865
ZB3-850F-2TB-4R57	ZBRICK3 850F 2TB 4RAID5(7+1)	ES-AF	\$2,238,220
ZB3-850F-2TB-4R57U	ZBRICK3 850F 2TB 4RAID5(7+1) UPG	ES-AF	\$2,685,865
ZB3-850X-1TB-2R57	ZBRICK3 850FX 1TB RAID5(7+1)	ES-AF	\$1,613,825
ZB3-850X-1TB-2R57U	ZBRICK3 850FX 1TB RAID5(7+1) UPG	ES-AF	\$1,936,590
ZB3-850X-1TB-2R614	ZBRICK3 850FX 1TB RAID6(14+2)	ES-AF	\$1,613,825
ZB3-850X-1TB-2R64U	ZBRICK3 850FX 1TB RAID6(14+2) UPG	ES-AF	\$1,936,590
ZB3-850X-1TB-4R57	ZBRICK3 850FX 1TB 4RAID5(7+1)	ES-AF	\$1,613,825
ZB3-850X-1TB-4R57U	ZBRICK3 850FX 1TB 4RAID5(7+1) UPG	ES-AF	\$1,936,590
ZB3-850X-2TB-2R57	ZBRICK3 850FX 2TB RAID5(7+1)	ES-AF	\$2,513,825
ZB3-850X-2TB-2R57U	ZBRICK3 850FX 2TB RAID5(7+1) UPG	ES-AF	\$3,016,590
ZB3-850X-2TB-2R614	ZBRICK3 850FX 2TB RAID6(14+2)	ES-AF	\$2,513,825
ZB3-850X-2TB-2R64U	ZBRICK3 850FX 2TB RAID6(14+2) UPG	ES-AF	\$3,016,590
ZB3-850X-2TB-4R57	ZBRICK3 850FX 2TB 4RAID5(7+1)	ES-AF	\$2,513,825
ZB3-850X-2TB-4R57U	ZBRICK3 850FX 2TB 4RAID5(7+1) UPG	ES-AF	\$3,016,590
ZB3-85TF-1TB-2R57U	ZBRICK3 850F 1TB RAID5(7+1) TAA UPG	ES-AF	\$1,605,865
ZB3-85TF-1TB-2R64U	ZBRICK3 850F 1TB RAID6(14+2) TAA UPG	ES-AF	\$1,605,865
ZB3-85TF-1TB-4R57U	ZBRICK3 850F 1TB 4RAID5(7+1) TAA UPG	ES-AF	\$1,605,865
ZB3-85TF-2TB-2R57U	ZBRICK3 850F 2TB RAID5(7+1) TAA UPG	ES-AF	\$2,685,865
ZB3-85TF-2TB-2R64U	ZBRICK3 850F 2TB RAID6(14+2) TAA UPG	ES-AF	\$2,685,865

ZB3-85TF-2TB-4R57U	ZBRICK3 850F 2TB 4RAID5(7+1) TAA UPG	ES-AF	\$2,685,865
ZB3-85TX-1TB-2R57U	ZBRICK3 850FX 1TB RAID5(7+1) TAA UPG	ES-AF	\$1,936,590
ZB3-85TX-1TB-2R64U	ZBRICK3 850FX 1TB RAID6(14+2) TAA UPG	ES-AF	\$1,936,590
ZB3-85TX-1TB-4R57U	ZBRICK3 850FX 1TB 4RAID5(7+1) TAA UPG	ES-AF	\$1,936,590
ZB3-85TX-2TB-2R57U	ZBRICK3 850FX 2TB RAID5(7+1) TAA UPG	ES-AF	\$3,016,590
ZB3-85TX-2TB-2R64U	ZBRICK3 850FX 2TB RAID6(14+2) TAA UPG	ES-AF	\$3,016,590
ZB3-85TX-2TB-4R57U	ZBRICK3 850FX 2TB 4RAID5(7+1) TAA UPG	ES-AF	\$3,016,590
ZB4-450F-1TB-2R57	ZBRICK4 450F 1TB RAID5(7+1)	ES-AF	\$1,192,035
ZB4-450F-1TB-2R57U	ZBRICK4 450F 1TB RAID5(7+1) UPG	ES-AF	\$1,430,440
ZB4-450F-1TB-2R614	ZBRICK4 450F 1TB RAID6(14+2)	ES-AF	\$1,192,035
ZB4-450F-1TB-2R64U	ZBRICK4 450F 1TB RAID6(14+2) UPG	ES-AF	\$1,430,440
ZB4-450F-1TB-4R57	ZBRICK4 450F 1TB 4RAID5(7+1)	ES-AF	\$1,192,035
ZB4-450F-1TB-4R57U	ZBRICK4 450F 1TB 4RAID5(7+1) UPG	ES-AF	\$1,430,440
ZB4-450F-2TB-2R57	ZBRICK4 450F 2TB RAID5(7+1)	ES-AF	\$2,092,035
ZB4-450F-2TB-2R57U	ZBRICK4 450F 2TB RAID5(7+1) UPG	ES-AF	\$2,510,440
ZB4-450F-2TB-2R614	ZBRICK4 450F 2TB RAID6(14+2)	ES-AF	\$2,092,035
ZB4-450F-2TB-2R64U	ZBRICK4 450F 2TB RAID6(14+2) UPG	ES-AF	\$2,510,440
ZB4-450F-2TB-4R57	ZBRICK4 450F 2TB 4RAID5(7+1)	ES-AF	\$2,092,035
ZB4-450F-2TB-4R57U	ZBRICK4 450F 2TB 4RAID5(7+1) UPG	ES-AF	\$2,510,440
ZB4-450X-1TB-2R57	ZBRICK4 450FX 1TB RAID5(7+1)	ES-AF	\$1,465,725
ZB4-450X-1TB-2R57U	ZBRICK4 450FX 1TB RAID5(7+1) UPG	ES-AF	\$1,758,870
ZB4-450X-1TB-2R614	ZBRICK4 450FX 1TB RAID6(14+2)	ES-AF	\$1,465,725
ZB4-450X-1TB-2R64U	ZBRICK4 450FX 1TB RAID6(14+2) UPG	ES-AF	\$1,758,870
ZB4-450X-1TB-4R57	ZBRICK4 450FX 1TB 4RAID5(7+1)	ES-AF	\$1,465,725
ZB4-450X-1TB-4R57U	ZBRICK4 450FX 1TB 4RAID5(7+1) UPG	ES-AF	\$1,758,870
ZB4-450X-2TB-2R57	ZBRICK4 450FX 2TB RAID5(7+1)	ES-AF	\$2,365,725
ZB4-450X-2TB-2R57U	ZBRICK4 450FX 2TB RAID5(7+1) UPG	ES-AF	\$2,838,870
ZB4-450X-2TB-2R614	ZBRICK4 450FX 2TB RAID6(14+2)	ES-AF	\$2,365,725
ZB4-450X-2TB-2R64U	ZBRICK4 450FX 2TB RAID6(14+2) UPG	ES-AF	\$2,838,870
ZB4-450X-2TB-4R57	ZBRICK4 450FX 2TB 4RAID5(7+1)	ES-AF	\$2,365,725
ZB4-450X-2TB-4R57U	ZBRICK4 450FX 2TB 4RAID5(7+1) UPG	ES-AF	\$2,838,870
ZB4-45TF-1TB-2R57U	ZBRICK4 450F 1TB RAID5(7+1) TAA UPG	ES-AF	\$1,430,440
ZB4-45TF-1TB-2R64U	ZBRICK4 450F 1TB RAID6(14+2) TAA UPG	ES-AF	\$1,430,440
ZB4-45TF-1TB-4R57U	ZBRICK4 450F 1TB 4RAID5(7+1) TAA UPG	ES-AF	\$1,430,440
ZB4-45TF-2TB-2R57U	ZBRICK4 450F 2TB RAID5(7+1) TAA UPG	ES-AF	\$2,510,440
ZB4-45TF-2TB-2R64U	ZBRICK4 450F 2TB RAID6(14+2) TAA UPG	ES-AF	\$2,510,440
ZB4-45TF-2TB-4R57U	ZBRICK4 450F 2TB 4RAID5(7+1) TAA UPG	ES-AF	\$2,510,440
ZB4-45TX-1TB-2R57U	ZBRICK4 450FX 1TB RAID5(7+1) TAA UPG	ES-AF	\$1,758,870
ZB4-45TX-1TB-2R64U	ZBRICK4 450FX 1TB RAID6(14+2) TAA UPG	ES-AF	\$1,758,870
ZB4-45TX-1TB-4R57U	ZBRICK4 450FX 1TB 4RAID5(7+1) TAA UPG	ES-AF	\$1,758,870
ZB4-45TX-2TB-2R57U	ZBRICK4 450FX 2TB RAID5(7+1) TAA UPG	ES-AF	\$2,838,870
ZB4-45TX-2TB-2R64U	ZBRICK4 450FX 2TB RAID6(14+2) TAA UPG	ES-AF	\$2,838,870
ZB4-45TX-2TB-4R57U	ZBRICK4 450FX 2TB 4RAID5(7+1) TAA UPG	ES-AF	\$2,838,870
ZB4-850F-1TB-2R57	ZBRICK4 850F 1TB RAID5(7+1)	ES-AF	\$1,338,220
ZB4-850F-1TB-2R57U	ZBRICK4 850F 1TB RAID5(7+1) UPG	ES-AF	\$1,605,865
ZB4-850F-1TB-2R614	ZBRICK4 850F 1TB RAID6(14+2)	ES-AF	\$1,338,220
ZB4-850F-1TB-2R64U	ZBRICK4 850F 1TB RAID6(14+2) UPG	ES-AF	\$1,605,865
ZB4-850F-1TB-4R57	ZBRICK4 850F 1TB 4RAID5(7+1)	ES-AF	\$1,338,220
ZB4-850F-1TB-4R57U	ZBRICK4 850F 1TB 4RAID5(7+1) UPG	ES-AF	\$1,605,865
ZB4-850F-2TB-2R57	ZBRICK4 850F 2TB RAID5(7+1)	ES-AF	\$2,238,220

ZB4-850F-2TB-2R57U	ZBRICK4 850F 2TB RAID5(7+1) UPG	ES-AF	\$2,685,865
ZB4-850F-2TB-2R614	ZBRICK4 850F 2TB RAID6(14+2)	ES-AF	\$2,238,220
ZB4-850F-2TB-2R64U	ZBRICK4 850F 2TB RAID6(14+2) UPG	ES-AF	\$2,685,865
ZB4-850F-2TB-4R57	ZBRICK4 850F 2TB 4RAID5(7+1)	ES-AF	\$2,238,220
ZB4-850F-2TB-4R57U	ZBRICK4 850F 2TB 4RAID5(7+1) UPG	ES-AF	\$2,685,865
ZB4-850X-1TB-2R57	ZBRICK4 850FX 1TB RAID5(7+1)	ES-AF	\$1,613,825
ZB4-850X-1TB-2R57U	ZBRICK4 850FX 1TB RAID5(7+1) UPG	ES-AF	\$1,936,590
ZB4-850X-1TB-2R614	ZBRICK4 850FX 1TB RAID6(14+2)	ES-AF	\$1,613,825
ZB4-850X-1TB-2R64U	ZBRICK4 850FX 1TB RAID6(14+2) UPG	ES-AF	\$1,936,590
ZB4-850X-1TB-4R57	ZBRICK4 850FX 1TB 4RAID5(7+1)	ES-AF	\$1,613,825
ZB4-850X-1TB-4R57U	ZBRICK4 850FX 1TB 4RAID5(7+1) UPG	ES-AF	\$1,936,590
ZB4-850X-2TB-2R57	ZBRICK4 850FX 2TB RAID5(7+1)	ES-AF	\$2,513,825
ZB4-850X-2TB-2R57U	ZBRICK4 850FX 2TB RAID5(7+1) UPG	ES-AF	\$3,016,590
ZB4-850X-2TB-2R614	ZBRICK4 850FX 2TB RAID6(14+2)	ES-AF	\$2,513,825
ZB4-850X-2TB-2R64U	ZBRICK4 850FX 2TB RAID6(14+2) UPG	ES-AF	\$3,016,590
ZB4-850X-2TB-4R57	ZBRICK4 850FX 2TB 4RAID5(7+1)	ES-AF	\$2,513,825
ZB4-850X-2TB-4R57U	ZBRICK4 850FX 2TB 4RAID5(7+1) UPG	ES-AF	\$3,016,590
ZB4-85TF-1TB-2R57U	ZBRICK4 850F 1TB RAID5(7+1) TAA UPG	ES-AF	\$1,605,865
ZB4-85TF-1TB-2R64U	ZBRICK4 850F 1TB RAID6(14+2) TAA UPG	ES-AF	\$1,605,865
ZB4-85TF-1TB-4R57U	ZBRICK4 850F 1TB 4RAID5(7+1) TAA UPG	ES-AF	\$1,605,865
ZB4-85TF-2TB-2R57U	ZBRICK4 850F 2TB RAID5(7+1) TAA UPG	ES-AF	\$2,685,865
ZB4-85TF-2TB-2R64U	ZBRICK4 850F 2TB RAID6(14+2) TAA UPG	ES-AF	\$2,685,865
ZB4-85TF-2TB-4R57U	ZBRICK4 850F 2TB 4RAID5(7+1) TAA UPG	ES-AF	\$2,685,865
ZB4-85TX-1TB-2R57U	ZBRICK4 850FX 1TB RAID5(7+1) TAA UPG	ES-AF	\$1,936,590
ZB4-85TX-1TB-2R64U	ZBRICK4 850FX 1TB RAID6(14+2) TAA UPG	ES-AF	\$1,936,590
ZB4-85TX-1TB-4R57U	ZBRICK4 850FX 1TB 4RAID5(7+1) TAA UPG	ES-AF	\$1,936,590
ZB4-85TX-2TB-2R57U	ZBRICK4 850FX 2TB RAID5(7+1) TAA UPG	ES-AF	\$3,016,590
ZB4-85TX-2TB-2R64U	ZBRICK4 850FX 2TB RAID6(14+2) TAA UPG	ES-AF	\$3,016,590
ZB4-85TX-2TB-4R57U	ZBRICK4 850FX 2TB 4RAID5(7+1) TAA UPG	ES-AF	\$3,016,590
ZB5-850F-1TB-2R57	ZBRICK5 850F 1TB RAID5(7+1)	ES-AF	\$1,338,220
ZB5-850F-1TB-2R57U	ZBRICK5 850F 1TB RAID5(7+1) UPG	ES-AF	\$1,605,865
ZB5-850F-1TB-2R614	ZBRICK5 850F 1TB RAID6(14+2)	ES-AF	\$1,338,220
ZB5-850F-1TB-2R64U	ZBRICK5 850F 1TB RAID6(14+2) UPG	ES-AF	\$1,605,865
ZB5-850F-1TB-4R57	ZBRICK5 850F 1TB 4RAID5(7+1)	ES-AF	\$1,338,220
ZB5-850F-1TB-4R57U	ZBRICK5 850F 1TB 4RAID5(7+1) UPG	ES-AF	\$1,605,865
ZB5-850F-2TB-2R57	ZBRICK5 850F 2TB RAID5(7+1)	ES-AF	\$2,238,220
ZB5-850F-2TB-2R57U	ZBRICK5 850F 2TB RAID5(7+1) UPG	ES-AF	\$2,685,865
ZB5-850F-2TB-2R614	ZBRICK5 850F 2TB RAID6(14+2)	ES-AF	\$2,238,220
ZB5-850F-2TB-2R64U	ZBRICK5 850F 2TB RAID6(14+2) UPG	ES-AF	\$2,685,865
ZB5-850F-2TB-4R57	ZBRICK5 850F 2TB 4RAID5(7+1)	ES-AF	\$2,238,220
ZB5-850F-2TB-4R57U	ZBRICK5 850F 2TB 4RAID5(7+1) UPG	ES-AF	\$2,685,865
ZB5-850X-1TB-2R57	ZBRICK5 850FX 1TB RAID5(7+1)	ES-AF	\$1,613,825
ZB5-850X-1TB-2R57U	ZBRICK5 850FX 1TB RAID5(7+1) UPG	ES-AF	\$1,936,590
ZB5-850X-1TB-2R614	ZBRICK5 850FX 1TB RAID6(14+2)	ES-AF	\$1,613,825
ZB5-850X-1TB-2R64U	ZBRICK5 850FX 1TB RAID6(14+2) UPG	ES-AF	\$1,936,590
ZB5-850X-1TB-4R57	ZBRICK5 850FX 1TB 4RAID5(7+1)	ES-AF	\$1,613,825
ZB5-850X-1TB-4R57U	ZBRICK5 850FX 1TB 4RAID5(7+1) UPG	ES-AF	\$1,936,590
ZB5-850X-2TB-2R57	ZBRICK5 850FX 2TB RAID5(7+1)	ES-AF	\$2,513,825
ZB5-850X-2TB-2R57U	ZBRICK5 850FX 2TB RAID5(7+1) UPG	ES-AF	\$3,016,590
ZB5-850X-2TB-2R614	ZBRICK5 850FX 2TB RAID6(14+2)	ES-AF	\$2,513,825

ZB5-850X-2TB-2R64U	ZBRICK5 850FX 2TB RAID6(14+2) UPG	ES-AF	\$3,016,590
ZB5-850X-2TB-4R57	ZBRICK5 850FX 2TB 4RAID5(7+1)	ES-AF	\$2,513,825
ZB5-850X-2TB-4R57U	ZBRICK5 850FX 2TB 4RAID5(7+1) UPG	ES-AF	\$3,016,590
ZB5-85TF-1TB-2R57U	ZBRICK5 850F 1TB RAID5(7+1) TAA UPG	ES-AF	\$1,605,865
ZB5-85TF-1TB-2R64U	ZBRICK5 850F 1TB RAID6(14+2) TAA UPG	ES-AF	\$1,605,865
ZB5-85TF-1TB-4R57U	ZBRICK5 850F 1TB 4RAID5(7+1) TAA UPG	ES-AF	\$1,605,865
ZB5-85TF-2TB-2R57U	ZBRICK5 850F 2TB RAID5(7+1) TAA UPG	ES-AF	\$2,685,865
ZB5-85TF-2TB-2R64U	ZBRICK5 850F 2TB RAID6(14+2) TAA UPG	ES-AF	\$2,685,865
ZB5-85TF-2TB-4R57U	ZBRICK5 850F 2TB 4RAID5(7+1) TAA UPG	ES-AF	\$2,685,865
ZB5-85TX-1TB-2R57U	ZBRICK5 850FX 1TB RAID5(7+1) TAA UPG	ES-AF	\$1,936,590
ZB5-85TX-1TB-2R64U	ZBRICK5 850FX 1TB RAID6(14+2) TAA UPG	ES-AF	\$1,936,590
ZB5-85TX-1TB-4R57U	ZBRICK5 850FX 1TB 4RAID5(7+1) TAA UPG	ES-AF	\$1,936,590
ZB5-85TX-2TB-2R57U	ZBRICK5 850FX 2TB RAID5(7+1) TAA UPG	ES-AF	\$3,016,590
ZB5-85TX-2TB-2R64U	ZBRICK5 850FX 2TB RAID6(14+2) TAA UPG	ES-AF	\$3,016,590
ZB5-85TX-2TB-4R57U	ZBRICK5 850FX 2TB 4RAID5(7+1) TAA UPG	ES-AF	\$3,016,590
ZB6-850F-1TB-2R57	ZBRICK6 850F 1TB RAID5(7+1)	ES-AF	\$1,338,220
ZB6-850F-1TB-2R57U	ZBRICK6 850F 1TB RAID5(7+1) UPG	ES-AF	\$1,605,865
ZB6-850F-1TB-2R614	ZBRICK6 850F 1TB RAID6(14+2)	ES-AF	\$1,338,220
ZB6-850F-1TB-2R64U	ZBRICK6 850F 1TB RAID6(14+2) UPG	ES-AF	\$1,605,865
ZB6-850F-1TB-4R57	ZBRICK6 850F 1TB 4RAID5(7+1)	ES-AF	\$1,338,220
ZB6-850F-1TB-4R57U	ZBRICK6 850F 1TB 4RAID5(7+1) UPG	ES-AF	\$1,605,865
ZB6-850F-2TB-2R57	ZBRICK6 850F 2TB RAID5(7+1)	ES-AF	\$2,238,220
ZB6-850F-2TB-2R57U	ZBRICK6 850F 2TB RAID5(7+1) UPG	ES-AF	\$2,685,865
ZB6-850F-2TB-2R614	ZBRICK6 850F 2TB RAID6(14+2)	ES-AF	\$2,238,220
ZB6-850F-2TB-2R64U	ZBRICK6 850F 2TB RAID6(14+2) UPG	ES-AF	\$2,685,865
ZB6-850F-2TB-4R57	ZBRICK6 850F 2TB 4RAID5(7+1)	ES-AF	\$2,238,220
ZB6-850F-2TB-4R57U	ZBRICK6 850F 2TB 4RAID5(7+1) UPG	ES-AF	\$2,685,865
ZB6-850X-1TB-2R57	ZBRICK6 850FX 1TB RAID5(7+1)	ES-AF	\$1,613,825
ZB6-850X-1TB-2R57U	ZBRICK6 850FX 1TB RAID5(7+1) UPG	ES-AF	\$1,936,590
ZB6-850X-1TB-2R614	ZBRICK6 850FX 1TB RAID6(14+2)	ES-AF	\$1,613,825
ZB6-850X-1TB-2R64U	ZBRICK6 850FX 1TB RAID6(14+2) UPG	ES-AF	\$1,936,590
ZB6-850X-1TB-4R57	ZBRICK6 850FX 1TB 4RAID5(7+1)	ES-AF	\$1,613,825
ZB6-850X-1TB-4R57U	ZBRICK6 850FX 1TB 4RAID5(7+1) UPG	ES-AF	\$1,936,590
ZB6-850X-2TB-2R57	ZBRICK6 850FX 2TB RAID5(7+1)	ES-AF	\$2,513,825
ZB6-850X-2TB-2R57U	ZBRICK6 850FX 2TB RAID5(7+1) UPG	ES-AF	\$3,016,590
ZB6-850X-2TB-2R614	ZBRICK6 850FX 2TB RAID6(14+2)	ES-AF	\$2,513,825
ZB6-850X-2TB-2R64U	ZBRICK6 850FX 2TB RAID6(14+2) UPG	ES-AF	\$3,016,590
ZB6-850X-2TB-4R57	ZBRICK6 850FX 2TB 4RAID5(7+1)	ES-AF	\$2,513,825
ZB6-850X-2TB-4R57U	ZBRICK6 850FX 2TB 4RAID5(7+1) UPG	ES-AF	\$3,016,590
ZB6-85TF-1TB-2R57U	ZBRICK6 850F 1TB RAID5(7+1) TAA UPG	ES-AF	\$1,605,865
ZB6-85TF-1TB-2R64U	ZBRICK6 850F 1TB RAID6(14+2) TAA UPG	ES-AF	\$1,605,865
ZB6-85TF-1TB-4R57U	ZBRICK6 850F 1TB 4RAID5(7+1) TAA UPG	ES-AF	\$1,605,865
ZB6-85TF-2TB-2R57U	ZBRICK6 850F 2TB RAID5(7+1) TAA UPG	ES-AF	\$2,685,865
ZB6-85TF-2TB-2R64U	ZBRICK6 850F 2TB RAID6(14+2) TAA UPG	ES-AF	\$2,685,865
ZB6-85TF-2TB-4R57U	ZBRICK6 850F 2TB 4RAID5(7+1) TAA UPG	ES-AF	\$2,685,865
ZB6-85TX-1TB-2R57U	ZBRICK6 850FX 1TB RAID5(7+1) TAA UPG	ES-AF	\$1,936,590
ZB6-85TX-1TB-2R64U	ZBRICK6 850FX 1TB RAID6(14+2) TAA UPG	ES-AF	\$1,936,590
ZB6-85TX-1TB-4R57U	ZBRICK6 850FX 1TB 4RAID5(7+1) TAA UPG	ES-AF	\$1,936,590
ZB6-85TX-2TB-2R57U	ZBRICK6 850FX 2TB RAID5(7+1) TAA UPG	ES-AF	\$3,016,590
ZB6-85TX-2TB-2R64U	ZBRICK6 850FX 2TB RAID6(14+2) TAA UPG	ES-AF	\$3,016,590

ZB6-85TX-2TB-4R57U	ZBRICK6 850FX 2TB 4RAID5(7+1) TAA UPG	ES-AF	\$3,016,590
ZB7-850F-1TB-2R57	ZBRICK7 850F 1TB RAID5(7+1)	ES-AF	\$1,338,220
ZB7-850F-1TB-2R57U	ZBRICK7 850F 1TB RAID5(7+1) UPG	ES-AF	\$1,605,865
ZB7-850F-1TB-2R614	ZBRICK7 850F 1TB RAID6(14+2)	ES-AF	\$1,338,220
ZB7-850F-1TB-2R64U	ZBRICK7 850F 1TB RAID6(14+2) UPG	ES-AF	\$1,605,865
ZB7-850F-1TB-4R57	ZBRICK7 850F 1TB 4RAID5(7+1)	ES-AF	\$1,338,220
ZB7-850F-1TB-4R57U	ZBRICK7 850F 1TB 4RAID5(7+1) UPG	ES-AF	\$1,605,865
ZB7-850F-2TB-2R57	ZBRICK7 850F 2TB RAID5(7+1)	ES-AF	\$2,238,220
ZB7-850F-2TB-2R57U	ZBRICK7 850F 2TB RAID5(7+1) UPG	ES-AF	\$2,685,865
ZB7-850F-2TB-2R614	ZBRICK7 850F 2TB RAID6(14+2)	ES-AF	\$2,238,220
ZB7-850F-2TB-2R64U	ZBRICK7 850F 2TB RAID6(14+2) UPG	ES-AF	\$2,685,865
ZB7-850F-2TB-4R57	ZBRICK7 850F 2TB 4RAID5(7+1)	ES-AF	\$2,238,220
ZB7-850F-2TB-4R57U	ZBRICK7 850F 2TB 4RAID5(7+1) UPG	ES-AF	\$2,685,865
ZB7-850X-1TB-2R57	ZBRICK7 850FX 1TB RAID5(7+1)	ES-AF	\$1,613,825
ZB7-850X-1TB-2R57U	ZBRICK7 850FX 1TB RAID5(7+1) UPG	ES-AF	\$1,936,590
ZB7-850X-1TB-2R614	ZBRICK7 850FX 1TB RAID6(14+2)	ES-AF	\$1,613,825
ZB7-850X-1TB-2R64U	ZBRICK7 850FX 1TB RAID6(14+2) UPG	ES-AF	\$1,936,590
ZB7-850X-1TB-4R57	ZBRICK7 850FX 1TB 4RAID5(7+1)	ES-AF	\$1,613,825
ZB7-850X-1TB-4R57U	ZBRICK7 850FX 1TB 4RAID5(7+1) UPG	ES-AF	\$1,936,590
ZB7-850X-2TB-2R57	ZBRICK7 850FX 2TB RAID5(7+1)	ES-AF	\$2,513,825
ZB7-850X-2TB-2R57U	ZBRICK7 850FX 2TB RAID5(7+1) UPG	ES-AF	\$3,016,590
ZB7-850X-2TB-2R614	ZBRICK7 850FX 2TB RAID6(14+2)	ES-AF	\$2,513,825
ZB7-850X-2TB-2R64U	ZBRICK7 850FX 2TB RAID6(14+2) UPG	ES-AF	\$3,016,590
ZB7-850X-2TB-4R57	ZBRICK7 850FX 2TB 4RAID5(7+1)	ES-AF	\$2,513,825
ZB7-850X-2TB-4R57U	ZBRICK7 850FX 2TB 4RAID5(7+1) UPG	ES-AF	\$3,016,590
ZB7-85TF-1TB-2R57U	ZBRICK7 850F 1TB RAID5(7+1) TAA UPG	ES-AF	\$1,605,865
ZB7-85TF-1TB-2R64U	ZBRICK7 850F 1TB RAID6(14+2) TAA UPG	ES-AF	\$1,605,865
ZB7-85TF-1TB-4R57U	ZBRICK7 850F 1TB 4RAID5(7+1) TAA UPG	ES-AF	\$1,605,865
ZB7-85TF-2TB-2R57U	ZBRICK7 850F 2TB RAID5(7+1) TAA UPG	ES-AF	\$2,685,865
ZB7-85TF-2TB-2R64U	ZBRICK7 850F 2TB RAID6(14+2) TAA UPG	ES-AF	\$2,685,865
ZB7-85TF-2TB-4R57U	ZBRICK7 850F 2TB 4RAID5(7+1) TAA UPG	ES-AF	\$2,685,865
ZB7-85TX-1TB-2R57U	ZBRICK7 850FX 1TB RAID5(7+1) TAA UPG	ES-AF	\$1,936,590
ZB7-85TX-1TB-2R64U	ZBRICK7 850FX 1TB RAID6(14+2) TAA UPG	ES-AF	\$1,936,590
ZB7-85TX-1TB-4R57U	ZBRICK7 850FX 1TB 4RAID5(7+1) TAA UPG	ES-AF	\$1,936,590
ZB7-85TX-2TB-2R57U	ZBRICK7 850FX 2TB RAID5(7+1) TAA UPG	ES-AF	\$3,016,590
ZB7-85TX-2TB-2R64U	ZBRICK7 850FX 2TB RAID6(14+2) TAA UPG	ES-AF	\$3,016,590
ZB7-85TX-2TB-4R57U	ZBRICK7 850FX 2TB 4RAID5(7+1) TAA UPG	ES-AF	\$3,016,590
ZB8-850F-1TB-2R57	ZBRICK8 850F 1TB RAID5(7+1)	ES-AF	\$1,338,220
ZB8-850F-1TB-2R57U	ZBRICK8 850F 1TB RAID5(7+1) UPG	ES-AF	\$1,605,865
ZB8-850F-1TB-2R614	ZBRICK8 850F 1TB RAID6(14+2)	ES-AF	\$1,338,220
ZB8-850F-1TB-2R64U	ZBRICK8 850F 1TB RAID6(14+2) UPG	ES-AF	\$1,605,865
ZB8-850F-1TB-4R57	ZBRICK8 850F 1TB 4RAID5(7+1)	ES-AF	\$1,338,220
ZB8-850F-1TB-4R57U	ZBRICK8 850F 1TB 4RAID5(7+1) UPG	ES-AF	\$1,605,865
ZB8-850F-2TB-2R57	ZBRICK8 850F 2TB RAID5(7+1)	ES-AF	\$2,238,220
ZB8-850F-2TB-2R57U	ZBRICK8 850F 2TB RAID5(7+1) UPG	ES-AF	\$2,685,865
ZB8-850F-2TB-2R614	ZBRICK8 850F 2TB RAID6(14+2)	ES-AF	\$2,238,220
ZB8-850F-2TB-2R64U	ZBRICK8 850F 2TB RAID6(14+2) UPG	ES-AF	\$2,685,865
ZB8-850F-2TB-4R57	ZBRICK8 850F 2TB 4RAID5(7+1)	ES-AF	\$2,238,220
ZB8-850F-2TB-4R57U	ZBRICK8 850F 2TB 4RAID5(7+1) UPG	ES-AF	\$2,685,865
ZB8-850X-1TB-2R57	ZBRICK8 850FX 1TB RAID5(7+1)	ES-AF	\$1,613,825

ZB8-850X-1TB-2R57U	ZBRICK8 850FX 1TB RAID5(7+1) UPG	ES-AF	\$1,936,590
ZB8-850X-1TB-2R614	ZBRICK8 850FX 1TB RAID6(14+2)	ES-AF	\$1,613,825
ZB8-850X-1TB-2R64U	ZBRICK8 850X 1TB RAID6(14+2) UPG	ES-AF	\$1,936,590
ZB8-850X-1TB-4R57	ZBRICK8 850FX 1TB 4RAID5(7+1)	ES-AF	\$1,613,825
ZB8-850X-1TB-4R57U	ZBRICK8 850FX 1TB 4RAID5(7+1) UPG	ES-AF	\$1,936,590
ZB8-850X-2TB-2R57	ZBRICK8 850FX 2TB RAID5(7+1)	ES-AF	\$2,513,825
ZB8-850X-2TB-2R57U	ZBRICK8 850FX 2TB RAID5(7+1) UPG	ES-AF	\$3,016,590
ZB8-850X-2TB-2R614	ZBRICK8 850FX 2TB RAID6(14+2)	ES-AF	\$2,513,825
ZB8-850X-2TB-2R64U	ZBRICK8 850FX 2TB RAID6(14+2) UPG	ES-AF	\$3,016,590
ZB8-850X-2TB-4R57	ZBRICK8 850FX 2TB 4RAID5(7+1)	ES-AF	\$2,513,825
ZB8-850X-2TB-4R57U	ZBRICK8 850FX 2TB 4RAID5(7+1) UPG	ES-AF	\$3,016,590
ZB8-85TF-1TB-2R57U	ZBRICK8 850F 1TB RAID5(7+1) TAA UPG	ES-AF	\$1,605,865
ZB8-85TF-1TB-2R64U	ZBRICK8 850F 1TB RAID6(14+2) TAA UPG	ES-AF	\$1,605,865
ZB8-85TF-1TB-4R57U	ZBRICK8 850F 1TB 4RAID5(7+1) TAA UPG	ES-AF	\$1,605,865
ZB8-85TF-2TB-2R57U	ZBRICK8 850F 2TB RAID5(7+1) TAA UPG	ES-AF	\$2,685,865
ZB8-85TF-2TB-2R64U	ZBRICK8 850F 2TB RAID6(14+2) TAA UPG	ES-AF	\$2,685,865
ZB8-85TF-2TB-4R57U	ZBRICK8 850F 2TB 4RAID5(7+1) TAA UPG	ES-AF	\$2,685,865
ZB8-85TX-1TB-2R57U	ZBRICK8 850FX 1TB RAID5(7+1) TAA UPG	ES-AF	\$1,936,590
ZB8-85TX-1TB-2R64U	ZBRICK8 850X 1TB RAID6(14+2) TAA UPG	ES-AF	\$1,936,590
ZB8-85TX-1TB-4R57U	ZBRICK8 850FX 1TB 4RAID5(7+1) TAA UPG	ES-AF	\$1,936,590
ZB8-85TX-2TB-2R57U	ZBRICK8 850FX 2TB RAID5(7+1) TAA UPG	ES-AF	\$3,016,590
ZB8-85TX-2TB-2R64U	ZBRICK8 850FX 2TB RAID6(14+2) TAA UPG	ES-AF	\$3,016,590
ZB8-85TX-2TB-4R57U	ZBRICK8 850FX 2TB 4RAID5(7+1) TAA UPG	ES-AF	\$3,016,590
450-001-643	PowerMax Essentials Suite 1TB=CC	ES-P1	\$0
450-001-644	PowerMax Pro Suite=IC	ES-P1	\$0
450-001-645	PowerMax Pro Suite 1TB=CC	ES-P1	\$0
450-001-646	PowerMax zEssentials Suite=IC	ES-P1	\$0
450-001-647	PowerMax zPro Suite=IC	ES-P1	\$0
450-001-648	PowerMax zPro Suite 1TB=CC	ES-P1	\$0
450-001-649	PowerMax Pro Suite Mixed 1TB=CC	ES-P1	\$0
456-113-413	RP/EX Local for PowerMax 2000 LIC=CC	ES-P1	\$2,400
456-113-414	RP/EX Local for PowerMax 8000 LIC=CC	ES-P1	\$2,400
456-113-415	RP/EX Remote for PowerMax 2000 LIC=CC	ES-P1	\$2,400
456-113-416	RP/EX Remote for PowerMax 8000 LIC=CC	ES-P1	\$2,400
458-002-210	PowerMax Essentials Suite OS 1TB=CC	ES-P1	\$0
458-002-211	PowerMax Essentials Suite=IC	ES-P1	\$0
458-002-212	PowerMax 2000 AppSync Str Pk-ESS=CC	ES-P1	\$0
458-002-215	PowerMax Rem Rep Product 1TB=CC	ES-P1	\$2,755
458-002-216	PowerMax Rem Rep Base Product=IC	ES-P1	\$0
458-002-218	PowerMax Unisphere360 Product=IC	ES-P1	\$44,445
458-002-219	PowerMax SRDF Metro Product 1TB=CC	ES-P1	\$2,915
458-002-220	PowerMax Essentials 8000 Encrypt=IC	ES-P1	\$256,000
458-002-222	PowerMax Events and Retention Prod=IC	ES-P1	\$13,335
458-002-223	PowerMax Pro Suite OS 1TB=CC	ES-P1	\$0
458-002-236	PowerMax AutoSwap Product=IC	ES-P1	\$325,925
458-002-237	PowerMax zDP Product 1TB=CC	ES-P1	\$565
458-002-238	PowerMax GDDR Product=IC	ES-P1	\$103,705
458-002-239	PowerMax MF Essentials Plus Product=IC	ES-P1	\$0
458-002-240	PowerMax MF Essentials Plus CAP 1TB=CC	ES-P1	\$900
458-002-247	PowerMax Pro Suite OSO Mixed 1TB=CC	ES-P1	\$0

458-002-248	PowerMax zPro Suite zDP Mixed 1TB=CC	ES-P1	\$0
458-002-270	PowerMax zEssentials Suite OS BR 1TB=CC	ES-P1	\$1,685
458-002-271	PowerMax zPro Suite OS BR 1TB=CC	ES-P1	\$4,245
458-002-272	PowerMax Essentials Suite OS BR 1TB=CC	ES-P1	\$3,195
458-002-273	PowerMax Pro Suite OS BR 1TB=CC	ES-P1	\$7,405
458-002-274	PowerMax Rem Rep MF Enabler=IC	ES-P1	\$0
458-002-275	PowerMax Pro Encryption Product=IC	ES-P1	\$0
458-002-291	PowerMax 8000 AppSync Str Pk-ESS=CC	ES-P1	\$0
458-002-293	AppSync Advanced for PowerMax 2000=CC	ES-P1	\$530
458-002-294	AppSync Advanced for PowerMax 8000=CC	ES-P1	\$530
458-002-297	PowerMax Essentials Suite OS Upg 1TB=CC	ES-P1	\$0
458-002-298	PowerMax Pro Suite OS Upg 1TB=CC	ES-P1	\$0
458-002-299	PowerMax Pro Conversion Add Cap=CC	ES-P1	\$4,210
458-002-300	PowerMax Pro Conversion Existg Cap=CC	ES-P1	\$5,600
458-002-301	PowerMax zPro Conversion Add Cap=CC	ES-P1	\$2,555
458-002-303	PowerMax Pro Suite OS Upg BR 1TB=CC	ES-P1	\$7,405
458-002-304	PowerMax zPro Conversion Exist Cap=CC	ES-P1	\$3,400
458-002-308	SRM for PowerMax-ESS=CC	ES-P1	\$1,645
458-002-312	SRM for PowerMax PRO=CC	ES-P1	\$0
458-002-320	PowerMax Essentials 2000 Encrypt=IC	ES-P1	\$46,665
458-002-321	AppSync Advanced PowerMax 2000-PRO=CC	ES-P1	\$0
458-002-322	AppSync Advanced?PowerMax 8000-PRO=CC	ES-P1	\$0
458-002-344	RP/EX Local for PowerMax 2000 F/FX=CC	ES-P1	\$0
458-002-345	RP/EX Local for PowerMax 8000 F/FX=CC	ES-P1	\$0
458-002-346	RP/EX Remote for PowerMax 2000 F/FX=CC	ES-P1	\$0
458-002-347	RP/EX Remote for PowerMax 8000 F/FX=CC	ES-P1	\$0
458-002-348	PowerPath for PowerMax Pro=IC	ES-P1	\$0
458-002-349	PowerMax Ess Suite OS BR Upg 1TB=CC	ES-P1	\$3,195
458-002-350	PowerMax zEss Suite OS BR Upg 1TB=CC	ES-P1	\$1,685
458-002-351	PowerMax zPro Suite OS BR Upg 1TB=CC	ES-P1	\$4,245
E-DRR	PowerMax 2/8K DATA REDUCTION RESERVATION	ES-P1	\$0
E-ENCRYPT H	PowerMax 2000 DATA REST ENCRYPT OS NEW TM	ES-P1	\$0
E-ENCRYPT Z	PowerMax 8000 DATA REST ENCRYPT OS NEW TM	ES-P1	\$0
EH-1024-2048UFD	PowerMax 2000 MEMCONV 2X512 to 2X1024 GB	ES-P1	\$257,080
EH-1024ADD	PowerMax 2000 ADD 1024GB	ES-P1	\$0
EH-1024ADD-3P	PowerMax 2000 ADD 1024GB 3RD PARTY	ES-P1	\$0
EH-1024ADDU	PowerMax 2000 ADD 1024GB UPG	ES-P1	\$0
EH-1024ADDU-3P	PowerMax 2000 ADD 1024GB 3RD PARTY UPG	ES-P1	\$0
EH-1024ADDUFD	PowerMax 2000 ADD 1024GB UPG FIELD	ES-P1	\$0
EH-1024ADDUFD-3P	PowerMax 2000 ADD 1024GB 3P UPG FIELD	ES-P1	\$0
EH-1024BASE	PowerMax 2000 BASE 1024GB	ES-P1	\$0
EH-1024BASE-3P	PowerMax 2000 BASE 1024GB 3P	ES-P1	\$0
EH-1600MOD	PowerMax 2000 FLASH MOD 1600	ES-P1	\$0
EH-1600MODCONV	PowerMax 2000 FLASH MOD 1600 CONVERSION	ES-P1	\$0
EH-1600MODU	PowerMax 2000 FLASH MOD 1600 UPG	ES-P1	\$0
EH-1600MODUF	PowerMax 2000 FLASH MOD 1600 CONV	ES-P1	\$0
EH-2048ADD	PowerMax 2000 ADD 2048GB	ES-P1	\$0
EH-2048ADD-3P	PowerMax 2000 ADD 2048GB 3RD PARTY	ES-P1	\$0
EH-2048ADDU	PowerMax 2000 ADD 2048GB UPG	ES-P1	\$0
EH-2048ADDU-3P	PowerMax 2000 ADD 2048GB 3RD PARTY UPG	ES-P1	\$0

EH-2048ADDUFD	PowerMax 2000 ADD 2048GB UPG FIELD	ES-P1	\$0
EH-2048ADDUFD-3P	PowerMax 2000 ADD 2048GB 3P UPG FIELD	ES-P1	\$0
EH-2048BASE	PowerMax 2000 BASE 2048GB	ES-P1	\$0
EH-2048BASE-3P	PowerMax 2000 BASE 2048GB 3P	ES-P1	\$0
EH-2NDSYS	PowerMax 2000 2ND SYS TRK MODEL	ES-P1	\$0
EH-2NDSYSU	PowerMax 2000 2ND SYS TRK MODEL UPG	ES-P1	\$0
EH-512-1024UFD	PowerMax 2000 MEMCONV 2X256 to 2X512 GB	ES-P1	\$128,540
EH-512-2048UFD	PowerMax 2000 MEMCONV 2X256 to 2X1024 GB	ES-P1	\$385,620
EH-512ADD	PowerMax 2000 ADD 512GB	ES-P1	\$0
EH-512ADD-3P	PowerMax 2000 ADD 512GB 3RD PARTY	ES-P1	\$0
EH-512ADDU	PowerMax 2000 ADD 512GB UPG	ES-P1	\$0
EH-512ADDU-3P	PowerMax 2000 ADD 512GB 3RD PARTY UPG	ES-P1	\$0
EH-512ADDUFD	PowerMax 2000 ADD 512GB UPG FIELD	ES-P1	\$0
EH-512ADDUFD-3P	PowerMax 2000 ADD 512GB 3P UPG FIELD	ES-P1	\$0
EH-512BASE	PowerMax 2000 BASE 512GB	ES-P1	\$0
EH-512BASE-3P	PowerMax 2000 BASE 512GB 3P	ES-P1	\$0
EH-ACON3P-50	ADPTR AC 3PH 50A W3-4IN CONDUIT ADPTR	ES-P1	\$0
EH-BK40000E	PowerMax 2000 FC BACKUP I/O FOR NAS	ES-P1	\$1,245
EH-BK40000EU	PowerMax 2000 FC BACKUP I/O FOR NAS UPG	ES-P1	\$3,235
EH-BK40000EUF	PowerMax 2000 FC BACKUP I/O FOR NAS CONV	ES-P1	\$11,325
EH-CAPF	PowerMax 2000 ESS CAPACITY	ES-P1	\$10,585
EH-CAPFU	PowerMax 2000 ESS CAPACITY UPG	ES-P1	\$12,700
EH-CAPX	PowerMax 2000 PRO CAPACITY	ES-P1	\$14,795
EH-CAPXU	PowerMax 2000 PRO CAPACITY UPG	ES-P1	\$17,755
EH-CNVINF-1PU	PowerMax 2000 SINGLE PHASE PDU CONV	ES-P1	\$3,235
EH-CNVINF-3DU	PowerMax 2000 3 PHASE DELTA PDU CONV	ES-P1	\$3,245
EH-CNVINF-3YNU	PowerMax 2000 3 PHASE WYE N PDU CONV	ES-P1	\$2,935
EH-CNVINF-3YU	PowerMax 2000 3 PHASE WYE PDU CONV	ES-P1	\$2,915
EH-COMPRESS	PowerMax 2000 HDW COMPRESSION	ES-P1	\$0
EH-COMPRESSU	PowerMax 2000 HDW COMPRESSION UPG	ES-P1	\$0
EH-COMPRESSUF	PowerMax 2000 HDW COMPRESSION CONV	ES-P1	\$0
EH-DATAMOVER	PowerMax 2000 DATA MOVER FOR NAS	ES-P1	\$0
EH-DATAMOVERU	PowerMax 2000 DATA MOVER FOR NAS UPG	ES-P1	\$0
EH-DE24	PowerMax 2000 DIRECT 24 SLT DR ENCL	ES-P1	\$0
EH-DE24-3P	PowerMax 2000 DIRECT 24 SLT DR ENCL 3P	ES-P1	\$0
EH-DE24-U	PowerMax 2000 DIRECT 24 SLT DR ENCL UPG	ES-P1	\$0
EH-DE24-UFD	PowerMax 2000 24 SLT DR ENCL FD UPG	ES-P1	\$0
EH-DE24-UFD-3P	PowerMax 2000 24 SLT DR ENCL FD UP 3P	ES-P1	\$0
EH-EBF-1024	PowerMax 2000 ESS HW ONLY BASE 1024GB	ES-P1	\$260,005
EH-EBF-1024-ADD	PowerMax 2000 ESS HW ONLY ADD 1024GB	ES-P1	\$260,005
EH-EBF-1024-ADDU	PowerMax 2000 ESS HW ONLY ADD 1024GB UPG	ES-P1	\$319,035
EH-EBF-1024-ADDUFD	PowerMax 2000 ESS HW ONLY ADD 1024GB UFD	ES-P1	\$319,035
EH-EBF-2048	PowerMax 2000 ESS HW ONLY BASE 2048GB	ES-P1	\$383,600
EH-EBF-2048-ADD	PowerMax 2000 ESS HW ONLY ADD 2048GB	ES-P1	\$383,600
EH-EBF-2048-ADDU	PowerMax 2000 ESS HW ONLY ADD 2048GB UPG	ES-P1	\$467,350
EH-EBF-2048-ADDUFD	PowerMax 2000 ESS HW ONLY ADD 2048GB UFD	ES-P1	\$467,350
EH-EBF-512	PowerMax 2000 ESS HW ONLY BASE 512GB	ES-P1	\$234,120
EH-EBF-512-ADD	PowerMax 2000 ESS HW ONLY ADD 512GB	ES-P1	\$234,120
EH-EBF-512-ADDU	PowerMax 2000 ESS HW ONLY ADD 512GB UPG	ES-P1	\$287,975
EH-EBF-512-ADDUFD	PowerMax 2000 ESS HW ONLY ADD 512GB UFD	ES-P1	\$287,975

EH-EBX-1024	PowerMax 2000 PRO HW ONLY BASE 1024GB	ES-P1	\$260,005
EH-EBX-1024-ADD	PowerMax 2000 PRO HW ONLY ADD 1024GB	ES-P1	\$260,005
EH-EBX-1024-ADDU	PowerMax 2000 PRO HW ONLY ADD 1024GB UPG	ES-P1	\$328,295
EH-EBX-1024-ADDUFD	PowerMax 2000 PRO HW ONLY ADD 1024GB UFD	ES-P1	\$328,295
EH-EBX-2048	PowerMax 2000 PRO HW ONLY BASE 2048GB	ES-P1	\$383,600
EH-EBX-2048-ADD	PowerMax 2000 PRO HW ONLY ADD 2048GB	ES-P1	\$383,600
EH-EBX-2048-ADDU	PowerMax 2000 PRO HW ONLY ADD 2048GB UPG	ES-P1	\$476,610
EH-EBX-2048-ADDUFD	PowerMax 2000 PRO HW ONLY ADD 2048GB UFD	ES-P1	\$476,610
EH-EBX-512	PowerMax 2000 PRO HW ONLY BASE 512GB	ES-P1	\$234,120
EH-EBX-512-ADD	PowerMax 2000 PRO HW ONLY ADD 512GB	ES-P1	\$234,120
EH-EBX-512-ADDU	PowerMax 2000 PRO HW ONLY ADD 512GB UPG	ES-P1	\$297,235
EH-EBX-512-ADDUFD	PowerMax 2000 PRO HW ONLY ADD 512GB UFD	ES-P1	\$297,235
EH-ECAPF	PowerMax 2000 ESS HW ONLY CAPACITY	ES-P1	\$7,390
EH-ECAPFU	PowerMax 2000 ESS HW ONLY CAPACITY UPG	ES-P1	\$9,505
EH-ECAPX	PowerMax 2000 PRO HW ONLY CAPACITY	ES-P1	\$7,390
EH-ECAPXU	PowerMax 2000 PRO HW ONLY CAPACITY UPG	ES-P1	\$10,350
EHF-BEDIR	PowerMax 2000 ESS DIR	ES-P1	\$5,780
EHF-BEDIRU	PowerMax 2000 ESS DIR UPG	ES-P1	\$5,780
EHF-BEDIRUFD	PowerMax 2000 ESS DIR FD UPG	ES-P1	\$5,780
EH-FDOORSYS1DE	PowerMax 2000 SB1 DellEMC Hex Door	ES-P1	\$3,300
EH-FDOORSYS1DKEYE	PowerMax 2000 SB1 DellEMC Key Door	ES-P1	\$3,300
EH-FE00200TC	PowerMax 2000 2PT 10 GBE BASE T	ES-P1	\$1,305
EH-FE00200TO	PowerMax 2000 2PT 10 GBE OPTICAL	ES-P1	\$1,245
EH-FE00200TOU	PowerMax 2000 2PT 10 GBE OPTICAL UPG	ES-P1	\$3,235
EH-FE00200TOUF	PowerMax 2000 2PT 10 GBE OPTICAL CONV	ES-P1	\$5,660
EH-FE00200TU	PowerMax 2000 2PT10 GBE BASE T UPG	ES-P1	\$3,390
EH-FE00200TUF	PowerMax 2000 2PT10 GBE BASE T CONV	ES-P1	\$11,865
EH-FE00800T	PowerMax 2000 8MM 10GIGE	ES-P1	\$3,245
EH-FE00800TU	PowerMax 2000 8MM 10GIGE UPG	ES-P1	\$4,220
EH-FE00800TUF	PowerMax 2000 8MM 10GIGE CONV	ES-P1	\$14,765
EH-FE00800TUFX	PowerMax 2000 8MM 10 GIGE FD UPG	ES-P1	\$0
EH-FE00800TUX	PowerMax 2000 8MM 10 GIGE UPG	ES-P1	\$0
EH-FE08000E	PowerMax 2000 8SM 8G FIBRE	ES-P1	\$2,455
EH-FE08000EU	PowerMax 2000 8SM 8G FIBRE UPG	ES-P1	\$3,190
EH-FE08000EUF	PowerMax 2000 8SM 8G FIBRE CONV	ES-P1	\$10,815
EH-FE08000S	PowerMax 2000 8SM 16G FC	ES-P1	\$6,405
EH-FE08000SU	PowerMax 2000 8SM 16G FC UPG	ES-P1	\$8,325
EH-FE08000SUF	PowerMax 2000 8SM 16G FC CONV	ES-P1	\$19,205
EH-FE80000E	PowerMax 2000 8MM 8G FIBRE	ES-P1	\$1,225
EH-FE80000EU	PowerMax 2000 8MM 8G FIBRE UPG	ES-P1	\$1,595
EH-FE80000EUF	PowerMax 2000 8MM 8G FIBRE CONV	ES-P1	\$4,910
EH-FE80000EUFX	PowerMax 2000 8MM 8G FIBRE FD UPG	ES-P1	\$0
EH-FE80000EUX	PowerMax 2000 8MM 8G FIBRE UPG	ES-P1	\$0
EH-FE80000S	PowerMax 2000 8MM 16G FC	ES-P1	\$3,200
EH-FE80000SU	PowerMax 2000 8MM 16G FC UPG	ES-P1	\$8,325
EH-FE80000SUF	PowerMax 2000 8MM 16G FC CONV	ES-P1	\$12,825
EH-FE80000SUFX	PowerMax 2000 8MM 16G FIBRE FD UPG	ES-P1	\$0
EH-FE80000SUX	PowerMax 2000 8MM 16G FIBRE UPG	ES-P1	\$0
EHF-NAS-SN	Embedded NAS BASE PowerMax 2000 ESS	ES-P1	\$75,555
EHF-NAS-SNU	Embedded NAS BASE PowerMax 2000 ESS UPG	ES-P1	\$75,555

EH-FORMTL	PowerMax 2000 FOR MTL TRK MODEL	ES-P1	\$0
EH-FORMTLU	PowerMax 2000 FOR MTL TRK MODEL UPG	ES-P1	\$0
EH-IB	PowerMax 2000 FABRIC	ES-P1	\$0
EH-IBU	PowerMax 2000 FABRIC UPG	ES-P1	\$0
EH-IBUFD	PowerMax 2000 FABRIC CONV	ES-P1	\$0
EH-MGMT	Embedded Management PowerMax 2000 TRK	ES-P1	\$0
EH-MGMT-U	Embedded Management PowerMax 2000 TRK UP	ES-P1	\$0
EH-MODEM	PowerMax 2000 ZBA MODEM LEAD FREE	ES-P1	\$655
EH-PC3YAFLA	32A 3PHASE WYE CORD SET IEC309-AMER	ES-P1	\$0
EH-PC3YAFLE	32A 3PHASE WYE CRD SET FLY LEAD EUROPE	ES-P1	\$0
EH-PCBL3DHH	PWR CBL HBL-HBL 3D	ES-P1	\$0
EH-PCBL3DHR	PWR CBL HBL-RSTOL 3D	ES-P1	\$0
EH-PCBL3YAG	INTL 3PHASE 32 AMP IEC309 TO GARO	ES-P1	\$0
EH-PCBL3YL23P	24A 3PH WYE L22-30P	ES-P1	\$0
EH-PSNT-1P	PowerMax 2000 SYS BAY1 1P PSNT	ES-P1	\$0
EH-PSNT-1P-3P	PowerMax 2000 SYS BAY1 1P PSNT 3P	ES-P1	\$0
EH-PSNT-3D	PowerMax 2000 SYS BAY1 3D PSNT	ES-P1	\$0
EH-PSNT-3D-3P	PowerMax 2000 SYS BAY1 3D PSNT 3P	ES-P1	\$0
EH-PSNT-3Y	PowerMax 2000 SYS BAY1 3Y PSNT	ES-P1	\$0
EH-PSNT-3Y-3P	PowerMax 2000 SYS BAY1 3Y PSNT 3P	ES-P1	\$0
EH-PW40UASTL	30A 1PHASE AUSIP57 CLIPSAL 56PA332	ES-P1	\$0
EH-PW40UIEC3	30A 1PHASE INTERNATNLIEC309-332P6	ES-P1	\$0
EH-PW40URUS	30A 1PH RUSSELLSTOLL 3750DP	ES-P1	\$0
EH-PW40U-US	30A 1PHASE NAMER JAPAN I6-30P	ES-P1	\$0
EH-PWRKIT-1P	PowerMax 2000 SINGLE PHASE PDU	ES-P1	\$935
EH-PWRKIT-1PU	PowerMax 2000 SINGLE PHASE PDU UPG	ES-P1	\$935
EH-PWRKIT-3D	PowerMax 2000 3 PHASE DELTA PDU	ES-P1	\$1,110
EH-PWRKIT-3DU	PowerMax 2000 3 PHASE DELTA PDU UPG	ES-P1	\$1,110
EH-PWRKIT-3Y	PowerMax 2000 3 PHASE WYE PDU	ES-P1	\$1,160
EH-PWRKIT-3YN	PowerMax 2000 3 PHASE WYE N PDU	ES-P1	\$1,160
EH-PWRKIT-3YNU	PowerMax 2000 3 PHASE WYE N PDU UPG	ES-P1	\$1,160
EH-PWRKIT-3YU	PowerMax 2000 3 PHASE WYE PDU UPG	ES-P1	\$1,160
EH-SECURE	PowerMax 2000 SECURE KIT SINGLE BAY	ES-P1	\$1,525
EH-SECUREJK	PowerMax 2000 SECURE JOINING KIT	ES-P1	\$1,000
EH-SKINS	PowerMax 2000 SIDE PANELS	ES-P1	\$0
EH-SKINSU	PowerMax 2000 SIDE PANELS UPG	ES-P1	\$0
EH-SYS1-1P	PowerMax 2000 SYS BAY1 1P	ES-P1	\$0
EH-SYS1-3D	PowerMax 2000 SYS BAY1 3D	ES-P1	\$0
EH-SYS1-3Y	PowerMax 2000 SYS BAY1 3Y	ES-P1	\$0
EH-SYS1-3YN	PowerMax 2000 SYS BAY1 3YN	ES-P1	\$0
EH-TELCO	PowerMax 2000 ZBA INTL TELCO KIT	ES-P1	\$40
EH-TOP-KIT	PowerMax 2000 TOP ROUTING KIT	ES-P1	\$295
EH-VBADD-KIT	PowerMax 2000 PB ADD INSTALL KIT	ES-P1	\$0
EH-VBADD-KIT-3P	PowerMax 2000 PB ADD INSTALL KIT 3P	ES-P1	\$0
EH-VBADD-KIT-UFD	PowerMax 2000 PB ADD FIELD INSTALL KIT	ES-P1	\$0
EH-VBADD-KIT-VCE	PowerMax 2000 PB ADD INSTALL KIT VXBLOCK	ES-P1	\$0
EH-VBBASE-KIT	PowerMax 2000 PB BASE INSTALL KIT	ES-P1	\$0
EH-VBBASE-KIT-3P	PowerMax 2000 PB BASE INSTALL KIT 3P	ES-P1	\$0
EH-VBBASE-KIT-VCE	PowerMax 2000 PB BASE INSTALL KIT VXBLOC	ES-P1	\$0
EH-VBF-1024	PowerMax 2000 ESS BASE 1024GB	ES-P1	\$295,150

EH-VBF-1024-ADD	PowerMax 2000 ESS ADD 1024GB	ES-P1	\$295,150
EH-VBF-1024-ADDU	PowerMax 2000 ESS ADD 1024GB UPG	ES-P1	\$354,180
EH-VBF-1024-ADDUFD	PowerMax 2000 ESS ADD 1024GB UFD	ES-P1	\$354,180
EH-VBF-2048	PowerMax 2000 ESS BASE 2048GB	ES-P1	\$418,745
EH-VBF-2048-ADD	PowerMax 2000 ESS ADD 2048GB	ES-P1	\$418,745
EH-VBF-2048-ADDU	PowerMax 2000 ESS ADD 2048GB UPG	ES-P1	\$502,495
EH-VBF-2048-ADDUFD	PowerMax 2000 ESS ADD 2048GB UFD	ES-P1	\$502,495
EH-VBF-512	PowerMax 2000 ESS BASE 512GB	ES-P1	\$269,265
EH-VBF-512-ADD	PowerMax 2000 ESS ADD 512GB	ES-P1	\$269,265
EH-VBF-512-ADDU	PowerMax 2000 ESS ADD 512GB UPG	ES-P1	\$323,120
EH-VBF-512-ADDUFD	PowerMax 2000 ESS ADD 512GB UFD	ES-P1	\$323,120
EH-VBX-1024	PowerMax 2000 PRO BASE 1024GB	ES-P1	\$341,460
EH-VBX-1024-ADD	PowerMax 2000 PRO ADD 1024GB	ES-P1	\$341,460
EH-VBX-1024-ADDU	PowerMax 2000 PRO ADD 1024GB UPG	ES-P1	\$409,750
EH-VBX-1024-ADDUFD	PowerMax 2000 PRO ADD 1024GB UFD	ES-P1	\$409,750
EH-VBX-2048	PowerMax 2000 PRO BASE 2048GB	ES-P1	\$465,055
EH-VBX-2048-ADD	PowerMax 2000 PRO ADD 2048GB	ES-P1	\$465,055
EH-VBX-2048-ADDU	PowerMax 2000 PRO ADD 2048GB UPG	ES-P1	\$558,065
EH-VBX-2048-ADDUFD	PowerMax 2000 PRO ADD 2048GB UFD	ES-P1	\$558,065
EH-VBX-512	PowerMax 2000 PRO BASE 512GB	ES-P1	\$315,575
EH-VBX-512-ADD	PowerMax 2000 PRO ADD 512GB	ES-P1	\$315,575
EH-VBX-512-ADDU	PowerMax 2000 PRO ADD 512GB UPG	ES-P1	\$378,690
EH-VBX-512-ADDUFD	PowerMax 2000 PRO ADD 512GB UFD	ES-P1	\$378,690
EH-VCERACK	PowerMax 2000 VXBLOCK RACK TRK MODEL	ES-P1	\$0
EH-VCERACKU	PowerMax 2000 VXBLOCK RACK TRK MODEL UP	ES-P1	\$0
EHX-BEDIR	PowerMax 2000 PRO DIR	ES-P1	\$0
EHX-BEDIRU	PowerMax 2000 PRO DIR UPG	ES-P1	\$0
EHX-BEDIRUFD	PowerMax 2000 PRO DIR FD UPG	ES-P1	\$0
EHX-NAS-SN	Embedded NAS BASE PowerMax 2000 PRO	ES-P1	\$0
EHX-NAS-SNU	Embedded NAS BASE PowerMax 2000 PRO UPG	ES-P1	\$0
EZ-1024-2048UFD	PowerMax 8000 MEMCONV 2X512 to 2X1024 GB	ES-P1	\$467,610
EZ-1024ADD	PowerMax 8000 ADD 1024GB	ES-P1	\$0
EZ-1024ADDU	PowerMax 8000 ADD 1024GB UPG	ES-P1	\$0
EZ-1024ADDUFD	PowerMax 8000 ADD 1024GB UPG FIELD	ES-P1	\$0
EZ-1024BASE	PowerMax 8000 BASE 1024GB	ES-P1	\$0
EZ-1600MOD	PowerMax 8000 FLASH MOD 1600	ES-P1	\$0
EZ-1600MODCONV	PowerMax 8000 FLASH MOD 1600 CONVERSION	ES-P1	\$0
EZ-1600MODU	PowerMax 8000 FLASH MOD 1600 UPG	ES-P1	\$0
EZ-1600MODUF	PowerMax 8000 FLASH MOD 1600 CONV	ES-P1	\$0
EZ-2048ADD	PowerMax 8000 ADD 2048GB	ES-P1	\$0
EZ-2048ADDU	PowerMax 8000 ADD 2048GB UPG	ES-P1	\$0
EZ-2048ADDUFD	PowerMax 8000 ADD 2048GB UPG FIELD	ES-P1	\$0
EZ-2048BASE	PowerMax 8000 BASE 2048GB	ES-P1	\$0
EZ-2UF-UFD-3P	PowerMax 8000 2U FILLER PANEL KIT 3P	ES-P1	\$0
EZ-ACON3P-50	ADPTR AC 3PH 50A W3-4IN CONDUIT ADPTR	ES-P1	\$0
EZ-BEDIR	PowerMax 8000 ESS DIR	ES-P1	\$5,780
EZ-BEDIRU	PowerMax 8000 ESS DIR UPG	ES-P1	\$5,780
EZ-BEDIRUFD	PowerMax 8000 ESS DIR FD UPG	ES-P1	\$5,780
EZ-BK40000E	PowerMax 8000 FC BACKUP I/O FOR NAS	ES-P1	\$1,245
EZ-BK40000EU	PowerMax 8000 FC BACKUP I/O FOR NAS UPG	ES-P1	\$3,235

EZ-BK4000EUF	PowerMax 8000 FC BACKUP I/O FOR NAS CONV	ES-P1	\$11,325
EZ-BLNK-SKINS	PowerMax 8000 SIDE PANELS BLANK	ES-P1	\$0
EZ-BLNK-SKINSU	PowerMax 8000 SIDE PANELS BLANK UPG	ES-P1	\$0
EZ-CAPF	PowerMax 8000 ESS CAPACITY	ES-P1	\$10,585
EZ-CAPFU	PowerMax 8000 ESS CAPACITY UPG	ES-P1	\$12,700
EZ-CAPX	PowerMax 8000 PRO CAPACITY	ES-P1	\$14,795
EZ-CAPXU	PowerMax 8000 PRO CAPACITY UPG	ES-P1	\$17,755
EZ-COMPRESS	PowerMax 8000 HDW COMPRESSION	ES-P1	\$0
EZ-COMPRESSU	PowerMax 8000 HDW COMPRESSION UPG	ES-P1	\$0
EZ-COMPRESSUF	PowerMax 8000 HDW COMPRESSION CONV	ES-P1	\$0
EZ-CONVINF-1PU	PowerMax 8000 SINGLE PHASE PDU	ES-P1	\$415
EZ-CONVINF-3DU	PowerMax 8000 3 PHASE DELTA PDU	ES-P1	\$590
EZ-CONVINF-3YNU	PowerMax 8000 3 PHASE WYEN PDU	ES-P1	\$645
EZ-CONVINF-3YU	PowerMax 8000 3 PHASE WYE PDU	ES-P1	\$645
EZ-DATAMOVER	PowerMax 8000 DATA MOVER FOR NAS	ES-P1	\$0
EZ-DATAMOVERU	PowerMax 8000 DATA MOVER FOR NAS UPG	ES-P1	\$0
EZ-DE24	PowerMax 8000 DIRECT 24 SLT DR ENCL	ES-P1	\$0
EZ-DE24-3P	PowerMax 8000 DIRECT 24 SLT DR ENCL 3P	ES-P1	\$0
EZ-DE24-U	PowerMax 8000 DIRECT 24 SLT DR ENCL UPG	ES-P1	\$0
EZ-DE24-UFD	PowerMax 8000 24 SLT DR ENCL FD UPG	ES-P1	\$0
EZ-DE24-UFD-3P	PowerMax 8000 24 SLT DR ENCL FD UP 3P	ES-P1	\$0
EZ-DSOPTICE5	PowerMax 8000 ENGINE 5 DSP CBLOPTICS KIT	ES-P1	\$9,060
EZ-DSOPTICE5U	PowerMax 8000 ENG 5 DSP CBLOPTIC KIT UPG	ES-P1	\$9,380
EZ-DSOPTICE6	PowerMax 8000 ENGINE 6 DSP CBLOPTICS KIT	ES-P1	\$9,060
EZ-DSOPTICE6U	PowerMax 8000 ENG 6 DSP CBLOPTIC KIT UPG	ES-P1	\$9,380
EZ-DSOPTICE7	PowerMax 8000 ENGINE 7 DSP CBLOPTICS KIT	ES-P1	\$9,060
EZ-DSOPTICE7U	PowerMax 8000 ENG 7 DSP CBLOPTIC KIT UPG	ES-P1	\$9,380
EZ-DSOPTICE8	PowerMax 8000 ENGINE 8 DSP CBLOPTICS KIT	ES-P1	\$9,060
EZ-DSOPTICE8U	PowerMax 8000 ENG 8 DSP CBLOPTIC KIT UPG	ES-P1	\$9,380
EZ-EBF-1024	PowerMax 8000 ESS HW ONLY BASE 1024GB	ES-P1	\$767,960
EZ-EBF-1024-ADD	PowerMax 8000 ESS HW ONLY ADD 1024GB	ES-P1	\$767,960
EZ-EBF-1024-ADDU	PowerMax 8000 ESS HW ONLY ADD 1024GB UPG	ES-P1	\$956,060
EZ-EBF-1024-ADDUFD	PowerMax 8000 ESS HW ONLY ADD 1024GB UFD	ES-P1	\$956,060
EZ-EBF-2048	PowerMax 8000 ESS HW ONLY BASE 2048GB	ES-P1	\$1,110,870
EZ-EBF-2048-ADD	PowerMax 8000 ESS HW ONLY ADD 2048GB	ES-P1	\$1,110,870
EZ-EBF-2048-ADDU	PowerMax 8000 ESS HW ONLY ADD 2048GB UPG	ES-P1	\$1,367,550
EZ-EBF-2048-ADDUFD	PowerMax 8000 ESS HW ONLY ADD 2048GB UFD	ES-P1	\$1,367,550
EZ-EBX-1024	PowerMax 8000 PRO HW ONLY BASE 1024GB	ES-P1	\$767,960
EZ-EBX-1024-ADD	PowerMax 8000 PRO HW ONLY ADD 1024GB	ES-P1	\$767,960
EZ-EBX-1024-ADDU	PowerMax 8000 PRO HW ONLY ADD 1024GB UPG	ES-P1	\$1,001,525
EZ-EBX-1024-ADDUFD	PowerMax 8000 PRO HW ONLY ADD 1024GB UFD	ES-P1	\$1,001,525
EZ-EBX-2048	PowerMax 8000 PRO HW ONLY BASE 2048GB	ES-P1	\$1,110,870
EZ-EBX-2048-ADD	PowerMax 8000 PRO HW ONLY ADD 2048GB	ES-P1	\$1,110,870
EZ-EBX-2048-ADDU	PowerMax 8000 PRO HW ONLY ADD 2048GB UPG	ES-P1	\$1,413,020
EZ-EBX-2048-ADDUFD	PowerMax 8000 PRO HW ONLY ADD 2048GB UFD	ES-P1	\$1,413,020
EZ-ECAPF	PowerMax 8000 ESS HW ONLY CAPACITY	ES-P1	\$7,390
EZ-ECAPFU	PowerMax 8000 ESS HW ONLY CAPACITY UPG	ES-P1	\$9,505
EZ-ECAPX	PowerMax 8000 PRO HW ONLY CAPACITY	ES-P1	\$7,390
EZ-ECAPXU	PowerMax 8000 PRO HW ONLY CAPACITY UPG	ES-P1	\$10,350
EZ-EZBF-1024	PowerMax 8000 ESS MF HW ONLY BASE 1024	ES-P1	\$439,030

EZ-EZBF-1024-ADD	PowerMax 8000 ESS MF HW ONLY ADD 1024GB	ES-P1	\$439,030
EZ-EZBF-1024-ADDU	PowerMax 8000 ESS MF HW ONLY ADD 1024 UP	ES-P1	\$531,215
EZ-EZBF-1024-ADDUF	PowerMax 8000 ESS MF HW ONLY ADD 1024 UF	ES-P1	\$531,215
EZ-EZBF-2048	PowerMax 8000 ESS MF HW ONLY BASE 2048	ES-P1	\$741,070
EZ-EZBF-2048-ADD	PowerMax 8000 ESS MF HW ONLY ADD 2048GB	ES-P1	\$741,070
EZ-EZBF-2048-ADDU	PowerMax 8000 ESS MF HW ONLY ADD 2048 UP	ES-P1	\$893,665
EZ-EZBF-2048-ADDUF	PowerMax 8000 ESS MF HW ONLY ADD 2048 UF	ES-P1	\$893,665
EZ-EZBX-1024	PowerMax 8000 PRO MF HW ONLY BASE 1024	ES-P1	\$439,030
EZ-EZBX-1024-ADD	PowerMax 8000 PRO MF HW ONLY ADD 1024GB	ES-P1	\$439,030
EZ-EZBX-1024-ADDU	PowerMax 8000 PRO MF HW ONLY ADD 1024 UP	ES-P1	\$537,875
EZ-EZBX-1024-ADDUF	PowerMax 8000 PRO MF HW ONLY ADD 1024 UF	ES-P1	\$537,875
EZ-EZBX-2048	PowerMax 8000 PRO MF HW ONLY BASE 2048	ES-P1	\$741,070
EZ-EZBX-2048-ADD	PowerMax 8000 PRO MF HW ONLY ADD 2048GB	ES-P1	\$741,070
EZ-EZBX-2048-ADDU	PowerMax 8000 PRO MF HW ONLY ADD 2048 UP	ES-P1	\$900,320
EZ-EZBX-2048-ADDUF	PowerMax 8000 PRO MF HW ONLY ADD 2048 UF	ES-P1	\$900,320
EZ-EZCAPF	PowerMax 8000 ESS MF HW ONLY CAPACITY	ES-P1	\$7,390
EZ-EZCAPFU	PowerMax 8000 ESS MF HW ONLY CAPACITY UP	ES-P1	\$9,205
EZ-EZCAPX	PowerMax 8000 PRO MF HW ONLY CAPACITY	ES-P1	\$7,390
EZ-EZCAPXU	PowerMax 8000 PRO MF HW ONLY CAPACITY UP	ES-P1	\$9,715
EZ-FABR	PowerMax 8000 FABRIC	ES-P1	\$0
EZ-FABR-3P	PowerMax 8000 FABRIC 3RD PARTY	ES-P1	\$0
EZ-FABR-UFD	PowerMax 8000 FABRIC UPG	ES-P1	\$0
EZ-FABR-UFD-3P	PowerMax 8000 FABRIC UPG 3RD PARTY	ES-P1	\$0
EZ-FDOORS1DKEYE	PowerMax 8000 SB1 DellEMC KEY DOOR	ES-P1	\$0
EZ-FDOORS28DKEYE	PowerMax 8000 SB2 DellEMC KEY DOOR	ES-P1	\$0
EZ-FDOORS28DKEYUE	PowerMax 8000 SB2 DellEMC KEY DOOR UPG	ES-P1	\$0
EZ-FDOORSYS1DE	PowerMax 8000 SB1 DellEMC HEX DOOR	ES-P1	\$0
EZ-FDOORSYS28DE	PowerMax 8000 SB2 DellEMC HEX DOOR	ES-P1	\$0
EZ-FDOORSYS28DUE	PowerMax 8000 SB2 DellEMC HEX DOOR UPG	ES-P1	\$0
EZ-FE00008S	PowerMax 8000 8SM 16G FICON	ES-P1	\$9,230
EZ-FE00008SU	PowerMax 8000 8SM 16G FICON UPG	ES-P1	\$12,000
EZ-FE00008SUF	PowerMax 8000 8SM 16G FICON CONV	ES-P1	\$10,815
EZ-FE00080S	PowerMax 8000 8MM 16G FICON	ES-P1	\$4,235
EZ-FE00080SU	PowerMax 8000 8MM 16G FICON UPG	ES-P1	\$5,510
EZ-FE00080SUF	PowerMax 8000 8MM 16G FICON CONV	ES-P1	\$18,680
EZ-FE00200TC	PowerMax 8000 2PT 10 GBE BASE T	ES-P1	\$1,305
EZ-FE00200TO	PowerMax 8000 2PT 10 GBE OPTICAL	ES-P1	\$1,245
EZ-FE00200TOU	PowerMax 8000 2PT 10 GBE OPTICAL UPG	ES-P1	\$3,235
EZ-FE00200TOUF	PowerMax 8000 2PT 10 GBE OPTICAL CONV	ES-P1	\$5,660
EZ-FE00200TU	PowerMax 8000 2PT?10 GBE BASE T UPG	ES-P1	\$3,390
EZ-FE00200TUF	PowerMax 8000 2PT?10 GBE BASE T CONV	ES-P1	\$5,930
EZ-FE00800T	PowerMax 8000 8MM 10GIGE	ES-P1	\$3,245
EZ-FE00800TU	PowerMax 8000 8MM 10GIGE UPG	ES-P1	\$4,220
EZ-FE00800TUF	PowerMax 8000 8MM 10GIGE CONV	ES-P1	\$14,765
EZ-FE00800TUFX	PowerMax 8000 8MM 10 GIGE FD UPG	ES-P1	\$0
EZ-FE00800TUX	PowerMax 8000 8MM 10 GIGE UPG	ES-P1	\$0
EZ-FE08000E	PowerMax 8000 8SM 8G FIBRE	ES-P1	\$2,455
EZ-FE08000EU	PowerMax 8000 8SM 8G FIBRE UPG	ES-P1	\$3,190
EZ-FE08000EUF	PowerMax 8000 8SM 8G FIBRE CONV	ES-P1	\$11,230
EZ-FE08000S	PowerMax 8000 8SM 16G FC	ES-P1	\$6,405

EZ-FE08000SU	PowerMax 8000 8SM 16G FC UPG	ES-P1	\$8,325
EZ-FE08000SUF	PowerMax 8000 8SM 16G FC CONV	ES-P1	\$19,205
EZ-FE80000E	PowerMax 8000 8MM 8G FIBRE	ES-P1	\$1,225
EZ-FE80000EU	PowerMax 8000 8MM 8G FIBRE UPG	ES-P1	\$1,595
EZ-FE80000EUF	PowerMax 8000 8MM 8G FIBRE CONV	ES-P1	\$4,910
EZ-FE80000EUFX	PowerMax 8000 8MM 8G FIBRE FD UPG	ES-P1	\$0
EZ-FE80000EUX	PowerMax 8000 8MM 8G FIBRE UPG	ES-P1	\$0
EZ-FE80000S	PowerMax 8000 8MM 16G FC	ES-P1	\$3,200
EZ-FE80000SU	PowerMax 8000 8MM 16G FC UPG	ES-P1	\$8,325
EZ-FE80000SUF	PowerMax 8000 8MM 16G FC CONV	ES-P1	\$12,825
EZ-FE80000SUFX	PowerMax 8000 8MM 16G FIBRE FD UPG	ES-P1	\$0
EZ-FE80000SUX	PowerMax 8000 8MM 16G FIBRE UPG	ES-P1	\$0
EZF-NAS-SN	Embedded NAS Base PowerMax 8000 ESS	ES-P1	\$133,335
EZF-NAS-SNU	Embedded NAS Base PowerMax 8000 ESS UPG	ES-P1	\$133,335
EZ-MGMT	Embedded Management PowerMax 8000 TRK	ES-P1	\$0
EZ-MGMT-U	Embedded Management PowerMax 8000 TRK UP	ES-P1	\$0
EZ-MODEM	PowerMax 8000 ZBA MODEM LEAD FREE	ES-P1	\$655
EZ-PC3YAFLA	32A 3PHASE WYE CORD SET IEC309-AMER	ES-P1	\$0
EZ-PC3YAFLE	32A 3PHASE WYE CRD SET FLY LEAD EUROPE	ES-P1	\$0
EZ-PCBL3DHH	PWR CBL HBL-HBL 3D	ES-P1	\$0
EZ-PCBL3DHR	PWR CBL HBL-RSTOL 3D	ES-P1	\$0
EZ-PCBL3YAG	INTL 3PHASE 32 AMP IEC309 TO GARO	ES-P1	\$0
EZ-PCBL3YL23P	24A 3PH WYE L22-30P	ES-P1	\$0
EZ-PSNT-1P	PowerMax 8000 SYS BAY1 1P PSNT	ES-P1	\$0
EZ-PSNT-1P-3P	PowerMax 8000 SYS BAY1 1P PSNT 3P	ES-P1	\$0
EZ-PSNT-3D	PowerMax 8000 SYS BAY1 3D PSNT	ES-P1	\$0
EZ-PSNT-3D-3P	PowerMax 8000 SYS BAY1 3D PSNT 3P	ES-P1	\$0
EZ-PSNT-3Y	PowerMax 8000 SYS BAY1 3Y PSNT	ES-P1	\$0
EZ-PSNT-3Y-3P	PowerMax 8000 SYS BAY1 3Y PSNT 3P	ES-P1	\$0
EZ-PW40UASTL	30A 1PHASE AUSIP57 CLIPSAL 56PA332	ES-P1	\$0
EZ-PW40UIEC3	30A 1PHASE INTERNATNLIEC309-332P6	ES-P1	\$0
EZ-PW40URUS	30A 1PH RUSSELLSTOLL 3750DP	ES-P1	\$0
EZ-PW40U-US	30A 1PHASE NAMER JAPAN I6-30P	ES-P1	\$0
EZ-SECURE	PowerMax 8000 SECURE KIT SINGLE BAY	ES-P1	\$1,525
EZ-SECUREJK	PowerMax 8000 SECURE JOINING KIT	ES-P1	\$1,000
EZ-SKINS	PowerMax 8000 SIDE PANELS	ES-P1	\$0
EZ-SKINSU	PowerMax 8000 SIDE PANELS UPG	ES-P1	\$0
EZ-SYS1-1P	PowerMax 8000 SYS BAY1 1P	ES-P1	\$0
EZ-SYS1-3D	PowerMax 8000 SYS BAY1 3D	ES-P1	\$0
EZ-SYS1-3Y	PowerMax 8000 SYS BAY1 3Y	ES-P1	\$0
EZ-SYS1-3YN	PowerMax 8000 SYS BAY1 3YN	ES-P1	\$0
EZ-SYSADD1P	PowerMax 8000 ADD SYS BAY 1P	ES-P1	\$0
EZ-SYSADD1PU	PowerMax 8000 ADD SYS BAY 1P UPG	ES-P1	\$0
EZ-SYSADD3D	PowerMax 8000 ADD SYS BAY 3D	ES-P1	\$0
EZ-SYSADD3DU	PowerMax 8000 ADD SYS BAY 3D UPG	ES-P1	\$0
EZ-SYSADD3Y	PowerMax 8000 ADD SYS BAY 3Y	ES-P1	\$0
EZ-SYSADD3YN	PowerMax 8000 ADD SYS BAY 3YN	ES-P1	\$0
EZ-SYSADD3YNU	PowerMax 8000 ADD SYS BAY 3YN UPG	ES-P1	\$0
EZ-SYSADD3YU	PowerMax 8000 ADD SYS BAY 3Y UPG	ES-P1	\$0
EZ-TELCO	PowerMax 8000 ZBA INTL TELCO KIT	ES-P1	\$40

EZ-TOP-KIT	PowerMax 8000 TOP ROUTING KIT	ES-P1	\$295
EZ-VB1KIT	PowerMax 8000 PB 1 INSTALL KIT	ES-P1	\$0
EZ-VB1KIT-3P	PowerMax 8000 PB 1 INSTALL KIT 3P	ES-P1	\$0
EZ-VB1KIT-VCE	PowerMax 8000 PB 1 INSTALL KIT VXBLOCK	ES-P1	\$0
EZ-VB2KIT	PowerMax 8000 PB 2 INSTALL KIT	ES-P1	\$0
EZ-VB2KIT-3P	PowerMax 8000 PB 2 INSTALL KIT 3P	ES-P1	\$0
EZ-VB2KIT-UFD	PowerMax 8000 PB 2 INSTALL KIT UPG	ES-P1	\$0
EZ-VB2KIT-VCE	PowerMax 8000 PB 2 INSTALL KIT VXBLOCK	ES-P1	\$0
EZ-VB3KIT	PowerMax 8000 PB 3 INSTALL KIT	ES-P1	\$0
EZ-VB3KIT-3P	PowerMax 8000 PB 3 INSTALL KIT 3P	ES-P1	\$0
EZ-VB3KIT-UFD	PowerMax 8000 PB 3 INSTALL KIT UPG	ES-P1	\$0
EZ-VB3KIT-VCE	PowerMax 8000 PB 3 INSTALL KIT VXBLOCK	ES-P1	\$0
EZ-VB4KIT	PowerMax 8000 PB 4 INSTALL KIT	ES-P1	\$0
EZ-VB4KIT-3P	PowerMax 8000 PB 4 INSTALL KIT 3P	ES-P1	\$0
EZ-VB4KIT-UFD	PowerMax 8000 PB 4 INSTALL KIT UPG	ES-P1	\$0
EZ-VB4KIT-VCE	PowerMax 8000 PB 4 INSTALL KIT VXBLOCK	ES-P1	\$0
EZ-VB5KIT	PowerMax 8000 PB 5 INSTALL KIT	ES-P1	\$0
EZ-VB5KIT-3P	PowerMax 8000 PB 5 INSTALL KIT 3P	ES-P1	\$0
EZ-VB5KIT-UFD	PowerMax 8000 PB 5 INSTALL KIT UPG	ES-P1	\$0
EZ-VB5KIT-VCE	PowerMax 8000 PB 5 INSTALL KIT VXBLOCK	ES-P1	\$0
EZ-VB6KIT	PowerMax 8000 PB 6 INSTALL KIT	ES-P1	\$0
EZ-VB6KIT-3P	PowerMax 8000 PB 6 INSTALL KIT 3P	ES-P1	\$0
EZ-VB6KIT-UFD	PowerMax 8000 PB 6 INSTALL KIT UPG	ES-P1	\$0
EZ-VB6KIT-VCE	PowerMax 8000 PB 6 INSTALL KIT VXBLOCK	ES-P1	\$0
EZ-VB7KIT	PowerMax 8000 PB 7 INSTALL KIT	ES-P1	\$0
EZ-VB7KIT-3P	PowerMax 8000 PB 7 INSTALL KIT 3P	ES-P1	\$0
EZ-VB7KIT-UFD	PowerMax 8000 PB 7 INSTALL KIT UPG	ES-P1	\$0
EZ-VB7KIT-VCE	PowerMax 8000 PB 7 INSTALL KIT VXBLOCK	ES-P1	\$0
EZ-VB8KIT	PowerMax 8000 PB 8 INSTALL KIT	ES-P1	\$0
EZ-VB8KIT-3P	PowerMax 8000 PB 8 INSTALL KIT 3P	ES-P1	\$0
EZ-VB8KIT-UFD	PowerMax 8000 PB 8 INSTALL KIT UPG	ES-P1	\$0
EZ-VB8KIT-VCE	PowerMax 8000 PB 8 INSTALL KIT VXBLOCK	ES-P1	\$0
EZ-VBF-1024	PowerMax 8000 ESS BASE 1024GB	ES-P1	\$940,490
EZ-VBF-1024-ADD	PowerMax 8000 ESS ADD 1024GB	ES-P1	\$940,490
EZ-VBF-1024-ADDU	PowerMax 8000 ESS ADD 1024GB UPG	ES-P1	\$1,128,590
EZ-VBF-1024-ADDUFD	PowerMax 8000 ESS ADD 1024GB UFD	ES-P1	\$1,128,590
EZ-VBF-2048	PowerMax 8000 ESS BASE 2048GB	ES-P1	\$1,283,400
EZ-VBF-2048-ADD	PowerMax 8000 ESS ADD 2048GB	ES-P1	\$1,283,400
EZ-VBF-2048-ADDU	PowerMax 8000 ESS ADD 2048GB UPG	ES-P1	\$1,540,080
EZ-VBF-2048-ADDUFD	PowerMax 8000 ESS ADD 2048GB UFD	ES-P1	\$1,540,080
EZ-VBX-1024	PowerMax 8000 PRO BASE 1024GB	ES-P1	\$1,167,830
EZ-VBX-1024-ADD	PowerMax 8000 PRO ADD 1024GB	ES-P1	\$1,167,830
EZ-VBX-1024-ADDU	PowerMax 8000 PRO ADD 1024GB UPG	ES-P1	\$1,401,395
EZ-VBX-1024-ADDUFD	PowerMax 8000 PRO ADD 1024GB UFD	ES-P1	\$1,401,395
EZ-VBX-2048	PowerMax 8000 PRO BASE 2048GB	ES-P1	\$1,510,740
EZ-VBX-2048-ADD	PowerMax 8000 PRO ADD 2048GB	ES-P1	\$1,510,740
EZ-VBX-2048-ADDU	PowerMax 8000 PRO ADD 2048GB UPG	ES-P1	\$1,812,890
EZ-VBX-2048-ADDUFD	PowerMax 8000 PRO ADD 2048GB UFD	ES-P1	\$1,812,890
EZ-VCERACK	PowerMax 8000 VXBLOCK RACK TRK MODEL	ES-P1	\$0
EZ-VCERACKU	PowerMax 8000 VXBLOCK RACK TRK MODEL UP	ES-P1	\$0

EZX-BEDIR	PowerMax 8000 PRO DIR	ES-P1	\$0
EZX-BEDIRU	PowerMax 8000 PRO DIR UPG	ES-P1	\$0
EZX-BEDIRUFD	PowerMax 8000 PRO DIR FD UPG	ES-P1	\$0
EZX-NAS-SN	Embedded NAS Base PowerMax 8000 PRO	ES-P1	\$0
EZX-NAS-SNU	Embedded NAS Base PowerMax 8000 PRO UPG	ES-P1	\$0
EZ-ZBF-1024	PowerMax 8000 ESS MF BASE 1024GB	ES-P1	\$460,935
EZ-ZBF-1024-ADD	PowerMax 8000 ESS MF ADD 1024GB	ES-P1	\$460,935
EZ-ZBF-1024-ADDU	PowerMax 8000 ESS MF ADD 1024GB UPG	ES-P1	\$553,120
EZ-ZBF-1024-ADDUFD	PowerMax 8000 ESS MF ADD 1024GB UFD	ES-P1	\$553,120
EZ-ZBF-2048	PowerMax 8000 ESS MF BASE 2048GB	ES-P1	\$762,975
EZ-ZBF-2048-ADD	PowerMax 8000 ESS MF ADD 2048GB	ES-P1	\$762,975
EZ-ZBF-2048-ADDU	PowerMax 8000 ESS MF ADD 2048GB UPG	ES-P1	\$915,570
EZ-ZBF-2048-ADDUFD	PowerMax 8000 ESS MF ADD 2048GB UFD	ES-P1	\$915,570
EZ-ZBX-1024	PowerMax 8000 PRO MF BASE 1024GB	ES-P1	\$494,215
EZ-ZBX-1024-ADD	PowerMax 8000 PRO MF ADD 1024GB	ES-P1	\$494,215
EZ-ZBX-1024-ADDU	PowerMax 8000 PRO MF ADD 1024GB UPG	ES-P1	\$593,060
EZ-ZBX-1024-ADDUFD	PowerMax 8000 PRO MF ADD 1024GB UFD	ES-P1	\$593,060
EZ-ZBX-2048	PowerMax 8000 PRO MF BASE 2048GB	ES-P1	\$796,255
EZ-ZBX-2048-ADD	PowerMax 8000 PRO MF ADD 2048GB	ES-P1	\$796,255
EZ-ZBX-2048-ADDU	PowerMax 8000 PRO MF ADD 2048GB UPG	ES-P1	\$955,505
EZ-ZBX-2048-ADDUFD	PowerMax 8000 PRO MF ADD 2048GB UFD	ES-P1	\$955,505
EZ-ZCAPF	PowerMax 8000 ESS MF CAPACITY	ES-P1	\$9,075
EZ-ZCAPFU	PowerMax 8000 ESS MF CAPACITY UPG	ES-P1	\$10,890
EZ-ZCAPX	PowerMax 8000 PRO MF CAPACITY	ES-P1	\$11,635
EZ-ZCAPXU	PowerMax 8000 PRO MF CAPACITY UPG	ES-P1	\$13,960
QNDN3192051	PowerMax 2000 RAID5(3+1) 1.92TB	ES-P1	\$0
QNDN3192051TU	PowerMax 2000 RAID5(3+1) 1.92TB TAA UPG	ES-P1	\$0
QNDN3192051U	PowerMax 2000 RAID5(3+1) 1.92TB UPG	ES-P1	\$0
QNDN3192061	PowerMax 2000 RAID6(6+2) 1.92TB	ES-P1	\$0
QNDN3192061TU	PowerMax 2000 RAID6(6+2) 1.92TB TAA UPG	ES-P1	\$0
QNDN3192061U	PowerMax 2000 RAID6(6+2) 1.92TB UPG	ES-P1	\$0
QNDN3192071	PowerMax 2000 RAID5(7+1) 1.92TB	ES-P1	\$0
QNDN3192071TU	PowerMax 2000 RAID5(7+1) 1.92TB TAA UPG	ES-P1	\$0
QNDN3192071U	PowerMax 2000 RAID5(7+1) 1.92TB UPG	ES-P1	\$0
QNDN31920R1	PowerMax 2000 1.92TB ADD SPARE	ES-P1	\$27,940
QNDN31920R1TU	PowerMax 2000 1.92TB ADD SPARE TAA UPG	ES-P1	\$36,320
QNDN31920R1U	PowerMax 2000 1.92TB ADD SPARE UPG	ES-P1	\$36,320
QNDN31920S1	PowerMax 2000 1.92TB SPARE	ES-P1	\$0
QNDN31920S1TU	PowerMax 2000 1.92TB SPARE TAA UPG	ES-P1	\$0
QNDN31920S1U	PowerMax 2000 1.92TB SPARE UPG	ES-P1	\$0
QNDN3384051	PowerMax 2000 RAID5(3+1) 3.84TB	ES-P1	\$0
QNDN3384051TU	PowerMax 2000 RAID5(3+1) 3.84TB TAA UPG	ES-P1	\$0
QNDN3384051U	PowerMax 2000 RAID5(3+1) 3.84TB UPG	ES-P1	\$0
QNDN3384061	PowerMax 2000 RAID6(6+2) 3.84TB	ES-P1	\$0
QNDN3384061TU	PowerMax 2000 RAID6(6+2) 3.84TB TAA UPG	ES-P1	\$0
QNDN3384061U	PowerMax 2000 RAID6(6+2) 3.84TB UPG	ES-P1	\$0
QNDN3384071	PowerMax 2000 RAID5(7+1) 3.84TB	ES-P1	\$0
QNDN3384071TU	PowerMax 2000 RAID5(7+1) 3.84TB TAA UPG	ES-P1	\$0
QNDN3384071U	PowerMax 2000 RAID5(7+1) 3.84TB UPG	ES-P1	\$0
QNDN33840R1	PowerMax 2000 3.84TB ADD SPARE	ES-P1	\$55,880

QNDN33840R1TU	PowerMax 2000 3.84TB ADD SPARE TAA UPG	ES-P1	\$72,645
QNDN33840R1U	PowerMax 2000 3.84TB ADD SPARE UPG	ES-P1	\$72,645
QNDN33840S1	PowerMax 2000 3.84TB SPARE	ES-P1	\$0
QNDN33840S1TU	PowerMax 2000 3.84TB SPARE TAA UPG	ES-P1	\$0
QNDN33840S1U	PowerMax 2000 3.84TB SPARE UPG	ES-P1	\$0
QNDN3768051	PowerMax 2000 RAID5(3+1) 7.68TB	ES-P1	\$0
QNDN3768051TU	PowerMax 2000 RAID5(3+1) 7.68TB TAA UPG	ES-P1	\$0
QNDN3768051U	PowerMax 2000 RAID5(3+1) 7.68TB UPG	ES-P1	\$0
QNDN3768061	PowerMax 2000 RAID6(6+2) 7.68TB	ES-P1	\$0
QNDN3768061TU	PowerMax 2000 RAID6(6+2) 7.68TB TAA UPG	ES-P1	\$0
QNDN3768061U	PowerMax 2000 RAID6(6+2) 7.68TB UPG	ES-P1	\$0
QNDN3768071	PowerMax 2000 RAID5(7+1) 7.68TB	ES-P1	\$0
QNDN3768071TU	PowerMax 2000 RAID5(7+1) 7.68TB TAA UPG	ES-P1	\$0
QNDN3768071U	PowerMax 2000 RAID5(7+1) 7.68TB UPG	ES-P1	\$0
QNDN37680R1	PowerMax 2000 7.68TB ADD SPARE	ES-P1	\$111,755
QNDN37680R1TU	PowerMax 2000 7.68TB ADD SPARE TAA UPG	ES-P1	\$145,285
QNDN37680R1U	PowerMax 2000 7.68TB ADD SPARE UPG	ES-P1	\$145,285
QNDN37680S1	PowerMax 2000 7.68TB SPARE	ES-P1	\$0
QNDN37680S1TU	PowerMax 2000 7.68TB SPARE TAA UPG	ES-P1	\$0
QNDN37680S1U	PowerMax 2000 7.68TB SPARE UPG	ES-P1	\$0
SMNDN3192061	PowerMax 8000 MF RAID6(6+2) 1.92TB	ES-P1	\$0
SMNDN3192061TU	PowerMax 8000 MF R6(6+2) 1.92TB TAA UPG	ES-P1	\$0
SMNDN3192061U	PowerMax 8000 MF RAID6(6+2) 1.92TB UPG	ES-P1	\$0
SMNDN3192071	PowerMax 8000 MF RAID5(7+1) 1.92TB	ES-P1	\$0
SMNDN3192071TU	PowerMax 8000 MF R5(7+1) 1.92TB TAA UPG	ES-P1	\$0
SMNDN3192071U	PowerMax 8000 MF RAID5(7+1) 1.92TB UPG	ES-P1	\$0
SMNDN31920R1	PowerMax 8000 MF 1.92TB ADD SPARE	ES-P1	\$27,940
SMNDN31920R1TU	PowerMax 8000 MF 1.92TB ADD SPARE TAA UP	ES-P1	\$36,320
SMNDN31920R1U	PowerMax 8000 MF 1.92TB ADD SPARE UPG	ES-P1	\$36,320
SMNDN31920S1	PowerMax 8000 MF 1.92TB SPARE	ES-P1	\$0
SMNDN31920S1TU	PowerMax 8000 MF 1.92TB SPARE TAA UPG	ES-P1	\$0
SMNDN31920S1U	PowerMax 8000 MF 1.92TB SPARE UPG	ES-P1	\$0
SMNDN3384061	PowerMax 8000 MF RAID6(6+2) 3.84TB	ES-P1	\$0
SMNDN3384061TU	PowerMax 8000 MF R6(6+2) 3.84TB TAA UPG	ES-P1	\$0
SMNDN3384061U	PowerMax 8000 MF RAID6(6+2) 3.84TB UPG	ES-P1	\$0
SMNDN3384071	PowerMax 8000 MF RAID5(7+1) 3.84TB	ES-P1	\$0
SMNDN3384071TU	PowerMax 8000 MF R5(7+1) 3.84TB TAA UPG	ES-P1	\$0
SMNDN3384071U	PowerMax 8000 MF RAID5(7+1) 3.84TB UPG	ES-P1	\$0
SMNDN33840R1	PowerMax 8000 MF 3.84TB ADD SPARE	ES-P1	\$55,880
SMNDN33840R1TU	PowerMax 8000 MF 3.84TB ADD SPARE TAA UP	ES-P1	\$72,645
SMNDN33840R1U	PowerMax 8000 MF 3.84TB ADD SPARE UPG	ES-P1	\$72,645
SMNDN33840S1	PowerMax 8000 MF 3.84TB SPARE	ES-P1	\$0
SMNDN33840S1TU	PowerMax 8000 MF 3.84TB SPARE TAA UPG	ES-P1	\$0
SMNDN33840S1U	PowerMax 8000 MF 3.84TB SPARE UPG	ES-P1	\$0
SMNDN3768061	PowerMax 8000 MF RAID6(6+2) 7.68TB	ES-P1	\$0
SMNDN3768061TU	PowerMax 8000 MF R6(6+2) 7.68TB TAA UPG	ES-P1	\$0
SMNDN3768061U	PowerMax 8000 MF RAID6(6+2) 7.68TB UPG	ES-P1	\$0
SMNDN3768071	PowerMax 8000 MF RAID5(7+1) 7.68TB	ES-P1	\$0
SMNDN3768071TU	PowerMax 8000 MF R5(7+1) 7.68TB TAA UPG	ES-P1	\$0
SMNDN3768071U	PowerMax 8000 MF RAID5(7+1) 7.68TB UPG	ES-P1	\$0

SMNDN37680R1	PowerMax 8000 MF 7.68TB ADD SPARE	ES-P1	\$111,755
SMNDN37680R1TU	PowerMax 8000 MF 7.68TB ADD SPARE TAA UP	ES-P1	\$145,285
SMNDN37680R1U	PowerMax 8000 MF 7.68TB ADD SPARE UPG	ES-P1	\$145,285
SMNDN37680S1	PowerMax 8000 MF 7.68TB SPARE	ES-P1	\$0
SMNDN37680S1TU	PowerMax 8000 MF 7.68TB SPARE TAA UPG	ES-P1	\$0
SMNDN37680S1U	PowerMax 8000 MF 7.68TB SPARE UPG	ES-P1	\$0
SNDN3192061	PowerMax 8000 RAID6(6+2) 1.92TB	ES-P1	\$0
SNDN3192061TU	PowerMax 8000 RAID6(6+2) 1.92TB TAA UPG	ES-P1	\$0
SNDN3192061U	PowerMax 8000 RAID6(6+2) 1.92TB UPG	ES-P1	\$0
SNDN3192071	PowerMax 8000 RAID5(7+1) 1.92TB	ES-P1	\$0
SNDN3192071TU	PowerMax 8000 RAID5(7+1) 1.92TB TAA UPG	ES-P1	\$0
SNDN3192071U	PowerMax 8000 RAID5(7+1) 1.92TB UPG	ES-P1	\$0
SNDN31920R1	PowerMax 8000 1.92TB ADD SPARE	ES-P1	\$27,940
SNDN31920R1TU	PowerMax 8000 1.92TB ADD SPARE TAA UPG	ES-P1	\$36,320
SNDN31920R1U	PowerMax 8000 1.92TB ADD SPARE UPG	ES-P1	\$36,320
SNDN31920S1	PowerMax 8000 1.92TB SPARE	ES-P1	\$0
SNDN31920S1TU	PowerMax 8000 1.92TB SPARE TAA UPG	ES-P1	\$0
SNDN31920S1U	PowerMax 8000 1.92TB SPARE UPG	ES-P1	\$0
SNDN3384061	PowerMax 8000 RAID6(6+2) 3.84TB	ES-P1	\$0
SNDN3384061TU	PowerMax 8000 RAID6(6+2) 3.84TB TAA UPG	ES-P1	\$0
SNDN3384061U	PowerMax 8000 RAID6(6+2) 3.84TB UPG	ES-P1	\$0
SNDN3384071	PowerMax 8000 RAID5(7+1) 3.84TB	ES-P1	\$0
SNDN3384071TU	PowerMax 8000 RAID5(7+1) 3.84TB TAA UPG	ES-P1	\$0
SNDN3384071U	PowerMax 8000 RAID5(7+1) 3.84TB UPG	ES-P1	\$0
SNDN33840R1	PowerMax 8000 3.84TB ADD SPARE	ES-P1	\$55,880
SNDN33840R1TU	PowerMax 8000 3.84TB ADD SPARE TAA UPG	ES-P1	\$72,645
SNDN33840R1U	PowerMax 8000 3.84TB ADD SPARE UPG	ES-P1	\$72,645
SNDN33840S1	PowerMax 8000 3.84TB SPARE	ES-P1	\$0
SNDN33840S1TU	PowerMax 8000 3.84TB SPARE TAA UPG	ES-P1	\$0
SNDN33840S1U	PowerMax 8000 3.84TB SPARE UPG	ES-P1	\$0
SNDN3768061	PowerMax 8000 RAID6(6+2) 7.68TB	ES-P1	\$0
SNDN3768061TU	PowerMax 8000 RAID6(6+2) 7.68TB TAA UPG	ES-P1	\$0
SNDN3768061U	PowerMax 8000 RAID6(6+2) 7.68TB UPG	ES-P1	\$0
SNDN3768071	PowerMax 8000 RAID5(7+1) 7.68TB	ES-P1	\$0
SNDN3768071TU	PowerMax 8000 RAID5(7+1) 7.68TB TAA UPG	ES-P1	\$0
SNDN3768071U	PowerMax 8000 RAID5(7+1) 7.68TB UPG	ES-P1	\$0
SNDN37680R1	PowerMax 8000 7.68TB ADD SPARE	ES-P1	\$111,755
SNDN37680R1TU	PowerMax 8000 7.68TB ADD SPARE TAA UPG	ES-P1	\$145,285
SNDN37680R1U	PowerMax 8000 7.68TB ADD SPARE UPG	ES-P1	\$145,285
SNDN37680S1	PowerMax 8000 7.68TB SPARE	ES-P1	\$0
SNDN37680S1TU	PowerMax 8000 7.68TB SPARE TAA UPG	ES-P1	\$0
SNDN37680S1U	PowerMax 8000 7.68TB SPARE UPG	ES-P1	\$0
PS-BAS VAEVBBA	V-Brick Sys Bay Upgd PowerMax 8000Add-on	F1	\$4,290
PS-BAS-2HAIE	VMAX Implementation for 2 Host	F1	\$2,980
PS-BAS-3PRACK	VMAX 10K Re-Rack Installation	F1	\$4,620
PS-BAS-4HAIE	VMAX Implementation for 4 Host	F1	\$6,270
PS-BAS-4HSME	SME CLARiiON SAN 4HOST QS	F1	\$7,630
PS-BAS-AD10N	Installation of upto 10 Isilon nodes	F1	\$2,880
PS-BAS-AD1N	INSTALLATION OF 1 ISILON NODE	F1	\$430
PS-BAS-ADBKLG	ADD BLOCK HOST LARGE	F1	\$5,350

PS-BAS-ADBKREP	Block Replication Deployment VNXe32000	F1	\$2,000
PS-BAS-ADBKSM	ADD BLOCK HOST SMALL	F1	\$3,020
PS-BAS-ADCEE	UNIFIED QS: EVENT ENABLER MODULE	F1	\$2,850
PS-BAS-ADDAE	RACK & STACK OF UPTO 2 DAE	F1	\$370
PS-BAS-ADENT	CIFS/NFS/ISCSI IMPLEMENT - 12 FS	F1	\$2,900
PS-BAS-ADFSLG	ADD FILESYSTEM LARGE	F1	\$3,780
PS-BAS-ADFSSM	ADD FILESYSTEM SMALL	F1	\$2,250
PS-BAS-ADINIQ	CONFIGURE INSIGHTIQ	F1	\$1,290
PS-BAS-ADME	Impl for AV Data Migration Export	F1	\$10,650
PS-BAS-ADMECBHYB	Impl. for CloudBoost for AV with hyb cld	F1	\$2,980
PS-BAS-ADMECBPVT	Implementation for ADMe CloudBoost Addon	F1	\$1,290
PS-BAS-ADMN	DATA STORE MULTI-NODE BASE IMP	F1	\$8,920
PS-BAS-ADMNA	DATA STORE MULTI-NODE ADD-ON IMP	F1	\$4,740
PS-BAS-ADMONR	MONITORING AND REPORTING IMPLEMENT	F1	\$1,970
PS-BAS-ADMVW	MIRRORVIEW QUICKSTART MODULE	F1	\$4,050
PS-BAS-ADREP	UNIFIED QS: REPLICATOR MODULE	F1	\$6,180
PS-BAS-ADSELG	ADD OF 25 SHARE/EXPORTS	F1	\$1,290
PS-BAS-ADSMLK	Configure upto 10 SmartLock Folders	F1	\$1,290
PS-BAS-ADSN	DATA STORE SINGLE-NODE BASE IMP	F1	\$5,990
PS-BAS-ADSNA	DATA STORE SINGLE-NODE ADD-ON IMP	F1	\$3,500
PS-BAS-ADSNAP	UNIFIED QS: SNAPSURE MODULE	F1	\$2,360
PS-BAS-ADSPOL	CONFIGURE UPTO 5 SMARTPOOLS	F1	\$1,050
PS-BAS-ADSPV	SNAPVIEW QUICKSTART MODULE	F1	\$2,240
PS-BAS-ADSQLG	ADD OF 25 SMARTQUOTAS	F1	\$1,290
PS-BAS-ADSSLG	ADD OF 25 SNAPSHOTIQ	F1	\$1,290
PS-BAS-ADSYIQ	Configure upto 5 SyncIQ Policies	F1	\$1,570
PS-BAS-ADVMTTR	VPLEX IMPLEMENT METRO CLUSTER ADDER	F1	\$1,940
PS-BAS-ADVPRO	VIRTUAL PROVISIONING FOR BLOCK MODU	F1	\$2,810
PS-BAS-ADVRCCK	VPLEX INSTALL IN CUSTOMER RACK	F1	\$2,750
PS-BAS-ADVSI	Virtual Storage Integrator (VSI) Impl	F1	\$1,770
PS-BAS-ADVSRV	VPLEX QUICKSTART: ADD SERVER MODULE	F1	\$1,390
PS-BAS-ADVSTG	VPLEX QUICKSTART: ADD ARRAY MODULE	F1	\$1,390
PS-BAS-ANCEE	VMAX File Event Enabler	F1	\$2,850
PS-BAS-ANFSLG	VMAX File Add up to 25 CIFS/NFS FS	F1	\$4,020
PS-BAS-ANFSSM	VMAX File Add up to 5 CIFS/NFS FS	F1	\$2,740
PS-BAS-ANREP	VMAX File Replicator PS	F1	\$6,180
PS-BAS-APPOLRP	DESIGN & IMPLMT ORACLE LOCAL REP APPSYN	F1	\$4,300
PS-BAS-AT240A	2 NODE ATMOS INSTALLATION 120/240	F1	\$730
PS-BAS-AT240B	EMC Site Deployment for Atmos: Base	F1	\$4,910
PS-BAS-AT360A	2 NODE ATMOS INSTALLATION 360/480	F1	\$1,930
PS-BAS-AT360B	INSTALLATION FOR ATMOS 360: BASE	F1	\$13,010
PS-BAS-ATDE	EMC DATA ERASURE FOR ATMOS	F1	\$4,000
PS-BAS-ATMIG	Atmos Migration Design & Implementation	F1	\$9,080
PS-BAS-ATMIGA	Atmos Migration Add-On	F1	\$2,170
PS-BAS-ATPLM	Atmos Policy Migration	F1	\$7,190
PS-BAS-ATSD	Atmos Solution Design	F1	\$5,340
PS-BAS-ATSR	Atmos Solutions Review	F1	\$6,190
PS-BAS-AVADPK	AV Mod for App DB Suite Client 10PK	F1	\$10,970
PS-BAS-AVBSNR	Avamar BE Single Node Remote Imp	F1	\$3,220
PS-BAS-AVDD	AVAMAR IMPLEMENTATION FOR DD BOOST	F1	\$9,880

PS-BAS-AVDE	EMC DATA ERASURE FOR AVAMAR	F1	\$4,000
PS-BAS-AVDSMI	AVAMAR DS INSTALL FOR MULTI NODE	F1	\$2,890
PS-BAS-AVDSDNI	AVAMAR DS INSTALL FOR SINGLE NODE	F1	\$1,300
PS-BAS-AVE	IMPLEMENTATION FOR AVE BASIC	F1	\$5,510
PS-BAS-AVEA	IMPLEMENTATION FOR AVE ADD-ON	F1	\$2,530
PS-BAS-AVERA	IMPL AVAMAR VIRT ED REMOTE ADDON	F1	\$3,780
PS-BAS-AVMIGM	EMC MIGRATION FOR MULTI AVAMAR QS	F1	\$8,360
PS-BAS-AVMIGS	EMC MIGRATION FOR SINGLE AVAMAR QS	F1	\$4,740
PS-BAS-AVMSPK	AV Mod for MS App Suite Client 10PK	F1	\$11,250
PS-BAS-AVNDMP	AVAMAR BASIC NDMP QUICKSTART	F1	\$3,740
PS-BAS-AVSN	AVAMAR BASIC QUICKSTART	F1	\$15,860
PS-BAS-AVVADP	AV VADP Integration QS	F1	\$9,640
PS-BAS-AVVBLK	Avamar Integration with Vsphere	F1	\$10,810
PS-BAS-AVVDP	Avamar Migration for VMware VDP	F1	\$12,450
PS-BAS-AVVMPK	AV VMware Proxy Server 5Pk Add-on Q	F1	\$4,980
PS-BAS-AVXIMP	AVAMAR NODE REBALANCE QUICKSTART	F1	\$4,420
PS-BAS-AVXINS	AVAMAR EXP NODE INSTALL QUICKSTART	F1	\$720
PS-BAS-BATCHSOL	ECD CONS SOL BatchPrint	F1	\$50,000
PS-BAS-BATCHSUP	ECD CONS SOLSUP BatchPrint	F1	\$11,500
PS-BAS-BDVW	Big Data Vision Workshop	F1	\$87,010
PS-BAS-BDVWL1	L1 Big data vision service	F1	\$87,010
PS-BAS-BSOPT	EMC SAN Optimization for Connectrix B-Se	F1	\$22,580
PS-BAS-BSOPTC	SAN Opt for B-Series Ctx Mgr Add-On	F1	\$3,860
PS-BAS-BSOPTD	SAN Opt for B-Series Director Add-On	F1	\$890
PS-BAS-BSOPTP	SAN Optimization for B-Series Policy Add	F1	\$890
PS-BAS-CADSOL	ECD CONS SOL CADRender	F1	\$25,000
PS-BAS-CADSUP	ECD CONS SOLSUP CADRender	F1	\$5,750
PS-BAS-CAP-DO	CAPTIVA DIGITAL OFFICE	F1	\$21,700
PS-BAS-CARSAPINFWS	CARS WS APP & INFR READINESS VPLEX METR	F1	\$49,550
PS-BAS-CBAPVRT	Install of CloudBoost Virtual Appliance	F1	\$2,130
PS-BAS-CBAV	Impl for CloudBoost Appliance for AV	F1	\$5,390
PS-BAS-CBNW	Impl for CloudBoost Appliance for NW	F1	\$5,140
PS-BAS-CBPMIG	MIGRATION FROM CB PORTAL TO CB VAPP	F1	\$1,350
PS-BAS-CBSOL1	ECD CONS SOL ContentBridge 1 Instance	F1	\$40,000
PS-BAS-CBSOL2	ECD CONS SOL ContentBridge 2 Instances	F1	\$60,000
PS-BAS-CBSOL3	ECD CONS SOL ContentBridge 3 Instances	F1	\$75,000
PS-BAS-CBSOL4	ECD CONS SOL ContentBridge 4 Instances	F1	\$90,000
PS-BAS-CBSOL5	ECD CONS SOL ContentBridge Add On>4	F1	\$10,000
PS-BAS-CBSUP1	ECD CONS SOLSUP ContentBridge 1 Instance	F1	\$9,200
PS-BAS-CBSUP2	ECD CONS SOLSUP ContentBridge 2Instances	F1	\$13,800
PS-BAS-CBSUP3	ECD CONS SOLSUP ContentBridge 3Instances	F1	\$17,250
PS-BAS-CBSUP4	ECD CONS SOLSUP ContentBridge 4Instances	F1	\$20,700
PS-BAS-CBSUP5	ECD CONS SOLSUP ContentBridge Add On>4	F1	\$2,300
PS-BAS-CENNDE	Data Erasure for Centera Nodes	F1	\$4,000
PS-BAS-CIS	IMPL FOR CENTERA	F1	\$10,500
PS-BAS-CISRMD	Imp for VMware SRM for Converged	F1	\$18,830
PS-BAS-CISRME	Imp for VMware SRM for Converged Add-on	F1	\$2,080
PS-BAS-CLA	CloudArray configuration (post-install)	F1	\$810
PS-BAS-CLAI	CloudArray install (HW or virtual)	F1	\$2,620
PS-BAS-CLRWTS	VPLEX WITNESS IMPLEMENTATION	F1	\$2,700

PS-BAS-CLSVMIMP	Implementation for CloudLink SecureVM	F1	\$5,430
PS-BAS-CONSBBAWS	Blueprint Backup Architecture Intro Adv	F1	\$81,720
PS-BAS-CSEASD	ASD CSE - block of time	F1	\$1,020
PS-BAS-CSECI	CI CSE - BLOCK OF TIME	F1	\$1,520
PS-BAS-CSEESD	ESD CSE - block of time	F1	\$1,020
PS-BAS-CSEFL	ETPD CSE - 4 HR BLOCK	F1	\$1,020
PS-BAS-CSEUSD	USD CSE - block of time	F1	\$1,020
PS-BAS-CTASW	Cloud Tiering Software Implementation	F1	\$4,050
PS-BAS-CTXHW	Connectrix Installation Director/Switch	F1	\$2,240
PS-BAS-CTXHWABLD	Connectrix Installation for Blades Adder	F1	\$440
PS-BAS-CTXHWADS	Connectrix Install Adder Director/Switch	F1	\$870
PS-BAS-CTXHWUBLD	Connectrix Blade Upgrade	F1	\$1,590
PS-BAS-CTXOPRES	Residency for Connectrix - OP	F1	\$30,800
PS-BAS-CTXTRRES	Residency for Connectrix - TR	F1	\$39,000
PS-BAS-CXDE	DATA ERASURE FOR CLARIION	F1	\$4,900
PS-BAS-DATALD	ANALYTICS DATA LOADING MAX 3 TB	F1	\$48,240
PS-BAS-DBPT	DB PERFORMANCE TIERING SERVICE	F1	\$26,780
PS-BAS-DCAIRA	DCA Adder Rack for New or Upgrade	F1	\$5,910
PS-BAS-DCTMRPT1	ECD CONS SOL Dctm Rpts 50 users	F1	\$105
PS-BAS-DCTMRPT2	ECD CONS SOL Dctm Rpts Server	F1	\$70
PS-BAS-DCTMRPT3	ECD CONS SOL Dctm Rpts 251-500 users	F1	\$62
PS-BAS-DCTMRPT4	ECD CONS SOL Dctm Rpts 501-1250 users	F1	\$53
PS-BAS-DCTMRPT5	ECD CONS SOL Dctm Rpts 1251+ users	F1	\$40
PS-BAS-DCTMSUP1	ECD CONS SOLSUP Dctm Rpts 50 users	F1	\$24
PS-BAS-DCTMSUP2	ECD CONS SOLSUP Dctm Rpts Server	F1	\$16
PS-BAS-DCTMSUP3	ECD CONS SOLSUP Dctm Rpts 251-500 users	F1	\$14
PS-BAS-DCTMSUP4	ECD CONS SOLSUP Dctm Rpts 501-1250 users	F1	\$12
PS-BAS-DCTMSUP5	ECD CONS SOLSUP Dctm Rpts 1251+ users	F1	\$9
PS-BAS-DD00	IMPL FOR DD 0 SHELF QS	F1	\$2,500
PS-BAS-DD00P	Impl for DD No Shelf for Partners	F1	\$1,930
PS-BAS-DDBDBA	Impl DDBoost DB Appl	F1	\$3,820
PS-BAS-DDBMSA	Impl DDBoost MS Appl	F1	\$3,060
PS-BAS-DDBT	IMPL DD BOOST NBU ADD-ON QS	F1	\$7,710
PS-BAS-DDCC	DD CONFIG AND CODE UPGRADE	F1	\$1,450
PS-BAS-DDCDRB	DDCDR Remote Implementation Service	F1	\$7,730
PS-BAS-DDCT	DD CLOUD TIER	F1	\$2,810
PS-BAS-DDCU	DD SYSTEM CONTROLLER UPGRADE	F1	\$2,500
PS-BAS-DDDE	EMC DATA ERASURE FOR DATA DOMAIN	F1	\$4,000
PS-BAS-DDDSA	Install Add-on for Data Domain DS Shelf	F1	\$880
PS-BAS-DDDSP	Capacity Disk Pak Expansion for DD	F1	\$2,220
PS-BAS-DDDSX	Install for Data Domain DS Expansion	F1	\$2,480
PS-BAS-DDDX	DiskXtender to DD Migration QS	F1	\$16,300
PS-BAS-DDER	DD Extend Retention Conversion QS	F1	\$9,560
PS-BAS-DDESA	Install Add-on for Data Domain ES Shelf	F1	\$440
PS-BAS-DDESX	Install New DD ES Shelf	F1	\$2,050
PS-BAS-DDGL	Guru Live for Data Domain	F1	\$1,320
PS-BAS-DDGP	GP DCA Integration with DD	F1	\$4,390
PS-BAS-DDHA	IMPLE DD WITH HA CONFIGURATION	F1	\$5,620
PS-BAS-DDIB	Impl Data Domain (Base)	F1	\$6,540
PS-BAS-DDIBMI	Implement DD with IBM iSeries	F1	\$2,170

PS-BAS-DDIR	Implement IR Air-Gap Scripting	F1	\$17,610
PS-BAS-DDMC	DD Mgmt Center Configuration QS	F1	\$4,620
PS-BAS-DDPH	IMPL PRERACKED CONTROLLER & SHELVES	F1	\$6,330
PS-BAS-DDRMAN	Int Enablement Wkshp for DD & RMAN	F1	\$12,370
PS-BAS-DDSM	DD SHELF MIGRATION	F1	\$4,340
PS-BAS-DDSMT	DD Secure Multi-Tenancy Design QS	F1	\$3,940
PS-BAS-DDSR	DD STAGING AND RELOCATION QS	F1	\$10,650
PS-BAS-DDVE	DD VE CONFIGURATION	F1	\$2,390
PS-BAS-DDVMC	Install Data Domain Cloud Virtual Machin	F1	\$3,530
PS-BAS-DDVRPA	Impl for DD VRPA (base)	F1	\$2,480
PS-BAS-DDVRPAE	Impl for DD VRPA (expansion)	F1	\$3,030
PS-BAS-DDVTL	IMPLEMENTATION FOR DD VTL	F1	\$2,000
PS-BAS-DLM	IMPLEMENTATION FOR DLM SA BLOCK	F1	\$1,970
PS-BAS-DLM00	IMPLE DD FOR DLM NO SHELF SYS QS	F1	\$5,710
PS-BAS-DLM06	IMPL DD FOR DLM 1 TO 6 SHELF SYS QS	F1	\$9,480
PS-BAS-DLM12	IMPL DD FOR DLM 6 TO 12 SHELF SYS Q	F1	\$9,960
PS-BAS-DLM24	IMPL DD FOR DLM 13TO24 SHELF SYS QS	F1	\$11,410
PS-BAS-DLMD	IMPL FOR DLM DESIGN QS	F1	\$21,120
PS-BAS-DLMHC	HealthCheck for DLm QS	F1	\$14,900
PS-BAS-DLMR	IMPL DLM REPLICATION QS	F1	\$16,630
PS-BAS-DLMVTU	Upgrade DLm VTE	F1	\$9,850
PS-BAS-DMBDA	Migration Architect Block Add	F1	\$3,660
PS-BAS-DMBDB	Migration Architect Block Base	F1	\$10,120
PS-BAS-DMBEE	Data Migration Block Event	F1	\$11,490
PS-BAS-DMEQS	Migration Impl Test	F1	\$3,780
PS-BAS-DMFDA	Migration Architect File Add	F1	\$2,530
PS-BAS-DMFDB	Data Migration Architect File Base	F1	\$5,620
PS-BAS-DMFEE	Migration File: Event	F1	\$8,320
PS-BAS-DPA	DPA BASIC QUICKSTART	F1	\$6,270
PS-BAS-DPACI	CUSTOMIZATION FOR DPA QS	F1	\$8,150
PS-BAS-DPADPS	DPA Implementation for DPS Base	F1	\$4,580
PS-BAS-DPADPSA	DPA Implementation for DPS Add-on	F1	\$1,970
PS-BAS-DPAFR	DPA Federated Reporting Implementation	F1	\$7,670
PS-BAS-DPAHCS	EMC HEALTH CHECK FOR DPA SUB	F1	\$23,330
PS-BAS-DPAR	IMPLEMENT FOR DPA REMOTE	F1	\$1,490
PS-BAS-DPAUM	DPA UPGRADE AND MIGRATION SERVICE	F1	\$17,150
PS-BAS-DPCDPS	Implement for Data Protection Central	F1	\$4,660
PS-BAS-DPDA	VCE Deploy for DP for CI - DPA Add-On	F1	\$3,490
PS-BAS-DPDB	VCE Deploy for DP for CI - Base	F1	\$7,350
PS-BAS-DPECV	UNIFIED DPE CONVERSION	F1	\$3,860
PS-BAS-DPMBLK	DATABASE PM BLOCK 4 HOURS	F1	\$1,970
PS-BAS-DPRA	DPA REPLICATION ANALYSIS QUICKSTART	F1	\$7,190
PS-BAS-DPSCDM	Impl for Enterprise Copy Data Management	F1	\$3,670
PS-BAS-DPSI	Impl Data Protection Search	F1	\$11,130
PS-BAS-DPSVMI	Impl for DPS for VM	F1	\$26,580
PS-BAS-DPSVMR	Impl for DPS for VM Replication Add-On	F1	\$14,370
PS-BAS-DSABLK	DATABASE SA BLOCK 4 HOURS	F1	\$1,970
PS-BAS-DXW	EMC IMPLEMENTATION FOR DISKXTENDER FOF	F1	\$10,990
PS-BAS-ECS4N	Implementation for ECS Node Expansion	F1	\$8,140
PS-BAS-ECSATEXP	Atmos to ECS Expansion	F1	\$4,220

PS-BAS-ECSCASEXP	ECS CAS Transformation	F1	\$14,620
PS-BAS-ECSCI	EMC Workshop for ECS Cloud Assessment	F1	\$17,310
PS-BAS-ECSCRA	ECS Installation in a Customer Rack	F1	\$3,060
PS-BAS-ECSDE	Data Erasure for ECS	F1	\$4,000
PS-BAS-ECSDRA	Implementation for ECS Drive Expansion	F1	\$3,400
PS-BAS-ECSIMP	ECS Appliance Implementation	F1	\$5,400
PS-BAS-ECSINS	ECS Appliance Install	F1	\$17,340
PS-BAS-ECSINSAD8N	ECS Add 8 Nodes Install or Expand	F1	\$2,800
PS-BAS-ECSMIG	EMC OBJECT MIGRATION DESING & IMPLEMEN	F1	\$15,810
PS-BAS-ECSMIGA	Object Migration Monitoring & Reporting	F1	\$1,970
PS-BAS-ECSSD	ECS Appliance Architecture and Design	F1	\$5,400
PS-BAS-EMASOL	ECD CONS SOL EMA	F1	\$50,000
PS-BAS-EPCWSF	Ent Priv Cloud Foundation Workshop	F1	\$30,580
PS-BAS-EPCWST	Ent Priv Cloud Transform Workshop	F1	\$42,620
PS-BAS-EX2S1	EMC EX TO SOURCEONE MIGRATION	F1	\$42,010
PS-BAS-EX360	INSTALL FOR 360 RACK	F1	\$5,020
PS-BAS-EXCOS	EXPAND ONE RACK TO FULL RACK	F1	\$3,310
PS-BAS-EXIS2U	ISILON 2U NODE EXPANSION BASE	F1	\$2,010
PS-BAS-EXIS4U	ISILON 4U NODE EXPANSION BASE	F1	\$2,590
PS-BAS-FCIA	FC Infra Assessment	F1	\$16,750
PS-BAS-FCREP	EVALUATE NETWORK FOR FC REPLICATION	F1	\$10,690
PS-BAS-FMAQS	CTA QuickStart Implementation	F1	\$8,560
PS-BAS-FMAVE	CTA-VE QuickStart Implementation	F1	\$4,580
PS-BAS-GPDE	EMC DATA ERASURE FOR GREENPLUM	F1	\$4,000
PS-BAS-GPEX	GP DCA IN-RACK EXPANSION	F1	\$7,310
PS-BAS-GPEXA	GP DCA IN-RACK EXPANSION ADD-ON	F1	\$2,530
PS-BAS-GPIHC	GP INFRAS HEALTH CHECK	F1	\$11,240
PS-BAS-GPMBLK	GREENPLUM PM BLOCK 4 HOURS	F1	\$1,970
PS-BAS-GPUPG	Greenplum Database Upgrade Service	F1	\$3,810
PS-BAS-GSABLK	GREENPLUM SA BLOCK 4 HOURS	F1	\$1,970
PS-BAS-HANA	2 hrs PM effort for SAP HANA oversight	F1	\$570
PS-BAS-HCBET	HEALTH CHECK FOR BLOCK/U - EVENT	F1	\$9,460
PS-BAS-HCBST	HEALTH CHECK FOR BLOCK - SUBS	F1	\$23,650
PS-BAS-HCIANCE	Install VxRail Cluster Expansion Node Ad	F1	\$3,270
PS-BAS-HCIANHE	Install for VxRail Node Hardware Upgrade	F1	\$4,060
PS-BAS-HCIANIMP	IMPLEMENT VXRAIL NODE	F1	\$2,150
PS-BAS-HCIANSE	Install VxRail Node Disk Group Upgrade	F1	\$3,560
PS-BAS-HCIAZCRIN	MHC Hardware Install Only Customer Rack	F1	\$5,420
PS-BAS-HCIAZRIMP	MHC Hardware Implementation Only	F1	\$13,940
PS-BAS-HCIAZRIN	MHC Hardware Install Only Dell EMC Rack	F1	\$2,310
PS-BAS-HCUET	HEALTH CHECK FOR FILE - EVENT	F1	\$10,890
PS-BAS-HCUST	HEALTH CHECK FOR FILE/U - SUBS	F1	\$27,230
PS-BAS-HCVP	Health Check for VPLEX	F1	\$13,660
PS-BAS-HDIS	Implem for Hadoop on Isilon Starter Kit	F1	\$11,610
PS-BAS-IAUX	Customer Implementation Assistance	F1	\$1,450
PS-BAS-IAUXV	UnityVSA Implementation Assistance	F1	\$1,450
PS-BAS-ICDM	iCDM:AppSync intall+1 replica on 1 host	F1	\$1,790
PS-BAS-IDMBA	IDM Data Migration Block Add-on	F1	\$2,080
PS-BAS-IDMBA	IDM Data Migration Block Base	F1	\$3,670
PS-BAS-IDMBE	IDM Data Migration Block, Event	F1	\$3,810

PS-BAS-IDMFA	IDM Data Migration File Add-on	F1	\$4,770
PS-BAS-IDMFB	IDM Data Migration File Base	F1	\$7,050
PS-BAS-IDMFE	IDM Data Migration File, Event	F1	\$3,940
PS-BAS-IDMVA	IDM Data Migration Virtual, Add-On	F1	\$1,075
PS-BAS-IDMVB	IDM Data Migration Virtual, Base	F1	\$1,750
PS-BAS-IDMVE	IDM Data Migration Virtual, Event	F1	\$2,150
PS-BAS-IDPAAE	Impl Int DP Appliance DP5x Series	F1	\$6,330
PS-BAS-IDPAAV	Impl Int DP Appliance DP8x Series	F1	\$7,520
PS-BAS-IDPANA	IDPA Network Validation Add-on	F1	\$2,590
PS-BAS-IDPAVE	Impl Int DP Appliance DP4x Series	F1	\$3,560
PS-BAS-IDSBLK	EMC IDS 4Hr Block	F1	\$1,690
PS-BAS-IDSCI	CI IDS - BLOCK OF TIME	F1	\$1,790
PS-BAS-IDSFL	ETPD IDS - 4 HR BLOCK	F1	\$1,690
PS-BAS-IDSISI	ISILON IDS BLOCK 4 HOURS	F1	\$1,690
PS-BAS-IDSUSD	USD IDS - block of time	F1	\$1,690
PS-BAS-IMAPSY	EMC UNIFIED IMPLEMENT APPSYNC QS	F1	\$6,020
PS-BAS-IMBS	ISILON BASE IMPLEMENTATION	F1	\$6,310
PS-BAS-IMBSP	ISILON BASE PLUS IMPLEMENTATION	F1	\$8,600
PS-BAS-IMFAST	DESIGN AND IMPLEMENT FAST VP/CACHE	F1	\$7,870
PS-BAS-IMFILE	IMPLEMENT FILE VNX	F1	\$5,350
PS-BAS-IMLEND	2 HOST OR 3 FILE IMPLEMENTATION	F1	\$1,870
PS-BAS-IMPRM	ISILON PREMIUM IMPLEMENTATION	F1	\$10,890
PS-BAS-INDIR	GENERIC DIRECTOR INSTALL	F1	\$2,250
PS-BAS-INGW	SETUP CELERRA GATEWAY	F1	\$7,810
PS-BAS-INIS2U	Isilon 2U Installation Base	F1	\$3,290
PS-BAS-INIS4U	Isilon 4U Installation Base	F1	\$3,870
PS-BAS-INSW	GENERIC SWITCH OR BLADE INSTAL	F1	\$2,040
PS-BAS-INSWIP	Installation for IP Switch	F1	\$2,040
PS-BAS-INTNBU	DD INTEGRATION WITH NBU	F1	\$12,370
PS-BAS-INVNX	VNX INSTALLATION	F1	\$2,160
PS-BAS-IOCARD2	IO Module Pair Install/Upgrade	F1	\$1,300
PS-BAS-IPSANEXT	Implementation for FCIP SAN Extension	F1	\$11,050
PS-BAS-IPTORSWC	VxRail TOR Switch Configuration	F1	\$3,510
PS-BAS-IRSDDIMPL	ISOLATED RECOVERY DATA DOMAIN IMPLEMEN	F1	\$88,830
PS-BAS-ISASD	ASD IMPLEMENTATION SPECIALIST- 4 HOURS	F1	\$1,690
PS-BAS-ISBRS	BRS IS BLOCK	F1	\$1,690
PS-BAS-ISDE	ERASURE SERVICE FOR ISILON	F1	\$4,000
PS-BAS-ISESD	ESD IS - block of time	F1	\$1,690
PS-BAS-ISIIDMA	Isilon IDM Data Migration File, Add-on	F1	\$4,770
PS-BAS-ISIIDMB	Isilon IDM Data Migration File, Base	F1	\$7,050
PS-BAS-ISIIDME	Isilon IDM Data Migration File, Event	F1	\$3,940
PS-BAS-ISIIMPADFEA	Implement Isilon Smart Feature	F1	\$6,360
PS-BAS-ISIIMPADV	Implement Isilon Advanced	F1	\$11,320
PS-BAS-ISIIMPENT	Implement Isilon Enterprise or Essential	F1	\$8,730
PS-BAS-ISIIMPOFSSY	Implement Isilon OFS and SyncIQ	F1	\$8,730
PS-BAS-ISIINS4N	Isilon Install 4 Nodes Base	F1	\$4,470
PS-BAS-ISIINSAD4N	Isilon Install Add 4 Nodes	F1	\$1,380
PS-BAS-ISIINSNSW	Install Network Switch for Isilon	F1	\$9,440
PS-BAS-ISIN2U	INSTALL FOR ISILON NODE 2U	F1	\$800
PS-BAS-ISNI4U	ISILON NODE INSTALL 4U	F1	\$1,500

PS-BAS-ISTECH	TECH REFRESH UPTO 10NODES DATA ONLY	F1	\$7,960
PS-BAS-ITCONADVWS	IT Continuity Introductory Advisory	F1	\$81,840
PS-BAS-MDSOPT	SAN Optimization for Connectrix MDS	F1	\$9,350
PS-BAS-MEMUP	UNIFIED MEMORY UPGRADE	F1	\$3,570
PS-BAS-METROPT	VPLEX METROPOINT IMPLEMENTATION	F1	\$3,020
PS-BAS-MHCACCEL	Dell EMC Accelerate for Azure Stack	F1	\$15,710
PS-BAS-MHCASRIMP	Azure Stack Remote Implementation	F1	\$13,420
PS-BAS-MHCDSIMP	Azure Stack Disconnected Implementation	F1	\$54,760
PS-BAS-MHCONIMP	Onsite implementation for Azure Stack	F1	\$51,120
PS-BAS-MSAT240B	Atmos Single Rack Imp Managed Serv	F1	\$12,834
PS-BAS-NMDAMS	EMC IMP FOR NMDA FOR MYSQL	F1	\$11,090
PS-BAS-NMMEX	IMP NETWORKER MIRCOSOF MODULE EXCH	F1	\$10,890
PS-BAS-NMMSQL	IMP NETWORKER MIRCOSOF MODULE SQL	F1	\$8,080
PS-BAS-NS6	NS INTEGRATED IMP QSES	F1	\$8,800
PS-BAS-NW	EMC NETWORKER BASIC QUICKSTART	F1	\$9,800
PS-BAS-NWCBHYB	Impl. for CloudBoost for NW in HYB Cld	F1	\$8,200
PS-BAS-NWCBPVT	Impelmentation for NetWorker CloudBoost	F1	\$3,860
PS-BAS-NWGL	Remote Implementation Design & Guidance	F1	\$3,640
PS-BAS-NWVG	Backup Migration Planning QS	F1	\$24,170
PS-BAS-NWOSMIG	NW Server Cross Platform OS Migration	F1	\$10,400
PS-BAS-NWSMBR	Remote Implementation for SMB base svc	F1	\$3,160
PS-BAS-NWSMBRADD	Remote implementation for SMB Add-on	F1	\$1,770
PS-BAS-NWSMBRVBA	NW Remote Impl. for SMB, VBA add-on	F1	\$1,770
PS-BAS-NWUPCLNT	NW Client Upgrade Add-On 10pk	F1	\$3,420
PS-BAS-NWUPIMP	NW Upgrade Implementation Base Service	F1	\$7,400
PS-BAS-NWUPNMDA	NW NMDA Upgrade Add-On	F1	\$5,520
PS-BAS-NWUPNMM	NW NMM Upgrade Add-On	F1	\$5,520
PS-BAS-NWUPP	NetWorker Upgrade Planning QS	F1	\$11,530
PS-BAS-NWUPVBA	NW Upgrade Add-On for VBA only	F1	\$4,510
PS-BAS-NWUPVMW	NW Upgrade Add-On for VMware Backup	F1	\$4,000
PS-BAS-OPSC	OPENSACLE IMPLEMENTATION	F1	\$5,510
PS-BAS-OSUPCE1U	Onsite Uplift for Local CSE 1 site visit	F1	\$660
PS-BAS-OSUPIS1U	Onsite Uplift for Local IS 1 site visit	F1	\$770
PS-BAS-OSUPPM1U	Onsite Uplift for Local PM 1 site visit	F1	\$890
PS-BAS-OSUPSA1U	Onsite Uplift for Local SA 1 site visit	F1	\$890
PS-BAS-OTSDP	OTS for Data Protection	F1	\$97,500
PS-BAS-OTSSTORAGE	Level 1 bundled pricing for VNX Out-Task	F1	\$97,500
PS-BAS-PCF-APTR-2L	PS PCF APP TRANS - 2 WEEKS LARGE	F1	\$110,000
PS-BAS-PCF-APTR-2M	PS PCF APP TRANS - 2 WEEKS MEDIUM	F1	\$84,000
PS-BAS-PCF-APTR-2S	PS PCF APP TRANS - 2 WEEKS SMALL	F1	\$58,000
PS-BAS-PCF-ARCH	PS SOLUTION ARCHITECT SVCS FOR PCF	F1	\$26,000
PS-BAS-PCF-DJ-2L	PS DOJO FOR PCF - 2 WEEKS LARGE	F1	\$110,000
PS-BAS-PCF-DJ-2M	PS DOJO FOR PCF - 2 WEEKS MEDIUM	F1	\$84,000
PS-BAS-PCF-DJ-2S	PS DOJO FOR PCF - 2 WEEKS SMALL	F1	\$58,000
PS-BAS-PCF-DOE	PS DESIGNATED OPS ENGINEER FOR PCF	F1	\$70,000
PS-BAS-PCF-PGM-2S	PS Senior Program Manager for PCF	F1	\$15,000
PS-BAS-PCFVSD-A-2L	CloudNative Application Migration VSD 2L	F1	\$41,320
PS-BAS-PCFVSD-A-2M	CloudNative Application Migration VSD 2M	F1	\$32,840
PS-BAS-PCFVSD-A-2S	CloudNative Application Migration VSD 2S	F1	\$24,360
PS-BAS-PCFVSD-ARCH	PCF Remote Solutions Architect VSD	F1	\$13,200

PS-BAS-PCFVSD-DOE	PCF Remote Operations Engineer VSD	F1	\$42,900
PS-BAS-PCFVSD-P-2L	CloudNative Platform Enable VSD 2L	F1	\$41,320
PS-BAS-PCFVSD-P-2M	CloudNative Platform Enable VSD 2M	F1	\$32,840
PS-BAS-PCFVSD-P-2S	CloudNative Platform Enable VSD 2S	F1	\$24,360
PS-BAS-PEBASE	PS Project Engagement Base	F1	\$2,830
PS-BAS-PMASD	ASD Project Manager - block of time	F1	\$1,970
PS-BAS-PMBLK	COMMERCIAL PMGMT 4HRS QS	F1	\$1,970
PS-BAS-PMBRS	BRS PROJECT MGMNT 4 HOURS QS	F1	\$1,970
PS-BAS-PMCI	CI PM - BLOCK OF TIME	F1	\$2,010
PS-BAS-PMDLM	PM BLOCK FOR DLM	F1	\$1,970
PS-BAS-PMESD	ESD Project Manager - block of time	F1	\$1,970
PS-BAS-PMFL	ETPD PM - 4 HR BLOCK	F1	\$1,970
PS-BAS-PMISI	ISILON PM BLOCK 4 HOURS	F1	\$1,970
PS-BAS-PMUSD	USD Project Manager - block of time	F1	\$1,970
PS-BAS-PMXENAS	Installation for eNAS PowerMax, Add-on	F1	\$1,020
PS-BAS-PP1	POWERPATH 1HOST QS	F1	\$770
PS-BAS-PP4	POWERPATH 4HOST QS	F1	\$2,490
PS-BAS-PPVE1	POWERPATH VE 1-HOST QUICKSTART	F1	\$1,010
PS-BAS-PPVE4	POWERPATH VE 4-HOST QUICKSTART	F1	\$2,740
PS-BAS-PROF	EMC AMERICAS ONLY APP PROFILING ADVISOR	F1	\$100,000
PS-BAS-PSGSOL	ECD CONS SOL PSG Modules (Single PROD)	F1	\$20,000
PS-BAS-PSGSOL2	ECD CONS SOL PSG Modules (Add on PROD)	F1	\$5,000
PS-BAS-PSGSUP	ECD CONS SOLSUP PSG Modules	F1	\$7,200
PS-BAS-RCSEUSD	Remote CSE 4 hr Block	F1	\$870
PS-BAS-RCVRPT	RECOVERPOINT FIXED	F1	\$18,720
PS-BAS-RISUSD	Remote Implemt Specialist 4 hr Block	F1	\$1,020
PS-BAS-RPAD2CG	RECOVERPOINT 2 CG ADDER	F1	\$490
PS-BAS-RPAD2HOST	RECOVERPOINT 2 HOST ADDER	F1	\$490
PS-BAS-RPADD	Install 2 addl RPAs to existing cluster	F1	\$2,900
PS-BAS-RPHCE	Health Check for RecoverPoint	F1	\$9,670
PS-BAS-RPHCR	Remote RPA Health Check No Performance	F1	\$3,780
PS-BAS-RPMUSD	Remote Project Management 4 hr Block	F1	\$1,180
PS-BAS-RPSIO	RecoverPoint Implementation VxFlex OS	F1	\$7,320
PS-BAS-RPUNI	EMC RECOVERPOINT IMP FOR UNIFIED QS	F1	\$5,950
PS-BAS-RPVMGL	RP FOR VMS IMPLEMENTATION ASSISTANCE	F1	\$1,450
PS-BAS-RPVMLR	Implement RPVM Local on 1 host as POC	F1	\$2,840
PS-BAS-RPVMRR	Implement RPVM Remote on 1 CG as POC	F1	\$3,920
PS-BAS-RPVMXE	RecoverPoint Implementation for VMAX	F1	\$6,730
PS-BAS-RPVPLX	RECOVERPOINT IMPLE WITH VPLEX SPLITTER	F1	\$10,930
PS-BAS-RSAUSD	Remote Solutions Architect 4 hr Block	F1	\$1,180
PS-BAS-RSAUXIMBNW	RSA NetWitness Implementation Unity	F1	\$15,490
PS-BAS-RSBASE	EMC RaaS Subscription Base	F1	\$53,930
PS-BAS-RSH1A	EMC RaaS: 1 Host Adder	F1	\$240
PS-BAS-RSH5A	EMC RaaS: 5 Host Adder	F1	\$1,200
PS-BAS-RSIM	RAAS BASE IMPLEMENTATION	F1	\$12,320
PS-BAS-RSOB1A	EMC RaaS: 1 Object Adder	F1	\$1,560
PS-BAS-RSOB5A	EMC RaaS: 5 Object Adder	F1	\$7,800
PS-BAS-RSU1A	EMC RaaS: 1 User Adder	F1	\$1,200
PS-BAS-RSU5A	EMC RaaS: 5 User Adder	F1	\$6,000
PS-BAS-RSVXED	REMOTE DEPLOY SUPPORT FOR VNXE UNIFIED	F1	\$1,250

PS-BAS-RUPSW	Remote Software Installation & Upgrades	F1	\$870
PS-BAS-S1	EMC S1 EM IMPLEMENTATION: BASE T1	F1	\$17,230
PS-BAS-S1A	EMC S1 EM IMPLEMENTATION: Add-on T1	F1	\$2,820
PS-BAS-S1A2	EMC S1 EM IMPLEMENTATION: Add-on T2	F1	\$5,630
PS-BAS-S1DM	EMC S1 DM IMPLEMENTATION: BASE T1	F1	\$12,770
PS-BAS-S1DMA	EMC S1 DM IMPLEMENTATION: Add-on T1	F1	\$2,530
PS-BAS-S1DMA2	EMC S1 DM IMPLEMENTATION: Add-on T2	F1	\$2,530
PS-BAS-S1DMT2	EMC S1 DM IMPLEMENTATION: BASE T2	F1	\$21,210
PS-BAS-S1DR	EMC S1 DR IMPLEMENTATION: BASE T1	F1	\$16,750
PS-BAS-S1DRA	EMC S1 DR IMPLEMENTATION: Add-on T1	F1	\$2,530
PS-BAS-S1DRA2	EMC S1 DR IMPLEMENTATION: Add-on T2	F1	\$7,760
PS-BAS-S1DRT2	EMC S1 DR IMPLEMENTATION: BASE T2	F1	\$25,100
PS-BAS-S1ES	Impl S1 Elastic Search	F1	\$9,160
PS-BAS-S1FI10	IMPL S1 FOR FILE ARCHIVE, 10TB SYSTEM	F1	\$16,270
PS-BAS-S1FI30	IMPL S1 FOR FILE ARCHIVE, 30TB SYSTEM	F1	\$21,730
PS-BAS-S1FI50	IMPL S1 FOR FILE ARCHIVE, 50TB SYSTEM	F1	\$30,800
PS-BAS-S1HC	SourceOne HealthCheck 5 Servers	F1	\$14,300
PS-BAS-S1HCT2	SOURCEONE HEALTHCHECK, 10 SERVERS	F1	\$27,590
PS-BAS-S1SH10	IMPL S1 FOR SHAREPOINT ARCHIVE, 10TB SYS	F1	\$16,270
PS-BAS-S1SH30	IMPL S1 FOR SHAREPOINT ARCHIVE, 30TB SYS	F1	\$21,730
PS-BAS-S1SH50	IMPL S1 FOR SHAREPOINT ARCHIVE, 50TB SYS	F1	\$30,800
PS-BAS-S1SPVR	SOURCEONE SUPERVISOR DEPLOYMENT	F1	\$12,770
PS-BAS-S1T2	EMC S1 EM IMPLEMENTATION: BASE T2	F1	\$30,000
PS-BAS-S1UPGR	SOURCEONE UPGRADE 6.X TO 7.X	F1	\$17,270
PS-BAS-S1UPT2	SOURCEONE EM 7.X UPGRADE TIER 2	F1	\$29,040
PS-BAS-SAASD	ASD Solutions Architect - block of time	F1	\$1,970
PS-BAS-SABLK	COMMERCIAL SA 4HOURS QS	F1	\$1,970
PS-BAS-SABRS	BRS SOL ARCHITECT 4 HOURS QS	F1	\$1,970
PS-BAS-SACI	CI SA - BLOCK OF TIME	F1	\$2,070
PS-BAS-SAESD	ESD Solutions Architect - block of time	F1	\$1,970
PS-BAS-SAFL	ETPD SA - 4 HR BLOCK	F1	\$1,970
PS-BAS-SAISI	ISILON SA BLOCK 4 HOURS	F1	\$1,970
PS-BAS-SAPESI	Implementation for ESI with SAP-LVM	F1	\$29,790
PS-BAS-SAUDS	USD Solutions Architect - block of time	F1	\$1,970
PS-BAS-SDDCHXA	Hardware Expansion SDDC 4 Add'l Nodes	F1	\$3,420
PS-BAS-SDDCHXB	Hardware Expansion for SDDC 4 Node Base	F1	\$13,410
PS-BAS-SDSWKS	SOFTWARE DEFINED STORGE WORKSHOP	F1	\$10,770
PS-BAS-SIOADDES	Add Design for VxFlex Node Install	F1	\$2,050
PS-BAS-SIOADOS	Install OS for VxFlex Node	F1	\$6,370
PS-BAS-SIOIMP	Standard Implementation for VxFlex OS	F1	\$6,180
PS-BAS-SIOINS	VxFlex Node Install or Expand	F1	\$5,850
PS-BAS-SRMAIMP	Imp for SRM Oper Readiness Add-on	F1	\$10,370
PS-BAS-SRMCACB	SRM CONFIG APP CHARGEBACK REPORTING	F1	\$21,920
PS-BAS-SRMCDCP	SRM CONFIG DATA PROT COMPLIANCE	F1	\$24,170
PS-BAS-SRMCPEP	SRM CONFIG PERF TREND REPORTING	F1	\$25,860
PS-BAS-SRMCSCAC	SRM CONFIG STORAGE CAPACITY TRENDS	F1	\$21,920
PS-BAS-SRMCSCM	SRM CONFIG STRG CFG MGT	F1	\$24,170
PS-BAS-SRMCSLA	SRM CONFIG SLA REPORTING	F1	\$21,920
PS-BAS-SRMEIMP	Expanded Implementation for SRM	F1	\$85,050
PS-BAS-SRMESI	EMC Storage M&R Implementation.	F1	\$2,840

PS-BAS-SRMESUP	EMC Storage M&R Upgrade	F1	\$3,100
PS-BAS-SRMEXP	SRM Expansion Service	F1	\$13,280
PS-BAS-SRMIIMP	Introductory Implementation for SRM	F1	\$15,500
PS-BAS-SRMIMP	Implementation for SRM	F1	\$11,720
PS-BAS-SRMRD	EMC Assessment for ViPR SRM Reporting D	F1	\$12,370
PS-BAS-SRMSIMP	Standard Implementation for SRM	F1	\$43,050
PS-BAS-SRMSR	SRM Solution Review	F1	\$15,840
PS-BAS-SRMUPG	SINGLE DEPLOYMENT UPGRADE FOR VIPR SRM	F1	\$21,050
PS-BAS-SYMAAD	VMAX Additional Array Deployment	F1	\$9,760
PS-BAS-SYMADP	VMAX Array Deployment	F1	\$21,770
PS-BAS-SYMDE	DATA ERASURE FOR SYMM	F1	\$6,500
PS-BAS-SYMHDP	VMAX Host Deployment	F1	\$5,570
PS-BAS-SYMMIE	VMAX Data Migration Event	F1	\$12,970
PS-BAS-SYMNAS	VMAX File Implementation	F1	\$8,600
PS-BAS-UCBASE	PS Upgrade Coordination Base	F1	\$600
PS-BAS-UPCONF	CONFIG UPDATE	F1	\$2,740
PS-BAS-UPCS	EMC UNIFIED CONTROL STATION UPGRADE	F1	\$1,740
PS-BAS-UPCT10	HW UPGRADES FOR UP TO 10 NODES	F1	\$3,860
PS-BAS-UPCT20	HW UPGRADES FOR UP TO 20 NODES	F1	\$5,720
PS-BAS-UPCT3	HW UPGRADES FOR UP TO 3 NODES	F1	\$2,710
PS-BAS-UPDAE	STANDARD DAE/DISK UPGRADE MODULE	F1	\$360
PS-BAS-UPDAEB	STANDARD DAE/DISK UPGRADE QUICKSTAR	F1	\$1,870
PS-BAS-UPGDIR	GENERIC DIRECTOR UPGRADE	F1	\$16,070
PS-BAS-UPGSW	GENERIC SWITCH OR BLADE UPGRADE	F1	\$10,970
PS-BAS-UPHW	Hardware Upgrades	F1	\$1,090
PS-BAS-UPISSW	REQD Isilon Software Expansion Base	F1	\$1,970
PS-BAS-USDMFA	EMC Select File Migration Add-on	F1	\$1,470
PS-BAS-USDMFB	EMC Select File Migration Base	F1	\$9,540
PS-BAS-USDMFE	EMC Select File Migration Event Add-on	F1	\$3,490
PS-BAS-UTYDE	Data Erasure for Unity	F1	\$4,900
PS-BAS-UXADHLG	Add Host Large	F1	\$2,160
PS-BAS-UXADHSM	Add Host Small	F1	\$1,355
PS-BAS-UXADSELG	Add Share/Export Large	F1	\$1,905
PS-BAS-UXADSESM	Add Share/Export Small	F1	\$1,355
PS-BAS-UXHC1	Unity Health Check	F1	\$2,130
PS-BAS-UXHWIN	Hardware Installation	F1	\$1,895
PS-BAS-UXIMAV	CAVA Implementation	F1	\$1,315
PS-BAS-UXIMB	Implementation for Unity	F1	\$3,000
PS-BAS-UXIMBP	Implementation for Unity with FAST	F1	\$3,000
PS-BAS-UXIMFAST	FAST Implementation	F1	\$1,870
PS-BAS-UXIMREP	Remote Replication Implementation	F1	\$4,280
PS-BAS-UXIMSNAP	Snap Implementation	F1	\$2,925
PS-BAS-V2B2UCV	VNX Block to Unified Upgrade	F1	\$4,240
PS-BAS-V2DMCV	VNX Data Mover Conversion	F1	\$940
PS-BAS-V2F2UCV	VNX File to Unified Upgrade	F1	\$3,150
PS-BAS-V2FBRUPA	VMAX 250F V-Brick Upg Add-On	F1	\$4,940
PS-BAS-V2FRAC	VMAX 250F Racking Essentials	F1	\$3,110
PS-BAS-V2IMVDMMS	VDM MetroSync Implementation	F1	\$6,670
PS-BAS-V2SPCV	VNX Storage Processor Conversion	F1	\$3,460
PS-BAS-VAECAPUA	Capacity Pack Upgrd for PowerMax, Add-on	F1	\$220

PS-BAS-VAEEVBFLA	V-Brick Upgd for PowerMax 2000, Add-on	F1	\$4,510
PS-BAS-VAEFEIOMA	FEIO Module Upgrade for PowerMax, Add-on	F1	\$690
PS-BAS-VAEMEMUA	Memory Upgrade for PowerMax, Add-on	F1	\$1,090
PS-BAS-VAEUPG	Upgrade for PowerMax, Base	F1	\$2,840
PS-BAS-VAEVBWFA	V-Brick Upgd PowerMax 8000 w/fab, Add-on	F1	\$8,410
PS-BAS-VAEVBWOFA	V-Brick Upgd PowerMax 8000 w/o fabAdd-on	F1	\$6,460
PS-BAS-VAEVFMUA	Vault Flash Module Upgd PowerMax, Add-on	F1	\$660
PS-BAS-VAFCAPUA	VMAX AF Capacity Pack Upgrade Add-On	F1	\$220
PS-BAS-VAFCOME	Impl for VMAX AF Compression Enablement	F1	\$0
PS-BAS-VAFMEMUA	VMAX AF Memory Upgrade Add-On	F1	\$1,090
PS-BAS-VAFUPGB	VMAX AF Base Upgrade	F1	\$2,510
PS-BAS-VAFVBBA	VMAX AF V-Brick Bay Upgrade Add-On	F1	\$4,660
PS-BAS-VAFVBFLA	VMAX AF V-Brick Upgrade Add-On	F1	\$10,080
PS-BAS-VAFVBWFA	VMAX AF V-Brick with Fabr Upgrade Add-On	F1	\$11,820
PS-BAS-VAFVFMUA	VMAX AF Vault Flash Upgrade Add-On	F1	\$660
PS-BAS-VBVMAX	VBLOCK VMAX IMPLEMENTATION	F1	\$89,236
PS-BAS-VBVNX	VBLOCK VNX IMPLEMENTATION	F1	\$81,890
PS-BAS-VCAC	Infra Automation Service for EPC	F1	\$44,270
PS-BAS-VCEAVED	EMC Imp for VCE AVE and DD	F1	\$7,520
PS-BAS-VCENWDD	EMC Integration for VCE NW and DD	F1	\$13,120
PS-BAS-VCEPPVX	EMC Imp for VCE PP DD for 740/TE VMAX	F1	\$15,050
PS-BAS-VIPRAFA	IMPLEMENTATION FOR VIPR-C WITH AFA BUND	F1	\$15,160
PS-BAS-VIPRIIMP	INTRODUCTORY STORAGE AUTOMATION FOR V	F1	\$18,550
PS-BAS-VIPRIMP	Impl. for ViPR Controller	F1	\$14,040
PS-BAS-VIPRIUIM	Transition vBlock customers UIM to ViPR	F1	\$23,170
PS-BAS-VIPRSIMP	STANDARD STORAGE AUTOMATION FOR VIPR	F1	\$34,130
PS-BAS-VIPRSUIM	TRANSITION VBLOCK CUSTOMERS UIM TO VIPI	F1	\$32,970
PS-BAS-VIPRVCO	ViPR V-Center Orchestrator	F1	\$5,430
PS-BAS-VIPRVPLEX	Integration service for ViPR and VPLEX	F1	\$11,370
PS-BAS-VMAXSPUPG	EMC Service Processor Upgrade for VMAX	F1	\$1,810
PS-BAS-VME	Installation for PowerMax 8000, Base	F1	\$5,190
PS-BAS-VME3PR	Racking Essentials for PowerMax 8000	F1	\$3,760
PS-BAS-VME3PRA	Racking Essentials PowerMax 8000, Add-on	F1	\$2,170
PS-BAS-VMEA	Installation for PowerMax 8000, Add-On	F1	\$870
PS-BAS-VMEE3PR	Racking Essentials for PowerMax 2000	F1	\$3,760
PS-BAS-VMEEB	Installation for PowerMax 2000 Base	F1	\$5,190
PS-BAS-VMESLM	Implementation for PowerMax SLM with QoS	F1	\$8,430
PS-BAS-VMFFEIOMA	VMAX AF FEIO Module Upgrade Add-On	F1	\$685
PS-BAS-VMN	VMAX Installation	F1	\$4,440
PS-BAS-VMN3PR	VMAX Racking Essentials	F1	\$2,900
PS-BAS-VMN3PRA	VMAX RACKING ESSENTIALS ADD-ON	F1	\$1,740
PS-BAS-VMNA	VMAX Installation Add-On	F1	\$580
PS-BAS-VMNAAD	VMAX Additional Array Deployment	F1	\$7,030
PS-BAS-VMNADP	VMAX Array Deployment	F1	\$12,650
PS-BAS-VMNBASEU	VMAX Base Upgrade	F1	\$2,510
PS-BAS-VMNDAEUA	VMAX DAE Upgrade Add-On	F1	\$1,960
PS-BAS-VMNDRVUA	VMAX Drive Upgrade Add-On	F1	\$220
PS-BAS-VMNEMGMT	Install eMgmt for VMAX3	F1	\$2,330
PS-BAS-VMNENGUA	VMAX Engine Upgrade Add-On	F1	\$9,210
PS-BAS-VMNFABUA	VMAX Fabric Upgrade Add-On	F1	\$1,740

PS-BAS-VMNFEMUA	VMAX FE IO Module Upgrade Add-On	F1	\$685
PS-BAS-VMNFST	Impl for VMAX Storage Group Provisioning	F1	\$8,430
PS-BAS-VMNFSTXEPR	Impl for VMAX3 FAST.X with Single SRP	F1	\$7,030
PS-BAS-VMNFSTXUPM	Impl for VMAX upgrade with MSRPs Config	F1	\$9,050
PS-BAS-VMNFSTXUPS	Impl for FAST.X Upg for Single SRP	F1	\$9,050
PS-BAS-VMNIMFAR	Implementation for File Auto Recovery	F1	\$5,220
PS-BAS-VMNMEMUA	VMAX Memory Upgrade Add-On	F1	\$1,090
PS-BAS-VMNMFFBAC	Impl for VMAX3 CKD and FBA Cap Reconfig	F1	\$2,720
PS-BAS-VMNSLA	VMAX Service Level Add-On	F1	\$1,540
PS-BAS-VMNSLB	VMAX Service Level Base	F1	\$6,860
PS-BAS-VMNSRP	VMAX Storage Resource Pool Design / Impl	F1	\$5,690
PS-BAS-VMNSYSUA	VMAX System Bay Upgrade Add-On	F1	\$4,660
PS-BAS-VMNTMFA	Assessment for VMAX TimeFinder Scripts	F1	\$5,910
PS-BAS-VMNVFMUA	VMAX Vault Flash Upgrade Add-On	F1	\$660
PS-BAS-VMOPRES	Residency for VMware - Operational	F1	\$30,800
PS-BAS-VMTRRES	Residency for VMware - Transitional	F1	\$39,000
PS-BAS-VMXENAS	Install eNAS on VMAX3 and VMAX AF	F1	\$1,020
PS-BAS-VMXFST	VMAX Implementation for FAST QS	F1	\$10,280
PS-BAS-VMXHAN	SAP HANA Impl Planning for VMAX	F1	\$2,810
PS-BAS-VMXHPOA	VMAX Host Port Optimization Add-On	F1	\$4,220
PS-BAS-VMXHPOB	VMAX Host Port Optimization Base	F1	\$15,180
PS-BAS-VMXNDMA	VMAX NDM with SRDF Event Add-On	F1	\$1,270
PS-BAS-VMXNDMB	VMAX NDM with SRDF Base	F1	\$2,740
PS-BAS-VMXORSA	VMAX Data Migration with OR Add-on	F1	\$9,870
PS-BAS-VMXORSB	VMAX Data Migration with OR Base	F1	\$14,130
PS-BAS-VMXSRM	VMAX Design and Impl for VMware SRM	F1	\$11,000
PS-BAS-VMXUPGD	VMAX Upgrade Design	F1	\$3,380
PS-BAS-VMXVI	EMC VI Enablement for VMAX	F1	\$2,270
PS-BAS-VNXDE	VNX DATA ERASURE	F1	\$4,900
PS-BAS-VNXHAN	Implementation for SAP Hana TDI for VNX	F1	\$2,250
PS-BAS-VP1ECR	Single Engine VPLEX 1 host Cust Rack	F1	\$5,210
PS-BAS-VPCLUPINSIM	INTALL & IMPLEMENT VPLEX CLUSTER UPG	F1	\$11,380
PS-BAS-VPENC1	VPLEX ENCAPSULATE 10-HOST MAX 8-HR	F1	\$5,750
PS-BAS-VPENC5	VPLEX ENCAPSULATE 50-HOST MAX 40-HR .	F1	\$19,560
PS-BAS-VPGHWA	VS2-to-VS6 Upgrade Additional Engine	F1	\$3,230
PS-BAS-VPGHWB	VS2-to-VS6 Local Upgrade 1st Engine	F1	\$10,630
PS-BAS-VPGHWM	VS2-to-VS6 Metro Upgrade 1st Engine	F1	\$7,660
PS-BAS-VPLEX	EMC DESIGN AND IMPL FOR V-PLEX QS	F1	\$5,130
PS-BAS-VPMADD	VPLEX Migration 20 Host Adder	F1	\$9,450
PS-BAS-VPMBASE	VPLEX Migration Service Base	F1	\$16,960
PS-BAS-VPMETS	Full Metro Solution Implement w/2 hosts	F1	\$5,550
PS-BAS-VPVEGL	VPLEX/VE REMOTE GURU LIVE IMPL ASSISTAN	F1	\$1,450
PS-BAS-VPXINS	VPLEX INSTALL ONLY (NO D&I)	F1	\$1,590
PS-BAS-VPXIPL	IMPL FOR V-PLEX QUICKSTART	F1	\$4,040
PS-BAS-VXE2HDA	VNXe Deployment Storage Adder	F1	\$2,050
PS-BAS-VXEDMH	VNXe Host Based Data Migration	F1	\$8,070
PS-BAS-VXEDMHA	VNXe Host Based Data Migration Adder	F1	\$3,340
PS-BAS-VXEUD	VNXe3200 Deployment	F1	\$6,350
PS-BAS-VXEUPS	VNXe Storage Upgrade	F1	\$3,660
PS-BAS-VXRKDE	Data Erasure for VxRack	F1	\$4,000

PS-BAS-VXRLDE	Data Erasure for VxRail	F1	\$4,000
PS-BAS-W4NWSK	SRM Reporting Design	F1	\$12,370
PS-BAS-XTAD1B	INSTALL 1 ADDL BRICK IN CUST CAB	F1	\$370
PS-BAS-XTDE	XTREMIO UP TO 4 BRICK DATA ERASURE	F1	\$4,900
PS-BAS-XTDUAX2	Adder to Base SSD upgrd for X2 (+54 max)	F1	\$440
PS-BAS-XTDUBX2	Base SSD upgrade for X2 (54 max)	F1	\$1,880
PS-BAS-XTEPIC	Epic Solution for deployed XtremIO	F1	\$15,740
PS-BAS-XTHBEX	10TB Starter Brk 5TB Expansion Disk Inst	F1	\$1,580
PS-BAS-XTHC	Remote Delivered Health Check Event	F1	\$1,890
PS-BAS-XTIMBS	IMPL ARRAY WITH 5 HOSTS	F1	\$4,220
PS-BAS-XTIMPM	IMPL ADDITIONAL 5 HOSTS	F1	\$1,730
PS-BAS-XTINBS	XtremIO Install Single Xbrick or EMC Cab	F1	\$3,440
PS-BAS-XTINCA	XtremIO Install of Additional EMC Cabinet	F1	\$2,250
PS-BAS-XTINX2	Install Full X2cab or 1st brk in CustCab	F1	\$5,560
PS-BAS-XTMIA	XTREMIO EVENT ADDER MIGR 5 HOSTS	F1	\$11,930
PS-BAS-XTMIB	XTREMIO BASE MIGR 5 HOSTS 1 EVENT	F1	\$20,200
PS-BAS-XTOLRP	XtremIO Snapshots for Oracle - 1 DB inst	F1	\$13,770
PS-BAS-XTUPAB	Add'l Xbrick after 1st Xbrick Expansion	F1	\$1,230
PS-BAS-XTUPSB	Cluster Expansion from 1 Xbrick only	F1	\$7,170
PS-BAS-XTUPXB	Cluster Expansion from 2 or more Xbricks	F1	\$6,370
PS-BD-CTXTRACKING	CTX BASIC DEPLOYMENT TRACKING	F1	\$0
PS-BD-ISNTRACKING	ISILON BASIC DEPLOYMENT TRACKING	F1	\$0
PS-BD-TRACKING	Basic Deploy Tracking Model	F1	\$0
PS-BD-UNYTRACKING	UNITY BASIC DEPLOYMENT TRACKING	F1	\$0
PS-BD-VMXTRACKING	VMAX Basic Deployment Tracking	F1	\$0
PS-BD-VPXTRACKING	VPLEX BASIC DEPLOYMENT TRACKING	F1	\$0
PS-BD-XIOTRACKING	XTREMIO BASIC DEPLOYMENT TRACKING	F1	\$0
PS-COP-AVAENA	AVAMAR ENABLE BNDLE PRICED IN CART	F1	\$0
PS-COP-DPA	Coop Implementation for DPA	F1	\$980
PS-COP-ECSDIG	ECS Cooperative Service	F1	\$2,250
PS-COP-HCIADIG	Cooperative Guidance for VxRAIL	F1	\$1,372
PS-COP-ISIDIG	Isilon Design Implement Guidance	F1	\$1,530
PS-COP-ITTW	COOPERATIVE IT TRANSFORMATION WORKSHO	F1	\$1,000
PS-COP-NWDIG	Coop Design & Implementation for NW	F1	\$980
PS-COP-VMNDIG	Design and Implement Guidance for VMAX	F1	\$2,260
PS-COP-VPDIG	GUIDANCE SERVICE FOR VPLEX PARTNERS	F1	\$1,070
PS-ESRES-NWL1	US ONLY-EMC NETWORKER IP RESIDENCY	F1	\$25,600
PS-EXP-ANARES	30DAY ANALYSIS RESIDENT	F1	\$26,000
PS-EXP-AVNDMP	AVAMAR EXPANDED NDMPQUICKSTART	F1	\$5,750
PS-EXP-DPABU	DPA BACKUP EXTENDED IMPLEMENTATION	F1	\$15,420
PS-EXP-DPRA	ADV IMPLMENTATION FOR DPA	F1	\$16,100
PS-EXP-FTSFVP	FTS FAST VP INTEGRATION	F1	\$16,430
PS-EXP-HCSYS	Health Check for VMAX (Sub)	F1	\$31,300
PS-EXP-MSIPW	MS INFRASTRUCTURE PROTECTION WRKSHP	F1	\$35,410
PS-EXP-RDFIQE	VMAX Implementation for SRDF QS	F1	\$12,730
PS-EXP-SNADD	ADDITION OF 4 HOSTSAN SET UP	F1	\$5,990
PS-EXP-SPA	Health Check for VMAX (Event)	F1	\$12,520
PS-EXP-TMFIQE	VMAX Implementation for TimeFinder QS	F1	\$9,440
PS-EXP-VMNFSTXCA	Impl for VMAX with MSRPs	F1	\$9,930
PSINST-ESRS	ZERO DOLLAR ESRS INSTALL	F1	\$0

PSINST-VMAX	ZERO DOLLAR VMAX INSTALL	F1	\$0
PSINST-VMNA	VMAX INSTALL ADD-ON	F1	\$580
PSINST-VPVE	VPLEX VE Environment Validation	F1	\$0
PS-L1-PV-ADVISORY	PS L1 ADVISORY FOR PIVOTAL DATA	F1	\$14,000
PS-L1-PV-BDS-ONB	PS L1 BDS ONBOARDING FOR PIVOTAL DATA	F1	\$32,000
PS-L1-PV-DE-REVIEW	PS L1 DE ARCH REVIEW FOR PIVOTAL DATA	F1	\$15,500
PS-L1-PV-DE-SA	PS L1 DE SOLUTION ASSUR FOR PIVOTAL DATA	F1	\$95,000
PS-L1-PV-DOJO-4L	PS L1 DOJO FOR PCF - 4 WEEKS LARGE	F1	\$265,000
PS-L1-PV-DOJO-4M	PS L1 DOJO FOR PCF - 4 WEEKS MEDIUM	F1	\$200,000
PS-L1-PV-DOJO-4S	PS L1 DOJO FOR PCF - 4 WEEKS SMALL	F1	\$140,000
PS-L1-PV-DOJO-6L	PS L1 DOJO FOR PCF - 6 WEEKS LARGE	F1	\$400,000
PS-L1-PV-DOJO-6M	PS L1 DOJO FOR PCF - 6 WEEKS MEDIUM	F1	\$300,000
PS-L1-PV-DS-LAB100	PIVOTAL DATA SCIENCE LAB 100	F1	\$43,000
PS-L1-PV-DS-RDMP	PIVOTAL DATA SCIENCE ROADMAPPING	F1	\$38,000
PS-L1-PV-ED-12FT	PV L1 ED 12 MONTHS FULLTIME	F1	\$360,000
PS-L1-PV-ED-12HT	PV L1 ED 12 MONTHS HALFTIME	F1	\$180,000
PS-L1-PV-ED-6FT	PS L1 PIVOTAL ENGT DIR 6 MO FULL TIME	F1	\$180,000
PS-L1-PV-ED-6HT	PS L1 PIVOTAL ENGT DIR 6 MO HALF TIME	F1	\$90,000
PS-L1-PV-PCF-SA-6	PS L1 SOLUTION ASSUR FOR PCF - 6 MONTHS	F1	\$180,000
PS-L1-PV-PRE-M	PS L1 Pre - Medium Pivotal	F1	\$300,000
PS-L1-PV-PRE-S	PS L1 Pre - Small Pivotal	F1	\$200,000
PS-OEM-INVNX	OEM VNX Installation	F1	\$2,950
PS-OEM-PRGM2	OEM Program Manager 2 hour adder	F1	\$650
PS-PDP-ADMNOS	Impl. for AV Datastore MultiNode Onsite	F1	\$13,885
PS-PDP-ADSNOS	Impl. for AV Datastore SingleNode Onsite	F1	\$8,695
PS-PDP-APSTRACKING	APPSYNC PRODEPLOYPLUS TRACKING	F1	\$0
PS-PDP-AVDDOS	Impl. for AV with Data Domain	F1	\$13,880
PS-PDP-AVEOS	Impl. for AVE Onsite	F1	\$7,325
PS-PDP-AVTRACKING	AVAMAR PRODEPLOYPLUS TRACKING	F1	\$0
PS-PDP-CDMTRACKING	ECDM PRODEPLOYPLUS TRACKING	F1	\$0
PS-PDP-CLAOS	CloudArray Implementation ProDeploy Plus	F1	\$2,240
PS-PDP-CLATACKING	CLOUDARRAY PRODEPLOYPLUS TRACKING	F1	\$0
PS-PDP-CLLTRACKING	CLOUDLINK PRODEPLOYPLUS TRACKING	F1	\$0
PS-PDP-CLSVIMIMPOS	Impl for CloudLink, ProDeploy Plus	F1	\$8,120
PS-PDP-CTXTRACKING	CTX PRODEPLOYPLUS TRACKING	F1	\$0
PS-PDP-DD00OS	Impl DD No Shelf System Plus	F1	\$6,140
PS-PDP-DDBDBA	Impl for DD Boost for DB Applications	F1	\$4,000
PS-PDP-DDBDBAOS	Impl for DDBEA Database	F1	\$5,790
PS-PDP-DDBMSAOS	Impl for DDBEA Microsoft	F1	\$4,990
PS-PDP-DDCTOS	Impl DD Cloud Tier Plus	F1	\$5,360
PS-PDP-DDIBOS	Impl DD (Base) Plus	F1	\$9,730
PS-PDP-DDPHOS	Impl for DD PreRacked System Plus	F1	\$8,755
PS-PDP-DDPPIOS	Impl ProtectPoint Plus	F1	\$8,800
PS-PDP-DDPPIP	Implementation for ProtectPoint Plus	F1	\$8,760
PS-PDP-DDPPMXOS	ProtectPoint VMAX Sol Pkg Plus	F1	\$2,620
PS-PDP-DDPPMXP	PP with VMAX3 Solution Package Plus	F1	\$1,130
PS-PDP-DDPPOIOS	Integrate ProtectPoint Database Plus	F1	\$14,530
PS-PDP-DDPPOIP	Integration for PP with Database Plus	F1	\$13,980
PS-PDP-DDPPXOOS	ProtectPoint XtremIO Sol Pkg Plus	F1	\$2,620
PS-PDP-DDPPXOP	PP with XtremIO Solution Package Plus	F1	\$1,130

PS-PDP-DDTRACKING	DATA DOMAIN PRODEPLOYPLUS TRACKING	F1	\$0
PS-PDP-DDVEOS	Configure DD Virtual Edition Plus	F1	\$6,620
PS-PDP-DPACIOS	Customization for DPA	F1	\$17,230
PS-PDP-DPAOS	Impl. for DPA Onsite	F1	\$8,265
PS-PDP-DPATRACKING	DPA PRODEPLOYPLUS TRACKING	F1	\$0
PS-PDP-DPSCDMOS	Configure eCDM Plus	F1	\$5,450
PS-PDP-DPSCDMP	Config 4 Enterprise Copy Data Mgmt Plus	F1	\$4,110
PS-PDP-DPSIOS	Impl DP Search Plus	F1	\$12,410
PS-PDP-DPSIP	Impl for Data Protection Search Plus	F1	\$9,130
PS-PDP-DPSOS	DP Suite Sol Pkg Plus	F1	\$3,500
PS-PDP-DPSP	DP Suite Solution Package Plus	F1	\$1,750
PS-PDP-DPSTRACKING	DPS PRODEPLOYPLUS TRACKING	F1	\$0
PS-PDP-DPSVMIOS	Impl DP Suite for VMware Plus	F1	\$27,330
PS-PDP-DPSVMROS	Impl DP Suite VMware Replication Plus	F1	\$14,490
PS-PDP-DSHTRACKING	DP Search PRODEPLOYPLUS TRACKING	F1	\$0
PS-PDP-ECSINSIMPOS	Install and Impl ECS ProDeploy Plus	F1	\$23,570
PS-PDP-ECSTRACKING	ECS PRODEPLOYPLUS TRACKING	F1	\$0
PS-PDP-HCIANIMPOS	Onsite Implementation for VxRail Node	F1	\$3,840
PS-PDP-IDPAAEOS	Impl IDPA DP5x Series Plus	F1	\$9,120
PS-PDP-IDPAAVOS	Impl IDPA DP8x Series Plus	F1	\$10,310
PS-PDP-IDPANAOS	IDPA Network Validation Add-on Plus	F1	\$5,140
PS-PDP-IDPAVEOS	Impl Int DP Appliance DP4x Series Plus	F1	\$6,310
PS-PDP-IDPTRACKING	IDPA PRODEPLOYPLUS TRACKING	F1	\$0
PS-PDP-IMAPSYOS	ONSITE APPSYNC IMPL FOR 4 HOSTS	F1	\$8,490
PS-PDP-IPTORSWCOS	Config of ToR Switch, ProDeploy Plus	F1	\$5,840
PS-PDP-ISIIMPADFOS	Impl Isilon Feature Prodeploy Plus	F1	\$8,400
PS-PDP-ISIIMPADVOS	Impl Isilon Advanced Prodeploy Plus	F1	\$17,865
PS-PDP-ISIIMPENTOS	Impl Isilon Enterprise Prodeploy Plus	F1	\$13,680
PS-PDP-ISIIMPOFSOS	Impl Isilon ONEFS Synciq Prodepoloy Plus	F1	\$13,980
PS-PDP-ISINTRACKING	ISILON PRODEPLOYPLUS TRACKING	F1	\$0
PS-PDP-NMDAMSOS	Impl. for NW Mod for DBApps MySQL Onsite	F1	\$15,495
PS-PDP-NMMEXOS	Impl. for NW Mod. for MS Exch Onsite	F1	\$15,195
PS-PDP-NMMSQLOS	Impl. for NW Mod. for MS SQL Onsite	F1	\$10,980
PS-PDP-NWOS	Implementation for NW Onsite	F1	\$13,560
PS-PDP-NWTRACKING	NETWORKER PRODEPLOYPLUS TRACKING	F1	\$0
PS-PDP-P30APPSYNC	30dayPostDeployAssist AppSync	F1	\$240
PS-PDP-P30AVAMAR	30dayPostDeployAssist Avamar	F1	\$240
PS-PDP-P30CLDARRAY	30dayPostDeployAssist CloudArray	F1	\$240
PS-PDP-P30CLDLINK	30dayPostDeployAssist Cloudlink	F1	\$240
PS-PDP-P30CNCTRIX	30dayPostDeployAssist Connectrix	F1	\$240
PS-PDP-P30DD	30dayPostDeployAssist DD	F1	\$240
PS-PDP-P30DPA	30dayPostDeployAssist DPA	F1	\$240
PS-PDP-P30DPS	30dayPostDeployAssist DPS	F1	\$240
PS-PDP-P30DPSEARCH	30dayPostDeployAssist DP Search	F1	\$240
PS-PDP-P30ECDM	30dayPostDeployAssist ECDM	F1	\$240
PS-PDP-P30ECS	30dayPostDeployAssist ECS	F1	\$240
PS-PDP-P30IDPA	30dayPostDeployAssist IDPA	F1	\$240
PS-PDP-P30ISILON	30dayPostDeployAssist Isilon	F1	\$240
PS-PDP-P30ISILSRCH	30dayPostDeployAssist Isilon Search	F1	\$240
PS-PDP-P30NW	30dayPostDeployAssist NetWorker	F1	\$240

PS-PDP-P30PROTCTPT	30dayPostDeployAssist ProtectPoint	F1	\$240
PS-PDP-P30RP	30dayPostDeployAssist RecoverPoint	F1	\$240
PS-PDP-P30RP4VM	30dayPostDeployAssist RP4VM	F1	\$240
PS-PDP-P30SCALEIO	30 Day Post Deploy-Assist VxFlex OS	F1	\$240
PS-PDP-P30SDDC	SDDC 30-day PostDeploy Assist PDP	F1	\$2,600
PS-PDP-P30SOURCE1	30dayPostDeployAssist SourceOne	F1	\$240
PS-PDP-P30SRM	30dayPostDeployAssist SRM	F1	\$240
PS-PDP-P30UNITY	30dayPostDeployAssist Unity	F1	\$240
PS-PDP-P30VIPR	30dayPostDeployAssist ViPR	F1	\$240
PS-PDP-P30VMAX	30dayPostDeployAssist VMAX	F1	\$240
PS-PDP-P30VPLEX	30dayPostDeployAssist VPLEX	F1	\$240
PS-PDP-P30VXRAIL	30dayPostDeployAssist VxRail	F1	\$240
PS-PDP-P30XTREMIO	30dayPostDeployAssist XtremIO	F1	\$240
PS-PDP-PPTRACKING	PROTECTPOINT PRODEPLOYPLUS TRACKING	F1	\$0
PS-PDP-RCVRPTOS	On Site RP Full Deploy for 4 RPAs	F1	\$24,840
PS-PDP-RPSIOOS	Imp RP for VxFlex OS, ProDeploy Plus	F1	\$9,130
PS-PDP-RPTRACKING	RECOVERPOINT PRODEPLOYPLUS TRACKING	F1	\$0
PS-PDP-RPUNIOS	OnSite RP for UnityVNX Deploy for 2 RPAs	F1	\$7,460
PS-PDP-RPVMLROS	ONSITE RP4VM LOCAL REPL IMPL FOR 1 HOST	F1	\$6,320
PS-PDP-RPVMRROS	ONSITE RP4VM REMOTE REPL IMPL FOR 1 CG	F1	\$7,670
PS-PDP-RPVMXEOS	On Site RP for VMAX Deploy for 2 RPAs	F1	\$9,055
PS-PDP-RPVPLXOS	On Site RP for VPLEX Deploy for 2 RPAs	F1	\$15,355
PS-PDP-RPXIOIMPSOS	On Site RP for XtremIO Deploy Add-On	F1	\$5,660
PS-PDP-RVMTRACKING	RP4VM PRODEPLOYPLUS TRACKING	F1	\$0
PS-PDP-S1DMOS	Impl SourceOne DM 1000 User Base Plus	F1	\$14,670
PS-PDP-S1DMT2OS	Impl SourceOne DM 6000 User Base Plus	F1	\$25,420
PS-PDP-S1DROS	Impl SourceOne DR 1000 User Base Plus	F1	\$19,660
PS-PDP-S1DRT2OS	Impl SourceOne DR 6000 User Base Plus	F1	\$30,780
PS-PDP-S1FI10OS	Impl SourceOne File 10Tb Plus	F1	\$19,740
PS-PDP-S1FI30OS	Impl SourceOne File 30Tb Plus	F1	\$34,670
PS-PDP-S1FI50OS	Impl SourceOne File 50Tb Plus	F1	\$35,620
PS-PDP-S1OS	Impl SourceOne EM 1000 User Base Plus	F1	\$20,110
PS-PDP-S1SH10OS	Impl SourceOne SharePoint 10Tb Plus	F1	\$19,740
PS-PDP-S1SH30OS	Impl SourceOne SharePoint 30Tb Plus	F1	\$26,510
PS-PDP-S1SH50OS	Impl SourceOne SharePoint 50Tb Plus	F1	\$38,170
PS-PDP-S1T2OS	Impl SourceOne EM 6000 User Base Plus	F1	\$36,700
PS-PDP-SDDCBOS	SDDC Implement 1st Rack PDP	F1	\$39,280
PS-PDP-SDDCNAOS	SDDC Plan/Design Per System PDP	F1	\$39,280
PS-PDP-SDDCRAOS	SDDC Implement Add I Rack PDP	F1	\$10,610
PS-PDP-SDDCTRACK	VxRack SDDC ProDeploy PlusTracking	F1	\$0
PS-PDP-SHTRACKING	SEARCH PRODEPLOYPLUS TRACKING	F1	\$0
PS-PDP-SIOIMPOS	Impl for VxFlex OS ProDeploy Plus	F1	\$12,545
PS-PDP-SIOTRACKING	VxFlex OS ProDeploy Plus Tracking	F1	\$0
PS-PDP-SOTRACKING	SOURCEONE PRODEPLOYPLUS TRACKING	F1	\$0
PS-PDP-SRMIMPOS	SRM Base Implementation, ProDeploy Plus	F1	\$17,010
PS-PDP-TRACKING	ProDeploy Plus Tracking Model	F1	\$0
PS-PDP-UNYTRACKING	UNITY PRODEPLOYPLUS TRACKING	F1	\$0
PS-PDP-UXIMBOS	PDP Onsite Base Implementation	F1	\$6,734
PS-PDP-UXIMBPOS	PDP Onsite Base Plus Implementation	F1	\$8,050
PS-PDP-UXSQLRB	Unity SQL Ready Bundle Add-on PDP	F1	\$1,430

PS-PDP-VICTRACKING	ViPR C PRODEPLOYPLUS TRACKING	F1	\$0
PS-PDP-VIPRIMPOS	ViPR Base Implementation, ProDeploy Plus	F1	\$19,900
PS-PDP-VISTRACKING	SRM PRODEPLOYPLUS TRACKING	F1	\$0
PS-PDP-VMESLMOS	Implement to PowerMax, ProDeploy Plus	F1	\$12,300
PS-PDP-VMNFSTOS	IMPLMT FOR VMAX ALL FLASH PRODEPLOY PLUS	F1	\$11,905
PS-PDP-VMXTRACKING	VMAX PRODEPLOYPLUS TRACKING	F1	\$0
PS-PDP-VP1ECROS	ONSITE SINGLE ENG VPLEX DEPLOY CUST RAC	F1	\$7,070
PS-PDP-VPLEXOS	ONSITE VPLEX DEPLOY IN EMC CAB	F1	\$7,550
PS-PDP-VPXIPOS	ONSITE VPLEX IMPL ONLY FOR 8 HOSTS	F1	\$6,495
PS-PDP-VPXTRACKING	VPLEX PRODEPLOYPLUS TRACKING	F1	\$0
PS-PDP-VRLTRACKING	VxRAIL PRODEPLOYPLUS TRACKING	F1	\$0
PS-PDP-XIOTRACKING	XTREMIO PRODEPLOYPLUS TRACKING	F1	\$0
PS-PDP-XTIMBSOS	ONSITE XTREMIO ARRAY IMPL WITH 5 HOSTS	F1	\$8,440
PS-PD-TRACKING	ProDeploy Tracking Model	F1	\$0
PS-PD-UXSQLRB	Unity SQL Ready Bundle Add-on PD	F1	\$750
PS-PKG-DDAV	AV AND DD INTEGRATED SOLUTION	F1	\$570
PS-PKG-DDPPMX	ProtectPoint with VMAX Solution Package	F1	\$570
PS-PKG-DDPPXO	DPSAPPS w XtremIO Solution Package	F1	\$570
PS-PKG-DDSAP	IMP FOR DD WITH SAP HANA STUDIO SOL	F1	\$1,290
PS-PKG-DMBDE	Architect & Impl Test Block Pkg	F1	\$13,900
PS-PKG-DMFDE	Architect & Impl Test File Pkg	F1	\$9,400
PS-PKG-DPS	DPS Solution Package	F1	\$1,690
PS-PKG-IMFSB	FAST Implementation Block Only	F1	\$6,150
PS-PKG-IMFSU	FAST IMPLEMENT	F1	\$6,150
PS-PKG-IMLPB	VNX - SNAPVIEW SNAPSURE IMPLEMENT	F1	\$2,730
PS-PKG-IMLPE	VNXE - SNAPSURE IMPLEMENT	F1	\$1,280
PS-PKG-IMLPU	VNX - SNAPVIEW SNAPSURE IMPLEMENT	F1	\$5,580
PS-PKG-IMMGTU	IMPLEMENT USM SUITE	F1	\$3,220
PS-PKG-IMRPB	VNX BLOCK - MIRRORVIEW IMPLEMENT	F1	\$3,210
PS-PKG-IMRPE	VNXE - REPLICATOR IMPLEMENT	F1	\$3,210
PS-PKG-IMRPU	VNX - MIRRORVIEW REPLICATOR IMP	F1	\$11,550
PS-PKG-IMSCE	SECURITY & COMP IMPLEMENT PKG-VNXE	F1	\$3,290
PS-PKG-IMSCU	SECURITY & COMP IMPLEMENT PKG -VNX	F1	\$5,510
PS-PKG-IMSCVE	IMP 4 VNXE SECURITY & COMPLIANCE SUITE	F1	\$2,250
PS-PKG-LEBD	VNX - BASIC INSTALL-IMPLEMENT BLOCK	F1	\$5,260
PS-PKG-MRBDE	VNX BLOCK INSTALL & IMPLEMENT	F1	\$8,620
PS-PKG-MRUD	VNX - BASIC INSTALL-IMPLEMENT	F1	\$8,080
PS-PKG-MRUDE	INSTALL IMPLEMENT VNX ENHANCED	F1	\$11,290
PS-PKG-RPDESCDP	RECOVERPOINT DESIGN FOR CDP	F1	\$3,800
PS-PKG-RPDESDR	RECOVERPOINT DESIGN FOR DR	F1	\$1,970
PS-PKG-RPIMPCDP	RECOVERPOINT IMPLE CDP REPLICATION	F1	\$2,880
PS-PKG-RPIMPDR	RECOVERPOINT IMPLE DR REPLICATION	F1	\$1,750
PS-PKG-RPINSRPA	RECOVERPOINT PRPA INSTALL	F1	\$550
PS-PKG-RPINSVRPA	RECOVERPOINT VRPA INSTALL	F1	\$610
PS-PKG-RPXIOIMPS	RECOVERPOINT IMPLE RP/XTREMIO SOLN	F1	\$1,010
PS-PKG-XIORPCINS	RECOVERPOINT CFG XTREMIO CONNECTOR	F1	\$290
PS-PPD-SERV	Deposit on PS Services	F1	\$0
PSUPGD-DMX	ZERO DOLLAR SYMM UPGRADE	F1	\$0
PSUPGD-ESRS	ZERO DOLLAR ESRSUPGRADE	F1	\$0
PSUPGD-VMAX	ZERO DOLLAR VMAX UPGRADE	F1	\$0

PSUPGD-VMNDARU	VMAX DARE Upgrade	F1	\$0
PS-VTS	VIRTUSTREAM SERVICES	F1	\$0
020-254-108	SEL Carb Onsite work travel per hour	F2	\$163
020-254-115	SEL Carb Cloud Backup Prof Svcs	F2	\$327
030-100-100	SEL Carb Cloud Backup 1yret 0.5TB 1 Yr	F2	\$2,230
030-100-101	SEL Carb Cloud Backup 1yret 1TB 1 Yr	F2	\$4,461
030-100-102	SEL Carb Cloud Backup 1yret 2TB 1 Yr	F2	\$8,028
030-100-103	SEL Carb Cloud Backup 1yret 3TB 1 Yr	F2	\$11,373
030-100-104	SEL Carb Cloud Backup 1yret 4TB 1 Yr	F2	\$14,272
030-100-105	SEL Carb Cloud Backup 1yret 5TB 1 Yr	F2	\$16,724
030-100-115	SEL Carb Cloud Backup 1yret 6-10TB 1 Yr	F2	\$3,060
030-100-116	SEL Carb Cloud Backup 1yret 11-25TB 1 Yr	F2	\$2,966
030-100-117	SEL Carb Cloud Backup 1yret 26-50TB 1 Yr	F2	\$2,872
030-100-118	SEL Carb Cloud Backup 1yret 50TB+ 1 Yr	F2	\$2,840
030-100-300	SEL Carb Cloud Backup 1yret 0.5TB 3 Yr	F2	\$6,021
030-100-301	SEL Carb Cloud Backup 1yret 1TB 3 Yr	F2	\$12,041
030-100-302	SEL Carb Cloud Backup 1yret 2TB 3 Yr	F2	\$21,675
030-100-303	SEL Carb Cloud Backup 1yret 3TB 3 Yr	F2	\$30,706
030-100-304	SEL Carb Cloud Backup 1yret 4TB 3 Yr	F2	\$38,534
030-100-305	SEL Carb Cloud Backup 1yret 5TB 3 Yr	F2	\$45,157
030-100-315	SEL Carb Cloud Backup 1yret 6-10TB 3 Yr	F2	\$8,263
030-100-316	SEL Carb Cloud Backup 1yret 11-25TB 3 Yr	F2	\$8,008
030-100-317	SEL Carb Cloud Backup 1yret 26-50TB 3 Yr	F2	\$7,753
030-100-318	SEL Carb Cloud Backup 1yret 50TB+ 3 Yr	F2	\$7,670
030-700-100	SEL Carb Cloud Backup 7yret 0.5TB 1 Yr	F2	\$2,974
030-700-101	SEL Carb Cloud Backup 7yret 1TB 1 Yr	F2	\$5,946
030-700-102	SEL Carb Cloud Backup 7yret 2TB 1 Yr	F2	\$10,703
030-700-103	SEL Carb Cloud Backup 7yret 3TB 1 Yr	F2	\$15,164
030-700-104	SEL Carb Cloud Backup 7yret 4TB 1 Yr	F2	\$19,030
030-700-105	SEL Carb Cloud Backup 7yret 5TB 1 Yr	F2	\$22,300
030-700-115	SEL Carb Cloud Backup 7yret 6-10TB 1 Yr	F2	\$4,101
030-700-116	SEL Carb Cloud Backup 7yret 11-25TB 1 Yr	F2	\$4,007
030-700-117	SEL Carb Cloud Backup 7yret 26-50TB 1 Yr	F2	\$3,913
030-700-118	SEL Carb Cloud Backup 7yret 50TB+ 1 Yr	F2	\$3,881
030-700-300	SEL Carb Cloud Backup 7yret 0.5TB 3 Yr	F2	\$8,028
030-700-301	SEL Carb Cloud Backup 7yret 1TB 3 Yr	F2	\$16,056
030-700-302	SEL Carb Cloud Backup 7yret 2TB 3 Yr	F2	\$28,900
030-700-303	SEL Carb Cloud Backup 7yret 3TB 3 Yr	F2	\$40,943
030-700-304	SEL Carb Cloud Backup 7yret 4TB 3 Yr	F2	\$51,378
030-700-305	SEL Carb Cloud Backup 7yret 5TB 3 Yr	F2	\$60,209
030-700-315	SEL Carb Cloud Backup 7yret 6-10TB 3 Yr	F2	\$11,072
030-700-316	SEL Carb Cloud Backup 7yret 11-25TB 3 Yr	F2	\$10,819
030-700-317	SEL Carb Cloud Backup 7yret 26-50TB 3 Yr	F2	\$10,564
030-700-318	SEL Carb Cloud Backup 7yret 50TB+ 3 Yr	F2	\$10,480
060-100-100	SEL Carb Recover 0.5TB 1 Yr	F2	\$2,368
060-100-101	SEL Carb Recover 1-4TB 1 Yr	F2	\$4,735
060-100-102	SEL Carb Recover 5-9TB 1 Yr	F2	\$4,498
060-100-103	SEL Carb Recover 10-49TB 1 Yr	F2	\$4,262
060-100-104	SEL Carb Recover 50TB+ 1 Yr	F2	\$4,025
060-100-105	SEL Carb Recover Premium 1 Yr	F2	\$8,682

060-100-106	SEL Carb Recover 1 IPSEC VPN 1 Yr	F2	\$664
060-100-107	SEL Carb Recover 10 SSL VPN 1 Yr	F2	\$664
060-100-108	SEL Carb Recover 1 External IP 1 Yr	F2	\$332
060-100-160	SEL Carb Recover Prof Svc 1 Svr	F2	\$1,046
060-100-161	SEL Carb Recover Prof Svc 5 Svr	F2	\$4,185
060-100-162	SEL Carb Recover Move Ipsec	F2	\$327
060-100-300	SEL Carb Recover 0.5TB 3 Yr	F2	\$6,393
060-100-301	SEL Carb Recover 1-4TB 3 Yr	F2	\$12,785
060-100-302	SEL Carb Recover 5-9TB 3 Yr	F2	\$12,146
060-100-303	SEL Carb Recover 10-49TB 3 Yr	F2	\$11,508
060-100-304	SEL Carb Recover 50TB+ 3 Yr	F2	\$10,868
060-100-305	SEL Carb Recover Premium 3 Yr	F2	\$24,674
060-100-306	SEL Carb Recover 1 IPSEC VPN 3 Yr	F2	\$2,111
060-100-307	SEL Carb Recover 10 SSL VPN 3 Yr	F2	\$2,111
060-100-308	SEL Carb Recover 1 External IP 3 Yr	F2	\$1,055
100-100198-MM	SEL MA VW Srvr Ent Lic Month	F2	\$459
100-100199-MM	SEL MA VW Srvr Dep Lic Month	F2	\$247
100-100202-MM	SEL MA FCX-0402 Lic Month	F2	\$229
100-100203-MM	SEL MA FCX-0408 Lic Month	F2	\$688
100-100206-MM	SEL MA ProbeSW-024 Lic Month	F2	\$31
100-100207-MM	SEL MA ProbeSW-032 Lic Month	F2	\$40
100-100208-MM	SEL MA ProbeSW-192 Lic Month	F2	\$239
100-100209-MM	SEL MA ProbeSW-256 Lic Month	F2	\$313
100-100210-MM	SEL MA ProbeSW-336 Lic Month	F2	\$406
100-100211-MM	SEL MA ProbeSW-384 Lic Month	F2	\$459
100-100212-MM	SEL MA ProbeSW-528 Lic Month	F2	\$618
100-100213-MM	SEL MA ProbeVM-001 Lic Month	F2	\$18
100-100214-MM	SEL MA ProbeVM-010 Lic Month	F2	\$199
100-100215-MM	SEL MA ProbeVM-050 Lic Month	F2	\$971
100-100216-MM	SEL MA ProbeVM-100 Lic Month	F2	\$1,747
100-100217-MM	SEL MA ProbeVM-500 Lic Month	F2	\$9,053
100-100288-MM	SEL MA TCV-008LFLFLF-57-RP Month	F2	\$20
100-100289-MM	SEL MA TCV-008LFLFLF-67-RP Month	F2	\$20
100-100290-MM	SEL MA TCV-012LRLFLF-57-RP Month	F2	\$29
100-100292-MM	SEL MA TCV-012MRLFLF-57-OB Month	F2	\$29
100-100293-MM	SEL MA TCV-024MRLFMR-57-OB Month	F2	\$59
100-100294-MM	SEL MA TPP-016A-57 Month	F2	\$76
100-100295-MM	SEL MA TPP-016A-67 Month	F2	\$76
100-100296-MM	SEL MA TPP-024B-57 Month	F2	\$112
100-100298-MM	SEL MA TPP-024C-57 Month	F2	\$113
100-100299-MM	SEL MA TPP-048D-57 Month	F2	\$229
100-100300-MM	SEL MA TPS-01OF Month	F2	\$4
100-100301-MM	SEL MA TPS-01OS Month	F2	\$2
100-100302	SEL PS SOS-4-IPM	F2	\$83,529
100-100303	SEL PS SOS-4-IPM Addtl Wk Onsite	F2	\$42,941
100-100304	SEL PS SOS-4-IPM Addtl Wk Rem	F2	\$29,118
100-100305	SEL PS Expert Svcs 5 Days	F2	\$15,882
100-100306	SEL PS Expert Svcs 20 Days	F2	\$63,529
100-100308	SEL PS PAK Addtl Wk Onsite	F2	\$14,412
100-100309	SEL PS Infrastrctr Perf Assessment (IPA)	F2	\$57,059

100-100310	SEL PS IPA Addtl Wk Onsite	F2	\$28,824
100-100311	SEL PS IPA Addtl Wk Rem	F2	\$19,412
100-100312	SEL PS Baseline ProbeSW-FC8	F2	\$28,824
100-100313	SEL PS Baseline ProbeSW	F2	\$19,118
100-100346-MM	SEL MA ProbeFC8 MM Month	F2	\$424
100-100402	SEL PS SOS-4-IPM Adv	F2	\$118,235
100-100408-MM	SEL MA TCV-012LFLFMR-57-RP Month	F2	\$29
100-100426-MM	SEL MA TPP-024D-57 Month	F2	\$113
100-100602-MM	SEL MA FC8-0802 Lic Month	F2	\$247
100-100603-MM	SEL MA FC8-0808 Lic Month	F2	\$988
100-100617-MM	SEL MA ProbeSWAG-24 Lic Month	F2	\$15
100-100618-MM	SEL MA ProbeSWAG-192 Lic Month	F2	\$119
100-100619-MM	SEL MA ProbeSWAG-528 Lic Month	F2	\$309
100-100695-MM	SEL MA FC8-0402 Lic Month	F2	\$212
100-100696-MM	SEL MA FC8-0408 Lic Month	F2	\$829
100-100744-MM	SEL MA ProbeFC8 MM R Month	F2	\$424
100-100842-MM	SEL MA ProbeFC8 SM R Month	F2	\$459
100-100843-MM	SEL MA ProbeFC8 SM Month	F2	\$459
100-100848-MM	SEL MA TCH-048LFLFMR-57-RP Month	F2	\$144
100-100850-MM	SEL MA TCV-012LRUFLF-57-A1 Month	F2	\$29
100-100851-MM	SEL MA TCV-024FFFFFF-57-TE Month	F2	\$59
100-100852-MM	SEL MA TCC-024LRLFMR-57-RP Month	F2	\$59
100-100860-MM	SEL MA TCV-012LRLFLF-57-SF Month	F2	\$29
100-100936-MM	SEL MA TCM-012MRLFLF-57-EB Month	F2	\$35
100-101060-MM	SEL MA TCV-008LFLFLF-57-SE Month	F2	\$20
100-101231-MM	SEL MA ProbeFC8-HD MM Month	F2	\$600
100-101321-MM	SEL MA ProbeFC8-HD SM Month	F2	\$662
100-101330	SEL PS QuickStart ProbeSW-VM-FC8	F2	\$61,059
100-101331	SEL PS QuickStart ProbeSW-VM	F2	\$48,118
100-101343-MM	SEL MA FC8HD-0816 Lic Month	F2	\$1,376
100-101377-MM	SEL MA TCV-012MRLRLF-57-UP Month	F2	\$29
100-101426-MM	SEL MA TCV-024MRMLF-57-UP Month	F2	\$59
100-101545-MM	SEL MA TCV-012LRLFLF-52-RP Month	F2	\$29
100-101753-MM	SEL MA VW Svr Ent DR Lic Month	F2	\$229
100-101804-MM	SEL MA ProbeFC8-HD48 MM Month	F2	\$1,694
100-101925-MM	SEL MA TCV-012MRLFLF-57-EB Month	F2	\$29
100-101929-MM	SEL MA TCV-024MFMFFF-57-PO Month	F2	\$59
100-101930-MM	SEL MA TCV-012LRLRLF-57-RP Month	F2	\$29
100-102036	SEL PS VIMS Mngd Svc Ent 12 Mnth	F2	\$576,471
100-102037	SEL PS VIMS Mngd Svc Ent 6 Mnth	F2	\$352,941
100-102038	SEL PS VIMS Mngd Svc Std 12 Mnth	F2	\$352,941
100-102039	SEL PS VIMS Mngd Svc Std 6 Mnth	F2	\$205,882
100-102043-MM	SEL MA ProbeFC8-HD48 SM Month	F2	\$1,853
100-102046-MM	SEL MA FC8HD48-0848 Lic Month	F2	\$2,788
100-102048-MM	SEL MA TCV-024MRFLF-57-UP Month	F2	\$59
100-102064-MM	SEL MA TCV-024MRLFMR-57-EB Month	F2	\$59
100-102065-MM	SEL MA FC8HD48-0824 Lic Month	F2	\$1,800
100-102069-MM	SEL MA Pltfrm Appl 4210 Month	F2	\$688
100-102070-MM	SEL MA VW Mgmt Ent Ed Month	F2	\$776
100-102071-MM	SEL MA VW Mgmt Virt Ed Month	F2	\$424

100-102072-MM	SEL MA VW Mgmt Ent DR Ed Month	F2	\$388
100-102091-MM	SEL MA ProbeFC8-HD Chass Mnth	F2	\$459
100-102092-MM	SEL MA ProbeFC8-HD48 Chass Mnth	F2	\$1,271
100-102267-MM	SEL MA ProbeSW-010 Lic Month	F2	\$14
100-102268-MM	SEL MA ProbeSW-100 Lic Month	F2	\$131
100-102269-MM	SEL MA ProbeSWAG-010 Lic Month	F2	\$7
100-102270-MM	SEL MA ProbeSWAG-100 Lic Month	F2	\$66
100-102271-MM	SEL MA ProbeNTAP-001 Lic Month	F2	\$21
100-102272-MM	SEL MA ProbeNTAP-100 Lic Month	F2	\$2,029
100-102375-MM	SEL MA ProbeFC-16G24 Chass Mnth	F2	\$882
100-102389	SEL PS Expert Svcs 5 Days Onsite	F2	\$28,235
100-102390	SEL PS Expert Svcs 20 Days Onsite	F2	\$88,235
100-102460	SEL PS Expert Svcs 5 Days Remote	F2	\$15,882
100-102461	SEL PS Expert Svcs 20 Days Remote	F2	\$63,529
100-102490-MM	SEL MA TCV-008LFLFLF-58-RP Month	F2	\$21
100-102491-MM	SEL MA TCV-012LRLFLF-58-RP Month	F2	\$32
100-102500-MM	SEL MA TCV-012LRLFLF-97 Month	F2	\$25
100-102579-MM	SEL MA SFP 4-Link Kit 8G MM Mnth	F2	\$35
100-102580-MM	SEL MA SFP 4-Link Kit 8G SM Mnth	F2	\$49
100-102581-MM	SEL MA LnkLic 8G 4-Link Kit Mnth	F2	\$282
100-102582-MM	SEL MA LnkLic 8G FC8-HD48 Mnth	F2	\$2,329
100-102583-MM	SEL MA LnkLic 8G FC16G24 Mnth	F2	\$1,147
100-102584-MM	SEL MA LnkLic 8G FC8-HD Mnth	F2	\$988
100-102595-MM	SEL MA LnkLic 16G 4Link Kit Mnth	F2	\$424
100-102596-MM	SEL MA LnkLic 16G FC16G24 Mnth	F2	\$1,588
100-102614-MM	SEL MA SFP 4-Link Kit 16GMM Mnth	F2	\$71
100-102615-MM	SEL MA SFP 4-Link Kit 16GSM Mnth	F2	\$85
100-102618-MM	SEL MA SFP 16GFC 1310NM SM Mnth	F2	\$11
100-102619-MM	SEL MA TCV-012MRLFLF-58-EB Month	F2	\$33
100-102620-MM	SEL MA TCV-012MRLFLF-58-OB Month	F2	\$33
100-102621-MM	SEL MA TCV-024MRLFMR-58-EB Month	F2	\$65
100-102622-MM	SEL MA TCV-024MRLFMR-58-OB Month	F2	\$65
100-102645-MM	SEL MA ProbeVM-001 Hyper-V Lic1M	F2	\$8
100-102646-MM	SEL MA ProbeVM-100 Hyper-V Lic1M	F2	\$865
100-102647-MM	SEL MA ProbeVM-001 PowerVM Lic1M	F2	\$8
100-102648-MM	SEL MA ProbeVM-100 PowerVM Lic1M	F2	\$874
100-102697-MM	SEL MA ProbeFC16G12 Chass Mnth	F2	\$459
100-102698-MM	SEL MA ProbeNAS10G16 Chass Mnt	F2	\$1,235
100-102711	SEL VI Managed Svc (VIMS) 3 M Activation	F2	\$29,412
100-102712	SEL VI Managed Svc (VIMS) 6 M Activation	F2	\$35,294
100-102713	SEL VI Managed Svc (VIMS) 1 Year Activa	F2	\$47,059
100-102714	SEL VI Managed Svc PM VM100 Month Sub	F2	\$3,529
100-102715	SEL VI Managed Svc PM VM500 Month Sub	F2	\$10,588
100-102716	SEL VI Managed Svc PM SW10K Month Sub	F2	\$4,118
100-102717	SEL VI Managed Svc PM SW25K Month Sub	F2	\$9,412
100-102718	SEL VI Managed Svc PM HW96L Month Sub	F2	\$16,471
100-102719	SEL VI Managed Svc PM HW192L Month Sub	F2	\$23,294
100-102751-MM	SEL MA TCV-008LFLFLF-97-RP Month	F2	\$21
100-102752-MM	SEL MA TCV-012MRLFLF-97-OB Month	F2	\$21
100-102753-MM	SEL MA TCV-012MRLFLF-97-EB Month	F2	\$21

100-102754-MM	SEL MA TCV-024MRLFMR-97-OB Month	F2	\$21
100-102755-MM	SEL MA TCV-024MRLFMR-97-EB Month	F2	\$21
100-102791-MM	SEL MA LnkLic 10G 1Lnk Actv Mnth	F2	\$80
100-102792-MM	SEL MA LnkLic 10G 1Lnk Pasv Mnth	F2	\$21
100-102793-MM	SEL MA LnkLic 10G NAS10G16 Mnth	F2	\$1,076
100-102794-MM	SEL MA TgtLic 10G 4-Tgt Kit Mnth	F2	\$106
100-102795-MM	SEL MA LnkLic 10G 4-Link Kit Mnt	F2	\$424
100-102796-MM	SEL MA LnkLic 10G FCoE10G24 Mnth	F2	\$1,747
100-102797-MM	SEL MA LnkLic 8G FC16G12 Mnth	F2	\$706
100-102798-MM	SEL MA LnkLic 16G FC16G12 Mnth	F2	\$1,059
100-102799-MM	SEL MA ProbeFCoE10G24 Chass Mnth	F2	\$882
100-103010-MM	SEL MA Pltfrm Appl 4220 Month	F2	\$688
100-103040-MM	SEL MA TCM-012MRLFLF-58-EB Month	F2	\$35
100-103051-MM	SEL MA VSAN-100 Lic Month	F2	\$1,747
100-103063-MM	SEL MA TCV-012LFLFLR-58-RP Month	F2	\$32
100-103077-MM	SEL MA ProbeSDS-001 Lic Month	F2	\$32
100-103078-MM	SEL MA ProbeNetFlow-100 Lic Mnt	F2	\$42
100-103083	SEL PS VW Silver Deployment	F2	\$58,824
100-103084	SEL PS VW Gold Deployment	F2	\$88,235
100-103085	SEL PS VW Platinum Deployment	F2	\$147,059
100-103086	SEL PS VW Silver Dply (No Inst)	F2	\$35,294
100-103087	SEL PS VW Gold Dply (No Inst)	F2	\$58,824
100-103088	SEL PS VW Platinm Dply (No Inst)	F2	\$105,882
100-103139-MM	SEL MA VWintg STS-1StorPt Mnth	F2	\$88
100-103140-MM	SEL MA VWintg STS-1LineCd Mnth	F2	\$1,412
100-TCX0857-MM	SEL MA TCX-008-57 Month	F2	\$25
100-TCX0858-MM	SEL MA TCX-008-58 Month	F2	\$25
100-TCX1257-MM	SEL MA TCX-012-57 Month	F2	\$36
100-TCX1258-MM	SEL MA TCX-012-58 Month	F2	\$38
100-TCX2457-MM	SEL MA TCX-024-57 Month	F2	\$69
100-TCX2458-MM	SEL MA TCX-024-58 Month	F2	\$73
100-TCX3657-MM	SEL MA TCX-036-57 Month	F2	\$102
100-TCX3658-MM	SEL MA TCX-036-58 Month	F2	\$114
100-TCX4857-MM	SEL MA TCX-048-57 Month	F2	\$138
100-TCX4858-MM	SEL MA TCX-048-58 Month	F2	\$153
11-1174-M1P	SEL: VU4-THINCLA-P-SSS-F	F2	\$58
11-1227-M1G	SEL: VF-DIR-25VM-G-SSS-F	F2	\$3,465
11-1227-M1P	SEL: VF-DIR-25VM-P-SSS-F	F2	\$4,125
11-1229-M1P	SEL: VU5-P500-P-SSS-FPRO	F2	\$34,375
11-1232-M1G	SEL: VU5-EN-A10-G-SSS-F	F2	\$208
11-1232-M1P	SEL: VU5-EN-A10-P-SSS-F	F2	\$248
11-1233-M1G	SEL: VU5-EN-A100-G-SSS-F	F2	\$2,079
11-1233-M1P	SEL: VU5-EN-A100-P-SSS-F	F2	\$2,475
11-1234-M1G	SEL: VU5-EN-STR-G-SSS-F	F2	\$347
11-1234-M1P	SEL: VU5-EN-STR-P-SSS-F	F2	\$413
11-1235-M1G	SEL: VU5-EN-100-G-SSS-F	F2	\$3,465
11-1235-M1P	SEL: VU5-EN-100-P-SSS-F	F2	\$4,125
11-1236-M1G	SEL: VU5-EN-10-G-SSS-F	F2	\$347
11-1236-M1P	SEL: VU5-EN-10-P-SSS-F	F2	\$413
11-1237-M1G	SEL: VU5-PR-STR-G-SSS-F	F2	\$578

11-1237-M1P	SEL: VU5-PR-STR-P-SSS-F	F2	\$688
11-1238-M1G	SEL: VU5-PR-100-G-SSS-F	F2	\$5,775
11-1238-M1P	SEL: VU5-PR-100-P-SSS-F	F2	\$6,875
11-1239-M1G	SEL: VU5-PR-10-G-SSS-F	F2	\$578
11-1239-M1P	SEL: VU5-PR-10-P-SSS-F	F2	\$688
11-1240-M1G	SEL: VU5-PR-A10-G-SSS-F	F2	\$439
11-1240-M1P	SEL: VU5-PR-A10-P-SSS-F	F2	\$523
11-1241-M1G	SEL: VU5-PR-A100-G-SSS-F	F2	\$4,389
11-1241-M1P	SEL: VU5-PR-A100-P-SSS-F	F2	\$5,225
11-1244-M1G	SEL: VU5-THINCLA-G-SSS-F	F2	\$48
11-1244-M1P	SEL: VU5-THINCLA-P-SSS-F	F2	\$58
11-1265-M1G	SEL: VF-HYPM-G-SSS-F	F2	\$84
11-1265-M1P	SEL: VF-HYPM-P-SSS-F	F2	\$99
11-1291-M1G	SEL: VF-APM-G-SSS-F	F2	\$84
11-1291-M1P	SEL: VF-APM-P-SSS-F	F2	\$99
11-1293-M1P	SEL: VU5-P250-P-SSS-FPRO	F2	\$17,188
11-1446-M1G	SEL: VU5-P250-G-SSS-FPRO	F2	\$14,438
11-1447-M1G	SEL: VU5-P500-G-SSS-FPRO	F2	\$28,875
11-1569-M1G	SEL: VF-APM5-G-SSS-F	F2	\$83
11-1569-M1P	SEL: VF-APM5-P-SSS-F	F2	\$99
11-1572-M1G	SEL: VF-DD2-5VM-G-SSS-F	F2	\$867
11-1572-M1P	SEL: VF-DD2-5VM-P-SSS-F	F2	\$1,032
11-1576-M1G	SEL: VF-ADPRV25-G-SSS-F	F2	\$1,447
11-1576-M1P	SEL: VF-ADPRV25-P-SSS-F	F2	\$1,722
11-1577-M1G	SEL: VF-ADRAU25-G-SSS-F	F2	\$2,167
11-1577-M1P	SEL: VF-ADRAU25-P-SSS-F	F2	\$2,580
111581LICM1GT1	SEL: VF-HYP5-G-TLSS-T1-F	F2	\$164
111581LICM1GT2	SEL: VF-HYP5-G-TLSS-T2-F	F2	\$123
111581LICM1GT3	SEL: VF-HYP5-G-TLSS-T3-F	F2	\$83
111581LICM1GT4	SEL: VF-HYP5-G-TLSS-T4-F	F2	\$41
111581LICM1PT1	SEL: VF-HYP5-P-TLSS-T1-F	F2	\$197
111581LICM1PT2	SEL: VF-HYP5-P-TLSS-T2-F	F2	\$147
111581LICM1PT3	SEL: VF-HYP5-P-TLSS-T3-F	F2	\$99
111581LICM1PT4	SEL: VF-HYP5-P-TLSS-T4-F	F2	\$50
111581LICM2GT1	SEL: VF-HYP5-2G-TLSS-T1-F	F2	\$328
111581LICM2GT2	SEL: VF-HYP5-2G-TLSS-T2-F	F2	\$246
111581LICM2GT3	SEL: VF-HYP5-2G-TLSS-T3-F	F2	\$165
111581LICM2GT4	SEL: VF-HYP5-2G-TLSS-T4-F	F2	\$81
111581LICM2PT1	SEL: VF-HYP5-2P-TLSS-T1-F	F2	\$394
111581LICM2PT2	SEL: VF-HYP5-2P-TLSS-T2-F	F2	\$295
111581LICM2PT3	SEL: VF-HYP5-2P-TLSS-T3-F	F2	\$198
111581LICM2PT4	SEL: VF-HYP5-2P-TLSS-T4-F	F2	\$99
111581LICM3GT1	SEL: VF-HYP5-3G-TLSS-T1-F	F2	\$492
111581LICM3GT2	SEL: VF-HYP5-3G-TLSS-T2-F	F2	\$370
111581LICM3GT3	SEL: VF-HYP5-3G-TLSS-T3-F	F2	\$248
111581LICM3GT4	SEL: VF-HYP5-3G-TLSS-T4-F	F2	\$122
111581LICM3PT1	SEL: VF-HYP5-3P-TLSS-T1-F	F2	\$591
111581LICM3PT2	SEL: VF-HYP5-3P-TLSS-T2-F	F2	\$442
111581LICM3PT3	SEL: VF-HYP5-3P-TLSS-T3-F	F2	\$297
111581LICM3PT4	SEL: VF-HYP5-3P-TLSS-T4-F	F2	\$149

11-1597-M1G	SEL: HZ-STE-10-G-SSS-F	F2	\$693
11-1597-M1P	SEL: HZ-STE-10-P-SSS-F	F2	\$825
11-1598-M1G	SEL: HZ-STE-100-G-SSS-F	F2	\$6,930
11-1598-M1P	SEL: HZ-STE-100-P-SSS-F	F2	\$8,250
11-1599-M1G	SEL: HZ-WSP-10-G-SSS-F	F2	\$347
11-1599-M1P	SEL: HZ-WSP-10-P-SSS-F	F2	\$413
11-1600-M1G	SEL: HZ-WSP-100-G-SSS-F	F2	\$3,465
11-1600-M1P	SEL: HZ-WSP-100-P-SSS-F	F2	\$4,125
11-1609-M1G	SEL: HZ-ST-20-G-SSS-F	F2	\$1,386
11-1609-M1P	SEL: HZ-ST-20-P-SSS-F	F2	\$1,650
11-1610-M1G	SEL: HZ-ST-200-G-SSS-F	F2	\$13,860
11-1610-M1P	SEL: HZ-ST-200-P-SSS-F	F2	\$16,500
11-1660-M1G	SEL: HZ-ST-250-G-SSS-F	F2	\$17,325
11-1660-M1P	SEL: HZ-ST-250-P-SSS-F	F2	\$20,625
11-1661-M1G	SEL: HZ-ST-500-G-SSS-F	F2	\$34,650
11-1661-M1P	SEL: HZ-ST-500-P-SSS-F	F2	\$41,250
11-1663-M1G	SEL: HZ-ST-1000-G-SSS-F	F2	\$69,300
11-1663-M1P	SEL: HZ-ST-1000-P-SSS-F	F2	\$82,500
11-1690-M1G	SEL: HZ-STC-10-G-SSS-F	F2	\$1,155
11-1690-M1P	SEL: HZ-STC-10-P-SSS-F	F2	\$1,375
11-1691-M1G	SEL: HZ-STC-100-G-SSS-F	F2	\$11,550
11-1691-M1P	SEL: HZ-STC-100-P-SSS-F	F2	\$13,750
11-1692-M1G	SEL: HZ-STC-250-G-SSS-F	F2	\$28,875
11-1692-M1P	SEL: HZ-STC-250-P-SSS-F	F2	\$34,375
11-1693-M1G	SEL: HZ-STC-500-G-SSS-F	F2	\$57,750
11-1693-M1P	SEL: HZ-STC-500-P-SSS-F	F2	\$68,750
11-1707-M1G	SEL: VC-LIS-25-G-SSS-F	F2	\$1,155
11-1707-M1P	SEL: VC-LIS-25-P-SSS-F	F2	\$1,375
11-1790-M1G	SEL: THIN5-STE-G-SSS-F	F2	\$1,155
11-1790-M1P	SEL: THIN5-STE-P-SSS-F	F2	\$1,375
11-1790-M3G	SEL: THIN5-STE-3G-SSS-F	F2	\$3,049
11-1790-M3P	SEL: THIN5-STE-3P-SSS-F	F2	\$3,630
11-1791-M1G	SEL: THIN5-100PK-G-SSS-F	F2	\$439
11-1791-M1P	SEL: THIN5-100PK-P-SSS-F	F2	\$523
11-1791-M3G	SEL: THIN5-100PK-3G-SSS-F	F2	\$1,159
11-1791-M3P	SEL: THIN5-100PK-3P-SSS-F	F2	\$1,379
11-1820-M1P	SEL Production Sns Vsan 5 1 Cpu	F2	\$686
11-1822-M1G	SEL M1G Vsan 5 Desktop 10P Ccu	F2	\$116
11-1822-M1P	SEL M1P Vsan 5 Desktop 10P Ccu	F2	\$138
11-1823-M1G	SEL M1G Vsan 5 Desktop 100P Ccu	F2	\$1,155
11-1823-M1P	SEL Vsan 5 Desktop 100P Ccu M1P	F2	\$1,375
11-1829-M1G	SEL Hor Adv: 10P Ccu M1G	F2	\$924
11-1830-M1G	SEL Hor Adv: 100P Ccu M1G	F2	\$9,240
11-1830-M1P	SEL Hor Adv: 100P Ccu M1P	F2	\$11,000
11-1831-M1G	SEL Hor Adv: 10P (Nus) M1G	F2	\$578
11-1831-M1P	SEL Hor Adv: 10P (Nus) M1P	F2	\$688
11-1832-M1G	SEL Hor Adv: 100P (Nus) M1G	F2	\$5,775
11-1832-M1P	SEL Hor Adv: 100P (Nus) M1P	F2	\$6,875
11-1833-M1G	SEL Ent: 10P Ccu M1G	F2	\$1,329
11-1833-M1P	SEL Ent: 10P Ccu M1P	F2	\$1,582

11-1834-M1G	SEL Ent: 100P Ccu M1G	F2	\$13,283
11-1834-M1P	SEL Ent: 100P Ccu M1P	F2	\$15,813
11-1835-M1G	SEL Ent: 10P (Nus) -M1G	F2	\$809
11-1835-M1P	SEL Ent: 10P (Nus) -M1P	F2	\$963
11-1836-M1G	SEL Ent: 100P (Nus) -M1G	F2	\$8,085
11-1836-M1P	SEL Ent: 100P (Nus) -M1P	F2	\$9,625
11-1863-M1G	SEL: VC-LIS-CPU-G-SSS-F	F2	\$347
11-1863-M1P	SEL: VC-LIS-CPU-P-SSS-F	F2	\$413
11-1866-M1G	SEL View Std 10P Ccu -M1G	F2	\$578
11-1866-M1P	SEL View Std 10P Ccu -M1P	F2	\$688
11-1867-M1G	SEL View Std 100P Ccu -M1G	F2	\$5,775
11-1867-M1P	SEL View Std 100P Ccu -M1P	F2	\$6,875
11-1868-M1G	SEL View Std Add 10P Ccu -M1G	F2	\$439
11-1868-M1P	SEL View Std Add 10P Ccu -M1P	F2	\$523
11-1869-M1G	SEL View Std Add 100P Ccu -M1G	F2	\$4,389
11-1869-M1P	SEL View Std Add 100P Ccu -M1P	F2	\$5,225
11-1951-M1G	SEL: VR-OIST-BUN-G-SSS-F	F2	\$462
11-1951-M1P	SEL: VR-OIST-BUN-P-SSS-F	F2	\$550
11-1954-M1G	SEL: VR-CMP-ADV-G-SSS-F	F2	\$3,321
11-1954-M1P	SEL: VR-CMP-ADV-P-SSS-F	F2	\$3,953
11-1955-M1G	SEL: VR-CMP-ENT-G-SSS-F	F2	\$5,746
11-1955-M1P	SEL: VR-CMP-ENT-P-SSS-F	F2	\$6,841
11-1968-M1G	SEL: VR-AT-ADV25-G-SSS-F	F2	\$1,155
11-1968-M1P	SEL: VR-AT-ADV25-P-SSS-F	F2	\$1,375
11-1969-M1G	SEL: VR-AT-ENT25-G-SSS-F	F2	\$2,281
11-1969-M1P	SEL: VR-AT-ENT25-P-SSS-F	F2	\$2,716
11-1980-M1G	SEL: VR6-OSTD25-G-SSS-F	F2	\$722
11-1980-M1P	SEL: VR6-OSTD25-P-SSS-F	F2	\$859
11-1980-M2MG	SEL: VR6-OADV-2M-GSSS-F	F2	\$265
11-1980-M2MP	SEL: VR6-OADV-2M-PSSS-F	F2	\$316
11-1980-M3G	SEL: VR6-OSTD25-3G-SSS-F	F2	\$1,905
11-1980-M3P	SEL: VR6-OSTD25-3P-SSS-F	F2	\$2,268
11-1981-M1G	SEL: VR6-OADV25-G-SSS-F	F2	\$1,588
11-1981-M1P	SEL: VR6-OADV25-P-SSS-F	F2	\$1,891
11-1981-M3G	SEL: VR6-OADV25-3G-SSS-F	F2	\$4,193
11-1981-M3P	SEL: VR6-OADV25-3P-SSS-F	F2	\$4,992
11-1982-M1G	SEL: VR6-OENT25-G-SSS-F	F2	\$4,014
11-1982-M1P	SEL: VR6-OENT25-P-SSS-F	F2	\$4,778
11-1982-M2MG	SEL: VR6-OENT-2M-GSSS-F	F2	\$669
11-1982-M2MP	SEL: VR6-OENT-2M-PSSS-F	F2	\$796
11-1982-M3G	SEL: VR6-OENT25-3G-SSS-F	F2	\$10,597
11-1982-M3P	SEL: VR6-OENT25-3P-SSS-F	F2	\$12,615
11-1986-M1G	SEL: VR6-ADVAD-P-SSS-F	F2	\$413
11-1986-M1P	SEL: VR6-ADVAD-G-SSS-F	F2	\$347
11-1987-M1G	SEL: VR6-PCADV25-G-SSS-F	F2	\$1,155
11-1987-M1P	SEL: VR6-PCADV25-P-SSS-F	F2	\$1,375
11-1988-M1G	SEL: VR6-PCENT25-G-SSS-F	F2	\$2,281
11-1988-M1P	SEL: VR6-PCENT25-P-SSS-F	F2	\$2,716
11-1998-M1G	SEL: VR6-VU10-G-SSS-F	F2	\$174
11-1998-M1P	SEL: VR6-VU10-P-SSS-F	F2	\$207

11-1998-M3G	SEL: VR6-VU10-3G-SSS-F	F2	\$459
11-1998-M3P	SEL: VR6-VU10-3P-SSS-F	F2	\$546
11-1999-M1G	SEL: VR6-VU100-G-SSS-F	F2	\$1,733
11-1999-M1P	SEL: VR6-VU100-P-SSS-F	F2	\$2,063
11-1999-M3G	SEL: VR6-VU100-3G-SSS-F	F2	\$4,574
11-1999-M3P	SEL: VR6-VU100-3P-SSS-F	F2	\$5,445
11-2006-M1G	SEL: VR6-BSTD-G-SSS-F	F2	\$347
11-2006-M1P	SEL: VR6-BSTD-P-SSS-F	F2	\$413
11-2009-M1G	SEL: VR6-BSTD25-G-SSS-F	F2	\$1,155
11-2009-M1P	SEL: VR6-BSTD25-P-SSS-F	F2	\$1,375
11-2013-M1G	SEL: VR-CODE-OSI-G-SSS-F	F2	\$289
11-2013-M1P	SEL: VR-CODE-OSI-P-SSS-F	F2	\$344
11-2014-M1G	SEL: VR-CODE-CPU-G-SSS-F	F2	\$1,733
11-2014-M1P	SEL: VR-CODE-CPU-P-SSS-F	F2	\$2,063
11-2015-M1G	SEL: HZ-FLX-10-G-SSS-F	F2	\$578
11-2015-M1P	SEL: HZ-FLX-10-P-SSS-F	F2	\$688
11-2015-M3G	SEL: HZ-FLX-10-3G-SSS-F	F2	\$1,525
11-2015-M3P	SEL: HZ-FLX-10-3P-SSS-F	F2	\$1,815
11-2018-M1G	SEL: HZ-FLX-1-G-SSS-F	F2	\$57
11-2018-M1P	SEL: HZ-FLX-1-P-SSS-F	F2	\$69
11-2018-M2MG	SEL: HZ-FLX-2M-GSSS-F	F2	\$9
11-2018-M2MP	SEL: HZ-FLX-2M-PSSS-F	F2	\$12
11-2018-M3G	SEL: HZ-FLX-1-3G-SSS-F	F2	\$151
11-2018-M3P	SEL: HZ-FLX-1-3P-SSS-F	F2	\$183
11-2053-M1G	SEL: VR-STE-ADV-G-SSS-F	F2	\$3,898
11-2053-M1P	SEL: VR-STE-ADV-P-SSS-F	F2	\$4,641
11-2109-M1G	SEL: ST6-VF-A100-G-SSS-F	F2	\$693
11-2109-M1P	SEL: ST6-VF-A100-P-SSS-F	F2	\$825
11-2110-M1G	SEL: ST6-VF-A10-G-SSS-F	F2	\$69
11-2110-M1P	SEL: ST6-VF-A10-P-SSS-F	F2	\$83
11-2111-M1G	SEL: ST6-VF-AD-G-SSS-F	F2	\$345
11-2111-M1P	SEL: ST6-VF-AD-P-SSS-F	F2	\$411
11-2112-M1G	SEL: ST6-VSAN-G-SSS-F	F2	\$576
11-2112-M1P	SEL: ST6-VSAN-P-SSS-F	F2	\$686
11-2112-M3G	SEL: ST6-VSAN-3G-SSS-F	F2	\$1,522
11-2112-M3P	SEL: ST6-VSAN-3P-SSS-F	F2	\$1,812
11-2113-M1G	SEL: ST6-VSAN-BN-G-SSS-F	F2	\$3,458
11-2113-M1P	SEL: ST6-VSAN-BN-P-SSS-F	F2	\$4,118
11-2113-M2MG	SEL: ST6-VSANBN-2M-GSSS-F	F2	\$576
11-2113-M2MP	SEL: ST6-VSANBN-2M-PSSS-F	F2	\$686
11-2113-M3G	SEL: ST6-VSAN-BN-3G-SSS-F	F2	\$9,130
11-2113-M3P	SEL: ST6-VSAN-BN-3P-SSS-F	F2	\$10,873
11-2244-M1G	SEL: HZ-LXC-10-G-SSS-F	F2	\$347
11-2244-M1P	SEL: HZ-LXC-10-P-SSS-F	F2	\$413
11-2245-M1G	SEL: HZ-LXC-100-G-SSS-F	F2	\$3,465
11-2245-M1P	SEL: HZ-LXC-100-P-SSS-F	F2	\$4,125
11-2248-M1G	SEL: VR6-MEDI-G-SSS-F	F2	\$13,860
11-2248-M1P	SEL: VR6-MEDI-P-SSS-F	F2	\$16,500
11-2248-M3G	SEL: VR6-MEDI-3G-SSS-F	F2	\$36,590
11-2248-M3P	SEL: VR6-MEDI-3P-SSS-F	F2	\$43,560

11-2270-M1G	SEL: VR-LIS3-25-G-SSS-F	F2	\$1,155
11-2270-M1P	SEL: VR-LIS3-25-P-SSS-F	F2	\$1,375
11-2271-M1G	SEL: VR-LIS3-CPU-G-SSS-F	F2	\$347
11-2271-M1P	SEL: VR-LIS3-CPU-P-SSS-F	F2	\$413
11-2288-M1G	SEL: HZ-FLX-AD10-G-SSS-F	F2	\$347
11-2288-M1P	SEL: HZ-FLX-AD10-P-SSS-F	F2	\$413
11-2288-M3G	SEL: HZ-FLX-AD10-3G-SSS-F	F2	\$915
11-2288-M3P	SEL: HZ-FLX-AD10-3P-SSS-F	F2	\$1,089
11-2315-M1G	SEL: VR7-BSTD25-G-SSS-F	F2	\$1,155
11-2315-M1P	SEL: VR7-BSTD25-P-SSS-F	F2	\$1,375
11-2316-M1G	SEL: VR7-BPSTD-G-SSS-F	F2	\$347
11-2316-M1P	SEL: VR7-BPSTD-P-SSS-F	F2	\$413
11-2317-M1G	SEL: VR7-ATAD25-G-SSS-F	F2	\$1,588
11-2317-M1P	SEL: VR7-ATAD25-P-SSS-F	F2	\$1,891
11-2317-M3G	SEL: VR7-ATAD25-3G-SSS-F	F2	\$4,193
11-2317-M3P	SEL: VR7-ATAD25-3P-SSS-F	F2	\$4,992
11-2318-M1G	SEL: VR7-ATEN25-G-SSS-F	F2	\$2,743
11-2318-M1P	SEL: VR7-ATEN25-P-SSS-F	F2	\$3,266
11-2318-M2MG	SEL: VR7-ATEN25-2M-GSSS-F	F2	\$457
11-2318-M2MP	SEL: VR7-ATEN25-2M-PSSS-F	F2	\$544
11-2318-M3G	SEL: VR7-ATEN25-3G-SSS-F	F2	\$7,243
11-2318-M3P	SEL: VR7-ATEN25-3P-SSS-F	F2	\$8,622
11-2319-M1G	SEL: VR7-ATPCA25-G-SSS-F	F2	\$1,155
11-2319-M1P	SEL: VR7-ATPCA25-P-SSS-F	F2	\$1,375
11-2320-M1G	SEL: VR7-ATPCE25-G-SSS-F	F2	\$2,281
11-2320-M1P	SEL: VR7-ATPCE25-P-SSS-F	F2	\$2,716
11-2321-M1G	SEL: VR7-AUTDT25-G-SSS-F	F2	\$769
11-2321-M1P	SEL: VR7-AUTDT25-P-SSS-F	F2	\$914
11-2321-M2MG	SEL: VR7-AUT10-G-SSS-F	F2	\$924
11-2321-M2MP	SEL: VR7-AUT10-P-SSS-F	F2	\$1,100
11-2321-M3G	SEL: VR7-AUTDT25-3G-SSS-F	F2	\$2,030
11-2321-M3P	SEL: VR7-AUTDT25-3P-SSS-F	F2	\$2,413
11-2358-M1G	SEL: HZ7-ADC-10-G-SSS-F	F2	\$924
11-2358-M1P	SEL: HZ7-ADC-10-P-SSS-F	F2	\$1,100
11-2358-M2MG	SEL: HZ7-ADC-10-2M-GSSS-F	F2	\$154
11-2358-M2MP	SEL: HZ7-ADC-10-2M-PSSS-F	F2	\$183
11-2358-M3G	SEL: HZ7-ADC-10-3G-SSS-F	F2	\$2,439
11-2358-M3P	SEL: HZ7-ADC-10-3P-SSS-F	F2	\$2,904
11-2359-M1G	SEL: HZ7-ADC-100-G-SSS-F	F2	\$9,240
11-2359-M1P	SEL: HZ7-ADC-100-P-SSS-F	F2	\$11,000
11-2359-M2MG	SEL: HZ7-ADC-100-2M-GSSS-F	F2	\$1,540
11-2359-M2MP	SEL: HZ7-ADC-100-2M-PSSS-F	F2	\$1,833
11-2359-M3G	SEL: HZ7-ADC-100-3G-SSS-F	F2	\$24,394
11-2359-M3P	SEL: HZ7-ADC-100-3P-SSS-F	F2	\$29,040
11-2362-M1G	SEL: HZ7-ADN-10-G-SSS-F	F2	\$578
11-2362-M1P	SEL: HZ7-ADN-10-P-SSS-F	F2	\$688
11-2362-M2MG	SEL: HZ7-ADN-10-2M-GSSS-F	F2	\$96
11-2362-M2MP	SEL: HZ7-ADN-10-2M-PSSS-F	F2	\$115
11-2362-M3G	SEL: HZ7-ADN-10-3G-SSS-F	F2	\$1,525
11-2362-M3P	SEL: HZ7-ADN-10-3P-SSS-F	F2	\$1,815

11-2363-M1G	SEL: HZ7-ADN-100-G-SSS-F	F2	\$5,775
11-2363-M1P	SEL: HZ7-ADN-100-P-SSS-F	F2	\$6,875
11-2363-M2MG	SEL: HZ7-ADN-100-2M-GSSS-F	F2	\$963
11-2363-M2MP	SEL: HZ7-ADN-100-2M-PSSS-F	F2	\$1,146
11-2363-M3G	SEL: HZ7-ADN-100-3G-SSS-F	F2	\$15,246
11-2363-M3P	SEL: HZ7-ADN-100-3P-SSS-F	F2	\$18,150
11-2380-M1G	SEL: HZ7-ENC-10-G-SSS-F	F2	\$1,329
11-2380-M1P	SEL: HZ7-ENC-10-P-SSS-F	F2	\$1,582
11-2380-M2MG	SEL: HZ7-ENC-10-2M-GSSS-F	F2	\$221
11-2380-M2MP	SEL: HZ7-ENC-10-2M-PSSS-F	F2	\$264
11-2380-M3G	SEL: HZ7-ENC-10-3G-SSS-F	F2	\$3,508
11-2380-M3P	SEL: HZ7-ENC-10-3P-SSS-F	F2	\$4,176
11-2381-M1G	SEL: HZ7-ENC-100-G-SSS-F	F2	\$13,283
11-2381-M1P	SEL: HZ7-ENC-100-P-SSS-F	F2	\$15,813
11-2381-M2MG	SEL: HZ7-ENC-100-2M-GSSS-F	F2	\$2,214
11-2381-M2MP	SEL: HZ7-ENC-100-2M-PSSS-F	F2	\$2,635
11-2381-M3G	SEL: HZ7-ENC-100-3G-SSS-F	F2	\$35,066
11-2381-M3P	SEL: HZ7-ENC-100-3P-SSS-F	F2	\$41,745
11-2382-M1G	SEL: HZ7-ENN-10-G-SSS-F	F2	\$809
11-2382-M1P	SEL: HZ7-ENN-10-P-SSS-F	F2	\$963
11-2382-M2MG	SEL: HZ7-ENN-10-2M-GSSS-F	F2	\$135
11-2382-M2MP	SEL: HZ7-ENN-10-2M-PSSS-F	F2	\$160
11-2382-M3G	SEL: HZ7-ENN-10-3G-SSS-F	F2	\$2,134
11-2382-M3P	SEL: HZ7-ENN-10-3P-SSS-F	F2	\$2,541
11-2383-M1G	SEL: HZ7-ENN-100-G-SSS-F	F2	\$8,085
11-2383-M1P	SEL: HZ7-ENN-100-P-SSS-F	F2	\$9,625
11-2383-M2MG	SEL: HZ7-ENN-100-2M-GSSS-F	F2	\$1,348
11-2383-M2MP	SEL: HZ7-ENN-100-2M-PSSS-F	F2	\$1,604
11-2383-M3G	SEL: HZ7-ENN-100-3G-SSS-F	F2	\$21,344
11-2383-M3P	SEL: HZ7-ENN-100-3P-SSS-F	F2	\$25,410
11-2388-M1G	SEL: HZ7-LXC-10-G-SSS-F	F2	\$347
11-2388-M1P	SEL: HZ7-LXC-10-P-SSS-F	F2	\$413
11-2388-M3G	SEL: HZ7-LXC-10-3G-SSS-F	F2	\$915
11-2388-M3P	SEL: HZ7-LXC-10-3P-SSS-F	F2	\$1,089
11-2389-M1G	SEL: HZ7-LXC-100-G-SSS-F	F2	\$3,465
11-2389-M1P	SEL: HZ7-LXC-100-P-SSS-F	F2	\$4,125
11-2389-M3G	SEL: HZ7-LXC-100-3G-SSS-F	F2	\$9,148
11-2389-M3P	SEL: HZ7-LXC-100-3P-SSS-F	F2	\$10,890
11-2416-M1G	SEL: HZ7-STD-10-G-SSS-F	F2	\$578
11-2416-M1P	SEL: HZ7-STD-10-P-SSS-F	F2	\$688
11-2416-M2MG	SEL: HZ7-STD-10-2M-GSSS-F	F2	\$96
11-2416-M2MP	SEL: HZ7-STD-10-2M-PSSS-F	F2	\$115
11-2416-M3G	SEL: HZ7-STD-10-3G-SSS-F	F2	\$1,525
11-2416-M3P	SEL: HZ7-STD-10-3P-SSS-F	F2	\$1,815
11-2417-M1G	SEL: HZ7-STD-100-G-SSS-F	F2	\$5,775
11-2417-M1P	SEL: HZ7-STD-100-P-SSS-F	F2	\$6,875
11-2417-M2MG	SEL: HZ7-STD-100-2M-GSSS-F	F2	\$963
11-2417-M2MP	SEL: HZ7-STD-100-2M-PSSS-F	F2	\$1,146
11-2417-M3G	SEL: HZ7-STD-100-3G-SSS-F	F2	\$15,246
11-2417-M3P	SEL: HZ7-STD-100-3P-SSS-F	F2	\$18,150

11-2418-M1G	SEL: HZ7-STD-A10-G-SSS-F	F2	\$439
11-2418-M1P	SEL: HZ7-STD-A10-P-SSS-F	F2	\$523
11-2418-M2MG	SEL: HZ7-STDA10-2M-GSSS-F	F2	\$73
11-2418-M2MP	SEL: HZ7-STDA10-2M-PSSS-F	F2	\$87
11-2418-M3G	SEL: HZ7-STD-A10-3G-SSS-F	F2	\$1,159
11-2418-M3P	SEL: HZ7-STD-A10-3P-SSS-F	F2	\$1,379
11-2419-M1G	SEL: HZ7-STD-A100-G-SSS-F	F2	\$4,389
11-2419-M1P	SEL: HZ7-STD-A100-P-SSS-F	F2	\$5,225
11-2419-M2MG	SEL: HZ7-STDA100-2M-GSSS-F	F2	\$732
11-2419-M2MP	SEL: HZ7-STDA100-2M-PSSS-F	F2	\$871
11-2419-M3G	SEL: HZ7-STD-A100-3G-SSS-F	F2	\$11,587
11-2419-M3P	SEL: HZ7-STD-A100-3P-SSS-F	F2	\$13,794
11-2431-M1G	SEL: ST6-AD-D10-G-SSS-F	F2	\$231
11-2431-M1P	SEL: ST6-AD-D10-P-SSS-F	F2	\$275
11-2431-M2MG	SEL: ST6-AD-D10-2M-GSSS-F	F2	\$39
11-2431-M2MP	SEL: ST6-AD-D10-2M-PSSS-F	F2	\$46
11-2431-M3G	SEL: ST6-AD-D10-3G-SSS-F	F2	\$610
11-2431-M3P	SEL: ST6-AD-D10-3P-SSS-F	F2	\$726
11-2432-M1G	SEL: ST6-AD-D100-G-SSS-F	F2	\$2,310
11-2432-M1P	SEL: ST6-AD-D100-P-SSS-F	F2	\$2,750
11-2432-M2MG	SEL: ST6-AD-D100-2M-GSSS-F	F2	\$385
11-2432-M2MP	SEL: ST6-AD-D100-2M-PSSS-F	F2	\$458
11-2432-M3G	SEL: ST6-AD-D100-3G-SSS-F	F2	\$6,098
11-2432-M3P	SEL: ST6-AD-D100-3P-SSS-F	F2	\$7,260
11-2434-M1G	SEL: ST6-AD-G-SSS-F	F2	\$923
11-2434-M1P	SEL: ST6-AD-P-SSS-F	F2	\$1,099
11-2434-M2MG	SEL: ST6-AD-2M-GSSS-F	F2	\$154
11-2434-M2MP	SEL: ST6-AD-2M-PSSS-F	F2	\$183
11-2434-M3G	SEL: ST6-AD-3G-SSS-F	F2	\$2,436
11-2434-M3P	SEL: ST6-AD-3P-SSS-F	F2	\$2,901
11-2439-M1G	SEL: ST6-EN-G-SSS-F	F2	\$1,269
11-2439-M1P	SEL: ST6-EN-P-SSS-F	F2	\$1,511
11-2439-M2MG	SEL: ST6-EN-2M-GSSS-F	F2	\$212
11-2439-M2MP	SEL: ST6-EN-2M-PSSS-F	F2	\$252
11-2439-M3G	SEL: ST6-EN-3G-SSS-F	F2	\$3,351
11-2439-M3P	SEL: ST6-EN-3P-SSS-F	F2	\$3,990
11-2446-M1G	SEL: VR-BCLADV-C-G-SSS-F	F2	\$693
11-2446-M1P	SEL: VR-BCLADV-C-P-SSS-F	F2	\$825
11-2446-M3G	SEL: VR-BCLADV-C-3G-SSS-F	F2	\$1,830
11-2446-M3P	SEL: VR-BCLADV-C-3P-SSS-F	F2	\$2,178
11-2447-M1G	SEL: VR-BCLADVO-25-G-SSS-F	F2	\$1,155
11-2447-M1P	SEL: VR-BCLADVO-25-P-SSS-F	F2	\$1,375
11-2447-M3G	SEL: VR-BCLADVO-25-3G-SSS-F	F2	\$3,049
11-2447-M3P	SEL: VR-BCLADVO-25-3P-SSS-F	F2	\$3,630
11-2448-M1G	SEL: VR-CODE2C-G-SSS-F	F2	\$1,260
11-2448-M1P	SEL: VR-CODE2C-P-SSS-F	F2	\$1,499
11-2448-M3G	SEL: VR-CODE2C-3G-SSS-F	F2	\$3,325
11-2448-M3P	SEL: VR-CODE2C-3P-SSS-F	F2	\$3,958
11-2449-M1G	SEL: VR-CODE2O-G-SSS-F	F2	\$125
11-2449-M1P	SEL: VR-CODE2O-P-SSS-F	F2	\$150

11-2449-M3G	SEL: VR-CODE20-3G-SSS-F	F2	\$331
11-2449-M3P	SEL: VR-CODE20-3P-SSS-F	F2	\$395
11-2450-M1G	SEL: VR-OAMAD-G-SSS-F	F2	\$347
11-2450-M1P	SEL: VR-OAMAD-P-SSS-F	F2	\$413
11-2450-M3G	SEL: VR-OAMAD-3G-SSS-F	F2	\$915
11-2450-M3P	SEL: VR-OAMAD-3P-SSS-F	F2	\$1,089
11-2454-M1G	SEL: VR7-ADV-G-SSS-F	F2	\$1,442
11-2454-M1P	SEL: VR7-ADV-P-SSS-F	F2	\$1,717
11-2460-M1G	SEL: VR7-ENT-G-SSS-F	F2	\$1,789
11-2460-M1P	SEL: VR7-ENT-P-SSS-F	F2	\$2,130
11-2484-M1G	SEL: VR7-STD-G-SSS-F	F2	\$865
11-2484-M1P	SEL: VR7-STD-P-SSS-F	F2	\$1,030
11-2505-M1G	SEL: HZ7-ADN-A10-G-SSS-F	F2	\$462
11-2505-M1P	SEL: HZ7-ADN-A10-P-SSS-F	F2	\$550
11-2505-M3G	SEL: HZ7-ADN-A10-3G-SSS-F	F2	\$1,220
11-2505-M3P	SEL: HZ7-ADN-A10-3P-SSS-F	F2	\$1,452
11-2506-M1G	SEL: HZ7-ADN-A100-G-SSS-F	F2	\$4,620
11-2506-M1P	SEL: HZ7-ADN-A100-P-SSS-F	F2	\$5,500
11-2506-M3G	SEL: HZ7-ADN-A100-3G-SSS-F	F2	\$12,197
11-2506-M3P	SEL: HZ7-ADN-A100-3P-SSS-F	F2	\$14,520
11-2507-M1G	SEL: HZ7-A100-AERC-G-SSS-F	F2	\$6,930
11-2507-M1P	SEL: HZ7-A100-AERC-P-SSS-F	F2	\$8,250
11-2507-M3G	SEL: HZ7-A100-AERC-3G-SSS-F	F2	\$18,295
11-2507-M3P	SEL: HZ7-A100-AERC-3P-SSS-F	F2	\$21,780
11-2508-M1G	SEL: HZ7-A10-AERC-G-SSS-F	F2	\$693
11-2508-M1P	SEL: HZ7-A10-AERC-P-SSS-F	F2	\$825
11-2508-M3G	SEL: HZ7-A10-AERC-3G-SSS-F	F2	\$1,830
11-2508-M3P	SEL: HZ7-A10-AERC-3P-SSS-F	F2	\$2,178
11-2509-M1G	SEL: HZ7-E100-AERC-G-SSS-F	F2	\$9,818
11-2509-M1P	SEL: HZ7-E100-AERC-P-SSS-F	F2	\$11,688
11-2509-M2MG	SEL: HZ7-E100-AERC-2M-GSSS-F	F2	\$1,636
11-2509-M2MP	SEL: HZ7-E100-AERC-2M-PSSS-F	F2	\$1,948
11-2509-M3G	SEL: HZ7-E100-AERC-3G-SSS-F	F2	\$25,918
11-2509-M3P	SEL: HZ7-E100-AERC-3P-SSS-F	F2	\$30,855
11-2511-M1G	SEL: HZ7-E10-AERC-G-SSS-F	F2	\$982
11-2511-M1P	SEL: HZ7-E10-AERC-P-SSS-F	F2	\$1,169
11-2511-M2MG	SEL: HZ7-E10-AERC-2M-GSSS-F	F2	\$164
11-2511-M2MP	SEL: HZ7-E10-AERC-2M-PSSS-F	F2	\$195
11-2511-M3G	SEL: HZ7-E10-AERC-3G-SSS-F	F2	\$2,593
11-2511-M3P	SEL: HZ7-E10-AERC-3P-SSS-F	F2	\$3,087
11-2513-M1G	SEL: HZ7-ENN-A100-G-SSS-F	F2	\$6,584
11-2513-M1P	SEL: HZ7-ENN-A100-P-SSS-F	F2	\$7,838
11-2513-M2MG	SEL: HZ7-ENN-A100-2M-GSSS-F	F2	\$1,097
11-2513-M2MP	SEL: HZ7-ENN-A100-2M-PSSS-F	F2	\$1,306
11-2513-M3G	SEL: HZ7-ENN-A100-3G-SSS-F	F2	\$17,380
11-2513-M3P	SEL: HZ7-ENN-A100-3P-SSS-F	F2	\$20,691
11-2515-M1G	SEL: HZ7-ENN-A10-G-SSS-F	F2	\$659
11-2515-M1P	SEL: HZ7-ENN-A10-P-SSS-F	F2	\$784
11-2515-M2MG	SEL: HZ7-ENN-A10-2M-GSSS-F	F2	\$110
11-2515-M2MP	SEL: HZ7-ENN-A10-2M-PSSS-F	F2	\$131

11-2515-M3G	SEL: HZ7-ENN-A10-3G-SSS-F	F2	\$1,740
11-2515-M3P	SEL: HZ7-ENN-A10-3P-SSS-F	F2	\$2,071
11-2530-M1G	SEL: VR6-OSTC-G-SSS-F	F2	\$289
11-2530-M1P	SEL: VR6-OSTC-P-SSS-F	F2	\$344
11-2530-M3G	SEL: VR6-OSTC-3G-SSS-F	F2	\$764
11-2530-M3P	SEL: VR6-OSTC-3P-SSS-F	F2	\$909
11-2535-M1G	SEL: VR-NI-ANXC-G-SSS-F	F2	\$287
11-2535-M1P	SEL: VR-NI-ANXC-P-SSS-F	F2	\$342
11-2535-M3G	SEL: VR-NI-ANXC-3G-SSS-F	F2	\$758
11-2535-M3P	SEL: VR-NI-ANXC-3P-SSS-F	F2	\$903
11-521-M1PACKG	SEL: THIN4-PACK-G-SSS-F	F2	\$656
11-521-M1PACKP	SEL: THIN4-PACK-P-SSS-F	F2	\$781
11-521-MNYBUNG	SEL: THIN4-NYBUN-G-SSS-F	F2	\$809
11-521-MNYBUNP	SEL: THIN4-NYBUN-P-SSS-F	F2	\$919
11-522-M1G	SEL 11-522-M1G THIN4-STE-G-SSS-F	F2	\$1,155
11-522-M1P	SEL 11-522-M1P THIN4-STE-P-SSS-F	F2	\$1,375
11-523-M1G	SEL 11-523-M1G THIN4-CL-G-SSS-F	F2	\$9
11-523-M1P	SEL 11-523-M1P THIN4-CL-P-SSS-F	F2	\$11
11-572-M1G	SEL: VU4-EN-10-G-SSS-F	F2	\$347
11-572-M1P	SEL: VU4-EN-10-P-SSS-F	F2	\$413
11-574-M1G	SEL: VU4-EN-100-G-SSS-F	F2	\$3,465
11-574-M1P	SEL: VU4-EN-100-P-SSS-F	F2	\$4,125
11-578-M1G	SEL: VU4-EN-STR-G-SSS-F	F2	\$347
11-578-M1P	SEL: VU4-EN-STR-P-SSS-F	F2	\$413
11-579-M1G	SEL: VU4-PR-10-G-SSS-F	F2	\$578
11-579-M1P	SEL: VU4-PR-10-P-SSS-F	F2	\$688
11-581-M1G	SEL: VU4-PR-100-G-SSS-F	F2	\$5,775
11-585-M1G	SEL: VU4-PR-STR-G-SSS-F	F2	\$578
11-585-M1P	SEL: VU4-PR-STR-P-SSS-F	F2	\$688
11-586-M1G	SEL: VU4-PR-U10-G-SSS-F	F2	\$231
11-586-M1P	SEL: VU4-PR-U10-P-SSS-F	F2	\$275
11-587-M1G	SEL: VU4-PR-U100-G-SSS-F	F2	\$2,310
11-587-M1P	SEL: VU4-PR-U100-P-SSS-F	F2	\$2,750
11-591-M1G	SEL: VU4-THINCLA-G-SSS-F	F2	\$48
11-592-M1P	SEL: VU4-PR-100-P-SSS-F	F2	\$6,875
11-593-M1IN	SEL: WS-SUP-1PAK-F	F2	\$54
11-593-M3IN	SEL: WS-SUP-3PAK-F	F2	\$142
11-593-M5IN	SEL: WS-SUP-5PAK-F	F2	\$219
11-593-MWS3G	SEL: WS-3G-SSS-F	F2	\$151
11-593-MWS3P	SEL: WS-3P-SSS-F	F2	\$180
11-593-MWSG	SEL: WS-G-SSS-F	F2	\$57
11-593-MWSP	SEL: WS-P-SSS-F	F2	\$68
11-837-LIC-T1	SEL: S2-ERS4-P-TLSS-T1-F	F2	\$1,375
11-901-M1P	SEL: VU4-PR-A50-P-SSS-F	F2	\$2,063
1271-M1G	SEL 1271-M1G THIN-100PK-G-SSS-F	F2	\$439
1271-M1P	SEL 1271-M1P THIN-100PK-P-SSS-F	F2	\$523
1433-M1G	SEL 1433-M1G VF-DD2-25VM-G-SSS-F	F2	\$4,332
1433-M1P	SEL 1433-M1P VF-DD2-25VM-P-SSS-F	F2	\$5,157
1433-M3G	SEL 1433-M3G VF-DD2-25VM-3G-SSS-F	F2	\$11,436
1433-M3P	SEL 1433-M3P VF-DD2-25VM-3P-SSS-F	F2	\$13,614

1568-M1G	SEL 1568-M1G VF-HYPM5-G-SSS-F	F2	\$83
1568-M1P	SEL 1568-M1P VF-HYPM5-P-SSS-F	F2	\$99
1568-M3G	SEL 1568-M3G VF-HYPM5-3G-SSS-F	F2	\$218
1568-M3P	SEL 1568-M3P VF-HYPM5-3P-SSS-F	F2	\$261
1601-M1G	SEL 1601-M1G HZ-MRG-10-G-SSS-F	F2	\$347
1601-M1P	SEL 1601-M1P HZ-MRG-10-P-SSS-F	F2	\$413
1602-M1G	SEL 1602-M1G HZ-MRG-100-G-SSS-F	F2	\$3,465
1602-M1P	SEL 1602-M1P HZ-MRG-100-P-SSS-F	F2	\$4,125
16G-SERV-APR	SEL-Advanced product repl. 16G optics	F2	\$212
16G-SERV-EWS	SEL-Extended Warranty 16G optics	F2	\$212
200-200000-MM	SEL-MA LDX-E1000 Month	F2	\$688
200-200003-MM	SEL-MA LDX-5108S Month	F2	\$2,614
200-200006-MM	SEL-MA LDX-6204 Month	F2	\$1,569
200-200007-MM	SEL-MA LDX-6208 Month	F2	\$2,614
200-200011-MM	SEL-MA LDX-U1044 Month	F2	\$3,138
200-200014-MM	SEL-MA LDX-E1040 Month	F2	\$2,187
200-200015-MM	SEL-MA LDX-E1004 Month	F2	\$2,187
200-200025-MM	SEL-MA LDX-E1000V-10TB-VW Month	F2	\$335
200-200069-MM	SEL-MA FCS-FCI1-4 Month	F2	\$695
200-200070-MM	SEL-MA ISC-10GC1-4 Month	F2	\$695
200-200072-MM	SEL-MA SMB-10GC2-4 Month	F2	\$695
200-200073-MM	SEL-MA SMB-10GC3-4 Month	F2	\$695
200-200075-MM	SEL-MA NFS-10GC3-4 Month	F2	\$695
200-200076-MM	SEL-MA NFS-10GC4-4 Month	F2	\$695
200-200077-MM	SEL-MA NFS-10GC41-4 Month	F2	\$695
200-200078-MM	SEL-MA HCS-10GC1-4 Month	F2	\$199
200-200079-MM	SEL-MA HCSS-10GC1-4 Month	F2	\$199
200-200080-MM	SEL-MA OSSWT-10GC1-4 Month	F2	\$199
200-200081-MM	SEL-MA AMZS3-10GC1-4 Month	F2	\$199
200-200084-MM	SEL-MA KER-10GC1-4 Month	F2	\$199
200-200086-MM	SEL-MA SMB-10GS2-4 Month	F2	\$491
200-200087-MM	SEL-MA SMB-10GS3-4 Month	F2	\$491
200-200089-MM	SEL-MA IPV6-10GC1-4 Month	F2	\$1,588
200-200090-MM	SEL-MA FCS-FCI1-8 Month	F2	\$1,159
200-200091-MM	SEL-MA ISC-10GC1-8 Month	F2	\$1,159
200-200093-MM	SEL-MA SMB-10GC2-8 Month	F2	\$1,159
200-200094-MM	SEL-MA SMB-10GC3-8 Month	F2	\$1,159
200-200096-MM	SEL-MA NFS-10GC3-8 Month	F2	\$1,159
200-200097-MM	SEL-MA NFS-10GC4-8 Month	F2	\$1,159
200-200098-MM	SEL-MA NFS-10GC41-8 Month	F2	\$1,159
200-200099-MM	SEL-MA HCS-10GC1-8 Month	F2	\$1,159
200-200100-MM	SEL-MA HCSS-10GC1-8 Month	F2	\$332
200-200101-MM	SEL-MA OSSWT-10GC1-8 Month	F2	\$332
200-200102-MM	SEL-MA AMZS3-10GC1-8 Month	F2	\$332
200-200105-MM	SEL-MA KER-10GC1-8 Month	F2	\$332
200-200107-MM	SEL-MA SMB-10GS2-8 Month	F2	\$816
200-200108-MM	SEL-MA SMB-10GS3-8 Month	F2	\$816
200-200110-MM	SEL-MA IPV6-10GC1-8 Month	F2	\$2,647
200-200111-MM	SEL-MA LDXE-APP02 Month	F2	\$464
200-200112-MM	SEL-MA LDXE-APP04 Month	F2	\$695

200-200113-MM	SEL-MA LDXE-APP08 Month	F2	\$1,159
200-200290	SEL-PS LDX Base Wkld Design	F2	\$34,118
200-200291	SEL-PS LDX Sample Wkld Design	F2	\$41,176
200-200292	SEL-PS LDX Prod Wkld Design	F2	\$44,706
200-200293	SEL-PS LDX Prod VW Wkld Design	F2	\$52,941
200-200294	SEL-PS LDX Week Addon	F2	\$17,647
200-200295	SEL-TR LDX Training Class	F2	\$5,882
200-200302-MM	SEL-MA LDX LDX-5104 Month	F2	\$1,569
200-200305-MM	SEL-MA LDX LDX-6204-32G Month	F2	\$3,774
200-200312-MM	SEL-MA NFSv3 NFS-10GS3-4 Month	F2	\$491
200-200313-MM	SEL-MA NFSv3 NFS-10GS3-8 Month	F2	\$816
200-200324-MM	SEL-MA HTTP HTTP-10GS3-4 Month	F2	\$491
200-200325-MM	SEL-MA HTTP HTTP-10GS3-8 Month	F2	\$816
200-200398-MM	SEL-MA FCS FCS-FCI2-4 Month	F2	\$1,738
200-200419-MM	SEL-MA LDX-7104 Month	F2	\$3,774
200-200430-MM	SEL-MA ISC-40GC1-4 Month	F2	\$1,672
200-200432-MM	SEL-MA SMB-40GC2-4 Month	F2	\$1,672
200-200433-MM	SEL-MA SMB-40GC3-4 Month	F2	\$1,672
200-200435-MM	SEL-MA NFS-40GC3-4 Month	F2	\$1,672
200-200437-MM	SEL-MA NFS-40GC3-4 Month	F2	\$1,672
200-200438-MM	SEL-MA NFS-40GC41-4 Month	F2	\$1,672
200-200439-MM	SEL-MA AMZS3-40GC1-4 Month	F2	\$1,672
200-200440-MM	SEL-MA HTTPS-40GC1-4 Month	F2	\$478
200-200441-MM	SEL-MA OSSWT-40GC1-4 Month	F2	\$478
200-200442-MM	SEL-MA AMZS3-40GC1-4 Month	F2	\$478
200-200445-MM	SEL-MA KER-40GC1-4 Month	F2	\$478
200-200450-MM	SEL-MA IPV6-40GC1-4 Month	F2	\$3,821
200-200482-MM	SEL MA 7104-25G 9x5Mo	F2	\$1,918
200-200487-MM	SEL MA ISC-25GC1-4 9x5Mo	F2	\$847
200-200489-MM	SEL MA SMB-25GC2-4 9x5Mo	F2	\$847
200-200490-MM	SEL MA SMB-25GC3-4 9x5Mo	F2	\$847
200-200492-MM	SEL MA NFS-25GC3-4 9x5Mo	F2	\$847
200-200493-MM	SEL MA NFS-25GC4-4 9x5Mo	F2	\$847
200-200494-MM	SEL MA NFS-25GC41-4 9x5Mo	F2	\$847
200-200495-MM	SEL MA HCS-25GC1-4 9x5Mo	F2	\$847
200-200496-MM	SEL MA HCSS-25GC1-4 9x5Mo	F2	\$247
200-200497-MM	SEL MA OSSWT-25GC1-4 9x5Mo	F2	\$247
200-200498-MM	SEL MA AMZS3-25GC1-4 9x5Mo	F2	\$247
200-200501-MM	SEL MA KER-25GC1-4 9x5Mo	F2	\$247
200-200506-MM	SEL MA IPV6-25GC1-4 9x5Mo	F2	\$1,941
200-200519-MM	SEL MA WWisdom E2000 9x5Mo	F2	\$688
200-200520-MM	SEL MA 7104-10G 9x5Mo	F2	\$1,020
200-200521-MM	SEL MA 7108-10G 9x5Mo	F2	\$1,699
200-200522-MM	SEL MA 6204-16G 9x5Mo	F2	\$1,568
200-200523-MM	SEL MA 6208-16G 9x5Mo	F2	\$2,614
200-200524-MM	SEL MA U2022-10G-16FC 9x5Mo	F2	\$1,662
200-200525-MM	SEL MA U2044-10G-16FC 9x5Mo	F2	\$2,771
200-200526-MM	SEL MA BN PROT 10G-2 9x5Mo	F2	\$15,393
200-200527-MM	SEL MA BN PROT 10G-4 9x5Mo	F2	\$7,667
200-200528-MM	SEL MA BN PROT 10G-8 9x5Mo	F2	\$11,500

200-200529-MM	SEL MA BN PROT 25G-4 9x5Mo	F2	\$14,382
200-200530-MM	SEL MA BN PROT 40G-2 9x5Mo	F2	\$12,353
200-200531-MM	SEL MA BN PROT 40G-4 9x5Mo	F2	\$18,529
300003-002	SELECT 1YR-GOLD-GMS-10 - MAINT	F2	\$1,899
300003-002R	SELECT 1YR-GOLD-GMS-10 - MAINT RENEW	F2	\$1,899
300003-005	SELECT 1YR-GOLD-GMS-50 - MAINT	F2	\$5,699
300003-005R	SELECT 1YR-GOLD-GMS-50 - MAINT RENEW	F2	\$5,699
300003-013	SELECT 1YR-GOLD-GMS-25 - MAINT	F2	\$3,799
300003-013R	SELECT 1YR-GOLD-GMS-25 - MAINT RENEW	F2	\$3,799
300011-001R	SEL NX-2600 - RENEWAL 1YR - PLAT	F2	\$1,228
300011-002R	SELNX-2600 - RENEWAL 1YR - GOLD	F2	\$949
300012-001R	SEL NX-2610 - RENEWAL 1YR - PLAT	F2	\$4,179
300012-002R	SEL NX-2610 - RENEWAL 1YR - GOLD	F2	\$2,670
300016-001R	SEL NX-5600 - RENEWAL 1YR - PLAT	F2	\$8,605
300016-002R	SEL NX-5600 - RENEWAL 1YR - GOLD	F2	\$5,811
300017-001R	SEL NX-7600 - RENEWAL 1YR - PLAT	F2	\$13,522
300017-002R	SEL NX-7600 - RENEWAL 1YR - GOLD	F2	\$9,052
300018-001R	SEL NX-8600 - RENEWAL 1YR - PLAT	F2	\$27,605
300018-002R	SEL NX-8600 - RENEWAL 1YR - GOLD	F2	\$24,140
300019-001	SELECT WANSTART 10 HRS - BUNDLED	F2	\$4,118
300032-001R	SEL NX-9610 - RENEWAL 1YR - PLAT	F2	\$44,593
300032-002R	SEL NX-9610 - RENEWAL 1YR - GOLD	F2	\$40,234
300036-001R	SEL NX-3600 - RENEWAL 1YR - PLAT	F2	\$5,408
300036-002R	SEL NX-3600 - RENEWAL 1YR - GOLD	F2	\$3,017
300039-001	SELECT 1YR-PLAT-NX-1700 - MAINT	F2	\$859
300039-001R	SELECT 1YR-PLAT-NX-1700 - MAINT	F2	\$859
300039-002	SELECT 1YR-GOLD-NX-1700 -MAINT	F2	\$664
300039-002R	SELECT 1YR-GOLD-NX-1700 -MAINT	F2	\$949
300040-001	SELECT 1YR-PLAT-NX-5700-MAINT	F2	\$6,638
300040-001R	SELECT 1YR-PLAT-NX-5700-MAINT	F2	\$6,638
300040-002	SELECT 1YR-GOLD-NX-5700-MAINT	F2	\$4,525
300040-002R	SELECT 1YR-GOLD-NX-5700-MAINT	F2	\$4,525
300044-001	SELECT 1YR-PLAT-NX-2700-MAINT	F2	\$2,827
300044-001R	SELECT 1YR-PLAT-NX-2700-MAINT	F2	\$2,827
300044-002	SELECT 1YR-GOLD-NX-2700-MAINT	F2	\$1,798
300044-002R	SELECT 1YR-GOLD-NX-2700-MAINT	F2	\$1,798
300044-003R	SELECT 1YR-PLAT-NX-2700-MAINT	F2	\$2,670
300044-004R	SELECT 1YR-GOLD-NX-2700-MAINT	F2	\$1,698
300045-001	SELECT 1YR-PLAT-NX-3700-MAINT	F2	\$4,917
300045-001R	SELECT 1YR-PLAT-NX-3700-MAINT	F2	\$4,917
300045-002	SELECT 1YR-GOLD-NX-3700-MAINT	F2	\$2,681
300045-002R	SELECT 1YR-GOLD-NX-3700-MAINT	F2	\$2,681
300046-001	SELECT 1YR-PLAT-NX-7700-MAINT	F2	\$13,522
300046-001R	SELECT 1YR-PLAT-NX-7700-MAINT	F2	\$13,522
300046-002	SELECT 1YR-GOLD-NX-7700-MAINT	F2	\$9,052
300046-002R	SELECT 1YR-GOLD-NX-7700-MAINT	F2	\$9,052
300047-001	SELECT NX-9700 MAINT 1YR PLAT	F2	\$38,222
300047-001R	SELECT NX-9700 MAINT 1YR PLAT	F2	\$38,222
300047-002	SELECT NX-9700 MAINT 1YR GOLD	F2	\$34,199
300047-002R	SELECT NX-9700 MAINT 1YR GOLD	F2	\$34,199

300052-001	SELECT 1YR-PLAT-NX-8700 - MAINT	F2	\$27,605
300052-001R	SELECT 1YR-PLAT-NX-8700 - MAINT	F2	\$27,605
300052-002	SELECT 1YR-GOLD-NX-8700-MAINT	F2	\$24,140
300052-002R	SELECT 1YR-GOLD-NX-8700-MAINT	F2	\$24,140
300053-001	SELECT VX-5000 - MAINT 1YR - PLATINUM	F2	\$5,654
300053-001R	SELECT VX-5000 - MAINT 1YR - PLATI	F2	\$5,654
300053-002	SELECT VX-5000 - MAINT 1YR - GOLD	F2	\$3,855
300053-002R	SELECT VX-5000 - MAINT 1YR - GOLD	F2	\$3,855
300054-001	SELECT VX-1000 - MAINT 1YR - PLATINUM	F2	\$491
300054-001R	SELECT VX-1000 - MAINT 1YR - PLAT	F2	\$491
300054-002	SELECT VX-1000 - MAINT 1YR - GOLD	F2	\$379
300054-002R	SELECT VX-1000 - MAINT 1YR - GOLD	F2	\$379
300055-001	SELECT VX-2000 - MAINT 1YR - PLATINUM	F2	\$1,966
300055-002	SELECT VX-2000 - MAINT 1YR - GOLD	F2	\$1,251
300055-003R	SELECT VX-2000 - MAINT 1YR - PLAT	F2	\$1,966
300055-004R	SELECT VX-2000 - MAINT 1YR - GOLD	F2	\$1,251
300056-001	SELECT VX-3000 - MAINT 1YR - PLATINUM	F2	\$3,933
300056-001R	SELECT VX-3000 - MAINT 1YR - PLAT	F2	\$3,933
300056-002	SELECT VX-3000 - MAINT 1YR - GOLD	F2	\$2,145
300056-002R	SELECT VX-3000 - MAINT 1YR - GOLD	F2	\$2,145
300057-001	SELECT 1YR-PLAT- VIRTUAL-GMS-10 - MAINT	F2	\$1,228
300057-001R	SEL 1YR-PLAT- VIRTUAL-GMS-10 - MAINT	F2	\$1,228
300057-002	SELECT 1YR-GOLD-VIRTUAL-GMS-10 - MAINT	F2	\$949
300057-002R	SELECT 1YR-GOLD-VIRTUAL-GMS-10 - MAINT	F2	\$949
300057-005	SELECT 1YR-GOLD-VIRTUAL-GMS-50 - MAINT	F2	\$2,849
300057-005R	SELECT 1YR-GOLD-VIRTUAL-GMS-50 - MAINT	F2	\$2,849
300057-006	SELECT 1YR-PLAT-VIRTUAL-GMS-50 - MAINT	F2	\$3,687
300057-006R	SEL 1YR-PLAT-VIRTUAL-GMS-50 - MAINT	F2	\$3,687
300057-013	SELECT 1YR-GOLD-VIRTUAL-GMS-25 - MAINT	F2	\$1,899
300057-013R	SELECT 1YR-GOLD-VIRTUAL-GMS-25 - MAINT	F2	\$1,899
300057-014	SELECT 1YR-PLAT-VIRTUAL-GMS-25 - MAINT	F2	\$4,916
300057-014R	SELT1YR-PLAT-VIRTUAL-GMS-25 - MAINT	F2	\$4,916
300060-001	SEL GMS-10 ON GX-1100 - MAINT 1YR - PLAT	F2	\$2,458
300060-001R	SEL GMS-10 - GX-1100 - MAINT - PLAT-R	F2	\$2,458
300060-002	SEL GMS-10 ON GX-1100 - MAINT 1YR -GOLD	F2	\$1,899
300060-002R	SEL GMS-10 ON GX-1100 - MAINT GOLD- R	F2	\$1,899
300060-005	SEL GMS-50 ON GX-1100 - MAINT 1YR -GOLD	F2	\$5,699
300060-005R	SEL GMS-50 ON GX-1100 - MAINT GOLD- R	F2	\$5,699
300060-006	SEL GMS-50 ON GX-1100 - MAINT 1YR -PLAT	F2	\$7,375
300060-006R	SEL GMS-50 ON GX-1100 - MAINT PLAT-R	F2	\$7,375
300060-007	SEL GMS-100 ON GX-1100 - MAINT 1YR -GOLD	F2	\$9,499
300060-007R	SEL GMS-100 ON GX-1100 - MAINT GOLD-R	F2	\$9,499
300060-008	SEL GMS-100 ON GX-1100 - MAINT 1YR -PLAT	F2	\$12,293
300060-008R	SEL GMS-100 ON GX-1100 - MAINT PLAT-R	F2	\$12,293
300060-009	SEL GMS-200 ON GX-1100 - MAINT 1YR -GOLD	F2	\$15,199
300060-009R	SEL GMS-200 ON GX-1100 - MAINT GOLD -R	F2	\$15,199
300060-010	SEL GMS-200 ON GX-1100 - MAINT1YR - PLAT	F2	\$19,669
300060-010R	SEL GMS-200 ON GX-1100 - MAINT PLAT-R	F2	\$19,669
300060-011	SEL GMS-500 ON GX-1100 - MAINT 1YR -GOLD	F2	\$28,499
300060-011R	SEL GMS-500 ON GX-1100 - MAINT GOLD-R	F2	\$28,499

300060-012	SEL GMS-500 ON GX-1100 - MAINT 1YR -PLAT	F2	\$36,881
300060-012R	SEL GMS-500 ON GX-1100 - MAINT PLAT-R	F2	\$36,881
300060-013	SEL GMS-25 ON GX-1100 - MAINT 1YR -GOLD	F2	\$3,799
300060-013R	SEL GMS-25 ON GX-1100 - MAINT- GOLD- R	F2	\$3,799
300060-014	SEL GMS-25 ON GX-1100 - MAINT 1YR -PLAT	F2	\$4,917
300060-014R	SEL:GMS-25 ON GX-1100 - MAINT PLAT R	F2	\$4,917
300061-001	SEL VRX-8 - MAINT CONTRACT; 1YR - PLAT	F2	\$17,211
300061-001R	SELECT VRX-8 - MAINT 1YR - PLAT- RENEW	F2	\$17,211
300061-002	SEL VRX-8 - MAINT CONTRACT; 1YR - GOLD	F2	\$13,299
300061-002R	SELECT VRX-8 - MAINT 1YR - GOLD- RENEW	F2	\$13,299
300063-001	SEL NX-10700 - MAINT CONTRACT 1YR - PLAT	F2	\$63,705
300063-001R	SEL NX-10700 MAIN CONTRACT1YR PLAT RENE	F2	\$63,705
300063-002	SEL NX-10700 - MAINT CONTRACT 1YR - GOLD	F2	\$56,999
300063-002R	SEL NX-10700 MAIN CONTRACT1YR GOLD RENE	F2	\$56,999
300068-001	SELECT:VX-1000 1 YR SUBSCRIP; INCL MAINT	F2	\$1,104
300069-001	SEL VX-2000 1 YR SUBSCRIPTION INC MNT	F2	\$4,424
300069-002	SELECT:VX-2000 1 YR SUBSCRIP, INCL MAINT	F2	\$4,178
300070-001	SELECT:VX-3000 1 YR SUBSCRIP; INCL MAINT	F2	\$8,851
300071-001	SELECT:VX-5000 1 YR SUBSCRIP; INCL MAINT	F2	\$12,724
300072-001	SELECT:VRX-8 1 YR SUBSCRIP; INCL MAINT	F2	\$38,731
300073-001	SEL GMS-10 ON GX-V 1 YR SUBSC INCL MAINT	F2	\$2,764
300074-001	SEL GMS-25 ON GX-V 1 YR SUBSC INCL MAINT	F2	\$11,064
300075-001	SEL GMS-50 ON GX-V 1 YR SUBSC INCL MAINT	F2	\$16,597
300076-001	SEL GMS-100 ON GX-V 1 YR SUBSC INC MAINT	F2	\$27,664
300077-001	SEL GMS-200 ON GX-V 1 YR SUBSC INC MAINT	F2	\$44,264
300078-001	SEL GMS-500 ON GX-V 1 YR SUBSC INC MAINT	F2	\$82,997
300079-001	SEL GMS-1000 ON GX-V 1 YR SUBS INC MAINT	F2	\$138,331
300080-001	SEL GMS-2000 ON GX-V 1 YR SUBS INC MAINT	F2	\$193,664
300085-001	SEL VX-500 - MAINT CONTRACT 1YR - PLAT	F2	\$245
300085-001R	SEL VX-500 - RENEWAL CONTRACT 1YR -PLAT	F2	\$245
300085-002	SEL VX-500 - MAINT CONTRACT 1YR - GOLD	F2	\$189
300085-002R	SEL VX-500 - RENEWAL CONTRACT 1YR-GOLD	F2	\$189
300086-001	SEL VX-6000 - MAINT CONTRACT 1YR - PLAT	F2	\$8,113
300086-001R	SEL VX-6000 - RENEWAL CONTRACT 1YR-PLAT	F2	\$8,113
300086-002	SEL VX-6000 - MAINT CONTRACT 1YR - GOLD	F2	\$5,531
300086-002R	SEL VX-6000 - RENEWAL CONTRACT 1YR-GOLD	F2	\$5,531
300087-001	SEL VX-7000 - MAINT CONTRACT PLAT	F2	\$11,801
300087-001R	SEL VX-7000 - RENEWAL CONTRACT PLAT	F2	\$11,801
300087-002	SEL VX-7000 - MAINT CONTRACT 1YR - GOLD	F2	\$7,968
300087-002R	SEL VX-7000 - RENEWAL CONTRACT 1YR-GOLD	F2	\$7,968
300099-001	SEL VX-8000 - MAINT CONTRACT 1YR - PLAT	F2	\$17,211
300099-001R	SEL VX-8000 - RENEWAL CONTRACT 1YR -PLAT	F2	\$17,211
300099-002	SEL VX-8000 - MAINT CONTRACT, 1YR - GOLD	F2	\$13,299
300099-002R	SEL VX-8000 - RENEWAL CONTRACT 1YR -GOLD	F2	\$13,299
300100-001	SEL VX-9000 - MAINT CONTRACT 1YR - PLAT	F2	\$24,587
300100-001R	SEL VX-9000 - RENEWAL CONTRACT,1YR -PLAT	F2	\$24,587
300100-002	SEL VX-9000 - MAINT CONTRACT, 1YR - GOLD	F2	\$18,999
300100-002R	SEL VX-9000 - RENEWAL CONTRACT 1YR -GOLD	F2	\$18,999
300101-001	SEL VRX-2 - MAINT CONTRACT, 1YR - PLAT	F2	\$1,228
300101-001R	SEL VRX-2 - RENEWAL CONTRACT, 1YR - PLAT	F2	\$1,228

300101-002	SEL VRX-2 - MAINT CONTRACT, 1YR - GOLD	F2	\$815
300101-002R	SEL VRX-2 - RENEWAL CONTRACT, 1YR - GOLD	F2	\$815
300102-001	SEL VRX-4 - MAINT CONTRACT, 1YR - PLAT	F2	\$3,687
300102-001R	SEL VRX-4 - RENEWAL CONTRACT, 1YR - PLAT	F2	\$3,687
300102-002	SEL VRX-4 - MAINT CONTRACT, 1YR - GOLD	F2	\$2,491
300102-002R	SEL VRX-4 - RENEWAL CONTRACT, 1YR - GOLD	F2	\$2,491
300111-001	SEL NX-11700 - MAINT CONTRACT 1YR - PLAT	F2	\$84,940
300111-001R	SEL NX-11700 - RENEW CONTRACT 1YR - PLAT	F2	\$84,940
300111-002	SEL NX-11700 - MAINT CONTRACT 1YR - GOLD	F2	\$75,999
300111-002R	SEL NX-11700 - RENEW CONTRACT 1YR - GOLD	F2	\$75,999
300116-001	SEL NX-6700 - MAINT CONTRACT, 1YR - PLAT	F2	\$9,342
300116-002	SEL NX-6700 - MAINT CONTRACT, 1YR - GOLD	F2	\$6,369
300129-001	SEL VRX-6 - MAINT CONTRACT, 1YR - PLAT	F2	\$8,113
300129-001R	SEL VRX-6 - RENEWAL CONTRACT, 1YR - PLAT	F2	\$8,113
300129-002	SEL VRX-6 - MAINT CONTRACT, 1YR - GOLD	F2	\$5,531
300129-002R	SEL VRX-6 - RENEWAL CONTRACT, 1YR - GOLD	F2	\$5,531
456-112-120	Bandwidth Overage For DC SUB=MA	F2	\$5
456-112-122	Bandwidth For DC SUB=MA	F2	\$0
500047-001	SELECT VX-2000; VIRTUAL; 10Mbps	F2	\$10,127
90940500	SEL: PS;ONSITE INSTALL;BASE;T950	F2	\$10,500
90940502SL	SEL: PS,EXPN FRM INSTL,W-BASE,T950	F2	\$3,800
90940503SL	SEL: PS,EXPN FRM INSTL,UPGRD,T950	F2	\$7,250
90940504SL	SEL: PS,ONSITE TRAIN-CNSLT DAY,T950	F2	\$3,200
90940505SL	SEL: PS,ONSITE TRAIN-CNSL WEEK,T950	F2	\$14,400
90940511SL	SEL: PS,RELO-RECONNECT BUSINESS HRS	F2	\$2,400
90940523	SEL: ENCRYPTION;PROF;SUPPORT;T950	F2	\$1,091
90940523Z2	SEL: ENCRYPTION,PROF,SUPPORT,T950,Z2	F2	\$1,206
90940535SL	SEL: PS,ENCRYPTION EXPRESS PRO,T950	F2	\$7,600
90940538SL	SEL: PS,ANNUAL PREVENT MNTCE,T950	F2	\$6,000
90940557SL	SEL: PS,ONSITE INSTALL,BASE,TFIN	F2	\$13,900
90940558SL	SEL: PS,EX-SRV FRM INST,W-BASE,TFIN	F2	\$4,750
90940559SL	SEL: PS,EX-SRV FRM INST,UPGRD,TFIN	F2	\$9,200
90940560SL	SEL: PS,ONSITE TRAIN-CNSLT DAY,TFIN	F2	\$3,200
90940561SL	SEL: PS,ONSITE TRAIN-CNSL WEEK,TFIN	F2	\$14,400
90940567SL	SEL: PS,ANNUAL PREVENT MNTCE,TFIN	F2	\$6,000
90940570	SEL: ENCRYPTION;PROF;SUPPORT;TFIN	F2	\$1,091
90940570Z2	SEL: ENCRYPTION,PROF,SUPPORT,TFIN,Z2	F2	\$1,206
90940572SL	SEL: PS,BS12 UPG 1 PREV MAINT VISIT	F2	\$2,400
90940573SL	SEL: PS,SINGLE PREVENT MNTCE,T950	F2	\$2,400
90940574SL	SEL: PS,SINGLE PREVENT MNTCE,TFIN	F2	\$2,400
90940590	SEL: PS, POWER RAIL INSTALL	F2	\$3,800
90950511	SEL: PS;T120 INSTALL-INTEGRATE	F2	\$5,000
90950516	SEL: ENCRYPTION;PROF;SUPPORT;T120	F2	\$1,091
90950516Z2	SEL: ENCRYPTION,PROF,SUPPORT,T120,Z2	F2	\$1,206
90950524SL	SEL: PS,DBA-TBA INSTALL	F2	\$3,200
90950530SL	SEL: PS,ONSITE TRAIN-CNSLT DAY,T120	F2	\$3,200
90950532SL	SEL: PS,ANNUAL PREVENT MNTCE,T120	F2	\$6,000
90950538SL	SEL: PS,SINGLE PREVENT MNTCE,T120	F2	\$2,400
90970522	SEL: ENCRYPTION SUPPORT;PROF;T50	F2	\$1,091
90970522Z2	SEL: ENCRYPTION SUPPORT,PROF,T50,Z2	F2	\$1,206

90970531SL	SEL: PS,2-HOUR PHONE CONSULT,T50E	F2	\$550
90970534	SEL: PS,PHONE CONSULT/PREP,INSTALL	F2	\$800
90970535	SEL: PS,ONSITE TRAIN/CNSLT DAY,T50E	F2	\$3,200
91010507	SEL: ENCRYPTION SUPPORT;PROF;T380	F2	\$1,091
91010507Z2	SEL: ENCRYPTION SUPPORT,PROF,T380,Z2	F2	\$1,206
91010508	SEL: PS;T380 INSTALL-INTEGRATE	F2	\$7,200
91010516	SEL: ENCRYPTION SUPPORT;PROF;T200	F2	\$1,091
91010516Z2	SEL: ENCRYPTION SUPPORT,PROF,T200,Z2	F2	\$1,206
91010517	SEL: PS;T200 INSTALL-INTEGRATE	F2	\$6,000
91010525	SEL: ENCRYPTION SUPPORT;PROF;T680	F2	\$1,091
91010525Z2	SEL: ENCRYPTION SUPPORT,PROF,T680,Z2	F2	\$1,206
91010526	SEL: PS;T680 INSTALL-INTEGRATE	F2	\$7,200
91010533SL	SEL: PS,ONSITE TRAIN-CNSLT DAY,T200	F2	\$3,200
91010535SL	SEL: PS,ANNUAL PREVENT MNTCE,T200	F2	\$6,000
91010543SL	SEL: PS,ONSITE TRAIN-CNSLT DAY,T380	F2	\$3,200
91010545SL	SEL: PS,ANNUAL PREVENT MNTCE,T380	F2	\$6,000
91010553SL	SEL: PS,ONSITE TRAIN-CNSLT DAY,T680	F2	\$3,200
91010555SL	SEL: PS,ANNUAL PREVENT MNTCE,T680	F2	\$6,000
91010565SL	SEL: PS,SINGLE PREVENT MNTCE,T200	F2	\$2,400
91010566SL	SEL: PS,SINGLE PREVENT MNTCE,T380	F2	\$2,400
91010567SL	SEL: PS,SINGLE PREVENT MNTCE,T680	F2	\$2,400
ADDSTUDENTTRNG	SEL Additional Student Private Trng	F2	\$1,176
AE-0-50MS	SEL Automation Engine MS	F2	\$23
AE-1001-1500MS	SEL Automation Engine MS	F2	\$7
AE-100K-150KMC	SEL Automation Engine M24*7	F2	\$6
AE-100K-150KMS	SEL Automation Engine MS	F2	\$3
AE-101-250MS	SEL Automation Engine MS	F2	\$13
AE-10K-20KMC	SEL Automation Engine M24*7	F2	\$7
AE-10K-20KMS	SEL Automation Engine MS	F2	\$4
AE-1501-2000MS	SEL Automation Engine MS	F2	\$6
AE-150K-MC	SEL Automation Engine M24*7	F2	\$6
AE-150K-MS	SEL Automation Engine MS	F2	\$3
AE-2001-2500MS	SEL Automation Engine MS	F2	\$6
AE-20K-35KMC	SEL Automation Engine M24*7	F2	\$7
AE-20K-35KMS	SEL Automation Engine MS	F2	\$4
AE-2501-4000MS	SEL Automation Engine MS	F2	\$5
AE-251-500MS	SEL Automation Engine MS	F2	\$10
AE-35K-50KMC	SEL Automation Engine M24*7	F2	\$6
AE-35K-50KMS	SEL Automation Engine MS	F2	\$4
AE-4001-6000MC	SEL Automation Engine M24*7	F2	\$8
AE-4001-6000MS	SEL Automation Engine MS	F2	\$5
AE-501-750MS	SEL Automation Engine MS	F2	\$8
AE-50K-100KMC	SEL Automation Engine M24*7	F2	\$6
AE-50K-100KMS	SEL Automation Engine MS	F2	\$4
AE-51-100MS	SEL Automation Engine MS	F2	\$16
AE-6001-8000MC	SEL Automation Engine M24*7	F2	\$8
AE-6001-8000MS	SEL Automation Engine MS	F2	\$4
AE-751-1000MS	SEL Automation Engine MS	F2	\$7
AE-8001-10KMC	SEL Automation Engine M24*7	F2	\$7
AE-8001-10KMS	SEL Automation Engine MS	F2	\$4

A-EDU-PV-1D-16MX	SEL Trning- 1 Day- 16 Students max	F2	\$12,235
A-EDU-PV-1D-6MX	SEL Trning- 1 Day- 6 Students max	F2	\$7,647
A-EDU-PV-ADD1-1D	SEL Training 1 Add Student for 1dayclass	F2	\$765
A-HDP-CONS-JMP	SEL- HDP JumpStart Services	F2	\$18,353
AMP-SVC-SECUP-1	SEL-SECURE UPLIFT SUPPORT, AMP-1yr	F2	\$750
AMP-SVC-SECUP-2	SEL-SECURE UPLIFT SUPPORT, AMP-2yr	F2	\$1,425
AMP-SVC-SECUP-3	SEL-SECURE UPLIFT SUPPORT, AMP-3yr	F2	\$2,063
AMP-SVC-SECUP-4	SEL-SECURE UPLIFT SUPPORT, AMP-4yr	F2	\$2,750
AMP-SVC-SECUP-5	SEL-SECURE UPLIFT SUPPORT, AMP-5yr	F2	\$3,438
AMP-SVS-4OS-1	SEL ESSENTIAL 4HR ONSITE SUPPORT-AMP 1yr	F2	\$37,500
AMP-SVS-4OS-2	SEL ESSENTIAL 4HR ONSITE SUPPORT-AMP 2yr	F2	\$71,250
AMP-SVS-4OS-3	SEL ESSENTIAL 4HR ONSITE SUPPORT-AMP 3yr	F2	\$103,125
AMP-SVS-4OS-4	SEL ESSENTIAL 4HR ONSITE SUPPORT-AMP 4yr	F2	\$137,500
AMP-SVS-4OS-5	SEL ESSENTIAL 4HR ONSITE SUPPORT-AMP 5yr	F2	\$171,875
AMP-SVS-4P-1	SEL ESSENTIAL 4HR PARTS ONLY SPT-AMP 1yr	F2	\$30,000
AMP-SVS-4P-2	SEL ESSENTIAL 4HR PARTS ONLY SPT-AMP 2yr	F2	\$57,000
AMP-SVS-4P-3	SEL ESSENTIAL 4HR PARTS ONLY SPT-AMP 3yr	F2	\$82,500
AMP-SVS-4P-4	SEL ESSENTIAL 4HR PARTS ONLY SPT-AMP 4yr	F2	\$110,000
AMP-SVS-4P-5	SEL ESSENTIAL 4HR PARTS ONLY SPT-AMP 5yr	F2	\$137,500
AMP-SVS-NDO-1	SEL ESSENTIAL NBD ONSITE SUPPORT-AMP 1yr	F2	\$23,440
AMP-SVS-NDO-2	SEL ESSENTIAL NBD ONSITE SUPPORT-AMP 2yr	F2	\$44,536
AMP-SVS-NDO-3	SEL ESSENTIAL NBD ONSITE SUPPORT-AMP 3yr	F2	\$64,460
AMP-SVS-NDO-4	SEL ESSENTIAL NBD ONSITE SUPPORT-AMP 4yr	F2	\$85,947
AMP-SVS-NDO-5	SEL ESSENTIAL NBD ONSITE SUPPORT-AMP 5yr	F2	\$107,433
AMP-SVS-NDP-1	SEL ESSENTIAL NBD PARTS ONLY SPT-AMP 1yr	F2	\$18,750
AMP-SVS-NDP-2	SEL ESSENTIAL NBD PARTS ONLY SPT-AMP 2yr	F2	\$35,625
AMP-SVS-NDP-3	SEL ESSENTIAL NBD PARTS ONLY SPT-AMP 3yr	F2	\$51,563
AMP-SVS-NDP-4	SEL ESSENTIAL NBD PARTS ONLY SPT-AMP 4yr	F2	\$68,750
AMP-SVS-NDP-5	SEL ESSENTIAL NBD PARTS ONLY SPT-AMP 5yr	F2	\$85,938
AMP-SVS-RTF-1	SEL ESSENTIAL RTN TO FACTORY SPT-AMP 1yr	F2	\$15,940
AMP-SVS-RTF-2	SEL ESSENTIAL RTN TO FACTORY SPT-AMP 2yr	F2	\$30,286
AMP-SVS-RTF-3	SEL ESSENTIAL RTN TO FACTORY SPT-AMP 3yr	F2	\$43,835
AMP-SVS-RTF-4	SEL ESSENTIAL RTN TO FACTORY SPT-AMP 4yr	F2	\$58,447
AMP-SVS-RTF-5	SEL ESSENTIAL RTN TO FACTORY SPT-AMP 5yr	F2	\$73,058
APPLXTNDR-5-E	DSE - REMOTE 5HR - APPLXTENDER FAMILY	F2	\$45,000
AVADVC1003GC	SEL AV-ADVC-100-3G-SSS-C)	F2	\$8,567
AVADVC1003GC-I	SEL AV-ADVC-100-3G-SSS-C)	F2	\$8,952
AVADVC1003GC-K	SEL AV-ADVC-100-3G-SSS-C)	F2	\$9,182
AVADVC1003PC	SEL AV-ADVC-100-3P-SSS-C)	F2	\$10,198
AVADVC1003PC-I	SEL AV-ADVC-100-3P-SSS-C)	F2	\$10,657
AVADVC1003PC-K	SEL AV-ADVC-100-3P-SSS-C)	F2	\$10,930
AVADVC100GC	SEL AV-ADVC-100-G-SSS-C)	F2	\$3,245
AVADVC100GC-I	SEL AV-ADVC-100-G-SSS-C)	F2	\$3,391
AVADVC100GC-K	SEL AV-ADVC-100-G-SSS-C)	F2	\$3,478
AVADVC100PC	SEL AV-ADVC-100-P-SSS-C)	F2	\$3,863
AVADVC100PC-I	SEL AV-ADVC-100-P-SSS-C)	F2	\$4,037
AVADVC100PC-K	SEL AV-ADVC-100-P-SSS-C)	F2	\$4,140
AVADVC103GC	SEL AV-ADVC-10-3G-SSS-C)	F2	\$855
AVADVC103GC-I	SEL AV-ADVC-10-3G-SSS-C)	F2	\$894
AVADVC103GC-K	SEL AV-ADVC-10-3G-SSS-C)	F2	\$917

AVADVC103PC	SEL AV-ADVC-10-3P-SSS-C)	F2	\$1,019
AVADVC103PC-I	SEL AV-ADVC-10-3P-SSS-C)	F2	\$1,065
AVADVC103PC-K	SEL AV-ADVC-10-3P-SSS-C)	F2	\$1,092
AVADVC10GC	SEL AV-ADVC-10-G-SSS-C)	F2	\$324
AVADVC10GC-I	SEL AV-ADVC-10-G-SSS-C)	F2	\$339
AVADVC10GC-K	SEL AV-ADVC-10-G-SSS-C)	F2	\$347
AVADVC10PC	SEL AV-ADVC-10-P-SSS-C)	F2	\$386
AVADVC10PC-I	SEL AV-ADVC-10-P-SSS-C)	F2	\$403
AVADVC10PC-K	SEL AV-ADVC-10-P-SSS-C)	F2	\$414
AVADVN1003GC	SEL AV-ADV-100-3G-SSS-C)	F2	\$5,684
AVADVN1003GC-I	SEL AV-ADV-100-3G-SSS-C)	F2	\$5,940
AVADVN1003GC-K	SEL AV-ADV-100-3G-SSS-C)	F2	\$6,092
AVADVN1003PC	SEL AV-ADV-100-3P-SSS-C)	F2	\$6,766
AVADVN1003PC-I	SEL AV-ADV-100-3P-SSS-C)	F2	\$7,071
AVADVN1003PC-K	SEL AV-ADV-100-3P-SSS-C)	F2	\$7,252
AVADVN100GC	SEL AV-ADV-100-G-SSS-C)	F2	\$2,153
AVADVN100GC-I	SEL AV-ADV-100-G-SSS-C)	F2	\$2,250
AVADVN100GC-K	SEL AV-ADV-100-G-SSS-C)	F2	\$2,308
AVADVN100PC	SEL AV-ADV-100-P-SSS-C)	F2	\$2,563
AVADVN100PC-I	SEL AV-ADV-100-P-SSS-C)	F2	\$2,678
AVADVN100PC-K	SEL AV-ADV-100-P-SSS-C)	F2	\$2,747
AVADVN103GC	SEL AV-ADV-10-3G-SSS-C)	F2	\$568
AVADVN103GC-I	SEL AV-ADV-10-3G-SSS-C)	F2	\$593
AVADVN103GC-K	SEL AV-ADV-10-3G-SSS-C)	F2	\$608
AVADVN103PC	SEL AV-ADV-10-3P-SSS-C)	F2	\$676
AVADVN103PC-I	SEL AV-ADV-10-3P-SSS-C)	F2	\$706
AVADVN103PC-K	SEL AV-ADV-10-3P-SSS-C)	F2	\$724
AVADVN10GC	SEL AV-ADV-10-G-SSS-C)	F2	\$215
AVADVN10GC-I	SEL AV-ADV-10-G-SSS-C)	F2	\$225
AVADVN10GC-K	SEL AV-ADV-10-G-SSS-C)	F2	\$230
AVADVN10PC	SEL AV-ADV-10-P-SSS-C)	F2	\$256
AVADVN10PC-I	SEL AV-ADV-10-P-SSS-C)	F2	\$268
AVADVN10PC-K	SEL AV-ADV-10-P-SSS-C)	F2	\$274
AVENTC1003GC	SEL AV-ENTC-100-3G-SSS-C)	F2	\$10,285
AVENTC1003GC-I	SEL AV-ENTC-100-3G-SSS-C)	F2	\$10,748
AVENTC1003GC-K	SEL AV-ENTC-100-3G-SSS-C)	F2	\$11,024
AVENTC1003PC	SEL AV-ENTC-100-3P-SSS-C)	F2	\$12,244
AVENTC1003PC-I	SEL AV-ENTC-100-3P-SSS-C)	F2	\$12,795
AVENTC1003PC-K	SEL AV-ENTC-100-3P-SSS-C)	F2	\$13,123
AVENTC100GC	SEL AV-ENTC-100-G-SSS-C)	F2	\$3,896
AVENTC100GC-I	SEL AV-ENTC-100-G-SSS-C)	F2	\$4,071
AVENTC100GC-K	SEL AV-ENTC-100-G-SSS-C)	F2	\$4,176
AVENTC100PC	SEL AV-ENTC-100-P-SSS-C)	F2	\$4,638
AVENTC100PC-I	SEL AV-ENTC-100-P-SSS-C)	F2	\$4,847
AVENTC100PC-K	SEL AV-ENTC-100-P-SSS-C)	F2	\$4,971
AVENTC103GC	SEL AV-ENTC-10-3G-SSS-C)	F2	\$1,030
AVENTC103GC-I	SEL AV-ENTC-10-3G-SSS-C)	F2	\$1,076
AVENTC103GC-K	SEL AV-ENTC-10-3G-SSS-C)	F2	\$1,104
AVENTC103PC	SEL AV-ENTC-10-3P-SSS-C)	F2	\$1,225
AVENTC103PC-I	SEL AV-ENTC-10-3P-SSS-C)	F2	\$1,280

AVENTC103PC-K	SEL AV-ENTC-10-3P-SSS-C)	F2	\$1,313
AVENTC10GC	SEL AV-ENTC-10-G-SSS-C)	F2	\$390
AVENTC10GC-I	SEL AV-ENTC-10-G-SSS-C)	F2	\$408
AVENTC10GC-K	SEL AV-ENTC-10-G-SSS-C)	F2	\$418
AVENTC10PC	SEL AV-ENTC-10-P-SSS-C)	F2	\$464
AVENTC10PC-I	SEL AV-ENTC-10-P-SSS-C)	F2	\$485
AVENTC10PC-K	SEL AV-ENTC-10-P-SSS-C)	F2	\$497
AVENTN1003GC	SEL AV-ENTN-100-3G-SSS-C)	F2	\$6,848
AVENTN1003GC-I	SEL AV-ENTN-100-3G-SSS-C)	F2	\$7,156
AVENTN1003GC-K	SEL AV-ENTN-100-3G-SSS-C)	F2	\$7,340
AVENTN1003PC	SEL AV-ENTN-100-3P-SSS-C)	F2	\$8,152
AVENTN1003PC-I	SEL AV-ENTN-100-3P-SSS-C)	F2	\$8,519
AVENTN1003PC-K	SEL AV-ENTN-100-3P-SSS-C)	F2	\$8,738
AVENTN100GC	SEL AV-ENTN-100-G-SSS-C)	F2	\$2,594
AVENTN100GC-I	SEL AV-ENTN-100-G-SSS-C)	F2	\$2,711
AVENTN100GC-K	SEL AV-ENTN-100-G-SSS-C)	F2	\$2,780
AVENTN100PC	SEL AV-ENTN-100-P-SSS-C)	F2	\$3,088
AVENTN100PC-I	SEL AV-ENTN-100-P-SSS-C)	F2	\$3,227
AVENTN100PC-K	SEL AV-ENTN-100-P-SSS-C)	F2	\$3,310
AVENTN103GC	SEL AV-ENTN-10-3G-SSS-C)	F2	\$684
AVENTN103GC-I	SEL AV-ENTN-10-3G-SSS-C)	F2	\$715
AVENTN103GC-K	SEL AV-ENTN-10-3G-SSS-C)	F2	\$733
AVENTN103PC	SEL AV-ENTN-10-3P-SSS-C)	F2	\$816
AVENTN103PC-I	SEL AV-ENTN-10-3P-SSS-C)	F2	\$852
AVENTN103PC-K	SEL AV-ENTN-10-3P-SSS-C)	F2	\$874
AVENTN10GC	SEL AV-ENTN-10-G-SSS-C)	F2	\$259
AVENTN10GC-I	SEL AV-ENTN-10-G-SSS-C)	F2	\$271
AVENTN10GC-K	SEL AV-ENTN-10-G-SSS-C)	F2	\$278
AVENTN10PC	SEL AV-ENTN-10-P-SSS-C)	F2	\$309
AVENTN10PC-I	SEL AV-ENTN-10-P-SSS-C)	F2	\$323
AVENTN10PC-K	SEL AV-ENTN-10-P-SSS-C)	F2	\$331
AVSTDC1003GC	SEL AV-STDC-100-3G-SSS-C)	F2	\$5,156
AVSTDC1003GC-I	SEL AV-STDC-100-3G-SSS-C)	F2	\$5,388
AVSTDC1003GC-K	SEL AV-STDC-100-3G-SSS-C)	F2	\$5,526
AVSTDC1003PC	SEL AV-STDC-100-3P-SSS-C)	F2	\$6,138
AVSTDC1003PC-I	SEL AV-STDC-100-3P-SSS-C)	F2	\$6,414
AVSTDC1003PC-K	SEL AV-STDC-100-3P-SSS-C)	F2	\$6,579
AVSTDC100GC	SEL AV-STDC-100-G-SSS-C)	F2	\$1,953
AVSTDC100GC-I	SEL AV-STDC-100-G-SSS-C)	F2	\$2,041
AVSTDC100GC-K	SEL AV-STDC-100-G-SSS-C)	F2	\$2,093
AVSTDC100PC	SEL AV-STDC-100-P-SSS-C)	F2	\$2,325
AVSTDC100PC-I	SEL AV-STDC-100-P-SSS-C)	F2	\$2,430
AVSTDC100PC-K	SEL AV-STDC-100-P-SSS-C)	F2	\$2,492
AVSTDC103GC	SEL AV-STDC-10-3G-SSS-C)	F2	\$515
AVSTDC103GC-I	SEL AV-STDC-10-3G-SSS-C)	F2	\$538
AVSTDC103GC-K	SEL AV-STDC-10-3G-SSS-C)	F2	\$552
AVSTDC103PC	SEL AV-STDC-10-3P-SSS-C)	F2	\$615
AVSTDC103PC-I	SEL AV-STDC-10-3P-SSS-C)	F2	\$643
AVSTDC103PC-K	SEL AV-STDC-10-3P-SSS-C)	F2	\$659
AVSTDC10GC	SEL AV-STDC-10-G-SSS-C)	F2	\$195

AVSTDC10GC-I	SEL AV-STDC-10-G-SSS-C)	F2	\$204
AVSTDC10GC-K	SEL AV-STDC-10-G-SSS-C)	F2	\$209
AVSTDC10PC	SEL AV-STDC-10-P-SSS-C)	F2	\$233
AVSTDC10PC-I	SEL AV-STDC-10-P-SSS-C)	F2	\$243
AVSTDC10PC-K	SEL AV-STDC-10-P-SSS-C)	F2	\$250
AVSTDN1003GC	SEL AV-STDN-100-3G-SSS-C)	F2	\$3,437
AVSTDN1003GC-I	SEL AV-STDN-100-3G-SSS-C)	F2	\$3,592
AVSTDN1003GC-K	SEL AV-STDN-100-3G-SSS-C)	F2	\$3,684
AVSTDN1003PC	SEL AV-STDN-100-3P-SSS-C)	F2	\$4,092
AVSTDN1003PC-I	SEL AV-STDN-100-3P-SSS-C)	F2	\$4,276
AVSTDN1003PC-K	SEL AV-STDN-100-3P-SSS-C)	F2	\$4,386
AVSTDN100GC	SEL AV-STDN-100-G-SSS-C)	F2	\$1,302
AVSTDN100GC-I	SEL AV-STDN-100-G-SSS-C)	F2	\$1,361
AVSTDN100GC-K	SEL AV-STDN-100-G-SSS-C)	F2	\$1,395
AVSTDN100PC	SEL AV-STDN-100-P-SSS-C)	F2	\$1,550
AVSTDN100PC-I	SEL AV-STDN-100-P-SSS-C)	F2	\$1,620
AVSTDN100PC-K	SEL AV-STDN-100-P-SSS-C)	F2	\$1,661
AVSTDN103GC	SEL AV-STDN-10-3G-SSS-C)	F2	\$343
AVSTDN103GC-I	SEL AV-STDN-10-3G-SSS-C)	F2	\$359
AVSTDN103GC-K	SEL AV-STDN-10-3G-SSS-C)	F2	\$368
AVSTDN103PC	SEL AV-STDN-10-3P-SSS-C)	F2	\$409
AVSTDN103PC-I	SEL AV-STDN-10-3P-SSS-C)	F2	\$428
AVSTDN103PC-K	SEL AV-STDN-10-3P-SSS-C)	F2	\$439
AVSTDN10GC	SEL AV-STDN-10-G-SSS-C)	F2	\$130
AVSTDN10GC-I	SEL AV-STDN-10-G-SSS-C)	F2	\$136
AVSTDN10GC-K	SEL AV-STDN-10-G-SSS-C)	F2	\$139
AVSTDN10PC	SEL AV-STDN-10-P-SSS-C)	F2	\$155
AVSTDN10PC-I	SEL AV-STDN-10-P-SSS-C)	F2	\$162
AVSTDN10PC-K	SEL AV-STDN-10-P-SSS-C)	F2	\$166
BDEDUAPPONS	SEL BlueData App Admin Training	F2	\$29,412
BDEDUCUSTOMONS	SEL BlueData Custom Training	F2	\$29,412
BDEDUDEVONS	SEL BlueData App Dev Training	F2	\$29,412
BDEDUPLTONS	SEL BlueData Platform Admin Training	F2	\$29,412
BDPS1ACCEL	SEL BlueData EPIC Accelerator Deployment	F2	\$58,824
BDPS1IMDVBASE	SEL App Store Image Development	F2	\$35,294
BDPS1IMDVIMG	SEL App Store Single Image Development	F2	\$17,647
BDPS1IMDVPLAN	SEL App Store Custom Image Design	F2	\$47,059
BDPSES1CUSTOM	SEL BlueData Service Credits	F2	\$1,176
BM-API-PS-O	SEL BOOMI API ProServ Hourly Onsite	F2	\$275
BM-API-PS-R	SEL BOOMI API ProServ-Hourly Remote	F2	\$225
BM-E-MS-LVL1	SEL BOOMI EDI Mngd Services 1-10 (PPP)	F2	\$1,000
BM-E-MS-LVL2	SEL BOOMI EDI Mngd Services 11-20 (PPP)	F2	\$875
BM-E-MS-LVL3	SEL BOOMI EDI Mngd Services 21-35 (PPP)	F2	\$750
BM-E-MS-LVL4	SEL BOOMI EDI Mngd Services 36-50 (PPP)	F2	\$625
BM-E-MS-LVL5	SEL BOOMI EDI Mngd Services 51-100 (PPP)	F2	\$500
BM-E-MS-LVL6	SEL BOOMI EDI Mngd Services >100 (PPP)	F2	\$375
BM-E-PS-CO	SEL BOOMI EDI ProServ-Hourly Onsite	F2	\$275
BM-E-PS-CR	SEL BOOMI EDI ProServ-Hourly Remote	F2	\$225
BM-F-PS-CO	SEL BOOMI Flow ProServ-Hourly Onsite	F2	\$275
BM-F-PS-CR	SEL BOOMI Flow ProServ-Hourly Remote	F2	\$225

BM-I-LC-PPA-1	SEL BOOMI Premier Plus Adjustment .01	F2	\$0
BM-I-LC-PPA-2	SEL BOOMI Premier Plus Adjustment 1	F2	\$1
BM-I-LC-PPA-3	SEL BOOMI Premier Plus Adjustment 100	F2	\$100
BM-I-LC-PPA-4	SEL BOOMI Premier Plus Adjustment 1000	F2	\$1,000
BM-I-LC-PPL-1	SEL BOOMI Premier Plus .01	F2	\$0
BM-I-LC-PPL-2	SEL BOOMI Premier Plus 1	F2	\$1
BM-I-LC-PPL-3	SEL BOOMI Premier Plus 100	F2	\$100
BM-I-LC-PPL-4	SEL BOOMI Premier Plus 1000	F2	\$1,000
BM-I-LC-PS-0	SEL BOOMI Premier Support .00	F2	\$0
BM-I-LC-PS-1	SEL BOOMI Premier Support .01	F2	\$0
BM-I-LC-PS-2	SEL BOOMI Premier Support 1	F2	\$1
BM-I-LC-PS-3	SEL BOOMI Premier Support 100	F2	\$100
BM-I-LC-PS-4	SEL BOOMI Premier Support 1000	F2	\$1,000
BM-I-LCS-SS	SEL BOOMI Standard Support	F2	\$0
BM-I-PS-CO	SEL BOOMI ProServ-Hourly Consult Onsite	F2	\$275
BM-I-PS-CR	SEL BOOMI ProServ-Hourly Consult Remote	F2	\$225
BM-I-PS-DAP	SEL BOOMI ProServ-Delivery Assurance Pgm	F2	\$225
BM-I-PS-IAW	SEL BOOMI Int Accel Workday/WD OT Fee	F2	\$17,500
BM-I-PS-IPSCO	SEL BOOMI iPaaS ProServ-Hourly Onsite	F2	\$275
BM-I-PS-IPSCR	SEL BOOMI iPaaS ProServ-Hourly Remote	F2	\$225
BM-I-PS-JS	SEL BOOMI ProServ-JumpStart - 5 hours	F2	\$2,000
BM-I-PS-NSAS	SEL BOOMI NS/SF Int Accl Service OT Fee	F2	\$3,800
BM-I-PS-TACO	SEL BOOMI TechArch-Hourly Consult Onsite	F2	\$300
BM-I-PS-TACR	SEL BOOMI TechArch-Hourly Consult Remote	F2	\$275
BM-MDM-PS-CO	SEL BOOMI MDM ProServ-Hourly Onsite	F2	\$275
BM-MDM-PS-CR	SEL BOOMI MDM Proserv-Hourly Remote	F2	\$225
BM-TR-PS-ADM1	SEL BOOMI Administrator I Per Class	F2	\$400
BM-TR-PS-ADM2	SEL BOOMI Administrator II Per Class	F2	\$400
BM-TR-PS-ARC2	SEL BOOMI Architect II Per Class	F2	\$1,000
BM-TR-PS-ARC3	SEL BOOMI Architect III Per Class	F2	\$1,200
BM-TR-PS-BCAR	SEL BOOMI Developer II Per Class	F2	\$1,200
BM-TR-PS-BCE	SEL BOOMI Int Developer EDI Per Class	F2	\$700
BM-TR-PS-BC-L	SEL BOOMI IntDev I & II Per Class	F2	\$3,500
BM-TR-PS-BCM	SEL BOOMI Master Data Mgmt I Per Class	F2	\$1,600
BM-TR-PS-BC-R	SEL BOOMI Developer I Per Class	F2	\$1,800
BM-TR-PS-DEV3	SEL BOOMI Developer III Per Class	F2	\$600
BM-TR-PS-IA	SEL BOOMI Architect I Per Class	F2	\$1,200
BM-TR-PS-ID-R	SEL BOOMI IntDev I & II Remote Per Class	F2	\$3,500
BS10-80V4-75-32	SEL 3Yrs Bronze supprt for Bullion HW	F2	\$16,828
BS10-90V4-10-64	SEL 3Yrs Bronze supprt for Bullion HW	F2	\$23,468
BS10-90V4-75-32	SEL 3Yrs Bronze supprt for Bullion HW	F2	\$18,030
BS12-80V4-9-32	SEL 3Yrs Bronze supprt for Bullion HW	F2	\$19,524
BS12-90V4-12-64	SEL 3Yrs Bronze supprt for Bullion HW	F2	\$27,492
BS12-90V4-9-32	SEL 3Yrs Bronze supprt for Bullion HW	F2	\$20,966
BS14-80V4-10-32	SEL 3Yrs Bronze supprt for Bullion HW	F2	\$22,220
BS14-90V4-10-32	SEL 3Yrs Bronze supprt for Bullion HW	F2	\$23,902
BS14-90V4-14-64	SEL 3Yrs Bronze supprt for Bullion HW	F2	\$31,516
BS16-80V4-12-32	SEL 3Yrs Bronze supprt for Bullion HW	F2	\$24,916
BS16-90V4-12-32	SEL 3Yrs Bronze supprt for Bullion HW	F2	\$26,839
BS16-90V4-12-64	SEL 3Yrs Bronze supprt for Bullion HW	F2	\$30,225

BS16-90V4-16-64	SEL 3Yrs Bronze supprt for Bullion HW	F2	\$35,540
BS2-80V4-1-32	SEL 3Yrs Bronze supprt for Bullion HW	F2	\$2,539
BS2-80V4-15-32-2	SEL 3Yrs Bronze supprt for Bullion HW	F2	\$2,974
BS2-80V4-512-32	SEL 3Yrs Bronze supprt for Bullion HW	F2	\$2,042
BS2-80V4-768-32	SEL 3Yrs Bronze supprt for Bullion HW	F2	\$2,260
BS2-90V4-2-64	SEL 3Yrs Bronze supprt for Bullion HW	F2	\$4,302
BS4-80V4-1-32	SEL 3Yrs Bronze supprt for Bullion HW	F2	\$3,895
BS4-80V4-15-32	SEL 3Yrs Bronze supprt for Bullion HW	F2	\$4,330
BS4-80V4-2-32	SEL 3Yrs Bronze supprt for Bullion HW	F2	\$4,888
BS4-80V4-3-32-2	SEL 3Yrs Bronze supprt for Bullion HW	F2	\$5,758
BS4-90V4-4-64	SEL 3Yrs Bronze supprt for Bullion HW	F2	\$8,414
BS6-80V4-45-32	SEL 3Yrs Bronze supprt for Bullion HW	F2	\$8,484
BS6-90V4-6-64	SEL 3Yrs Bronze supprt for Bullion HW	F2	\$12,479
BS8-80V4-3-32	SEL 3Yrs Bronze supprt for Bullion HW	F2	\$8,334
BS8-80V4-4-32	SEL 3Yrs Bronze supprt for Bullion HW	F2	\$9,450
BS8-80V4-6-32-2	SEL 3Yrs Bronze supprt for Bullion HW	F2	\$11,191
BS8-90V4-6-32	SEL 3Yrs Bronze supprt for Bullion HW	F2	\$12,152
BS8-90V4-8-64	SEL 3Yrs Bronze supprt for Bullion HW	F2	\$16,503
BT-DEPLOY-MGT	SEL BlueTalon Deployment Support	F2	\$29,412
CA6DEVK3GC	SEL CA6-DEVK-3G-SSS-C)	F2	\$11,394
CA6DEVK3GC-I	SEL CA6-DEVK-3G-SSS-C)	F2	\$13,331
CA6DEVK3GC-K	SEL CA6-DEVK-3G-SSS-C)	F2	\$12,808
CA6DEVK3PC	SEL CA6-DEVK-3P-SSS-C)	F2	\$13,564
CA6DEVK3PC-I	SEL CA6-DEVK-3P-SSS-C)	F2	\$15,870
CA6DEVK3PC-K	SEL CA6-DEVK-3P-SSS-C)	F2	\$15,248
CA6DEVKGC	SEL CA6-DEVK-G-SSS-C)	F2	\$4,316
CA6DEVKGC-I	SEL CA6-DEVK-G-SSS-C)	F2	\$5,050
CA6DEVKGC-K	SEL CA6-DEVK-G-SSS-C)	F2	\$4,852
CA6DEVKPC	SEL CA6-DEVK-P-SSS-C)	F2	\$5,138
CA6DEVKPC-I	SEL CA6-DEVK-P-SSS-C)	F2	\$6,011
CA6DEVKPC-K	SEL CA6-DEVK-P-SSS-C)	F2	\$5,776
CAS-CONSULT	SEL INTERLOCK CONSULT 4 HR BLOCK	F2	\$4,706
CAS-CTA-MIG1	SEL INTERLOCK CTA MIGRATION 10TB	F2	\$9,412
CAS-CTA-MIG2	SEL INTERLOCK CTA MIGRATION 50TB	F2	\$47,059
CAS-CTA-MIG3	SEL INTERLOCK CTA MIGRATION ADD 10TB	F2	\$9,412
CAS-CTA-MIG4	SEL INTERLOCK CTA MIGRATION ADD 1TB	F2	\$941
CAS-CUA-MIG1	SEL INTERLOCK CUA MIGRATION 10TB	F2	\$9,412
CAS-CUA-MIG2	SEL INTERLOCK CUA MIGRATION 50TB	F2	\$47,059
CAS-CUA-MIG3	SEL INTERLOCK CUA MIGRATION ADD 10TB	F2	\$9,412
CAS-CUA-MIG4	SEL INTERLOCK CUA MIGRATION ADD 1TB	F2	\$941
CAS-DX-MIG1	SEL INTERLOCK DX MIGRATION 10TB	F2	\$14,118
CAS-DX-MIG2	SEL INTERLOCK DX MIGRATION 50TB	F2	\$64,706
CAS-DX-MIG3	SEL INTERLOCK DX MIGRATION ADD 10TB	F2	\$12,941
CAS-DX-MIG4	SEL INTERLOCK DX MIGRATION ADD 1TB	F2	\$1,294
CAS-ECS-MIG1	SEL INTERLOCK ECS MIGRATION 10TB	F2	\$7,059
CAS-ECS-MIG2	SEL INTERLOCK ECS MIGRATION 50TB	F2	\$28,235
CAS-ECS-MIG3	SEL INTERLOCK ECS MIGRATION ADD 10TB	F2	\$7,059
CAS-ECS-MIG4	SEL INTERLOCK ECS MIGRATION ADD 1TB	F2	\$706
CAS-EV-MIG1	SEL INTERLOCK EV MIGRATION 10TB	F2	\$17,647
CAS-EV-MIG2	SEL INTERLOCK EV MIGRATION 50TB	F2	\$63,529

CAS-EV-MIG3	SEL INTERLOCK EV MIGRATION ADD 10TB	F2	\$12,706
CAS-EV-MIG4	SEL INTERLOCK EV MIGRATION ADD 1TB	F2	\$1,271
CAS-FN-MIG1	SEL INTERLOCK FILENET MIGRATION 10TB	F2	\$17,647
CAS-FN-MIG2	SEL INTERLOCK FILENET MIGRATION 50TB	F2	\$63,529
CAS-FN-MIG3	SEL INTERLOCK FILENET MIGRATION ADD 10TB	F2	\$12,706
CAS-FN-MIG4	SEL INTERLOCK FILENET MIGRATION ADD 1TB	F2	\$1,271
CAS-GE-MIG1	SEL INTERLOCK GE MIGRATION 10TB	F2	\$14,118
CAS-GE-MIG2	SEL INTERLOCK GE MIGRATION 50TB	F2	\$64,706
CAS-GE-MIG3	SEL INTERLOCK GE MIGRATION ADD 10TB	F2	\$12,941
CAS-GE-MIG4	SEL INTERLOCK GE MIGRATION ADD 1TB	F2	\$1,294
CAS-MIG-SETUP	SEL INTERLOCK MIGRATION SETUP	F2	\$14,118
CAS-NAS-MIG1	SEL INTERLOCK NAS MIGRATION 10TB	F2	\$9,412
CAS-NAS-MIG2	SEL INTERLOCK NAS MIGRATION 50TB	F2	\$41,176
CAS-NAS-MIG3	SEL INTERLOCK NAS MIGRATION ADD 10TB	F2	\$8,235
CAS-NAS-MIG4	SEL INTERLOCK NAS MIGRATION ADD 1TB	F2	\$824
CAS-NICE-MIG1	SEL INTERLOCK NICE MIGRATION 10TB	F2	\$17,647
CAS-NICE-MIG2	SEL INTERLOCK NICE MIGRATION 50TB	F2	\$63,529
CAS-NICE-MIG3	SEL INTERLOCK NICE MIGRATION ADD 10TB	F2	\$12,706
CAS-NICE-MIG4	SEL INTERLOCK NICE MIGRATION ADD 1TB	F2	\$1,271
CFADV3PSSSC	SEL CF-ADV-3P-SSS-C)	F2	\$15,101
CFADV3PSSSC-I	SEL CF-ADV-3P-SSS-C)	F2	\$17,668
CFADV3PSSSC-K	SEL CF-ADV-3P-SSS-C)	F2	\$16,975
CFADVPSSSC	SEL CF-ADV-P-SSS-C)	F2	\$5,720
CFADVPSSSC-I	SEL CF-ADV-P-SSS-C)	F2	\$6,692
CFADVPSSSC-K	SEL CF-ADV-P-SSS-C)	F2	\$6,430
CFB1PCEADV3PC	SEL CF-B1-PCES-ADV-3P-SSS-C)	F2	\$9,066
CFB1PCEADV3PC-I	SEL CF-B1-PCES-ADV-3P-SSS-C)	F2	\$10,607
CFB1PCEADV3PC-K	SEL CF-B1-PCES-ADV-3P-SSS-C)	F2	\$10,191
CFB1PCEENT3PC	SEL CF-B1-PCES-ENT-3P-SSS-C)	F2	\$11,341
CFB1PCEENT3PC-I	SEL CF-B1-PCES-ENT-3P-SSS-C)	F2	\$13,269
CFB1PCEENT3PC-K	SEL CF-B1-PCES-ENT-3P-SSS-C)	F2	\$12,749
CFB1PCESADVPC	SEL CF-B1-PCES-ADV-P-SSS-C)	F2	\$3,434
CFB1PCESADVPC-I	SEL CF-B1-PCES-ADV-P-SSS-C)	F2	\$4,018
CFB1PCESADVPC-K	SEL CF-B1-PCES-ADV-P-SSS-C)	F2	\$3,860
CFB1PCESENTPC	SEL CF-B1-PCES-ENT-P-SSS-C)	F2	\$4,296
CFB1PCESENTPC-I	SEL CF-B1-PCES-ENT-P-SSS-C)	F2	\$5,026
CFB1PCESENTPC-K	SEL CF-B1-PCES-ENT-P-SSS-C)	F2	\$4,829
CFB1PCESSTDPC	SEL CF-B1-PCES-STD-P-SSS-C)	F2	\$2,409
CFB1PCESSTDPC-I	SEL CF-B1-PCES-STD-P-SSS-C)	F2	\$2,819
CFB1PCESSTDPC-K	SEL CF-B1-PCES-STD-P-SSS-C)	F2	\$2,708
CFB1PCESTD3PC	SEL CF-B1-PCES-STD-3P-SSS-C)	F2	\$6,360
CFB1PCESTD3PC-I	SEL CF-B1-PCES-STD-3P-SSS-C)	F2	\$7,441
CFB1PCESTD3PC-K	SEL CF-B1-PCES-STD-3P-SSS-C)	F2	\$7,149
CFB1VS6ADV3PC	SEL CF-B1-VS6-ADV-3P-SSS-C)	F2	\$12,793
CFB1VS6ADV3PC-I	SEL CF-B1-VS6-ADV-3P-SSS-C)	F2	\$14,968
CFB1VS6ADV3PC-K	SEL CF-B1-VS6-ADV-3P-SSS-C)	F2	\$14,381
CFB1VS6ADVPC	SEL CF-B1-VS6-ADV-P-SSS-C)	F2	\$4,846
CFB1VS6ADVPC-I	SEL CF-B1-VS6-ADV-P-SSS-C)	F2	\$5,670
CFB1VS6ADVPC-K	SEL CF-B1-VS6-ADV-P-SSS-C)	F2	\$5,447
CFB1VS6ENT3PC	SEL CF-B1-VS6-ENT-3P-SSS-C)	F2	\$16,088

CFB1VS6ENT3PC-I	SEL CF-B1-VS6-ENT-3P-SSS-C)	F2	\$18,823
CFB1VS6ENT3PC-K	SEL CF-B1-VS6-ENT-3P-SSS-C)	F2	\$18,085
CFB1VS6ENTPSC	SEL CF-B1-VS6-ENT-P-SSS-C)	F2	\$6,094
CFB1VS6ENTPSC-I	SEL CF-B1-VS6-ENT-P-SSS-C)	F2	\$7,130
CFB1VS6ENTPSC-K	SEL CF-B1-VS6-ENT-P-SSS-C)	F2	\$6,850
CFB1VS6STD3PC	SEL CF-B1-VS6-STD-3P-SSS-C)	F2	\$10,087
CFB1VS6STD3PC-I	SEL CF-B1-VS6-STD-3P-SSS-C)	F2	\$11,802
CFB1VS6STD3PC-K	SEL CF-B1-VS6-STD-3P-SSS-C)	F2	\$11,339
CFB1VS6STDPSC	SEL CF-B1-VS6-STD-P-SSS-C)	F2	\$3,821
CFB1VS6STDPSC-I	SEL CF-B1-VS6-STD-P-SSS-C)	F2	\$4,471
CFB1VS6STDPSC-K	SEL CF-B1-VS6-STD-P-SSS-C)	F2	\$4,295
CFB2VS6ADV3PC	SEL CF-B2-VS6-ADV-3P-SSS-C)	F2	\$10,080
CFB2VS6ADV3PC-I	SEL CF-B2-VS6-ADV-3P-SSS-C)	F2	\$11,793
CFB2VS6ADV3PC-K	SEL CF-B2-VS6-ADV-3P-SSS-C)	F2	\$11,331
CFB2VS6ADVPC	SEL CF-B2-VS6-ADV-P-SSS-C)	F2	\$3,818
CFB2VS6ADVPC-I	SEL CF-B2-VS6-ADV-P-SSS-C)	F2	\$4,467
CFB2VS6ADVPC-K	SEL CF-B2-VS6-ADV-P-SSS-C)	F2	\$4,292
CFB2VS6ENT3PC	SEL CF-B2-VS6-ENT-3P-SSS-C)	F2	\$12,355
CFB2VS6ENT3PC-I	SEL CF-B2-VS6-ENT-3P-SSS-C)	F2	\$14,456
CFB2VS6ENT3PC-K	SEL CF-B2-VS6-ENT-3P-SSS-C)	F2	\$13,889
CFB2VS6ENTPSC	SEL CF-B2-VS6-ENT-P-SSS-C)	F2	\$4,680
CFB2VS6ENTPSC-I	SEL CF-B2-VS6-ENT-P-SSS-C)	F2	\$5,476
CFB2VS6ENTPSC-K	SEL CF-B2-VS6-ENT-P-SSS-C)	F2	\$5,261
CFB2VS6STD3PC	SEL CF-B2-VS6-STD-3P-SSS-C)	F2	\$7,374
CFB2VS6STD3PC-I	SEL CF-B2-VS6-STD-3P-SSS-C)	F2	\$8,627
CFB2VS6STD3PC-K	SEL CF-B2-VS6-STD-3P-SSS-C)	F2	\$8,289
CFB2VS6STDPSC	SEL CF-B2-VS6-STD-P-SSS-C)	F2	\$2,793
CFB2VS6STDPSC-I	SEL CF-B2-VS6-STD-P-SSS-C)	F2	\$3,268
CFB2VS6STDPSC-K	SEL CF-B2-VS6-STD-P-SSS-C)	F2	\$3,140
CFB3VS6ADV3PC	SEL CF-B3-VS6-ADV-3P-SSS-C)	F2	\$9,829
CFB3VS6ADV3PC-I	SEL CF-B3-VS6-ADV-3P-SSS-C)	F2	\$11,500
CFB3VS6ADV3PC-K	SEL CF-B3-VS6-ADV-3P-SSS-C)	F2	\$11,049
CFB3VS6ADVPC	SEL CF-B3-VS6-ADV-P-SSS-C)	F2	\$3,723
CFB3VS6ADVPC-I	SEL CF-B3-VS6-ADV-P-SSS-C)	F2	\$4,356
CFB3VS6ADVPC-K	SEL CF-B3-VS6-ADV-P-SSS-C)	F2	\$4,185
CFB3VS6ENT3PC	SEL CF-B3-VS6-ENT-3P-SSS-C)	F2	\$11,471
CFB3VS6ENT3PC-I	SEL CF-B3-VS6-ENT-3P-SSS-C)	F2	\$13,421
CFB3VS6ENT3PC-K	SEL CF-B3-VS6-ENT-3P-SSS-C)	F2	\$12,895
CFB3VS6ENTPSC	SEL CF-B3-VS6-ENT-P-SSS-C)	F2	\$4,345
CFB3VS6ENTPSC-I	SEL CF-B3-VS6-ENT-P-SSS-C)	F2	\$5,084
CFB3VS6ENTPSC-K	SEL CF-B3-VS6-ENT-P-SSS-C)	F2	\$4,884
CFB3VS6STD3PC	SEL CF-B3-VS6-STD-3P-SSS-C)	F2	\$7,123
CFB3VS6STD3PC-I	SEL CF-B3-VS6-STD-3P-SSS-C)	F2	\$8,334
CFB3VS6STD3PC-K	SEL CF-B3-VS6-STD-3P-SSS-C)	F2	\$8,007
CFB3VS6STDPSC	SEL CF-B3-VS6-STD-P-SSS-C)	F2	\$2,698
CFB3VS6STDPSC-I	SEL CF-B3-VS6-STD-P-SSS-C)	F2	\$3,157
CFB3VS6STDPSC-K	SEL CF-B3-VS6-STD-P-SSS-C)	F2	\$3,033
CFB4VS6ADV3PC	SEL CF-B4-VS6-ADV-3P-SSS-C)	F2	\$7,550
CFB4VS6ADV3PC-I	SEL CF-B4-VS6-ADV-3P-SSS-C)	F2	\$8,834
CFB4VS6ADV3PC-K	SEL CF-B4-VS6-ADV-3P-SSS-C)	F2	\$8,488

CFB4VS6ADVPC	SEL CF-B4-VS6-ADV-P-SSS-C)	F2	\$2,860
CFB4VS6ADVPC-I	SEL CF-B4-VS6-ADV-P-SSS-C)	F2	\$3,346
CFB4VS6ADVPC-K	SEL CF-B4-VS6-ADV-P-SSS-C)	F2	\$3,215
CFB4VS6ENT3PC	SEL CF-B4-VS6-ENT-3P-SSS-C)	F2	\$10,845
CFB4VS6ENT3PC-I	SEL CF-B4-VS6-ENT-3P-SSS-C)	F2	\$12,689
CFB4VS6ENT3PC-K	SEL CF-B4-VS6-ENT-3P-SSS-C)	F2	\$12,191
CFB4VS6ENTPSC	SEL CF-B4-VS6-ENT-P-SSS-C)	F2	\$4,108
CFB4VS6ENTPSC-I	SEL CF-B4-VS6-ENT-P-SSS-C)	F2	\$4,806
CFB4VS6ENTPSC-K	SEL CF-B4-VS6-ENT-P-SSS-C)	F2	\$4,618
CFB4VS6STD3PC	SEL CF-B4-VS6-STD-3P-SSS-C)	F2	\$7,550
CFB4VS6STD3PC-I	SEL CF-B4-VS6-STD-3P-SSS-C)	F2	\$8,834
CFB4VS6STD3PC-K	SEL CF-B4-VS6-STD-3P-SSS-C)	F2	\$8,488
CFB4VS6STDPSC	SEL CF-B4-VS6-STD-P-SSS-C)	F2	\$2,860
CFB4VS6STDPSC-I	SEL CF-B4-VS6-STD-P-SSS-C)	F2	\$3,346
CFB4VS6STDPSC-K	SEL CF-B4-VS6-STD-P-SSS-C)	F2	\$3,215
CFCPUB13PC	SEL CF-CPU-B1-3P-SSS-C)	F2	\$9,002
CFCPUB13PC-I	SEL CF-CPU-B1-3P-SSS-C)	F2	\$10,533
CFCPUB13PC-K	SEL CF-CPU-B1-3P-SSS-C)	F2	\$10,001
CFCPUB1PC	SEL CF-CPU-B1-P-SSS-C)	F2	\$3,410
CFCPUB1PC-I	SEL CF-CPU-B1-P-SSS-C)	F2	\$3,990
CFCPUB1PC-K	SEL CF-CPU-B1-P-SSS-C)	F2	\$3,788
CFCPUB23PC	SEL CF-CPU-B2-3P-SSS-C)	F2	\$6,695
CFCPUB23PC-I	SEL CF-CPU-B2-3P-SSS-C)	F2	\$7,833
CFCPUB23PC-K	SEL CF-CPU-B2-3P-SSS-C)	F2	\$7,407
CFCPUB2PC	SEL CF-CPU-B2-P-SSS-C)	F2	\$2,536
CFCPUB2PC-I	SEL CF-CPU-B2-P-SSS-C)	F2	\$2,967
CFCPUB2PC-K	SEL CF-CPU-B2-P-SSS-C)	F2	\$2,806
CFENT3PSSSC	SEL CF-ENT-3P-SSS-C)	F2	\$18,396
CFENT3PSSSC-I	SEL CF-ENT-3P-SSS-C)	F2	\$21,523
CFENT3PSSSC-K	SEL CF-ENT-3P-SSS-C)	F2	\$20,679
CFENTPSSSC	SEL CF-ENT-P-SSS-C)	F2	\$6,968
CFENTPSSSC-I	SEL CF-ENT-P-SSS-C)	F2	\$8,153
CFENTPSSSC-K	SEL CF-ENT-P-SSS-C)	F2	\$7,833
CFPCESADV3PSC	SEL CF-PCES-ADV-3P-S-C)	F2	\$11,373
CFPCESADV3PSC-I	SEL CF-PCES-ADV-3P-S-C)	F2	\$13,307
CFPCESADV3PSC-K	SEL CF-PCES-ADV-3P-S-C)	F2	\$12,785
CFPCESADVPSC	SEL CF-PCES-ADV-P-S-C)	F2	\$4,308
CFPCESADVPSC-I	SEL CF-PCES-ADV-P-S-C)	F2	\$5,040
CFPCESADVPSC-K	SEL CF-PCES-ADV-P-S-C)	F2	\$4,843
CFPCESENT3PSC	SEL CF-PCES-ENT-3P-S-C)	F2	\$13,649
CFPCESENT3PSC-I	SEL CF-PCES-ENT-3P-S-C)	F2	\$15,969
CFPCESENT3PSC-K	SEL CF-PCES-ENT-3P-S-C)	F2	\$15,343
CFPCESENTPSC	SEL CF-PCES-ENT-P-S-C)	F2	\$5,170
CFPCESENTPSC-I	SEL CF-PCES-ENT-P-S-C)	F2	\$6,049
CFPCESENTPSC-K	SEL CF-PCES-ENT-P-S-C)	F2	\$5,812
CFPCESSTD3PSC	SEL CF-PCES-STD-3P-S-C)	F2	\$8,667
CFPCESSTD3PSC-I	SEL CF-PCES-STD-3P-S-C)	F2	\$10,141
CFPCESSTD3PSC-K	SEL CF-PCES-STD-3P-S-C)	F2	\$9,743
CFPCESSTDPC	SEL CF-PCES-STD-P-S-C)	F2	\$3,283
CFPCESSTDPC-I	SEL CF-PCES-STD-P-S-C)	F2	\$3,841

CFPCESSTDPSC-K	SEL CF-PCES-STD-P-S-C)	F2	\$3,690
CFSDDCM1003PC	SEL CF-SDDC-M100-3P-SSS-C)	F2	\$2,035
CFSDDCM1003PC-I	SEL CF-SDDC-M100-3P-SSS-C)	F2	\$2,127
CFSDDCM1003PC-K	SEL CF-SDDC-M100-3P-SSS-C)	F2	\$2,122
CFSDDCM100PC	SEL CF-SDDC-M100-P-SSS-C)	F2	\$771
CFSDDCM100PC-I	SEL CF-SDDC-M100-P-SSS-C)	F2	\$806
CFSDDCM100PC-K	SEL CF-SDDC-M100-P-SSS-C)	F2	\$804
CFSDDCM103PC	SEL CF-SDDC-M10-3P-SSS-C)	F2	\$203
CFSDDCM103PC-I	SEL CF-SDDC-M10-3P-SSS-C)	F2	\$212
CFSDDCM103PC-K	SEL CF-SDDC-M10-3P-SSS-C)	F2	\$212
CFSDDCM10PC	SEL CF-SDDC-M10-P-SSS-C)	F2	\$77
CFSDDCM10PC-I	SEL CF-SDDC-M10-P-SSS-C)	F2	\$80
CFSDDCM10PC-K	SEL CF-SDDC-M10-P-SSS-C)	F2	\$80
CFSDDCMAC3PC	SEL CF-SDDC-MAC-3P-SSS-C)	F2	\$1,014
CFSDDCMAC3PC-I	SEL CF-SDDC-MAC-3P-SSS-C)	F2	\$1,186
CFSDDCMAC3PC-K	SEL CF-SDDC-MAC-3P-SSS-C)	F2	\$1,110
CFSDDCMACPC	SEL CF-SDDC-MAC-P-SSS-C)	F2	\$384
CFSDDCMACPC-I	SEL CF-SDDC-MAC-P-SSS-C)	F2	\$449
CFSDDCMACPC-K	SEL CF-SDDC-MAC-P-SSS-C)	F2	\$420
CFSTD3PSSSC	SEL CF-STD-3P-SSS-C)	F2	\$12,395
CFSTD3PSSSC-I	SEL CF-STD-3P-SSS-C)	F2	\$14,502
CFSTD3PSSSC-K	SEL CF-STD-3P-SSS-C)	F2	\$13,933
CFSTDPSSSC	SEL CF-STD-P-SSS-C)	F2	\$4,695
CFSTDPSSSC-I	SEL CF-STD-P-SSS-C)	F2	\$5,493
CFSTDPSSSC-K	SEL CF-STD-P-SSS-C)	F2	\$5,278
CFVDB11003PC	SEL CF-VD-B1-100-3P-SSS-C)	F2	\$47,084
CFVDB11003PC-I	SEL CF-VD-B1-100-3P-SSS-C)	F2	\$49,203
CFVDB11003PC-K	SEL CF-VD-B1-100-3P-SSS-C)	F2	\$49,163
CFVDB1100PC	SEL CF-VD-B1-100-P-SSS-C)	F2	\$17,835
CFVDB1100PC-I	SEL CF-VD-B1-100-P-SSS-C)	F2	\$18,638
CFVDB1100PC-K	SEL CF-VD-B1-100-P-SSS-C)	F2	\$18,622
CFVDB1103PC	SEL CF-VD-B1-10-3P-SSS-C)	F2	\$4,710
CFVDB1103PC-I	SEL CF-VD-B1-10-3P-SSS-C)	F2	\$4,922
CFVDB1103PC-K	SEL CF-VD-B1-10-3P-SSS-C)	F2	\$4,918
CFVDB110PC	SEL CF-VD-B1-10-P-SSS-C)	F2	\$1,784
CFVDB110PC-I	SEL CF-VD-B1-10-P-SSS-C)	F2	\$1,864
CFVDB110PC-K	SEL CF-VD-B1-10-P-SSS-C)	F2	\$1,863
CFVDB21003PC	SEL CF-VD-B2-100-3P-SSS-C)	F2	\$7,981
CFVDB21003PC-I	SEL CF-VD-B2-100-3P-SSS-C)	F2	\$8,340
CFVDB21003PC-K	SEL CF-VD-B2-100-3P-SSS-C)	F2	\$8,489
CFVDB2100PC	SEL CF-VD-B2-100-P-SSS-C)	F2	\$3,023
CFVDB2100PC-I	SEL CF-VD-B2-100-P-SSS-C)	F2	\$3,159
CFVDB2100PC-K	SEL CF-VD-B2-100-P-SSS-C)	F2	\$3,215
CFVDB2103PC	SEL CF-VD-B2-10-3P-SSS-C)	F2	\$797
CFVDB2103PC-I	SEL CF-VD-B2-10-3P-SSS-C)	F2	\$833
CFVDB2103PC-K	SEL CF-VD-B2-10-3P-SSS-C)	F2	\$849
CFVDB210PC	SEL CF-VD-B2-10-P-SSS-C)	F2	\$302
CFVDB210PC-I	SEL CF-VD-B2-10-P-SSS-C)	F2	\$316
CFVDB210PC-K	SEL CF-VD-B2-10-P-SSS-C)	F2	\$322
CFVDB31003PC	SEL CF-VD-B3-100-3P-SSS-C)	F2	\$11,281

CFVDB31003PC-I	SEL CF-VD-B3-100-3P-SSS-C)	F2	\$11,788
CFVDB31003PC-K	SEL CF-VD-B3-100-3P-SSS-C)	F2	\$12,025
CFVDB3100PC	SEL CF-VD-B3-100-P-SSS-C)	F2	\$4,273
CFVDB3100PC-I	SEL CF-VD-B3-100-P-SSS-C)	F2	\$4,465
CFVDB3100PC-K	SEL CF-VD-B3-100-P-SSS-C)	F2	\$4,555
CFVDB3103PC	SEL CF-VD-B3-10-3P-SSS-C)	F2	\$1,127
CFVDB3103PC-I	SEL CF-VD-B3-10-3P-SSS-C)	F2	\$1,178
CFVDB3103PC-K	SEL CF-VD-B3-10-3P-SSS-C)	F2	\$1,203
CFVDB310PC	SEL CF-VD-B3-10-P-SSS-C)	F2	\$427
CFVDB310PC-I	SEL CF-VD-B3-10-P-SSS-C)	F2	\$446
CFVDB310PC-K	SEL CF-VD-B3-10-P-SSS-C)	F2	\$456
CL-11-15MC	SEL Collector M24*7	F2	\$1,265
CL-11-15MS	SEL Collector MS	F2	\$723
CL-1-5MC	SEL Collector M24*7	F2	\$2,810
CL-1-5MS	SEL Collector MS	F2	\$1,606
CL-16-20MC	SEL Collector M24*7	F2	\$1,138
CL-16-20MS	SEL Collector MS	F2	\$650
CL17ADV3GC	SEL CL17-ADV-3G-SSS-C)	F2	\$4,599
CL17ADV3GC-I	SEL CL17-ADV-3G-SSS-C)	F2	\$5,381
CL17ADV3GC-K	SEL CL17-ADV-3G-SSS-C)	F2	\$5,170
CL17ADV3PC	SEL CL17-ADV-3P-SSS-C)	F2	\$5,475
CL17ADV3PC-I	SEL CL17-ADV-3P-SSS-C)	F2	\$6,406
CL17ADV3PC-K	SEL CL17-ADV-3P-SSS-C)	F2	\$6,155
CL17ADVGC	SEL CL17-ADV-G-SSS-C)	F2	\$1,742
CL17ADVGC-I	SEL CL17-ADV-G-SSS-C)	F2	\$2,038
CL17ADVGC-K	SEL CL17-ADV-G-SSS-C)	F2	\$1,958
CL17ADVPC	SEL CL17-ADV-P-SSS-C)	F2	\$2,074
CL17ADVPC-I	SEL CL17-ADV-P-SSS-C)	F2	\$2,427
CL17ADVPC-K	SEL CL17-ADV-P-SSS-C)	F2	\$2,331
CL17ENT3GC	SEL CL17-ENT-3G-SSS-C)	F2	\$5,430
CL17ENT3GC-I	SEL CL17-ENT-3G-SSS-C)	F2	\$6,354
CL17ENT3GC-K	SEL CL17-ENT-3G-SSS-C)	F2	\$6,105
CL17ENT3PC	SEL CL17-ENT-3P-SSS-C)	F2	\$6,465
CL17ENT3PC-I	SEL CL17-ENT-3P-SSS-C)	F2	\$7,564
CL17ENT3PC-K	SEL CL17-ENT-3P-SSS-C)	F2	\$7,268
CL17ENTGC	SEL CL17-ENT-G-SSS-C)	F2	\$2,057
CL17ENTGC-I	SEL CL17-ENT-G-SSS-C)	F2	\$2,407
CL17ENTGC-K	SEL CL17-ENT-G-SSS-C)	F2	\$2,312
CL17ENTPC	SEL CL17-ENT-P-SSS-C)	F2	\$2,449
CL17ENTPC-I	SEL CL17-ENT-P-SSS-C)	F2	\$2,865
CL17ENTPC-K	SEL CL17-ENT-P-SSS-C)	F2	\$2,753
CL17STD3GC	SEL CL17-STD-3G-SSS-C)	F2	\$3,157
CL17STD3GC-I	SEL CL17-STD-3G-SSS-C)	F2	\$3,694
CL17STD3GC-K	SEL CL17-STD-3G-SSS-C)	F2	\$3,549
CL17STD3PC	SEL CL17-STD-3P-SSS-C)	F2	\$3,759
CL17STD3PC-I	SEL CL17-STD-3P-SSS-C)	F2	\$4,398
CL17STD3PC-K	SEL CL17-STD-3P-SSS-C)	F2	\$4,226
CL17STDGC	SEL CL17-STD-G-SSS-C)	F2	\$1,196
CL17STDGC-I	SEL CL17-STD-G-SSS-C)	F2	\$1,399
CL17STDGC-K	SEL CL17-STD-G-SSS-C)	F2	\$1,344

CL17STDPC	SEL CL17-STD-P-SSS-C)	F2	\$1,424
CL17STDPC-I	SEL CL17-STD-P-SSS-C)	F2	\$1,666
CL17STDPC-K	SEL CL17-STD-P-SSS-C)	F2	\$1,601
CL-21-MC	SEL Collector M24*7	F2	\$1,025
CL-21-MS	SEL Collector MS	F2	\$585
CL-6-10MC	SEL Collector M24*7	F2	\$1,967
CL-6-10MS	SEL Collector MS	F2	\$1,124
CLC-11-15MC	SEL Collector 100 SL M24*7	F2	\$2,529
CLC-11-15MS	SEL Collector 100 SL MS	F2	\$1,445
CLC-1-5MC	SEL Collector 100 SL M24*7	F2	\$5,621
CLC-1-5MS	SEL Collector 100 SL MS	F2	\$3,212
CLC-16-20MC	SEL Collector 100 SL M24*7	F2	\$2,276
CLC-16-20MS	SEL Collector 100 SL MS	F2	\$1,301
CLC-21-MC	SEL Collector 100 SL M24*7	F2	\$2,049
CLC-21-MS	SEL Collector 100 SL MS	F2	\$1,171
CLC-6-10MC	SEL Collector 100 SL M24*7	F2	\$3,934
CLC-6-10MS	SEL Collector 100 SL MS	F2	\$2,248
CLU-11-15MC	SEL Collector Upgrade MC	F2	\$1,265
CLU-11-15MS	SEL Collector Upgrade MS	F2	\$723
CLU-1-5MC	SEL Collector Upgrade MC	F2	\$2,810
CLU-1-5MS	SEL Collector Upgrade MS	F2	\$1,606
CLU-16-20MC	SEL Collector Upgrade MC	F2	\$1,138
CLU-16-20MS	SEL Collector Upgrade MS	F2	\$650
CLU-21-M	SEL Collector Upgrade MC	F2	\$1,025
CLU-21-MS	SEL Collector Upgrade MS	F2	\$585
CLU-6-10MC	SEL Collector Upgrade MC	F2	\$1,967
CLU-6-10MS	SEL Collector Upgrade MS	F2	\$1,124
CNSTLPWK-EMC-001	SEL Bedrock Consulting Serv Person/Wk 1Y	F2	\$20,000
CODEREVIEW	SEL Puppet Code Review	F2	\$11,759
CS-BAS-CSA-ASD	CS ADVOCATE ASD .25 FTE-12M	F2	\$50,000
CS-BAS-CSA-DPS	CS ADVOCATE DPS .25 FTE-12M	F2	\$50,000
CS-BAS-CSA-ESD	CS ADVOCATE ESD .25 FTE-12M	F2	\$50,000
CS-BAS-CSA-ISILON	CS ADVOCATE ISILON .25 FTE-12M	F2	\$50,000
CS-BAS-CSA-USD	CS ADVOCATE USD .25 FTE-12M	F2	\$50,000
CS-BAS-CSA-XIO	CS ADVOCATE XIO .25 FTE-12M	F2	\$50,000
CS-BAS-DSE-ASD12M	DESIGNATED SUPPORT ENG ASD .25FTE -12M	F2	\$80,000
CS-BAS-DSE-ASD6M	DESIGNATED SUPPORT ENG ASD .25FTE -6M	F2	\$40,000
CS-BAS-DSE-DPS12M	DESIGNATED SUPPORT ENG DPS .25FTE -12M	F2	\$80,000
CS-BAS-DSE-DPS6M	DESIGNATED SUPPORT ENG DPS .25FTE -6M	F2	\$40,000
CS-BAS-DSE-DPSSO6M	DESIGNATED SUPPORT ENG SOL .25FTE -6M	F2	\$40,000
CS-BAS-DSE-DPSSOL	DESIGNATED SUPPORT ENG SOL .25FTE -12M	F2	\$80,000
CS-BAS-DSE-ESD12M	DESIGNATED SUPPORT ENG ESD .25FTE -12M	F2	\$80,000
CS-BAS-DSE-ESD6M	DESIGNATED SUPPORT ENG ESD .25FTE -6M	F2	\$40,000
CS-BAS-DSE-ISI12M	DESIGNATED SUPPORT ENG ISI .25FTE -12M	F2	\$80,000
CS-BAS-DSE-ISI6M	DESIGNATED SUPPORT ENG ISI .25FTE -6M	F2	\$40,000
CS-BAS-DSE-USD12M	DESIGNATED SUPPORT ENG USD .25FTE -12M	F2	\$80,000
CS-BAS-DSE-USD6M	DESIGNATED SUPPORT ENG USD .25FTE -6M	F2	\$40,000
CS-BAS-DSE-XIO12M	DESIGNATED SUPPORT ENG XIO .25FTE -12M	F2	\$80,000
CS-BAS-DSE-XIO6M	DESIGNATED SUPPORT ENG XIO .25FTE -6M	F2	\$40,000
CS-BAS-TAM-ASD	TECHNICAL ACCT MANAGER ASD .33FTE-12M	F2	\$100,000

CS-BAS-TAM-DPS	TECHNICAL ACCT MANAGER DPS .33FTE-12M	F2	\$100,000
CS-BAS-TAM-ESD	TECHNICAL ACCT MANAGER ESD .33FTE-12M	F2	\$100,000
CS-BAS-TAM-ISI6M	TECHNICAL ACCT MANAGER ISI .33FTE-6M	F2	\$50,000
CS-BAS-TAM-ISIH6M	TECHNICAL ACCT MANAGER ISI .50FTE-6M	F2	\$80,000
CS-BAS-TAM-ISILON	TECHNICAL ACCT MANAGER ISI .33FTE-12M	F2	\$100,000
CS-BAS-TAM-ISILONH	TECHNICAL ACCT MANAGER ISI .50FTE-12M	F2	\$160,000
CS-BAS-TAM-USD	TECHNICAL ACCT MANAGER USD .33FTE-12M	F2	\$100,000
CS-BAS-TAM-XIO	TECHNICAL ACCT MANAGER XIO .33FTE-12M	F2	\$100,000
CS-DSE-PV-DATA-12	CS BCS DSE for Pivotal Data 12 months	F2	\$100,000
CS-DSE-PVDATA-12FT	PIVOTAL DSE FOR DATA 12 MONTHS FULL TIME	F2	\$400,000
CS-DSE-PVDATA-12HT	PIVOTAL DSE FOR DATA 12 MONTHS HALF TIME	F2	\$200,000
CS-DSE-PV-DATA-6	CS BCS DSE for Pivotal Data 6 months	F2	\$50,000
CS-DSE-PVDATA-6FT	PIVOTAL DSE FOR DATA 6 MONTHS FULL TIME	F2	\$200,000
CS-DSE-PVDATA-6HT	PIVOTAL DSE FOR DATA 6 MONTHS HALF TIME	F2	\$100,000
CS-DSE-PV-PCF-12	CS BCS DSE for Pivotal PCF 12 months	F2	\$100,000
CS-DSE-PVPCF-12FT	PIVOTAL DSE FOR PCF 12 MONTHS FULL TIME	F2	\$400,000
CS-DSE-PVPCF-12HT	PIVOTAL DSE FOR PCF 12 MONTHS HALF TIME	F2	\$200,000
CS-DSE-PV-PCF-6	CS BCS DSE for Pivotal PCF 6 months	F2	\$50,000
CS-DSE-PVPCF-6FT	PIVOTAL DSE FOR PCF 6 MONTHS FULL TIME	F2	\$200,000
CS-DSE-PVPCF-6HT	PIVOTAL DSE FOR PCF 6 MONTHS HALF TIME	F2	\$100,000
CS-ONLACC-SUP	L40 ACCESS - SR TECH SUPPORT	F2	\$249,000
CSP-A-MTN	SEL VST CSP MTN 2,501-5,000 MICROVM	F2	\$31
CS-PARTRT-PRGM	PARTS RETENTION PROGRAM FEE	F2	\$4,000
CS-PARTRT-USG	PARTS RETENTION USAGE	F2	\$0
CSP-BASE-MTN	SEL VST CSP MTN UP TO 2,500 MICROVM	F2	\$32
CSP-B-MTN	SEL VST CSP MTN 5,001-7,500 MICROVM	F2	\$30
CSP-C-MTN	SEL VST CSP MTN 7,501-15,000 MICROVM	F2	\$26
CSP-D-MTN	SEL VST CSP MTN 15,001-25,000 MICROVM	F2	\$23
CSP-E-MTN	SEL VST CSP MTN 25,001-50,000 MICROVM	F2	\$18
CSP-F-MTN	SEL VST CSP MTN 50,001-100,000 MICROVM	F2	\$16
CS-REMSTRT-CL	REMOTE 90 DAY CELERRA START UP SERVICE	F2	\$11,250
CS-SRRCAP-01	SUPPORT READINESS REVIEW (CAPTIVA)	F2	\$12,000
CS-SRRDOC-01	SUPPORT READINESS REVIEW (DOCUMENTUM)	F2	\$12,000
CS-TAM-PV-DATA-DES	CS L1 CSD FOR DATA-6	F2	\$65,000
CS-TAM-PV-DATA-ENT	CS L1 CSD FOR DATA-12	F2	\$130,000
CS-TAM-PV-PCF-DES	CS L1 CSD FOR PCF-6	F2	\$65,000
CS-TAM-PV-PCF-ENT	CS L1 CSD FOR PCF-12	F2	\$130,000
CS-XT-AX-DSE	DSE REMOTE 10HR - APPLICATION EXTENDER	F2	\$90,000
CS-XT-AX-OSE	DSE - ONSITE - APPLICATION EXTENDER	F2	\$275,000
CS-ZN1-BASSAM-ASD	SERVICE ACCT MGR ASD 3M-FULL 6M-HALF ZN1	F2	\$80,000
CS-ZN1-BASSAM-DPS	SERVICE ACCT MGR DPS 3M-FULL 6M-HALF ZN1	F2	\$80,000
CS-ZN1-BASSAM-ESD	SERVICE ACCT MGR ESD 3M-FULL 6M-HALF ZN1	F2	\$80,000
CS-ZN1-BASSAM-ISI	SERVICE ACCT MGR ISI 3M-FULL 6M-HALF ZN1	F2	\$80,000
CS-ZN1-BASSAM-USD	SERVICE ACCT MGR USD 3M-FULL 6M-HALF ZN1	F2	\$80,000
CS-ZN1-BASSAM-XIO	SERVICE ACCT MGR XIO 3M-FULL 6M-HALF ZN1	F2	\$80,000
CS-ZN1-TAM-ASD	TECHNICAL ACCT MGR ASD .33FTE-12M ZN1	F2	\$118,800
CS-ZN1-TAM-DPS	TECHNICAL ACCT MGR DPS .33FTE-12M ZN1	F2	\$118,800
CS-ZN1-TAM-ESD	TECHNICAL ACCT MGR ESD .33FTE-12M ZN1	F2	\$118,800
CS-ZN1-TAM-ISI6M	TECHNICAL ACCT MGR ISI .33FTE-6M ZN1	F2	\$59,400
CS-ZN1-TAM-ISIH6M	TECHNICAL ACCT MGR ISI .50FTE-6M ZN1	F2	\$90,000

CS-ZN1-TAM-ISILON	TECHNICAL ACCT MGR ISI .33FTE-12M ZN1	F2	\$118,800
CS-ZN1-TAM-ISILONH	TECHNICAL ACCT MGR ISI .50FTE-12M ZN1	F2	\$180,000
CS-ZN1-TAM-SOLF	ENG SOLUTIONS TAM - 1FTE - 12M ZN1	F2	\$340,000
CS-ZN1-TAM-SOLH	ENG SOLUTIONS TAM - .50FTE - 12M ZN1	F2	\$170,000
CS-ZN1-TAM-USD	TECHNICAL ACCT MGR USD .33FTE-12M ZN1	F2	\$118,800
CS-ZN1-TAM-XIO	TECHNICAL ACCT MGR XIO .33FTE-12M ZN1	F2	\$118,800
CS-ZN2-BASSAM-ASD	SERVICE ACCT MGR ASD 3M-FULL 6M-HALF ZN2	F2	\$70,000
CS-ZN2-BASSAM-DPS	SERVICE ACCT MGR DPS 3M-FULL 6M-HALF ZN2	F2	\$70,000
CS-ZN2-BASSAM-ESD	SERVICE ACCT MGR ESD 3M-FULL 6M-HALF ZN2	F2	\$70,000
CS-ZN2-BASSAM-ISI	SERVICE ACCT MGR ISI 3M-FULL 6M-HALF ZN2	F2	\$70,000
CS-ZN2-BASSAM-USD	SERVICE ACCT MGR USD 3M-FULL 6M-HALF ZN2	F2	\$70,000
CS-ZN2-BASSAM-XIO	SERVICE ACCT MGR XIO 3M-FULL 6M-HALF ZN2	F2	\$70,000
CS-ZN2-TAM-ASD	TECHNICAL ACCT MGR ASD .33FTE-12M ZN2	F2	\$92,400
CS-ZN2-TAM-DPS	TECHNICAL ACCT MGR DPS .33FTE-12M ZN2	F2	\$92,400
CS-ZN2-TAM-ESD	TECHNICAL ACCT MGR ESD .33FTE-12M ZN2	F2	\$92,400
CS-ZN2-TAM-ISI6M	TECHNICAL ACCT MGR ISI .33FTE-6M ZN2	F2	\$46,200
CS-ZN2-TAM-ISIH6M	TECHNICAL ACCT MGR ISI .50FTE-6M ZN2	F2	\$70,000
CS-ZN2-TAM-ISILON	TECHNICAL ACCT MGR ISI .33FTE-12M ZN2	F2	\$92,400
CS-ZN2-TAM-ISILONH	TECHNICAL ACCT MGR ISI .50FTE-12M AN2	F2	\$140,000
CS-ZN2-TAM-SOLF	ENG SOLUTIONS TAM - 1FTE - 12M ZN2	F2	\$320,000
CS-ZN2-TAM-SOLH	ENG SOLUTIONS TAM - .50FTE - 12M ZN2	F2	\$160,000
CS-ZN2-TAM-USD	TECHNICAL ACCT MGR USD .33FTE-12M ZN2	F2	\$92,400
CS-ZN2-TAM-XIO	TECHNICAL ACCT MGR XIO .33FTE-12M ZN2	F2	\$92,400
CS-ZN3-BASSAM-ASD	SERVICE ACCT MGR ASD 3M-FULL 6M-HALF ZN3	F2	\$57,500
CS-ZN3-BASSAM-DPS	SERVICE ACCT MGR DPS 3M-FULL 6M-HALF ZN3	F2	\$57,500
CS-ZN3-BASSAM-ESD	SERVICE ACCT MGR ESD 3M-FULL 6M-HALF ZN3	F2	\$57,500
CS-ZN3-BASSAM-ISI	SERVICE ACCT MGR ISI 3M-FULL 6M-HALF ZN3	F2	\$57,500
CS-ZN3-BASSAM-USD	SERVICE ACCT MGR USD 3M-FULL 6M-HALF ZN3	F2	\$57,500
CS-ZN3-BASSAM-XIO	SERVICE ACCT MGR XIO 3M-FULL 6M-HALF ZN3	F2	\$57,500
CS-ZN3-TAM-ASD	TECHNICAL ACCT MGR ASD .33FTE- 12M ZN3	F2	\$75,900
CS-ZN3-TAM-DPS	TECHNICAL ACCT MGR DPS .33FTE-12M ZN3	F2	\$75,900
CS-ZN3-TAM-ESD	TECHNICAL ACCT MGR ESD .33FTE-12M ZN3	F2	\$75,900
CS-ZN3-TAM-ISI6M	TECHNICAL ACCT MGR ISI .33FTE-6M ZN3	F2	\$37,950
CS-ZN3-TAM-ISIH6M	TECHNICAL ACCT MGR ISI .50FTE-6M ZN3	F2	\$57,500
CS-ZN3-TAM-ISILON	TECHNICAL ACCT MGR ISI .33FTE-12M ZN3	F2	\$75,900
CS-ZN3-TAM-ISILONH	TECHNICAL ACCT MGR ISI .50FTE-12M ZN3	F2	\$115,000
CS-ZN3-TAM-SOLF	ENG SOLUTIONS TAM - 1FTE - 12M ZN3	F2	\$280,000
CS-ZN3-TAM-SOLH	ENG SOLUTIONS TAM - .50FTE - 12M ZN3	F2	\$140,000
CS-ZN3-TAM-USD	TECHNICAL ACCT MGR USD .33FTE-12M ZN3	F2	\$75,900
CS-ZN3-TAM-XIO	TECHNICAL ACCT MGR XIO .33FTE-12M ZN3	F2	\$75,900
CS-ZN4-BASSAM-ASD	SERVICE ACCT MGR ASD 3M-FULL 6M-HALF ZN4	F2	\$45,000
CS-ZN4-BASSAM-DPS	SERVICE ACCT MGR DPS 3M-FULL 6M-HALF ZN4	F2	\$45,000
CS-ZN4-BASSAM-ESD	SERVICE ACCT MGR ESD 3M-FULL 6M-HALF ZN4	F2	\$45,000
CS-ZN4-BASSAM-ISI	SERVICE ACCT MGR ISI 3M-FULL 6M-HALF ZN4	F2	\$45,000
CS-ZN4-BASSAM-USD	SERVICE ACCT MGR USD 3M-FULL 6M-HALF ZN4	F2	\$45,000
CS-ZN4-BASSAM-XIO	SERVICE ACCT MGR XIO 3M-FULL 6M-HALF ZN4	F2	\$45,000
CS-ZN4-TAM-ASD	TECHNICAL ACCT MGR ASD .33FTE-12M ZN4	F2	\$59,400
CS-ZN4-TAM-DPS	TECHNICAL ACCT MGR DPS .33FTE-12M ZN4	F2	\$59,400
CS-ZN4-TAM-ESD	TECHNICAL ACCT MGR ESD .33FTE-12M ZN4	F2	\$59,400
CS-ZN4-TAM-ISI6M	TECHNICAL ACCT MGR ISI .33FTE-6M ZN4	F2	\$29,700

CS-ZN4-TAM-ISIH6M	TECHNICAL ACCT MGR ISI .50FTE-6M ZN4	F2	\$45,000
CS-ZN4-TAM-ISILON	TECHNICAL ACCT MGR ISI .33FTE-12M ZN4	F2	\$59,400
CS-ZN4-TAM-ISILONH	TECHNICAL ACCT MGR ISI .50FTE-12M ZN4	F2	\$90,000
CS-ZN4-TAM-SOLF	ENG SOLUTIONS TAM - 1FTE - 12M ZN4	F2	\$235,000
CS-ZN4-TAM-SOLH	ENG SOLUTIONS TAM - .50FTE - 12M ZN4	F2	\$117,500
CS-ZN4-TAM-USD	TECHNICAL ACCT MGR USD .33FTE-12M ZN4	F2	\$59,400
CS-ZN4-TAM-XIO	TECHNICAL ACCT MGR XIO .33FTE-12M ZN4	F2	\$59,400
CS-ZN5-BASSAM-ASD	SERVICE ACCT MGR ASD 3M-FULL 6M-HALF ZN5	F2	\$31,250
CS-ZN5-BASSAM-DPS	SERVICE ACCT MGR DPS 3M-FULL 6M-HALF ZN5	F2	\$31,250
CS-ZN5-BASSAM-ESD	SERVICE ACCT MGR ESD 3M-FULL 6M-HALF ZN5	F2	\$31,250
CS-ZN5-BASSAM-ISI	SERVICE ACCT MGR ISI 3M-FULL 6M-HALF ZN5	F2	\$31,250
CS-ZN5-BASSAM-USD	SERVICE ACCT MGR USD 3M-FULL 6M-HALF ZN5	F2	\$31,250
CS-ZN5-BASSAM-XIO	SERVICE ACCT MGR XIO 3M-FULL 6M-HALF ZN5	F2	\$31,250
CS-ZN5-TAM-ASD	TECHNICAL ACCT MGR ASD .33FTE-12M ZN5	F2	\$41,250
CS-ZN5-TAM-DPS	TECHNICAL ACCT MGR DPS .33FTE-12M ZN5	F2	\$41,250
CS-ZN5-TAM-ESD	TECHNICAL ACCT MGR ESD .33FTE-12M ZN5	F2	\$41,250
CS-ZN5-TAM-ISI6M	TECHNICAL ACCT MGR ISI .33FTE-6M ZN5	F2	\$20,625
CS-ZN5-TAM-ISIH6M	TECHNICAL ACCT MGR ISI .50FTE-6M ZN5	F2	\$31,250
CS-ZN5-TAM-ISILON	TECHNICAL ACCT MGR ISI .33FTE-12M ZN5	F2	\$41,250
CS-ZN5-TAM-ISILONH	TECHNICAL ACCT MGR ISI .50FTE-12M ZN5	F2	\$62,500
CS-ZN5-TAM-SOLH	ENG SOLUTIONS TAM - .50FTE - 12M ZN5	F2	\$95,000
CS-ZN5-TAM-USD	TECHNICAL ACCT MGR USD .33FTE-12M ZN5	F2	\$41,250
CS-ZN5-TAM-XIO	TECHNICAL ACCT MGR XIO .33FTE-12M ZN5	F2	\$41,250
DAAZ-0-50MS	DatAdvantage - Azure MS	F2	\$30
DAAZ-1001-1500MS	DatAdvantage - Azure MS	F2	\$9
DAAZ-100K-150KMC	DatAdvantage - Azure MC	F2	\$8
DAAZ-100K-150KMS	DatAdvantage - Azure MS	F2	\$4
DAAZ-101-250MS	DatAdvantage - Azure MS	F2	\$16
DAAZ-10K-20KMC	DatAdvantage - Azure MC	F2	\$9
DAAZ-10K-20KMS	DatAdvantage - Azure MS	F2	\$5
DAAZ-1501-2000MS	DatAdvantage - Azure MS	F2	\$8
DAAZ-150K-MC	DatAdvantage - Azure MC	F2	\$8
DAAZ-150K-MS	DatAdvantage - Azure MS	F2	\$4
DAAZ-2001-2500MS	DatAdvantage - Azure MS	F2	\$7
DAAZ-20K-35KMC	DatAdvantage - Azure MC	F2	\$9
DAAZ-20K-35KMS	DatAdvantage - Azure MS	F2	\$5
DAAZ-2501-4000MS	DatAdvantage - Azure MS	F2	\$7
DAAZ-251-500MS	DatAdvantage - Azure MS	F2	\$12
DAAZ-35K-50KMC	DatAdvantage - Azure MC	F2	\$8
DAAZ-35K-50KMS	DatAdvantage - Azure MS	F2	\$5
DAAZ-4001-6000MC	DatAdvantage - Azure MC	F2	\$11
DAAZ-4001-6000MS	DatAdvantage - Azure MS	F2	\$6
DAAZ-501-750MS	DatAdvantage - Azure MS	F2	\$10
DAAZ-50K-100KMC	DatAdvantage - Azure MC	F2	\$8
DAAZ-50K-100KMS	DatAdvantage - Azure MS	F2	\$5
DAAZ-51-100MS	DatAdvantage - Azure MS	F2	\$21
DAAZ-6001-8000MC	DatAdvantage - Azure MC	F2	\$10
DAAZ-6001-8000MS	DatAdvantage - Azure MS	F2	\$6
DAAZ-751-1000MS	DatAdvantage - Azure MS	F2	\$9
DAAZ-8001-10KMC	DatAdvantage - Azure MC	F2	\$10

DAAZ-8001-10KMS	DatAdvantage - Azure MS	F2	\$6
DADS-0-50MS	SEL DatAdvantage - DS MS	F2	\$30
DADS-1001-1500MS	SEL DatAdvantage - DS MS	F2	\$8
DADS-100K-150KMC	SEL DatAdvantage - DS M24*7	F2	\$8
DADS-100K-150KMS	SEL DatAdvantage - DS MS	F2	\$4
DADS-101-250MS	SEL DatAdvantage - DS MS	F2	\$16
DADS-10K-20KMC	SEL DatAdvantage - DS M24*7	F2	\$9
DADS-10K-20KMS	SEL DatAdvantage - DS MS	F2	\$5
DADS-1501-2000MS	SEL DatAdvantage - DS MS	F2	\$8
DADS-150K-MC	SEL DatAdvantage - DS M24*7	F2	\$8
DADS-150K-MS	SEL DatAdvantage - DS MS	F2	\$4
DADS-2001-2500MS	SEL DatAdvantage - DS MS	F2	\$7
DADS-20K-35KMC	SEL DatAdvantage - DS M24*7	F2	\$9
DADS-20K-35KMS	SEL DatAdvantage - DS MS	F2	\$5
DADS-2501-4000MS	SEL DatAdvantage - DS MS	F2	\$7
DADS-251-500MS	SEL DatAdvantage - DS MS	F2	\$12
DADS-35K-50KMC	SEL DatAdvantage - DS M24*7	F2	\$8
DADS-35K-50KMS	SEL DatAdvantage - DS MS	F2	\$5
DADS-4001-6000MC	SEL DatAdvantage - DS M24*7	F2	\$11
DADS-4001-6000MS	SEL DatAdvantage - DS MS	F2	\$6
DADS-501-750MS	SEL DatAdvantage - DS MS	F2	\$10
DADS-50K-100KMC	SEL DatAdvantage - DS M24*7	F2	\$8
DADS-50K-100KMS	SEL DatAdvantage - DS MS	F2	\$5
DADS-51-100MS	SEL DatAdvantage - DS MS	F2	\$21
DADS-6001-8000MC	SEL DatAdvantage - DS M24*7	F2	\$10
DADS-6001-8000MS	SEL DatAdvantage - DS MS	F2	\$6
DADS-751-1000MS	SEL DatAdvantage - DS MS	F2	\$9
DADS-8001-10KMC	SEL DatAdvantage - DS M24*7	F2	\$10
DADS-8001-10KMS	SEL DatAdvantage - DS MS	F2	\$6
DAEL-0-50MS	SEL DatAdvantage - EX Lite MS	F2	\$23
DAEL-1001-1500MS	SEL DatAdvantage - EX Lite MS	F2	\$7
DAEL-100K-150KMC	SEL DatAdvantage - EX Lite M24x7	F2	\$6
DAEL-100K-150KMS	SEL DatAdvantage - EX Lite MS	F2	\$3
DAEL-101-250MS	SEL DatAdvantage - EX Lite MS	F2	\$13
DAEL-10K-20KMC	SEL DatAdvantage - EX Lite M24x7	F2	\$7
DAEL-10K-20KMS	SEL DatAdvantage - EX Lite MS	F2	\$4
DAEL-1501-2000MS	SEL DatAdvantage - EX Lite MS	F2	\$6
DAEL-150K-MC	SEL DatAdvantage - EX Lite M24x7	F2	\$6
DAEL-150K-MS	SEL DatAdvantage - EX Lite MS	F2	\$3
DAEL-2001-2500MS	SEL DatAdvantage - EX Lite MS	F2	\$6
DAEL-20K-35KMC	SEL DatAdvantage - EX Lite M24x7	F2	\$7
DAEL-20K-35KMS	SEL DatAdvantage - EX Lite MS	F2	\$4
DAEL-2501-4000MS	SEL DatAdvantage - EX Lite MS	F2	\$5
DAEL-251-500MS	SEL DatAdvantage - EX Lite MS	F2	\$10
DAEL-35K-50KMC	SEL DatAdvantage - EX Lite M24x7	F2	\$6
DAEL-35K-50KMS	SEL DatAdvantage - EX Lite MS	F2	\$4
DAEL-4001-6000MC	SEL DatAdvantage - EX Lite M24x7	F2	\$8
DAEL-4001-6000MS	SEL DatAdvantage - EX Lite MS	F2	\$5
DAEL-501-750MS	SEL DatAdvantage - EX Lite MS	F2	\$8
DAEL-50K-100KMC	SEL DatAdvantage - EX Lite M24x7	F2	\$6

DAEL-50K-100KMS	SEL DatAdvantage - EX Lite MS	F2	\$4
DAEL-51-100MS	SEL DatAdvantage - EX Lite MS	F2	\$16
DAEL-6001-8000MC	SEL DatAdvantage - EX Lite M24x7	F2	\$8
DAEL-6001-8000MS	SEL DatAdvantage - EX Lite MS	F2	\$4
DAEL-751-1000MS	SEL DatAdvantage - EX Lite MS	F2	\$7
DAEL-8001-10KMC	SEL DatAdvantage - EX Lite M24x7	F2	\$7
DAEL-8001-10KMS	SEL DatAdvantage - EX Lite MS	F2	\$4
DAEO-0-50MS	SEL DatAdvantage - EXOL MS	F2	\$46
DAEO-1001-1500MS	SEL DatAdvantage - EXOL MS	F2	\$13
DAEO-100K-150KMC	SEL DatAdvantage - EXOL MC	F2	\$12
DAEO-100K-150KMS	SEL DatAdvantage - EXOL MS	F2	\$7
DAEO-101-250MS	SEL DatAdvantage - EXOL MS	F2	\$25
DAEO-10K-20KMC	SEL DatAdvantage - EXOL MC	F2	\$14
DAEO-10K-20KMS	SEL DatAdvantage - EXOL MS	F2	\$8
DAEO-1501-2000MS	SEL DatAdvantage - EXOL MS	F2	\$12
DAEO-150K-MC	SEL DatAdvantage - EXOL MC	F2	\$12
DAEO-150K-MS	SEL DatAdvantage - EXOL MS	F2	\$7
DAEO-2001-2500MS	SEL DatAdvantage - EXOL MS	F2	\$11
DAEO-20K-35KMC	SEL DatAdvantage - EXOL MC	F2	\$13
DAEO-20K-35KMS	SEL DatAdvantage - EXOL MS	F2	\$8
DAEO-2501-4000MS	SEL DatAdvantage - EXOL MS	F2	\$10
DAEO-251-500MS	SEL DatAdvantage - EXOL MS	F2	\$19
DAEO-35K-50KMC	SEL DatAdvantage - EXOL MC	F2	\$13
DAEO-35K-50KMS	SEL DatAdvantage - EXOL MS	F2	\$7
DAEO-4001-6000MC	SEL DatAdvantage - EXOL MC	F2	\$17
DAEO-4001-6000MS	SEL DatAdvantage - EXOL MS	F2	\$10
DAEO-501-750MS	SEL DatAdvantage - EXOL MS	F2	\$15
DAEO-50K-100KMC	SEL DatAdvantage - EXOL MC	F2	\$13
DAEO-50K-100KMS	SEL DatAdvantage - EXOL MS	F2	\$7
DAEO-51-100MS	SEL DatAdvantage - EXOL MS	F2	\$32
DAEO-6001-8000MC	SEL DatAdvantage - EXOL MC	F2	\$16
DAEO-6001-8000MS	SEL DatAdvantage - EXOL MS	F2	\$9
DAEO-751-1000MS	SEL DatAdvantage - EXOL MS	F2	\$14
DAEO-8001-10KMC	SEL DatAdvantage - EXOL MC	F2	\$15
DAEO-8001-10KMS	SEL DatAdvantage - EXOL MS	F2	\$8
DAEX-0-50MS	SEL DatAdvantage - EX MS	F2	\$46
DAEX-1001-1500MS	SEL DatAdvantage - EX MS	F2	\$13
DAEX-100K-150KMC	SEL DatAdvantage - EX M24x7	F2	\$12
DAEX-100K-150KMS	SEL DatAdvantage - EX MS	F2	\$7
DAEX-101-250MS	SEL DatAdvantage - EX MS	F2	\$25
DAEX-10K-20KMC	SEL DatAdvantage - EX M24x7	F2	\$14
DAEX-10K-20KMS	SEL DatAdvantage - EX MS	F2	\$8
DAEX-1501-2000MS	SEL DatAdvantage - EX MS	F2	\$12
DAEX-150K-MC	SEL DatAdvantage - EX M24x7	F2	\$12
DAEX-150K-MS	SEL DatAdvantage - EX MS	F2	\$7
DAEX-2001-2500MS	SEL DatAdvantage - EX MS	F2	\$11
DAEX-20K-35KMC	SEL DatAdvantage - EX M24x7	F2	\$13
DAEX-20K-35KMS	SEL DatAdvantage - EX MS	F2	\$8
DAEX-2501-4000MS	SEL DatAdvantage - EX MS	F2	\$10
DAEX-251-500MS	SEL DatAdvantage - EX MS	F2	\$19

DAEX-35K-50KMC	SEL DatAdvantage - EX M24x7	F2	\$13
DAEX-35K-50KMS	SEL DatAdvantage - EX MS	F2	\$7
DAEX-4001-6000MC	SEL DatAdvantage - EX M24x7	F2	\$17
DAEX-4001-6000MS	SEL DatAdvantage - EX MS	F2	\$10
DAEX-501-750MS	SEL DatAdvantage - EX MS	F2	\$15
DAEX-50K-100KMC	SEL DatAdvantage - EX M24x7	F2	\$13
DAEX-50K-100KMS	SEL DatAdvantage - EX MS	F2	\$7
DAEX-51-100MS	SEL DatAdvantage - EX MS	F2	\$32
DAEX-6001-8000MC	SEL DatAdvantage - EX M24x7	F2	\$16
DAEX-6001-8000MS	SEL DatAdvantage - EX MS	F2	\$9
DAEX-751-1000MS	SEL DatAdvantage - EX MS	F2	\$14
DAEX-8001-10KMC	SEL DatAdvantage - EX M24x7	F2	\$15
DAEX-8001-10KMS	SEL DatAdvantage - EX MS	F2	\$8
DAOD-0-50MS	SEL DatAdvantage - OD MS	F2	\$46
DAOD-1001-1500MS	SEL DatAdvantage - OD MS	F2	\$13
DAOD-100K-150KMC	SEL DatAdvantage - OD M24*7	F2	\$12
DAOD-100K-150KMS	SEL DatAdvantage - OD MS	F2	\$7
DAOD-101-250MS	SEL DatAdvantage - OD MS	F2	\$25
DAOD-10K-20KMC	SEL DatAdvantage - OD M24*7	F2	\$14
DAOD-10K-20KMS	SEL DatAdvantage - OD MS	F2	\$8
DAOD-1501-2000MS	SEL DatAdvantage - OD MS	F2	\$12
DAOD-150K-MC	SEL DatAdvantage - OD M24*7	F2	\$12
DAOD-150K-MS	SEL DatAdvantage - OD MS	F2	\$7
DAOD-2001-2500MS	SEL DatAdvantage - OD MS	F2	\$11
DAOD-20K-35KMC	SEL DatAdvantage - OD M24*7	F2	\$13
DAOD-20K-35KMS	SEL DatAdvantage - OD MS	F2	\$8
DAOD-2501-4000MS	SEL DatAdvantage - OD MS	F2	\$10
DAOD-251-500MS	SEL DatAdvantage - OD MS	F2	\$19
DAOD-35K-50KMC	SEL DatAdvantage - OD M24*7	F2	\$13
DAOD-35K-50KMS	SEL DatAdvantage - OD MS	F2	\$7
DAOD-4001-6000MC	SEL DatAdvantage - OD M24*7	F2	\$17
DAOD-4001-6000MS	SEL DatAdvantage - OD MS	F2	\$10
DAOD-501-750MS	SEL DatAdvantage - OD MS	F2	\$15
DAOD-50K-100KMC	SEL DatAdvantage - OD M24*7	F2	\$13
DAOD-50K-100KMS	SEL DatAdvantage - OD MS	F2	\$7
DAOD-51-100MS	SEL DatAdvantage - OD MS	F2	\$32
DAOD-6001-8000MC	SEL DatAdvantage - OD M24*7	F2	\$16
DAOD-6001-8000MS	SEL DatAdvantage - OD MS	F2	\$9
DAOD-751-1000MS	SEL DatAdvantage - OD MS	F2	\$14
DAOD-8001-10KMC	SEL DatAdvantage - OD M24*7	F2	\$15
DAOD-8001-10KMS	SEL DatAdvantage - OD MS	F2	\$8
DAOL-0-50MS	SEL DatAdvantage - OD Lite MS	F2	\$23
DAOL-1001-1500MS	SEL DatAdvantage - OD Lite MS	F2	\$7
DAOL-100K-150KMC	SEL DatAdvantage - OD Lite M24*7	F2	\$6
DAOL-100K-150KMS	SEL DatAdvantage - OD Lite MS	F2	\$3
DAOL-101-250MS	SEL DatAdvantage - OD Lite MS	F2	\$13
DAOL-10K-20KMC	SEL DatAdvantage - OD Lite M24*7	F2	\$7
DAOL-10K-20KMS	SEL DatAdvantage - OD Lite MS	F2	\$4
DAOL-1501-2000MS	SEL DatAdvantage - OD Lite MS	F2	\$6
DAOL-150K-MC	SEL DatAdvantage - OD Lite M24*7	F2	\$6

DAOL-150K-MS	SEL DatAdvantage - OD Lite MS	F2	\$3
DAOL-2001-2500MS	SEL DatAdvantage - OD Lite MS	F2	\$6
DAOL-20K-35KMC	SEL DatAdvantage - OD Lite M24*7	F2	\$7
DAOL-20K-35KMS	SEL DatAdvantage - OD Lite MS	F2	\$4
DAOL-2501-4000MS	SEL DatAdvantage - OD Lite MS	F2	\$5
DAOL-251-500MS	SEL DatAdvantage - OD Lite MS	F2	\$10
DAOL-35K-50KMC	SEL DatAdvantage - OD Lite M24*7	F2	\$6
DAOL-35K-50KMS	SEL DatAdvantage - OD Lite MS	F2	\$4
DAOL-4001-6000MC	SEL DatAdvantage - OD Lite M24*7	F2	\$8
DAOL-4001-6000MS	SEL DatAdvantage - OD Lite MS	F2	\$5
DAOL-501-750MS	SEL DatAdvantage - OD Lite MS	F2	\$8
DAOL-50K-100KMC	SEL DatAdvantage - OD Lite M24*7	F2	\$6
DAOL-50K-100KMS	SEL DatAdvantage - OD Lite MS	F2	\$4
DAOL-51-100MS	SEL DatAdvantage - OD Lite MS	F2	\$16
DAOL-6001-8000MC	SEL DatAdvantage - OD Lite M24*7	F2	\$8
DAOL-6001-8000MS	SEL DatAdvantage - OD Lite MS	F2	\$4
DAOL-751-1000MS	SEL DatAdvantage - OD Lite MS	F2	\$7
DAOL-8001-10KMC	SEL DatAdvantage - OD Lite M24*7	F2	\$7
DAOL-8001-10KMS	SEL DatAdvantage - OD Lite MS	F2	\$4
DAOS-0-50MS	SEL DatAdvantage - SPOL & OD MS	F2	\$68
DAOS-1001-1500MS	SEL DatAdvantage - SPOL & OD MS	F2	\$20
DAOS-100K-150KMC	SEL DatAdvantage - SPOL & OD M24*7	F2	\$18
DAOS-100K-150KMS	SEL DatAdvantage - SPOL & OD MS	F2	\$10
DAOS-101-250MS	SEL DatAdvantage - SPOL & OD MS	F2	\$38
DAOS-10K-20KMC	SEL DatAdvantage - SPOL & OD M24*7	F2	\$21
DAOS-10K-20KMS	SEL DatAdvantage - SPOL & OD MS	F2	\$12
DAOS-1501-2000MS	SEL DatAdvantage - SPOL & OD MS	F2	\$18
DAOS-150K-MC	SEL DatAdvantage - SPOL & OD M24*7	F2	\$18
DAOS-150K-MS	SEL DatAdvantage - SPOL & OD MS	F2	\$10
DAOS-2001-2500MS	SEL DatAdvantage - SPOL & OD MS	F2	\$17
DAOS-20K-35KMC	SEL DatAdvantage - SPOL & OD M24*7	F2	\$20
DAOS-20K-35KMS	SEL DatAdvantage - SPOL & OD MS	F2	\$11
DAOS-2501-4000MS	SEL DatAdvantage - SPOL & OD MS	F2	\$15
DAOS-251-500MS	SEL DatAdvantage - SPOL & OD MS	F2	\$29
DAOS-35K-50KMC	SEL DatAdvantage - SPOL & OD M24*7	F2	\$19
DAOS-35K-50KMS	SEL DatAdvantage - SPOL & OD MS	F2	\$11
DAOS-4001-6000MC	SEL DatAdvantage - SPOL & OD M24*7	F2	\$25
DAOS-4001-6000MS	SEL DatAdvantage - SPOL & OD MS	F2	\$14
DAOS-501-750MS	SEL DatAdvantage - SPOL & OD MS	F2	\$23
DAOS-50K-100KMC	SEL DatAdvantage - SPOL & OD M24*7	F2	\$19
DAOS-50K-100KMS	SEL DatAdvantage - SPOL & OD MS	F2	\$11
DAOS-51-100MS	SEL DatAdvantage - SPOL & OD MS	F2	\$48
DAOS-6001-8000MC	SEL DatAdvantage - SPOL & OD M24*7	F2	\$24
DAOS-6001-8000MS	SEL DatAdvantage - SPOL & OD MS	F2	\$13
DAOS-751-1000MS	SEL DatAdvantage - SPOL & OD MS	F2	\$21
DAOS-8001-10KMC	SEL DatAdvantage - SPOL & OD M24*7	F2	\$22
DAOS-8001-10KMS	SEL DatAdvantage - SPOL & OD MS	F2	\$13
D-AS-CSM-ADV-AN	SEL Splunk AdvSvc CSM-Advanced-AN	F2	\$58,824
D-AS-CSM-ADV-AP	SEL Splunk AdvSvc CSM-Advanced-AP	F2	\$58,824
D-AS-CSM-ADV-EM	SEL Splunk AdvSvc CSM-Advanced-EM	F2	\$58,824

D-AS-CSM-ADV-US	SEL Splunk AdvSvcs CSM-Advanced-US	F2	\$58,824
D-AS-CSM-BAS-AN	SEL Splunk AdvSvcs CSM-Basic-AN	F2	\$35,294
D-AS-CSM-BAS-AP	SEL Splunk AdvSvcs CSM-Basic-AP	F2	\$35,294
D-AS-CSM-BAS-EM	SEL Splunk AdvSvcs CSM-Basic-EM	F2	\$35,294
D-AS-CSM-BAS-US	SEL Splunk AdvSvcs CSM-Basic-US	F2	\$35,294
D-ASCSM-ENTL1-AN	SEL Splunk AdvSvcs CSM-ENT (<5TB)-AN	F2	\$105,882
D-ASCSM-ENTL1-AP	SEL Splunk AdvSvcs CSM-ENT (<5TB)-AP	F2	\$105,882
D-ASCSM-ENTL1-EM	SEL Splunk AdvSvcs CSM-ENT (<5TB)-EM	F2	\$105,882
D-ASCSM-ENTL1-US	SEL Splunk AdvSvcs CSM-ENT (<5TB)-US	F2	\$141,176
D-ASCSM-ENTL2-AN	SEL Splunk AdvSvcs CSM-ENT (5-25TB)-AN	F2	\$192,941
D-ASCSM-ENTL2-AP	SEL Splunk AdvSvcs CSM-ENT (5-25TB)-AP	F2	\$192,941
D-ASCSM-ENTL2-EM	SEL Splunk AdvSvcs CSM-ENT (5-25TB)-EM	F2	\$192,941
D-ASCSM-ENTL2-US	SEL Splunk AdvSvcs CSM-ENT (5-25TB)-US	F2	\$258,824
D-ASCSM-ENTL3-AN	SEL Splunk AdvSvcs CSM-ENT (25TB+)-AN	F2	\$317,647
D-ASCSM-ENTL3-AP	SEL Splunk AdvSvcs CSM-ENT (25TB+)-AP	F2	\$317,647
D-ASCSM-ENTL3-EM	SEL Splunk AdvSvcs CSM-ENT (25TB+)-EM	F2	\$317,647
D-ASCSM-ENTL3-US	SEL Splunk AdvSvcs CSM-ENT (25TB+)-US	F2	\$411,765
DASL-0-50MS	SEL DatAdvantage - SP Lite MS	F2	\$23
DASL-1001-1500MS	SEL DatAdvantage - SP Lite MS	F2	\$7
DASL-100K-150KMC	SEL DatAdvantage - SP Lite M24*7	F2	\$6
DASL-100K-150KMS	SEL DatAdvantage - SP Lite MS	F2	\$3
DASL-101-250MS	SEL DatAdvantage - SP Lite MS	F2	\$13
DASL-10K-20KMC	SEL DatAdvantage - SP Lite M24*7	F2	\$7
DASL-10K-20KMS	SEL DatAdvantage - SP Lite MS	F2	\$4
DASL-1501-2000MS	SEL DatAdvantage - SP Lite MS	F2	\$6
DASL-150K-MC	SEL DatAdvantage - SP Lite M24*7	F2	\$6
DASL-150K-MS	SEL DatAdvantage - SP Lite MS	F2	\$3
DASL-2001-2500MS	SEL DatAdvantage - SP Lite MS	F2	\$6
DASL-20K-35KMC	SEL DatAdvantage - SP Lite M24*7	F2	\$7
DASL-20K-35KMS	SEL DatAdvantage - SP Lite MS	F2	\$4
DASL-2501-4000MS	SEL DatAdvantage - SP Lite MS	F2	\$5
DASL-251-500MS	SEL DatAdvantage - SP Lite MS	F2	\$10
DASL-35K-50KMC	SEL DatAdvantage - SP Lite M24*7	F2	\$6
DASL-35K-50KMS	SEL DatAdvantage - SP Lite MS	F2	\$4
DASL-4001-6000MC	SEL DatAdvantage - SP Lite M24*7	F2	\$8
DASL-4001-6000MS	SEL DatAdvantage - SP Lite MS	F2	\$5
DASL-501-750MS	SEL DatAdvantage - SP Lite MS	F2	\$8
DASL-50K-100KMC	SEL DatAdvantage - SP Lite M24*7	F2	\$6
DASL-50K-100KMS	SEL DatAdvantage - SP Lite MS	F2	\$4
DASL-51-100MS	SEL DatAdvantage - SP Lite MS	F2	\$16
DASL-6001-8000MC	SEL DatAdvantage - SP Lite M24*7	F2	\$8
DASL-6001-8000MS	SEL DatAdvantage - SP Lite MS	F2	\$4
DASL-751-1000MS	SEL DatAdvantage - SP Lite MS	F2	\$7
DASL-8001-10KMC	SEL DatAdvantage - SP Lite M24*7	F2	\$7
DASL-8001-10KMS	SEL DatAdvantage - SP Lite MS	F2	\$4
DASO-0-50MS	SEL DatAdvantage - SPOL MS	F2	\$46
DASO-1001-1500MS	SEL DatAdvantage - SPOL MS	F2	\$13
DASO-100K-150KMC	SEL DatAdvantage - SPOL M24*7	F2	\$12
DASO-100K-150KMS	SEL DatAdvantage - SPOL MS	F2	\$7
DASO-101-250MS	SEL DatAdvantage - SPOL MS	F2	\$25

DASO-10K-20KMC	SEL DatAdvantage - SPOL M24*7	F2	\$14
DASO-10K-20KMS	SEL DatAdvantage - SPOL MS	F2	\$8
DASO-1501-2000MS	SEL DatAdvantage - SPOL MS	F2	\$12
DASO-150K-MC	SEL DatAdvantage - SPOL M24*7	F2	\$12
DASO-150K-MS	SEL DatAdvantage - SPOL MS	F2	\$7
DASO-2001-2500MS	SEL DatAdvantage - SPOL MS	F2	\$11
DASO-20K-35KMC	SEL DatAdvantage - SPOL M24*7	F2	\$13
DASO-20K-35KMS	SEL DatAdvantage - SPOL MS	F2	\$8
DASO-2501-4000MS	SEL DatAdvantage - SPOL MS	F2	\$10
DASO-251-500MS	SEL DatAdvantage - SPOL MS	F2	\$19
DASO-35K-50KMC	SEL DatAdvantage - SPOL M24*7	F2	\$13
DASO-35K-50KMS	SEL DatAdvantage - SPOL MS	F2	\$7
DASO-4001-6000MC	SEL DatAdvantage - SPOL M24*7	F2	\$17
DASO-4001-6000MS	SEL DatAdvantage - SPOL MS	F2	\$10
DASO-501-750MS	SEL DatAdvantage - SPOL MS	F2	\$15
DASO-50K-100KMC	SEL DatAdvantage - SPOL M24*7	F2	\$13
DASO-50K-100KMS	SEL DatAdvantage - SPOL MS	F2	\$7
DASO-51-100MS	SEL DatAdvantage - SPOL MS	F2	\$32
DASO-6001-8000MC	SEL DatAdvantage - SPOL M24*7	F2	\$16
DASO-6001-8000MS	SEL DatAdvantage - SPOL MS	F2	\$9
DASO-751-1000MS	SEL DatAdvantage - SPOL MS	F2	\$14
DASO-8001-10KMC	SEL DatAdvantage - SPOL M24*7	F2	\$15
DASO-8001-10KMS	SEL DatAdvantage - SPOL MS	F2	\$8
DASP-0-50MS	SEL DatAdvantage - SP MS	F2	\$46
DASP-1001-1500MS	SEL DatAdvantage - SP MS	F2	\$13
DASP-100K-150KMC	SEL DatAdvantage - SP M24*7	F2	\$12
DASP-100K-150KMS	SEL DatAdvantage - SP MS	F2	\$7
DASP-101-250MS	SEL DatAdvantage - SP MS	F2	\$25
DASP-10K-20KMC	SEL DatAdvantage - SP M24*7	F2	\$14
DASP-10K-20KMS	SEL DatAdvantage - SP MS	F2	\$8
DASP-1501-2000MS	SEL DatAdvantage - SP MS	F2	\$12
DASP-150K-MC	SEL DatAdvantage - SP M24*7	F2	\$12
DASP-150K-MS	SEL DatAdvantage - SP MS	F2	\$7
DASP-2001-2500MS	SEL DatAdvantage - SP MS	F2	\$11
DASP-20K-35KMC	SEL DatAdvantage - SP M24*7	F2	\$13
DASP-20K-35KMS	SEL DatAdvantage - SP MS	F2	\$8
DASP-2501-4000MS	SEL DatAdvantage - SP MS	F2	\$10
DASP-251-500MS	SEL DatAdvantage - SP MS	F2	\$19
DASP-35K-50KMC	SEL DatAdvantage - SP M24*7	F2	\$13
DASP-35K-50KMS	SEL DatAdvantage - SP MS	F2	\$7
DASP-4001-6000MC	SEL DatAdvantage - SP M24*7	F2	\$17
DASP-4001-6000MS	SEL DatAdvantage - SP MS	F2	\$10
DASP-501-750MS	SEL DatAdvantage - SP MS	F2	\$15
DASP-50K-100KMC	SEL DatAdvantage - SP M24*7	F2	\$13
DASP-50K-100KMS	SEL DatAdvantage - SP MS	F2	\$7
DASP-51-100MS	SEL DatAdvantage - SP MS	F2	\$32
DASP-6001-8000MC	SEL DatAdvantage - SP M24*7	F2	\$16
DASP-6001-8000MS	SEL DatAdvantage - SP MS	F2	\$9
DASP-751-1000MS	SEL DatAdvantage - SP MS	F2	\$14
DASP-8001-10KMC	SEL DatAdvantage - SP M24*7	F2	\$15

DASP-8001-10KMS	SEL DatAdvantage - SP MS	F2	\$8
DAUX-0-50MS	SEL DatAdvantage - NIX MS	F2	\$46
DAUX-1001-1500MS	SEL DatAdvantage - NIX MS	F2	\$13
DAUX-100K-150KMC	SEL DatAdvantage - NIX M24*7	F2	\$12
DAUX-100K-150KMS	SEL DatAdvantage - NIX MS	F2	\$7
DAUX-101-250MS	SEL DatAdvantage - NIX MS	F2	\$25
DAUX-10K-20KMC	SEL DatAdvantage - NIX M24*7	F2	\$14
DAUX-10K-20KMS	SEL DatAdvantage - NIX MS	F2	\$8
DAUX-1501-2000MS	SEL DatAdvantage - NIX MS	F2	\$12
DAUX-150K-MC	SEL DatAdvantage - NIX M24*7	F2	\$12
DAUX-150K-MS	SEL DatAdvantage - NIX MS	F2	\$7
DAUX-2001-2500MS	SEL DatAdvantage - NIX MS	F2	\$11
DAUX-20K-35KMC	SEL DatAdvantage - NIX M24*7	F2	\$13
DAUX-20K-35KMS	SEL DatAdvantage - NIX MS	F2	\$8
DAUX-2501-4000MS	SEL DatAdvantage - NIX MS	F2	\$10
DAUX-251-500MS	SEL DatAdvantage - NIX MS	F2	\$19
DAUX-35K-50KMC	SEL DatAdvantage - NIX M24*7	F2	\$13
DAUX-35K-50KMS	SEL DatAdvantage - NIX MS	F2	\$7
DAUX-4001-6000MC	SEL DatAdvantage - NIX M24*7	F2	\$17
DAUX-4001-6000MS	SEL DatAdvantage - NIX MS	F2	\$10
DAUX-501-750MS	SEL DatAdvantage - NIX MS	F2	\$15
DAUX-50K-100KMC	SEL DatAdvantage - NIX M24*7	F2	\$13
DAUX-50K-100KMS	SEL DatAdvantage - NIX MS	F2	\$7
DAUX-51-100MS	SEL DatAdvantage - NIX MS	F2	\$32
DAUX-6001-8000MC	SEL DatAdvantage - NIX M24*7	F2	\$16
DAUX-6001-8000MS	SEL DatAdvantage - NIX MS	F2	\$9
DAUX-751-1000MS	SEL DatAdvantage - NIX MS	F2	\$14
DAUX-8001-10KMC	SEL DatAdvantage - NIX M24*7	F2	\$15
DAUX-8001-10KMS	SEL DatAdvantage - NIX MS	F2	\$8
DAW-0-50MS	SEL DatAdvantage - WIN MS	F2	\$46
DAW-1001-1500MS	SEL DatAdvantage - WIN MS	F2	\$13
DAW-100K-150KMC	SEL DatAdvantage - WIN M24*7	F2	\$12
DAW-100K-150KMS	SEL DatAdvantage - WIN MS	F2	\$7
DAW-101-250MS	SEL DatAdvantage - WIN MS	F2	\$25
DAW-10K-20KMC	SEL DatAdvantage - WIN M24*7	F2	\$14
DAW-10K-20KMS	SEL DatAdvantage - WIN MS	F2	\$8
DAW-1501-2000MS	SEL DatAdvantage - WIN MS	F2	\$12
DAW-150K-MC	SEL DatAdvantage - WIN M24*7	F2	\$12
DAW-150K-MS	SEL DatAdvantage - WIN MS	F2	\$7
DAW-2001-2500MS	SEL DatAdvantage - WIN MS	F2	\$11
DAW-20K-35KMC	SEL DatAdvantage - WIN M24*7	F2	\$13
DAW-20K-35KMS	SEL DatAdvantage - WIN MS	F2	\$8
DAW-2501-4000MS	SEL DatAdvantage - WIN MS	F2	\$10
DAW-251-500MS	SEL DatAdvantage - WIN MS	F2	\$19
DAW-35K-50KMC	SEL DatAdvantage - WIN M24*7	F2	\$13
DAW-35K-50KMS	SEL DatAdvantage - WIN MS	F2	\$7
DAW-4001-6000MC	SEL DatAdvantage - WIN M24*7	F2	\$17
DAW-4001-6000MS	SEL DatAdvantage - WIN MS	F2	\$10
DAW-501-750MS	SEL DatAdvantage - WIN MS	F2	\$15
DAW-50K-100KMC	SEL DatAdvantage - WIN M24*7	F2	\$13

DAW-50K-100KMS	SEL DatAdvantage - WIN MS	F2	\$7
DAW-51-100MS	SEL DatAdvantage - WIN MS	F2	\$32
DAW-6001-8000MC	SEL DatAdvantage - WIN M24*7	F2	\$16
DAW-6001-8000MS	SEL DatAdvantage - WIN MS	F2	\$9
DAW-751-1000MS	SEL DatAdvantage - WIN MS	F2	\$14
DAW-8001-10KMC	SEL DatAdvantage - WIN M24*7	F2	\$15
DAW-8001-10KMS	SEL DatAdvantage - WIN MS	F2	\$8
DAWL-0-50MS	SEL DatAdvantage - WIN Lite MS	F2	\$23
DAWL-1001-1500MS	SEL DatAdvantage - WIN Lite MS	F2	\$7
DAWL-100K-150KMC	SEL DatAdvantage - WIN Lite M24x7	F2	\$6
DAWL-100K-150KMS	SEL DatAdvantage - WIN Lite MS	F2	\$3
DAWL-101-250MS	SEL DatAdvantage - WIN Lite MS	F2	\$13
DAWL-10K-20KMC	SEL DatAdvantage - WIN Lite M24x7	F2	\$7
DAWL-10K-20KMS	SEL DatAdvantage - WIN Lite MS	F2	\$4
DAWL-1501-2000MS	SEL DatAdvantage - WIN Lite MS	F2	\$6
DAWL-150K-MC	SEL DatAdvantage - WIN Lite M24x7	F2	\$6
DAWL-150K-MS	SEL DatAdvantage - WIN Lite MS	F2	\$3
DAWL-2001-2500MS	SEL DatAdvantage - WIN Lite MS	F2	\$6
DAWL-20K-35KMC	SEL DatAdvantage - WIN Lite M24x7	F2	\$7
DAWL-20K-35KMS	SEL DatAdvantage - WIN Lite MS	F2	\$4
DAWL-2501-4000MS	SEL DatAdvantage - WIN Lite MS	F2	\$5
DAWL-251-500MS	SEL DatAdvantage - WIN Lite MS	F2	\$10
DAWL-35K-50KMC	SEL DatAdvantage - WIN Lite M24x7	F2	\$6
DAWL-35K-50KMS	SEL DatAdvantage - WIN Lite MS	F2	\$4
DAWL-4001-6000MC	SEL DatAdvantage - WIN Lite M24x7	F2	\$8
DAWL-4001-6000MS	SEL DatAdvantage - WIN Lite MS	F2	\$5
DAWL-501-750MS	SEL DatAdvantage - WIN Lite MS	F2	\$8
DAWL-50K-100KMC	SEL DatAdvantage - WIN Lite M24x7	F2	\$6
DAWL-50K-100KMS	SEL DatAdvantage - WIN Lite MS	F2	\$4
DAWL-51-100MS	SEL DatAdvantage - WIN Lite MS	F2	\$16
DAWL-6001-8000MC	SEL DatAdvantage - WIN Lite M24x7	F2	\$8
DAWL-6001-8000MS	SEL DatAdvantage - WIN Lite MS	F2	\$4
DAWL-751-1000MS	SEL DatAdvantage - WIN Lite MS	F2	\$7
DAWL-8001-10KMC	SEL DatAdvantage - WIN Lite M24x7	F2	\$7
DAWL-8001-10KMS	SEL DatAdvantage - WIN Lite MS	F2	\$4
DBMC-INS-004	SEL Datadobi Daily Rate for Centera	F2	\$2,941
DBMC-MCD-055	SEL Migrate service Centera/Atmos-to-All	F2	\$1,098
DBMI-INS-004	SEL Datadobi Daily Rate for Isilon	F2	\$2,941
DBMI-MCD-055	SEL Migrate service to Isilon	F2	\$1,098
DBMI-MNT-002	SEL Tier 2: 9TB-12TB Node Capacity Mtn	F2	\$170
DBMI-MNT-003	SEL Tier 3: 13TB-108TB Node Capacity Mtn	F2	\$959
DBMI-MNT-004	SEL Tier 4 109TB-144TB Node Capacity Mtn	F2	\$2,012
DBMI-MNT-005	SEL Tier 5 145TB-216TB Node Capacity Mtn	F2	\$2,873
DBMI-MNT-006	SEL Tier 6 >216TB (236-354) Node Cap Mtn	F2	\$4,707
DBMVNX-INS-004	SEL Datadobi Daily Rate for VNX/Unity	F2	\$2,941
DBMVNX-MCD-055	SEL Migrate service to VNX/Unity	F2	\$1,098
DCF-0-50MS	SEL Data Classification MS	F2	\$33
DCF-1001-1500MS	SEL Data Classification MS	F2	\$9
DCF-100K-150KMC	SEL Data Classification M24x7	F2	\$9
DCF-100K-150KMS	SEL Data Classification MS	F2	\$5

DCF-101-250MS	SEL Data Classification MS	F2	\$18
DCF-10K-20KMC	SEL Data Classification M24x7	F2	\$10
DCF-10K-20KMS	SEL Data Classification MS	F2	\$6
DCF-1501-2000MS	SEL Data Classification MS	F2	\$8
DCF-150K-MC	SEL Data Classification M24x7	F2	\$8
DCF-150K-MS	SEL Data Classification MS	F2	\$5
DCF-2001-2500MS	SEL Data Classification MS	F2	\$8
DCF-20K-35KMC	SEL Data Classification M24x7	F2	\$10
DCF-20K-35KMS	SEL Data Classification MS	F2	\$6
DCF-2501-4000MS	SEL Data Classification MS	F2	\$7
DCF-251-500MS	SEL Data Classification MS	F2	\$14
DCF-35K-50KMC	SEL Data Classification M24x7	F2	\$9
DCF-35K-50KMS	SEL Data Classification MS	F2	\$5
DCF-4001-6000MC	SEL Data Classification M24x7	F2	\$12
DCF-4001-6000MS	SEL Data Classification MS	F2	\$7
DCF-501-750MS	SEL Data Classification MS	F2	\$11
DCF-50K-100KMC	SEL Data Classification M24x7	F2	\$9
DCF-50K-100KMS	SEL Data Classification MS	F2	\$5
DCF-51-100MS	SEL Data Classification MS	F2	\$23
DCF-6001-8000MC	SEL Data Classification M24x7	F2	\$11
DCF-6001-8000MS	SEL Data Classification MS	F2	\$6
DCF-751-1000MS	SEL Data Classification MS	F2	\$10
DCF-8001-10KMC	SEL Data Classification M24x7	F2	\$11
DCF-8001-10KMS	SEL Data Classification MS	F2	\$6
DCFU-0-50MS	SEL Data Classification - Unix MS	F2	\$33
DCFU-1001-1500MS	SEL Data Classification - Unix MS	F2	\$9
DCFU-100K-150KMC	SEL Data Classification - Unix M24x7	F2	\$9
DCFU-100K-150KMS	SEL Data Classification - Unix MS	F2	\$5
DCFU-101-250MS	SEL Data Classification - Unix MS	F2	\$18
DCFU-10K-20KMC	SEL Data Classification - Unix M24x7	F2	\$10
DCFU-10K-20KMS	SEL Data Classification - Unix MS	F2	\$6
DCFU-1501-2000MS	SEL Data Classification - Unix MS	F2	\$8
DCFU-150K-MC	SEL Data Classification - Unix M24x7	F2	\$8
DCFU-150K-MS	SEL Data Classification - Unix MS	F2	\$5
DCFU-2001-2500MS	SEL Data Classification - Unix MS	F2	\$8
DCFU-20K-35KMC	SEL Data Classification - Unix M24x7	F2	\$10
DCFU-20K-35KMS	SEL Data Classification - Unix MS	F2	\$6
DCFU-2501-4000MS	SEL Data Classification - Unix MS	F2	\$7
DCFU-251-500MS	SEL Data Classification - Unix MS	F2	\$14
DCFU-35K-50KMC	SEL Data Classification - Unix M24x7	F2	\$9
DCFU-35K-50KMS	SEL Data Classification - Unix MS	F2	\$5
DCFU-4001-6000MC	SEL Data Classification - Unix M24x7	F2	\$12
DCFU-4001-6000MS	SEL Data Classification - Unix MS	F2	\$7
DCFU-501-750MS	SEL Data Classification - Unix MS	F2	\$11
DCFU-50K-100KMC	SEL Data Classification - Unix M24x7	F2	\$9
DCFU-50K-100KMS	SEL Data Classification - Unix MS	F2	\$5
DCFU-51-100MS	SEL Data Classification - Unix MS	F2	\$23
DCFU-6001-8000MC	SEL Data Classification - Unix M24x7	F2	\$11
DCFU-6001-8000MS	SEL Data Classification - Unix MS	F2	\$6
DCFU-751-1000MS	SEL Data Classification - Unix MS	F2	\$10

DCFU-8001-10KMC	SEL Data Classification - Unix M24x7	F2	\$11
DCFU-8001-10KMS	SEL Data Classification - Unix MS	F2	\$6
DCOD-0-50MS	SEL Data Classification - OD MS	F2	\$33
DCOD-1001-1500MS	SEL Data Classification - OD MS	F2	\$9
DCOD-100K-150KMC	SEL Data Classification - OD M24x7	F2	\$9
DCOD-100K-150KMS	SEL Data Classification - OD MS	F2	\$5
DCOD-101-250MS	SEL Data Classification - OD MS	F2	\$18
DCOD-10K-20KMC	SEL Data Classification - OD M24x7	F2	\$10
DCOD-10K-20KMS	SEL Data Classification - OD MS	F2	\$6
DCOD-1501-2000MS	SEL Data Classification - OD MS	F2	\$8
DCOD-150K-MC	SEL Data Classification - OD M24x7	F2	\$8
DCOD-150K-MS	SEL Data Classification - OD MS	F2	\$5
DCOD-2001-2500MS	SEL Data Classification - OD MS	F2	\$8
DCOD-20K-35KMC	SEL Data Classification - OD M24x7	F2	\$10
DCOD-20K-35KMS	SEL Data Classification - OD MS	F2	\$6
DCOD-2501-4000MS	SEL Data Classification - OD MS	F2	\$7
DCOD-251-500MS	SEL Data Classification - OD MS	F2	\$14
DCOD-35K-50KMC	SEL Data Classification - OD M24x7	F2	\$9
DCOD-35K-50KMS	SEL Data Classification - OD MS	F2	\$5
DCOD-4001-6000MC	SEL Data Classification - OD M24x7	F2	\$12
DCOD-4001-6000MS	SEL Data Classification - OD MS	F2	\$7
DCOD-501-750MS	SEL Data Classification - OD MS	F2	\$11
DCOD-50K-100KMC	SEL Data Classification - OD M24x7	F2	\$9
DCOD-50K-100KMS	SEL Data Classification - OD MS	F2	\$5
DCOD-51-100MS	SEL Data Classification - OD MS	F2	\$23
DCOD-6001-8000MC	SEL Data Classification - OD M24x7	F2	\$11
DCOD-6001-8000MS	SEL Data Classification - OD MS	F2	\$6
DCOD-751-1000MS	SEL Data Classification - OD MS	F2	\$10
DCOD-8001-10KMC	SEL Data Classification - OD M24x7	F2	\$11
DCOD-8001-10KMS	SEL Data Classification - OD MS	F2	\$6
DCOS-0-50MS	SEL Data Classification - SPOL MS	F2	\$49
DCOS-1001-1500MS	SEL Data Classification - SPOL MS	F2	\$14
DCOS-100K-150KMC	SEL Data Classification - SPOL M24x7	F2	\$13
DCOS-100K-150KMS	SEL Data Classification - SPOL MS	F2	\$7
DCOS-101-250MS	SEL Data Classification - SPOL MS	F2	\$27
DCOS-10K-20KMC	SEL Data Classification - SPOL M24x7	F2	\$15
DCOS-10K-20KMS	SEL Data Classification - SPOL MS	F2	\$9
DCOS-1501-2000MS	SEL Data Classification - SPOL MS	F2	\$13
DCOS-150K-MC	SEL Data Classification - SPOL M24x7	F2	\$13
DCOS-150K-MS	SEL Data Classification - SPOL MS	F2	\$7
DCOS-2001-2500MS	SEL Data Classification - SPOL MS	F2	\$12
DCOS-20K-35KMC	SEL Data Classification - SPOL M24x7	F2	\$14
DCOS-20K-35KMS	SEL Data Classification - SPOL MS	F2	\$8
DCOS-2501-4000MS	SEL Data Classification - SPOL MS	F2	\$11
DCOS-251-500MS	SEL Data Classification - SPOL MS	F2	\$21
DCOS-35K-50KMC	SEL Data Classification - SPOL M24x7	F2	\$14
DCOS-35K-50KMS	SEL Data Classification - SPOL MS	F2	\$8
DCOS-4001-6000MC	SEL Data Classification - SPOL M24x7	F2	\$18
DCOS-4001-6000MS	SEL Data Classification - SPOL MS	F2	\$10
DCOS-501-750MS	SEL Data Classification - SPOL MS	F2	\$17

DCOS-50K-100KMC	SEL Data Classification - SPOL M24x7	F2	\$13
DCOS-50K-100KMS	SEL Data Classification - SPOL MS	F2	\$8
DCOS-51-100MS	SEL Data Classification - SPOL MS	F2	\$34
DCOS-6001-8000MC	SEL Data Classification - SPOL M24x7	F2	\$17
DCOS-6001-8000MS	SEL Data Classification - SPOL MS	F2	\$10
DCOS-751-1000MS	SEL Data Classification - SPOL MS	F2	\$15
DCOS-8001-10KMC	SEL Data Classification - SPOL M24x7	F2	\$16
DCOS-8001-10KMS	SEL Data Classification - SPOL MS	F2	\$9
DCSO-0-50MS	SEL Data Classification - SPOL MS	F2	\$33
DCSO-1001-1500MS	SEL Data Classification - SPOL MS	F2	\$9
DCSO-100K-150KMC	SEL Data Classification - SPOL M24x7	F2	\$9
DCSO-100K-150KMS	SEL Data Classification - SPOL MS	F2	\$5
DCSO-101-250MS	SEL Data Classification - SPOL MS	F2	\$18
DCSO-10K-20KMC	SEL Data Classification - SPOL M24x7	F2	\$10
DCSO-10K-20KMS	SEL Data Classification - SPOL MS	F2	\$6
DCSO-1501-2000MS	SEL Data Classification - SPOL MS	F2	\$8
DCSO-150K-MC	SEL Data Classification - SPOL M24x7	F2	\$8
DCSO-150K-MS	SEL Data Classification - SPOL MS	F2	\$5
DCSO-2001-2500MS	SEL Data Classification - SPOL MS	F2	\$8
DCSO-20K-35KMC	SEL Data Classification - SPOL M24x7	F2	\$10
DCSO-20K-35KMS	SEL Data Classification - SPOL MS	F2	\$6
DCSO-2501-4000MS	SEL Data Classification - SPOL MS	F2	\$7
DCSO-251-500MS	SEL Data Classification - SPOL MS	F2	\$14
DCSO-35K-50KMC	SEL Data Classification - SPOL M24x7	F2	\$9
DCSO-35K-50KMS	SEL Data Classification - SPOL MS	F2	\$5
DCSO-4001-6000MC	SEL Data Classification - SPOL M24x7	F2	\$12
DCSO-4001-6000MS	SEL Data Classification - SPOL MS	F2	\$7
DCSO-501-750MS	SEL Data Classification - SPOL MS	F2	\$11
DCSO-50K-100KMC	SEL Data Classification - SPOL M24x7	F2	\$9
DCSO-50K-100KMS	SEL Data Classification - SPOL MS	F2	\$5
DCSO-51-100MS	SEL Data Classification - SPOL MS	F2	\$23
DCSO-6001-8000MC	SEL Data Classification - SPOL M24x7	F2	\$11
DCSO-6001-8000MS	SEL Data Classification - SPOL MS	F2	\$6
DCSO-751-1000MS	SEL Data Classification - SPOL MS	F2	\$10
DCSO-8001-10KMC	SEL Data Classification - SPOL M24x7	F2	\$11
DCSO-8001-10KMS	SEL Data Classification - SPOL MS	F2	\$6
DENOMTC1	SEL NH DENOMINATIONAL	F2	\$1
DFX-PS	SEL DFX Professional Services per day	F2	\$2,118
DFX-TRAIN-PS	SEL DFX Training per day	F2	\$2,118
DL-0-50MS	SEL DatAlert MS	F2	\$21
DL-1001-1500MS	SEL DatAlert MS	F2	\$6
DL-100K-150KMC	SEL DatAlert M24x7	F2	\$5
DL-100K-150KMS	SEL DatAlert MS	F2	\$3
DL-101-250MS	SEL DatAlert MS	F2	\$11
DL-10K-20KMC	SEL DatAlert M24x7	F2	\$6
DL-10K-20KMS	SEL DatAlert MS	F2	\$4
DL-1501-2000MS	SEL DatAlert MS	F2	\$5
DL-150K-MC	SEL DatAlert M24x7	F2	\$5
DL-150K-MS	SEL DatAlert MS	F2	\$3
DL-2001-2500MS	SEL DatAlert MS	F2	\$5

DL-20K-35KMC	SEL DatAlert M24x7	F2	\$6
DL-20K-35KMS	SEL DatAlert MS	F2	\$3
DL-2501-4000MS	SEL DatAlert MS	F2	\$5
DL-251-500MS	SEL DatAlert MS	F2	\$9
DL-35K-50KMC	SEL DatAlert M24x7	F2	\$6
DL-35K-50KMS	SEL DatAlert MS	F2	\$3
DL-4001-6000MC	SEL DatAlert M24x7	F2	\$8
DL-4001-6000MS	SEL DatAlert MS	F2	\$4
DL-501-750MS	SEL DatAlert MS	F2	\$7
DL-50K-100KMC	SEL DatAlert M24x7	F2	\$6
DL-50K-100KMS	SEL DatAlert MS	F2	\$3
DL-51-100MS	SEL DatAlert MS	F2	\$14
DL-6001-8000MC	SEL DatAlert M24x7	F2	\$7
DL-6001-8000MS	SEL DatAlert MS	F2	\$4
DL-751-1000MS	SEL DatAlert MS	F2	\$6
DL-8001-10KMC	SEL DatAlert M24x7	F2	\$7
DL-8001-10KMS	SEL DatAlert MS	F2	\$4
DLS-0-50MS	SEL DatAlert Suite MS	F2	\$32
DLS-1001-1500MS	SEL DatAlert Suite MS	F2	\$9
DLS-100K-150KMC	SEL DatAlert Suite M24x7	F2	\$8
DLS-100K-150KMS	SEL DatAlert Suite MS	F2	\$5
DLS-101-250MS	SEL DatAlert Suite MS	F2	\$18
DLS-10K-20KMC	SEL DatAlert Suite M24x7	F2	\$10
DLS-10K-20KMS	SEL DatAlert Suite MS	F2	\$6
DLS-1501-2000MS	SEL DatAlert Suite MS	F2	\$8
DLS-150K-MC	SEL DatAlert Suite M24x7	F2	\$8
DLS-150K-MS	SEL DatAlert Suite MS	F2	\$5
DLS-2001-2500MS	SEL DatAlert Suite MS	F2	\$8
DLS-20K-35KMC	SEL DatAlert Suite M24x7	F2	\$9
DLS-20K-35KMS	SEL DatAlert Suite MS	F2	\$5
DLS-2501-4000MS	SEL DatAlert Suite MS	F2	\$7
DLS-251-500MS	SEL DatAlert Suite MS	F2	\$13
DLS-35K-50KMC	SEL DatAlert Suite M24x7	F2	\$9
DLS-35K-50KMS	SEL DatAlert Suite MS	F2	\$5
DLS-4001-6000MC	SEL DatAlert Suite M24x7	F2	\$12
DLS-4001-6000MS	SEL DatAlert Suite MS	F2	\$7
DLS-501-750MS	SEL DatAlert Suite MS	F2	\$11
DLS-50K-100KMC	SEL DatAlert Suite M24x7	F2	\$9
DLS-50K-100KMS	SEL DatAlert Suite MS	F2	\$5
DLS-51-100MS	SEL DatAlert Suite MS	F2	\$22
DLS-6001-8000MC	SEL DatAlert Suite M24x7	F2	\$11
DLS-6001-8000MS	SEL DatAlert Suite MS	F2	\$6
DLS-751-1000MS	SEL DatAlert Suite MS	F2	\$10
DLS-8001-10KMC	SEL DatAlert Suite M24x7	F2	\$10
DLS-8001-10KMS	SEL DatAlert Suite MS	F2	\$6
DLX-0-50MS	SEL DatAlert Analytics MS	F2	\$14
DLX-1001-1500MS	SEL DatAlert Analytics MS	F2	\$4
DLX-100K-150KMC	SEL DatAlert Analytics M24*7	F2	\$4
DLX-100K-150KMS	SEL DatAlert Analytics MS	F2	\$2
DLX-101-250MS	SEL DatAlert Analytics MS	F2	\$7

DLX-10K-20KMC	SEL DatAlert Analytics M24*7	F2	\$4
DLX-10K-20KMS	SEL DatAlert Analytics MS	F2	\$2
DLX-1501-2000MS	SEL DatAlert Analytics MS	F2	\$4
DLX-150K-MC	SEL DatAlert Analytics M24*7	F2	\$4
DLX-150K-MS	SEL DatAlert Analytics MS	F2	\$2
DLX-2001-2500MS	SEL DatAlert Analytics MS	F2	\$3
DLX-20K-35KMC	SEL DatAlert Analytics M24*7	F2	\$4
DLX-20K-35KMS	SEL DatAlert Analytics MS	F2	\$2
DLX-2501-4000MS	SEL DatAlert Analytics MS	F2	\$3
DLX-251-500MS	SEL DatAlert Analytics MS	F2	\$6
DLX-35K-50KMC	SEL DatAlert Analytics M24*7	F2	\$4
DLX-35K-50KMS	SEL DatAlert Analytics MS	F2	\$2
DLX-4001-6000MC	SEL DatAlert Analytics M24*7	F2	\$5
DLX-4001-6000MS	SEL DatAlert Analytics MS	F2	\$3
DLX-501-750MS	SEL DatAlert Analytics MS	F2	\$5
DLX-50K-100KMC	SEL DatAlert Analytics M24*7	F2	\$4
DLX-50K-100KMS	SEL DatAlert Analytics MS	F2	\$2
DLX-51-100MS	SEL DatAlert Analytics MS	F2	\$10
DLX-6001-8000MC	SEL DatAlert Analytics M24*7	F2	\$5
DLX-6001-8000MS	SEL DatAlert Analytics MS	F2	\$3
DLX-751-1000MS	SEL DatAlert Analytics MS	F2	\$4
DLX-8001-10KMC	SEL DatAlert Analytics M24*7	F2	\$4
DLX-8001-10KMS	SEL DatAlert Analytics MS	F2	\$3
DMS-2000-LMA-1YR	SEL CDSI Annual Maintenance SM Config	F2	\$29,412
DMS-4000-LMA-1YR	SEL CDSI Annual Maintenance MED Config	F2	\$41,176
DMS-8000-LMA-1YR	SEL CDSI Annual Maintenance LG Config	F2	\$64,706
DMS-OS-CONS	SEL CDSI OnSite EngConsult PerDayT&Eexcl	F2	\$2,941
DMS-OS-TRNG	SEL CDSI OnSite BasicTrain PerDayT&Eexcl	F2	\$4,941
DMS-R-CONS	SEL CDSI Remote Eng Consult 4hr block	F2	\$1,176
DMS-R-TRNG	SEL CDSI Remote Basic Training 4HR Block	F2	\$2,353
DNI-MC	SEL DatAnywhere Instance Add-on MC	F2	\$2,810
DNI-MS	SEL DatAnywhere Instance Add-on MS	F2	\$1,606
DP-0-50MS	SEL DATAPRIVILEGE MS	F2	\$30
DP-1001-1500MS	SEL DATAPRIVILEGE MS	F2	\$8
DP-100K-150KMC	SEL DATAPRIVILEGE M24X7	F2	\$8
DP-100K-150KMS	SEL DATAPRIVILEGE MS	F2	\$4
DP-101-250MS	SEL DATAPRIVILEGE MS	F2	\$16
DP-10K-20KMC	SEL DATAPRIVILEGE M24X7	F2	\$9
DP-10K-20KMS	SEL DATAPRIVILEGE MS	F2	\$5
DP-1501-2000MS	SEL DATAPRIVILEGE MS	F2	\$8
DP-150K-MC	SEL DATAPRIVILEGE M24X7	F2	\$8
DP-150K-MS	SEL DATAPRIVILEGE MS	F2	\$4
DP-2001-2500MS	SEL DATAPRIVILEGE MS	F2	\$7
DP-20K-35KMC	SEL DATAPRIVILEGE M24X7	F2	\$9
DP-20K-35KMS	SEL DATAPRIVILEGE MS	F2	\$5
DP-2501-4000MS	SEL DATAPRIVILEGE MS	F2	\$7
DP-251-500MS	SEL DATAPRIVILEGE MS	F2	\$12
DP-35K-50KMC	SEL DATAPRIVILEGE M24X7	F2	\$8
DP-35K-50KMS	SEL DATAPRIVILEGE MS	F2	\$5
DP-4001-6000MC	SEL DATAPRIVILEGE M24X7	F2	\$11

DP-4001-6000MS	SEL DATAPRIVILEGE MS	F2	\$6
DP-501-750MS	SEL DATAPRIVILEGE MS	F2	\$10
DP-50K-100KMC	SEL DATAPRIVILEGE M24X7	F2	\$8
DP-50K-100KMS	SEL DATAPRIVILEGE MS	F2	\$5
DP-51-100MS	SEL DATAPRIVILEGE MS	F2	\$21
DP-6001-8000MC	SEL DATAPRIVILEGE M24X7	F2	\$10
DP-6001-8000MS	SEL DATAPRIVILEGE MS	F2	\$6
DP-751-1000MS	SEL DATAPRIVILEGE MS	F2	\$9
DP-8001-10KMC	SEL DATAPRIVILEGE M24X7	F2	\$10
DP-8001-10KMS	SEL DATAPRIVILEGE MS	F2	\$6
DPS-0-50MS	SEL DATAPRIVILEGE - SP MS	F2	\$30
DPS-1001-1500MS	SEL DATAPRIVILEGE - SP MS	F2	\$8
DPS-100K-150KMC	SEL DATAPRIVILEGE - SP M24X7	F2	\$8
DPS-100K-150KMS	SEL DATAPRIVILEGE - SP MS	F2	\$4
DPS-101-250MS	SEL DATAPRIVILEGE - SP MS	F2	\$16
DPS-10K-20KMC	SEL DATAPRIVILEGE - SP M24X7	F2	\$9
DPS-10K-20KMS	SEL DATAPRIVILEGE - SP MS	F2	\$5
DPS-1501-2000MS	SEL DATAPRIVILEGE - SP MS	F2	\$8
DPS-150K-MC	SEL DATAPRIVILEGE - SP M24X7	F2	\$8
DPS-150K-MS	SEL DATAPRIVILEGE - SP MS	F2	\$4
DPS-2001-2500MS	SEL DATAPRIVILEGE - SP MS	F2	\$7
DPS-20K-35KMC	SEL DATAPRIVILEGE - SP M24X7	F2	\$9
DPS-20K-35KMS	SEL DATAPRIVILEGE - SP MS	F2	\$5
DPS-2501-4000MS	SEL DATAPRIVILEGE - SP MS	F2	\$7
DPS-251-500MS	SEL DATAPRIVILEGE - SP MS	F2	\$12
DPS-35K-50KMC	SEL DATAPRIVILEGE - SP M24X7	F2	\$8
DPS-35K-50KMS	SEL DATAPRIVILEGE - SP MS	F2	\$5
DPS-4001-6000MC	SEL DATAPRIVILEGE - SP M24X7	F2	\$11
DPS-4001-6000MS	SEL DATAPRIVILEGE - SP MS	F2	\$6
DPS-501-750MS	SEL DATAPRIVILEGE - SP MS	F2	\$10
DPS-50K-100KMC	SEL DATAPRIVILEGE - SP M24X7	F2	\$8
DPS-50K-100KMS	SEL DATAPRIVILEGE - SP MS	F2	\$5
DPS-51-100MS	SEL DATAPRIVILEGE - SP MS	F2	\$21
DPS-6001-8000MC	SEL DATAPRIVILEGE - SP M24X7	F2	\$10
DPS-6001-8000MS	SEL DATAPRIVILEGE - SP MS	F2	\$6
DPS-751-1000MS	SEL DATAPRIVILEGE - SP MS	F2	\$9
DPS-8001-10KMC	SEL DATAPRIVILEGE - SP M24X7	F2	\$10
DPS-8001-10KMS	SEL DATAPRIVILEGE - SP MS	F2	\$6
D-PS-DAY-AN	SEL Splunk PS Daily-AN	F2	\$2,118
D-PS-DAY-AP	SEL Splunk PS Daily-AP	F2	\$2,118
D-PS-DAY-C-US	SEL Splunk PS Daily-Cleared Resource-US	F2	\$3,000
D-PS-DAY-R-EM	SEL Splunk PS Daily(Remote)-EM	F2	\$2,353
D-PS-DAY-R-US	SEL Splunk PS Daily (Remote)-US	F2	\$2,353
D-PS-DAY-T1-EM	SEL Splunk PS Daily (T1 T&E included)-EM	F2	\$2,471
D-PS-DAY-T2-EM	SEL Splunk PS Daily (T2 T&E included)-EM	F2	\$2,765
D-PS-DAY-T3-EM	SEL Splunk PS Daily (T3 T&E included)-EM	F2	\$2,941
D-PS-DAY-US	SEL Splunk Prof Services Daily-US	F2	\$2,941
D-PS-PM-DAY-AN	SEL Splunk Pro Svcs ProMgmt Daily-AN	F2	\$1,412
D-PS-PM-DAY-AP	SEL Splunk ProSvcs ProMgmtDaily-AP	F2	\$1,412
D-PS-PM-DAY-R-EM	SEL Splunk PS-ProjMgmt Daily(Remote)-EM	F2	\$1,765

D-PS-PM-DAY-R-US	SEL Splunk PS Pro Mgmt-Daily(R)-US	F2	\$1,765
D-PS-PMDAY-US	SEL Splunk PS Pro Mgmt-Daily-US	F2	\$2,353
D-PS-PREM-E-AN	SEL Splunk Pro Svcs Prem Daily noT&E-AN	F2	\$2,706
D-PS-PREM-E-AP	SEL Splunk ProSvcs PremDaily noT&E-AP	F2	\$2,706
D-PS-PREM-R-EM	SEL Splunk PS-Prem Daily(Remote)-EM	F2	\$3,529
D-PS-PREM-R-US	SEL Splunk PS - Premium Daily(R)-US	F2	\$3,529
D-PS-PREM-T1-EM	SE Splunk PS-Premium-Daily (T1 T&E)-EM	F2	\$3,647
D-PS-PREM-T2-EM	SE Splunk PS-Premium-Daily (T2 T&E)-EM	F2	\$3,941
D-PS-PREM-T3-EM	SE Splunk PS-Premium-Daily (T3 T&E)-EM	F2	\$4,118
D-PS-PREM-US	SEL Splunk PS - Premium Daily-US	F2	\$4,118
D-PSSVC-UNIT1-AN	SEL Services Unit 1 (PS-only)-AN	F2	\$118
D-PSSVC-UNIT1-AP	SEL Services Unit 1 (PS-only)-AP	F2	\$118
D-PSSVC-UNIT1-EM	SEL Services Unit 1 (PS-only)-EM	F2	\$118
D-PSSVC-UNIT1-US	SEL Services Unit 1 (PS-only)-US	F2	\$118
D-PS-SVEG-DAY-AN	SEL Splunk PS EngPostDply Daily(R)-AN	F2	\$1,412
D-PS-SVEG-DAY-AP	SEL Splunk PS EngPostDplyDaily(R)-AP	F2	\$1,412
D-PSSVEG-DAYR-EM	SEL Splunk SvcsEngPstDpl-Day(Remote)-EM	F2	\$1,765
D-PSSVEG-DAYR-US	SEL Splunk SvcsEngPstDpl-Day(Remote)-US	F2	\$1,500
D-PSSVEG-T1-EM	SEL Splunk SvcsEngPstDpl-Day (T1 T&E)-EM	F2	\$1,882
D-PSSVEG-T2-EM	SEL Splunk SvcsEngPstDpl-Day (T2 T&E)-EM	F2	\$2,176
D-PSSVEG-T3-EM	SEL Splunk SvcsEngPstDpl-Day (T3 T&E)-EM	F2	\$2,353
DR-MC	SEL Disaster Recovery Add-on MC	F2	\$4,015
DR-MS	SEL Disaster Recovery Add-on MS	F2	\$2,294
DTE-0-50MS	SEL Data Transport Engine MS	F2	\$27
DTE-1001-1500MS	SEL Data Transport Engine MS	F2	\$8
DTE-100K-150KMC	SEL Data Transport Engine M24x7	F2	\$7
DTE-100K-150KMS	SEL Data Transport Engine MS	F2	\$4
DTE-101-250MS	SEL Data Transport Engine MS	F2	\$15
DTE-10K-20KMC	SEL Data Transport Engine M24x7	F2	\$8
DTE-10K-20KMS	SEL Data Transport Engine MS	F2	\$5
DTE-1501-2000MS	SEL Data Transport Engine MS	F2	\$7
DTE-150K-MC	SEL Data Transport Engine M24x7	F2	\$7
DTE-150K-MS	SEL Data Transport Engine MS	F2	\$4
DTE-2001-2500MS	SEL Data Transport Engine MS	F2	\$7
DTE-20K-35KMC	SEL Data Transport Engine M24x7	F2	\$8
DTE-20K-35KMS	SEL Data Transport Engine MS	F2	\$5
DTE-2501-4000MS	SEL Data Transport Engine MS	F2	\$6
DTE-251-500MS	SEL Data Transport Engine MS	F2	\$11
DTE-35K-50KMC	SEL Data Transport Engine M24x7	F2	\$8
DTE-35K-50KMS	SEL Data Transport Engine MS	F2	\$4
DTE-4001-6000MC	SEL Data Transport Engine M24x7	F2	\$10
DTE-4001-6000MS	SEL Data Transport Engine MS	F2	\$6
DTE-501-750MS	SEL Data Transport Engine MS	F2	\$9
DTE-50K-100KMC	SEL Data Transport Engine M24x7	F2	\$7
DTE-50K-100KMS	SEL Data Transport Engine MS	F2	\$4
DTE-51-100MS	SEL Data Transport Engine MS	F2	\$19
DTE-6001-8000MC	SEL Data Transport Engine M24x7	F2	\$9
DTE-6001-8000MS	SEL Data Transport Engine MS	F2	\$5
DTE-751-1000MS	SEL Data Transport Engine MS	F2	\$8
DTE-8001-10KMC	SEL Data Transport Engine M24x7	F2	\$9

DTE-8001-10KMS	SEL Data Transport Engine MS	F2	\$5
DW-0-50MS	SEL DATANSWERS - WIN MS	F2	\$46
DW-1001-1500MS	SEL DATANSWERS - WIN MS	F2	\$13
DW-100K-150KMC	SEL DATANSWERS - WIN M24*7	F2	\$12
DW-100K-150KMS	SEL DATANSWERS - WIN MS	F2	\$7
DW-101-250MS	SEL DATANSWERS - WIN MS	F2	\$25
DW-10K-20KMC	SEL DATANSWERS - WIN M24*7	F2	\$14
DW-10K-20KMS	SEL DATANSWERS - WIN MS	F2	\$8
DW-1501-2000MS	SEL DATANSWERS - WIN MS	F2	\$12
DW-150K-MC	SEL DATANSWERS - WIN M24*7	F2	\$12
DW-150K-MS	SEL DATANSWERS - WIN MS	F2	\$7
DW-2001-2500MS	SEL DATANSWERS - WIN MS	F2	\$11
DW-20K-35KMC	SEL DATANSWERS - WIN M24*7	F2	\$13
DW-20K-35KMS	SEL DATANSWERS - WIN MS	F2	\$8
DW-2501-4000MS	SEL DATANSWERS - WIN MS	F2	\$10
DW-251-500MS	SEL DATANSWERS - WIN MS	F2	\$19
DW-35K-50KMC	SEL DATANSWERS - WIN M24*7	F2	\$13
DW-35K-50KMS	SEL DATANSWERS - WIN MS	F2	\$7
DW-4001-6000MC	SEL DATANSWERS - WIN M24*7	F2	\$17
DW-4001-6000MS	SEL DATANSWERS - WIN MS	F2	\$10
DW-501-750MS	SEL DATANSWERS - WIN MS	F2	\$15
DW-50K-100KMC	SEL DATANSWERS - WIN M24*7	F2	\$13
DW-50K-100KMS	SEL DATANSWERS - WIN MS	F2	\$7
DW-51-100MS	SEL DATANSWERS - WIN MS	F2	\$32
DW-6001-8000MC	SEL DATANSWERS - WIN M24*7	F2	\$16
DW-6001-8000MS	SEL DATANSWERS - WIN MS	F2	\$9
DW-751-1000MS	SEL DATANSWERS - WIN MS	F2	\$14
DW-8001-10KMC	SEL DATANSWERS - WIN M24*7	F2	\$15
DW-8001-10KMS	SEL DATANSWERS - WIN MS	F2	\$8
DWOD-0-50MS	SEL DATANSWERS - OD MS	F2	\$46
DWOD-1001-1500MS	SEL DATANSWERS - OD MS	F2	\$13
DWOD-100K-150KMC	SEL DATANSWERS - OD M24*7	F2	\$12
DWOD-100K-150KMS	SEL DATANSWERS - OD MS	F2	\$7
DWOD-101-250MS	SEL DATANSWERS - OD MS	F2	\$25
DWOD-10K-20KMC	SEL DATANSWERS - OD M24*7	F2	\$14
DWOD-10K-20KMS	SEL DATANSWERS - OD MS	F2	\$8
DWOD-1501-2000MS	SEL DATANSWERS - OD MS	F2	\$12
DWOD-150K-MC	SEL DATANSWERS - OD M24*7	F2	\$12
DWOD-150K-MS	SEL DATANSWERS - OD MS	F2	\$7
DWOD-2001-2500MS	SEL DATANSWERS - OD MS	F2	\$11
DWOD-20K-35KMC	SEL DATANSWERS - OD M24*7	F2	\$13
DWOD-20K-35KMS	SEL DATANSWERS - OD MS	F2	\$8
DWOD-2501-4000MS	SEL DATANSWERS - OD MS	F2	\$10
DWOD-251-500MS	SEL DATANSWERS - OD MS	F2	\$19
DWOD-35K-50KMC	SEL DATANSWERS - OD M24*7	F2	\$13
DWOD-35K-50KMS	SEL DATANSWERS - OD MS	F2	\$7
DWOD-4001-6000MC	SEL DATANSWERS - OD M24*7	F2	\$17
DWOD-4001-6000MS	SEL DATANSWERS - OD MS	F2	\$10
DWOD-501-750MS	SEL DATANSWERS - OD MS	F2	\$15
DWOD-50K-100KMC	SEL DATANSWERS - OD M24*7	F2	\$13

DWOD-50K-100KMS	SEL DATANSWERS - OD MS	F2	\$7
DWOD-51-100MS	SEL DATANSWERS - OD MS	F2	\$32
DWOD-6001-8000MC	SEL DATANSWERS - OD M24*7	F2	\$16
DWOD-6001-8000MS	SEL DATANSWERS - OD MS	F2	\$9
DWOD-751-1000MS	SEL DATANSWERS - OD MS	F2	\$14
DWOD-8001-10KMC	SEL DATANSWERS - OD M24*7	F2	\$15
DWOD-8001-10KMS	SEL DATANSWERS - OD MS	F2	\$8
DWOS-0-50MS	SEL DATANSWERS - OD & SPOL MS	F2	\$68
DWOS-1001-1500MS	SEL DATANSWERS - OD & SPOL MS	F2	\$20
DWOS-100K-150KMC	SEL DATANSWERS - OD & SPOL M24*7	F2	\$18
DWOS-100K-150KMS	SEL DATANSWERS - OD & SPOL MS	F2	\$10
DWOS-101-250MS	SEL DATANSWERS - OD & SPOL MS	F2	\$38
DWOS-10K-20KMC	SEL DATANSWERS - OD & SPOL M24*7	F2	\$21
DWOS-10K-20KMS	SEL DATANSWERS - OD & SPOL MS	F2	\$12
DWOS-1501-2000MS	SEL DATANSWERS - OD & SPOL MS	F2	\$18
DWOS-150K-MC	SEL DATANSWERS - OD & SPOL M24*7	F2	\$18
DWOS-150K-MS	SEL DATANSWERS - OD & SPOL MS	F2	\$10
DWOS-2001-2500MS	SEL DATANSWERS - OD & SPOL MS	F2	\$17
DWOS-20K-35KMC	SEL DATANSWERS - OD & SPOL M24*7	F2	\$20
DWOS-20K-35KMS	SEL DATANSWERS - OD & SPOL MS	F2	\$11
DWOS-2501-4000MS	SEL DATANSWERS - OD & SPOL MS	F2	\$15
DWOS-251-500MS	SEL DATANSWERS - OD & SPOL MS	F2	\$29
DWOS-35K-50KMC	SEL DATANSWERS - OD & SPOL M24*7	F2	\$19
DWOS-35K-50KMS	SEL DATANSWERS - OD & SPOL MS	F2	\$11
DWOS-4001-6000MC	SEL DATANSWERS - OD & SPOL M24*7	F2	\$25
DWOS-4001-6000MS	SEL DATANSWERS - OD & SPOL MS	F2	\$14
DWOS-501-750MS	SEL DATANSWERS - OD & SPOL MS	F2	\$23
DWOS-50K-100KMC	SEL DATANSWERS - OD & SPOL M24*7	F2	\$19
DWOS-50K-100KMS	SEL DATANSWERS - OD & SPOL MS	F2	\$11
DWOS-51-100MS	SEL DATANSWERS - OD & SPOL MS	F2	\$48
DWOS-6001-8000MC	SEL DATANSWERS - OD & SPOL M24*7	F2	\$24
DWOS-6001-8000MS	SEL DATANSWERS - OD & SPOL MS	F2	\$13
DWOS-751-1000MS	SEL DATANSWERS - OD & SPOL MS	F2	\$21
DWOS-8001-10KMC	SEL DATANSWERS - OD & SPOL M24*7	F2	\$22
DWOS-8001-10KMS	SEL DATANSWERS - OD & SPOL MS	F2	\$13
DWS-0-50MS	SEL DATANSWERS - SP MS	F2	\$46
DWS-1001-1500MS	SEL DATANSWERS - SP MS	F2	\$13
DWS-100K-150KMC	SEL DATANSWERS - SP M24*7	F2	\$12
DWS-100K-150KMS	SEL DATANSWERS - SP MS	F2	\$7
DWS-101-250MS	SEL DATANSWERS - SP MS	F2	\$25
DWS-10K-20KMC	SEL DATANSWERS - SP M24*7	F2	\$14
DWS-10K-20KMS	SEL DATANSWERS - SP MS	F2	\$8
DWS-1501-2000MS	SEL DATANSWERS - SP MS	F2	\$12
DWS-150K-MC	SEL DATANSWERS - SP M24*7	F2	\$12
DWS-150K-MS	SEL DATANSWERS - SP MS	F2	\$7
DWS-2001-2500MS	SEL DATANSWERS - SP MS	F2	\$11
DWS-20K-35KMC	SEL DATANSWERS - SP M24*7	F2	\$13
DWS-20K-35KMS	SEL DATANSWERS - SP MS	F2	\$8
DWS-2501-4000MS	SEL DATANSWERS - SP MS	F2	\$10
DWS-251-500MS	SEL DATANSWERS - SP MS	F2	\$19

DWS-35K-50KMC	SEL DATANSWERS - SP M24*7	F2	\$13
DWS-35K-50KMS	SEL DATANSWERS - SP MS	F2	\$7
DWS-4001-6000MC	SEL DATANSWERS - SP M24*7	F2	\$17
DWS-4001-6000MS	SEL DATANSWERS - SP MS	F2	\$10
DWS-501-750MS	SEL DATANSWERS - SP MS	F2	\$15
DWS-50K-100KMC	SEL DATANSWERS - SP M24*7	F2	\$13
DWS-50K-100KMS	SEL DATANSWERS - SP MS	F2	\$7
DWS-51-100MS	SEL DATANSWERS - SP MS	F2	\$32
DWS-6001-8000MC	SEL DATANSWERS - SP M24*7	F2	\$16
DWS-6001-8000MS	SEL DATANSWERS - SP MS	F2	\$9
DWS-751-1000MS	SEL DATANSWERS - SP MS	F2	\$14
DWS-8001-10KMC	SEL DATANSWERS - SP M24*7	F2	\$15
DWS-8001-10KMS	SEL DATANSWERS - SP MS	F2	\$8
DWSO-0-50MS	SEL DATANSWERS - SPOL MS	F2	\$46
DWSO-1001-1500MS	SEL DATANSWERS - SPOL MS	F2	\$13
DWSO-100K-150KMC	SEL DATANSWERS - SPOL M24*7	F2	\$12
DWSO-100K-150KMS	SEL DATANSWERS - SPOL MS	F2	\$7
DWSO-101-250MS	SEL DATANSWERS - SPOL MS	F2	\$25
DWSO-10K-20KMC	SEL DATANSWERS - SPOL M24*7	F2	\$14
DWSO-10K-20KMS	SEL DATANSWERS - SPOL MS	F2	\$8
DWSO-1501-2000MS	SEL DATANSWERS - SPOL MS	F2	\$12
DWSO-150K-MC	SEL DATANSWERS - SPOL M24*7	F2	\$12
DWSO-150K-MS	SEL DATANSWERS - SPOL MS	F2	\$7
DWSO-2001-2500MS	SEL DATANSWERS - SPOL MS	F2	\$11
DWSO-20K-35KMC	SEL DATANSWERS - SPOL M24*7	F2	\$13
DWSO-20K-35KMS	SEL DATANSWERS - SPOL MS	F2	\$8
DWSO-2501-4000MS	SEL DATANSWERS - SPOL MS	F2	\$10
DWSO-251-500MS	SEL DATANSWERS - SPOL MS	F2	\$19
DWSO-35K-50KMC	SEL DATANSWERS - SPOL M24*7	F2	\$13
DWSO-35K-50KMS	SEL DATANSWERS - SPOL MS	F2	\$7
DWSO-4001-6000MC	SEL DATANSWERS - SPOL M24*7	F2	\$17
DWSO-4001-6000MS	SEL DATANSWERS - SPOL MS	F2	\$10
DWSO-501-750MS	SEL DATANSWERS - SPOL MS	F2	\$15
DWSO-50K-100KMC	SEL DATANSWERS - SPOL M24*7	F2	\$13
DWSO-50K-100KMS	SEL DATANSWERS - SPOL MS	F2	\$7
DWSO-51-100MS	SEL DATANSWERS - SPOL MS	F2	\$32
DWSO-6001-8000MC	SEL DATANSWERS - SPOL M24*7	F2	\$16
DWSO-6001-8000MS	SEL DATANSWERS - SPOL MS	F2	\$9
DWSO-751-1000MS	SEL DATANSWERS - SPOL MS	F2	\$14
DWSO-8001-10KMC	SEL DATANSWERS - SPOL M24*7	F2	\$15
DWSO-8001-10KMS	SEL DATANSWERS - SPOL MS	F2	\$8
ECSB16TBSPMM1	SELECT ARC ECS 10-80TB Spt 1Mo-prTB	F2	\$9
ECSB16TBSPMT1	SELECT ARC ECS 10-80TB Spt 1Yr-prTB	F2	\$111
ECSB16TBSPMT3	SELECT ARC ECS 10-80TB Spt 3Yr-prTB	F2	\$329
ECSB16TBSPMT5	SELECT ARC ECS 10-80TB Spt 5Yr-prTB	F2	\$549
ECSB17TBSPMM1	SELECT ARC ECS 81-240TB Spt 1Mo-prTB	F2	\$8
ECSB17TBSPMT1	SELECT ARC ECS 81-240TB Spt 1Yr-prTB	F2	\$102
ECSB17TBSPMT3	SELECT ARC ECS 81-240TB Spt 3Yr-prTB	F2	\$309
ECSB17TBSPMT5	SELECT ARC ECS 81-240TB Spt 5Yr-prTB	F2	\$514
ECSB18TBSPMM1	SELECT ARC ECS 241-500TB Spt 1Mo-prTB	F2	\$8

ECSB18TBSPMT1	SELECT ARC ECS 241-500TB Spt 1Yr-prTB	F2	\$96
ECSB18TBSPMT3	SELECT ARC ECS 241-500TB Spt 3Yr-prTB	F2	\$288
ECSB18TBSPMT5	SELECT ARC ECS 241-500TB Spt 5Yr-prTB	F2	\$481
ECSB19TBSPMM1	SELECT ARC ECS 501-750TB Spt 1Mo-prTB	F2	\$7
ECSB19TBSPMT1	SELECT ARC ECS 501-750TB Spt 1Yr-prTB	F2	\$89
ECSB19TBSPMT3	SELECT ARC ECS 501-750TB Spt 3Yr-prTB	F2	\$267
ECSB19TBSPMT5	SELECT ARC ECS 501-750TB Spt 5Yr-prTB	F2	\$445
ECSB20TBSPMM1	SELECT ARC ECS 751-1024TB Spt 1Mo-prTB	F2	\$6
ECSB20TBSPMT1	SELECT ARC ECS 751-1024TB Spt 1Yr-prTB	F2	\$82
ECSB20TBSPMT3	SELECT ARC ECS 751-1024TB Spt 3Yr-prTB	F2	\$247
ECSB20TBSPMT5	SELECT ARC ECS 751-1024TB Spt 5Yr-prTB	F2	\$411
ECSB21TBSPMM1	SELECT ARC ECS 1025-1500TB Spt 1Mo-prTB	F2	\$6
ECSB21TBSPMT1	SELECT ARC ECS 1025-1500TB Spt 1Yr-prTB	F2	\$75
ECSB21TBSPMT3	SELECT ARC ECS 1025-1500TB Spt 3Yr-prTB	F2	\$225
ECSB21TBSPMT5	SELECT ARC ECS 1025-1500TB Spt 5Yr-prTB	F2	\$375
ECSB22TBSPMM1	SELECT ARC ECS 1501-2048TB Spt 1Mo-prTB	F2	\$6
ECSB22TBSPMT1	SELECT ARC ECS 1501-2048TB Spt 1Yr-prTB	F2	\$68
ECSB22TBSPMT3	SELECT ARC ECS 1501-2048TB Spt 3Yr-prTB	F2	\$205
ECSB22TBSPMT5	SELECT ARC ECS 1501-2048TB Spt 5Yr-prTB	F2	\$340
ECSB23TBSPMM1	SELECT ARC ECS 2049-2500TB Spt 1Mo-prTB	F2	\$6
ECSB23TBSPMT1	SELECT ARC ECS 2049-2500TB Spt 1Yr-prTB	F2	\$61
ECSB23TBSPMT3	SELECT ARC ECS 2049-2500TB Spt 3Yr-prTB	F2	\$185
ECSB23TBSPMT5	SELECT ARC ECS 2049-2500TB Spt 5Yr-prTB	F2	\$307
ECSB24TBSPMM1	SELECT ARC ECS 2501-3072TB Spt 1Mo-prTB	F2	\$5
ECSB24TBSPMT1	SELECT ARC ECS 2501-3072TB Spt 1Yr-prTB	F2	\$54
ECSB24TBSPMT3	SELECT ARC ECS 2501-3072TB Spt 3Yr-prTB	F2	\$162
ECSB24TBSPMT5	SELECT ARC ECS 2501-3072TB Spt 5Yr-prTB	F2	\$271
EDGE-0-50MS	SEL Varonis - EDGE MS	F2	\$46
EDGE-1001-1500MS	SEL Varonis - EDGE MS	F2	\$13
EDGE-100K-150KMC	SEL Varonis - EDGE MC	F2	\$12
EDGE-100K-150KMS	SEL Varonis - EDGE MS	F2	\$7
EDGE-101-250MS	SEL Varonis - EDGE MS	F2	\$25
EDGE-10K-20KMC	SEL Varonis - EDGE MC	F2	\$14
EDGE-10K-20KMS	SEL Varonis - EDGE MS	F2	\$8
EDGE-1501-2000MS	SEL Varonis - EDGE MS	F2	\$12
EDGE-150K-MC	SEL Varonis - EDGE MC	F2	\$12
EDGE-150K-MS	SEL Varonis - EDGE MS	F2	\$7
EDGE-2001-2500MS	SEL Varonis - EDGE MS	F2	\$11
EDGE-20K-35KMC	SEL Varonis - EDGE MC	F2	\$13
EDGE-20K-35KMS	SEL Varonis - EDGE MS	F2	\$8
EDGE-2501-4000MS	SEL Varonis - EDGE MS	F2	\$10
EDGE-251-500MS	SEL Varonis - EDGE MS	F2	\$19
EDGE-35K-50KMC	SEL Varonis - EDGE MC	F2	\$13
EDGE-35K-50KMS	SEL Varonis - EDGE MS	F2	\$7
EDGE-4001-6000MC	SEL Varonis - EDGE MC	F2	\$17
EDGE-4001-6000MS	SEL Varonis - EDGE MS	F2	\$10
EDGE-501-750MS	SEL Varonis - EDGE MS	F2	\$15
EDGE-50K-100KMC	SEL Varonis - EDGE MC	F2	\$13
EDGE-50K-100KMS	SEL Varonis - EDGE MS	F2	\$7
EDGE-51-100MS	SEL Varonis - EDGE MS	F2	\$32

EDGE-6001-8000MC	SEL Varonis - EDGE MC	F2	\$16
EDGE-6001-8000MS	SEL Varonis - EDGE MS	F2	\$9
EDGE-751-1000MS	SEL Varonis - EDGE MS	F2	\$14
EDGE-8001-10KMC	SEL Varonis - EDGE MC	F2	\$15
EDGE-8001-10KMS	SEL Varonis - EDGE MS	F2	\$8
EDU-ACLAB-1-D	SEL Splunk Arch Cert Lab V6 1 student	F2	\$1,176
EDU-ADSRPT-1-D	SEL Adv Search&Rptng Splunk V6.2 1 stdnt	F2	\$1,765
EDU-ADSRPT-4-D	SEL ADSRPT Splunk V6.2 DedVirtClassMax12	F2	\$10,588
EDUADSRPT-ON-D	SEL ADSRPT Splunk V6.2 OnsiteMax12noT&E	F2	\$14,118
EDU-ARCH-1-D	SEL Splunk Arch series V6 no lab 1 stdnt	F2	\$8,824
EDU-ARCHCERT-1-D	SEL Splunk Arch Series&Cert lab V6 1 stu	F2	\$10,000
EDU-BSAP-D	SEL Splunk Build Splunk Apps V6, 1	F2	\$1,765
EDU-BSAP-DV-D	SEL Build Splunk Apps V6 DVirtClassMax12	F2	\$8,824
EDU-BSAP-ON-D	SEL Build Splunk Apps V6 O Max12 no T&E	F2	\$12,353
EDU-BUSER-ELRN-D	SEL Using Splunk V6 eLearn PY sin domain	F2	\$29,412
EDU-CLSR-1-D	SEL Splunk Cluster Admin V6.3, 1 Student	F2	\$1,765
EDU-CLSR-DV-1-D	SEL Splunk ClstrAdmin V6.3, DedVirtMax12	F2	\$10,588
EDU-CLSR-ON-1-D	SEL Splunk ClstrAdmin V6.3, OnMax12noT&E	F2	\$14,118
EDUCR0	SEL EDU-CR-0)	F2	\$100
EDUCR0-I	SEL EDU-CR-0)	F2	\$100
EDUCR0-K	SEL EDU-CR-0)	F2	\$113
EDUCR10	SEL EDU-CR-10)	F2	\$90
EDUCR10-I	SEL EDU-CR-10)	F2	\$90
EDUCR10-K	SEL EDU-CR-10)	F2	\$101
EDUCR15	SEL EDU-CR-15)	F2	\$85
EDUCR15-I	SEL EDU-CR-15)	F2	\$85
EDUCR15-K	SEL EDU-CR-15)	F2	\$96
EDUCR20	SEL EDU-CR-20)	F2	\$80
EDUCR20-I	SEL EDU-CR-20)	F2	\$80
EDUCR20-K	SEL EDU-CR-20)	F2	\$90
EDU-CUSTCRSDEV-D	SEL Splunk Custom Course Del, per day	F2	\$2,353
EDU-CUSTOM-ED-D	SEL Splunk Custom Edu Day 1 Student	F2	\$588
EDU-CUST-ON-D	SEL Custom Course Del p day max12 no T&E	F2	\$4,706
EDU-DADM-D	SEL Data Administration, 1 Student	F2	\$1,765
EDU-DADM-DV-D	SEL Data Admin, DVirtClassMax12	F2	\$10,588
EDU-DADM-ON-D	SEL Data Admin, Ons Class, Max 12 stdnts	F2	\$14,118
EDU-DASH-D	SEL Splunk Adv. D & Vis V6, 1	F2	\$1,765
EDU-DASH-DV-D	SEL Adv. D & Vis V6 DVirtClassMax12	F2	\$8,824
EDU-DASH-ON-D	SEL Adv. D & Vis V6 Onsite Max12 no T&E	F2	\$12,353
EDU-DATA-D	SEL Splunk Alytcs & DataScV6 1	F2	\$1,765
EDU-DATA-DV-D	SEL Splunk Alytcs& DataScV6 DVirtCImax12	F2	\$10,588
EDU-DATA-ON-D	SEL Splunk Alytcs& DataScV6OMax12 no T&E	F2	\$14,118
EDU-DEPL-1-D	SEL Arch&Deploying Splunk V6 1 student	F2	\$1,765
EDU-DEPL-4-D	SEL Arch&Depl Splunk V6 DVirtCourseMax12	F2	\$8,824
EDU-DEPL-ON-D	SEL Arch&Depl Splunk V6 OnsiteMax12noT&E	F2	\$10,588
EDU-DEVSDK-1-D	SEL Splunk Dev Java&Python SDKs 1 stu	F2	\$1,176
EDU-DEVSDK-4-D	SEL Splunk DevSDK Java&Python DVirtMax12	F2	\$7,059
EDUDEVSDK-ON-D	SEL Splunk DevSDKs J&P OnsiteMax12noT&E	F2	\$9,412
EDU-ELRN-EXT-D	SEL eLearning Lab Setup	F2	\$118
EDU-FUN1-D	SEL Fundamentals 1, Single Student	F2	\$1,176

EDU-FUN1-DV-D	SEL Fundamentals 1, DedVirt Max12	F2	\$7,059
EDU-FUN1-ON-D	SEL Fundamentals 1, Onsite Max12 noT&E	F2	\$9,412
EDU-FUN2-D	SEL Fundamentals 2, Single Student	F2	\$2,353
EDU-FUN2-DV-D	SEL Fundamentals 2, DedVirt Max12	F2	\$14,118
EDU-FUN2-IOD-D	SEL Fund2,IODSub1Yr,singledom-1per-30day	F2	\$105,882
EDU-FUN2-ON-D	SEL Fundamentals 2, Onsite Max12 noT&E	F2	\$18,824
EDU-ICISS-1-D	SEL Splunk Admin Ent Security V4 1 Stdnt	F2	\$1,765
EDU-ICISS-4-D	SEL Spk Adm Ent Sec V4 DedVirtClassMax12	F2	\$8,824
EDU-ICISS-ON-D	SEL Splunk AdmEntSecV4OnsiteMax12NoT&E	F2	\$12,353
EDU-ICPCI-1-D	SEL Cnfgr Splunk App PCI Compl V2 1 stud	F2	\$1,765
EDU-ICPCI-4-D	SEL Splk CnfgrAppPCICmplV2DVirtClsMax12	F2	\$8,824
EDU-ICPCI-ON-D	SEL Splk CnfgrAppPCICmplV2OnsMax12NoT&E	F2	\$12,353
EDU-ITSI-D	SEL Impl. ITSI 1	F2	\$1,765
EDU-ITSI-DV-D	SEL Impl. ITSI DVirtClass Max12	F2	\$10,588
EDU-ITSI-ON-D	SEL Impl. ITSI O Max12 no T&E	F2	\$14,118
EDU-LABDAY-D	SEL Splunk Lab SandBox 1 day	F2	\$176
EDU-PRV-1D-16MAX	SEL Trning- 1 Day- 16 Students max	F2	\$9,412
EDU-PRV-1D-6MAX	SEL Trning- 1 Day- 6 Students max	F2	\$5,882
EDU-PRV-ADD1-1D	SEL Training 1 Add Student for 1dayclass	F2	\$588
EDU-SADM-D	SEL Sys Admin, 1 Student	F2	\$1,176
EDU-SADM-DV-D	SEL Sys Admin, Ded Virt Class, Max12	F2	\$7,059
EDU-SADM-ON-D	SEL Sys Admin, Ons Class, Max 12	F2	\$9,412
EDU-SUPP-1-D	SEL Supporting Splunk V6 1 student	F2	\$1,765
EDU-SUPP-4-D	SEL Sup Splunk V6 DedVirtualClassMax12	F2	\$8,824
EDU-SUPP-ON-D	SEL Sup Splunk V6 Onsite Max12 NoT&E	F2	\$10,588
EDU-TRBL-D	SEL Troubleshting Splunk Enterpr, 1	F2	\$1,176
EDU-TRBL-DV-D	SEL Trbleshtg Splk Enterpr, DVirtCIMax12	F2	\$7,059
EDU-TRBL-ON-D	SEL Trbleshg Splk Enterpr OnCIMax12	F2	\$9,412
EDU-UESS-1-D	SEL Using Splunk EntSec V4.5-1 student	F2	\$1,765
EDU-UESS-4-D	SEL Using Splunk UESS V4.5 DVirt Max12	F2	\$10,588
EDU-UESS-ON-D	SEL Splunk UESS V4.5 Onsite Max12 NoT&E	F2	\$14,118
EDU-UITSI-D	SEL Using ITSI, 1 Student	F2	\$588
EDU-UITSI-DV-D	SEL Using ITSI, DedVirt, Max12	F2	\$3,529
EDU-UITSI-ON-D	SEL Using ITSI, Onsite, Max12noT&E	F2	\$4,706
EDU-UNIT-100-D	SEL Splunk Education service Unit 100	F2	\$55,882
EDU-UNIT-1-D	SEL Splunk Education service Unit	F2	\$588
EDU-UNIT-200-D	SEL Splunk Education service Unit 200	F2	\$105,882
EDU-UNIT-50-D	SEL Splunk Education service Unit 50	F2	\$28,824
E-EDU-PV-1D-16MX	SEL Trning- 1 Day- 16 Students max	F2	\$11,294
E-EDU-PV-1D-6MX	SEL Trning- 1 Day- 6 Students max	F2	\$7,059
E-EDU-PV-AD1-1D	SEL Training 1 Add Student for 1dayclass	F2	\$706
EGL-0032PEM1-14	SEL EyeGlass clstr kit E-2pack maint 1yr	F2	\$1,395
EGL-0032PEM3-14	SEL EyeGlass clstr kit E-2pack maint 3yr	F2	\$4,187
EGL-0032PEM5-14	SEL EyeGlass clstr kit E-2pack maint 5yr	F2	\$6,979
EGL2-SRM-LIC-1Y	SEL Cluster Storage Monitor 1YR v2	F2	\$1,412
EGL2-SRM-LIC-3Y	SEL Cluster Storage Monitor 3YR v2	F2	\$4,235
EGL2-SRM-LIC-5Y	SEL Cluster Storage Monitor 5YR v2	F2	\$7,059
EGL-AUD-LIC-1Y	SEL Eyeglass Easy Auditor Agent 1YR	F2	\$1,059
EGL-AUD-LIC-3Y	SEL Eyeglass Easy Auditor Agent 3YR	F2	\$3,176
EGL-AUD-LIC-5Y	SEL Eyeglass Easy Auditor Agent 5YR	F2	\$5,294

EGL-CONFIG-1Y	SEL Eyeglass Configurator Site Maint-1y	F2	\$7,059
EGL-CONFIG-3Y	SEL Eyeglass Configurator Site Maint-3y	F2	\$21,176
EGL-CONFIG-5Y	SEL Eyeglass Configurator Site Maint-5y	F2	\$35,294
EGL-ENT-NODE-1Y	SEL MAINT EYEGLASS DR MANAGER Ent 1YR	F2	\$172
EGL-ENT-NODE-3Y	SEL MAINT EYEGLASS DR MANAGER Ent 3YR	F2	\$514
EGL-ENT-NODE-5Y	SEL MAINT EYEGLASS DR MANAGER Ent 5YR	F2	\$858
EGL-ES-C1-1Y	SEL Eyeglass Basic Search 1 Cluster 1y	F2	\$1,862
EGL-ES-C1-3Y	SEL Eyeglass Basic Search 1 Cluster 3y	F2	\$5,588
EGL-ES-C1-5Y	SEL Eyeglass Basic Search 1 Cluster 5y	F2	\$9,314
EGL-ES-N1-1Y	SEL Eyeglass Basic Search 1 Node 1y	F2	\$155
EGL-ES-N1-3Y	SEL Eyeglass Basic Search 1 Node 3y	F2	\$466
EGL-ES-N1-5Y	SEL Eyeglass Basic Search 1 Node 5y	F2	\$776
EGL-PA-1Y	SEL Performance Auditor 1YR	F2	\$1,471
EGL-PA-3Y	SEL Performance Auditor 3YR	F2	\$4,412
EGL-PA-5Y	SEL Performance Auditor 5YR	F2	\$7,353
EGL-RAND-LIC-1Y	SEL Ransomware Defender Agent 1YR	F2	\$588
EGL-RAND-LIC-3Y	SEL Ransomware Defender Agent 3YR	F2	\$1,765
EGL-RAND-LIC-5Y	SEL Ransomware Defender Agent 5YR	F2	\$2,941
E-HDP-CNS-JMP	SEL- HDP JumpStart Services	F2	\$17,647
END1-100-101	SEL Carb Endpoint Std 100GB annual 1 Yr	F2	\$40
END1-100-250	SEL Carb Endpoint Std 10-249 st 1 Yr	F2	\$78
END1-100-499	SEL Carb Endpoint Std 250-499 st 1 Yr	F2	\$72
END1-100-4999	SEL Carb Endpoint Std 1000-4999 st 1 Yr	F2	\$54
END1-100-999	SEL Carb Endpoint Std 500-999 st 1 Yr	F2	\$66
END1-100-9999	SEL Carb Endpoint Std 5000+ st 1Yr	F2	\$48
END1-200-250	SEL Carb Endpoint AdvUnl 10-249 st 1 Yr	F2	\$94
END1-200-499	SEL Carb Endpoint AdvUnl 250-499 st 1 Yr	F2	\$83
END1-200-4999	SEL Carb Endpoint AdvUnl 1000-4999 st 1Y	F2	\$60
END1-200-999	SEL Carb Endpoint AdvUnl 500-999 st 1 Yr	F2	\$72
END1-200-9999	SEL Carb Endpoint AdvUnl 5000+ st 1Yr	F2	\$54
END3-100-101	SEL Carb Endpoint Std 100GB annual 3 Yr	F2	\$40
END3-100-250	SEL Carb Endpoint Std 10-249 st 3 Yr	F2	\$211
END3-100-499	SEL Carb Endpoint Std 250-499 st 3 Yr	F2	\$194
END3-100-4999	SEL Carb Endpoint Std 1000-4999 st 3 Yr	F2	\$146
END3-100-999	SEL Carb Endpoint Std 500-999 st 3 Yr	F2	\$178
END3-100-9999	SEL Carb Endpoint Std 5000+ st 3Yr	F2	\$130
END3-200-250	SEL Carb Endpoint AdvUnl 10-249 st 3 Yr	F2	\$253
END3-200-499	SEL Carb Endpoint AdvUnl 250-499 st 3 Yr	F2	\$223
END3-200-4999	SEL Carb Endpoint AdvUnl 1000-4999 st 3Y	F2	\$162
END3-200-999	SEL Carb Endpoint AdvUnl 500-999 st 3 Yr	F2	\$194
END3-200-9999	SEL Carb Endpoint AdvUnl 5000+ st 3Yr	F2	\$146
ENDA1-100-250	SEL Carb Endpoint Std Add 10-249 st 1 Yr	F2	\$78
ENDA1-100-499	SEL Carb Endpoint Std Add 250-499 st 1Y	F2	\$72
ENDA1-100-4999	SEL Carb Endpoint Std Add 1000-4999 st1Y	F2	\$54
ENDA1-100-999	SEL Carb Endpoint Std Add 500-999 st 1Y	F2	\$66
ENDA1-100-9999	SEL Carb Endpoint Std Add 5000+ st 1Yr	F2	\$48
ENDA1-200-250	SEL Carb Endpt AdvUnl Add 10-249 1Yr	F2	\$84
ENDA1-200-499	SEL Carb Endpt AdvUnl Add 250-499 1Yr	F2	\$78
ENDA1-200-4999	SEL Carb Endpt AdvUnl Add 1000-4999 1Yr	F2	\$60
ENDA1-200-999	SEL Carb Endpt AdvUnl Add?500-999 1Yr	F2	\$72

ENDA1-200-9999	SEL Carb Endpt AdvUnl Add 5000+ 1Yr	F2	\$54
ENDA3-100-250	SEL Carb Endpoint Std Add 10-249 st 3 Yr	F2	\$211
ENDA3-100-499	SEL Carb Endpoint Std Add 250-499 st 3Y	F2	\$194
ENDA3-100-4999	SEL Carb Endpoint Std Add 1000-4999 st3Y	F2	\$146
ENDA3-100-999	SEL Carb Endpoint Std Add 500-999 st 3Y	F2	\$178
ENDA3-100-9999	SEL Carb Endpoint Std Add 5000+ st 3Yr	F2	\$130
ENDA3-200-250	SEL Carb Endpt AdvUnl Add 10-249 3Yr	F2	\$227
ENDA3-200-499	SEL Carb Endpt AdvUnl Add 250-499 3Yr	F2	\$211
ENDA3-200-4999	SEL Carb Endpt AdvUnl Add?1000-4999 3Yr	F2	\$162
ENDA3-200-999	SEL Carb Endpt AdvUnl Add?500-999 3Yr	F2	\$194
ENDA3-200-9999	SEL Carb Endpt AdvUnl Add 5000+ 3Yr	F2	\$146
EOL-0-50MS	SEL DatAdvantage - EXOL Lite MS	F2	\$23
EOL-1001-1500MS	SEL DatAdvantage - EXOL Lite MS	F2	\$7
EOL-100K-150KMC	SEL DatAdvantage - EXOL Lite M24x7	F2	\$6
EOL-100K-150KMS	SEL DatAdvantage - EXOL Lite MS	F2	\$3
EOL-101-250MS	SEL DatAdvantage - EXOL Lite MS	F2	\$13
EOL-10K-20KMC	SEL DatAdvantage - EXOL Lite M24x7	F2	\$7
EOL-10K-20KMS	SEL DatAdvantage - EXOL Lite MS	F2	\$4
EOL-1501-2000MS	SEL DatAdvantage - EXOL Lite MS	F2	\$6
EOL-150K-MC	SEL DatAdvantage - EXOL Lite M24x7	F2	\$6
EOL-150K-MS	SEL DatAdvantage - EXOL Lite MS	F2	\$3
EOL-2001-2500MS	SEL DatAdvantage - EXOL Lite MS	F2	\$6
EOL-20K-35KMC	SEL DatAdvantage - EXOL Lite M24x7	F2	\$7
EOL-20K-35KMS	SEL DatAdvantage - EXOL Lite MS	F2	\$4
EOL-2501-4000MS	SEL DatAdvantage - EXOL Lite MS	F2	\$5
EOL-251-500MS	SEL DatAdvantage - EXOL Lite MS	F2	\$10
EOL-35K-50KMC	SEL DatAdvantage - EXOL Lite M24x7	F2	\$6
EOL-35K-50KMS	SEL DatAdvantage - EXOL Lite MS	F2	\$4
EOL-4001-6000MC	SEL DatAdvantage - EXOL Lite M24x7	F2	\$8
EOL-4001-6000MS	SEL DatAdvantage - EXOL Lite MS	F2	\$5
EOL-501-750MS	SEL DatAdvantage - EXOL Lite MS	F2	\$8
EOL-50K-100KMC	SEL DatAdvantage - EXOL Lite M24x7	F2	\$6
EOL-50K-100KMS	SEL DatAdvantage - EXOL Lite MS	F2	\$4
EOL-51-100MS	SEL DatAdvantage - EXOL Lite MS	F2	\$16
EOL-6001-8000MC	SEL DatAdvantage - EXOL Lite M24x7	F2	\$8
EOL-6001-8000MS	SEL DatAdvantage - EXOL Lite MS	F2	\$4
EOL-751-1000MS	SEL DatAdvantage - EXOL Lite MS	F2	\$7
EOL-8001-10KMC	SEL DatAdvantage - EXOL Lite M24x7	F2	\$7
EOL-8001-10KMS	SEL DatAdvantage - EXOL Lite MS	F2	\$4
EPC-A-MTN	SEL VST MTN 2,501-5,000 MICROVM	F2	\$22
EPC-BASE-MTN	SEL VST MTN UP TO 2,500 MICROVM	F2	\$23
EPC-B-MTN	SEL VST MTN 5,001-7,500 MICROVM	F2	\$21
EPC-C-MTN	SEL VST MTN 7,501-15,000 MICROVM	F2	\$18
EPC-D-MTN	SEL VST MTN 15,001-25,000 MICROVM	F2	\$16
EPC-E-MTN	SEL VST MTN 25,001-50,000 MICROVM	F2	\$13
EPC-F-MTN	SEL VST MTN 50,001-100,000 MICROVM	F2	\$11
ESP-ES-1000AN-D	SEL Splunk Ent Sec STDSup Bucket 1000AN	F2	\$1,000
ESP-ES-1000AP-D	SEL Splunk Ent Sec STDSup Bucket 1000AP	F2	\$1,000
ESP-ES-1000EM-D	SEL Splunk Ent Sec STDSup Bucket 1000EM	F2	\$1,000
ESP-ES-1000US-D	SEL Splunk Ent Sec SSup Bucket 1000US	F2	\$1,000

ESP-ES-100AN-D	SEL Splunk Ent Sec STDSup Bucket 100AN	F2	\$100
ESP-ES-100AP-D	SEL Splunk Ent Sec STDSup Bucket 100AP	F2	\$100
ESP-ES-100EM-D	SEL Splunk Ent Sec STDSup Bucket 100EM	F2	\$100
ESP-ES-100US-D	SEL Splunk Ent Sec SSup Bucket 100US	F2	\$100
ESP-ES-1AN-D	SEL Splunk Ent Sec STDSup Bucket 1AN	F2	\$1
ESP-ES-1AP-D	SEL Splunk Ent Sec STDSup Bucket 1AP	F2	\$1
ESP-ES-1EM-D	SEL Splunk Ent Sec STDSup Bucket 1EM	F2	\$1
ESP-ES-1US-D	SEL Splunk Ent Sec SSup Bucket 1US	F2	\$1
ESP-GS-1000AN-D	SEL Splunk Ent Sec PRMSup Bucket 1000AN	F2	\$1,000
ESP-GS-1000AP-D	SEL Splunk Ent Sec PRMSup Bucket 1000AP	F2	\$1,000
ESP-GS-1000EM-D	SEL Splunk Ent Sec PRMSup Bucket 1000EM	F2	\$1,000
ESP-GS-1000US-D	SEL Splunk Ent Sec PSup Bucket 1000US	F2	\$1,000
ESP-GS-100AN-D	SEL Splunk Ent Sec PRMSup Bucket 100AN	F2	\$100
ESP-GS-100AP-D	SEL Splunk Ent Sec PRMSup Bucket 100AP	F2	\$100
ESP-GS-100EM-D	SEL Splunk Ent Sec PRMSup Bucket 100EM	F2	\$100
ESP-GS-100US-D	SEL Splunk Ent Sec PSup Bucket 100US	F2	\$100
ESP-GS-1AN-D	SEL Splunk Ent Sec PRMSup Bucket 1AN	F2	\$1
ESP-GS-1AP-D	SEL Splunk Ent Sec PRMSup Bucket 1AP	F2	\$1
ESP-GS-1EM-D	SEL Splunk Ent Sec PRMSup Bucket 1EM	F2	\$1
ESP-GS-1US-D	SEL Splunk Ent Sec PSup Bucket 1US	F2	\$1
ESPU-ES-1000AN-D	SEL Splunk ES UPG SSup Bucket 1000AN	F2	\$1,000
ESPU-ES-1000AP-D	SEL Splunk ES UPG SSup Bucket 1000AP	F2	\$1,000
ESPU-ES-1000EM-D	SEL Splunk ES UPG SSup Bucket 1000EM	F2	\$1,000
ESPU-ES-1000US-D	SEL Splunk ES UPG SSup Bucket 1000US	F2	\$1,000
ESPU-ES-100AN-D	SEL Splunk ES UPG SSup Bucket 100AN	F2	\$100
ESPU-ES-100AP-D	SEL Splunk ES UPG SSup Bucket 100AP	F2	\$100
ESPU-ES-100EM-D	SEL Splunk ES UPG SSup Bucket 100EM	F2	\$100
ESPU-ES-100US-D	SEL Splunk ES UPG SSup Bucket 100US	F2	\$100
ESPU-ES-1AN-D	SEL Splunk ES UPG SSup Bucket 1AN	F2	\$1
ESPU-ES-1AP-D	SEL Splunk ES UPG SSup Bucket 1AP	F2	\$1
ESPU-ES-1EM-D	SEL Splunk ES UPG SSup Bucket 1EM	F2	\$1
ESPU-ES-1US-D	SEL Splunk ES UPG SSup Bucket 1US	F2	\$1
ESPU-GS-1000AN-D	SEL Splunk ES UPG PSup Bucket 1000AN	F2	\$1,000
ESPU-GS-1000AP-D	SEL Splunk ES UPG PSup Bucket 1000AP	F2	\$1,000
ESPU-GS-1000EM-D	SEL Splunk ES UPG PSup Bucket 1000EM	F2	\$1,000
ESPU-GS-1000US-D	SEL Splunk ES UPG PSup Bucket 1000US	F2	\$1,000
ESPU-GS-100AN-D	SEL Splunk ES UPG PSup Bucket 100AN	F2	\$100
ESPU-GS-100AP-D	SEL Splunk ES UPG PSup Bucket 100AP	F2	\$100
ESPU-GS-100EM-D	SEL Splunk ES UPG PSup Bucket 100EM	F2	\$100
ESPU-GS-100US-D	SEL Splunk ES UPG PSup Bucket 100US	F2	\$100
ESPU-GS-1AN-D	SEL Splunk ES UPG PSup Bucket 1AN	F2	\$1
ESPU-GS-1AP-D	SEL Splunk ES UPG PSup Bucket 1AP	F2	\$1
ESPU-GS-1EM-D	SEL Splunk ES UPG PSup Bucket 1EM	F2	\$1
ESPU-GS-1US-D	SEL Splunk ES UPG PSup Bucket 1US	F2	\$1
ETS-CONF	Dell Technologies World (EMC) Conference	F2	\$2,095
EXP-ES-1000AN-D	SEL Splunk EX STDSup Bucket 1000AN	F2	\$1,000
EXP-ES-1000AP-D	SEL Splunk EX STDSup Bucket 1000AP	F2	\$1,000
EXP-ES-1000EM-D	SEL Splunk EX STDSup Bucket 1000EM	F2	\$1,000
EXP-ES-1000US-D	SEL Splunk EX STDSup Bucket 1000US	F2	\$1,000
EXP-ES-100AN-D	SEL Splunk EX STDSup Bucket 100AN	F2	\$100

EXP-ES-100AP-D	SEL Splunk EX STDSup Bucket 100AP	F2	\$100
EXP-ES-100EM-D	SEL Splunk EX STDSup Bucket 100EM	F2	\$100
EXP-ES-100US-D	SEL Splunk EX STDSup Bucket 100US	F2	\$100
EXP-ES-1AN-D	SEL Splunk EX STDSup Bucket 1AN	F2	\$1
EXP-ES-1AP-D	SEL Splunk EX STDSup Bucket 1AP	F2	\$1
EXP-ES-1EM-D	SEL Splunk EX STDSup Bucket 1EM	F2	\$1
EXP-ES-1US-D	SEL Splunk EX STDSup Bucket 1US	F2	\$1
EXP-GS-1000AN-D	SEL Splunk EX PRMSup Bucket 1000AN	F2	\$1,000
EXP-GS-1000AP-D	SEL Splunk EX PRMSup Bucket 1000AP	F2	\$1,000
EXP-GS-1000EM-D	SEL Splunk EX PRMSup Bucket 1000EM	F2	\$1,000
EXP-GS-1000US-D	SEL Splunk EX PRMSup Bucket 1000US	F2	\$1,000
EXP-GS-100AN-D	SEL Splunk EX PRMSup Bucket 100AN	F2	\$100
EXP-GS-100AP-D	SEL Splunk EX PRMSup Bucket 100AP	F2	\$100
EXP-GS-100EM-D	SEL Splunk EX PRMSup Bucket 100EM	F2	\$100
EXP-GS-100US-D	SEL Splunk EX PRMSup Bucket 100US	F2	\$100
EXP-GS-1AN-D	SEL Splunk EX PRMSup Bucket 1AN	F2	\$1
EXP-GS-1AP-D	SEL Splunk EX PRMSup Bucket 1AP	F2	\$1
EXP-GS-1EM-D	SEL Splunk EX PRMSup Bucket 1EM	F2	\$1
EXP-GS-1US-D	SEL Splunk EX PRMSup Bucket 1US	F2	\$1
EYEGL-003UA2EM3	SEL IGLS KIT B-A2E UPGRD 3YR	F2	\$1,244
EYEGL-003UA2EM5	SEL IGLS KIT B-A2E UPGRD 5YR	F2	\$2,073
EYEGLASS-B4-2	SEL 4 hour block Dr Plan Hours	F2	\$2,353
EYEGLASS-DI02	SEL Basic - EyeGlass Isilon D&I Ent	F2	\$2,353
EYEGLASS-P012	SEL-EyeGlass DR Plan-Design-lab-v2	F2	\$9,804
EYEGLASS-P013	SEL-EyeGlass DR Design-Implement-v1	F2	\$16,667
EYEGLASS-P015	SEL-SUPERNA-EYEGLASS DR QUICK START	F2	\$7,059
EYEGLASS-P016	SEL Eyeglass Cluster Addon Install Serv	F2	\$4,529
EYEGLASS-P017	SEL-EyeGlass Auditing Best Practices	F2	\$7,451
EYEGLASS-P018	SEL-EyeGlass 1 Cluster Migration Service	F2	\$11,765
EYEGLASS-P019	SEL-EyeGlass 2 Cluster Migration Service	F2	\$18,824
EYEGLASS-P020	SEL-DR Monitoring Subscription 1 year	F2	\$5,882
EYEGLASS-P021	SEL-DR Monitoring Subscription 3 year	F2	\$13,235
EYEGLASS-P022	SEL-DR Monitoring Subscription 5 year	F2	\$17,647
FAB1TBSPMM1	SELECT CT-FA 10-80TB Spt/Mnt 1Mo (perTB)	F2	\$12
FAB1TBSPMT1	SELECT CT-FA 10-80TB Spt/Mnt 1Yr (perTB)	F2	\$133
FAB1TBSPMT3	SELECT CT-FA 10-80TB Spt/Mnt 3Yr (perTB)	F2	\$400
FAB1TBSPMT5	SELECT CT-FA 10-80TB Spt/Mnt 5Yr (perTB)	F2	\$667
FAB2TBSPMM1	SELECT CT-FA 81-240TB Spt/Mnt 1Mo (prTB)	F2	\$11
FAB2TBSPMT1	SELECT CT-FA 81-240TB Spt/Mnt 1Yr (prTB)	F2	\$126
FAB2TBSPMT3	SELECT CT-FA 81-240TB Spt/Mnt 3Yr (prTB)	F2	\$378
FAB2TBSPMT5	SELECT CT-FA 81-240TB Spt/Mnt 5Yr (prTB)	F2	\$631
FAB3TBSPMM1	SELECT CT-FA 241-500TB Spt/Mt 1Mo (prTB)	F2	\$9
FAB3TBSPMT1	SELECT CT-FA 241-500TB Spt/Mt 1Yr (prTB)	F2	\$120
FAB3TBSPMT3	SELECT CT-FA 241-500TB Spt/Mt 3Yr (prTB)	F2	\$358
FAB3TBSPMT5	SELECT CT-FA 241-500TB Spt/Mt 5Yr (prTB)	F2	\$596
FAB4TBSPMM1	SELECT CT-FA 501-750TB Spt/Mt 1Mo (prTB)	F2	\$9
FAB4TBSPMT1	SELECT CT-FA 501-750TB Spt/Mt 1Yr (prTB)	F2	\$112
FAB4TBSPMT3	SELECT CT-FA 501-750TB Spt/Mt 3Yr (prTB)	F2	\$335
FAB4TBSPMT5	SELECT CT-FA 501-750TB Spt/Mt 5Yr (prTB)	F2	\$559
FAB5TBSPMM1	SELECT CT-FA 751-1024TB Spt/Mt 1Mo(prTB)	F2	\$8

FAB5TBSPMT1	SELECT CT-FA 751-1024TB Spt/Mt 1Yr(prTB)	F2	\$105
FAB5TBSPMT3	SELECT CT-FA 751-1024TB Spt/Mt 3Yr(prTB)	F2	\$315
FAB5TBSPMT5	SELECT CT-FA 751-1024TB Spt/Mt 5Yr(prTB)	F2	\$525
FAS-RGSTACK	SEL RG ACTIV. FEE FOR RG PRIV. CLOUD	F2	\$16,471
FATRAN2DBHD	SELECT NTPS FA ONSITE TRAINING (2-DAY)	F2	\$10,059
FC-0-50MS	SEL Framework Connector MS	F2	\$21
FC-1001-1500MS	SEL Framework Connector MS	F2	\$6
FC-100K-150KMC	SEL Framework Connector M24*7	F2	\$5
FC-100K-150KMS	SEL Framework Connector MS	F2	\$3
FC-101-250MS	SEL Framework Connector MS	F2	\$11
FC-10K-20KMC	SEL Framework Connector M24*7	F2	\$6
FC-10K-20KMS	SEL Framework Connector MS	F2	\$4
FC-1501-2000MS	SEL Framework Connector MS	F2	\$5
FC-150K-MC	SEL Framework Connector M24*7	F2	\$5
FC-150K-MS	SEL Framework Connector MS	F2	\$3
FC-2001-2500MS	SEL Framework Connector MS	F2	\$5
FC-20K-35KMC	SEL Framework Connector M24*7	F2	\$6
FC-20K-35KMS	SEL Framework Connector MS	F2	\$3
FC-2501-4000MS	SEL Framework Connector MS	F2	\$5
FC-251-500MS	SEL Framework Connector MS	F2	\$9
FC-35K-50KMC	SEL Framework Connector M24*7	F2	\$6
FC-35K-50KMS	SEL Framework Connector MS	F2	\$3
FC-4001-6000MC	SEL Framework Connector M24*7	F2	\$8
FC-4001-6000MS	SEL Framework Connector MS	F2	\$4
FC-501-750MS	SEL Framework Connector MS	F2	\$7
FC-50K-100KMC	SEL Framework Connector M24*7	F2	\$6
FC-50K-100KMS	SEL Framework Connector MS	F2	\$3
FC-51-100MS	SEL Framework Connector MS	F2	\$14
FC-6001-8000MC	SEL Framework Connector M24*7	F2	\$7
FC-6001-8000MS	SEL Framework Connector MS	F2	\$4
FC-751-1000MS	SEL Framework Connector MS	F2	\$6
FC-8001-10KMC	SEL Framework Connector M24*7	F2	\$7
FC-8001-10KMS	SEL Framework Connector MS	F2	\$4
FUSPRO3GC	SEL FUS-PRO-3G-SSS-C)	F2	\$90
FUSPRO3GC-I	SEL FUS-PRO-3G-SSS-C)	F2	\$92
FUSPRO3GC-K	SEL FUS-PRO-3G-SSS-C)	F2	\$93
FUSPRO3PC	SEL FUS-PRO-3P-SSS-C)	F2	\$106
FUSPRO3PC-I	SEL FUS-PRO-3P-SSS-C)	F2	\$108
FUSPRO3PC-K	SEL FUS-PRO-3P-SSS-C)	F2	\$109
FUSPROGC	SEL FUS-PRO-G-SSS-C)	F2	\$34
FUSPROGC-I	SEL FUS-PRO-G-SSS-C)	F2	\$35
FUSPROGC-K	SEL FUS-PRO-G-SSS-C)	F2	\$35
FUSPROPC	SEL FUS-PRO-P-SSS-C)	F2	\$40
FUSPROPC-I	SEL FUS-PRO-P-SSS-C)	F2	\$41
FUSPROPC-K	SEL FUS-PRO-P-SSS-C)	F2	\$41
GDPR-0-50MS	SEL GDPR Patterns MS	F2	\$11
GDPR-1001-1500MS	SEL GDPR Patterns MS	F2	\$3
GDPR-100K-150KMC	SEL GDPR Patterns M24*7	F2	\$3
GDPR-100K-150KMS	SEL GDPR Patterns MS	F2	\$2
GDPR-101-250MS	SEL GDPR Patterns MS	F2	\$6

GDPR-10K-20KMC	SEL GDPR Patterns M24*7	F2	\$4
GDPR-10K-20KMS	SEL GDPR Patterns MS	F2	\$2
GDPR-1501-2000MS	SEL GDPR Patterns MS	F2	\$3
GDPR-150K-MC	SEL GDPR Patterns M24*7	F2	\$3
GDPR-150K-MS	SEL GDPR Patterns MS	F2	\$2
GDPR-2001-2500MS	SEL GDPR Patterns MS	F2	\$3
GDPR-20K-35KMC	SEL GDPR Patterns M24*7	F2	\$3
GDPR-20K-35KMS	SEL GDPR Patterns MS	F2	\$2
GDPR-2501-4000MS	SEL GDPR Patterns MS	F2	\$3
GDPR-251-500MS	SEL GDPR Patterns MS	F2	\$5
GDPR-35K-50KMC	SEL GDPR Patterns M24*7	F2	\$3
GDPR-35K-50KMS	SEL GDPR Patterns MS	F2	\$2
GDPR-4001-6000MC	SEL GDPR Patterns M24*7	F2	\$4
GDPR-4001-6000MS	SEL GDPR Patterns MS	F2	\$2
GDPR-501-750MS	SEL GDPR Patterns MS	F2	\$4
GDPR-50K-100KMC	SEL GDPR Patterns M24*7	F2	\$3
GDPR-50K-100KMS	SEL GDPR Patterns MS	F2	\$2
GDPR-51-100MS	SEL GDPR Patterns MS	F2	\$8
GDPR-6001-8000MC	SEL GDPR Patterns M24*7	F2	\$4
GDPR-6001-8000MS	SEL GDPR Patterns MS	F2	\$2
GDPR-751-1000MS	SEL GDPR Patterns MS	F2	\$4
GDPR-8001-10KMC	SEL GDPR Patterns M24*7	F2	\$4
GDPR-8001-10KMS	SEL GDPR Patterns MS	F2	\$2
H7AADC1003GC	SEL HZ7-AP-ADC100-3G-SSS-C)	F2	\$18,546
H7AADC1003GC-I	SEL HZ7-AP-ADC100-3G-SSS-C)	F2	\$19,381
H7AADC1003GC-K	SEL HZ7-AP-ADC100-3G-SSS-C)	F2	\$19,877
H7APAC1003PC	SEL HZ7-AP-ADC100-3P-SSS-C)	F2	\$22,078
H7APAC1003PC-I	SEL HZ7-AP-ADC100-3P-SSS-C)	F2	\$23,072
H7APAC1003PC-K	SEL HZ7-AP-ADC100-3P-SSS-C)	F2	\$23,663
H7APAN1003GC	SEL HZ7-AP-ADN100-3G-SSS-C)	F2	\$11,394
H7APAN1003GC-I	SEL HZ7-AP-ADN100-3G-SSS-C)	F2	\$11,907
H7APAN1003GC-K	SEL HZ7-AP-ADN100-3G-SSS-C)	F2	\$12,212
H7APST1003GC	SEL HZ7-AP-STN100-3G-SSS-C)	F2	\$7,125
H7APST1003GC-I	SEL HZ7-AP-STN100-3G-SSS-C)	F2	\$7,446
H7APST1003GC-K	SEL HZ7-AP-STN100-3G-SSS-C)	F2	\$7,637
H7APST1003PC	SEL HZ7-AP-STN100-3P-SSS-C)	F2	\$8,482
H7APST1003PC-I	SEL HZ7-AP-STN100-3P-SSS-C)	F2	\$8,864
H7APST1003PC-K	SEL HZ7-AP-STN100-3P-SSS-C)	F2	\$9,091
H7ASTC1003GC	SEL HZ7-AP-STC100-3G-SSS-C)	F2	\$11,394
H7ASTC1003GC-I	SEL HZ7-AP-STC100-3G-SSS-C)	F2	\$11,907
H7ASTC1003GC-K	SEL HZ7-AP-STC100-3G-SSS-C)	F2	\$12,212
H7ASTC1003PC	SEL HZ7-AP-STC100-3P-SSS-C)	F2	\$13,564
H7ASTC1003PC-I	SEL HZ7-AP-STC100-3P-SSS-C)	F2	\$14,175
H7ASTC1003PC-K	SEL HZ7-AP-STC100-3P-SSS-C)	F2	\$14,538
H7PADN1003PC	SEL HZ7-AP-ADN100-3P-SSS-C)	F2	\$13,564
H7PADN1003PC-I	SEL HZ7-AP-ADN100-3P-SSS-C)	F2	\$14,175
H7PADN1003PC-K	SEL HZ7-AP-ADN100-3P-SSS-C)	F2	\$14,538
HCIADVUC3GC	SEL HCI-ADV-CPU-3G-SSS-C)	F2	\$4,219
HCIADVUC3GC-I	SEL HCI-ADV-CPU-3G-SSS-C)	F2	\$4,936
HCIADVUC3GC-K	SEL HCI-ADV-CPU-3G-SSS-C)	F2	\$4,742

HCIADVCUGC	SEL HCI-ADV-CPU-G-SSS-C)	F2	\$1,598
HCIADVCUGC-I	SEL HCI-ADV-CPU-G-SSS-C)	F2	\$1,870
HCIADVCUGC-K	SEL HCI-ADV-CPU-G-SSS-C)	F2	\$1,796
HCIAKCPU3GC	SEL HCI-AK-CPU-3G-SSS-C)	F2	\$6,431
HCIAKCPU3GC-I	SEL HCI-AK-CPU-3G-SSS-C)	F2	\$7,524
HCIAKCPU3GC-K	SEL HCI-AK-CPU-3G-SSS-C)	F2	\$7,229
HCIAKCPU3GSSSF	SEL: HCI-AK-CPU-3G-SSS-F	F2	\$6,943
HCIAKCPU3PC	SEL HCI-AK-CPU-3P-SSS-C)	F2	\$7,635
HCIAKCPU3PC-I	SEL HCI-AK-CPU-3P-SSS-C)	F2	\$8,933
HCIAKCPU3PC-K	SEL HCI-AK-CPU-3P-SSS-C)	F2	\$8,583
HCIAKCPU3PSSSF	SEL: HCI-AK-CPU-3P-SSS-F	F2	\$8,250
HCIAKCPUGC	SEL HCI-AK-CPU-G-SSS-C)	F2	\$2,436
HCIAKCPUGC-I	SEL HCI-AK-CPU-G-SSS-C)	F2	\$2,850
HCIAKCPUGC-K	SEL HCI-AK-CPU-G-SSS-C)	F2	\$2,738
HCIAKCPUGSSSF	SEL: HCI-AK-CPU-G-SSS-F	F2	\$2,630
HCIAKCPUPC	SEL HCI-AK-CPU-P-SSS-C)	F2	\$2,892
HCIAKCPUPC-I	SEL HCI-AK-CPU-P-SSS-C)	F2	\$3,384
HCIAKCPUPC-K	SEL HCI-AK-CPU-P-SSS-C)	F2	\$3,251
HCIAKCPUPSSSF	SEL: HCI-AK-CPU-P-SSS-F	F2	\$3,125
HCIAVCPUPC	SEL HCI-ADV-CPU-P-SSS-C)	F2	\$1,903
HCIAVCPUPC-I	SEL HCI-ADV-CPU-P-SSS-C)	F2	\$2,227
HCIAVCPUPC-K	SEL HCI-ADV-CPU-P-SSS-C)	F2	\$2,139
HCIDVCPUPC	SEL HCI-ADV-CPU-3P-SSS-C)	F2	\$5,024
HCIDVCPUPC-I	SEL HCI-ADV-CPU-3P-SSS-C)	F2	\$5,878
HCIDVCPUPC-K	SEL HCI-ADV-CPU-3P-SSS-C)	F2	\$5,647
HCIENTCP3GC	SEL HCI-ENT-CPU-3G-SSS-C)	F2	\$5,644
HCIENTCP3GC-I	SEL HCI-ENT-CPU-3G-SSS-C)	F2	\$6,604
HCIENTCP3GC-K	SEL HCI-ENT-CPU-3G-SSS-C)	F2	\$6,345
HCIENTCU3PC	SEL HCI-ENT-CPU-3P-SSS-C)	F2	\$6,719
HCIENTCU3PC-I	SEL HCI-ENT-CPU-3P-SSS-C)	F2	\$7,861
HCIENTCU3PC-K	SEL HCI-ENT-CPU-3P-SSS-C)	F2	\$7,553
HCIENTCUGC	SEL HCI-ENT-CPU-G-SSS-C)	F2	\$2,138
HCIENTCUGC-I	SEL HCI-ENT-CPU-G-SSS-C)	F2	\$2,501
HCIENTCUGC-K	SEL HCI-ENT-CPU-G-SSS-C)	F2	\$2,403
HCIENTPUPC	SEL HCI-ENT-CPU-P-SSS-C)	F2	\$2,545
HCIENTPUPC-I	SEL HCI-ENT-CPU-P-SSS-C)	F2	\$2,978
HCIENTPUPC-K	SEL HCI-ENT-CPU-P-SSS-C)	F2	\$2,861
HCIESKIT3GC	SEL HCI-ES-KIT-3G-SSS-C)	F2	\$11,025
HCIESKIT3GC-I	SEL HCI-ES-KIT-3G-SSS-C)	F2	\$12,899
HCIESKIT3GC-K	SEL HCI-ES-KIT-3G-SSS-C)	F2	\$12,393
HCIESKIT3PC	SEL HCI-ES-KIT-3P-SSS-C)	F2	\$13,123
HCIESKIT3PC-I	SEL HCI-ES-KIT-3P-SSS-C)	F2	\$15,354
HCIESKIT3PC-K	SEL HCI-ES-KIT-3P-SSS-C)	F2	\$14,752
HCIESKITGC	SEL HCI-ES-KIT-G-SSS-C)	F2	\$4,176
HCIESKITGC-I	SEL HCI-ES-KIT-G-SSS-C)	F2	\$4,886
HCIESKITGC-K	SEL HCI-ES-KIT-G-SSS-C)	F2	\$4,694
HCIESKITPC	SEL HCI-ES-KIT-P-SSS-C)	F2	\$4,971
HCIESKITPC-I	SEL HCI-ES-KIT-P-SSS-C)	F2	\$5,816
HCIESKITPC-K	SEL HCI-ES-KIT-P-SSS-C)	F2	\$5,588
HCIONKIT3GC	SEL HCI-OM-KIT-3G-SSS-C)	F2	\$6,645

HCIONKIT3GC-I	SEL HCI-OM-KIT-3G-SSS-C)	F2	\$11,961
HCIONKIT3GC-K	SEL HCI-OM-KIT-3G-SSS-C)	F2	\$11,492
HCIONKIT3PC	SEL HCI-OM-KIT-3P-SSS-C)	F2	\$7,909
HCIONKIT3PC-I	SEL HCI-OM-KIT-3P-SSS-C)	F2	\$14,237
HCIONKIT3PC-K	SEL HCI-OM-KIT-3P-SSS-C)	F2	\$13,679
HCIONKITGC	SEL HCI-OM-KIT-G-SSS-C)	F2	\$2,517
HCIONKITGC-I	SEL HCI-OM-KIT-G-SSS-C)	F2	\$4,531
HCIONKITGC-K	SEL HCI-OM-KIT-G-SSS-C)	F2	\$4,353
HCIONKITPC	SEL HCI-OM-KIT-P-SSS-C)	F2	\$2,996
HCIONKITPC-I	SEL HCI-OM-KIT-P-SSS-C)	F2	\$5,393
HCIONKITPC-K	SEL HCI-OM-KIT-P-SSS-C)	F2	\$5,181
HCIONKITPRO-I	SEL HCI-OM-KIT-PRO)	F2	\$17,258
HCIONKITPRO-K	SEL HCI-OM-KIT-PRO)	F2	\$16,561
HCIRA25VM3GC	SEL HCI-RBAD-25VM-3G-SSS-C)	F2	\$13,963
HCIRA25VM3GC-I	SEL HCI-RBAD-25VM-3G-SSS-C)	F2	\$16,337
HCIRA25VM3GC-K	SEL HCI-RBAD-25VM-3G-SSS-C)	F2	\$15,696
HCIRA25VM3PC	SEL HCI-RBAD-25VM-3P-SSS-C)	F2	\$16,621
HCIRA25VM3PC-I	SEL HCI-RBAD-25VM-3P-SSS-C)	F2	\$19,447
HCIRA25VM3PC-K	SEL HCI-RBAD-25VM-3P-SSS-C)	F2	\$18,684
HCIRBA25VGC	SEL HCI-RBAD-25VM-G-SSS-C)	F2	\$5,289
HCIRBA25VGC-I	SEL HCI-RBAD-25VM-G-SSS-C)	F2	\$6,188
HCIRBA25VGC-K	SEL HCI-RBAD-25VM-G-SSS-C)	F2	\$5,945
HCIRBEN25V3GC	SEL HCI-RBEN-25VM-3G-SSS-C)	F2	\$18,287
HCIRBEN25V3GC-I	SEL HCI-RBEN-25VM-3G-SSS-C)	F2	\$21,396
HCIRBEN25V3GC-K	SEL HCI-RBEN-25VM-3G-SSS-C)	F2	\$20,557
HCIRBEN25V3PC	SEL HCI-RBEN-25VM-3P-SSS-C)	F2	\$21,769
HCIRBEN25V3PC-I	SEL HCI-RBEN-25VM-3P-SSS-C)	F2	\$25,470
HCIRBEN25V3PC-K	SEL HCI-RBEN-25VM-3P-SSS-C)	F2	\$24,471
HCIRBEN25VGC	SEL HCI-RBEN-25VM-G-SSS-C)	F2	\$6,927
HCIRBEN25VGC-I	SEL HCI-RBEN-25VM-G-SSS-C)	F2	\$8,105
HCIRBEN25VGC-K	SEL HCI-RBEN-25VM-G-SSS-C)	F2	\$7,787
HCIRBEN25VMPC	SEL HCI-RBEN-25VM-P-SSS-C)	F2	\$8,246
HCIRBEN25VMPC-I	SEL HCI-RBEN-25VM-P-SSS-C)	F2	\$9,648
HCIRBEN25VMPC-K	SEL HCI-RBEN-25VM-P-SSS-C)	F2	\$9,269
HCIRBST25VGC	SEL HCI-RBST-25VM-G-SSS-C)	F2	\$3,346
HCIRBST25VGC-I	SEL HCI-RBST-25VM-G-SSS-C)	F2	\$3,915
HCIRBST25VGC-K	SEL HCI-RBST-25VM-G-SSS-C)	F2	\$3,761
HCIRBST25VMPC	SEL HCI-RBST-25VM-P-SSS-C)	F2	\$3,984
HCIRBST25VMPC-I	SEL HCI-RBST-25VM-P-SSS-C)	F2	\$4,661
HCIRBST25VMPC-K	SEL HCI-RBST-25VM-P-SSS-C)	F2	\$4,478
HCIRS25VM3GC	SEL HCI-RBST-25VM-3G-SSS-C)	F2	\$8,833
HCIRS25VM3GC-I	SEL HCI-RBST-25VM-3G-SSS-C)	F2	\$10,335
HCIRS25VM3GC-K	SEL HCI-RBST-25VM-3G-SSS-C)	F2	\$9,930
HCIRS25VM3PC	SEL HCI-RBST-25VM-3P-SSS-C)	F2	\$10,518
HCIRS25VM3PC-I	SEL HCI-RBST-25VM-3P-SSS-C)	F2	\$12,306
HCIRS25VM3PC-K	SEL HCI-RBST-25VM-3P-SSS-C)	F2	\$11,823
HCISTDCPU3GC	SEL HCI-STD-CPU-3G-SSS-C)	F2	\$2,144
HCISTDCPU3GC-I	SEL HCI-STD-CPU-3G-SSS-C)	F2	\$2,508
HCISTDCPU3GC-K	SEL HCI-STD-CPU-3G-SSS-C)	F2	\$2,365
HCISTDCPU3GSSSF	SEL: HCI-STD-CPU-3G-SSS-F	F2	\$2,129

HCISTDCPU3PC	SEL HCI-STD-CPU-3P-SSS-C)	F2	\$2,545
HCISTDCPU3PC-I	SEL HCI-STD-CPU-3P-SSS-C)	F2	\$2,978
HCISTDCPU3PC-K	SEL HCI-STD-CPU-3P-SSS-C)	F2	\$2,810
HCISTDCPU3PSSSF	SEL: HCI-STD-CPU-3P-SSS-F	F2	\$2,535
HCISTDCPUGC	SEL HCI-STD-CPU-G-SSS-C)	F2	\$812
HCISTDCPUGC-I	SEL HCI-STD-CPU-G-SSS-C)	F2	\$950
HCISTDCPUGC-K	SEL HCI-STD-CPU-G-SSS-C)	F2	\$896
HCISTDCPUGSSSF	SEL: HCI-STD-CPU-G-SSS-F	F2	\$806
HCISTDCPUPC	SEL HCI-STD-CPU-P-SSS-C)	F2	\$964
HCISTDCPUPC-I	SEL HCI-STD-CPU-P-SSS-C)	F2	\$1,128
HCISTDCPUPC-K	SEL HCI-STD-CPU-P-SSS-C)	F2	\$1,065
HCISTDCPUPSSSF	SEL: HCI-STD-CPU-P-SSS-F	F2	\$960
HCRBA25VMPC	SEL HCI-RBAD-25VM-P-SSS-C)	F2	\$6,296
HCRBA25VMPC-I	SEL HCI-RBAD-25VM-P-SSS-C)	F2	\$7,366
HCRBA25VMPC-K	SEL HCI-RBAD-25VM-P-SSS-C)	F2	\$7,077
HDP-CONS-JUMP	SEL- HDP JumpStart Services	F2	\$17,647
HZ7A100AERCGC	SEL HZ7-A100-AERC-G-SSS-C)	F2	\$6,479
HZ7A100AERCGC-I	SEL HZ7-A100-AERC-G-SSS-C)	F2	\$6,771
HZ7A100AERCGC-K	SEL HZ7-A100-AERC-G-SSS-C)	F2	\$6,944
HZ7A100AERCPC	SEL HZ7-A100-AERC-P-SSS-C)	F2	\$7,713
HZ7A100AERCPC-I	SEL HZ7-A100-AERC-P-SSS-C)	F2	\$8,060
HZ7A100AERCPC-K	SEL HZ7-A100-AERC-P-SSS-C)	F2	\$8,267
HZ7A100ER3PC	SEL HZ7-A100-AERC-3P-SSS-C)	F2	\$20,362
HZ7A100ER3PC-I	SEL HZ7-A100-AERC-3P-SSS-C)	F2	\$21,279
HZ7A100ER3PC-K	SEL HZ7-A100-AERC-3P-SSS-C)	F2	\$21,824
HZ7A100ERC3C	SEL HZ7-A100-AERC-3G-SSS-C)	F2	\$17,105
HZ7A100ERC3C-I	SEL HZ7-A100-AERC-3G-SSS-C)	F2	\$17,874
HZ7A100ERC3C-K	SEL HZ7-A100-AERC-3G-SSS-C)	F2	\$18,332
HZ7A10AERC3GC	SEL HZ7-A10-AERC-3G-SSS-C)	F2	\$1,711
HZ7A10AERC3GC-I	SEL HZ7-A10-AERC-3G-SSS-C)	F2	\$1,788
HZ7A10AERC3GC-K	SEL HZ7-A10-AERC-3G-SSS-C)	F2	\$1,834
HZ7A10AERC3PC	SEL HZ7-A10-AERC-3P-SSS-C)	F2	\$2,035
HZ7A10AERC3PC-I	SEL HZ7-A10-AERC-3P-SSS-C)	F2	\$2,127
HZ7A10AERC3PC-K	SEL HZ7-A10-AERC-3P-SSS-C)	F2	\$2,182
HZ7A10AERCGC	SEL HZ7-A10-AERC-G-SSS-C)	F2	\$648
HZ7A10AERCGC-I	SEL HZ7-A10-AERC-G-SSS-C)	F2	\$677
HZ7A10AERCGC-K	SEL HZ7-A10-AERC-G-SSS-C)	F2	\$695
HZ7A10AERCPC	SEL HZ7-A10-AERC-P-SSS-C)	F2	\$771
HZ7A10AERCPC-I	SEL HZ7-A10-AERC-P-SSS-C)	F2	\$806
HZ7A10AERCPC-K	SEL HZ7-A10-AERC-P-SSS-C)	F2	\$826
HZ7ADC1003GC	SEL HZ7-ADC-100-3G-SSS-C)	F2	\$22,815
HZ7ADC1003GC-I	SEL HZ7-ADC-100-3G-SSS-C)	F2	\$23,842
HZ7ADC1003GCV2-K	SEL HZ7-ADC-100-3G-SSS-C)	F2	\$24,453
HZ7ADC1003PC	SEL HZ7-ADC-100-3P-SSS-C)	F2	\$27,160
HZ7ADC1003PC-I	SEL HZ7-ADC-100-3P-SSS-C)	F2	\$28,383
HZ7ADC1003PCV2-K	SEL HZ7-ADC-100-3P-SSS-C)	F2	\$29,110
HZ7ADC100GC	SEL HZ7-ADC-100-G-SSS-C)	F2	\$8,642
HZ7ADC100GC-I	SEL HZ7-ADC-100-G-SSS-C)	F2	\$9,031
HZ7ADC100GCV2-K	SEL HZ7-ADC-100-G-SSS-C)	F2	\$9,262
HZ7ADC100PC	SEL HZ7-ADC-100-P-SSS-C)	F2	\$10,288

HZ7ADC100PC-I	SEL HZ7-ADC-100-P-SSS-C)	F2	\$10,751
HZ7ADC100PCV2-K	SEL HZ7-ADC-100-P-SSS-C)	F2	\$11,027
HZ7ADC103GC	SEL HZ7-ADC-10-3G-SSS-C)	F2	\$2,281
HZ7ADC103GC-I	SEL HZ7-ADC-10-3G-SSS-C)	F2	\$2,384
HZ7ADC103GCV2-K	SEL HZ7-ADC-10-3G-SSS-C)	F2	\$2,445
HZ7ADC103PC	SEL HZ7-ADC-10-3P-SSS-C)	F2	\$2,717
HZ7ADC103PC-I	SEL HZ7-ADC-10-3P-SSS-C)	F2	\$2,839
HZ7ADC103PCV2-K	SEL HZ7-ADC-10-3P-SSS-C)	F2	\$2,912
HZ7ADC10GC	SEL HZ7-ADC-10-G-SSS-C)	F2	\$864
HZ7ADC10GC-I	SEL HZ7-ADC-10-G-SSS-C)	F2	\$903
HZ7ADC10GCV2-K	SEL HZ7-ADC-10-G-SSS-C)	F2	\$926
HZ7ADC10PC	SEL HZ7-ADC-10-P-SSS-C)	F2	\$1,029
HZ7ADC10PC-I	SEL HZ7-ADC-10-P-SSS-C)	F2	\$1,075
HZ7ADC10PCV2-K	SEL HZ7-ADC-10-P-SSS-C)	F2	\$1,103
HZ7ADC2502MGSSSF	SEL: HZ7-ADC-250-2M-GSSS-F	F2	\$3,850
HZ7ADC2502MPSSSF	SEL: HZ7-ADC-250-2M-PSSS-F	F2	\$4,583
HZ7ADC5002MGSSSF	SEL: HZ7-ADC-500-2M-GSSS-F	F2	\$7,700
HZ7ADC5002MPSSSF	SEL: HZ7-ADC-500-2M-PSSS-F	F2	\$9,167
HZ7ADN1003GC	SEL HZ7-ADN-100-3G-SSS-C)	F2	\$14,277
HZ7ADN1003GC-I	SEL HZ7-ADN-100-3G-SSS-C)	F2	\$14,920
HZ7ADN1003GCV2-K	SEL HZ7-ADN-100-3G-SSS-C)	F2	\$15,302
HZ7ADN1003PC	SEL HZ7-ADN-100-3P-SSS-C)	F2	\$16,996
HZ7ADN1003PC-I	SEL HZ7-ADN-100-3P-SSS-C)	F2	\$17,761
HZ7ADN1003PCV2-K	SEL HZ7-ADN-100-3P-SSS-C)	F2	\$18,216
HZ7ADN100GC	SEL HZ7-ADN-100-G-SSS-C)	F2	\$5,408
HZ7ADN100GC-I	SEL HZ7-ADN-100-G-SSS-C)	F2	\$5,651
HZ7ADN100GCV2-K	SEL HZ7-ADN-100-G-SSS-C)	F2	\$5,796
HZ7ADN100PC	SEL HZ7-ADN-100-P-SSS-C)	F2	\$6,438
HZ7ADN100PC-I	SEL HZ7-ADN-100-P-SSS-C)	F2	\$6,728
HZ7ADN100PCV2-K	SEL HZ7-ADN-100-P-SSS-C)	F2	\$6,900
HZ7ADN103GC	SEL HZ7-ADN-10-3G-SSS-C)	F2	\$1,428
HZ7ADN103GC-I	SEL HZ7-ADN-10-3G-SSS-C)	F2	\$1,493
HZ7ADN103GCV2-K	SEL HZ7-ADN-10-3G-SSS-C)	F2	\$1,531
HZ7ADN103PC	SEL HZ7-ADN-10-3P-SSS-C)	F2	\$1,700
HZ7ADN103PC-I	SEL HZ7-ADN-10-3P-SSS-C)	F2	\$1,777
HZ7ADN103PCV2-K	SEL HZ7-ADN-10-3P-SSS-C)	F2	\$1,822
HZ7ADN10GC	SEL HZ7-ADN-10-G-SSS-C)	F2	\$541
HZ7ADN10GC-I	SEL HZ7-ADN-10-G-SSS-C)	F2	\$565
HZ7ADN10GCV2-K	SEL HZ7-ADN-10-G-SSS-C)	F2	\$580
HZ7ADN10PC	SEL HZ7-ADN-10-P-SSS-C)	F2	\$644
HZ7ADN10PC-I	SEL HZ7-ADN-10-P-SSS-C)	F2	\$673
HZ7ADN10PCV2-K	SEL HZ7-ADN-10-P-SSS-C)	F2	\$690
HZ7ADN1K2MGSSSF	SEL: HZ7-ADN-1K-2M-GSSS-F	F2	\$9,625
HZ7ADN1K2MPSSSF	SEL: HZ7-ADN-1K-2M-PSSS-F	F2	\$11,458
HZ7ADN2002MGSSSF	SEL: HZ7-ADN-200-2M-GSSS-F	F2	\$1,925
HZ7ADN2002MPSSSF	SEL: HZ7-ADN-200-2M-PSSS-F	F2	\$2,292
HZ7ADN202MGSSSF	SEL: HZ7-ADN-20-2M-GSSS-F	F2	\$193
HZ7ADN202MPSSSF	SEL: HZ7-ADN-20-2M-PSSS-F	F2	\$229
HZ7ADN5002MGSSSF	SEL: HZ7-ADN-500-2M-GSSS-F	F2	\$4,813
HZ7ADN5002MPSSSF	SEL: HZ7-ADN-500-2M-PSSS-F	F2	\$5,729

HZ7ADNA1003GC	SEL HZ7-ADN-A100-3G-SSS-C)	F2	\$11,394
HZ7ADNA1003GC-I	SEL HZ7-ADN-A100-3G-SSS-C)	F2	\$11,907
HZ7ADNA1003GC-K	SEL HZ7-ADN-A100-3G-SSS-C)	F2	\$12,212
HZ7ADNA1003PC	SEL HZ7-ADN-A100-3P-SSS-C)	F2	\$13,564
HZ7ADNA1003PC-I	SEL HZ7-ADN-A100-3P-SSS-C)	F2	\$14,175
HZ7ADNA1003PC-K	SEL HZ7-ADN-A100-3P-SSS-C)	F2	\$14,538
HZ7ADNA100GC	SEL HZ7-ADN-A100-G-SSS-C)	F2	\$4,316
HZ7ADNA100GC-I	SEL HZ7-ADN-A100-G-SSS-C)	F2	\$4,510
HZ7ADNA100GC-K	SEL HZ7-ADN-A100-G-SSS-C)	F2	\$4,626
HZ7ADNA100PC	SEL HZ7-ADN-A100-P-SSS-C)	F2	\$5,138
HZ7ADNA100PC-I	SEL HZ7-ADN-A100-P-SSS-C)	F2	\$5,369
HZ7ADNA100PC-K	SEL HZ7-ADN-A100-P-SSS-C)	F2	\$5,507
HZ7ADNA103GC	SEL HZ7-ADN-A10-3G-SSS-C)	F2	\$1,140
HZ7ADNA103GC-I	SEL HZ7-ADN-A10-3G-SSS-C)	F2	\$1,192
HZ7ADNA103GC-K	SEL HZ7-ADN-A10-3G-SSS-C)	F2	\$1,222
HZ7ADNA103PC	SEL HZ7-ADN-A10-3P-SSS-C)	F2	\$1,357
HZ7ADNA103PC-I	SEL HZ7-ADN-A10-3P-SSS-C)	F2	\$1,418
HZ7ADNA103PC-K	SEL HZ7-ADN-A10-3P-SSS-C)	F2	\$1,454
HZ7ADNA10GC	SEL HZ7-ADN-A10-G-SSS-C)	F2	\$432
HZ7ADNA10GC-I	SEL HZ7-ADN-A10-G-SSS-C)	F2	\$451
HZ7ADNA10GC-K	SEL HZ7-ADN-A10-G-SSS-C)	F2	\$463
HZ7ADNA10PC	SEL HZ7-ADN-A10-P-SSS-C)	F2	\$514
HZ7ADNA10PC-I	SEL HZ7-ADN-A10-P-SSS-C)	F2	\$537
HZ7ADNA10PC-K	SEL HZ7-ADN-A10-P-SSS-C)	F2	\$551
HZ7APADC100GC	SEL HZ7-AP-ADC100-G-SSS-C)	F2	\$7,025
HZ7APADC100GC-I	SEL HZ7-AP-ADC100-G-SSS-C)	F2	\$7,341
HZ7APADC100GC-K	SEL HZ7-AP-ADC100-G-SSS-C)	F2	\$7,529
HZ7APADC100PC	SEL HZ7-AP-ADC100-P-SSS-C)	F2	\$8,363
HZ7APADC100PC-I	SEL HZ7-AP-ADC100-P-SSS-C)	F2	\$8,739
HZ7APADC100PC-K	SEL HZ7-AP-ADC100-P-SSS-C)	F2	\$8,963
HZ7APADC103GC	SEL HZ7-AP-ADC10-3G-SSS-C)	F2	\$1,853
HZ7APADC103GC-I	SEL HZ7-AP-ADC10-3G-SSS-C)	F2	\$1,937
HZ7APADC103GC-K	SEL HZ7-AP-ADC10-3G-SSS-C)	F2	\$1,986
HZ7APADC103PC	SEL HZ7-AP-ADC10-3P-SSS-C)	F2	\$2,207
HZ7APADC103PC-I	SEL HZ7-AP-ADC10-3P-SSS-C)	F2	\$2,306
HZ7APADC103PC-K	SEL HZ7-AP-ADC10-3P-SSS-C)	F2	\$2,365
HZ7APADC10GC	SEL HZ7-AP-ADC10-G-SSS-C)	F2	\$702
HZ7APADC10GC-I	SEL HZ7-AP-ADC10-G-SSS-C)	F2	\$734
HZ7APADC10GC-K	SEL HZ7-AP-ADC10-G-SSS-C)	F2	\$752
HZ7APADC10PC	SEL HZ7-AP-ADC10-P-SSS-C)	F2	\$836
HZ7APADC10PC-I	SEL HZ7-AP-ADC10-P-SSS-C)	F2	\$874
HZ7APADC10PC-K	SEL HZ7-AP-ADC10-P-SSS-C)	F2	\$896
HZ7APADN100GC	SEL HZ7-AP-ADN100-G-SSS-C)	F2	\$4,316
HZ7APADN100GC-I	SEL HZ7-AP-ADN100-G-SSS-C)	F2	\$4,510
HZ7APADN100GC-K	SEL HZ7-AP-ADN100-G-SSS-C)	F2	\$4,626
HZ7APADN100PC	SEL HZ7-AP-ADN100-P-SSS-C)	F2	\$5,138
HZ7APADN100PC-I	SEL HZ7-AP-ADN100-P-SSS-C)	F2	\$5,369
HZ7APADN100PC-K	SEL HZ7-AP-ADN100-P-SSS-C)	F2	\$5,507
HZ7APADN103GC	SEL HZ7-AP-ADN10-3G-SSS-C)	F2	\$1,140
HZ7APADN103GC-I	SEL HZ7-AP-ADN10-3G-SSS-C)	F2	\$1,192

HZ7APADN103GC-K	SEL HZ7-AP-ADN10-3G-SSS-C)	F2	\$1,222
HZ7APADN103PC	SEL HZ7-AP-ADN10-3P-SSS-C)	F2	\$1,357
HZ7APADN103PC-I	SEL HZ7-AP-ADN10-3P-SSS-C)	F2	\$1,418
HZ7APADN103PC-K	SEL HZ7-AP-ADN10-3P-SSS-C)	F2	\$1,454
HZ7APADN10GC	SEL HZ7-AP-ADN10-G-SSS-C)	F2	\$432
HZ7APADN10GC-I	SEL HZ7-AP-ADN10-G-SSS-C)	F2	\$451
HZ7APADN10GC-K	SEL HZ7-AP-ADN10-G-SSS-C)	F2	\$463
HZ7APADN10PC	SEL HZ7-AP-ADN10-P-SSS-C)	F2	\$514
HZ7APADN10PC-I	SEL HZ7-AP-ADN10-P-SSS-C)	F2	\$537
HZ7APADN10PC-K	SEL HZ7-AP-ADN10-P-SSS-C)	F2	\$551
HZ7APSTC100GC	SEL HZ7-AP-STC100-G-SSS-C)	F2	\$4,316
HZ7APSTC100GC-I	SEL HZ7-AP-STC100-G-SSS-C)	F2	\$4,510
HZ7APSTC100GC-K	SEL HZ7-AP-STC100-G-SSS-C)	F2	\$4,626
HZ7APSTC100PC	SEL HZ7-AP-STC100-P-SSS-C)	F2	\$5,138
HZ7APSTC100PC-I	SEL HZ7-AP-STC100-P-SSS-C)	F2	\$5,369
HZ7APSTC100PC-K	SEL HZ7-AP-STC100-P-SSS-C)	F2	\$5,507
HZ7APSTC103GC	SEL HZ7-AP-STC10-3G-SSS-C)	F2	\$1,140
HZ7APSTC103GC-I	SEL HZ7-AP-STC10-3G-SSS-C)	F2	\$1,192
HZ7APSTC103GC-K	SEL HZ7-AP-STC10-3G-SSS-C)	F2	\$1,222
HZ7APSTC103PC	SEL HZ7-AP-STC10-3P-SSS-C)	F2	\$1,357
HZ7APSTC103PC-I	SEL HZ7-AP-STC10-3P-SSS-C)	F2	\$1,418
HZ7APSTC103PC-K	SEL HZ7-AP-STC10-3P-SSS-C)	F2	\$1,454
HZ7APSTC10GC	SEL HZ7-AP-STC10-G-SSS-C)	F2	\$432
HZ7APSTC10GC-I	SEL HZ7-AP-STC10-G-SSS-C)	F2	\$451
HZ7APSTC10GC-K	SEL HZ7-AP-STC10-G-SSS-C)	F2	\$463
HZ7APSTC10PC	SEL HZ7-AP-STC10-P-SSS-C)	F2	\$514
HZ7APSTC10PC-I	SEL HZ7-AP-STC10-P-SSS-C)	F2	\$537
HZ7APSTC10PC-K	SEL HZ7-AP-STC10-P-SSS-C)	F2	\$551
HZ7APSTN100GC	SEL HZ7-AP-STN100-G-SSS-C)	F2	\$2,699
HZ7APSTN100GC-I	SEL HZ7-AP-STN100-G-SSS-C)	F2	\$2,820
HZ7APSTN100GC-K	SEL HZ7-AP-STN100-G-SSS-C)	F2	\$2,893
HZ7APSTN100PC	SEL HZ7-AP-STN100-P-SSS-C)	F2	\$3,213
HZ7APSTN100PC-I	SEL HZ7-AP-STN100-P-SSS-C)	F2	\$3,358
HZ7APSTN100PC-K	SEL HZ7-AP-STN100-P-SSS-C)	F2	\$3,444
HZ7APSTN103GC	SEL HZ7-AP-STN10-3G-SSS-C)	F2	\$713
HZ7APSTN103GC-I	SEL HZ7-AP-STN10-3G-SSS-C)	F2	\$745
HZ7APSTN103GC-K	SEL HZ7-AP-STN10-3G-SSS-C)	F2	\$764
HZ7APSTN103PC	SEL HZ7-AP-STN10-3P-SSS-C)	F2	\$847
HZ7APSTN103PC-I	SEL HZ7-AP-STN10-3P-SSS-C)	F2	\$886
HZ7APSTN103PC-K	SEL HZ7-AP-STN10-3P-SSS-C)	F2	\$908
HZ7APSTN10GC	SEL HZ7-AP-STN10-G-SSS-C)	F2	\$270
HZ7APSTN10GC-I	SEL HZ7-AP-STN10-G-SSS-C)	F2	\$282
HZ7APSTN10GC-K	SEL HZ7-AP-STN10-G-SSS-C)	F2	\$289
HZ7APSTN10PC	SEL HZ7-AP-STN10-P-SSS-C)	F2	\$321
HZ7APSTN10PC-I	SEL HZ7-AP-STN10-P-SSS-C)	F2	\$335
HZ7APSTN10PC-K	SEL HZ7-AP-STN10-P-SSS-C)	F2	\$344
HZ7E100AERCGC	SEL HZ7-E100-AERC-G-SSS-C)	F2	\$9,188
HZ7E100AERCGC-I	SEL HZ7-E100-AERC-G-SSS-C)	F2	\$9,601
HZ7E100AERCGC-K	SEL HZ7-E100-AERC-G-SSS-C)	F2	\$9,848
HZ7E100AERCPC	SEL HZ7-E100-AERC-P-SSS-C)	F2	\$10,938

HZ7E100AERCPC-I	SEL HZ7-E100-AERC-P-SSS-C)	F2	\$11,430
HZ7E100AERCPC-K	SEL HZ7-E100-AERC-P-SSS-C)	F2	\$11,723
HZ7E100ER3PC	SEL HZ7-E100-AERC-3P-SSS-C)	F2	\$28,876
HZ7E100ER3PC-I	SEL HZ7-E100-AERC-3P-SSS-C)	F2	\$30,176
HZ7E100ER3PC-K	SEL HZ7-E100-AERC-3P-SSS-C)	F2	\$30,949
HZ7E100ERC3C	SEL HZ7-E100-AERC-3G-SSS-C)	F2	\$24,256
HZ7E100ERC3C-I	SEL HZ7-E100-AERC-3G-SSS-C)	F2	\$25,348
HZ7E100ERC3C-K	SEL HZ7-E100-AERC-3G-SSS-C)	F2	\$25,998
HZ7E10AERC3GC	SEL HZ7-E10-AERC-3G-SSS-C)	F2	\$2,426
HZ7E10AERC3GC-I	SEL HZ7-E10-AERC-3G-SSS-C)	F2	\$2,535
HZ7E10AERC3GC-K	SEL HZ7-E10-AERC-3G-SSS-C)	F2	\$2,600
HZ7E10AERC3PC	SEL HZ7-E10-AERC-3P-SSS-C)	F2	\$2,888
HZ7E10AERC3PC-I	SEL HZ7-E10-AERC-3P-SSS-C)	F2	\$3,018
HZ7E10AERC3PC-K	SEL HZ7-E10-AERC-3P-SSS-C)	F2	\$3,096
HZ7E10AERCGC	SEL HZ7-E10-AERC-G-SSS-C)	F2	\$919
HZ7E10AERCGC-I	SEL HZ7-E10-AERC-G-SSS-C)	F2	\$960
HZ7E10AERCGC-K	SEL HZ7-E10-AERC-G-SSS-C)	F2	\$985
HZ7E10AERCPC	SEL HZ7-E10-AERC-P-SSS-C)	F2	\$1,094
HZ7E10AERCPC-I	SEL HZ7-E10-AERC-P-SSS-C)	F2	\$1,143
HZ7E10AERCPC-K	SEL HZ7-E10-AERC-P-SSS-C)	F2	\$1,173
HZ7ENC1003GC	SEL HZ7-ENC-100-3G-SSS-C)	F2	\$32,850
HZ7ENC1003GC-I	SEL HZ7-ENC-100-3G-SSS-C)	F2	\$34,328
HZ7ENC1003GCV2-K	SEL HZ7-ENC-100-3G-SSS-C)	F2	\$35,208
HZ7ENC1003PC	SEL HZ7-ENC-100-3P-SSS-C)	F2	\$39,106
HZ7ENC1003PC-I	SEL HZ7-ENC-100-3P-SSS-C)	F2	\$40,866
HZ7ENC1003PCV2-K	SEL HZ7-ENC-100-3P-SSS-C)	F2	\$41,914
HZ7ENC100GC	SEL HZ7-ENC-100-G-SSS-C)	F2	\$12,443
HZ7ENC100GC-I	SEL HZ7-ENC-100-G-SSS-C)	F2	\$13,003
HZ7ENC100GCV2-K	SEL HZ7-ENC-100-G-SSS-C)	F2	\$13,336
HZ7ENC100PC	SEL HZ7-ENC-100-P-SSS-C)	F2	\$14,813
HZ7ENC100PC-I	SEL HZ7-ENC-100-P-SSS-C)	F2	\$15,480
HZ7ENC100PCV2-K	SEL HZ7-ENC-100-P-SSS-C)	F2	\$15,876
HZ7ENC103GC	SEL HZ7-ENC-10-3G-SSS-C)	F2	\$3,284
HZ7ENC103GC-I	SEL HZ7-ENC-10-3G-SSS-C)	F2	\$3,432
HZ7ENC103GCV2-K	SEL HZ7-ENC-10-3G-SSS-C)	F2	\$3,520
HZ7ENC103PC	SEL HZ7-ENC-10-3P-SSS-C)	F2	\$3,910
HZ7ENC103PC-I	SEL HZ7-ENC-10-3P-SSS-C)	F2	\$4,086
HZ7ENC103PCV2-K	SEL HZ7-ENC-10-3P-SSS-C)	F2	\$4,191
HZ7ENC10GC	SEL HZ7-ENC-10-G-SSS-C)	F2	\$1,244
HZ7ENC10GC-I	SEL HZ7-ENC-10-G-SSS-C)	F2	\$1,300
HZ7ENC10GCV2-K	SEL HZ7-ENC-10-G-SSS-C)	F2	\$1,333
HZ7ENC10PC	SEL HZ7-ENC-10-P-SSS-C)	F2	\$1,481
HZ7ENC10PC-I	SEL HZ7-ENC-10-P-SSS-C)	F2	\$1,548
HZ7ENC10PCV2-K	SEL HZ7-ENC-10-P-SSS-C)	F2	\$1,587
HZ7ENC2502MGSSSF	SEL: HZ7-ENC-250-2M-GSSS-F	F2	\$5,534
HZ7ENC2502MPSSSF	SEL: HZ7-ENC-250-2M-PSSS-F	F2	\$6,589
HZ7ENC5002MGSSSF	SEL: HZ7-ENC-500-2M-GSSS-F	F2	\$11,069
HZ7ENC5002MPSSSF	SEL: HZ7-ENC-500-2M-PSSS-F	F2	\$13,177
HZ7ENN1003GC	SEL HZ7-ENN-100-3G-SSS-C)	F2	\$19,987
HZ7ENN1003GC-I	SEL HZ7-ENN-100-3G-SSS-C)	F2	\$20,887

HZ7ENN1003GCV2-K	SEL HZ7-ENN-100-3G-SSS-C)	F2	\$21,422
HZ7ENN1003PC	SEL HZ7-ENN-100-3P-SSS-C)	F2	\$23,794
HZ7ENN1003PC-I	SEL HZ7-ENN-100-3P-SSS-C)	F2	\$24,865
HZ7ENN1003PCV2-K	SEL HZ7-ENN-100-3P-SSS-C)	F2	\$25,503
HZ7ENN100GC	SEL HZ7-ENN-100-G-SSS-C)	F2	\$7,571
HZ7ENN100GC-I	SEL HZ7-ENN-100-G-SSS-C)	F2	\$7,912
HZ7ENN100GCV2-K	SEL HZ7-ENN-100-G-SSS-C)	F2	\$8,115
HZ7ENN100PC	SEL HZ7-ENN-100-P-SSS-C)	F2	\$9,013
HZ7ENN100PC-I	SEL HZ7-ENN-100-P-SSS-C)	F2	\$9,419
HZ7ENN100PCV2-K	SEL HZ7-ENN-100-P-SSS-C)	F2	\$9,660
HZ7ENN103GC	SEL HZ7-ENN-10-3G-SSS-C)	F2	\$1,998
HZ7ENN103GC-I	SEL HZ7-ENN-10-3G-SSS-C)	F2	\$2,088
HZ7ENN103GCV2-K	SEL HZ7-ENN-10-3G-SSS-C)	F2	\$2,142
HZ7ENN103PC	SEL HZ7-ENN-10-3P-SSS-C)	F2	\$2,379
HZ7ENN103PC-I	SEL HZ7-ENN-10-3P-SSS-C)	F2	\$2,486
HZ7ENN103PCV2-K	SEL HZ7-ENN-10-3P-SSS-C)	F2	\$2,549
HZ7ENN10GC	SEL HZ7-ENN-10-G-SSS-C)	F2	\$757
HZ7ENN10GC-I	SEL HZ7-ENN-10-G-SSS-C)	F2	\$791
HZ7ENN10GCV2-K	SEL HZ7-ENN-10-G-SSS-C)	F2	\$811
HZ7ENN10PC	SEL HZ7-ENN-10-P-SSS-C)	F2	\$901
HZ7ENN10PC-I	SEL HZ7-ENN-10-P-SSS-C)	F2	\$942
HZ7ENN10PCV2-K	SEL HZ7-ENN-10-P-SSS-C)	F2	\$966
HZ7ENN1K2MGSSSF	SEL: HZ7-ENN-1K-2M-GSSS-F	F2	\$13,475
HZ7ENN1K2MPSSSF	SEL: HZ7-ENN-1K-2M-PSSS-F	F2	\$16,042
HZ7ENN2002MGSSSF	SEL: HZ7-ENN-200-2M-GSSS-F	F2	\$2,695
HZ7ENN2002MPSSSF	SEL: HZ7-ENN-200-2M-PSSS-F	F2	\$3,208
HZ7ENN202MGSSSF	SEL: HZ7-ENN-20-2M-GSSS-F	F2	\$270
HZ7ENN202MPSSSF	SEL: HZ7-ENN-20-2M-PSSS-F	F2	\$321
HZ7ENN5002MGSSSF	SEL: HZ7-ENN-500-2M-GSSS-F	F2	\$6,738
HZ7ENN5002MPSSSF	SEL: HZ7-ENN-500-2M-PSSS-F	F2	\$8,021
HZ7ENNA1003GC	SEL HZ7-ENN-A100-3G-SSS-C)	F2	\$16,273
HZ7ENNA1003GC-I	SEL HZ7-ENN-A100-3G-SSS-C)	F2	\$17,005
HZ7ENNA1003GC-K	SEL HZ7-ENN-A100-3G-SSS-C)	F2	\$17,441
HZ7ENNA1003PC	SEL HZ7-ENN-A100-3P-SSS-C)	F2	\$19,372
HZ7ENNA1003PC-I	SEL HZ7-ENN-A100-3P-SSS-C)	F2	\$20,244
HZ7ENNA1003PC-K	SEL HZ7-ENN-A100-3P-SSS-C)	F2	\$20,763
HZ7ENNA100GC	SEL HZ7-ENN-A100-G-SSS-C)	F2	\$6,164
HZ7ENNA100GC-I	SEL HZ7-ENN-A100-G-SSS-C)	F2	\$6,441
HZ7ENNA100GC-K	SEL HZ7-ENN-A100-G-SSS-C)	F2	\$6,607
HZ7ENNA100PC	SEL HZ7-ENN-A100-P-SSS-C)	F2	\$7,338
HZ7ENNA100PC-I	SEL HZ7-ENN-A100-P-SSS-C)	F2	\$7,668
HZ7ENNA100PC-K	SEL HZ7-ENN-A100-P-SSS-C)	F2	\$7,865
HZ7ENNA103GC	SEL HZ7-ENN-A10-3G-SSS-C)	F2	\$1,626
HZ7ENNA103GC-I	SEL HZ7-ENN-A10-3G-SSS-C)	F2	\$1,699
HZ7ENNA103GC-K	SEL HZ7-ENN-A10-3G-SSS-C)	F2	\$1,743
HZ7ENNA103PC	SEL HZ7-ENN-A10-3P-SSS-C)	F2	\$1,938
HZ7ENNA103PC-I	SEL HZ7-ENN-A10-3P-SSS-C)	F2	\$2,025
HZ7ENNA103PC-K	SEL HZ7-ENN-A10-3P-SSS-C)	F2	\$2,077
HZ7ENNA10GC	SEL HZ7-ENN-A10-G-SSS-C)	F2	\$616
HZ7ENNA10GC-I	SEL HZ7-ENN-A10-G-SSS-C)	F2	\$644

HZ7ENNA10GC-K	SEL HZ7-ENN-A10-G-SSS-C)	F2	\$660
HZ7ENNA10PC	SEL HZ7-ENN-A10-P-SSS-C)	F2	\$734
HZ7ENNA10PC-I	SEL HZ7-ENN-A10-P-SSS-C)	F2	\$767
HZ7ENNA10PC-K	SEL HZ7-ENN-A10-P-SSS-C)	F2	\$787
HZ7ENNW1003GSSSF	SEL: HZ7-ENN-W100-3G-SSS-F	F2	\$21,344
HZ7ENNW1003PSSSF	SEL: HZ7-ENN-W100-3P-SSS-F	F2	\$25,410
HZ7ENNW100GSSSF	SEL: HZ7-ENN-W100-G-SSS-F	F2	\$8,085
HZ7ENNW100PSSSF	SEL: HZ7-ENN-W100-P-SSS-F	F2	\$9,625
HZ7ENNW103GSSSF	SEL: HZ7-ENN-W10-3G-SSS-F	F2	\$2,134
HZ7ENNW103PSSSF	SEL: HZ7-ENN-W10-3P-SSS-F	F2	\$2,541
HZ7ENNW10GSSSF	SEL: HZ7-ENN-W10-G-SSS-F	F2	\$809
HZ7ENNW10PSSSF	SEL: HZ7-ENN-W10-P-SSS-F	F2	\$963
HZ7ENNWS10PSSSF	SEL: HZ7-ENN-WS10-P-SSS-F	F2	\$963
HZ7LXC1003GC	SEL HZ7-LXC-100-3G-SSS-C)	F2	\$8,567
HZ7LXC1003GC-I	SEL HZ7-LXC-100-3G-SSS-C)	F2	\$9,423
HZ7LXC1003GC-K	SEL HZ7-LXC-100-3G-SSS-C)	F2	\$9,342
HZ7LXC1003PC	SEL HZ7-LXC-100-3P-SSS-C)	F2	\$10,198
HZ7LXC1003PC-I	SEL HZ7-LXC-100-3P-SSS-C)	F2	\$11,218
HZ7LXC1003PC-K	SEL HZ7-LXC-100-3P-SSS-C)	F2	\$11,121
HZ7LXC100GC	SEL HZ7-LXC-100-G-SSS-C)	F2	\$3,245
HZ7LXC100GC-I	SEL HZ7-LXC-100-G-SSS-C)	F2	\$3,570
HZ7LXC100GC-K	SEL HZ7-LXC-100-G-SSS-C)	F2	\$3,539
HZ7LXC100PC	SEL HZ7-LXC-100-P-SSS-C)	F2	\$3,863
HZ7LXC100PC-I	SEL HZ7-LXC-100-P-SSS-C)	F2	\$4,249
HZ7LXC100PC-K	SEL HZ7-LXC-100-P-SSS-C)	F2	\$4,213
HZ7LXC103GC	SEL HZ7-LXC-10-3G-SSS-C)	F2	\$855
HZ7LXC103GC-I	SEL HZ7-LXC-10-3G-SSS-C)	F2	\$941
HZ7LXC103GC-K	SEL HZ7-LXC-10-3G-SSS-C)	F2	\$933
HZ7LXC103PC	SEL HZ7-LXC-10-3P-SSS-C)	F2	\$1,019
HZ7LXC103PC-I	SEL HZ7-LXC-10-3P-SSS-C)	F2	\$1,121
HZ7LXC103PC-K	SEL HZ7-LXC-10-3P-SSS-C)	F2	\$1,111
HZ7LXC10GC	SEL HZ7-LXC-10-G-SSS-C)	F2	\$324
HZ7LXC10GC-I	SEL HZ7-LXC-10-G-SSS-C)	F2	\$356
HZ7LXC10GC-K	SEL HZ7-LXC-10-G-SSS-C)	F2	\$353
HZ7LXC10PC	SEL HZ7-LXC-10-P-SSS-C)	F2	\$386
HZ7LXC10PC-I	SEL HZ7-LXC-10-P-SSS-C)	F2	\$425
HZ7LXC10PC-K	SEL HZ7-LXC-10-P-SSS-C)	F2	\$421
HZ7STA1003GV2-K	SEL HZ7-STD-A100-3G-SSS-C)	F2	\$11,618
HZ7STA1003PV2-K	SEL HZ7-STD-A100-3P-SSS-C)	F2	\$13,831
HZ7STD1003GC	SEL HZ7-STD-100-3G-SSS-C)	F2	\$14,277
HZ7STD1003GC-I	SEL HZ7-STD-100-3G-SSS-C)	F2	\$14,920
HZ7STD1003GCV2-K	SEL HZ7-STD-100-3G-SSS-C)	F2	\$15,302
HZ7STD1003PC	SEL HZ7-STD-100-3P-SSS-C)	F2	\$16,996
HZ7STD1003PC-I	SEL HZ7-STD-100-3P-SSS-C)	F2	\$17,761
HZ7STD1003PCV2-K	SEL HZ7-STD-100-3P-SSS-C)	F2	\$18,216
HZ7STD100GC	SEL HZ7-STD-100-G-SSS-C)	F2	\$5,408
HZ7STD100GC-I	SEL HZ7-STD-100-G-SSS-C)	F2	\$5,651
HZ7STD100GCV2-K	SEL HZ7-STD-100-G-SSS-C)	F2	\$5,796
HZ7STD100PC	SEL HZ7-STD-100-P-SSS-C)	F2	\$6,438
HZ7STD100PC-I	SEL HZ7-STD-100-P-SSS-C)	F2	\$6,728

HZ7STD100PCV2-K	SEL HZ7-STD-100-P-SSS-C)	F2	\$6,900
HZ7STD103GC	SEL HZ7-STD-10-3G-SSS-C)	F2	\$1,428
HZ7STD103GC-I	SEL HZ7-STD-10-3G-SSS-C)	F2	\$1,493
HZ7STD103GCV2-K	SEL HZ7-STD-10-3G-SSS-C)	F2	\$1,531
HZ7STD103PC	SEL HZ7-STD-10-3P-SSS-C)	F2	\$1,700
HZ7STD103PC-I	SEL HZ7-STD-10-3P-SSS-C)	F2	\$1,777
HZ7STD103PCV2-K	SEL HZ7-STD-10-3P-SSS-C)	F2	\$1,822
HZ7STD10GC	SEL HZ7-STD-10-G-SSS-C)	F2	\$541
HZ7STD10GC-I	SEL HZ7-STD-10-G-SSS-C)	F2	\$565
HZ7STD10GCV2-K	SEL HZ7-STD-10-G-SSS-C)	F2	\$580
HZ7STD10PC	SEL HZ7-STD-10-P-SSS-C)	F2	\$644
HZ7STD10PC-I	SEL HZ7-STD-10-P-SSS-C)	F2	\$673
HZ7STD10PCV2-K	SEL HZ7-STD-10-P-SSS-C)	F2	\$690
HZ7STDA1003GC	SEL HZ7-STD-A100-3G-SSS-C)	F2	\$10,840
HZ7STDA1003GC-I	SEL HZ7-STD-A100-3G-SSS-C)	F2	\$11,328
HZ7STDA1003PC	SEL HZ7-STD-A100-3P-SSS-C)	F2	\$12,904
HZ7STDA1003PC-I	SEL HZ7-STD-A100-3P-SSS-C)	F2	\$13,485
HZ7STDA100GC	SEL HZ7-STD-A100-G-SSS-C)	F2	\$4,106
HZ7STDA100GC-I	SEL HZ7-STD-A100-G-SSS-C)	F2	\$4,291
HZ7STDA100GCV2-K	SEL HZ7-STD-A100-G-SSS-C)	F2	\$4,401
HZ7STDA100PC	SEL HZ7-STD-A100-P-SSS-C)	F2	\$4,888
HZ7STDA100PC-I	SEL HZ7-STD-A100-P-SSS-C)	F2	\$5,108
HZ7STDA100PCV2-K	SEL HZ7-STD-A100-P-SSS-C)	F2	\$5,239
HZ7STDA103GC	SEL HZ7-STD-A10-3G-SSS-C)	F2	\$1,085
HZ7STDA103GC-I	SEL HZ7-STD-A10-3G-SSS-C)	F2	\$1,134
HZ7STDA103GCV2-K	SEL HZ7-STD-A10-3G-SSS-C)	F2	\$1,163
HZ7STDA103PC	SEL HZ7-STD-A10-3P-SSS-C)	F2	\$1,291
HZ7STDA103PC-I	SEL HZ7-STD-A10-3P-SSS-C)	F2	\$1,349
HZ7STDA103PCV2-K	SEL HZ7-STD-A10-3P-SSS-C)	F2	\$1,384
HZ7STDA10GC	SEL HZ7-STD-A10-G-SSS-C)	F2	\$411
HZ7STDA10GC-I	SEL HZ7-STD-A10-G-SSS-C)	F2	\$430
HZ7STDA10GCV2-K	SEL HZ7-STD-A10-G-SSS-C)	F2	\$441
HZ7STDA10PC	SEL HZ7-STD-A10-P-SSS-C)	F2	\$489
HZ7STDA10PC-I	SEL HZ7-STD-A10-P-SSS-C)	F2	\$511
HZ7STDA10PCV2-K	SEL HZ7-STD-A10-P-SSS-C)	F2	\$524
HZFLX103GC	SEL HZ-FLX-10-3G-SSS-C)	F2	\$1,428
HZFLX103GC-I	SEL HZ-FLX-10-3G-SSS-C)	F2	\$1,493
HZFLX103GCV2-K	SEL HZ-FLX-10-3G-SSS-C)	F2	\$1,531
HZFLX103PC	SEL HZ-FLX-10-3P-SSS-C)	F2	\$1,700
HZFLX103PC-I	SEL HZ-FLX-10-3P-SSS-C)	F2	\$1,777
HZFLX103PCV2-K	SEL HZ-FLX-10-3P-SSS-C)	F2	\$1,822
HZFLX10GC	SEL HZ-FLX-10-G-SSS-C)	F2	\$541
HZFLX10GC-I	SEL HZ-FLX-10-G-SSS-C)	F2	\$565
HZFLX10GCV2-K	SEL HZ-FLX-10-G-SSS-C)	F2	\$580
HZFLX10PC	SEL HZ-FLX-10-P-SSS-C)	F2	\$644
HZFLX10PC-I	SEL HZ-FLX-10-P-SSS-C)	F2	\$673
HZFLX10PCV2-K	SEL HZ-FLX-10-P-SSS-C)	F2	\$690
HZFLX13GC	SEL HZ-FLX-1-3G-SSS-C)	F2	\$143
HZFLX13GC-I	SEL HZ-FLX-1-3G-SSS-C)	F2	\$149
HZFLX13GC-K	SEL HZ-FLX-1-3G-SSS-C)	F2	\$153

HZFLX13PC	SEL HZ-FLX-1-3P-SSS-C)	F2	\$169
HZFLX13PC-I	SEL HZ-FLX-1-3P-SSS-C)	F2	\$177
HZFLX13PC-K	SEL HZ-FLX-1-3P-SSS-C)	F2	\$181
HZFLX1GC	SEL HZ-FLX-1-G-SSS-C)	F2	\$54
HZFLX1GC-I	SEL HZ-FLX-1-G-SSS-C)	F2	\$56
HZFLX1GC-K	SEL HZ-FLX-1-G-SSS-C)	F2	\$58
HZFLX1PC	SEL HZ-FLX-1-P-SSS-C)	F2	\$64
HZFLX1PC-I	SEL HZ-FLX-1-P-SSS-C)	F2	\$67
HZFLX1PC-K	SEL HZ-FLX-1-P-SSS-C)	F2	\$69
HZFLXAD103GC	SEL HZ-FLX-AD10-3G-SSS-C)	F2	\$855
HZFLXAD103GC-I	SEL HZ-FLX-AD10-3G-SSS-C)	F2	\$894
HZFLXAD103GCV2-K	SEL HZ-FLX-AD10-3G-SSS-C)	F2	\$917
HZFLXAD103PC	SEL HZ-FLX-AD10-3P-SSS-C)	F2	\$1,019
HZFLXAD103PC-I	SEL HZ-FLX-AD10-3P-SSS-C)	F2	\$1,065
HZFLXAD103PCV2-K	SEL HZ-FLX-AD10-3P-SSS-C)	F2	\$1,092
HZFLXAD10GC	SEL HZ-FLX-AD10-G-SSS-C)	F2	\$324
HZFLXAD10GC-I	SEL HZ-FLX-AD10-G-SSS-C)	F2	\$339
HZFLXAD10GCV2-K	SEL HZ-FLX-AD10-G-SSS-C)	F2	\$347
HZFLXAD10PC	SEL HZ-FLX-AD10-P-SSS-C)	F2	\$386
HZFLXAD10PC-I	SEL HZ-FLX-AD10-P-SSS-C)	F2	\$403
HZFLXAD10PCV2-K	SEL HZ-FLX-AD10-P-SSS-C)	F2	\$414
IDAPR-1P	SEL 1 DatAdvantage Pb/Collector 50SL	F2	\$9,635
IGL-0031PM1E	SEL EyeGlass DR 1 Cluster Lic Maint 1yr	F2	\$618
IGL-0031PM3E	SEL EyeGlass DR 1 Cluster Lic Maint 3yr	F2	\$1,854
IGL-0031PM5E	SEL EyeGlass DR 1 Cluster Lic Maint 5yr	F2	\$3,089
IGL-CA-010	SEL Eyeglass Isilon Probe-Basic 1yrM	F2	\$274
IGL-CA-011	SEL Eyeglass Isilon Probe-Basic 3yrM	F2	\$824
IGLS-TRAIN-1	SEL IGLS ILT DR Plan Cfg Execute Monitor	F2	\$6,862
IMPL-M3000-1	SELECT DISTANCE EXT IMPL SERVICE; M300-1	F2	\$8,100
IOM-BS1Y-0-10	SEL IOMART BAAS 1Y 0-10	F2	\$3,106
IOM-BS1Y-1001+	SEL IOMART BAAS 1Y 1001+	F2	\$1,412
IOM-BS1Y-11-50	SEL IOMART BAAS 1Y 11-50	F2	\$2,965
IOM-BS1Y-151-250	SEL IOMART BAAS 1Y 151-250	F2	\$2,541
IOM-BS1Y-251-400	SEL IOMART BAAS 1Y 251-400	F2	\$2,259
IOM-BS1Y-401-600	SEL IOMART BAAS 1Y 401-600	F2	\$1,835
IOM-BS1Y-51-150	SEL IOMART BAAS 1Y 51-150	F2	\$2,824
IOM-BS1Y-601-1K	SEL IOMART BAAS 1Y 601-1000	F2	\$1,694
IOM-BS2Y-0-10	SEL IOMART BAAS 2Y 0-10	F2	\$5,591
IOM-BS2Y-1001+	SEL IOMART BAAS 2Y 1001+	F2	\$2,541
IOM-BS2Y-11-50	SEL IOMART BAAS 2Y 11-50	F2	\$5,336
IOM-BS2Y-151-250	SEL IOMART BAAS 2Y 151-250	F2	\$4,574
IOM-BS2Y-251-400	SEL IOMART BAAS 2Y 251-400	F2	\$4,066
IOM-BS2Y-401-600	SEL IOMART BAAS 2Y 401-600	F2	\$3,304
IOM-BS2Y-51-150	SEL IOMART BAAS 2Y 51-150	F2	\$5,082
IOM-BS2Y-601-1K	SEL IOMART BAAS 2Y 601-1000	F2	\$3,049
IOM-BS3Y-0-10	SEL IOMART BAAS 3Y 0-10	F2	\$7,920
IOM-BS3Y-1001+	SEL IOMART BAAS 3Y 1001+	F2	\$3,600
IOM-BS3Y-11-50	SEL IOMART BAAS 3Y 11-50	F2	\$7,560
IOM-BS3Y-151-250	SEL IOMART BAAS 3Y 151-250	F2	\$6,480
IOM-BS3Y-251-400	SEL IOMART BAAS 3Y 251-400	F2	\$5,760

IOM-BS3Y-401-600	SEL IOMART BAAS 3Y 401-600	F2	\$4,680
IOM-BS3Y-51-150	SEL IOMART BAAS 3Y 51-150	F2	\$7,200
IOM-BS3Y-601-1K	SEL IOMART BAAS 3Y 601-1000	F2	\$4,320
IOM-M-1Y-0-10	SEL IOMART MTC 1Y 0-10	F2	\$1,900
IOM-M-1Y-1001+	SEL IOMART MTC 1Y 1001+	F2	\$400
IOM-M-1Y-11-50	SEL IOMART MTC 1Y 11-50	F2	\$1,800
IOM-M-1Y-151-250	SEL IOMART MTC 1Y 151-250	F2	\$1,600
IOM-M-1Y-251-400	SEL IOMART MTC 1Y 251-400	F2	\$1,500
IOM-M-1Y-401-600	SEL IOMART MTC 1Y 401-600	F2	\$1,000
IOM-M-1Y-51-150	SEL IOMART MTC 1Y 51-150	F2	\$1,700
IOM-M-1Y-601-1K	SEL IOMART MTC 1Y 601-1000	F2	\$600
IOM-M-2Y-0-10	SEL IOMART MTC 2Y 0-10	F2	\$3,230
IOM-M-2Y-1001+	SEL IOMART MTC 2Y 1001+	F2	\$680
IOM-M-2Y-11-50	SEL IOMART MTC 2Y 11-50	F2	\$3,060
IOM-M-2Y-151-250	SEL IOMART MTC 2Y 151-250	F2	\$2,720
IOM-M-2Y-251-400	SEL IOMART MTC 2Y 251-400	F2	\$2,550
IOM-M-2Y-401-600	SEL IOMART MTC 2Y 401-600	F2	\$1,700
IOM-M-2Y-51-150	SEL IOMART MTC 2Y 51-150	F2	\$2,890
IOM-M-2Y-601-1K	SEL IOMART MTC 2Y 601-1000	F2	\$1,020
IOM-M-3Y-0-10	SEL IOMART MTC 3Y 0-10	F2	\$4,560
IOM-M-3Y-1001+	SEL IOMART MTC 3Y 1001+	F2	\$960
IOM-M-3Y-11-50	SEL IOMART MTC 3Y 11-50	F2	\$4,320
IOM-M-3Y-151-250	SEL IOMART MTC 3Y 151-250	F2	\$3,840
IOM-M-3Y-251-400	SEL IOMART MTC 3Y 251-400	F2	\$3,600
IOM-M-3Y-401-600	SEL IOMART MTC 3Y 401-600	F2	\$2,400
IOM-M-3Y-51-150	SEL IOMART MTC 3Y 51-150	F2	\$4,080
IOM-M-3Y-601-1K	SEL IOMART MTC 3Y 601-1000	F2	\$1,440
IOM-PS-4HR	SEL IOMART PS 4HR BLOCK	F2	\$2,143
IOM-PS-INST-BLK	SEL IOMART INSTALLATION PER DEVICE	F2	\$2,857
IOM-SET1Y-001	SEL IOMART Setup (one time) Set/1Y-001	F2	\$82,353
IOM-SET2Y-002	SEL IOMART Setup (one time) Set/2Y-002	F2	\$41,176
IOM-SET3Y-003	SEL IOMART Setup (one time) Set/3Y-003	F2	\$24,706
IOM-WL1Y-001	SEL IOM White Label (one time) WL/1Y-001	F2	\$82,353
IOM-WL2Y-002	SEL IOM White Label (one time) WL/2Y-002	F2	\$41,176
IOM-WL3Y-003	SEL IOM White Label (one time) WL/3Y-003	F2	\$24,706
IPRS-1D	SEL 1Day Pro Ser(not to include expen)	F2	\$3,441
IPTC-1D	SEL 1Day DA Tra (not to include expen)	F2	\$3,441
ISD-ENT-NODE-1Y	SEL MAINT EYEGLASS DR MGR SDEdge 1YR	F2	\$256
ISD-ENT-NODE-3Y	SEL MAINT EYEGLASS DR MGR SDEdge 3YR	F2	\$768
ISD-ENT-NODE-5Y	SEL MAINT EYEGLASS DR MGR SDEdge 5YR	F2	\$1,280
ITP-ES-1000AN-D	SEL Splunk ITSI STDSup Bucket 1000AN	F2	\$1,000
ITP-ES-1000AP-D	SEL Splunk ITSI STDSup Bucket 1000AP	F2	\$1,000
ITP-ES-1000EM-D	SEL Splunk ITSI STDSup Bucket 1000EM	F2	\$1,000
ITP-ES-1000US-D	SEL Splunk ITSI SSUp Bucket 1000US	F2	\$1,000
ITP-ES-100AN-D	SEL Splunk ITSI STDSup Bucket 100AN	F2	\$100
ITP-ES-100AP-D	SEL Splunk ITSI STDSup Bucket 100AP	F2	\$100
ITP-ES-100EM-D	SEL Splunk ITSI STDSup Bucket 100EM	F2	\$100
ITP-ES-100US-D	SEL Splunk ITSI SSUp Bucket 100US	F2	\$100
ITP-ES-1AN-D	SEL Splunk ITSI STDSup Bucket 1AN	F2	\$1
ITP-ES-1AP-D	SEL Splunk ITSI STDSup Bucket 1AP	F2	\$1

ITP-ES-1EM-D	SEL Splunk ITSI STDSup Bucket 1EM	F2	\$1
ITP-ES-1US-D	SEL Splunk ITSI SSUp Bucket 1US	F2	\$1
ITP-GS-1000AN-D	SEL Splunk ITSI PRMSup Bucket 1000AN	F2	\$1,000
ITP-GS-1000AP-D	SEL Splunk ITSI PRMSup Bucket 1000AP	F2	\$1,000
ITP-GS-1000EM-D	SEL Splunk ITSI PRMSup Bucket 1000EM	F2	\$1,000
ITP-GS-1000US-D	SEL Splunk ITSI PSup Bucket 1000US	F2	\$1,000
ITP-GS-100AN-D	SEL Splunk ITSI PRMSup Bucket 100AN	F2	\$100
ITP-GS-100AP-D	SEL Splunk ITSI PRMSup Bucket 100AP	F2	\$100
ITP-GS-100EM-D	SEL Splunk ITSI PRMSup Bucket 100EM	F2	\$100
ITP-GS-100US-D	SEL Splunk ITSI PSup Bucket 100US	F2	\$100
ITP-GS-1AN-D	SEL Splunk ITSI PRMSup Bucket 1AN	F2	\$1
ITP-GS-1AP-D	SEL Splunk ITSI PRMSup Bucket 1AP	F2	\$1
ITP-GS-1EM-D	SEL Splunk ITSI PRMSup Bucket 1EM	F2	\$1
ITP-GS-1US-D	SEL Splunk ITSI PSup Bucket 1US	F2	\$1
ITPU-ES-1000AN-D	SEL Splunk ITSI UPG SSUp Bucket 1000AN	F2	\$1,000
ITPU-ES-1000AP-D	SEL Splunk ITSI UPG SSUp Bucket 1000AP	F2	\$1,000
ITPU-ES-1000EM-D	SEL Splunk ITSI UPG SSUp Bucket 1000EM	F2	\$1,000
ITPU-ES-1000US-D	SEL Splunk ITSI UPG SSUp Bucket 1000US	F2	\$1,000
ITPU-ES-100AN-D	SEL Splunk ITSI UPG SSUp Bucket 100AN	F2	\$100
ITPU-ES-100AP-D	SEL Splunk ITSI UPG SSUp Bucket 100AP	F2	\$100
ITPU-ES-100EM-D	SEL Splunk ITSI UPG SSUp Bucket 100EM	F2	\$100
ITPU-ES-100US-D	SEL Splunk ITSI UPG SSUp Bucket 100US	F2	\$100
ITPU-ES-1AN-D	SEL Splunk ITSI UPG SSUp Bucket 1AN	F2	\$1
ITPU-ES-1AP-D	SEL Splunk ITSI UPG SSUp Bucket 1AP	F2	\$1
ITPU-ES-1EM-D	SEL Splunk ITSI UPG SSUp Bucket 1EM	F2	\$1
ITPU-ES-1US-D	SEL Splunk ITSI UPG SSUp Bucket 1US	F2	\$1
ITPU-GS-1000AN-D	SEL Splunk ITSI UPG PSup Bucket 1000AN	F2	\$1,000
ITPU-GS-1000AP-D	SEL Splunk ITSI UPG PSup Bucket 1000AP	F2	\$1,000
ITPU-GS-1000EM-D	SEL Splunk ITSI UPG PSup Bucket 1000EM	F2	\$1,000
ITPU-GS-1000US-D	SEL Splunk ITSI UPG PSup Bucket 1000US	F2	\$1,000
ITPU-GS-100AN-D	SEL Splunk ITSI UPG PSup Bucket 100AN	F2	\$100
ITPU-GS-100AP-D	SEL Splunk ITSI UPG PSup Bucket 100AP	F2	\$100
ITPU-GS-100EM-D	SEL Splunk ITSI UPG PSup Bucket 100EM	F2	\$100
ITPU-GS-100US-D	SEL Splunk ITSI UPG PSup Bucket 100US	F2	\$100
ITPU-GS-1AN-D	SEL Splunk ITSI UPG PSup Bucket 1AN	F2	\$1
ITPU-GS-1AP-D	SEL Splunk ITSI UPG PSup Bucket 1AP	F2	\$1
ITPU-GS-1EM-D	SEL Splunk ITSI UPG PSup Bucket 1EM	F2	\$1
ITPU-GS-1US-D	SEL Splunk ITSI UPG PSup Bucket 1US	F2	\$1
M16-SERV-APR	SEL-Advanced product repl. M16	F2	\$1,329
M16-SERV-EWS	SEL-Extended Warranty M16	F2	\$1,329
M3809-SERV-APR	SEL-Advanced product repl. M3809	F2	\$108
M3809-SERV-EWS	SEL-Extended Warranty M3809	F2	\$108
M3840-SERV-APR	SEL-Advanced product repl. M3840	F2	\$400
M3840-SERV-EWS	SEL-Extended Warranty M3840	F2	\$400
M4X-SERV-APR	SEL-Advanced product repl. M4 pow sup	F2	\$44
M4X-SERV-EWS	SEL-Extended Warranty M4 pow sup	F2	\$44
MA-CN-P-AUDITDEL	SEL Audited Del Plugin for CN annual lic	F2	\$526
MA-CN-P-DUPFIND	SEL Dup Finder Plugin CN, annual lic	F2	\$789
MA-CN-SERVER	SEL CN Svr, Maint	F2	\$1,830
MA-CN-SERVERDM	SEL CN Svr w/ DM, Maint	F2	\$2,440

MA-TIB	SEL Cap for Svr, Maint /TiB	F2	\$6
MA-TIBDM	SEL CN Svr w/DM, Maint /TiB	F2	\$8
MBB10TBSPMM1	SELECT MB 751-1024TB Spt/Mnt 1Mo (prTB)	F2	\$6
MBB10TBSPMT1	SELECT MB 751-1024TB Spt/Mnt 1Yr (prTB)	F2	\$82
MBB10TBSPMT3	SELECT MB 751-1024TB Spt/Mnt 3Yr (prTB)	F2	\$247
MBB10TBSPMT5	SELECT MB 751-1024TB Spt/Mnt 5Yr (prTB)	F2	\$411
MBB11TBSPMM1	SELECT MB 1025-1500TB Spt/Mnt 1Mo-prTB	F2	\$6
MBB11TBSPMT1	SELECT MB 1025-1500TB Spt/Mnt 1Yr-prTB	F2	\$75
MBB11TBSPMT3	SELECT MB 1025-1500TB Spt/Mnt 3Yr-prTB	F2	\$225
MBB11TBSPMT5	SELECT MB 1025-1500TB Spt/Mnt 5Yr-prTB	F2	\$375
MBB12TBSPMM1	SELECT MB 1501-2048TB Spt/Mnt 1Mo-prTB	F2	\$6
MBB12TBSPMT1	SELECT MB 1501-2048TB Spt/Mnt 1Yr-prTB	F2	\$68
MBB12TBSPMT3	SELECT MB 1501-2048TB Spt/Mnt 3Yr-prTB	F2	\$205
MBB12TBSPMT5	SELECT MB 1501-2048TB Spt/Mnt 5Yr-prTB	F2	\$340
MBB13TBSPMM1	SELECT MB 2049-2500TB Spt/Mnt 1Mo-prTB	F2	\$6
MBB13TBSPMT1	SELECT MB 2049-2500TB Spt/Mnt 1Yr-prTB	F2	\$61
MBB13TBSPMT3	SELECT MB 2049-2500TB Spt/Mnt 3Yr-prTB	F2	\$185
MBB13TBSPMT5	SELECT MB 2049-2500TB Spt/Mnt 5Yr-prTB	F2	\$307
MBB14TBSPMM1	SELECT MB 2501-3072TB Spt/Mnt 1Mo-prTB	F2	\$5
MBB14TBSPMT1	SELECT MB 2501-3072TB Spt/Mnt 1Yr-prTB	F2	\$54
MBB14TBSPMT3	SELECT MB 2501-3072TB Spt/Mnt 3Yr-prTB	F2	\$162
MBB14TBSPMT5	SELECT MB 2501-3072TB Spt/Mnt 5Yr-prTB	F2	\$271
MBB6TBSPMM1	SELECT MB 10-80TB Spt/Mnt 1Mo (per TB)	F2	\$9
MBB6TBSPMT1	SELECT MB 10-80TB Spt/Mnt 1Yr (per TB)	F2	\$111
MBB6TBSPMT3	SELECT MB 10-80TB Spt/Mnt 3Yr (per TB)	F2	\$329
MBB6TBSPMT5	SELECT MB 10-80TB Spt/Mnt 5Yr (per TB)	F2	\$549
MBB7TBSPMM1	SELECT MB 81-240TB Spt/Mnt 1Mo (per TB)	F2	\$8
MBB7TBSPMT1	SELECT MB 81-240TB Spt/Mnt 1Yr (per TB)	F2	\$102
MBB7TBSPMT3	SELECT MB 81-240TB Spt/Mnt 3Yr (per TB)	F2	\$309
MBB7TBSPMT5	SELECT MB 81-240TB Spt/Mnt 5Yr (per TB)	F2	\$514
MBB8TBSPMM1	SELECT MB 241-500TB Spt/Mnt 1Mo (perTB)	F2	\$8
MBB8TBSPMT1	SELECT MB 241-500TB Spt/Mnt 1Yr (perTB)	F2	\$96
MBB8TBSPMT3	SELECT MB 241-500TB Spt/Mnt 3Yr (perTB)	F2	\$288
MBB8TBSPMT5	SELECT MB 241-500TB Spt/Mnt 5Yr (perTB)	F2	\$481
MBB9TBSPMM1	SELECT MB 501-750TB Spt/Mnt 1Mo (perTB)	F2	\$7
MBB9TBSPMT1	SELECT MB 501-750TB Spt/Mnt 1Yr (perTB)	F2	\$89
MBB9TBSPMT3	SELECT MB 501-750TB Spt/Mnt 3Yr (perTB)	F2	\$267
MBB9TBSPMT5	SELECT MB 501-750TB Spt/Mnt 5Yr (perTB)	F2	\$445
MBTRAIN2DBHD	SELECT DFXS MB Onsite Training (2-Day)	F2	\$10,059
M-CAA-CAP2100	SEL CASCADE ANALYT SUPPORT STD PROFILE	F2	\$7,059
M-CAA-CAP4100	SEL CASCADE ANALYT SUPPORT ENT PROFILE	F2	\$12,353
M-CAS-VE	SELECT SPT CASCADE VIRTUAL SENSOR	F2	\$113
M-CMC-H-10-1	SELECT Support 10 pack CMC Lic (0-4)	F2	\$441
M-CMC-H-10-2	SELECT Support 10 pack CMC Lic (5-19)	F2	\$353
M-CMC-H-10-3	SELECT Support 10 pack CMC Lic (20-44)	F2	\$212
M-CMC-H-10-4	SELECT Support 10 pack CMC Lic (45-94)	F2	\$159
M-CMC-H-10-5	SELECT Support 10 pack CMC Lic (95-194)	F2	\$132
M-CMC-H-10-6	SELECT Support 10 pack CMC Lic (195+)	F2	\$96
M-CMC-S-10-1	SELECT SPT 10 pack CMC-VE Lic (0-9)	F2	\$441
M-CMC-S-10-2	SELECT SPT 10 pack CMC-VE Lic (10-24)	F2	\$353

M-CMC-S-10-3	SELECT SPT 10 pack CMC-VE Lic (25-49)	F2	\$212
M-CMC-S-10-4	SELECT SPT 10 pack CMC-VE Lic (50-99)	F2	\$159
M-CMC-S-10-5	SELECT SPT 10 pack CMC-VE Lic 100-199	F2	\$132
M-CMC-S-10-6	SELECT SPT 10 pack CMC-VE Lic (200+)	F2	\$96
M-CMC-VE	SELECT SPT CMC-VE (Single Instance)	F2	\$265
M-CMC-VE-INST	SEL SUPPORT VIRTUAL CMC LICENSE	F2	\$265
M-CSKCNCLICU1-1	SEL Sup SteelCentPcktAnlyzConcLic1 (1-4)	F2	\$791
M-CSKCNCLICU1-2	SEL Sup SteelCentPcktAnlyzConcLic1 (5-9)	F2	\$635
M-CSKCNCLICU1-3	SEL SupSteelCentPackAnlyzCncLic1(10-24)	F2	\$508
M-CSKCNCLICU1-4	SEL SupSteelCentPktAnlyzr1CncLic25-99999	F2	\$438
M-CSP-CNCLICUSR1	SEL Support Pilot Concurrent User 1-4	F2	\$791
M-CSP-CNCLICUSR2	SEL Support Pilot Concurrent User 5-9	F2	\$635
M-CSP-CNCLICUSR3	SEL Support Pilot Concurrent User 10-24	F2	\$508
M-CSP-CNCLICUSR4	SEL Support Pilot Concurrent User 25+	F2	\$438
M-CSP-LICUSR1	SEL SUPPORT CASCADE PILOT 1 USER 1-2	F2	\$528
M-CSP-LICUSR2	SEL SUPPORT CASCADE PILOT 1 USER 3-4	F2	\$511
M-CSP-LICUSR3	SEL SUPPORT CASCADE PILOT 1 USER 5-9	F2	\$421
M-CSP-LICUSR4	SEL SUPPORT CASCADE PILOT 1 USER 10-24	F2	\$400
M-CSP-LICUSR5	SEL SUPPORT CASCADE PILOT 1 USER 25-49	F2	\$380
M-CSP-LICUSR6	SEL SUPPORT CASCADE PILOT 1 USER 50-99	F2	\$361
M-CSP-LICUSR7	SEL SUPPORT CASCADE PILOT1USER 100-9999	F2	\$307
M-EHR-2UA-CX	SEL Disc/Mem Support-xx55 CX5055/GC3000	F2	\$3,374
M-EHR-2UB-CX	SEL Disc/Memory Support-xx55 CX7055	F2	\$8,471
M-EHR-2U-EX1360	SEL Disc/Memory Support-xx60 EX1360	F2	\$7,647
M-EHR-CSK-1U	SEL DISC/MEMORY SUPPORT-CAS SHARK 1U	F2	\$1,053
M-EHR-CSK-2U	SEL DISC/MEMORY SUPPORT-CAS SHARK 2U	F2	\$1,994
M-EHR-CSK-3U	SEL DISC/MEMORY SUPPORT-CAS SHARK 3U	F2	\$3,406
MESSAGING-5-E	DSE REMOTE 5HR-EMAIL MGMT & ARCHIVING	F2	\$45,000
MESSAGING-DSE	DSE REMOTE 10HR-EMAIL MGMT & ARCHIVING	F2	\$90,000
MESSAGING-OSE	DSE - ONSITE - EMAIL MGMT & ARCHIVING	F2	\$275,000
M-G-CMC-8150	SELECT Gold SPT CMC (50 Steelheads)	F2	\$3,488
MGDUSCFG2270F1-2	SEL Support Upg SCFG2270-F1 to F2 Gold	F2	\$3,289
MGDUSCFG2270F1-3	SEL Support Upg SCFG2270-F1 to F3 Gold	F2	\$6,014
MGDUSCFG2270F1-4	SEL Support Upg SCFG2270-F1 to F4 Gold	F2	\$8,344
MGDUSCFG2270F1-5	SEL Support Upg SCFG2270-F1 to F5 Gold	F2	\$10,461
MGDUSCFG2270F1-6	SEL Support Upg SCFG2270-F1 to F6 Gold	F2	\$18,226
MGDUSCFG2270F2-3	SEL Support Upg SCFG2270-F2 to F3 Gold	F2	\$2,711
MGDUSCFG2270F2-4	SEL Support Upg SCFG2270-F2 to F4 Gold	F2	\$5,040
MGDUSCFG2270F2-5	SEL Support Upg SCFG2270-F2 to F5 Gold	F2	\$7,158
MGDUSCFG2270F2-6	SEL Support Upg SCFG2270-F2 to F6 Gold	F2	\$14,922
MGDUSCFG2270F3-4	SEL Support Upg SCFG2270-F3 to F4 Gold	F2	\$2,329
MGDUSCFG2270F3-5	SEL Support Upg SCFG2270-F3 to F5 Gold	F2	\$4,447
MGDUSCFG2270F3-6	SEL Support Upg SCFG2270-F3 to F6 Gold	F2	\$12,212
MGDUSCFG2270F4-5	SEL Support Upg SCFG2270-F4 to F5 Gold	F2	\$2,118
MGDUSCFG2270F4-6	SEL Support Upg SCFG2270-F4 to F6 Gold	F2	\$9,882
MGDUSCFG2270F5-6	SEL Support Upg SCFG2270-F5 to F6 Gold	F2	\$7,765
MGDUSCNP2270F1-2	SEL Support Upg SCNP2270-F1 to F2 Gold	F2	\$8,329
MGDUSCNP2270F1-3	SEL Support Upg SCNP2270-F1 to F3 Gold	F2	\$14,541
MGDUSCNP2270F1-4	SEL Support Upg SCNP2270-F1 to F4 Gold	F2	\$19,962
MGDUSCNP2270F1-5	SEL Support Upg SCNP2270-F1 to F5 Gold	F2	\$24,424

MGDUSCNP2270F2-3	SEL Support Upg SCNP2270-F2 to F3 Gold	F2	\$6,198
MGDUSCNP2270F2-4	SEL Support Upg SCNP2270-F2 to F4 Gold	F2	\$11,633
MGDUSCNP2270F2-5	SEL Support Upg SCNP2270-F2 to F5 Gold	F2	\$16,094
MGDUSCNP2270F3-4	SEL Support Upg SCNP2270-F3 to F4 Gold	F2	\$5,421
MGDUSCNP2270F3-5	SEL Support Upg SCNP2270-F3 to F5 Gold	F2	\$9,882
MGDUSCNP2270F4-5	SEL Support Upg SCNP2270-F4 to F5 Gold	F2	\$4,461
M-G-LCG2260F1	SEL CAS GATEWAY CAG2260F1 GOLD SUPPORT	F2	\$3,769
M-G-LCG2260F2	SEL CAS GATEWAY CAG2260F2 GOLD SUPPORT	F2	\$6,593
M-G-LCG2260F3	SEL CAS GATEWAY CAG2260F3 GOLD SUPPORT	F2	\$9,416
M-G-LCG2260F4	SEL CAS GATEWAY CAG2260F4 GOLD SUPPORT	F2	\$12,240
M-G-LCG2260F5	SEL CAS GATEWAY CAG2260F5 GOLD SUPPORT	F2	\$15,064
M-GLD-ARXDIR200	SEL AppRespDIR200 Gld Support(InclTrain)	F2	\$9,459
M-GLD-ARXDIR300	SEL AppRespDIR300 Gld Support(InclTrain)	F2	\$9,106
M-GLD-ARXEXP200	SEL AppRespEXP200 Gld Support(InclTrain)	F2	\$7,525
M-GLD-ARXEXP300	SEL AppRespEXP300 Gld Support(InclTrain)	F2	\$10,758
M-GLD-CAG-F1	SEL CASCADE CAG-2100-F1 GOLD SUPPORT	F2	\$4,574
M-GLD-CAG-F2	SEL CASCADE CAG-2100-F2 GOLD SUPPORT	F2	\$8,160
M-GLD-CAG-F3	SEL CASCADE CAG-2100-F3 GOLD SUPPORT	F2	\$11,619
M-GLD-CAG-F4	SEL CASCADE CAG-2100-F4 GOLD SUPPORT	F2	\$15,078
M-GLD-CAG-F5	SEL CASCADE CAG-2100-F5 GOLD SUPPORT	F2	\$18,536
M-GLD-CAP2120	SEL CASCADE PROFILER 2120 GOLD SUPPORT	F2	\$11,492
M-GLD-CAP2140	SEL CASCADE PROFILER 2140 GOLD SUPPORT	F2	\$18,536
M-GLD-CAP2160	SEL CASCADE PROFILER 2160 GOLD SUPPORT	F2	\$30,028
M-GLD-CAP4100	SEL CASCADE PROFILER 4100 GOLD SUPPORT	F2	\$41,139
M-GLD-CAP4110	SEL CAP-4110 EXP MOD GOLD SUPPORT	F2	\$21,374
M-GLD-CAS2260	SEL CAS SENSOR CAS-2260 GOLD SUPPORT	F2	\$7,031
M-GLD-CAS-2LR	SEL CAS-02100-2LR GOLD SUPPORT	F2	\$16,193
M-GLD-CAS-2LX	SEL CAS-02100-2LX GOLD SUPPORT	F2	\$9,529
M-GLD-CAS-2SR	SEL CAS-02100-2SR GOLD SUPPORT	F2	\$16,193
M-GLD-CAS-2SX	SEL CAS-02100-2SX GOLD SUPPORT	F2	\$9,515
M-GLD-CAS-2TX	SEL CAS-02100-2TX GOLD SUPPORT	F2	\$8,527
M-GLD-CAS-4SX	SEL CAS-02100-4SX GOLD SUPPORT	F2	\$10,871
M-GLD-CAS-4TX	SEL CAS-02100-4TX GOLD SUPPORT	F2	\$9,882
M-GLD-CAX0100	SEL CASCADE EXPRESS 100 GOLD SUPPORT	F2	\$9,021
M-GLD-CAX0200	SEL CASCADE EXPRESS 200 GOLD SUPPORT	F2	\$13,835
M-GLD-CAX0300	SEL CASCADE EXPRESS 300 GOLD SUPPORT	F2	\$18,536
M-GLD-CAX360H	SEL CAS EXP CAX360-HIGH GOLD SUPPORT	F2	\$15,148
M-GLD-CAX360L	SEL CAS EXP CAX360-LOW GOLD SUPPORT	F2	\$7,031
M-GLD-CAX360M	SEL CAS EXP CAX360-MID GOLD SUPPORT	F2	\$11,153
M-GLD-CP2260H	SEL CAS PROF CAP-2260-HIGH GOLD SUPPORT	F2	\$24,466
M-GLD-CP2260L	SEL CAS PROF CAP-2260-LOW GOLD SUPPORT	F2	\$9,318
M-GLD-CP2260M	SEL CAS PROF CAP-2260-MID GOLD SUPPORT	F2	\$15,064
M-GLDCP4260AN	SEL CAS ENT PROF CAP4260-AN GOLD SUPPOF	F2	\$23,534
M-GLDCP4260DB	SEL CAS ENT PROF CAP4260-DB GOLD SUPPOF	F2	\$5,647
M-GLDCP4260DP	SEL CAS ENT PROF CAP4260-DP GOLD SUPPOF	F2	\$5,647
M-GLDCP4260EX	SEL CAS ENT PROF CAP4260-EX GOLD SUPPOF	F2	\$17,407
M-GLDCP4260UI	SEL CAS ENT PROF CAP4260-UI GOLD SUPPOR	F2	\$5,647
M-GLD-CSK1100	SEL CSK-01100 GOLD SUPPORT	F2	\$4,976
M-GLD-CSK2100	SEL CSK-02100 GOLD SUPPORT	F2	\$9,318
M-GLD-CSK2200	SEL CSK-02200 GOLD SUPPORT	F2	\$11,965

M-GLD-CSK3100	SEL CSK-03100 GOLD SUPPORT	F2	\$16,624
M-GLD-CSK3200	SEL CSK-03200 GOLD SUPPORT	F2	\$21,071
M-GLD-CXA1555	SEL STEELHEAD CXA1555 GOLD SUPPORT	F2	\$5,082
M-GLD-CXA255	SEL Steelhead CXA255 Gold Support	F2	\$438
M-GLD-CXA5055	SEL Steelhead CXA 5055 Gold Support	F2	\$12,240
M-GLD-CXA555	SEL STEELHEAD CXA555 GOLD SUPPORT	F2	\$1,948
M-GLD-CXA570	SEL Steelhead CXA570 Gold Support	F2	\$1,553
M-GLD-CXA7055	SEL Steelhead CXA 7055 Gold Support	F2	\$30,593
M-GLD-CXA755	SEL STEELHEAD CXA755 GOLD SUPPORT	F2	\$2,555
M-GLD-CXA770	SEL Steelhead CXA770 Gold Support	F2	\$2,513
M-GLD-EXA0560	SEL STEELHEAD EXA 560 GOLD SUPPORT	F2	\$1,878
M-GLD-EXA0760	SEL STEELHEAD EXA 760 GOLD SUPPORT	F2	\$2,922
M-GLD-EXA1160	SEL STEELHEAD EXA 1160 GOLD SUPPORT	F2	\$3,572
M-GLD-EXA1260	SEL STEELHEAD EXA 1260 GOLD SUPPORT	F2	\$5,831
M-GLD-EXA1360	SEL Steelhead EXA 1360 Gold Support	F2	\$15,515
M-GLD-GCA2000	SEL GRANITE GCA 2000 GOLD SUPPORT	F2	\$3,572
M-GLD-SCAN-2170	SEL SCAN-02170 Gold Support	F2	\$5,449
M-GLD-SCAN-4170	SEL SCAN-04170 Gold Support	F2	\$17,449
M-GLD-SCAN-6170	SEL SCAN-06170 Gold Support	F2	\$16,348
M-GLD-SCANSU48TB	SEL SCAN-SU-48TB Gold Support	F2	\$10,899
M-GLD-SCANSU72TB	SEL SCAN-SU-72TB Gold Support	F2	\$21,812
M-GLD-SCFG2270F1	SEL SteelCentrFlowGtwySCFG2270F1GoldSup	F2	\$4,828
M-GLD-SCFG2270F2	SEL SteelCentrFlowGtwySCFG2270F2GoldSup	F2	\$8,132
M-GLD-SCFG2270F3	SEL SteelCentrFlowGtwySCFG2270F3GoldSup	F2	\$10,856
M-GLD-SCFG2270F4	SEL SteelCentrFlowGtwySCFG2270F4GoldSup	F2	\$13,186
M-GLD-SCFG2270F5	SEL SteelCentrFlowGtwySCFG2270F5GoldSup	F2	\$15,304
M-GLD-SCFG2270F6	SEL SteelCentrFlowGtwySCFG2270F6GoldSup	F2	\$23,068
M-GLD-SCNE470-F1	SEL SteelCentralNetExp SCNE470F1 GoldSup	F2	\$4,645
M-GLD-SCNE470-F2	SEL SteelCentralNetExp SCNE470F2 GoldSup	F2	\$7,158
M-GLD-SCNE470-F3	SEL SteelCentralNetExp SCNE470F3 GoldSup	F2	\$11,435
M-GLD-SCNE470-F4	SEL SteelCentralNetExp SCNE470F4 GoldSup	F2	\$15,304
M-GLD-SCNE470-F5	SEL SteelCentralNetExp SCNE470F5 GoldSup	F2	\$18,791
M-GLD-SCNP2270F1	SEL SteelCentNetProflerSCNP2270F1GoldSup	F2	\$20,358
M-GLD-SCNP2270F2	SEL SteelCentNetProflerSCNP2270F2GoldSup	F2	\$28,687
M-GLD-SCNP2270F3	SEL SteelCentNetProflerSCNP2270F3GoldSup	F2	\$34,899
M-GLD-SCNP2270F4	SEL SteelCentNetProflerSCNP2270F4GoldSup	F2	\$40,320
M-GLD-SCNP2270F5	SEL SteelCentNetProflerSCNP2270F5GoldSup	F2	\$44,781
M-GLD-SCNP4270AN	SEL SteelCentNetProfEntSCNP4270ANGoldSup	F2	\$29,661
M-GLD-SCNP4270DB	SEL SteelCentNetProfEntSCNP4270DBGoldSup	F2	\$12,395
M-GLD-SCNP4270DP	SEL SteelCentralDPEnterprProfilerGoldSup	F2	\$10,278
M-GLD-SCNP4270EX	SEL SteelCentNetProfEntSCNP4270EXGoldSup	F2	\$29,661
M-GLD-SCNP4270UI	SEL SteelCentNetProfEntSCNP4270UIGoldSup	F2	\$9,106
M-GLD-SFCR03500	SEL SFCR 3500 Gold Support	F2	\$8,471
M-GLD-SFED02200	SEL SFED 2200 Gold Support	F2	\$6,353
M-GLD-SFED03100	SEL SFED 3100 Gold Support	F2	\$10,588
M-GLD-SFED03200	SEL SFED 3100 Gold Support	F2	\$14,400
M-GLD-SFED05100	SEL SFED 5100 Gold Support	F2	\$23,294
M-GLD-SFED2100	SEL SFED 2100 Gold Support	F2	\$4,235
MGLDUSCNE470F1-2	SEL Support Upg SCNE470-F1 to F2 Gold	F2	\$2,513
MGLDUSCNE470F1-3	SEL Support Upg SCNE470-F1 to F3 Gold	F2	\$6,791

MGLDUSCNE470F1-4	SEL Support Upg SCNE470-F1 to F4 Gold	F2	\$10,645
MGLDUSCNE470F1-5	SEL Support Upg SCNE470-F1 to F5 Gold	F2	\$14,146
MGLDUSCNE470F2-3	SEL Support Upg SCNE470-F2 to F3 Gold	F2	\$4,264
MGLDUSCNE470F2-4	SEL Support Upg SCNE470-F2 to F4 Gold	F2	\$8,132
MGLDUSCNE470F2-5	SEL Support Upg SCNE470-F2 to F5 Gold	F2	\$11,633
MGLDUSCNE470F3-4	SEL Support Upg SCNE470-F3 to F4 Gold	F2	\$3,854
MGLDUSCNE470F3-5	SEL Support Upg SCNE470-F3 to F5 Gold	F2	\$7,355
MGLDUSCNE470F4-5	SEL Support Upg SCNE470-F4 to F5 Gold	F2	\$3,487
M-GPL-SFCR03500	SEL SFCR 3500 Gold Plus Support	F2	\$10,828
M-GPL-SFED02200	SEL SFED 2200 Gold Plus Support	F2	\$8,118
M-GPL-SFED03100	SEL SFED 3100 Gold Plus Support	F2	\$13,525
M-GPL-SFED03200	SEL SFED 3100 Gold Plus Support	F2	\$18,395
M-GPL-SFED05100	SEL SFED 5100 Gold Plus Support	F2	\$29,760
M-GPL-SFED2100	SEL SFED 2100 Gold Plus Support	F2	\$5,407
M-G-SMC-8500	SEL Gold support SMC (30 users)	F2	\$2,741
M-G-SMC-8650	SEL Gold support SMC (40 Users)	F2	\$3,176
M-L-CAX360CAA	SEL CAS ANALY LIC CAS EXPRCAX360 SUPPOR	F2	\$1,821
M-L-CP2260CAA	SEL CAS ANALY LIC PROF CAP2260 SUPPORT	F2	\$7,059
M-L-CP4260CAA	SEL CAS ANALY LIC CAP4260-UI SUPPORT	F2	\$12,353
M-LIC-CAX460-SDN	SEL SDN Feature Lic for CAX-460 Support	F2	\$353
M-LIC-GRAN560	SEL SUPPORT - GRANITE LICENSE 560	F2	\$529
M-LIC-GRN1160	SEL SUPPORT - GRANITE LICENSE 1160	F2	\$1,059
M-LICSCAN-SFED30	SEL SupprtNSharkVE StFusionEdg3100	F2	\$458
M-LICSCAN-SFED40	SEL SupprtNSharkVE StFusionEdg3200, 5100	F2	\$881
M-LIC-SCNE470SDN	SEL SupVirtSteelCntrlNetExpSDNLicSCNE470	F2	\$353
M-LIC-SCNPVE-SDN	SEL Support SteelCentralVirt SCNP-VE-SDN	F2	\$875
M-LIC-SCPS002	SEL SUPPORT SCPS LICENSE ON 555 SERIES	F2	\$353
M-LIC-SCPS004	SEL SUPPORT SCPS LICENSE ON 755 SERIES	F2	\$621
M-LIC-SCPS006	SEL SUPPORT SCPS LICENSE ON 1160 SERIES	F2	\$1,496
M-LIC-SCPS007	SEL SUPPORT SCPS LICENSE ON 1260 SERIES	F2	\$2,202
M-LIC-SCPS008	SEL SUPPORT SCPS LICENSE ON 1555 SERIES	F2	\$2,202
M-LIC-SCPS009	SEL SCPS License on 5055 Series	F2	\$2,202
M-LIC-SCPS010	SEL SCPS License on 7055 Series	F2	\$5,816
M-L-SCNEVE470SDN	SEL Sup SteelCentralSDN Lic SCNE-VE-0470	F2	\$353
M-L-SCNP2270SDN	SEL Support SteelCentralSDN Lic SCNP2270	F2	\$875
M-L-SCNP4270-SDN	SEL Support SteelCentSDN Lic Ent NetProf	F2	\$875
MNT-AIA-1	SEL SUPSTEELCNTRLAPPINTAGENT(QTY1-24)	F2	\$1,158
MNT-AIA-2	SEL SUPSTEELCNTRLAPPINTAGENT(QTY25-49)	F2	\$988
MNT-AIA-3	SEL SUPSTEELCNTRLAPPINTAGENT(QTY50-99)	F2	\$875
MNT-AIA-4	SEL SUPSTEELCNTRLAPPINTAGENT(QTY100-24	F2	\$819
MNT-AIA-5	SEL SUPSTEELCNTRLAPPINTAGENT(QTY250-49	F2	\$762
MNT-AIA-6	SEL SUPSTEELCNTRLAPPINTAGENT(QTY500-99	F2	\$664
MNT-AIA-7	SEL SUPSTEELCNTRLAPPINTAGENT(1000-2499)	F2	\$635
MNT-AIA-8	SEL SUPSTEELCNTRLAPPINTAGENT(2500-4999)	F2	\$579
MNT-AIA-9	SEL SUPSTEELCNTRLAPPINTAGENT(5000-9999)	F2	\$522
MNT-AIXBMX-40	SEL Supp AppRspXptBM10M Pg-Mth InclTrain	F2	\$4,786
MNT-AIXBMX-50	SEL Supp AppRspXptBM100M Pg-MthInclTrain	F2	\$40,659
MNT-AIXBMX-60	SEL Supp AppRspXpt BM1B Pg-Mth InclTrain	F2	\$160,249
MNT-AIXBMX-70	SEL Supp AppRspXptBM10B Pg-Mth InclTrain	F2	\$335,294
MNT-AIXCOL	SEL Support AppIntXpertColl(InclTrain)	F2	\$720

MNT-AIXCON	SEL SupportAppIntXpertMgntSvr(InclTrain)	F2	\$6,254
MNT-ARXCXT10	SEL Support CXTracer10Servers(InclTrain)	F2	\$3,572
MNT-ARXCXT100	SEL Support CXTracer100 Serv (InclTrain)	F2	\$23,915
MNT-ARXCXT500	SEL Support CXTracer500 Serv (InclTrain)	F2	\$59,788
MNT-ARXDB	SEL Supp AppRspXpt ModDB Perf(InclTrain)	F2	\$3,572
MNT-ARXNTFLOW	SEL SupportAppRspXprtModNetFL(InclTrain)	F2	\$2,640
MNT-ARXROVR	SEL Support AppRespXpertRover(InclTrain)	F2	\$1,186
MNT-ARX-SM-2000	SEL Shark Module AppResp2000 Support	F2	\$1,115
MNT-ARX-SM-3000	SEL SharkModAppRsp 3000 Supp (InclTrain)	F2	\$2,231
MNT-ARX-SM-4000	SEL SharkModAppRsp 4000 Supp (InclTrain)	F2	\$3,995
MNT-ARX-SM-5000	SEL SharkModAppRsp 5000 Supp (InclTrain)	F2	\$4,800
MNT-ARX-SM-6000	SEL SharkModAppRsp 6000 Supp (InclTrain)	F2	\$7,694
MNT-ARX-UCMM	SEL Support AppRspXptUCMonMod(InclTrain)	F2	\$7,172
MNT-ARX-V2000	SEL AppRespVirt 2000 Support(InclTrain)	F2	\$5,972
MNT-ARXVMON	SEL Support AppResp XprtVMon(Incl Train)	F2	\$2,640
MNT-ARXVOI1K	SEL SuppAppRspXptModVolIP1-1000 InclTrain	F2	\$3,572
MNT-ARXVOI250	SEL Supp AppRspXptModVolIP1-250 InclTrain	F2	\$1,426
MNT-ARXVOI500	SEL Supp AppRspXptModVolIP1-500 InclTrain	F2	\$2,386
MNT-ASENX	SEL Support AppSens Xpert (Incl Train)	F2	\$4,786
MNT-ASESNMP	SEL SupportAppSensSNMPAdptrPk(InclTrain)	F2	\$1,115
MNT-ATXP	SEL Support AppTransXpert PI (InclTrain)	F2	\$19,849
MNT-ATXS	SEL Support AppTransXpertStd(InclTrain)	F2	\$14,104
MNT-CAA-CAX	SEL CASCADE ANALYT SUPPORT EXPRESS	F2	\$1,765
MNT-EHR-1U	SEL Non-returned Disc/Mem Support-1U	F2	\$579
MNT-EHR-1U-CX	SEL DISC/MEMORY SUPPORT-XX55 CX1555	F2	\$551
MNT-EHR-1U-EX	SEL DISC/MEMORY SUPPORT-XX60 EX1160	F2	\$700
MNT-EHR-2UB-DX	SEL Disc/Memory Support-DX8000	F2	\$5,435
MNT-EHR-2U-EX	SEL DISC/MEM SUPPORT-XX60 EX1260/GC2000	F2	\$3,876
MNT-EHR-3U	SEL Non-returned Disc/Mem Support-3U	F2	\$3,191
MNT-EHR-7050	SELECT DISC/MEMORY SUPPORT- 7050	F2	\$8,809
MNT-EHR-DL-EX	SEL DISC/MEMORY SUPPORT-XX60 EX560/760	F2	\$607
MNT-EHR-DT	SEL Non-returned Disc/Mem SupportDesk	F2	\$311
MNT-EHR-DT-CX	SEL Disc/MemSupxx55CX255/555/755/570/770	F2	\$367
MNT-ENH-1	SEL OT Enhanced Maintenance 1	F2	\$1
MNT-ENH-10	SEL OT Enhanced Maintenance 10	F2	\$10
MNT-ENH-100	SEL OT Enhanced Maintenance 100	F2	\$100
MNT-ENH-1000	SEL OT Enhanced Maintenance 1000	F2	\$1,000
MNT-FPS-003	SEL Support FIPS License (CX555/EX560)	F2	\$438
MNT-FPS-004	SEL Support FIPS License (CX755/EX760)	F2	\$635
MNT-FPS-005	SEL Support FIPS Lic (CX1555/EX models	F2	\$720
MNT-FPS-006	SEL Support FIPS License (CX5055)	F2	\$1,327
MNT-FPS-007	SEL Support FIPS License (CX7055)	F2	\$2,654
MNT-FSYNC-001	SEL Support FusionSync GCA2000	F2	\$536
MNT-FSYNC-002	SEL Support FusionSync GCA3000	F2	\$791
MNT-FSYNC-003	SEL Support FusionSync VGC1000	F2	\$325
MNT-FSYNC-004	SEL Support FusionSync VGC1500	F2	\$536
MNT-FSYNC-005	SEL Support FusionSync SFCR3500	F2	\$1,059
MNT-GLD-1050	SEL GOLD ANNUAL SUPPORT - SHA-1050	F2	\$2,852
MNT-GLD-150	SEL Steelhead 150 Gold Support	F2	\$424
MNT-GLD-2050	SEL GOLD ANNUAL SUPPORT - SHA-2050	F2	\$5,633

MNT-GLD-250	SEL GOLD ANNUAL SUPPORT - SHA-250	F2	\$776
MNT-GLD-5050	SEL GOLD ANNUAL SUPPORT - SHA-5050	F2	\$8,442
MNT-GLD-550	SEL GOLD ANNUAL SUPPORT - SHA-550	F2	\$1,976
MNT-GLD-6050	SEL GOLD ANNUAL SUPPORT - SHA-6050	F2	\$27,162
MNT-GLD-7050	SEL GOLD ANNUAL SUPPORT - SHA-7050	F2	\$45,402
MNT-GLD-9350	SEL GOLD ANNUAL SUPPORT - INT-9350	F2	\$7,412
MNT-GLD-ARX1200	SEL AppResp1200 Gld Support (Incl Train)	F2	\$2,033
MNT-GLD-ARX2200	SEL AppResp2200 Gld Support (Incl Train)	F2	\$7,468
MNT-GLD-ARX3200	SEL AppResp3200 Gld Support (Incl Train)	F2	\$12,000
MNT-GLD-ARX3300	SEL AppResp3300 Gld Support (Incl Train)	F2	\$11,633
MNT-GLD-ARX3700	SEL AppResp3700 Gld Support (Incl Train)	F2	\$18,551
MNT-GLD-ARX3800	SEL AppResp3800 Gld Support (Incl Train)	F2	\$18,424
MNT-GLD-ARX4200	SEL AppResp4200 Gld Support (Incl Train)	F2	\$25,454
MNT-GLD-ARX4300	SEL AppResp4300 Gld Support (Incl Train)	F2	\$24,240
MNT-GLD-ARX5000	SEL AppResp5000 Gld Support(Incl Train)	F2	\$30,791
MNT-GLD-ARX5100	SEL AppResp5100 Gld Support(Incl Train)	F2	\$31,002
MNT-GLD-ARX6000	SEL AppResp6000 Gld Support(Incl Train)	F2	\$44,386
MNT-GLD-CAX460-H	SEL Cascade Exp CAX460H Gold Support	F2	\$15,120
MNT-GLD-CAX460-L	SEL Cascade Exp CAX460L Gold Support	F2	\$6,974
MNT-GLD-CAX460-M	SEL Cascade Exp CAX460M Gold Support	F2	\$11,238
MNT-GLD-CAX460-U	SEL Cascade Exp CAX460U Gold Support	F2	\$4,249
MNT-GLD-CAX460VH	SEL Cascade Exp CAX460VH Gold Support	F2	\$18,607
MNT-GLD-INT9600	SEL StHd Interceptor 9600 Gold Support	F2	\$9,699
MNT-GLD-SCC-1000	SEL SCC-1000 Gold Support	F2	\$1,962
MNT-GPL-INT9600	SEL StHd Interceptor 9600 Gld PI Support	F2	\$13,920
MNT-GPL-SCC-1000	SEL SCC-1000 Gold Plus Support	F2	\$2,499
MNT-PLT-INT9600	SEL StHd Interceptor 9600 Plat Support	F2	\$16,348
MNT-PLT-SCC-1000	SEL SCC-1000 Platinum Support	F2	\$2,936
MNT-SCFG-VE-F1	SEL Sup SteelCentFlowGate VirEd SCFGVEF1	F2	\$522
MNT-SCFG-VE-F10	SEL Sup SteelCentFlowGateVirEdSCFGVEF10	F2	\$18,522
MNT-SCFG-VE-F2	SEL Sup SteelCentFlowGate VirEd SCFGVEF2	F2	\$1,059
MNT-SCFG-VE-F3	SEL Sup SteelCentFlowGate VirEd SCFGVEF3	F2	\$1,765
MNT-SCFG-VE-F4	SEL Sup SteelCentFlowGate VirEd SCFGVEF4	F2	\$2,640
MNT-SCFG-VE-F5	SEL Sup SteelCentFlowGate VirEd SCFGVEF5	F2	\$3,176
MNT-SCFG-VE-F6	SEL Sup SteelCentFlowGate VirEd SCFGVEF6	F2	\$5,816
MNT-SCFG-VE-F7	SEL Sup SteelCentFlowGate VirEd SCFGVEF7	F2	\$8,471
MNT-SCFG-VE-F8	SEL Sup SteelCentFlowGate VirEd SCFGVEF8	F2	\$10,588
MNT-SCFG-VE-F9	SEL Sup SteelCentFlowGate VirEd SCFGVEF9	F2	\$12,353
MNT-SCNP-VE-F1	SEL Sup SteelCentNetProf VirEd SCNPVEF1	F2	\$1,581
MNT-SCNP-VE-F10	SEL Sup SteelCentNetProfiVirEdSCNPVEF10	F2	\$58,235
MNT-SCNP-VE-F2	SEL Sup SteelCentNetProf VirEd SCNPVEF2	F2	\$3,176
MNT-SCNP-VE-F3	SEL Sup SteelCentNetProf VirEd SCNPVEF3	F2	\$6,000
MNT-SCNP-VE-F4	SEL Sup SteelCentNetProf VirEd SCNPVEF4	F2	\$8,640
MNT-SCNP-VE-F5	SEL Sup SteelCentNetProf VirEd SCNPVEF5	F2	\$13,228
MNT-SCNP-VE-F6	SEL Sup SteelCentNetProf VirEd SCNPVEF6	F2	\$19,412
MNT-SCNP-VE-F7	SEL Sup SteelCentNetProf VirEd SCNPVEF7	F2	\$28,235
MNT-SCNP-VE-F8	SEL Sup SteelCentNetProf VirEd SCNPVEF8	F2	\$33,529
MNT-SCNP-VE-F9	SEL Sup SteelCentNetProf VirEd SCNPVEF9	F2	\$38,824
MNT-SCPRTL-FNDTN	SEL SteelCentral Portal Support	F2	\$11,760
MNT-SCPS-001	SEL Support SCPS on Steelhd 250 Series	F2	\$184

MNT-SCPS-004	SEL Support SCPS on Steelhd 2050 Series	F2	\$1,567
MNT-SCPS-005	SEL Support SCPS on Steelhd 5050 Series	F2	\$2,301
MNT-SCPS-006	SEL Support SCPS on Steelhd 6050 Series	F2	\$4,504
MNT-SCPS-007	SEL Support SCPS on Steelhd 7050 Series	F2	\$6,056
MNT-SCPS-01A	SEL Support SCPS on Steelhd 150 Series	F2	\$169
MNT-SLV-1050	SEL SILVER ANNUAL SUPPORT - SHA-1050	F2	\$2,598
MNT-SLV-150	SEL Steelhead 150 Silver Support	F2	\$367
MNT-SLV-2050	SEL SILVER ANNUAL SUPPORT - SHA-2050	F2	\$5,139
MNT-SLV-250	SEL SILVER ANNUAL SUPPORT - SHA-250	F2	\$621
MNT-SLV-5050	SEL SILVER ANNUAL SUPPORT - SHA-5050	F2	\$7,708
MNT-SLV-550	SEL SILVER ANNUAL SUPPORT - SHA-550	F2	\$1,736
MNT-SLV-6050	SEL SILVER ANNUAL SUPPORT - SHA-6050	F2	\$21,911
MNT-SLV-7050	SEL SILVER ANNUAL SUPPORT - SHA-7050	F2	\$32,922
MNT-SLV-9350	SEL SILVER ANNUAL SUPPORT - INT-9350	F2	\$5,765
MNT-SLV-ARX1200	SEL AppResp1200 Slvr Support(Incl Train)	F2	\$1,849
MNT-SLV-ARX2200	SEL AppResp2200 Slvr Support(Incl Train)	F2	\$6,748
MNT-SLV-ARX3200	SEL AppResp3200 Slvr Support(Incl Train)	F2	\$10,786
MNT-SLV-ARX3300	SEL AppResp3300 Slvr Support(Incl Train)	F2	\$10,532
MNT-SLV-ARX3700	SEL AppResp3700 Slvr Support(Incl Train)	F2	\$16,856
MNT-SLV-ARX3800	SEL AppResp3800 Slvr Support(Incl Train)	F2	\$16,687
MNT-SLV-ARX4200	SEL AppResp4200 Slvr Support(Incl Train)	F2	\$23,026
MNT-SLV-ARX4300	SEL AppResp4300 Slvr Support(Incl Train)	F2	\$21,953
MNT-SLV-ARX5000	SEL AppResp5000 Slvr Support(Incl Train)	F2	\$27,882
MNT-SLV-ARX5100	SEL AppResp5100 Slvr Support(Incl Train)	F2	\$28,094
MNT-SLV-ARX6000	SEL AppResp6000 Slvr Support(Incl Train)	F2	\$40,235
MNT-SLV-CAX460-H	SEL Cascade Exp CAX460H Silver Support	F2	\$13,694
MNT-SLV-CAX460-L	SEL Cascade Exp CAX460L Silver Support	F2	\$6,325
MNT-SLV-CAX460-M	SEL Cascade Exp CAX460M Silver Support	F2	\$10,193
MNT-SLV-CAX460-U	SEL Cascade Exp CAX460U Silver Support	F2	\$3,854
MNT-SLV-CAX460VH	SEL Cas Exp CAX-460-VH Slvr Support	F2	\$16,856
MNT-SLV-INT9600	SEL StHd Interceptor 9600 Silver Support	F2	\$8,781
MNT-SLV-SCC-1000	SEL SCC-1000 Silver Support	F2	\$1,525
MNT-UCXPL-T-P	SEL STLCNTRLUCXPENTPHONELICSUP-BASE	F2	\$7
MNT-VCX-1555	SEL Virtual Steelhead 1555 Support	F2	\$4,264
MNT-VCX-5055	SEL Virtual Steelhead 5055 Support	F2	\$10,546
MNT-VCX-555	SEL Virtual Steelhead 555 Support	F2	\$1,341
MNT-VCX-7055	SEL Virtual Steelhead 7055 Support	F2	\$21,106
MNT-VCX-755	SEL Virtual Steelhead 755 Support	F2	\$2,075
MNT-VGC-1000	SEL Virtual SteelFusion Core VGC1000 Sup	F2	\$1,412
MNT-VGC-1500	SEL Virtual SteelFusion Core VGC1500 Sup	F2	\$4,235
MNT-VSH-1050	SEL Virtual SH1050 Support	F2	\$2,329
MNT-VSH-150	SEL Virtual Steelhead 150 Support	F2	\$198
MNT-VSH-2050	SEL Virtual SH2050 Support	F2	\$4,899
MNT-VSH-250	SEL Virtual SH250 Support	F2	\$551
MNT-VSH-550	SEL Virtual SH550 Support	F2	\$1,652
MNT-VSK-00050	SEL Virtual Cascade Shark VSK 50 Support	F2	\$212
MNT-VSK-00200	SEL Virtual Cascade Shark VSK200 Support	F2	\$974
MNT-VSK-00400	SEL Virtual Cascade Shark VSK400 Support	F2	\$1,765
M-PLT-SFCR03500	SEL SFCR 3500 Platinum Support	F2	\$12,706
M-PLT-SFED02200	SEL SFED 2200 Platinum Support	F2	\$9,529

M-PLT-SFED03100	SEL SFED 3100 Platinum Support	F2	\$15,882
M-PLT-SFED03200	SEL SFED 3100 Platinum Support	F2	\$21,600
M-PLT-SFED05100	SEL SFED 5100 Platinum Support	F2	\$34,941
M-PLT-SFED2100	SEL SFED 2100 Platinum Support	F2	\$6,353
M-RSP-PCK-02	SEL SPT RSP multi-package license	F2	\$198
M-RSP-SCP-H	SEL SCPS Protocol SPT 20+ Mbps lic	F2	\$2,700
M-RSP-SCP-L	SEL SCPS Protocol SPT 1/2 Mbps lic	F2	\$265
M-RSP-SCP-M	SEL SCPS Protocol SPT 6/10Mbps lic	F2	\$882
M-RSP-SMC-VE1	SELECT VIRTUAL SMC SUPPORT	F2	\$1,144
M-RSP-WND-01	SELECT SUPPORT RSP WINDOWS PACKAGE	F2	\$198
MS10961PRVONS10	SEL NH PRV ONS MS 10961 TEN STUDENTS	F2	\$21,750
MS10961PRVVRT10	SEL NH PRV VRT MS 10961 TEN STUDENTS	F2	\$17,500
MS10961PUBVRT1	SEL NH PUB VRT MS 10961 ONE STUDENT	F2	\$2,975
MS10962PRVONS10	SEL NH PRV ONS MS 10962 TEN STUDENTS	F2	\$13,770
MS10962PRVVRT10	SEL NH PRV VRT MS 10962 TEN STUDENTS	F2	\$10,500
MS10962PUBVRT1	SEL NH PUB VRT MS 10962 ONE STUDENT	F2	\$1,785
MS10964PRVONS10	SEL NH PRV ONS MS 10964 TEN STUDENTS	F2	\$21,750
MS10964PRVVRT10	SEL NH PRV VRT MS 10964 TEN STUDENTS	F2	\$17,500
MS10964PUBVRT1	SEL NH PUB VRT MS 10964 ONE STUDENT	F2	\$2,975
MS10965PRVONS10	SEL NH PRV ONS MS 10965 TEN STUDENTS	F2	\$21,750
MS10965PRVVRT10	SEL NH PRV VRT MS 10965 TEN STUDENTS	F2	\$17,500
MS10965PUBVRT1	SEL NH PUB VRT MS 10965 ONE STUDENT	F2	\$2,975
MS10969PRVONS10	SEL NH PRV ONS MS 10969 TEN STUDENTS	F2	\$21,750
MS10969PRVVRT10	SEL NH PRV VRT MS 10969 TEN STUDENTS	F2	\$17,500
MS10969PUBVRT1	SEL NH PUB VRT MS 10969 ONE STUDENT	F2	\$2,975
MS10971PRVONS10	SEL NH PRV ONS MS 10971 TEN STUDENTS	F2	\$17,760
MS10971PRVVRT10	SEL NH PRV VRT MS 10971 TEN STUDENTS	F2	\$14,000
MS10971PUBVRT1	SEL NH PUB VRT MS 10971 ONE STUDENT	F2	\$2,380
MS10979PRVONS10	SEL NH PRV ONS MS 10979 TEN STUDENTS	F2	\$9,780
MS10979PRVVRT10	SEL NH PRV VRT MS 10979 TEN STUDENTS	F2	\$7,000
MS10979PUBVRT1	SEL NH PUB VRT MS 10979 ONE STUDENT	F2	\$1,190
MS10981PRVONS10	SEL NH PRV ONS MS 10981 TEN STUDENTS	F2	\$21,750
MS10981PRVVRT10	SEL NH PRV VRT MS 10981 TEN STUDENTS	F2	\$17,500
MS10981PUBVRT1	SEL NH PUB VRT MS 10981 ONE STUDENT	F2	\$2,975
MS10982PRVONS10	SEL NH PRV ONS MS 10982 TEN STUDENTS	F2	\$21,750
MS10982PRVVRT10	SEL NH PRV VRT MS 10982 TEN STUDENTS	F2	\$17,500
MS10982PUBVRT1	SEL NH PUB VRT MS 10982 ONE STUDENT	F2	\$2,975
MS10992PRVONS10	SEL NH PRV ONS MS 10992 TEN STUDENTS	F2	\$13,770
MS10992PRVVRT10	SEL NH PRV VRT MS 10992 TEN STUDENTS	F2	\$10,500
MS10992PUBVRT1	SEL NH PUB VRT MS 10992 ONE STUDENT	F2	\$1,785
MS10993PRVONS10	SEL NH PRV ONS MS 10993 TEN STUDENTS	F2	\$9,780
MS10993PRVVRT10	SEL NH PRV VRT MS 10993 TEN STUDENTS	F2	\$7,000
MS10993PUBVRT1	SEL NH PUB VRT MS 10993 ONE STUDENT	F2	\$1,190
MS10997PRVONS10	SEL NH PRV ONS MS 10997 TEN STUDENTS	F2	\$13,770
MS10997PRVVRT10	SEL NH PRV VRT MS 10997 TEN STUDENTS	F2	\$10,500
MS10997PUBVRT1	SEL NH PUB VRT MS 10997 ONE STUDENT	F2	\$1,785
MS20334PRVONS10	SEL NH PRV ONS MS 20334 TEN STUDENTS	F2	\$21,750
MS20334PRVVRT10	SEL NH PRV VRT MS 20334 TEN STUDENTS	F2	\$17,500
MS20334PUBVRT1	SEL NH PUB VRT MS 20334 ONE STUDENT	F2	\$2,975
MS203391PRVONS10	SEL NH PRV ONS MS 203391 TEN STUDENTS	F2	\$21,750

MS203391PRVVRT10	SEL NH PRV VRT MS 203391 TEN STUDENTS	F2	\$17,500
MS203391PUBVRT1	SEL NH PUB VRT MS 20339-1 ONE STUDENT	F2	\$2,975
MS203392PRVONS10	SEL NH PRV ONS MS 203392 TEN STUDENTS	F2	\$21,750
MS203392PRVVRT10	SEL NH PRV VRT MS 203392 TEN STUDENTS	F2	\$17,500
MS203392PUBVRT1	SEL NH PUB VRT MS 20339-2 ONE STUDENT	F2	\$2,975
MS203451PRVONS10	SEL NH PRV ONS MS 203451 TEN STUDENTS	F2	\$21,750
MS203451PRVVRT10	SEL NH PRV VRT MS 203451 TEN STUDENTS	F2	\$17,500
MS203451PUBVRT1	SEL NH PUB VRT MS 20345-1 ONE STUDENT	F2	\$2,975
MS203452PRVONS10	SEL NH PRV ONS MS 203452 TEN STUDENTS	F2	\$21,750
MS203452PRVVRT10	SEL NH PRV VRT MS 203452 TEN STUDENTS	F2	\$17,500
MS203452PUBVRT1	SEL NH PUB VRT MS 20345-2 ONE STUDENT	F2	\$2,975
MS20347PRVONS10	SEL NH PRV ONS MS 20347 TEN STUDENTS	F2	\$21,750
MS20347PRVVRT10	SEL NH PRV VRT MS 20347 TEN STUDENTS	F2	\$17,500
MS20347PUBVRT1	SEL NH PUB VRT MS 20347 ONE STUDENT	F2	\$2,975
MS20533PRVONS10	SEL NH PRV ONS MS 20533 TEN STUDENTS	F2	\$21,750
MS20533PRVVRT10	SEL NH PRV VRT MS 20533 TEN STUDENTS	F2	\$17,500
MS20533PUBVRT1	SEL NH PUB VRT MS 20533 ONE STUDENT	F2	\$2,975
MS20537PRVONS10	SEL NH PRV ONS MS 20537 TEN STUDENTS	F2	\$21,750
MS20537PRVVRT10	SEL NH PRV VRT MS 20537 TEN STUDENTS	F2	\$17,500
MS20537PUBVRT1	SEL NH PUB VRT MS 20537 ONE STUDENT	F2	\$2,975
MS206971PRVONS10	SEL NH PRV ONS MS 206971 TEN STUDENTS	F2	\$21,750
MS206971PRVVRT10	SEL NH PRV VRT MS 206971 TEN STUDENTS	F2	\$17,500
MS206971PUBVRT1	SEL NH PUB VRT MS 20697-1 ONE STUDENT	F2	\$2,975
MS206972PRVONS10	SEL NH PRV ONS MS 206972 TEN STUDENTS	F2	\$21,750
MS206972PRVVRT10	SEL NH PRV VRT MS 206972 TEN STUDENTS	F2	\$17,500
MS206972PUBVRT1	SEL NH PUB VRT MS 20697-2 ONE STUDENT	F2	\$2,975
MS20698PRVONS10	SEL NH PRV ONS MS 20698 TEN STUDENTS	F2	\$21,750
MS20698PRVVRT10	SEL NH PRV VRT MS 20698 TEN STUDENTS	F2	\$17,500
MS20698PUBVRT1	SEL NH PUB VRT MS 20698 ONE STUDENT	F2	\$2,975
MS207031PRVONS10	SEL NH PRV ONS MS 207031 TEN STUDENTS	F2	\$21,750
MS207031PRVVRT10	SEL NH PRV VRT MS 207031 TEN STUDENTS	F2	\$17,500
MS207031PUBVRT1	SEL NH PUB VRT MS 20703-1 ONE STUDENT	F2	\$2,975
MS207032PRVONS10	SEL NH PRV ONS MS 207032 TEN STUDENTS	F2	\$13,770
MS207032PRVVRT10	SEL NH PRV VRT MS 207032 TEN STUDENTS	F2	\$10,500
MS207032PUBVRT1	SEL NH PUB VRT MS 20703-2 ONE STUDENT	F2	\$1,785
MS20740PRVONS10	SEL NH PRV ONS MS 20740 TEN STUDENTS	F2	\$21,750
MS20740PRVVRT10	SEL NH PRV VRT MS 20740 TEN STUDENTS	F2	\$17,500
MS20740PUBVRT1	SEL NH PUB VRT MS 20740 ONE STUDENT	F2	\$2,975
MS20741PRVONS10	SEL NH PRV ONS MS 20741 TEN STUDENTS	F2	\$21,750
MS20741PRVVRT10	SEL NH PRV VRT MS 20741 TEN STUDENTS	F2	\$17,500
MS20741PUBVRT1	SEL NH PUB VRT MS 20741 ONE STUDENT	F2	\$2,975
MS20742PRVONS10	SEL NH PRV ONS MS 20742 TEN STUDENTS	F2	\$21,750
MS20742PRVVRT10	SEL NH PRV VRT MS 20742 TEN STUDENTS	F2	\$17,500
MS20742PUBVRT1	SEL NH PUB VRT MS 20742 ONE STUDENT	F2	\$2,975
MS20743PRVONS10	SEL NH PRV ONS MS 20743 TEN STUDENTS	F2	\$21,750
MS20743PRVVRT10	SEL NH PRV VRT MS 20743 TEN STUDENTS	F2	\$17,500
MS20743PUBVRT1	SEL NH PUB VRT MS 20743 ONE STUDENT	F2	\$2,975
MS20744PRVONS10	SEL NH PRV ONS MS 20744 TEN STUDENTS	F2	\$21,750
MS20744PRVVRT10	SEL NH PRV VRT MS 20744 TEN STUDENTS	F2	\$17,500
MS20744PUBVRT1	SEL NH PUB VRT MS 20744 ONE STUDENT	F2	\$2,975

MS20761PRVONS10	SEL NH PRV ONS MS 20761 TEN STUDENTS	F2	\$21,750
MS20761PRVVRT10	SEL NH PRV VRT MS 20761 TEN STUDENTS	F2	\$17,500
MS20761PUBVRT1	SEL NH PUB VRT MS 20761 ONE STUDENT	F2	\$2,975
MS20764PRVONS10	SEL NH PRV ONS MS 20764 TEN STUDENTS	F2	\$21,750
MS20764PRVVRT10	SEL NH PRV VRT MS 20764 TEN STUDENTS	F2	\$17,500
MS20764PUBVRT1	SEL NH PUB VRT MS 20764 ONE STUDENT	F2	\$2,975
MS40409PRVONS10	SEL NH PRV ONS MS 40409 TEN STUDENTS	F2	\$21,750
MS40409PRVVRT10	SEL NH PRV VRT MS 40409 TEN STUDENTS	F2	\$17,500
MS40409PUBVRT1	SEL NH PUB VRT MS 40409 ONE STUDENT	F2	\$2,975
M-S-CAP2260-H	SEL CAS PROF CAP2260-HIGHSILVER SUPPORT	F2	\$22,179
M-S-CAP2260-L	SEL CAS PROF CAP-2260-LOW SILVER SUPPOR	F2	\$8,442
M-S-CAP2260-M	SEL CAS PROF CAP-2260-MID SILVER SUPPORT	F2	\$13,652
M-S-CAP4260AN	SEL CAS ENTPROF CAP4260AN SILVER SUPPOF	F2	\$21,318
M-S-CAP4260DB	SEL CAS ENTPROF CAP4260DB SILVER SUPPOF	F2	\$5,111
M-S-CAP4260DP	SEL CAS ENTPROF CAP4260DP SILVER SUPPOF	F2	\$5,111
M-S-CAP4260EX	SEL CAS ENTPROF CAP4260EX SILVER SUPPOF	F2	\$15,784
M-S-CAP4260UI	SEL CAS ENTPROF CAP4260UI SILVER SUPPOR	F2	\$5,111
M-S-CAS2260	SEL CAS SENSOR CAS-2260 SILVER SUPPORT	F2	\$6,311
M-S-CAX360-H	SEL CAS EXP CAX360-HIGH SILVER SUPPORT	F2	\$13,694
M-S-CAX360-L	SEL CAS EXP CAX360-LOW SILVER SUPPORT	F2	\$6,311
M-S-CAX360-M	SEL CAS EXP CAX360-MID SILVER SUPPORT	F2	\$10,179
M-SCC-HWAMGT10-1	SEL SCC Appliance Mgmt Lic 10-pk Support	F2	\$441
M-SCC-HWAMGT10-2	SEL SCC Appliance Mgmt Lic 10-pk Support	F2	\$353
M-SCC-HWAMGT10-3	SEL SCC Appliance Mgmt Lic 10-pk Support	F2	\$212
M-SCC-HWAMGT10-4	SEL SCC Appliance Mgmt Lic 10-pk Support	F2	\$159
M-SCC-HWAMGT10-5	SEL SCC Appliance Mgmt Lic 10-pk Support	F2	\$132
M-SCC-HWAMGT10-6	SEL SCC Appliance Mgmt Lic 10-pk Support	F2	\$96
M-S-CMC-8150	SELECT Silver SPT CMC (50 Steelheads)	F2	\$2,712
M-SCNE-VE-470-F1	SEL Sup SteelCentNetExp Virt Ed, 15K FPM	F2	\$3,529
M-SCNE-VE-470-F2	SEL Sup SteelCentNetExp Virt Ed, 30K FPM	F2	\$5,816
M-SCNE-VE-470-F3	SEL Sup SteelCentNetExp Virt Ed, 60K FPM	F2	\$9,529
M-SCNE-VE-470-F4	SEL Sup SteelCentNetExp Virt Ed, 90K FPM	F2	\$13,059
M-SCNE-VE-470-F5	SEL Sup SteelCentNetExp Virt Ed, 120KFPM	F2	\$15,529
M-SCPS-VCX003	SEL Support SCPS on Virtual Steelhd 555	F2	\$353
M-SCPS-VCX004	SEL Support SCPS on Virtual Steelhd 755	F2	\$621
M-SCPS-VCX005	SEL Support SCPS Virtual Steelhd 1555	F2	\$1,496
M-SCPS-VSH001	SEL Support SCPS on Virtual Steelhd 250	F2	\$169
M-SCPS-VSH002	SEL Support SCPS on Virtual Steelhd 550	F2	\$353
M-SCPS-VSH003	SEL Support SCPS Virtual Steelhd 1050	F2	\$621
M-SCPS-VSH004	SEL Support SCPS Virtual Steelhd 2050	F2	\$1,496
M-SCPS-VSH01A	SEL Support SCPS on Virtual Steelhd 150	F2	\$169
M-S-CXA1555	SEL STEELHEAD CXA1555 SILVER SUPPORT	F2	\$4,602
M-S-CXA555	SEL STEELHEAD CXA555 SILVER SUPPORT	F2	\$1,821
M-S-CXA755	SEL STEELHEAD CXA755 SILVER SUPPORT	F2	\$2,315
MSILSO365PERUSER	SEL NH ILS O365 FOR ONE USER 1 YEAR	F2	\$5
MSILSO16PERUSER	SEL NH ILS OFF 2016 FOR ONE USER 1 YEAR	F2	\$5
MSILSPACKPERUSER	SEL NH ILS PACK FOR ONE USER 1 YEAR	F2	\$10
MSILSW10PERUSER	SEL NH ILS WIN10 FOR ONE USER 1 YEAR	F2	\$5
M-SLCG2260-F1	SEL CAS GATEWAY CAG2260F1 SILVER SUPPOF	F2	\$3,416
M-SLCG2260-F2	SEL CAS GATEWAY CAG2260F2 SILVER SUPPOF	F2	\$5,972

M-SLCG2260-F3	SEL CAS GATEWAY CAG2260F3 SILVER SUPPO	F2	\$8,527
M-SLCG2260-F4	SEL CAS GATEWAY CAG2260F4 SILVER SUPPO	F2	\$11,082
M-SLCG2260-F5	SEL CAS GATEWAY CAG2260F5 SILVER SUPPO	F2	\$13,652
M-SLV-ARXDIR200	SEL AppRespDIR200 Slv Support(InclTrain)	F2	\$8,485
M-SLV-ARXDIR300	SEL AppRespDIR300 Slv Support(InclTrain)	F2	\$8,259
M-SLV-ARXEXP200	SEL AppRespEXP200 Slv Support(InclTrain)	F2	\$6,791
M-SLV-ARXEXP300	SEL AppRespEXP300 Slv Support(InclTrain)	F2	\$9,755
M-SLV-CAG-F1	SEL CASCADE CAG-2100-F1 SILVER SUPPORT	F2	\$3,713
M-SLV-CAG-F2	SEL CASCADE CAG-2100-F2 SILVER SUPPORT	F2	\$6,551
M-SLV-CAG-F3	SEL CASCADE CAG-2100-F3 SILVER SUPPORT	F2	\$9,275
M-SLV-CAG-F4	SEL CASCADE CAG-2100-F4 SILVER SUPPORT	F2	\$12,113
M-SLV-CAG-F5	SEL CASCADE CAG-2100-F5 SILVER SUPPORT	F2	\$14,951
M-SLV-CAP2120	SEL CASCADE PROFILER 2120 SILVER SUPPOR	F2	\$9,275
M-SLV-CAP2140	SEL CASCADE PROFILER 2140 SILVER SUPPOR	F2	\$14,951
M-SLV-CAP2160	SEL CASCADE PROFILER 2160 SILVER SUPPOR	F2	\$24,212
M-SLV-CAP4100	SEL CASCADE PROFILER 4100 SILVER SUPPOR	F2	\$33,176
M-SLV-CAP4110	SEL CAP-4110 EXP MOD SILVER SUPPORT	F2	\$17,181
M-SLV-CAS-2LR	SEL CAS-02100-2LR SILVER SUPPORT	F2	\$13,101
M-SLV-CAS-2LX	SEL CAS-02100-2LX SILVER SUPPORT	F2	\$7,676
M-SLV-CAS-2SR	SEL CAS-02100-2SR SILVER SUPPORT	F2	\$13,101
M-SLV-CAS-2SX	SEL CAS-02100-2SX SILVER SUPPORT	F2	\$7,666
M-SLV-CAS-2TX	SEL CAS-02100-2TX SILVER SUPPORT	F2	\$6,918
M-SLV-CAS-4SX	SEL CAS-02100-4SX SILVER SUPPORT	F2	\$8,781
M-SLV-CAS-4TX	SEL CAS-02100-4TX SILVER SUPPORT	F2	\$8,033
M-SLV-CAX0100	SEL CASCADE EXPRESS 100 SILVER SUPPORT	F2	\$7,299
M-SLV-CAX0200	SEL CASCADE EXPRESS 200 SILVER SUPPORT	F2	\$11,125
M-SLV-CAX0300	SEL CASCADE EXPRESS 300 SILVER SUPPORT	F2	\$14,951
M-SLV-CSK1100	SEL CSK-01100 SILVER SUPPORT	F2	\$4,012
M-SLV-CSK2100	SEL CSK-02100 SILVER SUPPORT	F2	\$7,506
M-SLV-CSK2200	SEL CSK-02200 SILVER SUPPORT	F2	\$9,641
M-SLV-CSK3100	SEL CSK-03100 SILVER SUPPORT	F2	\$13,388
M-SLV-CSK3200	SEL CSK-03200 SILVER SUPPORT	F2	\$16,976
M-SLV-CXA255	SEL Steelhead CXA255 Silver Support	F2	\$353
M-SLV-CXA5055	SEL Steelhead CXA 5055 Silver Support	F2	\$11,082
M-SLV-CXA570	SEL Steelhead CXA570 Silver Support	F2	\$1,412
M-SLV-CXA7055	SEL Steelhead CXA 7055 Silver Support	F2	\$22,179
M-SLV-CXA770	SEL Steelhead CXA770 Silver Support	F2	\$2,273
M-SLV-EXA0560	SEL STEELHEAD EXA 560 SILVER SUPPORT	F2	\$1,708
M-SLV-EXA0760	SEL STEELHEAD EXA 760 SILVER SUPPORT	F2	\$2,640
M-SLV-EXA1160	SEL STEELHEAD EXA 1160 SILVER SUPPORT	F2	\$3,247
M-SLV-EXA1260	SEL STEELHEAD EXA 1260 SILVER SUPPORT	F2	\$5,294
M-SLV-EXA1360	SEL Steelhead EXA 1360 Silver Support	F2	\$14,061
M-SLV-GCA2000	SEL GRANITE GCA 2000 SILVER SUPPORT	F2	\$3,247
M-SLV-SCAN-2170	SEL SCAN-02170 Silver Support	F2	\$4,405
M-SLV-SCAN-4170	SEL SCAN-04170 Silver Support	F2	\$14,061
M-SLV-SCAN-6170	SEL SCAN-06170 Silver Support	F2	\$13,186
M-SLV-SCANSU48TB	SEL SCAN-SU-48TB Silver Support	F2	\$8,795
M-SLV-SCANSU72TB	SEL SCAN-SU-72TB Silver Support	F2	\$17,576
M-SLV-SCFG2270F1	SEL SteelCentrlFlowGtwySCFG2270F1SlvrSup	F2	\$4,391
M-SLV-SCFG2270F2	SEL SteelCentrlFlowGtwySCFG2270F2SlvrSup	F2	\$7,369

M-SLV-SCFG2270F3	SEL SteelCentrlFlowGtwySCFG2270F3SlvrSup	F2	\$9,840
M-SLV-SCFG2270F4	SEL SteelCentrlFlowGtwySCFG2270F4SlvrSup	F2	\$11,944
M-SLV-SCFG2270F5	SEL SteelCentrlFlowGtwySCFG2270F5SlvrSup	F2	\$13,878
M-SLV-SCFG2270F6	SEL SteelCentrlFlowGtwySCFG2270F6SlvrSup	F2	\$20,908
M-SLV-SCNE470-F1	SEL SteelCentNetExprSCNE470F1SilverSup	F2	\$4,207
M-SLV-SCNE470-F2	SEL SteelCentNetExprSCNE470F2SilverSup	F2	\$6,494
M-SLV-SCNE470-F3	SEL SteelCentNetExprSCNE470F3SilverSup	F2	\$10,362
M-SLV-SCNE470-F4	SEL SteelCentNetExprSCNE470F4SilverSup	F2	\$13,878
M-SLV-SCNE470-F5	SEL SteelCentNetExprSCNE470F5SilverSup	F2	\$17,040
M-SLV-SCNP2270F1	SEL SteelCentrNetProfSCNP2270F1SilverSup	F2	\$18,452
M-SLV-SCNP2270F2	SEL SteelCentrNetProfSCNP2270F2SilverSup	F2	\$25,991
M-SLV-SCNP2270F3	SEL SteelCentrNetProfSCNP2270F3SilverSup	F2	\$31,624
M-SLV-SCNP2270F4	SEL SteelCentrNetProfSCNP2270F4SilverSup	F2	\$36,536
M-SLV-SCNP2270F5	SEL SteelCentrNetProfSCNP2270F5SilverSup	F2	\$40,574
M-SLV-SCNP4270AN	SEL SteelCentNetProfEntSCNP4270AN SlvSup	F2	\$26,880
M-SLV-SCNP4270DB	SEL SteelCentNetProfEntSCNP4270DB SlvSup	F2	\$11,238
M-SLV-SCNP4270DP	SEL SteelCentDispatch Ent Prof Silv Sup	F2	\$9,304
M-SLV-SCNP4270EX	SEL SteelCentNetProfEntSCNP4270EX SlvSup	F2	\$26,880
M-SLV-SCNP4270UI	SEL SteelCentNetProfEntSCNP4270UI SlvSup	F2	\$8,259
M-SLV-SFCR03500	SEL SFCR 3500 Silver Support	F2	\$6,819
M-SLV-SFED02200	SEL SFED 2200 Silver Support	F2	\$5,111
M-SLV-SFED03100	SEL SFED 3100 Silver Support	F2	\$8,527
M-SLV-SFED03200	SEL SFED 3100 Silver Support	F2	\$11,605
M-SLV-SFED05100	SEL SFED 5100 Silver Support	F2	\$18,762
M-SLV-SFED2100	SEL SFED 2100 Silver Support	F2	\$3,416
MSLVUSCNE470F1-2	SEL Support Upg SCNE470-F1 toF2 Silver	F2	\$2,273
MSLVUSCNE470F1-3	SEL Support Upg SCNE470-F1 toF3 Silver	F2	\$6,141
MSLVUSCNE470F1-4	SEL Support Upg SCNE470-F1 toF4 Silver	F2	\$9,656
MSLVUSCNE470F1-5	SEL Support Upg SCNE470-F1 toF5 Silver	F2	\$12,819
MSLVUSCNE470F2-3	SEL Support Upg SCNE470-F2 toF3 Silver	F2	\$3,854
MSLVUSCNE470F2-4	SEL Support Upg SCNE470-F2 toF4 Silver	F2	\$7,384
MSLVUSCNE470F2-5	SEL Support Upg SCNE470-F2 toF5 Silver	F2	\$10,532
MSLVUSCNE470F3-4	SEL Support Upg SCNE470-F3 toF4 Silver	F2	\$3,515
MSLVUSCNE470F3-5	SEL Support Upg SCNE470-F3 toF5 Silver	F2	\$6,664
MSLVUSCNE470F4-5	SEL Support Upg SCNE470-F4 toF5 Silver	F2	\$3,148
M-SMC-U-10-1	SEL Support SMC 10 user lic 0-1	F2	\$352
M-SMC-U-10-10	SEL Support SMC 10 user lic 1001-2000	F2	\$208
M-SMC-U-10-11	SEL Support SMC 10 user lic 2001-5000	F2	\$204
M-SMC-U-10-2	SEL Support SMC 10 user lic 2-3	F2	\$348
M-SMC-U-10-3	SEL Support SMC 10 user lic 4-10	F2	\$345
M-SMC-U-10-4	SEL Support SMC 10 user lic 11-25	F2	\$295
M-SMC-U-10-5	SEL Support SMC 10 user lic 26-50	F2	\$292
M-SMC-U-10-6	SEL Support SMC 10 user lic 51-100	F2	\$282
M-SMC-U-10-7	SEL Support SMC 10 user lic 101-200	F2	\$274
M-SMC-U-10-8	SEL Support SMC 10 user lic 201-500	F2	\$221
M-SMC-U-10-9	SEL Support SMC 10 user lic 501-1000	F2	\$212
M-SMC-VRTV100	SEL Virtual SMC Support	F2	\$1,059
MSONSLECPERDAY	SEL NH ONS LECTURE PER DAY	F2	\$3,390
M-S-SMC-8500	SEL Silver support SMC (30 users)	F2	\$2,129
M-S-SMC-8650	SEL Silver support SMC (40 Users)	F2	\$2,559

MSTECH1DAYCLAS	SEL NH PUB VRT MS 1DAY ONE STUDENT	F2	\$595
MSTECH1PRVONS10	SEL NH PRV ONS MS 1DAY 10 STUDENTS	F2	\$5,340
MSTECH1PRVVRT10	SEL NH PRV VRT MS 1DAY 10 STUDENTS	F2	\$3,500
MSTECH2DAYCLAS	SEL NH PUB VRT MS 2DAY ONE STUDENT	F2	\$1,190
MSTECH2PRVONS10	SEL NH PRV ONS MS 2DAY 10 STUDENTS	F2	\$9,780
MSTECH2PRVVRT10	SEL NH PRV VRT MS 2DAY 10 STUDENTS	F2	\$7,000
MSTECH3DAYCLAS	SEL NH PUB VRT MS 3DAY ONE STUDENT	F2	\$1,785
MSTECH3PRVONS10	SEL NH PRV ONS MS 3DAY 10 STUDENTS	F2	\$13,770
MSTECH3PRVVRT10	SEL NH PRV VRT MS 3DAY 10 STUDENTS	F2	\$10,500
MSTECH4DAYCLAS	SEL NH PUB VRT MS 4DAY ONE STUDENT	F2	\$2,380
MSTECH4PRVONS10	SEL NH PRV ONS MS 4DAY 10 STUDENTS	F2	\$17,760
MSTECH4PRVVRT10	SEL NH PRV VRT MS 4DAY 10 STUDENTS	F2	\$14,000
MSTECH5DAYCLAS	SEL NH PUB VRT MS 5DAY ONE STUDENT	F2	\$2,975
MSTECH5PRVONS10	SEL NH PRV ONS MS 5DAY 10 STUDENTS	F2	\$21,750
MSTECH5PRVVRT10	SEL NH PRV VRT MS 5DAY 10 STUDENTS	F2	\$17,500
MSVUSCFG2270F1-2	SEL Support Upg SCFG2270-F1 toF2 Silver	F2	\$2,979
MSVUSCFG2270F1-3	SEL Support Upg SCFG2270-F1 toF3 Silver	F2	\$5,449
MSVUSCFG2270F1-4	SEL Support Upg SCFG2270-F1 toF4 Silver	F2	\$7,553
MSVUSCFG2270F1-5	SEL Support Upg SCFG2270-F1 toF5 Silver	F2	\$9,487
MSVUSCFG2270F1-6	SEL Support Upg SCFG2270-F1 toF6 Silver	F2	\$16,518
MSVUSCFG2270F2-3	SEL Support Upg SCFG2270-F2 toF3 Silver	F2	\$2,471
MSVUSCFG2270F2-4	SEL Support Upg SCFG2270-F2 toF4 Silver	F2	\$4,574
MSVUSCFG2270F2-5	SEL Support Upg SCFG2270-F2 toF5 Silver	F2	\$6,508
MSVUSCFG2270F2-6	SEL Support Upg SCFG2270-F2 toF6 Silver	F2	\$13,525
MSVUSCFG2270F3-4	SEL Support Upg SCFG2270-F3 toF4 Silver	F2	\$2,104
MSVUSCFG2270F3-5	SEL Support Upg SCFG2270-F3 toF5 Silver	F2	\$4,038
MSVUSCFG2270F3-6	SEL Support Upg SCFG2270-F3 toF6 Silver	F2	\$11,054
MSVUSCFG2270F4-5	SEL Support Upg SCFG2270-F4 toF5 Silver	F2	\$1,934
MSVUSCFG2270F4-6	SEL Support Upg SCFG2270-F4 toF6 Silver	F2	\$8,951
MSVUSCFG2270F5-6	SEL Support Upg SCFG2270-F5 toF6 Silver	F2	\$7,016
MSVUSCNP2270F1-2	SEL Support Upg SCNP2270-F1 toF2 Silver	F2	\$7,539
MSVUSCNP2270F1-3	SEL Support Upg SCNP2270-F1 toF3 Silver	F2	\$13,172
MSVUSCNP2270F1-4	SEL Support Upg SCNP2270-F1 toF4 Silver	F2	\$18,085
MSVUSCNP2270F1-5	SEL Support Upg SCNP2270-F1 toF5 Silver	F2	\$22,122
MSVUSCNP2270F2-3	SEL Support Upg SCNP2270-F2 toF3 Silver	F2	\$5,619
MSVUSCNP2270F2-4	SEL Support Upg SCNP2270-F2 toF4 Silver	F2	\$10,532
MSVUSCNP2270F2-5	SEL Support Upg SCNP2270-F2 toF5 Silver	F2	\$14,584
MSVUSCNP2270F3-4	SEL Support Upg SCNP2270-F3 toF4 Silver	F2	\$4,913
MSVUSCNP2270F3-5	SEL Support Upg SCNP2270-F3 toF5 Silver	F2	\$8,951
MSVUSCNP2270F4-5	SEL Support Upg SCNP2270-F4 toF5 Silver	F2	\$4,038
MSWEBINARPERDAY	SEL NH WEBINARS PER DAY	F2	\$1,500
M-ZN1-BAS-SAM-F	SAM FULL 12M ZN1	F2	\$320,000
M-ZN1-BAS-SAM-H	SAM HALF 12M ZN1	F2	\$160,000
M-ZN2-BAS-SAM-F	SAM FULL 12M ZN2	F2	\$280,000
M-ZN2-BAS-SAM-H	SAM HALF 12M ZN2	F2	\$140,000
M-ZN3-BAS-SAM-F	SAM FULL 12M ZN3	F2	\$230,000
M-ZN3-BAS-SAM-H	SAM HALF 12M ZN3	F2	\$115,000
M-ZN4-BAS-SAM-F	SAM FULL 12M ZN4	F2	\$180,000
M-ZN4-BAS-SAM-H	SAM HALF 12M ZN4	F2	\$90,000
M-ZN5-BAS-SAM-F	SAM FULL 12M ZN5	F2	\$125,000

M-ZN5-BAS-SAM-H	SAM HALF 12M ZN5	F2	\$62,500
NIC-10G-2LR	SEL 2-PORT 10GBE LR NIC SPARE	F2	\$16,994
NIC-10G-2SR	SEL 2-PORT 10GBE SR MULT MODE NIC SP	F2	\$13,494
NIC-CSK-210G	SEL 2P 10GBE FIBER NIC-CSK SPARE-REQ SFP	F2	\$15,288
NIC-CSK-2TX	SEL 2-PORT 1GBE TX CAPTURE NIC-CSK SPARE	F2	\$2,347
NIC-CSK-4TX	SEL 4-PORT 1GBE TX CAPTURE NIC-CSK SPARE	F2	\$3,524
NXDCADLE3GSC	SEL NX-DCAD-LE-3G-S-C)	F2	\$3,047
NXDCADLE3GSC-I	SEL NX-DCAD-LE-3G-S-C)	F2	\$3,564
NXDCADLE3GSC-K	SEL NX-DCAD-LE-3G-S-C)	F2	\$3,425
NXDCADLE3PSC	SEL NX-DCAD-LE-3P-S-C)	F2	\$3,627
NXDCADLE3PSC-I	SEL NX-DCAD-LE-3P-S-C)	F2	\$4,244
NXDCADLE3PSC-K	SEL NX-DCAD-LE-3P-S-C)	F2	\$4,078
NXDCADLEGSC	SEL NX-DCAD-LE-G-S-C)	F2	\$1,154
NXDCADLEGSC-I	SEL NX-DCAD-LE-G-S-C)	F2	\$1,350
NXDCADLEGSC-K	SEL NX-DCAD-LE-G-S-C)	F2	\$1,297
NXDCADLEPSC	SEL NX-DCAD-LE-P-S-C)	F2	\$1,374
NXDCADLEPSC-I	SEL NX-DCAD-LE-P-S-C)	F2	\$1,608
NXDCADLEPSC-K	SEL NX-DCAD-LE-P-S-C)	F2	\$1,545
NXDCADV100GSC	SEL NX-DC-ADV-100-G-S-C)	F2	\$2,310
NXDCADV100GSC-I	SEL NX-DC-ADV-100-G-S-C)	F2	\$2,703
NXDCADV100GSC-K	SEL NX-DC-ADV-100-G-S-C)	F2	\$2,597
NXDCADV103GSC	SEL NX-DC-ADV-10-3G-S-C)	F2	\$610
NXDCADV103GSC-I	SEL NX-DC-ADV-10-3G-S-C)	F2	\$714
NXDCADV103GSC-K	SEL NX-DC-ADV-10-3G-S-C)	F2	\$686
NXDCADV103PSC	SEL NX-DC-ADV-10-3P-S-C)	F2	\$726
NXDCADV103PSC-I	SEL NX-DC-ADV-10-3P-S-C)	F2	\$849
NXDCADV103PSC-K	SEL NX-DC-ADV-10-3P-S-C)	F2	\$816
NXDCADV10PSC	SEL NX-DC-ADV-10-P-S-C)	F2	\$275
NXDCADV10PSC-I	SEL NX-DC-ADV-10-P-S-C)	F2	\$322
NXDCADV10PSC-K	SEL NX-DC-ADV-10-P-S-C)	F2	\$309
NXDCADV3GSC	SEL NX-DC-ADV-3G-S-C)	F2	\$6,098
NXDCADV3GSC-I	SEL NX-DC-ADV-3G-S-C)	F2	\$7,135
NXDCADV3GSC-K	SEL NX-DC-ADV-3G-S-C)	F2	\$6,855
NXDCADV3GSSSC	SEL NX-DC-ADV-3G-SSS-C)	F2	\$3,047
NXDCADV3GSSSC-I	SEL NX-DC-ADV-3G-SSS-C)	F2	\$3,564
NXDCADV3GSSSC-K	SEL NX-DC-ADV-3G-SSS-C)	F2	\$3,425
NXDCADV3PSC	SEL NX-DC-ADV-3P-S-C)	F2	\$7,260
NXDCADV3PSC-I	SEL NX-DC-ADV-3P-S-C)	F2	\$8,494
NXDCADV3PSC-K	SEL NX-DC-ADV-3P-S-C)	F2	\$8,161
NXDCADV3PSSSC	SEL NX-DC-ADV-3P-SSS-C)	F2	\$3,627
NXDCADV3PSSSC-I	SEL NX-DC-ADV-3P-SSS-C)	F2	\$4,244
NXDCADV3PSSSC-K	SEL NX-DC-ADV-3P-SSS-C)	F2	\$4,078
NXDCADV10GSC	SEL NX-DC-ADVC-10-G-S-C)	F2	\$231
NXDCADV10GSC-I	SEL NX-DC-ADVC-10-G-S-C)	F2	\$270
NXDCADV10GSC-K	SEL NX-DC-ADVC-10-G-S-C)	F2	\$260
NXDCADV3GSSSC	SEL NX-DC-ADV-G-SSS-C)	F2	\$1,154
NXDCADV3GSSSC-I	SEL NX-DC-ADV-G-SSS-C)	F2	\$1,350
NXDCADV3GSSSC-K	SEL NX-DC-ADV-G-SSS-C)	F2	\$1,297
NXDCADV3PSC	SEL NX-DC-ADV-P-S-C)	F2	\$2,750
NXDCADV3PSC-I	SEL NX-DC-ADV-P-S-C)	F2	\$3,218

NXDCADVPSC-K	SEL NX-DC-ADV-P-S-C)	F2	\$3,091
NXDCADVPSSSC	SEL NX-DC-ADV-P-SSS-C)	F2	\$1,374
NXDCADVPSSSC-I	SEL NX-DC-ADV-P-SSS-C)	F2	\$1,608
NXDCADVPSSSC-K	SEL NX-DC-ADV-P-SSS-C)	F2	\$1,545
NXDCAK3GSSSC	SEL NX-DC-AK-3G-SSS-C)	F2	\$13,303
NXDCAK3GSSSC-I	SEL NX-DC-AK-3G-SSS-C)	F2	\$15,564
NXDCAK3GSSSC-K	SEL NX-DC-AK-3G-SSS-C)	F2	\$14,954
NXDCAK3PSSSC	SEL NX-DC-AK-3P-SSS-C)	F2	\$15,837
NXDCAK3PSSSC-I	SEL NX-DC-AK-3P-SSS-C)	F2	\$18,530
NXDCAK3PSSSC-K	SEL NX-DC-AK-3P-SSS-C)	F2	\$17,803
NXDCAKGSSSC	SEL NX-DC-AK-G-SSS-C)	F2	\$5,039
NXDCAKGSSSC-I	SEL NX-DC-AK-G-SSS-C)	F2	\$5,896
NXDCAKGSSSC-K	SEL NX-DC-AK-G-SSS-C)	F2	\$5,664
NXDCAKPSSSC	SEL NX-DC-AK-P-SSS-C)	F2	\$5,999
NXDCAKPSSSC-I	SEL NX-DC-AK-P-SSS-C)	F2	\$7,019
NXDCAKPSSSC-K	SEL NX-DC-AK-P-SSS-C)	F2	\$6,744
NXDCEP1003GSC	SEL NX-DC-EP-100-3G-S-C)	F2	\$9,425
NXDCEP1003GSC-I	SEL NX-DC-EP-100-3G-S-C)	F2	\$11,027
NXDCEP1003GSC-K	SEL NX-DC-EP-100-3G-S-C)	F2	\$10,595
NXDCEP1003PSC	SEL NX-DC-EP-100-3P-S-C)	F2	\$11,220
NXDCEP1003PSC-I	SEL NX-DC-EP-100-3P-S-C)	F2	\$13,127
NXDCEP1003PSC-K	SEL NX-DC-EP-100-3P-S-C)	F2	\$12,613
NXDCEP100GSC	SEL NX-DC-EP-100-G-S-C)	F2	\$3,570
NXDCEP100GSC-I	SEL NX-DC-EP-100-G-S-C)	F2	\$4,177
NXDCEP100GSC-K	SEL NX-DC-EP-100-G-S-C)	F2	\$4,013
NXDCEP100PSC	SEL NX-DC-EP-100-P-S-C)	F2	\$4,250
NXDCEP100PSC-I	SEL NX-DC-EP-100-P-S-C)	F2	\$4,973
NXDCEP100PSC-K	SEL NX-DC-EP-100-P-S-C)	F2	\$4,778
NXDCEPAD3GSC	SEL NX-DC-EP-AD-3G-S-C)	F2	\$528
NXDCEPAD3GSC-I	SEL NX-DC-EP-AD-3G-S-C)	F2	\$618
NXDCEPAD3GSC-K	SEL NX-DC-EP-AD-3G-S-C)	F2	\$594
NXDCEPAD3PSC	SEL NX-DC-EP-AD-3P-S-C)	F2	\$628
NXDCEPAD3PSC-I	SEL NX-DC-EP-AD-3P-S-C)	F2	\$735
NXDCEPAD3PSC-K	SEL NX-DC-EP-AD-3P-S-C)	F2	\$706
NXDCEPADGSC	SEL NX-DC-EP-AD-G-S-C)	F2	\$200
NXDCEPADGSC-I	SEL NX-DC-EP-AD-G-S-C)	F2	\$234
NXDCEPADGSC-K	SEL NX-DC-EP-AD-G-S-C)	F2	\$225
NXDCEPADPSC	SEL NX-DC-EP-AD-P-S-C)	F2	\$238
NXDCEPADPSC-I	SEL NX-DC-EP-AD-P-S-C)	F2	\$278
NXDCEPADPSC-K	SEL NX-DC-EP-AD-P-S-C)	F2	\$268
NXDCEPL103GSC	SEL NX-DC-EPL-10-3G-S-C)	F2	\$942
NXDCEPL103GSC-I	SEL NX-DC-EPL-10-3G-S-C)	F2	\$1,103
NXDCEPL103GSC-K	SEL NX-DC-EPL-10-3G-S-C)	F2	\$1,059
NXDCEPL103PSC	SEL NX-DC-EPL-10-3P-S-C)	F2	\$1,122
NXDCEPL103PSC-I	SEL NX-DC-EPL-10-3P-S-C)	F2	\$1,313
NXDCEPL103PSC-K	SEL NX-DC-EPL-10-3P-S-C)	F2	\$1,261
NXDCEPL10GSC	SEL NX-DC-EPL-10-G-S-C)	F2	\$357
NXDCEPL10GSC-I	SEL NX-DC-EPL-10-G-S-C)	F2	\$418
NXDCEPL10GSC-K	SEL NX-DC-EPL-10-G-S-C)	F2	\$401
NXDCEPL10PSC	SEL NX-DC-EPL-10-P-S-C)	F2	\$425

NXDCEPL10PSC-I	SEL NX-DC-EPL-10-P-S-C)	F2	\$497
NXDCEPL10PSC-K	SEL NX-DC-EPL-10-P-S-C)	F2	\$478
NXDCEPL3GSSSC	SEL NX-DC-EPL-3G-SSS-C)	F2	\$4,710
NXDCEPL3GSSSC-I	SEL NX-DC-EPL-3G-SSS-C)	F2	\$5,510
NXDCEPL3GSSSC-K	SEL NX-DC-EPL-3G-SSS-C)	F2	\$5,294
NXDCEPL3PSSSC	SEL NX-DC-EPL-3P-SSS-C)	F2	\$5,607
NXDCEPL3PSSSC-I	SEL NX-DC-EPL-3P-SSS-C)	F2	\$6,561
NXDCEPL3PSSSC-K	SEL NX-DC-EPL-3P-SSS-C)	F2	\$6,303
NXDCEPLGSSSC	SEL NX-DC-EPL-G-SSS-C)	F2	\$1,784
NXDCEPLGSSSC-I	SEL NX-DC-EPL-G-SSS-C)	F2	\$2,087
NXDCEPLGSSSC-K	SEL NX-DC-EPL-G-SSS-C)	F2	\$2,005
NXDCEPLPSSSC	SEL NX-DC-EPL-P-SSS-C)	F2	\$2,124
NXDCEPLPSSSC-I	SEL NX-DC-EPL-P-SSS-C)	F2	\$2,485
NXDCEPLPSSSC-K	SEL NX-DC-EPL-P-SSS-C)	F2	\$2,388
NXDCPF3GSSSC	SEL NX-DC-PF-3G-SSS-C)	F2	\$2,215
NXDCPF3GSSSC-I	SEL NX-DC-PF-3G-SSS-C)	F2	\$2,592
NXDCPF3GSSSC-K	SEL NX-DC-PF-3G-SSS-C)	F2	\$2,490
NXDCPF3PSSSC	SEL NX-DC-PF-3P-SSS-C)	F2	\$2,637
NXDCPF3PSSSC-I	SEL NX-DC-PF-3P-SSS-C)	F2	\$3,086
NXDCPF3PSSSC-K	SEL NX-DC-PF-3P-SSS-C)	F2	\$2,965
NXDCPF3GSSSC	SEL NX-DC-PF-G-SSS-C)	F2	\$839
NXDCPF3GSSSC-I	SEL NX-DC-PF-G-SSS-C)	F2	\$982
NXDCPF3GSSSC-K	SEL NX-DC-PF-G-SSS-C)	F2	\$943
NXDCPF3PSSSC	SEL NX-DC-PF-P-SSS-C)	F2	\$999
NXDCPF3PSSSC-I	SEL NX-DC-PF-P-SSS-C)	F2	\$1,169
NXDCPF3PSSSC-K	SEL NX-DC-PF-P-SSS-C)	F2	\$1,123
NXDCCR25VM3GSC	SEL NX-DCR-25VM-3G-S-C)	F2	\$8,456
NXDCCR25VM3GSC-I	SEL NX-DCR-25VM-3G-S-C)	F2	\$9,893
NXDCCR25VM3GSC-K	SEL NX-DCR-25VM-3G-S-C)	F2	\$9,505
NXDCCR25VM3PSC	SEL NX-DCR-25VM-3P-S-C)	F2	\$10,066
NXDCCR25VM3PSC-I	SEL NX-DCR-25VM-3P-S-C)	F2	\$11,778
NXDCCR25VM3PSC-K	SEL NX-DCR-25VM-3P-S-C)	F2	\$11,316
NXDCCR25VMGSC	SEL NX-DCR-25VM-G-S-C)	F2	\$3,203
NXDCCR25VMGSC-I	SEL NX-DCR-25VM-G-S-C)	F2	\$3,748
NXDCCR25VMGSC-K	SEL NX-DCR-25VM-G-S-C)	F2	\$3,601
NXDCCR25VMPSC	SEL NX-DCR-25VM-P-S-C)	F2	\$3,813
NXDCCR25VMPSC-I	SEL NX-DCR-25VM-P-S-C)	F2	\$4,461
NXDCCR25VMPSC-K	SEL NX-DCR-25VM-P-S-C)	F2	\$4,286
NXDCCSTD3GSSSC	SEL NX-DC-STD-3G-SSS-C)	F2	\$1,106
NXDCCSTD3GSSSC-I	SEL NX-DC-STD-3G-SSS-C)	F2	\$1,294
NXDCCSTD3GSSSC-K	SEL NX-DC-STD-3G-SSS-C)	F2	\$1,243
NXDCCSTD3PSSSC	SEL NX-DC-STD-3P-SSS-C)	F2	\$1,317
NXDCCSTD3PSSSC-I	SEL NX-DC-STD-3P-SSS-C)	F2	\$1,541
NXDCCSTD3PSSSC-K	SEL NX-DC-STD-3P-SSS-C)	F2	\$1,481
NXDCCSTDGSSSC	SEL NX-DC-STD-G-SSS-C)	F2	\$419
NXDCCSTDGSSSC-I	SEL NX-DC-STD-G-SSS-C)	F2	\$490
NXDCCSTDGSSSC-K	SEL NX-DC-STD-G-SSS-C)	F2	\$471
NXDCCSTD3PSSSC	SEL NX-DC-STD-P-SSS-C)	F2	\$499
NXDCCSTD3PSSSC-I	SEL NX-DC-STD-P-SSS-C)	F2	\$584
NXDCCSTD3PSSSC-K	SEL NX-DC-STD-P-SSS-C)	F2	\$561

ONSITEPRFSVC	SELECT NTPS Onsite Prof Svc (per Day)	F2	\$2,647
OSL-0-50MS	SEL DatAdvantage - SPOL & OD Lite MS	F2	\$34
OSL-1001-1500MS	SEL DatAdvantage - SPOL & OD Lite MS	F2	\$10
OSL-100K-150KMC	SEL DatAdvantage - SPOL & OD Lite M24*7	F2	\$9
OSL-100K-150KMS	SEL DatAdvantage - SPOL & OD Lite MS	F2	\$5
OSL-101-250MS	SEL DatAdvantage - SPOL & OD Lite MS	F2	\$19
OSL-10K-20KMC	SEL DatAdvantage - SPOL & OD Lite M24*7	F2	\$11
OSL-10K-20KMS	SEL DatAdvantage - SPOL & OD Lite MS	F2	\$6
OSL-1501-2000MS	SEL DatAdvantage - SPOL & OD Lite MS	F2	\$9
OSL-150K-MC	SEL DatAdvantage - SPOL & OD Lite M24*7	F2	\$9
OSL-150K-MS	SEL DatAdvantage - SPOL & OD Lite MS	F2	\$5
OSL-2001-2500MS	SEL DatAdvantage - SPOL & OD Lite MS	F2	\$8
OSL-20K-35KMC	SEL DatAdvantage - SPOL & OD Lite M24*7	F2	\$10
OSL-20K-35KMS	SEL DatAdvantage - SPOL & OD Lite MS	F2	\$6
OSL-2501-4000MS	SEL DatAdvantage - SPOL & OD Lite MS	F2	\$8
OSL-251-500MS	SEL DatAdvantage - SPOL & OD Lite MS	F2	\$14
OSL-35K-50KMC	SEL DatAdvantage - SPOL & OD Lite M24*7	F2	\$10
OSL-35K-50KMS	SEL DatAdvantage - SPOL & OD Lite MS	F2	\$6
OSL-4001-6000MC	SEL DatAdvantage - SPOL & OD Lite M24*7	F2	\$13
OSL-4001-6000MS	SEL DatAdvantage - SPOL & OD Lite MS	F2	\$7
OSL-501-750MS	SEL DatAdvantage - SPOL & OD Lite MS	F2	\$12
OSL-50K-100KMC	SEL DatAdvantage - SPOL & OD Lite M24*7	F2	\$9
OSL-50K-100KMS	SEL DatAdvantage - SPOL & OD Lite MS	F2	\$5
OSL-51-100MS	SEL DatAdvantage - SPOL & OD Lite MS	F2	\$24
OSL-6001-8000MC	SEL DatAdvantage - SPOL & OD Lite M24*7	F2	\$12
OSL-6001-8000MS	SEL DatAdvantage - SPOL & OD Lite MS	F2	\$7
OSL-751-1000MS	SEL DatAdvantage - SPOL & OD Lite MS	F2	\$11
OSL-8001-10KMC	SEL DatAdvantage - SPOL & OD Lite M24*7	F2	\$11
OSL-8001-10KMS	SEL DatAdvantage - SPOL & OD Lite MS	F2	\$6
OSPA1	SEL Open Source Puppet Assessment 1-week	F2	\$11,759
P1Y-CS1000HAI	Select Prem S&M-1 Year- CS1000HA-ISLN	F2	\$39,706
P1Y-CS100HAI	Select Prem S&M-1 Year- CS100HA-ISLN	F2	\$13,235
P1Y-CS155HAI	Select Prem S&M-1 Year- CS155HA-ISLN	F2	\$18,199
P1Y-CS2400HAI	Select Prem S&M-1 Year- CS2400HA-ISLN	F2	\$52,941
P1Y-CS450HAI	Select Prem S&M-1 Year- CS450HA-ISLN	F2	\$29,779
P1Y-CS45HAI	Select Prem S&M-1 Year- CS45HA-ISLN	F2	\$8,272
P1Y-CS5000HAI	Select Prem S&M-1 Year- CS5000HA-ISLN	F2	\$66,176
P1Y-ES1000HAI	Select Prem S&M-1 Year- ES1000HA-ISLN	F2	\$26,471
P1Y-ES100HAI	Select Prem S&M-1 Year- ES100HA-ISLN	F2	\$10,000
P1Y-ES155HAI	Select Prem S&M-1 Year- ES155HA-ISLN	F2	\$12,132
P1Y-ES2400HAI	Select Prem S&M-1 Year- ES2400HA-ISLN	F2	\$35,294
P1Y-ES450HAI	Select Prem S&M-1 Year- ES450HA-ISLN	F2	\$19,853
P1Y-ES45HAI	Select Prem S&M-1 Year- ES45HA-ISLN	F2	\$5,515
P1Y-ES5000HAI	Select Prem S&M-1 Year- ES5000HA-ISLN	F2	\$44,118
P3Y-CS1000HAI	Select Prem S&M-3 Year- CS1000HA-ISLN	F2	\$107,206
P3Y-CS100HAI	Select Prem S&M-3 Year- CS100HA-ISLN	F2	\$35,735
P3Y-CS155HAI	Select Prem S&M-3 Year- CS155HA-ISLN	F2	\$49,136
P3Y-CS2400HAI	Select Prem S&M-3 Year- CS2400HA-ISLN	F2	\$142,941
P3Y-CS450HAI	Select Prem S&M-3 Year- CS450HA-ISLN	F2	\$80,404
P3Y-CS45HAI	Select Prem S&M-3 Year- CS45HA-ISLN	F2	\$22,335

P3Y-CS5000HAI	Select Prem S&M-3 Year- CS5000HA-ISLN	F2	\$178,676
P3Y-ES1000HAI	Select Prem S&M-3 Year- ES1000HA-ISLN	F2	\$71,471
P3Y-ES100HAI	Select Prem S&M-3 Year- ES100HA-ISLN	F2	\$27,000
P3Y-ES155HAI	Select Prem S&M-3 Year- ES155HA-ISLN	F2	\$32,757
P3Y-ES2400HAI	Select Prem S&M-3 Year- ES2400HA-ISLN	F2	\$95,294
P3Y-ES450HAI	Select Prem S&M-3 Year- ES450HA-ISLN	F2	\$53,603
P3Y-ES45HAI	Select Prem S&M-3 Year- ES45HA-ISLN	F2	\$14,890
P3Y-ES5000HAI	Select Prem S&M-3 Year- ES5000HA-ISLN	F2	\$119,118
PEBESTBA	SEL Puppet Health Check	F2	\$11,759
PE-MC	SEL Production Environment Add-on MC	F2	\$4,015
PE-MS	SEL Production Environment Add-on MS	F2	\$2,294
PREMIUMPLUSTAM	SEL Technical Account Manager	F2	\$76,471
PROFSERV1DAY	SELECT NTPS Professional Svc (per day)	F2	\$2,647
PS-BAS-DAOPRES	Residency for Data Availability - OP	F2	\$30,800
PS-BAS-DATRRES	Residency for Data Availability - TR	F2	\$39,000
PS-BAS-DPOPRES	Residency for Data Protection - OP	F2	\$30,800
PS-BAS-DPTRRES	Residency for Data Protection - TR	F2	\$39,000
PS-BAS-ECSOPRES	Residency for Elastic Cloud Storage - OP	F2	\$30,800
PS-BAS-ECSTRRES	Residency for Elastic Cloud Storage - TR	F2	\$39,000
PS-BAS-ESDOPRES	Residency for Enterprise Storage - OP	F2	\$30,800
PS-BAS-ESDTRRES	Residency for Enterprise Storage - TR	F2	\$39,000
PS-BAS-ISIOPRES	Residency for Isilon - OP	F2	\$30,800
PS-BAS-ISITRRES	Residency for Isilon - TR	F2	\$39,000
PS-BAS-MFOPRES	Residency for Mainframe - OP	F2	\$30,800
PS-BAS-MFTRRES	Residency for Mainframe - TR	F2	\$39,000
PS-BAS-S1OPRES	Residency for Data Archive - OP	F2	\$30,800
PS-BAS-S1TRRES	Residency for Data Archive - TR	F2	\$39,000
PS-BAS-SASOPRES	Residency for Service Assurance Suite OP	F2	\$30,800
PS-BAS-SASTRRES	Residency for Service Assurance Suite TR	F2	\$39,000
PS-BAS-SIOOPRES	Residency for VxFlex OS: Operational	F2	\$30,800
PS-BAS-SIOTRRES	Residency for VxFlex OS: Transitional	F2	\$39,000
PS-BAS-SRMOPRES	Residency for SRM - OP	F2	\$30,800
PS-BAS-SRMTRRES	Residency for ViPR SRM - TR	F2	\$39,000
PS-BAS-UNIOPRES	Residency for Unity - OP	F2	\$30,800
PS-BAS-UNITRRES	Residency for Unity - TR	F2	\$39,000
PS-BAS-USDOPRES	Residency for Midrange Storage - OP	F2	\$30,800
PS-BAS-USDTRRES	Residency for Midrange Storage - TR	F2	\$39,000
PS-BAS-VDAOPRES	Virtual Residency for Data Availability	F2	\$11,500
PS-BAS-VDATRRES	Virtual Residency for Data Availability	F2	\$12,500
PS-BAS-VDPOPRES	Residency for Data Protection-OP Remote	F2	\$11,500
PS-BAS-VDPTRRES	Residency for Data Protection?TR Remote	F2	\$12,500
PS-BAS-VESDOPRES	Virtual Residency for Enterprise Storage	F2	\$11,500
PS-BAS-VESDTRRES	Virtual Residency for Enterprise Storage	F2	\$12,500
PS-BAS-VICOPRES	Residency for ViPR Controller - OP	F2	\$30,800
PS-BAS-VICTRRES	Residency for ViPR Controller - TR	F2	\$39,000
PS-BAS-VISIOPRES	Virtual Residency for Isilon	F2	\$11,500
PS-BAS-VISITRRES	Virtual Residency for Isilon	F2	\$12,500
PS-BAS-VMNOLR	Design and Impl for Oracle Local Rep	F2	\$13,770
PS-BAS-VMNTPRES	Residency for Network Virtualization OP	F2	\$30,800
PS-BAS-VRAOPRES	Residency for vRealize Automation - OP	F2	\$30,800

PS-BAS-VUNIOPRES	Virtual Operational Residency Unity	F2	\$11,500
PS-BAS-VUNITRRES	Virtual Transitional Residency Unity	F2	\$12,500
PS-BAS-VUSDOPRES	Virtual Residency for Midrange Storage	F2	\$11,500
PS-BAS-VUSDTRRES	Virtual Residency for Midrange Storage	F2	\$12,500
PS-BAS-VXROPRES	Residency for HCI OP	F2	\$30,800
PS-BAS-VXRTRRES	Residency for HCI TR	F2	\$39,000
PS-BAS-XIOOPRES	Residency for XtremIO - OP	F2	\$30,800
PS-BAS-XIOTRRES	Residency for XtremIO - TR	F2	\$39,000
PS-BAS-XTVSI	Virtual Infrastructure Module - XtremIO	F2	\$1,770
PS-COP-AVADIG	Avamar Design and Imp Guidance	F2	\$1,060
PS-COP-RPDIG	RecoverPoint Design & Imp Guidance	F2	\$1,040
PS-COP-SYMDIG	Symm Design and Implement Guidance	F2	\$2,260
PSJMPSTRTBASX	SELECT NTPS ONSITE IMLEMNTN SVC (3-DAY)	F2	\$9,529
PSJUMPSTRTADX	SELECT NTPS ONSITE IMPLMTN SVC (ADD 1DY)	F2	\$2,647
PSSABASEX	SELECT NTPS ONSITE STORASSMNT ENTERPR	F2	\$26,471
PSTRAVELDAYX	SELECT NTPS PROF SVC TRAVEL DAY (PR DAY)	F2	\$1,588
PS-ZN1A-BRRES	Backup RES IS 2-5yrs Exp	F2	\$39,380
PS-ZN1-DLRES3	DLm RES 90 Day 4-7yrs Exp	F2	\$128,540
PS-ZN1J-BRRES	Backup RES Assoc IS <2yr Exp	F2	\$34,430
PS-ZN1S-ISOPR	Isilon Op RES Sr SA 7+yrs Exp	F2	\$51,700
PS-ZN2A-BRRES	Backup RES IS 2-5yrs Exp	F2	\$27,500
PS-ZN2B-BRLV1	BURA OPS RESIDENCY LVL1	F2	\$30,800
PS-ZN2B-BRRES	Backup RES, Sr IS, 4-7yrs Exp	F2	\$30,800
PS-ZN2J-BRRES	Backup RES Assoc IS <2yr Exp	F2	\$21,670
PS-ZN2S-ISOPR	Isilon Op RES Sr SA 7+yrs Exp	F2	\$40,810
PS-ZN3A-BRRES	Backup RES IS 2-5yrs Exp	F2	\$22,660
PS-ZN3B-BRLV1	BURA OPS RESIDENCY LVL1	F2	\$26,800
PS-ZN3B-BRRES	Backup RES, Sr IS, 4-7yrs Exp	F2	\$26,800
PS-ZN3J-BRRES	Backup RES Assoc IS <2yr Exp	F2	\$19,030
PS-ZN3S-ISOPR	Isilon Op RES Sr SA 7+yrs Exp	F2	\$31,240
PS-ZN4A-BRRES	Backup RES IS 2-5yrs Exp	F2	\$16,170
PS-ZN4B-BRLV1	BURA OPS RESIDENCY LVL1	F2	\$19,300
PS-ZN4B-BRRES	Backup RES, Sr IS, 4-7yrs Exp	F2	\$19,300
PS-ZN4J-BRRES	Backup RES Assoc IS <2yr Exp	F2	\$14,630
PS-ZN4S-ISOPR	Isilon Op RES Sr SA 7+yrs Exp	F2	\$22,990
PS-ZN5A-BRRES	Backup RES IS 2-5yrs Exp	F2	\$12,320
PS-ZN5B-BRLV1	BURA OPS RESIDENCY LVL1	F2	\$14,900
PS-ZN5B-BRRES	Backup RES, Sr IS, 4-7yrs Exp	F2	\$14,900
PS-ZN5J-BRRES	Backup RES Assoc IS <2yr Exp	F2	\$10,230
PS-ZN5S-ISOPR	Isilon Op RES Sr SA 7+yrs Exp	F2	\$17,270
PTC-1D	SEL 1DAY DA TRAINING EXCLUDE EXPEPENSE	F2	\$3,441
PUPARCPRVVIR	SEL Puppet Architect - Virtual Trng	F2	\$14,118
PUPFUNPRVVIR	SEL Puppet Fundamentals Virtual Trng	F2	\$21,176
PUPINFRAPRV	SEL Puppetizing Infra Onsite Trng	F2	\$21,176
PUPINFRAPRVVIR	SEL Puppetizing Infra Virtual Trng	F2	\$21,176
PUPJUMPBASICSD	SEL Basic Jumpstart Package (SD)	F2	\$11,759
PUPJUMPEXTSD	SEL Extended Jumpstart Package (SD)	F2	\$47,053
PUPJUMPSTDSD	SEL Standard Jumpstart Package (SD)	F2	\$23,524
PUPPETARCTRNG	SEL Puppet Architect Onsite Trng	F2	\$14,118
PUPPETFUNTRNG	SEL Puppet Fundamentals Onsite Trng	F2	\$21,176

PUPPETPRACTRNG	SEL Puppet Practitioner Onsite Trng	F2	\$21,176
PUPPRACPRVVIR	SEL Puppet Practitioner Virtual Trng	F2	\$21,176
PUPWINTRNGADD	SEL Puppet Essentials Win Add Student	F2	\$588
PUPWINTRNGPRIV	SEL Puppet Essentials Win Virtual Trng	F2	\$7,059
PV-APAH-P-SUP-F	SEL: PV-APAH-P-SUP-F	F2	\$825
QFSB1TBSPMM1	SELECT CT-QFS 10-80TB Spt/Mnt 1Mo (prTB)	F2	\$12
QFSB1TBSPMT1	SELECT CT-QFS 10-80TB Spt/Mnt 1Yr (prTB)	F2	\$133
QFSB1TBSPMT3	SELECT CT-QFS 10-80TB Spt/Mnt 3Yr (prTB)	F2	\$400
QFSB1TBSPMT5	SELECT CT-QFS 10-80TB Spt/Mnt 5Yr (prTB)	F2	\$667
QFSB2TBSPMM1	SELECT CT-QFS 81-240TB Spt/Mt 1Mo (prTB)	F2	\$11
QFSB2TBSPMT1	SELECT CT-QFS 81-240TB Spt/Mt 1Yr (prTB)	F2	\$126
QFSB2TBSPMT3	SELECT CT-QFS 81-240TB Spt/Mt 3Yr (prTB)	F2	\$378
QFSB2TBSPMT5	SELECT CT-QFS 81-240TB Spt/Mt 5Yr (prTB)	F2	\$631
QFSB3TBSPMM1	SELECT CT-QFS 241-500TB Spt/Mt 1Mo(prTB)	F2	\$9
QFSB3TBSPMT1	SELECT CT-QFS 241-500TB Spt/Mt 1Yr(prTB)	F2	\$120
QFSB3TBSPMT3	SELECT CT-QFS 241-500TB Spt/Mt 3Yr(prTB)	F2	\$358
QFSB3TBSPMT5	SELECT CT-QFS 241-500TB Spt/Mt 5Yr(prTB)	F2	\$596
QFSB4TBSPMM1	SELECT CT-QFS 501-750TB Spt/Mt 1Mo(prTB)	F2	\$9
QFSB4TBSPMT1	SELECT CT-QFS 501-750TB Spt/Mt 1Yr(prTB)	F2	\$112
QFSB4TBSPMT3	SELECT CT-QFS 501-750TB Spt/Mt 3Yr(prTB)	F2	\$335
QFSB4TBSPMT5	SELECT CT-QFS 501-750TB Spt/Mt 5Yr(prTB)	F2	\$559
QFSB5TBSPMM1	SELECT CT-QFS 751-1024TB Spt/Mt1Mo(prTB)	F2	\$8
QFSB5TBSPMT1	SELECT CT-QFS 751-1024TB Spt/Mt1Yr(prTB)	F2	\$105
QFSB5TBSPMT3	SELECT CT-QFS 751-1024TB Spt/Mt3Yr(prTB)	F2	\$315
QFSB5TBSPMT5	SELECT CT-QFS 751-1024TB Spt/Mt5Yr(prTB)	F2	\$525
QFSTRAIN2BHD	SELECT NTPS QFS ONSITE TRAINING (2-DAY)	F2	\$10,059
REMINST1DAY	SELECT NTPS Remote Install Sppt (1 Day)	F2	\$1,906
REMPROFSVC	SELECT NTPS Remote Prof Svc (per Day)	F2	\$1,906
REN-ES-1000AN-D	SEL Splunk Standard SupREN Bucket 1000AN	F2	\$1,000
REN-ES-1000AP-D	SEL Splunk Standard SupREN Bucket 1000AP	F2	\$1,000
REN-ES-1000EM-D	SEL Splunk Standard SupREN Bucket 1000EM	F2	\$1,000
REN-ES-1000US-D	SEL Splunk Standard SupREN Bucket 1000US	F2	\$1,000
REN-ES-100AN-D	SEL Splunk Standard SupREN Bucket 100AN	F2	\$100
REN-ES-100AP-D	SEL Splunk Standard SupREN Bucket 100AP	F2	\$100
REN-ES-100EM-D	SEL Splunk Standard SupREN Bucket 100EM	F2	\$100
REN-ES-100US-D	SEL Splunk Standard SupREN Bucket 100US	F2	\$100
REN-ES-1AN-D	SEL Splunk Standard SupREN Bucket 1AN	F2	\$1
REN-ES-1AP-D	SEL Splunk Standard SupREN Bucket 1AP	F2	\$1
REN-ES-1EM-D	SEL Splunk Standard SupREN Bucket 1EM	F2	\$1
REN-ES-1US-D	SEL Splunk Standard SupREN Bucket 1US	F2	\$1
REN-GS-1000AN-D	SEL Splunk Premium SupREN Bucket 1000AN	F2	\$1,000
REN-GS-1000AP-D	SEL Splunk Premium SupREN Bucket 1000AP	F2	\$1,000
REN-GS-1000EM-D	SEL Splunk Premium SupREN Bucket 1000EM	F2	\$1,000
REN-GS-1000US-D	SEL Splunk Premium SupREN Bucket 1000US	F2	\$1,000
REN-GS-100AN-D	SEL Splunk Premium SupREN Bucket 100AN	F2	\$100
REN-GS-100AP-D	SEL Splunk Premium SupREN Bucket 100AP	F2	\$100
REN-GS-100EM-D	SEL Splunk Premium SupREN Bucket 100EM	F2	\$100
REN-GS-100US-D	SEL Splunk Premium SupREN Bucket 100US	F2	\$100
REN-GS-1AN-D	SEL Splunk Premium SupREN Bucket 1AN	F2	\$1
REN-GS-1AP-D	SEL Splunk Premium SupREN Bucket 1AP	F2	\$1

REN-GS-1EM-D	SEL Splunk Premium SupREN Bucket 1EM	F2	\$1
REN-GS-1US-D	SEL Splunk Premium SupREN Bucket 1US	F2	\$1
S120-ASMB-1	SEL: T120 ASM BASIC YEAR 1	F2	\$7,620
S120-ASMB-1Z2	SEL: T120 ASM Basic Year 1,Z2	F2	\$8,382
S120-ASMB-2	SEL: T120 ASM BASIC YEAR 2	F2	\$3,047
S120-ASMB-2Z2	SEL: T120 ASM Basic Year 2,Z2	F2	\$3,352
S120-ASMG-1	SEL: T120 ASM GOLD YEAR 1	F2	\$11,436
S120-ASMG-1Z2	SEL: T120 ASM Gold Year 1,Z2	F2	\$12,586
S120-ASMG-2	SEL: T120 ASM GOLD YEAR 2	F2	\$4,576
S120-ASMG-2Z2	SEL: T120 ASM Gold Year 2 ,Z2	F2	\$5,034
S120-B-1-4HR	SEL: T120 BASE;YEAR 1;4HR	F2	\$994
S120-B-1-4HRZ2	SEL: T120 Base,Year 1,4HR,Z2	F2	\$1,094
S120-B-1-NBD	SEL: T120 BASE;YEAR 1;NBD	F2	\$0
S120-B-1-NBDZ2	SEL: T120 Base,Year 1,NBD,Z2	F2	\$0
S120-B-1-PH	SEL: T120 Base,Year 1 ,7x24PH UP	F2	\$142
S120-B-1-PHZ2	SEL: T120 Base,Year 1 ,7x24PH UP,Z2	F2	\$157
S120-B-1-SBD	SEL: T120 BASE;YEAR 1;SBD	F2	\$898
S120-B-1-SBDZ2	SEL: T120 Base,Year 1,SBD,Z2	F2	\$989
S120-B-2-4HR	SEL: T120 BASE;YEARS 2 ;4HR	F2	\$1,309
S120-B-2-4HRZ2	SEL: T120 Base,Years 2,4HR,Z2	F2	\$1,445
S120-B-2-NBD	SEL: T120 BASE;YEARS 2 ;NBD	F2	\$942
S120-B-2-NBDZ2	SEL: T120 Base,Years 2,NBD,Z2	F2	\$1,044
S120-B-2-PH	SEL: T120 Base,Years 2 ,7x24PH UP	F2	\$142
S120-B-2-PHZ2	SEL: T120 Base,Years 2 ,7x24PH UP,Z2	F2	\$157
S120-B-2-SBD	SEL: T120 BASE; YEARS 2 ; SBD	F2	\$1,180
S120-B-2-SBDZ2	SEL: T120 Base, Years 2, SBD,Z2	F2	\$1,307
S120-BA-1-NBD	SEL: T120 Base,Year 1,NBD	F2	\$707
S120-BA-1-NBDZ2	SEL: T120 Base,Year 1,NBD,Z2	F2	\$783
S120-BL-1-4HR	SEL: T120 BLScLic;5 SLTS;Y1;4HO	F2	\$66
S120-BL-1-4HRZ2	SEL: T120 BLScLic,5 slts,Y1,4HO,Z2	F2	\$73
S120-BL-1-NBD	SEL: T120 BLScLic ,5 slts,Y1,NBD	F2	\$50
S120-BL-1-NBDZ2	SEL: T120 BLScLic ,5 slts,Y1,NBD,Z2	F2	\$58
S120-BL-1-PH	SEL: T120 BS ,5 slts,Y1,7x24PH UP	F2	\$11
S120-BL-1-PHZ2	SEL: T120 BS ,5SLTS,Y1,7x24PH UP,Z2	F2	\$12
S120-BL-1-SBD	SEL: T120 BLScLIC ;5 SLTS;Y1 ;SBD	F2	\$58
S120-BL-1-SBDZ2	SEL: T120 BLScLic ,5 slts,Y1,SBD,Z2	F2	\$64
S120-BL-2-4HR	SEL: T120 BLScLIC ;5 SLTS;Y2 ;4HR	F2	\$95
S120-BL-2-4HRZ2	SEL: T120 BLScLic ,5 slts,Y2,4HR,Z2	F2	\$104
S120-BL-2-NBDSL	SEL: T120 BLScLic ,5 slts,Y2,NBD	F2	\$67
S120-BL-2NBDZ2S1	SEL: T120 BLScLIC ,5SLTS,Y2,NBD,Z2	F2	\$77
S120-BL-2-PH	SEL: T120 BS ,5 slts,Y2,7x24PH UP	F2	\$11
S120-BL-2-PHZ2	SEL: T120 BS ,5SLTS,Y2,7x24PH UP,Z2	F2	\$12
S120-BL-2-SBD	SEL: T120 BLScLIC;5 SLTS;Y2 ;SBD	F2	\$82
S120-BL-2-SBDZ2	SEL: T120 BLScLic,5 slts,Y2 ,SBD,Z2	F2	\$90
S120-CT-100	SEL: 1 COTERM SUPPORT UNIT T120	F2	\$100
S120-D8-1-4HR	SEL: T120 Drvs,Year 1,4HR	F2	\$1,592
S120-D8-1-4HRZ2	SEL: T120 Drvs,Year 1,4HR,Z2	F2	\$1,734
S120-D8-1-NBD	SEL: T120 Drvs Year 1,NBD	F2	\$1,139
S120-D8-1-NBDZ2	SEL: T120DrvsYear1,NBD,Z2	F2	\$1,249
S120-D8-1-PH	SEL: T120 Drvs Year 1,7x24PH UP	F2	\$228

S120-D8-1-PHZ2	SEL: T120DrvsYear 1,7x24PH UP,Z2	F2	\$251
S120-D8-1-SBD	SEL: T120 Drvs,Year 1,SBD	F2	\$1,411
S120-D8-1-SBDZ2	SEL: T120 Drvs,Year 1,SBD,Z2	F2	\$1,536
S120-D8-2-4HR	SEL: T120 Drvs Years 2+,4HR	F2	\$2,213
S120-D8-2-4HRZ2	SEL: T120DrvsYears2+,4HR,Z2	F2	\$2,418
S120-D8-2-NBD	SEL: T120 Drvs Years 2+,NBD	F2	\$1,519
S120-D8-2-NBDZ2	SEL: T120DrvsYears2+,NBD,Z2	F2	\$1,666
S120-D8-2-PH	SEL: T120 Drvs Years 2+,7x24PH UP	F2	\$228
S120-D8-2-PHZ2	SEL: T120DrvsYears2+,7x24PH UP,Z2	F2	\$251
S120-D8-2-SBD	SEL: T120 Drvs Years 2+,SBD	F2	\$1,950
S120-D8-2-SBDZ2	SEL: T120DrvsYears2+,SBD,Z2	F2	\$2,130
S120-DR-1-4HR	SEL: T120 DRVS;YEAR 1;4HR	F2	\$1,433
S120-DR-1-4HRZ2	SEL: T120 Drvs,Year 1,4HR,Z2	F2	\$1,577
S120-DR-1-NBD	SEL: T120 Drvs Year 1 ,NBD	F2	\$1,022
S120-DR-1-NBDZ2	SEL: T120 Drvs Year 1 ,NBD,Z2	F2	\$1,131
S120-DR-1-PH	SEL: T120 Drvs Year 1 ,7x24PH UP	F2	\$205
S120-DR-1-PHZ2	SEL: T120 Drvs Year 1 ,7x24PH UP,Z2	F2	\$227
S120-DR-1-SBD	SEL: T120 DRVS;YEAR 1;SBD	F2	\$1,253
S120-DR-1-SBDZ2	SEL: T120 Drvs,Year 1,SBD,Z2	F2	\$1,379
S120-DR-2-4HR	SEL: T120 DRVS YEARS 2 ;4HR	F2	\$2,056
S120-DR-2-4HRZ2	SEL: T120 Drvs Years 2,4HR,Z2	F2	\$2,261
S120-DR-2-NBD	SEL: T120 DRVS YEARS 2 ;NBD	F2	\$1,362
S120-DR-2-NBDZ2	SEL: T120 Drvs Years 2,NBD,Z2	F2	\$1,508
S120-DR-2-PH	SEL: T120 Drvs Years 2 ,7x24PH UP	F2	\$205
S120-DR-2-PHZ2	SEL: T120 Drvs Years 2 ,7x24PH UP,Z2	F2	\$227
S120-DR-2-SBD	SEL: T120 DRVS YEARS 2 ;SBD	F2	\$1,792
S120-DR-2-SBDZ2	SEL: T120 Drvs Years 2,SBD,Z2	F2	\$1,972
S120-DV-1-4HR	SEL: T120 Drvs,Year 1,4HR	F2	\$1,496
S120-DV-1-4HRZ2	SEL: T120 Drvs,Year 1,4HR,Z2	F2	\$1,638
S120-DV-1-NBD	SEL: T120 Drvs Year 1,NBD	F2	\$1,067
S120-DV-1-NBDZ2	SEL: T120DrvsYear1,NBD,Z2	F2	\$1,177
S120-DV-1-PH	SEL: T120 Drvs Year 1,7x24PH UP	F2	\$214
S120-DV-1-PHZ2	SEL: T120DrvsYear 1,7x24PH UP,Z2	F2	\$236
S120-DV-1-SBD	SEL: T120 Drvs,Year 1,SBD	F2	\$1,315
S120-DV-1-SBDZ2	SEL: T120 Drvs,Year 1,SBD,Z2	F2	\$1,440
S120-DV-2-4HR	SEL: T120 Drvs Years 2+,4HR	F2	\$2,117
S120-DV-2-4HRZ2	SEL: T120DrvsYears2+,4HR,Z2	F2	\$2,322
S120-DV-2-NBD	SEL: T120 Drvs Years 2+,NBD	F2	\$1,423
S120-DV-2-NBDZ2	SEL: T120DrvsYears2+,NBD,Z2	F2	\$1,570
S120-DV-2-PH	SEL: T120 Drvs Years 2+,7x24PH UP	F2	\$214
S120-DV-2-PHZ2	SEL: T120DrvsYears2+,7x24PH UP,Z2	F2	\$236
S120-DV-2-SBD	SEL: T120 Drvs Years 2+,SBD	F2	\$1,854
S120-DV-2-SBDZ2	SEL: T120DrvsYears2+,SBD,Z2	F2	\$2,034
S120-RNW-100	SEL: 1 RENEWAL SUPPORT UNIT, T120	F2	\$118
S200-ASMB-1	SEL: T200 ASM BASIC YEAR 1	F2	\$10,888
S200-ASMB-1Z2	SEL: T200 ASM Basic Year 1,Z2	F2	\$11,984
S200-ASMB-2	SEL: T200 ASM BASIC YEAR 2	F2	\$4,354
S200-ASMB-2Z2	SEL: T200 ASM Basic Year 2 ,Z2	F2	\$4,795
S200-ASMG-1	SEL: T200 ASM GOLD YEAR 1	F2	\$24,503
S200-ASMG-1Z2	SEL: T200 ASM Gold Year 1,Z2	F2	\$26,953

S200-ASMG-2	SEL: T200 ASM GOLD YEAR 2	F2	\$9,802
S200-ASMG-2Z2	SEL: T200 ASM Gold Year 2 ,Z2	F2	\$10,792
S200-B-1-4HR	SEL: T200 BASE; YEAR 1; 4HR	F2	\$3,438
S200-B-1-4HRZ2	SEL: T200 Base, Year 1, 4HR,Z2	F2	\$3,782
S200-B-1-NBD	SEL: T200 BASE; YEAR 1; NBD	F2	\$0
S200-B-1-NBDZ2	SEL: T200 Base, Year 1, NBD,Z2	F2	\$0
S200-B-1-PH	SEL: T200 Base,Year 1,7x24PH UP	F2	\$485
S200-B-1-PHZ2	SEL: T200 Base,Year 1,7x24PH UP,Z2	F2	\$534
S200-B-1-SBD	SEL: T200 BASE; YEAR 1; SBD	F2	\$3,039
S200-B-1-SBDZ2	SEL: T200 Base, Year 1, SBD,Z2	F2	\$3,344
S200-B-2-4HR	SEL: T200 BASE; YEARS 2 4HR	F2	\$4,746
S200-B-2-4HRZ2	SEL: T200 Base, Years 2 4HR,Z2	F2	\$5,221
S200-B-2-NBD	SEL: T200 BASE;YEARS 2;NBD	F2	\$3,230
S200-B-2-NBDZ2	SEL: T200 Base,Years 2,NBD,Z2	F2	\$3,553
S200-B-2-PH	SEL: T200 Base,Years 2,7x24PH UP	F2	\$485
S200-B-2-PHZ2	SEL: T200 Base,Years 2,7x24PH UP,Z2	F2	\$534
S200-B-2-SBD	SEL: T200 BASE;YEARS 2;SBD	F2	\$4,183
S200-B-2-SBDZ2	SEL: T200 Base,Years 2,SBD,Z2	F2	\$4,606
S200-BA-1-NBD	SEL: T200 Base, Year 1, NBD	F2	\$2,423
S200-BA-1-NBDZ2	SEL: T200 Base, Year 1, NBD,Z2	F2	\$2,665
S200-BL-1-4HR	SEL: T200 BLSC Lic;10 SLTS;Y1;4HR	F2	\$71
S200-BL-1-4HRZ2	SEL: T200 BLSCLic,10 slts,Y1,4HR,Z2	F2	\$79
S200-BL-1-NBD	SEL: T200 BLSCLic,10 slts,Y1,NBD	F2	\$50
S200-BL-1-NBDZ2	SEL: T200 BLSCLic,10 slts,Y1,NBD,Z2	F2	\$58
S200-BL-1-PH	SEL: T200 BS,10 slts,Y1,7x24PH UP	F2	\$11
S200-BL-1-PHZ2	SEL: T200 BS,10 slts,Y1,7x24PH UP,Z2	F2	\$12
S200-BL-1-SBD	SEL: T200 BLSC Lic;10 SLTS;Y1;SBD	F2	\$62
S200-BL-1-SBDZ2	SEL: T200 BLSCLic,10 slts,Y1,SBD,Z2	F2	\$68
S200-BL-2-4HRSL	SEL: T200 BLSCLic,10 slts,Y2,4HR	F2	\$108
S200-BL-24HRZ2SL	SEL: T200 BLSC Lic;10 SLTS;Y2,4HR,Z2	F2	\$127
S200-BL-2-NBD	SEL: T200 BLSC Lic;10 SLTS;Y2;NBD	F2	\$67
S200-BL-2NBDZ2SL	SEL: T200 BLSCLic,10 slts,Y2,NBD,Z2	F2	\$77
S200-BL-2-PH	SEL: T200 BS,10 slts,Y2,7x24PH UP	F2	\$11
S200-BL-2-PHZ2	SEL: T200 BS,10 slts,Y2,7x24PH UP,Z2	F2	\$12
S200-BL-2-SBDSL	SEL: T200 BLSCLic,10 slts,Y2,SBD	F2	\$95
S200-BL-2SBDZ2SL	SEL: T200 BLSCLic,10 slts,Y2,SBD,Z2	F2	\$115
S200-CT-100	SEL: 1 COTERM SUPPORT UNIT T200	F2	\$100
S200-D8-1-4HR	SEL: T200 Drvs,Year 1,4HR	F2	\$1,924
S200-D8-1-4HRZ2	SEL: T200 Drvs,Year 1,4HR,Z2	F2	\$2,086
S200-D8-1-NBD	SEL: T200 Drvs Year 1,NBD	F2	\$1,388
S200-D8-1-NBDZ2	SEL: T200 Drvs Year 1,NBD,Z2	F2	\$1,512
S200-D8-1-PH	SEL: T200 Drvs Year 1,7x24PH UP	F2	\$278
S200-D8-1-PHZ2	SEL: T200 Drvs Year 1,7x24PH UP,Z2	F2	\$306
S200-D8-1-SBD	SEL: T200 Drvs,Year 1,SBD	F2	\$1,715
S200-D8-1-SBDZ2	SEL: T200 Drvs,Year 1,SBD,Z2	F2	\$1,857
S200-D8-2-4HR	SEL: T200 Drvs Years 2+,4HR	F2	\$2,635
S200-D8-2-4HRZ2	SEL: T200 Drvs Years 2+,4HR,Z2	F2	\$2,868
S200-D8-2-NBD	SEL: T200 Drvs Years 2+,NBD	F2	\$1,850
S200-D8-2-NBDZ2	SEL: T200 Drvs Years 2+,NBD,Z2	F2	\$2,016
S200-D8-2-PH	SEL: T200 Drvs Years 2+,7x24PH UP	F2	\$278

S200-D8-2-PHZ2	SEL: T200 Drvs Years 2+,7x24PH UP,Z2	F2	\$306
S200-D8-2-SBD	SEL: T200 Drvs Years 2+,SBD	F2	\$2,334
S200-D8-2-SBDZ2	SEL: T200 Drvs Years 2+,SBD,Z2	F2	\$2,545
S200-DR-1-4HR	SEL: T200 DRVS;YEAR 1;4HR	F2	\$1,621
S200-DR-1-4HRZ2	SEL: T200 Drvs,Year 1,4HR,Z2	F2	\$1,782
S200-DR-1-NBD	SEL: T200 Drvs Year 1,NBD	F2	\$1,148
S200-DR-1-NBDZ2	SEL: T200 Drvs Year 1,NBD,Z2	F2	\$1,272
S200-DR-1-PH	SEL: T200 Drvs Year 1,7x24PH UP	F2	\$230
S200-DR-1-PHZ2	SEL: T200 Drvs Year 1,7x24PH UP,Z2	F2	\$254
S200-DR-1-SBD	SEL: T200 DRVS;YEAR 1;SBD	F2	\$1,411
S200-DR-1-SBDZ2	SEL: T200 Drvs,Year 1,SBD,Z2	F2	\$1,552
S200-DR-2-4HR	SEL: T200 DRVS YEARS 2;4HR	F2	\$2,316
S200-DR-2-4HRZ2	SEL: T200 Drvs Years 2,4HR,Z2	F2	\$2,549
S200-DR-2-NBD	SEL: T200 DRVS YEARS 2;NBD	F2	\$1,531
S200-DR-2-NBDZ2	SEL: T200 Drvs Years 2,NBD,Z2	F2	\$1,696
S200-DR-2-PH	SEL: T200 Drvs Years 2,7x24PH UP	F2	\$230
S200-DR-2-PHZ2	SEL: T200 Drvs Years 2,7x24PH UP,Z2	F2	\$254
S200-DR-2-SBD	SEL: T200 DRVS YEARS 2;SBD	F2	\$2,015
S200-DR-2-SBDZ2	SEL: T200 Drvs Years 2,SBD,Z2	F2	\$2,222
S200-DV-1-4HR	SEL: T200 Drvs,Year 1,4HR	F2	\$1,724
S200-DV-1-4HRZ2	SEL: T200 Drvs,Year 1,4HR,Z2	F2	\$1,886
S200-DV-1-NBD	SEL: T200 Drvs Year 1,NBD	F2	\$1,226
S200-DV-1-NBDZ2	SEL: T200 Drvs Year 1,NBD,Z2	F2	\$1,350
S200-DV-1-PH	SEL: T200 Drvs Year 1,7x24PH UP	F2	\$246
S200-DV-1-PHZ2	SEL: T200 Drvs Year 1,7x24PH UP,Z2	F2	\$270
S200-DV-1-SBD	SEL: T200 Drvs,Year 1,SBD	F2	\$1,515
S200-DV-1-SBDZ2	SEL: T200 Drvs,Year 1,SBD,Z2	F2	\$1,657
S200-DV-2-4HR	SEL: T200 Drvs Years 2+,4HR	F2	\$2,419
S200-DV-2-4HRZ2	SEL: T200 Drvs Years 2+,4HR,Z2	F2	\$2,652
S200-DV-2-NBD	SEL: T200 Drvs Years 2+,NBD	F2	\$1,634
S200-DV-2-NBDZ2	SEL: T200 Drvs Years 2+,NBD,Z2	F2	\$1,800
S200-DV-2-PH	SEL: T200 Drvs Years 2+,7x24PH UP	F2	\$246
S200-DV-2-PHZ2	SEL: T200 Drvs Years 2+,7x24PH UP,Z2	F2	\$270
S200-DV-2-SBD	SEL: T200 Drvs Years 2+,SBD	F2	\$2,118
S200-DV-2-SBDZ2	SEL: T200 Drvs Years 2+,SBD,Z2	F2	\$2,329
S200-Q-1-4HR	SEL: T200 QIP;YEAR 1;4HR	F2	\$1,621
S200-Q-1-4HRZ2	SEL: T200 QIP,Year 1,4HR,Z2	F2	\$1,782
S200-Q-1-NBD	SEL: T200 QIP,Year 1,NBD	F2	\$1,148
S200-Q-1-NBDZ2	SEL: T200 QIP,Year 1,NBD,Z2	F2	\$1,272
S200-Q-1-PH	SEL: T200 QIP,Year 1,7x24PH UP	F2	\$230
S200-Q-1-PHZ2	SEL: T200 QIP,Year 1,7x24PH UP,Z2	F2	\$254
S200-Q-1-SBD	SEL: T200 QIP;YEAR 1;SBD	F2	\$1,411
S200-Q-1-SBDZ2	SEL: T200 QIP,Year 1,SBD,Z2	F2	\$1,552
S200-Q-2-4HR	SEL: T200 QIP;YEARS 2;4HR	F2	\$2,316
S200-Q-2-4HRZ2	SEL: T200 QIP,Years 2,4HR,Z2	F2	\$2,549
S200-Q-2-NBD	SEL: T200 QIP;YEARS 2;NBD	F2	\$1,531
S200-Q-2-NBDZ2	SEL: T200 QIP,Years 2,NBD,Z2	F2	\$1,696
S200-Q-2-PH	SEL: T200 QIP,Years 2,7x24PH UP	F2	\$230
S200-Q-2-PHZ2	SEL: T200 QIP,Years 2,7x24PH UP,Z2	F2	\$254
S200-Q-2-SBD	SEL: T200 QIP;YEARS 2;SBD	F2	\$2,015

S200-Q-2-SBDZ2	SEL: T200 QIP,Years 2,SBD,Z2	F2	\$2,222
S200-RNW-100	SEL: 1 RENEWAL SUPPORT UNIT, T200	F2	\$118
S380-ASMB-1	SEL: T380 ASM BASIC YEAR 1	F2	\$10,888
S380-ASMB-1Z2	SEL: T380 ASM Basic Year 1,Z2	F2	\$11,984
S380-ASMB-2	SEL: T380 ASM BASIC YEAR 2	F2	\$4,354
S380-ASMB-2Z2	SEL: T380 ASM Basic Year 2 ,Z2	F2	\$4,795
S380-ASMG-1	SEL: T380 ASM GOLD YEAR 1	F2	\$24,503
S380-ASMG-1Z2	SEL: T380 ASM Gold Year 1,Z2	F2	\$26,953
S380-ASMG-2	SEL: T380 ASM GOLD YEAR 2	F2	\$9,802
S380-ASMG-2Z2	SEL: T380 ASM Gold Year 2 ,Z2	F2	\$10,792
S380-B-1-4HR	SEL: T380 BASE; YEAR 1; 4HR	F2	\$4,923
S380-B-1-4HRZ2	SEL: T380 Base, Year 1, 4HR,Z2	F2	\$5,414
S380-B-1-NBD	SEL: T380 BASE; YEAR 1; NBD	F2	\$0
S380-B-1-NBDZ2	SEL: T380 Base, Year 1, NBD,Z2	F2	\$0
S380-B-1-PH	SEL: T380 Base,Year 1,7x24PH UP	F2	\$692
S380-B-1-PHZ2	SEL: T380 Base,Year 1,7x24PH UP,Z2	F2	\$762
S380-B-1-SBD	SEL: T380 BASE; YEAR 1; SBD	F2	\$4,346
S380-B-1-SBDZ2	SEL: T380 Base, Year 1, SBD,Z2	F2	\$4,781
S380-B-2-4HR	SEL: T380 BASE;YEARS 2;4HR	F2	\$6,797
S380-B-2-4HRZ2	SEL: T380 Base,Years 2,4HR,Z2	F2	\$7,477
S380-B-2-NBD	SEL: T380 BASE;YEARS 2;NBD	F2	\$4,615
S380-B-2-NBDZ2	SEL: T380 Base,Years 2,NBD,Z2	F2	\$5,077
S380-B-2-PH	SEL: T380 Base,Years 2,7x24PH UP	F2	\$692
S380-B-2-PHZ2	SEL: T380 Base,Years 2,7x24PH UP,Z2	F2	\$762
S380-B-2-SBD	SEL: T380 BASE;YEARS 2;SBD	F2	\$5,975
S380-B-2-SBDZ2	SEL: T380 Base,Years 2,SBD,Z2	F2	\$6,571
S380-BA-1-NBD	SEL: T380 Base, Year 1, NBD	F2	\$3,461
S380-BA-1-NBDZ2	SEL: T380 Base, Year 1, NBD,Z2	F2	\$3,808
S380-BL-1-4HR	SEL: T380 BLScLic;10 SLTS;Y1;4HR	F2	\$71
S380-BL-1-4HRZ2	SEL: T380 BLScLic,10 slts,Y1,4HR,Z2	F2	\$79
S380-BL-1-NBD	SEL: T380 BLScLic,10 slts,Y1,NBD	F2	\$50
S380-BL-1-NBDZ2	SEL: T380 BLScLic,10 slts,Y1,NBD,Z2	F2	\$58
S380-BL-1-PH	SEL: T380 BS,10 slts,Y1,7x24PH UP	F2	\$11
S380-BL-1-PHZ2	SEL: T380 BS,10 slts,Y1,7x24PH UP,Z2	F2	\$12
S380-BL-1-SBD	SEL: T380 BLScLic;10 SLTS;Y1;SBD	F2	\$62
S380-BL-1-SBDZ2	SEL: T380 BLScLic,10 slts,Y1,SBD,Z2	F2	\$68
S380-BL-2-4HRSL	SEL: T380 BLScLic,10 slts Y2,4HR	F2	\$108
S380-BL-2-4HRZ2	SEL: T380 BLScLic,10 slts Y2,4HR,Z2	F2	\$118
S380-BL-2-NBD	SEL: T380 BLScLic;10 SLTS;Y2;NBD	F2	\$67
S380-BL-2-NBDZ2	SEL: T380 BLScLic,10 slts,Y2,NBD,Z2	F2	\$77
S380-BL-2-PH	SEL: T380 BS,10 slts,Y2,7x24PH UP	F2	\$11
S380-BL-2-PHZ2	SEL: T380 BS,10 slts,Y2,7x24PH UP,Z2	F2	\$12
S380-BL-2-SBDSL	SEL: T380 BLScLic,10 slts,Y2,SBD	F2	\$95
S380-BL-2SBDZ2SL	SEL: T380 BLScLic,10 slts,Y2,SBD,Z2	F2	\$115
S380-CT-100	SEL: 1 COTERM SUPPORT UNIT T380	F2	\$100
S380-D8-1-4HR	SEL: T380 Drvs,Year 1,4HR	F2	\$1,928
S380-D8-1-4HRZ2	SEL: T380 Drvs,Year 1,4HR,Z2	F2	\$2,090
S380-D8-1-NBD	SEL: T380 Drvs Year 1,NBD	F2	\$1,388
S380-D8-1-NBDZ2	SEL: T380 Drvs Year 1,NBD,Z2	F2	\$1,512
S380-D8-1-PH	SEL: T380 Drvs Year 1,7x24PH UP	F2	\$278

S380-D8-1-PHZ2	SEL: T380 Drvs Year 1,7x24PH UP,Z2	F2	\$306
S380-D8-1-SBD	SEL: T380 Drvs,Year 1,SBD	F2	\$1,719
S380-D8-1-SBDZ2	SEL: T380 Drvs,Year 1,SBD,Z2	F2	\$1,861
S380-D8-2-4HR	SEL: T380 Drvs Years 2+,4HR	F2	\$2,635
S380-D8-2-4HRZ2	SEL: T380 Drvs Years 2+,4HR,Z2	F2	\$2,868
S380-D8-2-NBD	SEL: T380 Drvs Years 2+,NBD	F2	\$1,850
S380-D8-2-NBDZ2	SEL: T380 Drvs Years 2+,NBD,Z2	F2	\$2,016
S380-D8-2-PH	SEL: T380 Drvs Years 2+,7x24PH UP	F2	\$278
S380-D8-2-PHZ2	SEL: T380 Drvs Years 2+,7x24PH UP,Z2	F2	\$306
S380-D8-2-SBD	SEL: T380 Drvs Years 2+,SBD	F2	\$2,334
S380-D8-2-SBDZ2	SEL: T380 Drvs Years 2+,SBD,Z2	F2	\$2,543
S380-DR-1-4HR	SEL: T380 DRVS;YEAR 1,4HR	F2	\$1,621
S380-DR-1-4HRZ2	SEL: T380 Drvs,Year 1,4HR,Z2	F2	\$1,782
S380-DR-1-NBD	SEL: T380 Drvs Year 1,NBD	F2	\$1,148
S380-DR-1-NBDZ2	SEL: T380 Drvs Year 1,NBD,Z2	F2	\$1,272
S380-DR-1-PH	SEL: T380 Drvs Year 1,7x24PH UP	F2	\$230
S380-DR-1-PHZ2	SEL: T380 Drvs Year 1,7x24PH UP,Z2	F2	\$254
S380-DR-1-SBD	SEL: T380 DRVS;YEAR 1;SBD	F2	\$1,411
S380-DR-1-SBDZ2	SEL: T380 Drvs,Year 1,SBD,Z2	F2	\$1,552
S380-DR-2-4HR	SEL: T380 DRVS YEARS 2;4HR	F2	\$2,316
S380-DR-2-4HRZ2	SEL: T380 Drvs Years 2,4HR,Z2	F2	\$2,549
S380-DR-2-NBD	SEL: T380 DRVS YEARS 2;NBD	F2	\$1,531
S380-DR-2-NBDZ2	SEL: T380 Drvs Years 2,NBD,Z2	F2	\$1,696
S380-DR-2-PH	SEL: T380 Drvs Years 2,7x24PH UP	F2	\$230
S380-DR-2-PHZ2	SEL: T380 Drvs Years 2,7x24PH UP,Z2	F2	\$254
S380-DR-2-SBD	SEL: T380 DRVS YEARS 2;SBD	F2	\$2,015
S380-DR-2-SBDZ2	SEL: T380 Drvs Years 2,SBD,Z2	F2	\$2,222
S380-DV-1-4HR	SEL: T380 Drvs,Year 1,4HR	F2	\$1,724
S380-DV-1-4HRZ2	SEL: T380 Drvs,Year 1,4HR,Z2	F2	\$1,886
S380-DV-1-NBD	SEL: T380 Drvs Year 1,NBD	F2	\$1,226
S380-DV-1-NBDZ2	SEL: T380 Drvs Year 1,NBD,Z2	F2	\$1,350
S380-DV-1-PH	SEL: T380 Drvs Year 1,7x24PH UP	F2	\$246
S380-DV-1-PHZ2	SEL: T380 Drvs Year 1,7x24PH UP,Z2	F2	\$270
S380-DV-1-SBD	SEL: T380 Drvs,Year 1,SBD	F2	\$1,515
S380-DV-1-SBDZ2	SEL: T380 Drvs,Year 1,SBD,Z2	F2	\$1,657
S380-DV-2-4HR	SEL: T380 Drvs Years 2+,4HR	F2	\$2,419
S380-DV-2-4HRZ2	SEL: T380 Drvs Years 2+,4HR,Z2	F2	\$2,652
S380-DV-2-NBD	SEL: T380 Drvs Years 2+,NBD	F2	\$1,634
S380-DV-2-NBDZ2	SEL: T380 Drvs Years 2+,NBD,Z2	F2	\$1,800
S380-DV-2-PH	SEL: T380 Drvs Years 2+,7x24PH UP	F2	\$246
S380-DV-2-PHZ2	SEL: T380 Drvs Years 2+,7x24PH UP,Z2	F2	\$270
S380-DV-2-SBD	SEL: T380 Drvs Years 2+,SBD	F2	\$2,118
S380-DV-2-SBDZ2	SEL: T380 Drvs Years 2+,SBD,Z2	F2	\$2,327
S380-JASMB-1	SEL: T380-J ASM BASIC YEAR 1	F2	\$25,047
S380-JASMB-1Z2	SEL: T380-J ASM BASIC YEAR 1,Z2	F2	\$25,460
S380-JASMB-2	SEL: T380-J ASM BASIC YEAR 2	F2	\$10,020
S380-JASMB-2Z2	SEL: T380-J ASM BASIC YEAR 2 ,Z2	F2	\$11,023
S380-JASMG-1	SEL: T380-J ASM GOLD YEAR 1	F2	\$38,657
S380-JASMG-1Z2	SEL: T380-J ASM GOLD YEAR 1,Z2	F2	\$42,524
S380-JASMG-2	SEL: T380-J ASM GOLD YEAR 2	F2	\$15,466

S380-JASMG-2Z2	SEL: T380-J ASM GOLD YEAR 2 ,Z2	F2	\$17,015
S380-JDR-1-4HR	SEL: T380 ENT DRVS, YEAR 1,4HR	F2	\$3,373
S380-JDR-1-4HRZ2	SEL: T380 ENT DRVS, YEAR 1,4HR,Z2	F2	\$3,711
S380-JDR-1-NBD	SEL: T380 ENT DRVS Year 1,NBD	F2	\$2,814
S380-JDR-1-NBDZ2	SEL: T380 ENT DRVS Year 1,NBD,Z2	F2	\$3,097
S380-JDR-1-PH	SEL: T380 ENT DRVS Year 1,7x24PH UP	F2	\$564
S380-JDR-1-PHZ2	SEL: T380 ENT DRVS Year 1,7x24PH UP,Z2	F2	\$620
S380-JDR-1-SBD	SEL: T380 ENT DRVS, YEAR 1,SBD	F2	\$3,092
S380-JDR-1-SBDZ2	SEL: T380 ENT DRVS, YEAR 1,SBD,Z2	F2	\$3,401
S380-JDR-2-4HR	SEL: T380 ENT DRVS YEARS 2,4HR	F2	\$5,620
S380-JDR-2-4HRZ2	SEL: T380 ENT DRVS YEARS 2,4HR,Z2	F2	\$6,187
S380-JDR-2-NBD	SEL: T380 ENT DRVS YEARS 2,NBD	F2	\$3,752
S380-JDR-2-NBDZ2	SEL: T380 ENT DRVS YEARS 2,NBD,Z2	F2	\$4,129
S380-JDR-2-PH	SEL: T380 ENT DRVS YEARS 2,7x24PH UP	F2	\$564
S380-JDR-2-PHZ2	SEL: T380 ENT DRVS YEARS 2,7x24PH UP,Z2	F2	\$620
S380-JDR-2-SBD	SEL: T380 ENT DRVS YEARS 2,SBD	F2	\$5,150
S380-JDR-2-SBDZ2	SEL: T380 ENT DRVS YEARS 2,SBD,Z2	F2	\$5,672
S380-Q-1-4HR	SEL: T380 QIP;YEAR 1;4HR	F2	\$1,621
S380-Q-1-4HRZ2	SEL: T380 QIP,Year 1,4HR,Z2	F2	\$1,782
S380-Q-1-NBD	SEL: T380 QIP,Year 1 ,NBD	F2	\$1,148
S380-Q-1-NBDZ2	SEL: T380 QIP,Year 1 ,NBD,Z2	F2	\$1,272
S380-Q-1-PH	SEL: T380 QIP,Year 1 ,7x24PH UP	F2	\$230
S380-Q-1-PHZ2	SEL: T380 QIP,Year 1 ,7x24PH UP,Z2	F2	\$254
S380-Q-1-SBD	SEL: T380 QIP;YEAR 1;SBD	F2	\$1,411
S380-Q-1-SBDZ2	SEL: T380 QIP,Year 1,SBD,Z2	F2	\$1,552
S380-Q-2-4HR	SEL: T380 QIP;YEARS 2 4HR	F2	\$2,316
S380-Q-2-4HRZ2	SEL: T380 QIP,Years 2 4HR,Z2	F2	\$2,549
S380-Q-2-NBD	SEL: T380 QIP;YEARS 2 ;NBD	F2	\$1,531
S380-Q-2-NBDZ2	SEL: T380 QIP,Years 2 ,NBD,Z2	F2	\$1,696
S380-Q-2-PH	SEL: T380 QIP,Years 2 ,7x24PH UP	F2	\$230
S380-Q-2-PHZ2	SEL: T380 QIP,Years 2 ,7x24PH UP,Z2	F2	\$254
S380-Q-2-SBD	SEL: T380 QIP;YEARS 2;SBD	F2	\$2,015
S380-Q-2-SBDZ2	SEL: T380 QIP,Years 2,SBD,Z2	F2	\$2,222
S380-RNW-100	SEL: 1 RENEWAL SUPPORT UNIT, T380	F2	\$118
S50E-CT-50	SEL: 1 COTERM SUPPORT UNIT, T50e	F2	\$50
S50E-D-1-4HC	SEL: T50E,24HR ONSITE,1DR,UPG,1MT	F2	\$107
S50E-D-1-NBC	SEL: T50E,NBD ONSITE,1DR,UPG,1MT	F2	\$69
S50E-D-1-NRC	SEL: T50E,NBD REP,1DR,UPG,1MT	F2	\$39
S50E-D-1-SBC	SEL: T50E,SBD ONSITE,1DR,UPG,1MT	F2	\$85
S50E-RNW-50	SEL: 1 RENEWAL SUPPORT UNIT, T50e	F2	\$59
S680-ASMB-1	SEL: T680 ASM BASIC YEAR 1	F2	\$10,888
S680-ASMB-1Z2	SEL: T680 ASM Basic Year 1,Z2	F2	\$11,984
S680-ASMB-2	SEL: T680 ASM BASIC YEAR 2	F2	\$4,354
S680-ASMB-2Z2	SEL: T680 ASM Basic Year 2 ,Z2	F2	\$4,795
S680-ASMG-1	SEL: T680 ASM GOLD YEAR 1	F2	\$24,503
S680-ASMG-1Z2	SEL: T680 ASM Gold Year 1,Z2	F2	\$26,953
S680-ASMG-2	SEL: T680 ASM GOLD YEAR 2	F2	\$9,802
S680-ASMG-2Z2	SEL: T680 ASM Gold Year 2 ,Z2	F2	\$10,792
S680-B-1-4HR	SEL: T680 BASE; YEAR 1; 4HR	F2	\$6,402
S680-B-1-4HRZ2	SEL: T680 Base, Year 1, 4HR,Z2	F2	\$7,042

S680-B-1-NBD	SEL: T680 BASE; YEAR 1; NBD	F2	\$0
S680-B-1-NBDZ2	SEL: T680 Base, Year 1, NBD,Z2	F2	\$0
S680-B-1-PH	SEL: T680 Base,Year 1,7x24PH UP	F2	\$902
S680-B-1-PHZ2	SEL: T680 Base,Year 1,7x24PH UP,Z2	F2	\$995
S680-B-1-SBD	SEL: T680 BASE; YEAR 1; SBD	F2	\$5,653
S680-B-1-SBDZ2	SEL: T680 Base, Year 1, SBD,Z2	F2	\$6,219
S680-B-2-4HR	SEL: T680 BASE;YEARS 2,4HR	F2	\$8,834
S680-B-2-4HRZ2	SEL: T680 Base,Years 2,4HR,Z2	F2	\$9,725
S680-B-2-NBD	SEL: T680 BASE;YEARS 2;NBD	F2	\$6,013
S680-B-2-NBDZ2	SEL: T680 Base,Years 2,NBD,Z2	F2	\$6,626
S680-B-2-PH	SEL: T680 Base,Years 2,7x24PH UP	F2	\$902
S680-B-2-PHZ2	SEL: T680 Base,Years 2,7x24PH UP,Z2	F2	\$995
S680-B-2-SBD	SEL: T680 BASE;YEARS 2;SBD	F2	\$7,777
S680-B-2-SBDZ2	SEL: T680 Base,Years 2,SBD,Z2	F2	\$8,560
S680-BA-1-NBD	SEL: T680 Base, Year 1, NBD	F2	\$4,510
S680-BA-1-NBDZ2	SEL: T680 Base, Year 1, NBD,Z2	F2	\$4,970
S680-BL-1-4HR	SEL: T680 BLScLic;10 SLTS;Y1;4HR	F2	\$71
S680-BL-1-4HRZ2	SEL: T680 BLScLic,10 slts,Y1,4HR,Z2	F2	\$79
S680-BL-1-NBD	SEL: T680 BLScLic,10 slts,Y1,NBD	F2	\$50
S680-BL-1-NBDZ2	SEL: T680 BLScLic,10 slts,Y1,NBD,Z2	F2	\$58
S680-BL-1-PH	SEL: T680 BS,10 slts,Y1,7x24PH UP	F2	\$11
S680-BL-1-PHZ2	SEL: T680 BS,10 slts,Y1,7x24PH UP,Z2	F2	\$12
S680-BL-1-SBD	SEL: T680 BLScLic;10 SLTS;Y1;SBD	F2	\$62
S680-BL-1-SBDZ2	SEL: T680 BLScLic,10 slts,Y1,SBD,Z2	F2	\$68
S680-BL-2-4HRSL	SEL: T680 BLScLic,10 slts,Y2,4HR	F2	\$108
S680-BL-24HRZ2SL	SEL: T680 BLScLic,10 slts,Y2,4HR,Z2	F2	\$127
S680-BL-2-NBD	SEL: T680 BLScLic;10 SLTS;Y2;NBD	F2	\$67
S680-BL-2NBDZ2SL	SEL: T680 BLScLic,10 slts,Y2,NBD,Z2	F2	\$77
S680-BL-2-PH	SEL: T680 BS,10 slts,Y2,7x24PH UP	F2	\$11
S680-BL-2-PHZ2	SEL: T680 BS,10 slts,Y2,7x24PH UP,Z2	F2	\$12
S680-BL-2-SBD	SEL: T680 BLScLic,10 slts,Y2,SBD	F2	\$95
S680-BL-2SBDZ2SL	SEL: T680 BLScLic,10 slts,Y2,SBD,Z2	F2	\$115
S680-CT-100	SEL: 1 COTERM SUPPORT UNIT T680	F2	\$100
S680-D8-1-4HR	SEL: T680 Drvs Year 1,4HR	F2	\$1,928
S680-D8-1-4HRZ2	SEL: T680 Drvs Year 1,4HR,Z2	F2	\$2,090
S680-D8-1-NBD	SEL: T680 Drvs Year 1,NBD	F2	\$1,388
S680-D8-1-NBDZ2	SEL: T680 Drvs Year 1,NBD,Z2	F2	\$1,512
S680-D8-1-PH	SEL: T680 Drvs Year 1,7x24PH UP	F2	\$278
S680-D8-1-PHZ2	SEL: T680 Drvs Year 1,7x24PH UP,Z2	F2	\$306
S680-D8-1-SBD	SEL: T680 Drvs,Year 1,SBD	F2	\$1,719
S680-D8-1-SBDZ2	SEL: T680 Drvs,Year 1,SBD,Z2	F2	\$1,861
S680-D8-2-4HR	SEL: T680 Drvs Years 2+,4HR	F2	\$2,635
S680-D8-2-4HRZ2	SEL: T680 Drvs Years 2+,4HR,Z2	F2	\$2,868
S680-D8-2-NBD	SEL: T680 Drvs Years 2+,NBD	F2	\$1,850
S680-D8-2-NBDZ2	SEL: T680 Drvs Years 2+,NBD,Z2	F2	\$2,016
S680-D8-2-PH	SEL: T680 Drvs Years 2+,7x24PH UP	F2	\$278
S680-D8-2-PHZ2	SEL: T680 Drvs Years 2+,7x24PH UP,Z2	F2	\$306
S680-D8-2-SBD	SEL: T680 Drvs Years 2+,SBD	F2	\$2,334
S680-D8-2-SBDZ2	SEL: T680 Drvs Years 2+,SBD,Z2	F2	\$2,543
S680-DR-1-4HR	SEL: T680 DRVS YEAR 1;4HR	F2	\$1,621

S680-DR-1-4HRZ2	SEL: T680 Drvs Year 1,4HR,Z2	F2	\$1,782
S680-DR-1-NBD	SEL: T680 Drvs Year 1,NBD	F2	\$1,148
S680-DR-1-NBDZ2	SEL: T680 Drvs Year 1,NBD,Z2	F2	\$1,272
S680-DR-1-PH	SEL: T680 Drvs Year 1,7x24PH UP	F2	\$230
S680-DR-1-PHZ2	SEL: T680 Drvs Year 1,7x24PH UP,Z2	F2	\$254
S680-DR-1-SBD	SEL: T680 DRVS;YEAR 1;SBD	F2	\$1,411
S680-DR-1-SBDZ2	SEL: T680 Drvs,Year 1,SBD,Z2	F2	\$1,552
S680-DR-2-4HR	SEL: T680 DRVS YEARS 2;4HR	F2	\$2,316
S680-DR-2-4HRZ2	SEL: T680 Drvs Years 2,4HR,Z2	F2	\$2,549
S680-DR-2-NBD	SEL: T680 DRVS YEARS 2;NBD	F2	\$1,531
S680-DR-2-NBDZ2	SEL: T680 Drvs Years 2,NBD,Z2	F2	\$1,696
S680-DR-2-PH	SEL: T680 Drvs Years 2,7x24PH UP	F2	\$230
S680-DR-2-PHZ2	SEL: T680 Drvs Years 2,7x24PH UP,Z2	F2	\$254
S680-DR-2-SBD	SEL: T680 DRVS YEARS 2;SBD	F2	\$2,015
S680-DR-2-SBDZ2	SEL: T680 Drvs Years 2,SBD,Z2	F2	\$2,222
S680-DV-1-4HR	SEL: T680 Drvs Year 1,4HR	F2	\$1,724
S680-DV-1-4HRZ2	SEL: T680 Drvs Year 1,4HR,Z2	F2	\$1,886
S680-DV-1-NBD	SEL: T680 Drvs Year 1,NBD	F2	\$1,226
S680-DV-1-NBDZ2	SEL: T680 Drvs Year 1,NBD,Z2	F2	\$1,350
S680-DV-1-PH	SEL: T680 Drvs Year 1,7x24PH UP	F2	\$246
S680-DV-1-PHZ2	SEL: T680 Drvs Year 1,7x24PH UP,Z2	F2	\$270
S680-DV-1-SBD	SEL: T680 Drvs,Year 1,SBD	F2	\$1,515
S680-DV-1-SBDZ2	SEL: T680 Drvs,Year 1,SBD,Z2	F2	\$1,657
S680-DV-2-4HR	SEL: T680 Drvs Years 2+,4HR	F2	\$2,419
S680-DV-2-4HRZ2	SEL: T680 Drvs Years 2+,4HR,Z2	F2	\$2,652
S680-DV-2-NBD	SEL: T680 Drvs Years 2+,NBD	F2	\$1,634
S680-DV-2-NBDZ2	SEL: T680 Drvs Years 2+,NBD,Z2	F2	\$1,800
S680-DV-2-PH	SEL: T680 Drvs Years 2+,7x24PH UP	F2	\$246
S680-DV-2-PHZ2	SEL: T680 Drvs Years 2+,7x24PH UP,Z2	F2	\$270
S680-DV-2-SBD	SEL: T680 Drvs Years 2+,SBD	F2	\$2,118
S680-DV-2-SBDZ2	SEL: T680 Drvs Years 2+,SBD,Z2	F2	\$2,327
S680-Q-1-4HR	SEL: T680 QIP;YEAR 1;4HR	F2	\$1,621
S680-Q-1-4HRZ2	SEL: T680 QIP,Year 1,4HR,Z2	F2	\$1,782
S680-Q-1-NBD	SEL: T680 QIP,Year 1,NBD	F2	\$1,148
S680-Q-1-NBDZ2	SEL: T680 QIP,Year 1,NBD,Z2	F2	\$1,272
S680-Q-1-PH	SEL: T680 QIP,Year 1,7x24PH UP	F2	\$230
S680-Q-1-PHZ2	SEL: T680 QIP,Year 1,7x24PH UP,Z2	F2	\$254
S680-Q-1-SBD	SEL: T680 QIP;YEAR 1;SBD	F2	\$1,411
S680-Q-1-SBDZ2	SEL: T680 QIP,Year 1,SBD,Z2	F2	\$1,552
S680-Q-2-4HR	SEL: T680 QIP;YEARS 2;4HR	F2	\$2,316
S680-Q-2-4HRZ2	SEL: T680 QIP,Years 2,4HR,Z2	F2	\$2,549
S680-Q-2-NBD	SEL: T680 QIP;YEARS 2;NBD	F2	\$1,531
S680-Q-2-NBDZ2	SEL: T680 QIP,Years 2,NBD,Z2	F2	\$1,696
S680-Q-2-PH	SEL: T680 QIP,Years 2,7x24PH UP	F2	\$230
S680-Q-2-PHZ2	SEL: T680 QIP,Years 2,7x24PH UP,Z2	F2	\$254
S680-Q-2-SBD	SEL: T680 QIP;YEARS 2;SBD	F2	\$2,015
S680-Q-2-SBDZ2	SEL: T680 QIP,Years 2,SBD,Z2	F2	\$2,222
S680-RNW-100	SEL: 1 RENEWAL SUPPORT UNIT, T680	F2	\$118
S950-ASMB-1	SEL: T950 ASM BASIC YEAR 1	F2	\$10,888
S950-ASMB-1Z2	SEL: T950 ASM Basic Year 1,Z2	F2	\$11,984

S950-ASMB-2	SEL: T950 ASM BASIC YEAR 2	F2	\$4,354
S950-ASMB-2Z2	SEL: T950 ASM Basic Year 2 ,Z2	F2	\$4,795
S950-ASMG-1	SEL: T950 ASM GOLD YEAR 1	F2	\$24,503
S950-ASMG-1Z2	SEL: T950 ASM Gold Year 1,Z2	F2	\$26,953
S950-ASMG-2	SEL: T950 ASM GOLD YEAR 2	F2	\$9,802
S950-ASMG-2Z2	SEL: T950 ASM Gold Year 2 ,Z2	F2	\$10,792
S950-B-1-4HR	SEL: T950 BASE; YEAR 1; 4HR	F2	\$7,393
S950-B-1-4HRZ2	SEL: T950 Base, Year 1, 4HR,Z2	F2	\$8,131
S950-B-1-NBD	SEL: T950 BASE; YEAR 1; NBD	F2	\$0
S950-B-1-NBDZ2	SEL: T950 Base, Year 1, NBD,Z2	F2	\$0
S950-B-1-PH	SEL: T950 Base,Year 1,7x24PH UP	F2	\$1,042
S950-B-1-PHZ2	SEL: T950 Base,Year 1,7x24PH UP,Z2	F2	\$1,147
S950-B-1-SBD	SEL: T950 BASE; YEAR 1; SBD	F2	\$6,535
S950-B-1-SBDZ2	SEL: T950 Base, Year 1, SBD,Z2	F2	\$7,189
S950-B-2-4HR	SEL: T950 BASE;YEARS 2 4HR	F2	\$10,207
S950-B-2-4HRZ2	SEL: T950 Base,Years 2 4HR,Z2	F2	\$11,232
S950-B-2-NBD	SEL: T950 BASE;YEARS 2;NBD	F2	\$6,941
S950-B-2-NBDZ2	SEL: T950 Base,Years 2,NBD,Z2	F2	\$7,643
S950-B-2-PH	SEL: T950 Base,Years 2,7x24PH UP	F2	\$1,042
S950-B-2-PHZ2	SEL: T950 Base,Years 2,7x24PH UP,Z2	F2	\$1,147
S950-B-2-SBD	SEL: T950 BASE;YEARS 2;SBD	F2	\$8,992
S950-B-2-SBDZ2	SEL: T950 Base,Years 2,SBD,Z2	F2	\$9,902
S950-BA-1-NBD	SEL: T950 Base, Year 1, NBD	F2	\$5,206
S950-BA-1-NBDZ2	SEL: T950 Base, Year 1, NBD,Z2	F2	\$5,732
S950-BL-1-4HR	SEL: T950 BLScLic;100 SLTS;1;4HR	F2	\$703
S950-BL-1-4HRZ2	SEL: T950 BLScLic,100 slts,1,4HR,Z2	F2	\$773
S950-BL-1-NBD	SEL: T950 BLScLic,100 slts,Y1,NBD	F2	\$491
S950-BL-1-NBDZ2	SEL: T950 BLScLic,100 slts,Y1,NBD,Z2	F2	\$547
S950-BL-1-PH	SEL: T950 BS,100 slts,Y1,7x24PH UP	F2	\$98
S950-BL-1-PHZ2	SEL: T950 BS,100 slts,Y1,7x24PH UP,Z2	F2	\$110
S950-BL-1-SBD	SEL: T950 BLScLic;100 SLTS;Y1 SBD	F2	\$611
S950-BL-1-SBDZ2	SEL: T950 BLScLic,100 slts,Y1 SBD,Z2	F2	\$673
S950-BL-2-4HR	SEL: T950 BLScLic;100 SLTS Y2;4HR	F2	\$1,009
S950-BL-2-4HRZ2	SEL: T950 BLScLic,100 slts Y2,4HR,Z2	F2	\$1,118
S950-BL-2-NBD	SEL: T950 BLScLic;100 SLTS;Y2;NBD	F2	\$655
S950-BL-2-NBDZ2	SEL: T950 BLScLic,100 slts,Y2,NBD,Z2	F2	\$730
S950-BL-2-PH	SEL: T950 BS,100 slts,Y2,7x24PH UP	F2	\$98
S950-BL-2-PHZ2	SEL: T950 BS,100 slts,Y2,7x24PH UP,Z2	F2	\$110
S950-BL-2-SBD	SEL: T950 BLScLic;100 SLTS;Y2;SBD	F2	\$878
S950-BL-2-SBDZ2	SEL: T950 BLScLic,100 slts,Y2,SBD,Z2	F2	\$967
S950-CT-100	SEL: 1 COTERM SUPPORT UNIT T950	F2	\$100
S950-D8-1-4HR	SEL: T950 Drvs, Year 1,4HR	F2	\$1,928
S950-D8-1-4HRZ2	SEL: T950 Drvs, Year 1,4HR,Z2	F2	\$2,090
S950-D8-1-NBD	SEL: T950 Drvs Year 1,NBD	F2	\$1,388
S950-D8-1-NBDZ2	SEL: T950 Drvs Year 1,NBD,Z2	F2	\$1,350
S950-D8-1-PH	SEL: T950 Drvs Year 1,7x24PH UP	F2	\$278
S950-D8-1-PHZ2	SEL: T950 Drvs Year 1,7x24PH UP,Z2	F2	\$306
S950-D8-1-SBD	SEL: T950 Drvs,Year 1,SBD	F2	\$1,719
S950-D8-1-SBDZ2	SEL: T950 Drvs,Year 1,SBD,Z2	F2	\$1,861
S950-D8-2-4HR	SEL: T950 Drvs Years 2+,4HR	F2	\$2,635

S950-D8-2-4HRZ2	SEL: T950 Drvs Years 2+,4HR,Z2	F2	\$2,868
S950-D8-2-NBD	SEL: T950 Drvs Years 2+,NBD	F2	\$1,850
S950-D8-2-NBDZ2	SEL: T950 Drvs Years 2+,NBD,Z2	F2	\$2,016
S950-D8-2-PH	SEL: T950 Drvs Years 2+,7x24PH UP	F2	\$278
S950-D8-2-PHZ2	SEL: T950 Drvs Years 2+,7x24PH UP,Z2	F2	\$306
S950-D8-2-SBD	SEL: T950 Drvs Years 2+,SBD	F2	\$2,334
S950-D8-2-SBDZ2	SEL: T950 Drvs Years 2+,SBD,Z2	F2	\$2,543
S950-DR-1-4HR	SEL: T950 DRVS; YEAR 1;4HR	F2	\$1,621
S950-DR-1-4HRZ2	SEL: T950 Drvs, Year 1,4HR,Z2	F2	\$1,782
S950-DR-1-NBD	SEL: T950 Drvs Year 1,NBD	F2	\$1,148
S950-DR-1-NBDZ2	SEL: T950 Drvs Year 1,NBD,Z2	F2	\$1,272
S950-DR-1-PH	SEL: T950 Drvs Year 1,7x24PH UP	F2	\$230
S950-DR-1-PHZ2	SEL: T950 Drvs Year 1,7x24PH UP,Z2	F2	\$254
S950-DR-1-SBD	SEL: T950 DRVS;YEAR 1;SBD	F2	\$1,411
S950-DR-1-SBDZ2	SEL: T950 Drvs,Year 1,SBD,Z2	F2	\$1,552
S950-DR-2-4HR	SEL: T950 DRVS YEARS 2;4HR	F2	\$2,316
S950-DR-2-4HRZ2	SEL: T950 Drvs Years 2,4HR,Z2	F2	\$2,549
S950-DR-2-NBD	SEL: T950 DRVS YEARS 2;NBD	F2	\$1,531
S950-DR-2-NBDZ2	SEL: T950 Drvs Years 2,NBD,Z2	F2	\$1,696
S950-DR-2-PH	SEL: T950 Drvs Years 2,7x24PH UP	F2	\$230
S950-DR-2-PHZ2	SEL: T950 Drvs Years 2,7x24PH UP,Z2	F2	\$254
S950-DR-2-SBD	SEL: T950 DRVS YEARS 2;SBD	F2	\$2,015
S950-DR-2-SBDZ2	SEL: T950 Drvs Years 2,SBD,Z2	F2	\$2,222
S950-DV-1-4HR	SEL: T950 Drvs, Year 1,4HR	F2	\$1,724
S950-DV-1-4HRZ2	SEL: T950 Drvs, Year 1,4HR,Z2	F2	\$1,886
S950-DV-1-NBD	SEL: T950 Drvs Year 1,NBD	F2	\$1,226
S950-DV-1-NBDZ2	SEL: T950 Drvs Year 1,NBD,Z2	F2	\$1,350
S950-DV-1-PH	SEL: T950 Drvs Year 1,7x24PH UP	F2	\$246
S950-DV-1-PHZ2	SEL: T950 Drvs Year 1,7x24PH UP,Z2	F2	\$270
S950-DV-1-SBD	SEL: T950 Drvs,Year 1,SBD	F2	\$1,515
S950-DV-1-SBDZ2	SEL: T950 Drvs,Year 1,SBD,Z2	F2	\$1,657
S950-DV-2-4HR	SEL: T950 Drvs Years 2+,4HR	F2	\$2,419
S950-DV-2-4HRZ2	SEL: T950 Drvs Years 2+,4HR,Z2	F2	\$2,652
S950-DV-2-NBD	SEL: T950 Drvs Years 2+,NBD	F2	\$1,634
S950-DV-2-NBDZ2	SEL: T950 Drvs Years 2+,NBD,Z2	F2	\$1,800
S950-DV-2-PH	SEL: T950 Drvs Years 2+,7x24PH UP	F2	\$246
S950-DV-2-PHZ2	SEL: T950 Drvs Years 2+,7x24PH UP,Z2	F2	\$270
S950-DV-2-SBD	SEL: T950 Drvs Years 2+,SBD	F2	\$2,118
S950-DV-2-SBDZ2	SEL: T950 Drvs Years 2+,SBD,Z2	F2	\$2,327
S950-DX-1-4HRSL	SEL: T950 DEX (ea),Year 1,4HR	F2	\$1,632
S950-DX-14HRZ2SL	SEL: T950 DEX (ea),Year 1,4HR,Z2	F2	\$1,800
S950-DX-1-NBD	SEL: T950 DEX (ea),Year 1,NBD	F2	\$1,226
S950-DX-1-NBDZ2	SEL: T950 DEX (ea),Year 1,NBD,Z2	F2	\$1,357
S950-DX-1-PH	SEL: T950 DEX (ea),Year 1,7x24PH UP	F2	\$246
S950-DX-1-PHZ2	SEL: T950 DEX (ea),Year 1,7x24PH UP,Z2	F2	\$272
S950-DX-1-SBDSL	SEL: T950 DEX (ea),Year 1,SBD	F2	\$1,311
S950-DX-1SBDZ2SL	SEL: T950 DEX (ea),Year 1,SBD,Z2	F2	\$1,446
S950-DX-2-4HR	SEL: T950 DEX (EA);YEARS 2;4HR	F2	\$2,722
S950-DX-2-4HRZ2	SEL: T950 DEX (ea),Years 2,4HR,Z2	F2	\$3,001
S950-DX-2-NBD	SEL: T950 DEX (EA);YEARS 2;NBD	F2	\$1,634

S950-DX-2-NBDZ2	SEL: T950 DEX (ea),Years 2,NBD,Z2	F2	\$1,810
S950-DX-2-PH	SEL: T950 DEX (ea),Years 2,7x24PH UP	F2	\$246
S950-DX-2-PHZ2	SEL: T950 DEX (ea),Years 2,7x24PH UP,Z2	F2	\$272
S950-DX-2-SBD	SEL: T950 DEX (EA);YEARS 2;SBD	F2	\$2,184
S950-DX-2-SBDZ2	SEL: T950 DEX (ea),Years 2,SBD,Z2	F2	\$2,411
S950-JASMB-1	SEL: T950-J ASM BASIC YEAR 1	F2	\$25,048
S950-JASMB-1Z2	SEL: T950-J ASM BASIC YEAR 1,Z2	F2	\$25,460
S950-JASMB-2	SEL: T950-J ASM BASIC YEAR 2	F2	\$10,020
S950-JASMB-2Z2	SEL: T950-J ASM BASIC YEAR 2 ,Z2	F2	\$11,023
S950-JASMG-1	SEL: T950-J ASM GOLD YEAR 1	F2	\$38,658
S950-JASMG-1Z2	SEL: T950-J ASM GOLD YEAR 1,Z2	F2	\$42,524
S950-JASMG-2	SEL: T950-J ASM GOLD YEAR 2	F2	\$15,466
S950-JASMG-2Z2	SEL: T950-J ASM GOLD YEAR 2 ,Z2	F2	\$17,015
S950JDR-1-4HR	SEL: T950 ENT DRVS,YEAR 1,4HR	F2	\$3,373
S950-JDR-1-4HRZ2	SEL: T950 ENT DRVS,YEAR 1,4HR,Z2	F2	\$3,711
S950-JDR-1-NBD	SEL: T950 ENT DRVS Year 1,NBD	F2	\$2,814
S950-JDR-1-NBDZ2	SEL: T950 ENT DRVS Year 1,NBD,Z2	F2	\$3,097
S950-JDR-1-PH	SEL: T950 ENT DRVS Year 1,7x24PH UP	F2	\$564
S950-JDR-1-PHZ2	SEL: T950 ENT DRVS Year 1,7x24PH UP,Z2	F2	\$620
S950JDR-1-SBD	SEL: T950 ENT DRVS,YEAR 1,SBD	F2	\$3,092
S950-JDR-1-SBDZ2	SEL: T950 ENT DRVS,YEAR 1,SBD,Z2	F2	\$3,401
S950JDR-2-4HR	SEL: T950 ENT DRVS YEARS 2,4HR	F2	\$5,620
S950-JDR-2-4HRZ2	SEL: T950 ENT DRVS YEARS 2,4HR,Z2	F2	\$6,187
S950JDR-2-NBD	SEL: T950 ENT DRVS YEARS 2,NBD	F2	\$3,752
S950-JDR-2-NBDZ2	SEL: T950 ENT DRVS YEARS 2,NBD,Z2	F2	\$4,129
S950-JDR-2-PH	SEL: T950 ENT DRVS YEARS 2,7x24PH UP	F2	\$564
S950-JDR-2-PHZ2	SEL: T950 ENT DRVS YEARS 2,7x24PH UP,Z2	F2	\$620
S950JDR-2-SBD	SEL: T950 ENT DRVS YEARS 2,SBD	F2	\$5,150
S950-JDR-2-SBDZ2	SEL: T950 ENT DRVS YEARS 2,SBD,Z2	F2	\$5,672
S950-Q-1-4HR	SEL: T950 QIP;YEAR 1;4HR	F2	\$1,621
S950-Q-1-4HRZ2	SEL: T950 QIP,Year 1,4HR,Z2	F2	\$1,782
S950-Q-1-NBD	SEL: T950 QIP,Year 1,NBD	F2	\$1,148
S950-Q-1-NBDZ2	SEL: T950 QIP,Year 1,NBD,Z2	F2	\$1,272
S950-Q-1-PH	SEL: T950 QIP,Year 1,7x24PH UP	F2	\$230
S950-Q-1-PHZ2	SEL: T950 QIP,Year 1,7x24PH UP,Z2	F2	\$254
S950-Q-1-SBD	SEL: T950 QIP;YEAR 1;SBD	F2	\$1,411
S950-Q-1-SBDZ2	SEL: T950 QIP,Year 1,SBD,Z2	F2	\$1,552
S950-Q-2-4HR	SEL: T950 QIP;YEARS 2;4HR	F2	\$2,316
S950-Q-2-4HRZ2	SEL: T950 QIP,Years 2,4HR,Z2	F2	\$2,549
S950-Q-2-NBD	SEL: T950 QIP;YEARS 2;NBD	F2	\$1,531
S950-Q-2-NBDZ2	SEL: T950 QIP,Years 2,NBD,Z2	F2	\$1,696
S950-Q-2-PH	SEL: T950 QIP,Years 2,7x24PH UP	F2	\$230
S950-Q-2-PHZ2	SEL: T950 QIP,Years 2,7x24PH UP,Z2	F2	\$254
S950-Q-2-SBD	SEL: T950 QIP;YEARS 2;SBD	F2	\$2,015
S950-Q-2-SBDZ2	SEL: T950 QIP,Years 2,SBD,Z2	F2	\$2,222
S950-RNW-100	SEL: 1 RENEWAL SUPPORT UNIT, T950	F2	\$118
S950TAP-1-4HR	SEL: T950;BULK;TAP;SVC;YEAR 1;4HR	F2	\$4,517
S950-TAP-1-4HRZ2	SEL: T950;BULK;TAP;SVC;YEAR 1,4HR,Z2	F2	\$4,968
S950TAP-1-SBD	SEL: T950;BULK;TAP;SVC;YEAR 1;SBD	F2	\$3,765
S950-TAP-1-SBDZ2	SEL: T950;BULK;TAP;SVC;YEAR 1,SBD,Z2	F2	\$4,141

S950TAP-2-4HR	SEL: T950;BULK;TAP;SVC;YEAR 2;4HR	F2	\$6,274
S950-TAP-2-4HRZ2	SEL: T950,BULK,TAP,SVC,YEAR 2,4HR,Z2	F2	\$6,901
S950TAP-2-NBD	SEL: T950;BULK;TAP;SVC;YEAR 2;NBD	F2	\$4,236
S950-TAP-2-NBDZ2	SEL: T950,BULK,TAP,SVC,YEAR 2,NBD,Z2	F2	\$4,669
S950TAP-2-SBD	SEL: T950;BULK;TAP;SVC;YEAR 2;SBD	F2	\$5,230
S950-TAP-2-SBDZ2	SEL: T950,BULK,TAP,SVC,YEAR 2,SBD,Z2	F2	\$5,761
SA-458-000-026	ECS DCS U SERIES D DC GROUP 1 1YR=MA	F2	\$73,020
SA-458-000-027	ECS DCS U SERIES D DC GROUP 2 1YR=MA	F2	\$72,660
SA-458-000-028	ECS DCS U SERIES D DC GROUP 3 1YR=MA	F2	\$37,090
SA-458-000-029	ECS DCS U SERIES D DC GROUP 4 1YR=MA	F2	\$64,630
SA-458-000-030	ECS DCS D SERIES D DC GROUP 1 1YR=MA	F2	\$101,170
SA-458-000-031	ECS DCS D SERIES D DC GROUP 2 1YR=MA	F2	\$101,740
SA-458-000-032	ECS DCS D SERIES D DC GROUP 3 1YR=MA	F2	\$50,720
SA-458-000-033	ECS DCS D SERIES D DC GROUP 4 1YR=MA	F2	\$91,490
SA-458-000-034	ECS DCS U SERIES D DC GROUP 1 3YR=MA	F2	\$219,070
SA-458-000-035	ECS DCS U SERIES D DC GROUP 2 3YR=MA	F2	\$217,970
SA-458-000-036	ECS DCS U SERIES D DC GROUP 3 3YR=MA	F2	\$111,260
SA-458-000-037	ECS DCS U SERIES D DC GROUP 4 3YR=MA	F2	\$193,890
SA-458-000-038	ECS DCS D SERIES D DC GROUP 1 3YR=MA	F2	\$303,500
SA-458-000-039	ECS DCS D SERIES D DC GROUP 2 3YR=MA	F2	\$305,230
SA-458-000-040	ECS DCS D SERIES D DC GROUP 3 3YR=MA	F2	\$152,150
SA-458-000-041	ECS DCS D SERIES D DC GROUP 4 3YR=MA	F2	\$274,470
SA-458-000-042	Bandwidth Overage For DC SUB=MA	F2	\$0
SA-458-000-043	Bandwidth For DC SUB=MA	F2	\$0
SA-458-000-044	ECS DCS IMPL INSTALL A=MA	F2	\$13,330
SA-458-000-083	ECS DCS U Series I DC Group 1 1YR=MA	F2	\$84,870
SA-458-000-084	ECS DCS U Series I DC Group 2 1YR=MA	F2	\$84,510
SA-458-000-085	ECS DCS U Series I DC Group 3 1YR=MA	F2	\$48,940
SA-458-000-086	ECS DCS U Series I DC Group 4 1YR=MA	F2	\$76,480
SA-458-000-087	ECS DCS D Series I DC Group 1 1YR=MA	F2	\$113,020
SA-458-000-088	ECS DCS D Series I DC Group 2 1YR=MA	F2	\$113,590
SA-458-000-089	ECS DCS D Series I DC Group 3 1YR=MA	F2	\$62,570
SA-458-000-090	ECS DCS D Series I DC Group 4 1YR=MA	F2	\$103,340
SA-458-000-091	ECS DCS U Series I DC Group 1 3YR=MA	F2	\$254,640
SA-458-000-092	ECS DCS U Series I DC Group 2 3YR=MA	F2	\$253,540
SA-458-000-093	ECS DCS U Series I DC Group 3 3YR=MA	F2	\$146,830
SA-458-000-094	ECS DCS U Series I DC Group 4 3YR=MA	F2	\$229,460
SA-458-000-095	ECS DCS D Series I DC Group 1 3YR=MA	F2	\$339,070
SA-458-000-096	ECS DCS D Series I DC Group 2 3YR=MA	F2	\$340,800
SA-458-000-097	ECS DCS D Series I DC Group 3 3YR=MA	F2	\$187,720
SA-458-000-098	ECS DCS D Series I DC Group 4 3YR=MA	F2	\$310,040
SA-458-000-099	ECS DS U SERIES T2 D DC GROUP 1 1YR=MA	F2	\$81,940
SA-458-000-100	ECS DS U SERIES T2 D DC GROUP 2 1YR=MA	F2	\$81,870
SA-458-000-101	ECS DS U SERIES T2 D DC GROUP 3 1YR=MA	F2	\$41,410
SA-458-000-102	ECS DS U SERIES T2 D DC GROUP 4 1YR=MA	F2	\$73,130
SA-458-000-103	ECS DS U SERIES T2 D DC GROUP 1 3YR=MA	F2	\$245,820
SA-458-000-104	ECS DS U SERIES T2 D DC GROUP 2 3YR=MA	F2	\$245,600
SA-458-000-105	ECS DS U SERIES T2 D DC GROUP 3 3YR=MA	F2	\$124,220
SA-458-000-106	ECS DS U SERIES T2 D DC GROUP 4 3YR=MA	F2	\$219,400
SA-458-000-107	ECS DS U SERIES T2 I DC GROUP 1 1YR=MA	F2	\$93,790

SA-458-000-108	ECS DS U SERIES T2 DC GROUP 2 1YR=MA	F2	\$93,720
SA-458-000-109	ECS DS U SERIES T2 DC GROUP 3 1YR=MA	F2	\$53,260
SA-458-000-110	ECS DS U SERIES T2 DC GROUP 4 1YR=MA	F2	\$84,980
SA-458-000-111	ECS DS U SERIES T2 DC GROUP 1 3YR=MA	F2	\$281,390
SA-458-000-112	ECS DS U SERIES T2 DC GROUP 2 3YR=MA	F2	\$281,170
SA-458-000-113	ECS DS U SERIES T2 DC GROUP 3 3YR=MA	F2	\$159,790
SA-458-000-114	ECS DS U SERIES T2 DC GROUP 4 3YR=MA	F2	\$254,970
SAS10-80V4-75-32	SEL 3Yrs Gold support for S/H Applnce	F2	\$37,425
SAS10-90V4-10-64	SEL 3Yrs Gold support for S/H Applnce	F2	\$50,412
SAS10-90V4-75-32	SEL 3Yrs Gold support for S/H Applnce	F2	\$41,520
SAS12-80V4-9-32	SEL 3Yrs Gold support for S/H Applnce	F2	\$42,976
SAS12-90V4-12-64	SEL 3Yrs Gold support for S/H Applnce	F2	\$58,489
SAS12-90V4-9-32	SEL 3Yrs Gold support for S/H Applnce	F2	\$44,761
SAS14-80V4-10-32	SEL 3Yrs Gold support for S/H Applnce	F2	\$48,689
SAS14-90V4-10-32	SEL 3Yrs Gold support for S/H Applnce	F2	\$50,872
SAS14-90V4-14-64	SEL 3Yrs Gold support for S/H Applnce	F2	\$66,310
SAS16-80V4-12-32	SEL 3Yrs Gold support for S/H Applnce	F2	\$54,553
SAS16-90V4-12-32	SEL 3Yrs Gold support for S/H Applnce	F2	\$57,757
SAS16-90V4-12-64	SEL 3Yrs Gold support for S/H Applnce	F2	\$65,251
SAS16-90V4-16-64	SEL 3Yrs Gold support for S/H Applnce	F2	\$74,180
SAS2-80V4-1-32	SEL 3Yrs Gold support for S/H Applnce	F2	\$9,740
SAS2-80V4-15-32	SEL 3Yrs Gold support for S/H Applnce	F2	\$10,466
SAS2-80V4-512-32	SEL 3Yrs Gold support for S/H Applnce	F2	\$8,913
SAS2-80V4-768-32	SEL 3Yrs Gold support for S/H Applnce	F2	\$9,275
SAS2-90V4-2-64	SEL 3Yrs Gold support for S/H Applnce	F2	\$12,679
SAS4-80V4-1-32	SEL 3Yrs Gold support for S/H Applnce	F2	\$11,974
SAS4-80V4-15-32	SEL 3Yrs Gold support for S/H Applnce	F2	\$12,687
SAS4-80V4-2-32	SEL 3Yrs Gold support for S/H Applnce	F2	\$13,841
SAS4-80V4-3-32	SEL 3Yrs Gold support for S/H Applnce	F2	\$15,292
SAS4-90V4-4-64	SEL 3Yrs Gold support for S/H Applnce	F2	\$19,718
SAS6-80V4-45-32	SEL 3Yrs Gold support for S/H Applnce	F2	\$21,204
SAS6-90V4-6-64	SEL 3Yrs Gold support for S/H Applnce	F2	\$27,844
SAS8-80V4-3-32	SEL 3Yrs Gold support for S/H Applnce	F2	\$19,922
SAS8-80V4-4-32	SEL 3Yrs Gold support for S/H Applnce	F2	\$21,783
SAS8-80V4-6-32	SEL 3Yrs Gold support for S/H Applnce	F2	\$26,480
SAS8-90V4-6-32	SEL 3Yrs Gold support for S/H Applnce	F2	\$28,054
SAS8-90V4-8-64	SEL 3Yrs Gold support for S/H Applnce	F2	\$36,643
SEP-ES-1000AN-D	SEL Splunk Ent STDSup Bucket 1000AN	F2	\$1,000
SEP-ES-1000AP-D	SEL Splunk Ent STDSup Bucket 1000AP	F2	\$1,000
SEP-ES-1000EM-D	SEL Splunk Ent STDSup Bucket 1000EM	F2	\$1,000
SEP-ES-1000US-D	SEL Splunk Ent STDSup Bucket 1000US	F2	\$1,000
SEP-ES-100AN-D	SEL Splunk Ent STDSup Bucket 100AN	F2	\$100
SEP-ES-100AP-D	SEL Splunk Ent STDSup Bucket 100AP	F2	\$100
SEP-ES-100EM-D	SEL Splunk Ent STDSup Bucket 100EM	F2	\$100
SEP-ES-100US-D	SEL Splunk Ent STDSup Bucket 100US	F2	\$100
SEP-ES-1AN-D	SEL Splunk Ent STDSup Bucket 1AN	F2	\$1
SEP-ES-1AP-D	SEL Splunk Ent STDSup Bucket 1AP	F2	\$1
SEP-ES-1EM-D	SEL Splunk Ent STDSup Bucket 1EM	F2	\$1
SEP-ES-1US-D	SEL Splunk Ent STDSup Bucket 1US	F2	\$1
SEP-GS-1000AN-D	SEL Splunk Ent PRMSup Bucket 1000AN	F2	\$1,000

SEP-GS-1000AP-D	SEL Splunk Ent PRMSup Bucket 1000AP	F2	\$1,000
SEP-GS-1000EM-D	SEL Splunk Ent PRMSup Bucket 1000EM	F2	\$1,000
SEP-GS-1000US-D	SEL Splunk Ent PRMSup Bucket 1000US	F2	\$1,000
SEP-GS-100AN-D	SEL Splunk Ent PRMSup Bucket 100AN	F2	\$100
SEP-GS-100AP-D	SEL Splunk Ent PRMSup Bucket 100AP	F2	\$100
SEP-GS-100EM-D	SEL Splunk Ent PRMSup Bucket 100EM	F2	\$100
SEP-GS-100US-D	SEL Splunk Ent PRMSup Bucket 100US	F2	\$100
SEP-GS-1AN-D	SEL Splunk Ent PRMSup Bucket 1AN	F2	\$1
SEP-GS-1AP-D	SEL Splunk Ent PRMSup Bucket 1AP	F2	\$1
SEP-GS-1EM-D	SEL Splunk Ent PRMSup Bucket 1EM	F2	\$1
SEP-GS-1US-D	SEL Splunk Ent PRMSup Bucket 1US	F2	\$1
SEPU-ES-1000AN-D	SEL Splunk EntUPG STDSup Bucket 1000AN	F2	\$1,000
SEPU-ES-1000AP-D	SEL Splunk EntUPG STDSup Bucket 1000AP	F2	\$1,000
SEPU-ES-1000EM-D	SEL Splunk EntUPG STDSup Bucket 1000EM	F2	\$1,000
SEPU-ES-1000US-D	SEL Splunk EntUPG STDSup Bucket 1000US	F2	\$1,000
SEPU-ES-100AN-D	SEL Splunk EntUPG STDSup Bucket 100AN	F2	\$100
SEPU-ES-100AP-D	SEL Splunk EntUPG STDSup Bucket 100AP	F2	\$100
SEPU-ES-100EM-D	SEL Splunk EntUPG STDSup Bucket 100EM	F2	\$100
SEPU-ES-100US-D	SEL Splunk EntUPG STDSup Bucket 100US	F2	\$100
SEPU-ES-1AN-D	SEL Splunk EntUPG STDSup Bucket 1AN	F2	\$1
SEPU-ES-1AP-D	SEL Splunk EntUPG STDSup Bucket 1AP	F2	\$1
SEPU-ES-1EM-D	SEL Splunk EntUPG STDSup Bucket 1EM	F2	\$1
SEPU-ES-1US-D	SEL Splunk EntUPG STDSup Bucket 1US	F2	\$1
SEPU-GS-1000AN-D	SEL Splunk EntUPG PRMSup Bucket 1000AN	F2	\$1,000
SEPU-GS-1000AP-D	SEL Splunk EntUPG PRMSup Bucket 1000AP	F2	\$1,000
SEPU-GS-1000EM-D	SEL Splunk EntUPG PRMSup Bucket 1000EM	F2	\$1,000
SEPU-GS-1000US-D	SEL Splunk EntUPG PRMSup Bucket 1000US	F2	\$1,000
SEPU-GS-100AN-D	SEL Splunk EntUPG PRMSup Bucket 100AN	F2	\$100
SEPU-GS-100AP-D	SEL Splunk EntUPG PRMSup Bucket 100AP	F2	\$100
SEPU-GS-100EM-D	SEL Splunk EntUPG PRMSup Bucket 100EM	F2	\$100
SEPU-GS-100US-D	SEL Splunk EntUPG PRMSup Bucket 100US	F2	\$100
SEPU-GS-1AN-D	SEL Splunk EntUPG PRMSup Bucket 1AN	F2	\$1
SEPU-GS-1AP-D	SEL Splunk EntUPG PRMSup Bucket 1AP	F2	\$1
SEPU-GS-1EM-D	SEL Splunk EntUPG PRMSup Bucket 1EM	F2	\$1
SEPU-GS-1US-D	SEL Splunk EntUPG PRMSup Bucket 1US	F2	\$1
SERV-AI-0001	SEL Archive Index to Tape	F2	\$588
SERV-IR-0001	SEL Index Restoration	F2	\$5,294
SERV-MS-0001	SEL Media Storage (per Tape) per Month	F2	\$6
SERV-OA-0001	SEL Online Access per Month	F2	\$5,882
SERV-OS-0001	SEL Onsite Services per Day	F2	\$4,588
SERV-RM-0001	SEL 1 HOUR REMOTE IE SERVICES	F2	\$353
SFIN-ASMB-1	SEL: TFIN ASM BASIC YEAR 1	F2	\$14,702
SFIN-ASMB-1Z2	SEL: TFIN ASM Basic Year 1,Z2	F2	\$16,175
SFIN-ASMB-2	SEL: TFIN ASM BASIC YEAR 2	F2	\$5,881
SFIN-ASMB-2Z2	SEL: TFIN ASM Basic Year 2 ,Z2	F2	\$6,476
SFIN-ASMG-1	SEL: TFIN ASM GOLD YEAR 1	F2	\$33,072
SFIN-ASMG-1Z2	SEL: TFIN ASM Gold Year 1,Z2	F2	\$36,388
SFIN-ASMG-2	SEL: TFIN ASM GOLD YEAR 2	F2	\$13,238
SFIN-ASMG-2Z2	SEL: TFIN ASM Gold Year 2 ,Z2	F2	\$14,568
SFIN-B-1-4HR	SEL: TFIN BASE; YEAR 1; 4HR	F2	\$8,468

SFIN-B-1-4HRZ2	SEL: TFIN Base, Year 1, 4HR,Z2	F2	\$9,314
SFIN-B-1-NBD	SEL: TFIN BASE; YEAR 1; NBD	F2	\$0
SFIN-B-1-NBDZ2	SEL: TFIN Base, Year 1, NBD,Z2	F2	\$0
SFIN-B-1-PH	SEL: TFIN Base,Year 1,7x24PH UP	F2	\$1,042
SFIN-B-1-PHZ2	SEL: TFIN Base,Year 1,7x24PH UP,Z2	F2	\$1,147
SFIN-B-1-SBD	SEL: TFIN BASE; YEAR 1; SBD	F2	\$7,057
SFIN-B-1-SBDZ2	SEL: TFIN Base, Year 1, SBD,Z2	F2	\$7,764
SFIN-B-2-4HR	SEL: TFIN BASE; YEARS 2;4HR	F2	\$11,761
SFIN-B-2-4HRZ2	SEL: TFIN Base, Years 2,4HR,Z2	F2	\$12,950
SFIN-B-2-NBD	SEL: TFIN BASE;YEARS 2;NBD	F2	\$7,948
SFIN-B-2-NBDZ2	SEL: TFIN Base,Years 2,NBD,Z2	F2	\$8,747
SFIN-B-2-PH	SEL: TFIN Base,Years 2,7x24PH UP	F2	\$1,042
SFIN-B-2-PHZ2	SEL: TFIN Base,Years 2,7x24PH UP,Z2	F2	\$1,147
SFIN-B-2-SBD	SEL: TFIN BASE;YEARS 2;SBD	F2	\$9,802
SFIN-B-2-SBDZ2	SEL: TFIN Base,Years 2,SBD,Z2	F2	\$10,792
SFIN-BA-1-NBD	SEL: TFIN Base, Year 1, NBD	F2	\$5,961
SFIN-BA-1-NBDZ2	SEL: TFIN Base, Year 1, NBD,Z2	F2	\$6,560
SFIN-BL-1-4HR	SEL: TFIN BLScLic;100 SLTS;1;4HR	F2	\$703
SFIN-BL-1-4HRZ2	SEL: TFIN BLScLic,100 slts,1,4HR,Z2	F2	\$773
SFIN-BL-1-NBD	SEL: TFIN BLScLic,100 slts,Y1,NBD	F2	\$491
SFIN-BL-1-NBDZ2	SEL: TFIN BLScLic,100 slts,Y1,NBD,Z2	F2	\$547
SFIN-BL-1-PH	SEL: TFIN BS,100 slts,Y1,7x24PH UP	F2	\$98
SFIN-BL-1-PHZ2	SEL: TFIN BSLic,100 slts,Y1,7x24PH UP,Z2	F2	\$110
SFIN-BL-1-SBD	SEL: TFIN BLScLic;100 SLTS;Y1 SBD	F2	\$611
SFIN-BL-1-SBDZ2	SEL: TFIN BLScLic,100 slts,Y1 SBD,Z2	F2	\$673
SFIN-BL-2-4HR	SEL: TFIN BLScLic;100 SLTS Y2;4HR	F2	\$1,009
SFIN-BL-2-4HRZ2	SEL: TFIN BLScLic,100 slts Y2,4HR,Z2	F2	\$1,118
SFIN-BL-2-NBD	SEL: TFIN BLScLic;100 SLTS;Y2;NBD	F2	\$655
SFIN-BL-2-NBDZ2	SEL: TFIN BLScLic,100 slts,Y2,NBD,Z2	F2	\$730
SFIN-BL-2-PH	SEL: TFIN BS,100 slts,Y2,7x24PH UP	F2	\$98
SFIN-BL-2-PHZ2	SEL: TFIN BSLic,100 slts,Y2,7x24PH UP,Z2	F2	\$110
SFIN-BL-2-SBD	SEL: TFIN BLScLic;100 SLTS;Y2;SBD	F2	\$878
SFIN-BL-2-SBDZ2	SEL: TFIN BLScLic,100 slts,Y2,SBD,Z2	F2	\$967
SFIN-CT-100	SEL: 1 COTERM SUPPORT UNIT TFIN	F2	\$100
SFIN-D8-1-4HR	SEL: TFIN Drvs,Year 1,4HR	F2	\$1,929
SFIN-D8-1-4HRZ2	SEL: TFIN Drvs,Year 1,4HR,Z2	F2	\$2,092
SFIN-D8-1-NBD	SEL: TFIN Drvs Year 1,NBD	F2	\$1,388
SFIN-D8-1-NBDZ2	SEL: TFIN Drvs Year 1,NBD,Z2	F2	\$1,512
SFIN-D8-1-PH	SEL: TFIN Drvs Year 1,7x24PH UP	F2	\$278
SFIN-D8-1-PHZ2	SEL: TFIN Drvs Year 1,7x24PH UP,Z2	F2	\$306
SFIN-D8-1-SBD	SEL: TFIN Drvs,Year 1,SBD	F2	\$1,719
SFIN-D8-1-SBDZ2	SEL: TFIN Drvs,Year 1,SBD,Z2	F2	\$1,861
SFIN-D8-2-4HR	SEL: TFIN Drvs Years 2+,4HR	F2	\$2,635
SFIN-D8-2-4HRZ2	SEL: TFIN Drvs Years 2+,4HR,Z2	F2	\$2,868
SFIN-D8-2-NBD	SEL: TFIN Drvs Years 2+,NBD	F2	\$1,850
SFIN-D8-2-NBDZ2	SEL: TFIN Drvs Years 2+,NBD,Z2	F2	\$2,016
SFIN-D8-2-PH	SEL: TFIN Drvs Years 2+,7x24PH UP	F2	\$278
SFIN-D8-2-PHZ2	SEL: TFIN Drvs Years 2+,7x24PH UP,Z2	F2	\$306
SFIN-D8-2-SBD	SEL: TFIN Drvs Years 2+,SBD	F2	\$2,334
SFIN-D8-2-SBDZ2	SEL: TFIN Drvs Years 2+,SBD,Z2	F2	\$2,543

SFIN-DR-1-4HR	SEL: TFIN DRVS;YEAR 1;4HR	F2	\$1,621
SFIN-DR-1-4HRZ2	SEL: TFIN Drvs,Year 1,4HR,Z2	F2	\$1,783
SFIN-DR-1-NBD	SEL: TFIN Drvs Year 1,NBD	F2	\$1,148
SFIN-DR-1-NBDZ2	SEL: TFIN Drvs Year 1,NBD,Z2	F2	\$1,272
SFIN-DR-1-PH	SEL: TFIN Drvs Year 1,7x24PH UP	F2	\$230
SFIN-DR-1-PHZ2	SEL: TFIN Drvs Year 1,7x24PH UP,Z2	F2	\$254
SFIN-DR-1-SBD	SEL: TFIN DRVS;YEAR 1;SBD	F2	\$1,411
SFIN-DR-1-SBDZ2	SEL: TFIN Drvs,Year 1,SBD,Z2	F2	\$1,552
SFIN-DR-2-4HR	SEL: TFIN DRVS YEARS 2;4HR	F2	\$2,316
SFIN-DR-2-4HRZ2	SEL: TFIN Drvs Years 2,4HR,Z2	F2	\$2,549
SFIN-DR-2-NBD	SEL: TFIN DRVS YEARS 2;NBD	F2	\$1,531
SFIN-DR-2-NBDZ2	SEL: TFIN Drvs Years 2,NBD,Z2	F2	\$1,696
SFIN-DR-2-PH	SEL: TFIN Drvs Years 2,7x24PH UP	F2	\$230
SFIN-DR-2-PHZ2	SEL: TFIN Drvs Years 2,7x24PH UP,Z2	F2	\$254
SFIN-DR-2-SBD	SEL: TFIN DRVS YEARS 2;SBD	F2	\$2,015
SFIN-DR-2-SBDZ2	SEL: TFIN Drvs Years 2,SBD,Z2	F2	\$2,222
SFIN-DV-1-4HR	SEL: TFIN Drvs,Year 1,4HR	F2	\$1,725
SFIN-DV-1-4HRZ2	SEL: TFIN Drvs,Year 1,4HR,Z2	F2	\$1,888
SFIN-DV-1-NBD	SEL: TFIN Drvs Year 1,NBD	F2	\$1,226
SFIN-DV-1-NBDZ2	SEL: TFIN Drvs Year 1,NBD,Z2	F2	\$1,350
SFIN-DV-1-PH	SEL: TFIN Drvs Year 1,7x24PH UP	F2	\$246
SFIN-DV-1-PHZ2	SEL: TFIN Drvs Year 1,7x24PH UP,Z2	F2	\$270
SFIN-DV-1-SBD	SEL: TFIN Drvs,Year 1,SBD	F2	\$1,515
SFIN-DV-1-SBDZ2	SEL: TFIN Drvs,Year 1,SBD,Z2	F2	\$1,657
SFIN-DV-2-4HR	SEL: TFIN Drvs Years 2+,4HR	F2	\$2,419
SFIN-DV-2-4HRZ2	SEL: TFIN Drvs Years 2+,4HR,Z2	F2	\$2,652
SFIN-DV-2-NBD	SEL: TFIN Drvs Years 2+,NBD	F2	\$1,634
SFIN-DV-2-NBDZ2	SEL: TFIN Drvs Years 2+,NBD,Z2	F2	\$1,800
SFIN-DV-2-PH	SEL: TFIN Drvs Years 2+,7x24PH UP	F2	\$246
SFIN-DV-2-PHZ2	SEL: TFIN Drvs Years 2+,7x24PH UP,Z2	F2	\$270
SFIN-DV-2-SBD	SEL: TFIN Drvs Years 2+,SBD	F2	\$2,118
SFIN-DV-2-SBDZ2	SEL: TFIN Drvs Years 2+,SBD,Z2	F2	\$2,327
SFIN-DX-1-4HR	SEL: TFIN DEX (EA);YEAR 1;4HR	F2	\$2,125
SFIN-DX-1-4HRZ2	SEL: TFIN DEX (ea),Year 1,4HR,Z2	F2	\$2,337
SFIN-DX-1-NBD	SEL: TFIN DEX (ea),Year 1,NBD	F2	\$1,599
SFIN-DX-1-NBDZ2	SEL: TFIN DEX (ea),Year 1,NBD,Z2	F2	\$1,760
SFIN-DX-1-PH	SEL: TFIN DEX (ea),Year 1,7x24PH UP	F2	\$320
SFIN-DX-1-PHZ2	SEL: TFIN DEX (ea),Year 1,7x24PH UP,Z2	F2	\$353
SFIN-DX-1-SBD	SEL: TFIN DEX (EA);YEAR 1;SBD	F2	\$1,700
SFIN-DX-1-SBDZ2	SEL: TFIN DEX (ea),Year 1,SBD,Z2	F2	\$1,870
SFIN-DX-2-4HR	SEL: TFIN DEX (EA);YEARS 2;4HR	F2	\$3,545
SFIN-DX-2-4HRZ2	SEL: TFIN DEX (ea),Years 2,4HR,Z2	F2	\$3,904
SFIN-DX-2-NBD	SEL: TFIN DEX (EA);YEARS 2;NBD	F2	\$2,132
SFIN-DX-2-NBDZ2	SEL: TFIN DEX (ea),Years 2,NBD,Z2	F2	\$2,347
SFIN-DX-2-PH	SEL: TFIN DEX (ea),Years 2,7x24PH UP	F2	\$320
SFIN-DX-2-PHZ2	SEL: TFIN DEX (ea),Years 2,7x24PH UP,Z2	F2	\$353
SFIN-DX-2-SBD	SEL: TFIN DEX (EA);YEARS 2;SBD	F2	\$2,838
SFIN-DX-2-SBDZ2	SEL: TFIN DEX (ea),Years 2,SBD,Z2	F2	\$3,126
SFIN-JASMB-1	SEL: TFIN-J ASM BASIC YEAR 1	F2	\$25,048
SFIN-JASMB-1Z2	SEL: TFIN-J ASM BASIC YEAR 1,Z2	F2	\$25,460

SFIN-JASMB-2	SEL: TFIN-J ASM BASIC YEAR 2	F2	\$10,020
SFIN-JASMB-2Z2	SEL: TFIN-J ASM BASIC YEAR 2 ,Z2	F2	\$11,023
SFIN-JASMG-1	SEL: TFIN-J ASM GOLD YEAR 1	F2	\$38,658
SFIN-JASMG-1Z2	SEL: TFIN-J ASM GOLD YEAR 1,Z2	F2	\$42,524
SFIN-JASMG-2	SEL: TFIN-J ASM GOLD YEAR 2	F2	\$15,466
SFIN-JASMG-2Z2	SEL: TFIN-J ASM GOLD YEAR 2 ,Z2	F2	\$17,015
SFINJDR-1-4HR	SEL: TFIN ENT DRVS;YEAR 1;4HR	F2	\$3,373
SFIN-JDR-1-4HRZ2	SEL: TFIN ENT DRVS, YEAR 1,4HR,Z2	F2	\$3,711
SFIN-JDR-1-NBD	SEL: TFIN ENT DRVS Year 1,NBD	F2	\$2,814
SFIN-JDR-1-NBDZ2	SEL: TFIN ENT DRVS Year 1,NBD,Z2	F2	\$3,097
SFIN-JDR-1-PH	SEL: TFIN ENT DRVS Year 1,7x24PH UP	F2	\$564
SFIN-JDR-1-PHZ2	SEL: TFIN ENT DRVS Year 1,7x24PH UP,Z2	F2	\$620
SFINJDR-1-SBD	SEL: TFIN ENT DRVS;YEAR 1;SBD	F2	\$3,092
SFIN-JDR-1-SBDZ2	SEL: TFIN ENT DRVS, YEAR 1,SBD,Z2	F2	\$3,401
SFINJDR-2-4HR	SEL: TFIN ENT DRVS YEARS 2;4HR	F2	\$5,620
SFIN-JDR-2-4HRZ2	SEL: TFIN ENT DRVS YEARS 2,4HR,Z2	F2	\$6,187
SFINJDR-2-NBD	SEL: TFIN ENT DRVS YEARS 2;NBD	F2	\$3,752
SFIN-JDR-2-NBDZ2	SEL: TFIN ENT DRVS YEARS 2,NBD,Z2	F2	\$4,129
SFIN-JDR-2-PH	SEL: TFIN ENT DRVS YEARS 2,7x24PH UP	F2	\$564
SFIN-JDR-2-PHZ2	SEL: TFIN ENT DRVS YEARS 2,7x24PH UP,Z2	F2	\$620
SFINJDR-2-SBD	SEL: TFIN ENT DRVS YEARS 2;SBD	F2	\$5,150
SFIN-JDR-2-SBDZ2	SEL: TFIN ENT DRVS YEARS 2,SBD,Z2	F2	\$5,672
SFIN-Q-1-4HR	SEL: TFIN QIP;YEAR 1;4HR	F2	\$1,621
SFIN-Q-1-4HRZ2	SEL: TFIN QIP,Year 1,4HR,Z2	F2	\$1,783
SFIN-Q-1-NBD	SEL: TFIN QIP,Year 1,NBD	F2	\$1,148
SFIN-Q-1-NBDZ2	SEL: TFIN QIP,Year 1,NBD,Z2	F2	\$1,272
SFIN-Q-1-PH	SEL: TFIN QIP,Year 1,7x24PH UP	F2	\$230
SFIN-Q-1-PHZ2	SEL: TFIN QIP,Year 1,7x24PH UP,Z2	F2	\$254
SFIN-Q-1-SBD	SEL: TFIN QIP;YEAR 1;SBD	F2	\$1,411
SFIN-Q-1-SBDZ2	SEL: TFIN QIP,Year 1,SBD,Z2	F2	\$1,552
SFIN-Q-2-4HR	SEL: TFIN QIP;YEARS 2;4HR	F2	\$2,316
SFIN-Q-2-4HRZ2	SEL: TFIN QIP,Years 2,4HR,Z2	F2	\$2,549
SFIN-Q-2-NBD	SEL: TFIN QIP;YEARS 2;NBD	F2	\$1,531
SFIN-Q-2-NBDZ2	SEL: TFIN QIP,Years 2,NBD,Z2	F2	\$1,696
SFIN-Q-2-PH	SEL: TFIN QIP,Years 2,7x24PH UP	F2	\$230
SFIN-Q-2-PHZ2	SEL: TFIN QIP,Years 2,7x24PH UP,Z2	F2	\$254
SFIN-Q-2-SBD	SEL: TFIN QIP;YEARS 2;SBD	F2	\$2,015
SFIN-Q-2-SBDZ2	SEL: TFIN QIP,Years 2,SBD,Z2	F2	\$2,222
SFIN-R-1-4HR	SEL: TFIN ROBOT;YEAR 1;4HR	F2	\$3,765
SFIN-R-1-4HRZ2	SEL: TFIN Robot,Year 1,4HR,Z2	F2	\$4,141
SFIN-R-1-NBD	SEL: TFIN Robot,Year 1,NBD	F2	\$2,649
SFIN-R-1-NBDZ2	SEL: TFIN Robot,Year 1,NBD,Z2	F2	\$2,918
SFIN-R-1-PH	SEL: TFIN Robot,Year 1,7x24PH UP	F2	\$530
SFIN-R-1-PHZ2	SEL: TFIN Robot,Year 1,7x24PH UP,Z2	F2	\$584
SFIN-R-1-SBD	SEL: TFIN ROBOT;YEAR 1;SBD	F2	\$3,137
SFIN-R-1-SBDZ2	SEL: TFIN Robot,Year 1,SBD,Z2	F2	\$3,451
SFIN-R-2-4HR	SEL: TFIN ROBOT;YEARS 2;4HR	F2	\$5,230
SFIN-R-2-4HRZ2	SEL: TFIN Robot,Years 2,4HR,Z2	F2	\$5,761
SFIN-R-2-NBD	SEL: TFIN ROBOT;YEARS 2;NBD	F2	\$3,532
SFIN-R-2-NBDZ2	SEL: TFIN Robot,Years 2,NBD,Z2	F2	\$3,890

SFIN-R-2-PH	SEL: TFIN Robot,Years 2,7x24PH UP	F2	\$530
SFIN-R-2-PHZ2	SEL: TFIN Robot,Years 2,7x24PH UP,Z2	F2	\$584
SFIN-R-2-SBD	SEL: TFIN ROBOT;YEARS 2;SBD	F2	\$4,354
SFIN-R-2-SBDZ2	SEL: TFIN Robot,Years 2,SBD,Z2	F2	\$4,795
SFIN-RNW-100	SEL: 1 RENEWAL SUPPORT UNIT, TFIN	F2	\$118
SFINSVB-1-4HR	SEL: TFIN SBay;YEAR 1;4HR	F2	\$3,765
SFIN-SVB-1-4HRZ2	SEL: TFIN SBay,Year 1,4HR,Z2	F2	\$4,141
SFIN-SVB-1-NBD	SEL: TFIN SBay,Year 1,NBD	F2	\$2,649
SFIN-SVB-1-NBDZ2	SEL: TFIN SBay,Year 1,NBD,Z2	F2	\$2,918
SFIN-SVB-1-PH	SEL: TFIN SBay,Year 1,7x24PH UP	F2	\$530
SFIN-SVB-1-PHZ2	SEL: TFIN SBay,Year 1,7x24PH UP,Z2	F2	\$610
SFINSVB-1-SBD	SEL: TFIN SBAY;YEAR 1; BD	F2	\$3,137
SFIN-SVB-1-SBDZ2	SEL: TFIN SBay,Year 1, BD,Z2	F2	\$3,451
SFINSVB-2-4HR	SEL: TFIN SBAY;YEARS 2;4HR	F2	\$5,230
SFIN-SVB-2-4HRZ2	SEL: TFIN SBay,Years 2,4HR,Z2	F2	\$5,761
SFINSVB-2-NBD	SEL: TFIN SBAY;YEARS 2;NBD	F2	\$3,532
SFIN-SVB-2-NBDZ2	SEL: TFIN SBay,Years 2,NBD,Z2	F2	\$3,890
SFIN-SVB-2-PH	SEL: TFIN SBay,Years 2,7x24PH UP	F2	\$530
SFIN-SVB-2-PHZ2	SEL: TFIN SBay,Years 2,7x24PH UP,Z2	F2	\$610
SFINSVB-2-SBD	SEL: TFIN SBAY;YEARS 2;SBD	F2	\$4,354
SFIN-SVB-2-SBDZ2	SEL: TFIN SBay,Years 2,SBD,Z2	F2	\$4,795
SFINTAP-1-4HR	SEL: SFIN;BULK;TAP;SVC;YEAR 1;4HR	F2	\$4,517
SFIN-TAP-1-4HRZ2	SEL: SFIN,BULK,TAP,SVC,YEAR 1,4HR,Z2	F2	\$4,968
SFIN-TAP-1-NBD	SEL: SFIN,BULK,TA,SVC,YEAR 1,NBD	F2	\$3,177
SFIN-TAP-1-NBDZ2	SEL: SFIN,BULK,TA,SVC,YEAR 1,NBD,Z2	F2	\$3,502
SFIN-TAP-1-PH	SEL: SFIN,BULK,TA,SVC,Year 1,7x24PH UP	F2	\$636
SFIN-TAP-1-PHZ2	SEL SFIN,BULK,TA,SVC,Year 1,7x24PH UP,Z2	F2	\$701
SFINTAP-1-SBD	SEL: SFIN;BULK;TAP;SVC;YEAR 1;SBD	F2	\$3,765
SFIN-TAP-1-SBDZ2	SEL: SFIN,BULK,TAP,SVC,YEAR 1,SBD,Z2	F2	\$4,141
SFINTAP-2-4HR	SEL: SFIN;BULK;TAP;SVC;YEAR 2;4HR	F2	\$6,274
SFIN-TAP-2-4HRZ2	SEL: SFIN,BULK,TAP,SVC,YEAR 2,4HR,Z2	F2	\$6,901
SFINTAP-2-NBD	SEL: SFIN;BULK;TA;SVC;YEAR 2;NBD	F2	\$4,236
SFIN-TAP-2-NBDZ2	SEL: SFIN,BULK,TA,SVC,YEAR 2,NBD,Z2	F2	\$4,669
SFIN-TAP-2-PH	SEL: SFIN,BULK,TA,SVC,YEAR 2,7x24PH UP	F2	\$636
SFIN-TAP-2-PHZ2	SEL SFIN,BULK,TA,SVC,YEAR 2,7x24PH UP,Z2	F2	\$701
SFINTAP-2-SBD	SEL: SFIN;BULK;TAP;SVC;YEAR 2;SBD	F2	\$5,230
SFIN-TAP-2-SBDZ2	SEL: SFIN,BULK,TAP,SVC,YEAR 2,SBD,Z2	F2	\$5,761
SFP-CSK-LR	SEL 2 X LONG REACH SFP INSERT SPARE	F2	\$2,941
SFP-CSK-SR	SEL 2 X SHORT REACH SFP INSERT SPARE	F2	\$1,765
SGS10-80V4-75-32	SEL 3Yrs Gold supprt for Bullion HW	F2	\$28,047
SGS10-90V4-10-64	SEL 3Yrs Gold supprt for Bullion HW	F2	\$39,113
SGS10-90V4-75-32	SEL 3Yrs Gold supprt for Bullion HW	F2	\$30,049
SGS12-80V4-9-32	SEL 3Yrs Gold supprt for Bullion HW	F2	\$32,540
SGS12-90V4-12-64	SEL 3Yrs Gold supprt for Bullion HW	F2	\$45,820
SGS12-90V4-9-32	SEL 3Yrs Gold supprt for Bullion HW	F2	\$34,943
SGS14-80V4-10-32	SEL 3Yrs Gold supprt for Bullion HW	F2	\$37,034
SGS14-90V4-10-32	SEL 3Yrs Gold supprt for Bullion HW	F2	\$39,837
SGS14-90V4-14-64	SEL 3Yrs Gold supprt for Bullion HW	F2	\$52,526
SGS16-80V4-12-32	SEL 3Yrs Gold supprt for Bullion HW	F2	\$41,527
SGS16-90V4-12-32	SEL 3Yrs Gold supprt for Bullion HW	F2	\$44,731

SGS16-90V4-12-64	SEL 3Yrs Gold supprt for Bullion HW	F2	\$50,375
SGS16-90V4-16-64	SEL 3Yrs Gold supprt for Bullion HW	F2	\$59,233
SGS2-80V4-1-32	SEL 3Yrs Gold supprt for Bullion HW	F2	\$4,231
SGS2-80V4-1532-2	SEL 3Yrs Gold supprt for Bullion HW	F2	\$4,957
SGS2-80V4-512-32	SEL 3Yrs Gold supprt for Bullion HW	F2	\$3,403
SGS2-80V4-768-32	SEL 3Yrs Gold supprt for Bullion HW	F2	\$3,766
SGS2-90V4-2-64	SEL 3Yrs Gold supprt for Bullion HW	F2	\$7,170
SGS4-80V4-1-32	SEL 3Yrs Gold supprt for Bullion HW	F2	\$6,491
SGS4-80V4-15-32	SEL 3Yrs Gold supprt for Bullion HW	F2	\$7,216
SGS4-80V4-2-32	SEL 3Yrs Gold supprt for Bullion HW	F2	\$8,146
SGS4-80V4-3-32-2	SEL 3Yrs Gold supprt for Bullion HW	F2	\$9,597
SGS4-90V4-4-64	SEL 3Yrs Gold supprt for Bullion HW	F2	\$14,023
SGS6-80V4-45-32	SEL 3Yrs Gold supprt for Bullion HW	F2	\$14,140
SGS6-90V4-6-64	SEL 3Yrs Gold supprt for Bullion HW	F2	\$20,798
SGS8-80V4-3-32	SEL 3Yrs Gold supprt for Bullion HW	F2	\$13,890
SGS8-80V4-4-32	SEL 3Yrs Gold supprt for Bullion HW	F2	\$15,751
SGS8-80V4-6-32-2	SEL 3Yrs Gold supprt for Bullion HW	F2	\$18,652
SGS8-90V4-6-32	SEL 3Yrs Gold supprt for Bullion HW	F2	\$18,229
SGS8-90V4-8-64	SEL 3Yrs Gold supprt for Bullion HW	F2	\$27,505
SI-3	SEL Varonis Remote Server Install - 3h	F2	\$860
SI-5	SEL Varonis Remote Server Install - 5h	F2	\$1,147
SMSC-RNW-50	SEL: 1 RENEWAL SUPPORT UNIT, MISC	F2	\$59
SOL-0-50MS	SEL DatAdvantage - SPOL Lite MS	F2	\$23
SOL-1001-1500MS	SEL DatAdvantage - SPOL Lite MS	F2	\$7
SOL-100K-150KMC	SEL DatAdvantage - SPOL Lite M24*7	F2	\$6
SOL-100K-150KMS	SEL DatAdvantage - SPOL Lite MS	F2	\$3
SOL-101-250MS	SEL DatAdvantage - SPOL Lite MS	F2	\$13
SOL-10K-20KMC	SEL DatAdvantage - SPOL Lite M24*7	F2	\$7
SOL-10K-20KMS	SEL DatAdvantage - SPOL Lite MS	F2	\$4
SOL-1501-2000MS	SEL DatAdvantage - SPOL Lite MS	F2	\$6
SOL-150K-MC	SEL DatAdvantage - SPOL Lite M24*7	F2	\$6
SOL-150K-MS	SEL DatAdvantage - SPOL Lite MS	F2	\$3
SOL-2001-2500MS	SEL DatAdvantage - SPOL Lite MS	F2	\$6
SOL-20K-35KMC	SEL DatAdvantage - SPOL Lite M24*7	F2	\$7
SOL-20K-35KMS	SEL DatAdvantage - SPOL Lite MS	F2	\$4
SOL-2501-4000MS	SEL DatAdvantage - SPOL Lite MS	F2	\$5
SOL-251-500MS	SEL DatAdvantage - SPOL Lite MS	F2	\$10
SOL-35K-50KMC	SEL DatAdvantage - SPOL Lite M24*7	F2	\$6
SOL-35K-50KMS	SEL DatAdvantage - SPOL Lite MS	F2	\$4
SOL-4001-6000MC	SEL DatAdvantage - SPOL Lite M24*7	F2	\$8
SOL-4001-6000MS	SEL DatAdvantage - SPOL Lite MS	F2	\$5
SOL-501-750MS	SEL DatAdvantage - SPOL Lite MS	F2	\$8
SOL-50K-100KMC	SEL DatAdvantage - SPOL Lite M24*7	F2	\$6
SOL-50K-100KMS	SEL DatAdvantage - SPOL Lite MS	F2	\$4
SOL-51-100MS	SEL DatAdvantage - SPOL Lite MS	F2	\$16
SOL-6001-8000MC	SEL DatAdvantage - SPOL Lite M24*7	F2	\$8
SOL-6001-8000MS	SEL DatAdvantage - SPOL Lite MS	F2	\$4
SOL-751-1000MS	SEL DatAdvantage - SPOL Lite MS	F2	\$7
SOL-8001-10KMC	SEL DatAdvantage - SPOL Lite M24*7	F2	\$7
SOL-8001-10KMS	SEL DatAdvantage - SPOL Lite MS	F2	\$4

SO-SERVICE-1	SEL-SmartOptics Service SKU	F2	\$2
SPLK-1DAY-REG-D	SEL SPLUNK User Conf plus 1-DAY Univ	F2	\$3,053
SPLK-2DAY-REG-D	SEL SPLUNK User Conf plus 2-DAY Univ	F2	\$3,524
SPLK-3DAY-REG-D	SEL SPLUNK User Conf plus 3-DAY Univ	F2	\$3,876
SPLK-REG-USER-D	SEL SPLUNK User Conference Attendance	F2	\$2,112
SS10-80V4-75-32	SEL 3Yrs Silver supprt for Bullion HW	F2	\$22,438
SS10-90V4-10-64	SEL 3Yrs Silver supprt for Bullion HW	F2	\$31,290
SS10-90V4-75-32	SEL 3Yrs Silver supprt for Bullion HW	F2	\$24,040
SS12-80V4-9-32	SEL 3Yrs Silver supprt for Bullion HW	F2	\$26,032
SS12-90V4-12-64	SEL 3Yrs Silver supprt for Bullion HW	F2	\$36,656
SS12-90V4-9-32	SEL 3Yrs Silver supprt for Bullion HW	F2	\$27,955
SS14-80V4-10-32	SEL 3Yrs Silver supprt for Bullion HW	F2	\$29,627
SS14-90V4-10-32	SEL 3Yrs Silver supprt for Bullion HW	F2	\$31,870
SS14-90V4-14-64	SEL 3Yrs Silver supprt for Bullion HW	F2	\$42,021
SS16-80V4-12-32	SEL 3Yrs Silver supprt for Bullion HW	F2	\$33,222
SS16-90V4-12-32	SEL 3Yrs Silver supprt for Bullion HW	F2	\$35,785
SS16-90V4-12-64	SEL 3Yrs Silver supprt for Bullion HW	F2	\$40,300
SS16-90V4-16-64	SEL 3Yrs Silver supprt for Bullion HW	F2	\$47,386
SS2-80V4-1-32	SEL 3Yrs Silver supprt for Bullion HW	F2	\$3,385
SS2-80V4-15-32-2	SEL 3Yrs Silver supprt for Bullion HW	F2	\$3,965
SS2-80V4-512-32	SEL 3Yrs Silver supprt for Bullion HW	F2	\$2,723
SS2-80V4-768-32	SEL 3Yrs Silver supprt for Bullion HW	F2	\$3,013
SS2-90V4-2-64	SEL 3Yrs Silver supprt for Bullion HW	F2	\$5,736
SS4-80V4-1-32	SEL 3Yrs Silver supprt for Bullion HW	F2	\$5,193
SS4-80V4-15-32	SEL 3Yrs Silver supprt for Bullion HW	F2	\$5,773
SS4-80V4-2-32	SEL 3Yrs Silver supprt for Bullion HW	F2	\$6,517
SS4-80V4-3-32-2	SEL 3Yrs Silver supprt for Bullion HW	F2	\$7,678
SS4-90V4-4-64	SEL 3Yrs Silver supprt for Bullion HW	F2	\$11,219
SS6-80V4-45-32-2	SEL 3Yrs Silver supprt for Bullion HW	F2	\$11,312
SS6-90V4-6-64	SEL 3Yrs Silver supprt for Bullion HW	F2	\$16,639
SS8-80V4-3-32	SEL 3Yrs Silver supprt for Bullion HW	F2	\$11,112
SS8-80V4-4-32	SEL 3Yrs Silver supprt for Bullion HW	F2	\$12,601
SS8-80V4-6-32-2	SEL 3Yrs Silver supprt for Bullion HW	F2	\$14,922
SS8-90V4-6-32-2	SEL 3Yrs Silver supprt for Bullion HW	F2	\$16,203
SS8-90V4-8-64	SEL 3Yrs Silver supprt for Bullion HW	F2	\$22,004
ST6AD3GC	SEL ST6-AD-3G-SSS-C)	F2	\$2,281
ST6AD3GC-I	SEL ST6-AD-3G-SSS-C)	F2	\$2,669
ST6AD3GC-K	SEL ST6-AD-3G-SSS-C)	F2	\$2,564
ST6AD3PC	SEL ST6-AD-3P-SSS-C)	F2	\$2,717
ST6AD3PC-I	SEL ST6-AD-3P-SSS-C)	F2	\$3,178
ST6AD3PC-K	SEL ST6-AD-3P-SSS-C)	F2	\$3,054
ST6ADD1003GC	SEL ST6-AD-D100-3G-SSS-C)	F2	\$5,684
ST6ADD1003GC-I	SEL ST6-AD-D100-3G-SSS-C)	F2	\$6,650
ST6ADD1003GC-K	SEL ST6-AD-D100-3G-SSS-C)	F2	\$6,389
ST6ADD1003PC	SEL ST6-AD-D100-3P-SSS-C)	F2	\$6,766
ST6ADD1003PC-I	SEL ST6-AD-D100-3P-SSS-C)	F2	\$7,917
ST6ADD1003PC-K	SEL ST6-AD-D100-3P-SSS-C)	F2	\$7,606
ST6ADD100GC	SEL ST6-AD-D100-G-SSS-C)	F2	\$2,153
ST6ADD100GC-I	SEL ST6-AD-D100-G-SSS-C)	F2	\$2,519
ST6ADD100GC-K	SEL ST6-AD-D100-G-SSS-C)	F2	\$2,420

ST6ADD100PC	SEL ST6-AD-D100-P-SSS-C)	F2	\$2,563
ST6ADD100PC-I	SEL ST6-AD-D100-P-SSS-C)	F2	\$2,999
ST6ADD100PC-K	SEL ST6-AD-D100-P-SSS-C)	F2	\$2,881
ST6ADD103GC	SEL ST6-AD-D10-3G-SSS-C)	F2	\$568
ST6ADD103GC-I	SEL ST6-AD-D10-3G-SSS-C)	F2	\$664
ST6ADD103GC-K	SEL ST6-AD-D10-3G-SSS-C)	F2	\$638
ST6ADD103PC	SEL ST6-AD-D10-3P-SSS-C)	F2	\$676
ST6ADD103PC-I	SEL ST6-AD-D10-3P-SSS-C)	F2	\$791
ST6ADD103PC-K	SEL ST6-AD-D10-3P-SSS-C)	F2	\$760
ST6ADD10GC	SEL ST6-AD-D10-G-SSS-C)	F2	\$215
ST6ADD10GC-I	SEL ST6-AD-D10-G-SSS-C)	F2	\$252
ST6ADD10GC-K	SEL ST6-AD-D10-G-SSS-C)	F2	\$242
ST6ADD10PC	SEL ST6-AD-D10-P-SSS-C)	F2	\$256
ST6ADD10PC-I	SEL ST6-AD-D10-P-SSS-C)	F2	\$300
ST6ADD10PC-K	SEL ST6-AD-D10-P-SSS-C)	F2	\$288
ST6ADGC	SEL ST6-AD-G-SSS-C)	F2	\$864
ST6ADGC-I	SEL ST6-AD-G-SSS-C)	F2	\$1,011
ST6ADGC-K	SEL ST6-AD-G-SSS-C)	F2	\$971
ST6ADPC	SEL ST6-AD-P-SSS-C)	F2	\$1,029
ST6ADPC-I	SEL ST6-AD-P-SSS-C)	F2	\$1,204
ST6ADPC-K	SEL ST6-AD-P-SSS-C)	F2	\$1,157
ST6EDHA1003GC	SEL ST6-ED-HA100-3G-SSS-C)	F2	\$1,885
ST6EDHA1003GC-I	SEL ST6-ED-HA100-3G-SSS-C)	F2	\$2,205
ST6EDHA1003GC-K	SEL ST6-ED-HA100-3G-SSS-C)	F2	\$2,119
ST6EDHA1003GSSSF	SEL: ST6-ED-HA100-3G-SSS-F	F2	\$2,012
ST6EDHA1003PC	SEL ST6-ED-HA100-3P-SSS-C)	F2	\$2,244
ST6EDHA1003PC-I	SEL ST6-ED-HA100-3P-SSS-C)	F2	\$2,625
ST6EDHA1003PC-K	SEL ST6-ED-HA100-3P-SSS-C)	F2	\$2,523
ST6EDHA1003PSSSF	SEL: ST6-ED-HA100-3P-SSS-F	F2	\$2,396
ST6EDHA100GC	SEL ST6-ED-HA100-G-SSS-C)	F2	\$714
ST6EDHA100GC-I	SEL ST6-ED-HA100-G-SSS-C)	F2	\$835
ST6EDHA100GC-K	SEL ST6-ED-HA100-G-SSS-C)	F2	\$803
ST6EDHA100GSSSF	SEL: ST6-ED-HA100-G-SSS-F	F2	\$762
ST6EDHA100PC	SEL ST6-ED-HA100-P-SSS-C)	F2	\$850
ST6EDHA100PC-I	SEL ST6-ED-HA100-P-SSS-C)	F2	\$995
ST6EDHA100PC-K	SEL ST6-ED-HA100-P-SSS-C)	F2	\$956
ST6EDHA100PSSSF	SEL: ST6-ED-HA100-P-SSS-F	F2	\$908
ST6EDHA103GC	SEL ST6-ED-HA10-3G-SSS-C)	F2	\$187
ST6EDHA103GC-I	SEL ST6-ED-HA10-3G-SSS-C)	F2	\$219
ST6EDHA103GC-K	SEL ST6-ED-HA10-3G-SSS-C)	F2	\$211
ST6EDHA103GSSSF	SEL: ST6-ED-HA10-3G-SSS-F	F2	\$200
ST6EDHA103PC	SEL ST6-ED-HA10-3P-SSS-C)	F2	\$224
ST6EDHA103PC-I	SEL ST6-ED-HA10-3P-SSS-C)	F2	\$263
ST6EDHA103PC-K	SEL ST6-ED-HA10-3P-SSS-C)	F2	\$252
ST6EDHA103PSSSF	SEL: ST6-ED-HA10-3P-SSS-F	F2	\$241
ST6EDHA10GC	SEL ST6-ED-HA10-G-SSS-C)	F2	\$71
ST6EDHA10GC-I	SEL ST6-ED-HA10-G-SSS-C)	F2	\$83
ST6EDHA10GC-K	SEL ST6-ED-HA10-G-SSS-C)	F2	\$80
ST6EDHA10GSSSF	SEL: ST6-ED-HA10-G-SSS-F	F2	\$76
ST6EDHA10PC	SEL ST6-ED-HA10-P-SSS-C)	F2	\$85

ST6EDHA10PC-I	SEL ST6-ED-HA10-P-SSS-C)	F2	\$99
ST6EDHA10PC-K	SEL ST6-ED-HA10-P-SSS-C)	F2	\$96
ST6EDHA10PSSSF	SEL: ST6-ED-HA10-P-SSS-F	F2	\$91
ST6EN3GC	SEL ST6-EN-3G-SSS-C)	F2	\$3,136
ST6EN3GC-I	SEL ST6-EN-3G-SSS-C)	F2	\$3,669
ST6EN3GC-K	SEL ST6-EN-3G-SSS-C)	F2	\$3,526
ST6EN3PC	SEL ST6-EN-3P-SSS-C)	F2	\$3,733
ST6EN3PC-I	SEL ST6-EN-3P-SSS-C)	F2	\$4,368
ST6EN3PC-K	SEL ST6-EN-3P-SSS-C)	F2	\$4,196
ST6END1003GC	SEL ST6-EN-D100-3G-SSS-C)	F2	\$7,207
ST6END1003GC-I	SEL ST6-EN-D100-3G-SSS-C)	F2	\$8,432
ST6END1003GC-K	SEL ST6-EN-D100-3G-SSS-C)	F2	\$8,102
ST6END1003PC	SEL ST6-EN-D100-3P-SSS-C)	F2	\$8,580
ST6END1003PC-I	SEL ST6-EN-D100-3P-SSS-C)	F2	\$10,039
ST6END1003PC-K	SEL ST6-EN-D100-3P-SSS-C)	F2	\$9,645
ST6END100GC	SEL ST6-EN-D100-G-SSS-C)	F2	\$2,730
ST6END100GC-I	SEL ST6-EN-D100-G-SSS-C)	F2	\$3,194
ST6END100GC-K	SEL ST6-EN-D100-G-SSS-C)	F2	\$3,069
ST6END100PC	SEL ST6-EN-D100-P-SSS-C)	F2	\$3,250
ST6END100PC-I	SEL ST6-EN-D100-P-SSS-C)	F2	\$3,803
ST6END100PC-K	SEL ST6-EN-D100-P-SSS-C)	F2	\$3,653
ST6END103GC	SEL ST6-EN-D10-3G-SSS-C)	F2	\$721
ST6END103GC-I	SEL ST6-EN-D10-3G-SSS-C)	F2	\$843
ST6END103GC-K	SEL ST6-EN-D10-3G-SSS-C)	F2	\$810
ST6END103PC	SEL ST6-EN-D10-3P-SSS-C)	F2	\$858
ST6END103PC-I	SEL ST6-EN-D10-3P-SSS-C)	F2	\$1,004
ST6END103PC-K	SEL ST6-EN-D10-3P-SSS-C)	F2	\$965
ST6END10GC	SEL ST6-EN-D10-G-SSS-C)	F2	\$273
ST6END10GC-I	SEL ST6-EN-D10-G-SSS-C)	F2	\$319
ST6END10GC-K	SEL ST6-EN-D10-G-SSS-C)	F2	\$307
ST6END10PC	SEL ST6-EN-D10-P-SSS-C)	F2	\$325
ST6END10PC-I	SEL ST6-EN-D10-P-SSS-C)	F2	\$380
ST6END10PC-K	SEL ST6-EN-D10-P-SSS-C)	F2	\$365
ST6ENGC	SEL ST6-EN-G-SSS-C)	F2	\$1,188
ST6ENGC-I	SEL ST6-EN-G-SSS-C)	F2	\$1,390
ST6ENGC-K	SEL ST6-EN-G-SSS-C)	F2	\$1,335
ST6ENPC	SEL ST6-EN-P-SSS-C)	F2	\$1,414
ST6ENPC-I	SEL ST6-EN-P-SSS-C)	F2	\$1,654
ST6ENPC-K	SEL ST6-EN-P-SSS-C)	F2	\$1,590
ST6RB25VM3GC	SEL ST6-RB-25VM-3G-SSS-C)	F2	\$7,125
ST6RB25VM3GC-I	SEL ST6-RB-25VM-3G-SSS-C)	F2	\$8,337
ST6RB25VM3GC-K	SEL ST6-RB-25VM-3G-SSS-C)	F2	\$8,010
ST6RB25VM3GSSSF	SEL: ST6-RB-25VM-3G-SSS-F	F2	\$7,623
ST6RB25VM3PC	SEL ST6-RB-25VM-3P-SSS-C)	F2	\$8,482
ST6RB25VM3PC-I	SEL ST6-RB-25VM-3P-SSS-C)	F2	\$9,924
ST6RB25VM3PC-K	SEL ST6-RB-25VM-3P-SSS-C)	F2	\$9,535
ST6RB25VM3PSSSF	SEL: ST6-RB-25VM-3P-SSS-F	F2	\$9,075
ST6RB25VMGC	SEL ST6-RB-25VM-G-SSS-C)	F2	\$2,699
ST6RB25VMGC-I	SEL ST6-RB-25VM-G-SSS-C)	F2	\$3,158
ST6RB25VMGC-K	SEL ST6-RB-25VM-G-SSS-C)	F2	\$3,034

ST6RB25VMGSSSF	SEL: ST6-RB-25VM-G-SSS-F	F2	\$2,888
ST6RB25VMPC	SEL ST6-RB-25VM-P-SSS-C)	F2	\$3,213
ST6RB25VMPC-I	SEL ST6-RB-25VM-P-SSS-C)	F2	\$3,759
ST6RB25VMPC-K	SEL ST6-RB-25VM-P-SSS-C)	F2	\$3,612
ST6RB25VMPSSSF	SEL: ST6-RB-25VM-P-SSS-F	F2	\$3,438
ST6RBAD252MGSSSF	SEL: ST6-RBAD-25-2M-GSSS-F	F2	\$770
ST6RBAD252MPSSSF	SEL: ST6-RBAD-25-2M-PSSS-F	F2	\$917
ST6RBAD253GC	SEL ST6-RBAD-25-3G-SSS-C)	F2	\$11,394
ST6RBAD253GC-I	SEL ST6-RBAD-25-3G-SSS-C)	F2	\$13,331
ST6RBAD253GC-K	SEL ST6-RBAD-25-3G-SSS-C)	F2	\$12,808
ST6RBAD253GSSSF	SEL: ST6-RBAD-25-3G-SSS-F	F2	\$12,197
ST6RBAD253PC	SEL ST6-RBAD-25-3P-SSS-C)	F2	\$13,564
ST6RBAD253PC-I	SEL ST6-RBAD-25-3P-SSS-C)	F2	\$15,870
ST6RBAD253PC-K	SEL ST6-RBAD-25-3P-SSS-C)	F2	\$15,248
ST6RBAD253PSSSF	SEL: ST6-RBAD-25-3P-SSS-F	F2	\$14,520
ST6RBAD25GC	SEL ST6-RBAD-25-G-SSS-C)	F2	\$4,316
ST6RBAD25GC-I	SEL ST6-RBAD-25-G-SSS-C)	F2	\$5,050
ST6RBAD25GC-K	SEL ST6-RBAD-25-G-SSS-C)	F2	\$4,852
ST6RBAD25GSSSF	SEL: ST6-RBAD-25-G-SSS-F	F2	\$4,620
ST6RBAD25PC	SEL ST6-RBAD-25-P-SSS-C)	F2	\$5,138
ST6RBAD25PC-I	SEL ST6-RBAD-25-P-SSS-C)	F2	\$6,011
ST6RBAD25PC-K	SEL ST6-RBAD-25-P-SSS-C)	F2	\$5,776
ST6RBAD25PSSSF	SEL: ST6-RBAD-25-P-SSS-F	F2	\$5,500
ST6RBEN252MGSSSF	SEL: ST6-RBEN-25-2M-GSSS-F	F2	\$1,059
ST6RBEN252MPSSSF	SEL: ST6-RBEN-25-2M-PSSS-F	F2	\$1,260
ST6RBEN253GC	SEL ST6-RBEN-25-3G-SSS-C)	F2	\$15,719
ST6RBEN253GC-I	SEL ST6-RBEN-25-3G-SSS-C)	F2	\$18,391
ST6RBEN253GC-K	SEL ST6-RBEN-25-3G-SSS-C)	F2	\$17,670
ST6RBEN253GSSSF	SEL: ST6-RBEN-25-3G-SSS-F	F2	\$16,771
ST6RBEN253PC	SEL ST6-RBEN-25-3P-SSS-C)	F2	\$18,712
ST6RBEN253PC-I	SEL ST6-RBEN-25-3P-SSS-C)	F2	\$21,893
ST6RBEN253PC-K	SEL ST6-RBEN-25-3P-SSS-C)	F2	\$21,035
ST6RBEN253PSSSF	SEL: ST6-RBEN-25-3P-SSS-F	F2	\$19,965
ST6RBEN25GC	SEL ST6-RBEN-25-G-SSS-C)	F2	\$5,954
ST6RBEN25GC-I	SEL ST6-RBEN-25-G-SSS-C)	F2	\$6,966
ST6RBEN25GC-K	SEL ST6-RBEN-25-G-SSS-C)	F2	\$6,693
ST6RBEN25GSSSF	SEL: ST6-RBEN-25-G-SSS-F	F2	\$6,353
ST6RBEN25PC	SEL ST6-RBEN-25-P-SSS-C)	F2	\$7,088
ST6RBEN25PC-I	SEL ST6-RBEN-25-P-SSS-C)	F2	\$8,293
ST6RBEN25PC-K	SEL ST6-RBEN-25-P-SSS-C)	F2	\$7,968
ST6RBEN25PSSSF	SEL: ST6-RBEN-25-P-SSS-F	F2	\$7,563
ST6VSAN3GC	SEL ST6-VSAN-3G-SSS-C)	F2	\$1,423
ST6VSAN3GC-I	SEL ST6-VSAN-3G-SSS-C)	F2	\$1,665
ST6VSAN3GC-K	SEL ST6-VSAN-3G-SSS-C)	F2	\$1,600
ST6VSAN3PC	SEL ST6-VSAN-3P-SSS-C)	F2	\$1,692
ST6VSAN3PC-I	SEL ST6-VSAN-3P-SSS-C)	F2	\$1,980
ST6VSAN3PC-K	SEL ST6-VSAN-3P-SSS-C)	F2	\$1,902
ST6VSANBN3GC	SEL ST6-VSAN-BN-3G-SSS-C)	F2	\$8,567
ST6VSANBN3GC-I	SEL ST6-VSAN-BN-3G-SSS-C)	F2	\$10,023
ST6VSANBN3GC-K	SEL ST6-VSAN-BN-3G-SSS-C)	F2	\$9,630

ST6VSANBN3PC	SEL ST6-VSAN-BN-3P-SSS-C)	F2	\$10,198
ST6VSANBN3PC-I	SEL ST6-VSAN-BN-3P-SSS-C)	F2	\$11,932
ST6VSANBN3PC-K	SEL ST6-VSAN-BN-3P-SSS-C)	F2	\$11,464
ST6VSANBNGC	SEL ST6-VSAN-BN-G-SSS-C)	F2	\$3,245
ST6VSANBNGC-I	SEL ST6-VSAN-BN-G-SSS-C)	F2	\$3,797
ST6VSANBNGC-K	SEL ST6-VSAN-BN-G-SSS-C)	F2	\$3,648
ST6VSANBNPC	SEL ST6-VSAN-BN-P-SSS-C)	F2	\$3,863
ST6VSANBNPC-I	SEL ST6-VSAN-BN-P-SSS-C)	F2	\$4,520
ST6VSANBNPC-K	SEL ST6-VSAN-BN-P-SSS-C)	F2	\$4,342
ST6VSANGC	SEL ST6-VSAN-G-SSS-C)	F2	\$539
ST6VSANGC-I	SEL ST6-VSAN-G-SSS-C)	F2	\$631
ST6VSANGC-K	SEL ST6-VSAN-G-SSS-C)	F2	\$606
ST6VSANPC	SEL ST6-VSAN-P-SSS-C)	F2	\$641
ST6VSANPC-I	SEL ST6-VSAN-P-SSS-C)	F2	\$750
ST6VSANPC-K	SEL ST6-VSAN-P-SSS-C)	F2	\$721
ST6VSDT1003GC	SEL ST6-VSDT100-3G-SSS-C)	F2	\$3,049
ST6VSDT1003GC-I	SEL ST6-VSDT100-3G-SSS-C)	F2	\$3,568
ST6VSDT1003GC-K	SEL ST6-VSDT100-3G-SSS-C)	F2	\$3,428
ST6VSDT1003PC	SEL ST6-VSDT100-3P-SSS-C)	F2	\$3,630
ST6VSDT1003PC-I	SEL ST6-VSDT100-3P-SSS-C)	F2	\$4,247
ST6VSDT1003PC-K	SEL ST6-VSDT100-3P-SSS-C)	F2	\$4,081
ST6VSDT100GC	SEL ST6-VSDT100-G-SSS-C)	F2	\$1,155
ST6VSDT100GC-I	SEL ST6-VSDT100-G-SSS-C)	F2	\$1,351
ST6VSDT100GC-K	SEL ST6-VSDT100-G-SSS-C)	F2	\$1,298
ST6VSDT100PC	SEL ST6-VSDT100-P-SSS-C)	F2	\$1,375
ST6VSDT100PC-I	SEL ST6-VSDT100-P-SSS-C)	F2	\$1,609
ST6VSDT100PC-K	SEL ST6-VSDT100-P-SSS-C)	F2	\$1,546
ST6VSDT103GC	SEL ST6-VSDT10-3G-SSS-C)	F2	\$306
ST6VSDT103GC-I	SEL ST6-VSDT10-3G-SSS-C)	F2	\$358
ST6VSDT103GC-K	SEL ST6-VSDT10-3G-SSS-C)	F2	\$344
ST6VSDT103PC	SEL ST6-VSDT10-3P-SSS-C)	F2	\$364
ST6VSDT103PC-I	SEL ST6-VSDT10-3P-SSS-C)	F2	\$426
ST6VSDT103PC-K	SEL ST6-VSDT10-3P-SSS-C)	F2	\$410
ST6VSDT10GC	SEL ST6-VSDT10-G-SSS-C)	F2	\$116
ST6VSDT10GC-I	SEL ST6-VSDT10-G-SSS-C)	F2	\$136
ST6VSDT10GC-K	SEL ST6-VSDT10-G-SSS-C)	F2	\$130
ST6VSDT10PC	SEL ST6-VSDT10-P-SSS-C)	F2	\$138
ST6VSDT10PC-I	SEL ST6-VSDT10-P-SSS-C)	F2	\$161
ST6VSDT10PC-K	SEL ST6-VSDT10-P-SSS-C)	F2	\$155
STAM-LIB	SEL: TAM, ADDITIONAL LIBRARY PER YR	F2	\$5,118
STAM-SITE	SEL: TAM, SINGLE SITE PER YEAR	F2	\$25,588
SUPPORTRSTRT	SELECT NTPS CONTRACT REACTIVATION FEE	F2	\$529
SVCC0101PFPK0302	SEL SH STD IMPLEMENTATION SERVICE	F2	\$14,118
SVCC0101PFPK0303	SEL SH ADV IMPLEMENTATION SERVICE	F2	\$14,118
SVCC0102PFPK0314	SEL SHI APP IMPLEMENTATION SERVICE	F2	\$8,824
SVCC0201PFPK0302	SEL SF STD IMPLEMENTATION SERVICE	F2	\$14,118
SVCC0325PFPK0301	SEL SCNP IMPLEMENTATION SERVICE	F2	\$16,941
SVCCR0	SEL SVC-CR-0)	F2	\$100
SVCCR0-I	SEL SVC-CR-0)	F2	\$100
SVCCR0-K	SEL SVC-CR-0)	F2	\$113

SVCCR10	SEL SVC-CR-10)	F2	\$90
SVCCR10-I	SEL SVC-CR-10)	F2	\$90
SVCCR10-K	SEL SVC-CR-10)	F2	\$101
SVCCR15	SEL SVC-CR-15)	F2	\$85
SVCCR15-I	SEL SVC-CR-15)	F2	\$85
SVCCR15-K	SEL SVC-CR-15)	F2	\$96
SVCCR20	SEL SVC-CR-20)	F2	\$80
SVCCR20-I	SEL SVC-CR-20)	F2	\$80
SVCCR20-K	SEL SVC-CR-20)	F2	\$90
SVC-EMC-ADDON	SEL installation S-head appliance	F2	\$2,941
SVC-EMC-BASE	SEL Install upto 4 S-head appliances	F2	\$17,647
SVC-EXP-00004	SEL CASCADE FIXED EXPENSES	F2	\$588
SVC-EXP-00009	SEL Fixed Expenses	F2	\$588
SVC-EXP-00012	SEL FIXED EXPENSES	F2	\$588
SVC-HRY-00001	SEL Time and Mat. Consulting Hour(s)	F2	\$353
SVC-HRY-00002	SEL TIME AND MAT. CASCADE HOUR(S)	F2	\$353
SVC-PJM-00001	SEL Time and Materl Proj Mgmt Hours	F2	\$353
SVC-PJM-00002	SEL TIME AND MAT. CASCADE PROJ MGMT HOU	F2	\$353
SVC-PSD-00002	SEL Prof Svc per day (excluding T&E)	F2	\$2,824
SVC-PSD-00215	SEL RIVERBED CASCADE PROF SVC/DAY-ONSI	F2	\$2,824
SVC-PSD-00816	SEL SF Time Materials Consult Day	F2	\$2,824
SVC-PSDRMFPEXP5	SEL Fixed Exp SteelCentral Consulting	F2	\$588
SVCPSDRPMPRMPM01	SEL HrlyTimeMat StlCentralprjmgtextclT&E	F2	\$353
SVCPSDRPMPRMTM01	SEL Hourly Time and Mat SteelCentral	F2	\$353
SVC-TRA-00173	SEL CASCADE CONFIG/OPERATIONS-3DAYS PT	F2	\$1,765
SVC-TRACRCUST01C	SEL Training Credit Customer Student	F2	\$118
SVC-TRA-FEXP5	SEL T&E FOR TRAINING - FIXED EXPENSE	F2	\$588
SVC-TRA-NPM200-D	SEL NPM200 PME - DEDICATED TRAINING	F2	\$41,176
SVC-TRA-SD200-D	SEL SD200 - Dedicated Training	F2	\$41,176
T50-724-1-12	SEL: T50;24HR ONSITE;1 DRIVE;1YR	F2	\$2,064
T50-724-1-24	SEL: T50;24HR ONSITE;1 DRIVE;2YR	F2	\$4,762
T50-724-1-36	SEL: T50;24HR ONSITE;1 DRIVE;3YR	F2	\$7,460
T50-724-1-48	SEL: T50;24HR ONSITE;1 DRIVE;4YR	F2	\$10,158
T50-724-1-60	SEL: T50;24HR ONSITE;1 DRIVE;5YR	F2	\$12,857
T50-724-2-12	SEL: T50;24HR ONSITE;2 DRIVE;1YR	F2	\$3,069
T50-724-2-24	SEL: T50;24HR ONSITE;2 DRIVE;2YR	F2	\$7,090
T50-724-2-36	SEL: T50;24HR ONSITE;2 DRIVE;3YR	F2	\$11,110
T50-724-2-48	SEL: T50;24HR ONSITE;2 DRIVE;4YR	F2	\$15,131
T50-724-2-60	SEL: T50;24HR ONSITE;2 DRIVE;5YR	F2	\$19,152
T50-724-3-12	SEL: T50;24HR OS;3DR;1YR	F2	\$4,074
T50-724-3-24	SEL: T50;24HR ONSITE;3 DRIVE;2YR	F2	\$9,417
T50-724-3-36	SEL: T50;24HR ONSITE;3 DRIVE;3YR	F2	\$14,761
T50-724-3-48	SEL: T50;24HR ONSITE;3 DRIVE;4YR	F2	\$20,104
T50-724-3-60	SEL: T50;24HR ONSITE;3 DRIVE;5YR	F2	\$25,447
T50-724-4-12	SEL: T50;24HR ONSITE;4 DRIVE;1YR	F2	\$5,079
T50-724-4-24	SEL: T50;24HR ONSITE;4 DRIVE;2YR	F2	\$11,745
T50-724-4-36	SEL: T50;24HR ONSITE;4 DRIVE;3YR	F2	\$18,411
T50-724-4-48	SEL: T50;24HR ONSITE;4 DRIVE;4YR	F2	\$25,077
T50-724-4-60	SEL: T50;24HR ONSITE;4 DRIVE;5YR	F2	\$31,743
T50-NBD-1-12	SEL: T50;NBD ONSITE;1 DRIVE;1YR	F2	\$0

T50-NBD-1-24	SEL: T50;NBD ONSITE;1 DRIVE;2YR	F2	\$1,852
T50-NBD-1-36	SEL: T50;NBD ONSITE;1 DRIVE;3YR	F2	\$3,703
T50-NBD-1-48	SEL: T50;NBD ONSITE;1 DRIVE;4YR	F2	\$5,556
T50-NBD-1-60	SEL: T50;NBD ONSITE;1 DRIVE;5YR	F2	\$7,407
T50-NBD-2-24	SEL: T50;NBD ONSITE;2 DRIVE;2YR	F2	\$2,699
T50-NBD-2-36	SEL: T50;NBD ONSITE;2 DRIVE;3YR	F2	\$5,397
T50-NBD-2-48	SEL: T50;NBD ONSITE;2 DRIVE;4YR	F2	\$8,095
T50-NBD-2-60	SEL: T50;NBD ONSITE;2 DRIVE;5YR	F2	\$10,793
T50-NBD-3-24	SEL: T50;NBD ONSITE;3 DRIVE;2YR	F2	\$3,545
T50-NBD-3-36	SEL: T50;NBD ONSITE;3 DRIVE;3YR	F2	\$7,090
T50-NBD-3-48	SEL: T50;NBD ONSITE;3 DRIVE;4YR	F2	\$10,635
T50-NBD-3-60	SEL: T50;NBD ONSITE;3 DRIVE;5YR	F2	\$14,178
T50-NBD-4-24	SEL: T50;NBD ONSITE;4 DRIVE;2YR	F2	\$4,391
T50-NBD-4-36	SEL: T50;NBD ONSITE;4 DRIVE;3YR	F2	\$8,782
T50-NBD-4-48	SEL: T50;NBD ONSITE;4 DRIVE;4YR	F2	\$13,174
T50-NBD-4-60	SEL: T50;NBD ONSITE;4 DRIVE;5YR	F2	\$17,565
T50-SBD-1-12	SEL: T50;SBD ONSITE;1 DRIVE;1YR	F2	\$1,641
T50-SBD-1-24	SEL: T50;SBD ONSITE;1 DRIVE;2YR	F2	\$3,863
T50-SBD-1-36	SEL: T50;SBD ONSITE;1 DRIVE;3YR	F2	\$6,085
T50-SBD-1-48	SEL: T50;SBD ONSITE;1 DRIVE;4YR	F2	\$8,307
T50-SBD-1-60	SEL: T50;SBD ONSITE;1 DRIVE;5YR	F2	\$10,529
T50-SBD-2-12	SEL: T50;SBD ONSITE;2 DRIVE;1YR	F2	\$2,382
T50-SBD-2-24	SEL: T50;SBD ONSITE;2 DRIVE;2YR	F2	\$5,661
T50-SBD-2-36	SEL: T50;SBD ONSITE;2 DRIVE;3YR	F2	\$8,941
T50-SBD-2-48	SEL: T50;SBD ONSITE;2 DRIVE;4YR	F2	\$12,222
T50-SBD-2-60	SEL: T50;SBD ONSITE;2 DRIVE;5YR	F2	\$15,501
T50-SBD-3-12	SEL: T50;SBD ONSITE;3 DRIVE;1YR	F2	\$3,122
T50-SBD-3-24	SEL: T50;SBD ONSITE;3 DRIVE;2YR	F2	\$7,460
T50-SBD-3-36	SEL: T50;SBD ONSITE;3 DRIVE;3YR	F2	\$11,798
T50-SBD-3-48	SEL: T50;SBD ONSITE;3 DRIVE;4YR	F2	\$16,136
T50-SBD-3-60	SEL: T50;SBD ONSITE;3 DRIVE;5YR	F2	\$20,475
T50-SBD-4-12	SEL: T50;SBD ONSITE;4 DRIVE;1YR	F2	\$3,863
T50-SBD-4-24	SEL: T50;SBD ONSITE;4 DRIVE;2YR	F2	\$9,259
T50-SBD-4-36	SEL: T50;SBD ONSITE;4 DRIVE;3YR	F2	\$14,655
T50-SBD-4-48	SEL: T50;SBD ONSITE;4 DRIVE;4YR	F2	\$20,051
T50-SBD-4-60	SEL: T50;SBD ONSITE;4 DRIVE;5YR	F2	\$25,447
TAMSUPPORT1	SELECT NTPS TAM SUPPORT 1YR	F2	\$79,412
TE-MC	SEL Test Environment Add-on MC	F2	\$4,015
TE-MS	SEL Test Environment Add-on MS	F2	\$2,294
THIN51003GC	SEL THIN5-100PK-3G-SSS-C)	F2	\$1,085
THIN51003GC-I	SEL THIN5-100PK-3G-SSS-C)	F2	\$1,134
THIN51003GCV2-K	SEL THIN5-100PK-3G-SSS-C)	F2	\$1,163
THIN51003PC	SEL THIN5-100PK-3P-SSS-C)	F2	\$1,291
THIN51003PC-I	SEL THIN5-100PK-3P-SSS-C)	F2	\$1,349
THIN51003PCV2-K	SEL THIN5-100PK-3P-SSS-C)	F2	\$1,384
THIN5100PGC	SEL THIN5-100PK-G-SSS-C)	F2	\$411
THIN5100PGC-I	SEL THIN5-100PK-G-SSS-C)	F2	\$430
THIN5100PGCV2-K	SEL THIN5-100PK-G-SSS-C)	F2	\$441
THIN5100PPC	SEL THIN5-100PK-P-SSS-C)	F2	\$489
THIN5100PPC-I	SEL THIN5-100PK-P-SSS-C)	F2	\$511

THIN5100PPCV2-K	SEL THIN5-100PK-P-SSS-C)	F2	\$524
THIN5STE3GC	SEL THIN5-STE-3G-SSS-C)	F2	\$2,851
THIN5STE3GC-I	SEL THIN5-STE-3G-SSS-C)	F2	\$2,980
THIN5STE3GCV2-K	SEL THIN5-STE-3G-SSS-C)	F2	\$3,056
THIN5STE3PC	SEL THIN5-STE-3P-SSS-C)	F2	\$3,395
THIN5STE3PC-I	SEL THIN5-STE-3P-SSS-C)	F2	\$3,548
THIN5STE3PCV2-K	SEL THIN5-STE-3P-SSS-C)	F2	\$3,639
THIN5STEGC	SEL THIN5-STE-G-SSS-C)	F2	\$1,080
THIN5STEGC-I	SEL THIN5-STE-G-SSS-C)	F2	\$1,129
THIN5STEGCV2-K	SEL THIN5-STE-G-SSS-C)	F2	\$1,158
THIN5STEP	SEL THIN5-STE-P-SSS-C)	F2	\$1,286
THIN5STEP-I	SEL THIN5-STE-P-SSS-C)	F2	\$1,344
THIN5STEPV2-K	SEL THIN5-STE-P-SSS-C)	F2	\$1,378
TRAINING-RG	SEL RG SYSTEM TRAINING DAY	F2	\$1,047
TRV-1D	SEL ONE DAY PROSER TRAVEL EXP	F2	\$574
UEMCCU1003GC	SEL UEM-CCU-100-3G-SSS-C)	F2	\$2,856
UEMCCU1003GC-I	SEL UEM-CCU-100-3G-SSS-C)	F2	\$3,142
UEMCCU1003GC-K	SEL UEM-CCU-100-3G-SSS-C)	F2	\$3,091
UEMCCU1003PC	SEL UEM-CCU-100-3P-SSS-C)	F2	\$3,400
UEMCCU1003PC-I	SEL UEM-CCU-100-3P-SSS-C)	F2	\$3,740
UEMCCU1003PC-K	SEL UEM-CCU-100-3P-SSS-C)	F2	\$3,679
UEMCCU100GC	SEL UEM-CCU-100-G-SSS-C)	F2	\$1,082
UEMCCU100GC-I	SEL UEM-CCU-100-G-SSS-C)	F2	\$1,190
UEMCCU100GC-K	SEL UEM-CCU-100-G-SSS-C)	F2	\$1,171
UEMCCU100PC	SEL UEM-CCU-100-P-SSS-C)	F2	\$1,288
UEMCCU100PC-I	SEL UEM-CCU-100-P-SSS-C)	F2	\$1,417
UEMCCU100PC-K	SEL UEM-CCU-100-P-SSS-C)	F2	\$1,394
UEMCCU103GC	SEL UEM-CCU-10-3G-SSS-C)	F2	\$285
UEMCCU103GC-I	SEL UEM-CCU-10-3G-SSS-C)	F2	\$314
UEMCCU103GC-K	SEL UEM-CCU-10-3G-SSS-C)	F2	\$309
UEMCCU103PC	SEL UEM-CCU-10-3P-SSS-C)	F2	\$341
UEMCCU103PC-I	SEL UEM-CCU-10-3P-SSS-C)	F2	\$375
UEMCCU103PC-K	SEL UEM-CCU-10-3P-SSS-C)	F2	\$368
UEMCCU10GC	SEL UEM-CCU-10-G-SSS-C)	F2	\$108
UEMCCU10GC-I	SEL UEM-CCU-10-G-SSS-C)	F2	\$119
UEMCCU10GC-K	SEL UEM-CCU-10-G-SSS-C)	F2	\$117
UEMCCU10PC	SEL UEM-CCU-10-P-SSS-C)	F2	\$129
UEMCCU10PC-I	SEL UEM-CCU-10-P-SSS-C)	F2	\$142
UEMCCU10PC-K	SEL UEM-CCU-10-P-SSS-C)	F2	\$140
UEMNU1003GC	SEL UEM-NU-100-3G-SSS-C)	F2	\$1,713
UEMNU1003GC-I	SEL UEM-NU-100-3G-SSS-C)	F2	\$1,885
UEMNU1003GC-K	SEL UEM-NU-100-3G-SSS-C)	F2	\$1,854
UEMNU1003PC	SEL UEM-NU-100-3P-SSS-C)	F2	\$2,041
UEMNU1003PC-I	SEL UEM-NU-100-3P-SSS-C)	F2	\$2,245
UEMNU1003PC-K	SEL UEM-NU-100-3P-SSS-C)	F2	\$2,208
UEMNU100GC	SEL UEM-NU-100-G-SSS-C)	F2	\$649
UEMNU100GC-I	SEL UEM-NU-100-G-SSS-C)	F2	\$714
UEMNU100GC-K	SEL UEM-NU-100-G-SSS-C)	F2	\$702
UEMNU100PC	SEL UEM-NU-100-P-SSS-C)	F2	\$773
UEMNU100PC-I	SEL UEM-NU-100-P-SSS-C)	F2	\$850

UEMNU100PC-K	SEL UEM-NU-100-P-SSS-C)	F2	\$836
UEMNU103GC	SEL UEM-NU-10-3G-SSS-C)	F2	\$172
UEMNU103GC-I	SEL UEM-NU-10-3G-SSS-C)	F2	\$189
UEMNU103GC-K	SEL UEM-NU-10-3G-SSS-C)	F2	\$186
UEMNU103PC	SEL UEM-NU-10-3P-SSS-C)	F2	\$203
UEMNU103PC-I	SEL UEM-NU-10-3P-SSS-C)	F2	\$224
UEMNU103PC-K	SEL UEM-NU-10-3P-SSS-C)	F2	\$220
UEMNU10GC	SEL UEM-NU-10-G-SSS-C)	F2	\$65
UEMNU10GC-I	SEL UEM-NU-10-G-SSS-C)	F2	\$72
UEMNU10GC-K	SEL UEM-NU-10-G-SSS-C)	F2	\$70
UEMNU10PC	SEL UEM-NU-10-P-SSS-C)	F2	\$77
UEMNU10PC-I	SEL UEM-NU-10-P-SSS-C)	F2	\$85
UEMNU10PC-K	SEL UEM-NU-10-P-SSS-C)	F2	\$83
U-FS-VT-BCE-M-PD	SEL VT Compliance Edition 1YR Supp	F2	\$15,000
U-FS-VT-BC-M-PD	SEL VT Branded Conn PL 1YR Supp	F2	\$4,000
U-FS-VT-BI-M-PD	SEL VT BI PL Annual Supp	F2	\$10,000
U-FS-VT-BSE-M-PD	SEL VT Risk Mgmt Annual Supp	F2	\$34,000
U-FS-VT-BUS-M-PD	SEL VT UPG CMP to Risk Mgmt 1YR Supp	F2	\$19,000
U-FS-VT-IN-CP-B	SEL VT Installation - CMP Basic	F2	\$6,000
U-FS-VT-IN-CP-DR	SEL VT Installation - CMP - DR	F2	\$4,000
U-FS-VT-IN-RM-B	SEL VT Installation - Risk Mgmt - Basic	F2	\$10,000
U-FS-VT-IN-RM-DR	SEL VT Installation - Risk Mgmt - DR	F2	\$6,000
U-FS-VT-MD-M-PD	SEL VTMD PL 11-1000 MD 1YR Supp	F2	\$46
U-FS-VT-MD-M-PDE	SEL VTMD PL 1001-5000 MD 1YR Supp	F2	\$37
U-FS-VT-MD-M-PDG	SEL VTMD PL 5001-10,000 MD 1YR Supp	F2	\$33
U-FS-VT-MD-M-PDH	SEL VTMD PL 10,001-25,000 MD 1YR Supp	F2	\$30
U-FS-VT-MD-M-PDI	SEL VTMD PL 25,001-50,000 MD 1YR Supp	F2	\$27
U-FS-VT-MD-M-PDJ	SEL VTMD PL 50,001-100,000 MD 1YR Supp	F2	\$24
U-FS-VT-MD-M-PDK	SEL VTMD PL 100,001-ENT MD 1YR Supp	F2	\$22
U-FS-VT-RM-MS-MD	SEL VT Risk Mgmt MSS Per device Mo	F2	\$22
U-FS-VT-RM-SASMD	SEL VT Risk Mgmt SaaS Per device Mo	F2	\$8
U-FS-VT-TR-CP-AD	SEL VT Training - CMP Admin - 3Day	F2	\$6,000
U-FS-VT-TR-CP-AS	SEL VT Training - CMP Assessor - 2D	F2	\$4,000
U-FS-VT-TR-CP-MG	SEL VT Training - CMP Mgr - 2Day	F2	\$4,000
U-FS-VT-TR-CP-UR	SEL VT Training - CMP User - 2Day	F2	\$4,000
U-FS-VT-TR-RM-AD	SEL VT Training - Risk Mgmt Admin - 3Day	F2	\$6,000
U-FS-VT-TR-RM-MG	SEL VT Training - Risk Mgmt Mgr - 2Day	F2	\$4,000
U-FS-VT-TR-RM-UR	SEL VT Training - Risk Mgmt User - 2Day	F2	\$4,000
V7ATA253GCV2-K	SEL VR7-ATAD25-3G-SSS-C)	F2	\$4,416
V7ATA253PCV2-K	SEL VR7-ATAD25-3P-SSS-C)	F2	\$5,256
V7ATA25GCV2-K	SEL VR7-ATAD25-G-SSS-C)	F2	\$1,673
V7ATA25PCV2-K	SEL VR7-ATAD25-P-SSS-C)	F2	\$1,991
V7ATE253GCV2-K	SEL VR7-ATEN25-3G-SSS-C)	F2	\$7,636
V7ATE253PCV2-K	SEL VR7-ATEN25-3P-SSS-C)	F2	\$9,090
V7ATE25GCV2-K	SEL VR7-ATEN25-G-SSS-C)	F2	\$2,892
V7ATE25PCV2-K	SEL VR7-ATEN25-P-SSS-C)	F2	\$3,443
VAMAWD3GSSSC	SEL VA-MAW-D-3G-SSS-C)	F2	\$5
VAMAWD3GSSSC-I	SEL VA-MAW-D-3G-SSS-C)	F2	\$5
VAMAWD3GSSSC-K	SEL VA-MAW-D-3G-SSS-C)	F2	\$6
VAMAWD3PSSSC	SEL VA-MAW-D-3P-SSS-C)	F2	\$8

VAMAWD3PSSSC-I	SEL VA-MAW-D-3P-SSS-C)	F2	\$8
VAMAWD3PSSSC-K	SEL VA-MAW-D-3P-SSS-C)	F2	\$8
VAMAWDGSSSC	SEL VA-MAW-D-G-SSS-C)	F2	\$2
VAMAWDGSSSC-I	SEL VA-MAW-D-G-SSS-C)	F2	\$2
VAMAWDGSSSC-K	SEL VA-MAW-D-G-SSS-C)	F2	\$2
VAMAWDPSSSC	SEL VA-MAW-D-P-SSS-C)	F2	\$3
VAMAWDPSSSC-I	SEL VA-MAW-D-P-SSS-C)	F2	\$3
VAMAWDPSSSC-K	SEL VA-MAW-D-P-SSS-C)	F2	\$3
VAMBMD3GSUPC	SEL VA-MBM-D-3GSUP-C)	F2	\$4
VAMBMD3GSUPC-I	SEL VA-MBM-D-3GSUP-C)	F2	\$4
VAMBMD3GSUPC-K	SEL VA-MBM-D-3GSUP-C)	F2	\$4
VAMBMD3PSUPC	SEL VA-MBM-D-3PSUP-C)	F2	\$6
VAMBMD3PSUPC-I	SEL VA-MBM-D-3PSUP-C)	F2	\$6
VAMBMD3PSUPC-K	SEL VA-MBM-D-3PSUP-C)	F2	\$6
VAMBMDGSUPC	SEL VA-MBM-D-GSUP-C)	F2	\$1
VAMBMDGSUPC-I	SEL VA-MBM-D-GSUP-C)	F2	\$1
VAMBMDGSUPC-K	SEL VA-MBM-D-GSUP-C)	F2	\$1
VAMBMDPSUPC	SEL VA-MBM-D-PSUP-C)	F2	\$2
VAMBMDPSUPC-I	SEL VA-MBM-D-PSUP-C)	F2	\$2
VAMBMDPSUPC-K	SEL VA-MBM-D-PSUP-C)	F2	\$2
VAOMSD2MPSSSF	SEL: VA-OMS-D-2M-PSSS-F	F2	\$3
VAOMSD3PSSSF	SEL: VA-OMS-D-3P-SSS-F	F2	\$52
VAOMSDPSSSF	SEL: VA-OMS-D-P-SSS-F	F2	\$20
VAOMSU2MPSSSF	SEL: VA-OMS-U-2M-PSSS-F	F2	\$6
VAOMSUPSSSF	SEL: VA-OMS-U-P-SSS-F	F2	\$39
VATELD3GSSSC	SEL VA-TEL-D-3G-SSS-C)	F2	\$11
VATELD3GSSSC-I	SEL VA-TEL-D-3G-SSS-C)	F2	\$11
VATELD3GSSSC-K	SEL VA-TEL-D-3G-SSS-C)	F2	\$11
VATELD3PSSSC	SEL VA-TEL-D-3P-SSS-C)	F2	\$13
VATELD3PSSSC-I	SEL VA-TEL-D-3P-SSS-C)	F2	\$13
VATELD3PSSSC-K	SEL VA-TEL-D-3P-SSS-C)	F2	\$14
VATELDGSSSC	SEL VA-TEL-D-G-SSS-C)	F2	\$4
VATELDGSSSC-I	SEL VA-TEL-D-G-SSS-C)	F2	\$4
VATELDGSSSC-K	SEL VA-TEL-D-G-SSS-C)	F2	\$4
VATELDPSSSC	SEL VA-TEL-D-P-SSS-C)	F2	\$5
VATELDPSSSC-I	SEL VA-TEL-D-P-SSS-C)	F2	\$5
VATELDPSSSC-K	SEL VA-TEL-D-P-SSS-C)	F2	\$5
VAWCLDDPC-K	SEL V-MAW-CLD-D-P-C)	F2	\$8
VAWOSAD3GSSSC	SEL VA-WOS-A-D-3G-SSS-C)	F2	\$29
VAWOSAD3GSSSC-I	SEL VA-WOS-A-D-3G-SSS-C)	F2	\$30
VAWOSAD3GSSSC-K	SEL VA-WOS-A-D-3G-SSS-C)	F2	\$31
VAWOSAD3PSSSC	SEL VA-WOS-A-D-3P-SSS-C)	F2	\$34
VAWOSAD3PSSSC-I	SEL VA-WOS-A-D-3P-SSS-C)	F2	\$36
VAWOSAD3PSSSC-K	SEL VA-WOS-A-D-3P-SSS-C)	F2	\$37
VAWOSADGSSSC	SEL VA-WOS-A-D-G-SSS-C)	F2	\$11
VAWOSADGSSSC-I	SEL VA-WOS-A-D-G-SSS-C)	F2	\$12
VAWOSADGSSSC-K	SEL VA-WOS-A-D-G-SSS-C)	F2	\$12
VAWOSADPSSSC	SEL VA-WOS-A-D-P-SSS-C)	F2	\$13
VAWOSADPSSSC-I	SEL VA-WOS-A-D-P-SSS-C)	F2	\$14
VAWOSADPSSSC-K	SEL VA-WOS-A-D-P-SSS-C)	F2	\$14

VAWOSAUGSSSC	SEL VA-WOS-A-U-G-SSS-C)	F2	\$20
VAWOSAUGSSSC-I	SEL VA-WOS-A-U-G-SSS-C)	F2	\$21
VAWOSAUGSSSC-K	SEL VA-WOS-A-U-G-SSS-C)	F2	\$21
VAWOSAUPSSSC	SEL VA-WOS-A-U-P-SSS-C)	F2	\$23
VAWOSAUPSSSC-I	SEL VA-WOS-A-U-P-SSS-C)	F2	\$24
VAWOSAUPSSSC-K	SEL VA-WOS-A-U-P-SSS-C)	F2	\$25
VBCLADO253GC	SEL VR-BCLADVO-25-3G-SSS-C)	F2	\$2,851
VBCLADO253GC-I	SEL VR-BCLADVO-25-3G-SSS-C)	F2	\$3,336
VBCLADO253GC-K	SEL VR-BCLADVO-25-3G-SSS-C)	F2	\$3,205
VBCLADO253PC	SEL VR-BCLADVO-25-3P-SSS-C)	F2	\$3,395
VBCLADO253PC-I	SEL VR-BCLADVO-25-3P-SSS-C)	F2	\$3,972
VBCLADO253PC-K	SEL VR-BCLADVO-25-3P-SSS-C)	F2	\$3,816
VCEPIC3GC	SEL VC-EPIC-3G-SSS-C)	F2	\$34,236
VCEPIC3GC-I	SEL VC-EPIC-3G-SSS-C)	F2	\$40,056
VCEPIC3GC-K	SEL VC-EPIC-3G-SSS-C)	F2	\$38,485
VCEPIC3PC	SEL VC-EPIC-3P-SSS-C)	F2	\$40,756
VCEPIC3PC-I	SEL VC-EPIC-3P-SSS-C)	F2	\$47,685
VCEPIC3PC-K	SEL VC-EPIC-3P-SSS-C)	F2	\$45,815
VCEPICGC	SEL VC-EPIC-G-SSS-C)	F2	\$12,968
VCEPICGC-I	SEL VC-EPIC-G-SSS-C)	F2	\$15,173
VCEPICGC-K	SEL VC-EPIC-G-SSS-C)	F2	\$14,578
VCEPICPC	SEL VC-EPIC-P-SSS-C)	F2	\$15,438
VCEPICPC-I	SEL VC-EPIC-P-SSS-C)	F2	\$18,062
VCEPICPC-K	SEL VC-EPIC-P-SSS-C)	F2	\$17,354
VCS6FND3GC	SEL VCS6-FND-3G-SSS-C)	F2	\$1,478
VCS6FND3GC-I	SEL VCS6-FND-3G-SSS-C)	F2	\$1,730
VCS6FND3GC-K	SEL VCS6-FND-3G-SSS-C)	F2	\$1,741
VCS6FND3PC	SEL VCS6-FND-3P-SSS-C)	F2	\$1,748
VCS6FND3PC-I	SEL VCS6-FND-3P-SSS-C)	F2	\$2,045
VCS6FND3PC-K	SEL VCS6-FND-3P-SSS-C)	F2	\$2,059
VCS6FNDGC	SEL VCS6-FND-G-SSS-C)	F2	\$560
VCS6FNDGC-I	SEL VCS6-FND-G-SSS-C)	F2	\$655
VCS6FNDGC-K	SEL VCS6-FND-G-SSS-C)	F2	\$660
VCS6FNDPC	SEL VCS6-FND-P-SSS-C)	F2	\$662
VCS6FNDPC-I	SEL VCS6-FND-P-SSS-C)	F2	\$775
VCS6FNDPC-K	SEL VCS6-FND-P-SSS-C)	F2	\$780
VCS6STD3GC-I	SEL VCS6-STD-3G-SSS-C)	F2	\$4,006
VCS6STD3GCV2	SEL VCS6-STD-3G-SSS-C)	F2	\$3,424
VCS6STD3GCV2-K	SEL VCS6-STD-3G-SSS-C)	F2	\$4,033
VCS6STD3PC-I	SEL VCS6-STD-3P-SSS-C)	F2	\$4,769
VCS6STD3PCV2	SEL VCS6-STD-3P-SSS-C)	F2	\$4,076
VCS6STD3PCV2-K	SEL VCS6-STD-3P-SSS-C)	F2	\$4,801
VCS6STDGC-I	SEL VCS6-STD-G-SSS-C)	F2	\$1,517
VCS6STDGCV2	SEL VCS6-STD-G-SSS-C)	F2	\$1,297
VCS6STDGCV2-K	SEL VCS6-STD-G-SSS-C)	F2	\$1,528
VCS6STDPC-I	SEL VCS6-STD-P-SSS-C)	F2	\$1,806
VCS6STDPCV2	SEL VCS6-STD-P-SSS-C)	F2	\$1,544
VCS6STDPCV2-K	SEL VCS6-STD-P-SSS-C)	F2	\$1,819
VC SRM625EGC	SEL VC-SRM6-25E-G-SSS-C)	F2	\$2,678
VC SRM625EGC-I	SEL VC-SRM6-25E-G-SSS-C)	F2	\$3,133

VCSR625EGC-K	SEL VC-SRM6-25E-G-SSS-C)	F2	\$3,010
VCSR625EPC	SEL VC-SRM6-25E-P-SSS-C)	F2	\$3,188
VCSR625EPC-I	SEL VC-SRM6-25E-P-SSS-C)	F2	\$3,730
VCSR625EPC-K	SEL VC-SRM6-25E-P-SSS-C)	F2	\$3,584
VCSR625SGC	SEL VC-SRM6-25S-G-SSS-C)	F2	\$1,055
VCSR625SGC-I	SEL VC-SRM6-25S-G-SSS-C)	F2	\$1,234
VCSR625SGC-K	SEL VC-SRM6-25S-G-SSS-C)	F2	\$1,186
VCSR625SPC	SEL VC-SRM6-25S-P-SSS-C)	F2	\$1,256
VCSR625SPC-I	SEL VC-SRM6-25S-P-SSS-C)	F2	\$1,470
VCSR625SPC-K	SEL VC-SRM6-25S-P-SSS-C)	F2	\$1,412
VCSR825E3GC	SEL VC-SRM8-25E-3G-C)	F2	\$7,070
VCSR825E3GC-I	SEL VC-SRM8-25E-3G-C)	F2	\$8,272
VCSR825E3GC-K	SEL VC-SRM8-25E-3G-C)	F2	\$7,947
VCSR825E3PC	SEL VC-SRM8-25E-3P-C)	F2	\$8,416
VCSR825E3PC-I	SEL VC-SRM8-25E-3P-C)	F2	\$9,847
VCSR825E3PC-K	SEL VC-SRM8-25E-3P-C)	F2	\$9,461
VCSR825EGC	SEL VC-SRM8-25E-G-C)	F2	\$2,678
VCSR825EGC-I	SEL VC-SRM8-25E-G-C)	F2	\$3,133
VCSR825EGC-K	SEL VC-SRM8-25E-G-C)	F2	\$3,010
VCSR825EPC	SEL VC-SRM8-25E-P-C)	F2	\$3,188
VCSR825EPC-I	SEL VC-SRM8-25E-P-C)	F2	\$3,730
VCSR825EPC-K	SEL VC-SRM8-25E-P-C)	F2	\$3,584
VCSR825GC	SEL VC-SRM8-25-G-C)	F2	\$1,055
VCSR825GC-I	SEL VC-SRM8-25-G-C)	F2	\$1,234
VCSR825GC-K	SEL VC-SRM8-25-G-C)	F2	\$1,186
VCSR825S3GC	SEL VC-SRM8-25S-3G-C)	F2	\$2,785
VCSR825S3GC-I	SEL VC-SRM8-25S-3G-C)	F2	\$3,259
VCSR825S3GC-K	SEL VC-SRM8-25S-3G-C)	F2	\$3,131
VCSR825S3PC	SEL VC-SRM8-25S-3P-C)	F2	\$3,316
VCSR825S3PC-I	SEL VC-SRM8-25S-3P-C)	F2	\$3,880
VCSR825S3PC-K	SEL VC-SRM8-25S-3P-C)	F2	\$3,727
VCSR825SPC	SEL VC-SRM8-25S-P-C)	F2	\$1,256
VCSR825SPC-I	SEL VC-SRM8-25S-P-C)	F2	\$1,470
VCSR825SPC-K	SEL VC-SRM8-25S-P-C)	F2	\$1,412
VELDLDDGC-K	SEL V-TEL-DLD-D-G-C)	F2	\$26
VF-ERS-G-TLSST1F	SEL: S2-OERS-PSUP-F	F2	\$27,500
VFHYP53GSC	SEL VF-HYPM5-3G-SSS-C)	F2	\$206
VFHYP53GSC-I	SEL VF-HYPM5-3G-SSS-C)	F2	\$241
VFHYP53GSCV2-K	SEL VF-HYPM5-3G-SSS-C)	F2	\$231
VFHYP53PSC	SEL VF-HYPM5-3P-SSS-C)	F2	\$246
VFHYP53PSC-I	SEL VF-HYPM5-3P-SSS-C)	F2	\$287
VFHYP53PSCV2-K	SEL VF-HYPM5-3P-SSS-C)	F2	\$276
VFHYP5GSC	SEL VF-HYPM5-G-SSS-C)	F2	\$78
VFHYP5GSC-I	SEL VF-HYPM5-G-SSS-C)	F2	\$91
VFHYP5GSCV2-K	SEL VF-HYPM5-G-SSS-C)	F2	\$88
VFHYP5PSC	SEL VF-HYPM5-P-SSS-C)	F2	\$93
VFHYP5PSC-I	SEL VF-HYPM5-P-SSS-C)	F2	\$109
VFHYP5PSCV2-K	SEL VF-HYPM5-P-SSS-C)	F2	\$105
VMAWCLDDC-K	SEL V-MAW-CLD-D-G-C)	F2	\$7
VMAWCLDDGC	SEL V-MAW-CLD-D-G-C)	F2	\$6

VMAWCLDDGC-I	SEL V-MAW-CLD-D-G-C)	F2	\$6
VMAWCLDDPC	SEL V-MAW-CLD-D-P-C)	F2	\$7
VMAWCLDDPC-I	SEL V-MAW-CLD-D-P-C)	F2	\$7
VMAWDLDDGC	SEL V-MAW-DLD-D-G-C)	F2	\$6
VMAWDLDDGC-I	SEL V-MAW-DLD-D-G-C)	F2	\$6
VMAWDLDDPC	SEL V-MAW-DLD-D-P-C)	F2	\$7
VMAWDLDDPC-I	SEL V-MAW-DLD-D-P-C)	F2	\$7
VMAWDLDDPC-K	SEL V-MAW-DLD-D-P-C)	F2	\$8
VMAWLDDGC-K	SEL V-MAW-DLD-D-G-C)	F2	\$7
VMBMCLDDC-K	SEL V-MBM-CLD-D-P-C)	F2	\$28
VMBMCLDDGC	SEL V-MBM-CLD-D-G-C)	F2	\$25
VMBMCLDDGC-I	SEL V-MBM-CLD-D-G-C)	F2	\$25
VMBMCLDDG-K	SEL V-MBM-CLD-D-G-C)	F2	\$26
VMBMCLDDPC	SEL V-MBM-CLD-D-P-C)	F2	\$26
VMBMCLDDPC-I	SEL V-MBM-CLD-D-P-C)	F2	\$26
VMBMDDDDPC-K	SEL V-MBM-DLD-D-P-C)	F2	\$41
VMBMDLDDGC	SEL V-MBM-DLD-D-G-C)	F2	\$37
VMBMDLDDGC-I	SEL V-MBM-DLD-D-G-C)	F2	\$37
VMBMDLDDPC	SEL V-MBM-DLD-D-P-C)	F2	\$38
VMBMDLDDPC-I	SEL V-MBM-DLD-D-P-C)	F2	\$38
VMBMDLDGC-K	SEL V-MBM-DLD-D-G-C)	F2	\$40
VMP-ES-1000AN-D	SEL Splunk VM STDSup Bucket 1000AN	F2	\$1,000
VMP-ES-1000AP-D	SEL Splunk VM STDSup Bucket 1000AP	F2	\$1,000
VMP-ES-1000EM-D	SEL Splunk VM STDSup Bucket 1000EM	F2	\$1,000
VMP-ES-1000US-D	SEL Splunk VM STDSup Bucket 1000US	F2	\$1,000
VMP-ES-100AN-D	SEL Splunk VM STDSup Bucket 100AN	F2	\$100
VMP-ES-100AP-D	SEL Splunk VM STDSup Bucket 100AP	F2	\$100
VMP-ES-100EM-D	SEL Splunk VM STDSup Bucket 100EM	F2	\$100
VMP-ES-100US-D	SEL Splunk VM STDSup Bucket 100US	F2	\$100
VMP-ES-1AN-D	SEL Splunk VM STDSup Bucket 1AN	F2	\$1
VMP-ES-1AP-D	SEL Splunk VM STDSup Bucket 1AP	F2	\$1
VMP-ES-1EM-D	SEL Splunk VM STDSup Bucket 1EM	F2	\$1
VMP-ES-1US-D	SEL Splunk VM STDSup Bucket 1US	F2	\$1
VMP-GS-1000AN-D	SEL Splunk VM PRMSup Bucket 1000AN	F2	\$1,000
VMP-GS-1000AP-D	SEL Splunk VM PRMSup Bucket 1000AP	F2	\$1,000
VMP-GS-1000EM-D	SEL Splunk VM PRMSup Bucket 1000EM	F2	\$1,000
VMP-GS-1000US-D	SEL Splunk VM PRMSup Bucket 1000US	F2	\$1,000
VMP-GS-100AN-D	SEL Splunk VM PRMSup Bucket 100AN	F2	\$100
VMP-GS-100AP-D	SEL Splunk VM PRMSup Bucket 100AP	F2	\$100
VMP-GS-100EM-D	SEL Splunk VM PRMSup Bucket 100EM	F2	\$100
VMP-GS-100US-D	SEL Splunk VM PRMSup Bucket 100US	F2	\$100
VMP-GS-1AN-D	SEL Splunk VM PRMSup Bucket 1AN	F2	\$1
VMP-GS-1AP-D	SEL Splunk VM PRMSup Bucket 1AP	F2	\$1
VMP-GS-1EM-D	SEL Splunk VM PRMSup Bucket 1EM	F2	\$1
VMP-GS-1US-D	SEL Splunk VM PRMSup Bucket 1US	F2	\$1
VMWORLDINT	SEL EMC VMWORLD PASS - EUROPE	F2	\$2,695
VMWORLDUS	SEL EMC VMWORLD PASS - US	F2	\$2,695
V-OMS-CLD-D-2P-F	SEL: V-OMS-CLD-D-2P-F	F2	\$133
V-OMS-CLD-D-3P-F	SEL: V-OMS-CLD-D-3P-F	F2	\$186
V-OMS-CLD-D-P-F	SEL: V-OMS-CLD-D-P-F	F2	\$70

V-OMS-CLD-U-2P-F	SEL: V-OMS-CLD-U-2P-F	F2	\$263
V-OMS-CLD-U-3P-F	SEL: V-OMS-CLD-U-3P-F	F2	\$370
V-OMS-CLD-U-P-F	SEL: V-OMS-CLD-U-P-F	F2	\$140
V-OMS-DLD-D-2P-F	SEL: V-OMS-DLD-D-2P-F	F2	\$157
V-OMS-DLD-D-3P-F	SEL: V-OMS-DLD-D-3P-F	F2	\$221
V-OMS-DLD-D-P-F	SEL: V-OMS-DLD-D-P-F	F2	\$84
V-OMS-DLD-U-2P-F	SEL: V-OMS-DLD-U-2P-F	F2	\$312
V-OMS-DLD-U-3P-F	SEL: V-OMS-DLD-U-3P-F	F2	\$439
V-OMS-DLD-U-P-F	SEL: V-OMS-DLD-U-P-F	F2	\$166
V-OMS-SSS-D-3P-F	SEL: V-OMS-SSS-D-3P-F	F2	\$52
V-OMS-SSS-D-P-F	SEL: V-OMS-SSS-D-P-F	F2	\$20
V-OMS-SSS-U-P-F	SEL: V-OMS-SSS-U-P-F	F2	\$39
VPS-1D	SEL Varonis Professional Services -1d	F2	\$3,441
VPS-5	SEL Varonis Professional Services -5d	F2	\$14,338
VPTO	SEL Varonis Training Online	F2	\$2,638
VR17ADAM32MGSSSF	SEL: VR17-ADAM3-2M-GSSS-F	F2	\$721
VR17ADAM32MPSSSF	SEL: VR17-ADAM3-2M-PSSS-F	F2	\$859
VR17ADAM33GSSSF	SEL: VR17-ADAM3-3G-SSS-F	F2	\$11,424
VR17ADAM33PSSSF	SEL: VR17-ADAM3-3P-SSS-F	F2	\$13,602
VR17ADAM3GSSSF	SEL: VR17-ADAM3-G-SSS-F	F2	\$4,327
VR17ADAM3PSSSF	SEL: VR17-ADAM3-P-SSS-F	F2	\$5,152
VR17ADV22MGSSSF	SEL: VR17-ADV2-2M-GSSS-F	F2	\$481
VR17ADV22MPSSSF	SEL: VR17-ADV2-2M-PSSS-F	F2	\$573
VR17ADV23GSSSF	SEL: VR17-ADV2-3G-SSS-F	F2	\$7,617
VR17ADV23PSSSF	SEL: VR17-ADV2-3P-SSS-F	F2	\$9,069
VR17ADV2GSSSF	SEL: VR17-ADV2-G-SSS-F	F2	\$2,885
VR17ADV2MGSSSF	SEL: VR17-ADV-2M-GSSS-F	F2	\$240
VR17ADV2MPSSSF	SEL: VR17-ADV-2M-PSSS-F	F2	\$286
VR17ADV2PSSSF	SEL: VR17-ADV2-P-SSS-F	F2	\$3,435
VR17ADV3GC	SEL VR17-ADV-3G-SSS-C)	F2	\$3,572
VR17ADV3GC-I	SEL VR17-ADV-3G-SSS-C)	F2	\$4,179
VR17ADV3GC-K	SEL VR17-ADV-3G-SSS-C)	F2	\$4,015
VR17ADV3GSSSF	SEL: VR17-ADV-3G-SSS-F	F2	\$3,807
VR17ADV3PC	SEL VR17-ADV-3P-SSS-C)	F2	\$4,253
VR17ADV3PC-I	SEL VR17-ADV-3P-SSS-C)	F2	\$4,976
VR17ADV3PC-K	SEL VR17-ADV-3P-SSS-C)	F2	\$4,781
VR17ADV3PSSSF	SEL: VR17-ADV-3P-SSS-F	F2	\$4,533
VR17ADVGC	SEL VR17-ADV-G-SSS-C)	F2	\$1,353
VR17ADVGC-I	SEL VR17-ADV-G-SSS-C)	F2	\$1,583
VR17ADVGC-K	SEL VR17-ADV-G-SSS-C)	F2	\$1,521
VR17ADVGSSSF	SEL: VR17-ADV-G-SSS-F	F2	\$1,442
VR17ADVPC	SEL VR17-ADV-P-SSS-C)	F2	\$1,611
VR17ADVPC-I	SEL VR17-ADV-P-SSS-C)	F2	\$1,885
VR17ADVPC-K	SEL VR17-ADV-P-SSS-C)	F2	\$1,811
VR17ADVPSSSF	SEL: VR17-ADV-P-SSS-F	F2	\$1,717
VR17ENT22MGSSSF	SEL: VR17-ENT2-2M-GSSS-F	F2	\$596
VR17ENT22MPSSSF	SEL: VR17-ENT2-2M-PSSS-F	F2	\$710
VR17ENT23GSSSF	SEL: VR17-ENT2-3G-SSS-F	F2	\$9,447
VR17ENT23PSSSF	SEL: VR17-ENT2-3P-SSS-F	F2	\$11,247
VR17ENT2GSSSF	SEL: VR17-ENT2-G-SSS-F	F2	\$3,578

VR17ENT2MGSSSF	SEL: VR17-ENT-2M-GSSS-F	F2	\$298
VR17ENT2MPSSSF	SEL: VR17-ENT-2M-PSSS-F	F2	\$355
VR17ENT2PSSSF	SEL: VR17-ENT2-P-SSS-F	F2	\$4,260
VR17ENT32MGSSSF	SEL: VR17-ENT3-2M-GSSS-F	F2	\$894
VR17ENT32MPSSSF	SEL: VR17-ENT3-2M-PSSS-F	F2	\$1,065
VR17ENT33GSSSF	SEL: VR17-ENT3-3G-SSS-F	F2	\$14,169
VR17ENT33PSSSF	SEL: VR17-ENT3-3P-SSS-F	F2	\$16,869
VR17ENT3GC	SEL VR17-ENT-3G-SSS-C)	F2	\$4,404
VR17ENT3GC-I	SEL VR17-ENT-3G-SSS-C)	F2	\$5,152
VR17ENT3GC-K	SEL VR17-ENT-3G-SSS-C)	F2	\$4,950
VR17ENT3GSSSF	SEL: VR17-ENT3-G-SSS-F	F2	\$5,367
VR17ENT3G-SSSF	SEL: VR17-ENT-3G-SSS-F	F2	\$4,722
VR17ENT3PC	SEL VR17-ENT-3P-SSS-C)	F2	\$5,243
VR17ENT3PC-I	SEL VR17-ENT-3P-SSS-C)	F2	\$6,134
VR17ENT3PC-K	SEL VR17-ENT-3P-SSS-C)	F2	\$5,894
VR17ENT3PSSSF	SEL: VR17-ENT3-P-SSS-F	F2	\$6,390
VR17ENT3P-SSSF	SEL: VR17-ENT-3P-SSS-F	F2	\$5,622
VR17ENTGC	SEL VR17-ENT-G-SSS-C)	F2	\$1,668
VR17ENTGC-I	SEL VR17-ENT-G-SSS-C)	F2	\$1,952
VR17ENTGC-K	SEL VR17-ENT-G-SSS-C)	F2	\$1,875
VR17ENTGSSSF	SEL: VR17-ENT-G-SSS-F	F2	\$1,789
VR17ENTPC	SEL VR17-ENT-P-SSS-C)	F2	\$1,986
VR17ENTPC-I	SEL VR17-ENT-P-SSS-C)	F2	\$2,324
VR17ENTPC-K	SEL VR17-ENT-P-SSS-C)	F2	\$2,233
VR17ENTPSSSF	SEL: VR17-ENT-P-SSS-F	F2	\$2,130
VR17STAM42MGSSSF	SEL: VR17-STAM4-2M-GSSS-F	F2	\$577
VR17STAM42MPSSSF	SEL: VR17-STAM4-2M-PSSS-F	F2	\$687
VR17STAM43GSSSF	SEL: VR17-STAM4-3G-SSS-F	F2	\$9,136
VR17STAM43PSSSF	SEL: VR17-STAM4-3P-SSS-F	F2	\$10,875
VR17STAM4GSSSF	SEL: VR17-STAM4-G-SSS-F	F2	\$3,461
VR17STAM4PSSSF	SEL: VR17-STAM4-P-SSS-F	F2	\$4,120
VR17STD22MGSSSF	SEL: VR17-STD2-2M-GSSS-F	F2	\$288
VR17STD22MPSSSF	SEL: VR17-STD2-2M-PSSS-F	F2	\$343
VR17STD23GSSSF	SEL: VR17-STD2-3G-SSS-F	F2	\$4,568
VR17STD23PSSSF	SEL: VR17-STD2-3P-SSS-F	F2	\$5,439
VR17STD2GSSSF	SEL: VR17-STD2-G-SSS-F	F2	\$1,730
VR17STD2MGSSSF	SEL: VR17-STD-2M-GSSS-F	F2	\$144
VR17STD2MPSSSF	SEL: VR17-STD-2M-PSSS-F	F2	\$172
VR17STD2PSSSF	SEL: VR17-STD2-P-SSS-F	F2	\$2,060
VR17STD3GC	SEL VR17-STD-3G-SSS-C)	F2	\$2,130
VR17STD3GC-I	SEL VR17-STD-3G-SSS-C)	F2	\$2,493
VR17STD3GC-K	SEL VR17-STD-3G-SSS-C)	F2	\$2,395
VR17STD3GSSSF	SEL: VR17-STD-3G-SSS-F	F2	\$2,283
VR17STD3PC	SEL VR17-STD-3P-SSS-C)	F2	\$2,537
VR17STD3PC-I	SEL VR17-STD-3P-SSS-C)	F2	\$2,968
VR17STD3PC-K	SEL VR17-STD-3P-SSS-C)	F2	\$2,852
VR17STD3PSSSF	SEL: VR17-STD-3P-SSS-F	F2	\$2,718
VR17STDGC	SEL VR17-STD-G-SSS-C)	F2	\$807
VR17STDGC-I	SEL VR17-STD-G-SSS-C)	F2	\$944
VR17STDGC-K	SEL VR17-STD-G-SSS-C)	F2	\$907

VR17STDGSSSF	SEL: VR17-STD-G-SSS-F	F2	\$865
VR17STDPC	SEL VR17-STD-P-SSS-C)	F2	\$961
VR17STDPC-I	SEL VR17-STD-P-SSS-C)	F2	\$1,124
VR17STDPC-K	SEL VR17-STD-P-SSS-C)	F2	\$1,080
VR17STDPSSSF	SEL: VR17-STD-P-SSS-F	F2	\$1,030
VR6OADVC2MGSSSF	SEL: VR6-OADVC-2M-GSSS-F	F2	\$106
VR6OADVC2MPSSSF	SEL: VR6-OADVC-2M-PSSS-F	F2	\$126
VR6OADVC3GC	SEL VR6-OADVC-3G-SSS-C)	F2	\$1,571
VR6OADVC3GC-I	SEL VR6-OADVC-3G-SSS-C)	F2	\$1,838
VR6OADVC3GC-K	SEL VR6-OADVC-3G-SSS-C)	F2	\$1,766
VR6OADVC3GSSSF	SEL: VR6-OADVC-3G-SSS-F	F2	\$1,679
VR6OADVC3PC	SEL VR6-OADVC-3P-SSS-C)	F2	\$1,872
VR6OADVC3PC-I	SEL VR6-OADVC-3P-SSS-C)	F2	\$2,190
VR6OADVC3PC-K	SEL VR6-OADVC-3P-SSS-C)	F2	\$2,104
VR6OADVC3PSSSF	SEL: VR6-OADVC-3P-SSS-F	F2	\$1,998
VR6OADVCGC	SEL VR6-OADVC-G-SSS-C)	F2	\$595
VR6OADVCGC-I	SEL VR6-OADVC-G-SSS-C)	F2	\$696
VR6OADVCGC-K	SEL VR6-OADVC-G-SSS-C)	F2	\$669
VR6OADVCGSSSF	SEL: VR6-OADVC-G-SSS-F	F2	\$636
VR6OADVCPC	SEL VR6-OADVC-P-SSS-C)	F2	\$709
VR6OADVCPC-I	SEL VR6-OADVC-P-SSS-C)	F2	\$830
VR6OADVCPC-K	SEL VR6-OADVC-P-SSS-C)	F2	\$797
VR6OADVCPSSSF	SEL: VR6-OADVC-P-SSS-F	F2	\$757
VR6OSTC3GC	SEL VR6-OSTC-3G-SSS-C)	F2	\$713
VR6OSTC3GC-I	SEL VR6-OSTC-3G-SSS-C)	F2	\$834
VR6OSTC3GC-K	SEL VR6-OSTC-3G-SSS-C)	F2	\$801
VR6OSTC3PC	SEL VR6-OSTC-3P-SSS-C)	F2	\$847
VR6OSTC3PC-I	SEL VR6-OSTC-3P-SSS-C)	F2	\$992
VR6OSTC3PC-K	SEL VR6-OSTC-3P-SSS-C)	F2	\$953
VR6OSTCGC	SEL VR6-OSTC-G-SSS-C)	F2	\$270
VR6OSTCGC-I	SEL VR6-OSTC-G-SSS-C)	F2	\$316
VR6OSTCGC-K	SEL VR6-OSTC-G-SSS-C)	F2	\$304
VR6OSTCPC	SEL VR6-OSTC-P-SSS-C)	F2	\$321
VR6OSTCPC-I	SEL VR6-OSTC-P-SSS-C)	F2	\$376
VR6OSTCPC-K	SEL VR6-OSTC-P-SSS-C)	F2	\$361
VR6OSTDCGSSSF	SEL: VR6-OSTDC-G-SSS-F	F2	\$174
VR6OSTDCPSSSF	SEL: VR6-OSTDC-P-SSS-F	F2	\$207
VR6VU1003GC	SEL VR6-VU100-3G-SSS-C)	F2	\$4,282
VR6VU1003GC-I	SEL VR6-VU100-3G-SSS-C)	F2	\$5,010
VR6VU1003GC-K	SEL VR6-VU100-3G-SSS-C)	F2	\$4,814
VR6VU1003PC	SEL VR6-VU100-3P-SSS-C)	F2	\$5,098
VR6VU1003PC-I	SEL VR6-VU100-3P-SSS-C)	F2	\$5,964
VR6VU1003PC-K	SEL VR6-VU100-3P-SSS-C)	F2	\$5,731
VR6VU100GC	SEL VR6-VU100-G-SSS-C)	F2	\$1,622
VR6VU100GC-I	SEL VR6-VU100-G-SSS-C)	F2	\$1,898
VR6VU100GC-K	SEL VR6-VU100-G-SSS-C)	F2	\$1,823
VR6VU100PC	SEL VR6-VU100-P-SSS-C)	F2	\$1,931
VR6VU100PC-I	SEL VR6-VU100-P-SSS-C)	F2	\$2,259
VR6VU100PC-K	SEL VR6-VU100-P-SSS-C)	F2	\$2,171
VR6VU103GC	SEL VR6-VU10-3G-SSS-C)	F2	\$428

VR6VU103GC-I	SEL VR6-VU10-3G-SSS-C)	F2	\$500
VR6VU103GC-K	SEL VR6-VU10-3G-SSS-C)	F2	\$481
VR6VU103PC	SEL VR6-VU10-3P-SSS-C)	F2	\$510
VR6VU103PC-I	SEL VR6-VU10-3P-SSS-C)	F2	\$596
VR6VU103PC-K	SEL VR6-VU10-3P-SSS-C)	F2	\$573
VR6VU10GC	SEL VR6-VU10-G-SSS-C)	F2	\$162
VR6VU10GC-I	SEL VR6-VU10-G-SSS-C)	F2	\$190
VR6VU10GC-K	SEL VR6-VU10-G-SSS-C)	F2	\$182
VR6VU10PC	SEL VR6-VU10-P-SSS-C)	F2	\$193
VR6VU10PC-I	SEL VR6-VU10-P-SSS-C)	F2	\$226
VR6VU10PC-K	SEL VR6-VU10-P-SSS-C)	F2	\$217
VR7ATAD253GCV2	SEL VR7-ATAD25-3G-SSS-C)	F2	\$3,928
VR7ATAD253GCV2-I	SEL VR7-ATAD25-3G-SSS-C)	F2	\$4,596
VR7ATAD253PCV2	SEL VR7-ATAD25-3P-SSS-C)	F2	\$4,675
VR7ATAD253PCV2-I	SEL VR7-ATAD25-3P-SSS-C)	F2	\$5,470
VR7ATAD25GCV2	SEL VR7-ATAD25-G-SSS-C)	F2	\$1,488
VR7ATAD25GCV2-I	SEL VR7-ATAD25-G-SSS-C)	F2	\$1,741
VR7ATAD25PCV2	SEL VR7-ATAD25-P-SSS-C)	F2	\$1,771
VR7ATAD25PCV2-I	SEL VR7-ATAD25-P-SSS-C)	F2	\$2,072
VR7ATEN253GCV2	SEL VR7-ATEN25-3G-SSS-C)	F2	\$6,793
VR7ATEN253GCV2-I	SEL VR7-ATEN25-3G-SSS-C)	F2	\$7,947
VR7ATEN253PCV2	SEL VR7-ATEN25-3P-SSS-C)	F2	\$8,086
VR7ATEN253PCV2-I	SEL VR7-ATEN25-3P-SSS-C)	F2	\$9,461
VR7ATEN25GCV2	SEL VR7-ATEN25-G-SSS-C)	F2	\$2,573
VR7ATEN25GCV2-I	SEL VR7-ATEN25-G-SSS-C)	F2	\$3,010
VR7ATEN25PCV2	SEL VR7-ATEN25-P-SSS-C)	F2	\$3,063
VR7ATEN25PCV2-I	SEL VR7-ATEN25-P-SSS-C)	F2	\$3,584
VR7ATSTDGSSSF	SEL: VR7-ATSTD-G-SSS-F	F2	\$1
VR7ATSTDPSSSF	SEL: VR7-ATSTD-P-SSS-F	F2	\$1
VR7AUTDT253GC	SEL VR7-AUTDT25-3G-SSS-C)	F2	\$1,898
VR7AUTDT253GC-I	SEL VR7-AUTDT25-3G-SSS-C)	F2	\$2,221
VR7AUTDT253GC-K	SEL VR7-AUTDT25-3G-SSS-C)	F2	\$2,134
VR7AUTDT253PC	SEL VR7-AUTDT25-3P-SSS-C)	F2	\$2,260
VR7AUTDT253PC-I	SEL VR7-AUTDT25-3P-SSS-C)	F2	\$2,644
VR7AUTDT253PC-K	SEL VR7-AUTDT25-3P-SSS-C)	F2	\$2,540
VR7AUTDT25GC	SEL VR7-AUTDT25-G-SSS-C)	F2	\$719
VR7AUTDT25GC-I	SEL VR7-AUTDT25-G-SSS-C)	F2	\$841
VR7AUTDT25GC-K	SEL VR7-AUTDT25-G-SSS-C)	F2	\$808
VR7AUTDT25PC	SEL VR7-AUTDT25-P-SSS-C)	F2	\$856
VR7AUTDT25PC-I	SEL VR7-AUTDT25-P-SSS-C)	F2	\$1,002
VR7AUTDT25PC-K	SEL VR7-AUTDT25-P-SSS-C)	F2	\$962
VRBCLADVC3GC	SEL VR-BCLADVC-3G-SSS-C)	F2	\$1,711
VRBCLADVC3GC-I	SEL VR-BCLADVC-3G-SSS-C)	F2	\$2,002
VRBCLADVC3GC-K	SEL VR-BCLADVC-3G-SSS-C)	F2	\$1,923
VRBCLADVC3PC	SEL VR-BCLADVC-3P-SSS-C)	F2	\$2,035
VRBCLADVC3PC-I	SEL VR-BCLADVC-3P-SSS-C)	F2	\$2,381
VRBCLADVC3PC-K	SEL VR-BCLADVC-3P-SSS-C)	F2	\$2,288
VRBCLADVCGC	SEL VR-BCLADVC-G-SSS-C)	F2	\$648
VRBCLADVCGC-I	SEL VR-BCLADVC-G-SSS-C)	F2	\$758
VRBCLADVCGC-K	SEL VR-BCLADVC-G-SSS-C)	F2	\$728

VRBCLADV CPC	SEL VR-BCLADV C-P-SSS-C)	F2	\$771
VRBCLADV CPC-I	SEL VR-BCLADV C-P-SSS-C)	F2	\$902
VRBCLADV CPC-K	SEL VR-BCLADV C-P-SSS-C)	F2	\$867
VRBCLADV O25GC	SEL VR-BCLADV O-25-G-SSS-C)	F2	\$1,080
VRBCLADV O25GC-I	SEL VR-BCLADV O-25-G-SSS-C)	F2	\$1,264
VRBCLADV O25GC-K	SEL VR-BCLADV O-25-G-SSS-C)	F2	\$1,214
VRBCLADV O25PC	SEL VR-BCLADV O-25-P-SSS-C)	F2	\$1,286
VRBCLADV O25PC-I	SEL VR-BCLADV O-25-P-SSS-C)	F2	\$1,505
VRBCLADV O25PC-K	SEL VR-BCLADV O-25-P-SSS-C)	F2	\$1,446
VRCODE2C3GC	SEL VR-CODE2C-3G-SSS-C)	F2	\$3,134
VRCODE2C3GC-I	SEL VR-CODE2C-3G-SSS-C)	F2	\$3,666
VRCODE2C3GC-K	SEL VR-CODE2C-3G-SSS-C)	F2	\$3,523
VRCODE2C3PC	SEL VR-CODE2C-3P-SSS-C)	F2	\$3,730
VRCODE2C3PC-I	SEL VR-CODE2C-3P-SSS-C)	F2	\$4,364
VRCODE2C3PC-K	SEL VR-CODE2C-3P-SSS-C)	F2	\$4,193
VRCODE2CGC	SEL VR-CODE2C-G-SSS-C)	F2	\$1,187
VRCODE2CGC-I	SEL VR-CODE2C-G-SSS-C)	F2	\$1,389
VRCODE2CGC-K	SEL VR-CODE2C-G-SSS-C)	F2	\$1,334
VRCODE2CPC	SEL VR-CODE2C-P-SSS-C)	F2	\$1,413
VRCODE2CPC-I	SEL VR-CODE2C-P-SSS-C)	F2	\$1,653
VRCODE2CPC-K	SEL VR-CODE2C-P-SSS-C)	F2	\$1,588
VRCODE2O3GC	SEL VR-CODE2O-3G-SSS-C)	F2	\$314
VRCODE2O3GC-I	SEL VR-CODE2O-3G-SSS-C)	F2	\$368
VRCODE2O3GC-K	SEL VR-CODE2O-3G-SSS-C)	F2	\$353
VRCODE2O3PC	SEL VR-CODE2O-3P-SSS-C)	F2	\$372
VRCODE2O3PC-I	SEL VR-CODE2O-3P-SSS-C)	F2	\$436
VRCODE2O3PC-K	SEL VR-CODE2O-3P-SSS-C)	F2	\$418
VRCODE2OGC	SEL VR-CODE2O-G-SSS-C)	F2	\$119
VRCODE2OGC-I	SEL VR-CODE2O-G-SSS-C)	F2	\$139
VRCODE2OGC-K	SEL VR-CODE2O-G-SSS-C)	F2	\$134
VRCODE2OPC	SEL VR-CODE2O-P-SSS-C)	F2	\$141
VRCODE2OPC-I	SEL VR-CODE2O-P-SSS-C)	F2	\$165
VRCODE2OPC-K	SEL VR-CODE2O-P-SSS-C)	F2	\$159
VRLIS4CPU3GC	SEL VR-LIS4-CPU-3G-SSS-C)	F2	\$855
VRLIS4CPU3GC-I	SEL VR-LIS4-CPU-3G-SSS-C)	F2	\$1,001
VRLIS4CPU3GC-K	SEL VR-LIS4-CPU-3G-SSS-C)	F2	\$962
VRLIS4CPU3GSSSF	SEL: VR-LIS4-CPU-3G-SSS-F	F2	\$915
VRLIS4CPU3PC	SEL VR-LIS4-CPU-3P-SSS-C)	F2	\$1,019
VRLIS4CPU3PC-I	SEL VR-LIS4-CPU-3P-SSS-C)	F2	\$1,192
VRLIS4CPU3PC-K	SEL VR-LIS4-CPU-3P-SSS-C)	F2	\$1,146
VRLIS4CPU3PSSSF	SEL: VR-LIS4-CPU-3P-SSS-F	F2	\$1,089
VRLIS4CPUGC	SEL VR-LIS4-CPU-G-SSS-C)	F2	\$324
VRLIS4CPUGC-I	SEL VR-LIS4-CPU-G-SSS-C)	F2	\$379
VRLIS4CPUGC-K	SEL VR-LIS4-CPU-G-SSS-C)	F2	\$364
VRLIS4CPUGSSSF	SEL: VR-LIS4-CPU-G-SSS-F	F2	\$347
VRLIS4CPUPC	SEL VR-LIS4-CPU-P-SSS-C)	F2	\$386
VRLIS4CPUPC-I	SEL VR-LIS4-CPU-P-SSS-C)	F2	\$452
VRLIS4CPUPC-K	SEL VR-LIS4-CPU-P-SSS-C)	F2	\$434
VRLIS4CPUPSSSF	SEL: VR-LIS4-CPU-P-SSS-F	F2	\$413
VRLIS4O253GC	SEL VR-LIS4O-25-3G-SSS-C)	F2	\$2,856

VRLIS4O253GC-I	SEL VR-LIS4O-25-3G-SSS-C)	F2	\$3,342
VRLIS4O253GC-K	SEL VR-LIS4O-25-3G-SSS-C)	F2	\$3,211
VRLIS4O253PC	SEL VR-LIS4O-25-3P-SSS-C)	F2	\$3,400
VRLIS4O253PC-I	SEL VR-LIS4O-25-3P-SSS-C)	F2	\$3,978
VRLIS4O253PC-K	SEL VR-LIS4O-25-3P-SSS-C)	F2	\$3,822
VRLIS4O25GC	SEL VR-LIS4O-25-G-SSS-C)	F2	\$1,082
VRLIS4O25GC-I	SEL VR-LIS4O-25-G-SSS-C)	F2	\$1,266
VRLIS4O25GC-K	SEL VR-LIS4O-25-G-SSS-C)	F2	\$1,216
VRLIS4O25PC	SEL VR-LIS4O-25-P-SSS-C)	F2	\$1,288
VRLIS4O25PC-I	SEL VR-LIS4O-25-P-SSS-C)	F2	\$1,507
VRLIS4O25PC-K	SEL VR-LIS4O-25-P-SSS-C)	F2	\$1,448
VRNBAD253GC	SEL VR-NI-RBAD25-3G-SSS-C)	F2	\$2,009
VRNBAD253GC-I	SEL VR-NI-RBAD25-3G-SSS-C)	F2	\$3,616
VRNBAD253PC	SEL VR-NI-RBAD25-3P-SSS-C)	F2	\$2,392
VRNBAD253PC-I	SEL VR-NI-RBAD25-3P-SSS-C)	F2	\$4,305
VRNBAD25PC	SEL VR-NI-RBAD25-P-SSS-C)	F2	\$906
VRNBAD25PC-I	SEL VR-NI-RBAD25-P-SSS-C)	F2	\$1,631
VRNIANX1003GC	SEL VR-NI-ANX100-3G-SSS-C)	F2	\$1,436
VRNIANX1003GC-I	SEL VR-NI-ANX100-3G-SSS-C)	F2	\$1,680
VRNIANX1003GC-K	SEL VR-NI-ANX100-3G-SSS-C)	F2	\$1,614
VRNIANX1003GSSSF	SEL: VR-NI-ANX100-3G-SSS-F	F2	\$1,525
VRNIANX1003PC	SEL VR-NI-ANX100-3P-SSS-C)	F2	\$1,711
VRNIANX1003PC-I	SEL VR-NI-ANX100-3P-SSS-C)	F2	\$2,002
VRNIANX1003PC-K	SEL VR-NI-ANX100-3P-SSS-C)	F2	\$1,923
VRNIANX1003PSSSF	SEL: VR-NI-ANX100-3P-SSS-F	F2	\$1,815
VRNIANX100GC	SEL VR-NI-ANX100-G-SSS-C)	F2	\$544
VRNIANX100GC-I	SEL VR-NI-ANX100-G-SSS-C)	F2	\$636
VRNIANX100GC-K	SEL VR-NI-ANX100-G-SSS-C)	F2	\$612
VRNIANX100GSSSF	SEL: VR-NI-ANX100-G-SSS-F	F2	\$578
VRNIANX100PC	SEL VR-NI-ANX100-P-SSS-C)	F2	\$648
VRNIANX100PC-I	SEL VR-NI-ANX100-P-SSS-C)	F2	\$758
VRNIANX100PC-K	SEL VR-NI-ANX100-P-SSS-C)	F2	\$728
VRNIANX100PSSSF	SEL: VR-NI-ANX100-P-SSS-F	F2	\$688
VRNIANX103GC	SEL VR-NI-ANX10-3G-SSS-C)	F2	\$143
VRNIANX103GC-I	SEL VR-NI-ANX10-3G-SSS-C)	F2	\$167
VRNIANX103GC-K	SEL VR-NI-ANX10-3G-SSS-C)	F2	\$160
VRNIANX103GSSSF	SEL: VR-NI-ANX10-3G-SSS-F	F2	\$154
VRNIANX103PC	SEL VR-NI-ANX10-3P-SSS-C)	F2	\$172
VRNIANX103PC-I	SEL VR-NI-ANX10-3P-SSS-C)	F2	\$201
VRNIANX103PC-K	SEL VR-NI-ANX10-3P-SSS-C)	F2	\$193
VRNIANX103PSSSF	SEL: VR-NI-ANX10-3P-SSS-F	F2	\$183
VRNIANX10GC	SEL VR-NI-ANX10-G-SSS-C)	F2	\$54
VRNIANX10GC-I	SEL VR-NI-ANX10-G-SSS-C)	F2	\$63
VRNIANX10GC-K	SEL VR-NI-ANX10-G-SSS-C)	F2	\$61
VRNIANX10GSSSF	SEL: VR-NI-ANX10-G-SSS-F	F2	\$58
VRNIANX10PC	SEL VR-NI-ANX10-P-SSS-C)	F2	\$65
VRNIANX10PC-I	SEL VR-NI-ANX10-P-SSS-C)	F2	\$76
VRNIANX10PC-K	SEL VR-NI-ANX10-P-SSS-C)	F2	\$73
VRNIANX10PSSSF	SEL: VR-NI-ANX10-P-SSS-F	F2	\$69
VRNIANXC3GC	SEL VR-NI-ANXC-3G-SSS-C)	F2	\$718

VRNIANXC3GC-I	SEL VR-NI-ANXC-3G-SSS-C)	F2	\$840
VRNIANXC3GC-K	SEL VR-NI-ANXC-3G-SSS-C)	F2	\$807
VRNIANXC3PC	SEL VR-NI-ANXC-3P-SSS-C)	F2	\$855
VRNIANXC3PC-I	SEL VR-NI-ANXC-3P-SSS-C)	F2	\$1,001
VRNIANXC3PC-K	SEL VR-NI-ANXC-3P-SSS-C)	F2	\$962
VRNIANXCGC	SEL VR-NI-ANXC-G-SSS-C)	F2	\$272
VRNIANXCGC-I	SEL VR-NI-ANXC-G-SSS-C)	F2	\$318
VRNIANXCGC-K	SEL VR-NI-ANXC-G-SSS-C)	F2	\$306
VRNIANXCPC	SEL VR-NI-ANXC-P-SSS-C)	F2	\$324
VRNIANXCPC-I	SEL VR-NI-ANXC-P-SSS-C)	F2	\$379
VRNIANXCPC-K	SEL VR-NI-ANXC-P-SSS-C)	F2	\$364
VRNIENX1002MGSSF	SEL: VR-NI-ENX100-2M-GSSS-F	F2	\$171
VRNIENX1002MPSSF	SEL: VR-NI-ENX100-2M-PSSS-F	F2	\$204
VRNIENX1003GC	SEL VR-NI-ENX100-3G-SSS-C)	F2	\$2,490
VRNIENX1003GC-I	SEL VR-NI-ENX100-3G-SSS-C)	F2	\$2,913
VRNIENX1003GC-K	SEL VR-NI-ENX100-3G-SSS-C)	F2	\$2,799
VRNIENX1003GSSSF	SEL: VR-NI-ENX100-3G-SSS-F	F2	\$2,715
VRNIENX1003PC	SEL VR-NI-ENX100-3P-SSS-C)	F2	\$2,965
VRNIENX1003PC-I	SEL VR-NI-ENX100-3P-SSS-C)	F2	\$3,469
VRNIENX1003PC-K	SEL VR-NI-ENX100-3P-SSS-C)	F2	\$3,333
VRNIENX1003PSSSF	SEL: VR-NI-ENX100-3P-SSS-F	F2	\$3,232
VRNIENX100GC	SEL VR-NI-ENX100-G-SSS-C)	F2	\$943
VRNIENX100GC-I	SEL VR-NI-ENX100-G-SSS-C)	F2	\$1,103
VRNIENX100GC-K	SEL VR-NI-ENX100-G-SSS-C)	F2	\$1,060
VRNIENX100GSSSF	SEL: VR-NI-ENX100-G-SSS-F	F2	\$1,029
VRNIENX100PC	SEL VR-NI-ENX100-P-SSS-C)	F2	\$1,123
VRNIENX100PC-I	SEL VR-NI-ENX100-P-SSS-C)	F2	\$1,314
VRNIENX100PC-K	SEL VR-NI-ENX100-P-SSS-C)	F2	\$1,262
VRNIENX100PSSSF	SEL: VR-NI-ENX100-P-SSS-F	F2	\$1,224
VRNIENX102MGSSSF	SEL: VR-NI-ENX10-2M-GSSS-F	F2	\$17
VRNIENX102MPSSSF	SEL: VR-NI-ENX10-2M-PSSS-F	F2	\$20
VRNIENX103GC	SEL VR-NI-ENX10-3G-SSS-C)	F2	\$248
VRNIENX103GC-I	SEL VR-NI-ENX10-3G-SSS-C)	F2	\$290
VRNIENX103GC-K	SEL VR-NI-ENX10-3G-SSS-C)	F2	\$279
VRNIENX103GSSSF	SEL: VR-NI-ENX10-3G-SSS-F	F2	\$270
VRNIENX103PC	SEL VR-NI-ENX10-3P-SSS-C)	F2	\$296
VRNIENX103PC-I	SEL VR-NI-ENX10-3P-SSS-C)	F2	\$346
VRNIENX103PC-K	SEL VR-NI-ENX10-3P-SSS-C)	F2	\$332
VRNIENX103PSSSF	SEL: VR-NI-ENX10-3P-SSS-F	F2	\$322
VRNIENX10GC	SEL VR-NI-ENX10-G-SSS-C)	F2	\$94
VRNIENX10GC-I	SEL VR-NI-ENX10-G-SSS-C)	F2	\$110
VRNIENX10GC-K	SEL VR-NI-ENX10-G-SSS-C)	F2	\$106
VRNIENX10GSSSF	SEL: VR-NI-ENX10-G-SSS-F	F2	\$102
VRNIENX10PC	SEL VR-NI-ENX10-P-SSS-C)	F2	\$112
VRNIENX10PC-I	SEL VR-NI-ENX10-P-SSS-C)	F2	\$131
VRNIENX10PC-K	SEL VR-NI-ENX10-P-SSS-C)	F2	\$126
VRNIENX10PSSSF	SEL: VR-NI-ENX10-P-SSS-F	F2	\$122
VRNIENXC2MGSSSF	SEL: VR-NI-ENXC-2M-GSSS-F	F2	\$85
VRNIENXC2MPSSSF	SEL: VR-NI-ENXC-2M-PSSS-F	F2	\$101
VRNIENXC3GC	SEL VR-NI-ENXC-3G-SSS-C)	F2	\$1,243

VRNIENXC3GC-I	SEL VR-NI-ENXC-3G-SSS-C)	F2	\$1,455
VRNIENXC3GC-K	SEL VR-NI-ENXC-3G-SSS-C)	F2	\$1,398
VRNIENXC3GSSSF	SEL: VR-NI-ENXC-3G-SSS-F	F2	\$1,339
VRNIENXC3PC	SEL VR-NI-ENXC-3P-SSS-C)	F2	\$1,481
VRNIENXC3PC-I	SEL VR-NI-ENXC-3P-SSS-C)	F2	\$1,733
VRNIENXC3PC-K	SEL VR-NI-ENXC-3P-SSS-C)	F2	\$1,665
VRNIENXC3PSSSF	SEL: VR-NI-ENXC-3P-SSS-F	F2	\$1,594
VRNIENXCGC	SEL VR-NI-ENXC-G-SSS-C)	F2	\$471
VRNIENXCGC-I	SEL VR-NI-ENXC-G-SSS-C)	F2	\$551
VRNIENXCGC-K	SEL VR-NI-ENXC-G-SSS-C)	F2	\$529
VRNIENXCGSSSF	SEL: VR-NI-ENXC-G-SSS-F	F2	\$507
VRNIENXCPC	SEL VR-NI-ENXC-P-SSS-C)	F2	\$561
VRNIENXCPC-I	SEL VR-NI-ENXC-P-SSS-C)	F2	\$656
VRNIENXCPC-K	SEL VR-NI-ENXC-P-SSS-C)	F2	\$631
VRNIENXCPSSSF	SEL: VR-NI-ENXC-P-SSS-F	F2	\$604
VRNIRBAD253GC-K	SEL VR-NI-RBAD25-3G-SSS-C)	F2	\$3,474
VRNIRBAD253PC-K	SEL VR-NI-RBAD25-3P-SSS-C)	F2	\$4,136
VRNIRBAD25GC-K	SEL VR-NI-RBAD25-G-SSS-C)	F2	\$1,316
VRNIRBAD25PC-K	SEL VR-NI-RBAD25-P-SSS-C)	F2	\$1,567
VRNRBAD25GC	SEL VR-NI-RBAD25-G-SSS-C)	F2	\$761
VRNRBAD25GC-I	SEL VR-NI-RBAD25-G-SSS-C)	F2	\$1,370
VROADV253GC	SEL VR6-OADV25-3G-SSS-C)	F2	\$3,928
VROADV253GC-I	SEL VR6-OADV25-3G-SSS-C)	F2	\$4,596
VROADV253GC-K	SEL VR6-OADV25-3G-SSS-C)	F2	\$4,416
VROADV253PC	SEL VR6-OADV25-3P-SSS-C)	F2	\$4,675
VROADV253PC-I	SEL VR6-OADV25-3P-SSS-C)	F2	\$5,470
VROADV253PC-K	SEL VR6-OADV25-3P-SSS-C)	F2	\$5,256
VROADV25GC	SEL VR6-OADV25-G-SSS-C)	F2	\$1,488
VROADV25GC-I	SEL VR6-OADV25-G-SSS-C)	F2	\$1,741
VROADV25GC-K	SEL VR6-OADV25-G-SSS-C)	F2	\$1,673
VROADV25PC	SEL VR6-OADV25-P-SSS-C)	F2	\$1,771
VROADV25PC-I	SEL VR6-OADV25-P-SSS-C)	F2	\$2,072
VROADV25PC-K	SEL VR6-OADV25-P-SSS-C)	F2	\$1,991
VROAMAD3GC	SEL VR-OAMAD-3G-SSS-C)	F2	\$855
VROAMAD3GC-I	SEL VR-OAMAD-3G-SSS-C)	F2	\$1,001
VROAMAD3GC-K	SEL VR-OAMAD-3G-SSS-C)	F2	\$962
VROAMAD3PC	SEL VR-OAMAD-3P-SSS-C)	F2	\$1,019
VROAMAD3PC-I	SEL VR-OAMAD-3P-SSS-C)	F2	\$1,192
VROAMAD3PC-K	SEL VR-OAMAD-3P-SSS-C)	F2	\$1,146
VROAMADGC	SEL VR-OAMAD-G-SSS-C)	F2	\$324
VROAMADGC-I	SEL VR-OAMAD-G-SSS-C)	F2	\$379
VROAMADGC-K	SEL VR-OAMAD-G-SSS-C)	F2	\$364
VROAMADPC	SEL VR-OAMAD-P-SSS-C)	F2	\$386
VROAMADPC-I	SEL VR-OAMAD-P-SSS-C)	F2	\$452
VROAMADPC-K	SEL VR-OAMAD-P-SSS-C)	F2	\$434
VROENT253GC	SEL VR6-OENT25-3G-SSS-C)	F2	\$9,897
VROENT253GC-I	SEL VR6-OENT25-3G-SSS-C)	F2	\$11,580
VROENT253GC-K	SEL VR6-OENT25-3G-SSS-C)	F2	\$11,126
VROENT253PC	SEL VR6-OENT25-3P-SSS-C)	F2	\$11,782
VROENT253PC-I	SEL VR6-OENT25-3P-SSS-C)	F2	\$13,785

VROENT253PC-K	SEL VR6-OENT25-3P-SSS-C)	F2	\$13,245
VROENT25GC	SEL VR6-OENT25-G-SSS-C)	F2	\$3,749
VROENT25GC-I	SEL VR6-OENT25-G-SSS-C)	F2	\$4,386
VROENT25GC-K	SEL VR6-OENT25-G-SSS-C)	F2	\$4,214
VROENT25PC	SEL VR6-OENT25-P-SSS-C)	F2	\$4,463
VROENT25PC-I	SEL VR6-OENT25-P-SSS-C)	F2	\$5,222
VROENT25PC-K	SEL VR6-OENT25-P-SSS-C)	F2	\$5,017
VROST5DC3PSC	SEL VR-OST5-DC-3P-S-C)	F2	\$657
VROST5DC3PSC-I	SEL VR-OST5-DC-3P-S-C)	F2	\$769
VROST5DC3PSC-K	SEL VR-OST5-DC-3P-S-C)	F2	\$739
VROST5DCPSSSC	SEL VR-OST5-DC-P-SSS-C)	F2	\$249
VROST5DCPSSSC-I	SEL VR-OST5-DC-P-SSS-C)	F2	\$291
VROST5DCPSSSC-K	SEL VR-OST5-DC-P-SSS-C)	F2	\$280
VROSTACK43PSSSF	SEL: VR-OSTACK4-3P-SSS-F	F2	\$723
VROSTACK4PSSSF	SEL: VR-OSTACK4-P-SSS-F	F2	\$274
VROSTD253GC	SEL VR6-OSTD25-3G-SSS-C)	F2	\$1,782
VROSTD253GC-I	SEL VR6-OSTD25-3G-SSS-C)	F2	\$2,085
VROSTD253GC-K	SEL VR6-OSTD25-3G-SSS-C)	F2	\$2,003
VROSTD253PC	SEL VR6-OSTD25-3P-SSS-C)	F2	\$2,123
VROSTD253PC-I	SEL VR6-OSTD25-3P-SSS-C)	F2	\$2,483
VROSTD253PC-K	SEL VR6-OSTD25-3P-SSS-C)	F2	\$2,386
VROSTD25GC	SEL VR6-OSTD25-G-SSS-C)	F2	\$675
VROSTD25GC-I	SEL VR6-OSTD25-G-SSS-C)	F2	\$790
VROSTD25GC-K	SEL VR6-OSTD25-G-SSS-C)	F2	\$759
VROSTD25PC	SEL VR6-OSTD25-P-SSS-C)	F2	\$804
VROSTD25PC-I	SEL VR6-OSTD25-P-SSS-C)	F2	\$941
VROSTD25PC-K	SEL VR6-OSTD25-P-SSS-C)	F2	\$904
VS6DT100VM3GC	SEL VS6-DT100VM-3G-SSS-C)	F2	\$4,565
VS6DT100VM3GC-I	SEL VS6-DT100VM-3G-SSS-C)	F2	\$5,341
VS6DT100VM3GC-K	SEL VS6-DT100VM-3G-SSS-C)	F2	\$5,377
VS6DT100VM3PC	SEL VS6-DT100VM-3P-SSS-C)	F2	\$5,436
VS6DT100VM3PC-I	SEL VS6-DT100VM-3P-SSS-C)	F2	\$6,360
VS6DT100VM3PC-K	SEL VS6-DT100VM-3P-SSS-C)	F2	\$6,403
VS6DT100VMGC	SEL VS6-DT100VM-G-SSS-C)	F2	\$1,729
VS6DT100VMGC-I	SEL VS6-DT100VM-G-SSS-C)	F2	\$2,023
VS6DT100VMGC-K	SEL VS6-DT100VM-G-SSS-C)	F2	\$2,037
VS6DT100VMPC	SEL VS6-DT100VM-P-SSS-C)	F2	\$2,059
VS6DT100VMPC-I	SEL VS6-DT100VM-P-SSS-C)	F2	\$2,409
VS6DT100VMPC-K	SEL VS6-DT100VM-P-SSS-C)	F2	\$2,425
VS6EPL3GC	SEL VS6-EPL-3G-SSS-C)	F2	\$1,938
VS6EPL3GC-I	SEL VS6-EPL-3G-SSS-C)	F2	\$2,267
VS6EPL3GC-K	SEL VS6-EPL-3G-SSS-C)	F2	\$2,282
VS6EPL3PC	SEL VS6-EPL-3P-SSS-C)	F2	\$2,307
VS6EPL3PC-I	SEL VS6-EPL-3P-SSS-C)	F2	\$2,700
VS6EPL3PC-K	SEL VS6-EPL-3P-SSS-C)	F2	\$2,718
VS6EPLAK3GC	SEL VS6-EPL-AK-3G-SSS-C)	F2	\$15,383
VS6EPLAK3GC-I	SEL VS6-EPL-AK-3G-SSS-C)	F2	\$17,998
VS6EPLAK3GC-K	SEL VS6-EPL-AK-3G-SSS-C)	F2	\$18,120
VS6EPLAK3PC	SEL VS6-EPL-AK-3P-SSS-C)	F2	\$18,314
VS6EPLAK3PC-I	SEL VS6-EPL-AK-3P-SSS-C)	F2	\$21,427

VS6EPLAK3PC-K	SEL VS6-EPL-AK-3P-SSS-C)	F2	\$21,572
VS6EPLAKGC	SEL VS6-EPL-AK-G-SSS-C)	F2	\$5,827
VS6EPLAKGC-I	SEL VS6-EPL-AK-G-SSS-C)	F2	\$6,818
VS6EPLAKGC-K	SEL VS6-EPL-AK-G-SSS-C)	F2	\$6,864
VS6EPLAKPC	SEL VS6-EPL-AK-P-SSS-C)	F2	\$6,937
VS6EPLAKPC-I	SEL VS6-EPL-AK-P-SSS-C)	F2	\$8,116
VS6EPLAKPC-K	SEL VS6-EPL-AK-P-SSS-C)	F2	\$8,171
VS6EPLGC	SEL VS6-EPL-G-SSS-C)	F2	\$734
VS6EPLGC-I	SEL VS6-EPL-G-SSS-C)	F2	\$859
VS6EPLGC-K	SEL VS6-EPL-G-SSS-C)	F2	\$865
VS6EPLPC	SEL VS6-EPL-P-SSS-C)	F2	\$874
VS6EPLPC-I	SEL VS6-EPL-P-SSS-C)	F2	\$1,023
VS6EPLPC-K	SEL VS6-EPL-P-SSS-C)	F2	\$1,029
VS6ESPKIT3GC	SEL VS6-ESP-KIT-3G-SSS-C)	F2	\$2,492
VS6ESPKIT3GC-I	SEL VS6-ESP-KIT-3G-SSS-C)	F2	\$2,492
VS6ESPKIT3GC-K	SEL VS6-ESP-KIT-3G-SSS-C)	F2	\$2,936
VS6ESPKIT3PC	SEL VS6-ESP-KIT-3P-SSS-C)	F2	\$2,967
VS6ESPKIT3PC-I	SEL VS6-ESP-KIT-3P-SSS-C)	F2	\$2,967
VS6ESPKIT3PC-K	SEL VS6-ESP-KIT-3P-SSS-C)	F2	\$3,495
VS6ESPKITGC	SEL VS6-ESP-KIT-G-SSS-C)	F2	\$944
VS6ESPKITGC-I	SEL VS6-ESP-KIT-G-SSS-C)	F2	\$944
VS6ESPKITGC-K	SEL VS6-ESP-KIT-G-SSS-C)	F2	\$1,112
VS6ESPKITPC	SEL VS6-ESP-KIT-P-SSS-C)	F2	\$1,124
VS6ESPKITPC-I	SEL VS6-ESP-KIT-P-SSS-C)	F2	\$1,124
VS6ESPKITPC-K	SEL VS6-ESP-KIT-P-SSS-C)	F2	\$1,324
VS6ESSL3SUBC	SEL VS6-ESSL-3SUB-C)	F2	\$172
VS6ESSL3SUBC-I	SEL VS6-ESSL-3SUB-C)	F2	\$201
VS6ESSL3SUBC-K	SEL VS6-ESSL-3SUB-C)	F2	\$202
VS6ESSLSUBC	SEL VS6-ESSL-SUB-C)	F2	\$65
VS6ESSLSUBC-I	SEL VS6-ESSL-SUB-C)	F2	\$76
VS6ESSLSUBC-K	SEL VS6-ESSL-SUB-C)	F2	\$77
VS6OEPL3GC	SEL VS6-OEPL-3G-SSS-C)	F2	\$2,508
VS6OEPL3GC-I	SEL VS6-OEPL-3G-SSS-C)	F2	\$2,934
VS6OEPL3GC-K	SEL VS6-OEPL-3G-SSS-C)	F2	\$2,819
VS6OEPL3PC	SEL VS6-OEPL-3P-SSS-C)	F2	\$2,986
VS6OEPL3PC-I	SEL VS6-OEPL-3P-SSS-C)	F2	\$3,493
VS6OEPL3PC-K	SEL VS6-OEPL-3P-SSS-C)	F2	\$3,356
VS6OEPLAK3GC	SEL VS6-OEPL-AK-3G-SSS-C)	F2	\$18,498
VS6OEPLAK3GC-I	SEL VS6-OEPL-AK-3G-SSS-C)	F2	\$21,643
VS6OEPLAK3GC-K	SEL VS6-OEPL-AK-3G-SSS-C)	F2	\$20,794
VS6OEPLAK3PC	SEL VS6-OEPL-AK-3P-SSS-C)	F2	\$22,018
VS6OEPLAK3PC-I	SEL VS6-OEPL-AK-3P-SSS-C)	F2	\$25,761
VS6OEPLAK3PC-K	SEL VS6-OEPL-AK-3P-SSS-C)	F2	\$24,750
VS6OEPLAKGC	SEL VS6-OEPL-AK-G-SSS-C)	F2	\$7,007
VS6OEPLAKGC-I	SEL VS6-OEPL-AK-G-SSS-C)	F2	\$8,198
VS6OEPLAKGC-K	SEL VS6-OEPL-AK-G-SSS-C)	F2	\$7,877
VS6OEPLAKPC	SEL VS6-OEPL-AK-P-SSS-C)	F2	\$8,340
VS6OEPLAKPC-I	SEL VS6-OEPL-AK-P-SSS-C)	F2	\$9,758
VS6OEPLAKPC-K	SEL VS6-OEPL-AK-P-SSS-C)	F2	\$9,375
VS6OEPLGC	SEL VS6-OEPL-G-SSS-C)	F2	\$950

VS6OEPLGC-I	SEL VS6-OEPL-G-SSS-C)	F2	\$1,112
VS6OEPLGC-K	SEL VS6-OEPL-G-SSS-C)	F2	\$1,068
VS6OEPLPC	SEL VS6-OEPL-P-SSS-C)	F2	\$1,131
VS6OEPLPC-I	SEL VS6-OEPL-P-SSS-C)	F2	\$1,323
VS6OEPLPC-K	SEL VS6-OEPL-P-SSS-C)	F2	\$1,271
VS6RBADV253GC	SEL VS6-RBADV25-3G-SSS-C)	F2	\$2,569
VS6RBADV253GC-I	SEL VS6-RBADV25-3G-SSS-C)	F2	\$3,005
VS6RBADV253GC-K	SEL VS6-RBADV25-3G-SSS-C)	F2	\$3,026
VS6RBADV253PC	SEL VS6-RBADV25-3P-SSS-C)	F2	\$3,060
VS6RBADV253PC-I	SEL VS6-RBADV25-3P-SSS-C)	F2	\$3,580
VS6RBADV253PC-K	SEL VS6-RBADV25-3P-SSS-C)	F2	\$3,604
VS6RBADV25GC	SEL VS6-RBADV25-G-SSS-C)	F2	\$973
VS6RBADV25GC-I	SEL VS6-RBADV25-G-SSS-C)	F2	\$1,138
VS6RBADV25GC-K	SEL VS6-RBADV25-G-SSS-C)	F2	\$1,146
VS6RBADV25PC	SEL VS6-RBADV25-P-SSS-C)	F2	\$1,159
VS6RBADV25PC-I	SEL VS6-RBADV25-P-SSS-C)	F2	\$1,356
VS6RBADV25PC-K	SEL VS6-RBADV25-P-SSS-C)	F2	\$1,365
VS6RBSTD253GC	SEL VS6-RBSTD25-3G-SSS-C)	F2	\$1,711
VS6RBSTD253GC-I	SEL VS6-RBSTD25-3G-SSS-C)	F2	\$2,002
VS6RBSTD253GC-K	SEL VS6-RBSTD25-3G-SSS-C)	F2	\$2,015
VS6RBSTD253PC	SEL VS6-RBSTD25-3P-SSS-C)	F2	\$2,035
VS6RBSTD253PC-I	SEL VS6-RBSTD25-3P-SSS-C)	F2	\$2,381
VS6RBSTD253PC-K	SEL VS6-RBSTD25-3P-SSS-C)	F2	\$2,398
VS6RBSTD25GC	SEL VS6-RBSTD25-G-SSS-C)	F2	\$648
VS6RBSTD25GC-I	SEL VS6-RBSTD25-G-SSS-C)	F2	\$758
VS6RBSTD25GC-K	SEL VS6-RBSTD25-G-SSS-C)	F2	\$763
VS6RBSTD25PC	SEL VS6-RBSTD25-P-SSS-C)	F2	\$771
VS6RBSTD25PC-I	SEL VS6-RBSTD25-P-SSS-C)	F2	\$902
VS6RBSTD25PC-K	SEL VS6-RBSTD25-P-SSS-C)	F2	\$908
VS6SO8CPU3GC	SEL VS6-SO-8CPU-3G-SSS-C)	F2	\$2,658
VS6SO8CPU3GC-I	SEL VS6-SO-8CPU-3G-SSS-C)	F2	\$3,110
VS6SO8CPU3GC-K	SEL VS6-SO-8CPU-3G-SSS-C)	F2	\$3,131
VS6SO8CPU3PC	SEL VS6-SO-8CPU-3P-SSS-C)	F2	\$3,165
VS6SO8CPU3PC-I	SEL VS6-SO-8CPU-3P-SSS-C)	F2	\$3,703
VS6SO8CPU3PC-K	SEL VS6-SO-8CPU-3P-SSS-C)	F2	\$3,728
VS6SO8CPUGC	SEL VS6-SO-8CPU-G-SSS-C)	F2	\$1,007
VS6SO8CPUGC-I	SEL VS6-SO-8CPU-G-SSS-C)	F2	\$1,178
VS6SO8CPUGC-K	SEL VS6-SO-8CPU-G-SSS-C)	F2	\$1,186
VS6SO8CPUPC	SEL VS6-SO-8CPU-P-SSS-C)	F2	\$1,199
VS6SO8CPUPC-I	SEL VS6-SO-8CPU-P-SSS-C)	F2	\$1,403
VS6SO8CPUPC-K	SEL VS6-SO-8CPU-P-SSS-C)	F2	\$1,412
VS6STD3GC	SEL VS6-STD-3G-SSS-C)	F2	\$721
VS6STD3GC-I	SEL VS6-STD-3G-SSS-C)	F2	\$843
VS6STD3GC-K	SEL VS6-STD-3G-SSS-C)	F2	\$849
VS6STD3PC	SEL VS6-STD-3P-SSS-C)	F2	\$853
VS6STD3PC-I	SEL VS6-STD-3P-SSS-C)	F2	\$998
VS6STD3PC-K	SEL VS6-STD-3P-SSS-C)	F2	\$1,004
VS6STD8AK3GSC	SEL VS6-STD-8AK-3G-S-C)	F2	\$7,244
VS6STD8AK3GSC-I	SEL VS6-STD-8AK-3G-S-C)	F2	\$8,476
VS6STD8AK3GSC-K	SEL VS6-STD-8AK-3G-S-C)	F2	\$8,533

VS6STD8AK3PSC	SEL VS6-STD-8AK-3P-S-C)	F2	\$8,569
VS6STD8AK3PSC-I	SEL VS6-STD-8AK-3P-S-C)	F2	\$10,026
VS6STD8AK3PSC-K	SEL VS6-STD-8AK-3P-S-C)	F2	\$10,094
VS6STD8AKGSC	SEL VS6-STD-8AK-G-S-C)	F2	\$2,744
VS6STD8AKGSC-I	SEL VS6-STD-8AK-G-S-C)	F2	\$3,210
VS6STD8AKGSC-K	SEL VS6-STD-8AK-G-S-C)	F2	\$3,232
VS6STD8AKPSC	SEL VS6-STD-8AK-P-S-C)	F2	\$3,246
VS6STD8AKPSC-I	SEL VS6-STD-8AK-P-S-C)	F2	\$3,798
VS6STD8AKPSC-K	SEL VS6-STD-8AK-P-S-C)	F2	\$3,823
VS6STDAK3GC	SEL VS6-STD-AK-3G-SSS-C)	F2	\$6,853
VS6STDAK3GC-I	SEL VS6-STD-AK-3G-SSS-C)	F2	\$8,019
VS6STDAK3GC-K	SEL VS6-STD-AK-3G-SSS-C)	F2	\$8,073
VS6STDAK3PC	SEL VS6-STD-AK-3P-SSS-C)	F2	\$8,176
VS6STDAK3PC-I	SEL VS6-STD-AK-3P-SSS-C)	F2	\$9,566
VS6STDAK3PC-K	SEL VS6-STD-AK-3P-SSS-C)	F2	\$9,631
VS6STDAKGC	SEL VS6-STD-AK-G-SSS-C)	F2	\$2,596
VS6STDAKGC-I	SEL VS6-STD-AK-G-SSS-C)	F2	\$3,037
VS6STDAKGC-K	SEL VS6-STD-AK-G-SSS-C)	F2	\$3,058
VS6STDAKPC	SEL VS6-STD-AK-P-SSS-C)	F2	\$3,097
VS6STDAKPC-I	SEL VS6-STD-AK-P-SSS-C)	F2	\$3,623
VS6STDAKPC-K	SEL VS6-STD-AK-P-SSS-C)	F2	\$3,648
VS6STDGC	SEL VS6-STD-G-SSS-C)	F2	\$273
VS6STDGC-I	SEL VS6-STD-G-SSS-C)	F2	\$319
VS6STDGC-K	SEL VS6-STD-G-SSS-C)	F2	\$322
VS6STDPC	SEL VS6-STD-P-SSS-C)	F2	\$323
VS6STDPC-I	SEL VS6-STD-P-SSS-C)	F2	\$378
VS6STDPC-K	SEL VS6-STD-P-SSS-C)	F2	\$380
VS61TBSPMM1	SELECT VS 10-80TB Spt/Mnt 1Mo (per TB)	F2	\$12
VS61TBSPMT1	SELECT VS 10-80TB Spt/Mnt 1Yr (per TB)	F2	\$133
VS61TBSPMT3	SELECT VS 10-80TB Spt/Mnt 3Yr (per TB)	F2	\$400
VS61TBSPMT5	SELECT VS 10-80TB Spt/Mnt 5Yr (per TB)	F2	\$667
VS62TBSPMM1	SELECT VS 81-240TB Spt/Mnt 1Mo (per TB)	F2	\$11
VS62TBSPMT1	SELECT VS 81-240TB Spt/Mnt 1Yr (per TB)	F2	\$126
VS62TBSPMT3	SELECT VS 81-240TB Spt/Mnt 3Yr (per TB)	F2	\$378
VS62TBSPMT5	SELECT VS 81-240TB Spt/Mnt 5Yr (per TB)	F2	\$631
VS63TBSPMM1	SELECT VS 241-500TB Spt/Mnt 1Mo (per TB)	F2	\$9
VS63TBSPMT1	SELECT VS 241-500TB Spt/Mnt 1Yr (per TB)	F2	\$120
VS63TBSPMT3	SELECT VS 241-500TB Spt/Mnt 3Yr (per TB)	F2	\$358
VS63TBSPMT5	SELECT VS 241-500TB Spt/Mnt 5Yr (per TB)	F2	\$596
VS64TBSPMM1	SELECT VS 501-750TB Spt/Mnt 1Mo (per TB)	F2	\$9
VS64TBSPMT1	SELECT VS 501-750TB Spt/Mnt 1Yr (per TB)	F2	\$112
VS64TBSPMT3	SELECT VS 501-750TB Spt/Mnt 3Yr (per TB)	F2	\$335
VS64TBSPMT5	SELECT VS 501-750TB Spt/Mnt 5Yr (per TB)	F2	\$559
VS65TBSPMM1	SELECT VS 751-1024TB Spt/Mnt 1Mo (perTB)	F2	\$8
VS65TBSPMT1	SELECT VS 751-1024TB Spt/Mnt 1Yr (perTB)	F2	\$105
VS65TBSPMT3	SELECT VS 751-1024TB Spt/Mnt 3Yr (perTB)	F2	\$315
VS65TBSPMT5	SELECT VS 751-1024TB Spt/Mnt 5Yr (perTB)	F2	\$525
VSTRAIN2DBHD	SELECT DFXS VS Onsite Training (2-Day)	F2	\$10,059
VTC	SEL Varonis Training Course	F2	\$574
VTCLCLDC-K	SEL V-TEL-CLD-D-P-C)	F2	\$14

VTELCDDGC	SEL V-TEL-CLD-D-G-C)	F2	\$12
VTELCDDGC-I	SEL V-TEL-CLD-D-G-C)	F2	\$12
VTELCDDPC	SEL V-TEL-CLD-D-P-C)	F2	\$13
VTELCDDPC-I	SEL V-TEL-CLD-D-P-C)	F2	\$13
VTELDLDDGC	SEL V-TEL-DLD-D-G-C)	F2	\$25
VTELDLDDGC-I	SEL V-TEL-DLD-D-G-C)	F2	\$25
VTELDLDDPC	SEL V-TEL-DLD-D-P-C)	F2	\$26
VTELDLDDPC-I	SEL V-TEL-DLD-D-P-C)	F2	\$26
VTELDLPC-K	SEL V-TEL-DLD-D-P-C)	F2	\$28
VTELLDDGC-K	SEL V-TEL-CLD-D-G-C)	F2	\$13
VUGBDWSSSUGC	SEL V-UG-BDW-SSS-U-G-C)	F2	\$21
VUGBDWSSSUGC-I	SEL V-UG-BDW-SSS-U-G-C)	F2	\$22
VUGBDWSSSUGC-K	SEL V-UG-BDW-SSS-U-G-C)	F2	\$29
VUGBDWSSSUPC	SEL V-UG-BDW-SSS-U-P-C)	F2	\$26
VUGBDWSSSUPC-I	SEL V-UG-BDW-SSS-U-P-C)	F2	\$27
VUGBDWSSSUPC-K	SEL V-UG-BDW-SSS-U-P-C)	F2	\$36
VUGGDWSSSDGC	SEL V-UG-GDW-SSS-D-G-C)	F2	\$9
VUGGDWSSSDGC-I	SEL V-UG-GDW-SSS-D-G-C)	F2	\$9
VUGGDWSSSDGC-K	SEL V-UG-GDW-SSS-D-G-C)	F2	\$13
VUGGDWSSSDPC	SEL V-UG-GDW-SSS-D-P-C)	F2	\$11
VUGGDWSSSDPC-I	SEL V-UG-GDW-SSS-D-P-C)	F2	\$12
VUGGDWSSSDPC-K	SEL V-UG-GDW-SSS-D-P-C)	F2	\$15
VUGGDWSSSUGC	SEL V-UG-GDW-SSS-U-G-C)	F2	\$31
VUGGDWSSSUGC-I	SEL V-UG-GDW-SSS-U-G-C)	F2	\$32
VUGGDWSSSUGC-K	SEL V-UG-GDW-SSS-U-G-C)	F2	\$43
VUGGDWSSSUPC	SEL V-UG-GDW-SSS-U-P-C)	F2	\$37
VUGGDWSSSUPC-I	SEL V-UG-GDW-SSS-U-P-C)	F2	\$39
VUGGDWSSSUPC-K	SEL V-UG-GDW-SSS-U-P-C)	F2	\$52
VUGGDWSUGC	SEL V-UG-GDW-S-U-G-C)	F2	\$9
VUGGDWSUGC-I	SEL V-UG-GDW-S-U-G-C)	F2	\$9
VUGGDWSUGC-K	SEL V-UG-GDW-S-U-G-C)	F2	\$13
VUGGDWSUPC	SEL V-UG-GDW-S-U-P-C)	F2	\$11
VUGGDWSUPC-I	SEL V-UG-GDW-S-U-P-C)	F2	\$12
VUGGDWSUPC-K	SEL V-UG-GDW-S-U-P-C)	F2	\$15
VUGGUWSSSUGC	SEL V-UG-GUW-SSS-U-G-C)	F2	\$19
VUGGUWSSSUGC-I	SEL V-UG-GUW-SSS-U-G-C)	F2	\$20
VUGGUWSSSUGC-K	SEL V-UG-GUW-SSS-U-G-C)	F2	\$27
VUGGUWSSSUPC	SEL V-UG-GUW-SSS-U-P-C)	F2	\$23
VUGGUWSSSUPC-I	SEL V-UG-GUW-SSS-U-P-C)	F2	\$24
VUGGUWSSSUPC-K	SEL V-UG-GUW-SSS-U-P-C)	F2	\$32
VUGODWSSSDGC	SEL V-UG-ODW-SSS-D-G-C)	F2	\$5
VUGODWSSSDGC-I	SEL V-UG-ODW-SSS-D-G-C)	F2	\$5
VUGODWSSSDGC-K	SEL V-UG-ODW-SSS-D-G-C)	F2	\$7
VUGODWSSSDPC	SEL V-UG-ODW-SSS-D-P-C)	F2	\$6
VUGODWSSSDPC-I	SEL V-UG-ODW-SSS-D-P-C)	F2	\$6
VUGODWSSSDPC-K	SEL V-UG-ODW-SSS-D-P-C)	F2	\$8
VUGODWSSSUGC	SEL V-UG-ODW-SSS-U-G-C)	F2	\$26
VUGODWSSSUGC-I	SEL V-UG-ODW-SSS-U-G-C)	F2	\$27
VUGODWSSSUGC-K	SEL V-UG-ODW-SSS-U-G-C)	F2	\$36
VUGODWSSSUPC	SEL V-UG-ODW-SSS-U-P-C)	F2	\$31

VUGODWSSSUPC-I	SEL V-UG-ODW-SSS-U-P-C)	F2	\$32
VUGODWSSSUPC-K	SEL V-UG-ODW-SSS-U-P-C)	F2	\$43
VUGOUWSSSUGC	SEL V-UG-OUW-SSS-U-G-C)	F2	\$9
VUGOUWSSSUGC-I	SEL V-UG-OUW-SSS-U-G-C)	F2	\$9
VUGOUWSSSUGC-K	SEL V-UG-OUW-SSS-U-G-C)	F2	\$13
VUGOUWSSSUPC	SEL V-UG-OUW-SSS-U-P-C)	F2	\$11
VUGOUWSSSUPC-I	SEL V-UG-OUW-SSS-U-P-C)	F2	\$12
VUGOUWSSSUPC-K	SEL V-UG-OUW-SSS-U-P-C)	F2	\$15
VUGWADWSSSUGC	SEL V-UG-WAD-W-SSS-U-G-C)	F2	\$21
VUGWADWSSSUGC-I	SEL V-UG-WAD-W-SSS-U-G-C)	F2	\$22
VUGWADWSSSUGC-K	SEL V-UG-WAD-W-SSS-U-G-C)	F2	\$29
VUGWADWSSSUPC	SEL V-UG-WAD-W-SSS-U-P-C)	F2	\$26
VUGWADWSSSUPC-I	SEL V-UG-WAD-W-SSS-U-P-C)	F2	\$27
VUGWADWSSSUPC-K	SEL V-UG-WAD-W-SSS-U-P-C)	F2	\$36
VUGWSASSSDGC	SEL V-UG-WSA-SSS-D-G-C)	F2	\$9
VUGWSASSSDGC-I	SEL V-UG-WSA-SSS-D-G-C)	F2	\$9
VUGWSASSSDGC-K	SEL V-UG-WSA-SSS-D-G-C)	F2	\$10
VUGWSASSSDPC	SEL V-UG-WSA-SSS-D-P-C)	F2	\$11
VUGWSASSSDPC-I	SEL V-UG-WSA-SSS-D-P-C)	F2	\$12
VUGWSASSSDPC-K	SEL V-UG-WSA-SSS-D-P-C)	F2	\$12
VUGWSASSSUGC	SEL V-UG-WSA-SSS-U-G-C)	F2	\$21
VUGWSASSSUGC-I	SEL V-UG-WSA-SSS-U-G-C)	F2	\$22
VUGWSASSSUGC-K	SEL V-UG-WSA-SSS-U-G-C)	F2	\$23
VUGWSASSSUPC	SEL V-UG-WSA-SSS-U-P-C)	F2	\$26
VUGWSASSSUPC-I	SEL V-UG-WSA-SSS-U-P-C)	F2	\$27
VUGWSASSSUPC-K	SEL V-UG-WSA-SSS-U-P-C)	F2	\$28
VUGWSDWSSSUGC	SEL V-UG-WSD-W-SSS-U-G-C)	F2	\$31
VUGWSDWSSSUGC-I	SEL V-UG-WSD-W-SSS-U-G-C)	F2	\$32
VUGWSDWSSSUGC-K	SEL V-UG-WSD-W-SSS-U-G-C)	F2	\$33
VUGWSDWSSSUPC	SEL V-UG-WSD-W-SSS-U-P-C)	F2	\$37
VUGWSDWSSSUPC-I	SEL V-UG-WSD-W-SSS-U-P-C)	F2	\$39
VUGWSDWSSSUPC-K	SEL V-UG-WSD-W-SSS-U-P-C)	F2	\$40
VUGWSDWSUGC	SEL V-UG-WSD-W-S-U-G-C)	F2	\$9
VUGWSDWSUGC-I	SEL V-UG-WSD-W-S-U-G-C)	F2	\$9
VUGWSDWSUGC-K	SEL V-UG-WSD-W-S-U-G-C)	F2	\$10
VUGWSDWSUPC	SEL V-UG-WSD-W-S-U-P-C)	F2	\$11
VUGWSDWSUPC-I	SEL V-UG-WSD-W-S-U-P-C)	F2	\$12
VUGWSDWSUPC-K	SEL V-UG-WSD-W-S-U-P-C)	F2	\$12
VWOAADSSSU3GC	SEL V-WOA-AD-SSS-U-3G-C)	F2	\$92
VWOAADSSSU3GC-I	SEL V-WOA-AD-SSS-U-3G-C)	F2	\$97
VWOAADSSSU3GC-K	SEL V-WOA-AD-SSS-U-3G-C)	F2	\$99
VWOAADSSSU3PC	SEL V-WOA-AD-SSS-U-3P-C)	F2	\$108
VWOAADSSSU3PC-I	SEL V-WOA-AD-SSS-U-3P-C)	F2	\$113
VWOAADSSSU3PC-K	SEL V-WOA-AD-SSS-U-3P-C)	F2	\$116
VWOAADSSSUGC	SEL V-WOA-AD-SSS-U-G-C)	F2	\$35
VWOAADSSSUGC-I	SEL V-WOA-AD-SSS-U-G-C)	F2	\$37
VWOAADSSSUGC-K	SEL V-WOA-AD-SSS-U-G-C)	F2	\$38
VWOAADSSSUPC	SEL V-WOA-AD-SSS-U-P-C)	F2	\$41
VWOAADSSSUPC-I	SEL V-WOA-AD-SSS-U-P-C)	F2	\$43
VWOAADSSSUPC-K	SEL V-WOA-AD-SSS-U-P-C)	F2	\$44

VWOAASSSD3GC	SEL V-WOAA-SSS-D-3G-C)	F2	\$13
VWOAASSSD3GC-I	SEL V-WOAA-SSS-D-3G-C)	F2	\$14
VWOAASSSD3GC-K	SEL V-WOAA-SSS-D-3G-C)	F2	\$14
VWOAASSSD3PC	SEL V-WOAA-SSS-D-3P-C)	F2	\$16
VWOAASSSD3PC-I	SEL V-WOAA-SSS-D-3P-C)	F2	\$17
VWOAASSSD3PC-K	SEL V-WOAA-SSS-D-3P-C)	F2	\$17
VWOAASSSDGC	SEL V-WOAA-SSS-D-G-C)	F2	\$5
VWOAASSSDGC-I	SEL V-WOAA-SSS-D-G-C)	F2	\$5
VWOAASSSDGC-K	SEL V-WOAA-SSS-D-G-C)	F2	\$5
VWOAASSSDPC	SEL V-WOAA-SSS-D-P-C)	F2	\$6
VWOAASSSDPC-I	SEL V-WOAA-SSS-D-P-C)	F2	\$6
VWOAASSSDPC-K	SEL V-WOAA-SSS-D-P-C)	F2	\$6
VWOAASSSU3GC	SEL V-WOAA-SSS-U-3G-C)	F2	\$21
VWOAASSSU3GC-I	SEL V-WOAA-SSS-U-3G-C)	F2	\$22
VWOAASSSU3GC-K	SEL V-WOAA-SSS-U-3G-C)	F2	\$23
VWOAASSSU3PC	SEL V-WOAA-SSS-U-3P-C)	F2	\$24
VWOAASSSU3PC-I	SEL V-WOAA-SSS-U-3P-C)	F2	\$25
VWOAASSSU3PC-K	SEL V-WOAA-SSS-U-3P-C)	F2	\$25
VWOAASSSUGC	SEL V-WOAA-SSS-U-G-C)	F2	\$8
VWOAASSSUGC-I	SEL V-WOAA-SSS-U-G-C)	F2	\$8
VWOAASSSUGC-K	SEL V-WOAA-SSS-U-G-C)	F2	\$9
VWOAASSSUPC	SEL V-WOAA-SSS-U-P-C)	F2	\$9
VWOAASSSUPC-I	SEL V-WOAA-SSS-U-P-C)	F2	\$9
VWOAASSSUPC-K	SEL V-WOAA-SSS-U-P-C)	F2	\$10
VWOAESSSU3GC	SEL V-WOAE-SSS-U-3G-C)	F2	\$103
VWOAESSSU3GC-I	SEL V-WOAE-SSS-U-3G-C)	F2	\$108
VWOAESSSU3GC-K	SEL V-WOAE-SSS-U-3G-C)	F2	\$110
VWOAESSSU3PC	SEL V-WOAE-SSS-U-3P-C)	F2	\$121
VWOAESSSU3PC-I	SEL V-WOAE-SSS-U-3P-C)	F2	\$127
VWOAESSSU3PC-K	SEL V-WOAE-SSS-U-3P-C)	F2	\$130
VWOAESSSUGC	SEL V-WOAE-SSS-U-G-C)	F2	\$39
VWOAESSSUGC-I	SEL V-WOAE-SSS-U-G-C)	F2	\$41
VWOAESSSUGC-K	SEL V-WOAE-SSS-U-G-C)	F2	\$42
VWOAESSSUPC	SEL V-WOAE-SSS-U-P-C)	F2	\$46
VWOAESSSUPC-I	SEL V-WOAE-SSS-U-P-C)	F2	\$48
VWOAESSSUPC-K	SEL V-WOAE-SSS-U-P-C)	F2	\$49
VWOASSSD3GC	SEL V-WOA-SSS-D-3G-C)	F2	\$53
VWOASSSD3GC-I	SEL V-WOA-SSS-D-3G-C)	F2	\$55
VWOASSSD3GC-K	SEL V-WOA-SSS-D-3G-C)	F2	\$57
VWOASSSD3PC	SEL V-WOA-SSS-D-3P-C)	F2	\$61
VWOASSSD3PC-I	SEL V-WOA-SSS-D-3P-C)	F2	\$63
VWOASSSD3PC-K	SEL V-WOA-SSS-D-3P-C)	F2	\$65
VWOASSSDGC	SEL V-WOA-SSS-D-G-C)	F2	\$20
VWOASSSDGC-I	SEL V-WOA-SSS-D-G-C)	F2	\$21
VWOASSSDGC-K	SEL V-WOA-SSS-D-G-C)	F2	\$21
VWOASSSDPC	SEL V-WOA-SSS-D-P-C)	F2	\$23
VWOASSSDPC-I	SEL V-WOA-SSS-D-P-C)	F2	\$24
VWOASSSDPC-K	SEL V-WOA-SSS-D-P-C)	F2	\$25
VWOASSSU3GC	SEL V-WOA-SSS-U-3G-C)	F2	\$103
VWOASSSU3GC-I	SEL V-WOA-SSS-U-3G-C)	F2	\$108

VWOASSSU3GC-K	SEL V-WOA-SSS-U-3G-C)	F2	\$110
VWOASSSU3PC	SEL V-WOA-SSS-U-3P-C)	F2	\$121
VWOASSSU3PC-I	SEL V-WOA-SSS-U-3P-C)	F2	\$127
VWOASSSU3PC-K	SEL V-WOA-SSS-U-3P-C)	F2	\$130
VWOASSSUGC	SEL V-WOA-SSS-U-G-C)	F2	\$39
VWOASSSUGC-I	SEL V-WOA-SSS-U-G-C)	F2	\$41
VWOASSSUGC-K	SEL V-WOA-SSS-U-G-C)	F2	\$42
VWOASSSUPC	SEL V-WOA-SSS-U-P-C)	F2	\$46
VWOASSSUPC-I	SEL V-WOA-SSS-U-P-C)	F2	\$48
VWOASSSUPC-K	SEL V-WOA-SSS-U-P-C)	F2	\$49
VWOES200U3GC	SEL V-WOE-S-200U-3G-C)	F2	\$66,158
VWOES200U3GC-I	SEL V-WOE-S-200U-3G-C)	F2	\$69,136
VWOES200U3GC-K	SEL V-WOE-S-200U-3G-C)	F2	\$70,908
VWOES200U3PC	SEL V-WOE-S-200U-3P-C)	F2	\$78,762
VWOES200U3PC-I	SEL V-WOE-S-200U-3P-C)	F2	\$82,306
VWOES200U3PC-K	SEL V-WOE-S-200U-3P-C)	F2	\$84,416
VWOESSS10U3GC	SEL V-WOE-SSS-10U-3G-C)	F2	\$3,308
VWOESSS10U3GC-I	SEL V-WOE-SSS-10U-3G-C)	F2	\$3,457
VWOESSS10U3GC-K	SEL V-WOE-SSS-10U-3G-C)	F2	\$3,545
VWOESSS10U3PC	SEL V-WOE-SSS-10U-3P-C)	F2	\$3,939
VWOESSS10U3PC-I	SEL V-WOE-SSS-10U-3P-C)	F2	\$4,116
VWOESSS10U3PC-K	SEL V-WOE-SSS-10U-3P-C)	F2	\$4,222
VWOESSS10UGC	SEL V-WOE-SSS-10U-G-C)	F2	\$1,253
VWOESSS10UGC-I	SEL V-WOE-SSS-10U-G-C)	F2	\$1,309
VWOESSS10UGC-K	SEL V-WOE-SSS-10U-G-C)	F2	\$1,343
VWOESSS10UPC	SEL V-WOE-SSS-10U-P-C)	F2	\$1,492
VWOESSS10UPC-I	SEL V-WOE-SSS-10U-P-C)	F2	\$1,559
VWOESSS10UPC-K	SEL V-WOE-SSS-10U-P-C)	F2	\$1,599
VWOESSS200UGC	SEL V-WOE-SSS-200U-G-C)	F2	\$25,060
VWOESSS200UGC-I	SEL V-WOE-SSS-200U-G-C)	F2	\$26,188
VWOESSS200UGC-K	SEL V-WOE-SSS-200U-G-C)	F2	\$26,859
VWOESSS200UPC	SEL V-WOE-SSS-200U-P-C)	F2	\$29,834
VWOESSS200UPC-I	SEL V-WOE-SSS-200U-P-C)	F2	\$31,177
VWOESSS200UPC-K	SEL V-WOE-SSS-200U-P-C)	F2	\$31,976
VWOESSS20U3GC	SEL V-WOE-SSS-20U-3G-C)	F2	\$6,616
VWOESSS20U3GC-I	SEL V-WOE-SSS-20U-3G-C)	F2	\$6,914
VWOESSS20U3GC-K	SEL V-WOE-SSS-20U-3G-C)	F2	\$7,091
VWOESSS20U3PC	SEL V-WOE-SSS-20U-3P-C)	F2	\$7,875
VWOESSS20U3PC-I	SEL V-WOE-SSS-20U-3P-C)	F2	\$8,230
VWOESSS20U3PC-K	SEL V-WOE-SSS-20U-3P-C)	F2	\$8,440
VWOESSS20UGC	SEL V-WOE-SSS-20U-G-C)	F2	\$2,506
VWOESSS20UGC-I	SEL V-WOE-SSS-20U-G-C)	F2	\$2,619
VWOESSS20UGC-K	SEL V-WOE-SSS-20U-G-C)	F2	\$2,686
VWOESSS20UPC	SEL V-WOE-SSS-20U-P-C)	F2	\$2,983
VWOESSS20UPC-I	SEL V-WOE-SSS-20U-P-C)	F2	\$3,117
VWOESSS20UPC-K	SEL V-WOE-SSS-20U-P-C)	F2	\$3,197
VWOESSSU3GC	SEL V-WOE-SSS-U-3G-C)	F2	\$33,079
VWOESSSU3GC-I	SEL V-WOE-SSS-U-3G-C)	F2	\$34,568
VWOESSSU3GC-K	SEL V-WOE-SSS-U-3G-C)	F2	\$35,454
VWOESSSU3PC	SEL V-WOE-SSS-U-3P-C)	F2	\$39,381

VWOESSU3PC-I	SEL V-WOE-SSS-U-3P-C)	F2	\$41,153
VWOESSU3PC-K	SEL V-WOE-SSS-U-3P-C)	F2	\$42,208
VWOESSUGC	SEL V-WOE-SSS-U-G-C)	F2	\$12,530
VWOESSUGC-I	SEL V-WOE-SSS-U-G-C)	F2	\$13,094
VWOESSUGC-K	SEL V-WOE-SSS-U-G-C)	F2	\$13,430
VWOESSUPC	SEL V-WOE-SSS-U-P-C)	F2	\$14,917
VWOESSUPC-I	SEL V-WOE-SSS-U-P-C)	F2	\$15,588
VWOESSUPC-K	SEL V-WOE-SSS-U-P-C)	F2	\$15,988
VWOSSSD3GC	SEL V-WOS-SSS-D-3G-C)	F2	\$29
VWOSSSD3GC-I	SEL V-WOS-SSS-D-3G-C)	F2	\$30
VWOSSSD3GC-K	SEL V-WOS-SSS-D-3G-C)	F2	\$31
VWOSSSD3PC	SEL V-WOS-SSS-D-3P-C)	F2	\$34
VWOSSSD3PC-I	SEL V-WOS-SSS-D-3P-C)	F2	\$36
VWOSSSD3PC-K	SEL V-WOS-SSS-D-3P-C)	F2	\$37
VWOSSSDGC	SEL V-WOS-SSS-D-G-C)	F2	\$11
VWOSSSDGC-I	SEL V-WOS-SSS-D-G-C)	F2	\$12
VWOSSSDGC-K	SEL V-WOS-SSS-D-G-C)	F2	\$12
VWOSSSDPC	SEL V-WOS-SSS-D-P-C)	F2	\$13
VWOSSSDPC-I	SEL V-WOS-SSS-D-P-C)	F2	\$14
VWOSSSDPC-K	SEL V-WOS-SSS-D-P-C)	F2	\$14
VWOSSSU3GC	SEL V-WOS-SSS-U-3G-C)	F2	\$53
VWOSSSU3GC-I	SEL V-WOS-SSS-U-3G-C)	F2	\$55
VWOSSSU3GC-K	SEL V-WOS-SSS-U-3G-C)	F2	\$57
VWOSSSU3PC	SEL V-WOS-SSS-U-3P-C)	F2	\$61
VWOSSSU3PC-I	SEL V-WOS-SSS-U-3P-C)	F2	\$63
VWOSSSU3PC-K	SEL V-WOS-SSS-U-3P-C)	F2	\$65
WAR-RGSTACK	SEL RG SW MAINT. FOR PRIV. CLOUD	F2	\$70,588
WINPRIVONADD	SEL Puppet Essentials Onsite Trng Addon	F2	\$7,059
WS12-PLAY-G-SSSF	SEL: WS12-PLAY-G-SSSF	F2	\$34
WS12-PLAY-P-SSSF	SEL: WS12-PLAY-P-SSSF	F2	\$41
WS14PLAY3GC	SEL WS14-PLAY-3G-SSS-C)	F2	\$82
WS14PLAY3GC-I	SEL WS14-PLAY-3G-SSS-C)	F2	\$83
WS14PLAY3GC-K	SEL WS14-PLAY-3G-SSS-C)	F2	\$84
WS14PLAY3GSSSF	SEL: WS14-PLAY-3G-SSS-F	F2	\$90
WS14PLAY3PC	SEL WS14-PLAY-3P-SSS-C)	F2	\$98
WS14PLAY3PC-I	SEL WS14-PLAY-3P-SSS-C)	F2	\$100
WS14PLAY3PC-K	SEL WS14-PLAY-3P-SSS-C)	F2	\$101
WS14PLAY3PSSSF	SEL: WS14-PLAY-3P-SSS-F	F2	\$107
WS14PLAYGC	SEL WS14-PLAY-G-SSS-C)	F2	\$31
WS14PLAYGC-I	SEL WS14-PLAY-G-SSS-C)	F2	\$32
WS14PLAYGC-K	SEL WS14-PLAY-G-SSS-C)	F2	\$32
WS14PLAYGSSSF	SEL: WS14-PLAY-G-SSS-F	F2	\$34
WS14PLAYPC	SEL WS14-PLAY-P-SSS-C)	F2	\$37
WS14PLAYPC-I	SEL WS14-PLAY-P-SSS-C)	F2	\$38
WS14PLAYPC-K	SEL WS14-PLAY-P-SSS-C)	F2	\$38
WS14PLAYPSSSF	SEL: WS14-PLAY-P-SSS-F	F2	\$41
WS3GC	SEL WS-3G-SSS-C)	F2	\$137
WS3GC-I	SEL WS-3G-SSS-C)	F2	\$140
WS3GCV2-K	SEL WS-3G-SSS-C)	F2	\$142
WS3PC	SEL WS-3P-SSS-C)	F2	\$164

WS3PC-I	SEL WS-3P-SSS-C)	F2	\$167
WS3PCV2-K	SEL WS-3P-SSS-C)	F2	\$169
WSGC	SEL WS-G-SSS-C)	F2	\$52
WSGC-I	SEL WS-G-SSS-C)	F2	\$53
WSGCV2-K	SEL WS-G-SSS-C)	F2	\$54
WSP100GSSSC	SEL WSP-100-G-SSS-C)	F2	\$1,082
WSP100GSSSC-I	SEL WSP-100-G-SSS-C)	F2	\$1,131
WSP100GSSSC-K	SEL WSP-100-G-SSS-C)	F2	\$1,514
WSP100PSSSC	SEL WSP-100-P-SSS-C)	F2	\$1,288
WSP100PSSSC-I	SEL WSP-100-P-SSS-C)	F2	\$1,346
WSP100PSSSC-K	SEL WSP-100-P-SSS-C)	F2	\$1,802
WSP10GSSSC	SEL WSP-10-G-SSS-C)	F2	\$108
WSP10GSSSC-I	SEL WSP-10-G-SSS-C)	F2	\$113
WSP10GSSSC-K	SEL WSP-10-G-SSS-C)	F2	\$151
WSP10PSSSC	SEL WSP-10-P-SSS-C)	F2	\$129
WSP10PSSSC-I	SEL WSP-10-P-SSS-C)	F2	\$135
WSP10PSSSC-K	SEL WSP-10-P-SSS-C)	F2	\$180
WSPC	SEL WS-P-SSS-C)	F2	\$62
WSPC-I	SEL WS-P-SSS-C)	F2	\$63
WSPCV2-K	SEL WS-P-SSS-C)	F2	\$64
AVATD-TRN	ADDITIONAL TRAINING-DOM	I	\$5,000
AVATI-TRN	ADDITIONAL TRAINING-INTL	I	\$10,000
CE-1YRSCREDTU0001	1 Training Unit Valid 1 Year (S-Credit)	I	\$100
CE-1YTLATC0001	1 Training Credit Valid 1 Year (TLA)	I	\$1
CE-2YTLATC0001	1 Training Credit Valid 2 Years (TLA)	I	\$1
CE-3YTLATC0001	1 Training Credit Valid 3 Years (TLA)	I	\$1
CE-4YTLATC0001	1 Training Credit Valid 4 Years (TLA)	I	\$1
CE-5YTLATC0001	1 Training Credit Valid 5 Years (TLA)	I	\$1
CEALLSUBCUSEV	Collection Sub VILTS 5 Titles=UC	I	\$0
CE-ATPIEVNX	EMC ATP ONLY VNX UNIFIED STOR. IMPLEMEN	I	\$1,000
CE-ATPRIMPL	EMC ATP ONLY RECOVERPOINT IMPLEMENTAT	I	\$1,000
CE-ATVTG	ADVTG Col PtrONLY VILTS 25 Titles=UD	I	\$15,000
CE-ATVTGBUILD	ADVTGBLD COL PTR ONLY VILTS 50 titles=UD	I	\$18,000
CE-ATVTGGROW	ADVTGGW COL PTR ONLY VILTS 100 titles=UD	I	\$21,000
CE-ATVTGPLUS	ADVTG+ Col PtrONLY VILTS 200 Titles=UD	I	\$25,000
CE-AVAMAROS	AVAMAR ONSITE TRAINING	I	\$24,000
CE-AVAXIADMIN	Avamar Training ValuePak	I	\$3,300
CE-AVAXIADV	EMCIE-Avamar Inst-Led Partner ONLY	I	\$2,500
CE-BCDIRREG	Bootcamp: Seat	I	\$100
CE-BCONSITE	Bootcamp: Dedicated Class	I	\$100
CE-BCSUBCUS01	Bootcamp: 1 Year Subscription	I	\$12,500
CE-BCTU0001	Bootcamp: 1 Training Unit	I	\$100
CE-BCTU0100	Bootcamp: 100 Training Units	I	\$10,000
CE-BDSADMIN	Big Data Solution Admin ILT - OILT	I	\$2,000
CE-BDSADMINVILT	Big Data Sol Admin VILTS 1 Title=UC	I	\$1,200
CE-BDSPRCT	Big Data Solution in Practice ILT - OILT	I	\$3,000
CE-BDSPRCTVILT	Big Data Sol in Practice VILTS 1Title=UC	I	\$1,800
CE-BRCDL2FCAT	BROCADE INTR.TO L2 FIBRE CHANNEL ADMIN	I	\$3,000
CE-BRTU001	1 TRAINING UNIT VALID 1 YR (BRS0	I	\$100
CE-BRTU0055	55 Training Units Valid 1yr (BRS)	I	\$5,500

CE-BRTU0110	110 Training Units Valid 1yr (BRS)		\$11,000
CE-BRTU0300	300 Training Units Valid 1yr (BRS)		\$30,000
CE-BRTU050	50 TRAINING UNITS VALID 1YR (BRS0		\$5,000
CE-BRTU100	100 TRAINING UNITS VALID 1YR (BRS)		\$10,000
CE-BRTU250	250 TRAINING UNITS VALID 1 YR (BRS0		\$25,000
CE-CHLTC0001	1 Training Credit Valid 1YR (Chan only)		\$1
CE-CISCODCNI	CISCO SYS: IMP CISCO DATA CENTER NET		\$3,500
CE-CISCOICASN	IMPLEMENTING CISCO ADVANCED STORAGE N		\$3,500
CE-CISCOICSNS	IMPLEMENTING CISCO STORAGE NWKG SOL.		\$3,500
CE-CISCOUCSI	CISCO SYS: DATA CENTER UNIFIED COMP IMP		\$3,500
CE-CLSECUREVALPAK	CloudLink SecureVM Value Pak		\$300
CE-CNCGDIRREG	CONCHANGO TRAINING ONLY		\$100
CE-CORSUBFL1	Cust Sub-1 Person, 1 Year (COR)		\$12,500
CE-CORSUBOD1	Vid Sub Exp 1yr (COR) VILTS 6 Titles=UC		\$5,000
CE-CORTC0001	1 Training Credit Valid 1yr (COR)		\$1
CE-CORTU0001	1 Training Unit Valid 1yr (COR)		\$100
CE-CSUBVSBASE	Video ILT-Stream Corp Sub - Base=UD		\$60,000
CE-CSUBVSREFILL	Video ILT-Stream Corp Sub - Refill=UD		\$30,000
CE-CUSTSUBXL	Full Sub with On-Demand Lab Exp 1 Year		\$15,000
CE-CUSTVSUBXL	vSub w/On-DemLab Exp1yr VILTS 6Titles=UC		\$7,500
CE-DDSUBCUS01	CUSTOMER SUBSCRIPTION-1 PERSON 1 YEAR		\$12,500
CE-DIFFAVAMAR	EMC AVAMAR DIFFERENCES COURSE		\$1,000
CE-DIFFCLNUNI	CLARIION AND UNISPHERE DIFFERENCES		\$1,000
CE-DIFFVMAX	SYMMETRIX VMAX SERIES DIFFERENCES COUF		\$2,000
CE-DIRREG-GP	GP HD DIRECT REGISTRATION		\$100
CE-DLMONSITE	DLM ONSITE TRAINING		\$100
CE-DPAOS	DPA ONSITE TRAINING		\$100
CE-DPDSUBFL1	Cust Sub-1 Person, 1 Year (DP)		\$12,500
CE-DPDSUBOD1	Vid Sub Exp 1yr (DP) VILTS 6 Titles=UC		\$5,000
CE-DPDTC0001	1 Training Credit Valid 1yr (DP)		\$1
CE-DPDTU0001	1 Training Unit Valid 1yr (DP)		\$100
CE-DPMSTAR	Data Protection & Management StarterKit		\$600
CE-ECOLLCUS1	eLearning Collection Tier 1 Lmt 1000 =UD		\$55,000
CE-ECOLLCUS2	eLearning Collection Tier 2 Lmt 1500 =UD		\$67,500
CE-ECOLLCUS3	eLearning Collection Tier 3 Lmt 2000 =UD		\$80,000
CE-ECSDCAAS3	ECS Data Client Access Amazon S3		\$300
CE-ECSDCAHDFS	ECS Data Client Access HDFS		\$300
CE-ECSDCANFSV3	ECS Data Client Access NFSv3		\$300
CE-ECSDCAOSW	ECS Data Client Access OpenStack Swift		\$300
CE-ECSIMPLEMENT	ECS Implementation		\$2,000
CE-ECSVALPAK	ECS Management and Monitoring		\$1,800
CE-ECSVALPAKR2	ECS Management and Monitoring ValuePak		\$3,000
CE-EDISONSITE	SOURCEONE EDISCOVERY ONSITE TRN PER D,		\$6,000
CE-EDUCAREBR2	EduCare Tier2		\$15,000
CE-EHCIL1DAY	Enterprise Hybrid Cloud 1-day (100 TU)		\$10,000
CE-EHCIL3DAY	Enterprise Hybrid Cloud 3-day (300 TU)		\$30,000
CE-EHCIL5DAY	Enterprise Hybrid Cloud 5-day (470 TU)		\$47,000
CE-ELP-VDC	VDC USAGE FEE FOR EMC LEARNING PARTNEF		\$0
CE-EMCDCAIADM	INFORMATION AVAILABILITY EMCDCA VALUEPA		\$5,000
CE-EMCDCASNDM	STORAGE NETWORKING EMCDCA VALUEPAK		\$5,000

CE-EMCPROEXVC	EMC PROVEN PROFESSIONAL EXAM VOUCHER		\$200
CE-ESVLVDC01	INDIVIDUAL ESVL SESSION - 1 MONTH		\$800
CE-ESVLVDC03	INDIVIDUAL ESVL MONTHLY SESSION - 3 MOS		\$2,300
CE-ESVLVDC06	INDIVIDUAL ESVL MONTHLY SESSION - 6 MOS		\$4,400
CE-ESVLVDC12	INDIVIDUAL ESVL MONTHLY SESSION - 12 MOS		\$8,200
CE-EVALPAKAPP	AppSync eValuePak		\$800
CE-EVALPAKBRS	BACKUP RECOVERY SYSTEMS EVALUEPAK		\$800
CE-EVALPAKISM	Info. Storage and Mgmt v2 eValuePak		\$800
CE-EVALPAKVNXE	VNXe eLearning ValuePak		\$500
CE-EVALPAKVPLXVE	VPLEX VE eValuePak		\$500
CE-EVPBRINTG	Backup Recov. Sol. Integration eValuePak		\$1,500
CE-EVPCEL2VNX	CELERRA TO VNX EVALUEPAK		\$800
CE-EVPCLN2VNX	CLARIION TO VNX EVALUEPAK		\$800
CE-FEDVDIRREG	Federation V Resell: Seat		\$100
CE-FEDVRONSITE	Federation V Resell: Dedicated Class		\$100
CE-FEDVRSUBCUS01	Federation V Resell: 1 Year Subscription		\$12,500
CE-FEDVRTC0001	Federation V Resell: 1 Training Credit		\$1
CE-FEDVRTU0100	Federation V Resell: 100 Training Units		\$10,000
CE-FEDVDIRREG	Federation V VATC: Seat		\$100
CE-FEDVVONSITE	Federation V VATC: Dedicated Class		\$100
CE-FEDVVSUBCUS01	Federation V VATC: 1 Year Subscription		\$12,500
CE-FEDVVTC0001	Federation V VATC: 1 Training Credit		\$1
CE-FEDVVTU0100	Federation V VATC: 100 Training Units		\$10,000
CE-GPTU0001	1 TRAINING UNIT VALID 1 YR (GREENPLUM)		\$100
CE-GPTU0055	55 TRAINING UNITS VALID 1 YR (GREENPLUM)		\$5,500
CE-HCISUBFL1	Cust Sub-1 Person, 1 Year (HCI)		\$12,500
CE-HCISUBOD1	Vid Sub Exp 1yr (HCI) VILTS 6 Titles=UC		\$5,000
CE-HCITC0001	1 Training Credit Valid 1yr (HCI)		\$1
CE-HCITU0001	1 Training Unit Valid 1yr (HCI)		\$100
CE-IBIGDATABT	IntroDataScience-BizTran VILTS 1Title=UC		\$200
CE-ICLOUDBT	IntroCloudITaaS-BizTran VILTS 1 Title=UC		\$200
CE-ILCE-FEHC	EMCCE-Hybrid Cloud Sol Inst-Led PtrONLY		\$5,000
CE-ILIE-AVAE	EMCIE-Avamar Exp Inst-Led PartnerOnly		\$2,500
CE-ILIE-NW-E	EMCIE-NW Exp Inst-Led Partner ONLY		\$2,500
CE-ILIE-VMAX3	EMCIE-VMAX3 Inst-Led Partner Only		\$2,500
CE-ILPE-ISIL	EMCPE-ISIL INST-LED PARTNER ONLY		\$2,500
CE-ILPE-VMAX3	EMCPE-VMAX3 Inst-Led Partner Only		\$2,500
CE-ILPTSIO	ScaleIO ILT Partner Only		\$2,500
CE-ILPTSIO2	EMCPT-ScaleIO ILT Partner Only		\$3,000
CE-ILPT-XIO	EMCPT-XtremIO Inst Led PartnerONLY		\$1,500
CE-ILTA-BRSOL	EMCTA-BR SOL. INST-LED PARTNER ONLY		\$4,000
CE-ILTA-CLN	EMCTA-CLN SOL. INST-LED PARTNER ONLY		\$4,000
CE-ILTA-SBC	EMCTA-SYMM. SOL. INST-LED PARTNER ONLY		\$4,000
CE-ILTA-VNX	EMCTA-VNX SOL. INST-LED PARTNERS ONLY		\$4,000
CE-ILTBRS	BACKUP-RECOVERY SYSTEMS & ARCH INST-LE		\$2,700
CE-ILTBTCLOUD	CLOUD ITAAS FOR BIZ TRANSF. ILT		\$1,000
CE-ILTBTDATA	DATA SCIENCE FOR BIZ TRANSF. ILT		\$1,000
CE-ILTCIS	Cloud Infrastructure and Services v2 ILT		\$2,700
CE-ILTDSBDA	Data Science and Big Data Analytics ILT		\$5,000
CE-ILTITAAS	IT-AS-A-SERVICE PLANNING AND DESIGN ILT		\$5,000

CE-ILTSONEEM	SourceOne Email Management ILT		\$3,000
CE-INFRAATPKIT	INFRA ATP STUDENT DAY KIT FEE		\$100
CE-INFRAATPVDC	INFRA ATP 1 DAY VDC USAGE FEE		\$250
CE-INFRAIRREG	DIRECT REGISTRATION (INFRA)		\$100
CE-INFRAITC	TRAINING CONSULTANT FOR 1 DAY (INFRA)		\$1,650
CE-INFRAITRCOST	INFRA TRAINING DELIVERY TRAVEL COST		\$0
CE-ISILONADMNAUSER	Isilon Administrators for NetApp Users		\$5,000
CE-ISLSUBFL1	Cust Sub-1 Person, 1 Year (ISL)		\$12,500
CE-ISLSUBOD1	Vid Sub Exp 1yr (ISL) VILTS 6 Titles=UC		\$5,000
CE-ISLTC0001	1 Training Credit Valid 1yr (ISL)		\$1
CE-ISTU0001	1 Training Unit Valid 1yr (Isilon)		\$100
CE-ISTU0055	55 Training Units Valid 1yr (Isilon)		\$5,500
CE-ISTU0110	110 Training Units Valid 1yr (Isilon)		\$11,000
CE-ISTU0300	300 Training Units Valid 1yr (Isilon)		\$30,000
CE-LGSUBCUS01	CUSTOMER SUB EXPIRE 1YR FROM INV DATE		\$12,500
CE-LGSUBCUS02	CUSTOMER SUB EXPIRE 2YR FROM INV DATE		\$22,000
CE-LGSUBCUSEL	ELEARNING SUB EXPIRE 1YR FROM INV DATE		\$2,000
CE-LGSUBPNR01	Partner Subscription Expire 1yr from Inv		\$8,500
CE-LGTU30	30 Training Units Valid 1 year (BR)		\$9,395
CE-MILESTU0001	1 Training Unit Valid 1 Year (MILES)		\$100
CE-MILESTU0100	100 Training Units Valid 1 Year (MILES)		\$10,000
CE-NETWKR-LAB	Networker 9 Implementation and Mgt Lab		\$2,500
CE-NETWKR-VALPAK	Networker 9 ILT ValuePak with Lab Access		\$7,300
CE-NETWKR-VIDVPK	Networker 9 VVPK w/ Lab VILTS 1 Title=UC		\$5,300
CE-ODLCFD10	ODLC Foundation 12mo 10 Learners		\$50,000
CE-ODLCFD100	ODLC Foundation 12mo 100 Learners		\$300,000
CE-ODLCFD22	ODLC Foundation 12mo 22 Learners		\$100,000
CE-ODLCFD50	ODLC Foundation 12mo 50 Learners		\$200,000
CE-ODLCFDNLG	ODLC Foundation 12mo 480 Registrations		\$200,000
CE-ODLCFDNMD	ODLC Foundation 12mo 220 Registrations		\$100,000
CE-ODLCFDNSM	ODLC Foundation 12mo 100 Registrations		\$50,000
CE-ODLCFDNXLG	ODLC Foundation 12mo 780 Registrations		\$300,000
CE-ODLCIND01	On-demand Learning Center for Individual		\$800
CE-OLIE-AV	EMC Avamar Online Lab PARTNERS ONLY		\$600
CE-OLIE-BR	NetWorker Online Lab PARTNERS ONLY		\$600
CE-OLIE-DD	DATA DOMAIN IMP ONLINE LAB PARTNERS ONL		\$600
CE-OLIE-ISIL	ISILON IMP. ONLINE LAB PARTNERS ONLY		\$600
CE-OLIE-RP	RecoverPoint Online Lab PARTNERS ONLY		\$600
CE-OLIE-SBC	Symm. Sol. Online Lab PARTNERS ONLY		\$1,200
CE-OLIE-VNX	VNX Imp. Online Lab PARTNERS ONLY		\$600
CE-OLPT-XIO	XtremIO Online Lab PARTNERS ONLY		\$600
CE-ONDEMAND4	Promo OnDemand Subscription 4Users1YR=UD		\$15,000
CE-ONSITE	EMC ONSITE TRAINING		\$100
CE-ONSITE-01	1-DAY ONSITE 12 STDNT MAX-SOW REQ (EMC)		\$15,800
CE-ONSITE-02	2-DAY ONSITE 12 STDNT MAX-SOW REQ (EMC)		\$18,900
CE-ONSITE-03	3-DAY ONSITE 12 STDNT MAX-SOW REQ (EMC)		\$25,200
CE-ONSITE-04	4-DAY ONSITE 12 STDNT MAX-SOW REQ (EMC)		\$33,600
CE-ONSITE-05	5-DAY ONSITE 12 STDNT MAX-SOW REQ (EMC)		\$42,000
CE-ONSITECIS	Cloud Infra Services v2 Onsite		\$30,000
CE-ONSITEIAD	IAD ONSITE		\$42,000

CE-ONSITEISIL	Isilon Onsite Training		\$42,000
CE-ONSITESND	SND ONSITE		\$42,000
CE-OPENSUB2	Open Video Sub Exp 1yr VILTS 3 Titles=UC		\$2,200
CE-OSCCNDC	CISCO CCNDC ONSITE		\$37,500
CE-OSDCUCI	CISCO DCUCI ONSITE		\$40,000
CE-OSDCUFD	CISCO DCUFD ONSITE		\$40,000
CE-OSDCUFI	CISCO DCUFI ONSITE		\$40,000
CE-OSDSBDA	DSBDA ONSITE		\$42,000
CE-OSITAAS	ITAAS ONSITE		\$42,000
CE-OSVCLDDM	VCLOUD DDM ONSITE		\$28,000
CE-OSVDCCI	VDCCI ONSITE		\$42,000
CE-OSVSPICM	VSPHERE ICM ONSITE		\$35,000
CEPASRPTOS	ONSITE TRAINING		\$100
CE-PDPTC0001	1 Training Credit Valid 1yr (PDP)		\$1
CE-PIVPALILT	Pivotal Platform Acceleration Lab (PAL)		\$12,500
CE-PIVTC0001	1 Training Credit Valid 1YR (PIV)		\$1
CE-PNHTEMEA	EMEA PARTNER NEW HIRE TRAINING WORKSH		\$1,900
CE-PSKT-LA	CUSTOMER EDUCATION?KNOWLEDGE TRANSF		\$8,000
CE-PTRCLNBC	CLARIION INTEG. & MGMT VILT PARTNER ONLY		\$500
CE-PTRRPPD	RECOVERPOINT P & D INST-LED PARTNER ONL		\$1,200
CE-PTRSPCA2L	EMCCA 2 Levels Self-Paced Partners Only		\$700
CE-PTRSPCA2LM	EMCCA 2 Levels Self-Paced Partners Only		\$1,400
CE-PTRSPCA3L	EMCCA 3 Levels Self-Paced Partners Only		\$1,000
CE-PTRSPSCA2L	EMCCA 2 Level PtrONLY VILTS 2Titles=UC		\$1,200
CE-PTRSPSCA3L	EMCCA 3 Level PtrONLY VILTS 3Titles=UC		\$1,700
CE-PTRVPLEXI	VPLEX IMPLEMENT INSTALLED PARTNER ONLY		\$2,500
CE-RSATU0001	1 TRAINING UNIT VALID 1YR (RSA)		\$100
CE-RTIADMILT	RTI Admin Instructor Led Training		\$2,000
CE-RTIDEVILT	RTI Developer Instructor Led Training		\$2,000
CE-SDSSUBFL1	Cust Sub-1 Person, 1 Year (SDS)		\$12,500
CE-SDSSUBOD1	Vid Sub Exp 1yr (SDS) VILTS 6 Titles=UC		\$5,000
CE-SDSTC0001	1 Training Credit Valid 1yr (SDS)		\$1
CE-SDSTU0001	1 Training Unit Valid 1 Year (SDS)		\$100
CE-SIOVXIMPLMGT	ScaleIO - VxRack Node Implement & Mgmt		\$5,000
CE-SIOVXIMPLMGT5	VxFlex OS Implementation and Management		\$5,000
CE-SMARTOS-02	2-DAY ONSITE 12 STDNT MAX-SOW REQ-SMART		\$18,900
CE-SMARTOS-03	3-DAY ONSITE 12 STDNT MAX-SOW REQ-SMART		\$25,200
CE-SMARTOS-04	4-DAY ONSITE 12 STDNT MAX-SOW REQ-SMART		\$33,600
CE-SMARTOS-05	5-DAY ONSITE 12 STDNT MAX-SOW REQ-SMART		\$42,000
CE-SMSUBCUS01	CUSTOMER SUB EXPIRE 1YR FROM INV DATE		\$12,500
CE-SMSUBCUS02	CUSTOMER SUB EXPIRE 2YR FROM INV DATE		\$22,000
CE-SMSUBCUSEL	ELEARNING SUB EXPIRE 1YR FROM INV DATE		\$2,000
CE-SMSUBPNR01	PARTNER SUB - 1 PERSON; 1 YR (SMARTS)		\$9,000
CE-SPCE-FEHC	EMCCE-HybCldSol USB PtrONLY		\$1,200
CE-SPIE-AVA	EMCIE-Avamar Self-Paced PARTNERS ONLY		\$1,200
CE-SPIE-AVAE	EMCIE-Avamar Exp Spaced PARTNER ONLY		\$1,200
CE-SPIE-BR	EMCIE-NetWorker Self-Paced Partner ONLY		\$1,200
CE-SPIE-CLN	EMCIE-CLN SOL. SELF PACED PARTNERS ONLY		\$1,200
CE-SPIE-DATD	EMCIE DataDomain Self-Paced Partner Only		\$1,200
CE-SPIE-ISIL	EMCIE-ISIL Self-Paced Partner ONLY		\$1,200

CE-SPIEOL-AV	Avamar S-Paced w/Olab PARTNERS ONLY		\$1,800
CE-SPIEOL-BR	NetWorker S-Paced w/Olab PARTNERS ONLY		\$1,800
CE-SPIEOL-DD	DATA DOMAIN S-PACED W/OLAB PARTNERS ON		\$1,800
CE-SPIEOL-ISI	ISILON IMP. S-PACED W/OLAB PARTNERS ONLY		\$1,800
CE-SPIEOL-RP	RecoverPt S-Paced w/Olab PARTNERS ONLY		\$1,800
CE-SPIEOL-SBC	Symm. Sol. S-Paced w/Olab PARTNERS ONLY		\$2,400
CE-SPIEOL-VNX	VNX Imp. S-Paced Inc. Olab PARTNERS ONLY		\$1,800
CE-SPIE-SBC	EMCIE-SYMM. SOL. SLF-PACED PARTNER ONLY		\$1,200
CE-SPIE-SYME	EMCIE-SYM SOL EXP SPACED PARTNERONLY		\$1,200
CE-SPIE-VMAX3	EMCIE-VMAX3 Self-Paced USB Ptr Only		\$1,200
CE-SPIE-VNX	EMCIE-VNX IMP. SELF-PACED PARTNERS ONLY		\$1,200
CE-SPIE-VNXE	EMCIE-VNX IMP EXP SPACED PARTNERONLY		\$1,200
CE-SPIE-VPLEX	EMCIE-VPLEX Self-Paced Partner Only		\$1,200
CE-SPLIE-CAS	EMCIE-CAS SELF-PACED PARTNERS ONLY		\$1,200
CE-SPPE-ISIL	EMCPE ISILON SELF-PACED PARTNER ONLY		\$1,200
CE-SPPE-VMAX3	EMCPE-VMAX3 S-Paced USB Partner Only		\$1,200
CE-SPPE-VNX	EMCPE VNX SOL. SELF-PACED PARTNER ONLY		\$1,200
CE-SPSCE-FEHC	EMCCE-HybCldSol PtrONLY VILTS 2TITLES=UC		\$1,000
CE-SPSIE-AVA	EMCIE-Avamar PtrONLY VILTS 1 Title=UC		\$1,000
CE-SPSIE-AVAE	EMCIE-Avamar Ex PtrONLY VILTS 1Title=UC		\$1,000
CE-SPSIE-BR	EMCIE NetWorker PtrONLY VILTS 1 Title=UC		\$1,000
CE-SPSIE-CAS	EMCIE-CAS PtrONLY VILTS 1 Title=UC		\$1,000
CE-SPSIE-DATD	EMCIE DataDomain PtrONLY VILTS 1Title=UC		\$1,000
CE-SPSIE-ISIL	EMCIE-ISIL PtrONLY VILTS 1 Title=UC		\$1,000
CE-SPSIE-NW-E	EMCIE-NW Exp PtrONLY VILTS 1 Title=UC		\$1,000
CE-SPSIEOL-AV	Avamar w/Olab PtrONLY VILTS 1 Title=UC		\$1,600
CE-SPSIEOL-BR	Networker w/OlabPtrONLY VILTS 1 Title=UC		\$1,600
CE-SPSIEOL-DD	Data Domain Stream w/Olab PartnerONLY=UC		\$1,600
CE-SPSIEOLISI	Isilon Imp w/OlabPtrONLY VILTS 1Title=UC		\$1,600
CE-SPSIEOL-RP	RP w/Olab PartnerONLY VILTS 1 Title=UC		\$1,600
CE-SPSIEOLRSE	RP/SE w/Olab PartnerONLY VILTS 1Title=UC		\$1,300
CE-SPSIEOLSBC	Symm Sol w/Olab PtrONLY VILTS 1 Title=UC		\$2,200
CE-SPSIEOLVNX	VNX Imp w/Olab PtrONLY VILTS 1 Title=UC		\$1,600
CE-SPSIE-RP	EMCIE-RP PtrONLY VILTS 1 Title=UC		\$1,000
CE-SPSIE-RPSE	EMCIE-RPSE PtrONLY VILTS 1 Title=UC		\$1,000
CE-SPSIE-SBC	EMCIE?Symm Sol PtrONLY VILTS 2 Titles=UC		\$1,000
CE-SPSIE-SYME	EMCIE-SymSol Exp PtrONLY VILTS 1Title=UC		\$1,000
CE-SPSIE-VIPR	ViPR Imp PtrONLY VILTS 1 Title=UC		\$1,000
CE-SPSIE-VMAX3	EMCIE-VMAX3 Ptr Only VILTS 2TITLES=UC		\$1,000
CE-SPSIE-VNX	EMCIE-VNX Imp PtrONLY VILTS 1 Title=UC		\$1,000
CE-SPSIE-VNXE	EMCIE-VNX ImpExp PrONLY VILTS 3Titles=UC		\$1,000
CE-SPSIEVPLEX	EMCIE-VPLEX PtrONLY VILTS 1 Title=UC		\$1,000
CE-SPSIE-XIOSOL	EMCIE-XtremIO PtrOnly VILTS 1 Title=UC		\$1,000
CE-SPSOLPT-XIO	XtremIO w/Olab PtrONLY VILTS 1 Title=UC		\$1,600
CE-SPSPE-ISIL	EMCPE Isilon PtrONLY VILTS 1 Title=UC		\$1,000
CE-SPSPE-SYM	EMCPE-SYM Stream PartnerONLY=UC		\$1,000
CE-SPSPE-VMAX3	EMCPE-VMAX3 Ptr Only VILTS 1TITLES=UC		\$1,000
CE-SPSPE-VNX	EMCPE VNX Sol PtrONLY VILTS 1 Title=UC		\$1,000
CE-SPSPT-SCALEIO	EMCPT-ScaleIO PtrONLY VILTS 1 Title=UC		\$500
CE-SPSPT-XIO	EMCPT-XtremIO PtrONLY VILTS 1 Title=UC		\$1,000

CE-SPSTA-AVAILSOL	EMCTA-Avail Sol PtrOnly VILTS 1 Title=UC		\$1,000
CE-SPSTA-BR	EMCTA-BR Sol PtrONLY VILTS 2 Titles=UC		\$1,000
CE-SPSTA-ISIL	EMCTA-Isilon PtrONLY VILTS 1 Title=UC		\$1,000
CE-SPSTA-SBC	EMCTA Symm Sol PtrONLY VILTS 1 Title=UC		\$1,000
CE-SPSTA-SYME	EMCTA?Sym Exp SPaced Strm PartnerONLY=UC		\$1,000
CE-SPSTA-VMAX3	EMCTA-VMAX3 Ptr Only VILTS 2TITLES=UC		\$1,000
CE-SPSTA-VNX	EMCTA VNX Sol PtrONLY VILTS 2 Titles=UC		\$1,000
CE-SPSTA-VNXE	EMCTA-VNX Exp PtrONLY VILT 1 Title=UC		\$1,000
CE-SPSTA-XIOSOL	EMCTA-XtremIO PtrOnly VILTS 1 Title=UC		\$1,000
CE-SPTA-ISIL	EMCTA ISILON SELF-PACED PARTNER ONLY		\$1,200
CE-SPTA-SYME	EMCTA-Sym Sol Exp Spaced PartnerONLY		\$1,200
CE-SPTA-VNX	EMCTA-VNX SOL. SELF-PACED PARTNERS ONL		\$1,200
CE-SPTA-VNXE	EMCTA-VNX Sol Exp Spaced PartnerONLY		\$1,200
CE-STRSUBFL1	Cust Sub-1 Person, 1 Year (STO)		\$12,500
CE-STRSUBOD1	Vid Sub Exp 1yr (STO) VILTS 6 Titles=UC		\$5,000
CE-STRTC0001	1 Training Credit Valid 1yr (STR)		\$1
CE-STRTU0001	1 Training Unit Valid 1yr (STO)		\$100
CE-SUBCUS01	CUSTOMER SUB EXPIRE 1YR FROM INV DATE		\$12,500
CE-SUBCUS02	CUSTOMER SUB EXPIRE 2YR FROM INV DATE		\$22,000
CE-SUBCUSELN	ELEARNING SUB EXPIRE 1YR FROM INV DATE		\$2,000
CE-SUBCUSEV	Video Sub Expire 1yr VILTS 6 Titles=UC		\$5,000
CE-SUBPNR01	PARTNER SUB EXPIRE 1YR FROM INV DATE		\$9,000
CE-SUBPNR02	PARTNER SUB EXPIRE 2YR FROM INV DATE		\$15,000
CE-SUBTRANSFM01	Trans.Sub Exp.1yr from invoice date		\$7,500
CE-SVRSUBFL1	Cust Sub-1 Person, 1 Year (SRV)		\$12,500
CE-SVRSUBOD1	Vid Sub Exp 1yr (SRV) VILTS 6 Titles=UC		\$5,000
CE-SVRTC0001	1 Training Credit Valid 1yr (SRV)		\$1
CE-SVRTU0001	1 Training Unit Valid 1yr (SRV)		\$100
CETRUBCUSEV	MOJO PromoOnlyGFS ID ReqVILTS 6Titles=UC		\$2,500
CE-TU0001	1 TRAINING UNITS VALID 1YR (EMC)		\$100
CE-TU0050	50 TRAINING UNITS VALID 1YR		\$5,000
CE-TU0055	55 TRAINING UNITS VALID 1YR (EMC)		\$5,500
CE-TU0100	100 TRAINING UNITS VALID 1YR (EMC)		\$10,000
CE-TU0110	110 TRAINING UNITS VALID 1YR (EMC)		\$11,000
CE-TU0250	250 TRAINING UNITS VALID 1YR		\$25,000
CE-TU0300	300 Training Units Valid 1yr (EMC)		\$30,000
CE-UNITYDD	UNITY training class 1 person		\$4,000
CE-UNITYLRNCTR	Unity Learning Ctr VILTS 1 Title=UC		\$600
CE-VALCE-CAS	PARTNER ONLY CAS PE VALUEPAK		\$2,500
CE-VALCE-CLN	PARTNER ONLY CLARIION SOL. PE VALUEPAK		\$2,500
CE-VALCE-NS	PARTNER ONLY NAS PE VALUEPAK		\$2,500
CE-VALCE-SYM	PARTNER ONLY Symmetrix PE ValuePak		\$4,000
CE-VALIE-CAS	EMCIE-CAS INSTRUCTOR-LED PARTNERS ONLY		\$2,500
CE-VALIE-CLN	EMCIE-CLN SOL. INST-LED PARTNER ONLY		\$2,500
CE-VALIE-DATD	EMCIE Data Domain Inst-Led Partner Only		\$2,000
CE-VALIE-ISIL	EMCIE ISILON INST-LED PARTNER ONLY		\$2,500
CE-VALIE-RP	EMCIE-RP Instructor-Led Partner ONLY		\$2,000
CE-VALIE-SBC	EMCIE SYMM. SOL. INST-LED PARTNER ONLY		\$4,000
CE-VALIE-SYME	EMCIE SYM SOL EXP INST-LED PARTNER ONLY		\$2,000
CE-VALIE-VIPR	ViPR Imp Inst-Led PartnerOnly		\$1,500

CE-VALIE-VNX	EMCIE-VNX SOL. INST-LED PARTNERS ONLY		\$2,500
CE-VALIE-VNXE	EMCIE-VNX SOL EXP INST-LED PARTNERS ONL		\$4,000
CE-VALIEVPLEX	EMCIE-VPLEX Inst-Led PARTNER ONLY		\$2,500
CE-VALIE-XIOSOL	EMCIE-XtremIO Inst-Led PartnerOnly		\$2,000
CE-VALPAKATMS	ATMOS VALUEPAK		\$2,000
CE-VALPAKAX	CLARIION AX SERIES ELEARNING VALUEPAK		\$300
CE-VALPAKBC	BUS. CONT FOR SYMMETRIX VALUEPAK		\$5,500
CE-VALPAKBR	Networker Training ValuePak		\$5,000
CE-VALPAKCBC	CLARIION BUSINESS CONTINUITY VALUEPAK		\$5,500
CE-VALPAKCC	CONTROLCENTER VALUEPAK		\$5,500
CE-VALPAKDD	Data Domain Training ValuePak		\$4,400
CE-VALPAKDLM	DISK LIBRARY FOR MAINFRAME VALUEPAK		\$2,000
CE-VALPAKDPA	DATA PROTECTION ADVISOR (DPA) VALUEPAK		\$3,000
CE-VALPAKDPROA	Data Protection Advisor 6.x ValuePak		\$5,000
CE-VALPAKDSAA	Advanced Analytics DSBV ValuePak		\$5,000
CE-VALPAKDSS	INFO. STORAGE SECURITY EMCDCA VALUEPAK		\$5,500
CE-VALPAKDX	DISKXTENDER VALUEPAK		\$3,300
CE-VALPAKEDL	EMC Disk Library 4000 ValuePak		\$2,000
CE-VALPAKESMITAAS	Est Serv Mgmt for ITaaS ValuePak		\$4,000
CE-VALPAKGRNP	GREENPLUM VALUEPAK		\$5,000
CE-VALPAKNS	CELERRA VALUEPAK		\$5,500
CE-VALPAKSAN	SAN VALUEPAK		\$5,500
CE-VALPAKSAS	Service Assurance Suite ValuePak		\$4,000
CE-VALPAKSCA	Storage Config Adv VVPK VILTS 1 Title=UC		\$1,800
CE-VALPAKSMGT	SYMMETRIX MANAGEMENT VALUEPAK		\$5,500
CE-VALPAKSO	SourceOne ValuePak		\$5,000
CE-VALPAKSRMIM	SRM 3.x Imp. And Maint. ValuePak		\$5,000
CE-VALPAKSRMSA	SRM Storage Administration ValuePak		\$3,000
CE-VALPAKSTF	Information Storage and Management		\$2,700
CE-VALPAKSYMP	Symmetrix Performance ValuePak		\$4,000
CE-VALPAKUIM	UNIFIED INFRA. MGR MGMT AND REPORTING		\$2,000
CE-VALPAKVBL	VBLOCK VALUEPAK		\$5,000
CE-VALPAKVI	VIRTUALIZED INFRA.EMCCA VALUEPAK		\$5,000
CE-VALPAKVIPRIAM	ViPR Imp and Mgmt ValuePak		\$5,000
CE-VALPAKVIPRSRMAR	ViPR SRM Advanced Reporting ValuePak		\$5,000
CE-VALPAKVMAX3MAN	VMAX3 Mgmt & Biz Cont ValuePak		\$5,000
CE-VALPAKVNX	VNX SOL. (FAST; LOCAL PROTECT) VALUEPAK		\$5,500
CE-VALPAKVPX	VPLEX VALUEPAK		\$3,000
CE-VALPAKW4N	Watch4net ValuePak		\$4,000
CE-VALPAKXTIO	XtremIO X2 Training ValuePak		\$3,000
CE-VALPAKXTIOMGMT	XtremIO Solutions ValuePak		\$2,000
CE-VALPE-VNX	EMCPE VNX SOL.INST-LED PARTNER ONLY		\$2,500
CE-VALPKVNXC	VNX CA Solutions ValuePak		\$6,600
CE-VALPKVNXFB	VNX File or Block Solutions ValuePak		\$3,300
CE-VALPTDD	DATADOMAIN INST-LED PARTNERS ONLY		\$2,000
CE-VALTABRSOL	EMCTA-BR SOL. SLF-PACED PARTNER ONLY		\$1,200
CE-VALTA-CAS	EMCTA-CAS SELF-PACED PARTNERS ONLY		\$1,200
CE-VALTA-CLN	EMCTA-CLN SOL. SLF-PACED PARTNER ONLY		\$1,200
CE-VALTA-SBC	EMCTA SYMM. SOL. SLF-PACED PARTNER ONL		\$1,200
CE-VALTASIIIE	EMCTA-SI2 ENT. SLF-PACED PARTNER ONLY		\$1,200

CE-VALTA-SYME	EMCTA-Symm Sol Exp Inst-Led PartnerOnly		\$2,000
CE-VALTA-VNX	EMCTA-VNX SOL. INST.-LED PARTNERS ONLY		\$4,000
CE-VALTA-VNXE	EMCTA-VNX Sol. Exp Inst-Led PartnerOnly		\$2,500
CE-VIDPKDDD	Data Domain VVPK VILTS 1 Title=UC		\$2,400
CE-VIDPKVMAXE	Symm VMAXe Mgmt VVPK VILTS 1 Title=UC		\$3,000
CE-VIDPKVNXCA	VNX CA Sol VVPK VILTS 1 Title=UC		\$3,600
CE-VIDPKVNXF	VNX F Sol VVPK VILTS 1 Title=UC		\$1,800
CE-VIDPKVNXFB	VNX FileOrBlock Sol VVPK VILTS 1Title=UC		\$1,800
CE-VIDVPKAV	Avamar Mgmt VVPK VILTS 1 Title=UC		\$1,800
CE-VIDVPKBC	Symmetrix BC VVPK VILTS 1 Title=UC		\$3,000
CE-VIDVPKBR	Networker VVPK VILTS 1 Title=UC		\$3,000
CE-VIDVPKCAS	CAS (Centera) VVPK VILTS 1 Title=UC		\$1,800
CE-VIDVPKCBC	CLARiiON BC VVPK VILTS 1 Title=UC		\$3,000
CE-VIDVPKCC	ControlCenter VVPK VILTS 1 Title=UC		\$3,000
CE-VIDVPKCLS	CLARiiON BC VVPK VILTS 1 Title=UC		\$3,000
CE-VIDVPKCUF	Celerra VVPK VILTS 1 Title=UC		\$3,000
CE-VIDVPKDPROA	Data Prot Adv 6.x VVPK VILTS 1 Title=UC		\$3,000
CE-VIDVPKDSAA	Adv Analytics DSBDA VVPK VILTS 1TITLE=UC		\$3,000
CE-VIDVPKDX	DISKXTENDER VIDEO VALUEPAK		\$1,800
CE-VIDVPKESMITAAS	EstServMgmtForITaas VVPK VILTS 1TITLE=UC		\$2,400
CE-VIDVPKFEHC	FedEnt HybCloud Ops VVPK VILTS 1TITLE=UC		\$3,000
CE-VIDVPKGP	Greenplum VVPK VILTS 1 Title=UC		\$3,000
CE-VIDVPKISAM	Isilon Solution VVPK VILTS 1Title=UC		\$3,000
CE-VIDVPKMF	Mainframe Vid VVPK VITLS 1 Title=UC		\$1,800
CE-VIDVPKMSG	Messaging VVPK VILTS 1 Title=UC		\$1,800
CE-VIDVPKRM	Replication Mngr VVPK VILTS 1 Title=UC		\$3,000
CE-VIDVPKRP	RecoverPoint VVPK VILTS 1 Title=UC		\$1,800
CE-VIDVPKSAN	SAN VVPK VILTS 1 Title=UC		\$3,000
CE-VIDVPKSAS	Serv Assur Suite VVPK VILTS 1 Title=UC		\$2,400
CE-VIDVPKSMGT	Symmetrix Mgmt VVPK VILTS 1 Title=UC		\$3,000
CE-VIDVPKSMT	Smarts-IT Mgmt&Serv VVPK VILTS 1Title=UC		\$3,000
CE-VIDVPKSO	SourceOne VVPK VILTS 1TITLE=UC		\$3,000
CE-VIDVPKSRMIM	ViPR SRM 3.x I&M VVPK VILTS 1 Title=UC		\$3,000
CE-VIDVPKSRMSA	ViPR SRM Stge Adm VVPK VILTS 1 Title=UC		\$1,800
CE-VIDVPKVIPIR	ViPR VVPK VILTS 1 Title=UC		\$1,200
CE-VIDVPKVIPIRSRMAR	ViPR SRM Adv Rep. VVPK VILTS 1 Title=UC		\$3,000
CE-VIDVPKVMAX3MAN	VMAX3 Mgmt&Biz Cont VVPK VILTS 1TITLE=UC		\$3,000
CE-VIDVPKVNX	VNX Unified Sol VVPK VILTS 1 Title=UC		\$3,000
CE-VIDVPKVPX	VPLEX VVPK VILTS 1 Title=UC		\$1,800
CE-VIDVPKW4N	Watch4net VVPK VILTS 1 Title=UC		\$2,400
CE-VIDVPKXTIO	XtremIO 3.x Video VVPK VILTS 1 Title=UC		\$1,800
CE-VIDVPKXTIOMGMT	XtremIO Sol. Video VVPK VILTS 1 Title=UC		\$2,000
CE-VILTBTCLOU	Cloud ITaaS-Biz Trans VILTS 1 Title=UC		\$400
CE-VILTBTDATA	Data Sci-Biz Trans VILTS 1 Title=UC		\$400
CE-VILTCLNF30	CLARIIION SME W/ UNISPHERE & FLARE30 VILT		\$2,400
CE-VILTCLNSME	CLARIIION SOL. SME WITH NAVISPHERE VILT		\$2,400
CE-VILTDSBDA	DSBDA VILTS 1 Title=UC		\$600
CE-VILTIAD	Enterprise BR Design VILTS 1 Title=UC		\$1,200
CE-VILTISM	ISM v2 VILTS 1 Title=UC		\$600
CE-VILTSL050	License-Agree Form ReqVILTS 50 Titles=UD		\$60,000

CE-VILTSL150	License-Agree Form ReqVILTS 150Titles=UD	I	\$150,000
CE-VILTSL300	License-Agree Form ReqVILTS 300Titles=UD	I	\$225,000
CE-VILTSL600	License-Agree Form ReqVILTS 600Titles=UD	I	\$300,000
CE-VILTSLADJ	Add I VILTS Licenses-Agree Form Req=UD	I	\$100
CE-VILTSLOVR	Overage Strm Licenses-Agree Form Req=UD	I	\$100
CE-VILTSND	Enterprise StrNetwkg Dgn VILTS 1Title=UC	I	\$1,200
CE-VILTSNDM	STORAGE NETWORKING DESIGN AND MGMT VI	I	\$1,600
CE-VMAXAF-VALPAK	VMAX Training ValuePak	I	\$6,000
CE-VMAXAF-VIDVPK	VMAX Video ValuePaK VILTS 2 Titles=UC	I	\$4,000
CE-VMSERMGRCD	VMWARE SERVICE MANAGER-CERT. DEVELOPE	I	\$7,300
CE-VMSERMGRSD	VMWARE SERVICE MANAGER-SVC DESK ADMIN	I	\$1,000
CE-VMSERMGRWT	VMWARE SVC MGR: WORKFLOW TEMPLATE DE	I	\$1,000
CE-VMVADVVC	ADVANCED VMWARE VCENTER CONFIG MGR	I	\$3,000
CE-VMVIEWDBP	VMWARE VIEW: DESIGN BEST PRACTICES	I	\$800
CE-VMVIEWIC	VMWARE VIEW: INSTALL; CONFIGURE; MANAGE	I	\$3,000
CE-VMVINTVCM	INTRO TO VMWARE VCENTER CONFIG MGR	I	\$3,000
CE-VMVSERMGR	VMWARE SERVICE MANAGER	I	\$5,000
CE-VMVSPHADFT	VMWARE VSPHERE ADVANCED FAST TRACK	I	\$5,100
CE-VMVSPHATFT	VMWARE VSPHERE AUTOMATION FAST TRACK	I	\$4,700
CE-VMVSPHDIFF	VMWARE VSPHERE: WHATS NEW	I	\$1,700
CE-VMVSPHDW	VMWARE VSPHERE: DESIGN WORKSHOP	I	\$2,300
CE-VMVSPHMGA	VMWARE VSPHERE MANAGE AVAILABILITY	I	\$745
CE-VMVSPHMGS	VMWARE VSPHERE: MANAGE SCALABILITY	I	\$745
CE-VMVSPHMP	VMWARE VSHPERE: MANAGE FOR PERFORMAC	I	\$2,500
CE-VMVSPHSFO	VMWARE VSPHERE: SKILLS FOR OPERATORS	I	\$1,500
CE-VMVVCMBUND	VMWARE VCENTER CONFIG MGR BUNDLE	I	\$5,000
CE-VMWAVCL	VMWARE VCLOUD:ARCHITECTING VMWARE CL	I	\$2,500
CE-VMWSRM	VMWARE SITE RECOVERY MANGER COURSE	I	\$1,700
CE-VMWVCLOV	VMWARE VCLOUD OVERVIEW	I	\$800
CE-VMWVXR	VMware and VxRail Baseline	I	\$7,075
CE-VOYENOS-01	1DAY ONSITE 12 STDNT MAX-SOW REQ-VOYEN	I	\$15,800
CE-VOYENOS-02	2DAY ONSITE 12 STDNT MAX-SOW REQ-VOYEN	I	\$18,900
CE-VOYENOS-03	3DAY ONSITE 12 STDNT MAX-SOW REQ-VOYEN	I	\$25,200
CE-VOYENOS-04	4DAY ONSITE 12 STDNT MAX-SOW REQ-VOYEN	I	\$33,600
CE-VOYENOS-05	5DAY ONSITE 12 STDNT MAX-SOW REQ-VOYEN	I	\$42,000
CE-VOYTU01	1 TRAINING UNIT VALID 1 YEAR (VOYENCE)	I	\$330
CE-VPKSCALEIOR2	VxFlex OS ValuePak	I	\$5,000
CE-VPVMAXEMAN	SYMMETRIX VMAX 10K MANAGERMENT	I	\$5,000
CE-VSUBTRANSFM01	vTrans.Sub Exp 1yr VILTS 6 Titles=UC	I	\$3,500
CE-VXRAIL-VILT	VxRail A&M VILTS 1 Title=UC	I	\$600
CE-XIOTU0001	1 Training Unit Valid 1 Year (XIO)	I	\$100
PIV-SPRINGONE	Pivotal SpringOne Platform	I	\$2,200
200-0100	ISCSI	IS	\$0
200-0245	ENTERPRISE-SMARTPOOLS (Tier 1)	IS	\$0
200-0245-CF	Enterprise-Smartpools Tier 1 Gen5 =ID	IS	\$3,465
200-0247	ENTERPRISE-SNAPSHOTIQ (Tier 1)	IS	\$0
200-0247-CF	Enterprise-SnapshotIQ Tier 1 Gen5 =ID	IS	\$2,065
200-0248	ENTERPRISE-SMARTCONN ADV (Tier 1)	IS	\$0
200-0248-CF	Enterprise-Smartconn Adv Tier 1 Gen5=ID	IS	\$3,465
200-0249	ENTERPRISE-SYNCIQ (Tier 1)	IS	\$0

200-0249-CF	Enterprise-SyncIQ Tier 1 Gen5 =ID	IS	\$3,465
200-0250	ENTERPRISE-SYNCIQ/MIGIQ (LOW DENSITY)	IS	\$0
200-0251	ENTERPRISE-SMARTQUOTAS (Tier 1)	IS	\$0
200-0251-CF	Enterprise-Smartquotas Tier 1 Gen5 =ID	IS	\$1,365
200-0252	ENTERPRISE-SMARTPOOLS (Tier 2)	IS	\$0
200-0252-CF	Enterprise-Smartpools Tier 2 Gen5 =ID	IS	\$4,655
200-0254	ENTERPRISE-SNAPSHOTIQ (Tier 2)	IS	\$0
200-0254-CF	Enterprise-SnapshotIQ Tier 2 Gen5 =ID	IS	\$2,765
200-0255	ENTERPRISE-SMARTCONN ADV (Tier 2)	IS	\$0
200-0255-CF	Enterprise-Smartconn Adv Tier 2 Gen5=ID	IS	\$4,655
200-0256	ENTERPRISE-SYNCIQ (Tier 2)	IS	\$0
200-0256-CF	Enterprise-SyncIQ Tier 2 Gen5 =ID	IS	\$4,655
200-0257	ENTERPRISE-SYNCIQ/MIGIQ (MEDIUM DENSITY)	IS	\$0
200-0258	ENTERPRISE-SMARTQUOTAS (Tier 2)	IS	\$0
200-0258-CF	Enterprise-Smartquotas Tier 2 Gen5 =ID	IS	\$1,855
200-0259	ENTERPRISE-SMARTPOOLS (Tier 3)	IS	\$0
200-0259-CF	Enterprise-Smartpools Tier 3 Gen5 =ID	IS	\$6,615
200-0261	ENTERPRISE-SNAPSHOTIQ (Tier 3)	IS	\$0
200-0261-CF	Enterprise-SnapshotIQ Tier 3 Gen5 =ID	IS	\$3,885
200-0262	ENTERPRISE-SMARTCONN ADV (Tier 3)	IS	\$0
200-0262-CF	Enterprise-Smartconn Adv Tier 3 Gen5=ID	IS	\$6,615
200-0263	ENTERPRISE-SYNCIQ (Tier 3)	IS	\$0
200-0263-CF	Enterprise-SyncIQ Tier 3 Gen5 =ID	IS	\$6,615
200-0264	ENTERPRISE-SYNCIQ/MIGIQ (HIGH DENSITY)	IS	\$0
200-0265	ENTERPRISE-SMARTQUOTAS (Tier 3)	IS	\$0
200-0265-CF	Enterprise-Smartquotas Tier 3 Gen5 =ID	IS	\$2,695
200-0286	PLATFORM API	IS	\$0
200-0289	ENTERPRISE-VCENTER (Tier 1)	IS	\$0
200-0289-CF	Enterprise-Vcenter Tier 1 Gen5 =ID	IS	\$1,365
200-0290	ENTERPRISE-VCENTER (Tier 2)	IS	\$0
200-0290-CF	Enterprise-Vcenter Tier 2 Gen5 =ID	IS	\$1,855
200-0291	ENTERPRISE-VCENTER (Tier 3)	IS	\$0
200-0291-CF	Enterprise-Vcenter Tier 3 Gen5 =ID	IS	\$2,695
200-0332-CF	HDFS For OneFS Gen5 =ID	IS	\$0
200-0349	ENTERPRISE-SMARTQUOTAS (Tier 4)	IS	\$0
200-0349-CF	Enterprise-Smartquotas Tier 4 Gen5 =ID	IS	\$3,480
200-0350	ENTERPRISE-VCENTER (Tier 4)	IS	\$0
200-0350-CF	Enterprise-Vcenter Tier 4 Gen5 =ID	IS	\$3,480
200-0351	ENTERPRISE-SMARTLOCK (Tier 4)	IS	\$0
200-0351-CF	Enterprise-Smartlock Tier 4 Gen5 =ID	IS	\$3,480
200-0352	ENTERPRISE-SNAPSHOTIQ (Tier 4)	IS	\$0
200-0352-CF	Enterprise-SnapshotIQ Tier 4 Gen5 =ID	IS	\$5,016
200-0353	ENTERPRISE-SMARTCONN ADV (Tier 4)	IS	\$0
200-0353-CF	Enterprise-Smartconn Adv Tier 4 Gen5=ID	IS	\$8,541
200-0354	ENTERPRISE-SMARTPOOLS (Tier 4)	IS	\$0
200-0354-CF	Enterprise-Smartpools Tier 4 Gen5 =ID	IS	\$8,541
200-0355	ENTERPRISE-SYNCIQ (Tier 4)	IS	\$0
200-0355-CF	Enterprise-SyncIQ Tier 4 Gen5 =ID	IS	\$8,541
200-0357	ENTERPRISE-SMARTDEDUPE (Tier 1)	IS	\$0
200-0357-CF	Enterprise-Smartdedupe Tier 1 Gen5 =ID	IS	\$3,465

200-0358	ENTERPRISE-SMARTDEDUPE (Tier 2)	IS	\$0
200-0358-CF	Enterprise-Smartdedupe Tier 2 Gen5 =ID	IS	\$4,655
200-0359	ENTERPRISE-SMARTDEDUPE (Tier 3)	IS	\$0
200-0359-CF	Enterprise-Smartdedupe Tier 3 Gen5 =ID	IS	\$8,678
200-0360	ENTERPRISE-SMARTDEDUPE (Tier 4)	IS	\$0
200-0360-CF	Enterprise-Smartdedupe Tier 4 Gen5 =ID	IS	\$12,317
200-0365	SWIFT FOR ONEFS	IS	\$0
200-0365-CF	Swift For OneFS Gen5 =ID	IS	\$0
200-0368	ENTERPRISE-SMARTCONN ADV (Tier 5)	IS	\$0
200-0368-CF	Enterprise-Smartconn Adv Tier 5 Gen5=ID	IS	\$12,456
200-0369	ENTERPRISE-SMARTCONN ADV (Tier 7)	IS	\$0
200-0369-CF	Enterprise-Smartconn Adv Tier 7 Gen5=ID	IS	\$20,600
200-0370	ENTERPRISE-SMARTLOCK (Tier 5)	IS	\$0
200-0370-CF	Enterprise-Smartlock Tier 5 Gen5 =ID	IS	\$5,075
200-0371	ENTERPRISE-SMARTLOCK (Tier 7)	IS	\$0
200-0371-CF	Enterprise-Smartlock Tier 7 Gen5 =ID	IS	\$8,394
200-0372	ENTERPRISE-SMARTPOOLS (Tier 5)	IS	\$0
200-0372-CF	Enterprise-Smartpools Tier 5 Gen5 =ID	IS	\$12,456
200-0373	ENTERPRISE-SMARTPOOLS (Tier 7)	IS	\$0
200-0373-CF	Enterprise-Smartpools Tier 7 Gen5 =ID	IS	\$20,600
200-0374	ENTERPRISE-SMARTQUOTAS (Tier 5)	IS	\$0
200-0374-CF	Enterprise-Smartquotas Tier 5 Gen5 =ID	IS	\$5,075
200-0375	ENTERPRISE-SMARTQUOTAS (Tier 7)	IS	\$0
200-0375-CF	Enterprise-Smartquotas Tier 7 Gen5 =ID	IS	\$8,394
200-0376	ENTERPRISE-SNAPSHOTIQ (Tier 5)	IS	\$0
200-0376-CF	Enterprise-SnapshotIQ Tier 5 Gen5 =ID	IS	\$7,315
200-0377	ENTERPRISE-SNAPSHOTIQ (Tier 7)	IS	\$0
200-0377-CF	Enterprise-SnapshotIQ Tier 7 Gen5 =ID	IS	\$12,098
200-0378	ENTERPRISE-SYNClQ (Tier 5)	IS	\$0
200-0378-CF	Enterprise-SyncIQ Tier 5 Gen5 =ID	IS	\$12,456
200-0379	ENTERPRISE-SYNClQ (Tier 7)	IS	\$0
200-0379-CF	Enterprise-SyncIQ Tier 7 Gen5 =ID	IS	\$20,600
200-0380	ENTERPRISE-SMARTDEDUPE (Tier 5)	IS	\$0
200-0380-CF	Enterprise-Smartdedupe Tier 5 Gen5 =ID	IS	\$17,962
200-0381	ENTERPRISE-SMARTDEDUPE (Tier 7)	IS	\$0
200-0381-CF	Enterprise-Smartdedupe Tier 7 Gen5 =ID	IS	\$29,708
200-0384	ENTERPRISE-VCENTER (Tier 5)	IS	\$0
200-0384-CF	Enterprise-Vcenter Tier 5 Gen5 =ID	IS	\$5,075
200-0385	ENTERPRISE-VCENTER (Tier 7)	IS	\$0
200-0385-CF	Enterprise-Vcenter Tier 7 Gen5 =ID	IS	\$8,394
200-0386	STIG HARDENING FOR ONEFS	IS	\$0
200-0386-CF	Stig Hardening For OneFS Gen5 =ID	IS	\$0
200-0387	CLOUDPOOLS FOR ONEFS	IS	\$0
200-0388	ENTERPRISE-SMARTCONN ADV (Tier 6)	IS	\$0
200-0388-CF	Enterprise-Smartconn Adv Tier 6 Gen5=ID	IS	\$16,294
200-0389	ENTERPRISE-SMARTLOCK (Tier 6)	IS	\$0
200-0389-CF	Enterprise-Smartlock Tier 6 Gen5 =ID	IS	\$6,639
200-0390	ENTERPRISE-SMARTPOOLS (Tier 6)	IS	\$0
200-0390-CF	Enterprise-Smartpools Tier 6 Gen5 =ID	IS	\$16,294
200-0391	ENTERPRISE-SMARTQUOTAS (Tier 6)	IS	\$0

200-0391-CF	Enterprise-Smartquotas Tier 6 Gen5 =ID	IS	\$6,639
200-0392	ENTERPRISE-SNAPSHOTIQ (Tier 6)	IS	\$0
200-0392-CF	Enterprise-SnapshotIQ Tier 6 Gen5 =ID	IS	\$9,569
200-0393	ENTERPRISE-SYNCIQ (Tier 6)	IS	\$0
200-0393-CF	Enterprise-SyncIQ Tier 6 Gen5 =ID	IS	\$16,294
200-0394	ENTERPRISE-SMARTDEDUPE (Tier 6)	IS	\$0
200-0394-CF	Enterprise-Smartdedupe Tier 6 Gen5 =ID	IS	\$23,498
200-0395	ENTERPRISE-VCENTER (Tier 6)	IS	\$0
200-0395-CF	Enterprise-Vcenter Tier 6 Gen5 =ID	IS	\$6,639
200-0396	ENTERPRISE-SMARTCONN ADV (Tier 8)	IS	\$0
200-0396-CF	Enterprise-Smartconn Adv Tier 8 Gen5=ID	IS	\$26,949
200-0397	ENTERPRISE-SMARTLOCK (Tier 8)	IS	\$0
200-0397-CF	Enterprise-Smartlock Tier 8 Gen5 =ID	IS	\$10,980
200-0398	ENTERPRISE-SMARTPOOLS (Tier 8)	IS	\$0
200-0398-CF	Enterprise-Smartpools Tier 8 Gen5 =ID	IS	\$26,949
200-0399	ENTERPRISE-SMARTQUOTAS (Tier 8)	IS	\$0
200-0399-CF	Enterprise-Smartquotas Tier 8 Gen5 =ID	IS	\$10,980
200-0400	ENTERPRISE-SNAPSHOTIQ (Tier 8)	IS	\$0
200-0400-CF	Enterprise-SnapshotIQ Tier 8 Gen5 =ID	IS	\$15,827
200-0401	ENTERPRISE-SYNCIQ (Tier 8)	IS	\$0
200-0401-CF	Enterprise-SyncIQ Tier 8 Gen5 =ID	IS	\$26,949
200-0402	ENTERPRISE-SMARTDEDUPE (Tier 8)	IS	\$0
200-0402-CF	Enterprise-Smartdedupe Tier 8 Gen5 =ID	IS	\$38,863
200-0403	ENTERPRISE-VCENTER (Tier 8)	IS	\$0
200-0403-CF	Enterprise-Vcenter Tier 8 Gen5 =ID	IS	\$10,980
200-0404	INSIGHTIQ FOR ONEFS	IS	\$0
200-0404-CF	InsightIQ For OneFS Gen5 =ID	IS	\$0
200-0405	OneFS OE Tier 2 Capacity	IS	\$333
200-0406	OneFS OE Tier 3 Capacity	IS	\$208
200-0410	OneFS OE Tier 1 Base	IS	\$68,750
200-0411	OneFS OE Tier 2 Base	IS	\$12,500
200-0412	OneFS OE Tier 3 Base	IS	\$4,167
200-0413	OneFS OE Tier 1 Capacity	IS	\$333
200-0414	CloudPools for Third Party	IS	\$0
200-0414-CF	Cloudpools For Third Party Gen5 =ID	IS	\$429
200-0422	OneFS OE Encryption Key Mgmt Tier 1 TRK	IS	\$20,833
200-0423	OneFS OE Encryption Key Mgmt Tier 2 TRK	IS	\$11,458
200-0424	OneFS OE Encryption Key Mgmt Tier 3 TRK	IS	\$11,458
200-0983	ENTERPRISE-SMARTLOCK (Tier 1)	IS	\$0
200-0983-CF	Enterprise-Smartlock Tier 1 Gen5 =ID	IS	\$1,365
200-0984	ENTERPRISE-SMARTLOCK (Tier 2)	IS	\$0
200-0984-CF	Enterprise-Smartlock Tier 2 Gen5 =ID	IS	\$1,855
200-0986	ENTERPRISE-SMARTLOCK (Tier 3)	IS	\$0
200-0986-CF	Enterprise-Smartlock Tier 3 Gen5 =ID	IS	\$2,695
201-0218	EAB01-SNAP/CONADV-Tier 1	IS	\$0
201-0219	EAB02-SNAP/SYNC-Tier 1	IS	\$0
201-0220	EAB03-CONADV/SYNC-Tier 1	IS	\$0
201-0221	EAB04-SNAP/CONADV/SYNC-Tier 1	IS	\$0
201-0222	EAB06-SNAP/CONADV/SYNC/MIG -LOW	IS	\$0
201-0223	EAB07-SNAP/CONADV/QUOTA-Tier 1	IS	\$0

201-0224	EAB08-SNAP/CONADV/QUOTA/SYNC/MIG-LOW	IS	\$0
201-0225	EAB09-SNAP/QUOTA-Tier 1	IS	\$0
201-0226	EAB10-SNAP/CONADV/QUOTA/SYNC-Tier 1	IS	\$0
201-0227	EAB11-POOL/INS/SNAP/CONADV/QTA/SYNC-Tr 1	IS	\$0
201-0228	EAB12-POOL/INS/SNAP/CONADV/QUOTA-Tier 1	IS	\$0
201-0229	EAB13-POOL/CONADV-Tier 1	IS	\$0
201-0230	EAB14-POOL/CONADV/INS-Tier 1	IS	\$0
201-0231	EAB01-SNAP/CONADV-Tier 2	IS	\$0
201-0232	EAB02-SNAP/SYNC-Tier 2	IS	\$0
201-0233	EAB03-CONADV/SYNC-Tier 2	IS	\$0
201-0234	EAB04-SNAP/CONADV/SYNC-Tier 2	IS	\$0
201-0235	EAB06-SNAP/CONADV/SYNC/MIG-MED	IS	\$0
201-0236	EAB07-SNAP/CONADV/QUOTA-Tier 2	IS	\$0
201-0237	EAB08-SNAP/CONADV/QUOTA/SYNC/MIG-MED	IS	\$0
201-0238	EAB09-SNAP/QUOTA-Tier 2	IS	\$0
201-0239	EAB10-SNAP/CONADV/QUOTA/SYNC-Tier 2	IS	\$0
201-0240	EAB11-POOL/INS/SNAP/CONADV/QTA/SYNC-Tr 2	IS	\$0
201-0241	EAB12-POOL/INS/SNAP/CONADV/QUOTA-Tier 2	IS	\$0
201-0242	EAB13-POOL/CONADV-Tier 2	IS	\$0
201-0243	EAB14-POOL/CONADV/INS-Tier 2	IS	\$0
201-0244	EAB01-SNAP/CONADV-Tier 3	IS	\$0
201-0245	EAB02-SNAP/SYNC-Tier 3	IS	\$0
201-0246	EAB03-CONADV/SYNC-Tier 3	IS	\$0
201-0247	EAB04-SNAP/CONADV/SYNC-Tier 3	IS	\$0
201-0248	EAB06-SNAP/CONADV/SYNC/MIG-HIGH	IS	\$0
201-0249	EAB07-SNAP/CONADV/QUOTA-Tier 3	IS	\$0
201-0250	EAB08-SNAP/CONADV/QUOTA/SYNC/MIG-HIGH	IS	\$0
201-0251	EAB09-SNAP/QUOTA-Tier 3	IS	\$0
201-0252	EAB10-SNAP/CONADV/QUOTA/SYNC-Tier 3	IS	\$0
201-0253	EAB11-POOL/INS/SNAP/CONADV/QTA/SYNC-Tr 3	IS	\$0
201-0254	EAB12-POOL/INS/SNAP/CONADV/QUOTA-Tier 3	IS	\$0
201-0255	EAB13-POOL/CONADV-Tier 3	IS	\$0
201-0256	EAB14-POOL/CONADV/INS-Tier 3	IS	\$0
201-0282	EAB01-SNAP/CONADV-Tier 4	IS	\$0
201-0283	EAB02-SNAP/SYNC-Tier 4	IS	\$0
201-0284	EAB03-CONADV/SYNC-Tier 4	IS	\$0
201-0285	EAB04-SNAP/CONADV/SYNC-Tier 4	IS	\$0
201-0287	EAB07-SNAP/CONADV/QUOTA-Tier 4	IS	\$0
201-0289	EAB09-SNAP/QUOTA-Tier 4	IS	\$0
201-0290	EAB10-SNAP/CONADV/QUOTA/SYNC-Tier 4	IS	\$0
201-0291	EAB11 POOL/INS/SNAP/CONADV/QTA/SYNC-Tr 4	IS	\$0
201-0292	EAB12-POOL/INS/SNAP/CONADV/QUOTA-Tier 4	IS	\$0
201-0293	EAB13-POOL/CONADV-Tier 4	IS	\$0
201-0294	EAB14-POOL/CONADV/INS-Tier 4	IS	\$0
201-0295	SW: Basic Bundle (Tier 1)	IS	\$0
201-0295-CF	SW: Basic Bundle Tier 1 Gen5 =ID	IS	\$4,978
201-0296	SW: Basic Bundle (Tier 2)	IS	\$0
201-0296-CF	SW: Basic Bundle Tier 2 Gen5 =ID	IS	\$6,679
201-0297	SW: Basic Bundle (Tier 3)	IS	\$0
201-0297-CF	SW: Basic Bundle Tier 3 Gen5 =ID	IS	\$9,451

201-0298	SW: Basic Bundle (Tier 4)	IS	\$0
201-0298-CF	SW: Basic Bundle Tier 4 Gen5 =ID	IS	\$12,201
201-0299	SW: Enterprise Bundle (Tier 1)	IS	\$0
201-0299-CF	SW: Enterprise Bundle Tier 1 Gen5 =ID	IS	\$6,206
201-0300	SW: Enterprise Bundle (Tier 2)	IS	\$0
201-0300-CF	SW: Enterprise Bundle Tier 2 Gen5 =ID	IS	\$8,348
201-0301	SW: Enterprise Bundle (Tier 3)	IS	\$0
201-0301-CF	SW: Enterprise Bundle Tier 3 Gen5 =ID	IS	\$11,876
201-0302	SW: Enterprise Bundle (Tier 4)	IS	\$0
201-0302-CF	SW: Enterprise Bundle Tier 4 Gen5 =ID	IS	\$15,333
201-0303	SW: Enterprise Advanced Bundle (Tier 1)	IS	\$0
201-0303-CF	SW: Enterprise Adv Bundle Tier 1 Gen5=ID	IS	\$12,443
201-0304	SW: Enterprise Advanced Bundle (Tier 2)	IS	\$0
201-0304-CF	SW: Enterprise Adv Bundle Tier 2 Gen5=ID	IS	\$16,727
201-0305	SW: Enterprise Advanced Bundle (Tier 3)	IS	\$0
201-0305-CF	SW: Enterprise Adv Bundle Tier 3 Gen5=ID	IS	\$23,783
201-0306	SW: Enterprise Advanced Bundle (Tier 4)	IS	\$0
201-0306-CF	SW: Enterprise Adv Bundle Tier 4 Gen5=ID	IS	\$30,707
201-0307	SW: Elite Bundle (Tier 1)	IS	\$0
201-0308	SW: Elite Bundle (Tier 2)	IS	\$0
201-0309	SW: Elite Bundle (Tier 3)	IS	\$0
201-0310	SW: Elite Bundle (Tier 4)	IS	\$0
201-0311	SW: Basic Bundle (Tier 5)	IS	\$0
201-0311-CF	SW: Basic Bundle Tier 5 Gen5 =ID	IS	\$17,793
201-0312	SW: Basic Bundle (Tier 7)	IS	\$0
201-0312-CF	SW: Basic Bundle Tier 7 Gen5 =ID	IS	\$29,427
201-0313	SW: Enterprise Bundle (Tier 5)	IS	\$0
201-0313-CF	SW: Enterprise Bundle Tier 5 Gen5 =ID	IS	\$22,361
201-0314	SW: Enterprise Bundle (Tier 7)	IS	\$0
201-0314-CF	SW: Enterprise Bundle Tier 7 Gen5 =ID	IS	\$36,982
201-0315	SW: Enterprise Advanced Bundle (Tier 5)	IS	\$0
201-0315-CF	SW: Enterprise Adv Bundle Tier 5 Gen5=ID	IS	\$44,781
201-0316	SW: Enterprise Advanced Bundle (Tier 7)	IS	\$0
201-0316-CF	SW: Enterprise Adv Bundle Tier 7 Gen5=ID	IS	\$74,063
201-0319	EAB01-SNAP/CONADV-(Tier 5)	IS	\$0
201-0320	EAB02-SNAP/SYNC-(Tier 5)	IS	\$0
201-0321	EAB03-CONADV/SYNC-(Tier 5)	IS	\$0
201-0322	EAB04-SNAP/CONADV/SYNC-(Tier 5)	IS	\$0
201-0323	EAB07-SNAP/CONADV/QUOTA-(Tier 5)	IS	\$0
201-0324	EAB09-SNAP/QUOTA-(Tier 5)	IS	\$0
201-0325	EAB10-SNAP/CONADV/QUOTA/SYNC-(Tier 5)	IS	\$0
201-0326	EAB11 POOL/INS/SNAP/CONADV/QTA/SYNC (T5)	IS	\$0
201-0327	EAB12-POOL/INS/SNAP/CONADV/QUOTA-(Tier5)	IS	\$0
201-0328	EAB13-POOL/CONADV-(Tier 5)	IS	\$0
201-0329	EAB14-POOL/CONADV/INS-(Tier 5)	IS	\$0
201-0330	EAB01-SNAP/CONADV-(Tier 6)	IS	\$0
201-0331	EAB02-SNAP/SYNC-(Tier 6)	IS	\$0
201-0332	EAB03-CONADV/SYNC-(Tier 6)	IS	\$0
201-0333	EAB04-SNAP/CONADV/SYNC-(Tier 6)	IS	\$0
201-0334	EAB07-SNAP/CONADV/QUOTA-(Tier 6)	IS	\$0

201-0335	EAB09-SNAP/QUOTA-(Tier 6)	IS	\$0
201-0336	EAB10-SNAP/CONADV/QUOTA/SYNC-(Tier 6)	IS	\$0
201-0337	EAB11 POOL/INS/SNAP/CONADV/QTA/SYNC-(T6)	IS	\$0
201-0338	EAB12-POOL/INS/SNAP/CONADV/QUOTA-(Tier6)	IS	\$0
201-0339	EAB13-POOL/CONADV-(Tier 6)	IS	\$0
201-0340	EAB14-POOL/CONADV/INS-(Tier 6)	IS	\$0
201-0341	SW: Basic Bundle (Tier 6)	IS	\$0
201-0341-CF	SW: Basic Bundle Tier 6 Gen5 =ID	IS	\$23,277
201-0342	SW: Enterprise Bundle (Tier 6)	IS	\$0
201-0342-CF	SW: Enterprise Bundle Tier 6 Gen5 =ID	IS	\$29,252
201-0343	SW: Enterprise Advanced Bundle (Tier 6)	IS	\$0
201-0343-CF	SW: Enterprise Adv Bundle Tier 6 Gen5=ID	IS	\$58,582
201-0344	SW: Basic Bundle (Tier 8)	IS	\$0
201-0344-CF	SW: Basic Bundle Tier 8 Gen5 =ID	IS	\$38,498
201-0345	SW: Enterprise Bundle (Tier 8)	IS	\$0
201-0345-CF	SW: Enterprise Bundle Tier 8 Gen5 =ID	IS	\$48,380
201-0346	SW: Enterprise Advanced Bundle (Tier 8)	IS	\$0
201-0346-CF	SW: Enterprise Adv Bundle Tier 8 Gen5=ID	IS	\$96,889
456-105-366	SRMSUITE ISILON LO DNSTY =ID	IS	\$0
456-105-367	SRMSUITE ISILON MED DNSTY =ID	IS	\$0
456-105-368	SRMSUITE ISILON HI DNSTY =ID	IS	\$0
456-105-945	SRMSUITE ISILON UPR DNSTY =ID	IS	\$0
456-110-166	IsilonSD Edge 36TB 3-6 Node Cluster =ID	IS	\$15,000
456-110-765	SRM ISILON LO DNSTY =ID	IS	\$3,930
456-110-766	SRM ISILON MED DNSTY =ID	IS	\$5,280
456-110-767	SRM ISILON HI DNSTY =ID	IS	\$7,510
456-110-780	SRM ISILON UPR DNSTY =ID	IS	\$10,670
456-111-509	OneFS Sub Gen5 Esntl Base Lic T1=ID	IS	\$2,954
456-111-510	OneFS Sub Gen5 Esntl Base Lic T2=ID	IS	\$829
456-111-511	OneFS Sub Gen5 Esntl Base Lic T3=ID	IS	\$514
456-111-512	OneFS Sub Gen5 Esntl Capacity T1=CB	IS	\$15
456-111-513	OneFS Sub Gen5 Esntl Capacity T2=CB	IS	\$15
456-111-514	OneFS Sub Gen5 Esntl Capacity T3=CB	IS	\$11
456-111-515	OneFS Sub Gen5 Esntl REN Base T1=ID	IS	\$2,954
456-111-516	OneFS Sub Gen5 Esntl REN Base T2=ID	IS	\$829
456-111-517	OneFS Sub Gen5 Esntl REN Base T3=ID	IS	\$514
456-111-518	OneFS Sub Gen5 Esntl REN Cap T1=CB	IS	\$15
456-111-519	OneFS Sub Gen5 Esntl REN Cap T2=CB	IS	\$15
456-111-520	OneFS Sub Gen5 Esntl REN Cap T3=CB	IS	\$11
456-111-521	OneFS Sub Gen5 Esntl Bse Lic 2Y/PP T1=ID	IS	\$2,806
456-111-522	OneFS Sub Gen5 Esntl Bse Lic 2Y/PP T2=ID	IS	\$787
456-111-523	OneFS Sub Gen5 Esntl Bse Lic 2Y/PP T3=ID	IS	\$488
456-111-524	OneFS Sub Gen5 Esntl Cap 2Y/PP T1=CB	IS	\$15
456-111-525	OneFS Sub Gen5 Esntl Cap 2Y/PP T2=CB	IS	\$15
456-111-526	OneFS Sub Gen5 Esntl Cap 2Y/PP T3=CB	IS	\$10
456-111-527	OneFS Sub Gen5 Esntl REN Bse 2Y/PP T1=ID	IS	\$2,806
456-111-528	OneFS Sub Gen5 Esntl REN Bse 2Y/PP T2=ID	IS	\$787
456-111-529	OneFS Sub Gen5 Esntl REN Bse 2Y/PP T3=ID	IS	\$488
456-111-530	OneFS Sub Gen5 Esntl REN Cap 2Y/PP T1=CB	IS	\$15
456-111-531	OneFS Sub Gen5 Esntl REN Cap 2Y/PP T2=CB	IS	\$15

456-111-532	OneFS Sub Gen5 Esntl REN Cap 2Y/PP T3=CB	IS	\$10
456-111-533	OneFS Sub Gen5 Esntl Bse Lic 3Y/PP T1=ID	IS	\$2,658
456-111-534	OneFS Sub Gen5 Esntl Bse Lic 3Y/PP T2=ID	IS	\$746
456-111-535	OneFS Sub Gen5 Esntl Bse Lic 3Y/PP T3=ID	IS	\$463
456-111-536	OneFS Sub Gen5 Esntl Cap 3Y/PP T1=CB	IS	\$14
456-111-537	OneFS Sub Gen5 Esntl Cap 3Y/PP T2=CB	IS	\$14
456-111-538	OneFS Sub Gen5 Esntl Cap 3Y/PP T3=CB	IS	\$9
456-111-539	OneFS Sub Gen5 Esntl REN Bse 3Y/PP T1=ID	IS	\$2,658
456-111-540	OneFS Sub Gen5 Esntl REN Bse 3Y/PP T2=ID	IS	\$746
456-111-541	OneFS Sub Gen5 Esntl REN Bse 3Y/PP T3=ID	IS	\$463
456-111-542	OneFS Sub Gen5 Esntl REN Cap 3Y/PP T1=CB	IS	\$14
456-111-543	OneFS Sub Gen5 Esntl REN Cap 3Y/PP T2=CB	IS	\$14
456-111-544	OneFS Sub Gen5 Esntl REN Cap 3Y/PP T3=CB	IS	\$9
456-111-545	OneFS Sub Gen5 Adv Base Lic T1=ID	IS	\$3,667
456-111-546	OneFS Sub Gen5 Adv Base Lic T2=ID	IS	\$1,542
456-111-547	OneFS Sub Gen5 Adv Base Lic T3=ID	IS	\$1,227
456-111-548	OneFS Sub Gen5 Adv Capacity T1=CB	IS	\$20
456-111-549	OneFS Sub Gen5 Adv Capacity T2=CB	IS	\$20
456-111-550	OneFS Sub Gen5 Adv Capacity T3=CB	IS	\$15
456-111-551	OneFS Sub Gen5 Adv REN Base T1=ID	IS	\$3,667
456-111-552	OneFS Sub Gen5 Adv REN Base T2=ID	IS	\$1,542
456-111-553	OneFS Sub Gen5 Adv REN Base T3=ID	IS	\$1,227
456-111-554	OneFS Sub Gen5 Adv REN Cap T1=CB	IS	\$20
456-111-555	OneFS Sub Gen5 Adv REN Cap T2=CB	IS	\$20
456-111-556	OneFS Sub Gen5 Adv REN Cap T3=CB	IS	\$15
456-111-557	OneFS Sub Gen5 Adv Base Lic 2Y/PP T1=ID	IS	\$3,483
456-111-558	OneFS Sub Gen5 Adv Base Lic 2Y/PP T2=ID	IS	\$1,465
456-111-559	OneFS Sub Gen5 Adv Base Lic 2Y/PP T3=ID	IS	\$1,166
456-111-560	OneFS Sub Gen5 Adv Capacity 2Y/PP T1=CB	IS	\$19
456-111-561	OneFS Sub Gen5 Adv Capacity 2Y/PP T2=CB	IS	\$19
456-111-562	OneFS Sub Gen5 Adv Capacity 2Y/PP T3=CB	IS	\$14
456-111-563	OneFS Sub Gen5 Adv REN Base 2Y/PP T1=ID	IS	\$3,483
456-111-564	OneFS Sub Gen5 Adv REN Base 2Y/PP T2=ID	IS	\$1,465
456-111-565	OneFS Sub Gen5 Adv REN Base 2Y/PP T3=ID	IS	\$1,166
456-111-566	OneFS Sub Gen5 Adv REN Cap 2Y/PP T1=CB	IS	\$19
456-111-567	OneFS Sub Gen5 Adv REN Cap 2Y/PP T2=CB	IS	\$19
456-111-568	OneFS Sub Gen5 Adv REN Cap 2Y/PP T3=CB	IS	\$14
456-111-569	OneFS Sub Gen5 Adv Base Lic 3Y/PP T1=ID	IS	\$3,300
456-111-570	OneFS Sub Gen5 Adv Base Lic 3Y/PP T2=ID	IS	\$1,388
456-111-571	OneFS Sub Gen5 Adv Base Lic 3Y/PP T3=ID	IS	\$1,104
456-111-572	OneFS Sub Gen5 Adv Capacity 3Y/PP T1=CB	IS	\$18
456-111-573	OneFS Sub Gen5 Adv Capacity 3Y/PP T2=CB	IS	\$18
456-111-574	OneFS Sub Gen5 Adv Capacity 3Y/PP T3=CB	IS	\$14
456-111-575	OneFS Sub Gen5 Adv REN Base 3Y/PP T1=ID	IS	\$3,300
456-111-576	OneFS Sub Gen5 Adv REN Base 3Y/PP T2=ID	IS	\$1,388
456-111-577	OneFS Sub Gen5 Adv REN Base 3Y/PP T3=ID	IS	\$1,104
456-111-578	OneFS Sub Gen5 Adv REN Cap 3Y/PP T1=CB	IS	\$18
456-111-579	OneFS Sub Gen5 Adv REN Cap 3Y/PP T2=CB	IS	\$18
456-111-580	OneFS Sub Gen5 Adv REN Cap 3Y/PP T3=CB	IS	\$14
456-111-588	OneFS Sub Gen5 Adv REN Encr 3Y/PP T1=ID	IS	\$708

456-111-589	OneFS Sub Gen5 Adv REN Encr 3Y/PP T2=ID	IS	\$390
456-111-590	OneFS Sub Gen5 Adv REN Encr 3Y/PP T3=ID	IS	\$390
456-111-597	OneFS Sub Gen5 Esntl Encrypt T1=ID	IS	\$787
456-111-598	OneFS Sub Gen5 Esntl Encrypt T2=ID	IS	\$433
456-111-599	OneFS Sub Gen5 Esntl Encrypt T3=ID	IS	\$433
456-111-600	OneFS Sub Gen5 Esntl REN Encr T1=ID	IS	\$787
456-111-601	OneFS Sub Gen5 Esntl REN Encr T2=ID	IS	\$433
456-111-602	OneFS Sub Gen5 Esntl REN Encr T3=ID	IS	\$433
456-111-603	OneFS Sub Gen5 Esntl Encrypt 2Y/PP T1=ID	IS	\$748
456-111-604	OneFS Sub Gen5 Esntl Encrypt 2Y/PP T2=ID	IS	\$411
456-111-605	OneFS Sub Gen5 Esntl Encrypt 2Y/PP T3=ID	IS	\$411
456-111-606	OneFS Sub Gen5 Esntl REN Enc 2Y/PP T1=ID	IS	\$748
456-111-607	OneFS Sub Gen5 Esntl REN Enc 2Y/PP T2=ID	IS	\$411
456-111-608	OneFS Sub Gen5 Esntl REN Enc 2Y/PP T3=ID	IS	\$411
456-111-609	OneFS Sub Gen5 Esntl Encrypt 3Y/PP T1=ID	IS	\$708
456-111-610	OneFS Sub Gen5 Esntl Encrypt 3Y/PP T2=ID	IS	\$390
456-111-611	OneFS Sub Gen5 Esntl Encrypt 3Y/PP T3=ID	IS	\$390
456-111-612	OneFS Sub Gen5 Esntl REN Enc 3Y/PP T1=ID	IS	\$708
456-111-613	OneFS Sub Gen5 Esntl REN Enc 3Y/PP T2=ID	IS	\$390
456-111-614	OneFS Sub Gen5 Esntl REN Enc 3Y/PP T3=ID	IS	\$390
456-111-615	OneFS Sub Gen5 Adv Encrypt T1=ID	IS	\$787
456-111-616	OneFS Sub Gen5 Adv Encrypt T2=ID	IS	\$433
456-111-617	OneFS Sub Gen5 Adv Encrypt T3=ID	IS	\$433
456-111-618	OneFS Sub Gen5 Adv REN Encr T1=ID	IS	\$787
456-111-619	OneFS Sub Gen5 Adv REN Encr T2=ID	IS	\$433
456-111-620	OneFS Sub Gen5 Adv REN Encr T3=ID	IS	\$433
456-111-621	OneFS Sub Gen5 Adv Encrypt 2Y/PP T1=ID	IS	\$748
456-111-622	OneFS Sub Gen5 Adv Encrypt 2Y/PP T2=ID	IS	\$411
456-111-623	OneFS Sub Gen5 Adv Encrypt 2Y/PP T3=ID	IS	\$411
456-111-624	OneFS Sub Gen5 Adv REN Encr 2Y/PP T1=ID	IS	\$748
456-111-625	OneFS Sub Gen5 Adv REN Encr 2Y/PP T2=ID	IS	\$411
456-111-626	OneFS Sub Gen5 Adv REN Encr 2Y/PP T3=ID	IS	\$411
456-111-627	OneFS Sub Gen5 Adv Encrypt 3Y/PP T1=ID	IS	\$708
456-111-628	OneFS Sub Gen5 Adv Encrypt 3Y/PP T2=ID	IS	\$390
456-111-629	OneFS Sub Gen5 Adv Encrypt 3Y/PP T3=ID	IS	\$390
456-112-871	IsilonSD Flex 1Host/36T ShareStorage=IF	IS	\$15,000
458-000-199	SRM for ISILON	IS	\$0
458-001-252	IsilonSD Edge =ID	IS	\$0
611-0004	12TB HDD/3.5in	IS	\$0
611-0005	11TB+200GB SSD/ 3.5in	IS	\$0
611-0006	6TB+1.2TB SSD/3.5in	IS	\$0
611-0007	24TB HDD/3.5in	IS	\$0
611-0008	20TB+400GB SSD/3.5in	IS	\$0
611-0009	12TB+1.2TB SSD/3.5in	IS	\$0
611-0010	36TB HDD/3.5in	IS	\$0
611-0011	27TB+600GB SSD/3.5in	IS	\$0
611-0012	18TB+1.2TB SSD/3.5in	IS	\$0
611-0013	7.2TB HDD/2.5in	IS	\$0
611-0014	6.9TB+200GB SSD/2.5in	IS	\$0
611-0015	5.4TB+1.2TB SSD/2.5in	IS	\$0

611-0016	14.4TB HDD/2.5in	IS	\$0
611-0017	13.2TB+400GB SSD/2.5in	IS	\$0
611-0018	10.8TB+1.2TB SSD/2.5in	IS	\$0
611-0037	3.5 30TB HDD / 200GB SSD	IS	\$0
611-0038	3.5 30TB HDD / 400GB SSD	IS	\$0
611-0041	1.2TB SSD; 3.5 IN	IS	\$0
611-0042	2.4TB SSD; 3.5 IN	IS	\$0
611-0044	4.8TB SSD/2.5in	IS	\$0
611-0045	36TB HDD/3.5in	IS	\$0
611-0046	72TB HDD/3.5in	IS	\$0
611-0047	108TB HDD/3.5in	IS	\$0
611-0051	35TB HDD / 400GB SSD; 3.5 IN	IS	\$0
611-0053	68TB HDD / 800GB SSD; 3.5 IN	IS	\$0
611-0056	90TB/2.4TB SSD/3.5in	IS	\$0
611-0058	35TB HDD / 200GB SSD; 3.5 IN	IS	\$0
611-0059	70TB HDD / 400GB SSD; 3.5 IN	IS	\$0
611-0060	70TB HDD / 200GB SSD; 3.5 IN	IS	\$0
611-0061	102TB HDD / 800GB SSD; 3.5 IN	IS	\$0
611-0062	105TB HDD / 400GB SSD; 3.5 IN	IS	\$0
611-0063	144TB HDD/3.5in	IS	\$0
611-0064	128TB HDD / 1.6TB SSD; 3.5 IN	IS	\$0
611-0065	132TB HDD / 1.2TB SSD; 3.5 IN	IS	\$0
611-0066	136TB HDD / 800GB SSD; 3.5 IN	IS	\$0
611-0067	140TB HDD / 400GB SSD; 3.5 IN	IS	\$0
611-0068	21.6TB HDD/2.5in	IS	\$0
611-0070	20.7TB+400GB SSD/2.5in	IS	\$0
611-0071	19.8TB HDD/800GB SSD/2.5in	IS	\$0
611-0072	18.9TB+1.2TB SSD/2.5in	IS	\$0
611-0074	34TB+800GB SSD/3.5in	IS	\$0
611-0075	66TB+1.2TB SSD/3.5in	IS	\$0
611-0076	96TB+1.6TB SSD/3.5in	IS	\$0
611-0077	124TB HDD / 2TB SSD; 3.5 IN	IS	\$0
611-0078	19.8TB+400GB SSD/2.5in	IS	\$0
611-0098	9.6TB SSD/2.5in	IS	\$0
611-0099	120TB+2.4TB SSD/3.5in	IS	\$0
611-0101	13.2TB+800GB SSD/2.5in	IS	\$0
611-0102	16.2TB+2.4TB SSD/2.5in	IS	\$0
611-0103	10.8TB/2.4TB SSD/2.5in	IS	\$0
611-0104	108TB SED HDD/3.5in	IS	\$0
611-0105	36TB SED HDD/3.5in	IS	\$0
611-0106	5.5TB/400GB SSD/3.5IN	IS	\$0
611-0107	10TB/800GB SSD/3.5IN	IS	\$0
611-0108	60TB+4.8TB SSD/3.5in	IS	\$0
611-0109	120TB+4.8TB SSD/3.5in	IS	\$0
611-0110	62TB HDD /2TB SSD/3.5IN	IS	\$0
611-0111	13.2TB+1.6TB SSD/2.5in	IS	\$0
611-0112	19.2TB SSD/2.5in	IS	\$0
611-0113	26.4TB+1.6TB SSD/2.5in	IS	\$0
611-0115	48TB SED HDD/3.5in	IS	\$0
611-0116	144TB SED HDD/3.5in	IS	\$0

611-0118	34TB+1.6TB SSD/3.5in	IS	\$0
611-0119	64TB+3.2TB SSD/3.5in	IS	\$0
611-0120	90TB+4.8TB SSD/3.5in	IS	\$0
611-0121	6.6TB/1.6TB SSD/2.5in	IS	\$0
611-0122	19.8TB HDD+1.6TB SSD/2.5in	IS	\$0
611-0124	128TB+3.2TB SSD/3.5in	IS	\$0
611-0125	25.2TB+2.4TB SSD/2.5in	IS	\$0
611-0126	24TB+3.2TB SSD/2.5in	IS	\$0
611-0128	6.6TB HDD/400GB SSD/2.5in	IS	\$0
611-0129	64TB HDD/1.6TB SSD/3.5in	IS	\$0
611-0130	99TB+2.4TB SSD/3.5in	IS	\$0
611-0131	136TB+1.6TB SSD/3.5in	IS	\$0
611-0132	26.4TB+800GB SSD/2.5in	IS	\$0
611-0133	96TB+3.2TB SSD/3.5in	IS	\$0
611-0134	10TB+1.6TB SSD/3.5in	IS	\$0
611-0135	20TB+1.6TB SSD/3.5in	IS	\$0
611-0136	6TB+4.8TB SSD/3.5in	IS	\$0
611-0137	16TB+3.2TB SSD/3.5in	IS	\$0
611-0138	12TB+4.8TB SSD/3.5in	IS	\$0
611-0139	33TB+800GB SSD/3.5in	IS	\$0
611-0140	11TB+800GB SSD/3.5in	IS	\$0
611-0141	22TB+800GB SSD/3.5in	IS	\$0
611-0142	30TB+1.6TB SSD/3.5in	IS	\$0
611-0143	24TB+3.2TB SSD/3.5in	IS	\$0
611-0144	18TB+4.8TB SSD/3.5in	IS	\$0
611-0145	28.8TB HDD/2.5in	IS	\$0
611-0146	13.8TB+800GB SSD/2.5in	IS	\$0
611-0147	102TB+1.6TB SSD/3.5in	IS	\$0
611-0156	354TB+800GB SSD/3.5in	IS	\$0
611-0168	21.6TB SED HDD/2.5in	IS	\$0
611-0169	20.7TB SED+800GB SED SSD/2.5in	IS	\$0
611-0170	19.8TB SED+1.6T SED SSD/2.5in	IS	\$0
611-0171	6.9TB+400GB SSD/2.5in	IS	\$0
611-0172	6.9TB+800GB SSD/2.5in	IS	\$0
611-0173	13.8TB+400GB SSD/2.5in	IS	\$0
611-0174	20.7TB+800GB SSD/2.5in	IS	\$0
611-0175	27.6TB+400GB SSD/2.5in	IS	\$0
611-0176	27.6TB+800GB SSD/2.5in	IS	\$0
611-0177	70TB+800GB SSD/3.5in	IS	\$0
611-0178	68TB+1.6TB SSD/3.5in	IS	\$0
611-0179	136TB HDD+1.6TB SSD 3.5in	IS	\$0
611-0180	136TB SED+1.6TB SED SSD/3.5in	IS	\$0
611-0181	128TB SED+3.2TB SED SSD/3.5in	IS	\$0
611-0182	120TB SED+4.8TB SED SSD/3.5in	IS	\$0
611-0183	33TB SED+800GB SED SSD/3.5in	IS	\$0
611-0184	30TB SED+1.6TB SED SSD/3.5in	IS	\$0
611-0185	24TB SED+3.2TB SED SSD/3.5in	IS	\$0
611-0186	102TB SED+1.6TB SED SSD/3.5in	IS	\$0
611-0187	96TB SED+3.2TB SED SSD/3.5in	IS	\$0
611-0188	105TB SED+800GB SED SSD/3.5in	IS	\$0

611-0189	140TB SED+800GB SED SSD/3.5in	IS	\$0
611-0190	132TB SED HDD/2.4TB SED SSD/3.5in.	IS	\$0
611-0191	35TB+800GB SSD/3.5in	IS	\$0
611-0192	132TB+2.4TB SSD/3.5in	IS	\$0
611-0195	16.2TB+4.8TB SSD/2.5in	IS	\$0
611-0196	18.9TB+2.4TB SSD/2.5in	IS	\$0
611-0197	18TB+3.2TB SSD/2.5in	IS	\$0
611-0198	21.6TB+4.8TB SSD/2.5in	IS	\$0
611-0199	24T HDD+3.2T SSD/2.5in.	IS	\$0
611-0200	25.2T HDD+2.4T SSD/2.5in.	IS	\$0
611-0201	6.6TB+1.6TB SSD/2.5in	IS	\$0
611-0202	9.6T SSD/2.5in.	IS	\$0
611-0203	32TB+3.2TB SSD/3.5in	IS	\$0
611-0205	90TB SED+4.8TB SED SSD/3.5in	IS	\$0
611-0206	99TB SED HDD/2.4TB SED SSD/3.5 IN	IS	\$0
611-0207	210TB+800GB SSD/3.5in	IS	\$0
611-0208	140TB+800GB SSD/3.5in	IS	\$0
611-0210	48TB HDD/3.5in	IS	\$0
611-0211	44TB HDD + 800G SSD 3.5in	IS	\$0
611-0212	40TB HDD + 1.6T SSD 3.5in	IS	\$0
611-0213	44TB SED HDD + 800G SED SSD 3.5in	IS	\$0
611-0214	40TB SED HDD + 1.6TB SED SSD 3.5in	IS	\$0
611-0215	32TB SED HDD /3.2TB SED SSD, 3.5in.	IS	\$0
611-0216	280TB+1.6TB SSD/3.5in	IS	\$0
611-0217	472TB+1.6TB SSD/3.5in	IS	\$0
611-0218	6.9TB+1.6TB SSD/2.5in	IS	\$0
611-0219	13.8TB+1.6TB SSD/2.5in	IS	\$0
611-0220	13.2TB+3.2TB SSD/2.5in	IS	\$0
611-0221	20.7TB+1.6TB SSD/2.5in	IS	\$0
611-0222	19.8TB+3.2TB SSD/2.5in	IS	\$0
611-0223	18.0TB+6.4TB SSD/2.5in	IS	\$0
611-0224	27.6TB+1.6TB SSD/2.5in	IS	\$0
611-0225	26.4TB+3.2TB SSD/2.5in	IS	\$0
611-0226	24.0TB+6.4TB SSD/2.5in	IS	\$0
611-0227	21.6TB+9.6TB SSD/2.5in	IS	\$0
611-0228	70TB+1.6TB SSD/3.5in	IS	\$0
611-0229	68TB+3.2TB SSD/3.5in	IS	\$0
611-0230	66TB+4.8TB SSD/3.5in	IS	\$0
611-0231	64TB+6.4TB SSD/3.5in	IS	\$0
611-0232	60TB+9.6TB SSD/3.5in	IS	\$0
611-0233	140TB+1.6TB SSD/3.5in	IS	\$0
611-0234	136TB+3.2TB SSD/3.5in	IS	\$0
611-0235	132TB+4.8TB SSD/3.5in	IS	\$0
611-0236	128TB+6.4TB SSD/3.5in	IS	\$0
611-0237	120TB+9.6TB SSD/3.5in	IS	\$0
611-0238	32TB HDD + 3.2TB SSD 3.5in	IS	\$0
611-0239	105TB+800GB SSD/3.5in	IS	\$0
611-0240	354TB+800GB SSD/3.5in/4kn	IS	\$0
611-0241	210TB+800GB SSD/3.5in/4kn	IS	\$0
611-0242	210TB SED+800TB SED SSD/3.5in	IS	\$0

611-0243	354TB SED+800GB SSD SED/3.5in	IS	\$0
611-0244	280TB HDD SED +1.6TB SSD SED 3.5in	IS	\$0
611-0245	472TB HDD SED+1.6TB SSD SED 3.5in	IS	\$0
611-0246	210TB HDD + 1.6TB SSD 3.5in	IS	\$0
611-0247	105TB + 1.6TB SSD/3.5IN	IS	\$0
611-0248	102TB + 3.2TB SSD/3.5IN	IS	\$0
611-0249	99TB + 4.8TB SSD/3.5IN	IS	\$0
611-0250	96TB + 6.4TB SSD/3.5IN	IS	\$0
611-0251	90TB + 9.6TB SSD/3.5IN	IS	\$0
611-0252	35TB + 1.6TB SSD/3.5IN	IS	\$0
611-0253	34TB + 3.2TB SSD/3.5IN	IS	\$0
611-0254	20.7TB SED + 1.6TB SED SSD/2.5in	IS	\$0
611-0255	19.8TB SED + 3.2TB SED SSD/2.5in	IS	\$0
611-0256	18TB SED + 6.4TB SED SSD/2.5in	IS	\$0
611-0257	105TB SED + 1.6TB SED SSD/3.5in	IS	\$0
611-0258	102TB SED + 3.2TB SED SSD/3.5in	IS	\$0
611-0259	99TB SED + 4.8TB SED SSD/3.5in	IS	\$0
611-0260	96TB SED + 6.4TB SED SSD/3.5in	IS	\$0
611-0261	90TB SED + 9.6TB SED SSD/3.5in	IS	\$0
611-0262	140TB SED + 1.6TB SED SSD/3.5in	IS	\$0
611-0263	136TB SED + 3.2TB SED SSD/3.5in	IS	\$0
611-0264	132TB SED + 4.8TB SED SSD/3.5in	IS	\$0
611-0265	128TB SED + 6.4TB SED SSD/3.5in	IS	\$0
611-0266	120TB SED + 9.6TB SED SSD/3.5in	IS	\$0
612-0001	6GB RAM	IS	\$0
612-0002	12GB RAM	IS	\$0
612-0003	24GB RAM	IS	\$0
612-0004	48GB RAM	IS	\$0
612-0005	24GB RAM	IS	\$0
612-0006	48GB RAM 12x4G	IS	\$0
612-0008	12GB RAM	IS	\$0
612-0009	192GB RAM	IS	\$0
612-0014	32GB RAM	IS	\$0
612-0015	64GB RAM	IS	\$0
612-0016	128GB RAM	IS	\$0
612-0017	128GB RAM 16x8GB	IS	\$0
612-0018	256GB RAM	IS	\$0
612-0019	48GB RAM	IS	\$0
612-0020	24GB RAM	IS	\$0
612-0021	96GB RAM	IS	\$0
612-0022	INA 12GB RAM 6x2G	IS	\$0
612-0023	24GB RAM	IS	\$0
612-0024	48GB RAM	IS	\$0
612-0027	24GB RAM (Next Gen)	IS	\$0
612-0028	48GB RAM (Next Gen)	IS	\$0
612-0031	24GB RAM 3x8G Gen5-HD	IS	\$0
613-0001	1GBE BASE-T DUAL-PORT PCIE	IS	\$0
613-0002	10GBE; DUAL-PORT; SFP+; WITHOUT OPTICS	IS	\$0
613-0003	1GBE BASE-T DUAL-PORT PCIE X2	IS	\$0
613-0008	10GBE DUAL-PORT SFP WITHOUT OPTICS	IS	\$0

613-0009	10GBE DUAL-PORT SFP W/O OPTICS HD400	IS	\$0
800-0010	PWRCRD,2,NEMA 5-15A-C13,110V NORTH AMER	IS	\$40
800-0012	PWRCRD,2,IEC320 C14-C13,208V UNIVERSAL	IS	\$49
800-0014	PWRCRD,2,BS1363-C13,240V UK/IRLND	IS	\$101
800-0015	PWRCRD,2,CEE7/7 KSC8305-C13,220V EU/KREA	IS	\$88
800-0017	PWRCRD,2,JIS 8303-C13,100V JAPAN	IS	\$89
800-0020	PWRCRD,2,AS3112-C13,230V AUS/NZ	IS	\$89
800-0021	PWRCRD,2,IS1293-C13,240V SA	IS	\$97
800-0022	PWRCRD,2,SI-32 TO C13,230V ISRAEL	IS	\$127
800-0024	PWRCRD,2,SEV 1011-C13,220V SWTZLAND	IS	\$96
800-0025	PWRCRD,2,IRAM 2073-C13,220V ARGENTINA	IS	\$86
800-0026	PWRCRD,2,AFSNIT107-2-D1-C13,220V DENMRK	IS	\$87
800-0029	PWRCRD,2,NEMA 5-15A-C19,110V North AMER	IS	\$110
800-0030	PWRCRD,2,IEC320 C14-C19,208-240V UNIVL	IS	\$110
800-0031	PWRCRD,2,CEE7/7 KSC8305-C19,220V EU/KREA	IS	\$96
800-0032	PWRCRD,2,PSE JIS 8303-C19,100V JAPAN	IS	\$118
800-0033	PWRCRD,2,BS 1363-C19,240V UK/IRLND	IS	\$112
800-0034	PWRCRD,2,AS3112-C19,230V AUS/NZ	IS	\$106
800-0035	PWRCRD,2,IS1293-C19,240V INDIA/SA	IS	\$124
800-0037	PWRCRD,2,SI-32 TO C19,230V ISRAEL	IS	\$265
800-0038	PWRCRD,2,SEV 1011-C19,220V SWTZLAND	IS	\$218
800-0039	PWRCRD,2,AFSNIT107-2-D1-C19,220V DENMRK	IS	\$84
800-0054	MOUNTING KIT; TITAN RACK; ANTI-TIP	IS	\$1,630
800-0055	MOUNTING KIT; TITAN RACK; ANTI-MOVE	IS	\$299
800-0056	MOUNTING KIT; TITAN RACK; SEISMIC	IS	\$1,702
800-0057	TOP ROUTING KIT; TITAN RACK	IS	\$830
800-0061	PWRCRD,1,TITAN,15F,L6-30P,250V NO AM/JAP	IS	\$268
800-0062	PWRCRD,1,TITAN,15F,3750DP,250V NO AM/JAP	IS	\$1,341
800-0063	PWRCRD,1,TITAN,15F,IEC60309, 230V UNIVL	IS	\$264
800-0064	PWRCRD,1,TITAN,15F,56PA332,250V AU	IS	\$569
800-0065	Deep Rack Installation Kit HD400	IS	\$770
800-0066	Normal Depth Rack Installation Kit HD400	IS	\$975
800-0067	PWRCRD 1 TITAN 3-PHASE 40A 15FT NO AM	IS	\$828
800-0068	PWRCRD 1 TITAN 3-PHASE 40A 15FT INTL	IS	\$1,154
800-0069	TITAN D RACK ANTI-TIP MOUNT KIT	IS	\$287
800-0070	TITAN D RACK ANTI-MOVE MOUNT KIT	IS	\$1,732
800-0071	TITAN-D ANCHORING BRACKET KIT	IS	\$2,749
800-0072	TITAN-D TOP COVER ROUTING KIT	IS	\$717
800-0073	PWRCRD IEC60320 C13 TO C14 1M 15A/250V	IS	\$52
800-0074	HD400 Pre-Racked Install Kit	IS	\$11,835
800-0075	PWRCRD 3-PHASE WYE 32A 15FT NO AM	IS	\$750
800-0076	PWRCRD 3-PHASE WYE 32A 15FT INT'L	IS	\$703
800-0094	MOUNTING KIT; TITAN-HD RACK; ANTI-MOVE	IS	\$420
800-0095	MOUNTING KIT; TITAN-HD RACK; ANTI-TIP	IS	\$520
810-0021	KIT - 1 SPARE 400GB HD; SATA	IS	\$426
811-0006	SPARES KIT, DUAL GIGABIT NIC, ROHS	IS	\$0
811-0007	SPARES KIT, NVRAM	IS	\$0
811-0009	SPARES KIT, INFINIBAND HCA, ROHS	IS	\$0
811-0011	SPARES KIT, 250GB HD, SATA	IS	\$0
811-0017	SPARES KIT, DIMM, 1GB	IS	\$0

811-0018	SPARES KIT, RISER CARD, ROHS	IS	\$0
811-0022	SPARES KIT, 500 GB HD, SATA II	IS	\$0
811-0023	SPARES KIT, 160GB HD, SATA II	IS	\$0
811-0025	SPARES KIT, CPU, XEON, 3.2GHZ, 2MB	IS	\$0
811-0028	SPARES KIT, FRONT PANEL ASSY, 1U, ACCEL	IS	\$0
811-0029	SPARES KIT, PASSIVE RISER, 1U	IS	\$0
811-0031	SPARES KIT, POWER SUPPLY, 1U	IS	\$0
811-0032	SPARES KIT, FRONT PANEL ASSY, EX6000	IS	\$0
811-0048	SPARES KIT, 750 GB HD, SATA, ROHS	IS	\$0
811-0053	SPARES KIT, CPU, GRAHAM	IS	\$0
811-0058	SPARES KIT, 160GB HD, SATA, ROHS	IS	\$0
811-0060	SPARES KIT, 750 GB HD, SATA, ROHS	IS	\$0
811-0069	SPARES KIT, FRONT PANEL ASSY BU ACCEL	IS	\$0
811-0073	SPARES KIT, 300 GB HD, SAS, ROHS	IS	\$0
811-0102	SPARES KIT, 2 TB HD, SATA, 5400RPM	IS	\$0
811-0113	SPARES KIT, NIC 10GESFP+ ACCEL-X W/OP	IS	\$0
811-0117	SPARES KIT, NVRAM, 2010, ROHS	IS	\$0
811-0120	SPARES KIT, POWER SUPPLY, BF	IS	\$0
811-0127	SPARES KIT, 100 GB SSD, WF, ROHS	IS	\$0
811-0133	SPARES KIT, 100 GB SSD, BF, ROHS	IS	\$0
811-0138	SPARES KIT, SIDE RAIL SOLID BEAR SPECIAL	IS	\$0
811-0141	FRU, PS, QLOGIC 12800-XXX QDR IB SWITCH	IS	\$0
811-0142	FRU, IN QLOGIC 12800-XXX QDR IB SWITCH	IS	\$0
811-0144	FRU, LEAF QLOGIC 12800-XXX QDR IB SWITCH	IS	\$0
811-0145	FRU, EX QLOGIC 12800-XXX QDR IB SWITCH	IS	\$0
811-0152	SPARES KIT, CABLE ASSY SATA 1.5G 0.5M	IS	\$0
811-0153	SPARES KIT, CABLE ASSY,SATA 1.5G,STR,1M	IS	\$0
811-0154	FRU, PS, MELLANOX MIS50XX QDR SWITCH	IS	\$0
811-0155	FRU, POWER DISTRIBUTION PANEL TITAN RACK	IS	\$0
811-0156	FRU, POWER DISTRIBUTION UNIT, TITAN RACK	IS	\$0
811-0157	FRU, CABLE, MINI SAS TITAN RACK INTERCON	IS	\$0
811-0165	FRU, MANAGEMENT MODULE, QLOGIC, 12800	IS	\$0
811-0166	SPARES KIT, 4 TB HD, 3.5 IN, ROHS	IS	\$0
811-0168	SPARES KIT, 250GB HD, SATA, ROHS ACCEL-X	IS	\$0
811-0174	FRU, RACK INST KIT MELLANOX IS5022 CTR	IS	\$0
811-0175	FRU, RACK INSTALL KIT, MELLANOX, 1U GT	IS	\$0
811-0190	SPARES KIT, BOOT DRIVE	IS	\$0
811-0192	FRU,QDR, INTEL,SWITCH, IB, 18 PORT	IS	\$0
811-0193	FRU,QDR, MELLANOX, SWITCH IB, 18 PORT	IS	\$0
811-0194	FRU,QDR, INTEL,SWITCH, IB, 36 PORT	IS	\$0
811-0195	FRU,QDR, MELLANOX, SWITCH, IB 36 PORT	IS	\$0
811-0201	SPARES KIT, 3TB SED HD, 3.5 IN, ROHS	IS	\$0
811-0202	SPARE KIT, CABLE, IB QDR, QSFP-QSFP, 1M	IS	\$0
811-0203	SPARE KIT, CABLE, IB QDR, QSFP-QSFP, 3M	IS	\$0
811-0204	SPARE KIT, CABLE, IB QDR, QSFP-QSFP, 5M	IS	\$0
811-0206	SPARE KIT CABLE IB DDR CX4-CX4 1M?	IS	\$0
811-0207	SPARE KIT CABLE IB DDR CX4-CX4 3M	IS	\$0
811-0208	SPARE KIT CABLE IB DDR CX4-CX4 5M	IS	\$0
811-0209	SPARE KIT,SWITCH,IB QDR,36 PORT,2PS,1U	IS	\$0
811-0210	SPARE KIT-CABLE-IB QDR-QSFP-ACT OPT-10M	IS	\$0

811-0224	SPARES KIT-SAS CONTROLLER-S210/X410	IS	\$0
811-0225	SPARES KIT-BOOT DRIVE CARRIER-S210/X410	IS	\$0
811-0226	SPARES KIT-INTRUSION SWCH ASSY-S210/X410	IS	\$0
811-0227	SPARES KIT-BATTERY-S210/X410	IS	\$0
811-0229	SPARES KIT 900GB SED HDD 2.5 IN	IS	\$0
811-0230	SPARES KIT 800GB SED SSD 2.5 IN	IS	\$0
811-0231	SPARES KIT 800GB SED SSD 3.5 IN	IS	\$0
811-0232	Spares Kit/Optic/SFP+/SR/ 40Gbe	IS	\$0
811-0233	SPARES KIT 6TB HDD 3.5 IN SATA	IS	\$0
811-0234	SPARE KIT,DIMM, 4GB DDR3-1600, HD400	IS	\$0
811-0235	SPARE KIT, DIMM,16GB DDR3-1600,HD400	IS	\$0
811-0236	SPARE KIT, COVER SENSOR ASSEMBLY HD400	IS	\$0
811-0237	SPARE KIT, ASSY DISPLAY BOARD HD400	IS	\$0
811-0238	SPARE KIT, DENSE DPE SUITECASE HD400	IS	\$0
811-0239	SPARE KIT, ASSY BATTERY TWIN PACK HD400	IS	\$0
811-0240	SPARE KIT, CHASSIS WITH BASEBOARD HD400	IS	\$0
811-0241	SPARES KIT-DUAL SAS QUAD PORT HBA-GEN5	IS	\$0
811-0242	SPARE KIT, CONNECT DUAL QDR IB HD400	IS	\$0
811-0243	SPARE KIT, PCB TLA LOX PCIE NVRAM HD400	IS	\$0
811-0244	SPARE KIT, PCB M SATA CARR W/HOLD HD400	IS	\$0
811-0245	SPARE KIT, MSATA DEVICES HD400	IS	\$0
811-0246	SPARE KIT, FAN MODULE ASSY HD400	IS	\$0
811-0247	SPARE KIT, POWER SUPPLY SNGL CHNL HD400	IS	\$0
811-0248	SPARE KIT, ASSY 4U FRONT DENSE DPE HD400	IS	\$0
811-0249	SPARE KIT, 1U CABLE NOR DEPTH RACK HD400	IS	\$0
811-0250	SPARE KIT, 6TB SATA 512 ASSY HD400	IS	\$0
811-0251	SPARE KIT, ASSY 800GB MLC 3.5 SAS HD400	IS	\$0
811-0252	SPARE KIT, TITAN D 3 PHASE PDU HD400	IS	\$0
811-0253	SPARES KIT 1.6TB SSD 3.5 IN ROHS	IS	\$0
811-0254	SPARES KIT 1.6TB SSD 2.5 IN ROHS	IS	\$0
811-0255	SPARES KIT, 800G eMLC+ SSD, 2.5 IN, ROHS	IS	\$0
811-0256	SPARES KIT, 800G eMLC+ SSD, 3.5 IN, ROHS	IS	\$0
811-0257	SPARES KIT, 400G eMLC+ SSD, 2.5 IN, ROHS	IS	\$0
811-0258	SPARES KIT, 400G eMLC+ SSD, 3.5 IN, ROHS	IS	\$0
811-0259	SPARES KIT, 200G eMLC+ SSD, 2.5 IN, ROHS	IS	\$0
811-0260	SPARES KIT, 200G eMLC+ SSD, 3.5 IN, ROHS	IS	\$0
811-0261	SPARES KIT, 800G eMLC+ SSD SED, 2.5 ROHS	IS	\$0
811-0262	SPARES KIT, 800G eMLC+ SSD SED, 3.5 ROHS	IS	\$0
811-0263	SPARES KIT - 8TB HDD 3.5in NL-Series	IS	\$0
811-0264	SPARES KIT-FRONT PANEL ASSY-4U-NL410	IS	\$0
811-0265	SPARES KIT - FRONT PANEL ASSEMBLY-X210	IS	\$0
811-0266	SPARES KIT - POWER SUPPLY MODULE NL410	IS	\$0
811-0267	SPARES KIT - PCB LOX PCIe NVRAM w/ MLC	IS	\$0
811-0268	SPARES KIT - DIMM 8GB DDR3-1600	IS	\$0
811-0269	SPARES KIT - SLIDE RAIL KIT 2U	IS	\$0
811-0270	SPARES KIT - BATTERY PACK/LI-ION/18650	IS	\$0
811-0271	SPARES KIT DEEP RACK INSTALL KIT	IS	\$0
811-0272	SPARES KIT NORMAL DEPTH RACK INSTALL KIT	IS	\$0
811-0273	SPARES KIT - 6TB HDD 3.5in 4kn NL-Series	IS	\$0
811-0274	SPARES KIT - 6TB HDD 3.5in 4kn HD-Series	IS	\$0

811-0275	SPARES KIT - 6TB HDD SED 3.5in NL-Series	IS	\$0
811-0276	SPARES KIT - 6TB HDD SED 3.5in HD-Series	IS	\$0
811-0277	SPARES KIT - 8TB HDD 3.5in HD-Series	IS	\$0
811-0280	SPARE KIT - TITAN-D 3-PHASE WYE PDU	IS	\$0
811-0281	SPARE KIT - 32G BOOT DRIVE GEN 4	IS	\$0
812-0006	ASSY, S200 CHASSIS, 2U, 2.5, QDR	IS	\$0
812-0007	ASSY, X200 CHASSIS, 2U, 3.5, QDR	IS	\$0
812-0021	S210 CHASSIS - 2U	IS	\$0
812-0023	X410 CHASSIS - 4U	IS	\$0
812-0024	X210 CHASSIS - 2U	IS	\$0
812-0026	NL410 CHASSIS - 4U	IS	\$0
820-0003	FLD UPGRD KIT X-Series 1 x 200GB SSD	IS	\$8,373
820-0004	FLD UPGRD KIT X-Series 2 x 200GB SSD	IS	\$16,731
820-0005	FLD UPGRD KIT X-Series 3 x 200GB SSD	IS	\$25,515
820-0006	FLD UPGRD KIT X-Series 4 x 200GB SSD	IS	\$33,403
820-0007	FLD UPGRD KIT X-Series 5 x 200GB SSD	IS	\$41,738
820-0008	FLD UPGRD KIT X-Series 6 x 200GB SSD	IS	\$50,074
820-0009	FLD UPGRD KIT S-Series 1 x 200GB SSD	IS	\$8,419
820-0010	FLD UPGRD KIT S-Series 2 x 200GB SSD	IS	\$16,678
820-0011	FLD UPGRD KIT S-Series 4 x 200GB SSD	IS	\$33,212
820-0012	FLD UPGRD KIT S-Series 5 x 200GB SSD	IS	\$41,500
820-0013	FLD UPGRD KIT S-Series 6 x 200GB SSD	IS	\$49,788
820-0014	FLD UPGRD KIT DDR3 MEMORY 3 x 2GB	IS	\$1,043
820-0015	FLD UPGRD KIT DDR3 MEMORY 6 x 4GB	IS	\$2,514
820-0016	FLD UPGRD KIT DDR3 MEMORY 6 x 8GB	IS	\$4,268
820-0017	FLD UPGRD KIT DDR3 MEMORY 12 x 4GB	IS	\$4,947
820-0018	FLD UPGRD KIT DDR3 MEMORY 12 x 8GB	IS	\$9,039
820-0019	FLD UPGRD KIT 200/400 Dual 1GbE BaseT	IS	\$1,203
820-0020	FLD UPGRD KIT 200/400 2x10GE SFP+ NO OP	IS	\$3,597
820-0032	FLD UPGRD KIT DDR3 MEMORY 12 x 16GB	IS	\$22,240
820-0033	FLD UPGRD KIT X-Series 1 x 400GB SSD	IS	\$15,160
820-0034	FLD UPGRD KIT X-Series 2 x 400GB SSD	IS	\$30,374
820-0035	FLD UPGRD KIT X-Series 3 x 400GB SSD	IS	\$45,479
820-0036	FLD UPGRD KIT X-Series 4 x 400GB SSD	IS	\$60,639
820-0038	FLD UPGRD KIT 3.5IN 5x800GB SSD	IS	\$141,486
820-0039	FLD UPGRD KIT 3.5IN 5x800GB SSD SED	IS	\$183,932
820-0043	FLD UPGRD KIT X-Series 4 x 100GB SSD	IS	\$18,604
820-0044	FLD UPGRD KIT X-Series 5 x 400GB SSD	IS	\$75,799
820-0045	FLD UPGRD KIT S-Series 3 x 400GB SSD	IS	\$44,345
820-0056	FLD UPGRD KIT X-Series 6 x 400GB SSD	IS	\$92,218
820-0057	FLD UPGRD KIT S-Series 2 x 400GB SSD	IS	\$29,633
820-0058	FLD UPGRD KIT DDR3 MEMORY 3 x 16GB	IS	\$4,689
820-0059	FLD UPGRD KIT DDR3 MEMORY 3 x 8GB	IS	\$2,733
820-0060	FLD UPGRD KIT DDR3 MEMORY 6 x 16GB	IS	\$9,247
820-0061	FLD UPGRD KIT S-Series 2 x 800GB SSD	IS	\$58,038
820-0062	FLD UPGRD KIT X-Series 6 x 800GB SSD	IS	\$173,972
820-0063	FLD UPGRD KIT X-Series 4 x 800GB SSD	IS	\$116,231
820-0064	FLD UPGRD KIT S-Series 1 x 800GB SSD	IS	\$29,057
820-0065	FLD UPGRD KIT X-Series 2 x 800GB SSD	IS	\$54,653
820-0066	FLD UPGRD KIT X-Series 1 x 800GB SSD	IS	\$27,326

820-0067	FLD UPGRD KIT 3.5 IN 3 x 800GB SSD	IS	\$81,429
820-0068	FLD UPGRD KIT 3.5 IN 1 x 800GB SED SSD	IS	\$35,524
820-0069	FLD UPGRD KIT 3.5 IN 2 x 800GB SED SSD	IS	\$71,048
820-0070	FLD UPGRD KIT 3.5 IN 3 x 800GB SED SSD	IS	\$106,573
820-0071	FLD UPGRD KIT 3.5 IN 4 x 800GB SED SSD	IS	\$151,100
820-0072	FLD UPGRD KIT 3.5 IN 6 x 800GB SED SSD	IS	\$226,163
820-0073	Field Upgrade Kit, Memory 16x16GB	IS	\$25,737
820-0074	Field Upgrade Kit, Memory 8x16GB	IS	\$12,869
820-0075	FLD UPGRD KIT 2.5 IN 1 x 400GB SSD	IS	\$10,120
820-0076	FLD UPGRD KIT 2.5 IN 3 x 800GB SSD	IS	\$81,184
820-0077	FLD UPGRD KIT 2.5 IN 4 x 800GB SSD	IS	\$108,219
820-0078	FLD UPGRD KIT DDR3 MEMORY 3 x 16GB GEN5	IS	\$5,227
820-0079	FLD UPGRD KIT 3.5IN 1x1.6 TB SSD	IS	\$33,718
820-0080	FLD UPGRD KIT 3.5IN 2x1.6 TB SSD	IS	\$67,497
820-0081	FLD UPGRD KIT 3.5IN 4x1.6 TB SSD	IS	\$134,999
820-0082	FLD UPGRD KIT 3.5IN 6x1.6 TB SSD	IS	\$202,602
820-0083	FLD UPGRD KIT 2.5IN 1x1.6 TB SSD	IS	\$33,858
820-0084	FLD UPGRD KIT 2.5IN 2x1.6TB SSD	IS	\$67,545
820-0085	FLD UPGRD KIT 2.5IN 4x1.6TB SSD	IS	\$134,979
820-0086	FLD UPGRD KIT 2.5IN 6x1.6TB SSD	IS	\$202,412
820-0087	FIELD UPGRADE KIT MEMORY 8X8GB	IS	\$6,782
820-0088	FLD UPGRD KIT 3.5IN 3x1.6 TB SSD	IS	\$100,102
820-0089	FLD UPGRD KIT 2.5IN 3x1.6 TB SSD	IS	\$99,759
820-0090	FLD UPGRD KIT 3.5IN 1x1.6 TB SSD SED	IS	\$43,834
820-0091	FLD UPGRD KIT 3.5IN 2x1.6 TB SSD SED	IS	\$87,746
820-0092	FLD UPGRD KIT 3.5IN 3x1.6 TB SSD SED	IS	\$130,132
820-0093	FLD UPGRD KIT 3.5IN 4x1.6 TB SSD SED	IS	\$175,499
820-0094	FLD UPGRD KIT 3.5IN 6x1.6 TB SSD SED	IS	\$263,383
820-0095	FLD UPGRD KIT 2.5IN 1x1.6 TB SSD SED	IS	\$40,630
820-0096	FLD UPGRD KIT 2.5IN 2x1.6 TB SSD SED	IS	\$81,054
820-0097	FLD UPGRD KIT 2.5IN 4x1.6 TB SSD SED	IS	\$161,974
820-0098	FLD UPGRD KIT 24GB MEMORY 3 X 8GB GEN5	IS	\$2,866
820-0099	FLD UPGRD KIT S210/X410 2X40GBE	IS	\$6,349
851-0001	IQ 1920 GE SYSTEM	IS	\$0
851-0002	IQ 1920 IB SYSTEM	IS	\$0
851-0021	IQ 6000 GE SYSTEM	IS	\$0
851-0023	IQ 6000 IB SYSTEM	IS	\$0
851-0024	SWITCH, IB, 48 PORT, 7008P, CISCO	IS	\$0
851-0057	IQ ACCELERATOR-X	IS	\$0
851-0058	IQ ACCELERATOR-X CX4-8	IS	\$0
851-0059	IQ ACCELERATOR-X CX4-32	IS	\$0
851-0065	IQ ACCELERATOR-X SR-8 SFP+	IS	\$0
851-0066	IQ ACCELERATOR-X SR-32 SFP+	IS	\$0
851-0074	IQ BACKUP ACCELERATOR	IS	\$0
851-0099	2 SFP+ OPTICS KIT - 10GbE	IS	\$498
851-0157	R-SPR KIT - X/NL-Series 2 x 1TB HDD	IS	\$946
851-0158	R-SPR KIT - X/NL-Series 2 x 2TB HDD	IS	\$1,603
851-0159	R-SPR KIT - X/NL-Series 2 x 3TB HDD	IS	\$2,189
851-0160	R-SPR KIT - S-Series 2 x 300GB HDD	IS	\$1,089
851-0161	R-SPR KIT - S-Series 2 x 600GB HDD	IS	\$1,711

851-0163	R-SPR KIT - X-Series 1 x 200GB SLC SSD	IS	\$3,683
851-0164	R-SPR KIT - S-Series 1 x 200GB SLC SSD	IS	\$3,685
851-0176	FILLER PANEL KIT; 2U PANEL WITH CLIPS	IS	\$35
851-0177	DB9 TO RJ45 CONNECTOR	IS	\$35
851-0192	R-SPR KIT - S-Series 2 x 900GB HDD	IS	\$2,264
851-0193	R-SPR KIT - S-Series 1 x 400GB SLC SSD	IS	\$6,465
851-0194	RACK ASSY,TITAN 40U,4 PDU, EMC/ISILON	IS	\$11,202
851-0195	R-SPR KIT - X-Series 1 x 400GB SLC SSD	IS	\$6,529
851-0196	R-SPR KIT - S-Series 1 x 200GB SSD	IS	\$3,685
851-0197	R-SPR KIT - X-Series 1 x 200GB SSD	IS	\$3,683
851-0198	R-SPR KIT - S-Series 1 x 400GB SSD	IS	\$6,465
851-0199	R-SPR KIT - X-Series 1 x 400GB SSD	IS	\$6,529
851-0202	R-SPR KIT - X/NL-Series 2 x 4TB HDD	IS	\$2,903
851-0213	R-SPR KIT - X/NL-Series 2 x 3TB SED HDD	IS	\$3,065
851-0215	R-SPR KIT - X-Series 1 x 800GB SSD	IS	\$12,247
851-0216	R-SPR KIT - S-Series 1 x 800GB SSD	IS	\$12,247
851-0217	R-SPR KIT - S-Series 1 x 1.2TB HDD	IS	\$1,597
851-0218	R-SPR KIT - X/NL-Series 2 x 4TB SED HDD	IS	\$2,479
851-0219	R-SPR KIT - S210 2 x 900GB SED HDD	IS	\$2,717
851-0220	R-SPR KIT - S210 1 x 800GB SED SSD	IS	\$14,696
851-0221	R-SPR KIT - X-Series 1 x 800GB SED SSD	IS	\$15,921
851-0222	Transceiver/Optic/SFP+/SR/ 40Gbe	IS	\$2,369
851-0223	R-SPR KIT - NL-Series 1 x 6TB HDD	IS	\$1,537
851-0224	CABLE IB/40GBE MPO TRANSCEIVER 10M	IS	\$468
851-0225	CABLE IB/40GBE MPO TRANSCEIVER 30M	IS	\$991
851-0226	CABLE IB/40GBE MPO TRANSCEIVER 50M	IS	\$1,679
851-0227	CABLE IB/40GBE MPO TRANSCEIVER 100M	IS	\$2,818
851-0229	RACK ASSY TITAN D 40U 4 PDU SINGLE PHASE	IS	\$17,419
851-0230	RACK ASSY TITAN-D 40U 4PDU 3-PHASE DELTA	IS	\$19,908
851-0231	R-SPR KIT - HD-Series 1 x 6TB HDD	IS	\$1,596
851-0232	R-SPR KIT - HD-Series 1 x 800GB SSD	IS	\$8,973
851-0233	R-SPR KIT - S210 1 X 1.6TB SSD	IS	\$10,847
851-0234	R-SPR KIT - X410 1 X 1.6TB SSD	IS	\$10,849
851-0235	R-SPR KIT - NL-Series 1 X 8TB HDD	IS	\$1,684
851-0236	R-SPR KIT - NL-Series 1 x 6TB HDD 4kn	IS	\$1,304
851-0237	R-SPR KIT - HD-Series 1 x 6TB HDD 4kn	IS	\$1,377
851-0238	R-SPR KIT - NL-Series 1 x 6TB SED HDD	IS	\$1,422
851-0239	R-SPR KIT - HD-Series 1 x 6TB SED HDD	IS	\$1,499
851-0240	R-SPR KIT - HD-Series 1 x 8TB HDD	IS	\$1,472
851-0241	R-SPR KIT - S210 1 x 1.6TB SED SSD	IS	\$9,410
851-0242	R-SPR KIT - X410/NL410 1 x 1.6TB SED SSD	IS	\$9,420
851-0243	RACK ASSY TITAN-D 40U 4 PDU 3-PHASE WYE	IS	\$17,121
851-0244	TITAN-D 40U 4 PDU 3-PHASE WYE CONVERSION	IS	\$10,069
851-0245	R-SPR KIT - NL-Series 1 x 8TB HDD SED	IS	\$2,523
851-0246	R-SPR KIT - HD-Series 1 x 8TB HDD SED	IS	\$2,801
851-0247	CABLE/IB QDR/QSFP-QSFP/1M ORANGE	IS	\$303
851-0248	CABLE/IB QDR/QSFP-QSFP/1M GREEN	IS	\$303
851-0249	CABLE/IB QDR/QSFP-QSFP/3M ORANGE	IS	\$787
851-0250	CABLE/IB QDR/QSFP-QSFP/3M GREEN	IS	\$787
851-0251	CABLE/IB QDR/QSFP-QSFP/5M ORANGE	IS	\$1,525

851-0252	CABLE/IB QDR/QSFP-QSFP/5M GREEN	IS	\$1,525
851-0253	CABLE, ETHERNET, 40G, PASS, HALFFREE, 1M	IS	\$224
851-0254	CABLE, ETHERNET, 40G, PASS, HALFFREE, 3M	IS	\$323
851-0255	CABLE, ETHERNET, 40G, PASS, PLENUM, 5M	IS	\$893
851-0256	CABLE, ETHERNET, 40GbE, ACT OPT, 10M	IS	\$1,389
851-0295	R-SPR KIT - HD-Series 1 x 1.6TB SSD	IS	\$29,080
851-0301	CABLE, ETHERNET, 40G, PASS, HALFFREE, 4M	IS	\$420
861-0022	X400-36TB 24GB RAM 2X10GESFP+2X1GE	IS	\$73,204
861-0024	X400-72TB 24GB 2X10GESFP+2X1GE	IS	\$95,222
861-0025	X400-108TB 24GB 2X10GESFP+2X1GE	IS	\$114,830
861-0026	NL400-36TB 12GB 2X10GESFP+2X1GE	IS	\$55,846
861-0027	NL400-72TB 12GB 2X10GESFP+2X1GE	IS	\$72,471
861-0028	NL400-108TB 12GB 2X10GESFP+2X1GE	IS	\$90,518
861-0029	X400-144TB 24GB 2X10GESFP+2X1GE	IS	\$138,315
861-0030	NL400-144TB 12GB 2X10GESFP+2X1GE	IS	\$107,986
861-0031	X400-34TB 800GBSSD 24GB 2X10GESFP+2X1GE	IS	\$96,565
861-0032	S200-13.2TB 400GBSSD 96G 2X10GESFP+2X1GE	IS	\$70,557
861-0033	S200-10.8TB SSD 1.2T SSD 96GB 4X1GE	IS	\$87,163
861-0034	X200-24TB 6GB 4X1GE	IS	\$38,957
861-0035	X200-36TB 24GB 2X10GESFP+2X1GE	IS	\$50,681
861-0036	X400-66TB 1.2T SSD 24GB 2X10GESFP+2X1GE	IS	\$128,351
861-0038	NL400-36TB 12GB 4x1GE	IS	\$53,363
861-0039	NL400-72TB 12GB 4x1GE	IS	\$70,084
861-0040	NL400-108TB 12GB 4x1GE	IS	\$88,824
861-0042	X400-36TB 24GB 4x1GE	IS	\$71,260
861-0043	X400-72TB 24GB 4x1GE	IS	\$93,014
861-0044	X400-108TB 24GB RAM 4x1GE	IS	\$112,458
861-0046	X400-34TB 800GBSSD 24GB 4X1GE	IS	\$82,612
861-0056	X400-120T/2.4 T/SSD/24G/2X10GESFP+2X1GE	IS	\$198,117
861-0057	X400-108TB, 48GB RAM, 2x10GE SFP+ & 2x1G	IS	\$118,050
861-0058	NL400-108TB, 48GB RAM, 2x10GE SFP+ & 2x1	IS	\$93,669
861-0059	X200-24TB, 12GB RAM, 2x10GE SFP+ & 2x1GE	IS	\$40,423
861-0064	NL400-108TB/24GB/2x10GE SFP+/2x1GE	IS	\$92,427
861-0065	NL400-144TB/24GB/2x10GE SFP+/2x1GE	IS	\$109,709
861-0066	NL400-144TB/48GB/2x10GE SFP+/2x1GE	IS	\$110,914
861-0067	X400-96TB+1.6TBSSD/48G/2x10GE SFP+/2x1GE	IS	\$156,952
861-0114	X200-12TB 6GB 4X1GE	IS	\$25,654
861-0115	X200-12TB 6GB 2X10GESFP+2X1GE	IS	\$27,375
861-0116	X200-12TB 12GB 2X10GESFP+2X1GE	IS	\$27,658
861-0117	X200-36TB 6GB 4X1GE	IS	\$46,833
861-0118	X200-36TB 12GB 4X1GE	IS	\$47,182
861-0119	X200-36TB 6GB 2X10GESFP+2X1GE	IS	\$48,953
861-0120	X200-36TB 12GB 2X10GESFP+2X1GE	IS	\$49,306
861-0121	X200-11TB 200GBSSD 24GB 2X10GESFP+2X1GE	IS	\$39,703
861-0122	X200-20TB 400GBSSD 24GB 2X10GESFP+2X1GE	IS	\$50,398
861-0123	X200-12T+1.2T SSD/24G/2X10GE SFP+2X1GE	IS	\$74,082
861-0124	X200-27TB 600GBSSD 24GB 2X10GESFP+2X1GE	IS	\$62,168
861-0125	S200-7.2TB 24GB 4X1GE	IS	\$48,255
861-0126	S200-7.2TB 24GB 2X10GESFP+2X1GE	IS	\$50,320
861-0127	S200-6.9TB 200GBSSD 48GB 2X10GESFP+2X1GE	IS	\$52,767

861-0128	S200-14.4TB 24GB 4X1GE	IS	\$61,598
861-0129	S200-14.4TB 24GB 2X10GESFP+2X1GE	IS	\$63,527
861-0130	S200-13.2TB 400GBSSD 48G 2X10GESFP+2X1GE	IS	\$68,927
985-0100	DOCUMENT - SPECIAL ORDER INSTRUCTION	IS	\$0
A100-BACKUP	A100 Backup 4x8GFC 4x1GE	IS	\$36,158
A100-BACKUP-64	A100 Backup Accelerator 64G 4x8GFC 4x1GE	IS	\$39,183
A100-PERF-256	A100 Performance 256GB 2x10GE 4x1GE	IS	\$42,750
HD400-RACK-S17	HD400 PRERACK-354T+800G SSD/24G/2x10GE	IS	\$213,810
HD400-RACK-S17-HO	HD400 PRERACK-354T+800G SSD/24G/2x10G HO	IS	\$138,514
HD400-RACK-S18	HD400 PRERACK-354T+800G SSD/48G/2x10GE	IS	\$216,158
HD400-RACK-S18-HO	HD400 PRERACK-354T+800G SSD/48G/2x10G HO	IS	\$139,191
HD400-RACK-S37	HD400 PRERACK-472T+1.6T SSD/24G/2x10GE	IS	\$256,572
HD400-RACK-S37-HO	HD400 PRERACK-472T+1.6T SSD/24G/2x10G HO	IS	\$155,888
HD400-RACK-S38	HD400 PRERACK-472T+1.6T SSD/48G/2x10GE	IS	\$259,390
HD400-RACK-S38-HO	HD400 PRERACK-472T+1.6T SSD/48G/2x10G HO	IS	\$158,648
HD400-RACK-S39	HD400 PRERACK-354T+800G SSD4kn/24G/2x10G	IS	\$213,810
HD400-RACK-S39-HO	HD400 RACK-354T+800G SSD4kn/24G/2x10G HO	IS	\$138,514
HD400-RACK-S40	HD400 PRERACK-354T+800G SSD4kn/48G/2x10G	IS	\$216,158
HD400-RACK-S40-HO	HD400 RACK-354T+800G SSD4kn/48G/2x10G HO	IS	\$139,191
HD400-SATA-E07	HD400-354T+800G SSD-SED/24G/2x10GE 2x1GE	IS	\$277,953
HD400-SATA-E07-HO	HD400-354T+800G SSD-SED/24G/2x10GE/HO	IS	\$186,993
HD400-SATA-E08	HD400-354T+800G SSD-SED/48G/2x10GE 2x1GE	IS	\$281,006
HD400-SATA-E08-HO	HD400-354T+800G SSD-SED/48G/2x10GE/HO	IS	\$187,908
HD400-SATA-E09	HD400-472T+1.6T SSD-SED/24G/2x10GE/2x1GE	IS	\$333,543
HD400-SATA-E09-HO	HD400-472T+1.6T SSD-SED/24G/2x10GE/HO	IS	\$210,448
HD400-SATA-E10	HD400-472T+1.6T SSD-SED/48G/2x10GE/2x1GE	IS	\$337,207
HD400-SATA-E10-HO	HD400-472T+1.6T SSD-SED/48G/2x10GE/HO	IS	\$214,175
HD400-SATA-S17	HD400-354T+800G SSD/24G/2x10GE/2x1GE	IS	\$213,810
HD400-SATA-S17-HO	HD400-354T+800G SSD/24G/2x10GE/2x1GE	IS	\$138,514
HD400-SATA-S18	HD400-354T+800G SSD/48G/2x10GE/2x1GE	IS	\$216,158
HD400-SATA-S18-HO	HD400-354T+800G SSD/48G/2x10GE 2x1GE/HO	IS	\$139,191
HD400-SATA-S37	HD400-472TB+1.6TB SSD/24G/2x10GbE+2x1GE	IS	\$256,572
HD400-SATA-S37-HO	HD400-472TB+1.6TB SSD/24G/2x10GE/HO	IS	\$155,888
HD400-SATA-S38	HD400-472TB+1.6TB SSD/48G/2x10GbE+2x1GE	IS	\$259,390
HD400-SATA-S38-HO	HD400-472TB+1.6TB SSD/48G/2x10GE/HO	IS	\$158,648
HD400-SATA-S39	HD400-354T+800G SSD 4kn/24G/2x10GE/2x1GE	IS	\$213,810
HD400-SATA-S39-HO	HD400-354T+800G SSD 4kn/24G/2x10GE/HO	IS	\$138,514
HD400-SATA-S40	HD400-354T+800G SSD 4kn/48G/2x10GE/2x1GE	IS	\$216,158
HD400-SATA-S40-HO	HD400-354T+800G SSD 4kn/48G/2x10GE/HO	IS	\$139,191
LADDER	CUSTOMER SERVICE LADDER KIT-ISILON	IS	\$200
NL400-SAS-E01	NL400-108TB-SED/12G/4x1GE	IS	\$115,472
NL400-SAS-E02	NL400-108TB-SED/12G/2x10GE SFP 2x1GE	IS	\$117,673
NL400-SAS-E03	NL400-108TB-SED/24G/4x1GE	IS	\$117,875
NL400-SAS-E04	NL400-108TB-SED/24G/2x10GE SFP 2x1GE	IS	\$120,155
NL400-SAS-E05	NL400-108TB-SED/48G/4x1GE	IS	\$119,490
NL400-SAS-E06	NL400-108TB-SED/48G/2x10GE SFP 2x1GE	IS	\$121,770
NL400-SAS-E07	NL400-144TB-SED/12G/4x1GE	IS	\$138,979
NL400-SAS-E08	NL400-144TB-SED/12G/2x10GE SFP 2x1GE	IS	\$140,382
NL400-SAS-E09	NL400-144TB-SED/24G/4x1GE	IS	\$140,410
NL400-SAS-E10	NL400-144TB-SED/24G/2x10GE SFP 2x1GE	IS	\$142,622

NL400-SAS-E11	NL400-144TB-SED/48G/4x1GE	IS	\$141,977
NL400-SAS-E12	NL400-144TB-SED/48G/2x10GE SFP 2x1GE	IS	\$144,188
NL400-SAT-001	NL400-36T/24G/4x1GE	IS	\$56,105
NL400-SAT-002	NL400-36T/24G/2x10GE SFP+2x1GE	IS	\$57,858
NL400-SAT-003	NL400-36T/48G/4x1GE	IS	\$57,347
NL400-SAT-004	NL400-36T/48G/2x10GE SFP+2x1GE	IS	\$59,101
NL400-SAT-005	NL400-72T/24G/4x1GE	IS	\$72,932
NL400-SAT-006	NL400-72T/24G/2x10GE SFP+2x1GE	IS	\$74,633
NL400-SAT-007	NL400-72T/48G/4x1GE	IS	\$74,137
NL400-SAT-008	NL400-72T/48G/2x10GE SFP+2x1GE	IS	\$75,838
NL400-SAT-009	NL400-108T/24G/4x1GE	IS	\$90,673
NL400-SAT-010	NL400-108T/24G/2x10GE SFP+2x1GE	IS	\$95,285
NL400-SAT-011	NL400-108T/48G/4x1GE	IS	\$91,915
NL400-SAT-012	NL400-108T/48G/2x10GE SFP+2x1GE	IS	\$96,566
NL400-SAT-013	NL400-144T/12G/4x1GE	IS	\$106,907
NL400-SAT-014	NL400-144T/24G/4x1GE	IS	\$108,008
NL400-SAT-015	NL400-144T/24G/2x10GE SFP+2x1GE	IS	\$116,600
NL400-SAT-016	NL400-144T/48G/4x1GE	IS	\$109,213
NL400-SAT-017	NL400-144T/48G/2x10GE SFP+2x1GE	IS	\$117,881
NL400-SATA-E01	NL400-140T/800G SSD-SED/12G/2X10GE+2X1GE	IS	\$181,561
NL400-SATA-E02	NL400-140T/800G SSD-SED/12G/4x1GE	IS	\$178,094
NL400-SATA-E03	NL400-140T/800G SSD-SED/24G/2X10GE+2X1GE	IS	\$182,673
NL400-SATA-E04	NL400-140T/800G SSD-SED/24G/4x1GE	IS	\$179,206
NL400-SATA-E05	NL400-140T/800G SSD-SED/48G/2X10GE+2X1GE	IS	\$185,715
NL400-SATA-E06	NL400-140T/800G SSD-SED/48G/4x1GE	IS	\$182,248
NL400-SATA-E19	NL400-105T/800G-SSD-SED/12G/2X10GE+2X1GE	IS	\$161,650
NL400-SATA-E20	NL400-105T/800G-SSD-SED/12G/4x1GE	IS	\$158,432
NL400-SATA-E21	NL400-105T/800G-SSD-SED/24G/2X10GE+2X1GE	IS	\$163,041
NL400-SATA-E22	NL400-105T/800G-SSD-SED/24G/4x1GE	IS	\$159,524
NL400-SATA-E23	NL400-105T/800G-SSD-SED/48G/2X10GE+2X1GE	IS	\$166,073
NL400-SATA-E24	NL400-105T/800G-SSD-SED/48G/4x1GE	IS	\$162,557
NL400-SATA-E31	NL400-128T+3.2T SSD-SED/12G/2x10GE 2x1GE	IS	\$266,403
NL400-SATA-E32	NL400-128T+3.2T SSD-SED/12G/4x1GE	IS	\$263,149
NL400-SATA-E33	NL400-128T+3.2T SSD-SED/24G/2x10GE 2x1GE	IS	\$267,923
NL400-SATA-E34	NL400-128T+3.2T SSD-SED/24G/4x1GE	IS	\$264,669
NL400-SATA-E35	NL400-128T+3.2T SSD-SED/48G/2x10GE 2x1GE	IS	\$276,825
NL400-SATA-E36	NL400-128T+3.2T SSD-SED/48G/4x1GE	IS	\$267,779
NL400-SATA-E37	NL400-99T+2.4T SSD-SED/12G/2x10GE 2x1GE	IS	\$245,625
NL400-SATA-E38	NL400-99T+2.4T SSD-SED/12G/4x1GE	IS	\$242,037
NL400-SATA-E39	NL400-99T+2.4T SSD-SED/24G/2x10GE 2x1GE	IS	\$246,787
NL400-SATA-E40	NL400-99T+2.4T SSD-SED/24G/4x1GE	IS	\$243,198
NL400-SATA-E41	NL400-99T+2.4T SSD-SED/48G/2x10GE 2x1GE	IS	\$249,949
NL400-SATA-E42	NL400-99T+2.4T SSD-SED/48G/4x1GE	IS	\$246,361
NL400-SATA-E43	NL400-96T+3.2T SSD-SED/12G/2x10GE 2x1GE	IS	\$271,814
NL400-SATA-E44	NL400-96T+3.2T SSD-SED/12G/4x1GE	IS	\$268,225
NL400-SATA-E45	NL400-96T+3.2T SSD-SED/24G/2x10GE 2x1GE	IS	\$272,975
NL400-SATA-E46	NL400-96T+3.2T SSD-SED/24G/4x1GE	IS	\$269,387
NL400-SATA-E47	NL400-96T+3.2T SSD-SED/48G/2x10GE 2x1GE	IS	\$276,138
NL400-SATA-E48	NL400-96T+3.2T SSD-SED/48G/4x1GE	IS	\$272,549
NL400-SAT-S01	NL400-120T+2.4T SSD/12G/4x1GE	IS	\$181,620

NL400-SAT-S02	NL400-120T+2.4T SSD/12G/2x10GE SFP+2x1GE	IS	\$183,659
NL400-SAT-S03	NL400-120T+2.4T SSD/24G/4x1GE	IS	\$182,940
NL400-SAT-S04	NL400-120T+2.4T SSD/24G/2x10GE SFP+2x1GE	IS	\$184,979
NL400-SAT-S05	NL400-120T+2.4T SSD/48G/4x1GE	IS	\$184,385
NL400-SAT-S06	NL400-120T+2.4T SSD/48G/2x10GE SFP+2x1GE	IS	\$186,424
NL400-SAT-S07	NL400-136T+800GB SSD/24G/4x1GE	IS	\$150,245
NL400-SAT-S08	NL400-136T+800GBSSD/24G/2x10GE SFP+2x1GE	IS	\$152,348
NL400-SAT-S09	NL400-136T+800GB SSD/48G/4x1GE	IS	\$151,735
NL400-SAT-S10	NL400-136T+800GBSSD/48G/2x10GE SFP+2x1GE	IS	\$151,735
NL400-SAT-S11	NL400-140T+400GB SSD/24G/4x1GE	IS	\$145,007
NL400-SAT-S12	NL400-140T+400GBSSD/24G/2x10GE SFP+2x1GE	IS	\$147,175
NL400-SAT-S13	NL400-140T+400GB SSD/48G/4x1GE	IS	\$146,543
NL400-SAT-S14	NL400-140T+400GBSSD/48G/2x10GE SFP+2x1GE	IS	\$146,543
NL400-SAT-S41	NL400-102T+1.6T SSD/48G/2x10GE SFP+2x1GE	IS	\$170,417
NL400-SAT-S42	NL400-35T+800GB SSD/48G/2x10GbE+2x1GE	IS	\$96,071
NL400-SAT-S43	NL400-68T+1.6TB SSD/48G/2x10GbE+2x1GE	IS	\$133,617
NL400-SAT-S44	NL400-132T+2.4TB SSD/48GB/2x10GbE+2x1GE	IS	\$182,523
NL400-SAT-S45	NL400-210T+800G SSD/48G/2x10GE 2x1GE	IS	\$161,750
NL400-SAT-S46	NL400-210T+800G SSD/48G/4x1GE	IS	\$159,269
NL400-SAT-S47	NL400-210T+800G SSD/12G/2x10GE 2x1GE	IS	\$157,480
NL400-SAT-S48	NL400-210T+800G SSD/12G/4x1GE	IS	\$155,906
NL400-SAT-S49	NL400-210T+800G SSD/24G/2x10GE 2x1GE	IS	\$159,993
NL400-SAT-S50	NL400-210T+800G SSD/24G/4x1GE	IS	\$157,512
NL400-SAT-S51	NL400-140T+800G SSD/12G/4x1GE	IS	\$136,995
NL400-SAT-S52	NL400-140T+800G SSD/12G/2x10GE 2x1GE	IS	\$139,662
NL400-SAT-S53	NL400-140T+800G SSD/24G/4x1GE	IS	\$137,851
NL400-SAT-S54	NL400-140T+800G SSD/24G/2x10GE 2x1GE	IS	\$140,518
NL400-SAT-S55	NL400-140T+800G SSD/48G/4x1GE	IS	\$140,190
NL400-SAT-S56	NL400-140T+800G SSD/48G/2x10GE 2x1GE	IS	\$142,858
NL400-SAT-S57	NL400-105T+800G SSD/12G/4x1GE	IS	\$131,029
NL400-SAT-S58	NL400-35T+800G SSD/12G/4x1GE	IS	\$87,999
NL400-SAT-S59	NL400-35T+800G SSD/12G/2x10GE 2x1GE	IS	\$90,623
NL400-SAT-S60	NL400-35T+800G SSD/24G/4x1GE	IS	\$89,036
NL400-SAT-S61	NL400-35T+800G SSD/24G/2x10GE 2x1GE	IS	\$91,661
NL400-SAT-S62	NL400-35T+800G SSD/48G/4x1GE	IS	\$91,299
NL400-SAT-S63	NL400-105T+800G SSD/12G/2x10GE 2x1GE	IS	\$124,346
NL400-SAT-S64	NL400-105T+800G SSD/24G/4x1GE	IS	\$122,711
NL400-SAT-S65	NL400-105T+800G SSD/24G/2x10GE 2x1GE	IS	\$125,416
NL400-SAT-S66	NL400-105T+800G SSD/48G/4x1GE	IS	\$125,044
NL400-SAT-S67	NL400-105T+800G SSD/48G/2x10GE 2x1GE	IS	\$127,749
NL400-SAT-S68	NL400-70T+800G SSD/12G/4x1GE	IS	\$105,523
NL400-SAT-S69	NL400-70T+800G SSD/12G/2x10GE 2x1GE	IS	\$108,229
NL400-SAT-S70	NL400-70T+800G SSD/24G/4x1GE	IS	\$106,593
NL400-SAT-S71	NL400-70T+800G SSD/24G/2x10GE 2x1GE	IS	\$109,298
NL400-SAT-S72	NL400-70T+800G SSD/48G/4x1GE	IS	\$108,926
NL400-SAT-S73	NL400-70T+800G SSD/48G/2x10GE 2x1GE	IS	\$111,631
NL410-SAT-002	NL410-72T/24G/2x10GE 2x1GE	IS	\$71,678
NL410-SAT-002-HO	NL410-72T/24G/2x10GE 2x1GE/HO	IS	\$41,954
NL410-SAT-003	NL410-72T/48G/2x10GE 2x1GE	IS	\$72,835
NL410-SAT-003-HO	NL410-72T/48G/2x10GE 2x1GE/HO	IS	\$42,689

NL410-SAT-005	NL410-144T/24G/2x10GE 2x1GE	IS	\$105,365
NL410-SAT-005-HO	NL410-144T/24G/2x10GE 2x1GE/HO	IS	\$49,072
NL410-SAT-006	NL410-144T/48G/2x10GE 2x1GE	IS	\$106,522
NL410-SAT-006-HO	NL410-144T/48G/2x10GE 2x1GE/HO	IS	\$49,808
NL410-SAT-008	NL410-36T/24G/2x10GE 2x1GE	IS	\$55,567
NL410-SAT-008-HO	NL410-36T/24G/2x10GE 2x1GE/HO	IS	\$39,129
NL410-SAT-009	NL410-36T/48G/2x10GE 2x1GE	IS	\$56,760
NL410-SAT-009-HO	NL410-36T/48G/2x10GE 2x1GE/HO	IS	\$39,865
NL410-SAT-011	NL410-108T/24G/2x10GE 2x1GE	IS	\$88,767
NL410-SAT-011-HO	NL410-108T/24G/2x10GE 2x1GE/HO	IS	\$47,467
NL410-SAT-012	NL410-108T/48G/2x10GE 2x1GE	IS	\$89,960
NL410-SAT-012-HO	NL410-108T/48G/2x10GE 2x1GE/HO	IS	\$48,203
NL410-SAT-E02	NL410-144T SED/24G/2x10GE 2x1GE	IS	\$136,974
NL410-SAT-E02-HO	NL410-144T SED/24G/2x10GE 2x1GE/HO	IS	\$66,247
NL410-SAT-E03	NL410-144T SED/48G/2x10GE 2x1GE	IS	\$138,479
NL410-SAT-E03-HO	NL410-144T SED/48G/2x10GE 2x1GE/HO	IS	\$67,241
NL410-SAT-E04	INA NL410-140T+800G SSD-SED/12G/2x10GE	IS	\$181,561
NL410-SAT-E05	NL410-140T+800G SSD-SED/24G/2x10GE 2x1GE	IS	\$168,422
NL410-SAT-E05-HO	NL410-140T+800G SSD-SED/24G/2x10GE/HO	IS	\$83,575
NL410-SAT-E06	NL410-140T+800G SSD-SED/48G/2x10GE 2x1GE	IS	\$171,226
NL410-SAT-E06-HO	NL410-140T+800G SSD-SED/48G/2x10GE/HO	IS	\$84,650
NL410-SAT-E08	NL410-108T SED/24G/2x10GE 2x1GE	IS	\$115,397
NL410-SAT-E08-HO	NL410-108T SED/24G/2x10GE 2x1GE/HO	IS	\$64,080
NL410-SAT-E09	NL410-108T SED/48G/2x10GE 2x1GE	IS	\$116,948
NL410-SAT-E09-HO	NL410-108T SED/48G/2x10GE 2x1GE/HO	IS	\$65,074
NL410-SAT-E11	NL410-105T+800G SSD-SED/24G/2x10GE 2x1GE	IS	\$150,321
NL410-SAT-E11-HO	NL410-105T+800G SSD-SED/24G/2x10GE/HO	IS	\$81,428
NL410-SAT-E12	NL410-105T+800G SSD-SED/48G/2x10GE 2x1GE	IS	\$153,117
NL410-SAT-E12-HO	NL410-105T+800G SSD-SED/48G/2x10GE/HO	IS	\$82,483
NL410-SAT-E31	NL410-210T+800G SSD-SED/24G/2x10GE 2x1GE	IS	\$191,764
NL410-SAT-E31-HO	NL410-210T+800G SSD-SED/24G/2x10GE/HO	IS	\$111,025
NL410-SAT-E32	NL410-210T+800G SSD-SED/48G/2x10GE 2x1GE	IS	\$193,870
NL410-SAT-E32-HO	NL410-210T+800G SSD-SED/48G/2x10GE/HO	IS	\$111,999
NL410-SAT-E33	NL410-280T+1.6T SSD SED/24G/2x10GE 2x1GE	IS	\$230,116
NL410-SAT-E33-HO	NL410-280T+1.6T SSD SED/24G/2x10GE/HO	IS	\$120,477
NL410-SAT-E34	NL410-280T+1.6T SSD SED/48G/2x10GE 2x1GE	IS	\$232,644
NL410-SAT-E34-HO	NL410-280T+1.6T SSD SED/48G/2x10GE/HO	IS	\$120,882
NL410-SAT-S02	NL410-90T+2.4T SSD/24G/2x10GE 2x1GE	IS	\$156,960
NL410-SAT-S03	NL410-90T+2.4T SSD/48G/2x10GE 2x1GE	IS	\$159,202
NL410-SAT-S05	NL410-140T+800G SSD/24G/2x10GE 2x1GE	IS	\$129,555
NL410-SAT-S05-HO	NL410-140T+800G SSD/24G/2x10GE 2x1GE/HO	IS	\$61,907
NL410-SAT-S06	NL410-140T+800G SSD/48G/2x10GE 2x1GE	IS	\$131,564
NL410-SAT-S06-HO	NL410-140T+800G SSD/48G/2x10GE 2x1GE/HO	IS	\$62,703
NL410-SAT-S08	NL410-210T+800G SSD/24G/2x10GE 2x1GE	IS	\$147,511
NL410-SAT-S08-HO	NL410-210T+800G SSD/24G/2x10GE 2x1GE/HO	IS	\$82,241
NL410-SAT-S09	NL410-210T+800G SSD/48G/2x10GE 2x1GE	IS	\$149,131
NL410-SAT-S09-HO	NL410-210T+800G SSD/48G/2x10GE 2x1GE/HO	IS	\$82,962
NL410-SAT-S11	NL410-280T+1.6T SSD/24G/2x10GE 2x1GE	IS	\$177,013
NL410-SAT-S11-HO	NL410-280T+1.6T SSD/24G/2x10GE 2x1GE/HO	IS	\$89,243
NL410-SAT-S12	NL410-280T+1.6T SSD/48G/2x10GE 2x1GE	IS	\$178,957

NL410-SAT-S12-HO	NL410-280T+1.6T SSD/48G/2x10GE 2x1GE/HO	IS	\$89,542
NL410-SAT-S14	NL410-120T+2.4T SSD/24G/2x10GE 2x1GE	IS	\$170,548
NL410-SAT-S15	NL410-120T+2.4T SSD/48G/2x10GE 2x1GE	IS	\$171,880
NL410-SAT-S16	NL410-35T+800G SSD/48G/2x10GE 2x1GE	IS	\$82,214
NL410-SAT-S17	NL410-140T+400G SSD/24G/2x10GE 2x1GE	IS	\$115,158
NL410-SAT-S17-HO	NL410-140T+400G SSD/24G/2x10GE 2x1GE	IS	\$55,752
NL410-SAT-S18	NL410-140T+400G SSD/48G/2x10GE 2x1GE	IS	\$116,665
NL410-SAT-S18-HO	NL410-140T+400G SSD/48G/2x10GE 2x1GE/HO	IS	\$56,524
NL410-SAT-S20	NL410-34T+800G SSD/24G/2x10GE 2x1GE	IS	\$89,898
NL410-SAT-S21	NL410-34T+800G SSD/48G/2x10GE 2x1GE	IS	\$92,153
NL410-SAT-S22	NL410-68T+1.6T SSD/48G/2x10GE 2x1GE	IS	\$123,193
NL410-SAT-S23	NL410-102T+1.6T SSD/48G/2x10GE 2x1GE	IS	\$157,122
NL410-SAT-S24	NL410-136T+800G SSD/24G/2x10GE 2x1GE	IS	\$140,462
NL410-SAT-S25	NL410-136T+800G SSD/48G/2x10GE 2x1GE	IS	\$139,897
NL410-SAT-S26	NL410-66T+1.2T SSD/48G/2x10GE 2x1GE	IS	\$113,382
NL410-SAT-S27	NL410-132T+2.4T SSD/48G/2x10GE 2x1GE	IS	\$168,283
NL410-SAT-S29	NL410-64T+1.6T SSD/24G/2x10GE 2x1GE	IS	\$122,702
NL410-SAT-S30	NL410-64T+1.6T SSD/48G/2x10GE 2x1GE	IS	\$124,888
NL410-SAT-S31	NL410-96T+1.6T SSD/24G/2x10GE 2x1GE	IS	\$139,951
NL410-SAT-S33	NL410-128T+3.2T SSD/24G/2x10GE 2x1GE	IS	\$190,016
NL410-SAT-S34	NL410-128T+3.2T SSD/48G/2x10GE 2x1GE	IS	\$196,329
NL410-SAT-S37	NL410-70T+400G SSD/24G/2x10GE 2x1GE	IS	\$82,810
NL410-SAT-S37-HO	NL410-70T+400G SSD/24G/2x10GE 2x1GE/HO	IS	\$48,508
NL410-SAT-S38	NL410-70T+400G SSD/48G/2x10GE 2x1GE	IS	\$84,125
NL410-SAT-S38-HO	NL410-70T+400G SSD/48G/2x10GE 2x1GE/HO	IS	\$49,279
NL410-SAT-S40	NL410-35T+200G SSD/24G/2x10GE 2x1GE	IS	\$64,111
NL410-SAT-S40-HO	NL410-35T+200G SSD/24G/2x10GE 2x1GE/HO	IS	\$42,324
NL410-SAT-S41	NL410-35T+200G SSD/48G/2x10GE 2x1GE	IS	\$65,252
NL410-SAT-S41-HO	NL410-35T+200G SSD/48G/2x10GE 2x1GE/HO	IS	\$43,078
NL410-SAT-S42	NL410-105T+800G SSD/24G/2x10GE 2x1GE	IS	\$115,631
NL410-SAT-S42-HO	NL410-105T+800G SSD/24G/2x10GE 2x1GE/HO	IS	\$60,317
NL410-SAT-S43	NL410-105T+800G SSD/48G/2x10GE 2x1GE	IS	\$117,782
NL410-SAT-S43-HO	NL410-105T+800G SSD/48G/2x10GE 2x1GE/HO	IS	\$61,099
NL410-SAT-S44	NL410-210T+800G SSD 4kn/24G/2x10GE 2x1GE	IS	\$147,511
NL410-SAT-S45	NL410-210T+800G SSD 4kn/48G/2x10GE 2x1GE	IS	\$149,131
NL410-SAT-S47	NL410-35T+800G SSD/24G/2x10GE 2x1GE	IS	\$80,963
NL800-0072	Field Upgrade Kit,3.5in,6x800GB SED SSD	IS	\$271,916
NL820-0006	NL400 GNA ENABLER KIT 2 X 800GB	IS	\$69,722
NL820-0034	NL400 GNA ENABLER KIT 2 X 400GB SSD	IS	\$36,647
NL820-0035	INACTIVE - NL400 GNA ENABLER KIT	IS	\$52,274
NL820-0036	NL400 GNA ENABLER KIT 4 X 400GB SSD	IS	\$69,152
NL820-0056	NL400 GNA ENABLER KIT 6 x 400GB SSD	IS	\$95,594
NL820-0063	NL400 GNA ENABLER KIT 4 x 800GB SSD	IS	\$120,617
NL820-0066	Metadata Acc Kit NL400 1x800GB SSD	IS	\$30,816
NL820-0067	Metadata Acc Kit NL400 3x800GB SSD	IS	\$104,792
NL820-0068	Field Upgrade Kit,3.5in,1x800GB SED SSD	IS	\$46,182
NL820-0069	Field Upgrade Kit,3.5in,2x800GB SED SSD	IS	\$90,639
NL820-0070	Field Upgrade Kit,3.5in,3x800GB SED SSD	IS	\$136,229
NL820-0071	Field Upgrade Kit,3.5in,4x800GB SED SSD	IS	\$156,802
S200-SAS-001	S200-7.2T/48G/4x1GE	IS	\$50,689

S200-SAS-002	S200-7.2T/48G/2x10GE SFP+2x1GE	IS	\$52,613
S200-SAS-003	S200-7.2T/96G/4x1GE	IS	\$52,982
S200-SAS-004	S200-7.2T/96G/2x10GE SFP+2x1GE	IS	\$54,905
S200-SAS-005	S200-14.4T/48G/4x1GE	IS	\$63,583
S200-SAS-006	S200-14.4T/48G/2x10GE SFP+2x1GE	IS	\$65,506
S200-SAS-007	S200-14.4T/96G/4x1GE	IS	\$65,875
S200-SAS-008	S200-14.4T/96G/2x10GE SFP+2x1GE	IS	\$67,799
S200-SAS-009	S200-7.2T/24G/4x1GE	IS	\$0
S200-SAS-010	S200-7.2T/24G/2x10GE SFP+2x1GE	IS	\$0
S200-SAS-011	S200-14.4T/24G/4x1GE	IS	\$0
S200-SAS-012	S200-14.4T/24G/2x10GE SFP+2x1GE	IS	\$0
S200-SAS-013	S200-21.6T/96G/4x1GE	IS	\$79,759
S200-SAS-014	S200-21.6T/96G/2x10GE SFP+2x1GE	IS	\$81,683
S200-SAS-015	S200-21.6T/24G/4x1GE	IS	\$76,104
S200-SAS-016	S200-21.6T/24G/2x10GE SFP+2x1GE	IS	\$78,028
S200-SAS-017	S200-21.6T/48G/4x1GE	IS	\$77,467
S200-SAS-018	S200-21.6T/48G/2x10GE SFP+2x1GE	IS	\$79,391
S200-SAS-019	S200-28.8T/48G/2x10GE SFP+2x1GE	IS	\$91,801
S200-SAS-020	S200-28.8T/96G/2x10GE SFP+2x1GE	IS	\$95,508
S200-SAS-S01	S200-6.9T+200G SSD/24G/4x1GE	IS	\$50,215
S200-SAS-S02	S200-6.9T+200G SSD/24G/2x10GE SFP+2x1GE	IS	\$51,975
S200-SAS-S03	S200-6.9T+200G SSD/48G/4x1GE	IS	\$51,462
S200-SAS-S04	S200-6.9T+200G SSD/96G/4x1GE	IS	\$53,559
S200-SAS-S05	S200-6.9T+200G SSD/96G/2x10GE SFP+2x1GE	IS	\$55,320
S200-SAS-S06	S200-5.4T+1.2T SSD/24G/4x1GE	IS	\$75,281
S200-SAS-S07	S200-5.4T+1.2T SSD/24G/2x10GE SFP+2x1GE	IS	\$77,112
S200-SAS-S08	S200-5.4T+1.2T SSD/48G/4x1GE	IS	\$76,477
S200-SAS-S09	S200-5.4T+1.2T SSD/48G/2x10GE SFP+2x1GE	IS	\$78,308
S200-SAS-S10	S200-5.4T+1.2T SSD/96G/4x1GE	IS	\$78,206
S200-SAS-S11	S200-5.4T+1.2T SSD/96G/2x10GE SFP+2x1GE	IS	\$79,966
S200-SAS-S12	S200-13.2T+400G SSD/24G/4x1GE	IS	\$66,210
S200-SAS-S13	S200-13.2T+400G SSD/24G/2x10GE SFP+2x1GE	IS	\$67,970
S200-SAS-S14	S200-13.2T+400G SSD/48G/4x1GE	IS	\$67,457
S200-SAS-S15	S200-13.2T+400G SSD/96G/4x1GE	IS	\$69,554
S200-SAS-S16	S200-10.8T+1.2T SSD/24G/4x1GE	IS	\$84,488
S200-SAS-S17	S200-10.8T+1.2T SSD/24G/2x10GE SFP+2x1GE	IS	\$86,248
S200-SAS-S18	S200-10.8T+1.2T SSD/48G/4x1GE	IS	\$85,735
S200-SAS-S19	S200-10.8T+1.2T SSD/48G/2x10GE SFP+2x1GE	IS	\$87,495
S200-SAS-S20	S200-10.8T+1.2T SSD/96G/2x10GE SFP+2x1GE	IS	\$89,593
S200-SAS-S21	S200-5.5T+200G SSD/24G/2x10GE SFP+2x1GE	IS	\$99,562
S200-SAS-S22	S200-6.9T+200G SSD/24G/2x10GE SFP+2x1GE	IS	\$100,713
S200-SAS-S23	S200-6.9T+200G SSD/48G/2x10GE SFP+2x1GE	IS	\$100,189
S200-SAS-S24	S200-6.9T+200G SSD/48G/2x1GE	IS	\$105,140
S200-SAS-S25	S200-13.2T+400G SSD/48G/2x10GE SFP+2x1GE	IS	\$102,330
S200-SAS-S26	S200-10.8T+1.2T SSD/48G/2x10GE SFP+2x1GE	IS	\$104,126
S200-SAS-S27	S200-19.8T+400G SSD/24G/4x1GE	IS	\$77,841
S200-SAS-S28	S200-19.8T+400G SSD/24G/2x10GE SFP+2x1GE	IS	\$79,602
S200-SAS-S29	S200-19.8T+400G SSD/48G/4x1GE	IS	\$79,088
S200-SAS-S30	S200-19.8T+400G SSD/48G/2x10GE SFP+2x1GE	IS	\$80,849
S200-SAS-S31	S200-19.8T+400G SSD/96G/4x1GE	IS	\$81,186

S200-SAS-S32	S200-19.8T+400G SSD/96G/2x10GE SFP+2x1GE	IS	\$82,946
S200-SAS-S33	S200-18.9T+1.2T SSD/24G/4x1GE	IS	\$97,014
S200-SAS-S34	S200-18.9T+1.2T SSD/24G/2x10GE SFP+2x1GE	IS	\$98,855
S200-SAS-S35	S200-18.9T+1.2T SSD/48G/4x1GE	IS	\$98,294
S200-SAS-S36	S200-18.9T+1.2T SSD/48G/2x10GE SFP+2x1GE	IS	\$100,135
S200-SAS-S37	S200-18.9T+1.2T SSD/96G/4x1GE	IS	\$100,521
S200-SAS-S38	S200-18.9T+1.2T SSD/96G/2x10GE SFP+2x1GE	IS	\$102,361
S200-SAS-S39	S200-13.2T+800G SSD/48G/2x10GE SFP+2x1GE	IS	\$91,012
S200-SAS-S40	S200-16.2T+2.4T SSD/48G/2x10GE SFP+2x1GE	IS	\$145,651
S200-SAS-S41	S200-13.2T 800G SSD/48G/4x1GE	IS	\$75,998
S200-SAS-S42	S200-13.2T 800G SSD/24G/4x1GE	IS	\$74,751
S200-SAS-S43	S200-13.2T 800G SSD/24G/2x10GE SFP 2x1GE	IS	\$76,511
S200-SAS-S44	S200-13.2T 800G SSD/96G/4x1GE	IS	\$78,096
S200-SAS-S45	S200-13.2T 800G SSD/96G/2x10GE SFP 2x1GE	IS	\$79,856
S200-SAS-S46	S200-16.2T 2.4T SSD/48G/4x1GE	IS	\$122,600
S200-SAS-S47	S200-16.2T 2.4T SSD/24G/4x1GE	IS	\$121,322
S200-SAS-S48	S200-16.2T 2.4T SSD/24G/2x10GE SFP 2x1GE	IS	\$123,162
S200-SAS-S49	S200-16.2T 2.4T SSD/96G/4x1GE	IS	\$124,818
S200-SAS-S50	S200-16.2T 2.4T SSD/96G/2x10GE SFP 2x1GE	IS	\$126,656
S200-SAS-S51	S200-10.8TB/2.4 TB/96G/4x1GE	IS	\$121,122
S200-SAS-S52	S200-13.2T/1.6T SSD/48G/2X10GE SFP 2X1GE	IS	\$98,991
S200-SAS-S53	S200-26.4T/1.6T SSD/48G/4x1GE	IS	\$130,542
S200-SAS-S54	S200-26.4T/1.6T SSD/48G/2x10GE SFP 2x1GE	IS	\$132,503
S200-SAS-S55	S200-13.2T/1.6T SSD/48G/4X1GE	IS	\$97,031
S200-SAS-S56	S200-26.4T/1.6T SSD/96G/2x10GE SFP 2x1GE	IS	\$136,210
S200-SAS-S57	S200-25.2T/2.4T SSD/96G/2x10GE SFP 2x1GE	IS	\$150,536
S200-SAS-S58	S200-24T/3.2T SSD/96G/2x10GE SFP 2x1GE	IS	\$164,862
S200-SAS-S59	S200-26.4T/800G SSD/48G/2x10GE 2x1GE	IS	\$106,084
S200-SAS-S60	S200-6.9T/800GB SSD/48G/2x10GE/2x1GE	IS	\$66,005
S200-SAS-S61	S200-6.9T/800GB SSD/96G/2x10GE/2x1GE	IS	\$69,396
S200-SAS-S62	S200-13.8T/800GB SSD/48G/2x10GE/2x1GE	IS	\$77,221
S200-SAS-S63	S200-13.8T/800GB SSD/96G/2x10GE/2x1GE	IS	\$80,612
S200-SAS-S64	S200-20.7T/800GB SSD/48G/2x10GE/2x1GE	IS	\$83,014
S200-SAS-S65	S200-20.7T/800GB SSD/96G/2x10GE/2x1GE	IS	\$86,323
S200-SAS-S66	S200-19.8T/1.6T SSD/48G/2x10GE/2x1GE	IS	\$97,345
S200-SAS-S67	S200-19.8T/1.6T SSD/96G/2x10GE/2x1GE	IS	\$100,654
S200-SAS-S68	S200-27.6T/800GB SSD/48G/2x10GE/2x1GE	IS	\$106,392
S200-SAS-S69	S200-27.6T/800GB SSD/96G/2x10GE/2x1GE	IS	\$110,037
S200-SAS-S70	S200-13.2T/1.6T SSD/96G/2x10GE/2x1GE	IS	\$101,342
S200-SSD-001	S200-2.4T/24G/4x1GE	IS	\$0
S200-SSD-002	S200-2.4T/24G/2x10GE SFP+2x1GE	IS	\$0
S200-SSD-003	S200-2.4T/48G/4x1GE	IS	\$0
S200-SSD-004	S200-2.4T/48G/2x10GE SFP+2x1GE	IS	\$0
S200-SSD-005	S200-2.4T/96G/4x1GE	IS	\$0
S200-SSD-006	S200-2.4T/96G/2x10GE SFP+2x1GE	IS	\$0
S200-SSD-007	S200-4.8T/24G/4x1GE	IS	\$166,839
S200-SSD-008	S200-4.8T/24G/2x10GE SFP+2x1GE	IS	\$168,691
S200-SSD-009	S200-4.8T/48G/4x1GE	IS	\$168,151
S200-SSD-010	S200-4.8T/48G/2x10GE SFP+2x1GE	IS	\$170,002
S200-SSD-011	S200-4.8T/96G/4x1GE	IS	\$170,357

S200-SSD-012	S200-4.8T/96G/2x10GE SFP+2x1GE	IS	\$172,209
S200-SSD-013	S200-9.6T/48G/2x10GE SFP+2x1GE	IS	\$346,609
S200-SSD-014	S200-9.6T SSD/48G/4x1GE	IS	\$294,280
S200-SSD-015	S200-9.6T SSD/24G/4x1GE	IS	\$292,969
S200-SSD-016	S200-9.6T SSD/24G/2x10GE SFP+2x1GE	IS	\$294,820
S200-SSD-017	S200-9.6T SSD/96G/4x1GE	IS	\$296,487
S200-SSD-018	S200-9.6T SSD/96G/2x10GE SFP+2x1GE	IS	\$298,339
S200-SSD-019	S200-19.2T/48G/2X10GE SFP 2X1GE	IS	\$547,302
S200-SSD-020	S200-19.2T SSD/48G/4X1GE	IS	\$544,905
S210-SAS-001	S210-7.2TB/32G/2x10GE+2x1GE	IS	\$53,752
S210-SAS-002	S210-7.2TB/64G/2x10GE+2x1GE	IS	\$55,899
S210-SAS-003	S210-14.4TB/32G/2x10GE+2x1GE	IS	\$65,983
S210-SAS-004	S210-14.4TB/64G/2x10GE+2x1GE	IS	\$68,504
S210-SAS-005	S210-21.6TB/64G/2x10GE+2x1GE	IS	\$76,789
S210-SAS-006	S210-21.6TB/128G/2x10GE+2x1GE	IS	\$81,485
S210-SAS-007	S210-21.6TB/256G/2x10GE+2x1GE	IS	\$92,218
S210-SAS-008	S210-28.8TB/64G/2x10GE+2x1GE	IS	\$91,925
S210-SAS-009	S210-28.8TB/128G/2x10GE+2x1GE	IS	\$96,621
S210-SAS-010	S210-28.8TB/256G/2x10GE+2x1GE	IS	\$107,354
S210-SAS-011	S210-14.4T/128G/2x10GE/2x1GE	IS	\$76,200
S210-SAS-012	S210-14.4T/256G/2x10GE/2x1GE	IS	\$87,214
S210-SAS-013	S210-7.2T/128G/2x10GE/2x1GE	IS	\$63,379
S210-SAS-014	S210-7.2T/256G/2x10GE/2x1GE	IS	\$74,110
S210-SAS-015	S210-14.4T/128G/2x40GE/2x1GE	IS	\$77,847
S210-SAS-016	S210-14.4T/256G/2x40GE/2x1GE	IS	\$88,903
S210-SAS-017	S210-14.4T/64G/2x40GE/2x1GE	IS	\$70,068
S210-SAS-018	S210-21.6T/128G/2x40GE/2x1GE	IS	\$83,117
S210-SAS-019	S210-21.6T/256G/2x40GE/2x1GE	IS	\$93,885
S210-SAS-020	S210-21.6T/64G/2x40GE/2x1GE	IS	\$78,406
S210-SAS-021	S210-28.8T/128G/2x40GE/2x1GE	IS	\$98,368
S210-SAS-022	S210-28.8T/256G/2x40GE/2x1GE	IS	\$109,122
S210-SAS-023	S210-28.8T/64G/2x40GE/2x1GE	IS	\$93,664
S210-SAS-024	S210-7.2T/128G/2x40GE/2x1GE	IS	\$64,841
S210-SAS-025	S210-7.2T/256G/2x40GE/2x1GE	IS	\$75,631
S210-SAS-026	S210-7.2T/64G/2x40GE/2x1GE	IS	\$57,266
S210-SAS-E01	S210-21.6T SED/64G/2x10GE+2x1GE	IS	\$96,056
S210-SAS-E01-HO	S210-21.6T SED/64G/2x10GE 2x1GE/HO	IS	\$46,070
S210-SAS-E02	S210-21.6T SED/128G/2x10GE+2x1GE	IS	\$101,737
S210-SAS-E02-HO	S210-21.6T SED/128G/2x10GE 2x1GE/HO	IS	\$49,050
S210-SAS-E03	S210-21.6T SED/256G/2x10GE+2x1GE	IS	\$114,722
S210-SAS-E03-HO	S210-21.6T SED/256G/2x10GE 2x1GE/HO	IS	\$55,789
S210-SAS-E04	S210-20.7T+800G SSD-SED/64G/2x10GE+2x1GE	IS	\$114,547
S210-SAS-E04-HO	S210-20.7T/800G SSD-SED/64G/2x10GE/HO	IS	\$55,615
S210-SAS-E05	S210-20.7T+800G SSD-SED/128G/2x10GE2x1GE	IS	\$120,417
S210-SAS-E05-HO	S210-20.7T/800G SSD-SED/128G/2x10GE/HO	IS	\$58,595
S210-SAS-E06	S210-20.7T+800G SSD-SED/256G/2x10GE2x1GE	IS	\$133,834
S210-SAS-E06-HO	S210-20.7T/800G SSD-SED/256G/2x10GE/HO	IS	\$65,334
S210-SAS-E07	S210-19.8T+1.6T SSD-SED/64G/2x10GE+2x1GE	IS	\$134,240
S210-SAS-E07-HO	S210-19.8T/1.6T SSD-SED/64G/2x10GE/HO	IS	\$65,267
S210-SAS-E08	S210-19.8T+1.6T SSD-SED/128G/2x10G+2x1GE	IS	\$140,110

S210-SAS-E08-HO	S210-19.8T/1.6T SSD-SED/128G/2x10G/HO	IS	\$68,247
S210-SAS-E09	S210-19.8T+1.6T SSD-SED/256G/2x10G+2x1GE	IS	\$153,526
S210-SAS-E09-HO	S210-19.8T/1.6T SSD-SED/256G/2x10G/HO	IS	\$74,986
S210-SAS-E10	S210-20.7T+1.6T SSD-SED/64G/2x10GE 2x1GE	IS	\$122,654
S210-SAS-E11	S210-20.7T+1.6T SSD-SED/128G/2x10GE 2x1	IS	\$128,080
S210-SAS-E12	S210-20.7T+1.6T SSD-SED/256G/2x10GE 2x1	IS	\$140,481
S210-SAS-E13	S210-19.8T+3.2T SSD-SED/64G/2x10GE 2x1GE	IS	\$168,488
S210-SAS-E14	S210-19.8T+3.2T SSD-SED/128G/2x10GE 2x1	IS	\$174,123
S210-SAS-E15	S210-19.8T+3.2T SSD-SED/256G/2x10GE 2x1	IS	\$187,003
S210-SAS-E16	S210-18T+6.4T SSD-SED/64G/2x10GE 2x1GE	IS	\$269,025
S210-SAS-E17	S210-18T+6.4T SSD-SED/128G/2x10GE 2x1GE	IS	\$277,612
S210-SAS-E18	S210-18T+6.4T SSD-SED/256G/2x10GE 2x1GE	IS	\$297,047
S210-SAS-E19	S210-18T+6.4T SSD-SED/128G/2x40GE 2x1GE	IS	\$280,322
S210-SAS-E20	S210-18T+6.4T SSD-SED/256G/2x40GE 2x1GE	IS	\$299,803
S210-SAS-E21	S210-18T+6.4T SSD-SED/64G/2x40GE 2x1GE	IS	\$271,716
S210-SAS-E22	S210-19.8T/1.6T SSD-SED/128G/2x40GE/2x1G	IS	\$142,105
S210-SAS-E23	S210-19.8T/1.6T SSD-SED/256G/2x40GE/2x1G	IS	\$155,557
S210-SAS-E24	S210-19.8T/1.6T SSD-SED/64G/2x40GE/2x1GE	IS	\$136,221
S210-SAS-E25	S210-19.8T+3.2T SSD-SED/128G/2x40GE 2x1G	IS	\$176,399
S210-SAS-E26	S210-19.8T+3.2T SSD-SED/256G/2x40GE 2x1G	IS	\$189,286
S210-SAS-E27	S210-19.8T+3.2T SSD-SED/64G/2x40GE 2x1GE	IS	\$170,763
S210-SAS-E28	S210-20.7T/800G SSD-SED/128G/2x40GE2x1GE	IS	\$122,302
S210-SAS-E29	S210-20.7T/800G SSD-SED/256G/2x40GE2x1GE	IS	\$135,765
S210-SAS-E30	S210-20.7T/800G SSD-SED/64G/2x40GE/2x1GE	IS	\$116,412
S210-SAS-E31	S210-20.7T+1.6T SSD-SED/128G/2x40GE 2x1G	IS	\$130,110
S210-SAS-E32	S210-20.7T+1.6T SSD-SED/256G/2x40GE 2x1G	IS	\$142,532
S210-SAS-E33	S210-20.7T+1.6T SSD-SED/64G/2x40GE 2x1GE	IS	\$124,677
S210-SAS-E34	S210-21.6T SED/128G/2x40GE/2x1GE	IS	\$103,511
S210-SAS-E35	S210-21.6T SED/256G/2x40GE/2x1GE	IS	\$116,550
S210-SAS-E36	S210-21.6T SED/64G/2x40GE/2x1GE	IS	\$97,806
S210-SAS-S01	S210-13.2T/1.6T SSD/64G/2x10GE 2x1GE	IS	\$98,086
S210-SAS-S02	S210-13.2T/1.6T SSD/256G/2x10GE 2x1GE	IS	\$113,515
S210-SAS-S02-HO	S210-13.2T/1.6T SSD/256G/2x10GE 2x1GE/HO	IS	\$56,041
S210-SAS-S03	S210-6.9TB+400GB SSD/32G/2x10GE+2x1GE	IS	\$63,539
S210-SAS-S04	S210-6.9TB+400GB SSD/64G/2x10GE+2x1GE	IS	\$65,754
S210-SAS-S05	S210-6.9TB+800GB SSD/32G/2x10GE+2x1GE	IS	\$67,488
S210-SAS-S06	S210-6.9TB+800GB SSD/64G/2x10GE+2x1GE	IS	\$69,801
S210-SAS-S07	S210-13.8TB+400GB SSD/32G/2x10GE+2x1GE	IS	\$73,203
S210-SAS-S08	S210-13.8TB+400GB SSD/64G/2x10GE+2x1GE	IS	\$75,724
S210-SAS-S09	S210-13.8TB+800GB SSD/32G/2x10GE+2x1GE	IS	\$78,989
S210-SAS-S10	S210-13.8TB+800GB SSD/64G/2x10GE+2x1GE	IS	\$81,413
S210-SAS-S100	S210-6.9T+1.6T SSD/256G/2x10GE 2x1GE	IS	\$106,272
S210-SAS-S101	S210-13.8T+1.6T SSD/64G/2x10GE 2x1GE	IS	\$98,086
S210-SAS-S102	S210-13.8T+1.6T SSD/128G/2x10GE 2x1GE	IS	\$103,394
S210-SAS-S103	S210-13.8T+1.6T SSD/256G/2x10GE 2x1GE	IS	\$113,515
S210-SAS-S104	S210-13.2T+3.2T SSD/64G/2x10GE 2x1GE	IS	\$138,326
S210-SAS-S105	S210-13.2T+3.2T SSD/128G/2x10GE 2x1GE	IS	\$144,638
S210-SAS-S106	S210-13.2T+3.2T SSD/256G/2x10GE 2x1GE	IS	\$158,925
S210-SAS-S107	S210-20.7T+1.6T SSD/64G/2x10GE 2x1GE	IS	\$102,212
S210-SAS-S108	S210-20.7T+1.6T SSD/128G/2x10GE 2x1GE	IS	\$106,733

S210-SAS-S109	S210-20.7T+1.6T SSD/256G/2x10GE 2x1GE	IS	\$117,067
S210-SAS-S11	S210-13.8TB+800GB SSD/256G/2x10GE+2x1GE	IS	\$96,636
S210-SAS-S110	S210-19.8T+3.2T SSD/64G/2x10GE 2x1GE	IS	\$140,407
S210-SAS-S111	S210-19.8T+3.2T SSD/128G/2x10GE 2x1GE	IS	\$145,103
S210-SAS-S112	S210-19.8T+3.2T SSD/256G/2x10GE 2x1GE	IS	\$155,836
S210-SAS-S113	S210-18T+6.4T SSD/64G/2x10GE 2x1GE	IS	\$224,188
S210-SAS-S114	S210-18T+6.4T SSD/128G/2x10GE 2x1GE	IS	\$231,343
S210-SAS-S115	S210-18T+6.4T SSD/256G/2x10GE 2x1GE	IS	\$247,539
S210-SAS-S116	S210-27.6T+1.6T SSD/64G/2x10GE 2x1GE	IS	\$120,976
S210-SAS-S117	S210-27.6T+1.6T SSD/128G/2x10GE 2x1GE	IS	\$125,672
S210-SAS-S118	S210-27.6T+1.6T SSD/256G/2x10GE 2x1GE	IS	\$136,405
S210-SAS-S118-HO	S210-27.6T+1.6T SSD/256G/2x10GE 2x1GE/HO	IS	\$64,777
S210-SAS-S119	S210-26.4T+3.2T SSD/64G/2x10GE 2x1GE	IS	\$160,347
S210-SAS-S11-HO	S210-13.8T+800G SSD/256G/2x10GE 2x1GE/HO	IS	\$50,931
S210-SAS-S12	S210-20.7TB+400GB SSD/64G/2x10GE+2x1GE	IS	\$83,838
S210-SAS-S120	S210-26.4T+3.2T SSD/128G/2x10GE 2x1GE	IS	\$165,265
S210-SAS-S121	S210-26.4T+3.2T SSD/256G/2x10GE 2x1GE	IS	\$176,507
S210-SAS-S121-HO	S210-26.4T+3.2T SSD/256G/2x10GE 2x1GE/HO	IS	\$85,713
S210-SAS-S122	S210-24T+6.4T SSD/64G/2x10GE 2x1GE	IS	\$238,864
S210-SAS-S123	S210-24T+6.4T SSD/128G/2x10GE 2x1GE	IS	\$246,019
S210-SAS-S124	S210-24T+6.4T SSD/256G/2x10GE 2x1GE	IS	\$262,216
S210-SAS-S124-HO	S210-24T+6.4T SSD/256G/2x10GE 2x1GE/HO	IS	\$127,584
S210-SAS-S125	S210-21.6T+9.6T SSD/64G/2x10GE 2x1GE	IS	\$279,464
S210-SAS-S126	S210-21.6T+9.6T SSD/128G/2x10GE 2x1GE	IS	\$286,215
S210-SAS-S127	S210-21.6T+9.6T SSD/256G/2x10GE 2x1GE	IS	\$301,496
S210-SAS-S128	S210-10.8T+1.2T SSD/128/2x40GE 2x1GE	IS	\$97,878
S210-SAS-S129	S210-10.8T+1.2T SSD/64G/2x40GE 2x1GE	IS	\$92,802
S210-SAS-S13	S210-20.7TB+400GB SSD/128G/2x10GE+2x1GE	IS	\$88,534
S210-SAS-S130	S210-13.2T/1.6T SSD/128G/2x40GE/2x1GE	IS	\$109,507
S210-SAS-S131	S210-13.2T/1.6T SSD/256G/2x40GE 2x1GE	IS	\$120,062
S210-SAS-S132	S210-13.2T/1.6T SSD/64G/2x40GE 2x1GE	IS	\$103,958
S210-SAS-S133	S210-13.2T+3.2T SSD/128G/2x40GE 2x1GE	IS	\$152,737
S210-SAS-S134	S210-13.2T+3.2T SSD/256G/2x40GE 2x1GE	IS	\$167,666
S210-SAS-S135	S210-13.2T+3.2T SSD/64G/2x40GE 2x1GE	IS	\$146,141
S210-SAS-S136	S210-13.2T+400G SSD/128/2x40GE 2x1GE	IS	\$81,757
S210-SAS-S137	S210-13.2T+400G SSD/64G/2x40GE 2x1GE	IS	\$76,724
S210-SAS-S138	S210-13.2T+800G SSD/128/2x40GE 2x1GE	IS	\$87,594
S210-SAS-S139	S210-13.2T+800G SSD/64G/2x40GE 2x1GE	IS	\$82,711
S210-SAS-S14	S210-20.7TB+400GB SSD/256G/2x10GE+2x1GE	IS	\$99,267
S210-SAS-S140	S210-13.8T/400GB SSD/128G/2x40GE/2x1GE	IS	\$82,164
S210-SAS-S141	S210-13.8T/400GB SSD/256G/2x40GE/2x1GE	IS	\$94,620
S210-SAS-S142	S210-13.8T/400GB SSD/64G/2x40GE/2x1GE	IS	\$77,327
S210-SAS-S143	S210-13.8T/800GB SSD/128G/2x40GE/2x1GE	IS	\$85,418
S210-SAS-S144	S210-13.8T/800GB SSD/256G/2x40GE/2x1GE	IS	\$98,295
S210-SAS-S145	S210-13.8T/800GB SSD/64G/2x40GE/2x1GE	IS	\$83,028
S210-SAS-S146	S210-13.8T+1.6T SSD/128G/2x40GE 2x1GE	IS	\$109,514
S210-SAS-S147	S210-13.8T+1.6T SSD/256G/2x40GE 2x1GE	IS	\$120,069
S210-SAS-S148	S210-13.8T+1.6T SSD/64G/2x40GE 2x1GE	IS	\$103,966
S210-SAS-S149	S210-16.2T+2.4T SSD/128/2x40GE 2x1GE	IS	\$131,310
S210-SAS-S14-HO	S210-20.7T+400G SSD/256G/2x10GE 2x1GE/HO	IS	\$50,223

S210-SAS-S15	S210-20.7TB+800GB SSD/64G/2x10GE+2x1GE	IS	\$87,375
S210-SAS-S150	S210-16.2T+2.4T SSD/64G/2x40GE 2x1GE	IS	\$126,223
S210-SAS-S151	S210-16.2T+4.8T SSD/128/2x40GE 2x1GE	IS	\$177,454
S210-SAS-S152	S210-16.2T+4.8T SSD/256/2x40GE 2x1GE	IS	\$188,190
S210-SAS-S153	S210-16.2T+4.8T SSD/64G/2x40GE 2x1GE	IS	\$172,759
S210-SAS-S154	S210-18.9T+1.2T SSD/128/2x40GE 2x1GE	IS	\$106,821
S210-SAS-S155	S210-18.9T+1.2T SSD/64G/2x40GE 2x1GE	IS	\$101,785
S210-SAS-S156	S210-18.9T+2.4T SSD/128/2x40GE 2x1GE	IS	\$131,749
S210-SAS-S157	S210-18.9T+2.4T SSD/256/2x40GE 2x1GE	IS	\$142,492
S210-SAS-S158	S210-18.9T+2.4T SSD/64G/2x40GE 2x1GE	IS	\$127,051
S210-SAS-S159	S210-18T+3.2T SSD/128/2x40GE 2x1GE	IS	\$146,992
S210-SAS-S16	S210-20.7TB+800GB SSD/128G/2x10GE+2x1GE	IS	\$91,896
S210-SAS-S160	S210-18T+3.2T SSD/256/2x40GE 2x1GE	IS	\$157,732
S210-SAS-S161	S210-18T+3.2T SSD/64G/2x40GE 2x1GE	IS	\$142,295
S210-SAS-S162	S210-18T+6.4T SSD/128G/2x40GE 2x1GE	IS	\$233,602
S210-SAS-S163	S210-18T+6.4T SSD/256G/2x40GE 2x1GE	IS	\$249,835
S210-SAS-S164	S210-18T+6.4T SSD/64G/2x40GE 2x1GE	IS	\$226,430
S210-SAS-S165	S210-19.8T/1.6T SSD/128G/2x40GE/2x1GE	IS	\$108,417
S210-SAS-S166	S210-19.8T/1.6T SSD/256G/2x40GE/2x1GE	IS	\$118,770
S210-SAS-S167	S210-19.8T/1.6T SSD/64G/2x40GE/2x1GE	IS	\$103,890
S210-SAS-S168	S210-19.8T+3.2T SSD/128G/2x40GE 2x1GE	IS	\$146,999
S210-SAS-S169	S210-19.8T+3.2T SSD/256G/2x40GE 2x1GE	IS	\$157,738
S210-SAS-S16-HO	S210-20.7T+800G SSD/128G/2x10GE 2x1GE/HO	IS	\$48,829
S210-SAS-S17	S210-20.7TB+800GB SSD/256G/2x10GE+2x1GE	IS	\$102,230
S210-SAS-S170	S210-19.8T+3.2T SSD/64G/2x40GE 2x1GE	IS	\$142,303
S210-SAS-S171	S210-19.8T+400G SSD/128/2x40GE 2x1GE	IS	\$90,965
S210-SAS-S172	S210-19.8T+400G SSD/64G/2x40GE 2x1GE	IS	\$85,901
S210-SAS-S173	S210-20.7T/400GB SSD/128G/2x40GE/2x1GE	IS	\$90,194
S210-SAS-S174	S210-20.7T/400GB SSD/256G/2x40GE/2x1GE	IS	\$100,958
S210-SAS-S175	S210-20.7T/400GB SSD/64G/2x40GE/2x1GE	IS	\$85,486
S210-SAS-S176	S210-20.7T/800GB SSD/128G/2x40GE/2x1GE	IS	\$93,517
S210-SAS-S177	S210-20.7T/800GB SSD/256G/2x40GE/2x1GE	IS	\$103,877
S210-SAS-S178	S210-20.7T/800GB SSD/64G/2x40GE/2x1GE	IS	\$88,986
S210-SAS-S179	S210-20.7T+1.6T SSD/128G/2x40GE 2x1GE	IS	\$108,425
S210-SAS-S17-HO	S210-20.7T+800G SSD/256G/2x10GE 2x1GE/HO	IS	\$54,445
S210-SAS-S18	S210-19.8TB+1.6TB SSD/64G/2x10GE+2x1GE	IS	\$102,212
S210-SAS-S180	S210-20.7T+1.6T SSD/256G/2x40GE 2x1GE	IS	\$118,777
S210-SAS-S181	S210-20.7T+1.6T SSD/64G/2x40GE 2x1GE	IS	\$103,898
S210-SAS-S182	S210-21.6T+4.8T SSD/128/2x40GE 2x1GE	IS	\$188,932
S210-SAS-S183	S210-21.6T+4.8T SSD/256/2x40GE 2x1GE	IS	\$199,664
S210-SAS-S184	S210-21.6T+4.8T SSD/64G/2x40GE 2x1GE	IS	\$184,238
S210-SAS-S185	S210-21.6T+9.6T SSD/128G/2x40GE 2x1GE	IS	\$288,374
S210-SAS-S186	S210-21.6T+9.6T SSD/256G/2x40GE 2x1GE	IS	\$303,682
S210-SAS-S187	S210-21.6T+9.6T SSD/64G/2x40GE 2x1GE	IS	\$281,612
S210-SAS-S188	S210-24T+3.2T SSD/128/2x40GE 2x1GE	IS	\$167,302
S210-SAS-S189	S210-24T+3.2T SSD/256/2x40GE 2x1GE	IS	\$178,546
S210-SAS-S19	S210-19.8TB+1.6TB SSD/128G/2x10GE+2x1GE	IS	\$106,733
S210-SAS-S190	S210-24T+3.2T SSD/64G/2x40GE 2x1GE	IS	\$162,385
S210-SAS-S191	S210-24T+6.4T SSD/128G/2x40GE 2x1GE	IS	\$248,324
S210-SAS-S192	S210-24T+6.4T SSD/256G/2x40GE 2x1GE	IS	\$264,554

S210-SAS-S193	S210-24T+6.4T SSD/64G/2x40GE 2x1GE	IS	\$241,154
S210-SAS-S194	S210-25.2T+2.4T SSD/128/2x40GE 2x1GE	IS	\$153,064
S210-SAS-S195	S210-25.2T+2.4T SSD/256/2x40GE 2x1GE	IS	\$164,389
S210-SAS-S196	S210-25.2T+2.4T SSD/64G/2x40GE 2x1GE	IS	\$148,112
S210-SAS-S197	S210-26.4T/1.6T SSD/128G/2x40GE/2x1GE	IS	\$127,520
S210-SAS-S198	S210-26.4T/1.6T SSD/256G/2x40GE/2x1GE	IS	\$138,263
S210-SAS-S199	S210-26.4T/1.6T SSD/64G/2x40GE/2x1GE	IS	\$122,821
S210-SAS-S20	S210-19.8TB+1.6TB SSD/256G/2x10GE+2x1GE	IS	\$117,067
S210-SAS-S200	S210-26.4T+3.2T SSD/128G/2x40GE 2x1GE	IS	\$167,306
S210-SAS-S201	S210-26.4T+3.2T SSD/256G/2x40GE 2x1GE	IS	\$178,550
S210-SAS-S202	S210-26.4T+3.2T SSD/64G/2x40GE 2x1GE	IS	\$162,389
S210-SAS-S203	S210-26.4T+800G SSD/64G/2x40GE 2x1GE	IS	\$107,743
S210-SAS-S204	S210-27.6T/400GB SSD/128G/2x40GE/2x1GE	IS	\$104,560
S210-SAS-S205	S210-27.6T/400GB SSD/256G/2x40GE/2x1GE	IS	\$115,313
S210-SAS-S206	S210-27.6T/400GB SSD/64G/2x40GE/2x1GE	IS	\$99,858
S210-SAS-S207	S210-27.6T/800GB SSD/128G/2x40GE/2x1GE	IS	\$112,774
S210-SAS-S208	S210-27.6T/800GB SSD/256G/2x40GE/2x1GE	IS	\$123,522
S210-SAS-S209	S210-27.6T/800GB SSD/64G/2x40GE/2x1GE	IS	\$108,074
S210-SAS-S20-HO	S210-19.8T+1.6T SSD/256G/2x10GE 2x1GE/HO	IS	\$62,488
S210-SAS-S21	S210-27.6TB+400GB SSD/64G/2x10GE+2x1GE	IS	\$98,105
S210-SAS-S210	S210-27.6T+1.6T SSD/128G/2x40GE 2x1GE	IS	\$127,522
S210-SAS-S211	S210-27.6T+1.6T SSD/256G/2x40GE 2x1GE	IS	\$138,265
S210-SAS-S212	S210-27.6T+1.6T SSD/64G/2x40GE 2x1GE	IS	\$122,823
S210-SAS-S213	S210-5.4T+1.2T SSD/128/2x40GE 2x1GE	IS	\$88,609
S210-SAS-S214	S210-5.4T+1.2T SSD/64G/2x40GE 2x1GE	IS	\$83,903
S210-SAS-S215	S210-6.6T+1.6T SSD/128/2x40GE 2x1GE	IS	\$97,205
S210-SAS-S216	S210-6.6T+1.6T SSD/256/2x40GE 2x1GE	IS	\$107,965
S210-SAS-S217	S210-6.6T+1.6T SSD/64G/2x40GE 2x1GE	IS	\$92,499
S210-SAS-S218	S210-6.9T/400GB SSD/128G/2x40GE/2x1GE	IS	\$72,835
S210-SAS-S219	S210-6.9T/400GB SSD/256G/2x40GE/2x1GE	IS	\$83,615
S210-SAS-S21-HO	S210-27.6TB+400GB SSD/64G/2x10GE/HO	IS	\$49,252
S210-SAS-S22	S210-27.6TB+400GB SSD/128G/2x10GE+2x1GE	IS	\$102,801
S210-SAS-S220	S210-6.9T/400GB SSD/64G/2x40GE/2x1GE	IS	\$67,225
S210-SAS-S221	S210-6.9T/800GB SSD/128G/2x40GE/2x1GE	IS	\$75,914
S210-SAS-S222	S210-6.9T/800GB SSD/256G/2x40GE/2x1GE	IS	\$86,551
S210-SAS-S223	S210-6.9T/800GB SSD/64G/2x40GE/2x1GE	IS	\$71,260
S210-SAS-S224	S210-6.9T+1.6T SSD/128G/2x40GE 2x1GE	IS	\$97,222
S210-SAS-S225	S210-6.9T+1.6T SSD/256G/2x40GE 2x1GE	IS	\$107,981
S210-SAS-S226	S210-6.9T+1.6T SSD/64G/2x40GE 2x1GE	IS	\$92,517
S210-SAS-S227	S210-6.9T+200G SSD/128/2x40GE 2x1GE	IS	\$63,700
S210-SAS-S228	S210-6.9T+200G SSD/64G/2x40GE 2x1GE	IS	\$59,160
S210-SAS-S23	S210-27.6TB+400GB SSD/256G/2x10GE+2x1GE	IS	\$113,534
S210-SAS-S23-HO	S210-27.6T+400G SSD/256G/2x10GE 2x1GE/HO	IS	\$55,381
S210-SAS-S24	S210-27.6TB+800GB SSD/64G/2x10GE+2x1GE	IS	\$106,276
S210-SAS-S25	S210-27.6TB+800GB SSD/128G/2x10GE+2x1GE	IS	\$110,972
S210-SAS-S26	S210-27.6TB+800GB SSD/256G/2x10GE+2x1GE	IS	\$121,705
S210-SAS-S26-HO	S210-27.6T+800G SSD/256G/2x10GE 2x1GE/HO	IS	\$59,602
S210-SAS-S27	S210-26.4TB+1.6TB SSD/64G/2x10GE+2x1GE	IS	\$120,976
S210-SAS-S28	S210-26.4TB+1.6TB SSD/128G/2x10GE+2x1GE	IS	\$125,672
S210-SAS-S28-HO	S210-26.4T/1.6T SSD/128G/2x10GE 2x1GE HO	IS	\$63,500

S210-SAS-S29	S210-26.4TB+1.6TB SSD/256G/2x10GE+2x1GE	IS	\$136,405
S210-SAS-S29-HO	S210-26.4T+1.6T SSD/256G/2x10GE 2x1GE/HO	IS	\$67,422
S210-SAS-S30	S210-13.8TB+400GB SSD/256G/2x10GE+2x1GE	IS	\$92,933
S210-SAS-S30-HO	S210-13.8T+400G SSD/256G/2x10GE 2x1GE/HO	IS	\$46,710
S210-SAS-S31	S210-13.2T/1.6T SSD/128G/2x10GE/2x1GE	IS	\$103,394
S210-SAS-S31-HO	S210-13.2T+1.6T SSD/128G/2x10GE 2x1GE/HO	IS	\$53,512
S210-SAS-S32	S210-13.2T/1.6T SSD/32G/2x10GE/2x1GE	IS	\$96,112
S210-SAS-S33	S210-13.8T/400GB SSD/128G/2x10GE/2x1GE	IS	\$80,543
S210-SAS-S34	S210-13.8T/800GB SSD/128G/2x10GE/2x1GE	IS	\$83,832
S210-SAS-S35	S210-6.9T/400GB SSD/128G/2x10GE/2x1GE	IS	\$71,323
S210-SAS-S36	S210-6.9T/400GB SSD/256G/2x10GE/2x1GE	IS	\$82,054
S210-SAS-S37	S210-6.9T/800GB SSD/128G/2x10GE/2x1GE	IS	\$74,434
S210-SAS-S38	S210-6.9T/800GB SSD/256G/2x10GE/2x1GE	IS	\$85,024
S210-SAS-S39	S210-16.2T+4.8T SSD/256/2x10GE 2x1GE	IS	\$186,250
S210-SAS-S40	S210-16.2T+4.8T SSD/64G/2x10GE 2x1GE	IS	\$170,821
S210-SAS-S41	S210-16.2T+4.8T SSD/128/2x10GE 2x1GE	IS	\$175,517
S210-SAS-S42	S210-18.9T+2.4T SSD/128/2x10GE 2x1GE	IS	\$129,896
S210-SAS-S43	S210-18.9T+2.4T SSD/256/2x10GE 2x1GE	IS	\$140,628
S210-SAS-S44	S210-18.9T+2.4T SSD/64G/2x10GE 2x1GE	IS	\$125,200
S210-SAS-S45	S210-18T+3.2T SSD/128/2x10GE 2x1GE	IS	\$145,103
S210-SAS-S46	S210-18T+3.2T SSD/256/2x10GE 2x1GE	IS	\$155,836
S210-SAS-S47	S210-18T+3.2T SSD/64G/2x10GE 2x1GE	IS	\$140,407
S210-SAS-S48	S210-21.6T+4.8T SSD/128/2x10GE 2x1GE	IS	\$186,936
S210-SAS-S49	S210-21.6T+4.8T SSD/256/2x10GE 2x1GE	IS	\$197,669
S210-SAS-S49-HO	S210-21.6T+4.8T SSD/256/2x10GE 2x1GE/HO	IS	\$109,293
S210-SAS-S50	S210-21.6T+4.8T SSD/64G/2x10GE 2x1GE	IS	\$182,240
S210-SAS-S51	S210-24T+3.2T SSD/128/2x10GE 2x1GE	IS	\$165,265
S210-SAS-S52	S210-24T+3.2T SSD/256/2x10GE 2x1GE	IS	\$176,507
S210-SAS-S53	S210-24T+3.2T SSD/64G/2x10GE 2x1GE	IS	\$160,347
S210-SAS-S54	S210-25.2T+2.4T SSD/128/2x10GE 2x1GE	IS	\$151,041
S210-SAS-S55	S210-25.2T+2.4T SSD/256/2x10GE 2x1GE	IS	\$162,360
S210-SAS-S56	S210-25.2T+2.4T SSD/64G/2x10GE 2x1GE	IS	\$146,088
S210-SAS-S57	S210-6.6T+1.6T SSD/128/2x10GE 2x1GE	IS	\$95,541
S210-SAS-S58	S210-6.6T+1.6T SSD/256/2x10GE 2x1GE	IS	\$106,272
S210-SAS-S59	S210-6.6T+1.6T SSD/32G/2x10GE 2x1GE	IS	\$88,390
S210-SAS-S60	S210-6.6T+1.6T SSD/64G/2x10GE 2x1GE	IS	\$90,846
S210-SAS-S61	INA S210-5.4T+1.2T SSD/32G/2x10GE/2x1GE	IS	\$83,963
S210-SAS-S62	S210-5.4T+1.2T SSD/64G/2x10GE/2x1GE	IS	\$82,307
S210-SAS-S63	S210-5.4T+1.2T SSD/128G/2x10GE/2x1GE	IS	\$86,999
S210-SAS-S64	INA S210-5.4T+1.2T SSD/256G/2x10GE/2x1GE	IS	\$99,912
S210-SAS-S65	S210-6.9T+200G SSD/32G/2x10GE/2x1GE	IS	\$56,536
S210-SAS-S66	S210-6.9T+200G SSD/64G/2x10GE/2x1GE	IS	\$57,807
S210-SAS-S66-HO	S210-6.9T+200G SSD/64G/2x10GE 2x1GE HO	IS	\$35,026
S210-SAS-S67	S210-6.9T+200G SSD/128G/2x10GE/2x1GE	IS	\$62,321
S210-SAS-S68	INA S210-6.9T+200G SSD/256G/2x10GE/2x1GE	IS	\$74,592
S210-SAS-S69	S210-10.8T+1.2T SSD/32G/2x10GE/2x1GE	IS	\$89,050
S210-SAS-S70	S210-10.8T+1.2T SSD/64G/2x10GE/2x1GE	IS	\$91,113
S210-SAS-S71	S210-10.8T+1.2T SSD/128G/2x10GE/2x1GE	IS	\$96,172
S210-SAS-S71-HO	S210-10.8T+1.2T SSD/128/2x10GE 2x1GE/HO	IS	\$49,834
S210-SAS-S72	INA S210-10.8T+1.2T SSD/256G/2x10GE/2x1G	IS	\$109,933

S210-SAS-S73	S210-13.2T+400G SSD/32G/2x10GE/2x1GE	IS	\$73,327
S210-SAS-S74	S210-13.2T+400G SSD/64G/2x10GE/2x1GE	IS	\$75,128
S210-SAS-S75	S210-13.2T+400G SSD/128G/2x10GE/2x1GE	IS	\$0
S210-SAS-S76	INA S210-13.2T+400G SSD/256G/2x10GE/2x1G	IS	\$0
S210-SAS-S77	INA S210-13.2T+800G SSD/32G/2x10GE/2x1GE	IS	\$0
S210-SAS-S78	S210-13.2T+800G SSD/64G/2x10GE/2x1GE	IS	\$0
S210-SAS-S79	S210-13.2T+800G SSD/128G/2x10GE/2x1GE	IS	\$85,982
S210-SAS-S80	INA S210-13.2T+800G SSD/256G/2x10GE/2x1G	IS	\$101,105
S210-SAS-S81	S210-16.2T+2.4T SSD/32G/2x10GE/2x1GE	IS	\$122,415
S210-SAS-S82	S210-16.2T+2.4T SSD/64G/2x10GE/2x1GE	IS	\$124,398
S210-SAS-S83	S210-16.2T+2.4T SSD/128G/2x10GE/2x1GE	IS	\$129,476
S210-SAS-S84	INA S210-16.2T+2.4T SSD/256G/2x10GE/2x1G	IS	\$153,020
S210-SAS-S85	S210-18.9T+1.2T SSD/32G/2x10GE/2x1GE	IS	\$98,011
S210-SAS-S86	S210-18.9T+1.2T SSD/64G/2x10GE/2x1GE	IS	\$100,049
S210-SAS-S87	S210-18.9T+1.2T SSD/128G/2x10GE/2x1GE	IS	\$105,072
S210-SAS-S88	INA S210-18.9T+1.2T SSD/256G/2x10GE/2x1G	IS	\$126,415
S210-SAS-S89	S210-19.8T+400G SSD/32G/2x10GE/2x1GE	IS	\$82,170
S210-SAS-S90	S210-19.8T+400G SSD/64G/2x10GE/2x1GE	IS	\$84,230
S210-SAS-S91	S210-19.8T+400G SSD/128G/2x10GE/2x1GE	IS	\$89,276
S210-SAS-S91-HO	S210-19.8T+400G SSD/128/2x10GE 2x1GE/HO	IS	\$44,584
S210-SAS-S92	INA S210-19.8T+400G SSD/256G/2x10GE/2x1G	IS	\$104,966
S210-SAS-S93	INA S210-26.4T+800G SSD/32G/2x10GE/2x1GE	IS	\$112,089
S210-SAS-S94	S210-26.4T+800G SSD/64G/2x10GE/2x1GE	IS	\$105,958
S210-SAS-S94-HO	S210-26.4T+800G SSD/64G/2x10GE 2x1GE HO	IS	\$53,500
S210-SAS-S95	INA S210-26.4T+800G SSD/128G/2x10GE/2x1G	IS	\$120,342
S210-SAS-S96	INA S210-26.4T+800G SSD/256G/2x10GE/2x1G	IS	\$132,726
S210-SAS-S97	S210-21.6TB/32G/2x10GE 2x1GE	IS	\$74,331
S210-SAS-S98	S210-6.9T+1.6T SSD/64G/2x10GE 2x1GE	IS	\$90,846
S210-SAS-S99	S210-6.9T+1.6T SSD/128G/2x10GE 2x1GE	IS	\$95,541
S210-SSD-001	S210-19.2TB SSD/32G/2x10GE+2x1GE	IS	\$438,067
S210-SSD-002	S210-19.2TB SSD/64G/2x10GE+2x1GE	IS	\$440,523
S210-SSD-003	S210-9.6T SSD/2.5in./128/2x10GE 2x1GE	IS	\$301,254
S210-SSD-004	S210-9.6T SSD/2.5in./256/2x10GE 2x1GE	IS	\$313,995
S210-SSD-005	S210-9.6T SSD/2.5in./64G/2x10GE 2x1GE	IS	\$295,680
S210-SSD-005-HO	S210-9.6T SSD/2.5in./64G/2x10GE 2x1GE	IS	\$221,670
S210-SSD-006	S210-19.2T SSD/128G/2x10GE/2x1GE	IS	\$445,252
S210-SSD-007	S210-19.2T SSD/256G/2x10GE/2x1GE	IS	\$455,945
S210-SSD-008	INA S210-4.8T SSD/32G/2x10GE/2x1GE	IS	\$184,990
S210-SSD-009	S210-4.8T SSD/64G/2x10GE/2x1GE	IS	\$172,311
S210-SSD-010	S210-4.8T SSD/128G/2x10GE/2x1GE	IS	\$177,367
S210-SSD-011	INA S210-4.8T SSD/256G/2x10GE/2x1GE	IS	\$204,837
S210-SSD-012	INA S210-9.6TB SSD/32G/2x10GE 2x1GE	IS	\$317,534
S210-SSD-013	S210-19.2T SSD/128G/2x40GE/2x1GE	IS	\$447,365
S210-SSD-014	S210-19.2T SSD/256G/2x40GE/2x1GE	IS	\$458,056
S210-SSD-015	S210-19.2T SSD/64G/2x40GE/2x1GE	IS	\$442,639
S210-SSD-016	S210-4.8T SSD/128/2x40GE 2x1GE	IS	\$179,422
S210-SSD-017	S210-4.8T SSD/64G/2x40GE 2x1GE	IS	\$174,366
S210-SSD-018	S210-9.6T SSD/2.5in./128/2x40GE 2x1GE	IS	\$303,532
S210-SSD-019	S210-9.6T SSD/2.5in./256/2x40GE 2x1GE	IS	\$316,276
S210-SSD-020	S210-9.6T SSD/2.5in./64G/2x40GE 2x1GE	IS	\$297,957

SH-458-000-132	OneFS Subscrip Gen5 Essential NEW	IS	\$0
SH-458-000-133	OneFS Subscrip Gen5 Essential RENEW	IS	\$0
SH-458-000-134	OneFS Subscrip Gen5 Esntl 2Y/PP NEW	IS	\$0
SH-458-000-135	OneFS Subscrip Gen5 Esntl 2Y/PP RENEW	IS	\$0
SH-458-000-136	OneFS Subscrip Gen5 Esntl 3Y/PP NEW	IS	\$0
SH-458-000-137	OneFS Subscrip Gen5 Esntl 3Y/PP RENEW	IS	\$0
SH-458-000-138	OneFS Subscrip Gen5 Advanced NEW	IS	\$0
SH-458-000-139	OneFS Subscrip Gen5 Advanced RENEW	IS	\$0
SH-458-000-140	OneFS Subscrip Gen5 Advanced 2Y/PP NEW	IS	\$0
SH-458-000-141	OneFS Subscrip Gen5 Advanced 2Y/PP RENEW	IS	\$0
SH-458-000-142	OneFS Subscrip Gen5 Advanced 3Y/PP NEW	IS	\$0
SH-458-000-143	OneFS Subscrip Gen5 Advanced 3Y/PP RENEW	IS	\$0
SH-458-000-144	Cloudpools Gen5 Subscription 3Y/PP	IS	\$17
SH-458-000-145	Cloudpools Gen5 Subscription 2Y/PP	IS	\$17
SH-458-000-146	Cloudpools Gen5 Subscription	IS	\$18
SP106-575-003	SPARES KIT 2U SLIDE RAIL	IS	\$233
SP811-0012	R-SPR KIT - FRNT PANEL ASSY - 2U - ROHS	IS	\$752
SP811-0013	R-SPR KIT - FAN MODULE ASSY	IS	\$109
SP811-0026	R-SPR KIT - LG BLOWR - 1U - ACCELERATOR	IS	\$120
SP811-0027	R-SPR KIT - SM BLOWR - 1U	IS	\$89
SP811-0028	R-SPR KIT - FRNT PANEL ASSY- 1U - ACCEL	IS	\$297
SP811-0029	R-SPR KIT - PASSIVE RISER - 1U	IS	\$0
SP811-0030	R-SPR KIT - CABLE ASSY - SATA - R/A	IS	\$38
SP811-0031	R-SPR KIT - PWR SUPPLY - 1U	IS	\$102
SP811-0032	R-SPR KIT - FRNT PANEL ASSY - EX6000	IS	\$441
SP811-0034	R-SPR KIT - CABLE ASSY - SATA R/A TO ST	IS	\$8
SP811-0042	R-SPR KIT - SLIDE RAIL KIT - 1U	IS	\$357
SP811-0043	R-SPR KIT - SLIDE RAIL KIT - 2U	IS	\$359
SP811-0049	R-SPR KIT - FBDIMM - 1GB - ROHS	IS	\$207
SP811-0050	R-SPR KIT - BATTERY TRAY - 2U - ROHS	IS	\$164
SP811-0051	R-SPR KIT - IB-NVRAM CARD 2U/4U X/S200	IS	\$1,688
SP811-0052	R-SPR KIT - RISER CARD - 2U - ROHS	IS	\$318
SP811-0054	R-SPR KIT - CPU - FAN MODULE	IS	\$72
SP811-0055	R-SPR KIT - PWR SUPPLY - 1U/2U	IS	\$641
SP811-0062	R-SPR KIT - FBDIMM - 2GB	IS	\$249
SP811-0063	R-SPR KIT - FBDIMM - 4GB	IS	\$489
SP811-0064	R-SPR KIT - FRNT PANEL ASSY - 1U - ACC-X	IS	\$454
SP811-0065	R-SPR KIT - INFINIBAND -1U - ACC-X	IS	\$1,846
SP811-0067	R-SPR KIT - NIC -10GE-SR - 1U - ACC-X	IS	\$1,724
SP811-0069	R-SPR KIT - FRNT PANEL ASSY BU ACCEL	IS	\$423
SP811-0070	R-SPR KIT - NIC - FC - 1U - BACKUP ACC	IS	\$8,860
SP811-0071	R-SPR KIT - NIC - 2 PORT GE	IS	\$566
SP811-0074	R-SPR KIT - FRNT PANEL ASSY - 2U - BLACK	IS	\$766
SP811-0075	R-SPR KIT - FRNT PANEL ASSY - 4U -SILVER	IS	\$453
SP811-0076	R-SPR KIT - FRNT PANEL ASSY - 4U - BLUE	IS	\$458
SP811-0077	R-SPR KIT - PWR SUPPLY - 1200W - 4U	IS	\$1,111
SP811-0078	R-SPR KIT - SAS CONTRLR - 4U	IS	\$669
SP811-0079	R-SPR KIT - DIMM - 1GB - SINGLE RANK	IS	\$218
SP811-0081	R-SPR KIT - CABLE ASSY - IPASS ST 4X ST	IS	\$24
SP811-0083	R-SPR KIT - SLIDE RAIL KIT - 4U	IS	\$422

SP811-0105	R-SPR KIT - NIC - 10GE CX4	IS	\$2,483
SP811-0106	R-SPR KIT - NIC - 10GE SFP+	IS	\$1,699
SP811-0108	R-SPR KIT - SFP+ OPTIC - 10GE	IS	\$270
SP811-0110	R-SPR KIT -SLIDE RAIL-24 PORT-FLEX SWTCH	IS	\$0
SP811-0113	R-SPR KIT - NIC 10GESFP+ ACCEL-X W/OP	IS	\$2,231
SP811-0114	R-SPR KIT - FRNT PANEL ASSY - X200	IS	\$531
SP811-0115	R-SPR KIT - FRNT PANEL ASSY - S200	IS	\$530
SP811-0118	R-SPR KIT - 200/400 2x1GE	IS	\$530
SP811-0119	R-SPR KIT - 200/400 2x10GE SFP+ NO OP	IS	\$1,604
SP811-0121	R-SPR KIT - PWR SUPPLY - 1U - 750W	IS	\$582
SP811-0122	R-SPR KIT - FAN MODULE ASSY - ROHS	IS	\$71
SP811-0123	R-SPR KIT - S/X/NL-Series 1 x 2GB DIMM	IS	\$162
SP811-0124	R-SPR KIT - S/X/NL-Series 1 x 4GB DIMM	IS	\$209
SP811-0125	R-SPR KIT - S/X/NL-Series 1 x 8GB DIMM	IS	\$342
SP811-0126	R-SPR KIT - S/X/NL-Series 1 x BOOT DRVE	IS	\$175
SP811-0137	R-SPR KIT - HW KIT SIDE RAIL	IS	\$67
SP811-0138	R-SPR KIT - SIDE RAIL SOLID BEAR SPECIAL	IS	\$237
SP811-0140	R-SPR KIT - SAS CONTRLR - 108NL	IS	\$683
SP811-0146	R-SPR KIT - ASSY - 28P SAS CONT - 1 PORT	IS	\$1,197
SP811-0147	R-SPR KIT - FAN MODULES & FAN GUARD - 4U	IS	\$407
SP811-0154	FRU - PS - MELLANOX MIS50XX QDR SWITCH	IS	\$1,109
SP811-0155	FRU - PWR DSTRBSN PANEL TITAN RACK	IS	\$283
SP811-0156	FRU - PWR DSTRBSN UNIT - TITAN RACK	IS	\$440
SP811-0157	FRU - CBL - MINI SAS TITAN RACK INTERCON	IS	\$160
SP811-0159	R-SPR KIT - FRNT PANEL - 4U - X400	IS	\$754
SP811-0160	R-SPR KIT - FRNT PANEL - 4U - NL400	IS	\$736
SP811-0161	R-SPR KIT - FAN MODULE - 4U - X/NL400	IS	\$165
SP811-0162	R-SPR KIT - PWR SUPPLY - 4U - X/NL400	IS	\$902
SP811-0176	INSTL KIT MLNX IS5022 SIDEBYSIDE MOUNT	IS	\$667
SP811-0177	R-SPR KIT - ISILON CONSOLE ASSY REPLACE	IS	\$792
SP811-0178	R-SPR KIT - RACK INSTALL - INTEL - 12800	IS	\$0
SP811-0182	R-SPR KIT - HW KIT FOR SIDE RAIL 4U	IS	\$54
SP811-0183	FRU - PDU TITAN PDU RACK	IS	\$959
SP811-0184	FRU - CBL PDU-PDU MINI-JUMPER TITAN IC	IS	\$963
SP811-0189	R-SPR KIT - S/X/NL-Series 1 x 16GB DIMM	IS	\$955
SP811-0234	SPARE KIT,DIMM, 4GB DDR3-1600, HD400	IS	\$1,484
SP811-0235	SPARE KIT,DIMM,16GB DDR3-1600,HD400	IS	\$2,286
SP811-0236	R-SPR KIT - COVER SENSOR ASSEMBLY HD400	IS	\$185
SP811-0237	R-SPR KIT - ASSY DISPLAY BOARD HD400	IS	\$480
SP811-0238	R-SPR KIT - DENSE DPE SUITCASE HD400	IS	\$6,016
SP811-0239	SPARE KIT, ASSY BATTERY TWIN PACK HD400	IS	\$172
SP811-0240	R-SPR KIT - CHASSIS WITH BASEBOARD HD400	IS	\$4,634
SP811-0241	R-SPR KIT - DUAL SAS QUAD PORT HBA	IS	\$533
SP811-0243	SPARE KIT, PCB TLA LOX PCIE NVRAM HD400	IS	\$1,536
SP811-0244	R-SPR KIT - PCB M SATA CARR W/HOLD	IS	\$273
SP811-0246	SPARE KIT, FAN MODULE ASSY HD400	IS	\$964
SP811-0247	SPARE KIT, POWER SUPPLY SNGL CHNL HD400	IS	\$1,310
SP811-0248	R-SPR KIT -ASSY 4U FRONT DENSE DPE HD400	IS	\$257
SP811-0252	SPARE KIT, TITAN D 3 PHASE PDU HD400	IS	\$1,030
SP811-0264	R-SPR KIT-FRONT PANEL ASSY-4U-NL410	IS	\$480

SP811-0265	R-SPR KIT - FRONT PANEL ASSEMBLY X210	IS	\$427
SP811-0266	R-SPR KIT - POWER SUPPLY MODULE NL410	IS	\$499
SP811-0267	R-SPR KIT - PCB LOX PCIe NVRAM w/ MLC	IS	\$1,207
SP811-0268	R-SPR KIT - DIMM 8GB DDR3-1600	IS	\$298
SP811-0269	R-SPR KIT - 2U SLIDE RAIL	IS	\$244
SP811-0270	R-SPR KIT - BATTERY PACK/LI-ION/18650	IS	\$68
SP811-0273	R-SPR KIT - INTEL 48 PT 5U 2PS ACC KIT	IS	\$9,483
SP811-0274	R-SPR KIT - INTEL 48 PT 10U 2PS ACC KIT	IS	\$14,428
SP811-0275	R-SPR KIT - MELLANOX 8 PT ACCESSORY KIT	IS	\$825
SP811-0276	R-SPR KIT - MELLANOX 18 PT ACCESSORY KIT	IS	\$997
SP811-0277	R-SPR KIT - INTEL 18 PORT ACCESSORY KIT	IS	\$1,456
SP811-0278	R-SPR KIT - MELLANOX 36 PT ACCESSORY KIT	IS	\$997
SP811-0279	R-SPR KIT - INTEL 36 PORT ACCESSORY KIT	IS	\$4,698
SP811-0280	R-SPR KIT -TITAN-D 3-PHASE WYE PDU QTY 1	IS	\$3,971
SP811-0281	R-SPR KIT - 32G BOOT DRIVE GEN 4	IS	\$772
SP812-0002	IQX CHASSIS, 4U	IS	\$17,445
SP812-0003	IQ 108NL CHASSIS; 4U	IS	\$17,640
SP812-0008	S200 CHASSIS; 2U	IS	\$11,591
SP812-0009	X200 CHASSIS; 2U	IS	\$8,598
SP812-0010	X400 CHASSIS; 4U	IS	\$17,045
SP812-0013	NL400 CHASSIS; 4U	IS	\$13,623
SP812-0024	R-SPR KIT - X210 CHASSIS - 2U	IS	\$11,422
SP812-0026	R-SPR KIT - NL410 CHASSIS - 4U	IS	\$10,995
SP812-0027	R-SPR KIT - CHASSIS WITH WR PSU X410	IS	\$20,793
SRSTW-ISLN-HD	SRM SUITE W4N ISILON HI DENSITY =ID	IS	\$0
SRSTW-ISLN-LD	SRM SUITE W4N ISILON LO DENSITY =ID	IS	\$0
SRSTW-ISLN-MD	SRM SUITE W4N ISILON MED DENSITY =ID	IS	\$0
TRK-BASIC DESC	CONADV/SNAP	IS	\$0
TRK-ENT ADV DESC	CONADV/SNAP/QTA/SYNC/POOL	IS	\$0
X200-SAS-E01	X200-36TB-SED/12G/4x1GE	IS	\$64,666
X200-SAS-E02	X200-36TB-SED/12G/2x10GE SFP 2x1GE	IS	\$65,168
X200-SAS-E03	X200-36TB-SED/24G/4x1GE	IS	\$65,524
X200-SAS-E04	X200-36TB-SED/24G/2x10GE SFP 2x1GE	IS	\$66,985
X200-SAS-E05	X200-36TB-SED/48G/4x1GE	IS	\$67,186
X200-SAS-E06	X200-36TB-SED/48G/2x10GE SFP 2x1GE	IS	\$70,059
X200-SAS-E07	X200-33T+800G SSD-SED/12G/2x10GE+2x1GE	IS	\$88,619
X200-SAS-E08	X200-33T+800G SSD-SED/12G/4x1GE	IS	\$85,472
X200-SAS-E09	X200-33T+800G SSD-SED/24G/2X10GE+2X1GE	IS	\$90,571
X200-SAS-E10	X200-33T+800G SSD-SED/24G/4x1GE	IS	\$87,424
X200-SAS-E11	X200-33T+800G SSD-SED/48G/2X10GE+2X1GE	IS	\$93,318
X200-SAS-E12	X200-33T+800G SSD-SED/48G/4x1GE	IS	\$90,171
X200-SAS-E13	X200-30T+1.6T SSD-SED/12G/2X10GE+2X1GE	IS	\$110,880
X200-SAS-E14	X200-30T+1.6T SSD-SED/12G/4x1GE	IS	\$107,757
X200-SAS-E15	X200-30T+1.6T SSD-SED/24G/2X10GE+2X1GE	IS	\$112,818
X200-SAS-E16	X200-30T+1.6T SSD-SED/24G/4x1GE	IS	\$109,694
X200-SAS-E17	X200-30T+1.6T SSD-SED/48G/2X10GE+2X1GE	IS	\$115,545
X200-SAS-E18	X200-30T+1.6T SSD-SED/48G/4x1GE	IS	\$112,421
X200-SAS-E19	X200-24T+3.2T SSD-SED/12G/2X10GE+2X1GE	IS	\$155,402
X200-SAS-E20	X200-24T+3.2T SSD-SED/12G/4x1GE	IS	\$152,954
X200-SAS-E21	X200-24T+3.2T SSD-SED/24G/2X10GE+2X1GE	IS	\$154,552

X200-SAS-E22	X200-24T+3.2T SSD-SED/24G/4x1GE	IS	\$153,235
X200-SAS-E23	X200-24T+3.2T SSD-SED/48G/2X10GE+2X1GE	IS	\$156,218
X200-SAS-E24	X200-24T+3.2T SSD-SED/48G/4x1GE	IS	\$153,701
X200-SATA-001	X200-6T/12G/4x1GE	IS	\$0
X200-SATA-002	X200-6T/12G/2x10GE SFP+2x1GE	IS	\$0
X200-SATA-003	X200-6T/24G/4x1GE	IS	\$0
X200-SATA-004	X200-6T/24G/2x10GE SFP+2x1GE	IS	\$0
X200-SATA-005	X200-6T/48G/4x1GE	IS	\$0
X200-SATA-006	X200-6T/48G/2x10GE SFP+2x1GE	IS	\$0
X200-SATA-007	X200-12T/12G/4x1GE	IS	\$27,601
X200-SATA-008	X200-12T/24G/4x1GE	IS	\$28,124
X200-SATA-009	X200-12T/24G/2x10GE SFP+2x1GE	IS	\$29,876
X200-SATA-010	X200-12T/48G/4x1GE	IS	\$29,138
X200-SATA-011	X200-12T/48G/2x10GE SFP+2x1GE	IS	\$30,889
X200-SATA-012	X200-24T/6G/2x10GE SFP+2x1GE	IS	\$40,043
X200-SATA-013	X200-24T/12G/4x1GE	IS	\$40,796
X200-SATA-014	X200-24T/12G/2x10GE SFP+2x1GE	IS	\$46,769
X200-SATA-015	X200-24T/24G/4x1GE	IS	\$41,426
X200-SATA-016	X200-24T/24G/2x10GE SFP+2x1GE	IS	\$43,534
X200-SATA-017	X200-24T/48G/4x1GE	IS	\$42,646
X200-SATA-018	X200-24T/48G/2x10GE SFP+2x1GE	IS	\$44,754
X200-SATA-019	X200-36T/24G/4x1GE	IS	\$49,575
X200-SATA-020	X200-36T/48G/4x1GE	IS	\$50,833
X200-SATA-021	X200-36T/48G/2x10GE SFP+2x1GE	IS	\$53,006
X200-SATA-023	X200-36T/12G/4x1GE	IS	\$50,181
X200-SATA-S01	X200-5.5T+200G SSD/6G/4x1GE	IS	\$0
X200-SATA-S02	X200-5.5T+200G SSD/6G/2x10GE SFP+2x1GE	IS	\$0
X200-SATA-S03	X200-5.5T+200G SSD/12G/4x1GE	IS	\$0
X200-SATA-S04	X200-5.5T+200G SSD/12G/2x10GE SFP+2x1GE	IS	\$0
X200-SATA-S05	X200-5.5T+200G SSD/24G/4x1GE	IS	\$0
X200-SATA-S06	X200-5.5T+200G SSD/24G/2x10GE SFP+2x1GE	IS	\$0
X200-SATA-S07	X200-5.5T+200G SSD/48G/4x1GE	IS	\$0
X200-SATA-S08	X200-5.5T+200G SSD/48G/2x10GE SFP+2x1GE	IS	\$0
X200-SATA-S09	X200-3T+1.2T SSD/6G/4x1GE	IS	\$0
X200-SATA-S10	X200-3T+1.2T SSD/6G/2x10GE SFP+2x1GE	IS	\$0
X200-SATA-S100	X200-12TB+4.8TB/12GB/4x1GE	IS	\$156,437
X200-SATA-S101	X200-12TB+4.8TB/24GB/2x10GE 2x1GE	IS	\$156,807
X200-SATA-S102	X200-12TB+4.8TB/24GB/4x1GE	IS	\$156,514
X200-SATA-S103	X200-12TB+4.8TB/48GB/2x10GE 2x1GE	IS	\$158,400
X200-SATA-S104	X200-12TB+4.8TB/48GB/4x1GE	IS	\$156,581
X200-SATA-S105	X200-33TB+800GB/12GB/2x10GE 2x1GE	IS	\$70,895
X200-SATA-S106	X200-33TB+800GB/12GB/4x1GE	IS	\$68,743
X200-SATA-S107	X200-33TB+800GB/24GB/2x10GE 2x1GE	IS	\$70,982
X200-SATA-S108	X200-33TB+800GB/24GB/4x1GE	IS	\$69,359
X200-SATA-S109	X200-33TB+800GB/48GB/2x10GE 2x1GE	IS	\$72,703
X200-SATA-S11	X200-3T+1.2T SSD/12G/4x1GE	IS	\$0
X200-SATA-S110	X200-33TB+800GB/48GB/4x1GE	IS	\$70,547
X200-SATA-S111	X200-11T+800GB/12GB/2x10GE 2x1GE	IS	\$55,129
X200-SATA-S112	X200-11T+800GB/12GB/4x1GE	IS	\$52,991
X200-SATA-S113	X200-11T+800GB/24GB/2x10GE 2x1GE	IS	\$54,892

X200-SATA-S114	X200-11T+800GB/24GB/4x1GE	IS	\$53,514
X200-SATA-S115	X200-11T+800GB/48GB/2x10GE 2x1GE	IS	\$56,671
X200-SATA-S116	X200-11T+800GB/48GB/4x1GE	IS	\$54,513
X200-SATA-S117	X200-22TB+800GB/12GB/2x10GE 2x1GE	IS	\$61,615
X200-SATA-S118	X200-22TB+800GB/12GB/4x1GE	IS	\$59,538
X200-SATA-S119	X200-22TB+800GB/24GB/2x10GE 2x1GE	IS	\$62,111
X200-SATA-S12	X200-3T+1.2T SSD/12G/2x10GE SFP+2x1GE	IS	\$0
X200-SATA-S120	X200-22TB+800GB/24GB/4x1GE	IS	\$60,102
X200-SATA-S121	X200-22TB+800GB/48GB/2x10GE 2x1GE	IS	\$63,274
X200-SATA-S122	X200-22TB+800GB/48GB/4x1GE	IS	\$61,187
X200-SATA-S123	X200-30TB+1.6TB/12GB/2x10GE 2x1GE	IS	\$88,704
X200-SATA-S124	X200-30TB+1.6TB/12GB/4x1GE	IS	\$86,617
X200-SATA-S125	X200-30TB+1.6TB/24GB/2x10GE 2x1GE	IS	\$88,535
X200-SATA-S126	X200-30TB+1.6TB/24GB/4x1GE	IS	\$87,102
X200-SATA-S127	X200-30TB+1.6TB/48GB/2x10GE 2x1GE	IS	\$90,127
X200-SATA-S128	X200-30TB+1.6TB/48GB/4x1GE	IS	\$88,018
X200-SATA-S129	X200-24TB+3.2TB/12GB/2x10GE 2x1GE	IS	\$124,322
X200-SATA-S13	X200-3T+1.2T SSD/24G/4x1GE	IS	\$0
X200-SATA-S130	X200-24TB+3.2TB/12GB/4x1GE	IS	\$122,364
X200-SATA-S131	X200-24TB+3.2TB/24GB/2x10GE 2x1GE	IS	\$123,642
X200-SATA-S132	X200-24TB+3.2TB/24GB/4x1GE	IS	\$122,588
X200-SATA-S133	X200-24TB+3.2TB/48GB/2x10GE 2x1GE	IS	\$124,974
X200-SATA-S134	X200-24TB+3.2TB/48GB/4x1GE	IS	\$122,961
X200-SATA-S135	X200-18TB+4.8TB/12GB/2x10GE 2x1GE	IS	\$163,770
X200-SATA-S136	X200-18TB+4.8TB/12GB/4x1GE	IS	\$161,908
X200-SATA-S137	X200-18TB+4.8TB/24GB/2x10GE 2x1GE	IS	\$163,913
X200-SATA-S138	X200-18TB+4.8TB/24GB/4x1GE	IS	\$162,031
X200-SATA-S139	X200-18TB+4.8TB/48GB/2x10GE 2x1GE	IS	\$164,108
X200-SATA-S14	X200-3T+1.2T SSD/24G/2x10GE SFP+2x1GE	IS	\$0
X200-SATA-S140	X200-18TB+4.8TB/48GB/4x1GE	IS	\$162,187
X200-SATA-S141	X200-30T+400G SSD/48G/2x10GE 2x1GE	IS	\$60,735
X200-SATA-S15	X200-3T+1.2T SSD/48G/4x1GE	IS	\$0
X200-SATA-S16	X200-3T+1.2T SSD/48G/2x10GE SFP+2x1GE	IS	\$0
X200-SATA-S17	X200-11T+200G SSD/6G/4x1GE	IS	\$37,420
X200-SATA-S18	X200-11T+200G SSD/6G/2x10GE SFP+2x1GE	IS	\$39,470
X200-SATA-S19	X200-11T+200G SSD/12G/4x1GE	IS	\$38,280
X200-SATA-S20	X200-11T+200G SSD/12G/2x10GE SFP+2x1GE	IS	\$40,330
X200-SATA-S21	X200-11T+200G SSD/24G/4x1GE	IS	\$38,892
X200-SATA-S22	X200-11T+200G SSD/48G/4x1GE	IS	\$40,079
X200-SATA-S23	X200-11T+200G SSD/48G/2x10GE SFP+2x1GE	IS	\$42,129
X200-SATA-S24	X200-6T+1.2T SSD/6G/4x1GE	IS	\$68,065
X200-SATA-S25	X200-6T+1.2T SSD/6G/2x10GE SFP+2x1GE	IS	\$70,195
X200-SATA-S26	X200-6T+1.2T SSD/12G/4x1GE	IS	\$68,548
X200-SATA-S27	X200-6T+1.2T SSD/12G/2x10GE SFP+2x1GE	IS	\$70,681
X200-SATA-S28	X200-6T+1.2T SSD/24G/4x1GE	IS	\$68,269
X200-SATA-S29	X200-6T+1.2T SSD/24G/2x10GE SFP+2x1GE	IS	\$70,319
X200-SATA-S30	X200-6T+1.2T SSD/48G/4x1GE	IS	\$69,455
X200-SATA-S31	X200-6T+1.2T SSD/48G/2x10GE SFP+2x1GE	IS	\$71,505
X200-SATA-S32	X200-20T+400G SSD/6G/4x1GE	IS	\$48,177
X200-SATA-S33	X200-20T+400G SSD/6G/2x10GE SFP+2x1GE	IS	\$50,165

X200-SATA-S34	X200-20T+400G SSD/12G/4x1GE	IS	\$49,011
X200-SATA-S35	X200-20T+400G SSD/12G/2x10GE SFP+2x1GE	IS	\$51,000
X200-SATA-S36	X200-20T+400G SSD/24G/4x1GE	IS	\$49,605
X200-SATA-S37	X200-20T+400G SSD/48G/4x1GE	IS	\$50,756
X200-SATA-S38	X200-20T+400G SSD/48G/2x10GE SFP+2x1GE	IS	\$52,789
X200-SATA-S39	X200-12T+1200G SSD/6G/4x1GE	IS	\$72,110
X200-SATA-S40	X200-12T+1200G SSD/6G/2x10GE SFP+2x1GE	IS	\$74,227
X200-SATA-S41	X200-12T+1200G SSD/12G/4x1GE	IS	\$72,985
X200-SATA-S42	X200-12T+1200G SSD/12G/2x10GE SFP+2x1GE	IS	\$75,102
X200-SATA-S43	X200-12T+1200G SSD/24G/4x1GE	IS	\$73,793
X200-SATA-S44	X200-12T+1200G SSD/48G/4x1GE	IS	\$75,320
X200-SATA-S45	X200-12T+1200G SSD/48G/2x10GE SFP+2x1GE	IS	\$77,432
X200-SATA-S46	X200-27T+600G SSD/6G/4x1GE	IS	\$60,038
X200-SATA-S47	X200-27T+600G SSD/6G/2x10GE SFP+2x1GE	IS	\$62,088
X200-SATA-S48	X200-27T+600G SSD/12G/4x1GE	IS	\$60,898
X200-SATA-S49	X200-27T+600G SSD/12G/2x10GE SFP+2x1GE	IS	\$62,948
X200-SATA-S50	X200-27T+600G SSD/24G/4x1GE	IS	\$61,511
X200-SATA-S51	X200-27T+600G SSD/48G/4x1GE	IS	\$62,697
X200-SATA-S52	X200-27T+600G SSD/48G/2x10GE SFP+2x1GE	IS	\$64,747
X200-SATA-S53	X200-18T+1.2T SSD/6G/4x1GE	IS	\$73,861
X200-SATA-S54	X200-18T+1.2T SSD/6G/2x10GE SFP+2x1GE	IS	\$75,999
X200-SATA-S55	X200-18T+1.2T SSD/12G/4x1GE	IS	\$74,532
X200-SATA-S56	X200-18T+1.2T SSD/12G/2x10GE SFP+2x1GE	IS	\$74,589
X200-SATA-S57	X200-18T+1.2T SSD/24G/4x1GE	IS	\$75,144
X200-SATA-S58	X200-18T+1.2T SSD/24G/2x10GE SFP+2x1GE	IS	\$77,194
X200-SATA-S59	X200-18T+1.2T SSD/48G/4x1GE	IS	\$76,330
X200-SATA-S60	X200-18T+1.2T SSD/48G/2x10GE SFP+2x1GE	IS	\$78,380
X200-SATA-S71	X200-5.5TB+400GB SSD/6G/2X10GE SFP+2X1GE	IS	\$44,774
X200-SATA-S72	X200-10TB+800GB SSD/12G/2X10GE SFP+2X1GE	IS	\$59,373
X200-SATA-S73	X200-5.5TB 400GB SSD/6G/4X1GE	IS	\$42,606
X200-SATA-S74	X200-10TB 800GB SSD/12G/4X1GE	IS	\$57,205
X200-SATA-S75	X200-10TB+1.6TB/12GB/2x10GE 2x1GE	IS	\$72,987
X200-SATA-S76	X200-10TB+1.6TB/12GB/4x1GE	IS	\$70,892
X200-SATA-S77	X200-10TB+1.6TB/24GB/2x10GE 2x1GE	IS	\$72,339
X200-SATA-S78	X200-10TB+1.6TB/24GB/4x1GE	IS	\$71,237
X200-SATA-S79	X200-10TB+1.6TB/48GB/2x10GE 2x1GE	IS	\$74,016
X200-SATA-S80	X200-10TB+1.6TB/48GB/4x1GE	IS	\$71,870
X200-SATA-S81	X200-20TB+1.6TB/12GB/2x10GE 2x1GE	IS	\$78,937
X200-SATA-S82	X200-20TB+1.6TB/12GB/4x1GE	IS	\$76,914
X200-SATA-S83	X200-20TB+1.6TB/24GB/2x10GE 2x1GE	IS	\$79,276
X200-SATA-S84	X200-20TB+1.6TB/24GB/4x1GE	IS	\$77,336
X200-SATA-S85	X200-20TB+1.6TB/48GB/2x10GE 2x1GE	IS	\$80,176
X200-SATA-S86	X200-20TB+1.6TB/48GB/4x1GE	IS	\$78,124
X200-SATA-S87	X200-6TB+4.8TB/12GB/2x10GE 2x1GE	IS	\$156,780
X200-SATA-S88	X200-6TB+4.8TB/12GB/4x1GE	IS	\$154,950
X200-SATA-S89	X200-6TB+4.8TB/24GB/2x10GE 2x1GE	IS	\$156,872
X200-SATA-S90	X200-6TB+4.8TB/24GB/4x1GE	IS	\$155,017
X200-SATA-S91	X200-6TB+4.8TB/48GB/2x10GE 2x1GE	IS	\$156,965
X200-SATA-S92	X200-6TB+4.8TB/48GB/4x1GE	IS	\$155,063
X200-SATA-S93	X200-16TB+3.2TB/12GB/2x10GE 2x1GE	IS	\$119,345

X200-SATA-S94	X200-16TB+3.2TB/12GB/4x1GE	IS	\$117,393
X200-SATA-S95	X200-16TB+3.2TB/24GB/2x10GE 2x1GE	IS	\$119,724
X200-SATA-S96	X200-16TB+3.2TB/24GB/4x1GE	IS	\$117,763
X200-SATA-S97	X200-16TB+3.2TB/48GB/2x10GE 2x1GE	IS	\$120,419
X200-SATA-S98	X200-16TB+3.2TB/48GB/4x1GE	IS	\$118,438
X200-SATA-S99	X200-12TB+4.8TB/12GB/2x10GE 2x1GE	IS	\$158,189
X210-SAS-E02	X210-30T+1.6T SSD-SED/24G/2x10GE 2x1GE	IS	\$110,562
X210-SAS-E02-HO	X210-30T+1.6T SSD-SED/24G/2x10GE 2x1/HO	IS	\$72,289
X210-SAS-E03	X210-30T+1.6T SSD-SED/48G/2x10GE 2x1GE	IS	\$113,234
X210-SAS-E03-HO	X210-30T+1.6T SSD-SED/48G/2x10GE 2x1G/HO	IS	\$73,570
X210-SAS-E05	X210-32T+3.2T SSD-SED/24G/2x10GE 2x1GE	IS	\$161,537
X210-SAS-E05-HO	X210-32T+3.2T SSD-SED/24G/2x10GE 2x1/HO	IS	\$109,307
X210-SAS-E06	X210-32T+3.2T SSD-SED/48G/2x10GE 2x1GE	IS	\$163,576
X210-SAS-E06-HO	X210-32T+3.2T SSD-SED/48G/2x10GE 2x1/HO	IS	\$111,060
X210-SAS-E08	X210-33T+800G SSD-SED/24G/2x10GE 2x1GE	IS	\$88,760
X210-SAS-E08-HO	X210-33T+800G SSD-SED/24G/2x10GE 2x1/HO	IS	\$54,955
X210-SAS-E09	X210-33T+800G SSD-SED/48G/2x10GE 2x1GE	IS	\$91,452
X210-SAS-E09-HO	X210-33T+800G SSD-SED/48G/2x10GE 2x1/HO	IS	\$56,170
X210-SAS-E11	X210-36T SED/24G/2x10GE 2x1GE	IS	\$65,645
X210-SAS-E11-HO	X210-36T SED/24G/2x10GE 2x1GE/HO	IS	\$37,662
X210-SAS-E12	X210-36T SED/48G/2x10GE 2x1GE	IS	\$68,657
X210-SAS-E12-HO	X210-36T SED/48G/2x10GE 2x1GE/HO	IS	\$38,770
X210-SAS-E14	X210-40T+1.6T SSD-SED /24G/2x10GE 2x1GE	IS	\$115,949
X210-SAS-E14-HO	X210-40T+1.6T SSD-SED /24G/2x10GE 2x1/HO	IS	\$74,946
X210-SAS-E15	X210-40T+1.6T SSD-SED /48G/2x10GE 2x1GE	IS	\$117,982
X210-SAS-E15-HO	X210-40T+1.6T SSD-SED /48G/2x10GE 2x1/HO	IS	\$76,260
X210-SAS-E17	X210-44T+800G SSD-SED/24G/2x10GE 2x1GE	IS	\$95,298
X210-SAS-E17-HO	X210-44T+800G SSD-SED/24G/2x10GE 2x1/HO	IS	\$57,604
X210-SAS-E18	X210-44T+800G SSD-SED/48G/2x10GE 2x1GE	IS	\$97,376
X210-SAS-E18-HO	X210-44T+800G SSD-SED/48G/2x10GE 2x1/HO	IS	\$58,860
X210-SAS-E20	X210-48T SED/24G/2x10GE 2x1GE	IS	\$70,362
X210-SAS-E20-HO	X210-48T SED/24G/2x10GE 2x1GE/HO	IS	\$40,299
X210-SAS-E21	X210-48T SED/48G/2x10GE 2x1GE	IS	\$72,388
X210-SAS-E21-HO	X210-48T SED/48G/2x10GE 2x1GE/HO	IS	\$41,460
X210-SATA-003	X210-12T/24G/2x10GE 2x1GE	IS	\$29,278
X210-SATA-003-HO	X210-12T/24G/2x10GE 2x1GE/HO	IS	\$23,999
X210-SATA-004	X210-12T/48G/2x10GE 2x1GE	IS	\$30,271
X210-SATA-004-HO	X210-12T/48G/2x10GE 2x1GE/HO	IS	\$24,792
X210-SATA-006	X210-24T/24G/2x10GE 2x1GE	IS	\$42,663
X210-SATA-006-HO	X210-24T/24G/2x10GE 2x1GE/HO	IS	\$25,088
X210-SATA-007	X210-24T/48G/2x10GE 2x1GE	IS	\$43,859
X210-SATA-007-HO	X210-24T/48G/2x10GE 2x1GE/HO	IS	\$25,883
X210-SATA-008	X210-24T/6GB/2x10GE 2x1GE	IS	\$26,827
X210-SATA-010	X210-36T/24G/2x10GE 2x1GE	IS	\$49,667
X210-SATA-010-HO	X210-36T/24G/2x10GE 2x1GE/HO	IS	\$30,130
X210-SATA-011	X210-36T/48G/2x10GE 2x1GE	IS	\$51,946
X210-SATA-011-HO	X210-36T/48G/2x10GE 2x1GE/HO	IS	\$31,016
X210-SATA-012	X210-36T/6GB/2x10GE 2x1GE	IS	\$47,974
X210-SATA-014	X210-48T/48G/2x10GE 2x1GE	IS	\$57,910
X210-SATA-014-HO	X210-48T/48G/2x10GE 2x1GE/HO	IS	\$33,168

X210-SATA-015	X210-48T/24G/2x10GE 2x1GE	IS	\$56,289
X210-SATA-015-HO	X210-48T/24G/2x10GE 2x1GE/HO	IS	\$32,239
X210-SATA-S01	X210-11T+200G SSD/6GB/2x10GE 2x1GE	IS	\$38,680
X210-SATA-S03	X210-11T+200G SSD/24G/2x10GE 2x1GE	IS	\$38,909
X210-SATA-S03-HO	X210-11T+200G SSD/24G/2x10GE 2x1GE/HO	IS	\$27,553
X210-SATA-S04	X210-11T+200G SSD/48G/2x10GE 2x1GE	IS	\$41,286
X210-SATA-S04-HO	X210-11T+200G SSD/48G/2x10GE 2x1GE/HO	IS	\$28,382
X210-SATA-S07	X210-11T+800G SSD/24G/2x10GE 2x1GE	IS	\$53,794
X210-SATA-S07-HO	X210-11T+800G SSD/24G/2x10GE 2x1GE/HO	IS	\$37,807
X210-SATA-S08	X210-11T+800G SSD/48G/2x10GE 2x1GE	IS	\$55,538
X210-SATA-S08-HO	X210-11T+800G SSD/48G/2x10GE 2x1GE/HO	IS	\$38,712
X210-SATA-S10	X210-12T+1.2 T SSD/48G/2x10GE 2x1GE	IS	\$75,883
X210-SATA-S12	X210-12T+4.8T SSD/24G/2x10GE 2x1GE	IS	\$153,671
X210-SATA-S13	X210-12T+4.8T SSD/48G/2x10GE 2x1GE	IS	\$155,232
X210-SATA-S14	X210-18T+1.2T SSD/24G/2x10GE 2x1GE	IS	\$75,650
X210-SATA-S15	X210-18T+1.2T SSD/48G/2x10GE 2x1GE	IS	\$76,812
X210-SATA-S18	X210-20T+400G SSD/24G/2x10GE 2x1GE	IS	\$49,390
X210-SATA-S18-HO	X210-20T+400G SSD/24G/2x10GE 2x1GE/HO	IS	\$32,267
X210-SATA-S19	X210-20T+400G SSD/48G/2x10GE 2x1GE	IS	\$51,733
X210-SATA-S19-HO	X210-20T+400G SSD/48G/2x10GE 2x1GE/HO	IS	\$33,133
X210-SATA-S21	X210-22T+800G SSD/24G/2x10GE 2x1GE	IS	\$60,869
X210-SATA-S21-HO	X210-22T+800G SSD/24G/2x10GE 2x1GE/HO	IS	\$38,898
X210-SATA-S22	X210-22T+800G SSD/48G/2x10GE 2x1GE	IS	\$62,008
X210-SATA-S22-HO	X210-22T+800G SSD/48G/2x10GE 2x1GE/HO	IS	\$39,803
X210-SATA-S23	X210-27T+600G SSD/6GB/2x10GE 2x1GE	IS	\$60,846
X210-SATA-S25	X210-27T+600G SSD/24G/2x10GE 2x1GE	IS	\$60,924
X210-SATA-S26	X210-27T+600G SSD/48G/2x10GE 2x1GE	IS	\$63,452
X210-SATA-S26-HO	X210-27T+600G SSD/48G/2x10GE 2x1GE	IS	\$41,517
X210-SATA-S28	X210-33T+800G SSD/24G/2x10GE 2x1GE	IS	\$69,562
X210-SATA-S28-HO	X210-33T+800G SSD/24G/2x10GE 2x1GE/HO	IS	\$43,964
X210-SATA-S29	X210-33T+800G SSD/48G/2x10GE 2x1GE	IS	\$71,249
X210-SATA-S29-HO	X210-33T+800G SSD/48G/2x10GE 2x1GE/HO	IS	\$44,936
X210-SATA-S32	X210-6T+1.2T SSD/24G/2x10GE 2x1GE	IS	\$68,912
X210-SATA-S32-HO	X210-6T+1.2T SSD/24G/2x10GE 2x1GE	IS	\$45,594
X210-SATA-S33	X210-6T+1.2T SSD/48G/2x10GE 2x1GE	IS	\$70,075
X210-SATA-S34	X210-32T+3.2T SSD/24G/2x10GE 2x1GE	IS	\$129,229
X210-SATA-S35	X210-32T+3.2T SSD/48G/2x10GE 2x1GE	IS	\$130,860
X210-SATA-S37	X210-20T+1.6T SSD/24G/2x10GE 2x1GE	IS	\$77,691
X210-SATA-S38	X210-20T+1.6T SSD/48G/2x10GE 2x1GE	IS	\$78,572
X210-SATA-S40	X210-30T+1.6T SSD/24G/2x10GE 2x1GE	IS	\$86,765
X210-SATA-S41	X210-30T+1.6T SSD/48G/2x10GE 2x1GE	IS	\$88,324
X210-SATA-S41-HO	X210-30T+1.6T SSD/48G/2x10GE 2x1GE/HO	IS	\$58,856
X210-SATA-S43	X210-44T+800G SSD/24G/2x10GE 2x1GE	IS	\$76,238
X210-SATA-S43-HO	X210-44T+800G SSD/24G/2x10GE 2x1GE/HO	IS	\$46,083
X210-SATA-S44	X210-44T+800G SSD/48G/2x10GE 2x1GE	IS	\$77,901
X210-SATA-S44-HO	X210-44T+800G SSD/48G/2x10GE 2x1GE/HO	IS	\$47,088
X210-SATA-S46	X210-40T+1.6T SSD/24G/2x10GE 2x1GE	IS	\$92,759
X210-SATA-S47	X210-40T+1.6T SSD/48G/2x10GE 2x1GE	IS	\$94,385
X210-SATA-S49	X210-10T+1.6T SSD/24G/2x10GE 2x1GE	IS	\$70,892
X210-SATA-S50	X210-10T+1.6T SSD/48G/2x10GE 2x1GE	IS	\$72,536

X400-SAS-E01	X400-108TB-SED/48G/4x1GE	IS	\$156,720
X400-SAS-E02	X400-108TB-SED/48G/2x10GE SFP 2x1GE	IS	\$159,537
X400-SAS-E03	X400-108TB-SED/96G/4x1GE	IS	\$160,077
X400-SAS-E04	X400-108TB-SED/96G/2x10GE SFP 2x1GE	IS	\$162,895
X400-SAS-E05	X400-108TB-SED/192G/4x1GE	IS	\$177,298
X400-SAS-E06	X400-108TB-SED/192G/2x10GE SFP 2x1GE	IS	\$180,116
X400-SAS-E07	X400-144TB-SED/48G/4x1GE	IS	\$189,939
X400-SAS-E08	X400-144TB-SED/48G/2x10GE SFP 2x1GE	IS	\$192,757
X400-SAS-E09	X400-144TB-SED/96G/4x1GE	IS	\$193,297
X400-SAS-E10	X400-144TB-SED/96G/2x10GE SFP 2x1GE	IS	\$196,115
X400-SAS-E11	X400-144TB-SED/192G/4x1GE	IS	\$210,518
X400-SAS-E12	X400-144TB-SED/192G/2x10GE SFP 2x1GE	IS	\$213,336
X400-SAS-E13	X400-102T+1.6T SSD-SED/48G/2X10GE+2X1GE	IS	\$208,723
X400-SAS-E14	X400-102T+1.6T SSD-SED/48G/4x1GE	IS	\$205,499
X400-SAS-E15	X400-102T+1.6T SSD-SED/96G/2X10GE+2X1GE	IS	\$214,201
X400-SAS-E16	X400-102T+1.6T SSD-SED/192G/4x1GE	IS	\$223,276
X400-SAS-E17	X400-96T+3.2T SSD-SED/48G/2X10GE+2X1GE	IS	\$256,027
X400-SAS-E18	X400-96T+3.2T SSD-SED/48G/4x1GE	IS	\$252,803
X400-SAS-E19	X400-96T+3.2T SSD-SED/96G/2X10GE+2X1GE	IS	\$261,504
X400-SAS-E20	X400-96T+3.2T SSD-SED/96G/4x1GE	IS	\$258,280
X400-SAS-E21	X400-96T+3.2T SSD-SED/192G/2X10GE+2X1GE	IS	\$273,804
X400-SAS-E22	X400-96T+3.2T SSD-SED/192G/4x1GE	IS	\$270,580
X400-SAS-E23	X400-136T+1.6T SSD-SED/48G/2X10GE+2X1GE	IS	\$229,674
X400-SAS-E24	X400-136T+1.6T SSD-SED/48G/4x1GE	IS	\$226,449
X400-SAS-E25	X400-136T+1.6T SSD-SED/96G/2X10GE+2X1GE	IS	\$235,151
X400-SAS-E26	X400-136T+1.6T SSD-SED/96G/4x1GE	IS	\$231,926
X400-SAS-E27	X400-136T+1.6T SSD-SED/192G/2X10GE+2X1GE	IS	\$247,451
X400-SAS-E28	X400-136T+1.6T SSD-SED/192G/4x1GE	IS	\$244,226
X400-SAS-E29	X400-128T+3.2T SSD-SED/48G/2X10GE+2X1GE	IS	\$275,745
X400-SAS-E30	X400-128T+3.2T SSD-SED/48G/4x1GE	IS	\$272,520
X400-SAS-E31	X400-128T+3.2T SSD-SED/96G/2X10GE+2X1GE	IS	\$281,222
X400-SAS-E32	X400-128T+3.2T SSD-SED/96G/4x1GE	IS	\$277,997
X400-SAS-E33	X400-128T+3.2T SSD-SED/192G/2X10GE+2X1GE	IS	\$293,522
X400-SAS-E34	X400-128T+3.2T SSD-SED/192G/4x1GE	IS	\$290,297
X400-SAS-E35	X400-120T+4.8T SSD-SED/48G/4x1GE	IS	\$318,592
X400-SAS-E36	X400-120T+4.8T SSD-SED/48G/2X10GE+2X1GE	IS	\$321,816
X400-SAS-E37	X400-120T+4.8T SSD-SED/96G/2X10GE+2X1GE	IS	\$327,293
X400-SAS-E38	X400-120T+4.8T SSD-SED/96G/4x1GE	IS	\$324,069
X400-SAS-E39	X400-120T+4.8T SSD-SED/192G/2X10GE+2X1GE	IS	\$339,593
X400-SAS-E40	X400-120T+4.8T SSD-SED/192G/4x1GE	IS	\$336,369
X400-SAS-E41	X400-102T+1.6T SSD-SED/96G/4x1GE	IS	\$210,976
X400-SAS-E42	X400-102T+1.6T SSD-SED/192G/2X10GE+2X1GE	IS	\$226,500
X400-SATA-001	X400-108T/48G/4x1GE	IS	\$114,598
X400-SATA-002	X400-108T/48G/2x10GE SFP+2x1GE	IS	\$122,721
X400-SATA-003	X400-108T/96G/4x1GE	IS	\$117,053
X400-SATA-004	X400-108T/96G/2x10GE SFP+2x1GE	IS	\$119,114
X400-SATA-005	X400-108T/192G/4x1GE	IS	\$129,646
X400-SATA-006	X400-108T/192G/2x10GE SFP+2x1GE	IS	\$131,707
X400-SATA-007	X400-36T/48G/4x1GE	IS	\$73,984
X400-SATA-008	X400-36T/48G/2x10GE SFP+2x1GE	IS	\$76,045

X400-SATA-009	X400-36T/96G/4x1GE	IS	\$76,440
X400-SATA-010	X400-36T/96G/2x10GE SFP+2x1GE	IS	\$78,500
X400-SATA-011	X400-36T/192G/4x1GE	IS	\$89,032
X400-SATA-012	X400-36T/192G/2x10GE SFP+2x1GE	IS	\$91,093
X400-SATA-013	X400-72T/48G/4x1GE	IS	\$96,405
X400-SATA-014	X400-72T/48G/2x10GE SFP+2x1GE	IS	\$98,465
X400-SATA-015	X400-72T/96G/4x1GE	IS	\$98,860
X400-SATA-016	X400-72T/96G/2x10GE SFP+2x1GE	IS	\$100,920
X400-SATA-017	X400-72T/192G/4x1GE	IS	\$111,452
X400-SATA-018	X400-72T/192G/2x10GE SFP+2x1GE	IS	\$113,513
X400-SATA-019	X400-144T/24G/4x1GE	IS	\$137,430
X400-SATA-020	X400-144T/48G/4x1GE	IS	\$138,889
X400-SATA-021	X400-144T/48G/2x10GE SFP+2x1GE	IS	\$140,950
X400-SATA-022	X400-144T/96G/4x1GE	IS	\$141,345
X400-SATA-023	X400-144T/96G/2x10GE SFP+2x1GE	IS	\$143,405
X400-SATA-024	X400-144T/192G/4x1GE	IS	\$153,937
X400-SATA-025	X400-144T/192G/2x10GE SFP+2x1GE	IS	\$155,998
X400-SATA-S01	X400-34T+800G SSD/48G/4x1GE	IS	\$97,080
X400-SATA-S02	X400-34T+800G SSD/48G/2x10GE SFP+2x1GE	IS	\$99,140
X400-SATA-S03	X400-34T+800G SSD/96G/4x1GE	IS	\$99,535
X400-SATA-S04	X400-34T+800G SSD/96G/2x10GE SFP+2x1GE	IS	\$101,595
X400-SATA-S05	X400-34T+800G SSD/192G/4x1GE	IS	\$112,128
X400-SATA-S06	X400-34T+800G SSD/192G/2x10GE SFP+2x1GE	IS	\$114,188
X400-SATA-S07	X400-66T+1.2T SSD/24G/4x1GE	IS	\$127,332
X400-SATA-S08	X400-66T+1.2T SSD/48G/4x1GE	IS	\$128,791
X400-SATA-S09	X400-66T+1.2T SSD/48G/2x10GE SFP+2x1GE	IS	\$130,852
X400-SATA-S10	X400-66T+1.2T SSD/96G/4x1GE	IS	\$131,246
X400-SATA-S11	X400-66T+1.2T SSD/96G/2x10GE SFP+2x1GE	IS	\$133,307
X400-SATA-S12	X400-66T+1.2T SSD/192G/4x1GE	IS	\$143,839
X400-SATA-S13	X400-66T+1.2T SSD/192G/2x10GE SFP+2x1GE	IS	\$145,900
X400-SATA-S14	X400-96T+1.6T SSD/24G/4x1GE	IS	\$153,305
X400-SATA-S15	X400-96T+1.6T SSD/24G/2x10GE SFP+2x1GE	IS	\$155,366
X400-SATA-S16	X400-96T+1.6T SSD/48G/4x1GE	IS	\$154,765
X400-SATA-S17	X400-96T+1.6T SSD/48G/2x10GE SFP+2x1GE	IS	\$164,975
X400-SATA-S18	X400-96T+1.6T SSD/96G/4x1GE	IS	\$157,220
X400-SATA-S19	X400-96T+1.6T SSD/96G/2x10GE SFP+2x1GE	IS	\$159,281
X400-SATA-S20	X400-96T+1.6T SSD/192G/4x1GE	IS	\$169,813
X400-SATA-S21	X400-96T+1.6T SSD/192G/2x10GE SFP+2x1GE	IS	\$171,873
X400-SATA-S22	X400-32T+400G SSD/24G/4x1GE	IS	\$0
X400-SATA-S23	X400-32T+400G SSD/24G/2x10GE SFP+2x1GE	IS	\$0
X400-SATA-S24	X400-102T+800G SSD/24G/2x10GE SFP+2x1GE	IS	\$161,689
X400-SATA-S25	X400-105T+400G SSD/48G/2x10GE SFP+2x1GE	IS	\$132,626
X400-SATA-S27	X400-120T+2.4T SSD/24G/4x1GE	IS	\$191,434
X400-SATA-S28	X400-120T+2.4T SSD/48G/4x1GE	IS	\$192,894
X400-SATA-S29	X400-120T+2.4T SSD/48G/2x10GE SFP+2x1GE	IS	\$194,954
X400-SATA-S30	X400-120T+2.4T SSD/96G/4x1GE	IS	\$195,349
X400-SATA-S31	X400-120T+2.4T SSD/96G/2x10GE SFP+2x1GE	IS	\$197,409
X400-SATA-S32	X400-120T+2.4T SSD/192G/4x1GE	IS	\$207,942
X400-SATA-S33	X400-120T+2.4T SSD/192G/2x10GE SFP+2x1GE	IS	\$210,002
X400-SATA-S34	X400-32T+400G SSD/48G/2x10GE SFP+2x1GE	IS	\$0

X400-SATA-S35	X400-32T+400G SSD/96G/2x10GE SFP+2x1GE	IS	\$0
X400-SATA-S36	X400-136T/800GB SSD/24G/4x1GE	IS	\$161,843
X400-SATA-S37	X400-136T/800GB SSD/24G/2x10GE SFP/2x1GE	IS	\$164,011
X400-SATA-S38	X400-136T+800GB SSD/48G/4x1GE	IS	\$163,379
X400-SATA-S39	X400-136T+800GB SSD/48G/2x10GE SFP+2x1GE	IS	\$165,546
X400-SATA-S40	X400-140T+400GB SSD/24G/4x1GE	IS	\$151,959
X400-SATA-S41	X400-140T+400GB SSD/24G/2x10GE SFP+2x1GE	IS	\$154,126
X400-SATA-S42	X400-140T+400GB SSD/48G/4x1GE	IS	\$153,494
X400-SATA-S43	X400-140T+400GB SSD/48G/2x10GE SFP+2x1GE	IS	\$155,662
X400-SATA-S44	X400-32T+400G SSD/48G/4x1GE	IS	\$0
X400-SATA-S45	X400-32T+400G SSD/96G/4x1GE	IS	\$0
X400-SATA-S46	X400-32T+400G SSD/192G/4x1GE	IS	\$0
X400-SATA-S47	X400-32T+400G SSD/192G/2x10GE SFP+2x1GE	IS	\$0
X400-SATA-S48	X400-60T/4.8T SSD/48G/2X10GE SFP 2X1GE	IS	\$227,680
X400-SATA-S49	X400-60T/4.8T SSD/48G/4X1GE	IS	\$225,285
X400-SATA-S50	X400-120T/4.8T SSD/96G/2X10GE SFP 2X1GE	IS	\$271,920
X400-SATA-S51	X400-120T/4.8T SSD/96G/4X1GE	IS	\$269,468
X400-SATA-S52	X400-62TB 2TB SSD/48G/2X10GE SFP 2X1GE	IS	\$155,658
X400-SATA-S53	X400-120T/4.8T SSD/192G/2x10GE SFP 2x1GE	IS	\$284,360
X400-SATA-S54	X400-128T/3.2T SSD/192G/2x10GE SFP 2x1GE	IS	\$246,831
X400-SATA-S55	X400-96T/3.2T SSD/192G/2x10GE SFP 2x1GE	IS	\$215,356
X400-SATA-S56	X400-96T/3.2T SSD/96G/2x10GE SFP 2x1GE	IS	\$201,157
X400-SATA-S57	X400-60T+4.8T SSD/96G/2x10GE SFP+2x1GE	IS	\$232,209
X400-SATA-S58	X400-120T/4.8T SSD/48G/2x10GE/2x1GE	IS	\$267,158
X400-SATA-S59	INA X400-120T/4.8T SSD/96G/2x10GE/2x1GE	IS	\$253,370
X400-SATA-S60	X400-128T/3.2T SSD/48G/2x10GE/2x1GE	IS	\$230,402
X400-SATA-S61	X400-128T/3.2T SSD/96G/2x10GE/2x1GE	IS	\$235,274
X400-SATA-S62	X400-136T/1.6T SSD/48G/2x10GE/2x1GE	IS	\$188,291
X400-SATA-S63	X400-136T/1.6T SSD/96G/2x10GE/2x1GE	IS	\$193,144
X400-SATA-S64	X400-64T/3.2T SSD/48G/2x10GE SFP 2x1GE	IS	\$180,763
X400-SATA-S65	X400-64T/3.2T SSD/96G/2x10GE/2x1GE	IS	\$185,170
X400-SATA-S66	X400-68T/1.6T SSD/48G/2x10GE/2x1GE	IS	\$141,645
X400-SATA-S67	X400-68T/1.6T SSD/96G/2x10GE/2x1GE	IS	\$146,052
X400-SATA-S68	X400-70T/800G SSD/48G/2x10GE/2x1GE	IS	\$122,058
X400-SATA-S69	X400-70T/800G SSD/96G/2x10GE/2x1GE	IS	\$126,465
X400-SATA-S70	X400-132T+2.4T SSD/48G/2x10GE 2x1GE	IS	\$209,505
X400-SATA-S71	X400-132T+2.4T SSD/96G/2x10GE 2x1GE	IS	\$214,358
X400-SATA-S72	X400-34TB+1.6T SSD/48G/2x10GE 2x1GE	IS	\$119,054
X400-SATA-S73	X400-34TB+1.6T SSD/96G/2x10GE 2x1GE	IS	\$123,291
X400-SATA-S74	X400-35T+800G SSD/48G/2x10GE 2x1GE	IS	\$100,405
X400-SATA-S75	X400-35T+800G SSD/96G/2x10GE 2x1GE	IS	\$104,643
X400-SATA-S76	X400-96T+3.2T SSD/48G/2x10GE 2x1GE	IS	\$197,941
X400-SATA-S77	X400-99T+2.4T SSD/48G/2x10GE 2x1GE	IS	\$178,135
X400-SATA-S78	X400-99T+2.4T SSD/96G/2x10GE 2x1GE	IS	\$182,591
X400-SATA-S79	X400-102T+1.6T SSD/48G/2x10GE 2x1GE	IS	\$158,200
X400-SATA-S80	X400-102T+1.6T SSD/96G/2x10GE 2x1GE	IS	\$163,207
X400-SATA-S81	X400-140T+1.6T SSD/96G/2x10GE 2x1GE	IS	\$196,384
X400-YH-001	X400-102T+800G SSD/24G/4x1GE	IS	\$142,156
X410-SAS-E01	X410-144T SED/64G/2x10GE+2x1GE	IS	\$197,393
X410-SAS-E01-HO	X410-144T SED/64G/2x10GE 2x1GE/HO	IS	\$93,043

X410-SAS-E02	X410-144T SED/32G/2x10GE+2x1GE	IS	\$193,716
X410-SAS-E02-HO	X410-144T SED/32G/2x10GE 2x1GE/HO	IS	\$94,937
X410-SAS-E03	X410-144T SED/128G/2x10GE+2x1GE	IS	\$204,424
X410-SAS-E03-HO	X410-144T SED/128G/2x10GE 2x1GE/HO	IS	\$99,185
X410-SAS-E04	X410-144T SED/256G/2x10GE+2x1GE	IS	\$220,492
X410-SAS-E04-HO	X410-144T SED/256G/2x10GE 2x1GE/HO	IS	\$108,791
X410-SAS-E05	X410-136T+1.6T SSD-SED/32G/2x10GE+2x1GE	IS	\$245,954
X410-SAS-E05-HO	X410-136T/1.6T SSD-SED/32G/2x10GE 2x1/HO	IS	\$120,934
X410-SAS-E06	X410-136T+1.6T SSD-SED/64G/2x10GE+2x1GE	IS	\$249,893
X410-SAS-E06-HO	X410-136T/1.6T SSD-SED/64G/2x10GE 2x1/HO	IS	\$122,837
X410-SAS-E07	X410-136T+1.6T SSD-SED/128G/2x10GE+2x1GE	IS	\$257,423
X410-SAS-E07-HO	X410-136T/1.6T SSD-SED/128G/2x10GE/HO	IS	\$127,105
X410-SAS-E08	X410-136T+1.6T SSD-SED/256G/2x10GE+2x1GE	IS	\$274,635
X410-SAS-E08-HO	X410-136T/1.6T SSD-SED/256G/2x10GE/HO	IS	\$136,757
X410-SAS-E09	X410-128T+3.2T SSD-SED/32G/2x10GE+2x1GE	IS	\$293,954
X410-SAS-E09-HO	X410-128T/3.2T SSD-SED/32G/2x10GE/HO	IS	\$153,473
X410-SAS-E10	X410-128T+3.2T SSD-SED/64G/2x10GE+2x1GE	IS	\$297,893
X410-SAS-E100	X410-144T SED/256G/2x40GE/2x1GE	IS	\$222,925
X410-SAS-E101	X410-144T SED/64G/2x40GE/2x1GE	IS	\$199,778
X410-SAS-E102	X410-90T+4.8T SSD-SED/128/2x40GE 2x1GE	IS	\$325,477
X410-SAS-E103	X410-90T+4.8T SSD-SED/256/2x40GE 2x1GE	IS	\$341,462
X410-SAS-E104	X410-90T+4.8T SSD-SED/64G/2x40GE 2x1GE	IS	\$318,373
X410-SAS-E105	X410-90T+9.6T SSD-SED/128G/2x40GE 2x1GE	IS	\$502,688
X410-SAS-E106	X410-90T+9.6T SSD-SED/256G/2x40GE 2x1GE	IS	\$527,016
X410-SAS-E107	X410-90T+9.6T SSD-SED/64G/2x40GE 2x1GE	IS	\$491,930
X410-SAS-E108	X410-96T+3.2T SSD-SED/128/2x40GE 2x1GE	IS	\$276,910
X410-SAS-E109	X410-96T+3.2T SSD-SED/256/2x40GE 2x1GE	IS	\$294,366
X410-SAS-E10-HO	X410-128T/3.2T SSD-SED/64G/2x10GE/HO	IS	\$155,441
X410-SAS-E11	X410-128T+3.2T SSD-SED/128G/2x10GE+2x1GE	IS	\$305,424
X410-SAS-E110	X410-96T+3.2T SSD-SED/64G/2x40GE 2x1GE	IS	\$269,274
X410-SAS-E111	X410-96T+6.4T SSD-SED/128G/2x40GE 2x1GE	IS	\$379,676
X410-SAS-E112	X410-96T+6.4T SSD-SED/256G/2x40GE 2x1GE	IS	\$402,006
X410-SAS-E113	X410-96T+6.4T SSD-SED/64G/2x40GE 2x1GE	IS	\$369,803
X410-SAS-E114	X410-99T+4.8T SSD-SED/128G/2x40GE 2x1GE	IS	\$327,575
X410-SAS-E115	X410-99T+4.8T SSD-SED/256G/2x40GE 2x1GE	IS	\$345,018
X410-SAS-E116	X410-99T+4.8T SSD-SED/64G/2x40GE 2x1GE	IS	\$319,945
X410-SAS-E11-HO	X410-128T/3.2T SSD-SED/128G/2x10GE/HO	IS	\$159,853
X410-SAS-E12	X410-128T+3.2T SSD-SED/256G/2x10GE+2x1GE	IS	\$322,635
X410-SAS-E12-HO	X410-128T/3.2T SSD-SED/256G/2x10GE/HO	IS	\$169,831
X410-SAS-E13	X410-120T+4.8T SSD-SED/32G/2x10GE+2x1GE	IS	\$341,955
X410-SAS-E13-HO	X410-120T/4.8T SSD-SED/32G/2x10GE/HO	IS	\$186,166
X410-SAS-E14	X410-120T+4.8T SSD-SED/64G/2x10GE+2x1GE	IS	\$345,894
X410-SAS-E14-HO	X410-120T/4.8T SSD-SED/64G/2x10GE/HO	IS	\$188,179
X410-SAS-E15	X410-120T+4.8T SSD-SED/128G/2x10GE+2x1GE	IS	\$353,424
X410-SAS-E15-HO	X410-120T/4.8T SSD-SED/128G/2x10GE/HO	IS	\$192,694
X410-SAS-E16	X410-120T+4.8T SSD-SED/256G/2x10GE+2x1GE	IS	\$370,635
X410-SAS-E16-HO	X410-120T/4.8T SSD-SED/256G/2x10GE/HO	IS	\$202,905
X410-SAS-E17	X410-108T SED/32G/2x10GE 2x1GE	IS	\$162,619
X410-SAS-E17-HO	X410-108T SED/32G/2x10GE 2x1GE/HO	IS	\$75,869
X410-SAS-E18	X410-108T SED/64G/2x10GE 2x1GE	IS	\$166,607

X410-SAS-E18-HO	X410-108T SED/64G/2x10GE 2x1GE/HO	IS	\$77,459
X410-SAS-E19	X410-108T SED/128/2x10GE 2x1GE	IS	\$174,232
X410-SAS-E19-HO	X410-108T SED/128/2x10GE 2x1GE/HO	IS	\$81,025
X410-SAS-E20	X410-108T SED/256/2x10GE 2x1GE	IS	\$191,657
X410-SAS-E20-HO	X410-108T SED/256/2x10GE 2x1GE/HO	IS	\$89,091
X410-SAS-E21	X410-102T+1.6T SSD-SED/32G/2x10GE 2x1GE	IS	\$212,479
X410-SAS-E21-HO	X410-102T+1.6T SSD-SED/32G/2x10GE 2x1/HO	IS	\$103,174
X410-SAS-E22	X410-102T+1.6T SSD-SED/64G/2x10GE 2x1GE	IS	\$216,467
X410-SAS-E22-HO	X410-102T+1.6T SSD-SED/64G/2x10GE 2x1/HO	IS	\$104,832
X410-SAS-E23	X410-102T+1.6T SSD-SED/128/2x10GE 2x1GE	IS	\$224,091
X410-SAS-E23-HO	X410-102T+1.6T SSD-SED/128/2x10GE 2x1/HO	IS	\$108,551
X410-SAS-E24	X410-102T+1.6T SSD-SED/256/2x10GE 2x1GE	IS	\$241,517
X410-SAS-E24-HO	X410-102T+1.6T SSD-SED/256/2x10GE 2x1/HO	IS	\$116,962
X410-SAS-E25	X410-96T+3.2T SSD-SED/32G/2x10GE 2x1GE	IS	\$262,697
X410-SAS-E25-HO	X410-96T+3.2T SSD-SED/32G/2x10GE 2x1/HO	IS	\$133,864
X410-SAS-E26	X410-96T+3.2T SSD-SED/64G/2x10GE 2x1GE	IS	\$266,685
X410-SAS-E26-HO	X410-96T+3.2T SSD-SED/64G/2x10GE 2x1/HO	IS	\$135,501
X410-SAS-E27	X410-96T+3.2T SSD-SED/128/2x10GE 2x1GE	IS	\$274,310
X410-SAS-E27-HO	X410-96T+3.2T SSD-SED/128/2x10GE 2x1/HO	IS	\$139,174
X410-SAS-E28	X410-96T+3.2T SSD-SED/256/2x10GE 2x1GE	IS	\$291,735
X410-SAS-E28-HO	X410-96T+3.2T SSD-SED/256/2x10GE 2x1/HO	IS	\$147,481
X410-SAS-E29	X410-90T+4.8T SSD-SED/32G/2x10GE 2x1GE	IS	\$311,914
X410-SAS-E29-HO	X410-90T+4.8T SSD-SED/32G/2x10GE 2x1/HO	IS	\$163,279
X410-SAS-E30	X410-90T+4.8T SSD-SED/64G/2x10GE 2x1GE	IS	\$315,653
X410-SAS-E30-HO	X410-90T+4.8T SSD-SED/64G/2x10GE 2x1/HO	IS	\$165,067
X410-SAS-E31	X410-90T+4.8T SSD-SED/128/2x10GE 2x1GE	IS	\$322,754
X410-SAS-E31-HO	X410-90T+4.8T SSD-SED/128/2x10GE 2x1/HO	IS	\$169,079
X410-SAS-E32	X410-90T+4.8T SSD-SED/256/2x10GE 2x1GE	IS	\$338,728
X410-SAS-E32-HO	X410-90T+4.8T SSD-SED/256/2x10GE 2x1/HO	IS	\$178,149
X410-SAS-E33	X410-102T+3.2T SSD-SED/64G/2x10GE 2x1GE	IS	\$266,685
X410-SAS-E34	X410-102T+3.2T SSD-SED/128G/2x10GE 2x1GE	IS	\$274,310
X410-SAS-E34-HO	X410-102T+3.2T SSD-SED/128G/2x10GE/HO	IS	\$142,400
X410-SAS-E35	X410-102T+3.2T SSD-SED/256G/2x10GE 2x1GE	IS	\$291,735
X410-SAS-E36	X410-105T+1.6T SSD-SED/64G/2x10GE 2x1GE	IS	\$216,467
X410-SAS-E37	X410-105T+1.6T SSD-SED/128G/2x10GE 2x1GE	IS	\$224,091
X410-SAS-E38	X410-105T+1.6T SSD-SED/256G/2x10GE 2x1GE	IS	\$241,517
X410-SAS-E39	X410-120T+9.6T SSD-SED/64G/2x10GE 2x1GE	IS	\$522,006
X410-SAS-E40	X410-120T+9.6T SSD-SED/128G/2x10GE 2x1GE	IS	\$533,317
X410-SAS-E41	X410-120T+9.6T SSD-SED/256G/2x10GE 2x1GE	IS	\$558,919
X410-SAS-E42	X410-128T+6.4T SSD-SED/64G/2x10GE 2x1GE	IS	\$407,274
X410-SAS-E43	X410-128T+6.4T SSD-SED/128G/2x10GE 2x1GE	IS	\$418,002
X410-SAS-E44	X410-128T+6.4T SSD-SED/256G/2x10GE 2x1GE	IS	\$442,284
X410-SAS-E45	X410-132T+4.8T SSD-SED/64G/2x10GE 2x1GE	IS	\$354,419
X410-SAS-E46	X410-132T+4.8T SSD-SED/128G/2x10GE 2x1GE	IS	\$362,523
X410-SAS-E47	X410-132T+4.8T SSD-SED/256G/2x10GE 2x1GE	IS	\$381,044
X410-SAS-E48	X410-136T+3.2T SSD-SED/64G/2x10GE 2x1GE	IS	\$302,385
X410-SAS-E49	X410-136T+3.2T SSD-SED/128G/2x10GE 2x1GE	IS	\$329,010
X410-SAS-E49-HO	X410-136T+3.2T SSD-SED/128G/2X10GE/HO	IS	\$174,725
X410-SAS-E50	X410-136T+3.2T SSD-SED/256G/2x10GE 2x1GE	IS	\$310,489
X410-SAS-E51	X410-140T+1.6T SSD-SED/64G/2x10GE 2x1GE	IS	\$250,193

X410-SAS-E52	X410-140T+1.6T SSD-SED/128G/2x10GE 2x1GE	IS	\$258,296
X410-SAS-E52-HO	X410-140T+1.6T SSD-SED/128G/2x10GE/HO	IS	\$130,041
X410-SAS-E53	X410-140T+1.6T SSD-SED/256G/2x10GE 2x1GE	IS	\$276,817
X410-SAS-E53-HO	X410-140T+1.6T SSD-SED/256G/2x10GE/HO	IS	\$135,098
X410-SAS-E54	X410-90T+9.6T SSD-SED/64G/2x10GE 2x1GE	IS	\$488,574
X410-SAS-E55	X410-90T+9.6T SSD-SED/128G/2x10GE 2x1GE	IS	\$499,315
X410-SAS-E56	X410-90T+9.6T SSD-SED/256G/2x10GE 2x1GE	IS	\$523,604
X410-SAS-E57	X410-96T+6.4T SSD-SED/64G/2x10GE 2x1GE	IS	\$366,730
X410-SAS-E58	X410-96T+6.4T SSD-SED/128G/2x10GE 2x1GE	IS	\$376,584
X410-SAS-E59	X410-96T+6.4T SSD-SED/256G/2x10GE 2x1GE	IS	\$398,869
X410-SAS-E60	X410-99T+4.8T SSD-SED/64G/2x10GE 2x1GE	IS	\$317,094
X410-SAS-E61	X410-99T+4.8T SSD-SED/128G/2x10GE 2x1GE	IS	\$324,718
X410-SAS-E62	X410-99T+4.8T SSD-SED/256G/2x10GE 2x1GE	IS	\$342,144
X410-SAS-E63	X410-102T+1.6T SSD-SED/128/2x40GE 2x1GE	IS	\$226,514
X410-SAS-E64	X410-102T+1.6T SSD-SED/256/2x40GE 2x1GE	IS	\$243,984
X410-SAS-E65	X410-102T+1.6T SSD-SED/64G/2x40GE 2x1GE	IS	\$218,871
X410-SAS-E66	X410-102T+3.2T SSD-SED/128G/2x40GE 2x1GE	IS	\$277,046
X410-SAS-E67	X410-102T+3.2T SSD-SED/256G/2x40GE 2x1GE	IS	\$294,497
X410-SAS-E68	X410-102T+3.2T SSD-SED/64G/2x40GE 2x1GE	IS	\$269,413
X410-SAS-E69	X410-105T+1.6T SSD-SED/128G/2x40GE 2x1GE	IS	\$226,693
X410-SAS-E70	X410-105T+1.6T SSD-SED/256G/2x40GE 2x1GE	IS	\$244,156
X410-SAS-E70-HO	X410-105T+1.6T SSD-SED/256G/2x40GE-HO	IS	\$119,547
X410-SAS-E71	X410-105T+1.6T SSD-SED/64G/2x40GE 2x1GE	IS	\$219,054
X410-SAS-E72	X410-108T SED/128/2x40GE 2x1GE	IS	\$176,426
X410-SAS-E73	X410-108T SED/256/2x40GE 2x1GE	IS	\$193,918
X410-SAS-E74	X410-108T SED/64G/2x40GE 2x1GE	IS	\$168,773
X410-SAS-E75	X410-120T/4.8T SSD-SED/128G/2x40GE/2x1GE	IS	\$356,289
X410-SAS-E76	X410-120T/4.8T SSD-SED/256G/2x40GE/2x1GE	IS	\$373,514
X410-SAS-E77	X410-120T/4.8T SSD-SED/64G/2x40GE/2x1GE	IS	\$348,754
X410-SAS-E78	X410-120T+9.6T SSD-SED/128G/2x40GE 2x1GE	IS	\$536,871
X410-SAS-E79	X410-120T+9.6T SSD-SED/256G/2x40GE 2x1GE	IS	\$562,514
X410-SAS-E80	X410-120T+9.6T SSD-SED/64G/2x40GE 2x1GE	IS	\$525,542
X410-SAS-E81	X410-128T/3.2T SSD-SED/128G/2x40GE/2x1GE	IS	\$308,184
X410-SAS-E82	X410-128T/3.2T SSD-SED/256G/2x40GE/2x1GE	IS	\$325,415
X410-SAS-E83	X410-128T/3.2T SSD-SED/64G/2x40GE/2x1GE	IS	\$300,647
X410-SAS-E84	X410-128T+6.4T SSD-SED/128G/2x40GE 2x1GE	IS	\$421,375
X410-SAS-E85	X410-128T+6.4T SSD-SED/256G/2x40GE 2x1GE	IS	\$445,704
X410-SAS-E86	X410-128T+6.4T SSD-SED/64G/2x40GE 2x1GE	IS	\$410,627
X410-SAS-E87	X410-132T+4.8T SSD-SED/128G/2x40GE 2x1GE	IS	\$365,784
X410-SAS-E88	X410-132T+4.8T SSD-SED/256G/2x40GE 2x1GE	IS	\$384,313
X410-SAS-E89	X410-132T+4.8T SSD-SED/64G/2x40GE 2x1GE	IS	\$357,679
X410-SAS-E90	X410-136T/1.6T SSD-SED/128G/2x40GE/2x1GE	IS	\$260,052
X410-SAS-E91	X410-136T/1.6T SSD-SED/256G/2x40GE/2x1GE	IS	\$277,292
X410-SAS-E92	X410-136T/1.6T SSD-SED/64G/2x40GE/2x1GE	IS	\$252,510
X410-SAS-E93	X410-136T+3.2T SSD-SED/128G/2x40GE 2x1GE	IS	\$313,667
X410-SAS-E94	X410-136T+3.2T SSD-SED/256G/2x40GE 2x1GE	IS	\$332,201
X410-SAS-E95	X410-136T+3.2T SSD-SED/64G/2x40GE 2x1GE	IS	\$305,560
X410-SAS-E96	X410-140T+1.6T SSD-SED/128G/2x40GE 2x1GE	IS	\$261,350
X410-SAS-E97	X410-140T+1.6T SSD-SED/256G/2x40GE 2x1GE	IS	\$279,894
X410-SAS-E98	X410-140T+1.6T SSD-SED/64G/2x40GE 2x1GE	IS	\$253,239

X410-SAS-E99	X410-144T SED/128G/2x40GE/2x1GE	IS	\$206,822
X410-SATA-001	X410-72T/32G/2x10GE+2x1GE	IS	\$104,514
X410-SATA-002	X410-72T/64G/2x10GE+2x1GE	IS	\$107,367
X410-SATA-002-HO	X410-72T/64G/2x10GE/2x1GE/HO	IS	\$59,045
X410-SATA-003	X410-72T/128G/2x10GE+2x1GE	IS	\$110,328
X410-SATA-004	X410-144T/64G/2x10GE+2x1GE	IS	\$151,841
X410-SATA-004-HO	X410-144T/64G/2x10GE 2x1GE HO	IS	\$70,323
X410-SATA-005	X410-144T/32G/2x10GE+2x1GE	IS	\$148,580
X410-SATA-006	X410-144T/128G/2x10GE+2x1GE	IS	\$158,074
X410-SATA-006-HO	X410-144T/128G/2x10GE 2x1GE/HO	IS	\$73,470
X410-SATA-007	X410-144T/256G/2x10GE+2x1GE	IS	\$172,321
X410-SATA-007-HO	X410-144T/256G/2x10GE 2x1GE/HO	IS	\$80,586
X410-SATA-008	X410-72T/256G/2x10GE/2x1GE	IS	\$125,908
X410-SATA-008-HO	X410-72T/256G/2x10GE 2x1GE/HO	IS	\$60,367
X410-SATA-009	X410-108T/128G/2x40GE/2x1GE	IS	\$135,960
X410-SATA-010	X410-108T/256G/2x40GE/2x1GE	IS	\$149,404
X410-SATA-011	X410-108T/64G/2x40GE/2x1GE	IS	\$130,078
X410-SATA-012	X410-144T/128G/2x40GE/2x1GE	IS	\$160,285
X410-SATA-013	X410-144T/256G/2x40GE/2x1GE	IS	\$174,562
X410-SATA-014	X410-144T/64G/2x40GE/2x1GE	IS	\$154,040
X410-SATA-015	X410-36T/128G/2x40GE/2x1GE	IS	\$94,878
X410-SATA-016	X410-36T/256G/2x40GE/2x1GE	IS	\$107,691
X410-SATA-017	X410-36T/64G/2x40GE/2x1GE	IS	\$89,270
X410-SATA-018	X410-72T/128G/2x40GE/2x1GE	IS	\$112,061
X410-SATA-019	X410-72T/256G/2x40GE/2x1GE	IS	\$127,732
X410-SATA-020	X410-72T/64G/2x40GE/2x1GE	IS	\$109,122
X410-SATA-LP006	X410-144T/128G/2x10GE/2x1GE/LP	IS	\$163,077
X410-SATA-LP008	X410-72T/256G/2x10GE/2x1GE/LP	IS	\$129,895
X410-SATA-LPS04	X410-70T/800G SSD/128G/2x10GE/2x1GE/LP	IS	\$135,904
X410-SATA-LPS13	X410-136T/1.6T SSD/256G/2x10GE 2x1GE/LP	IS	\$219,634
X410-SATA-LPS37	X410-108T/256G/2x10GE/2x1GE/LP	IS	\$152,087
X410-SATA-S01	X410-64T/3.2T SSD/64G/2x10GE SFP 2x1GE	IS	\$189,030
X410-SATA-S02	X410-70T+800G SSD/32G/2x10GE+2x1GE	IS	\$126,951
X410-SATA-S03	X410-70T+800G SSD/64G/2x10GE+2x1GE	IS	\$129,994
X410-SATA-S03-HO	X410-70T/800G SSD/64G/2x10GE/2x1GE/HO	IS	\$62,931
X410-SATA-S04	X410-70T+800G SSD/128G/2x10GE+2x1GE	IS	\$135,812
X410-SATA-S04-HO	X410-70T+800G SSD/128G/2x10GE 2x1GE/HO	IS	\$63,087
X410-SATA-S05	X410-68T+1.6T SSD/32G/2x10GE+2x1GE	IS	\$146,568
X410-SATA-S06	X410-68T+1.6T SSD/64G/2x10GE+2x1GE	IS	\$149,612
X410-SATA-S07	X410-68T+1.6T SSD/128G/2x10GE+2x1GE	IS	\$155,429
X410-SATA-S07-HO	X410-68T+1.6T SSD/128G/2x10GE 2x1GE/HO	IS	\$71,807
X410-SATA-S08	X410-64T+3.2T SSD/32G/2x10GE+2x1GE	IS	\$185,987
X410-SATA-S09	X410-64T+3.2T SSD/128G/2x10GE+2x1GE	IS	\$194,848
X410-SATA-S09-HO	X410-64T+3.2T SSD/128G/2x10GE 2x1GE/HO	IS	\$93,776
X410-SATA-S10	X410-136T+1.6T SSD/32G/2x10GE+2x1GE	IS	\$189,195
X410-SATA-S100	X410-140T+1.6T SSD/64G/2x10GE 2x1GE	IS	\$192,456
X410-SATA-S100-HO	X410-140T+1.6T SSD/64G/2x10GE 2x1GE HO	IS	\$89,113
X410-SATA-S101	X410-140T+1.6T SSD/128G/2x10GE 2x1GE	IS	\$198,690
X410-SATA-S101-HO	X410-140T+1.6T SSD/128G/2x10GE 2x1GE/HO	IS	\$92,473
X410-SATA-S102	X410-140T+1.6T SSD/256G/2x10GE 2x1GE	IS	\$212,937

X410-SATA-S102-HO	X410-140T+1.6T SSD/256G/2x10GE 2x1GE/HO	IS	\$100,072
X410-SATA-S103	X410-136T+3.2T SSD/64G/2x10GE 2x1GE	IS	\$232,604
X410-SATA-S103-HO	X410-136T+3.2T SSD/64G/2x10GE 2x1GE HO	IS	\$112,656
X410-SATA-S104	X410-136T+3.2T SSD/256G/2x10GE 2x1GE	IS	\$253,085
X410-SATA-S104-HO	X410-136T+3.2T SSD/256G/2x10GE 2x1GE/HO	IS	\$124,572
X410-SATA-S105	X410-136T+3.2T SSD/128G/2x10GE 2x1GE	IS	\$238,838
X410-SATA-S105-HO	X410-136T+3.2T SSD/128G/2x10GE 2x1GE/HO	IS	\$116,310
X410-SATA-S106	X410-132T+4.8T SSD/64G/2x10GE 2x1GE	IS	\$272,630
X410-SATA-S107	X410-132T+4.8T SSD/128G/2x10GE 2x1GE	IS	\$278,864
X410-SATA-S107-HO	X410-132T+4.8T SSD/128G/2x10GE 2x1GE/HO	IS	\$140,246
X410-SATA-S108	X410-132T+4.8T SSD/256G/2x10GE 2x1GE	IS	\$293,111
X410-SATA-S108-HO	X410-132T+4.8T SSD/256G/2x10GE 2x1GE/HO	IS	\$149,071
X410-SATA-S109	X410-128T+6.4T SSD/64G/2x10GE 2x1GE	IS	\$313,288
X410-SATA-S11	X410-136T+1.6T SSD/64G/2x10GE+2x1GE	IS	\$192,456
X410-SATA-S110	X410-128T+6.4T SSD/128G/2x10GE 2x1GE	IS	\$321,540
X410-SATA-S111	X410-128T+6.4T SSD/256G/2x10GE 2x1GE	IS	\$340,219
X410-SATA-S112	X410-120T+9.6T SSD/64G/2x10GE 2x1GE	IS	\$401,543
X410-SATA-S113	X410-120T+9.6T SSD/128G/2x10GE 2x1GE	IS	\$410,244
X410-SATA-S114	X410-120T+9.6T SSD/256G/2x10GE 2x1GE	IS	\$429,938
X410-SATA-S115	X410-102T+800G SSD/32G/2x10GE/2x1GE	IS	\$144,755
X410-SATA-S116	X410-210T+1.6T SSD/128G/2x10GE 2x1GE	IS	\$289,557
X410-SATA-S117	X410-140T+400G SSD/64G/2x10GE 2x1GE	IS	\$174,393
X410-SATA-S118	X410-105T+1.6T SSD/32G/2x10GE 2x1GE	IS	\$163,445
X410-SATA-S119	X410-105T+1.6T SSD/64G/2x10GE 2x1GE	IS	\$166,513
X410-SATA-S111-HO	X410-136T/1.6T SSD/64G/2x10GE/2x1GE/HO	IS	\$70,448
X410-SATA-S12	X410-136T+1.6T SSD/128G/2x10GE+2x1GE	IS	\$198,690
X410-SATA-S120	X410-105T+1.6T SSD/128G/2x10GE 2x1GE	IS	\$172,378
X410-SATA-S120-HO	X410-105T+1.6T SSD/128G/2x10GE 2x1GE/HO	IS	\$79,657
X410-SATA-S121	X410-105T+1.6T SSD/256G/2x10GE 2x1GE	IS	\$185,782
X410-SATA-S121-HO	X410-105T+1.6T SSD/256G/2x10GE 2x1GE/HO	IS	\$86,639
X410-SATA-S122	X410-102T+3.2T SSD/32G/2x10GE 2x1GE	IS	\$202,075
X410-SATA-S123	X410-102T+3.2T SSD/64G/2x10GE 2x1GE	IS	\$205,142
X410-SATA-S124	X410-102T+3.2T SSD/128G/2x10GE 2x1GE	IS	\$211,007
X410-SATA-S124-HO	X410-102T+3.2T SSD/128G/2x10GE 2x1GE/HO	IS	\$101,262
X410-SATA-S125	X410-102T+3.2T SSD/256G/2x10GE 2x1GE	IS	\$224,412
X410-SATA-S125-HO	X410-102T+3.2T SSD/256G/2x10GE 2x1GE/HO	IS	\$108,911
X410-SATA-S126	X410-99T+4.8T SSD/32G/2x10GE 2x1GE	IS	\$240,851
X410-SATA-S127	X410-99T+4.8T SSD/64G/2x10GE 2x1GE	IS	\$243,918
X410-SATA-S128	X410-99T+4.8T SSD/128G/2x10GE 2x1GE	IS	\$249,783
X410-SATA-S128-HO	X410-99T+4.8T SSD/128G/2x10GE 2x1GE/HO	IS	\$123,541
X410-SATA-S129	X410-99T+4.8T SSD/256G/2x10GE 2x1GE	IS	\$263,187
X410-SATA-S129-HO	X410-99T+4.8T SSD/256G/2x10GE 2x1GE/HO	IS	\$131,740
X410-SATA-S12-HO	X410-136T+1.6T SSD/128G/2x10GE 2x1GE/HO	IS	\$94,152
X410-SATA-S13	X410-136T+1.6TB SSD,256G/2x10GE+2x1GE	IS	\$212,937
X410-SATA-S130	X410-96T+6.4T SSD/32G/2x10GE 2x1GE	IS	\$278,720
X410-SATA-S131	X410-96T+6.4T SSD/64G/2x10GE 2x1GE	IS	\$282,100
X410-SATA-S132	X410-96T+6.4T SSD/128G/2x10GE 2x1GE	IS	\$289,680
X410-SATA-S133	X410-96T+6.4T SSD/256G/2x10GE 2x1GE	IS	\$306,823
X410-SATA-S134	X410-90T+9.6T SSD/32G/2x10GE 2x1GE	IS	\$372,143
X410-SATA-S135	X410-90T+9.6T SSD/64G/2x10GE 2x1GE	IS	\$375,826

X410-SATA-S136	X410-90T+9.6T SSD/128G/2x10GE 2x1GE	IS	\$384,088
X410-SATA-S137	X410-90T+9.6T SSD/256G/2x10GE 2x1GE	IS	\$402,772
X410-SATA-S138	X410-35T+1.6T SSD/32G/2x10GE 2x1GE	IS	\$123,977
X410-SATA-S139	X410-35T+1.6T SSD/64G/2x10GE 2x1GE	IS	\$126,893
X410-SATA-S13-HO	X410-136T+1.6T SSD/256G/2x10GE 2x1GE/HO	IS	\$101,301
X410-SATA-S14	X410-128T+3.2T SSD/32G/2x10GE+2x1GE	IS	\$229,343
X410-SATA-S140	X410-35T+1.6T SSD/128G/2x10GE 2x1GE	IS	\$132,469
X410-SATA-S141	X410-35T+1.6T SSD/256G/2x10GE 2x1GE	IS	\$145,213
X410-SATA-S141-HO	X410-35T+1.6T SSD/256G/2x10GE 2x1GE/HO	IS	\$71,584
X410-SATA-S142	X410-34T+3.2T SSD/32G/2x10GE 2x1GE	IS	\$162,826
X410-SATA-S143	X410-34T+3.2T SSD/64G/2x10GE 2x1GE	IS	\$165,742
X410-SATA-S144	X410-34T+3.2T SSD/128G/2x10GE 2x1GE	IS	\$171,318
X410-SATA-S144-HO	X410-34T+3.2T SSD/128G/2x10GE 2x1GE	IS	\$86,532
X410-SATA-S145	X410-34T+3.2T SSD/256G/2x10GE 2x1GE	IS	\$184,062
X410-SATA-S146	X410-102T/1.6T SSD/128G/2x40GE/2x1GE	IS	\$174,460
X410-SATA-S147	X410-102T/1.6T SSD/256G/2x40GE/2x1GE	IS	\$187,889
X410-SATA-S148	X410-102T/1.6T SSD/64G/2x40GE/2x1GE	IS	\$168,585
X410-SATA-S149	X410-102T+3.2T SSD/128G/2x40GE 2x1GE	IS	\$213,113
X410-SATA-S15	X410-128T+3.2T SSD/64G/2x10GE+2x1GE	IS	\$232,604
X410-SATA-S150	X410-102T+3.2T SSD/256G/2x40GE 2x1GE	IS	\$226,536
X410-SATA-S151	X410-102T+3.2T SSD/64G/2x40GE 2x1GE	IS	\$207,241
X410-SATA-S152	X410-105T+1.6T SSD/128G/2x40GE 2x1GE	IS	\$174,379
X410-SATA-S153	X410-105T+1.6T SSD/256G/2x40GE 2x1GE	IS	\$187,812
X410-SATA-S154	X410-105T+1.6T SSD/64G/2x40GE 2x1GE	IS	\$168,503
X410-SATA-S155	X410-120T/4.8T SSD/128G/2x40GE/2x1GE	IS	\$281,373
X410-SATA-S156	X410-120T/4.8T SSD/256G/2x40GE/2x1GE	IS	\$295,626
X410-SATA-S157	X410-120T/4.8T SSD/64G/2x40GE/2x1GE	IS	\$275,138
X410-SATA-S158	X410-120T+2.4T SSD/128/2x40GE 2x1GE	IS	\$219,228
X410-SATA-S159	X410-120T+2.4T SSD/256/2x40GE 2x1GE	IS	\$234,193
X410-SATA-S16	X410-128T+3.2T SSD/128G/2x10GE+2x1GE	IS	\$238,838
X410-SATA-S160	X410-120T+2.4T SSD/64G/2x40GE 2x1GE	IS	\$209,126
X410-SATA-S161	X410-120T+9.6T SSD/128G/2x40GE 2x1GE	IS	\$412,977
X410-SATA-S162	X410-120T+9.6T SSD/256G/2x40GE 2x1GE	IS	\$432,703
X410-SATA-S163	X410-120T+9.6T SSD/64G/2x40GE 2x1GE	IS	\$404,263
X410-SATA-S164	X410-128T/3.2T SSD/128G/2x40GE/2x1GE	IS	\$241,264
X410-SATA-S165	X410-128T/3.2T SSD/256G/2x40GE/2x1GE	IS	\$255,522
X410-SATA-S166	X410-128T/3.2T SSD/64G/2x40GE/2x1GE	IS	\$235,028
X410-SATA-S167	X410-128T+6.4T SSD/128G/2x40GE 2x1GE	IS	\$324,135
X410-SATA-S168	X410-128T+6.4T SSD/256G/2x40GE 2x1GE	IS	\$342,849
X410-SATA-S169	X410-128T+6.4T SSD/64G/2x40GE 2x1GE	IS	\$315,867
X410-SATA-S16-HO	X410-128T+3.2T SSD/128G/2x10GE 2x1GE/HO	IS	\$118,410
X410-SATA-S17	X410-128T+3.2T SSD/256G/2x10GE+2x1GE	IS	\$253,085
X410-SATA-S170	X410-132T/2.4T SSD/128G/2x40GE/2x1GE	IS	\$236,027
X410-SATA-S171	X410-132T/2.4T SSD/256G/2x40GE/2x1GE	IS	\$251,235
X410-SATA-S172	X410-132T/2.4T SSD/64G/2x40GE/2x1GE	IS	\$229,376
X410-SATA-S173	X410-132T+4.8T SSD/128G/2x40GE 2x1GE	IS	\$281,372
X410-SATA-S174	X410-132T+4.8T SSD/256G/2x40GE 2x1GE	IS	\$295,625
X410-SATA-S175	X410-132T+4.8T SSD/64G/2x40GE 2x1GE	IS	\$275,138
X410-SATA-S176	X410-136T/1.6T SSD,256G/2x40GE/2x1GE	IS	\$215,297
X410-SATA-S177	X410-136T/1.6T SSD/128G/2x40GE/2x1GE	IS	\$201,032

X410-SATA-S178	X410-136T/1.6T SSD/64G/2x40GE/2x1GE	IS	\$194,792
X410-SATA-S179	X410-136T+3.2T SSD/128G/2x40GE 2x1GE	IS	\$241,282
X410-SATA-S17-HO	X410-128T+3.2T SSD/256G/2x10GE 2x1GE/HO	IS	\$125,800
X410-SATA-S18	X410-120T+4.8T SSD/32G/2x10GE+2x1GE	IS	\$269,370
X410-SATA-S180	X410-136T+3.2T SSD/256G/2x40GE 2x1GE	IS	\$255,540
X410-SATA-S181	X410-136T+3.2T SSD/64G/2x40GE 2x1GE	IS	\$235,046
X410-SATA-S182	X410-140T+1.6T SSD/128G/2x40GE 2x1GE	IS	\$201,038
X410-SATA-S183	X410-140T+1.6T SSD/256G/2x40GE 2x1GE	IS	\$215,303
X410-SATA-S184	X410-140T+1.6T SSD/64G/2x40GE 2x1GE	IS	\$194,799
X410-SATA-S184-HO	X410-140T+1.6T SSD/64G/2x40GE 2x1GE HO	IS	\$91,408
X410-SATA-S185	X410-32T+3.2T SSD/128/2x40GE 2x1GE	IS	\$173,195
X410-SATA-S186	X410-32T+3.2T SSD/256/2x40GE 2x1GE	IS	\$185,965
X410-SATA-S187	X410-32T+3.2T SSD/64G/2x40GE 2x1GE	IS	\$167,608
X410-SATA-S188	X410-34T/1.6T SSD/128G/2x40GE/2x1GE	IS	\$134,180
X410-SATA-S189	X410-34T/1.6T SSD/256G/2x40GE/2x1GE	IS	\$146,965
X410-SATA-S19	X410-120T+4.8T SSD/64G/2x10GE+2x1GE	IS	\$272,630
X410-SATA-S190	X410-34T/1.6T SSD/64G/2x40GE/2x1GE	IS	\$128,586
X410-SATA-S191	X410-34T+3.2T SSD/128G/2x40GE 2x1GE	IS	\$173,216
X410-SATA-S192	X410-34T+3.2T SSD/256G/2x40GE 2x1GE	IS	\$185,986
X410-SATA-S193	X410-34T+3.2T SSD/64G/2x40GE 2x1GE	IS	\$167,630
X410-SATA-S194	X410-34T+800G SSD/128/2x40GE 2x1GE	IS	\$118,076
X410-SATA-S195	X410-34T+800G SSD/256/2x40GE 2x1GE	IS	\$130,871
X410-SATA-S196	X410-34T+800G SSD/64G/2x40GE 2x1GE	IS	\$111,634
X410-SATA-S197	X410-35T/800G-SSD/128G/2x40GE/2x1GE	IS	\$119,079
X410-SATA-S198	X410-35T/800G-SSD/256G/2x40GE/2x1GE	IS	\$131,872
X410-SATA-S199	X410-35T/800G-SSD/64G/2x40GE/2x1GE	IS	\$113,481
X410-SATA-S20	X410-120T+4.8T SSD/128G/2x10GE+2x1GE	IS	\$278,864
X410-SATA-S200	X410-35T+1.6T SSD/128G/2x40GE 2x1GE	IS	\$134,190
X410-SATA-S201	X410-35T+1.6T SSD/256G/2x40GE 2x1GE	IS	\$146,976
X410-SATA-S202	X410-35T+1.6T SSD/64G/2x40GE 2x1GE	IS	\$128,596
X410-SATA-S203	X410-60T/4.8T SSD/128G/2x40GE/2x1GE	IS	\$239,988
X410-SATA-S204	X410-60T/4.8T SSD/256G/2x40GE/2x1GE	IS	\$253,481
X410-SATA-S205	X410-60T/4.8T SSD/64G/2x40GE/2x1GE	IS	\$234,086
X410-SATA-S206	X410-60T+9.6T SSD/128G/2x40GE 2x1GE	IS	\$380,878
X410-SATA-S207	X410-60T+9.6T SSD/256G/2x40GE 2x1GE	IS	\$400,370
X410-SATA-S208	X410-60T+9.6T SSD/64G/2x40GE 2x1GE	IS	\$372,267
X410-SATA-S209	X410-64T/3.2T SSD/128G/2x40GE/2x1GE	IS	\$196,987
X410-SATA-S20-HO	X410-120T+4.8T SSD/128G/2x10GE 2x1GE/HO	IS	\$142,736
X410-SATA-S21	X410-120T+4.8T SSD/256G/2x10GE+2x1GE	IS	\$293,111
X410-SATA-S210	X410-64T/3.2T SSD/256G/2x40GE/2x1GE	IS	\$210,302
X410-SATA-S211	X410-64T/3.2T SSD/64G/2x40GE SFP 2x1GE	IS	\$191,163
X410-SATA-S212	X410-64T+6.4T SSD/128G/2x40GE 2x1GE	IS	\$278,512
X410-SATA-S213	X410-64T+6.4T SSD/256G/2x40GE 2x1GE	IS	\$296,106
X410-SATA-S214	X410-64T+6.4T SSD/64G/2x40GE 2x1GE	IS	\$270,739
X410-SATA-S215	X410-66T+1.2T SSD/128/2x40GE 2x1GE	IS	\$155,556
X410-SATA-S216	X410-66T+1.2T SSD/256/2x40GE 2x1GE	IS	\$169,985
X410-SATA-S217	X410-66T+1.2T SSD/64G/2x40GE 2x1GE	IS	\$145,357
X410-SATA-S218	X410-66T+4.8T SSD/128G/2x40GE 2x1GE	IS	\$240,010
X410-SATA-S219	X410-66T+4.8T SSD/256G/2x40GE 2x1GE	IS	\$253,502
X410-SATA-S21-HO	X410-120T+4.8T SSD/256G/2x10GE 2x1GE/HO	IS	\$150,300

X410-SATA-S22	X410-36T/32G/2x10GE+2x1GE	IS	\$84,918
X410-SATA-S220	X410-66T+4.8T SSD/64G/2x40GE 2x1GE	IS	\$234,108
X410-SATA-S221	X410-68T/1.6T SSD/128G/2x40GE/2x1GE	IS	\$157,437
X410-SATA-S222	X410-68T/1.6T SSD/256G/2x40GE/2x1GE	IS	\$171,051
X410-SATA-S223	X410-68T/1.6T SSD/64G/2x40GE/2x1GE	IS	\$151,607
X410-SATA-S224	X410-68T+3.2T SSD/128G/2x40GE 2x1GE	IS	\$197,005
X410-SATA-S225	X410-68T+3.2T SSD/256G/2x40GE 2x1GE	IS	\$210,319
X410-SATA-S226	X410-68T+3.2T SSD/64G/2x40GE 2x1GE	IS	\$191,181
X410-SATA-S227	X410-70T/800G SSD/128G/2x40GE/2x1GE	IS	\$137,737
X410-SATA-S228	X410-70T/800G SSD/256G/2x40GE/2x1GE	IS	\$151,382
X410-SATA-S229	X410-70T/800G SSD/64G/2x40GE/2x1GE	IS	\$131,904
X410-SATA-S23	X410-36T/64G/2x10GE+2x1GE	IS	\$87,834
X410-SATA-S230	X410-70T+1.6T SSD/128G/2x40GE 2x1GE	IS	\$157,451
X410-SATA-S231	X410-70T+1.6T SSD/256G/2x40GE 2x1GE	IS	\$171,065
X410-SATA-S232	X410-70T+1.6T SSD/64G/2x40GE 2x1GE	IS	\$151,622
X410-SATA-S233	X410-90T+4.8T SSD/128/2x40GE 2x1GE	IS	\$252,059
X410-SATA-S234	X410-90T+4.8T SSD/256/2x40GE 2x1GE	IS	\$265,473
X410-SATA-S235	X410-90T+4.8T SSD/64G/2x40GE 2x1GE	IS	\$246,192
X410-SATA-S236	X410-90T+9.6T SSD/128G/2x40GE 2x1GE	IS	\$386,683
X410-SATA-S237	X410-90T+9.6T SSD/256G/2x40GE 2x1GE	IS	\$405,397
X410-SATA-S238	X410-90T+9.6T SSD/64G/2x40GE 2x1GE	IS	\$378,408
X410-SATA-S239	X410-96T/3.2T SSD/128G/2x40GE/2x1GE	IS	\$213,200
X410-SATA-S24	X410-36T/128G/2x10GE+2x1GE	IS	\$93,410
X410-SATA-S240	X410-96T/3.2T SSD/256G/2x40GE/2x1GE	IS	\$226,619
X410-SATA-S241	X410-96T/3.2T SSD/64G/2x40GE/2x1GE	IS	\$207,330
X410-SATA-S242	X410-96T+1.6T SSD/128/2x40GE 2x1GE	IS	\$178,425
X410-SATA-S243	X410-96T+1.6T SSD/256/2x40GE 2x1GE	IS	\$192,891
X410-SATA-S244	X410-96T+1.6T SSD/64G/2x40GE 2x1GE	IS	\$168,567
X410-SATA-S245	X410-96T+6.4T SSD/128G/2x40GE 2x1GE	IS	\$292,059
X410-SATA-S246	X410-96T+6.4T SSD/256G/2x40GE 2x1GE	IS	\$309,235
X410-SATA-S247	X410-96T+6.4T SSD/64G/2x40GE 2x1GE	IS	\$284,464
X410-SATA-S248	X410-99T+2.4T SSD/128G/2x40GE 2x1GE	IS	\$193,838
X410-SATA-S249	X410-99T+2.4T SSD/256G/2x40GE 2x1GE	IS	\$207,262
X410-SATA-S24-HO	X410-36T/128G/2x10GE 2x1GE HO	IS	\$51,425
X410-SATA-S25	X410-36T/256G/2x10GE+2x1GE	IS	\$106,154
X410-SATA-S250	X410-99T+2.4T SSD/64G/2x40GE 2x1GE	IS	\$187,967
X410-SATA-S251	X410-99T+4.8T SSD/128G/2x40GE 2x1GE	IS	\$251,981
X410-SATA-S252	X410-99T+4.8T SSD/256G/2x40GE 2x1GE	IS	\$265,398
X410-SATA-S253	X410-99T+4.8T SSD/64G/2x40GE 2x1GE	IS	\$246,112
X410-SATA-S26	X410-35T+800G-SSD/32G/2x10GE+2x1GE	IS	\$108,920
X410-SATA-S27	X410-35T+800G-SSD/64G/2x10GE+2x1GE	IS	\$111,836
X410-SATA-S28	X410-35T+800G-SSD/128G/2x10GE+2x1GE	IS	\$117,412
X410-SATA-S29	X410-35T+800G-SSD/256G/2x10GE+2x1GE	IS	\$130,156
X410-SATA-S29-HO	X410-35T+800G-SSD/256G/2x10GE 2x1GE/HO	IS	\$66,216
X410-SATA-S30	X410-34T+1.6T SSD/32G/2x10GE+2x1GE	IS	\$123,977
X410-SATA-S31	X410-34T+1.6T SSD/64G/2x10GE+2x1GE	IS	\$126,893
X410-SATA-S32	X410-34T+1.6T SSD/128G/2x10GE+2x1GE	IS	\$132,469
X410-SATA-S32-HO	X410-34TB+1.6T SSD/128G/2x10GE 2x1GE HO	IS	\$69,044
X410-SATA-S33	X410-34T+1.6T SSD/256G/2x10GE+2x1GE	IS	\$145,213
X410-SATA-S33-HO	X410-34T+1.6T SSD/256G/2x10GE 2x1GE/HO	IS	\$75,018

X410-SATA-S34	X410-108T/32G/2x10GE+2x1GE	IS	\$125,092
X410-SATA-S35	X410-108T/64G/2x10GE+2x1GE	IS	\$128,159
X410-SATA-S36	X410-108T/128G/2x10GE+2x1GE	IS	\$134,024
X410-SATA-S37	X410-108T/256G/2x10GE+2x1GE	IS	\$147,429
X410-SATA-S38	X410-102T+1.6T SSD/32G/2x10GE+2x1GE	IS	\$163,445
X410-SATA-S39	X410-102T+1.6T SSD/64G/2x10GE+2x1GE	IS	\$166,513
X410-SATA-S40	X410-102T+1.6T SSD/128G/2x10GE+2x1GE	IS	\$172,378
X410-SATA-S40-HO	X410-102T+1.6T SSD/128G/2x10GE 2x1GE/HO	IS	\$80,408
X410-SATA-S41	X410-102T+1.6T SSD/256G/2x10GE+2x1GE	IS	\$185,782
X410-SATA-S41-HO	X410-102T+1.6T SSD/256G/2x10GE 2x1GE/HO	IS	\$86,639
X410-SATA-S42	X410-99T+2.4T SSD/32G/2x10GE+2x1GE	IS	\$182,760
X410-SATA-S43	X410-99T+2.4T SSD/64G/2x10GE+2x1GE	IS	\$185,828
X410-SATA-S44	X410-99T+2.4T SSD/128G/2x10GE+2x1GE	IS	\$191,693
X410-SATA-S44-HO	X410-99T+2.4T SSD/128G/2x10GE 2x1GE/HO	IS	\$91,401
X410-SATA-S45	X410-99T+2.4T SSD/256G/2x10GE+2x1GE	IS	\$205,097
X410-SATA-S45-HO	X410-99T+2.4T SSD/256G/2x10GE 2x1GE/HO	IS	\$97,775
X410-SATA-S46	X410-96T+3.2T SSD/32G/2x10GE+2x1GE	IS	\$202,075
X410-SATA-S47	X410-96T+3.2T SSD/64G/2x10GE+2x1GE	IS	\$205,142
X410-SATA-S48	X410-96T+3.2T SSD/128G/2x10GE+2x1GE	IS	\$211,007
X410-SATA-S49	X410-96T+3.2T SSD/256G/2x10GE+2x1GE	IS	\$224,412
X410-SATA-S50	X410-132T/2.4T SSD/128G/2x10GE/2x1GE	IS	\$233,478
X410-SATA-S50-HO	X410-132T+2.4T SSD/128G/2x10GE 2x1GE/HO	IS	\$106,270
X410-SATA-S51	X410-132T/2.4T SSD/256G/2x10GE/2x1GE	IS	\$248,671
X410-SATA-S51-HO	X410-132T+2.4T SSD/256G/2x10GE 2x1GE/HO	IS	\$113,551
X410-SATA-S52	X410-132T/2.4T SSD/32G/2x10GE/2x1GE	IS	\$223,354
X410-SATA-S53	X410-132T/2.4T SSD/64G/2x10GE/2x1GE	IS	\$226,831
X410-SATA-S54	X410-60T/4.8T SSD/128G/2x10GE/2x1GE	IS	\$237,715
X410-SATA-S55	X410-60T/4.8T SSD/256G/2x10GE/2x1GE	IS	\$251,197
X410-SATA-S56	X410-60T/4.8T SSD/32G/2x10GE/2x1GE	IS	\$228,731
X410-SATA-S57	X410-60T/4.8T SSD/64G/2x10GE/2x1GE	IS	\$231,816
X410-SATA-S58	X410-64T/3.2T SSD/256G/2x10GE/2x1GE	IS	\$208,144
X410-SATA-S58-HO	X410-64T+3.2T SSD/256G/2x10GE 2x1GE/HO	IS	\$100,054
X410-SATA-S59	X410-68T/1.6T SSD/256G/2x10GE/2x1GE	IS	\$169,010
X410-SATA-S59-HO	X410-68T+1.6T SSD/256G/2x10GE 2x1GE/HO	IS	\$77,782
X410-SATA-S60	X410-70T/800G SSD/256G/2x10GE/2x1GE	IS	\$149,414
X410-SATA-S60-HO	X410-70T+800G SSD/256G/2x10GE 2x1GE/HO	IS	\$69,061
X410-SATA-S61	X410-32T+3.2T SSD/128/2x10GE 2x1GE	IS	\$171,318
X410-SATA-S62	X410-32T+3.2T SSD/256/2x10GE 2x1GE	IS	\$184,062
X410-SATA-S63	X410-32T+3.2T SSD/32G/2x10GE 2x1GE	IS	\$162,826
X410-SATA-S64	X410-32T+3.2T SSD/64G/2x10GE 2x1GE	IS	\$165,742
X410-SATA-S65	X410-90T+4.8T SSD/128/2x10GE 2x1GE	IS	\$249,783
X410-SATA-S66	X410-90T+4.8T SSD/256/2x10GE 2x1GE	IS	\$263,187
X410-SATA-S67	X410-90T+4.8T SSD/32G/2x10GE 2x1GE	IS	\$240,851
X410-SATA-S68	X410-90T+4.8T SSD/64G/2x10GE 2x1GE	IS	\$243,918
X410-SATA-S69	X410-34T+800G SSD/32G/2x10GE/2x1GE	IS	\$107,940
X410-SATA-S70	X410-34T+800G SSD/64G/2x10GE/2x1GE	IS	\$110,024
X410-SATA-S70-HO	X410-34T+800G SSD/64G/2x10GE 2x1GE	IS	\$57,981
X410-SATA-S71	X410-34T+800G SSD/128G/2x10GE/2x1GE	IS	\$116,432
X410-SATA-S72	X410-34T+800G SSD/256G/2x10GE/2x1GE	IS	\$129,176
X410-SATA-S73	X410-66T+1.2T SSD /32G/2x10GE/2x1GE	IS	\$142,977

X410-SATA-S74	X410-66T+1.2T SSD /64G/2x10GE/2x1GE	IS	\$143,369
X410-SATA-S74-HO	X410-66T+1.2T SSD/64G/2x10GE 2x1GE	IS	\$65,255
X410-SATA-S75	X410-66T+1.2T SSD /128G/2x10GE/2x1GE	IS	\$153,498
X410-SATA-S75-HO	X410-66T+1.2T SSD/128/2x10GE 2x1GE/HO	IS	\$67,897
X410-SATA-S76	X410-66T+1.2T SSD /256G/2x10GE/2x1GE	IS	\$167,886
X410-SATA-S77	X410-96T+1.6T SSD/32G/2x10GE/2x1GE	IS	\$166,291
X410-SATA-S78	X410-96T+1.6T SSD/64G/2x10GE/2x1GE	IS	\$166,500
X410-SATA-S79	X410-96T+1.6T SSD/128G/2x10GE/2x1GE	IS	\$176,301
X410-SATA-S79-HO	X410-96T+1.6T SSD/128/2x10GE 2x1GE/HO	IS	\$85,466
X410-SATA-S80	X410-96T+1.6T SSD/256G/2x10GE/2x1GE	IS	\$190,733
X410-SATA-S80-HO	X410-96T+1.6T SSD/256/2x10GE 2x1GE/HO	IS	\$92,063
X410-SATA-S81	X410-120T+2.4T SSD/32G/2x10GE/2x1GE	IS	\$206,122
X410-SATA-S82	X410-120T+2.4T SSD/64G/2x10GE/2x1GE	IS	\$206,818
X410-SATA-S83	X410-120T+2.4T SSD/128G/2x10GE/2x1GE	IS	\$216,872
X410-SATA-S83-HO	X410-120T+2.4T SSD/128/2x10GE 2x1GE/HO	IS	\$96,160
X410-SATA-S84	X410-120T+2.4T SSD/256G/2x10GE/2x1GE	IS	\$231,814
X410-SATA-S84-HO	X410-120T+2.4T SSD/256/2x10GE 2x1GE/HO	IS	\$124,518
X410-SATA-S85	X410-70T+1.6T SSD/64G/2x10GE 2x1GE	IS	\$149,612
X410-SATA-S86	X410-70T+1.6T SSD/128G/2x10GE 2x1GE	IS	\$155,429
X410-SATA-S86-HO	X410-70T+1.6T SSD/128G/2x10GE 2x1GE/HO	IS	\$71,291
X410-SATA-S87	X410-70T+1.6T SSD/256G/2x10GE 2x1GE	IS	\$169,010
X410-SATA-S87-HO	X410-70T+1.6T SSD/256G/2x10GE 2x1GE/HO	IS	\$77,782
X410-SATA-S88	X410-68T+3.2T SSD/64G/2x10GE 2x1GE	IS	\$189,030
X410-SATA-S89	X410-68T+3.2T SSD/128G/2x10GE 2x1GE	IS	\$194,848
X410-SATA-S89-HO	X410-68T+3.2T SSD/128G/2x10GE 2x1GE/HO	IS	\$92,848
X410-SATA-S90	X410-68T+3.2T SSD/256G/2x10GE 2x1GE	IS	\$208,144
X410-SATA-S90-HO	X410-68T+3.2T SSD/256G/2x10GE 2x1GE/HO	IS	\$100,054
X410-SATA-S91	X410-66T+4.8T SSD/64G/2x10GE 2x1GE	IS	\$231,816
X410-SATA-S92	X410-66T+4.8T SSD/128G/2x10GE 2x1GE	IS	\$237,715
X410-SATA-S93	X410-66T+4.8T SSD/256G/2x10GE 2x1GE	IS	\$251,197
X410-SATA-S94	X410-64T+6.4T SSD/64G/2x10GE 2x1GE	IS	\$268,394
X410-SATA-S95	X410-64T+6.4T SSD/128G/2x10GE 2x1GE	IS	\$276,150
X410-SATA-S96	X410-64T+6.4T SSD/256G/2x10GE 2x1GE	IS	\$293,705
X410-SATA-S97	X410-60T+9.6T SSD/64G/2x10GE 2x1GE	IS	\$369,646
X410-SATA-S98	X410-60T+9.6T SSD/128G/2x10GE 2x1GE	IS	\$378,242
X410-SATA-S99	X410-60T+9.6T SSD/256G/2x10GE 2x1GE	IS	\$397,699
456-111-834	OneFS Base License Tier 1=ID	IS2	\$23,333
456-111-835	OneFS Base License Tier 2=ID	IS2	\$19,600
456-111-836	OneFS Base License Tier 3=ID	IS2	\$19,600
456-111-837	OneFS Base License Tier 4=ID	IS2	\$8,167
456-111-838	OneFS Capacity License Tier 1 =CB	IS2	\$1,417
456-111-839	OneFS Capacity License Tier 2 =CB	IS2	\$1,388
456-111-840	OneFS Capacity License Tier 3 =CB	IS2	\$474
456-111-841	OneFS Capacity License Tier 4 =CB	IS2	\$91
456-111-842	OneFS Enc/Key Mgt License Tier 1 =ID	IS2	\$9,000
456-111-843	OneFS Enc/Key Mgt License Tier 2 =ID	IS2	\$9,000
456-111-844	OneFS Enc/Key Mgt License Tier 3 =ID	IS2	\$9,000
456-111-845	OneFS Enc/Key Mgt License Tier 4 =ID	IS2	\$2,500
456-111-996	SmartPools Base License Tier 1=ID	IS2	\$4,167
456-111-997	SmartPools Base License Tier 2=ID	IS2	\$4,167

456-111-998	SmartPools Base License Tier 3=ID	IS2	\$1,667
456-111-999	SmartPools Base License Tier 4=ID	IS2	\$1,192
456-112-000	SmartPools Capacity License Tier 1 =CB	IS2	\$50
456-112-001	SmartPools Capacity License Tier 2 =CB	IS2	\$50
456-112-002	SmartPools Capacity License Tier 3 =CB	IS2	\$27
456-112-003	SmartPools Capacity License Tier 4 =CB	IS2	\$25
456-112-004	SnapshotIQ Base License Tier 1=ID	IS2	\$2,458
456-112-005	SnapshotIQ Base License Tier 2=ID	IS2	\$2,458
456-112-006	SnapshotIQ Base License Tier 3=ID	IS2	\$983
456-112-007	SnapshotIQ Base License Tier 4=ID	IS2	\$703
456-112-008	SnapshotIQ Capacity License Tier 1 =CB	IS2	\$30
456-112-009	SnapshotIQ Capacity License Tier 2 =CB	IS2	\$30
456-112-010	SnapshotIQ Capacity License Tier 3 =CB	IS2	\$16
456-112-011	SnapshotIQ Capacity License Tier 4 =CB	IS2	\$15
456-112-012	SmartConnect Base License Tier 1=ID	IS2	\$4,167
456-112-013	SmartConnect Base License Tier 2=ID	IS2	\$4,167
456-112-014	SmartConnect Base License Tier 3=ID	IS2	\$1,667
456-112-015	SmartConnect Base License Tier 4=ID	IS2	\$1,192
456-112-016	SmartConnect Capacity License Tier 1 =CB	IS2	\$50
456-112-017	SmartConnect Capacity License Tier 2 =CB	IS2	\$50
456-112-018	SmartConnect Capacity License Tier 3 =CB	IS2	\$27
456-112-019	SmartConnect Capacity License Tier 4 =CB	IS2	\$25
456-112-020	SyncIQ Base License Tier 1=ID	IS2	\$4,167
456-112-021	SyncIQ Base License Tier 2=ID	IS2	\$4,167
456-112-022	SyncIQ Base License Tier 3=ID	IS2	\$1,667
456-112-023	SyncIQ Base License Tier 4=ID	IS2	\$1,192
456-112-024	SyncIQ Capacity License Tier 1 =CB	IS2	\$50
456-112-025	SyncIQ Capacity License Tier 2 =CB	IS2	\$50
456-112-026	SyncIQ Capacity License Tier 3 =CB	IS2	\$27
456-112-027	SyncIQ Capacity License Tier 4 =CB	IS2	\$25
456-112-028	SmartQuotas Base License Tier 1=ID	IS2	\$1,696
456-112-029	SmartQuotas Base License Tier 2=ID	IS2	\$1,696
456-112-030	SmartQuotas Base License Tier 3=ID	IS2	\$679
456-112-031	SmartQuotas Base License Tier 4=ID	IS2	\$485
456-112-032	SmartQuotas Capacity License Tier 1 =CB	IS2	\$20
456-112-033	SmartQuotas Capacity License Tier 2 =CB	IS2	\$20
456-112-034	SmartQuotas Capacity License Tier 3 =CB	IS2	\$11
456-112-035	SmartQuotas Capacity License Tier 4 =CB	IS2	\$10
456-112-036	SmartDedupe Base License Tier 1=ID	IS2	\$5,462
456-112-037	SmartDedupe Base License Tier 2=ID	IS2	\$5,462
456-112-038	SmartDedupe Base License Tier 3=ID	IS2	\$2,103
456-112-039	SmartDedupe Base License Tier 4=ID	IS2	\$1,737
456-112-040	SmartDedupe Capacity License Tier 1 =CB	IS2	\$66
456-112-041	SmartDedupe Capacity License Tier 2 =CB	IS2	\$66
456-112-042	SmartDedupe Capacity License Tier 3 =CB	IS2	\$37
456-112-043	SmartDedupe Capacity License Tier 4 =CB	IS2	\$36
456-112-044	SmartLock Base License Tier 1=ID	IS2	\$1,696
456-112-045	SmartLock Base License Tier 2=ID	IS2	\$1,696
456-112-046	SmartLock Base License Tier 3=ID	IS2	\$679
456-112-047	SmartLock Base License Tier 4=ID	IS2	\$485

456-112-048	SmartLock Capacity License Tier 1 =CB	IS2	\$20
456-112-049	SmartLock Capacity License Tier 2 =CB	IS2	\$20
456-112-050	SmartLock Capacity License Tier 3 =CB	IS2	\$11
456-112-051	SmartLock Capacity License Tier 4 =CB	IS2	\$10
456-112-093	CloudPools Capacity License=CB	IS2	\$315
456-112-345	Cloudpools Subscription Base 0.00=ID	IS2	\$0
456-112-346	Cloudpools Subscription Cap 2 YR =CB	IS2	\$13
456-112-347	Cloudpools Subscription Cap 3 YR =CB	IS2	\$12
456-112-349	Cloudpools Subscription Cap 1 YR=CB	IS2	\$13
456-112-496	CloudPools 0.00 Base License=ID	IS2	\$0
456-113-383	OneFS Base License PROMO Tier 4=ID	IS2	\$6,369
456-113-384	OneFS Cap License PROMO Tier 4 =CB	IS2	\$71
456-113-586	ECS Base License EX=ID	IS2	\$6,533
456-113-587	ECS Capacity License EX 1TB=CB	IS2	\$91
456-113-588	ECS D@RE Capacity License EX 1TB=CB	IS2	\$0
458-001-863	OneFS Product	IS2	\$0
458-001-864	Basic Bundle Tier 3=ID	IS2	\$2,385
458-001-865	Basic Bundle Capacity Tier 3 Per TB=CB	IS2	\$38
458-001-866	Enterprise Bundle Tier 3=ID	IS2	\$2,996
458-001-867	Enterprise Bundle Capacity T3 Per TB=CB	IS2	\$48
458-001-868	Enterprise Advanced Bundle Tier 3=ID	IS2	\$5,996
458-001-869	Enterprise Adv Bundle Cap T3 Per TB=CB	IS2	\$96
458-001-941	SmartPools	IS2	\$0
458-001-942	SnapshotIQ	IS2	\$0
458-001-943	SmartConnect	IS2	\$0
458-001-944	SynclQ	IS2	\$0
458-001-945	SmartQuotas	IS2	\$0
458-001-946	SmartDedupe	IS2	\$0
458-001-947	SmartLock	IS2	\$0
458-001-948	Basic Bundle Tier 2=ID	IS2	\$5,963
458-001-949	Basic Bundle Capacity Tier 2 Per TB=CB	IS2	\$72
458-001-950	Enterprise Bundle Tier 2=ID	IS2	\$7,489
458-001-951	Enterprise Bundle Capacity T2 Per TB=CB	IS2	\$90
458-001-952	Enterprise Advanced Bundle Tier 2=ID	IS2	\$14,989
458-001-953	Enterprise Adv Bundle Cap T2 Per TB=CB	IS2	\$180
458-001-954	Basic Bundle Tier 1=ID	IS2	\$5,963
458-001-955	Basic Bundle Capacity Tier 1 Per TB=CB	IS2	\$72
458-001-956	Enterprise Bundle Tier 1=ID	IS2	\$7,489
458-001-957	Enterprise Bundle Capacity T1 Per TB=CB	IS2	\$90
458-001-958	Enterprise Advanced Bundle Tier 1=ID	IS2	\$14,989
458-001-959	Enterprise Adv Bundle Cap T1 Per TB=CB	IS2	\$180
458-001-960	Basic Bundle Tier 4=ID	IS2	\$1,705
458-001-961	Basic Bundle Capacity Tier 4 Per TB=CB	IS2	\$36
458-001-962	Enterprise Bundle Tier 4=ID	IS2	\$2,142
458-001-963	Enterprise Bundle Capacity T4 Per TB=CB	IS2	\$45
458-001-964	Enterprise Advanced Bundle Tier 4=ID	IS2	\$4,287
458-001-965	Enterprise Adv Bundle Cap T4 Per TB=CB	IS2	\$90
458-001-966	OneFS Conversion Materials	IS2	\$0
458-001-967	CloudPools for Third Party	IS2	\$0
458-001-968	CloudPools for EMC(\$0.00)	IS2	\$0

458-001-969	HDFS for OneFS (\$0.00)	IS2	\$0
458-001-970	SWIFT for OneFS (\$0.00)	IS2	\$0
458-001-971	STIG Hardening for OneFS (\$0.00)	IS2	\$0
458-002-326	OneFS Product PROMO	IS2	\$0
458-002-327	SmartConnect PROMO	IS2	\$0
458-002-328	SmartQuotas PROMO	IS2	\$0
458-002-434	ECS Base License EX=ID	IS2	\$0
458-002-435	ECS Capacity License EX 1TB=CB	IS2	\$0
800-0077	PWCRD KIT for Gen6 Deep Chassis	IS2	\$22
800-0077-PR	PWCRD KIT for Gen6 Deep Chassis/PROMO	IS2	\$17
800-0078	PWCRD KIT for Gen6 Normal Chassis	IS2	\$23
800-0079	PWCRD,6,TITAN-HD 15F L6-30P/NORTH AMER	IS2	\$344
800-0080	PWCRD,6,TITAN-HD 15F 56PA332/AU	IS2	\$1,244
800-0081	PWCRD,6,TITAN-HD 15F 332P6W/EU	IS2	\$509
800-0082	PWCRD,6,TITAN-HD 15F 3750DP/UNIV	IS2	\$1,682
800-0083	PWCRD,6,TITAN-HD 15F L7-30P/NORTH AMER	IS2	\$631
800-0084	PWCRD,2,TITAN-HD 3P-DELTA 15F CS-8365C	IS2	\$1,522
800-0085	PWCRD,2,TITAN-HD 3P-WYE 15F C530P6S/INTL	IS2	\$587
800-0086	PWCRD,2,TITAN-HD 3P-WYE 15F C530P6S/US	IS2	\$1,078
800-0087	PWCRD,2,TITAN-HD 3P-WYE 15F L22-30P/INTL	IS2	\$1,450
800-0088	PWCRD,2,TITAN-HD 3P-WYE 15F FLYLEAD/INTL	IS2	\$539
800-0089	PWCRD,2,TITAN-HD 3P-WYE 15F FLYLEAD/US	IS2	\$880
800-0090	Node Pair Shipping Kit Gen6-EMC	IS2	\$208
800-0091	Node Pair Shipping Kit Gen6	IS2	\$208
800-0092	Node Pair Shipping Kit Gen6 DEEP-EMC	IS2	\$256
800-0093	Node Pair Shipping Kit Gen6 DEEP	IS2	\$256
800-0096	PWCRD,2,ISI293-C13, 240V INDIA	IS2	\$41
851-0262	CABLE ETHERNET 10G PASS SFP+ 1M	IS2	\$127
851-0263	CABLE ETHERNET 10G PASS SFP+ 3M	IS2	\$151
851-0264	CABLE ETHERNET 10G PASS SFP+ 5M	IS2	\$143
851-0265	CABLE ETHERNET 10G ACT OPT SFP+ 10M	IS2	\$0
851-0266	CABLE ETHERNET 10G PASS OM4 LC-LC 10M	IS2	\$248
851-0267	CABLE ETHERNET 10G PASS OM4 LC-LC 30M	IS2	\$311
851-0268	CABLE ETHERNET 10G PASS OM4 LC-LC 50M	IS2	\$374
851-0269	CABLE ETHERNET 10G PASS OM4 LC-LC 100M	IS2	\$527
851-0270	CABLE ETHERNET 10G PASS OM4 LC-LC 150M	IS2	\$696
851-0271	CABLE ETHERNET 10G PASS SFP+ 1M FLEX	IS2	\$127
851-0272	CABLE ETHERNET 10G PASS SFP+ 1.5M FLEX	IS2	\$99
851-0273	CABLE ETHERNET 10G PASS SFP+ 2M FLEX	IS2	\$119
851-0274	CABLE IB/40GBE MPO TRANSCEIVER 1M	IS2	\$263
851-0275	CABLE IB/40GBE MPO TRANSCEIVER 3M	IS2	\$289
851-0276	CABLE IB/40GBE MPO TRANSCEIVER 5M	IS2	\$309
851-0277	CABLE IB/40GBE PASS OPT MPO TRNSCVR 150M	IS2	\$3,702
851-0278	CABLE ETHERNET QSFP+-SFP+ BREAKOUT 1M	IS2	\$261
851-0279	CABLE ETHERNET QSFP+-SFP+ BREAKOUT 3M	IS2	\$369
851-0280	CABLE ETHERNET QSFP+-SFP+ BREAKOUT 5M	IS2	\$495
851-0281	Step Up Transformer	IS2	\$14,419
851-0285	Transceivers/Optic/QSFP/SR/40GbE/2 GEN6	IS2	\$1,717
851-0286	R-SPR KIT - 8TB HDD GEN6	IS2	\$1,531
851-0287	R-SPR KIT - 10TB HDD GEN6	IS2	\$1,942

851-0288	R-SPR KIT - 2TB HDD GEN6	IS2	\$490
851-0289	R-SPR KIT - 4TB HDD GEN6	IS2	\$627
851-0290	R-SPR KIT - 600GB HDD GEN6	IS2	\$496
851-0291	R-SPR KIT - 1.2TB HDD GEN6	IS2	\$705
851-0292	R-SPR KIT - 1.6TB SSD GEN6	IS2	\$4,592
851-0293	R-SPR KIT - 3.2TB SSD GEN6	IS2	\$8,629
851-0294	R-SPR KIT - 15.4TB SSD GEN6	IS2	\$35,709
851-0296	Transceivers/Optic/SFP+/SR/10GbE/2 GEN6	IS2	\$185
851-0297	RACK ASSY TITAN-HD 42U 4PDU SINGLE PHASE	IS2	\$23,318
851-0298	RACK ASSY TITAN-HD 42U 4PDU 3PHASE DELTA	IS2	\$23,421
851-0299	RACK ASSY TITAN-HD 42U 4PDU 3PHASE WYE	IS2	\$28,317
851-0302	R-SPR KIT - 8TB SED HDD GEN6	IS2	\$1,452
851-0303	R-SPR KIT - 10TB SED HDD GEN6	IS2	\$1,810
851-0304	R-SPR KIT - 2TB SED HDD GEN6	IS2	\$588
851-0305	R-SPR KIT - 4TB SED HDD GEN6	IS2	\$732
851-0306	R-SPR KIT - 600GB SED HDD GEN6	IS2	\$572
851-0307	R-SPR KIT - 1.2TB SED HDD GEN6	IS2	\$596
851-0308	R-SPR KIT - 1.6TB SED SSD GEN6	IS2	\$4,873
851-0309	R-SPR KIT - 3.2TB SED SSD GEN6	IS2	\$8,787
851-0310	CABLE KIT 10GE QTY72 A2000 PRE-RACK	IS2	\$7,351
ECS6-SLES	ECS6 SUSE LINUX ENTPRSE SERVER OS TRCK	IS2	\$0
ECS-SP-100-0001	ECS SPR-KIT RINJIN 2U-16 CHASSIS	IS2	\$5,700
ECS-SP-100-0002	ECS SPR-KIT CAPACITY COMPUTE BLADE	IS2	\$72,000
ECS-SP-100-0003	ECS SPR-KIT INTEL 1600W POWER SUPPLY	IS2	\$4,000
ECS-SP-100-0004	ECS SPR-KIT 400GB SC+ SSD 512 ENCRYP 2.5	IS2	\$10,300
ECS-SP-100-0005	ECS SPR-KIT 8TB 7.2 3.5 6GB SAS 4096 60T	IS2	\$10,500
ECS-SP-100-0006	ECS SPR-KIT VOY 6G LCC ASSY 8K EPROM	IS2	\$8,000
ECS-SP-100-0007	ECS SPR-KIT VOY 6G ICM ASSY 8K EPROM	IS2	\$5,000
ECS-SP-100-0008	ECS SPR-KIT VOY FRONT FAN CTRL MOD	IS2	\$850
ECS-SP-100-0009	ECS SPR-KIT VOY 1300W HP 4U DAE PWR SPLY	IS2	\$1,800
ECS-SP-100-0010	ECS SPR-KIT ASSY WHOLE CHASSIS DRAWER	IS2	\$21,500
ECS-SP-100-0011	ECS SPR-KIT ASSY HDD 8T ARIES CARIER PP	IS2	\$130,000
ECS-SP-100-0012	ECS SPR-KIT ASSY HDD 10T ARIES CARIER PP	IS2	\$160,000
ECS-SP-100-0013	ECS SPR-KIT ASSY JBOD BASE CHASSIS PP	IS2	\$51,000
ECS-SP-100-0014	ECS SPR-KIT ASSY JBOD 10 MODULE PP	IS2	\$26,000
ECS-SP-100-0015	ECS SPR-KIT ASSY JBOD 10 MODULE PP I	IS2	\$26,000
ECS-SP-100-0016	ECS SPR-KIT ASSY JBOD PWR SPLY MODULE P	IS2	\$5,200
ECS-SP-100-0017	ECS SPR-KIT ASSY JBOD FAN MODULE PP	IS2	\$6,500
ECS-SP-100-0018	ECS SPR-KIT ARISTA 7050S-52 10GB SWITCH	IS2	\$63,000
ECS-SP-100-0019	ECS SPR-KIT ARISTA 7048T-A 1GB SWITCH	IS2	\$32,000
ECS-SP-100-0020	ECS SPR-KIT ARISTA FAN-7000-R FRU	IS2	\$1,500
ECS-SP-100-0021	ECS SPR-KIT ARISTA PWR-460AC-R PWR FRU	IS2	\$4,800
ECS-SP-100-0022	ECS SPR-KIT ARISTA 10GBASESRLSFP MODULE	IS2	\$2,000
ECS-SP-100-0023	ECS SPR-KIT ARISTA 100/1000BASE_T MODULE	IS2	\$3,500
ECS-SP-100-0024	ECS SPR-KIT ARISTA 7050SX-52 10GB SWITCH	IS2	\$46,400
ECS-SP-100-0025	ECS SPR-KIT ETHERNET SWITCH 7010T	IS2	\$13,500
ECS-SP-100-0026	ECS SPR-KIT ARISTA FAN-7010 FRU	IS2	\$450
ECS-SP-100-0027	ECS SPR-KIT 3M MINSAS HD TO MINSAS FLEX	IS2	\$1,500
ECS-SP-100-0028	ECS SPR-KIT 4M X8 TO X8 MINSAS HD 12G	IS2	\$700
ECS-SP-100-0029	ECS SPR-KIT ARISTA 10GBASESRLSFP MODULE	IS2	\$2,000

ECS-SP-100-0030	ECS SPR-KIT ARISTA 100/1000BASE_T SFP	IS2	\$3,500
ECS-SP-100-0031	ECS SPR-KIT ACTIVE SFP TO SFP 1M 8G/10G	IS2	\$350
ECS-SP-100-0032	ECS SPR-KIT 1.5 METER SFP TO SFP TWN CBL	IS2	\$1,500
ES6-100GB-CWDM4	Module 100GB CWDM4	IS2	\$11,000
ES6-100GB-LR4	Module 100GB LR4	IS2	\$16,700
ES6-100GB-PSM4	Module 100GB PSM4	IS2	\$9,400
ES6-100GB-QSA	Module 100GB QSA	IS2	\$700
ES6-100GB-SR4	Module 100GB SR4	IS2	\$4,000
ES6-10GB-ER	Module 10GB ER	IS2	\$4,300
ES6-10GB-LR	Module 10GB LR	IS2	\$600
ES6-10GB-SR	Module 10GB SR	IS2	\$600
ES6-1GBASET-XVR	Module 1GBASET XVR	IS2	\$250
ES6-1PH-PDU-X	CABLE 1 Phase PDU	IS2	\$5,000
ES6-25GB-LR	Module 25GB LR	IS2	\$3,700
ES6-25GB-SR	Module 25GB SR	IS2	\$2,000
ES6-3PD-PDU-X	CABLE Kit 3 Phase Delta PDU	IS2	\$4,300
ES6-3PD-RINT-0U	PWCRD 3P-RSLSTL 0U QTY2	IS2	\$0
ES6-3PD-RINT-2U	PWCRD 3P-DELTA INT RSLSTL	IS2	\$0
ES6-3PD-RS-0U	PWCRD 3P-RSLSTL 0U QTY2	IS2	\$0
ES6-3PD-RS-2U	PWCRD 3P-RSLSTL 2U QTY2	IS2	\$0
ES6-3PD-US-0U	PWCRD 3P-US 0U QTY2	IS2	\$0
ES6-3PD-US-2U	PWCRD 3P-US 2U QTY2	IS2	\$0
ES6-3PW-INTFL-0U	PWCRD 3P-FLYLEAD/INTL 0U QTY2	IS2	\$0
ES6-3PW-INTFL-2U	PWCRD 3P-FLYLEAD/INTL 2U QTY2	IS2	\$0
ES6-3PW-INTG-0U	PWCRD 3P-GARO 0U QTY2	IS2	\$0
ES6-3PW-INTG-2U	PWCRD 3P-GARO 2U QTY2	IS2	\$0
ES6-3PW-PDU-X	CABLE 3P-WYE PDU Fld Int	IS2	\$4,200
ES6-3PW-US-2U	PWCRD 3P-US 2U QTY2	IS2	\$0
ES6-3PW-USL22-0U	PWCRD 3P-USL22 0U QTY2	IS2	\$0
ES6-3PW-USL22-2U	PWCRD 3P-USL22 2U QTY2	IS2	\$0
ES6-ANTI-MOV	ANTI-MOVE BRACKET	IS2	\$0
ES6-DOOR-BRND-D	Door Branded D QTY1	IS2	\$0
ES6-DOOR-BRND-E	Door Branded E QTY1	IS2	\$0
ES6-DS-15D-UPG-KTS	EX3000 15 Disk Upg Kit	IS2	\$25,000
ES6-DS-1N-45D	EX3000 Single Node 45x12TB	IS2	\$100,700
ES6-DS-1N-45D-X	EX3000 Single Node 45x12TB Fld	IS2	\$100,700
ES6-DS-1N-60D	EX3000 Single Node 60x12TB	IS2	\$127,000
ES6-DS-1N-60D-X	EX3000 Single Node 60x12TB Fld	IS2	\$127,000
ES6-DS-1N-90D	EX3000 Single Node 90x12TB	IS2	\$181,800
ES6-DS-1N-90D-X	EX3000 Single Node 90x12TB Fld	IS2	\$181,800
ES6-DS-2N-60D	EX3000 Dual Node 60x12TB	IS2	\$155,100
ES6-DS-2N-60D-X	EX3000 Dual Node 60x12TB Fld	IS2	\$155,100
ES6-DS-2N-90D	EX3000 Dual Node 90x12TB	IS2	\$205,400
ES6-DS-2N-90D-X	EX3000 Dual Node 90x12TB Fld	IS2	\$205,400
ES6-DS-3M-10G	EX3000 CABLE 3M Back End 10GbE	IS2	\$300
ES6-DS-3M-B1-KTS	EX3000 CABLE Kit 3M NonHA Back End	IS2	\$500
ES6-DS-3M-BE-KTS	EX3000 CABLE Kit 3M Back End	IS2	\$500
ES6-DS-3M-FE-KTS	EX3000 CABLE Kit 3M Front End	IS2	\$300
ES6-DS-5M-10G	EX3000 CABLE 5M Back End 10GbE	IS2	\$300
ES6-DS-5M-B1-KTS	EX3000 CABLE Kit 5M NonHA Back End	IS2	\$550

ES6-DS-5M-BE-KTS	EX3000 CABLE Kit 5M Back End	IS2	\$600
ES6-DS-5M-FE-KTS	EX3000 CABLE Kit 5M Front End	IS2	\$350
ES6-DS-PSNT	EX3000 Product Serial Number Tag	IS2	\$0
ES6-DS-RACK	RACK EX3000 SINGLE PHASE	IS2	\$13,500
ES6-DS-RACK-P3D	RACK EX3000 3 PHASE DELTA	IS2	\$13,500
ES6-DS-RACK-P3W	RACK EX3000 3 PHASE WYE	IS2	\$13,500
ES6-DS-SW25GB-BE	EX3000 SWITCH SW25GB HA Back End MFG	IS2	\$14,400
ES6-DS-SW25GBBE1	EX3000 SWITCH SW25GB NonHAS Back End Mfg	IS2	\$14,400
ES6-DS-SW25GBBE1-X	EX3000 SWITCH SW25GB NonHAS Back End Fld	IS2	\$14,400
ES6-DS-SW25GBBE2-X	EX3000 SWITCH SW25GB HA Back End Upg Fld	IS2	\$14,400
ES6-DS-SW25GB-BE-X	EX3000 SWITCH SW25GB HA Back End Fld	IS2	\$14,400
ES6-DS-SW25GB-FE	EX3000 SWITCH SW25GB Front End	IS2	\$14,400
ES6-DS-SW25GB-FE-X	EX3000 SWITCH SW25GB Front End Fld	IS2	\$14,400
ES6-P40U-ASTL-0U	PWCRD AUST 0U QTY2	IS2	\$0
ES6-P40U-ASTL-2U	PWCRD AUST 2U QTY2	IS2	\$0
ES6-P40U-IEC3-0U	PWCRD INTL 0U QTY2	IS2	\$0
ES6-P40U-IEC3-2U	PWCRD INTL 2U QTY2	IS2	\$0
ES6-P40U-RS-0U	PWCRD RSLSTL 0U QTY2	IS2	\$0
ES6-P40U-RS-2U	PWCRD RSLSTL 2U QTY2	IS2	\$0
ES6-P40U-US-0U	PWCRD L6-30A US 0U QTY2	IS2	\$0
ES6-P40U-US-2U	PWCRD L6-30A US 2U QTY2	IS2	\$0
ES6-PS-1M-10G	EX300 CABLE 1M Back End 10GbE	IS2	\$150
ES6-PS-1M-B1-KTS	EX300 CABLE Kit 1M NonHA Back End	IS2	\$450
ES6-PS-1M-BE-KTS	EX300 CABLE Kit 1M Back End	IS2	\$450
ES6-PS-1M-FE-KTS	EX300 CABLE Kit 1M Front End	IS2	\$250
ES6-PS-3M-10G	EX300 CABLE 3M Back End 10GbE	IS2	\$150
ES6-PS-3M-B1-KTS	EX300 CABLE Kit 3M NonHA Back End	IS2	\$450
ES6-PS-3M-BE-KTS	EX300 CABLE Kit 3M Back End	IS2	\$500
ES6-PS-3M-FE-KTS	EX300 CABLE Kit 3M Front End	IS2	\$300
ES6-PS-5M-10G	EX300 CABLE 5M Back End 10GbE	IS2	\$200
ES6-PS-5M-B1-KTS	EX300 CABLE Kit 5M NonHA Back End	IS2	\$500
ES6-PS-5M-BE-KTS	EX300 CABLE Kit 5M Back End	IS2	\$500
ES6-PS-5M-FE-KTS	EX300 CABLE Kit 5M Front End	IS2	\$300
ES6-PS-PSNT	EX300 Product Serial Number Tag	IS2	\$0
ES6-PS-RACK	RACK EX300 SINGLE PHASE	IS2	\$13,500
ES6-PS-RACK-P3D	RACK EX300 3 PHASE DELTA	IS2	\$13,500
ES6-PS-RACK-P3W	RACK EX300 3 PHASE WYE	IS2	\$13,500
ES6-PS-SVR-12TB	EX300 Node 12x1TB	IS2	\$14,300
ES6-PS-SVR-12TB-X	EX300 Node 12x1TB Fld	IS2	\$14,300
ES6-PS-SVR-24TB	EX300 Node 12x2TB	IS2	\$15,900
ES6-PS-SVR-24TB-X	EX300 Node 12x2TB Fld	IS2	\$15,900
ES6-PS-SVR-48TB	EX300 Node 12x4TB	IS2	\$17,900
ES6-PS-SVR-48TB-X	EX300 Node 12x4TB Fld	IS2	\$17,900
ES6-PS-SVR-96TB	EX300 Node 12x8TB	IS2	\$24,500
ES6-PS-SVR-96TB-X	EX300 Node 12x8TB Fld	IS2	\$24,500
ES6-PS-SW25GB-BE	EX300 SWITCH SW25GB HA Back End MFG	IS2	\$14,400
ES6-PS-SW25GBBE1	EX300 SWITCH SW25GB NonHAS Back End Mfg	IS2	\$14,400
ES6-PS-SW25GBBE1-X	EX300 SWITCH SW25GB NonHAS Back End Fld	IS2	\$14,400
ES6-PS-SW25GBBE2-X	EX300 SWITCH SW25GB HA Back End Upg Fld	IS2	\$14,400
ES6-PS-SW25GB-BE-X	EX300 SWITCH SW25GB HA Back End Fld	IS2	\$14,400

ES6-PS-SW25GB-FE	EX300 SWITCH SW25GB Front End	IS2	\$14,400
ES6-PS-SW25GB-FE-X	EX300 SWITCH SW25GB Front End Fld	IS2	\$14,400
ES6-RACK-TOPR	RACK Top Route KIT	IS2	\$0
ES6-TRAY-X	Service Tray Kit Fld Int	IS2	\$0
IA2000-10T-400G	A2000-2.2GHZ/2C/16G+20x10TB SAT/400GB	IS2	\$34,627
IA2000-10T-400G-VS	A2000-10TB SAT/400GB/VIS PROMO	IS2	\$27,005
IA2000-E-10T-400G	A2000-2.2GHZ/2C/16G+SED/20x10TB SAT/400GB	IS2	\$46,746
IA200-2T-400G	A200-2.2GHZ/2C/16G+15x2TB SAT/400GB	IS2	\$15,320
IA200-4T-400G	A200-2.2GHZ/2C/16G+15x4TB SAT/400GB	IS2	\$18,619
IA200-8T-400G	A200-2.2GHZ/2C/16G+15x8TB SAT/400GB	IS2	\$26,315
IA200-E-2T-400G	A200-2.2GHZ/2C/16G+SED/15x2TB SAT/400GB	IS2	\$20,682
IA200-E-4T-400G	A200-2.2GHZ/2C/16G+SED/15x4TB SAT/400GB	IS2	\$25,135
IA200-E-8T-400G	A200-2.2GHZ/2C/16G+SED/15x8TB SAT/400GB	IS2	\$35,525
IBEIO-10GBE	2x10GbE (SFP+) Back End W/O OPTICS	IS2	\$761
IBEIO-10GBE-PR	2x10GbE (SFP+)Back End/PROMO W/O OPTICS	IS2	\$593
IBEIO-40GBE	2x40GbE (QSFP+) Back End W/O OPTICS	IS2	\$977
IBEIO-40GBE-F	2x40GbE (QSFP+) Back End F800 W/O OPTICS	IS2	\$997
IBEIO-IB-40GBE	Infiniband NIC - 40GbE Mig W/O OPTICS	IS2	\$3,346
IBEIO-IB40GE-F	Infiniband NIC-40GbE Mig F800 W/O OPTICS	IS2	\$3,415
IBEIO-IBQDR	Infiniband NIC - 10GbE Mig W/O OPTICS	IS2	\$1,620
IBEIO-IBQDR-PR	IB NIC - 10GbE Mig/PROMO W/O OPTICS	IS2	\$1,263
ICH-DEEP	Base Chassis - Deep	IS2	\$4,266
ICH-DEEP-EMC	Base Chassis - Deep	IS2	\$4,266
ICH-DEEP-PR	Base Chassis - Deep/PROMO	IS2	\$3,327
ICH-DEEP-RACK	Base Chassis - Deep - Pre-Racked	IS2	\$4,353
ICH-NORM	Base Chassis - Normal	IS2	\$4,182
ICH-NORM-EMC	Base Chassis - Normal	IS2	\$4,182
ICH-NORM-EMC-F	Base Chassis - Normal EMC - F800	IS2	\$4,267
ICH-NORM-F800	Base Chassis - Normal - F800	IS2	\$4,267
IF800-1.6T	F800-2.6GHZ/16C/256G+15x1.6TB SSD	IS2	\$86,772
IF800-1.6T-PR	F800-2.6GHZ/16C/256G+15x1.6TB SSD-PROMO	IS2	\$65,053
IF800-15.4T	F800-2.6GHZ/16C/256G+15x15.4TB SSD	IS2	\$517,751
IF800-15.4T-PR	F800-2.6GHZ/16C/256G+15x15.4TB SSD-PROMO	IS2	\$390,785
IF800-3.2T	F800-2.6GHZ/16C/256G+15x3.2TB SSD	IS2	\$154,882
IF800-3.2T-PR	F800-2.6GHZ/16C/256G+15x3.2TB SSD-PROMO	IS2	\$118,239
IF800-E-1.6T	F800-2.6GHZ/16C/256G+SED/15x1.6TB SSD-PRO	IS2	\$98,711
IF800-E-3.2T	F800-2.6GHZ/16C/256G+SED/15x3.2TB SSD	IS2	\$176,193
IFEIO-10GBE	2x10GbE (SFP+) W/O OPTICS	IS2	\$759
IFEIO-10GBE-B	2x10GbE (SFP+) L/M W/O OPTICS	IS2	\$223
IFEIO-10GBE-B-PR	2x10GbE (SFP+) L/M/PROMO W/O OPTICS	IS2	\$174
IFEIO-10GBE-F	2x10GbE (SFP+) - F800 W/O OPTICS	IS2	\$774
IFEIO-40GBE	2x40GbE (QSFP+) W/O OPTICS	IS2	\$1,023
IFEIO-40GBE-F	2x40GbE (QSFP+) - F800 W/O OPTICS	IS2	\$1,044
IFILL-NODE-DEEP	Node Filler with Deep Sleds	IS2	\$1,487
IFILL-NODE-NORM	Node Filler with Normal Sleds	IS2	\$1,322
IH400-2T-1.6T	H400-2.2GHZ/4C/64G+15x2TB SAT/1.6TB	IS2	\$20,604
IH400-2T-3.2T	H400-2.2GHZ/4C/64G+15x2TB SAT/3.2TB	IS2	\$24,638
IH400-2T-800G	H400-2.2GHZ/4C/64G+15x2TB SAT/800GB	IS2	\$18,587
IH400-4T-1.6T	H400-2.2GHZ/4C/64G+15x4TB SAT/1.6TB	IS2	\$22,919
IH400-4T-3.2T	H400-2.2GHZ/4C/64G+15x4TB SAT/3.2TB	IS2	\$26,953

IH400-4T-800G	H400-2.2GHZ/4C/64G+15x4TB SAT/800GB	IS2	\$20,902
IH400-8T-1.6T	H400-2.2GHZ/4C/64G+15x8TB SAT/1.6TB	IS2	\$31,599
IH400-8T-3.2T	H400-2.2GHZ/4C/64G+15x8TB SAT/3.2TB	IS2	\$35,633
IH400-8T-800G	H400-2.2GHZ/4C/64G+15x8TB SAT/800GB	IS2	\$29,582
IH400-E-2T-1.6T	H400-2.2GHZ/4C/64G+SED/15x2TB SAT/1.6TB	IS2	\$27,815
IH400-E-2T-3.2T	H400-2.2GHZ/4C/64G+SED/15x2TB SAT/3.2TB	IS2	\$33,261
IH400-E-2T-800G	H400-2.2GHZ/4C/64G+SED/15x2TB SAT/800GB	IS2	\$25,092
IH400-E-4T-1.6T	H400-2.2GHZ/4C/64G+SED/15x4TB SAT/1.6TB	IS2	\$30,941
IH400-E-4T-3.2T	H400-2.2GHZ/4C/64G+SED/15x4TB SAT/3.2TB	IS2	\$36,387
IH400-E-4T-800G	H400-2.2GHZ/4C/64G+SED/15x4TB SAT/800GB	IS2	\$28,218
IH400-E-8T-1.6T	H400-2.2GHZ/4C/64G+SED/15x8TB SAT/1.6TB	IS2	\$42,658
IH400-E-8T-3.2T	H400-2.2GHZ/4C/64G+SED/15x8TB SAT/3.2TB	IS2	\$48,104
IH400-E-8T-800G	H400-2.2GHZ/4C/64G+SED/15x8TB SAT/800GB	IS2	\$39,935
IH500-2T-1.6T	H500-2.2GHZ/10C/128G+15x2TB SAT/1.6TB	IS2	\$28,268
IH500-2T-3.2T	H500-2.2GHZ/10C/128G+15x2TB SAT/3.2TB	IS2	\$32,302
IH500-4T-1.6T	H500-2.2GHZ/10C/128G+15x4TB SAT/1.6TB	IS2	\$30,583
IH500-4T-3.2T	H500-2.2GHZ/10C/128G+15x4TB SAT/3.2TB	IS2	\$34,618
IH500-8T-1.6T	H500-2.2GHZ/10C/128G+15x8TB SAT/1.6TB	IS2	\$39,263
IH500-8T-3.2T	H500-2.2GHZ/10C/128G+15x8TB SAT/3.2TB	IS2	\$43,297
IH500-E-2T-1.6T	H500-2.2GHZ/10C/128G+SED/15x2T SAT/1.6TB	IS2	\$38,162
IH500-E-2T-3.2T	H500-2.2GHZ/10C/128G+SED/15x2T SAT/3.2TB	IS2	\$43,608
IH500-E-4T-1.6T	H500-2.2GHZ/10C/128G+SED/15x4T SAT/1.6TB	IS2	\$41,287
IH500-E-4T-3.2T	H500-2.2GHZ/10C/128G+SED/15x4T SAT/3.2TB	IS2	\$46,734
IH500-E-8T-1.6T	H500-2.2GHZ/10C/128G+SED/15x8T SAT/1.6TB	IS2	\$53,005
IH500-E-8T-3.2T	H500-2.2GHZ/10C/128G+SED/15x8T SAT/3.2TB	IS2	\$58,451
IH600-1.2T-1.6T	H600-2.4GHZ/14C/256G+30x1.2TB SAS/1.6TB	IS2	\$49,099
IH600-1.2T-3.2T	H600-2.4GHZ/14C/256G+30x1.2TB SAS/3.2TB	IS2	\$53,134
IH600-600G-1.6T	H600-2.4GHZ/14C/256G+30x600GB SAS/1.6TB	IS2	\$42,647
IH600-600G-3.2T	H600-2.4GHZ/14C/256G+30x600GB SAS/3.2TB	IS2	\$46,681
IH600-E-1.2T-1.6T	H600-2.4GH/14C/256G+SED/30x1.2T SAS/1.6T	IS2	\$66,284
IH600-E-1.2T-3.2T	H600-2.4GH/14C/256G+SED/30x1.2T SAS/3.2T	IS2	\$71,730
IH600-E-600G-1.6T	H600-2.4GH/14C/256G+SED/30x600G SAS/1.6T	IS2	\$57,573
IH600-E-600G-3.2T	H600-2.4GH/14C/256G+SED/30x600G SAS/3.2T	IS2	\$63,020
ISSD-1.6TB	ISD - 1.6TB SSD	IS2	\$4,592
ISSD-3.2TB	ISD - 3.2TB SSD	IS2	\$8,708
ISSD-400GB	ISD - 400GB SSD	IS2	\$1,557
ISSD-400GB-PR	ISD - 400GB SSD/PROMO	IS2	\$1,557
ISSD-800GB	ISD - 800GB SSD	IS2	\$2,533
ISSD-E-1.6TB	ISD - 1.6TB SED SSD	IS2	\$5,969
ISSD-E-3.2TB	ISD - 3.2TB SED SSD	IS2	\$11,321
ISSD-E-400GB	ISD - 400GB SED SSD	IS2	\$2,024
ISSD-E-800GB	ISD - 800GB SED SSD	IS2	\$3,293
SH-458-000-169	OneFS Sub Essential Base T1 w/HW=ID	IS2	\$1,163
SH-458-000-170	OneFS Sub Enc Key Mgt 3Y/PP T1 w/HW=ID	IS2	\$293
SH-458-000-171	OneFS Sub Enc Key Mgt T2 w/HW=ID	IS2	\$340
SH-458-000-172	OneFS Sub Enc Key Mgt 2Y/PP T2 w/HW=ID	IS2	\$323
SH-458-000-173	OneFS Sub Enc Key Mgt 3Y/PP T2 w/HW=ID	IS2	\$306
SH-458-000-174	OneFS Sub Enc Key Mgt T3 w/HW=ID	IS2	\$340
SH-458-000-175	OneFS Sub Enc Key Mgt 2Y/PP T3 w/HW=ID	IS2	\$323
SH-458-000-176	OneFS Sub Enc Key Mgt 3Y/PP T3 w/HW=ID	IS2	\$306

SH-458-000-177	OneFS Sub Advanced Base T1 w/HW=ID	IS2	\$1,790
SH-458-000-178	OneFS Sub Advanced Base 2Y/PP T1 w/HW=ID	IS2	\$1,701
SH-458-000-179	OneFS Sub Advanced Base 3Y/PP T1 w/HW=ID	IS2	\$1,611
SH-458-000-180	OneFS Sub Advanced Base T2 w/HW=ID	IS2	\$1,703
SH-458-000-181	OneFS Sub Advanced Base 2Y/PP T2 w/HW=ID	IS2	\$1,618
SH-458-000-182	OneFS Sub Advanced Base 3Y/PP T2 w/HW=ID	IS2	\$1,533
SH-458-000-183	OneFS Sub Advanced Base T3 w/HW=ID	IS2	\$1,131
SH-458-000-184	OneFS Sub Advanced Base 2Y/PP T3 w/HW=ID	IS2	\$1,074
SH-458-000-185	OneFS Sub Advanced Base 3Y/PP T3 w/HW=ID	IS2	\$1,018
SH-458-000-186	OneFS Sub Advanced Base T4 w/HW=ID	IS2	\$593
SH-458-000-187	OneFS Sub Advanced Base 2Y/PP T4 w/HW=ID	IS2	\$564
SH-458-000-188	OneFS Sub Advanced Base 3Y/PP T4 w/HW=ID	IS2	\$534
SH-458-000-189	OneFS Sub Advanced Cap T1 w/HW=CB	IS2	\$63
SH-458-000-190	OneFS Sub Advanced Cap 2Y/PP T1 w/HW=CB	IS2	\$59
SH-458-000-191	OneFS Sub Advanced Cap 3Y/PP T1 w/HW=CB	IS2	\$56
SH-458-000-192	OneFS Sub Advanced Cap T2 w/HW=CB	IS2	\$65
SH-458-000-193	OneFS Sub Advanced Cap 2Y/PP T2 w/HW=CB	IS2	\$62
SH-458-000-194	OneFS Sub Advanced Cap 3Y/PP T2 w/HW=CB	IS2	\$58
SH-458-000-195	OneFS Sub Advanced Cap T3 w/HW=CB	IS2	\$24
SH-458-000-196	OneFS Sub Essentl Base 2Y/PP T1 w/HW=ID	IS2	\$1,105
SH-458-000-197	OneFS Sub Advanced Cap 2Y/PP T3 w/HW=CB	IS2	\$23
SH-458-000-198	OneFS Sub Advanced Cap 3Y/PP T3 w/HW=CB	IS2	\$22
SH-458-000-199	OneFS Sub Advanced Cap T4 w/HW=CB	IS2	\$9
SH-458-000-200	OneFS Sub Advanced Cap 2Y/PP T4 w/HW=CB	IS2	\$9
SH-458-000-201	OneFS Sub Advanced Cap 3Y/PP T4 w/HW=CB	IS2	\$8
SH-458-000-202	Cloudpools Subscription	IS2	\$0
SH-458-000-203	Cloudpools Subscription 2Y/PP	IS2	\$0
SH-458-000-204	Cloudpools Subscription 3Y/PP	IS2	\$0
SH-458-000-205	OneFS Sub Essentl Base 3Y/PP T1 w/HW=ID	IS2	\$1,047
SH-458-000-206	OneFS Sub Essential Base T2 w/HW=ID	IS2	\$1,076
SH-458-000-207	OneFS Sub Essentl Base 2Y/PP T2 w/HW=ID	IS2	\$1,022
SH-458-000-208	OneFS Sub Essentl Base 3Y/PP T2 w/HW=ID	IS2	\$968
SH-458-000-209	OneFS Sub Essential Base T3 w/HW=ID	IS2	\$884
SH-458-000-210	OneFS Sub Essentl Base 2Y/PP T3 w/HW=ID	IS2	\$840
SH-458-000-211	OneFS Sub Essentl Base 3Y/PP T3 w/HW=ID	IS2	\$795
SH-458-000-212	OneFS Sub Essential Base T4 w/HW=ID	IS2	\$406
SH-458-000-213	OneFS Sub Essentl Base 2Y/PP T4 w/HW=ID	IS2	\$386
SH-458-000-214	OneFS Sub Essentl Base 3Y/PP T4 w/HW=ID	IS2	\$366
SH-458-000-215	OneFS Sub Essential Cap T1 w/HW=CB	IS2	\$55
SH-458-000-216	OneFS Sub Essential Cap 2Y/PP T1 w/HW=CB	IS2	\$52
SH-458-000-217	OneFS Sub Essential Cap 3Y/PP T1 w/HW=CB	IS2	\$50
SH-458-000-218	OneFS Sub Essential Cap T2 w/HW=CB	IS2	\$57
SH-458-000-219	OneFS Sub Essential Cap 2Y/PP T2 w/HW=CB	IS2	\$54
SH-458-000-220	OneFS Sub Essential Cap 3Y/PP T2 w/HW=CB	IS2	\$52
SH-458-000-221	OneFS Sub Essential Cap T3 w/HW=CB	IS2	\$20
SH-458-000-222	OneFS Sub Essential Cap 2Y/PP T3 w/HW=CB	IS2	\$19
SH-458-000-223	OneFS Sub Essential Cap 3Y/PP T3 w/HW=CB	IS2	\$18
SH-458-000-224	OneFS Sub Essential Cap T4 w/HW=CB	IS2	\$5
SH-458-000-225	OneFS Sub Essential Cap 2Y/PP T4 w/HW=CB	IS2	\$5
SH-458-000-226	OneFS Sub Essential Cap 3Y/PP T4 w/HW=CB	IS2	\$5

SH-458-000-227	OneFS Sub Enc Key Mgt T1 w/HW=ID	IS2	\$325
SH-458-000-228	OneFS Sub Enc Key Mgt 2Y/PP T1 w/HW=ID	IS2	\$309
SH-458-000-240	OneFS Sub Enc Key Mgt 3Y/PP T4 w/HW=ID	IS2	\$85
SH-458-000-241	OneFS Sub Enc Key Mgt T4 w/HW=ID	IS2	\$94
SH-458-000-242	OneFS Sub Enc Key Mgt 2Y/PP T4 w/HW=ID	IS2	\$90
SP811-0282	R-SPR KIT - LOW COMPUTE NODE FRU GEN6	IS2	\$10,237
SP811-0283	R-SPR KIT - MEDIUM COMPUTE NODE FRU GEN6	IS2	\$10,806
SP811-0284	R-SPR KIT - HIGH COMPUTE NODE FRU GEN6	IS2	\$12,415
SP811-0285	R-SPR KIT - TURBO COMPUTE NODE FRU GEN6	IS2	\$18,961
SP811-0286	R-SPR KIT - ULTRA COMPUTE NODE FRU GEN6	IS2	\$17,062
SP811-0287	R-SPR KIT - GEN2 CFF 1100W AC DC PSU AET	IS2	\$449
SP811-0288	R-SPR KIT - GEN2 CFF 1450W AC DC PSU AET	IS2	\$554
SP811-0289	R-SPR KIT - DEEP ADJ RAIL ASSEMBLY GEN6	IS2	\$188
SP811-0290	R-SPR KIT - NORM ADJ RAIL ASSEMBLY GEN6	IS2	\$175
SP811-0291	R-SPR KIT - FILLER DRIVE SLED DEEP GEN6	IS2	\$137
SP811-0292	R-SPR KIT - FILLER DRIVE SLED NORM GEN6	IS2	\$95
SP811-0293	R-SPR KIT - FILLER COMPUTE GEN6	IS2	\$22
SP811-0294	R-SPR KIT - FAN ASSEMBLY GEN6	IS2	\$81
SP811-0295	R-SPR KIT - 30% BATTERY/RISER FRU GEN6	IS2	\$1,710
SP811-0296	R-SPR KIT - CHASSIS FRU DEEP GEN6	IS2	\$15,833
SP811-0297	R-SPR KIT - CHASSIS FRU NORM GEN6	IS2	\$15,041
SP811-0298	R-SPR KIT - FRONT LCD DISPLAY GEN6	IS2	\$630
SP811-0299	R-SPR KIT - FILLER 2.5 DRIVE SLOT GEN6	IS2	\$3
SP811-0300	R-SPR KIT - FILLER 2.5 DRIVE SLED F800	IS2	\$588
SP811-0301	R-SPR KIT - 32G DIMM DDR4-2400 GEN6	IS2	\$1,756
SP811-0302	R-SPR KIT - 16G DIMM DDR4-2400 GEN6	IS2	\$965
SP811-0303	R-SPR KIT - DEEP 3.5 DRIVE SLED GEN6	IS2	\$617
SP811-0304	R-SPR KIT - NORMAL 3.5 DRIVE SLED GEN6	IS2	\$407
SP811-0305	R-SPR KIT - NORMAL 2.5 DRIVE SLED GEN6	IS2	\$566
SP811-0306	R-SPR KIT - 64G LRDIMM DDR4-2400 GEN6	IS2	\$3,113
SP811-0307	R-SPR KIT - 4U DE Bezel GEN6	IS2	\$105
SP811-0308	R-SPR KIT - F800 Nameplate GEN6	IS2	\$21
SP811-0309	R-SPR KIT - H600 Nameplate GEN6	IS2	\$21
SP811-0310	R-SPR KIT - H500 Nameplate GEN6	IS2	\$21
SP811-0311	R-SPR KIT - H400 Nameplate GEN6	IS2	\$21
SP811-0312	R-SPR KIT - A200 Nameplate GEN6	IS2	\$21
SP811-0313	R-SPR KIT - A2000 Nameplate GEN6	IS2	\$21
SP811-0314	R-SPR KIT - 4U EMC Bezel GEN6	IS2	\$110
SP811-0315	R-SPR KIT - X10 64G MLC BOOT DRIVE GEN6	IS2	\$301
SP811-0316	R-SPR KIT - X10 128G MLC BOOT DRIVE GEN6	IS2	\$459
SP811-0317	FIXED RAIL KIT GEN6 NORM VXBLOCK	IS2	\$370
SP811-0318	FIXED RAIL KIT GEN6 DEEP VXBLOCK	IS2	\$370
SP811-0319	R-SPR KIT - X10 80G MLC BOOT DRIVE GEN6	IS2	\$460
1S5STDFANE560165L	VxRail-500 1S 5 STD FAN LESS THAN 165W	J	\$89
1S8HPFANE560165GR	VxRail-500 1S 8 HIGH PERF FAN 165W/GRT	J	\$233
1SE560HSKDM165G	VxRail-500 1SE560 165WGR HTKDIMM CPUBLNK	J	\$36
1SE560HSKDM165OL	VxRail-500 1S E560 165WL HTK DIMM BLNK	J	\$24
1SP570HSDM125GR	VxRail-500 1SP570 125GR CHASSIS,FAN,HSK	J	\$2,217
1SP570HSDM125OL	VxRail-500 1SP570 125WL CHASSIS,FAN,HSK	J	\$2,217
1SS570HSKDMFN	VxRail-500 1SS570 HSK DIMM CPU BLK FAN	J	\$787

2S5STDFANE560165L	VxRail-500 2S 8 STD FAN LESS THAN 165W	J	\$142
2S8HPFANE560165GR	VxRail-500 2S 8 HIGH PERF FAN 165W/GRT	J	\$233
2SE560HSKDM165GR	VxRail-500 2S E560 165GR HTK DIMM BLNK	J	\$35
2SE560HSKDM165OL	VxRail-500 2S E560 165WL HTK DIMM BLNK	J	\$27
2SP570HSDM125GR	VxRail-500 2SP570 125GR CHASSIS,FAN,HSK	J	\$2,217
2SP570HSDM125OL	VxRail-500 2SP570 125WL CHASSIS,FAN,HSK	J	\$2,217
2SS570HSKDMFN	VxRail-500 2SS570 HSK DIMM CPU BLK FAN	J	\$786
3250-VL2E	EOU 8-PORT FOR AX100	J	\$3,000
3250-VL2EU	EOU 8-PORT (US) FOR AX100	J	\$3,000
456-105-133	EMC XtremCache software=IA	J	\$0
456-105-135	XtremCache Software - QTY 5=IA	J	\$0
456-105-155	X-Pack - XtremCache software=IA	J	\$0
456-110-954	HCIA Software NFR =IB	J	\$0
456-111-210	HCIA SW V3.5=IB	J	\$0
457-101-344	EMC XtremCache software=IA	J	\$0
458-001-527	HCIA SW V3.5	J	\$0
458-002-448	DELL EMC Automation SW-4=ID	J	\$13,044
458-002-449	DELL EMC Automation SW-8=ID	J	\$9,801
458-002-450	DELL EMC Automation SW-12=ID	J	\$8,719
458-002-452	DELL EMC Automation w/Dell CSP=ID	J	\$0
458-002-453	OMNM 25 Devices Software=ID	J	\$6,015
458-002-454	DELL EMC Automation w/MSFT CSP=ID	J	\$0
458-002-455	DELL EMC Automation w/3rd Party CSP=ID	J	\$0
458-002-478	CloudLink for MAS Perpetual Tier1=IB	J	\$700
458-002-479	CloudLink for MAS Perpetual Tier2=IB	J	\$575
458-002-480	CloudLink for MAS Perpetual Tier3=IB	J	\$500
458-002-481	CloudLink for MAS Perpetual Tier4=IB	J	\$400
AX100I-SPKIT	AX100I SPARES KIT	J	\$5,500
AX100I-SUIT	AX100I SUITCASE SPARE	J	\$5,300
AX100MEM	SPARE - 512 MEM DIMM	J	\$350
AX100PFAN	SPARE - Processor FAN	J	\$30
AX100PS	SPARE - Power Supply	J	\$150
AX100SC-AX100	AX100SC TO AX100	J	\$11,000
AX100SCI-AX100I	AX100SCI UPGRDE TO AX100I	J	\$11,000
AX100SCI-SPKIT	AX100SCI SPARES KIT	J	\$4,000
AX100SCI-SUIT	AX100SCI SUITCASE SPARE	J	\$2,700
AX100SC-SPKIT	AX100SC SPARES KIT	J	\$4,000
AX100SC-SUIT	AX100SC SUITCASE SPARE	J	\$2,700
AX100SFAN	SPARE - System FAN	J	\$110
AX150CACHE	SPARE AX150SC CACHE MEM	J	\$1,100
AX150-CHASSIS	SPARE AX150 CHASSIS	J	\$400
AX150I-SPKIT	SPARE KIT FOR AX150I	J	\$5,500
AX150I-SUIT	SPARE AX150I SP SUITCASE	J	\$5,300
AX150MEM	SPARE AX150 512 MEM DIMM	J	\$350
AX150PFAN	SPARE AX150 PROCESSOR FAN	J	\$150
AX150-PS	SPARE AX150 POWER SUPPLY	J	\$400
AX150SC-AX150	AX150 SINGLE TO DUAL UPGR	J	\$5,700
AX150SCI-150I	AX150I ISCSI SINGLE TO DUAL UPGRADE	J	\$5,700
AX150SCI-SPKIT	SPARE KIT FOR AX150SCI	J	\$4,000
AX150SCI-SUIT	SPARE AX150SCI SUITCASE	J	\$2,700

AX150SC-SPKIT	SPARE KIT FOR AX150SC FC	J	\$4,000
AX150SC-SUIT	SPARE - AX100SC SUITCASE	J	\$2,700
AX150SCXI-250	2U SINGLE ISCSI SATA DPE-3 250GB - NO US	J	\$5,600
AX150SFAN	SPARE AX150 SYSTEM FAN	J	\$175
AX150-SPKIT	SPARE KIT FOR AX150	J	\$5,500
AX150-SUIT	SPARE AX150 SUITCASE	J	\$5,300
AX-2SS10-146	2.5 146GB 10K SAS DISK DRIVE	J	\$0
AX-2SS10-300	2.5 10K 300GB SAS DISK DRIVE	J	\$0
AX4-5DAE	2U SAS/SATA 12 DRIVE DAE	J	\$0
AX4-5DAEDC	2U SAS/SATA 12DRIVE DAE DC POWER	J	\$0
AX4-5D-FL	ASSY ICA/FLARE IMAGE FOR AX4-5 DUAL SP	J	\$0
AX4-5-DP-504	AX4 DUAL SP FACT INST FLARE 504 & DOCS	J	\$0
AX4-5-DP-703	AX4 DUAL SP FACT INST FLARE 703 & DOCS	J	\$0
AX4-5-DP-705	AX4 DUAL SP FACT INST FLARE 705 + DOCS	J	\$0
AX4-5EXPAN	AX4-5 Expansion Pack	J	\$0
AX4-5F	2U DUAL SP DPE FC FRONT END W 1U SPS	J	\$0
AX4-5F-12X1TB	AX4-5F DUAL WITH 12X1TB SATA	J	\$0
AX4-5F-12X600	AX4-5F DUAL WITH 12X600GB SAS	J	\$0
AX4-5F-6X1TB	AX4-5F DUAL WITH 6X1TB SATA	J	\$0
AX4-5F-6X600	AX4-5F DUAL WITH 6X600GB SAS	J	\$0
AX4-5FC4IO	4 PORT FC I/O MODULE FOR AX4	J	\$0
AX4-5FDC	2U DUAL SP DPE FC FRONT END & DC POWER	J	\$0
AX4-5FDC-PPS	AX4 2U DUAL SP DPE W DC SUPPLY - FC-PPS	J	\$8,488
AX4-5F-PPS	2U SAS/SATA DPE - FC- PPS	J	\$7,687
AX4-5FSC	2U SINGLE SP DPE FC FRONT END	J	\$0
AX4-5FSC-750	2U 1 SP DPEFC FE & 4X750GB 7200K VAULT	J	\$7,133
AX4-5FSC-DP	AX4-5 FC SINGLE TO DUAL PROCESSOR HW UPG	J	\$0
AX4-5FSC-PPS	AX4 FC SINGLE SP - PPS	J	\$4,916
AX4-5FSCX	2U SINGLE SP DPEFC FRONT END - 4 FC PORT	J	\$0
AX4-5FSCX-750	2U SINGLE SP DPEFC FE-4FC & 750GB VAULT	J	\$7,806
AX4-5FSCX-DP	AX4-5F SING-SP W 4FC TO DUAL UPG	J	\$0
AX4-5FSCX-NEC	2U 1SP DPEFC FRONT END 4 FC PORT NEC	J	\$5,914
AX4-5FSCX-PPS	AX4 2U SINGLE SP DPEFC FE-4 FC PORTS PPS	J	\$5,589
AX4-5FX	2U 2SP DPE FC FRONTEND 1U SPS 8 FC PORT	J	\$0
AX4-5FX-NEC	2U DUAL SP DPE FC FE - 8FC PORTS FOR NEC	J	\$9,690
AX4-5FX-PPS	DUAL SP DPE FC FRONT END 8 FC PORTS- PPS	J	\$9,365
AX4-5I	2U DUAL SP DPE ISCSI FRONT END W 1U SPS	J	\$0
AX4-5I-12X1TB	AX4-5I DUAL WITH 12X1TB SATA	J	\$0
AX4-5I-12X600	AX4-5I DUAL WITH 12X600GB SAS	J	\$0
AX4-5I-6X1TB	AX4-5I DUAL WITH 6X1TB SATA	J	\$0
AX4-5I-6X600	AX4-5I DUAL WITH 6X600GB SAS	J	\$0
AX4-5IDC	2U DUAL SP DPE ISCSI FRONT END DC POWER	J	\$0
AX4-5IDC-PPS	AX4 2U DPE W DC SUPPLY ISCSI PPS	J	\$8,018
AX4-5I-PPS	2U SAS/SATA DPE - ISCSI- PPS	J	\$7,236
AX4-5ISC	2U SINGLE SP DPE ISCSI FRONT END	J	\$0
AX4-5ISC-750	2U 1SP DPEISCSI FE & 4X750GB 7200K VAULT	J	\$7,133
AX4-5ISC-DP	AX4-5 ISCSI 1 TO 2 PROCESSOR HW UPGRADE	J	\$0
AX4-5ISC-PPS	AX4 ISCSI SINGLE SP-PPS	J	\$4,681
AX4-5S-FL	ASSY ICA/FLARE IMAGE FOR AX4-5 SINGLE SP	J	\$0
AX4-5-SP-504	AX4 1SP FACT INST FLARE IMG 504 & DOCS	J	\$0

AX4-5-SP-703	AX4 1SP FACT INST FLARE IMG 703 & DOCS	J	\$0
AX4-5-SP-705	AX4 1 SP FACT INST FLARE IMG 705 + DOCS	J	\$0
AX-S207-250	250GB 7.2K SATA II DISK	J	\$325
AX-S207-500	500GB SATA II 7.2K DISK	J	\$0
AX-S207-750	750GB 7200RPM SATA II DRIVE	J	\$775
AX-SA07-160	160GB 7200RPM SATA	J	\$225
AX-SA07-250	250GB 7200RPM SATA	J	\$325
AX-SA07-500	500GB 7200RPM SATA DISK	J	\$630
AX-SS07-010	1000GB 7200RPM SATA 3GB DRIVE	J	\$0
AX-SS07-020	2TB 7200RPM SATA II DISK DRIVE	J	\$0
AX-SS07-750	750GB 7200RPM SATA II DRIVE	J	\$580
AX-SS10-400	400GB 10K SAS DRIVE	J	\$910
AX-SS10-600	600GB 10K 3GB SAS DISK DRIVE	J	\$0
AX-SS15-146	146GB 15K SAS DRIVE	J	\$485
AX-SS15-300	300GB 15K SAS 3GB DISK DRIVE	J	\$0
AX-SS15-450	450GB 15K 3GB SAS DISK DRIVE	J	\$0
AX-SS15-600	600GB 15K 3GB SAS DISK DRIVE	J	\$0
CACHENVME1.6TBF	VxRail-500 CACHE NVME 1.6TB 5WPD 2.5I F	J	\$5,393
CACHENVME1.6TBH	VxRail-500 CACHE NVME 1.6TB 5WPD 2.5I H	J	\$5,393
CACHENVME1.6TBSP	VxRail-500 CACHE NVME 1.6TB 5WPD 2.5I SP	J	\$6,006
CACHENVME1.6TBU	VxRail-500 CACHE NVME 1.6TB 5WPD 2.5I U	J	\$6,006
CACHENVME800GBF	VxRail-500 CACHE NVME 800GB 5WPD 2.5I F	J	\$3,047
CACHENVME800GBH	VxRail-500 CACHE NVME 800GB 5WPD 2.5I H	J	\$3,047
CACHENVME800GBSP	VxRail-500 CACHE NVME 800GB 5WPD 2.5I SP	J	\$3,595
CACHENVME800GBU	VxRail-500 CACHE NVME 800GB 5WPD 2.5I U	J	\$3,595
CAPHDD12TB10K25U	HCIA HDD SAS 1.2TB 10K RPM 2.5 INCH UPG	J	\$681
CAPHDD12TB10K25VX5	VxRail-500 HDD SAS 1.2TB 10K RPM 2.5INCH	J	\$802
CAPHDD18TB10K25VX5	VxRail500 HDD SAS 1.8TB 10K 512e 2.5INCH	J	\$1,133
CAPHDD20TB72K25U	HCIA HDD SAS 2TB 7.2K RPM 2.5 INCH UPG	J	\$1,014
CAPHDD20TB72K25VX5	VxRail-500 HDD SAS 2TB 7.2K RPM 2.5INCH	J	\$1,102
CAPHDD24TB10K25VX5	VxRail500 HDD SAS 2.4TB 10K 512e 2.5INCH	J	\$1,307
CAPHDD40TB72K35U	HCIA HDD SAS 4TB 7.2K RPM 3.5 INCH UPG	J	\$1,014
CAPHDD40TB72K35VX5	VxRail-500 HDD SAS 4TB 7.2K RPM 3.5INCH	J	\$855
CAPSATASSD192TBU	HCIA Capacity SATA SSD 1.92TB 1WPD U	J	\$3,315
CAPSATASSD192TBVX5	VxRail-500 CAPACITY SATA SSD 1.92TB1WPD	J	\$2,751
CAPSATASSD384TBU	HCIA Capacity SATA SSD 3.84TB 1WPD U	J	\$6,238
CAPSATASSD384TBVX5	VxRail-500 CAPACITY SATA SSD 3.84TB1WPD	J	\$5,129
CAPSSD192TB1WPDU	HCIA CAPACITY SAS SSD 1.92TB 1WPD UPG	J	\$4,903
CAPSSD192TB1WPDVX5	VxRail-500 CAPACITY SAS SSD 1.92TB1WPD	J	\$4,251
CAPSSD192TB3WPDVX5	VxR 14G Cap SAS SSD MixUse 1.92TB 3WPD	J	\$5,541
CAPSSD384TB1WPDU	HCIA CAPACITY SAS SSD 3.84TB 1WPD UPG	J	\$9,216
CAPSSD384TB1WPDVX5	VxRail-500 CAPACITY SAS SSD 3.84TB1WPD	J	\$6,970
COMBORAILKIT1U1NAF	VxRail-500 Drop-in/Stab-in Rails 1U1N AF	J	\$104
COMBORAILKIT1U1NH	VxRail-500 Combo Drop-in/Stab-inRail1U1N	J	\$104
COMBORAILKIT1U1NU	HCIA Combo Drop-in/Stab-in Kit 1U1NU	J	\$132
COMBORAILKIT2U1NAF	VxRail-500 Drop-in/Stab-in Rails 2U1N AF	J	\$104
COMBORAILKIT2U1NH	VxRail-500 Combo Drop-in/Stab-inRail2U1N	J	\$104
COMBORAILKIT2U1NU	HCIA Combo Drop-in/Stab-in Kit 2U1NU	J	\$132
DE-16GSDCRDIDSDMSP	HCIA Mod FSD SDIG 16Gb UHS IDSDM SP	J	\$52
DE-CAPHDD12TB10KSP	HCIA HDD Sas 1.2TB 10K RPM 2.5 INCH SP	J	\$881

DE-CAPHDD20TB72KSP	HCIA HDD Sas 2TB 7.2K RPM 2.5 INCH SP	J	\$1,049
DE-CAPHDD4TB72KSP	HCIA HDD SAS 4TB 7.2K RPM 3.5 INCH SP	J	\$1,049
DE-CAPSATASSD192SP	HCIA Capacity SATA SSD 1.92TB 1WPD SP	J	\$3,315
DE-CAPSATASSD384SP	HCIA Capacity SATA SSD 3.84TB 1WPD SP	J	\$6,238
DE-CAPSSD192TBPS	HCIA Capacity SSD 1.92TB 1WPD SP	J	\$4,341
DE-CAPSSD384TBSP	HCIA Capacity SSD 3.84TB 1WPD SP	J	\$7,525
DE-GPUAMDFPS7150SP	HCIA Gpu Amd Firepro S7150 SP	J	\$4,724
DE-GPUAMDS7150X2SP	HCIA Gpu Amd Firepro S7150X2 SP	J	\$8,099
DE-GPUTESLAM10SP	HCIA Gpu Nvidia Tesla M10 SP	J	\$8,099
DE-GPUTESLAM60SP	HCIA Gpu Nvidia Tesla M60 SP	J	\$12,824
DE-HBA33012GBMCDSP	HCIA Mod Crd Ctl HBA330 Mini Card SP	J	\$286
DE-INTDUALSDMOD13G	HCIA Mod,Mod,PWA,RSR,IDSMD,13G SP	J	\$52
DE-MEMLDIMM16GBSP	HCIA Memory 16GB DIMM SP	J	\$567
DE-MEMLDIMM32GBSP	HCIA Memory 32GB DIMM SP	J	\$1,103
DE-MEMLRDIMM64GBSP	HCIA Memory 64GB DIMM SP	J	\$2,744
DE-NICDX550LPRJSP	HCIA Intel X550 LP Pcie 2X10GBE RJ45 SP	J	\$713
DE-NICX52010GBI350	HCIA Intel X520 DP 10Gb + I350 DP 1Gb SP	J	\$724
DE-NICX520FHSFSP	HCIA Intel X520 FH Pcie 2X10GBE SFP+ SP	J	\$618
DE-NICX520LPSFPLPS	HCIA Intel X520 LP Pcie 2X10GBE SFP+ SP	J	\$618
DE-NICX54010GBI350	HCIA Intel X540 DP 10Gb + I350 DP 1Gb SP	J	\$786
DE-NICX540LPPCRJSP	HCIA Intel X540 LP Pcie 2X10GBE RJ45 SP	J	\$786
DE-NICX540PCFHRJSP	HCIA Intel X540 FH Pcie 2X10GBE RJ45 SP	J	\$786
DE-NICX550PCFHRJSP	HCIA Intel X550 FH Pcie 2X10GBE RJ45 SP	J	\$713
DE-PS1100W110220SP	HCIA Dual Hotplg 1100W PS 100V-240VAC SP	J	\$824
DE-SATADOM64GBSSDS	HCIA Mod,SSDR,64GB,SataDom,V2,INNOD	J	\$1,893
DE-SSD1600GB10WDSP	HCIA Cache SSD 1600GB 10WPD 2.5 INCH SP	J	\$5,922
DE-SSD400GB10WPDSP	HCIA Cache SSD 400GB 10WPD 2.5 INCH SP	J	\$1,945
DE-SSD800GB10WPDSP	HCIA Cache SSD 800GB 10WPD 2.5 INCH SP	J	\$3,430
DE-VX128GBLRDIMMSP	VxRail-400 Memory 128GB LRDIMM SP	J	\$12,000
DE-VXR-OPTIC-SRSP	Intel Ethernet SFP+SR Optic-E10GSFSPSR SP	J	\$304
DP-1X2SSD-3XHDD	HCIA Disk Pack 1x200GB SSD 3x1.2TB HDD	J	\$4,344
DP-1X2SSD-3XHDDU	HCIA DISK PACK 1X200GB SSD 3X1.2TB HDD U	J	\$4,344
DP-1X2SSD-4XHDD	HCIA Disk Pack 1x200GB SSD 4x1.2TB HDD	J	\$5,236
DP-1X2SSD-4XHDDU	HCIA Disk Pack 1x200GB SSD 4x1.2TB HDD U	J	\$5,236
DP-1X2SSD-5XHDD	HCIA Disk Pack 1x200GB SSD 5x1.2TB HDD	J	\$6,127
DP-1X2SSD-5XHDDU	HCIA Disk Pack 1x200GB SSD 5x1.2TB HDD U	J	\$6,127
DP-1X4SSD-1X38SSD	HCIA Disk Pack 1x400GB SSD 1x3.8TB SSD	J	\$11,934
DP-1X4SSD-1X38SSDU	HCIA Disk Pack 1x400GB SSD 1x3.8TB SSD U	J	\$11,934
DP-1X4SSD-2X38SSD	HCIA Disk Pack 1x400GB SSD 2x3.8TB SSD	J	\$20,840
DP-1X4SSD-2X38SSDU	HCIA Disk Pack 1x400GB SSD 2x3.8TB SSD U	J	\$20,840
DP-1X4SSD-3X2HDD	HCIA Disk Pack 1x400GB SSD 3x2TB HDD	J	\$7,652
DP-1X4SSD-3X2HDDU	HCIA Disk Pack 1x400GB SSD 3x2TB HDD U	J	\$7,652
DP-1X4SSD-3X38SSD	HCIA Disk Pack 1x400GB SSD 3x3.8TB SSD	J	\$29,746
DP-1X4SSD-3X38SSDU	HCIA Disk Pack 1x400GB SSD 3x3.8TB SSD U	J	\$29,746
DP-1X4SSD-3XHDD	HCIA Disk Pack 1x400GB SSD 3x1.2TB HDD	J	\$5,702
DP-1X4SSD-3XHDDU	HCIA Disk Pack 1x400GB SSD 3x1.2TB HDD U	J	\$5,702
DP-1X4SSD-4X2HDD	HCIA Disk Pack 1x400GB SSD 4x2TB HDD	J	\$9,193
DP-1X4SSD-4X2HDDU	HCIA Disk Pack 1x400GB SSD 4x2TB HDD U	J	\$9,193
DP-1X4SSD-4X38SSD	HCIA Disk Pack 1x400GB SSD 4x3.8TB SSD	J	\$38,652
DP-1X4SSD-4X38SSDU	HCIA Disk Pack 1x400GB SSD 4x3.8TB SSD U	J	\$38,652

DP-1X4SSD-4XHDD	HCIA Disk Pack 1x400GB SSD 4x1.2TB HDD	J	\$6,593
DP-1X4SSD-4XHDDU	HCIA Disk Pack 1x400GB SSD 4x1.2TB HDD U	J	\$6,593
DP-1X4SSD-5X2HDD	HCIA Disk Pack 1x400GB SSD 5x2TB HDD	J	\$10,735
DP-1X4SSD-5X2HDDU	HCIA Disk Pack 1x400GB SSD 5x2TB HDD U	J	\$10,735
DP-1X4SSD-5X38SSD	HCIA Disk Pack 1x400GB SSD 5x3.8TB SSD	J	\$47,559
DP-1X4SSD-5X38SSDU	HCIA Disk Pack 1x400GB SSD 5x3.8TB SSD U	J	\$47,559
DP-1X4SSD-5XHDD	HCIA Disk Pack 1x400GB SSD 5x1.2TB HDD	J	\$7,485
DP-1X4SSD-5XHDDU	HCIA Disk Pack 1x400GB SSD 5x1.2TB HDD U	J	\$7,485
DP-1X8SSD-1X38SSD	HCIA Disk Pack 1x800GB SSD 1x3.8TB SSD	J	\$14,232
DP-1X8SSD-1X38SSDU	HCIA Disk Pack 1x800GB SSD 1x3.8TB SSD U	J	\$14,232
DP-1X8SSD-2X38SSD	HCIA Disk Pack 1x800GB SSD 2x3.8TB SSD	J	\$23,138
DP-1X8SSD-2X38SSDU	HCIA Disk Pack 1x800GB SSD 2x3.8TB SSD U	J	\$23,138
DP-1X8SSD-3X2HDD	HCIA Disk Pack 1x800GB SSD 3x2TB HDD	J	\$9,950
DP-1X8SSD-3X2HDDU	HCIA Disk Pack 1x800GB SSD 3x2TB HDD U	J	\$9,950
DP-1X8SSD-3X38SSD	HCIA Disk Pack 1x800GB SSD 3x3.8TB SSD	J	\$32,044
DP-1X8SSD-3X38SSDU	HCIA Disk Pack 1x800GB SSD 3x3.8TB SSD U	J	\$32,044
DP-1X8SSD-3XHDD	HCIA Disk Pack 1x800GB SSD 3x1.2TB HDD	J	\$8,000
DP-1X8SSD-3XHDDU	HCIA Disk Pack 1x800GB SSD 3x1.2TB HDD U	J	\$8,000
DP-1X8SSD-4X2HDD	HCIA Disk Pack 1x800GB SSD 4x2TB HDD	J	\$11,491
DP-1X8SSD-4X2HDDU	HCIA Disk Pack 1x800GB SSD 4x2TB HDD U	J	\$11,491
DP-1X8SSD-4X38SSD	HCIA Disk Pack 1x800GB SSD 4x3.8TB SSD	J	\$40,950
DP-1X8SSD-4X38SSDU	HCIA Disk Pack 1x800GB SSD 4x3.8TB SSD U	J	\$40,950
DP-1X8SSD-4XHDD	HCIA Disk Pack 1x800GB SSD 4x1.2TB HDD	J	\$8,892
DP-1X8SSD-4XHDDU	HCIA Disk Pack 1x800GB SSD 4x1.2TB HDD U	J	\$8,892
DP-1X8SSD-5X2HDD	HCIA Disk Pack 1x800GB SSD 5x2TB HDD	J	\$13,033
DP-1X8SSD-5X2HDDU	HCIA Disk Pack 1x800GB SSD 5x2TB HDD U	J	\$13,033
DP-1X8SSD-5X38SSD	HCIA Disk Pack 1x800GB SSD 5x3.8TB SSD	J	\$49,857
DP-1X8SSD-5X38SSDU	HCIA Disk Pack 1x800GB SSD 5x3.8TB SSD U	J	\$49,857
DP-1X8SSD-5XHDD	HCIA Disk Pack 1x800GB SSD 5x1.2TB HDD	J	\$9,783
DP-1X8SSD-5XHDDU	HCIA Disk Pack 1x800GB SSD 5x1.2TB HDD U	J	\$9,783
DR-1200GB-HDDU	HCIA 1.2TB 2.5" 10K RPM SAS 512BPS U	J	\$1,070
DR-2000GB-HDDU	HCIA 2.0TB 2.5" 7.2K RPM SAS U	J	\$1,850
DR-3800G-SSDU	HCIA 3.8TB SSD IN 2.5" U	J	\$10,688
DR-400G-SSDU	HCIA 400GB SSD in 2.5" U	J	\$3,633
DR-800G-SSDU	HCIA 800GB SSD in 2.5" U	J	\$6,391
DSKLESSNVMECONFIGF	VxRail-500 Diskless NVMe Configuration F	J	\$0
DSKLESSNVMECONFIGH	VxRail-500 Diskless NVMe Configuration H	J	\$0
GPUAMDFPS7150U	HCIA GPU AMD FIREPRO S7150 U	J	\$5,213
GPUAMDFPS7150X2U	HCIA GPU AMD FIREPRO S7150X2 U	J	\$9,011
GPUNVDIATESLAM10F	VxRail-500 GPU NVIDIA TESLA M10 F	J	\$5,694
GPUNVDIATESLAM10H	VxRail-500 GPU NVIDIA TESLA M10 H	J	\$5,694
GPUNVDIATESLAM10U	HCIA GPU NVIDIA TESLA M10	J	\$7,640
GPUNVDIATESLAM60F	VxRail-500 GPU NVIDIA TESLA M60 F	J	\$10,799
GPUNVDIATESLAM60H	VxRail-500 GPU NVIDIA TESLA M60 H	J	\$10,799
GPUNVDIATESLAM60U	HCIA GPU NVIDIA TESLA M60 U	J	\$13,881
GPUNVDIATESLAP40F	VxRail-500 GPU NVIDIA TESLA P40 F	J	\$13,379
GPUNVDIATESLAP40H	VxRail-500 GPU NVIDIA TESLA P40 H	J	\$13,379
GPUNVDIATESLAP40SP	VxRail 13G GPU NVIDIA TESLA P40 SP	J	\$19,512
GPUNVDIATESLAP40U	VxRail GPU NVIDIA TESLA P40 U	J	\$19,512
GPUP40INSTALLKITSP	VxRail 13G GPU P40 INSTALL KIT SP	J	\$244

GPUP40INSTALLKITU	VxRail 13G GPU P40 INSTALL KIT	J	\$244
HBA330CTRL1SF	VxRail-500 PercHBA330RAIDCTR MINI12Gb1SF	J	\$190
HBA330CTRL1SH	VxRail-500 PercHBA330RAIDCTR MINI12Gb 1S	J	\$190
HBA330CTRL2SF	VxRail-500 PercHBA330+RAIDCTR12Gb 2SLP F	J	\$189
HBA330CTRL2SH	VxRail-500 PercHBA330+ RAIDCTR 12Gb 2SLP	J	\$189
HTSNK460-1S-LO-W	HEAT SINK FILLERS E460 1PROC LO WATT	J	\$0
HTSNK460-2S-HI-W	HEAT SINK FILLERS E460 2PROC HI WATT	J	\$0
HTSNK460-2S-LO-W	HEAT SINK FILLERS E460 2PROC LO WATT	J	\$0
INSTALCTRYAFGR640H	VxRail-500 AFGANISTAN SHIPMOD H	J	\$84
INSTALCTRYAFGR740H	VxRail-500 AFGANISTAN SHIPMOD H	J	\$102
INSTALCTRYAREG560C	VxRail-14G G560 CHS UAE SHIPMOD	J	\$102
INSTALCTRYAREG560N	VxRail-14G G560 ND UAE SHIPMOD	J	\$102
INSTALCTRYARER640H	VxRail-500 UAE SHIPMOD H	J	\$84
INSTALCTRYARER740H	VxRail-500 UAE SHIPMOD H	J	\$102
INSTALCTRYARGR640H	VxRail-500 ARGENTINA SHIPMOD H	J	\$82
INSTALCTRYARGR740H	VxRail-500 ARGENTINA SHIPMOD H	J	\$88
INSTALCTRYAUSG560C	VxRail-14G G560 CHS AUSTRALIA SHIPMOD	J	\$102
INSTALCTRYAUSG560N	VxRail-14G G560 ND AUSTRALIA SHIPMOD	J	\$102
INSTALCTRYAUSR640H	VxRail-500 AUSTRALIA SHIPMOD H	J	\$85
INSTALCTRYAUSR740H	VxRail-500 AUSTRALIA SHIPMOD H	J	\$83
INSTALCTRYAUTR640H	VxRail-500 AUSTRIA SHIPMOD H	J	\$84
INSTALCTRYAUTR740H	VxRail-500 AUSTRIA SHIPMOD H	J	\$102
INSTALCTRYBELG560C	VxRail-14G G560 CHS BELGIUM SHIPMOD	J	\$102
INSTALCTRYBELG560N	VxRail-14G G560 ND BELGIUM SHIPMOD	J	\$102
INSTALCTRYBELR640H	VxRail-500 BELGIUM SHIPMOD H	J	\$84
INSTALCTRYBELR740H	VxRail-500 BELGIUM SHIPMOD H	J	\$102
INSTALCTRYBGDR640H	VxRail-500 BANGLADESH SHIPMOD H	J	\$85
INSTALCTRYBGDR740H	VxRail-500 BANGLADESH SHIPMOD H	J	\$83
INSTALCTRYBOLR640H	VxRail-500 BOLIVIA SHIPMOD H	J	\$82
INSTALCTRYBOLR740H	VxRail-500 BOLIVIA SHIPMOD H	J	\$88
INSTALCTRYBTNR640H	VxRail-500 BHUTAN SHIPMOD H	J	\$85
INSTALCTRYBTNR740H	VxRail-500 BHUTAN SHIPMOD H	J	\$83
INSTALCTRYCANG560C	VxRail-14G G560 CHS CANADA SHIPMOD	J	\$102
INSTALCTRYCANG560N	VxRail-14G G560 ND CANADA SHIPMOD	J	\$102
INSTALCTRYCANR640H	VxRail-500 CANADA SHIPMOD H	J	\$81
INSTALCTRYCANR740H	VxRail-500 CANADA SHIPMOD H	J	\$83
INSTALCTRYCHEG560C	VxRail-14G G560 CHS SWITZERLAND SHIPMOD	J	\$102
INSTALCTRYCHEG560N	VxRail-14G G560 ND SWITZERLAND SHIPMOD	J	\$102
INSTALCTRYCHER640H	VxRail-500 SWITZERLAND SHIPMOD H	J	\$84
INSTALCTRYCHER740H	VxRail-500 SWITZERLAND SHIPMOD H	J	\$102
INSTALCTRYCHLR640H	VxRail-500 CHILE SHIPMOD H	J	\$82
INSTALCTRYCHLR740H	VxRail-500 CHILE SHIPMOD H	J	\$88
INSTALCTRYCOLR640H	VxRail-500 COLOMBIA SHIPMOD H	J	\$82
INSTALCTRYCOLR740H	VxRail-500 COLOMBIA SHIPMOD H	J	\$88
INSTALCTRYCZER640H	VxRail-500 CZECH REPUBLIC SHIPMOD H	J	\$84
INSTALCTRYCZER740H	VxRail-500 CZECH REPUBLIC SHIPMOD H	J	\$102
INSTALCTRYDEUG560C	VxRail-14G G560 CHS GERMANY SHIPMOD	J	\$102
INSTALCTRYDEUG560N	VxRail-14G G560 ND GERMANY SHIPMOD	J	\$102
INSTALCTRYDEUR640H	VxRail-500 GERMANY SHIPMOD H	J	\$84
INSTALCTRYDEUR740H	VxRail-500 GERMANY SHIPMOD H	J	\$102

INSTALCTRYDNKG560C	VxRail-14G G560 CHS DENMARK SHIPMOD	J	\$102
INSTALCTRYDNKG560N	VxRail-14G G560 ND DENMARK SHIPMOD	J	\$102
INSTALCTRYDNKR640H	VxRail-500 DENMARK SHIPMOD H	J	\$84
INSTALCTRYDNKR740H	VxRail-500 DENMARK SHIPMOD H	J	\$102
INSTALCTRYECUR640H	VxRail-500 ECUADOR SHIPMOD H	J	\$82
INSTALCTRYECUR740H	VxRail-500 ECUADOR SHIPMOD H	J	\$88
INSTALCTRYEGYR640H	VxRail-500 EGYPT SHIPMOD H	J	\$84
INSTALCTRYEGYR740H	VxRail-500 EGYPT SHIPMOD H	J	\$102
INSTALCTRYESPG560C	VxRail-14G G560 CHS SPAIN SHIPMOD	J	\$102
INSTALCTRYESPG560N	VxRail-14G G560 ND SPAIN SHIPMOD	J	\$102
INSTALCTRYESPR640H	VxRail-500 SPAIN SHIPMOD H	J	\$84
INSTALCTRYESPR740H	VxRail-500 SPAIN SHIPMOD H	J	\$102
INSTALCTRYFING560C	VxRail-14G G560 CHS FINLAND SHIPMOD	J	\$102
INSTALCTRYFING560N	VxRail-14G G560 ND FINLAND SHIPMOD	J	\$102
INSTALCTRYFINR640H	VxRail-500 FINLAND SHIPMOD H	J	\$84
INSTALCTRYFINR740H	VxRail-500 FINLAND SHIPMOD H	J	\$102
INSTALCTRYFJIR640H	VxRail-500 FIJI SHIPMOD H	J	\$85
INSTALCTRYFJIR740H	VxRail-500 FIJI SHIPMOD H	J	\$83
INSTALCTRYFRAG560C	VxRail-14G G560 CHS FRANCE SHIPMOD	J	\$102
INSTALCTRYFRAG560N	VxRail-14G G560 ND FRANCE SHIPMOD	J	\$102
INSTALCTRYFRAR640H	VxRail-500 FRANCE SHIPMOD H	J	\$84
INSTALCTRYFRAR740H	VxRail-500 FRANCE SHIPMOD H	J	\$102
INSTALCTRYGBRG560C	VxRail-14G G560 CHS UK SHIPMOD	J	\$102
INSTALCTRYGBRG560N	VxRail-14G G560 ND UK SHIPMOD	J	\$102
INSTALCTRYGBRR640H	VxRail-500 UNITED KINGDOM SHIPMOD H	J	\$84
INSTALCTRYGBRR740H	VxRail-500 UNITED KINGDOM SHIPMOD H	J	\$102
INSTALCTRYGRCR640H	VxRail-500 GREECE SHIPMOD H	J	\$84
INSTALCTRYGRCR740H	VxRail-500 GREECE SHIPMOD H	J	\$102
INSTALCTRYGUMR640H	VxRail-500 GUAM SHIPMOD H	J	\$85
INSTALCTRYGUMR740H	VxRail-500 GUAM SHIPMOD H	J	\$83
INSTALCTRYHKG560C	VxRail-14G G560 CHS HONG KONG SHIPMOD	J	\$102
INSTALCTRYHKG560N	VxRail-14G G560 ND HONG KONG SHIPMOD	J	\$102
INSTALCTRYHKGR640H	VxRail-500 HONG KONG SHIPMOD H	J	\$86
INSTALCTRYHKGR740H	VxRail-500 HONG KONG SHIPMOD H	J	\$83
INSTALCTRYHUNR640H	VxRail-500 HUNGARY SHIPMOD H	J	\$84
INSTALCTRYHUNR740H	VxRail-500 HUNGARY SHIPMOD H	J	\$102
INSTALCTRYIDNR640H	VxRail-500 INDONESIA SHIPMOD H	J	\$85
INSTALCTRYIDNR740H	VxRail-500 INDONESIA SHIPMOD H	J	\$83
INSTALCTRYINDG560C	VxRail-14G G560 CHS INDIA SHIPMOD	J	\$102
INSTALCTRYINDG560N	VxRail-14G G560 ND INDIA SHIPMOD	J	\$102
INSTALCTRYINDR640H	VxRail-500 INDIA SHIPMOD H	J	\$85
INSTALCTRYINDR740H	VxRail-500 INDIA SHIPMOD H	J	\$83
INSTALCTRYIRLG560C	VxRail-14G G560 CHS IRELAND SHIPMOD	J	\$102
INSTALCTRYIRLG560N	VxRail-14G G560 ND IRELAND SHIPMOD	J	\$102
INSTALCTRYIRLR640H	VxRail-500 IRELAND SHIPMOD H	J	\$84
INSTALCTRYIRLR740H	VxRail-500 IRELAND SHIPMOD H	J	\$102
INSTALCTRYISRG560C	VxRail-14G G560 CHS ISRAEL SHIPMOD	J	\$102
INSTALCTRYISRG560N	VxRail-14G G560 ND ISRAEL SHIPMOD	J	\$102
INSTALCTRYISRR640H	VxRail-500 ISRAEL SHIPMOD H	J	\$84
INSTALCTRYISRR740H	VxRail-500 ISRAEL SHIPMOD H	J	\$102

INSTALCTRYITAG560C	VxRail-14G G560 CHS ITALY SHIPMOD	J	\$102
INSTALCTRYITAG560N	VxRail-14G G560 ND ITALY SHIPMOD	J	\$102
INSTALCTRYITAR640H	VxRail-500 ITALY SHIPMOD H	J	\$84
INSTALCTRYITAR740H	VxRail-500 ITALY SHIPMOD H	J	\$102
INSTALCTRYJPNG560C	VxRail-14G G560 CHS JAPAN SHIPMOD	J	\$102
INSTALCTRYJPNG560N	VxRail-14G G560 ND JAPAN SHIPMOD	J	\$102
INSTALCTRYJPNR640H	VxRail-500 JAPAN SHIPMOD H	J	\$85
INSTALCTRYJPNR740H	VxRail-500 JAPAN SHIPMOD H	J	\$83
INSTALCTRYKAZR640H	VxRail-500 KAZAKHSTAN SHIPMOD H	J	\$84
INSTALCTRYKAZR740H	VxRail-500 KAZAKHSTAN SHIPMOD H	J	\$102
INSTALCTRYKENR640H	VxRail-500 KENYA SHIPMOD H	J	\$84
INSTALCTRYKENR740H	VxRail-500 KENYA SHIPMOD H	J	\$102
INSTALCTRYKHMR640H	VxRail-500 CAMBODIA SHIPMOD H	J	\$85
INSTALCTRYKHMR740H	VxRail-500 CAMBODIA SHIPMOD H	J	\$83
INSTALCTRYKIRR640H	VxRail-500 KIRIBATI SHIPMOD H	J	\$85
INSTALCTRYKIRR740H	VxRail-500 KIRIBATI SHIPMOD H	J	\$83
INSTALCTRYKORG560C	VxRail-14G G560 CHS SOUTH KOREA SHIPMOD	J	\$102
INSTALCTRYKORG560N	VxRail-14G G560 ND SOUTH KOREA SHIPMOD	J	\$102
INSTALCTRYKORR640H	VxRail-500 SOUTH KOREA SHIPMOD H	J	\$86
INSTALCTRYKORR740H	VxRail-500 SOUTH KOREA SHIPMOD H	J	\$83
INSTALCTRYLAOR640H	VxRail-500 LAOS SHIPMOD H	J	\$85
INSTALCTRYLAOR740H	VxRail-500 LAOS SHIPMOD H	J	\$83
INSTALCTRYLKAR640H	VxRail-500 SRI LANKA SHIPMOD H	J	\$85
INSTALCTRYLKAR740H	VxRail-500 SRI LANKA SHIPMOD H	J	\$83
INSTALCTRYLTUR640H	VxRail-500 LITHUANIA SHIPMOD H	J	\$84
INSTALCTRYLTUR740H	VxRail-500 LITHUANIA SHIPMOD H	J	\$102
INSTALCTRYLUXR640H	VxRail-500 LUXEMBOURG SHIPMOD H	J	\$84
INSTALCTRYLUXR740H	VxRail-500 LUXEMBOURG SHIPMOD H	J	\$102
INSTALCTRYMACR640H	VxRail-500 MACAO SHIPMOD H	J	\$86
INSTALCTRYMACR740H	VxRail-500 MACAO SHIPMOD H	J	\$83
INSTALCTRYMARR640H	VxRail-500 MOROCCO SHIPMOD H	J	\$84
INSTALCTRYMARR740H	VxRail-500 MOROCCO SHIPMOD H	J	\$102
INSTALCTRYMEXG560C	VxRail-14G G560 CHS MEXICO SHIPMOD	J	\$102
INSTALCTRYMEXG560N	VxRail-14G G560 ND MEXICO SHIPMOD	J	\$102
INSTALCTRYMEXR640H	VxRail-500 MEXICO SHIPMOD H	J	\$81
INSTALCTRYMEXR740H	VxRail-500 MEXICO SHIPMOD H	J	\$83
INSTALCTRYMNGR640H	VxRail-500 MONGOLIA SHIPMOD H	J	\$85
INSTALCTRYMNGR740H	VxRail-500 MONGOLIA SHIPMOD H	J	\$83
INSTALCTRYMNPR640H	VxRail-500 N. MARIANAS ISLANDS SHIPMOD H	J	\$85
INSTALCTRYMNPR740H	VxRail-500 N. MARIANAS ISLANDS SHIPMOD H	J	\$83
INSTALCTRYMYSR640H	VxRail-500 MALAYSIA SHIPMOD H	J	\$85
INSTALCTRYMYSR740H	VxRail-500 MALAYSIA SHIPMOD H	J	\$83
INSTALCTRYNCLR640H	VxRail-500 NEW CALEDONIA SHIPMOD H	J	\$85
INSTALCTRYNCLR740H	VxRail-500 NEW CALEDONIA SHIPMOD H	J	\$83
INSTALCTRYNGAR640H	VxRail-500 NIGERIA SHIPMOD H	J	\$84
INSTALCTRYNGAR740H	VxRail-500 NIGERIA SHIPMOD H	J	\$102
INSTALCTRYNLDG560C	VxRail-14G G560 CHS NETHERLANDS SHIPMOD	J	\$102
INSTALCTRYNLDG560N	VxRail-14G G560 ND NETHERLANDS SHIPMOD	J	\$102
INSTALCTRYNLDR640H	VxRail-500 NETHERLANDS SHIPMOD H	J	\$84
INSTALCTRYNLDR740H	VxRail-500 NETHERLANDS SHIPMOD H	J	\$102

INSTALCTRYNORG560C	VxRail-14G G560 CHS NORWAY SHIPMOD	J	\$102
INSTALCTRYNORG560N	VxRail-14G G560 ND NORWAY SHIPMOD	J	\$102
INSTALCTRYNORR640H	VxRail-500 NORWAY SHIPMOD H	J	\$84
INSTALCTRYNORR740H	VxRail-500 NORWAY SHIPMOD H	J	\$102
INSTALCTRYNPLR640H	VxRail-500 NEPAL SHIPMOD H	J	\$85
INSTALCTRYNPLR740H	VxRail-500 NEPAL SHIPMOD H	J	\$83
INSTALCTRYNZLR640H	VxRail-500 NEW ZEALAND SHIPMOD H	J	\$85
INSTALCTRYNZLR740H	VxRail-500 NEW ZEALAND SHIPMOD H	J	\$83
INSTALCTRYPAKR640H	VxRail-500 PAKISTAN SHIPMOD H	J	\$85
INSTALCTRYPAKR740H	VxRail-500 PAKISTAN SHIPMOD H	J	\$83
INSTALCTRYPERR640H	VxRail-500 LATAM R640 SHIPMOD H	J	\$82
INSTALCTRYPERR740H	VxRail-500 LATAM R740xd SHIPMOD H	J	\$88
INSTALCTRYPHLR640H	VxRail-500 PHILIPPINES SHIPMOD H	J	\$85
INSTALCTRYPHLR740H	VxRail-500 PHILIPPINES SHIPMOD H	J	\$83
INSTALCTRYPLWR640H	VxRail-500 PALAU SHIPMOD H	J	\$85
INSTALCTRYPLWR740H	VxRail-500 PALAU SHIPMOD H	J	\$83
INSTALCTRYPNGR640H	VxRail-500 PAPUA NEW GUINEA SHIPMOD H	J	\$85
INSTALCTRYPNGR740H	VxRail-500 PAPUA NEW GUINEA SHIPMOD H	J	\$83
INSTALCTRYPOLG560C	VxRail-14G G560 CHS POLAND SHIPMOD	J	\$102
INSTALCTRYPOLG560N	VxRail-14G G560 ND POLAND SHIPMOD	J	\$102
INSTALCTRYPOLR640H	VxRail-500 POLAND SHIPMOD H	J	\$84
INSTALCTRYPOLR740H	VxRail-500 POLAND SHIPMOD H	J	\$102
INSTALCTRYPRIR640H	VxRail-500 PUERTO RICO SHIPMOD H	J	\$81
INSTALCTRYPRIR740H	VxRail-500 PUERTO RICO SHIPMOD H	J	\$83
INSTALCTRYPRTR640H	VxRail-500 PORTUGAL SHIPMOD H	J	\$84
INSTALCTRYPRTR740H	VxRail-500 PORTUGAL SHIPMOD H	J	\$102
INSTALCTRYPRYR640H	VxRail-500 PARAGUAY SHIPMOD H	J	\$82
INSTALCTRYPRYR740H	VxRail-500 PARAGUAY SHIPMOD H	J	\$79
INSTALCTRYQATR640H	VxRail-500 QATAR SHIPMOD H	J	\$84
INSTALCTRYQATR740H	VxRail-500 QATAR SHIPMOD H	J	\$102
INSTALCTRYROUR640H	VxRail-500 ROMANIA SHIPMOD H	J	\$84
INSTALCTRYROUR740H	VxRail-500 ROMANIA SHIPMOD H	J	\$102
INSTALCTRYSAUG560C	VxRail-14G G560 CHS SAUDI ARABIA SHPMOD	J	\$102
INSTALCTRYSAUG560N	VxRail-14G G560 ND SAUDI ARABIA SHPMOD	J	\$102
INSTALCTRYSAUR640H	VxRail-500 SAUDI ARABIA SHIPMOD H	J	\$84
INSTALCTRYSAUR740H	VxRail-500 SAUDI ARABIA SHIPMOD H	J	\$102
INSTALCTRYSGPG560C	VxRail-14G G560 CHS SINGAPORE SHIPMOD	J	\$102
INSTALCTRYSGPG560N	VxRail-14G G560 ND SINGAPORE SHIPMOD	J	\$102
INSTALCTRYSGPR640H	VxRail-500 SINGAPORE SHIPMOD H	J	\$85
INSTALCTRYSGPR740H	VxRail-500 SINGAPORE SHIPMOD H	J	\$83
INSTALCTRYSLBR640H	VxRail-500 SOLOMON ISLAND SHIPMOD H	J	\$85
INSTALCTRYSLBR740H	VxRail-500 SOLOMON ISLAND SHIPMOD H	J	\$83
INSTALCTRYSVKR640H	VxRail-500 SLOVAKIA SHIPMOD H	J	\$84
INSTALCTRYSVKR740H	VxRail-500 SLOVAKIA SHIPMOD H	J	\$102
INSTALCTRYSVNR640H	VxRail-500 SLOVENIA SHIPMOD H	J	\$84
INSTALCTRYSVNR740H	VxRail-500 SLOVENIA SHIPMOD H	J	\$102
INSTALCTRYSWEG560C	VxRail-14G G560 CHS SWEDEN SHIPMOD	J	\$102
INSTALCTRYSWEG560N	VxRail-14G G560 ND SWEDEN SHIPMOD	J	\$102
INSTALCTRYSWER640H	VxRail-500 SWEDEN SHIPMOD H	J	\$84
INSTALCTRYSWER740H	VxRail-500 SWEDEN SHIPMOD H	J	\$102

INSTALCTRYTHAR640H	VxRail-500 THAILAND SHIPMOD H	J	\$85
INSTALCTRYTHAR740H	VxRail-500 THAILAND SHIPMOD H	J	\$83
INSTALCTRYTONR640H	VxRail-500 TONGA SHIPMOD H	J	\$85
INSTALCTRYTONR740H	VxRail-500 TONGA SHIPMOD H	J	\$83
INSTALCTRYTURR640H	VxRail-500 TURKEY SHIPMOD H	J	\$84
INSTALCTRYTURR740H	VxRail-500 TURKEY SHIPMOD H	J	\$102
INSTALCTRYTWNG560C	VxRail-14G G560 CHS TAIWAN SHIPMOD	J	\$102
INSTALCTRYTWNG560N	VxRail-14G G560 ND TAIWAN SHIPMOD	J	\$102
INSTALCTRYTWRN640H	VxRail-500 TAIWAN SHIPMOD H	J	\$86
INSTALCTRYTWRN740H	VxRail-500 TAIWAN SHIPMOD H	J	\$83
INSTALCTRYUKRR640H	VxRail-500 UKRAINE SHIPMOD H	J	\$84
INSTALCTRYUKRR740H	VxRail-500 UKRAINE SHIPMOD H	J	\$102
INSTALCTRYURYR640H	VxRail-500 URUGUAY SHIPMOD H	J	\$82
INSTALCTRYURYR740H	VxRail-500 URUGUAY SHIPMOD H	J	\$88
INSTALCTRYUSAG560C	VxRail-14G G560 CHS USA SHIPMOD	J	\$102
INSTALCTRYUSAG560N	VxRail-14G G560 ND USA SHIPMOD	J	\$102
INSTALCTRYUSAR640H	VxRail-500 USA SHIPMOD H	J	\$81
INSTALCTRYUSAR740H	VxRail-500 USA SHIPMOD H	J	\$83
INSTALCTRYVENR640H	VxRail-500 VENEZUELA SHIPMOD H	J	\$82
INSTALCTRYVENR740H	VxRail-500 VENEZUELA SHIPMOD H	J	\$88
INSTALCTRYVMYR640H	VxRail-500 MYANMAR SHIPMOD H	J	\$85
INSTALCTRYVMYR740F	VxRail-500 MYANMAR SHIPMOD F	J	\$83
INSTALCTRYVMYR740H	VxRail-500 MYANMAR SHIPMOD H	J	\$83
INSTALCTRYVNM640H	VxRail-500 VIETNAM SHIPMOD H	J	\$85
INSTALCTRYVNM740H	VxRail-500 VIETNAM SHIPMOD H	J	\$83
INSTALCTRYVUTR640H	VxRail-500 VANUATU SHIPMOD H	J	\$85
INSTALCTRYVUTR740H	VxRail-500 VANUATU SHIPMOD H	J	\$83
INSTALCTRYWSMR640H	VxRail-500 SAMOA SHIPMOD H	J	\$85
INSTALCTRYWSMR740H	VxRail-500 SAMOA SHIPMOD H	J	\$83
INSTALCTRYZAFG560C	VxRail-14G G560 CHS S. AFRICA SHIPMOD	J	\$102
INSTALCTRYZAFG560N	VxRail-14G G560 ND S. AFRICA SHIPMOD	J	\$102
INSTALCTRYZAFR640H	VxRail-500 SOUTH AFRICA SHIPMOD H	J	\$84
INSTALCTRYZAFR740H	VxRail-500 SOUTH AFRICA SHIPMOD H	J	\$102
INSTALLKITGPUM10	VxRail-500 GPU INSTALL KIT M10	J	\$117
INSTALLKITGPUM60	VxRail-500 GPU INSTALL KIT M60	J	\$110
INSTALLKITGPUP40	VxRail-500 GPU INSTALL KIT P40	J	\$110
INSTGR13AFGR740	VxRail-500 AFGANISTAN SHIPMOD GR1300	J	\$102
INSTGR13ARER740	VxRail-500 UAE SHIPMOD GR1300	J	\$102
INSTGR13ARGR740	VxRail-500 LATAM SHIPMOD GR1300	J	\$102
INSTGR13AUSR740	VxRail-500 AUSTRALIA SHIPMOD GR1300	J	\$102
INSTGR13AUTR740	VxRail-500 AUSTRIA SHIPMOD GR1300	J	\$102
INSTGR13BELR740	VxRail-500 BELGIUM SHIPMOD GR1300	J	\$102
INSTGR13BGDR740	VxRail-500 BANGLADESH SHIPMOD GR1300	J	\$102
INSTGR13BOLR740	VxRail-500 BOLIVIA SHIPMOD GR1300	J	\$102
INSTGR13BRNR740	VxRail-500 BRUNEI SHIPMOD GR1300	J	\$102
INSTGR13BTNR740	VxRail-500 BHUTAN SHIPMOD GR1300	J	\$102
INSTGR13CANR740	VxRail-500 CANADA SHIPMOD GR1300	J	\$102
INSTGR13CHER740	VxRail-500 SWITZERLAND SHIPMOD GR1300	J	\$102
INSTGR13CHLR740	VxRail-500 CHILE SHIPMOD GR1300	J	\$102
INSTGR13COLR740	VxRail-500 COLOMBIA SHIPMOD GR1300	J	\$102

INSTGR13CZER740	VxRail-500 CZECH REPUBLIC SHIPMOD GR1300	J	\$102
INSTGR13DEUR740	VxRail-500 GERMANY SHIPMOD GR1300	J	\$102
INSTGR13DNKR740	VxRail-500 DENMARK SHIPMOD GR1300	J	\$102
INSTGR13ECUR740	VxRail-500 ECUADOR SHIPMOD GR1300	J	\$102
INSTGR13EGYR740	VxRail-500 EGYPT SHIPMOD GR1300	J	\$102
INSTGR13ESPR740	VxRail-500 SPAIN SHIPMOD GR1300	J	\$102
INSTGR13FINR740	VxRail-500 FINLAND SHIPMOD GR1300	J	\$102
INSTGR13FJIR740	VxRail-500 FIJI SHIPMOD GR1300	J	\$102
INSTGR13FRAR740	VxRail-500 FRANCE SHIPMOD GR1300	J	\$102
INSTGR13GBRR740	VxRail-500 UNITED KINGDOM SHIPMOD GR1300	J	\$102
INSTGR13GRCR740	VxRail-500 EMEA2 SHIPMOD GR1300	J	\$102
INSTGR13GUMR740	VxRail-500 GUAM SHIPMOD GR1300	J	\$102
INSTGR13HKGR740	VxRail-500 HONG KONG SHIPMOD GR1300	J	\$102
INSTGR13HUNR740	VxRail-500 HUNGARY SHIPMOD GR1300	J	\$102
INSTGR13IDNR740	VxRail-500 INDONESIA SHIPMOD GR1300	J	\$102
INSTGR13INDR740	VxRail-500 INDIA SHIPMOD GR1300	J	\$102
INSTGR13IRLR740	VxRail-500 IRELAND SHIPMOD GR1300	J	\$102
INSTGR13ISRR740	VxRail-500 ISRAEL SHIPMOD GR1300	J	\$102
INSTGR13ITAR740	VxRail-500 ITALY SHIPMOD GR1300	J	\$102
INSTGR13JPNR740	VxRail-500 JAPAN SHIPMOD GR1300	J	\$102
INSTGR13KAZR740	VxRail-500 KAZAKHSTAN SHIPMOD GR1300	J	\$102
INSTGR13KENR740	VxRail-500 KENYA SHIPMOD GR1300	J	\$102
INSTGR13KHMR740	VxRail-500 CAMBODIA SHIPMOD GR1300	J	\$102
INSTGR13KIRR740	VxRail-500 KIRIBATI SHIPMOD GR1300	J	\$102
INSTGR13KORR740	VxRail-500 SOUTH KOREA SHIPMOD GR1300	J	\$102
INSTGR13LAOR740	VxRail-500 LAOS SHIPMOD GR1300	J	\$102
INSTGR13LKAR740	VxRail-500 SRI LANKA SHIPMOD GR1300	J	\$102
INSTGR13LTUR740	VxRail-500 LITHUANIA SHIPMOD GR1300	J	\$102
INSTGR13LUXR740	VxRail-500 LUXEMBOURG SHIPMOD GR1300	J	\$102
INSTGR13MACR740	VxRail-500 MACAU SHIPMOD GR1300	J	\$102
INSTGR13MARR740	VxRail-500 MOROCCO SHIPMOD GR1300	J	\$102
INSTGR13MEXR740	VxRail-500 MEXICO SHIPMOD GR1300	J	\$102
INSTGR13MNGR740	VxRail-500 MONGOLIA SHIPMOD GR1300	J	\$102
INSTGR13MNPR740	VxRail-500 N. MARIANAS SHIPMOD GR1300	J	\$102
INSTGR13MYSR740	VxRail-500 MALAYSIA SHIPMOD GR1300	J	\$102
INSTGR13NCLR740	VxRail-500 NEW CALEDONIA SHIPMOD GR1300	J	\$102
INSTGR13NGAR740	VxRail-500 NIGERIA SHIPMOD GR1300	J	\$102
INSTGR13NLDR740	VxRail-500 NETHERLANDS SHIPMOD GR1300	J	\$102
INSTGR13NORR740	VxRail-500 NORWAY SHIPMOD GR1300	J	\$102
INSTGR13NPLR740	VxRail-500 NEPAL SHIPMOD GR1300	J	\$102
INSTGR13NZLR740	VxRail-500 NEW ZEALAND SHIPMOD GR1300	J	\$102
INSTGR13PAKR740	VxRail-500 PAKISTAN SHIPMOD GR1300	J	\$102
INSTGR13PERR740	VxRail-500 LATAM SHIPMOD GR1300	J	\$102
INSTGR13PHLR740	VxRail-500 PHILIPPINES SHIPMOD GR1300	J	\$102
INSTGR13PLWR740	VxRail-500 PALAU SHIPMOD GR1300	J	\$102
INSTGR13PNGR740	VxRail-500 PAPUA N GUINEA SHIPMOD GR1300	J	\$102
INSTGR13POLR740	VxRail-500 POLAND SHIPMOD GR1300	J	\$102
INSTGR13PRIR740	VxRail-500 PUERTO RICO SHIPMOD GR1300	J	\$102
INSTGR13PRTR740	VxRail-500 PORTUGAL SHIPMOD GR1300	J	\$102
INSTGR13PRYR740	VxRail-500 PARAGUAY SHIPMOD GR1300	J	\$102

INSTGR13QATR740	VxRail-500 QATAR SHIPMOD GR1300	J	\$102
INSTGR13ROUR740	VxRail-500 ROMANIA SHIPMOD GR1300	J	\$102
INSTGR13SAUR740	VxRail-500 SAUDI ARABIA SHIPMOD GR1300	J	\$102
INSTGR13SGPR740	VxRail-500 SINGAPORE SHIPMOD GR1300	J	\$102
INSTGR13SLBR740	VxRail-500 SOLOMON ISLAND SHIPMOD GR1300	J	\$102
INSTGR13SVKR740	VxRail-500 SLOVAKIA SHIPMOD GR1300	J	\$102
INSTGR13SVNR740	VxRail-500 SLOVENIA SHIPMOD GR1300	J	\$102
INSTGR13SWER740	VxRail-500 SWEDEN SHIPMOD GR1300	J	\$102
INSTGR13THAR740	VxRail-500 THAILAND SHIPMOD GR1300	J	\$102
INSTGR13TONR740	VxRail-500 TONGA SHIPMOD GR1300	J	\$102
INSTGR13TURR740	VxRail-500 TURKEY SHIPMOD GR1300	J	\$102
INSTGR13TWNR740	VxRail-500 TAIWAN SHIPMOD GR1300	J	\$102
INSTGR13UKRR740	VxRail-500 UKRAINE SHIPMOD GR1300	J	\$102
INSTGR13URYR740	VxRail-500 URUGUAY SHIPMOD GR1300	J	\$102
INSTGR13USAR740	VxRail-500 USA SHIPMOD GR1300	J	\$102
INSTGR13VENR740	VxRail-500 VENEZUELA SHIPMOD GR1300	J	\$102
INSTGR13VMYR740	VxRail-500 MYANMAR SHIPMOD GR1300	J	\$102
INSTGR13VNM740	VxRail-500 VIETNAM SHIPMOD GR1300	J	\$102
INSTGR13VUTR740	VxRail-500 VANUATU SHIPMOD GR1300	J	\$102
INSTGR13WSMR740	VxRail-500 SAMOA SHIPMOD GR1300	J	\$102
INSTGR13ZAFR740	VxRail-500 SOUTH AFRICA SHIPMOD GR1300	J	\$102
INSTKITRJ45AF	HCIA INSTALL KIT 10GBE RJ45 AF	J	\$99
INSTKITRJ45H	HCIA INSTALL KIT 10GBE RJ45 H	J	\$99
INSTKITSFPAF	VxRail 14G CAT6 Cable AF	J	\$60
INSTKITSFPH	VxRail 14G CAT6 Cable Hybrid	J	\$60
INSTLCTRYAFGFR640F	VxRail-500 AFGANISTAN SHIPMOD F	J	\$84
INSTLCTRYAFGFR740F	VxRail-500 AFGANISTAN SHIPMOD F	J	\$102
INSTLCTRYAMERR640	VxRail-500 Americas Region R640	J	\$102
INSTLCTRYAMERR740	VxRail-500 Americas Region R740	J	\$102
INSTLCTRYAREFR640F	VxRail-500 UAE SHIPMOD F	J	\$84
INSTLCTRYAREFR740F	VxRail-500 UAE SHIPMOD F	J	\$102
INSTLCTRYARGFR640F	VxRail-500 ARGENTINA SHIPMOD F	J	\$82
INSTLCTRYARGFR740F	VxRail-500 ARGENTINA SHIPMOD F	J	\$88
INSTLCTRYAUSFR640F	VxRail-500 AUSTRALIA SHIPMOD F	J	\$85
INSTLCTRYAUSFR740F	VxRail-500 AUSTRALIA SHIPMOD F	J	\$83
INSTLCTRYAUTFR640F	VxRail-500 AUSTRIA SHIPMOD F	J	\$84
INSTLCTRYAUTFR740F	VxRail-500 AUSTRIA SHIPMOD F	J	\$102
INSTLCTRYBELFR640F	VxRail-500 BELGIUM SHIPMOD F	J	\$84
INSTLCTRYBELFR740F	VxRail-500 BELGIUM SHIPMOD F	J	\$102
INSTLCTRYBGDFR640F	VxRail-500 BANGLADESH SHIPMOD F	J	\$85
INSTLCTRYBGDFR740F	VxRail-500 BANGLADESH SHIPMOD F	J	\$83
INSTLCTRYBOLFR640F	VxRail-500 BOLIVIA SHIPMOD F	J	\$82
INSTLCTRYBOLFR740F	VxRail-500 BOLIVIA SHIPMOD F	J	\$88
INSTLCTRYBTNFR640F	VxRail-500 BHUTAN SHIPMOD F	J	\$85
INSTLCTRYBTNFR740F	VxRail-500 BHUTAN SHIPMOD F	J	\$83
INSTLCTRYCANFR640F	VxRail-500 CANADA SHIPMOD F	J	\$81
INSTLCTRYCANFR740F	VxRail-500 CANADA SHIPMOD F	J	\$83
INSTLCTRYCHEFR640F	VxRail-500 SWITZERLAND SHIPMOD F	J	\$84
INSTLCTRYCHEFR740F	VxRail-500 SWITZERLAND SHIPMOD F	J	\$102
INSTLCTRYCHLFR640F	VxRail-500 CHILE SHIPMOD F	J	\$82

INSTLCTRYCHLFR740F	VxRail-500 CHILE SHIPMOD F	J	\$88
INSTLCTRYCOLFR640F	VxRail-500 COLOMBIA SHIPMOD F	J	\$82
INSTLCTRYCOLFR740F	VxRail-500 COLOMBIA SHIPMOD F	J	\$88
INSTLCTRYCZEFR640F	VxRail-500 CZECH REPUBLIC SHIPMOD F	J	\$84
INSTLCTRYCZEFR740F	VxRail-500 CZECH REPUBLIC SHIPMOD F	J	\$102
INSTLCTRYDEUFR640F	VxRail-500 GERMANY SHIPMOD F	J	\$84
INSTLCTRYDEUFR740F	VxRail-500 GERMANY SHIPMOD F	J	\$102
INSTLCTRYDNKFR640F	VxRail-500 DENMARK SHIPMOD F	J	\$84
INSTLCTRYDNKFR740F	VxRail-500 DENMARK SHIPMOD F	J	\$102
INSTLCTRYECUFR640F	VxRail-500 ECUADOR SHIPMOD F	J	\$82
INSTLCTRYECUFR740F	VxRail-500 ECUADOR SHIPMOD F	J	\$88
INSTLCTRYEGYFR640F	VxRail-500 EGYPT SHIPMOD F	J	\$84
INSTLCTRYEGYFR740F	VxRail-500 EGYPT SHIPMOD F	J	\$102
INSTLCTRYEMEAR640	VxRail-500 EMEA R640	J	\$102
INSTLCTRYEMEAR740	VxRail-500 EMEA R740	J	\$102
INSTLCTRYESPFR640F	VxRail-500 SPAIN SHIPMOD F	J	\$84
INSTLCTRYESPFR740F	VxRail-500 SPAIN SHIPMOD F	J	\$102
INSTLCTRYFINFR640F	VxRail-500 FINLAND SHIPMOD F	J	\$84
INSTLCTRYFINFR740F	VxRail-500 FINLAND SHIPMOD F	J	\$102
INSTLCTRYFJIFR640F	VxRail-500 FIJI SHIPMOD F	J	\$85
INSTLCTRYFJIFR740F	VxRail-500 FIJI SHIPMOD F	J	\$83
INSTLCTRYFRAFR640F	VxRail-500 FRANCE SHIPMOD F	J	\$84
INSTLCTRYFRAFR740F	VxRail-500 FRANCE SHIPMOD F	J	\$102
INSTLCTRYGBRFR640F	VxRail-500 UNITED KINGDOM SHIPMOD F	J	\$84
INSTLCTRYGBRFR740F	VxRail-500 UNITED KINGDOM SHIPMOD F	J	\$102
INSTLCTRYGRCFR640F	VxRail-500 GREECE SHIPMOD F	J	\$84
INSTLCTRYGRCFR740F	VxRail-500 GREECE SHIPMOD F	J	\$102
INSTLCTRYGUMFR640F	VxRail-500 GUAM SHIPMOD F	J	\$85
INSTLCTRYGUMFR740F	VxRail-500 GUAM SHIPMOD F	J	\$83
INSTLCTRYHKGFR640F	VxRail-500 FONG KONG SHIPMOD F	J	\$86
INSTLCTRYHKGFR740F	VxRail-500 FONG KONG SHIPMOD F	J	\$83
INSTLCTRYHUNFR640F	VxRail-500 FUNGARY SHIPMOD F	J	\$84
INSTLCTRYHUNFR740F	VxRail-500 FUNGARY SHIPMOD F	J	\$102
INSTLCTRYIDNFR640F	VxRail-500 INDONESIA SHIPMOD F	J	\$85
INSTLCTRYIDNFR740F	VxRail-500 INDONESIA SHIPMOD F	J	\$83
INSTLCTRYINDFR640F	VxRail-500 INDIA SHIPMOD F	J	\$85
INSTLCTRYINDFR740F	VxRail-500 INDIA SHIPMOD F	J	\$83
INSTLCTRYIRLFR640F	VxRail-500 IRELAND SHIPMOD F	J	\$84
INSTLCTRYIRLFR740F	VxRail-500 IRELAND SHIPMOD F	J	\$102
INSTLCTRYISRFR640F	VxRail-500 ISRAEL SHIPMOD F	J	\$84
INSTLCTRYISRFR740F	VxRail-500 ISRAEL SHIPMOD F	J	\$102
INSTLCTRYITAFR640F	VxRail-500 ITALY SHIPMOD F	J	\$84
INSTLCTRYITAFR740F	VxRail-500 ITALY SHIPMOD F	J	\$102
INSTLCTRYJPNFR640F	VxRail-500 JAPAN SHIPMOD F	J	\$85
INSTLCTRYJPNFR740F	VxRail-500 JAPAN SHIPMOD F	J	\$83
INSTLCTRYKAZFR640F	VxRail-500 KAZAKHSTAN SHIPMOD F	J	\$84
INSTLCTRYKAZFR740F	VxRail-500 KAZAKHSTAN SHIPMOD F	J	\$102
INSTLCTRYKENFR640F	VxRail-500 KENYA SHIPMOD F	J	\$84
INSTLCTRYKENFR740F	VxRail-500 KENYA SHIPMOD F	J	\$102
INSTLCTRYKHMFR640F	VxRail-500 CAMBODIA SHIPMOD F	J	\$85

INSTLCTRYKHMFR740F	VxRail-500 CAMBODIA SHIPMOD F	J	\$83
INSTLCTRYKIRFR640F	VxRail-500 KIRIBATI SHIPMOD F	J	\$85
INSTLCTRYKIRFR740F	VxRail-500 KIRIBATI SHIPMOD F	J	\$83
INSTLCTRYKORFR640F	VxRail-500 SOUTH KOREA SHIPMOD F	J	\$86
INSTLCTRYKORFR740F	VxRail-500 SOUTH KOREA SHIPMOD F	J	\$83
INSTLCTRYLAOFR640F	VxRail-500 LAOS SHIPMOD F	J	\$85
INSTLCTRYLAOFR740F	VxRail-500 LAOS SHIPMOD F	J	\$83
INSTLCTRYLKAFR640F	VxRail-500 SRI LANKA SHIPMOD F	J	\$85
INSTLCTRYLKAFR740F	VxRail-500 SRI LANKA SHIPMOD F	J	\$83
INSTLCTRYLTUFR640F	VxRail-500 LITHUANIA SHIPMOD F	J	\$84
INSTLCTRYLTUFR740F	VxRail-500 LITHUANIA SHIPMOD F	J	\$102
INSTLCTRYLUXFR640F	VxRail-500 LUXEMBOURG SHIPMOD F	J	\$84
INSTLCTRYLUXFR740F	VxRail-500 LUXEMBOURG SHIPMOD F	J	\$102
INSTLCTRYMACFR640F	VxRail-500 MACAO SHIPMOD F	J	\$86
INSTLCTRYMACFR740F	VxRail-500 MACAO SHIPMOD F	J	\$83
INSTLCTRYMARFR640F	VxRail-500 MOROCCO SHIPMOD F	J	\$84
INSTLCTRYMARFR740F	VxRail-500 MOROCCO SHIPMOD F	J	\$102
INSTLCTRYMEXFR640F	VxRail-500 MEXICO SHIPMOD F	J	\$81
INSTLCTRYMEXFR740F	VxRail-500 MEXICO SHIPMOD F	J	\$83
INSTLCTRYMNGFR640F	VxRail-500 MONGOLIA SHIPMOD F	J	\$85
INSTLCTRYMNGFR740F	VxRail-500 MONGOLIA SHIPMOD F	J	\$83
INSTLCTRYMNPFR640F	VxRail-500 N. MARIANAS ISLANDS SHIPMOD F	J	\$85
INSTLCTRYMNPFR740F	VxRail-500 N. MARIANAS ISLANDS SHIPMOD F	J	\$83
INSTLCTRYMYSFR640F	VxRail-500 MALAYSIA SHIPMOD F	J	\$85
INSTLCTRYMYSFR740F	VxRail-500 MALAYSIA SHIPMOD F	J	\$83
INSTLCTRYNCLFR640F	VxRail-500 NEW CALEDONIA SHIPMOD F	J	\$85
INSTLCTRYNCLFR740F	VxRail-500 NEW CALEDONIA SHIPMOD F	J	\$83
INSTLCTRYNGAFR640F	VxRail-500 NIGERIA SHIPMOD F	J	\$84
INSTLCTRYNGAFR740F	VxRail-500 NIGERIA SHIPMOD F	J	\$102
INSTLCTRYNLDFR640F	VxRail-500 NETHERLANDS SHIPMOD F	J	\$84
INSTLCTRYNLDFR740F	VxRail-500 NETHERLANDS SHIPMOD F	J	\$102
INSTLCTRYNORFR640F	VxRail-500 NORWAY SHIPMOD F	J	\$84
INSTLCTRYNORFR740F	VxRail-500 NORWAY SHIPMOD F	J	\$102
INSTLCTRYNPLFR640F	VxRail-500 NEPAL SHIPMOD F	J	\$85
INSTLCTRYNPLFR740F	VxRail-500 NEPAL SHIPMOD F	J	\$83
INSTLCTRYNZLFR640F	VxRail-500 NEW ZEALAND SHIPMOD F	J	\$85
INSTLCTRYNZLFR740F	VxRail-500 NEW ZEALAND SHIPMOD F	J	\$83
INSTLCTRYPAKFR640F	VxRail-500 PAKISTAN SHIPMOD F	J	\$85
INSTLCTRYPAKFR740F	VxRail-500 PAKISTAN SHIPMOD F	J	\$83
INSTLCTRYPERFR640F	VxRail-500 LATAM R640 SHIPMOD F	J	\$82
INSTLCTRYPERFR740F	VxRail-500 LATAM R740xd SHIPMOD F	J	\$88
INSTLCTRYPHLFR640F	VxRail-500 PHILIPPINES SHIPMOD F	J	\$85
INSTLCTRYPHLFR740F	VxRail-500 PHILIPPINES SHIPMOD F	J	\$83
INSTLCTRYPLWFR640F	VxRail-500 PALAU SHIPMOD F	J	\$85
INSTLCTRYPLWFR740F	VxRail-500 PALAU SHIPMOD F	J	\$83
INSTLCTRYPNGFR640F	VxRail-500 PAPUA NEW GUINEA SHIPMOD F	J	\$85
INSTLCTRYPNGFR740F	VxRail-500 PAPUA NEW GUINEA SHIPMOD F	J	\$83
INSTLCTRYPOLFR640F	VxRail-500 POLAND SHIPMOD F	J	\$84
INSTLCTRYPOLFR740F	VxRail-500 POLAND SHIPMOD F	J	\$102
INSTLCTRYPRIFR640F	VxRail-500 PUERTO RICO SHIPMOD F	J	\$81

INSTLCTRYPRIFR740F	VxRail-500 PUERTO RICO SHIPMOD F	J	\$83
INSTLCTRYPRTFR640F	VxRail-500 PORTUGAL SHIPMOD F	J	\$84
INSTLCTRYPRTFR740F	VxRail-500 PORTUGAL SHIPMOD F	J	\$102
INSTLCTRYPRYFR640F	VxRail-500 PARAGUAY SHIPMOD F	J	\$82
INSTLCTRYPRYFR740F	VxRail-500 PARAGUAY SHIPMOD F	J	\$79
INSTLCTRYQATFR640F	VxRail-500 QATAR SHIPMOD F	J	\$84
INSTLCTRYQATFR740F	VxRail-500 QATAR SHIPMOD F	J	\$102
INSTLCTRYROUFR640F	VxRail-500 ROMANIA SHIPMOD F	J	\$84
INSTLCTRYROUFR740F	VxRail-500 ROMANIA SHIPMOD F	J	\$102
INSTLCTRYSAUFR640F	VxRail-500 SAUDI ARABIA SHIPMOD F	J	\$84
INSTLCTRYSAUFR740F	VxRail-500 SAUDI ARABIA SHIPMOD F	J	\$102
INSTLCTRYSGPFR640F	VxRail-500 SINGAPORE SHIPMOD F	J	\$85
INSTLCTRYSGPFR740F	VxRail-500 SINGAPORE SHIPMOD F	J	\$83
INSTLCTRYSLBFR640F	VxRail-500 SOLOMON ISLAND SHIPMOD F	J	\$85
INSTLCTRYSLBFR740F	VxRail-500 SOLOMON ISLAND SHIPMOD F	J	\$83
INSTLCTRYSVKFR640F	VxRail-500 SLOVAKIA SHIPMOD F	J	\$84
INSTLCTRYSVKFR740F	VxRail-500 SLOVAKIA SHIPMOD F	J	\$102
INSTLCTRYSVNFR640F	VxRail-500 SLOVENIA SHIPMOD F	J	\$84
INSTLCTRYSVNFR740F	VxRail-500 SLOVENIA SHIPMOD F	J	\$102
INSTLCTRYSWEFR640F	VxRail-500 SWEDEN SHIPMOD F	J	\$84
INSTLCTRYSWEFR740F	VxRail-500 SWEDEN SHIPMOD F	J	\$102
INSTLCTRYTHAFR640F	VxRail-500 THAILAND SHIPMOD F	J	\$85
INSTLCTRYTHAFR740F	VxRail-500 THAILAND SHIPMOD F	J	\$83
INSTLCTRYTONFR640F	VxRail-500 TONGA SHIPMOD F	J	\$85
INSTLCTRYTONFR740F	VxRail-500 TONGA SHIPMOD F	J	\$83
INSTLCTRYTURFR640F	VxRail-500 TURKEY SHIPMOD F	J	\$84
INSTLCTRYTURFR740F	VxRail-500 TURKEY SHIPMOD F	J	\$102
INSTLCTRYTWNFR640F	VxRail-500 TAIWAN SHIPMOD F	J	\$86
INSTLCTRYTWNFR740F	VxRail-500 TAIWAN SHIPMOD F	J	\$83
INSTLCTRYUKRFR640F	VxRail-500 UKRAINE SHIPMOD F	J	\$84
INSTLCTRYUKRFR740F	VxRail-500 UKRAINE SHIPMOD F	J	\$102
INSTLCTRYURYFR640F	VxRail-500 URUGUAY SHIPMOD F	J	\$82
INSTLCTRYURYFR740F	VxRail-500 URUGUAY SHIPMOD F	J	\$88
INSTLCTRYUSAFR640F	VxRail-500 USA SHIPMOD F	J	\$81
INSTLCTRYUSAFR740F	VxRail-500 USA SHIPMOD F	J	\$83
INSTLCTRYVENFR640F	VxRail-500 VENEZUELA SHIPMOD F	J	\$82
INSTLCTRYVENFR740F	VxRail-500 VENEZUELA SHIPMOD F	J	\$88
INSTLCTRYVMYR640F	VxRail-500 MYANMAR SHIPMOD F	J	\$85
INSTLCTRYVNMFR640F	VxRail-500 VIETNAM SHIPMOD F	J	\$85
INSTLCTRYVNMFR740F	VxRail-500 VIETNAM SHIPMOD F	J	\$83
INSTLCTRYVUTFR640F	VxRail-500 VANUATU SHIPMOD F	J	\$85
INSTLCTRYVUTFR740F	VxRail-500 VANUATU SHIPMOD F	J	\$83
INSTLCTRYWSMFR640F	VxRail-500 SAMOA SHIPMOD F	J	\$85
INSTLCTRYWSMFR740F	VxRail-500 SAMOA SHIPMOD F	J	\$83
INSTLCTRYZAFFR640F	VxRail-500 SOUTH AFRICA SHIPMOD F	J	\$84
INSTLCTRYZAFFR740F	VxRail-500 SOUTH AFRICA SHIPMOD F	J	\$102
INSTLKIT-10GE-RJ45	HCIA Field Install Kit 10GE RJ45	J	\$935
INSTLKIT-10GE-SFP+	HCIA Field Install Kit 10GE SFP+	J	\$706
INSTLKIT-1GE-RJ45	HCIA Field Install Kit 1GE RJ45	J	\$1,067
INSTLKITSFP28F	VxRail-500 INSTALL KIT SFP28 25GB F	J	\$21

INSTLKITSFP28H	VxRail-500 INSTALL KIT SFP28 25GB H	J	\$21
LRDIMM2666INFO	VxRail-500 FactoryOrd Rq 2666Mhz LRDIMMs	J	\$0
MEMLDIMM128GBBCCF	VxRail-500 MEMORY 128GB LRDIMM BCC F	J	\$12,699
MEMLDIMM128GBCCH	VxRail-500 MEMORY 128GB LRDIMM BCC H	J	\$12,699
MEMLDIMM128GBF	VxRail-500 MEMORY 128GB LRDIMM F	J	\$12,699
MEMLDIMM128GBH	VxRail-500 MEMORY 128GB LRDIMM H	J	\$12,699
MEMLDIMM16GBAF	VxRail-500 MEMORY 16GB RDIMM AF	J	\$669
MEMLDIMM16GBBCCF	VxRail-500 MEMORY 16GB RDIMM BCC F	J	\$669
MEMLDIMM16GBCCCH	VxRail-500 MEMORY 16GB RDIMM BCC H	J	\$669
MEMLDIMM16GBH	VxRail-500 MEMORY 16GB RDIMM H	J	\$669
MEMLDIMM16GBU	HCIA MEMORY 16GB RDIMM U	J	\$567
MEMLDIMM32GBAF	VxRail-500 MEMORY 32GB RDIMM AF	J	\$1,282
MEMLDIMM32GBBCCF	VxRail-500 MEMORY 32GB RDIMM BCC F	J	\$1,282
MEMLDIMM32GBCCCH	VxRail-500 MEMORY 32GB RDIMM BCC H	J	\$1,282
MEMLDIMM32GBH	VxRail-500 MEMORY 32GB RDIMM H	J	\$1,282
MEMLDIMM32GBU	HCIA MEMORY 32GB RDIMM U	J	\$1,103
MEMLRDIMM64GBAF	VxRail-500 MEMORY 64GB LRDIMM AF	J	\$2,998
MEMLRDIMM64GBBCCF	VxRail-500 MEMORY 64GB LRDIMM BCC F	J	\$2,998
MEMLRDIMM64GBCCCH	VxRail-500 MEMORY 64GB LRDIMM BCC H	J	\$2,998
MEMLRDIMM64GBH	VxRail-500 MEMORY 64GB LRDIMM H	J	\$2,998
MEMLRDIMM64GBU	HCIA MEMORY 64GB LRDIMM U	J	\$2,744
MHC-DOOR-AF	MHC Titan Door All Flash	J	\$2,589
MHC-DOOR-DELLEMC	MHC Titan Door DELLEMC	J	\$2,589
MHC-DOOR-EMC	MHC Titan Door EMC	J	\$2,589
MHCFRC1GBRJ45	MHC 1GB RJ45	J	\$206
MHC-HIGH-AF-FD	MHC High R640 - 6130/576G FD	J	\$121,434
MHC-HIGH-AF-NODE	MHC High R640 - 6130/576G	J	\$121,434
MHC-HIGH-CAP-FD	MHC High Capacity R740XD/8160/768GB	J	\$95,965
MHC-HIGH-CAP-NODE	MHC High Capacity R740XD/8160/768GB	J	\$95,965
MHC-LOW-AF-FD	MHC Base R640 - 5118/384G FD	J	\$69,256
MHC-LOW-AF-NODE	MHC Base R640 - 5118/384G	J	\$69,256
MHC-LOW-CABLE-KIT	Cable Kit for factory 4 or 8 nodes	J	\$2,205
MHC-LOW-CAP-FD	MHC Low Capacity R740XD/5118/384GB	J	\$50,383
MHC-LOW-CAP-NODE	MHC Low Capacity R740XD/5118/384GB	J	\$50,383
MHCLR10GBSFP	MHC 10GB Long Range SFP	J	\$305
MHCLR25GBSFP	MHC 25GB Long Range SFP	J	\$2,229
MHC-MED-CAP-FD	MHC Med Cap R740XD/6130/576GB	J	\$75,568
MHC-MED-CAP-NODE	MHC Med Capacity R740XD/6130/576GB	J	\$75,568
MHC-MGMT-AF-FD	MHC Mgmt R640 -6130/96G FD	J	\$19,258
MHC-MGMT-NODE	MHC Mgmt R640 -6130/96G	J	\$19,258
MHC-MGMT-NODE-AF	MHC Mgmt R640 -6130/96G	J	\$19,258
MHC-MGMT-NODE-FD	MHC Mgmt R640 -6130/96G	J	\$19,258
MHC-MGMT-S3048	Dell EMC Networking S3048 1GbE	J	\$10,208
MHC-MGMT-S3048-FD	Dell EMC Networking S3048 1GbE FD	J	\$10,208
MHC-MGMT-SWITCH	Dell EMC Networking S3048 1GbE	J	\$10,207
MHC-MGMT-SWITCH-FD	Dell EMC Networking S3048 1GbE	J	\$10,208
MHC-MINI-RACK-1	MHC Mini Rack 1	J	\$0
MHC-MINI-RACK1-AF	MHC Mini Rack1 All Flash	J	\$0
MHC-MINI-RACK-2	MHC Mini Rack 2	J	\$0
MHC-MINI-RACK2-AF	MHC Mini Rack 2 All Flash	J	\$0

MHC-PWR-1PH-AUS	PWR CORD 24A SP 15FT 56PA332 AUS	J	\$2,655
MHC-PWR-1PH-INTL	PWR CORD 24A SP 15FT IEC309P INTL	J	\$1,108
MHC-PWR-1PH-L7	PWR CORD 24A SP 15FT L7-30P	J	\$949
MHC-PWR-1PH-RUS	24A 1PH RUSSELLSTOLL 3750DP	J	\$2,600
MHC-PWR-1PH-US	PWR CORD 24A SP 15FT L6-30P; N.AMER,JAP	J	\$530
MHC-PWR-3PH-INTL	PWR CORD, 3-PH DELTA, 40A, 15FT, INTL	J	\$3,291
MHC-PWR-3PH-RSUS	PWR CORD, 3-PH DELTA, 40A,RS 15FT, N. Am	J	\$3,897
MHC-PWR-3PH-US	PWR CORD, 3-PH DELTA, 40A, 15FT, US	J	\$2,093
MHC-PWR-3PWYE-FL1	PWR 3PWYE,32A, 15FT, INTL Flying Leads	J	\$803
MHC-PWR-3PWYE-FL2	PWR 3PWYE 32A,15FT,N. Am. Flying Leads	J	\$1,311
MHC-PWR-3PWYE-INT1	PWR CORD, 3-PH WYE, 32A, 15FT, INTL	J	\$835
MHC-PWR-3PWYE-INT2	PWR CORD, 3-PH WYE, 24A, 15FT, INTL	J	\$2,160
MHC-PWR-3PWYE-US	PWR CORD, 3-PH WYE, 32A, 15FT, US	J	\$1,606
MHC-RACK-1PH	MHC Rack 40U Single Phase	J	\$11,326
MHC-RACK-1PH-AF	MHC Rack 40U Single Phase All Flash	J	\$11,326
MHC-RACK-3PH-AF	MHC Rack 40U 3 Phase Delta All Flash	J	\$15,005
MHC-RACK-3PH-DELTA	MHC Rack 40U 3 Phase Delta	J	\$15,005
MHC-RACK-3PH-WYE	MHC Rack 40U 3 Phase WYE	J	\$15,499
MHC-RACK-3PWYE-AF	MHC Rack 40U 3 Phase WYE All Flash	J	\$15,499
MHCSR10GBSFP	MHC 10GB Short Range SFP	J	\$266
MHCSR25GBSFP	MHC 25GB Short Range SFP	J	\$1,333
MHC-SRV-CAB-AF	MHC Server AF Cable Kit	J	\$2,563
MHC-SRV-CAB-AF-FD	MHC Server AF Cable Field Kit	J	\$2,563
MHC-SRV-CAB-KIT-FD	Cable Kit for factory 4 or 8 nodes	J	\$2,563
MHC-TOR-AF-KIT-FD	MHC TOR/MGMT Field Kit All flash	J	\$2,629
MHC-TOR-KIT-FD	MHC TOR/MGMT Field Kit	J	\$2,629
MHC-TOR-S5048	MHC TOR Switch Dell S5048/25G	J	\$28,615
MHC-TOR-S5048-FD	MHC TOR Switch Dell S5048/25G FD	J	\$28,615
MHC-TOR-SWITCH	Dell EMC Networking S4048 10GbE	J	\$19,626
MHC-TOR-SWITCH-FD	Dell EMC Networking S4048 10GbE	J	\$19,626
MHC-UP-CABLE-KIT	Cable Kit for factory 9-12 nodes	J	\$2,205
MVAAX4-5	MIRRORVIEW ASYNC FOR THE AX4-5	J	\$0
MVALAX4-5	MIRRORVIEW BUNDLE FOR THE AX4-5	J	\$0
MV-CEMAX4-5	MIRRORVIEW/CE SW APPLICATION FOR AX4-5	J	\$0
MVSAX4-5	MIRRORVIEW SYNC FOR THE AX4-5	J	\$0
NA-2SS10-146	2.5 146GB 10K SAS DISK DRIVE	J	\$0
NA-2SS10-146H	2.5 146GB 10K SAS DISK DRIVE HOT SPARE	J	\$0
NA-2SS10-146U	2.5 146GB 10K SAS DISK DRIVE UPGRADE	J	\$0
NA-2SS10-300	2.5 300G 10K SAS DISK DRIVE	J	\$0
NA-2SS10-300H	2.5 300G 10K SAS DISK DRIVE HOT SPARE	J	\$0
NA-2SS10-300U	2.5 300G 10K SAS DISK DRIVE UPGRADE	J	\$0
NA-3PDAE	NX4 SAS/SATA DAE-FACTORY INSTALL	J	\$0
NA-3PDAE-FD	NX4 SAS/SATA EXPANSION DAE-FIELD INSTALL	J	\$0
NA-SS07-010	DISK 1000GB 7.2K 512BPS SATA 3GB 32MB	J	\$0
NA-SS07-010HS	1000GB 7200RPM SATA II DRIVE HS	J	\$0
NA-SS07-010U	1000GB 7200RPM SATA II DRIVE UPG	J	\$0
NA-SS07-020	2TB 7200RPM SATA II DISK DRIVE	J	\$0
NA-SS07-020HS	2TB 7200RPM SATA II DISK DRIVE HOT SPARE	J	\$0
NA-SS07-020U	2TB 7200RPM SATA II DISK DRIVE UPGRADE	J	\$0
NA-SS10-400	DISK 400GB 10K 520BPS 5/12V 3GB SAS	J	\$0

NA-SS10-400HS	DISK 400GB 10K 520BPS 5/12V 3GB SAS HS	J	\$0
NA-SS10-400U	DISK 400GB 10K 520BPS 5/12V 3GB SAS UPG	J	\$0
NA-SS10-600	600GB 10K RPM SAS DRIVE	J	\$0
NA-SS10-600HS	600GB 10K RPM SAS DRIVE HOT SPARE	J	\$0
NA-SS10-600U	600GB 10K RPM SAS DRIVE UPGRADE	J	\$0
NA-SS15-146	DISK ASSMBLY 146GB 15K SA	J	\$485
NA-SS15-146HS	DISK ASSMBLY 146GB 15K SA HS	J	\$485
NA-SS15-146U	DISK ASSMBLY 146GB 15K SA UPG	J	\$662
NA-SS15-300	DISK 300GB 15K SAS SGT	J	\$0
NA-SS15-300HS	DISK 300GB 15K SAS SGT HS	J	\$0
NA-SS15-300U	DISK 300GB 15K SAS SGT UPG	J	\$0
NA-SS15-450	450GB 15K 3GB SAS DISK DRIVE	J	\$0
NA-SS15-450HS	450GB 15K 3GB SAS DISK DRIVE HOT SPARE	J	\$0
NA-SS15-600	600GB 15K 3G SAS NX DISK DRIVE	J	\$0
NA-SS15-600HS	600GB 15K 3G SAS NX DISK DRIVE HOT SPARE	J	\$0
NA-SS15-600U	600GB 15K 3G SAS NX DISK DRIVE UPGRADE	J	\$0
NAV100	NAVI MANAGER AX100 SERIES	J	\$1,100
NAV100-KIT	NAVI MGR AX100 MEDIA	J	\$0
NAVAX4-5	NAVI MANAGER FOR AX4-5	J	\$0
NAVAYZAX4-5	NAVI ANALYZER FR AX4-5	J	\$0
NB-2SS10-146	2.5 146GB 10K SAS DISK DRIVE - NEBS	J	\$0
NB-2SS10-300	2.5 300GB 10K SAS - NEBS	J	\$0
NB-SS15-146	146GB 15K SAS 3GB NEBS DISK DRIVE	J	\$485
NB-SS15-300	300GB 15K SAS 3GB NEBS DISK DRIVE	J	\$0
NB-SS15-450	450GB 15K NEBS COMPLIANT SAS DRIVE	J	\$0
ND08C17V40128RJ	ND 8C1.7GHZ 1XE5-2609V4 128GB 1GBE	J	\$11,414
ND08C17V40128RJU	ND 8C1.7GHZ 1XE5-2609V4 128GB 1GBE U	J	\$11,414
ND08C17V4064RJ	ND 8C1.7GHZ 1XE5-2609V4 64GB 1GBE	J	\$10,007
ND08C17V4064RJU	ND 8C1.7GHZ 1XE5-2609V4 64GB 1GBE U	J	\$10,007
ND16C21V4128RJ	ND 16C2.1GHZ 2XE5-2620V4 128GB RJ45	J	\$21,734
ND16C21V4128RJAF	ND 16C2.1GHZ 2XE5-2620V4 128GB RJ45 AF	J	\$21,734
ND16C21V4128RJAFU	ND 16C2.1GHZ 2XE5-2620V4 128GB RJ45 AF U	J	\$21,734
ND16C21V4128RJU	ND 16C2.1GHZ 2XE5-2620V4 128GB RJ45 U	J	\$21,734
ND16C21V4128SFP	ND 16C2.1GHZ 2XE5-2620V4 128GB SFP	J	\$21,734
ND16C21V4128SFP AF	ND 16C2.1GHZ 2XE5-2620V4 128GB SFP AF	J	\$21,734
ND16C21V4128SFP AF U	ND 16C2.1GHZ 2XE5-2620V4 128GB SFP AF U	J	\$21,734
ND16C21V4128SFP U	ND 16C2.1GHZ 2XE5-2620V4 128GB SFP U	J	\$21,734
ND16C21V4256RJ	ND 16C2.1GHZ 2XE5-2620V4 256GB RJ45	J	\$25,300
ND16C21V4256RJAF	ND 16C2.1GHZ 2XE5-2620V4 256GB RJ45 AF	J	\$25,300
ND16C21V4256RJAFU	ND 16C2.1GHZ 2XE5-2620V4 256GB RJ45 AF U	J	\$25,300
ND16C21V4256RJU	ND 16C2.1GHZ 2XE5-2620V4 256GB RJ45 U	J	\$25,300
ND16C21V4256SFP	ND 16C2.1GHZ 2XE5-2620V4 256GB SFP	J	\$25,300
ND16C21V4256SFP AF	ND 16C2.1GHZ 2XE5-2620V4 256GB SFP AF	J	\$25,300
ND16C21V4256SFP AF U	ND 16C2.1GHZ 2XE5-2620V4 256GB SFP AF U	J	\$25,300
ND16C21V4256SFP U	ND 16C2.1GHZ 2XE5-2620V4 256GB SFP U	J	\$25,300
ND16C21V4384RJ	ND 16C2.1GHZ 2XE5-2620V4 384GB RJ45	J	\$28,866
ND16C21V4384RJAF	ND 16C2.1GHZ 2XE5-2620V4 384GB RJ45 AF	J	\$28,866
ND16C21V4384RJAFU	ND 16C2.1GHZ 2XE5-2620V4 384GB RJ45 AF U	J	\$28,866
ND16C21V4384RJU	ND 16C2.1GHZ 2XE5-2620V4 384GB RJ45 U	J	\$28,866
ND16C21V4384SFP	ND 16C2.1GHZ 2XE5-2620V4 384GB SFP	J	\$28,866

ND16C21V4384SFPAF	ND 16C2.1GHZ 2XE5-2620V4 384GB SFP AF	J	\$28,866
ND16C21V4384SFPAFU	ND 16C2.1GHZ 2XE5-2620V4 384GB SFP AF U	J	\$28,866
ND16C21V4384SFPU	ND 16C2.1GHZ 2XE5-2620V4 384GB SFP U	J	\$28,866
ND16C21V4512RJ	ND 16C2.1GHZ 2XE5-2620V4 512GB RJ45	J	\$32,432
ND16C21V4512RJAF	ND 16C2.1GHZ 2XE5-2620V4 512GB RJ45 AF	J	\$32,432
ND16C21V4512RJAFU	ND 16C2.1GHZ 2XE5-2620V4 512GB RJ45 AF U	J	\$32,432
ND16C21V4512RJU	ND 16C2.1GHZ 2XE5-2620V4 512GB RJ45 U	J	\$32,432
ND16C21V4512SFP	ND 16C2.1GHZ 2XE5-2620V4 512GB SFP	J	\$32,432
ND16C21V4512SFPAF	ND 16C2.1GHZ 2XE5-2620V4 512GB SFP AF	J	\$32,432
ND16C21V4512SFPAFU	ND 16C2.1GHZ 2XE5-2620V4 512GB SFP AF U	J	\$32,432
ND16C21V4512SFPU	ND 16C2.1GHZ 2XE5-2620V4 512GB SFP U	J	\$32,432
ND20C22V4128RJ	ND 20C2.2GHZ 2XE5-2630V4 128GB RJ45	J	\$25,385
ND20C22V4128RJAF	ND 20C2.2GHZ 2XE5-2630V4 128GB RJ45 AF	J	\$25,385
ND20C22V4128RJAFU	ND 20C2.2GHZ 2XE5-2630V4 128GB RJ45 AF U	J	\$25,385
ND20C22V4128RJU	ND 20C2.2GHZ 2XE5-2630V4 128GB RJ45 U	J	\$25,385
ND20C22V4128SFP	ND 20C2.2GHZ 2XE5-2630V4 128GB SFP	J	\$25,385
ND20C22V4128SFPAF	ND 20C2.2GHZ 2XE5-2630V4 128GB SFP AF	J	\$25,385
ND20C22V4128SFPAFU	ND 20C2.2GHZ 2XE5-2630V4 128GB SFP AF U	J	\$25,385
ND20C22V4128SFPU	ND 20C2.2GHZ 2XE5-2630V4 128GB SFP U	J	\$25,385
ND20C22V4256RJ	ND 20C2.2GHZ 2XE5-2630V4 256GB RJ45	J	\$29,213
ND20C22V4256RJAF	ND 20C2.2GHZ 2XE5-2630V4 256GB RJ45 AF	J	\$29,213
ND20C22V4256RJAFU	ND 20C2.2GHZ 2XE5-2630V4 256GB RJ45 AF U	J	\$29,213
ND20C22V4256RJU	ND 20C2.2GHZ 2XE5-2630V4 256GB RJ45 U	J	\$29,213
ND20C22V4256SFP	ND 20C2.2GHZ 2XE5-2630V4 256GB SFP	J	\$29,213
ND20C22V4256SFPAF	ND 20C2.2GHZ 2XE5-2630V4 256GB SFP AF	J	\$29,213
ND20C22V4256SFPAFU	ND 20C2.2GHZ 2XE5-2630V4 256GB SFP AF U	J	\$29,213
ND20C22V4256SFPU	ND 20C2.2GHZ 2XE5-2630V4 256GB SFP U	J	\$29,213
ND20C22V4384RJ	ND 20C2.2GHZ 2XE5-2630V4 384GB RJ45	J	\$33,042
ND20C22V4384RJAF	ND 20C2.2GHZ 2XE5-2630V4 384GB RJ45 AF	J	\$33,042
ND20C22V4384RJAFU	ND 20C2.2GHZ 2XE5-2630V4 384GB RJ45 AF U	J	\$33,042
ND20C22V4384RJU	ND 20C2.2GHZ 2XE5-2630V4 384GB RJ45 U	J	\$33,042
ND20C22V4384SFP	ND 20C2.2GHZ 2XE5-2630V4 384GB SFP	J	\$33,042
ND20C22V4384SFPAF	ND 20C2.2GHZ 2XE5-2630V4 384GB SFP AF	J	\$33,042
ND20C22V4384SFPAFU	ND 20C2.2GHZ 2XE5-2630V4 384GB SFP AF U	J	\$33,042
ND20C22V4384SFPU	ND 20C2.2GHZ 2XE5-2630V4 384GB SFP U	J	\$33,042
ND20C22V4512RJ	ND 20C2.2GHZ 2XE5-2630V4 512GB RJ45	J	\$36,871
ND20C22V4512RJAF	ND 20C2.2GHZ 2XE5-2630V4 512GB RJ45 AF	J	\$36,871
ND20C22V4512RJAFU	ND 20C2.2GHZ 2XE5-2630V4 512GB RJ45 AF U	J	\$36,871
ND20C22V4512RJU	ND 20C2.2GHZ 2XE5-2630V4 512GB RJ45 U	J	\$36,871
ND20C22V4512SFP	ND 20C2.2GHZ 2XE5-2630V4 512GB SFP	J	\$36,871
ND20C22V4512SFPAF	ND 20C2.2GHZ 2XE5-2630V4 512GB SFP AF	J	\$36,871
ND20C22V4512SFPAFU	ND 20C2.2GHZ 2XE5-2630V4 512GB SFP AF U	J	\$36,871
ND20C22V4512SFPU	ND 20C2.2GHZ 2XE5-2630V4 512GB SFP U	J	\$36,871
ND24C22V4128RJAF	ND 24C2.2GHZ 2XE5-2650V4 128GB RJ45 AF	J	\$30,331
ND24C22V4128RJAFU	ND 24C2.2GHZ 2XE5-2650V4 128GB RJ45 AF U	J	\$30,331
ND24C22V4128SFPAF	ND 24C2.2GHZ 2XE5-2650V4 128GB SFP AF	J	\$30,331
ND24C22V4128SFPAFU	ND 24C2.2GHZ 2XE5-2650V4 128GB SFP AF U	J	\$30,331
ND24C22V4256RJAF	ND 24C2.2GHZ 2XE5-2650V4 256GB RJ45 AF	J	\$34,159
ND24C22V4256RJAFU	ND 24C2.2GHZ 2XE5-2650V4 256GB RJ45 AF U	J	\$34,159
ND24C22V4256SFPAF	ND 24C2.2GHZ 2XE5-2650V4 256GB SFP AF	J	\$34,159

ND24C22V4256SFPAFU	ND 24C2.2GHZ 2XE5-2650V4 256GB SFP AF U	J	\$34,159
ND24C22V4384RJAF	ND 24C2.2GHZ 2XE5-2650V4 384GB RJ45 AF	J	\$37,988
ND24C22V4384RJAFU	ND 24C2.2GHZ 2XE5-2650V4 384GB RJ45 AF U	J	\$37,988
ND24C22V4384SFPAF	ND 24C2.2GHZ 2XE5-2650V4 384GB SFP AF	J	\$37,988
ND24C22V4384SFPAFU	ND 24C2.2GHZ 2XE5-2650V4 384GB SFP AF U	J	\$37,988
ND24C22V4512RJAF	ND 24C2.2GHZ 2XE5-2650V4 512GB RJ45 AF	J	\$41,817
ND24C22V4512RJAFU	ND 24C2.2GHZ 2XE5-2650V4 512GB RJ45 AF U	J	\$41,817
ND24C22V4512SFPAF	ND 24C2.2GHZ 2XE5-2650V4 512GB SFP AF	J	\$41,817
ND24C22V4512SFPAFU	ND 24C2.2GHZ 2XE5-2650V4 512GB SFP AF U	J	\$41,817
ND28C24V4128SFPAF	ND 28C2.4GHZ 2XE5-2680V4 128GB SFP AF	J	\$35,174
ND28C24V4128SFPAFU	ND 28C2.4GHZ 2XE5-2680V4 128GB SFP AF U	J	\$35,174
ND28C24V4256SFPAF	ND 28C2.4GHZ 2XE5-2680V4 256GB SFP AF	J	\$39,002
ND28C24V4256SFPAFU	ND 28C2.4GHZ 2XE5-2680V4 256GB SFP AF U	J	\$39,002
ND28C24V4384SFPAF	ND 28C2.4GHZ 2XE5-2680V4 384GB SFP AF	J	\$42,831
ND28C24V4384SFPAFU	ND 28C2.4GHZ 2XE5-2680V4 384GB SFP AF U	J	\$42,831
ND28C24V4512SFPAF	ND 28C2.4GHZ 2XE5-2680V4 512GB SFP AF	J	\$46,659
ND28C24V4512SFPAFU	ND 28C2.4GHZ 2XE5-2680V4 512GB SFP AF U	J	\$46,659
ND32C21V4128SFPAF	ND 32C2.1GHZ 2XE5-2683V4 128GB SFP AF	J	\$36,115
ND32C21V4128SFPAFU	ND 32C2.1GHZ 2XE5-2683V4 128GB SFP AF U	J	\$36,115
ND32C21V4256SFPAF	ND 32C2.1GHZ 2XE5-2683V4 256GB SFP AF	J	\$39,944
ND32C21V4256SFPAFU	ND 32C2.1GHZ 2XE5-2683V4 256GB SFP AF U	J	\$39,944
ND32C21V4384SFPAF	ND 32C2.1GHZ 2XE5-2683V4 384GB SFP AF	J	\$43,772
ND32C21V4384SFPAFU	ND 32C2.1GHZ 2XE5-2683V4 384GB SFP AF U	J	\$43,772
ND32C21V4512SFPAF	ND 32C2.1GHZ 2XE5-2683V4 512GB SFP AF	J	\$47,601
ND32C21V4512SFPAFU	ND 32C2.1GHZ 2XE5-2683V4 512GB SFP AF U	J	\$47,601
NDCSFP28DP25GBSP	VxRail-500 NDC SFP28 DP 25GB SP	J	\$1,200
NDCSFP28DP25GBU	VxRail-500 NDC SFP28 DP 25GB U	J	\$1,200
NDCSFP28DP25GF	VxRail-500 NDC SFP28 DP 25GB F	J	\$934
NDCSFP28DP25GH	VxRail-500 NDC SFP28 DP 25GB H	J	\$934
NDCX550QP10GBRJAF	VxRail-500 NDC INTELX550 QP 10Gb RJ45 AF	J	\$881
NDCX550QP10GBRJH	VxRail-500 NDC INTEL X550 QP 10Gb RJ45 H	J	\$881
NDCX710DP10GBSF	VxRail-500 NDC INTEL X710 DP 10Gb SFP+ F	J	\$498
NDCX710DP10GBSFPH	VxRail-500 NDC INTEL X710 DP 10Gb SFP+ H	J	\$498
NDCX710QP10GBSFPAF	VxRail-500 NDC INTELX710 QP 10Gb SFP+ AF	J	\$892
NDCX710QP10GBSFPH	VxRail-500 NDC INTEL X710 QP 10Gb SFP+ H	J	\$892
NIC2X10GBERJPCFHU	HCIA INTEL X540 FH PCIE 2X10GBE RJ45 U	J	\$899
NIC2X10GBERJPCIEU	HCIA INTEL X540 LP PCIE 2X10GBE RJ45 U	J	\$899
NIC2X10GBSFPPCFHU	HCIA INTEL X520 FH PCIE 2X10GBE SFP+ U	J	\$622
NIC2X10GBSFPPCLPU	HCIA INTEL X520 LP PCIE 2X10GBE SFP+ U	J	\$622
NIC2X1E2X10ERJU	NIC NDC X540 DP 10Gb RJ45 +I350 DP 1GB U	J	\$768
NIC2X1E2X10ESFPU	NIC NDC X520 DP 10Gb SFP + I350 DP 1GB U	J	\$618
NIC4X10GBX710FHU	HCIA INTEL X710 FH PCIE 4X10GBE SFP+ U	J	\$1,073
NICDPRJX550PCFHU	HCIA INTEL X550 FH PCIE 2X10GBE RJ45 U	J	\$830
NICDPRJX550PCLPU	HCIA INTEL X550 LP PCIE 2X10GBE RJ45 U	J	\$830
NICDPSFPX710PCFHU	HCIA INTEL X710 FH PCIE 2X10GBE SFP+ U	J	\$859
NICDPSFPX710PCLPU	HCIA INTEL X710 LP PCIE 2X10GBE SFP+ U	J	\$859
NICX550FH2X10GBRJ	VxRail-500 X550 FH PCIE 2X10GBE RJ45 H	J	\$787
NICX550FH2X10GBRJF	VxRail-500 X550 FH PCIE 2X10GBE RJ45 AF	J	\$787
NICX550LP2X10GBRJ	VxRail-500 X550 LP PCIE 2X10GBE RJ45 H	J	\$787
NICX550LP2X10GBRJF	VxRail-500 X550 LP PCIE 2X10GBE RJ45 AF	J	\$787

NICX710FH2X10GBSF	VxRail-500 X710 FH PCIE 2X10GBE SFP+ AF	J	\$682
NICX710FH2X10GBSFP	VxRail-500 X710 FH PCIE 2X10GBE SFP+ H	J	\$682
NICX710FH4X10GBRJ	VxRail-500 X710 FH PCIE 4X10GBE RJ45 H	J	\$1,291
NICX710FH4X10GBRJF	VxRail-500 X710 FH PCIE 4X10GBE RJ45 AF	J	\$1,291
NICX710FH4X10GBSF	VxRail-500 X710 FH PCIE 4X10GBE SFP+ AF	J	\$976
NICX710FH4X10GBSFP	VxRail-500 X710 FH PCIE 4X10GBE SFP+ H	J	\$976
NICX710LP2X10GBSFF	VxRail-500 X710 LP PCIE 2X10GBE SFP+ AF	J	\$682
NICX710LP2X10GBSFP	VxRail-500 X710 LP PCIE 2X10GBE SFP+ H	J	\$682
NICX710LP4X10GBRJ	VxRail-500 X710 LP PCIE 4X10GBE RJ45 H	J	\$1,291
NICX710LP4X10GBRJF	VxRail-500 X710 LP PCIE 4X10GBE RJ45 AF	J	\$1,291
NICXFH2X25GBSFP28F	VxRail-500 FH PCIE 2X25GBE SFP28 F	J	\$671
NICXFH2X25GBSFP28H	VxRail-500 FH PCIE 2X25GBE SFP28 H	J	\$671
NICXFH2X25GBSFP28U	VxRail-500 FH PCIE 2X25GBE SFP28 U	J	\$806
NICXFH2X25GSFP28SP	VxRail-500 FH PCIE 2X25GBE SFP28 SP	J	\$806
NICXLP2X25GBSFP28F	VxRail-500 LP PCIE 2X25GBE SFP28 F	J	\$671
NICXLP2X25GBSFP28H	VxRail-500 LP PCIE 2X25GBE SFP28 H	J	\$671
NICXLP2X25GBSFP28U	VxRail-500 LP PCIE 2X25GBE SFP28 U	J	\$844
NICXLP2X25GSFP28SP	VxRail-500 LP PCIE 2X25GBE SFP28 SP	J	\$844
NO-PWR-CRD	NO POWER CORD	J	\$0
NORAILKIT	VxRail-500 NO RAILKIT	J	\$0
NO-TPMMOD	VxRail-500 NO TPM MODULE	J	\$0
NS-3GDAE	NS20 CAPTIVE ARRAY AX DAE	J	\$5,900
NS-3GDAE-FD	NS20 CAPTIVE ARRAY AX DAE (FLD INST)	J	\$5,900
NS-3GDAE-U	NS20 CAPTIVE ARRAY AX DAE (UPGRADE)	J	\$5,900
NS-SS10-600HS	600GB 10K SAS DRIVE - HOT SPARE	J	\$1,350
NX3-DPE-BASE	2XSP; 16GB MEMORY; DISK PROCESSOR ENCL	J	\$8,812
NX3-FC-DK	ASSY DISK 300GB 15K FC DISK	J	\$2,570
NX3-SSD	DPE 15GB SSD	J	\$1,449
NX4-1-2-NF-UL	NX4 ONE TO TWO BLADE NFS FIELD UPGRADE	J	\$0
NX4-1-2-U	NX4 1 TO 2 BLADE POST INSTALL UPGRADE	J	\$0
NX4-1BLADE-SW	NX4 SINGLE BLADE SW BUNDLE	J	\$0
NX4-1C-2C-U	NX4 BLADE UG - 2 10GBEOP 2 CU 1GBE PORTS	J	\$0
NX4-1C-A	NX4 NAS ENCLOSURE W/ ONE BLADE - FACTOR	J	\$0
NX4-1C-A-FD	NX4 ENCLOSURE W/ 1 BLADE - FIELD INSTALL	J	\$0
NX4-1C-C	NX4-1DM-4GB-2 OP 10GE 2 CU 1GE (FACTORY)	J	\$0
NX4-1C-C-FD	NX4-1DM-4GB-2 OP 10GE 2CU 1GE FLD INSTAL	J	\$0
NX4-1-CI-RYLT	CELERRA NX4 SINGLE BLADE CIFS LICENSE	J	\$0
NX4-1-UNIX-L	CELERRA NX4 SINGLE BLADE UNIX NFS LICENS	J	\$0
NX4-2BLADE-SW	NX4 DUAL BLADE SW BUNDLE	J	\$0
NX4-2C-A	NX4 NAS ENCL W/ 2 BLADES - FACT INSTALL	J	\$0
NX4-2C-A-FD	NX4 NAS ENCL W/ TWO BLADES FLD INSTALL	J	\$0
NX4-2C-C	NX4 INT-2DM-4GB-2 OP 10GE 2CU 1GE FACT	J	\$0
NX4-2C-C-FD	NX4 INT-2DM-4GB-2 OP 10GE 2 CU 1GE FLD	J	\$0
NX4-2-CI-RYLT	CELERRA NX4 DUAL BLADE CIFS LICENSE	J	\$0
NX4-2-UNIX-L	CELERRA NX4 DUAL BLADE UNIX NFS LICENSE	J	\$0
NX4-AUXF	NX4 CAPTIVE ARRAY - FACTORY INSTALLED	J	\$0
NX4-AUXFCR	NX4 CAPTIVE ARRAY - FIELD INSTALLED	J	\$0
NX4-BDL-CAP	NX4 CAPACITY DUAL SP 12X1TB SATA	J	\$20,038
NX4-BDL-ENT	NX4 ENTRY SINGLE SP 6X1TB SATA	J	\$13,501
NX4-BDL-PERF	NX4 PERF DUAL SP 12X300GB 15K	J	\$20,533

NX4-BDL-PRFCP	NX4 PERF&CAP DUAL SP 12X600GB 15K	J	\$28,345
NX4-CEE2-L	NS CEE-ANTI-VIRUS	J	\$0
NX4-CEE-L	NX4 CEL EVENT ENBLR FOR ADDON SERVER	J	\$0
NX4-CS	NX4 CONTROL STATION - FACTORY INSTALLED	J	\$0
NX4-CS-FD	NX4 CONTROL STATION - FIELD INSTALLED	J	\$0
NX4-EXPAN	NX4 EXPANSION ENABLER SAS/SATA DRIVES	J	\$0
NX4-FASTVE	FAST FMA/VE FOR NX4	J	\$21,500
NX4-FCOPT-L	NX4 FC PORT OPTION ENABLEMENT LICENSE	J	\$0
NX4-FCOPT-UL	FIBRE CHANNEL LICENCE FOR NX4 UPGRADE	J	\$0
NX4-FLR-L	NX4 FLR LICENSE	J	\$0
NX4-FLR-L-U	NX4 FLR LICENSE POST INSTALL	J	\$3,250
NX4-ISCSI-L	CELERRA NX4 ISCSI LICENSE	J	\$0
NX4-NF-UL	NX4 ADD NFS POST INSTALL	J	\$0
NX4-REPV2-L	NX4 REPLICATOR V2 LICENSE	J	\$0
NX4-REPV2-LU	NX4 REPLICATOR V2 UPGRADE LICENSE	J	\$0
NX4-SPS	NX4 OPTIONAL 2ND SPS-FACTORY INSTALLED	J	\$0
NX4-SPS-FD	NX4 OPTIONAL 2ND SPS-FIELD INSTALLED	J	\$0
PCIE-FF-L	VFCACHE FOR VIRTUAL ENV - FF PROMOTION	J	\$0
PCIE-FF-M	VFCACHE FOR PHYSICAL ENV - FF PROMOTION	J	\$0
PCIEHMM-350M	350GB MLC PCIE CARD	J	\$0
PCIEHHS-3XXL	EMC VFCACHE FOR VMWARE ENVIRONMENTS	J	\$0
PCIEHHS-3XXL5	VFCACHE FOR VIRTUAL ENV - QTY 5	J	\$0
PCIEHHS-3XXM	EMC VFCACHE FOR PHYSICAL ENVIRONMENTS	J	\$0
PCIEHHS-3XXM5	VFCACHE FOR PHYSICAL ENVIRONMENT - QTY	J	\$0
PR3104BN6C17	VxRail-500 Intel CPU 3104 6C 1.7GHz H	J	\$5,066
PR3104BN6C17-2	VxRail-500 INTEL CPU 3104 6C 1.7GHz 2ndH	J	\$5,066
PR3104BN6C17AF	VxRail-500 Intel CPU 3104 6C 1.7GHz AF	J	\$5,066
PR3104BN6C17AF-2	VxRail-500 Intel CPU 3104 6C 1.7GHz2ndAF	J	\$5,066
PR3104BN8C17	VxRail-500 Intel CPU 3104 6C 1.7GHz H	J	\$0
PR3104BN8C17-2	VxRail-500 INTEL CPU 3104 6C 1.7GHz 2ndH	J	\$0
PR3104BN8C17AF	VxRail-500 Intel CPU 3104 6C 1.7GHz AF	J	\$0
PR3104BN8C17AF-2	VxRail-500 Intel CPU 3104 6C 1.7GHz2ndAF	J	\$0
PR3106BN8C17	VxRail-500 Intel CPU 3106 8C 1.7 GHz H	J	\$5,135
PR3106BN8C17-2	VxRail-500 Intel CPU 3106 8C 1.7 GHz2ndH	J	\$5,135
PR3106BN8C17AF	VxRail-500 Intel CPU 3106 8C 1.7 GHz AF	J	\$5,135
PR3106BN8C17AF-2	VxRail-500 Intel CPU 3106 8C 1.7GHz2ndAF	J	\$5,135
PR4108SV8C18	VxRail-500 Intel CPU 4108 8C 1.8 GHz H	J	\$5,737
PR4108SV8C18-2	VxRail-500 Intel CPU 4108 8C 1.8 GHz2ndH	J	\$5,737
PR4108SV8C18AF	VxRail-500 Intel CPU 4108 8C 1.8 GHz AF	J	\$5,737
PR4108SV8C18AF-2	VxRail-500 Intel CPU 4108 8C 1.8GHz2ndAF	J	\$5,737
PR4109TSV8C20	VxRail-500 Intel CPU 4109T 8C 2.0 GHz H	J	\$5,898
PR4109TSV8C20-2	VxRail-500 IntelCPU 4109T 8C 2.0 GHz2ndH	J	\$5,898
PR4109TSV8C20F	VxRail-500 Intel CPU 4109T 8C 2.0 GHzHAF	J	\$5,898
PR4109TSV8C20F-2	VxRail-500 Intel CPU4109T 8C2.0GHzH2ndAF	J	\$5,898
PR4110SV8C21	VxRail-500 Intel CPU 4110 8C 2.1 GHz H	J	\$5,867
PR4110SV8C21-2	VxRail-500 Intel CPU 4110 8C 2.1GHz2ndH	J	\$5,867
PR4110SV8C21AF	VxRail-500 Intel CPU 4110 8C 2.1 GHz AF	J	\$5,867
PR4110SV8C21AF-2	VxRail-500 Intel CPU 4110 8C2.1GHz2ndAF	J	\$5,867
PR4112SV4C26	VxRail-500 Intel CPU 4112 4C 2.6 GHz H	J	\$5,956
PR4112SV4C26-2	VxRail-500 Intel CPU 4112 4C 2.6GHz 2ndH	J	\$5,956

PR4112SV4C26AF	VxRail-500 Intel CPU 4112 4C 2.6 GHz AF	J	\$5,956
PR4112SV4C26AF-2	VxRail-500 Intel CPU 4112 4C2.6GHz 2ndAF	J	\$5,956
PR4114SV10C22	VxRail-500 Intel CPU 4114 10C 2.2 GHz H	J	\$7,923
PR4114SV10C22-2	VxRail-500 Intel CPU 4114 10C 2.2GHz2ndH	J	\$7,923
PR4114SV10C22AF	VxRail-500 Intel CPU 4114 10C 2.2 GHz AF	J	\$7,923
PR4114SV10C22AF-2	VxRail-500 IntelCPU 4114 10C2.2GHz 2ndAF	J	\$7,923
PR4116SV12C21	VxRail-500 Intel CPU 4116 12C 2.1 GHz H	J	\$8,391
PR4116SV12C21-2	VxRail-500 Intel CPU 4116 12C 2.1GHz2ndH	J	\$8,391
PR4116SV12C21AF	VxRail-500 Intel CPU 4116 12C 2.1 GHz AF	J	\$8,391
PR4116SV12C21AF-2	VxRail-500IntelCPU 4116 12C 2.1 GHz2ndAF	J	\$8,391
PR5115GD10C24	VxRail-500 Intel CPU 5115 10C 2.4 GHz H	J	\$8,733
PR5115GD10C24-2	VxRail-500 Intel CPU 5115 10C 2.4GHz2ndH	J	\$8,733
PR5115GD10C24AF	VxRail-500 Intel CPU 5115 10C 2.4 GHz AF	J	\$8,733
PR5115GD10C24AF-2	VxRail-500IntelCPU 5115 10C 2.4 GHz2ndAF	J	\$8,733
PR5118GD12C23	VxRail-500 Intel CPU 5118 12C 2.3 GHz H	J	\$8,736
PR5118GD12C23-2	VxRail-500 Intel CPU 5118 12C 2.3GHz2ndH	J	\$8,736
PR5118GD12C23AF	VxRail-500 Intel CPU 5118 12C 2.3 GHz AF	J	\$8,736
PR5118GD12C23AF-2	VxRail-500IntelCPU 5118 12C 2.3 GHz2ndAF	J	\$8,736
PR5120GD14C22	VxRail-500 Intel CPU 5120 14C 2.2 GHz H	J	\$9,155
PR5120GD14C22-2	VxRail-500 Intel CPU 5120 14C 2.2GHz2ndH	J	\$9,155
PR5120GD14C22AF	VxRail-500 Intel CPU 5120 14C 2.2 GHz AF	J	\$9,155
PR5120GD14C22AF-2	VxRail-500IntelCPU 5120 14C 2.2 GHz2ndAF	J	\$9,155
PR5122GD4C35	VxRail-500 Intel CPU 5122 4C 3.5 GHz H	J	\$8,377
PR5122GD4C35-2	VxRail-500 Intel CPU 5122 4C 3.5 GHz2ndH	J	\$8,377
PR5122GD4C35AF	VxRail-500 Intel CPU 5122 4C 3.5 GHz AF	J	\$8,377
PR5122GD4C35AF-2	VxRail-500IntelCPU 5122 4C 3.5 GHz2ndAF	J	\$8,377
PR6126GD12C26	VxRail-500 Intel CPU 6126 12C 2.6 GHz H	J	\$9,510
PR6126GD12C26-2	VxRail-500 Intel CPU 6126 12C 2.6GHz2ndH	J	\$9,510
PR6126GD12C26AF	VxRail-500 Intel CPU 6126 12C 2.6 GHz AF	J	\$9,510
PR6126GD12C26AF-2	VxRail-500IntelCPU 6126 12C 2.6 GHz2ndAF	J	\$9,510
PR6128GD6C34	VxRail-500 Intel CPU 6128 6C 3.4 GHz H	J	\$9,330
PR6128GD6C34-2	VxRail-500 Intel CPU 6128 6C 3.4 GHz2ndH	J	\$9,330
PR6128GD6C34AF	VxRail-500 Intel CPU 6128 6C 3.4 GHz AF	J	\$9,330
PR6128GD6C34AF-2	VxRail-500IntelCPU 6128 6C 3.4 GHz2ndAF	J	\$9,330
PR6130GD16C21	VxRail-500 Intel CPU 6130 16C 2.1 GHz H	J	\$12,309
PR6130GD16C21-2	VxRail-500 Intel CPU 6130 16C 2.1GHz2ndH	J	\$12,309
PR6130GD16C21AF	VxRail-500 Intel CPU 6130 16C 2.1 GHz AF	J	\$12,309
PR6130GD16C21AF-2	VxRail-500IntelCPU 6130 16C 2.1 GHz2ndAF	J	\$12,309
PR6132GD14C26	VxRail-500 Intel CPU 6132 14C 2.6 GHz H	J	\$12,622
PR6132GD14C26-2	VxRail-500 Intel CPU 6132 14C 2.6GHz2ndH	J	\$12,622
PR6132GD14C26AF	VxRail-500 Intel CPU 6132 14C 2.6 GHz AF	J	\$12,622
PR6132GD14C26AF-2	VxRail-500IntelCPU 6132 14C 2.6 GHz2ndAF	J	\$12,622
PR6134GD8C32	VxRail-500 Intel CPU 6134 8C 3.2 GHz H	J	\$12,916
PR6134GD8C32-2	VxRail-500 Intel CPU 6134 8C 3.2 GHz2ndH	J	\$12,916
PR6134GD8C32AF	VxRail-500 Intel CPU 6134 8C 3.2 GHz AF	J	\$12,916
PR6134GD8C32AF-2	VxRail-500IntelCPU 6134 8C 3.2 GHz2ndAF	J	\$12,916
PR6134M8C32AF-2	VxRail-500IntelCPU6134M 8C 3.2 GHz2ndAF	J	\$15,329
PR6134MGD8C32	VxRail-500 Intel CPU 6134M 8C 3.2 GHz H	J	\$15,329
PR6134MGD8C32-2	VxRail-500 Intel CPU 6134M 8C 3.2GHz2ndH	J	\$15,329
PR6134MGD8C32AF	VxRail-500 Intel CPU 6134M 8C 3.2 GHz AF	J	\$15,329

PR6136GD12C30	VxRail-500 Intel CPU 6136 12C 3.0 GHz H	J	\$13,170
PR6136GD12C30-2	VxRail-500 Intel CPU 6136 12C 3.0GHz2ndH	J	\$13,170
PR6136GD12C30AF	VxRail-500 Intel CPU 6136 12C 3.0 GHz AF	J	\$13,170
PR6136GD12C30AF-2	VxRail-500IntelCPU 6136 12C 3.0 GHz2ndAF	J	\$13,170
PR6138GD20C20	VxRail-500 Intel CPU 6138 20C 2.0 GHz H	J	\$13,700
PR6138GD20C20-2	VxRail-500 Intel CPU 6138 20C 2.0GHz2ndH	J	\$13,700
PR6138GD20C20AF	VxRail-500 Intel CPU 6138 20C 2.0 GHz AF	J	\$13,700
PR6138GD20C20AF-2	VxRail-500IntelCPU 6138 20C 2.0 GHz2ndAF	J	\$13,700
PR6140GD18C23	VxRail-500 Intel CPU 6140 18C 2.3 GHz H	J	\$13,705
PR6140GD18C23-2	VxRail-500 Intel CPU 6140 18C 2.3GHz2ndH	J	\$13,705
PR6140GD18C23AF	VxRail-500 Intel CPU 6140 18C 2.3 GHz AF	J	\$13,705
PR6140GD18C23AF-2	VxRail-500IntelCPU 6140 18C 2.3 GHz2ndAF	J	\$13,705
PR6140M18C23AF-2	VxRail-500IntelCPU6140M 18C 2.3GHz2ndAF	J	\$16,449
PR6140MGD18C23	VxRail-500 Intel CPU 6140M 18C 2.3 GHz H	J	\$16,449
PR6140MGD18C23-2	VxRail-500 Intel CPU 6140M 18C2.3GHz2ndH	J	\$16,449
PR6140MGD18C23AF	VxRail-500 Intel CPU 6140M 18C 2.3 GHzAF	J	\$16,449
PR6142GD16C26	VxRail-500 Intel CPU 6142 16C 2.6 GHz H	J	\$13,759
PR6142GD16C26-2	VxRail-500 Intel CPU 6142 16C 2.6GHz2ndH	J	\$13,759
PR6142GD16C26AF	VxRail-500 Intel CPU 6142 16C 2.6 GHz AF	J	\$13,759
PR6142GD16C26AF-2	VxRail-500IntelCPU 6142 16C 2.6 GHz2ndAF	J	\$13,759
PR6142M16C26AF-2	VxRail-500IntelCPU 6142M16C 2.6 GHz2ndAF	J	\$17,349
PR6142MGD16C26	VxRail-500 Intel CPU 6142M 16C 2.6 GHz H	J	\$17,349
PR6142MGD16C26-2	VxRail-500 IntelCPU 6142M 16C 2.6GHz2ndH	J	\$17,349
PR6142MGD16C26AF	VxRail-500 Intel CPU 6142M 16C 2.6 GHzAF	J	\$17,349
PR6144GD8C35	VxRail-500 Intel CPU 6144 8C 3.5 GHz H	J	\$13,699
PR6144GD8C35-2	VxRail-500 Intel CPU 6144 8C 3.5 GHz2ndH	J	\$13,699
PR6144GD8C35AF	VxRail-500 Intel CPU 6144 8C 3.5 GHzAF	J	\$13,699
PR6144GD8C35AF-2	VxRail-500 IntelCPU 6144 8C 3.5GHz2ndAF	J	\$13,699
PR6146GD12C32	VxRail-500 Intel CPU 6146 12C 3.2 GHz H	J	\$14,299
PR6146GD12C32-2	VxRail-500 Intel CPU 6146 12C 3.2GHz2ndH	J	\$14,299
PR6146GD12C32AF	VxRail-500 Intel CPU 6146 12C 3.2 GHz AF	J	\$14,299
PR6146GD12C32AF-2	VxRail-500IntelCPU 6146 12C 3.2 GHz2ndAF	J	\$14,299
PR6148GD20C24	VxRail-500 Intel CPU 6148 20C 2.4 GHz H	J	\$13,919
PR6148GD20C24-2	VxRail-500 Intel CPU 6148 20C 2.4GHz2ndH	J	\$13,919
PR6148GD20C24AF	VxRail-500 Intel CPU 6148 20C 2.4 GHz AF	J	\$13,919
PR6148GD20C24AF-2	VxRail-500IntelCPU 6148 20C 2.4 GHz2ndAF	J	\$13,919
PR6150GD18C27	VxRail-500 Intel CPU 6150 18C 2.7 GHz H	J	\$14,659
PR6150GD18C27-2	VxRail-500 Intel CPU 6150 18C 2.7GHz2ndH	J	\$14,659
PR6150GD18C27AF	VxRail-500 Intel CPU 6150 18C 2.7 GHz AF	J	\$14,659
PR6150GD18C27AF-2	VxRail-500IntelCPU 6150 18C 2.7 GHz2ndAF	J	\$14,659
PR6152GD22C21	VxRail-500 Intel CPU 6152 22C 2.1 GHz H	J	\$14,769
PR6152GD22C21-2	VxRail-500 Intel CPU 6152 22C 2.1GHz2ndH	J	\$14,769
PR6152GD22C21AF	VxRail-500 Intel CPU 6152 22C 2.1 GHz AF	J	\$14,769
PR6152GD22C21AF-2	VxRail-500IntelCPU 6152 22C 2.1 GHz2ndAF	J	\$14,769
PR6154GD18C30	VxRail-500 Intel CPU 6154 18C 3.0 GHz H	J	\$14,749
PR6154GD18C30-2	VxRail-500 Intel CPU 6154 18C 3.0GHz2ndH	J	\$14,749
PR6154GD18C30AF	VxRail-500 Intel CPU 6154 18C 3.0 GHz AF	J	\$14,749
PR6154GD18C30AF-2	VxRail-500IntelCPU 6154 18C 3.0 GHz2ndAF	J	\$14,749
PR8153PT16C20	VxRail-500 Intel CPU 8153 16C 2.0 GHz H	J	\$14,279
PR8153PT16C20-2	VxRail-500 Intel CPU 8153 16C 2.0GHz2ndH	J	\$14,279

PR8153PT16C20AF	VxRail-500 Intel CPU 8153 16C 2.0 GHz AF	J	\$14,279
PR8153PT16C20AF-2	VxRail-500IntelCPU 8153 16C 2.0 GHz2ndAF	J	\$14,279
PR8160M24C21AF-2	VxRail-500IntelCPU8160M 24C 2.1GHz2ndAF	J	\$20,349
PR8160MPT24C21	VxRail-500 Intel CPU 8160M 24C 2.1 GHz H	J	\$20,349
PR8160MPT24C21-2	VxRail-500 Intel CPU 8160M 24C2.1GHz2ndH	J	\$20,349
PR8160MPT24C21AF	VxRail-500 Intel CPU 8160M 24C2.1 GHz AF	J	\$20,349
PR8160PT24C21	VxRail-500 Intel CPU 8160 24C 2.1 GHz H	J	\$16,589
PR8160PT24C21-2	VxRail-500 Intel CPU 8160 24C 2.1GHz2ndH	J	\$16,589
PR8160PT24C21AF	VxRail-500 Intel CPU 8160 24C 2.1 GHz AF	J	\$16,589
PR8160PT24C21AF-2	VxRail-500IntelCPU 8160 24C 2.1 GHz2ndAF	J	\$16,589
PR8164PT26C20	VxRail-500 Intel CPU 8164 26C 2.0 GHz H	J	\$18,789
PR8164PT26C20-2	VxRail-500 Intel CPU 8164 26C 2.0GHz2ndH	J	\$18,789
PR8164PT26C20AF	VxRail-500 Intel CPU 8164 26C 2.0 GHz AF	J	\$18,789
PR8164PT26C20AF-2	VxRail-500IntelCPU 8164 26C 2.0 GHz2ndAF	J	\$18,789
PR8168PT24C27	VxRail-500 Intel CPU 8168 24C 2.7 GHz H	J	\$18,509
PR8168PT24C27-2	VxRail-500 Intel CPU 8168 24C 2.7GHz2ndH	J	\$18,509
PR8168PT24C27AF	VxRail-500 Intel CPU 8168 24C 2.7 GHz AF	J	\$18,509
PR8168PT24C27AF-2	VxRail-500IntelCPU 8168 24C 2.7 GHz2ndAF	J	\$18,509
PR8170M26C21AF-2	VxRail-500IntelCPU 8170M 26C 2.1 GHz2AF	J	\$24,599
PR8170MPT26C21	VxRail-500 Intel CPU 8170M 26C 2.1 GHz H	J	\$24,599
PR8170MPT26C21-2	VxRail-500 Intel CPU 8170M 26C2.12ndGHzH	J	\$24,599
PR8170MPT26C21AF	VxRail-500 Intel CPU 8170M 26C 2.1 GHzAF	J	\$24,599
PR8170PT26C21	VxRail-500 Intel CPU 8170 26C 2.1 GHz H	J	\$20,849
PR8170PT26C21-2	VxRail-500 Intel CPU 8170 26C 2.1GHz2ndH	J	\$20,849
PR8170PT26C21AF	VxRail-500 Intel CPU 8170 26C 2.1 GHz AF	J	\$20,849
PR8170PT26C21AF-2	VxRail-500IntelCPU 8170 26C 2.1 GHz2ndAF	J	\$20,849
PR8176M28C21	VxRail-500 Intel CPU 8176M 28C 2.1 GHz H	J	\$26,479
PR8176M28C21-2	VxRail-500 Intel CPU 8176M 28C2.1GHz2ndH	J	\$26,479
PR8176M28C21AF	VxRail-500 Intel CPU 8176M 28C 2.1 GHzAF	J	\$26,479
PR8176M28C21AF-2	VxRail-500IntelCPU 8176M 28C 2.1 GHz2AF	J	\$26,479
PR8176PT28C21	VxRail-500 Intel CPU 8176 28C 2.1 GHz H	J	\$22,967
PR8176PT28C21-2	VxRail-500 Intel CPU 8176 28C 2.1GHz2ndH	J	\$22,967
PR8176PT28C21AF	VxRail-500 Intel CPU 8176 28C 2.1 GHz AF	J	\$22,967
PR8176PT28C21AF-2	VxRail-500IntelCPU 8176 28C 2.1 GHz2ndAF	J	\$22,967
PR8180M28C25-2	VxRail-500Intel CPU 8180M 28C 2.5GHz2ndH	J	\$28,799
PR8180M28C25AF-2	VxRail-500Intel CPU 8180M 28C 2.5GHz2ndF	J	\$28,799
PR8180MPT28C25	VxRail-500 Intel CPU 8180M 28C 2.5 GHz H	J	\$28,799
PR8180MPT28C25AF	VxRail-500 Intel CPU 8180M28C 2.5 GHz AF	J	\$28,799
PR8180PT28C25	VxRail-500 Intel CPU 8180 28C 2.5 GHz H	J	\$25,829
PR8180PT28C25-2	VxRail-500 Intel CPU 8180 28C 2.5GHz2ndH	J	\$25,829
PR8180PT28C25AF	VxRail-500 Intel CPU 8180 28C 2.5 GHz AF	J	\$25,829
PR8180PT28C25AF-2	VxRail-500IntelCPU 8180 28C 2.5 GHz2ndAF	J	\$25,829
PR-NO-2ND-PROC	HCIA NO SECOND PROCESSOR	J	\$0
PR-NO-2ND-PROCVXR5	VxRail-500 NO SECOND PROCESSOR	J	\$0
PS1100W110220VACF	VxR-500 DUALHOTPLG 1100W PS100V-240VAC F	J	\$0
PS1100W110220VACH	VxRail-500 DUALHOTPLG1100WPS100V-240VACH	J	\$0
PS1100W-380VDCF	VxRail-500 DUALHOTPLG 1100W PS-380VDC F	J	\$913
PS1100W-380VDCH	VxRail-500 DUALHOTPLG 1100W PS-380VDC H	J	\$913
PS1100W-48VDCF	VxRail-500 DUAL HOTPLG 1100W PS-48VDC F	J	\$1,501
PS1100W-48VDCH	VxRail-500 DUAL HOTPLG 1100W PS-48VDC H	J	\$1,501

PS1100WPSF	VxRail-500 DUAL HOTPLG 1100W PS F	J	\$825
PS1100WPSH	VxRail-500 DUAL HOTPLG 1100W PS H	J	\$825
PS1600W-250VACF	VxRail-500 DUALHOTPLG 1600W PS-250VAC F	J	\$893
PS1600W-250VACH	VxRail-500 DUALHOTPLG 1600W PS-250VAC H	J	\$893
PS2000W-240VACF	VxRail-500 DUALHOTPLG 2000W PS 240V AC F	J	\$1,049
PS2000W-240VACH	VxRail-500 DUALHOTPLG 2000W PS 240V AC H	J	\$1,049
PWR13-14-2M-ARG	C13-C14 PDU RACK JUMPERCRD 2M ARGENTIN	J	\$12
PWR13-14-2M-AUS	C13-C14 250V PDU RACK PWR CRD 2M AUS	J	\$0
PWR13-14-2M-EMEA	C13-C14 PDU RACK PWR CRD 2M EMEA	J	\$0
PWR13-14-2M-EURO	C13-C14 PDU RACK JUMPERCRD 2M EURO STY	J	\$0
PWR13-14-2M-IND	C13-C14 PDU RACK JUMPER CRD 2M INDIA	J	\$0
PWR13-14-2M-JPN	C13-C14 PDU RACK PWR CRD 2M JPN	J	\$0
PWR13-14-2M-SMGUAM	C13-C14 PDU RACK JUMPERCRD 2M GM,SMA	J	\$0
PWR13-14-4M-ANZ	C13-C14 PDU RACK JUMPERCRD 4M ANZ	J	\$0
PWR13-14-4M-ARG	C13-C14 PDU RACK JUMPERCRD 4M ARGENTIN	J	\$21
PWR13-14-4M-CH-K	C13-C14 PDU RACK JUMPER CRD 4M GR CH KO	J	\$0
PWR13-14-4M-EMEA	C13-C14 PDU RACK PWR CRD 4M EMEA	J	\$30
PWR13-14-4M-EURO	C13-C14 PDU RACK JUMPERCRD 4M EURO STY	J	\$0
PWR13-14-4M-IND	C13-C14 PDU RACK JUMPER CRD 4M INDIA	J	\$0
PWR13-14-4M-JPN	2-PACK C13-C14 PDU RACK PWR CRDS JPN	J	\$0
PWR13-14-4M-SMGUAM	C13-C14 PDU RACK JUMPERCRD 4M GM,SMA	J	\$0
PWR13-BS1363-2M	C13 PWRCORD W/BS1363/SS145/A 250V 10A 2M	J	\$0
PWR13-BS456	C13 PWRCORD W/ BS546 PLUG 250V 10A	J	\$0
PWR13-BS546-2M	PowerCord C13 BS546 2M 250V 10A SAF	J	\$0
PWR13-BSI1363	C13 PWRCORD W/ BSI 1363 250V 10A	J	\$0
PWR13-CEE7-7	C13 PWRCORD W/ CEE7/7 PLUG 250V 10A	J	\$0
PWR13-CEI23-16	C13 PWRCORD W/ CEI 23-16 250V 10A	J	\$0
PWR13-CEI23-50-2M	C13 PWRCORD W/ CEI 23-50 250V 10A 2M	J	\$0
PWR13-CNS690	C13 PWRCORD W/ CNS 690 125V,15A,3M,C13	J	\$0
PWR13-GB1002	C13 PWRCORD W/ GB1002 250V 2M	J	\$0
PWR13-IN6SA3	C13 PWRCORD W/ IS 1293 1.8M INDIA	J	\$0
PWR13-IRAM2073	C13 PWRCORD W/ IRSM 2073 250V 10 A 2.5M	J	\$0
PWR13-JISC8303	C13 CORD JISC8303 125V 10A - NON DPE	J	\$0
PWR13-KSC8305	C13 PWRCORD W/ KS C 8305 220V 2M	J	\$0
PWR13-NBR14136	C13 PWRCORD W/ NBR 14136 250V 10A	J	\$0
PWR13-NEMA5-15P-3M	C13 PWRCORD W/ NEMA5-15P 125V 15A 3M	J	\$0
PWR13-SAA3	C13 PWRCORD W/ SAA/3 PLUG 250V 10A	J	\$0
PWR13-SEV1011	C13 PWRCORD W/ SEV1011 PLUG 250V 10A	J	\$0
PWR13-SI-32	C13 PWRCORD W/ SI-32 PLUG 250V 10A	J	\$0
PWR13-TI16S3	HCIA 2 C13PWR CRDS TI16S3 PLUG	J	\$0
PWR200VRACK	C13-C14 PDU RACK PWR CRD 2M N. AM	J	\$0
PWR2400W-240VACF	VxRail-500 DUALHOTPLG 2400W PS 240V AC F	J	\$1,559
PWR2400W-240VACH	VxRail-500 DUALHOTPLG 2400W PS 240V AC H	J	\$1,559
PWR400VRACK	C13-C14 PDU RACK PWR CRD 4M N. AM	J	\$0
PWRC13-1.8MSCHUKO	PowerCrd C13 1.8M Schuko Plug CMBD	J	\$0
PWRC13AFSNIT107	C13 CORD W/ AFSNIT 107-2-D1 250V 10A	J	\$0
PWRC13-NEMA5-15P	C13 CORD NEMA 5-15 125V 10A - NON DPE	J	\$0
PWR-C13-SCHUCO	HCIA C13PWR CORD 250V,10A,1.8M,SCHUCO	J	\$0
PWRC1920-12F-JPN-U	VXR C19-C20 PduRack Jumper 12F JAPAN U	J	\$12
PWRC19-20-12FT-EUR	VXR500 C19-C20 PDURACK JMP CRD 12FT EURC	J	\$0

PWRC19-20-12FT-JPN	VXR C19-C20 PDURACK JUMPER CRD 12F JAPA	J	\$0
PWRC19C20-12F-CH-U	VXR C19-C20 PduRack Jumper 12FT CHN U	J	\$12
PWRC19-C20-12FT-CH	VXR C19-C20 PDU RACK JUMPER CRD 12FT CHI	J	\$0
PWRC19-C20-12FT-KR	VXR C19-C20 PDURACK JUMPR CRD 12FT KORE	J	\$0
PWRC19C20-12FT-K-U	VXR C19-C20 PduRack Jumper 12FT KOREA U	J	\$12
PWRC19C20-2F-ANZ-U	VXR C19-C20 PduRack Jumper 2FT ANZ U	J	\$11
PWRC19-C20-2F-JP-U	VXR C19-C20 PduRack Jumper 2F JAPAN U	J	\$11
PWRC19-C20-2FT250V	VXRIL500C19-C20 PDU RACK JUMPER CRD 2F	J	\$0
PWRC19-C20-2FT-ANZ	VXR C19-C20 PDU RACK JUMPER CRD 2FT ANZ	J	\$0
PWRC19-C20-2FT-JPN	VXR C19-C20 PDU RACK JUMPER CRD 2F JAPAN	J	\$0
PWRC19-C20-2FT-NAM	VXR C19-C20 PDURACK JUMPER CRD 2F NAM	J	\$0
PWRC19C20-2FT-NA-U	VXR C19-C20 PduRack Jumper 2F NAM U	J	\$11
PWRC19-C20-2FT-USA	VXR C19-C20 PDU RACK JUMPER CRD 2FT USA	J	\$0
PWRC19C20-2F-USA-U	VXR C19-C20 PduRack Jumper 2FT USA U	J	\$11
PWRC19-C20-2M-AUS	VXR C19-C20 PDU RACK JUMPER CRD 2.4M AUS	J	\$0
PWRC19C20-2M-AUS-U	VXR C19-C20 PduRack Jumper 2.4M AUS U	J	\$13
PWRC19-C20-2M-IND	VXR C19-C20 PDU RACK JUMPER CRD 2.5M IND	J	\$0
PWRC19C20-2M-IND-U	VXR C19-C20 PduRack Jumper 2.5M IND U	J	\$13
PWRC19-C20-2M-NAM	VXR C19-C20 PDURACK JUMPER CRD 2.5M NAM	J	\$0
PWRC19-C20-2M-UK	VXR C19-C20 PDU RACK JUMPER CRD 2.5M UK	J	\$0
PWRC19-C20-APJ	VxRail500C19-C20 PDU RACK JUMPER CRD APJ	J	\$0
PWRC19-C20-APJ-U	VXR C19-C20 PduRack Jumper APJ U	J	\$10
Q-08C17V40128RJ	ND 8C1.7GHZ 1XE5-2609V4 128GB 1GBE	J	\$7,963
Q-08C17V4064RJ	ND 8C1.7GHZ 1XE5-2609V4 64GB 1GBE	J	\$6,556
Q-1200GB-HDD	HCIA 1.2TB 2.5" 10K RPM SAS 512bps	J	\$892
Q-1200PWR-SUPP	HCIA 1200W Power Supply	J	\$594
Q-12C128GB-RJ45	HCIA Node 12core CPU 128GBMem 10GE RJ45	J	\$10,474
Q-12C128GB-SFP+	HCIA Node 12core CPU 128GBMem 10GE SFP+	J	\$10,474
Q-12C192GB-RJ45	HCIA Node 12core CPU 192GBMem 10GE RJ45	J	\$12,013
Q-12C192GB-SFP+	HCIA Node 12core CPU 192GBMem 10GE SFP+	J	\$12,013
Q-12C256GB-RJ45-12	Node 12core CPU 256GBMem 10GE RJ45 12G	J	\$13,305
Q-12C256GB-SFP+-12	Node 12core CPU 256GBMem 10GE SFP+ 12G	J	\$13,305
Q-1600PWR-SUPP	HCIA 1600W Power Supply	J	\$701
Q-16C21V4128RJ	ND 16C2.1GHZ 2XE5-2620V4 128GB RJ45	J	\$12,991
Q-16C21V4128RJAF	ND 16C2.1GHZ 2XE5-2620V4 128GB RJ45 AF	J	\$12,991
Q-16C21V4128SFP	ND 16C2.1GHZ 2XE5-2620V4 128GB SFP	J	\$12,991
Q-16C21V4128SFP AF	ND 16C2.1GHZ 2XE5-2620V4 128GB SFP AF	J	\$12,991
Q-16C21V4256RJ	ND 16C2.1GHZ 2XE5-2620V4 256GB RJ45	J	\$16,557
Q-16C21V4256RJAF	ND 16C2.1GHZ 2XE5-2620V4 256GB RJ45 AF	J	\$16,557
Q-16C21V4256SFP	ND 16C2.1GHZ 2XE5-2620V4 256GB SFP	J	\$16,557
Q-16C21V4256SFP AF	ND 16C2.1GHZ 2XE5-2620V4 256GB SFP AF	J	\$16,557
Q-16C21V4384RJ	ND 16C2.1GHZ 2XE5-2620V4 384GB RJ45	J	\$20,123
Q-16C21V4384RJAF	ND 16C2.1GHZ 2XE5-2620V4 384GB RJ45 AF	J	\$20,123
Q-16C21V4384SFP	ND 16C2.1GHZ 2XE5-2620V4 384GB SFP	J	\$20,123
Q-16C21V4384SFP AF	ND 16C2.1GHZ 2XE5-2620V4 384GB SFP AF	J	\$20,123
Q-16C21V4512RJ	ND 16C2.1GHZ 2XE5-2620V4 512GB RJ45	J	\$23,689
Q-16C21V4512RJAF	ND 16C2.1GHZ 2XE5-2620V4 512GB RJ45 AF	J	\$23,689
Q-16C21V4512SFP	ND 16C2.1GHZ 2XE5-2620V4 512GB SFP	J	\$23,689
Q-16C21V4512SFP AF	ND 16C2.1GHZ 2XE5-2620V4 512GB SFP AF	J	\$23,689
Q-16C256GB-RJ45	HCIA Node 16core CPU 256GBMem 10GE RJ45	J	\$20,483

Q-16C256GB-RJ45-12	Node 16core CPU 256GBMem 10GE RJ45 12G	J	\$20,146
Q-16C256GB-SFP+	HCIA Node 16core CPU 256GBMem 10GE SFP+	J	\$20,483
Q-16C256GB-SFP+-12	Node 16core CPU 256GBMem 10GE SFP+ 12G	J	\$20,146
Q-16C512GB-RJ45	HCIA Node 16core CPU 512GBMem 10GE RJ45	J	\$28,276
Q-16C512GB-RJ45-12	Node 16core CPU 512GBMem 10GE RJ45 12G	J	\$28,354
Q-16C512GB-SFP+	HCIA Node 16core CPU 512GBMem 10GE SFP+	J	\$28,276
Q-16C512GB-SFP+-12	Node 16core CPU 512GBMem 10GE SFP+ 12G	J	\$28,354
Q-2000GB-HDD	HCIA 2.0TB 2.5" 7.2K RPM SAS	J	\$1,541
Q-200G-SSD	2.5in 200GB SC+ HGST SSD QNTA	J	\$1,669
Q-20C22V4128RJ	ND 20C2.2GHZ 2XE5-2630V4 128GB RJ45	J	\$15,997
Q-20C22V4128RJAF	ND 20C2.2GHZ 2XE5-2630V4 128GB RJ45 AF	J	\$15,997
Q-20C22V4128SFP	ND 20C2.2GHZ 2XE5-2630V4 128GB SFP	J	\$15,997
Q-20C22V4128SFP AF	ND 20C2.2GHZ 2XE5-2630V4 128GB SFP AF	J	\$15,997
Q-20C22V4256RJ	ND 20C2.2GHZ 2XE5-2630V4 256GB RJ45	J	\$19,826
Q-20C22V4256RJAF	ND 20C2.2GHZ 2XE5-2630V4 256GB RJ45 AF	J	\$19,826
Q-20C22V4256SFP	ND 20C2.2GHZ 2XE5-2630V4 256GB SFP	J	\$19,826
Q-20C22V4256SFP AF	ND 20C2.2GHZ 2XE5-2630V4 256GB SFP AF	J	\$19,826
Q-20C22V4384RJ	ND 20C2.2GHZ 2XE5-2630V4 384GB RJ45	J	\$23,655
Q-20C22V4384RJAF	ND 20C2.2GHZ 2XE5-2630V4 384GB RJ45 AF	J	\$23,655
Q-20C22V4384SFP	ND 20C2.2GHZ 2XE5-2630V4 384GB SFP	J	\$23,655
Q-20C22V4384SFP AF	ND 20C2.2GHZ 2XE5-2630V4 384GB SFP AF	J	\$23,655
Q-20C22V4512RJ	ND 20C2.2GHZ 2XE5-2630V4 512GB RJ45	J	\$27,483
Q-20C22V4512RJAF	ND 20C2.2GHZ 2XE5-2630V4 512GB RJ45 AF	J	\$27,483
Q-20C22V4512SFP	ND 20C2.2GHZ 2XE5-2630V4 512GB SFP	J	\$27,483
Q-20C22V4512SFP AF	ND 20C2.2GHZ 2XE5-2630V4 512GB SFP AF	J	\$27,483
Q-20C256GB-RJ45	HCIA Node 20core CPU 256GBMem 10GE RJ45	J	\$27,551
Q-20C256GB-RJ45-12	Node 20core CPU 256GBMem 10GE RJ45 12G	J	\$27,214
Q-20C256GB-SFP+	HCIA Node 20core CPU 256GBMem 10GE SFP+	J	\$27,551
Q-20C256GB-SFP+-12	Node 20core CPU 256GBMem 10GE SFP+ 12G	J	\$27,214
Q-20C512GB-RJ45	HCIA Node 20core CPU 512GBMem 10GE RJ45	J	\$35,344
Q-20C512GB-RJ45-12	Node 20core CPU 512GBMem 10GE RJ45 12G	J	\$35,421
Q-20C512GB-SFP+	HCIA Node 20core CPU 512GBMem 10GE SFP+	J	\$35,344
Q-20C512GB-SFP+-12	Node 20core CPU 512GBMem 10GE SFP+ 12G	J	\$35,421
Q-24C22V4128RJAF	ND 24C2.2GHZ 2XE5-2650V4 128GB RJ45 AF	J	\$20,944
Q-24C22V4128SFP AF	ND 24C2.2GHZ 2XE5-2650V4 128GB SFP AF	J	\$20,944
Q-24C22V4256RJAF	ND 24C2.2GHZ 2XE5-2650V4 256GB RJ45 AF	J	\$24,772
Q-24C22V4256SFP AF	ND 24C2.2GHZ 2XE5-2650V4 256GB SFP AF	J	\$24,772
Q-24C22V4384RJAF	ND 24C2.2GHZ 2XE5-2650V4 384GB RJ45 AF	J	\$28,601
Q-24C22V4384SFP AF	ND 24C2.2GHZ 2XE5-2650V4 384GB SFP AF	J	\$28,601
Q-24C22V4512RJAF	ND 24C2.2GHZ 2XE5-2650V4 512GB RJ45 AF	J	\$32,429
Q-24C22V4512SFP AF	ND 24C2.2GHZ 2XE5-2650V4 512GB SFP AF	J	\$32,429
Q-24C256GB-RJ45-12	Node 24core CPU 256GBMem 10GE RJ45 12G	J	\$29,950
Q-24C256GB-SFP+-12	Node 24core CPU 256GBMem 10GE SFP+ 12G	J	\$29,950
Q-24C512GB-RJ45-12	Node 24core CPU 512GBMem 10GE RJ45 12G	J	\$38,157
Q-24C512GB-SFP+-12	Node 24core CPU 512GBMem 10GE SFP+ 12G	J	\$38,157
Q-28C24V4128SFP AF	ND 28C2.4GHZ 2XE5-2680V4 128GB SFP AF	J	\$25,786
Q-28C24V4256SFP AF	ND 28C2.4GHZ 2XE5-2680V4 256GB SFP AF	J	\$29,615
Q-28C24V4384SFP AF	ND 28C2.4GHZ 2XE5-2680V4 384GB SFP AF	J	\$33,443
Q-28C24V4512SFP AF	ND 28C2.4GHZ 2XE5-2680V4 512GB SFP AF	J	\$37,272
Q-28C256GB-RJ45-12	Node 28core CPU 256GBMem 10GE RJ45 12G	J	\$30,064

Q-28C256GB-SFP+-12	Node 28core CPU 256GBMem 10GE SFP+ 12G	J	\$30,064
Q-28C512GB-RJ45-12	Node 28core CPU 512GBMem 10GE RJ45 12G	J	\$38,271
Q-28C512GB-SFP+-12	Node 28core CPU 512GBMem 10GE SFP+ 12G	J	\$38,271
Q-32C21V4128SFPAF	ND 32C2.1GHZ 2XE5-2683V4 128GB SFP AF	J	\$26,728
Q-32C21V4256SFPAF	ND 32C2.1GHZ 2XE5-2683V4 256GB SFP AF	J	\$30,556
Q-32C21V4384SFPAF	ND 32C2.1GHZ 2XE5-2683V4 384GB SFP AF	J	\$34,385
Q-32C21V4512SFPAF	ND 32C2.1GHZ 2XE5-2683V4 512GB SFP AF	J	\$38,214
Q-3800G-SSD	HCIA 3.8TB SSD in 2.5	J	\$8,906
Q-400G-SSD	HCIA 400GB SSD in 2.5	J	\$3,027
Q-6C64GB-RJ45	HCIA Node 6core CPU 64GBMem 1GE RJ45	J	\$5,908
Q-800G-SSD	HCIA 800GB SSD in 2.5	J	\$5,325
Q-CHAS-1600PS-FN12	HCIA Chassis w/ 1600W PS and Fan 12G	J	\$4,816
Q-CHASSIS-1200PS12	HCIA Chassis w/ 1200 PS and Fan 12G	J	\$4,528
Q-CHASSIS-1600PS12	HCIA Chassis w/ 1600 PS and Fan 12G	J	\$4,816
Q-FAN	HCIA Fan	J	\$89
RAILKIT1U1NHAF	VxRail-500 A8 RRAILS 2-4POSTRACKS1U1N AF	J	\$52
RAILKIT1U1NU	HCIA A8 ReadyRails 2-4 Post Racks 1U1N U	J	\$98
RAILKIT2U1NAF	VxRail-500 B4 RDYRAILS2-4POSTRACKS2U1NAF	J	\$52
RAILKIT2U1NU	HCIA B4 ReadyRails 2-4 Post Racks 2U1N U	J	\$98
RDIMM2666INFO	VxRail-500 FactoryOrd Rq 2666Mhz RDIMMs	J	\$0
RISER640CNFG2DUAL	VxRail-500 RISER R640 CONFIG2 LP	J	\$19
RISER640CNFG4SNGL	VxRail-500 RISER R640 CONFIG4 LP	J	\$19
RISER740CNFG1SNGL	VxRail-500 RISER R740 CONFIG1	J	\$690
RISER740CNFG4DUAL	VxRail-500 RISER R740 CONFIG4	J	\$819
RISER740CNFG6DUAL	VxRail-500 RISER R740CNFG6 AND BOSS CTR	J	\$277
RISERR740S5701S2S	VxRail-500 RISER R740 S570 1B 2B	J	\$68
RRAILKIT1U1NCMAAF	VxRail-500 A7 RRAILS II WITH CMA 1U1N AF	J	\$199
RRAILKIT1U1NCMAH	VxRail-500 A7 READYRAILS II W/CMA 1U1N	J	\$199
RRAILKIT1U1NCMAU	HCIA Cable Management Arm Only 1U1N U	J	\$98
RRAILKIT1U1NH	VxRail-500 A8READYRAILS2-4 POSTRACKS1U1N	J	\$52
RRAILKIT1U1NNOCMAF	VxRail-500 A7 RRAILS II W/O CMA 1U1N AF	J	\$157
RRAILKIT1U1NNOCMAH	VxRail-500 A7 READYRAILS II W/O CMA 1U1N	J	\$157
RRAILKIT1U1NNOCMAU	HCIA A7 ReadyRails II Without CMA 1U1N U	J	\$146
RRAILKIT2U1NCMAAF	VxRail-500 B6 READYRAILS II W/CMA 2U1NAF	J	\$199
RRAILKIT2U1NCMAH	VxRail-500 B6 READYRAILS II W/CMA 2U1N H	J	\$199
RRAILKIT2U1NCMAU	HCIA Cable Management Arm Only 2U1N U	J	\$98
RRAILKIT2U1NH	VxRail-500 B4 RR 2-4 POST RACKS 2U1NH	J	\$52
RRAILKIT2U1NNOCMAF	VxRail-500 B6 READYRAILS IIW/OCMA 2U1NAF	J	\$157
RRAILKIT2U1NNOCMAH	VxRail-500 B6 READYRAILS II W/O CMA 2U1N	J	\$157
RRAILKIT2U1NNOCMAU	HCIA B6 ReadyRails II Without CMA 2U1N U	J	\$146
SCAX4-5	SAN COPY FOR THE AX4-5	J	\$0
SCE100	SAN COPY/E AX100	J	\$2,000
SCE100-KIT	SAN COPY/E MEDIA AX100	J	\$0
SH-458-000-249	DELL EMC Automation 1YR PP PS-4=ZC	J	\$611
SH-458-000-250	DELL EMC Automation 36Mo+ Sub PS -4=ZC	J	\$556
SH-458-000-251	DELL EMC Automation 1YR PP PSM -4=ZC	J	\$614
SH-458-000-252	DELL EMC Automation 36Mo+ Sub PSM -4=ZC	J	\$558
SH-458-000-253	DELL EMC Automation 36Mo+PP Sub PS -4=ZC	J	\$500
SH-458-000-254	DELL EMC Automation 36Mo+PP Sub PSM-4=ZC	J	\$502
SH-458-000-376	DELL EMC Automation SW W/Dell CSP=ZC	J	\$0

SH-458-000-377	DELL EMC Automation W/Third Party CSP=ZC	J	\$0
SH-458-000-378	DELL EMC Automation W/Microsoft CSP=ZC	J	\$0
SH-458-000-382	OMNM 25 Devices 1 YR PP Sub PS=ZC	J	\$169
SH-458-000-383	OMNM 25 Devices 36Mo Sub PS=ZC	J	\$153
SH-458-000-384	OMNM 25 Devices 36Mo PP Sub PS=ZC	J	\$139
SH-458-000-385	OMNM 25 Devices 1 YR PP Sub PSM=ZC	J	\$169
SH-458-000-386	OMNM 25 Devices 36Mo Sub PSM=ZC	J	\$153
SH-458-000-387	OMNM 25 Devices 36Mo PP Sub PSM=ZC	J	\$139
SH-458-000-388	DELL EMC Automation 36Mo+ Sub PS -8=ZC	J	\$417
SH-458-000-389	DELL EMC Automation 36Mo+ PP Sub PS-8=ZC	J	\$375
SH-458-000-390	DELL EMC Automation 1YR PP PS -8=ZC	J	\$458
SH-458-000-391	DELL EMC Automation 36Mo+ Sub PSM-8=ZC	J	\$419
SH-458-000-392	DELL EMC Automation 36Mo+PP Sub PSM-8=ZC	J	\$377
SH-458-000-393	DELL EMC Automation 1YR PP PSM -8=ZC	J	\$461
SH-458-000-394	DELL EMC Automation 36Mo+ Sub PS -12=ZC	J	\$370
SH-458-000-395	DELL EMC Automation 1YR PP PS -12=ZC	J	\$407
SH-458-000-396	DELL EMC Automation 36Mo+ Sub PSM -12=ZC	J	\$373
SH-458-000-397	DELL EMC Automation36Mo+PP Sub PSM-12=ZC	J	\$336
SH-458-000-398	DELL EMC Automation 1YR PP PSM -12=ZC	J	\$410
SH-458-000-399	DELL EMC Automation 36Mo+PP Sub PS-12=ZC	J	\$333
SH-458-000-441	CloudLink 6.6 MAS PSMC 1 Yr T1=IB	J	\$26
SH-458-000-442	CloudLink 6.6 MAS PSMC 1 Yr Tr 2=IB	J	\$22
SH-458-000-443	CloudLink 6.6 MAS PSMC 1 Yr Tr 3=IB	J	\$19
SH-458-000-444	CloudLink 6.6 MAS PSMC 1 Yr Tr 4=IB	J	\$14
SH-458-000-445	CloudLink 6.6 MAS PS 1 Yr Tr 1=IB	J	\$26
SH-458-000-446	CloudLink 6.6 MAS PS 1 Yr Tr 2=IB	J	\$21
SH-458-000-447	CloudLink 6.6 MAS PS 1 Yr Tr 3=IB	J	\$18
SH-458-000-448	CloudLink 6.6 MAS PS 1 Yr Tr 4=IB	J	\$14
SH-458-000-449	CloudLink MAS PSMC 36Mo+ Sub PP Tr1=IB	J	\$22
SH-458-000-450	CloudLink MAS PSMC 36Mo+ Sub Tr1=IB	J	\$24
SH-458-000-451	CloudLink MAS PSMC 36Mo+ Sub PP Tr2=IB	J	\$18
SH-458-000-452	CloudLink MAS PSMC 36Mo+ Sub Tr2=IB	J	\$20
SH-458-000-453	CloudLink MAS PSMC 36Mo+ Sub PP Tr3=IB	J	\$15
SH-458-000-454	CloudLink MAS PSMC 36Mo+ Sub Tr3=IB	J	\$17
SH-458-000-455	CloudLink MAS PSMC 36Mo+ Sub PP Tr4=IB	J	\$12
SH-458-000-456	CloudLink MAS PSMC 36Mo+ Sub Tr4=IB	J	\$13
SH-458-000-457	CloudLink MAS PS 36Mo+ Sub?PP Tr 1=IB	J	\$21
SH-458-000-458	CloudLink MAS PS 36Mo+ Sub Tr 1=IB	J	\$24
SH-458-000-459	CloudLink MAS PS 36Mo+ Sub PP Tr 2=IB	J	\$18
SH-458-000-460	CloudLink MAS PS 36Mo+ Sub Tr 2=IB	J	\$19
SH-458-000-461	CloudLink MAS PS 36Mo+ Sub PP Tr 3=IB	J	\$15
SH-458-000-462	CloudLink MAS PS 36Mo+ Sub Tr 3=IB	J	\$17
SH-458-000-463	CloudLink MAS PS 36Mo+ Sub PP Tr 4=IB	J	\$12
SH-458-000-464	CloudLink MAS PS 36Mo+ Sub Tr 4=IB	J	\$13
SH-458-000-492	OMNM 25 Devices 36Mo+ Sub PS=ZC	J	\$153
SH-458-000-493	OMNM 25 Devices 36Mo+ PP Sub PS=ZC	J	\$139
SH-458-000-494	OMNM 25 Devices 36Mo+ Sub PSM=ZC	J	\$153
SH-458-000-495	OMNM 25 Devices 36Mo+ PP Sub PSM=ZC	J	\$139
SSD1600GB10WPD25AU	S470 CACHE SSD 1600GB 10WPD 2.5 INCH UPG	J	\$6,128
SSD1600GB10WPD25F	VxRail-500 CACHESSD 1600GB10WP 2.5INCH F	J	\$5,444

SSD1600GB10WPD25U	HCIA CACHE SSD 1600GB 10WPD 2.5 INCH UPG	J	\$6,128
SSD1600GB10WPD25V5	VxRail-500 CACHE SSD 1600GB 10WP 2.5INCH	J	\$5,444
SSD1600GB25S570	VxRail-500CACHESSD S570 1600GB 10WPD2.5I	J	\$5,444
SSD400GB10W25S570	VxRail-500CACHESSD S570 400GB 10WPD 2.5I	J	\$1,957
SSD400GB10WPD25AU	S470 CACHE SSD 400GB 10WPD 2.5 INCH UPG	J	\$2,043
SSD400GB10WPD25F	VxRail-500 CACHESSD 400GB10WPD 2.5INCH F	J	\$1,957
SSD400GB10WPD25U	HCIA CACHE SSD 400GB 10WPD 2.5 INCH UPG	J	\$2,043
SSD400GB10WPD25VX5	VxRail-500 CACHE SSD 400GB 10WPD 2.5INCH	J	\$1,957
SSD800GB10W25S570	VxRail-500CACHESSD S570 800GB 10WPD 2.5I	J	\$3,431
SSD800GB10WPD25AU	S470 CACHE SSD 800GB 10WPD 2.5 INCH UPG	J	\$4,085
SSD800GB10WPD25F	VxRail-500 CACHESSD 800GB10WPD 2.5INCH F	J	\$3,431
SSD800GB10WPD25U	HCIA CACHE SSD 800GB 10WPD 2.5 INCH UPG	J	\$4,085
SSD800GB10WPD25VX5	VxRail-500 CACHE SSD 800GB 10WPD 2.5INCH	J	\$3,431
SVAX4-5	SNAPVIEW FOR THE AX4-5	J	\$0
SYS6401U1N10D	VxRail-500 1U1N 10x2.5 NON-NVMe H	J	\$4,029
SYS6401U1N10DAF	VxRail-500 1U1N 10x2.5 NON-NVMe AF	J	\$8,359
SYS6401U1N10DAFX	VxRail-500 1U1N 10x2.5 NON-NVMe GC AF	J	\$8,359
SYS6401U1N10DNAF	VxRail-500 1U1N 10x2.5 NVMe Capable AF	J	\$9,259
SYS6401U1N10DNBRF	VxRail-500 1U1N 10x2.5 NVMe Capable BR F	J	\$9,259
SYS6401U1N10DNBRH	VxRail-500 1U1N 10x2.5 NVMe Capable BR H	J	\$4,929
SYS6401U1N10DX	VxRail-500 1U1N 10x2.5 NON-NVMe GC H	J	\$4,029
SYS6401U1N10NDH	VxRail-500 1U1N 10x2.5 NVMe Capable H	J	\$4,929
SYS7402U1N12D	VxRail-500 2U1N 12x3.5 DISK SLTS H	J	\$7,494
SYS7402U1N12DX	VxRail-500 2U1N 12x3.5 DISK SLTS GC H	J	\$7,494
SYS7402U1N24D	VxRail-500 2U1N 24x2.5 NON-NVMe H	J	\$5,173
SYS7402U1N24DAF	VxRail-500 2U1N 24x2.5 NON-NVMe AF	J	\$9,502
SYS7402U1N24DAFX	VxRail-500 2U1N 24x2.5 NON-NVMe AF GC	J	\$9,502
SYS7402U1N24DNVBRF	VxRail-500 2U1N 24x2.5 NVMe Capable BR F	J	\$10,402
SYS7402U1N24DNVBRH	VxRail-500 2U1N 24x2.5 NVMe Capable BR H	J	\$6,073
SYS7402U1N24DNVF	VxRail-500 2U1N 24x2.5 NVMe Capable AF	J	\$10,402
SYS7402U1N24DX	VxRail-500 2U1N 24x2.5 NON-NVMe GC H	J	\$5,173
SYS7402U1N24NVD	VxRail-500 2U1N 24x2.5 NVMe Capable H	J	\$6,073
SYS7402U1NG24D	VxRail-500 2U1N GPU 24x2.5 DISK SLTS H	J	\$7,389
SYS7402U1NG24DAF	VxRail-500 2U1N GPU 24x2.5 DISKSLT AF	J	\$11,719
SYS7402U1NG24DAFX	VxRail-500 2U1NGPU 24x2.5 DISK SLT AF GC	J	\$11,719
SYS7402U1NG24DX	VxRail-500 2U1N GPU 24x2.5 DISKSLTS GC H	J	\$7,389
SYSG5602U4N24D	VxRail 14G 2U4N 24X2.5 DISK SLTS H	J	\$6,924
SYSG5602U4N24DF	VxRail 14G 2U4N 24X2.5 DISK SLTS F	J	\$9,754
SYSG560CHASSISF	VxRail 14G G560 CHASSIS F	J	\$4,894
SYSG560CHASSISH	VxRail 14G G560 CHASSIS H	J	\$4,894
TPM1.2MODULEAF	VxRail-500 TPM 1.2 MODULE AF	J	\$62
TPM1.2MODULEH	VxRail-500 TPM 1.2 MODULE H	J	\$62
TPM2.0MODULEAF	VxRail-500 TPM 2.0 MODULE AF	J	\$104
TPM2.0MODULE-CAF	VxRail-500 TPM 2.0 MODULE FOR C AF	J	\$104
TPM2.0MODULE-CH	VxRail-500 TPM 2.0 MODULE FOR C H	J	\$104
TPM2.0MODULEH	VxRail-500 TPM 2.0 MODULE H	J	\$104
UNIF4-NX4U	UNISPHERE UNIFIED UPG NX4	J	\$0
UNIU4-NX4	UNISPHERE FOR UNIFIED ON NX4	J	\$0
V400MEMLDIMM128GBU	VxRail-400 Memory 128GB LRDIMM U	J	\$12,297
V500MEMLDIMM128GBU	VxRail-500 Memory 128GB LRDIMM U	J	\$12,297

V500MEMLRD128GBSP	VxRail-500 Memory 128GB LRDIMM SP	J	\$12,297
V5706PERFFAN	VxRail-500 V570 6 PERF FAN	J	\$148
VAX-2SS10-146	QTY 4 OF 146 GB 2.5 10K SAS FOR VAULT	J	\$0
VAX-2SS10146N	QTY 4 OF 146GB 2.5 10K NEBS FOR VAULT SW	J	\$0
VAX-2SS10-300	QTY 4 OF 300 GB 2.5 10K SAS FOR VAULT	J	\$0
VAX-2SS10300N	QTY 4 OF 300GB 2.5 10K NEBS FOR VAULT SW	J	\$0
V-AX4514615K	4 - 146 GB 15K SAS W VAULT SOFTWARE	J	\$1,940
V-AX4514615KN	AX4-5 VAULT 4 NEBS 146 GB 15K SAS	J	\$1,940
V-AX451TB72K	4 - 1TB 7200K SATA W VAULT SOFTWARE	J	\$0
V-AX452TB72K	QTY 4 2TB 7.2K RPM SATA DRIVE FOR VAULT	J	\$0
V-AX4530015K	4 - 300 GB 15K SAS W VAULT SOFTWARE	J	\$0
V-AX4530015KN	AX4-5 4 NEBS 300 GB 15K SAS VAULT DRIVES	J	\$0
V-AX4540010K	4 - 400 GB 10K SAS W VAULT SOFTWARE	J	\$3,640
V-AX4545015K	AX4-5 4 450 GB 15K SAS VAULT DRIVES	J	\$0
V-AX4545015KN	450GB 15K SAS & NEBS DRIVES FOR VAULT SW	J	\$0
V-AX4560010K	QTY 4 OF 600GB 10KSAS FOR VAULT SOFTWARE	J	\$0
V-AX4560015K	QTY 4 OF 600GB 15KSAS FOR VAULT SOFTWARE	J	\$0
V-AX4575072K	4 - 750GB 7.2K SATA W VAULT SOFTWARE	J	\$2,320
VFC-MEZZ-SW	XtremSW Cache for UCS Mezzanine card	J	\$0
VFC-SOFTWARE	EMC XtremSW Cache software	J	\$0
VFC-VOL-3XXM5	300GB SLC PCIe Card - QTY 5	J	\$0
VFC-VOL-550V5	550GB MLC PCIe Card - QTY 5	J	\$0
VFS-SOFTWARE	EMC XtremSF Drivers	J	\$0
VNCX710FH4X10RGBSP	VxRail 14G X710 FH PCIE 4X10GBE RJ45 SP	J	\$2,055
VNCX710FH4X10SGBSP	VxRail 14G X710 FH PCIE 4X10GBE SFP+ SP	J	\$1,650
VNICX710FH4X10RGBU	VxRail 14G X710 FH PCIE 4X10GBE RJ45 U	J	\$2,055
VNICX710FH4X10SGBU	VxRail 14G X710 FH PCIE 4X10GBE SFP+ U	J	\$1,650
VNX4-1000ATA4	NX4 VAULT PACK 4X1000GB SATA DISKS	J	\$0
VNX4-1000ATA5	NX4 VAULT PACK 5X1000GB SATA DISKS	J	\$0
V-NX4-14615K4	NX4 VAULT PACK 4X146GB 15K SAS DISKS	J	\$1,710
V-NX4-14615K5	NX4 VAULT PACK 5X146GB 15K SAS DISKS	J	\$2,140
VNX4-2000ATA4	NX4 VAULT PACK 4X 2TB 7200RPM SATA DISKS	J	\$0
VNX4-2000ATA5	NX4 VAULT PACK 5X 2TB 7200RPM SATA DISKS	J	\$0
VNX4-214610K4	NX4 DAE OS W4 2.5 146GB 10K SAS DRIVES	J	\$0
VNX4-214610K5	NX4 DAE OS W5 2.5 146GB 10K SAS DRIVES	J	\$0
VNX4-230010K4	NX4 DAE OS W4 2.5 300GB 10K SAS DRIVES	J	\$0
VNX4-230010K5	NX4 DAE OS W5 2.5 300GB 10K SAS DRIVES	J	\$0
V-NX4-30015K4	NX4 VAULT PACK 4X300GB 15K SAS DISKS	J	\$0
V-NX4-30015K5	NX4 VAULT PACK 5X300GB 15K SAS DISKS	J	\$0
V-NX4-40010K4	NX4 VAULT PACK 4X400GB 10K SAS DISKS	J	\$0
V-NX4-40010K5	NX4 VAULT PACK 5X400GB 10K SAS DISKS	J	\$0
V-NX4-45015K4	NX4 VAULT 450GB 15K 3GB SAS DRIVES QTY 4	J	\$0
V-NX4-45015K5	NX4 VAULT 450GB 15K 3GB SAS DRIVES QTY 5	J	\$0
V-NX4-60010K4	NX4 4 600GB 10K CONTROL DRIVES	J	\$0
V-NX4-60010K5	NX4 5 600GB 10K CONTROL DRIVES	J	\$0
V-NX4-60015K4	NX4 DAE OS W 4 600GB 15K SAS DRIVES	J	\$0
V-NX4-60015K5	NX4 DAE OS W 5 600GB 15K SAS DRIVES	J	\$0
VX14G1SHIGHFREQHS	VxRail 14G 1S HIGH FREQ HEATSINK	J	\$65
VX14G1SLOWFREQHS	VxRail 14G 1S LOW FREQ HEATSINK	J	\$57
VX14G2SHIGHFREQHS	VxRail 14G 2S HIGH FREQ HEATSINK	J	\$102

VX14G2SLOWFREQHS	VxRail 14G 2S LOW FREQ HEATSINK	J	\$94
VX14GDRVBLANK	VxRail 14G DRIVE BLANK	J	\$10
VX14GNODEBLANK	VxRail 14G NODE BLANK	J	\$10
VX500SFP28OPHTTSP	VxRail-500 SFP28 Optic High Thermal SP	J	\$1,375
VX500SFP28OPHTTU	VxRail-500 SFP28 Optic High Thermal Upg	J	\$1,375
VX500SFP28OPSTTSP	VxRail-500 SFP28 Optic Std Thermal SP	J	\$1,375
VX500SFP28OPSTTU	VxRail-500 SFP28 Optic Std Thermal Upg	J	\$1,375
VXCACHESSD1600GBSP	VxRail 14G CACHE SSD 1600GB 10WP 2.5 SP	J	\$6,128
VXCACHESSD400GBSP	VxRail 14G CACHE SSD 400GB 10WPD 2.5 SP	J	\$2,043
VXCACHESSD800GBSP	VxRail 14G CACHE SSD 800GB 10WPD 2.5 SP	J	\$4,085
VXCAP12TB10K25SP	VxRail 14G HDD SAS 1.2TB 10K RPM 2.5 SP	J	\$681
VXCAPHDD1.8TB10KSP	VxRail-500 HDD SAS 1.8TB 10K RPM 512e SP	J	\$1,384
VXCAPHDD1.8TB10KU	VxRail 14G HDD SAS 1.8TB 10K RPM 512e U	J	\$1,384
VXCAPHDD12TB10K25U	VxRail 14G HDD SAS 1.2TB 10K RPM 2.5 U	J	\$681
VXCAPHDD2.4TB10KSP	VxRail-500 HDD SAS 2.4TB 10K RPM 512e SP	J	\$1,597
VXCAPHDD2.4TB10KU	VxRail 14G HDD SAS 2.4TB 10K RPM 512e U	J	\$1,597
VXCAPHDD20TB72K25U	VxRail 14G HDD SAS 2TB 7.2K RPM 2.5 U	J	\$1,014
VXCAPHDD2TBSP	VxRail 14G HDD SAS 2TB 7.2K RPM 2.5 SP	J	\$1,014
VXCAPHDD40TB72K35U	VxRail 14G HDD SAS 4TB 7.2K RPM 3.5U	J	\$1,014
VXCAPHDD4TBSP	VxRail 14G HDD SAS 4TB 7.2K RPM 3.5 SP	J	\$1,014
VXCAPSATASSD192TBU	VxRail 14G CAPACITY SATA SSD 1.92TB U	J	\$3,500
VXCAPSATASSD384TBU	VxRail 14G CAPACITY SATA SSD 3.84TB U	J	\$6,900
VXCAPSSD192TB1WPDU	VxRail 14G CAPACITY SAS SSD 1.92TB U	J	\$4,903
VXCAPSSD192TBSP	VxRail 14G CAPACITY SAS SSD 1.92TB SP	J	\$4,903
VXCAPSSD384TB1WPDU	VxRail 14G CAPACITY SAS SSD 3.84TB1WPD U	J	\$9,805
VXCAPSSD384TBSP	VxRail 14G CAPACITY SAS SSD 3.84TB1WPD SP	J	\$9,805
VXCPSATASSD192TBSP	VxRail 14G CAPACITY SATA SSD 1.92TB SP	J	\$3,500
VXCPSATASSD384TBSP	VxRail 14G CAPACITY SATA SSD 3.84TB SP	J	\$6,900
VXG560BEZELU	VXRAIL 14G G560 Bezel	J	\$546
VXG560NORAILKITF	VxRail 14G G560 No RAIL KIT F	J	\$0
VXG560NORAILKITH	VxRail 14G G560 No RAIL KIT	J	\$0
VXG560STATICRAILF	VxRail 14G G560 STATIC RAIL KIT F	J	\$176
VXG560STATICRAILH	VxRail 14G G560 STATIC RAIL KITH	J	\$176
VXG560STATICRAILU	VXRAIL 14G G560 Static Rail Kit	J	\$190
VXGPUNVDTESLAM10SP	VxRail-500 GPU NVIDIA TESLA M10 SP	J	\$7,640
VXGPUNVDTESLAM10U	VxRail 14G GPU NVIDIA TESLA M10 U	J	\$7,640
VXGPUNVDTESLAM60SP	VxRail-500 GPU NVIDIA TESLA M60 SP	J	\$13,881
VXGPUNVDTESLAM60U	VxRail 14G GPU NVIDIA TESLA M60 U	J	\$13,881
VXMEMLDIMM16GBSP	VxRail 14G MEMORY 16GB RDIMM SP	J	\$882
VXMEMLDIMM16GBU	VxRail 14G MEMORY 16GB RDIMM U	J	\$882
VXMEMLDIMM32GBSP	VxRail 14G MEMORY 32GB RDIMM SP	J	\$1,749
VXMEMLDIMM32GBU	VxRail 14G MEMORY 32GB RDIMM U	J	\$1,749
VXMEMLDIMM64GBSP	VxRail 14G MEMORY 64GB LRDIMM SP	J	\$3,639
VXMEMLDIMM64GBU	VxRail 14G MEMORY 64GB LRDIMM U	J	\$3,639
VXNCX550FH2X10GBSP	VxRail 14G X550 FH PCIE 2X10GBE RJ45 SP	J	\$900
VXNCX550LP2X10GBSP	VxRail 14G X550 LP PCIE 2X10GBE RJ45F SP	J	\$900
VXNCX710FH2X10GBSP	VxRail 14G X710 FH PCIE 2X10GBE SFP+ SP	J	\$975
VXNCX710LP2X10GBSP	VxRail 14G X710 LP PCIE 2X10GBE SFP+ SP	J	\$974
VXNCX710LP4X10GBSP	VxRail 14G X710 LP PCIE 4X10GBE RJ45 SP	J	\$2,055
VXNDCX550QP10GBRJU	VxRail 14G NDC INTEL X550 QP 10Gb RJ45 U	J	\$990

VXNDCX550QP10GBRSF	VxRail 14G NDC INTEL X550QP 10Gb RJ45 SP	J	\$990
VXNDCX710QP10GBSP	VxRail 14G NDC INTEL X710QP 10Gb SFP+ SP	J	\$1,200
VXNDCX710QP10GBU	VxRail 14G NDC INTEL X710 QP 10Gb SFP+ U	J	\$1,200
VXNICX550FH2X10GBU	VxRail 14G X550 FH PCIE 2X10GBE RJ45 U	J	\$900
VXNICX550LP2X10GBU	VxRail 14G X550 LP PCIE 2X10GBE RJ45 AFU	J	\$900
VXNICX710FH2X10GBU	VxRail 14G X710 FH PCIE 2X10GBE SFP+ U	J	\$975
VXNICX710LP2X10GBU	VxRail 14G X710 LP PCIE 2X10GBE SFP+ U	J	\$974
VXNICX710LP4X10GBU	VxRail 14G X710 LP PCIE 4X10GBE RJ45 U	J	\$2,055
VXR-14G-MGR-DE-45	VxRail 14G SW Manager EMDL V4.5=MA	J	\$0
VXR-14G-MGR-DE-G	VxRail 14G SW Manager EMDL V4.5.200=MA	J	\$0
VXRAIL14GNOGPU	VxRail 14G No GPU - Cable only	J	\$64
VXRAIL14GSSDDRIVE	VxRail14G CAP 1.6TB SAS SSD MixUse Drive	J	\$5,112
VXRAIL-OPTIC-LR	Intel Ethernet SFP+ LR Optic - E10GSFPLR	J	\$1,646
VXRAIL-OPTIC-SR	Intel Ethernet SFP+ SR Optic - E10GSFPSR	J	\$526
VXRAILVDSTKITSKU	Virtual Desktop Starter Kit	J	\$0
VXR-HCIA-MGR-40	VXRAIL HCIA MANAGER V4.0=MA	J	\$0
VXR-HCIA-MGR-DE-40	VXRAIL HCIA MANAGER EMDL V4.0=MA	J	\$0
VXR-HCIA-MGR-DE-45	VXRAIL HCIA MANAGER EMDL V4.5=MA	J	\$0
VXSSD1600GB10WPDU	VxRail 14G CACHE SSD 1600GB 10WP 2.5 U	J	\$6,128
VXSSD1600GBS570SP	VxRail 14G CACHE SSD S570 1600GB 3.5 SP	J	\$6,128
VXSSD1600GBS570U	VxRail 14G CACHE SSD S570 1600GB 3.5U	J	\$6,128
VXSSD400GB10WPD25U	VxRail 14G CACHE SSD 400GB 10WPD 2.5 U	J	\$2,043
VXSSD400GBS570SP	VxRail 14G CACHE SSD S570 400GB 3.5 SP	J	\$2,043
VXSSD400GBS570U	VxRail 14G CACHE SSD S570 400GB 3.5U	J	\$2,043
VXSSD800GB10WPD25U	VxRail 14G CACHE SSD 800GB 10WPD 2.5 U	J	\$4,085
VXSSD800GBS570SP	VxRail 14G CACHE SSD S570 800GB 3.5 SP	J	\$4,085
VXSSD800GBS570U	VxRail 14G CACHE SSD S570 800GB 3.5U	J	\$4,085
XCVRSFPSR1G10G	TRANSCEIVER SFP LC SR 1G 10G	J	\$303
XCVRSFPSR1G10GAF	VxRail-500 TRANSCEIVER LC SR 1G 10G AF	J	\$293
XCVRSFPSR1G10GH	VxRail-500 TRANSCEIVER LC SR 1G 10G H	J	\$293
XPACK-HW-2200	XTREM PERF PACK 2200GB	J	\$0
XSF-SOFTWARE	EMC XTREMSF DRIVERS=IA	J	\$0
XSF-VOL-3XXM5	300GB SLC PCIE CARD - QTY 5	J	\$0
XSF-VOL-550V5	550GB MLC PCIE CARD - QTY 5	J	\$0
XTRSWC-PHY1	XtremCache Phy Delivery=IA	J	\$0
XTRSWC-PHY5	XTREMSW CACHE PHY DELIVERY QTY 5=IA	J	\$0
100-100198	SEL SW VWisdom Server Ent Lic	K	\$40,000
100-100199	SEL SW VWisdom Server Dept Lic	K	\$21,538
100-100206-AM	SEL AS ProbeSW-024 Lic Mnth	K	\$22
100-100207-AM	SEL AS ProbeSW-032 Lic Mnth	K	\$29
100-100208-AM	SEL AS ProbeSW-192 Lic Mnth	K	\$177
100-100209-AM	SEL AS ProbeSW-256 Lic Mnth	K	\$237
100-100210-AM	SEL AS ProbeSW-336 Lic Mnth	K	\$311
100-100211-AM	SEL AS ProbeSW-384 Lic Mnth	K	\$354
100-100212-AM	SEL AS ProbeSW-528 Lic Mnth	K	\$488
100-100213	SEL SW ProbeVM-001 vSphere Lic	K	\$1,523
100-100213-AM	SEL AS ProbeVM-001 Lic Mnth	K	\$12
100-100213-SM	SEL SS ESX-001 Host MSub	K	\$97
100-100214-AM	SEL AS ProbeVM-010 Lic Mnth	K	\$123
100-100215-AM	SEL AS ProbeVM-050 Lic Mnth	K	\$615

100-100216	SEL SW ProbeVM-100 vSphere Lic	K	\$152,308
100-100216-AM	SEL AS ProbeVM-100 Lic Mnth	K	\$1,231
100-100216-SM	SEL SS ESX-100 Host MSub	K	\$9,643
100-100217-AM	SEL AS ProbeVM-500 Lic Mnth	K	\$6,154
100-100276	SEL HW PCbl OM3 2F LC-LC 2M	K	\$62
100-100278	SEL HW PCbl OM3 2F LC-LC 3M	K	\$69
100-100280	SEL HW PCbl OM3 2F LC-LC 5M	K	\$77
100-100288	SEL HW TCV-008LFLFLF-57-RP Cass	K	\$1,692
100-100290	SEL HW TCV-012LRLFLF-57-RP Cass	K	\$2,538
100-100292	SEL HW TCV-012MRLFLF-57-OB Cass	K	\$2,538
100-100293	SEL HW TCV-024MRLFMR-57-OB Cass	K	\$5,077
100-100300	SEL HW TPS-010F TCV TAP Shelf 1U	K	\$285
100-100301	SEL HW TPS-010S TCV TAP Shelf 1U	K	\$192
100-100346	SEL HW ProbeFC8 8G MM	K	\$36,923
100-100602	SEL SW FC8-0802 2 Link Lic	K	\$21,538
100-100602-AM	SEL AS ProbeFC8-0802 Lic Mnth	K	\$169
100-100603	SEL SW FC8-0808 8 Link Lic	K	\$86,154
100-100603-AM	SEL AS ProbeFC8-0808 Lic Mnth	K	\$669
100-100617-AM	SEL AS ProbeSWAG-24 Lic Mnth	K	\$3
100-100618-AM	SEL AS ProbeSWAG-192 Lic Mnth	K	\$29
100-100619-AM	SEL AS ProbeSWAG-528 Lic Mnth	K	\$82
100-100837	SEL HW ProbeFC8/-HD FRU Pwr Sup	K	\$846
100-101019	SEL HW Mob Rack Cab Probe	K	\$17,308
100-101048	SEL HW Pwr Cord C19-515 15A 15FT	K	\$62
100-101049	SEL HW Pwr Cord C19-520 20A 15FT	K	\$92
100-101050	SEL HW Pwr Cord C19-620 20A 15FT	K	\$85
100-101051	SEL HW Pwr Cord C19-615 15A 15FT	K	\$85
100-101052	SEL HW Pwr Cord C13-515 18IN x2	K	\$11
100-101053	SEL HW Pwr Cord C13-515 6FT x2	K	\$17
100-101054	SEL HW Pwr Cord C13-C14 6FT x2	K	\$23
100-101055	SEL HW Pwr Cord C13-C14 18IN x2	K	\$14
100-101056	SEL HW Pwr Cord C13-CEE77 2M x2	K	\$20
100-101057	SEL HW Pwr Cord C13-1363 2M x2	K	\$31
100-101058	SEL HW Pwr Cord C13-C14 3FT x2	K	\$17
100-101085	SEL HW PCbl OM3 12F MPOf-LC 2M	K	\$462
100-101216	SEL HW PCbl OM3 2F LC-LC 10M	K	\$100
100-101228	SEL HW PCbl OM3 2F LC-LC 15M	K	\$100
100-101231	SEL HW ProbeFC8-HD 8G MM	K	\$52,308
100-101281	SEL HW FibIns CIT Kit MPO Addon	K	\$4,462
100-101309	SEL HW FibIns CIT Kit Refill	K	\$2,231
100-101310	SEL HW FibIns CIT MPO Refill	K	\$538
100-101311	SEL HW TCbl OM3 1F LCLC 2M x2	K	\$208
100-101312	SEL HW TCbl OM3 12F MPOfLC 2M x2	K	\$885
100-101313	SEL HW TCbl OM3 1F LCSC 2M x2	K	\$208
100-101314	SEL HW TCbl OM3 1F LCMU 2M x2	K	\$231
100-101315	SEL HW TCbl OM3 12F MPOmLC 2M x2	K	\$885
100-101318	SEL HW Ship Rack Cab 2 Probe	K	\$9,231
100-101319	SEL HW Ship Rack Cab 1 Probe	K	\$7,308
100-101322	SEL HW ProbeFC8/-HD FRU Fan	K	\$577
100-101324	SEL HW Rack Shelf 1U 20	K	\$485

100-101325	SEL HW Rack Shelf 1U 24	K	\$577
100-101343	SEL SW FC8HD-0816 16 Link Lic	K	\$120,000
100-101343-AM	SEL AS ProbeFC8-0816 Lic Mnth	K	\$923
100-101348	SEL HW Pwr Cord C19-C14 15A 15FT	K	\$108
100-101566	SEL HW SFP 8GFC 850NM MM HS x16	K	\$7,308
100-101570	SEL HW FibIns Cass Refill	K	\$615
100-101571	SEL HW FibIns MPO Cass Refill	K	\$692
100-101753	SEL SW VWisdom Srvr Ent DR Lic	K	\$20,000
100-101804	SEL HW ProbeFC8-HD48 8G MM	K	\$147,692
100-101854	SEL HW FibIns CIT Adv Kit	K	\$22,308
100-101855	SEL HW Pwr Cord C13-C20 6FT x2	K	\$31
100-101925	SEL HW TCV-012MRLFLF-57-EB Cass	K	\$2,538
100-102044	SEL HW ProbeFC8-HD48 FRU Fan	K	\$1,115
100-102045	SEL HW ProbeFC8-HD48 FRU Pwr Sup	K	\$923
100-102046	SEL SW FC8HD48-0848 48 Link Lic	K	\$243,077
100-102046-AM	SEL AS ProbeFC8-0848 Lic Mnth	K	\$1,923
100-102064	SEL HW TCV-024MRLFMR-57-EB Cass	K	\$5,077
100-102065	SEL SW FC8HD48-0824 24 Link Lic	K	\$156,923
100-102065-AM	SEL AS ProbeFC8-0824 Lic Mnth	K	\$1,223
100-102069	SEL HW VWisdom Pltfrm Appl 4210	K	\$60,000
100-102070	SEL SW VWisdom Mgmt Ent Ed	K	\$67,692
100-102070-SM	SEL SS VW Mgmt Ent MSub	K	\$3,548
100-102071	SEL SW VWisdom Mgmt Virt Ed	K	\$36,923
100-102071-SM	SEL SS VW Mgmt Virt MSub	K	\$1,935
100-102072	SEL SW VWisdom Mgmt Ent DR Ed	K	\$33,846
100-102073	SEL HW PA 4210 FRU Pwr Sup	K	\$538
100-102074	SEL HW PA 4210 FRU Data Drv 1TB	K	\$346
100-102075	SEL HW PA 4210 FRU Sys Drv 80GB	K	\$385
100-102076	SEL HW PA 4210 Shllw Mnt Kit	K	\$115
100-102077	SEL HW PA 4210 FRU Bezel/Keys	K	\$69
100-102091	SEL HW ProbeFC8-HD Chass	K	\$40,000
100-102092	SEL HW ProbeFC8-HD48 Chass	K	\$110,769
100-102094	SEL HW ProbeFC8-HD48 Recess Mnt	K	\$308
100-102267	SEL SW ProbeSW-010 Port Lic	K	\$1,138
100-102267-AM	SEL AS ProbeSW-010 Lic Mnth	K	\$9
100-102267-SM	SEL SS FCSW-010 Port MSub	K	\$75
100-102268	SEL SW ProbeSW-100 Port Lic	K	\$11,385
100-102268-AM	SEL AS ProbeSW-100 Lic Mnth	K	\$92
100-102268-SM	SEL SS FCSW-100 Port MSub	K	\$723
100-102269	SEL SW ProbeSWAG-010 Port Lic	K	\$569
100-102269-AM	SEL AS ProbeSWAG-010 Lic Mnth	K	\$2
100-102270	SEL SW ProbeSWAG-100 Port Lic	K	\$5,692
100-102270-AM	SEL AS ProbeSWAG-100 Lic Mnth	K	\$15
100-102271	SEL SW ProbeNTAP-001 Node Lic	K	\$1,769
100-102271-AM	SEL AS ProbeNTAP-001 Lic Mnth	K	\$14
100-102271-SM	SEL SS NTAP-001 Node MSub	K	\$114
100-102272	SEL SW ProbeNTAP-100 Node Lic	K	\$176,923
100-102272-AM	SEL AS ProbeNTAP-100 Lic Mnth	K	\$1,385
100-102272-SM	SEL SS NTAP-100 Node MSub	K	\$11,140
100-102301	SEL HW PA 4210 Std Mnt Kit	K	\$115

100-102341	SEL HW TCV Blank Plate Kit x3	K	\$38
100-102375	SEL HW ProbeFC-16G-24 Chass	K	\$76,923
100-102455	SEL HW ProbeFC8/All Shllw Mnt Kit	K	\$115
100-102456	SEL HW ProbeFC8/All Std Mnt Kit	K	\$115
100-102457	SEL HW ProbeFC8/All Rk Adpt 1U35	K	\$115
100-102458	SEL HW PA-4210 Rk Adpt 2U35	K	\$115
100-102490	SEL HW TCV-008LFLFLF-58-RP Cass	K	\$1,846
100-102491	SEL HW TCV-012LRLFLF-58-RP Cass	K	\$2,769
100-102500	SEL HW TCV-012LRLFLF-97-RP Cass	K	\$2,169
100-102579	SEL HW SFP 4-Link Kit 8G MM HS	K	\$3,077
100-102580	SEL HW SFP 4-Link Kit 8G SM SR	K	\$4,308
100-102581	SEL SW Link Lic 8G 4-Link Kit	K	\$24,615
100-102581-AM	SEL AS LnkLic 8G 4Lnk Kit Mnth	K	\$185
100-102581-SM	SEL SS ProbeFC 8G 4Lnk MSub	K	\$1,538
100-102582	SEL SW Link Lic 8G Full FC8-HD48	K	\$203,077
100-102582-AM	SEL AS LnkLic 8G FC8-HD48 Mnth	K	\$1,923
100-102582-SM	SEL SS ProbeFC 8G48Lnk MSub	K	\$13,237
100-102583	SEL SW Link Lic 8G Full FC16G24	K	\$100,000
100-102583-AM	SEL AS LnkLic 8G FC16G24 Mnth	K	\$1,108
100-102583-SM	SEL SS ProbeFC 8G24Lnk MSub	K	\$6,735
100-102584	SEL SW Link Lic 8G Full FC8-HD	K	\$86,154
100-102584-AM	SEL AS LnkLic 8G FC8-HD Mnth	K	\$738
100-102595	SEL SW Link Lic 16G 4-Link Kit	K	\$36,923
100-102595-AM	SEL AS LnkLic 16G 4Lnk Kit Mnth	K	\$246
100-102595-SM	SEL SS ProbeFC 16G 4Lnk MSub	K	\$2,268
100-102596	SEL SW Link Lic 16G FullFC16G24	K	\$138,462
100-102596-AM	SEL AS LnkLic 16G FC16G24 Mnth	K	\$1,477
100-102596-SM	SEL SS ProbeFC 16G24Lnk MSub	K	\$9,249
100-102614	SEL HW SFP 4-Link Kit 16G MM UHS	K	\$6,154
100-102615	SEL HW SFP 4-Link Kit 16G SM SR	K	\$7,385
100-102618	SEL HW SFP 16GFC 1310NM SM LR	K	\$922
100-102619	SEL HW TCV-012MRLFLF-58-EB	K	\$2,846
100-102620	SEL HW TCV-012MRLFLF-58-OB	K	\$2,846
100-102624	SEL Opt patch cable 50m OM4 MM LC-LC 2M	K	\$88
100-102625	SEL Opt patch cable 50um OM4 MM LC-LC 3M	K	\$92
100-102626	SEL Opt patch cable 50um OM4 MM LC-LC 5M	K	\$102
100-102627	SEL Opt patch cable 50um OM4 MM LCLC 10M	K	\$129
100-102645	SEL SW ProbeVM-001 HyperV Lic	K	\$754
100-102645-AM	SEL AS ProbeVM-001 Hyper-V Mnth	K	\$6
100-102645-SM	SEL SS HyperV-001 Host MSub	K	\$48
100-102646	SEL SW ProbeVM-100 HyperV Lic	K	\$75,385
100-102646-AM	SEL AS ProbeVM-100 Hyper-V Mnth	K	\$615
100-102646-SM	SEL SS HyperV-100 Host MSub	K	\$4,782
100-102647	SEL SW ProbeVM-001 PowerVM Lic	K	\$762
100-102647-AM	SEL AS ProbeVM-001 PowerVM Mnth	K	\$6
100-102647-SM	SEL SS PowerVM-001 Core MSub	K	\$48
100-102648	SEL SW ProbeVM-100 PowerVM Lic	K	\$76,154
100-102648-AM	SEL AS ProbeVM-100 PowerVM Mnth	K	\$615
100-102648-SM	SEL SS PowerVM-100 Core MSub	K	\$4,823
100-102697	SEL HW ProbeFC-16G-12 Chass	K	\$40,000

100-102698	SEL HW ProbeNAS-10G-16 Chass	K	\$107,692
100-102700	SEL CABLE OM4 MM MTP MALE - LC B	K	\$392
100-102701	SEL CABLE OM4 MM MTP FEMALE2M12F	K	\$374
100-102702	SEL CABLE OS2 SM MTP MALE 2M12F	K	\$263
100-102703	SEL CABLE OS2 SM MTP FEMALE2M12F	K	\$245
100-102739	SEL HW PCbl OM4 12F MTPmLC 3M	K	\$471
100-102740	SEL HW PCbl OM4 12F MTPfLC 3M	K	\$449
100-102741	SEL HW PCbl OM4 12F MTPmLC 5M	K	\$523
100-102742	SEL HW PCbl OM4 12F MTPfLC 5M	K	\$497
100-102743	SEL HW PCbl OM4 12F MTPmLC 10M	K	\$649
100-102744	SEL HW PCbl OM4 12F MTPfLC 10M	K	\$623
100-102745	SEL HW PCbl OS2 SM 12F MTPmLC 3M	K	\$309
100-102746	SEL HW PCbl OS2 SM 12F MTPfLC 3M	K	\$283
100-102747	SEL HW PCbl OS2 SM 12F MTPmLC 5M	K	\$318
100-102748	SEL HW PCbl OS2 SM 12F MTPfLC 5M	K	\$298
100-102749	SEL HW PCbl OS2 SM 12F MTPmLC10M	K	\$351
100-102750	SEL HW PCbl OS2 SM 12F MTPfLC10M	K	\$329
100-102751	SEL HW TCV-008LFLFLF-97-RP Cass	K	\$2,358
100-102752	SEL HW TCV-012MRLFLF-97-OB Cass	K	\$3,448
100-102753	SEL HW TCV-012MRLFLF-97-EB Cass	K	\$3,448
100-102754	SEL HW TCV-024MRLFMR-97-OB Cass	K	\$6,894
100-102755	SEL HW TCV-024MRLFMR-97-EB Cass	K	\$6,894
100-102791	SEL SW Link Lic NAS 10G 1Active	K	\$6,923
100-102791-AM	SEL AS LnkLic 10G 1Lnk Actv Mnth	K	\$62
100-102791-SM	SEL SS ProbeNAS 10G 1Actv MSub	K	\$449
100-102792	SEL SW Link Lic NAS 10G 1Passive	K	\$1,846
100-102792-AM	SEL AS LnkLic 10G 1Lnk Pasv Mnth	K	\$8
100-102792-SM	SEL SS ProbeNAS 10G 1Pasv MSub	K	\$108
100-102793	SEL SW Link Lic 10G FullNAS10G16	K	\$93,846
100-102793-AM	SEL AS LnkLic 10G NAS10G16 Mnth	K	\$769
100-102793-SM	SEL SS ProbeNAS 10G16Lnk MSub	K	\$5,957
100-102794	SEL SW Target Lic 10G 4-Tgt Kit	K	\$9,231
100-102794-AM	SEL AS TgtLic 10G 4Tgt Kit Mnth	K	\$77
100-102795	SEL SW Link Lic 10G 4-Link Kit	K	\$36,923
100-102795-AM	SEL AS LnkLic 10G 4Lnk Kit Mnth	K	\$308
100-102796	SEL SW LinkLic 10G FullFCoE10G24	K	\$152,308
100-102796-AM	SEL AS LnkLic 10G FCoE10G24 Mnth	K	\$1,269
100-102797	SEL SW Link Lic 8G Full FC16G12	K	\$61,538
100-102797-AM	SEL AS LnkLic 8G FC16G12 Mnth	K	\$500
100-102798	SEL SW Link Lic 16G Full FC16G12	K	\$92,308
100-102798-AM	SEL AS LnkLic 16G FC16G12 Mnth	K	\$769
100-102799	SEL HW ProbeFCoE-10G-24 Chass	K	\$76,923
100-103010	SEL HW VWisdom Pltfrm Appl 4220	K	\$60,000
100-103051-AM	SEL AS VSAN-100 Lic Mnth	K	\$1,231
100-103077	SEL SW ProbeSDS-001 Server Lic	K	\$2,769
100-103077-AM	SEL AS ProbeSDS-001 Lic Mnth	K	\$25
100-103077-SM	SEL SS SDS-001 Host MSub	K	\$178
100-103078	SEL SW ProbeNetFlow-100 Endpoint Lic	K	\$3,692
100-103078-AM	SEL AS ProbeNetFlow-100 Lic Mnt	K	\$37
100-103078-SM	SEL SS NetFlow-100 Endpt MSub	K	\$245

100-103139	SEL SW VWintg CiscoSTS-1StorPt	K	\$7,692
100-103139-AM	SEL AS VWintg STS-1StorPt Mnth	K	\$69
100-103139-SM	SEL SS VWintg STS-1StorPt Mnth	K	\$369
100-103140	SEL SW VWintg CiscoSTS-1LineCd	K	\$123,077
100-103140-AM	SEL AS VWintg STS-1LineCd Mnth	K	\$1,108
100-103140-SM	SEL SS VWintg STS-1LineCd Mnth	K	\$5,885
100-103142	SEL HW PA 4220 FRU Sys Drv 240GB	K	\$385
11-1568-LIC	SEL: VF-HYPM5-F	K	\$396
11-1790-LIC	SEL: THIN5-STE-F	K	\$5,500
11-1791-LIC	SEL: THIN5-100PK-F	K	\$2,090
11-1980-LIC	SEL: VR6-OSTD25-F	K	\$3,438
11-1981-LIC	SEL: VR6-OADV25-F	K	\$7,563
11-1982-LIC	SEL: VR6-OENT25-F	K	\$19,113
11-1983-LIC	SEL: VR6-OSTD-OADV-UG-F	K	\$4,538
11-1984-LIC	SEL: VR6-OSTD-OENT-UG-F	K	\$17,243
11-1985-LIC	SEL: VR6-OADV-OENT-UG-F	K	\$12,705
11-1998-LIC	SEL: VR6-VU10-F	K	\$825
11-1999-LIC	SEL: VR6-VU100-F	K	\$8,250
11-2015-LIC	SEL: HZ-FLX-10-F	K	\$2,750
11-2112-LIC	SEL: ST6-VSAN-F	K	\$2,745
11-2113-LIC	SEL: ST6-VSA-VSAN-UG-F	K	\$12,623
11-2248-LIC	SEL: VR6-MEDI-F	K	\$66,000
11-2288-LIC	SEL: HZ-FLX-AD10-F	K	\$1,650
11-2313-LIC	SEL: HZ-F7WS11-FLX-UG-F	K	\$165
11-2314-LIC	SEL: HZ-F8WS12-FLX-UG-F	K	\$110
11-2317-LIC	SEL: VR7-ATAD25-F	K	\$7,563
11-2318-LIC	SEL: VR7-ATEN25-F	K	\$13,063
11-2321-LIC	SEL: VR7-AUTDT25-F	K	\$3,658
11-2322-LIC	SEL: VR7-ATAD-ATEN-UG-F	K	\$6,050
11-2325-LIC	SEL: HZ7-TCL-STA10-UG-F	K	\$1,870
11-2358-LIC	SEL: HZ7-ADC-10-F	K	\$4,400
11-2359-LIC	SEL: HZ7-ADC-100-F	K	\$44,000
11-2360-LIC	SEL: HZ7-ADC-ENC-10-UG-F	K	\$2,118
11-2361-LIC	SEL: HZ7-ADC-ENC-100-UG-F	K	\$21,175
11-2362-LIC	SEL: HZ7-ADN-10-F	K	\$2,750
11-2363-LIC	SEL: HZ7-ADN-100-F	K	\$27,500
11-2364-LIC	SEL: HZ7-ADN-ENN-10-UG-F	K	\$1,210
11-2365-LIC	SEL: HZ7-ADN-ENN-100-UG-F	K	\$12,100
11-2366-LIC	SEL: HZ7-AVA-ENC10-UG-F	K	\$5,143
11-2367-LIC	SEL: HZ7-AVA-ENC100-UG-F	K	\$51,425
11-2368-LIC	SEL: HZ7-AVA-ENN10-UG-F	K	\$3,025
11-2369-LIC	SEL: HZ7-AVA-ENN100-UG-F	K	\$30,250
11-2370-LIC	SEL: HZ7-AVE-ENC10-UG-F	K	\$4,780
11-2371-LIC	SEL: HZ7-AVE-ENC100-UG-F	K	\$47,795
11-2372-LIC	SEL: HZ7-AVE-ENN10-UG-F	K	\$2,783
11-2373-LIC	SEL: HZ7-AVE-ENN100-UG-F	K	\$27,830
11-2374-LIC	SEL: HZ7-AVS-ENC10-UG-F	K	\$5,869
11-2375-LIC	SEL: HZ7-AVS-ENC100-UG-F	K	\$58,685
11-2376-LIC	SEL: HZ7-AVS-ENN10-UG-F	K	\$3,509
11-2377-LIC	SEL: HZ7-AVS-ENN100-UG-F	K	\$35,090

11-2378-LIC	SEL: HZ7-EAD-STD10-UG-F	K	\$1,925
11-2379-LIC	SEL: HZ7-EAD-STD100-UG-F	K	\$19,250
11-2380-LIC	SEL: HZ7-ENC-10-F	K	\$6,325
11-2381-LIC	SEL: HZ7-ENC-100-F	K	\$63,250
11-2382-LIC	SEL: HZ7-ENN-10-F	K	\$3,850
11-2383-LIC	SEL: HZ7-ENN-100-F	K	\$38,500
11-2384-LIC	SEL: HZ7-ENN-ENC-10-UG-F	K	\$2,723
11-2385-LIC	SEL: HZ7-ENN-ENC-100-UG-F	K	\$27,225
11-2386-LIC	SEL: HZ7-ENTA-STDA10-UG-F	K	\$1,100
11-2387-LIC	SEL: HZ7-ENTA-STDA100-UG-F	K	\$11,000
11-2388-LIC	SEL: HZ7-LXC-10-F	K	\$1,650
11-2389-LIC	SEL: HZ7-LXC-100-F	K	\$16,500
11-2390-LIC	SEL: HZ7-LXC-ENC-10-UG-F	K	\$5,143
11-2391-LIC	SEL: HZ7-LXC-ENC-100-UG-F	K	\$51,425
11-2392-LIC	SEL: HZ7-MGP-ADC-10-UG-F	K	\$3,025
11-2393-LIC	SEL: HZ7-MGP-ADC-100-UG-F	K	\$30,250
11-2394-LIC	SEL: HZ7-MGP-ADN-10-UG-F	K	\$1,210
11-2395-LIC	SEL: HZ7-MGP-ADN-100-UG-F	K	\$12,100
11-2396-LIC	SEL: HZ7-MRG-ADC-10-UG-F	K	\$3,025
11-2397-LIC	SEL: HZ7-MRG-ADC-100-UG-F	K	\$30,250
11-2398-LIC	SEL: HZ7-MRG-ADN-10-UG-F	K	\$1,210
11-2399-LIC	SEL: HZ7-MRG-ADN-100-UG-F	K	\$12,100
11-2400-LIC	SEL: HZ7-ST-ADC-10-UG-F	K	\$1,815
11-2401-LIC	SEL: HZ7-ST-ADC-100-UG-F	K	\$18,150
11-2402-LIC	SEL: HZ7-ST-ADC-250-UG-F	K	\$45,375
11-2403-LIC	SEL: HZ7-ST-ADC-500-UG-F	K	\$90,750
11-2404-LIC	SEL: HZ7-ST-ADN-1K-UG-F	K	\$151,250
11-2405-LIC	SEL: HZ7-ST-ADN-20-UG-F	K	\$3,025
11-2406-LIC	SEL: HZ7-ST-ADN-200-UG-F	K	\$30,250
11-2407-LIC	SEL: HZ7-ST-ADN-500-UG-F	K	\$75,625
11-2408-LIC	SEL: HZ7-ST-ENC-10-UG-F	K	\$3,933
11-2409-LIC	SEL: HZ7-ST-ENC-100-UG-F	K	\$39,325
11-2410-LIC	SEL: HZ7-ST-ENC-250-UG-F	K	\$98,313
11-2411-LIC	SEL: HZ7-ST-ENC-500-UG-F	K	\$196,625
11-2412-LIC	SEL: HZ7-ST-ENN-1K-UG-F	K	\$272,250
11-2413-LIC	SEL: HZ7-ST-ENN-20-UG-F	K	\$5,445
11-2414-LIC	SEL: HZ7-ST-ENN-200-UG-F	K	\$54,450
11-2415-LIC	SEL: HZ7-ST-ENN-500-UG-F	K	\$136,125
11-2416-LIC	SEL: HZ7-STD-10-F	K	\$2,750
11-2417-LIC	SEL: HZ7-STD-100-F	K	\$27,500
11-2418-LIC	SEL: HZ7-STD-A10-F	K	\$2,090
11-2419-LIC	SEL: HZ7-STD-A100-F	K	\$20,900
11-2420-LIC	SEL: HZ7-STDA-STD10-UG-F	K	\$770
11-2421-LIC	SEL: HZ7-STDA-STD100-UG-F	K	\$7,700
11-2422-LIC	SEL: HZ7-TAC-STA100-UG-F	K	\$18,810
11-2423-LIC	SEL: HZ7-THIN-ST100-UG-F	K	\$22,000
11-2424-LIC	SEL: HZ7-TPRO-ST10-UG-F	K	\$2,310
11-2425-LIC	SEL: HZ7-VAD-ADC-10-UG-F	K	\$2,530
11-2426-LIC	SEL: HZ7-VAD-ADC-100-UG-F	K	\$25,300
11-2427-LIC	SEL: HZ7-VAD-ENC-10-UG-F	K	\$4,648

11-2428-LIC	SEL: HZ7-VAD-ENC-100-UG-F	K	\$46,475
11-2429-LIC	SEL: HZ7-VENT-ST10-UG-F	K	\$1,100
11-2430-LIC	SEL: HZ7-VENT-ST100-UG-F	K	\$11,000
11-2431-LIC	SEL: ST6-AD-D10-F	K	\$1,100
11-2432-LIC	SEL: ST6-AD-D100-F	K	\$11,000
11-2433-LIC	SEL: ST6-AD-EN-UG-F	K	\$1,815
11-2434-LIC	SEL: ST6-AD-F	K	\$4,395
11-2439-LIC	SEL: ST6-EN-F	K	\$6,045
11-2440-LIC	SEL: ST6-ST-AD-UG-F	K	\$1,815
11-2441-LIC	SEL: ST6-ST-EN-UG-F	K	\$3,630
11-2446-LIC	SEL: VR-BCLADVCF	K	\$3,300
11-2447-LIC	SEL: VR-BCLADVO-25-F	K	\$5,500
11-2448-LIC	SEL: VR-CODE2C-F	K	\$5,995
11-2449-LIC	SEL: VR-CODE2O-F	K	\$600
11-2450-LIC	SEL: VR-OAMAD-F	K	\$1,650
11-2493-LIC	SEL: HZ7-PA50-STA100-UG-F	K	\$13,750
11-2494-LIC	SEL: HZ7-PRA50-ST100-UG-F	K	\$13,750
11-2495-LIC	SEL: HZ7-UEM-ENC-100-UG-F	K	\$57,750
11-2496-LIC	SEL: HZ7-UEM-ENC-10-UG-F	K	\$5,775
11-2497-LIC	SEL: HZ7-UEM-ENN-100-UG-F	K	\$35,200
11-2498-LIC	SEL: HZ7-UEM-ENN-10-UG-F	K	\$3,520
11-2499-LIC	SEL: HZ7-WSP-ADN-100-UG-F	K	\$12,100
11-2500-LIC	SEL: HZ7-WSP-ADN-10-UG-F	K	\$1,210
11-2505-LIC	SEL: HZ7-ADN-A10-F	K	\$2,200
11-2506-LIC	SEL: HZ7-ADN-A100-F	K	\$22,000
11-2507-LIC	SEL: HZ7-A100-AERC-F	K	\$33,000
11-2508-LIC	SEL: HZ7-A10-AERC-F	K	\$3,300
11-2509-LIC	SEL: HZ7-E100-AERC-F	K	\$46,750
11-2510-LIC	SEL: HZ7-E100-AERC-UG-F	K	\$15,125
11-2511-LIC	SEL: HZ7-E10-AERC-F	K	\$4,675
11-2512-LIC	SEL: HZ7-E10-AERC-UG-F	K	\$1,513
11-2513-LIC	SEL: HZ7-ENN-A100-F	K	\$31,350
11-2514-LIC	SEL: HZ7-ENN-A100-UG-F	K	\$10,285
11-2515-LIC	SEL: HZ7-ENN-A10-F	K	\$3,135
11-2516-LIC	SEL: HZ7-ENN-A10-UG-F	K	\$1,029
11-2530-LIC	SEL: VR6-OSTC-F	K	\$1,375
11-2535-LIC	SEL: VR-NI-ANXC-F	K	\$1,370
1433-LIC	SEL 1433-LIC VF-DD2-25VM-F	K	\$20,625
16G-ER-D210-BR2	SEL-SFP+,16/8/4Gbps,FC,D9210,13dB,40km	K	\$5,531
16G-ER-D220-BR2	SEL-SFP+,16/8/4Gbps,FC,D9220,13dB,40km	K	\$5,531
16G-ER-D230-BR2	SEL-SFP+,16/8/4Gbps,FC,D9230,13dB,40km	K	\$5,531
16G-ER-D240-BR2	SEL-SFP+,16/8/4Gbps,FC,D9240,13dB,40km	K	\$5,531
16G-ER-D250-BR2	SEL-SFP+,16/8/4Gbps,FC,D9250,13dB,40km	K	\$5,531
16G-ER-D260-BR2	SEL-SFP+,16/8/4Gbps,FC,D9260,13dB,40km	K	\$5,531
16G-ER-D270-BR2	SEL-SFP+,16/8/4Gbps,FC,D9270,13dB,40km	K	\$5,531
16G-ER-D280-BR2	SEL-SFP+,16/8/4Gbps,FC,D9280,13dB,40km	K	\$5,531
16G-ER-D290-BR2	SEL-SFP+,16/8/4Gbps,FC,D9290,13dB,40km	K	\$5,531
16G-ER-D300-BR2	SEL-SFP+,16/8/4Gbps,FC,D9300,13dB,40km	K	\$5,531
16G-ER-D310-BR2	SEL-SFP+,16/8/4Gbps,FC,D9310,13dB,40km	K	\$5,531
16G-ER-D320-BR2	SEL-SFP+,16/8/4Gbps,FC,D9320,13dB,40km	K	\$5,531

16G-ER-D330-BR2	SEL-SFP+,16/8/4Gbps,FC,D9330,13dB,40km	K	\$5,531
16G-ER-D340-BR2	SEL-SFP+,16/8/4Gbps,FC,D9340,13dB,40km	K	\$5,531
16G-ER-D350-BR2	SEL-SFP+,16/8/4Gbps,FC,D9350,13dB,40km	K	\$5,531
16G-ER-D360-BR2	SEL-SFP+,16/8/4Gbps,FC,D9360,13dB,40km	K	\$5,531
1YR-ENT-BUNDLE	SEL Catalog/Data Mgmt Starter for ENT	K	\$38,462
1YR-ENTGOV-BUNDL	SEL Primary Data Governance POC for ENT	K	\$15,000
1YR-MM-BUNDLE	SEL Catalog/Data Mgmt Starter for MM	K	\$15,385
1YR-MMGOV-BUNDLE	SEL Primary Data Governance POC for MM	K	\$5,000
200-200000	SEL-HW LDX-E PltfrmAppl LDX-E1000	K	\$60,000
200-200003	SEL-HW LDX LoadGenAppl LDX-5108S	K	\$227,885
200-200006	SEL-HW LDX LoadGenAppl LDX-6204	K	\$136,731
200-200007	SEL-HW LDX LoadGenAppl LDX-6208	K	\$227,885
200-200011	SEL-HW LDX LoadGenAppl LDX-U1044	K	\$273,462
200-200014	SEL-HW LDXE+LoadGnAppl LDX-E1040	K	\$190,577
200-200015	SEL-HW LDXE+LoadGnAppl LDX-E1004	K	\$190,577
200-200025	SEL-SW Virt LDX-E1000V-10TB-VW	K	\$29,231
200-200069	SEL-SW LG Clnt FCS FCS-FCI1-4	K	\$60,577
200-200070	SEL-SW LG Clnt iSCSI ISC-10GC1-4	K	\$60,577
200-200072	SEL-SW LG Clnt SMB2 SMB-10GC2-4	K	\$60,577
200-200073	SEL-SW LG Clnt SMB3 SMB-10GC3-4	K	\$60,577
200-200075	SEL-SW LG Clnt NFSv3 NFS-10GC3-4	K	\$60,577
200-200076	SEL-SW LG Clnt NFSv4NFS-10GC4-4	K	\$60,577
200-200077	SEL-SW LG ClntNFS41 NFS-10GC41-4	K	\$60,577
200-200078	SEL-SW LG Clnt HTTP HCS-10GC1-4	K	\$60,577
200-200079	SEL-SW LG Clnt HTTPS HCSS-10GC1-4	K	\$17,308
200-200080	SEL-SW LG Clnt Swt OSSWT-10GC1-4	K	\$17,308
200-200081	SEL-SW LG Clnt S3 AMZS3-10GC1-4	K	\$17,308
200-200084	SEL-SW LG Clnt Kerb KER-10GC1-4	K	\$17,308
200-200089	SEL-SW LG Clnt IPv6 IPV6-10GC1-4	K	\$138,462
200-200090	SEL-SW LG Clnt FCS FCS-FCI1-8	K	\$100,962
200-200091	SEL-SW LG Clnt iSCSI ISC-10GC1-8	K	\$100,962
200-200093	SEL-SW LG Clnt SMB2 SMB-10GC2-8	K	\$100,962
200-200094	SEL-SW LG Clnt SMB3 SMB-10GC3-8	K	\$100,962
200-200096	SEL-SW LG Clnt NFSv3 NFS-10GC3-8	K	\$100,962
200-200097	SEL-SW LG Clnt NFSv4 NFS-10GC4-8	K	\$100,962
200-200098	SEL-SW LG ClntNFS41 NFS-10GC41-8	K	\$100,962
200-200099	SEL-SW LG Clnt HTTP HCS-10GC1-8	K	\$100,962
200-200100	SEL-SW LG Clnt HTTPS HCSS-10GC1-8	K	\$28,846
200-200101	SEL-SW LG Clnt Swt OSSWT-10GC1-8	K	\$28,846
200-200102	SEL-SW LG Clnt S3 AMZS3-10GC1-8	K	\$28,846
200-200105	SEL-SW LG Clnt Kerb KER-10GC1-8	K	\$28,846
200-200110	SEL-SW LG Clnt IPv6 IPV6-10GC1-8	K	\$230,769
200-200111	SEL-SW LDX-E Mgmt 2P LDXE-APP02	K	\$40,385
200-200112	SEL-SW LDX-E Mgmt 4P LDXE-APP04	K	\$60,577
200-200113	SEL-SW LDX-E Mgmt 8P LDXE-APP08	K	\$100,962
200-200302	SEL-HW LDX LoadGenAppl LDX-5104	K	\$136,731
200-200305	SEL-HW LDX LoadGenA LDX-6204-32G	K	\$329,008
200-200398	SEL-SW LG Clnt FCS FCS-FCI2-4	K	\$151,442
200-200419	SEL-HW LDX LoadGenAppl LDX-7104	K	\$329,008
200-200430	SEL-SW LG Clnt iSCSI ISC-40GC1-4	K	\$145,769

200-200432	SEL-SW LG Clnt SMB2 SMB-40GC2-4	K	\$145,769
200-200433	SEL-SW LG Clnt SMB3 SMB-40GC3-4	K	\$145,769
200-200435	SEL-SW LG Clnt NFSv3 NFS-40GC3-4	K	\$145,769
200-200437	SEL-SW LG Clnt NFSv4 NFS-40GC4-4	K	\$145,769
200-200438	SEL-SW LG Clnt NFS41 NFS-40GC41-	K	\$145,769
200-200439	SEL-SW LG Clnt HTTP HCS-40GC1-4	K	\$145,769
200-200440	SEL-SW LG Clnt HTTPS-40GC1-4	K	\$41,646
200-200441	SEL-SW LG Clnt Swt OSSWT-40GC1-4	K	\$41,646
200-200442	SEL-SW LG Clnt S3 AMZS3-40GC1-4	K	\$41,646
200-200445	SEL-SW LG Clnt Kerb KER-40GC1-4	K	\$41,646
200-200450	SEL-SW LG Clnt IPv6 IPV6-40GC1-4	K	\$333,169
200-200482	SEL HW WL Gen 7104-25G	K	\$166,769
200-200487	SEL SW LG Clnt iSCSI ISC-25GC1-4	K	\$73,846
200-200489	SEL SW LG Clnt SMB2 SMB-25GC2-4	K	\$73,846
200-200490	SEL SW LG Clnt SMB3 SMB-25GC3-4	K	\$73,846
200-200492	SEL SW LG Clnt NFSv3 NFS-25GC3-4	K	\$73,846
200-200493	SEL SW LG Clnt NFSv4 NFS-25GC4-4	K	\$73,846
200-200494	SEL SW LG Clnt NFS41 NFS-25GC41-4	K	\$73,846
200-200495	SEL SW LG Clnt HTTP HCS-25GC1-4	K	\$73,846
200-200496	SEL SW LG Clnt HTTPS HCSS-25GC1-4	K	\$21,231
200-200497	SEL SW LG Clnt Swt OSSWT-25GC1-4	K	\$21,231
200-200498	SEL SW LG Clnt S3 AMZS3-25GC1-4	K	\$21,231
200-200501	SEL SW LG Clnt Kerb KER-25GC1-4	K	\$21,231
200-200506	SEL SW LG Clnt IPv6 IPV6-25GC1-4	K	\$168,923
200-200520	SEL HW WL Gen 7104-10G	K	\$88,877
200-200521	SEL HW WL Gen 7108-10G	K	\$148,123
200-200522	SEL HW WL Gen 6204-16G	K	\$136,731
200-200523	SEL HW WL Gen 6208-16G	K	\$227,885
200-200524	SEL HW WL Gen U2022-10G-16FC	K	\$144,938
200-200525	SEL HW WL Gen U2044-10G-16FC	K	\$241,554
200-200526	SEL SW BN PROT 10G-2	K	\$80,308
200-200527	SEL SW BN PROT 10G-4	K	\$120,308
200-200528	SEL SW BN PROT 10G-8	K	\$180,462
200-200529	SEL SW BN PROT 25G-4	K	\$225,692
200-200530	SEL SW BN PROT 40G-2	K	\$193,846
200-200531	SEL SW BN PROT 40G-4	K	\$290,769
300068-001R	SEL VX-1000 1 YR SUBSCRIPT RENEW INC MNT	K	\$1,251
300069-001R	SEL VX-2000 1 YR SUBSCRIPT RENEW INC MNT	K	\$5,013
300070-001R	SEL VX-3000 1 YR SUBSCRIPT RENEW INC MNT	K	\$10,031
300071-001R	SEL VX-5000 1 YR SUBSCRIPT RENEW INC MNT	K	\$14,420
300072-001R	SEL VRX-8 1 YR SUBSCRIPT RENEWAL INC MNT	K	\$43,895
300088-001	SEL VX-500 1 YR SUBSCRIPTION INC MNT	K	\$624
300088-001R	SEL VX-500 1 YR SUBSCRIPT RENEW INC MNT	K	\$624
300089-001	SEL VX-6000 1 YR SUBSCRIPTION INC MNT	K	\$20,691
300089-001R	SEL VX-6000 1 YR SUBSCRIPT RENEW INC MNT	K	\$20,691
300090-001	SEL VX-7000 1 YR SUBSCRIPTION INC MNT	K	\$30,097
300090-001R	SEL VX-7000 1 YR SUBSCRIPT RENEW INC MNT	K	\$30,097
300103-001	SEL VX-8000 1 YR SUBSCRIPTTION INC MNT	K	\$43,895
300103-001R	SEL VX-8000 1 YR SUBSCRIPT RENEW INC MNT	K	\$43,895
300104-001	SEL VX-9000 1 YR SUBSCRIPTION INC MNT	K	\$62,708

300104-001R	SEL VX-9000 1 YR SUBSCRIPT RENEW INC MNT	K	\$62,708
300105-001	SEL VRX-2 1 YR SUBSCRIPTTION INC MNT	K	\$3,133
300105-001R	SEL VRX-2 1 YR SUBSCRIPT RENEWAL INC MNT	K	\$3,133
300106-001	SEL VRX-4 1 YR SUBSCRIPTION INC MNT	K	\$9,403
300106-001R	SEL VRX-4 1 YR SUBSCRIPT RENEWAL INC MNT	K	\$9,403
300121-001	SEL VRX-6 1 YR SUBSCRIPTION, INCL MAINT	K	\$20,691
300121-001R	SEL VRX-6 1 YR SUBSCRIPT RENEWAL INC MNT	K	\$20,691
30DAY-CC-PROMO	SEL IE Workshop 30 Day Single Server	K	\$0
3136SL	SEL: CORD,PWR,N5-15 C13,18AWG,6FT	K	\$5
34585	STORCENTER IX4-100 6TB	K	\$1,875
456-111-483	HCIA NP UPG VSPH E+ TO VSOM E+ 1CPU=IG	K	\$961
456-111-484	HCIA NP UPG VSPH STD TO VSOM E+ 1CPU=IG	K	\$3,632
456-111-485	HCIA NP UPG VSPH STD TO E+ 1CPU=IG	K	\$2,670
456-111-486	HCIA NP UPG VSPH ROBO STD TO ADV 25VM=IE	K	\$1,602
456-112-181	CloudLink KMIP Client Perpetual=IA	K	\$8,000
456-112-413	HCIA NP VSOM E+ 1CPU w/ 1Yr Maint=IG	K	\$4,268
456-112-414	HCIA NP VSOM E+ 1CPU w/ 2Yr Maint=IG	K	\$4,268
456-112-415	HCIA NP VSOM E+ 1CPU w/ 3Yr Maint=IG	K	\$4,268
456-112-416	HCIA NP VSOM E+ 1CPU w/ 4Yr Maint=IG	K	\$4,268
456-112-417	HCIA NP VSOM E+ 1CPU w/ 5Yr Maint=IG	K	\$4,268
456-112-418	HCIA NP VSPH E+ 1CPU w/ 1Yr Maint=IG	K	\$3,394
456-112-419	HCIA NP VSPH E+ 1CPU w/ 2Yr Maint=IG	K	\$3,394
456-112-420	HCIA NP VSPH E+ 1CPU w/ 3Yr Maint=IG	K	\$3,394
456-112-421	HCIA NP VSPH E+ 1CPU w/ 4Yr Maint=IG	K	\$3,394
456-112-422	HCIA NP VSPH E+ 1CPU w/ 5Yr Maint=IG	K	\$3,394
456-112-423	HCIA NP VSPH STD 1CPU w/ 1Yr Maint=IG	K	\$966
456-112-424	HCIA NP VSPH STD 1CPU w/ 2Yr Maint=IG	K	\$966
456-112-425	HCIA NP VSPH STD 1CPU w/ 3Yr Maint=IG	K	\$966
456-112-426	HCIA NP VSPH STD 1CPU w/ 4Yr Maint=IG	K	\$966
456-112-427	HCIA NP VSPH STD 1CPU w/ 5Yr Maint=IG	K	\$966
456-112-428	HCIA NP VSPH ROBO ADV 25VM w/1YrMaint=IB	K	\$4,370
456-112-429	HCIA NP VSPH ROBO ADV 25VM w/2YrMaint=IB	K	\$4,370
456-112-430	HCIA NP VSPH ROBO ADV 25VM w/3YrMaint=IB	K	\$4,370
456-112-431	HCIA NP VSPH ROBO ADV 25VM w/4YrMaint=IB	K	\$4,370
456-112-432	HCIA NP VSPH ROBO ADV 25VM w/5YrMaint=IB	K	\$4,370
456-112-433	HCIA NP VSPH ROBO STD 25VM w/1YrMaint=IB	K	\$2,913
456-112-434	HCIA NP VSPH ROBO STD 25VM w/2YrMaint=IB	K	\$2,913
456-112-435	HCIA NP VSPH ROBO STD 25VM w/3YrMaint=IB	K	\$2,913
456-112-436	HCIA NP VSPH ROBO STD 25VM w/4YrMaint=IB	K	\$2,913
456-112-437	HCIA NP VSPH ROBO STD 25VM w/5YrMaint=IB	K	\$2,913
456-112-438	HCIA NP VSPH DSKTP 100VM w/ 1Yr Maint=IB	K	\$7,768
456-112-439	HCIA NP VSPH DSKTP 100VM w/ 2Yr Maint=IB	K	\$7,768
456-112-440	HCIA NP VSPH DSKTP 100VM w/ 3Yr Maint=IB	K	\$7,768
456-112-441	HCIA NP VSPH DSKTP 100VM w/ 4Yr Maint=IB	K	\$7,768
456-112-442	HCIA NP VSPH DSKTP 100VM w/ 5Yr Maint=IB	K	\$7,768
456-112-443	HCIA UP VSOM E+ 1CPU w/ 1Yr Maint=IG	K	\$4,268
456-112-444	HCIA UP VSOM E+ 1CPU w/ 2Yr Maint=IG	K	\$4,268
456-112-445	HCIA UP VSOM E+ 1CPU w/ 3Yr Maint=IG	K	\$4,268
456-112-446	HCIA UP VSOM E+ 1CPU w/ 4Yr Maint=IG	K	\$4,268
456-112-447	HCIA UP VSOM E+ 1CPU w/ 5Yr Maint=IG	K	\$4,268

456-112-448	HCIA UP VSPH E+ 1CPU w/ 1Yr Maint=IG	K	\$3,394
456-112-449	HCIA UP VSPH E+ 1CPU w/ 2Yr Maint=IG	K	\$3,394
456-112-450	HCIA UP VSPH E+ 1CPU w/ 3Yr Maint=IG	K	\$3,394
456-112-451	HCIA UP VSPH E+ 1CPU w/ 4Yr Maint=IG	K	\$3,394
456-112-452	HCIA UP VSPH E+ 1CPU w/ 5Yr Maint=IG	K	\$3,394
456-112-453	HCIA UP VSPH STD 1CPU w/ 1Yr Maint=IG	K	\$966
456-112-454	HCIA UP VSPH STD 1CPU w/ 2Yr Maint=IG	K	\$966
456-112-455	HCIA UP VSPH STD 1CPU w/ 3Yr Maint=IG	K	\$966
456-112-456	HCIA UP VSPH STD 1CPU w/ 4Yr Maint=IG	K	\$966
456-112-457	HCIA UP VSPH STD 1CPU w/ 5Yr Maint=IG	K	\$966
456-112-458	HCIA UP VSPH ROBO ADV 25VM w/1YrMaint=IB	K	\$4,370
456-112-459	HCIA UP VSPH ROBO ADV 25VM w/2YrMaint=IB	K	\$4,370
456-112-460	HCIA UP VSPH ROBO ADV 25VM w/3YrMaint=IB	K	\$4,370
456-112-461	HCIA UP VSPH ROBO ADV 25VM w/4YrMaint=IB	K	\$4,370
456-112-462	HCIA UP VSPH ROBO ADV 25VM w/5YrMaint=IB	K	\$4,370
456-112-463	HCIA UP VSPH ROBO STD 25VM w/1YrMaint=IB	K	\$2,913
456-112-464	HCIA UP VSPH ROBO STD 25VM w/2YrMaint=IB	K	\$2,913
456-112-465	HCIA UP VSPH ROBO STD 25VM w/3YrMaint=IB	K	\$2,913
456-112-466	HCIA UP VSPH ROBO STD 25VM w/4YrMaint=IB	K	\$2,913
456-112-467	HCIA UP VSPH ROBO STD 25VM w/5YrMaint=IB	K	\$2,913
456-112-468	HCIA UP VSPH DSKTP 100VM w/ 1Yr Maint=IB	K	\$7,768
456-112-469	HCIA UP VSPH DSKTP 100VM w/ 2Yr Maint=IB	K	\$7,768
456-112-470	HCIA UP VSPH DSKTP 100VM w/ 3Yr Maint=IB	K	\$7,768
456-112-471	HCIA UP VSPH DSKTP 100VM w/ 4Yr Maint=IB	K	\$7,768
456-112-472	HCIA UP VSPH DSKTP 100VM w/ 5Yr Maint=IB	K	\$7,768
456-112-473	UPG VSPH E+ TO VSOM E+ 1CPU w/1Yr Mnt=IG	K	\$961
456-112-474	UPG VSPH E+ TO VSOM E+ 1CPU w/2Yr Mnt=IG	K	\$961
456-112-475	UPG VSPH E+ TO VSOM E+ 1CPU w/3Yr Mnt=IG	K	\$961
456-112-476	UPG VSPH E+ TO VSOM E+ 1CPU w/4Yr Mnt=IG	K	\$961
456-112-477	UPG VSPH E+ TO VSOM E+ 1CPU w/5Yr Mnt=IG	K	\$961
456-112-478	UPG VSPH STD TO VSOM E+ 1CPUw/1Yr Mnt=IG	K	\$3,632
456-112-479	UPG VSPH STD TO VSOM E+ 1CPUw/2Yr Mnt=IG	K	\$3,632
456-112-480	UPG VSPH STD TO VSOM E+ 1CPUw/3Yr Mnt=IG	K	\$3,632
456-112-481	UPG VSPH STD TO VSOM E+ 1CPUw/4Yr Mnt=IG	K	\$3,632
456-112-482	UPG VSPH STD TO VSOM E+ 1CPUw/5Yr Mnt=IG	K	\$3,632
456-112-483	UPG VSPH STD TO E+ 1CPU w/ 1Yr Maint=IG	K	\$2,670
456-112-484	UPG VSPH STD TO E+ 1CPU w/ 2Yr Maint=IG	K	\$2,670
456-112-485	UPG VSPH STD TO E+ 1CPU w/ 3Yr Maint=IG	K	\$2,670
456-112-486	UPG VSPH STD TO E+ 1CPU w/ 4Yr Maint=IG	K	\$2,670
456-112-487	UPG VSPH STD TO E+ 1CPU w/ 5Yr Maint=IG	K	\$2,670
456-112-488	UPG VSPH ROBO STD TO ADV 25VM-1Yr Mnt=IB	K	\$1,602
456-112-489	UPG VSPH ROBO STD TO ADV 25VM-2Yr Mnt=IB	K	\$1,602
456-112-490	UPG VSPH ROBO STD TO ADV 25VM-3Yr Mnt=IB	K	\$1,602
456-112-491	UPG VSPH ROBO STD TO ADV 25VM-4Yr Mnt=IB	K	\$1,602
456-112-492	UPG VSPH ROBO STD TO ADV 25VM-5Yr Mnt=IB	K	\$1,602
456-113-115	CloudLink 6.0 Perp 10 VM HCP Bundle=IB	K	\$1
456-113-139	HCIA NP VSOM E+ 6.5 1CPU w/ 1Yr Maint=IG	K	\$4,268
456-113-140	HCIA NP VSOM E+ 6.5 1CPU w/ 2Yr Maint=IG	K	\$4,268
456-113-141	HCIA NP VSOM E+ 6.5 1CPU w/ 3Yr Maint=IG	K	\$4,268
456-113-142	HCIA NP VSOM E+ 6.5 1CPU w/ 4Yr Maint=IG	K	\$4,268

456-113-143	HCIA NP VSOM E+ 6.5 1CPU w/ 5Yr Maint=IG	K	\$4,268
456-113-144	HCIA NP VSPH E+ 6.5 1CPU w/ 1Yr Maint=IG	K	\$3,394
456-113-145	HCIA NP VSPH E+ 6.5 1CPU w/ 2Yr Maint=IG	K	\$3,394
456-113-146	HCIA NP VSPH E+ 6.5 1CPU w/ 3Yr Maint=IG	K	\$3,394
456-113-147	HCIA NP VSPH E+ 6.5 1CPU w/ 4Yr Maint=IG	K	\$3,394
456-113-148	HCIA NP VSPH E+ 6.5 1CPU w/ 5Yr Maint=IG	K	\$3,394
456-113-149	HCIA NP VSPH STD 6.5 1CPU w/1Yr Maint=IG	K	\$966
456-113-150	HCIA NP VSPH STD 6.5 1CPU w/2Yr Maint=IG	K	\$966
456-113-151	HCIA NP VSPH STD 6.5 1CPU w/3Yr Maint=IG	K	\$966
456-113-152	HCIA NP VSPH STD 6.5 1CPU w/4Yr Maint=IG	K	\$966
456-113-153	HCIA NP VSPH STD 6.5 1CPU w/5Yr Maint=IG	K	\$966
456-113-154	HCIA NP VSPH ROBOADV6.5 25VM w/1YrMnt=IB	K	\$4,370
456-113-155	HCIA NP VSPH ROBOADV6.5 25VM w/2YrMnt=IB	K	\$4,370
456-113-156	HCIA NP VSPH ROBOADV6.5 25VM w/3YrMnt=IB	K	\$4,370
456-113-157	HCIA NP VSPH ROBOADV6.5 25VM w/4YrMnt=IB	K	\$4,370
456-113-158	HCIA NP VSPH ROBOADV6.5 25VM w/5YrMnt=IB	K	\$4,370
456-113-159	HCIA NP VSPH ROBOSTD6.5 25VM w/1YrMnt=IB	K	\$2,913
456-113-160	HCIA NP VSPH ROBOSTD6.5 25VM w/2YrMnt=IB	K	\$2,913
456-113-161	HCIA NP VSPH ROBOSTD6.5 25VM w/3YrMnt=IB	K	\$2,913
456-113-162	HCIA NP VSPH ROBOSTD6.5 25VM w/4YrMnt=IB	K	\$2,913
456-113-163	HCIA NP VSPH ROBOSTD6.5 25VM w/5YrMnt=IB	K	\$2,913
456-113-164	HCIA NP VSPH DSKTP 6.5 100VM w/1YrMnt=IB	K	\$7,768
456-113-165	HCIA NP VSPH DSKTP 6.5 100VM w/2YrMnt=IB	K	\$7,768
456-113-166	HCIA NP VSPH DSKTP 6.5 100VM w/3YrMnt=IB	K	\$7,768
456-113-167	HCIA NP VSPH DSKTP 6.5 100VM w/4YrMnt=IB	K	\$7,768
456-113-168	HCIA NP VSPH DSKTP 6.5 100VM w/5YrMnt=IB	K	\$7,768
456-113-169	HCIA UP VSOM E+ 6.5 1CPU w/ 1Yr Maint=IG	K	\$4,268
456-113-170	HCIA UP VSOM E+ 6.5 1CPU w/ 2Yr Maint=IG	K	\$4,268
456-113-171	HCIA UP VSOM E+ 6.5 1CPU w/ 3Yr Maint=IG	K	\$4,268
456-113-172	HCIA UP VSOM E+ 6.5 1CPU w/ 4Yr Maint=IG	K	\$4,268
456-113-173	HCIA UP VSOM E+ 6.5 1CPU w/ 5Yr Maint=IG	K	\$4,268
456-113-174	HCIA UP VSPH E+ 6.5 1CPU w/ 1Yr Maint=IG	K	\$3,394
456-113-175	HCIA UP VSPH E+ 6.5 1CPU w/ 2Yr Maint=IG	K	\$3,394
456-113-176	HCIA UP VSPH E+ 6.5 1CPU w/ 3Yr Maint=IG	K	\$3,394
456-113-177	HCIA UP VSPH E+ 6.5 1CPU w/ 4Yr Maint=IG	K	\$3,394
456-113-178	HCIA UP VSPH E+ 6.5 1CPU w/ 5Yr Maint=IG	K	\$3,394
456-113-179	HCIA UP VSPH STD 6.5 1CPU w/1Yr Maint=IG	K	\$966
456-113-180	HCIA UP VSPH STD 6.5 1CPU w/2Yr Maint=IG	K	\$966
456-113-181	HCIA UP VSPH STD 6.5 1CPU w/3Yr Maint=IG	K	\$966
456-113-182	HCIA UP VSPH STD 6.5 1CPU w/4Yr Maint=IG	K	\$966
456-113-183	HCIA UP VSPH STD 6.5 1CPU w/5Yr Maint=IG	K	\$966
456-113-184	HCIA UP VSPH ROBOADV6.5 25VM w/1YrMnt=IB	K	\$4,370
456-113-185	HCIA UP VSPH ROBOADV6.5 25VM w/2YrMnt=IB	K	\$4,370
456-113-186	HCIA UP VSPH ROBOADV6.5 25VM w/3YrMnt=IB	K	\$4,370
456-113-187	HCIA UP VSPH ROBOADV6.5 25VM w/4YrMnt=IB	K	\$4,370
456-113-188	HCIA UP VSPH ROBOADV6.5 25VM w/5YrMnt=IB	K	\$4,370
456-113-189	HCIA UP VSPH ROBOSTD6.5 25VM w/1YrMnt=IB	K	\$2,913
456-113-190	HCIA UP VSPH ROBOSTD6.5 25VM w/2YrMnt=IB	K	\$2,913
456-113-191	HCIA UP VSPH ROBOSTD6.5 25VM w/3YrMnt=IB	K	\$2,913
456-113-192	HCIA UP VSPH ROBOSTD6.5 25VM w/4YrMnt=IB	K	\$2,913

456-113-193	HCIA UP VSPH ROBOSTD6.5 25VM w/5YrMnt=IB	K	\$2,913
456-113-194	HCIA UP VSPH DSKTP 6.5 100VM w/1YrMnt=IB	K	\$7,768
456-113-195	HCIA UP VSPH DSKTP 6.5 100VM w/2YrMnt=IB	K	\$7,768
456-113-196	HCIA UP VSPH DSKTP 6.5 100VM w/3YrMnt=IB	K	\$7,768
456-113-197	HCIA UP VSPH DSKTP 6.5 100VM w/4YrMnt=IB	K	\$7,768
456-113-198	HCIA UP VSPH DSKTP 6.5 100VM w/5YrMnt=IB	K	\$7,768
456-113-199	UPG VSPH E+TOVSOM 6.5 E+ 1CPUw/1YrMnt=IG	K	\$961
456-113-200	UPG VSPH E+TOVSOM 6.5 E+ 1CPUw/2YrMnt=IG	K	\$961
456-113-201	UPG VSPH E+TOVSOM 6.5 E+ 1CPUw/3YrMnt=IG	K	\$961
456-113-202	UPG VSPH E+TOVSOM 6.5 E+ 1CPUw/4YrMnt=IG	K	\$961
456-113-203	UPG VSPH E+TOVSOM 6.5 E+ 1CPUw/5YrMnt=IG	K	\$961
456-113-204	UPG VSPH STDTOVSOM 6.5 E+1CPUw/1YrMnt=IC	K	\$3,632
456-113-205	UPG VSPH STDTOVSOM 6.5 E+1CPUw/2YrMnt=IC	K	\$3,632
456-113-206	UPG VSPH STDTOVSOM 6.5 E+1CPUw/3YrMnt=IC	K	\$3,632
456-113-207	UPG VSPH STDTOVSOM 6.5 E+1CPUw/4YrMnt=IC	K	\$3,632
456-113-208	UPG VSPH STDTOVSOM 6.5 E+1CPUw/5YrMnt=IC	K	\$3,632
456-113-209	UPG VSPH STD TO E+ 6.5 1CPU w/1Yr Mnt=IG	K	\$2,670
456-113-210	UPG VSPH STD TO E+ 6.5 1CPU w/2Yr Mnt=IG	K	\$2,670
456-113-211	UPG VSPH STD TO E+ 6.5 1CPU w/3Yr Mnt=IG	K	\$2,670
456-113-212	UPG VSPH STD TO E+ 6.5 1CPU w/4Yr Mnt=IG	K	\$2,670
456-113-213	UPG VSPH STD TO E+ 6.5 1CPU w/5Yr Mnt=IG	K	\$2,670
456-113-214	UPG VSPH ROBO STDTOADV6.5 25VM-1YrMnt=IE	K	\$1,602
456-113-215	UPG VSPH ROBO STDTOADV6.5 25VM-2YrMnt=IE	K	\$1,602
456-113-216	UPG VSPH ROBO STDTOADV6.5 25VM-3YrMnt=IE	K	\$1,602
456-113-217	UPG VSPH ROBO STDTOADV6.5 25VM-4YrMnt=IE	K	\$1,602
456-113-218	UPG VSPH ROBO STDTOADV6.5 25VM-5YrMnt=IE	K	\$1,602
456-113-448	CloudLink 6.6 SecVM Perpetual Tier 1=IB	K	\$1,425
456-113-449	CloudLink 6.6 SecVM Perpetual Tier 2=IB	K	\$1,175
456-113-450	CloudLink 6.6 SecVM Perpetual Tier 3=IB	K	\$1,010
456-113-451	CloudLink 6.6 SecVM Perpetual Tier 4=IB	K	\$775
456-113-452	CloudLink 6.6 SVM for CPSD HW per VM=IB	K	\$500
456-113-453	CloudLink 6.6 SVM CPSD HW per socket=ZC	K	\$5,000
456-113-454	CloudLink 6.6 KMIP Client Perpetual=IA	K	\$8,000
456-113-502	VMware Cloud Foundation Basic 3Y=ZA	K	\$13,135
456-113-503	VMware Cloud Foundation Basic 4Y=ZA	K	\$13,135
456-113-504	VMware Cloud Foundation Basic 5Y=ZA	K	\$13,135
456-113-507	UPG of vSphere to VCF Basic 3Y=ZA	K	\$9,645
456-113-508	UPG of vSphere to VCF Basic 4Y=ZA	K	\$9,645
456-113-509	UPG of vSphere to VCF Basic 5Y=ZA	K	\$9,645
456-113-512	VCF SDDCMgr NSXAdv w/HZN ENT 100PK 3Y=UB	K	\$73,340
456-113-513	VCF SDDCMgr NSXAdv w/HZN ENT 100PK 4Y=UB	K	\$73,340
456-113-514	VCF SDDCMgr NSXAdv w/HZN ENT 100PK 5Y=UB	K	\$73,340
456-113-517	VCF SDDCMgr NSXAdv w/ HZN ENT 10PK 3Y=UB	K	\$7,334
456-113-518	VCF SDDCMgr NSXAdv w/ HZN ENT 10PK 4Y=UB	K	\$7,334
456-113-519	VCF SDDCMgr NSXAdv w/ HZN ENT 10PK 5Y=UB	K	\$7,334
456-113-522	VCF SDDCMgrNSXAdv w/o HZNENT 100PK 3Y=UB	K	\$14,090
456-113-523	VCF SDDCMgrNSXAdv w/o HZNENT 100PK 4Y=UB	K	\$14,090
456-113-524	VCF SDDCMgrNSXAdv w/o HZNENT 100PK 5Y=UB	K	\$14,090
456-113-527	VCF SDDCMgrNSXAdv w/o HZN ENT 10PK 3Y=UB	K	\$1,409
456-113-528	VCF SDDCMgrNSXAdv w/o HZN ENT 10PK 4Y=UB	K	\$1,409

456-113-529	VCF SDDCMgrNSXAdv w/o HZN ENT 10PK 5Y=UB	K	\$1,409
456-113-532	VMware vCtr Srvr 6 Std vSphere 6 3Y=IA	K	\$6,175
456-113-533	VMware vCtr Srvr 6 Std vSphere 6 4Y=IA	K	\$6,175
456-113-534	VMware vCtr Srvr 6 Std vSphere 6 5Y=IA	K	\$6,175
456-113-537	VCF Upg VMw vCtr 6 Fnd - vCtr Srv 3Y=IA	K	\$5,104
456-113-538	VCF Upg VMw vCtr 6 Fnd - vCtr Srv 4Y=IA	K	\$5,104
456-113-539	VCF Upg VMw vCtr 6 Fnd - vCtr Srv 5Y=IA	K	\$5,104
456-113-626	SDDC MGR for Desktop 100 Pack 3Y=ZA	K	\$3,085
456-113-627	SDDC MGR for Desktop 100 Pack 4Y=ZA	K	\$3,085
456-113-628	SDDC MGR for Desktop 100 Pack 5Y=ZA	K	\$3,085
456-113-629	SDDC MGR for Desktop 10 Pack 3Y=ZA	K	\$309
456-113-630	SDDC MGR for Desktop 10 Pack 4Y=ZA	K	\$309
456-113-631	SDDC MGR for Desktop 10 Pack 5Y=ZA	K	\$309
456-113-632	VCF for VDI:ENT 100 PK w/o Horiz 3Y=ZA	K	\$20,090
456-113-633	VCF for VDI:ENT 100 PK w/o Horiz 4Y=ZA	K	\$20,090
456-113-634	VCF for VDI:ENT 100 PK w/o Horiz 5Y=ZA	K	\$20,090
456-113-635	VCF for VDI:ENT 10 PK w/o Horiz 3Y=ZA	K	\$2,009
456-113-636	VCF for VDI:ENT 10 PK w/o Horiz 4Y=ZA	K	\$2,009
456-113-637	VCF for VDI:ENT 10 PK w/o Horiz 5Y=ZA	K	\$2,009
456-113-650	VCF Standard (Per CPU) 3Y=ZA	K	\$17,795
456-113-651	VCF Standard (Per CPU) 4Y=ZA	K	\$17,795
456-113-652	VCF Standard (Per CPU) 5Y=ZA	K	\$17,795
456-113-653	VCF Advanced (Per CPU) 3Y=ZA	K	\$20,795
456-113-654	VCF Advanced (Per CPU) 4Y=ZA	K	\$20,795
456-113-655	VCF Advanced (Per CPU) 5Y=ZA	K	\$20,795
456-113-656	VCF Enterprise (Per CPU) 3Y=ZA	K	\$23,995
456-113-657	VCF Enterprise (Per CPU) 4Y=ZA	K	\$23,995
456-113-658	VCF Enterprise (Per CPU) 5Y=ZA	K	\$23,995
456-113-667	VMware Cloud Foundation Basic UPG 1Y=ZA	K	\$13,135
456-113-668	VMware Cloud Foundation Basic UPG 2Y=ZA	K	\$13,135
456-113-669	VMware Cloud Foundation Basic UPG 3Y=ZA	K	\$13,135
456-113-670	VMware Cloud Foundation Basic UPG 4Y=ZA	K	\$13,135
456-113-671	VMware Cloud Foundation Basic UPG 5Y=ZA	K	\$13,135
456-113-672	UPG of vSphere to VCF Basic UPG 1Y=ZA	K	\$9,645
456-113-673	UPG of vSphere to VCF Basic UPG 2Y=ZA	K	\$9,645
456-113-674	UPG of vSphere to VCF Basic UPG 3Y=ZA	K	\$9,645
456-113-675	UPG of vSphere to VCF Basic UPG 4Y=ZA	K	\$9,645
456-113-676	UPG of vSphere to VCF Basic UPG 5Y=ZA	K	\$9,645
456-113-677	VCF SDMGR NSXAdv w/HZN ENT 100PK U 1Y=UE	K	\$73,340
456-113-678	VCF SDMGR NSXAdv w/HZN ENT 100PK U 2Y=UE	K	\$73,340
456-113-679	VCF SDMGR NSXAdv w/HZN ENT 100PK U 3Y=UE	K	\$73,340
456-113-680	VCF SDMGR NSXAdv w/HZN ENT 100PK U 4Y=UE	K	\$73,340
456-113-681	VCF SDMGR NSXAdv w/HZN ENT 100PK U 5Y=UE	K	\$73,340
456-113-682	VCF SDMGR NSXAdv w/HZN ENT 10PK U 1Y=UB	K	\$7,334
456-113-683	VCF SDMGR NSXAdv w/HZN ENT 10PK U 2Y=UB	K	\$7,334
456-113-684	VCF SDMGR NSXAdv w/HZN ENT 10PK U 3Y=UB	K	\$7,334
456-113-685	VCF SDMGR NSXAdv w/HZN ENT 10PK U 4Y=UB	K	\$7,334
456-113-686	VCF SDMGR NSXAdv w/HZN ENT 10PK U 5Y=UB	K	\$7,334
456-113-687	VCF SDMgrNSXAdv w/o HZONENT 100PK U 1Y=UB	K	\$14,090
456-113-688	VCF SDMgrNSXAdv w/o HZONENT 100PK U 2Y=UB	K	\$14,090

456-113-689	VCF SDMgrNSXAdv w/o HZNENT 100PK U 3Y=UB	K	\$14,090
456-113-690	VCF SDMgrNSXAdv w/o HZNENT 100PK U 4Y=UB	K	\$14,090
456-113-691	VCF SDMgrNSXAdv w/o HZNENT 100PK U 5Y=UB	K	\$14,090
456-113-692	VCF SDMgrNSXAdv w/o HZN ENT 10PK U 1Y=UB	K	\$1,409
456-113-693	VCF SDMgrNSXAdv w/o HZN ENT 10PK U 2Y=UB	K	\$1,409
456-113-694	VCF SDMgrNSXAdv w/o HZN ENT 10PK U 3Y=UB	K	\$1,409
456-113-695	VCF SDMgrNSXAdv w/o HZN ENT 10PK U 4Y=UB	K	\$1,409
456-113-696	VCF SDMgrNSXAdv w/o HZN ENT 10PK U 5Y=UB	K	\$1,409
456-113-697	VMware vCtr Srvr 6 Std vSphere 6 U 1Y=IA	K	\$6,175
456-113-698	VMware vCtr Srvr 6 Std vSphere 6 U 2Y=IA	K	\$6,175
456-113-699	VMware vCtr Srvr 6 Std vSphere 6 U 3Y=IA	K	\$6,175
456-113-700	VMware vCtr Srvr 6 Std vSphere 6 U 4Y=IA	K	\$6,175
456-113-701	VMware vCtr Srvr 6 Std vSphere 6 U 5Y=IA	K	\$6,175
456-113-702	VCF Upg VM vCtr 6 Fnd - vCtr Srv U 1Y=IA	K	\$5,104
456-113-703	VCF Upg VM vCtr 6 Fnd - vCtr Srv U 2Y=IA	K	\$5,104
456-113-704	VCF Upg VM vCtr 6 Fnd - vCtr Srv U 3Y=IA	K	\$5,104
456-113-705	VCF Upg VM vCtr 6 Fnd - vCtr Srv U 4Y=IA	K	\$5,104
456-113-706	VCF Upg VM vCtr 6 Fnd - vCtr Srv U 5Y=IA	K	\$5,104
456-113-707	SDDC MGR for Desktop 100 Pack 1Y UPG=UB	K	\$3,085
456-113-708	SDDC MGR for Desktop 100 Pack 2Y UPG=UB	K	\$3,085
456-113-709	SDDC MGR for Desktop 100 Pack 3Y UPG=UB	K	\$3,085
456-113-710	SDDC MGR for Desktop 100 Pack 4Y UPG=UB	K	\$3,085
456-113-711	SDDC MGR for Desktop 100 Pack 5Y UPG=UB	K	\$3,085
456-113-712	SDDC MGR for Desktop 10 Pack 1Y UPG=UB	K	\$309
456-113-713	SDDC MGR for Desktop 10 Pack 2Y UPG=UB	K	\$309
456-113-714	SDDC MGR for Desktop 10 Pack 3Y UPG=UB	K	\$309
456-113-715	SDDC MGR for Desktop 10 Pack 4Y UPG=UB	K	\$309
456-113-716	SDDC MGR for Desktop 10 Pack 5Y UPG=UB	K	\$309
456-113-717	VCF for VDI:ENT 100 PK w/o Horiz 1Y U=ZA	K	\$20,090
456-113-718	VCF for VDI:ENT 100 PK w/o Horiz 2Y U=ZA	K	\$20,090
456-113-719	VCF for VDI:ENT 100 PK w/o Horiz 3Y U=ZA	K	\$20,090
456-113-720	VCF for VDI:ENT 100 PK w/o Horiz 4Y U=ZA	K	\$20,090
456-113-721	VCF for VDI:ENT 100 PK w/o Horiz 5Y U=ZA	K	\$20,090
456-113-722	VCF for VDI:ENT 10 PK w/o Horiz 1Y U=ZA	K	\$2,009
456-113-723	VCF for VDI:ENT 10 PK w/o Horiz 2Y U=ZA	K	\$2,009
456-113-724	VCF for VDI:ENT 10 PK w/o Horiz 3Y U=ZA	K	\$2,009
456-113-725	VCF for VDI:ENT 10 PK w/o Horiz 4Y U=ZA	K	\$2,009
456-113-726	VCF for VDI:ENT 10 PK w/o Horiz 5Y U=ZA	K	\$2,009
456-113-727	VCF Standard (Per CPU) 1Y UPG=ZA	K	\$17,795
456-113-728	VCF Standard (Per CPU) 2Y UPG=ZA	K	\$17,795
456-113-729	VCF Standard (Per CPU) 3Y UPG=ZA	K	\$17,795
456-113-730	VCF Standard (Per CPU) 4Y UPG=ZA	K	\$17,795
456-113-731	VCF Standard (Per CPU) 5Y UPG=ZA	K	\$17,795
456-113-732	VCF Advanced (Per CPU) 1Y UPG=ZA	K	\$20,795
456-113-733	VCF Advanced (Per CPU) 2Y UPG=ZA	K	\$20,795
456-113-734	VCF Advanced (Per CPU) 3Y UPG=ZA	K	\$20,795
456-113-735	VCF Advanced (Per CPU) 4Y UPG=ZA	K	\$20,795
456-113-736	VCF Advanced (Per CPU) 5Y UPG=ZA	K	\$20,795
456-113-737	VCF Enterprise (Per CPU) 1Y UPG=ZA	K	\$23,995
456-113-738	VCF Enterprise (Per CPU) 2Y UPG=ZA	K	\$23,995

456-113-739	VCF Enterprise (Per CPU) 3Y UPG=ZA	K	\$23,995
456-113-740	VCF Enterprise (Per CPU) 4Y UPG=ZA	K	\$23,995
456-113-741	VCF Enterprise (Per CPU) 5Y UPG=ZA	K	\$23,995
458-001-738	HCIA NP VxRail vSphere SOFTWARE	K	\$0
458-001-739	HCIA UP VxRail vSphere SOFTWARE	K	\$0
458-002-012	CloudLink SecVM Perp HCP Bundle	K	\$0
458-002-204	HCIA NP VxRail vSphere 6.5 Software	K	\$0
458-002-205	HCIA UP VxRail vSphere 6.5 Software	K	\$0
458-002-340	CloudLink SED Perp Tier 1=IA	K	\$1,250
458-002-361	CloudLink SED Perp Tier 2=IA	K	\$1,000
458-002-362	CloudLink SED Perp Tier 3=IA	K	\$750
458-002-363	CloudLink SED Perp Tier 4=IA	K	\$500
458-002-371	CloudLink 6.6 SecVM Perpetual	K	\$0
458-002-372	CloudLink 6.6 SVM for CPSD HW Perpetual	K	\$0
458-002-373	CloudLink 6.6 KMIP Client Perpetual	K	\$0
458-002-391	VMware Cloud Foundation Suite	K	\$0
458-002-442	CloudLink: VxFlex SED KMS Perp Tier 1=IA	K	\$2,500
458-002-443	CloudLink: VxFlex SED KMS Perp Tier 2=IA	K	\$2,000
458-002-444	CloudLink: VxFlex SED KMS Perp Tier 3=IA	K	\$1,500
458-002-445	CloudLink: VxFlex SED KMS Perp Tier 4=IA	K	\$1,000
458-002-456	VMware Cloud FDN w/o vSphere	K	\$0
458-002-457	VCF SDDCMgr NSXAdv w/ HZN ENT	K	\$0
458-002-458	VCF SDDCMgr NSXAdv w/ HZN ENT 10PK	K	\$0
458-002-459	VCF SDDCMgrNSXAdv w/o HZNENT 100PK	K	\$0
458-002-460	VCF SDDCMgrNSXAdv w/o HZN ENT 10PK	K	\$0
458-002-461	VMware vCtr Srvr 6 Std vSphere 6	K	\$0
458-002-462	VCF Upg VMw vCtr 6 Fnd - vCtr Srv	K	\$0
458-002-463	SDDC MGR for Desktop 100 Pack	K	\$0
458-002-464	SDDC MGR for Desktop 10 Pack	K	\$0
458-002-465	VCF for VDI: ENT 100 Pack w/o Horiz	K	\$0
458-002-466	VCF for VDI: ENT 10 Pack w/o Horiz	K	\$0
458-002-471	VCF Standard (Per CPU)	K	\$0
458-002-472	VCF Advanced (Per CPU)	K	\$0
458-002-473	VCF Enterprise (Per CPU)	K	\$0
458-002-486	VMware Cloud Foundation Suite UPG	K	\$0
458-002-487	VMware Cloud FDN w/o vSphere UPG	K	\$0
458-002-488	VCF SDDCMgr NSXAdv w/HZN ENT UPG	K	\$0
458-002-489	VCF SDDCMgr NSXAdv w/HZN ENT 10PK UPG	K	\$0
458-002-490	VCF SDDCMgrNSXAdv w/o HZNENT 100PK UPG	K	\$0
458-002-491	VCF SDDCMgrNSXAdv w/o HZN ENT 10PK UPG	K	\$0
458-002-492	VMware vCtr Srvr 6 Std vSphere 6 UPG	K	\$0
458-002-493	VCF Upg VMw vCtr 6 Fnd - vCtr Srv UPG	K	\$0
458-002-494	SDDC MGR for Desktop 100 Pack UPG	K	\$0
458-002-495	SDDC MGR for Desktop 10 Pack UPG	K	\$0
458-002-496	VCF for VDI: ENT 100 Pack w/o Horiz UPG	K	\$0
458-002-497	VCF for VDI: ENT 10 Pack w/o Horiz UPG	K	\$0
458-002-498	VCF Standard (Per CPU) UPG	K	\$0
458-002-499	VCF Advanced (Per CPU) UPG	K	\$0
458-002-500	VCF Enterprise (Per CPU) UPG	K	\$0
5000184-001	SEL USB GIGABIT BYPASS ADAPTER	K	\$504

500031-001	SELECT NX-1700 4MBPS WAN ACCL	K	\$3,961
500032-001	SELECT NX-5700 50MBPS WAN ACCEL	K	\$30,594
500039-001	SELECT NX-8700 500MBPS WAN ACCL	K	\$147,328
500040-001	SELECT NX-2700 10MBPS WAN ACCEL	K	\$13,028
500041-001	SELECT NX-3700 20MBPS WAN ACCEL	K	\$22,661
500042-001	SELECT NX-7700 200MBPS WAN ACCEL	K	\$62,328
500043-001	SELECT NX-9700 1GBPS WAN ACCEL	K	\$203,994
500045-001	SELECT VX-5000; VIRTUAL; 50Mbps	K	\$29,127
500046-001	SELECT VX-1000; VIRTUAL; 4Mbps	K	\$2,261
500048-001	SELECT VX-3000; VIRTUAL; 20Mbps	K	\$20,260
500049-001	SELECT GMS-10 VIRTUAL WAN ACCL MNGT	K	\$5,661
500049-100	SELECT UPGRD VIRTUAL GMS-10 TO GMS-25	K	\$11,333
500049-101	SELECT UPGRD VIRTUAL GMS-10 TO GMS-50	K	\$22,667
500070-001	SELECT VRX-8; VIRTUAL; 1GBPS; 1K FLOWS	K	\$79,328
500075-001	SEL NX-10700 2.5Gbps SSD 256K FLOWS FIBR	K	\$339,994
500101-001	SEL-FREE TRIAL SP 30-DAY VIRTUAL WAN OPT	K	\$0
500113-001	SEL VX-500 VIRTUAL 2Mbps 8K FLOWS	K	\$1,128
500114-001	SEL VX-6000 VIRTUAL 100Mbps 128K FLOWS	K	\$37,394
500115-001	SEL VX-7000 VIRTUAL 200Mbps 128K FLOWS	K	\$54,394
500137-001	SEL VX-8000 VIRTUAL, 622MBPS, 256K FLOWS	K	\$79,328
500138-001	SEL VX-9000, VIRTUAL, 1GBPS, 256K FLOWS	K	\$113,328
500139-001	SEL VRX-2, VELOCITY, 60GBPH	K	\$5,661
500140-001	SEL VRX-4, VELOCITY, 300GBPH	K	\$16,994
500163-001	SEL NX-11700, 5Gbps SSD 512K FLOWS FIBER	K	\$453,328
500172-001	SEL NX-6700, 100Mbps, 128K FLOWS, 4PORT	K	\$43,061
500180-001	SEL VRX-6, VELOCITY, 300Mbps	K	\$37,394
500187-001	SEL UNITY CLOUD INTELLIGENCE	K	\$5,667
5500SL	SEL: CORD SET,4.5M,NEMA L6-20P	K	\$84
6349	SEL: CABLE;OPTICAL;50U;SC-LC;10M	K	\$208
6803SL	SEL: CORD,POWER,220V,AUSTRALIA	K	\$37
6804SL	SEL: CORD,POWER,220V,S.AFRICA-INDIA	K	\$55
6805SL	SEL: CORD,POWER,220V,UK	K	\$46
6806SL	SEL: CORD,POWER,220V,ISRAEL	K	\$35
6807SL	SEL: CORD,POWER,220V,JAPAN	K	\$81
6808SL	SEL: CORD,POWER,220V,EUROPE	K	\$36
6MONTH-CC-PROMO	SEL IE Workshop Promo Single Server	K	\$15,385
7029SL	SEL: CORD SET,4.5M,NEMA L6-30P	K	\$74
7741SL	SEL: CORD,POWER,S. AFRICA	K	\$20
8147SL	SEL: CORD SET,2.5M,NEMA5-15,IEC C19	K	\$76
8289SL	SEL: CORD,PWR,N5-15 C13,14AWG,2M	K	\$9
8296SL	SEL: CORD,POWER,C14-C13,16AWG,6FT	K	\$6
8297SL	SEL: CORD,POWER,C14-C19,14AWG,6FT	K	\$21
8665SL	SEL: CORD,POWER,60309-C19,15FT	K	\$109
8840SL	SEL: CABLE;EX;SAS;SFF8088-SF8088;2M	K	\$194
90879028	SEL: FRU;TAPE;CLEAN;LTO;W-BARCODE	K	\$56
90940740	SEL: RAMP,PYTHON,ADJUSTABLE	K	\$1
90943365	SEL: ASY,EDBA,SINGLE,PYTHON	K	\$35
90943366	SEL: FRU,EDBA,DOUBLE,PYTHON	K	\$69
90949024	SEL: FRU;LTO TERAPK COVER;NO MEDIA	K	\$395
90949024-A	SEL: FRU;TRPK-ACCS;W-COVER;NO MEDIA	K	\$0

90949030	SEL: PYTHON;CHAMBER-SLOT KEY ENABLE	K	\$1,308
90949030-F	SEL: PYTHON;CHAMBER-SLOT KEY ENABLE	K	\$1,308
90949030FIN-D	SEL: CHAMBER-SLOT KEY;DICOUNT;TFIN	K	\$1,112
90949030FIN-F	SEL: CHAMBER-SLOT;UPG;KEYENABLE;FIN	K	\$1,308
90949030-J-D	SEL: CHAMB-SLOT KEY;DIS;TFIN;ENT	K	\$1,112
90949030T380J	SEL: CHAMB/SLOT KEY ENABLE,T380 ENT	K	\$1,635
90949030T380J-F	SEL: UPG,CHAMB/SLOT KEY,T380,ENT	K	\$1,635
90949030T950-J	SEL: CHAMB/SLOT KEY ENABLE,T950 ENT	K	\$1,635
90949030T950-J-F	SEL: UPG,CHAMB/SLOT KEY,T950,ENT	K	\$1,635
90949030TFIN	SEL: CHAMBER-SLOT KEY ENABLE;TFIN	K	\$1,308
90949030TFIN-J	SEL: CHAMB-SLOT KEY ENABLE,TFIN ENT	K	\$1,635
90949030TFIN-J-F	SEL: UPG,CHAMB-SLOT KEY,TFIN,ENT	K	\$1,635
90949048	SEL: FRU;TERAPACK W-O COVER;LTO	K	\$368
90949099	SEL: T950;ENCRYPTION;PROFESSIONAL	K	\$6,538
90949099-F	SEL: T950;ENCRYPTION;PROFESSIONAL	K	\$6,538
90949099FIN-F	SEL: TFIN;UPG;ENCRYPT;PROFESSIONAL	K	\$6,538
90949099TFIN	SEL: TFIN;ENCRYPTION;PROFESSIONAL	K	\$6,538
90949106	SEL: FRU;TAPE;CLEAN;LTO;W-BCOD;CUST	K	\$56
90949112T200	SEL: FRU;5-12V PWR SUPPLY;ROHS;T200	K	\$3,877
90949112T380	SEL: FRU;5-12V PWR SUPPLY;ROHS;T380	K	\$3,877
90949112T680	SEL: FRU;5-12V PWR SUPPLY;ROHS;T680	K	\$3,877
90949112T68-F	SEL: FRU;5-12V PWR SUPPLY;ROHS;T680	K	\$3,877
90949118	SEL: FRU,TRANSPORTER,PYTH	K	\$19,615
90949120	SEL: FRU;DBA;PYTHON;ROHS ONLY	K	\$6,148
90949120T68-F	SEL: FRU;DBA;ROHS ONLY;T680	K	\$6,092
90949132	SEL: FRU;N 1 PWR SUPPLIES;ROHS ONLY	K	\$9,138
90949156SL	SEL: CLN TPS X5,W TPK,BCD,CERT	K	\$328
90949157SL	SEL: CLN TPS X10,W TPK,BCD,CERT	K	\$596
90949166	SEL: FRU;5-12V PWRSUP;8AMP;ROHS	K	\$3,877
90949166-F	SEL: FRU;5-12V PWRSUP;8AMPFUSE;ROHS	K	\$3,877
90949166FIN-F	SEL: FRU;UP;5-12VPWRSUP;8AP;ROH;FIN	K	\$3,877
90949166TFIN	SEL: FRU;5-12VPWRSUP;8AMP;ROHS;TFIN	K	\$3,877
90949170SL	SEL: FRU,MAINT TAPES,10-TPK,CERT	K	\$596
90949171SL	SEL: FRU,MAINT TAPES,10-TPK,CUST	K	\$596
90949175SL	SEL: FRU,MAINT TAPES,5-TPK,CERT	K	\$328
90949219	SEL: TAPES;20;WO-TPK;CERT;LTO-5	K	\$922
90949221	SEL: TAPES;TERAPACK;CERT;LTO-5	K	\$495
90949222	SEL: TAPES;TERAPACK;CUST;LTO-5	K	\$495
90949258	SEL: FRU;VAX;BUMPER;T950	K	\$55
90949259	SEL: SLS;SW KEY;DIRECT-CON;T950	K	\$6,538
90949259-F	SEL: FRU;SLS SW-KEY;DIRECT-CON;T950	K	\$6,538
90949261	SEL: FRU;TAPE;LTO-5;CERTIFIED	K	\$48
90949264	SEL: TAPES;TRPK;CERT;LTO5 WORM;T950	K	\$588
90949266	SEL: TAPES;TRPK;CUST;LTO5 WORM;T950	K	\$588
90949294	SEL: TAPES;TPK;CERT;3592 JC	K	\$3,005
90949295	SEL: TAPES;TPK;CUST;3592 JC	K	\$3,005
90949303	SEL: TPK,LTO-M8,CERT,NCVR	K	\$1,564
90949304	SEL: TPK,LTO-M8,CUST,NCVR	K	\$1,564
90949305-A	SEL: ACCESS TPK;W-O CVR;NO MED;3592	K	\$0
90949310SPL	SEL: FRU,MAINT TPK, 9-TPS,CERT,3592	K	\$2,382

90949311SPL	SEL: FRU,MAINT TPK, 9-TPS,CUST,3592	K	\$2,382
90949312SPL	SEL: FRU,MAINT TPS, 5-TPK,CERT,3592	K	\$1,352
90949334	SEL: FRU,TRANSPORTER,ENT	K	\$19,615
90949349	SEL: TAPES;TPK;NO CVR;CERT;LTO-5	K	\$489
90949350	SEL: TAPES;TPK;NO CVR;CUST;LTO-5	K	\$489
90949367	SEL: TPK,LTO-M8,CERT	K	\$1,572
90949371	SEL: FRU,CABLES,T950,EXP,UPGRADE	K	\$1
90949374SL	SEL: TAPES,LTO5,CUST,10,CASE,NOTPK	K	\$468
90949375SL	SEL: TAPES,LTO5,10,CERT,CASE,NOTPK	K	\$468
90949382-F	SEL: FRU,UPG,LTO-6,FC,FH,T950	K	\$15,769
90949382T20-F	SEL: FRU,UPG,LTO-6,FC,FH,T200	K	\$15,769
90949382T38-F	SEL: FRU,UPG,LTO-6,FC,FH,T380	K	\$15,769
90949382T68-F	SEL: FRU,UPG,LTO-6,FC,FH,T680	K	\$15,769
90949382TFI-F	SEL: FRU,UPG,LTO-6,FC,FH,TFIN	K	\$15,769
90949396	SEL: TAPES,TERAPACK,CERT,LTO-6	K	\$723
90949397	SEL: TAPES,TERAPACK,CUST,LTO-6	K	\$723
90949398	SEL: TAPES,TPK,NO CVR,CERT,LTO-6	K	\$716
90949399	SEL: TAPES,TPK,NO CVR,CUST,LTO-6	K	\$716
90949402SL	SEL: TPK,LTO-M8,CUST	K	\$1,572
90949403SL	SEL: 20TPK,LTO-M8,CERT	K	\$31,414
90949404	SEL: TAPES,20 TERAPACKS,CERT,LTO-6	K	\$14,319
90949405	SEL: TAPES,20 TERAPACKS,CUST,LTO-6	K	\$14,319
90949406	SEL: TAPES,20 TPKS,NO CVR,CERT,LTO6	K	\$14,185
90949408	SEL: TAPES,20,WO-TPK,CERT,LTO-6	K	\$1,379
90949410	SEL: FRU,TAPE,LTO-6,CERTIFIED	K	\$74
90949412	SEL: TAPES,LTO6,10,CERT,CASE,NOTPK	K	\$727
90949414SL	SEL: TAPES,TRPK,CUST,LTO6 WORM,T950	K	\$869
90949415SL	SEL: TAPES,TRPK,CERT,LTO6 WORM,T950	K	\$869
90949439	SEL: FRU,EDBA,PYTHON	K	\$6,148
90949439TFIN	SEL: FRU,EDBA,TFIN	K	\$6,092
90949442	SEL FRU,LTO-6,FC,FH,IMPACT	K	\$15,769
90949442-F	SEL UPG,FRU,LTO-6,FC,FH,IMPACT	K	\$15,769
90949442T200	SEL FRU,LTO-6,T200,FC,FH,IMPACT	K	\$15,769
90949442T20-F	SEL UPG,LTO-6,T200,FC,FH,IMPACT	K	\$15,769
90949442T380	SEL FRU,LTO-6,T380,FC,FH,IMPACT	K	\$15,769
90949442T38-F	SEL UPG,LTO-6,T380,FC,FH,IMPACT	K	\$15,769
90949442T680	SEL FRU,LTO-6,T680,FC,FH,IMPACT	K	\$15,769
90949442T68-F	SEL UPG,LTO-6,T680,FC,FH,IMPACT	K	\$15,769
90949442TFI-F	SEL UPG,LTO-6,TFIN,FC,FH,IMPACT	K	\$15,769
90949442TFIN	SEL FRU,LTO-6,TFIN,FC,FH,IMPACT	K	\$15,769
90949468	SEL: TAPES,TERAPACK,CERT,LTO-6,MP	K	\$645
90949469	SEL: TAPES,TERAPACK,CUST,LTO-6,MP	K	\$645
90949470	SEL: TPS,TPK,NOCVR,CERT,LTO-6,MP	K	\$638
90949472	SEL: TAPES,20 TPKS,CERT,LTO-6,MP	K	\$12,883
90949476	SEL: TAPES,20,WO-TP,CERT,LTO-6,MP	K	\$1,222
90949488	SEL: SLS,SW-KEY,QIP-CON,T950	K	\$6,538
90949488-F	SEL: UPG,SLS,SW-KEY,QIP-CON,T950	K	\$6,538
90949489	SEL: SLS,SW-KEY,QIP-CON,TFIN	K	\$6,538
90949489-F	SEL: UPG,SLS,SW-KEY,QIP-CON,TFIN	K	\$6,538
90949538-F	SEL: FRU,IP CAMERA,GN2,DRV-FR,T950B	K	\$4,154

90949538TFIN	SEL: FRU,IP CAMERA,GN2,DRV-FR,TFIN	K	\$4,154
90949538TFIN-F	SEL: FRU,IP CAMERA,GN2,DRV-FR,TFIN	K	\$4,154
90949539-F	SEL: FRU,IP CAMERA,GEN2,MED-FR,T950B	K	\$4,154
90949539TFIN	SEL: FRU,IP CAMERA,GEN2,MED-FR,TFIN	K	\$4,154
90949539TFIN-F	SEL: FRU,IP CAMERA,GEN2,MED-FR,TFIN	K	\$4,154
90949553	SEL: FRU LS SD CARD IND TFIN	K	\$1
90949554	SEL: FRU LS SD CARD IND T-SERIES	K	\$1
90949558T2	SEL: FRU,TS1150,DRV,T950,IMPACT,T2	K	\$49,846
90949558T2-F	SEL: FRU,TS1150,DRV,T950,IMPACT,T2	K	\$49,846
90949558T380T2	SEL: FRU,TS1150,DRV,T380,IMPACT,T2	K	\$49,846
90949558T380T2-F	SEL: FRU,TS1150,DRV,T380,IMPACT,T2	K	\$49,846
90949558TFINT2	SEL: FRU,TS1150,DRV,TFIN,IMPACT,T2	K	\$49,846
90949558TFINT2-F	SEL: UPG,TS1150,DRV,TFIN,IMPACT,T2	K	\$49,846
90949559TFINT2-F	SEL: FRU,TS1150,DRIVE,TFIN,ENT,T2	K	\$49,846
90949564	SEL: TAPES,20 TPK,CERT,3592 JD	K	\$79,309
90949565	SEL: TAPES,20 TPK,CUST,3592 JD	K	\$79,309
90949566	SEL: TAPES,TPK,CERT,3592 JD	K	\$3,973
90949567	SEL: TAPES,TPK,CUST,3592 JD	K	\$3,973
90949578	SEL: FRU,RIM2,T950	K	\$12,462
90949578-F	SEL: FRU,RIM2,T950	K	\$12,462
90949578T200	SEL: FRU,RIM2,T200	K	\$12,462
90949578T200-F	SEL: FRU,RIM2,T200	K	\$12,462
90949578T380	SEL: FRU,RIM2,T380	K	\$12,462
90949578T380-F	SEL: FRU,RIM2,T380	K	\$12,462
90949578T680	SEL: FRU,RIM2,T680	K	\$12,462
90949578T680-F	SEL: FRU,RIM2,T680	K	\$12,462
90949578TFIN	SEL: FRU,RIM2,TFIN	K	\$12,462
90949578TFIN-F	SEL: FRU,RIM2,TFIN	K	\$12,462
90949613	SEL: TAPES,TERAPACK,CERT,LTO-7	K	\$1,513
90949614	SEL: TAPES,TERAPACK,CUST,LTO-7	K	\$1,513
90949615-F	SEL: FRU,UPG,LTO-7,FC,FH,T950	K	\$18,292
90949615T200-F	SEL: FRU,UPG,LTO-7,FC,FH,T200	K	\$18,292
90949615T380-F	SEL: FRU,UPG,LTO-7,FC,FH,T380	K	\$18,292
90949615T680-F	SEL: FRU,UPG,LTO-7,FC,FH,T680	K	\$18,292
90949615TFIN-F	SEL: FRU,UPG,LTO-7,FC,FH,TFIN	K	\$18,292
90949616	SEL: FRU,LTO-7,FC,FH,IMPACT,T950	K	\$18,292
90949616-F	SEL: UPG,LTO-7,FC,FH,IMPACT,T950	K	\$18,292
90949616T200	SEL: FRU,LTO-7,FC,FH,IMPACT,T200	K	\$18,292
90949616T200-F	SEL: UPG,LTO-7,FC,FH,IMPACT,T200	K	\$18,292
90949616T380	SEL: FRU,LTO-7,FC,FH,IMPACT,T380	K	\$18,292
90949616T380-F	SEL: UPG,LTO-7,FC,FH,IMPACT,T380	K	\$18,292
90949616T680	SEL: FRU,LTO-7,FC,FH,IMPACT,T680	K	\$18,292
90949616T680-F	SEL: UPG,LTO-7,FC,FH,IMPACT,T680	K	\$18,292
90949616TFIN	SEL: FRU,LTO-7,FC,FH,IMPACT,TFIN	K	\$18,292
90949616TFIN-F	SEL: UPG,LTO-7,FC,FH,IMPACT,TFIN	K	\$18,292
90949621	SEL: FRU,BRUSHES,TFIN,CARBON	K	\$1
90949625	SEL: FRU,MAIN,PWR RAILS,G2,UPG KIT	K	\$1
90949626	SEL: FRU,LSB,PWR RAILS,G2,UPG KIT	K	\$1
90949627	SEL: FRU,RSB,PWR RAILS,G2,UPG KIT	K	\$1
90949628	SEL: FRU,DRV,PWR RAILS,G2,UPG KIT	K	\$1

90949629	SEL: FRU,MEDIA,PWR RAILS,G2,UPG KIT	K	\$1
90949635	SEL: TPK,LTO-7,CERT,NCVR	K	\$1,505
90949636	SEL: TPK,LTO-7,CUST,NCVR	K	\$1,505
90949637	SEL: 20TPK,LTO-7,CERT	K	\$30,245
90949638	SEL: 20TPK,LTO-7,CUST	K	\$30,245
90949639	SEL: 20TPK,LTO-7,CERT,NCVR	K	\$30,099
90949640	SEL: 20TPK,LTO-7,CUST,NCVR	K	\$30,099
90949641	SEL: TAPES,LTO-7,CERT,CLAM20	K	\$2,956
90949642	SEL: TAPES,LTO-7,CUST,CLAM20	K	\$2,956
90949643	SEL: FRU,TAPE,LTO-7,CERT	K	\$150
90949644	SEL: FRU,TAPE,LTO-7,CUST	K	\$150
90949645	SEL: TAPES,LTO-7,CERT,CASE10	K	\$1,488
90949646	SEL: TAPES,LTO-7,CUST,CASE10	K	\$1,488
90949647	SEL: TPK,LTO-7,CUST,WORM	K	\$1,729
90949648	SEL: TPK,LTO-7,CERT,WORM	K	\$1,729
90949717	SEL: TPS,LTO-6BAFE,CERT,WORM,CASE10	K	\$861
90949720	SEL: FRU,TAPE,LTO6,BAFE,WORM,CUSTOM	K	\$87
90949721	SEL: FRU,TAPE,LTO-6,BAFE,WORM,CERT	K	\$87
90949723	SEL: FRU,TAPE,LTO-7,WORM,CERT	K	\$172
90949724	SEL: FRU,TAPE,LTO-7,WORM,CUST	K	\$172
90949725	SEL: TPS,LTO-7,CERT,WORM,CASE10	K	\$1,710
90949728	SEL: TPS,LTO-6BAFE,CUST,WORM,CASE10	K	\$861
90949729	SEL: TPS,LTO-7,CUST,WORM,CASE10	K	\$1,710
90949739	SEL: FRU;24V POW SUP;8AMPFUSE;ROHS	K	\$3,877
90949740	SEL: FRU;5-12V PWRSUP;8AMPFUSE;ROH	K	\$3,877
90949743	SEL: FRU;N+1 PWR SUPPLIES;ROHS ONLY	K	\$9,138
90949744	SEL: FRU,TS1155,DRV,T950,IMPACT,T2	K	\$46,385
90949744-F	SEL: FRU,TS1155,DRV,T950,IMPACT,T2	K	\$46,385
90949744T380	SEL: FRU,TS1155,DRV,T380,IMPACT,T2	K	\$46,385
90949744T380-F	SEL: FRU,TS1155,DRV,T380,IMPACT,T2	K	\$46,385
90949744TFIN	SEL: FRU,TS1155,DRV,TFIN,IMPACT,T2	K	\$46,385
90949744TFIN-F	SEL: UPG,TS1155,DRV,TFIN,IMPACT,T2	K	\$46,385
90949745TFIN-F	SEL: FRU,TS1155,DRIVE,TFIN,ENT,T2	K	\$46,385
90949746	SEL: FRU,HP TRANSPORTER	K	\$32,692
90949752	SEL: 20TPK,LTO-M8,CUST	K	\$31,414
90949753	SEL: 20TPK,LTO-M8,CERT,NCVR	K	\$31,268
90949783	SEL: 20TPK,LTO-8,CUST,NCVR	K	\$72,070
90949784-F	SEL: FRU,UPG,LTO-8,FC,FH,T950	K	\$24,600
90949784T200-F	SEL: FRU,UPG,LTO-8,FC,FH,T200	K	\$24,600
90949784T380-F	SEL: FRU,UPG,LTO-8,FC,FH,T380	K	\$24,600
90949784T680-F	SEL: FRU,UPG,LTO-8,FC,FH,T680	K	\$24,600
90949784TFIN-F	SEL: FRU,UPG,LTO-8,FC,FH,TFIN	K	\$24,600
90949785	SEL: FRU,LTO-8,FC,FH,IMPACT,T950	K	\$24,600
90949785-F	SEL: UPG,LTO-8,FC,FH,IMPACT,T950	K	\$24,600
90949785T200	SEL: FRU,LTO-8,FC,FH,IMPACT,T200	K	\$24,600
90949785T200-F	SEL: UPG,LTO-8,FC,FH,IMPACT,T200	K	\$24,600
90949785T380	SEL: FRU,LTO-8,FC,FH,IMPACT,T380	K	\$24,600
90949785T380-F	SEL: UPG,LTO-8,FC,FH,IMPACT,T380	K	\$24,600
90949785T680	SEL: FRU,LTO-8,FC,FH,IMPACT,T680	K	\$24,600
90949785T680-F	SEL: UPG,LTO-8,FC,FH,IMPACT,T680	K	\$24,600

90949785TFIN	SEL: FRU,LTO-8,FC,FH,IMPACT,TFIN	K	\$24,600
90949785TFIN-F	SEL: UPG,LTO-8,FC,FH,IMPACT,TFIN	K	\$24,600
90949786	SEL: TPK,LTO-8,CERT	K	\$3,612
90949787	SEL: TPK,LTO-8,CUST	K	\$3,612
90949788	SEL: TPK,LTO-8,CERT,NCVR	K	\$3,604
90949789	SEL: TPK,LTO-8,CUST,NCVR	K	\$3,604
90949790	SEL: 20TPK,LTO-8,CERT	K	\$72,216
90949791	SEL: 20TPK,LTO-8,CUST	K	\$72,216
90949792	SEL: 20TPK,LTO-8,CERT,NCVR	K	\$72,070
90949793	SEL: 20TPK,LTO-M8,CUST,NCVR	K	\$31,268
90949794	SEL: TAPES,LTO-8,CERT,CLAM20	K	\$7,154
90949795	SEL: TAPES,LTO-8,CUST,CLAM20	K	\$7,154
90949796	SEL: FRU,TAPE,LTO-8,CERT	K	\$360
90949797	SEL: FRU,TAPE,LTO-8,CUST	K	\$360
90949798	SEL: TAPES,LTO-8,CERT,CASE10	K	\$3,587
90949799	SEL: TAPES,LTO-8,CUST,CASE10	K	\$3,587
90949803	SEL: FRU,UPG,SPECTRA LS,GEN IV	K	\$2,520
90949815	SEL: TAPES,LTO-M8,CUST,CLAM20	K	\$3,073
90949816	SEL: FRU,TAPE,LTO-M8,CUST	K	\$156
90949817	SEL: TAPES,LTO-M8,CERT,CASE10	K	\$1,546
90949818	SEL: TAPES,LTO-M8,CUST,CASE10	K	\$1,546
90949827	SEL: FRU,TAPE,LTO-M8,CERT	K	\$156
90949828	SEL: TAPES,LTO-M8,CERT,CLAM20	K	\$3,073
90959034	SEL: FRU;T120;COD;5 SLOT KEY	K	\$647
90959034-F	SEL: FRU;T120;COD;5 SLOT KEY	K	\$647
90959042	SEL: FRU;SLS;SOFTWARE;DIRECT;T120	K	\$6,538
90959042-F	SEL: FRU;SLS;SOFTWARE;DIRECT;T120	K	\$6,538
90959209	SEL: T120;ENCRYPTION;PROFESSIONAL	K	\$6,538
90959209-F	SEL: T120;ENCRYPTION;PROFESSIONAL	K	\$6,538
90959226	SEL: FRU;N 1 POWER PACK;ROHS ONLY	K	\$2,769
90959240	SEL: FRU;DRIVE SHELF;HH;T120	K	\$24
90959244	SEL: TAPES;TERAPACK;CERT;LTO-5;T120	K	\$452
90959245	SEL: TAPES;TERAPACK;CUST;LTO-5;T120	K	\$452
90959257	SEL: TAPES;TPK;NOCVR;CERT;LTO5;T120	K	\$446
90959261-FSL	SEL: FRU,LTO-6,HH,FC,UPGRD,T120	K	\$11,354
90959261SL	SEL: FRU,LTO-6,HH,FC,T120	K	\$11,354
90959262-FSL	SEL: FRU,LTO-6,HH,SAS,UPGRD,T120	K	\$9,462
90959262SL	SEL: FRU,LTO-6,HH,SAS,T120	K	\$9,462
90959268	SEL: TAPES,TPK,NOCVR,CERT,LTO6,T120	K	\$629
90959272	SEL: TAPES,TERAPACK,CERT,LTO-6,T120	K	\$636
90959273	SEL: TAPES,TERAPACK,CUST,LTO-6,T120	K	\$636
90959274	SEL: TAPES,TPK,CERT,LTO-6,T120,MP	K	\$573
90959276	SEL: TPK,NOCVR,CERT,LTO6,T120,MP	K	\$566
90959295	SEL: FRU,LTO-7,HH,FC,T120	K	\$13,246
90959295-F	SEL: UPG,LTO-7,HH,FC,T120	K	\$13,246
90959296	SEL: FRU,LTO-7,HH,SAS,T120	K	\$11,354
90959296-F	SEL: UPG,LTO-7,HH,SAS,T120	K	\$11,354
90959297	SEL: TPK,LTO-7,CERT,120,NCVR	K	\$1,245
90959298	SEL: TPK,LTO-7,CUST,120,NCVR	K	\$1,245
90959299	SEL: TPK,LTO-7,CERT,WORM,120	K	\$1,423

90959300	SEL: TPK,LTO-7,CUST,WORM,120	K	\$1,423
90959301	SEL: TPK,LTO-7,CERT,120	K	\$1,252
90959302	SEL: TPK,LTO-7,CUST,120	K	\$1,252
90959308	SEL: FRU,LTO-8,HH,SAS,T120	K	\$13,246
90959308-F	SEL: UPG,LTO-8,HH,SAS,T120	K	\$13,246
90959309	SEL: FRU,LTO-8,HH,FC,T120	K	\$15,138
90959309-F	SEL: UPG,LTO-8,HH,FC,T120	K	\$15,138
90959310	SEL: TPK,LTO-8,CERT,120	K	\$2,931
90959311	SEL: TPK,LTO-8,CUST,120	K	\$2,931
90959312	SEL: TPK,LTO-8,CUST,120,NCVR	K	\$2,924
90959313	SEL: TPK,LTO-8,CERT,120,NCVR	K	\$2,924
90959319	SEL: TPK,LTO-M8,CERT,120,NCVR	K	\$1,291
90959320	SEL: TPK,LTO-M8,CUST,120,NCVR	K	\$1,291
90959321	SEL: TPK,LTO-M8,CERT,120	K	\$1,299
90959322	SEL: TPK,LTO-M8,CUST,120	K	\$1,299
90979018-F	SEL: FRU;SLS;SOFTWARE;UPGRADE;T50E	K	\$3,269
90979438	SEL: T50,ENCRYPTION,PROFESSIONAL	K	\$6,538
90979438-F	SEL: T50;ENCRYPTION;PROFESSIONAL	K	\$6,538
90979471	SEL: FRU;POWER SUPPLY;T50E	K	\$1,149
90979471-F	SEL: FRU;UPGRD;POWER SUPPLY;T50E	K	\$1,149
90979473	SEL: FRU;SLOT CARTRIDGE SLED;T50E	K	\$0
90979476U-F	SEL: FRU,COD-KEY,5 SLOT,T50E	K	\$647
90979478-F	SEL: FRU;COD-KEY;1 SLOT;T50E	K	\$129
90979510-FSL	SEL: FRU,UPG,LTO-6,FC,HH,T50E	K	\$10,917
90979511-FSL	SEL: FRU,UPG,LTO-6,SAS,HH,T50E	K	\$8,734
90979523-FSL	SEL: UPG,LTO-7,HH,FC,T50E	K	\$13,101
90979524-FSL	SEL: UPG,LTO-7,HH,SAS,T50E	K	\$10,917
90979526-FSL	SEL: UPG,LTO-8,HH,FC,T50E	K	\$15,284
90979527-FSL	SEL: UPG,LTO-8,HH,SAS,T50E	K	\$13,101
91019814T200	SEL: CHAMBER-SLOT KEY ENABLE;T200	K	\$1,308
91019814T20-F	SEL: CHAMBER-SLOT KEY ENABLE;T200	K	\$1,308
91019814T380	SEL: CHAMBER-SLOT KEY ENABLE;T380	K	\$1,308
91019814T38-F	SEL: FRU;CHAMBER-SLOT KEY;T380	K	\$1,308
91019814T680	SEL: CHAMBER-SLOT KEY ENABLE;T680	K	\$1,308
91019814T68-F	SEL: FRU;CHAMBER-SLOT KEY;T680	K	\$1,308
91019816	SEL: ENCRYPTION;PRO;T200-380-680	K	\$6,538
91019816-F	SEL: FRU;ENCRYPTON;PRO;T200-380-680	K	\$6,538
91019817	SEL: SLS SFTWR KEY;QIP-RIM-CONN;BOA	K	\$6,538
91019817-F	SEL: FRU;SLS SFTWR-KEY;QIP-RIM;BOA	K	\$6,538
91019818	SEL: SLS SFTWR KEY;DIRECT-CONN;T200	K	\$6,538
91019818-F	SEL: FRU;SLS SFTWR-KEY;DIRECT;T200	K	\$6,538
91019824	SEL: RACK;STANDARD 19 INCH	K	\$4,015
91019832	SEL: SLS SW KEY;DIRECTCONN;T380-680	K	\$6,538
91019832-F	SEL: FRU;SLS SW-KEY;DIRECT;T380-680	K	\$6,538
9198	SEL: CNTR,SFP,8GB,850NM,OPTICAL	K	\$263
9313	SEL: CABLEOPTICAL50ULC-LC10M	K	\$187
9314	SEL: CABLE,OPTICAL,50U,LC-LC,20M	K	\$235
9317	SEL: CABLE,OPTICAL,LC-LC,50M	K	\$291
9594SL	SEL: CORD,4.5M,L6-20P / LOCKING C19	K	\$75
AADENC100UC	SEL AV-ADV-ENTC100-UG-C)	K	\$3,410

AADENC100UC-I	SEL AV-ADV-ENTC100-UG-C)	K	\$3,563
AADENC100UC-K	SEL AV-ADV-ENTC100-UG-C)	K	\$3,658
AADENT100UC	SEL AV-ADV-ENTN100-UG-C)	K	\$2,310
AADENT100UC-I	SEL AV-ADV-ENTN100-UG-C)	K	\$2,414
AADENT100UC-K	SEL AV-ADV-ENTN100-UG-C)	K	\$2,479
AADENT10UC	SEL AV-ADV-ENTC10-UG-C)	K	\$341
AADENT10UC-I	SEL AV-ADV-ENTC10-UG-C)	K	\$356
AADENT10UC-K	SEL AV-ADV-ENTC10-UG-C)	K	\$366
AADETN10UC	SEL AV-ADV-ENTN10-UG-C)	K	\$231
AADETN10UC-I	SEL AV-ADV-ENTN10-UG-C)	K	\$241
AADETN10UC-K	SEL AV-ADV-ENTN10-UG-C)	K	\$248
ADU-1YR-00000001	SEL 1YR 1-9 ADMIN USER LOGIN	K	\$2,308
ADU-1YR-00000010	SEL 1YR 10-99 ADMIN USER LOGIN	K	\$1,923
ADU-3YR-00000001	SEL 3YR 1-9 ADMIN USER LOGIN	K	\$6,231
ADU-3YR-00000010	SEL 3YR 10-99 ADMIN USER LOGIN	K	\$5,192
ADU-5YR-00000001	SEL 5YR 1-9 ADMIN USER LOGIN	K	\$9,231
ADU-5YR-00000010	SEL 5YR 10-99 ADMIN USER LOGIN	K	\$7,692
AE-0-50PL	SEL Automation Engine PL	K	\$149
AE-0-50TL	SEL Automation Engine TL	K	\$60
AE-1001-1500PL	SEL Automation Engine PL	K	\$43
AE-1001-1500TL	SEL Automation Engine TL	K	\$17
AE-100K-150KPL	SEL Automation Engine PL	K	\$23
AE-100K-150KTL	SEL Automation Engine TL	K	\$9
AE-101-250PL	SEL Automation Engine PL	K	\$82
AE-101-250TL	SEL Automation Engine TL	K	\$33
AE-10K-20KPL	SEL Automation Engine PL	K	\$26
AE-10K-20KTL	SEL Automation Engine TL	K	\$11
AE-1501-2000PL	SEL Automation Engine PL	K	\$39
AE-1501-2000TL	SEL Automation Engine TL	K	\$15
AE-150K-PL	SEL Automation Engine PL	K	\$22
AE-150K-TL	SEL Automation Engine TL	K	\$9
AE-2001-2500PL	SEL Automation Engine PL	K	\$36
AE-2001-2500TL	SEL Automation Engine TL	K	\$14
AE-20K-35KPL	SEL Automation Engine PL	K	\$25
AE-20K-35KTL	SEL Automation Engine TL	K	\$10
AE-2501-4000PL	SEL Automation Engine PL	K	\$34
AE-2501-4000TL	SEL Automation Engine TL	K	\$14
AE-251-500PL	SEL Automation Engine PL	K	\$62
AE-251-500TL	SEL Automation Engine TL	K	\$25
AE-35K-50KPL	SEL Automation Engine PL	K	\$24
AE-35K-50KTL	SEL Automation Engine TL	K	\$10
AE-4001-6000PL	SEL Automation Engine PL	K	\$32
AE-4001-6000TL	SEL Automation Engine TL	K	\$13
AE-501-750PL	SEL Automation Engine PL	K	\$50
AE-501-750TL	SEL Automation Engine TL	K	\$20
AE-50K-100KPL	SEL Automation Engine PL	K	\$23
AE-50K-100KTL	SEL Automation Engine TL	K	\$9
AE-51-100PL	SEL Automation Engine PL	K	\$104
AE-51-100TL	SEL Automation Engine TL	K	\$42
AE-6001-8000PL	SEL Automation Engine PL	K	\$29

AE-6001-8000TL	SEL Automation Engine TL	K	\$12
AE-751-1000PL	SEL Automation Engine PL	K	\$47
AE-751-1000TL	SEL Automation Engine TL	K	\$19
AE-8001-10KPL	SEL Automation Engine PL	K	\$28
AE-8001-10KTL	SEL Automation Engine TL	K	\$11
A-HDF-AGT-100-1Y	SEL HDF Edge Agent Sub- 100 Agents	K	\$100,000
A-HDF-AGT-10K-1Y	SEL HDF Edge Agent Sub- 10,000 Agents	K	\$2,000,000
A-HDF-AGT-1K-1Y	SEL HDF Edge Agent Sub- 1000 Agents	K	\$500,000
A-HDF-DIM-1Y	Sel HDF Data in Motion Bundle	K	\$700,000
A-HDF-EDG-10-1Y	SEL HDF Edge Brnch Office Sub - 10 Nodes	K	\$100,000
A-HDF-EDG-1Y	SEL HWX DataFlow Edge Pack 100 Devices	K	\$300,000
A-HDF-EDG-25-1Y	SEL HDF Edge Brnch Office Sub - 25 Nodes	K	\$150,000
A-HDF-EFM-1Y	Sel HDF Ent Flow Mngt- 16 Cores	K	\$72,000
A-HDF-EMS-1Y	Sel HDF MNGT Services 1 Cluster	K	\$20,000
A-HDF-ESP-1Y	Sel HDF Stream Processing 4 Nodes	K	\$36,000
A-HDP-ENT-1Y	SEL HDP Ent. 4 Nodes or 50TB Raw Stor	K	\$16,000
A-HDP-EPL-1Y	SEL HDP Ent.+ 4 Nodes or 50TB Raw Stor	K	\$28,800
A-HDP-JSS-6M	SEL HDP Jumpstart Sub. 200TB- 6M sub.	K	\$48,000
A-HDP-SCHNG-1Y	SEL Solr Search	K	\$32,000
A-HWC-FLX-CNT-1Y	SEL Flx Sprt Contact - 1 yr - Required	K	\$15,385
A-HWC-FLXCRDTS	SEL HWX Connect Flx Crdts - 12 Credits	K	\$8,615
A-HWC-FLXPLN-1Y	SEL HWX Connect Flex Plan 1Y	K	\$23,077
AIA-1	SEL STEELCNT APPINT AGENT (QTY 1-24)	K	\$6,399
AIA-2	SEL STEELCNT APPINT AGENT (QTY 25-49)	K	\$5,439
AIA-3	SEL STEELCNT APPINT AGENT (QTY 50-99)	K	\$4,799
AIA-4	SEL STEELCNT APPINT AGENT (QTY 100-249)	K	\$4,479
AIA-5	SEL STEELCNT APPINT AGENT (QTY 250-499)	K	\$4,159
AIA-6	SEL STEELCNT APPINT AGENT (QTY 500-999)	K	\$3,679
AIA-7	SEL STEELCNT APPINT AGENT (1000-2499)	K	\$3,519
AIA-8	SEL STEELCNT APPINT AGENT (2500-4999)	K	\$3,200
AIA-9	SEL STEELCNT APPINT AGENT (5000-99999)	K	\$2,880
AIXBMX-40	SEL AI Xprt BrwsrMetrix 10MPgViews-Month	K	\$26,332
AIXBMX-50	SEL AI XprtBrwsrMetrix 100MPgViews-Month	K	\$223,871
AIXBMX-60	SEL AI Xprt BrwsrMetrix 1BPgViews-Month	K	\$882,332
AIXBMX-70	SEL AI Xprt BrwsrMetrix 10BPgViews-Month	K	\$1,846,148
AIXCOL	SEL AppInternals Xpert Agent	K	\$3,932
AIXCON	SEL AppInternals Xpert Management Server	K	\$34,455
ARX-03300-B010	SEL AppResponse 3300	K	\$66,455
ARX-03800-B010	SEL AppResponse 3800	K	\$105,225
ARX-04300-B010	SEL AppResponse 4300	K	\$138,455
ARX-05100-B010	SEL AppResponse 5100	K	\$177,225
ARX-06000-B010	SEL AppResponse 6000	K	\$253,532
ARXCXT10	SEL CX-Tracer - 10 Servers	K	\$19,686
ARXCXT100	SEL CX-Tracer - 100 Servers	K	\$131,686
ARXCXT500	SEL CX-Tracer - 500 Servers	K	\$329,225
ARXDB	SEL AppResponse DB Module	K	\$19,686
ARX-DIR300-B010	SEL AppResponse Director	K	\$52,055
ARX-EXP300-B010	SEL AppResponse Expansion Chassis	K	\$68,302
ARX-SM-3000	SEL Shark Module for AppResp 3000 series	K	\$12,302
ARX-SM-4000	SEL Shark Module for AppResp 4000 series	K	\$22,025

ARX-SM-5000	SEL Shark Module for AppResp 5000 series	K	\$26,455
ARX-SM-6000	SEL Shark Module for AppResp 6000 series	K	\$42,332
ARX-UCMM	SEL AppResponse UC Module	K	\$39,502
ARX-V2000	SEL AppResponse v2000	K	\$32,855
ARXVMON	SEL AppResponse VMon	K	\$14,517
ARXVOI1K	SEL AppResp VoIP Module 1-1000 Calls	K	\$19,686
ARXVOI250	SEL AppResponse VoIP Module 1-250 Calls	K	\$7,871
ARXVOI500	SEL AppResponse VoIP Module 1-500 Calls	K	\$13,163
ASENX	SEL AppSensor Xpert	K	\$26,332
ASESNMP	SEL AppSensor SNMP Adapter Pack	K	\$6,154
ASTADC10UC	SEL AV-STD-ADVC10-UG-C)	K	\$677
ASTADC10UC-I	SEL AV-STD-ADVC10-UG-C)	K	\$707
ASTADC10UC-K	SEL AV-STD-ADVC10-UG-C)	K	\$726
ASTADV100UC	SEL AV-STD-ADVC100-UG-C)	K	\$6,765
ASTADV100UC-I	SEL AV-STD-ADVC100-UG-C)	K	\$7,069
ASTADV100UC-K	SEL AV-STD-ADVC100-UG-C)	K	\$7,252
ASTADV10UC	SEL AV-STD-ADV10-UG-C)	K	\$446
ASTADV10UC-I	SEL AV-STD-ADV10-UG-C)	K	\$466
ASTADV10UC-K	SEL AV-STD-ADV10-UG-C)	K	\$478
ASTDADV100UC	SEL AV-STD-ADV100-UG-C)	K	\$4,455
ASTDADV100UC-I	SEL AV-STD-ADV100-UG-C)	K	\$4,655
ASTDADV100UC-K	SEL AV-STD-ADV100-UG-C)	K	\$4,777
ASTDENC10UC	SEL AV-STD-ENTC10-UG-C)	K	\$1,018
ASTDENC10UC-I	SEL AV-STD-ENTC10-UG-C)	K	\$1,064
ASTDENC10UC-K	SEL AV-STD-ENTC10-UG-C)	K	\$1,092
ASTDNT100UC	SEL AV-STD-ENTN100-UG-C)	K	\$6,765
ASTDNT100UC-I	SEL AV-STD-ENTN100-UG-C)	K	\$7,069
ASTDNT100UC-K	SEL AV-STD-ENTN100-UG-C)	K	\$7,252
ASTENN10UC	SEL AV-STD-ENTN10-UG-C)	K	\$677
ASTENN10UC-I	SEL AV-STD-ENTN10-UG-C)	K	\$707
ASTENN10UC-K	SEL AV-STD-ENTN10-UG-C)	K	\$726
ASTENT100UC	SEL AV-STD-ENTC100-UG-C)	K	\$10,175
ASTENT100UC-I	SEL AV-STD-ENTC100-UG-C)	K	\$10,633
ASTENT100UC-K	SEL AV-STD-ENTC100-UG-C)	K	\$10,918
ATXP	SEL AppTransaction Plus	K	\$109,286
ATXS	SEL AppTransaction Standard	K	\$77,655
AVADVC100C	SEL AV-ADVC-100-C)	K	\$15,450
AVADVC100C-I	SEL AV-ADVC-100-C)	K	\$16,145
AVADVC100C-K	SEL AV-ADVC-100-C)	K	\$16,588
AVADVC10C	SEL AV-ADVC-10-C)	K	\$1,545
AVADVC10C-I	SEL AV-ADVC-10-C)	K	\$1,615
AVADVC10C-K	SEL AV-ADVC-10-C)	K	\$1,659
AVADV100C	SEL AV-ADV100-C)	K	\$10,250
AVADV100C-I	SEL AV-ADV100-C)	K	\$10,711
AVADV100C-K	SEL AV-ADV100-C)	K	\$10,994
AVADV10C	SEL AV-ADV10-C)	K	\$1,025
AVADV10C-I	SEL AV-ADV10-C)	K	\$1,071
AVADV10C-K	SEL AV-ADV10-C)	K	\$1,099
AVENTC100C	SEL AV-ENTC-100-C)	K	\$18,550
AVENTC100C-I	SEL AV-ENTC-100-C)	K	\$19,385

AVENTC100C-K	SEL AV-ENTC-100-C)	K	\$19,882
AVENTC10C	SEL AV-ENTC-10-C)	K	\$1,855
AVENTC10C-I	SEL AV-ENTC-10-C)	K	\$1,938
AVENTC10C-K	SEL AV-ENTC-10-C)	K	\$1,988
AVENTN100C	SEL AV-ENTN-100-C)	K	\$12,350
AVENTN100C-I	SEL AV-ENTN-100-C)	K	\$12,906
AVENTN100C-K	SEL AV-ENTN-100-C)	K	\$13,216
AVENTN10C	SEL AV-ENTN-10-C)	K	\$1,235
AVENTN10C-I	SEL AV-ENTN-10-C)	K	\$1,291
AVENTN10C-K	SEL AV-ENTN-10-C)	K	\$1,322
AVSTDC100C	SEL AV-STDC-100-C)	K	\$9,300
AVSTDC100C-I	SEL AV-STDC-100-C)	K	\$9,719
AVSTDC100C-K	SEL AV-STDC-100-C)	K	\$9,998
AVSTDC10C	SEL AV-STDC-10-C)	K	\$930
AVSTDC10C-I	SEL AV-STDC-10-C)	K	\$972
AVSTDC10C-K	SEL AV-STDC-10-C)	K	\$1,000
AVSTDN100C	SEL AV-STDN-100-C)	K	\$6,200
AVSTDN100C-I	SEL AV-STDN-100-C)	K	\$6,479
AVSTDN100C-K	SEL AV-STDN-100-C)	K	\$6,646
AVSTDN10C	SEL AV-STDN-10-C)	K	\$620
AVSTDN10C-I	SEL AV-STDN-10-C)	K	\$648
AVSTDN10C-K	SEL AV-STDN-10-C)	K	\$665
BCB-1YR-00001000	SEL 1Y BU Catalog Bundle Up to 1k Tapes	K	\$15,385
BCB-1YR-00005000	SEL 1Y BU Catalog Bundle Up to 5k Tapes	K	\$30,769
BCB-1YR-00010000	SEL 1Y BU Catalog Bundle Upto 10k Tapes	K	\$46,154
BCB-1YR-00025000	SEL 1Y BU Catalog Bundle Up to 25k Tapes	K	\$76,923
BCB-1YR-00050000	SEL 1Y BU Catalog Bundle Up to 50k Tapes	K	\$138,462
BCB-1YR-00100000	SEL 1Y BU Catalog Bundle Up to 100k Tape	K	\$230,769
BCB-3YR-00001000	SEL 3Y BU Catalog Bundle Up to 1k Tapes	K	\$30,769
BCB-3YR-00005000	SEL 3Y BU Catalog Bundle Up to 5k Tapes	K	\$61,538
BCB-3YR-00010000	SEL 3Y BU Catalog Bundle Up to 10k Tapes	K	\$92,308
BCB-3YR-00025000	SEL 3Y BU Catalog Bundle Up to 25k Tapes	K	\$153,846
BCB-3YR-00050000	SEL 3Y BU Catalog Bundle Up to 50k Tapes	K	\$276,923
BCB-3YR-00100000	SEL 3Y BU Catalog Bundle Up to 100k Tape	K	\$461,538
BCB-5YR-00001000	SEL 5Y BU Catalog Bundle Up to 1k Tapes	K	\$46,154
BCB-5YR-00005000	SEL 5Y BU Catalog Bundle Up to 5k Tapes	K	\$92,308
BCB-5YR-00010000	SEL 5Y BU Catalog Bundle Up to 10k Tapes	K	\$138,462
BCB-5YR-00025000	SEL 5Y BU Catalog Bundle Up to 25k Tapes	K	\$230,769
BCB-5YR-00050000	SEL 5Y BU Catalog Bundle Up to 50k Tapes	K	\$415,385
BCB-5YR-00100000	SEL 5Y BU Catalog Bundle Up to 100k Tape	K	\$692,308
BDAW2AD1Y15	SEL BlueData AWS v3,15vnodes,1Yr,24x7	K	\$10,065
BDAW2AD1Y30	SEL BlueData AWS v3,30vnodes,1Yr,24x7	K	\$20,149
BDAW2AD1Y60	SEL BlueData AWS v3,60vnodes,1Yr,24x7	K	\$36,285
BDAW2AD1Y90	SEL BlueData AWS v3,90vnodes,1Yr,24x7	K	\$48,386
BDAW2ST1Y15	SEL BlueData AWS v3,15vnodes,1Yr,12x5	K	\$8,752
BDAW2ST1Y30	SEL BlueData AWS v3,30vnodes,1Yr,12x5	K	\$17,522
BDAW2ST1Y60	SEL BlueData AWS v3,60vnodes,1Yr,12x5	K	\$31,552
BDAW2ST1Y90	SEL BlueData AWS v3,90vnodes,1Yr,12x5	K	\$42,075
BDEN2AD1Y1C	SEL BlueData Ent Soft v3,1Yr,24x7	K	\$885
BDEN2AD2Y1C	SEL BlueData Ent Soft v3,2Yr,24x7	K	\$1,592

BDEN2AD3Y1C	SEL BlueData Ent Soft v3,3Yr,24x7	K	\$2,123
BDEN2ST1Y1C	SEL BlueData Ent Soft v3,1Yr,12x5	K	\$769
BDEN2ST2Y1C	SEL BlueData Ent Soft v3,2Yr,12x5	K	\$1,385
BDEN2ST3Y1C	SEL BlueData Ent Soft v3,3Yr,12x5	K	\$1,846
BDENTPKG1YR	SEL BlueData EPIC480CDPLYTC3AD4WS1Yr24x7	K	\$294,118
BDENTPKG2YR	SEL BlueData EPIC480CDPLYTC6AD8WS2Yr24x7	K	\$529,412
BDENTPKG3YR	SEL BlueData EPIC480CDPLYTC9AD8WS3Yr24x7	K	\$705,882
BDSTARTPKG1YR	SEL BlueData EPIC240CDPLYTC2AD2WS1Yr12x5	K	\$176,471
BDSTARTPKG2YR	SEL BlueData EPIC240CDPLYTC4AD6WS2Yr12x5	K	\$317,647
BDSTARTPKG3YR	SEL BlueData EPIC240CDPLYTC6AD6WS3Yr12x5	K	\$423,529
BEDROCK-001	SEL Bedrock Ingest/Mgmt per Core AIM 1Y	K	\$1,538
BEDROCK-002	SEL Bedrock Ingest/Mgmt Per Core AIM 2Y	K	\$3,077
BEDROCK-003	SEL Bedrock Ingest/Mgmt per Core AIM 3Y	K	\$4,615
BM-API-LC-ADV	SEL BOOMI API Publish Features	K	\$650
BM-API-LC-T1	SEL BOOMI API Mgmt Tier 1 Up to 100K T/D	K	\$1,500
BM-API-LC-T2	SEL BOOMI API Mgmt Tier 2 Up to 1M T/D	K	\$3,000
BM-API-LC-T3	SEL BOOMI API Mgmt Tier 3 Up to 10M T/D	K	\$8,000
BM-API-LC-T4	SEL BOOMI API Mgmt Tier 4 >10M T/D	K	\$15,000
BM-E-C101-200	SEL BOOMI TradePartnerConnect (101-200)	K	\$71
BM-E-C41-100	SEL BOOMI TradePartnerConnect (41-100)	K	\$71
BM-E-CT1001Y	SEL BOOMI TradePartnerConnect (81-100)	K	\$30
BM-E-CT100P1Y	SEL BOOMI TradePartnerConnect > 100	K	\$23
BM-E-CT101Y	SEL BOOMI TradePartnerConnect (5-10)	K	\$68
BM-E-CT201P	SEL BOOMI TradePartnerConnect (201 plus)	K	\$71
BM-E-CT201Y	SEL BOOMI TradePartnerConnect (11-20)	K	\$60
BM-E-CT401Y	SEL BOOMI TradePartnerConnect (21-40)	K	\$53
BM-E-CT601Y	SEL BOOMI TradePartnerConnect (41-60)	K	\$45
BM-E-CT6-40	SEL BOOMI TradePartnerConnect (6-40)	K	\$71
BM-E-CT801Y	SEL BOOMI TradePartnerConnect (61-80)	K	\$38
BM-E-CTP	SEL BOOMI Trading Partner Connection	K	\$75
BM-E-CTP41Y	SEL BOOMI TradePartnerConnect (1-4)	K	\$75
BM-E-CTPCT-NS	SEL BOOMI TradePartnerConnectProd NonSub	K	\$75
BM-E-CTPTEST	SEL BOOMI TradePartnerConnect Test	K	\$38
BM-E-CTTCT-NS	SEL BOOMI TradePartnerConnectTest NonSub	K	\$38
BM-E-LC-B2BF	SEL BOOMI EDI/B2B Framework	K	\$0
BM-E-LC-BETA	SEL BOOMI Beta EDI Features	K	\$0
BM-E-LC-FY18	SEL BOOMI EDI Edition	K	\$550
BM-E-LC-RAVI	SEL BOOMI EDI Ed - NetSuite RAVI Bundle	K	\$467
BM-E-LC-TRD1Y	SEL BOOMI Trading Partner Edition	K	\$550
BM-F-LC-AL-1	SEL BOOMI Flow Addtnl AppLaunches .01	K	\$0
BM-F-LC-AL-2	SEL BOOMI Flow Addtnl AppLaunches 1	K	\$1
BM-F-LC-AL-3	SEL BOOMI Flow Addtnl AppLaunches 100	K	\$100
BM-F-LC-AL-4	SEL BOOMI Flow Addtnl AppLaunches 1000	K	\$1,000
BM-F-LC-CONT	SEL BOOMI Flow Continual	K	\$45
BM-F-LC-EBRNZ	SEL BOOMI Flow Enterprise Bronze	K	\$2,250
BM-F-LC-EG-1	SEL BOOMI Flow Enterprise Gold .01	K	\$0
BM-F-LC-EG-2	SEL BOOMI Flow Enterprise Gold 1	K	\$1
BM-F-LC-EG-3	SEL BOOMI Flow Enterprise Gold 100	K	\$100
BM-F-LC-EG-4	SEL BOOMI Flow Enterprise Gold 1000	K	\$1,000
BM-F-LC-ESLVR	SEL BOOMI Flow Enterprise Silver	K	\$4,500

BM-F-LC-ESSNT	SEL BOOMI Flow Essential	K	\$25
BM-F-LC-ESTRT	SEL BOOMI Flow Enterprise Starter	K	\$1,000
BM-F-LC-FS-1	SEL BOOMI Flow Addtnl Flows .01	K	\$0
BM-F-LC-FS-2	SEL BOOMI Flow Addtnl Flows 1	K	\$1
BM-F-LC-FS-3	SEL BOOMI Flow Addtnl Flows 100	K	\$100
BM-F-LC-FS-4	SEL BOOMI Flow Addtnl Flows 1000	K	\$1,000
BM-F-LC-HS-1	SEL BOOMI Flow Hosting Services .01	K	\$0
BM-F-LC-HS-2	SEL BOOMI Flow Hosting Services 1	K	\$1
BM-F-LC-HS-3	SEL BOOMI Flow Hosting Services 100	K	\$100
BM-F-LC-HS-4	SEL BOOMI Flow Hosting Services 1000	K	\$1,000
BM-F-LC-OCC	SEL BOOMI Flow Occasional	K	\$10
BM-I-LC-ACA	SEL BOOMI Atom Cloud Attachment	K	\$300
BM-I-LC-ACA-A	SEL BOOMI ANZ Atom Cloud Attachment	K	\$300
BM-I-LC-ACA-E	SEL BOOMI EMEA Atom Cloud Attachment	K	\$300
BM-I-LC-ACA-T	SEL BOOMI Atom Cloud Attachment - Test	K	\$150
BM-I-LC-ADVW	SEL BOOMI Advanced Workflow	K	\$650
BM-I-LC-ASOAP	SEL BOOMI Advanced Soap Processing	K	\$0
BM-I-LC-AUC	SEL BOOMI Advanced User Controls	K	\$650
BM-I-LC-AW	SEL BOOMI Atom Worker	K	\$250
BM-I-LC-AW-T	SEL BOOMI Atom Worker - Test	K	\$125
BM-I-LC-BESC	SEL BOOMI Base Ed - Standard Connection	K	\$550
BM-I-LC-BESMB	SEL BOOMI Base Ed - SmallBiz Connection	K	\$550
BM-I-LC-CL	SEL BOOMI Component Locking	K	\$0
BM-I-LC-CLOUD	SEL BOOMI Clouds	K	\$0
BM-I-LC-EC1Y	SEL BOOMI Enterprise Connection	K	\$900
BM-I-LC-EDV	SEL BOOMI Excess Data Volume-1Gb	K	\$100
BM-I-LC-EE1Y	SEL BOOMI Enterprise Edition	K	\$8,000
BM-I-LC-ENV	SEL BOOMI Environments	K	\$0
BM-I-LC-EPCNS	SEL BOOMI Enterprise Prod Connect NonSub	K	\$900
BM-I-LC-EPE	SEL BOOMI Enterprise Plus Edition	K	\$12,000
BM-I-LC-ETC	SEL BOOMI Enterprise Test Connection	K	\$450
BM-I-LC-ETCNS	SEL BOOMI Enterprise Test Connect NonSub	K	\$450
BM-I-LC-ETM	SEL BOOMI Enhanced Test Mode	K	\$650
BM-I-LC-GCRM	SEL BOOMI GearsCRM CSV to SFDC Bundle	K	\$225
BM-I-LC-HL7	SEL BOOMI HL7 Option	K	\$0
BM-I-LC-IAW	SEL BOOMI Integration Accel Workday/AD	K	\$1,500
BM-I-LC-MCA-E	SEL BOOMI EMEA MDM Cloud Attachment	K	\$300
BM-I-LC-MOL1Y	SEL BOOMI Molecule	K	\$1,300
BM-I-LC-MQ	SEL BOOMI Message Queuing	K	\$650
BM-I-LC-NS33	SEL BOOMI NetSuite OpenAir SFDC 3300	K	\$275
BM-I-LC-NS50	SEL BOOMI NetSuite Salesforce Q2C 5000	K	\$417
BM-I-LC-NS72	SEL BOOMI NetSuite OpenAir SFDC 7200	K	\$600
BM-I-LC-NSSIA	SEL BOOMI NetSuite-SF Integration Accel	K	\$500
BM-I-LC-PE1Y	SEL BOOMI Professional Edition	K	\$2,000
BM-I-LC-PESB2	SEL BOOMI ProEd-Spcl Bundle 2 connection	K	\$1,200
BM-I-LC-PESB3	SEL BOOMI ProEd-Spcl Bundle 3 connection	K	\$1,650
BM-I-LC-PESB4	SEL BOOMI ProEd-Spcl Bundle 4 connection	K	\$1,850
BM-I-LC-PF	SEL BOOMI Partner Account Features	K	\$0
BM-I-LC-PP	SEL BOOMI Parallel Processing	K	\$650
BM-I-LC-PPE	SEL BOOMI Pro Plus Edition	K	\$4,000

BM-I-LC-PR	SEL BOOMI Process Route	K	\$0
BM-I-LC-RAVI2	SEL BOOMI ProEd - 2 Connection NS RAVI	K	\$960
BM-I-LC-RAVI3	SEL BOOMI ProEd - 3 Connection NS RAVI	K	\$1,320
BM-I-LC-RAVI4	SEL BOOMI ProEd - 4 Connection NS RAVI	K	\$1,480
BM-I-LC-RAVI5	SEL BOOMI ProEd - 5 Connection NS RAVI	K	\$1,600
BM-I-LC-RAVIB	SEL BOOMI Base Ed - NetSuite RAVI Bundle	K	\$467
BM-I-LC-RPI-1	SEL BOOMI Renewal Price Increase .01	K	\$0
BM-I-LC-RPI-2	SEL BOOMI Renewal Price Increase 1	K	\$1
BM-I-LC-RPI-3	SEL BOOMI Renewal Price Increase 100	K	\$100
BM-I-LC-RPI-4	SEL BOOMI Renewal Price Increase 1000	K	\$1,000
BM-I-LC-SBC1Y	SEL BOOMI Small Business Connection	K	\$65
BM-I-LC-SC1Y	SEL BOOMI Standard Connection	K	\$300
BM-I-LC-SE	SEL BOOMI Services Enablement	K	\$1,300
BM-I-LC-SMBTC	SEL BOOMI SMB Test Connection	K	\$33
BM-I-LC-SPCNS	SEL BOOMI Standard Prod Connect NonSub	K	\$300
BM-I-LCS-SPC	SEL BOOMI Support Case Per Case	K	\$95
BM-I-LC-STC	SEL BOOMI Standard Test Connection	K	\$150
BM-I-LC-STCNS	SEL BOOMI Standard Test Connect NonSub	K	\$150
BM-I-LC-STO	SEL BOOMI Session Timeout	K	\$0
BM-I-LC-SWA	SEL BOOMI Salesforce Wave Analytics Ed	K	\$833
BM-I-LC-VC	SEL BOOMI Version Control	K	\$0
BM-MDM-CST-1	SEL BOOMI MDM Ed (Custom Tier) .01	K	\$0
BM-MDM-CST-2	SEL BOOMI MDM Ed (Custom Tier) 1	K	\$1
BM-MDM-CST-3	SEL BOOMI MDM Ed (Custom Tier) 100	K	\$100
BM-MDM-CST-4	SEL BOOMI MDM Ed (Custom Tier) 1000	K	\$1,000
BM-MDM-LC-B	SEL BOOMI MDM Ed (Base Tier)	K	\$6,000
BM-MDM-LC-CA	SEL BOOMI MDM Cloud Attachment	K	\$300
BM-MDM-LC-CAA	SEL BOOMI ANZ MDM Cloud Attachment	K	\$300
BM-MDM-LC-ENT	SEL BOOMI MDM Ed (Enterprise Tier)	K	\$18,000
BM-MDM-LC-PRO	SEL BOOMI MDM Ed (Professional Tier)	K	\$12,000
BM-MDM-LC-TR1	SEL BOOMI MDM Ed (Tier 1 <10K GRecords)	K	\$355
BM-MDM-LC-TR2	SEL BOOMI MDM Ed (Tier 2 <50K GRecords)	K	\$1,750
BM-MDM-LC-TR3	SEL BOOMI MDM Ed (Tier 3 <100K GRecords)	K	\$3,000
BR-AMPFIPAAM-01	SEL-AMP FABRIC INSIGHT ADV ANA MGMT SW	K	\$249,900
BR-AMP-MAXCAP-01	SEL-ANALYTICS MONITORING PL MAXCAP 24SF	K	\$349,900
BRAND-RG-BASIC	SEL RG BASIC BRANDING	K	\$1,000
BRAND-RG-WLABEL	SEL RG WHITE LABEL BRANDING	K	\$9,231
BT-CDH-NONPD-1YR	SEL BlueTalon Suite - CDH - Non-prod 1Y	K	\$2,538
BT-CDH-NONPD-3YR	SEL BlueTalon Suite - CDH - Non-prod 3Y	K	\$1,908
BT-CDH-PROD-1YR	SEL BlueTalon Suite - CDH - Standard 1Y	K	\$5,077
BT-CDH-PROD-3YR	SEL BlueTalon Suite - CDH - Standard 3Y	K	\$3,808
BT-EEP-1YR	SEL BlueTalon Enterprise EP Standard 1Y	K	\$240,538
BT-EEP-3YR	SEL BlueTalon Enterprise EP Standard 3Y	K	\$541,154
BT-EP-PK2-1YR	SEL BlueTalon EP Pick 2 Standard 1Y	K	\$90,000
BT-EP-PK2-3YR	SEL BlueTalon EP Pick 2 Standard 3Y	K	\$202,500
BT-HDP-NONPD-1YR	SEL BlueTalon Suite - HDP - Non-prod 1Y	K	\$2,538
BT-HDP-NONPD-3YR	SEL BlueTalon Suite - HDP - Non-prod 3Y	K	\$1,908
BT-HDP-PROD-1YR	SEL BlueTalon Suite - HDP - Standard 1Y	K	\$5,077
BT-HDP-PROD-3YR	SEL BlueTalon Suite - HDP - Standard 3Y	K	\$3,808
BT-HEP-1YR	SEL BlueTalon Hadoop EP Standard 1Y	K	\$185,000

BT-HEP-3YR	SEL BlueTalon Hadoop EP Standard 3Y	K	\$416,154
BT-PE-NPD-1YR	SEL BlueTalon Policy Engine Non-prod 1Y	K	\$89,423
BT-PE-NPD-3YR	SEL BlueTalon Policy Engine Non-prod 3Y	K	\$201,923
BT-PE-S-1YR	SEL BlueTalon Policy Engine Standard 1Y	K	\$155,000
BT-PE-S-3YR	SEL BlueTalon Policy Engine Standard 3Y	K	\$346,154
BT-PG-NONPD-1YR	SEL BlueTalon Suite - PG - Non-prod 1Y	K	\$385
BT-PG-NONPD-3YR	SEL BlueTalon Suite - PG - Non-prod 3Y	K	\$292
BT-PG-PROD-1YR	SEL BlueTalon Suite - PG - Standard 1Y	K	\$769
BT-PG-PROD-3YR	SEL BlueTalon Suite - PG - Standard 3Y	K	\$577
CA6DEVKC	SEL CA6-DEVK-C)	K	\$20,550
CA6DEVKC-I	SEL CA6-DEVK-C)	K	\$24,044
CA6DEVKC-K	SEL CA6-DEVK-C)	K	\$23,100
CD1YPRM10002499	SEL CD4PE addon 1000-2499 nodes PrmSub	K	\$35
CD1YPRM100249	SEL CD4PE addon 100-249 nodes PrmSub	K	\$54
CD1YPRM10K19999	SEL CD4PE addon 10K-19999 nodes PrmSub	K	\$28
CD1YPRM20K49999	SEL CD4PE addon 20K-49999 nodes PrmSub	K	\$25
CD1YPRM25004999	SEL CD4PE addon 2500-4999 nodes PrmSub	K	\$34
CD1YPRM250499	SEL CD4PE addon 250-499 nodes PrmSub	K	\$43
CD1YPRM25K9999	SEL CD4PE addon 5K-9999 nodes PrmSub	K	\$31
CD1YPRM500999	SEL CD4PE addon 500-999 nodes PrmSub	K	\$38
CD1YSTD10002499	SEL CD4PE addon 1000-2499 nodes StdSub	K	\$32
CD1YSTD100249	SEL CD4PE addon 100-249 nodes StdSub	K	\$35
CD1YSTD10K19999	SEL CD4PE addon 10K-19999 nodes StdSub	K	\$23
CD1YSTD20K49999	SEL CD4PE addon 20K-49999 nodes StdSub	K	\$23
CD1YSTD25004999	SEL CD4PE addon 2500-4999 nodes StdSub	K	\$29
CD1YSTD250499	SEL CD4PE addon 250-499 nodes StdSub	K	\$34
CD1YSTD25K9999	SEL CD4PE addon 5K-9999 nodes StdSub	K	\$28
CD1YSTD500999	SEL CD4PE addon 500-999 nodes StdSub	K	\$32
CDPLIC10002499	SEL CD4PE addon 1000-2499 PerpLicOnly	K	\$63
CDPLIC100249	SEL CD4PE addon 100-249 PerpLicOnly	K	\$97
CDPLIC10K19999	SEL CD4PE addon 10K-19999 PerpLicOnly	K	\$49
CDPLIC20K49999	SEL CD4PE addon 20K-49999 PerpLicOnly	K	\$45
CDPLIC25004999	SEL CD4PE addon 2500-4999 PerpLicOnly	K	\$62
CDPLIC250499	SEL CD4PE addon 250-499 PerpLicOnly	K	\$78
CDPLIC25K9999	SEL CD4PE addon 5K-9999 PerpLicOnly	K	\$55
CDPLIC500999	SEL CD4PE addon 500-999 PerpLicOnly	K	\$69
CDPRMSS10002499	SEL CD4PE addon 1000-2499 Perp PrmSub	K	\$22
CDPRMSS100249	SEL CD4PE addon 100-249 Perp PrmSub	K	\$34
CDPRMSS10K19999	SEL CD4PE addon 10K-19999 Perp PrmSub	K	\$17
CDPRMSS20K49999	SEL CD4PE addon 20K-49999 Perp PrmSub	K	\$15
CDPRMSS25004999	SEL CD4PE addon 2500-4999 Perp PrmSub	K	\$20
CDPRMSS250499	SEL CD4PE addon 250-499 Perp PrmSub	K	\$26
CDPRMSS25K9999	SEL CD4PE addon 5K-9999 Perp PrmSub	K	\$20
CDPRMSS500999	SEL CD4PE addon 500-999 Perp PrmSub	K	\$25
CEADC-BRNZ	SEL Cloudera Analytic Brnz TB (100 min)	K	\$788
CEADC-GOLD	SEL Cloudera Analytic Gold TB (100 min)	K	\$985
CEADN-BRNZ	SEL Cloudera Analytic Brnz Node (10 min)	K	\$7,877
CEADN-GOLD	SEL Cloudera Analytic Gold Node (10 min)	K	\$9,846
CEBC-BRNZ-I	SEL Cloudera Basic Bronze TB (100 min)	K	\$197
CEBC-GOLD-I	SEL Cloudera Basic Gold TB (100 min)	K	\$246

CEBN-BRNZ-I	SEL Cloudera Basic Bronze Node (10 min)	K	\$1,969
CEBN-GOLD-I	SEL Cloudera Basic Gold Node (10 min)	K	\$2,462
CEDEC-BRNZ	SEL Cloudera Data Eng Brnz TB (100 min)	K	\$394
CEDEC-GOLD	SEL Cloudera Data Eng Gold TB (100 min)	K	\$492
CEDEN-BRNZ	SEL Cloudera Data Eng Brnz Node (10 min)	K	\$3,938
CEDEN-GOLD	SEL Cloudera Data Eng Gold Node (10 min)	K	\$4,923
CEDHC-BRNZ	SEL Cloudera EDHub Bronze TB (100 min)	K	\$985
CEDHC-GOLD	SEL Cloudera EDHub Gold TB (100 min)	K	\$1,231
CEDHN-BRNZ	SEL Cloudera EDHub Bronze Node (10 min)	K	\$9,846
CEDHN-GOLD	SEL Cloudera EDHub Gold Node (10 min)	K	\$12,308
CEDSW	SEL Cloudera Data Science Workbench 10Pk	K	\$61,538
CEODC-BRNZ	SEL Cloudera Operatnl Brnz TB (100 min)	K	\$591
CEODC-GOLD	SEL Cloudera Operatnl Gold TB (100 min)	K	\$738
CEODN-BRNZ	SEL Cloudera Operatnl Brnz Node (10 min)	K	\$5,908
CEODN-GOLD	SEL Cloudera Operatnl Gold Node (10 min)	K	\$7,385
CFADVC	SEL CF-ADV-C)	K	\$19,995
CFADVC-I	SEL CF-ADV-C)	K	\$23,394
CFADVC-K	SEL CF-ADV-C)	K	\$22,487
CFB1PCESADVC	SEL CF-B1-PCES-ADV-C)	K	\$12,705
CFB1PCESADVC-I	SEL CF-B1-PCES-ADV-C)	K	\$14,865
CFB1PCESADVC-K	SEL CF-B1-PCES-ADV-C)	K	\$14,289
CFB1PCESENTC	SEL CF-B1-PCES-ENT-C)	K	\$15,530
CFB1PCESENTC-I	SEL CF-B1-PCES-ENT-C)	K	\$18,170
CFB1PCESENTC-K	SEL CF-B1-PCES-ENT-C)	K	\$17,430
CFB1PCESSTDC	SEL CF-B1-PCES-STD-C)	K	\$9,635
CFB1PCESSTDC-I	SEL CF-B1-PCES-STD-C)	K	\$11,273
CFB1PCESSTDC-K	SEL CF-B1-PCES-STD-C)	K	\$10,841
CFB1VS6ADVC	SEL CF-B1-VS6-ADV-C)	K	\$17,555
CFB1VS6ADVC-I	SEL CF-B1-VS6-ADV-C)	K	\$20,539
CFB1VS6ADVC-K	SEL CF-B1-VS6-ADV-C)	K	\$19,729
CFB1VS6ENTC	SEL CF-B1-VS6-ENT-C)	K	\$21,850
CFB1VS6ENTC-I	SEL CF-B1-VS6-ENT-C)	K	\$25,565
CFB1VS6ENTC-K	SEL CF-B1-VS6-ENT-C)	K	\$24,556
CFB1VS6STDC	SEL CF-B1-VS6-STD-C)	K	\$14,195
CFB1VS6STDC-I	SEL CF-B1-VS6-STD-C)	K	\$16,608
CFB1VS6STDC-K	SEL CF-B1-VS6-STD-C)	K	\$15,975
CFB2VS6ADVC	SEL CF-B2-VS6-ADV-C)	K	\$13,835
CFB2VS6ADVC-I	SEL CF-B2-VS6-ADV-C)	K	\$16,187
CFB2VS6ADVC-K	SEL CF-B2-VS6-ADV-C)	K	\$15,515
CFB2VS6ENTC	SEL CF-B2-VS6-ENT-C)	K	\$16,791
CFB2VS6ENTC-I	SEL CF-B2-VS6-ENT-C)	K	\$19,645
CFB2VS6ENTC-K	SEL CF-B2-VS6-ENT-C)	K	\$18,886
CFB2VS6STDC	SEL CF-B2-VS6-STD-C)	K	\$10,375
CFB2VS6STDC-I	SEL CF-B2-VS6-STD-C)	K	\$12,139
CFB2VS6STDC-K	SEL CF-B2-VS6-STD-C)	K	\$11,684
CFB3VS6ADVC	SEL CF-B3-VS6-ADV-C)	K	\$13,491
CFB3VS6ADVC-I	SEL CF-B3-VS6-ADV-C)	K	\$15,784
CFB3VS6ADVC-K	SEL CF-B3-VS6-ADV-C)	K	\$15,132
CFB3VS6ENTC	SEL CF-B3-VS6-ENT-C)	K	\$15,592
CFB3VS6ENTC-I	SEL CF-B3-VS6-ENT-C)	K	\$18,243

CFB3VS6ENTC-K	SEL CF-B3-VS6-ENT-C)	K	\$17,507
CFB3VS6STDC	SEL CF-B3-VS6-STD-C)	K	\$10,021
CFB3VS6STDC-I	SEL CF-B3-VS6-STD-C)	K	\$11,725
CFB3VS6STDC-K	SEL CF-B3-VS6-STD-C)	K	\$11,301
CFB4VS6ADVC	SEL CF-B4-VS6-ADV-C)	K	\$10,343
CFB4VS6ADVC-I	SEL CF-B4-VS6-ADV-C)	K	\$12,101
CFB4VS6ADVC-K	SEL CF-B4-VS6-ADV-C)	K	\$11,607
CFB4VS6ENTC	SEL CF-B4-VS6-ENT-C)	K	\$14,716
CFB4VS6ENTC-I	SEL CF-B4-VS6-ENT-C)	K	\$17,218
CFB4VS6ENTC-K	SEL CF-B4-VS6-ENT-C)	K	\$16,511
CFB4VS6STDC	SEL CF-B4-VS6-STD-C)	K	\$10,343
CFB4VS6STDC-I	SEL CF-B4-VS6-STD-C)	K	\$12,101
CFB4VS6STDC-K	SEL CF-B4-VS6-STD-C)	K	\$11,607
CFCPUB1C	SEL CF-CPU-B1-C)	K	\$13,640
CFCPUB1C-I	SEL CF-CPU-B1-C)	K	\$15,959
CFCPUB1C-K	SEL CF-CPU-B1-C)	K	\$15,132
CFCPUB2C	SEL CF-CPU-B2-C)	K	\$10,145
CFCPUB2C-I	SEL CF-CPU-B2-C)	K	\$11,870
CFCPUB2C-K	SEL CF-CPU-B2-C)	K	\$11,224
CFENTC	SEL CF-ENT-C)	K	\$23,995
CFENTC-I	SEL CF-ENT-C)	K	\$28,074
CFENTC-K	SEL CF-ENT-C)	K	\$27,007
CFPCESADVC	SEL CF-PCES-ADV-C)	K	\$15,495
CFPCESADVC-I	SEL CF-PCES-ADV-C)	K	\$18,129
CFPCESADVC-K	SEL CF-PCES-ADV-C)	K	\$17,430
CFPCESENTC	SEL CF-PCES-ENT-C)	K	\$17,995
CFPCESENTC-I	SEL CF-PCES-ENT-C)	K	\$21,054
CFPCESENTC-K	SEL CF-PCES-ENT-C)	K	\$20,265
CFPCESSTDC	SEL CF-PCES-STD-C)	K	\$13,125
CFPCESSTDC-I	SEL CF-PCES-STD-C)	K	\$15,356
CFPCESSTDC-K	SEL CF-PCES-STD-C)	K	\$14,749
CFSDDCM100C	SEL CF-SDDC-M100-C)	K	\$3,085
CFSDDCM100C-I	SEL CF-SDDC-M100-C)	K	\$3,224
CFSDDCM100C-K	SEL CF-SDDC-M100-C)	K	\$3,214
CFSDDCM10C	SEL CF-SDDC-M10-C)	K	\$309
CFSDDCM10C-I	SEL CF-SDDC-M10-C)	K	\$323
CFSDDCM10C-K	SEL CF-SDDC-M10-C)	K	\$321
CFSDDCMACC	SEL CF-SDDC-MAC-C)	K	\$1,535
CFSDDCMACC-I	SEL CF-SDDC-MAC-C)	K	\$1,796
CFSDDCMACC-K	SEL CF-SDDC-MAC-C)	K	\$1,682
CFSTDC	SEL CF-STD-C)	K	\$16,995
CFSTDC-I	SEL CF-STD-C)	K	\$19,884
CFSTDC-K	SEL CF-STD-C)	K	\$19,116
CFVDB1100C	SEL CF-VD-B1-100-C)	K	\$71,340
CFVDB1100C-I	SEL CF-VD-B1-100-C)	K	\$74,550
CFVDB1100C-K	SEL CF-VD-B1-100-C)	K	\$74,510
CFVDB110C	SEL CF-VD-B1-10-C)	K	\$7,134
CFVDB110C-I	SEL CF-VD-B1-10-C)	K	\$7,455
CFVDB110C-K	SEL CF-VD-B1-10-C)	K	\$7,451
CFVDB2100C	SEL CF-VD-B2-100-C)	K	\$12,090

CFVDB2100C-I	SEL CF-VD-B2-100-C)	K	\$12,634
CFVDB2100C-K	SEL CF-VD-B2-100-C)	K	\$12,833
CFVDB210C	SEL CF-VD-B2-10-C)	K	\$1,209
CFVDB210C-I	SEL CF-VD-B2-10-C)	K	\$1,263
CFVDB210C-K	SEL CF-VD-B2-10-C)	K	\$1,283
CFVDB3100C	SEL CF-VD-B3-100-C)	K	\$17,090
CFVDB3100C-I	SEL CF-VD-B3-100-C)	K	\$17,859
CFVDB3100C-K	SEL CF-VD-B3-100-C)	K	\$18,196
CFVDB310C	SEL CF-VD-B3-10-C)	K	\$1,709
CFVDB310C-I	SEL CF-VD-B3-10-C)	K	\$1,786
CFVDB310C-K	SEL CF-VD-B3-10-C)	K	\$1,820
CL-11-15PL	SEL Collector PL	K	\$4,725
CL-11-15TL	SEL Collector TL	K	\$1,890
CL-1-5PL	SEL Collector PL	K	\$10,500
CL-1-5TL	SEL Collector TL	K	\$4,200
CL-16-20PL	SEL Collector PL	K	\$4,253
CL-16-20TL	SEL Collector TL	K	\$1,701
CL17ADVC	SEL CL17-ADV-C)	K	\$8,295
CL17ADVC-I	SEL CL17-ADV-C)	K	\$9,705
CL17ADVC-K	SEL CL17-ADV-C)	K	\$9,309
CL17ENTADVUGC	SEL CL17-ENT-ADV-UG-C)	K	\$7,125
CL17ENTADVUGC-I	SEL CL17-ENT-ADV-UG-C)	K	\$8,336
CL17ENTADVUGC-K	SEL CL17-ENT-ADV-UG-C)	K	\$8,006
CL17ENTC	SEL CL17-ENT-C)	K	\$9,795
CL17ENTC-I	SEL CL17-ENT-C)	K	\$11,460
CL17ENTC-K	SEL CL17-ENT-C)	K	\$10,994
CL17ENTENTUGC	SEL CL17-ENT-ENT-UG-C)	K	\$8,625
CL17ENTENTUGC-I	SEL CL17-ENT-ENT-UG-C)	K	\$10,091
CL17ENTENTUGC-K	SEL CL17-ENT-ENT-UG-C)	K	\$9,692
CL17ENTSTDUGC	SEL CL17-ENT-STD-UG-C)	K	\$4,525
CL17ENTSTDUGC-I	SEL CL17-ENT-STD-UG-C)	K	\$5,294
CL17ENTSTDUGC-K	SEL CL17-ENT-STD-UG-C)	K	\$5,084
CL17EPAVUGC	SEL CL17-EPL-ADV-UG-C)	K	\$6,445
CL17EPAVUGC-I	SEL CL17-EPL-ADV-UG-C)	K	\$7,541
CL17EPAVUGC-K	SEL CL17-EPL-ADV-UG-C)	K	\$7,244
CL17EPLENTUGC	SEL CL17-EPL-ENT-UG-C)	K	\$7,945
CL17EPLENTUGC-I	SEL CL17-EPL-ENT-UG-C)	K	\$9,296
CL17EPLENTUGC-K	SEL CL17-EPL-ENT-UG-C)	K	\$8,926
CL17EPLSTDUGC	SEL CL17-EPL-STD-UG-C)	K	\$3,845
CL17EPLSTDUGC-I	SEL CL17-EPL-STD-UG-C)	K	\$4,499
CL17EPLSTDUGC-K	SEL CL17-EPL-STD-UG-C)	K	\$4,325
CL17OEADUGC	SEL CL17-OENT-ADV-UG-C)	K	\$5,995
CL17OEADUGC-I	SEL CL17-OENT-ADV-UG-C)	K	\$7,014
CL17OEADUGC-K	SEL CL17-OENT-ADV-UG-C)	K	\$6,738
CL17OEENUGC	SEL CL17-OEPL-ENT-UG-C)	K	\$6,810
CL17OEENUGC-I	SEL CL17-OEPL-ENT-UG-C)	K	\$7,968
CL17OEENUGC-K	SEL CL17-OEPL-ENT-UG-C)	K	\$7,658
CL17OENNTUGC	SEL CL17-OENT-ENT-UG-C)	K	\$7,495
CL17OENNTUGC-I	SEL CL17-OENT-ENT-UG-C)	K	\$8,769
CL17OENNTUGC-K	SEL CL17-OENT-ENT-UG-C)	K	\$8,390

CL17OPLAUGC	SEL CL17-OEPL-ADV-UG-C)	K	\$5,310
CL17OPLAUGC-I	SEL CL17-OEPL-ADV-UG-C)	K	\$6,213
CL17OPLAUGC-K	SEL CL17-OEPL-ADV-UG-C)	K	\$5,972
CL17OTSTDUGC	SEL CL17-OENT-STD-UG-C)	K	\$3,395
CL17OTSTDUGC-I	SEL CL17-OENT-STD-UG-C)	K	\$3,972
CL17OTSTDUGC-K	SEL CL17-OENT-STD-UG-C)	K	\$3,819
CL17STDADVUGC	SEL CL17-STD-ADV-UG-C)	K	\$8,030
CL17STDADVUGC-I	SEL CL17-STD-ADV-UG-C)	K	\$9,395
CL17STDADVUGC-K	SEL CL17-STD-ADV-UG-C)	K	\$9,002
CL17STDC	SEL CL17-STD-C)	K	\$5,695
CL17STDC-I	SEL CL17-STD-C)	K	\$6,663
CL17STDC-K	SEL CL17-STD-C)	K	\$6,401
CL17STDENTUGC	SEL CL17-STD-ENT-UG-C)	K	\$9,680
CL17STDENTUGC-I	SEL CL17-STD-ENT-UG-C)	K	\$11,326
CL17STDENTUGC-K	SEL CL17-STD-ENT-UG-C)	K	\$10,918
CL17STDSTDUGC	SEL CL17-STD-STD-UG-C)	K	\$5,170
CL17STDSTDUGC-I	SEL CL17-STD-STD-UG-C)	K	\$6,049
CL17STDSTDUGC-K	SEL CL17-STD-STD-UG-C)	K	\$5,811
CL-21-PL	SEL Collector PL	K	\$3,828
CL-21-TL	SEL Collector TL	K	\$1,531
CL-6-10PL	SEL Collector PL	K	\$7,350
CL-6-10TL	SEL Collector TL	K	\$2,940
CL7PLSTDUGC	SEL CL17-OEPL-STD-UG-C)	K	\$2,710
CL7PLSTDUGC-I	SEL CL17-OEPL-STD-UG-C)	K	\$3,171
CL7PLSTDUGC-K	SEL CL17-OEPL-STD-UG-C)	K	\$3,046
CLC-11-15PL	SEL Collector 100 SL PL	K	\$9,450
CLC-11-15TL	SEL Collector 100 SL TL	K	\$3,780
CLC-1-5PL	SEL Collector 100 SL PL	K	\$21,000
CLC-1-5TL	SEL Collector 100 SL TL	K	\$8,400
CLC-16-20PL	SEL Collector 100 SL PL	K	\$8,505
CLC-16-20TL	SEL Collector 100 SL TL	K	\$3,402
CLC-21-PL	SEL Collector 100 SL PL	K	\$7,656
CLC-21-TL	SEL Collector 100 SL TL	K	\$3,062
CLC-6-10PL	SEL Collector 100 SL PL	K	\$14,700
CLC-6-10TL	SEL Collector 100 SL TL	K	\$5,880
CLU-11-15PL	SEL Collector Upgrade PL	K	\$4,725
CLU-11-15TL	SEL Collector Upgrade TL	K	\$1,890
CLU-1-5PL	SEL Collector Upgrade PL	K	\$10,500
CLU-1-5TL	SEL Collector Upgrade TL	K	\$4,200
CLU-16-20PL	SEL Collector Upgrade PL	K	\$4,253
CLU-16-20TL	SEL Collector Upgrade TL	K	\$1,701
CLU-21-PL	SEL Collector Upgrade PL	K	\$3,828
CLU-21-TL	SEL Collector Upgrade TL	K	\$1,531
CLU-6-10PL	SEL Collector Upgrade PL	K	\$7,350
CLU-6-10TL	SEL Collector Upgrade TL	K	\$2,940
CMC-H-10-1	SELECT 10 PACK CMC LICENSES (QTY 0-4)	K	\$3,077
CMC-H-10-2	SELECT 10 PACK CMC LICENSES (QTY 5-19)	K	\$2,462
CMC-H-10-3	SELECT 10 PACK CMC LICENSES (QTY 20-44)	K	\$1,477
CMC-H-10-4	SELECT 10 PACK CMC LICENSES (QTY 45-94)	K	\$1,108
CMC-H-10-5	SELECT 10 PACK CMC LICENSES (QTY 95-194)	K	\$923

CMC-H-10-6	SELECT 10 PACK CMC LICENSES (QTY 195+)	K	\$677
CMC-S-10-1	SELECT CMC-VE Licenses (Qty 0-9)	K	\$3,077
CMC-S-10-2	SELECT CMC-VE LICENSES (QTY 10-24)	K	\$2,462
CMC-S-10-3	SELECT CMC-VE LICENSES (QTY 24-29)	K	\$1,477
CMC-S-10-4	SELECT CMC-VE LICENSES (QTY 50-99)	K	\$1,108
CMC-S-10-5	SEL CMC-VE Licenses (Qty 100-199)	K	\$923
CMC-S-10-6	SEL CMC-VE Licenses (Qty 200+)	K	\$677
CMC-VE-INST	SEL VIRTUAL CMC LICENSE	K	\$1,846
CNAPKSC83PTLC	SEL CNA-PKSC-8-3P-TL-C)	K	\$12,000
CNAPKSC83PTLC-I	SEL CNA-PKSC-8-3P-TL-C)	K	\$14,040
CNAPKSC83PTLC-K	SEL CNA-PKSC-8-3P-TL-C)	K	\$13,523
CNAPKSC8PTLC	SEL CNA-PKSC-8-P-TL-C)	K	\$4,000
CNAPKSC8PTLC-I	SEL CNA-PKSC-8-P-TL-C)	K	\$4,680
CNAPKSC8PTLC-K	SEL CNA-PKSC-8-P-TL-C)	K	\$4,494
CNAPKSCAK3PTC	SEL CNA-PKSC-AK-3P-T-C)	K	\$384,000
CNAPKSCAK3PTC-I	SEL CNA-PKSC-AK-3P-T-C)	K	\$449,280
CNAPKSCAK3PTC-K	SEL CNA-PKSC-AK-3P-T-C)	K	\$431,735
CNAPKSCAKPTLC	SEL CNA-PKSC-AK-P-TL-C)	K	\$128,000
CNAPKSCAKPTLC-I	SEL CNA-PKSC-AK-P-TL-C)	K	\$149,760
CNAPKSCAKPTLC-K	SEL CNA-PKSC-AK-P-TL-C)	K	\$143,656
CN-P-AUDITDEL	SEL Audited Del Plugin for CN, perp lic	K	\$4,911
CN-PAUDITDEL-SUB	SEL Audited Del Plugin for CN /year /Svr	K	\$2,652
CN-P-DUPFIND	SEL Dup Finder Plugin for CN perp lic	K	\$7,372
CN-P-DUPFIND-SUB	SEL Dup Finder Plugin for CN /year /Svr	K	\$3,981
CN-SERVER	SEL CN Svr, perp lic	K	\$17,094
CN-SERVERDM	SEL CN Svr w/ DM, perp lic	K	\$22,792
CN-SERVERDM-SUB	SEL CN Svr w/DM /year	K	\$12,308
CN-SERVER-SUB	SEL CN Svr/year	K	\$9,231
CN-TIB	SEL Cap for Svr /TiB, perp lic	K	\$55
CN-TIBDM	SEL Cap for CN Svr w/DM /TiB perp lic	K	\$73
CN-TIBDM-SUB	SEL Cap for CN Svr w/DM /TiB /year	K	\$39
CN-TIB-SUB	SEL Cap for Svr /TiB /year	K	\$30
CN-UNDM-UNIT-SUB	SEL Unl w/DM Cap Unit /year, see notes	K	\$1,333
CN-UN-UNIT-SUB	SEL Unlimited Cap Unit /year, see notes	K	\$1,000
CS1000HA-ISLN	SEL Aspera Cnct Svr-1 Gbps-HA-ISLN	K	\$144,000
CS100HA-ISLN	SEL Aspera Cnct Svr-100 Mbps-HA-ISLN	K	\$48,000
CS155HA-ISLN	SEL Aspera Cnct Svr-155 Mbps-HA-ISLN	K	\$66,000
CS2400HA-ISLN	SEL Aspera Cnct Svr-2.4 Gbps-HA-ISLN	K	\$192,000
CS450HA-ISLN	SEL Aspera Cnct Svr-450 Mbps-HA-ISLN	K	\$108,000
CS45HA-ISLN	SEL Aspera Cnct Svr-45 Mbps-HA-ISLN	K	\$30,000
CS5000HA-ISLN	SEL Aspera Cnct Svr-5 Gbps-HA-ISLN	K	\$240,000
CSK-CNCLICUSR1-1	SEL SteelCentNetShkPckAnlyz1ConcLic(1-4)	K	\$5,532
CSK-CNCLICUSR1-2	SEL SteelCentNetShkPckAnlyz1ConcLic(5-9)	K	\$4,425
CSK-CNCLICUSR1-3	SEL SteelCentNSharkPackAnaly1CncLic10-24	K	\$3,563
CSK-CNCLICUSR1-4	SEL SteelCentNetSharkPktAnlz1CncLic25 up	K	\$3,071
CSP-A	SEL VST CSP 2,501-5,000 MICROVM	K	\$154
CSP-B	SEL VST CSP 5,001-7,500 MICROVM	K	\$148
CSP-BASE	SEL VST CSP UP TO 2,500 MICROVM	K	\$161
CSP-C	SEL VST CSP 7,501-15,000 MICROVM	K	\$130
CSP-CNC-LICUSR-1	SEL Pilot Concurrent User 1-4	K	\$5,532

CSP-CNC-LICUSR-2	SEL Pilot Concurrent User 5-9	K	\$4,425
CSP-CNC-LICUSR-3	SEL Pilot Concurrent User 10-24	K	\$3,563
CSP-CNC-LICUSR-4	SEL Pilot Concurrent User 25+	K	\$3,071
CSP-D	SEL VST CSP 15,001-25,000 MICROVM	K	\$115
CSP-E	SEL VST CSP 25,001-50,000 MICROVM	K	\$92
CSP-F	SEL VST CSP 50,001-100,000 MICROVM	K	\$78
CSP-LIC-USR-1	SEL CASCADE PILOT 1 USER 1-2	K	\$3,686
CSP-LIC-USR-2	SEL CASCADE PILOT 1 USER 3-4	K	\$3,563
CSP-LIC-USR-3	SEL CASCADE PILOT 1 USER 5-9	K	\$2,938
CSP-LIC-USR-4	SEL CASCADE PILOT 1 USER 10-24	K	\$2,791
CSP-LIC-USR-5	SEL CASCADE PILOT 1 USER 25-49	K	\$2,651
CSP-LIC-USR-6	SEL CASCADE PILOT 1 USER 50-99	K	\$2,518
CSP-LIC-USR-7	SEL CASCADE PILOT 1 USER 100-99999	K	\$2,140
CSP-PE-LIC	SEL Cascade Pilot Personal Edition	K	\$1,594
CSP-SAPM3T-A	SEL VST CSP 251-500 Managed VM	K	\$1,152
CSP-SAPM3T-B	SEL VST CSP 501-750 Managed VM	K	\$1,104
CSP-SAPM3T-BASE	SEL VST CSP UP TO 250 Managed VM	K	\$1,200
CSP-SAPM3T-C	SEL VST CSP 751-1,500 Managed VM	K	\$972
CSP-SAPM3T-D	SEL VST CSP 1,501-2,500 Managed VM	K	\$862
CSP-SAPM3T-E	SEL VST CSP 2,501-5,000 Managed VM	K	\$689
CSP-SAPM3T-F	SEL VST CSP 5,001-10,000 Managed VM	K	\$584
CT10PB1YRSB	SELECT DFXS CT ELA, 10PB 1Yr Sub	K	\$2,160,000
CT1PB1YRSB	SELECT DFXS CT ELA, 1PB 1Yr Sub	K	\$304,200
CT3PB1YRSB	SELECT DFXS CT ELA, 3PB 1Yr Sub	K	\$707,400
CT5PB1YRSB	SELECT DFXS CT ELA, 5PB 1Yr Sub	K	\$1,125,000
CTAD1PB1YRSB	SELECT DFXS CT ELA, ADD 1PB 1Yr Sub	K	\$216,000
CTP10PB1YRSB	SELECT DFXS CTP ELA, 10PB 1Yr Sub	K	\$2,880,000
CTP1PB1YRSB	SELECT DFXS CTP ELA, 1PB 1Yr Sub	K	\$441,000
CTP3PB1YRSB	SELECT DFXS CTP ELA, 3PB 1Yr Sub	K	\$966,600
CTP5PB1YRSB	SELECT DFXS CTP ELA, 5PB 1Yr Sub	K	\$1,530,000
CTPAD1PB1YRSB	SELECT DFXS CTP ELA, ADD 1PB 1Yr Sub	K	\$288,000
CX-255-B020	SEL SteelHead CX255B020 with RiOS (TAA)	K	\$2,209
DAAZ-0-50PL	DatAdvantage - Azure PL	K	\$194
DAAZ-0-50TL	DatAdvantage - Azure TL	K	\$78
DAAZ-1001-1500PL	DatAdvantage - Azure PL	K	\$56
DAAZ-1001-1500TL	DatAdvantage - Azure TL	K	\$22
DAAZ-100K-150KPL	DatAdvantage - Azure PL	K	\$29
DAAZ-100K-150KTL	DatAdvantage - Azure TL	K	\$12
DAAZ-101-250PL	DatAdvantage - Azure PL	K	\$106
DAAZ-101-250TL	DatAdvantage - Azure TL	K	\$43
DAAZ-10K-20KPL	DatAdvantage - Azure PL	K	\$34
DAAZ-10K-20KTL	DatAdvantage - Azure TL	K	\$14
DAAZ-1501-2000PL	DatAdvantage - Azure PL	K	\$50
DAAZ-1501-2000TL	DatAdvantage - Azure TL	K	\$20
DAAZ-150K-PL	DatAdvantage - Azure PL	K	\$29
DAAZ-150K-TL	DatAdvantage - Azure TL	K	\$12
DAAZ-2001-2500PL	DatAdvantage - Azure PL	K	\$47
DAAZ-2001-2500TL	DatAdvantage - Azure TL	K	\$19
DAAZ-20K-35KPL	DatAdvantage - Azure PL	K	\$32
DAAZ-20K-35KTL	DatAdvantage - Azure TL	K	\$13

DAAZ-2501-4000PL	DatAdvantage - Azure PL	K	\$44
DAAZ-2501-4000TL	DatAdvantage - Azure TL	K	\$18
DAAZ-251-500PL	DatAdvantage - Azure PL	K	\$81
DAAZ-251-500TL	DatAdvantage - Azure TL	K	\$32
DAAZ-35K-50KPL	DatAdvantage - Azure PL	K	\$31
DAAZ-35K-50KTL	DatAdvantage - Azure TL	K	\$12
DAAZ-4001-6000PL	DatAdvantage - Azure PL	K	\$41
DAAZ-4001-6000TL	DatAdvantage - Azure TL	K	\$16
DAAZ-501-750PL	DatAdvantage - Azure PL	K	\$65
DAAZ-501-750TL	DatAdvantage - Azure TL	K	\$26
DAAZ-50K-100KPL	DatAdvantage - Azure PL	K	\$30
DAAZ-50K-100KTL	DatAdvantage - Azure TL	K	\$12
DAAZ-51-100PL	DatAdvantage - Azure PL	K	\$136
DAAZ-51-100TL	DatAdvantage - Azure TL	K	\$54
DAAZ-6001-8000PL	DatAdvantage - Azure PL	K	\$38
DAAZ-6001-8000TL	DatAdvantage - Azure TL	K	\$15
DAAZ-751-1000PL	DatAdvantage - Azure PL	K	\$60
DAAZ-751-1000TL	DatAdvantage - Azure TL	K	\$24
DAAZ-8001-10KPL	DatAdvantage - Azure PL	K	\$36
DAAZ-8001-10KTL	DatAdvantage - Azure TL	K	\$14
DADS-0-50PL	SEL DatAdvantage - DS PL	K	\$194
DADS-0-50TL	SEL DatAdvantage - DS TL	K	\$78
DADS-1001-1500PL	SEL DatAdvantage - DS PL	K	\$56
DADS-1001-1500TL	SEL DatAdvantage - DS TL	K	\$22
DADS-100K-150KPL	SEL DatAdvantage - DS PL	K	\$29
DADS-100K-150KTL	SEL DatAdvantage - DS TL	K	\$12
DADS-101-250PL	SEL DatAdvantage - DS PL	K	\$106
DADS-101-250TL	SEL DatAdvantage - DS TL	K	\$42
DADS-10K-20KPL	SEL DatAdvantage - DS PL	K	\$34
DADS-10K-20KTL	SEL DatAdvantage - DS TL	K	\$14
DADS-1501-2000PL	SEL DatAdvantage - DS PL	K	\$50
DADS-1501-2000TL	SEL DatAdvantage - DS TL	K	\$20
DADS-150K-PL	SEL DatAdvantage - DS PL	K	\$29
DADS-150K-TL	SEL DatAdvantage - DS TL	K	\$12
DADS-2001-2500PL	SEL DatAdvantage - DS PL	K	\$47
DADS-2001-2500TL	SEL DatAdvantage - DS TL	K	\$19
DADS-20K-35KPL	SEL DatAdvantage - DS PL	K	\$32
DADS-20K-35KTL	SEL DatAdvantage - DS TL	K	\$13
DADS-2501-4000PL	SEL DatAdvantage - DS PL	K	\$44
DADS-2501-4000TL	SEL DatAdvantage - DS TL	K	\$18
DADS-251-500PL	SEL DatAdvantage - DS PL	K	\$81
DADS-251-500TL	SEL DatAdvantage - DS TL	K	\$32
DADS-35K-50KPL	SEL DatAdvantage - DS PL	K	\$31
DADS-35K-50KTL	SEL DatAdvantage - DS TL	K	\$12
DADS-4001-6000PL	SEL DatAdvantage - DS PL	K	\$41
DADS-4001-6000TL	SEL DatAdvantage - DS TL	K	\$16
DADS-501-750PL	SEL DatAdvantage - DS PL	K	\$65
DADS-501-750TL	SEL DatAdvantage - DS TL	K	\$26
DADS-50K-100KPL	SEL DatAdvantage - DS PL	K	\$30
DADS-50K-100KTL	SEL DatAdvantage - DS TL	K	\$12

DADS-51-100PL	SEL DatAdvantage - DS PL	K	\$136
DADS-51-100TL	SEL DatAdvantage - DS TL	K	\$54
DADS-6001-8000PL	SEL DatAdvantage - DS PL	K	\$38
DADS-6001-8000TL	SEL DatAdvantage - DS TL	K	\$15
DADS-751-1000PL	SEL DatAdvantage - DS PL	K	\$60
DADS-751-1000TL	SEL DatAdvantage - DS TL	K	\$24
DADS-8001-10KPL	SEL DatAdvantage - DS PL	K	\$36
DADS-8001-10KTL	SEL DatAdvantage - DS TL	K	\$14
DAEL-0-50PL	SEL DatAdvantage for Exchange Lite PL	K	\$149
DAEL-0-50TL	SEL DatAdvantage for Exchange Lite TL	K	\$60
DAEL-1001-1500PL	SEL DatAdvantage for Exchange Lite PL	K	\$43
DAEL-1001-1500TL	SEL DatAdvantage for Exchange Lite TL	K	\$17
DAEL-100K-150KPL	SEL DatAdvantage for Exchange Lite PL	K	\$23
DAEL-100K-150KTL	SEL DatAdvantage for Exchange Lite TL	K	\$9
DAEL-101-250PL	SEL DatAdvantage for Exchange Lite PL	K	\$82
DAEL-101-250TL	SEL DatAdvantage for Exchange Lite TL	K	\$33
DAEL-10K-20KPL	SEL DatAdvantage for Exchange Lite PL	K	\$26
DAEL-10K-20KTL	SEL DatAdvantage for Exchange Lite TL	K	\$11
DAEL-1501-2000PL	SEL DatAdvantage for Exchange Lite PL	K	\$39
DAEL-1501-2000TL	SEL DatAdvantage for Exchange Lite TL	K	\$15
DAEL-150K-PL	SEL DatAdvantage for Exchange Lite PL	K	\$22
DAEL-150K-TL	SEL DatAdvantage for Exchange Lite TL	K	\$9
DAEL-2001-2500PL	SEL DatAdvantage for Exchange Lite PL	K	\$36
DAEL-2001-2500TL	SEL DatAdvantage for Exchange Lite TL	K	\$14
DAEL-20K-35KPL	SEL DatAdvantage for Exchange Lite PL	K	\$25
DAEL-20K-35KTL	SEL DatAdvantage for Exchange Lite TL	K	\$10
DAEL-2501-4000PL	SEL DatAdvantage for Exchange Lite PL	K	\$34
DAEL-2501-4000TL	SEL DatAdvantage for Exchange Lite TL	K	\$14
DAEL-251-500PL	SEL DatAdvantage for Exchange Lite PL	K	\$62
DAEL-251-500TL	SEL DatAdvantage for Exchange Lite TL	K	\$25
DAEL-35K-50KPL	SEL DatAdvantage for Exchange Lite PL	K	\$24
DAEL-35K-50KTL	SEL DatAdvantage for Exchange Lite TL	K	\$10
DAEL-4001-6000PL	SEL DatAdvantage for Exchange Lite PL	K	\$32
DAEL-4001-6000TL	SEL DatAdvantage for Exchange Lite TL	K	\$13
DAEL-501-750PL	SEL DatAdvantage for Exchange Lite PL	K	\$50
DAEL-501-750TL	SEL DatAdvantage for Exchange Lite TL	K	\$20
DAEL-50K-100KPL	SEL DatAdvantage for Exchange Lite PL	K	\$23
DAEL-50K-100KTL	SEL DatAdvantage for Exchange Lite TL	K	\$9
DAEL-51-100PL	SEL DatAdvantage for Exchange Lite PL	K	\$104
DAEL-51-100TL	SEL DatAdvantage for Exchange Lite TL	K	\$42
DAEL-6001-8000PL	SEL DatAdvantage for Exchange Lite PL	K	\$29
DAEL-6001-8000TL	SEL DatAdvantage for Exchange Lite TL	K	\$12
DAEL-751-1000PL	SEL DatAdvantage for Exchange Lite PL	K	\$47
DAEL-751-1000TL	SEL DatAdvantage for Exchange Lite TL	K	\$19
DAEL-8001-10KPL	SEL DatAdvantage for Exchange Lite PL	K	\$28
DAEL-8001-10KTL	SEL DatAdvantage for Exchange Lite TL	K	\$11
DAEO-0-50PL	SEL DatAdvantage - EXOL PL	K	\$299
DAEO-0-50TL	SEL DatAdvantage - EXOL TL	K	\$119
DAEO-1001-1500PL	SEL DatAdvantage - EXOL PL	K	\$86
DAEO-1001-1500TL	SEL DatAdvantage - EXOL TL	K	\$34

DAEO-100K-150KPL	SEL DatAdvantage - EXOL PL	K	\$45
DAEO-100K-150KTL	SEL DatAdvantage - EXOL TL	K	\$18
DAEO-101-250PL	SEL DatAdvantage - EXOL PL	K	\$164
DAEO-101-250TL	SEL DatAdvantage - EXOL TL	K	\$65
DAEO-10K-20KPL	SEL DatAdvantage - EXOL PL	K	\$53
DAEO-10K-20KTL	SEL DatAdvantage - EXOL TL	K	\$21
DAEO-1501-2000PL	SEL DatAdvantage - EXOL PL	K	\$77
DAEO-1501-2000TL	SEL DatAdvantage - EXOL TL	K	\$31
DAEO-150K-PL	SEL DatAdvantage - EXOL PL	K	\$44
DAEO-150K-TL	SEL DatAdvantage - EXOL TL	K	\$18
DAEO-2001-2500PL	SEL DatAdvantage - EXOL PL	K	\$72
DAEO-2001-2500TL	SEL DatAdvantage - EXOL TL	K	\$29
DAEO-20K-35KPL	SEL DatAdvantage - EXOL PL	K	\$50
DAEO-20K-35KTL	SEL DatAdvantage - EXOL TL	K	\$20
DAEO-2501-4000PL	SEL DatAdvantage - EXOL PL	K	\$68
DAEO-2501-4000TL	SEL DatAdvantage - EXOL TL	K	\$27
DAEO-251-500PL	SEL DatAdvantage - EXOL PL	K	\$125
DAEO-251-500TL	SEL DatAdvantage - EXOL TL	K	\$50
DAEO-35K-50KPL	SEL DatAdvantage - EXOL PL	K	\$48
DAEO-35K-50KTL	SEL DatAdvantage - EXOL TL	K	\$19
DAEO-4001-6000PL	SEL DatAdvantage - EXOL PL	K	\$63
DAEO-4001-6000TL	SEL DatAdvantage - EXOL TL	K	\$25
DAEO-501-750PL	SEL DatAdvantage - EXOL PL	K	\$101
DAEO-501-750TL	SEL DatAdvantage - EXOL TL	K	\$40
DAEO-50K-100KPL	SEL DatAdvantage - EXOL PL	K	\$47
DAEO-50K-100KTL	SEL DatAdvantage - EXOL TL	K	\$19
DAEO-51-100PL	SEL DatAdvantage - EXOL PL	K	\$209
DAEO-51-100TL	SEL DatAdvantage - EXOL TL	K	\$83
DAEO-6001-8000PL	SEL DatAdvantage - EXOL PL	K	\$59
DAEO-6001-8000TL	SEL DatAdvantage - EXOL TL	K	\$23
DAEO-751-1000PL	SEL DatAdvantage - EXOL PL	K	\$93
DAEO-751-1000TL	SEL DatAdvantage - EXOL TL	K	\$37
DAEO-8001-10KPL	SEL DatAdvantage - EXOL PL	K	\$56
DAEO-8001-10KTL	SEL DatAdvantage - EXOL TL	K	\$22
DAEX-0-50PL	SEL DatAdvantage for Exchange PL	K	\$299
DAEX-0-50TL	SEL DatAdvantage for Exchange TL	K	\$119
DAEX-1001-1500PL	SEL DatAdvantage for Exchange PL	K	\$86
DAEX-1001-1500TL	SEL DatAdvantage for Exchange TL	K	\$34
DAEX-100K-150KPL	SEL DatAdvantage for Exchange PL	K	\$45
DAEX-100K-150KTL	SEL DatAdvantage for Exchange TL	K	\$18
DAEX-101-250PL	SEL DatAdvantage for Exchange PL	K	\$164
DAEX-101-250TL	SEL DatAdvantage for Exchange TL	K	\$65
DAEX-10K-20KPL	SEL DatAdvantage for Exchange PL	K	\$53
DAEX-10K-20KTL	SEL DatAdvantage for Exchange TL	K	\$21
DAEX-1501-2000PL	SEL DatAdvantage for Exchange PL	K	\$77
DAEX-1501-2000TL	SEL DatAdvantage for Exchange TL	K	\$31
DAEX-150K-PL	SEL DatAdvantage for Exchange PL	K	\$44
DAEX-150K-TL	SEL DatAdvantage for Exchange TL	K	\$18
DAEX-2001-2500PL	SEL DatAdvantage for Exchange PL	K	\$72
DAEX-2001-2500TL	SEL DatAdvantage for Exchange TL	K	\$29

DAEX-20K-35KPL	SEL DatAdvantage for Exchange PL	K	\$50
DAEX-20K-35KTL	SEL DatAdvantage for Exchange TL	K	\$20
DAEX-2501-4000PL	SEL DatAdvantage for Exchange PL	K	\$68
DAEX-2501-4000TL	SEL DatAdvantage for Exchange TL	K	\$27
DAEX-251-500PL	SEL DatAdvantage for Exchange PL	K	\$125
DAEX-251-500TL	SEL DatAdvantage for Exchange TL	K	\$50
DAEX-35K-50KPL	SEL DatAdvantage for Exchange PL	K	\$48
DAEX-35K-50KTL	SEL DatAdvantage for Exchange TL	K	\$19
DAEX-4001-6000PL	SEL DatAdvantage for Exchange PL	K	\$63
DAEX-4001-6000TL	SEL DatAdvantage for Exchange TL	K	\$25
DAEX-501-750PL	SEL DatAdvantage for Exchange PL	K	\$101
DAEX-501-750TL	SEL DatAdvantage for Exchange TL	K	\$40
DAEX-50K-100KPL	SEL DatAdvantage for Exchange PL	K	\$47
DAEX-50K-100KTL	SEL DatAdvantage for Exchange TL	K	\$19
DAEX-51-100PL	SEL DatAdvantage for Exchange PL	K	\$209
DAEX-51-100TL	SEL DatAdvantage for Exchange TL	K	\$83
DAEX-6001-8000PL	SEL DatAdvantage for Exchange PL	K	\$59
DAEX-6001-8000TL	SEL DatAdvantage for Exchange TL	K	\$23
DAEX-751-1000PL	SEL DatAdvantage for Exchange PL	K	\$93
DAEX-751-1000TL	SEL DatAdvantage for Exchange TL	K	\$37
DAEX-8001-10KPL	SEL DatAdvantage for Exchange PL	K	\$56
DAEX-8001-10KTL	SEL DatAdvantage for Exchange TL	K	\$22
DAOD-0-50PL	SEL DatAdvantage - OD PL	K	\$299
DAOD-0-50TL	SEL DatAdvantage - OD TL	K	\$119
DAOD-1001-1500PL	SEL DatAdvantage - OD PL	K	\$86
DAOD-1001-1500TL	SEL DatAdvantage - OD TL	K	\$34
DAOD-100K-150KPL	SEL DatAdvantage - OD PL	K	\$45
DAOD-100K-150KTL	SEL DatAdvantage - OD TL	K	\$18
DAOD-101-250PL	SEL DatAdvantage - OD PL	K	\$164
DAOD-101-250TL	SEL DatAdvantage - OD TL	K	\$65
DAOD-10K-20KPL	SEL DatAdvantage - OD PL	K	\$53
DAOD-10K-20KTL	SEL DatAdvantage - OD TL	K	\$21
DAOD-1501-2000PL	SEL DatAdvantage - OD PL	K	\$77
DAOD-1501-2000TL	SEL DatAdvantage - OD TL	K	\$31
DAOD-150K-PL	SEL DatAdvantage - OD PL	K	\$44
DAOD-150K-TL	SEL DatAdvantage - OD TL	K	\$18
DAOD-2001-2500PL	SEL DatAdvantage - OD PL	K	\$72
DAOD-2001-2500TL	SEL DatAdvantage - OD TL	K	\$29
DAOD-20K-35KPL	SEL DatAdvantage - OD PL	K	\$50
DAOD-20K-35KTL	SEL DatAdvantage - OD TL	K	\$20
DAOD-2501-4000PL	SEL DatAdvantage - OD PL	K	\$68
DAOD-2501-4000TL	SEL DatAdvantage - OD TL	K	\$27
DAOD-251-500PL	SEL DatAdvantage - OD PL	K	\$125
DAOD-251-500TL	SEL DatAdvantage - OD TL	K	\$50
DAOD-35K-50KPL	SEL DatAdvantage - OD PL	K	\$48
DAOD-35K-50KTL	SEL DatAdvantage - OD TL	K	\$19
DAOD-4001-6000PL	SEL DatAdvantage - OD PL	K	\$63
DAOD-4001-6000TL	SEL DatAdvantage - OD TL	K	\$25
DAOD-501-750PL	SEL DatAdvantage - OD PL	K	\$101
DAOD-501-750TL	SEL DatAdvantage - OD TL	K	\$40

DAOD-50K-100KPL	SEL DatAdvantage - OD PL	K	\$47
DAOD-50K-100KTL	SEL DatAdvantage - OD TL	K	\$19
DAOD-51-100PL	SEL DatAdvantage - OD PL	K	\$209
DAOD-51-100TL	SEL DatAdvantage - OD TL	K	\$83
DAOD-6001-8000PL	SEL DatAdvantage - OD PL	K	\$59
DAOD-6001-8000TL	SEL DatAdvantage - OD TL	K	\$23
DAOD-751-1000PL	SEL DatAdvantage - OD PL	K	\$93
DAOD-751-1000TL	SEL DatAdvantage - OD TL	K	\$37
DAOD-8001-10KPL	SEL DatAdvantage - OD PL	K	\$56
DAOD-8001-10KTL	SEL DatAdvantage - OD TL	K	\$22
DAOL-0-50PL	SEL DatAdvantage - OD Lite PL	K	\$149
DAOL-0-50TL	SEL DatAdvantage - OD Lite TL	K	\$60
DAOL-1001-1500PL	SEL DatAdvantage - OD Lite PL	K	\$43
DAOL-1001-1500TL	SEL DatAdvantage - OD Lite TL	K	\$17
DAOL-100K-150KPL	SEL DatAdvantage - OD Lite PL	K	\$23
DAOL-100K-150KTL	SEL DatAdvantage - OD Lite TL	K	\$9
DAOL-101-250PL	SEL DatAdvantage - OD Lite PL	K	\$82
DAOL-101-250TL	SEL DatAdvantage - OD Lite TL	K	\$33
DAOL-10K-20KPL	SEL DatAdvantage - OD Lite PL	K	\$26
DAOL-10K-20KTL	SEL DatAdvantage - OD Lite TL	K	\$11
DAOL-1501-2000PL	SEL DatAdvantage - OD Lite PL	K	\$39
DAOL-1501-2000TL	SEL DatAdvantage - OD Lite TL	K	\$15
DAOL-150K-PL	SEL DatAdvantage - OD Lite PL	K	\$22
DAOL-150K-TL	SEL DatAdvantage - OD Lite TL	K	\$9
DAOL-2001-2500PL	SEL DatAdvantage - OD Lite PL	K	\$36
DAOL-2001-2500TL	SEL DatAdvantage - OD Lite TL	K	\$14
DAOL-20K-35KPL	SEL DatAdvantage - OD Lite PL	K	\$25
DAOL-20K-35KTL	SEL DatAdvantage - OD Lite TL	K	\$10
DAOL-2501-4000PL	SEL DatAdvantage - OD Lite PL	K	\$34
DAOL-2501-4000TL	SEL DatAdvantage - OD Lite TL	K	\$14
DAOL-251-500PL	SEL DatAdvantage - OD Lite PL	K	\$62
DAOL-251-500TL	SEL DatAdvantage - OD Lite TL	K	\$25
DAOL-35K-50KPL	SEL DatAdvantage - OD Lite PL	K	\$24
DAOL-35K-50KTL	SEL DatAdvantage - OD Lite TL	K	\$10
DAOL-4001-6000PL	SEL DatAdvantage - OD Lite PL	K	\$32
DAOL-4001-6000TL	SEL DatAdvantage - OD Lite TL	K	\$13
DAOL-501-750PL	SEL DatAdvantage - OD Lite PL	K	\$50
DAOL-501-750TL	SEL DatAdvantage - OD Lite TL	K	\$20
DAOL-50K-100KPL	SEL DatAdvantage - OD Lite PL	K	\$23
DAOL-50K-100KTL	SEL DatAdvantage - OD Lite TL	K	\$9
DAOL-51-100PL	SEL DatAdvantage - OD Lite PL	K	\$104
DAOL-51-100TL	SEL DatAdvantage - OD Lite TL	K	\$42
DAOL-6001-8000PL	SEL DatAdvantage - OD Lite PL	K	\$29
DAOL-6001-8000TL	SEL DatAdvantage - OD Lite TL	K	\$12
DAOL-751-1000PL	SEL DatAdvantage - OD Lite PL	K	\$47
DAOL-751-1000TL	SEL DatAdvantage - OD Lite TL	K	\$19
DAOL-8001-10KPL	SEL DatAdvantage - OD Lite PL	K	\$28
DAOL-8001-10KTL	SEL DatAdvantage - OD Lite TL	K	\$11
DAOS-0-50PL	SEL DatAdvantage - SPOL & OD PL	K	\$448
DAOS-0-50TL	SEL DatAdvantage - SPOL & OD TL	K	\$179

DAOS-1001-1500PL	SEL DatAdvantage - SPOL & OD PL	K	\$128
DAOS-1001-1500TL	SEL DatAdvantage - SPOL & OD TL	K	\$51
DAOS-100K-150KPL	SEL DatAdvantage - SPOL & OD PL	K	\$68
DAOS-100K-150KTL	SEL DatAdvantage - SPOL & OD TL	K	\$27
DAOS-101-250PL	SEL DatAdvantage - SPOL & OD PL	K	\$245
DAOS-101-250TL	SEL DatAdvantage - SPOL & OD TL	K	\$98
DAOS-10K-20KPL	SEL DatAdvantage - SPOL & OD PL	K	\$79
DAOS-10K-20KTL	SEL DatAdvantage - SPOL & OD TL	K	\$32
DAOS-1501-2000PL	SEL DatAdvantage - SPOL & OD PL	K	\$116
DAOS-1501-2000TL	SEL DatAdvantage - SPOL & OD TL	K	\$46
DAOS-150K-PL	SEL DatAdvantage - SPOL & OD PL	K	\$66
DAOS-150K-TL	SEL DatAdvantage - SPOL & OD TL	K	\$27
DAOS-2001-2500PL	SEL DatAdvantage - SPOL & OD PL	K	\$108
DAOS-2001-2500TL	SEL DatAdvantage - SPOL & OD TL	K	\$43
DAOS-20K-35KPL	SEL DatAdvantage - SPOL & OD PL	K	\$74
DAOS-20K-35KTL	SEL DatAdvantage - SPOL & OD TL	K	\$30
DAOS-2501-4000PL	SEL DatAdvantage - SPOL & OD PL	K	\$101
DAOS-2501-4000TL	SEL DatAdvantage - SPOL & OD TL	K	\$41
DAOS-251-500PL	SEL DatAdvantage - SPOL & OD PL	K	\$187
DAOS-251-500TL	SEL DatAdvantage - SPOL & OD TL	K	\$75
DAOS-35K-50KPL	SEL DatAdvantage - SPOL & OD PL	K	\$72
DAOS-35K-50KTL	SEL DatAdvantage - SPOL & OD TL	K	\$29
DAOS-4001-6000PL	SEL DatAdvantage - SPOL & OD PL	K	\$95
DAOS-4001-6000TL	SEL DatAdvantage - SPOL & OD TL	K	\$38
DAOS-501-750PL	SEL DatAdvantage - SPOL & OD PL	K	\$151
DAOS-501-750TL	SEL DatAdvantage - SPOL & OD TL	K	\$60
DAOS-50K-100KPL	SEL DatAdvantage - SPOL & OD PL	K	\$70
DAOS-50K-100KTL	SEL DatAdvantage - SPOL & OD TL	K	\$28
DAOS-51-100PL	SEL DatAdvantage - SPOL & OD PL	K	\$313
DAOS-51-100TL	SEL DatAdvantage - SPOL & OD TL	K	\$125
DAOS-6001-8000PL	SEL DatAdvantage - SPOL & OD PL	K	\$88
DAOS-6001-8000TL	SEL DatAdvantage - SPOL & OD TL	K	\$35
DAOS-751-1000PL	SEL DatAdvantage - SPOL & OD PL	K	\$140
DAOS-751-1000TL	SEL DatAdvantage - SPOL & OD TL	K	\$56
DAOS-8001-10KPL	SEL DatAdvantage - SPOL & OD PL	K	\$83
DAOS-8001-10KTL	SEL DatAdvantage - SPOL & OD TL	K	\$33
DASL-0-50PL	SEL DatAdvantage - SP Lite PL	K	\$149
DASL-0-50TL	SEL DatAdvantage - SP Lite TL	K	\$60
DASL-1001-1500PL	SEL DatAdvantage - SP Lite PL	K	\$43
DASL-1001-1500TL	SEL DatAdvantage - SP Lite TL	K	\$17
DASL-100K-150KPL	SEL DatAdvantage - SP Lite PL	K	\$23
DASL-100K-150KTL	SEL DatAdvantage - SP Lite TL	K	\$9
DASL-101-250PL	SEL DatAdvantage - SP Lite PL	K	\$82
DASL-101-250TL	SEL DatAdvantage - SP Lite TL	K	\$33
DASL-10K-20KPL	SEL DatAdvantage - SP Lite PL	K	\$26
DASL-10K-20KTL	SEL DatAdvantage - SP Lite TL	K	\$11
DASL-1501-2000PL	SEL DatAdvantage - SP Lite PL	K	\$39
DASL-1501-2000TL	SEL DatAdvantage - SP Lite TL	K	\$15
DASL-150K-PL	SEL DatAdvantage - SP Lite PL	K	\$22
DASL-150K-TL	SEL DatAdvantage - SP Lite TL	K	\$9

DASL-2001-2500PL	SEL DatAdvantage - SP Lite PL	K	\$36
DASL-2001-2500TL	SEL DatAdvantage - SP Lite TL	K	\$14
DASL-20K-35KPL	SEL DatAdvantage - SP Lite PL	K	\$25
DASL-20K-35KTL	SEL DatAdvantage - SP Lite TL	K	\$10
DASL-2501-4000PL	SEL DatAdvantage - SP Lite PL	K	\$34
DASL-2501-4000TL	SEL DatAdvantage - SP Lite TL	K	\$14
DASL-251-500PL	SEL DatAdvantage - SP Lite PL	K	\$62
DASL-251-500TL	SEL DatAdvantage - SP Lite TL	K	\$25
DASL-35K-50KPL	SEL DatAdvantage - SP Lite PL	K	\$24
DASL-35K-50KTL	SEL DatAdvantage - SP Lite TL	K	\$10
DASL-4001-6000PL	SEL DatAdvantage - SP Lite PL	K	\$32
DASL-4001-6000TL	SEL DatAdvantage - SP Lite TL	K	\$13
DASL-501-750PL	SEL DatAdvantage - SP Lite PL	K	\$50
DASL-501-750TL	SEL DatAdvantage - SP Lite TL	K	\$20
DASL-50K-100KPL	SEL DatAdvantage - SP Lite PL	K	\$23
DASL-50K-100KTL	SEL DatAdvantage - SP Lite TL	K	\$9
DASL-51-100PL	SEL DatAdvantage - SP Lite PL	K	\$104
DASL-51-100TL	SEL DatAdvantage - SP Lite TL	K	\$42
DASL-6001-8000PL	SEL DatAdvantage - SP Lite PL	K	\$29
DASL-6001-8000TL	SEL DatAdvantage - SP Lite TL	K	\$12
DASL-751-1000PL	SEL DatAdvantage - SP Lite PL	K	\$47
DASL-751-1000TL	SEL DatAdvantage - SP Lite TL	K	\$19
DASL-8001-10KPL	SEL DatAdvantage - SP Lite PL	K	\$28
DASL-8001-10KTL	SEL DatAdvantage - SP Lite TL	K	\$11
DASO-0-50PL	SEL DatAdvantage - SPOL PL	K	\$299
DASO-0-50TL	SEL DatAdvantage - SPOL TL	K	\$119
DASO-1001-1500PL	SEL DatAdvantage - SPOL PL	K	\$86
DASO-1001-1500TL	SEL DatAdvantage - SPOL TL	K	\$34
DASO-100K-150KPL	SEL DatAdvantage - SPOL PL	K	\$45
DASO-100K-150KTL	SEL DatAdvantage - SPOL TL	K	\$18
DASO-101-250PL	SEL DatAdvantage - SPOL PL	K	\$164
DASO-101-250TL	SEL DatAdvantage - SPOL TL	K	\$65
DASO-10K-20KPL	SEL DatAdvantage - SPOL PL	K	\$53
DASO-10K-20KTL	SEL DatAdvantage - SPOL TL	K	\$21
DASO-1501-2000PL	SEL DatAdvantage - SPOL PL	K	\$77
DASO-1501-2000TL	SEL DatAdvantage - SPOL TL	K	\$31
DASO-150K-PL	SEL DatAdvantage - SPOL PL	K	\$44
DASO-150K-TL	SEL DatAdvantage - SPOL TL	K	\$18
DASO-2001-2500PL	SEL DatAdvantage - SPOL PL	K	\$72
DASO-2001-2500TL	SEL DatAdvantage - SPOL TL	K	\$29
DASO-20K-35KPL	SEL DatAdvantage - SPOL PL	K	\$50
DASO-20K-35KTL	SEL DatAdvantage - SPOL TL	K	\$20
DASO-2501-4000PL	SEL DatAdvantage - SPOL PL	K	\$68
DASO-2501-4000TL	SEL DatAdvantage - SPOL TL	K	\$27
DASO-251-500PL	SEL DatAdvantage - SPOL PL	K	\$125
DASO-251-500TL	SEL DatAdvantage - SPOL TL	K	\$50
DASO-35K-50KPL	SEL DatAdvantage - SPOL PL	K	\$48
DASO-35K-50KTL	SEL DatAdvantage - SPOL TL	K	\$19
DASO-4001-6000PL	SEL DatAdvantage - SPOL PL	K	\$63
DASO-4001-6000TL	SEL DatAdvantage - SPOL TL	K	\$25

DASO-501-750PL	SEL DatAdvantage - SPOL PL	K	\$101
DASO-501-750TL	SEL DatAdvantage - SPOL TL	K	\$40
DASO-50K-100KPL	SEL DatAdvantage - SPOL PL	K	\$47
DASO-50K-100KTL	SEL DatAdvantage - SPOL TL	K	\$19
DASO-51-100PL	SEL DatAdvantage - SPOL PL	K	\$209
DASO-51-100TL	SEL DatAdvantage - SPOL TL	K	\$83
DASO-6001-8000PL	SEL DatAdvantage - SPOL PL	K	\$59
DASO-6001-8000TL	SEL DatAdvantage - SPOL TL	K	\$23
DASO-751-1000PL	SEL DatAdvantage - SPOL PL	K	\$93
DASO-751-1000TL	SEL DatAdvantage - SPOL TL	K	\$37
DASO-8001-10KPL	SEL DatAdvantage - SPOL PL	K	\$56
DASO-8001-10KTL	SEL DatAdvantage - SPOL TL	K	\$22
DASP-0-50PL	SEL DatAdvantage - SP PL	K	\$299
DASP-0-50TL	SEL DatAdvantage - SP TL	K	\$119
DASP-1001-1500PL	SEL DatAdvantage - SP PL	K	\$86
DASP-1001-1500TL	SEL DatAdvantage - SP TL	K	\$34
DASP-100K-150KPL	SEL DatAdvantage - SP PL	K	\$45
DASP-100K-150KTL	SEL DatAdvantage - SP TL	K	\$18
DASP-101-250PL	SEL DatAdvantage - SP PL	K	\$164
DASP-101-250TL	SEL DatAdvantage - SP TL	K	\$65
DASP-10K-20KPL	SEL DatAdvantage - SP PL	K	\$53
DASP-10K-20KTL	SEL DatAdvantage - SP TL	K	\$21
DASP-1501-2000PL	SEL DatAdvantage - SP PL	K	\$77
DASP-1501-2000TL	SEL DatAdvantage - SP TL	K	\$31
DASP-150K-PL	SEL DatAdvantage - SP PL	K	\$44
DASP-150K-TL	SEL DatAdvantage - SP TL	K	\$18
DASP-2001-2500PL	SEL DatAdvantage - SP PL	K	\$72
DASP-2001-2500TL	SEL DatAdvantage - SP TL	K	\$29
DASP-20K-35KPL	SEL DatAdvantage - SP PL	K	\$50
DASP-20K-35KTL	SEL DatAdvantage - SP TL	K	\$20
DASP-2501-4000PL	SEL DatAdvantage - SP PL	K	\$68
DASP-2501-4000TL	SEL DatAdvantage - SP TL	K	\$27
DASP-251-500PL	SEL DatAdvantage - SP PL	K	\$125
DASP-251-500TL	SEL DatAdvantage - SP TL	K	\$50
DASP-35K-50KPL	SEL DatAdvantage - SP PL	K	\$48
DASP-35K-50KTL	SEL DatAdvantage - SP TL	K	\$19
DASP-4001-6000PL	SEL DatAdvantage - SP PL	K	\$63
DASP-4001-6000TL	SEL DatAdvantage - SP TL	K	\$25
DASP-501-750PL	SEL DatAdvantage - SP PL	K	\$101
DASP-501-750TL	SEL DatAdvantage - SP TL	K	\$40
DASP-50K-100KPL	SEL DatAdvantage - SP PL	K	\$47
DASP-50K-100KTL	SEL DatAdvantage - SP TL	K	\$19
DASP-51-100PL	SEL DatAdvantage - SP PL	K	\$209
DASP-51-100TL	SEL DatAdvantage - SP TL	K	\$83
DASP-6001-8000PL	SEL DatAdvantage - SP PL	K	\$59
DASP-6001-8000TL	SEL DatAdvantage - SP TL	K	\$23
DASP-751-1000PL	SEL DatAdvantage - SP PL	K	\$93
DASP-751-1000TL	SEL DatAdvantage - SP TL	K	\$37
DASP-8001-10KPL	SEL DatAdvantage - SP PL	K	\$56
DASP-8001-10KTL	SEL DatAdvantage - SP TL	K	\$22

DAUX-0-50PL	SEL DatAdvantage - NIX PL	K	\$299
DAUX-0-50TL	SEL DatAdvantage - NIX TL	K	\$119
DAUX-1001-1500PL	SEL DatAdvantage - NIX PL	K	\$86
DAUX-1001-1500TL	SEL DatAdvantage - NIX TL	K	\$34
DAUX-100K-150KPL	SEL DatAdvantage - NIX PL	K	\$45
DAUX-100K-150KTL	SEL DatAdvantage - NIX TL	K	\$18
DAUX-101-250PL	SEL DatAdvantage - NIX PL	K	\$164
DAUX-101-250TL	SEL DatAdvantage - NIX TL	K	\$65
DAUX-10K-20KPL	SEL DatAdvantage - NIX PL	K	\$53
DAUX-10K-20KTL	SEL DatAdvantage - NIX TL	K	\$21
DAUX-1501-2000PL	SEL DatAdvantage - NIX PL	K	\$77
DAUX-1501-2000TL	SEL DatAdvantage - NIX TL	K	\$31
DAUX-150K-PL	SEL DatAdvantage - NIX PL	K	\$44
DAUX-150K-TL	SEL DatAdvantage - NIX TL	K	\$18
DAUX-2001-2500PL	SEL DatAdvantage - NIX PL	K	\$72
DAUX-2001-2500TL	SEL DatAdvantage - NIX TL	K	\$29
DAUX-20K-35KPL	SEL DatAdvantage - NIX PL	K	\$50
DAUX-20K-35KTL	SEL DatAdvantage - NIX TL	K	\$20
DAUX-2501-4000PL	SEL DatAdvantage - NIX PL	K	\$68
DAUX-2501-4000TL	SEL DatAdvantage - NIX TL	K	\$27
DAUX-251-500PL	SEL DatAdvantage - NIX PL	K	\$125
DAUX-251-500TL	SEL DatAdvantage - NIX TL	K	\$50
DAUX-35K-50KPL	SEL DatAdvantage - NIX PL	K	\$48
DAUX-35K-50KTL	SEL DatAdvantage - NIX TL	K	\$19
DAUX-4001-6000PL	SEL DatAdvantage - NIX PL	K	\$63
DAUX-4001-6000TL	SEL DatAdvantage - NIX TL	K	\$25
DAUX-501-750PL	SEL DatAdvantage - NIX PL	K	\$101
DAUX-501-750TL	SEL DatAdvantage - NIX TL	K	\$40
DAUX-50K-100KPL	SEL DatAdvantage - NIX PL	K	\$47
DAUX-50K-100KTL	SEL DatAdvantage - NIX TL	K	\$19
DAUX-51-100PL	SEL DatAdvantage - NIX PL	K	\$209
DAUX-51-100TL	SEL DatAdvantage - NIX TL	K	\$83
DAUX-6001-8000PL	SEL DatAdvantage - NIX PL	K	\$59
DAUX-6001-8000TL	SEL DatAdvantage - NIX TL	K	\$23
DAUX-751-1000PL	SEL DatAdvantage - NIX PL	K	\$93
DAUX-751-1000TL	SEL DatAdvantage - NIX TL	K	\$37
DAUX-8001-10KPL	SEL DatAdvantage - NIX PL	K	\$56
DAUX-8001-10KTL	SEL DatAdvantage - NIX TL	K	\$22
DAW-0-50PL	SEL DatAdvantage for Windows PL	K	\$299
DAW-0-50TL	SEL DatAdvantage for Windows TL	K	\$119
DAW-1001-1500PL	SEL DatAdvantage for Windows PL	K	\$86
DAW-1001-1500TL	SEL DatAdvantage for Windows TL	K	\$34
DAW-100K-150KPL	SEL DatAdvantage for Windows PL	K	\$45
DAW-100K-150KTL	SEL DatAdvantage for Windows TL	K	\$18
DAW-101-250PL	SEL DatAdvantage for Windows PL	K	\$164
DAW-101-250TL	SEL DatAdvantage for Windows TL	K	\$65
DAW-10K-20KPL	SEL DatAdvantage for Windows PL	K	\$53
DAW-10K-20KTL	SEL DatAdvantage for Windows TL	K	\$21
DAW-1501-2000PL	SEL DatAdvantage for Windows PL	K	\$77
DAW-1501-2000TL	SEL DatAdvantage for Windows TL	K	\$31

DAW-150K-PL	SEL DatAdvantage for Windows PL	K	\$44
DAW-150K-TL	SEL DatAdvantage for Windows TL	K	\$18
DAW-2001-2500PL	SEL DatAdvantage for Windows PL	K	\$72
DAW-2001-2500TL	SEL DatAdvantage for Windows TL	K	\$29
DAW-20K-35KPL	SEL DatAdvantage for Windows PL	K	\$50
DAW-20K-35KTL	SEL DatAdvantage for Windows TL	K	\$20
DAW-2501-4000PL	SEL DatAdvantage for Windows PL	K	\$68
DAW-2501-4000TL	SEL DatAdvantage for Windows TL	K	\$27
DAW-251-500PL	SEL DatAdvantage for Windows PL	K	\$125
DAW-251-500TL	SEL DatAdvantage for Windows TL	K	\$50
DAW-35K-50KPL	SEL DatAdvantage for Windows PL	K	\$48
DAW-35K-50KTL	SEL DatAdvantage for Windows TL	K	\$19
DAW-4001-6000PL	SEL DatAdvantage for Windows PL	K	\$63
DAW-4001-6000TL	SEL DatAdvantage for Windows TL	K	\$25
DAW-501-750PL	SEL DatAdvantage for Windows PL	K	\$101
DAW-501-750TL	SEL DatAdvantage for Windows TL	K	\$40
DAW-50K-100KPL	SEL DatAdvantage for Windows PL	K	\$47
DAW-50K-100KTL	SEL DatAdvantage for Windows TL	K	\$19
DAW-51-100PL	SEL DatAdvantage for Windows PL	K	\$209
DAW-51-100TL	SEL DatAdvantage for Windows TL	K	\$83
DAW-6001-8000PL	SEL DatAdvantage for Windows PL	K	\$59
DAW-6001-8000TL	SEL DatAdvantage for Windows TL	K	\$23
DAW-751-1000PL	SEL DatAdvantage for Windows PL	K	\$93
DAW-751-1000TL	SEL DatAdvantage for Windows TL	K	\$37
DAW-8001-10KPL	SEL DatAdvantage for Windows PL	K	\$56
DAW-8001-10KTL	SEL DatAdvantage for Windows TL	K	\$22
DAWL-0-50PL	SEL DatAdvantage for Windows Lite PL	K	\$149
DAWL-0-50TL	SEL DatAdvantage for Windows Lite TL	K	\$60
DAWL-1001-1500PL	SEL DatAdvantage for Windows Lite PL	K	\$43
DAWL-1001-1500TL	SEL DatAdvantage for Windows Lite TL	K	\$17
DAWL-100K-150KPL	SEL DatAdvantage for Windows Lite PL	K	\$23
DAWL-100K-150KTL	SEL DatAdvantage for Windows Lite TL	K	\$9
DAWL-101-250PL	SEL DatAdvantage for Windows Lite PL	K	\$82
DAWL-101-250TL	SEL DatAdvantage for Windows Lite TL	K	\$33
DAWL-10K-20KPL	SEL DatAdvantage for Windows Lite PL	K	\$26
DAWL-10K-20KTL	SEL DatAdvantage for Windows Lite TL	K	\$11
DAWL-1501-2000PL	SEL DatAdvantage for Windows Lite PL	K	\$39
DAWL-1501-2000TL	SEL DatAdvantage for Windows Lite TL	K	\$15
DAWL-150K-PL	SEL DatAdvantage for Windows Lite PL	K	\$22
DAWL-150K-TL	SEL DatAdvantage for Windows Lite TL	K	\$9
DAWL-2001-2500PL	SEL DatAdvantage for Windows Lite PL	K	\$36
DAWL-2001-2500TL	SEL DatAdvantage for Windows Lite TL	K	\$14
DAWL-20K-35KPL	SEL DatAdvantage for Windows Lite PL	K	\$25
DAWL-20K-35KTL	SEL DatAdvantage for Windows Lite TL	K	\$10
DAWL-2501-4000PL	SEL DatAdvantage for Windows Lite PL	K	\$34
DAWL-2501-4000TL	SEL DatAdvantage for Windows Lite TL	K	\$14
DAWL-251-500PL	SEL DatAdvantage for Windows Lite PL	K	\$62
DAWL-251-500TL	SEL DatAdvantage for Windows Lite TL	K	\$25
DAWL-35K-50KPL	SEL DatAdvantage for Windows Lite PL	K	\$24
DAWL-35K-50KTL	SEL DatAdvantage for Windows Lite TL	K	\$10

DAWL-4001-6000PL	SEL DatAdvantage for Windows Lite PL	K	\$32
DAWL-4001-6000TL	SEL DatAdvantage for Windows Lite TL	K	\$13
DAWL-501-750PL	SEL DatAdvantage for Windows Lite PL	K	\$50
DAWL-501-750TL	SEL DatAdvantage for Windows Lite TL	K	\$20
DAWL-50K-100KPL	SEL DatAdvantage for Windows Lite PL	K	\$23
DAWL-50K-100KTL	SEL DatAdvantage for Windows Lite TL	K	\$9
DAWL-51-100PL	SEL DatAdvantage for Windows Lite PL	K	\$104
DAWL-51-100TL	SEL DatAdvantage for Windows Lite TL	K	\$42
DAWL-6001-8000PL	SEL DatAdvantage for Windows Lite PL	K	\$29
DAWL-6001-8000TL	SEL DatAdvantage for Windows Lite TL	K	\$12
DAWL-751-1000PL	SEL DatAdvantage for Windows Lite PL	K	\$47
DAWL-751-1000TL	SEL DatAdvantage for Windows Lite TL	K	\$19
DAWL-8001-10KPL	SEL DatAdvantage for Windows Lite PL	K	\$28
DAWL-8001-10KTL	SEL DatAdvantage for Windows Lite TL	K	\$11
DBMI-MCD-020	SEL Migrate NAS-to-Isilon Initial 50	K	\$42,348
DBMI-MCD-021	SEL Migrate NAS-to-Isilon Addl 10	K	\$6,489
DBM/VNX-MCD-020	SEL Migrate NAS-to-VNX/Unity Initial 50	K	\$42,348
DBM/VNX-MCD-021	SEL Migrate NAS-to-VNX/Unity Addl 10	K	\$6,489
DBRECS-MCD-010	SEL Replicate 10TB ECS Annual Renewal	K	\$14,089
DBRECS-MCD-050	SEL Replicate 50TB ECS Annual Renewal	K	\$83,320
DBRI-MCD-010	SEL Replicate 10TB Isilon Annual Renewal	K	\$14,089
DBRI-MCD-050	SEL Replicate 50TB Isilon Annual Renewal	K	\$83,320
DBRVNX-MCD-010	SEL Replicate 10TB VNXUty Annual Renewal	K	\$14,089
DBRVNX-MCD-050	SEL Replicate 50TB VNXUty Annual Renewal	K	\$83,320
DCF-0-50PL	SEL Data Classification Framework PL	K	\$215
DCF-0-50TL	SEL Data Classification Framework TL	K	\$86
DCF-1001-1500PL	SEL Data Classification Framework PL	K	\$62
DCF-1001-1500TL	SEL Data Classification Framework TL	K	\$25
DCF-100K-150KPL	SEL Data Classification Framework PL	K	\$32
DCF-100K-150KTL	SEL Data Classification Framework TL	K	\$13
DCF-101-250PL	SEL Data Classification Framework PL	K	\$118
DCF-101-250TL	SEL Data Classification Framework TL	K	\$47
DCF-10K-20KPL	SEL Data Classification Framework PL	K	\$38
DCF-10K-20KTL	SEL Data Classification Framework TL	K	\$15
DCF-1501-2000PL	SEL Data Classification Framework PL	K	\$56
DCF-1501-2000TL	SEL Data Classification Framework TL	K	\$22
DCF-150K-PL	SEL Data Classification Framework PL	K	\$32
DCF-150K-TL	SEL Data Classification Framework TL	K	\$13
DCF-2001-2500PL	SEL Data Classification Framework PL	K	\$52
DCF-2001-2500TL	SEL Data Classification Framework TL	K	\$21
DCF-20K-35KPL	SEL Data Classification Framework PL	K	\$36
DCF-20K-35KTL	SEL Data Classification Framework TL	K	\$14
DCF-2501-4000PL	SEL Data Classification Framework PL	K	\$49
DCF-2501-4000TL	SEL Data Classification Framework TL	K	\$20
DCF-251-500PL	SEL Data Classification Framework PL	K	\$90
DCF-251-500TL	SEL Data Classification Framework TL	K	\$36
DCF-35K-50KPL	SEL Data Classification Framework PL	K	\$35
DCF-35K-50KTL	SEL Data Classification Framework TL	K	\$14
DCF-4001-6000PL	SEL Data Classification Framework PL	K	\$45
DCF-4001-6000TL	SEL Data Classification Framework TL	K	\$18

DCF-501-750PL	SEL Data Classification Framework PL	K	\$72
DCF-501-750TL	SEL Data Classification Framework TL	K	\$29
DCF-50K-100KPL	SEL Data Classification Framework PL	K	\$33
DCF-50K-100KTL	SEL Data Classification Framework TL	K	\$13
DCF-51-100PL	SEL Data Classification Framework PL	K	\$150
DCF-51-100TL	SEL Data Classification Framework TL	K	\$60
DCF-6001-8000PL	SEL Data Classification Framework PL	K	\$42
DCF-6001-8000TL	SEL Data Classification Framework TL	K	\$17
DCF-751-1000PL	SEL Data Classification Framework PL	K	\$67
DCF-751-1000TL	SEL Data Classification Framework TL	K	\$27
DCF-8001-10KPL	SEL Data Classification Framework PL	K	\$40
DCF-8001-10KTL	SEL Data Classification Framework TL	K	\$16
DCFU-0-50PL	SEL DataClass Framework for UNIX PL	K	\$215
DCFU-0-50TL	SEL DataClass Framework for UNIX TL	K	\$86
DCFU-1001-1500PL	SEL DataClass Framework for UNIX PL	K	\$62
DCFU-1001-1500TL	SEL DataClass Framework for UNIX TL	K	\$25
DCFU-100K-150KPL	SEL DataClass Framework for UNIX PL	K	\$32
DCFU-100K-150KTL	SEL DataClass Framework for UNIX TL	K	\$13
DCFU-101-250PL	SEL DataClass Framework for UNIX PL	K	\$118
DCFU-101-250TL	SEL DataClass Framework for UNIX TL	K	\$47
DCFU-10K-20KPL	SEL DataClass Framework for UNIX PL	K	\$38
DCFU-10K-20KTL	SEL DataClass Framework for UNIX TL	K	\$15
DCFU-1501-2000PL	SEL DataClass Framework for UNIX PL	K	\$56
DCFU-1501-2000TL	SEL DataClass Framework for UNIX TL	K	\$22
DCFU-150K-PL	SEL DataClass Framework for UNIX PL	K	\$32
DCFU-150K-TL	SEL DataClass Framework for UNIX TL	K	\$13
DCFU-2001-2500PL	SEL DataClass Framework for UNIX PL	K	\$52
DCFU-2001-2500TL	SEL DataClass Framework for UNIX TL	K	\$21
DCFU-20K-35KPL	SEL DataClass Framework for UNIX PL	K	\$36
DCFU-20K-35KTL	SEL DataClass Framework for UNIX TL	K	\$14
DCFU-2501-4000PL	SEL DataClass Framework for UNIX PL	K	\$49
DCFU-2501-4000TL	SEL DataClass Framework for UNIX TL	K	\$20
DCFU-251-500PL	SEL DataClass Framework for UNIX PL	K	\$90
DCFU-251-500TL	SEL DataClass Framework for UNIX TL	K	\$36
DCFU-35K-50KPL	SEL DataClass Framework for UNIX PL	K	\$35
DCFU-35K-50KTL	SEL DataClass Framework for UNIX TL	K	\$14
DCFU-4001-6000PL	SEL DataClass Framework for UNIX PL	K	\$45
DCFU-4001-6000TL	SEL DataClass Framework for UNIX TL	K	\$18
DCFU-501-750PL	SEL DataClass Framework for UNIX PL	K	\$72
DCFU-501-750TL	SEL DataClass Framework for UNIX TL	K	\$29
DCFU-50K-100KPL	SEL DataClass Framework for UNIX PL	K	\$33
DCFU-50K-100KTL	SEL DataClass Framework for UNIX TL	K	\$13
DCFU-51-100PL	SEL DataClass Framework for UNIX PL	K	\$150
DCFU-51-100TL	SEL DataClass Framework for UNIX TL	K	\$60
DCFU-6001-8000PL	SEL DataClass Framework for UNIX PL	K	\$42
DCFU-6001-8000TL	SEL DataClass Framework for UNIX TL	K	\$17
DCFU-751-1000PL	SEL DataClass Framework for UNIX PL	K	\$67
DCFU-751-1000TL	SEL DataClass Framework for UNIX TL	K	\$27
DCFU-8001-10KPL	SEL DataClass Framework for UNIX PL	K	\$40
DCFU-8001-10KTL	SEL DataClass Framework for UNIX TL	K	\$16

DCOD-0-50PL	SEL DCF for OneDrive PL	K	\$215
DCOD-0-50TL	SEL DCF for OneDrive TL	K	\$86
DCOD-1001-1500PL	SEL DCF for OneDrive PL	K	\$62
DCOD-1001-1500TL	SEL DCF for OneDrive TL	K	\$25
DCOD-100K-150KPL	SEL DCF for OneDrive PL	K	\$32
DCOD-100K-150KTL	SEL DCF for OneDrive TL	K	\$13
DCOD-101-250PL	SEL DCF for OneDrive PL	K	\$118
DCOD-101-250TL	SEL DCF for OneDrive TL	K	\$47
DCOD-10K-20KPL	SEL DCF for OneDrive PL	K	\$38
DCOD-10K-20KTL	SEL DCF for OneDrive TL	K	\$15
DCOD-1501-2000PL	SEL DCF for OneDrive PL	K	\$56
DCOD-1501-2000TL	SEL DCF for OneDrive TL	K	\$22
DCOD-150K-PL	SEL DCF for OneDrive PL	K	\$32
DCOD-150K-TL	SEL DCF for OneDrive TL	K	\$13
DCOD-2001-2500PL	SEL DCF for OneDrive PL	K	\$52
DCOD-2001-2500TL	SEL DCF for OneDrive TL	K	\$21
DCOD-20K-35KPL	SEL DCF for OneDrive PL	K	\$36
DCOD-20K-35KTL	SEL DCF for OneDrive TL	K	\$14
DCOD-2501-4000PL	SEL DCF for OneDrive PL	K	\$49
DCOD-2501-4000TL	SEL DCF for OneDrive TL	K	\$20
DCOD-251-500PL	SEL DCF for OneDrive PL	K	\$90
DCOD-251-500TL	SEL DCF for OneDrive TL	K	\$36
DCOD-35K-50KPL	SEL DCF for OneDrive PL	K	\$35
DCOD-35K-50KTL	SEL DCF for OneDrive TL	K	\$14
DCOD-4001-6000PL	SEL DCF for OneDrive PL	K	\$45
DCOD-4001-6000TL	SEL DCF for OneDrive TL	K	\$18
DCOD-501-750PL	SEL DCF for OneDrive PL	K	\$72
DCOD-501-750TL	SEL DCF for OneDrive TL	K	\$29
DCOD-50K-100KPL	SEL DCF for OneDrive PL	K	\$33
DCOD-50K-100KTL	SEL DCF for OneDrive TL	K	\$13
DCOD-51-100PL	SEL DCF for OneDrive PL	K	\$150
DCOD-51-100TL	SEL DCF for OneDrive TL	K	\$60
DCOD-6001-8000PL	SEL DCF for OneDrive PL	K	\$42
DCOD-6001-8000TL	SEL DCF for OneDrive TL	K	\$17
DCOD-751-1000PL	SEL DCF for OneDrive PL	K	\$67
DCOD-751-1000TL	SEL DCF for OneDrive TL	K	\$27
DCOD-8001-10KPL	SEL DCF for OneDrive PL	K	\$40
DCOD-8001-10KTL	SEL DCF for OneDrive TL	K	\$16
DCOS-0-50PL	SEL DCF for SP Online & OneDrive PL	K	\$322
DCOS-0-50TL	SEL DCF for SP Online & OneDrive TL	K	\$129
DCOS-1001-1500PL	SEL DCF for SP Online & OneDrive PL	K	\$92
DCOS-1001-1500TL	SEL DCF for SP Online & OneDrive TL	K	\$37
DCOS-100K-150KPL	SEL DCF for SP Online & OneDrive PL	K	\$49
DCOS-100K-150KTL	SEL DCF for SP Online & OneDrive TL	K	\$20
DCOS-101-250PL	SEL DCF for SP Online & OneDrive PL	K	\$177
DCOS-101-250TL	SEL DCF for SP Online & OneDrive TL	K	\$71
DCOS-10K-20KPL	SEL DCF for SP Online & OneDrive PL	K	\$57
DCOS-10K-20KTL	SEL DCF for SP Online & OneDrive TL	K	\$23
DCOS-1501-2000PL	SEL DCF for SP Online & OneDrive PL	K	\$83
DCOS-1501-2000TL	SEL DCF for SP Online & OneDrive TL	K	\$33

DCOS-150K-PL	SEL DCF for SP Online & OneDrive PL	K	\$48
DCOS-150K-TL	SEL DCF for SP Online & OneDrive TL	K	\$19
DCOS-2001-2500PL	SEL DCF for SP Online & OneDrive PL	K	\$78
DCOS-2001-2500TL	SEL DCF for SP Online & OneDrive TL	K	\$31
DCOS-20K-35KPL	SEL DCF for SP Online & OneDrive PL	K	\$53
DCOS-20K-35KTL	SEL DCF for SP Online & OneDrive TL	K	\$21
DCOS-2501-4000PL	SEL DCF for SP Online & OneDrive PL	K	\$73
DCOS-2501-4000TL	SEL DCF for SP Online & OneDrive TL	K	\$29
DCOS-251-500PL	SEL DCF for SP Online & OneDrive PL	K	\$134
DCOS-251-500TL	SEL DCF for SP Online & OneDrive TL	K	\$54
DCOS-35K-50KPL	SEL DCF for SP Online & OneDrive PL	K	\$52
DCOS-35K-50KTL	SEL DCF for SP Online & OneDrive TL	K	\$21
DCOS-4001-6000PL	SEL DCF for SP Online & OneDrive PL	K	\$68
DCOS-4001-6000TL	SEL DCF for SP Online & OneDrive TL	K	\$27
DCOS-501-750PL	SEL DCF for SP Online & OneDrive PL	K	\$109
DCOS-501-750TL	SEL DCF for SP Online & OneDrive TL	K	\$43
DCOS-50K-100KPL	SEL DCF for SP Online & OneDrive PL	K	\$50
DCOS-50K-100KTL	SEL DCF for SP Online & OneDrive TL	K	\$20
DCOS-51-100PL	SEL DCF for SP Online & OneDrive PL	K	\$225
DCOS-51-100TL	SEL DCF for SP Online & OneDrive TL	K	\$90
DCOS-6001-8000PL	SEL DCF for SP Online & OneDrive PL	K	\$63
DCOS-6001-8000TL	SEL DCF for SP Online & OneDrive TL	K	\$25
DCOS-751-1000PL	SEL DCF for SP Online & OneDrive PL	K	\$101
DCOS-751-1000TL	SEL DCF for SP Online & OneDrive TL	K	\$40
DCOS-8001-10KPL	SEL DCF for SP Online & OneDrive PL	K	\$60
DCOS-8001-10KTL	SEL DCF for SP Online & OneDrive TL	K	\$24
DCSO-0-50PL	SEL DCF for SharePoint Online PL	K	\$215
DCSO-0-50TL	SEL DCF for SharePoint Online TL	K	\$86
DCSO-1001-1500PL	SEL DCF for SharePoint Online PL	K	\$62
DCSO-1001-1500TL	SEL DCF for SharePoint Online TL	K	\$25
DCSO-100K-150KPL	SEL DCF for SharePoint Online PL	K	\$32
DCSO-100K-150KTL	SEL DCF for SharePoint Online TL	K	\$13
DCSO-101-250PL	SEL DCF for SharePoint Online PL	K	\$118
DCSO-101-250TL	SEL DCF for SharePoint Online TL	K	\$47
DCSO-10K-20KPL	SEL DCF for SharePoint Online PL	K	\$38
DCSO-10K-20KTL	SEL DCF for SharePoint Online TL	K	\$15
DCSO-1501-2000PL	SEL DCF for SharePoint Online PL	K	\$56
DCSO-1501-2000TL	SEL DCF for SharePoint Online TL	K	\$22
DCSO-150K-PL	SEL DCF for SharePoint Online PL	K	\$32
DCSO-150K-TL	SEL DCF for SharePoint Online TL	K	\$13
DCSO-2001-2500PL	SEL DCF for SharePoint Online PL	K	\$52
DCSO-2001-2500TL	SEL DCF for SharePoint Online TL	K	\$21
DCSO-20K-35KPL	SEL DCF for SharePoint Online PL	K	\$36
DCSO-20K-35KTL	SEL DCF for SharePoint Online TL	K	\$14
DCSO-2501-4000PL	SEL DCF for SharePoint Online PL	K	\$49
DCSO-2501-4000TL	SEL DCF for SharePoint Online TL	K	\$20
DCSO-251-500PL	SEL DCF for SharePoint Online PL	K	\$90
DCSO-251-500TL	SEL DCF for SharePoint Online TL	K	\$36
DCSO-35K-50KPL	SEL DCF for SharePoint Online PL	K	\$35
DCSO-35K-50KTL	SEL DCF for SharePoint Online TL	K	\$14

DCSO-4001-6000PL	SEL DCF for SharePoint Online PL	K	\$45
DCSO-4001-6000TL	SEL DCF for SharePoint Online TL	K	\$18
DCSO-501-750PL	SEL DCF for SharePoint Online PL	K	\$72
DCSO-501-750TL	SEL DCF for SharePoint Online TL	K	\$29
DCSO-50K-100KPL	SEL DCF for SharePoint Online PL	K	\$33
DCSO-50K-100KTL	SEL DCF for SharePoint Online TL	K	\$13
DCSO-51-100PL	SEL DCF for SharePoint Online PL	K	\$150
DCSO-51-100TL	SEL DCF for SharePoint Online TL	K	\$60
DCSO-6001-8000PL	SEL DCF for SharePoint Online PL	K	\$42
DCSO-6001-8000TL	SEL DCF for SharePoint Online TL	K	\$17
DCSO-751-1000PL	SEL DCF for SharePoint Online PL	K	\$67
DCSO-751-1000TL	SEL DCF for SharePoint Online TL	K	\$27
DCSO-8001-10KPL	SEL DCF for SharePoint Online PL	K	\$40
DCSO-8001-10KTL	SEL DCF for SharePoint Online TL	K	\$16
DECHO-AD	SEL Mozy Fed ID Quickstart	K	\$10,000
DECHO-API	SEL MOZY API WORKSHOP	K	\$2,900
DECHO-AS	SEL MOZY ACTIVATION & SET-UP	K	\$10,000
DECHO-BST	SEL MOZY BASIC SETUP AND TEST	K	\$1,100
DECHO-DS	SEL MOZY DATA SHUTTLE	K	\$500
DECHO-IM1	SEL MOZY ADMINISTRATOR TRAINING 4 HRS	K	\$1,000
DECHO-IM2	SEL MOZY ADMINISTRATOR TRAINING 1 DAY	K	\$2,000
DECHO-IM3	SEL MOZY L1 SUPPORT TRAINING	K	\$3,700
DECHO-SOL	SEL MOZY SOLUTIONS ASSURANCE	K	\$6,500
DECHO-WS	SEL MOZY OEM PARTNER WORKSHOPS	K	\$5,500
DFXSECSB16TB	SELECT Archiver for ECS 10-80TB Lic	K	\$577
DFXSECSB17TB	SELECT Archiver for ECS 81-240TB Lic	K	\$538
DFXSECSB18TB	SELECT Archiver for ECS 241-500TB Lic	K	\$503
DFXSECSB19TB	SELECT Archiver for ECS 501-750TB Lic	K	\$466
DFXSECSB20TB	SELECT Archiver for ECS 751-1024TB Lic	K	\$429
DFXSECSB21TB	SELECT Archiver for ECS 1025-1500TB Lic	K	\$392
DFXSECSB22TB	SELECT Archiver for ECS 1501-2048TB Lic	K	\$355
DFXSECSB23TB	SELECT Archiver for ECS 2049-2500TB Lic	K	\$322
DFXSECSB24TB	SELECT Archiver for ECS 2501-3072TB Lic	K	\$283
DFXSFAB1TB	SELECT DefendX CT-FA 10-80TB License	K	\$694
DFXSFAB2TB	SELECT DefendX CT-FA 81-240TB License	K	\$658
DFXSFAB3TB	SELECT DefendX CT-FA 241-500TB License	K	\$623
DFXSFAB4TB	SELECT DefendX CT-FA 501-750TB License	K	\$588
DFXSFAB5TB	SELECT DefendX CT-FA 751-1024TB License	K	\$549
DFXSFILEMGNT	SELECT DFXS File Mgnt Prod	K	\$138
DFXSMBB10TB	SELECT DefendX MB 751-1024TB License	K	\$429
DFXSMBB11TB	SELECT DefendX MB 1025-1500TB License	K	\$392
DFXSMBB12TB	SELECT DefendX MB 1501-2048TB License	K	\$355
DFXSMBB13TB	SELECT DefendX MB 2049-2500TB License	K	\$322
DFXSMBB14TB	SELECT DefendX MB 2501-3072TB License	K	\$283
DFXSMBB6TB	SELECT DefendX MB 10-80TB License	K	\$577
DFXSMBB7TB	SELECT DefendX MB 81-240TB License	K	\$538
DFXSMBB8TB	SELECT DefendX MB 241-500TB License	K	\$503
DFXSMBB9TB	SELECT DefendX MB 501-750TB License	K	\$466
DFXSQFSB1TB	SELECT DefendX CT-QFS 10-80TB License	K	\$694
DFXSQFSB2TB	SELECT DefendX CT-QFS 81-240TB License	K	\$658

DFXSQFSB3TB	SELECT DefendX CT-QFS 241-500TB License	K	\$623
DFXSQFSB4TB	SELECT DefendX CT-QFS 501-750TB License	K	\$588
DFXSQFSB5TB	SELECT DefendX CT-QFS 751-1024TB License	K	\$549
DFXSVSB1TB	SELECT DefendX VS 10-80TB License	K	\$694
DFXSVSB2TB	SELECT DefendX VS 81-240TB License	K	\$658
DFXSVSB3TB	SELECT DefendX VS 241-500TB License	K	\$623
DFXSVSB4TB	SELECT DefendX VS 501-750TB License	K	\$588
DFXSVSB5TB	SELECT DefendX VS 751-1024TB License	K	\$549
DL-0-50PL	SEL DatAlert PL	K	\$134
DL-0-50TL	SEL DatAlert TL	K	\$54
DL-1001-1500PL	SEL DatAlert PL	K	\$39
DL-1001-1500TL	SEL DatAlert TL	K	\$15
DL-100K-150KPL	SEL DatAlert PL	K	\$20
DL-100K-150KTL	SEL DatAlert TL	K	\$8
DL-101-250PL	SEL DatAlert PL	K	\$74
DL-101-250TL	SEL DatAlert TL	K	\$29
DL-10K-20KPL	SEL DatAlert PL	K	\$24
DL-10K-20KTL	SEL DatAlert TL	K	\$9
DL-1501-2000PL	SEL DatAlert PL	K	\$35
DL-1501-2000TL	SEL DatAlert TL	K	\$14
DL-150K-PL	SEL DatAlert PL	K	\$20
DL-150K-TL	SEL DatAlert TL	K	\$8
DL-2001-2500PL	SEL DatAlert PL	K	\$32
DL-2001-2500TL	SEL DatAlert TL	K	\$13
DL-20K-35KPL	SEL DatAlert PL	K	\$22
DL-20K-35KTL	SEL DatAlert TL	K	\$9
DL-2501-4000PL	SEL DatAlert PL	K	\$30
DL-2501-4000TL	SEL DatAlert TL	K	\$12
DL-251-500PL	SEL DatAlert PL	K	\$56
DL-251-500TL	SEL DatAlert TL	K	\$22
DL-35K-50KPL	SEL DatAlert PL	K	\$22
DL-35K-50KTL	SEL DatAlert TL	K	\$9
DL-4001-6000PL	SEL DatAlert PL	K	\$28
DL-4001-6000TL	SEL DatAlert TL	K	\$11
DL-501-750PL	SEL DatAlert PL	K	\$45
DL-501-750TL	SEL DatAlert TL	K	\$18
DL-50K-100KPL	SEL DatAlert PL	K	\$21
DL-50K-100KTL	SEL DatAlert TL	K	\$8
DL-51-100PL	SEL DatAlert PL	K	\$94
DL-51-100TL	SEL DatAlert TL	K	\$38
DL-6001-8000PL	SEL DatAlert PL	K	\$26
DL-6001-8000TL	SEL DatAlert TL	K	\$11
DL-751-1000PL	SEL DatAlert PL	K	\$42
DL-751-1000TL	SEL DatAlert TL	K	\$17
DL-8001-10KPL	SEL DatAlert PL	K	\$25
DL-8001-10KTL	SEL DatAlert TL	K	\$10
DLS-0-50PL	SEL DatAlert Suite PL	K	\$209
DLS-0-50TL	SEL DatAlert Suite TL	K	\$84
DLS-1001-1500PL	SEL DatAlert Suite PL	K	\$60
DLS-1001-1500TL	SEL DatAlert Suite TL	K	\$24

DLS-100K-150KPL	SEL DatAlert Suite PL	K	\$32
DLS-100K-150KTL	SEL DatAlert Suite TL	K	\$13
DLS-101-250PL	SEL DatAlert Suite PL	K	\$114
DLS-101-250TL	SEL DatAlert Suite TL	K	\$46
DLS-10K-20KPL	SEL DatAlert Suite PL	K	\$37
DLS-10K-20KTL	SEL DatAlert Suite TL	K	\$15
DLS-1501-2000PL	SEL DatAlert Suite PL	K	\$54
DLS-1501-2000TL	SEL DatAlert Suite TL	K	\$22
DLS-150K-PL	SEL DatAlert Suite PL	K	\$31
DLS-150K-TL	SEL DatAlert Suite TL	K	\$12
DLS-2001-2500PL	SEL DatAlert Suite PL	K	\$50
DLS-2001-2500TL	SEL DatAlert Suite TL	K	\$20
DLS-20K-35KPL	SEL DatAlert Suite PL	K	\$35
DLS-20K-35KTL	SEL DatAlert Suite TL	K	\$14
DLS-2501-4000PL	SEL DatAlert Suite PL	K	\$47
DLS-2501-4000TL	SEL DatAlert Suite TL	K	\$19
DLS-251-500PL	SEL DatAlert Suite PL	K	\$87
DLS-251-500TL	SEL DatAlert Suite TL	K	\$35
DLS-35K-50KPL	SEL DatAlert Suite PL	K	\$34
DLS-35K-50KTL	SEL DatAlert Suite TL	K	\$14
DLS-4001-6000PL	SEL DatAlert Suite PL	K	\$44
DLS-4001-6000TL	SEL DatAlert Suite TL	K	\$18
DLS-501-750PL	SEL DatAlert Suite PL	K	\$70
DLS-501-750TL	SEL DatAlert Suite TL	K	\$28
DLS-50K-100KPL	SEL DatAlert Suite PL	K	\$33
DLS-50K-100KTL	SEL DatAlert Suite TL	K	\$13
DLS-51-100PL	SEL DatAlert Suite PL	K	\$146
DLS-51-100TL	SEL DatAlert Suite TL	K	\$58
DLS-6001-8000PL	SEL DatAlert Suite PL	K	\$41
DLS-6001-8000TL	SEL DatAlert Suite TL	K	\$16
DLS-751-1000PL	SEL DatAlert Suite PL	K	\$65
DLS-751-1000TL	SEL DatAlert Suite TL	K	\$26
DLS-8001-10KPL	SEL DatAlert Suite PL	K	\$39
DLS-8001-10KTL	SEL DatAlert Suite TL	K	\$16
DLX-0-50PL	SEL DatAlert Analytics PL	K	\$90
DLX-0-50TL	SEL DatAlert Analytics TL	K	\$36
DLX-1001-1500PL	SEL DatAlert Analytics PL	K	\$26
DLX-1001-1500TL	SEL DatAlert Analytics TL	K	\$10
DLX-100K-150KPL	SEL DatAlert Analytics PL	K	\$14
DLX-100K-150KTL	SEL DatAlert Analytics TL	K	\$5
DLX-101-250PL	SEL DatAlert Analytics PL	K	\$49
DLX-101-250TL	SEL DatAlert Analytics TL	K	\$20
DLX-10K-20KPL	SEL DatAlert Analytics PL	K	\$16
DLX-10K-20KTL	SEL DatAlert Analytics TL	K	\$6
DLX-1501-2000PL	SEL DatAlert Analytics PL	K	\$23
DLX-1501-2000TL	SEL DatAlert Analytics TL	K	\$9
DLX-150K-PL	SEL DatAlert Analytics PL	K	\$13
DLX-150K-TL	SEL DatAlert Analytics TL	K	\$5
DLX-2001-2500PL	SEL DatAlert Analytics PL	K	\$22
DLX-2001-2500TL	SEL DatAlert Analytics TL	K	\$9

DLX-20K-35KPL	SEL DatAlert Analytics PL	K	\$15
DLX-20K-35KTL	SEL DatAlert Analytics TL	K	\$6
DLX-2501-4000PL	SEL DatAlert Analytics PL	K	\$20
DLX-2501-4000TL	SEL DatAlert Analytics TL	K	\$8
DLX-251-500PL	SEL DatAlert Analytics PL	K	\$37
DLX-251-500TL	SEL DatAlert Analytics TL	K	\$15
DLX-35K-50KPL	SEL DatAlert Analytics PL	K	\$14
DLX-35K-50KTL	SEL DatAlert Analytics TL	K	\$6
DLX-4001-6000PL	SEL DatAlert Analytics PL	K	\$19
DLX-4001-6000TL	SEL DatAlert Analytics TL	K	\$8
DLX-501-750PL	SEL DatAlert Analytics PL	K	\$30
DLX-501-750TL	SEL DatAlert Analytics TL	K	\$12
DLX-50K-100KPL	SEL DatAlert Analytics PL	K	\$14
DLX-50K-100KTL	SEL DatAlert Analytics TL	K	\$6
DLX-51-100PL	SEL DatAlert Analytics PL	K	\$63
DLX-51-100TL	SEL DatAlert Analytics TL	K	\$25
DLX-6001-8000PL	SEL DatAlert Analytics PL	K	\$18
DLX-6001-8000TL	SEL DatAlert Analytics TL	K	\$7
DLX-751-1000PL	SEL DatAlert Analytics PL	K	\$28
DLX-751-1000TL	SEL DatAlert Analytics TL	K	\$11
DLX-8001-10KPL	SEL DatAlert Analytics PL	K	\$17
DLX-8001-10KTL	SEL DatAlert Analytics TL	K	\$7
DMS-2000-LMA	SEL CDSI SM Config Unlim SW local mig	K	\$192,308
DMS-2000-LMA-RU	SEL CDSI Upg to Remote Lic DMS-2000-LMA	K	\$19,231
DMS-4000-LMA	SEL CDSI MED Config Unlim SW local mig	K	\$269,231
DMS-4000-LMA-RU	SEL CDSI Upg to Remote Lic DMS-4000-LMA	K	\$42,308
DMS-8000-LMA	SEL CDSI LG Config Unlim SW local mig	K	\$423,077
DMS-8000-LMA-RU	SEL CDSI Upg to Remote Lic DMS-8000-LMA	K	\$134,615
DMS-CAP-L	SEL CDSI Local Capacity Per/TB	K	\$431
DMS-CAP-R	SEL CDSI Remote Migration Cap Per/TB	K	\$862
DMS-CAP-S	SEL CDSI Scrubbing Capacity Per/TB	K	\$215
DNI-PL	SEL DatAnywhere Instance Add-on PL	K	\$10,500
DNI-TL	SEL DatAnywhere Instance Add-on TL	K	\$4,200
DP-0-50PL	SEL DataPrivilege PL	K	\$194
DP-0-50TL	SEL DataPrivilege TL	K	\$78
DP-1001-1500PL	SEL DataPrivilege PL	K	\$56
DP-1001-1500TL	SEL DataPrivilege TL	K	\$22
DP-100K-150KPL	SEL DataPrivilege PL	K	\$29
DP-100K-150KTL	SEL DataPrivilege TL	K	\$12
DP-101-250PL	SEL DataPrivilege PL	K	\$106
DP-101-250TL	SEL DataPrivilege TL	K	\$42
DP-10K-20KPL	SEL DataPrivilege PL	K	\$34
DP-10K-20KTL	SEL DataPrivilege TL	K	\$14
DP-1501-2000PL	SEL DataPrivilege PL	K	\$50
DP-1501-2000TL	SEL DataPrivilege TL	K	\$20
DP-150K-PL	SEL DataPrivilege PL	K	\$29
DP-150K-TL	SEL DataPrivilege TL	K	\$12
DP-2001-2500PL	SEL DataPrivilege PL	K	\$47
DP-2001-2500TL	SEL DataPrivilege TL	K	\$19
DP-20K-35KPL	SEL DataPrivilege PL	K	\$32

DP-20K-35KTL	SEL DataPrivilege TL	K	\$13
DP-2501-4000PL	SEL DataPrivilege PL	K	\$44
DP-2501-4000TL	SEL DataPrivilege TL	K	\$18
DP-251-500PL	SEL DataPrivilege PL	K	\$81
DP-251-500TL	SEL DataPrivilege TL	K	\$32
DP-35K-50KPL	SEL DataPrivilege PL	K	\$31
DP-35K-50KTL	SEL DataPrivilege TL	K	\$12
DP-4001-6000PL	SEL DataPrivilege PL	K	\$41
DP-4001-6000TL	SEL DataPrivilege TL	K	\$16
DP-501-750PL	SEL DataPrivilege PL	K	\$65
DP-501-750TL	SEL DataPrivilege TL	K	\$26
DP-50K-100KPL	SEL DataPrivilege PL	K	\$30
DP-50K-100KTL	SEL DataPrivilege TL	K	\$12
DP-51-100PL	SEL DataPrivilege PL	K	\$136
DP-51-100TL	SEL DataPrivilege TL	K	\$54
DP-6001-8000PL	SEL DataPrivilege PL	K	\$38
DP-6001-8000TL	SEL DataPrivilege TL	K	\$15
DP-751-1000PL	SEL DataPrivilege PL	K	\$60
DP-751-1000TL	SEL DataPrivilege TL	K	\$24
DP-8001-10KPL	SEL DataPrivilege PL	K	\$36
DP-8001-10KTL	SEL DataPrivilege TL	K	\$14
DPS-0-50PL	SEL DataPrivilege for SharePoint PL	K	\$194
DPS-0-50TL	SEL DataPrivilege for SharePoint TL	K	\$78
DPS-1001-1500PL	SEL DataPrivilege for SharePoint PL	K	\$56
DPS-1001-1500TL	SEL DataPrivilege for SharePoint TL	K	\$22
DPS-100K-150KPL	SEL DataPrivilege for SharePoint PL	K	\$29
DPS-100K-150KTL	SEL DataPrivilege for SharePoint TL	K	\$12
DPS-101-250PL	SEL DataPrivilege for SharePoint PL	K	\$106
DPS-101-250TL	SEL DataPrivilege for SharePoint TL	K	\$42
DPS-10K-20KPL	SEL DataPrivilege for SharePoint PL	K	\$34
DPS-10K-20KTL	SEL DataPrivilege for SharePoint TL	K	\$14
DPS-1501-2000PL	SEL DataPrivilege for SharePoint PL	K	\$50
DPS-1501-2000TL	SEL DataPrivilege for SharePoint TL	K	\$20
DPS-150K-PL	SEL DataPrivilege for SharePoint PL	K	\$29
DPS-150K-TL	SEL DataPrivilege for SharePoint TL	K	\$12
DPS-2001-2500PL	SEL DataPrivilege for SharePoint PL	K	\$47
DPS-2001-2500TL	SEL DataPrivilege for SharePoint TL	K	\$19
DPS-20K-35KPL	SEL DataPrivilege for SharePoint PL	K	\$32
DPS-20K-35KTL	SEL DataPrivilege for SharePoint TL	K	\$13
DPS-2501-4000PL	SEL DataPrivilege for SharePoint PL	K	\$44
DPS-2501-4000TL	SEL DataPrivilege for SharePoint TL	K	\$18
DPS-251-500PL	SEL DataPrivilege for SharePoint PL	K	\$81
DPS-251-500TL	SEL DataPrivilege for SharePoint TL	K	\$32
DPS-35K-50KPL	SEL DataPrivilege for SharePoint PL	K	\$31
DPS-35K-50KTL	SEL DataPrivilege for SharePoint TL	K	\$12
DPS-4001-6000PL	SEL DataPrivilege for SharePoint PL	K	\$41
DPS-4001-6000TL	SEL DataPrivilege for SharePoint TL	K	\$16
DPS-501-750PL	SEL DataPrivilege for SharePoint PL	K	\$65
DPS-501-750TL	SEL DataPrivilege for SharePoint TL	K	\$26
DPS-50K-100KPL	SEL DataPrivilege for SharePoint PL	K	\$30

DPS-50K-100KTL	SEL DataPrivilege for SharePoint TL	K	\$12
DPS-51-100PL	SEL DataPrivilege for SharePoint PL	K	\$136
DPS-51-100TL	SEL DataPrivilege for SharePoint TL	K	\$54
DPS-6001-8000PL	SEL DataPrivilege for SharePoint PL	K	\$38
DPS-6001-8000TL	SEL DataPrivilege for SharePoint TL	K	\$15
DPS-751-1000PL	SEL DataPrivilege for SharePoint PL	K	\$60
DPS-751-1000TL	SEL DataPrivilege for SharePoint TL	K	\$24
DPS-8001-10KPL	SEL DataPrivilege for SharePoint PL	K	\$36
DPS-8001-10KTL	SEL DataPrivilege for SharePoint TL	K	\$14
DR-PL	SEL Disaster Recovery Add-on PL	K	\$15,000
DR-TL	SEL Disaster Recovery Add-on TL	K	\$6,000
DS-16G-ER-D4851	SEL-SFP+,16/8/4Gbps,FC,D9360,13dB,40km	K	\$5,531
DS-16G-ER-D4932	SEL-SFP+,16/8/4Gbps,FC,D9350,13dB,40km	K	\$5,531
DS-16G-ER-D5012	SEL-SFP+,16/8/4Gbps,FC,D9340,13dB,40km	K	\$5,531
DS-16G-ER-D5092	SEL-SFP+,16/8/4Gbps,FC,D9330,13dB,40km	K	\$5,531
DS-16G-ER-D5172	SEL-SFP+,16/8/4Gbps,FC,D9320,13dB,40km	K	\$5,531
DS-16G-ER-D5252	SEL-SFP+,16/8/4Gbps,FC,D9310,13dB,40km	K	\$5,531
DS-16G-ER-D5333	SEL-SFP+,16/8/4Gbps,FC,D9300,13dB,40km	K	\$5,531
DS-16G-ER-D5413	SEL-SFP+,16/8/4Gbps,FC,D9290,13dB,40km	K	\$5,531
DS-16G-ER-D5494	SEL-SFP+,16/8/4Gbps,FC,D9280,13dB,40km	K	\$5,531
DS-16G-ER-D5575	SEL-SFP+,16/8/4Gbps,FC,D9270,13dB,40km	K	\$5,531
DS-16G-ER-D5655	SEL-SFP+,16/8/4Gbps,FC,D9260,13dB,40km	K	\$5,531
DS-16G-ER-D5736	SEL-SFP+,16/8/4Gbps,FC,D9250,13dB,40km	K	\$5,531
DS-16G-ER-D5817	SEL-SFP+,16/8/4Gbps,FC,D9240,13dB,40km	K	\$5,531
DS-16G-ER-D5898	SEL-SFP+,16/8/4Gbps,FC,D9230,13dB,40km	K	\$5,531
DS-16G-ER-D5979	SEL-SFP+,16/8/4Gbps,FC,D9220,13dB,40km	K	\$5,531
DS-16G-ER-D6061	SEL-SFP+,16/8/4Gbps,FC,D9210,13dB,40km	K	\$5,531
DTE-0-50PL	SEL Data Transport Engine PL	K	\$179
DTE-0-50TL	SEL Data Transport Engine TL	K	\$72
DTE-1001-1500PL	SEL Data Transport Engine PL	K	\$51
DTE-1001-1500TL	SEL Data Transport Engine TL	K	\$21
DTE-100K-150KPL	SEL Data Transport Engine PL	K	\$27
DTE-100K-150KTL	SEL Data Transport Engine TL	K	\$11
DTE-101-250PL	SEL Data Transport Engine PL	K	\$98
DTE-101-250TL	SEL Data Transport Engine TL	K	\$39
DTE-10K-20KPL	SEL Data Transport Engine PL	K	\$32
DTE-10K-20KTL	SEL Data Transport Engine TL	K	\$13
DTE-1501-2000PL	SEL Data Transport Engine PL	K	\$46
DTE-1501-2000TL	SEL Data Transport Engine TL	K	\$19
DTE-150K-PL	SEL Data Transport Engine PL	K	\$27
DTE-150K-TL	SEL Data Transport Engine TL	K	\$11
DTE-2001-2500PL	SEL Data Transport Engine PL	K	\$43
DTE-2001-2500TL	SEL Data Transport Engine TL	K	\$17
DTE-20K-35KPL	SEL Data Transport Engine PL	K	\$30
DTE-20K-35KTL	SEL Data Transport Engine TL	K	\$12
DTE-2501-4000PL	SEL Data Transport Engine PL	K	\$41
DTE-2501-4000TL	SEL Data Transport Engine TL	K	\$16
DTE-251-500PL	SEL Data Transport Engine PL	K	\$75
DTE-251-500TL	SEL Data Transport Engine TL	K	\$30
DTE-35K-50KPL	SEL Data Transport Engine PL	K	\$29

DTE-35K-50KTL	SEL Data Transport Engine TL	K	\$12
DTE-4001-6000PL	SEL Data Transport Engine PL	K	\$38
DTE-4001-6000TL	SEL Data Transport Engine TL	K	\$15
DTE-501-750PL	SEL Data Transport Engine PL	K	\$60
DTE-501-750TL	SEL Data Transport Engine TL	K	\$24
DTE-50K-100KPL	SEL Data Transport Engine PL	K	\$28
DTE-50K-100KTL	SEL Data Transport Engine TL	K	\$11
DTE-51-100PL	SEL Data Transport Engine PL	K	\$125
DTE-51-100TL	SEL Data Transport Engine TL	K	\$50
DTE-6001-8000PL	SEL Data Transport Engine PL	K	\$35
DTE-6001-8000TL	SEL Data Transport Engine TL	K	\$14
DTE-751-1000PL	SEL Data Transport Engine PL	K	\$56
DTE-751-1000TL	SEL Data Transport Engine TL	K	\$22
DTE-8001-10KPL	SEL Data Transport Engine PL	K	\$33
DTE-8001-10KTL	SEL Data Transport Engine TL	K	\$13
DW-0-50PL	SEL DATANSWERS - WIN PL	K	\$299
DW-0-50TL	SEL DATANSWERS - WIN TL	K	\$119
DW-1001-1500PL	SEL DATANSWERS - WIN PL	K	\$86
DW-1001-1500TL	SEL DATANSWERS - WIN TL	K	\$34
DW-100K-150KPL	SEL DATANSWERS - WIN PL	K	\$45
DW-100K-150KTL	SEL DATANSWERS - WIN TL	K	\$18
DW-101-250PL	SEL DATANSWERS - WIN PL	K	\$164
DW-101-250TL	SEL DATANSWERS - WIN TL	K	\$65
DW-10K-20KPL	SEL DATANSWERS - WIN PL	K	\$53
DW-10K-20KTL	SEL DATANSWERS - WIN TL	K	\$21
DW-1501-2000PL	SEL DATANSWERS - WIN PL	K	\$77
DW-1501-2000TL	SEL DATANSWERS - WIN TL	K	\$31
DW-150K-PL	SEL DATANSWERS - WIN PL	K	\$44
DW-150K-TL	SEL DATANSWERS - WIN TL	K	\$18
DW-2001-2500PL	SEL DATANSWERS - WIN PL	K	\$72
DW-2001-2500TL	SEL DATANSWERS - WIN TL	K	\$29
DW-20K-35KPL	SEL DATANSWERS - WIN PL	K	\$50
DW-20K-35KTL	SEL DATANSWERS - WIN TL	K	\$20
DW-2501-4000PL	SEL DATANSWERS - WIN PL	K	\$68
DW-2501-4000TL	SEL DATANSWERS - WIN TL	K	\$27
DW-251-500PL	SEL DATANSWERS - WIN PL	K	\$125
DW-251-500TL	SEL DATANSWERS - WIN TL	K	\$50
DW-35K-50KPL	SEL DATANSWERS - WIN PL	K	\$48
DW-35K-50KTL	SEL DATANSWERS - WIN TL	K	\$19
DW-4001-6000PL	SEL DATANSWERS - WIN PL	K	\$63
DW-4001-6000TL	SEL DATANSWERS - WIN TL	K	\$25
DW-501-750PL	SEL DATANSWERS - WIN PL	K	\$101
DW-501-750TL	SEL DATANSWERS - WIN TL	K	\$40
DW-50K-100KPL	SEL DATANSWERS - WIN PL	K	\$47
DW-50K-100KTL	SEL DATANSWERS - WIN TL	K	\$19
DW-51-100PL	SEL DATANSWERS - WIN PL	K	\$209
DW-51-100TL	SEL DATANSWERS - WIN TL	K	\$83
DW-6001-8000PL	SEL DATANSWERS - WIN PL	K	\$59
DW-6001-8000TL	SEL DATANSWERS - WIN TL	K	\$23
DW-751-1000PL	SEL DATANSWERS - WIN PL	K	\$93

DW-751-1000TL	SEL DATANSWERS - WIN TL	K	\$37
DW-8001-10KPL	SEL DATANSWERS - WIN PL	K	\$56
DW-8001-10KTL	SEL DATANSWERS - WIN TL	K	\$22
DWOD-0-50PL	SEL DATANSWERS - OD PL	K	\$299
DWOD-0-50TL	SEL DATANSWERS - OD TL	K	\$119
DWOD-1001-1500PL	SEL DATANSWERS - OD PL	K	\$86
DWOD-1001-1500TL	SEL DATANSWERS - OD TL	K	\$34
DWOD-100K-150KPL	SEL DATANSWERS - OD PL	K	\$45
DWOD-100K-150KTL	SEL DATANSWERS - OD TL	K	\$18
DWOD-101-250PL	SEL DATANSWERS - OD PL	K	\$164
DWOD-101-250TL	SEL DATANSWERS - OD TL	K	\$65
DWOD-10K-20KPL	SEL DATANSWERS - OD PL	K	\$53
DWOD-10K-20KTL	SEL DATANSWERS - OD TL	K	\$21
DWOD-1501-2000PL	SEL DATANSWERS - OD PL	K	\$77
DWOD-1501-2000TL	SEL DATANSWERS - OD TL	K	\$31
DWOD-150K-PL	SEL DATANSWERS - OD PL	K	\$44
DWOD-150K-TL	SEL DATANSWERS - OD TL	K	\$18
DWOD-2001-2500PL	SEL DATANSWERS - OD PL	K	\$72
DWOD-2001-2500TL	SEL DATANSWERS - OD TL	K	\$29
DWOD-20K-35KPL	SEL DATANSWERS - OD PL	K	\$50
DWOD-20K-35KTL	SEL DATANSWERS - OD TL	K	\$20
DWOD-2501-4000PL	SEL DATANSWERS - OD PL	K	\$68
DWOD-2501-4000TL	SEL DATANSWERS - OD TL	K	\$27
DWOD-251-500PL	SEL DATANSWERS - OD PL	K	\$125
DWOD-251-500TL	SEL DATANSWERS - OD TL	K	\$50
DWOD-35K-50KPL	SEL DATANSWERS - OD PL	K	\$48
DWOD-35K-50KTL	SEL DATANSWERS - OD TL	K	\$19
DWOD-4001-6000PL	SEL DATANSWERS - OD PL	K	\$63
DWOD-4001-6000TL	SEL DATANSWERS - OD TL	K	\$25
DWOD-501-750PL	SEL DATANSWERS - OD PL	K	\$101
DWOD-501-750TL	SEL DATANSWERS - OD TL	K	\$40
DWOD-50K-100KPL	SEL DATANSWERS - OD PL	K	\$47
DWOD-50K-100KTL	SEL DATANSWERS - OD TL	K	\$19
DWOD-51-100PL	SEL DATANSWERS - OD PL	K	\$209
DWOD-51-100TL	SEL DATANSWERS - OD TL	K	\$83
DWOD-6001-8000PL	SEL DATANSWERS - OD PL	K	\$59
DWOD-6001-8000TL	SEL DATANSWERS - OD TL	K	\$23
DWOD-751-1000PL	SEL DATANSWERS - OD PL	K	\$93
DWOD-751-1000TL	SEL DATANSWERS - OD TL	K	\$37
DWOD-8001-10KPL	SEL DATANSWERS - OD PL	K	\$56
DWOD-8001-10KTL	SEL DATANSWERS - OD TL	K	\$22
DWOS-0-50PL	SEL DATANSWERS - OD & SPOL PL	K	\$448
DWOS-0-50TL	SEL DATANSWERS - OD & SPOL TL	K	\$179
DWOS-1001-1500PL	SEL DATANSWERS - OD & SPOL PL	K	\$128
DWOS-1001-1500TL	SEL DATANSWERS - OD & SPOL TL	K	\$51
DWOS-100K-150KPL	SEL DATANSWERS - OD & SPOL PL	K	\$68
DWOS-100K-150KTL	SEL DATANSWERS - OD & SPOL TL	K	\$27
DWOS-101-250PL	SEL DATANSWERS - OD & SPOL PL	K	\$245
DWOS-101-250TL	SEL DATANSWERS - OD & SPOL TL	K	\$98
DWOS-10K-20KPL	SEL DATANSWERS - OD & SPOL PL	K	\$79

DWOS-10K-20KTL	SEL DATANSWERS - OD & SPOL TL	K	\$32
DWOS-1501-2000PL	SEL DATANSWERS - OD & SPOL PL	K	\$116
DWOS-1501-2000TL	SEL DATANSWERS - OD & SPOL TL	K	\$46
DWOS-150K-PL	SEL DATANSWERS - OD & SPOL PL	K	\$66
DWOS-150K-TL	SEL DATANSWERS - OD & SPOL TL	K	\$27
DWOS-2001-2500PL	SEL DATANSWERS - OD & SPOL PL	K	\$108
DWOS-2001-2500TL	SEL DATANSWERS - OD & SPOL TL	K	\$43
DWOS-20K-35KPL	SEL DATANSWERS - OD & SPOL PL	K	\$74
DWOS-20K-35KTL	SEL DATANSWERS - OD & SPOL TL	K	\$30
DWOS-2501-4000PL	SEL DATANSWERS - OD & SPOL PL	K	\$101
DWOS-2501-4000TL	SEL DATANSWERS - OD & SPOL TL	K	\$41
DWOS-251-500PL	SEL DATANSWERS - OD & SPOL PL	K	\$187
DWOS-251-500TL	SEL DATANSWERS - OD & SPOL TL	K	\$75
DWOS-35K-50KPL	SEL DATANSWERS - OD & SPOL PL	K	\$72
DWOS-35K-50KTL	SEL DATANSWERS - OD & SPOL TL	K	\$29
DWOS-4001-6000PL	SEL DATANSWERS - OD & SPOL PL	K	\$95
DWOS-4001-6000TL	SEL DATANSWERS - OD & SPOL TL	K	\$38
DWOS-501-750PL	SEL DATANSWERS - OD & SPOL PL	K	\$151
DWOS-501-750TL	SEL DATANSWERS - OD & SPOL TL	K	\$60
DWOS-50K-100KPL	SEL DATANSWERS - OD & SPOL PL	K	\$70
DWOS-50K-100KTL	SEL DATANSWERS - OD & SPOL TL	K	\$28
DWOS-51-100PL	SEL DATANSWERS - OD & SPOL PL	K	\$313
DWOS-51-100TL	SEL DATANSWERS - OD & SPOL TL	K	\$125
DWOS-6001-8000PL	SEL DATANSWERS - OD & SPOL PL	K	\$88
DWOS-6001-8000TL	SEL DATANSWERS - OD & SPOL TL	K	\$35
DWOS-751-1000PL	SEL DATANSWERS - OD & SPOL PL	K	\$140
DWOS-751-1000TL	SEL DATANSWERS - OD & SPOL TL	K	\$56
DWOS-8001-10KPL	SEL DATANSWERS - OD & SPOL PL	K	\$83
DWOS-8001-10KTL	SEL DATANSWERS - OD & SPOL TL	K	\$33
DWS-0-50PL	SEL DATANSWERS - SP PL	K	\$299
DWS-0-50TL	SEL DATANSWERS - SP TL	K	\$119
DWS-1001-1500PL	SEL DATANSWERS - SP PL	K	\$86
DWS-1001-1500TL	SEL DATANSWERS - SP TL	K	\$34
DWS-100K-150KPL	SEL DATANSWERS - SP PL	K	\$45
DWS-100K-150KTL	SEL DATANSWERS - SP TL	K	\$18
DWS-101-250PL	SEL DATANSWERS - SP PL	K	\$164
DWS-101-250TL	SEL DATANSWERS - SP TL	K	\$65
DWS-10K-20KPL	SEL DATANSWERS - SP PL	K	\$53
DWS-10K-20KTL	SEL DATANSWERS - SP TL	K	\$21
DWS-1501-2000PL	SEL DATANSWERS - SP PL	K	\$77
DWS-1501-2000TL	SEL DATANSWERS - SP TL	K	\$31
DWS-150K-PL	SEL DATANSWERS - SP PL	K	\$44
DWS-150K-TL	SEL DATANSWERS - SP TL	K	\$18
DWS-2001-2500PL	SEL DATANSWERS - SP PL	K	\$72
DWS-2001-2500TL	SEL DATANSWERS - SP TL	K	\$29
DWS-20K-35KPL	SEL DATANSWERS - SP PL	K	\$50
DWS-20K-35KTL	SEL DATANSWERS - SP TL	K	\$20
DWS-2501-4000PL	SEL DATANSWERS - SP PL	K	\$68
DWS-2501-4000TL	SEL DATANSWERS - SP TL	K	\$27
DWS-251-500PL	SEL DATANSWERS - SP PL	K	\$125

DWS-251-500TL	SEL DATANSWERS - SP TL	K	\$50
DWS-35K-50KPL	SEL DATANSWERS - SP PL	K	\$48
DWS-35K-50KTL	SEL DATANSWERS - SP TL	K	\$19
DWS-4001-6000PL	SEL DATANSWERS - SP PL	K	\$63
DWS-4001-6000TL	SEL DATANSWERS - SP TL	K	\$25
DWS-501-750PL	SEL DATANSWERS - SP PL	K	\$101
DWS-501-750TL	SEL DATANSWERS - SP TL	K	\$40
DWS-50K-100KPL	SEL DATANSWERS - SP PL	K	\$47
DWS-50K-100KTL	SEL DATANSWERS - SP TL	K	\$19
DWS-51-100PL	SEL DATANSWERS - SP PL	K	\$209
DWS-51-100TL	SEL DATANSWERS - SP TL	K	\$83
DWS-6001-8000PL	SEL DATANSWERS - SP PL	K	\$59
DWS-6001-8000TL	SEL DATANSWERS - SP TL	K	\$23
DWS-751-1000PL	SEL DATANSWERS - SP PL	K	\$93
DWS-751-1000TL	SEL DatAnswers - SP TL	K	\$37
DWS-8001-10KPL	SEL DATANSWERS - SP PL	K	\$56
DWS-8001-10KTL	SEL DATANSWERS - SP TL	K	\$22
DWSO-0-50PL	SEL DATANSWERS - SPOL PL	K	\$299
DWSO-0-50TL	SEL DATANSWERS - SPOL TL	K	\$119
DWSO-1001-1500PL	SEL DATANSWERS - SPOL PL	K	\$86
DWSO-1001-1500TL	SEL DATANSWERS - SPOL TL	K	\$34
DWSO-100K-150KPL	SEL DATANSWERS - SPOL PL	K	\$45
DWSO-100K-150KTL	SEL DATANSWERS - SPOL TL	K	\$18
DWSO-101-250PL	SEL DATANSWERS - SPOL PL	K	\$164
DWSO-101-250TL	SEL DATANSWERS - SPOL TL	K	\$65
DWSO-10K-20KPL	SEL DATANSWERS - SPOL PL	K	\$53
DWSO-10K-20KTL	SEL DATANSWERS - SPOL TL	K	\$21
DWSO-1501-2000PL	SEL DATANSWERS - SPOL PL	K	\$77
DWSO-1501-2000TL	SEL DATANSWERS - SPOL TL	K	\$31
DWSO-150K-PL	SEL DATANSWERS - SPOL PL	K	\$44
DWSO-150K-TL	SEL DATANSWERS - SPOL TL	K	\$18
DWSO-2001-2500PL	SEL DATANSWERS - SPOL PL	K	\$72
DWSO-2001-2500TL	SEL DATANSWERS - SPOL TL	K	\$29
DWSO-20K-35KPL	SEL DATANSWERS - SPOL PL	K	\$50
DWSO-20K-35KTL	SEL DATANSWERS - SPOL TL	K	\$20
DWSO-2501-4000PL	SEL DATANSWERS - SPOL PL	K	\$68
DWSO-2501-4000TL	SEL DATANSWERS - SPOL TL	K	\$27
DWSO-251-500PL	SEL DATANSWERS - SPOL PL	K	\$125
DWSO-251-500TL	SEL DATANSWERS - SPOL TL	K	\$50
DWSO-35K-50KPL	SEL DATANSWERS - SPOL PL	K	\$48
DWSO-35K-50KTL	SEL DATANSWERS - SPOL TL	K	\$19
DWSO-4001-6000PL	SEL DATANSWERS - SPOL PL	K	\$63
DWSO-4001-6000TL	SEL DATANSWERS - SPOL TL	K	\$25
DWSO-501-750PL	SEL DATANSWERS - SPOL PL	K	\$101
DWSO-501-750TL	SEL DATANSWERS - SPOL TL	K	\$40
DWSO-50K-100KPL	SEL DATANSWERS - SPOL PL	K	\$47
DWSO-50K-100KTL	SEL DATANSWERS - SPOL TL	K	\$19
DWSO-51-100PL	SEL DATANSWERS - SPOL PL	K	\$209
DWSO-51-100TL	SEL DATANSWERS - SPOL TL	K	\$83
DWSO-6001-8000PL	SEL DATANSWERS - SPOL PL	K	\$59

DWSO-6001-8000TL	SEL DATANSWERS - SPOL TL	K	\$23
DWSO-751-1000PL	SEL DATANSWERS - SPOL PL	K	\$93
DWSO-751-1000TL	SEL DATANSWERS - SPOL TL	K	\$37
DWSO-8001-10KPL	SEL DATANSWERS - SPOL PL	K	\$56
DWSO-8001-10KTL	SEL DATANSWERS - SPOL TL	K	\$22
ECB-1YR-00001000	SEL 1YR Content Bundle Up to 1000 Users	K	\$92,308
ECB-1YR-00002500	SEL 1YR Content Bundle Up to 2500 Users	K	\$184,615
ECB-1YR-00005000	SEL 1YR Content Bundle Up to 5000 Users	K	\$323,077
ECB-1YR-00010000	SEL 1YR Content Bundle Up to 10000 Users	K	\$461,538
ECB-3YR-00001000	SEL 3YR Content Bundle Up to 1000 Users	K	\$249,231
ECB-3YR-00002500	SEL 3YR Content Bundle Up to 2500 Users	K	\$498,462
ECB-3YR-00005000	SEL 3YR Content Bundle Up to 5000 Users	K	\$872,308
ECB-3YR-00010000	SEL 3YR Content Bundle Up to 10000 Users	K	\$1,246,154
ECB-5YR-00001000	SEL 5YR Content Bundle Up to 1000 Users	K	\$369,231
ECB-5YR-00002500	SEL 5YR Content Bundle Up to 2500 Users	K	\$738,462
ECB-5YR-00005000	SEL 5YR Content Bundle Up to 5000 Users	K	\$1,292,308
ECB-5YR-00010000	SEL 5YR Content Bundle Up to 10000 Users	K	\$1,846,154
EDGE-0-50PL	SEL Varonis - EDGE PL	K	\$299
EDGE-0-50TL	SEL Varonis - EDGE TL	K	\$119
EDGE-1001-1500PL	SEL Varonis - EDGE PL	K	\$86
EDGE-1001-1500TL	SEL Varonis - EDGE TL	K	\$34
EDGE-100K-150KPL	SEL Varonis - EDGE PL	K	\$45
EDGE-100K-150KTL	SEL Varonis - EDGE TL	K	\$18
EDGE-101-250PL	SEL Varonis - EDGE PL	K	\$164
EDGE-101-250TL	SEL Varonis - EDGE TL	K	\$65
EDGE-10K-20KPL	SEL Varonis - EDGE PL	K	\$53
EDGE-10K-20KTL	SEL Varonis - EDGE TL	K	\$21
EDGE-1501-2000PL	SEL Varonis - EDGE PL	K	\$77
EDGE-1501-2000TL	SEL Varonis - EDGE TL	K	\$31
EDGE-150K-PL	SEL Varonis - EDGE PL	K	\$44
EDGE-150K-TL	SEL Varonis - EDGE TL	K	\$18
EDGE-2001-2500PL	SEL Varonis - EDGE PL	K	\$72
EDGE-2001-2500TL	SEL Varonis - EDGE TL	K	\$29
EDGE-20K-35KPL	SEL Varonis - EDGE PL	K	\$50
EDGE-20K-35KTL	SEL Varonis - EDGE TL	K	\$20
EDGE-2501-4000PL	SEL Varonis - EDGE PL	K	\$68
EDGE-2501-4000TL	SEL Varonis - EDGE TL	K	\$27
EDGE-251-500PL	SEL Varonis - EDGE PL	K	\$125
EDGE-251-500TL	SEL Varonis - EDGE TL	K	\$50
EDGE-35K-50KPL	SEL Varonis - EDGE PL	K	\$48
EDGE-35K-50KTL	SEL Varonis - EDGE TL	K	\$19
EDGE-4001-6000PL	SEL Varonis - EDGE PL	K	\$63
EDGE-4001-6000TL	SEL Varonis - EDGE TL	K	\$25
EDGE-501-750PL	SEL Varonis - EDGE PL	K	\$101
EDGE-501-750TL	SEL Varonis - EDGE TL	K	\$40
EDGE-50K-100KPL	SEL Varonis - EDGE PL	K	\$47
EDGE-50K-100KTL	SEL Varonis - EDGE TL	K	\$19
EDGE-51-100PL	SEL Varonis - EDGE PL	K	\$209
EDGE-51-100TL	SEL Varonis - EDGE TL	K	\$83
EDGE-6001-8000PL	SEL Varonis - EDGE PL	K	\$59

EDGE-6001-8000TL	SEL Varonis - EDGE TL	K	\$23
EDGE-751-1000PL	SEL Varonis - EDGE PL	K	\$93
EDGE-751-1000TL	SEL Varonis - EDGE TL	K	\$37
EDGE-8001-10KPL	SEL Varonis - EDGE PL	K	\$56
EDGE-8001-10KTL	SEL Varonis - EDGE TL	K	\$22
EGL-0032PE14-I	SEL Eyeglass 2 Cluster Kit Ent-Installed	K	\$14,369
EGL-0032PE15-P	SEL IGLS 2 CLST KIT ENT-QUICK START PLUS	K	\$36,165
EGL-0032PE15-Q	SEL IGLS 2 CLST KIT ENT-QUICK START	K	\$23,600
EGL-0032UE-2	SEL IGLS Basic-ADV to ENT Upg 2 Pack v2	K	\$7,338
EGL2-SRM-LIC	SEL Cluster Storage Monitor Lic v2	K	\$9,231
EGL-AUD-AGT	SEL Eyeglass Easy Auditor Agent Lic	K	\$4,615
EGL-AUD-LIC	SEL Eyeglass Easy Auditor Feature Lic	K	\$2,565
EGL-CONFIG	SEL Eyeglass Configurator Site License	K	\$46,154
EGL-ENT-NODE-LIC	SEL EYEGLASS DR MANAGER Enterprise VAPP	K	\$617
EGL-ES-C1-LIC	SEL Eyeglass Basic Search 1 Cluster Lic	K	\$9,743
EGL-ES-N1-LIC	SEL Eyeglass Basic Search 1 Node Lic	K	\$812
EGL-ES-NAS-1	SEL Eyeglass Search NAS Device License	K	\$577
EGL-NTC-1	SEL Node to 1 Cluster DR Conversion	K	\$9,231
EGL-PA-LIC	SEL Performance Auditor Feature Lic	K	\$6,411
EGL-RAND-AGT	SEL Ransomware Defender Agent Lic	K	\$2,565
EGL-RAND-LIC	SEL Ransomware Defender Feature Lic	K	\$1,923
E-HDF-AGT-100-1Y	SEL HDF Edge Agent Sub- 100 Agents	K	\$92,308
E-HDF-AGT-10K-1Y	SEL HDF Edge Agent Sub- 10,000 Agents	K	\$1,846,154
E-HDF-AGT-1K-1Y	SEL HDF Edge Agent Sub- 1000 Agents	K	\$461,538
E-HDF-DIM-1Y	Sel HDF Data in Motion Bundle	K	\$646,154
E-HDF-EDG-10-1Y	SEL HDF Edge Brnch Office Sub - 10 Nodes	K	\$92,308
E-HDF-EDG-1Y	SEL HWX DataFlow Edge Pack 100 Devices	K	\$276,923
E-HDF-EDG-25-1Y	SEL HDF Edge Brnch Office Sub - 25 Nodes	K	\$138,462
E-HDF-EFM-1Y	Sel HDF Ent Flow Mngt- 16 Cores	K	\$66,462
E-HDF-EMS-1Y	Sel HDF MNGT Services 1 Cluster	K	\$18,462
E-HDF-ESP-1Y	Sel HDF Stream Processing 4 Nodes	K	\$33,231
E-HDP-ENT-1Y	SEL HDP Ent. 4 Nodes or 50TB Raw Stor	K	\$14,769
E-HDP-EPL-1Y	SEL HDP Ent.+ 4 Nodes or 50TB Raw Stor	K	\$26,585
E-HDP-JSS-6M	SEL HDP Jumpstart Sub. 200TB- 6M sub.	K	\$46,154
E-HDP-SCHNG-1Y	SEL Solr Search	K	\$29,538
E-HWC-FLX-CNT-1Y	SEL Flx Sprt Contact - 1 yr - Required	K	\$18,462
E-HWC-FLXCRDTS	SEL HWX Connect Flx Crdts - 12 Credits	K	\$10,338
E-HWC-FLXPLN-1Y	SEL HWX Connect Flex Plan 1Y	K	\$27,692
EMCMAEVAL	SEL 30Day Free Trial of NTP Software M-A	K	\$0
EMCQFSEVAL	SEL 30Day Free Trial of NTP Software QFS	K	\$0
ENT10PB1YRSB	SELECT DFXS ENT ELA, 10PB 1Yr Sub	K	\$4,140,000
ENT1PB1YRSB	SELECT DFXS ENT ELA, 1PB 1Yr Sub	K	\$613,800
ENT3PB1YRSB	SELECT DFXS ENT ELA, 3PB 1Yr Sub	K	\$1,377,000
ENT5PB1YRSB	SELECT DFXS ENT ELA, 5PB 1Yr Sub	K	\$2,160,000
ENTAD1PB1YRSB	SELECT DFXS ENT ELA, ADD 1PB 1Yr Sub	K	\$414,000
EOL-0-50PL	SEL DatAdvantage for EO Lite PL	K	\$149
EOL-0-50TL	SEL DatAdvantage for EO Lite TL	K	\$60
EOL-1001-1500PL	SEL DatAdvantage for EO Lite PL	K	\$43
EOL-1001-1500TL	SEL DatAdvantage for EO Lite TL	K	\$17
EOL-100K-150KPL	SEL DatAdvantage for EO Lite PL	K	\$23

EOL-100K-150KTL	SEL DatAdvantage for EO Lite TL	K	\$9
EOL-101-250PL	SEL DatAdvantage for EO Lite PL	K	\$82
EOL-101-250TL	SEL DatAdvantage for EO Lite TL	K	\$33
EOL-10K-20KPL	SEL DatAdvantage for EO Lite PL	K	\$26
EOL-10K-20KTL	SEL DatAdvantage for EO Lite TL	K	\$11
EOL-1501-2000PL	SEL DatAdvantage for EO Lite PL	K	\$39
EOL-1501-2000TL	SEL DatAdvantage for EO Lite TL	K	\$15
EOL-150K-PL	SEL DatAdvantage for EO Lite PL	K	\$22
EOL-150K-TL	SEL DatAdvantage for EO Lite TL	K	\$9
EOL-2001-2500PL	SEL DatAdvantage for EO Lite PL	K	\$36
EOL-2001-2500TL	SEL DatAdvantage for EO Lite TL	K	\$14
EOL-20K-35KPL	SEL DatAdvantage for EO Lite PL	K	\$25
EOL-20K-35KTL	SEL DatAdvantage for EO Lite TL	K	\$10
EOL-2501-4000PL	SEL DatAdvantage for EO Lite PL	K	\$34
EOL-2501-4000TL	SEL DatAdvantage for EO Lite TL	K	\$14
EOL-251-500PL	SEL DatAdvantage for EO Lite PL	K	\$62
EOL-251-500TL	SEL DatAdvantage for EO Lite TL	K	\$25
EOL-35K-50KPL	SEL DatAdvantage for EO Lite PL	K	\$24
EOL-35K-50KTL	SEL DatAdvantage for EO Lite TL	K	\$10
EOL-4001-6000PL	SEL DatAdvantage for EO Lite PL	K	\$32
EOL-4001-6000TL	SEL DatAdvantage for EO Lite TL	K	\$13
EOL-501-750PL	SEL DatAdvantage for EO Lite PL	K	\$50
EOL-501-750TL	SEL DatAdvantage for EO Lite TL	K	\$20
EOL-50K-100KPL	SEL DatAdvantage for EO Lite PL	K	\$23
EOL-50K-100KTL	SEL DatAdvantage for EO Lite TL	K	\$9
EOL-51-100PL	SEL DatAdvantage for EO Lite PL	K	\$104
EOL-51-100TL	SEL DatAdvantage for EO Lite TL	K	\$42
EOL-6001-8000PL	SEL DatAdvantage for EO Lite PL	K	\$29
EOL-6001-8000TL	SEL DatAdvantage for EO Lite TL	K	\$12
EOL-751-1000PL	SEL DatAdvantage for EO Lite PL	K	\$47
EOL-751-1000TL	SEL DatAdvantage for EO Lite TL	K	\$19
EOL-8001-10KPL	SEL DatAdvantage for EO Lite PL	K	\$28
EOL-8001-10KTL	SEL DatAdvantage for EO Lite TL	K	\$11
EPC-A	SEL VST 2,501-5,000 MICROVM	K	\$108
EPC-B	SEL VST 5,001-7,500 MICROVM	K	\$104
EPC-BASE	SEL VST UP TO 2,500 MICROVM	K	\$113
EPC-C	SEL VST 7,501-15,000 MICROVM	K	\$91
EPC-D	SEL VST 15,001-25,000 MICROVM	K	\$81
EPC-E	SEL VST 25,001-50,000 MICROVM	K	\$65
EPC-F	SEL VST 50,001-100,000 MICROVM	K	\$55
EPC-SAPM3T-A	SEL VST 251-500 Managed VM	K	\$806
EPC-SAPM3T-B	SEL VST 501-750 Managed VM	K	\$773
EPC-SAPM3T-BASE	SEL VST UP TO 250 Managed VM	K	\$840
EPC-SAPM3T-C	SEL VST 751-1,500 Managed VM	K	\$680
EPC-SAPM3T-D	SEL VST 1,501-2,500 Managed VM	K	\$603
EPC-SAPM3T-E	SEL VST 2,501-5,000 Managed VM	K	\$482
EPC-SAPM3T-F	SEL VST 5,001-10,000 Managed VM	K	\$409
ES1000HA-ISLN	SEL Aspera Entrp Svr-1 Gbps-HA-ISLN	K	\$96,000
ES100HA-ISLN	SEL Aspera Entrp Svr-100 Mbps-HA-ISLN	K	\$32,000
ES155HA-ISLN	SEL Aspera Entrp Svr-155 Mbps-HA-ISLN	K	\$44,000

ES2400HA-ISLN	SEL Aspera Entrp Svr-2.4 Gbps-HA-ISLN	K	\$128,000
ES450HA-ISLN	SEL Aspera Entrp Svr-450 Mbps-HA-ISLN	K	\$72,000
ES45HA-ISLN	SEL Aspera Entrp Svr-45 Mbps-HA-ISLN	K	\$20,000
ES5000HA-ISLN	SEL Aspera Entrp Svr-5 Gbps-HA-ISLN	K	\$160,000
ESP-100-199AN-D	SEL Splunk Ent Sec Perp Lic 100-199GBAN	K	\$721
ESP-100-199AP-D	SEL Splunk Ent Sec Perp Lic 100-199GBAP	K	\$865
ESP-100-199EM-D	SEL Splunk Ent Sec Perp Lic 100-199GBEM	K	\$663
ESP-100-199US-D	SEL Splunk EntSecPerpLic 100-199GB/dayUS	K	\$577
ESP-10-19AN-D	SEL Splunk Ent Sec Perp 10-19GB/dayAN	K	\$2,163
ESP-10-19AP-D	SEL Splunk Ent Sec Perp 10-19GB/dayAP	K	\$2,596
ESP-10-19EM-D	SEL Splunk Ent Sec Perp 10-19GB/dayEM	K	\$1,990
ESP-10-19US-D	SEL Splunk Ent Sec Perp 10-19GB/dayUS	K	\$1,731
ESP-1K-1999AN-D	SEL Splunk Ent Sec Perp Lic 1K-1999GBAN	K	\$433
ESP-1K-1999AP-D	SEL Splunk Ent Sec Perp Lic 1K-1999GBAP	K	\$519
ESP-1K-1999EM-D	SEL Splunk Ent Sec Perp Lic 1K-1999GBEM	K	\$398
ESP-1K-1999US-D	SEL Splunk Ent Sec Perp 1K-1999GB/dayUS	K	\$346
ESP-200-499AN-D	SEL Splunk Ent Sec Perp Lic 200-499GBAN	K	\$541
ESP-200-499AP-D	SEL Splunk Ent Sec Perp Lic 200-499GBAP	K	\$649
ESP-200-499EM-D	SEL Splunk Ent Sec Perp Lic 200-499GBEM	K	\$498
ESP-200-499US-D	SEL Splunk EntSecPerpLic 200-499GB/dayUS	K	\$433
ESP-20-49AN-D	SEL Splunk Ent Sec Perp 20-49GB/dayAN	K	\$1,659
ESP-20-49AP-D	SEL Splunk Ent Sec Perp 20-49GB/dayAP	K	\$1,990
ESP-20-49EM-D	SEL Splunk Ent Sec Perp 20-49GB/dayEM	K	\$1,526
ESP-20-49US-D	SEL Splunk Ent Sec Perp 20-49GB/dayUS	K	\$1,327
ESP2K-4999AN-D	SEL Splunk Ent Sec Perp Lic 2K-4999GBAN	K	\$397
ESP-2K-4999AP-D	SEL Splunk Ent Sec Perp Lic 2K-4999GBAP	K	\$476
ESP-2K-4999EM-D	SEL Splunk Ent Sec Perp Lic 2K-4999GBEM	K	\$365
ESP-2K-4999US-D	SEL Splunk Ent Sec Perp 2K-4999GB/dayUS	K	\$317
ESP-500-999AN-D	SEL Splunk Ent Sec Perp Lic 500-999GBAN	K	\$469
ESP-500-999AP-D	SEL Splunk Ent Sec Perp Lic 500-999GBAP	K	\$563
ESP-500-999EM-D	SEL Splunk Ent Sec Perp Lic 500-999GBEM	K	\$431
ESP-500-999US-D	SEL Splunk Ent Sec Perp 500-999GB/dayUS	K	\$375
ESP-50-99AN-D	SEL Splunk Ent Sec Perp Lic 50-99GBAN	K	\$1,154
ESP-50-99AP-D	SEL Splunk Ent Sec Perp Lic 50-99GBAP	K	\$1,385
ESP-50-99EM-D	SEL Splunk Ent Sec Perp Lic 50-99GBEM	K	\$1,062
ESP-50-99US-D	SEL Splunk Ent Sec Perp Lic 50-99GBdayUS	K	\$923
ESP-5K-9999AN-D	SEL Splunk Ent Sec Perp Lic 5K-9999GBAN	K	\$361
ESP-5K-9999AP-D	SEL Splunk Ent Sec Perp Lic 5K-9999GBAP	K	\$433
ESP-5K-9999EM-D	SEL Splunk Ent Sec Perp Lic 5K-9999GBEM	K	\$332
ESP-5K-9999US-D	SEL Splunk Ent Sec Perp 5K-9999GB/dayUS	K	\$288
ESP-LIC-1000-D	SEL Splunk ES Perp Bucket 1000	K	\$1,000
ESP-LIC-100-D	SEL Splunk ES Perp Bucket 100	K	\$100
ESP-LIC-100K-D	SEL Splunk ES Perp Bucket 100K	K	\$100,000
ESP-LIC-10K-D	SEL Splunk ES Perp Bucket 10K	K	\$10,000
ESP-LIC-1-D	SEL Splunk ES Perp Bucket 1	K	\$1
ESPU100-199AN-D	SEL Splunk ES Perp UPG 100-199GB/dayAN	K	\$721
ESPU-100-199AP-D	SEL Splunk ES Perp UPG 100-199GB/dayAP	K	\$865
ESPU-100-199EM-D	SEL Splunk ES Perp UPG 100-199GB/dayEM	K	\$663
ESPU-100-199US-D	SEL Splunk ES Perp UPG 100-199GB/dayUS	K	\$577
ESPU-10-19AN-D	SEL Splunk ES Perp UPG 10-19GB/dayAN	K	\$2,163

ESPU-10-19AP-D	SEL Splunk ES Perp UPG 10-19GB/dayAP	K	\$2,596
ESPU-10-19EM-D	SEL Splunk ES Perp UPG 10-19GB/dayEM	K	\$1,990
ESPU-10-19US-D	SEL Splunk ES Perp UPG 10-19GB/dayUS	K	\$1,731
ESPU1K-1999AN-D	SEL Splunk ES Perp UPG 1K-1999GB/dayAN	K	\$433
ESPU-1K-1999AP-D	SEL Splunk ES Perp UPG 1K-1999GB/dayAP	K	\$519
ESPU-1K-1999EM-D	SEL Splunk ES Perp UPG 1K-1999GB/dayEM	K	\$398
ESPU-1K-1999US-D	SEL Splunk ES Perp UPG 1K-1999GB/dayUS	K	\$346
ESPU200-499AN-D	SEL Splunk ES Perp UPG 200-499GB/dayAN	K	\$541
ESPU-200-499AP-D	SEL Splunk ES Perp UPG 200-499GB/dayAP	K	\$650
ESPU-200-499EM-D	SEL Splunk ES Perp UPG 200-499GB/dayEM	K	\$497
ESPU-200-499US-D	SEL Splunk ES Perp UPG 200-499GB/dayUS	K	\$433
ESPU-20-49AN-D	SEL Splunk ES Perp UPG 20-49GB/dayAN	K	\$1,659
ESPU-20-49AP-D	SEL Splunk ES Perp UPG 20-49GB/dayAP	K	\$1,990
ESPU-20-49EM-D	SEL Splunk ES Perp UPG 20-49GB/dayEM	K	\$1,526
ESPU-20-49US-D	SEL Splunk ES Perp UPG 20-49GB/dayUS	K	\$1,327
ESPU2K-4999AN-D	SEL Splunk ES Perp UPG 2K-4999GB/dayAN	K	\$397
ESPU-2K-4999AP-D	SEL Splunk ES Perp UPG 2K-4999GB/dayAP	K	\$477
ESPU-2K-4999EM-D	SEL Splunk ES Perp UPG 2K-4999GB/dayEM	K	\$365
ESPU-2K-4999US-D	SEL Splunk ES Perp UPG 2K-4999GB/dayUS	K	\$317
ESPU500-999AN-D	SEL Splunk ES Perp UPG 500-999GB/dayAN	K	\$468
ESPU-500-999AP-D	SEL Splunk ES Perp UPG 500-999GB/dayAP	K	\$563
ESPU-500-999EM-D	SEL Splunk ES Perp UPG 500-999GB/dayEM	K	\$432
ESPU-500-999US-D	SEL Splunk ES Perp UPG 500-999GB/dayUS	K	\$375
ESPU50-99AN-D	SEL Splunk ES Perp UPG 50-99GB/dayAN	K	\$1,154
ESPU-50-99AP-D	SEL Splunk ES Perp UPG 50-99GB/dayAP	K	\$1,385
ESPU-50-99EM-D	SEL Splunk ES Perp UPG 50-99GB/dayEM	K	\$1,062
ESPU-50-99US-D	SEL Splunk ES Perp UPG 50-99GB/dayUS	K	\$923
ESPU-5K-9999AN-D	SEL Splunk ES Perp UPG 5K-9999GB/dayAN	K	\$361
ESPU-5K-9999AP-D	SEL Splunk ES Perp UPG 5K-9999GB/dayAP	K	\$433
ESPU-5K-9999EM-D	SEL Splunk ES Perp UPG 5K-9999GB/dayEM	K	\$332
ESPU-5K-9999US-D	SEL Splunk ES Perp UPG 5K-9999GB/dayUS	K	\$288
ESTE-100-199AN-D	SEL Splunk Ent Sec Term SSup 100-199GBAN	K	\$288
ESTE-100-199AP-D	SEL Splunk Ent Sec Term Ssup 100-199GBAP	K	\$346
ESTE-100-199EM-D	SEL Splunk Ent Sec Term Ssup 100-199GBEM	K	\$265
ESTE-100-199US-D	SEL Splunk Ent Sec Term SSup100-199GBUS	K	\$231
ESTE-10-19AN-D	SEL Splunk Ent Sec Term SSup 10-19GBAN	K	\$865
ESTE-10-19AP-D	SEL Splunk Ent Sec Term Ssup 10-19GBAP	K	\$1,038
ESTE-10-19EM-D	SEL Splunk Ent Sec Term Ssup 10-19GBEM	K	\$796
ESTE-10-19US-D	SEL Splunk Ent Sec Term SSup10-19GBUS	K	\$692
ESTE-1K-1999AN-D	SEL Splunk Ent Sec Term SSup 1K-199GBAN	K	\$195
ESTE-1K-1999AP-D	SEL Splunk Ent Sec Term Ssup 1K-199GBAP	K	\$234
ESTE-1K-1999EM-D	SEL Splunk Ent Sec Term Ssup 1K-199GBEM	K	\$179
ESTE-1K-1999US-D	SEL Splunk Ent Sec Term SSup1K-199GBUS	K	\$156
ESTE-200-499AN-D	SEL Splunk Ent Sec Term SSup 200-499GBAN	K	\$224
ESTE-200-499AP-D	SEL Splunk Ent Sec Term Ssup 200-499GBAP	K	\$268
ESTE-200-499EM-D	SEL Splunk Ent Sec Term Ssup 200-499GBEM	K	\$206
ESTE-200-499US-D	SEL Splunk Ent Sec Term SSup200-499GBUS	K	\$179
ESTE-20-49AN-D	SEL Splunk Ent Sec Term SSup 20-49GBAN	K	\$663
ESTE-20-49AP-D	SEL Splunk Ent Sec Term Ssup 20-49GBAP	K	\$796
ESTE-20-49EM-D	SEL Splunk Ent Sec Term Ssup 20-49GBEM	K	\$610

ESTE-20-49US-D	SEL Splunk Ent Sec Term SSup20-49GBUS	K	\$531
ESTE-2K-4999AN-D	SEL Splunk Ent Sec Term SSup 2K-4999GBAN	K	\$188
ESTE-2K-4999AP-D	SEL Splunk Ent Sec Term Ssup 2K-4999GBAP	K	\$225
ESTE-2K-4999EM-D	SEL Splunk Ent Sec Term Ssup 2K-4999GBEM	K	\$173
ESTE-2K-4999US-D	SEL Splunk Ent Sec Term SSup2K-4999GBUS	K	\$150
ESTE-500-999AN-D	SEL Splunk Ent Sec Term SSup 500-999GBAN	K	\$202
ESTE-500-999AP-D	SEL Splunk Ent Sec Term Ssup 500-999GBAP	K	\$242
ESTE-500-999EM-D	SEL Splunk Ent Sec Term Ssup 500-999GBEM	K	\$186
ESTE-500-999US-D	SEL Splunk Ent Sec Term SSup500-999GBUS	K	\$162
ESTE-50-99AN-D	SEL Splunk Ent Sec Term SSup 50-99GBAN	K	\$462
ESTE-50-99AP-D	SEL Splunk Ent Sec Term Ssup 50-99GBAP	K	\$554
ESTE-50-99EM-D	SEL Splunk Ent Sec Term Ssup 50-99GBEM	K	\$425
ESTE-50-99US-D	SEL Splunk Ent Sec Term SSup50-99GBUS	K	\$369
ESTE-5K-9999AN-D	SEL Splunk Ent Sec Term SSup 5K-9999GBAN	K	\$180
ESTE-5K-9999AP-D	SEL Splunk Ent Sec Term Ssup 5K-9999GBAP	K	\$217
ESTE-5K-9999EM-D	SEL Splunk Ent Sec Term Ssup 5K-9999GBEM	K	\$166
ESTE-5K-9999US-D	SEL Splunk Ent Sec Term SSup5K-9999GBUS	K	\$144
ESTG-1K-1999AN-D	SEL Splunk Ent Sec Term PSup1K-199GBAN	K	\$231
ESTG-1K-1999AP-D	SEL Splunk Ent Sec Term PSup1K-199GBAP	K	\$277
ESTG-1K-1999EM-D	SEL Splunk Ent Sec Term PSup1K-199GBEM	K	\$212
ESTG-1K-1999US-D	SEL Splunk Ent Sec Term PSup1K-199GBUS	K	\$185
ESTG-2K-4999AN-D	SEL Splunk Ent Sec Term PSup2K-4999GBAN	K	\$224
ESTG-2K-4999AP-D	SEL Splunk Ent Sec Term PSup2K-4999GBAP	K	\$269
ESTG-2K-4999EM-D	SEL Splunk Ent Sec Term PSup2K-4999GBEM	K	\$205
ESTG-2K-4999US-D	SEL Splunk Ent Sec Term PSup2K-4999GBUS	K	\$179
ESTG-500-999AN-D	SEL Splunk Ent Sec Term PSup500-999GBAN	K	\$246
ESTG-500-999AP-D	SEL Splunk Ent Sec Term PSup500-999GBAP	K	\$294
ESTG-500-999EM-D	SEL Splunk Ent Sec Term PSup500-999GBEM	K	\$226
ESTG-500-999US-D	SEL Splunk Ent Sec Term PSup500-999GBUS	K	\$196
ESTG-5K-9999AN-D	SEL Splunk Ent Sec Term PSup5K-9999GBAN	K	\$217
ESTG-5K-9999AP-D	SEL Splunk Ent Sec Term PSup5K-9999GBAP	K	\$260
ESTG-5K-9999EM-D	SEL Splunk Ent Sec Term PSup5K-9999GBEM	K	\$200
ESTG-5K-9999US-D	SEL Splunk Ent Sec Term PSup5K-9999GBUS	K	\$173
EST-PRM-1000-D	SEL Splunk ES Term PrmSup Buck 1000	K	\$1,000
EST-PRM-100-D	SEL Splunk ES Term PrmSup Buck 100	K	\$100
EST-PRM-100K-D	SEL Splunk ES Term PrmSup Buck 100K	K	\$100,000
EST-PRM-10K-D	SEL Splunk ES Term PrmSup Buck 10K	K	\$10,000
EST-PRM-1-D	SEL Splunk ES Term PrmSup Buck 1	K	\$1
EST-STD-1000-D	SEL Splunk ES Term StdSup Buck 1000	K	\$1,000
EST-STD-100-D	SEL Splunk ES Term StdSup Buck 100	K	\$100
EST-STD-100K-D	SEL Splunk ES Term StdSup Buck 100K	K	\$100,000
EST-STD-10K-D	SEL Splunk ES Term StdSup Buck 10K	K	\$10,000
EST-STD-1-D	SEL Splunk ES Term StdSup Buck 1	K	\$1
ESTU-ES-1000AN-D	SEL Splunk ES TermUPG SSup Buck 1000AN	K	\$1,000
ESTU-ES-1000AP-D	SEL Splunk ES TermUPG SSup Buck 1000AP	K	\$1,000
ESTU-ES-1000EM-D	SEL Splunk ES TermUPG SSup Buck 1000EM	K	\$1,000
ESTU-ES-1000US-D	SEL Splunk ES TermUPG SSup Buck 1000US	K	\$1,000
ESTU-ES-100AN-D	SEL Splunk ES TermUPG SSup Buck 100AN	K	\$100
ESTU-ES-100AP-D	SEL Splunk ES TermUPG SSup Buck 100AP	K	\$100
ESTU-ES-100EM-D	SEL Splunk ES TermUPG SSup Buck 100EM	K	\$100

ESTU-ES-100US-D	SEL Splunk ES TermUPG SSup Buck 100US	K	\$100
ESTU-ES-1AN-D	SEL Splunk ES TermUPG SSup Buck 1AN	K	\$1
ESTU-ES-1AP-D	SEL Splunk ES TermUPG SSup Buck 1AP	K	\$1
ESTU-ES-1EM-D	SEL Splunk ES TermUPG SSup Buck 1EM	K	\$1
ESTU-ES-1US-D	SEL Splunk ES TermUPG SSup Buck 1US	K	\$1
ESTU-GS-1000AN-D	SEL Splunk ES TermUPG PSup Buck 1000AN	K	\$1,000
ESTU-GS-1000AP-D	SEL Splunk ES TermUPG PSup Buck 1000AP	K	\$1,000
ESTU-GS-1000EM-D	SEL Splunk ES TermUPG PSup Buck 1000EM	K	\$1,000
ESTU-GS-1000US-D	SEL Splunk ES TermUPG PSup Buck 1000US	K	\$1,000
ESTU-GS-100AN-D	SEL Splunk ES TermUPG PSup Buck 100AN	K	\$100
ESTU-GS-100AP-D	SEL Splunk ES TermUPG PSup Buck 100AP	K	\$100
ESTU-GS-100EM-D	SEL Splunk ES TermUPG PSup Buck 100EM	K	\$100
ESTU-GS-100US-D	SEL Splunk ES TermUPG PSup Buck 100US	K	\$100
ESTU-GS-1AN-D	SEL Splunk ES TermUPG PSup Buck 1AN	K	\$1
ESTU-GS-1AP-D	SEL Splunk ES TermUPG PSup Buck 1AP	K	\$1
ESTU-GS-1EM-D	SEL Splunk ES TermUPG PSup Buck 1EM	K	\$1
ESTU-GS-1US-D	SEL Splunk ES TermUPG PSup Buck 1US	K	\$1
EXP-100GB-AN-D	SEL Splunk EXCH Perp Lic 51-100GB/dayAN	K	\$108,173
EXP-100GB-AP-D	SEL Splunk EXCH Perp Lic 51-100GB/dayAP	K	\$129,808
EXP-100GB-EM-D	SEL Splunk EXCH Perp Lic 51-100GB/dayEM	K	\$99,519
EXP-100GB-US-D	SEL Splunk EXCH Perp Lic 51-100GB/dayUS	K	\$86,538
EXP-101GB-AN-D	SEL Splunk EXCH Perp Lic > 100+GB/dayAN	K	\$201,923
EXP-101GB-AP-D	SEL Splunk EXCH Perp Lic > 100+GB/dayAP	K	\$242,308
EXP-101GB-EM-D	SEL Splunk EXCH Perp Lic > 100+GB/dayEM	K	\$185,769
EXP-101GB-US-D	SEL Splunk EXCH Perp Lic > 100+GB/dayUS	K	\$161,538
EXP-10GB-AN-D	SEL Splunk EXCH Perp Lic 6-10GB/dayAN	K	\$18,029
EXP-10GB-AP-D	SEL Splunk EXCH Perp Lic 6-10GB/dayAP	K	\$21,635
EXP-10GB-EM-D	SEL Splunk EXCH Perp Lic 6-10GB/dayEM	K	\$16,587
EXP-10GB-US-D	SEL Splunk EXCH Perp Lic 6-10GB/dayUS	K	\$14,423
EXP-20GB-AN-D	SEL Splunk EXCH Perp Lic 11-20GB/dayAN	K	\$32,452
EXP-20GB-AP-D	SEL Splunk EXCH Perp Lic 11-20GB/dayAP	K	\$38,942
EXP-20GB-EM-D	SEL Splunk EXCH Perp Lic 11-20GB/dayEM	K	\$29,856
EXP-20GB-US-D	SEL Splunk EXCH Perp Lic 11-20GB/dayUS	K	\$25,962
EXP-50GB-AN-D	SEL Splunk EXCH Perp Lic 21-50GB/dayAN	K	\$68,510
EXP-50GB-AP-D	SEL Splunk EXCH Perp Lic 21-50GB/dayAP	K	\$82,212
EXP-50GB-EM-D	SEL Splunk EXCH Perp Lic 21-50GB/dayEM	K	\$63,029
EXP-50GB-US-D	SEL Splunk EXCH Perp Lic 21-50GB/dayUS	K	\$54,808
EXP-5GB-AN-D	SEL Splunk EXCH Perp Lic 3-5GB/dayAN	K	\$10,817
EXP-5GB-AP-D	SEL Splunk EXCH Perp Lic 3-5GB/dayAP	K	\$12,981
EXP-5GB-EM-D	SEL Splunk EXCH Perp Lic 3-5GB/dayEM	K	\$9,952
EXP-5GB-US-D	SEL Splunk EXCH Perp Lic 3-5GB/dayUS	K	\$8,654
EXTE-100GB-AN-D	SEL Splunk EXCH Term SSup 51-100GB/dayAN	K	\$43,269
EXTE-100GB-AP-D	SEL Splunk EXCH Term SSup 51-100GB/dayAP	K	\$51,923
EXTE-100GB-EM-D	SEL Splunk EXCH Term SSup 51-100GB/dayEM	K	\$39,808
EXTE-100GB-US-D	SEL Splunk EXCH Term SSup 51-100GB/dayUS	K	\$34,615
EXTE-101GB-AN-D	SEL Splunk EXCH Term SSup >100+GB/dayAN	K	\$107,668
EXTE-101GB-AP-D	SEL Splunk EXCH Term SSup >100+GB/dayAP	K	\$129,202
EXTE-101GB-EM-D	SEL Splunk EXCH Term SSup >100+GB/dayEM	K	\$99,055
EXTE-101GB-US-D	SEL Splunk EXCH Term SSup >100+GB/dayUS	K	\$86,135
EXTE-10GB-AN-D	SEL Splunk EXCH Term SSup 6-10GB/dayAN	K	\$7,212

EXTE-10GB-AP-D	SEL Splunk EXCH Term SSup 6-10GB/dayAP	K	\$8,654
EXTE-10GB-EM-D	SEL Splunk EXCH Term SSup 6-10GB/dayEM	K	\$6,635
EXTE-10GB-US-D	SEL Splunk EXCH Term SSup 6-10GB/dayUS	K	\$5,769
EXTE-20GB-AN-D	SEL Splunk EXCH Term SSup 11-20GB/dayAN	K	\$12,981
EXTE-20GB-AP-D	SEL Splunk EXCH Term SSup 11-20GB/dayAP	K	\$15,577
EXTE-20GB-EM-D	SEL Splunk EXCH Term SSup 11-20GB/dayEM	K	\$11,942
EXTE-20GB-US-D	SEL Splunk EXCH Term SSup 11-20GB/dayUS	K	\$10,385
EXTE-50GB-AN-D	SEL Splunk EXCH Term SSup 21-50GB/dayAN	K	\$27,404
EXTE-50GB-AP-D	SEL Splunk EXCH Term SSup 21-50GB/dayAP	K	\$32,885
EXTE-50GB-EM-D	SEL Splunk EXCH Term SSup 21-50GB/dayEM	K	\$25,212
EXTE-50GB-US-D	SEL Splunk EXCH Term SSup 21-50GB/dayUS	K	\$21,923
EXTE-5GB-AN-D	SEL Splunk EXCH Term SSup 3-5GB/dayAN	K	\$4,327
EXTE-5GB-AP-D	SEL Splunk EXCH Term SSup 3-5GB/dayAP	K	\$5,192
EXTE-5GB-EM-D	SEL Splunk EXCH Term SSup 3-5GB/dayEM	K	\$3,981
EXTE-5GB-US-D	SEL Splunk EXCH Term SSup 3-5GB/dayUS	K	\$3,462
EXTG-100GB-AN-D	SEL Splunk EXCH Term PSup 51-100GB/dayAN	K	\$51,923
EXTG-100GB-AP-D	SEL Splunk EXCH Term PSup 51-100GB/dayAP	K	\$62,308
EXTG-100GB-EM-D	SEL Splunk EXCH Term PSup 51-100GB/dayEM	K	\$47,769
EXTG-100GB-US-D	SEL Splunk EXCH Term PSup 51-100GB/dayUS	K	\$41,538
EXTG-101GB-AN-D	SEL Splunk EXCH Term PSup >100+GB/dayAN	K	\$129,202
EXTG-101GB-AP-D	SEL Splunk EXCH Term PSup >100+GB/dayAP	K	\$155,042
EXTG-101GB-EM-D	SEL Splunk EXCH Term PSup >100+GB/dayEM	K	\$118,866
EXTG-101GB-US-D	SEL Splunk EXCH Term PSup >100+GB/dayUS	K	\$103,362
EXTG-10GB-AN-D	SEL Splunk EXCH Term PSup 6-10GB/dayAN	K	\$8,654
EXTG-10GB-AP-D	SEL Splunk EXCH Term PSup 6-10GB/dayAP	K	\$10,385
EXTG-10GB-EM-D	SEL Splunk EXCH Term PSup 6-10GB/dayEM	K	\$7,962
EXTG-10GB-US-D	SEL Splunk EXCH Term PSup 6-10GB/dayUS	K	\$6,923
EXTG-20GB-AN-D	SEL Splunk EXCH Term PSup 11-20GB/dayAN	K	\$15,577
EXTG-20GB-AP-D	SEL Splunk EXCH Term PSup 11-20GB/dayAP	K	\$18,692
EXTG-20GB-EM-D	SEL Splunk EXCH Term PSup 11-20GB/dayEM	K	\$14,331
EXTG-20GB-US-D	SEL Splunk EXCH Term PSup 11-20GB/dayUS	K	\$12,462
EXTG-50GB-AN-D	SEL Splunk EXCH Term PSup 21-50GB/dayAN	K	\$32,885
EXTG-50GB-AP-D	SEL Splunk EXCH Term PSup 21-50GB/dayAP	K	\$39,462
EXTG-50GB-EM-D	SEL Splunk EXCH Term PSup 21-50GB/dayEM	K	\$30,254
EXTG-50GB-US-D	SEL Splunk EXCH Term PSup 21-50GB/dayUS	K	\$26,308
EXTG-5GB-AN-D	SEL Splunk EXCH Term PSup 3-5GB/dayAN	K	\$5,192
EXTG-5GB-AP-D	SEL Splunk EXCH Term PSup 3-5GB/dayAP	K	\$6,231
EXTG-5GB-EM-D	SEL Splunk EXCH Term PSup 3-5GB/dayEM	K	\$4,777
EXTG-5GB-US-D	SEL Splunk EXCH Term PSup 3-5GB/dayUS	K	\$4,154
EYEGLOSS-003E	SEL EyeGlass DR Single Cluster License	K	\$5,986
EYEGLOSS-I1	SEL IGLS RHEL-Centos Installer License	K	\$3,077
EZ-VFRIDGE	PowerMax Dell EMC Fridge	K	\$12,770
FC-0-50PL	SEL Framework Connector PL	K	\$134
FC-0-50TL	SEL Framework Connector TL	K	\$54
FC-1001-1500PL	SEL Framework Connector PL	K	\$39
FC-1001-1500TL	SEL Framework Connector TL	K	\$15
FC-100K-150KPL	SEL Framework Connector PL	K	\$20
FC-100K-150KTL	SEL Framework Connector TL	K	\$8
FC-101-250PL	SEL Framework Connector PL	K	\$74
FC-101-250TL	SEL Framework Connector TL	K	\$29

FC-10K-20KPL	SEL Framework Connector PL	K	\$24
FC-10K-20KTL	SEL Framework Connector TL	K	\$9
FC-1501-2000PL	SEL Framework Connector PL	K	\$35
FC-1501-2000TL	SEL Framework Connector TL	K	\$14
FC-150K-PL	SEL Framework Connector PL	K	\$20
FC-150K-TL	SEL Framework Connector TL	K	\$8
FC-2001-2500PL	SEL Framework Connector PL	K	\$32
FC-2001-2500TL	SEL Framework Connector TL	K	\$13
FC-20K-35KPL	SEL Framework Connector PL	K	\$22
FC-20K-35KTL	SEL Framework Connector TL	K	\$9
FC-2501-4000PL	SEL Framework Connector PL	K	\$30
FC-2501-4000TL	SEL Framework Connector TL	K	\$12
FC-251-500PL	SEL Framework Connector PL	K	\$56
FC-251-500TL	SEL Framework Connector TL	K	\$22
FC-35K-50KPL	SEL Framework Connector PL	K	\$22
FC-35K-50KTL	SEL Framework Connector TL	K	\$9
FC-4001-6000PL	SEL Framework Connector PL	K	\$28
FC-4001-6000TL	SEL Framework Connector TL	K	\$11
FC-501-750PL	SEL Framework Connector PL	K	\$45
FC-501-750TL	SEL Framework Connector TL	K	\$18
FC-50K-100KPL	SEL Framework Connector PL	K	\$21
FC-50K-100KTL	SEL Framework Connector TL	K	\$8
FC-51-100PL	SEL Framework Connector PL	K	\$94
FC-51-100TL	SEL Framework Connector TL	K	\$38
FC-6001-8000PL	SEL Framework Connector PL	K	\$26
FC-6001-8000TL	SEL Framework Connector TL	K	\$11
FC-751-1000PL	SEL Framework Connector PL	K	\$42
FC-751-1000TL	SEL Framework Connector TL	K	\$17
FC-8001-10KPL	SEL Framework Connector PL	K	\$25
FC-8001-10KTL	SEL Framework Connector TL	K	\$10
FMI-1YR-00000025	SEL 1YR 25-49TB FILE METADATA INDEX	K	\$769
FMI-1YR-00000050	SEL 1YR 50-99TB FILE METADATA INDEX	K	\$635
FMI-1YR-00000100	SEL 1YR 100-249TB FILE METADATA INDEX	K	\$519
FMI-1YR-00000250	SEL 1YR 250-499TB FILE METADATA INDEX	K	\$385
FMI-1YR-00000500	SEL 1YR 500-999TB FILE METADATA INDEX	K	\$327
FMI-1YR-00001000	SEL 1YR 1000-1999TB FILE METADATA INDE	K	\$269
FMI-3YR-00000025	SEL 3YR 25-49TB FILE METADATA INDEX	K	\$2,077
FMI-3YR-00000050	SEL 3YR 50-99TB FILE METADATA INDEX	K	\$1,713
FMI-3YR-00000100	SEL 3YR 100-249TB FILE METADATA INDEX	K	\$1,402
FMI-3YR-00000250	SEL 3YR 250-499TB FILE METADATA INDEX	K	\$1,038
FMI-3YR-00000500	SEL 3YR 500-999TB FILE METADATA INDEX	K	\$883
FMI-3YR-00001000	SEL 3YR 1000-1999TB FILE METADATA INDE	K	\$727
FMI-5YR-00000025	SEL 5YR 25-49TB FILE METADATA INDEX	K	\$3,077
FMI-5YR-00000050	SEL 5YR 50-99TB FILE METADATA INDEX	K	\$2,538
FMI-5YR-00000100	SEL 5YR 100-249TB FILE METADATA INDEX	K	\$2,077
FMI-5YR-00000250	SEL 5YR 250-499TB FILE METADATA INDEX	K	\$1,538
FMI-5YR-00000500	SEL 5YR 500-999TB FILE METADATA INDEX	K	\$1,308
FMI-5YR-00001000	SEL 5YR 1000-1999TB FILE METADATA INDE	K	\$1,077
FPS-003	SEL FIPS License (CX555/570/EX560)	K	\$3,077
FPS-004	SEL FIPS License (CX755/770/EX760)	K	\$4,431

FPS-005	SELFIPS2050/1555/3070/EX/SFED21/22/3100	K	\$5,046
FPS-006	SEL FIPS 5050/6050/5055/5070/SFED32/5100	K	\$9,231
FPS-007	SEL FIPS License (SH7050/CX7055/CX7070)	K	\$18,462
FSYNC-001	SEL FusionSync GCA2000	K	\$3,077
FSYNC-002	SEL FusionSync GCA 3000	K	\$4,615
FSYNC-003	SEL FusionSync VGC1000	K	\$1,846
FSYNC-004	SEL FusionSync VGC1500	K	\$3,077
FSYNC-005	SEL FusionSync SFCR3500	K	\$6,154
FUS10PROC	SEL FUS10-PRO-C)	K	\$160
FUS10PROC-I	SEL FUS10-PRO-C)	K	\$163
FUS10PROC-K	SEL FUS10-PRO-C)	K	\$165
FUS10PROUGC	SEL FUS10-PRO-UG-C)	K	\$120
FUS10PROUGC-I	SEL FUS10-PRO-UG-C)	K	\$122
FUS10PROUGC-K	SEL FUS10-PRO-UG-C)	K	\$124
GDPR-0-50PL	SEL GDPR Patterns PL	K	\$75
GDPR-0-50TL	SEL GDPR Patterns TL	K	\$30
GDPR-1001-1500PL	SEL GDPR Patterns PL	K	\$21
GDPR-1001-1500TL	SEL GDPR Patterns TL	K	\$9
GDPR-100K-150KPL	SEL GDPR Patterns PL	K	\$11
GDPR-100K-150KTL	SEL GDPR Patterns TL	K	\$5
GDPR-101-250PL	SEL GDPR Patterns PL	K	\$41
GDPR-101-250TL	SEL GDPR Patterns TL	K	\$16
GDPR-10K-20KPL	SEL GDPR Patterns PL	K	\$13
GDPR-10K-20KTL	SEL GDPR Patterns TL	K	\$5
GDPR-1501-2000PL	SEL GDPR Patterns PL	K	\$19
GDPR-1501-2000TL	SEL GDPR Patterns TL	K	\$8
GDPR-150K-PL	SEL GDPR Patterns PL	K	\$11
GDPR-150K-TL	SEL GDPR Patterns TL	K	\$4
GDPR-2001-2500PL	SEL GDPR Patterns PL	K	\$18
GDPR-2001-2500TL	SEL GDPR Patterns TL	K	\$7
GDPR-20K-35KPL	SEL GDPR Patterns PL	K	\$12
GDPR-20K-35KTL	SEL GDPR Patterns TL	K	\$5
GDPR-2501-4000PL	SEL GDPR Patterns PL	K	\$17
GDPR-2501-4000TL	SEL GDPR Patterns TL	K	\$7
GDPR-251-500PL	SEL GDPR Patterns PL	K	\$31
GDPR-251-500TL	SEL GDPR Patterns TL	K	\$12
GDPR-35K-50KPL	SEL GDPR Patterns PL	K	\$12
GDPR-35K-50KTL	SEL GDPR Patterns TL	K	\$5
GDPR-4001-6000PL	SEL GDPR Patterns PL	K	\$16
GDPR-4001-6000TL	SEL GDPR Patterns TL	K	\$6
GDPR-501-750PL	SEL GDPR Patterns PL	K	\$25
GDPR-501-750TL	SEL GDPR Patterns TL	K	\$10
GDPR-50K-100KPL	SEL GDPR Patterns PL	K	\$12
GDPR-50K-100KTL	SEL GDPR Patterns TL	K	\$5
GDPR-51-100PL	SEL GDPR Patterns PL	K	\$52
GDPR-51-100TL	SEL GDPR Patterns TL	K	\$21
GDPR-6001-8000PL	SEL GDPR Patterns PL	K	\$15
GDPR-6001-8000TL	SEL GDPR Patterns TL	K	\$6
GDPR-751-1000PL	SEL GDPR Patterns PL	K	\$23
GDPR-751-1000TL	SEL GDPR Patterns TL	K	\$9

GDPR-8001-10KPL	SEL GDPR Patterns PL	K	\$14
GDPR-8001-10KTL	SEL GDPR Patterns TL	K	\$6
H7AAPAN10UGC	SEL HZ7-AVA-APADN10-UG-C)	K	\$1,133
H7AAPAN10UGC-I	SEL HZ7-AVA-APADN10-UG-C)	K	\$1,184
H7AAPAN10UGC-K	SEL HZ7-AVA-APADN10-UG-C)	K	\$1,214
H7AANN100UC	SEL HZ7-AVA-ENN100-UG-C)	K	\$28,380
H7AANN100UC-I	SEL HZ7-AVA-ENN100-UG-C)	K	\$29,657
H7AANN100UC-K	SEL HZ7-AVA-ENN100-UG-C)	K	\$30,455
H7ACEC100UC	SEL HZ7-ADC-ENC-100-UG-C)	K	\$19,853
H7ACEC100UC-I	SEL HZ7-ADC-ENC-100-UG-C)	K	\$20,746
H7ACEC100UCV2-K	SEL HZ7-ADC-ENC-100-UG-C)	K	\$21,261
H7ACEC10UC	SEL HZ7-ADC-ENC-10-UG-C)	K	\$1,984
H7ACEC10UC-I	SEL HZ7-ADC-ENC-10-UG-C)	K	\$2,073
H7ACEC10UCV2-K	SEL HZ7-ADC-ENC-10-UG-C)	K	\$2,126
H7ADAUGN10UC	SEL HZ7-ADA-ENN10-UG-C)	K	\$1,705
H7ADAUGN10UC-I	SEL HZ7-ADA-ENN10-UG-C)	K	\$1,782
H7ADAUGN10UC-K	SEL HZ7-ADA-ENN10-UG-C)	K	\$1,827
H7AEEC100GC	SEL HZ7-AVE-ENC100-UG-C)	K	\$44,770
H7AEEC100GC-I	SEL HZ7-AVE-ENC100-UG-C)	K	\$46,785
H7AEEC100GC-K	SEL HZ7-AVE-ENC100-UG-C)	K	\$48,000
H7AEENC10GC	SEL HZ7-AVE-ENC10-UG-C)	K	\$4,477
H7AEENC10GC-I	SEL HZ7-AVE-ENC10-UG-C)	K	\$4,678
H7AEENC10GC-K	SEL HZ7-AVE-ENC10-UG-C)	K	\$4,800
H7AEN100UGC	SEL HZ7-AVE-ENN100-UG-C)	K	\$26,070
H7AEN100UGC-I	SEL HZ7-AVE-ENN100-UG-C)	K	\$27,243
H7AEN100UGC-K	SEL HZ7-AVE-ENN100-UG-C)	K	\$27,927
H7ANEN100UC	SEL HZ7-ADN-ENN-100-UG-C)	K	\$11,352
H7ANEN100UC-I	SEL HZ7-ADN-ENN-100-UG-C)	K	\$11,863
H7ANEN100UCV2-K	SEL HZ7-ADN-ENN-100-UG-C)	K	\$12,144
H7ANEN10UC	SEL HZ7-ADN-ENN-10-UG-C)	K	\$1,135
H7ANEN10UC-I	SEL HZ7-ADN-ENN-10-UG-C)	K	\$1,186
H7ANEN10UCV2-K	SEL HZ7-ADN-ENN-10-UG-C)	K	\$1,214
H7ASAPA100UC	SEL HZ7-AVS-APADC100-UG-C)	K	\$26,565
H7ASAPA100UC-I	SEL HZ7-AVS-APADC100-UG-C)	K	\$27,760
H7ASAPA100UC-K	SEL HZ7-AVS-APADC100-UG-C)	K	\$28,463
H7ASAPAN100UC	SEL HZ7-AVS-APADN100-UG-C)	K	\$15,785
H7ASAPAN100UC-I	SEL HZ7-AVS-APADN100-UG-C)	K	\$16,495
H7ASAPAN100UC-K	SEL HZ7-AVS-APADN100-UG-C)	K	\$16,894
H7AVAPAC10UGC	SEL HZ7-AVA-APADC10-UG-C)	K	\$1,980
H7AVAPAC10UGC-I	SEL HZ7-AVA-APADC10-UG-C)	K	\$2,069
H7AVAPAC10UGC-K	SEL HZ7-AVA-APADC10-UG-C)	K	\$2,118
H7AVAPAD100UC	SEL HZ7-AVA-APADN100-UG-C)	K	\$11,330
H7AVAPAD100UC-I	SEL HZ7-AVA-APADN100-UG-C)	K	\$11,840
H7AVAPAD100UC-K	SEL HZ7-AVA-APADN100-UG-C)	K	\$12,144
H7AVEE10UGC	SEL HZ7-AVE-ENN10-UG-C)	K	\$2,607
H7AVEE10UGC-I	SEL HZ7-AVE-ENN10-UG-C)	K	\$2,724
H7AVEE10UGC-K	SEL HZ7-AVE-ENN10-UG-C)	K	\$2,793
H7AVEN10UC	SEL HZ7-AVA-ENN10-UG-C)	K	\$2,838
H7AVEN10UC-I	SEL HZ7-AVA-ENN10-UG-C)	K	\$2,966
H7AVEN10UC-K	SEL HZ7-AVA-ENN10-UG-C)	K	\$3,046

H7AVENC100UC	SEL HZ7-AVS-ENC100-UG-C)	K	\$54,945
H7AVENC100UC-I	SEL HZ7-AVS-ENC100-UG-C)	K	\$57,418
H7AVENC100UC-K	SEL HZ7-AVS-ENC100-UG-C)	K	\$58,880
H7AVENC10UC	SEL HZ7-AVA-ENC10-UG-C)	K	\$4,818
H7AVENC10UC-I	SEL HZ7-AVA-ENC10-UG-C)	K	\$5,035
H7AVENC10UC-K	SEL HZ7-AVA-ENC10-UG-C)	K	\$5,160
H7AVNN10UC	SEL HZ7-AVS-ENN10-UG-C)	K	\$3,284
H7AVNN10UC-I	SEL HZ7-AVS-ENN10-UG-C)	K	\$3,432
H7AVNN10UC-K	SEL HZ7-AVS-ENN10-UG-C)	K	\$3,521
H7AVSAAC10UGC	SEL HZ7-AVS-APADC10-UG-C)	K	\$2,657
H7AVSAAC10UGC-I	SEL HZ7-AVS-APADC10-UG-C)	K	\$2,777
H7AVSAAC10UGC-K	SEL HZ7-AVS-APADC10-UG-C)	K	\$2,846
H7AVSAAD10UGC	SEL HZ7-AVS-APADN10-UG-C)	K	\$1,579
H7AVSAAD10UGC-I	SEL HZ7-AVS-APADN10-UG-C)	K	\$1,650
H7AVSAAD10UGC-K	SEL HZ7-AVS-APADN10-UG-C)	K	\$1,689
H7AVSEC10GC	SEL HZ7-AVS-ENC10-UG-C)	K	\$5,495
H7AVSEC10GC-I	SEL HZ7-AVS-ENC10-UG-C)	K	\$5,742
H7AVSEC10GC-K	SEL HZ7-AVS-ENC10-UG-C)	K	\$5,888
H7DDAAC10GC	SEL HZ7-ADA-ADC10-UG-C)	K	\$1,133
H7DDAAC10GC-I	SEL HZ7-ADA-ADC10-UG-C)	K	\$1,184
H7DDAAC10GC-K	SEL HZ7-ADA-ADC10-UG-C)	K	\$1,214
H7DENNA100UC	SEL HZ7-ADA-ENN100-UG-C)	K	\$17,050
H7DENNA100UC-I	SEL HZ7-ADA-ENN100-UG-C)	K	\$17,817
H7DENNA100UC-K	SEL HZ7-ADA-ENN100-UG-C)	K	\$18,273
H7E100ERCUC	SEL HZ7-E100-AERC-UG-C)	K	\$14,190
H7E100ERCUC-I	SEL HZ7-E100-AERC-UG-C)	K	\$14,829
H7E100ERCUC-K	SEL HZ7-E100-AERC-UG-C)	K	\$15,208
H7EAEC100UGC	SEL HZ7-ENA-ENC100-UG-C)	K	\$17,050
H7EAEC100UGC-I	SEL HZ7-ENA-ENC100-UG-C)	K	\$17,817
H7EAEC100UGC-K	SEL HZ7-ENA-ENC100-UG-C)	K	\$18,273
H7EASD100UCV2-K	SEL HZ7-ENTA-STDA100-UG-C)	K	\$11,071
H7EAST100UC	SEL HZ7-EAD-STD100-UG-C)	K	\$18,029
H7EAST100UC-I	SEL HZ7-EAD-STD100-UG-C)	K	\$18,840
H7EAST100UCV2-K	SEL HZ7-EAD-STD100-UG-C)	K	\$19,346
H7EAST10UC	SEL HZ7-EAD-STD10-UG-C)	K	\$1,803
H7EAST10UC-I	SEL HZ7-EAD-STD10-UG-C)	K	\$1,884
H7EAST10UCV2-K	SEL HZ7-EAD-STD10-UG-C)	K	\$1,935
H7ENASDA100UC	SEL HZ7-ENTA-STDA100-UG-C)	K	\$10,300
H7ENASDA100UC-I	SEL HZ7-ENTA-STDA100-UG-C)	K	\$10,764
H7ENASDA10UC	SEL HZ7-ENTA-STDA10-UG-C)	K	\$1,029
H7ENASDA10UC-I	SEL HZ7-ENTA-STDA10-UG-C)	K	\$1,075
H7ENASDA10UCV2-K	SEL HZ7-ENTA-STDA10-UG-C)	K	\$1,099
H7ENEC100UC	SEL HZ7-ENN-ENC-100-UG-C)	K	\$25,493
H7ENEC100UC-I	SEL HZ7-ENN-ENC-100-UG-C)	K	\$26,640
H7ENEC100UCV2-K	SEL HZ7-ENN-ENC-100-UG-C)	K	\$27,314
H7ENEC10UC	SEL HZ7-ENN-ENC-10-UG-C)	K	\$2,549
H7ENEC10UC-I	SEL HZ7-ENN-ENC-10-UG-C)	K	\$2,664
H7ENEC10UCV2-K	SEL HZ7-ENN-ENC-10-UG-C)	K	\$2,731
H7ENNC10UGC	SEL HZ7-ENA-ENC10-UG-C)	K	\$1,705
H7ENNC10UGC-I	SEL HZ7-ENA-ENC10-UG-C)	K	\$1,782

H7ENNC10UGC-K	SEL HZ7-ENA-ENC10-UG-C)	K	\$1,827
H7LXCEC100UC	SEL HZ7-LXC-ENC-100-UG-C)	K	\$48,180
H7LXCEC100UC-I	SEL HZ7-LXC-ENC-100-UG-C)	K	\$52,998
H7LXCEC100UC-K	SEL HZ7-LXC-ENC-100-UG-C)	K	\$52,521
H7LXCEC100UC	SEL HZ7-LXC-ENC-10-UG-C)	K	\$4,818
H7LXCEC100UC-I	SEL HZ7-LXC-ENC-10-UG-C)	K	\$5,300
H7LXCEC100UC-K	SEL HZ7-LXC-ENC-10-UG-C)	K	\$5,252
H7MGAC100UC	SEL HZ7-MRG-ADC-100-UG-C)	K	\$28,270
H7MGAC100UC-I	SEL HZ7-MRG-ADC-100-UG-C)	K	\$29,542
H7MGAC100UCV2-K	SEL HZ7-MRG-ADC-100-UG-C)	K	\$30,302
H7MGAC100UC	SEL HZ7-MRG-ADC-10-UG-C)	K	\$2,827
H7MGAC100UC-I	SEL HZ7-MRG-ADC-10-UG-C)	K	\$2,954
H7MGAC100UCV2-K	SEL HZ7-MRG-ADC-10-UG-C)	K	\$3,030
H7MGAN100UC	SEL HZ7-MRG-ADN-100-UG-C)	K	\$11,330
H7MGAN100UC-I	SEL HZ7-MRG-ADN-100-UG-C)	K	\$11,840
H7MGAN100UCV2-K	SEL HZ7-MRG-ADN-100-UG-C)	K	\$12,144
H7MGAN100UC	SEL HZ7-MRG-ADN-10-UG-C)	K	\$1,133
H7MGAN100UC-I	SEL HZ7-MRG-ADN-10-UG-C)	K	\$1,184
H7MGAN100UCV2-K	SEL HZ7-MRG-ADN-10-UG-C)	K	\$1,214
H7MPAC100UC	SEL HZ7-MGP-ADC-100-UG-C)	K	\$28,270
H7MPAC100UC-I	SEL HZ7-MGP-ADC-100-UG-C)	K	\$29,542
H7MPAC100UCV2-K	SEL HZ7-MGP-ADC-100-UG-C)	K	\$30,302
H7MPAC100UC	SEL HZ7-MGP-ADC-10-UG-C)	K	\$2,827
H7MPAC100UC-I	SEL HZ7-MGP-ADC-10-UG-C)	K	\$2,954
H7MPAC100UCV2-K	SEL HZ7-MGP-ADC-10-UG-C)	K	\$3,030
H7MPAN100UC	SEL HZ7-MGP-ADN-100-UG-C)	K	\$11,330
H7MPAN100UC-I	SEL HZ7-MGP-ADN-100-UG-C)	K	\$11,840
H7MPAN100UCV2-K	SEL HZ7-MGP-ADN-100-UG-C)	K	\$12,144
H7MPAN100UC	SEL HZ7-MGP-ADN-10-UG-C)	K	\$1,133
H7MPAN100UC-I	SEL HZ7-MGP-ADN-10-UG-C)	K	\$1,184
H7MPAN100UCV2-K	SEL HZ7-MGP-ADN-10-UG-C)	K	\$1,214
H7PEPEC100GC	SEL HZ7-APA-ENC100-UG-C)	K	\$28,365
H7PEPEC100GC-I	SEL HZ7-APA-ENC100-UG-C)	K	\$29,641
H7PEPEC100GC-K	SEL HZ7-APA-ENC100-UG-C)	K	\$30,378
H7SACA100UGC	SEL HZ7-STA-ADCA100-UG-C)	K	\$12,430
H7SACA100UGC-I	SEL HZ7-STA-ADCA100-UG-C)	K	\$12,989
H7SACA100UGC-K	SEL HZ7-STA-ADCA100-UG-C)	K	\$13,293
H7SADC100UC	SEL HZ7-ST-ADC-100-UG-C)	K	\$16,940
H7SADC100UC-I	SEL HZ7-ST-ADC-100-UG-C)	K	\$17,702
H7SADC100UCV2-K	SEL HZ7-ST-ADC-100-UG-C)	K	\$18,120
H7SADC100UC	SEL HZ7-ST-ADC-10-UG-C)	K	\$1,694
H7SADC100UC-I	SEL HZ7-ST-ADC-10-UG-C)	K	\$1,770
H7SADC100UCV2-K	SEL HZ7-ST-ADC-10-UG-C)	K	\$1,812
H7SAENSA10UC	SEL HZ7-STA-ENCA10-UG-C)	K	\$2,662
H7SAENSA10UC-I	SEL HZ7-STA-ENCA10-UG-C)	K	\$2,782
H7SAENSA10UC-K	SEL HZ7-STA-ENCA10-UG-C)	K	\$2,854
H7SENC100UC	SEL HZ7-ST-ENC-100-UG-C)	K	\$36,842
H7SENC100UC-I	SEL HZ7-ST-ENC-100-UG-C)	K	\$38,500
H7SENC100UCV2-K	SEL HZ7-ST-ENC-100-UG-C)	K	\$39,496
H7SENC10UC	SEL HZ7-ST-ENC-10-UG-C)	K	\$3,684

H7SENC10UC-I	SEL HZ7-ST-ENC-10-UG-C)	K	\$3,850
H7SENC10UCV2-K	SEL HZ7-ST-ENC-10-UG-C)	K	\$3,950
H7STACA10UGC	SEL HZ7-STA-ADCA10-UG-C)	K	\$1,243
H7STACA10UGC-I	SEL HZ7-STA-ADCA10-UG-C)	K	\$1,299
H7STACA10UGC-K	SEL HZ7-STA-ADCA10-UG-C)	K	\$1,329
H7STADC10UGC	SEL HZ7-STA-ADC10-UG-C)	K	\$2,376
H7STADC10UGC-I	SEL HZ7-STA-ADC10-UG-C)	K	\$2,483
H7STADC10UGC-K	SEL HZ7-STA-ADC10-UG-C)	K	\$2,548
H7STASD100UC	SEL HZ7-STDA-STD100-UG-C)	K	\$7,233
H7STASD100UC-I	SEL HZ7-STDA-STD100-UG-C)	K	\$7,558
H7STASD100UCV2-K	SEL HZ7-STDA-STD100-UG-C)	K	\$7,777
H7STASD10UC	SEL HZ7-STDA-STD10-UG-C)	K	\$723
H7STASD10UC-I	SEL HZ7-STDA-STD10-UG-C)	K	\$756
H7STASD10UCV2-K	SEL HZ7-STDA-STD10-UG-C)	K	\$778
H7TAST100UC	SEL HZ7-TAC-STA100-UG-C)	K	\$17,595
H7TAST100UC-I	SEL HZ7-TAC-STA100-UG-C)	K	\$18,387
H7TAST100UCV2-K	SEL HZ7-TAC-STA100-UG-C)	K	\$18,886
H7TCST10GC	SEL HZ7-TCL-STA10-UG-C)	K	\$1,749
H7TCST10GC-I	SEL HZ7-TCL-STA10-UG-C)	K	\$1,828
H7TCST10GC-K	SEL HZ7-TCL-STA10-UG-C)	K	\$1,873
H7THIST100UC	SEL HZ7-THIN-ST100-UG-C)	K	\$20,605
H7THIST100UC-I	SEL HZ7-THIN-ST100-UG-C)	K	\$21,532
H7THIST100UCV2-K	SEL HZ7-THIN-ST100-UG-C)	K	\$22,104
H7TPOS10UC	SEL HZ7-TPRO-ST10-UG-C)	K	\$2,163
H7TPOS10UC-I	SEL HZ7-TPRO-ST10-UG-C)	K	\$2,260
H7TPOS10UCV2-K	SEL HZ7-TPRO-ST10-UG-C)	K	\$2,318
H7UEENC100UC	SEL HZ7-UEM-ENC-100-UG-C)	K	\$54,100
H7UEENC100UC-I	SEL HZ7-UEM-ENC-100-UG-C)	K	\$56,535
H7UEENC100UC-K	SEL HZ7-UEM-ENC-100-UG-C)	K	\$57,960
H7UEENC10UC	SEL HZ7-UEM-ENC-10-UG-C)	K	\$5,410
H7UEENC10UC-I	SEL HZ7-UEM-ENC-10-UG-C)	K	\$5,653
H7UEENC10UC-K	SEL HZ7-UEM-ENC-10-UG-C)	K	\$5,796
H7UEENN100UC	SEL HZ7-UEM-ENN-100-UG-C)	K	\$32,960
H7UEENN100UC-I	SEL HZ7-UEM-ENN-100-UG-C)	K	\$34,443
H7UEENN100UC-K	SEL HZ7-UEM-ENN-100-UG-C)	K	\$35,359
H7UEENN10UC	SEL HZ7-UEM-ENN-10-UG-C)	K	\$3,296
H7UEENN10UC-I	SEL HZ7-UEM-ENN-10-UG-C)	K	\$3,444
H7UEENN10UC-K	SEL HZ7-UEM-ENN-10-UG-C)	K	\$3,536
H7VAAC100UC	SEL HZ7-VAD-ADC-100-UG-C)	K	\$23,760
H7VAAC100UC-I	SEL HZ7-VAD-ADC-100-UG-C)	K	\$24,829
H7VAAC100UCV2-K	SEL HZ7-VAD-ADC-100-UG-C)	K	\$25,475
H7VAAC10UC	SEL HZ7-VAD-ADC-10-UG-C)	K	\$2,376
H7VAAC10UC-I	SEL HZ7-VAD-ADC-10-UG-C)	K	\$2,483
H7VAAC10UCV2-K	SEL HZ7-VAD-ADC-10-UG-C)	K	\$2,548
H7VAEC100UC	SEL HZ7-VAD-ENC-100-UG-C)	K	\$43,670
H7VAEC100UC-I	SEL HZ7-VAD-ENC-100-UG-C)	K	\$45,635
H7VAEC100UCV2-K	SEL HZ7-VAD-ENC-100-UG-C)	K	\$46,774
H7VAEC10UC	SEL HZ7-VAD-ENC-10-UG-C)	K	\$4,367
H7VAEC10UC-I	SEL HZ7-VAD-ENC-10-UG-C)	K	\$4,564
H7VAEC10UCV2-K	SEL HZ7-VAD-ENC-10-UG-C)	K	\$4,677

H7VANC100UC	SEL HZ7-AVA-ENC100-UG-C)	K	\$48,180
H7VANC100UC-I	SEL HZ7-AVA-ENC100-UG-C)	K	\$50,348
H7VANC100UC-K	SEL HZ7-AVA-ENC100-UG-C)	K	\$51,601
H7VAPADC100UC	SEL HZ7-AVA-APADC100-UG-C)	K	\$19,800
H7VAPADC100UC-I	SEL HZ7-AVA-APADC100-UG-C)	K	\$20,691
H7VAPADC100UC-K	SEL HZ7-AVA-APADC100-UG-C)	K	\$21,184
H7VENS100UC	SEL HZ7-VENT-ST100-UG-C)	K	\$10,300
H7VENS100UC-I	SEL HZ7-VENT-ST100-UG-C)	K	\$10,764
H7VENS100UCV2-K	SEL HZ7-VENT-ST100-UG-C)	K	\$11,071
H7VETS10UC	SEL HZ7-VENT-ST10-UG-C)	K	\$1,030
H7VETS10UC-I	SEL HZ7-VENT-ST10-UG-C)	K	\$1,076
H7VETS10UCV2-K	SEL HZ7-VENT-ST10-UG-C)	K	\$1,107
H7VSEN100GC	SEL HZ7-AVS-ENN100-UG-C)	K	\$32,835
H7VSEN100GC-I	SEL HZ7-AVS-ENN100-UG-C)	K	\$34,313
H7VSEN100GC-K	SEL HZ7-AVS-ENN100-UG-C)	K	\$35,205
H7WSAD100UGC	SEL HZ7-WSP-ADN-100-UG-C)	K	\$11,333
H7WSAD100UGC-I	SEL HZ7-WSP-ADN-100-UG-C)	K	\$11,843
H7WSAD100UGC-K	SEL HZ7-WSP-ADN-100-UG-C)	K	\$12,144
H7WSAD10UGC	SEL HZ7-WSP-ADN-10-UG-C)	K	\$1,133
H7WSAD10UGC-I	SEL HZ7-WSP-ADN-10-UG-C)	K	\$1,184
H7WSAD10UGC-K	SEL HZ7-WSP-ADN-10-UG-C)	K	\$1,214
HA-BUNDLE	SEL High Avail Bundle (25% ea adj LP)	K	\$0
HAPA7NC10UC	SEL HZ7-APA-ENC10-UG-C)	K	\$2,837
HAPA7NC10UC-I	SEL HZ7-APA-ENC10-UG-C)	K	\$2,965
HAPA7NC10UC-K	SEL HZ7-APA-ENC10-UG-C)	K	\$3,038
HCIAD25VMPO	SEL HCI-RBAD-25VM-PROMO)	K	\$20,148
HCIAD25VMPO-I	SEL HCI-RBAD-25VM-PROMO)	K	\$23,573
HCIAD25VMPO-K	SEL HCI-RBAD-25VM-PROMO)	K	\$22,027
HCIADCPUPRO	SEL HCI-ADV-CPU-PROMO)	K	\$6,088
HCIADCPUPRO-I	SEL HCI-ADV-CPU-PROMO)	K	\$7,123
HCIADCPUPRO-K	SEL HCI-ADV-CPU-PROMO)	K	\$6,738
HCIADVPUC	SEL HCI-ADV-CPU-C)	K	\$7,610
HCIADVPUC-I	SEL HCI-ADV-CPU-C)	K	\$8,904
HCIADVPUC-K	SEL HCI-ADV-CPU-C)	K	\$8,543
HCIAKCPUC	SEL HCI-AK-CPU-C)	K	\$8,085
HCIAKCPUC-I	SEL HCI-AK-CPU-C)	K	\$9,459
HCIAKCPUC-K	SEL HCI-AK-CPU-C)	K	\$9,079
HCIAKCPUF	SEL: HCI-AK-CPU-F	K	\$8,638
HCIEN25VMPO	SEL HCI-RBEN-25VM-PROMO)	K	\$26,388
HCIEN25VMPO-I	SEL HCI-RBEN-25VM-PROMO)	K	\$30,874
HCIEN25VMPO-K	SEL HCI-RBEN-25VM-PROMO)	K	\$28,770
HCIENCPUC	SEL HCI-ENT-CPU-C)	K	\$10,180
HCIENCPUC-I	SEL HCI-ENT-CPU-C)	K	\$11,911
HCIENCPUC-K	SEL HCI-ENT-CPU-C)	K	\$11,454
HCIESKITC	SEL HCI-ES-KIT-C)	K	\$19,885
HCIESKITC-I	SEL HCI-ES-KIT-C)	K	\$23,265
HCIESKITC-K	SEL HCI-ES-KIT-C)	K	\$22,334
HCIESKTPRO	SEL HCI-ES-KIT-PROMO)	K	\$15,908
HCIESKTPRO-I	SEL HCI-ES-KIT-PROMO)	K	\$18,612
HCIESKTPRO-K	SEL HCI-ES-KIT-PROMO)	K	\$17,507

HCIETCPUPRO	SEL HCI-ENT-CPU-PROMO)	K	\$8,144
HCIETCPUPRO-I	SEL HCI-ENT-CPU-PROMO)	K	\$9,528
HCIETCPUPRO-K	SEL HCI-ENT-CPU-PROMO)	K	\$8,926
HCIOMKITC	SEL HCI-OM-KIT-C)	K	\$11,985
HCIOMKITC-I	SEL HCI-OM-KIT-C)	K	\$20,494
HCIOMKITC-K	SEL HCI-OM-KIT-C)	K	\$19,652
HCIOMKITPRO	SEL HCI-OM-KIT-PRO)	K	\$9,588
HCIRBAD25VMC	SEL HCI-RBAD-25VM-C)	K	\$25,185
HCIRBAD25VMC-I	SEL HCI-RBAD-25VM-C)	K	\$29,466
HCIRBAD25VMC-K	SEL HCI-RBAD-25VM-C)	K	\$28,310
HCIRBEN25VC	SEL HCI-RBEN-25VM-C)	K	\$32,985
HCIRBEN25VC-I	SEL HCI-RBEN-25VM-C)	K	\$38,592
HCIRBEN25VC-K	SEL HCI-RBEN-25VM-C)	K	\$37,044
HCIRBT25VMC	SEL HCI-RBST-25VM-C)	K	\$15,935
HCIRBT25VMC-I	SEL HCI-RBST-25VM-C)	K	\$18,644
HCIRBT25VMC-K	SEL HCI-RBST-25VM-C)	K	\$17,890
HCIST25VMPO	SEL HCI-RBST-25VM-PROMO)	K	\$12,748
HCIST25VMPO-I	SEL HCI-RBST-25VM-PROMO)	K	\$14,915
HCIST25VMPO-K	SEL HCI-RBST-25VM-PROMO)	K	\$13,906
HCISTCPUPOM	SEL HCI-STD-CPU-PROMO)	K	\$2,848
HCISTCPUPOM-I	SEL HCI-STD-CPU-PROMO)	K	\$3,332
HCISTCPUPOM-K	SEL HCI-STD-CPU-PROMO)	K	\$3,137
HCISTDCPUC	SEL HCI-STD-CPU-C)	K	\$3,560
HCISTDCPUC-I	SEL HCI-STD-CPU-C)	K	\$4,165
HCISTDCPUC-K	SEL HCI-STD-CPU-C)	K	\$4,003
HCISTDCPUF	SEL: HCI-STD-CPU-F	K	\$3,839
HDF-AGT-100-1Y	SEL HDF Edge Agent Sub- 100 Agents	K	\$76,923
HDF-AGT-10K-1Y	SEL HDF Edge Agent Sub- 10,000 Agents	K	\$1,538,462
HDF-AGT-1K-1Y	SEL HDF Edge Agent Sub- 1000 Agents	K	\$384,615
HDF-DIM-1Y	Sel HDF Data in Motion Bundle	K	\$538,462
HDF-EDG-10-1Y	SEL HDF Edge Brnch Office Sub - 10 Nodes	K	\$76,923
HDF-EDG-1Y	SEL HWX DataFlow Edge Pack 100 Devices	K	\$230,769
HDF-EDG-25-1Y	SEL HDF Edge Brnch Office Sub - 25 Nodes	K	\$115,385
HDF-EFM-1Y	Sel HDF Ent Flow Mngt- 16 Cores	K	\$55,385
HDF-EMS-1Y	Sel HDF MNGT Services 1 Cluster	K	\$15,385
HDF-ESP-1Y	Sel HDF Stream Processing 4 Nodes	K	\$27,692
HDP-ENT-1Y	SEL HDP Ent. 4 Nodes or 50TB Raw Stor	K	\$12,308
HDP-EPL-1Y	SEL HDP Ent.+ 4 Nodes or 50TB Raw Stor	K	\$22,154
HDP-JSS-6M	SEL HDP Jumpstart Sub. 200TB- 6M sub.	K	\$46,154
HDP-SCHNG-1Y	SEL Solr Search	K	\$24,615
HF8W12FXUC	SEL HZ-F8WS12-FLX-UG-C)	K	\$107
HF8W12FXUC-I	SEL HZ-F8WS12-FLX-UG-C)	K	\$112
HF8W12FXUC-K	SEL HZ-F8WS12-FLX-UG-C)	K	\$115
HGANEN100UGC	SEL HZ7-APS-ENN100-UG-C)	K	\$25,520
HGANEN100UGC-I	SEL HZ7-APS-ENN100-UG-C)	K	\$26,668
HGANEN100UGC-K	SEL HZ7-APS-ENN100-UG-C)	K	\$27,314
HGENANN100UC	SEL HZ7-ENA-ENN100-UG-C)	K	\$7,370
HGENANN100UC-I	SEL HZ7-ENA-ENN100-UG-C)	K	\$7,702
HGENANN100UC-K	SEL HZ7-ENA-ENN100-UG-C)	K	\$7,930
HSTENCA100UGC	SEL HZ7-STA-ENCA100-UG-C)	K	\$26,626

HSTENCA100UGC-I	SEL HZ7-STA-ENCA100-UG-C)	K	\$27,824
HSTENCA100UGC-K	SEL HZ7-STA-ENCA100-UG-C)	K	\$28,540
HUTE-100-249AN-D	SEL Splunk-Hadoop Term+SSup100-249NdAN	K	\$3,808
HUTE-100-249AP-D	SEL Splunk-Hadoop Term+SSup100-249NdAP	K	\$4,569
HUTE-100-249EM-D	SEL Splunk-Hadoop Term+SSup100-249NdEM	K	\$3,503
HUTE-100-249US-D	SEL Splunk-Hadoop Term+STDSup100-249NdUS	K	\$3,046
HUTE-10-24AN-D	SEL Splunk-Hadoop Term+SSup10-24NdAN	K	\$4,327
HUTE-10-24AP-D	SEL Splunk-Hadoop Term+SSup10-24NdAP	K	\$5,192
HUTE-10-24EM-D	SEL Splunk-Hadoop Term+SSup10-24NdEM	K	\$3,981
HUTE-10-24US-D	SEL Splunk-Hadoop Term+STDSup10-24NdUS	K	\$3,462
HUTE-250-499AN-D	SEL Splunk-Hadoop Term+SSup250-499NdAN	K	\$3,462
HUTE-250-499AP-D	SEL Splunk-Hadoop Term+SSup250-499NdAP	K	\$4,154
HUTE-250-499EM-D	SEL Splunk-Hadoop Term+SSup250-499NdEM	K	\$3,185
HUTE-250-499US-D	SEL Splunk-Hadoop Term+STDSup250-499NdUS	K	\$2,769
HUTE-25-49AN-D	SEL Splunk-Hadoop Term+SSup25-49NdAN	K	\$4,154
HUTE-25-49AP-D	SEL Splunk-Hadoop Term+SSup25-49NdAP	K	\$4,985
HUTE-25-49EM-D	SEL Splunk-Hadoop Term+SSup25-49NdEM	K	\$3,822
HUTE-25-49US-D	SEL Splunk-Hadoop Term+STDSup25-49NdUS	K	\$3,323
HUTE-500-999AN-D	SEL Splunk-Hadoop Term+SSup500-999NdAN	K	\$3,029
HUTE-500-999AP-D	SEL Splunk-Hadoop Term+SSup500-999NdAP	K	\$3,635
HUTE-500-999EM-D	SEL Splunk-Hadoop Term+SSup500-999NdEM	K	\$2,787
HUTE-500-999US-D	SEL Splunk-Hadoop Term+STDSup500-999NdUS	K	\$2,423
HUTE-50-99AN-D	SEL Splunk-Hadoop Term+SSup50-99NdAN	K	\$3,981
HUTE-50-99AP-D	SEL Splunk-Hadoop Term+SSup50-99NdAP	K	\$4,777
HUTE-50-99EM-D	SEL Splunk-Hadoop Term+SSup50-99NdEM	K	\$3,662
HUTE-50-99US-D	SEL Splunk-Hadoop Term+STDSup50-99NdUS	K	\$3,185
HUTG-100-249AN-D	SEL Splunk-Hadoop Term +PSup100-249NdAN	K	\$4,573
HUTG-100-249AP-D	SEL Splunk-Hadoop Term +PSup100-249NdAP	K	\$5,487
HUTG-100-249EM-D	SEL Splunk-Hadoop Term +PSup100-249NdEM	K	\$4,207
HUTG-100-249US-D	SEL Splunk-Hadoop Term+PRMSup100-249NdUS	K	\$3,658
HUTG-10-24AN-D	SEL Splunk-Hadoop Term +PSup10-24NdAN	K	\$5,192
HUTG-10-24AP-D	SEL Splunk-Hadoop Term +PSup10-24NdAP	K	\$6,231
HUTG-10-24EM-D	SEL Splunk-Hadoop Term +PSup10-24NdEM	K	\$4,777
HUTG-10-24US-D	SEL Splunk-Hadoop Term+PRMSup10-24NdUS	K	\$4,154
HUTG-250-499AN-D	SEL Splunk-Hadoop Term +PSup250-499NdAN	K	\$4,154
HUTG-250-499AP-D	SEL Splunk-Hadoop Term +PSup250-499NdAP	K	\$4,985
HUTG-250-499EM-D	SEL Splunk-Hadoop Term +PSup250-499NdEM	K	\$3,822
HUTG-250-499US-D	SEL Splunk-Hadoop Term+PRMSup250-499NdUS	K	\$3,323
HUTG-25-49AN-D	SEL Splunk-Hadoop Term +PSup25-49NdAN	K	\$4,983
HUTG-25-49AP-D	SEL Splunk-Hadoop Term +PSup25-49NdAP	K	\$5,980
HUTG-25-49EM-D	SEL Splunk-Hadoop Term +PSup25-49NdEM	K	\$4,584
HUTG-25-49US-D	SEL Splunk-Hadoop Term+PRMSup25-49NdUS	K	\$3,987
HUTG-500-999AN-D	SEL Splunk-Hadoop Term +PSup500-999NdAN	K	\$3,635
HUTG-500-999AP-D	SEL Splunk-Hadoop Term +PSup500-999NdAP	K	\$4,362
HUTG-500-999EM-D	SEL Splunk-Hadoop Term +PSup500-999NdEM	K	\$3,344
HUTG-500-999US-D	SEL Splunk-Hadoop Term+PRMSup500-999NdUS	K	\$2,908
HUTG-50-99AN-D	SEL Splunk-Hadoop Term +PSup50-99NdAN	K	\$4,775
HUTG-50-99AP-D	SEL Splunk-Hadoop Term +PSup50-99NdAP	K	\$5,729
HUTG-50-99EM-D	SEL Splunk-Hadoop Term +PSup50-99NdEM	K	\$4,393
HUTG-50-99US-D	SEL Splunk-Hadoop Term+PRMSup50-99NdUS	K	\$3,819

HWC-FLEX-CNT-1Y	SEL Flx Sprt Contact - 1 yr - Required	K	\$15,385
HWC-FLEXCREDITS	SEL HWX Connect Flx Crdts - 12 Credits	K	\$8,615
HWC-FLEXPLAN-1Y	SEL HWX Connect Flex Plan 1Y	K	\$23,077
HZ7A100AERCC	SEL HZ7-A100-AERC-C)	K	\$30,850
HZ7A100AERCC-I	SEL HZ7-A100-AERC-C)	K	\$32,238
HZ7A100AERCC-K	SEL HZ7-A100-AERC-C)	K	\$33,060
HZ7A10AERCC	SEL HZ7-A10-AERC-C)	K	\$3,085
HZ7A10AERCC-I	SEL HZ7-A10-AERC-C)	K	\$3,224
HZ7A10AERCC-K	SEL HZ7-A10-AERC-C)	K	\$3,306
HZ7ADC100C	SEL HZ7-ADC-100-C)	K	\$41,150
HZ7ADC100C-I	SEL HZ7-ADC-100-C)	K	\$43,002
HZ7ADC100CV2-K	SEL HZ7-ADC-100-C)	K	\$44,093
HZ7ADC10C	SEL HZ7-ADC-10-C)	K	\$4,115
HZ7ADC10C-I	SEL HZ7-ADC-10-C)	K	\$4,300
HZ7ADC10CV2-K	SEL HZ7-ADC-10-C)	K	\$4,409
HZ7ADC2503GSSSF	SEL: HZ7-ADC-250-3G-SSS-F	K	\$60,984
HZ7ADC2503PSSSF	SEL: HZ7-ADC-250-3P-SSS-F	K	\$72,600
HZ7ADC250GSSSF	SEL: HZ7-ADC-250-G-SSS-F	K	\$23,100
HZ7ADC250PSSSF	SEL: HZ7-ADC-250-P-SSS-F	K	\$27,500
HZ7ADC5003GSSSF	SEL: HZ7-ADC-500-3G-SSS-F	K	\$121,968
HZ7ADC5003PSSSF	SEL: HZ7-ADC-500-3P-SSS-F	K	\$145,200
HZ7ADC500GSSSF	SEL: HZ7-ADC-500-G-SSS-F	K	\$46,200
HZ7ADC500PSSSF	SEL: HZ7-ADC-500-P-SSS-F	K	\$55,000
HZ7ADN100C	SEL HZ7-ADN-100-C)	K	\$25,750
HZ7ADN100C-I	SEL HZ7-ADN-100-C)	K	\$26,909
HZ7ADN100CV2-K	SEL HZ7-ADN-100-C)	K	\$27,620
HZ7ADN10C	SEL HZ7-ADN-10-C)	K	\$2,575
HZ7ADN10C-I	SEL HZ7-ADN-10-C)	K	\$2,691
HZ7ADN10CV2-K	SEL HZ7-ADN-10-C)	K	\$2,762
HZ7ADN1K3GSSSF	SEL: HZ7-ADN-1K-3G-SSS-F	K	\$152,460
HZ7ADN1K3PSSSF	SEL: HZ7-ADN-1K-3P-SSS-F	K	\$181,500
HZ7ADN1KGSSSF	SEL: HZ7-ADN-1K-G-SSS-F	K	\$57,750
HZ7ADN1KPSSSF	SEL: HZ7-ADN-1K-P-SSS-F	K	\$68,750
HZ7ADN2003GSSSF	SEL: HZ7-ADN-200-3G-SSS-F	K	\$30,492
HZ7ADN2003PSSSF	SEL: HZ7-ADN-200-3P-SSS-F	K	\$36,300
HZ7ADN200GSSSF	SEL: HZ7-ADN-200-G-SSS-F	K	\$11,550
HZ7ADN200PSSSF	SEL: HZ7-ADN-200-P-SSS-F	K	\$13,750
HZ7ADN203GSSSF	SEL: HZ7-ADN-20-3G-SSS-F	K	\$3,049
HZ7ADN203PSSSF	SEL: HZ7-ADN-20-3P-SSS-F	K	\$3,630
HZ7ADN20GSSSF	SEL: HZ7-ADN-20-G-SSS-F	K	\$1,155
HZ7ADN20PSSSF	SEL: HZ7-ADN-20-P-SSS-F	K	\$1,375
HZ7ADN5003GSSSF	SEL: HZ7-ADN-500-3G-SSS-F	K	\$76,230
HZ7ADN5003PSSSF	SEL: HZ7-ADN-500-3P-SSS-F	K	\$90,750
HZ7ADN500GSSSF	SEL: HZ7-ADN-500-G-SSS-F	K	\$28,875
HZ7ADN500PSSSF	SEL: HZ7-ADN-500-P-SSS-F	K	\$34,375
HZ7ADNA100C	SEL HZ7-ADN-A100-C)	K	\$20,550
HZ7ADNA100C-I	SEL HZ7-ADN-A100-C)	K	\$21,475
HZ7ADNA100C-K	SEL HZ7-ADN-A100-C)	K	\$22,027
HZ7ADNA10C	SEL HZ7-ADN-A10-C)	K	\$2,055
HZ7ADNA10C-I	SEL HZ7-ADN-A10-C)	K	\$2,147

HZ7ADNA10C-K	SEL HZ7-ADN-A10-C)	K	\$2,203
HZ7APADC100C	SEL HZ7-AP-ADC100-C)	K	\$33,450
HZ7APADC100C-I	SEL HZ7-AP-ADC100-C)	K	\$34,955
HZ7APADC100C-K	SEL HZ7-AP-ADC100-C)	K	\$35,818
HZ7APADC10C	SEL HZ7-AP-ADC10-C)	K	\$3,345
HZ7APADC10C-I	SEL HZ7-AP-ADC10-C)	K	\$3,496
HZ7APADC10C-K	SEL HZ7-AP-ADC10-C)	K	\$3,582
HZ7APADN100C	SEL HZ7-AP-ADN100-C)	K	\$20,550
HZ7APADN100C-I	SEL HZ7-AP-ADN100-C)	K	\$21,475
HZ7APADN100C-K	SEL HZ7-AP-ADN100-C)	K	\$22,027
HZ7APADN10C	SEL HZ7-AP-ADN10-C)	K	\$2,055
HZ7APADN10C-I	SEL HZ7-AP-ADN10-C)	K	\$2,147
HZ7APADN10C-K	SEL HZ7-AP-ADN10-C)	K	\$2,203
HZ7APSCAC10UC	SEL HZ7-AP-STC-ADC10-UG-C)	K	\$1,419
HZ7APSCAC10UC-I	SEL HZ7-AP-STC-ADC10-UG-C)	K	\$1,483
HZ7APSCAC10UC-K	SEL HZ7-AP-STC-ADC10-UG-C)	K	\$1,521
HZ7APSTC100C	SEL HZ7-AP-STC100-C)	K	\$20,550
HZ7APSTC100C-I	SEL HZ7-AP-STC100-C)	K	\$21,475
HZ7APSTC100C-K	SEL HZ7-AP-STC100-C)	K	\$22,027
HZ7APSTC10C	SEL HZ7-AP-STC10-C)	K	\$2,055
HZ7APSTC10C-I	SEL HZ7-AP-STC10-C)	K	\$2,147
HZ7APSTC10C-K	SEL HZ7-AP-STC10-C)	K	\$2,203
HZ7APSTCADC100UF	SEL: HZ7-AP-STC-ADC100-UG-F	K	\$15,125
HZ7APSTCADC10UGF	SEL: HZ7-AP-STC-ADC10-UG-F	K	\$1,513
HZ7APSTN100C	SEL HZ7-AP-STN100-C)	K	\$12,850
HZ7APSTN100C-I	SEL HZ7-AP-STN100-C)	K	\$13,428
HZ7APSTN100C-K	SEL HZ7-AP-STN100-C)	K	\$13,753
HZ7APSTN10C	SEL HZ7-AP-STN10-C)	K	\$1,285
HZ7APSTN10C-I	SEL HZ7-AP-STN10-C)	K	\$1,343
HZ7APSTN10C-K	SEL HZ7-AP-STN10-C)	K	\$1,375
HZ7APSTNADN100UF	SEL: HZ7-AP-STN-ADN100-UG-F	K	\$9,075
HZ7APSTNADN10UGF	SEL: HZ7-AP-STN-ADN10-UG-F	K	\$908
HZ7DADC100GC	SEL HZ7-ADA-ADC100-UG-C)	K	\$11,330
HZ7DADC100GC-I	SEL HZ7-ADA-ADC100-UG-C)	K	\$11,840
HZ7DADC100GC-K	SEL HZ7-ADA-ADC100-UG-C)	K	\$12,144
HZ7E100AERCC	SEL HZ7-E100-AERC-C)	K	\$43,750
HZ7E100AERCC-I	SEL HZ7-E100-AERC-C)	K	\$45,719
HZ7E100AERCC-K	SEL HZ7-E100-AERC-C)	K	\$46,928
HZ7E10AERCC	SEL HZ7-E10-AERC-C)	K	\$4,375
HZ7E10AERCC-I	SEL HZ7-E10-AERC-C)	K	\$4,572
HZ7E10AERCC-K	SEL HZ7-E10-AERC-C)	K	\$4,693
HZ7E10AERCUGC	SEL HZ7-E10-AERC-UG-C)	K	\$1,419
HZ7E10AERCUGC-I	SEL HZ7-E10-AERC-UG-C)	K	\$1,483
HZ7E10AERCUGC-K	SEL HZ7-E10-AERC-UG-C)	K	\$1,521
HZ7EDENC100UC	SEL HZ7-ADA-ENC100-UG-C)	K	\$31,240
HZ7EDENC100UC-I	SEL HZ7-ADA-ENC100-UG-C)	K	\$32,646
HZ7EDENC100UC-K	SEL HZ7-ADA-ENC100-UG-C)	K	\$33,520
HZ7ENC100C	SEL HZ7-ENC-100-C)	K	\$59,250
HZ7ENC100C-I	SEL HZ7-ENC-100-C)	K	\$61,916
HZ7ENC100CV2-K	SEL HZ7-ENC-100-C)	K	\$63,477

HZ7ENC10C	SEL HZ7-ENC-10-C)	K	\$5,925
HZ7ENC10C-I	SEL HZ7-ENC-10-C)	K	\$6,192
HZ7ENC10CV2-K	SEL HZ7-ENC-10-C)	K	\$6,348
HZ7ENC2503GSSSF	SEL: HZ7-ENC-250-3G-SSS-F	K	\$87,666
HZ7ENC2503PSSSF	SEL: HZ7-ENC-250-3P-SSS-F	K	\$104,364
HZ7ENC250GSSSF	SEL: HZ7-ENC-250-G-SSS-F	K	\$33,207
HZ7ENC250PSSSF	SEL: HZ7-ENC-250-P-SSS-F	K	\$39,532
HZ7ENC5003GSSSF	SEL: HZ7-ENC-500-3G-SSS-F	K	\$175,329
HZ7ENC5003PSSSF	SEL: HZ7-ENC-500-3P-SSS-F	K	\$208,725
HZ7ENC500GSSSF	SEL: HZ7-ENC-500-G-SSS-F	K	\$66,413
HZ7ENC500PSSSF	SEL: HZ7-ENC-500-P-SSS-F	K	\$79,063
HZ7ENN100C	SEL HZ7-ENN-100-C)	K	\$36,050
HZ7ENN100C-I	SEL HZ7-ENN-100-C)	K	\$37,672
HZ7ENN100CV2-K	SEL HZ7-ENN-100-C)	K	\$38,653
HZ7ENN10C	SEL HZ7-ENN-10-C)	K	\$3,605
HZ7ENN10C-I	SEL HZ7-ENN-10-C)	K	\$3,767
HZ7ENN10CV2-K	SEL HZ7-ENN-10-C)	K	\$3,865
HZ7ENN1K3GSSSF	SEL: HZ7-ENN-1K-3G-SSS-F	K	\$213,444
HZ7ENN1K3PSSSF	SEL: HZ7-ENN-1K-3P-SSS-F	K	\$254,100
HZ7ENN1KGSSSF	SEL: HZ7-ENN-1K-G-SSS-F	K	\$80,850
HZ7ENN1KPSSSF	SEL: HZ7-ENN-1K-P-SSS-F	K	\$96,250
HZ7ENN2003GSSSF	SEL: HZ7-ENN-200-3G-SSS-F	K	\$42,689
HZ7ENN2003PSSSF	SEL: HZ7-ENN-200-3P-SSS-F	K	\$50,820
HZ7ENN200GSSSF	SEL: HZ7-ENN-200-G-SSS-F	K	\$16,170
HZ7ENN200PSSSF	SEL: HZ7-ENN-200-P-SSS-F	K	\$19,250
HZ7ENN203GSSSF	SEL: HZ7-ENN-20-3G-SSS-F	K	\$4,269
HZ7ENN203PSSSF	SEL: HZ7-ENN-20-3P-SSS-F	K	\$5,082
HZ7ENN20GSSSF	SEL: HZ7-ENN-20-G-SSS-F	K	\$1,617
HZ7ENN20PSSSF	SEL: HZ7-ENN-20-P-SSS-F	K	\$1,925
HZ7ENN5003GSSSF	SEL: HZ7-ENN-500-3G-SSS-F	K	\$106,722
HZ7ENN5003PSSSF	SEL: HZ7-ENN-500-3P-SSS-F	K	\$127,050
HZ7ENN500GSSSF	SEL: HZ7-ENN-500-G-SSS-F	K	\$40,425
HZ7ENN500PSSSF	SEL: HZ7-ENN-500-P-SSS-F	K	\$48,125
HZ7ENNA100C	SEL HZ7-ENN-A100-C)	K	\$29,350
HZ7ENNA100C-I	SEL HZ7-ENN-A100-C)	K	\$30,671
HZ7ENNA100C-K	SEL HZ7-ENN-A100-C)	K	\$31,451
HZ7ENNA100UGC	SEL HZ7-ENN-A100-UG-C)	K	\$9,680
HZ7ENNA100UGC-I	SEL HZ7-ENN-A100-UG-C)	K	\$10,116
HZ7ENNA100UGC-K	SEL HZ7-ENN-A100-UG-C)	K	\$10,382
HZ7ENNA10C	SEL HZ7-ENN-A10-C)	K	\$2,935
HZ7ENNA10C-I	SEL HZ7-ENN-A10-C)	K	\$3,067
HZ7ENNA10C-K	SEL HZ7-ENN-A10-C)	K	\$3,145
HZ7ENNA10UGC	SEL HZ7-ENN-A10-UG-C)	K	\$968
HZ7ENNA10UGC-I	SEL HZ7-ENN-A10-UG-C)	K	\$1,012
HZ7ENNA10UGC-K	SEL HZ7-ENN-A10-UG-C)	K	\$1,038
HZ7GAEN10UGC	SEL HZ7-APS-ENN10-UG-C)	K	\$2,552
HZ7GAEN10UGC-I	SEL HZ7-APS-ENN10-UG-C)	K	\$2,667
HZ7GAEN10UGC-K	SEL HZ7-APS-ENN10-UG-C)	K	\$2,731
HZ7GUAN10UGC	SEL HZ7-ENA-ENN10-UG-C)	K	\$737
HZ7GUAN10UGC-I	SEL HZ7-ENA-ENN10-UG-C)	K	\$770

HZ7GUAN10UGC-K	SEL HZ7-ENA-ENN10-UG-C)	K	\$793
HZ7LXC100C	SEL HZ7-LXC-100-C)	K	\$15,450
HZ7LXC100C-I	SEL HZ7-LXC-100-C)	K	\$16,995
HZ7LXC100C-K	SEL HZ7-LXC-100-C)	K	\$16,817
HZ7LXC10C	SEL HZ7-LXC-10-C)	K	\$1,545
HZ7LXC10C-I	SEL HZ7-LXC-10-C)	K	\$1,700
HZ7LXC10C-K	SEL HZ7-LXC-10-C)	K	\$1,682
HZ7PCAC100GC	SEL HZ7-AP-STC-ADC100-UG-C)	K	\$14,190
HZ7PCAC100GC-I	SEL HZ7-AP-STC-ADC100-UG-C)	K	\$14,829
HZ7PCAC100GC-K	SEL HZ7-AP-STC-ADC100-UG-C)	K	\$15,208
HZ7PSADN10UGC	SEL HZ7-AP-STN-ADN10-UG-C)	K	\$847
HZ7PSADN10UGC-I	SEL HZ7-AP-STN-ADN10-UG-C)	K	\$885
HZ7PSADN10UGC-K	SEL HZ7-AP-STN-ADN10-UG-C)	K	\$908
HZ7SNAD100UC	SEL HZ7-AP-STN-ADN100-UG-C)	K	\$8,470
HZ7SNAD100UC-I	SEL HZ7-AP-STN-ADN100-UG-C)	K	\$8,851
HZ7SNAD100UC-K	SEL HZ7-AP-STN-ADN100-UG-C)	K	\$9,079
HZ7STD100C	SEL HZ7-STD-100-C)	K	\$25,750
HZ7STD100C-I	SEL HZ7-STD-100-C)	K	\$26,909
HZ7STD100CV2-K	SEL HZ7-STD-100-C)	K	\$27,620
HZ7STD10C	SEL HZ7-STD-10-C)	K	\$2,575
HZ7STD10C-I	SEL HZ7-STD-10-C)	K	\$2,691
HZ7STD10CV2-K	SEL HZ7-STD-10-C)	K	\$2,762
HZ7STDA100C	SEL HZ7-STD-A100-C)	K	\$19,550
HZ7STDA100C-I	SEL HZ7-STD-A100-C)	K	\$20,430
HZ7STDA100CV2-K	SEL HZ7-STD-A100-C)	K	\$20,955
HZ7STDA10C	SEL HZ7-STD-A10-C)	K	\$1,955
HZ7STDA10C-I	SEL HZ7-STD-A10-C)	K	\$2,043
HZ7STDA10CV2-K	SEL HZ7-STD-A10-C)	K	\$2,095
HZAAAN100UC	SEL HZ7-ADA-ADN100-UG-C)	K	\$5,720
HZAAAN100UC-I	SEL HZ7-ADA-ADN100-UG-C)	K	\$5,977
HZAAAN100UC-K	SEL HZ7-ADA-ADN100-UG-C)	K	\$6,133
HZADEC10UGC	SEL HZ7-ADA-ENC10-UG-C)	K	\$3,124
HZADEC10UGC-I	SEL HZ7-ADA-ENC10-UG-C)	K	\$3,265
HZADEC10UGC-K	SEL HZ7-ADA-ENC10-UG-C)	K	\$3,352
HZDDNAA10UGC	SEL HZ7-ADA-ADN10-UG-C)	K	\$572
HZDDNAA10UGC-I	SEL HZ7-ADA-ADN10-UG-C)	K	\$598
HZDDNAA10UGC-K	SEL HZ7-ADA-ADN10-UG-C)	K	\$613
HZF7W11FXUC	SEL HZ-F7WS11-FLX-UG-C)	K	\$158
HZF7W11FXUC-I	SEL HZ-F7WS11-FLX-UG-C)	K	\$165
HZF7W11FXUC-K	SEL HZ-F7WS11-FLX-UG-C)	K	\$170
HZFLX10C	SEL HZ-FLX-10-C)	K	\$2,575
HZFLX10C-I	SEL HZ-FLX-10-C)	K	\$2,691
HZFLX10CV2-K	SEL HZ-FLX-10-C)	K	\$2,762
HZFLX1C	SEL HZ-FLX-1-C)	K	\$250
HZFLX1C-I	SEL HZ-FLX-1-C)	K	\$261
HZFLX1C-K	SEL HZ-FLX-1-C)	K	\$268
HZFLXAD10C	SEL HZ-FLX-AD10-C)	K	\$1,545
HZFLXAD10C-I	SEL HZ-FLX-AD10-C)	K	\$1,615
HZFLXAD10CV2-K	SEL HZ-FLX-AD10-C)	K	\$1,659
HZPANA100UC	SEL HZ7-APA-ENN100-UG-C)	K	\$16,998

HZPANA100UC-I	SEL HZ7-APA-ENN100-UG-C)	K	\$17,763
HZPANA100UC-K	SEL HZ7-APA-ENN100-UG-C)	K	\$18,196
HZPASE100UGC	SEL HZ7-APS-ENC100-UG-C)	K	\$42,570
HZPASE100UGC-I	SEL HZ7-APS-ENC100-UG-C)	K	\$44,486
HZPASE100UGC-K	SEL HZ7-APS-ENC100-UG-C)	K	\$45,625
HZPSEC10UGC	SEL HZ7-APS-ENC10-UG-C)	K	\$4,257
HZPSEC10UGC-I	SEL HZ7-APS-ENC10-UG-C)	K	\$4,449
HZPSEC10UGC-K	SEL HZ7-APS-ENC10-UG-C)	K	\$4,563
HZPUGENN10UGC	SEL HZ7-APA-ENN10-UG-C)	K	\$1,699
HZPUGENN10UGC-I	SEL HZ7-APA-ENN10-UG-C)	K	\$1,775
HZPUGENN10UGC-K	SEL HZ7-APA-ENN10-UG-C)	K	\$1,820
HZTAADC100UC	SEL HZ7-STA-ADC100-UG-C)	K	\$23,760
HZTAADC100UC-I	SEL HZ7-STA-ADC100-UG-C)	K	\$24,829
HZTAADC100UC-K	SEL HZ7-STA-ADC100-UG-C)	K	\$25,475
IA-PER-T0	SEL InfoArchive 1-5TB	K	\$73,077
IA-PER-T1	SEL InfoArchive 6-20TB	K	\$43,846
IA-PER-T2	SEL InfoArchive 21-50TB	K	\$27,404
IA-PER-T3	SEL InfoArchive 51-100TB	K	\$16,077
IA-PER-T4	SEL InfoArchive 101-300TB	K	\$10,523
IA-PER-T5	SEL InfoArchive 301+TB	K	\$5,262
IDAW-0-500	SEL DAWin+Pb+SS&Sup 1yr 1 user 500band	K	\$142
IDAW-1000-2500	SEL DAWin+Pb+SS&Sup 1yr 1 user 1001-2500	K	\$81
IDAW-10K-25K	SEL DAWin+Pb+SS&Sup1yr 1user 10001-25000	K	\$52
IDAW-2500-5000	SEL DAWin+Pb+SS&Sup 1yr 1 user 2501-5000	K	\$69
IDAW-25K-50K	SEL DAWin+Pb+SS&Sup1yr 1user 25001-50000	K	\$49
IDAW-5000-10K	SEL DAWin+Pb+SS&Sup 1yr 1user 5001-10000	K	\$57
IDAW-500-1000	SEL DAWin+Pb+SS&Sup 1yr 1 user 501-1000	K	\$108
IDAW-OVER50K	SEL DAWin+Pb+SS&Sup 1yr 1 user 50001+	K	\$47
IDTE-0-500	SEL DTE+SS&Sup 1 yr 1 user 500band	K	\$59
IDTE-1000-2500	SEL DTE+SS&Sup 1 yr 1 user 1001-2500	K	\$46
IDTE-10K-25K	SEL DTE+SS&Sup 1 yr 1 user 10001-25000	K	\$31
IDTE-2500-5000	SEL DTE+SS&Sup 1 yr 1 user 2501-5000	K	\$40
IDTE-25K-50K	SEL DTE+SS&Sup 1 yr 1 user 25001-50000	K	\$30
IDTE-5000-10K	SEL DTE+SS&Sup 1 yr 1 user 5001-10000	K	\$34
IDTE-500-1000	SEL DTE+SS&Sup 1 yr 1 user 501-1000	K	\$56
IDTE-OVER50K	SEL DTE+SS&Sup 1 yr 1 user 50000+	K	\$29
IGL-CA-009	SEL Eyeglass Isilon Probe-Basic	K	\$1,795
IGLS-CB-3YR	SEL IGLS Starter Suite 2 CLSTR Bundle 3y	K	\$43,840
IGLS-CB-5YR	SEL IGLS Starter Suite 2 CLSTR Bundle 5y	K	\$51,391
IGLS-NB-3YR	SEL IGLS Starter Suite 6 Node Bundle 3y	K	\$35,926
IGLS-NB-5YR	SEL IGLS Starter Suite 6 Node Bundle 5y	K	\$42,822
IGLS-NB8-3YR	SEL IGLS Starter Suite 8 Node Bundle 3y	K	\$37,754
IGLS-NB8-5YR	SEL IGLS Starter Suite 8 Node Bundle 5y	K	\$45,285
IGLS-SUITE-1YR	SEL IGLS Bundle 1 Writeable Cluster 1yr	K	\$19,851
IGLS-SUITE2-1YR	SEL IGLS Bundle 2 Writeable Cluster 1y	K	\$25,918
IGLS-SUITE2-3YR	SEL IGLS Bundle 2 Writeable Cluster 3y	K	\$33,918
IGLS-SUITE2-5YR	SEL IGLS Bundle 2 Writeable Cluster 5y	K	\$41,918
IGLS-SUITE-3YR	SEL IGLS Bundle 1 Writeable Cluster 3yr	K	\$25,051
IGLS-SUITE-5YR	SEL IGLS Bundle 1 Writeable Cluster 5yr	K	\$30,251
INT-09600-B010	SEL SteelHead Interceptor 9600 Base	K	\$55,378

INT-09600-B010-C	SEL SteelHead Interceptor 9600 Base-C	K	\$55,378
IOM-SW1Y-0-10	SEL IOMART SW 1Y 0-10	K	\$538
IOM-SW1Y-1001+	SEL IOMART SW 1Y 1001+	K	\$183
IOM-SW1Y-11-50	SEL IOMART SW 1Y 11-50	K	\$431
IOM-SW1Y-151-250	SEL IOMART SW 1Y 151-250	K	\$323
IOM-SW1Y-251-400	SEL IOMART SW 1Y 251-400	K	\$269
IOM-SW1Y-401-600	SEL IOMART SW 1Y 401-600	K	\$215
IOM-SW1Y-51-150	SEL IOMART SW 1Y 51-150	K	\$377
IOM-SW1Y-601-1K	SEL IOMART SW 1Y 601-1000	K	\$194
IOM-SW2Y-0-10	SEL IOMART SW 2Y 0-10	K	\$915
IOM-SW2Y-1001+	SEL IOMART SW 2Y 1001+	K	\$311
IOM-SW2Y-11-50	SEL IOMART SW 2Y 11-50	K	\$732
IOM-SW2Y-151-250	SEL IOMART SW 2Y 151-250	K	\$549
IOM-SW2Y-251-400	SEL IOMART SW 2Y 251-400	K	\$458
IOM-SW2Y-401-600	SEL IOMART SW 2Y 401-600	K	\$366
IOM-SW2Y-51-150	SEL IOMART SW 2Y 51-150	K	\$641
IOM-SW2Y-601-1K	SEL IOMART SW 2Y 601-1000	K	\$330
IOM-SW3Y-0-10	SEL IOMART SW 3Y 0-10	K	\$1,292
IOM-SW3Y-1001+	SEL IOMART SW 3Y 1001+	K	\$439
IOM-SW3Y-11-50	SEL IOMART SW 3Y 11-50	K	\$1,034
IOM-SW3Y-151-250	SEL IOMART SW 3Y 151-250	K	\$775
IOM-SW3Y-251-400	SEL IOMART SW 3Y 251-400	K	\$646
IOM-SW3Y-401-600	SEL IOMART SW 3Y 401-600	K	\$517
IOM-SW3Y-51-150	SEL IOMART SW 3Y 51-150	K	\$905
IOM-SW3Y-601-1K	SEL IOMART SW 3Y 601-1000	K	\$465
ISD-ENT-NODE-LIC	SEL EYEGLASS DR MANAGER SDEdge 36TB	K	\$1,674
ITP-100-199AN-D	SEL Splunk ITSI Perp Lic100-199GB/dayAN	K	\$865
ITP-100-199AP-D	SEL Splunk ITSI Perp Lic100-199GB/dayAP	K	\$1,038
ITP-100-199EM-D	SEL Splunk ITSI Perp Lic100-199GB/dayEM	K	\$796
ITP-100-199US-D	SEL Splunk ITSI Perp Lic100-199GB/dayUS	K	\$692
ITP-10-19AN-D	SEL Splunk ITSI Perp Lic10-19GB/dayAN	K	\$2,596
ITP-10-19AP-D	SEL Splunk ITSI Perp Lic10-19GB/dayAP	K	\$3,115
ITP-10-19EM-D	SEL Splunk ITSI Perp Lic10-19GB/dayEM	K	\$2,388
ITP-10-19US-D	SEL Splunk ITSI Perp Lic10-19GB/dayUS	K	\$2,077
ITP-1K-1999AN-D	SEL Splunk ITSI Perp Lic1K-1999GB/dayAN	K	\$433
ITP-1K-1999AP-D	SEL Splunk ITSI Perp Lic1K-1999GB/dayAP	K	\$519
ITP-1K-1999EM-D	SEL Splunk ITSI Perp Lic1K-1999GB/dayEM	K	\$398
ITP-1K-1999US-D	SEL Splunk ITSI Perp Lic1K-1999GB/dayUS	K	\$346
ITP-200-499AN-D	SEL Splunk ITSI Perp Lic200-499GB/dayAN	K	\$650
ITP-200-499AP-D	SEL Splunk ITSI Perp Lic200-499GB/dayAP	K	\$779
ITP-200-499EM-D	SEL Splunk ITSI Perp Lic200-499GB/dayEM	K	\$598
ITP-200-499US-D	SEL Splunk ITSI Perp Lic200-499GB/dayUS	K	\$519
ITP-20-49AN-D	SEL Splunk ITSI Perp Lic20-49GB/dayAN	K	\$1,947
ITP-20-49AP-D	SEL Splunk ITSI Perp Lic20-49GB/dayAP	K	\$2,337
ITP-20-49EM-D	SEL Splunk ITSI Perp Lic20-49GB/dayEM	K	\$1,791
ITP-20-49US-D	SEL Splunk ITSI Perp Lic20-49GB/dayUS	K	\$1,558
ITP2K-4999AN-D	SEL Splunk ITSI Perp Lic2K-4999GB/dayAN	K	\$397
ITP-2K-4999AP-D	SEL Splunk ITSI Perp Lic2K-4999GB/dayAP	K	\$476
ITP-2K-4999EM-D	SEL Splunk ITSI Perp Lic2K-4999GB/dayEM	K	\$365
ITP-2K-4999US-D	SEL Splunk ITSI Perp Lic2K-4999GB/dayUS	K	\$317

ITP-500-999AN-D	SEL Splunk ITSI Perp Lic500-999GB/dayAN	K	\$468
ITP-500-999AP-D	SEL Splunk ITSI Perp Lic500-999GB/dayAP	K	\$563
ITP-500-999EM-D	SEL Splunk ITSI Perp Lic500-999GB/dayEM	K	\$432
ITP-500-999US-D	SEL Splunk ITSI Perp Lic500-999GB/dayUS	K	\$375
ITP-50-99AN-D	SEL Splunk ITSI Perp Lic50-99GB/dayAN	K	\$1,371
ITP-50-99AP-D	SEL Splunk ITSI Perp Lic50-99GB/dayAP	K	\$1,644
ITP-50-99EM-D	SEL Splunk ITSI Perp Lic50-99GB/dayEM	K	\$1,261
ITP-50-99US-D	SEL Splunk ITSI Perp Lic50-99GB/dayUS	K	\$1,096
ITP-5K-9999AN-D	SEL Splunk ITSI Perp Lic5K-9999GB/dayAN	K	\$361
ITP-5K-9999AP-D	SEL Splunk ITSI Perp Lic5K-9999GB/dayAP	K	\$433
ITP-5K-9999EM-D	SEL Splunk ITSI Perp Lic5K-9999GB/dayEM	K	\$332
ITP-5K-9999US-D	SEL Splunk ITSI Perp Lic5K-9999GB/dayUS	K	\$288
ITP-LIC-1000-D	SEL Splunk ITSI Perp Bucket 1000	K	\$1,000
ITP-LIC-100-D	SEL Splunk ITSI Perp Bucket 100	K	\$100
ITP-LIC-100K-D	SEL Splunk ITSI Perp Bucket 100K	K	\$100,000
ITP-LIC-10K-D	SEL Splunk ITSI Perp Bucket 10K	K	\$10,000
ITP-LIC-1-D	SEL Splunk ITSI Perp Bucket 1	K	\$1
ITPU-100-199AN-D	SEL Splunk ITSI Perp UPG100-199GB/dayAN	K	\$865
ITPU-100-199AP-D	SEL Splunk ITSI Perp UPG100-199GB/dayAP	K	\$1,038
ITPU-100-199EM-D	SEL Splunk ITSI Perp UPG100-199GB/dayEM	K	\$796
ITPU-100-199US-D	SEL Splunk ITSI Perp UPG100-199GB/dayUS	K	\$692
ITPU-10-19AN-D	SEL Splunk ITSI Perp UPG10-19GB/dayAN	K	\$2,596
ITPU-10-19AP-D	SEL Splunk ITSI Perp UPG10-19GB/dayAP	K	\$3,115
ITPU-10-19EM-D	SEL Splunk ITSI Perp UPG10-19GB/dayEM	K	\$2,388
ITPU-10-19US-D	SEL Splunk ITSI Perp UPG10-19GB/dayUS	K	\$2,077
ITPU-1K-1999AN-D	SEL Splunk ITSI Perp UPG1K-1999GB/dayAN	K	\$433
ITPU-1K-1999AP-D	SEL Splunk ITSI Perp UPG1K-1999GB/dayAP	K	\$519
ITPU-1K-1999EM-D	SEL Splunk ITSI Perp UPG1K-1999GB/dayEM	K	\$398
ITPU-1K-1999US-D	SEL Splunk ITSI Perp UPG1K-1999GB/dayUS	K	\$346
ITPU-200-499AN-D	SEL Splunk ITSI Perp UPG200-499GB/dayAN	K	\$650
ITPU-200-499AP-D	SEL Splunk ITSI Perp UPG200-499GB/dayAP	K	\$779
ITPU-200-499EM-D	SEL Splunk ITSI Perp UPG200-499GB/dayEM	K	\$598
ITPU-200-499US-D	SEL Splunk ITSI Perp UPG200-499GB/dayUS	K	\$519
ITPU-20-49AN-D	SEL Splunk ITSI Perp UPG20-49GB/dayAN	K	\$1,947
ITPU-20-49AP-D	SEL Splunk ITSI Perp UPG20-49GB/dayAP	K	\$2,337
ITPU-20-49EM-D	SEL Splunk ITSI Perp UPG20-49GB/dayEM	K	\$1,791
ITPU-20-49US-D	SEL Splunk ITSI Perp UPG20-49GB/dayUS	K	\$1,558
ITPU2K-4999AN-D	SEL Splunk ITSI Perp UPG2K-4999GB/dayAN	K	\$397
ITPU-2K-4999AP-D	SEL Splunk ITSI Perp UPG2K-4999GB/dayAP	K	\$477
ITPU-2K-4999EM-D	SEL Splunk ITSI Perp UPG2K-4999GB/dayEM	K	\$365
ITPU-2K-4999US-D	SEL Splunk ITSI Perp UPG2K-4999GB/dayUS	K	\$317
ITPU-500-999AN-D	SEL Splunk ITSI Perp UPG500-999GB/dayAN	K	\$468
ITPU-500-999AP-D	SEL Splunk ITSI Perp UPG500-999GB/dayAP	K	\$563
ITPU-500-999EM-D	SEL Splunk ITSI Perp UPG500-999GB/dayEM	K	\$432
ITPU-500-999US-D	SEL Splunk ITSI Perp UPG500-999GB/dayUS	K	\$375
ITPU-50-99AN-D	SEL Splunk ITSI Perp UPG50-99GB/dayAN	K	\$1,371
ITPU-50-99AP-D	SEL Splunk ITSI Perp UPG50-99GB/dayAP	K	\$1,644
ITPU-50-99EM-D	SEL Splunk ITSI Perp UPG50-99GB/dayEM	K	\$1,261
ITPU-50-99US-D	SEL Splunk ITSI Perp UPG50-99GB/dayUS	K	\$1,096
ITPU-5K-9999AN-D	SEL Splunk ITSI Perp UPG5K-9999GB/dayAN	K	\$361

ITPU-5K-9999AP-D	SEL Splunk ITSI Perp UPG5K-9999GB/dayAP	K	\$433
ITPU-5K-9999EM-D	SEL Splunk ITSI Perp UPG5K-9999GB/dayEM	K	\$332
ITPU-5K-9999US-D	SEL Splunk ITSI Perp UPG5K-9999GB/dayUS	K	\$288
ITTE-100-199AN-D	SEL Splunk ITSI Term SSup100-199GB/dayAN	K	\$346
ITTE-100-199AP-D	SEL Splunk ITSI Term SSup100-199GB/dayAP	K	\$415
ITTE-100-199EM-D	SEL Splunk ITSI Term SSup100-199GB/dayEM	K	\$318
ITTE-100-199US-D	SEL Splunk ITSI Term SSup100-199GB/dayUS	K	\$277
ITTE-10-19AN-D	SEL Splunk ITSI Term SSup10-19GBAN	K	\$1,038
ITTE-10-19AP-D	SEL Splunk ITSI Term SSup10-19GBAP	K	\$1,246
ITTE-10-19EM-D	SEL Splunk ITSI Term SSup10-19GBEM	K	\$955
ITTE-10-19US-D	SEL Splunk ITSI Term SSup10-19GBUS	K	\$831
ITTE-1K-1999AN-D	SEL Splunk ITSI Term SSup1K-1999GB/dayAN	K	\$195
ITTE-1K-1999AP-D	SEL Splunk ITSI Term SSup1K-1999GB/dayAP	K	\$234
ITTE-1K-1999EM-D	SEL Splunk ITSI Term SSup1K-1999GB/dayEM	K	\$179
ITTE-1K-1999US-D	SEL Splunk ITSI Term SSup1K-1999GB/dayUS	K	\$156
ITTE-200-499AN-D	SEL Splunk ITSI Term SSup200-499GB/dayAN	K	\$267
ITTE-200-499AP-D	SEL Splunk ITSI Term SSup200-499GB/dayAP	K	\$321
ITTE-200-499EM-D	SEL Splunk ITSI Term SSup200-499GB/dayEM	K	\$246
ITTE-200-499US-D	SEL Splunk ITSI Term SSup200-499GB/dayUS	K	\$213
ITTE-20-49AN-D	SEL Splunk ITSI Term SSup20-49GBAN	K	\$779
ITTE-20-49AP-D	SEL Splunk ITSI Term SSup20-49GBAP	K	\$935
ITTE-20-49EM-D	SEL Splunk ITSI Term SSup20-49GBEM	K	\$717
ITTE-20-49US-D	SEL Splunk ITSI Term SSup20-49GBUS	K	\$623
ITTE-2K-4999AN-D	SEL Splunk ITSI Term SSup2K-4999GB/dayAN	K	\$188
ITTE-2K-4999AP-D	SEL Splunk ITSI Term SSup2K-4999GB/dayAP	K	\$225
ITTE-2K-4999EM-D	SEL Splunk ITSI Term SSup2K-4999GB/dayEM	K	\$173
ITTE-2K-4999US-D	SEL Splunk ITSI Term SSup2K-4999GB/dayUS	K	\$150
ITTE-500-999AN-D	SEL Splunk ITSI Term SSup500-999GB/dayAN	K	\$202
ITTE-500-999AP-D	SEL Splunk ITSI Term SSup500-999GB/dayAP	K	\$242
ITTE-500-999EM-D	SEL Splunk ITSI Term SSup500-999GB/dayEM	K	\$186
ITTE-500-999US-D	SEL Splunk ITSI Term SSup500-999GB/dayUS	K	\$162
ITTE-50-99AN-D	SEL Splunk ITSI Term SSup50-99GB/dayAN	K	\$548
ITTE-50-99AP-D	SEL Splunk ITSI Term SSup50-99GB/dayAP	K	\$658
ITTE-50-99EM-D	SEL Splunk ITSI Term SSup50-99GB/dayEM	K	\$504
ITTE-50-99US-D	SEL Splunk ITSI Term SSup50-99GB/dayUS	K	\$438
ITTE-5K-9999AN-D	SEL Splunk ITSI Term SSup5K-9999GB/dayAN	K	\$180
ITTE-5K-9999AP-D	SEL Splunk ITSI Term SSup5K-9999GB/dayAP	K	\$217
ITTE-5K-9999EM-D	SEL Splunk ITSI Term SSup5K-9999GB/dayEM	K	\$166
ITTE-5K-9999US-D	SEL Splunk ITSI Term SSup5K-9999GB/dayUS	K	\$144
ITTG-1K-1999AN-D	SEL Splunk ITSI Term PSup1K-1999GB/dayAN	K	\$231
ITTG-1K-1999AP-D	SEL Splunk ITSI Term PSup1K-1999GB/dayAP	K	\$277
ITTG-1K-1999EM-D	SEL Splunk ITSI Term PSup1K-1999GB/dayEM	K	\$212
ITTG-1K-1999US-D	SEL Splunk ITSI Term PSup1K-1999GB/dayUS	K	\$185
ITTG-2K-4999AN-D	SEL Splunk ITSI Term PSup2K-4999GB/dayAN	K	\$224
ITTG-2K-4999AP-D	SEL Splunk ITSI Term PSup2K-4999GB/dayAP	K	\$269
ITTG-2K-4999EM-D	SEL Splunk ITSI Term PSup2K-4999GB/dayEM	K	\$205
ITTG-2K-4999US-D	SEL Splunk ITSI Term PSup2K-4999GB/dayUS	K	\$179
ITTG-500-999AN-D	SEL Splunk ITSI Term PSup500-999GB/dayAN	K	\$246
ITTG-500-999AP-D	SEL Splunk ITSI Term PSup500-999GB/dayAP	K	\$294
ITTG-500-999EM-D	SEL Splunk ITSI Term PSup500-999GB/dayEM	K	\$226

ITTG-500-999US-D	SEL Splunk ITSI Term PSup500-999GB/dayUS	K	\$196
ITTG-5K-9999AN-D	SEL Splunk ITSI Term PSup5K-9999GB/dayAN	K	\$217
ITTG-5K-9999AP-D	SEL Splunk ITSI Term PSup5K-9999GB/dayAP	K	\$260
ITTG-5K-9999EM-D	SEL Splunk ITSI Term PSup5K-9999GB/dayEM	K	\$200
ITTG-5K-9999US-D	SEL Splunk ITSI Term PSup5K-9999GB/dayUS	K	\$173
ITT-PRM-1000-D	SEL Splunk ITSI Term PrmSup Buck 1000	K	\$1,000
ITT-PRM-100-D	SEL Splunk ITSI Term PrmSup Buck 100	K	\$100
ITT-PRM-100K-D	SEL Splunk ITSI Term PrmSup Buck 100K	K	\$100,000
ITT-PRM-10K-D	SEL Splunk ITSI Term PrmSup Buck 10K	K	\$10,000
ITT-PRM-1-D	SEL Splunk ITSI Term PrmSup Buck 1	K	\$1
ITT-STD-1000-D	SEL Splunk ITSI Term StdSup Buck 1000	K	\$1,000
ITT-STD-100-D	SEL Splunk ITSI Term StdSup Buck 100	K	\$100
ITT-STD-100K-D	SEL Splunk ITSI Term StdSup Buck 100K	K	\$100,000
ITT-STD-10K-D	SEL Splunk ITSI Term StdSup Buck 10K	K	\$10,000
ITT-STD-1-D	SEL Splunk ITSI Term StdSup Buck 1	K	\$1
ITTU-ES-1000AN-D	SEL Splunk IT TermUPG SSup Buck 1000AN	K	\$1,000
ITTU-ES-1000AP-D	SEL Splunk IT TermUPG SSup Buck 1000AP	K	\$1,000
ITTU-ES-1000EM-D	SEL Splunk IT TermUPG SSup Buck 1000EM	K	\$1,000
ITTU-ES-1000US-D	SEL Splunk IT TermUPG SSup Buck 1000US	K	\$1,000
ITTU-ES-100AN-D	SEL Splunk IT TermUPG SSup Buck 100AN	K	\$100
ITTU-ES-100AP-D	SEL Splunk IT TermUPG SSup Buck 100AP	K	\$100
ITTU-ES-100EM-D	SEL Splunk IT TermUPG SSup Buck 100EM	K	\$100
ITTU-ES-100US-D	SEL Splunk IT TermUPG SSup Buck 100US	K	\$100
ITTU-ES-1AN-D	SEL Splunk IT TermUPG SSup Buck 1AN	K	\$1
ITTU-ES-1AP-D	SEL Splunk IT TermUPG SSup Buck 1AP	K	\$1
ITTU-ES-1EM-D	SEL Splunk IT TermUPG SSup Buck 1EM	K	\$1
ITTU-ES-1US-D	SEL Splunk IT TermUPG SSup Buck 1US	K	\$1
ITTU-GS-1000AN-D	SEL Splunk IT TermUPG PSup Buck 1000AN	K	\$1,000
ITTU-GS-1000AP-D	SEL Splunk IT TermUPG PSup Buck 1000AP	K	\$1,000
ITTU-GS-1000EM-D	SEL Splunk IT TermUPG PSup Buck 1000EM	K	\$1,000
ITTU-GS-1000US-D	SEL Splunk IT TermUPG PSup Buck 1000US	K	\$1,000
ITTU-GS-100AN-D	SEL Splunk IT TermUPG PSup Buck 100AN	K	\$100
ITTU-GS-100AP-D	SEL Splunk IT TermUPG PSup Buck 100AP	K	\$100
ITTU-GS-100EM-D	SEL Splunk IT TermUPG PSup Buck 100EM	K	\$100
ITTU-GS-100US-D	SEL Splunk IT TermUPG PSup Buck 100US	K	\$100
ITTU-GS-1AN-D	SEL Splunk IT TermUPG PSup Buck 1AN	K	\$1
ITTU-GS-1AP-D	SEL Splunk IT TermUPG PSup Buck 1AP	K	\$1
ITTU-GS-1EM-D	SEL Splunk IT TermUPG PSup Buck 1EM	K	\$1
ITTU-GS-1US-D	SEL Splunk IT TermUPG PSup Buck 1US	K	\$1
IVSB-0-500	SEL SecBun+SS&Sup 1yr 1 user 500band	K	\$282
IVSB-1000-2500	SEL SecBun+SS&Sup 1yr 1 user 1001-2500	K	\$187
IVSB-10K-25K	SEL SecBun+SS&Sup 1yr 1 user 10001-25000	K	\$125
IVSB-2500-5000	SEL SecBun+SS&Sup 1yr 1 user 2501-5000	K	\$164
IVSB-25K-50K	SEL SecBun+SS&Sup 1yr 1 user 25001-50000	K	\$118
IVSB-5000-10K	SEL SecBun+SS&Sup 1yr 1 user 5001-10000	K	\$138
IVSB-500-1000	SEL SecBun+SS&Sup 1yr 1 user 501-1000	K	\$241
IVSB-OVER50K	SEL SecBun+SS&Sup 1yr 1 user 50001+	K	\$113
KIT-MEM1-1260	SEL MEMORY UPGR LIC KIT EX1260 (TO 32GB)	K	\$2,462
KIT-MEM2-1260	SEL MEMORY UPGR LIC KIT EX1260 (TO 64GB)	K	\$9,846
L-CAP2260-CAA	SEL CAS ANALYTICS LIC FOR CAP-2260-B010	K	\$49,225

L-CAP4260-CAA	SEL CAS ANALYTICS LICENSE FOR ENT PROF	K	\$86,148
LIC-ADD-100MB	SEL License 100Mbps add on-VH only	K	\$4,923
LIC-ARX3300	SEL AppResponse 3300 licenses	K	\$7,385
LIC-ARX3800	SEL AppResponse 3800 licenses	K	\$11,692
LIC-ARX4300	SEL AppResponse 4300 licenses	K	\$15,385
LIC-ARX5100	SEL AppResponse 5100 licenses	K	\$19,692
LIC-ARX6000	SEL AppResponse 6000 licenses	K	\$28,314
LIC-ARXDIR300	SEL AppResponse Director 300 licenses	K	\$5,785
LIC-CAPVE100-SDN	SEL SDN Feature License for CAP-VE-100	K	\$6,148
LIC-CAX-460-SDN	SEL SDN Feature License for CAX-460	K	\$2,455
LIC-CXA-255-H	SEL License SteelHead CX255-H	K	\$6,400
LIC-CXA-255-L	SEL License SteelHead CX255-L	K	\$1,477
LIC-CXA-255-M	SEL License SteelHead CX255-M	K	\$3,938
LIC-CXA-255-U	SEL License SteelHead CX255-U	K	\$246
LIC-CXA-570-H	SEL Lic SteelHead CX570H 10Mbps 700conn	K	\$5,292
LIC-CXA-570-L	SEL Lic SteelHead CX570L 10Mbps 275conn	K	\$985
LIC-CXA-570-M	SEL Lic SteelHead CX570M 10Mbps 450conn	K	\$3,446
LIC-CXA-770-H	SEL Lic SteelHead CX770H 30Mbps 2500conn	K	\$10,209
LIC-CXA-770-L	SEL Lic SteelHead CX770L 20Mbps 1000conn	K	\$1,594
LIC-CXA-770-M	SEL Lic SteelHead CX770M 20Mbps 1500conn	K	\$4,055
LIC-INT-09600	SEL License Steelhead INT-9600	K	\$6,154
LIC-RG-AGT-1Y	SEL RG 1Y SUBSCRIPTION 1 RG SYSTEM AGT	K	\$23
LIC-RG-AGT-3Y	SEL RG 3Y SUBSCRIPTION 1 RG SYSTEM AGT	K	\$46
LIC-RG-ORCH-1Y	SEL RG SW SUB. PER TB-BACK END VOLUME 1Y	K	\$392
LIC-RG-ORCH-3Y	SEL RG SW SUB. PER TB-BACK END VOLUME 3Y	K	\$754
LIC-RGSTACK10	SEL RG STACK10 SW FOR PRIV. CLOUD	K	\$184,615
LIC-RGSTACK5	SEL RG STACK5 SW FOR PRIV. CLOUD	K	\$138,462
LIC-RGSTACK50	SEL RG STACK50 SW FOR PRIV. CLOUD	K	\$295,385
LIC-SCAN-02170	SEL SteelCentral NetShark 2170 license	K	\$4,923
LIC-SCAN-04170	SEL SteelCentral NetShark 4170 license	K	\$9,231
LIC-SCAN-06170	SEL SteelCentral NetShark 6170 license	K	\$12,308
LIC-SCAN-SFED20	SEL NetSharkVE SteelFusionEdge2100, 2200	K	\$2,209
LIC-SCAN-SFED30	SEL NetSharkVE SteelFusionEdge3100	K	\$3,194
LIC-SCAN-SFED40	SEL NetSharkVE SteelFusionEdge3200, 5100	K	\$6,148
LIC-SCC-1000	SELLic SCC1000incl bundled20 Appliances	K	\$1,108
LIC-SCFG-2270-F1	SEL SteelCentralFlowGateway Lic 200K FPM	K	\$6,154
LIC-SCFG-2270-F2	SEL SteelCentralFlowGateway Lic 400K FPM	K	\$27,077
LIC-SCFG-2270-F3	SEL SteelCentralFlowGateway Lic 600K FPM	K	\$44,308
LIC-SCFG-2270-F4	SEL SteelCentralFlowGateway Lic 800K FPM	K	\$59,077
LIC-SCFG-2270-F5	SEL SteelCentral Flow Gateway Lic 1M FPM	K	\$72,615
LIC-SCFG-2270-F6	SEL SteelCentral Flow Gateway Lic 2M FPM	K	\$121,846
LIC-SCNE-470-F1	SEL SteelCentral NetExpress Lic 15K FPM	K	\$2,462
LIC-SCNE-470-F2	SEL SteelCentral NetExpress Lic 30K FPM	K	\$18,462
LIC-SCNE-470-F3	SEL SteelCentral NetExpress Lic 60K FPM	K	\$45,538
LIC-SCNE-470-F4	SEL SteelCentral NetExpress Lic 90K FPM	K	\$70,154
LIC-SCNE-470-F5	SEL SteelCentral NetExpress Lic 120K FPM	K	\$92,308
LIC-SCNEVE470SDN	SEL SteelCentral SDN License SCNEVE470	K	\$2,455
LICSCNP04270UIF1	SEL SteelCentralNetProfilerEnterprUILic	K	\$4,923
LIC-SCNP-2270-F1	SEL SteelCentralNetProfiler Lic 200K FPM	K	\$12,923
LIC-SCNP-2270-F2	SEL SteelCentralNetProfiler Lic 400K FPM	K	\$65,846

LIC-SCNP-2270-F3	SEL SteelCentralNetProfiler Lic 600K FPM	K	\$105,231
LIC-SCNP-2270-F4	SEL SteelCentralNetProfiler Lic 800K FPM	K	\$139,692
LIC-SCNP-2270-F5	SEL SteelCentral NetProfiler Lic 1M FPM	K	\$168,000
LIC-SCNP2270-SDN	SEL SteelCentral SDN Lic SCNP-02270-B010	K	\$6,148
LICSCNP4270AN-F1	SEL SteelCentrNetProfilerEntANLic1MFPM	K	\$18,831
LICSCNP4270DB-F1	SEL SteelCentralNetProfilerEnterpr DBLic	K	\$7,877
LIC-SCNP4270DPF1	SEL SteelCentralNetProfilerEnterpr DPLic	K	\$6,523
LIC-SCNP4270EXF1	SEL SteelCentrNetProfilerEntEXLic1MFPM	K	\$18,831
LIC-SCNP4270-SDN	SEL SteelCentralNetProfilerEnterprSDNLic	K	\$6,148
LIC-SCNP-VE-SDN	SEL SDN License for SCNP-VE-SDN	K	\$6,148
LIC-SCPS-002	SEL SCPS LICENSE ON 555 SERIES	K	\$2,455
LIC-SCPS-004	SEL SCPS License on 755/770 Series	K	\$4,302
LIC-SCPS-006	SEL SCPS Lic EX1160/SFED2100/2200	K	\$10,455
LIC-SCPS-006E	SEL EVAL SCPS LICENSE ON 1160 SERIES	K	\$0
LIC-SCPS-007	SEL SCPS Lic 1260/1360/SFED3100/3200	K	\$15,378
LIC-SCPS-008	SEL SCPS License on 1555/3070 Series	K	\$10,455
LIC-SCPS-009	SEL SCPS License on 5055/5070 Series	K	\$15,378
LIC-SCPS-010	SEL SCPS License 7055/7070/DX8000 Series	K	\$40,609
LIC-SFCR-3500-C1	SEL LIC SFCR3500, C1, 25TB, 150LUNs	K	\$9,225
LIC-SFCR-3500-C2	SEL LIC SFCR3500, C2, 50TB, 200 LUNs	K	\$19,071
LIC-SFCR-3500-C3	SEL LIC SFCR3500, C3, 100 TB, 300 LUNs	K	\$46,148
LIC-SFED-2100-W0	SEL SFED2100, BlockStream Only, Lic W0	K	\$0
LIC-SFED-2100-W1	SEL LIC SFED2100 W1 1500cxns, 20Mbps	K	\$4,923
LIC-SFED-2100-W2	SEL LIC SFED2100 W2 2500 cxns, 30Mbps	K	\$14,769
LIC-SFED-2100-W3	SEL LIC SFED2100 W3 5000 cxns, 50Mbps	K	\$29,538
LIC-SFED-2200-W0	SEL SFED2200, BlockStream Only, Lic W0	K	\$0
LIC-SFED-2200-W1	SEL LIC SFED2200 W1 1500cxns, 20Mbps	K	\$6,154
LIC-SFED-2200-W2	SEL LIC SFED2200 W2 2500 cxns, 30Mbps	K	\$12,308
LIC-SFED-2200-W3	SEL LIC SFED2200 W3 5000 cxns, 50Mbps	K	\$30,769
LIC-SFED-3100-W0	SEL LIC SFED3100 W0 BlockStream 30Mbps	K	\$0
LIC-SFED-3100-W1	SEL LIC SFED3100 W1 2500 cxns, 30Mbps	K	\$12,308
LIC-SFED-3100-W2	SEL LIC SFED3100 W2 5000 cxns, 50Mbps	K	\$24,615
LIC-SFED-3100-W3	SEL LIC SFED3100 W3 10000 cxns, 100Mbps	K	\$33,846
LIC-SFED-3200-W0	SEL LIC SFED3200 W0 BlockStream 30Mbps	K	\$0
LIC-SFED-3200-W1	SEL LIC SFED3200 W1 2500 cxns, 30Mbps	K	\$9,846
LIC-SFED-3200-W2	SEL LIC SFED3200 W2 5000 cxns, 50Mbps	K	\$27,077
LIC-SFED-3200-W3	SEL LIC SFED3200 W3 10000 cxns, 100Mbps	K	\$39,385
LIC-SFED-5100-W0	SEL LIC SFED5100 W0 BlockStream 50Mbps	K	\$0
LIC-SFED-5100-W1	SEL LIC SFED5100 W1 5000 cxns, 50Mbps	K	\$18,462
LIC-SFED-5100-W2	SEL LIC SFED5100 W2 10000 cxns, 100Mbps	K	\$30,769
LPE12000-E	SELECT SINGLE-PORT 8GB FC PCI EXPRESS	K	\$1,245
LPE12002-E	SELECT DUAL-PORT 8GB FC PCI EXPRESS	K	\$1,660
LPE16000B-E	SEL SINGLE-PORT 16GB FC PCI EXPRESS	K	\$1,670
LPE16002B-E	SEL DUAL-PORT 16GB FC PCI EXPRESS	K	\$2,199
LPE31000-M6-E	SEL SINGLE-PORT 16GB FC PCI EXPRESS - G6	K	\$1,670
LPE31002-M6-E	SEL DUAL-PORT 16GB FC PCI EXPRESS - G6	K	\$2,199
M16-2136-C0000C1	SEL-16ch. exp port,D921-936,OSC,IL=6.6dB	K	\$19,551
M16-2136-D0030C1	SEL-16ch. exp port,D921-D936,OSC,Rx EDF	K	\$30,715
M16-2136-D003AC1	SEL-D921-D936,OSC,Rx EDFA,Rx DC 40km	K	\$35,043
M16-2136-D1A3TC1	SEL-D921-D936,Tx ED,Tx D40,Rx ED,Rx TD	K	\$52,077

M-3809-921928-M	SEL-8 ch. M/Demux,D921-D928,IL=4.8dB	K	\$2,815
M-3809-929936-M	SEL-8 ch. M/Demux,D929-D936,IL=4.8dB	K	\$2,815
M-3840-LL	SEL-40 ch. M/Demux,D921-D960, IL=7.5dB	K	\$10,446
M-410	SEL-DC power supply, M-series	K	\$1,215
M-420	SEL-AC power supply, M-series	K	\$1,062
M-ADJ-19	SEL-Smartoptics 19"" AdjKit-2 8ch modul	K	\$151
MB10PB1YRSB	SELECT DFXS MB ELA, 10PB 1Yr Sub	K	\$2,160,000
MB1PB1YRSB	SELECT DFXS MB ELA, 1PB 1Yr Sub	K	\$300,600
MB3PB1YRSB	SELECT DFXS MB ELA, 3PB 1Yr Sub	K	\$702,000
MB5PB1YRSB	SELECT DFXS MB ELA, 5PB 1Yr Sub	K	\$1,125,000
MBAD1PB1YRSB	SELECT DFXS MB ELA, ADD 1PB 1Yr Sub	K	\$216,000
MBP10PB1YRSB	SELECT DFXS MBP ELA, 10PB 1Yr Sub	K	\$2,880,000
MBP1PB1YRSB	SELECT DFXS MBP ELA, 1PB 1Yr Sub	K	\$433,800
MBP3PB1YRSB	SELECT DFXS MBP ELA, 3PB 1Yr Sub	K	\$950,400
MBP5PB1YRSB	SELECT DFXS MBP ELA, 5PB 1Yr Sub	K	\$1,530,000
MBPAD1PB1YRSB	SELECT DFXS MBP ELA, ADD 1PB 1Yr Sub	K	\$288,000
ME-S-11T25T-1	SEL Mozy ENT FOR DPS 11 - 25 TB 1-YEAR	K	\$4,528
ME-S-11T25T-2	SEL Mozy ENT FOR DPS 11 - 25 TB 2-YEAR	K	\$8,630
ME-S-11T25T-3	SEL Mozy ENT FOR DPS 11 - 25 TB 3-YEAR	K	\$12,348
ME-S-1T10T-1	SEL Mozy ENT FOR DPS 1 - 10 TB 1-YEAR	K	\$4,585
ME-S-1T10T-2	SEL Mozy ENT FOR DPS 1 - 10 TB 2-YEAR	K	\$8,739
ME-S-1T10T-3	SEL Mozy ENT FOR DPS 1 - 10 TB 3-YEAR	K	\$12,503
ME-S-1T-U	SEL Mozy ENT FOR DPS 1TB UPG MONTH	K	\$459
ME-S-25T50T-1	SEL Mozy ENT FOR DPS 26 - 50 TB 1-YEAR	K	\$4,470
ME-S-25T50T-2	SEL Mozy ENT FOR DPS 26 - 50 TB 2-YEAR	K	\$8,520
ME-S-25T50T-3	SEL Mozy ENT FOR DPS 26 - 50 TB 3-YEAR	K	\$12,190
ME-S-OV50T-1	SEL Mozy ENT FOR DPS 51+ TB 1-YEAR	K	\$4,356
ME-S-OV50T-2	SEL Mozy ENT FOR DPS 51+ TB 2-YEAR	K	\$8,303
ME-S-OV50T-3	SEL Mozy ENT FOR DPS 51+ TB 3-YEAR	K	\$11,879
MIB-1YR-00000003	SEL 1YR File Metadata Bundle Up to 3PB	K	\$415,385
MIB-1YR-00000006	SEL 1YR File Metadata Bundle Up to 6PB	K	\$553,846
MIB-1YR-00000009	SEL 1YR File Metadata Bundle Up to 9PB	K	\$830,769
MIB-1YR-00000012	SEL 1YR File Metadata Bundle Up to 12PB	K	\$969,231
MIB-3YR-00000003	SEL 3YR File Metadata Bundle Up to 3PB	K	\$1,121,538
MIB-3YR-00000006	SEL 3YR File Metadata Bundle Up to 6PB	K	\$1,495,385
MIB-3YR-00000009	SEL 3YR File Metadata Bundle Up to 9PB	K	\$2,243,077
MIB-3YR-00000012	SEL 3YR File Metadata Bundle Up to 12PB	K	\$2,616,923
MIB-5YR-00000003	SEL 5YR File Metadata Bundle Up to 3PB	K	\$1,661,538
MIB-5YR-00000006	SEL 5YR File Metadata Bundle Up to 6PB	K	\$2,215,385
MIB-5YR-00000009	SEL 5YR File Metadata Bundle Up to 9PB	K	\$3,323,077
MIB-5YR-00000012	SEL 5YR File Metadata Bundle Up to 12PB	K	\$3,876,923
M-LICSCAN-SFED20	SEL SupprtNSharkVE StFusionEdg2100, 2200	K	\$317
MOZY-D-100GB-1	SEL MOZYPRO DESKTOP 100GB BUNDLE - 1 YR	K	\$587
MOZY-D-100GB-2	SEL MOZYPRO DESKTOP 100GB BUNDLE - 2 YR	K	\$1,120
MOZY-D-100GB-3	SEL MOZYPRO DESKTOP 100GB BUNDLE - 3 YR	K	\$1,600
MOZY-D-100GB-U	SEL MOZYPRO DESKTOP 100GB BUNDLE - UPG	K	\$53
MOZY-D-10GB-1	SEL MOZYPRO DESKTOP 10GB BUNDLE - 1 YEA	K	\$147
MOZY-D-10GB-2	SEL MOZYPRO DESKTOP 10GB BUNDLE - 2 YEA	K	\$280
MOZY-D-10GB-3	SEL MOZYPRO DESKTOP 10GB BUNDLE - 3 YEA	K	\$400
MOZY-D-10GB-U	SEL MOZYPRO DESKTOP 10GB BUNDLE - UPG	K	\$13

MOZY-D-1TB-1	SEL MOZYPRO DESKTOP 1TB BUNDLE - 1 YEAR	K	\$5,573
MOZY-D-1TB-2	SEL MOZYPRO DESKTOP 1TB BUNDLE - 2 YEAR	K	\$10,640
MOZY-D-1TB-3	SEL MOZYPRO DESKTOP 1TB BUNDLE - 3 YEAR	K	\$15,200
MOZY-D-1TB-U	SEL MOZYPRO DESKTOP 1TB BUNDLE - UPGRA	K	\$507
MOZY-D-250GB-1	SEL MOZYPRO DESKTOP 250GB BUNDLE - 1 YR	K	\$1,393
MOZY-D-250GB-2	SEL MOZYPRO DESKTOP 250GB BUNDLE - 2 YR	K	\$2,660
MOZY-D-250GB-3	SEL MOZYPRO DESKTOP 250GB BUNDLE - 3 YR	K	\$3,800
MOZY-D-250GB-U	SEL MOZYPRO DESKTOP 250GB BUNDLE - UPG	K	\$127
MOZY-D-2TB-1	SEL MOZYPRO DESKTOP 2TB BUNDLE - 1 YEAR	K	\$11,000
MOZY-D-2TB-2	SEL MOZYPRO DESKTOP 2TB BUNDLE - 2 YEAR	K	\$21,000
MOZY-D-2TB-3	SEL MOZYPRO DESKTOP 2TB BUNDLE - 3 YEAR	K	\$30,000
MOZY-D-2TB-U	SEL MOZYPRO DESKTOP 2TB BUNDLE - UPGRA	K	\$1,000
MOZY-D-4TB-1	SEL MOZYPRO DESKTOP 4TB BUNDLE - 1 YEAR	K	\$21,120
MOZY-D-4TB-2	SEL MOZYPRO DESKTOP 4TB BUNDLE - 2 YEAR	K	\$40,320
MOZY-D-4TB-3	SEL MOZYPRO DESKTOP 4TB BUNDLE - 3 YEAR	K	\$57,600
MOZY-D-4TB-U	SEL MOZYPRO DESKTOP 4TB BUNDLE - UPGRA	K	\$1,920
MOZY-D-500GB-1	SEL MOZYPRO DESKTOP 500GB BUNDLE - 1 YR	K	\$2,787
MOZY-D-500GB-2	SEL MOZYPRO DESKTOP 500GB BUNDLE - 2 YR	K	\$5,320
MOZY-D-500GB-3	SEL MOZYPRO DESKTOP 500GB BUNDLE - 3 YR	K	\$7,600
MOZY-D-500GB-U	SEL MOZYPRO DESKTOP 500GB BUNDLE - UPG	K	\$253
MOZY-D-50GB-1	SEL MOZYPRO DESKTOP 50GB BUNDLE - 1 YEA	K	\$293
MOZY-D-50GB-2	SEL MOZYPRO DESKTOP 50GB BUNDLE - 2 YEA	K	\$560
MOZY-D-50GB-3	SEL MOZYPRO DESKTOP 50GB BUNDLE - 3 YEA	K	\$800
MOZY-D-50GB-U	SEL MOZYPRO DESKTOP 50GB BUNDLE - UPG	K	\$27
MOZY-ENT-1	SEL MOZYENTERPRISE - 1 YEAR	K	\$85
MOZY-ENT-2	SEL MOZYENTERPRISE - 2 YEAR	K	\$162
MOZY-ENT-3	SEL MOZYENTERPRISE - 3 YEAR	K	\$228
MOZY-ENT-U	SEL MOZYENTERPRISE - UPGRADE	K	\$8
MOZY-S-100GB-1	SEL MozyPro Server 100GB Bundle - 1 Year	K	\$777
MOZY-S-100GB-2	SEL MozyPro Server 100GB Bundle - 2 Year	K	\$1,483
MOZY-S-100GB-3	SEL MozyPro Server 100GB Bundle - 3 Year	K	\$2,119
MOZY-S-100GB-U	SEL MozyPro Server 100GB Bundle - UPG	K	\$71
MOZY-S-10GB-1	SEL MozyPro Server 10GB Bundle - 1 Year	K	\$205
MOZY-S-10GB-2	SEL MozyPro Server 10GB Bundle - 2 Year	K	\$391
MOZY-S-10GB-3	SEL MozyPro Server 10GB Bundle - 3 Year	K	\$559
MOZY-S-10GB-U	SEL MozyPro Server 10TB Bundle - UPGRADE	K	\$19
MOZY-S-1TB-1	SEL MozyPro Server 1TB Bundle - 1 Year	K	\$6,013
MOZY-S-1TB-2	SEL MozyPro Server 1TB Bundle - 2 Year	K	\$11,479
MOZY-S-1TB-3	SEL MozyPro Server 1TB Bundle - 3 Year	K	\$16,399
MOZY-S-1TB-U	SEL MozyPro Server 1TB Bundle - UPGRADE	K	\$547
MOZY-S-250GB-1	SEL MozyPro Server 250GB Bundle - 1 Year	K	\$1,628
MOZY-S-250GB-2	SEL MozyPro Server 250GB Bundle - 2 Year	K	\$3,107
MOZY-S-250GB-3	SEL MozyPro Server 250GB Bundle - 3 Year	K	\$4,439
MOZY-S-250GB-U	SEL MozyPro Server 250GB Bundle - UPG	K	\$148
MOZY-S-2TB-1	SEL MozyPro Server 2TB Bundle - 1 Year	K	\$11,586
MOZY-S-2TB-2	SEL MozyPro Server 2TB Bundle - 2 Year	K	\$22,119
MOZY-S-2TB-U	SEL MozyPro Server 2TB Bundle - UPGRADE	K	\$1,053
MOZY-S-2TGB-3	SEL MozyPro Server 2TB Bundle - 3 Year	K	\$31,599
MOZY-S-4TB-1	SEL MozyPro Server 4TB Bundle - 1 Year	K	\$21,853
MOZY-S-4TB-2	SEL MozyPro Server 4TB Bundle - 2 Year	K	\$41,719

MOZY-S-4TB-3	SEL MozyPro Server 4TB Bundle - 3 Year	K	\$59,599
MOZY-S-4TB-U	SEL MozyPro Server 4TB Bundle - UPGRADE	K	\$1,987
MOZY-S-500GB-1	SEL MozyPro Server 500GB Bundle - 1 Year	K	\$3,080
MOZY-S-500GB-2	SEL MozyPro Server 500GB Bundle - 2 Year	K	\$5,879
MOZY-S-500GB-3	SEL MozyPro Server 500GB Bundle - 3 Year	K	\$8,399
MOZY-S-500GB-U	SEL MozyPro Server 500GB Bundle - UPG	K	\$280
MOZY-S-50GB-1	SEL MozyPro Server 50GB Bundle - 1 Year	K	\$396
MOZY-S-50GB-2	SEL MozyPro Server 50GB Bundle - 2 Year	K	\$755
MOZY-S-50GB-3	SEL MozyPro Server 50GB Bundle - 3 Year	K	\$1,079
MOZY-S-50GB-U	SEL MozyPro Server 50GB Bundle - UPGRADE	K	\$36
NEW-PDPRM-0	SEL Puppet Discovery Prem First 500	K	\$50
NEW-PDPRM-1000	SEL Puppet Discovery Prem Next 1500	K	\$47
NEW-PDPRM-10000	SEL Puppet Discovery Prem Next 10,000	K	\$32
NEW-PDPRM195000	SEL Puppet Discovery Prem 5000add >195K	K	\$14
NEW-PDPRM-20000	SEL Puppet Discovery Prem Next 25,000	K	\$28
NEW-PDPRM-2500	SEL Puppet Discovery Prem Next 2500	K	\$42
NEW-PDPRM-45000	SEL Puppet Discovery Prem Next 50,000	K	\$23
NEW-PDPRM-500	SEL Puppet Discovery Prem Next 500	K	\$50
NEW-PDPRM-5000	SEL Puppet Discovery Prem Next 5000	K	\$37
NEW-PDPRM-95000	SEL Puppet Discovery Prem Next 100,000	K	\$18
NEW-PDSTD-0	SEL Puppet Discovery Std First 500	K	\$38
NEW-PDSTD-1000	SEL Puppet Discovery Std Next 1500	K	\$37
NEW-PDSTD-10000	SEL Puppet Discovery Std Next 10,000	K	\$27
NEW-PDSTD195000	SEL Puppet Discovery Std 5000add >195K	K	\$12
NEW-PDSTD-20000	SEL Puppet Discovery Std Next 25,000	K	\$23
NEW-PDSTD-2500	SEL Puppet Discovery Std Next 2500	K	\$35
NEW-PDSTD-45000	SEL Puppet Discovery Std Next 50,000	K	\$19
NEW-PDSTD-500	SEL Puppet Discovery Std Next 500	K	\$38
NEW-PDSTD-5000	SEL Puppet Discovery Std Next 5000	K	\$31
NEW-PDSTD-95000	SEL Puppet Discovery Std Next 100,000	K	\$15
NEWPP4AENT-NP	SEL Pipelines-App-Ent-Node-PremSub	K	\$923
NEWPP4AENT-NS	SEL Pipelines-App-Ent-Node-StdSub	K	\$769
NEWPP4AENT-SP	SEL Pipelines-App-Ent-Server-PremSub	K	\$92,308
NEWPP4AENT-SS	SEL Pipelines-App-Ent-Server-StdSub	K	\$76,923
NEWPP4CENT-PP	SEL Pipelines-Con-Ent-Project-PremSub	K	\$923
NEWPP4CENT-PS	SEL Pipelines-Con-Ent-Project-StdSub	K	\$769
NEWPP4CENT-SP	SEL Pipelines-Con-Ent-Server-PremSub	K	\$92,308
NEWPP4CENT-SS	SEL Pipelines-Con-Ent-Server-StdSub	K	\$76,923
NIC-001-2TX	SEL 2PORT1GBE TX COPPER NIC-VSH USE ONL	K	\$1,838
NIC-002-4TX	SEL 4PORT1GBE TXCOPPER NIC EX560/760/VSH	K	\$3,992
NIC-003-4TX	SEL 4P 1GBE TX NIC CX;EX (SPARE)	K	\$3,992
NIC-003-4TX-C	SEL 4P1GBE TX COPPER NIC	K	\$3,194
NIC-003-4TXEC	SEL EVAL 4-PORT 1GBE TX COPPER NIC	K	\$3,194
NIC-004-4SX	SEL 4P 1GBE SX MULT MDE NIC-CX;EX(SPARE)	K	\$19,992
NIC-004-4SX-C	SEL 4-PORT 1GBE SX MULTI MODE FIBER NIC	K	\$15,994
NIC-005-4LX	SEL 4P 1GBE LX SGL E MDE NIC-CX;EX(SPARE)	K	\$23,069
NIC-005-4LX-C	SEL 4-PORT 1GBE LX SINGLE MODE FIBER NIC	K	\$18,455
NIC-007-2LR	SEL 2-port 10GbE LR Fiber NIC- Gen 2 Spr	K	\$26,146
NIC-007-2LR-C	SEL 2-port 10GbE LR Fiber NIC- Gen 2	K	\$20,917
NIC-008-2SR	SEL 2P10GbE SR MultiModeFiberNIC-Gen2Spr	K	\$20,762

NIC-008-2SR-C	SEL 2P 10GbE SR Mult Mode Fiber NIC-Gen2	K	\$16,609
NIC-009-2XF	SEL 2P 10G FIBER (LR;SR) REQUIRES SFP'S	K	\$19,992
NIC-009-2XF-C	SEL 2-PORT 10G FIBER (LR; SR) SFP+	K	\$15,994
NIC-01G-2LX	SEL 2-PORT 1GBE LX NIC (XX50) SPARE	K	\$7,495
NIC-01G-2LX-C	SEL 2-PORT 1GBE LX NIC (XX50) ADD-ON	K	\$9,954
NIC-01G-2SX	SEL 2-PORT 1GBE SX NIC (XX50) SPARE	K	\$6,495
NIC-01G-2SX-C	SEL 2-PORT 1GBE SX NIC (XX50) ADD-ON	K	\$8,626
NIC-01G-4LX	SEL 4-PORT 1GBE LX NIC (XX50) SPARE	K	\$14,995
NIC-01G-4LX-C	SEL 4-PORT 1GBE LX NIC (XX50) ADD-ON	K	\$19,915
NIC-01G-4SX	SEL 4-PORT 1GBE SX NIC (XX50) SPARE	K	\$12,495
NIC-01G-4SX-C	SEL 4-PORT 1GBE SX NIC (XX50) ADD-ON	K	\$17,259
NIC-01G-4TX	SEL 4-PORT 1GBE TX NIC (XX50) SPARE	K	\$2,595
NIC-01G-4TX-C	SEL 4-PORT 1GBE TX NIC (XX50) ADD-ON	K	\$3,446
NIC04-4SX-E-C	SEL EVAL 4P 1GBE SX MULT MODE FIBER NIC	K	\$15,994
NIC05-4LX-E-C	SEL EVAL 4P 1GBE LX SINGLEMODE FIBER NIC	K	\$18,455
NIC-1-001G-2LXBP	SEL Dual 1 GbE Fiber LX	K	\$9,225
NIC-1-001G-2SXBP	SEL Dual 1 GbE Fiber SX	K	\$7,994
NIC-1-001G-4LXBP	SEL Quad 1 GbE Fiber LX	K	\$18,455
NIC1-001G-4SFP-C	SEL Quad 1 GbE Fiber SFP	K	\$10,455
NIC-1-001G-4TX	SEL Quad 1 GbE Copper Base-T	K	\$2,086
NIC-1-001G-4TXBP	SEL Quad 1 GbE Copper Base-T	K	\$2,702
NIC-1-001G-4TX-C	SEL Quad 1 GbE Copper Base-T	K	\$2,086
NIC-1-010G-2LRBP	SEL Dual 10 GbE Fiber LR	K	\$20,917
NIC-1-010G-2SFPP	SEL Dual 10 GbE Fiber SFP+	K	\$11,686
NIC1-010G-2SFPPC	SEL Dual 10 GbE Fiber SFP+	K	\$11,686
NIC-1-010G-2SRBP	SEL Dual 10 GbE Fiber SR	K	\$16,609
NIC-1-010G-2TX	SEL Dual 10 GbE Copper Base-T	K	\$7,378
NIC-1-010G-2TX-C	SEL Dual 10 GbE Copper Base-T	K	\$7,378
NIC1-010G-4SFPPC	SEL Quad 10 GbE Fiber SFP+	K	\$17,840
NIC-1-010G-4TX	SEL Quad 10 GbE Copper Base-T	K	\$6,148
NIC-1-010G-4TX-C	SEL Quad 10 GbE Copper Base-T	K	\$6,148
NIC-10G-2LR-C	SEL 2-PORT 10GBE LR NIC ADD ON	K	\$22,570
NIC-10G-2SR-C	SEL 2-PORT 10GBE SR MM NIC ADD ON	K	\$17,922
NIC-CSK210G-C	SEL 2P10GBE FIBER NIC-CSK ADD ON-REQ SFP	K	\$15,994
NIC-CSK-2TX-C	SEL 2PORT 1GBE TX CAPTURE NIC-CSK ADD OF	K	\$2,455
NIC-CSK-4TX-C	SEL 4PORT 1GBE TX CAPTURE NIC-CSK ADD OF	K	\$3,686
NXDCADEP100UC	SEL NX-DC-ADEP-100-U-C)	K	\$6,600
NXDCADEP100UC-I	SEL NX-DC-ADEP-100-U-C)	K	\$7,722
NXDCADEP100UC-K	SEL NX-DC-ADEP-100-U-C)	K	\$7,420
NXDCADEP10UGC	SEL NX-DC-ADEP-10-UG-C)	K	\$660
NXDCADEP10UGC-I	SEL NX-DC-ADEP-10-UG-C)	K	\$772
NXDCADEP10UGC-K	SEL NX-DC-ADEP-10-UG-C)	K	\$742
NXDCADEPLUGC	SEL NX-DC-ADEPL-UG-C)	K	\$3,300
NXDCADEPLUGC-I	SEL NX-DC-ADEPL-UG-C)	K	\$3,861
NXDCADEPLUGC-K	SEL NX-DC-ADEPL-UG-C)	K	\$3,712
NXDCADVC	SEL NX-DC-ADVC)	K	\$5,495
NXDCADVC100C	SEL NX-DC-ADVC-100-C)	K	\$11,000
NXDCADVC100C-I	SEL NX-DC-ADVC-100-C)	K	\$12,870
NXDCADVC100C-K	SEL NX-DC-ADVC-100-C)	K	\$12,374
NXDCADVC10C	SEL NX-DC-ADVC-10-C)	K	\$1,100

NXDCADVC10C-I	SEL NX-DC-ADVC-10-C)	K	\$1,287
NXDCADVC10C-K	SEL NX-DC-ADVC-10-C)	K	\$1,237
NXDCADVC-I	SEL NX-DC-ADV-C)	K	\$6,429
NXDCADVC-K	SEL NX-DC-ADV-C)	K	\$6,179
NXDCADVLEC	SEL NX-DCADV-LE-C)	K	\$5,495
NXDCADVLEC-I	SEL NX-DCADV-LE-C)	K	\$6,429
NXDCADVLEC-K	SEL NX-DCADV-LE-C)	K	\$6,179
NXDCAKC	SEL NX-DC-AK-C)	K	\$23,995
NXDCAKC-I	SEL NX-DC-AK-C)	K	\$28,074
NXDCAKC-K	SEL NX-DC-AK-C)	K	\$27,007
NXDCENE100UGC	SEL NX-DC-ENE-100-UG-C)	K	\$2,590
NXDCENE100UGC-I	SEL NX-DC-ENE-100-UG-C)	K	\$3,030
NXDCENE100UGC-K	SEL NX-DC-ENE-100-UG-C)	K	\$2,915
NXDCENE10UGC	SEL NX-DC-ENE-10-UG-C)	K	\$259
NXDCENE10UGC-I	SEL NX-DC-ENE-10-UG-C)	K	\$303
NXDCENE10UGC-K	SEL NX-DC-ENE-10-UG-C)	K	\$292
NXDCENEPLUGC	SEL NX-DC-ENEPL-UG-C)	K	\$1,295
NXDCENEPLUGC-I	SEL NX-DC-ENEPL-UG-C)	K	\$1,515
NXDCENEPLUGC-K	SEL NX-DC-ENEPL-UG-C)	K	\$1,460
NXDCEPLADC	SEL NX-DC-EPL-AD-C)	K	\$950
NXDCEPLADC-I	SEL NX-DC-EPL-AD-C)	K	\$1,112
NXDCEPLADC-K	SEL NX-DC-EPL-AD-C)	K	\$1,069
NXDCEPLC	SEL NX-DC-EPL-C)	K	\$8,495
NXDCEPLC100C	SEL NX-DC-EPLC-100-C)	K	\$17,000
NXDCEPLC100C-I	SEL NX-DC-EPLC-100-C)	K	\$19,890
NXDCEPLC100C-K	SEL NX-DC-EPLC-100-C)	K	\$19,116
NXDCEPLC10C	SEL NX-DC-EPLC-10-C)	K	\$1,700
NXDCEPLC10C-I	SEL NX-DC-EPLC-10-C)	K	\$1,989
NXDCEPLC10C-K	SEL NX-DC-EPLC-10-C)	K	\$1,912
NXDCEPLC-I	SEL NX-DC-EPL-C)	K	\$9,939
NXDCEPLC-K	SEL NX-DC-EPL-C)	K	\$9,539
NXDCPFADVUGC	SEL NX-DC-PFADV-UG-C)	K	\$1,650
NXDCPFADVUGC-I	SEL NX-DC-PFADV-UG-C)	K	\$1,931
NXDCPFADVUGC-K	SEL NX-DC-PFADV-UG-C)	K	\$1,858
NXDCPFC	SEL NX-DC-PF-C)	K	\$3,995
NXDCPFC-I	SEL NX-DC-PF-C)	K	\$4,674
NXDCPFC-K	SEL NX-DC-PF-C)	K	\$4,494
NXDCPFEPUBLIC	SEL NX-DC-PFEPL-UG-C)	K	\$4,950
NXDCPFEPUBLIC-I	SEL NX-DC-PFEPL-UG-C)	K	\$5,792
NXDCPFEPUBLIC-K	SEL NX-DC-PFEPL-UG-C)	K	\$5,566
NXDRCB25VMC	SEL NX-DCRB-25VM-C)	K	\$15,250
NXDRCB25VMC-I	SEL NX-DCRB-25VM-C)	K	\$17,843
NXDRCB25VMC-K	SEL NX-DCRB-25VM-C)	K	\$17,124
NXDCSTADVUGC	SEL NX-DC-STADV-UG-C)	K	\$3,850
NXDCSTADVUGC-I	SEL NX-DC-STADV-UG-C)	K	\$4,505
NXDCSTADVUGC-K	SEL NX-DC-STADV-UG-C)	K	\$4,325
NXDCSTDC	SEL NX-DC-STD-C)	K	\$1,995
NXDCSTDC-I	SEL NX-DC-STD-C)	K	\$2,334
NXDCSTDC-K	SEL NX-DC-STD-C)	K	\$2,241
NXDCSTDPFUGC	SEL NX-DC-STDPF-UG-C)	K	\$2,200

NXDCSTDPFUGC-I	SEL NX-DC-STDPF-UG-C)	K	\$2,574
NXDCSTDPFUGC-K	SEL NX-DC-STDPF-UG-C)	K	\$2,471
NXDCSTEPLUGC	SEL NX-DC-STEPL-UG-C)	K	\$7,150
NXDCSTEPLUGC-I	SEL NX-DC-STEPL-UG-C)	K	\$8,366
NXDCSTEPLUGC-K	SEL NX-DC-STEPL-UG-C)	K	\$8,006
OSL-0-50PL	SEL DatAdvantage - SPOL & OD Lite PL	K	\$224
OSL-0-50TL	SEL DatAdvantage - SPOL & OD Lite TL	K	\$90
OSL-1001-1500PL	SEL DatAdvantage - SPOL & OD Lite PL	K	\$64
OSL-1001-1500TL	SEL DatAdvantage - SPOL & OD Lite TL	K	\$26
OSL-100K-150KPL	SEL DatAdvantage - SPOL & OD Lite PL	K	\$34
OSL-100K-150KTL	SEL DatAdvantage - SPOL & OD Lite TL	K	\$14
OSL-101-250PL	SEL DatAdvantage - SPOL & OD Lite PL	K	\$123
OSL-101-250TL	SEL DatAdvantage - SPOL & OD Lite TL	K	\$49
OSL-10K-20KPL	SEL DatAdvantage - SPOL & OD Lite PL	K	\$39
OSL-10K-20KTL	SEL DatAdvantage - SPOL & OD Lite TL	K	\$16
OSL-1501-2000PL	SEL DatAdvantage - SPOL & OD Lite PL	K	\$58
OSL-1501-2000TL	SEL DatAdvantage - SPOL & OD Lite TL	K	\$23
OSL-150K-PL	SEL DatAdvantage - SPOL & OD Lite PL	K	\$33
OSL-150K-TL	SEL DatAdvantage - SPOL & OD Lite TL	K	\$13
OSL-2001-2500PL	SEL DatAdvantage - SPOL & OD Lite PL	K	\$54
OSL-2001-2500TL	SEL DatAdvantage - SPOL & OD Lite TL	K	\$22
OSL-20K-35KPL	SEL DatAdvantage - SPOL & OD Lite PL	K	\$37
OSL-20K-35KTL	SEL DatAdvantage - SPOL & OD Lite TL	K	\$15
OSL-2501-4000PL	SEL DatAdvantage - SPOL & OD Lite PL	K	\$51
OSL-2501-4000TL	SEL DatAdvantage - SPOL & OD Lite TL	K	\$20
OSL-251-500PL	SEL DatAdvantage - SPOL & OD Lite PL	K	\$93
OSL-251-500TL	SEL DatAdvantage - SPOL & OD Lite TL	K	\$37
OSL-35K-50KPL	SEL DatAdvantage - SPOL & OD Lite PL	K	\$36
OSL-35K-50KTL	SEL DatAdvantage - SPOL & OD Lite TL	K	\$14
OSL-4001-6000PL	SEL DatAdvantage - SPOL & OD Lite PL	K	\$47
OSL-4001-6000TL	SEL DatAdvantage - SPOL & OD Lite TL	K	\$19
OSL-501-750PL	SEL DatAdvantage - SPOL & OD Lite PL	K	\$75
OSL-501-750TL	SEL DatAdvantage - SPOL & OD Lite TL	K	\$30
OSL-50K-100KPL	SEL DatAdvantage - SPOL & OD Lite PL	K	\$35
OSL-50K-100KTL	SEL DatAdvantage - SPOL & OD Lite TL	K	\$14
OSL-51-100PL	SEL DatAdvantage - SPOL & OD Lite PL	K	\$156
OSL-51-100TL	SEL DatAdvantage - SPOL & OD Lite TL	K	\$63
OSL-6001-8000PL	SEL DatAdvantage - SPOL & OD Lite PL	K	\$44
OSL-6001-8000TL	SEL DatAdvantage - SPOL & OD Lite TL	K	\$18
OSL-751-1000PL	SEL DatAdvantage - SPOL & OD Lite PL	K	\$70
OSL-751-1000TL	SEL DatAdvantage - SPOL & OD Lite TL	K	\$28
OSL-8001-10KPL	SEL DatAdvantage - SPOL & OD Lite PL	K	\$42
OSL-8001-10KTL	SEL DatAdvantage - SPOL & OD Lite TL	K	\$17
PC AUS	SEL Pwrcrd for RPS5/8/9/X424/X448 - AUS	K	\$48
PCEURO	SEL Pwrcrd for RPS2/3/5/9 EU version	K	\$17
PCINDIA	SEL Pwrcrd for RPS2/3/5/9 India version	K	\$40
PCJAPAN	SEL Pwrcrd for RPS2/3/5/9 Japan version	K	\$17
PCUK-EPS	SEL Pwrcrd UK 13A 250V	K	\$75
PCUSA2	SEL-PWR CRD,USA,NEMA5-15/C13, 13A, 125V	K	\$34
PE1000019999SPRM	SEL Puppet Ent 10K- 19999 nodes Prem Sub	K	\$142

PE1000019999SSTD	SEL Puppet Ent 10K- 19999 nodes Stnd Sub	K	\$118
PE10002499PL	SEL PupEnt1000-2499nodes Perpet LicOnly	K	\$337
PE10002499PPRMS	SEL PE1000-2499nodesPerpetPrmSupSub	K	\$118
PE10002499SPRM	SEL Puppet Ent 1K-2499 nodes Prem Sub	K	\$185
PE10002499SSTD	SEL Puppet Ent 1K-2499 nodes Stnd Sub	K	\$152
PE100249PL	SEL PupEnt100-249nodes Perpet LicOnly	K	\$505
PE100249PPRMS	SEL PE100-249nodesPerpetPrmSupSub	K	\$177
PE100249SPRM	SEL Puppet Ent 100-249 nodes Prem Sub	K	\$277
PE100249SSTD	SEL Puppet Ent 100-249 nodes Stnd Sub	K	\$172
PE10K19999PL	SEL PupEnt10K-19999nodes Perpet LicOnly	K	\$258
PE10K19999PPRMS	SEL PE10K-19999nodesPerpetPrmSupSub	K	\$91
PE2000049999SPRM	SEL Puppet Ent 20K- 49999 nodes Prem Sub	K	\$128
PE2000049999SSTD	SEL Puppet Ent 20K- 49999 nodes Stnd Sub	K	\$108
PE20K49999PL	SEL PupEnt20K-49999nodes Perpet LicOnly	K	\$232
PE20K49999PPRMS	SEL PE20K-49999nodesPerpetPrmSupSub	K	\$82
PE25004999PL	SEL PupEnt2500-4999nodes Perpet LicOnly	K	\$314
PE25004999PPRMS	SEL PE2500-4999nodesPerpetPrmSupSub	K	\$111
PE25004999SPRM	SEL Puppet Ent 2.5K-4999 nodes Prem Sub	K	\$172
PE25004999SSTD	SEL Puppet Ent 2.5K-4999 nodes Stnd Sub	K	\$143
PE250499PL	SEL PupEnt250-499nodes Perpet LicOnly	K	\$403
PE250499PPRMS	SEL PE250-499nodesPerpetPrmSupSub	K	\$142
PE250499SPRM	SEL Puppet Ent 250-499 nodes Prem Sub	K	\$222
PE250499SSTD	SEL Puppet Ent 250-499 nodes Stnd Sub	K	\$163
PE50009999PL	SEL PupEnt5000-9999nodes Perpet LicOnly	K	\$286
PE50009999PPRMS	SEL PE5000-9999nodesPerpetPrmSupSub	K	\$100
PE50009999SPRM	SEL Puppet Ent 5K- 9999 nodes Prem Sub	K	\$157
PE50009999SSTD	SEL Puppet Ent 5K- 9999 nodes Stnd Sub	K	\$131
PE500999PL	SEL PupEnt500-999nodes Perpet LicOnly	K	\$355
PE500999PPRMS	SEL PE500-999nodesPerpetPrmSupSub	K	\$125
PE500999SPRM	SEL Puppet Ent 500-999 nodes Prem Sub	K	\$195
PE500999SSTD	SEL Puppet Ent 500-999 nodes Stnd Sub	K	\$157
PEEHCBUNDLEDSPRM	SEL Puppet Ent Bundled-EHC Min Qty=3000	K	\$151
PE-PL	SEL Production Environment Add-on PL	K	\$15,000
PE-TL	SEL Production Environment Add-on TL	K	\$6,000
PWS-001-C	SELECT ADD ON POWER SUPPLY FOR SH1050-0	K	\$400
S10-80V4-75-32	SEL BullionS10,Intel 8880V4,7,5TB, 32GB	K	\$519,387
S10-90V4-10-64	SEL BullionS10,Intel 8890V4,10TB, 64GB	K	\$724,314
S10-90V4-75-32	SEL BullionS10,Intel 8890V4,7,5TB, 32GB	K	\$556,470
S12-80V4-9-32	SEL BullionS12,Intel 8880V4,9TB, 32GB	K	\$602,599
S12-90V4-12-64	SEL BullionS12,Intel 8890V4,12TB, 64GB	K	\$848,512
S12-90V4-9-32	SEL BullionS12,Intel 8890V4,9TB, 32GB	K	\$647,099
S14-80V4-10-32	SEL BullionS14,Intel 8880V4,10TB, 32GB	K	\$685,811
S14-90V4-10-32	SEL BullionS14,Intel 8890V4,10TB, 32GB	K	\$737,728
S14-90V4-14-64	SEL BullionS14,Intel 8890V4,14TB, 64GB	K	\$972,710
S16-80V4-12-32	SEL BullionS16,Intel 8880V4,12TB, 32GB	K	\$769,024
S16-90V4-12-32	SEL BullionS16,Intel 8890V4,12TB, 32GB	K	\$828,358
S16-90V4-12-64	SEL BullionS16,Intel 8890V4,12TB, 64GB	K	\$932,862
S16-90V4-16-64	SEL BullionS16,Intel 8890V4,16TB, 64GB	K	\$1,096,907
S2-80V4-1-32-2	SEL BullionS2,Intel 8880V4,1TB,32GB	K	\$78,356
S2-80V4-15-32-2	SEL BullionS2,Intel 8880V4,1.5TB,32GB	K	\$91,788

S2-80V4-512-32-2	SEL BullionS2,Intel 8880V4,512MB,32GB	K	\$63,027
S2-80V4-768-32-2	SEL BullionS2,Intel 8880V4,768MB,32GB	K	\$69,743
S2-90V4-2-64	SEL BullionS2,Intel 8880V4,2TB,64GB	K	\$132,773
S4-80V4-1-32-2	SEL BullionS4,Intel 8880V4,1TB,32GB	K	\$120,202
S4-80V4-15-32-2	SEL BullionS4,Intel 8880V4,1.5TB,32GB	K	\$133,633
S4-80V4-2-32-2	SEL BullionS4,Intel 8880V4,2TB,32GB	K	\$150,860
S4-80V4-3-32-2	SEL BullionS4,Intel 8880V4,3TB,32GB	K	\$177,723
S4-90V4-4-64	SEL BullionS4,Intel 8880V4,4TB,64GB	K	\$259,694
S6-80V4-4.5-32-2	SEL BullionS4,Intel 8880V4,4.5TB,32GB	K	\$261,856
S6-90V4-6-64	SEL BullionS6,Intel 8890V4,6TB, 64GB	K	\$385,151
S6ADED10UCV2	SEL ST6-ADEN-D10-UG-C)	K	\$344
S6ADED10UCV2-I	SEL ST6-ADEN-D10-UG-C)	K	\$402
S6ADED10UCV2-K	SEL ST6-ADEN-D10-UG-C)	K	\$387
S6AEN100UCV2	SEL ST6-ADEN-D100-UG-C)	K	\$3,436
S6AEN100UCV2-I	SEL ST6-ADEN-D100-UG-C)	K	\$4,020
S6AEN100UCV2-K	SEL ST6-ADEN-D100-UG-C)	K	\$3,865
S6SAD100UC	SEL ST6-STAD-D100-UG-C)	K	\$5,195
S6SAD100UC-I	SEL ST6-STAD-D100-UG-C)	K	\$6,078
S6SAD100UC-K	SEL ST6-STAD-D100-UG-C)	K	\$5,842
S6SEN100UC	SEL ST6-STEN-D100-UG-C)	K	\$8,250
S6SEN100UC-I	SEL ST6-STEN-D100-UG-C)	K	\$9,653
S6SEN100UC-K	SEL ST6-STEN-D100-UG-C)	K	\$9,309
S6SEND10UC	SEL ST6-STEN-D10-UG-C)	K	\$825
S6SEND10UC-I	SEL ST6-STEN-D10-UG-C)	K	\$965
S6SEND10UC-K	SEL ST6-STEN-D10-UG-C)	K	\$931
S8-80V4-3-32-2	SEL BullionS8,Intel 8880V4,3TB, 32GB	K	\$257,226
S8-80V4-4-32-2	SEL BullionS8,Intel 8880V4,4TB, 32GB	K	\$291,680
S8-80V4-6-32-2	SEL BullionS8,Intel 8880V4,6TB, 32GB	K	\$345,406
S8-90V4-6-32-2	SEL BullionS8,Intel 8890V4,6TB, 32GB	K	\$375,073
S8-90V4-8-64	SEL BullionS8,Intel 8890V4,8TB, 64GB	K	\$509,348
SAN-001-C	SEL SAN ATTACHED STORAGE CONN (CAP;CAX	K	\$18,455
SB365-1	SEL Spanning O365 Base 1-500	K	\$48
SB365-10001	SEL Spanning O365 Base 10001+	K	\$24
SB365-10001-3Y	SEL Spanning 3Y O365 Base 10001+	K	\$65
SB365-10001-3Y-P	SEL Spanning 3Y O365 Base 10001+ PRORTD	K	\$2
SB365-10001-P	SEL Spanning O365 Base 10001+PRORTD	K	\$2
SB365-1-3Y	SEL Spanning 3Y O365 Base 1-500	K	\$130
SB365-1-3Y-P	SEL Spanning 3Y O365 Base 1-500 PRORTD	K	\$4
SB365-1-P	SEL Spanning O365 Base 1-500 PRORATION	K	\$4
SB365-2001	SEL Spanning O365 Base 2001-5000	K	\$34
SB365-2001-3Y	SEL Spanning 3Y O365 Base 2001-5000	K	\$91
SB365-2001-3Y-P	SEL Spanning 3Y O365 Base 2001-5KPRORTD	K	\$3
SB365-2001-P	SEL Spanning O365 Base 2001-5000 PRORTD	K	\$3
SB365-5001	SEL Spanning O365 Base 5001-10000	K	\$29
SB365-5001-3Y	SEL Spanning 3Y O365 Base 5001-10000	K	\$78
SB365-5001-3Y-P	SEL Spanning 3Y O365Base5001-10K PRORTD	K	\$2
SB365-5001-P	SEL Spanning O365 Base 5001-10000 PRORTD	K	\$2
SB365-501	SEL Spanning O365 Base 501-2000	K	\$38
SB365-501-3Y	SEL Spanning 3Y O365 Base 501-2000	K	\$104
SB365-501-3Y-P	SEL Spanning 3Y O365 Base 501-2K PRORTD	K	\$3

SB365-501-P	SEL Spanning O365 Base 501-2K PRTD	K	\$3
SB4GS-1	SEL Spanning GSuite Base 1-500	K	\$48
SB4GS-10001	SEL Spanning GSuite Base 10001+	K	\$24
SB4GS-10001-3Y	SEL Spanning 3Y GSuite Base 10001+	K	\$65
SB4GS-10001-3Y-P	SEL Spanning 3Y GSte Base 10001+ PRORTD	K	\$2
SB4GS-10001-P	SEL Spanning GSuiteBase 10001+ PRORTD	K	\$2
SB4GS-1-3Y	SEL Spanning 3Y GSuite Base 1-500	K	\$130
SB4GS-1-3Y-P	SEL Spanning 3Y GSte Base 1-500 PRORTD	K	\$4
SB4GS-1-P	SEL Spanning GSuite Base 1-500 PRORATED	K	\$4
SB4GS-2001	SEL Spanning GSuite Base 2001-5000	K	\$34
SB4GS-2001-3Y	SEL Spanning 3Y GSuite Base 2001-5000	K	\$91
SB4GS-2001-3Y-P	SEL Spanning 3Y GSte Base 2001-5K PRORTD	K	\$3
SB4GS-2001-P	SEL Spanning GSuiteBase 2001-5000 PRORTD	K	\$3
SB4GS-5001	SEL Spanning GSuite Base 5001-10K	K	\$29
SB4GS-5001-3Y	SEL Spanning 3Y GSuite Base 5001-10K	K	\$78
SB4GS-5001-3Y-P	SEL Spanning 3Y GSteBase5001-10K PRORTD	K	\$2
SB4GS-5001-P	SEL Spanning GSuite Base 5001-10K PRORTD	K	\$2
SB4GS-501	SEL Spanning GSuite Base 501-2000	K	\$38
SB4GS-501-3Y	SEL Spanning 3Y GSuite Base 501-2000	K	\$104
SB4GS-501-3Y-P	SEL Spanning 3Y GSte Base 501-2K PRORTD	K	\$3
SB4GS-501-P	SEL Spanning GSuite Base 501-2000 PRORTD	K	\$3
SBSF-1	SEL Spanning BU Salesforce 1-50	K	\$48
SBSF-1001	SEL Spanning BU Salesforce 1001-5000	K	\$29
SBSF-1001-3Y	SEL Spanning BU 3Y Salesforce 1001-5000	K	\$78
SBSF-1001-3Y-P	SEL Spanning BU 3Y SFDC 1001-5K PRTD	K	\$2
SBSF-1001-P	SEL Spanning BU SFDC 1001-5K PRTD	K	\$2
SBSF-1-3Y	SEL Spanning BU 3Y Salesforce 1-50	K	\$130
SBSF-1-3Y-P	SEL Spanning BU 3Y SFDC 1-50 PRTD	K	\$4
SBSF-1-P	SEL Spanning BU SFDC 1-50 PRTD	K	\$4
SBSF-201	SEL Spanning BU Salesforce 201-1000	K	\$34
SBSF-201-3Y	SEL Spanning BU 3Y Salesforce 201-1000	K	\$91
SBSF-201-3Y-P	SEL Spanning BU 3Y SFDC 201-1000 PRORTD	K	\$3
SBSF-201-P	SEL Spanning BU SFDC 201-1000 PRTD	K	\$3
SBSF-5001	SEL Spanning BU Salesforce 5001+	K	\$24
SBSF-5001-3Y	SEL Spanning BU 3Y Salesforce 5001+	K	\$65
SBSF-5001-3Y-P	SEL Spanning BU 3Y SFDC 5001+ PRTD	K	\$2
SBSF-5001-P	SEL Spanning BU SFDC 5001+ PRTD	K	\$2
SBSF-51	SEL Spanning BU Salesforce 51-200	K	\$38
SBSF-51-3Y	SEL Spanning BU 3Y Salesforce 51-200	K	\$104
SBSF-51-3Y-P	SEL Spanning BU 3Y SFDC 51-200 PRTD	K	\$3
SBSF-51-P	SEL Spanning BU SFDC 51-200 PRTD	K	\$3
SCAN-2170-B010-C	SEL 1U8TBBBaseSteelCentNetSharkappl2170-C	K	\$25,846
SCAN-4170-B010-C	SEL 2U32TB,BaseSteelCentNetShark4170cfg	K	\$89,231
SCAN-6170-B010-C	SEL 2UBaseStlCentNetShark6170Creq1SCANSU	K	\$80,000
SCAN-SU-48TB	SEL Storage, 48TB SteelCentral NetShark	K	\$61,538
SCAN-SU-72TB	SEL Storage, 72TB SteelCentral NetShark	K	\$123,077
SCC-01000-BASE	SELSteelCentral Controller1000 Appliance	K	\$9,963
SCC-HWA-MGT-10-1	SEL SCC Add StHd Mgnt Lic 10-pack (1-4)	K	\$3,077
SCC-HWA-MGT-10-2	SEL SCC Add StHd Mgnt Lic 10-pack (5-19)	K	\$2,462
SCC-HWA-MGT-10-3	SEL SCC Add StHd Mgnt Lic 10-pk (20-44)	K	\$1,477

SCC-HWA-MGT-10-4	SEL SCC Add StHd Mgnt Lic 10-pk (45-94)	K	\$1,108
SCC-HWA-MGT-10-5	SEL SCC Add StHd Mgnt Lic 10-pk (95-194)	K	\$923
SCC-HWA-MGT-10-6	SEL SCC Add StHd Mgnt Lic 10-pk (195 up)	K	\$677
SCFG-02270-B010	SEL SteelCentrl Flow Gateway SCFG2270B010	K	\$24,609
SCFG-VE-F1	SEL SteelCentralFlow GatewayVirEd,15KFPM	K	\$3,686
SCFG-VE-F10	SEL SteelCentralFlow GatewayVirEdit,2MFPM	K	\$129,225
SCFG-VE-F2	SEL SteelCentralFlow GatewayVirEd,30KFPM	K	\$7,378
SCFG-VE-F3	SEL SteelCentralFlow GatewayVirEd,60KFPM	K	\$12,302
SCFG-VE-F4	SEL SteelCentralFlow GatewayVirEd,90KFPM	K	\$18,455
SCFG-VE-F5	SEL SteelCentralFlowGatewayVirEd,200KFPM	K	\$22,148
SCFG-VE-F6	SEL SteelCentralFlowGatewayVirEd,400KFPM	K	\$40,609
SCFG-VE-F7	SEL SteelCentralFlowGatewayVirEd,600KFPM	K	\$59,071
SCFG-VE-F8	SEL SteelCentralFlowGatewayVirEd,800KFPM	K	\$73,840
SCFG-VE-F9	SEL SteelCentrlFlow GatewayVirEdit,1MFPM	K	\$86,148
SCNE-470-B010-C	SEL SteelCentral NetExpress SCNE470-B10C	K	\$27,071
SCNE-VE-00470-F1	SEL SteelCentralNetExpressVirEdit,15KFPM	K	\$24,609
SCNE-VE-00470-F2	SEL SteelCentralNetExpressVirEdit,30KFPM	K	\$40,609
SCNE-VE-00470-F3	SEL SteelCentralNetExpressVirEdit,60KFPM	K	\$66,455
SCNE-VE-00470-F4	SEL SteelCentralNetExpressVirEdit,90KFPM	K	\$91,071
SCNE-VE-00470-F5	SEL SteelCentralNetExpressVirEd,120KFPM	K	\$108,302
SCNP-02270-B010	SEL SteelCentrl NetProfiler SCNP2270B010	K	\$116,302
SCNP-2270-B10-C	SEL SteelCentralNetProfiler SCNP2270B10C	K	\$116,302
SCNP-4270-AN-B30	SEL SteelCentrlNetProfilrEnterprANModule	K	\$169,471
SCNP4270-AN-B30C	SEL SteelCentNetProf Ent AnalysisMod Cfg	K	\$169,471
SCNP-4270-DB-B20	SEL SteelCentrlNetProfilrEnterprDBModule	K	\$70,886
SCNP-4270-DP-B50	SEL SteelCntrl Dispatch Enterprise Proflr	K	\$58,702
SCNP-4270-EX-B40	SEL SteelCentNetProfEntSCNP4270 Exp Mod	K	\$169,471
SCNP4270EX-B40-C	SEL SteelCentNetPrfirEntSCNP4270ExpMdCfg	K	\$169,471
SCNP-4270-UI-B10	SEL SteelCentlNetProf Ent UI Module	K	\$52,917
SCNP-VE-F1	SEL SteelCentrlNetProfilerVirEdit,15KFPM	K	\$11,071
SCNP-VE-F10	SEL SteelCentralNetProfilerVirEdit,2MFPM	K	\$406,148
SCNP-VE-F2	SEL SteelCentrlNetProfilerVirEdit,30KFPM	K	\$22,148
SCNP-VE-F3	SEL SteelCentrlNetProfilerVirEdit,60KFPM	K	\$41,840
SCNP-VE-F4	SEL SteelCentrlNetProfilerVirEdit,90KFPM	K	\$60,302
SCNP-VE-F5	SEL SteelCentralNetProfilerVirEd,200KFPM	K	\$92,302
SCNP-VE-F6	SEL SteelCentralNetProfilerVirEd,400KFPM	K	\$135,378
SCNP-VE-F7	SEL SteelCentralNetProfilerVirEd,600KFPM	K	\$196,917
SCNP-VE-F8	SEL SteelCentralNetProfilerVirEd,800KFPM	K	\$233,840
SCNP-VE-F9	SEL SteelCentralNetProfilerVirEdit,1MFPM	K	\$270,763
SCRTRL-FNDTN	SEL SteelCentral Portal	K	\$61,532
SCPS-001	SEL SCPS on Steelhead 250 Series	K	\$1,225
SCPS-004	SEL SCPS on Steelhead 2050 Series	K	\$10,455
SCPS-005	SEL SCPS on Steelhead 5050 Series	K	\$15,378
SCPS-006	SEL SCPS on Steelhead 6050 Series	K	\$30,148
SCPS-007	SEL SCPS on Steelhead 7050 Series	K	\$40,609
SCPS-01A	SEL SCPS on Steelhead 150 Series	K	\$1,225
SCPS-VCX-003	SEL SCPS on Virtual Steelhead 555 Series	K	\$2,455
SCPS-VCX-004	SEL SCPS on Virtual Steelhead 755 Series	K	\$4,302
SCPS-VCX-005	SEL SCPS on Virtual Steelhd 1555 Series	K	\$10,455
SCPS-VSH-001	SEL SCPS on Virtual Steelhead 250 Series	K	\$1,225

SCPS-VSH-002	SEL SCPS on Virtual Steelhead 550 Series	K	\$2,455
SCPS-VSH-003	SEL SCPS on Virtual Steelhd 1050 Series	K	\$4,302
SCPS-VSH-004	SEL SCPS on Virtual Steelhd 2050 Series	K	\$10,455
SCPS-VSH-01A	SEL SCPS on Virtual Steelhead 150 Series	K	\$1,225
SEP-100-199AN-D	SEL Splunk Ent Perp Lic 100-199GB/day AN	K	\$2,163
SEP-100-199AP-D	SEL Splunk Ent Perp Lic 100-199GB/day AP	K	\$2,596
SEP-100-199EM-D	SEL Splunk Ent Perp Lic 100-199GB/day EM	K	\$1,990
SEP-100-199US-D	SEL Splunk Ent Perp Lic 100-199GB/day US	K	\$1,731
SEP-10-19AN-D	SEL Splunk Ent Perp Lic 10-19GB/dayAN	K	\$3,606
SEP-10-19AP-D	SEL Splunk Ent Perp Lic 10-19GB/dayAP	K	\$4,327
SEP-10-19EM-D	SEL Splunk Ent Perp Lic 10-19GB/dayEM	K	\$3,317
SEP-10-19US-D	SEL Splunk Ent Perp Lic 10-19GB/dayUS	K	\$2,885
SEP-1K-1999AN-D	SEL Splunk Ent Perp Lic 1K-1999GB/day AN	K	\$1,731
SEP-1K-1999AP-D	SEL Splunk Ent Perp Lic 1K-1999GB/day AP	K	\$2,077
SEP-1K-1999EM-D	SEL Splunk Ent Perp Lic 1K-1999GB/day EM	K	\$1,592
SEP-1K-1999US-D	SEL Splunk Ent Perp Lic 1K-1999GB/day US	K	\$1,385
SEP-200-499AN-D	SEL Splunk Ent Perp Lic 200-499GB/day AN	K	\$2,019
SEP-200-499AP-D	SEL Splunk Ent Perp Lic 200-499GB/day AP	K	\$2,423
SEP-200-499EM-D	SEL Splunk Ent Perp Lic 200-499GB/day EM	K	\$1,858
SEP-200-499US-D	SEL Splunk Ent Perp Lic 200-499GB/day US	K	\$1,615
SEP-20-49AN-D	SEL Splunk Ent Perp Lic 20-49GB/dayAN	K	\$3,245
SEP-20-49AP-D	SEL Splunk Ent Perp Lic 20-49GB/dayAP	K	\$3,894
SEP-20-49EM-D	SEL Splunk Ent Perp Lic 20-49GB/dayEM	K	\$2,986
SEP-20-49US-D	SEL Splunk Ent Perp Lic 20-49GB/dayUS	K	\$2,596
SEP-2K-4999AN-D	SEL Splunk Ent Perp Lic 2K-4999GB/dayAN	K	\$1,587
SEP-2K-4999AP-D	SEL Splunk Ent Perp Lic 2K-4999GB/dayAP	K	\$1,904
SEP-2K-4999EM-D	SEL Splunk Ent Perp Lic 2K-4999GB/dayEM	K	\$1,460
SEP-2K-4999US-D	SEL Splunk Ent Perp Lic 2K-4999GB/dayUS	K	\$1,269
SEP-500-999AN-D	SEL Splunk Ent Perp Lic 500-999GB/day AN	K	\$1,875
SEP-500-999AP-D	SEL Splunk Ent Perp Lic 500-999GB/day AP	K	\$2,250
SEP-500-999EM-D	SEL Splunk Ent Perp Lic 500-999GB/day EM	K	\$1,725
SEP-500-999US-D	SEL Splunk Ent Perp Lic 500-999GB/day US	K	\$1,500
SEP-50-99AN-D	SEL Splunk Ent Perp Lic 50-99GB/day AN	K	\$2,740
SEP-50-99AP-D	SEL Splunk Ent Perp Lic 50-99GB/day AP	K	\$3,288
SEP-50-99EM-D	SEL Splunk Ent Perp Lic 50-99GB/day EM	K	\$2,521
SEP-50-99US-D	SEL Splunk Ent Perp Lic 50-99GB/day US	K	\$2,192
SEP-5K-9999AN-D	SEL Splunk Ent Perp Lic 5K-9999GB/dayAN	K	\$1,442
SEP-5K-9999AP-D	SEL Splunk Ent Perp Lic 5K-9999GB/dayAP	K	\$1,731
SEP-5K-9999EM-D	SEL Splunk Ent Perp Lic 5K-9999GB/dayEM	K	\$1,327
SEP-5K-9999US-D	SEL Splunk Ent Perp Lic 5K-9999GB/dayUS	K	\$1,154
SEP-LIC-1000-D	SEL Splunk Ent Perp Bucket 1000	K	\$1,000
SEP-LIC-100-D	SEL Splunk Ent Perp Bucket 100	K	\$100
SEP-LIC-100K-D	SEL Splunk Ent Perp Bucket 100K	K	\$100,000
SEP-LIC-10K-D	SEL Splunk Ent Perp Bucket 10K	K	\$10,000
SEP-LIC-1-D	SEL Splunk Ent Perp Bucket 1	K	\$1
SEPU-100-199AN-D	SEL Splunk Ent Perp UPG 100-199GB/dayAN	K	\$2,163
SEPU-100-199AP-D	SEL Splunk Ent Perp UPG 100-199GB/dayAP	K	\$2,596
SEPU-100-199EM-D	SEL Splunk Ent Perp UPG 100-199GB/dayEM	K	\$1,990
SEPU-100-199US-D	SEL Splunk Ent Perp UPG 100-199GB/dayUS	K	\$1,731
SEPU-10-19AN-D	SEL Splunk Ent Perp UPG 10-19GB/dayAN	K	\$3,606

SEPU-10-19AP-D	SEL Splunk Ent Perp UPG 10-19GB/dayAP	K	\$4,327
SEPU-10-19EM-D	SEL Splunk Ent Perp UPG 10-19GB/dayEM	K	\$3,317
SEPU-10-19US-D	SEL Splunk Ent Perp UPG 10-19GB/dayUS	K	\$2,885
SEPU-1K-1999AN-D	SEL Splunk Ent Perp UPG 1K-1999GB/dayAN	K	\$1,731
SEPU-1K-1999AP-D	SEL Splunk Ent Perp UPG 1K-1999GB/dayAP	K	\$2,077
SEPU-1K-1999EM-D	SEL Splunk Ent Perp UPG 1K-1999GB/dayEM	K	\$1,592
SEPU-1K-1999US-D	SEL Splunk Ent Perp UPG 1K-1999GB/dayUS	K	\$1,385
SEPU-200-499AN-D	SEL Splunk Ent Perp UPG 200-499GB/dayAN	K	\$2,019
SEPU-200-499AP-D	SEL Splunk Ent Perp UPG 200-499GB/dayAP	K	\$2,423
SEPU-200-499EM-D	SEL Splunk Ent Perp UPG 200-499GB/dayEM	K	\$1,858
SEPU-200-499US-D	SEL Splunk Ent Perp UPG 200-499GB/dayUS	K	\$1,615
SEPU-20-49AN-D	SEL Splunk Ent Perp UPG 20-49GB/dayAN	K	\$3,245
SEPU-20-49AP-D	SEL Splunk Ent Perp UPG 20-49GB/dayAP	K	\$3,894
SEPU-20-49EM-D	SEL Splunk Ent Perp UPG 20-49GB/dayEM	K	\$2,986
SEPU-20-49US-D	SEL Splunk Ent Perp UPG 20-49GB/dayUS	K	\$2,596
SEPU-2K-4999AN-D	SEL Splunk Ent Perp UPG 2K-4999GB/dayAN	K	\$1,587
SEPU-2K-4999AP-D	SEL Splunk Ent Perp UPG 2K-4999GB/dayAP	K	\$1,904
SEPU-2K-4999EM-D	SEL Splunk Ent Perp UPG 2K-4999GB/dayEM	K	\$1,460
SEPU-2K-4999US-D	SEL Splunk Ent Perp UPG 2K-4999GB/dayUS	K	\$1,269
SEPU-500-999AN-D	SEL Splunk Ent Perp UPG 500-999GB/dayAN	K	\$1,875
SEPU-500-999AP-D	SEL Splunk Ent Perp UPG 500-999GB/dayAP	K	\$2,250
SEPU-500-999EM-D	SEL Splunk Ent Perp UPG 500-999GB/dayEM	K	\$1,725
SEPU-500-999US-D	SEL Splunk Ent Perp UPG 500-999GB/dayUS	K	\$1,500
SEPU-50-99AN-D	SEL Splunk Ent Perp UPG 50-99GB/dayAN	K	\$2,740
SEPU-50-99AP-D	SEL Splunk Ent Perp UPG 50-99GB/dayAP	K	\$3,288
SEPU-50-99EM-D	SEL Splunk Ent Perp UPG 50-99GB/dayEM	K	\$2,521
SEPU-50-99US-D	SEL Splunk Ent Perp UPG 50-99GB/dayUS	K	\$2,192
SEPU-5K-9999AN-D	SEL Splunk Ent Perp UPG 5K-9999GB/dayAN	K	\$1,442
SEPU-5K-9999AP-D	SEL Splunk Ent Perp UPG 5K-9999GB/dayAP	K	\$1,731
SEPU-5K-9999EM-D	SEL Splunk Ent Perp UPG 5K-9999GB/dayEM	K	\$1,154
SEPU-5K-9999US-D	SEL Splunk Ent Perp UPG 5K-9999GB/dayUS	K	\$1,154
SETE-100-199AN-D	SEL Splunk Ent TermL SSup100-199GB/dayAN	K	\$865
SETE-100-199AP-D	SEL Splunk Ent TermL SSup100-199GB/dayAP	K	\$1,038
SETE-100-199EM-D	SEL Splunk Ent TermL SSup100-199GB/dayEM	K	\$796
SETE-100-199US-D	SEL Splunk Ent TermL SSup100-199GB/dayUS	K	\$692
SETE-10-19AN-D	SEL Splunk Ent TermL SSup10-19GB/dayAN	K	\$1,442
SETE-10-19AP-D	SEL Splunk Ent TermL SSup10-19GB/dayAP	K	\$1,731
SETE-10-19EM-D	SEL Splunk Ent TermL SSup10-19GB/dayEM	K	\$1,327
SETE-10-19US-D	SEL Splunk Ent TermL SSup10-19GB/dayUS	K	\$1,154
SETE-1K-1999AN-D	SEL Splunk Ent TermL SSup1K-1999GB/dayAN	K	\$779
SETE-1K-1999AP-D	SEL Splunk Ent TermL SSup1K-1999GB/dayAP	K	\$935
SETE-1K-1999EM-D	SEL Splunk Ent TermL SSup1K-1999GB/dayEM	K	\$717
SETE-1K-1999US-D	SEL Splunk Ent TermL SSup1K-1999GB/dayUS	K	\$623
SETE-200-499AN-D	SEL Splunk Ent TermL SSup200-499GB/dayAN	K	\$837
SETE-200-499AP-D	SEL Splunk Ent TermL SSup200-499GB/dayAP	K	\$1,004
SETE-200-499EM-D	SEL Splunk Ent TermL SSup200-499GB/dayEM	K	\$770
SETE-200-499US-D	SEL Splunk Ent TermL SSup200-499GB/dayUS	K	\$669
SETE-20-49AN-D	SEL Splunk Ent TermL SSup20-49GB/dayAN	K	\$1,298
SETE-20-49AP-D	SEL Splunk Ent TermL SSup20-49GB/dayAP	K	\$1,558
SETE-20-49EM-D	SEL Splunk Ent TermL SSup20-49GB/dayEM	K	\$1,194

SETE-20-49US-D	SEL Splunk Ent TermL SSup20-49GB/dayUS	K	\$1,038
SETE-2K-4999AN-D	SEL Splunk Ent TermL SSup2K-4999GB/dayAN	K	\$750
SETE-2K-4999AP-D	SEL Splunk Ent TermL SSup2K-4999GB/dayAP	K	\$900
SETE-2K-4999EM-D	SEL Splunk Ent TermL SSup2K-4999GB/dayEM	K	\$690
SETE-2K-4999US-D	SEL Splunk Ent TermL SSup2K-4999GB/dayUS	K	\$600
SETE-500-999AN-D	SEL Splunk Ent TermL SSup500-999GB/dayAN	K	\$808
SETE-500-999AP-D	SEL Splunk Ent TermL SSup500-999GB/dayAP	K	\$969
SETE-500-999EM-D	SEL Splunk Ent TermL SSup500-999GB/dayEM	K	\$743
SETE-500-999US-D	SEL Splunk Ent TermL SSup500-999GB/dayUS	K	\$646
SETE-50-99AN-D	SEL Splunk Ent TermL SSup50-99GB/dayAN	K	\$1,096
SETE-50-99AP-D	SEL Splunk Ent TermL SSup50-99GB/dayAP	K	\$1,315
SETE-50-99EM-D	SEL Splunk Ent TermL SSup50-99GB/dayEM	K	\$1,008
SETE-50-99US-D	SEL Splunk Ent TermL SSup50-99GB/dayUS	K	\$877
SETE-5K-9999AN-D	SEL Splunk Ent TermL SSup5K-9999GB/dayAN	K	\$721
SETE-5K-9999AP-D	SEL Splunk Ent TermL SSup5K-9999GB/dayAP	K	\$865
SETE-5K-9999EM-D	SEL Splunk Ent TermL SSup5K-9999GB/dayEM	K	\$663
SETE-5K-9999US-D	SEL Splunk Ent TermL SSup5K-9999GB/dayUS	K	\$577
SETG-1K-1999AN-D	SEL Splunk Ent TermL PSup1K-1999GB/dayAN	K	\$938
SETG-1K-1999AP-D	SEL Splunk Ent TermL PSup1K-1999GB/dayAP	K	\$1,125
SETG-1K-1999EM-D	SEL Splunk Ent TermL PSup1K-1999GB/dayEM	K	\$863
SETG-1K-1999US-D	SEL Splunk Ent TermL PSup1K-1999GB/dayUS	K	\$750
SETG-2K-4999AN-D	SEL Splunk Ent TermL PSup2K-4999GB/dayAN	K	\$901
SETG-2K-4999AP-D	SEL Splunk Ent TermL PSup2K-4999GB/dayAP	K	\$1,082
SETG-2K-4999EM-D	SEL Splunk Ent TermL PSup2K-4999GB/dayEM	K	\$830
SETG-2K-4999US-D	SEL Splunk Ent TermL PSup2K-4999GB/dayUS	K	\$721
SETG-500-999AN-D	SEL Splunk Ent TermL PSup500-999GB/dayAN	K	\$967
SETG-500-999AP-D	SEL Splunk Ent TermL PSup500-999GB/dayAP	K	\$1,160
SETG-500-999EM-D	SEL Splunk Ent TermL PSup500-999GB/dayEM	K	\$890
SETG-500-999US-D	SEL Splunk Ent TermL PSup500-999GB/dayUS	K	\$773
SETG-5K-9999AN-D	SEL Splunk Ent TermL PSup5K-9999GB/dayAN	K	\$865
SETG-5K-9999AP-D	SEL Splunk Ent TermL PSup5K-9999GB/dayAP	K	\$1,038
SETG-5K-9999EM-D	SEL Splunk Ent TermL PSup5K-9999GB/dayEM	K	\$796
SETG-5K-9999US-D	SEL Splunk Ent TermL PSup5K-9999GB/dayUS	K	\$692
SET-PRM-1000-D	SEL Splunk Ent Term PrmSup Buck 1000	K	\$1,000
SET-PRM-100-D	SEL Splunk Ent Term PrmSup Buck 100	K	\$100
SET-PRM-100K-D	SEL Splunk Ent Term PrmSup Buck 100K	K	\$100,000
SET-PRM-10K-D	SEL Splunk Ent Term PrmSup Buck 10K	K	\$10,000
SET-PRM-1-D	SEL Splunk Ent Term PrmSup Buck 1	K	\$1
SET-STD-1000-D	SEL Splunk Ent Term StdSup Buck 1000	K	\$1,000
SET-STD-100-D	SEL Splunk Ent Term StdSup Buck 100	K	\$100
SET-STD-100K-D	SEL Splunk Ent Term StdSup Buck 100K	K	\$100,000
SET-STD-10K-D	SEL Splunk Ent Term StdSup Buck 10K	K	\$10,000
SET-STD-1-D	SEL Splunk Ent Term StdSup Buck 1	K	\$1
SETU-ES-1000AN-D	SEL Splunk Ent TermUPG SSup Buck 1000AN	K	\$1,000
SETU-ES-1000AP-D	SEL Splunk Ent TermUPG SSup Buck 1000AP	K	\$1,000
SETU-ES-1000EM-D	SEL Splunk Ent TermUPG SSup Buck 1000EM	K	\$1,000
SETU-ES-1000US-D	SEL Splunk Ent TermUPG SSup Buck 1000US	K	\$1,000
SETU-ES-100AN-D	SEL Splunk Ent TermUPG SSup Buck 100AN	K	\$100
SETU-ES-100AP-D	SEL Splunk Ent TermUPG SSup Buck 100AP	K	\$100
SETU-ES-100EM-D	SEL Splunk Ent TermUPG SSup Buck 100EM	K	\$100

SETU-ES-100US-D	SEL Splunk Ent TermUPG SSup Buck 100US	K	\$100
SETU-ES-1AN-D	SEL Splunk Ent TermUPG SSup Buck 1AN	K	\$1
SETU-ES-1AP-D	SEL Splunk Ent TermUPG SSup Buck 1AP	K	\$1
SETU-ES-1EM-D	SEL Splunk Ent TermUPG SSup Buck 1EM	K	\$1
SETU-ES-1US-D	SEL Splunk Ent TermUPG SSup Buck 1US	K	\$1
SETU-GS-1000AN-D	SEL Splunk Ent TermUPG PSup Buck 1000AN	K	\$1,000
SETU-GS-1000AP-D	SEL Splunk Ent TermUPG PSup Buck 1000AP	K	\$1,000
SETU-GS-1000EM-D	SEL Splunk Ent TermUPG PSup Buck 1000EM	K	\$1,000
SETU-GS-1000US-D	SEL Splunk Ent TermUPG PSup Buck 1000US	K	\$1,000
SETU-GS-100AN-D	SEL Splunk Ent TermUPG PSup Buck 100AN	K	\$100
SETU-GS-100AP-D	SEL Splunk Ent TermUPG PSup Buck 100AP	K	\$100
SETU-GS-100EM-D	SEL Splunk Ent TermUPG PSup Buck 100EM	K	\$100
SETU-GS-100US-D	SEL Splunk Ent TermUPG PSup Buck 100US	K	\$100
SETU-GS-1AN-D	SEL Splunk Ent TermUPG PSup Buck 1AN	K	\$1
SETU-GS-1AP-D	SEL Splunk Ent TermUPG PSup Buck 1AP	K	\$1
SETU-GS-1EM-D	SEL Splunk Ent TermUPG PSup Buck 1EM	K	\$1
SETU-GS-1US-D	SEL Splunk Ent TermUPG PSup Buck 1US	K	\$1
SFCR-3500-B010	SEL SteelFusion Core, SFCR3500	K	\$40,000
SFCR-3500-B010-C	SEL SteelFusion Core, SFCR3500	K	\$40,000
SFED-2100-B010	SEL SteelFusion Edge SFED 2100	K	\$19,686
SFED-2100-B010-C	SEL SteelFusion Edge SFED 2100-C	K	\$19,686
SFED-2200-B010	SEL SteelFusion Edge SFED 2200	K	\$30,763
SFED-2200-B010-C	SEL SteelFusion Edge SFED 2200-C	K	\$30,763
SFED-3100-B010	SEL SteelFusion Edge SFED 3100	K	\$49,225
SFED-3100-B010-C	SEL SteelFusion Edge SFED 3100-C	K	\$49,225
SFED-3200-B010	SEL SteelFusion Edge SFED 3200	K	\$73,840
SFED-3200-B010-C	SEL SteelFusion Edge SFED 3200-C	K	\$73,840
SFED-5100-B010	SEL SteelFusion Edge SFED 5100	K	\$116,917
SFED-5100-B010-C	SEL SteelFusion Edge SFED 5100-C	K	\$116,917
SFP-003-LR	SEL Long Reach 10GbE SFP+ module	K	\$1,785
SFP-004-SR	SEL Short Reach 10GbE SFP+ module	K	\$1,046
SFP-005-TX	SEL Copper 1GbE SFP module	K	\$615
SFP-006-LX	SEL Long haul 1GbE fiber SFP module	K	\$732
SFP-007-SX	SEL Short haul 1GbE fiber SFP module	K	\$486
SH10-80V4-75-32	SEL S10,Intel 8880V4,7.5T,32GB,VNX16Gbps	K	\$693,056
SH10-90V4-10-64	SEL S10,Intel 8890V4,10TB, 64G,VNX16Gbps	K	\$933,556
SH10-90V4-75-32	SEL S10,Intel 8890V4,7.5T, 32G,VNX16Gbps	K	\$768,898
SH12-80V4-9-32	SEL S12,Intel 8880V4,9TB, 32G,VNX16Gbps	K	\$795,861
SH12-90V4-12-64	SEL S12,Intel 8890V4,12TB, 64G,VNX16Gbps	K	\$1,083,126
SH12-90V4-9-32	SEL S12,Intel 8890V4,9TB, 32G,VNX16Gbps	K	\$828,902
SH14-80V4-10-32	SEL S14,Intel 8880V4,10TB, 32G,VNX16Gbps	K	\$901,654
SH14-90V4-10-32	SEL S14,Intel 8890V4,10TB, 32G,VNX16Gbps	K	\$942,076
SH14-90V4-14-64	SEL S14,Intel 8890V4,14TB, 64G,VNX16Gbps	K	\$1,227,969
SH16-80V4-12-32	SEL S16,Intel 8880V4,12TB, 32G,VNX16Gbps	K	\$1,010,238
SH16-90V4-12-32	SEL S16,Intel 8890V4,12TB, 32G,VNX16Gbps	K	\$1,069,573
SH16-90V4-12-64	SEL S16,Intel 8890V4,12TB, 64G,VNX16Gbps	K	\$1,208,346
SH16-90V4-16-64	SEL S16,Intel 8890V4,16TB, 64G,VNX16Gbps	K	\$1,373,695
SH2-80V4-1-32	SEL S2,Intel 8880V4,1TB,32G, VNX16Gbps	K	\$180,378
SH2-80V4-15-32	SEL S2,Intel 8880V4,1.5TB,32G, VNX16Gbps	K	\$193,809
SH2-80V4-512-32	SEL S2,Intel 8880V4,512MB,32G,VNX16Gbps	K	\$165,047

SH2-80V4-768-32	SEL S2,Intel 8880V4,768MB,32G,VNX16Gbps	K	\$171,763
SH2-90V4-2-64	SEL S2,Intel 8880V4,2TB,64G,VNX16Gbps	K	\$234,795
SH-458-000-408	CloudLink SecVM PSMC Sub Tier 1=IB	K	\$59
SH-458-000-409	CloudLink SecVM PSMC Sub Tier 2=IB	K	\$48
SH-458-000-410	CloudLink SecVM PSMC Sub Tier 3=IB	K	\$42
SH-458-000-411	CloudLink SecVM PSMC Sub Tier 4=IB	K	\$32
SH-458-000-412	CloudLink SecVM PSPlus Sub Tier 1=IB	K	\$60
SH-458-000-413	CloudLink SecVM PSPlus Sub Tier 2=IB	K	\$49
SH-458-000-414	CloudLink SecVM PSPlus Sub Tier 3=IB	K	\$42
SH-458-000-415	CloudLink SecVM PSPlus Sub Tier 4=IB	K	\$33
SH4-80V4-1-32	SEL S4,Intel 8880V4,1TB,32G,VNX16Gbps	K	\$221,734
SH4-80V4-15-32	SEL S4,Intel 8880V4,1.5TB,32G,VNX16Gbps	K	\$234,947
SH4-80V4-2-32-2	SEL S4,Intel 8880V4,2TB,32GB,VNX16Gbps	K	\$256,321
SH4-80V4-3-32-2	SEL S4,Intel 8880V4,3TB,32G,VNX16Gbps	K	\$283,184
SH4-90V4-4-64	SEL S4,Intel 8880V4,4TB,64G,VNX16Gbps	K	\$365,155
SH6-80V4-4.532-2	SEL S4,Intel 8880V4,4.5TB,32G,VNX16Gbps	K	\$392,671
SH6-90V4-6-64	SEL S6,Intel 8890V4,6TB, 64G,VNX16Gbps	K	\$515,628
SH8-80V4-3-32-2	SEL S8,Intel 8880V4,3TB, 32G,VNX16Gbps	K	\$368,927
SH8-80V4-4-32-2	SEL S8,Intel 8880V4,4TB, 32G,VNX16Gbps	K	\$403,382
SH8-80V4-6-32-2	SEL S8,Intel 8880V4,6TB, 32G,VNX16Gbps	K	\$490,371
SH8-90V4-6-32-2	SEL S8,Intel 8890V4,6TB, 32GB,VNX16Gbps	K	\$519,511
SH8-90V4-8-64	SEL S8,Intel 8890V4,8TB, 64GB,VNX16Gbps	K	\$678,577
SMC-U-10-1	SELECT 10 SH MOBILE USER LIC (0-1)	K	\$2,449
SMC-U-10-10	SELECT 10 SH MOBILE USER LIC (1001-2000)	K	\$1,452
SMC-U-10-11	SELECT 10 SH MOBILE USER LIC (2001-5000)	K	\$1,415
SMC-U-10-2	SELECT 10 SH MOBILE USER LIC (2-3)	K	\$2,425
SMC-U-10-3	SELECT 10 SH MOBILE USER LIC (4-10)	K	\$2,400
SMC-U-10-4	SELECT 10 SH MOBILE USER LIC (11-25)	K	\$2,055
SMC-U-10-5	SELECT 10 SH MOBILE USER LIC (26-50)	K	\$2,031
SMC-U-10-6	SELECT 10 SH MOBILE USER LIC (51-100)	K	\$1,969
SMC-U-10-7	SELECT 10 SH MOBILE USER LIC (101-200)	K	\$1,908
SMC-U-10-8	SELECT 10 SH MOBILE USER LIC (201-500)	K	\$1,538
SMC-U-10-9	SELECT 10 SH MOBILE USER LIC (501-1000)	K	\$1,477
SMC-VRT-V100	SEL VirtualSMC manage10 concurrent users	K	\$7,378
SOL-0-50PL	SEL DatAdvantage - SPOL Lite PL	K	\$149
SOL-0-50TL	SEL DatAdvantage - SPOL Lite TL	K	\$60
SOL-1001-1500PL	SEL DatAdvantage - SPOL Lite PL	K	\$43
SOL-1001-1500TL	SEL DatAdvantage - SPOL Lite TL	K	\$17
SOL-100K-150KPL	SEL DatAdvantage - SPOL Lite PL	K	\$23
SOL-100K-150KTL	SEL DatAdvantage - SPOL Lite TL	K	\$9
SOL-101-250PL	SEL DatAdvantage - SPOL Lite PL	K	\$82
SOL-101-250TL	SEL DatAdvantage - SPOL Lite TL	K	\$33
SOL-10K-20KPL	SEL DatAdvantage - SPOL Lite PL	K	\$26
SOL-10K-20KTL	SEL DatAdvantage - SPOL Lite TL	K	\$11
SOL-1501-2000PL	SEL DatAdvantage - SPOL Lite PL	K	\$39
SOL-1501-2000TL	SEL DatAdvantage - SPOL Lite TL	K	\$15
SOL-150K-PL	SEL DatAdvantage - SPOL Lite PL	K	\$22
SOL-150K-TL	SEL DatAdvantage - SPOL Lite TL	K	\$9
SOL-2001-2500PL	SEL DatAdvantage - SPOL Lite PL	K	\$36
SOL-2001-2500TL	SEL DatAdvantage - SPOL Lite TL	K	\$14

SOL-20K-35KPL	SEL DatAdvantage - SPOL Lite PL	K	\$25
SOL-20K-35KTL	SEL DatAdvantage - SPOL Lite TL	K	\$10
SOL-2501-4000PL	SEL DatAdvantage - SPOL Lite PL	K	\$34
SOL-2501-4000TL	SEL DatAdvantage - SPOL Lite TL	K	\$14
SOL-251-500PL	SEL DatAdvantage - SPOL Lite PL	K	\$62
SOL-251-500TL	SEL DatAdvantage - SPOL Lite TL	K	\$25
SOL-35K-50KPL	SEL DatAdvantage - SPOL Lite PL	K	\$24
SOL-35K-50KTL	SEL DatAdvantage - SPOL Lite TL	K	\$10
SOL-4001-6000PL	SEL DatAdvantage - SPOL Lite PL	K	\$32
SOL-4001-6000TL	SEL DatAdvantage - SPOL Lite TL	K	\$13
SOL-501-750PL	SEL DatAdvantage - SPOL Lite PL	K	\$50
SOL-501-750TL	SEL DatAdvantage - SPOL Lite TL	K	\$20
SOL-50K-100KPL	SEL DatAdvantage - SPOL Lite PL	K	\$23
SOL-50K-100KTL	SEL DatAdvantage - SPOL Lite TL	K	\$9
SOL-51-100PL	SEL DatAdvantage - SPOL Lite PL	K	\$104
SOL-51-100TL	SEL DatAdvantage - SPOL Lite TL	K	\$42
SOL-6001-8000PL	SEL DatAdvantage - SPOL Lite PL	K	\$29
SOL-6001-8000TL	SEL DatAdvantage - SPOL Lite TL	K	\$12
SOL-751-1000PL	SEL DatAdvantage - SPOL Lite PL	K	\$47
SOL-751-1000TL	SEL DatAdvantage - SPOL Lite TL	K	\$19
SOL-8001-10KPL	SEL DatAdvantage - SPOL Lite PL	K	\$28
SOL-8001-10KTL	SEL DatAdvantage - SPOL Lite TL	K	\$11
ST6ADC	SEL ST6-AD-C)	K	\$4,115
ST6ADC-I	SEL ST6-AD-C)	K	\$4,815
ST6ADC-K	SEL ST6-AD-C)	K	\$4,624
ST6ADD100C	SEL ST6-AD-D100-C)	K	\$10,250
ST6ADD100C-I	SEL ST6-AD-D100-C)	K	\$11,993
ST6ADD100C-K	SEL ST6-AD-D100-C)	K	\$11,531
ST6ADD10C	SEL ST6-AD-D10-C)	K	\$1,025
ST6ADD10C-I	SEL ST6-AD-D10-C)	K	\$1,199
ST6ADD10C-K	SEL ST6-AD-D10-C)	K	\$1,153
ST6ADENUGC	SEL ST6-AD-EN-UG-C)	K	\$1,700
ST6ADENUGC-I	SEL ST6-AD-EN-UG-C)	K	\$1,989
ST6ADENUGC-K	SEL ST6-AD-EN-UG-C)	K	\$1,912
ST6EDHA100C	SEL ST6-ED-HA100-C)	K	\$3,400
ST6EDHA100C-I	SEL ST6-ED-HA100-C)	K	\$3,978
ST6EDHA100C-K	SEL ST6-ED-HA100-C)	K	\$3,819
ST6EDHA100F	SEL: ST6-ED-HA100-F	K	\$3,630
ST6EDHA10C	SEL ST6-ED-HA10-C)	K	\$340
ST6EDHA10C-I	SEL ST6-ED-HA10-C)	K	\$398
ST6EDHA10C-K	SEL ST6-ED-HA10-C)	K	\$382
ST6EDHA10F	SEL: ST6-ED-HA10-F	K	\$363
ST6ENC	SEL ST6-EN-C)	K	\$5,655
ST6ENC-I	SEL ST6-EN-C)	K	\$6,616
ST6ENC-K	SEL ST6-EN-C)	K	\$6,355
ST6END100C	SEL ST6-EN-D100-C)	K	\$13,000
ST6END100C-I	SEL ST6-EN-D100-C)	K	\$15,210
ST6END100C-K	SEL ST6-EN-D100-C)	K	\$14,595
ST6END10C	SEL ST6-EN-D10-C)	K	\$1,300
ST6END10C-I	SEL ST6-EN-D10-C)	K	\$1,521

ST6END10C-K	SEL ST6-EN-D10-C)	K	\$1,460
ST6RB25VMC	SEL ST6-RB-25VM-C)	K	\$12,850
ST6RB25VMC-I	SEL ST6-RB-25VM-C)	K	\$15,035
ST6RB25VMC-K	SEL ST6-RB-25VM-C)	K	\$14,442
ST6-RB-25VM-F	SEL: ST6-RB-25VM-F	K	\$13,750
ST6RBAD25C	SEL ST6-RBAD-25-C)	K	\$20,550
ST6RBAD25C-I	SEL ST6-RBAD-25-C)	K	\$24,044
ST6RBAD25C-K	SEL ST6-RBAD-25-C)	K	\$23,100
ST6-RBAD-25-F	SEL: ST6-RBAD-25-F	K	\$22,000
ST6RBADEN25UGF	SEL: ST6-RB-ADEN-25-UG-F	K	\$9,075
ST6RBADV25UGF	SEL: ST6-RB-ADV-25-UG-F	K	\$9,075
ST6RBEN25C	SEL ST6-RBEN-25-C)	K	\$28,350
ST6RBEN25C-I	SEL ST6-RBEN-25-C)	K	\$33,170
ST6RBEN25C-K	SEL ST6-RBEN-25-C)	K	\$31,834
ST6RBEN25F	SEL: ST6-RBEN-25-F	K	\$30,250
ST6RBEN25UGC	SEL ST6-RBEN-25-UG-C)	K	\$17,050
ST6RBEN25UGC-I	SEL ST6-RBEN-25-UG-C)	K	\$19,949
ST6RBEN25UGC-K	SEL ST6-RBEN-25-UG-C)	K	\$19,192
ST6RBEN25UGF	SEL: ST6-RBEN-25-UG-F	K	\$18,150
ST6STADD10UC	SEL ST6-STAD-D10-UG-C)	K	\$525
ST6STADD10UC-I	SEL ST6-STAD-D10-UG-C)	K	\$614
ST6STADD10UC-K	SEL ST6-STAD-D10-UG-C)	K	\$590
ST6STADUC	SEL ST6-ST-AD-UG-C)	K	\$1,704
ST6STADUC-I	SEL ST6-ST-AD-UG-C)	K	\$1,994
ST6STADUC-K	SEL ST6-ST-AD-UG-C)	K	\$1,919
ST6STENUC	SEL ST6-ST-EN-UG-C)	K	\$3,399
ST6STENUC-I	SEL ST6-ST-EN-UG-C)	K	\$3,977
ST6STENUC-K	SEL ST6-ST-EN-UG-C)	K	\$3,819
ST6VSANBNC	SEL ST6-VSAN-BN-C)	K	\$14,970
ST6VSANBNC-I	SEL ST6-VSAN-BN-C)	K	\$17,515
ST6VSANBNC-K	SEL ST6-VSAN-BN-C)	K	\$16,817
ST6VSANC	SEL ST6-VSAN-C)	K	\$2,565
ST6VSANC-I	SEL ST6-VSAN-C)	K	\$3,001
ST6VSANC-K	SEL ST6-VSAN-C)	K	\$2,885
ST6VSAVSANUGC	SEL ST6-VSA-VSAN-UG-C)	K	\$11,715
ST6VSAVSANUGC-I	SEL ST6-VSA-VSAN-UG-C)	K	\$13,707
ST6VSAVSANUGC-K	SEL ST6-VSA-VSAN-UG-C)	K	\$13,140
ST6VSDT100C	SEL ST6-VSDT100-C)	K	\$5,500
ST6VSDT100C-I	SEL ST6-VSDT100-C)	K	\$6,435
ST6VSDT100C-K	SEL ST6-VSDT100-C)	K	\$6,179
ST6VSDT10C	SEL ST6-VSDT10-C)	K	\$550
ST6VSDT10C-I	SEL ST6-VSDT10-C)	K	\$644
ST6VSDT10C-K	SEL ST6-VSDT10-C)	K	\$618
STRADE25UGC	SEL ST6-RB-ADEN-25-UG-C)	K	\$8,580
STRADE25UGC-I	SEL ST6-RB-ADEN-25-UG-C)	K	\$10,039
STRADE25UGC-K	SEL ST6-RB-ADEN-25-UG-C)	K	\$9,615
STRBAD25UC	SEL ST6-RB-ADV-25-UG-C)	K	\$8,470
STRBAD25UC-I	SEL ST6-RB-ADV-25-UG-C)	K	\$9,910
STRBAD25UC-K	SEL ST6-RB-ADV-25-UG-C)	K	\$9,539
SUB-RG-GB-Y	SEL RG ANNUAL SUBSC FOR 1 GB IN RG CLOUD	K	\$18

SUB-RG-TB-Y	SEL RG ANNUAL SUBSC FOR 1 TB IN RG CLOUD	K	\$8,308
SYNCCD-STG-T1-1Y	SEL Sync EE CLD Storage 1-10 TB 1 yr	K	\$2,160
SYNCCD-STG-T1-2Y	SEL Sync EE CLD Storage 1-10 TB 2 yr	K	\$4,104
SYNCCD-STG-T1-3Y	SEL Sync EE CLD Storage 1-10 TB 3 yr	K	\$5,832
SYNCCD-STG-T2-1Y	SEL Sync EE CLD Storage 11-100 TB 1 yr	K	\$1,800
SYNCCD-STG-T2-2Y	SEL Sync EE CLD Storage 11-100 TB 2 yr	K	\$3,420
SYNCCD-STG-T2-3Y	SEL Sync EE CLD Storage 11-100 TB 3 yr	K	\$4,860
SYNCCD-STG-T3-1Y	SEL Sync EE CLD Storage 101-1,000 TB 1yr	K	\$1,620
SYNCCD-STG-T3-2Y	SEL Sync EE CLD Storage 101-1,000 TB 2yr	K	\$3,078
SYNCCD-STG-T3-3Y	SEL Sync EE CLD Storage 101-1,000 TB 3yr	K	\$4,374
SYNCCD-STG-T4-1Y	SEL Sync EE CLD Storage 1,001 TB+ 1yr	K	\$1,440
SYNCCD-STG-T4-2Y	SEL Sync EE CLD Storage 1,001 TB+ 2 yr	K	\$2,736
SYNCCD-STG-T4-3Y	SEL Sync EE CLD Storage 1,001 TB+ 3 yr	K	\$3,888
SYNC-EE-T1-1Y	SEL Sync EE 25-1,000 sts 1 yr	K	\$150
SYNC-EE-T1-2Y	SEL Sync EE 25-1,000 sts 2 yr	K	\$286
SYNC-EE-T1-3Y	SEL Sync EE 25-1,000 sts 3 yr	K	\$405
SYNC-EE-T2-1Y	SEL Sync EE 1,001-5,000 sts 1 yr	K	\$120
SYNC-EE-T2-2Y	SEL Sync EE 1,001-5,000 sts 2 yr	K	\$228
SYNC-EE-T2-3Y	SEL Sync EE 1,001-5,000 sts 3 yr	K	\$324
SYNC-EE-T3-1Y	SEL Sync EE 5,001-10,000 sts 1 yr	K	\$96
SYNC-EE-T3-2Y	SEL Sync EE 5,001-10,000 sts 2 yr	K	\$182
SYNC-EE-T3-3Y	SEL Sync EE 5,001-10,000 sts 3 yr	K	\$258
SYNC-EE-T4-1Y	SEL Sync EE 10,001+ sts 1 yr	K	\$85
SYNC-EE-T4-2Y	SEL Sync EE 10,001+ sts 2 yr	K	\$160
SYNC-EE-T4-3Y	SEL Sync EE 10,001+ sts 3 yr	K	\$225
SYNC-GV-EE-T1-1Y	SEL Sync Gov EE 25-1,000 sts 1 yr	K	\$225
SYNC-GV-EE-T1-2Y	SEL Sync Gov EE 25-1,000 sts 2 yr	K	\$429
SYNC-GV-EE-T1-3Y	SEL Sync Gov EE 25-1,000 sts 3 yr	K	\$608
SYNC-GV-EE-T2-1Y	SEL Sync Gov EE 1,001-5,000 sts 1 yr	K	\$180
SYNC-GV-EE-T2-2Y	SEL Sync Gov EE 1,001-5,000 sts 2 yr	K	\$342
SYNC-GV-EE-T2-3Y	SEL Sync Gov EE 1,001-5,000 sts 3 yr	K	\$486
SYNC-GV-EE-T3-1Y	SEL Sync Gov EE 5,001-10,000 sts 1 yr	K	\$144
SYNC-GV-EE-T3-2Y	SEL Sync Gov EE 5,001-10,000 sts 2 yr	K	\$273
SYNC-GV-EE-T3-3Y	SEL Sync Gov EE 5,001-10,000 sts 3 yr	K	\$387
SYNC-GV-EE-T4-1Y	SEL Sync Gov EE 10,001+ sts 1 yr	K	\$128
SYNC-GV-EE-T4-2Y	SEL Sync Gov EE 10,001+ sts 2 yr	K	\$240
SYNC-GV-EE-T4-3Y	SEL Sync Gov EE 10,001+ sts 3 yr	K	\$338
SYNC-GV-ST-T1-1Y	SEL Sync Gov EE CLD STG 1-10 TB 1 yr	K	\$3,240
SYNC-GV-ST-T1-2Y	SEL Sync Gov EE CLD STG 1-10 TB 2 yr	K	\$6,156
SYNC-GV-ST-T1-3Y	SEL Sync Gov EE CLD STG 1-10 TB 3 yr	K	\$8,748
SYNC-GV-ST-T2-1Y	SEL Sync Gov EE CLD STG 11-100 TB 1 yr	K	\$2,700
SYNC-GV-ST-T2-2Y	SEL Sync Gov EE CLD STG 11-100 TB 2 yr	K	\$5,130
SYNC-GV-ST-T2-3Y	SEL Sync Gov EE CLD STG 11-100 TB 3 yr	K	\$7,290
SYNC-GV-ST-T3-1Y	SEL Sync Gov EE CLD STG 101-1,000 TB 1yr	K	\$2,430
SYNC-GV-ST-T3-2Y	SEL Sync Gov EE CLD STG 101-1,000 TB 2yr	K	\$4,617
SYNC-GV-ST-T3-3Y	SEL Sync Gov EE CLD STG 101-1,000 TB 3yr	K	\$6,561
SYNC-GV-ST-T4-1Y	SEL Sync Gov EE CLD STG 1,001 TB+ 1 yr	K	\$2,160
SYNC-GV-ST-T4-2Y	SEL Sync Gov EE CLD STG 1,001 TB+ 2 yr	K	\$4,104
SYNC-GV-ST-T4-3Y	SEL Sync Gov EE CLD STG 1,001 TB+ 3 yr	K	\$5,832
SYNC-S1-EE-1Y	SEL Sync EE 1-10TB 1 yr	K	\$26,125

SYNC-S1-EE-2Y	SEL Sync EE 1-10TB 2 yr	K	\$49,775
SYNC-S1-EE-3Y	SEL Sync EE 1-10TB 3 yr	K	\$71,225
T120-6-H-A-2-30	SEL: T120BUNDLE 2 LTO-6 HH SAS 30S	K	\$37,890
T120-6HA-2-50	SEL: T120BUNDLE,2 LTO-6,HH,SAS,50S	K	\$39,198
T120-6HA-3-50	SEL: T120BUNDLE,3 LTO-6,HH,SAS,50S	K	\$50,019
T120-6HA-4-50	SEL: T120BUNDLE,4 LTO-6,HH,SAS,50S	K	\$61,788
T120-6-H-F-2-30	SEL: T120BUNDLE 2 LTO-6 HH FC 30S	K	\$43,088
T120-6HF-2-50	SEL: T120BUNDLE,2 LTO-6,HH,FC,50S	K	\$44,396
T120-6HF-3-50	SEL: T120BUNDLE,3 LTO-6,HH,FC,50S	K	\$56,198
T120-6HF-4-50	SEL: T120BUNDLE,4 LTO-6,HH,FC,50S	K	\$68,556
T120-7-H-A-2-30	SEL: T120BUNDLE,2 LTO-7,HH,SAS,30S	K	\$39,885
T120-7-H-A-2-50	SEL: T120BUNDLE,2 LTO-7,HH,SAS,50S	K	\$39,885
T120-7-H-A-3-50	SEL: T120BUNDLE,3 LTO-7,HH,SAS,50S	K	\$52,177
T120-7-H-A-4-50	SEL: T120BUNDLE,4 LTO-7,HH,SAS,50S	K	\$63,423
T120-7-H-F-2-30	SEL: T120BUNDLE,2 LTO-7,HH,FC,30S	K	\$45,638
T120-7-H-F-2-50	SEL: T120BUNDLE,2 LTO-7,HH,FC,50S	K	\$45,769
T120-7-H-F-3-50	SEL: T120BUNDLE,3 LTO-7,HH,FC,50S	K	\$58,192
T120-7-H-F-4-50	SEL: T120BUNDLE,4 LTO-7,HH,FC,50S	K	\$70,485
T120-8-H-A-2-30	SEL: T120BUNDLE,2 LTO-8,HH,SAS,30S	K	\$45,115
T120-8-H-A-2-50	SEL: T120BUNDLE,2 LTO-8,HH,SAS,50S	K	\$47,077
T120-8-H-A-3-50	SEL: T120BUNDLE,3 LTO-8,HH,SAS,50S	K	\$61,462
T120-8-H-A-4-50	SEL: T120BUNDLE,4 LTO-8,HH,SAS,50S	K	\$76,500
T120-8-H-F-2-30	SEL: T120BUNDLE,2 LTO-8,HH,FC,30S	K	\$54,269
T120-8-H-F-2-50	SEL: T120BUNDLE,2 LTO-8,HH,FC,50S	K	\$56,231
T120-8-H-F-3-50	SEL: T120BUNDLE,3 LTO-8,HH,FC,50S	K	\$72,577
T120-8-H-F-4-50	SEL: T120BUNDLE,4 LTO-8,HH,FC,50S	K	\$91,538
T200-DBA-1	SEL: T200;BASE UNIT W- 1 DBA	K	\$47,574
T200-DBA-2	SEL: T200;BASE UNIT W- 2 DBA	K	\$54,112
T380-DBA-1	SEL: T380;BASE UNIT W-1 DBA	K	\$67,189
T380-DBA-2	SEL: T380;BASE UNIT W- 2 DBA	K	\$73,074
T380-DBA-3	SEL: T380;BASE UNIT W- 3 DBA	K	\$78,958
T380-J-DBA-1	SEL: T380 ENT,BASE UNIT W-1 DBA	K	\$67,189
T380-J-DBA-2	SEL: T380 ENT,BASE UNIT W- 2 DBA	K	\$73,074
T380-J-DBA-3	SEL: T380 ENT,BASE UNIT W- 3 DBA	K	\$78,958
T680-DBA-1	SEL: T680;BASE UNIT W- 1 DBA	K	\$102,366
T680-DBA-2	SEL: T680;BASE UNIT W- 2 DBA	K	\$108,251
T680-DBA-3	SEL: T680;BASE UNIT W- 3 DBA	K	\$114,135
T9502FRMEXP	SEL: T950 2 FRAME HAX EXPANSION KIT	K	\$0
T9503FRMEXP	SEL: T950 3 FRAME HAX EXPANSION KIT	K	\$0
T9504FRMEXP	SEL: T950 4 FRM HAX EXPANSION KIT	K	\$0
T9505FRMEXP	SEL: T950 5 FRAME HAX EXPANSION KIT	K	\$0
T9506FRMEXP	SEL: T950 6 FRAME HAX EXPANSION KIT	K	\$0
T9508FRMEXP	SEL: T950 8 FRAME HAX EXPANSION KIT	K	\$0
T950B1D	SEL: T950B WITH 1 DBA	K	\$112,658
T950B3D3T	SEL: T950 W-3 DBA'S & 3 TBA'S	K	\$112,658
T950B3D3TDVXP	SEL: T950 DRV EXP 3D 3T	K	\$49,758
T950B3D3TDX-F	SEL: T950 DRV EXP 3D 3T	K	\$49,758
T950B6D0DVXP	SEL: T950 DRV EXP 6D 0T	K	\$63,292
T950B6D0T	SEL: T950 W- 6 DBA'S & 0 TBA'S	K	\$128,808
T950B6D0TDX-F	SEL: T950 DRV EXP 6D 0T	K	\$63,292

T950B-J-1D	SEL: T950B ENT 1 DBA	K	\$112,658
T950B-J-3D	SEL: T950B ENT 3 DBA	K	\$112,658
T950B-J3DDVXP	SEL: T950B ENT DRV EXP 3DBA	K	\$49,758
T950BJ3DDVXPF	SEL: FRU,T950B ENT DRV EXP 3DBA	K	\$49,758
T950B-J-6D	SEL: T950B ENT 6 DBA	K	\$128,808
T950B-J6DDVXP	SEL: T950B ENT DRV EXP 6DBA	K	\$63,292
T950BJ6DDVXPF	SEL: FRU,T950B ENT DRV EXP 6DBA	K	\$63,292
T950B-JMEDEXF	SEL: FRU,T950 ENT MEDIA EXP FRAME	K	\$26,023
T950BJMEDIAEX	SEL: T950B ENT MEDIA EXP	K	\$26,023
T950BJMULTI1D	SEL: T950B ENT,MULTI,1 DBA	K	\$112,658
T950BJMULTI3D	SEL: T950B ENT,MULTI,3 DBA	K	\$112,658
T950BJMULTI6D	SEL: T950B ENT,MULTI,6 DBA	K	\$128,808
T950BMEDBLJ-F	SEL: T950B ENT BULK TAP	K	\$45,769
T950BMEDBLK-F	SEL: T950,LEFT,MED,EX,FR,W-BULK,UPG	K	\$45,769
T950BMEDBULK	SEL: T950,LEFT,MED,EX,FRAME,W-BULK	K	\$45,769
T950BMEDEX-F	SEL: T950 MEDIA ONLY EXPANSN FRAME	K	\$26,023
T950BMEDIAEXP	SEL: T950 MEDIA ONLY EXPANSN FRAME	K	\$26,023
T950BMEDLBLKJ	SEL: T950B ENT BULK TAP	K	\$45,769
T950BMULT1D	SEL: T950,MULTI,WITH 1 DBA	K	\$112,658
T950BMULT3D3T	SEL: T950,MULTI,W-3 DBA'S & 3 TBA'S	K	\$112,658
T950BMULT6D0T	SEL: T950,MULTI,W-6DBA'S & 0TBA'S	K	\$128,808
TCI-1YR-00001000	SEL 1YR 1000-1999 TAPE CATALOG INGEST	K	\$12
TCI-1YR-00002000	SEL 1YR 2000-4999 TAPE CATALOG INGEST	K	\$10
TCI-1YR-00005000	SEL 1YR 5000-9999 TAPE CATALOG INGEST	K	\$7
TCI-1YR-00010000	SEL 1YR 10000-19999 TAPE CATALOG INGES	K	\$6
TCI-1YR-00020000	SEL 1YR 20000-49999 TAPE CATALOG INGES	K	\$5
TCI-1YR-00050000	SEL 1YR 50000-99999 TAPE CATALOG INGES	K	\$4
TCI-3YR-00001000	SEL 3YR 1000-1999 TAPE CATALOG INGEST	K	\$24
TCI-3YR-00002000	SEL 3YR 2000-4999 TAPE CATALOG INGEST	K	\$20
TCI-3YR-00005000	SEL 3YR 5000-9999 TAPE CATALOG INGEST	K	\$15
TCI-3YR-00010000	SEL 3YR 10000-19999 TAPE CATALOG INGES	K	\$12
TCI-3YR-00020000	SEL 3YR 20000-49999 TAPE CATALOG INGES	K	\$10
TCI-3YR-00050000	SEL 3YR 50000-99999 TAPE CATALOG INGES	K	\$8
TCI-5YR-00001000	SEL 5YR 1000-1999 TAPE CATALOG INGEST	K	\$36
TCI-5YR-00002000	SEL 5YR 2000-4999 TAPE CATALOG INGEST	K	\$29
TCI-5YR-00005000	SEL 5YR 5000-9999 TAPE CATALOG INGEST	K	\$22
TCI-5YR-00010000	SEL 5YR 10000-19999 TAPE CATALOG INGES	K	\$18
TCI-5YR-00020000	SEL 5YR 20000-49999 TAPE CATALOG INGES	K	\$15
TCI-5YR-00050000	SEL 5YR 50000-99999 TAPE CATALOG INGES	K	\$11
TCR-1YR-00000010	SEL 1YR 10-49 TAPE CATALOG REBUILD	K	\$96
TCR-1YR-00000050	SEL 1YR 50-99 TAPE CATALOG REBUILD	K	\$63
TCR-1YR-00000100	SEL 1YR 100-249 TAPE CATALOG REBUILD	K	\$48
TCR-1YR-00000250	SEL 1YR 250-499 TAPE CATALOG REBUILD	K	\$38
TCR-1YR-00000500	SEL 1YR 500-999 TAPE CATALOG REBUILD	K	\$34
TCR-1YR-00001000	SEL 1YR 1000-1999 TAPE CATALOG REBUILD	K	\$24
TCR-1YR-00002000	SEL 1YR 2000-4999 TAPE CATALOG REBUILD	K	\$20
TCR-1YR-00005000	SEL 1YR 5000-9999 TAPE CATALOG REBUILD	K	\$15
TCR-1YR-00010000	SEL 1YR 10000-24999 TAPE CATALOG REBUI	K	\$12
TCR-1YR-00025000	SEL 1YR 25000-49999 TAPE CATALOG REBUI	K	\$9
TCR-1YR-00050000	SEL 1YR 50000-99999 Tape Catalog Rebuild	K	\$8

TCR-3YR-00000010	SEL 3YR 10-49 TAPE CATALOG REBUILD	K	\$144
TCR-3YR-00000050	SEL 3YR 50-99 TAPE CATALOG REBUILD	K	\$94
TCR-3YR-00000100	SEL 3YR 100-249 TAPE CATALOG REBUILD	K	\$72
TCR-3YR-00000250	SEL 3YR 250-499 TAPE CATALOG REBUILD	K	\$58
TCR-3YR-00000500	SEL 3YR 500-999 TAPE CATALOG REBUILD	K	\$51
TCR-3YR-00001000	SEL 3YR 1000-1999 TAPE CATALOG REBUILD	K	\$36
TCR-3YR-00002000	SEL 3YR 2000-4999 TAPE CATALOG REBUILD	K	\$29
TCR-3YR-00005000	SEL 3YR 5000-9999 TAPE CATALOG REBUILD	K	\$22
TCR-3YR-00010000	SEL 3YR 10000-24999 TAPE CATALOG REBUI	K	\$18
TCR-3YR-00025000	SEL 3YR 25000-49999 TAPE CATALOG REBUI	K	\$14
TCR-3YR-00050000	SEL 3YR 50000-99999 Tape Catalog Rebuild	K	\$12
TCR-5YR-00000010	SEL 5YR 10-49 TAPE CATALOG REBUILD	K	\$192
TCR-5YR-00000050	SEL 5YR 50-99 TAPE CATALOG REBUILD	K	\$125
TCR-5YR-00000100	SEL 5YR 100-249 TAPE CATALOG REBUILD	K	\$96
TCR-5YR-00000250	SEL 5YR 250-499 TAPE CATALOG REBUILD	K	\$77
TCR-5YR-00000500	SEL 5YR 500-999 TAPE CATALOG REBUILD	K	\$67
TCR-5YR-00001000	SEL 5YR 1000-1999 TAPE CATALOG REBUILD	K	\$48
TCR-5YR-00002000	SEL 5YR 2000-4999 TAPE CATALOG REBUILD	K	\$39
TCR-5YR-00005000	SEL 5YR 5000-9999 TAPE CATALOG REBUILD	K	\$30
TCR-5YR-00010000	SEL 5YR 10000-24999 TAPE CATALOG REBUI	K	\$24
TCR-5YR-00025000	SEL 5YR 25000-49999 TAPE CATALOG REBUI	K	\$18
TCR-5YR-00050000	SEL 5YR 50000-99999 Tape Catalog Rebuild	K	\$15
TE-PL	SEL Test Environment Add-on PL	K	\$15,000
TE-TL	SEL Test Environment Add-on TL	K	\$6,000
TFIN3D3T	SEL: TFIN W- 3 DBA'S & 3 TBA'S	K	\$122,923
TFIN3D3TDVX-F	SEL: TFIN;UPG;DRV EXP 3D 3T	K	\$57,538
TFIN3D3TDVXP	SEL: TFIN DRV EXP 3D 3T	K	\$57,538
TFIN6D0T	SEL: TFIN W- 6 DBA'S & 0 TBA'S	K	\$142,538
TFIN6D0TDVX-F	SEL: TFIN;UPG;DRV EXP 6D 0T	K	\$73,231
TFIN6D0TDVXP	SEL: TFIN DRV EXP 6D 0T	K	\$73,231
TFINBSB-LEFT	SEL: TFIN BULK SERV BAY;LEFT	K	\$58,846
TFINBSBLFT-F	SEL: FRU;TFIN BULK SV BAY;LEFT	K	\$58,846
TFINBSBRGT-F	SEL: FRU;TFIN BULK SV BAY;RIGHT	K	\$58,846
TFIN-BSB-RIGHT	SEL: TFIN BULK SERV BAY,RIGHT WITH ROBOT	K	\$91,538
TFIN-J3D3S	SEL: TFIN ENT 3D 3S	K	\$122,923
TFINJ3D3SDVXP	SEL: TFIN ENT DRV EXP 3D 3S	K	\$57,538
TFINJ3D3SDX-F	SEL: FRU;TFIN ENT DRV EXP 3D 3S	K	\$57,538
TFIN-J6D0S	SEL: TFIN ENT 6D 0S	K	\$142,538
TFINJ6D0SDVXP	SEL: TFIN ENT DRV EXP 6D 0S	K	\$73,231
TFINJ6D0SDX-F	SEL: FRU;TFIN ENT DRV EXP 6D 0S	K	\$73,231
TFINJBSBLEFT	SEL: TFIN ENT BULK SERV BAY;LEFT	K	\$58,846
TFINJBSBLFT-F	SEL: FRU;TFIN ENT BULK SV BAY;LEFT	K	\$58,846
TFINJBSBRGT-F	SEL: FRU;TFIN ENT BULK SV BAY;RIGHT	K	\$58,846
TFIN-J-BSB-RIGHT	SEL: TFIN ENT BULK SERV BAY,RGT W/ROBOT	K	\$91,538
TFINJMEDEX-F	SEL: FRU;TFIN ENT MEDIA EXP FRAME	K	\$26,154
TFINJMEDIAEXP	SEL: TFIN ENT MEDIA EXP	K	\$26,154
TFINJSBLEFT	SEL: TFIN ENT SERV BAY;LEFT	K	\$45,769
TFINJSBLEFT-F	SEL: FRU;TFIN ENT SERV BAY;LEFT	K	\$45,769
TFINJSBRGT-F	SEL: FRU;TFIN ENT SERV BAY;RIGHT	K	\$45,769
TFIN-J-SB-RIGHT	SEL: TFIN ENT SERV BAY,RIGHT WITH ROBOT	K	\$78,462

TFINMEDEX-F	SEL: TFIN;UPG;MEDIA EXP	K	\$26,154
TFINMEDIAEXP	SEL: TFIN MEDIA EXP	K	\$26,154
TFINSB-LEFT	SEL: TFIN SERV BAY;LEFT	K	\$45,769
TFINSBLEFT-F	SEL: TFIN;UPG;SERV BAY;LEFT	K	\$45,769
TFIN-SB-RIGHT	SEL: TFIN SERV BAY,RIGHT, WITH ROBOT	K	\$78,462
TFINSBRIGHT-F	SEL: TFIN;UPG;SERV BAY;RIGHT	K	\$45,769
THIN5100PKC	SEL THIN5-100PK-C)	K	\$1,955
THIN5100PKC-I	SEL THIN5-100PK-C)	K	\$2,043
THIN5100PKCV2-K	SEL THIN5-100PK-C)	K	\$2,095
THIN5-STE-C	SEL THIN5-STE-C)	K	\$5,145
THIN5-STE-C-I	SEL THIN5-STE-C)	K	\$5,377
THIN5STECV2-K	SEL THIN5-STE-C)	K	\$5,513
TMI-1YR-00000010	SEL 1YR 10-49 TAPE METADATA INDEX	K	\$385
TMI-1YR-00000050	SEL 1YR 50-99 TAPE METADATA INDEX	K	\$250
TMI-1YR-00000100	SEL 1YR 100-249 TAPE METADATA INDEX	K	\$192
TMI-1YR-00000250	SEL 1YR 250-499 TAPE METADATA INDEX	K	\$146
TMI-1YR-00000500	SEL 1YR 500-999 TAPE METADATA INDEX	K	\$119
TMI-1YR-00001000	SEL 1YR 1000-1999 TAPE METADATA INDEX	K	\$97
TMI-1YR-00002000	SEL 1YR 2000-4999 TAPE METADATA INDEX	K	\$78
TMI-1YR-00005000	SEL 1YR 5000-9999 TAPE METADATA INDEX	K	\$60
TMI-1YR-00010000	SEL 1YR 10000-24999 TAPE METADATA INDE	K	\$49
TMI-1YR-00025000	SEL 1YR 25000-49999 TAPE METADATA INDE	K	\$37
TMI-3YR-00000010	SEL 3YR 10-49 TAPE METADATA INDEX	K	\$500
TMI-3YR-00000050	SEL 3YR 50-99 TAPE METADATA INDEX	K	\$325
TMI-3YR-00000100	SEL 3YR 100-249 TAPE METADATA INDEX	K	\$250
TMI-3YR-00000250	SEL 3YR 250-499 TAPE METADATA INDEX	K	\$190
TMI-3YR-00000500	SEL 3YR 500-999 TAPE METADATA INDEX	K	\$155
TMI-3YR-00001000	SEL 3YR 1000-1999 TAPE METADATA INDEX	K	\$126
TMI-3YR-00002000	SEL 3YR 2000-4999 TAPE METADATA INDEX	K	\$102
TMI-3YR-00005000	SEL 3YR 5000-9999 TAPE METADATA INDEX	K	\$78
TMI-3YR-00010000	SEL 3YR 10000-24999 TAPE METADATA INDE	K	\$64
TMI-3YR-00025000	SEL 3YR 25000-49999 TAPE METADATA INDE	K	\$48
TMI-5YR-00000010	SEL 5YR 10-49 TAPE METADATA INDEX	K	\$596
TMI-5YR-00000050	SEL 5YR 50-99 TAPE METADATA INDEX	K	\$388
TMI-5YR-00000100	SEL 5YR 100-249 TAPE METADATA INDEX	K	\$298
TMI-5YR-00000250	SEL 5YR 250-499 TAPE METADATA INDEX	K	\$227
TMI-5YR-00000500	SEL 5YR 500-999 TAPE METADATA INDEX	K	\$185
TMI-5YR-00001000	SEL 5YR 1000-1999 TAPE METADATA INDEX	K	\$150
TMI-5YR-00002000	SEL 5YR 2000-4999 TAPE METADATA INDEX	K	\$121
TMI-5YR-00005000	SEL 5YR 5000-9999 TAPE METADATA INDEX	K	\$93
TMI-5YR-00010000	SEL 5YR 10000-24999 TAPE METADATA INDE	K	\$76
TMI-5YR-00025000	SEL 5YR 25000-49999 TAPE METADATA INDE	K	\$57
TRC-1-SFP-LX-C	SEL SFP - 1GbE LX	K	\$277
TRC-1-SFPP-DAC-C	SEL 10GbE DAC Twinax	K	\$302
TRC-1-SFPP-LR	SEL SFP+ - 10GbE LR	K	\$1,471
TRC-1-SFPP-LR-C	SEL SFP+ - 10GbE LR	K	\$1,471
TRC-1-SFPP-SR	SEL SFP+ - 10GbE SR	K	\$855
TRC-1-SFPP-SR-C	SEL SFP+ - 10GbE SR	K	\$855
TRC-1-SFP-SX-C	SEL SFP - 1GbE SX	K	\$240
UCXPL-T-P	SEL STEELCNTRL UCXPENTPHONELIC-BASET	K	\$37

UEMCCU100C	SEL UEM-CCU-100-C)	K	\$5,150
UEMCCU100C-I	SEL UEM-CCU-100-C)	K	\$5,665
UEMCCU100C-K	SEL UEM-CCU-100-C)	K	\$5,574
UEMCCU10C	SEL UEM-CCU-10-C)	K	\$515
UEMCCU10C-I	SEL UEM-CCU-10-C)	K	\$567
UEMCCU10C-K	SEL UEM-CCU-10-C)	K	\$557
UEMNU100C	SEL UEM-NU-100-C)	K	\$3,090
UEMNU100C-I	SEL UEM-NU-100-C)	K	\$3,399
UEMNU100C-K	SEL UEM-NU-100-C)	K	\$3,344
UEMNU10C	SEL UEM-NU-10-C)	K	\$309
UEMNU10C-I	SEL UEM-NU-10-C)	K	\$340
UEMNU10C-K	SEL UEM-NU-10-C)	K	\$334
U-FS-VT-BCE-P-PD	SEL VT Compliance Edition 10 MD	K	\$75,000
U-FS-VT-BC-P-PD	SEL VT Branded Conn PL	K	\$20,000
U-FS-VT-BI-P-PD	SEL VT BI PL	K	\$50,000
U-FS-VT-BSE-P-PD	SEL VT Risk Mgmt 10 MD PL	K	\$170,000
U-FS-VT-BUS-P-PD	SEL VT UPG CMP to Risk Mgmt PL	K	\$95,000
U-FS-VT-MD-P-PD	SEL VTMD PL 11-1000 MD	K	\$230
U-FS-VT-MD-P-PDE	SEL VTMD PL 1001-5000 MD	K	\$186
U-FS-VT-MD-P-PDG	SEL VTMD PL 5001-10,000 MD	K	\$167
U-FS-VT-MD-P-PDH	SEL VTMD PL 10,001-25,000 MD	K	\$151
U-FS-VT-MD-P-PDI	SEL VTMD PL 25,001-50,000 MD	K	\$136
U-FS-VT-MD-P-PDJ	SEL VTMD PL 50,001-100,000 MD	K	\$122
U-FS-VT-MD-P-PDK	SEL VTMD PL 100,001-ENT MD	K	\$110
U-SFCR3500-C1-C2	SEL Upgrade LIC-SFCR-03500-C1 to C2	K	\$11,323
U-SFCR3500-C1-C3	SEL Upgrade LIC-SFCR-03500-C1 to C3	K	\$42,462
U-SFCR3500-C2-C3	SEL Upgrade LIC-SFCR-03500-C2 to C3	K	\$31,138
U-SFED2100-W0-W1	SEL Upgrade LIC-SFED-02100-W0 to W1	K	\$5,662
U-SFED2100-W0-W2	SEL Upgrade LIC-SFED-02100-W0 to W2	K	\$16,985
U-SFED2100-W0-W3	SEL Upgrade LIC-SFED-02100-W0 to W3	K	\$33,969
U-SFED2100-W1-W2	SEL Upgrade LIC-SFED-02100-W1 to W2	K	\$11,323
U-SFED2100-W1-W3	SEL Upgrade LIC-SFED-02100-W1 to W3	K	\$28,308
U-SFED2100-W2-W3	SEL Upgrade LIC-SFED-02100-W2 to W3	K	\$16,985
U-SFED2200-W0-W1	SEL Upgrade LIC-SFED-02200-W0 to W1	K	\$7,077
U-SFED2200-W0-W2	SEL Upgrade LIC-SFED-02200-W0 to W2	K	\$14,154
U-SFED2200-W0-W3	SEL Upgrade LIC-SFED-02200-W0 to W3	K	\$35,385
U-SFED2200-W1-W2	SEL Upgrade LIC-SFED-02200-W1 to W2	K	\$7,077
U-SFED2200-W1-W3	SEL Upgrade LIC-SFED-02200-W1 to W3	K	\$28,308
U-SFED2200-W2-W3	SEL Upgrade LIC-SFED-02200-W2 to W3	K	\$21,231
U-SFED3100-W0-W1	SEL Upgrade LIC-SFED-03100-W0 to W1	K	\$14,154
U-SFED3100-W0-W2	SEL Upgrade LIC-SFED-03100-W0 to W2	K	\$28,308
U-SFED3100-W0-W3	SEL Upgrade LIC-SFED-03100-W0 to W3	K	\$38,923
U-SFED3100-W1-W2	SEL Upgrade LIC-SFED-03100-W1 to W2	K	\$14,154
U-SFED3100-W1-W3	SEL Upgrade LIC-SFED-03100-W1 to W3	K	\$24,769
U-SFED3100-W2-W3	SEL Upgrade LIC-SFED-03100-W2 to W3	K	\$10,615
U-SFED3200-W0-W1	SEL Upgrade LIC-SFED-03200-W0 to W1	K	\$11,323
U-SFED3200-W0-W2	SEL Upgrade LIC-SFED-03200-W0 to W2	K	\$31,138
U-SFED3200-W0-W3	SEL Upgrade LIC-SFED-03200-W0 to W3	K	\$45,292
U-SFED3200-W1-W2	SEL Upgrade LIC-SFED-03200-W1 to W2	K	\$19,815
U-SFED3200-W1-W3	SEL Upgrade LIC-SFED-03200-W1 to W3	K	\$33,969

U-SFED3200-W2-W3	SEL Upgrade LIC-SFED-03200-W2 to W3	K	\$14,154
U-SFED5100-W0-W1	SEL Upgrade LIC-SFED-05100-W0 to W1	K	\$21,231
U-SFED5100-W0-W2	SEL Upgrade LIC-SFED-05100-W0 to W2	K	\$35,385
U-SFED5100-W1-W2	SEL Upgrade LIC-SFED-05100-W1 to W2	K	\$14,154
U-VT-CP-SAS-1000	SEL VT Compliance Edition 1000 MD	K	\$263,340
U-VT-CP-SAS-4000	SEL VT Compliance Edition 4000 MD	K	\$738,360
U-VT-CP-SAS-500	SEL VT Compliance Edition 500 MD	K	\$163,170
U-VT-RM-SAS-1000	SEL VT Risk Mgmt Edition 1000 MD	K	\$343,140
U-VT-RM-SAS-4000	SEL VT Risk Mgmt Edition 4000 MD	K	\$818,160
U-VT-RM-SAS-500	SEL VT Risk Mgmt Edition 500 MD	K	\$248,220
V6EEPLAUGC	SEL VS6-ES-EPL-AK-UG-C)	K	\$23,412
V6EEPLAUGC-I	SEL VS6-ES-EPL-AK-UG-C)	K	\$27,392
V6EEPLAUGC-K	SEL VS6-ES-EPL-AK-UG-C)	K	\$27,544
V6ENOEPLUC	SEL VS6-ENT-OEPL-UG-C)	K	\$1,815
V6ENOEPLUC-I	SEL VS6-ENT-OEPL-UG-C)	K	\$2,124
V6ENOEPLUC-K	SEL VS6-ENT-OEPL-UG-C)	K	\$2,042
V6ENTEPLUC	SEL VS6-ENT-EPL-UG-C)	K	\$682
V6ENTEPLUC-I	SEL VS6-ENT-EPL-UG-C)	K	\$798
V6ENTEPLUC-K	SEL VS6-ENT-EPL-UG-C)	K	\$801
V6EPOPLAKUC	SEL VS6-ESP-OEPL-AK-UG-C)	K	\$24,122
V6EPOPLAKUC-I	SEL VS6-ESP-OEPL-AK-UG-C)	K	\$28,223
V6EPOPLAKUC-K	SEL VS6-ESP-OEPL-AK-UG-C)	K	\$27,084
V6EPSTDAUGC	SEL VS6-ESP-STD-AK-UG-C)	K	\$7,529
V6EPSTDAUGC-I	SEL VS6-ESP-STD-AK-UG-C)	K	\$8,809
V6EPSTDAUGC-K	SEL VS6-ESP-STD-AK-UG-C)	K	\$8,849
V6ESEPLAKUC	SEL VS6-ES-OEPL-AK-UG-C)	K	\$25,255
V6ESEPLAKUC-I	SEL VS6-ES-OEPL-AK-UG-C)	K	\$29,548
V6ESEPLAKUC-K	SEL VS6-ES-OEPL-AK-UG-C)	K	\$28,386
V6ESPELAUGC	SEL VS6-ESP-EPL-AK-UG-C)	K	\$21,812
V6ESPELAUGC-I	SEL VS6-ESP-EPL-AK-UG-C)	K	\$25,520
V6ESPELAUGC-K	SEL VS6-ESP-EPL-AK-UG-C)	K	\$25,705
V6ESTDKUC	SEL VS6-ES-STD-AK-UG-C)	K	\$11,113
V6ESTDKUC-I	SEL VS6-ES-STD-AK-UG-C)	K	\$13,002
V6ESTDKUC-K	SEL VS6-ES-STD-AK-UG-C)	K	\$13,063
V6HPOELUC	SEL VS6-HYP-OEPL-UG-C)	K	\$4,525
V6HPOELUC-I	SEL VS6-HYP-OEPL-UG-C)	K	\$5,294
V6HPOELUC-K	SEL VS6-HYP-OEPL-UG-C)	K	\$5,084
V6HPSTUGC	SEL VS6-HYP-STD-UG-C)	K	\$995
V6HPSTUGC-I	SEL VS6-HYP-STD-UG-C)	K	\$1,164
V6HPSTUGC-K	SEL VS6-HYP-STD-UG-C)	K	\$1,168
V6HYEPLUC	SEL VS6-HYP-EPL-UG-C)	K	\$3,495
V6HYEPLUC-I	SEL VS6-HYP-EPL-UG-C)	K	\$4,089
V6HYEPLUC-K	SEL VS6-HYP-EPL-UG-C)	K	\$4,118
V6OENOELUC	SEL VS6-OENT-OEPL-UG-C)	K	\$869
V6OENOELUC-I	SEL VS6-OENT-OEPL-UG-C)	K	\$1,017
V6OENOELUC-K	SEL VS6-OENT-OEPL-UG-C)	K	\$977
V6RBSAD25UC	SEL VS6-RBSTD-ADV25-UG-C)	K	\$1,705
V6RBSAD25UC-I	SEL VS6-RBSTD-ADV25-UG-C)	K	\$1,995
V6RBSAD25UC-K	SEL VS6-RBSTD-ADV25-UG-C)	K	\$2,011
V6STDEPUGC	SEL VS6-STD-OEPL-UG-C)	K	\$3,883

V6STDEPUGC-I	SEL VS6-STD-OEPL-UG-C)	K	\$4,543
V6STDEPUGC-K	SEL VS6-STD-OEPL-UG-C)	K	\$4,363
V6STEPLUC	SEL VS6-STD-EPL-UG-C)	K	\$2,750
V6STEPLUC-I	SEL VS6-STD-EPL-UG-C)	K	\$3,218
V6STEPLUC-K	SEL VS6-STD-EPL-UG-C)	K	\$3,237
V7ATA25CV2-K	SEL VR7-ATAD25-C)	K	\$7,930
V7ATATEUCV2-K	SEL VR7-ATAD-ATEN-UG-C)	K	\$6,386
V7ATE25CV2-K	SEL VR7-ATEN25-C)	K	\$13,753
VAMAWPLLDC	SEL VA-MAW-PLL-D-C)	K	\$10
VAMAWPLLDC-I	SEL VA-MAW-PLL-D-C)	K	\$10
VAMAWPLLDC-K	SEL VA-MAW-PLL-D-C)	K	\$11
VAMBMPLLDC	SEL VA-MBM-PLL-D-C)	K	\$21
VAMBMPLLDC-I	SEL VA-MBM-PLL-D-C)	K	\$21
VAMBMPLLDC-K	SEL VA-MBM-PLL-D-C)	K	\$22
VAOMSPLLDF	SEL: VA-OMS-PLL-D-F	K	\$77
VAOMSPLLUF	SEL: VA-OMS-PLL-U-F	K	\$154
VAOMSTLSSD2PF	SEL: VA-OMS-TLSS-D-2P-F	K	\$108
VAOMSTLSSD3PF	SEL: VA-OMS-TLSS-D-3P-F	K	\$152
VAOMSTLSSDPF	SEL: VA-OMS-TLSS-D-P-F	K	\$57
VARONIS-30DAY	SEL VRNS 30DAY FREETRIAL	K	\$0
VATELPLLDC	SEL VA-TEL-PLL-D-C)	K	\$21
VATELPLLDC-I	SEL VA-TEL-PLL-D-C)	K	\$21
VATELPLLDC-K	SEL VA-TEL-PLL-D-C)	K	\$22
VAWOSPLLADC	SEL VA-WOS-PLL-A-D-C)	K	\$52
VAWOSPLLADC-I	SEL VA-WOS-PLL-A-D-C)	K	\$54
VAWOSPLLADC-K	SEL VA-WOS-PLL-A-D-C)	K	\$55
VAWOSPLLAUC	SEL VA-WOS-PLL-A-U-C)	K	\$93
VAWOSPLLAUC-I	SEL VA-WOS-PLL-A-U-C)	K	\$97
VAWOSPLLAUC-K	SEL VA-WOS-PLL-A-U-C)	K	\$100
VCEPICC	SEL VC-EPIC-C)	K	\$61,750
VCEPICC-I	SEL VC-EPIC-C)	K	\$72,248
VCEPICC-K	SEL VC-EPIC-C)	K	\$69,376
VCS6FNDC	SEL VCS6-FND-C)	K	\$1,535
VCS6FNDC-I	SEL VCS6-FND-C)	K	\$1,796
VCS6FNDC-K	SEL VCS6-FND-C)	K	\$1,804
VCS6FNSTUCV2	SEL VCS6-FND-STD-UG-C)	K	\$5,104
VCS6FNSTUCV2-I	SEL VCS6-FND-STD-UG-C)	K	\$5,972
VCS6FNSTUCV2-K	SEL VCS6-FND-STD-UG-C)	K	\$6,011
VCS6STDC-I	SEL VCS6-STD-C)	K	\$7,225
VCS6STDCV2	SEL VCS6-STD-C)	K	\$6,175
VCS6STDCV2-K	SEL VCS6-STD-C)	K	\$7,275
VCSR825EC	SEL VC-SRM8-25E-C)	K	\$12,750
VCSR825EC-I	SEL VC-SRM8-25E-C)	K	\$14,918
VCSR825EC-K	SEL VC-SRM8-25E-C)	K	\$14,366
VCSR825EUGC	SEL VC-SRM8-25E-UG-C)	K	\$8,498
VCSR825EUGC-I	SEL VC-SRM8-25E-UG-C)	K	\$9,943
VCSR825EUGC-K	SEL VC-SRM8-25E-UG-C)	K	\$9,539
VCSR825SC	SEL VC-SRM8-25S-C)	K	\$5,025
VCSR825SC-I	SEL VC-SRM8-25S-C)	K	\$5,879
VCSR825SC-K	SEL VC-SRM8-25S-C)	K	\$5,650

VCX-1555-H	SEL Virtual Steelhead 1555 High	K	\$42,825
VCX-1555-L	SEL Virtual Steelhead 1555 Low	K	\$29,778
VCX-1555-M	SEL Virtual Steelhead 1555 Mid	K	\$38,394
VCX-5055-H	SEL Virtual Steelhead 5055 High	K	\$113,225
VCX-5055-M	SEL Virtual Steelhead 5055 Mid	K	\$73,594
VCX-555-H	SEL Virtual Steelhead 555 High	K	\$12,917
VCX-555-M	SEL Virtual Steelhead 555 Mid	K	\$9,348
VCX-7055-L	SEL Virtual Steelhead 7055 Low	K	\$147,194
VCX-7055-M	SEL Virtual Steelhead 7055 Mid	K	\$203,809
VCX-755-H	SEL Virtual Steelhead 755 High	K	\$22,763
VCX-755-L	SEL Virtual Steelhead 755 Low	K	\$14,517
VCX-755-M	SEL Virtual Steelhead 755 Mid	K	\$16,978
VFHYPM5C	SEL VF-HYPM5-C)	K	\$371
VFHYPM5C-I	SEL VF-HYPM5-C)	K	\$434
VFHYPM5CV2-K	SEL VF-HYPM5-C)	K	\$417
VGC-1000-L	SEL Virtual SteelFusion Core VGC 1000-L	K	\$17,225
VGC-1000-M	SEL Virtual SteelFusion Core VGC 1000-M	K	\$23,378
VGC-1000-U	SEL Virtual SteelFusion Core VGC 1000-U	K	\$9,840
VGC-1500-L	SEL Virtual SteelFusion Core VGC 1500-L	K	\$29,532
VGC-1500-M	SEL Virtual SteelFusion Core VGC 1500-M	K	\$40,609
VMP-100GB-AN-D	SEL Splunk VM Perp Lic 21-100GB/dayAN	K	\$28,846
VMP-100GB-AP-D	SEL Splunk VM Perp Lic 21-100GB/dayAP	K	\$34,615
VMP-100GB-EM-D	SEL Splunk VM Perp Lic 21-100GB/dayEM	K	\$26,538
VMP-100GB-US-D	SEL Splunk VM Perp Lic 21-100GB/dayUS	K	\$23,077
VMP-101GB-AN-D	SEL Splunk VM Perp Lic 101+GB/dayAN	K	\$50,481
VMP-101GB-AP-D	SEL Splunk VM Perp Lic 101+GB/dayAP	K	\$60,577
VMP-101GB-EM-D	SEL Splunk VM Perp Lic 101+GB/dayEM	K	\$46,442
VMP-101GB-US-D	SEL Splunk VM Perp Lic 101+GB/dayUS	K	\$40,385
VMP-20GB-AN-D	SEL Splunk VM Perp Lic 6-20GB/dayAN	K	\$14,423
VMP-20GB-AP-D	SEL Splunk VM Perp Lic 6-20GB/dayAP	K	\$17,308
VMP-20GB-EM-D	SEL Splunk VM Perp Lic 6-20GB/dayEM	K	\$13,269
VMP-20GB-US-D	SEL Splunk VM Perp Lic 6-20GB/dayUS	K	\$11,538
VMP-5GB-AN-D	SEL Splunk VM Perp Lic 1-5GB/dayAN	K	\$7,212
VMP-5GB-AP-D	SEL Splunk VM Perp Lic 1-5GB/dayAP	K	\$8,654
VMP-5GB-EM-D	SEL Splunk VM Perp Lic 1-5GB/dayEM	K	\$6,635
VMP-5GB-US-D	SEL Splunk VM Perp Lic 1-5GB/dayUS	K	\$5,769
VMTE-100GB-AN-D	SEL Splunk VM Term SSUp 21-100GB/dayAN	K	\$11,538
VMTE-100GB-AP-D	SEL Splunk VM Term SSUp 21-100GB/dayAP	K	\$13,846
VMTE-100GB-EM-D	SEL Splunk VM Term SSUp 21-100GB/dayEM	K	\$10,615
VMTE-100GB-US-D	SEL Splunk VM Term SSUp 21-100GB/dayUS	K	\$9,231
VMTE-101GB-AN-D	SEL Splunk VM Term SSUp 101+GB/dayAN	K	\$26,899
VMTE-101GB-AP-D	SEL Splunk VM Term SSUp 101+GB/dayAP	K	\$32,279
VMTE-101GB-EM-D	SEL Splunk VM Term SSUp 101+GB/dayEM	K	\$24,747
VMTE-101GB-US-D	SEL Splunk VM Term SSUp 101+GB/dayUS	K	\$21,519
VMTE-20GB-AN-D	SEL Splunk VM Term SSUp 6-20GB/dayAN	K	\$5,769
VMTE-20GB-AP-D	SEL Splunk VM Term SSUp 6-20GB/dayAP	K	\$6,923
VMTE-20GB-EM-D	SEL Splunk VM Term SSUp 6-20GB/dayEM	K	\$5,308
VMTE-20GB-US-D	SEL Splunk VM Term SSUp 6-20GB/dayUS	K	\$4,615
VMTE-5GB-AN-D	SEL Splunk VM Term SSUp 1-5GB/dayAN	K	\$2,885
VMTE-5GB-AP-D	SEL Splunk VM Term SSUp 1-5GB/dayAP	K	\$3,462

VMTE-5GB-EM-D	SEL Splunk VM Term SSup 1-5GB/dayEM	K	\$2,654
VMTE-5GB-US-D	SEL Splunk VM Term SSup 1-5GB/dayUS	K	\$2,308
VMTG-100GB-AN-D	SEL Splunk VM Term PSup 21-100GB/dayAN	K	\$13,846
VMTG-100GB-AP-D	SEL Splunk VM Term PSup 21-100GB/dayAP	K	\$16,615
VMTG-100GB-EM-D	SEL Splunk VM Term PSup 21-100GB/dayEM	K	\$12,738
VMTG-100GB-US-D	SEL Splunk VM Term PSup 21-100GB/dayUS	K	\$11,077
VMTG-101GB-AN-D	SEL Splunk VM Term PSup 101+GB/dayAN	K	\$32,279
VMTG-101GB-AP-D	SEL Splunk VM Term PSup 101+GB/dayAP	K	\$38,735
VMTG-101GB-EM-D	SEL Splunk VM Term PSup 101+GB/dayEM	K	\$29,697
VMTG-101GB-US-D	SEL Splunk VM Term PSup 101+GB/dayUS	K	\$25,823
VMTG-20GB-AN-D	SEL Splunk VM Term PSup 6-20GB/dayAN	K	\$6,923
VMTG-20GB-AP-D	SEL Splunk VM Term PSup 6-20GB/dayAP	K	\$8,308
VMTG-20GB-EM-D	SEL Splunk VM Term PSup 6-20GB/dayEM	K	\$6,369
VMTG-20GB-US-D	SEL Splunk VM Term PSup 6-20GB/dayUS	K	\$5,538
VMTG-5GB-AN-D	SEL Splunk VM Term PSup 1-5GB/dayAN	K	\$3,462
VMTG-5GB-AP-D	SEL Splunk VM Term PSup 1-5GB/dayAP	K	\$4,154
VMTG-5GB-EM-D	SEL Splunk VM Term PSup 1-5GB/dayEM	K	\$3,185
VMTG-5GB-US-D	SEL Splunk VM Term PSup 1-5GB/dayUS	K	\$2,769
VNIUGEN100UC	SEL VR-NI-UG-AENX100-UG-C)	K	\$2,090
VNIUGEN100UC-I	SEL VR-NI-UG-AENX100-UG-C)	K	\$2,445
VNIUGEN100UC-K	SEL VR-NI-UG-AENX100-UG-C)	K	\$2,348
VNIUGENX10UC	SEL VR-NI-UG-AENX10-UG-C)	K	\$209
VNIUGENX10UC-I	SEL VR-NI-UG-AENX10-UG-C)	K	\$245
VNIUGENX10UC-K	SEL VR-NI-UG-AENX10-UG-C)	K	\$235
V-OMS-PLL-D-F	SEL: V-OMS-PLL-D-F	K	\$77
V-OMS-PLL-U-F	SEL: V-OMS-PLL-U-F	K	\$154
VPSACCAODEP	SEL V-PS-ACCAO-DEP)	K	\$12,360
VPSACCAODEP-I	SEL V-PS-ACCAO-DEP)	K	\$12,916
VPSACCAODEP-K	SEL V-PS-ACCAO-DEP)	K	\$17,250
VPSACCAOPROF	SEL V-PS-ACCAO-PROF)	K	\$5,665
VPSACCAOPROF-I	SEL V-PS-ACCAO-PROF)	K	\$5,920
VPSACCAOPROF-K	SEL V-PS-ACCAO-PROF)	K	\$7,925
VPSMDM	SEL V-PS-MDM)	K	\$4,125
VPSMDMEP	SEL V-PS-MDMEP)	K	\$7,725
VPSMDMEP-I	SEL V-PS-MDMEP)	K	\$8,073
VPSMDMEP-K	SEL V-PS-MDMEP)	K	\$10,850
VPSMDM-I	SEL V-PS-MDM)	K	\$4,311
VPSMDM-K	SEL V-PS-MDM)	K	\$5,775
V-PS-SUPP-INC-F	SEL: V-PS-SUPP-INC-F	K	\$1,100
VPSWOADEP	SEL V-PS-WOA-DEP)	K	\$11,845
VPSWOADEP-I	SEL V-PS-WOA-DEP)	K	\$12,378
VPSWOADEP-K	SEL V-PS-WOA-DEP)	K	\$16,550
VPSWOSDEP	SEL V-PS-WOS-DEP)	K	\$8,240
VPSWOSDEP-I	SEL V-PS-WOS-DEP)	K	\$8,611
VPSWOSDEP-K	SEL V-PS-WOS-DEP)	K	\$11,550
VR17AADENTUC	SEL VR17-AADV-ENT-UG-C)	K	\$946
VR17AADENTUC-I	SEL VR17-AADV-ENT-UG-C)	K	\$1,107
VR17AADENTUC-K	SEL VR17-AADV-ENT-UG-C)	K	\$1,061
VR17AADVADVUGF	SEL: VR17-AADV-ADV-UG-F	K	\$6,798
VR17AADVENTUGF	SEL: VR17-AADV-ENT-UG-F	K	\$1,056

VR17ADENTGC	SEL VR17-ADV-ENT-UG-C)	K	\$1,700
VR17ADENTGC-I	SEL VR17-ADV-ENT-UG-C)	K	\$1,989
VR17ADENTGC-K	SEL VR17-ADV-ENT-UG-C)	K	\$1,912
VR17ADENUGC	SEL VR17-OADV-ENT-UG-C)	K	\$946
VR17ADENUGC-I	SEL VR17-OADV-ENT-UG-C)	K	\$1,107
VR17ADENUGC-K	SEL VR17-OADV-ENT-UG-C)	K	\$1,061
VR17ADV C	SEL VR17-ADV-C)	K	\$6,445
VR17ADV C-I	SEL VR17-ADV-C)	K	\$7,541
VR17ADV C-K	SEL VR17-ADV-C)	K	\$7,244
VR17ADVENTUGF	SEL: VR17-ADV-ENT-UG-F	K	\$1,815
VR17ADV F	SEL: VR17-ADV-F	K	\$6,870
VR17AENTENTUGF	SEL: VR17-AENT-ENT-UG-F	K	\$4,378
VR17BCLCADVUGF	SEL: VR17-BCLC-ADV-UG-F	K	\$3,927
VR17BCLCENTUGF	SEL: VR17-BCLC-ENT-UG-F	K	\$5,742
VR17BCLOADVUGF	SEL: VR17-BCLO-ADV-UG-F	K	\$1,507
VR17BCLOENTUGF	SEL: VR17-BCLO-ENT-UG-F	K	\$3,322
VR17BLADVUGC	SEL VR17-BCLC-ADV-UG-C)	K	\$3,696
VR17BLADVUGC-I	SEL VR17-BCLC-ADV-UG-C)	K	\$4,324
VR17BLADVUGC-K	SEL VR17-BCLC-ADV-UG-C)	K	\$4,156
VR17BLENTUC	SEL VR17-BCLC-ENT-UG-C)	K	\$5,346
VR17BLENTUC-I	SEL VR17-BCLC-ENT-UG-C)	K	\$6,255
VR17BLENTUC-K	SEL VR17-BCLC-ENT-UG-C)	K	\$6,011
VR17BLOAUGC	SEL VR17-BCLO-ADV-UG-C)	K	\$1,430
VR17BLOAUGC-I	SEL VR17-BCLO-ADV-UG-C)	K	\$1,673
VR17BLOAUGC-K	SEL VR17-BCLO-ADV-UG-C)	K	\$1,605
VR17CLENTUC	SEL VR17-BCLO-ENT-UG-C)	K	\$3,080
VR17CLENTUC-I	SEL VR17-BCLO-ENT-UG-C)	K	\$3,604
VR17CLENTUC-K	SEL VR17-BCLO-ENT-UG-C)	K	\$3,459
VR17ENTC	SEL VR17-ENT-C)	K	\$7,945
VR17ENTC-I	SEL VR17-ENT-C)	K	\$9,296
VR17ENTC-K	SEL VR17-ENT-C)	K	\$8,926
VR17ENTF	SEL: VR17-ENT-F	K	\$8,520
VR17ISODVUGC	SEL VR17-LIS40-ADV-UG-C)	K	\$1,425
VR17ISODVUGC-I	SEL VR17-LIS40-ADV-UG-C)	K	\$1,667
VR17ISODVUGC-K	SEL VR17-LIS40-ADV-UG-C)	K	\$1,605
VR17L4CADUGC	SEL VR17-LIS4C-ADV-UG-C)	K	\$5,390
VR17L4CADUGC-I	SEL VR17-LIS4C-ADV-UG-C)	K	\$6,306
VR17L4CADUGC-K	SEL VR17-LIS4C-ADV-UG-C)	K	\$6,057
VR17LI4CSTUC	SEL VR17-LIS4C-STD-UG-C)	K	\$2,530
VR17LI4CSTUC-I	SEL VR17-LIS4C-STD-UG-C)	K	\$2,960
VR17LI4CSTUC-K	SEL VR17-LIS4C-STD-UG-C)	K	\$2,846
VR17LIOETUGC	SEL VR17-LIS40-ENT-UG-C)	K	\$3,075
VR17LIOETUGC-I	SEL VR17-LIS40-ENT-UG-C)	K	\$3,598
VR17LIOETUGC-K	SEL VR17-LIS40-ENT-UG-C)	K	\$3,459
VR17LIS4CADVUGF	SEL: VR17-LIS4C-ADV-UG-F	K	\$5,742
VR17LIS4CENTUGF	SEL: VR17-LIS4C-ENT-UG-F	K	\$7,557
VR17LIS4CSTDUGF	SEL: VR17-LIS4C-STD-UG-F	K	\$2,717
VR17LIS4OADVUGF	SEL: VR17-LIS40-ADV-UG-F	K	\$1,507
VR17LIS4OENTUGF	SEL: VR17-LIS40-ENT-UG-F	K	\$3,322
VR17LIS4OSTDUGF	SEL: VR17-LIS40-STD-UG-F	K	\$3,013

VR17LISENUGC	SEL VR17-LIS4C-ENT-UG-C)	K	\$7,040
VR17LISENUGC-I	SEL VR17-LIS4C-ENT-UG-C)	K	\$8,237
VR17LISENUGC-K	SEL VR17-LIS4C-ENT-UG-C)	K	\$7,930
VR17OADCSUDUC	SEL VR17-OADVC-STD-UG-C)	K	\$1,111
VR17OADCSUDUC-I	SEL VR17-OADVC-STD-UG-C)	K	\$1,300
VR17OADCSUDUC-K	SEL VR17-OADVC-STD-UG-C)	K	\$1,253
VR17OADVADVUGF	SEL: VR17-OADV-ADV-UG-F	K	\$6,798
VR17OADVCADVUGF	SEL: VR17-OADVC-ADV-UG-F	K	\$4,230
VR17OADVCENTUGF	SEL: VR17-OADVC-ENT-UG-F	K	\$6,045
VR17OADVCSTDUGF	SEL: VR17-OADVC-STD-UG-F	K	\$1,205
VR17OADVENTUGF	SEL: VR17-OADV-ENT-UG-F	K	\$1,056
VR17OADVSTDUGF	SEL: VR17-OADV-STD-UG-F	K	\$748
VR17ODENTUGC	SEL VR17-OADVC-ENT-UG-C)	K	\$5,621
VR17ODENTUGC-I	SEL VR17-OADVC-ENT-UG-C)	K	\$6,577
VR17ODENTUGC-K	SEL VR17-OADVC-ENT-UG-C)	K	\$6,317
VR17OENTADVUGF	SEL: VR17-OENT-ADV-UG-F	K	\$7,095
VR17OENTENTUGF	SEL: VR17-OENT-ENT-UG-F	K	\$7,095
VR17OENTSTDUGF	SEL: VR17-OENT-STD-UG-F	K	\$4,362
VR17OISSTUC	SEL VR17-OIST-STD-UG-C)	K	\$1,969
VR17OISSTUC-I	SEL VR17-OIST-STD-UG-C)	K	\$2,304
VR17OISSTUC-K	SEL VR17-OIST-STD-UG-C)	K	\$2,210
VR17OISTADVUGF	SEL: VR17-OIST-ADV-UG-F	K	\$5,137
VR17OISTENTUGF	SEL: VR17-OIST-ENT-UG-F	K	\$6,952
VR17OISTSTDUGF	SEL: VR17-OIST-STD-UG-F	K	\$2,112
VR17OISVUGC	SEL VR17-OIST-ADV-UG-C)	K	\$4,829
VR17OISVUGC-I	SEL VR17-OIST-ADV-UG-C)	K	\$5,650
VR17OISVUGC-K	SEL VR17-OIST-ADV-UG-C)	K	\$5,428
VR17OSCDVUC	SEL VR17-OSTC-ADV-UG-C)	K	\$5,676
VR17OSCDVUC-I	SEL VR17-OSTC-ADV-UG-C)	K	\$6,641
VR17OSCDVUC-K	SEL VR17-OSTC-ADV-UG-C)	K	\$6,378
VR17OSENTGC	SEL VR17-OSTC-ENT-UG-C)	K	\$7,326
VR17OSENTGC-I	SEL VR17-OSTC-ENT-UG-C)	K	\$8,571
VR17OSENTGC-K	SEL VR17-OSTC-ENT-UG-C)	K	\$8,236
VR17OSTCADVUGF	SEL: VR17-OSTC-ADV-UG-F	K	\$6,045
VR17OSTCENTUGF	SEL: VR17-OSTC-ENT-UG-F	K	\$7,860
VR17OSTCSDGC	SEL VR17-OSTDC-STD-UG-C)	K	\$3,394
VR17OSTCSDGC-I	SEL VR17-OSTDC-STD-UG-C)	K	\$3,971
VR17OSTCSDGC-K	SEL VR17-OSTDC-STD-UG-C)	K	\$3,812
VR17OSTCSTDUGF	SEL: VR17-OSTC-STD-UG-F	K	\$3,020
VR17OSTDCADVUGF	SEL: VR17-OSTDC-ADV-UG-F	K	\$6,650
VR17OSTDCENTUGF	SEL: VR17-OSTDC-ENT-UG-F	K	\$7,695
VR17OSTDCSTDUGF	SEL: VR17-OSTDC-STD-UG-F	K	\$3,625
VR17OSTDOADVUGF	SEL: VR17-OSTDO-ADV-UG-F	K	\$3,779
VR17OSTDOENTUGF	SEL: VR17-OSTDO-ENT-UG-F	K	\$5,594
VR17OSTDOSTDUGF	SEL: VR17-OSTDO-STD-UG-F	K	\$754
VR17OSTONGC	SEL VR17-OSTDO-ENT-UG-C)	K	\$5,203
VR17OSTONGC-I	SEL VR17-OSTDO-ENT-UG-C)	K	\$6,088
VR17OSTONGC-K	SEL VR17-OSTDO-ENT-UG-C)	K	\$5,850
VR17OTCTDUC	SEL VR17-OSTC-STD-UG-C)	K	\$2,816
VR17OTCTDUC-I	SEL VR17-OSTC-STD-UG-C)	K	\$3,295

VR17OTCTDUC-K	SEL VR17-OSTC-STD-UG-C)	K	\$3,168
VR17SAVUC	SEL VR17-STD-ADV-UG-C)	K	\$2,860
VR17SAVUC-I	SEL VR17-STD-ADV-UG-C)	K	\$3,346
VR17SAVUC-K	SEL VR17-STD-ADV-UG-C)	K	\$3,214
VR17SENTUC	SEL VR17-OIST-ENT-UG-C)	K	\$6,479
VR17SENTUC-I	SEL VR17-OIST-ENT-UG-C)	K	\$7,580
VR17SENTUC-K	SEL VR17-OIST-ENT-UG-C)	K	\$7,282
VR17STDADVUGF	SEL: VR17-STD-ADV-UG-F	K	\$3,025
VR17STDC	SEL VR17-STD-C)	K	\$3,845
VR17STDC-I	SEL VR17-STD-C)	K	\$4,499
VR17STDC-K	SEL VR17-STD-C)	K	\$4,325
VR17STDENTUGF	SEL: VR17-STD-ENT-UG-F	K	\$4,840
VR17STDF	SEL: VR17-STD-F	K	\$4,120
VR17STDSTDGC	SEL VR17-OSTDO-STD-UG-C)	K	\$693
VR17STDSTDGC-I	SEL VR17-OSTDO-STD-UG-C)	K	\$811
VR17STDSTDGC-K	SEL VR17-OSTDO-STD-UG-C)	K	\$778
VR17STETUGC	SEL VR17-STD-ENT-UG-C)	K	\$4,510
VR17STETUGC-I	SEL VR17-STD-ENT-UG-C)	K	\$5,277
VR17STETUGC-K	SEL VR17-STD-ENT-UG-C)	K	\$5,068
VR10AADVUGC	SEL VR17-OADVC-ADV-UG-C)	K	\$3,971
VR10AADVUGC-I	SEL VR17-OADVC-ADV-UG-C)	K	\$4,646
VR10AADVUGC-K	SEL VR17-OADVC-ADV-UG-C)	K	\$4,463
VR1STADVUGC	SEL VR17-OSTDC-ADV-UG-C)	K	\$6,226
VR1STADVUGC-I	SEL VR17-OSTDC-ADV-UG-C)	K	\$7,284
VR1STADVUGC-K	SEL VR17-OSTDC-ADV-UG-C)	K	\$6,999
VR6OADVCC	SEL VR6-OADVC-C)	K	\$2,835
VR6OADVCC-I	SEL VR6-OADVC-C)	K	\$3,317
VR6OADVCC-K	SEL VR6-OADVC-C)	K	\$3,183
VR6-OADVC-F	SEL: VR6-OADVC-F	K	\$3,025
VR6OSCOADCUC	SEL VR6-OSTC-OADVC-UG-C)	K	\$1,705
VR6OSCOADCUC-I	SEL VR6-OSTC-OADVC-UG-C)	K	\$1,995
VR6OSCOADCUC-K	SEL VR6-OSTC-OADVC-UG-C)	K	\$1,919
VR6OSTCC	SEL VR6-OSTC-C)	K	\$1,285
VR6OSTCC-I	SEL VR6-OSTC-C)	K	\$1,503
VR6OSTCC-K	SEL VR6-OSTC-C)	K	\$1,444
VR6OSTCOADVUGF	SEL: VR6-OSTC-OADVC-UG-F	K	\$1,815
VR6OSTCOAVCUC	SEL VR6-OSTDC-OADVC-UG-C)	K	\$2,266
VR6OSTCOAVCUC-I	SEL VR6-OSTDC-OADVC-UG-C)	K	\$2,651
VR6OSTCOAVCUC-K	SEL VR6-OSTDC-OADVC-UG-C)	K	\$2,548
VR6OSTDCOADVUGF	SEL: VR6-OSTDC-OADVC-UG-F	K	\$2,420
VR6VU100C	SEL VR6-VU100-C)	K	\$7,725
VR6VU100C-I	SEL VR6-VU100-C)	K	\$9,038
VR6VU100C-K	SEL VR6-VU100-C)	K	\$8,696
VR6VU10C	SEL VR6-VU10-C)	K	\$773
VR6VU10C-I	SEL VR6-VU10-C)	K	\$904
VR6VU10C-K	SEL VR6-VU10-C)	K	\$870
VR7ATAD25CV2	SEL VR7-ATAD25-C)	K	\$7,085
VR7ATAD25CV2-I	SEL VR7-ATAD25-C)	K	\$8,289
VR7ATATENUVCV2	SEL VR7-ATAD-ATEN-UG-C)	K	\$5,682
VR7ATATENUVCV2-I	SEL VR7-ATAD-ATEN-UG-C)	K	\$6,648

VR7ATEN25CV2	SEL VR7-ATEN25-C)	K	\$12,250
VR7ATEN25CV2-I	SEL VR7-ATEN25-C)	K	\$14,333
VR7AUTDT25C	SEL VR7-AUTDT25-C)	K	\$3,425
VR7AUTDT25C-I	SEL VR7-AUTDT25-C)	K	\$4,007
VR7AUTDT25C-K	SEL VR7-AUTDT25-C)	K	\$3,850
VR7OADVADVUGFPRO	SEL: VR7-OADV-ADV-UG-FPRO	K	\$5,099
VR7OADVSTUGFPRO	SEL: VR7-OADV-ENT-UG-FPRO	K	\$792
VR7OADVSTDUGFPRO	SEL: VR7-OADV-STD-UG-FPRO	K	\$561
VR7OENTADVUGFPRO	SEL: VR7-OENT-ADV-UG-FPRO	K	\$5,324
VR7OENTENTUGFPRO	SEL: VR7-OENT-ENT-UG-FPRO	K	\$5,324
VR7OENTSTDUGFPRO	SEL: VR7-OENT-STD-UG-FPRO	K	\$3,273
VR7OISTSTDUGFPRO	SEL: VR7-OIST-STD-UG-FPRO	K	\$1,584
VR7OOAVUGC	SEL VR17-OSTDO-ADV-UG-C)	K	\$3,553
VR7OOAVUGC-I	SEL VR17-OSTDO-ADV-UG-C)	K	\$4,157
VR7OOAVUGC-K	SEL VR17-OSTDO-ADV-UG-C)	K	\$3,996
VR7OSTCADVUGFPRO	SEL: VR7-OSTC-ADV-UG-FPRO	K	\$4,538
VR7OSTCENTUGFPRO	SEL: VR7-OSTC-ENT-UG-FPRO	K	\$5,896
VR7OSTCSTDUGFPRO	SEL: VR7-OSTC-STD-UG-FPRO	K	\$2,266
VR7OSTDCADVUGPRO	SEL: VR7-OSTDC-ADV-UG-FPRO	K	\$4,989
VR7OSTDCENTUGPRO	SEL: VR7-OSTDC-ENT-UG-FPRO	K	\$5,770
VR7OSTDCSTDUGPRO	SEL: VR7-OSTDC-STD-UG-FPRO	K	\$2,723
VR7OSTDOADVUGPRO	SEL: VR7-OSTDO-ADV-UG-FPRO	K	\$2,838
VR7OSTDOENTUGPRO	SEL: VR7-OSTDO-ENT-UG-FPRO	K	\$4,197
VR7OSTDOSTDUGPRO	SEL: VR7-OSTDO-STD-UG-FPRO	K	\$567
VR7STCENTUGC	SEL VR17-OSTDC-ENT-UG-C)	K	\$7,205
VR7STCENTUGC-I	SEL VR17-OSTDC-ENT-UG-C)	K	\$8,430
VR7STCENTUGC-K	SEL VR17-OSTDC-ENT-UG-C)	K	\$8,083
VRBCLADVCC	SEL VR-BCLADVC-C)	K	\$3,085
VRBCLADVCC-I	SEL VR-BCLADVC-C)	K	\$3,609
VRBCLADVCC-K	SEL VR-BCLADVC-C)	K	\$3,467
VRBCLADVO25C	SEL VR-BCLADVO-25-C)	K	\$5,145
VRBCLADVO25C-I	SEL VR-BCLADVO-25-C)	K	\$6,020
VRBCLADVO25C-K	SEL VR-BCLADVO-25-C)	K	\$5,781
VRCODE2CC	SEL VR-CODE2C-C)	K	\$5,650
VRCODE2CC-I	SEL VR-CODE2C-C)	K	\$6,611
VRCODE2CC-K	SEL VR-CODE2C-C)	K	\$6,348
VRCODE2OC	SEL VR-CODE2O-C)	K	\$565
VRCODE2OC-I	SEL VR-CODE2O-C)	K	\$661
VRCODE2OC-K	SEL VR-CODE2O-C)	K	\$635
VRLIS4CPUC	SEL VR-LIS4-CPU-C)	K	\$1,545
VRLIS4CPUC-I	SEL VR-LIS4-CPU-C)	K	\$1,808
VRLIS4CPUC-K	SEL VR-LIS4-CPU-C)	K	\$1,735
VR-LIS4-CPU-F	SEL: VR-LIS4-CPU-F	K	\$1,650
VRLIS4O253GSSSF	SEL: VR-LIS4O-25-3G-SSS-F	K	\$3,049
VRLIS4O253PSSSF	SEL: VR-LIS4O-25-3P-SSS-F	K	\$3,630
VRLIS4O25C	SEL VR-LIS4O-25-C)	K	\$5,150
VRLIS4O25C-I	SEL VR-LIS4O-25-C)	K	\$6,026
VRLIS4O25C-K	SEL VR-LIS4O-25-C)	K	\$5,788
VR-LIS4O-25-F	SEL: VR-LIS4O-25-F	K	\$5,500
VRLIS4O25GSSSF	SEL: VR-LIS4O-25-G-SSS-F	K	\$1,155

VRLIS4O25PSSSF	SEL: VR-LIS4O-25-P-SSS-F	K	\$1,375
VRNIAENXCUGFPRO	SEL: VR-NI-AENXC-UG-FPRO	K	\$230
VRNIANX100C	SEL VR-NI-ANX100-C)	K	\$2,590
VRNIANX100C-I	SEL VR-NI-ANX100-C)	K	\$3,030
VRNIANX100C-K	SEL VR-NI-ANX100-C)	K	\$2,915
VR-NI-ANX100-F	SEL: VR-NI-ANX100-F	K	\$2,750
VRNIANX10C	SEL VR-NI-ANX10-C)	K	\$259
VRNIANX10C-I	SEL VR-NI-ANX10-C)	K	\$303
VRNIANX10C-K	SEL VR-NI-ANX10-C)	K	\$292
VR-NI-ANX10-F	SEL: VR-NI-ANX10-F	K	\$275
VRNIANXCC	SEL VR-NI-ANXC-C)	K	\$1,295
VRNIANXCC-I	SEL VR-NI-ANXC-C)	K	\$1,515
VRNIANXCC-K	SEL VR-NI-ANXC-C)	K	\$1,460
VRNIENX100C	SEL VR-NI-ENX100-C)	K	\$4,490
VRNIENX100C-I	SEL VR-NI-ENX100-C)	K	\$5,253
VRNIENX100C-K	SEL VR-NI-ENX100-C)	K	\$5,045
VRNIENX100F	SEL: VR-NI-ENX100-F	K	\$4,895
VRNIENX10C	SEL VR-NI-ENX10-C)	K	\$449
VRNIENX10C-I	SEL VR-NI-ENX10-C)	K	\$525
VRNIENX10C-K	SEL VR-NI-ENX10-C)	K	\$505
VRNIENX10F	SEL: VR-NI-ENX10-F	K	\$490
VRNIENXCC	SEL VR-NI-ENXC-C)	K	\$2,245
VRNIENXCC-I	SEL VR-NI-ENXC-C)	K	\$2,627
VRNIENXCC-K	SEL VR-NI-ENXC-C)	K	\$2,525
VRNIENXCF	SEL: VR-NI-ENXC-F	K	\$2,415
VRNIRBAD25C	SEL VR-NI-RBAD25-C)	K	\$3,625
VRNIRBAD25C-I	SEL VR-NI-RBAD25-C)	K	\$6,199
VRNIRBAD25C-K	SEL VR-NI-RBAD25-C)	K	\$5,952
VRNIUAEXCUC	SEL VR-NI-UG-AENXC-UG-C)	K	\$1,045
VRNIUAEXCUC-I	SEL VR-NI-UG-AENXC-UG-C)	K	\$1,223
VRNIUAEXCUC-K	SEL VR-NI-UG-AENXC-UG-C)	K	\$1,176
VRNIUGAENX100UGF	SEL: VR-NI-UG-AENX100-UG-F	K	\$2,360
VRNIUGAENX10UGF	SEL: VR-NI-UG-AENX10-UG-F	K	\$237
VRNIUGAENXCUGF	SEL: VR-NI-UG-AENXC-UG-F	K	\$1,150
VROADV25C	SEL VR6-OADV25-C)	K	\$7,085
VROADV25C-I	SEL VR6-OADV25-C)	K	\$8,289
VROADV25C-K	SEL VR6-OADV25-C)	K	\$7,930
VROADVOENTUGC	SEL VR6-OADV-OENT-UG-C)	K	\$11,842
VROADVOENTUGC-I	SEL VR6-OADV-OENT-UG-C)	K	\$13,855
VROADVOENTUGC-K	SEL VR6-OADV-OENT-UG-C)	K	\$13,293
VROAMADC	SEL VR-OAMAD-C)	K	\$1,545
VROAMADC-I	SEL VR-OAMAD-C)	K	\$1,808
VROAMADC-K	SEL VR-OAMAD-C)	K	\$1,735
VROENT25C	SEL VR6-OENT25-C)	K	\$17,850
VROENT25C-I	SEL VR6-OENT25-C)	K	\$20,885
VROENT25C-K	SEL VR6-OENT25-C)	K	\$20,035
VROST5ADC	SEL VR-OST5-AD-C)	K	\$495
VROST5ADC-I	SEL VR-OST5-AD-C)	K	\$579
VROST5ADC-K	SEL VR-OST5-AD-C)	K	\$557
VROST5DCC	SEL VR-OST5-DC-C)	K	\$995

VROST5DCC-I	SEL VR-OST5-DC-C)	K	\$1,164
VROST5DCC-K	SEL VR-OST5-DC-C)	K	\$1,115
VROSTACK4ADF	SEL: VR-OSTACK4-AD-F	K	\$545
VROSTACK4F	SEL: VR-OSTACK4-F	K	\$1,095
VROSTD25C	SEL VR6-OSTD25-C)	K	\$3,215
VROSTD25C-I	SEL VR6-OSTD25-C)	K	\$3,762
VROSTD25C-K	SEL VR6-OSTD25-C)	K	\$3,612
VROSTDOADVUGC	SEL VR6-OSTD-OADV-UG-C)	K	\$4,257
VROSTDOADVUGC-I	SEL VR6-OSTD-OADV-UG-C)	K	\$4,981
VROSTDOADVUGC-K	SEL VR6-OSTD-OADV-UG-C)	K	\$4,785
VROSTDOENTUGC	SEL VR6-OSTD-OENT-UG-C)	K	\$16,099
VROSTDOENTUGC-I	SEL VR6-OSTD-OENT-UG-C)	K	\$18,836
VROSTDOENTUGC-K	SEL VR6-OSTD-OENT-UG-C)	K	\$18,120
VS10PB1YRSB	SELECT DFXS VS ELA, 10PB 1Yr Sub	K	\$900,000
VS1PB1YRSB	SELECT DFXS VS ELA, 1PB 1Yr Sub	K	\$181,800
VS3PB1YRSB	SELECT DFXS VS ELA, 3PB 1Yr Sub	K	\$356,400
VS5PB1YRSB	SELECT DFXS VS ELA, 5PB 1Yr Sub	K	\$540,000
VS6DT100VMC	SEL VS6-DT100VM-C)	K	\$8,235
VS6DT100VMC-I	SEL VS6-DT100VM-C)	K	\$9,635
VS6DT100VMC-K	SEL VS6-DT100VM-C)	K	\$9,692
VS6EPLAKC	SEL VS6-EPL-AK-C)	K	\$23,650
VS6EPLAKC-I	SEL VS6-EPL-AK-C)	K	\$27,671
VS6EPLAKC-K	SEL VS6-EPL-AK-C)	K	\$27,850
VS6EPLC	SEL VS6-EPL-C)	K	\$3,495
VS6EPLC-I	SEL VS6-EPL-C)	K	\$4,089
VS6EPLC-K	SEL VS6-EPL-C)	K	\$4,118
VS6ESESPLUGC	SEL VS6-ES-ESPL-UG-C)	K	\$4,400
VS6ESESPLUGC-I	SEL VS6-ES-ESPL-UG-C)	K	\$4,400
VS6ESESPLUGC-K	SEL VS6-ES-ESPL-UG-C)	K	\$5,183
VS6ESPKITC	SEL VS6-ESP-KIT-C)	K	\$4,495
VS6ESPKITC-I	SEL VS6-ESP-KIT-C)	K	\$4,495
VS6ESPKITC-K	SEL VS6-ESP-KIT-C)	K	\$5,298
VS6ESSLKITC	SEL VS6-ESSL-KIT-C)	K	\$495
VS6ESSLKITC-I	SEL VS6-ESSL-KIT-C)	K	\$579
VS6ESSLKITC-K	SEL VS6-ESSL-KIT-C)	K	\$583
VS6OEPLAKC	SEL VS6-OEPL-AK-C)	K	\$25,750
VS6OEPLAKC-I	SEL VS6-OEPL-AK-C)	K	\$30,128
VS6OEPLAKC-K	SEL VS6-OEPL-AK-C)	K	\$28,923
VS6OEPLC	SEL VS6-OEPL-C)	K	\$4,525
VS6OEPLC-I	SEL VS6-OEPL-C)	K	\$5,294
VS6OEPLC-K	SEL VS6-OEPL-C)	K	\$5,084
VS6RBADV25C	SEL VS6-RBADV25-C)	K	\$4,635
VS6RBADV25C-I	SEL VS6-RBADV25-C)	K	\$5,423
VS6RBADV25C-K	SEL VS6-RBADV25-C)	K	\$5,459
VS6RBSTD25C	SEL VS6-RBSTD25-C)	K	\$3,085
VS6RBSTD25C-I	SEL VS6-RBSTD25-C)	K	\$3,609
VS6RBSTD25C-K	SEL VS6-RBSTD25-C)	K	\$3,635
VS6SO8CPUC	SEL VS6-SO-8CPU-C)	K	\$4,795
VS6SO8CPUC-I	SEL VS6-SO-8CPU-C)	K	\$5,610
VS6SO8CPUC-K	SEL VS6-SO-8CPU-C)	K	\$5,650

VS6SOEPLUGC	SEL VS6-SO-EPL-UG-C)	K	\$3,185
VS6SOEPLUGC-I	SEL VS6-SO-EPL-UG-C)	K	\$3,726
VS6SOEPLUGC-K	SEL VS6-SO-EPL-UG-C)	K	\$3,750
VS6SOEPUGC	SEL VS6-SO-OEPL-UG-C)	K	\$4,175
VS6SOEPUGC-I	SEL VS6-SO-OEPL-UG-C)	K	\$4,885
VS6SOEPUGC-K	SEL VS6-SO-OEPL-UG-C)	K	\$4,915
VS6STD8AKC	SEL VS6-STD-8AK-C)	K	\$8,875
VS6STD8AKC-I	SEL VS6-STD-8AK-C)	K	\$10,384
VS6STD8AKC-K	SEL VS6-STD-8AK-C)	K	\$10,458
VS6STDAKC	SEL VS6-STD-AK-C)	K	\$11,350
VS6STDAKC-I	SEL VS6-STD-AK-C)	K	\$13,280
VS6STDAKC-K	SEL VS6-STD-AK-C)	K	\$13,370
VS6STDC	SEL VS6-STD-C)	K	\$995
VS6STDC-I	SEL VS6-STD-C)	K	\$1,164
VS6STDC-K	SEL VS6-STD-C)	K	\$1,168
VSAD1PB1YRSB	SELECT DFXS VS ELA, ADD 1PB 1Yr Sub	K	\$90,000
VSC-OS-PIA-12-T0	SEL Storage Cloud Prm IA Cap	K	\$307
VSC-OS-PIA-24-T0	SEL Storage Cloud Prm IA Cap	K	\$614
VSC-OS-PIA-36-T0	SEL Storage Cloud Prm IA Cap	K	\$922
VSC-OS-PRM-12-T0	SEL Storage Cloud Prm Cap 1TB	K	\$725
VSC-OS-PRM-12-T1	SEL Storage Cloud Prm Cap 2-50TB	K	\$713
VSC-OS-PRM-12-T2	SEL Storage Cloud Prm Cap 51-500TB	K	\$700
VSC-OS-PRM-12-T3	SEL Storage Cloud Prm Cap 501-1000TB	K	\$688
VSC-OS-PRM-12-T4	SEL Storage Cloud Prm Cap 1001+TB	K	\$676
VSC-OS-PRM-24-T0	SEL Storage Cloud Prm Cap 1TB	K	\$1,450
VSC-OS-PRM-24-T1	SEL Storage Cloud Prm Cap 2-50TB	K	\$1,425
VSC-OS-PRM-24-T2	SEL Storage Cloud Prm Cap 51-500TB	K	\$1,401
VSC-OS-PRM-24-T3	SEL Storage Cloud Prm Cap 501-1000TB	K	\$1,376
VSC-OS-PRM-24-T4	SEL Storage Cloud Prm Cap 1001+TB	K	\$1,352
VSC-OS-PRM-36-T0	SEL Storage Cloud Prm Cap 1TB	K	\$2,175
VSC-OS-PRM-36-T1	SEL Storage Cloud Prm Cap 2-50TB	K	\$2,138
VSC-OS-PRM-36-T2	SEL Storage Cloud Prm Cap 51-500TB	K	\$2,101
VSC-OS-PRM-36-T3	SEL Storage Cloud Prm Cap 501-1000TB	K	\$2,064
VSC-OS-PRM-36-T4	SEL Storage Cloud Prm Cap 1001+TB	K	\$2,028
VSC-OS-SIA-12-T0	SEL Storage Cloud Std IA Cap	K	\$154
VSC-OS-SIA-24-T0	SEL Storage Cloud Std IA Cap	K	\$307
VSC-OS-SIA-36-T0	SEL Storage Cloud Std IA Cap	K	\$461
VSC-OS-STD-12-T0	SEL Storage Cloud Std Cap 1TB	K	\$369
VSC-OS-STD-12-T1	SEL Storage Cloud Std Cap 2-50TB	K	\$363
VSC-OS-STD-12-T2	SEL Storage Cloud Std Cap 51-500TB	K	\$356
VSC-OS-STD-12-T3	SEL Storage Cloud Std Cap 501-1000TB	K	\$350
VSC-OS-STD-12-T4	SEL Storage Cloud Std Cap 1001+TB	K	\$344
VSC-OS-STD-24-T0	SEL Storage Cloud Std Cap 1TB	K	\$737
VSC-OS-STD-24-T1	SEL Storage Cloud Std Cap 2-50TB	K	\$725
VSC-OS-STD-24-T2	SEL Storage Cloud Std Cap 51-500TB	K	\$713
VSC-OS-STD-24-T3	SEL Storage Cloud Std Cap 501-1000TB	K	\$700
VSC-OS-STD-24-T4	SEL Storage Cloud Std Cap 1001+TB	K	\$688
VSC-OS-STD-36-T0	SEL Storage Cloud Std Cap 1TB	K	\$1,106
VSC-OS-STD-36-T1	SEL Storage Cloud Std Cap 2-50TB	K	\$1,087
VSC-OS-STD-36-T2	SEL Storage Cloud Std Cap 51-500TB	K	\$1,069

VSC-OS-STD-36-T3	SEL Storage Cloud Std Cap 501-1000TB	K	\$1,051
VSC-OS-STD-36-T4	SEL Storage Cloud Std Cap 1001+TB	K	\$1,032
VS-CREDIT-250K	SEL Virtustream IaaS \$250K Credits	K	\$250,000
VSK-00050	SEL Virtual Cascade Shark 50-50 GB Disk	K	\$1,471
VSK-00200	SEL Virtual Cascade Shark 200-1 TB Disk	K	\$6,763
VSK-00400	SEL Virtual Cascade Shark 400-2 TB Disk	K	\$12,302
VUGAEWCLDDGC	SEL V-UG-AEW-CLD-D-G-C)	K	\$41
VUGAEWCLDDGC-I	SEL V-UG-AEW-CLD-D-G-C)	K	\$43
VUGAEWCLDDGC-K	SEL V-UG-AEW-CLD-D-G-C)	K	\$57
VUGAEWCLDUGC	SEL V-UG-AEW-CLD-U-G-C)	K	\$102
VUGAEWCLDUGC-I	SEL V-UG-AEW-CLD-U-G-C)	K	\$107
VUGAEWCLDUGC-K	SEL V-UG-AEW-CLD-U-G-C)	K	\$143
VUGAEWCLUGC	SEL V-UG-AEW-CL-U-G-C)	K	\$48
VUGAEWCLUGC-I	SEL V-UG-AEW-CL-U-G-C)	K	\$50
VUGAEWCLUGC-K	SEL V-UG-AEW-CL-U-G-C)	K	\$67
VUGBDWCLDUGC	SEL V-UG-BDW-CLD-U-G-C)	K	\$50
VUGBDWCLDUGC-I	SEL V-UG-BDW-CLD-U-G-C)	K	\$52
VUGBDWCLDUGC-K	SEL V-UG-BDW-CLD-U-G-C)	K	\$70
VUGBDWCLDUPC	SEL V-UG-BDW-CLD-U-P-C)	K	\$53
VUGBDWCLDUPC-I	SEL V-UG-BDW-CLD-U-P-C)	K	\$56
VUGBDWCLDUPC-K	SEL V-UG-BDW-CLD-U-P-C)	K	\$74
VUGBDWOAPLLUC	SEL V-UG-BDWOA-PLL-U-C)	K	\$102
VUGBDWOAPLLUC-I	SEL V-UG-BDWOA-PLL-U-C)	K	\$107
VUGBDWOAPLLUC-K	SEL V-UG-BDWOA-PLL-U-C)	K	\$143
VUGDPLWOHOSUC	SEL V-UG-DPL-WOHOS-U-C)	K	\$27
VUGDPLWOHOSUC-I	SEL V-UG-DPL-WOHOS-U-C)	K	\$28
VUGDPLWOHOSUC-K	SEL V-UG-DPL-WOHOS-U-C)	K	\$38
VUGGDCLDUGC	SEL V-UG-GD-CLD-U-G-C)	K	\$23
VUGGDCLDUGC-I	SEL V-UG-GD-CLD-U-G-C)	K	\$24
VUGGDCLDUGC-K	SEL V-UG-GD-CLD-U-G-C)	K	\$32
VUGGDWCLDDGC	SEL V-UG-GDW-CLD-D-G-C)	K	\$16
VUGGDWCLDDGC-I	SEL V-UG-GDW-CLD-D-G-C)	K	\$17
VUGGDWCLDDGC-K	SEL V-UG-GDW-CLD-D-G-C)	K	\$22
VUGGDWCLDDPC	SEL V-UG-GDW-CLD-D-P-C)	K	\$18
VUGGDWCLDDPC-I	SEL V-UG-GDW-CLD-D-P-C)	K	\$19
VUGGDWCLDDPC-K	SEL V-UG-GDW-CLD-D-P-C)	K	\$25
VUGGDWCLDUGC	SEL V-UG-GDW-CLD-U-G-C)	K	\$77
VUGGDWCLDUGC-I	SEL V-UG-GDW-CLD-U-G-C)	K	\$81
VUGGDWCLDUGC-K	SEL V-UG-GDW-CLD-U-G-C)	K	\$108
VUGGDWCLDUPC	SEL V-UG-GDW-CLD-U-P-C)	K	\$83
VUGGDWCLDUPC-I	SEL V-UG-GDW-CLD-U-P-C)	K	\$86
VUGGDWCLDUPC-K	SEL V-UG-GDW-CLD-U-P-C)	K	\$116
VUGGDWCLUPC	SEL V-UG-GDW-CL-U-P-C)	K	\$25
VUGGDWCLUPC-I	SEL V-UG-GDW-CL-U-P-C)	K	\$26
VUGGDWCLUPC-K	SEL V-UG-GDW-CL-U-P-C)	K	\$35
VUGGDWOAPLLDC	SEL V-UG-GDWOA-PLL-D-C)	K	\$45
VUGGDWOAPLLDC-I	SEL V-UG-GDWOA-PLL-D-C)	K	\$47
VUGGDWOAPLLDC-K	SEL V-UG-GDWOA-PLL-D-C)	K	\$63
VUGGDWOAPLLUC	SEL V-UG-GDWOA-PLL-U-C)	K	\$148
VUGGDWOAPLLUC-I	SEL V-UG-GDWOA-PLL-U-C)	K	\$155

VUGGDWOAPLLUC-K	SEL V-UG-GDWOA-PLL-U-C)	K	\$208
VUGGDWOSPLLUC	SEL V-UG-GDWOS-PLL-U-C)	K	\$45
VUGGDWOSPLLUC-I	SEL V-UG-GDWOS-PLL-U-C)	K	\$47
VUGGDWOSPLLUC-K	SEL V-UG-GDWOS-PLL-U-C)	K	\$63
VUGGUWCLDUGC	SEL V-UG-GUW-CLD-U-G-C)	K	\$19
VUGGUWCLDUGC-I	SEL V-UG-GUW-CLD-U-G-C)	K	\$20
VUGGUWCLDUGC-K	SEL V-UG-GUW-CLD-U-G-C)	K	\$27
VUGGUWCLDUPC	SEL V-UG-GUW-CLD-U-P-C)	K	\$23
VUGGUWCLDUPC-I	SEL V-UG-GUW-CLD-U-P-C)	K	\$24
VUGGUWCLDUPC-K	SEL V-UG-GUW-CLD-U-P-C)	K	\$32
VUGGUWOAPLLUC	SEL V-UG-GUWOA-PLL-U-C)	K	\$91
VUGGUWOAPLLUC-I	SEL V-UG-GUWOA-PLL-U-C)	K	\$95
VUGGUWOAPLLUC-K	SEL V-UG-GUWOA-PLL-U-C)	K	\$128
VUGODWCLDDGC	SEL V-UG-ODW-CLD-D-G-C)	K	\$6
VUGODWCLDDGC-I	SEL V-UG-ODW-CLD-D-G-C)	K	\$6
VUGODWCLDDGC-K	SEL V-UG-ODW-CLD-D-G-C)	K	\$8
VUGODWCLDDPC	SEL V-UG-ODW-CLD-D-P-C)	K	\$7
VUGODWCLDDPC-I	SEL V-UG-ODW-CLD-D-P-C)	K	\$7
VUGODWCLDDPC-K	SEL V-UG-ODW-CLD-D-P-C)	K	\$10
VUGODWCLDUGC	SEL V-UG-ODW-CLD-U-G-C)	K	\$67
VUGODWCLDUGC-I	SEL V-UG-ODW-CLD-U-G-C)	K	\$70
VUGODWCLDUGC-K	SEL V-UG-ODW-CLD-U-G-C)	K	\$94
VUGODWCLDUPC	SEL V-UG-ODW-CLD-U-P-C)	K	\$71
VUGODWCLDUPC-I	SEL V-UG-ODW-CLD-U-P-C)	K	\$75
VUGODWCLDUPC-K	SEL V-UG-ODW-CLD-U-P-C)	K	\$100
VUGODWOAPLLDC	SEL V-UG-ODWOA-PLL-D-C)	K	\$23
VUGODWOAPLLDC-I	SEL V-UG-ODWOA-PLL-D-C)	K	\$24
VUGODWOAPLLDC-K	SEL V-UG-ODWOA-PLL-D-C)	K	\$32
VUGODWOAPLLUC	SEL V-UG-ODWOA-PLL-U-C)	K	\$125
VUGODWOAPLLUC-I	SEL V-UG-ODWOA-PLL-U-C)	K	\$131
VUGODWOAPLLUC-K	SEL V-UG-ODWOA-PLL-U-C)	K	\$175
VUGOUWOAPLLUC	SEL V-UG-OUWOA-PLL-U-C)	K	\$45
VUGOUWOAPLLUC-I	SEL V-UG-OUWOA-PLL-U-C)	K	\$47
VUGOUWOAPLLUC-K	SEL V-UG-OUWOA-PLL-U-C)	K	\$63
VUGSPLWOHOSUC	SEL V-UG-SPL-WOHOS-U-C)	K	\$14
VUGSPLWOHOSUC-I	SEL V-UG-SPL-WOHOS-U-C)	K	\$14
VUGSPLWOHOSUC-K	SEL V-UG-SPL-WOHOS-U-C)	K	\$19
VUGWADWCLDUGC	SEL V-UG-WAD-W-CLD-U-G-C)	K	\$61
VUGWADWCLDUGC-I	SEL V-UG-WAD-W-CLD-U-G-C)	K	\$64
VUGWADWCLDUGC-K	SEL V-UG-WAD-W-CLD-U-G-C)	K	\$86
VUGWADWCLDUPC	SEL V-UG-WAD-W-CLD-U-P-C)	K	\$65
VUGWADWCLDUPC-I	SEL V-UG-WAD-W-CLD-U-P-C)	K	\$67
VUGWADWCLDUPC-K	SEL V-UG-WAD-W-CLD-U-P-C)	K	\$90
VUGWADWPLLUC	SEL V-UG-WAD-W-PLL-U-C)	K	\$102
VUGWADWPLLUC-I	SEL V-UG-WAD-W-PLL-U-C)	K	\$107
VUGWADWPLLUC-K	SEL V-UG-WAD-W-PLL-U-C)	K	\$143
VUGWESACLDUGC	SEL V-UG-WESA-CLD-U-G-C)	K	\$85
VUGWESACLDUGC-I	SEL V-UG-WESA-CLD-U-G-C)	K	\$89
VUGWESACLDUGC-K	SEL V-UG-WESA-CLD-U-G-C)	K	\$119
VUGWESACLDUPC	SEL V-UG-WESA-CLD-U-P-C)	K	\$90

VUGWESACLDUPC-I	SEL V-UG-WESA-CLD-U-P-C)	K	\$94
VUGWESACLDUPC-K	SEL V-UG-WESA-CLD-U-P-C)	K	\$126
VUGWESSCLDUGC	SEL V-UG-WESS-CLD-U-G-C)	K	\$31
VUGWESSCLDUGC-I	SEL V-UG-WESS-CLD-U-G-C)	K	\$32
VUGWESSCLDUGC-K	SEL V-UG-WESS-CLD-U-G-C)	K	\$43
VUGWESSCLDUPC	SEL V-UG-WESS-CLD-U-P-C)	K	\$32
VUGWESSCLDUPC-I	SEL V-UG-WESS-CLD-U-P-C)	K	\$33
VUGWESSCLDUPC-K	SEL V-UG-WESS-CLD-U-P-C)	K	\$44
VUGWSACLDDGC	SEL V-UG-WSA-CLD-D-G-C)	K	\$27
VUGWSACLDDGC-I	SEL V-UG-WSA-CLD-D-G-C)	K	\$28
VUGWSACLDDGC-K	SEL V-UG-WSA-CLD-D-G-C)	K	\$38
VUGWSACLDDPC	SEL V-UG-WSA-CLD-D-P-C)	K	\$29
VUGWSACLDDPC-I	SEL V-UG-WSA-CLD-D-P-C)	K	\$31
VUGWSACLDDPC-K	SEL V-UG-WSA-CLD-D-P-C)	K	\$41
VUGWSACLDUGC	SEL V-UG-WSA-CLD-U-G-C)	K	\$54
VUGWSACLDUGC-I	SEL V-UG-WSA-CLD-U-G-C)	K	\$57
VUGWSACLDUGC-K	SEL V-UG-WSA-CLD-U-G-C)	K	\$76
VUGWSACLDUPC	SEL V-UG-WSA-CLD-U-P-C)	K	\$58
VUGWSACLDUPC-I	SEL V-UG-WSA-CLD-U-P-C)	K	\$60
VUGWSACLDUPC-K	SEL V-UG-WSA-CLD-U-P-C)	K	\$81
VUGWSAPLLDC	SEL V-UG-WSA-PLL-D-C)	K	\$45
VUGWSAPLLDC-I	SEL V-UG-WSA-PLL-D-C)	K	\$47
VUGWSAPLLDC-K	SEL V-UG-WSA-PLL-D-C)	K	\$48
VUGWSAPLLUC	SEL V-UG-WSA-PLL-U-C)	K	\$102
VUGWSAPLLUC-I	SEL V-UG-WSA-PLL-U-C)	K	\$107
VUGWSAPLLUC-K	SEL V-UG-WSA-PLL-U-C)	K	\$109
VUGWSDWCLDUGC	SEL V-UG-WSD-W-CLD-U-G-C)	K	\$88
VUGWSDWCLDUGC-I	SEL V-UG-WSD-W-CLD-U-G-C)	K	\$92
VUGWSDWCLDUGC-K	SEL V-UG-WSD-W-CLD-U-G-C)	K	\$95
VUGWSDWCLDUPC	SEL V-UG-WSD-W-CLD-U-P-C)	K	\$94
VUGWSDWCLDUPC-I	SEL V-UG-WSD-W-CLD-U-P-C)	K	\$98
VUGWSDWCLDUPC-K	SEL V-UG-WSD-W-CLD-U-P-C)	K	\$101
VUGWSDWCLUGC	SEL V-UG-WSD-W-CL-U-G-C)	K	\$34
VUGWSDWCLUGC-I	SEL V-UG-WSD-W-CL-U-G-C)	K	\$36
VUGWSDWCLUGC-K	SEL V-UG-WSD-W-CL-U-G-C)	K	\$36
VUGWSDWCLUPC	SEL V-UG-WSD-W-CL-U-P-C)	K	\$36
VUGWSDWCLUPC-I	SEL V-UG-WSD-W-CL-U-P-C)	K	\$38
VUGWSDWCLUPC-K	SEL V-UG-WSD-W-CL-U-P-C)	K	\$39
VUGWSDWPLLUC	SEL V-UG-WSD-W-PLL-U-C)	K	\$148
VUGWSDWPLLUC-I	SEL V-UG-WSD-W-PLL-U-C)	K	\$155
VUGWSDWPLLUC-K	SEL V-UG-WSD-W-PLL-U-C)	K	\$159
VUGWSDWPLUC	SEL V-UG-WSD-W-PL-U-C)	K	\$45
VUGWSDWPLUC-I	SEL V-UG-WSD-W-PL-U-C)	K	\$47
VUGWSDWPLUC-K	SEL V-UG-WSD-W-PL-U-C)	K	\$48
VWACLDDGUGC	SEL V-WA-CLD-D-G-UG-C)	K	\$61
VWACLDDGUGC-I	SEL V-WA-CLD-D-G-UG-C)	K	\$64
VWACLDDGUGC-K	SEL V-WA-CLD-D-G-UG-C)	K	\$65
VWACLDDUGUGC	SEL V-WA-CLD-DU-G-UG-C)	K	\$115
VWACLDDUGUGC-I	SEL V-WA-CLD-DU-G-UG-C)	K	\$121
VWACLDDUGUGC-K	SEL V-WA-CLD-DU-G-UG-C)	K	\$124

VWACLDDUPUGC	SEL V-WA-CLD-DU-P-UG-C)	K	\$123
VWACLDDUPUGC-I	SEL V-WA-CLD-DU-P-UG-C)	K	\$128
VWACLDDUPUGC-K	SEL V-WA-CLD-DU-P-UG-C)	K	\$131
VWACLDUPUGC	SEL V-WA-CL-DU-P-UG-C)	K	\$65
VWACLDUPUGC-I	SEL V-WA-CL-DU-P-UG-C)	K	\$68
VWACLDUPUGC-K	SEL V-WA-CL-DU-P-UG-C)	K	\$70
VWAOACLDDGUGC	SEL V-WAOA-CLD-D-G-UG-C)	K	\$55
VWAOACLDDGUGC-I	SEL V-WAOA-CLD-D-G-UG-C)	K	\$57
VWAOACLDDGUGC-K	SEL V-WAOA-CLD-D-G-UG-C)	K	\$59
VWAOACLDDPUGC	SEL V-WAOA-CLD-D-P-UG-C)	K	\$58
VWAOACLDDPUGC-I	SEL V-WAOA-CLD-D-P-UG-C)	K	\$60
VWAOACLDDPUGC-K	SEL V-WAOA-CLD-D-P-UG-C)	K	\$62
VWAOACLDUGUGC	SEL V-WAOA-CLD-U-G-UG-C)	K	\$102
VWAOACLDUGUGC-I	SEL V-WAOA-CLD-U-G-UG-C)	K	\$107
VWAOACLDUGUGC-K	SEL V-WAOA-CLD-U-G-UG-C)	K	\$109
VWAOACLDUPUGC	SEL V-WAOA-CLD-U-P-UG-C)	K	\$108
VWAOACLDUPUGC-I	SEL V-WAOA-CLD-U-P-UG-C)	K	\$113
VWAOACLDUPUGC-K	SEL V-WAOA-CLD-U-P-UG-C)	K	\$116
VWAOSCLDDGUGC	SEL V-WAOS-CLD-D-G-UG-C)	K	\$27
VWAOSCLDDGUGC-I	SEL V-WAOS-CLD-D-G-UG-C)	K	\$28
VWAOSCLDDGUGC-K	SEL V-WAOS-CLD-D-G-UG-C)	K	\$29
VWAOSCLDDPUGC	SEL V-WAOS-CLD-D-P-UG-C)	K	\$29
VWAOSCLDDPUGC-I	SEL V-WAOS-CLD-D-P-UG-C)	K	\$30
VWAOSCLDDPUGC-K	SEL V-WAOS-CLD-D-P-UG-C)	K	\$31
VWAOSCLDUGUGC	SEL V-WAOS-CLD-U-G-UG-C)	K	\$47
VWAOSCLDUGUGC-I	SEL V-WAOS-CLD-U-G-UG-C)	K	\$50
VWAOSCLDUGUGC-K	SEL V-WAOS-CLD-U-G-UG-C)	K	\$51
VWAOSCLDUPUGC	SEL V-WAOS-CLD-U-P-UG-C)	K	\$50
VWAOSCLDUPUGC-I	SEL V-WAOS-CLD-U-P-UG-C)	K	\$53
VWAOSCLDUPUGC-K	SEL V-WAOS-CLD-U-P-UG-C)	K	\$54
VWOOACLDD2GC	SEL V-WOAA-CLD-D-2G-C)	K	\$35
VWOOACLDD2GC-I	SEL V-WOAA-CLD-D-2G-C)	K	\$36
VWOOACLDD2GC-K	SEL V-WOAA-CLD-D-2G-C)	K	\$37
VWOOACLDD2PC	SEL V-WOAA-CLD-D-2P-C)	K	\$37
VWOOACLDD2PC-I	SEL V-WOAA-CLD-D-2P-C)	K	\$38
VWOOACLDD2PC-K	SEL V-WOAA-CLD-D-2P-C)	K	\$39
VWOOACLDD3GC	SEL V-WOAA-CLD-D-3G-C)	K	\$49
VWOOACLDD3GC-I	SEL V-WOAA-CLD-D-3G-C)	K	\$51
VWOOACLDD3GC-K	SEL V-WOAA-CLD-D-3G-C)	K	\$52
VWOOACLDD3PC	SEL V-WOAA-CLD-D-3P-C)	K	\$51
VWOOACLDD3PC-I	SEL V-WOAA-CLD-D-3P-C)	K	\$54
VWOOACLDD3PC-K	SEL V-WOAA-CLD-D-3P-C)	K	\$55
VWOOACLDDGC	SEL V-WOAA-CLD-D-G-C)	K	\$19
VWOOACLDDGC-I	SEL V-WOAA-CLD-D-G-C)	K	\$19
VWOOACLDDGC-K	SEL V-WOAA-CLD-D-G-C)	K	\$20
VWOOACLDDPC	SEL V-WOAA-CLD-D-P-C)	K	\$19
VWOOACLDDPC-I	SEL V-WOAA-CLD-D-P-C)	K	\$20
VWOOACLDDPC-K	SEL V-WOAA-CLD-D-P-C)	K	\$21
VWOOACLDDU2GC	SEL V-WOAA-CLD-U-2G-C)	K	\$58
VWOOACLDDU2GC-I	SEL V-WOAA-CLD-U-2G-C)	K	\$61

VWOAACLDU2GC-K	SEL V-WOAA-CLD-U-2G-C)	K	\$62
VWOAACLDU2PC	SEL V-WOAA-CLD-U-2P-C)	K	\$61
VWOAACLDU2PC-I	SEL V-WOAA-CLD-U-2P-C)	K	\$64
VWOAACLDU2PC-K	SEL V-WOAA-CLD-U-2P-C)	K	\$65
VWOAACLDU3GC	SEL V-WOAA-CLD-U-3G-C)	K	\$82
VWOAACLDU3GC-I	SEL V-WOAA-CLD-U-3G-C)	K	\$85
VWOAACLDU3GC-K	SEL V-WOAA-CLD-U-3G-C)	K	\$88
VWOAACLDU3PC	SEL V-WOAA-CLD-U-3P-C)	K	\$85
VWOAACLDU3PC-I	SEL V-WOAA-CLD-U-3P-C)	K	\$89
VWOAACLDU3PC-K	SEL V-WOAA-CLD-U-3P-C)	K	\$92
VWOAACLDUGC	SEL V-WOAA-CLD-U-G-C)	K	\$31
VWOAACLDUGC-I	SEL V-WOAA-CLD-U-G-C)	K	\$32
VWOAACLDUGC-K	SEL V-WOAA-CLD-U-G-C)	K	\$33
VWOAACLDUGUGC	SEL V-WOAA-CLD-U-G-UG-C)	K	\$13
VWOAACLDUGUGC-I	SEL V-WOAA-CLD-U-G-UG-C)	K	\$14
VWOAACLDUGUGC-K	SEL V-WOAA-CLD-U-G-UG-C)	K	\$14
VWOAACLDUPC	SEL V-WOAA-CLD-U-P-C)	K	\$32
VWOAACLDUPC-I	SEL V-WOAA-CLD-U-P-C)	K	\$34
VWOAACLDUPC-K	SEL V-WOAA-CLD-U-P-C)	K	\$35
VWOAACLDUPUGC	SEL V-WOAA-CLD-U-P-UG-C)	K	\$14
VWOAACLDUPUGC-I	SEL V-WOAA-CLD-U-P-UG-C)	K	\$15
VWOAACLDUPUGC-K	SEL V-WOAA-CLD-U-P-UG-C)	K	\$15
VWOAADCLDU2GC	SEL V-WOA-AD-CLD-U-2G-C)	K	\$163
VWOAADCLDU2GC-I	SEL V-WOA-AD-CLD-U-2G-C)	K	\$170
VWOAADCLDU2GC-K	SEL V-WOA-AD-CLD-U-2G-C)	K	\$174
VWOAADCLDU2PC	SEL V-WOA-AD-CLD-U-2P-C)	K	\$172
VWOAADCLDU2PC-I	SEL V-WOA-AD-CLD-U-2P-C)	K	\$180
VWOAADCLDU2PC-K	SEL V-WOA-AD-CLD-U-2P-C)	K	\$184
VWOAADCLDU3GC	SEL V-WOA-AD-CLD-U-3G-C)	K	\$228
VWOAADCLDU3GC-I	SEL V-WOA-AD-CLD-U-3G-C)	K	\$239
VWOAADCLDU3GC-K	SEL V-WOA-AD-CLD-U-3G-C)	K	\$245
VWOAADCLDU3PC	SEL V-WOA-AD-CLD-U-3P-C)	K	\$242
VWOAADCLDU3PC-I	SEL V-WOA-AD-CLD-U-3P-C)	K	\$253
VWOAADCLDU3PC-K	SEL V-WOA-AD-CLD-U-3P-C)	K	\$259
VWOAADCLDUGC	SEL V-WOA-AD-CLD-U-G-C)	K	\$87
VWOAADCLDUGC-I	SEL V-WOA-AD-CLD-U-G-C)	K	\$90
VWOAADCLDUGC-K	SEL V-WOA-AD-CLD-U-G-C)	K	\$93
VWOAADCLDUPC	SEL V-WOA-AD-CLD-U-P-C)	K	\$92
VWOAADCLDUPC-I	SEL V-WOA-AD-CLD-U-P-C)	K	\$96
VWOAADCLDUPC-K	SEL V-WOA-AD-CLD-U-P-C)	K	\$98
VWOAADPLLUC	SEL V-WOA-AD-PLL-U-C)	K	\$130
VWOAADPLLUC-I	SEL V-WOA-AD-PLL-U-C)	K	\$136
VWOAADPLLUC-K	SEL V-WOA-AD-PLL-U-C)	K	\$139
VWOAAPLLDC	SEL V-WOAA-PLL-D-C)	K	\$23
VWOAAPLLDC-I	SEL V-WOAA-PLL-D-C)	K	\$24
VWOAAPLLDC-K	SEL V-WOAA-PLL-D-C)	K	\$24
VWOAAPLLUC	SEL V-WOAA-PLL-U-C)	K	\$37
VWOAAPLLUC-I	SEL V-WOAA-PLL-U-C)	K	\$39
VWOAAPLLUC-K	SEL V-WOAA-PLL-U-C)	K	\$40
VWOACLDD2GC	SEL V-WOA-CLD-D-2G-C)	K	\$128

VWOACLDD2GC-I	SEL V-WOA-CLD-D-2G-C)	K	\$134
VWOACLDD2GC-K	SEL V-WOA-CLD-D-2G-C)	K	\$137
VWOACLDD2PC	SEL V-WOA-CLD-D-2P-C)	K	\$136
VWOACLDD2PC-I	SEL V-WOA-CLD-D-2P-C)	K	\$142
VWOACLDD2PC-K	SEL V-WOA-CLD-D-2P-C)	K	\$145
VWOACLDD3GC	SEL V-WOA-CLD-D-3G-C)	K	\$179
VWOACLDD3GC-I	SEL V-WOA-CLD-D-3G-C)	K	\$188
VWOACLDD3GC-K	SEL V-WOA-CLD-D-3G-C)	K	\$193
VWOACLDD3PC	SEL V-WOA-CLD-D-3P-C)	K	\$190
VWOACLDD3PC-I	SEL V-WOA-CLD-D-3P-C)	K	\$199
VWOACLDD3PC-K	SEL V-WOA-CLD-D-3P-C)	K	\$204
VWOACLDDGC	SEL V-WOA-CLD-D-G-C)	K	\$68
VWOACLDDGC-I	SEL V-WOA-CLD-D-G-C)	K	\$71
VWOACLDDGC-K	SEL V-WOA-CLD-D-G-C)	K	\$73
VWOACLDDPC	SEL V-WOA-CLD-D-P-C)	K	\$72
VWOACLDDPC-I	SEL V-WOA-CLD-D-P-C)	K	\$75
VWOACLDDPC-K	SEL V-WOA-CLD-D-P-C)	K	\$77
VWOACLDU2GC	SEL V-WOA-CLD-U-2G-C)	K	\$232
VWOACLDU2GC-I	SEL V-WOA-CLD-U-2G-C)	K	\$243
VWOACLDU2GC-K	SEL V-WOA-CLD-U-2G-C)	K	\$249
VWOACLDU2PC	SEL V-WOA-CLD-U-2P-C)	K	\$246
VWOACLDU2PC-I	SEL V-WOA-CLD-U-2P-C)	K	\$257
VWOACLDU2PC-K	SEL V-WOA-CLD-U-2P-C)	K	\$264
VWOACLDU3GC	SEL V-WOA-CLD-U-3G-C)	K	\$326
VWOACLDU3GC-I	SEL V-WOA-CLD-U-3G-C)	K	\$341
VWOACLDU3GC-K	SEL V-WOA-CLD-U-3G-C)	K	\$350
VWOACLDU3PC	SEL V-WOA-CLD-U-3P-C)	K	\$345
VWOACLDU3PC-I	SEL V-WOA-CLD-U-3P-C)	K	\$361
VWOACLDU3PC-K	SEL V-WOA-CLD-U-3P-C)	K	\$370
VWOACLDUGC	SEL V-WOA-CLD-U-G-C)	K	\$124
VWOACLDUGC-I	SEL V-WOA-CLD-U-G-C)	K	\$129
VWOACLDUGC-K	SEL V-WOA-CLD-U-G-C)	K	\$132
VWOACLDUPC	SEL V-WOA-CLD-U-P-C)	K	\$131
VWOACLDUPC-I	SEL V-WOA-CLD-U-P-C)	K	\$137
VWOACLDUPC-K	SEL V-WOA-CLD-U-P-C)	K	\$140
VWOAPLLDC	SEL V-WOA-PLL-D-C)	K	\$93
VWOAPLLDC-I	SEL V-WOA-PLL-D-C)	K	\$97
VWOAPLLDC-K	SEL V-WOA-PLL-D-C)	K	\$100
VWOAPLLUC	SEL V-WOA-PLL-U-C)	K	\$186
VWOAPLLUC-I	SEL V-WOA-PLL-U-C)	K	\$194
VWOAPLLUC-K	SEL V-WOA-PLL-U-C)	K	\$199
VWOEPLL10UC	SEL V-WOE-PLL-10U-C)	K	\$4,115
VWOEPLL10UC-I	SEL V-WOE-PLL-10U-C)	K	\$4,300
VWOEPLL10UC-K	SEL V-WOE-PLL-10U-C)	K	\$4,409
VWOEPLLUC	SEL V-WOE-PLL-U-C)	K	\$41,150
VWOEPLLUC-I	SEL V-WOE-PLL-U-C)	K	\$43,002
VWOEPLLUC-K	SEL V-WOE-PLL-U-C)	K	\$44,093
VWOHOS2AMCLDC	SEL V-WOHOS-2AMCL-D-C)	K	\$25
VWOHOS2AMCLDC-I	SEL V-WOHOS-2AMCL-D-C)	K	\$26
VWOHOS2AMCLDC-K	SEL V-WOHOS-2AMCL-D-C)	K	\$26

VWOHOS2AMCLUC	SEL V-WOHOS-2AMCL-U-C)	K	\$49
VWOHOS2AMCLUC-I	SEL V-WOHOS-2AMCL-U-C)	K	\$52
VWOHOS2AMCLUC-K	SEL V-WOHOS-2AMCL-U-C)	K	\$53
VWOHOS3AMCLDC	SEL V-WOHOS-3AMCL-D-C)	K	\$37
VWOHOS3AMCLDC-I	SEL V-WOHOS-3AMCL-D-C)	K	\$39
VWOHOS3AMCLDC-K	SEL V-WOHOS-3AMCL-D-C)	K	\$40
VWOHOS3AMCLUC	SEL V-WOHOS-3AMCL-U-C)	K	\$74
VWOHOS3AMCLUC-I	SEL V-WOHOS-3AMCL-U-C)	K	\$78
VWOHOS3AMCLUC-K	SEL V-WOHOS-3AMCL-U-C)	K	\$79
VWOHOS3AMPLDC	SEL V-WOHOS-3AMPL-D-C)	K	\$74
VWOHOS3AMPLDC-I	SEL V-WOHOS-3AMPL-D-C)	K	\$78
VWOHOS3AMPLDC-K	SEL V-WOHOS-3AMPL-D-C)	K	\$79
VWOHOS3AMPLUC	SEL V-WOHOS-3AMPL-U-C)	K	\$148
VWOHOS3AMPLUC-I	SEL V-WOHOS-3AMPL-U-C)	K	\$155
VWOHOS3AMPLUC-K	SEL V-WOHOS-3AMPL-U-C)	K	\$159
VWOHOS3CLDDC	SEL V-WOHOS-3CLD-D-C)	K	\$37
VWOHOS3CLDDC-I	SEL V-WOHOS-3CLD-D-C)	K	\$39
VWOHOS3CLDDC-K	SEL V-WOHOS-3CLD-D-C)	K	\$40
VWOHOS3CLDUC	SEL V-WOHOS-3CLD-U-C)	K	\$74
VWOHOS3CLDUC-I	SEL V-WOHOS-3CLD-U-C)	K	\$78
VWOHOS3CLDUC-K	SEL V-WOHOS-3CLD-U-C)	K	\$79
VWOHOSAMCLDC	SEL V-WOHOS-AMCL-D-C)	K	\$12
VWOHOSAMCLDC-I	SEL V-WOHOS-AMCL-D-C)	K	\$13
VWOHOSAMCLDC-K	SEL V-WOHOS-AMCL-D-C)	K	\$13
VWOHOSAMCLUC	SEL V-WOHOS-AMCL-U-C)	K	\$25
VWOHOSAMCLUC-I	SEL V-WOHOS-AMCL-U-C)	K	\$26
VWOHOSAMCLUC-K	SEL V-WOHOS-AMCL-U-C)	K	\$26
VWOHOSAMPLDC	SEL V-WOHOS-AMPL-D-C)	K	\$25
VWOHOSAMPLDC-I	SEL V-WOHOS-AMPL-D-C)	K	\$26
VWOHOSAMPLDC-K	SEL V-WOHOS-AMPL-D-C)	K	\$26
VWOHOSAMPLUC	SEL V-WOHOS-AMPL-U-C)	K	\$49
VWOHOSAMPLUC-I	SEL V-WOHOS-AMPL-U-C)	K	\$52
VWOHOSAMPLUC-K	SEL V-WOHOS-AMPL-U-C)	K	\$53
VWOHOSCLDDC	SEL V-WOHOS-CLD-D-C)	K	\$12
VWOHOSCLDDC-I	SEL V-WOHOS-CLD-D-C)	K	\$13
VWOHOSCLDDC-K	SEL V-WOHOS-CLD-D-C)	K	\$13
VWOHOSCLDUC	SEL V-WOHOS-CLD-U-C)	K	\$25
VWOHOSCLDUC-I	SEL V-WOHOS-CLD-U-C)	K	\$26
VWOHOSCLDUC-K	SEL V-WOHOS-CLD-U-C)	K	\$27
VWOHOSIDM2DC	SEL V-WOHOS-IDM-2D-C)	K	\$13
VWOHOSIDM2DC-I	SEL V-WOHOS-IDM-2D-C)	K	\$13
VWOHOSIDM2DC-K	SEL V-WOHOS-IDM-2D-C)	K	\$13
VWOHOSIDM2UC	SEL V-WOHOS-IDM-2U-C)	K	\$25
VWOHOSIDM2UC-I	SEL V-WOHOS-IDM-2U-C)	K	\$26
VWOHOSIDM2UC-K	SEL V-WOHOS-IDM-2U-C)	K	\$27
VWOHOSIDM3DC	SEL V-WOHOS-IDM-3D-C)	K	\$19
VWOHOSIDM3DC-I	SEL V-WOHOS-IDM-3D-C)	K	\$20
VWOHOSIDM3DC-K	SEL V-WOHOS-IDM-3D-C)	K	\$20
VWOHOSIDM3UC	SEL V-WOHOS-IDM-3U-C)	K	\$38
VWOHOSIDM3UC-I	SEL V-WOHOS-IDM-3U-C)	K	\$39

VWOHOSIDM3UC-K	SEL V-WOHOS-IDM-3U-C)	K	\$40
VWOHOSIDMDC	SEL V-WOHOS-IDM-D-C)	K	\$6
VWOHOSIDMDC-I	SEL V-WOHOS-IDM-D-C)	K	\$7
VWOHOSIDMDC-K	SEL V-WOHOS-IDM-D-C)	K	\$7
VWOHOSIDMUC	SEL V-WOHOS-IDM-U-C)	K	\$13
VWOHOSIDMUC-I	SEL V-WOHOS-IDM-U-C)	K	\$13
VWOHOSIDMUC-K	SEL V-WOHOS-IDM-U-C)	K	\$13
VWOPDADCLDDGC	SEL V-WOPD-AD-CLD-D-G-C)	K	\$9
VWOPDADCLDDGC-I	SEL V-WOPD-AD-CLD-D-G-C)	K	\$9
VWOPDADCLDDGC-K	SEL V-WOPD-AD-CLD-D-G-C)	K	\$9
VWOPDADCLDDPC	SEL V-WOPD-AD-CLD-D-P-C)	K	\$9
VWOPDADCLDDPC-I	SEL V-WOPD-AD-CLD-D-P-C)	K	\$10
VWOPDADCLDDPC-K	SEL V-WOPD-AD-CLD-D-P-C)	K	\$10
VWOPDADHOSDGC	SEL V-WOPD-AD-HOS-D-G-C)	K	\$9
VWOPDADHOSDGC-I	SEL V-WOPD-AD-HOS-D-G-C)	K	\$9
VWOPDADHOSDGC-K	SEL V-WOPD-AD-HOS-D-G-C)	K	\$9
VWOPDADHOSDPC	SEL V-WOPD-AD-HOS-D-P-C)	K	\$9
VWOPDADHOSDPC-I	SEL V-WOPD-AD-HOS-D-P-C)	K	\$10
VWOPDADHOSDPC-K	SEL V-WOPD-AD-HOS-D-P-C)	K	\$10
VWOSCLDD2GC	SEL V-WOS-CLD-D-2G-C)	K	\$81
VWOSCLDD2GC-I	SEL V-WOS-CLD-D-2G-C)	K	\$85
VWOSCLDD2GC-K	SEL V-WOS-CLD-D-2G-C)	K	\$87
VWOSCLDD2PC	SEL V-WOS-CLD-D-2P-C)	K	\$85
VWOSCLDD2PC-I	SEL V-WOS-CLD-D-2P-C)	K	\$89
VWOSCLDD2PC-K	SEL V-WOS-CLD-D-2P-C)	K	\$92
VWOSCLDD3GC	SEL V-WOS-CLD-D-3G-C)	K	\$114
VWOSCLDD3GC-I	SEL V-WOS-CLD-D-3G-C)	K	\$119
VWOSCLDD3GC-K	SEL V-WOS-CLD-D-3G-C)	K	\$122
VWOSCLDD3PC	SEL V-WOS-CLD-D-3P-C)	K	\$120
VWOSCLDD3PC-I	SEL V-WOS-CLD-D-3P-C)	K	\$125
VWOSCLDD3PC-K	SEL V-WOS-CLD-D-3P-C)	K	\$128
VWOSCLDDGC	SEL V-WOS-CLD-D-G-C)	K	\$43
VWOSCLDDGC-I	SEL V-WOS-CLD-D-G-C)	K	\$45
VWOSCLDDGC-K	SEL V-WOS-CLD-D-G-C)	K	\$46
VWOSCLDDPC	SEL V-WOS-CLD-D-P-C)	K	\$45
VWOSCLDDPC-I	SEL V-WOS-CLD-D-P-C)	K	\$47
VWOSCLDDPC-K	SEL V-WOS-CLD-D-P-C)	K	\$49
VWOSCLDU2GC	SEL V-WOS-CLD-U-2G-C)	K	\$139
VWOSCLDU2GC-I	SEL V-WOS-CLD-U-2G-C)	K	\$146
VWOSCLDU2GC-K	SEL V-WOS-CLD-U-2G-C)	K	\$150
VWOSCLDU2PC	SEL V-WOS-CLD-U-2P-C)	K	\$147
VWOSCLDU2PC-I	SEL V-WOS-CLD-U-2P-C)	K	\$154
VWOSCLDU2PC-K	SEL V-WOS-CLD-U-2P-C)	K	\$157
VWOSCLDU3GC	SEL V-WOS-CLD-U-3G-C)	K	\$196
VWOSCLDU3GC-I	SEL V-WOS-CLD-U-3G-C)	K	\$205
VWOSCLDU3GC-K	SEL V-WOS-CLD-U-3G-C)	K	\$210
VWOSCLDU3PC	SEL V-WOS-CLD-U-3P-C)	K	\$207
VWOSCLDU3PC-I	SEL V-WOS-CLD-U-3P-C)	K	\$216
VWOSCLDU3PC-K	SEL V-WOS-CLD-U-3P-C)	K	\$222
VWOSCLDUGC	SEL V-WOS-CLD-U-G-C)	K	\$74

VWOSCLDUGC-I	SEL V-WOS-CLD-U-G-C)	K	\$78
VWOSCLDUGC-K	SEL V-WOS-CLD-U-G-C)	K	\$79
VWOSCLDUPC	SEL V-WOS-CLD-U-P-C)	K	\$78
VWOSCLDUPC-I	SEL V-WOS-CLD-U-P-C)	K	\$82
VWOSCLDUPC-K	SEL V-WOS-CLD-U-P-C)	K	\$84
VWOSPLLDC	SEL V-WOS-PLL-D-C)	K	\$52
VWOSPLLDC-I	SEL V-WOS-PLL-D-C)	K	\$54
VWOSPLLDC-K	SEL V-WOS-PLL-D-C)	K	\$55
VWOSPLLUC	SEL V-WOS-PLL-U-C)	K	\$93
VWOSPLLUC-I	SEL V-WOS-PLL-U-C)	K	\$97
VWOSPLLUC-K	SEL V-WOS-PLL-U-C)	K	\$100
WS14PLAYC	SEL WS14-PLAY-C)	K	\$150
WS14PLAYC-I	SEL WS14-PLAY-C)	K	\$153
WS14PLAYC-K	SEL WS14-PLAY-C)	K	\$155
WS14PLAYF	SEL: WS14-PLAY-F	K	\$165
WS14PLAYUGC	SEL WS14-PLAY-UG-C)	K	\$80
WS14PLAYUGC-I	SEL WS14-PLAY-UG-C)	K	\$82
WS14PLAYUGC-K	SEL WS14-PLAY-UG-C)	K	\$83
WS14PLAYUGF	SEL: WS14-PLAY-UG-F	K	\$88
WS14POPAYUGC	SEL WS14-PRO-PLAY-UG-C)	K	\$100
WS14POPAYUGC-I	SEL WS14-PRO-PLAY-UG-C)	K	\$102
WS14POPAYUGC-K	SEL WS14-PRO-PLAY-UG-C)	K	\$103
WS14PROC	SEL WS14-PRO-C)	K	\$250
WS14PROC-I	SEL WS14-PRO-C)	K	\$255
WS14PROC-K	SEL WS14-PRO-C)	K	\$258
WS14PROF	SEL: WS14-PRO-F	K	\$275
WS14PROPLAYUGF	SEL: WS14-PRO-PLAY-UG-F	K	\$110
WS14PROUGC	SEL WS14-PRO-UG-C)	K	\$150
WS14PROUGC-I	SEL WS14-PRO-UG-C)	K	\$153
WS14PROUGC-K	SEL WS14-PRO-UG-C)	K	\$155
WS14PROUGF	SEL: WS14-PRO-UG-F	K	\$165
WS-PLAY-SUP-1PAK	SEL: WS-PLAY-SUP-1PAK	K	\$33
WS-PLAY-SUP-3PAK	SEL: WS-PLAY-SUP-3PAK	K	\$88
WS-PLAY-SUP-5PAK	SEL: WS-PLAY-SUP-5PAK	K	\$134
XBR-000195	SEL-FIPS SECURITY SEAL FOR SYSTEM	K	\$499
XBR-R000294	SEL 2 POST MID MOUNT KIT/FLUSH MOUNT KIT	K	\$315
XBR-R000296	SEL FRU,UNIVERSAL RACK MOUNT KIT,4 POST	K	\$430
XFP-001-LR	SEL Long Reach 10GbE fiber XFP module	K	\$1,662
XFP-002-SR	SEL Short Reach 10GbE fiber XFP module	K	\$1,169
ZDP-PLAT-001	SEL Zaloni Data Platform pernode 1-8 1Y	K	\$26,462
ZDP-PLAT-002	SEL Zaloni Data Platform pernode 9-15 1Y	K	\$20,862
ZDP-PLAT-003	SEL Zaloni DataPlatform pernode 16-30 1Y	K	\$16,538
ZDP-PLAT-004	SEL Zaloni Data Platform pernode >31 1Y	K	\$10,769
456-103-477	GP DB PERP T01 0-14TB	P	\$0
456-103-478	GP DB PERP T02 15-25TB	P	\$0
456-103-479	GP DB PERP T03 26-40TB	P	\$0
456-103-480	GP DB PERP T04 41-60TB	P	\$0
456-103-481	GP DB PERP T05 61-100TB	P	\$0
456-103-482	GP DB PERP T06 101-150TB	P	\$0
456-103-483	GP DB PERP T07 151-250TB	P	\$0

456-103-484	GP DB PERP T08 251-400TB	P	\$0
456-103-485	GP DB PERP T09 401-600TB	P	\$0
456-103-486	GP DB PERP T10 601-999TB	P	\$0
456-103-487	GP DB PERP T11 1000TB+	P	\$0
456-103-521	GP DB SBSC ANNUAL 4YRMAX T01 1-14TB	P	\$0
456-103-522	GP DB SBSC ANNUAL 4YRMAX T02 15-25TB	P	\$0
456-103-523	GP DB SBSC ANNUAL 4YRMAX T03 26-40TB	P	\$0
456-103-524	GP DB SBSC ANNUAL 4YRMAX T04 41-60TB	P	\$0
456-103-525	GP DB SBSC ANNUAL 4YRMAX T05 61-100TB	P	\$0
456-103-526	GP DB SBSC ANNUAL 4YRMAX T06 101-150TB	P	\$0
456-103-527	GP DB SBSC ANNUAL 4YRMAX T07 151-250TB	P	\$0
456-103-528	GP DB SBSC ANNUAL 4YRMAX T08 251-400TB	P	\$0
456-103-529	GP DB SBSC ANNUAL 4YRMAX T09 401-600TB	P	\$0
456-103-530	GP DB SBSC ANNUAL 4YRMAX T10 601-999TB	P	\$0
456-103-531	GP DB SBSC ANNUAL 4YRMAX T11 1000TB+	P	\$0
456-103-734	GP HD SBSC ANNUAL 4YRMAX 1-24 SVR IA	P	\$0
456-103-735	GP HD SBSC ANNUAL 4YRMAX 25-74 SVR IA	P	\$0
456-103-736	GP HD SBSC ANNUAL 4YRMAX 75-249 SVR IA	P	\$0
456-103-737	GP HD SBSC ANNUAL 4YRMAX 250-999 SVR IA	P	\$0
456-103-738	GP HD SBSC ANNUAL 4YRMAX 1000+ SVR IA	P	\$0
456-103-745	GP MR SBSC ANNUAL 4YRMAX 1-24 SVR IA	P	\$0
456-103-746	GP MR SBSC ANNUAL 4YRMAX 25-74 SVR IA	P	\$0
456-103-747	GP MR SBSC ANNUAL 4YRMAX 75-249 SVR IA	P	\$0
456-103-748	GP MR SBSC ANNUAL 4YRMAX 250-999 SVR IA	P	\$0
456-103-749	GP MR SBSC ANNUAL 4YRMAX 1000+ SVR IA	P	\$0
456-103-798	GP HD PERP 1-24 SVR IA	P	\$0
456-103-799	GP HD PERP 25-74 SVR IA	P	\$0
456-103-800	GP HD PERP 75-249 SVR IA	P	\$0
456-103-801	GP HD PERP 250-999 SVR IA	P	\$0
456-103-802	GP HD PERP 1000+ SVR IA	P	\$0
456-103-803	GP MR PERP 1-24 SVR IA	P	\$0
456-103-804	GP MR PERP 25-74 SVR IA	P	\$0
456-103-805	GP MR PERP 75-249 SVR IA	P	\$0
456-103-806	GP MR PERP 250-999 SVR IA	P	\$0
456-103-807	GP MR PERP 1000+ SVR IA	P	\$0
456-104-242	GP CHORUS PERP MGD SVR IA	P	\$0
456-104-243	GP CHORUS SBSC ANNUAL 4YRMAX MGD SVR	P	\$8,250
456-104-365	SEL Alpine Team 5 Miner-5 Illum Lic	P	\$0
456-104-366	SEL Alpine Dept 15 Miner-25 Illum Lic	P	\$0
456-104-367	SEL Alpine Entpr 50 Miner-100 Illum Lic	P	\$0
456-104-368	SEL Alpine DB Connector for Greenplum	P	\$0
456-104-370	GP HD SUBSCRIPTION ANNUAL 4YR MAX SVR=I	P	\$0
456-104-371	GP HD PERPETUAL SVR=IA	P	\$0
456-104-800	GPTEXT Perpetual Tier TB01=CA	P	\$0
456-104-801	GPTEXT Perpetual Tier TB02=CA	P	\$0
456-104-802	GPTEXT Perpetual Tier TB03=CA	P	\$0
456-104-803	GPTEXT Perpetual Tier TB04=CA	P	\$0
456-104-804	GPTEXT Perpetual Tier TB05=CA	P	\$0
456-104-805	GPTEXT Perpetual Tier TB06=CA	P	\$0
456-104-806	GPTEXT Perpetual Tier TB07=CA	P	\$0

456-104-807	GPTEXT Perpetual Tier TB08=CA	P	\$0
456-104-808	GPTEXT Perpetual Tier TB09=CA	P	\$0
456-104-809	GPTEXT Perpetual Tier TB10=CA	P	\$0
456-104-810	GPTEXT Perpetual Tier TB11=CA	P	\$0
456-104-811	GPTEXT SBSC 4YRMAX Tier TB01=CA	P	\$0
456-104-812	GPTEXT SBSC 4YRMAX Tier TB02=CA	P	\$0
456-104-813	GPTEXT SBSC 4YRMAX Tier TB03=CA	P	\$0
456-104-814	GPTEXT SBSC 4YRMAX Tier TB04=CA	P	\$0
456-104-815	GPTEXT SBSC 4YRMAX Tier TB05=CA	P	\$0
456-104-816	GPTEXT SBSC 4YRMAX Tier TB06=CA	P	\$0
456-104-817	GPTEXT SBSC 4YRMAX Tier TB07=CA	P	\$0
456-104-818	GPTEXT SBSC 4YRMAX Tier TB08=CA	P	\$0
456-104-819	GPTEXT SBSC 4YRMAX Tier TB09=CA	P	\$0
456-104-820	GPTEXT SBSC 4YRMAX Tier TB10=CA	P	\$0
456-104-821	GPTEXT SBSC 4YRMAX Tier TB11=CA	P	\$0
456-104-983	SEL Alpine Individual Software Bundle=IA	P	\$0
456-104-984	SEL Alpine Team Software Bundle=IA	P	\$0
456-104-985	SEL Alpine Department Software Bundle=IA	P	\$0
456-104-986	SEL Alpine Enterprise Software Bundle=IA	P	\$0
456-105-063	PIVOTAL HD ENTERPRISE PERP =IA	P	\$0
456-105-064	Pivotal HD Enterprise SUBSC SVR=IA	P	\$0
456-105-065	PIVOTAL HDB PERP=IA	P	\$12,025
456-105-066	Pivotal HDB SVCS SUBSC SVR=IA	P	\$0
456-105-067	Pivotal Command Center PERP SVR=IA	P	\$0
456-105-165	PVCF 1Y SBSC OPS MANAGER PACK OF 1=FA	P	\$0
456-105-166	PVCF 1Y SBSC 1-9 ELTIC RUNTIME(50 AI)=FC	P	\$0
456-105-167	PVCF 1Y SBSC 10+ ELTIC RUNTIME(50 AI)=FC	P	\$0
456-105-168	PVCF 1Y SBSC CONNECTOR PACK OF 1 INST=F	P	\$17,140
456-105-169	PVCF 1Y SBSC LOG PACK OF 50 INST=FD	P	\$17,140
456-105-766	PVTL DATA DISPATCH SERVER PERP=ID	P	\$400,000
456-105-767	PVTL DATA DISPATCH ADAPTER PERP=ID	P	\$35,000
456-105-768	PVAN SBSC T1 1-9 PACK OF 1 TB INST=CA	P	\$0
456-105-769	PVAN SBSC T2 10+ PACK OF 1 TB INST=CA	P	\$0
456-105-770	PVAN PERP T1 1-9 PACK OF 1 TB INST=CA	P	\$0
456-105-771	PVAN PERP T2 10+ PACK OF 1 TB INST=CA	P	\$0
456-105-950	PHD AND PADS FOR PVCF SBSC 25 NODES=IA	P	\$0
456-105-951	PHD AND PADS FOR PVCF SBSC NODE=IA	P	\$0
456-105-952	PHD FOR PVCF SBSC NODE=IA	P	\$0
456-105-953	PADS FOR PVCF SBSC NODE=IA	P	\$0
456-105-954	PHD AND PADS FOR PVCF PERP 25 NODES=IA	P	\$0
456-105-955	PHD AND PADS FOR PVCF PERP NODE=IA	P	\$0
456-105-956	PHD FOR PVCF PERP NODE=IA	P	\$0
456-105-957	PADS FOR PVCF PERP NODE=IA	P	\$0
456-106-014	PVCHORUS PERP MGD SVR =IA	P	\$0
456-106-102	PV GEMXD PERP BY NODE = IA	P	\$0
456-106-103	PVTL GEMFIRE XD SBSC=IA	P	\$0
456-106-113	PVCF 2Y SBSC OPS MANAGER PACK OF 1=FA	P	\$0
456-106-114	PVCF 2Y SBSC 1-9 ELTIC RUNTIME(50 AI)=FC	P	\$0
456-106-115	PVCF 2Y SBSC 10+ ELTIC RUNTIME(50 AI)=FC	P	\$0
456-106-116	PVCF 3Y SBSC OPS MANAGER PACK OF 1=FA	P	\$0

456-106-117	PVCF 3Y SBSC 1-9 ELTIC RUNTIME(50 AI)=FC	P	\$0
456-106-118	PVCF 3Y SBSC 10+ ELTIC RUNTIME(50 AI)=FC	P	\$0
456-106-171	PIVOTAL RABBITMQ PERP=ZA	P	\$5,000
456-106-172	PVTL Perp Web Server=ZA	P	\$0
456-106-181	PVGF PERP PROD = ZC	P	\$0
456-106-182	PVGF 1Y SBSC PROD = ZC	P	\$0
456-106-183	PVGF PERP TSTDEV = ZC	P	\$0
456-106-184	PVGF 1Y SBSC TSTDEV = ZC	P	\$0
456-106-185	PVGF PERP CLIENT = ZC	P	\$0
456-106-186	PVGF 1Y SBSC CLIENT = ZC	P	\$0
456-106-187	PVGF PERP CLIENTUNL = ZC	P	\$0
456-106-188	PVGF 1Y SBSC CLIENTUNL = ZC	P	\$0
456-106-189	PVGF 1Y SBSC COMM = ZC	P	\$0
456-106-196	PIVOTAL TC SERVER STANDARD PERP=ZA	P	\$2,000
456-106-197	PIVOTAL TC SERVER SPRING PERP=ZA	P	\$2,500
456-106-198	PVTL 1yr SBSC tc Server Standard=ZA	P	\$0
456-106-199	PVTL 2yr SBSC tc Server Standard=ZA	P	\$0
456-106-200	PVTL 3yr SBSC tc Server Standard=ZA	P	\$0
456-106-201	PVTL 1 yr SBSC tc Server Spring=ZA	P	\$1,180
456-106-202	PVTL 2 yr SBSC tc Server Spring=ZA	P	\$0
456-106-203	PVTL 3 yr SBSC tc Server Spring=ZA	P	\$0
456-106-566	Pivotal Greenplum Database SUB=ZC	P	\$0
456-106-567	Pivotal HD SUB=ZC	P	\$0
456-106-568	Pivotal HAWQ SUB=ZC	P	\$0
456-106-569	Pivotal GemXD SUB=ZC	P	\$0
456-106-570	Pivotal GemFire SUB=ZC	P	\$0
456-106-571	Pivotal GemFire Client SUB=ZC	P	\$0
456-106-572	Pivotal SQLFire SUB=ZC	P	\$0
456-106-573	Pivotal GPText SUB=ZC	P	\$0
456-106-574	Pivotal Command Center SUB=ZC	P	\$0
456-106-587	PV TC SERVER SUBS=ZC	P	\$0
456-106-588	PV WEB SERVER SUBS=TC	P	\$0
456-106-589	PV RABBITMQ SUBS=ZC	P	\$0
456-106-590	PV CF JAVA BUILDPACK SUBS=ZC	P	\$0
456-106-591	PV CF TC SERVER BUILDPACK SUBS=ZC	P	\$0
456-106-592	PV CF RABBITMQ SVC SUBS=ZC	P	\$0
456-106-593	PV TC SERVER DEV SUBS=UA	P	\$0
456-106-594	PV WEB SERVER DEV SUBS=UA	P	\$0
456-106-595	PV RABBITMQ DEV SUBS=UA	P	\$0
456-106-596	PV CF JAVA BUILDPACK DEV SUBS=UA	P	\$0
456-106-597	PV CF TC SERVER BUILDPACK DEV SUBS=UA	P	\$0
456-106-598	PV CF RABBITMQ SVC DEV SUBS=UA	P	\$0
456-106-599	PV TC SERVER PERP=ZC	P	\$0
456-106-600	PV WEB SERVER PERP=TC	P	\$0
456-106-601	PV RABBITMQ PERP=ZC	P	\$0
456-106-602	PV CF JAVA BUILDPACK PERP=ZC	P	\$0
456-106-603	PV CF TC SERVER BUILDPACK PERP=ZC	P	\$0
456-106-604	PV CF RABBITMQ SVC PERP=ZC	P	\$0
456-106-605	PV TC SERVER DEV PERP=UA	P	\$0
456-106-606	PV WEB SERVER DEV PERP=UA	P	\$0

456-106-607	PV RABBITMQ DEV PERP=UA	P	\$0
456-106-608	PV CF JAVA BUILDPACK DEV PERP=UA	P	\$0
456-106-609	PV CF TC SERVER BUILDPACK DEV PERP=UA	P	\$0
456-106-610	PV CF RABBITMQ SVC DEV PERP=UA	P	\$0
456-106-645	PVTL Mobile Push Notifications Sub=FC	P	\$0
456-106-646	PVTL Mobile API Gateway Sub=FC	P	\$0
456-106-647	PVTL Mobile Data Sync Sub=FC	P	\$0
456-106-800	PV GEMXD PERP BY CORE=ZC	P	\$0
456-107-129	PVTL Tracker for PCF - 1yr Sub=UA	P	\$500
456-107-130	PVTL Tracker for PCF - 2yr Sub=UA	P	\$1,000
456-107-131	PVTL Tracker for PCF - 3yr Sub=UA	P	\$1,500
456-107-132	PVTL Tracker for PCF - 4yr Sub=UA	P	\$2,000
456-107-133	PVTL Tracker for PCF - 5yr Sub=UA	P	\$2,500
456-107-148	Pivotal App Suite Dev Support=UA	P	\$1
456-107-282	PVGF PERP PROD=ZC	P	\$2,500
456-107-283	PIVOTAL GEMFIRE ENT PERP=ZC	P	\$0
456-107-284	PVGF PERP TSTDEV=ZC	P	\$0
456-107-285	PVGF 1Y SBSC TSTDEV=ZC	P	\$0
456-107-286	PIVOTAL GEMFIRE CLIENT PERP=ZC	P	\$150
456-107-287	PVGF 1Y SBSC CLIENT=ZC	P	\$0
456-107-288	PIVOTAL GEMFIRE CLIENTUNL PERP=ZC	P	\$1,000
456-107-289	PVGF 1Y SBSC CLIENTUNL=ZC	P	\$0
456-107-290	PVGF 1Y SBSC COMM=ZC	P	\$0
456-107-291	Pivotal GemFire SUB=ZC	P	\$0
456-107-292	Pivotal GemFire Client SUB=ZC	P	\$0
456-107-309	Pivotal BDS 2 1yr Sub =ZC	P	\$0
456-107-310	Pivotal BDS 2 2yr Sub =ZC	P	\$0
456-107-311	Pivotal BDS 2 3yr Sub =ZC	P	\$0
456-107-312	Pivotal BDS 2 4yr Sub =ZC	P	\$4,000
456-107-313	Pivotal BDS 2 5yr Sub =ZC	P	\$5,000
456-107-314	Pivotal BDS 2 Open 1yr Sub =ZC	P	\$0
456-107-315	Pivotal BDS 2 Open 2yr Sub =ZC	P	\$0
456-107-316	Pivotal BDS 2 Open 3yr Sub =ZC	P	\$0
456-107-317	Pivotal BDS 2 Open 4yr Sub =ZC	P	\$4,000
456-107-318	Pivotal BDS 2 Open 5yr Sub =ZC	P	\$5,000
456-107-319	Pivotal App Suite 2 1yr Sub =ZC	P	\$0
456-107-320	Pivotal App Suite 2 2yr Sub =ZC	P	\$0
456-107-321	Pivotal App Suite 2 3yr Sub =ZC	P	\$0
456-107-322	Pivotal App Suite 2 4yr Sub =ZC	P	\$2,000
456-107-323	Pivotal App Suite 2 5yr Sub =ZC	P	\$2,500
456-107-324	Pivotal App Suite 2 PERP =ZC	P	\$900
456-107-325	PVTL Serv for PCF 1Y SBSC (25 SI)=FE	P	\$0
456-107-326	PVTL Serv for PCF 2Y SBSC (25 SI)=FE	P	\$0
456-107-327	PVTL Serv for PCF 3Y SBSC (25 SI)=FE	P	\$0
456-107-328	PVTL Serv for PCF 4Y SBSC (25 SI)=FE	P	\$514,280
456-107-329	PVTL Serv for PCF 5Y SBSC (25 SI)=FE	P	\$642,850
456-107-964	PVTL Big Data Suite NONPROD 1yr Sub=ZC	P	\$0
456-107-965	PVTL Big Data Suite NONPROD 2yr Sub=ZC	P	\$0
456-107-966	PVTL Big Data Suite NONPROD 3yr Sub=ZC	P	\$0
456-107-967	PVCF 1y SBSC Ops Manager 2=FA	P	\$0

456-107-968	PVCF 2y SBSC Ops Manager 2=FA	P	\$0
456-107-969	PVCF 3y SBSC Ops Manager 2=FA	P	\$0
456-107-970	PIVOTAL GREENPLUM PERP=TB	P	\$25,000
456-107-971	PVTL Mble Svcs Suite for PCF 1yr Sub=FC	P	\$0
456-107-972	PVTL Mble Svcs Suite for PCF 2yr Sub=FC	P	\$0
456-107-973	PVTL Mble Svcs Suite for PCF 3yr Sub=FC	P	\$0
456-109-587	Pivotal BDS 3 with DCA 2yr Sub =ZC	P	\$83
456-109-588	Pivotal BDS 3 with DCA 3yr Sub =ZC	P	\$83
456-109-589	Pivotal BDS 3 with DCA 4yr Sub =ZC	P	\$83
456-109-590	Pivotal BDS 3 with DCA 5yr Sub =ZC	P	\$83
456-110-130	Pivotal BDS 2a NONPROD 1yr Sub=ZC	P	\$0
456-110-131	Pivotal BDS 2a NONPROD 2yr Sub=ZC	P	\$0
456-110-132	Pivotal BDS 2a NONPROD 3yr Sub=ZC	P	\$0
456-110-133	Pivotal BDS 2a 1yr Sub =ZC	P	\$0
456-110-134	Pivotal BDS 2a 2yr Sub =ZC	P	\$0
456-110-135	Pivotal BDS 2a 3yr Sub =ZC	P	\$0
456-110-136	Pivotal BDS 2a 4yr Sub =ZC	P	\$4,000
456-110-137	Pivotal BDS 2a 5yr Sub =ZC	P	\$5,000
456-110-138	Pivotal BDS?2a?with DCA?1yr Sub =ZC	P	\$83
456-110-141	Pivotal BDS?2a?with DCA?4yr Sub =ZC	P	\$4,000
456-110-142	Pivotal BDS?2a?with DCA?5yr Sub =ZC	P	\$5,000
456-112-945	Pivotal Data Suite for DCA=ZC	P	\$83
457-101-757	Pivotal Big Data Suite 1yr Sub=ZC	P	\$0
457-101-758	Pivotal Big Data Suite 2yr Sub=ZC	P	\$0
457-101-759	Pivotal Big Data Suite 3yr Sub=ZC	P	\$0
457-101-760	Pivotal Big Data Suite 4yr Sub=ZC	P	\$0
457-101-761	Pivotal Big Data Suite 5yr Sub=ZC	P	\$0
457-101-762	Pivotal App Suite 1yr Sub=ZC	P	\$0
457-101-763	Pivotal App Suite 2yr Sub=ZC	P	\$0
457-101-764	Pivotal App Suite 3yr Sub=ZC	P	\$0
457-101-765	Pivotal App Suite 4yr Sub=ZC	P	\$0
457-101-766	Pivotal App Suite 5yr Sub=ZC	P	\$0
457-101-767	Pivotal App Suite Dev Sup 1yr Sub=UA	P	\$0
457-101-768	Pivotal App Suite Dev Sup 2yr Sub=UA	P	\$0
457-101-769	Pivotal App Suite Dev Sup 3yr Sub=UA	P	\$0
457-101-770	Pivotal App Suite Dev Sup 4yr Sub=UA	P	\$0
457-101-771	Pivotal App Suite Dev Sup 5yr Sub=UA	P	\$0
457-101-772	Pivotal App Suite PERP=ZC	P	\$0
457-101-773	PVTL Mble Svcs Suite for PCF 1yr Sub=FC	P	\$0
457-101-774	PVTL Mble Svcs Suite for PCF 2yr Sub=FC	P	\$0
457-101-775	PVTL Mble Svcs Suite for PCF 3yr Sub=FC	P	\$0
457-101-776	PVTL Mble Svcs Suite for PCF 4yr Sub=FC	P	\$0
457-101-777	PVTL Mble Svcs Suite for PCF 5yr Sub=FC	P	\$0
458-000-939	PIVOTAL GREENPLUM PERP	P	\$0
458-000-940	PIVOTAL HD ENTERPRISE PERP	P	\$0
458-000-942	Pivotal App Suite 2 PERP	P	\$0
458-000-943	PIVOTAL RABBITMQ PERP	P	\$0
458-000-944	PIVOTAL TC SERVER STANDARD PERP	P	\$0
458-000-945	PIVOTAL TC SERVER SPRING PERP	P	\$0
458-000-946	Pivotal App Suite Dev Support	P	\$0

458-000-947	PIVOTAL GEMFIRE ENT PERP	P	\$0
458-000-948	PIVOTAL GEMFIRE CLIENT PERP	P	\$0
458-000-949	PIVOTAL GEMFIRE CLIENT UNL PERP	P	\$0
DCA2H-AGGREG	DCA 40U AGGREGATION RACK	P	\$0
DCA2H-AGGREGL	DCA 30ULIM AGGREGATION RACK	P	\$0
DCA2H-AGGREGLU	DCA 30LIM AGGREGATION RACK UPG	P	\$0
DCA2H-AGGREGM	DCA 3ZONE AGGREGATION RACK HW	P	\$0
DCA2H-AGGREGMU	DCA 3ZONE AGGREGATION RACK UPG HW	P	\$0
DCA2H-AGGREG-U	DCA 40U AGGREGATION RACK UPG	P	\$0
DCA2H-CS-HD	DCA HD COMP SVR 64GB MEM 6X300GB HDD	P	\$0
DCA2H-CS-HD-2BDL	DCA HD COMP SVR 64GB MEM 6X300G HDD BDL	P	\$0
DCA2H-CS-HD-2BDLU	DCA HD COMP SVR 64GB MEM 6X300GB BDL UPG	P	\$0
DCA2H-CS-HD-U	DCA HD COMP SVR 64GB MEM 6x300GB HDD UPG	P	\$0
DCA2H-DS-HD	DCA HD SVR 64GB MEM 12X3TB HDD	P	\$0
DCA2H-DS-HD-4BDL	DCA HD SVR 64GB MEM 12X3TB HDD BDL	P	\$0
DCA2H-DS-HD-4BDLU	DCA HD SVR 64GB MEM 12x3TB HDD BDL UPG	P	\$0
DCA2H-DS-HD-U	DCA HD SVR 64GB MEM 12x3TB HDD UPG	P	\$0
DCA2H-EXPAND	DCA 40U EXPANSION RACK	P	\$0
DCA2H-EXPANDL	DCA 30ULIM EXPANSION RACK	P	\$0
DCA2H-EXPANDLU	DCA 30ULIM EXPANSION RACK UPG	P	\$0
DCA2H-EXPANDM	DCA 3ZONE EXPANSION RACK HW	P	\$0
DCA2H-EXPANDMU	DCA 3ZONE EXPANSION RACK UPG HW	P	\$0
DCA2H-EXPAND-U	DCA 40U EXPANSION RACK UPG	P	\$0
DCA2H-LSM-HD	DCA HD SVR 256GB MEM 12x6TB HDD	P	\$0
DCA2H-LSM-HD-4BDL	DCA HD SVR 256GB MEM 12x6TB HDD BDL	P	\$0
DCA2H-LSM-HD-4BDLU	DCA HD SVR 256GB MEM 12x6TB HDD BDL UPG	P	\$0
DCA2H-LSM-HD-U	DCA HD SVR 256GB MEM 12x6TB HDD UPG	P	\$0
DCA2H-SS	DCA GPDB COM SV 64GB MEM 24X300GB	P	\$0
DCA2H-SS-4BDL	DCA GPDB COM SV 64GB MEM 24X300GB BDL	P	\$0
DCA2H-SS-4BDLU	DCA GPDB COM SV 64GB 24X300GB BDL UPG	P	\$0
DCA2H-SSC	DCA GPDB STD 64GB MEM 24X900GB	P	\$0
DCA2H-SSC-4BDL	DCA GPDB STD 64GB MEM 24X900GB BDL	P	\$0
DCA2H-SSC-4BDLU	DCA GPDB STD 64GB MEM 24X900GB BDL UPG	P	\$0
DCA2H-SSC-U	DCA GPDB STD 64GB MEM 24X900GB UPG	P	\$0
DCA2H-SSM	DCA GPDB SVR 256GB MEM 24X300GB	P	\$0
DCA2H-SSM-4BDL	DCA GPDB SVR 256GB MEM 24X300GB BDL	P	\$0
DCA2H-SSM-4BDLU	DCA GPDB SVR 256GB MEM 24X300GB BDL UPG	P	\$0
DCA2H-SSM-U	DCA GPDB SVR 256GB MEM 24X300GB UPG	P	\$0
DCA2H-SS-U	DCA GPDB COM SV 64GB MEM 24X300GB UPG	P	\$0
DCA2H-SYSRCKX	DCA 40U SYS RACK HIGH DENSITY	P	\$0
DCA2H-SYSRCKXL	DCA 30ULIM SYSTEM RACK	P	\$0
DCA2H-SYSRCKXM	DCA 3ZONE SYSTEM RACK HW	P	\$0
DCA2-SWAGG-U	GP DCA INT SWITCH AGGREGATION	P	\$0
DCA2-SWINT-EX	GP DCA INT SWITCH HIGH DENSITY RACK	P	\$0
DCA2-SWINTEXU	GP DCA INT SWITCH HIGH DENSITY RACK	P	\$0
DCA2-SYSRCKX	GP DCA 40U SYS RACK HIGH DENSITY	P	\$0
DCA2-SYSRCKXL	GP DCA 30ULIM SYSTEM RACK	P	\$0
DCA2-SYSRCKXM	DCA 3ZONE SYSTEM RACK	P	\$0
DCA2-US-15	GP DCA-1P 30A BTM RK L6-30P INCL	P	\$0
DCA3H-10GBEXTLR	DCAv3 Ext Master Intel 10GBase-LR Kit	P	\$0

DCA3H-10GBEXTSR	DCAv3 Ext Master Intel 10GBase-SR Kit	P	\$0
DCA3H-3PH-DELTA-01	3Ph DELTA Pwr crd int Russellstohl 15ft	P	\$0
DCA3H-3PH-DELTA-02	3-Phase DELTA Power cord, Hubell, 15ft	P	\$0
DCA3H-3PH-DELTA-03	3Ph DELTA Pwr crd US Russellstohl 15ft	P	\$0
DCA3H-3PH-WYE-01	3-Phase Wye power cord Intl GARO	P	\$0
DCA3H-3PH-WYE-02	3-Phase Wye power cord Intl Flying Lead	P	\$0
DCA3H-3PH-WYE-03	3-Phase Wye power cord US L22, 15ft	P	\$0
DCA3H-3PH-WYE-04	3-Phase Wye power cord US Flying Lead	P	\$0
DCA3H-AGGRCK1D	DCA v3.1 40U AggRack 3phase Delta	P	\$136,370
DCA3H-AGGRCK1D-U	DCA v3.1 40U AggRack 3phase Delta UPG	P	\$136,370
DCA3H-AGGRCK1W	DCA v3.1 40U AggRack 3phase Wye	P	\$136,370
DCA3H-AGGRCK1W-U	DCA v3.1 40U AggRack 3phase Wye UPG	P	\$136,370
DCA3H-AGGREG	DCA 40U V3 Agg Rack single phase PDU	P	\$136,370
DCA3H-AGGREG1	DCA v3.1 40U Agg Rack single phase PDU	P	\$136,370
DCA3H-AGGREG1-U	DCA v3.1 40U Agg Rack single phase UPG	P	\$136,370
DCA3H-AGGREG-U	DCA 40U V3 Agg Rack single phase UPG	P	\$136,370
DCA3H-CBL10M	DCAv3 10GBase-LR 10M SM cable	P	\$0
DCA3H-CBL10MSR	DCAv3 10GBase-SR 10M MM cable	P	\$0
DCA3H-CBL30M	DCAv3 10GBase-LR 30M SM cable	P	\$0
DCA3H-CBL50M	DCAv3 10GBase-LR 50M SM cable	P	\$0
DCA3H-EXPAND	DCA 40U V3 Expn Rack single phase	P	\$81,820
DCA3H-EXPAND1	DCA v3.1 40U Expn Rck single phase	P	\$81,820
DCA3H-EXPAND1-U	DCA v3.1 40U Expn Rck single phase UPG	P	\$81,820
DCA3H-EXPAND-U	DCA 40U V3 Expn Rack single phase UPG	P	\$81,820
DCA3H-EXPRCK1D	DCA v3.1 40U Expn Rck 3phase Delta	P	\$81,820
DCA3H-EXPRCK1D-U	DCA v3.1 40U Expn Rck 3phase Delta UPG	P	\$81,820
DCA3H-EXPRCK1W	DCA v3.1 40U Expn Rck 3phase Wye	P	\$81,820
DCA3H-EXPRCK1W-U	DCA v3.1 40U Expn Rck 3phase Wye UPG	P	\$81,820
DCA3H-GBEXT	DCA v3 EXT MASTER RJ45 GBE CONNECTION	P	\$0
DCA3H-MS	DCA Master Server 1U 256GB MEM 6X1.8TB	P	\$0
DCA3H-SFP10GBLR	DCAv3 10GBase-LR Switch SFP Kit	P	\$4,500
DCA3H-SFP10GBSR	DCAv3 10GBase-SR Switch SFP Kit	P	\$1,600
DCA3H-SS	DCA GPDB SVR 256GB MEM 24X1.8TB	P	\$0
DCA3H-SS1-4BDL	DCA v3.1 GPDB Svr 256GB MEM 24X1.8TB BDL	P	\$270,000
DCA3H-SS1-4BDLU	DCA v3.1 GPDB Svr 256GB-24x1.8TB BDL UPG	P	\$270,000
DCA3H-SS1-4BDU-FLD	DCAv3.1 GPDB SVR 256GB 24x1.8TB BDLU FLD	P	\$270,000
DCA3H-SS-4BDL	DCA GPDB SVR 256GB MEM 24X1.8TB BDL	P	\$270,000
DCA3H-SS-4BDLU	DCA GPDB SVR 256GB MEM 24X1.8TBBDL UPG	P	\$270,000
DCA3H-SSU	DCA GPDB SVR 256GB MEM 24X1.8TB UPG	P	\$0
DCA3H-SSU-FLD	DCA GPDB SVR 256GB MEM 24X1.8TB UPG FLD	P	\$0
DCA3H-SWADM1	DCA v3.1 Admin 1GB Switch	P	\$0
DCA3H-SWADM1-U	DCA v3.1 Admin 1GB Switch UPG	P	\$0
DCA3H-SWAGG1	DCA v3.1 Aggregation 10GB Switch	P	\$0
DCA3H-SWAGG1-U	DCA v3.1 Aggregation 10GB Switch UPG	P	\$0
DCA3H-SWINT1-EX	DCA v3.1 Interconnect 10GB Switch	P	\$0
DCA3H-SWINT1EXU	DCA v3.1 Interconnect 10GB Switch UPG	P	\$0
DCA3H-SYSRACK	DCA 40U V3 System Rack single phase PDU	P	\$109,100
DCA3H-SYSRACK1	DCA v3.1 40U Sys Rack single phase PDU	P	\$109,100
DCA3H-SYSRCK1D	DCA v3.1 40U Sys Rack 3phase Delta	P	\$109,100
DCA3H-SYSRCK1W	DCA v3.1 40U Sys Rack 3phase Wye	P	\$109,100

DIA2H-CS	DCA DIA COMP 64GB MEM 6X300GB HDD	P	\$0
DIA2H-CS-2BDL	DCA DIA COMP 64GB MEM 6X300GB HDD BDL	P	\$0
DIA2H-CS-2BLDU	DCA DIA COMP 64GB MEM 6X300GB BDL UPG	P	\$0
DIA2H-CSM	DCA DIA SVR 256GB MEM 24X300GB HDD	P	\$0
DIA2H-CSM-2BDL	DCA DIA SVR 256GB MEM 24X300GB HDD CBL	P	\$0
DIA2H-CSM-2BDLU	DCA DIA SVR 256GB MEM 24X300GB CBL UPG	P	\$0
DIA2H-CSM-U	DCA DIA SVR 256GB MEM 24X300GB HDD UPG	P	\$0
DIA2H-CS-U	DCA DIA COMP 64GB MEM 6X300GB HDD UPG	P	\$0
DIA2H-DS	DCA DIA SVR 64GB MEM 12x3TB HDD	P	\$0
DIA2H-DS-2BDL	DCA DIA SVR 64GB MEM 12x3TB HDD BDL	P	\$0
DIA2H-DS-2BDLU	DCA DIA SVR 64GB MEM 12x3TB HDD BDL UPG	P	\$0
DIA2H-DS-U	DCA DIA SVR 64GB MEM 12x3TB HDD	P	\$0
SAS-458-000-062	PCF TRACKER ENT SAAS SUB=UA	P	\$25
SH-458-000-001	Pivotal BDS for DCA=ZC	P	\$0
SH-458-000-243	Pivotal Data Suite for DCA=ZC	P	\$0
SU-456-000-321	Pivotal HDP SUB=ZC	P	\$0
SU-458-000-167	Pivotal BDS 2a Sub=ZC	P	\$83
SU-458-000-168	PIVOTAL BDS 2A FLEX SUB=ZC	P	\$83
SU-458-000-169	Pivotal BDS 2a NONPROD Sub=ZC	P	\$42
SU-458-000-170	PCF OPS MANAGER 2 SUB=FA	P	\$2,357
SU-458-000-171	Pivotal App Service fka ERT 50 AI SUB=FC	P	\$13,095
SU-458-000-174	PCF SVCS FOR PCF (25 SI) SUB=FE	P	\$10,714
SU-458-000-175	PIVOTAL HD ENTERPRISE SUB=IA	P	\$0
SU-458-000-177	Pivotal App Suite 2 Sub=ZC	P	\$42
SU-458-000-178	PIVOTAL TC SERVER STANDARD SUB=ZA	P	\$66
SU-458-000-179	PIVOTAL TC SERVER SPRING SUB=ZA	P	\$98
SU-458-000-221	Pivotal HDP=ZC	P	\$42
SU-458-000-292	Pivotal Data Suite Sub=ZC	P	\$83
SU-458-000-293	Pivotal Data Suite NonProd Sub=ZC	P	\$42
SU-458-000-294	Pivotal Cloud Cache Sub=CF	P	\$262
SU-458-000-899	Pivotal Container Service=PD	P	\$42
SU-458-001-044	VMware NSX-T Pivotal App Svc 50 AI=FC	P	\$833
C-CB-10GMOP2P	OPTION, DUAL 10GbE LAN, OPTICAL	PE	\$0
DD INTEL SFP SRS	Intel Ethernet SFP+SR Optic-E10GSFSPR SP	PE	\$304
DD2200	SYSTEM DD2200 NFS CIFS	PE	\$0
DD2200-14TB	SYSTEM DD2200-7X2TB SAS 14TB NFS CIFS	PE	\$10,353
DD2200-14TB-EDP	SYSTEM DD2200-7X2TB SAS 14TB EDP	PE	\$10,353
DD2200-24TB	SYSTEM DD2200-12X2HDD SAS 24TB NFS CIFS	PE	\$18,217
DD2200-24TB-EDP	SYSTEM DD2200-12X2HDD SAS 24TB EDP	PE	\$18,217
DD2200-4TB	SYSTEM,DD2200-7X2,4TB,NFS,CIFS	PE	\$5,867
DD2200-4TB-EDP	SYSTEM,DD2200-7X2,4TB,NFS,CIFS EDP	PE	\$5,867
DD3300	SYSTEM DD3300 NFS CIFS	PE	\$0
DD33-16-1P1N	DD3300 16TB 1PSU 1GbE BZ-CO	PE	\$27,868
DD33-16-1P2N	DD3300 16TB 1PSU 1GbE 10GbE BZ-CO	PE	\$28,518
DD33-16-2P1N	DD3300 16TB 2PSU 1GbE BZ-CO	PE	\$28,118
DD33-16-2P2N	DD3300 16TB 2PSU 1GbE 10GbE BZ-CO	PE	\$28,768
DD33-32-1P1N	DD3300 32TB 1PSU 1GbE BZ-CO	PE	\$48,000
DD33-32-1P2N	DD3300 32TB 1PSU 1GbE 10GbE BZ-CO	PE	\$48,650
DD33-32-2P1N	DD3300 32TB 2PSU 1GbE BZ-CO	PE	\$48,250
DD33-32-2P2N	DD3300 32TB 2PSU 1GbE 10GbE BZ-CO	PE	\$48,900

DD33-4-1P1N	DD3300 4TB 1PSU 1GbE BZ-CO	PE	\$8,823
DD33-4-1P2N	DD3300 4TB 1PSU 1GbE 10GbE BZ-CO	PE	\$9,473
DD33-4-2P1N	DD3300 4TB 2PSU 1GbE BZ-CO	PE	\$9,073
DD33-4-2P2N	DD3300 4TB 2PSU 1GbE 10GbE BZ-CO	PE	\$9,723
DP4400_12TB_PACK	DP4400 12TB Capacity Expansion Pack	PE	\$38,670
DP4400_24TB_SFP8	IDPA DP4400 24TB 8X10G SFP	PE	\$77,340
DP4400_24TB_SFP8-N	IDPA DP4400 24TB 8X10G SFP NO-TPM	PE	\$77,340
DPAPPL_4400	ANCHOR DP APPLIANCE 4400	PE	\$0
DPCBL-LC-OM4-10ME	10 M LC to LC Cable Kit	PE	\$61
DPCBL-TWX10GB-1M	Cable Twinax DP4400 1 meter	PE	\$135
DPCBL-TWX10GB-2M	Cable Twinax DP4400 2 meter	PE	\$150
DPCBL-TWX10GB-3M	Cable Twinax DP4400 3 meter	PE	\$210
DPCBL-TWX10GB-5M	Cable Twinax DP4400 5 meter	PE	\$220
DPCBL-TWX10GB-7M	Cable Twinax DP4400 7 meter	PE	\$310
DPXCVR-10GBE-4400	Transceiver 10GBE SFP+ DP4400 300M	PE	\$900
R-FACIN2200	OPTION FACTORY INSTALL KIT DD2200	PE	\$0
U-160-AX	DD160;INCL: LICENSE;5 HDD(2.5TB)	PE	\$0
U-2200-AX	ADD 5X2TB SAS HDD 10TB DD2200 UPGRADE	PE	\$4,400
U-2200XMEM	MEM KIT CAP EXP MORETHAN 14TB DD2200 UP	PE	\$1,500
U-CB-10GMOP2P	DUAL 10GbE LAN, OPTICAL, UPGRADE	PE	\$0
U-DD3300-10G	DD3300 10GbE Upgrade Kit	PE	\$650
U-DD3300-16-32	DD3300 16TB to 32TB Upgrade Kit	PE	\$25,165
U-DD3300-4-16	DD3300 4TB to 16TB Upgrade Kit	PE	\$23,806
U-DD3300-PS	DD3300 PSU Upgrade Kit	PE	\$250
U-DP4400_12TB_PACK	UPG DP4400 12TB Cap Exp Pack	PE	\$48,340
X-160-CHAS1	SPARE,CHASSIS W/O HDD,DD160	PE	\$5,040
X-2200SPMOD	SPARE STOR PROCESSOR W/O DIMMS PS DD2200	PE	\$7,500
X-2UC-2TBS	SPARE DD HDD 2TB SAS W/2200 CARRIER	PE	\$1,800
X-2UC-VLTBB	SPARE DD BBU VAULT DD2200	PE	\$1,100
X-4110-1PSUCHASSIS	DD3300 4110 1PSU Chassis	PE	\$12,500
X-4UB-PS	SPARE POWERSUPPLY DD3300	PE	\$350
XC-160SPKIT	SPARE KIT;1XFANTRAY;PWRSUP;500GB HDD;16	PE	\$1,780
XC-2200SPKT	SPARE 1XFAN PWRSUP 2TB SAS HDD DD2200	PE	\$2,325
X-MEM1X4G-2	SPARE DD DIMM 4GB 1XDIMM DD2200	PE	\$1,750
3D4000	DL4000 DATA DEDUPE XPE MODULE	PH	\$0
C-10GBTM4P	OPTION DD 10GBASE T IO MODULE 4PORT	PH	\$5,000
C-10GMCU2P	OPTION,DD 10GBE,IO MODULE,CU SFP,2PORT	PH	\$5,000
C-10GMCU4P	DD 10GBE IO MOD CU TWINAX 4PORT OPTION	PH	\$6,000
C-10GMOP2P	OPTION,DD 10GBE,IO MODULE,OP SFP,2PORT	PH	\$5,000
C-10GMOP4P	DD 10GBE IO MOD OPTICAL SFP 4PORT OPTION	PH	\$6,000
C-10G-S2PO	OPTION;NIC;10GBE;SP;PCIE;SFPP;LC;DP;OPT	PH	\$5,000
C-16GFC-M2P	DD 16GBIT FC IO MOD LC 2PORT OPTION	PH	\$6,000
C-1GMCU4P	OPTION,DD 1GBE,IO MODULE,CU,4PORT	PH	\$2,500
C-1GMCUOP4P	OPTION,DD 1GBE,IO MODULE,2P CU,2P OP	PH	\$3,700
C-1G-S4PC1	OPTION;NIC;GBE;SP;PCIE;TX;4-PORT;COP	PH	\$2,500
C-4GFC-2P	OPTION;HBA;4GBIT FC;PCIE;2-PORT	PH	\$0
C-8GFC-2P	OPTION;HBA;8GBIT FC;PCIE;2-PORT	PH	\$0
C-8GFC-M2P	OPTION,DD 8GBIT FC,IO MODULE,LC,2PORT	PH	\$4,500
C-9500-MEM256	MEMKIT ADD 256GB DD9500 16X16GB OPTION	PH	\$30,000
C-A16E30	OPT ADD9TO16ES30 2X2M 2X3M CBLKT FLD INS	PH	\$600

C-A16E30-H	OPTION,ADD 9TO16 ES30 SAS,CABLE KIT	PH	\$600
C-A24E30	OPT ADD 17TO24 ES30 4X3M CBLKIT FLD INS	PH	\$600
C-A24E30-H	OPTION,ADD 17TO24 ES30 SAS CABLE KIT	PH	\$600
C-A8E30-HN	OPTION ADD 1TO8 ES30 SAS CABLE KIT	PH	\$600
C-DS60-3-135S	OPT DS60 SHELF 45X3TB SAS HDD	PH	\$157,250
C-DS60-3-135SE	OPT DS60 SHELF 45X3TB SAS HDD E	PH	\$157,250
C-DS60-3-135SN	OPT DS60 SHELF 45X3TB SAS HDD	PH	\$157,250
C-DS60-3-135SR	OPT DS60 SHELF 45X3TB SAS HDD RETN	PH	\$157,250
C-DS60-3-135SRE	OPT DS60 SHELF 45X3TB SAS HDD RETN E	PH	\$157,250
C-DS60-3-135SRN	OPT DS60 SHELF 45X3TB SAS HDD RETN	PH	\$157,250
C-DS60-3-180S	OPT DS60 SHELF 60X3TB SAS HDD	PH	\$209,000
C-DS60-3-180SE	OPT DS60 SHELF 60X3TB SAS HDD E	PH	\$209,000
C-DS60-3-180SN	OPT DS60 SHELF 60X3TB SAS HDD	PH	\$209,000
C-DS60-3-180SR	OPT DS60 SHELF 60X3TB SAS HDD RETN	PH	\$209,000
C-DS60-3-180SRE	OPT DS60 SHELF 60X3TB SAS HDD RETN E	PH	\$209,000
C-DS60-3-180SRN	OPT DS60 SHELF 60X3TB SAS HDD RETN	PH	\$209,000
C-DS60-3-45S	OPT DS60 SHELF 15X3TB SAS HDD	PH	\$55,950
C-DS60-3-45SE	OPT DS60 SHELF 15X3TB SAS HDD E	PH	\$55,950
C-DS60-3-45SN	OPT DS60 SHELF 15X3TB SAS HDD	PH	\$55,950
C-DS60-3-45SR	OPT DS60 SHELF 15X3TB SAS HDD RETN	PH	\$55,950
C-DS60-3-45SRE	OPT DS60 SHELF 15X3TB SAS HDD RETN E	PH	\$55,950
C-DS60-3-45SRN	OPT DS60 SHELF 15X3TB SAS HDD RETN	PH	\$55,950
C-DS60-3-90S	OPT DS60 SHELF 30X3TB SAS HDD	PH	\$104,950
C-DS60-3-90SE	OPT DS60 SHELF 30X3TB SAS HDD E	PH	\$104,950
C-DS60-3-90SN	OPT DS60 SHELF 30X3TB SAS HDD	PH	\$104,950
C-DS60-3-90SR	OPT DS60 SHELF 30X3TB SAS HDD RETN	PH	\$104,950
C-DS60-3-90SRE	OPT DS60 SHELF 30X3TB SAS HDD RETN E	PH	\$104,950
C-DS60-3-90SRN	OPT DS60 SHELF 30X3TB SAS HDD RETN	PH	\$104,950
C-DS60-4-120S	OPT DS60 SHELF 30X4TB SAS HDD	PH	\$127,200
C-DS60-4-120SE	OPT DS60 SHELF 30X4TB SAS HDD E	PH	\$127,200
C-DS60-4-120SN	OPT DS60 SHELF 30X4TB SAS HDD	PH	\$127,200
C-DS60-4-120SR	OPT DS60 SHELF 30X4TB SAS HDD RETN	PH	\$127,200
C-DS60-4-120SRE	OPT DS60 SHELF 30X4TB SAS HDD RETN E	PH	\$127,200
C-DS60-4-120SRN	OPT DS60 SHELF 30X4TB SAS HDD RETN	PH	\$127,200
C-DS60-4-180S	OPT DS60 SHELF 45X4TB SAS HDD	PH	\$190,600
C-DS60-4-180SE	OPT DS60 SHELF 45X4TB SAS HDD E	PH	\$190,600
C-DS60-4-180SN	OPT DS60 SHELF 45X4TB SAS HDD	PH	\$190,600
C-DS60-4-180SR	OPT DS60 SHELF 45X4TB SAS HDD RETN	PH	\$190,600
C-DS60-4-180SRE	OPT DS60 SHELF 45X4TB SAS HDD RETN E	PH	\$190,600
C-DS60-4-180SRN	OPT DS60 SHELF 45X4TB SAS HDD RETN	PH	\$190,600
C-DS60-4-240S	OPT DS60 SHELF 60X4TB SAS HDD	PH	\$253,300
C-DS60-4-240SE	OPT DS60 SHELF 60X4TB SAS HDD E	PH	\$253,300
C-DS60-4-240SN	OPT DS60 SHELF 60X4TB SAS HDD	PH	\$253,300
C-DS60-4-240SR	OPT DS60 SHELF 60X4TB SAS HDD RETN	PH	\$253,300
C-DS60-4-240SRE	OPT DS60 SHELF 60X4TB SAS HDD RETN E	PH	\$253,300
C-DS60-4-240SRN	OPT DS60 SHELF 60X4TB SAS HDD RETN	PH	\$253,300
C-DS60-4-60S	OPT DS60 SHELF 15X4TB SAS HDD	PH	\$67,850
C-DS60-4-60SE	OPT DS60 SHELF 15X4TB SAS HDD E	PH	\$67,850
C-DS60-4-60SN	OPT DS60 SHELF 15X4TB SAS HDD	PH	\$67,850
C-DS60-4-60SR	OPT DS60 SHELF 15X4TB SAS HDD RETN	PH	\$67,850

C-DS60-4-60SRE	OPT DS60 SHELF 15X4TB SAS HDD RETN E	PH	\$67,850
C-DS60-4-60SRN	OPT DS60 SHELF 15X4TB SAS HDD RETN	PH	\$67,850
C-E16-DC	OPTION; ES20 STORSHELF;16 TB; DUALCTRL	PH	\$0
C-E32-DC	OPTION; ES20 STORSHELF;32 TB; DUALCTRL	PH	\$0
C-ES20-16A	OPTION;ES20 SHELF;16X1TB HDD;2XCTL;ARCHV	PH	\$0
C-ES20-32A	OPTION;ES20 SHELF;16X2TB HDD;2XCTL;ARCHV	PH	\$0
C-ES30-15	OPTION;ES30 SHELF;15X1TB HDD;2XLCC	PH	\$26,250
C-ES30-15A	OPTION;ES30 SHELF;15X1T SATA HDD;EXTDRE	PH	\$25,500
C-ES30-30	OPTION;ES30 SHELF;15X2TB HDD;2XLCC	PH	\$36,400
C-ES30-30A	OPTION;ES30 SHELF;15X2T SATA HDD;EXTDRE	PH	\$36,400
C-ES30-30S	OPTION,ES30 SHELF, 15X2TB SAS HDD	PH	\$36,400
C-ES30-30S-B	OPTION,ES30 SHELF, 15X2TB SAS HDD	PH	\$0
C-ES30-30SE	OPTION,ES30 SHELF, 15X2TB SAS HDD,RACK E	PH	\$36,400
C-ES30-30SR	OPTION,ES30 SHELF, 15X2TB SAS HDD,RETN	PH	\$36,400
C-ES30-30SRE	OPTION,ES30 SHELF, 15X2TB SAS HDD,RETN E	PH	\$36,400
C-ES30-45	OPTION;ES30 SHELF;15X3TB SATA HDD	PH	\$53,150
C-ES30-45A	OPTION;ES30 SHELF;15X3TB SATA HDD;RETN	PH	\$53,150
C-ES30-45-B	OPTION;ES30 SHELF;15X3TB SATA HDD	PH	\$0
C-ES30-45S	OPTION,ES30 SHELF, 15X3TB SAS HDD	PH	\$53,150
C-ES30-45S-B	OPTION,ES30 SHELF, 15X3TB SAS HDD	PH	\$0
C-ES30-45SE	OPTION,ES30 SHELF, 15X3TB SAS HDD E	PH	\$53,150
C-ES30-45SR	OPTION,ES30 SHELF, 15X3TB SAS HDD,RETN	PH	\$53,150
C-ES30-45SRE	OPTION,ES30 SHELF, 15X3TB SAS HDD,RETN E	PH	\$53,150
C-ES30-60S	OPTION ES30 SHELF 15X4TB SAS HDD	PH	\$63,800
C-ES30-60SE	OPTION ES30 SHELF 15X4TB SAS HDD E	PH	\$63,800
C-ES30-60SR	OPTION ES30 SHELF 15X4TB SAS HDD RETN	PH	\$63,800
C-ES30-60SRE	OPTION ES30 SHELF 15X4TB SAS HDD RETN E	PH	\$63,800
C-FLDIN9500	OPTION FIELD INSTALL KIT DD9500	PH	\$0
C-HA-DS60-SAS-3	CABLE HA INTERCONNECT DS60 3M;	PH	\$322
C-HA-ES30-SAS-2	CABLE HA INTERCONNECT ES30 2M	PH	\$150
C-HA-ES30-SAS-5	CABLE HA INTERCONNECT ES30 5M	PH	\$380
C-HA-INTER-1	CABLE HA INTERCONNECT CTRLR 1M	PH	\$500
C-SAS-M4PMC	DD 6GBIT SAS IO MOD 4PORT ER OPTION	PH	\$5,000
D-BST-DOCS4N	DOCS, LICENSE, BOOST, S4	PH	\$0
DD690-1E16	SYSTEM; DD690 CTRL+1ES16T;16TB;NFS;CIFS	PH	\$0
DD690-2E16	SYSTEM; DD690 CTRL+2ES16T;32TB;NFS;CIFS	PH	\$0
DD690-2E8	SYSTEM; DD690 CTRL+2ES8T;16TB;NFS;CIFS	PH	\$0
DD690-3E16	SYSTEM; DD690 CTRL+3ES16T;48TB;NFS;CIFS	PH	\$0
DD690-3E8	SYSTEM; DD690 CTRL+3ES8T;24TB;NFS;CIFS	PH	\$0
DD690-4E8	SYSTEM; DD690 CTRL+4ES8T;32TB;NFS;CIFS	PH	\$0
DD690-5E8	SYSTEM; DD690 CTRL+5ES8T;40TB;NFS;CIFS	PH	\$0
DD690-6E8	SYSTEM; DD690 CTRL+6ES8T;48TB;NFS;CIFS	PH	\$0
DD7200-10E45	SYSTEM,DD7200+10ES30,3TB SASHDD,NFS,CIFS	PH	\$803,900
DD7200-11E45	SYSTEM,DD7200+11ES30,3TB SASHDD,NFS,CIFS	PH	\$857,000
DD7200-12E45	SYSTEM,DD7200+12ES30,3TB SASHDD,NFS,CIFS	PH	\$910,100
DD7200-3E45	SYSTEM,DD7200+3ES30,3TB SAS HDD,NFS,CIFS	PH	\$393,350
DD7200-4E45	SYSTEM,DD7200+4ES30,3TB SAS HDD,NFS,CIFS	PH	\$446,450
DD7200-5E45	SYSTEM,DD7200+5ES30,3TB SAS HDD,NFS,CIFS	PH	\$499,550
DD7200-6E45	SYSTEM,DD7200+6ES30,3TB SAS HDD,NFS,CIFS	PH	\$552,650
DD7200-7E45	SYSTEM,DD7200+7ES30,3TB SAS HDD,NFS,CIFS	PH	\$605,800

DD7200-8E45	SYSTEM,DD7200+8ES30,3TB SAS HDD,NFS,CIFS	PH	\$658,900
DD7200-9E45	SYSTEM,DD7200+9ES30,3TB SAS HDD,NFS,CIFS	PH	\$750,800
DD7200-CTL	SYSTEM,DD7200,CTL,ENTRY MEM,NFS,CIFS	PH	\$234,000
DD7200-CTL-B	SYSTEM,DD7200,CTL,ENTRY MEM,NFS,CIFS	PH	\$0
DD7200-CTLX	SYSTEM,DD7200,CTL,EXP MEM,NFS,CIFS	PH	\$255,450
DD7200-CTLX-B	SYSTEM,DD7200,CTL,EXP MEM,NFS,CIFS	PH	\$0
DD860-1E30	SYSTEM; DD860+1ES30;30TB;NFS;CIFS	PH	\$0
DD860-1E32	SYSTEM; DD860+1ES32;32TB;NFS;CIFS	PH	\$0
DD860-2E30	SYSTEM; DD860+2ES30;60TB;NFS;CIFS	PH	\$0
DD860-2E32	SYSTEM; DD860+2ES32;64TB;NFS;CIFS	PH	\$0
DD860-3E30	SYSTEM; DD860+3ES30;90TB;NFS;CIFS	PH	\$0
DD860-3E32	SYSTEM; DD860+3ES32;96TB;NFS;CIFS	PH	\$0
DD860-4E30	SYSTEM; DD860+4ES30;120TB;NFS;CIFS	PH	\$0
DD860-4E32	SYSTEM; DD860+4ES32;128TB;NFS;CIFS	PH	\$0
DD860-5E30	SYSTEM; DD860+5ES30;150TB;NFS;CIFS	PH	\$0
DD860-5E32	SYSTEM; DD860+5ES32;160TB;NFS;CIFS	PH	\$0
DD860-6E30	SYSTEM; DD860+6ES30;180TB;NFS;CIFS	PH	\$0
DD860-6E32	SYSTEM; DD860+6ES32;192TB;NFS;CIFS	PH	\$0
DD860-CTL	SYSTEM; DD860; CTL; NFS; CIFS	PH	\$0
DD860-CTX	SYSTEM; DD860;CTLX;NFS;CIFS	PH	\$0
DD880-12E16	SYSTEM;DD880 CTRL+12ES16T;192TB;NFS;CIFS	PH	\$942,000
DD880-1E16	SYSTEM; DD880 CTRL+1ES16T;16TB;NFS;CIFS	PH	\$331,000
DD880-1E32	SYSTEM;DD880CTRL+1ES32T;32TB;NFS;CIFS	PH	\$368,000
DD880-2E16	SYSTEM; DD880 CTRL+2ES16T;32TB;NFS;CIFS	PH	\$382,000
DD880-2E32	SYSTEM;DD880CTRL+2ES32T;64TB;NFS;CIFS	PH	\$456,000
DD880-2GD	SYSTEM; GD ARRAY;DD880;DUAL-CTRL	PH	\$710,000
DD880-3E16	SYSTEM; DD880 CTRL+3ES16T;48TB;NFS;CIFS	PH	\$433,000
DD880-3E32	SYSTEM;DD880CTRL+3ES32T;96TB;NFS;CIFS	PH	\$544,000
DD880-4E16	SYSTEM; DD880 CTRL+4ES16T;64TB;NFS;CIFS	PH	\$484,000
DD880-4E32	SYSTEM;DD880CTRL+4ES32T;128TB;NFS;CIFS	PH	\$682,000
DD880-5E16	SYSTEM; DD880 CTRL+5ES16T;80TB;NFS;CIFS	PH	\$535,000
DD880-5E32	SYSTEM;DD880CTRL+5ES32T;160TB;NFS;CIFS	PH	\$770,000
DD880-6E16	SYSTEM; DD880 CTRL+6ES16T;96TB;NFS;CIFS	PH	\$586,000
DD880-6E32	SYSTEM;DD880CTRL+6ES32T;192TB;NFS;CIFS	PH	\$858,000
DD880DLM	SYSTEM;DD880 FOR DLM;NFS;CIFS	PH	\$0
DD890-12E30	SYSTEM; DD890+12ES30;360TB;NFS;CIFS	PH	\$0
DD890-12E32	SYSTEM;DD890+12ES32;384TB;NFS;CIFS	PH	\$0
DD890-1E30	SYSTEM; DD890+1ES30;30TB;NFS;CIFS	PH	\$0
DD890-1E32	SYSTEM;DD890+1ES32;32TB;NFS;CIFS	PH	\$0
DD890-2E30	SYSTEM; DD890+2ES30;60TB;NFS;CIFS	PH	\$0
DD890-2E32	SYSTEM;DD890+2ES32;64TB;NFS;CIFS	PH	\$0
DD890-2GD	SYSTEM;GD ARRAY;DD890;DUAL-CTL	PH	\$750,000
DD890-3E30	SYSTEM; DD890+3ES30;90TB;NFS;CIFS	PH	\$0
DD890-3E32	SYSTEM;DD890+3ES32;96TB;NFS;CIFS	PH	\$0
DD890-4E30	SYSTEM; DD890+4ES30;120TB;NFS;CIFS	PH	\$0
DD890-4E32	SYSTEM;DD890+4ES32;128TB;NFS;CIFS	PH	\$0
DD890-5E30	SYSTEM; DD890+5ES30;150TB;NFS;CIFS	PH	\$0
DD890-5E32	SYSTEM;DD890+5ES32;160TB;NFS;CIFS	PH	\$0
DD890-6E30	SYSTEM; DD890+6ES30;180TB;NFS;CIFS	PH	\$0
DD890-6E32	SYSTEM;DD890+6ES32;192TB;NFS;CIFS	PH	\$0

DD890-CTL	SYSTEM;DD890;CTL;NFS;CIFS	PH	\$0
DD890-CTX	SYSTEM; DD890; CTX; NFS; CIFS	PH	\$0
DD9500	SYSTEM DD9500 256GB NFS CIFS	PH	\$0
DD9500-10E45	SYSTEM DD9500+10ES30 3TB SASHDD NFS CIFS	PH	\$882,600
DD9500-11E45	SYSTEM DD9500+11ES30 3TB SASHDD NFS CIFS	PH	\$935,700
DD9500-12E45	SYSTEM DD9500+12ES30 3TB SASHDD NFS CIFS	PH	\$988,800
DD9500-16E45	SYSTEM DD9500+16ES30 3TB SASHDD NFS CIFS	PH	\$1,201,250
DD9500-20E45	SYSTEM DD9500+20ES30 3TB SASHDD NFS CIFS	PH	\$1,413,650
DD9500-24E45	SYSTEM DD9500+24ES30 3TB SASHDD NFS CIFS	PH	\$1,626,100
DD9500-4E45	SYSTEM DD9500+4ES30 3TB SAS HDD NFS CIFS	PH	\$563,950
DD9500-5E45	SYSTEM DD9500+5ES30 3TB SAS HDD NFS CIFS	PH	\$617,050
DD9500-6E45	SYSTEM DD9500+6ES30 3TB SAS HDD NFS CIFS	PH	\$670,150
DD9500-7E45	SYSTEM DD9500+7ES30 3TB SAS HDD NFS CIFS	PH	\$723,300
DD9500-8E45	SYSTEM DD9500+8ES30 3TB SAS HDD NFS CIFS	PH	\$776,400
DD9500-9E45	SYSTEM DD9500+9ES30 3TB SAS HDD NFS CIFS	PH	\$829,500
DD9500-CTL	SYSTEM DD9500 CTL 256GB NFS CIFS	PH	\$351,500
DD9500-CTL-B	SYSTEM DD9500 CTL 256GB NFS CIFS	PH	\$0
DD9500-CTL-HA	SYSTEM DD9500 CTL 256GB NFS CIFS;HA	PH	\$351,500
DD990	SYSTEM;DD990;NFS;CIFS	PH	\$0
DD990-10E45	SYSTEM DD990 10ES45 3TB SATA HDD NFS	PH	\$0
DD990-11E45	SYSTEM DD990 11ES45 3TB SATA HDD NFS	PH	\$0
DD990-12E30	SYSTEM;DD990+12ES30;2TB SATAHDD;NFS;CIFS	PH	\$0
DD990-12E45	SYSTEM;DD990;12ES45;3TB SATA HD;NFS;CIFS	PH	\$0
DD990-16E45	SYSTEM;DD990;16ES45;3TB SATA HD;NFS;CIFS	PH	\$0
DD990-18E30	SYSTEM;DD990+18ES30;2TB SATAHDD;NFS;CIFS	PH	\$0
DD990-24E30	SYSTEM;DD990+24ES30;2TB SATAHDD;NFS;CIFS	PH	\$0
DD990-4E30	SYSTEM;DD990+4ES30;2TB SATA HDD;NFS;CIFS	PH	\$0
DD990-4E45	SYSTEM;DD990;4ES45;3TB SATA HDD;NFS;CIFS	PH	\$0
DD990-5E30	SYSTEM;DD990+5ES30;2TB SATA HDD;NFS;CIFS	PH	\$0
DD990-5E45	SYSTEM;DD990;5ES45;3TB SATA HDD;NFS;CIFS	PH	\$0
DD990-6E30	SYSTEM;DD990+6ES30;2TB SATA HDD;NFS;CIFS	PH	\$0
DD990-6E45	SYSTEM DD990 6ES45 3TB SATA HDD NFS CIFS	PH	\$0
DD990-7E45	SYSTEM DD990 7ES45 3TB SATA HDD NFS CIFS	PH	\$0
DD990-8E45	SYSTEM;DD990;8ES45;3TB SATA HDD;NFS;CIFS	PH	\$0
DD990-9E45	SYSTEM DD990 9ES45 3TB SATA HDD NFS CIFS	PH	\$0
DD990-CTL	SYSTEM;DD990;CTL;NFS;CIFS	PH	\$0
DD990-CTL-B	SYSTEM;DD990;CTL;NFS;CIFS	PH	\$0
DDMC	DATA DOMAIN MANAGEMENT CENTER	PH	\$0
DDRACK-1PH-2N	RACK DATA DOMAIN 40U SNGL PHASE;RK-BEZE	PH	\$4,200
DDRACK-1PH-DR2N	RACK DATA DOMAIN 40U SNGL PHASE;DOOR	PH	\$4,200
DDRACK-3PD	RACK DATA DOMAIN 40U 3P DELTA	PH	\$4,200
DDRACK-3PD-2N	RACK DATA DOMAIN 40U 3P DELTA;RK-BEZEL	PH	\$4,200
DDRACK-3PD-DR2N	RACK DATA DOMAIN 40U 3P DELTA;DOOR	PH	\$4,200
DDRACK-3PY	RACK DATA DOMAIN 40U 3P WYE	PH	\$4,200
DDRACK-3PY-2N	RACK DATA DOMAIN 40U 3P WYE;RK-BEZEL	PH	\$4,200
DDRACK-3PY-DR2N	RACK DATA DOMAIN 40U 3P WYE;DOOR	PH	\$4,200
DDRACK-40U	RACK; DATA DOMAIN;40U	PH	\$4,200
DDRACK-40U-1	RACK DATA DOMAIN 40U SINGLE PHASE	PH	\$4,200
DDRACK-40UN	RACK, DATA DOMAIN,40U	PH	\$4,200
DD-UIDN	LABEL,DATA DOMAIN,UID,4500,6200	PH	\$0

DDX-690-12	SYSTEM; DDX; 12X690 BASEUNIT;NFS;CIFS	PH	\$0
DDX-690-16	SYSTEM; DDX; 16X690 BASEUNIT;NFS;CIFS	PH	\$0
DDX-690-4	SYSTEM; DDX; 4X690 BASEUNIT;NFS;CIFS	PH	\$0
DDX-690-8	SYSTEM; DDX; 8X690 BASEUNIT;NFS;CIFS	PH	\$0
DDX-880-12	SYSTEM; DDX; 12X880 BASEUNIT;NFS;CIFS	PH	\$0
DDX-880-16	SYSTEM; DDX; 16X880 BASEUNIT;NFS;CIFS	PH	\$0
DDX-880-4	SYSTEM; DDX; 4X880 BASEUNIT;NFS;CIFS	PH	\$0
DDX-880-8	SYSTEM; DDX; 8X880 BASEUNIT;NFS;CIFS	PH	\$0
DL1000S5DAE	EDL 4G DAE W/(15) 1000GB 7.2K SATA DISKS	PH	\$0
DL1000S-DAE	EDL 4G DAE W/(15) 1000GB 7.2K SATA DISKS	PH	\$0
DL1000S-DAEFD	EDL 4G DAE W/(15) 1TB 7.2K SATA DISK-FIE	PH	\$0
DL1000W-DAE	FULLY LOADED 4GB STILETTO DAE W/WD 1TB L	PH	\$0
DL1KBASE-DAE	EDL GEN4 BASE DAE W/1TB SATA DRIVES CONI	PH	\$0
DL2000S-DAE	EDL 4G DAE W/(15) 2000GB 7.2K SATA DISKS	PH	\$0
DL2000W-G3DAE	EDL DL4000 SERIES DAE W(15) 2TB SATA DRI	PH	\$0
DL210BA2	AX150SC BASE ARRAY FOR DL210	PH	\$0
DL210BA2-FD	AX150SC BASE ARRAY FOR DL210 FIELD INSTA	PH	\$0
DL210EXP2	AX150SC EXPANSION ARRAY FOR DL210	PH	\$0
DL210EXP2-FD	AX150SC EXPANSION FOR DL210 FLD INSTALL	PH	\$0
DL2KS-2TDRV	EDL DL4X06 2TB 7.2K UPGRADE HOT SPARES	PH	\$0
DL2KS-DAEFD	EDL DL4000 SERIES DAE W(15) 2TB 7.2K SAT	PH	\$0
DL2KW-2TDRV	EDL DL4X06 UPGRADE HOT SPARES	PH	\$0
DL2KW-3PK	EDL DL4X06 UPGRADE HOT SPARES	PH	\$0
DL2KW-DAEFD	EDL DL4X06 DAE W(15) 2TB SATA DRIVES FIE	PH	\$0
DL3D1500	DL3D 1500 config array CX3-10C clone	PH	\$0
DL3D1500-FD	DL3D 1500 config array CX3-10C-FD clone	PH	\$0
DL3D1KVDAE-FD	DL3D 1500 config vault DAE with 9 SATA 1	PH	\$0
DL3D1KVLTDAE	DL3D 1500 config vault DAE with 9 SATA 1	PH	\$0
DL3D1T-1PK	1 TB DRIVE DEDUP TIER	PH	\$0
DL3D1T-6PK	DL3D 6 pack of 1TB SATA drives	PH	\$0
DL3D1T-6PK-FD	DL3D 6 pack of 1TB SATA drives FD	PH	\$0
DL3D1T-DAE	DL3D SATA DAE without disks	PH	\$0
DL3D1T-N3D	1 TB DRIVE PERFORMANCE TIER (WITHOUT DEI	PH	\$0
DL3D3000	DL3D 3000 config CX3-40 clone	PH	\$0
DL3D3KBASEDAE	DL3D 3000 base DAE shelf for min config	PH	\$0
DL3D3KVLTDAE	DL3D 3000 Config vault DAE with 9 FC 300	PH	\$0
DL3DENG-FD	DL3D 1500 config server FD	PH	\$0
DL3DENGINE	DL3D 1500 config server	PH	\$0
DL3DENGINE2	DL3D 3000 config server	PH	\$0
DL-3DFCSW	DISK LIBRARY 3D FIBER CHANNEL SWITCH	PH	\$0
DL3DHS-DAE	DL3D 1500 config SATA DAE without disk d	PH	\$0
DL4106	CX3-80 (RAID 6) ARRAY FOR SINGLE ENGINE	PH	\$0
DL4206	CX3-80 (RAID 6) ARRAY FOR DUAL ENGINE DL	PH	\$0
DL4406A	CX3-80 (RAID 6) ARRAY 1 OF 2 FOR 2X2 DL	PH	\$0
DL4406B	CX3-80 (RAID 6) ARRAY 2 OF 2 FOR 2X2 DL	PH	\$0
DL-500B-DAE	FULLY LOADED DAE W/500GB	PH	\$0
DL-500B-DAE-FD	UPGRD DAE W/500GB	PH	\$0
DL500GB1PK-FD	DL1500 500GB DRIVE 1-PK - FLD INSTALL	PH	\$0
DL500GVDAE-FD	DL1500 VAULT DAE 2 TB USEABLE - FLD INST	PH	\$0
DL-500S-DAE	FULLY LOADED 4GB STILETTO DAE W/NORTHS	PH	\$0

DL-500S-DAE-FD	FIELD INSTALL FULL LOADED 4GB DAE W/500G	PH	\$0
DL5100-1TB72	EDL 5100 1TB 7.2K DRIVE	PH	\$0
DL5100A240	DL5100 STORAGE ARRAY WITH 240 DISK DRIVE	PH	\$0
DL5100-DAE	EMPTY EDL 4G DAE 1TB OR 2TB SATA DRIVES	PH	\$0
DL5100ENGINE	2U INTEL SERVER NEHALEM 12 FC PORTS	PH	\$0
DL5200A960	DISK LIBRARY DPE WITH 8GB I/O CLONE OF C	PH	\$0
DL5200DREXP	EDL DRIVE EXPANSION ADDITIONAL PAIR 4G F	PH	\$0
DL5200ENGINE	DL5200 2U SERVER NEHALEM 12 FC	PH	\$0
DL5VAULTDAE	DL5000 VAULT DAE WITH 7 FC DRIVES	PH	\$0
DL700-2GDAE	DL FC DAE	PH	\$0
DL700-710_UPG	UGRD KIT DL700 TO DL710	PH	\$0
DL-ENGINE2	DL Server Module	PH	\$0
DL-ENGINE210	SVR W/2 QUAD HBA & SCSI	PH	\$0
DL-ENGINE210FD	SVR W/2 QUAD HBA & SCSI	PH	\$0
DL-ENGINE-5U	5U INTEL BASED SERVER W/3.2 GHZ CPU & 2G	PH	\$0
DL-ENGINE-5UC	INTEL 5U SRV w/4GB RAM, (12) FC PRTS & H	PH	\$0
DLM-1000S-FD	STORAGE SHELF FOR DLM FIELD INSTALLED	PH	\$0
DLM-1000W-DAE	FULLY LOADED 4GB STILETTO DAE	PH	\$0
DLM-1000W-FD	FIELD INSTALLED DLM-1000W-DAE	PH	\$0
DLM-10GB6740	DLM Brocade VDX6740 10GigE switch	PH	\$0
DLM120-2DM-A	DLM120 DUAL XBLADE STORAGE CONTROLLER	PH	\$0
DLM120-4PDAE	DLM120 VAULT DAE	PH	\$0
DLM120-AUX	DLM120 AUX XPE - 1 FC SLIC PER SP	PH	\$0
DLM120-CS	DLM120 CONTROL STATION	PH	\$0
DLM120-CS2	DLM120 BACKUP CONTROL STATION	PH	\$0
DLM120-VAULT	DLM VAULT; 300GB; 15K; 4GB DRIVE; QTY: 5	PH	\$0
DLM-2000V-DAE	DLM 2TB VIPER DAE	PH	\$22,779
DLM-2000V-FD	DLM 2TB VIPER DAE FIELD DEPLOY	PH	\$22,779
DLM2-ACPF	DLM GEN II - ACP-FIELD DEPLOY	PH	\$8,198
DLM3-10GES	DLM 10 GIGE SWITCH	PH	\$39,667
DLM3-ACP	DLM GEN 3 - ACCESS CONTROL POINT	PH	\$8,198
DLM3-CS	DLM GEN3 CONTROL STATION	PH	\$0
DLM3-CS2	DLM GEN3 2ND CONTROL STATION	PH	\$5,000
DLM3-DD-BASE	DLM GEN3 DATA DOMAIN RACK BASE	PH	\$5,000
DLM3-DM	DLM3 STORAGE CONTROLLER	PH	\$17,500
DLM3-DME	DLM3 DUAL STORAGE CONTROLLER ENCLOSURE	PH	\$40,000
DLM3-DMERES	DLM3 SPACE RESERVE FOR DME	PH	\$0
DLM3-DME-U	DLM3 DUAL STORAGE CONTROLLER ENCL UPG	PH	\$54,000
DLM3-DMEX	DLM3 EMPTY STORAGE CONTROLLER ENCLOSURE	PH	\$9,402
DLM3-DMEX-U	DLM3 EMPTY SC ENCLOSURE - UPGRADE	PH	\$12,693
DLM3-DM-U	DLM3 STORAGE CONTROLLER UPGRADE	PH	\$23,625
DLM3-GES	DLM GEN 3 - 1 GIGE SWITCHES AT-9924TL	PH	\$7,625
DLM3-RACKB	DLM GEN3 40U TITAN RACK SKINS & DOOR	PH	\$12,000
DLM3-RACK-SL	DLM GEN3 SKINLESS 40U TITAN RACK	PH	\$8,465
DLM3-SPE	DLM GEN3 SPE	PH	\$85,347
DLM3-SPS	DLM GEN3 STANDBY POWER SUPPLY	PH	\$1,500
DLM3-STR-BASE	DLM GEN3 STORAGE RACK BASE	PH	\$2,600
DLM3-VAULTDAE	DLM GEN3 DISK ARRAY ENCLOSURE	PH	\$16,649
DLM3-VNX-BASE	DLM GEN3 VNX RACK BASE	PH	\$4,500
DLM3-VNX-UPG	DLM3 EXP VNX UPGRADE RACK BASE	PH	\$6,075

DLM3-VTECBASE	DLM GEN3 VTEC RACK BASE	PH	\$4,000
DLM3-VTEFMM	DLM GEN3 - FICON MULTI-MODE VTE	PH	\$120,000
DLM3-VTEFMMFD	DLM GEN 3 - FICON MULTI-MODE VTE UPGRADE	PH	\$162,000
DLM3-VTEFSM	DLM GEN3 - FICON SINGLE-MODE VTE	PH	\$120,000
DLM3-VTEFSMFD	DLM GEN3 - FICON SINGLE-MODE VTE UPGRAD	PH	\$162,000
DLM4080-CBL-U	CABLES TO UPGRADE DLM4080 TO USE DLM 2.	PH	\$135
DLM4-7500BASE	DLm4 VNX7500 rack base	PH	\$4,500
DLM4-7500-CS	DLm8100 VNX7500 Control Station	PH	\$0
DLM4-7500-CS2	DLm8100 VNX7500 2nd Control Station	PH	\$5,000
DLM4-7500-VLT	DLm8100 VNX7500 Vault DAE	PH	\$16,649
DLM4-8100FMM	DLm8100 FICON Multi-Mode VTE	PH	\$0
DLM4-8100FMMU	DLm8100 FICON Multi-Mode VTE Upgrade	PH	\$0
DLM4-8100FSM	DLm8100 FICON Single-Mode VTE	PH	\$0
DLM4-8100FSMU	DLm8100 FICON Single-Mode VTE Upgrade	PH	\$0
DLM4-CA-BASE	DLM8100 CLOUD ARRAY BASE KIT	PH	\$4,585
DLM4-DD890BAS	DLm4 DD rack base for DD890	PH	\$5,000
DLM4-DD990BAS	DLm4 DD rack base for DD990	PH	\$5,000
DLM4-DDSTRBAS	DLm4 DD Rack Base for Expansion Storage	PH	\$5,000
DLM4-RACK	DLm 4 40U Titan Rack skins/doors/blue	PH	\$12,000
DLM4-VNX-UPG	DLm4 Exp VNX upgrade rack base	PH	\$6,075
DLM4-VTECBASE	DLm8100 VTEC rack base	PH	\$6,800
DLM4VTECBASE2	DLm8100 VTEC rack base #2	PH	\$6,800
DLM8K-10GES	DLM8000 10GIGE SWITCH	PH	\$48,800
DLM8K-ACP	DLM GEN 3 - ACCESS CONTROL POINT	PH	\$8,198
DLM8K-GES	DLM8000 - 1 GIGE SWITCHES AT-9924TL	PH	\$0
DLM8K-RACK	DLM8000 40U TITAN RACK SKINS/DOORS/BLUE	PH	\$12,000
DLM8K-VTECBAS	DLM8000 VTEC RACK BASE	PH	\$6,800
DLM8K-VTEFMM	DLM8000 - FICON MULTI-MODE VTE	PH	\$120,000
DLM8K-VTEFMMU	DLM8000 - FICON MULTI-MODE VTE UPGRADE	PH	\$162,000
DLM8K-VTEFSM	DLM8000 - FICON SINGLE-MODE VTE	PH	\$120,000
DLM8K-VTEFSMU	DLM8000 - FICON SINGLE-MODE VTE UPGRADE	PH	\$162,000
DLM-BEZEL-DELL	DLM Dell EMC Bezel	PH	\$0
DLM-BEZEL-EMC	DLM EMC Bezel	PH	\$0
DLM-CBL-ESCFD	ESCON MT-RJ TO ST CABLE	PH	\$300
DLM-CX4-CBLKT	CX4 CABLE KIT FOR VTES	PH	\$619
DLM-DOOR-DELL	Dlm VE Dell EMC Door Assy	PH	\$0
DLM-DOOR-EMC	Dlm VE Front Door A Assy	PH	\$0
DLMP40U-60-AS	POWER KIT FOR AUSTRALIAN POWER	PH	\$2,200
DLMP40U-60-IE	EUROPEAN POWER KIT -RACK-40U-60 PWR COF	PH	\$1,150
DLMP40U-60-RS	Russellstoll 3750DP Power kit	PH	\$2,200
DLMP40U-60-US	POWER KIT FOR US POWER	PH	\$1,150
DLMRK-40U-DR	40U TITAN RACK DOOR W DL LOGO SIDESKINS	PH	\$4,200
DLMRK-SECURE	40U RACK STABILIZING KIT	PH	\$190
DLM-SFPP	DLM OPTICAL SFP+	PH	\$950
DLM-XFP-OPT	DLM OPTICAL XFP	PH	\$1,014
DL-STBY	STANDBY SERVER OPTION FOR DL4100	PH	\$0
DL-STBYC	OPTIONAL STANDBY SERVER W/CMRSS CRD	PH	\$0
DL-STBYC-FD	OPTN FLD INSTL STNBY SRVR W/CMRSS CRD	PH	\$0
DL-STBY-FD	FIELD INSTALL STANDBY SERVER OPTION FOR	PH	\$0
DL-VAULT-DAE	4GB VAULT DAE W/(6) 146GB FC DRIVES	PH	\$0

L-890U384-B	LICENSE;DD890 CAP EXP KIT;MORE THAN 180T	PH	\$0
PC-ARGENT-1	POWER CORD,DD ARGENTINA,IRAM2073,C13,2M	PH	\$0
PC-ASTLNZ-1	POWER CORD,DD AUSTRALIA-NZ,AS3112,C13,2	PH	\$0
PC-AUS-NZ	POWER CORD; AUSTRALIA-NZ;AS3112;C13;2.5M	PH	\$0
PC-EUROPE	POWER CORD;CONTENTEUROPE;CEE77;C13;2	PH	\$0
PC-EUROPE-1	POWER CORD,DD EUROPE CONT,CEE77,C13,2	PH	\$0
PC-ISRAEL-1	POWER CORD,DD ISRAEL,SI32,C13,2M	PH	\$0
PC-ITALY-1	POWER CORD,DD ITALY,10A,CEI-23-16,C13,2M	PH	\$0
PC-JAPAN-1	POWER CORD,DD JAPAN,JIS8303,C13,2M	PH	\$0
PC-KOREA	POWER CORD; KOREA;KSC8305;C13;2.5M	PH	\$0
PC-KOREA-1	POWER CORD,DD KOREA,KSC8305,C13,2M	PH	\$0
PC-NA120V-1	POWER CORD NORAMERICA120V 5-15P C13 2M	PH	\$0
PC-NA120VL-1	POWER CORD NORAMERICA120V L5-15P C13 2M	PH	\$0
PC-NA240V6-1	POWER CORD;DD NORAMERIC240V,6-15PC13,6	PH	\$0
PC-PDU-10F	POWER CORD; TO-PDU;C14;C13;10FT	PH	\$0
PC-PDU10F-1	POWER CORD,DD TO-PDU,C14,C13,2M10FT	PH	\$0
PC-PDU-1M	POWER CORD; TO-PDU;10A;C14;C13;1M	PH	\$0
PC-PDU1M-1	POWER CORD,DD TO-PDU,10A,C14,C13,1M	PH	\$0
PC-PDUJAP-1	POWER CORD,DD TO-PDU,JAPN,PSE,C14,C13,2	PH	\$0
PC-RK30ASTL	POWER CORD;AUSTRALIA;RACK;DUAL;TWISTLOCK	PH	\$1,100
PC-RK30ASTL-1	POWER CORD SINGLE PHASE AUSTL RACK DUAL	PH	\$1,100
PC-RK30ASTLN	POWER CORD,AUSTRALIA,RACK,DUAL,TWISTLOCK	PH	\$1,100
PC-RK30IEC3	POWER CORD;INTERNATIONAL;RK;DUAL;IEC309	PH	\$575
PC-RK30IEC3-1	POWER CORD SINGLE PHASE INTL RACK DL	PH	\$575
PC-RK30IEC3-1-US	POWER CORD Single Phase US (UL) RACK DL	PH	\$311
PC-RK30IEC3N	POWER CORD,INTERNATIONAL,RK,DUAL,IEC309	PH	\$575
PC-RK30-RS	POWER CORD;US;RACK;DUAL;R&S CONNECTOR	PH	\$1,100
PC-RK30-RS-1	POWER CORD SINGLE PHASE US RACK DUAL R	PH	\$1,100
PC-RK30-RSN	POWER CORD,US,RACK,DUAL,R&S CONNECTOR	PH	\$1,100
PC-RK30-US	POWER CORD;US&JAP;RACK;DUAL;TWISTLOCK	PH	\$575
PC-RK30-US-1	POWER CORD SINGLE PHASE US&JAP RACK DL	PH	\$575
PC-RK30-USN	POWER CORD,US&JAP,RACK,DUAL,TWISTLOCK	PH	\$575
PC-RK3D50HH	POWER CORD,3PH,50A,DELTA,HBL-HBL,N.AMER	PH	\$2,255
PC-RK3D50HR	POWER CORD,3PH,50A,DELTA,HBL-R&S,N.AMER	PH	\$2,255
PC-RK3DPPH-1	POWER CORD 3PH 40A DELTA PP-HBL N AMER	PH	\$575
PC-RK3DPPRS-1	POWER CORD 3PH 40A DELTA PP-RS N AMER	PH	\$575
PC-RK3Y32FLA	POWER CORD,3PH,32A,FLYINGLEAD,N.AMER	PH	\$2,255
PC-RK3Y32IEC	POWER CORD,3PH,32A,WYE,IEC309-GARO,INTL	PH	\$3,920
PC-RK3YFLA-1	POWER CORD 3PH 32A FLYINGLEAD N AMER	PH	\$575
PC-RK3YFLE-1	POWER CORD 3PH 32A FLYING LEAD INTL	PH	\$575
PC-RK3YIEC-1	POWER CORD 3PH 32A WYE IEC309-GARO INTL	PH	\$575
PC-SAFR-IND	POWER CORD;S.AFRICA-INDIA;BS546;C13;2.5M	PH	\$0
PC-SAFRIND-1	POWER CORD,DD S AFRICA-INDIA,BS546C13,2M	PH	\$0
PC-SWITZ-1	POWER CORD,DD SWITZERLAND,SEV1011,C13,	PH	\$0
PC-TAIWAN	POWER CORD; TAIWAN; BSMI; C13; 6FT	PH	\$0
PC-TAIWAN-1	POWER CORD,DD TAIWAN, BSMI, C13,2M	PH	\$0
PC-UK	POWER CORD; UK;BS1363;C13;2.5M	PH	\$0
PC-UK-1	POWER CORD,DD UK,BS1363,C13,2M	PH	\$0
R-A12E30	OPT;ADD 7TO12 ES30;4X3M CBLKIT;FAC INS	PH	\$1,100
R-A16E30	OPT/ADD 9TO16 ES30/2X2M/2X3M/CBLKIT/40U	PH	\$600

R-A16E30-CT	PT/ADD 9TO16 ES30/2X2M2X3M/CBLKIT/40U CT	PH	\$0
R-A16E30-H	OPTION,ADD 9TO16 ES30 SAS,CABLE KIT	PH	\$600
R-A24E30	OPT;ADD 17TO24 ES30;4X5M CBLKIT;40U	PH	\$600
R-A24E30-CT	OPT;ADD 17TO24 ES30;4X5M CBLKIT;40U CT	PH	\$0
R-A24E30-H	OPTION,ADD 17TO24 ES30 SAS,CABLE KIT	PH	\$600
R-A6E30	OPT;ADD1TO6ES30;2X2M;2X3M;CBLKT;FAC INS	PH	\$600
R-DS60-3-135S	OPT DS60 SHELF 45X3TB SAS HDD RACK	PH	\$157,250
R-DS60-3-135SE	OPT DS60 SHELF 45X3TB SAS HDD RACK E	PH	\$157,250
R-DS60-3-135SN	OPT DS60 SHELF 45X3TB SAS HDD RACK	PH	\$157,250
R-DS60-3-135SR	OPT DS60 SHELF 45X3T SASHD RACK RETN	PH	\$157,250
R-DS60-3-135SRE	OPT DS60 SHELF 45X3T SASHD RACK RETN E	PH	\$157,250
R-DS60-3-135SRN	OPT DS60 SHELF 45X3T SASHD RACK RETN	PH	\$157,250
R-DS60-3-180S	OPT DS60 SHELF 60X3TB SAS HDD RACK	PH	\$209,000
R-DS60-3-180SE	OPT DS60 SHELF 60X3TB SAS HDD RACK E	PH	\$209,000
R-DS60-3-180SN	OPT DS60 SHELF 60X3TB SAS HDD RACK	PH	\$209,000
R-DS60-3-180SR	OPT DS60 SHELF 60X3T SASHD RACK RETN	PH	\$209,000
R-DS60-3-180SRE	OPT DS60 SHELF 60X3T SASHD RACK RETN E	PH	\$209,000
R-DS60-3-180SRN	OPT DS60 SHELF 60X3T SASHD RACK RETN	PH	\$209,000
R-DS60-3-45S	OPT DS60 SHELF 15X3TB SAS HDD RACK	PH	\$55,950
R-DS60-3-45SE	OPT DS60 SHELF 15X3TB SAS HDD RACK E	PH	\$55,950
R-DS60-3-45SN	OPT DS60 SHELF 15X3TB SAS HDD RACK	PH	\$55,950
R-DS60-3-45SR	OPT DS60 SHELF 15X3T SASHD RACK RETN	PH	\$55,950
R-DS60-3-45SRE	OPT DS60 SHELF 15X3T SASHD RACK RETN E	PH	\$55,950
R-DS60-3-45SRN	OPT DS60 SHELF 15X3T SASHD RACK RETN	PH	\$55,950
R-DS60-3-90S	OPT DS60 SHELF 30X3TB SAS HDD RACK	PH	\$104,950
R-DS60-3-90SE	OPT DS60 SHELF 30X3TB SAS HDD RACK E	PH	\$104,950
R-DS60-3-90SN	OPT DS60 SHELF 30X3TB SAS HDD RACK	PH	\$104,950
R-DS60-3-90SR	OPT DS60 SHELF 30X3T SASHD RACK RETN	PH	\$104,950
R-DS60-3-90SRE	OPT DS60 SHELF 30X3T SASHD RACK RETN E	PH	\$104,950
R-DS60-3-90SRN	OPT DS60 SHELF 30X3T SASHD RACK RETN	PH	\$104,950
R-DS60-4-120S	OPT DS60 SHELF 30X4TB SAS HDD RACK	PH	\$127,200
R-DS60-4-120SE	OPT DS60 SHELF 30X4TB SAS HDD RACK E	PH	\$127,200
R-DS60-4-120SN	OPT DS60 SHELF 30X4TB SAS HDD RACK	PH	\$127,200
R-DS60-4-120SR	OPT DS60 SHELF 30X4T SAS HDD RACK RETN	PH	\$127,200
R-DS60-4-120SRE	OPT DS60 SHELF 30X4T SAS HDD RACK RETN E	PH	\$127,200
R-DS60-4-120SRN	OPT DS60 SHELF 30X4T SAS HDD RACK RETN	PH	\$127,200
R-DS60-4-180S	OPT DS60 SHELF 45X4TB SAS HDD RACK	PH	\$190,600
R-DS60-4-180SE	OPT DS60 SHELF 45X4TB SAS HDD RACK E	PH	\$190,600
R-DS60-4-180SN	OPT DS60 SHELF 45X4TB SAS HDD RACK	PH	\$190,600
R-DS60-4-180SR	OPT DS60 SHELF 45X4T SASHD RACK RETN	PH	\$190,600
R-DS60-4-180SRE	OPT DS60 SHELF 45X4T SASHD RACK RETN E	PH	\$190,600
R-DS60-4-180SRN	OPT DS60 SHELF 45X4T SASHD RACK RETN	PH	\$190,600
R-DS60-4-240S	OPT DS60 SHELF 60X4TB SAS HDD RACK	PH	\$253,300
R-DS60-4-240SE	OPT DS60 SHELF 60X4TB SAS HDD RACK E	PH	\$253,300
R-DS60-4-240SN	OPT DS60 SHELF 60X4TB SAS HDD RACK	PH	\$253,300
R-DS60-4-240SR	OPT DS60 SHELF 60X4T SASHD RACK RETN	PH	\$253,300
R-DS60-4-240SRE	OPT DS60 SHELF 60X4T SASHD RACK RETN E	PH	\$253,300
R-DS60-4-240SRN	OPT DS60 SHELF 60X4T SASHD RACK RETN	PH	\$253,300
R-DS60-4-60S	OPT DS60 SHELF 15X4TB SAS HDD RACK	PH	\$67,850
R-DS60-4-60SE	OPT DS60 SHELF 15X4TB SAS HDD RACK E	PH	\$67,850

R-DS60-4-60SN	OPT DS60 SHELF 15X4TB SAS HDD RACK	PH	\$67,850
R-DS60-4-60SR	OPT DS60 SHELF 15X4T SASHD RACK RETN	PH	\$67,850
R-DS60-4-60SRE	OPT DS60 SHELF 15X4T SASHD RACK RETN E	PH	\$67,850
R-DS60-4-60SRN	OPT DS60 SHELF 15X4T SASHD RACK RETN	PH	\$67,850
R-ES30-15	OPTION;ES30 SHELF;15X1TB SATA HDD;RACK	PH	\$26,250
R-ES30-15A	OPTION;ES30 SHELF;15X1TSATAHD;RK;EXTDRE	PH	\$26,250
R-ES30-15A-B	OPTION;ES30 SHELF;15X1T SATAHD;RACK;ARH	PH	\$0
R-ES30-15-B	OPTION;ES30 SHELF;15X1TB SATA HDD;RACK	PH	\$0
R-ES30-30	OPTION;ES30 SHELF;15X2TB SATA HDD;RACK	PH	\$36,400
R-ES30-30A	OPTION;ES30 SHELF;15X2TSATAHD;RK;EXTDRE	PH	\$36,400
R-ES30-30A-B	OPTION;ES30 SHELF;15X2T SATAHD;RACK;ARH	PH	\$0
R-ES30-30-B	OPTION;ES30 SHELF;15X2TB SATA HDD;RACK	PH	\$0
R-ES30-30S	OPTION,ES30 SHELF, 15X2TB SAS HDD,RACK	PH	\$36,400
R-ES30-30S-B	OPTION,ES30 SHELF, 15X2TB SAS HDD,RACK	PH	\$0
R-ES30-30SE	OPTION,ES30 SHELF, 15X2TB SAS HDD,RACK E	PH	\$36,400
R-ES30-30SR	OPTION,ES30 SHELF, 15X2T SASHD,RACK,RETN	PH	\$36,400
R-ES30-30SRE	OPTION,ES30SHELF, 15X2T SASHD,RACK,RETN	PH	\$36,400
R-ES30-45	OPTION;ES30 SHELF;15X3TB SATA HDD;RACK	PH	\$53,150
R-ES30-45A	OPTION;ES30 SHELF;15X3T SATAHD;RACK;RETI	PH	\$53,150
R-ES30-45-B	OPTION;ES30 SHELF;15X3TB SATA HDD;RACK	PH	\$0
R-ES30-45S	OPTION,ES30 SHELF, 15X3TB SAS HDD,RACK	PH	\$53,150
R-ES30-45S-B	OPTION,ES30 SHELF, 15X3TB SAS HDD,RACK	PH	\$0
R-ES30-45SE	OPTION,ES30 SHELF, 15X3TB SAS HDD,RACK E	PH	\$53,150
R-ES30-45SR	OPTION,ES30 SHELF, 15X3T SASHD,RACK,RETN	PH	\$53,150
R-ES30-45SRE	OPTION,ES30 SHELF, 15X3TSASHD,RACK,RETN	PH	\$53,150
R-ES30-60S	OPTION ES30 SHELF 15X4TB SAS HDD	PH	\$63,800
R-ES30-60SE	OPTION ES30 SHELF 15X4TB SAS HDD E	PH	\$63,800
R-ES30-60SR	OPTION ES30 SHELF 15X4TB SAS HDD RETN	PH	\$63,800
R-ES30-60SRE	OPTION ES30 SHELF 15X4TB SAS HDD RETN E	PH	\$63,800
R-FACIN7200	OPTION,FACTORY INSTALL KIT,DD7200	PH	\$0
R-FACIN9500	OPTION FACTORY INSTALL KIT DD9500	PH	\$0
R-FACINS2UA	OPTION;FACTORY INSTALL KIT;40U;860/890	PH	\$0
R-FACINS990	OPTION;FACTORY INSTALL;KIT;40URACK;DD990	PH	\$0
R-HA-DS60-SAS-3	CABLE HA INTERCONNECT DS60 3M;RACK	PH	\$322
R-HA-ES30-SAS-2	CABLE HA INTERCONNECT ES30 2M;RACK	PH	\$150
R-HA-ES30-SAS-5	CABLE HA INTERCONNECT ES30 5M; RACK	PH	\$380
R-HA-INTER-1	CABLE HA INTERCONNECT CTRLR 1M;RACK	PH	\$500
T-9500-MEM256	MEMKIT ADD 256GB DD9500 16X16GB OPT	PH	\$0
U-10GBTM4P	DD 10GBASE T IO MODULE 4PORT UPGRADE	PH	\$5,000
U-10GMCU2P	DD 10GBE,IO MODULE,CU SFP,2PORT,UPGRADE	PH	\$5,000
U-10GMCU4P	DD 10GBE IO MOD CU TWINAX 4PORT UPG	PH	\$6,000
U-10GMOP2P	DD 10GBE,IO MODULE,OP SFP,2PORT,UPGRADE	PH	\$5,000
U-10GMOP4P	DD 10GBE IO MOD OPTICAL SFP 4PORT UPG	PH	\$6,000
U-16GFC-M2P	DD 16GBIT FC IO MOD LC 2PORT UPG	PH	\$6,000
U-7200XMEM	DD MEMKIT,DD7200,MORE THAN 360TB,UPGRADE	PH	\$22,000
U-8GFC-2P	UPGRADE;HBA;8GBIT FC;PCIE;2-PORT	PH	\$0
U-8GFC-M2P	DD 8GBIT FC,IO MODULE,LC,2PORT,UPGRADE	PH	\$4,500
U-9500-MEM256	MEMKIT ADD 256GB DD9500 16X16GB UPG	PH	\$30,000
U-A16E30	ADD 9TO16 ES30;2X2M;2X5M;CBLKIT;40U;UPG	PH	\$600
U-A16E30-1	ADD 9TO16 ES30,CBLKIT,40U, UPGRADE	PH	\$600

U-A24E30	ADD 17TO24 ES30;4X5M CBLKIT;40U;UPGRADE	PH	\$600
U-A24E30-1	ADD 17TO24 ES30,CBLKIT 40U,UPGRADE	PH	\$600
U-A24E30-H	ADD 17TO24 ES30;4X5M CBLKIT;40U;UPGRADE	PH	\$578
U-DS60-3-135S	DS60 SHELF 45X3TB SAS HDD UPGRADE	PH	\$196,550
U-DS60-3-135SE	DS60 SHELF 45X3TB SAS HDD UPGRADE E	PH	\$196,550
U-DS60-3-135SR	DS60 SHELF 45X3TB SAS HDD RETN UPGRADE	PH	\$196,550
U-DS60-3-135SRE	DS60 SHELF 45X3TB SAS HDD RETN UPGRADE	PH	\$196,550
U-DS60-3-180S	DS60 SHELF 60X3TB SAS HDD UPGRADE	PH	\$261,200
U-DS60-3-180SE	DS60 SHELF 60X3TB SAS HDD UPGRADE E	PH	\$261,200
U-DS60-3-180SR	DS60 SHELF 60X3TB SAS HDD RETN UPGRADE	PH	\$261,200
U-DS60-3-180SRE	DS60 SHELF 60X3TB SAS HDD RETN UPGRADE	PH	\$261,200
U-DS60-3-45S	DS60 SHELF 15X3TB SAS HDD UPGRADE	PH	\$69,950
U-DS60-3-45SE	DS60 SHELF 15X3TB SAS HDD UPGRADE E	PH	\$69,950
U-DS60-3-45SR	DS60 SHELF 15X3TB SAS HDD RETN UPGRADE	PH	\$69,950
U-DS60-3-45SRE	DS60 SHELF 15X3TB SAS HDD RETN UPGRADE	PH	\$69,950
U-DS60-3-90S	DS60 SHELF 30X3TB SAS HDD UPGRADE	PH	\$131,150
U-DS60-3-90SE	DS60 SHELF 30X3TB SAS HDD UPGRADE E	PH	\$131,150
U-DS60-3-90SR	DS60 SHELF 30X3TB SAS HDD RETN UPGRADE	PH	\$131,150
U-DS60-3-90SRE	DS60 SHELF 30X3TB SAS HDD RETN UPGRADE	PH	\$131,150
U-DS60-3HDD-15	HDD EXP PACK 15X3TB SAS W/ DS60 CARR	PH	\$56,980
U-DS60-3HDD-15-CT	HDD EXP PACK 15X3TB SAS W/ DS60 CARR CT	PH	\$1
U-DS60-3HDD-15R	HDD EXP PACK 15X3TB SAS W/ DS60 CARR RET	PH	\$64,750
U-DS60-4-120S	DS60 SHELF 30X4TB SAS HDD UPGRADE	PH	\$159,000
U-DS60-4-120SE	DS60 SHELF 30X4TB SAS HDD UPGRADE E	PH	\$159,000
U-DS60-4-120SR	DS60 SHELF 30X4TB SAS HDD RETN UPGRADE	PH	\$159,000
U-DS60-4-120SRE	DS60 SHELF 30X4TB SAS HDD RETN UPGRADE	PH	\$159,000
U-DS60-4-180S	DS60 SHELF 45X4TB SAS HDD UPGRADE	PH	\$238,200
U-DS60-4-180SE	DS60 SHELF 45X4TB SAS HDD UPGRADE E	PH	\$238,200
U-DS60-4-180SR	DS60 SHELF 45X4TB SAS HDD RETN UPGRADE	PH	\$238,200
U-DS60-4-180SRE	DS60 SHELF 45X4TB SAS HDD RETN UPGRADE	PH	\$238,200
U-DS60-4-240S	DS60 SHELF 60X4TB SAS HDD UPGRADE	PH	\$316,600
U-DS60-4-240SE	DS60 SHELF 60X4TB SAS HDD UPGRADE E	PH	\$316,600
U-DS60-4-240SR	DS60 SHELF 60X4TB SAS HDD RETN UPGRADE	PH	\$316,600
U-DS60-4-240SRE	DS60 SHELF 60X4TB SAS HDD RETN UPGRADE	PH	\$316,600
U-DS60-4-60S	DS60 SHELF 15X4TB SAS HDD UPGRADE	PH	\$84,800
U-DS60-4-60SE	DS60 SHELF 15X4TB SAS HDD UPGRADE E	PH	\$84,800
U-DS60-4-60SR	DS60 SHELF 15X4TB SAS HDD RETN UPGRADE	PH	\$84,800
U-DS60-4-60SRE	DS60 SHELF 15X4TB SAS HDD RETN UPGRADE	PH	\$84,800
U-DS60-4HDD-15	HDD EXP PACK 15X4TB SAS W/ DS60 CARR	PH	\$70,180
U-DS60-4HDD-15-CT	HDD EXP PACK 15X4TB SAS W/ DS60 CARR CT	PH	\$1
U-DS60-4HDD-15R	HDD EXP PACK 15X4TB SAS W/ DS60 CARR RET	PH	\$79,750
U-E16-DC	UPGRADE; ES20 STORSHELF;16 TB; DUALCTRL	PH	\$0
U-E32-DC	UPGRADE; ES20 STORSHELF;32 TB; DUALCTRL	PH	\$0
U-ES20-16A	ES20SHELF;16X1TB HDD;2XCTL;ARCHV;UPGRA	PH	\$0
U-ES20-32A	ES20SHELF;16X2TB HDD;2XCTL;ARCHV;UPGRA	PH	\$0
U-ES30-15	ES30 SHELF;15X1TB HDD;2XLCC;UPGRADE	PH	\$0
U-ES30-15A	ES30 SHELF;15X1TB HDD;2XLCC;ARCHVUPGRA	PH	\$0
U-ES30-30	ES30 SHELF;15X2TB HDD;2XLCCUPGRADE	PH	\$0
U-ES30-30A	ES30 SHELF;15X2TB HDD;2XLCC;ARCHVUPGRA	PH	\$0
U-ES30-30S	ES30 SHELF,15X2TB SAS HDD,UPGRADE	PH	\$0

U-ES30-30SE	ES30 SHELF,15X2TB SAS HDD,UPGRADE E	PH	\$38,350
U-ES30-30SR	ES30 SHELF,15X2TB SAS HDD,RETN,UPGRADE	PH	\$0
U-ES30-30SRE	ES30 SHELF,15X2TB SAS HDD,RETN,UPGRADE	PH	\$38,350
U-ES30-45	ES30 SHELF;15X3TB SATA HDD;UPGRADE	PH	\$69,150
U-ES30-45A	ES30 SHELF;15X3TB SATA HDD;ARCHV;UPGRADE	PH	\$0
U-ES30-45-CT	ES30 SHELF;15X3TB SATA HDD;UPGRADE CT	PH	\$1
U-ES30-45S	ES30 SHELF,15X3TB SAS HDD,UPGRADE	PH	\$69,150
U-ES30-45S-CT	ES30 SHELF,15X3TB SAS HDD,UPGRADE CT	PH	\$1
U-ES30-45SE	ES30 SHELF,15X3TB SAS HDD,UPGRADE E	PH	\$69,150
U-ES30-45SR	ES30 SHELF,15X3TB SAS HDD,RETN,UPGRADE	PH	\$69,150
U-ES30-45SRE	ES30 SHELF,15X3TB SAS HDD,RETN,UPGRADE	PH	\$69,150
U-ES30-60S	ES30 SHELF 15X4TB SAS HDD UPGRADE	PH	\$79,750
U-ES30-60S-CT	ES30 SHELF 15X4TB SAS HDD UPGRADE CT	PH	\$1
U-ES30-60SE	ES30 SHELF 15X4TB SAS HDD UPGRADE E	PH	\$79,750
U-ES30-60SR	ES30 SHELF 15X4TB SAS HDD RETN UPGRADE	PH	\$79,750
U-ES30-60SRE	ES30 SHELF 15X4TB SAS HDD RETN UPGRADE	PH	\$79,750
U-FS15-15X800G-SSD	UPGRD - FS15 15x800GB SSD FIELD INSTL	PH	\$65,000
U-HA-DS60-SAS-3	CABLE HA INTERCONNECT DS60 3M;UPGRADE	PH	\$322
U-HA-ES30-SAS-2	CABLE HA INTERCONNECT ES30 2M;UPGRADE	PH	\$150
U-HA-ES30-SAS-5	CABLE HA INTERCONNECT ES30 5M;UPGRADE	PH	\$380
U-HA-INTER-1	CABLE HA INTERCONNECT CTRLR 1M;UPGRADE	PH	\$500
U-SAS-M4P	DD SAS,6G,EXTD RETN,IO MODULE,4PORT,UPG	PH	\$4,500
U-SAS-M4PMC	DD 6GBIT SAS IO MOD 4PORT ER UPG	PH	\$5,000
X-10GBTM4P	SPARE DD 10GBASE T IO MODULE 4PORT	PH	\$5,000
X-10GMCU2P	SPARE,DD 10GBE,IO MODULE,CU SFP,2PORT	PH	\$5,000
X-10GMCU4P	DD 10GBE IO MOD CU TWINAX 4PORT SPARE	PH	\$6,000
X-10GMOP2P	SPARE,DD 10GBE,IO MODULE,OP SFP,2PORT	PH	\$5,000
X-10GMOP4P	DD 10GBE IO MOD OPTICAL SFP 4PORT SPARE	PH	\$6,000
X-16GB-DIMM	SPARE 16GB DDR3-1600 RDIMM DD9500	PH	\$1,600
X-16GFC-M2P	DD 16GBIT FC IO MOD LC 2PORT SPARE	PH	\$6,000
X-1GMCU4P	SPARE,DD 1GBE,IO MODULE,CU,4PORT	PH	\$2,500
X-1GMCUOP4P	SPARE,DD 1GBE, IO MODULE,2P CU,2P OP	PH	\$3,700
X-2G-MNVRM	SPARE,DD,NVRAM,IO MODULE,2GB,DD2500	PH	\$2,000
X-2UA-RISRPG	SPARE RISER MODULE DD140 160 610 620 630	PH	\$2,200
X-2UB-RISRPG	SPARE RISER MODULE DD140 160 610 620 630	PH	\$2,200
X-4G-FC-L2P	SPARE;PCIE;4GB FC;DUALPORT;3U/LP	PH	\$4,500
X-4G-MNVRM	SPARE NVRAM IO MOD 4GB DD4200 4500 7200	PH	\$2,000
X-4UB-ACPWR	SPARE DD AC PWR EXTNDR DD4200 4500 7200	PH	\$350
X-4UB-BEZEL	SPARE DD BEZEL DD4200 4500 7200	PH	\$100
X-4UB-BEZEL-A	SPARE BEZEL DD9500 NO LOGO	PH	\$200
X-4UB-BEZEL-AF	SPARE BEZEL DD9500 WITH LOGO	PH	\$200
X-4UB-CHASS	SPARE CHASS W/O HDD SP DD4200 4500 7200	PH	\$6,000
X-4UB-CHASS-A	SPARE CHASS W/O HDD STORPROC DD9500	PH	\$6,000
X-4UB-FAN	SPARE DD FAN DD4200 4500 7200	PH	\$150
X-4UB-FAN-A	SPARE FAN DD9500	PH	\$250
X-4UBMGTMOD	SPARE DD MGMT MODULE DD4200 4500 7200	PH	\$1,850
X-4UB-MNVBB	SPARE BBU NVRAM IO MOD DD4200 4500 7200	PH	\$1,600
X-4UB-PS-A	SPARE POWER SUPPLY DD9500	PH	\$350
X-4UB-URAIL	SPARE UNIV RAILKIT DD4200 4500 7200	PH	\$300
X-4UB-URAIL-A	SPARE UNIVERSAL RAIL KIT DD9500	PH	\$350

X-7200SPMOD	SPARE,STORAGE PROCESSOR W/O DIMMS,DD7	PH	\$74,000
X-860-CHAS1	SPARE,CHASSIS W/O HDD,DD860	PH	\$50,000
X-860-CHSX1	SPARE,CHASSIS W/O HDD,DD860	PH	\$50,000
X-890-CHAS1	SPARE,CHASSIS W/O HDD,DD890	PH	\$80,000
X-890-CHSX1	SPARE,CHASSIS W/O HDD,DD890	PH	\$80,000
X-8GB-DIMM	SPARE 8GB DDR3-1600 RDIMM DD9500	PH	\$800
X-8GFC-2P-G	SPARE;8GBIT FC HBA;LP;PCIE;2-PORT	PH	\$4,500
X-8GFC-M2P	SPARE,DD 8GBIT FC,IO MODULE,LC,2PORT	PH	\$4,500
X-9500-MEMR	SPARE MEM RISER DD9500	PH	\$1,200
X-9500-MGMT	SPARE IO MANAGEMENT MOD DD9500	PH	\$350
X-9500SPMOD	SPARE STOR PROCESSOR W/O DIMMS PS DD95	PH	\$148,000
XC-10GBT15M	CABLE 10GBASE-T 15 METER	PH	\$225
XC-10GBT5M	CABLE 10GBASE-T 5 METER	PH	\$75
XC-10GCX-15	CABLE;10GBE;CX4;COPPER;15 METER	PH	\$650
XC-10GCX-5	SPARE; CABLE; 10GBE;CX4;COPPER;5 METER	PH	\$325
XC-10GOP-15	CABLE;10GBE;LC;OPTICAL;15 METER	PH	\$325
XC-10GOP-30	SPARE,CABLE,10GBE,LC,IO MOD,OPTICAL,30M	PH	\$325
XC-10GSFP10	CABLE;10GBE;SFP+;COPPER;10 METER	PH	\$400
XC-10GSFP-5	CABLE;10GBE;SFP+;COPPER;5 METER	PH	\$325
XC-10GSFP5MN	SPARE,CABLE,10GBE,SFP+,IO MOD,COPPER,5M	PH	\$325
XC-7200SPKT	SPARE,POWER SUPPLY,FAN,SDD,DD7200	PH	\$1,700
XC-880-SHLF	SPARE; SHELF; 24+ IN; 0U	PH	\$500
XC-9500SPKT	SPARE POWER SUPPLY FAN SDD DD9500	PH	\$2,500
XC-BLANK-1U	SPARE;BLANKING PANEL;1U; DDRACK	PH	\$50
XC-BLANK-2U	SPARE;BLANKING PANEL;2U; DDRACK	PH	\$60
XC-BLANK-3U	SPARE;BLANKING PANEL;3U; DDRACK	PH	\$70
XC-CBLJUMP-1	CABLE SINGLE PHASE PDU JUMPER	PH	\$2,050
XC-CBLJUMP-2	CABLE 3PHASE PDU JUMPER	PH	\$2,050
XC-CBLKT-11	CABLE:EXTD RETN,SAS MSHD-MS,KIT,25TO36ES	PH	\$2,050
XC-CBLKT-12	CABLE:EXTD RETN,SAS MSHD-MS,KIT,37TO56ES	PH	\$1,500
XC-CBLKT-A1	CABLE;SAS CABLE KIT;EXTENDED RETENTION	PH	\$3,300
XC-CBLKTA10	CABLE;EXTD RET;MINISAS CABLEKIT;37TO56ES	PH	\$1,500
XC-CBLKT-A2	CABLE;SAS CABLE KIT;ARCHIVER;4TO5ES	PH	\$1,000
XC-CBLKT-A3	CABLE;SAS CABLE KIT;EXTD RET;6TO12ES	PH	\$1,300
XC-CBLKT-A4	CABLE;SAS CABLE KIT;EXTD RET;13TO24ES	PH	\$2,200
XC-CBLKT-A5	CABLE;EXTD RETN;MINISAS CABLEKIT	PH	\$2,050
XC-CBLKT-A6	CABLE;EXTD RETN,MINISAS CABLEKIT;4TO5ES	PH	\$470
XC-CBLKT-A7	CABLE;EXTD RETN,MINISAS CABLEKIT;6TO12ES	PH	\$700
XC-CBLKT-A8	CABLE;EXTD RETN,MINISAS CABLEKIT;13TO24ES	PH	\$1,310
XC-CBLKT-A9	CABLE;EXTD RET;MINISAS CABLEKIT;25TO36ES	PH	\$2,050
XC-DS60-CBL160IN	SPARE 160IN CABLE RA CONN	PH	\$57
XC-DS60-CBL160IN-N	SPARE 160IN CABLE RA CONN	PH	\$57
XC-DS60-CBL66IN	SPARE 66IN CABLE RA CONN	PH	\$31
XC-DS60-CBL66IN-N	SPARE 66IN CABLE RA CONN	PH	\$31
XC-DS60-SAS-3M	3M 12G MINI-HDX4 TO MINI-HDX4 CABLE	PH	\$322
XC-DS60-SAS-3M-N	3M 12G MINI-HDX4 TO MINI-HDX4 CABLE	PH	\$322
XC-DS60-SAS-4M	4M 12G MINI-HDX4 TO MINI-HDX4 CABLE	PH	\$608
XC-DS60-SAS-4M-N	4M 12G MINI-HDX4 TO MINI-HDX4 CABLE	PH	\$608
XC-DS60-SAS-5M	5M 12G MINI-HDX4 TO MINI-HDX4 CABLE	PH	\$731
XC-DS60-SAS-5M-N	5M 12G MINI-HDX4 TO MINI-HDX4 CABLE	PH	\$731

XC-DS60-SAS-7M	7M 12G MINI-HDX4 TO MINI-HDX4 CABLE	PH	\$841
XC-DS60-SAS-7M-N	7M 12G MINI-HDX4 TO MINI-HDX4 CABLE	PH	\$841
XC-RKPDP3DU	PDP 3PHASE DELTA N AMER JAPAN DD RACK	PH	\$2,680
XC-RKPDP3YU	PDP,3PHASE,WYE,N.AMER&INTL,DD RACK	PH	\$2,680
XC-SECUR-40N	SPARE,SECURE,STABILIZING KIT,40U DDRACK	PH	\$1,000
XC-SECUREBAR	SECURING BAR KIT	PH	\$1,000
X-DS60-3TBS	SPARE DD HDD 3TB SAS W/DS60 CARR	PH	\$4,700
X-DS60-4TBS	SPARE DD HDD 4TB SAS W/DS60 CARR	PH	\$5,700
X-DS60-BEZ-1U	SPARE CMA 1U BEZEL	PH	\$52
X-DS60-BEZ-4U	SPARE DS60 4U BEZEL	PH	\$71
X-DS60-CHAS	SPARE DS60 CHASSIS	PH	\$17,866
X-DS60-CMA-1U	SPARE CMA 1U	PH	\$1,931
X-DS60-CMA-1U-RAIL	SPARE CMA 1U RAIL (PAIR)	PH	\$44
X-DS60-CMA-REAR	SPARE CMA REAR	PH	\$1,795
X-DS60-CTL	SPARE DS60 CONTROLLER	PH	\$4,326
X-DS60-FAN	SPARE DS60 FAN	PH	\$231
X-DS60-PS	SPARE DS60 PSU	PH	\$2,287
X-DS60-RAIL	SPARE RAIL DS60 (PAIR)	PH	\$1,435
X-ES30-1TB	SPARE;DISK DRIVE;1TB W/ ES30 CARRIER	PH	\$1,700
X-ES30-2TB	SPARE;DISK DRIVE;2TB W/ ES30 CARRIER	PH	\$2,600
X-ES30-2TBS	SPARE,DD,HDD,2TB SAS,W/ES30 CARRIER	PH	\$2,600
X-ES30-3TB	SPARE;DISK DRIVE;3TB SATA;ES30 CARRIER	PH	\$3,500
X-ES30-3TBS	SPARE,DD,HDD,3TB SAS,W/ES30 CARRIER	PH	\$3,500
X-ES30-4TBS	SPARE DD HDD 4TB SAS W/ES30 CARRIER	PH	\$1,078
X-ES30-BEZL	SPARE;BEZEL;ES30	PH	\$100
X-ES30-CHAS	SPARE;CHASSIS W/O HDD & 2XLCC;ES30	PH	\$10,100
X-ES30-CTL	SPARE;SHELF CONTROLLER;LCC;ES30	PH	\$3,000
X-ES30-PS	SPARE;POWER SUPPLY AND FAN;ES30	PH	\$2,000
X-ES30-RAIL	SSPARE;UNIV RAILKIT;ES30	PH	\$120
X-HA-DS60-SAS-3	CABLE HA INTERCONNECT DS60 3M;SPARE	PH	\$322
X-HA-ES30-SAS-2	CABLE HA INTERCONNECT ES30 2M; SPARE	PH	\$150
X-HA-ES30-SAS-5	CABLE HA INTERCONNECT ES30 5M;SPARE	PH	\$380
X-HA-INTER-1	CABLE HA INTERCONNECT CTLR 1M;SPARE	PH	\$125
X-HA-INTER-5	CABLE HA INTERCONNECT CTLR 5M;SPARE	PH	\$125
X-MEM1X8G-1	SPARE DIMM 8GB 1XDIMM DD4200 4500 7200	PH	\$3,500
X-NVRAM2GS	SPARE;NVRAM;SP;PCIE;2GB;DD990	PH	\$2,300
X-NVRAM-8G	DD NVRAM IO MOD 8G SPARE	PH	\$6,000
X-RKCONSOLE	SPARE;CONSOLE KIT;40U DDRACK	PH	\$1,000
X-RKCONSOLE-2	SPARE,CONSOLE KIT,40U DDRACK V2	PH	\$1,000
X-RKFRONTDOOR	SPARE,FRONT DOOR KIT,40U DDRACK	PH	\$1,000
X-RK-PDP-SP	SPARE;PDP;SINGLE PHASE;L6-30;DDRACK	PH	\$450
X-RK-PDU	SPARE;PDU;C13;DDRACK	PH	\$450
X-RKPDU3D-1	SPARE PDU 3PH DELTA N AMER JAPAN DDRACK	PH	\$2,680
X-RKPDU3Y-1	SPARE PDU 3PH WYE N AMER INTL DDRACK	PH	\$2,680
X-RKPDUSP-1	SPARE PDU SINGLE PHASE DDRACK	PH	\$450
X-RRDOOR-40	SPARE;REAR DOOR;40U DDRACK	PH	\$1,800
X-SAS-0.5M	CABLE; SAS; IB-IB; 0.5 METER	PH	\$220
X-SAS-2M	CABLE; SAS; IB-IB; 2 METER	PH	\$220
X-SAS-5M	CABLE; SAS; IB-IB; 5 METER	PH	\$430
X-SAS-HDMS1	CABLE,DD,SAS,MINISAS HD-MINISAS,1 METER	PH	\$150

X-SAS-HDMS2	CABLE,DD,SAS,MINISAS HD-MINISAS,2 METER	PH	\$150
X-SAS-HDMS3	CABLE,DD,SAS,MINISAS HD-MINISAS,3 METER	PH	\$200
X-SAS-HDMS5	CABLE,DD,SAS,MINISAS HD-MINISAS,5 METER	PH	\$380
X-SAS-M4P	SPARE,DD 6G SAS,EXTD RETN,IO MOD,4PORT	PH	\$4,500
X-SAS-M4PMC	DD 6GBIT SAS IO MOD 4PORT ER UPG	PH	\$5,000
X-SAS-MSIB1	CABLE; SAS;MINISAS-IB;1 METER	PH	\$280
X-SAS-MSIB2	CABLE; SAS;MINISAS-IB;2 METER	PH	\$280
X-SAS-MSIB3	CABLE;SAS;MINISAS-IB;3 METER	PH	\$350
X-SAS-MSIB5	CABLE; SAS;MINISAS-IB;5 METER	PH	\$470
X-SAS-MSMS1	CABLE;SAS;MINISAS-MINISAS;1 METER	PH	\$120
X-SAS-MSMS2	CABLE;SAS;MINISAS-MINISAS;2 METER	PH	\$150
X-SAS-MSMS3	SPARE;CBL;SAS;MINISAS-MINISAS;3 METER	PH	\$200
X-SAS-MSMS4	SPARE;CBL;SAS;MINISAS-MINISAS;4 METER	PH	\$310
X-SAS-MSMS5	CABLE;SAS;MINISAS-MINISAS;5 METER	PH	\$380
X-SIDEPNL40	SPARE;SIDE PANEL;40U DDRACK	PH	\$1,800
X-SSD-400GB	SPARE SSD 400G 2.5 SATA 512 DV DD9500	PH	\$1,900
X-SSD-4UB	SPARE DD 200GB SSD DD4200 4500 7200	PH	\$1,200
A2-12-D15T1	DAE 15 1T SATA 7.2K HAPW MFG QTY2 G2	PM	\$0
A2-12-D15T1-X	DAE 15 1T SATA 7.2K HAPW FLD QTY2 G2	PM	\$0
A2-12-D15T2	DAE 15 2T SATA 7.2K HAPW MFG QTY2 G2	PM	\$0
A2-12-D15T2-X	DAE 15 2T SATA 7.2K HAPW FLD QTY2 G2	PM	\$0
A2-12-D15T3	DAE 15 3T SATA 7.2K HAPW MFG QTY2 G2	PM	\$0
A2-12-D15T3-X	DAE 15 3T SATA 7.2K HAPW FLD QTY2 G2	PM	\$0
A2-12-RE	ATMOS G2 PLATFORM BASE	PM	\$0
A2-12-SVR3G	SVR 1U 1GBE HAPW MFG QTY2 G2	PM	\$0
A2-12-SVR3G-X	SVR 1U 1GBE HAPW FLD QTY2 G2	PM	\$0
A2-12-SVR6G	SVR 1U 1GBE HAPW MFG QTY2 G2	PM	\$0
A2-12-SVR6G-X	SVR 1U 1GBE HAPW FLD QTY2 G2	PM	\$0
A2-12-SWGB	SWCH 1GBE 24P HAPW MFG QTY1 G2	PM	\$0
A2-12-XE	ATMOS G2 PLATFORM EXPANSION	PM	\$0
A2-8-D15T1	DAE 15 1T SATA 7.2K HAPW MFG QTY2 G2	PM	\$0
A2-8-D15T1-X	DAE 15 1T SATA 7.2K HAPW FLD QTY2 G2	PM	\$0
A2-8-D15T2	DAE 15 2T SATA 7.2K HAPW MFG QTY2 G2	PM	\$0
A2-8-D15T2-X	DAE 15 2T SATA 7.2K HAPW FLD QTY2 G2	PM	\$0
A2-8-D15T3	DAE 15 3T SATA 7.2K HAPW MFG QTY2 G2	PM	\$0
A2-8-D15T3-X	DAE 15 3T SATA 7.2K HAPW FLD QTY2 G2	PM	\$0
A2-8-RE	ATMOS G2 PLATFORM BASE	PM	\$0
A2-8-SVR3G	SVR 1U 1GBE HAPW MFG QTY2 G2	PM	\$0
A2-8-SVR3G-X	SVR 1U 1GBE HAPW FLD QTY2 G2	PM	\$0
A2-8-SVR6G	SVR 1U 1GBE HAPW MFG QTY2 G2	PM	\$0
A2-8-SVR6G-X	SVR 1U 1GBE HAPW FLD QTY2 G2	PM	\$0
A2-8-SWGB	SWCH 1GBE 24P HAPW MFG QTY1 G2	PM	\$0
A2-8-XE	ATMOS G2 PLATFORM EXPANSION	PM	\$0
A2-ND15-T1	ATMOS G2 PLATFORM NODE 15 DISK 1T	PM	\$0
A2-ND15-T2	ATMOS G2 PLATFORM NODE 15 DISK 2T	PM	\$0
A2-ND15-T3	ATMOS G2 PLATFORM NODE 15 DISK 3T	PM	\$0
A2-ND60-T1	ATMOS G2 PLATFORM NODE 60 DISK 1T	PM	\$0
A2-ND60-T2	ATMOS G2 PLATFORM NODE 60 DISK 2T	PM	\$0
A2-ND60-T3	ATMOS G2 PLATFORM NODE 60 DISK 3T	PM	\$0
A2-T-D15T1	DAE 15 1T SATA 7.2K HAPW MFG QTY1 G2	PM	\$0

A2-T-D15T1-X	DAE 15 1T SATA 7.2K HAPW FLD QTY1 G2	PM	\$0
A2-T-D15T2	DAE 15 2T SATA 7.2K HAPW MFG QTY1 G2	PM	\$0
A2-T-D15T2-X	DAE 15 2T SATA 7.2K HAPW FLD QTY1 G2	PM	\$0
A2-T-D15T3	DAE 15 3T SATA 7.2K HAPW MFG QTY1 G2	PM	\$0
A2-T-D15T3-X	DAE 15 3T SATA 7.2K HAPW FLD QTY1 G2	PM	\$0
A2-T-RC	ATMOS G2 PLATFORM BASE	PM	\$0
A2-T-RE	ATMOS G2 PLATFORM BASE	PM	\$0
A2-T-SVR3G	SVR 1U 1GBE HAPW MFG QTY2 G2	PM	\$0
A2-T-SVR3G-X	SVR 1U 1GBE HAPW FLD QTY2 G2	PM	\$0
A2-T-SVR6G	SVR 1U 1GBE HAPW MFG QTY2 G2	PM	\$0
A2-T-SVR6G-X	SVR 1U 1GBE HAPW FLD QTY2 G2	PM	\$0
A2-T-SWGB	SWCH 1GBE 24P HAPW MFG QTY1 G2	PM	\$0
A2-T-SWGB-X	SWCH 1GBE 24P HAPW FLD QTY1 G2	PM	\$0
A2-T-XC	ATMOS G2 PLATFORM EXPANSION	PM	\$0
A2-T-XE	ATMOS G2 PLATFORM EXPANSION	PM	\$0
A3D-D30-T1-X	DAE 30 1TB SATA 7.2K HAPW FLD QTY1 G3	PM	\$0
A3D-D30-T2-X	DAE 30 2TB SATA 7.2K HAPW FLD QTY1 G3	PM	\$0
A3D-D30-T4-X	DAE 30 4TB SATA 7.2K HAPW FLD QTY1 G3	PM	\$0
A3D-D60-T4-X	DAE 60 4TB SATA 7.2K HAPW FLD QTY1 G3	PM	\$0
A3-DISK60-T1T	DISK PACK 60 1TB SATA 7.2K QTY1 TAA G3	PM	\$0
A3-DISK60-T2T	DISK PACK 60 2TB SATA 7.2K QTY1 TAA G3	PM	\$0
A3-DISK60-T4T	DISK PACK 60 4TB SATA 7.2K QTY1 TAA G3	PM	\$0
A3-DISK60-T6T	DISK PACK 60 6TB SATA 7.2K QTY1 TAA G3	PM	\$0
A3D-ND30-T1	ATMOS G3D PLATFORM NODE 30 DISK 1T	PM	\$0
A3D-ND30-T2	ATMOS G3D PLATFORM NODE 30 DISK 2T	PM	\$0
A3D-ND30-T4	ATMOS G3D PLATFORM NODE 30 DISK 4T	PM	\$0
A3D-ND60-T1	ATMOS G3D PLATFORM NODE 60 DISK 1T	PM	\$0
A3D-ND60-T2	ATMOS G3D PLATFORM NODE 60 DISK 2T	PM	\$0
A3D-ND60-T3	ATMOS G3D PLATFORM NODE 60 DISK 3T	PM	\$0
A3D-ND60-T4	ATMOS G3D PLATFORM NODE 60 DISK 4T	PM	\$0
A3D-RE-HA10G	ATMOS G3 DENSE PLATFORM BASE	PM	\$0
A3D-XC	ATMOS G3D PLATFORM EXPANSION	PM	\$0
A3D-XE	ATMOS G3D PLATFORM EXPANSION	PM	\$0
A3F-CHS-B4-X	SVR 2U CHS 4BL 10GBE HAPW FLD QTY1 G3	PM	\$0
A3F-D30-T1-X	DAE 30 1TB SATA 7.2K HAPW FLD QTY1 G3	PM	\$0
A3F-D30-T2-X	DAE 30 2TB SATA 7.2K HAPW FLD QTY1 G3	PM	\$0
A3F-D30-T4-X	DAE 30 4TB SATA 7.2K HAPW FLD QTY1 G3	PM	\$0
A3F-D60-T1-X	DAE 60 1TB SATA 7.2K HAPW FLD QTY1 G3	PM	\$0
A3F-D60-T2	DAE 60 2TB SATA 7.2K HAPW MFG QTY1 G3	PM	\$0
A3F-D60-T2-X	DAE 60 2TB SATA 7.2K HAPW FLD QTY1 G3	PM	\$0
A3F-D60-T4-X	DAE 60 4TB SATA 7.2K HAPW FLD QTY1 G3	PM	\$0
A3F-ND15-T1	ATMOS G3F PLATFORM NODE 15 DISK 1T	PM	\$0
A3F-ND15-T2	ATMOS G3F PLATFORM NODE 15 DISK 2T	PM	\$0
A3F-ND15-T4	ATMOS G3F PLATFORM NODE 15 DISK 4T	PM	\$0
A3F-ND30-T1	ATMOS G3F PLATFORM NODE 30 DISK 1T	PM	\$0
A3F-ND30-T2	ATMOS G3F PLATFORM NODE 30 DISK 2T	PM	\$0
A3F-ND30-T4	ATMOS G3F PLATFORM NODE 30 DISK 4T	PM	\$0
A3F-RC	ATMOS G3 FLEX PLATFORM BASE	PM	\$0
A3F-RE	ATMOS G3 FLEX PLATFORM BASE	PM	\$0
A3F-RE-10G	ATMOS G3 FLEX PLATFORM BASE	PM	\$0

A3F-RE-HA10G	ATMOS G3 FLEX PLATFORM BASE	PM	\$0
A3F-XC	ATMOS G3F PLATFORM EXPANSION	PM	\$0
A3F-XE	ATMOS G3F PLATFORM EXPANSION	PM	\$0
A-DAE-1T-HTX	DAE 15 1T SATA 7.2K HAPW FLD QTY1 G2	PM	\$0
A-DAE-1T-HX	DAE 15 1T SATA 7.2K HAPW FLD QTY2 G2	PM	\$0
A-DAE-2H-H	DAE 15 2T SATA 7.2K HAPW MFG QTY2 G2	PM	\$0
A-DAE-2H-HD	DAE 15 2T SATA 7.2K HAPW MFG QTY2 G2	PM	\$0
A-DAE-2H-HT	DAE 15 2T SATA 7.2K HAPW MFG QTY1 G2	PM	\$0
A-DAE-2T-HTX	DAE 15 2T SATA 7.2K HAPW FLD QTY1 G2	PM	\$0
A-DAE-2T-HX	DAE 15 2T SATA 7.2K HAPW FLD QTY2 G2	PM	\$0
A-DAE-2WG-H	DAE 15 2T SATA 5.4K HAPW MFG QTY2 G2	PM	\$0
A-DAE-2WG-HD	DAE 15 2T SATA 5.4K HAPW MFG QTY2 G2	PM	\$0
A-DAE-2WG-HT	DAE 15 2T SATA 5.4K HAPW MFG QTY1 G2	PM	\$0
A-DAE-3H-H	DAE 15 3T SATA 7.2K HAPW MFG QTY2 G2	PM	\$0
A-DAE-3H-HD	DAE 15 3T SATA 7.2K HAPW MFG QTY2 G2	PM	\$0
A-DAE-3H-HT	DAE 15 3T SATA 7.2K HAPW MFG QTY1 G2	PM	\$0
A-DAE-3T-HTX	DAE 15 3T SATA 7.2K HAPW FLD QTY1 G2	PM	\$0
A-DAE-3T-HX	DAE 15 3T SATA 7.2K HAPW FLD QTY2 G2	PM	\$0
A-S-6G-1GH	SVR 1U 1GBE HAPW MFG QTY2 G2	PM	\$0
A-S-6G-1GHT	SVR 1U 1GBE HAPW MFG QTY2 G2	PM	\$0
A-S-6G-HTX	SVR 1U 1GBE HAPW FLD QTY2 G2	PM	\$0
A-S-6G-HX	SVR 1U 1GBE HAPW FLD QTY2 G2	PM	\$0
A-S-DISK-C	ATMOS CRU R610 SERVER DISK REPLACEMENT	PM	\$0
A-S-DP-1GH	SVR 1U 1GBE HAPW MFG QTY2 G2	PM	\$0
A-S-DP-1GHT	SVR 1U 1GBE HAPW MFG QTY2 G2	PM	\$0
A-S-DP-1GN	SVR 1U 1GBE HAPW MFG QTY2 G2	PM	\$0
A-S-HTX	SVR 1U 1GBE HAPW FLD QTY2 G2	PM	\$0
A-S-HX	SVR 1U 1GBE HAPW FLD QTY2 G2	PM	\$0
AVM10GBFCU	AVAMAR G4T QUAD 10GB CU FLD INSL	PM	\$3,000
AVM10GBFOPT-NC	AVAMAR G4T QUAD 10GB OPT NO CONN FLD	PM	\$3,000
AVM10GBFOPT-SFP	AVAMAR G4T QUAD 10GB OPT+SFP FLD INSTL	PM	\$3,000
AVM10GBMCU	AVAMAR G4T QUAD 10GB CU MANF INSTL	PM	\$0
AVM10GBMOPT-NC	AVAMAR G4T QUAD 10GB OPT NO CONN MANF	PM	\$0
AVM10GBMOPT-SFP	AVAMAR G4T QUAD 10GB OPT+SFP MANF INSTL	PM	\$0
AVM1200FG4S	AVAMAR G4S M1200 STORAGE NODE FLD INST	PM	\$0
AVM1200FG4ST	AVAMAR G4S M1200 STGNODE FLD INST RR	PM	\$0
AVM1200FG4T	AVAMAR G4T M1200 NODE FLD INSTL	PM	\$24,250
AVM1200FG4TD	Avamar G4T M1200 Node Fld Instl	PM	\$24,250
AVM1200MG4S	AVAMAR G4S M1200 STORAGE NODE MFG INST	PM	\$0
AVM1200MG4ST	AVAMAR GEN4S M1200 NODE MFG INST RR	PM	\$0
AVM1200MG4T	AVAMAR G4T M1200 NODE MANF INSTL	PM	\$24,250
AVM1200MG4TD	Avamar G4T M1200 Node Manf Instl	PM	\$24,250
AVM1200UG4T	AVAMAR G4T M1200 UPGRD FLD INSTL	PM	\$30,313
AVM1200UG4TD	Avamar G4T M1200 Upgrd Fld Instl	PM	\$30,313
AVM19CBINTG4S	AVAMAR G4S INTERNAL 19-CABLE BUNDLE	PM	\$200
AVM1NACC32FG2	AVAMAR GEN2 32GB ACCEL NODE (FLD INST)	PM	\$0
AVM1NLGACCFG4	Avamar Gen4 Large Acc Node (Fld Inst)	PM	\$0
AVM1NMAFG4	AVAMAR GEN4 MEDIA ACCESS NODE (FLD INST)	PM	\$0
AVM1NODEFG1	1 NODE FIELD INSTALLED AVAMAR GEN1 (2U)	PM	\$0
AVM1NODEMG1	1 NODE MFG INSTALLED AVAMAR GEN1 (2U)	PM	\$0

AVM1NSTG1FG2	AVAMAR GEN2 1TB STG NODE (FLD INST)	PM	\$0
AVM1NSTG1FG4	Avamar Gen4 1.3TB Stg Node (Fld Inst)	PM	\$0
AVM1NSTG1MG2	AVAMAR GEN2 1TB STRG NODE (MFG INST)	PM	\$0
AVM1NSTG2FG2	AVAMAR GEN2 2TB STRG NODE (FIELD INST)	PM	\$0
AVM1NSTG2FG4	Avamar Gen4 2.6TB Stg Node (Fld Inst)	PM	\$0
AVM1NSTG2MG2	AVAMAR GEN2 2TB STRG NODE (MFG INST)	PM	\$0
AVM1NSTG3FG4	Avamar Gen4 3.9TB Stg Node (Fld Inst)	PM	\$0
AVM1NSTG3MG4	Avamar Gen4 3.9TB Stg Node (Mfg Inst)	PM	\$0
AVM1NSTG7FG4	Avamar Gen4 7.8TB Stg Node (Fld Inst)	PM	\$0
AVM1NSTG7MG4	Avamar Gen4 7.8TB Stg Node (Mfg Inst)	PM	\$0
AVM1NUTILFG2	AVAMAR GEN2 UTILITY/ACCEL NODE (FLD INST)	PM	\$0
AVM1NUTILFG4	Avamar Gen4 Utility/Acc Node (Fld Inst)	PM	\$0
AVM1NUTILMG2	AVAMAR GEN2 UTILITY NODE (MFG INSTALLED)	PM	\$0
AVM1NUTILMG4	Avamar Gen4 Utility Node (Mfg Inst)	PM	\$0
AVM1TBRN	TELCO RAIL FOR NODES	PM	\$400
AVM1TBRSW	TELCO RAIL FOR SWITCH	PM	\$300
AVM2400DG4S	AVAMAR G4S M2400 SNG NODE (DD IN INST)	PM	\$0
AVM2400EG4S	AVAMAR G4S M2400 SNG NODE (DD EX INST)	PM	\$0
AVM2400FG4S	AVAMAR G4S M2400 STORAGE NODE FLD INST	PM	\$0
AVM2400FG4ST	AVAMAR G4S M2400 STG NODE FLD INST RR	PM	\$0
AVM2400FG4T	AVAMAR G4T M2400 NODE FLD INSTL	PM	\$45,250
AVM2400FG4TD	Avamar G4T M2400 Node Fld Instl	PM	\$45,250
AVM2400MG4S	AVAMAR G4S M2400 STORAGE NODE MFG INST	PM	\$0
AVM2400MG4ST	AVAMAR GEN4S M2400 NODE MFG INST RR	PM	\$0
AVM2400MG4T	AVAMAR G4T M2400 NODE MANF INSTL	PM	\$45,250
AVM2400MG4TD	Avamar G4T M2400 Node Manf Instl	PM	\$45,250
AVM2400UG4T	AVAMAR G4T M2400 UPGRD FLD INSTL	PM	\$56,563
AVM2400UG4TD	Avamar G4T M2400 Upgrd Fld Instl	PM	\$56,563
AVM-40UC-SECURE1	ANTI-TIP KIT, 12", TITAN	PM	\$2,500
AVM-40UC-SECURE2	ANTI-MOVE KIT, TITAN	PM	\$1,000
AVM-40UC-SEISMIC	SEISMIC KIT, TITAN	PM	\$1,000
AVM600DG4S	AVAMAR G4S M600 SNG NODE (DD IN INST)	PM	\$0
AVM600EG4S	AVAMAR G4S M600 SNG NODE (DD EX INST)	PM	\$0
AVM600FG4S	AVAMAR G4S M600 STORAGE NODE FLD INST	PM	\$0
AVM600FG4ST	AVAMAR G4S M600 STG NODE FLD INST RR	PM	\$0
AVM600FG4T	AVAMAR G4T M600 NODE FLD INSTL	PM	\$14,250
AVM600FG4TD	Avamar G4T M600 Node Fld Instl	PM	\$14,250
AVM600MG4S	AVAMAR G4S M600 STORAGE NODE MFG INST	PM	\$0
AVM600MG4ST	AVAMAR GEN4S M600 NODE MFG INST RR	PM	\$0
AVM600MG4T	AVAMAR G4T M600 NODE MANF INSTL	PM	\$14,250
AVM600MG4TD	Avamar G4T M600 Node Manf Instl	PM	\$14,250
AVM600UG4T	AVAMAR G4T M600 UPGRD FLD INSTL	PM	\$17,813
AVM600UG4TD	Avamar G4T M600 Upgrd Fld Instl	PM	\$17,813
AVM6CBLEXT	6 NODE LONG CABLE BNDL EXTERNAL ROUTIN	PM	\$150
AVM6CBLINT	6 NODE SHORT CABLE BNDL INTERNAL ROUTIN	PM	\$100
AVMA1200FG4T	AVAMAR G4T M1200 SVR FLD INSTL	PM	\$24,250
AVMA1200FG4TD	Avamar G4T M1200 Svr Fld Instl	PM	\$24,250
AVMA2400FG4T	AVAMAR G4T M2400 SVR FLD INSTL	PM	\$45,250
AVMA2400FG4TD	Avamar G4T M2400 Svr Fld Instl	PM	\$45,250
AVMA600FG4T	AVAMAR G4T M600 SVR FLD INSTL	PM	\$14,250

AVMA600FG4TD	Avamar G4T M600 Svr Fld Instl	PM	\$14,250
AVMACC10FG4S	AVAMAR G4S NDMP ACCEL 10GBE FLD INST	PM	\$0
AVMACC10FG4T	AVAMAR G4T ACCELERATOR 10GB FLD INSTL	PM	\$14,000
AVMACC10FG4TD	Avamar G4T Accelerator 10GB Fld Instl	PM	\$14,000
AVMCOMFG4S	Avamar Gen4S Int Comm Module (Fld Inst)	PM	\$4,000
AVMCOMG4S	AVAMAR G4S INTERNAL COMM MODULE	PM	\$4,000
AVMCOMG4SF-1	AVAMAR GEN4S INT COMM MODULE SW FLD IN	PM	\$4,000
AVMCOMG4SM-1	AVAMAR GEN4S INT COMM MODULE SW FAC IN	PM	\$4,000
AVMCOMG4TF	AVAMAR G4T COMM MODULE FLD INSTL	PM	\$4,000
AVMCOMG4TM	AVAMAR G4T COMM MODULE MANF INSTL	PM	\$4,000
AVMCOMKIT4S-1	AVAMAR GEN4S COMM RAIL INSTALL KIT	PM	\$200
AVMCOMKIT4T	AVAMAR G4T COMM MODULE INSTALL KIT	PM	\$200
AVMCOMKITG4S	AVAMAR G4S COM INSTALL KIT	PM	\$200
AVMCONSOLEG4T	Avamar G4T Console Door	PM	\$0
AVMCONSOLEG4TD	Avamar G4T Console Door Cobranded	PM	\$0
AVM-E-PC3YAFLA	32A 3PHASE WYE CRD SET IEC309-AMER	PM	\$1,155
AVM-E-PC3YAFILE	32A 3PHASE WYE CRD SET FLY LEAD EUROPE	PM	\$2,800
AVMFACTORYKITG4T	Avamar G4T Factory Kit	PM	\$0
AVMFACTORYKITG4TD	Avamar G4T Factory Kit Cobranded	PM	\$0
AVMFIELDKITG4TD	Avamar G4T Field Kit Cobranded	PM	\$0
AVMMAFG4S	AVAMAR G4S MEDIA ACCESS FLD INST	PM	\$0
AVMMAFG4ST	AVAMAR G4S MEDIA ACCESS FLD INST RR	PM	\$0
AVM-MDS-TWNX-5M	10G BASE COPPER PASSIVE TWINAX CABLE; 5M	PM	\$325
AVM-PWR-1PH-01	PWR CORD 24A SP 15FT 56PA332	PM	\$2,485
AVM-PWR-1PH-02	PWR CORD 24A SP 15FT IEC309P	PM	\$1,468
AVM-PWR-1PH-03	POWER CORD SINGLE PHASE US&JAP RACK	PM	\$470
AVM-PWR-1PH-04	PWR CORD 24A SP 15FT 3750DP	PM	\$2,194
AVM-PWR-3PH-DEL-01	PWR CORD 3-PH DELTA, 40A, 15FT, Int'l	PM	\$2,426
AVM-PWR-3PH-DEL-02	PWR CORD 3-PH DELTA, 40A, 15FT, N. Am.	PM	\$1,754
AVM-PWR-3PH-DEL-03	PWR CORD 3-PH DELTA, 40A/RS 15FT, N.A.	PM	\$3,175
AVM-PWR-3PH-WYE-01	PWR CORD 3-PH WYE, 32A, 15FT, INT'L	PM	\$838
AVM-P-XC-CBLJUMP-1	CABLE SINGLE PHASE PDU JUMPER	PM	\$2,050
AVMRACKG4S	AVAMAR G4S 40U TITAN RACK	PM	\$4,200
AVMRAILG4T	AVAMAR G4T RAIL KIT LEFT AND RIGHT	PM	\$200
AVMS2400FG4T	AVAMAR G4T S2400 ABE FLD INSTL	PM	\$27,000
AVMS2400FG4TD	Avamar G4T S2400 ABE Fld Inst	PM	\$27,000
AVMSWITCHG1	CUBE SWITCH AVAMAR GEN1 (2U)	PM	\$0
AVMSWITCHG4	Avamar Gen4 Internal Comm module	PM	\$0
AVMTITAN1PHASE	AVAMAR G4T TITAN RACK SINGLE PHASE	PM	\$4,200
AVMTITAN1PHASED	Avamar G4T Titan Rack Single Phase	PM	\$4,200
AVMTITAN3DELTA	AVAMAR G4T TITAN RACK 3-PHASE DELTA	PM	\$4,200
AVMTITAN3DELTAD	Avamar G4T Titan Rack 3-Phase Delta	PM	\$4,200
AVMTITAN3WYE	AVAMAR G4T TITAN RACK 3-PHASE WYE	PM	\$4,200
AVMTITAN3WYED	Avamar G4T Titan Rack 3-Phase WYE	PM	\$4,200
AVMUTILFG4T	AVAMAR G4T UTILITY NODE FLD INSTL	PM	\$14,000
AVMUTILFG4TD	Avamar G4T Utility Node Fld Instl	PM	\$14,000
AVMUTILMG4T	AVAMAR G4T UTILITY NODE MANF INSTL	PM	\$14,000
AVMUTILMG4TD	Avamar G4T Utility Node Manf Instl	PM	\$14,000
AVM-XC-CBLJUMP-2	3P DELTA PDU TO PDU JMPR CABLE	PM	\$2,050
BDX20K-DAECR	BULLET SAS DAE NON HA	PM	\$0

BDX20K-DAE-HH	DAE 15 1T SATA 7.2K HAPW MFG QTY2 G1	PM	\$0
BDX20K-DAE-HN	DAE 15 1T SATA 7.2K HAPW MFG QTY2 G1	PM	\$0
BDX20K-DAE-HT	DAE 15 1T SATA 7.2K HAPW MFG QTY1 G1	PM	\$0
BDX20K-DAE-WH	BULLET DAE (QTY:2) W/30 1TB WD DRIVES HA	PM	\$0
BDX20K-DAE-WN	BULLET DAE (QTY:2) W/30 1TB WD DRIVES NO	PM	\$0
BDX20K-S-1GH	SVR 1U 1GBE HAPW MFG QTY2 G1	PM	\$0
BDX20K-S-1GHT	SVR 1U 1GBE HAPW MFG QTY2 G1	PM	\$0
BDX20K-S-1GN	SVR 1U 1GBE HAPW MFG QTY2 G1	PM	\$0
BDX20K-SWCH-H	SWCH 1GBE 24P HAPW MFG QTY1 G1	PM	\$0
BDX20K-SW-HT	SWCH 1GBE 24P HAPW MFG QTY1 G1	PM	\$0
BRSS1-ECS	BRS S1 EDISC - ECS SERVER	PM	\$0
BRSS1-ECSI	BRS S1 EDISC ECS SERVER (INTL)	PM	\$0
BRSS1-IC-ECS	BRS S1 EDISCO INFOCTR ECS SRVR	PM	\$0
BRSS1-IC-ECSI	BRS S1 EDISCO INFOCTR ECS SRVR (INTL)	PM	\$0
BTI-MAN-1300	MAN SR1300 ESCON	PM	\$0
BTI-MAN-1450	MAN SR1450 ESCON	PM	\$0
BTI-ZDASD-E	ZDASD ESCON V4.0	PM	\$0
BTI-ZDASD-S	ZDASD SM FICON	PM	\$0
BTI-ZSTOR-M	ZSTOR MM FICON	PM	\$0
C-2500-AES	OPTION,DD2500 ADD ES EXP KIT,DUAL PATH	PM	\$3,750
C-2500-AES-B	OPTION,DD2500 ADD ES EXP KIT,DUAL PATH	PM	\$0
C-2500XMEM	OPTION,MEMKIT,DD2500,MORE THAN 66TB	PM	\$6,000
C-2500XMEM-B	OPTION,MEMKIT,DD2500,MORE THAN 66TB	PM	\$0
C-640-AES-B	OPTION;DD640 ADD ES EXP KIT;DUAL PATH	PM	\$0
C-670AUP76T	OPTION;DD670 CAP EXPKIT; 30TB TO 76TB	PM	\$0
DD2500	SYSTEM,DD2500,NFS,CIFS	PM	\$0
DD2500-1E30	SYSTEM,DD2500+1ES30 SAS,66TB,NFS,CIFS	PM	\$65,350
DD2500-1E45	SYSTEM,DD2500+1ES45 SAS,81TB,NFS,CIFS	PM	\$71,450
DD2500-21TB	SYSTEM,DD2500-7X3TB SAS,21TB,NFS,CIFS	PM	\$28,500
DD2500-2E30	SYSTEM,DD2500+2ES30 SAS,96TB,NFS,CIFS	PM	\$78,450
DD2500-2E45	SYSTEM,DD2500+2ES45 SAS,126TB,NFS,CIFS	PM	\$90,600
DD2500-36TB	SYSTEM,DD2500-12X3HDD SAS,36TB,NFS,CIFS	PM	\$52,250
DD2500-36TB-B	SYSTEM,DD2500-12X3HDD SAS,36TB,NFS,CIFS	PM	\$0
DD2500-3E30	SYSTEM,DD2500+3ES30 SAS,126TB,NFS,CIFS	PM	\$91,550
DD2500-3E45	SYSTEM,DD2500+3ES45 SAS,171TB,NFS,CIFS	PM	\$109,750
DD2500-4E30	SYSTEM,DD2500+4ES30 SAS,156TB,NFS,CIFS	PM	\$104,650
DD4200	SYSTEM,DD4200,NFS,CIFS	PM	\$0
DD4200-1E30	SYSTEM,DD4200+1ES30,2TB SAS HDD,NFS,CIFS	PM	\$44,550
DD4200-1E45	SYSTEM,DD4200+1ES30,3TB SAS HDD,NFS,CIFS	PM	\$60,900
DD4200-2E30	SYSTEM,DD4200+2ES30,2TB SAS HDD,NFS,CIFS	PM	\$80,550
DD4200-2E45	SYSTEM,DD4200+2ES30,3TB SAS HDD,NFS,CIFS	PM	\$114,050
DD4200-3E45	SYSTEM,DD4200+3ES30,3TB SAS HDD,NFS,CIFS	PM	\$186,550
DD4200-4E45	SYSTEM,DD4200+4ES30,3TB SAS HDD,NFS,CIFS	PM	\$239,650
DD4200-5E45	SYSTEM,DD4200+5ES30,3TB SAS HDD,NFS,CIFS	PM	\$292,750
DD4200-CTL	SYSTEM,DD4200,CTL,NFS,CIFS	PM	\$49,500
DD4200-CTL-B	SYSTEM,DD4200,CTL,NFS,CIFS	PM	\$0
DD4500	SYSTEM,DD4500,NFS,CIFS	PM	\$0
DD4500-2E30	SYSTEM,DD4500+2ES30,2TB SAS HDD,NFS,CIFS	PM	\$176,250
DD4500-2E45	SYSTEM,DD4500+2ES30,3TB SAS HDD,NFS,CIFS	PM	\$209,750
DD4500-3E45	SYSTEM,DD4500+3ES30,3TB SAS HDD,NFS,CIFS	PM	\$262,850

DD4500-4E45	SYSTEM,DD4500+4ES30,3TB SAS HDD,NFS,CIFS	PM	\$315,950
DD4500-5E45	SYSTEM,DD4500+5ES30,3TB SAS HDD,NFS,CIFS	PM	\$398,150
DD4500-6E45	SYSTEM,DD4500+6ES30,3TB SAS HDD,NFS,CIFS	PM	\$451,250
DD4500-7E45	SYSTEM,DD4500+7ES30,3TB SAS HDD,NFS,CIFS	PM	\$504,400
DD4500-8E45	SYSTEM,DD4500+8ES30,3TB SAS HDD,NFS,CIFS	PM	\$557,500
DD4500-CTL	SYSTEM,DD4500,CTL,NFS,CIFS	PM	\$103,500
DD4500-CTL-B	SYSTEM,DD4500,CTL,NFS,CIFS	PM	\$0
DD565	SYSTEM; DD565 BASEUNIT; NFS; CIFS (ROHS)	PM	\$0
DD620-12TB	SYSTEM; DD620-12X1;12T;NFS;CIFS	PM	\$0
DD620-7TB	SYSTEM;DD620-7X1;7T;NFS;CIFS	PM	\$0
DD640-12TB	SYSTEM DD640-12X1;12T;NFS;CIFS	PM	\$0
DD640-1E15	SYSTEM;DD640+1ES15;27TB;NFS;CIFS	PM	\$0
DD640-1E30	SYSTEM;DD640+1ES30;42TB;NFS;CIFS	PM	\$0
DD640-2E15	SYSTEM;DD640+2ES15;42TB;NFS;CIFS	PM	\$0
DD640-7TB	SYSTEM DD640-7X1;7T;NFS;CIFS	PM	\$0
DD660-12T-B	SYSTEM; DD660;12TB;NFS;CIFS	PM	\$0
DD660-12TB-B	SYSTEM; DD660;12TB;NFS;CIFS	PM	\$0
DD670-12TB	SYSTEM; DD670; 12TB; NFS; CIFS	PM	\$0
DD670-12TX	SYSTEM; DD670; 12TB; NFS; CIFS	PM	\$0
DD670-1E15	SYSTEM; DD670+1ES30;27TB;NFS;CIFS	PM	\$0
DD670-1E16	SYSTEM; DD670+1ES16;28TB;NFS;CIFS	PM	\$0
DD670-1E30	SYSTEM; DD670+1ES30;42TB;NFS;CIFS	PM	\$0
DD670-1E32	SYSTEM; DD670+1ES32;44TB;NFS;CIFS	PM	\$0
DD670-2E15	SYSTEM; DD670+2ES30;42TB;NFS;CIFS	PM	\$0
DD670-2E16	SYSTEM; DD670+2ES16;44TB;NFS;CIFS	PM	\$0
DD670-2E30	SYSTEM; DD670+2ES30;72TB;NFS;CIFS	PM	\$0
DD670-2E32	SYSTEM; DD670+2ES32;76TB;NFS;CIFS	PM	\$0
DD670-3E15	SYSTEM; DD670+3ES30;57TB;NFS;CIFS	PM	\$0
DD670-3E16	SYSTEM; DD670+3ES16;60TB;NFS;CIFS	PM	\$0
DD670-4E15	SYSTEM; DD670+4ES30;72TB;NFS;CIFS	PM	\$0
DD670-4E16	SYSTEM; DD670+4ES16;76TB;NFS;CIFS	PM	\$0
DLM2000-BASE	DLM2000 RACK BASE	PM	\$5,000
DLM2K-10PACK	DLM2000 2TB VIPER DRIVE 10 PACK	PM	\$13,212
DLM2K-10PACKU	DLM2000 2TB VIPER DRIVE 10 PACK UPGRADE	PM	\$17,837
DLM2K-ACP	DLM2000 - ACCESS CONTROL POINT	PM	\$8,198
DLM2K-CS	DLM2000 CONTROL STATION	PM	\$0
DLM2K-CS2	DLM2000 2ND CONTROL STATION	PM	\$4,700
DLM2K-DAE	DLM2000 2TB VIPER DAE	PM	\$3,709
DLM2K-DAE-FD	DLM2000 2TB VIPER DAE FIELD DEPLOY	PM	\$3,709
DLM2K-DME-10G	DLM2000 10G DUAL STORAGE CONTROLLER EN	PM	\$14,927
DLM2K-DPE	DLM2000 DPE W/ VAULT AND 2ND SPS	PM	\$27,759
DLM2K-GES	DLM2000 - 1 GIGE SWITCHES AT-9924TL	PM	\$7,625
DLM2K-RACKB	DLM2000 40U TITAN RACK SKINS/DOORS/BLUE	PM	\$8,465
DLM2K-VTE2FMM	DLM2000 DUAL FICON MULTI-MODE VTE	PM	\$120,000
DLM2KVTE2FMMU	DLM2000 DUAL FICON MM VTE UPGRADE	PM	\$162,000
DLM2K-VTE2FSM	DLM2000 DUAL FICON SINGLE-MODE VTE	PM	\$120,000
DLM2KVTE2FSMU	DLM2000 DUAL FICON SM VTE UPGRADE	PM	\$162,000
DLM42100DFM12	DLm2100 DD Ficon MM 1 Channel IVB	PM	\$52,500
DLM4-2100DFMM	DLm2100 DD Ficon Multi-Mode	PM	\$0
DLM42100DFMM1	DLM2100 DD FICON MULTI-MODE 1 CHANNEL	PM	\$0

DLM42100DFMM2	DLm2100 DD Ficon MM 2 Channel IVB	PM	\$97,500
DLM42100DFS12	DLm2100 DD Ficon SM 1 Channel IVB	PM	\$52,500
DLM4-2100DFSM	DLm2100 DD Ficon Single-Mode	PM	\$0
DLM42100DFSM1	DLM2100 DD FICON SINGLE-MODE 1 CHANNEL	PM	\$0
DLM42100DFSM2	DLm2100 DD Ficon SM 2 Channel IVB	PM	\$97,500
DLM4-2100VBAS	DLM2100V RACK BASE	PM	\$5,000
DLM4-2100VFMM	DLM2100V FICON MULTI-MODE VTE	PM	\$0
DLM42100VFMM2	DLm2100V FICON Multi-Mode VTE IVB	PM	\$97,500
DLM4-2100VFMU	DLM2100V FICON MULTI-MODE VTE UPGRADE	PM	\$0
DLM42100VFMU2	DLm2100V FICON Multi-Mode VTE Upg IVB	PM	\$129,000
DLM4-2100VFSM	DLM2100V FICON SINGLE-MODE VTE	PM	\$0
DLM42100VFSM2	DLm2100V FICON Single-Mode VTE IVB	PM	\$97,500
DLM4-2100VFSU	DLM2100V FICON SINGLE-MODE VTE UPGRADE	PM	\$0
DLM42100VFSU2	DLm2100V FICON Single-Mode VTE Upg IVB	PM	\$129,000
DLM4-5300-CS	DLM2100 VNX5300 CONTROL STATION	PM	\$0
DLM4-5300-CS2	DLM2100 VNX5300 2ND CONTROL STATION	PM	\$4,700
DLM4-5300-DPE	DLM2100 VNX5300 DPE W/ VAULT + 2ND SPS	PM	\$27,818
DLM4-6510-KIT	DLm8100 S-6510-B Rack Mount Kit	PM	\$600
DLM4-6510R-8G	DLm8100 FC Switch DS-6510R-B 24P/48P 8GB	PM	\$19,300
DLM4-8100FMM2	DLm8100 FICON Multi-Mode VTE IVB	PM	\$0
DLM48100FMMU2	DLm8100 FICON Multi-Mode VTE Upg IVB	PM	\$131,625
DLM4-8100FSM2	DLm8100 FICON Single-Mode VTE IVB	PM	\$0
DLM48100FSMU2	DLm8100 FICON Single-Mode VTE Upg IVB	PM	\$131,625
DLM4-8G12PU	DLm8100 DS-6510B 8G 12Port Upgrade Kit	PM	\$8,300
DLM4-DD-BASE1	DLm4 Generic DD base kit1	PM	\$5,000
DLM4-DD-BASE2	DLm4 Generic DD base kit2	PM	\$5,000
DLM4-VG8-BASE	DLm4 VG8 rack base	PM	\$5,200
DLM4-VNXBRACK	DLm VNX2 40U rack with front panel	PM	\$2,484
DLM8K-5100KIT	DLm8000 DS-5100B install kit	PM	\$290
DLM8K-8G8PU	DLm8000 DS-5100B 8G 8Port Upgrade Kit	PM	\$5,390
DLM8K-CSB	DLm8000 Control Station	PM	\$6,350
DLM8K-CSB2	DLm8000 2nd Control Station	PM	\$6,350
DLM8K-DME0	DLm8000 Dual Storage Controller Enc	PM	\$111,450
DLM8K-DS5100B	DLm8000 FC Switch DS-5100B	PM	\$18,900
DLM8K-VG8-DM	DLm8000 VG8 Storage Controller	PM	\$73,325
DLM8K-VG8DMEX	DLm8000 VG8 Empty Storage Controller Enc	PM	\$35,000
DLM8KVG8DMEXU	DLm8000 VG8 Empty SC Enclosure - Upg	PM	\$47,250
DLM8K-VG8DM-U	DLm8000 VG8 Storage Controller Upgrade	PM	\$98,990
DLM8K-VG8INST	DLm8000 Factory Service VG8 Cab Install	PM	\$0
DLM8K-VG8RACK	DLm8000 VG8 RACK	PM	\$5,200
DLM-V54STR-BA	DLm2100 VNX5400 Storage rack base	PM	\$2,600
DLM-V76STR-BA	DLm VNX7600 Storage Rack Base	PM	\$2,600
DLM-VNX2-10PK	DLm VNX2 2TB Viper Drive 10-pack	PM	\$8,950
DLM-VNX210PKU	DLm VNX2 2TB Viper Drive 10-pack Upg	PM	\$12,150
DLM-VNX2-2TB	DLm VNX2 2TB Viper Drive Hot Spare	PM	\$895
DLM-VNX2-2TBU	DLm VNX2 2TB Viper Drive Hot Spare Upg	PM	\$1,215
DLM-VNX2-BASE	DLm Generic VNX2 Controller Rack Base	PM	\$5,000
DLM-VNX2STRBA	DLm Generic VNX2 Storage rack base	PM	\$2,600
DLM-VNX3TBDAE	DLm VNX 15x3.5" 3TB SAS DAE	PM	\$21,713
DLMVNX3TBDAEF	DLm VNX 15x3.5" 3TB SAS DAE field	PM	\$21,713

DLM-VNX4TBDAE	DLm VNX 15x3.5" 4TB SAS DAE	PM	\$23,963
DLMVNX4TBDAEF	DLm VNX 15x3.5" 4TB SAS DAE field	PM	\$23,963
DLM-VNX5400BA	DLm2100 VNX5400 VTEC Base	PM	\$5,000
DLM-VNX54-DAE	DLm VNX5400 15x3.5" 2TB SAS DAE	PM	\$3,488
DLM-VNX54DAEF	DLm VNX5400 15x3.5" 2TB SAS DAE Field	PM	\$3,488
DLMVNX54DAEHS	DLm VNX5400 15x3.5" 2TB Hot Spare DAE	PM	\$7,963
DLM-VNX54DMEX	DLm VNX5400 Empty DM Enclosure	PM	\$7,992
DLMVNX54DMEXU	DLm VNX5400 Empty DM Enclosure - upgrade	PM	\$10,789
DLM-VNX54DPEM	DLm VNX5400 DPE w/ Vault - modular	PM	\$16,121
DLM-VNX7600BA	DLm VNX7600 Rack Base	PM	\$4,500
DLM-VNX7600BU	DLm Expansion VNX7600 Rack Base	PM	\$4,500
DLM-VNX76-DAE	DLm VNX7600 15x3.5" 2TB SAS DAE	PM	\$16,913
DLM-VNX76DAEF	DLm VNX7600 15x3.5" 2TB SAS DAE Field	PM	\$16,913
DLMVNX76DAEHS	DLm VNX7600 15x3.5" 2TB Hot Spare DAE	PM	\$8,858
DLM-VNX76DME	DLm VNX7600 DME: 2 DM+FC SLICs+cbls	PM	\$21,776
DLMVNX76DMEX	DLm VNX7600 Empty DM Enclosure	PM	\$7,992
DLMVNX76DMEXU	DLm VNX7600 Empty DM Enclosure Upg	PM	\$10,789
DLM-VNXB1UFIL	DLm 1U Solid Filler for VNX 40U rack	PM	\$34
DLM-VNXB2UFIL	DLm 2U Solid Filler for VNX 40U rack	PM	\$38
DLM-VNXB3UFIL	DLm 3U Solid Filler for VNX 40U rack	PM	\$43
DLM-VNXB54DM	DLm VNX5400 DM + SLICs + cables	PM	\$7,741
DLM-VNXB54DME	DLm VNX5400 DME: 2 DM+SLICs+cbls	PM	\$13,653
DLMVNXB54DMEM	DLm VNX5400 DME: 2 DM - Modular	PM	\$13,653
DLM-VNXB54DMU	DLm VNX5400 DM + SLICs + cables upgrade	PM	\$8,381
DLM-VNXB54DPE	DLm VNX5400 DPE w/Vault	PM	\$16,675
DLM-VNXB76DM	DLm VNX7600 Storage Controller	PM	\$36,441
DLM-VNXB76DMU	DLm VNX7600 Storage Controller Upg	PM	\$46,862
DLM-VNXB76DPE	DLm VNX7600 DPE 25X2.5" Vault	PM	\$68,316
DLM-VNXBCS	DLm VNX2 Control Station	PM	\$0
DLM-VNXBCS2	DLm VNX2 2nd Control Station	PM	\$1,935
DLM-VNXBCS2-M	DLm VNX2 2nd Control Station - Modular	PM	\$1,935
DLM-VNXBCS-M	DLm VNX2 Control Station - Modular	PM	\$0
DSKRTAV-2	DISK RETENTION UPLIFT 2YR-AVAMAR	PM	\$28
DSKRTAV-3	DISK RETENTION UPLIFT 3YR-AVAMAR	PM	\$42
DSKRTAV-4	DISK RETENTION UPLIFT 4YR-AVAMAR	PM	\$56
DSKRTAV-5	DISK RETENTION UPLIFT 5YR-AVAMAR	PM	\$70
MAS-E4	MAS ESCON V4.0	PM	\$0
MAS-E5	MAS ESCON V5.0	PM	\$0
MAS-M4	MAS MM FICON V4.0	PM	\$0
MAS-M5	MAS MM FICON V5.0	PM	\$0
MAS-ME	MAS ENTRY MM FICON	PM	\$0
MAS-S4	MAS SM FICON V4.0	PM	\$0
MAS-S5	MAS SM FICON V5.0	PM	\$0
MAS-SE	MAS ENTRY SM FICON	PM	\$0
MDL-1000-E	MDL-1000E ESCON	PM	\$0
MDL-1000-EC	MDL-1000E ESCON CENTERA	PM	\$0
MDL-1000-ED	MDL-1000 ESCON DEDUPE	PM	\$0
MDL-1000-M	MDL-1000F MM FICON	PM	\$0
MDL-1000-M6	MDL-1000 MM FICON V6.0	PM	\$0
MDL-1000-MC	MDL-1000F MM FICON CENTERA	PM	\$0

MDL-1000-MD	MDL-1000 MM FICON DEDUPE	PM	\$0
MDL-1000-S	MDL-1000F SM FICON	PM	\$0
MDL-1000-S6	MDL-1000 SM FICON V6.0	PM	\$0
MDL-1000-SC	MDL-1000F SM FICON CENTERA	PM	\$0
MDL-1000-SD	MDL-1000 SM FICON DEDUPE	PM	\$0
MDL-100S-E	MDL-100S ESCON	PM	\$0
MDL-100S-E6	MDL-100S ESCON V6.0	PM	\$0
MDL-100S-M	MDL-100S MM FICON	PM	\$0
MDL-100S-MF	MM FICON UPGRADE FOR MDL-100S	PM	\$0
MDL-100S-S	MDL-100S SM FICON	PM	\$0
MDL-100S-S6	MDL-100S SM FICON V6.0	PM	\$0
MDL-100S-SF	SM FICON UPGRADE FOR MDL-100S	PM	\$0
MDL-100U-E	MDL-100U ESCON	PM	\$0
MDL-100U-M	MDL-100U MM FICON	PM	\$0
MDL-100U-MF	MM FICON UPGRADE FOR MDL-100U	PM	\$0
MDL-100U-S	MDL-100U SM FICON	PM	\$0
MDL-100U-SF	SM FICON UPGRADE FOR MDL-100U	PM	\$0
MDL-100V-E	MDL-100V ESCON	PM	\$0
MDL-100V-M	MDL-100V MM FICON	PM	\$0
MDL-100V-S	MDL-100V SM FICON	PM	\$0
MDL-10GIG-CX4	CX4 XFP FOR MDL-4000 10 GIG SWITCH	PM	\$0
MDL-10GIG-LR	LR XFP FOR MDL-4000 10 GIG SWITCH	PM	\$0
MDL-10GIG-SR	SR XFP FOR MDL-4000 10 GIG SWITCH	PM	\$0
MDL-2000-3590	MDL-2000/1000 3590 TAPE DRIVE ATTACHMENT	PM	\$0
MDL-2000-E	MDL-2000E ESCON	PM	\$0
MDL-2000-E6	MDL-2000 ESCON V6.0	PM	\$0
MDL-2000-EC	MDL-2000E ESCON CENTERA	PM	\$0
MDL-2000-ESC	MDL-2000 ESCON CHNL INTERFACE	PM	\$0
MDL-2000-HBA	MDL-2000 / 1000 FBR CHNL 2-PRT MM LC CON	PM	\$0
MDL-2000-M	MDL-2000F MM FICON	PM	\$0
MDL-2000-M6	MDL-2000 MM FICON V6.0	PM	\$0
MDL-2000-MC	MDL-2000F MM FICON CENTERA	PM	\$0
MDL-2000-MD	MDL-2000 MM FICON DEDUPE	PM	\$0
MDL-2000-S	MDL-2000F SM FICON	PM	\$0
MDL-2000-S6	MDL-2000 SM FICON V6.0	PM	\$0
MDL-2000-SC	MDL-2000F SM FICON CENTERA	PM	\$0
MDL-2000-SD	MDL-2000 SM FICON DEDUPE	PM	\$0
MDL-200-E	MDL-200E ESCON NODE	PM	\$0
MDL-200-E4	MDL-200 ESCON V4.0	PM	\$0
MDL-200-E5	MDL-200 ESCON V5.0	PM	\$0
MDL-200-EC	MDL-200E ESC CENTERA	PM	\$0
MDL-200-M	MDL-200F MM FICON NODE	PM	\$0
MDL-200-M10	MDL-200F MM FICON 10 GIG IP NODE	PM	\$0
MDL-200-M4	MDL-200 MM FICON V4.0	PM	\$0
MDL-200-M5	MDL-200 MM FICON V5.0	PM	\$0
MDL-200-MC	MDL-200F MM FIC CENTERA	PM	\$0
MDL-200-MSAN	MDL-200 MM FICON NODE SAN STORAGE	PM	\$0
MDL-200RF-S5	MDL-200RF REMOTE NODE SM FICON V5.0	PM	\$0
MDL-200-S	MDL-200F SM FICON NODE	PM	\$0
MDL-200-S10	MDL-200F SM FICON 10 GIG IP NODE	PM	\$0

MDL-200-S4	MDL-200 SM FICON V4.0	PM	\$0
MDL-200-S5	MDL-200 SM FICON V5.0	PM	\$0
MDL-200-S6	MDL-200 SM FICON V6.0	PM	\$0
MDL-200-SC	MDL-200F SM FIC CENTERA	PM	\$0
MDL-200-SSAN	MDL-200 SM FICON NODE SAN STORAGE	PM	\$0
MDL-4000-3590	MDL-4000 NODE 3590 ATTACHMENT	PM	\$0
MDL-4000-E	MDL-4000E ESCON SYSTEM	PM	\$0
MDL-4000-E4	MDL-4000 ESCON V4.0	PM	\$0
MDL-4000-E5	MDL-4000 ESCON V5.0	PM	\$0
MDL-4000-EC	MDL-4000E ESC CENTERA	PM	\$0
MDL-4000-ESN	MDL-4000 ESCON CHNL INTERFACE	PM	\$0
MDL-4000-M	MDL-4000F MM FICON SYSTEM	PM	\$0
MDL-4000-M10	MDL-4000 MM FICON 10 GIG IP SYSTEM	PM	\$0
MDL-4000-M4	MDL-4000 MM FICON V4.0	PM	\$0
MDL-4000-M5	MDL-4000 MM FICON V5.0	PM	\$0
MDL-4000-MC	MDL-4000F MM FIC CENTERA	PM	\$0
MDL-4000-MSAN	MDL-4000 MM FICON SAN STORAGE	PM	\$0
MDL-4000-S	MDL-4000F SM FICON SYSTEM	PM	\$0
MDL-4000-S10	MDL-4000 SM FICON 10 GIG IP SYSTEM	PM	\$0
MDL-4000-S4	MDL-4000 SM FICON V4.0	PM	\$0
MDL-4000-S5	MDL-4000 SM FICON V5.0	PM	\$0
MDL-4000-S6	MDL-4000 SM FICON V6.0	PM	\$0
MDL-4000-SC	MDL-4000F SM FIC CENTERA	PM	\$0
MDL-4000-SSAN	MDL-4000 SM FICON SAN STORAGE	PM	\$0
MDL-6000-S	MDL-6000 SM FICON	PM	\$0
MDL-6000-S10	MDL-6000 SM FICON 10 GIGABIT	PM	\$0
R-FACIN2500	OPTION,FACTORYINSTALL KIT,40URACK,DD250	PM	\$0
R-FACIN4200	OPTION,FACTORY INSTALL KIT,DD4200	PM	\$0
R-FACIN4500	OPTION,FACTORY INSTALL KIT,DD4500	PM	\$0
R-MDATA1	AVM G4S M1200 STORAGE NODE MFG INST	PM	\$0
R-MDATA1N	DD METADATA NODE MFG INST	PM	\$0
R-MEDACC1	DD MEDIA ACCESS NODE MFG INT	PM	\$0
R-MEDACC1N	DD MEDIA ACCESS NODE MFGINT	PM	\$0
R-NDMPACL1	DD NDMP ACCELERATOR NODE MFG INST	PM	\$0
R-NDMPACL1N	DD NDMP ACCELERATOR NODE MFG INST	PM	\$0
U-2500-AES	ADD ES EXP KIT,DUAL PATH,DD2500,UPG	PM	\$3,750
U-2500-AX	ADD 5X3TB SAS HDD,15TB,DD2500,UPGRADE	PM	\$24,250
U-2500XMEM	MEMKIT,DD2500,MORE THAN 66TB,UPGRADE	PM	\$6,000
U-510-AX	UPGRADE;DD510;INCL: LICENSE;6 HDD(1.5TB)	PM	\$0
U-620-AX	DD620;INCL: LICENSE;5 HDD(5TB)	PM	\$0
U-640-AX	DD640;ADD 5X1TBHDD(5TB);UPGRADE	PM	\$4,850
U-670AUP76T	UPGRADE; DD670 CAP EXPKIT; 30TB TO 76TB	PM	\$0
U-MDL-200-E	MDL-200E ESCON NODE	PM	\$0
U-MDL-200-EC	MDL-200E ESC CENTERA	PM	\$0
U-MDL-200-M	MDL-200F MM FICON NODE	PM	\$0
U-MDL-200-M10	MDL-200F MM FICON 10 GIG IP NODE	PM	\$0
U-MDL-200-MC	MDL-200F MM FIC CENTERA	PM	\$0
U-MDL-200-MS	MDL-2000 MM FICON NODE SAN STORAGE	PM	\$0
U-MDL-200-S	MDL-200F SM FICON NODE	PM	\$0
U-MDL-200-S10	MDL-200F SM FICON 10 GIG IP NODE	PM	\$0

U-MDL-200-SC	MDL-200F SM FIC CENTERA	PM	\$0
U-MDL-200-SS	MDL-2000 SM FICON NODE SAN STORAGE	PM	\$0
X-2500SPMOD	SPARE,STORAGE PROCESSOR W/O DIMMS,DD2	PM	\$13,000
X-2UB-1TB	SPARE;HDD;1TB W/DD620 CARRIER;3G	PM	\$900
X-2UB-BEZEL	SPARE;BEZEL;DD160;620	PM	\$100
X-2UC-3TBS	SPARE,DD,HDD,3TB SAS,W/2500 CARRIER	PM	\$2,700
X-2UC-BEZEL	SPARE,DD,BEZEL,DD2500	PM	\$100
X-2UC-CHASS	SPARE,CHASS W/O HDD,STORPROC,DD2500	PM	\$2,000
X-2UC-FAN	SPARE,DD,FAN,DD2500	PM	\$175
X-2UC-NVBB	SPARE,DD,BBU,NVRAM,DD2500	PM	\$1,100
X-2UC-URAIL	SPARE,UNIV RAILKIT,DD2500	PM	\$180
X-400FAN-CT	SPARE; FAN; CENTER; DD400 AND DD500	PM	\$136
X-4500SPMOD	SPARE,STORAGE PROCESSOR W/O DIMMS,DD4	PM	\$42,700
X-620-CHAS1	SPARE,CHASSIS W/O HDD,DD620	PM	\$13,700
X-640-CHAS1	SPARE,CHASSIS W/O HDD,DD640	PM	\$14,700
X-670-CHAS1	SPARE,CHASSIS W/O HDD,DD670	PM	\$40,000
X-670-CHSX1	SPARE,CHASSIS W/O HDD,DD670	PM	\$40,000
XC-2500SPKT	SPARE,1XFAN,PWRSUP,3TB SAS HDD,DD2500	PM	\$1,725
XC-4500SPKT	SPARE,1xFAN,POWER SUPPLY,SSD,DD4500	PM	\$1,700
XC-620SPKIT	SPARE KIT;1XFANTRAY;PWRSUP;1TB HDD;620	PM	\$2,170
X-CHA-2600-12	SR2600 SPARE CHASSIS; MDL 1000/2000	PM	\$16,194
X-CHA-2600-46	SPARE CHASSIS SR2600	PM	\$15,722
X-DIMM1G-DDR3	DIMM 1GB DDR3	PM	\$1,604
X-DISK-300-15	DISK; SAS 300; 300 GB; 15K RPM	PM	\$2,444
X-DVDR-SR2600	DVD/CDRW DRIVE	PM	\$262
X-ETH-10GB-SR	2 PORT 10 GB ETHERNET ADAPTER SR	PM	\$5,816
X-FAN-SR2600C	FAN KIT; SR2600	PM	\$300
X-IOMOD-10GX2	I/O MODULE; 10 GIGE; DUAL PORT	PM	\$3,050
X-IOMOD-1GBX2	I/O DUAL GIG E	PM	\$665
X-IOMOD-1GBX4	I/O MODULE; GIGE; QUAD PORT	PM	\$2,158
X-MEM1X8G-2	SPARE,DD,DIMM,8GB,1XDIMMS,DD2500	PM	\$3,500
X-PEFA-MULTIM	PEFA-LP MULTI MODE FICON ADAPTER	PM	\$6,022
X-PEFA-SINGLE	PEFA-LP SINGLE MODE FICON ADAPTER	PM	\$6,492
X-PESA-W-CABL	ESCON SPARE PCI-E W/CABLE	PM	\$11,603
X-PSUP-SR2600	POWER SUPPLY 750W SR2600	PM	\$1,025
X-RAIL-XTND	SPARE; RAIL EXTENDER	PM	\$180
201-0347-CF	SW: Starter Promo Ent Bundle T2 Gen5 =ID	UE	\$0
40UC-SECURE2S	CLRN 40UC ANTI-MOVE KIT	UE	\$400
450-000-068	VNXe3150 Total Value Pack=IC	UE	\$8,643
450-000-069	VNXe3300 Total Protection Pack=IC	UE	\$15,971
450-000-627	Application Protection VNX5100=IC	UE	\$7,832
450-000-628	Application Protection VNX5300=IC	UE	\$12,531
450-001-629	VNXe3150 Total Value Pack=IC	UE	\$8,210
450-001-630	VNXE3100 Total Value Pack=IC	UE	\$8,210
450-001-631	VNXe3300 Total Protection Pack=IC	UE	\$15,170
456-005-700	VNXE3100 APPLICATION PROTECTION SUITE=IC	UE	\$0
456-005-702	Replication Manager: VNX5100	UE	\$0
456-005-705	Replication Manager: VNX5300	UE	\$0
456-102-448	VNXE UNISPHERE INCLUDED IN BASE SW=IC	UE	\$0
456-102-449	VNXE ISCSI INCLUDED IN BASE SW=IC	UE	\$0

456-102-450	VNXe3300 Local Replication=IC	UE	\$0
456-102-451	VNXE THIN PROVISIONING IN BASE SW=IC	UE	\$0
456-102-452	VNXE NFS INCLUDED IN BASE SW=IC	UE	\$0
456-102-453	VNXE3300 SECURITY AND COMPLIANCE SUITE	UE	\$0
456-102-454	VNXE3300 FILE LEVEL RETENTION MGMT =IC	UE	\$0
456-102-455	VNXE CIFS INCLUDED IN BASE SW=IC	UE	\$0
456-102-456	VNXE FILE DEDUPLICATION IN BASE SW=IC	UE	\$0
456-102-457	VNXe3300 Remote Protection=IC	UE	\$0
456-102-458	VNXE3100 UNISPHERE-INCLUDED IN OE =IC	UE	\$0
456-102-459	VNXE3100 ISCSI-INCLUDED IN OE =IC	UE	\$0
456-102-460	VNXE LOCAL PROTECT SUITE INCL IN OE =IC	UE	\$0
456-102-461	VNXE3100 THIN PROVISIONING-INCL IN OE=IC	UE	\$0
456-102-462	VNXE3100 NFS-INCLUDED IN OE =IC	UE	\$0
456-102-463	VNXE3100 SECURITY & COMPLIANCE SUITE =IC	UE	\$0
456-102-464	VNXE FILE-LEVEL RETENTION	UE	\$0
456-102-465	VNXe3100 CIFS INCLUDED IN OE =IC	UE	\$0
456-102-466	VNXe3100 FILE DEDUPE-INCL IN OE =IC	UE	\$0
456-102-467	VNXE3100 REMOTE PROTECTION SUITE	UE	\$0
456-103-616	VNXe3100 TOTAL VALUE PACK =IC	UE	\$0
456-103-617	DPA REPLICATION ANALYSIS: VNX5100(BLOCK)	UE	\$0
456-103-619	DPA REPLICATION ANALYSIS: VNX5300(BLOCK)	UE	\$0
456-103-678	CC / PROSPHERE MGMT PKG VNX 5100	UE	\$0
456-103-679	CC / PROSPHERE MGMT PKG VNX 5300	UE	\$0
456-103-750	VNXe3100 SP SW UPG KIT =IC	UE	\$1,176
456-103-911	VNXE3150 DATA-AT-REST ENCRYPTION	UE	\$0
456-103-912	VNXE3300 DATA-AT-REST ENCRYPTION	UE	\$0
456-104-060	SECURITY AND COMPLIANCE STE FOR VNXE31	UE	\$0
456-104-061	VNXE3150 FILE-LEVEL RETENTION=IC	UE	\$0
456-104-062	REMOTE PROTECTION SUITE FOR VNXE3150	UE	\$0
456-104-065	VNXe3150 SP SW Upgrade Kit=IC	UE	\$0
456-104-066	VNXE UNISPHERE INCLUDED IN BASE SW=IC	UE	\$0
456-104-067	VNXE ISCSI INCLUDED IN BASE SW=IC	UE	\$0
456-104-068	VNXE LOCAL PROTECTION INCL IN BASE SW=IC	UE	\$0
456-104-069	VNXE THIN PROVISIONING IN BASE SW=IC	UE	\$0
456-104-070	VNXE NFS INCLUDED IN BASE SW=IC	UE	\$0
456-104-071	VNXE CIFS INCLUDED IN BASE SW=IC	UE	\$0
456-104-072	VNXE FILE DEDUP INCLUDED IN BASE SW=IC	UE	\$0
456-104-236	APPSYNC: VNX5100 =IC	UE	\$0
456-104-237	APPSYNC: VNX5300 =IC	UE	\$0
456-104-614	RecoverPoint/SE LOC for VNX5200=IC	UE	\$0
456-104-615	RecoverPoint/SE LOC for VNX5400=IC	UE	\$0
456-104-619	RecoverPoint/SE REM for VNX5200=IC	UE	\$0
456-104-620	RecoverPoint/SE REM for VNX5400=IC	UE	\$0
456-104-637	RP/SE TO RP/EX LOC UG V51 CX=IC	UE	\$2,050
456-104-638	RP/SE TO RP/EX LOC UG V53 CX120=IC	UE	\$3,030
456-104-642	RP/SE TO RP/EX REM UG V51 CX=IC	UE	\$4,065
456-104-643	RP/SE TO RP/EX REM UG V53 CX120=IC	UE	\$7,815
456-104-903	VNXE3200 BASE SW DUAL SP=IC	UE	\$0
456-104-905	VNXE3200 BASE DUAL SP ECOSYS =IC	UE	\$0
456-104-907	VNXE3200 STORAGE ANALYTICS SUITE =IC	UE	\$0

456-104-909	VNXE3200 FAST SUITE =IC	UE	\$0
456-104-928	RP/EX LOC FRAME BASED V51 FOR VPLEX =IC	UE	\$4,115
456-104-929	RP/EX LOC FRAME BASED V53 FOR VPLEX =IC	UE	\$6,060
456-104-933	RP/EX REM FRAME BASED V51 FOR VPLEX =IC	UE	\$8,130
456-104-934	RP/EX REM FRAME BASED V53 FOR VPLEX =IC	UE	\$15,630
456-104-957	RP/EX LOC FOR V32 =IC	UE	\$0
456-104-960	RP/EX REM FOR V32=IC	UE	\$0
456-105-078	AppSync: VNXe 3200 = IC	UE	\$0
456-105-282	VIPR SRM VNX TIER 1=IC	UE	\$0
456-105-283	VIPR SRM VNX TIER 2=IC	UE	\$0
456-105-383	VIPR SRM UPG VNX TIER 1=IC	UE	\$0
456-105-384	VIPR SRM UPG VNX TIER 2=IC	UE	\$0
456-106-025	SRMSUITE VNXE2 =IC	UE	\$0
456-106-424	VPLEX VE STD PROTECTION PACK 25 VM =IB	UE	\$0
456-106-557	AppSync for VNX5150 =IC	UE	\$0
456-106-558	Replication Manager for VNX5150 =IC	UE	\$0
456-106-712	VIRTUAL RPA FOR VNXe=IB	UE	\$0
456-106-737	RP4VM for VNX2 STARTER PACK =IB	UE	\$0
456-106-747	VNXE3200 Remote Protection=IC	UE	\$0
456-106-922	VPLEX VE STD PROTECTION PACK 25 VM =IB	UE	\$0
456-107-334	VNXe3200 Software Express=IC	UE	\$0
456-107-335	VNXe3200 SW 12TB Cap w/200GB Flash=IC	UE	\$4,880
456-107-336	VNXe3200 SW 20TB Cap w/800GB Flash=IC	UE	\$4,880
456-107-337	VNXe3200 SW 20TB Cap w/1200GB Flash=IC	UE	\$4,880
456-107-338	VNXe3200 SW 25TB Cap w/3600GB Flash=IC	UE	\$4,880
456-107-339	VNXe3200 SW 35TB Cap w/800GB Flash=IC	UE	\$4,880
456-107-340	VNXe3200 SW 35TB Cap w/1200GB Flash=IC	UE	\$4,880
456-107-341	VNXe3200 SW 40TB Cap w/3600GB Flash=IC	UE	\$4,880
456-107-342	VNXe3200 SW 8TB Cap w/400GB Flash=IC	UE	\$4,880
456-107-343	VNXe3200 SW 12TB Cap w/400GB Flash=IC	UE	\$4,880
456-107-788	VNXe3200 Base Software Upgrade=IC	UE	\$0
456-107-800	RP/SE LOC UG TO RP/EX LOC - VNXE3200=IC	UE	\$528
456-107-801	RP/SE REM UG TO RP/EX REM - VNXE3200=IC	UE	\$1,320
456-108-468	RP/EX ADV PROTECTION FOR VNXe3200=IC	UE	\$0
456-109-279	VNXE EMC SUPPORT ECOSYSTEM=IC	UE	\$0
456-109-280	VNXE SNAP=IC	UE	\$0
456-109-281	VNXE BASE SW V2.0=IC	UE	\$0
456-109-282	VNXe3300 Local Replication=IC	UE	\$0
456-109-283	VNXe3300 Replication Manager=IC	UE	\$0
456-109-284	VNXe3300 Remote Protection=IC	UE	\$0
456-109-372	CLOUDARRAY SW SA APP 6TBU-12TBU UPG=IC	UE	\$6,370
456-110-214	CLOUDARRAY VIRTUAL EDITN SW 3TB=IC	UE	\$6,735
456-110-215	CLOUDARRAY VIRTUAL EDITN SW 6TB=IC	UE	\$13,475
456-110-216	CLOUDARRAY VIRTUAL EDITN SW 12TB=IC	UE	\$20,565
456-110-217	CLOUDARRAY VIRT EDITN 3 TO 6 SW UPG=IC	UE	\$3,780
456-110-218	CLOUDARRAY VIRT EDITN 3TO12 SW UPG=IC	UE	\$5,675
456-110-219	CLOUDARRAY VIRT EDITN 6TO12 SW UPG=IC	UE	\$10,095
456-110-220	CLOUDARRAY SW FOR 12TBU=IC	UE	\$18,910
456-110-221	CLOUDARRAY SW FOR 18TBU=IC	UE	\$28,365
456-110-222	CLOUDARRAY SW FOR 40TBU=IC	UE	\$47,275

456-110-223	CLOUDARRAY SW FOR 60TBU=IC	UE	\$66,180
456-110-489	CLOUDARRAY VIRTDL EDTN BULK SW 50TB=IC	UE	\$64,290
456-110-490	CLOUDARRAY VIRTDL EDTN BULK SW 100TB=IC	UE	\$101,635
456-110-491	CLOUDARRAY VIRTDL EDTN BULK SW 500TB=IC	UE	\$406,545
456-110-681	VIPR SRM VNX TIER 1 =IC	UE	\$2,580
456-110-783	SRM VNXE2 =IC	UE	\$3,655
456-110-828	VIPR SRM VNX TIER 2 =IC	UE	\$7,210
456-110-890	CLOUDARRAY SW FOR SA APPLIANCE 6TBU=IC	UE	\$10,400
456-111-380	RP/EX REM FRAME V51 FOR VPLEX VS6=IC	UE	\$8,130
456-111-385	RP/EX REM FRAME V52 FOR VPLEX VS6=IC	UE	\$15,630
456-111-391	RP/EX LOC FRAME V51 FOR VPLEX VS6=IC	UE	\$4,115
456-111-396	RP/EX LOC FRAME V52 FOR VPLEX VS6=IC	UE	\$6,060
456-112-198	CloudArray Base Solution with 3TB=CC	UE	\$6,735
456-112-199	CloudArray Capacity License=CC	UE	\$1,535
456-112-200	CloudArray Capacity License Upg=CC	UE	\$1,535
457-100-299	VNXe3300 BASE SW INCL OE v2.0 DUAL SP	UE	\$0
457-100-347	VNXe330 BASE OE V2.0 (EMC ECOSYS)	UE	\$0
457-100-348	VNXE3100 BASE OE V2.0,DUAL SP	UE	\$0
457-100-349	VNXE3100 BASE OE v2.0 DUAL SP EMC ECOSYS	UE	\$0
457-100-682	VNEX3100 BASE OE v2.0 SGL SP EMC ECOSYS	UE	\$0
457-100-683	VNXE3100 BASE OE v2.0, SINGLE SP	UE	\$0
457-100-980	VNXE3150 BASE OE v2.0, DUAL SP	UE	\$0
457-100-981	VNXE3150 BASE OE v2.0 DUAL SP EMC ECOSYS	UE	\$0
457-100-982	VNXE3150 BASE OE v2.0 SGL SP EMC ECOSYS	UE	\$0
457-100-983	VNXE3150 BASE OE v2.0, SINGLE SP	UE	\$0
457-101-843	RecoverPoint Adv. Protect - v32 =IC	UE	\$0
458-000-122	VNXE BASE SW OE v2.0 DUAL SP EMC ECO=IC	UE	\$3,723
458-000-123	VNXE BASE SW INCL OE v2.0, DUAL SP=IC	UE	\$3,723
458-000-128	VNXe3150 Remote Protection Suite=IC	UE	\$4,063
458-000-129	VNXe3150 Security & Compliance Suite=IC	UE	\$837
458-000-177	VNXE BASE SW OE v2.0 SNGL SP EMC ECO=IC	UE	\$2,606
458-000-178	VNXE BASE SW INCL OE v2.0, SNGL SP=IC	UE	\$2,606
458-000-179	VNXE BASE SW OE 2.0 DUAL SP (EMC ECO)=IC	UE	\$6,472
458-000-180	VNXE BASE SW INCL OE v2.0, DUAL SP=IC	UE	\$6,472
458-000-181	VNXe3300 Local Protection Suite-IC	UE	\$2,576
458-000-182	VNXe3300 Application Protection =IC	UE	\$10,651
458-000-183	VNXe3300 Remote Protection Suite=IC	UE	\$6,641
458-000-184	VNXe3300 Security & Compliance Suite=IC	UE	\$1,361
458-000-191	SRM for VNX	UE	\$0
458-000-204	VIPR SRM UPG for VNX =IC	UE	\$0
458-000-216	RP/EX VPLEX FB VNX REMOTE PRODUCT	UE	\$0
458-000-225	RP/EX ADV PROTECTION FOR VNXe3200 PROD.	UE	\$6,730
458-000-227	VPLEX VE STD PROT PRODUCT 25 VM=IB	UE	\$0
458-000-400	VNXe3200 BASE DUAL SP ECOSYS=IC	UE	\$0
458-000-401	VNXE3200 BASE SW INCLU OE DUAL SP=IC	UE	\$0
458-000-402	VNXe3200 FAST Suite=IC	UE	\$0
458-000-657	VNXe3200 AppSync Copy Mgmt	UE	\$0
458-000-758	VNXe3200 SW 8TB Cap w/200GB Flash=IC	UE	\$4,880
458-000-775	VNXe3200 Base Software Upgrade=IC	UE	\$0
458-000-868	VNXE3200 Remote Protection=IC	UE	\$0

458-000-873	ViPR SRM for VNX1	UE	\$0
458-000-973	VNXe1600 BASE SW+OE DUAL SP NO-ECOSYS=	UE	\$3,500
458-000-974	VNXe1600 BASE SW+OE DUAL SP ECOSYS =IC	UE	\$3,500
458-000-975	VNXe3200 DP for Direct Availability=IC	UE	\$0
458-001-122	VNXE3200 RP/SE PRODUCT=IC	UE	\$0
458-001-186	VNXE3300 DATA-AT-REST ENCRYPTION=IC	UE	\$0
458-001-190	RP/EX UPG FROM SE FOR VNXe 3200 PRODUCT	UE	\$0
458-001-202	SRM VNXE	UE	\$0
458-001-360	VIRTUAL RPA for VNXe3200=IB	UE	\$0
458-001-361	VNXe3200 RP4VMS=IB	UE	\$0
458-001-714	RP/EX VPLEX VS6 FB VNX REMOTE PRODUCT	UE	\$0
458-001-973	VNXE3200 EFFICIENT-VIDEO-MG=IC	UE	\$1,850
458-001-974	VNXE3200 EFFICIENT-VIDEO-AG=IC	UE	\$250
458-001-975	VNXE1600 EFFICIENT-VIDEO-MG=IC	UE	\$1,850
458-001-976	VNXE1600 EFFICIENT-VIDEO-AG=IC	UE	\$250
458-002-014	CloudArray Capacity License	UE	\$0
800-0012-P	PROMO 2 PWRCRD C14-C13,208V UNIVERSAL	UE	\$0
851-0099-P	PROMO 2 SFP+ OPTICS KIT - 10GbE	UE	\$0
851-0167-P	PROMO MELLANOX 8 PORT QDR SWITCH	UE	\$0
851-0209-P	PROMO CABLE, 1B QDR, QSFP-QSFP, 3M	UE	\$0
ADMNRP5100	VNX MONITORING AND REPORTING-5100	UE	\$0
ADMNRP5300	VNX MONITORING AND REPORTING-5300	UE	\$0
ADV-P-V53	ADV FILE LIC (NFS; MPFS & PNFS) FOR 5300	UE	\$0
AFM-V53	VNX5300 AUTOMATIC FAILOVER MGR RTU LIC	UE	\$0
BASEP-V53	BASE FILE LICENSE (CIFS/FTP) FOR VNX5300	UE	\$0
CLA-CLDARRHW-12TBU	CLOUDARRAY HW APPLIANCE 12TBU	UE	\$7,565
CLA-CLDARRHW-18TBU	CLOUDARRAY HW APPLIANCE 18TBU	UE	\$8,510
CLA-CLDARRHW-40TBU	CLOUDARRAY HW APPLIANCE 40TBU	UE	\$11,345
CLA-CLDARRHW-60TBU	CLOUDARRAY HW APPLIANCE 60TBU	UE	\$14,180
CLA-SAHW6-12TBU	CLOUDARRAY SA HW APPLIANCE 6-12TBU	UE	\$7,565
CX4-SPE2UADJS	ADJUSTABLE RAIL KIT FOR THE 2U DAE	UE	\$34
CX-SPS-ADJS	ADJUSTABLE RAIL KIT FOR 1U SPS	UE	\$120
DPE-TELCO-3US	VNX51/53 TELCO RAIL KIT FOR 3U DPE	UE	\$226
EMCSASVNX5100	EMC Storage Analytics for VNX5100 =IC	UE	\$4,750
EMCSASVNX5300	EMC Storage Analytics for VNX5300 =IC	UE	\$6,200
EPAK-V53UPG	TOT EFF PACK UPGRADE FOR VNX5300	UE	\$9,815
FLN52S6F-100	VNXE1600 100GB FAST CACHE 25X2.5 NEBS	UE	\$0
FLN52S6F-100TU	VNXE1600 100GB FAST CACHE 25X2.5 NEBS UG	UE	\$2,420
FLN52S6F-100U	VNXE1600 100GB FAST CACHE 25X2.5 NEBS UG	UE	\$2,420
FLN5PS6F-100	VNXE1600 100GB FAST CACHE 12X3.5 NEBS	UE	\$0
FLN5PS6F-100TU	VNXE1600 100GB FAST CACHE 12X3.5 NEBS UG	UE	\$2,420
FLN5PS6F-100U	VNXE1600 100GB FAST CACHE 12X3.5 NEBS UG	UE	\$2,420
FLN5PS6F-200	VNXE1600 200GB FAST CACHE 12X3.5 NEBS	UE	\$0
FLN5PS6F-200TU	VNXE1600 200GB FAST CACHE 12X3.5 NEBS UG	UE	\$3,830
FLN5PS6F-200U	VNXE1600 200GB FAST CACHE 12X3.5 NEBS UG	UE	\$3,830
FLN62S6F-100	VNXe 3200 100GB F-CACHE 25X2.5 NEBS	UE	\$0
FLN62S6F-100TU	VNXe 3200 100GB F-CACHE 25X2.5 NEB U/G	UE	\$2,725
FLN62S6F-100U	VNXe 3200 100GB F-CACHE 25X2.5 NEB U/G	UE	\$2,725
FLN62S6F-200	VNXe 3200 200GB F-CACHE 25X2.5 NEBS	UE	\$0
FLN62S6F-200TU	VNXe 3200 200GB F-CACHE 25X2.5 NEBS U/G	UE	\$4,315

FLN62S6F-200U	VNXe 3200 200GB F-CACHE 25X2.5 NEBS U/G	UE	\$4,315
FLN6PS6F-100	VNXe 3200 100GB F-CACHE 12X3.5 NEBS	UE	\$0
FLN6PS6F-100TU	VNXe 3200 100GB F-CACHE 12X3.5 NEB U/G	UE	\$2,725
FLN6PS6F-100U	VNXe 3200 100GB F-CACHE 12X3.5 NEB U/G	UE	\$2,725
FLN6PS6F-200	VNXe 3200 200GB F-CACHE 12X3.5 NEBS	UE	\$0
FLN6PS6F-200TU	VNXe 3200 200GB F-CACHE 12X3.5 NEB U/G	UE	\$4,315
FLN6PS6F-200U	VNXe 3200 200GB F-CACHE 12X3.5 NEB U/G	UE	\$4,315
FLV32S6F-100	100GB FSTCACHE FLSH-25X2.5 IN DPE/DAE	UE	\$1,985
FLV32S6F-100N	VNX51/53 100GFCACHEFLSH-25X2.5 DPE/DAE N	UE	\$2,335
FLV32S6F100NU	VNX51/53 100G FCF 25X2.5 DPE/DAE NU	UE	\$0
FLV32S6F-100U	VNX51/53 100GB FCACHE FLSH-25X2.5IN UPG	UE	\$0
FLV32S6F-200	200GB FSTCACHE FLSH-25X2.5 IN DPE/DAE	UE	\$3,755
FLV32S6F-200N	VNX51/53 200GFCACHEFLSH-25X2.5 DPE/DAE N	UE	\$4,420
FLV32S6F200NU	VNX51/53 200G FCF 25X2.5 DAE/DPE NU	UE	\$5,970
FLV32S6F-200U	VNX51/53 200GB FCACHE FLSH-25X2.5IN UPG	UE	\$5,075
FLV3VS6F-100	100GB FST CACHE FLSH 15X3.5IN DPE/DAE	UE	\$1,995
FLV3VS6F-100N	VNX 51/53 100G FCACHE 15X3.5 DPE/DAE N	UE	\$2,345
FLV3VS6F100NU	VNX 51/53 100GFSTCACHE15X3.5 DPE/DAE NU	UE	\$0
FLV3VS6F-100U	VNX51/53 100GB FCACHE FLSH-15X3.5IN UPG	UE	\$0
FLV3VS6F-200	200GB FST CACHE FLSH 15X3.5IN DPE/DAE	UE	\$3,780
FLV3VS6F-200N	VNX 51/53 200B FCACHE 15X3.5 DPE/DAE N	UE	\$4,445
FLV3VS6F200NU	VNX 51/53 200GFSTCACHE15X3.5 DPE/DAE NU	UE	\$6,000
FLV3VS6F-200U	VNX51/53 200GB FCACHE FLSH-15X3.5IN UPG	UE	\$5,100
FLV52S6F-100	VNXE1600 100GB FAST CACHE 25X2.5	UE	\$0
FLV52S6F-100TU	VNXE1600 100GB FAST CACHE 25X2.5 U/G	UE	\$2,200
FLV52S6F-100U	VNXE1600 100GB FAST CACHE 25X2.5 U/G	UE	\$2,200
FLV52S6F-200	VNXE1600 200GB FAST CACHE 25X2.5	UE	\$0
FLV52S6F-200TU	VNXE1600 200GB FAST CACHE 25X2.5 U/G	UE	\$3,485
FLV52S6F-200U	VNXE1600 200GB FAST CACHE 25X2.5 U/G	UE	\$3,485
FLV5PS6F-100	VNXE1600 100GB FAST CACHE 12X3.5	UE	\$0
FLV5PS6F-100TU	VNXE1600 100GB FAST CACHE 12X3.5 U/G	UE	\$2,200
FLV5PS6F-100U	VNXE1600 100GB FAST CACHE 12X3.5 U/G	UE	\$2,200
FLV5PS6F-200	VNXE1600 200GB FAST CACHE 12X3.5	UE	\$0
FLV5PS6F-200TU	VNXE1600 200GB FAST CACHE 12X3.5 U/G	UE	\$3,485
FLV5PS6F-200U	VNXE1600 200GB FAST CACHE 12X3.5 U/G	UE	\$3,485
FLV62S6F-100	VNXe 3200 100GB FAST CACHE 25X2.5	UE	\$0
FLV62S6F-100U	VNXe 3200 100GB FAST CACHE 25X2.5 U/G	UE	\$2,475
FLV62S6F-200	VNXe 3200 200GB FAST CACHE 25X2.5	UE	\$0
FLV62S6F-200U	VNXe 3200 200GB FAST CACHE 25X2.5 U/G	UE	\$3,920
FLV6PS6F-100	VNXe 3200 100GB FAST CACHE 12X3.5	UE	\$0
FLV6PS6F-100U	VNXe 3200 100GB FAST CACHE 12X3.5 U/G	UE	\$2,475
FLV6PS6F-200	VNXe 3200 200GB FAST CACHE 12X3.5	UE	\$0
FLV6PS6F-200U	VNXe 3200 200GB FAST CACHE 12X3.5 U/G	UE	\$3,920
FRAME-T25DAES	TELCO RAIL KIT FOR 25 DRIVE 2U DAE	UE	\$136
FRAME-T-CSS	TELCO RAIL KIT FOR VNX CONTROL STATION	UE	\$625
FRAME-T-PDAES	TELCO RAIL KIT FOR THE 3U DAE	UE	\$136
FSTC-V51	FAST CACHE FOR VNX5100	UE	\$1,856
FSTC-V53	FAST CACHE FOR VNX5300	UE	\$2,813
FSTC-V53-UPG	FAST CACHE FOR VNX5300 UPG	UE	\$957
FSTS-V51	FAST SUITE FOR VNX5100	UE	\$2,506

FSTS-V53	FAST SUITE FOR VNX5300	UE	\$3,797
FSTS-V53-UPG	FAST SUITE FOR VNX5300 UPG	UE	\$1,291
FSTVP-V53	FAST VP FOR VNX5300	UE	\$2,813
FV32S6F100NTU	VNX51/53 100G FCF 25X2.5 DPE/DAE NU	UE	\$0
FV32S6F-100TU	VNX51/53 100G FCF 25X2.5 DPE/DAE UG	UE	\$0
FV32S6F200NTU	VNX51/53 200G FCF 25X2.5 DPE/DAE NU	UE	\$5,970
FV32S6F-200TU	VNX51/53 200G FCF 25X2.5 DPE/DAE UG	UE	\$5,970
FV3VS6F100NTU	VNX 51/53 100GFSTCACHE15X3.5 DPE/DAE NU	UE	\$3,165
FV3VS6F-100TU	VNX 51/53 100GFSTCACHE15X3.5 DPE/DAE UG	UE	\$3,165
FV3VS6F200NTU	VNX 51/53 200GFSTCACHE15X3.5 DPE/DAE NU	UE	\$6,000
FV3VS6F-200TU	VNX 51/53 200GFSTCACHE15X3.5 DPE/DAE UG	UE	\$6,000
LPS32-V51	OE32 LOCAL PROTECT SUITE FOR VNX5100	UE	\$2,063
LPS32-V53	OE32 LOCAL PROTECT SUITE FOR VNX5300	UE	\$3,031
LPS-V51	LOCAL PROTECTION SUITE FOR VNX5100	UE	\$0
LPS-V53	LOCAL PROTECTION SUITE FOR VNX5300	UE	\$0
LPS-V53-UPG	RECPNT & LPS RTU FOR VNX5300	UE	\$968
N3-2S10-300	NEBS 2.5IN 300G 10K SAS DISK DRV	UE	\$0
N3-2S10-300E	300GB 10K 6G SAS 2.5" NEBS DRIVE	UE	\$0
N3-2S10300EU	300GB 10K 6G SAS 2.5 SPARE	UE	\$0
N3-2S10-300TU	VNX51/53 300G10K DRV-25X2.5IN DPE/DAE N	UE	\$0
N3-2S10-300U	VNX51/53 300G10K DRV-25X2.5IN DPE/DAE N	UE	\$0
N3-2S10-600	NEBS 2.5IN 600G 10K SAS DISK DRV	UE	\$705
N3-2S10-600E	600GB 10K 6G SAS 2.5" NEBS DRIVE	UE	\$0
N3-2S10600EU	600GB 10K 6G SAS 2.5 SPARE	UE	\$975
N3-2S10-600TU	VNX51/53 600G10K DRV-25X2.5IN DPE/DAE N	UE	\$955
N3-2S10-600U	VNX51/53 600G10K DRV-25X2.5IN DPE/DAE N	UE	\$955
N3-2S10-900	NEBS 2.5IN 900G 10K SAS DISK DRV	UE	\$990
N3-2S10-900E	900GB 10K 6G SAS 2.5" NEBS DRIVE	UE	\$0
N3-2S10900EU	900GB 10K 6G SAS 2.5 SPARE	UE	\$1,310
N3-2S10-900TU	VNX51/53 900G10K DRV-25X2.5IN DPE/DAE N	UE	\$1,340
N3-2S10-900U	VNX51/53 900G10K DRV-25X2.5IN DPE/DAE N	UE	\$1,340
N3-2S15-300	NEBS 2.5 300GB 15K 520 BPS 6GB SAS DRIVE	UE	\$0
N3-2S6F-100	NEBS 2.5IN 100GB FLSH SAS DRV	UE	\$2,335
N3-2S6F-100E	100GB EFD 6G SAS 2.5" NEBS DRIVE	UE	\$0
N3-2S6F100EU	100GB EFD 6G SAS 2.5 SPARE	UE	\$0
N3-2S6F-100TU	VNX51/53 100GFLSHDRV-25X2.5IN DAE/DPE N	UE	\$0
N3-2S6F-100U	VNX51/53 100GFLSHDRV-25X2.5IN DAE/DPE N	UE	\$0
N3-2S6F-200	NEBS 2.5IN 200GB FLSH SAS DRV	UE	\$4,420
N3-2S6F-200E	200GB EFD 6G SAS 2.5" NEBS DRIVE	UE	\$0
N3-2S6F200EU	200GB EFD 6G SAS 2.5 SPARE	UE	\$5,970
N3-2S6F-200TU	VNX51/53 200GFLSHDRV-25X2.5IN DAE/DPE N	UE	\$5,970
N3-2S6F-200U	VNX51/53 200G 6GSASFLASHDRV-25X2.5IN DAE	UE	\$5,970
N3-VS07-020	VNX 2TB NLSAS NEBS DRV-15X3.5 DPE/DAE	UE	\$735
N3-VS07-020U	VNX 2TB NLSAS NEBS DRV-15X3.5 DPE/DAE UG	UE	\$990
N3-VS07-030	VNX 3TB NLSAS NEBS DRV-15X3.5 DPE/DAE	UE	\$1,045
N3-VS07-030U	VNX 3TB NLSAS NEBS DRV-15X3.5 DPE/DAE UG	UE	\$1,410
N3-VS07-040	VNX 4TB NLSAS NEBS DRV-15X3.5 DPE/DAE	UE	\$1,275
N3-VS07-040TU	VNX 4TB NLSAS NEBS DRV-15X3.5 DPE/DAE UG	UE	\$1,720
N3-VS07-040U	VNX 4TB NLSAS NEBS DRV-15X3.5 DPE/DAE UG	UE	\$1,720
N3-VS10-300	3.5 IN 300G 10K DISK DRIVE - NEBS	UE	\$515

N3-VS10-300TU	VNX33/35 300G10K 15X3.5IN DPE/DAE NEBS U	UE	\$695
N3-VS10-300U	VNX33/35 300G10K 15X3.5IN DPE/DAE NEBS U	UE	\$695
N3-VS10-600	NEBS 3.5IN 600G 10K SAS DISK DRV	UE	\$705
N3-VS10-600TU	VNX33/35 600G10K 15X3.5IN DPE/DAE NEBS U	UE	\$955
N3-VS10-600U	VNX33/35 600G10K 6G15X3.5IN DPE/DAE N	UE	\$955
N3-VS10-900	NEBS 3.5IN 900G 10K SAS DISK DRV	UE	\$1,050
N3-VS10-900E	900GB 10K 6G SAS 3.5" NEBS DRIVE	UE	\$0
N3-VS10-900EU	900GB 10K 6G SAS 3.5 NEBS SPARE	UE	\$1,420
N3-VS10-900TU	VNX33/35 900G10K 15X3.5IN DPE/DAE NEBS U	UE	\$1,420
N3-VS10-900U	VNX33/35 900G10K 6G15X3.5IN DPE/DAE N	UE	\$1,420
N3-VS15-300	300GB 15K 520BPS 6GB SAS DISK DRIVE	UE	\$660
N3-VS15-300-7	2100GB SAS DISKPACK 7X300GB 15K3.5" NEBS	UE	\$4,605
N3-VS15-3007U	2100GB DISK PK(7x300GB 15K)NEBS UPG	UE	\$6,215
N3-VS15-300E	300GB 15K SAS DRIVE NEBS	UE	\$0
N3-VS15-300EU	300GB 15K NEBS SAS DISK DRIVE	UE	\$890
N3-VS15-300TU	VNX33/35 300G15K 6G15X3.5IN DPE/DAE N	UE	\$890
N3-VS15-300U	VNX33/35 300G15K 6G15X3.5IN DPE/DAE N	UE	\$890
N3-VS15-300UE	300GB 15K SAS DRIVE NEBS UPGRADE	UE	\$890
N3-VS15-600	600GB 15K 520BPS 6GB SAS DISK DRIVE	UE	\$1,040
N3-VS15-600-7	4200GB SAS DISKPACK 7X600GB 15K3.5" NEBS	UE	\$7,310
N3-VS15-6007U	4200GB SAS DISK PK(7x600GB 15K)NEBS UPG	UE	\$9,870
N3-VS15-600E	600GB 15K SAS DRIVE NEBS	UE	\$0
N3-VS15-600EU	600GB 15K NEBS SAS DISK DRIVE	UE	\$1,405
N3-VS15-600TU	VNX33/51/53 600G15K-15X3.5IN DPE/DAE N	UE	\$1,415
N3-VS15-600U	VNX33/51/53 600G15K-15X3.5IN DPE/DAE N	UE	\$1,415
N3-VS15-600UE	600GB 15K SAS DRIVE NEBS UPGRADE	UE	\$1,405
N3-VS6F-100	NEBS 3.5 IN 100GB FLASH DRIVE NEBS	UE	\$2,345
N3-VS6F-100-5	500GB FLASH DISK PACK (5 X 100GB) NEBS	UE	\$11,725
N3-VS6F-1005U	500GB FLASH DISK PK(5 x 100GB)NEBS UPG	UE	\$15,835
N3-VS6F-100E	100GB FLASH SAS 3.5" DRIVE NEBS	UE	\$0
N3-VS6F-100EU	100GB 3.5 NEBS EFD DISK DRIVE	UE	\$3,165
N3-VS6F-100TU	VNX33/51/53 100GFLSH-15X3.5IN DPE/DAE N	UE	\$0
N3-VS6F-100U	VNX33/51/53 100GFLSH-15X3.5IN DPE/DAE N	UE	\$0
N3-VS6F-100UE	100GB FLASH SAS 3.5" DRIVE NEBS UPGRADE	UE	\$0
N3-VS6F-200	NEBS 3.5 IN 200 GB FLASH DRIVE NEBS	UE	\$4,445
N3-VS6F-200TU	VNX33/51/53 200GFLSH-15X3.5IN DPE/DAE N	UE	\$6,000
N3-VS6F-200U	200GB 3.5IN SAS SSD VNX51/53-NEBS-UPG	UE	\$6,000
N5-2S10-012	VNXE1600 1.2TB 10K SAS 25X2.5 NEBS	UE	\$0
N5-2S10-012TU	VNXE1600 1.2TB 10K SAS 25X2.5 NEBS U/G	UE	\$1,265
N5-2S10-012U	VNXE1600 1.2TB 10K SAS 25X2.5 NEBS U/G	UE	\$1,265
N5-2S10-600	VNXE1600 600GB 10K SAS 25X2.5 NEBS	UE	\$0
N5-2S10-600TU	VNXE1600 600GB 10K SAS 25X2.5 NEBS U/G	UE	\$675
N5-2S10-600U	VNXE1600 600GB 10K SAS 25X2.5 NEBS U/G	UE	\$675
N5-2S10-900	VNXE1600 900GB 10K SAS 25X2.5 NEBS	UE	\$0
N5-2S10-900TU	VNXE1600 900GB 10K SAS 25X2.5 NEBS U/G	UE	\$975
N5-2S10-900U	VNXE1600 900GB 10K SAS 25X2.5 NEBS U/G	UE	\$975
N5-2S15-300	VNXE1600 300GB 15K SAS 25X2.5 NEBS	UE	\$0
N5-2S15-300TU	VNXE1600 300GB 15K SAS 25X2.5 NEBS U/G	UE	\$1,045
N5-2S15-300U	VNXE1600 300GB 15K SAS 25X2.5 NEBS U/G	UE	\$1,045
N5-2S15-600	VNXE1600 600GB 15K SAS 25X2.5 NEBS	UE	\$800

N5-2S15-600TU	VNXE1600 600GB 15K SAS 25X2.5 NEBS U/G	UE	\$1,075
N5-2S15-600U	VNXE1600 600GB 15K SAS 25X2.5 NEBS U/G	UE	\$1,075
N5-2S6F-200	VNXE1600 200GB SSD 25X2.5 NEBS	UE	\$0
N5-2S6F-200TU	VNXE1600 200GB SSD 25X2.5 NEBS U/G	UE	\$3,830
N5-2S6F-200U	VNXE1600 200GB SSD 25X2.5 NEBS U/G	UE	\$3,830
N5-2S6FX-200	VNXE1600 200GB SSD 25X2.5 NEBS	UE	\$1,595
N5-2S6FX-200TU	VNXE1600 200GB SSD 25X2.5 NEBSUG	UE	\$1,915
N5-2S6FX-200U	VNXE1600 200GB SSD 25X2.5 NEBSUG	UE	\$1,915
N5-2S6FX-800	VNXE1600 800GB SSD 25X2.5 NEBS	UE	\$0
N5-2S6FX-800TU	VNXE1600 800GB SSD 25X2.5 NEBSUG	UE	\$6,850
N5-2S6FX-800U	VNXE1600 800GB SSD 25X2.5 NEBSUG	UE	\$6,850
N5-PS07-020	VNXE1600 2TB NL SAS 12X3.5 NEBS	UE	\$0
N5-PS07-020TU	VNXE1600 2TB NL SAS 12X3.5 NEBS U/G	UE	\$910
N5-PS07-020U	VNXE1600 2TB NL SAS 12X3.5 NEBS U/G	UE	\$910
N5-PS07-040	VNXE1600 4TB NL SAS 12X3.5 NEBS	UE	\$0
N5-PS07-040TU	VNXE1600 4TB NL SAS 12X3.5 NEBS U/G	UE	\$1,345
N5-PS07-040U	VNXE1600 4TB NL SAS 12X3.5 NEBS U/G	UE	\$1,345
N5-PS10-012	VNXE1600 1.2TB 10K SAS 12X3.5 NEBS	UE	\$0
N5-PS10-012TU	VNXE1600 1.2TB 10K SAS 12X3.5 NEBS U/G	UE	\$0
N5-PS10-012U	VNXE1600 1.2TB 10K SAS 12X3.5 NEBS U/G	UE	\$0
N5-PS10-600	VNXE1600 600GB 10K SAS 12X3.5 NEBS	UE	\$0
N5-PS10-600TU	VNXE1600 600GB 10K SAS 12X3.5 NEBS U/G	UE	\$0
N5-PS10-600U	VNXE1600 600GB 10K SAS 12X3.5 NEBS U/G	UE	\$0
N5-PS10-900	VNXE1600 900GB 10K SAS 12X3.5 NEBS	UE	\$0
N5-PS10-900TU	VNXE1600 900GB 10K SAS 12X3.5 NEBS U/G	UE	\$975
N5-PS10-900U	VNXE1600 900GB 10K SAS 12X3.5 NEBS U/G	UE	\$975
N5-PS15-300	VNXE1600 300GB 15K SAS 12X3.5 NEBS	UE	\$0
N5-PS15-300TU	VNXE1600 300GB 15K SAS 12X3.5 NEBS U/G	UE	\$0
N5-PS15-300U	VNXE1600 300GB 15K SAS 12X3.5 NEBS U/G	UE	\$0
N5-PS15-600	VNXE1600 600GB 15K SAS 12X3.5 NEBS	UE	\$0
N5-PS15-600TU	VNXE1600 600GB 15K SAS 12X3.5 NEBS U/G	UE	\$1,075
N5-PS15-600U	VNXE1600 600GB 15K SAS 12X3.5 NEBS U/G	UE	\$1,075
N5-PS6F-200	VNXE1600 200GB SSD 12X3.5 NEBS	UE	\$0
N5-PS6F-200TU	VNXE1600 200GB SSD 12X3.5 NEBS U/G	UE	\$3,830
N5-PS6F-200U	VNXE1600 200GB SSD 12X3.5 NEBS U/G	UE	\$3,830
N5-PS6FX-200	VNXE1600 200GB SSD 12X3.5 NEBS	UE	\$0
N5-PS6FX-200TU	VNXE1600 200GB SSD 12X3.5 NEBSUG	UE	\$0
N5-PS6FX-200U	VNXE1600 200GB SSD 12X3.5 NEBSUG	UE	\$0
N5-PS6FX-800	VNXE1600 800GB SSD 12X3.5 NEBS	UE	\$0
N5-PS6FX-800TU	VNXE1600 800GB SSD 12X3.5 NEBSUG	UE	\$0
N5-PS6FX-800U	VNXE1600 800GB SSD 12X3.5 NEBSUG	UE	\$0
N5-SP-L6X1200-10K	VNXe1600 3.5 NEBS Systempack 6x1.2TB 10K	UE	\$0
N5-SP-L6X200-SSD	VNXe1600 3.5 NEBS Systempack 6x200GB SSD	UE	\$0
N5-SP-L6X300-15K	VNXe1600 3.5 NEBS Systempack 6x300GB 15K	UE	\$0
N5-SP-L6X600-10K	VNXe1600 3.5 NEBS Systempack 6x600GB 10K	UE	\$0
N5-SP-L6X600-15K	VNXe1600 3.5 NEBS Systempack 6x600GB 15K	UE	\$0
N5-SP-L6X800-SSD	VNXe1600 3.5 NEBS Systempack 6x800GB SSD	UE	\$0
N5-SP-L6X900-10K	VNXe1600 3.5 NEBS Systempack 6x900GB 10K	UE	\$0
N5-SP-L9X2TB-NL	VNXe1600 3.5 NEBS Systempack 9x2TB NLSAS	UE	\$0
N5-SP-L9X4TB-NL	VNXe1600 3.5 NEBS Systempack 9x4TB NLSAS	UE	\$0

N5-SP-S6X1200-10K	VNXe1600 2.5 NEBS Systempack 6x1.2TB 10K	UE	\$0
N5-SP-S6X200-SSD	VNXe1600 2.5 NEBS Systempack 6x200GB SSD	UE	\$0
N5-SP-S6X300-15K	VNXe1600 2.5 NEBS Systempack 6x300GB 15K	UE	\$0
N5-SP-S6X600-10K	VNXe1600 2.5 NEBS Systempack 6x600GB 10K	UE	\$0
N5-SP-S6X600-15K	VNXe1600 2.5 NEBS Systempack 6x600GB 15K	UE	\$3,345
N5-SP-S6X800-SSD	VNXe1600 2.5 NEBS Systempack 6x800GB SSD	UE	\$0
N5-SP-S6X900-10K	VNXe1600 2.5 NEBS Systempack 6x900GB 10K	UE	\$0
N6-2S10-012	VNXe 3200 1.2TB 10K SAS 25X2.5 NEBS	UE	\$0
N6-2S10-012TU	VNXe 3200 1.2TB 10KSAS 25X2.5 NEBS U/G	UE	\$1,475
N6-2S10-012U	VNXe 3200 1.2TB 10KSAS 25X2.5 NEBS U/G	UE	\$1,475
N6-2S10-600	VNXe 3200 600GB 10K SAS 25X2.5 NEBS	UE	\$0
N6-2S10-600TU	VNXe 3200 600GB 10KSAS 25X2.5 NEBS U/G	UE	\$875
N6-2S10-600U	VNXe 3200 600GB 10KSAS 25X2.5 NEBS U/G	UE	\$875
N6-2S10-900	VNXe 3200 900GB 10K SAS 25X2.5 NEBS	UE	\$0
N6-2S10-900TU	VNXe 3200 900GB 10KSAS 25X2.5 NEBS UG	UE	\$1,150
N6-2S10-900U	VNXe 3200 900GB 10KSAS 25X2.5 NEBS UG	UE	\$1,170
N6-2S15-300	VNXe 3200 300GB 15K SAS 25X2.5 NEBS	UE	\$0
N6-2S15-300TU	VNXe 3200 300GB 15KSAS 25X2.5 NEBS U/G	UE	\$1,255
N6-2S15-300U	VNXe 3200 300GB 15KSAS 25X2.5 NEBS U/G	UE	\$1,255
N6-2S6F-100	VNXe 3200 100GB EFD 25X2.5 NEBS	UE	\$0
N6-2S6F-100TU	VNXe 3200 100GB EFD 25X2.5 NEBS U/G	UE	\$2,725
N6-2S6F-100U	VNXe 3200 100GB EFD 25X2.5 NEBS U/G	UE	\$2,725
N6-2S6F-200	VNXe 3200 200GB EFD 25X2.5 NEBS	UE	\$0
N6-2S6F-200TU	VNXe 3200 200GB EFD 25X2.5 NEBS U/G	UE	\$4,315
N6-2S6F-200U	VNXe 3200 200GB EFD 25X2.5 NEBS U/G	UE	\$4,315
N6-2S6FX-100	VNXe 3200 100GB FASTVP EFD 25X2.5 NEBS	UE	\$0
N6-2S6FX-100TU	VNXe 3200 100GB FASTVP EFD 25X2.5 NB UG	UE	\$0
N6-2S6FX-100U	VNXe 3200 100GB FASTVP EFD 25X2.5 NB UG	UE	\$0
N6-2S6FX-200	VNXe 3200 200GB FASTVP EFD 25X2.5 NEB	UE	\$0
N6-2S6FX-200TU	VNXe 3200 200GB FASTVP EFD 25X2.5 NB UG	UE	\$2,130
N6-2S6FX-200U	VNXe 3200 200GB FASTVP EFD 25X2.5 NB UG	UE	\$2,130
N6-PS07-020	VNXe 3200 2TB NL SAS 12X3.5 NEBS	UE	\$0
N6-PS07-020TU	VNXe 3200 2TB NL SAS 12X3.5 NEBS U/G	UE	\$980
N6-PS07-020U	VNXe 3200 2TB NL SAS 12X3.5 NEBS U/G	UE	\$980
N6-PS07-040	VNXe 3200 4TB NL SAS 12X3.5 NEBS	UE	\$0
N6-PS07-040TU	VNXe 3200 4TB NL SAS 12X3.5 NEBS U/G	UE	\$1,345
N6-PS07-040U	VNXe 3200 4TB NL SAS 12X3.5 NEBS U/G	UE	\$1,345
N6-PS10-012	VNXe 3200 1.2TB 10K SAS 12X3.5 NEBS	UE	\$0
N6-PS10-012TU	VNXe 3200 1.2TB 10KSAS 12X3.5 NEBS U/G	UE	\$0
N6-PS10-012U	VNXe 3200 1.2TB 10KSAS 12X3.5 NEBS U/G	UE	\$0
N6-PS10-600	VNXe 3200 600GB 10K SAS 12X3.5 NEBS	UE	\$0
N6-PS10-600TU	VNXe 3200 600GB 10KSAS 12X3.5 NEBS U/G	UE	\$0
N6-PS10-600U	VNXe 3200 600GB 10KSAS 12X3.5 NEBS U/G	UE	\$0
N6-PS10-900	VNXe 3200 900GB 10K SAS 12X3.5 NEBS	UE	\$0
N6-PS10-900TU	VNXe 3200 900GB 10KSAS 12X3.5 NEBS UG	UE	\$1,150
N6-PS10-900U	VNXe 3200 900GB 10KSAS 12X3.5 NEBS UG	UE	\$1,150
N6-PS15-300	VNXe 3200 300GB 15K SAS 12X3.5 NEBS	UE	\$0
N6-PS15-300TU	VNXe 3200 300GB 15K SAS 12X3.5 NEBS U/G	UE	\$0
N6-PS15-300U	VNXe 3200 300GB 15K SAS 12X3.5 NEBS U/G	UE	\$0
N6-PS15-600	VNXe 3200 600GB 15K SAS 12X3.5 NEBS	UE	\$0

N6-PS15-600TU	VNXe 3200 600GB 15KSAS 12X3.5 NEBS U/G	UE	\$1,445
N6-PS15-600U	VNXe 3200 600GB 15KSAS 12X3.5 NEBS U/G	UE	\$1,445
N6-PS6F-100	VNXe 3200 100GB EFD 12X3.5 NEBS	UE	\$0
N6-PS6F-100TU	VNXe 3200 100GB EFD 12X3.5 NEBS U/G	UE	\$2,725
N6-PS6F-100U	VNXe 3200 100GB EFD 12X3.5 NEBS U/G	UE	\$2,725
N6-PS6F-200	VNXe 3200 200GB EFD 12X3.5 NEBS	UE	\$0
N6-PS6F-200TU	VNXe 3200 200GB EFD 12X3.5' NEBS U/G	UE	\$4,315
N6-PS6F-200U	VNXe 3200 200GB EFD 12X3.5 NEBS U/G	UE	\$4,315
N6-PS6FX-100	VNXe 3200 100GB FASTVP EFD 12X3.5 NEB	UE	\$0
N6-PS6FX-100TU	VNXe 3200 100GB FASTVP EFD 12X3.5 NB UG	UE	\$0
N6-PS6FX-100U	VNXe 3200 100GB FASTVP EFD 12X3.5 NB UG	UE	\$0
N6-PS6FX-200	VNXe 3200 200GB FASTVP EFD 12X3.5 NEB	UE	\$0
N6-PS6FX-200TU	VNXe 3200 200GB FASTVP EFD 12X3.5 NB UG	UE	\$0
N6-PS6FX-200U	VNXe 3200 200GB FASTVP EFD 12X3.5 NB UG	UE	\$0
PPAK-V53UPG	T. P. PACK UPGRADE FOR THE VNX5300	UE	\$7,534
PW40U60-ASTLS	RACK-40U-60 PWR CORD ASTL	UE	\$880
PW40U60-IEC3S	RACK-40U-60 PWR CORD IEC 309	UE	\$460
PW40U60-RSS	RACK-40U-60 PWR CORD R&S	UE	\$880
PW40U60-USS	RACK-40U-60 PWR CORD US	UE	\$460
RPEX-CDP51-UG	RP SE TO EX LOC REG CAP UG FOR 5100/OTH	UE	\$0
RPEX-CDP53-UG	RP SE TO EX LOC REG CAP UG FOR 5300/120	UE	\$0
RPEX-CRR51-UG	RP SE TO EX REM REG CAP UG FOR 5100/OTH	UE	\$0
RPEX-CRR53-UG	RP SE TO EX REM REG CAP UG FOR 5300/120	UE	\$0
RPS-V51	REMOTE PROTECTION SUITE FOR VNX5100	UE	\$0
RPS-V53	REMOTE PROTECTION SUITE FOR VNX5300	UE	\$0
RPS-V53-UPG	RECPNT & RPS RTU FOR VNX5300	UE	\$3,750
SCS-V51	Events & Retention Suite for VNX5100=IC	UE	\$837
SCS-V53	Events & Retention Suite for VNX5300=IC	UE	\$1,361
SCS-V53-GOOGLE	VNX5300 CONNECTOR FOR GOOGLE	UE	\$1,361
SCS-V53-UPG	Events & Retention Suite VNX5300 UPG=IC	UE	\$524
SFPTWNACT-1MS	QTY 2 SFP+ TO SFP+1M ACTIVE 8G/10G CABLE	UE	\$300
SFPTWNACT-3MS	QTY 2 SFP+ TO SFP+3M ACTIVE 8G/10G CABLE	UE	\$360
SFPTWNACT-5MS	QTY 2 SFP+ TO SFP+ 5M ACTIVE 10G CABLE	UE	\$440
SPE-TELCO-2US	TELCO RAIL KIT FOR THE 2U AC SPE	UE	\$300
SPST-2GBS	TELCO RAIL KIT FOR THE 1U SPS	UE	\$300
STKVN16K-B12	VNXe1600;2xSP DPE;12x3.5;noSFP;TWAX Enet	UE	\$5,500
STKVN16K-B25	VNXe1600;2xSP DPE;25x2.5;noSFP;TWAX Enet	UE	\$5,500
STKVN16K-DAE-12	2U DAE WITH 12 x 3.5 INCH DRIVE SLOTS	UE	\$1,890
STKVN16K-DAE-25	2U DAE WITH 25 x 2.5 INCH DRIVE SLOTS	UE	\$1,890
TP-V51	THIN PROVISIONING FOR VNX5100	UE	\$0
UAYZ-V51	UNISPHERE ANALYZER FOR A VNX5100	UE	\$1,670
UAYZ-V53	UNISPHERE ANALYZER FORA VNX5300	UE	\$2,532
UNIB-V51	Unisphere Block & VNX OE VNX5100	UE	\$2,369
UNIB-V53	UNISPHERE BLOCK & VNX OE VNX 5300	UE	\$6,413
UNIB-V53UPG	UNISPHERE UPG FOR VNX OE BLOCK & VNX5300	UE	\$5,130
UNIB-VSS	UNISPHERE BLOCK & VNX OE VSS=IC	UE	\$5,063
UNIF-V53	UNISPHERE FILE & VNX OE VNX5300	UE	\$4,988
UNIF-V53UPG	UNI FOR FILE AND VNX OE FOR A VNX5300	UE	\$3,990
UNIU-V53	UNISPHERE UNIFIED & VNX OE VNX5300	UE	\$8,194
UNIU-V53UPG	UNISPHERE UPG FOR VNXOE & 5300UNI	UE	\$6,555

V13-PWR-0	2 C13 PWRCORDS W/ SEV1011 PLUGS 250V 10A	UE	\$0
V13-PWR-1	2 C13 PWRCORDS W/NBR 14136 PLUG 250V 10A	UE	\$0
V13-PWR-10	2 C13 PWRCORDS W/ KSC8305 PLUGS 250V 10A	UE	\$0
V13-PWR-11	2 C13 PWRCORDS W/ CNS690 PLUGS 125V 10A	UE	\$0
V13-PWR-12	2 C13 PWRCORDS W/NEMA 5-15 PLUG 125V 10A	UE	\$0
V13-PWR-13	2 C13 PWRCORDS W/ BS546 PLUGS 250V 10A	UE	\$0
V13-PWR-14	2 C13 PWRCORDS W/ SI-32 PLUGS 250V 10A	UE	\$0
V13-PWR-15	2 C13 POWER CORDS W/IN6SA3 PLUG 250V 10A	UE	\$0
V13-PWR-2	2 C13 PWRCORDS W/JISC 8303 PLUG 125V 10A	UE	\$0
V13-PWR-3	2 C13 PWRCORDS W/ GB1002 PLUGS 250V 10A	UE	\$0
V13-PWR-4	2 C13 PWRCORDS W/IRAM 2073 PLUG 250V 10A	UE	\$0
V13-PWR-5	2 C13 PWRCORDS W/BSI 1363 PLUGS 250V 10A	UE	\$0
V13-PWR-6	2 C13 PWRCORDS W/ SAA/3 PLUGS 250V 10A	UE	\$0
V13-PWR-7	2 C13 PWRCORDS W/ CEE7/7 PLUGS 250V 10A	UE	\$0
V13-PWR-8	2 C13 PWRCORDS W/CEI 23-16 PLUG 250V 10A	UE	\$0
V13-PWR-9	2 C13 PC W/AFSNIT 107-2-D1 PLG 250V 10A	UE	\$0
V16-SNAPR12	12 DRV SNAP IN Rails	UE	\$600
V16-SNAPR25	25 DRV SNAP In Rails	UE	\$600
V2-10GB-ETH-C	2 PORT 10G BASE-T EERUPTION SLIC	UE	\$2,900
V2-10G-C-SPRE	2 PORT 10G BASE-T ERUPTION ESLIC	UE	\$2,900
V212D08A12CL	VNXE3150;2XSP DPE;8GB;12X3.5;6X3TB NLSAS	UE	\$0
V212D08A12CLE	VNXE3150;2SP;12X3.5 DS;6X3TB NLSAS Enct	UE	\$0
V212D08A12CM	VNXE3150;2XSP DPE;8GB;12X3.5;6X2TB NLSAS	UE	\$0
V212D08A12CS	VNXE3150;2XSP DPE;8GB;12X3.5;6X1TB NLSAS	UE	\$0
V212D08A12CXL	VNXE3150;2XSP DPE;8GB;12X3.5;6X4TB NLSAS	UE	\$14,000
V212D08A12PL	VNXE3150; 2XSP DPE;8GB;12X3.5 DS;6X900GB	UE	\$0
V212D08A12PL8	VNXE3150;2XSPDPE;8GB;12X3.5DS;8X900GBSA3	UE	\$0
V212D08A12PLE	VNXE3150;2XSP;8GB;12X3.5 DS;6X900GB Enct	UE	\$0
V212D08A12PM	VNXE3150;2XSPDPE;8GB;12X3.5DS;6X600GBSA3	UE	\$0
V212D08A12PM8	VNXE3150 2XSP DPE; 8GB;12X3.5 DS;8X600GB	UE	\$0
V212D08A12PS	VNXE3150;2XSPDPE;8GB;12X3.5DS;6X300GBSA3	UE	\$0
V212D08A12PS8	VNXE3150;2XSP DPE;8GB;12X3.5 DS; 8X300GB	UE	\$0
V212D08A25FM	VNXE3150; 2xSP DPE; 25x2.5 DS; 6x200 EFD	UE	\$0
V212D08A25FS	VNXE3150; 2xSP DPE; 25x2.5 DS; 6x100 EFD	UE	\$0
V212D08A25PL	VNXE3150;2xSP DPE; 8GB;25x2.5 DS;6x900GB	UE	\$0
V212D08A25PL8	VNXE3150;2XSPDPE;8GB;25X2.5DS;8X900GBSA3	UE	\$0
V212D08A25PLE	VNXE3150;2xSP;8GB;25x2.5 DS;6x900GB Enct	UE	\$0
V212D08A25PM	VNXE3150;2xSP DPE; 8GB;25x2.5 DS;6x600GB	UE	\$0
V212D08A25PM8	VNXE3150;2XSPDPE;8GB;25X2.5DS;8X600GBSA3	UE	\$0
V212D08A25PS	VNXE3150; 2xSP DPE;8GB;25x2.5 DS;6x300GB	UE	\$0
V212D08A25PS8	VNXE3150;2XSPDPE;8GB;25X2.5DS;8X300GBSA3	UE	\$0
V212D8A12CL12	VNXE3150 2XSP DPE 8GB 12X3.5 12X3TB NLSA	UE	\$0
V212D8A12CM12	VNXE3150;2SPDPE;8GB;12X3.5;12X2TB NLS	UE	\$0
V212D8A12CS12	VNXE3150;2SPDPE;8GB;12X3.5;12X1TB NLS	UE	\$0
V212D8A12CXL12	VNXE3150 2XSP DPE 8GB 12X3.5 12X4TB NLSA	UE	\$23,000
V212D8A12PL12	VNXE3150;2XSP DPE; 8GB;12X3.5;12X900GB	UE	\$0
V212D8A12PL8E	VNXE3150;2SPDPE;8GB;12X3.5;8X900GB;SED	UE	\$0
V212D8A12PM12	VNXE3150;2SPDPE;8GB;12X3.5;12x600GB	UE	\$0
V212D8A12PS12	VNXE3150;2SPDPE;8GB;12X3.5;12x300GB	UE	\$0
V212D8A25PL12	VNXE3150; 2XSP DPE; 8GB; 25X2.5;12X900GB	UE	\$0

V212D8A25PL8E	VNxE3150;2SPDPE;8GB;25x2.5;8x900GB;SED	UE	\$0
V212D8A25PM12	VNxE3150;2SPDPE;8GB;25X2.5;12X600GB	UE	\$0
V212D8A25PS12	VNxE3150;2SPDPE;8GB;25X2.5;12X300GB	UE	\$0
V212S04A12CL	VNxE3150;1XSP DPE;12X3.5 DS;6X3TB NLSAS	UE	\$0
V212S04A12CM	VNxE3150;1XSP DPE;12X3.5 DS;6X2TB NLSAS	UE	\$0
V212S04A12CS	VNxE3150; 1XSP DPE;12X3.5 DS;6X1TB NLSAS	UE	\$0
V212S04A12CXL	VNxE3150;1XSP DPE;12X3.5 DS;6X4TB NLSAS	UE	\$11,200
V212S04A12PL	VNxE3150; 1xSP DPE; 12x3.5 DS; 6x900GB	UE	\$0
V212S04A12PL8	VNxE3150;1XSPDPE;4GB;12X3.5DS;8X900GBSAS	UE	\$0
V212S04A12PM	VNxE3150; 1XSP DPE;12X3.5 DS;6X600GB	UE	\$0
V212S04A12PM8	VNxE3150; 1XSP DPE;4GB 12X3.5 DS;8X600GB	UE	\$0
V212S04A12PS	VNxE3150;1XSP DPE;12X3.5 DS;6X300GB	UE	\$0
V212S04A12PS8	VNxE3150; 1XSP DPE;4GB 12X3.5 DS;8X300GB	UE	\$0
V212S04A25FM	VNxE3150;1XSP DPE;4GB;25X2.5DS;6X200 EFD	UE	\$25,734
V212S04A25FS	VNxE3150;1XSP DPE;4GB;25X2.5DS;6X100 EFD	UE	\$13,840
V212S04A25PL	VNxE3150; 1xSP DPE; 25x2.5 DS; 6x900GB	UE	\$0
V212S04A25PL8	VNxE3150;1XSPDPE;4GB;25X2.5DS;8X900GBSAS	UE	\$0
V212S04A25PM	VNxE3150; 1xSP DPE; 25x2.5 DS; 6x600GB	UE	\$0
V212S04A25PM8	VNxE3150;1XSPDPE;4GB;25X2.5DS;8X600GBSAS	UE	\$0
V212S04A25PS	VNxE3150; 1xSP DPE; 25x2.5 DS;6x300GB	UE	\$0
V212S04A25PS8	VNxE3150;1XSPDPE;4GB;25X2.5DS;8X300GBSAS	UE	\$0
V212S4A12CL12	VNxE3150;1SP DPE;12X3.5;12X3TB NLS	UE	\$0
V212S4A12CM12	VNxE3150;1SP DPE;12X3.5;12X2TB NLS	UE	\$0
V212S4A12CS12	VNxE3150;1SP DPE;12X3.5;12X1TB NLS	UE	\$0
V212S4A12CXL12	VNxE3150;1SP DPE;12X3.5;12X4TB NLSAS	UE	\$18,400
V212S4A12PS12	VNxE3150;1SP DPE;4;12X3.5;12X300GB	UE	\$0
V212S4A25PL12	VNxE3150;1SP DPE;4;25X2.5;12X900GB	UE	\$0
V212S4A25PM12	VNxE3150;1SP DPE;4;25X2.5;12X600GB	UE	\$0
V212S4A25PS12	VNxE3150;1SP DPE;4;25X2.5;12X300GB	UE	\$0
V21-BBU	BATTERY BACKUP UNIT	UE	\$197
V21-CCARD	CACHE CARD	UE	\$1,119
V21-ESLIC	1 GB ETHERNET IO MODULE	UE	\$1,000
V2-1GB-IO	1 GB IO MODULE	UE	\$1,000
V21-LCC	LINK CONTROL CARD FOR 2U DAE	UE	\$1,774
V21-LCC-DAE25	LCC FOR 2U DAE 25 DRIVE	UE	\$1,774
V21-MEM-DUPG8	VNxe 3100 UPGKIT 2xSP 4GB-8GB & 8GB-16GB	UE	\$950
V21-PS	POWER SUPPLY	UE	\$484
V21-PS-DAE25	Power Supply for 25 DRIVE DAE	UE	\$484
V22D4825PL12E	VNxE3150;2SP DPE;8;25x2.5;12x900GB;SED	UE	\$0
V22D8A12CL12E	VNxE3150;2SP DPE;8;12X3.5;12X3TB NLS;SED	UE	\$20,929
V22D8A12PL12E	VNxE3150;2SP DPE;8;12X3.5;12X900GB;SED	UE	\$0
V2-2S10-300	300GB 10K 6GB SAS 2.5" DRIVE	UE	\$0
V2-2S10-300U	300 GB 10K 6GB SAS 2.5 SPARE UPG	UE	\$0
V2-2S10-600	600GB 10K 6GB SAS 2.5" DRIVE	UE	\$0
V2-2S10-600U	600 GB 10K 6GB SAS 2.5 SPARE UPG	UE	\$955
V2-2S10-900	900GB 10K 6GB SAS 2.5" DRIVE	UE	\$0
V2-2S10-900U	900 GB 10K 6GB SAS 2.5 SPARE UPG	UE	\$1,290
V2-2S10E-900	900GB 2.5" SELF ENCRYPT DRIVE	UE	\$0
V2-2S10E-900U	900GB 2.5" SELF ENCRYPT DRIVE UPG	UE	\$0
V2-2S6F-100	100GB 6GB SAS 2.5" EFD DRIVE	UE	\$0

V2-2S6F-100TU	100 GB 10K 6GB SAS 2.5 EFD SPARE UPG	UE	\$0
V2-2S6F-100U	100GB 6GB SAS 2.5 EFD SPARE UPG	UE	\$0
V2-2S6F-200	200GB 6GB SAS 2.5" EFD DRIVE	UE	\$0
V2-2S6F-200U	200 GB 10K 6GB SAS 2.5 EFD SPARE UPG	UE	\$5,970
V22-SP	VNXE 3150 STORAGE PROCESSOR SPARE	UE	\$7,015
V22-SWFEATURE	VNXE3150 SOFTWARE FEATURES	UE	\$0
V2-DAE-12	DAE WITH 12 X 3.5 INCH DRIVE SLOTS	UE	\$1,888
V2-DAE-25	DAE WITH 25 X 2.5 INCH DRIVE SLOTS	UE	\$3,343
V2-DAE-N-25-A	25 x 2.5 IN 2U DAE FIELD INSTALL	UE	\$3,343
V2-DAE-N-25-D	2U DAE;25X2.5IN;DC POWER CUSTOMER INSTA	UE	\$3,510
V2-DAE-R-25-A	25X2.5 IN 2U DAE FACTORY INSTALL	UE	\$3,343
V2-PS07-010	1TB 7200RPM NL-SAS 3.5 DRIVE	UE	\$0
V2-PS07-010-6	6TB SAS DISK PACK (6 X 1TB 7200RPM)	UE	\$2,830
V2-PS07-0106U	6TB NL-SAS DISK PACK (6 X 1TB 72k) UPG	UE	\$0
V2-PS07-010U	1TB 7200RPM NL-SAS 3.5 DRIVE UPG	UE	\$0
V2-PS07-020	2TB 7200RPM NL-SAS 3.5 DRIVE	UE	\$0
V2-PS07-020-6	12TB SAS DISK PACK (6 X 2TB 7200RPM)	UE	\$4,320
V2-PS07-0206U	12TB NL-SAS DISK PACK (6 x 2TB 72k) UPG	UE	\$5,850
V2-PS07-020U	2TB 7200RPM NL-SAS 3.5 DRIVE UPG	UE	\$975
V2-PS07-030	3TB 7.2K NL-SAS 3.5" DRIVE	UE	\$0
V2-PS07-030U	3TB 7.2K NL SAS 3.5 SPARE UPG	UE	\$0
V2-PS07-040	4TB 7.2K NL-SAS 3.5" DRIVE	UE	\$1,240
V2-PS07-040U	4TB 7.2K NL-SAS 3.5" DRIVE UPG	UE	\$1,670
V2-PS07E-030	3TB 3.5" SELF ENCRYPT DRIVE	UE	\$0
V2-PS07E-030U	3TB 3.5" SELF ENCRYPT DRIVE UPG	UE	\$0
V2-PS10-900	900GB 10K 6GB SAS 3.5" DRIVE	UE	\$0
V2-PS10-900U	900GB 10K 6GB SAS 3.5 SPARE UPG	UE	\$1,290
V2-PS10E-900	900GB 3.5" SELF ENCRYPT DRIVE	UE	\$0
V2-PS10E-900U	900GB 3.5" SELF ENCRYPT DRIVE UPG	UE	\$0
V2-PS15-300	300GB 15K 6GB SAS 3.5 DRIVE	UE	\$0
V2-PS15-300-5	1500 GB SAS DISK PACK (5X 300GB 15K 3.5)	UE	\$3,290
V2-PS15-3005U	1500GB DISK PK(5 X 300GB 15K 3.5)UPG	UE	\$4,440
V2-PS15-300-6	1800GB SAS DISK PACK (6 X 300GB 15K 3.5)	UE	\$3,945
V2-PS15-3006U	1800GB DISK PACK(6 X 300GB 15K 3.5)UPG	UE	\$5,330
V2-PS15-300-7	2100GB SAS DISK PACK (7 X 300GB 15K)	UE	\$4,605
V2-PS15-3007U	2100GB DISK PACK (7 X 300GB 15K 3.5)UPG	UE	\$5,255
V2-PS15-300U	300GB 15K 6GB SAS 3.5" DRIVE UPG	UE	\$0
V2-PS15-600	600GB 15K 6GB SAS 3.5 DRIVE	UE	\$0
V2-PS15-600-5	3000 GB SAS DISK PACK (5X 600GB 15K 3.5)	UE	\$5,220
V2-PS15-6005U	3000GB DISK PACK (5 X 600GB 15K 3.5)UPG	UE	\$7,050
V2-PS15-600-6	3600GB SAS DISK PACK (6 X 600GB 15K 3.5)	UE	\$6,270
V2-PS15-6006U	3600GB DISK PACK (6 X 600GB 15K 3.5)UPG	UE	\$8,460
V2-PS15-600-7	4200GB SAS DISK PACK (7 X 600GB 15K)	UE	\$7,310
V2-PS15-6007U	4200GB DISK PACK (7 X 600GB 15K 3.5)UPG	UE	\$9,870
V2-PS15-600U	600GB 15K 6GB SAS DRIVE 3.5 UPG	UE	\$1,405
V3-10GB-ETH-C	2 port x 10GBASET Copper IO (2 Modules)	UE	\$2,900
V31-10GB	10 GB ETHERNET OPTICAL IO MODULE	UE	\$3,000
V31-10GB-C	2 PORT 10GBASE-T IO Copper (Two Modules)	UE	\$2,900
V31-10GB-ETHO	2 port x 10 GbE? OPTICAL IO (2 Modules)	UE	\$3,600
V311D12AN15CE	VNXE3300;2SP DPE;15X3.5;6X3TB NLS;SED	UE	\$0

V311D12AN15CL	VNXE3300;2XSPDPE;15X3.5DS;6X3TBSAS;AC	UE	\$0
V311D12AN15CM	VNXE3300;2XSP DPE;15X3.5 6X2TB;AC;NORACK	UE	\$0
V311D12AN15CS	VNXE3300;2XSP DPE;15X3.5 6X1TB;AC;NORACK	UE	\$0
V311D12AN15CXL	VNXE3300;2XSPDPE;15X3.5DS;6X4TBSAS;AC	UE	\$16,800
V311D12AN15EL	VNXE3300;2SP DPE;15X3.5;8X900GB;SED	UE	\$0
V311D12AN15FS	VNXE3300;2XSPDPE;15X3.5DS;6X100GBSAS;AC	UE	\$20,730
V311D12AN15PL	VNXE3300;2XSPDPE;15X3.5DS;8X900GBSAS;AC	UE	\$0
V311D12AN15PM	VNXE3300;DPE;15X3.5DS;8X600GSAS;AC;NO RK	UE	\$0
V311D12AN15PS	VNXE3300;DPE;15X3.5DS;8X300GSAS;AC;NO RK	UE	\$0
V311D12AN25	VNXE3300;2XSP DPE;25X2.5 DS;;AC;NR	UE	\$12,063
V311D12AN25EL	VNXE3300;2SP DPE;25X2.5;8x900GB;SED	UE	\$0
V311D12AN25FM	VNXE3300;2XSPDPE;25X2.5DS;6X200GBSAS;AC	UE	\$0
V311D12AN25FS	VNXE3300;2XSPDPE;25X2.5DS;6X100GBSAS;AC;	UE	\$0
V311D12AN25PL	VNXE3300;2XSPDPE;25X2.5DS;8X900GBSAS;AC	UE	\$0
V311D12AN25PM	VNXE3300;2XSPDPE;25X2.5DS;8X600GBSAS;AC	UE	\$0
V311D12AN25PS	VNXE3300;2XSPDPE;25X2.5DS;8X300GBSAS;AC	UE	\$0
V311D12AR15CE	VNXE3300;2XSP DPE;15X3.5 DS;6X3TBSAS;SED	UE	\$0
V311D12AR15CL	VNXE3300;2XSP DPE;15X3.5DS;6X3TB SAS;AC	UE	\$0
V311D12AR15CM	VNXE3300;DPE;15X3.5DS;6x2TBNLSAS;AC;W/RK	UE	\$0
V311D12AR15CS	VNXE3300;2XSP DPE;15X3.5 6X1TB;AC;W/RACK	UE	\$0
V311D12AR15CXL	VNXE3300;2XSP DPE;15X3.5DS;6X4TB SAS;AC	UE	\$16,800
V311D12AR15EL	VNXE3300;2XSP DPE;15X3.5 DS;8X900GB;SED	UE	\$0
V311D12AR15FS	VNXE3300;2XSPDPE;15X2.5DS;6X100GBSAS;AC	UE	\$20,730
V311D12AR15PL	VNXE3300;2XSPDPE;15X3.5DS;8X900GBSAS;AC	UE	\$0
V311D12AR15PM	VNXE3300;DPE;15X3.5DS;8x600GBSAS;AC;W/RK	UE	\$0
V311D12AR15PS	VNXE3300;DPE;15X3.5DS;8x300GBSAS;AC;W/RK	UE	\$0
V311D12AR25	3U DPE;2XSP;12GB MEM;25DS;AC;W/RACK	UE	\$12,063
V311D12AR25EL	VNXE3300;2xSP DPE;25X2.5 DS;8x900GB;SED	UE	\$0
V311D12AR25FM	VNXE3300;2XSPDPE;25X2.5DS;6X200GBSAS;AC	UE	\$0
V311D12AR25FS	VNXE3300;2XSPDPE;25X2.5DS;6X100GBSAS;AC	UE	\$0
V311D12AR25PL	VNXE3300;2XSPDPE;25X2.5DS;8X900GBSAS;AC	UE	\$0
V311D12AR25PM	VNXE3300;2XSPDPE;25X2.5DS;8X600GBSAS;AC	UE	\$0
V311D12AR25PS	VNXE3300;2XSPDPE;25X2.5DS;8X300GBSAS;AC	UE	\$0
V311D12DN15PL	VNXE3300;2XSPDPE;15X3.5DS;8X900GBSAS;DC	UE	\$0
V311D12DN15PM	VNXE3300;DPE;15X3.5DS;8X600GSAS;DC;NO RK	UE	\$0
V311D12DN15PS	VNXE3300;DPE;15X3.5DS;8X300GSAS;DC;NO RK	UE	\$0
V311D12DN25	3U DPE;2XSP;12GB MEM;25DS;DC;NR	UE	\$13,872
V311D12DN25PL	VNXE3300;2XSPDPE;25X2.5DS;8X900GBSAS;DC	UE	\$0
V311D12DN25PM	VNXE3300;2XSPDPE;25X2.5DS;8X600GBSAS;DC	UE	\$0
V311D12DN25PS	VNXE3300;2XSPDPE;25X2.5DS;8X300GBSAS;DC	UE	\$0
V31-1GB	1 GB ETHERNET IO (Two Modules)	UE	\$1,000
V31-1GB-ETH	4 port x 1 GbE? IO (2 Modules)	UE	\$2,000
V31-BBU	BATTERY BACKUP UNIT FRU	UE	\$440
V31-DAE-DPS	DC POWER SUPPLY (DAE)	UE	\$500
V31-DAE-N-15	3U DAE WITH 15X3.5 INCH DRIVE SLOTS	UE	\$2,360
V31-DAE-N-15D	3U DAE 15X3.5IN DC POWER;CUSTOMER INSTA	UE	\$2,478
V31-DAE-N15DC	VNXE3300 3U DAE;15X3.5 DRIVE SLOTS; DC	UE	\$2,478
V31-DAE-N-15E	VNXE3300 3U DAE; 15X3.5 INCH DRIVE SLOTS	UE	\$2,360
V31-DAE-N-25	2U DAE;25X2.5INCH DRIVESLOTS NO RACK	UE	\$3,343
V31-DAE-N-25D	2U DAE;25x2.5;DC POWER;CUSTOMER INSTALL	UE	\$3,510

V31-DAE-PS	POWER SUPPLY DAE FRU	UE	\$500
V31-DAE-R-15	DAE WITH 15X3.5 IN DRV SLOTS WITH RCK	UE	\$2,360
V31-DAE-R-15E	VNXE3300 3U DAE; 15X3.5 W/RACK	UE	\$2,360
V31-DAE-R-25	2U DAE;25X2.5 INCH DRIVE SLOTS W/RACK	UE	\$3,343
V31-DPE-DPS	DC POWER SUPPLY (DPE)	UE	\$715
V31-DPE-PS	POWER SUPPLY DPE FRU	UE	\$715
V31-LCC	LINK CONTROL CARD FOR 3U DAE FRU	UE	\$715
V31-SP	STORAGE PROCESSOR FRU	UE	\$6,929
V31-SP-DIMM	SP MEMORY FRU	UE	\$425
V31-SSD	STORAGE PROCESSOR SSD FRU	UE	\$1,024
V31-SWFEATURE	VNXE3300 SOFTWARE FEATURES	UE	\$0
V32-10GOPT	10GbE4port Optical IO module without SFP	UE	\$0
V32-10GOPTSFP	10GbE 4 port Optical IO module with SFP	UE	\$0
V32-10GOPTSFPU	10GbE Optical IO Module with SFP Upgrade	UE	\$0
V32-10GOPTU	10GbE Optical IO Module without SFP Upg	UE	\$0
V3212TB200GBHW	VNXe3200 DPE 12TB Cap w/ 200GB Flash	UE	\$36,785
V3212TB400GBHW	VNXe3200 DPE 12TB Cap w/ 400GB Flash	UE	\$43,025
V32-1G-IO	4 Port 1GbE iSCSI/IP	UE	\$0
V32-1G-IOU	4 Port 1GbE iSCSI/IP IO Module Upgrade	UE	\$0
V3220TB1200GBHW	VNXe3200 DPE 20TB Cap w/ 1200GB Flash	UE	\$41,375
V3220TB800GBHW	VNXe3200 DPE 20TB Cap w/ 800GB Flash	UE	\$39,580
V3225TB3600GBHW	VNXe3200 DPE 25TB Cap w/ 3600GB Flash	UE	\$71,830
V322TB600GB	VNXe3200 DAE w/22TB Cap-600GB10K HS	UE	\$14,870
V322TB900GB	VNXe3200 DAE w/22TB Cap-900GB10K HS	UE	\$15,095
V3235TB1200GBHW	VNXe3200 DPE 35TB Cap w/ 1200GB Flash	UE	\$41,375
V3235TB800GBHW	VNXe3200 DPE 35TB Cap w/ 800GB Flash	UE	\$39,580
V3240TB3600GBHW	VNXe3200 DPE 40TB Cap w/ 3600GB Flash	UE	\$71,830
V324TB600GB	VNXe3200 DAE w/44TB Cap-600GB10K HS	UE	\$22,730
V324TB900GB	VNXe3200 DAE w/44TB Cap-900GB10K HS	UE	\$22,955
V32-5TELRAIL	Telco Rail Kit for 2U DPE or DAE	UE	\$150
V32600S200FDAE	VNXe3200 DAE 10x600GBSAS/10x200GBFLASH	UE	\$30,225
V32-800W-PS	800W Power Supply 12V and 12V STBY DPE	UE	\$500
V32-8GFC	ONE 4 Port 8GB Fibre Channel IO Module	UE	\$0
V32-8GFCU	4 Port 8GB Fibre Channel IO Module Upgr	UE	\$0
V328TB200GBHW	VNXe3200 DPE 8TB Cap w/ 200GB Flash	UE	\$27,645
V328TB400GBHW	VNXe3200 DPE 8TB Cap w/ 400GB Flash	UE	\$36,685
V32900S200FDAE	VNXe3200 DAE 10x900GBSAS/10x200GBFLASH	UE	\$34,080
V32900S800FDAE	VNXe3200 DAE 10x900GBSAS/10x800GBFLASH	UE	\$78,840
V32-BBU	BATTERY BACKUP UNIT	UE	\$200
V32-BC-12ARK	ASSY BEACHCOMBER 12 ADJUSTABLE RAIL KIT	UE	\$240
V32-BC-25ARK	ASSY BEACHCOMBER 25 ADJUSTABLE RAIL KIT	UE	\$240
V32-BC-FM	FAN MODULE BC	UE	\$300
V32-CCARD	CACHE CARD	UE	\$1,120
V32D12AN2CM12	VNXe3200;2xSP DPE;12x3.5 DS;12x2TB 7200K	UE	\$0
V32D12AN2CM9	VNXe3200;2xSP DPE;12x3.5 DS;9x2TB 7200K	UE	\$0
V32D12AN2CX12	VNXe3200;2xSP DPE;12x3.5 DS;12x4TB 7200K	UE	\$0
V32D12AN2CX9	VNXE3200;2XSP DPE;12X3.5 DS;9X4TB 7200K	UE	\$0
V32D12AN2F80	VNXe32;2xSP DPE;12x3.5DS;8x800GB FAST VP	UE	\$39,700
V32D12AN2PM12	VNXe3200;2xSP DPE;12x3.5 DS;12x600GB 15K	UE	\$0
V32D12AN2PM6	VNXe3200 2xSP DPE 12x3.5 DS 6x600GB 15K	UE	\$0

V32D12AN2QM12	VNXe3200;2xSP DPE;12x3.5 DS;12x900GB 10K	UE	\$0
V32D12AN2QM6	VNXe3200 2xSP DPE 12x3.5 DS 6x900GB 10K	UE	\$0
V32D12AN2QN12	VNXe3200;2xSP DPE;12x3.5DS;12x1200GB 10K	UE	\$0
V32D12AN2QN6	VNXe3200;2xSP DPE;12x3.5 DS;6x1200GB 10K	UE	\$0
V32D12AN5F211	VNXe32;2xSP DPE;25x2.5DS;11x200GB FASTVP	UE	\$0
V32D12AN5F216	VNXe32:2xSP DPE:25x2.5DS:16x200GB FASTVP	UE	\$0
V32D12AN5F221	VNXe32;2xSP DPE;25x2.5DS;21x200GB FASTVP	UE	\$0
V32D12AN5F28	VNXe32:2xSP DPE:25x2.5DS:8x200GB FAST VP	UE	\$19,380
V32D12AN5F80	VNXe32:2xSP DPE;25x2.5DS;8x800GB FAST VP	UE	\$39,700
V32D12AN5F810	VNXe32;2xSP DPE;25x2.5DS;10x800GB FASTVP	UE	\$0
V32D12AN5PS12	VNXe3200;2xSP DPE;25x2.5 DS;12x300GB 15K	UE	\$0
V32D12AN5PS25	VNXe3200;2xSP DPE;25x2.5 DS;25x300GB 15K	UE	\$0
V32D12AN5PS6	VNXe3200;2xSP DPE;25x2.5 DS;6x300GB 15K	UE	\$0
V32D12AN5QM12	VNXe3200;2xSP DPE;25x2.5 DS;12x900GB 10K	UE	\$0
V32D12AN5QM25	VNXe3200;2xSP DPE;25x2.5 DS;25x900GB 10K	UE	\$0
V32D12AN5QM6	VNXe3200 2xSP DPE 25x2.5 DS 6x900GB 10K	UE	\$0
V32D12AN5QN12	VNXe3200;2xSP DPE;25x2.5DS;12x1200GB 10K	UE	\$0
V32D12AN5QN25	VNXe3200;2xSP DPE;25x2.5DS;25x1200GB 10K	UE	\$0
V32D12AN5QN6	VNXe3200;2xSP DPE;25x2.5 DS;6x1200GB 10K	UE	\$0
V32D12AN5QS12	VNXe3200;2xSP DPE;25x2.5 DS;12x600GB 10K	UE	\$0
V32D12AN5QS25	VNXe3200;2xSP DPE;25x2.5 DS;25x600GB 10K	UE	\$0
V32D12AN5QS6	VNXe3200 2xSP DPE 25x2.5 DS 6x600GB 10K	UE	\$0
V32D12AN5QT12	VNXe3200;2xSP DPE;25x2.5 DS;12x600GB 15K	UE	\$0
V32D12AN5QT25	VNXe3200;2xSP DPE;25x2.5 DS;25x600GB 15K	UE	\$0
V32D12AN5QT6	VNXe3200;2xSP DPE;25x2.5 DS;6x600GB 15K	UE	\$0
V32D12DN2	VNXe32;2xSP DPE;DC;12X3.5DS; DISKLESS	UE	\$9,390
V32D12DN2CM12	VNXe32:2xSP DPE:DC:12x3.5DS:12x2TB 7200K	UE	\$0
V32D12DN2CM9	VNXe32:2xSP DPE:DC:12x3.5DS:9x2TB 7200K	UE	\$0
V32D12DN2CX12	VNXe32;2xSP DPE;DC;12x3.5DS;12x4TB 7200K	UE	\$0
V32D12DN2CX9	VNXe32;2xSP DPE;DC;12x3.5DS;9x4TB 7200K	UE	\$0
V32D12DN2PM12	VNXe32;2xSP DPE;DC;12x3.5DS;12x600GB 15K	UE	\$0
V32D12DN2PM6	VNXe32;2xSP DPE;DC;12x3.5DS;6x600GB 15K	UE	\$0
V32D12DN2QM12	VNXe32:2xSP DPE:DC:12x3.5DS:12x900GB 10K	UE	\$0
V32D12DN2QM6	VNXe32:2xSP DPE:DC:12x3.5DS:6x900GB 10K	UE	\$0
V32D12DN2QN12	VNXe32;2xSP DPE;DC;12x3.5DS;12x1200GB10K	UE	\$0
V32D12DN2QN6	VNXe32;2xSP DPE;DC;12x3.5DS;6x1200GB10K	UE	\$0
V32D12DN5	VNXe32;2xSP DPE;DC;25X2.5DS; DISKLESS	UE	\$7,270
V32D12DN5F28	VNXe32:2xSP DPE:DC:25x2.5:8x200GB FAST	UE	\$0
V32D12DN5PS12	VNXe32;2xSP DPE;DC;25x2.5DS;12x300GB 15K	UE	\$0
V32D12DN5PS25	VNXe32;2xSP DPE;DC;25x2.5DS;25x300GB 15K	UE	\$0
V32D12DN5PS6	VNXe32;2xSP DPE;DC;25x2.5DS;6x300GB 15K	UE	\$0
V32D12DN5QM12	VNXe32:2xSP DPE:DC:25x2.5DS:12x900GB 10K	UE	\$0
V32D12DN5QM25	VNXe32:2xSP DPE:DC:25x2.5DS:25x900GB 10K	UE	\$0
V32D12DN5QM6	VNXe32:2xSP DPE:DC:25x2.5DS:6x900GB 10K	UE	\$0
V32D12DN5QN12	VNXe32;2xSP DPE;DC;25x2.5DS;12x1200GB10K	UE	\$0
V32D12DN5QN25	VNXe32;2xSP DPE;DC;25x2.5DS;25x1200GB10K	UE	\$0
V32D12DN5QN6	VNXe32;2xSP DPE;DC;25x2.5DS;6x1200GB10K	UE	\$0
V32D12DN5QS12	VNXe32;2xSP DPE;DC;25x2.5DS;12x600GB 10K	UE	\$0
V32D12DN5QS25	VNXe32;2xSP DPE;DC;25x2.5DS;25x600GB 10K	UE	\$0
V32D12DN5QS6	VNXe32;2xSP DPE;DC;25x2.5DS;6x600GB 10K	UE	\$0

V32-DAE-12	2U DAE WITH 12 x 3.5 INCH DRIVE SLOTS	UE	\$0
V32-DAE-12U	2U DAE w/12x3.5 INCH DRIVE SLOTS;UPGRADE	UE	\$2,550
V32-DAE-25	2U DAE WITH 25 x 2.5 INCH DRIVE SLOTS	UE	\$0
V32-DAE-25D	VNXe3200 DC DAE-25x2.5	UE	\$0
V32-DAE-25DU	VNXe3200 DC DAE-25x2.5"" Upgrade	UE	\$5,870
V32-DAE-25U	2U DAE w/25x2.5 INCH DRIVE SLOTS;UPGRADE	UE	\$4,515
V32-DC-PS	DC PSU for the 25 drive DAE	UE	\$485
V32-DC-PSU	DC PSU For VNXe3200 DC DPE	UE	\$485
V32-LCC-DAE12	LCC FOR 2U DAE 12 DRIVE	UE	\$1,775
V32-LCC-DAE25	LCC FOR 2U DAE 25 DRIVE	UE	\$1,775
V32-MSAS-2M	Two Mini-SAS to Mini-SAS 2 M cable	UE	\$360
V32-MSAS-5M	Two Mini-SAS to Mini-SAS 5 M cable	UE	\$900
V32MSAS-HD-2M	Two Mini-SAS HD to Mini-SAS 2 M cable	UE	\$540
V32MSAS-HD-5M	Two Mini-SAS HD to Mini-SAS 5 M cable	UE	\$1,350
V32-PS	PWR SUPPLY FOR VNXE3200/3400 DPE	UE	\$485
V32-PS-DAE12	Power Supply for 2U 12 DRIVE DAE	UE	\$485
V32-PS-DAE25	Power Supply for 2U 25 DRIVE DAE	UE	\$485
V32-PWR-0	2 C13 PWRCRD W/ SEV1011 PLUGS 250V 10A	UE	\$0
V32-PWR-1	2 C13 PWRCRD W/ NBR 14136 PLUGS 250V 10A	UE	\$0
V32-PWR-10	2 C13 PWRCRD W/ KSC8305 PLUGS 250V 10A	UE	\$0
V32-PWR-11	2 C13 PWRCRD w/ CNS690 PLUGS 125V 10A	UE	\$0
V32-PWR-12	2 C13 PWRCRD W/ NEMA 5-15 PLUGS 125V 10A	UE	\$0
V32-PWR-13	2 C13 PWRCRD W/ BS546 PLUGS 250V 10A	UE	\$0
V32-PWR-14	2 C13 PWRCRD W/ SI-32 PLUGS 250V 10A	UE	\$0
V32-PWR-15	2 C13 PWRCRD with IN6SA3 plugs 250V 10A	UE	\$0
V32-PWR-2	2 C13 PWRCRD W/ JISC 8303 PLUGS 125V 10A	UE	\$0
V32-PWR-3	2 C13 PWRCRD W/ GB1002 PLUGS 250V 10A	UE	\$0
V32-PWR-4	2 C13 PWRCRD W/ IRAM 2073 PLUGS 250V 10A	UE	\$0
V32-PWR-5	2 C13 PWRCRD W/ BSI 1363 PLUGS 250V 10A	UE	\$0
V32-PWR-6	2 C13 PWRCRD w/ SAA/3 PLUGS 250V 10A	UE	\$0
V32-PWR-7	2 C13 PWRCRD W/ CEE7/7 PLUGS 250V 10A	UE	\$0
V32-PWR-8	2 C13 PWRCRD W/ CEI 23-16 PLUGS 250V 10A	UE	\$0
V32-PWR-9	2 C13PWRCRD W/AFSNIT 107-2-D1PLG 250V10A	UE	\$0
V3-2S10-300	2.5 IN 300GB 10K 6GB SAS DISK DRIVE	UE	\$0
V3-2S10-300E	300GB 10K 6G SAS 2.5" DRIVE	UE	\$0
V3-2S10300EU	300GB 10K 6G SAS 2.5 SPARE	UE	\$0
V3-2S10-300TU	VNX51/53 300GB 10KSAS DRV25X2.5 DPEDAE	UE	\$0
V3-2S10-300U	VNX51/53 300GB 10KSAS DRV25X2.5 DPEDAE	UE	\$0
V3-2S10-600	2.5 IN 600GB 10K 6GB SAS DISK DRIVE	UE	\$600
V3-2S10-600E	600GB 10K 6G SAS 2.5" DRIVE	UE	\$0
V3-2S10600EU	600GB 10K 6G SAS 2.5 SPARE	UE	\$955
V3-2S10-600TU	VNX 51/53 600GB 10K DRV-25X2.5 DPE/DAE	UE	\$955
V3-2S10-600U	VNX 51/53 600GB 10K DRV-25X2.5 DPE/DAE	UE	\$810
V3-2S10-900	2.5 IN 900GB 10K 6GB SAS DISK DRIVE	UE	\$820
V3-2S10-900E	900GB 10K 6G SAS 2.5" DRIVE	UE	\$0
V3-2S10900EU	900GB 10K 6G SAS 2.5 SPARE	UE	\$1,290
V3-2S10-900TU	VNX51/53 900GB 10K 25X2.5IN DRV DPE/DAE	UE	\$1,290
V3-2S10-900U	VNX51/53 900GB 10K 25X2.5IN DRV DPE/DAE	UE	\$1,095
V3-2S10E-900E	900GB 2.5" SELF ENCRYPT DRIVE	UE	\$0
V32S10E900ETU	900GB 10K 6G SAS 2.5 SPARE	UE	\$0

V3-2S10E900EU	900GB 2.5" SELF ENCRYPT DRIVE UPG	UE	\$0
V3-2S6F-100	2.5 IN 100GB 6GB SAS FLASH DRIVE	UE	\$1,985
V3-2S6F-100E	100GB EFD 6G SAS 2.5" DRIVE	UE	\$0
V32S6F100ETU	100GB 2.5 EFD SPARE	UE	\$0
V3-2S6F100EU	100GB EFD 6G SAS 2.5 SPARE	UE	\$0
V3-2S6F-100TU	VNX 51/53 100GB FLSH-25X2.5 DRV DPE/DAE	UE	\$0
V3-2S6F-100U	VNX 51/53 100GB FLSH-25X2.5 DRV DPE/DAE	UE	\$0
V3-2S6F-200	2.5 IN 200GB 6GB SAS FLASH DRIVE	UE	\$3,755
V3-2S6F-200E	200GB EFD 6G SAS 2.5" DRIVE	UE	\$0
V32S6F200ETU	200GB 2.5 EFD SPARE	UE	\$5,965
V3-2S6F200EU	200GB EFD 6G SAS 2.5 SPARE	UE	\$5,970
V3-2S6F-200TU	VNX 51/53 200GB FLSH-25X2.5 DRV DPE/DAE	UE	\$5,970
V3-2S6F-200U	VNX 51/53 200GB FLSH-25X2.5 DRV DPE/DAE	UE	\$5,075
V32SFP-TWAX-1M	Qty 4 1M ACTIVE TWINAX 10G CABLE	UE	\$980
V32SFP-TWAX-3M	Qty 4 3M ACTIVE TWINAX 10G CABLE	UE	\$1,175
V32SFP-TWAX-5M	Qty 4 5M ACTIVE TWINAX 10G CABLE	UE	\$1,440
V32-SP	VNXe 3200 STORAGE PROCESSOR NO DIMM	UE	\$7,015
V32-SP-DIMM	VNXe 3200 SP MEMORY 8GB DIMM	UE	\$305
V32-SSD	STORAGE PROCESSOR SSD MSATA	UE	\$1,024
V3D12AN15CE12	VNXE3300;2SP DPE;15X3.5;12x3TB NLS;SED	UE	\$0
V3D12AN15CL12	VNXE3300;2SP DPE;15X3.5;12x3TB NLS	UE	\$0
V3D12AN15CM12	VNXE3300;2SP DPE;15X3.5;12x2TB NLS	UE	\$0
V3D12AN15CS12	VNXE3300;2SP DPE;15X3.5;12x1TB NLS	UE	\$0
V3D12AN15CXL12	VNXE3300;2SP DPE;15X3.5;12x4TB NLS	UE	\$27,600
V3D12AN15EL12	VNXE3300;2SP DPE;15X3.5;12x900GB;SED	UE	\$0
V3D12AN15PL12	VNXE3300;2SP DPE;15X3.5;12x900GB	UE	\$0
V3D12AN15PM12	VNXE3300;2SP DPE;15X3.5;12x600GB	UE	\$0
V3D12AN15PS12	VNXE3300;2SP DPE;15X3.5;12x300GB	UE	\$0
V3D12AN25EL12	VNXE3300;2SP DPE;25X2.5;12x900GB;SED	UE	\$0
V3D12AN25PL12	VNXE3300;2SP DPE;25X2.5;12x900GB	UE	\$0
V3D12AN25PM12	VNXE3300;2SP DPE;25X2.5;12x600GB	UE	\$0
V3D12AN25PS12	VNXE3300;2SP DPE;25X2.5;12x300GB	UE	\$0
V3D12AR15CE12	VNXE3300;2SP DPE;15X3.5;12x3TB NLS;RK;SED	UE	\$0
V3D12AR15CL12	VNXE3300;2SP DPE;15X3.5;12x3TB NLS;RK	UE	\$0
V3D12AR15CM12	VNXE3300;2SP DPE;15X3.5;12x2TB NLS;RK	UE	\$0
V3D12AR15CS12	VNXE3300;2SP DPE;15x3.5;12x1TB NLS;RK	UE	\$0
V3D12AR15CXL12	VNXE3300;2SP DPE;15X3.5;12x4TB NLS;RK	UE	\$27,600
V3D12AR15EL12	VNXE3300;2SP DPE;15X3.5;12x900GB;RK;SED	UE	\$0
V3D12AR15PL12	VNXE3300;2SP DPE;15X3.5;12x900GB;RK	UE	\$0
V3D12AR15PM12	VNXE3300;2SP DPE;15X3.5;12x600GB;RK	UE	\$0
V3D12AR15PS12	VNXE3300;2SP DPE;15X3.5;12x300GB;RK	UE	\$0
V3D12AR25EL12	VNXE3300;2SP DPE;25X2.5;12x900GB;RK;SED	UE	\$0
V3D12AR25PL12	VNXE3300;2SP DPE;25X2.5;12x900GB;RK	UE	\$0
V3D12AR25PM12	VNXE3300;2SP DPE;25X2.5;12x600GB;RK	UE	\$0
V3D12AR25PS12	VNXE3300;2SP DPE;25X2.5;12x300GB;RK	UE	\$0
V3D12DN15PL12	VNXE3300;2SP DPE;15X3.5;12x900GB;DC	UE	\$0
V3D12DN15PM12	VNXE3300;2SP DPE;15X3.5;12x600GB;DC	UE	\$0
V3D12DN15PS12	VNXE3300;2SP DPE;15X3.5;12x300GB;DC	UE	\$0
V3D12DN25PL12	VNXE3300;2SP DPE;25X2.5;12x900GB;DC	UE	\$0
V3D12DN25PM12	VNXE3300;2SP DPE;25X2.5;12x600GB;DC	UE	\$0

V3D12DN25PS12	VNXE3300;2SP DPE;25X2.5;12x300GB;DC	UE	\$0
V3-RACK-40U	VNXE3300 RACK	UE	\$1,680
V3-VS07-010	1TB 7200RPM 6GB SAS DISK DRIVE	UE	\$400
V3-VS07-010-6	6TB SAS DISK PACK (6 x 1TB 7200RPM)	UE	\$2,830
V3-VS07-0106U	6TB SAS DISK PACK (6 x 1TB 72k)UPG	UE	\$3,830
V3-VS07-010E	1TB 7200RPM NL-SAS DRIVE	UE	\$0
V3-VS07-010EU	1TB 7200RPM NL-SAS DRIVE	UE	\$0
V3-VS07-010TU	VNX 33/51/53 1T DRV-15X3.5IN DPE/DAE U	UE	\$0
V3-VS07-010U	VNX 51/53 1T DRV-15X3.5IN DPE/DAE U	UE	\$0
V3-VS07-010UE	1TB 7200RPM NL-SAS DRIVE UPGRADE	UE	\$0
V3-VS07-020	2TB 7200RPM 6GB SAS DISK DRIVE	UE	\$625
V3-VS07-020-6	12TB SAS DISK PACK 6X2TB 7200RPM DISKS	UE	\$4,320
V3-VS07-0206U	12TB SAS DISK PACK (6 x 2TB 72k)UPG	UE	\$5,850
V3-VS07-020E	2TB 7200RPM NL-SAS DRIVE	UE	\$0
V3-VS07-020EU	2TB 7200RPM 3.5 SAS DRIVE SPARE UPGRADE	UE	\$975
V3-VS07-020TU	VNX51/53 2TB NL-SAS UP DRV-15X3.5 DPEDAE	UE	\$990
V3-VS07-020U	VNX51/53 2TB NL-SAS UP DRV-15X3.5 DPEDAE	UE	\$840
V3-VS07-020UE	2TB 7200RPM NL-SAS DRIVE UPGRADE	UE	\$975
V3-VS07-030	3.5 IN 3TB 7.2K 6GB SAS DISK DRIVE	UE	\$890
V3-VS07-030E	3TB 7200RPM NL-SAS DRIVE	UE	\$0
V3-VS07-030EU	3TB 7200RPM NL-SAS SPARE	UE	\$1,385
V3-VS07-030TU	VNX 3TB NL SAS DRV UPG-15X3.5IN DPE/DAE	UE	\$1,410
V3-VS07-030U	VNX 3TB NL SAS DRV UPG-15X3.5IN DPE/DAE	UE	\$1,200
V3-VS07-040	3.5 IN 4TB 7.2K 6GB SAS DISK DRIVE	UE	\$1,085
V3-VS07-040E	4TB 7.2K NL-SAS 3.5" DRIVE	UE	\$1,250
V3-VS07-040EU	4TB 7.2K NL-SAS 3.5" DRIVE UPG	UE	\$1,670
V3-VS07-040TU	VNX 4TB NL SAS DRV UPG-15X3.5IN DPE/DAE	UE	\$1,670
V3-VS07-040U	VNX51/53 4TB NL SAS DRV DPE/DAE UPGRADE	UE	\$1,420
V3-VS07E-030E	3TB NL-SAS 3.5" SELF ENCRYPT DRIVE	UE	\$0
V3VS07E030ETU	3TB NL-SAS 3.5" SELF ENCRYPT DRIVE UPG	UE	\$0
V3-VS07E030EU	3TB NL-SAS 3.5" SELF ENCRYPT DRIVE UPG	UE	\$0
V3-VS10-300	3.5 IN 300GB 10K 6GB SAS DISK DRIVE	UE	\$440
V3-VS10-300TU	VNX51/53 300GB10KSAS UP DRV15X3.5DPE/DAE	UE	\$695
V3-VS10-300U	VNX51/53 300GB10KSAS UP DRV15X3.5DPE/DAE	UE	\$590
V3-VS10-600	3.5 IN 600GB 10K 6GB SAS DISK DRIVE	UE	\$600
V3-VS10-600TU	VNX51/53 600GB 10K SAS UPDRV15X3.5DPEDAE	UE	\$955
V3-VS10-600U	VNX51/53 600GB 10K SAS UPDRV15X3.5DPEDAE	UE	\$810
V3-VS10-900	3.5 IN 900GB 10K SAS DISK DRIVE	UE	\$820
V3-VS10-900E	900GB 10K 6G SAS 3.5" DRIVE	UE	\$0
V3-VS10900EU	900GB 10K 6G SAS 3.5 SPARE	UE	\$1,290
V3-VS10-900TU	VNX 33/35 900G10KDRV-15X3.5IN DPE/DAE U	UE	\$1,420
V3-VS10-900U	VNX 51/53 900G10KDRV-15X3.5IN DPE/DAE U	UE	\$1,205
V3-VS10E-900E	900GB 3.5" SELF ENCRYPT DRIVE	UE	\$0
V3VS10E900ETU	900GB 3.5" SELF ENCRYPT DRIVE UPG	UE	\$0
V3-VS10E900EU	900GB 3.5" SELF ENCRYPT DRIVE UPG	UE	\$0
V3-VS15-300	300GB 15K SAS DISK DRIVE	UE	\$560
V3-VS15-300-6	1800GB SAS DISK PACK (6 X 300GB 15K 3.5)	UE	\$3,945
V3-VS15-3006U	1800GB SAS DISK PK(6x300GB 15K 3.5)UPG	UE	\$5,330
V3-VS15-300-7	2100GB SAS DISK PACK (7X 300GB 15K 3.5")	UE	\$4,605
V3-VS15-3007U	2100GB SAS DISK PACK (7 x 300GB 15K) UPG	UE	\$6,215

V3-VS15-300E	300GB 15K SAS DRIVE	UE	\$0
V3-VS15-300EU	300GB 15K 3.5 SAS SPARE	UE	\$890
V3-VS15-300TU	VNX51/53 300GB15K SAS UPGDRV15X3.5DPEDA	UE	\$890
V3-VS15-300U	VNX51/53 300GB15K SAS UPGDRV15X3.5DPEDA	UE	\$755
V3-VS15-300UE	300GB 15K SAS DRIVE UPGRADE	UE	\$890
V3-VS15-600	600GB 15K SAS DISK DRIVE	UE	\$885
V3-VS15-600-6	3600GB SAS DISK PACK (6 X 600GB 15K 3.5)	UE	\$6,270
V3-VS15-6006U	3600GB SAS DISK PK(6x600GB 15K 3.5)UPG	UE	\$8,460
V3-VS15-600-7	4200GB SAS DISK PACK (7X 600GB 15K 3.5")	UE	\$7,310
V3-VS15-6007U	4200GB SAS DISK PK (7x600GB 15K)UPG	UE	\$9,870
V3-VS15-600E	600GB 15K SAS DRIVE	UE	\$0
V3-VS15-600EU	600GB 15K 3.5 SAS SPARE	UE	\$1,405
V3-VS15-600TU	VNX51/53 600GB15K SAS UPGDRV15X3.5DPEDA	UE	\$1,415
V3-VS15-600U	VNX51/53 600GB15K SAS UPGDRV15X3.5DPEDA	UE	\$1,205
V3-VS15-600UE	600GB 15K SAS DRIVE UPGRADE	UE	\$1,405
V3-VS6F-100	100GB FLASH DRIVE	UE	\$1,995
V3-VS6F-100-5	500GB FLASH DISK PACK	UE	\$11,725
V3-VS6F-1005U	500GB FLASH DISK PACK (5 x 100GB)UPG	UE	\$15,835
V3-VS6F-100E	100GB 3.5" EFD DRIVE	UE	\$0
V3-VS6F100ETU	100GB EFD SAS DRIVE UPGRADE	UE	\$0
V3-VS6F-100EU	100GB 3.5 EFD SPARE	UE	\$3,165
V3-VS6F-100TU	VNX51/53 100GB SAS FLSH UPG15X3.5DPEDAE	UE	\$0
V3-VS6F-100U	VNX51/53 100GB SAS FLSH UPG15X3.5DPEDAE	UE	\$0
V3-VS6F-100UE	100GB 3.5" EFD DRIVE UPGRADE	UE	\$0
V3-VS6F-200	3.5IN 200GB 6GB SAS 520BPS FLASH DRIVE	UE	\$3,780
V3-VS6F-200TU	VNX51/53 200GB SAS FLSH UPG15X3.5DPEDAE	UE	\$6,000
V3-VS6F-200U	VNX51/53 200GB SAS FLSH UPG15X3.5DPEDAE	UE	\$5,100
V51-LPS	LOCAL PROTECTION SUITE FOR VNX5100=IC	UE	\$2,063
V51-PPAK	Total Protection Pack for VNX5100=IC	UE	\$11,166
V51-RPS	REMOTE PROTECTION SUITE FOR VNX5100=IC	UE	\$4,063
V51-VPK	TOTAL VALUE PACK for VNX5100=IC	UE	\$6,835
V5-2S10-012	VNXE1600 1.2TB 10K SAS 25X2.5	UE	\$0
V5-2S10-012TU	VNXE1600 1.2TB 10K SAS 25X2.5 U/G	UE	\$1,150
V5-2S10-012U	VNXE1600 1.2TB 10K SAS 25X2.5 U/G	UE	\$1,150
V5-2S10-600	VNXE1600 600GB 10K SAS 25X2.5	UE	\$0
V5-2S10-600TU	VNXE1600 600GB 10K SAS 25X2.5 U/G	UE	\$615
V5-2S10-600U	VNXE1600 600GB 10K SAS 25X2.5 U/G	UE	\$615
V5-2S10-900	VNXE1600 900GB 10K SAS 25X2.5	UE	\$0
V5-2S10-900TU	VNXE1600 900GB 10K SAS 25X2.5 U/G	UE	\$885
V5-2S10-900U	VNXE1600 900GB 10K SAS 25X2.5 U/G	UE	\$885
V5-2S15-300	VNXE1600 300GB 15K SAS 25X2.5	UE	\$0
V5-2S15-300TU	VNXE1600 300GB 15K SAS 25X2.5 U/G	UE	\$950
V5-2S15-300U	VNXE1600 300GB 15K SAS 25X2.5 U/G	UE	\$950
V5-2S15-600	VNXE1600 600GB 15K SAS 25X2.5	UE	\$0
V5-2S15-600TU	VNXE1600 600GB 15K SAS 25X2.5 U/G	UE	\$975
V5-2S15-600U	VNXE1600 600GB 15K SAS 25X2.5 U/G	UE	\$975
V5-2S6FX-200	VNXE1600 200GB SSD 25X2.5	UE	\$0
V5-2S6FX-200TU	VNXE1600 200GB SSD 25X2.5 U/G	UE	\$1,735
V5-2S6FX-200U	VNXE1600 200GB SSD 25X2.5 U/G	UE	\$1,735
V5-2S6FX-800	VNXE1600 800GB SSD 25X2.5	UE	\$0

V5-2S6FX-800TU	VNXE1600 800GB SSD 25X2.5 UG	UE	\$4,985
V5-2S6FX-800U	VNXE1600 800GB SSD 25X2.5 UG	UE	\$4,985
V53-EPAK	TOTAL EFFICENCY PACK for VNX5300=IC	UE	\$21,399
V53-LPS	LOCAL PROTECTION SUITE FOR VNX5300=IC	UE	\$3,031
V53-PPAK	Total Protection Pack for VNX5300=IC	UE	\$18,700
V53-RPS	REMOTE PROTECTION SUITE FOR VNX5300=IC	UE	\$7,813
V5-PS07-020	VNXE1600 2TB NL SAS 12X3.5	UE	\$0
V5-PS07-020TU	VNXE1600 2TB NL SAS 12X3.5 U/G	UE	\$825
V5-PS07-020U	VNXE1600 2TB NL SAS 12X3.5 U/G	UE	\$825
V5-PS07-040	VNXE1600 4TB NL SAS 12X3.5	UE	\$0
V5-PS07-040TU	VNXE1600 4TB NL SAS 12X3.5 U/G	UE	\$1,220
V5-PS07-040U	VNXE1600 4TB NL SAS 12X3.5 U/G	UE	\$1,220
V5-PS10-012	VNXE1600 1.2TB 10K SAS 12X3.5	UE	\$0
V5-PS10-012TU	VNXE1600 1.2TB 10K SAS 12X3.5 U/G	UE	\$0
V5-PS10-012U	VNXE1600 1.2TB 10K SAS 12X3.5 U/G	UE	\$0
V5-PS10-600	VNXE1600 600GB 10K SAS 12X3.5	UE	\$0
V5-PS10-600TU	VNXE1600 600GB 10K SAS 12X3.5 U/G	UE	\$0
V5-PS10-600U	VNXE1600 600GB 10K SAS 12X3.5 U/G	UE	\$0
V5-PS10-900	VNXE1600 900GB 10K SAS 12X3.5	UE	\$0
V5-PS10-900TU	VNXE1600 900GB 10K SAS 12X3.5 U/G	UE	\$885
V5-PS10-900U	VNXE1600 900GB 10K SAS 12X3.5 U/G	UE	\$885
V5-PS15-300	VNXE1600 300GB 15K SAS 12X3.5	UE	\$0
V5-PS15-300TU	VNXE1600 300GB 15K SAS 12X3.5 U/G	UE	\$0
V5-PS15-300U	VNXE1600 300GB 15K SAS 12X3.5 U/G	UE	\$0
V5-PS15-600	VNXE1600 600GB 15K SAS 12X3.5	UE	\$0
V5-PS15-600TU	VNXE1600 600GB 15K SAS 12X3.5 U/G	UE	\$975
V5-PS15-600U	VNXE1600 600GB 15K SAS 12X3.5 U/G	UE	\$975
V5-PS6FX-200	VNXE1600 200GB SSD 12X3.5	UE	\$0
V5-PS6FX-200TU	VNXE1600 200GB SSD 12X3.5 U/G	UE	\$0
V5-PS6FX-200U	VNXE1600 200GB SSD 12X3.5 U/G	UE	\$0
V5-PS6FX-800	VNXE1600 800GB SSD 12X3.5	UE	\$0
V5-PS6FX-800TU	VNXE1600 800GB SSD 12X3.5 U/G	UE	\$0
V5-PS6FX-800U	VNXE1600 800GB SSD 12X3.5 U/G	UE	\$0
V5-SP-L6X1200-10K	VNXe1600 3.5 System Pack 6X 1.2TB 10K	UE	\$0
V5-SP-L6X200-SSD	VNXe1600 3.5 System Pack 6X 200GB SSD	UE	\$0
V5-SP-L6X300-15K	VNXe1600 3.5 System Pack 6X 300GB 15K	UE	\$0
V5-SP-L6X600-10K	VNXe1600 3.5 System Pack 6X 600GB 10K	UE	\$0
V5-SP-L6X600-15K	VNXe1600 3.5 System Pack 6X 600GB 15K	UE	\$0
V5-SP-L6X800-SSD	VNXe1600 3.5 System Pack 6X 800GB SSD	UE	\$0
V5-SP-L6X900-10K	VNXe1600 3.5 System Pack 6X 900GB 10K	UE	\$0
V5-SP-L9X2TB-NL	VNXe1600 3.5 System Pack 9X 2TB NLSAS	UE	\$0
V5-SP-L9X4TB-NL	VNXe1600 3.5 System Pack 9X 4TB NLSAS	UE	\$0
V5-SP-S6X1200-10K	VNXe1600 2.5 System Pack 6X 1.2TB 10K	UE	\$0
V5-SP-S6X200-SSD	VNXe1600 2.5 System Pack 6X 200GB SSD	UE	\$0
V5-SP-S6X300-15K	VNXe1600 2.5 System Pack 6X 300GB 15K	UE	\$0
V5-SP-S6X600-10K	VNXe1600 2.5 System Pack 6X 600GB 10K	UE	\$0
V5-SP-S6X600-15K	VNXe1600 2.5 System Pack 6X 600GB 15K	UE	\$0
V5-SP-S6X800-SSD	VNXe1600 2.5 System Pack 6X 800GB SSD	UE	\$0
V5-SP-S6X900-10K	VNXe1600 2.5 System Pack 6X 900GB 10K	UE	\$0
V6-2S10-012	VNXe 3200 1.2TB 10K SAS 25X2.5	UE	\$0

V6-2S10-012TU	VNXe 3200 1.2TB 10K SAS 25X2.5 U/G	UE	\$1,340
V6-2S10-012U	VNXe 3200 1.2TB 10K SAS 25X2.5 U/G	UE	\$1,340
V6-2S10-600	VNXe 3200 600GB 10K SAS 25X2.5	UE	\$0
V6-2S10-600U	VNXe 3200 600GB 10K SAS 25X2.5 U/G	UE	\$790
V6-2S10-900	VNXe 3200 900GB 10K SAS 25X2.5	UE	\$0
V6-2S10-900U	VNXe 3200 900GB 10K SAS 25X2.5 U/G	UE	\$1,060
V6-2S15-300	VNXe 3200 300GB 15K SAS 25X2.5	UE	\$0
V6-2S15-300U	VNXe 3200 300GB 15K SAS 25X2.5 U/G	UE	\$1,145
V6-2S15-600	VNXe3200 600GB 15K SAS 25X2.5	UE	\$0
V6-2S15-600TU	VNXe3200 600GB 15K SAS 25X2.5 TAA UPG	UE	\$1,175
V6-2S15-600U	VNXe3200 600GB 15K SAS 25X2.5 UPG	UE	\$1,175
V6-2S6F-100	VNXe 3200 100GB EFD 25X2.5	UE	\$0
V6-2S6F-100U	VNXe 3200 100GB EFD 25X2.5 U/G	UE	\$2,475
V6-2S6F-200	VNXe 3200 200GB EFD 25X2.5	UE	\$0
V6-2S6F-200U	VNXe 3200 200GB EFD 25X2.5 U/G	UE	\$3,920
V6-2S6FX-100	VNXe 3200 100GB FAST VP EFD 25X2.5	UE	\$0
V6-2S6FX-100U	VNXe 3200 100GB FAST VP EFD 25X2.5 U/G	UE	\$0
V6-2S6FX-1600	VNXe 3200 1600GB FAST VP EFD 25X2.5	UE	\$6,780
V6-2S6FX1600TU	VNXe 3200 1600GB FAST VP EFD 25X2.5 U/G	UE	\$8,130
V6-2S6FX1600U	VNXe 3200 1600GB FAST VP EFD 25X2.5 U/G	UE	\$8,130
V6-2S6FX-200	VNXe 3200 200GB FAST VP EFD 25X2.5	UE	\$0
V6-2S6FX-200-10	Flash Power Pack VNXe 200GB 10X2.5	UE	\$16,100
V6-2S6FX-200-19	Flash Power Pack VNXe 200GB 19X2.5	UE	\$30,590
V6-2S6FX-200-25	Flash Power Pack VNXe 200GB 25X2.5	UE	\$40,250
V6-2S6FX-200-50	Flash Power Pack VNXe 200GB 50X2.5	UE	\$75,725
V6-2S6FX-200TU-50	Flash Power Pack VNXe 200GB 50X2.5 UPG	UE	\$90,870
V6-2S6FX-200U	VNXe 3200 200GB FAST VP EFD 25X2.5 U/G	UE	\$1,935
V6-2S6FX-200U-10	Flash Power Pack VNXe 200GB 10X2.5 UPG	UE	\$19,350
V6-2S6FX-200U-19	Flash Power Pack VNXe 200GB 19X2.5 UPG	UE	\$36,765
V6-2S6FX-200U-25	Flash Power Pack VNXe 200GB 25X2.5 UPG	UE	\$48,375
V6-2S6FX-200U-50	Flash Power Pack VNXe 200GB 50X2.5 UPG	UE	\$90,870
V6-2S6FX-800	VNXe 3200 800GB FASTVP EFD 25X2.5	UE	\$0
V6-2S6FX-800-10	Flash Power Pack VNXe 800GB 10X2.5	UE	\$57,650
V6-2S6FX-800-19	Flash Power Pack VNXe 800GB 19X2.5	UE	\$109,535
V6-2S6FX-800-25	Flash Power Pack VNXe 800GB 25X2.5	UE	\$144,125
V6-2S6FX-800-50	Flash Power Pack VNXe 800GB 50X2.5	UE	\$278,050
V6-2S6FX-800TU	VNXe 3200 800GB FASTVP EFD 25X2.5 UG	UE	\$4,985
V6-2S6FX-800TU-50	Flash Power Pack VNXe 800GB 50X2.5 UPG	UE	\$333,645
V6-2S6FX-800U	VNXe 3200 800GB FASTVP EFD 25X2.5 UG	UE	\$4,985
V6-2S6FX-800U-10	Flash Power Pack VNXe 800GB 10X2.5 UPG	UE	\$69,250
V6-2S6FX-800U-19	Flash Power Pack VNXe 800GB 19X2.5 UPG	UE	\$131,575
V6-2S6FX-800U-25	Flash Power Pack VNXe 800GB 25X2.5 UPG	UE	\$173,125
V6-2S6FX-800U-50	Flash Power Pack VNXe 800GB 50X2.5 UPG	UE	\$333,645
V6-PS07-020	VNXe 3200 2TB NL SAS 12X3.5	UE	\$0
V6-PS07-020U	VNXe 3200 2TB NL SAS 12X3.5 U/G	UE	\$890
V6-PS07-040	VNXe 3200 4TB NL SAS 12X3.5	UE	\$0
V6-PS07-040U	VNXe 3200 4TB NL SAS 12X3.5 U/G	UE	\$1,225
V6-PS10-012	VNXe 3200 1.2TB 10K SAS 12X3.5	UE	\$0
V6-PS10-012TU	VNXe 3200 1.2TB 10K SAS 12X3.5 U/G	UE	\$0
V6-PS10-012U	VNXe 3200 1.2TB 10K SAS 12X3.5 U/G	UE	\$0

V6-PS10-600	VNXe 3200 600GB 10K SAS 12X3.5	UE	\$0
V6-PS10-600U	VNXe 3200 600GB 10K SAS 12X3.5 U/G	UE	\$0
V6-PS10-900	VNXe 3200 900GB 10K SAS 12X3.5	UE	\$0
V6-PS10-900U	VNXe 3200 900GB 10K SAS 12X3.5 U/G	UE	\$1,050
V6-PS15-300	VNXe 3200 300GB 15K SAS 12X3.5	UE	\$0
V6-PS15-300U	VNXe 3200 300GB 15K SAS 12X3.5 U/G	UE	\$0
V6-PS15-600	VNXe 3200 600GB 15K SAS 12X3.5	UE	\$0
V6-PS15-600U	VNXe 3200 600GB 15K SAS 12X3.5 U/G	UE	\$1,315
V6-PS6F-100	VNXe 3200 100GB EFD 12X3.5	UE	\$0
V6-PS6F-100U	VNXe 3200 100GB EFD 12X3.5 U/G	UE	\$2,475
V6-PS6F-200	VNXe 3200 200GB EFD 12X3.5	UE	\$0
V6-PS6F-200U	VNXe 3200 200GB EFD 12X3.5 U/G	UE	\$3,920
V6-PS6FX-100	VNXe 3200 100GB FAST VP EFD 12X3.5	UE	\$0
V6-PS6FX-100U	VNXe 3200 100GB FAST VP EFD 12X3.5 U/G	UE	\$0
V6-PS6FX-200	VNXe 3200 200GB FAST VP EFD 12X3.5	UE	\$0
V6-PS6FX-200-10	Flash Power Pack VNXe 200GB 10X3.5	UE	\$16,100
V6-PS6FX-200-19	Flash Power Pack VNXe 200GB 19X3.5	UE	\$30,590
V6-PS6FX-200-25	Flash Power Pack VNXe 200GB 25X3.5	UE	\$40,250
V6-PS6FX-200-50	Flash Power Pack VNXe 200GB 50X3.5	UE	\$75,725
V6-PS6FX-200TU	VNXe 3200 200GB FAST VP EFD 12X3.5 U/G	UE	\$0
V6-PS6FX-200TU-50	Flash Power Pack VNXe 200GB 50X3.5 UPG	UE	\$90,870
V6-PS6FX-200U	VNXe 3200 200GB FAST VP EFD 12X3.5 U/G	UE	\$0
V6-PS6FX-200U-10	Flash Power Pack VNXe 200GB 10X3.5 UPG	UE	\$19,350
V6-PS6FX-200U-19	Flash Power Pack VNXe 200GB 19X3.5 UPG	UE	\$36,765
V6-PS6FX-200U-25	Flash Power Pack VNXe 200GB 25X3.5 UPG	UE	\$48,375
V6-PS6FX-200U-50	Flash Power Pack VNXe 200GB 50X3.5 UPG	UE	\$90,870
V6-PS6FX-800	VNXe 3200 800GB FASTVP EFD 12X3.5	UE	\$0
V6-PS6FX-800-10	Flash Power Pack VNXe 800GB 10X3.5	UE	\$57,650
V6-PS6FX-800-19	Flash Power Pack VNXe 800GB 19X3.5	UE	\$109,535
V6-PS6FX-800-25	Flash Power Pack VNXe 800GB 25X3.5	UE	\$144,125
V6-PS6FX-800-50	Flash Power Pack VNXe 800GB 50X3.5	UE	\$278,050
V6-PS6FX-800TU	VNXe 3200 800GB FASTVP EFD 12X3.5 U/G	UE	\$0
V6-PS6FX-800TU-50	Flash Power Pack VNXe 800GB 50X3.5 UPG	UE	\$333,645
V6-PS6FX-800U	VNXe 3200 800GB FASTVP EFD 12X3.5 U/G	UE	\$0
V6-PS6FX-800U-10	Flash Power Pack VNXe 800GB 10X3.5 UPG	UE	\$69,250
V6-PS6FX-800U-19	Flash Power Pack VNXe 800GB 19X3.5 UPG	UE	\$131,575
V6-PS6FX-800U-25	Flash Power Pack VNXe 800GB 25X3.5 UPG	UE	\$173,125
V6-PS6FX-800U-50	Flash Power Pack VNXe 800GB 50X3.5 UPG	UE	\$333,645
VDMM1GCUAS	1GBE DM MODULE 4 PORT FOR VNX5300	UE	\$0
VDMM1GCUOPAS	1GBE DM MODULE 2 CU 2 OP PORTS - VNX5300	UE	\$0
VDMM1GCUOPUS	10GBE DM MODULE 2 CU - 2 OP PORTS-UPG	UE	\$1,960
VDMM1GCUUS	1GBE DM MODULE 4 PORT-UPGRADE	UE	\$1,400
VDMMXG20PAS	10GBE 2 OP MODULE (2 SFP+) - VNX5300	UE	\$0
VDMMXG20PAS	10GBE DM MOD 2 OP PRTS (INCL 2 SFP) FACT	UE	\$0
VDMMXG20PBAS	VNX5300 2-PORT 10GBE OPT DM MODULE-FCTF	UE	\$0
VDMMXG20PBUS	VNX5300 2-PORT 10GBE OPT DM MODULE-UPG	UE	\$4,200
VDMMXG20PUS	10GBE DM MOD 2 OP PRTS (INCL 2 SFP+)UPG	UE	\$4,200
VDMMXG2Twas	10GBE 2 OP MODULE (TWINAX) FOR VNX5300	UE	\$0
VDMMXG2TWBAS	VNX5300 2PT 10GBE TWINAX DM MODULE-FCTF	UE	\$0
VDMMXG2TWBUS	VNX5300 2PORT 10GBE TWINAX DM MODULE-U	UE	\$2,800

VDMMXG2TWUS	10GBE 2 OP MODULE (FOR TWINAX)-UPGRADE	UE	\$2,800
VDMMXGTAS	VNX5300 10GBASE-T DM MODULE 2 PORT	UE	\$0
VDMMXGTUS	10GBASET DM MODULE 2 CU PORTS-UPGRADE	UE	\$3,640
VJ-DS07-030	3TB NL SAS DRV 512 BPS; 3.5X60 DRV DAE	UE	\$1,175
VJ-VS07-020	2TB NL SAS DRIVE 7.2RPM, 3.5 IN, 512	UE	\$735
VJ-VS07-030	3TB NLSAS DRV 512 BPS;3.5 IN X15 DPE/DAE	UE	\$1,175
VNX16K-10GSFPCRUI	10Gb SFP qty 1 for iSCSI connection	UE	\$630
VNX16K-10OPTSFP	4 port 10GbE Optical IO module	UE	\$0
VNX16K-10OPTTWN	4 port 10GbE TwinAx IO module	UE	\$0
VNX16K-16GSFPCRUI	16Gb SFP qty 1 for FC connection	UE	\$1,200
VNX16K-1GB-IO	4 port 1GbE IO Module	UE	\$0
VNX16K-5TELRAIL	Telco Rail Kit for 2U DPE or DAE	UE	\$150
VNX16K-800W-PS	800W Power Supply, 12V and 12V STBY DPE	UE	\$500
VNX16K-8GFC	4 Port 8GB Fibre Channel IO Module	UE	\$0
VNX16K-8GSFPCRUI	8Gb SFP qty 1 for FC connection	UE	\$0
VNX16K-B12	VNXe1600 ;2xSP DPE;12x3.5, no SFP, Twin	UE	\$0
VNX16K-B12D	VNXe1600DC;2xSPDPE;12x3.5,noSFP;TWAXEnet	UE	\$0
VNX16K-B25	VNXe1600 ;2xSP DPE;25x2.5, no SFP, Twin	UE	\$0
VNX16K-B25D	VNXe1600DC;2xSPDPE;25x2.5;noSFP;TWAXEnet	UE	\$0
VNX16K-BBU	BATTERY BACKUP UNIT	UE	\$200
VNX16K-BC-12ARK	DPE 12 Drive Adjustable Rail Kit	UE	\$240
VNX16K-BC-25ARK	DPE 25 Drive Adjustable Rail Kit	UE	\$240
VNX16K-BC-FM	Fan Module BC	UE	\$300
VNX16K-DAE-12	2U DAE WITH 12 x 3.5 INCH DRIVE SLOTS	UE	\$0
VNX16K-DAE-12U	2U DAE w/12x3.5 INCH DRIVE SLOTS;UPGRADE	UE	\$2,550
VNX16K-DAE-25	2U DAE WITH 25 x 2.5 INCH DRIVE SLOTS	UE	\$0
VNX16K-DAE-25U	2U DAE w/25x2.5 INCH DRIVE SLOTS;UPGRADE	UE	\$2,550
VNX16KD-DAE-25	2U DAE DC w/ 25x2.5 INCH DRIVE SLOTS	UE	\$0
VNX16KD-DAE-25U	2U DAE DC w/ 25x2.5 INCH DRIVE SLOTS-UPG	UE	\$2,678
VNX16K-LCC-DAE12	LCC FOR 2U DAE 12 DRIVE	UE	\$1,775
VNX16K-LCC-DAE25	LCC FOR 2U DAE 25 DRIVE	UE	\$1,775
VNX16K-OM3100MS	100M MM FIBRE CABLE LC-LC	UE	\$270
VNX16K-OM3-10MS	10M MM FIBRE CABLE LC-LC	UE	\$125
VNX16K-OM3-1MS	1M MM FIBRE CABLE LC-LC	UE	\$140
VNX16K-OM3-30MS	30M MM FIBRE CABLE LC-LC	UE	\$180
VNX16K-OM3-3MS	3M MM FIBRE CABLE LC-LC	UE	\$115
VNX16K-OM3-50MS	50M MM FIBRE CABLE LC-LC	UE	\$125
VNX16K-OM3-5MS	5M MM FIBRE CABLE LC-LC	UE	\$145
VNX16K-PS-DAE12	Power Supply for 2U 12 DRIVE DAE	UE	\$485
VNX16K-PS-DAE25	Power Supply for 2U 25 DRIVE DAE	UE	\$485
VNX16K-PWR-0	2 C13 PWRCRD W/ SEV1011 PLUGS 250V 10A	UE	\$0
VNX16K-PWR-1	2 C13 PWRCRD W/ NBR 14136 PLUGS 250V 10A	UE	\$0
VNX16K-PWR-10	2 C13 PWRCRD W/ KSC8305 PLUGS 250V 10A	UE	\$0
VNX16K-PWR-11	2 C13 PWRCRD w/ CNS690 PLUGS 125V 10A	UE	\$0
VNX16K-PWR-12	2 C13 PWRCRD W/ NEMA 5-15 PLUGS 125V 10A	UE	\$0
VNX16K-PWR-13	2 C13 PWRCRD W/ BS546 PLUGS 250V 10A	UE	\$0
VNX16K-PWR-14	2 C13 PWRCRD W/ SI-32 PLUGS 250V 10A	UE	\$0
VNX16K-PWR-15	2 C13 PWRCRD with IN6SA3 plugs 250V 10A	UE	\$0
VNX16K-PWR-2	2 C13 PWRCRD W/ JISC 8303 PLUGS 125V 10A	UE	\$0
VNX16K-PWR-3	2 C13 PWRCRD W/ GB1002 PLUGS 250V 10A	UE	\$0

VNX16K-PWR-4	2 C13 PWRCRD W/ IRAM 2073 PLUGS 250V 10A	UE	\$0
VNX16K-PWR-5	2 C13 PWRCRD W/ BSI 1363 PLUGS 250V 10A	UE	\$0
VNX16K-PWR-6	2 C13 PWRCRD w/ SAA/3 PLUGS 250V 10A	UE	\$0
VNX16K-PWR-7	2 C13 PWRCRD W/ CEE7/7 PLUGS 250V 10A	UE	\$0
VNX16K-PWR-8	2 C13 PWRCRD W/ CEI 23-16 PLUGS 250V 10A	UE	\$0
VNX16K-PWR-9	2 C13PWRCRD W/AFSNIT 107-2-D1PLG 250V10A	UE	\$0
VNX16K-SP	VNXe1600 STORAGE PROCESSOR NO DIMM	UE	\$7,015
VNX16K-SP-DIMM	VNXe1600 SP MEMORY 8GB DIMM	UE	\$305
VNX16K-SSD	STORAGE PROCESSOR SSD MSATA	UE	\$1,024
VNX16K-UNI	Bundled FAST Cache AND Replication=IC	UE	\$0
VNX1SPSISOKIT	1.2KW SPS; MUSTANG&SPITFIRE; ISO INST KT	UE	\$0
VNX-1U-BLANKS	1U FILLER PANEL FOR VNX RACK	UE	\$20
VNX2SPSISOKIT	2KW SPS; MUSTANG&SPITFIRE; ISO INST KIT	UE	\$0
VNX-2U-BLANKS	2U FILLER PANEL FOR VNX RACK	UE	\$24
VNX-3U-BLANKS	3U FILLER PANEL FOR VNX RACK	UE	\$28
VNX5100DP15	VNX5100 DPE; 15X3.5 DRIVES - EMC RACK	UE	\$0
VNX5100DP15D	VNX5100 DPE; 15X3.5 DRIVES - DC	UE	\$0
VNX5100DP15F	VNX5100 DPE; 15X3.5 DRIVES - FIELD INST	UE	\$0
VNX5100DP25	VNX5100 DPE; 25X2.5 DRIVES - EMC RACK	UE	\$0
VNX5100DP25D	VNX5100 DPE; 25X2.5 DRIVES - DC	UE	\$0
VNX5100DP25F	VNX5100 DPE; 25X2.5 DRIVES - FIELD INST	UE	\$0
VNX51153010FN	VNX5100 DPE; 15X3.5-FLD IN 6X300G 10K N	UE	\$0
VNX51153015FN	VNX5100 DPE 15X3.5 - FLD IN 6X300G 15K N	UE	\$0
VNX51156010FN	VNX5100 DPE; 15X3.5- FLD IN 6X600G 10K N	UE	\$0
VNX51156015FN	VNX5100 DPE 15X3.5 - FLD IN 6X600G 15K N	UE	\$0
VNX51253010F	VNX5100 DPE; 25X2.5 DRV-FLD IN 6X300G	UE	\$0
VNX51253010FN	VNX5100 DPE; 25X2.5 DRV- FLD IN 6X300G N	UE	\$0
VNX51256010FN	VNX5100 DPE 25X2.5 - FLD IN 6X600G 10K N	UE	\$0
VNX51259010FN	VNX5100 DPE 25X2.5" DRV-F I 6x900G 10K	UE	\$0
VNX51-53B	CONVERT VNX5100 DPE TO VNX5300 DPE	UE	\$10,500
VNX5153ISOKIT	SENTRY 15 BLOCK; VNX; ISO KIT	UE	\$0
VNX51D151T72	VNX5100 DPE; 15X3.5 DIV-EMC RCK 6X1TB	UE	\$0
VNX51D151T72F	VNX5100 DPE; 15X3.5 DRV-FLD IN 6X1T	UE	\$0
VNX51D152T72	VNX5100 DPE; FC 15X3.5 DRV-EMC RK 6X2T	UE	\$0
VNX51D152T72F	VNX5100 DPE; FC; 15X3.5 DRV FD IN 6X2T	UE	\$0
VNX51D152TDC	VNX5100 DPE 15X3.5IN DRV 8X2TB 7.2K DC	UE	\$0
VNX51D153010	VNX5100 DPE; 15X3.5 DRV-EMC RCK 6X300G	UE	\$0
VNX51D153010D	VNX5100 DPE 15X3.5 DRIVES - DC 6 X 300G	UE	\$0
VNX51D153010F	VNX 5100 DPE; 15X3.5 DRV-FLD IN 6X300G	UE	\$0
VNX51D153010N	VNX5100 DPE; 15X3.5 - E R 6X300G 10K N	UE	\$0
VNX51D153015	VNX5100 DPE; 15X3.5 DRV-EMC RCK 6X300G	UE	\$0
VNX51D153015D	VNX5100 DPE; 15X3.5 DRV-DC 6X300G 15K	UE	\$0
VNX51D153015F	VNX5100 DPE; 15X3.5 DRV-FLD INST 6X300	UE	\$0
VNX51D153015N	VNX5100 DPE; 15X3.5 - E R 6X300G 15K N	UE	\$0
VNX51D153T72	VNX5100 DPE, 15X3.5IN 6 X 3TB EMC RACK	UE	\$0
VNX51D153T72F	VNX5100 DPE; 15X3.5 - 6X3TB DRIV - FLD	UE	\$0
VNX51D153TDC	VNX5100 DPE 15X3.5IN DRV 8X3TB 7.2K DC	UE	\$0
VNX51D154T72	VNX5100 DPE, 15X3.5IN 6 X 4TB EMC RACK	UE	\$0
VNX51D154T72F	VNX5100 DPE; 15X3.5 - 6X4TB DRIV - FLD	UE	\$0
VNX51D154TDC	VNX5100 DPE 15X3.5IN DRV 8X4TB 7.2K DC	UE	\$0

VNX51D156010	VNX5100 DPE; 15X3.5 DRV-EMC RCK 6X600G	UE	\$0
VNX51D156010D	VNX5100 DPE 15X3.5IN DRV 6X600 10K DC	UE	\$0
VNX51D156010F	VNX5100 DPE 15X3.5 DRV FLD IN 6X600 10K	UE	\$0
VNX51D156010N	VNX5100 DPE; 15X3.5 - E R 6X600G 10K N	UE	\$0
VNX51D156015	VNX5100 DPE; 15X3.5 DRV EMC RCK 6X600G	UE	\$0
VNX51D156015D	VNX5100 DPE; 15X3.5 DRV-DC 6X600G 15K	UE	\$0
VNX51D156015F	VNX5100 DPE; 15X3.5 DRV-FLD INST 6X600	UE	\$0
VNX51D156015N	VNX5100 DPE; 15X3.5 EMC RCK 6X600G 15K N	UE	\$0
VNX51D159010	VNX5100 DPE 15X3.5 6X900 10K EMC RACK	UE	\$0
VNX51D159010D	VNX5100 DPE 15X3.5" DC Power 6x900G 10K	UE	\$0
VNX51D159010F	VNX5100 DPE 15 X 3.5 DRV 6 X 900 10K FLD	UE	\$0
VNX51D159010FN	VNX5100 DPE 15X3.5" DRV-F I 6x900G 10K	UE	\$0
VNX51D159010N	VNX5100 DPE 15X3.5" DRV-E R 6x900G 10K	UE	\$0
VNX51D253010	VNX5100 DPE; 25X2.5 DRV-EMC RCK 6X300G	UE	\$0
VNX51D253010D	VNX5100 DPE 25X2.5 DRV 6 X 300 10K DC	UE	\$0
VNX51D253010F	VNX5100 DPE; 25X2.5 DRV-FLD IN 6X300G	UE	\$0
VNX51D253010N	VNX5100 DPE; 25X2.5 DRV EMC RCK 6X300G N	UE	\$0
VNX51D256010	VNX5100 DPE; 25X2.5 DRV EMCRK 6X600G 10K	UE	\$0
VNX51D256010D	VNX5100 DPE; 25X2.5 DRV-DC 6X600GB 10K	UE	\$0
VNX51D256010F	VNX5100 DPE; 25X2.5 DRV-FLD IN 6X600 10K	UE	\$0
VNX51D256010N	VNX5100 DPE; 25X2.5 EMC RCK 6X600G 10K N	UE	\$0
VNX51D259010	VNX5100 DPE 25X 2.5 DRV 6X900 10KEMC RCK	UE	\$0
VNX51D259010D	VNX 5100 DPE FC, 25X2.5 DC 6x900G 10K	UE	\$0
VNX51D259010F	VNX5100 DPE 25X 2.5 DRV 6 X 900 10K FLD	UE	\$0
VNX51D259010N	VNX5100 DPE 25X2.5" DRV-E R 6x900G 10K	UE	\$0
VNX51-KIT	DOCUMENTATION KIT FOR VNX5100	UE	\$0
VNX5300CS	VNX5300 CONTROL STATION - EMC RACK	UE	\$0
VNX5300CS2	VNX5300 2ND CONTROL STATION-EMC RACK	UE	\$0
VNX5300CS2M	VNX5300 2ND CONTROL STATION - Mini RACK	UE	\$0
VNX5300CS2U	VNX5300 2ND CONTROL STATION FOR FLD UPG	UE	\$1,833
VNX5300CSD2A	2ND OPTIONALINVRTR FOR VNX 5300 FACTORY	UE	\$1,440
VNX5300CSD2AU	2ND OPTIONALINVRTR FOR VNX 5300 FIELD	UE	\$2,016
VNX5300CSU	VNX5300 CONTROL STATION FOR FIELD UPG	UE	\$0
VNX5300DM	VNX5300 ADD ON DM+FC SLIC-EMC RACK	UE	\$0
VNX5300DMDU	VNX5300 ADDON DATA MOVER+FC SLIC-UPGRA	UE	\$2,226
VNX5300DMEMD	VNX5300 DME SINGLE DM FC SLIC MR DC	UE	\$0
VNX5300DMEU	VNX5300 DME: 1 DATA MOVER+FC SLIC-UPG	UE	\$0
VNX5300DMM	VNX5300 ADD ON DM+FC SLIC-MINI RCK	UE	\$0
VNX5300DMMD	VNX5300 SINGLE DM FC SLIC MINI RACK DC	UE	\$1,649
VNX5300DMU	VNX5300 ADD ON DATA MOVER+FC IO-UPGRAD	UE	\$2,024
VNX5300DP15	VNX5300 DPE; 15X3.5 DRIVE SLOTS-EMC RACK	UE	\$0
VNX5300DP15D	VNX5300 DPE; 15X3.5 DRIVE SLOTS-DC	UE	\$0
VNX5300DP15F	VNX5300 DPE; 15X3.5 DRIVE SLOTS-FLD	UE	\$0
VNX5300DP15M	VNX5300 DPE; 15X3.5 DRIVE SLOTS-MINIRACK	UE	\$0
VNX5300DP25	VNX5300 DPE; 25X2.5 DRIVE SLOTS-EMC RACK	UE	\$0
VNX5300DP25D	VNX5300 DPE; 25X2.5 DRIVES - DC	UE	\$0
VNX5300DP25F	VNX5300 DPE; 25X2.5 DRIVE SLOTS-FLD	UE	\$0
VNX5300DP25M	VNX5300 DPE; 25X2.5 DRIVE SLOTS-MINIRACK	UE	\$0
VNX53BTU-KIT	BLOCK TO UNIFIED UPG KIT FOR VNX5300	UE	\$4,988
VNX53D151T72	VNX5300 DPE; 15X3.5 DRV-EMC RCK 6X1T	UE	\$0

VNX53D151T72F	VNX5300 DPE; 15X3.5 DRV-FLD IN 6X1T	UE	\$0
VNX53D151T72M	VNX5300 DPE; 15X3.5 DRV-MIN RCK 6X1T	UE	\$0
VNX53D152T72	VNX5300 DPE; 15X3.5 DRV-EMC RCK 6X2TB	UE	\$0
VNX53D152T72F	VNX5300 DPE; 15X3.5 DRV-FLD INST 6 X 2T	UE	\$0
VNX53D152T72M	VNX5300 DPE; 15X3.5 DRVS - 6X2TB 7200	UE	\$0
VNX53D152TDC	VNX5300 DPE 15X3.5IN DRV 8X2TB 7.2K DC	UE	\$0
VNX53D153010	VNX5300 DPE; 15X3.5 DRV; ER 8X300G 10K	UE	\$0
VNX53D153010D	VNX5300 DPE; 15X3.5 DRV-DC 8X300G 10K	UE	\$0
VNX53D153010F	VNX5300 DPE; 15X3.5 DRV-FLD IN 8X300 10K	UE	\$0
VNX53D153010M	VNX5300 DPE; 15X3.5 DRIVES - 8X300G 10K	UE	\$0
VNX53D153015	VNX5300 DPE 15X3.5 DRV EMC RCK 8X300G	UE	\$0
VNX53D153015D	VNX5300 DPE 15 x3.5 DC 8 x300GB 15K	UE	\$0
VNX53D153015F	VNX5300 DPE; 15X3.5 DRIVES-FLD IN 8X300	UE	\$0
VNX53D153015M	VNX5300 DPE; 15X3.5 DRV-MIN RCK 8X300G	UE	\$0
VNX53D15301MD	VNX5300DPE;15X3.5DRV-MR8X300GB 10KDC	UE	\$0
VNX53D15305MD	VNX5300DPE;FC;15X3.5DRV-MR8X300GB 15KDC	UE	\$0
VNX53D153T72	VNX5300 DPE; 15X3.5; 6X3TB DRV EMC RACK	UE	\$0
VNX53D153T72F	VNX5300 DPE;15X3.5 6X3TB DRV - FIELD INS	UE	\$0
VNX53D153T72M	VNX5300 DPE 15X3.5 3TBX6 DRV- MINI RACK	UE	\$0
VNX53D153TDC	VNX5300 DPE 15X3.5IN DRV 8X3TB 7.2K DC	UE	\$0
VNX53D154T72	VNX5300 DPE; 15X3.5; 6X4TB DRV EMC RACK	UE	\$0
VNX53D154T72F	VNX5300 DPE;15X3.5 6X4TB DRV - FIELD INS	UE	\$0
VNX53D154T72M	VNX5300 DPE 15X3.5 4TBX6 DRV- MINI RACK	UE	\$0
VNX53D154TDC	VNX5300 DPE 15X3.5IN DRV 8X4TB 7.2K DC	UE	\$0
VNX53D156010	VNX5300 DPE; 15X3.5 DRV-ER 8X600G 10K	UE	\$0
VNX53D156010D	VNX5300 DPE; 15X3.5 DRV-DC 8X600GB 10K	UE	\$0
VNX53D156010F	VNX5300 DPE; 15X3.5 DRV-FLD IN 8X600 10K	UE	\$0
VNX53D156010M	VNX5300 DPE;15X3.5 DRIVES - 8X600G 10K	UE	\$0
VNX53D156015	VNX5300 DPE; 15X3.5 DRV E R 8X600G 15K	UE	\$0
VNX53D156015D	VNX5300 DPE; 15X3.5 DRV-DC 8X600G 15K	UE	\$0
VNX53D156015F	VNX5300 DPE; 15X3.5 DRV FD IN 8X600 15K	UE	\$0
VNX53D156015M	VNX5300 DPE, 15X3.5 DRIVES - 8X600G, 15K	UE	\$0
VNX53D15601MD	VNX5300 DPE;15X3.5 DRV-MR 8X600GB 10K DC	UE	\$0
VNX53D15605MD	VNX5300DPE;15X3.5DRV-MR8X600GB 15KDC	UE	\$0
VNX53D159010	VNX5300 DPE; 15X 3.5 DRV 8 X 900 10K EMC	UE	\$0
VNX53D159010D	VNX 5300DPE FC 15X3.5" DRV-DC 8x900G 10K	UE	\$0
VNX53D159010F	VNX5300 DPE 15 X 3.5 DRV 8 X 900 10K FLD	UE	\$0
VNX53D159010M	VNX5300 DPE 15 X 3.5 DRV 8 900 10K MR	UE	\$0
VNX53D253010	VNX5300 DPE; 25X2.5 DRV-E R 8X300G 10K	UE	\$0
VNX53D253010D	VNX5300 DPE; 25X2.5 DRV-DC 8 X 300G 10K	UE	\$0
VNX53D253010F	VNX5300 DPE; 25X2.5 DRV-FLD IN 8X300 10K	UE	\$0
VNX53D253010M	VNX5300 DPE; 25X2.5 DRIVE - 8X300G 10K	UE	\$0
VNX53D25301MD	VNX5300DPE;25X2.5 DRV-MR8X300GB 10KDC	UE	\$0
VNX53D256010	VNX5300 DPE; 25X2.5 DRV-E R 8X600G 10K	UE	\$0
VNX53D256010D	VNX5300 DPE; 25X2.5 DRV-DC 8X600GB 10K	UE	\$0
VNX53D256010F	VNX5300 DPE; 25X2.5 DRV-FD IN 8X600 10K	UE	\$0
VNX53D256010M	VNX5300 DPE; 25X2.5 DRIVE - 8X600G 10K	UE	\$0
VNX53D25601MD	VNX5300DPE;FC;25X2.5 DRV-MR8X600GB 10KDC	UE	\$0
VNX53D259010	VNX5300 DPE 25X2.5 DRV-8X900 10K EMC RCK	UE	\$0
VNX53D259010D	VNX 5300DPE FC 25X2.5" DRV-DC 8x900G 10K	UE	\$0

VNX53D259010F	VNX5300DPE 25 x 2.5 DRV 8 x 900 FLD INS	UE	\$0
VNX53D259010M	VNX5300 DPE 25X 2.5 DRV 8 X 900 10K MR	UE	\$0
VNX53D25901MD	VNX5300 DPE FC 25X2.5DR MR 8X900GB10K DC	UE	\$0
VNX53FTU-KIT	FILE TO UNIFIED UPG KIT FOR VNX5300	UE	\$6,413
VNX53-KIT	DOCUMENTATION KIT FOR VNX5300	UE	\$0
VNX53N153010	VNX5300 DPE; 15X3.5 DRV-EMC RCK 8X300G N	UE	\$0
VNX53N153010F	VNX5300 DPE; 15X3.5 DRV-FLD IN 8X300 N	UE	\$0
VNX53N153010M	VNX5300 DPE; 15X3.5 DRV-8X300G 10K N	UE	\$0
VNX53N153015	VNX5300 DPE; 15X3.5 DRV-E R 8X300G 15K N	UE	\$0
VNX53N153015F	VNX5300 DPE; 15X3.5 DRV-FLD IN 8X300 N	UE	\$0
VNX53N153015M	VNX5300 DPE; 15X3.5 DRV-8X300G 15K NEBS	UE	\$0
VNX53N156010	VNX5300 DPE; 15X3.5 DRV E R 8X600G 10K N	UE	\$0
VNX53N156010F	VNX5300 DPE; 15X3.5 DRV F I 8X600 10K N	UE	\$0
VNX53N156010M	VNX5300 DPE; 15X3.5 DRV-8X600G 10K N	UE	\$0
VNX53N156015	VNX5300 DPE; 15X3.5 DRV E R 8X600 15K N	UE	\$0
VNX53N156015F	VNX5300 DPE;15X3.5 DRV-FLD IN 8X600 N	UE	\$0
VNX53N156015M	VNX5300 DPE; 15X3.5 DRV-8X600G 15K NEBS	UE	\$0
VNX53N159010	VNX5300 DPE 15X3.5" DRV-E R 8x900G 10K	UE	\$0
VNX53N159010F	VNX5300 DPE 15X3.5" DRV-F I 8x900G 10K	UE	\$0
VNX53N159010M	VNX5300 DPE 15X3.5" DRV-M R 8x900G 10K	UE	\$0
VNX53N253010	VNX5300 DPE; 25X2.5 DRV-EMC RCK 8X300G N	UE	\$0
VNX53N253010F	VNX5300 DPE; 25X2.5 DRV-FLD IN 8X300 N	UE	\$0
VNX53N253010M	VNX5300 DPE; 25X2.5 DRV-8X300G 10K N	UE	\$0
VNX53N256010	VNX5300 DPE; 25X2.5 DRV-EMC RCK 8X600G N	UE	\$0
VNX53N256010F	VNX5300 DPE; 25X2.5 DRV-FLD INST 8X600 N	UE	\$0
VNX53N256010M	VNX5300 DPE; 25X2.5 DRV-8X600G 10K NEBS	UE	\$0
VNX53N259010	VNX5300 DPE 25X2.5" DRV-E R 8x900G 10K	UE	\$0
VNX53N259010F	VNX5300 DPE 25X2.5" DRV-F I 8x900G 10K	UE	\$0
VNX53N259010M	VNX5300 DPE 25X2.5" DRV-M R 8x900G 10K	UE	\$0
VNXC51D151T72F	VNX5100 DPE;15X3.5"" DS;4X1TB 7200K;FLD	UE	\$0
VNXC51D152T72F	VNX5100 DPE;15X3.5"" DS;4X2TB 7200K;FLD	UE	\$0
VNXC51D153T72F	VNX5100 DPE;15X3.5"" DS;4X3TB 7200K;FLD	UE	\$0
VNXC51D154T72F	VNX5100 DPE;15X3.5"" DS;4X4TB 7200K;FLD	UE	\$0
VNXC51D156010F	VNX5100 DPE;15X3.5" DS;4x600GB 10K;FLD	UE	\$0
VNXC51D156015F	VNX5100 DPE;15X3.5"" DS;4x600GB 15K;FLD	UE	\$0
VNXC51D159010F	VNX5100 DPE;15X3.5" DS;4x900GB 10K;FLD	UE	\$0
VNXC51D256010F	VNX5100 DPE;25X2.5"" DS;4X600GB 10K;FLD	UE	\$0
VNXC51D259010F	VNX5100 DPE;25X2.5" DS;4X900GB 10K;FLD	UE	\$0
VNX-CS-ADJS	ADJUSTABLE RAIL KIT FOR 1U CS	UE	\$136
VNX-DAE15ADJS	ADJUSTABLE RAIL KIT FOR 3U 15 DRIVE DAE	UE	\$60
VNX-DAE25ADJS	ADJUSTABLE RAIL KIT FOR 2U 25 DRIVE DAE	UE	\$60
VNX-DAE2UADJS	ADJUSTABLE RAIL KIT FOR THE 2U DAE	UE	\$59
VNX-DMEADJS	ADJUSTABLE RAIL KIT FOR 2U DME	UE	\$60
VNX-DPE15ADJS	ADJUSTABLE RAIL KIT FOR 3U 15 DRIVE DPE	UE	\$120
VNX-DPE25ADJS	ADJUSTABLE RAIL KIT FOR 3U 25 DRIVE DPE	UE	\$120
VNXDPERESS	VNX5300 SPACE Res DME+CS IN EMC RACK	UE	\$0
VNXECAPTBU	VNXE OE PER TB HI CAP FOR VNXe3200	UE	\$0
VNXECAPTBU	VNXEOE PER TB CAP FOR VNXE3200 UPG=CB	UE	\$195
VNXE-LS-SN	VNXe LICENSE SOLUTION PSNT AS LAC	UE	\$0
VNXE-LS-UPG	VNXe LICENSE SOLUTION UPGRADE	UE	\$0

VNXEOM3100MS	100M MM FIBRE CABLE LC-LC	UE	\$270
VNXEOM3-10MS	10M MM FIBRE CABLE LC-LC	UE	\$140
VNXEOM3-1MS	1M MM FIBRE CABLE LC-LC	UE	\$115
VNXEOM3-30MS	30M MM FIBRE CABLE LC-LC	UE	\$145
VNXEOM3-3MS	3M MM FIBRE CABLE LC-LC	UE	\$125
VNXEOM3-50MS	50M MM FIBRE CABLE LC-LC	UE	\$180
VNXEOM3-5MS	5M MM FIBRE CABLE LC-LC	UE	\$125
VNXEPERFTB	VNXE OE PER TB PERFOR FOR VNXe3200	UE	\$0
VNXEPERFTBU	VNXEOE PER TB PERF FOR VNXE3200 UPG=CB	UE	\$428
VNXFCSFPS	ADDITIONAL 8 G FC SFP FOR VNX 51/53	UE	\$400
VNX-OM3-100MS	100M MM FIBRE CABLE LC-LC	UE	\$228
VNX-OM3-10MS	10M MM FIBRE CABLE LC-LC	UE	\$116
VNX-OM3-1MS	1M MM FIBRE CABLE LC-LC	UE	\$92
VNX-OM3-30MS	30M MM FIBRE CABLE LC-LC	UE	\$124
VNX-OM3-3MS	3M MM FIBRE CABLE LC-LC	UE	\$100
VNX-OM3-50MS	50M MM FIBRE CABLE LC-LC	UE	\$156
VNX-OM3-5MS	5M MM FIBRE CABLE LC-LC	UE	\$104
VNXRACK-40US	VNX 40U RACK WITH FRONT PANEL	UE	\$1,680
VNX-RPHW3-G5T	RPA GEN5-TAA FOR VNX L1	UE	\$0
VNX-RPHW3-G6T	RPA FOR VNX v51, v53	UE	\$19,250
VNX-SPS-ADJS	ADJUSTABLE RAIL KIT FOR 1U SPS	UE	\$120
VNXSPSAS	2ND OPTIONAL SPS FOR VNX 51/53	UE	\$492
VNXSPSASU	2ND OPT SPS FOR VNX5100/5300 FLD UPG	UE	\$664
VSPEX_CONSOLE	Front panel console for VSPEX rack	UE	\$350
VSPM1GI4CUAS	VNX5300 4 PT 1GBASE-T ISCSI IO MOD PR	UE	\$2,000
VSPM1GI4CUUS	VNX5300 4PT1GBASE-T ISCSI IO MOD PR-UPG	UE	\$2,800
VSPM6GS4AS	VNX5300 4 PT 6G SAS FE IO MODULE PAIR	UE	\$0
VSPM8GFFEAS	VNX5300 4 PORT 8G FC IO MODULE PAIR	UE	\$2,500
VSPM8GFFEUS	VNX5300 4 PORT 8G FC IO MODULE PAIR-UPG	UE	\$3,500
VSPMXGFCOOPAS	VNX5300 2 PT FCOE IO MOD PAIR-SFP	UE	\$1,920
VSPMXGFCOOPUS	VNX5300 2 PT FCOE IO MOD PAIR-SFP-UPG	UE	\$2,688
VSPMXGFCOTWAS	VNX5300 2 PT FCOE IO MOD PAIR-TWAX	UE	\$1,680
VSPMXGFCOTWUS	VNX5300 2 PT FCOE IO MOD PAIR-TWAX-UPG	UE	\$2,352
VSPMXGI2AS	VNX5300 2 PT OP 10G ISCSI IO MOD PR-SFP	UE	\$4,800
VSPMXGI2CUAC	VNX 5300 2 PT 10GBASE-T ISCSI IO MOD PR	UE	\$3,000
VSPMXGI2CUUC	VNX5300 2PT 10GBASE-T ISCSI IO MOD PR-UG	UE	\$4,200
VSPMXGI2TWAS	VNX5300 2 PT OP 10G ISCSI IO MOD PR-TWAX	UE	\$4,000
VSPMXGI2TWUS	VNX5300 2PT OP 10G ISCSI IO MOD PR-TWX-U	UE	\$5,600
VSPMXGI2US	VNX5300 2PT OP 10G ISCSI IO MOD PR-SFP-U	UE	\$6,720
VSS-15X4TB	VSS 4TB 7200K 15x3.5 DPE/DAE	UE	\$11,815
VSS16K-EMCKIT12	VSS1600 Install Kit for 12 Drive DPE	UE	\$0
VSS1-ERK	VSS1 DPE;15X3.5 DR;6X4TB 7200;EMC RK	UE	\$0
VSS1-FLD	VSS1 DPE;15X3.5 DR;6X4TB 7200;FLD INST	UE	\$0
VSS2-ERK	VSS2 DPE 15X3.5 DR 15X4TB 7200 EMC RK	UE	\$0
VSS2-FLD	VSS2 DPE 15X3.5 DR 15X4TB 7200 FLD INST	UE	\$0
VSS-4PT-1G	VSS 4 PT 1GBASE-T ISCSI IO MOD PR	UE	\$1,410
VSS-9X4TB	VSS 4TB 7200K 9x3.5 DPE/DAE	UE	\$7,090
VSS-DAE-15	VSS 15x3.5"" 6G SAS EXP DAE-EMC RACK	UE	\$1,664
VSS-DAE-15F	VSS 15x3.5"" 6G SAS EXP DAE-FLD INST	UE	\$1,664
VSS-KIT	Documentation Kit for VSS	UE	\$0

VSS-RACK-40	VSS 40U RACK WITH FRONT PANEL	UE	\$1,680
VSS-VS07-4TB	VSS 4TB NL SAS DRV-15x3.5 DRV DPE/DAE	UE	\$1,375
X210-SATA-003-P	PROMO X210-12T/24G/2x10GE 2x1GE	UE	\$14,120
X210-SATA-S03-P	PROMO X210-11T+200G SSD/24G/2x10GE 2x1GE	UE	\$14,120
450-001-521	ViPR SUITE VNX2 Tier 1=IC	UM	\$17,880
450-001-522	ViPR SUITE VNX2 Tier 2=IC	UM	\$27,100
450-001-523	ViPR SUITE VNX2 Tier 3=IC	UM	\$49,540
450-001-524	ViPR SUITE VNX2 Tier 4=IC	UM	\$93,270
450-001-525	ViPR SUITE VNX2 Tier 5=IC	UM	\$130,790
450-001-526	ViPR SUITE VNX2 Tier 6=IC	UM	\$202,730
456-104-626	RecoverPoint/SE LOC for VNX8000=IC	UM	\$0
456-104-627	RecoverPoint/SE REM for VNX8000=IC	UM	\$0
456-104-628	RP/SE TO RP/EX LOC UG V80=IC	UM	\$23,560
456-104-629	RP/SE TO RP/EX REM UG V80=IC	UM	\$101,310
456-104-851	CC / PROSPHERE MGMT PKG VNX 5200 =IC	UM	\$0
456-104-852	CC / PROSPHERE MGMT PKG VNX 5400 =IC	UM	\$0
456-104-853	CC / PROSPHERE MGMT PKG VNX 5600 =IC	UM	\$0
456-104-854	CC / PROSPHERE MGMT PKG VNX 5800 =IC	UM	\$0
456-104-855	CC / PROSPHERE MGMT PKG VNX 7600 =IC	UM	\$0
456-104-856	CC / PROSPHERE MGMT PKG VNX 8000 =IC	UM	\$0
456-104-874	AppSync: VNX8000 = IC	UM	\$0
456-104-938	RP/EX LOC FRAME BASED V52 FOR VPLEX =IC	UM	\$6,670
456-104-939	RP/EX LOC FRAME BASED V54 FOR VPLEX =IC	UM	\$11,880
456-104-940	RP/EX LOC FRAME BASED V56 FOR VPLEX =IC	UM	\$19,730
456-104-941	RP/EX LOC FRAME BASED V58 FOR VPLEX =IC	UM	\$27,120
456-104-942	RP/EX LOC FRAME BASED V76 FOR VPLEX =IC	UM	\$31,190
456-104-943	RP/EX LOC FRAME BASED V80 FOR VPLEX =IC	UM	\$47,120
456-104-944	RP/EX REM FRAME BASED V52 FOR VPLEX =IC	UM	\$17,190
456-104-945	RP/EX REM FRAME BASED V54 FOR VPLEX =IC	UM	\$30,630
456-104-946	RP/EX REM FRAME BASED V56 FOR VPLEX =IC	UM	\$44,050
456-104-947	RP/EX REM FRAME BASED V58 FOR VPLEX =IC	UM	\$67,800
456-104-948	RP/EX REM FRAME BASED V76 FOR VPLEX =IC	UM	\$134,100
456-104-949	RP/EX REM FRAME BASED V80 FOR VPLEX =IC	UM	\$202,610
456-104-951	RP/EX LOC for VNX-F5000 =IC	UM	\$0
456-104-952	RP/EX REM for VNX-F5000 =IC	UM	\$0
456-104-954	RP/EX LOC for VNX-F7000 =IC	UM	\$0
456-104-955	RP/EX REM for VNX-F7000 =IC	UM	\$0
456-104-958	RP4VM REM1 for VNX STARTER PACK =IB	UM	\$0
456-104-961	RP4VM REM2 for VNX STARTER PACK =IB	UM	\$0
456-105-068	RP/SE TO RP/EX LOC UG V52 = IC	UM	\$3,335
456-105-069	RP/SE TO RP/EX LOC UG V54 =IC	UM	\$5,940
456-105-070	RP/SE TO RP/EX LOC UG V56 = IC	UM	\$9,860
456-105-071	RP/SE TO RP/EX LOC UG V58 = IC	UM	\$13,560
456-105-072	RP/SE TO RP/EX LOC UG V76 = IC	UM	\$15,590
456-105-073	RP/SE TO RP/EX REM UG V52 = IC	UM	\$8,600
456-105-074	RP/SE TO RP/EX REM UG V54 =IC	UM	\$15,310
456-105-075	RP/SE TO RP/EX REM UG V56 = IC	UM	\$22,030
456-105-076	RP/SE TO RP/EX REM UG V58 = IC	UM	\$33,900
456-105-077	RP/SE TO RP/EX REM UG V76 = IC	UM	\$67,050
456-105-136	AppSync for VNX5200 =IC	UM	\$0

456-105-137	AppSync for VNX5400 =IC	UM	\$0
456-105-138	AppSync for VNX5600 =IC	UM	\$0
456-105-139	AppSync for VNX5800 =IC	UM	\$0
456-105-140	AppSync for VNX7600 =IC	UM	\$0
456-105-292	SRMSUITE VNX2 TIER 1 =IC	UM	\$0
456-105-293	SRMSUITE VNX2 TIER 2 =IC	UM	\$0
456-105-294	SRMSUITE VNX2 TIER 3 =IC	UM	\$0
456-105-295	SRMSUITE VNX2 TIER 4 =IC	UM	\$0
456-105-296	SRMSUITE VNX2 TIER 5 =IC	UM	\$0
456-105-297	SRMSUITE VNX2 TIER 6 =IC	UM	\$0
456-105-393	SRMSUITE UPG VNX2 TIER 1 =IC	UM	\$0
456-105-394	SRMSUITE UPG VNX2 TIER 2 =IC	UM	\$0
456-105-395	SRMSUITE UPG VNX2 TIER 3 =IC	UM	\$0
456-105-396	SRMSUITE UPG VNX2 TIER 4 =IC	UM	\$0
456-105-397	SRMSUITE UPG VNX2 TIER 5 =IC	UM	\$0
456-105-398	SRMSUITE UPG VNX2 TIER 6 =IC	UM	\$0
456-105-939	RP/EX LOC FRAME BASED VNX CA=IC	UM	\$0
456-105-940	RP/EX REM FRAME BASED VNX CA=IC	UM	\$0
456-106-945	VIPR SRM VNX-F5000=IC	UM	\$0
456-106-946	VIPR SRM VNX-F7000=IC	UM	\$0
456-107-373	VPLEX VE STD STARTER PACK 5 VM =IB	UM	\$0
456-107-781	EMC Storage Analytics VNX5200 Suite=IC	UM	\$0
456-107-782	EMC Storage Analytics VNX5400 Suite=IC	UM	\$0
456-107-783	EMC Storage Analytics VNX5600 Suite=IC	UM	\$0
456-107-784	EMC Storage Analytics VNX5800 Suite=IC	UM	\$0
456-107-785	EMC Storage Analytics VNX7600 Suite=IC	UM	\$0
456-107-786	EMC Storage Analytics VNX8000 Suite=IC	UM	\$0
456-107-811	EMC Storage Analytics VNX54 Suite UPG=IC	UM	\$0
456-107-812	EMC Storage Analytics VNX56 Suite UPG=IC	UM	\$0
456-107-813	EMC Storage Analytics VNX58 Suite UPG=IC	UM	\$0
456-107-814	EMC Storage Analytics VNX76 Suite UPG=IC	UM	\$0
456-107-975	RP/EX LOC FRAME BASED VNX-F5000-VPLEX=IC	UM	\$6,675
456-107-976	RP/EX REM FRAME BASED VNX-F5000-VPLEX=IC	UM	\$15,575
456-107-977	RP/EX LOC FRAME BASED VNX-F7000-VPLEX=IC	UM	\$22,745
456-107-978	RP/EX REM FRAME BASED VNX-F7000-VPLEX=IC	UM	\$53,065
456-108-466	RP/EX ADV PROTECTION FOR VNX-F5000=IC	UM	\$22,250
456-108-467	RP/EX ADV PROTECTION FOR VNX-F7000 =IC	UM	\$75,810
456-108-866	VNX2 MIRROR VIEW A ENABLER=IC	UM	\$3,723
456-109-980	Storage M&R for VNX 5200=IC	UM	\$1,720
456-109-981	Storage M&R for VNX 5400=IC	UM	\$3,690
456-109-982	Storage M&R for VNX 5600=IC	UM	\$6,480
456-109-983	Storage M&R for VNX 5800=IC	UM	\$11,370
456-109-984	Storage M&R for VNX 7600=IC	UM	\$14,650
456-110-531	VS SRM VNX2 TIER 1=IC	UM	\$0
456-110-532	VS SRM VNX2 TIER 2=IC	UM	\$0
456-110-533	VS SRM VNX2 TIER 3=IC	UM	\$0
456-110-534	VS SRM VNX2 TIER 4=IC	UM	\$0
456-110-535	VS SRM VNX2 TIER 5=IC	UM	\$0
456-110-536	VS SRM VNX2 TIER 6=IC	UM	\$0
456-110-537	VS VIPRC VNX2 LIC=IC	UM	\$0

456-110-691	SRM VNX2 TIER 1 =IC	UM	\$9,245
456-110-692	SRM VNX2 TIER 2 =IC	UM	\$14,185
456-110-693	SRM VNX2 TIER 3 =IC	UM	\$34,200
456-110-694	SRM VNX2 TIER 4 =IC	UM	\$64,400
456-110-695	SRM VNX2 TIER 5 =IC	UM	\$90,305
456-110-696	SRM VNX2 TIER 6 =IC	UM	\$139,980
456-110-815	SRM VNX-F5000=IC	UM	\$20,700
456-110-816	SRM VNX-F7000=IC	UM	\$103,500
456-111-383	RP/EX REM FRAME V57 FOR VPLEX VS6=IC	UM	\$30,630
456-111-384	RP/EX REM FRAME V75 FOR VPLEX VS6=IC	UM	\$67,800
456-111-387	RP/EX REM FRAME V56 FOR VPLEX VS6=IC	UM	\$17,190
456-111-388	RP/EX REM FRAME V58 FOR VPLEX VS6=IC	UM	\$44,050
456-111-389	RP/EX REM FRAME V76 FOR VPLEX VS6=IC	UM	\$134,100
456-111-390	RP/EX REM FRAME V80 FOR VPLEX VS6=IC	UM	\$202,610
456-111-394	RP/EX LOC FRAME V57 FOR VPLEX VS6=IC	UM	\$11,880
456-111-395	RP/EX LOC FRAME V75 FOR VPLEX VS6=IC	UM	\$27,120
456-111-398	RP/EX LOC FRAME V56 FOR VPLEX VS6=IC	UM	\$6,670
456-111-399	RP/EX LOC FRAME V58 FOR VPLEX VS6=IC	UM	\$19,730
456-111-400	RP/EX LOC FRAME V76 FOR VPLEX VS6=IC	UM	\$31,190
456-111-401	RP/EX LOC FRAME V80 FOR VPLEX VS6=IC	UM	\$47,120
456-111-464	RP/EX LOC for VNX-F5000 =IC	UM	\$6,675
456-111-465	RP/EX REM for VNX-F5000 =IC	UM	\$15,575
456-111-466	RP/EX LOC for VNX-F7000 =IC	UM	\$22,745
456-111-467	RP/EX REM for VNX-F7000 =IC	UM	\$53,065
456-112-148	Storage M&R for VNX 8000=IC	UM	\$21,415
456-113-338	Storage M&R for Unity lic=IC	UM	\$0
457-101-184	APPLICATION PROTECTION FOR VNX5200=IC	UM	\$0
457-101-185	APPLICATION PROTECTION FOR VNX5400=IC	UM	\$0
457-101-186	APPLICATION PROTECTION FOR VNX5600=IC	UM	\$0
457-101-187	APPLICATION PROTECTION FOR VNX5800=IC	UM	\$0
457-101-188	APPLICATION PROTECTION FOR VNX7600=IC	UM	\$0
457-101-189	APPLICATION PROTECTION FOR VNX8000=IC	UM	\$0
457-101-844	RecoverPoint Adv. Protect - VNXF5000 =IC	UM	\$0
457-101-845	RecoverPoint Adv. Protect - VNXF7000 =IC	UM	\$0
457-102-008	VNX5400 APPLICATION PROT UPG=IC	UM	\$0
457-102-009	VNX5600 APPLICATION PROT UPG=IC	UM	\$0
457-102-010	VNX5800 APPLICATION PROT UPG=IC	UM	\$0
457-102-011	VNX7600 APPLICATION PROT UPG=IC	UM	\$0
458-000-112	VNX5200 Application Protection=IC	UM	\$13,784
458-000-113	VNX5400 Application Protection=IC	UM	\$0
458-000-114	VNX5600 Application Protection=IC	UM	\$0
458-000-115	VNX5800 Application Protection=IC	UM	\$0
458-000-116	VNX7600 Application Protection=IC	UM	\$0
458-000-117	VNX8000 Application Protection=IC	UM	\$0
458-000-165	RP/SE TO RP/EX LOCAL PRODUCT	UM	\$0
458-000-224	RP/EX ADV PROTECTION FOR VNX-F 5000=IC	UM	\$22,250
458-000-463	EMC Storage Analytics VNX5200 Suite=IC	UM	\$0
458-000-466	EMC Storage Analytics VNX5400 Suite=IC	UM	\$0
458-000-539	EMC Storage Analytics VNX5600 Suite=IC	UM	\$0
458-000-561	EMC Storage Analytics VNX5800 Suite=IC	UM	\$0

458-000-562	EMC Storage Analytics VNX7600 Suite=IC	UM	\$0
458-000-565	EMC Storage Analytics VNX8000 Suite=IC	UM	\$0
458-000-776	EMC Storage Analytics VNX54 Suite UPG=IC	UM	\$6,075
458-000-777	EMC Storage Analytics VNX56 Suite UPG=IC	UM	\$10,630
458-000-778	EMC Storage Analytics VNX58 Suite UPG=IC	UM	\$15,120
458-000-779	EMC Storage Analytics VNX76 Suite UPG=IC	UM	\$18,550
458-000-958	RP/EX FOR VPLEX FRAME BASE VNXF PROD	UM	\$0
458-001-182	VNX5400 Application Prot UPG=IC	UM	\$19,650
458-001-183	VNX5600 Application Prot UPG=IC	UM	\$30,285
458-001-184	VNX5800 Application Prot UPG=IC	UM	\$35,530
458-001-185	VNX7600 Application Prot UPG=IC	UM	\$39,700
458-001-189	RP/EX ADV PROTECTION FOR VNX-F7000=IC	UM	\$75,810
458-001-463	Storage M&R for VNX2	UM	\$0
458-001-641	VS SRM VNX2=IC	UM	\$0
458-001-642	VS VIPRC VNX2=IC	UM	\$0
458-001-727	RP/EX ADV PROT V6 FOR VNX-F 5000=IC	UM	\$0
458-001-728	RP/EX ADV PROT V6 FOR VNX-F 7000=IC	UM	\$0
458-001-795	VS SRM VNX2 T2=IC	UM	\$0
458-001-796	VS SRM VNX2 T3=IC	UM	\$0
458-001-797	VS SRM VNX2 T4=IC	UM	\$0
458-001-798	VS SRM VNX2 T5=IC	UM	\$0
458-001-799	VS SRM VNX2 T6=IC	UM	\$0
458-001-838	VNX2 EFFICIENT-VIDEO-MG=IC	UM	\$3,000
458-001-884	VNX2 EFFICIENT-VIDEO-AG=IC	UM	\$400
458-002-287	Storage M&R for Unity=IC	UM	\$0
C13-250V-BSMI2	250V PWR CRD C13 TO 6-20P BSMI	UM	\$0
C13-250V-PSE	250V PWR CRD C13 TO 6-15P PSE	UM	\$0
C13-250V-ULCSA	250V PWR CRD C13 TO 6-15P UL/CSA	UM	\$0
CEE-ISILON	CEE-ISILON Common Event Enabler (CEE)=IC	UM	\$2,500
DARE-VNX5200	VNX5200 Controller Based Encryp Suite=IC	UM	\$0
DARE-VNX5400	Data at Rest Encryption for VNX5400=IC	UM	\$0
DARE-VNX5400-UPG	Data at Rest Encryption for VNX5400=IC	UM	\$0
DARE-VNX5600	Data at Rest Encryption for VNX5600=IC	UM	\$0
DARE-VNX5600-UPG	Data at Rest Encryption for VNX5600=IC	UM	\$0
DARE-VNX5800	Data at Rest Encryption for VNX5800=IC	UM	\$0
DARE-VNX5800-UPG	Data at Rest Encryption for VNX5800=IC	UM	\$0
DARE-VNX7600	Data at Rest Encryption for VNX7600=IC	UM	\$0
DARE-VNX7600-UPG	Data at Rest Encryption for VNX7600=IC	UM	\$0
DARE-VNX8000	Data at Rest Encryption for VNX8000=IC	UM	\$0
DARE-VNX-F5000	Data at Rest Encryption VNX-F5000=IC	UM	\$0
DARE-VNX-F7000	Data at Rest Encryption VNX-F7000=IC	UM	\$0
DP-VNX-F5000	VNX-F5000 Data Protection=IC	UM	\$0
DP-VNX-F7000	VNX-F7000 Data Protection=IC	UM	\$0
ESA-VNX5200	EMC Storage Analytics VNX5200 Suite=IC	UM	\$0
ESA-VNX5400	EMC Storage Analytics VNX5400 Suite=IC	UM	\$0
ESA-VNX5600	EMC Storage Analytics VNX5600 Suite=IC	UM	\$0
ESA-VNX5800	EMC Storage Analytics VNX5800 Suite=IC	UM	\$0
ESA-VNX7600	EMC Storage Analytics VNX7600 Suite=IC	UM	\$0
ESA-VNX8000	EMC Storage Analytics VNX8000 Suite=IC	UM	\$0
ESA-VNX-F5000	VNX-F5000 EMC Storage Analytics Suite=IC	UM	\$0

ESA-VNX-F7000	VNX-F7000 EMC Storage Analytics Suite=IC	UM	\$0
EXPSAS-V56	Unisphere VNX5600 SAS EXP Software=IC	UM	\$0
EXPSAS-V58	Unisphere VNX5800 SAS EXP Software=IC	UM	\$0
EXPSAS-V76	Unisphere VNX7600 SAS EXP Software=IC	UM	\$0
EXPSAS-V80	Unisphere VNX8000 SAS EXP Software=IC	UM	\$0
FLN42S6F-100	VNX 100GB FAST CACHE 25X2.5 DPE/DAE NEBS	UM	\$0
FLN42S6F-100TU	VNX 100GB FASTCACHE 25X2.5DPE/DAE NEB UG	UM	\$3,620
FLN42S6F-100U	VNX 100GB FASTCACHE 25X2.5DPE/DAE NEB UG	UM	\$3,620
FLN42S6F-200	VNX 200GB FAST CACHE 25X2.5 DPE/DAE NEBS	UM	\$0
FLN42S6F-200TU	VNX 200GB FASTCACHE 25X2.5DPE/DAE NEB UG	UM	\$5,710
FLN42S6F-200U	VNX 200GB FASTCACHE 25X2.5DPE/DAE NEB UG	UM	\$5,710
FLN42S6FX-200	VNX 200G SF2 FASTCACHE 25X2.5 DPEDAE NBS	UM	\$0
FLN42S6FX-200TU	VNX 200GB SF2 FAST CACHE 25X2.5 NEBS UPG	UM	\$3,165
FLN42S6FX-200U	VNX 200GB SF2 FAST CACHE 25X2.5 NEBS UPG	UM	\$3,165
FLN42S6FX-400	VNX 400G SF2 FASTCACHE 25X2.5 DPEDAE NBS	UM	\$0
FLN42S6FX-400TU	VNX 400GB SF2 FAST CACHE 25X2.5 NEBS UPG	UM	\$5,035
FLN42S6FX-400U	VNX 400GB SF2 FAST CACHE 25X2.5 NEBS UPG	UM	\$5,035
FLN4VS6F-100	VNX 100GB FAST CACHE 15X3.5 DAE NEBS	UM	\$2,680
FLN4VS6F-100TU	VNX 100GB FASTCACHE 15X3.5DPE/DAE NEB UG	UM	\$3,620
FLN4VS6F-100U	VNX 100GB FASTCACHE 15X3.5 DAE NEBS UPG	UM	\$3,620
FLN4VS6F-200	VNX 200GB FAST CACHE 15X3.5 DAE NEBS	UM	\$4,230
FLN4VS6F-200TU	VNX 200GB FASTCACHE 15X3.5DPE/DAE NEB UG	UM	\$5,710
FLN4VS6F-200U	VNX 200GB FASTCACHE 15X3.5 DAE NEBS UPG	UM	\$5,710
FLN4VS6FX-200	VNX 200GB SF2 FAST CACHE 15X3.5 DAE NEBS	UM	\$2,345
FLN4VS6FX-200TU	VNX 200G SF2 FASTCACHE 15X3.5 DAE NBS UG	UM	\$3,165
FLN4VS6FX-200U	VNX 200G SF2 FASTCACHE 15X3.5 DAE NBS UG	UM	\$3,165
FLN4VS6FX-400	VNX 400GB SF2 FAST CACHE 15X3.5 DAE NEBS	UM	\$3,730
FLN4VS6FX-400TU	VNX 400G SF2 FASTCACHE 15X3.5 DAE NBS UG	UM	\$5,035
FLN4VS6FX-400U	VNX 400G SF2 FASTCACHE 15X3.5 DAE NBS UG	UM	\$5,035
FLV42S6F-100	VNX 100GB FAST CACHE 25X2.5 DPE/DAE	UM	\$0
FLV42S6F-100-FP	VNX 100GB FAST CACHE 25X2.5 DPE/DAE-FP	UM	\$0
FLV42S6F-100TU	VNX 100GB FAST CACHE 25X2.5 DPE/DAE UPG	UM	\$3,290
FLV42S6F-100U	VNX 100GB FAST CACHE 25X2.5 DPE/DAE UPG	UM	\$3,290
FLV42S6F-200	VNX 200GB FAST CACHE 25X2.5 DPE/DAE	UM	\$0
FLV42S6F-200-FP	VNX 200GB FAST CACHE 25X2.5 DPE/DAE-FP	UM	\$0
FLV42S6F-200TU	VNX 200GB FAST CACHE 25X2.5 DPE/DAE UPG	UM	\$5,190
FLV42S6F-200U	VNX 200GB FAST CACHE 25X2.5 DPE/DAE UPG	UM	\$5,190
FLV42S6FX-200	VNX 200GB SF2 FAST CACHE 25X2.5 DPE/DAE	UM	\$0
FLV42S6FX-200TU	VNX 200G SF2 FASTCACHE 25X2.5 DPE/DAE UG	UM	\$2,875
FLV42S6FX-200U	VNX 200G SF2 FASTCACHE 25X2.5 DPE/DAE UG	UM	\$2,875
FLV42S6FX-400	VNX 400GB SF2 FAST CACHE 25X2.5 DPE/DAE	UM	\$0
FLV42S6FX-400TU	VNX 400G SF2 FASTCACHE 25X2.5 DPE/DAE UG	UM	\$4,575
FLV42S6FX-400U	VNX 400G SF2 FASTCACHE 25X2.5 DPE/DAE UG	UM	\$4,575
FLV4D2S6F-100	VNX 100GB FAST CACHE 120X2.5 DPE/DAE	UM	\$0
FLV4D2S6F-100TU	VNX 100GB FAST CACHE 120X2.5 DPE/DAE UPG	UM	\$3,290
FLV4D2S6F-100U	VNX 100GB FAST CACHE 120X2.5 DPE/DAE UPG	UM	\$3,290
FLV4D2S6F-200	VNX 200GB FAST CACHE 120X2.5 DPE/DAE	UM	\$0
FLV4D2S6F-200TU	VNX 200GB FAST CACHE 120X2.5 DPE/DAE UPG	UM	\$5,190
FLV4D2S6F-200U	VNX 200GB FAST CACHE 120X2.5 DPE/DAE UPG	UM	\$5,190
FLV4D2S6FX-200	VNX 200GB SF2 FAST CACHE 120X2.5 DAE	UM	\$0

FLV4D2S6FX-200TU	VNX 200GB SF2 FAST CACHE 120X2.5 DAE UPG	UM	\$2,875
FLV4D2S6FX-200U	VNX 200GB SF2 FAST CACHE120X2.5 DAE UPG	UM	\$2,875
FLV4D2S6FX-400	VNX 400GB SF2 FAST CACHE 120X2.5 DAE	UM	\$0
FLV4D2S6FX-400TU	VNX 400GB SF2 FAST CACHE 120X2.5 DAE UPG	UM	\$4,575
FLV4D2S6FX-400U	VNX 400GB SF2 FAST CACHE 120X2.5 DAE UPG	UM	\$4,575
FLV4DS6F-100	VNX 100GB FAST CACHE 60X3.5 DAE	UM	\$0
FLV4DS6F-100-FP	VNX 100GB FAST CACHE 60X3.5 DAE-FP	UM	\$0
FLV4DS6F-100TU	VNX 100GB FAST CACHE 60X3.5 DPE/DAE UPG	UM	\$3,290
FLV4DS6F-100U	VNX 100GB FAST CACHE 60X3.5 DAE UPG	UM	\$3,290
FLV4DS6F-200	VNX 200GB FAST CACHE 60X3.5 DAE	UM	\$0
FLV4DS6F-200-FP	VNX 200GB FAST CACHE 60X3.5 DAE-FP	UM	\$0
FLV4DS6F-200TU	VNX 200GB FAST CACHE 60X3.5 DPE/DAE UPG	UM	\$5,190
FLV4DS6F-200U	VNX 200GB FAST CACHE 60X3.5 DAE UPG	UM	\$5,190
FLV4DS6FX-200	VNX 200GB SF2 FAST CACHE 60X3.5 DAE	UM	\$2,130
FLV4DS6FX-200TU	VNX 200GB SF2 FAST CACHE 60X3.5 DAE UPG	UM	\$2,875
FLV4DS6FX-200U	VNX 200GB SF2 FAST CACHE 60X3.5 DAE UPG	UM	\$2,875
FLV4DS6FX-400	VNX 400GB SF2 FAST CACHE 60X3.5 DAE	UM	\$3,390
FLV4DS6FX-400TU	VNX 400GB SF2 FAST CACHE 60X3.5 DAE UPG	UM	\$4,575
FLV4DS6FX-400U	VNX 400GB SF2 FAST CACHE 60X3.5 DAE UPG	UM	\$4,575
FLV4VS6F-100	VNX 100GB FAST CACHE 15X3.5 DAE	UM	\$0
FLV4VS6F-100-FP	VNX 100GB FAST CACHE 15X3.5 DAE-FP	UM	\$0
FLV4VS6F-100TU	VNX 100GB FAST CACHE 15X3.5 DPE/DAE UPG	UM	\$3,290
FLV4VS6F-100U	VNX 100GB FAST CACHE 15X3.5 DAE UPG	UM	\$3,290
FLV4VS6F-200	VNX 200GB FAST CACHE 15X3.5 DAE	UM	\$0
FLV4VS6F-200-FP	VNX 200GB FAST CACHE 15X3.5 DAE-FP	UM	\$0
FLV4VS6F-200TU	VNX 200GB FAST CACHE 15X3.5 DPE/DAE UPG	UM	\$5,190
FLV4VS6F-200U	VNX 200GB FAST CACHE 15X3.5 DAE UPG	UM	\$5,190
FLV4VS6FX-200	VNX 200GB SF2 FAST CACHE 15X3.5 DAE	UM	\$0
FLV4VS6FX-200TU	VNX 200GB SF2 FAST CACHE 15X3.5 DAE UPG	UM	\$2,875
FLV4VS6FX-200U	VNX 200GB SF2 FAST CACHE 15X3.5 DAE UPG	UM	\$2,875
FLV4VS6FX-400	VNX 400GB SF2 FAST CACHE 15X3.5 DAE	UM	\$0
FLV4VS6FX-400TU	VNX 400GB SF2 FAST CACHE 15X3.5 DAE UPG	UM	\$4,575
FLV4VS6FX-400U	VNX 400GB SF2 FAST CACHE 15X3.5 DAE UPG	UM	\$4,575
FSTS-VNX5200	VNX5200 FAST Suite=IC	UM	\$0
FSTS-VNX5400	VNX5400 FAST Suite=IC	UM	\$0
FSTS-VNX5400-UPG	VNX5400 FAST Suite=IC	UM	\$0
FSTS-VNX5600	VNX5600 FAST Suite=IC	UM	\$0
FSTS-VNX5600-UPG	VNX5600 FAST Suite=IC	UM	\$0
FSTS-VNX5800	VNX5800 FAST Suite=IC	UM	\$0
FSTS-VNX5800-UPG	VNX5800 FAST Suite=IC	UM	\$0
FSTS-VNX7600	VNX7600 FAST Suite=IC	UM	\$0
FSTS-VNX7600-UPG	VNX7600 FAST Suite=IC	UM	\$0
FSTS-VNX8000	VNX8000 FAST Suite=IC	UM	\$0
FSTS-VNXCA2	VNXCA2 FAST SUITE=IC	UM	\$0
FSTS-VNXCA4	VNXCA4 FAST SUITE=IC	UM	\$0
LPS-VNX5200	VNX5200 Local Protection Suite=IC	UM	\$0
LPS-VNX5400	VNX5400 Local Protection Suite=IC	UM	\$0
LPS-VNX5400-UPG	VNX5400 Local Protection Suite=IC	UM	\$0
LPS-VNX5600	VNX5600 Local Protection Suite=IC	UM	\$0
LPS-VNX5600-UPG	VNX5600 Local Protection Suite=IC	UM	\$0

LPS-VNX5800	VNX5800 Local Protection Suite=IC	UM	\$0
LPS-VNX5800-UPG	VNX5800 Local Protection Suite=IC	UM	\$0
LPS-VNX7600	VNX7600 Local Protection Suite=IC	UM	\$0
LPS-VNX7600-UPG	VNX7600 Local Protection Suite=IC	UM	\$0
LPS-VNX8000	VNX8000 Local Protection Suite=IC	UM	\$0
LPS-VNXCA2	VNXCA2 LOCAL PROTECTION SUITE=IC	UM	\$0
LPS-VNXCA4	VNXCA4 LOCAL PROTECTION SUITE=IC	UM	\$0
N4-2S07-010	VNX 1TB NL SAS 25X2.5 DPE/DAE NEBS	UM	\$0
N4-2S07-010TU	VNX 1TB NL SAS 25X2.5 DPE/DAE NEBS UPG	UM	\$1,325
N4-2S07-010U	VNX 1TB NL SAS 25X2.5 DPE/DAE NEBS UPG	UM	\$1,325
N4-2S10-012	VNX 1.2TB 10K SAS 25X2.5 DPE/DAE NEBS	UM	\$0
N4-2S10-012TU	VNX 1.2TB 10K SAS 25X2.5 DPE/DAE NEBS UG	UM	\$2,080
N4-2S10-012U	VNX 1.2TB 10K SAS 25X2.5 DPE/DAE NEBS UG	UM	\$2,130
N4-2S10-600	VNX 600GB 10K SAS 25X2.5 DPE/DAE NEBS	UM	\$0
N4-2S10-600TU	VNX 600GB 10K SAS 25X2.5 DPE/DAE NEBS UG	UM	\$1,285
N4-2S10-600U	VNX 600GB 10K SAS 25X2.5 DPE/DAE NEBS UG	UM	\$1,285
N4-2S10-900	VNX 900GB 10K SAS 25X2.5 DPE/DAE NEBS	UM	\$0
N4-2S10-900TU	VNX 900GB 10K SAS 25X2.5 DPE/DAE NEBS UG	UM	\$1,685
N4-2S10-900U	VNX 900GB 10K SAS 25X2.5 DPE/DAE NEBS UG	UM	\$1,685
N4-2S15-300	VNX 300GB 15K SAS 25X2.5 DPE/DAE NEBS	UM	\$0
N4-2S15-300TU	VNX 300GB 15K SAS 25X2.5 DPE/DAE NEBS UG	UM	\$1,850
N4-2S15-300U	VNX 300GB 15K SAS 25X2.5 DPE/DAE NEBS UG	UM	\$1,850
N4-2S6F-100	VNX 100GB SSD 25X2.5 DPE/DAE NEBS	UM	\$0
N4-2S6F-100TU	VNX 100GB EFD 25X2.5 DPE/DAE NEBS UPG	UM	\$3,620
N4-2S6F-100U	VNX 100GB SSD 25X2.5 DPE/DAE NEBS UPG	UM	\$3,620
N4-2S6F-200	VNX 200GB SSD 25X2.5 DPE/DAE NEBS	UM	\$0
N4-2S6F-200TU	VNX 200GB EFD 25X2.5 DPE/DAE NEBS UPG	UM	\$5,710
N4-2S6F-200U	VNX 200GB SSD 25X2.5 DPE/DAE NEBS UPG	UM	\$5,710
N4-2S6FX-100	VNX 100GB FASTVP SSD 25X2.5 DPE/DAE NEBS	UM	\$0
N4-2S6FX-100U	VNX 100GB FASTVP SSD 25X2.5 NEBS UPG	UM	\$0
N4-2S6FX-1600	VNX 1600GB NEBS MLC SSD 25X2.5 DAE	UM	\$10,770
N4-2S6FX-1600TU	VNX 1600GB NEBS MLC SSD 25X2.5 DAE U/G	UM	\$14,540
N4-2S6FX-1600U	VNX 1600GB NEBS MLC SSD 25X2.5 DAE U/G	UM	\$14,540
N4-2S6FX-200	VNX 200GB FASTVP SSD 25X2.5 DPE/DAE NEBS	UM	\$0
N4-2S6FX-200TU	VNX 200GB FASTVP EFD 25X2.5 NEBS UPG	UM	\$2,815
N4-2S6FX-200U	VNX 200GB FASTVP SSD 25X2.5 NEBS UPG	UM	\$2,815
N4-2S6FX-400	VNX 400GB FASTVP SSD 25X2.5 DPE/DAE NEBS	UM	\$0
N4-2S6FX-400TU	VNX 400GB FASTVP EFD 25X2.5 NEBS UPG	UM	\$5,265
N4-2S6FX-400U	VNX 400GB FASTVP SSD 25X2.5 NEBS UPG	UM	\$5,265
N4-2S6FX-800	VNX 800GB NEBS MLC SSD 25X2.5 DAE	UM	\$6,595
N4-2S6FX-800TU	VNX 800GB NEBS MLC SSD 25X2.5 DAE U/G	UM	\$8,905
N4-2S6FX-800U	VNX 800GB NEBS MLC SSD 25X2.5 DAE U/G	UM	\$8,905
N4-VS07-020	VNX 2TB NL SAS 15X3.5 DAE NEBS	UM	\$0
N4-VS07-020TU	VNX 2TB NL SAS 15X3.5 DAE NEBS UPG	UM	\$1,335
N4-VS07-020U	VNX 2TB NL SAS 15X3.5 DAE NEBS UPG	UM	\$1,335
N4-VS07-030	VNX 3TB NL SAS 15X3.5 DAE NEBS	UM	\$0
N4-VS07-030TU	VNX 3TB NL SAS 15X3.5 DAE NEBS UPG	UM	\$1,800
N4-VS07-030U	VNX 3TB NL SAS 15X3.5 DAE NEBS UPG	UM	\$1,800
N4-VS07-040	VNX 4TB NL SAS 15X3.5 DAE NEBS	UM	\$0
N4-VS07-040TU	VNX 4TB NL SAS 15X3.5 DAE NEBS UPG	UM	\$2,020

N4-VS07-040U	VNX 4TB NL SAS 15X3.5 DAE NEBS UPG	UM	\$2,020
N4-VS10-012	VNX 1.2TB 10K SAS 15X3.5 DAE NEBS	UM	\$0
N4-VS10-012TU	VNX 1.2TB 10K SAS 15X3.5 DAE NEBS UPG	UM	\$2,130
N4-VS10-012U	VNX 1.2TB 10K SAS 15X3.5 DAE NEBS UPG	UM	\$2,130
N4-VS10-600	VNX 600GB 10K SAS 15X3.5 DAE NEBS	UM	\$0
N4-VS10-600TU	VNX 600GB 10K SAS 15X3.5 DAE NEBS UPG	UM	\$1,285
N4-VS10-600U	VNX 600GB 10K SAS 15X3.5 DAE NEBS UPG	UM	\$1,285
N4-VS10-900	VNX 900GB 10K SAS 15X3.5 DAE NEBS	UM	\$0
N4-VS10-900TU	VNX 900GB 10K SAS 15X3.5 DAE NEBS UPG	UM	\$1,685
N4-VS10-900U	VNX 900GB 10K SAS 15X3.5 DAE NEBS UPG	UM	\$1,685
N4-VS15-300	VNX 300GB 15K SAS 15X3.5 DAE NEBS	UM	\$0
N4-VS15-300TU	VNX 300GB 15K SAS 15X3.5 DAE NEBS UPG	UM	\$1,355
N4-VS15-300U	VNX 300GB 15K SAS 15X3.5 DAE NEBS UPG	UM	\$1,355
N4-VS15-600	VNX 600GB 15K SAS 15X3.5 DAE NEBS	UM	\$0
N4-VS15-600TU	VNX 600GB 15K SAS 15X3.5 DAE NEBS UPG	UM	\$2,075
N4-VS15-600U	VNX 600GB 15K SAS 15X3.5 DAE NEBS UPG	UM	\$2,075
N4-VS6F-100	VNX 100GB SSD 15X3.5 DAE NEBS	UM	\$0
N4-VS6F-100TU	VNX 100GB EFD 15X3.5 DAE NEBS UPG	UM	\$3,620
N4-VS6F-100U	VNX 100GB SSD 15X3.5 DAE NEBS UPG	UM	\$3,620
N4-VS6F-200	VNX 200GB SSD 15X3.5' DAE NEBS	UM	\$0
N4-VS6F-200TU	VNX 200GB EFD 15X3.5' DAE NEBS UPG	UM	\$5,710
N4-VS6F-200U	VNX 200GB SSD 15X3.5' DAE NEBS UPG	UM	\$5,710
N4-VS6FX-100	VNX 100GB FAST VP SSD 15X3.5 DAE NEBS	UM	\$0
N4-VS6FX-100U	VNX 100GB FAST VP SSD 15X3.5 DAE NEBS	UM	\$0
N4-VS6FX-1600	VNX 1600GB NEBS MLC SSD 15X3.5 DAE	UM	\$10,770
N4-VS6FX-1600TU	VNX 1600GB NEBS MLC SSD 15X3.5 DAE U/G	UM	\$14,540
N4-VS6FX-1600U	VNX 1600GB NEBS MLC SSD 15X3.5 DAE U/G	UM	\$14,540
N4-VS6FX-200	VNX 200GB FAST VP SSD 15X3.5 DAE NEBS	UM	\$0
N4-VS6FX-200TU	VNX 200GB FAST VP EFD 15X3.5 DAE NEBS UG	UM	\$2,815
N4-VS6FX-200U	VNX 200GB FAST VP SSD 15X3.5 DAE NEBS UG	UM	\$2,815
N4-VS6FX-800	VNX 800GB NEBS MLC SSD 15X3.5 DAE	UM	\$6,595
N4-VS6FX-800TU	VNX 800GB NEBS MLC SSD 15X3.5 DAE U/G	UM	\$8,905
N4-VS6FX-800U	VNX 800GB NEBS MLC SSD 15X3.5 DAE U/G	UM	\$8,905
ONX52DP60015F	ONX5200 DPE 25X2.5" DR-8X600G15K-FLD INS	UM	\$21,280
ONX5400-UNISB	VNX5400 Unisphere Block Suite=IC	UM	\$4,365
ONXB54DP25F	OEM VNXB54 DPE, 25X2.5" DR- BLOCK FIELD	UM	\$8,270
ONXB54DP25M	OEM VNXB54 DPE, 25X2.5" DR- MINI RACK	UM	\$8,270
ONXB56DP25F	OEM VNXB56 DPE 25X2.5" DR- FIELD INST	UM	\$13,657
ONXB56DP25M	OEM VNXB56 DPE 25X2.5" DR- MINI RACK	UM	\$13,657
ONXB58DP25	OEM VNXB58 DPE 25X2.5" DR- EMC RACK	UM	\$23,120
ONXB58DP25F	OEM VNXB58 DPE 25X2.5" DR- FIELD INST	UM	\$23,120
ONXB6GSDAE15	VNXB 15X3.5" 6G SAS EXP DAE-EMC RACK	UM	\$3,488
ONXB6GSDAE15F	VNXB 15X3.5" 6G SAS EXP DAE-FIELD INST	UM	\$3,488
ONXB6GSDAE25	VNXB 25X2.5" 6G SAS EXP DAE-EMC RACK	UM	\$4,942
ONXB6GSDAE25F	VNXB 25X2.5" 6G SAS EXP DAE-FIELD INST	UM	\$4,942
ONXB6GSDAE25P	VNXB 25X2.5" 6G SAS PRI DAE-EMC RACK	UM	\$4,942
ONXB6GSDAE25W	VNXB 25X2.5" 6G SAS PRI DAE-FIELD INST	UM	\$4,942
ONXBCS2	VNXB 2ND CONTROL STATION-EMC RACK	UM	\$1,935
ONXBCS2M	VNXB 2ND CONTROL ST FIELD MINI-RACK	UM	\$1,935
ONXBCS2U	VNXB 2ND CTR STAT-FIELD UPGRADE	UM	\$2,612

ONXBOECAPT B-CF	OEM VNX OE CAP LIMITED EDITION LIC=IC	UM	\$133
ONXBOEPERF T B-CF	OEM VNX OE PERF LIMITED EDITION LIC=IC	UM	\$291
PPAK-VNX5400-UPG	VNX5400 Total Protection Pack=IC	UM	\$26,190
PPAK-VNX5600-UPG	VNX5600 Total Protection Pack=IC	UM	\$0
PPAK-VNX5800-UPG	VNX5800 Total Protection Pack=IC	UM	\$0
PPAK-VNX7600-UPG	VNX7600 Total Protection Pack=IC	UM	\$0
RPS-VNX5200	VNX5200 Remote Protection Suite=IC	UM	\$0
RPS-VNX5400	VNX5400 Remote Protection Suite=IC	UM	\$0
RPS-VNX5400-UPG	VNX5400 Remote Protection Suite=IC	UM	\$0
RPS-VNX5600	VNX5600 Remote Protection Suite=IC	UM	\$0
RPS-VNX5600-UPG	VNX5600 Remote Protection Suite=IC	UM	\$0
RPS-VNX5800	VNX5800 Remote Protection Suite=IC	UM	\$0
RPS-VNX5800-UPG	VNX5800 Remote Protection Suite=IC	UM	\$0
RPS-VNX7600	VNX7600 Remote Protection Suite=IC	UM	\$0
RPS-VNX7600-UPG	VNX7600 Remote Protection Suite=IC	UM	\$0
RPS-VNX8000	VNX8000 Remote Protection Suite=IC	UM	\$0
RPS-VNXCA2	VNXCA2 REMOTE PROTECTION SUITE=IC	UM	\$0
RPS-VNXCA4	VNXCA4 REMOTE PROTECTION SUITE=IC	UM	\$0
SCS-VNX5200	VNX5200 Events and Retention Suite=IC	UM	\$0
SCS-VNX5400	VNX5400 Events and Retention Suite=IC	UM	\$0
SCS-VNX5400-UPG	VNX5400 Events and Retention Suite=IC	UM	\$0
SCS-VNX5600	VNX5600 Events and Retention Suite=IC	UM	\$0
SCS-VNX5600-UPG	VNX5600 Events and Retention Suite=IC	UM	\$0
SCS-VNX5800	VNX5800 Events and Retention Suite=IC	UM	\$0
SCS-VNX5800-UPG	VNX5800 Events and Retention Suite=IC	UM	\$0
SCS-VNX7600	VNX7600 Events and Retention Suite=IC	UM	\$0
SCS-VNX7600-UPG	VNX7600 Events and Retention Suite=IC	UM	\$0
SCS-VNX8000	VNX8000 Events and Retention Suite=IC	UM	\$0
SRSTC-VNX2-1	SRM SUITE C VNX2 TIER 1 =IC	UM	\$0
SRSTC-VNX2-2	SRM SUITE C VNX2 TIER 2 =IC	UM	\$0
SRSTC-VNX2-3	SRM SUITE C VNX2 TIER 3 =IC	UM	\$0
SRSTC-VNX2-4	SRM SUITE C VNX2 TIER 4 =IC	UM	\$0
SRSTC-VNX2-5	SRM SUITE C VNX2 TIER 5 =IC	UM	\$0
SRSTC-VNX2-6	SRM SUITE C VNX2 TIER 6 =IC	UM	\$0
SRSTW-VNX2-1	SRM SUITE W VNX2 TIER 1 =IC	UM	\$0
SRSTW-VNX2-2	SRM SUITE W VNX2 TIER 2 =IC	UM	\$0
SRSTW-VNX2-3	SRM SUITE W VNX2 TIER 3 =IC	UM	\$0
SRSTW-VNX2-4	SRM SUITE W VNX2 TIER 4 =IC	UM	\$0
SRSTW-VNX2-5	SRM SUITE W VNX2 TIER 5 =IC	UM	\$0
SRSTW-VNX2-6	SRM SUITE W VNX2 TIER 6 =IC	UM	\$0
TMEPAK-VNXCA2	VNXCA2 TOTAL EFFICIENCY PACK=IC	UM	\$0
TMEPAK-VNXCA4	VNXCA4 TOTAL EFFICIENCY PACK=IC	UM	\$0
UNIB-V54UPG	VNX5400 Unisphere Block Suite UPG=IC	UM	\$0
UNIB-V56UPG	VNX5600 Unisphere Block Suite UPG=IC	UM	\$0
UNIB-V58UPG	VNX5800 Unisphere Block Suite UPG=IC	UM	\$0
UNIB-V76UPG	VNX7600 Unisphere Block Suite UPG=IC	UM	\$0
UNIF-V54UPG	VNX5400 Unisphere File Suite UPG=IC	UM	\$0
UNIF-V56UPG	VNX5600 Unisphere File Suite UPG=IC	UM	\$0
UNIF-V58UPG	VNX5800 Unisphere File Suite UPG=IC	UM	\$0
UNIF-V76UPG	VNX7600 Unisphere File Suite UPG=IC	UM	\$0

UNISB-VNX5200	VNX5200 Unisphere Block Suite =IC	UM	\$0
UNISB-VNX5400	VNX5400 Unisphere Block Suite=IC	UM	\$0
UNISB-VNX5600	VNX5600 Unisphere Block Suite=IC	UM	\$0
UNISB-VNX5800	VNX5800 Unisphere Block Suite=IC	UM	\$0
UNISB-VNX7600	VNX7600 Unisphere Block Suite=IC	UM	\$0
UNISB-VNX8000	VNX8000 Unisphere Block Suite=IC	UM	\$0
UNISB-VNXCA2	VNXCA2 UNISPHERE BLOCK SUITE=IC	UM	\$0
UNISB-VNXCA4	VNXCA4 UNISPHERE BLOCK SUITE=IC	UM	\$0
UNISB-VNX-F5000	VNX-F5000 Unisphere Block Suite=IC	UM	\$0
UNISB-VNX-F7000	VNX-F7000 Unisphere Block Suite=IC	UM	\$0
UNISF-VNX5200	VNX5200 Unisphere File Suite=IC	UM	\$0
UNISF-VNX5400	VNX5400 Unisphere File Suite=IC	UM	\$0
UNISF-VNX5600	VNX5600 Unisphere File Suite=IC	UM	\$0
UNISF-VNX5800	VNX5800 Unisphere File Suite=IC	UM	\$0
UNISF-VNX7600	VNX7600 Unisphere File Suite=IC	UM	\$0
UNISF-VNX8000	VNX8000 Unisphere File Suite=IC	UM	\$0
UNISU-VNX5200	VNX5200 Unisphere Unified Suite=IC	UM	\$0
UNISU-VNX5400	VNX5400 Unisphere Unified Suite=IC	UM	\$0
UNISU-VNX5600	VNX5600 Unisphere Unified Suite=IC	UM	\$0
UNISU-VNX5800	VNX5800 Unisphere Unified Suite=IC	UM	\$0
UNISU-VNX7600	VNX7600 Unisphere Unified Suite=IC	UM	\$0
UNISU-VNX8000	VNX8000 Unisphere Unified Suite=IC	UM	\$0
UNIS-VNXCA4-U	VNXCA4 Unisphere Block w VPLEX Local	UM	\$0
UNIU-V54UPG	VNX5400 Unisphere Unified Suite UPG=IC	UM	\$0
UNIU-V56UPG	VNX5600 Unisphere Unified Suite UPG=IC	UM	\$0
UNIU-V58UPG	VNX5800 Unisphere Unified Suite UPG=IC	UM	\$0
UNIU-V76UPG	VNX7600 Unisphere Unified Suite UPG=IC	UM	\$0
V15SLOTSFFKIT1	VNX 15 slot SFF drive kit 1	UM	\$21
V4-2S07-010	VNX 1TB NL SAS 25X2.5 DPE/DAE	UM	\$0
V4-2S07-010TU	VNX 1TB NL SAS 25X2.5 DPE/DAE UPG	UM	\$1,205
V4-2S07-010U	VNX 1TB NL SAS 25X2.5 DPE/DAE UPG	UM	\$1,205
V4-2S10-012	VNX 1.2TB 10K SAS 25X2.5 DPE/DAE	UM	\$0
V4-2S10-012TU	VNX 1.2TB 10K SAS 25X2.5 DPE/DAE UPG	UM	\$1,890
V4-2S10-012U	VNX 1.2TB 10K SAS 25X2.5 DPE/DAE UPG	UM	\$1,945
V4-2S10-600	VNX 600GB 10K SAS 25X2.5 DPE/DAE	UM	\$0
V4-2S10-600TU	VNX 600GB 10K SAS 25X2.5 DPE/DAE UPG	UM	\$1,165
V4-2S10-600U	VNX 600GB 10K SAS 25X2.5 DPE/DAE UPG	UM	\$1,165
V4-2S10-900	VNX 900GB 10K SAS 25X2.5 DPE/DAE	UM	\$0
V4-2S10-900TU	VNX 900GB 10K SAS 25X2.5 DPE/DAE UPG	UM	\$1,530
V4-2S10-900U	VNX 900GB 10K SAS 25X2.5 DPE/DAE UPG	UM	\$1,530
V4-2S15-300	VNX 300GB 15K SAS 25X2.5 DPE/DAE	UM	\$0
V4-2S15-300TU	VNX 300GB 15K SAS 25X2.5 DPE/DAE UPG	UM	\$1,680
V4-2S15-300U	VNX 300GB 15K SAS 25X2.5 DPE/DAE UPG	UM	\$1,680
V4-2S15-600	VNX2 600GB 15K SAS 25X2.5 DPE/DAE	UM	\$0
V4-2S15-600TU	VNX2 600GB 15K SAS 25X2.5 TAA UPG	UM	\$1,885
V4-2S15-600U	VNX2 600GB 15K SAS 25X2.5 DPE/DAE UPG	UM	\$1,885
V4-2S6F-100	VNX 100GB SSD 25X2.5 DPE/DAE	UM	\$0
V4-2S6F-100-FP	VNX 100GB SSD 25X2.5 DPE/DAE-FP	UM	\$0
V4-2S6F-100TU	VNX 100GB EFD 25X2.5 DPE/DAE UPG	UM	\$3,290
V4-2S6F-100U	VNX 100GB SSD 25X2.5 DPE/DAE UPG	UM	\$3,290

V4-2S6F-200	VNX 200GB SSD 25X2.5 DPE/DAE	UM	\$0
V4-2S6F-200-FP	VNX 200GB SSD 25X2.5 DPE/DAE-FP	UM	\$0
V4-2S6F-200TU	VNX 200GB EFD 25X2.5 DPE/DAE UPG	UM	\$5,190
V4-2S6F-200U	VNX 200GB SSD 25X2.5 DPE/DAE UPG	UM	\$5,190
V4-2S6FX1.6TB-10	Flash Power Pack VNX2 1.6TB 10X2.5	UM	\$97,900
V4-2S6FX1.6TB-100	Flash Power Pack VNX2 1.6TB 100X2.5	UM	\$979,000
V4-2S6FX1.6TB-25	Flash Power Pack VNX2 1.6TB 25X2.5	UM	\$244,750
V4-2S6FX1.6TB-50	Flash Power Pack VNX2 1.6TB 50X2.5	UM	\$489,500
V4-2S6FX1.6TBU-10	Flash Power Pack VNX2 1.6TB 10X2.5 UPG	UM	\$117,450
V4-2S6FX1.6TBU-100	Flash Power Pack VNX2 1.6TB 100X2.5 UPG	UM	\$1,174,500
V4-2S6FX1.6TBU-25	Flash Power Pack VNX2 1.6TB 25X2.5 UPG	UM	\$293,625
V4-2S6FX1.6TBU-50	Flash Power Pack VNX2 1.6TB 50X2.5 UPG	UM	\$587,250
V4-2S6FX1.6TU-100	Flash Power Pack VNX2 1.6TB 100X2.5 UPG	UM	\$1,174,500
V4-2S6FX1.6TU-50	Flash Power Pack VNX2 1.6TB 50X2.5 UPG	UM	\$587,250
V4-2S6FX-100	VNX 100GB FAST VP SSD 25X2.5 DPE/DAE	UM	\$0
V4-2S6FX-100-FP	VNX 100GB FAST VP SSD 25X2.5 DPE/DAE-FP	UM	\$0
V4-2S6FX-100U	VNX 100GB FAST VP SSD 25X2.5 DPE/DAE UPG	UM	\$0
V4-2S6FX-1600	VNX 1600GB MLC SSD 25X2.5 DAE	UM	\$0
V4-2S6FX-1600TU	VNX 1600GB MLC SSD 25X2.5 DAE U/G	UM	\$11,745
V4-2S6FX-1600U	VNX 1600GB MLC SSD 25X2.5 DAE U/G	UM	\$11,745
V4-2S6FX-200	VNX 200GB FAST VP SSD 25X2.5 DPE/DAE	UM	\$0
V4-2S6FX-200-10	Flash Power Pack VNX2 200GB 10X2.5	UM	\$21,300
V4-2S6FX-200-100	Flash Power Pack VNX2 200GB 100X2.5	UM	\$185,400
V4-2S6FX-200-21	Flash Power Pack VNX2 200GB 21X2.5	UM	\$44,730
V4-2S6FX-200-25	Flash Power Pack VNX2 200GB 25X2.5	UM	\$53,250
V4-2S6FX-200-50	Flash Power Pack VNX2 200GB 50X2.5	UM	\$100,425
V4-2S6FX-200-FP	VNX 200GB FAST VP SSD 25X2.5 DPE/DAE-FP	UM	\$0
V4-2S6FX-200TU	VNX 200GB FAST VP EFD 25X2.5 DPE/DAE UPG	UM	\$2,555
V4-2S6FX-200TU-100	Flash Power Pack VNX2 200GB 100X2.5 UPG	UM	\$222,480
V4-2S6FX-200TU-50	Flash Power Pack VNX2 200GB 50X2.5 UPG	UM	\$120,510
V4-2S6FX-200U	VNX 200GB FAST VP SSD 25X2.5 DPE/DAE UPG	UM	\$2,555
V4-2S6FX-200U-10	Flash Power Pack VNX2 200GB 10X2.5 UPG	UM	\$25,550
V4-2S6FX-200U-100	Flash Power Pack VNX2 200GB 100X2.5 UPG	UM	\$222,480
V4-2S6FX-200U-21	Flash Power Pack VNX2 200GB 21X2.5 UPG	UM	\$53,655
V4-2S6FX-200U-25	Flash Power Pack VNX2 200GB 25X2.5 UPG	UM	\$63,875
V4-2S6FX-200U-50	Flash Power Pack VNX2 200GB 50X2.5 UPG	UM	\$120,510
V4-2S6FX-400	VNX 400GB FAST VP SSD 25X2.5 DPE/DAEE	UM	\$0
V4-2S6FX-400-10	Flash Power Pack VNX2 400GB 10X2.5	UM	\$33,900
V4-2S6FX-400-100	Flash Power Pack VNX2 400GB 100X2.5	UM	\$339,000
V4-2S6FX-400-21	Flash Power Pack VNX2 400GB 21X2.5	UM	\$71,190
V4-2S6FX-400-25	Flash Power Pack VNX2 400GB 25X2.5	UM	\$84,750
V4-2S6FX-400-50	Flash Power Pack VNX2 400GB 50X2.5	UM	\$169,500
V4-2S6FX-400-FP	VNX 400GB FAST VP SSD 25X2.5 DPE/DAE-FP	UM	\$0
V4-2S6FX-400TU	VNX 400GB FAST VP EFD 25X2.5 DPE/DAE UPG	UM	\$4,070
V4-2S6FX-400TU-100	Flash Power Pack VNX2 400GB 100X2.5 UPG	UM	\$407,000
V4-2S6FX-400TU-50	Flash Power Pack VNX2 400GB 50X2.5 UPG	UM	\$203,500
V4-2S6FX-400U	VNX 400GB FAST VP SSD 25X2.5 DPE/DAE UPG	UM	\$4,070
V4-2S6FX-400U-10	Flash Power Pack VNX2 400GB 10X2.5 UPG	UM	\$40,700
V4-2S6FX-400U-100	Flash Power Pack VNX2 400GB 100X2.5 UPG	UM	\$407,000
V4-2S6FX-400U-21	Flash Power Pack VNX2 400GB 21X2.5 UPG	UM	\$85,470

V4-2S6FX-400U-25	Flash Power Pack VNX2 400GB 25X2.5 UPG	UM	\$101,750
V4-2S6FX-400U-50	Flash Power Pack VNX2 400GB 50X2.5 UPG	UM	\$203,500
V4-2S6FX-800	VNX 800GB MLC SSD 25X2.5 DAE	UM	\$0
V4-2S6FX-800-10	Flash Power Pack VNX2 800GB 10X2.5	UM	\$59,950
V4-2S6FX-800-100	Flash Power Pack VNX2 800GB 100X2.5	UM	\$599,500
V4-2S6FX-800-25	Flash Power Pack VNX2 800GB 25X2.5	UM	\$149,875
V4-2S6FX-800-50	Flash Power Pack VNX2 800GB 50X2.5	UM	\$299,750
V4-2S6FX-800TU	VNX 800GB MLC SSD 25X2.5 DAE U/G	UM	\$7,195
V4-2S6FX-800TU-100	Flash Power Pack VNX2 800GB 100X2.5 UPG	UM	\$719,500
V4-2S6FX-800TU-50	Flash Power Pack VNX2 800GB 50X2.5 UPG	UM	\$359,750
V4-2S6FX-800U	VNX 800GB MLC SSD 25X2.5 DAE U/G	UM	\$7,195
V4-2S6FX-800U-10	Flash Power Pack VNX2 800GB 10X2.5 UPG	UM	\$71,950
V4-2S6FX-800U-100	Flash Power Pack VNX2 800GB 100X2.5 UPG	UM	\$719,500
V4-2S6FX-800U-25	Flash Power Pack VNX2 800GB 25X2.5 UPG	UM	\$179,875
V4-2S6FX-800U-50	Flash Power Pack VNX2 800GB 50X2.5 UPG	UM	\$359,750
V4-2S6FXL-1600	VNX 1600GB AFP SSD 25X2.5 DAE	UM	\$0
V4-2S6FXL-1600TU	VNX 1600GB AFP SSD 25X2.5 DAE UPG	UM	\$10,465
V4-2S6FXL-1600U	VNX 1600GB AFP SSD 25X2.5 DAE UPG	UM	\$10,465
V4-2S6FXL-3200	VNX 3200GB AFP SSD 25X2.5 DAE	UM	\$15,780
V4-2S6FXL-3200TU	VNX 3200GB AFP SSD 25X2.5 DAE UPG	UM	\$21,305
V4-2S6FXL-3200U	VNX 3200GB AFP SSD 25X2.5 DAE UPG	UM	\$21,305
V4-2S6FXL-400	VNX 400GB AFP SSD 25X2.5 DPE/DAE	UM	\$0
V4-2S6FXL-400TU	VNX 400GB AFP SSD 25X2.5 DPE/DAE UPG	UM	\$4,030
V4-2S6FXL-400U	VNX 400GB AFP SSD 25X2.5 DPE/DAE UPG	UM	\$4,030
V4-2S6FXL-800	VNX 800GB AFP SSD 25X2.5 DAE	UM	\$0
V4-2S6FXL-800TU	VNX 800GB AFP SSD 25X2.5 DAE UPG	UM	\$6,880
V4-2S6FXL-800U	VNX 800GB AFP SSD 25X2.5 DAE UPG	UM	\$6,880
V4-D2S10-012	VNX 1.2TB 10K SAS 120X2.5 DAE	UM	\$0
V4-D2S10-012TU	VNX 1.2TB 10K SAS 120X2.5 DAE UPG	UM	\$1,890
V4-D2S10-012U	VNX 1.2TB 10K SAS 120X2.5 DAE UPG	UM	\$1,945
V4-D2S10-600	VNX 600GB 10K SAS 120X2.5 DAE	UM	\$0
V4-D2S10-600TU	VNX 600GB 10K SAS 120X2.5 DAE UPG	UM	\$1,165
V4-D2S10-600U	VNX 600GB 10K SAS 120X2.5 DAE UPG	UM	\$1,165
V4-D2S10-900	VNX 900GB 10K SAS 120X2.5 DAE	UM	\$0
V4-D2S10-900TU	VNX 900GB 10K SAS 120X2.5 DAE UPG	UM	\$1,530
V4-D2S10-900U	VNX 900GB 10K SAS 120X2.5 DAE UPG	UM	\$1,530
V4-D2S15-300	VNX 300GB 15K SAS 120X2.5 DAE	UM	\$0
V4-D2S15-300TU	VNX 300GB 15K SAS 120X2.5 DAE UPG	UM	\$1,680
V4-D2S15-300U	VNX 300GB 15K SAS 120X2.5 DAE UPG	UM	\$1,680
V4-D2S15-600	VNX 600GB 15K SAS 120X2.5 DAE	UM	\$0
V4-D2S15-600TU	VNX 600GB 15K SAS 120X2.5 DAE UPG	UM	\$1,885
V4-D2S15-600U	VNX 600GB 15K SAS 120X2.5 DAE UPG	UM	\$1,885
V4-D2S6F-100	VNX 100GB EFD 120X2.5 DAE	UM	\$0
V4-D2S6F-100TU	VNX 100GB EFD 120X2.5 DAE UPG	UM	\$3,290
V4-D2S6F-100U	VNX 100GB EFD 120X2.5 DAE UPG	UM	\$3,290
V4-D2S6F-200	VNX 200GB EFD 120X2.5 DAE	UM	\$0
V4-D2S6F-200TU	VNX 200GB EFD 120X2.5 DAE UPG	UM	\$5,190
V4-D2S6F-200U	VNX 200GB EFD 120X2.5 DAE UPG	UM	\$5,190
V4-D2S6FX1.6TB-100	Flash PowerPack VNX2 1.6TB 100X2.5D	UM	\$979,000
V4-D2S6FX1.6TB-25	Flash Power Pack VNX2 1.6TB 25X2.5D	UM	\$244,750

V4-D2S6FX1.6TB-50	Flash Power Pack VNX2 1.6TB 50X2.5D	UM	\$489,500
V4-D2S6FX1.6TBU100	Flash PowerPack VNX2 1.6TB 100X2.5D UPG	UM	\$1,174,500
V4-D2S6FX1.6TBU-25	Flash Power Pack VNX2 1.6TB 25X2.5D UPG	UM	\$293,625
V4-D2S6FX1.6TBU-50	Flash Power Pack VNX2 1.6TB 50X2.5D UPG	UM	\$587,250
V4-D2S6FX1.6TU100	Flash Power Pack VNX2 1.6TB 100X2.5D UPG	UM	\$1,174,500
V4-D2S6FX1.6TU-50	Flash Power Pack VNX2 1.6TB 50X2.5D UPG	UM	\$587,250
V4-D2S6FX-100	VNX 100GB FAST VP EFD 120X2.5 DAE	UM	\$0
V4-D2S6FX-100TU	VNX 100GB FAST VP EFD 120X2.5 DAE UPG	UM	\$0
V4-D2S6FX-100U	VNX 100GB FAST VP EFD 120X2.5 DAE UPG	UM	\$0
V4-D2S6FX-1600	VNX 1600GB MLC SSD 120X2.5 DAE	UM	\$0
V4-D2S6FX-1600TU	VNX 1600GB MLC SSD 120X2.5 DAE U/G	UM	\$11,745
V4-D2S6FX-1600U	VNX 1600GB MLC SSD 120X2.5 DAE U/G	UM	\$11,745
V4-D2S6FX-200	VNX 200GB FAST VP EFD 120X2.5 DAE	UM	\$0
V4-D2S6FX-200-10	Flash Power Pack VNX2 200GB 10X2.5D	UM	\$21,300
V4-D2S6FX-200-100	Flash Power Pack VNX2 200GB 100X2.5D	UM	\$185,400
V4-D2S6FX-200-25	Flash Power Pack VNX2 200GB 25X2.5D	UM	\$53,250
V4-D2S6FX-200-50	Flash Power Pack VNX2 200GB 50X2.5D	UM	\$100,425
V4-D2S6FX-200TU	VNX 200GB FAST VP EFD 120X2.5 DAE UPG	UM	\$2,555
V4-D2S6FX-200TU100	Flash Power Pack VNX2 200GB 100X2.5D UPG	UM	\$222,480
V4-D2S6FX-200TU-50	Flash Power Pack VNX2 200GB 50X2.5D UPG	UM	\$120,510
V4-D2S6FX-200U	VNX 200GB FAST VP EFD120X2.5 DAE UPG	UM	\$2,555
V4-D2S6FX-200U-10	Flash Power Pack VNX2 200GB 10X2.5D UPG	UM	\$25,550
V4-D2S6FX-200U-100	Flash Power Pack VNX2 200GB 100X2.5D UPG	UM	\$222,480
V4-D2S6FX-200U-25	Flash Power Pack VNX2 200GB 25X2.5D UPG	UM	\$63,875
V4-D2S6FX-200U-50	Flash Power Pack VNX2 200GB 50X2.5D UPG	UM	\$120,510
V4-D2S6FX-400	VNX 400GB FAST VP EFD 120X2.5 DAE	UM	\$0
V4-D2S6FX-400-10	Flash Power Pack VNX2 400GB 10X2.5D	UM	\$33,900
V4-D2S6FX-400-100	Flash Power Pack VNX2 400GB 100X2.5D	UM	\$339,000
V4-D2S6FX-400-25	Flash Power Pack VNX2 400GB 25X2.5D	UM	\$84,750
V4-D2S6FX-400-50	Flash Power Pack VNX2 400GB 50X2.5D	UM	\$169,500
V4-D2S6FX-400TU	VNX 400GB FAST VP EFD 120X2.5 DAE UPG	UM	\$4,070
V4-D2S6FX-400TU100	Flash Power Pack VNX2 400GB 100X2.5D UPG	UM	\$407,000
V4-D2S6FX-400TU-50	Flash Power Pack VNX2 400GB 50X2.5D UPG	UM	\$203,500
V4-D2S6FX-400U	VNX 400GB FAST VP EFD 120X2.5 DAE UPG	UM	\$4,070
V4-D2S6FX-400U-10	Flash Power Pack VNX2 400GB 10X2.5D UPG	UM	\$40,700
V4-D2S6FX-400U-100	Flash Power Pack VNX2 400GB 100X2.5D UPG	UM	\$407,000
V4-D2S6FX-400U-25	Flash Power Pack VNX2 400GB 25X2.5D UPG	UM	\$101,750
V4-D2S6FX-400U-50	Flash Power Pack VNX2 400GB 50X2.5D UPG	UM	\$203,500
V4-D2S6FX-800	VNX 800GB MLC SSD 120X2.5 DAE	UM	\$0
V4-D2S6FX-800-10	Flash Power Pack VNX2 800GB 10X2.5D	UM	\$59,950
V4-D2S6FX-800-100	Flash Power Pack VNX2 800GB 100X2.5D	UM	\$599,500
V4-D2S6FX-800-25	Flash Power Pack VNX2 800GB 25X2.5D	UM	\$149,875
V4-D2S6FX-800-50	Flash Power Pack VNX2 800GB 50X2.5D	UM	\$299,750
V4-D2S6FX-800TU	VNX 800GB MLC SSD 120X2.5 DAE U/G	UM	\$7,195
V4-D2S6FX-800TU100	Flash Power Pack VNX2 800GB 100X2.5D UPG	UM	\$719,500
V4-D2S6FX-800TU-50	Flash Power Pack VNX2 800GB 50X2.5D UPG	UM	\$359,750
V4-D2S6FX-800U	VNX 800GB MLC SSD 120X2.5 DAE U/G	UM	\$7,195
V4-D2S6FX-800U-10	Flash Power Pack VNX2 800GB 10X2.5D UPG	UM	\$71,950
V4-D2S6FX-800U-100	Flash Power Pack VNX2 800GB 100X2.5D UPG	UM	\$719,500
V4-D2S6FX-800U-25	Flash Power Pack VNX2 800GB 25X2.5D UPG	UM	\$179,875

V4-D2S6FX-800U-50	Flash Power Pack VNX2 800GB 50X2.5D UPG	UM	\$359,750
V4-D2S6FXL-1600	VNX 1600GB AFP SSD 120X2.5 DAE	UM	\$0
V4-D2S6FXL-1600TU	VNX 1600GB AFP SSD 120X2.5 DAE UPG	UM	\$10,465
V4-D2S6FXL-1600U	VNX 1600GB AFP SSD 120X2.5 DAE UPG	UM	\$10,465
V4-D2S6FXL-3200	VNX 3200GB AFP SSD 120X2.5 DAE	UM	\$15,780
V4-D2S6FXL-3200TU	VNX 3200GB AFP SSD 120X2.5 DAE UPG	UM	\$21,305
V4-D2S6FXL-3200U	VNX 3200GB AFP SSD 120X2.5 DAE UPG	UM	\$21,305
V4-D2S6FXL-400	VNX 400GB AFP SSD 120X2.5 DAE	UM	\$0
V4-D2S6FXL-400TU	VNX 400GB AFP SSD 120X2.5 DAE UPG	UM	\$4,030
V4-D2S6FXL-400U	VNX 400GB AFP SSD 120X2.5 DAE UPG	UM	\$4,030
V4-D2S6FXL-800	VNX 800GB AFP SSD 120X2.5 DAE	UM	\$0
V4-D2S6FXL-800TU	VNX 800GB AFP SSD 120X2.5 DAE UPG	UM	\$6,880
V4-D2S6FXL-800U	VNX 800GB AFP SSD 120X2.5 DAE UPG	UM	\$6,880
V4-DS07-020	VNX 2TB NL SAS 60X3.5 DAE	UM	\$0
V4-DS07-020TU	VNX 2TB NL SAS 60X3.5 DAE UPG	UM	\$1,215
V4-DS07-020U	VNX 2TB NL SAS 60X3.5 DAE UPG	UM	\$1,215
V4-DS07-030	VNX 3TB NL SAS 60X3.5 DAE	UM	\$0
V4-DS07-030TU	VNX 3TB NL SAS 60X3.5 DAE UPG	UM	\$1,640
V4-DS07-030U	VNX 3TB NL SAS 60X3.5 DAE UPG	UM	\$1,640
V4-DS07-040	VNX 4TB NL SAS 60X3.5 DAE	UM	\$0
V4-DS07-040TU	VNX 4TB NL SAS 60X3.5 DAE UPG	UM	\$1,835
V4-DS07-040U	VNX 4TB NL SAS 60X3.5 DAE UPG	UM	\$1,835
V4-DS10-012	VNX 1.2TB 10K SAS 60X3.5 DAE	UM	\$0
V4-DS10-012TU	VNX 1.2TB 10K SAS 60X3.5 DAE UPG	UM	\$1,945
V4-DS10-012U	VNX 1.2TB 10K SAS 60X3.5 DAE UPG	UM	\$1,945
V4-DS10-600	VNX 600GB 10K SAS 60X3.5 DAE	UM	\$0
V4-DS10-600TU	VNX 600GB 10K SAS 60X3.5 DAE UPG	UM	\$0
V4-DS10-600U	VNX 600GB 10K SAS 60X3.5 DAE UPG	UM	\$0
V4-DS10-900	VNX 900GB 10K SAS 60X3.5 DAE	UM	\$0
V4-DS10-900TU	VNX 900GB 10K SAS 60X3.5 DAE UPG	UM	\$1,530
V4-DS10-900U	VNX 900GB 10K SAS 60X3.5 DAE UPG	UM	\$1,530
V4-DS15-300	VNX 300GB 15K SAS 60X3.5 DAE	UM	\$0
V4-DS15-300U	VNX 300GB 15K SAS 60X3.5 DAE UPG	UM	\$0
V4-DS15-600	VNX2 600GB 15K SAS 60X3.5 DPE/DAE	UM	\$0
V4-DS15-600TU	VNX2 600GB 15K SAS 60X3.5 TAA UPG	UM	\$0
V4-DS15-600U	VNX2 600GB 15K SAS 60X3.5 DPE/DAE UPG	UM	\$0
V4-DS6F-100	VNX 100GB SSD 60X3.5 DAE	UM	\$0
V4-DS6F-100-FP	VNX 100GB SSD 60X3.5 DAE-FP	UM	\$0
V4-DS6F-100TU	VNX 100GB EFD 60X3.5 DAE UPG	UM	\$3,290
V4-DS6F-100U	VNX 100GB SSD 60X3.5 DAE UPG	UM	\$3,290
V4-DS6F-200	VNX 200GB SSD 60X3.5 DAE	UM	\$0
V4-DS6F-200-FP	VNX 200GB SSD 60X3.5 DAE-FP	UM	\$0
V4-DS6F-200TU	VNX 200GB EFD 60X3.5 DAE UPG	UM	\$5,190
V4-DS6F-200U	VNX 200GB SSD 60X3.5 DAE UPG	UM	\$5,190
V4-DS6FX1.6TB-100	Flash Power Pack VNX2 1.6TB 100X3.5D	UM	\$979,000
V4-DS6FX1.6TB-25	Flash Power Pack VNX2 1.6TB 25X3.5D	UM	\$244,750
V4-DS6FX1.6TB-50	Flash Power Pack VNX2 1.6TB 50X3.5D	UM	\$489,500
V4-DS6FX1.6TBU-100	Flash Power Pack VNX2 1.6TB 100X3.5D UPG	UM	\$1,174,500
V4-DS6FX1.6TBU-25	Flash Power Pack VNX2 1.6TB 25X3.5D UPG	UM	\$293,625
V4-DS6FX1.6TBU-50	Flash Power Pack VNX2 1.6TB 50X3.5D UPG	UM	\$587,250

V4-DS6FX1.6TU-100	Flash Power Pack VNX2 1.6TB 100X3.5D UPG	UM	\$1,174,500
V4-DS6FX1.6TU-50	Flash Power Pack VNX2 1.6TB 50X3.5D UPG	UM	\$587,250
V4-DS6FX-100	VNX 100GB FAST VP SSD 60X3.5 DAE	UM	\$0
V4-DS6FX-100-FP	VNX 100GB FAST VP SSD 60X3.5 DAE-FP	UM	\$0
V4-DS6FX-100U	VNX 100GB FAST VP SSD 60X3.5 DAE UPG	UM	\$0
V4-DS6FX-1600	VNX 1600GB MLC SSD 60X3.5 DAE	UM	\$0
V4-DS6FX-1600TU	VNX 1600GB MLC SSD 60X3.5 DAE U/G	UM	\$11,745
V4-DS6FX-1600U	VNX 1600GB MLC SSD 60X3.5 DAE U/G	UM	\$11,745
V4-DS6FX-200	VNX 200GB FAST VP SSD 60X3.5 DAE	UM	\$0
V4-DS6FX-200-10	Flash Power Pack VNX2 200GB 10X3.5D	UM	\$21,300
V4-DS6FX-200-100	Flash Power Pack VNX2 200GB 100X3.5D	UM	\$185,400
V4-DS6FX-200-25	Flash Power Pack VNX2 200GB 25X3.5D	UM	\$53,250
V4-DS6FX-200-50	Flash Power Pack VNX2 200GB 50X3.5D	UM	\$100,425
V4-DS6FX-200-FP	VNX 200GB FAST VP SSD 60X3.5 DAE-FP	UM	\$0
V4-DS6FX-200TU	VNX 200GB FAST VP EFD 60X3.5 DAE UPG	UM	\$0
V4-DS6FX-200TU-100	Flash Power Pack VNX2 200GB 100X3.5D UPG	UM	\$222,480
V4-DS6FX-200TU-50	Flash Power Pack VNX2 200GB 50X3.5D UPG	UM	\$120,510
V4-DS6FX-200U	VNX 200GB FAST VP SSD 60X3.5 DAE UPG	UM	\$0
V4-DS6FX-200U-10	Flash Power Pack VNX2 200GB 10X3.5D UPG	UM	\$25,550
V4-DS6FX-200U-100	Flash Power Pack VNX2 200GB 100X3.5D UPG	UM	\$222,480
V4-DS6FX-200U-25	Flash Power Pack VNX2 200GB 25X3.5D UPG	UM	\$63,875
V4-DS6FX-200U-50	Flash Power Pack VNX2 200GB 50X3.5D UPG	UM	\$120,510
V4-DS6FX-400	VNX 400GB FAST VP SSD 60X3.5 DAE	UM	\$0
V4-DS6FX-400-10	Flash Power Pack VNX2 400GB 10X3.5D	UM	\$33,900
V4-DS6FX-400-100	Flash Power Pack VNX2 400GB 100X3.5D	UM	\$339,000
V4-DS6FX-400-25	Flash Power Pack VNX2 400GB 25X3.5D	UM	\$84,750
V4-DS6FX-400-50	Flash Power Pack VNX2 400GB 50X3.5D	UM	\$169,500
V4-DS6FX-400-FP	VNX 400GB FAST VP SSD 60X3.5 DAE-FP	UM	\$0
V4-DS6FX-400TU	VNX 400GB FAST VP EFD 60X3.5 DAE UPG	UM	\$0
V4-DS6FX-400TU-100	Flash Power Pack VNX2 400GB 100X3.5D UPG	UM	\$407,000
V4-DS6FX-400TU-50	Flash Power Pack VNX2 400GB 50X3.5D UPG	UM	\$203,500
V4-DS6FX-400U	VNX 400GB FAST VP SSD 60X3.5 DAE UPG	UM	\$0
V4-DS6FX-400U-10	Flash Power Pack VNX2 400GB 10X3.5D UPG	UM	\$40,700
V4-DS6FX-400U-100	Flash Power Pack VNX2 400GB 100X3.5D UPG	UM	\$407,000
V4-DS6FX-400U-25	Flash Power Pack VNX2 400GB 25X3.5D UPG	UM	\$101,750
V4-DS6FX-400U-50	Flash Power Pack VNX2 400GB 50X3.5D UPG	UM	\$203,500
V4-DS6FX-800	VNX 800GB MLC SSD 60X3.5 DAE	UM	\$0
V4-DS6FX-800-10	Flash Power Pack VNX2 800GB 10X3.5D	UM	\$59,950
V4-DS6FX-800-100	Flash Power Pack VNX2 800GB 100X3.5D	UM	\$599,500
V4-DS6FX-800-25	Flash Power Pack VNX2 800GB 25X3.5D	UM	\$149,875
V4-DS6FX-800-50	Flash Power Pack VNX2 800GB 50X3.5D	UM	\$299,750
V4-DS6FX-800TU	VNX 800GB MLC SSD 60X3.5 DAE U/G	UM	\$0
V4-DS6FX-800TU-100	Flash Power Pack VNX2 800GB 100X3.5D UPG	UM	\$719,500
V4-DS6FX-800TU-50	Flash Power Pack VNX2 800GB 50X3.5D UPG	UM	\$359,750
V4-DS6FX-800U	VNX 800GB MLC SSD 60X3.5 DAE U/G	UM	\$0
V4-DS6FX-800U-10	Flash Power Pack VNX2 800GB 10X3.5D UPG	UM	\$71,950
V4-DS6FX-800U-100	Flash Power Pack VNX2 800GB 100X3.5D UPG	UM	\$719,500
V4-DS6FX-800U-25	Flash Power Pack VNX2 800GB 25X3.5D UPG	UM	\$179,875
V4-DS6FX-800U-50	Flash Power Pack VNX2 800GB 50X3.5D UPG	UM	\$359,750
V4-VS07-020	VNX 2TB NL SAS 15X3.5 DAE	UM	\$0

V4-VS07-020TU	VNX 2TB NL SAS 15X3.5 DAE UPG	UM	\$1,215
V4-VS07-020U	VNX 2TB NL SAS 15X3.5 DAE UPG	UM	\$1,215
V4-VS07-030	VNX 3TB NL SAS 15X3.5 DAE	UM	\$0
V4-VS07-030TU	VNX 3TB NL SAS 15X3.5 DAE UPG	UM	\$1,640
V4-VS07-030U	VNX 3TB NL SAS 15X3.5 DAE UPG	UM	\$1,640
V4-VS07-040	VNX 4TB NL SAS 15X3.5 DAE	UM	\$0
V4-VS07-040TU	VNX 4TB NL SAS 15X3.5 DAE UPG	UM	\$1,835
V4-VS07-040U	VNX 4TB NL SAS 15X3.5 DAE UPG	UM	\$1,835
V4-VS10-012	VNX 1.2TB 10K SAS 15X3.5 DAE	UM	\$0
V4-VS10-012TU	VNX 1.2TB 10K SAS 15X3.5 DAE UPG	UM	\$1,945
V4-VS10-012U	VNX 1.2TB 10K SAS 15X3.5 DAE UPG	UM	\$1,945
V4-VS10-600	VNX 600GB 10K SAS 15X3.5 DAE	UM	\$0
V4-VS10-600TU	VNX 600GB 10K SAS 15X3.5 DAE UPG	UM	\$1,165
V4-VS10-600U	VNX 600GB 10K SAS 15X3.5 DAE UPG	UM	\$1,165
V4-VS10-900	VNX 900GB 10K SAS 15X3.5 DAE	UM	\$0
V4-VS10-900TU	VNX 900GB 10K SAS 15X3.5 DAE UPG	UM	\$1,530
V4-VS10-900U	VNX 900GB 10K SAS 15X3.5 DAE UPG	UM	\$1,530
V4-VS15-300	VNX 300GB 15K SAS 15X3.5 DAE	UM	\$0
V4-VS15-300TU	VNX 300GB 15K SAS 15X3.5 DAE UPG	UM	\$1,230
V4-VS15-300U	VNX 300GB 15K SAS 15X3.5 DAE UPG	UM	\$1,230
V4-VS15-600	VNX 600GB 15K SAS 15X3.5 DAE	UM	\$0
V4-VS15-600TU	VNX 600GB 15K SAS 15X3.5 DAE UPG	UM	\$1,885
V4-VS15-600U	VNX 600GB 15K SAS 15X3.5 DAE UPG	UM	\$1,885
V4-VS6F-100	VNX 100GB SSD 15X3.5 DAE	UM	\$0
V4-VS6F-100-FP	VNX 100GB SSD 15X3.5 DAE-FP	UM	\$0
V4-VS6F-100TU	VNX 100GB EFD 15X3.5 DAE UPG	UM	\$3,290
V4-VS6F-100U	VNX 100GB SSD 15X3.5 DAE UPG	UM	\$3,290
V4-VS6F-200	VNX 200GB SSD 15X3.5 DAE	UM	\$0
V4-VS6F-200-FP	VNX 200GB SSD 15X3.5 DAE-FP	UM	\$0
V4-VS6F-200TU	VNX 200GB EFD 15X3.5 DAE UPG	UM	\$5,190
V4-VS6F-200U	VNX 200GB SSD 15X3.5 DAE UPG	UM	\$5,190
V4-VS6FX1.6TB-10	Flash Power Pack VNX2 1.6TB 10X3.5	UM	\$97,900
V4-VS6FX1.6TB-100	Flash Power Pack VNX2 1.6TB 100X3.5	UM	\$979,000
V4-VS6FX1.6TB-25	Flash Power Pack VNX2 1.6TB 25X3.5	UM	\$244,750
V4-VS6FX1.6TB-50	Flash Power Pack VNX2 1.6TB 50X3.5	UM	\$489,500
V4-VS6FX1.6TBU-10	Flash Power Pack VNX2 1.6TB 10X3.5 UPG	UM	\$117,450
V4-VS6FX1.6TBU-100	Flash Power Pack VNX2 1.6TB 100X3.5 UPG	UM	\$1,174,500
V4-VS6FX1.6TBU-25	Flash Power Pack VNX2 1.6TB 25X3.5 UPG	UM	\$293,625
V4-VS6FX1.6TBU-50	Flash Power Pack VNX2 1.6TB 50X3.5 UPG	UM	\$587,250
V4-VS6FX1.6TU-100	Flash Power Pack VNX2 1.6TB 100X3.5 UPG	UM	\$1,174,500
V4-VS6FX1.6TU-50	Flash Power Pack VNX2 1.6TB 50X3.5 UPG	UM	\$587,250
V4-VS6FX-100	VNX 100GB FAST VP SSD 15X3.5 DAE	UM	\$0
V4-VS6FX-100-FP	VNX 100GB FAST VP SSD 15X3.5 DAE-FP	UM	\$0
V4-VS6FX-100U	VNX 100GB FAST VP SSD 15X3.5 DAE UPG	UM	\$0
V4-VS6FX-1600	VNX 1600GB MLC SSD 15X3.5 DAE	UM	\$0
V4-VS6FX-1600TU	VNX 1600GB MLC SSD 15X3.5 DAE U/G	UM	\$0
V4-VS6FX-1600U	VNX 1600GB MLC SSD 15X3.5 DAE U/G	UM	\$0
V4-VS6FX-200	VNX 200GB FAST VP SSD 15X3.5 DAE	UM	\$0
V4-VS6FX-200-10	Flash Power Pack VNX2 200GB 10X3.5	UM	\$21,300
V4-VS6FX-200-100	Flash Power Pack VNX2 200GB 100x3.5	UM	\$185,400

V4-VS6FX-200-21	Flash Power Pack VNX2 200GB 21x3.5	UM	\$44,730
V4-VS6FX-200-25	Flash Power Pack VNX2 200GB 25x3.5	UM	\$53,250
V4-VS6FX-200-50	Flash Power Pack VNX2 200GB 50x3.5	UM	\$100,425
V4-VS6FX-200-FP	VNX 200GB FAST VP SSD 15X3.5 DAE-FP	UM	\$0
V4-VS6FX-200TU	VNX 200GB FAST VP EFD 15X3.5 DAE UPG	UM	\$2,555
V4-VS6FX-200TU-100	Flash Power Pack VNX2 200GB 100x3.5 UPG	UM	\$222,480
V4-VS6FX-200TU-50	Flash Power Pack VNX2 200GB 50x3.5 UPG	UM	\$120,510
V4-VS6FX-200U	VNX 200GB FAST VP SSD 15X3.5 DAE UPG	UM	\$2,555
V4-VS6FX-200U-10	Flash Power Pack VNX2 200GB 10X3.5 UPG	UM	\$25,550
V4-VS6FX-200U-100	Flash Power Pack VNX2 200GB 100x3.5 UPG	UM	\$222,480
V4-VS6FX-200U-21	Flash Power Pack VNX2 200GB 21x3.5 UPG	UM	\$53,655
V4-VS6FX-200U-25	Flash Power Pack VNX2 200GB 25x3.5 UPG	UM	\$63,875
V4-VS6FX-200U-50	Flash Power Pack VNX2 200GB 50x3.5 UPG	UM	\$120,510
V4-VS6FX-400	VNX 400GB FAST VP SSD 15X3.5 DAE	UM	\$0
V4-VS6FX-400-10	Flash Power Pack VNX2 400GB 10X3.5	UM	\$33,900
V4-VS6FX-400-100	Flash Power Pack VNX2 400GB 100x3.5	UM	\$339,000
V4-VS6FX-400-21	Flash Power Pack VNX2 400GB 21x3.5	UM	\$71,190
V4-VS6FX-400-25	Flash Power Pack VNX2 400GB 25x3.5	UM	\$84,750
V4-VS6FX-400-50	Flash Power Pack VNX2 400GB 50x3.5	UM	\$169,500
V4-VS6FX-400-FP	VNX 400GB FAST VP SSD 15X3.5 DAE-FP	UM	\$0
V4-VS6FX-400TU	VNX 400GB FAST VP EFD 15X3.5 DAE UPG	UM	\$4,070
V4-VS6FX-400TU-100	Flash Power Pack VNX2 400GB 100x3.5 UPG	UM	\$407,000
V4-VS6FX-400TU-50	Flash Power Pack VNX2 400GB 50x3.5 UPG	UM	\$203,500
V4-VS6FX-400U	VNX 400GB FAST VP SSD 15X3.5 DAE UPG	UM	\$4,070
V4-VS6FX-400U-10	Flash Power Pack VNX2 400GB 10X3.5 UPG	UM	\$40,700
V4-VS6FX-400U-100	Flash Power Pack VNX2 400GB 100x3.5 UPG	UM	\$407,000
V4-VS6FX-400U-21	Flash Power Pack VNX2 400GB 21x3.5 UPG	UM	\$85,470
V4-VS6FX-400U-25	Flash Power Pack VNX2 400GB 25x3.5 UPG	UM	\$101,750
V4-VS6FX-400U-50	Flash Power Pack VNX2 400GB 50x3.5 UPG	UM	\$203,500
V4-VS6FX-800	VNX 800GB MLC SSD 15X3.5 DAE	UM	\$0
V4-VS6FX-800-10	Flash Power Pack VNX2 800GB 10X3.5	UM	\$59,950
V4-VS6FX-800-100	Flash Power Pack VNX2 800GB 100x3.5	UM	\$599,500
V4-VS6FX-800-21	Flash Power Pack VNX2 800GB 21x3.5	UM	\$125,895
V4-VS6FX-800-25	Flash Power Pack VNX2 800GB 25x3.5	UM	\$149,875
V4-VS6FX-800-50	Flash Power Pack VNX2 800GB 50x3.5	UM	\$299,750
V4-VS6FX-800TU	VNX 800GB MLC SSD 15X3.5 DAE U/G	UM	\$7,195
V4-VS6FX-800TU-100	Flash Power Pack VNX2 800GB 100x3.5 UPG	UM	\$719,500
V4-VS6FX-800TU-50	Flash Power Pack VNX2 800GB 50x3.5 UPG	UM	\$359,750
V4-VS6FX-800U	VNX 800GB MLC SSD 15X3.5 DAE U/G	UM	\$7,195
V4-VS6FX-800U-10	Flash Power Pack VNX2 800GB 10X3.5 UPG	UM	\$71,950
V4-VS6FX-800U-100	Flash Power Pack VNX2 800GB 100x3.5 UPG	UM	\$719,500
V4-VS6FX-800U-21	Flash Power Pack VNX2 800GB 21x3.5 UPG	UM	\$151,095
V4-VS6FX-800U-25	Flash Power Pack VNX2 800GB 25x3.5 UPG	UM	\$179,875
V4-VS6FX-800U-50	Flash Power Pack VNX2 800GB 50x3.5 UPG	UM	\$359,750
VBMSASHDMSAS2	ONE PR 2M MINI SAS HD TO MINI SAS CBLs	UM	\$554
VBMSASHDMSAS5	ONE PR 5M MINI SAS HD TO MINI SAS CBLs	UM	\$1,386
VBMSASHDMSAS8	ONE PR 8M MINI SAS HD TO MINI SAS CBLs	UM	\$2,772
VBMSAS-MSAS10	ONE PR OF 10M MINI SAS TO MINI SAS CBLs	UM	\$1,063
VBMSAS-MSAS2M	ONE PR OF 2M MINI SAS TO MINI SAS CBLs	UM	\$370
VBMSAS-MSAS5M	ONE PR OF 5M MINI SAS TO MINI SAS CBLs	UM	\$924

VBPW40U-ASTL	CAB QUAD POWER CORD AUSTRALIA TWISTLO	UM	\$1,301
VBPW40UD-ASTL	40U DEEP RACK PWR CORD PAIR ASTL LP-58	UM	\$2,661
VBPW40UD-IEC3	40U DEEP RACK PWR CORD PAIR IEC309	UM	\$1,127
VBPW40UD-RS	40U DEEP RACK PWR CORD PAIR R&S	UM	\$3,850
VBPW40UD-US	40U DEEP RACK PWR CORD PAIR US TWISTLOC	UM	\$680
VBPW40U-IEC3	CAB QUAD POWER CORD IEC309	UM	\$680
VBPW40U-RS	CAB QUAD POWER CORD US R&S CONNECTOR	UM	\$1,301
VBPW40U-US	CAB QUAD POWER CORD US TWISTLOCK	UM	\$680
VBSAS-FLEX2M	HI-FLEX 2M MINISAS TO MINISAS CBL PR	UM	\$812
VBSAS-FLEX3M	HI-FLEX 3M MINISAS TO MINISAS CBL PR	UM	\$1,217
VBSAS-FLEX5M	HI-FLEX 5M MINISAS TO MINISAS CBL PR	UM	\$2,028
VBSASHD-FLX2M	HI-FLEX 2M MINISASHD TO MINISAS CBL PR	UM	\$1,093
VBSASHD-FLX3M	HI-FLEX 3M MINISASHD TO MINISAS CBL PR	UM	\$1,639
VBSASHD-FLX5M	HI-FLEX 5M MINISASHD TO MINISAS CBL PR	UM	\$2,732
VBSASHD-FLX8M	HI-FLEX 8M MINISASHD TO MINISAS CBL PR	UM	\$4,372
VBSFP-TWAX-1M	Qty 2 SFP+ TO SFP+ 1M ACTIVE 8G/10G CBL	UM	\$638
VBSFP-TWAX-3M	Qty 2 SFP+ TO SFP+ 3M ACTIVE 8G/10G CBL	UM	\$765
VBSFP-TWAX-5M	Qty 2 SFP+ TO SFP+ 5M ACTIVE 8G/10G CBL	UM	\$935
VBTELCO1UCS	Telco Rail Kit for the 1U CS	UM	\$924
VBTELCO2UDAE	Telco Rail kit for the 2U DAE	UM	\$201
VBTELCO2UDME	Telco Rail Kit for the 2U DME	UM	\$201
VBTELCO3UDAE	Telco Rail kit for the 3U DAE	UM	\$201
VDMBM1GCUA	VNXB 1GBASE-T DM MODULE 4 PORT	UM	\$0
VDMBM1GCUU	VNXB 1GBASE-T DM MODULE 4 PORT	UM	\$2,074
VDMBMXG2OPA	VNXB 10GBE 2 OP MODULE (2 SFP+)	UM	\$0
VDMBMXG2OPU	VNXB 10GBE 2 OP MODULE (2 SFP+)	UM	\$6,226
VDMBMXG2TWA	VNXB 10GBE 2 OP MODULE (TWINAX)	UM	\$0
VDMBMXG2TWU	VNXB 10GBE 2 OP MODULE (TWINAX)	UM	\$4,144
VDMBMXGTA	VNXB 10GBASE-T DM MODULE 2 PORT	UM	\$0
VDMBMXGTU	VNXB 10GBASE-T DM MODULE 2 PORT	UM	\$3,104
V-N4-201210	VNX 1.2TB 10K VAULT 25X2.5 DPE/DAE NEBS	UM	\$0
V-N4-230015	VNX 300GB 15K VAULT 25X2.5 DPE/DAE NEBS	UM	\$0
V-N4-2400FX	VNX 400GB SSD VAULT 25X2.5 DPE/DAE NEBS	UM	\$0
V-N4-260010	VNX 600GB 10K VAULT 25X2.5 DPE/DAE NEBS	UM	\$0
V-N4-290010	VNX 900GB 10K VAULT 25X2.5 DPE/DAE NEBS	UM	\$0
V-N4-2S0701	VNX 1000GB SAS VAULT 25X2.5 DPE/DAE NEBS	UM	\$0
V-N4-D90010	VNX 900GB 10K VAULT 60X3.5 DAE NEBS	UM	\$4,985
V-N4-V30015	VNX 300GB 15K VAULT 15X3.5 DAE NEBS	UM	\$4,005
V-N4-V400FX	VNX 400GB SSD VAULT 15X3.5 DAE NEBS	UM	\$17,560
V-N4-V60010	VNX 600GB 10K VAULT 15X3.5 DAE NEBS	UM	\$3,785
V-N4-V60015	VNX 600GB 15K VAULT 15X3.5 DAE NEBS	UM	\$6,140
V-N4-V90010	VNX 900GB 10K VAULT 15X3.5 DAE NEBS	UM	\$4,985
VN52DP010NLFD	VNX5200 DPE 25 DR-6X1TNL DC-FLD INST	UM	\$0
VN52DP010NLMD	VNX5200 DPE 25 DR-6X1TNL DC-MIN RK	UM	\$0
VN52DP01210FD	VNX5200 DPE 25 DR-8X1.2T10K DC-FLD INS	UM	\$0
VN52DP01210MD	VNX5200 DPE 25 DR-8X1.2T10K DC-MIN RK	UM	\$0
VN52DP112NLFD	VNX5200 DPE 25 DR-12X1T NL DC-FLD IN	UM	\$0
VN52DP112NLMD	VNX5200 DPE 25 DR-12X1T NL DC-MIN RK	UM	\$0
VN52DP12210FD	VNX5200 DPE 25x2.5";12x1.2TB 10k DC-FL	UM	\$0
VN52DP12210MD	VNX5200 DPE 25x2.5";12x1.2TB DC-MIN RK	UM	\$0

VN52DP12510FD	VNX5200 DPE 25x2.5";25x1.2TB 10k DC-FL	UM	\$0
VN52DP12510MD	VNX5200 DPE 25x2.5";25x1.2TB DC-MIN RK	UM	\$0
VN52DP125NLF	VNX5200 DPE 25 DR-25X1T NL DC-FLD IN	UM	\$0
VN52DP125NLMD	VNX5200 DPE 25 DR-25X1T NL DC-MIN RK	UM	\$0
VN52DP30015FD	VNX5200 DPE 25 DR-8X300G15K DC-FLD INS	UM	\$0
VN52DP30015MD	VNX5200 DPE 25 DR-8X300G15K DC-MIN RK	UM	\$0
VN52DP31215FD	VNX5200 DPE 25 DR-12X300G15K DC-FLD IN	UM	\$0
VN52DP31215MD	VNX5200 DPE 25 DR-12X300G15K DC-MIN RK	UM	\$0
VN52DP32515FD	VNX5200 DPE 25 DR-25X300G15K DC-FLD IN	UM	\$0
VN52DP32515MD	VNX5200 DPE 25 DR-25X300G15K DC-MIN RK	UM	\$0
VN52DP400FXFD	VNX5200 DPE 25 DR-8X400GFL DC-FLD INS	UM	\$0
VN52DP400FXMD	VNX5200 DPE 25 DR-8X400GFL DC-MIN RK	UM	\$0
VN52DP60010FD	VNX5200 DPE 25 DR-8X600G10K DC-FLD INS	UM	\$0
VN52DP60010MD	VNX5200 DPE 25 DR-8X600G10K DC-MIN RK	UM	\$0
VN52DP61210FD	VNX5200 DPE 25 DR-12X600G10K DC-FLD IN	UM	\$0
VN52DP61210MD	VNX5200 DPE 25 DR-12X600G10K DC-MIN RK	UM	\$0
VN52DP62510FD	VNX5200 DPE 25 DR-25X600G10K DC-FLD IN	UM	\$0
VN52DP62510MD	VNX5200 DPE 25 DR-25X600G10K DC-MIN RK	UM	\$0
VN52DP90010FD	VNX5200 DPE 25 DR-8X900G10K DC-FLD INS	UM	\$0
VN52DP90010MD	VNX5200 DPE 25 DR-8X900G10K DC-MIN RK	UM	\$0
VN52DP91210FD	VNX5200 DPE 25 DR-12X900G10K DC-FLD INS	UM	\$0
VN52DP91210MD	VNX5200 DPE 25 DR-12X900G10K DC-MIN RK	UM	\$0
VN52DP92510FD	VNX5200 DPE 25 DR-25X900G10K DC-FLD INS	UM	\$0
VN52DP92510MD	VNX5200 DPE 25 DR-25X900G10K DC-MIN RK	UM	\$0
VNX2-ROCK-NX	VNX2 N-X OE 05.33.000.5.079/8.1.3.79=IC	UM	\$0
VNX5200-BTU-KIT	BLOCK TO UNIFIED UPG KIT FOR VNX5200=IC	UM	\$2,940
VNX5200-DARE	VNX5200 Controller Based Encryp Suite=IC	UM	\$2,340
VNX5200DMEXDU	VNXB52 DME: 1 DM+FC SLIC-BTU Fld Install	UM	\$9,460
VNX5200-EPAK	VNX5200 Total Efficiency Pack=IC	UM	\$22,191
VNX5200-ESSPCK	VNX5200 Software Essentials Pack=IC	UM	\$6,015
VNX5200-FSTS	VNX5200 FAST Suite=IC	UM	\$4,177
VNX5200-LPS	VNX5200 Local Protection Suite=IC	UM	\$3,334
VNX5200-OE	VNX OE License VNX5200=IC	UM	\$0
VNX5200-PPAK	VNX5200 Total Protection Pack=IC	UM	\$19,972
VNX5200-RPS	VNX5200 Remote Protection Suite=IC	UM	\$8,594
VNX5200-SCS	VNX5200 Events and Retention Suite=IC	UM	\$1,497
VNX5200-UNISB	VNX5200 Unisphere Block Suite=IC	UM	\$7,054
VNX5200-UNISF	VNX5200 Unisphere File Suite=IC	UM	\$5,486
VNX5200-UNISU	VNX5200 Unisphere Unified Suite=IC	UM	\$9,014
VNX524-56B	CONVERT VNX52/54 DPE TO VNX5600 DPE	UM	\$13,657
VNX524-56F	CONVERT VNX52/54 DM TO VNX5600 DM	UM	\$7,612
VNX5246-58B	CONVERT VNX52/54/56 DPE TO VNX58 DPE	UM	\$23,120
VNX5246-58F	CONVERT VNX52/54/56 DM TO VNX58 DM	UM	\$23,476
VNX52468-76B	CONVERT VNX52/4/6/58 DPE TO VNX76 DPE	UM	\$43,761
VNX52468-76F	CONVERT VNX52/4/6/58 DM TO VNX76 DM	UM	\$51,106
VNX52-54B	CONVERT VNX5200 DPE TO VNX5400 DPE	UM	\$8,270
VNX52BTU-KIT	BLOCK TO UNIFIED UPG KIT FOR VNX5200	UM	\$0
VNX52DP010NL	VNX5200 DPE 25X2.5" DR-6X1TNL-EMC RK	UM	\$0
VNX52DP010NLF	VNX5200 DPE 25X2.5" DR-6X1TNL-FLD INST	UM	\$0
VNX52DP010NLM	VNX5200 DPE 25X2.5" DR-6X1TNL-MIN RK	UM	\$0

VNX52DP01210	VNX5200 DPE 25X2.5" DR-8X1.2T10K-EMC RK	UM	\$0
VNX52DP01210F	VNX5200 DPE 25X2.5" DR-8X1.2T10K-FLD I	UM	\$0
VNX52DP01210M	VNX5200 DPE 25X2.5" DR-8X1.2T10K-MIN RK	UM	\$0
VNX52DP112NL	VNX5200 DPE 25X2.5" DR-12X1TNL-EMC RK	UM	\$0
VNX52DP112NLF	VNX5200 DPE 25X2.5" DR-12X1TNL-FLD INST	UM	\$0
VNX52DP112NLM	VNX5200 DPE 25X2.5" DR-12X1TNL-MIN RK	UM	\$0
VNX52DP12210	VNX5200 DPE 25X2.5"DR-12X1.2T10K-EMC RK	UM	\$21,775
VNX52DP12210F	VNX5200 DPE 25X2.5"DR-12X1.2T10K-FLD I	UM	\$21,775
VNX52DP12210M	VNX5200 DPE 25X2.5"DR-12X1.2T10K-MIN RK	UM	\$21,775
VNX52DP12510	VNX5200 DPE 25X2.5" DR-25X1.2T10K-EMC	UM	\$28,243
VNX52DP12510F	VNX5200 DPE 25X2.5" DR-25X1.2T10K-FLD I	UM	\$28,243
VNX52DP12510M	VNX5200 DPE 25X2.5" DR-25X1.2T10K-MIN	UM	\$28,243
VNX52DP125NL	VNX5200 DPE 25X2.5"DR-25X1TNL-EMC RK	UM	\$0
VNX52DP125NLF	VNX5200 DPE 25X2.5"DR-25X1TNL-FLD INS	UM	\$0
VNX52DP125NLM	VNX5200 DPE 25X2.5"DR-25X1TNL-MIN RK	UM	\$0
VNX52DP30015	VNX5200 DPE 25X2.5" DR-8X300G15K-EMC RK	UM	\$0
VNX52DP30015F	VNX5200 DPE 25X2.5" DR-8X300G15K-FLD I	UM	\$0
VNX52DP30015M	VNX5200 DPE 25X2.5" DR-8X300G15K-MIN RK	UM	\$0
VNX52DP31215	VNX5200 DPE 25X2.5" DR-12X300G15K-EMC	UM	\$0
VNX52DP31215F	VNX5200 DPE 25X2.5" DR-12X300G15K-FLD I	UM	\$0
VNX52DP31215M	VNX5200 DPE 25X2.5" DR-12X300G15K-MIN	UM	\$0
VNX52DP32515	VNX5200 DPE 25X2.5" DR-25X300G15K-EMC	UM	\$0
VNX52DP32515F	VNX5200 DPE 25X2.5" DR-25X300G15K-FLD I	UM	\$0
VNX52DP32515M	VNX5200 DPE 25X2.5" DR-25X300G15K-MIN	UM	\$0
VNX52DP400FX	VNX5200 DPE 25X2.5" DR-8X400GFL-EMC RK	UM	\$0
VNX52DP400FXF	VNX5200 DPE 25X2.5" DR-8X400GFL-FLD INS	UM	\$0
VNX52DP400FXM	VNX5200 DPE 25X2.5" DR-8X400GFL-MIN RK	UM	\$0
VNX52DP60010	VNX5200 DPE 25X2.5" DR-8X600G10K-EMC RK	UM	\$0
VNX52DP60010F	VNX5200 DPE 25X2.5" DR-8X600G10K-FLD I	UM	\$0
VNX52DP60010M	VNX5200 DPE 25X2.5" DR-8X600G10K-MIN RK	UM	\$0
VNX52DP60015	VNX5200 DPE 25X2.5" DR-8X600G15K-EMC RK	UM	\$21,900
VNX52DP60015F	VNX5200 DPE 25X2.5" DR-8X600G15K-FLD INS	UM	\$21,900
VNX52DP60015M	VNX5200 DPE 25X2.5" DR-8X600G15K-MIN RK	UM	\$21,900
VNX52DP61210	VNX5200 DPE 25X2.5" DR-12X600G10K-EMC	UM	\$0
VNX52DP61210F	VNX5200 DPE 25X2.5" DR-12X600G10K-FLD I	UM	\$0
VNX52DP61210M	VNX5200 DPE 25X2.5" DR-12X600G10K-MIN	UM	\$0
VNX52DP62510	VNX5200 DPE 25X2.5" DR-25X600G10K-EMC	UM	\$0
VNX52DP62510F	VNX5200 DPE 25X2.5" DR-25X600G10K-FLD I	UM	\$0
VNX52DP62510M	VNX5200 DPE 25X2.5" DR-25X600G10K-MIN	UM	\$0
VNX52DP90010	VNX5200 DPE 25X2.5" DR-8X900G10K-EMC RK	UM	\$0
VNX52DP90010F	VNX5200 DPE 25X2.5" DR-8X900G10K-FLD I	UM	\$0
VNX52DP90010M	VNX5200 DPE 25X2.5" DR-8X900G10K-MIN RK	UM	\$0
VNX52DP91210	VNX5200 DPE 25X2.5"DR-12X900G10K-EMC RK	UM	\$18,146
VNX52DP91210F	VNX5200 DPE 25X2.5"DR-12x900G10K-FLD I	UM	\$18,146
VNX52DP91210M	VNX5200 DPE 25X2.5"DR-12x900G10K-MIN RK	UM	\$18,146
VNX52DP92510	VNX5200 DPE 25X2.5"DR-25X900G10K-EMC RK	UM	\$23,536
VNX52DP92510F	VNX5200 DPE 25X2.5"DR-25X900G10K-FLD I	UM	\$23,536
VNX52DP92510M	VNX5200 DPE 25X2.5"DR-25X900G10K-MIN RK	UM	\$23,536
VNX52DPM1210	VNX5200 DPE 25X2.5" 4-600-8 1TNL-EMC RK	UM	\$0
VNX52DPM1210F	VNX5200 DPE 25X2.5" 4-600-8 1TNL-FLD INS	UM	\$0

VNX52DPM1210M	VNX5200 DPE 25X2.5" 4-600-8 1TNL-MIN RK	UM	\$0
VNX52DPM2510	VNX5200 DPE 25X2.5" 4-600-211TNL-EMC RK	UM	\$0
VNX52DPM2510F	VNX5200 DPE 25X2.5" 4-600-211TNL-FLD INS	UM	\$0
VNX52DPM2510M	VNX5200 DPE 25X2.5" 4-600-211TNL-MIN RK	UM	\$0
VNX52-ESSPCK	VNX5200 Software Essentials Pack=IC	UM	\$0
VNX52-ESSPCK-PROMO	VNX5200 SoftwareEssentials Promo Pack=IC	UM	\$0
VNX52-KIT	VNX5200 Documentation Kit=IC	UM	\$0
VNX52VP010NLF	VNX5200 DPE 25X2.5" DR-6X1TNL-FLD INST	UM	\$10,960
VNX52VP010NLM	VNX5200 DPE 25X2.5" DR-6X1TNL-MIN RK	UM	\$10,960
VNX52VP01210F	VNX5200 DPE 25X2.5" DR-8X1.2T10K-FLD INS	UM	\$18,146
VNX52VP01210M	VNX5200 DPE 25X2.5" DR-8X1.2T10K-MIN RK	UM	\$18,146
VNX52VP112NLF	VNX5200 DPE 25X2.5" DR-12X1T NL-FLD IN	UM	\$13,315
VNX52VP112NLM	VNX5200 DPE 25X2.5" DR-12X1T NL-MIN RK	UM	\$13,315
VNX52VP12210F	VNX5200 DPE 25X2.5" DR-12X1.2T10K-FLD I	UM	\$21,775
VNX52VP12210M	VNX5200 DPE 25X2.5" DR-12X1.2T10K-MIN RK	UM	\$21,775
VNX52VP12510F	VNX5200 DPE 25X2.5" DR-25X1.2T10K-FLD I	UM	\$28,243
VNX52VP12510M	VNX5200 DPE 25X2.5" DR-25X1.2T10K-MIN RK	UM	\$28,243
VNX52VP125NLF	VNX5200 DPE 25X2.5" DR-25X1T NL-FLD IN	UM	\$19,814
VNX52VP125NLM	VNX5200 DPE 25X2.5" DR-25X1T NL-MIN RK	UM	\$19,814
VNX52VP30015F	VNX5200 DPE 25X2.5" DR-8X300G15K-FLD I	UM	\$13,132
VNX52VP30015M	VNX5200 DPE 25X2.5" DR-8X300G15K-MIN RK	UM	\$13,132
VNX52VP31215F	VNX5200 DPE 25X2.5" DR-12X300G15K-FLD	UM	\$14,445
VNX52VP31215M	VNX5200 DPE 25X2.5" DR-12X300G15K-MIN	UM	\$14,445
VNX52VP32515F	VNX5200 DPE 25X2.5" DR-25X300G15K-FLD	UM	\$19,814
VNX52VP32515M	VNX5200 DPE 25X2.5" DR-25X300G15K-MIN	UM	\$19,814
VNX52VP400FXF	VNX5200 DPE 25X2.5" DR-8X400GFL-FLD INS	UM	\$75,109
VNX52VP400FXM	VNX5200 DPE 25X2.5" DR-8X400GFL-MIN RK	UM	\$75,109
VNX52VP60010F	VNX5200 DPE 25X2.5" DR-8X600G10K-FLD I	UM	\$14,019
VNX52VP60010M	VNX5200 DPE 25X2.5" DR-8X600G10K-MIN RK	UM	\$14,019
VNX52VP61210F	VNX5200 DPE 25X2.5" DR-12X600G10K-FLD	UM	\$15,421
VNX52VP61210M	VNX5200 DPE 25X2.5" DR-12X600G10K-MIN	UM	\$15,421
VNX52VP62510F	VNX5200 DPE 25X2.5" DR-25X600G10K-FLD	UM	\$17,767
VNX52VP62510M	VNX5200 DPE 25X2.5" DR-25X600G10K-MIN	UM	\$17,767
VNX52VP90010F	VNX5200 DPE 25X2.5" DR-8X900G10K-FLD I	UM	\$15,122
VNX52VP90010M	VNX5200 DPE 25X2.5" DR-8X900G10K-MIN RK	UM	\$15,122
VNX52VP91210F	VNX5200 DPE 25x2.5"DR-12x900G10K-FLD I	UM	\$18,146
VNX52VP91210M	VNX5200 DPE 25x2.5"DR-12x900G10K-MIN RK	UM	\$18,146
VNX52VP92510F	VNX5200 DPE 25x2.5"DR-25x900G10K-FLD I	UM	\$23,536
VNX52VP92510M	VNX5200 DPE 25x2.5"DR-25x900G10K-MIN RK	UM	\$23,536
VNX52VPM1210F	VNX5200 DPE 25X2.5" 4-600-8 1TNL-FLD I	UM	\$11,810
VNX52VPM1210M	VNX5200 DPE 25X2.5" 4-600-8 1TNL-MIN RK	UM	\$11,810
VNX52VPM2410F	VNX5200 DPE 25X2.5" 4-600-20 1TNL-FLD	UM	\$0
VNX52VPM2410M	VNX5200 DPE 25X2.5" 4-600-20 1TNL-MIN	UM	\$0
VNX52VPM2510F	VNX5200 DPE 25X2.5"4-600-211TNL-FLD INS	UM	\$19,814
VNX52VPM2510M	VNX5200 DPE 25X2.5"4-600-211TNL-MIN RK	UM	\$19,814
VNX5400-BTU-KIT	BLOCK TO UNIFIED UPG KIT FOR VNX5400=IC	UM	\$3,020
VNX5400-DARE	VNX5400 Controller Based Encryp Suite=IC	UM	\$3,725
VNX5400-DARE-UPG	Data at Rest Encryption for VNX5400=IC	UM	\$2,980
VNX5400DMEXDU	VNXB54 DME: 1 DM+FC SLIC-BTU Fld Install	UM	\$9,820
VNX5400-EPAK	VNX5400 Total Efficiency Pack=IC	UM	\$0

VNX5400-EPAK-UPG	VNX5400 Total Efficiency Pack=IC	UM	\$29,100
VNX5400-ESSPCK	VNX5400 Software Essentials=IC	UM	\$11,535
VNX5400-ESSPCK-UPG	VNX5400 Upg DIP SW Essentials=IC	UM	\$9,230
VNX5400-FSTS	VNX5400 FAST Suite=IC	UM	\$0
VNX5400-FSTS-UPG	VNX5400 FAST Suite=IC	UM	\$6,835
VNX5400-LPS	VNX5400 Local Protection Suite=IC	UM	\$0
VNX5400-LPS-UPG	VNX5400 Local Protection Suite=IC	UM	\$4,755
VNX5400-OE	VNX OE License VNX5400=IC	UM	\$0
VNX5400-PPAK	VNX5400 Total Protection Pack=IC	UM	\$0
VNX5400-PPAK-UPG	VNX5400 Total Protection Pack=IC	UM	\$42,030
VNX5400-RPS	VNX5400 Remote Protection Suite=IC	UM	\$0
VNX5400-RPS-UPG	VNX5400 Remote Protection Suite=IC	UM	\$12,250
VNX5400-SCS	VNX5400 Events and Retention Suite=IC	UM	\$0
VNX5400-SCS-UPG	VNX5400 Events and Retention Suite=IC	UM	\$1,905
VNX5400-UNISB	VNX5400 Unisphere Block Suite=IC	UM	\$0
VNX5400-UNISF	VNX5400 Unisphere File Suite=IC	UM	\$0
VNX5400-UNISU	VNX5400 Unisphere Unified Suite=IC	UM	\$0
VNX54BTU-KIT	BLOCK TO UNIFIED UPG KIT FOR VNX5400	UM	\$0
VNX54-ESSPCK	VNX5400 Software Essentials Pack=IC	UM	\$0
VNX54-ESSPCK-PROMO	VNX5400 SoftwareEssentials Promo Pack=IC	UM	\$0
VNX54-KIT	VNX5400 Documentation Kit=IC	UM	\$0
VNX54-UNIB-UPG	VNX5400 Unisphere Block Suite UPG=IC	UM	\$6,985
VNX54-UNIF-UPG	VNX5400 Unisphere File Suite UPG=IC	UM	\$5,195
VNX54-UNIU-UPG	VNX5400 Unisphere Unified Suite UPG=IC	UM	\$8,595
VNX5600-BTU-KIT	BLOCK TO UNIFIED UPG KIT FOR VNX5600=IC	UM	\$4,740
VNX5600-DARE	VNX5600 Controller Based Encryp Suite=IC	UM	\$6,515
VNX5600-DARE-UPG	Data at Rest Encryption for VNX5600=IC	UM	\$5,210
VNX5600DMEXDU	VNXB56 DME: 1 DM+FC SLIC-BTU Fld Install	UM	\$11,800
VNX5600-EPAK	VNX5600 Total Efficiency Pack=IC	UM	\$0
VNX5600-EPAK-UPG	VNX5600 Total Efficiency Pack=IC	UM	\$46,700
VNX5600-ESSPCK	VNX5600 Software Essentials Pack=IC	UM	\$33,130
VNX5600-ESSPCK-UPG	VNX5600 Upg DIP SW Essentials=IC	UM	\$26,505
VNX5600-FSTS	VNX5600 FAST Suite=IC	UM	\$0
VNX5600-FSTS-UPG	VNX5600 FAST Suite=IC	UM	\$22,085
VNX5600-LPS	VNX5600 Local Protection Suite=IC	UM	\$0
VNX5600-LPS-UPG	VNX5600 Local Protection Suite=IC	UM	\$7,890
VNX5600-OE	VNX OE License VNX5600=IC	UM	\$0
VNX5600-PPAK	VNX5600 Total Protection Pack=IC	UM	\$0
VNX5600-PPAK-UPG	VNX5600 Total Protection Pack=IC	UM	\$42,030
VNX5600-RPS	VNX5600 Remote Protection Suite=IC	UM	\$0
VNX5600-RPS-UPG	VNX5600 Remote Protection Suite=IC	UM	\$17,620
VNX5600-SCS	VNX5600 Events and Retention Suite=IC	UM	\$0
VNX5600-SCS-UPG	VNX5600 Events and Retention Suite=IC	UM	\$3,210
VNX5600-UNISB	VNX5600 Unisphere Block Suite=IC	UM	\$0
VNX5600-UNISF	VNX5600 Unisphere File Suite=IC	UM	\$0
VNX5600-UNISU	VNX5600 Unisphere Unified Suite=IC	UM	\$0
VNX56BTU-KIT	BLOCK TO UNIFIED UPG KIT FOR VNX5600	UM	\$0
VNX56-ESSPCK	VNX5600 Software Essentials Pack=IC	UM	\$0
VNX56-ESSPCK-PROMO	VNX5600 SoftwareEssentials Promo Pack=IC	UM	\$0
VNX56-KIT	VNX5600 Documentation Kit=IC	UM	\$0

VNX56-UNIB-UPG	VNX5600 Unisphere Block Suite UPG=IC	UM	\$12,650
VNX56-UNIF-UPG	VNX5600 Unisphere File Suite UPG=IC	UM	\$9,405
VNX56-UNIU-UPG	VNX5600 Unisphere Unified Suite UPG=IC	UM	\$15,565
VNX5800-BTU-KIT	BLOCK TO UNIFIED UPG KIT FOR VNX5800=IC	UM	\$13,310
VNX5800-DARE	VNX5800 Controller Based Encryp Suite=IC	UM	\$9,265
VNX5800-DARE-UPG	Data at Rest Encryption for VNX5800=IC	UM	\$7,410
VNX5800DMEXDU	VNXB58 DME: 1 DM+FC SLIC-BTU Fld install	UM	\$19,730
VNX5800-EPAK	VNX5800 Total Efficiency Pack=IC	UM	\$0
VNX5800-EPAK-UPG	VNX5800 Total Efficiency Pack=IC	UM	\$83,715
VNX5800-ESSPCK	VNX5800 Software Essentials Pack=IC	UM	\$73,690
VNX5800-ESSPCK-UPG	VNX5800 Upg DIP SW Essentials=IC	UM	\$58,950
VNX5800-FSTS	VNX5800 FAST Suite=IC	UM	\$0
VNX5800-FSTS-UPG	VNX5800 FAST Suite=IC	UM	\$56,465
VNX5800-LPS	VNX5800 Local Protection Suite=IC	UM	\$0
VNX5800-LPS-UPG	VNX5800 Local Protection Suite=IC	UM	\$10,845
VNX5800-OE	VNX OE License VNX5800=IC	UM	\$0
VNX5800-PPAK	VNX5800 Total Protection Pack=IC	UM	\$0
VNX5800-PPAK-UPG	VNX5800 Total Protection Pack=IC	UM	\$58,795
VNX5800-RPS	VNX5800 Remote Protection Suite=IC	UM	\$0
VNX5800-RPS-UPG	VNX5800 Remote Protection Suite=IC	UM	\$27,120
VNX5800-SCS	VNX5800 Events and Retention Suite=IC	UM	\$0
VNX5800-SCS-UPG	VNX5800 Events and Retention Suite=IC	UM	\$3,410
VNX5800-UNISB	VNX5800 Unisphere Block Suite=IC	UM	\$0
VNX5800-UNISF	VNX5800 Unisphere File Suite=IC	UM	\$0
VNX5800-UNISU	VNX5800 Unisphere Unified Suite=IC	UM	\$0
VNX58BTU-KIT	BLOCK TO UNIFIED UPG KIT FOR VNX5800	UM	\$0
VNX58-ESSPCK	VNX5800 Software Essentials Pack=IC	UM	\$0
VNX58-ESSPCK-PROMO	VNX5800 SoftwareEssentials Promo Pack=IC	UM	\$0
VNX58-KIT	VNX5800 Documentation Kit=IC	UM	\$0
VNX58-UNIB-UPG	VNX5800 Unisphere Block Suite UPG=IC	UM	\$25,860
VNX58-UNIF-UPG	VNX5800 Unisphere File Suite UPG=IC	UM	\$25,860
VNX58-UNIU-UPG	VNX5800 Unisphere Unified Suite UPG=IC	UM	\$34,730
VNX7600-BTU-KIT	BLOCK TO UNIFIED UPG KIT FOR VNX7600=IC	UM	\$25,265
VNX7600-DARE	VNX7600 Controller Based Encryp Suite=IC	UM	\$11,365
VNX7600-DARE-UPG	Data at Rest Encryption for VNX7600=IC	UM	\$9,090
VNX7600DMEXDU	VNXB76 DME: 2 DM+FC SLIC-BTU Fld Install	UM	\$33,545
VNX7600-EPAK	VNX7600 Total Efficiency Pack=IC	UM	\$0
VNX7600-EPAK-UPG	VNX7600 Total Efficiency Pack=IC	UM	\$125,460
VNX7600-ESSPCK	VNX7600 Software Essentials Pack=IC	UM	\$109,095
VNX7600-ESSPCK-UPG	VNX7600 Upg DIP SW Essentials=IC	UM	\$87,275
VNX7600-FSTS	VNX7600 FAST Suite=IC	UM	\$0
VNX7600-FSTS-UPG	VNX7600 FAST Suite=IC	UM	\$76,555
VNX7600-LPS	VNX7600 Local Protection Suite=IC	UM	\$0
VNX7600-LPS-UPG	VNX7600 Local Protection Suite=IC	UM	\$12,475
VNX7600-OE	VNX OE License VNX7600=IC	UM	\$0
VNX7600-PPAK	VNX7600 Total Protection Pack=IC	UM	\$0
VNX7600-PPAK-UPG	VNX7600 Total Protection Pack=IC	UM	\$84,650
VNX7600-RPS	VNX7600 Remote Protection Suite=IC	UM	\$0
VNX7600-RPS-UPG	VNX7600 Remote Protection Suite=IC	UM	\$53,640
VNX7600-SCS	VNX7600 Events and Retention Suite=IC	UM	\$0

VNX7600-SCS-UPG	VNX7600 Events and Retention Suite=IC	UM	\$3,660
VNX7600-UNISB	VNX7600 Unisphere Block Suite=IC	UM	\$0
VNX7600-UNISF	VNX7600 Unisphere File Suite=IC	UM	\$0
VNX7600-UNISU	VNX7600 Unisphere Unified Suite=IC	UM	\$0
VNX76BTU-KIT	BLOCK TO UNIFIED UPG KIT FOR VNX7600	UM	\$0
VNX76-ESSPCK	VNX7600 Software Essentials Pack=IC	UM	\$0
VNX76-ESSPCK-PROMO	VNX7600 SoftwareEssentials Promo Pack=IC	UM	\$0
VNX76-KIT	VNX7600 Documentation Kit=IC	UM	\$0
VNX76-UNIB-UPG	VNX7600 Unisphere Block Suite UPG=IC	UM	\$34,705
VNX76-UNIF-UPG	VNX7600 Unisphere File Suite UPG=IC	UM	\$34,705
VNX76-UNIU-UPG	VNX7600 Unisphere Unified Suite UPG=IC	UM	\$53,080
VNX8000-BTU-KIT	BLOCK TO UNIFIED UPG KIT FOR VNX8000=IC	UM	\$37,895
VNX8000-DARE	VNX8000 Controller Based Encryp Suite=IC	UM	\$17,170
VNX8000DMEXDU	VNXB80 DME: 2 DM+FC SLIC-BTU Fld Install	UM	\$48,145
VNX8000-EPAK	VNX8000 Total Efficiency Pack=IC	UM	\$0
VNX8000-ESSPCK	VNX8000 Software Essentials Pack=IC	UM	\$166,270
VNX8000-FSTS	VNX8000 FAST Suite=IC	UM	\$0
VNX8000-LPS	VNX8000 Local Protection Suite=IC	UM	\$23,559
VNX8000-OE	VNX OE License VNX8000=IC	UM	\$0
VNX8000-PPAK	VNX8000 Total Protection Pack=IC	UM	\$0
VNX8000-RPS	VNX8000 Remote Protection Suite=IC	UM	\$0
VNX8000-SCS	VNX8000 Events and Retention Suite=IC	UM	\$0
VNX8000-UNISB	VNX8000 Unisphere Block Suite=IC	UM	\$0
VNX8000-UNISF	VNX8000 Unisphere File Suite=IC	UM	\$0
VNX8000-UNISU	VNX8000 Unisphere Unified Suite=IC	UM	\$0
VNX80BTU-KIT	BLOCK TO UNIFIED UPG KIT FOR VNX8000	UM	\$0
VNX80-ESSPCK	VNX8000 Software Essentials Pack=IC	UM	\$0
VNX80-ESSPCK-PROMO	VNX8000 SoftwareEssentials Promo Pack=IC	UM	\$0
VNX80-KIT	VNX8000 Documentation Kit=IC	UM	\$0
VNXAFADAE1	VNX 25x2.5" SSD EXP DAE-EMC RACK	UM	\$0
VNXAFADAE1F	VNX 25x2.5" SSD EXP DAE-FIELD INST	UM	\$0
VNXAFADAE1U	VNXF 25x2.5"" DAE 19x400GB-EMC-FLD	UM	\$108,000
VNXAFADAE2	VNX 25x2.5" SSD EXP DAE-EMC RACK	UM	\$0
VNXAFADAE2F	VNX 25x2.5" SSD EXP DAE-FIELD INST	UM	\$0
VNXAFADAE2U	VNXF 25x2.5"" DAE 20x400GB-EMC-FLD	UM	\$112,000
VNXAFADAE3	VNX 25x2.5" SSD EXP DAE-EMC RACK	UM	\$0
VNXAFADAE3F	VNX 25x2.5" SSD EXP DAE-FIELD INST	UM	\$0
VNXAFADAE3U	VNXF 25x2.5"" DAE 23x400GB-EMC-FLD	UM	\$120,000
VNXAFADAE4	VNX 25x2.5" SSD EXP DAE-EMC RACK	UM	\$0
VNXAFADAE4F	VNX 25x2.5" SSD EXP DAE-FIELD INST	UM	\$0
VNXAFADAE5	VNX 25x2.5" SSD EXP DAE-EMC RACK	UM	\$0
VNXAFADAE5F	VNX 25x2.5" SSD EXP DAE-FIELD INST	UM	\$0
VNXB-1U-BLANK	1U Solid Filler for VNXB 40U rack	UM	\$34
VNXB-2U-BLANK	2U Solid Filler for VNXB 40U rack	UM	\$38
VNXB-3U-BLANK	3U Solid Filler for VNXB 40U rack	UM	\$43
VNXB52DM	VNX5200 ADD ON DM+FC SLIC-EMC RACK	UM	\$0
VNXB52DME	VNX5200 DME: 1 DM+FC SLIC-EMC RACK	UM	\$0
VNXB52DMEM	VNX5200 DME: 1 DM+FC SLIC-MINI RACK	UM	\$0
VNXB52DMEMD	VNX5200 DME: 1 DM+FC SLIC-MINI RACK DC	UM	\$0
VNXB52DMEX	EMPTY VNX5200 DM ENCLOSURE-EMC RACK	UM	\$0

VNXB52DMEXM	EMPTY VNX5200 DM ENCLOSURE-MINI RACK	UM	\$0
VNXB52DMEXMD	EMPTY DC VNX5200 DM ENCLOSURE-MINI RACK	UM	\$0
VNXB52DMEXMDU	EMPTY VNX52 DM ENCLOSURE-UPG DC	UM	\$14,565
VNXB52DMEXU	EMPTY VNX5200 DM ENCLOSURE-UPG	UM	\$10,789
VNXB52DMM	VNX5200 ADD ON DM+FC SLIC-MINI RACK	UM	\$0
VNXB52DMMD	VNX5200 ADD ON DM+FC SLIC-MINI RACK-DC	UM	\$0
VNXB52DMU	VNX5200 ADD ON DM+FC SLIC-UPG	UM	\$1,984
VNXB52DMUD	VNX5200 ADD ON DM+FC SLIC-UPG DC	UM	\$2,678
VNXB52DP25F	VNX5200 DPE 25X2.5" DRIVE SLOTS-FLD IN	UM	\$7,770
VNXB52DP25FD	VNX 5200 DPE DISKLESS DC-FIELD INST	UM	\$9,713
VNXB52DP25MD	VNX 5200 DPE DISKLESS DC-MINI RACK	UM	\$9,713
VNXB54DM	VNX5400 ADD ON DM+FC SLIC-EMC RACK	UM	\$0
VNXB54DME	VNX5400 DME: 1 DM+FC SLIC-EMC RACK	UM	\$0
VNXB54DMEM	VNX5400 DME: 1 DM+FC SLIC-MINI RACK	UM	\$0
VNXB54DMEMD	VNX5400 DME: 1 DM+FC SLIC-MINI RACK DC	UM	\$0
VNXB54DMEX	EMPTY VNX5400 DM ENCLOSURE-EMC RACK	UM	\$0
VNXB54DMEXM	EMPTY VNX5400 DM ENCLOSURE-MINI RACK	UM	\$0
VNXB54DMEXMD	EMPTY DC VNX5400 DM ENCLOSURE-MINI RACK	UM	\$0
VNXB54DMEXMDU	EMPTY VNX54 DM ENCLOSURE-UPG DC	UM	\$14,565
VNXB54DMEXU	EMPTY VNX5400 DM ENCLOSURE-UPG	UM	\$10,789
VNXB54DMM	VNX5400 ADD ON DM+FC SLIC-MINI RACK	UM	\$0
VNXB54DMMD	VNX5400 ADD ON DM+FC SLIC-MINI RACK-DC	UM	\$0
VNXB54DMU	VNX5400 ADD ON DM+FC SLIC-UPG	UM	\$2,469
VNXB54DMUD	VNX5400 ADD ON DM+FC SLIC-UPG DC	UM	\$3,333
VNXB54DP25	VNX5400 DPE 25X2.5" DRIVE SLOTS-EMC RA	UM	\$0
VNXB54DP25F	VNX5400 DPE 25X2.5" DRIVE SLOTS-FLD IN	UM	\$0
VNXB54DP25FD	VNX 5400 DPE DISKLESS DC-FIELD INST	UM	\$10,338
VNXB54DP25M	VNX5400 DPE 25X2.5" DRIVE SLOTS-MIN RA	UM	\$0
VNXB54DP25MD	VNX 5400 DPE DISKLESS DC-MINI RACK	UM	\$0
VNXB54VP25F	VNX5400 DPE 25X2.5" DRIVE SLOTS-FLD IN	UM	\$8,270
VNXB54VP25M	VNX5400 DPE 25X2.5" DRIVE SLOTS-MIN RA	UM	\$8,270
VNXB56DM	VNX5600 ADD ON DM+FC SLIC-EMC RACK	UM	\$0
VNXB56DME	VNX5600 DME: 1 DM+FC SLIC-EMC RACK	UM	\$0
VNXB56DMEM	VNX5600 DME: 1 DM+FC SLIC-MINI RACK	UM	\$0
VNXB56DMEMD	VNX5600 DME: 1 DM+FC SLIC-MINI RACK-DC	UM	\$0
VNXB56DMEX	EMPTY VNX56 DM ENCLOSURE-EMC RACK	UM	\$0
VNXB56DMEXM	EMPTY VNX56 DM ENCLOSURE-MINI RACK	UM	\$0
VNXB56DMEXMD	EMPTY DC VNX5600 DM ENCLOSURE-MINI RACK	UM	\$0
VNXB56DMEXMDU	EMPTY VNX56 DM ENCLOSURE-UPG DC	UM	\$14,565
VNXB56DMEXU	EMPTY VNX5600 DM ENCLOSURE-UPG	UM	\$10,789
VNXB56DMM	VNX5600 ADD ON DM+FC SLIC-MINI RACK	UM	\$0
VNXB56DMMD	VNX5600 ADD ON DM+FC SLIC-MINI RACK-DC	UM	\$0
VNXB56DMU	VNX5600 ADD ON DM+FC SLIC-UPG	UM	\$5,139
VNXB56DMUD	VNX5600 ADD ON DM+FC SLIC-UPG DC	UM	\$6,938
VNXB56DP25	VNX5600 DPE 25X2.5" DRIVE SLOTS-EMC RA	UM	\$0
VNXB56DP25F	VNX5600 DPE 25X2.5" DRIVE SLOTS-FLD IN	UM	\$0
VNXB56DP25FD	VNX 5600 DPE DISKLESS DC-FIELD INST	UM	\$17,071
VNXB56DP25M	VNX5600 DPE 25X2.5" DRIVE SLOTS-MIN RA	UM	\$0
VNXB56DP25MD	VNX 5600 DPE DISKLESS DC-MINI RACK	UM	\$0
VNXB58DM	VNX5800 ADD ON DM+FC SLIC-EMC RACK	UM	\$0

VNXB58DME	VNX5800 DME: 1 DM+FC SLIC-EMC RACK	UM	\$0
VNXB58DMEM	VNX5800 DME: 1 DM+FC SLIC-MINI RACK	UM	\$0
VNXB58DMEX	EMPTY VNX58 DM ENCLOSURE-EMC RACK	UM	\$0
VNXB58DMEXF	EMPTY VNX5800 DM ENCLOSURE-FLD INST	UM	\$0
VNXB58DMEXM	EMPTY VNX58 DM ENCLOSURE-MINI RACK	UM	\$0
VNXB58DMEXU	EMPTY VNX58 DM ENCLOSURE-UPG	UM	\$10,789
VNXB58DMM	VNX5800 ADD ON DM+FC SLIC-MINI RACK	UM	\$0
VNXB58DMU	VNX5800 ADD ON DM+FC SLIC-UPG	UM	\$15,846
VNXB58DP25	VNX5800 DPE 25X2.5" DRIVE SLOTS-EMC RA	UM	\$0
VNXB58DP25F	VNX5800 DPE 25X2.5" DRIVE SLOTS-FLD IN	UM	\$0
VNXB58DP25M	VNX5800 DPE 25X2.5" DRIVE SLOTS-MIN RA	UM	\$0
VNXB5XPS	TWO AC Power Supplies for VNX52-VNX76	UM	\$0
VNXB6GS3UDAE120	VNXB 120X2.5 6G SAS EXP DAE-EMC RACK	UM	\$0
VNXB6GS3UDAE120F	VNXB 120X2.5 6G SAS EXP DAE-FIELD INST	UM	\$18,000
VNXB6GS3UDAE120L	VNXB 120X2.5 6G SAS EXP DAE-FLD INST-LDR	UM	\$18,000
VNXB6GS3UDAE120P	VNXB 120X2.5 6G SAS PRI DAE-EMC RACK	UM	\$0
VNXB6GSDAE15	VNXB 15X3.5 6G SAS EXP DAE-EMC RACK	UM	\$0
VNXB6GSDAE15D	VNXB 15X3.5 6G SAS DAE-DC	UM	\$0
VNXB6GSDAE15F	VNXB 15X3.5 6G SAS EXP DAE-FIELD INST	UM	\$3,488
VNXB6GSDAE15P	VNXB 15X3.5 6G SAS PRI DAE-EMC RACK	UM	\$0
VNXB6GSDAE15W	VNXB 15X3.5 6G SAS PRI DAE-FIELD INST	UM	\$0
VNXB6GSDAE25	VNXB 25X2.5 6G SAS EXP DAE-EMC RACK	UM	\$0
VNXB6GSDAE25D	VNX 25x2.5 6G SAS DC DAE-FIELD INST	UM	\$0
VNXB6GSDAE25DW	VNX25x2.5 6G SAS DC PRIMARY DAE-FLD INST	UM	\$6,425
VNXB6GSDAE25F	VNXB 25X2.5 6G SAS EXP DAE-FIELD INST	UM	\$4,942
VNXB6GSDAE25P	VNXB 25X2.5 6G SAS PRI DAE-EMC RACK	UM	\$0
VNXB6GSDAE25W	VNXB 25X2.5 6G SAS PRI DAE-FIELD INST	UM	\$0
VNXB6GSDAE60	VNXB 60X3.5 6G SAS EXP DAE-EMC RACK	UM	\$0
VNXB6GSDAE60F	VNXB 60X3.5 6G SAS EXP DAE-FIELD INST	UM	\$13,954
VNXB6GSDAE60L	VNXB 60X3.5 6G SAS EXP DAE-FLD INST-LDR	UM	\$13,954
VNXB6GSDAE60P	VNXB 60X3.5 6G SAS PRI DAE-EMC RACK	UM	\$0
VNXB6GSDAE60W	VNXB 60X3.5 6G SAS PRI DAE-FIELD INST	UM	\$13,954
VNXB6GSDAED15	VNXB 15x3.5" 6G SAS PRI DAE-DENSE RACK	UM	\$3,488
VNXB76DM	VNX7600 ADD ON DM+FC SLIC-EMC RACK	UM	\$0
VNXB76DME	VNX7600 DME: 2 DM+FC SLIC-EMC RACK	UM	\$0
VNXB76DMEM	VNX7600 DME: 2 DM+FC SLIC-MINI RACK	UM	\$0
VNXB76DMEX	EMPTY VNX76 DM ENCLOSURE-EMC RACK	UM	\$0
VNXB76DMEXF	EMPTY VNX7600 DM ENCLOSURE-FLD INST	UM	\$0
VNXB76DMEXM	EMPTY VNX76 DM ENCLOSURE-MINI RACK	UM	\$0
VNXB76DMEXU	EMPTY VNX76 DM ENCLOSURE-UPG	UM	\$10,789
VNXB76DMF	VNXB76 ADD ON DM+FC SLIC-MINI RACK	UM	\$25,553
VNXB76DMM	VNXB76 ADD ON DM+FC SLIC-MINI RACK	UM	\$0
VNXB76DMU	VNX7600 ADD ON DM+FC SLIC-UPG	UM	\$34,496
VNXB76DP25	VNX7600 DPE 25X2.5" DRIVE SLOTS-EMC RA	UM	\$0
VNXB76DP25F	VNX7600 DPE 25X2.5" DRIVE SLOTS-FLD IN	UM	\$0
VNXB76DP25M	VNX7600 DPE 25X2.5" DRIVE SLOTS-MIN RA	UM	\$0
VNXB76DPFE2	VNX7600F DPE 8.8TB EV-EMC RACK	UM	\$0
VNXB76DPFE2F	VNX7600F DPE 8.8TB EV-FLD INST	UM	\$0
VNXB76DPFE4	VNX7600F DPE 14.7TB EV-EMC RACK	UM	\$0
VNXB76DPFE4F	VNX7600F DPE 14.7TB EV-FLD INST	UM	\$0

VNXB76DPFE6	VNX7600F DPE 20.5TB EV-EMC RACK	UM	\$0
VNXB76DPFE6F	VNX7600F DPE 20.5TB EV-FLD INST	UM	\$0
VNXB76DPFE8	VNX7600F DPE 41.0TB EV-EMC RACK	UM	\$0
VNXB76DPFE8F	VNX7600F DPE 41.0TB EV-FLD INST	UM	\$0
VNXB76DPFH2	VNX7600F DPE 8.8TB HV-EMC RACK	UM	\$0
VNXB76DPFH2F	VNX7600F DPE 8.8TB HV-FLD INST	UM	\$0
VNXB76DPFH4	VNX7600F DPE 14.7TB HV-EMC RACK	UM	\$0
VNXB76DPFH4F	VNX7600F DPE 14.7TB HV-FLD INST	UM	\$0
VNXB76DPFH6	VNX7600F DPE 20.5TB HV-EMC RACK	UM	\$0
VNXB76DPFH6F	VNX7600F DPE 20.5TB HV-FLD INST	UM	\$0
VNXB76DPFH8	VNX7600F DPE 41.0TB HV-EMC RACK	UM	\$0
VNXB76DPFH8F	VNX7600F DPE 41.0TB HV-FLD INST	UM	\$0
VNXB80DM	VNX8000 ADD ON DM+FC SLIC-EMC RACK	UM	\$0
VNXB80DME	VNX8000 DME: 2 DM+FC SLIC-EMC RACK	UM	\$0
VNXB80DMEM	VNX8000 DME: 2 DM+FC SLIC-MINI RACK	UM	\$0
VNXB80DMEX	EMPTY VNX80 DM ENCLOSURE-EMC RACK	UM	\$0
VNXB80DMEXF	EMPTY VNX80 DM ENCLOSURE-FLD INST	UM	\$0
VNXB80DMEXM	EMPTY VNX80 DM ENCLOSURE-MINI RACK	UM	\$0
VNXB80DMEXU	EMPTY VNX80 DM ENCLOSURE-UPG	UM	\$15,485
VNXB80DMM	VNX8000 ADD ON DM+FC SLIC-MINI RACK	UM	\$0
VNXB80DMU	VNX8000 ADD ON DM+FC SLIC-UPG	UM	\$49,512
VNXB80DSPE	VNX8000 SPE-EMC DENSE RACK	UM	\$0
VNXB80SPE	VNX8000 SPE-EMC RACK	UM	\$0
VNXB80SPEF	VNX8000 SPE-FIELD INST	UM	\$0
VNXB80SPEM	VNX8000 SPE-MINI RACK	UM	\$0
VNXB-BEZ54LTS	DPE LOTUS BEZEL FOR VNX5400	UM	\$950
VNXBCS	VNXB CONTROL STATION-EMC RACK	UM	\$0
VNXBCS1UADJ	Adjustable VNXB 1U CS RAIL KIT	UM	\$201
VNXBCS2	VNXB 2ND CONTROL STATION-EMC RACK	UM	\$0
VNXBCS2M	VNXB 2ND CONTROL STATION-MINI RACK	UM	\$0
VNXBCS2U	VNXB 2ND CONTROL STATION-UPG	UM	\$2,612
VNXBCSM	VNXB CONTROL STATION-MINI RACK	UM	\$0
VNXBCSU	VNXB Control Station-BTU FIELD INSTALL	UM	\$2,612
VNXBDAE2UADJ	Adjustable VNXB 2U DAE RAIL KIT	UM	\$50
VNXBDAE3UADJ	Adjustable VNXB 3U DAE RAIL KIT	UM	\$88
VNXBDMCBLD7	Mini Rack Cable Kit for DPE +7 DM + 1 CS	UM	\$0
VNXBDMCBLD8	Mini Rack Cable Kit for DPE +8 DM + 1 CS	UM	\$0
VNXBDMCBLS2	VNXB MINI RACK CBL KIT FOR SPE+2 DM+1 CS	UM	\$0
VNXBDMCBLS3	VNXB MINI RACK CBL KIT FOR SPE+3 DM+1 CS	UM	\$0
VNXBDMCBLS4	VNXB MINI RACK CBL KIT FOR SPE+4 DM+1 CS	UM	\$0
VNXBDME2UADJ	Adjustable VNXB 2U DME RAIL KIT	UM	\$88
VNXBDMEX	EMPTY VNXB DM ENCLOSURE-EMC RACK	UM	\$7,992
VNXBDMEXM	EMPTY VNXB DM ENCLOSURE-MINI RACK	UM	\$7,992
VNXBDPE3UADJ	Adjustable VNXB 3U DPE RAIL KIT	UM	\$177
VNXBDPERES	VNXB 4U SPACE RES FOR FILE UPG-EMC RACK	UM	\$0
VNXBDRACK140U	VNXB 40U DEEP RACK 1-PHASE 30A CONSOLE	UM	\$3,726
VNXBDRACK240U	VNXB 40U DEEP RACK 1-PHASE 30A CONSOLE	UM	\$3,726
VNXBOECAPTBU	VNX OE CAPACITY TIER PER TB for VNX=IC	UM	\$0
VNXBOECAPTBU	VNXB OE PER TB HI CAPACITY UPGRADE	UM	\$266
VNXBOEPPERFTB	VNX OE PERF TIER PER TB for VNX=IC	UM	\$0

VNXBOEPERFTBU	VNXB OE PER TB PERFORMANCE UPGRADE	UM	\$583
VNXB-OM3-100M	100M MM FIBRE CABLE LC-LC	UM	\$400
VNXB-OM3-10M	10M MM FIBRE CABLE LC-LC	UM	\$204
VNXB-OM3-1M	1M MM FIBRE CABLE LC-LC	UM	\$170
VNXB-OM3-30M	30M MM FIBRE CABLE LC-LC	UM	\$213
VNXB-OM3-3M	3M MM FIBRE CABLE LC-LC	UM	\$187
VNXB-OM3-50M	50M MM FIBRE CABLE LC-LC	UM	\$264
VNXB-OM3-5M	5M MM FIBRE CABLE LC-LC	UM	\$187
VNXBPWSP1	Two 100-240V PS for VNX5200-5400	UM	\$0
VNXBPWSP2	Two 100-240V PS for VNX5200-7600	UM	\$0
VNXBPWSPV	Trigger for Adding BLK Enabler to Vault	UM	\$0
VNXBRACK-40U	VNXB 40U RACK WITH FRONT PANEL	UM	\$2,484
VNXBRKSECURE	VNXB 40U Rack Stabilizing Kit	UM	\$592
VNXBSPE4UADJ	Adjustable VNXB 4U SPE RAIL KIT	UM	\$50
VNXBSPERES	VNXB 6U SPACE RES FOR FILE UPG-EMC RACK	UM	\$0
VNXCA2BDP25	VNXCA2 DPE 25X2.5" DRIVE SLOTS-EMC RACK	UM	\$0
VNXCA2BDP25F	VNXCA2 DPE 25X2.5" DRIVE SLOTS-FLD INST	UM	\$0
VNXCA2OECAPT	VNXCA2 OE PER TB CAPACITY=CB	UM	\$0
VNXCA2OEPERT	VNXCA2 OE PER TB PERFORMANCE=CB	UM	\$0
VNXCA4BDP25	VNXCA4 DPE 25X2.5" DRIVE SLOTS-EMC RACK	UM	\$0
VNXCA4BDP25F	VNXCA4 DPE 25X2.5" DRIVE SLOTS-FLD INST	UM	\$0
VNXCA4BDP25FU	VNXCA2 TO VNXCA4 DPE FIELD UPGRADE	UM	\$0
VNXCA4BDP25-U	VNXCA2 TO VNXCA4 DPE UPGRADE	UM	\$0
VNXCA4OECAPT	VNXCA4 OE PER TB CAPACITY=CB	UM	\$0
VNXCA4OEPERT	VNXCA4 OE PER TB PERFORMANCE=CB	UM	\$0
VNXCSD2M	VNX DC CONVERTER FOR CS-MINI RACK	UM	\$0
VNXCSD2U	VNX 2ND DC CONVERTER FOR 2ND CS UPG	UM	\$3,527
VNXF-2S6FX-1600HS	VNX-F FLASH Pack HS SSD 2.5"-1600GB	UM	\$0
VNXF-2S6FX-1600HSU	VNX-F FLASH Pack HS SSD 2.5"-1600GB UPG	UM	\$0
VNXF-2S6FX-16HSTU	VNX-F FLASH Pack HS SSD 2.5"-1.6TB U T	UM	\$0
VNXF-2S6FX-400HS	VNX-F FLASH Pack HS SSD 2.5"-400GB	UM	\$0
VNXF-2S6FX-400HSTU	VNX-F FLASH Pack HS SSD 2.5"-400GB U T	UM	\$0
VNXF-2S6FX-400HSU	VNX-F FLASH Pack HS SSD 2.5"-400GB UPG	UM	\$0
VNXF-2S6FX-800HS	VNX-F FLASH Pack HS SSD 2.5"-800GB	UM	\$0
VNXF-2S6FX-800HSTU	VNX-F FLASH Pack HS SSD 2.5"-800GB U T	UM	\$0
VNXF-2S6FX-800HSU	VNX-F FLASH Pack HS SSD 2.5"-800GB UPG	UM	\$0
VNXF-2S6FX-9X1600	VNX-F FLASH Pack SSD 2.5"-9x1600GB	UM	\$0
VNXF-2S6FX-9X1600U	VNX-F FLASH Pack SSD 2.5"-9x1600GB UPG	UM	\$0
VNXF-2S6FX-9X16TU	VNX-F FLASH Pack SSD 2.5"-9x1.6TB U TAA	UM	\$0
VNXF-2S6FX-9X400	VNX-F FLASH Pack SSD 2.5"-9x400GB	UM	\$0
VNXF-2S6FX-9X400TU	VNX-F FLASH Pack SSD 2.5"-9x400GB U TAA	UM	\$0
VNXF-2S6FX-9X400U	VNX-F FLASH Pack SSD 2.5"-9x400GB UPG	UM	\$0
VNXF-2S6FX-9X800	VNX-F FLASH Pack SSD 2.5"-9x800GB	UM	\$0
VNXF-2S6FX-9X800TU	VNX-F FLASH Pack SSD 2.5"-9x800GB U TAA	UM	\$0
VNXF-2S6FX-9X800U	VNX-F FLASH Pack SSD 2.5"-9x800GB UPG	UM	\$0
VNX-F5000-DARE	VNX-F5000 Data at Rest Encryption=IC	UM	\$3,725
VNX-F5000-DP	Data Protection Suite for VNX-F5000=IC	UM	\$16,079
VNX-F5000-INSGUIDE	VNX-F5000 Installation Guide	UM	\$0
VNX-F5000-OE	VNX-F5000 Operating Environment=IC	UM	\$0
VNX-F5000-UNISB	VNX-F5000 Unisphere Block Suite=IC	UM	\$8,730

VNXF50DP25	VNX-F5000 DPE 25X2.5" DRIVE SLOTS-EMC	UM	\$0
VNXF50DP25F	VNX-F5000 DPE 25X2.5" DRIVE SLOTS-FLD	UM	\$0
VNXF50VP25F	VNX-F5000 DPE 25X2.5" DRIVE SLOTS-FLD	UM	\$0
VNXF6GSDAE120	VNX-F 120x2.5" 6G SAS EXP DAE-EMC RACK	UM	\$0
VNXF6GSDAE120F	VNX-F 120x2.5" 6G SAS EXP DAE-FIELD IN	UM	\$0
VNXF6GSDAE25	VNX-F 25x2.5" 6G SAS EXP DAE-EMC RK	UM	\$0
VNXF6GSDAE25F	VNX-F 25x2.5" 6G SAS EXP DAE-FIELD IN	UM	\$0
VNX-F7000-CWOE	VNX-F7000 OE=IC	UM	\$0
VNX-F7000-DARE	VNX-F7000 Data at Rest Encryption=IC	UM	\$11,365
VNX-F7000-DP	Data Protection Suite for VNX-F7000=IC	UM	\$70,404
VNX-F7000-INSGUIDE	VNX-F7000 Installation Guide	UM	\$0
VNX-F7000-OE	VNX-F7000 Operating Environment=IC	UM	\$0
VNX-F7000-UNISB	VNX-F7000 Unisphere Block Suite=IC	UM	\$43,380
VNXF70DP25	VNX-F7000 DPE 25X2.5" DRIVE SLOTS-EMC	UM	\$0
VNXF70DP25F	VNX-F7000 DPE 25X2.5" DRIVE SLOTS-FLD	UM	\$0
VNXF8LNBE	VNXF BACK END EXP 8 BUSES	UM	\$13,008
VNXFBEAU	VNXF BACK END EXP 4 BUSES	UM	\$9,780
VNX-F-VSPBM16GFQA	VNX-F 2 PORT 16G FC IO MODULE PAIR	UM	\$9,900
VNX-F-VSPBM16GFQU	VNX-F 4 PORT 16G FC IO MODULE PAIR-UPG	UM	\$13,860
VNXOE31	Elias VNX Block R31 and VNX File OE 7.0	UM	\$0
VNXOE-5200	VNX5200 Operating Environment	UM	\$0
VNXOE-5400	VNX5400 Operating Environment	UM	\$0
VNXOE-5600	VNX5600 Operating Environment	UM	\$0
VNXOE-5800	VNX5800 Operating Environment	UM	\$0
VNXOE-7600	VNX7600 Operating Environment	UM	\$0
VNXOE-8000	VNX8000 Operating Environment	UM	\$0
VNXOE-CA	VNXCA OPERATING ENVIRONMENT=IC	UM	\$0
VNXOE-F5000	VNX OE License VNX-F5000=IC	UM	\$0
VNXOE-F7000	VNX OE License VNX-F7000=IC	UM	\$0
VSPBEXPSASBEA	VNXB SAS BE EXP 4 BUSES	UM	\$0
VSPBEXPSASBEAF	VNXB Non Dense 4x4 Lane EXP FIELD INST	UM	\$0
VSPBEXPSASBEU	VNXB SAS BE EXP 4 BUSES-UPG	UM	\$18,275
VSPBEXPSASDBE	VNXB SAS BE EXP 4 BUSES-EMC DENSE RACK	UM	\$0
VSPBEXPSASDBE5	VNXB Dense 4x4 Lane EXP EMC Rack 5M	UM	\$0
VSPBEXPSASDBE5F	VNXB Dense 4x4 Lane EXP FIELD INSTALL 5M	UM	\$0
VSPBEXPSASDBU	VNXB SAS BE EXP 4 LN BUSES-DENSE RK-UPG	UM	\$18,275
VSPBEXPSASDHB	VNXB SAS BE EXP 8X BUSES-DENSE RACK	UM	\$0
VSPBEXPSASDHU	VNXB SAS BE EXP 8 LN BUSES-DENSE RK-UPG	UM	\$18,275
VSPBF1GI4CUA	4 PORT 1GBASE-T ISCSI IO MODULE PAIR	UM	\$0
VSPBF1GI4CUAU	4 Port 1GBase-t ISCSI IO Mod Pr UPG	UM	\$2,956
VSPBF8GFFEA	4 PORT 8G FC IO MODULE PAIR	UM	\$0
VSPBF8GFFEAU	4 port 8G FC IO Module Pair UPG	UM	\$3,696
VSPBFXGFCOOPA	2 PORT FCOE IO MODULE PAIR-SFP	UM	\$0
VSPBFXGFCOOPAU	2 Port FCOE IO Module Pair-SFP UPG	UM	\$3,548
VSPBFXGFCOTWA	2 PORT FCOE IO MODULE PAIR- ACTIVE TWAX	UM	\$0
VSPBFXGI2A	2 PORT OP 10GBE ISCSI IO MODULE PAIR-SFP	UM	\$0
VSPBFXGI2AU	2 Port OP 10GbE ISCSI IO Mod Pr-SFP UPG	UM	\$8,870
VSPBFXGI2CUA	2 PORT 10GBASE-T ISCSI IO MODULE PAIR	UM	\$0
VSPBFXGI2CUAU	2 Port 10GBase-T ISCSI IO Mod Pr UPG	UM	\$4,434
VSPBFXGI2TWA	2 PORT OP 10GBE ISCSI IO MODULE PAIR-TWA	UM	\$0

VSPBM16GFQA	VNXB 4 PORT 16G FC IO MODULE PAIR	UM	\$0
VSPBM16GFQU	VNXB 4 PORT 16G FC IO MODULE PAIR-UPG	UM	\$13,860
VSPBM1GI4CUA	VNXB 4 PT 1GBASE-T ISCSI IO MOD PR	UM	\$0
VSPBM1GI4CUU	VNXB 4 PT 1GBASE-T ISCSI IO MOD PR-UPG	UM	\$4,139
VSPBM8GFFEA	VNXB 4 PORT 8G FC IO MODULE PAIR	UM	\$0
VSPBM8GFFEU	VNXB 4 PORT 8G FC IO MODULE PAIR-UPG	UM	\$5,174
VSPBMXGFCOOPA	VNXB 2 PT FCOE IO MOD PAIR-SFP	UM	\$0
VSPBMXGFCOOPU	VNXB 2 PT FCOE IO MOD PAIR-SFP-UPG	UM	\$4,967
VSPBMXGFCOTWA	VNBX 2 PT FCOE IO MOD PAIR-TWAX	UM	\$0
VSPBMXGFCOTWU	VNBX 2 PT FCOE IO MOD PAIR-TWAX-UPG	UM	\$3,477
VSPBMXGI2A	VNXB 2 PT OP 10G ISCSI IO MOD PR-SFP	UM	\$0
VSPBMXGI2CUA	VNXB 2 PT 10GBASE-T ISCSI IO MOD PR	UM	\$0
VSPBMXGI2CUU	VNXB 2 PT 10GBASE-T ISCSI IO MOD PR-UPG	UM	\$6,226
VSPBMXGI2TWA	VNXB 2 PT OP 10G ISCSI IO MOD PR-TWAX	UM	\$0
VSPBMXGI2TWU	VNXB 2 PT OP 10G ISCSI IO MOD PR-TWX-UPG	UM	\$8,279
VSPBMXGI2U	VNXB 2 PT OP 10G ISCSI IO MOD PR-SFP-UPG	UM	\$12,418
VSPEXBCONSOLE	VSPEX Console for 40U VNX Rack	UM	\$350
V-V4-201210	VNX 1.2TB 10K VAULT 25X2.5 DPE/DAE	UM	\$0
V-V4-230015	VNX 300GB 15K VAULT 25X2.5 DPE/DAE	UM	\$0
V-V4-2400FX	VNX 400GB SSD VAULT 25X2.5 DPE/DAE	UM	\$0
V-V4-260010	VNX 600GB 10K VAULT 25X2.5 DPE/DAE	UM	\$0
V-V4-260015	VNX2 600GB 15K VAULT 25X2.5 DAE	UM	\$0
V-V4-2800FX	VNX 800GB EFD VAULT 25X2.5 DAE	UM	\$0
V-V4-290010	VNX 900GB 10K VAULT 25X2.5 DPE/DAE	UM	\$0
V-V4-2S0701	VNX 1000GB SAS VAULT 25X2.5 DPE/DAE	UM	\$0
V-V4-2S1600FX	VNX 1600GB VAULT 25X2.5 DAE	UM	\$0
V-V4-D230015	VNX 300GB 15K VAULT 120X2.5 DAE	UM	\$0
V-V4-D2400FX	VNX 400GB EFD VAULT 120X2.5 DAE	UM	\$0
V-V4-D260015	VNX 600GB 15K VAULT 120X2.5 DAE	UM	\$0
V-V4-D2800FX	VNX 800GB VAULT 120X2.5 DAE	UM	\$0
V-V4-D2S1600FX	VNX 1600GB VAULT 120X2.5 DAE	UM	\$0
V-V4-D30015	VNX 300GB 15K VAULT 60X3.5 DAE	UM	\$0
V-V4-D400FX	VNX 400GB SSD VAULT 60X3.5 DAE	UM	\$0
V-V4-D60010	VNX 600GB 10K VAULT 60X3.5 DAE	UM	\$3,450
V-V4-D60015	VNX2 600GB 15K VAULT 60X3.5 DAE	UM	\$5,585
V-V4-D800FX	VNX 800GB EFD VAULT 60X3.5 DAE	UM	\$0
V-V4-D90010	VNX 900GB 10K VAULT 60X3.5 DAE	UM	\$4,530
V-V4-DS1600FX	VNX 1600GB VAULT 60X3.5 DAE	UM	\$39,160
V-V4-V30015	VNX 300GB 15K VAULT 15X3.5 DAE	UM	\$0
V-V4-V400FX	VNX 400GB SSD VAULT 15X3.5 DAE	UM	\$0
V-V4-V60010	VNX 600GB 10K VAULT 15X3.5 DAE	UM	\$3,450
V-V4-V60015	VNX 600GB 15K VAULT 15X3.5 DAE	UM	\$0
V-V4-V800FX	VNX 800GB EFD VAULT 15X3.5 DAE	UM	\$29,985
V-V4-V90010	VNX 900GB 10K VAULT 15X3.5 DAE	UM	\$4,530
V-V4-VS1600FX	VNX 1600GB VAULT 15X3.5 DAE	UM	\$39,160
12DRV-RK	FIXED RAIL KIT Unity 12 DR FACTORY HT	UM-1	\$110
1U-FILLER	Unity 1U Solid Filler 40U EMC Rck	UM-1	\$0
25DRV-RK	FIXED RAIL KIT Unity 25 DR FACTORY HT	UM-1	\$70
2U-FILLER	Unity 2U Solid Filler 40U EMC Rck	UM-1	\$0
3U-FILLER	Unity 3U Solid Filler 40U EMC Rck	UM-1	\$0

40U-PWR-ASTL	CAB POWER CORD AUSTRALIA TWISTLOCK	UM-1	\$705
40U-PWR-IEC	CAB POWER CORD IEC309	UM-1	\$370
40U-PWR-RS	CAB POWER CORD US R&S CONNECTOR	UM-1	\$705
40U-PWR-US	CAB POWER CORD US TWISTLOCK	UM-1	\$370
40U-RACK-DOOR	40U RACK W/Door	UM-1	\$1,350
40U-RACK-DOORD	40U RACK WITH Door	UM-1	\$1,350
40U-RK-DOORLCK	EMC 40U Rack with Door lock	UM-1	\$1,350
40U-RK-DOORLCKD	40U RACK WITH DOOR LOCK	UM-1	\$1,350
40U-SECURE	40U Rack Stabilizing Kit	UM-1	\$325
450-001-602	ViPR SUITE Unity 300=IC	UM-1	\$6,960
450-001-603	ViPR SUITE Unity 400=IC	UM-1	\$16,705
450-001-604	ViPR SUITE Unity 500=IC	UM-1	\$33,390
450-001-605	ViPR SUITE Unity 600=IC	UM-1	\$48,690
456-107-803	RP4VM ESSENTIAL SW FOR UNITY=IB	UM-1	\$0
456-109-985	Storage M&R for Unity 300=IC	UM-1	\$0
456-109-986	Storage M&R for Unity 400=IC	UM-1	\$0
456-109-987	Storage M&R for Unity 500=IC	UM-1	\$0
456-109-988	Storage M&R for Unity 600=IC	UM-1	\$0
456-110-674	vUnity CE 4TB=IC	UM-1	\$0
456-110-675	vUnity SE 10TB=IC	UM-1	\$0
456-110-676	vUnity SE 25TB=IC	UM-1	\$0
456-110-677	vUnity SE 50TB=IC	UM-1	\$0
456-110-678	vUnity SE 10TB-25TB=IC	UM-1	\$0
456-110-679	vUnity SE 10TB-50TB=IC	UM-1	\$0
456-110-680	vUnity SE 25TB-50TB=IC	UM-1	\$0
456-110-951	RP VRTL APPLIANCE FOR UNITY =IB	UM-1	\$0
456-111-048	SRM UPG Unity 300 =IC	UM-1	\$4,360
456-111-049	SRM UPG Unity 400=IC	UM-1	\$10,480
456-111-050	SRM UPG Unity 500 =IC	UM-1	\$20,950
456-111-051	SRM UPG Unity 600 =IC	UM-1	\$30,550
456-111-101	SRM for Unity 300 =IC	UM-1	\$5,460
456-111-102	SRM for Unity 400=IC	UM-1	\$13,100
456-111-103	SRM for Unity 500 =IC	UM-1	\$26,190
456-111-104	SRM for Unity 600 =IC	UM-1	\$38,190
456-111-144	RP/EX LOC FRAME UNITY 300 FOR VPLEX =IC	UM-1	\$3,560
456-111-145	RP/EX LOC FRAME UNITY 400 FOR VPLEX =IC	UM-1	\$7,820
456-111-146	RP/EX LOC FRAME UNITY 500 FOR VPLEX =IC	UM-1	\$13,320
456-111-147	RP/EX LOC FRAME UNITY 600 FOR VPLEX =IC	UM-1	\$19,000
456-111-148	RP/EX REM FRAME UNITY 300 FOR VPLEX =IC	UM-1	\$9,170
456-111-149	RP/EX REM FRAME UNITY 400 FOR VPLEX =IC	UM-1	\$20,140
456-111-150	RP/EX REM FRAME UNITY 500 FOR VPLEX =IC	UM-1	\$29,730
456-111-151	RP/EX REM FRAME UNITY 600 FOR VPLEX =IC	UM-1	\$47,490
456-111-364	RP/EX LOC FRAME UNITY300 VPLEX VS6=IC	UM-1	\$3,560
456-111-365	RP/EX LOC FRAME UNITY400 VPLEX VS6=IC	UM-1	\$7,820
456-111-366	RP/EX LOC FRAME UNITY500 VPLEX VS6=IC	UM-1	\$13,320
456-111-367	RP/EX LOC FRAME UNITY600 VPLEX VS6=IC	UM-1	\$19,000
456-111-372	RP/EX REM FRAME UNITY300 VPLEX VS6=IC	UM-1	\$9,170
456-111-373	RP/EX REM FRAME UNITY400 VPLEX VS6=IC	UM-1	\$20,140
456-111-374	RP/EX REM FRAME UNITY500 VPLEX VS6=IC	UM-1	\$29,730
456-111-375	RP/EX REM FRAME UNITY600 VPLEX VS6=IC	UM-1	\$47,490

458-001-288	Unity 300 Base Software + D@RE=IC	UM-1	\$0
458-001-289	Unity 400 Base Software + D@RE=IC	UM-1	\$0
458-001-290	Unity 500 Base Software + D@RE=IC	UM-1	\$0
458-001-291	Unity 600 Base Software + D@RE=IC	UM-1	\$0
458-001-292	Unity 300 Base Software =IC	UM-1	\$0
458-001-293	Unity 400 Base Software =IC	UM-1	\$0
458-001-294	Unity 500 Base Software =IC	UM-1	\$0
458-001-295	Unity 600 Base Software =IC	UM-1	\$0
458-001-362	RP ADV LOC FOR UNITY 300 =IC	UM-1	\$3,560
458-001-363	RP ADV LOC FOR UNITY 400 =IC	UM-1	\$7,820
458-001-364	RP ADV LOC FOR UNITY 500 =IC	UM-1	\$13,320
458-001-365	RP ADV LOC FOR UNITY 600 =IC	UM-1	\$19,000
458-001-366	RP Virt Appl for Unity 300/300F/350F =IB	UM-1	\$860
458-001-370	RP BASIC TO ADV LOC UG FOR UNITY 300 =IC	UM-1	\$9,550
458-001-371	RP BASIC TO ADV LOC UG FOR UNITY 400 =IC	UM-1	\$20,960
458-001-372	RP BASIC TO ADV LOC UG FOR UNITY 500 =IC	UM-1	\$32,290
458-001-373	RP BASIC TO ADV LOC UG FOR UNITY 600 =IC	UM-1	\$49,860
458-001-374	RP Basic for Unity 300/300F/350F =IC	UM-1	\$0
458-001-375	RP Basic for Unity 400/400F/450F =IC	UM-1	\$0
458-001-376	RP Basic for Unity 500/500F/550F =IC	UM-1	\$0
458-001-377	RP Basic for Unity 600/600F/650F =IC	UM-1	\$0
458-001-425	APPSYNC BASIC FOR UNITY 300 =IC	UM-1	\$0
458-001-426	APPSYNC BASIC FOR UNITY 400 =IC	UM-1	\$0
458-001-427	APPSYNC BASIC FOR UNITY 500 =IC	UM-1	\$0
458-001-428	APPSYNC BASIC FOR UNITY 600 =IC	UM-1	\$0
458-001-449	RP ADV REM FOR UNITY 300 =IC	UM-1	\$9,170
458-001-450	RP ADV REM FOR UNITY 400 =IC	UM-1	\$20,140
458-001-451	RP ADV REM FOR UNITY 500 =IC	UM-1	\$29,730
458-001-452	RP ADV REM FOR UNITY 600 =IC	UM-1	\$47,490
458-001-453	RP Virt Appl for Unity 400/400F/450F =IB	UM-1	\$8,570
458-001-454	RP Virt Appl for Unity 500/500F/550F =IB	UM-1	\$8,570
458-001-455	RP Virt Appl for Unity 600/600F/650F =IB	UM-1	\$8,570
458-001-456	RP BASIC TO ADV REM UG FOR UNITY 300 =IC	UM-1	\$9,550
458-001-457	RP BASIC TO ADV REM UG FOR UNITY 400 =IC	UM-1	\$20,960
458-001-458	RP BASIC TO ADV REM UG FOR UNITY 500 =IC	UM-1	\$32,290
458-001-459	RP BASIC TO ADV REM UG FOR UNITY 600 =IC	UM-1	\$49,860
458-001-472	SRM UPG for Unity	UM-1	\$0
458-001-478	SRM for Unity	UM-1	\$0
458-001-482	RP/EX VPLEX FB UNITY LOCAL PRODUCT	UM-1	\$0
458-001-483	RP/EX VPLEX FB UNITY REMOTE PRODUCT	UM-1	\$0
458-001-489	UnityVSA CE 4TB=IC	UM-1	\$0
458-001-490	UnityVSA VVols Edition=IC	UM-1	\$0
458-001-529	UnityVSA VVOLS STORAGE CAPACITY=CB	UM-1	\$0
458-001-588	APPSYNC ADVANCED FOR UNITY 300 =IC	UM-1	\$10,930
458-001-590	APPSYNC ADVANCED FOR UNITY 400 =IC	UM-1	\$24,000
458-001-592	APPSYNC ADVANCED FOR UNITY 500 =IC	UM-1	\$37,980
458-001-594	APPSYNC ADVANCED FOR UNITY 600 =IC	UM-1	\$46,240
458-001-712	RP/EX VPLEX VS6 FB UNITY LOCAL PRODUCT	UM-1	\$0
458-001-713	RP/EX VPLEX VS6 FB UNITY REMOTE PRODUCT	UM-1	\$0
458-001-839	Unity 300 BASE Software+ D@RE=IC	UM-1	\$0

458-001-841	Unity 400 BASE Software+ D@RE=IC	UM-1	\$0
458-001-843	Unity 500 BASE Software+D@RE=IC	UM-1	\$0
458-001-845	Unity 600 BASE Software+D@RE=IC	UM-1	\$0
458-001-847	Unity 300 BASE Software=IC	UM-1	\$0
458-001-849	Unity 400 BASE Software=IC	UM-1	\$0
458-001-851	Unity 500 Base Software=IC	UM-1	\$0
458-001-853	Unity 600 BASE Software=IC	UM-1	\$0
CS-OPT-UXHF-MON-1Y	OPTIMIZE FOR UNITY HYA MON 1YEAR	UM-1	\$20,000
CS-OPT-UXHF-MON-2Y	OPTIMIZE FOR UNITY HYA MON 2YEAR	UM-1	\$40,000
CS-OPT-UXHF-MON-3Y	OPTIMIZE FOR UNITY HYA MON 3YEAR	UM-1	\$60,000
CS-OPT-UXHF-MON-4Y	OPTIMIZE FOR UNITY HYA MON 4YEAR	UM-1	\$80,000
CS-OPT-UXHF-MON-5Y	OPTIMIZE FOR UNITY HYA MON 5YEAR	UM-1	\$100,000
CS-OPT-UXHF-QTR-1Y	OPTIMIZE FOR UNITY HYA QTRLY 1YEAR	UM-1	\$12,000
CS-OPT-UXHF-QTR-2Y	OPTIMIZE FOR UNITY HYA QTRLY 2YEAR	UM-1	\$24,000
CS-OPT-UXHF-QTR-3Y	OPTIMIZE FOR UNITY HYA QTRLY 3YEAR	UM-1	\$36,000
CS-OPT-UXHF-QTR-4Y	OPTIMIZE FOR UNITY HYA QTRLY 4YEAR	UM-1	\$48,000
CS-OPT-UXHF-QTR-5Y	OPTIMIZE FOR UNITY HYA QTRLY 5YEAR	UM-1	\$60,000
D3122AD	Unity 2U 25x2.5 Drive DAE EMC Rck	UM-1	\$2,440
D3122ADF	Unity 2U 25x2.5 DRV DAE EMC FLD Rck UPG	UM-1	\$2,440
D3122DF15	3U 15x3.5 12G EXP DAE - DC Customer Rck	UM-1	\$2,385
D3122DF25	Unity 2U 25x2.5 Drive DAE FLD Rck DC	UM-1	\$2,685
D3122DPF15	3U 15x3.5 12G EXP DC PRM- Customer Rck	UM-1	\$2,385
D3122DPF25	Unity 2U 25x2.5 Drive DAE FLD Rck Prm DC	UM-1	\$2,685
D3122F	Unity 2U 25x2.5 Drive DAE FLD Rck	UM-1	\$2,440
D3122PAD	Unity 2U 25x2.5 Drive DAE PRM EMC RCK	UM-1	\$2,440
D3122PF	2U 25x2.5 12G EXPDAE PRM- FLD Ins	UM-1	\$2,440
D312380AD	Unity 3U 80x2.5 Drive DAE EMC Rck	UM-1	\$9,200
D312380F	Unity 3U 80x2.5 Drive DAE FLD RCK	UM-1	\$9,200
D312380FU	UNITY 3U 80X2.5 DRIVE DAE FLD UPG	UM-1	\$9,200
D3123AD	Unity 3U 15x3.5 Drive DAE EMC Rck	UM-1	\$2,170
D3123ADF	Unity 3U 15x3.5 DRV DAE EMC FLD Rck UPG	UM-1	\$2,170
D3123DF15	3U 15x3.5 12G EXP DAE - DC Customer Rck	UM-1	\$2,385
D3123DPF15	3U 15x3.5 12G EXP DC PRM- Customer Rck	UM-1	\$2,385
D3123F	Unity 3U 15x3.5 Drive DAE FLD Rck	UM-1	\$2,170
D3123PAD	Unity 3U 15x3.5 Drive DAE PRM EMC Rck	UM-1	\$2,170
D3123PF	3U 15x3.5 12G EXPDAE PRM-FLD Ins	UM-1	\$2,170
D31D12CKITO	12 Drive DPE FLD INSTALL KIT	UM-1	\$0
D31D24AD12	Unity 300 2U DPE 12x3.5 Drive EMC Rck	UM-1	\$9,865
D31D24AD25	Unity 300 2U DPE 25x2.5 Drive EMC Rck	UM-1	\$9,865
D31D24AF12	Unity 300 2U DPE 12x3.5 Drive FLD Rck	UM-1	\$9,865
D31D24AF25	Unity 300 2U DPE 25x2.5 Drive FLD Rck	UM-1	\$9,865
D31D24DF12	Unity 300 2U DPE 12x3.5 Drive FLD Rck DC	UM-1	\$10,850
D31D24DF25	Unity 300 2U DPE 25x2.5 Drive FLD Rck DC	UM-1	\$10,850
D31D25CKITO	25 Drive DPE FLD INSTALL KIT	UM-1	\$0
D31DEMCK12KIT	Unity 12 Drive DPE FLD INSTALL KIT	UM-1	\$0
D31DEMCK25KIT	Unity 25 Drive DPE FLD INSTALL KIT	UM-1	\$0
D31EMCK12KIT	Unity 12 Drive EMC DPE FLD INST KIT	UM-1	\$0
D31EMCK25KIT	Unity 25 Drive EMC DPE FLD INST KIT	UM-1	\$0
D31TD32	Unity DIP 300 to 400	UM-1	\$21,225
D31TD33	Unity DIP 300 to 500	UM-1	\$44,295

D31TD34	Unity DIP 300 to 600	UM-1	\$93,560
D32D32AD12	Unity 400 2U DPE 12x3.5 Drive EMC Rck	UM-1	\$22,340
D32D32AD25	Unity 400 2U DPE 25x2.5 Drive EMC Rck	UM-1	\$22,340
D32D32AF12	Unity 400 2U DPE 12x3.5 Drive FLD Rck	UM-1	\$22,340
D32D32AF25	Unity 400 2U DPE 25x2.5 Drive FLD Rck	UM-1	\$22,340
D32D32DF12	Unity 400 2U DPE 12x3.5 Drive FLD Rck DC	UM-1	\$24,575
D32D32DF25	Unity 400 2U DPE 25x2.5 Drive FLD Rck DC	UM-1	\$24,575
D3-2S10-1200	UNITY 1.2TB 10K SAS 25X2.5 DRIVE	UM-1	\$1,065
D3-2S10-1200TU	UNITY 1.2TB 10K SAS 25X2.5 DRIVE UPG	UM-1	\$1,280
D3-2S10-1200U	UNITY 1.2TB 10K SAS 25X2.5 DRIVE UPG	UM-1	\$1,280
D3-2S10-1800	UNITY 1.8TB 10K SAS 25X2.5 DRIVE	UM-1	\$1,320
D3-2S10-1800TU	UNITY 1.8TB 10K SAS 25X2.5 DRIVE UPG	UM-1	\$1,585
D3-2S10-1800U	UNITY 1.8TB 10K SAS 25X2.5 DRIVE UPG	UM-1	\$1,585
D3-2S10-600	UNITY 600GB 10K SAS 25X2.5 DRIVE	UM-1	\$655
D3-2S10-600TU	UNITY 600GB 10K SAS 25X2.5 DRIVE UPG	UM-1	\$785
D3-2S10-600U	UNITY 600GB 10K SAS 25X2.5 DRIVE UPG	UM-1	\$785
D3-2S12FX-1600	UNITY 1.6TB FLASH 25X2.5 DRIVE	UM-1	\$6,225
D3-2S12FX-1600TU	UNITY 1.6TB FAST VP SSD 25X2.5 DRIVE UG	UM-1	\$7,470
D3-2S12FX-1600U	UNITY 1.6TB FLASH 25X2.5 DRIVE UG	UM-1	\$7,470
D3-2S12FX-200	UNITY 200GB FLASH 25X2.5 DRIVE	UM-1	\$1,335
D3-2S12FX-200TU	UNITY 200GB FAST VP SSD 25X2.5 DRIVE UG	UM-1	\$1,600
D3-2S12FX-200U	UNITY 200GB FLASH 25X2.5 DRIVE UG	UM-1	\$1,600
D3-2S12FX-400	UNITY 400GB FLASH 25X2.5 DRIVE	UM-1	\$2,135
D3-2S12FX-400TU	UNITY 400GB FAST VP SSD 25X2.5 DRIVE UG	UM-1	\$2,560
D3-2S12FX-400U	UNITY 400GB FLASH 25X2.5 DRIVE UG	UM-1	\$2,560
D3-2S12FX-800	UNITY 800GB FLASH 25X2.5 DRIVE	UM-1	\$3,790
D3-2S12FX-800TU	UNITY 800GB FAST VP SSD 25X2.5 DRIVE UG	UM-1	\$4,550
D3-2S12FX-800U	UNITY 800GB FLASH 25X2.5 DRIVE UG	UM-1	\$4,550
D3-2S12FXL-1600	UNITY 1.6TB AFP SSD 25X2.5 DRIVE	UM-1	\$0
D3-2S12FXL-1600TU	UNITY 1.6TB AFP SSD 25X2.5 DRIVE UPG	UM-1	\$0
D3-2S12FXL-1600U	UNITY 1.6TB AFP SSD 25X2.5 DRIVE UPG	UM-1	\$0
D3-2S12FXL-3200	UNITY 3.2TB FLASH 25X2.5 DRIVE	UM-1	\$8,695
D3-2S12FXL-3200TU	UNITY 3.2TB AFP SSD 25X2.5 DRIVE UPG	UM-1	\$10,435
D3-2S12FXL-3200U	UNITY 3.2TB FLASH 25X2.5 DRIVE UPG	UM-1	\$10,435
D3-2S12FXL-400	UNITY 400GB AFP SSD 25X2.5 DRIVE	UM-1	\$0
D3-2S12FXL-400TU	UNITY 400GB AFP SSD 25X2.5 DRIVE UPG	UM-1	\$0
D3-2S12FXL-400U	UNITY 400GB AFP SSD 25X2.5 DRIVE UPG	UM-1	\$0
D3-2S12FXL-800	UNITY 800GB AFP SSD 25X2.5 DRIVE	UM-1	\$0
D3-2S12FXL-800TU	UNITY 800GB AFP SSD 25X2.5 DRIVE UPG	UM-1	\$0
D3-2S12FXL-800U	UNITY 800GB AFP SSD 25X2.5 DRIVE UPG	UM-1	\$0
D3-2S15-600	UNITY 600GB 15K SAS 25X2.5 DRIVE	UM-1	\$865
D3-2S15-600TU	UNITY 600GB 15K SAS 25X2.5 DRIVE UPG	UM-1	\$1,040
D3-2S15-600U	UNITY 600GB 15K SAS 25X2.5 DRIVE UPG	UM-1	\$1,040
D3-2SFXL2-15360	UNITY 15.36TB SSD 25X2.5	UM-1	\$38,015
D3-2SFXL2-15360TU	UNITY 15.36TB SSD 25X2.5 UPG	UM-1	\$45,620
D3-2SFXL2-15360U	UNITY 15.36TB SSD 25X2.5 UPG	UM-1	\$45,620
D3-2SFXL2-7680	UNITY 7.68TB SSD 25X2.5	UM-1	\$19,270
D3-2SFXL2-7680TU	UNITY 7.68TB SSD 25X2.5 UPG	UM-1	\$23,125
D3-2SFXL2-7680U	UNITY 7.68TB SSD 25X2.5 UPG	UM-1	\$23,125
D32TD33	Unity DIP 400 to 500	UM-1	\$44,295

D32TD34	Unity DIP 400 to 600	UM-1	\$93,560
D33D48AD12	Unity 500 2U DPE 12x3.5 Drive EMC Rck	UM-1	\$46,625
D33D48AD25	Unity 500 2U DPE 25x2.5 Drive EMC Rck	UM-1	\$46,625
D33D48AF12	Unity 500 2U DPE 12x3.5 Drive FLD Rck	UM-1	\$46,625
D33D48AF25	Unity 500 2U DPE 25x2.5 Drive FLD Rck	UM-1	\$46,625
D33D48DF12	Unity 500 2U DPE 12x3.5 Drive FLD Rck DC	UM-1	\$51,290
D33D48DF25	Unity 500 2U DPE 25x2.5 Drive FLD Rck DC	UM-1	\$51,290
D33TD34	Unity DIP 500 to 600	UM-1	\$93,560
D34D64AD12	Unity 600 2U DPE 12x3.5 Drive EMC Rck	UM-1	\$98,485
D34D64AD25	Unity 600 2U DPE 25x2.5 Drive EMC Rck	UM-1	\$98,485
D34D64AF12	Unity 600 2U DPE 12x3.5 Drive FLD Rck	UM-1	\$98,485
D34D64AF25	Unity 600 2U DPE 25x2.5 Drive FLD Rck	UM-1	\$98,485
D34D64DF12	Unity 600 2U DPE 12x3.5 Drive FLD Rck DC	UM-1	\$108,335
D34D64DF25	Unity 600 2U DPE 25x2.5 Drive FLD Rck DC	UM-1	\$108,335
D3-D2S10-1200	UNITY 1.2TB 10K SAS 80X2.5 DRIVE	UM-1	\$1,065
D3-D2S10-1200TU	UNITY 1.2TB 10K SAS 80X2.5 DRIVE UPG	UM-1	\$1,280
D3-D2S10-1200U	UNITY 1.2TB 10K SAS 80X2.5 DRIVE UPG	UM-1	\$1,280
D3-D2S10-1800	UNITY 1.8TB 10K SAS 80X2.5 DRIVE	UM-1	\$1,320
D3-D2S10-1800TU	UNITY 1.8TB 10K SAS 80X2.5 DRIVE UPG	UM-1	\$1,585
D3-D2S10-1800U	UNITY 1.8TB 10K SAS 80X2.5 DRIVE UPG	UM-1	\$1,585
D3-D2S10-600	UNITY 600GB 10K SAS 80X2.5 DRIVE	UM-1	\$655
D3-D2S10-600TU	UNITY 600GB 10K SAS 80X2.5 DRIVE UPG	UM-1	\$785
D3-D2S10-600U	UNITY 600GB 10K SAS 80X2.5 DRIVE UPG	UM-1	\$785
D3-D2S12FX-1600	UNITY 1.6TB FLASH 80X2.5 DRIVE	UM-1	\$6,225
D3-D2S12FX-1600TU	UNITY 1.6TB FLASH 80X2.5 DRIVE UG	UM-1	\$7,470
D3-D2S12FX-1600U	UNITY 1.6TB FLASH 80X2.5 DRIVE UG	UM-1	\$7,470
D3-D2S12FX-200	UNITY 200GB FLASH 80X2.5 DRIVE	UM-1	\$1,335
D3-D2S12FX-200TU	UNITY 200GB FLASH 80X2.5 DRIVE UG	UM-1	\$1,600
D3-D2S12FX-200U	UNITY 200GB FLASH 80X2.5 DRIVE UG	UM-1	\$1,600
D3-D2S12FX-400	UNITY 400GB FLASH 80X2.5 DRIVE	UM-1	\$2,135
D3-D2S12FX-400TU	UNITY 400GB FLASH 80X2.5 DRIVE UG	UM-1	\$2,560
D3-D2S12FX-400U	UNITY 400GB FLASH 80X2.5 DRIVE UG	UM-1	\$2,560
D3-D2S12FX-800	UNITY 800GB FLASH 80X2.5 DRIVE	UM-1	\$3,790
D3-D2S12FX-800TU	UNITY 800GB FLASH 80X2.5 DRIVE UG	UM-1	\$4,550
D3-D2S12FX-800U	UNITY 800GB FLASH 80X2.5 DRIVE UG	UM-1	\$4,550
D3-D2S12FXL-3200	UNITY 3.2TB FLASH 80X2.5 DRIVE	UM-1	\$8,695
D3-D2S12FXL-3200TU	UNITY 3.2TB FLASH 80X2.5 DRIVE UPG	UM-1	\$10,435
D3-D2S12FXL-3200U	UNITY 3.2TB FLASH 80X2.5 DRIVE UPG	UM-1	\$10,435
D3-D2S15-600	UNITY 600GB 15K SAS 80X2.5 DRIVE	UM-1	\$865
D3-D2S15-600TU	UNITY 600GB 15K SAS 80X2.5 DRIVE UPG	UM-1	\$1,040
D3-D2S15-600U	UNITY 600GB 15K SAS 80X2.5 DRIVE UPG	UM-1	\$1,040
D3-D2SFXL2-15360	UNITY 15.36TB SSD 80X2.5	UM-1	\$38,015
D3-D2SFXL2-15360TU	UNITY 15.36TB SSD 80X2.5 UPG	UM-1	\$45,620
D3-D2SFXL2-15360U	UNITY 15.36TB SSD 80X2.5 UPG	UM-1	\$45,620
D3-D2SFXL2-7680	UNITY 7.68TB SSD 80X2.5	UM-1	\$19,270
D3-D2SFXL2-7680TU	UNITY 7.68TB SSD 80X2.5 UPG	UM-1	\$23,125
D3-D2SFXL2-7680U	UNITY 7.68TB SSD 80X2.5 UPG	UM-1	\$23,125
D3DAE2URK	Unity Snap In RAIL Kit 2U 25 Drive DAE	UM-1	\$135
D3DAE3URK	Unity Snap In RAIL Kit 3U 15 Drive DAE	UM-1	\$135
D3DAE80RK	Unity Snap In RAIL Kit 80 Drive DAE	UM-1	\$225

D3DPE2URK12	Unity Snap In RAIL Kit 2U 12 Drive DPE	UM-1	\$135
D3DPE2URK25	Unity Snap In RAIL Kit 2U 25 Drive DPE	UM-1	\$135
D3FC-2S12FX-200	UNITY 200GB FAST CACHE 25X2.5 DRIVE	UM-1	\$1,335
D3FC-2S12FX-200TU	UNITY 200GB FAST CACHE 25X2.5 DRIVE UPG	UM-1	\$1,600
D3FC-2S12FX-200U	UNITY 200GB FAST CACHE 25X2.5 DRIVE UPG	UM-1	\$1,600
D3FC-2S12FX-400	UNITY 400GB FAST CACHE 25X2.5 DRIVE	UM-1	\$2,135
D3FC-2S12FX-400TU	UNITY 400GB FAST CACHE 25X2.5 DRIVE UPG	UM-1	\$2,560
D3FC-2S12FX-400U	UNITY 400GB FAST CACHE 25X2.5 DRIVE UPG	UM-1	\$2,560
D3FC-2S12FX-800	UNITY 800GB FAST CACHE 25X2.5 DRIVE	UM-1	\$3,790
D3FC-2S12FX-800TU	UNITY 800GB FAST CACHE 25X2.5 DRIVE UPG	UM-1	\$4,550
D3FC-2S12FX-800U	UNITY 800GB FAST CACHE 25X2.5 DRIVE UPG	UM-1	\$4,550
D3FC-D2S12FX-200	UNITY 200GB FAST CACHE 80X2.5 DRIVE	UM-1	\$1,335
D3FC-D2S12FX-200TU	UNITY 200GB FAST CACHE 80X2.5 DRIVE UPG	UM-1	\$1,600
D3FC-D2S12FX-200U	UNITY 200GB FAST CACHE 80X2.5 DRIVE UPG	UM-1	\$1,600
D3FC-D2S12FX-400	UNITY 400GB FAST CACHE 80X2.5 DRIVE	UM-1	\$2,135
D3FC-D2S12FX-400TU	UNITY 400GB FAST CACHE 80X2.5 DRIVE UPG	UM-1	\$2,560
D3FC-D2S12FX-400U	UNITY 400GB FAST CACHE 80X2.5 DRIVE UPG	UM-1	\$2,560
D3FC-D2S12FX-800	UNITY 800GB FAST CACHE 80X2.5 DRIVE	UM-1	\$3,790
D3FC-D2S12FX-800TU	UNITY 800GB FAST CACHE 80X2.5 DRIVE UPG	UM-1	\$4,550
D3FC-D2S12FX-800U	UNITY 800GB FAST CACHE 80X2.5 DRIVE UPG	UM-1	\$4,550
D3FC-OM3-100M	100M MM FIBRE CABLE LC-LC	UM-1	\$220
D3FC-OM3-10M	10M MM FIBRE CABLE LC-LC	UM-1	\$135
D3FC-OM3-1M	1M MM FIBRE CABLE LC-LC	UM-1	\$100
D3FC-OM3-30M	30M MM FIBRE CABLE LC-LC	UM-1	\$160
D3FC-OM3-3M	3M MM FIBRE CABLE LC-LC	UM-1	\$110
D3FC-OM3-50M	50M MM FIBRE CABLE LC-LC	UM-1	\$190
D3FC-OM3-5M	5M MM FIBRE CABLE LC-LC	UM-1	\$120
D3FC-OM4-100M	100M MM FIBRE CABLE LC-LC	UM-1	\$440
D3FC-OM4-10M	10M MM FIBRE CABLE LC-LC	UM-1	\$135
D3FC-OM4-1M	1M MM FIBRE CABLE LC-LC	UM-1	\$100
D3FC-OM4-30M	30M MM FIBRE CABLE LC-LC	UM-1	\$240
D3FC-OM4-3M	3M MM FIBRE CABLE LC-LC	UM-1	\$110
D3FC-OM4-50M	50M MM FIBRE CABLE LC-LC	UM-1	\$333
D3FC-OM4-5M	5M MM FIBRE CABLE LC-LC	UM-1	\$120
D3FC-PS12FX-200	UNITY 200GB FAST CACHE 12X3.5 DRIVE	UM-1	\$1,335
D3FC-PS12FX-200TU	UNITY 200GB FAST CACHE 12X3.5 DRIVE UPG	UM-1	\$1,600
D3FC-PS12FX-200U	UNITY 200GB FAST CACHE 12X3.5 DRIVE UPG	UM-1	\$1,600
D3FC-PS12FX-400	UNITY 400GB FAST CACHE 12X3.5 DRIVE	UM-1	\$2,135
D3FC-PS12FX-400TU	UNITY 400GB FAST CACHE 12X3.5 DRIVE UPG	UM-1	\$2,560
D3FC-PS12FX-400U	UNITY 400GB FAST CACHE 12X3.5 DRIVE UPG	UM-1	\$2,560
D3FC-PS12FX-800	UNITY 800GB FAST CACHE 12X3.5 DRIVE	UM-1	\$0
D3FC-PS12FX-800TU	UNITY 800GB FAST CACHE 12X3.5 DRIVE UPG	UM-1	\$0
D3FC-PS12FX-800U	UNITY 800GB FAST CACHE 12X3.5 DRIVE UPG	UM-1	\$0
D3FC-VS12FX-200	UNITY 200GB FAST CACHE 15X3.5 DRIVE	UM-1	\$0
D3FC-VS12FX-200TU	UNITY 200GB FAST CACHE 15X3.5 DRIVE UPG	UM-1	\$0
D3FC-VS12FX-200U	UNITY 200GB FAST CACHE 15X3.5 DRIVE UPG	UM-1	\$0
D3FC-VS12FX-400	UNITY 400GB FAST CACHE 15X3.5 DRIVE	UM-1	\$2,135
D3FC-VS12FX-400TU	UNITY 400GB FAST CACHE 15X3.5 DRIVE UPG	UM-1	\$2,560
D3FC-VS12FX-400U	UNITY 400GB FAST CACHE 15X3.5 DRIVE UPG	UM-1	\$2,560
D3FC-VS12FX-800	UNITY 800GB FAST CACHE 15X3.5 DRIVE	UM-1	\$3,790

D3FC-VS12FX-800TU	UNITY 800GB FAST CACHE 15X3.5 DRIVE UPG	UM-1	\$4,550
D3FC-VS12FX-800U	UNITY 800GB FAST CACHE 15X3.5 DRIVE UPG	UM-1	\$4,550
D3MSHD4L0HD2U	UNITY 2X2M 4L M SAS \$0 HD Cables	UM-1	\$0
D3MSHD4LHD2	UNITY 2X2M 4L MINI SAS HD Cables	UM-1	\$270
D3MSHD4LHD3	UNITY 2X3M 4L MINI SAS HD Cables	UM-1	\$360
D3MSHD4LHD5	UNITY 2X5M 4L MINI SAS HD Cables	UM-1	\$530
D3MSHD8LHD2	UNITY 2X2M 8L MINI SAS HD Cables	UM-1	\$525
D3MSHD8LHD3	UNITY 2X3M 8L MINI SAS HD Cables	UM-1	\$835
D3MSHD8LHD5	UNITY 2X5M 8L MINI SAS HD Cables	UM-1	\$1,150
D3MSHDMSSHD2	Unity 2x2M MINI SAS HD Cables	UM-1	\$270
D3MSHDMSSHD5	Unity 2x5M MINI SAS HD Cables	UM-1	\$545
D3MSHDMSSHD8	Unity 2x8M MINI SAS HD Cables	UM-1	\$815
D3N-2S10-1200	UNITY 1.2TB 10K SAS 25X2.5 NEBS DRIVE	UM-1	\$1,170
D3N-2S10-1200TU	UNITY 1.2TB 10K SAS 25X2.5 NEBS DRV UPG	UM-1	\$1,405
D3N-2S10-1200U	UNITY 1.2TB 10K SAS 25X2.5 NEBS DRV UPG	UM-1	\$1,405
D3N-2S10-1800	UNITY 1.8TB 10K SAS 25X2.5 NEBS DRIVE	UM-1	\$1,450
D3N-2S10-1800TU	UNITY 1.8TB 10K SAS 25X2.5 NEBS DRV UPG	UM-1	\$1,740
D3N-2S10-1800U	UNITY 1.8TB 10K SAS 25X2.5 NEBS DRV UPG	UM-1	\$1,740
D3N-2S10-600	UNITY 600GB 10K SAS 25X2.5 NEBS DRIVE	UM-1	\$720
D3N-2S10-600TU	UNITY 600GB 10K SAS 25X2.5 NEBS DRV UPG	UM-1	\$865
D3N-2S10-600U	UNITY 600GB 10K SAS 25X2.5 NEBS DRV UPG	UM-1	\$865
D3N-2S12FX-1600	UNITY 1.6TB FAST VP SSD 25X2.5 NEBS DRV	UM-1	\$6,850
D3N-2S12FX-1600TU	UNITY 1.6TB FASTVP SSD 25X2.5 NBS DRV UG	UM-1	\$8,220
D3N-2S12FX-1600U	UNITY 1.6TB FASTVP SSD 25X2.5 NBS DRV UG	UM-1	\$8,220
D3N-2S12FX-200	UNITY 200GB FAST VP SSD 25X2.5 NEBS DRV	UM-1	\$1,470
D3N-2S12FX-200TU	UNITY 200GB FAST VPSSD 25X2.5 NBS DRV UG	UM-1	\$1,765
D3N-2S12FX-200U	UNITY 200GB FAST VPSSD 25X2.5 NBS DRV UG	UM-1	\$1,765
D3N-2S12FX-400	UNITY 400GB FAST VP SSD 25X2.5 NEBS DRV	UM-1	\$2,350
D3N-2S12FX-400TU	UNITY 400GB FAST VPSSD 25X2.5 NBS DRV UG	UM-1	\$2,820
D3N-2S12FX-400U	UNITY 400GB FAST VPSSD 25X2.5 NBS DRV UG	UM-1	\$2,820
D3N-2S12FX-800	UNITY 800GB FAST VP SSD 25X2.5 NEBS DRV	UM-1	\$4,170
D3N-2S12FX-800TU	UNITY 800GB FASTVP SSD 25X2.5 NBS DRV UG	UM-1	\$5,005
D3N-2S12FX-800U	UNITY 800GB FASTVP SSD 25X2.5 NBS DRV UG	UM-1	\$5,005
D3N-2S12FXL-3200	UNITY 3.2TB AFP SSD 25X2.5 NEBS DRIVE	UM-1	\$9,565
D3N-2S12FXL-3200TU	UNITY 3.2TB AFP SSD 25X2.5 NEBS DRV UPG	UM-1	\$11,480
D3N-2S12FXL-3200U	UNITY 3.2TB AFP SSD 25X2.5 NEBS DRV UPG	UM-1	\$11,480
D3N-2S15-600	UNITY 600GB 15K SAS 25X2.5 NEBS DRIVE	UM-1	\$950
D3N-2S15-600TU	UNITY 600GB 15K SAS 25X2.5 NEBS DRV UG	UM-1	\$1,140
D3N-2S15-600U	UNITY 600GB 15K SAS 25X2.5 NEBS DRV UPG	UM-1	\$1,140
D3NFC-2S12FX-200	UNITY 200GB FAST CACHE 25X2.5 NEBS DRV	UM-1	\$1,470
D3NFC-2S12FX-200TU	UNITY 200GB FAST CACHE 25X2.5 NBS DRV UG	UM-1	\$1,765
D3NFC-2S12FX-200U	UNITY 200GB FAST CACHE 25X2.5 NBS DRV UG	UM-1	\$1,765
D3NFC-2S12FX-400	UNITY 400GB FAST CACHE 25X2.5 NEBS DRV	UM-1	\$2,350
D3NFC-2S12FX-400TU	UNITY 400GB FAST CACHE 25X2.5 NBS DRV UG	UM-1	\$2,820
D3NFC-2S12FX-400U	UNITY 400GB FAST CACHE 25X2.5 NBS DRV UG	UM-1	\$2,820
D3NFC-2S12FX-800	UNITY 800GB FAST CACHE 25X2.5 NEBS DRV	UM-1	\$4,170
D3NFC-2S12FX-800TU	UNITY 800GB FAST CACHE 25X2.5 NBS DRV UG	UM-1	\$5,005
D3NFC-2S12FX-800U	UNITY 800GB FAST CACHE 25X2.5 NBS DRV UG	UM-1	\$5,005
D3NSP-S4X1200-10K	UNITY NBS SYSPACK 4x1.2TB 10K SAS 25X2.5	UM-1	\$4,680
D3NSP-S4X1600X-SSD	UNITYNBS SYSPCK 4x1.6TB FLASH 25X2.5	UM-1	\$27,390

D3NSP-S4X1800-10K	UNITY NBS SYSPACK 4X1.8TB 10KSAS 25X2.5	UM-1	\$5,800
D3NSP-S4X3200XLSSD	UNITY NBS SYSPACK 4x3.2TB AFP SSD 25X2.5	UM-1	\$38,260
D3NSP-S4X400X-SSD	UNITY NBS SYSPK 4x400GB FLASH 25X2.5	UM-1	\$9,395
D3NSP-S4X600-10K	UNITY NBS SYSPACK 4x600GB 10K SAS 25X2.5	UM-1	\$2,880
D3NSP-S4X600-15K	UNITY NBS SYSPACK 4x600GB 15K SAS 25X2.5	UM-1	\$3,805
D3NSP-S4X800X-SSD	UNITY NBS SYSPK 4x800GB FLASH 25X2.5	UM-1	\$16,675
D3NSP-S6X1200-10K	UNITY NBS SYSPACK 6X1.2TB 10K SAS 25X2.5	UM-1	\$7,020
D3NSP-S6X1600X-SSD	UNITY NBS SYSPK 6X1.6TB FLASH 25X2.5	UM-1	\$41,090
D3NSP-S6X1800-10K	UNITY NBS SYSPACK 6X1.8TB 10KSAS 25X2.5	UM-1	\$8,700
D3NSP-S6X3200XLSSD	UNITY NBS SYSPACK 6X3.2TB AFP SSD 25X2.5	UM-1	\$57,390
D3NSP-S6X400X-SSD	UNITY NBS SYSPK 6X400GB FLASH 25X2.5	UM-1	\$14,090
D3NSP-S6X600-10K	UNITY NBS SYSPACK 6X600GB 10K SAS 25X2.5	UM-1	\$4,375
D3NSP-S6X600-15K	UNITY NBS SYSPACK 6X600GB 15K SAS 25X2.5	UM-1	\$5,715
D3NSP-S6X800X-SSD	UNITY NBS SYSPK 6X800GB FLASH 25X2.5	UM-1	\$25,000
D3-PS07-2000	UNITY 2TB NLSAS 12X3.5 DRIVE	UM-1	\$745
D3-PS07-2000TU	UNITY 2TB NLSAS 12X3.5 DRIVE UPG	UM-1	\$895
D3-PS07-2000U	UNITY 2TB NLSAS 12X3.5 DRIVE UPG	UM-1	\$895
D3-PS07-4000	UNITY 4TB NLSAS 12X3.5 DRIVE	UM-1	\$1,280
D3-PS07-4000TU	UNITY 4TB NLSAS 12X3.5 DRIVE UPG	UM-1	\$1,535
D3-PS07-4000U	UNITY 4TB NLSAS 12X3.5 DRIVE UPG	UM-1	\$1,535
D3-PS07-6000	UNITY 6TB NLSAS 12X3.5 DRIVE	UM-1	\$1,820
D3-PS07-6000TU	UNITY 6TB NLSAS 12X3.5 DRIVE UPG	UM-1	\$2,185
D3-PS07-6000U	UNITY 6TB NLSAS 12X3.5 DRIVE UPG	UM-1	\$2,185
D3-PS10-1200	UNITY 1.2TB 10K SAS 12X3.5 DRIVE	UM-1	\$0
D3-PS10-1200TU	UNITY 1.2TB 10K SAS 12X3.5 DRIVE UPG	UM-1	\$0
D3-PS10-1200U	UNITY 1.2TB 10K SAS 12X3.5 DRIVE UPG	UM-1	\$0
D3-PS10-1800	UNITY 1.8TB 10K SAS 12X3.5 DRIVE	UM-1	\$0
D3-PS10-1800TU	UNITY 1.8TB 10K SAS 12X3.5 DRIVE UPG	UM-1	\$0
D3-PS10-1800U	UNITY 1.8TGB 10K SAS 12X3.5 DRIVE UPG	UM-1	\$0
D3-PS10-600	UNITY 600GB 10K SAS 12X3.5 DRIVE	UM-1	\$0
D3-PS10-600TU	UNITY 600GB 10K SAS 12X3.5 DRIVE UPG	UM-1	\$0
D3-PS10-600U	UNITY 600GB 10K SAS 12X3.5 DRIVE UPG	UM-1	\$0
D3-PS12FX-1600	UNITY 1.6TB FLASH 12X3.5 DRIVE	UM-1	\$6,225
D3-PS12FX-1600TU	UNITY 1.6TB FAST VP SSD 12X3.5 DRIVE UG	UM-1	\$7,470
D3-PS12FX-1600U	UNITY 1.6TB FLASH 12X3.5 DRIVE UG	UM-1	\$7,470
D3-PS12FX-200	UNITY 200GB FLASH 12X3.5 DRIVE	UM-1	\$1,335
D3-PS12FX-200TU	UNITY 200GB FAST VP SSD 12X3.5 DRIVE UG	UM-1	\$1,600
D3-PS12FX-200U	UNITY 200GB FLASH 12X3.5 DRIVE UG	UM-1	\$1,600
D3-PS12FX-400	UNITY 400GB FLASH 12X3.5 DRIVE	UM-1	\$2,135
D3-PS12FX-400TU	UNITY 400GB FAST VP SSD 12X3.5 DRIVE UG	UM-1	\$2,560
D3-PS12FX-400U	UNITY 400GB FLASH 12X3.5 DRIVE UG	UM-1	\$2,560
D3-PS12FX-800	UNITY 800GB FLASH12X3.5 DRIVE	UM-1	\$0
D3-PS12FX-800TU	UNITY 800GB FAST VP SSD 12X3.5 DRIVE UG	UM-1	\$0
D3-PS12FX-800U	UNITY 800GB FLASH 12X3.5 DRIVE UG	UM-1	\$0
D3-PS15-600	UNITY 600GB 15K SAS 12X3.5 DRIVE	UM-1	\$0
D3-PS15-600TU	UNITY 600GB 15K SAS 12X3.5 DRIVE UPG	UM-1	\$0
D3-PS15-600U	UNITY 600GB 15K SAS 12X3.5 DRIVE UPG	UM-1	\$0
D3SFP1	Unity 4x1Gb SFP iSCSI/Eth	UM-1	\$0
D3SFP10I	Unity 4x10Gb SFP iSCSI/Eth connection	UM-1	\$0
D3SFP10IU	Unity 4x10Gb SFP iSCSI/Eth connect upg	UM-1	\$755

D3SFP16F	Unity 4x16Gb SFP FC connection	UM-1	\$0
D3SFP16FU	Unity 4x16Gb SFP FC connection	UM-1	\$1,135
D3SFP1U	Unity 4x1Gb SFP iSCSI/Eth FLD UPG	UM-1	\$755
D3SFP8F	Unity 4x8Gb SFP FC connection	UM-1	\$0
D3SFP8FU	Unity 4x8Gb SFP FC connect upg	UM-1	\$300
D3SFPSM16F	UNITY 4X16GB SFP SM FC CONNECTION	UM-1	\$3,000
D3SFPSM16FU	UNITY 4X16GB SFP SM FC CONNECTION UPG	UM-1	\$3,600
D3SL10ICU	Unity 2x4 Port 10GBASE-T iSCSI IO	UM-1	\$2,305
D3SL10ICUU	Unity 2x4 Port 10GBASE-T iSCSI IO UPG	UM-1	\$2,765
D3SL10IG	Unity 2x4 Port 10Gb iSCSI/Eth TwinAX IO	UM-1	\$1,630
D3SL10IGU	Unity 2x4 Port 10Gb iSCSI/Eth TWAX UPG	UM-1	\$1,955
D3SL10IO2PT	Unity 2x2 Port 10Gb iSCSI/Eth OPT IO	UM-1	\$2,440
D3SL10IO2PTTW	Unity 2x2 Port 10Gb iSCSI/Eth TwinAX IO	UM-1	\$1,630
D3SL10IO2PTTWU	Unity 2x2 Port 10Gb iSCSI/Eth TWAX UPG	UM-1	\$1,955
D3SL10IO2PTU	Unity 2x2 Port 10Gb iSCSI/Eth OPT UPG	UM-1	\$2,930
D3SL10IO4PT	Unity 2x4 Port 10Gb iSCSI/Eth OPT IO	UM-1	\$2,440
D3SL10IO4PTU	Unity 2x4 Port 10Gb iSCSI/Eth OPT UPG	UM-1	\$2,930
D3SL12SAS	Unity 2x4 Port SAS BE EXP BUS IO EMC Rck	UM-1	\$7,055
D3SL12SAS8L	UNITY 2x4 PORT 8L SAS BE EXP IO EMC RCK	UM-1	\$7,055
D3SL12SAS8LF	UNITY 2X4 PORT SAS EXP IO 8L FLD RCK	UM-1	\$7,055
D3SL12SASF	Unity 2x4 Port SAS BE EXP BUS IO FLD Rck	UM-1	\$7,055
D3SL12SASU	Unity 2x4 SAS BE EXP BUS IO EMC RK UPG	UM-1	\$8,465
D3SL16F	Unity 2x4 Port 16G FC IO	UM-1	\$3,530
D3SL16FSM	UNITY 2X4 PORT 16G FC IO S MODE SFPS	UM-1	\$6,265
D3SL16FSMMM	UNITY 2X4 PORT 16G FC IO S&M MODE SFPS	UM-1	\$5,060
D3SL16FSMMMU	Unity 2x4 Port 16G FC IO SM SFPS FLD U	UM-1	\$6,070
D3SL16FSMU	Unity 2x4 Port 16G FC IO SFPS FLD UPG	UM-1	\$7,520
D3SL16FU	Unity 2x4 Port 16Gb FC IO UPG	UM-1	\$4,235
D3SL1G	Unity 2x4 Port 1Gb iSCSI/Eth IO	UM-1	\$1,355
D3SL1GU	Unity 2x4 Port 1Gb iSCSI/Eth IO UPG	UM-1	\$1,625
D3SP-L4X1200-10K	UNITY SYSPACK 4X1.2TB 10K SAS 12X3.5	UM-1	\$0
D3SP-L4X1600X-SSD	UNITY SYSPACK 4X1.6TB FLASH 12X3.5	UM-1	\$24,900
D3SP-L4X1800-10K	UNITY SYSPACK 4X1.8TB 10K SAS 12X3.5	UM-1	\$0
D3SP-L4X2000-NL	UNITY SYSPACK 4X2TB NLSAS 12X3.5	UM-1	\$2,980
D3SP-L4X4000-NL	UNITY SYSPACK 4X4TB NLSAS 12X3.5	UM-1	\$5,120
D3SP-L4X400X-SSD	UNITY SYSPACK 4X400GB FLASH 12X3.5	UM-1	\$8,540
D3SP-L4X6000-NL	UNITY SYSPACK 4X6TB NLSAS 12X3.5	UM-1	\$7,280
D3SP-L4X600-10K	UNITY SYSPACK 4X600GB 10K SAS 12X3.5	UM-1	\$0
D3SP-L4X600-15K	UNITY SYSPACK 4X600GB 15K SAS 12X3.5	UM-1	\$0
D3SP-L4X800X-SSD	UNITY SYSPACK 4X800GB FLASH 12X3.5	UM-1	\$0
D3SP-L6X1200-10K	UNITY SYSPACK 6X1.2TB 10K SAS 12X3.5	UM-1	\$0
D3SP-L6X1600X-SSD	UNITY SYSPACK 6X1.6TB FLASH 12X3.5	UM-1	\$37,350
D3SP-L6X1800-10K	Unity SysPack 6X1.8TB 10K SAS 12X3.5	UM-1	\$0
D3SP-L6X400X-SSD	UNITY SYSPACK 6X400GB FLASH 12X3.5	UM-1	\$12,810
D3SP-L6X600-10K	UNITY SYSPACK 6X600GB 10K SAS 12X3.5	UM-1	\$0
D3SP-L6X600-15K	UNITY SYSPACK 6X600GB 15K SAS 12X3.5	UM-1	\$0
D3SP-L6X800X-SSD	UNITY SYSPACK 6X800GB FLASH 12X3.5	UM-1	\$0
D3SP-L9X2000-NL	UNITY SYSPACK 9X2TB NLSAS 12X3.5	UM-1	\$6,705
D3SP-L9X4000-NL	UNITY SYSPACK 9X4TB NLSAS 12X3.5	UM-1	\$11,520
D3SP-L9X6000-NL	UNITY SYSPACK 9X6TB NLSAS 12X3.5	UM-1	\$16,375

D3SP-S4X1200-10K	UNITY SYSPACK 4X1.2TB 10K SAS 25X2.5	UM-1	\$4,260
D3SP-S4X15TBXL2SSD	UNITY SYSPACK 4X15360GB FLASH 25X2.5	UM-1	\$152,060
D3SP-S4X1600XL-SSD	UNITY SYSPACK 4X1.6TB AFP SSD 25X2.5	UM-1	\$0
D3SP-S4X1600X-SSD	UNITY SYSPACK 4X1.6TB FLASH 25X2.5	UM-1	\$24,900
D3SP-S4X1800-10K	UNITY SYSPACK 4X1.8TB 10K SAS 25X2.5	UM-1	\$5,280
D3SP-S4X3200XL-SSD	UNITY SYSPACK 4X3.2TB FLASH 25X2.5	UM-1	\$34,780
D3SP-S4X400XL-SSD	UNITY SYSPACK 4X400GB AFP SSD 25X2.5	UM-1	\$0
D3SP-S4X400X-SSD	UNITY SYSPACK 4X400GB FLASH 25X2.5	UM-1	\$8,540
D3SP-S4X600-10K	UNITY SYSPACK 4X600GB 10K SAS 25X2.5	UM-1	\$2,620
D3SP-S4X600-15K	UNITY SYSPACK 4X600GB 15K SAS 25X2.5	UM-1	\$3,460
D3SP-S4X7TBXL2-SSD	UNITY SYSPACK 4X7680GB FLASH 25X2.5	UM-1	\$77,080
D3SP-S4X800XL-SSD	UNITY SYSPACK 4X800GB AFP SSD 25X2.5	UM-1	\$0
D3SP-S4X800X-SSD	UNITY SYSPACK 4X800GB FLASH 25X2.5	UM-1	\$15,160
D3SP-S6X1200-10K	UNITY SYSPACK 6X1.2TB 10K SAS 25X2.5	UM-1	\$6,390
D3SP-S6X15TBXL2SSD	UNITY SYSPACK 6X15360GB FLASH 25X2.5	UM-1	\$228,090
D3SP-S6X1600XL-SSD	UNITY SYSPACK 6X1.6TB AFP SSD 25X2.5	UM-1	\$0
D3SP-S6X1600X-SSD	UNITY SYSPACK 6X1.6TB FLASH 25X2.5	UM-1	\$37,350
D3SP-S6X1800-10K	UNITY SYSPACK 6X1.8TB 10K SAS 25X2.5	UM-1	\$7,920
D3SP-S6X3200XL-SSD	UNITY SYSPACK 6X3.2TB FLASH 25X2.5	UM-1	\$52,170
D3SP-S6X400XL-SSD	UNITY SYSPACK 6X400GB AFP SSD 25X2.5	UM-1	\$0
D3SP-S6X400X-SSD	UNITY SYSPACK 6X400GB FLASH 25X2.5	UM-1	\$12,810
D3SP-S6X600-10K	UNITY SYSPACK 6X600GB 10K SAS 25X2.5	UM-1	\$3,930
D3SP-S6X600-15K	UNITY SYSPACK 6X600GB 15K SAS 25X2.5	UM-1	\$5,190
D3SP-S6X7TBXL2-SSD	UNITY SYSPACK 6X7680GB FLASH 25X2.5	UM-1	\$115,620
D3SP-S6X800XL-SSD	UNITY SYSPACK 6X800GB AFP SSD 25X2.5	UM-1	\$0
D3SP-S6X800X-SSD	UNITY SYSPACK 6X800GB FLASH 25X2.5	UM-1	\$22,725
D3TX-TWAX-1M	1M Active TwinAX Cable QTY 4	UM-1	\$695
D3TX-TWAX-3M	3M Active TwinAX Cable QTY 4	UM-1	\$830
D3TX-TWAX-5M	5M Active TwinAX Cable QTY 4	UM-1	\$1,015
D3-VS07-2000	UNITY 2TB NLSAS 15X3.5 DRIVE	UM-1	\$745
D3-VS07-2000TU	UNITY 2TB NLSAS 15X3.5 DRIVE UPG	UM-1	\$895
D3-VS07-2000U	UNITY 2TB NLSAS 15X3.5 DRIVE UPG	UM-1	\$895
D3-VS07-4000	UNITY 4TB NLSAS 15X3.5 DRIVE	UM-1	\$1,280
D3-VS07-4000TU	UNITY 4TB NLSAS 15X3.5 DRIVE UPG	UM-1	\$1,535
D3-VS07-4000U	UNITY 4TB NLSAS 15X3.5 DRIVE UPG	UM-1	\$1,535
D3-VS07-6000	UNITY 6TB NLSAS 15X3.5 DRIVE	UM-1	\$1,820
D3-VS07-6000TU	UNITY 6TB NLSAS 15X3.5 DRIVE UPG	UM-1	\$2,185
D3-VS07-6000U	UNITY 6TB NLSAS 15X3.5 DRIVE UPG	UM-1	\$2,185
D3-VS10-1200	UNITY 1.2TB 10K SAS 15X3.5 DRIVE	UM-1	\$0
D3-VS10-1200TU	UNITY 1.2TB 10K SAS 15X3.5 DRIVE UPG	UM-1	\$0
D3-VS10-1200U	UNITY 1.2TB 10K SAS 15X3.5 DRIVE UPG	UM-1	\$0
D3-VS10-1800	Unity 1.8TB 10K SAS 15X3.5 Drive	UM-1	\$0
D3-VS10-1800TU	UNITY 1.8TB 10K SAS 15X3.5 DRIVE UPG	UM-1	\$0
D3-VS10-1800U	Unity 1.8TB 10K SAS 15X3.5 Drive Upg	UM-1	\$0
D3-VS10-600	UNITY 600GB 10K SAS 15X3.5 DRIVE	UM-1	\$0
D3-VS10-600TU	UNITY 600GB 10K SAS 15X3.5 DRIVE UPG	UM-1	\$0
D3-VS10-600U	UNITY 600GB 10K SAS 15X3.5 DRIVE UPG	UM-1	\$0
D3-VS12FX-1600	UNITY 1.6TB FLASH 15X3.5 DRIVE	UM-1	\$0
D3-VS12FX-1600TU	UNITY 1.6TB FAST VP SSD 15X3.5 DRIVE UG	UM-1	\$0
D3-VS12FX-1600U	UNITY 1.6TB FLASH 15X3.5 DRIVE UG	UM-1	\$0

D3-VS12FX-200	UNITY 200GB FLASH 15X3.5 DRIVE	UM-1	\$0
D3-VS12FX-200TU	UNITY 200GB FAST VP SSD 15X3.5 DRIVE UG	UM-1	\$0
D3-VS12FX-200U	UNITY 200GB FLASH 15X3.5 DRIVE UG	UM-1	\$0
D3-VS12FX-400	UNITY 400GB FLASH 15X3.5 DRIVE	UM-1	\$2,135
D3-VS12FX-400TU	UNITY 400GB FAST VP SSD 15X3.5 DRIVE UG	UM-1	\$2,560
D3-VS12FX-400U	UNITY 400GB FLASH 15X3.5 DRIVE UG	UM-1	\$2,560
D3-VS12FX-800	UNITY 800GB FLASH 15X3.5 DRIVE	UM-1	\$3,790
D3-VS12FX-800TU	UNITY 800GB FAST VP SSD 15X3.5 DRIVE UG	UM-1	\$4,550
D3-VS12FX-800U	UNITY 800GB FLASH 15X3.5 DRIVE UG	UM-1	\$4,550
D3-VS15-600	UNITY 600GB 15K SAS 15X3.5 DRIVE	UM-1	\$865
D3-VS15-600TU	UNITY 600GB 15K SAS 15X3.5 DRIVE UPG	UM-1	\$1,040
D3-VS15-600U	UNITY 600GB 15K SAS 15X3.5 DRIVE UPG	UM-1	\$1,040
DAE2UCHASSIS	2U DAE LF 12G SAS DAE CHASSIS 2 LCC	UM-1	\$1,435
DAE3UCHASSIS	3U DAE LF 12G SAS DAE CHASSIS MD P	UM-1	\$925
DLBASSY	Unity VG3R VE Lightbar FRU Assy	UM-1	\$870
DPE12CHASSIS	ASSY 12 DRV CHASSIS Midplane Unity DPE	UM-1	\$1,155
DPE25CHASSIS	ASSY 25 DRV CHASSIS Midplane Unity DPE	UM-1	\$955
DRVFILL25	DRIVE FILLER, 2.5IN	UM-1	\$5
DRVFILL35	DRIVE FILLER, 3.5IN	UM-1	\$5
DRVFILLU	FILLER,DISK DRIVE,UNIVERSAL	UM-1	\$5
FANMHT	FAN ASSEMBLY Unity HT	UM-1	\$80
M2SATA120GB	INTEL S3500 DRV 120G MLC M.2 SATA 6G 51	UM-1	\$345
M2SATA64GB	SMART XP DRV 64GB MLC M.2 6G 512 A19	UM-1	\$240
M2SATA80GB	INTEL S3500 DRV 80G MLC M.2 SATA 6G 512	UM-1	\$235
PSU1050W	GEN1 PLUS CFF Wide R 1050W ACDC PSU	UM-1	\$365
PSU1050WF	GEN1 PLUS CFF Wide R 1050W ACDC PSU FLEX	UM-1	\$345
PSU400W	3RD GEN VE PS 400W DUAL 12V-5VSB OUTPUT	UM-1	\$300
PSUCM2UDAE	Unity 2U DAE Power Supply Cooling Module	UM-1	\$425
PSUDAEDC	DC Unity 2U DAE PSU	UM-1	\$770
PSUDPEDC	DC Blastoff DPE PSU	UM-1	\$820
SFP1GBASET	SFP 1GB BASE T RJ 45	UM-1	\$100
SFPSM16GFC	SFP SM 16G FC 10KM	UM-1	\$710
SU-456-000-334	UnityVSA 10TB STORAGE CAP EXPANSION=CB	UM-1	\$0
SU-456-000-335	UnityVSA 25TB STORAGE CAP EXPANSION=CB	UM-1	\$0
SU-456-000-336	UnityVSA 50TB STORAGE CAP EXPANSION=CB	UM-1	\$0
SU-456-000-337	UnityVSA 10-25TB STORAGE CAP EXPAN=CB	UM-1	\$0
SU-456-000-338	UnityVSA 10-50TB STORAGE CAP EXPAN=CB	UM-1	\$0
SU-456-000-339	UnityVSA 25-50TB STORAGE CAP EXPAN=CB	UM-1	\$0
SU-458-000-200	UnityVSA PE Base SW=IC	UM-1	\$0
SU-458-000-201	UnityVSA PE 12Mo PrePay 10TB=CB	UM-1	\$555
SU-458-000-202	UnityVSA PE 12Mo PrePay 25TB=CB	UM-1	\$740
SU-458-000-203	UnityVSA PE 12Mo PrePay 50TB=CB	UM-1	\$925
SU-458-000-204	UnityVSA PE 12Mo PrePay 10TB-25TB=CB	UM-1	\$215
SU-458-000-205	UnityVSA PE 12Mo PrePay 10TB-50TB=CB	UM-1	\$425
SU-458-000-206	UnityVSA PE 12Mo PrePay 25TB-50TB=CB	UM-1	\$215
SU-458-000-254	UnityVSA PE Base SW 12Mo PrePay=IC	UM-1	\$0
SU-458-000-694	UnityVSA PE Base SW 36Mo+, PrePay=IC	UM-1	\$0
SU-458-000-695	UnityVSA PE Base SW 36Mo+, Annual AIP=IC	UM-1	\$0
SU-458-000-696	UnityVSA PE 36Mo+, PrePay, 10TB=CB	UM-1	\$455
SU-458-000-697	UnityVSA PE 36Mo+, Annual, 10TB AIP=CB	UM-1	\$505

SU-458-000-698	UnityVSA PE 36Mo+, PrePay, 25TB=CB	UM-1	\$606
SU-458-000-699	UnityVSA PE 36Mo+, Annual, 25TB AIP=CB	UM-1	\$673
SU-458-000-700	UnityVSA PE 36Mo+, PrePay, 50TB=CB	UM-1	\$757
SU-458-000-701	UnityVSA PE 36Mo+, Annual, 50TB AIP=CB	UM-1	\$841
SU-458-000-702	UnityVSA PE 36Mo+, PrePay, 10TB-25TB=CB	UM-1	\$176
SU-458-000-703	UnityVSA PE 36Mo+, Annual 10-25TB AIP=CB	UM-1	\$195
SU-458-000-704	UnityVSA PE 36Mo+, PrePay, 10TB-50TB=CB	UM-1	\$347
SU-458-000-705	UnityVSA PE 36Mo+, Annual 10-50TB AIP=CB	UM-1	\$386
SU-458-000-706	UnityVSA PE 36Mo+, PrePay, 25TB-50TB=CB	UM-1	\$176
SU-458-000-707	UnityVSA PE 36Mo+, Annual 25-50TB AIP=CB	UM-1	\$195
VCBTELCO3UDPE	Telco Rail KT for the 2U DPE	UM-1	\$160
VCTELCO2UDAE	Telco Rail KT for the 2U DAE	UM-1	\$160
VCTELCO3UDAE	Telco Rail KT for the 3U DAE	UM-1	\$160
1U-FILLERAF	Unity 1U Solid Filler 40U EMC Rck	UM-F1	\$0
25DRV-RKAF	FIXED RAIL KIT Unity 25 DR FACTORY HT	UM-F1	\$70
2U-FILLERAF	Unity 2U Solid Filler 40U EMC Rck	UM-F1	\$0
3U-FILLERAF	Unity 3U Solid Filler 40U EMC Rck	UM-F1	\$0
40U-PWR-ASTLAF	CAB POWER CORD AUSTRALIA	UM-F1	\$705
40U-PWR-IECAF	CAB POWER CORD IEC309	UM-F1	\$370
40U-PWR-RSAF	CAB POWER CORD US R&S	UM-F1	\$705
40U-PWR-USAF	CAB POWER CORD US	UM-F1	\$370
40U-RK-DOORAF	Unity AFA Rack W/Door	UM-F1	\$1,350
40U-RK-DOORAFD	40U AFA RACK WITH DOOR	UM-F1	\$1,350
40U-RK-DRLKAF	Unity AFA Rack W/Door Lock	UM-F1	\$1,350
40U-RK-DRLKAFD	40U AFA RACK WITH DOOR LOCK	UM-F1	\$1,350
40U-SECUREAF	40U Rack Stabilizing Kit	UM-F1	\$325
450-001-606	ViPR SUITE Unity 300F=IC	UM-F1	\$6,960
450-001-607	ViPR SUITE Unity 400F=IC	UM-F1	\$16,705
450-001-608	ViPR SUITE Unity 500F=IC	UM-F1	\$33,390
450-001-609	ViPR SUITE Unity 600F=IC	UM-F1	\$48,690
450-001-632	ViPR Suite for Unity 350F=IC	UM-F1	\$6,960
450-001-633	ViPR Suite for Unity 450F=IC	UM-F1	\$16,705
450-001-634	ViPR Suite for Unity 550F=IC	UM-F1	\$33,390
450-001-635	ViPR Suite for Unity 650F=IC	UM-F1	\$48,690
456-111-265	RP/EX LOC FRAME UNITY 300F FOR VPLEX =IC	UM-F1	\$3,560
456-111-266	RP/EX LOC FRAME UNITY 400F FOR VPLEX=IC	UM-F1	\$7,820
456-111-267	RP/EX LOC FRAME UNITY 500F FOR VPLEX =IC	UM-F1	\$13,320
456-111-268	RP/EX LOC FRAME UNITY 600F FOR VPLEX =IC	UM-F1	\$19,000
456-111-269	RP/EX REM FRAME UNITY 300F FOR VPLEX =IC	UM-F1	\$9,170
456-111-270	RP/EX REM FRAME UNITY 400F FOR VPLEX =IC	UM-F1	\$20,140
456-111-271	RP/EX REM FRAME UNITY 500F FOR VPLEX =IC	UM-F1	\$29,730
456-111-272	RP/EX REM FRAME UNITY 600F FOR VPLEX =IC	UM-F1	\$47,490
456-111-368	RP/EX LOC FRAME UNITY300F VPLEX VS6=IC	UM-F1	\$3,560
456-111-369	RP/EX LOC FRAME UNITY400F VPLEX VS6=IC	UM-F1	\$7,820
456-111-370	RP/EX LOC FRAME UNITY500F VPLEX VS6=IC	UM-F1	\$13,320
456-111-371	RP/EX LOC FRAME UNITY600F VPLEX VS6=IC	UM-F1	\$19,000
456-111-376	RP/EX REM FRAME UNITY300F VPLEX VS6=IC	UM-F1	\$9,170
456-111-377	RP/EX REM FRAME UNITY400F VPLEX VS6=IC	UM-F1	\$20,140
456-111-378	RP/EX REM FRAME UNITY500F VPLEX VS6=IC	UM-F1	\$29,730
456-111-379	RP/EX REM FRAME UNITY600F VPLEX VS6=IC	UM-F1	\$47,490

456-111-473	AppSync Basic for Unity 300F/350F LIC=IC	UM-F1	\$0
456-111-474	AppSync Basic for Unity 400F/450F LIC=IC	UM-F1	\$0
456-111-475	AppSync Basic for Unity 500F/550F LIC=IC	UM-F1	\$0
456-111-476	AppSync Basic for Unity 600F/650F LIC=IC	UM-F1	\$0
456-111-501	SRM Unity 300F =IC	UM-F1	\$5,460
456-111-502	SRM Unity 400F=IC	UM-F1	\$13,100
456-111-503	SRM Unity 500F =IC	UM-F1	\$26,190
456-111-504	SRM Unity 600F =IC	UM-F1	\$38,190
456-111-505	Storage M&R for Unity 300F=IC	UM-F1	\$0
456-111-506	Storage M&R for Unity 400F=IC	UM-F1	\$0
456-111-507	Storage M&R for Unity 500F=IC	UM-F1	\$0
456-111-508	Storage M&R for Unity 600F=IC	UM-F1	\$0
456-111-583	VS SRM Unity 300F LIC=IC	UM-F1	\$0
456-111-584	VS VIPRC Unity F LIC=IC	UM-F1	\$0
456-111-585	VS SRM Unity 400F LIC=IC	UM-F1	\$0
456-111-586	VS SRM Unity 500F LIC=IC	UM-F1	\$0
456-111-587	VS SRM Unity 600F LIC=IC	UM-F1	\$0
456-111-891	SRM UPG Unity 300F =IC	UM-F1	\$4,360
456-111-892	SRM UPG Unity 400F=IC	UM-F1	\$10,480
456-111-893	SRM UPG Unity 500F =IC	UM-F1	\$20,950
456-111-894	SRM UPG Unity 600F =IC	UM-F1	\$30,550
456-112-845	Storage M&R for Unity 350F=IC	UM-F1	\$0
456-112-846	Storage M&R for Unity 450F=IC	UM-F1	\$0
456-112-847	Storage M&R for Unity 550F=IC	UM-F1	\$0
456-112-848	Storage M&R for Unity 650F=IC	UM-F1	\$0
456-112-849	SRM Unity 350F =IC	UM-F1	\$5,460
456-112-850	SRM Unity 450F=IC	UM-F1	\$13,100
456-112-851	SRM Unity 550F =IC	UM-F1	\$26,190
456-112-852	SRM Unity 650F =IC	UM-F1	\$38,190
456-112-854	SRM UPG From M&R Unity 350F=IC	UM-F1	\$4,360
456-112-855	SRM UPG From M&R Unity 450F=IC	UM-F1	\$10,480
456-112-856	SRM UPG From M&R Unity 550F=IC	UM-F1	\$20,950
456-112-857	SRM UPG From M&R Unity 650F=IC	UM-F1	\$30,550
458-001-486	Unity AFA Base Software=IC	UM-F1	\$0
458-001-487	Unity AFA Base Software + D@RE=IC	UM-F1	\$0
458-001-569	RP/EX VPLEX FB UNITY/F LOCAL PRODUCT	UM-F1	\$0
458-001-570	RP/EX VPLEX FB UNITY/F REMOTE PRODUCT	UM-F1	\$0
458-001-571	RP Adv Loc for Unity 300F/350F =IC	UM-F1	\$3,560
458-001-572	RP Adv Rem for Unity 300F/350F =IC	UM-F1	\$9,170
458-001-573	RP Adv Loc for Unity 400F/450F =IC	UM-F1	\$7,820
458-001-574	RP Adv Rem for Unity 400F/450F =IC	UM-F1	\$20,140
458-001-575	RP Adv Loc for Unity 500F/550F =IC	UM-F1	\$13,320
458-001-576	RP Adv Rem for Unity 500F/550F =IC	UM-F1	\$29,730
458-001-577	RP Adv Loc for Unity 600F/650F =IC	UM-F1	\$19,000
458-001-578	RP Adv Rem for Unity 600F/650F =IC	UM-F1	\$47,490
458-001-589	AppSync ADV for Unity 300F/350F=IC	UM-F1	\$10,930
458-001-591	AppSync ADV for Unity 400F/450F=IC	UM-F1	\$24,000
458-001-593	AppSync ADV for Unity 500F/550F=IC	UM-F1	\$37,980
458-001-595	AppSync ADV for Unity 600F/650F=IC	UM-F1	\$46,240
458-001-734	AppSync Basic for Unity 300F/350F =IC	UM-F1	\$0

458-001-735	AppSync Basic for Unity 400F/450F =IC	UM-F1	\$0
458-001-736	AppSync Basic for Unity 500F/550F =IC	UM-F1	\$0
458-001-737	AppSync Basic for Unity 600F/650F =IC	UM-F1	\$0
458-001-743	RP BASIC TO ADV LOC UG FOR UNITY 300F=IC	UM-F1	\$9,550
458-001-744	RP BASIC TO ADV REM UG FOR UNITY 300F=IC	UM-F1	\$9,550
458-001-745	RP BASIC TO ADV LOC UG FOR UNITY 400F=IC	UM-F1	\$20,960
458-001-746	RP BASIC TO ADV REM UG FOR UNITY 400F=IC	UM-F1	\$20,960
458-001-747	RP BASIC TO ADV LOC UG FOR UNITY 500F=IC	UM-F1	\$32,290
458-001-748	RP BASIC TO ADV REM UG FOR UNITY 500F=IC	UM-F1	\$32,290
458-001-749	RP BASIC TO ADV LOC UG FOR UNITY 600F=IC	UM-F1	\$49,860
458-001-750	RP BASIC TO ADV REM UG FOR UNITY 600F=IC	UM-F1	\$49,860
458-001-751	SRM for Unity F	UM-F1	\$0
458-001-840	Unity 300F/350F Base Software+ D@RE=IC	UM-F1	\$0
458-001-842	Unity 400F/450F Base Software+ D@RE=IC	UM-F1	\$0
458-001-844	Unity 500F/550F Base Software+ D@RE=IC	UM-F1	\$0
458-001-846	Unity 600F/650F Base Software+ D@RE=IC	UM-F1	\$0
458-001-848	Unity 300F/350F Base Software=IC	UM-F1	\$0
458-001-850	Unity 400F/450F Base Software=IC	UM-F1	\$0
458-001-852	Unity 500F/550F Base Software=IC	UM-F1	\$0
458-001-854	Unity 600F/650F Base Software=IC	UM-F1	\$0
458-001-879	SRM UPG for Unity AF	UM-F1	\$0
458-002-130	SRM UPG From M&R for Unity F	UM-F1	\$0
CS-OPT-UXAF-MON-1Y	OPTIMIZE FOR UNITY AFA MON 1YEAR	UM-F1	\$20,000
CS-OPT-UXAF-MON-2Y	OPTIMIZE FOR UNITY AFA MON 2YEAR	UM-F1	\$40,000
CS-OPT-UXAF-MON-3Y	OPTIMIZE FOR UNITY AFA MON 3YEAR	UM-F1	\$60,000
CS-OPT-UXAF-MON-4Y	OPTIMIZE FOR UNITY AFA MON 4YEAR	UM-F1	\$80,000
CS-OPT-UXAF-MON-5Y	OPTIMIZE FOR UNITY AFA MON 5YEAR	UM-F1	\$100,000
CS-OPT-UXAF-QTR-1Y	OPTIMIZE FOR UNITY AFA QTRLY 1YEAR	UM-F1	\$12,000
CS-OPT-UXAF-QTR-2Y	OPTIMIZE FOR UNITY AFA QTRLY 2YEAR	UM-F1	\$24,000
CS-OPT-UXAF-QTR-3Y	OPTIMIZE FOR UNITY AFA QTRLY 3YEAR	UM-F1	\$36,000
CS-OPT-UXAF-QTR-4Y	OPTIMIZE FOR UNITY AFA QTRLY 4YEAR	UM-F1	\$48,000
CS-OPT-UXAF-QTR-5Y	OPTIMIZE FOR UNITY AFA QTRLY 5YEAR	UM-F1	\$60,000
D3122ADAF	Unity 2U 25x2.5 12G EXPDAE -EMC Rck D	UM-F1	\$2,440
D3122ADFAF	Unity 2U 25x2.5 DAE Dell EMC RCK Fld Upg	UM-F1	\$2,440
D3122DF25AF	UNITYF 25x2.5 12G DAE DC FLD RK	UM-F1	\$2,685
D3122FAF	Unity 2U 25x2.5 12G EXPDAE -FLD INS	UM-F1	\$2,440
D312380ADAF	UNITY 3U 80x2.5 DRIVE DAE EMC Rck	UM-F1	\$9,200
D312380FAF	UNITYF 3U 80X2.5 DRIVE DAE FLD RCK	UM-F1	\$9,200
D312380FUAF	UNITYF 3U 80X2.5 DRIVE DAE FLD UPG	UM-F1	\$9,200
D315TD325AF	Unity AFA DIP 350F to 450F	UM-F1	\$22,075
D315TD335AF	Unity AFA DIP 350F to 550F	UM-F1	\$46,955
D315TD345AF	UNITY AFA DIP 350F to 650F	UM-F1	\$102,920
D31BD24AD25AF	UNITY 350F 2U DPE 25x2.5 DRIVE EMC RK	UM-F1	\$9,865
D31BD24AF25AF	UNITY 350F 2U DPE 25x2.5 DRIVE FLD RK	UM-F1	\$9,865
D31BD24DF25AF	UNITY 350F 2U DPE 25x2.5 DRIVE FLD RK DC	UM-F1	\$12,330
D31D24AD25AF	Unity 300 AFA DPE 25x2.5 EMC Rck D	UM-F1	\$9,865
D31D24AF25AF	Unity 300 AFA DPE 25x2.5 FLD Ins	UM-F1	\$9,865
D31D25CKITOAF	25 Drive DPE FLD INSTALL KIT AF	UM-F1	\$0
D31DEMCK25KITAF	Unity 25 Drive DPE AF FLD INSTALL KIT	UM-F1	\$0
D31EMCK25KITAF	Unity AFA 25 Drive EMC DPE FLD INST KIT	UM-F1	\$0

D31TD315AF	Unity AFA DIP 300F to 350F	UM-F1	\$9,370
D31TD325AF	Unity AFA DIP 300F to 450F	UM-F1	\$22,075
D31TD32AF	Unity DIP 300F to 400F	UM-F1	\$21,225
D31TD335AF	Unity AFA DIP 300F to 550F	UM-F1	\$46,955
D31TD33AF	Unity DIP 300F to 500F	UM-F1	\$44,295
D31TD345AF	Unity AFA DIP 300F to 650F	UM-F1	\$102,920
D31TD34AF	Unity DIP 300F to 600F	UM-F1	\$93,560
D325TD335AF	Unity AFA DIP 450F to 550F	UM-F1	\$46,955
D325TD345AF	Unity AFA DIP 450F to 650F	UM-F1	\$102,920
D32BD32AD25AF	UNITY 450F 2U DPE 25x2.5 DRIVE EMC RK	UM-F1	\$23,235
D32BD32AF25AF	UNITY 450F 2U DPE 25x2.5 DRIVE FLD RK	UM-F1	\$23,235
D32BD32DF25AF	UNITY 450F 2U DPE 25x2.5 DRIVE FLD RK DC	UM-F1	\$29,045
D32D32AD25AF	Unity 400 AFA DPE 25x2.5 EMC Rck D	UM-F1	\$22,340
D32D32AF25AF	Unity 400 AFA DPE 25x2.5 FLD Ins	UM-F1	\$22,340
D32TD325AF	Unity AFA DIP 400F to 450F	UM-F1	\$22,075
D32TD335AF	Unity AFA DIP 400F to 550F	UM-F1	\$46,955
D32TD33AF	Unity DIP 400F to 500F	UM-F1	\$44,295
D32TD345AF	Unity AFA DIP 400F to 650F	UM-F1	\$102,920
D32TD34AF	Unity DIP 400F to 600F	UM-F1	\$93,560
D335TD345AF	Unity AFA DIP 550F to 650F	UM-F1	\$102,920
D33BD48AD25AF	UNITY 550F 2U DPE 25x2.5 DRIVE EMC RK	UM-F1	\$49,425
D33BD48AF25AF	UNITY 550F 2U DPE 25x2.5 DRIVE FLD RK	UM-F1	\$49,425
D33BD48DF25AF	UNITY 550F 2U DPE 25x2.5 DRIVE FLD RK DC	UM-F1	\$61,780
D33D48AD25AF	Unity 500 AFA DPE 25x2.5 EMC Rck D	UM-F1	\$46,625
D33D48AF25AF	Unity 500 AFA DPE 25x2.5 FLD Ins	UM-F1	\$46,625
D33TD335AF	Unity AFA DIP 500F to 550F	UM-F1	\$46,955
D33TD345AF	Unity AFA DIP 500F to 650F	UM-F1	\$102,920
D33TD34AF	Unity DIP 500F to 600F	UM-F1	\$93,560
D34BD64AD25AF	UNITY 650F 2U DPE 25x2.5 DRIVE EMC RK	UM-F1	\$108,335
D34BD64AF25AF	UNITY 650F 2U DPE 25x2.5 DRIVE FLD RK	UM-F1	\$108,335
D34BD64DF25AF	UNITY 650F 2U DPE 25x2.5 DRIVE FLD RK DC	UM-F1	\$135,420
D34D64AD25AF	Unity 600 AFA DPE 25x2.5 EMC Rck D	UM-F1	\$98,485
D34D64AF25AF	Unity 600 AFA DPE 25x2.5 FLD Ins	UM-F1	\$98,485
D34TD345AF	Unity AFA DIP 600F to 650F	UM-F1	\$102,920
D3DAE2URKAF	Unity Snap In RAIL Kit 2U 25 Drive DAE	UM-F1	\$135
D3DAE80RKAF	UnityF Snap In RAIL Kit 80 Drive DAE	UM-F1	\$225
D3DPE2URK25AF	Unity Snap In RAIL Kit 2U 25 Drive DPE	UM-F1	\$135
D3F-2S12FXL-1600	Unity AFA 1.6TB SSD 25X2.5	UM-F1	\$4,720
D3F-2S12FXL-1600TU	Unity AFA 1.6TB SSD 25X2.5 UPG	UM-F1	\$5,665
D3F-2S12FXL-1600U	Unity AFA 1.6TB SSD 25X2.5 UPG	UM-F1	\$5,665
D3F-2S12FXL-3200	Unity AFA 3.2TB SSD 25X2.5	UM-F1	\$8,695
D3F-2S12FXL-3200TU	Unity AFA 3.2TB SSD 25X2.5 UPG	UM-F1	\$10,435
D3F-2S12FXL-3200U	Unity AFA 3.2TB SSD 25X2.5 UPG	UM-F1	\$10,435
D3F-2S12FXL-400	Unity AFA 400GB SSD 25X2.5	UM-F1	\$1,730
D3F-2S12FXL-400TU	Unity AFA 400GB SSD 25X2.5 UPG	UM-F1	\$2,075
D3F-2S12FXL-400U	Unity AFA 400GB SSD 25X2.5 UPG	UM-F1	\$2,075
D3F-2S12FXL-800	Unity AFA 800GB SSD 25X2.5	UM-F1	\$2,935
D3F-2S12FXL-800TU	Unity AFA 800GB SSD 25X2.5 UPG	UM-F1	\$3,520
D3F-2S12FXL-800U	Unity AFA 800GB SSD 25X2.5 UPG	UM-F1	\$3,520
D3F-2SFXL2-15360	Unity AFA 15.36TB SSD 25X2.5	UM-F1	\$38,015

D3F-2SFXL2-15360TU	Unity AFA 15.36TB SSD 25X2.5 UPG	UM-F1	\$45,620
D3F-2SFXL2-15360U	Unity AFA 15.36TB SSD 25X2.5 UPG	UM-F1	\$45,620
D3F-2SFXL2-1920	Unity AFA 1.92TB SSD 25X2.5	UM-F1	\$5,525
D3F-2SFXL2-1920TU	Unity AFA 1.92TB SSD 25X2.5 UPG	UM-F1	\$6,630
D3F-2SFXL2-1920U	Unity AFA 1.92TB SSD 25X2.5 UPG	UM-F1	\$6,630
D3F-2SFXL2-3840	Unity AFA 3.84TB SSD 25X2.5	UM-F1	\$10,365
D3F-2SFXL2-3840TU	Unity AFA 3.84TB SSD 25X2.5 UPG	UM-F1	\$12,440
D3F-2SFXL2-3840U	Unity AFA 3.84TB SSD 25X2.5 UPG	UM-F1	\$12,440
D3F-2SFXL2-7680	Unity AFA 7.68TB SSD 25X2.5	UM-F1	\$19,270
D3F-2SFXL2-7680TU	Unity AFA 7.68TB SSD 25X2.5 UPG	UM-F1	\$23,125
D3F-2SFXL2-7680U	Unity AFA 7.68TB SSD 25X2.5 UPG	UM-F1	\$23,125
D3FC-OM3-100MAF	100M MM FIBRE CABLE LC-LC	UM-F1	\$220
D3FC-OM3-10MAF	10M MM FIBRE CABLE LC-LC	UM-F1	\$135
D3FC-OM3-1MAF	1M MM FIBRE CABLE LC-LC	UM-F1	\$100
D3FC-OM3-30MAF	30M MM FIBRE CABLE LC-LC	UM-F1	\$160
D3FC-OM3-3MAF	3M MM FIBRE CABLE LC-LC	UM-F1	\$110
D3FC-OM3-50MAF	50M MM FIBRE CABLE LC-LC	UM-F1	\$190
D3FC-OM3-5MAF	5M MM FIBRE CABLE LC-LC	UM-F1	\$120
D3FC-OM4-100MAF	100M MM FIBRE CABLE LC-LC	UM-F1	\$440
D3FC-OM4-10MAF	10M MM FIBRE CABLE LC-LC	UM-F1	\$135
D3FC-OM4-1MAF	1M MM FIBRE CABLE LC-LC	UM-F1	\$100
D3FC-OM4-30MAF	30M MM FIBRE CABLE LC-LC	UM-F1	\$240
D3FC-OM4-3MAF	3M MM FIBRE CABLE LC-LC	UM-F1	\$110
D3FC-OM4-50MAF	50M MM FIBRE CABLE LC-LC	UM-F1	\$333
D3FC-OM4-5MAF	5M MM FIBRE CABLE LC-LC	UM-F1	\$120
D3F-D2S12FXL-1600	Unity AFA 1.6TB SSD 80X2.5	UM-F1	\$4,720
D3F-D2S12FXL1600TU	Unity AFA 1.6TB SSD 80X2.5 UPG	UM-F1	\$5,665
D3F-D2S12FXL-1600U	Unity AFA 1.6TB SSD 80X2.5 UPG	UM-F1	\$5,665
D3F-D2S12FXL-3200	Unity AFA 3.2TB SSD 80X2.5	UM-F1	\$8,695
D3F-D2S12FXL3200TU	Unity AFA 3.2TB SSD 80X2.5 UPG	UM-F1	\$10,435
D3F-D2S12FXL-3200U	Unity AFA 3.2TB SSD 80X2.5 UPG	UM-F1	\$10,435
D3F-D2S12FXL-400	Unity AFA 400GB SSD 80X2.5	UM-F1	\$1,730
D3F-D2S12FXL-400TU	Unity AFA 400GB SSD 80X2.5 UPG	UM-F1	\$2,075
D3F-D2S12FXL-400U	Unity AFA 400GB SSD 80X2.5 UPG	UM-F1	\$2,075
D3F-D2S12FXL-800	Unity AFA 800GB SSD 80X2.5	UM-F1	\$2,935
D3F-D2S12FXL-800TU	Unity AFA 800GB SSD 80X2.5 UPG	UM-F1	\$3,520
D3F-D2S12FXL-800U	Unity AFA 800GB SSD 80X2.5 UPG	UM-F1	\$3,520
D3F-D2SFXL2-15360	Unity AFA 15.36TB SSD 80X2.5	UM-F1	\$38,015
D3F-D2SFXL215360TU	Unity AFA 15.36TB SSD 80X2.5 UPG	UM-F1	\$45,620
D3F-D2SFXL2-15360U	Unity AFA 15.36TB SSD 80X2.5 UPG	UM-F1	\$45,620
D3F-D2SFXL2-1920	Unity AFA 1.92TB SSD 80X2.5	UM-F1	\$5,525
D3F-D2SFXL2-1920TU	Unity AFA 1.92TB SSD 80X2.5 UPG	UM-F1	\$6,630
D3F-D2SFXL2-1920U	Unity AFA 1.92TB SSD 80X2.5 UPG	UM-F1	\$6,630
D3F-D2SFXL2-3840	Unity AFA 3.84TB SSD 80X2.5	UM-F1	\$10,365
D3F-D2SFXL2-3840TU	Unity AFA 3.84TB SSD 80X2.5 UPG	UM-F1	\$12,440
D3F-D2SFXL2-3840U	Unity AFA 3.84TB SSD 80X2.5 UPG	UM-F1	\$12,440
D3F-D2SFXL2-7680	Unity AFA 7.68TB SSD 80X2.5	UM-F1	\$19,270
D3F-D2SFXL2-7680TU	Unity AFA 7.68TB SSD 80X2.5 UPG	UM-F1	\$23,125
D3F-D2SFXL2-7680U	Unity AFA 7.68TB SSD 80X2.5 UPG	UM-F1	\$23,125
D3FSP-5X400GBSSD	UNITY AFA 5X400GB SYSPACK	UM-F1	\$8,650

D3MSHD4L0HD2UAF	UNITYF 2X2M 4L M SAS \$0 HD Cables	UM-F1	\$0
D3MSHD4LHD2AF	UNITYF 2X2M 4L MINI SAS HD Cables	UM-F1	\$270
D3MSHD4LHD3AF	UNITYF 2X3M 4L MINI SAS HD Cables	UM-F1	\$360
D3MSHD4LHD5AF	UNITYF 2X5M 4L MINI SAS HD Cables	UM-F1	\$530
D3MSHD8LHD2AF	UNITYF 2X2M 8L MINI SAS HD Cables	UM-F1	\$525
D3MSHD8LHD3AF	UNITYF 2X3M 8L MINI SAS HD Cables	UM-F1	\$835
D3MSHD8LHD5AF	UNITYF 2X5M 8L MINI SAS HD Cables	UM-F1	\$1,150
D3MSHDMSSHD2AF	Unity 2x2M MINI SAS HD Cables	UM-F1	\$270
D3MSSHDMSSHD5AF	Unity 2x5M MINI SAS HD Cables	UM-F1	\$530
D3MSSHDMSSHD8AF	Unity 2x8M MINI SAS HD Cables	UM-F1	\$795
D3NF-2SFXL-1600	Unity NEBS AFA 1.6TB SSD 25X2.5	UM-F1	\$5,190
D3NF-2SFXL-1600TU	Unity NEBS AFA 1.6TB SSD 25X2.5 UPG	UM-F1	\$6,230
D3NF-2SFXL-1600U	Unity NEBS AFA 1.6TB SSD 25X2.5 UPG	UM-F1	\$6,230
D3NF-2SFXL2-15360	Unity NEBS AFA 15.36TB SSD 25X2.5	UM-F1	\$41,815
D3NF-2SFXL2-15360U	Unity NEBS AFA 15.36TB SSD 25X2.5 UPG	UM-F1	\$50,180
D3NF-2SFXL2-1536TU	Unity NEBS AFA 15.36TB SSD 25X2.5 UPG	UM-F1	\$50,180
D3NF-2SFXL2-3840	Unity NEBS AFA 3.84TB SSD 25X2.5	UM-F1	\$11,400
D3NF-2SFXL2-3840TU	Unity NEBS AFA 3.84TB SSD 25X2.5 UPG	UM-F1	\$13,685
D3NF-2SFXL2-3840U	Unity NEBS AFA 3.84TB SSD 25X2.5 UPG	UM-F1	\$13,685
D3NF-2SFXL2-7680	Unity NEBS AFA 7.68TB SSD 25X2.5	UM-F1	\$21,195
D3NF-2SFXL2-7680TU	Unity NEBS AFA 7.68TB SSD 25X2.5 UPG	UM-F1	\$25,440
D3NF-2SFXL2-7680U	Unity NEBS AFA 7.68TB SSD 25X2.5 UPG	UM-F1	\$25,440
D3NF-2SFXL-3200	Unity NEBS AFA 3.2TB SSD 25X2.5	UM-F1	\$9,565
D3NF-2SFXL-3200TU	Unity NEBS AFA 3.2TB SSD 25X2.5 UPG	UM-F1	\$11,480
D3NF-2SFXL-3200U	Unity NEBS AFA 3.2TB SSD 25X2.5 UPG	UM-F1	\$11,480
D3NF-2SFXL-400	Unity NEBS AFA 400GB SSD 25X2.5	UM-F1	\$1,905
D3NF-2SFXL-400TU	Unity NEBS AFA 400GB SSD 25X2.5 UPG	UM-F1	\$2,285
D3NF-2SFXL-400U	Unity NEBS AFA 400GB SSD 25X2.5 UPG	UM-F1	\$2,285
D3NF-2SFXL-800	Unity NEBS AFA 800GB SSD 25X2.5	UM-F1	\$3,230
D3NF-2SFXL-800TU	Unity NEBS AFA 800GB SSD 25X2.5 UPG	UM-F1	\$3,870
D3NF-2SFXL-800U	Unity NEBS AFA 800GB SSD 25X2.5 UPG	UM-F1	\$3,870
D3SFP10IAF	Unity 4x10Gb SFP iSCSI/Eth connection	UM-F1	\$0
D3SFP10IUAF	Unity 4x10Gb SFP iSCSI/Eth connect upg	UM-F1	\$755
D3SFP16FAF	Unity 4x16Gb SFP FC connection	UM-F1	\$0
D3SFP16FUAF	Unity 4x16Gb SFP FC connection	UM-F1	\$1,135
D3SFP1AF	Unity 4x1Gb SFP iSCSI/Eth connection	UM-F1	\$0
D3SFP1UAF	Unity 4x1Gb SFP iSCSI/Eth connect FLD U	UM-F1	\$755
D3SFP8FAF	Unity 4x8Gb SFP FC connection	UM-F1	\$0
D3SFP8FUAF	Unity 4x8Gb SFP FC connect upg	UM-F1	\$300
D3SFPSM16FAF	UNITY AF 4X16GB SFP SM FC CONNECTION	UM-F1	\$3,000
D3SFPSM16FAFU	UNITY AF 4X16GB SFP SM FC CONNECTION UPG	UM-F1	\$3,600
D3SL10ICUAF	Unity 2x4 Port 10GBASE-T iSCSI IO	UM-F1	\$2,305
D3SL10ICUUAF	Unity 2x4 Port 10GBASE-T iSCSI IO UPG	UM-F1	\$2,765
D3SL10IGAF	Unity 2x4 Port 10Gb iSCSI/Eth TwinAX IO	UM-F1	\$1,630
D3SL10IGUAF	Unity 2x4 Port 10Gb iSCSI/Eth TWAX UPG	UM-F1	\$1,955
D3SL10IO2PTAF	Unity 2x2 Port 10Gb iSCSI/Eth OPT IO	UM-F1	\$2,440
D3SL10IO2PTTWAF	Unity 2x2 Port 10Gb iSCSI/Eth TwinAX IO	UM-F1	\$1,630
D3SL10IO2PTTWUAF	Unity 2x2 Port 10Gb iSCSI/Eth TWAX UPG	UM-F1	\$1,955
D3SL10IO2PTUAF	Unity 2x2 Port 10Gb iSCSI/Eth OPT UPG	UM-F1	\$2,930
D3SL10IO4PTAF	Unity 2x4 Port 10Gb iSCSI/Eth OPT IO	UM-F1	\$2,440

D3SL10IO4PTUAF	Unity 2x4 Port 10Gb iSCSI/Eth OPT UPG	UM-F1	\$2,930
D3SL12SAS8LAF	UNITYF 2x4 PORT 8L SAS BE EXP IO EMC RCK	UM-F1	\$7,055
D3SL12SAS8LFAF	UNITY AF 2X4 PORT SAS EXP IO 8L FLD RCK	UM-F1	\$7,055
D3SL12SASAF	Unity 2x4 Port SAS BE EXP BUS IO EMC Rck	UM-F1	\$7,055
D3SL12SASF	Unity 2x4 Port SAS BE EXP BUS IO FLD Rck	UM-F1	\$7,055
D3SL12SASUAF	Unity SAS BE EXP 4 BUSES UPG	UM-F1	\$8,465
D3SL16FAF	Unity 2x4 Port 16G FC IO	UM-F1	\$3,530
D3SL16FSMAF	UNITY 2X4 PORT 16G FC IO S MODE SFPS	UM-F1	\$6,265
D3SL16FSMMMAF	UNITY 2X4 PORT 16G FC IO S&M MODE SFPS	UM-F1	\$5,060
D3SL16FSMMMUAF	Unity 2x4 Port 16G FC IO SM SFPS FLD U	UM-F1	\$6,070
D3SL16FSMUAF	Unity 2x4 Port 16G FC IO SM SFPS FLD U	UM-F1	\$7,520
D3SL16FUAF	Unity 2x4 Port 16Gb FC IO UPG	UM-F1	\$4,235
D3SL1GAF	Unity 2x4 Port 1Gb iSCSI/Eth IO	UM-F1	\$1,355
D3SL1GUAF	Unity 2x4 Port 1Gb iSCSI/Eth IO UPG	UM-F1	\$1,625
D3TX-TWAX-1MAF	1M Active TwinAX Cable QTY 4	UM-F1	\$695
D3TX-TWAX-3MAF	3M Active TwinAX Cable QTY 4	UM-F1	\$830
D3TX-TWAX-5MAF	5M Active TwinAX Cable QTY 4	UM-F1	\$1,015
DAE2UCHASSISAF	2U DAE LF 12G SAS DAE CHASSIS 2 LCC	UM-F1	\$1,435
DLBASSYAF	Unity VG3R VE Lightbar FRU Assy	UM-F1	\$870
DPE25CHASSISAF	ASSY 25 DRV CHASSIS Midplane Unity DPE	UM-F1	\$955
DRVFILL25AF	DRIVE FILLER, 2.5IN	UM-F1	\$5
FANMHTAF	FAN ASSEMBLY Unity HT	UM-F1	\$80
M2SATA120GBAF	INTEL S3500 DRV 120G MLC M.2 SATA 6G 51	UM-F1	\$345
M2SATA64GBAF	SMART XP DRV 64GB MLC M.2 6G 512 A19	UM-F1	\$240
M2SATA80GBAF	INTEL S3500 DRV 80G MLC M.2 SATA 6G 512	UM-F1	\$235
PSU1050WAF	GEN1 PLUS CFF Wide R 1050W ACDC PSU	UM-F1	\$365
PSU1050WFAF	GEN1 PLUS CFF Wide R 1050W ACDC PSU FLEX	UM-F1	\$345
PSUCM2UDAEAF	Unity 2U DAE Power Supply Cooling Module	UM-F1	\$425
T3FSP-5X400GBSSD	UNITY AFA 5X400GB SYSPACK	UM-F1	\$7,350
40UC-SECURE2V	40UC RACK STABILIZING KIT	UM-H	\$696
DPE-TELCO-3U	TELCO RAILS FOR 3U DPE	UM-H	\$393
FLVX2S6F-100	VNX 100G F CACHE FLASH-25X2.5 DPE/DAE	UM-H	\$0
FLVX2S6F-100N	VNX 100G FCACHE FLASH-25X2.5 DPE/DAE N	UM-H	\$3,515
FLVX2S6F100NU	VNX 100G FCACHE FSH-25X2.5 DPE/DAE UPG N	UM-H	\$0
FLVX2S6F-100U	VNX 100G FCACHE FLASH UPG-25X2.5 DPE/DAE	UM-H	\$0
FLVX2S6F-200	VNX 200G F CACHE FLASH-25X2.5 DPE/DAE	UM-H	\$0
FLVX2S6F-200N	VNX 200G FCACHE FLASH-25X2.5 DPE/DAE N	UM-H	\$6,675
FLVX2S6F200NU	VNX 200G FCACHE FLH-25X2.5 DPE/DAE UPG N	UM-H	\$9,010
FLVX2S6F-200U	VNX 200G FCACHE FLASH UPG-25X2.5 DPE/DAE	UM-H	\$9,010
FLVXDS6F-100	VNX 100G FCACHE FLASH-60X3.5IN DRV DAE	UM-H	\$3,535
FLVXDS6F-100N	VNX 100G FAST CACHE FLASH-60X3.5 DAE N	UM-H	\$3,535
FLVXDS6F100NU	VNX 100GB FAST CACHE FLASH-60X3.5 DAE N	UM-H	\$0
FLVXDS6F-100U	VNX 100G FAST CACHE FLASH UPG-60X3.5 DAE	UM-H	\$0
FLVXDS6F-200	VNX 200G FAST CACHE FLASH-60X3.5 DAE	UM-H	\$6,720
FLVXDS6F-200N	VNX 200G FAST CACHE FLASH-60X3.5 DAE N	UM-H	\$6,720
FLVXDS6F200NU	VNX200G FASTCACHE FLASH-60X3.5 DAE UPG N	UM-H	\$9,070
FLVXDS6F-200U	VNX 200G FAST CACHE FLASH UPG-60X3.5 DAE	UM-H	\$9,070
FLVXVS6F-100	VNX 100G F CACHE FLASH-15X3.5 DPE/DAE	UM-H	\$0
FLVXVS6F-100N	VNX 100GB FAST CACHE-15X3.5 DPE/DAE NEBS	UM-H	\$3,535
FLVXVS6F100NU	VNX 100G FAST CACHE-15X3.5 DPE/DAE UPG N	UM-H	\$0

FLVXVS6F-100U	VNX 100G FCACHE FLH UPG-15X3.5IN DPE/DAE	UM-H	\$0
FLVXVS6F-200	200GB FAST CACHE FLASH-15X3.5 DPE/DAE	UM-H	\$0
FLVXVS6F-200N	VNX 200G FAST CACHE -15X3.5 DPE/DAE N	UM-H	\$6,720
FLVXVS6F200NU	VNX 200G FAST CACHE 15X3.5 DPE/DAE UPG N	UM-H	\$9,070
FLVXVS6F-200U	VNX 200G FCACHE FLH UPG-15X3.5IN DPE/DAE	UM-H	\$9,070
FRAME-T25DAE	TELCO RAIL KIT FOR 2U 25 DRIVE DAE	UM-H	\$237
FRAME-T-CSV	TELCO RAIL KIT FOR THE VNX CS	UM-H	\$1,087
FRAME-T-PDAEV	TELCO RAIL KIT FOR THE 3U DAE	UM-H	\$237
FVX2S6F100NTU	VNX 100G FCACHE FSH-25X2.5 DPE/DAE UPG N	UM-H	\$0
FVX2S6F-100TU	VNX 100G FCACHE FSH-25X2.5 DPE/DAE UPG	UM-H	\$0
FVX2S6F200NTU	VNX 200G FCACHE FSH-25X2.5 DPE/DAE UPG N	UM-H	\$9,010
FVX2S6F-200TU	VNX 200G FCACHE FSH-25X2.5 DPE/DAE UPG	UM-H	\$9,010
FVXDS6F100NTU	VNX 100GB FAST CACHE FLASH-60X3.5 DAE N	UM-H	\$0
FVXDS6F-100TU	VNX 100GB FAST CACHE FLASH-60X3.5 DAE U	UM-H	\$0
FVXDS6F200NTU	VNX 200GB FAST CACHE FLASH-60X3.5 DAE N	UM-H	\$9,070
FVXDS6F-200TU	VNX 200GB FAST CACHE FLASH-60X3.5 DAE U	UM-H	\$9,070
FVXVS6F100NTU	VNX 100G FAST CACHE-15X3.5 DPE/DAE UPG N	UM-H	\$0
FVXVS6F-100TU	VNX 100G FAST CACHE-15X3.5 DPE/DAE UG	UM-H	\$0
FVXVS6F200NTU	VNX 200G FAST CACHE-15X3.5 DPE/DAE UPG N	UM-H	\$9,070
FVXVS6F-200TU	VNX 200G FAST CACHE-15X3.5 DPE/DAE UG	UM-H	\$9,070
MSASHD-MSAS10	ONE PR 8M MINI-SAS HD TO MINI-SAS CABLES	UM-H	\$3,261
MSASHD-MSAS2	ONE PR OF 2M MINI-SAS HD - MINI-SAS CBL	UM-H	\$652
MSASHD-MSAS5	ONE PR OF 5M MINI-SAS HD - MINI SAS CBL	UM-H	\$1,630
MSASHD-MSAS8	ONE PR 8M MINI-SAS HD TO MINI-SAS CABLES	UM-H	\$3,260
MSAS-MSAS-10	One pr of Mini-SAS-Mini-SAS 10M cables	UM-H	\$1,250
MSAS-MSAS-2M	One pr of Mini-SAS - Mini-SAS 2M cables	UM-H	\$435
MSAS-MSAS-5M	One pr of Mini-SAS - Mini-SAS 5M cables	UM-H	\$1,087
NB-2S10-300	NEBS 2.5 IN 300G 10K 6GB SAS DSK DRV	UM-H	\$0
NB-2S10-300TU	DISK 300GB 15K SAS SGT NEBS UPG	UM-H	\$0
NB-2S10-300U	VNX 300G 10K UPG DRV-25X2.5DRV DPE/DAE N	UM-H	\$0
NB-2S10-600	NEBS 2.5 IN 600G 10K 6GB SAS DSK DRV	UM-H	\$1,135
NB-2S10-600TU	VNX 600GB 10K DRV-25X2.5 DPE/DAE NEBS UG	UM-H	\$1,500
NB-2S10-600U	VNX 600G 10K UPG DRV-25X2.5 DPE/DAE N	UM-H	\$1,530
NB-2S10-900	NEBS 2.5 IN 900G 10K 6GB SAS DSK DRV	UM-H	\$1,595
NB-2S10-900TU	VNX 900GG 10K DRV-25X2.5 DPE/DAE NEBS UG	UM-H	\$2,155
NB-2S10-900U	VNX 900G 10K UPG DRV-25X2.5 DPE/DAE N	UM-H	\$2,155
NB-2S6F-100	NEBS 2.5 IN 100GB FLASH 6GB SAS DRIVE	UM-H	\$3,515
NB-2S6F-100TU	2.5IN 100GB FLASH UPG DRIVE - NEBS	UM-H	\$0
NB-2S6F-100U	2.5IN 100GB FLASH UPG DRIVE - NEBS	UM-H	\$0
NB-2S6F-200	NEBS 2.5 IN 200GB FLASH 6GB SAS DRIVE	UM-H	\$6,675
NB-2S6F-200TU	2.5IN 200GB FLASH UPG DRIVE - NEBS	UM-H	\$9,010
NB-2S6F-200U	VNX 200G FLASH UPG DRV-25X2.5 DPE/DAE N	UM-H	\$9,010
NB-DS10-600	VNX 600G 10K SAS DRV 3.5X60 DRV DAE NEBS	UM-H	\$0
NB-DS10-600TU	VNX 600G 10K UPG DRV-60X3.5IN DRV DAE N	UM-H	\$0
NB-DS10-600U	VNX 600G 10K UPG DRV-60X3.5IN DRV DAE N	UM-H	\$0
NB-DS10-900	VNX 900G 10K SAS DRV 3.5X60 DRV DAE NEBS	UM-H	\$1,745
NB-DS10-900TU	VNX 900G 10K UPG DRV-60X3.5IN DRV DAE N	UM-H	\$2,360
NB-DS10-900U	VNX 900G 10K UPG DRV-60X3.5IN DRV DAE N	UM-H	\$2,360
NB-DS6F-100	VNX 100G SAS FLASH 3.5X60 DRV DAE NEBS	UM-H	\$3,535
NB-DS6F-100TU	VNX 100G FLASH UPG-60X3.5IN DRV DAE N	UM-H	\$0

NB-DS6F-100U	VNX 100G FLASH UPG-60X3.5IN DRV DAE N	UM-H	\$0
NB-DS6F-200	VNX 200GB 520BPS FLASH 3.5INX60 DRV	UM-H	\$6,720
NB-DS6F-200TU	VNX 200G FLASH UPG-60X3.5IN DRV DAE N	UM-H	\$9,070
NB-DS6F-200U	VNX 200GB SAS FLASH UPG-60X3.5IN DRIVE	UM-H	\$9,070
NB-VS07-020	VNX 2TB NLSAS NEBS DRV-15X3.5 DPE/DAE	UM-H	\$1,245
NB-VS07-020U	VNX 2TB NLSAS NEBS DRV-15X3.5 DPE/DAE UG	UM-H	\$1,685
NB-VS07-030	VNX 3TB NLSAS NEBS DRV-15X3.5 DPE/DAE	UM-H	\$1,805
NB-VS07-030U	VNX 3TB NLSAS NEBS DRV-15X3.5 DPE/DAE UG	UM-H	\$2,435
NB-VS07-040	VNX 4TB NLSAS NEBS DRV-15X3.5 DPE/DAE	UM-H	\$2,245
NB-VS07-040TU	VNX 4TB NLSAS NEBS DRV-15X3.5 DPE/DAE UG	UM-H	\$3,030
NB-VS07-040U	VNX 4TB NLSAS NEBS DRV-15X3.5 DPE/DAE UG	UM-H	\$3,030
NB-VS10-300	NEBS 3.5 IN 300GB 10K 520BPS 6GB SAS	UM-H	\$770
NB-VS10-300TU	VNX 300G 10K UPG DRV-15X3.5IN DPE/DAE N	UM-H	\$0
NB-VS10-300U	VNX 300G 10K UPG DRV-15X3.5IN DPE/DAE N	UM-H	\$0
NB-VS10-600	NEBS 3.5 IN 600GB 10K 520BPS 6GB SAS	UM-H	\$1,205
NB-VS10-600TU	VNX 600G 10K UPG DRV-15X3.5IN DPE/DAE N	UM-H	\$1,660
NB-VS10-600U	VNX 600G 10K UPG DRV-15X3.5IN DPE/DAE N	UM-H	\$1,660
NB-VS10-900	NEBS 3.5 IN 900GB 10K 520BPS 6GB SAS	UM-H	\$1,710
NB-VS10-900TU	VNX 900G 10K UPG DRV-15X3.5IN DPE/DAE N	UM-H	\$2,360
NB-VS10-900U	VNX 900G 10K UPG DRV-15X3.5IN DPE/DAE N	UM-H	\$2,360
NB-VS15-300	NEBS 3.5 IN 300GB 15K 520BPS 6GB SAS	UM-H	\$1,015
NB-VS15-300TU	VNX 300G 15K UPG DRV-15X3.5IN DPE/DAE N	UM-H	\$1,370
NB-VS15-300U	VNX 300G 15K UPG DRV-15X3.5IN DPE/DAE N	UM-H	\$1,370
NB-VS15-600	NEBS 3.5 IN 600GB 15K 520BPS 6GB SAS	UM-H	\$1,615
NB-VS15-600TU	VNX 600G 15K UPG DRV-15X3.5IN DPE/DAE N	UM-H	\$2,180
NB-VS15-600U	VNX 600G 15K UPG DRV-15X3.5IN DPE/DAE N	UM-H	\$2,180
NB-VS6F-100	NEBS 3.5 IN 100GB FLASH DRV 6GB SAS	UM-H	\$3,535
NB-VS6F-100TU	VNX 100G UPG FLASH-15X3.5IN DPE/DAE N	UM-H	\$0
NB-VS6F-100U	VNX 100G UPG FLASH-15X3.5IN DPE/DAE N	UM-H	\$0
NB-VS6F-200	200GB SAS FLASH-15X3.5IN DPE/DAE-NEBS	UM-H	\$6,720
NB-VS6F-200TU	VNX 200G UPG FLASH-15X3.5IN DPE/DAE N	UM-H	\$9,070
NB-VS6F-200U	200GB SAS FLASH-15X3.5IN DPE/DAE-NEBS-UP	UM-H	\$9,070
N-VX-VS0704	3.5 IN 4T SAS DISK DRIVE VAULT PACK	UM-H	\$0
PW40U60-ASTLV	CAB QUAD POWER CORD AUSTRALIA TWISTLO	UM-H	\$1,530
PW40U60-IEC3V	CAB QUAD POWER CORD IEC309	UM-H	\$800
PW40U60-RSV	CAB QUAD POWER CORD US R&S CONNECTOR	UM-H	\$1,530
PW40U-60-USV	CAB QUAD POWER CORD US TWISTLOCK	UM-H	\$800
SASCONN-T90	Storage Analytics Connector	UM-H	\$0
SAS-FLEX-2M	QTY 2 MSAS TO MSAS 2M FLEX CBLS	UM-H	\$955
SAS-FLEX-3M	QTY 2 MSAS TO MSAS 3M FLEX CBLS	UM-H	\$1,432
SAS-FLEX-5M	QTY 2 MSAS TO MSAS 5M FLEX CBLS	UM-H	\$2,386
SAS-FLEX-8M	QTY 2 MSAS TO MSAS 8M FLEX CBLS	UM-H	\$3,818
SASHD-FLEX-2M	QTY 2 MSAS TO MSASHD 2M FLEX CBLS	UM-H	\$1,286
SASHD-FLEX-3M	QTY 2 MSAS TO MSASHD 3M FLEX CBLS	UM-H	\$1,928
SASHD-FLEX-5M	QTY 2 MSAS TO MSASHD 5M FLEX CBLS	UM-H	\$3,214
SASHD-FLEX-8M	QTY 2 MSAS TO MSASHD 8M FLEX CBLS	UM-H	\$5,143
SFP10G-4	FOUR 10G SFP+ CONNECTORS	UM-H	\$0
SPE-TELCO-2UV	TELCO RAIL KIT FOR THE 2U AC SPE	UM-H	\$522
SPST-2GBV	TELCO RAIL KIT FOR THE 1U SPS	UM-H	\$522
VDMM1GCUA	VNX 1GBASE-T DM MODULE 4 PORT	UM-H	\$0

VDMM1GCUOPA	VNX 1GBE DM MODULE 2 CU 2 OP PORTS	UM-H	\$0
VDMM1GCUOPU	1GBE DM MODULE 2 CU - 2 OP PORTS - UPG	UM-H	\$3,415
VDMM1GCUU	1GBE DM MODULE 4 PORT UPGRADE	UM-H	\$2,440
VDMMXG2OPA	VNX 10GBE 2 OP MODULE (2 SFP+)	UM-H	\$0
VDMMXG2OPBA	VNX 2-PORT 10GBE OPT DM MODULE-FCTRY	UM-H	\$0
VDMMXG2OPBU	VNX 2-PORT 10GBE OPT DM MODULE-UPG	UM-H	\$7,325
VDMMXG2OPU	10GBE DM MOD 2 OP PRTS (INCL 2 SFP+)UPG	UM-H	\$0
VDMMXG2TWA	VNX 10GBE 2 OP MODULE (TWINAX)	UM-H	\$0
VDMMXG2TWBA	VNX 2-PORT 10GBE TWINAX DM MODULE-FCTR	UM-H	\$0
VDMMXG2TWBU	VNX 2-PORT 10GBE TWINAX DM MODULE-UPG	UM-H	\$4,875
VDMMXG2TWU	10GBE 2 OP MODULE (FOR TWINAX)-UPGRADE	UM-H	\$0
VDMMXGTA	VNX 10GBASE-T DM MODULE 2 PORT	UM-H	\$0
VDMMXGTU	10GBASET DM MODULE 2 CU PORTS - UPGRAD	UM-H	\$7,325
VDPEXPSASBEA	4 SAS BE BUS EXPANSION DPE OPTION	UM-H	\$0
VDPEXPSASBEAU	4 SAS BE BUS EXPANSION UPGRADE OPTION	UM-H	\$21,500
V-NB-230010	NEBS 4X300G 10K SAS VAULT DRV-25X2.5 ENC	UM-H	\$0
V-NB-260010	NEBS 4X600G 10K SAS VAULT DRV-25X2.5 ENC	UM-H	\$0
V-NB-290010	NEBS 4X900G 10K SAS VAULT DRV-25X2.5 ENC	UM-H	\$6,395
V-NB-D60010	VNX 60X3.5IN DRV ENC 4X600G 10K VAULT N	UM-H	\$4,915
V-NB-D90010	VNX 60X3.5IN DRV ENC 4X900G 10K VAULT N	UM-H	\$6,980
V-NB-V30010	NEBS 4X300G 10K SAS VAULT DRV-15X3.5 ENC	UM-H	\$0
V-NB-V60010	NEBS 4X600G 10K SAS VAULT DRV-15X3.5 ENC	UM-H	\$0
V-NB-V90010	NEBS 4X900G 10K SAS VAULT DRV-15X3.5 ENC	UM-H	\$6,980
V-NB-VS1530	NEBS 4X300G 15K SAS VAULT DRV-15X3.5 ENC	UM-H	\$0
V-NB-VS1560	NEBS 4X600G 15K SAS VAULT DRV-15X3.5 ENC	UM-H	\$0
VNX-1U-BLANK	1U FILLER PANEL FOR VNX RACK	UM-H	\$35
VNX-2U-BLANK	2U FILLER PANEL FOR VNX RACK	UM-H	\$42
VNX-3U-BLANK	3U FILLER PANEL FOR VNX RACK	UM-H	\$49
VNX5135-57B	CONVERT VNX51/53/5500 DPE TO VNX5700 SPE	UM-H	\$54,856
VNX5135-75B	CONVERT VNX51/53/55 DPE TO VNX7500 SPE	UM-H	\$79,396
VNX5153-55B	CONVERT VNX5100&5300 DPE TO VNX5500 DPE	UM-H	\$16,097
VNX535-57F	CONVERT VNX5300&5500 DME TO VNX5700 DME	UM-H	\$4,340
VNX53-55F	CONVERT VNX5300 DME TO VNX5500 DME	UM-H	\$5,819
VNX5357-75F	CONVERT VNX53 55 57 DME TO VNX7500 DME	UM-H	\$4,340
VNX5500CSD2A	2ND OPTIONALINVRTR FOR VNX 5500 FACTORY	UM-H	\$2,504
VNX5500CSD2AU	2ND OPTIONALINVRTR FOR VNX 5500 FIELD	UM-H	\$3,380
VNX5500DM	VNX5500 ADD ON DATA MOVER+FC SLIC-E R	UM-H	\$0
VNX5500DMDU	VNX5500 ADD ON DM+FC SLIC-UPGRADE(DC)	UM-H	\$8,313
VNX5500DMEMD	VNX5500DME W/SINGLE DM DC	UM-H	\$0
VNX5500DMEU	VNX5500 DME: 1 DATA MOVER+FC IO-UPGRADE	UM-H	\$0
VNX5500DMM	VNX 5500 ADD ON DATA MOVER+FC SLIC-M R	UM-H	\$0
VNX5500DMMD	VNX5500 SINGLE DATA MOVER FC SLIC DC	UM-H	\$6,158
VNX5500DMU	VNX5500 ADD ON DATA MOVER+FC IO -UPGRADE	UM-H	\$6,046
VNX5500DP15	VNX5500 DPE; 15X3.5 DRIVE SLOTS-EMC RACK	UM-H	\$0
VNX5500DP15D	VNX5500 DPE; 15X3.5 DRIVE SLOTS-DC	UM-H	\$0
VNX5500DP15F	VNX5500 DPE; 15X3.5 DRV SLOTS-FLD INST	UM-H	\$0
VNX5500DP15M	VNX5500 DPE; 15X3.5 DRV SLOTS-MINI RACK	UM-H	\$0
VNX5500DP15MD	VNX5500 DPE,15X3.5 DRIVE SLOTS-MR-DC	UM-H	\$0
VNX5500DP25	VNX5500 DPE; 25X2.5 DRIVE SLOTS-EMC RACK	UM-H	\$0
VNX5500DP25D	VNX5500 DPE; 25X2.5 DRIVE SLOTS-DC	UM-H	\$0

VNX5500DP25F	VNX5500 DPE; 25X2.5 DRV SLOTS-FLD INST	UM-H	\$0
VNX5500DP25M	VNX5500 DPE; 25X2.5 DRV SLOTS-MINI RACK	UM-H	\$0
VNX5500DP25MD	VNX5500 DPE,25X2.5 DRIVE SLOTS-MR-DC	UM-H	\$0
VNX5500FL100	VNX5500-F FLASH ARRAY 21 X 100G F D & 4	UM-H	\$0
VNX5500FL100F	VNX5500-F FLASH ARRAY 21 X 100G F D & 4	UM-H	\$0
VNX5500FL100M	VNX5500-F FLASH ARY 21X100GFD &4x300HD	UM-H	\$0
VNX5500FL200	VNX5500-F FL A 21X200G FD & 4X300 10K VD	UM-H	\$0
VNX5500FL200F	VNX5500-F FL A 21X200G FD & 4X300 10K VD	UM-H	\$0
VNX5500FL200M	VNX5500-F FL 21X200G FD & 4X300 10K VD	UM-H	\$0
VNX5500ISOKIT	LIGHTNING 15&25; ISO KIT	UM-H	\$0
VNX55DMEX	EMPTY VNX55 DM ENCLOSURE - EMC RACK	UM-H	\$0
VNX55DMEXDU	VNX5500DME:1DATAMOVER+FC SLIC-UPGRADE	UM-H	\$13,962
VNX55DMEXM	EMPTY VNX55 DM ENCLOSURE - MINI RACK	UM-H	\$0
VNX55DMEXMD	VNX5500 DMEX SINGLE DM FC SLIC MINI DC	UM-H	\$10,342
VNX55DMEXU	VNX5500 EMPTY DM ENCLOSURE - UPGRADE	UM-H	\$10,154
VNX55-KIT	DOCUMENTATION KIT FOR VNX5500	UM-H	\$0
VNX5700DM	VNX5700 ADD ON DATA MOVER+FC SLIC-E R	UM-H	\$0
VNX5700DMEM	VNX5700 DME: 2 DATA MOVER+FC SLIC-M R	UM-H	\$0
VNX5700DMEU	VNX5700 DME: 2 DATA MOVER+FC SLIC-UPG	UM-H	\$0
VNX5700DMM	VNX5700 ADD ON DATA MOVER+FC SLIC-M R	UM-H	\$0
VNX5700DMU	VNX5700 ADD ON DATA MOVER+FC SLIC-UPG	UM-H	\$18,642
VNX5700DSPE	VNX5700 SPE 4X6G SAS BE-EMC DENSE RACK	UM-H	\$0
VNX5700DSPEF	VNX5700 SPE FOR DENSE RACK-FIELD INST	UM-H	\$0
VNX5700DSPEM	VNX5700 SPE FOR DENSE RACK-MINI RACK	UM-H	\$0
VNX5700ISOKIT	ARGONAUT; SPITFIRE; ISO KIT	UM-H	\$0
VNX5700SPE	VNX5700 SPE 4X6G SAS BE-EMC RACK	UM-H	\$0
VNX5700SPEF	VNX5700 SPE 4X6G SAS BE-FIELD INST	UM-H	\$0
VNX5700SPEM	VNX5700 SPE 4X6G SAS BE-MINI RACK	UM-H	\$0
VNX57-75B	CONVERT VNX5700 SPE TO VNX7500 SPE	UM-H	\$58,540
VNX57DMEX	EMPTY VNX57 DM ENCLOSURE - EMC RACK	UM-H	\$0
VNX57DMEXM	EMPTY VNX57 DM ENCLOSURE - MINI RACK	UM-H	\$0
VNX57DMEXU	EMPTY VNX57 DM ENCLOSURE - UPGRADE	UM-H	\$12,693
VNX57-KIT	DOCUMENTATION KIT FOR VNX5700	UM-H	\$0
VNX6GSDAE15	VNX 15X3.5 IN 6GB SAS EXP DAE -EMC RACK	UM-H	\$0
VNX6GSDAE15F	VNX 15X3.5 IN 6GB SAS EXP DAE-FLD INST	UM-H	\$4,104
VNX6GSDAE15FD	3U DAE 15X3.5IN DC POWER ENCLOSURE	UM-H	\$4,309
VNX6GSDAE15P	VNX57/75 15X3.5 6GB SAS PRIMARY DAE-E R	UM-H	\$0
VNX6GSDAE15PF	VNX 55/75 15X3.5 6GB SAS PRIMARY DAE F I	UM-H	\$4,104
VNX6GSDAE25	VNX 25X2.5 IN6GB SAS EXP DAE-EMC RACK	UM-H	\$0
VNX6GSDAE25F	VNX 25X2.5 IN6GB SAS DAE-FIELD INSTALL	UM-H	\$5,814
VNX6GSDAE25FD	2U 6G SAS 25 DRIVE DAE WITH DC POWER	UM-H	\$6,105
VNX6GSDAE25P	VNX 25X2.5 6GB SAS PRIMARY DAE-EMC RACK	UM-H	\$0
VNX6GSDAE25PF	VNX 55/75 25X2.5 6GB SAS PRIMARY DAE-F I	UM-H	\$5,814
VNX6GSDAE60	VNX60X3.5IN 6G SAS EXP DAE - EMC RACK	UM-H	\$16,416
VNX6GSDAE60F	VNX 60X3.5IN 6G SAS EXP DAE - FLD INST	UM-H	\$16,416
VNX6GSDAE60F2	VNX 60X3.5IN 6G SAS EXP DAE - FLD W LDR	UM-H	\$16,416
VNX6GSDAE60P	VNX 55/75 60X3.5 6G SAS PRIMARY DAE-E R	UM-H	\$16,416
VNX6GSDAED15P	VNX 15X3.5IN PRIMARY DAE-EMC DENSE RACK	UM-H	\$4,104
VNX7500DM	VNX7500 ADD ON DATA MOVER+FC SLIC-E R	UM-H	\$0
VNX7500DMEU	VNX7500 DME: 2 DATA MOVER+FC SLIC-UPG	UM-H	\$0

VNX7500DMM	VNX7500 ADD ON DATA MOVER+FC SLIC-M R	UM-H	\$0
VNX7500DMU	VNX7500 ADD ON DATA MOVER+FC SLIC-UPG	UM-H	\$40,584
VNX7500DSPE	VNX7500 SPE 4X6G SAS BE-EMC DENSE RACK	UM-H	\$0
VNX7500DSPEF	VNX7500 SPE FOR DENSE RACK-FIELD INST	UM-H	\$0
VNX7500DSPEM	VNX7500 SPE FOR DENSE RACK-MINI RACK	UM-H	\$0
VNX7500SPE	VNX7500 SPE 4X6G SAS BE-EMC RACK	UM-H	\$0
VNX7500SPEF	VNX7500 SPE 4X6G SAS BE-FIELD INST	UM-H	\$0
VNX7500SPEM	VNX7500 SPE 4X6G SAS BE-MINI RACK	UM-H	\$0
VNX7501DSPE	VNX7501 SPE 48GB SP-DENSE RACK-EMC RACK	UM-H	\$0
VNX7501DSPEF	VNX7501 SPE 48GB SP-DENSE RACK-FLD INST	UM-H	\$0
VNX7501DSPEM	VNX7501 SPE 48GB SP-DENSE RACK-MINI RACK	UM-H	\$0
VNX7501SPE	VNX7501 SPE 48GB SP-EMC RACK	UM-H	\$0
VNX7501SPEF	VNX7501 SPE 48GB SP-FIELD INST	UM-H	\$0
VNX7501SPEM	VNX7501 SPE 48GB SP-MINI RACK	UM-H	\$0
VNX7524-75EXB	CONVERT VNX7500 SP WITH EXP MEMORY	UM-H	\$9,000
VNX75DMEX	EMPTY VNX75 DM ENCLOSURE - EMC RACK	UM-H	\$0
VNX75DMEXF	EMPTY VNX75 DM ENCLOSURE - FIELD INST	UM-H	\$0
VNX75DMEXM	EMPTY VNX75 DM ENCLOSURE - MINI RACK	UM-H	\$0
VNX75DMEXU	EMPTY VNX75 DM ENCLOSURE - UPGRADE	UM-H	\$12,693
VNX75-KIT	DOCUMENTATION KIT FOR VNX7500	UM-H	\$0
VNXCS2	VNX 2ND CONTROL STATION-EMC RACK	UM-H	\$0
VNXCS2M	VNX 2ND CONTROL STATION-MINI RACK	UM-H	\$0
VNXCS2U	VNX 2ND CONTROL STATION - UPGRADE	UM-H	\$3,073
VNX-CS-ADJ	ADJUSTABLE RAIL KIT FOR 1U CS	UM-H	\$237
VNXCSU	VNX 1ST CONTROL STATION - UPGRADE	UM-H	\$0
VNX-DAE15ADJ	ADJUSTABLE RAIL KIT FOR 3U 15 DRIVE DAE	UM-H	\$104
VNX-DAE25ADJ	ADJUSTABLE RAIL KIT FOR 2U 25 DRIVE DAE	UM-H	\$104
VNX-DAE2U-ADJ	ADJUSTABLE RAIL KIT FOR THE 2U DAE	UM-H	\$59
VNXDMCBLD1S2	VNX CABLE KIT FOR DPE;+ 1 DM; 1CS; 2 SPS	UM-H	\$0
VNXDMCBLD2S2	VNX CABLE KIT FOR DPE+2 DM; 1 CS; 2 SPS	UM-H	\$0
VNXDMCBLD3S2	VNX CABLE KIT FOR DPE+3 DM; 1 CS; 2 SPS	UM-H	\$0
VNXDMCBL2S	VNX MINI RCK CBL KIT FOR SPE+2 DM&1 CS	UM-H	\$0
VNXDMCBL3S	VNX MINI RCK CBL KIT FOR SPE+3 DM&1 CS	UM-H	\$0
VNXDMCBL4S	VNX MINI RCK CBL KIT FOR SPE+4 DM&1 CS	UM-H	\$0
VNXDMCBL5S	VNX MINI RCK CBL KIT FOR SPE+5 DM&1 CS	UM-H	\$0
VNXDMCBL6S	VNX MINI RCK CBL KIT FOR SPE+6 DM&1 CS	UM-H	\$0
VNXDMCBL7S	VNX MINI RCK CBL KIT FOR SPE+7 DM&1 CS	UM-H	\$0
VNXDMCBL8S	VNX MINI RCK CBL KIT FOR SPE+8 DM&1 CS	UM-H	\$0
VNX-DMEADJ	ADJUSTABLE RAIL KIT FOR 2U DME	UM-H	\$104
VNX-DPE15ADJ	ADJUSTABLE RAIL KIT FOR 3U 15 DRIVE DPE	UM-H	\$208
VNX-DPE25ADJ	ADJUSTABLE RAIL KIT FOR 3U 25 DRIVE DPE	UM-H	\$208
VNXDRACK1-40U	VNXB 40U DEEP RACK WITH FRONT PANEL	UM-H	\$4,383
VNXDRACK2-40U	VNXB 40U DEEP RACK WITH FRONT PANEL	UM-H	\$4,383
VNXFCSFP	ADDITIONAL 8 G SFP FOR VNX5500	UM-H	\$0
VNXOE32	VNX BLK & FILE OE INYO=IC	UM-H	\$0
VNX-OM3-100M	100M MM FIBRE CABLE LC-LC	UM-H	\$397
VNX-OM3-10M	10M MM FIBRE CABLE LC-LC	UM-H	\$202
VNX-OM3-1M	1M MM FIBRE CABLE LC-LC	UM-H	\$160
VNX-OM3-30M	30M MM FIBRE CABLE LC-LC	UM-H	\$216
VNX-OM3-3M	3M MM FIBRE CABLE LC-LC	UM-H	\$174

VNX-OM3-50M	50M MM FIBRE CABLE LC-LC	UM-H	\$271
VNX-OM3-5M	5M MM FIBRE CABLE LC-LC	UM-H	\$181
VNXRACK-40U	VNX 40U RACK WITH FRONT PANEL	UM-H	\$2,922
VNX-RPHW5-G4	GEN4 RPA FOR VNX5500; VNX5700; VNX7500	UM-H	\$0
VNX-RPHW5-G5T	RPA GEN5-TAA FOR VNX L2	UM-H	\$0
VNX-RPHW5-G6T	RPA FOR v55 - v75	UM-H	\$19,250
VNX-SPE2UADJ	ADJUSTABLE RAIL KIT FOR THE 2U SPE	UM-H	\$59
VNXSPS1KW	VNX57/75 1.2KW SPS 15/25 DRV VLT DAE-E R	UM-H	\$0
VNXSPS1KWF	VNX57/75 1.2KW SPS 15/25 DRV VLT DAE-F I	UM-H	\$856
VNXSPS1KWM	VNX57/75 1.2KW SPS 15/25 DRV VLT DAE-M R	UM-H	\$0
VNXSPS2KW	VNX57/75 2.2KW SPS 60 DRV VAULT DAE-E R	UM-H	\$1,900
VNXSPS2KWF	VNX57/75 2.2KW SPS 60 DRV VAULT DAE-FLD	UM-H	\$1,900
VNX-SPS-ADJ	ADJUSTABLE RAIL KIT FOR 1U SPS	UM-H	\$209
VSPEXPDSASBEA	VNX7500 DENSE SAS BE EXP TO 8 BUSES	UM-H	\$15,304
VSPEXPDSASBEU	VNX7500 DENSE SAS BE EXP TO 8 BUS UPG	UM-H	\$21,500
VSPEXPSASBEA	VNX7500 SAS BE EXPAN TO 8 BUSES ADD-ON	UM-H	\$15,304
VSPEXPSASBEU	VNX7500 SAS BE EXPANSION TO 8 BUSES UPG	UM-H	\$21,500
VSPM1GI4CUA	VNX 4 PT 1GBASE-T ISCSI IO MOD PR	UM-H	\$0
VSPM1GI4CUU	VNX 4 PT 1GBASE-T ISCSI IO MOD PR-UPG	UM-H	\$4,869
VSPM6GS4A	VNX 4 PT 6G SAS FE IO MODULE PAIR	UM-H	\$0
VSPM8GFFEA	VNX 4 PORT 8G FC IO MODULE PAIR	UM-H	\$0
VSPM8GFFEU	VNX 4 PORT 8G FC IO MODULE PAIR - UPG	UM-H	\$6,087
VSPMXGFCOEOPA	2 PORT FCOE IO MODULE OPTICAL	UM-H	\$0
VSPMXGFCOEOPU	VNX 2 PT FCOE IO MOD PAIR-SFP-UPGRADE	UM-H	\$4,675
VSPMXGFCOETWA	2 PORT FCOE IO MODULE ACTIVE TWINAX PAIR	UM-H	\$0
VSPMXGFCOETWU	VNX 2 PT FCOE IO MOD PAIR-TWAX-UPGRADE	UM-H	\$4,091
VSPMXGI2A	VNX 2 PT OP 10G ISCSI IO MOD PR-SFP	UM-H	\$0
VSPMXGI2CUA	VNX 2 PT 10GBASE-T ISCSI IO MOD PR	UM-H	\$0
VSPMXGI2CUU	VNX 2PT 10GBASE-T ISCSI IO MOD PR-UG	UM-H	\$7,325
VSPMXGI2TWA	VNX 2 PT OP 10G ISCSI IO MOD PR-TWAX	UM-H	\$0
VSPMXGI2TWU	VNX 2 PT OP 10G ISCSI IO MOD PR-TWAX-UPG	UM-H	\$9,740
VSPMXGI2U	VNX 2 PT OP 10G ISCSI IO MOD PR-SFP-UPG	UM-H	\$11,687
V-VX-230010	2.5 300G 10K 6GB SAS DSK DRV VAULT PACK	UM-H	\$0
V-VX-260010	2.5 IN 600G 10K 6GB DISK DRV VAULT PACK	UM-H	\$0
V-VX-290010	2.5 IN 900G 10K 6GB DISK DRV VAULT PACK	UM-H	\$0
V-VX-D60010	VNX 3.5X60 DRV ENC 4X600G 10K SAS VAULT	UM-H	\$4,915
V-VX-D90010	VNX 3.5X60 DRV ENC 4X900G 10K SAS VAULT	UM-H	\$6,980
V-VX-V30010	3.5 300G 10K VAULT PCK 6GSDAE/DPE	UM-H	\$0
V-VX-V60010	3.5 600G 10K VAULT PCK 6GSDAE/DPE	UM-H	\$0
V-VX-V90010	3.5 IN 900G 10K VAULT PACK FOR 6GSDAE-15	UM-H	\$0
V-VX-VS0701	3.5 IN 1TB 7.2K SAS DISK DRIVE VAULT PK	UM-H	\$0
V-VX-VS0702	3.5 IN 2T SAS DISK DRIVE VAULT PACK	UM-H	\$0
V-VX-VS0703	3.5 IN 3T SAS DISK DRIVE VAULT PACK	UM-H	\$0
V-VX-VS0704	3.5 IN 4T SAS DISK DRIVE VAULT PACK	UM-H	\$0
V-VX-VS1530	3.5 300G 15K VAULT PCK 6GSDAE/DPE	UM-H	\$0
V-VX-VS1560	3.5 600G 15K VAULT PCK 6GSDAE/DPE	UM-H	\$0
VX-2S10-300	2.5 IN 300G 10K DISK DRV FOR 6GSDAE-25	UM-H	\$0
VX-2S10-300TU	VNX 300GB 10K UPG DRV - 25X2.5IN DAE/DPE	UM-H	\$0
VX-2S10-300U	VNX 300GB 10K UPG DRV - 25X2.5IN DAE/DPE	UM-H	\$0
VX-2S10-600	2.5 IN 600G 10K DISK DRV FOR 6GSDAE-25	UM-H	\$0

VX-2S10-600TU	VNX 600G 10K UPG DRV-25X2.5IN DAE/DPE	UM-H	\$1,530
VX-2S10-600U	VNX 600G 10K UPG DRV-25X2.5IN DAE/DPE	UM-H	\$1,530
VX-2S10-900	2.5 IN 900GB 10K DRIVE FOR 6GSDAE-25	UM-H	\$0
VX-2S10-900TU	VNX 900G 10K UPG DRV-25X2.5IN DAE/DPE	UM-H	\$2,155
VX-2S10-900U	VNX 900G 10K UPG DRV-25X2.5IN DAE/DPE	UM-H	\$2,155
VX-2S6F-100	2.5 IN 100GB FLASH DRIVE FOR 6GSDAE-25	UM-H	\$0
VX-2S6F-100TU	VNX 100G FLASH UPG DRV-25X2.5IN DPE/DAE	UM-H	\$0
VX-2S6F-100U	VNX 100G FLASH UPG DRV-25X2.5IN DPE/DAE	UM-H	\$0
VX-2S6F-200	2.5 IN 200GB FLASH FOR 6GSDAE-25	UM-H	\$0
VX-2S6F-200TU	VNX 200G FLASH UPG DRV 25X2.5IN DPE/DAE	UM-H	\$9,010
VX-2S6F-200U	VNX 200G FLASH UPG DRV 25X2.5IN DPE/DAE	UM-H	\$9,010
VX-DS07-010	VNX 1TB NL SAS DRV-60X3.5IN DRV DAE	UM-H	\$690
VX-DS07-010TU	VNX 1TB NL SAS UPG DRV-60X3.5IN DRV DAE	UM-H	\$0
VX-DS07-010U	VNX 1TB NL SAS UPG DRV-60X3.5IN DRV DAE	UM-H	\$0
VX-DS07-020	VNX 2TB NL SAS DRV 3.5X60 DRV DAE	UM-H	\$1,245
VX-DS07-020TU	VNX 2TB NL SAS UPG DRV-60X3.5IN DRV DAE	UM-H	\$1,685
VX-DS07-020U	VNX 2TB NL SAS UPG DRV-60X3.5IN DRV DAE	UM-H	\$1,685
VX-DS07-030	VNX 3TB NL SAS DRV 3.5X60 DRV DAE	UM-H	\$1,805
VX-DS07-030TU	VNX 3TB NL SAS UPG DRV-60X3.5IN DRV DAE	UM-H	\$2,435
VX-DS07-030U	VNX 3TB NL SAS UPG DRV-60X3.5IN DRV DAE	UM-H	\$2,435
VX-DS07-040	VNX 4TB NL-SAS 60X3.5IN DAE	UM-H	\$2,245
VX-DS07-040TU	VNX 4TB NL SAS UPG DRV-60X3.5IN DRV DAE	UM-H	\$3,030
VX-DS07-040U	VNX 4TB NL-SAS 60X3.5IN DAE UPGRADE	UM-H	\$3,030
VX-DS10-600	VNX 600GB 10K SAS DRV 60X3.5IN DRV DAE	UM-H	\$0
VX-DS10-600TU	VNX 600G 10K UPG DRV-60X3.5IN DRV DAE	UM-H	\$0
VX-DS10-600U	VNX 600G 10K UPG DRV-60X3.5IN DRV DAE	UM-H	\$0
VX-DS10-900	VNX 900GB 10K SAS DRV 60X3.5IN DRV DAE	UM-H	\$1,745
VX-DS10-900TU	VNX 900G 10K UPG DRV-60X3.5IN DRV DAE	UM-H	\$2,360
VX-DS10-900U	VNX 900G SAS UPG DRV-60X3.5IN DRV DAE	UM-H	\$2,360
VX-DS6F-100	VNX 100GB SAS FLASH DRV 3.5X60 DRV DAE	UM-H	\$3,535
VX-DS6F-100TU	VNX 100GB SAS FLASH UPG-60X3.5IN DRV DAE	UM-H	\$0
VX-DS6F-100U	VNX 100GB SAS FLASH UPG-60X3.5IN DRV DAE	UM-H	\$0
VX-DS6F-200	VNX 200GB SAS FLASH DRV 3.5X60 DRV DAE	UM-H	\$6,720
VX-DS6F-200TU	VNX 200GB SAS FLASH UPG-60X3.5IN DRV DAE	UM-H	\$9,070
VX-DS6F-200U	VNX 200GB SAS FLASH UPG-60X3.5IN DRV DAE	UM-H	\$9,070
VX-VS07-010	VNX 1TB NL SAS DRV-15X3.5IN DRV DPE/DAE	UM-H	\$0
VX-VS07-010TU	VNX 1TB NL SAS -15X3.5IN DPE/DAE UPG DRV	UM-H	\$0
VX-VS07-010U	VNX 1TB NL SAS -15X3.5IN DPE/DAE UPG DRV	UM-H	\$0
VX-VS07-020	2TB 7200RPM 6GB SAS 3.5 CARRIER	UM-H	\$0
VX-VS07-020TU	VNX 2TB NL SAS -15X3.5IN DPE/DAE UPG DRV	UM-H	\$1,685
VX-VS07-020U	VNX 2TB NL SAS UPG DRV-15X3.5IN DAE/DPE	UM-H	\$1,685
VX-VS07-030	3.5 IN 3T 7200RPM DISK DRV FOR 6GSDAE-15	UM-H	\$0
VX-VS07-030TU	VNX 3TB NL SAS -15X3.5IN DPE/DAE UPG DRV	UM-H	\$2,435
VX-VS07-030U	VNX 3TB NL SAS UPG DRV-15X3.5IN DPE/DAE	UM-H	\$2,435
VX-VS07-040	VNX 4TB NL-SAS 15X3.5IN DAE / DPE	UM-H	\$0
VX-VS07-040TU	VNX 4TB NL SAS -15X3.5IN DPE/DAE UPG DRV	UM-H	\$3,030
VX-VS07-040U	VNX 4TB NL-SAS 15X3.5IN DAE / DPE UPGRAD	UM-H	\$3,030
VX-VS10-300	300GB 10K 520BPS 6GB SAS 3.5 CARRIER	UM-H	\$0
VX-VS10-300TU	VNX 300G 10K UPG DRV-15X3.5IN DAE/DPE	UM-H	\$0
VX-VS10-300U	VNX 300G 10K UPG DRV-15X3.5IN DAE/DPE	UM-H	\$0

VX-VS10-600	600GB 10K 520BPS 6GB SAS 3.5 CARRIER	UM-H	\$0
VX-VS10-600TU	VNX 600G 10K UPG DRV-15X3.5IN DAE/DPE	UM-H	\$1,660
VX-VS10-600U	600GB 10K SAS UPG DRV - 15X3.5IN DAE/DPE	UM-H	\$1,660
VX-VS10-900	3.5 IN 900G 10K DISK DRV FOR 6GSDAE-15	UM-H	\$0
VX-VS10-900TU	VNX 900G 10K UPG DRV-15X3.5IN DAE/DPE	UM-H	\$2,360
VX-VS10-900U	900GB 10K SAS UPG DRV - 15X3.5IN DAE/DPE	UM-H	\$2,360
VX-VS15-300	300GB 15K 520BPS 6GB SAS 3.5 CARRIER	UM-H	\$0
VX-VS15-300TU	VNX 300G 15K UPG DRV-15X3.5IN DAE/DPE	UM-H	\$1,370
VX-VS15-300U	VNX 300G 15K UPG DRV-15X3.5IN DAE/DPE	UM-H	\$1,370
VX-VS15-600	600GB 15K 520BPS 6GB SAS 3.5 CARRIER	UM-H	\$0
VX-VS15-600TU	VNX 600G 15K UPG DRV-15X3.5IN DAE/DPE	UM-H	\$2,180
VX-VS15-600U	VNX 600G 15K UPG DRV-15X3.5IN DAE/DPE	UM-H	\$2,180
VX-VS6F-100	100GB 6GB SAS FLASH DRIVE	UM-H	\$0
VX-VS6F-100TU	VNX 100G FLASH UPG DRV-15X3.5IN DAE/DPE	UM-H	\$0
VX-VS6F-100U	VNX 100G FLASH UPG DRV-15X3.5IN DAE/DPE	UM-H	\$0
VX-VS6F-200	200GB 6GB SAS FLASH DRIVE	UM-H	\$0
VX-VS6F-200TU	VNX 200G FLASH UPG DRV-15X3.5IN DAE/DPE	UM-H	\$9,070
VX-VS6F-200U	VNX 200G FLASH UPG DRV-15X3.5IN DAE/DPE	UM-H	\$9,070
450-000-629	Application Protection VNX5500=IC	UM-S	\$33,502
450-000-630	Application Protection VNX5700=IC	UM-S	\$44,410
450-000-631	Application Protection VNX7500=IC	UM-S	\$53,939
456-005-708	Replication Manager: VNX5500	UM-S	\$0
456-005-711	Replication Manager: VNX5700	UM-S	\$0
456-005-714	Replication Manager: VNX7500	UM-S	\$0
456-103-621	DPA REPLICATION ANALYSIS: VNX5500(BLOCK)	UM-S	\$0
456-103-623	DPA REPLICATION ANALYSIS: VNX5700(BLOCK)	UM-S	\$0
456-103-625	DPA REPLICATION ANALYSIS: VNX7500(BLOCK)	UM-S	\$0
456-103-680	CC / PROSPHERE MGMT PKG VNX 5500	UM-S	\$0
456-103-681	CC / PROSPHERE MGMT PKG VNX 5700	UM-S	\$0
456-103-682	CC / PROSPHERE MGMT PKG VNX 7500	UM-S	\$0
456-104-238	APPSYNC: VNX5500 =IC	UM-S	\$0
456-104-239	APPSYNC: VNX5700 =IC	UM-S	\$0
456-104-240	APPSYNC: VNX7500 =IC	UM-S	\$0
456-104-241	APPSYNC UPG FOR APP PROTECTION=IC	UM-S	\$0
456-104-616	RecoverPoint/SE LOC for VNX5600=IC	UM-S	\$0
456-104-617	RecoverPoint/SE LOC for VNX5800=IC	UM-S	\$0
456-104-618	RecoverPoint/SE LOC for VNX7600=IC	UM-S	\$0
456-104-621	RecoverPoint/SE REM for VNX5600=IC	UM-S	\$0
456-104-622	RecoverPoint/SE REM for VNX5800=IC	UM-S	\$0
456-104-623	RecoverPoint/SE REM for VNX7600=IC	UM-S	\$0
456-104-639	RP/SE TO RP/EX LOC UG V55 CX240 = IC	UM-S	\$8,730
456-104-640	RP/SE TO RP/EX LOC UG V57 CX480 = IC	UM-S	\$13,600
456-104-641	RP/SE TO RP/EX LOC UG V75 CX960 = IC	UM-S	\$16,950
456-104-644	RP/SE TO RP/EX REM UG V55 CX240 = IC	UM-S	\$19,495
456-104-645	RP/SE TO RP/EX REM UG V57 CX480 = IC	UM-S	\$33,900
456-104-646	RP/SE TO RP/EX REM UG V75 CX960 = IC	UM-S	\$72,880
456-104-930	RP/EX LOC FRAME BASED V55 FOR VPLEX =IC	UM-S	\$17,460
456-104-931	RP/EX LOC FRAME BASED V57 FOR VPLEX =IC	UM-S	\$27,160
456-104-932	RP/EX LOC FRAME BASED V75 FOR VPLEX =IC	UM-S	\$33,900
456-104-935	RP/EX REM FRAME BASED V55 FOR VPLEX =IC	UM-S	\$38,985

456-104-936	RP/EX REM FRAME BASED V57 FOR VPLEX =IC	UM-S	\$67,800
456-104-937	RP/EX REM FRAME BASED V75 FOR VPLEX =IC	UM-S	\$145,760
456-105-284	VIPR SRM VNX TIER 3=IC	UM-S	\$0
456-105-285	VIPR SRM VNX TIER 4=IC	UM-S	\$0
456-105-286	VIPR SRM VNX TIER 5=IC	UM-S	\$0
456-105-385	VIPR SRM UPG VNX TIER 3=IC	UM-S	\$0
456-105-386	VIPR SRM UPG VNX TIER 4=IC	UM-S	\$0
456-105-387	VIPR SRM UPG VNX TIER 5=IC	UM-S	\$0
456-110-507	vVNX Community Edition=IC	UM-S	\$0
456-110-508	vVNX Community Edition-20TB=IC	UM-S	\$0
456-110-509	vVNX Community Edition-50TB=IC	UM-S	\$0
456-110-683	VIPR SRM VNX TIER 3 =IC	UM-S	\$34,410
456-110-685	VIPR SRM VNX TIER 5 =IC	UM-S	\$110,400
456-110-829	VIPR SRM VNX TIER 4 =IC	UM-S	\$64,020
456-111-381	RP/EX REM FRAME V53 FOR VPLEX VS6 =IC	UM-S	\$38,985
456-111-382	RP/EX REM FRAME V55 FOR VPLEX VS6=IC	UM-S	\$145,760
456-111-386	RP/EX REM FRAME V54 FOR VPLEX VS6=IC	UM-S	\$67,800
456-111-392	RP/EX LOC FRAME V53 FOR VPLEX VS6 =IC	UM-S	\$17,460
456-111-393	RP/EX LOC FRAME V55 FOR VPLEX VS6=IC	UM-S	\$33,900
456-111-397	RP/EX LOC FRAME V54 FOR VPLEX VS6=IC	UM-S	\$27,160
458-000-215	RP/EX VPLEX FB VNX LOCAL PRODUCT	UM-S	\$0
458-000-219	RP/SE TO RP/EX REMOTE PRODUCT	UM-S	\$0
458-001-304	APPSYNC UPG FOR APP PROTECTION SUITE	UM-S	\$0
458-001-715	RP/EX VPLEX VS6 FB VNX LOCAL PRODUCT	UM-S	\$0
ADMNRP5500	VNX MONITORING AND REPORTING-5500	UM-S	\$0
ADMNRP5700	VNX MONITORING AND REPORTING-5700	UM-S	\$0
ADMNRP7500	VNX MONITORING AND REPORTING-7500	UM-S	\$0
ADVP-V55	ADV FILE LICENSE (NFS; MPFS&PNFS)VNX5500	UM-S	\$0
ADVP-V57	ADV FILE LICENSE (NFS; MPFS&PNFS)VNX5700	UM-S	\$0
ADVP-V75	ADV FILE LICENSE (NFS; MPFS&PNFS)VNX7500	UM-S	\$0
AFM-V55	VNX5500 AUTOMATIC FAILOVER MGR RTU LIC	UM-S	\$0
AFM-V57	VNX5700 AUTOMATIC FAILOVER MGR RTU LIC	UM-S	\$0
AFM-V75	VNX7500 AUTOMATIC FAILOVER MGR RTU LIC	UM-S	\$0
APPSYNC-KIT	APPSYNC MEDIA KIT	UM-S	\$0
APS-1-LS	LS FOR VNX APPLICATION PROTECTION	UM-S	\$0
BASEP-V55	BASE FILE LICENSE (CIFS&FTP) FOR VNX5500	UM-S	\$0
BASEP-V57	BASE FILE LICENSE (CIFS&FTP) FOR VNX5700	UM-S	\$0
BASEP-V75	BASE FILE LICENSE (CIFS&FTP) FOR VNX7500	UM-S	\$0
CC-VNX-5500	EMC CC 6.1 MGMT PKG LICENSE FOR VNX-5500	UM-S	\$0
CC-VNX-5700	EMC CC 6.1 MGMT PKG LICENSE FOR VNX-5700	UM-S	\$0
CC-VNX-7500	EMC CC 6.1 MGMT PKG LICENSE FOR VNX-7500	UM-S	\$0
EMCSASVNX5500	EMC Storage Analytics for VNX5500 = IC	UM-S	\$16,800
EMCSASVNX5700	EMC Storage Analytics for VNX5700 = IC	UM-S	\$27,000
EMCSASVNX7500	EMC Storage Analytics for VNX7500 = IC	UM-S	\$36,000
EPAK-V55UPG	TOT EFF PACK UPGRADE FOR VNX5500	UM-S	\$39,919
EPAK-V57UPG	TOT EFF PACK UPGRADE FOR VNX5700	UM-S	\$114,535
EPAK-V75UPG	TOT EFF PACK UPGRADE FOR VNX7500	UM-S	\$196,809
EXPSAS-V75	UNISPHERE VNX7500 SAS EXPANSION LICENSE	UM-S	\$26,543
FSTC-V55	FAST CACHE FOR VNX5500	UM-S	\$20,109
FSTC-V55-UPG	FAST CACHE FOR VNX5500 UPG	UM-S	\$17,502

FSTC-V57	FAST CACHE FOR VNX5700	UM-S	\$52,283
FSTC-V57-UPG	FAST CACHE FOR VNX5700 UPG	UM-S	\$49,676
FSTC-V75	FAST CACHE FOR VNX7500	UM-S	\$64,457
FSTC-V75-UPG	FAST CACHE FOR VNX7500 UPG	UM-S	\$61,850
FSTS-V55	FAST SUITE FOR VNX5500	UM-S	\$24,432
FSTS-V55-UPG	FAST SUITE FOR VNX5500 UPG	UM-S	\$20,912
FSTS-V57	FAST SUITE FOR VNX5700	UM-S	\$70,582
FSTS-V57-UPG	FAST SUITE FOR VNX5700 UPG	UM-S	\$67,062
FSTS-V75	FAST SUITE FOR VNX7500	UM-S	\$104,016
FSTS-V75-UPG	FAST SUITE FOR VNX7500 UPG	UM-S	\$100,496
FSTVP-V55	FAST VP FOR VNX5500	UM-S	\$18,098
FSTVP-V57	FAST VP FOR VNX5700	UM-S	\$52,283
FSTVP-V75	FAST VP FOR VNX7500	UM-S	\$84,457
LPS32-V55	OE32 LOCAL PROTECT SUITE FOR VNX5500	UM-S	\$8,729
LPS32-V57	OE32 LOCAL PROTECT SUITE FOR VNX5700	UM-S	\$13,559
LPS32-V75	OE32 LOCAL PROTECT SUITE FOR VNX7500	UM-S	\$16,949
LPS-V55	LOCAL PROTECTION SUITE FOR VNX5500	UM-S	\$0
LPS-V55-UPG	RECPNT AND LPS RTU FOR VNX5500	UM-S	\$5,831
LPS-V57	LOCAL PROTECTION SUITE FOR VNX5700	UM-S	\$0
LPS-V57-UPG	RECPNT & LPS RTU FOR VNX5700	UM-S	\$10,661
LPS-V75	LOCAL PROTECTION SUITE FOR VNX7500	UM-S	\$0
LPS-V75-UPG	RECPNT & LPS RTU FOR VNX7500	UM-S	\$14,051
PPAK-V55UPG	T. P. PACK UPGRADE FOR THE VNX5500	UM-S	\$33,692
PPAK-V57UPG	T. P. PACK UPGRADE FOR THE VNX5700	UM-S	\$57,808
PPAK-V75UPG	T. P. PACK UPGRADE FOR THE VNX7500	UM-S	\$99,330
RPEX-CDP55-UG	RP SE TO EX LOC REG CAP UG FOR 5500/240	UM-S	\$0
RPEX-CDP57-UG	RP SE TO EX LOC REG CAP UG FOR 5700/480	UM-S	\$0
RPEX-CDP75-UG	RP SE TO EX LOC REG CAP UG FOR 7500/960	UM-S	\$0
RPEX-CDPCX-UG	RPSE TO RPEX LOCAL REG CAP UG FOR CX	UM-S	\$2,050
RPEX-CRR55-UG	RP SE TO EX REM REG CAP UG FOR 5500/240	UM-S	\$0
RPEX-CRR57-UG	RP SE TO EX REM REG CAP UG FOR 5700/480	UM-S	\$0
RPEX-CRR75-UG	RP SE TO EX REM REG CAP UG FOR 7500/960	UM-S	\$0
RPEX-CRRCX-UG	RPSE TO RPEX REMOTE REG CAP UG FOR CX	UM-S	\$4,065
RPS-V55	REMOTE PROTECTION SUITE FOR VNX5500	UM-S	\$0
RPS-V55-UPG	RECPNT & RPS RTU FOR VNX5500	UM-S	\$13,784
RPS-V57	REMOTE PROTECTION SUITE FOR VNX5700	UM-S	\$0
RPS-V57-UPG	RECPNTS & RPS RTU FOR VNX5700	UM-S	\$28,190
RPS-V75	REMOTE PROTECTION SUITE FOR VNX7500	UM-S	\$0
RPS-V75-UPG	RECPNTS & RPS RTU FOR VNX7500	UM-S	\$67,173
SCS-V55	Events & Retention Suite for VNX5500=IC	UM-S	\$3,552
SCS-V55-GOOGLE	VNX5500 CONNECTOR FOR GOOGLE	UM-S	\$3,552
SCS-V55-UPG	Events & Retention Suite VNX5500 UPG=IC	UM-S	\$2,376
SCS-V57	Events & Retention Suite for VNX5700=IC	UM-S	\$4,262
SCS-V57-GOOGLE	VNX5700 CONNECTOR FOR GOOGLE	UM-S	\$4,262
SCS-V57-UPG	Events & Retention Suite VNX5700 UPG=IC	UM-S	\$3,086
SCS-V75	Events & Retention Suite for VNX7500=IC	UM-S	\$4,972
SCS-V75-GOOGLE	VNX7500 CONNECTOR FOR GOOGLE	UM-S	\$4,972
SCS-V75-UPG	Events & Retention Suite VNX7500 UPG=IC	UM-S	\$3,796
UAYZ-V55	UNISPHERE ANALYZER FOR A VNX5500	UM-S	\$18,098
UAYZ-V57	UNISPHERE ANALYZER FOR A VNX5700	UM-S	\$47,055

UAYZ-V75	UNISPHERE ANALYZER FOR A VNX7500	UM-S	\$76,011
UNIB-V55	Unisphere for Block for VNX5500	UM-S	\$12,548
UNIB-V55UPG	UNISPHERE BLOCK UPG FOR VNX5500	UM-S	\$10,038
UNIB-V57	UNISPHERE FOR BLOCK FOR A VNX 5700	UM-S	\$34,386
UNIB-V57UPG	UNISPHERE BLOCK UPG FOR VNX5700	UM-S	\$27,509
UNIB-V75	UNISPHERE FOR BLOCK FOR A VNX7500	UM-S	\$46,149
UNIB-V75UPG	UNISPHERE BLOCK UPG FOR VNX7500	UM-S	\$36,919
UNIF-V55	UNISPHERE FOR FILE FOR A VNX5500	UM-S	\$9,330
UNIF-V55UPG	UNISPHERE FOR FILE FOR A VNX5500	UM-S	\$7,464
UNIF-V57	UNISPHERE FOR FILE FOR A VNX5700	UM-S	\$34,386
UNIF-V57UPG	UNISPHERE FOR FILE FOR A VNX5700	UM-S	\$27,509
UNIF-V75	UNISPHERE FOR FILE FOR A VNX 7500	UM-S	\$46,149
UNIF-V75UPG	UNISPHERE FOR FILE FOR A VNX7500	UM-S	\$36,919
UNIU-V55	UNISPHERE FOR UNIFIED FOR A VNX-5500	UM-S	\$15,443
UNIU-V55UPG	UNISPHERE UPG FOR UNIFIED VNX5500	UM-S	\$12,354
UNIU-V57	UNISPHERE FOR UNIFIED FOR A VNX 5700	UM-S	\$54,293
UNIU-V57UPG	UNISPHERE UPG FOR UNIFIED VNX5700	UM-S	\$43,434
UNIU-V75	UNISPHERE FOR UNIFIED FOR A VNX7500	UM-S	\$70,582
UNIU-V75UPG	UNISPHERE UPG FOR UNIFIED VNX7500	UM-S	\$56,466
UR-VNX-VNXE	Unisphere Remote for VNX and VNXe	UM-S	\$0
V55-EPAK	TOTAL EFFICENCY PACK for VNX5500=IC	UM-S	\$56,192
V55-LPS	LOCAL PROTECTION SUITE FOR VNX5500=IC	UM-S	\$8,729
V55-PPAK	Total Protection Pack for VNX5500=IC	UM-S	\$49,378
V55-RPS	REMOTE PROTECTION SUITE FOR VNX5500=IC	UM-S	\$19,492
V57-EPAK	TOTAL EFFICENCY PACK for VNX5700=IC	UM-S	\$130,808
V57-LPS	LOCAL PROTECTION SUITE FOR VNX5700=IC	UM-S	\$13,559
V57-PPAK	Total Protection Pack for VNX5700=IC	UM-S	\$73,494
V57-RPS	REMOTE PROTECTION SUITE FOR VNX5700=IC	UM-S	\$33,898
V75-EPAK	TOTAL EFFICENCY PACK for VNX7500=IC	UM-S	\$213,082
V75-LPS	LOCAL PROTECTION SUITE FOR VNX7500=IC	UM-S	\$16,949
V75-PPAK	Total Protection Pack for VNX7500=IC	UM-S	\$115,016
V75-RPS	REMOTE PROTECTION SUITE FOR VNX7500=IC	UM-S	\$72,881
VNX55BTU-KIT	BLOCK TO UNIFIED UPG KIT FOR VNX5500	UM-S	\$11,663
VNX55FTU-KIT	FILE TO UNIFIED UPG KIT FOR VNX5500	UM-S	\$15,685
VNX57BTU-KIT	BLOCK TO UNIFIED UPG KIT FOR VNX5700	UM-S	\$34,386
VNX57FTU-KIT	FILE TO UNIFIED UPG KIT FOR VNX5700	UM-S	\$34,386
VNX75BTU-KIT	BLOCK TO UNIFIED UPG KIT FOR VNX7500	UM-S	\$46,149
VNX75FTU-KIT	FILE TO UNIFIED UPG KIT FOR VNX7500	UM-S	\$46,149
VNX-LS	VNX LICENSE SOLUTION	UM-S	\$0
VNXOE-55	VNX OE LICENSE MODEL FOR VNX5500	UM-S	\$0
VNXOE-57	VNX OE LICENSE MODEL FOR VNX5700	UM-S	\$0
VNXOE-75	VNX OE LICENSE MODEL FOR VNX7500	UM-S	\$0
VNXOECAPT	VNX OE PER TB HI CAP-VNX5500;5700;7500	UM-S	\$400
VNXOECAPTBU	VNX OE CAP TIER/TB FOR VNX5500/5700/7500	UM-S	\$400
VNXOECPTBU-DP	VNXOE CAP TIER/TB FOR DIP CONV	UM-S	\$320
VNXOEPERFTB	VNX OE PER TB PER FOR VNX5500;5700;7500	UM-S	\$1,091
VNXOEPERFTBU	VNX OE PERF TIER/TB FOR VNX55/57/75-UPG	UM-S	\$1,091
VNXOEPFTBU-DP	VNXOE PERF TIER/TB FOR DIP CONV	UM-S	\$873
450-001-527	ViPR SUITE ECS 1-100TB=CB	V	\$130
450-001-528	ViPR SUITE ECS 101-250TB=CB	V	\$98

450-001-529	ViPR SUITE ECS 251-500TB=CB	V	\$78
450-001-530	ViPR SUITE ECS 501-1000TB=CB	V	\$70
450-001-531	ViPR SUITE ECS 1001-5000TB=CB	V	\$48
450-001-532	ViPR SUITE ECS 5001-10000TB=CB	V	\$38
450-001-533	ViPR SUITE ECS 10001TB+=CB	V	\$34
456-104-784	ViPR Controller 50-100TB=CA	V	\$270
456-104-785	ViPR Controller 101-250TB=CA	V	\$220
456-104-786	ViPR Controller 251-500TB=CA	V	\$200
456-104-787	ViPR Controller 501-1000TB=CA	V	\$180
456-104-788	ViPR CONTROLLER 1001-5000TB=CA	V	\$170
456-104-789	ViPR CONTROLLER 5001TB+=CA	V	\$150
456-104-790	ViPR Object 50-100TB=CA	V	\$0
456-104-791	ViPR Object 101-250TB=CA	V	\$0
456-104-792	ViPR Object 251-500TB=CA	V	\$0
456-104-793	ViPR OBJECT 501-1000TB=CA	V	\$0
456-104-794	ViPR OBJECT 1001-5000TB=CA	V	\$0
456-104-795	ViPR OBJECT 5001TB+=CA	V	\$0
456-104-796	ViPR HDFS 50-100TB=CA	V	\$0
456-104-797	ViPR HDFS 101-250TB=CA	V	\$0
456-104-798	ViPR HDFS 251-500TB=CA	V	\$0
456-104-799	ViPR HDFS 501-1000TB=CA	V	\$0
456-104-876	ViPR HDFS 1001-5000TB=CA	V	\$0
456-104-877	ViPR HDFS 5001TB+=CA	V	\$0
456-105-621	ViPR Controller Pack 50-100TB=CA	V	\$0
456-105-625	ViPR Controller Pack 251-500TB=CA	V	\$0
456-105-626	ViPR Object Pack 251-500TB=CA	V	\$0
456-105-959	ViPR Obj+HDFS 50-100TB=CA	V	\$0
456-105-960	ViPR Obj+HDFS 101-250TB=CA	V	\$0
456-105-961	ViPR Obj+HDFS 251-500TB=CA	V	\$0
456-105-962	ViPR Obj+HDFS 501-1000TB=CA	V	\$0
456-105-963	ViPR Obj+HDFS 1001-5000TB=CA	V	\$0
456-105-964	ViPR Obj+HDFS 5000+TB=CA	V	\$0
456-106-502	ViPR Controller Com=CB	V	\$0
456-106-503	ViPR Com SP=CB	V	\$0
456-106-504	ViPR Object Com Tier 1=CB	V	\$0
456-106-505	ViPR Object Com Tier 2=CB	V	\$0
456-106-506	ViPR Object Com Tier 3=CB	V	\$0
456-106-507	ViPR Object Com Tier 4=CB	V	\$0
456-106-508	ViPR Object Com Tier 5=CB	V	\$0
456-106-509	ViPR Object Com Tier 6=CB	V	\$0
456-106-510	ViPR HDFS Com Tier 1=CB	V	\$0
456-106-511	ViPR HDFS Com Tier 2=CB	V	\$0
456-106-512	ViPR HDFS Com Tier 3=CB	V	\$0
456-106-513	ViPR HDFS Com Tier 4=CB	V	\$0
456-106-514	ViPR HDFS Com Tier 5=CB	V	\$0
456-106-515	ViPR HDFS Com Tier 6=CB	V	\$0
456-106-516	ViPR Object+HDFS Com Tier 1=CB	V	\$0
456-106-517	ViPR Object+HDFS Com Tier 2=CB	V	\$0
456-106-518	ViPR Object+HDFS Com Tier 3=CB	V	\$0
456-106-519	ViPR Object+HDFS Com Tier 4=CB	V	\$0

456-106-520	VIPR Object+HDFS Com Tier 5=CB	V	\$0
456-106-521	VIPR Object+HDFS Com Tier 6=CB	V	\$0
456-106-522	VIPR Block Com Tier 1=CB	V	\$0
456-106-523	VIPR Block Com Tier 2=CB	V	\$0
456-106-524	VIPR Block Com Tier 3=CB	V	\$0
456-106-525	VIPR Block Com Tier 4=CB	V	\$0
456-106-526	VIPR Block Com Tier 5=CB	V	\$0
456-106-527	VIPR Block Com Tier 6=CB	V	\$0
456-106-528	VIPR CAS Com Tier 1=CB	V	\$0
456-106-529	VIPR CAS Com Tier 2=CB	V	\$0
456-106-530	VIPR CAS Com Tier 3=CB	V	\$0
456-106-531	VIPR CAS Com Tier 4=CB	V	\$0
456-106-532	VIPR CAS Com Tier 5=CB	V	\$0
456-106-533	VIPR CAS Com Tier 6=CB	V	\$0
456-106-534	VIPR Controller ECS=CB	V	\$0
456-106-535	ECS SP=CB	V	\$0
456-106-544	VIPR CAS 50-100TB=CA	V	\$0
456-106-545	VIPR CAS 101-250TB=CA	V	\$0
456-106-546	VIPR CAS 251-500TB=CA	V	\$0
456-106-547	VIPR CAS 501-1000TB=CA	V	\$0
456-106-548	VIPR CAS 1001-5000TB=CA	V	\$0
456-106-549	VIPR CAS 5000+TB=CA	V	\$0
456-106-550	VIPR CAS Pack 50-100TB=CA	V	\$0
456-106-551	VIPR CAS Pack 101-250TB=CA	V	\$0
456-106-552	VIPR CAS Pack 251-500TB=CA	V	\$0
456-106-553	VIPR CAS Pack 501-1000TB=CA	V	\$0
456-106-554	VIPR CAS Pack 1001-5000TB=CA	V	\$0
456-106-555	VIPR CAS Pack 5001+TB=CA	V	\$0
456-106-560	ECS Upg Cst SW 101-250TB=CB	V	\$200
456-106-561	ECS Upg Cst SW 251-500TB=CB	V	\$165
456-106-562	ECS Upg Cst SW 501-1000TB=CB	V	\$150
456-106-563	ECS Upg Cst SW 1001-5000TB=CB	V	\$130
456-106-564	ECS Upg Cst SW 5001-10000TB=CB	V	\$125
456-106-565	ECS Upg Cst SW 10001+TB=CB	V	\$115
456-106-649	VIPR Controller Starter 50 TB Lic Pck=CA	V	\$0
456-106-779	VIPR SRM ECS Tier 0=CB	V	\$0
456-106-780	VIPR SRM ECS Tier 1=CB	V	\$0
456-106-781	VIPR SRM ECS Tier 2=CB	V	\$0
456-106-782	VIPR SRM ECS Tier 3=CB	V	\$0
456-106-783	VIPR SRM ECS Tier 4=CB	V	\$0
456-106-784	VIPR SRM ECS Tier 5=CB	V	\$0
456-106-785	VIPR SRM ECS Tier 6=CB	V	\$0
456-106-786	VIPR SRM Comm Tier 0=CB	V	\$0
456-106-787	VIPR SRM Comm Tier 1=CB	V	\$0
456-106-788	VIPR SRM Comm Tier 2=CB	V	\$0
456-106-789	VIPR SRM Comm Tier 3=CB	V	\$0
456-106-790	VIPR SRM Comm Tier 4=CB	V	\$0
456-106-791	VIPR SRM Comm Tier 5=CB	V	\$0
456-106-792	VIPR SRM Comm Tier 6=CB	V	\$0
456-106-793	VIPR SRM SIO Tier 0=CB	V	\$0

456-106-794	VIPR SRM SIO Tier 1=CB	V	\$0
456-106-795	VIPR SRM SIO Tier 2=CB	V	\$0
456-106-796	VIPR SRM SIO Tier 3=CB	V	\$0
456-106-797	VIPR SRM SIO Tier 4=CB	V	\$0
456-106-798	VIPR SRM SIO Tier 5=CB	V	\$0
456-106-799	VIPR SRM SIO Tier 6=CB	V	\$0
456-106-928	VIPR Controller Object Pack 100TB=CA	V	\$0
456-107-135	VIPR Object Com 1-100TB=CB	V	\$0
456-107-136	VIPR HDFS Com 1-100TB=CB	V	\$0
456-107-137	VIPR Object+HDFS Com 1-100TB=CB	V	\$0
456-107-138	VIPR Block Com 1-100TB=CB	V	\$0
456-107-139	VIPR CAS Com 1-100TB=CB	V	\$0
456-107-140	ECS Upg Cst SW 1-100TB=CB	V	\$225
456-107-141	ECS DIY SW 1-100TB=CB	V	\$235
456-107-142	ECS DIY SW 101-250TB=CB	V	\$210
456-107-143	ECS DIY SW 251-500TB=CB	V	\$175
456-107-144	ECS DIY SW 501-1000TB=CB	V	\$160
456-107-145	ECS DIY SW 1001-5000TB=CB	V	\$140
456-107-146	ECS DIY SW 5001-10000TB=CB	V	\$135
456-107-147	ECS DIY SW 10001+TB=CB	V	\$125
456-107-331	VIPR Ctrl Starter 2 - 50 TB Lic Pck=CA	V	\$0
456-107-815	EMC VIPR SP=CA	V	\$0
456-108-437	ECS Appliance SW 101-250TB=CB	V	\$200
456-108-438	ECS Appliance SW 251-500TB=CB	V	\$165
456-108-439	ECS Appliance SW 501-1000TB=CB	V	\$150
456-108-440	ECS Appliance SW 1001-5000TB=CB	V	\$130
456-108-441	ECS Appliance SW 5001-10000TB=CB	V	\$125
456-108-442	ECS Appliance SW 10001+TB=CB	V	\$115
456-109-004	ECS Appliance SW 1-100TB=CB	V	\$235
456-110-347	ECS Promotion SW=CB	V	\$80
456-110-402	OBJ BUNDL ATM CAP 1-100TB=CB	V	\$235
456-110-403	OBJ BUNDL ATM CAP 101-250TB=CB	V	\$210
456-110-404	OBJ BUNDL ATM CAP 251-500TB=CB	V	\$175
456-110-405	OBJ BUNDL ATM CAP 501-1000TB=CB	V	\$160
456-110-406	OBJ BUNDL ATM CAP 1001-5000TB=CB	V	\$140
456-110-407	OBJ BUNDL ATM CAP 5001-10000TB=CB	V	\$135
456-110-408	OBJ BUNDL ATM CAP 10001TB+=CB	V	\$125
456-110-409	OBJ BUNDL CENT CAP 1-100TB=CB	V	\$0
456-110-410	OBJ BUNDL CENT CAP 101-250TB=CB	V	\$0
456-110-411	OBJ BUNDL CENT CAP 251-500TB=CB	V	\$0
456-110-412	OBJ BUNDL CENT CAP 501-1000TB=CB	V	\$0
456-110-413	OBJ BUNDL CENT CAP 1001-5000TB=CB	V	\$0
456-110-414	OBJ BUNDL CENT CAP 5001-10000TB=CB	V	\$0
456-110-415	OBJ BUNDL CENT CAP 10001TB+=CB	V	\$0
456-110-546	VS SRM ECS 1-100 TB=CB	V	\$130
456-110-554	VS VIPRC ECS LIC=CB	V	\$0
456-110-794	SRM ECS 1-100 TB=CB	V	\$88
456-110-795	SRM ECS 101-250 TB=CB	V	\$67
456-110-796	SRM ECS 251-500 TB=CB	V	\$52
456-110-797	SRM ECS 501-1000 TB=CB	V	\$45

456-110-798	SRM ECS 1001-5000 TB=CB	V	\$30
456-110-799	SRM ECS 5001-10000 TB=CB	V	\$25
456-110-800	SRM ECS 10000+ TB=CB	V	\$23
456-110-801	SRM Comm 1-100 TB=CB	V	\$170
456-110-802	SRM Comm 101-250 TB=CB	V	\$130
456-110-803	SRM Comm 251-500 TB=CB	V	\$100
456-110-804	SRM Comm 501-1000 TB=CB	V	\$90
456-110-805	SRM Comm 1001-5000 TB=CB	V	\$70
456-110-806	SRM Comm 5001-10000 TB=CB	V	\$60
456-110-807	SRM Comm 10000+ TB=CB	V	\$55
456-110-942	EMC ECS DARE= CB	V	\$0
456-111-686	ECS SW Certified 1-100TB=CB	V	\$225
456-111-687	ECS SW Certified 101-250TB=CB	V	\$200
456-111-688	ECS SW Certified 251-500TB=CB	V	\$165
456-111-689	ECS SW Certified 501-1000TB=CB	V	\$150
456-111-690	ECS SW Certified 1001-5000TB=CB	V	\$130
456-111-691	ECS SW Certified 5001-10000TB=CB	V	\$125
456-111-692	ECS SW Certified 10001+TB=CB	V	\$115
456-112-099	NHC SOFTWARE vSphere	V	\$0
456-112-805	NHC Developer Workbench =ZC	V	\$0
456-112-872	ECS SW DARE CERTIFIED DIY=CB	V	\$0
457-101-417	ViPR Data Services Pack 50-100TB=CA	V	\$0
457-101-418	ViPR Data Services Pack 101-250TB=CA	V	\$0
457-101-419	ViPR Data Services Pack 251-500TB=CA	V	\$0
457-101-420	ViPR Data Services Pack 501-1000TB=CA	V	\$0
457-101-421	ViPR Data Services Pack 1001-5000TB=CA	V	\$0
457-101-422	ViPR Data Services Pack 5001TB+=CA	V	\$0
457-101-548	ViPR Data Service HDFS Pack 50-100TB=CA	V	\$0
457-101-549	ViPR Data Srv HDFS Pack 101-250TB=CA	V	\$0
457-101-550	ViPR Data Srv HDFS Pack 251-500TB=CA	V	\$0
457-101-551	ViPR Data Srv HDFS Pack 501-1000TB=CA	V	\$0
457-101-552	ViPR Data Srv HDFS Pack 1001-5000TB=CA	V	\$0
457-101-553	ViPR Data Srv HDFS Pack 5001+TB=CA	V	\$0
457-101-554	ViPR Analytics Pack 50-100TB=CA	V	\$0
457-101-555	ViPR Analytics Pack 101-250TB=CA	V	\$0
457-101-556	ViPR Analytics Pack 251-500TB=CA	V	\$0
457-101-557	ViPR Analytics Pack 501-1000TB=CA	V	\$0
457-101-558	ViPR Analytics Pack 1001-5000TB=CA	V	\$0
457-101-559	ViPR Analytics Pack 5001+TB=CA	V	\$0
457-101-705	ViPR Object Com Pack Tier 1=CB	V	\$0
457-101-706	ViPR Object Com Pack Tier 2=CB	V	\$0
457-101-707	ViPR Object Pack Tier 3=CB	V	\$0
457-101-708	ViPR Object Com Pack Tier 4=CB	V	\$0
457-101-709	ViPR Object Com Pack Tier 5=CB	V	\$0
457-101-710	ViPR Object Com Pack Tier 6=CB	V	\$0
457-101-711	ViPR HDFS Pack Tier 1=CB	V	\$0
457-101-712	ViPR HDFS Com Pack Tier 2=CB	V	\$0
457-101-713	ViPR HDFS Com Pack Tier 3=CB	V	\$0
457-101-714	ViPR HDFS Com Pack Tier 4=CB	V	\$0
457-101-715	ViPR HDFS Com Pack Tier 5=CB	V	\$0

457-101-716	VIPR HDFS Com Pack Tier 6=CB	V	\$0
457-101-717	VIPR Object+HDFS Com Pack Tier 1=CB	V	\$0
457-101-718	VIPR Object+HDFS Com Pack Tier 2=CB	V	\$0
457-101-719	VIPR Object+HDFS Com Pack Tier 3=CB	V	\$0
457-101-720	VIPR Object+HDFS Com Pack Tier 4=CB	V	\$0
457-101-721	VIPR Object+HDFS Com Pack Tier 5=CB	V	\$0
457-101-722	VIPR Object+HDFS Com Pack Tier 6=CB	V	\$0
457-101-729	VIPR CAS Com Pack Tier 1=CB	V	\$0
457-101-730	VIPR CAS Com Pack Tier 2=CB	V	\$0
457-101-731	VIPR CAS Com Pack Tier 3=CB	V	\$0
457-101-732	VIPR CAS Com Pack Tier 4=CB	V	\$0
457-101-733	VIPR CAS Com Pack Tier 5=CB	V	\$0
457-101-734	VIPR CAS Com Pack Tier 6=CB	V	\$0
457-101-735	ECS Appliance SW 101-250TB=CB	V	\$0
457-101-736	ECS Appliance SW 251-500TB=CB	V	\$0
457-101-737	ECS Appliance SW 501-1000TB=CB	V	\$0
457-101-738	ECS Appliance SW 1001-5000TB=CB	V	\$0
457-101-739	ECS Appliance SW 5001-10000TB=CB	V	\$0
457-101-740	ECS Appliance SW 10001+TB=CB	V	\$0
457-101-745	VIPR Data Srv CAS Pack 50-100TB=CA	V	\$0
457-101-746	VIPR Data Srv CAS Pack 101-250TB=CA	V	\$0
457-101-747	VIPR Data Srv CAS Pack 251-500TB=CA	V	\$0
457-101-748	VIPR Data Srv CAS Pack 501-1000TB=CA	V	\$0
457-101-749	VIPR Data Srv CAS Pack 1001-5000TB=CA	V	\$0
457-101-750	VIPR Data Srv CAS Pack 5001+TB=CA	V	\$0
457-101-859	ECS Appliance SW 1-100TB=CB	V	\$0
458-000-001	VIPR Controller=CA	V	\$0
458-000-587	VIPR Controller Starter 50 TB Lic Pck	V	\$1
458-000-648	SRM for ECS	V	\$0
458-000-649	SRM for VxFlex OS	V	\$0
458-000-842	VIPR CONTROLLER	V	\$0
458-000-872	Elastic Cloud Strg	V	\$0
458-000-877	SRM Comm	V	\$0
458-000-989	AppSync for ViPR	V	\$0
458-000-995	ECS Promotion	V	\$0
458-001-160	SRM Open	V	\$0
458-001-198	Object Bundle Atmos	V	\$0
458-001-199	Object Bundle Centera	V	\$0
458-001-200	ECS DARE	V	\$0
458-001-214	VIPR Object Com Pack Tier 1=CB	V	\$0
458-001-215	VIPR Object Com Pack Tier 2=CB	V	\$0
458-001-216	VIPR Object Pack Tier 3=CB	V	\$0
458-001-217	VIPR Object Com Pack Tier 4=CB	V	\$0
458-001-218	VIPR Object Com Pack Tier 5=CB	V	\$0
458-001-219	Elastic Cloud Storage DIY (ECS)	V	\$0
458-001-220	VIPR HDFS Pack Tier 1=CB	V	\$0
458-001-221	VIPR HDFS Com Pack Tier 2=CB	V	\$0
458-001-222	VIPR HDFS Com Pack Tier 3=CB	V	\$0
458-001-223	VIPR HDFS Com Pack Tier 4=CB	V	\$0
458-001-224	VIPR HDFS Com Pack Tier 5=CB	V	\$0

458-001-225	VIPR HDFS Com Pack Tier 6=CB	V	\$0
458-001-226	VIPR Object+HDFS Com Pack Tier 1=CB	V	\$0
458-001-227	VIPR Object+HDFS Com Pack Tier 2=CB	V	\$0
458-001-228	VIPR Object+HDFS Com Pack Tier 3=CB	V	\$0
458-001-229	VIPR Object+HDFS Com Pack Tier 4=CB	V	\$0
458-001-230	VIPR Object+HDFS Com Pack Tier 5=CB	V	\$0
458-001-231	VIPR Object+HDFS Com Pack Tier 6=CB	V	\$0
458-001-232	VIPR CAS Com Pack Tier 1=CB	V	\$0
458-001-233	VIPR CAS Com Pack Tier 2=CB	V	\$0
458-001-234	VIPR CAS Com Pack Tier 3=CB	V	\$0
458-001-235	VIPR CAS Com Pack Tier 4=CB	V	\$0
458-001-236	VIPR CAS Com Pack Tier 5=CB	V	\$0
458-001-237	VIPR CAS Com Pack Tier 6=CB	V	\$0
458-001-238	VIPR Com SP	V	\$0
458-001-239	VIPR Unstrct Com	V	\$0
458-001-461	Object Bundle Atmos	V	\$0
458-001-643	VS SRM ECS=CB	V	\$0
458-001-684	ECS Upg Cst SW	V	\$0
458-001-780	ECS SW CERTIFIED	V	\$0
458-002-111	NHC Developer Workbench	V	\$0
ATMCEOB3-CF	ATMOS BUNDLE3 CE SW=ID	V	\$0
ATMCERTUOB3-CF	ATMOS BUNDLE3 CE RTU SW=ID	V	\$0
ATMOSCEOBJ2	ATMOS BUNDLE CE SW=ID	V	\$0
ATMOSCEOBJ3	ATMOS BUNDLE3 CE SW=ID	V	\$0
ATMOSCERTUOBJ2	ATMOS BUNDLE CE RTU SW=ID	V	\$0
ATMOSCERTUOBJ3	ATMOS BUNDLE3 CE RTU SW=ID	V	\$0
ATMOSLEOBJ2	ATMOS BUNDLE LE SW=ID	V	\$0
ATMOSLERTUOBJ2	ATMOS BUNDLE LE RTU SW=ID	V	\$0
ATMOSOB3-CF	ATMOS BUNDLE3 OS SW=ID	V	\$0
ATMOSOSOBJ2	ATMOS BUNDLE OS SW=ID	V	\$0
ATMOSOSOBJ3	ATMOS BUNDLE3 OS SW=ID	V	\$0
CENCEPLSOBJ2	CENTERA BUNDLE CE PLS SW=ID	V	\$0
CENTGOVEDOBJ2	CENTERA BUNDLE GOV ED SW=ID	V	\$0
CENTREPLICOBJ2	CENTERA BUNDLE REP SW=ID	V	\$0
CNR2NADVRMLICOBJ2	CENTERA BUNDLE ADVANCED RETENTION MNC	V	\$0
CNR2NMSWOBJ2	CENTERA BUNDLE MIRROR SW (2 NODE)=ID	V	\$0
CNR2NPSWOBJ2	CENTERA BUNDLE PARITY SW (2 NODE)=ID	V	\$0
CNR2NPUPG4OBJ2	CENTERA BUNDLE PARITY UPGRADE=ID	V	\$0
CNRCNSLSWKITOBJ2	CENTERA BUNDLE CONSOLE SOFTWARE=IC	V	\$0
CNRCUAISWOBJ2	CENTERA BUNDLE CNR INT BOX CUA SW=IC	V	\$0
CNRWRK2RKOBJ2	CENTERA BUNDLE RACK TO RACK ENT SW=IC	V	\$0
CNRTOOLSSWOBJ2	CENTERA BUNDLE CUS TOOLS & DOCS=IC	V	\$0
ECS4-SLES	ECS4 SUSE LINUX ENTPRSE SERVER OS TRCK	V	\$0
ECS5-SLES	ECS5 SUSE LINUX ENTPRSE SERVER OS TRCK	V	\$0
ECS-DARE-KIT	EMC ECS Dare 2.2 SW Media Kit=CB	V	\$0
ECS-LS-UPG	ECS UPGRADE LICENSE SOLUTION=CB	V	\$0
ECS-SW-KIT	EMC ECS SW MEDIA KIT=CB	V	\$0
ES4-10G-SFP	10GBE OPTICAL SFP	V	\$670
ES4-15-T6	DAE 15 6TB SATA 7.2K HAPW MFG ECS G4	V	\$17,510
ES4-15-T6-U	DAE 15 6TB SATA 7.2K HAPW CST ECS G4	V	\$17,510

ES4-15-T6-X	DAE 15 6TB SATA 7.2K HAPW FLD ECS G4	V	\$17,510
ES4-30-T1	DAE 30 1TBSATA 7.2K HAPW MFG QTY1 ECS G4	V	\$16,940
ES4-30-T1-U	DAE 30 1TB U SATA 7.2K HAPW MFG ECS G4	V	\$20,320
ES4-30-T1-X	DAE 30 1TB X SATA 7.2K HAPW MFG ECS G4	V	\$16,940
ES4-30-T6	DAE 30 6TB SATA 7.2K HAPW MFG ECS G4	V	\$25,900
ES4-30-T6-U	DAE 30 6TB SATA 7.2K HAPW CST ECS G4	V	\$25,900
ES4-30-T6-X	DAE 30 6TB SATA 7.2K HAPW FLD ECS G4	V	\$25,900
ES4-3PD-RINT	CBLE CABPWR 3 PHS INT RSLSTL QTY2 ECS G4	V	\$0
ES4-3PD-RINT-2U	CBLE CABPWR 3 PHS QTY2 ECS G4U	V	\$0
ES4-3PD-RS	CBLE CABPWR 3 PHS RUSSELL QTY2 ECS G4	V	\$0
ES4-3PD-RS-2U	CBLE CABPWR 3 PHS RUSSELL QTY2 ECS G4U	V	\$0
ES4-3PD-US	CBLE CABPWR 3 PHS HUBELL QTY2 ECS G4	V	\$0
ES4-3PD-US-2U	CBLE CABPWR 3 PHS HUBELL QTY2 ECS G4U	V	\$0
ES4-3PW-INTFL	CBL CBPR 3 PHSE WYE INL FLYNG LDS ECS G4	V	\$0
ES4-3PW-INTG	CBL CBPR 3 PHSE WYE INTL GARO ECS G4	V	\$0
ES4-3PW-US	CBL CBPR 3 PHSE WYE US FLYNG LDS ECS G4	V	\$0
ES4-3PW-USL22	CBL CBPR 3 PHASE WYE US L22 ECS G4	V	\$0
ES4-45-T6	DAE 45 6TB SATA 7.2K HAPW MFG ECS G4	V	\$34,350
ES4-45-T6-U	DAE 45 6TB SATA 7.2K HAPW CST ECS G4	V	\$34,350
ES4-45-T6-X	DAE 45 6TB SATA 7.2K HAPW FLD ECS G4	V	\$34,350
ES4-60-T6	DAE 60 6TB SATA 7.2K HAPW MFG ECS G4	V	\$42,980
ES4-60-T6T	DRIVES 60 6TB SATA 7.2K MFG ECS G4 TAA	V	\$44,730
ES4-60-T6-U	DAE 60 6TB SATA 7.2K HAPW CST ECS G4	V	\$42,980
ES4-60-T6-X	DAE 60 6TB SATA 7.2K HAPW FLD ECS G4	V	\$42,980
ES4-ANTI-MOV	BRACKET ANTI MOVE QTY1 ECS G4	V	\$0
ES4-CR-SVR-BK-B4X	SVR 2U CHS CR BL 10GBE HAPW FLD ECS G4	V	\$109,880
ES4-CR-SVR-OB-B4X	SVR 2U CHS CR OB 10GBE HAPW FLD ECS G4	V	\$0
ES4-DC1-SW10GB	SWCH DC 10GBE 52P HAPW MFG QTY1 ECS G4	V	\$22,890
ES4-DC1-SW10GB-X	SWCH DC 10GBE 52P HAPW FLD QTY1 ECS G4	V	\$27,470
ES4-DC-RACK	RACK DC 40UD 4DROP HAPW MFG QTY1 ECS G	V	\$0
ES4-DC-RACK-P3D	RACK DC 40UD 2DROP D3PH MFG QTY1 ECS G4	V	\$0
ES4-DC-RACK-P3W	RACK DC 40UD 3 PHASE WYE MFG QTY1 ECS G	V	\$0
ES4-DC-SVR-OB-B4	SVR 2U CHS DC 4BL 10GBE HAPW MFG ECS G4	V	\$0
ES4-DC-SVR-OB-B4X	SVR 2U CHS DC 4BL 10GBE HAPW FLD ECS G4	V	\$0
ES4-DC-SWGB	SWCH DC 1GBE 48P HAPW MFG QTY1 ECS G4	V	\$12,370
ES4-DC-SWGB-X	SWCH DC 1GBE 48P HAPW FLD QTY1 ECS G4	V	\$14,840
ES4-DOOR-BRND	DOOR BRANDED QTY1 ECS G4	V	\$0
ES4-P40U-ASTL	CBLE CABPWR AUST QTY2 ECS G4	V	\$0
ES4-P40U-ASTL-2U	CBLE CABPWR AUST QTY2 ECS G4U	V	\$0
ES4-P40U-IEC3	CBLE CABPWR INTERNTL QTY2 ECS G4	V	\$0
ES4-P40U-IEC3-2U	CBLE CABPWR INTERNTL QTY2 ECS G4U	V	\$0
ES4-P40U-RS	CBLE CABPWR RUSSELLSTOHL QTY2 ECS G4	V	\$0
ES4-P40U-RS-2U	CBLE CABPWR RUSSELLSTOHL QTY2 ECS G4U	V	\$0
ES4-P40U-US	CBLE CABPWR L6-30A US QTY2 ECS G4	V	\$0
ES4-P40U-US-2U	CBLE CABPWR L6-30A US QTY2 ECS G4U	V	\$0
ES4-PSNT	ECS Product Serial Number Tag	V	\$0
ES4-RACK	RACK 40UD 4DROP HAPW MFG QTY1 ECS G4	V	\$9,980
ES4-RACK-P3D	RACKD 40UD 2DROP D3PH MFG QTY1 ECS G4	V	\$9,980
ES4-RACK-P3W	RACK 40UD 3 PHASE WYE MFG QTY1 ECS G4	V	\$9,980
ES4-RACK-TRAY	RACK TRAY QTY1 ECS G4	V	\$0

ES4-SR-SVR-BK-B4	SVR 2U CHS SR 4BL 10GBE HAPW MFG ECS G4	V	\$109,880
ES4-SR-SVR-BK-B4X	SVR 2U CHS SR 4BL 10GBE HAPW FLD ECS G4	V	\$109,880
ES4-SR-SVR-OB-B4	SVR 2U CHS SR 4BL 10GBE HAPW MFG ECS G4	V	\$0
ES4-SR-SVR-OB-B4X	SVR 2U CHS SR 4BL 10GBE HAPW FLD ECS G4	V	\$0
ES4-SVR-B4	SVR 2U CHS 4BL 10GBE HAPW MFG ECS G4	V	\$0
ES4-SVR-B4-U	SVR 2U CHS 4BL 10GBE HAPW CST ECS G4	V	\$0
ES4-SVR-B4-X	SVR 2U CHS 4BL 10GBE HAPW FLD ECS G4	V	\$0
ES4-SW10GB	SWCH 10GBE 24P HAPW MFG QTY1 ECS G4	V	\$18,400
ES4-SW10G-X	SWCH 10GBE 24P HAPW FLD QTY1 ECS G4	V	\$18,400
ES4-SWGB	SWCH 1GBE 48P HAPW MFG QTY1 ECS G4	V	\$11,510
ES4-SWGB-X	SWCH 1GBE 48P HAPW FLD QTY1 ECS G4	V	\$11,500
ES4-V1-DC1-SW10GB	SWCH DC 10GBE 64P HAPW MFG QTY1 ECS G4	V	\$22,890
ES4-V1-DC1-SW10GBX	SWCH DC 10GBE 64P HAPW CUS QTY1 ECS G4	V	\$27,470
ES4-V1-DC-SWGB	SWCH DC 1GBE 48P HAPW MFG QTY1 ECS G4	V	\$12,370
ES4-V1-DC-SWGB-X	SWCH DC 1GBE 48P HAPW CUS QTY1 ECS G4	V	\$14,840
ES4-V1-SWGB	SWCH 1GBE 48P HAPW MFG QTY1 ECS G4	V	\$11,510
ES4-V1-SWGB-X	SWCH 1GBE 48P HAPW CUS QTY1 ECS G4	V	\$11,500
ES5-10G-SFP	10GBE OPTICAL SFP	V	\$670
ES5-10-T12	DAE 10 12 TB SAS 7.2K HAPW MFG G5	V	\$27,000
ES5-10-T12T	DRIVES 10 12 TB SAS 7.2K HAPW FLD G5 TAA	V	\$10,822
ES5-10-T12T-UF	DRIVES 10 12 TB SAS 7.2K HAPW MFG G5 TAA	V	\$18,882
ES5-10-T12-U	DAE 10 12 TB SAS 7.2K HAPW FLD G5 U	V	\$27,000
ES5-10-T12-X	DAE 10 12 TB SAS 7.2K HAPW FLD G5 X	V	\$27,000
ES5-10-T8	DAE 10 8TB SAS 7.2K HAPW MFG ECS G5	V	\$19,150
ES5-10-T8T	DRIVES 10 8TB SAS 7.2K MFG ECS G5 TAA	V	\$13,260
ES5-10-T8T-UF	DRIVES 10 8TB SAS 7.2K FLD ECS G5 TAA	V	\$7,600
ES5-10-T8-U	DAE 10 8TB SAS 7.2K HAPW FLD ECS G5 U	V	\$19,150
ES5-10-T8-X	DAE 10 8TB SAS 7.2K HAPW FLD ECS G5 X	V	\$19,150
ES5-112-T10T	DRIVE SLEDS 112 10TB SAS 7.2K MFG ECS G5	V	\$197,740
ES5-112-T10T-TA	DAE 112 10TB SAS 7.2K HAPW MFG ECS G5 TA	V	\$197,740
ES5-112-T8T	DRIVE SLEDS 112 8TB SAS 7.2K MFG ECS G5	V	\$154,680
ES5-112-T8T-TA	DAE 112 8TB SAS 7.2K HAPW MFG ECS G5 TA	V	\$154,680
ES5-12-SSD-U	DAE 12 SSD MFG ECS G5 UPG	V	\$24,600
ES5-15-T8	DAE 15 8TB SAS 7.2K HAPW MFG ECS G5	V	\$24,600
ES5-15-T8-U	DAE 15 8TB SAS 7.2K HAPW FLD ECS G5 U	V	\$24,600
ES5-15-T8-X	DAE 15 8TB SAS 7.2K HAPW FLD ECS G5 X	V	\$24,600
ES5-20-T12	DAE 20 12 TB SAS 7.2K HAPW MFG G5	V	\$32,500
ES5-20-T12-U	DAE 20 12 TB SAS 7.2K HAPW FLD G5 U	V	\$32,500
ES5-20-T12-X	DAE 20 12 TB SAS 7.2K HAPW FLD G5 X	V	\$32,500
ES5-20-T8	DAE 20 8TB SAS 7.2K HAPW MFG ECS G5	V	\$27,300
ES5-20-T8-U	DAE 20 8TB SAS 7.2K HAPW FLD ECS G5 U	V	\$27,300
ES5-20-T8-X	DAE 20 8TB SAS 7.2K HAPW FLD ECS G5 X	V	\$27,300
ES5-30-T12	DAE 30 12 TB SAS 7.2K HAPW MFG G5	V	\$41,500
ES5-30-T12-U	DAE 30 12 TB SAS 7.2K HAPW FLD G5 U	V	\$41,500
ES5-30-T12-X	DAE 30 12 TB SAS 7.2K HAPW FLD G5 X	V	\$41,500
ES5-30-T8	DAE 30 8TB SAS 7.2K HAPW MFG ECS G5	V	\$33,590
ES5-30-T8-U	DAE 30 8TB SAS 7.2K HAPW FLD ECS G5 U	V	\$33,590
ES5-30-T8-X	DAE 30 8TB SAS 7.2K HAPW FLD ECS G5 X	V	\$33,590
ES5-3PD-RINT	CBLE CABPWR 3 PHS INT RSLSTL QTY2 ECS G5	V	\$0
ES5-3PD-RINT-2U	CBLE CABPWR 3 PHS QTY2 ECS G5U	V	\$0

ES5-3PD-RS	CBLE CABPWR 3 PHS RUSSELL QTY2 ECS G5	V	\$0
ES5-3PD-RS-2U	CBLE CABPWR 3 PHS RUSSELL QTY2 ECS G5U	V	\$0
ES5-3PD-US	CBLE CABPWR 3 PHS HUBELL QTY2 ECS G5	V	\$0
ES5-3PD-US-2U	CBLE CABPWR 3 PHS HUBELL QTY2 ECS G5U	V	\$0
ES5-3PW-INTFL	CBL CBPR 3 PHSE WYE INL FLYNG LDS ECS G5	V	\$0
ES5-3PW-INTG	CBL CBPR 3 PHSE WYE INTL GARO ECS G5	V	\$0
ES5-3PW-US	CBL CBPR 3 PHSE WYE US FLYNG LDS ECS G5	V	\$0
ES5-3PW-USL22	CBL CBPR 3 PHASE WYE US L22 ECS G5	V	\$0
ES5-40-T8T	DRIVES 40 8TB SAS 7.2K FLD ECS G5 TAA	V	\$53,030
ES5-40-T8T-UF	DRIVES 40 8TB SAS 7.2K MFG ECS G5 TAA	V	\$30,400
ES5-42-T8-X	DAE 42 8TB SAS 7.2K HAPW FLD ECS G5	V	\$45,050
ES5-45-T12	DAE 45 12 TB SAS 7.2K HAPW MFG G5	V	\$58,000
ES5-45-T12-U	DAE 45 12 TB SAS 7.2K HAPW FLD G5 U	V	\$58,000
ES5-45-T12-X	DAE 45 12 TB SAS 7.2K HAPW FLD G5 X	V	\$58,000
ES5-45-T8	DAE 45 8TB SAS 7.2K HAPW MFG ECS G5	V	\$43,000
ES5-45-T8-U	DAE 45 8TB SAS 7.2K HAPW FLD ECS G5 U	V	\$43,000
ES5-45-T8-X	DAE 45 8TB SAS 7.2K HAPW FLD QTY1 ECS G5	V	\$43,000
ES5-5-T12T	DRIVES 5 12 TB SAS 7.2K HAPW FLD G5 TAA	V	\$5,411
ES5-5-T12T-UF	DRIVES 5 12 TB SAS 7.2K HAPW MFG G5 TAA	V	\$9,441
ES5-5-T8T	Drives 5 8TBSAS 7.2K HAPW MFG ECS G5 TAA	V	\$6,630
ES5-5-T8T-UF	DRIVES 5 8TB SAS 7.2K HAPW MFG G5 TAA	V	\$3,800
ES5-60-T12	DAE 60 12 TB SAS 7.2K HAPW MFG G5	V	\$74,240
ES5-60-T12-U	DAE 60 12 TB SAS 7.2K HAPW FLD G5 U	V	\$74,240
ES5-60-T12-X	DAE 60 12 TB SAS 7.2K HAPW FLD G5 X	V	\$74,240
ES5-60-T8	DAE 60 8TB SAS 7.2K HAPW MFG ECS G5	V	\$54,130
ES5-60-T8-U	DAE 60 8TB SAS 7.2K HAPW FLD ECS G5 U	V	\$54,130
ES5-60-T8-X	DAE 60 8TB SAS 7.2K HAPW FLD ECS G5 X	V	\$54,130
ES5-7048-10T-E	V2 INTL SWCH LIC 7048T-A 7010T-48 E	V	\$0
ES5-7050-SX-E	V2 INTL SWCH LIC 7050S-52 7050SX-64 E	V	\$0
ES5-7050-SX-Z	V2 INTL SWCH LIC 7050S-52 7050SX-64 Z	V	\$0
ES5-70-T10	DAE 70 10TB SAS 7.2K HAPW MFG ECS G5	V	\$73,440
ES5-70-T10-TA	DAE 70 10TB SAS 7.2K HAPW MFG ECS G5 TAT	V	\$73,440
ES5-70-T10-TAX	DAE 70 10TB SAS 7.2K HAPW MFG ECS G5 TAX	V	\$73,440
ES5-70-T10-X	DAE 70 10TB SAS 7.2K HAPW FLD ECS G5	V	\$73,440
ES5-70-T8	DAE 70 8TB SAS 7.2K HAPW MFG ECS G5	V	\$69,980
ES5-70-T8-TA	DAE 70 8TB SAS 7.2K HAPW MFG ECS G5 TAT	V	\$69,980
ES5-70-T8-TAU	DAE 70 8TB SAS 7.2K HAPW MFG ECS G5 TAU	V	\$69,980
ES5-70-T8-TAX	DAE 70 8TB SAS 7.2K HAPW MFG ECS G5 TAX	V	\$69,980
ES5-70-T8-U	DAE 70 8TB SAS 7.2K HAPW CST ECS G5	V	\$69,980
ES5-70-T8-X	DAE 70 8TB SAS 7.2K HAPW FLD ECS G5	V	\$69,980
ES5-7150S-E	V2 INTL SWCH LIC 7150S-24 E	V	\$0
ES5-7150S-Z	V2 INTL SWCH LIC 7150S-24 Z	V	\$0
ES5-98-T10	DAE 98 10TB SAS 7.2K HAPW MFG ECS G5	V	\$85,860
ES5-98-T10-TA	DAE 98 10TB SAS 7.2K HAPW MFG ECS G5 TAT	V	\$85,860
ES5-98-T10-TAX	DAE 98 10TB SAS 7.2K HAPW MFG ECS G5 TAX	V	\$85,860
ES5-98-T10-X	DAE 98 10TB SAS 7.2K HAPW FLD ECS G5	V	\$85,860
ES5-98-T8	DAE 98 8TB SAS 7.2K HAPW MFG ECS G5	V	\$75,570
ES5-98-T8-TA	DAE 98 8TB SAS 7.2K HAPW MFG ECS G5 TAT	V	\$75,570
ES5-98-T8-TAU	DAE 98 8TB SAS 7.2K HAPW MFG ECS G5 TAU	V	\$75,570
ES5-98-T8-TAX	DAE 98 8TB SAS 7.2K HAPW MFG ECS G5 TAX	V	\$75,570

ES5-98-T8-U	DAE 98 8TB SAS 7.2K HAPW CST ECS G5	V	\$75,570
ES5-98-T8-X	DAE 98 8TB SAS 7.2K HAPW FLD ECS G5	V	\$75,570
ES5-ANTI-MOV	BRACKET ANTI MOVE QTY1 ECS G5	V	\$0
ES5-CR-SVR-OB-B4X	SVR 2U CHS CR 4BL 10GBE HAPW FLD ECS G5	V	\$37,780
ES5-DC-PSNT	ECS PODUCT SERIAL NUMBER TAG DC	V	\$0
ES5-DC-RACK	RACK DC 40UD 4DROP HAPW MFG QTY1 ECS G5	V	\$10,190
ES5-DC-RACK-P3D	RACK DC 40UD 2DROP D3PH MFG QTY1 ECS G5	V	\$10,190
ES5-DC-RACK-P3W	RACK DC 40UD 3 PHASE WYE MFG QTY1 ECS G5	V	\$10,190
ES5-DC-SVR-OB-B4	SVR 2U CHS DC 4BL 10GBE HAPW MFG ECS G5	V	\$37,780
ES5-DC-SVR-OB-B4X	SVR 2U CHS DC 4BL 10GBE HAPW FLD ECS G5	V	\$37,780
ES5-DC-SW10GB	SWCH DC 10GBE 52P HAPW MFG QTY1 ECS G5	V	\$14,330
ES5-DC-SW10GB-X	SWCH DC 10GBE 24P HAPW FLD QTY1 ECS G5	V	\$14,330
ES5-DC-SWGB	SWCH DC 1GBE 48P HAPW MFG QTY1 ECS G5	V	\$12,830
ES5-DC-SWGB-C	SWCH DC 1GBE 48P HAPW MFG QTY1 ECS G5	V	\$12,360
ES5-DC-SWGB-C-X	SWCH DC 1GBE 48P HAPW FLD QTY1 ECS G5	V	\$12,360
ES5-DC-SWGB-X	SWCH DC 1GBE 48P HAPW FLD QTY1 ECS G5	V	\$12,830
ES5-DC-TRAY-X	RACK TRAY DC QTY1 ECS G5	V	\$0
ES5-DOOR-BRND	DOOR BRANDED QTY1 ECS G5	V	\$0
ES5-DOOR-BRND-D	DOOR BRANDED QTY1 ECS G5	V	\$0
ES5-P40U-ASTL	CBLE CABPWR AUST QTY2 ECS G5	V	\$0
ES5-P40U-ASTL-2U	CBLE CABPWR AUST QTY2 ECS G5U	V	\$0
ES5-P40U-IEC3	CBLE CABPWR INTERNTL QTY2 ECS G5	V	\$0
ES5-P40U-IEC3-2U	CBLE CABPWR INTERNTL QTY2 ECS G5U	V	\$0
ES5-P40U-RS	CBLE CABPWR RUSSELLSTOHL QTY2 ECS G5	V	\$0
ES5-P40U-RS-2U	CBLE CABPWR RUSSELLSTOHL QTY2 ECS G5U	V	\$0
ES5-P40U-US	CBLE CABPWR L6-30A US QTY2 ECS G5	V	\$0
ES5-P40U-US-2U	CBLE CABPWR L6-30A US QTY2 ECS G5U	V	\$0
ES5-PP-PSNT	ECS PRODUCT SERIAL NUMBER TAG PP	V	\$0
ES5-PP-RACK	RACK 40UD PP 4DROP HAPW MFG QTY1 ECS G5	V	\$9,980
ES5-PP-RACK-D	RACK 40UD PP 4DROP HAPW MFG QTY1 ECS	V	\$9,980
ES5-PP-RACK-P3D	RACKD 40UD 2DROP D3PH MFG QTY1 ECS G5	V	\$9,980
ES5-PP-RACK-P3D-D	RACKD 40UD PP 2DROP D3PH MFG QTY1 ECS G5	V	\$9,980
ES5-PP-RACK-P3W	RACK 40UD 3 PHASE WYE MFG QTY1 ECS G5	V	\$9,980
ES5-PP-RACK-P3W-D	RACK 40UD PP 3 PHASE WYE MFG QTY1 ECS G5	V	\$9,980
ES5-PP-TRAY-X	RACK TRAY PP QTY1 ECS G5	V	\$0
ES5-PSNT	ECS PRODUCT SERIAL NUMBER TAG	V	\$0
ES5-RACK	RACK 40UD 4DROP HAPW MFG QTY1 ECS G5	V	\$9,980
ES5-RACK-D	RACK 40UD 4DROP HAPW MFG QTY1 ECS G5	V	\$9,980
ES5-RACK-P3D	RACKD 40UD 2DROP D3PH MFG QTY1 ECS G5	V	\$9,980
ES5-RACK-P3D-D	RACKD 40UD 2DROP D3PH MFG QTY1 ECS G5	V	\$9,980
ES5-RACK-P3W	RACK 40UD 3 PHASE WYE MFG QTY1 ECS G5	V	\$9,980
ES5-RACK-P3W-D	RACK 40UD 3 PHASE WYE MFG QTY1 ECS G5	V	\$9,980
ES5-RUBICON	V2 ECS RUBICON MODEL	V	\$0
ES5-SR-SVR-OB-B4	SVR 2U CHS SR 4BL 10GBE HAPW MFG ECS G5	V	\$37,780
ES5-SR-SVR-OB-B4X	SVR 2U CHS SR 4BL 10GBE HAPW fld ECS G5	V	\$37,780
ES5-SVR-B1	SVR 2U CHS 1BL 10GBE HAPW MFG ECS G5	V	\$0
ES5-SVR-B1-D-X	SVR 2U CHS 1BL 10GBE HAPW FLD ECS G5	V	\$0
ES5-SVR-B1-U	SVR 2U CHS 1BL 10GBE HAPW FLD ECS G5	V	\$7,000
ES5-SVR-B1-X	SVR 2U CHS 1BL 10GBE HAPW CST ECS G5	V	\$0
ES5-SVR-B2	SVR 2U CHS 2BL 10GBE HAPW MFG ECS G5	V	\$0

ES5-SVR-B2-D-X	SVR 2U CHS 2BL 10GBE HAPW FLD ECS G5	V	\$0
ES5-SVR-B2-U	SVR 2U CHS 2BL 10GBE HAPW FLD ECS G5	V	\$14,000
ES5-SVR-B2-X	SVR 2U CHS 2BL 10GBE HAPW CST ECS G5	V	\$0
ES5-SVR-B4	SVR 2U CHS 4BL 10GBE HAPW MFG ECS G5	V	\$0
ES5-SVR-B4-D-X	SVR 2U CHS 4BL 10GBE HAPW FLD ECS G5	V	\$0
ES5-SVR-B4-U	SVR 2U CHS 4BL 10GBE HAPW CST ECS G5	V	\$0
ES5-SVR-B4-X	SVR 2U CHS 4BL 10GBE HAPW FLD ECS G5	V	\$0
ES5-SVR-UPG-B1-X	SVR 1BL 10GBE HAPW UPG ECS G5	V	\$7,000
ES5-SW10GB	SWCH 10GBE 24P HAPW MFG QTY1 ECS G5	V	\$15,790
ES5-SW10GB-X	SWCH 10GBE 52P HAPW FLD QTY1 ECS G4	V	\$15,790
ES5-SWGB	SWCH 1GBE 48P HAPW MFG QTY1 ECS G5	V	\$14,140
ES5-SWGB-C	SWCH 1GBE 48P HAPW MFG QTY1 ECS G5	V	\$0
ES5-SWGB-C-X	SWCH 1GBE 48P HAPW FLD QTY1 ECS G5	V	\$0
ES5-SWGB-X	SWCH 1GBE 48P HAPW FLD QTY1 ECS G5	V	\$14,140
ES5-V2-DC-SW10GB	10 GBE switch, MFG Install, Compute Rack	V	\$14,330
ES5-V2-DC-SW10GB-X	10 GBE switch Field Install, Compute Ra	V	\$14,330
ES5-V2-DC-SWGB	1 GBE switch, MFG Install, Compute Rack	V	\$12,830
ES5-V2-DC-SWGB-X	1 GBE switch, Field install, Compute Ra	V	\$12,830
ES5-V2-SW10GB	SWCH 10GBE 48P HAPW MFG QTY1 ECS G5	V	\$12,800
ES5-V2-SW10GB-X	10 GBE SWC, FLD INSTL, STOR OR CUSS RACK	V	\$12,800
ES5-V2-SWGB	SWCH 1GBE 48P HAPW MFG QTY1 ECS G5	V	\$12,360
ES5-V2-SWGB-X	1 GBE SWC, FLD INSTL, STOR OR CUSS RACK	V	\$12,360
OBJ-BUNDL	EMC Object Bundle=CB	V	\$235
SH-458-000-162	NHC SW vSphere 1 yr PP Sub= ZC	V	\$0
SH-458-000-163	NHC SW vSphere 3 yr PP Sub= ZC	V	\$0
SH-458-000-164	NHC SW vSphere 3 yr commit Sub= ZC	V	\$0
VIPR-SITE-SP	EMC VIPR SP=CA	V	\$0
456-104-592	RP/EX LOC REG CAP VPLEX (0-14TB) =CA	VPLEX	\$1,850
456-104-593	RP/EX LOC REG CAP VPLEX (15-25TB) =CA	VPLEX	\$1,795
456-104-594	RP/EX LOC REG CAP VPLEX (26-40TB) =CA	VPLEX	\$1,740
456-104-595	RP/EX LOC REG CAP VPLEX (41-60TB) =CA	VPLEX	\$1,690
456-104-596	RP/EX LOC REG CAP VPLEX (61-100TB)=CA	VPLEX	\$1,640
456-104-597	RP/EX LOC REG CAP VPLEX (101-150TB) =CA	VPLEX	\$1,590
456-104-598	RP/EX LOC REG CAP VPLEX (151-250TB) =CA	VPLEX	\$1,540
456-104-599	RP/EX LOC REG CAP - VPLEX (251-400TB)=CA	VPLEX	\$1,500
456-104-600	RP/EX LOC REG CAP VPLEX (401-600TB) =CA	VPLEX	\$1,410
456-104-601	RP/EX LOC REG CAP VPLEX (601-1000TB) =CA	VPLEX	\$1,185
456-104-602	RP/EX LOC REG CAP T11 VPLEX (1001TB+)=CA	VPLEX	\$870
456-104-603	RP/EX REM REG CAP VPLEX (0-14TB) =CA	VPLEX	\$3,010
456-104-604	RP/EX REM REG CAP VPLEX (15-25TB) =CA	VPLEX	\$2,750
456-104-605	RP/EX REM REG CAP VPLEX (26-40TB) =CA	VPLEX	\$2,515
456-104-606	RP/EX REM REG CAP VPLEX (41-60TB) =CA	VPLEX	\$2,315
456-104-607	RP/EX REM REG CAP VPLEX (61-100TB) =CA	VPLEX	\$2,080
456-104-608	RP/EX REM REG CAP VPLEX (101-150TB) =CA	VPLEX	\$1,950
456-104-609	RP/EX REM REG CAP VPLEX (151-250TB) =CA	VPLEX	\$1,925
456-104-610	RP/EX REM REG CAP VPLEX (251-400TB) =CA	VPLEX	\$1,800
456-104-611	RP/EX REM REG CAP VPLEX (401-600TB) =CA	VPLEX	\$1,700
456-104-612	RP/EX REM REG CAP VPLEX (601-1000TB) =CA	VPLEX	\$1,428
456-104-613	RP/EX REM REG CAP VPLEX (1001TB+) =CA	VPLEX	\$1,050
456-104-953	RP-EX Local for VPLEX Large Capacity =IC	VPLEX	\$709,300

456-104-956	RP-EX Remote for VPLEX Large Capacity=IC	VPLEX	\$1,296,070
456-106-490	EMC Storage Analytics for VPLEX =IC	VPLEX	\$0
456-106-583	VPLEX GEOSYNCHRONY for Large Capacity=IC	VPLEX	\$401,390
456-106-584	VPLEX LOCAL for Large Capacity =IC	VPLEX	\$0
456-106-585	VPLEX METRO for Large Capacity=IC	VPLEX	\$1,207,530
456-106-611	VPLEX GeoSynchrony Base (incl. 10TB)=CA	VPLEX	\$0
456-106-613	VPLEX Local Base (incl. 10TB) =CA	VPLEX	\$0
456-106-615	VPLEX Metro Base New License =CA	VPLEX	\$0
456-106-617	VPLEX Geo Base New License =CA	VPLEX	\$0
456-106-619	VPLEX BASE VNX5100 Frame Based Lisc =IC	VPLEX	\$0
456-106-620	VPLEX METRO VNX5100 Frame Based Lisc =IC	VPLEX	\$0
456-106-621	VPLEX BASE VNX5300 Frame Based Lisc =IC	VPLEX	\$0
456-106-622	VPLEX METRO VNX5300 Frame Based Lisc =IC	VPLEX	\$0
456-106-623	VPLEX BASE VNX5500 Frame Based Lisc =IC	VPLEX	\$0
456-106-624	VPLEX METRO VNX5500 Frame Based Lisc =IC	VPLEX	\$0
456-106-625	VPLEX BASE VNX5700 Frame Based Lisc =IC	VPLEX	\$0
456-106-626	VPLEX METRO VNX5700 Frame Based Lisc =IC	VPLEX	\$0
456-106-627	VPLEX BASE VNX7500 Frame Based Lisc =IC	VPLEX	\$0
456-106-628	VPLEX METRO VNX7500 Frame Based Lisc =IC	VPLEX	\$0
456-106-629	VPLEX BASE VNX5200 Frame Based Lisc =IC	VPLEX	\$0
456-106-630	VPLEX METRO VNX5200 Frame Based Lisc =IC	VPLEX	\$0
456-106-631	VPLEX BASE VNX5400 Frame Based Lisc =IC	VPLEX	\$0
456-106-632	VPLEX METRO VNX5400 Frame Based Lisc =IC	VPLEX	\$0
456-106-633	VPLEX BASE VNX5600 Frame Based Lisc =IC	VPLEX	\$0
456-106-634	VPLEX METRO VNX5600 Frame Based Lisc =IC	VPLEX	\$0
456-106-635	VPLEX BASE VNX5800 Frame Based Lisc =IC	VPLEX	\$0
456-106-636	VPLEX METRO VNX5800 Frame Based Lisc =IC	VPLEX	\$0
456-106-637	VPLEX BASE VNX7600 Frame Based Lisc =IC	VPLEX	\$0
456-106-638	VPLEX METRO VNX7600 Frame Based Lisc =IC	VPLEX	\$0
456-106-639	VPLEX BASE VNX8000 Frame Based Lisc =IC	VPLEX	\$0
456-106-640	VPLEX METRO VNX8000 Frame Based Lisc =IC	VPLEX	\$0
456-106-641	VPLEX Local License for 20TB X-Brick =ID	VPLEX	\$0
456-106-642	VPLEX Metro License for 20TB X-Brick =ID	VPLEX	\$0
456-106-643	VPLEX Local License for 10TB X-Brick =ID	VPLEX	\$0
456-106-644	VPLEX Metro License for 10TB X-Brick =ID	VPLEX	\$0
456-107-822	VPLEX Base VNX5100 Frame Based LIC=IC	VPLEX	\$28,650
456-107-823	VPLEX Base VNX5300 Frame Based LIC=IC	VPLEX	\$28,650
456-107-824	VPLEX Base VNX5500 Frame Based LIC=IC	VPLEX	\$42,020
456-107-825	VPLEX Base VNX5700 Frame Based LIC=IC	VPLEX	\$61,120
456-107-826	VPLEX Base VNX7500 Frame Based LIC=IC	VPLEX	\$95,490
456-107-827	VPLEX Base VNX5200 Frame Based LIC=IC	VPLEX	\$16,070
456-107-828	VPLEX Base VNX5400 Frame Based LIC=IC	VPLEX	\$28,880
456-107-829	VPLEX Base VNX5600 Frame Based LIC=IC	VPLEX	\$30,290
456-107-830	VPLEX Base VNX5800 Frame Based LIC=IC	VPLEX	\$39,490
456-107-831	VPLEX Base VNX7600 Frame Based LIC=IC	VPLEX	\$59,980
456-107-832	VPLEX Base VNX8000 Frame Based LIC=IC	VPLEX	\$107,710
456-107-833	VPLEX Base VNX-F5000 Frame Base Lisc=IC	VPLEX	\$33,660
456-107-834	VPLEX Base VNX-F7000 Frame Base Lisc=IC	VPLEX	\$112,205
456-107-835	VPLEX Metro VNX5100 Frame Based LIC=IC	VPLEX	\$85,940
456-107-836	VPLEX Metro VNX5300 Frame Based LIC=IC	VPLEX	\$85,940

456-107-837	VPLEX Metro VNX5500 Frame Based LIC=IC	VPLEX	\$101,220
456-107-838	VPLEX Metro VNX5700 Frame Based LIC=IC	VPLEX	\$139,420
456-107-839	VPLEX Metro VNX7500 Frame Based LIC=IC	VPLEX	\$190,990
456-107-840	VPLEX Metro VNX5200 Frame Based LIC=IC	VPLEX	\$43,830
456-107-841	VPLEX Metro VNX5400 Frame Based LIC=IC	VPLEX	\$75,800
456-107-842	VPLEX Metro VNX5600 Frame Based LIC=IC	VPLEX	\$144,740
456-107-843	VPLEX Metro VNX5800 Frame Based LIC=IC	VPLEX	\$172,880
456-107-844	VPLEX Metro VNX7600 Frame Based LIC=IC	VPLEX	\$217,730
456-107-845	VPLEX Metro VNX8000 Frame Based LIC=IC	VPLEX	\$330,410
456-107-846	VPLEX Metro VNX-F5000 Frame Base LIC=IC	VPLEX	\$99,020
456-107-847	VPLEX Metro VNX-F7000 Frame Base LIC=IC	VPLEX	\$272,825
456-107-848	VPLEX 180 Day Migration LIC=IC	VPLEX	\$0
456-107-849	VPLEX GEOSYNCHRONY BASE INCL 10TB=CA	VPLEX	\$0
456-107-850	VPLEX GEOSYNCHRONY 1TB 11-14TB=CA	VPLEX	\$2,235
456-107-851	VPLEX GEOSYNCHRONY 1TB 15-25TB=CA	VPLEX	\$2,010
456-107-852	VPLEX GEOSYNCHRONY 1TB 26-40TB=CA	VPLEX	\$1,710
456-107-853	VPLEX GEOSYNCHRONY 1TB 41-60TB=CA	VPLEX	\$1,450
456-107-854	VPLEX GEOSYNCHRONY 1TB 61-100TB=CA	VPLEX	\$1,305
456-107-855	VPLEX GEOSYNCHRONY 1TB 101-150TB=CA	VPLEX	\$1,110
456-107-856	VPLEX GEOSYNCHRONY 1TB 151-250TB=CA	VPLEX	\$910
456-107-857	VPLEX GEOSYNCHRONY 1TB 251-400TB=CA	VPLEX	\$760
456-107-858	VPLEX GEOSYNCHRONY 1TB 401-600TB=CA	VPLEX	\$645
456-107-859	VPLEX GEOSYNCHRONY 1TB 601-1000 TB=CA	VPLEX	\$550
456-107-860	VPLEX GEOSYNCHRONY 1TB 1001+ TB=CA	VPLEX	\$505
456-107-861	VPLEX LOCAL BASE INCL 10 TB=CA	VPLEX	\$0
456-107-862	VPLEX LOCAL 1TB 11-14 TB=CA	VPLEX	\$0
456-107-863	VPLEX LOCAL 1TB 15-25 TB=CA	VPLEX	\$0
456-107-864	VPLEX LOCAL 1TB 26-40 TB=CA	VPLEX	\$0
456-107-865	VPLEX LOCAL 1TB 41-60 TB=CA	VPLEX	\$0
456-107-866	VPLEX LOCAL 1TB 61-100 TB=CA	VPLEX	\$0
456-107-867	VPLEX LOCAL 1TB 101-150 TB=CA	VPLEX	\$0
456-107-868	VPLEX LOCAL 1TB 151-250 TB=CA	VPLEX	\$0
456-107-869	VPLEX LOCAL 1TB 251-400 TB=CA	VPLEX	\$0
456-107-870	VPLEX LOCAL 1TB 401-600 TB=CA	VPLEX	\$0
456-107-871	VPLEX LOCAL 1TB 601-1000 TB=CA	VPLEX	\$0
456-107-872	VPLEX LOCAL 1TB 1001+ TB=CA	VPLEX	\$0
456-107-873	VPLEX METRO BASE NEW LICENSE=CA	VPLEX	\$9,000
456-107-874	VPLEX METRO 0-14 TB=CA	VPLEX	\$5,850
456-107-875	VPLEX METRO 15-25 TB=CA	VPLEX	\$5,468
456-107-876	VPLEX METRO 26-40 TB=CA	VPLEX	\$5,085
456-107-877	VPLEX METRO 41-60 TB=CA	VPLEX	\$4,729
456-107-878	VPLEX METRO 61-100 TB=CA	VPLEX	\$4,256
456-107-879	VPLEX METRO 101-150 TB=CA	VPLEX	\$2,880
456-107-880	VPLEX METRO 151-250 TB=CA	VPLEX	\$2,300
456-107-881	VPLEX METRO 251-400 TB=CA	VPLEX	\$2,070
456-107-882	VPLEX METRO 401-600 TB=CA	VPLEX	\$1,865
456-107-883	VPLEX METRO 601-1000 TB=CA	VPLEX	\$1,680
456-107-884	VPLEX METRO 1001+ TB=CA	VPLEX	\$1,595
456-107-885	VPLEX GEO BASE NEW LICENSE=CA	VPLEX	\$9,000
456-107-886	VPLEX GEO 0-14 TB=CA	VPLEX	\$5,850

456-107-887	VPLEX GEO 15-25 TB=CA	VPLEX	\$5,468
456-107-888	VPLEX GEO 26-40 TB=CA	VPLEX	\$5,085
456-107-889	VPLEX GEO 41-60 TB=CA	VPLEX	\$4,729
456-107-890	VPLEX GEO 61-100 TB=CA	VPLEX	\$4,256
456-107-891	VPLEX GEO 101-150 TB=CA	VPLEX	\$2,880
456-107-892	VPLEX GEO 151-250 TB=CA	VPLEX	\$2,300
456-107-893	VPLEX GEO 251-400 TB=CA	VPLEX	\$2,070
456-107-894	VPLEX GEO 401-600 TB=CA	VPLEX	\$1,865
456-107-895	VPLEX GEO 601-1000 TB=CA	VPLEX	\$1,680
456-107-896	VPLEX GEO 1001+ TB=CA	VPLEX	\$1,595
456-107-897	VPLEX GEOSYNCHRONY CAPACITY UPGRADE=	VPLEX	\$0
456-107-898	VPLEX LOCAL CAPACITY UPGRADE=CA	VPLEX	\$0
456-107-899	VPLEX METRO UPG LICENSE=CA	VPLEX	\$0
456-107-900	VPLEX GEO UPG LICENSE=CA	VPLEX	\$0
456-107-901	VPLEX GEOSYNCHRONY BASE 1YR INCL 10TB=	VPLEX	\$0
456-107-902	VPLEX GEOSYNCHRONY 1TB 1YR 11-14TB=CA	VPLEX	\$0
456-107-903	VPLEX GEOSYNCHRONY 1TB 1YR 15-25TB=CA	VPLEX	\$0
456-107-904	VPLEX GEOSYNCHRONY 1TB 1YR 26-40TB=CA	VPLEX	\$0
456-107-905	VPLEX GEOSYNCHRONY 1TB 1YR 41-60TB=CA	VPLEX	\$0
456-107-906	VPLEX GEOSYNCHRONY 1TB 1YR 61-100TB=CA	VPLEX	\$0
456-107-907	VPLEX GEOSYNCHRONY 1TB 1YR 101-150TB=C,	VPLEX	\$0
456-107-908	VPLEX GEOSYNCHRONY 1TB 1YR 151-250TB=C,	VPLEX	\$0
456-107-909	VPLEX GEOSYNCHRONY 1TB 1YR 251-400TB=C,	VPLEX	\$0
456-107-910	VPLEX GEOSYNCHRONY 1TB 1YR 401-600TB=C,	VPLEX	\$0
456-107-911	VPLEX GEOSYNCHRONY 1TB 1YR 601-1000TB=C	VPLEX	\$0
456-107-912	VPLEX GEOSYNCHRONY 1TB 1YR 1001+ TB=CA	VPLEX	\$0
456-107-913	VPLEX LOCAL BASE 1YR INCL 10 TB=CA	VPLEX	\$0
456-107-914	VPLEX LOCAL 1TB 1YR 11-14 TB=CA	VPLEX	\$0
456-107-915	VPLEX LOCAL 1TB 1YR 15-25 TB=CA	VPLEX	\$0
456-107-916	VPLEX LOCAL 1TB 1YR 26-40 TB=CA	VPLEX	\$0
456-107-917	VPLEX LOCAL 1TB 1YR 41-60 TB=CA	VPLEX	\$0
456-107-918	VPLEX LOCAL 1TB 1YR 61-100 TB=CA	VPLEX	\$0
456-107-919	VPLEX LOCAL 1TB 1YR 101-150 TB=CA	VPLEX	\$0
456-107-920	VPLEX LOCAL 1TB 1YR 151-250 TB=CA	VPLEX	\$0
456-107-921	VPLEX LOCAL 1TB 1YR 251-400 TB=CA	VPLEX	\$0
456-107-922	VPLEX LOCAL 1TB 1YR 401-600 TB=CA	VPLEX	\$0
456-107-923	VPLEX LOCAL 1TB 1YR 601-1000 TB=CA	VPLEX	\$0
456-107-924	VPLEX LOCAL 1TB 1YR 1001+ TB=CA	VPLEX	\$0
456-107-925	VPLEX METRO 1 YR. BASE NEW LICENSE=CA	VPLEX	\$0
456-107-926	VPLEX METRO 1 YR. 0-14 TB=CA	VPLEX	\$0
456-107-927	VPLEX METRO 1 YR. 15-25 TB=CA	VPLEX	\$0
456-107-928	VPLEX METRO 1 YR. 26-40 TB=CA	VPLEX	\$0
456-107-929	VPLEX METRO 1 YR. 41-60 TB=CA	VPLEX	\$0
456-107-930	VPLEX METRO 1 YR. 61-100 TB=CA	VPLEX	\$0
456-107-931	VPLEX METRO 1 YR. 101-150 TB=CA	VPLEX	\$0
456-107-932	VPLEX METRO 1 YR. 151-250 TB=CA	VPLEX	\$0
456-107-933	VPLEX METRO 1 YR. 251-400 TB=CA	VPLEX	\$0
456-107-934	VPLEX METRO 1 YR. 401-600 TB=CA	VPLEX	\$0
456-107-935	VPLEX METRO 1 YR. 601-1000 TB=CA	VPLEX	\$0
456-107-936	VPLEX METRO 1 YR. 1001+ TB=CA	VPLEX	\$0

456-107-937	VPLEX GEO 1 YR. BASE NEW LICENSE=CA	VPLEX	\$3,960
456-107-938	VPLEX GEO 1 YR. 0-14 TB=CA	VPLEX	\$2,574
456-107-939	VPLEX GEO 1 YR. 15-25 TB=CA	VPLEX	\$2,406
456-107-940	VPLEX GEO 1 YR. 26-40 TB=CA	VPLEX	\$2,237
456-107-941	VPLEX GEO 1 YR. 41-60 TB=CA	VPLEX	\$2,081
456-107-942	VPLEX GEO 1 YR. 61-100 TB=CA	VPLEX	\$1,873
456-107-943	VPLEX GEO 1 YR. 101-150 TB=CA	VPLEX	\$1,265
456-107-944	VPLEX GEO 1 YR. 151-250 TB=CA	VPLEX	\$1,015
456-107-945	VPLEX GEO 1 YR. 251-400 TB=CA	VPLEX	\$910
456-107-946	VPLEX GEO 1 YR. 401-600 TB=CA	VPLEX	\$820
456-107-947	VPLEX GEO 1 YR. 601-1000 TB=CA	VPLEX	\$740
456-107-948	VPLEX GEO 1 YR. 1001+ TB=CA	VPLEX	\$876
456-107-949	VPLEX Local License for 10TB X-Brick=ID	VPLEX	\$36,375
456-107-950	VPLEX Local License for 20TB X-Brick=ID	VPLEX	\$61,990
456-107-951	VPLEX Local License for 5TB X-Brick=ID	VPLEX	\$24,500
456-107-952	VPLEX Metro License for 10TB X-Brick=ID	VPLEX	\$98,425
456-107-953	VPLEX Metro License for 20TB X-Brick=ID	VPLEX	\$167,795
456-107-954	VPLEX Metro License for 5TB X-Brick=ID	VPLEX	\$66,295
456-107-955	VPLEX Local 5TB X-Brick Upgrade=ID	VPLEX	\$15,750
456-107-956	VPLEX Metro 5TB X-Brick Upgrade=ID	VPLEX	\$42,620
456-107-957	VPLEX Local License for 40TB X-Brick=ID	VPLEX	\$98,515
456-107-958	VPLEX Metro License for 40TB X-Brick=ID	VPLEX	\$266,670
456-107-959	VPLEX Splitter for VMAX3 = IC	VPLEX	\$26,500
456-107-960	VPLEX 1-1 CA VNX5200 Frame TF LIC=IC	VPLEX	\$35,000
456-107-961	VPLEX 1-1 CA VNX5400 Frame TF LIC=IC	VPLEX	\$50,500
456-107-962	VPLEX 1-1 CA VNX5600 Frame TF LIC=IC	VPLEX	\$112,600
456-107-963	VPLEX 1-1 CA VNX5800 Frame TF LIC=IC	VPLEX	\$161,600
456-108-135	RP/EX LOC BASE FOR VPLEX LIC=IC	VPLEX	\$27,000
456-108-136	RP/EX REM BASE FOR VPLEX LIC=IC	VPLEX	\$27,000
456-109-470	VPLEX V6 Base VNX5100 Frame Base LIC=IC	VPLEX	\$28,650
456-109-471	VPLEX V6 Base VNX5300 Frame Base LIC=IC	VPLEX	\$28,650
456-109-472	VPLEX V6 Base VNX5500 Frame Base LIC=IC	VPLEX	\$42,020
456-109-473	VPLEX V6 Base VNX5700 Frame Base LIC=IC	VPLEX	\$61,120
456-109-474	VPLEX V6 Base VNX7500 Frame Base LIC=IC	VPLEX	\$95,490
456-109-475	VPLEX V6 Base VNX5200 Frame Base LIC=IC	VPLEX	\$16,070
456-109-476	VPLEX V6 Base VNX5400 Frame Base LIC=IC	VPLEX	\$28,880
456-109-477	VPLEX V6 Base VNX5600 Frame Base LIC=IC	VPLEX	\$30,290
456-109-478	VPLEX V6 Base VNX5800 Frame Base LIC=IC	VPLEX	\$39,490
456-109-479	VPLEX V6 Base VNX7600 Frame Base LIC=IC	VPLEX	\$59,980
456-109-480	VPLEX V6 Base VNX8000 Frame Base LIC=IC	VPLEX	\$107,710
456-109-481	VPLEX V6 Base VNXF5000 Frame Base LIC=IC	VPLEX	\$33,660
456-109-482	VPLEX V6 Base VNXF7000 Frame Base LIC=IC	VPLEX	\$112,205
456-109-483	VPLEX V6 Metro VNX5100 Frame Base LIC=IC	VPLEX	\$85,940
456-109-484	VPLEX V6 Metro VNX5300 Frame Base LIC=IC	VPLEX	\$85,940
456-109-485	VPLEX V6 Metro VNX5500 Frame Base LIC=IC	VPLEX	\$101,220
456-109-486	VPLEX V6 Metro VNX5700 Frame Base LIC=IC	VPLEX	\$139,420
456-109-487	VPLEX V6 Metro VNX7500 Frame Base LIC=IC	VPLEX	\$190,990
456-109-488	VPLEX V6 Metro VNX5200 Frame Base LIC=IC	VPLEX	\$43,830
456-109-489	VPLEX V6 Metro VNX5400 Frame Base LIC=IC	VPLEX	\$75,800
456-109-490	VPLEX V6 Metro VNX5600 Frame Base LIC=IC	VPLEX	\$144,740

456-109-491	VPLEX V6 Metro VNX5800 Frame Base LIC=IC	VPLEX	\$172,880
456-109-492	VPLEX V6 Metro VNX7600 Frame Base LIC=IC	VPLEX	\$217,730
456-109-493	VPLEX V6 Metro VNX8000 Frame Base LIC=IC	VPLEX	\$330,410
456-109-494	VPLEX V6 Metro VNXF5000 Frame LIC=IC	VPLEX	\$99,020
456-109-495	VPLEX V6 Metro VNXF7000 Frame LIC=IC	VPLEX	\$272,825
456-109-496	VPLEX V6 180 Day Migration LIC=IC	VPLEX	\$0
456-109-497	VPLEX V6 GEOSYNCHRONY BASE INCL 10TB=C	VPLEX	\$0
456-109-498	VPLEX V6 GEOSYNCHRONY 1TB 11-14TB=CA	VPLEX	\$2,235
456-109-499	VPLEX V6 GEOSYNCHRONY 1TB 15-25TB=CA	VPLEX	\$2,010
456-109-500	VPLEX V6 GEOSYNCHRONY 1TB 26-40TB=CA	VPLEX	\$1,710
456-109-501	VPLEX V6 GEOSYNCHRONY 1TB 41-60TB=CA	VPLEX	\$1,450
456-109-502	VPLEX V6 GEOSYNCHRONY 1TB 61-100TB=CA	VPLEX	\$1,305
456-109-503	VPLEX V6 GEOSYNCHRONY 1TB 101-150TB=CA	VPLEX	\$1,110
456-109-504	VPLEX V6 GEOSYNCHRONY 1TB 151-250TB=CA	VPLEX	\$910
456-109-505	VPLEX V6 GEOSYNCHRONY 1TB 251-400TB=CA	VPLEX	\$760
456-109-506	VPLEX V6 GEOSYNCHRONY 1TB 401-600TB=CA	VPLEX	\$645
456-109-507	VPLEX V6 GEOSYNCHRONY 1TB 601-1000 TB=C	VPLEX	\$550
456-109-508	VPLEX V6 GEOSYNCHRONY 1TB 1001+ TB=CA	VPLEX	\$505
456-109-509	VPLEX V6 LOCAL BASE INCL 10 TB=CA	VPLEX	\$0
456-109-510	VPLEX V6 LOCAL 1TB 11-14 TB=CA	VPLEX	\$0
456-109-511	VPLEX V6 LOCAL 1TB 15-25 TB=CA	VPLEX	\$0
456-109-512	VPLEX V6 LOCAL 1TB 26-40 TB=CA	VPLEX	\$0
456-109-513	VPLEX V6 LOCAL 1TB 41-60 TB=CA	VPLEX	\$0
456-109-514	VPLEX V6 LOCAL 1TB 61-100 TB=CA	VPLEX	\$0
456-109-515	VPLEX V6 LOCAL 1TB 101-150 TB=CA	VPLEX	\$0
456-109-516	VPLEX V6 LOCAL 1TB 151-250 TB=CA	VPLEX	\$0
456-109-517	VPLEX V6 LOCAL 1TB 251-400 TB=CA	VPLEX	\$0
456-109-518	VPLEX V6 LOCAL 1TB 401-600 TB=CA	VPLEX	\$0
456-109-519	VPLEX V6 LOCAL 1TB 601-1000 TB=CA	VPLEX	\$0
456-109-520	VPLEX V6 LOCAL 1TB 1001+ TB=CA	VPLEX	\$0
456-109-521	VPLEX V6 METRO BASE NEW LICENSE=CA	VPLEX	\$9,000
456-109-522	VPLEX V6 METRO 0-14 TB=CA	VPLEX	\$5,850
456-109-523	VPLEX V6 METRO 15-25 TB=CA	VPLEX	\$5,468
456-109-524	VPLEX V6 METRO 26-40 TB=CA	VPLEX	\$5,085
456-109-525	VPLEX V6 METRO 41-60 TB=CA	VPLEX	\$4,729
456-109-526	VPLEX V6 METRO 61-100 TB=CA	VPLEX	\$4,256
456-109-527	VPLEX V6 METRO 101-150 TB=CA	VPLEX	\$2,880
456-109-528	VPLEX V6 METRO 151-250 TB=CA	VPLEX	\$2,300
456-109-529	VPLEX V6 METRO 251-400 TB=CA	VPLEX	\$2,070
456-109-530	VPLEX V6 METRO 401-600 TB=CA	VPLEX	\$1,865
456-109-531	VPLEX V6 METRO 601-1000 TB=CA	VPLEX	\$1,680
456-109-532	VPLEX V6 METRO 1001+ TB=CA	VPLEX	\$1,595
456-109-533	VPLEX V6 GEOSYNCHRONY CAPACITY UPG=CA	VPLEX	\$0
456-109-534	VPLEX V6 LOCAL CAPACITY UPG=CA	VPLEX	\$0
456-109-535	VPLEX V6 METRO UPG LICENSE=CA	VPLEX	\$0
456-109-536	VPLEX V6 Local License 10TB X-Brick=ID	VPLEX	\$36,375
456-109-537	VPLEX V6 Local License 20TB X-Brick=ID	VPLEX	\$61,990
456-109-538	VPLEX V6 Local License 5TB X-Brick=ID	VPLEX	\$24,500
456-109-540	VPLEX V6 Local License 40TB X-Brick=ID	VPLEX	\$98,515
456-109-541	VPLEX V6 Metro License 10TB X-Brick=ID	VPLEX	\$98,425

456-109-542	VPLEX V6 Metro License 20TB X-Brick=ID	VPLEX	\$167,795
456-109-543	VPLEX V6 Metro License 5TB X-Brick=ID	VPLEX	\$66,295
456-109-545	VPLEX V6 Metro License 40TB X-Brick=ID	VPLEX	\$266,670
456-109-549	VPLEX V6 LOCAL for Large Capacity =IC	VPLEX	\$0
456-109-550	VPLEX V6 METRO for Large Capacity=IC	VPLEX	\$1,207,530
456-109-551	VPLEX V6 GEOSYN for Large Capacity=IC	VPLEX	\$401,390
456-109-552	VPLEX V6 1-1 CA VNX5200 Frame TF LIC=IC	VPLEX	\$35,000
456-109-553	VPLEX V6 1-1 CA VNX5400 Frame TF LIC=IC	VPLEX	\$50,500
456-109-554	VPLEX V6 1-1 CA VNX5600 Frame TF LIC=IC	VPLEX	\$112,600
456-109-555	VPLEX V6 1-1 CA VNX5800 Frame TF LIC=IC	VPLEX	\$161,600
456-110-101	VPLEX Metro VNX5200 Frame UPG LIC=IC	VPLEX	\$52,660
456-110-102	VPLEX Metro VNX5400 Frame UPG LIC=IC	VPLEX	\$57,780
456-110-103	VPLEX Metro VNX5600 Frame UPG LIC=IC	VPLEX	\$32,140
456-110-104	VPLEX Metro VNX5800 Frame UPG LIC=IC	VPLEX	\$11,280
456-110-117	VPLEX Migration Only for VMAX LIC=IC	VPLEX	\$250
456-110-118	VPLEX Base VNXe3200 Frame Based LIC=IC	VPLEX	\$8,200
456-110-119	ESA Management Pack only for VPLEX=IC	VPLEX	\$12,000
456-110-120	VPLEX Metro VNXe3200 Frame Based LIC=IC	VPLEX	\$22,400
456-110-896	VPLEX LOCAL CLOUDARRAY FC 40TBU LIC=IC	VPLEX	\$0
456-110-897	VPLEX METRO CLOUDARRAY FC 40TBU LIC=IC	VPLEX	\$0
456-110-898	VPLEX LOCAL CLOUDARRAY FC 20TBU LIC=IC	VPLEX	\$0
456-110-899	VPLEX METRO CLOUDARRAY FC 20TBU LIC=IC	VPLEX	\$0
456-110-900	VPLEX LOCAL CLOUDARRAY UPG 40 TBU LIC=IC	VPLEX	\$0
456-110-901	VPLEX METRO CLOUDARRAY UPG 40TBU LIC=IC	VPLEX	\$0
456-110-902	VPLEX BASE UNITY 300 FRAME LIC=IC	VPLEX	\$12,140
456-110-903	VPLEX METRO UNITY 300 FRAME LIC=IC	VPLEX	\$33,120
456-110-904	VPLEX BASE UNITY 400 FRAME LIC=IC	VPLEX	\$28,880
456-110-905	VPLEX METRO UNITY 400 FRAME LIC=IC	VPLEX	\$75,800
456-110-906	VPLEX BASE UNITY 500 FRAME LIC=IC	VPLEX	\$30,260
456-110-907	VPLEX METRO UNITY 500 FRAME LIC=IC	VPLEX	\$144,740
456-110-908	VPLEX BASE UNITY 600 FRAME LIC=IC	VPLEX	\$39,490
456-110-909	VPLEX METRO UNITY 600 FRAME LIC=IC	VPLEX	\$172,880
456-111-194	VPLEX 1-1 CA UNITY 300 TF LIC=IC	VPLEX	\$35,000
456-111-195	VPLEX 1-1 CA UNITY 400 TF LIC=IC	VPLEX	\$50,500
456-111-196	VPLEX 1-1 CA UNITY 500 TF LIC=IC	VPLEX	\$112,600
456-111-197	VPLEX 1-1 CA UNITY 600 TF LIC=IC	VPLEX	\$161,600
456-111-198	VPLEX 1-1 Metro UNITY 300 UPG LIC=IC	VPLEX	\$0
456-111-199	VPLEX 1-1 Metro UNITY 400 UPG LIC=IC	VPLEX	\$25,300
456-111-200	VPLEX 1-1 Metro UNITY 500 UPG LIC=IC	VPLEX	\$32,140
456-111-201	VPLEX 1-1 Metro UNITY 600 UPG LIC=IC	VPLEX	\$11,280
456-111-232	Storage M&R for VPLEX VS2 Single=IC	VPLEX	\$0
456-111-233	Storage M&R for VPLEX VS2 Dual=IC	VPLEX	\$0
456-111-234	Storage M&R for VPLEX VS2 Quad=IC	VPLEX	\$0
456-111-245	VPLEX VS2 Base Unity300F/350F LIC=IC	VPLEX	\$12,140
456-111-246	VPLEX VS2 Base Unity400F/450F LIC=IC	VPLEX	\$28,880
456-111-247	VPLEX VS2 Base Unity500F/550F LIC=IC	VPLEX	\$30,260
456-111-248	VPLEX VS2 Base Unity600F/650F LIC=IC	VPLEX	\$39,490
456-111-249	VPLEX VS2 Metro Unity300F/350F LIC=IC	VPLEX	\$33,120
456-111-250	VPLEX VS2 Metro Unity400F/450F LIC=IC	VPLEX	\$75,800
456-111-251	VPLEX VS2 Metro Unity500F/550F LIC=IC	VPLEX	\$144,740

456-111-252	VPLEX VS2 Metro Unity600F/650F LIC=IC	VPLEX	\$172,880
456-111-410	RP/EX LOC BASE FOR VPLEX LIC=IC	VPLEX	\$27,000
456-111-411	RP/EX LOC REG CAP VPLX (0-14TB)=CA	VPLEX	\$1,850
456-111-412	RP/EX LOC REG CAP VPLX (15-25TB)=CA	VPLEX	\$1,795
456-111-413	RP/EX LOC REG CAP VPLX (26-40TB)=CA	VPLEX	\$1,740
456-111-414	RP/EX LOC REG CAP VPLX (41-60TB)=CA	VPLEX	\$1,690
456-111-415	RP/EX LOC REG CAP VPLX (61-100TB)=CA	VPLEX	\$1,640
456-111-416	RP/EX LOC REG CAP VPLX (101-150TB)=CA	VPLEX	\$1,590
456-111-417	RP/EX LOC REG CAP VPLX (151-250TB)=CA	VPLEX	\$1,540
456-111-418	RP/EX LOC REG CAP VPLX (251-400TB)=CA	VPLEX	\$1,500
456-111-419	RP/EX LOC REG CAP VPLX (401-600TB)=CA	VPLEX	\$1,410
456-111-420	RP/EX LOC REG CAP VPLX (601-1000TB)=CA	VPLEX	\$1,185
456-111-421	RP/EX LOC REG CAP VPLX (1001TB+)=CA	VPLEX	\$870
456-111-422	RP/EX REM BASE FOR VPLEX LIC=IC	VPLEX	\$27,000
456-111-423	RP/EX REM REG CAP VPLEX (0-14TB) =CA	VPLEX	\$3,010
456-111-424	RP/EX REM REG CAP VPLEX (15-25TB) =CA	VPLEX	\$2,750
456-111-425	RP/EX REM REG CAP VPLEX (26-40TB) =CA	VPLEX	\$2,515
456-111-426	RP/EX REM REG CAP VPLEX (41-60TB) =CA	VPLEX	\$2,315
456-111-427	RP/EX REM REG CAP VPLEX (61-100TB) =CA	VPLEX	\$2,080
456-111-428	RP/EX REM REG CAP VPLEX (101-150TB) =CA	VPLEX	\$1,950
456-111-429	RP/EX REM REG CAP VPLEX (151-250TB) =CA	VPLEX	\$1,925
456-111-430	RP/EX REM REG CAP VPLEX (251-400TB) =CA	VPLEX	\$1,800
456-111-431	RP/EX REM REG CAP VPLEX (401-600TB) =CA	VPLEX	\$1,700
456-111-432	RP/EX REM REG CAP VPLEX (601-1000TB) =CA	VPLEX	\$1,428
456-111-433	RP/EX REM REG CAP VPLEX (1001TB+) =CA	VPLEX	\$1,050
456-111-434	RP-EX Loc for VPLEX Large Capacity = IC	VPLEX	\$709,300
456-111-435	RP-EX Rem for VPLEX Large Capacity = IC	VPLEX	\$1,296,070
456-111-436	VPLEX LOCAL CLOUDARRAY FC 20TBU LIC=IC	VPLEX	\$0
456-111-437	VPLEX LOCAL CLOUDARRAY FC 40TBU LIC=IC	VPLEX	\$0
456-111-444	VPLEX V6 Base Unity300 Frame LIC=IC	VPLEX	\$12,140
456-111-445	VPLEX V6 Base Unity400 Frame LIC=IC	VPLEX	\$28,880
456-111-446	VPLEX V6 Base Unity500 Frame LIC=IC	VPLEX	\$30,260
456-111-447	VPLEX V6 Base Unity600 Frame LIC=IC	VPLEX	\$39,490
456-111-448	VPLEX VS6 Base Unity300F/350F LIC=IC	VPLEX	\$12,140
456-111-449	VPLEX VS6 Base Unity400F/450F LIC=IC	VPLEX	\$28,880
456-111-450	VPLEX VS6 Base Unity500F/550F LIC=IC	VPLEX	\$30,260
456-111-451	VPLEX VS6 Base Unity600F/650F LIC=IC	VPLEX	\$39,490
456-111-452	VPLEX V6 Metro Unity300 Frame LIC=IC	VPLEX	\$33,120
456-111-453	VPLEX V6 Metro Unity400 Base LIC=IC	VPLEX	\$75,800
456-111-454	VPLEX V6 Metro Unity500 Base LIC=IC	VPLEX	\$144,740
456-111-455	VPLEX V6 Metro Unity600 Base LIC=IC	VPLEX	\$172,880
456-111-456	VPLEX VS6 Metro Unity300F/350F?LIC=IC	VPLEX	\$33,120
456-111-457	VPLEX VS6 Metro Unity400F/450F?LIC=IC	VPLEX	\$75,800
456-111-458	VPLEX VS6 Metro Unity500F/550F?LIC=IC	VPLEX	\$144,740
456-111-459	VPLEX VS6 Metro Unity600F/650F?LIC=IC	VPLEX	\$172,880
456-111-460	VPLEX V6 1-1 CA Unity300 Frame TF LIC=IC	VPLEX	\$35,000
456-111-461	VPLEX V6 1-1 CA Unity400 Frame TF LIC=IC	VPLEX	\$50,500
456-111-462	VPLEX V6 1-1 CA Unity500 Frame TF LIC=IC	VPLEX	\$112,600
456-111-463	VPLEX V6 1-1 CA Unity600 Frame TF LIC=IC	VPLEX	\$161,600
456-111-468	VPLEX V6 Base VNXE3200 Frame Base LIC=IC	VPLEX	\$8,200

456-111-469	VPLEX V6 Metro VNXE3200 Frame LIC=IC	VPLEX	\$22,400
456-111-471	VPLEX VS6 VAFA LOCAL LICENSE= CA	VPLEX	\$0
456-111-472	VPLEX VS6 VAFA METRO LICENSE= CA	VPLEX	\$0
456-111-582	VPLEX V6 Migration for VMAX3 LIC=IC	VPLEX	\$26,500
456-111-712	VPLX VS2 MET DL SCV2000/3000/3020=IC	VPLEX	\$33,120
456-111-713	VPLX VS2 MET DL SC4020=IC	VPLEX	\$40,960
456-111-714	VPLEX VS2 MET BASE DELL COMP SC8000 =IC	VPLEX	\$110,270
456-111-715	VPLX VS2 MET DL SC8000/9000=IC	VPLEX	\$172,880
456-111-716	VPLX VS2 LOC DL SCV2000/3000/3020=IC	VPLEX	\$12,140
456-111-717	VPLX VS2 LOC DL SC4020=IC	VPLEX	\$14,385
456-111-718	VPLEX VS2 LOC BASE DELL COMP SC8000 =IC	VPLEX	\$29,578
456-111-719	VPLX VS2 LOC DL SC8000/9000=IC	VPLEX	\$39,490
456-111-720	VPLX VS6 MET DL SCV2000/3000/3020=IC	VPLEX	\$33,120
456-111-721	VPLX VS6 MET DL? SC4020=IC	VPLEX	\$40,960
456-111-722	VPLEX VS6 MET BASE DELL COMP SC8000 =IC	VPLEX	\$110,270
456-111-723	VPLX VS6 MET DL SC8000/9000=IC	VPLEX	\$172,880
456-111-724	VPLX VS6 LOC DL SCV2000/3000/3020=IC	VPLEX	\$12,140
456-111-725	VPLX VS6 LOC DL? SC4020=IC	VPLEX	\$14,385
456-111-726	VPLEX VS6 LOC BASE DELL COMP SC8000 =IC	VPLEX	\$29,578
456-111-727	VPLX VS6 LOC DL SC8000/9000=IC	VPLEX	\$39,490
456-111-728	VPLEX VS2 VAFA LOCAL LICENSE= CA	VPLEX	\$0
456-111-729	VPLEX VS2 VAFA METRO LICENSE= CA	VPLEX	\$0
456-111-730	RP/EX VPLEX V6 VAFA Local = IC	VPLEX	\$123,000
456-111-731	RP/EX VPLEX V6 VAFA Remote = IC	VPLEX	\$151,000
456-111-732	RP/EX VPLEX V2 VAFA Local = IC	VPLEX	\$77,000
456-111-733	RP/EX VPLEX V2 VAFA Remote = IC	VPLEX	\$95,000
456-111-753	VPLEX V6 MET VNX5200 Frame UPG LIC=IC	VPLEX	\$52,660
456-111-754	VPLEX V6 MET VNX5400 Frame UPG LIC=IC	VPLEX	\$57,780
456-111-755	VPLEX V6 MET VNX5600 Frame UPG LIC=IC	VPLEX	\$32,140
456-111-756	VPLEX V6 MET VNX5800 Frame UPG LIC=IC	VPLEX	\$11,280
456-111-757	VPLX VS6 Unity 3x0F 1-1 Metro UPG LIC=IC	VPLEX	\$0
456-111-758	VPLX VS6 Unity 4x0F 1-1 Metro UPG LIC=IC	VPLEX	\$25,300
456-111-759	VPLX VS6 Unity 5x0F 1-1 Metro UPG LIC=IC	VPLEX	\$32,140
456-111-760	VPLX VS6 Unity 6x0F 1-1 Metro UPG LIC=IC	VPLEX	\$11,280
456-111-761	VPLX V6 1-1CA Unity300F/350F LIC=IC	VPLEX	\$35,000
456-111-762	VPLX V6 1-1CA Unity400F/450F LIC=IC	VPLEX	\$50,500
456-111-763	VPLX V6 1-1CA Unity500F/550F LIC=IC	VPLEX	\$112,600
456-111-764	VPLX V6 1-1CA Unity600F/650F LIC=IC	VPLEX	\$161,600
456-111-869	Storage M&R for VPLEX VS6 Single=IC	VPLEX	\$0
456-111-870	Storage M&R for VPLEX VS6 Dual=IC	VPLEX	\$0
456-111-871	Storage M&R for VPLEX VS6 Quad=IC	VPLEX	\$0
456-111-986	VPLEX VS6 Single M and R=IC	VPLEX	\$0
456-111-987	VPLEX VS6 Dual M and R=IC	VPLEX	\$0
456-111-988	VPLEX VS6 Quad M and R=IC	VPLEX	\$0
456-111-989	VPLEX VS6 LOCAL 5TB X-BRICK UPG=ID	VPLEX	\$15,750
456-111-990	VPLEX VS6 METRO 5TB X-BRICK UPG=ID	VPLEX	\$42,620
456-111-991	VPLEX LOCAL CLOUDARRAY UPG 40 TBU LIC=IC	VPLEX	\$0
456-111-992	VPLEX 1-1 Metro UNITY 300 UPG LIC=IC	VPLEX	\$0
456-111-993	VPLEX 1-1 Metro UNITY 400 UPG LIC=IC	VPLEX	\$25,300
456-111-994	VPLEX 1-1 Metro UNITY 500 UPG LIC=IC	VPLEX	\$32,140

456-111-995	VPLEX 1-1 Metro UNITY 600 UPG LIC=IC	VPLEX	\$11,280
456-112-392	VPLX VS2 LOC DL SC7020/F=IC	VPLEX	\$30,260
456-112-393	VPLX VS6 LOC DL SC7020/F=IC	VPLEX	\$30,260
456-112-394	VPLX VS2 MET DL SC7020/F=IC	VPLEX	\$144,740
456-112-395	VPLX VS6 MET DL SC7020/F=IC	VPLEX	\$144,740
456-112-409	VPLX VS2 LOC DL SC5000/5020/F=IC	VPLEX	\$28,880
456-112-410	VPLX VS6 LOC DL SC5000/5020/F=IC	VPLEX	\$28,880
456-112-411	VPLX VS2 MET DL SC5000/5020/F=IC	VPLEX	\$75,800
456-112-412	VPLX VS6 MET DL SC5000/5020/F=IC	VPLEX	\$75,800
456-113-133	Storage M&R for VPLEX LIC=IC	VPLEX	\$0
456-113-219	VPLEX VS2 CloudArray Frame LIC=IC	VPLEX	\$0
456-113-220	VPLEX VS6 CloudArray Frame LIC=IC	VPLEX	\$0
457-101-160	RP/EX LOC BASE FOR VPLEX =CA	VPLEX	\$0
457-101-162	RP/EX REM BASE FOR VPLEX =CA	VPLEX	\$0
458-000-066	VPLEX MIGRATION PRODUCT	VPLEX	\$0
458-000-067	VPLEX VS2 LOCAL FRAME PRODUCT	VPLEX	\$0
458-000-090	VPLEX GEOSYN PRODUCT	VPLEX	\$0
458-000-091	VPLEX GEO PRODUCT	VPLEX	\$0
458-000-092	VPLEX LOCAL PRODUCT	VPLEX	\$0
458-000-110	VPLEX LOCAL XTREMIO PRODUCT	VPLEX	\$0
458-000-161	RP/EX LOCAL VPLEX PRODUCT	VPLEX	\$0
458-000-162	RP/EX REMOTE VPLEX PRODUCT	VPLEX	\$0
458-000-261	VPLEX SPLITTER FOR VMAX3 PRODUCT	VPLEX	\$0
458-000-399	RP-EX VPLEX Large Capacity Promo	VPLEX	\$0
458-000-513	VPLEX METRO XTREMIO PRODUCT	VPLEX	\$0
458-000-535	VPLEX METRO PRODUCT	VPLEX	\$0
458-001-118	VPLEX GEOSYNCHRONY CAPACITY	VPLEX	\$0
458-001-120	ESA MANAGEMENT PACK FOR VPLEX PRODUCT	VPLEX	\$0
458-001-125	VPLEX LARGE CAPACITY LICENSES	VPLEX	\$0
458-001-126	VPLEX 1-1 CA VNX FRAME TF PRODUCT	VPLEX	\$0
458-001-128	VPLEX GEOSYNCHRONY LARGE CAP LICENSE	VPLEX	\$0
458-001-131	VPLEX MIGRATION FOR VMAX PRODUCT	VPLEX	\$0
458-001-166	VPLEX VS2 METRO FRAME PRODUCT	VPLEX	\$0
458-001-346	VPLEX V6 VNX LOCAL FRAME PRODUCT	VPLEX	\$0
458-001-347	VPLEX V6 VNX METRO FRAME PRODUCT	VPLEX	\$0
458-001-348	VPLEX V6 MIGRATION PRODUCT	VPLEX	\$0
458-001-350	VPLEX V6 LOCAL PRODUCT	VPLEX	\$0
458-001-351	VPLEX V6 METRO PRODUCT	VPLEX	\$0
458-001-352	VPLEX V6 LOCAL XTREMIO PRODUCT	VPLEX	\$0
458-001-353	VPLEX V6 METRO XTREMIO PRODUCT	VPLEX	\$0
458-001-356	VPLEX V6 SPLITTER FOR VMAX3 PRODUCT	VPLEX	\$0
458-001-358	VPLEX V6 GEOSYN LARGE CAP LICENSE	VPLEX	\$0
458-001-359	VPLEX V6 1-1 CA VNX FRAME TF PRODUCT	VPLEX	\$0
458-001-493	VPLEX 1-1 CA UNITY FRAME TF PRODUCT	VPLEX	\$0
458-001-718	RP/EX LOCAL VPLEX VS6 PRODUCT	VPLEX	\$0
458-001-719	RP/EX REMOTE VPLEX VS6 PRODUCT	VPLEX	\$0
458-001-720	RP-EX VPLEX for Large Capacity Promo	VPLEX	\$0
458-001-724	VPLEX V6 UNITY LOCAL FRAME PRODUCT	VPLEX	\$0
458-001-725	VPLEX V6 UNITY METRO FRAME PRODUCT	VPLEX	\$0
458-001-726	VPLEX V6 1-1 CA UNITY FRAME TF PRODUCT	VPLEX	\$0

458-001-732	VPLEX VS6 VAFA LOCAL PRODUCT=CA	VPLEX	\$0
458-001-733	VPLEX VS6 VAFA METRO PRODUCT=CA	VPLEX	\$0
458-001-754	VPLEX V6 LOCAL LARGE CAPACITY LICENSES	VPLEX	\$0
458-001-755	VPLEX V6 METRO LARGE CAPACITY LICENSES	VPLEX	\$0
458-001-807	VPLX VS2 METRO DELL SC SERIES	VPLEX	\$0
458-001-808	VPLX VS2 LOCAL DELL SC SERIES	VPLEX	\$0
458-001-809	VPLX VS6 METRO DELL SC SERIES	VPLEX	\$0
458-001-810	VPLX VS6 LOCAL DELL SC SERIES	VPLEX	\$0
458-001-817	VPLEX VS2 VAFA LOCAL PRODUCT	VPLEX	\$0
458-001-818	VPLEX VS2 VAFA METRO PRODUCT	VPLEX	\$0
458-001-819	RP/EX VPLEX V6 VAFA Local Product	VPLEX	\$0
458-001-820	RP/EX VPLEX V6 VAFA Remote Product	VPLEX	\$0
458-001-821	RP/EX VPLEX V2 VAFA Local Product	VPLEX	\$0
458-001-822	RP/EX VPLEX V2 VAFA Remote Product	VPLEX	\$0
458-002-184	VPLEX V6 GEOSYNCHRONY CAPACITY=CA	VPLEX	\$0
458-002-185	VPLEX V6 GEOSYN PRODUCT=CA	VPLEX	\$0
458-002-202	Storage M&R for VPLEX=IC	VPLEX	\$0
458-002-206	VPLEX VS2 CloudArray SW	VPLEX	\$0
458-002-207	VPLEX VS6 CloudArray SW	VPLEX	\$0
458-002-324	VPLEX VS2AF Geosyn Local to MetroUPG=IC	VPLEX	\$0
458-002-325	VPLEX VS6AF Geosyn Local to MetroUPG=IC	VPLEX	\$0
RPD1-10FS	RAPIDPATH 10GBE FIBER SR - GEN 1	VPLEX	\$0
RPD1-1CR	RAPIDPATH 1GBE COPPER RJ45 - GEN 1	VPLEX	\$0
RPDS-MH-VP	RAPIDPATH FOR VPLEX MULTIHOMED SOFTWARE	VPLEX	\$0
RPEXV-CDP-BAS	LOCAL REG CAP BASE LIC FOR VPLEX	VPLEX	\$0
RPEXV-CDP-T1	LOCAL REG CAP T1 FOR VPLEX (0-14TB)	VPLEX	\$0
RPEXV-CDP-T10	LOCAL REG CAP T10 FOR VPLEX (601-1000TB)	VPLEX	\$0
RPEXV-CDP-T11	LOCAL REG CAP T11 FOR VPLEX (1001+ TB)	VPLEX	\$0
RPEXV-CDP-T2	LOCAL REG CAP T2 FOR VPLEX (15-25TB)	VPLEX	\$0
RPEXV-CDP-T3	LOCAL REG CAP T3 FOR VPLEX (26-40TB)	VPLEX	\$0
RPEXV-CDP-T4	LOCAL REG CAP T4 FOR VPLEX (41-60TB)	VPLEX	\$0
RPEXV-CDP-T5	LOCAL REG CAP T5 FOR VPLEX (61-100TB)	VPLEX	\$0
RPEXV-CDP-T6	LOCAL REG CAP T6 FOR VPLEX (101-150TB)	VPLEX	\$0
RPEXV-CDP-T7	LOCAL REG CAP T7 FOR VPLEX (151-250TB)	VPLEX	\$0
RPEXV-CDP-T8	LOCAL REG CAP T8 FOR VPLEX (251-400TB)	VPLEX	\$0
RPEXV-CDP-T9	LOCAL REG CAP T9 FOR VPLEX (401-600TB)	VPLEX	\$0
RPEXV-CDP-UG	LOCAL REG CAP 1TB UPGRADE FOR VPLEX	VPLEX	\$0
RPEXV-CRR-BAS	REMOTE REG CAP BASE LICENSE FOR VPLEX	VPLEX	\$0
RPEXV-CRR-T1	REMOTE REG CAP T1 FOR VPLEX (0-14TB)	VPLEX	\$0
RPEXV-CRR-T10	REMOTE REG CAP T10 FOR VPLEX(601-1000TB)	VPLEX	\$0
RPEXV-CRR-T11	REMOTE REG CAP T11 FOR VPLEX(1001+ TB)	VPLEX	\$0
RPEXV-CRR-T2	REMOTE REG CAP T2 FOR VPLEX (15-25TB)	VPLEX	\$0
RPEXV-CRR-T3	REMOTE REG CAP T3 FOR VPLEX (26-40TB)	VPLEX	\$0
RPEXV-CRR-T4	REMOTE REG CAP T4 FOR VPLEX (41-60TB)	VPLEX	\$0
RPEXV-CRR-T5	REMOTE REG CAP T5 FOR VPLEX (61-100TB)	VPLEX	\$0
RPEXV-CRR-T6	REMOTE REG CAP T6 FOR VPLEX (101-150TB)	VPLEX	\$0
RPEXV-CRR-T7	REMOTE REG CAP T7 FOR VPLEX (151-250TB)	VPLEX	\$0
RPEXV-CRR-T8	REMOTE REG CAP T8 FOR VPLEX (251-400TB)	VPLEX	\$0
RPEXV-CRR-T9	REMOTE REG CAP T9 FOR VPLEX (401-600TB)	VPLEX	\$0
RPEXV-CRR-UG	REMOTE REG CAP 1TB UPGRADE FOR VPLEX	VPLEX	\$0

VNXCA2BASE	BL for VNX CA-2	VPLEX	\$0
VNXCA2METR	METRO LICENSE FOR VNX CA-2 =IC	VPLEX	\$0
VNXCA4BASE	BL for VNX CA-4	VPLEX	\$0
VNXCA4BAUP	BU for VNX CA-2 to CA-4	VPLEX	\$0
VNXCA4METR	METRO LICENSE FOR VNX CA-4 =IC	VPLEX	\$0
VNXCA4MEUP	METRO UPGR VNX CA-2 TO CA-4 =IC	VPLEX	\$0
VNXCAENGFA	BE For VNX CA Factory	VPLEX	\$0
VNXCAENGIN	BE For VNX CA Field	VPLEX	\$0
VPL-0204-U-FACT-F	VPLEX VPL SING TO DUAL FCT UPG KIT VAFA	VPLEX	\$0
VPL-0204-U-FACTORY	VPLEX VPL SING TO DUAL FCT UPG KIT	VPLEX	\$8,850
VPL-0204-U-FIELD	VPLEX VPL SING TO DUAL FLD UPG KIT	VPLEX	\$8,850
VPL-0204-U-FIELD-F	VPLEX VPL SING TO DUAL FLD UPG KIT VAFA	VPLEX	\$0
VPL-0204-U-FLD-D	DELL VPLX VS6 SING TO DUAL FLD UPG KIT	VPLEX	\$8,850
VPL-0204-U-FLD-F-D	DELL VPLX VAF6 SING TO DUAL FLD UPG KIT	VPLEX	\$0
VPL-02-KIT-FD	VPLEX VPL SMALL CONFIG KIT (FIELD DEPL)	VPLEX	\$2,370
VPL-02-KIT-FD-D	DELL VPLX VS6 SM CONFIG KIT (FLD DEPL)	VPLEX	\$2,370
VPL-02-KIT-FD-F	VPLEX VPL SMALL CONFIG KIT (FD) VAFA	VPLEX	\$0
VPL-02-KIT-FD-F-D	DELL VPLX VAF6 SM CONFIG KIT (FLD DEPL)	VPLEX	\$0
VPL-02-RACK	REDWOOD SINGLE-ENG CONFIG RACK (TITAN)	VPLEX	\$11,060
VPL-02-RACK-D	DELL VPLX VS6 SING-ENG CONFIG RAC (TTN)	VPLEX	\$11,060
VPL-02-RACK-F	REDWOOD SING-ENG CONF RACK (TITAN) VAFA	VPLEX	\$11,060
VPL-02-RACK-F-D	DELL VPLX VAF6 SING-ENG CONFIG RAC (TTN)	VPLEX	\$11,060
VPL-02-UPG-KIT	VPLEX SINGLE-ENG UPGRADE KIT	VPLEX	\$0
VPL-02-UPG-KIT-F	VPLEX SINGLE-ENG UPGRADE KIT VAFA	VPLEX	\$0
VPL-0408-U-FACT-F	VPLEX VPL DUAL TO QUAD FCT UPG KIT VAFA	VPLEX	\$0
VPL-0408-U-FACTORY	VPLEX VPL DUAL TO QUAD FCT UPG KIT	VPLEX	\$13,275
VPL-0408-U-FIELD	VPLEX VPL DUAL TO QUAD FLD UPG KIT	VPLEX	\$13,275
VPL-0408-U-FIELD-F	VPLEX VPL DUAL TO QUAD FLD UPG KIT VAFA	VPLEX	\$0
VPL-0408-U-FLD-D	DELL VPLX VS6 DUAL TO QUAD FLD UPG KIT	VPLEX	\$13,275
VPL-0408-U-FLD-F-D	DELL VPLX VAF6 DUAL TO QUAD FLD UPG KIT	VPLEX	\$0
VPL-04-KIT-FD	VPLEX VPL MEDIUM CONFIG KIT (FIELD DEPL)	VPLEX	\$6,950
VPL-04-KIT-FD-D	DELL VPLX VS6 MED CONFIG KIT (FLD DEPL)	VPLEX	\$6,950
VPL-04-KIT-FD-F	VPLEX VPL MEDIUM CONFIG KIT (FD) VAFA	VPLEX	\$0
VPL-04-KIT-FD-F-D	DELL VPLX VAF6 MED CONFIG KIT (FLD DEPL)	VPLEX	\$0
VPL-04-RACK	REDWOOD DUAL-ENG CONFIG RACK (TITAN)	VPLEX	\$11,340
VPL-04-RACK-D	DELL VPLX VS6 DUAL-ENG CONFIG RAC (TTN)	VPLEX	\$11,340
VPL-04-RACK-F	REDWOOD DUAL-ENG CONF RACK (TITAN) VAF	VPLEX	\$11,340
VPL-04-RACK-F-D	DELL VPLX VAF6 DUAL-ENG CONFIG RAC (TTN)	VPLEX	\$11,340
VPL-04-UPG-KIT	VPLEX DUAL-ENG UPGRADE KIT	VPLEX	\$0
VPL-04-UPG-KIT-F	VPLEX DUAL-ENG UPGRADE KIT VAFA	VPLEX	\$0
VPL-08-KIT-FD	VPLEX VPL LARGE CONFIG KIT (FIELD DEPL)	VPLEX	\$9,500
VPL-08-KIT-FD-D	DELL VPLX VS6 LG CONFIG KIT (FLD DEPL)	VPLEX	\$9,500
VPL-08-KIT-FD-F	VPLEX VPL LARGE CONFIG KIT (FD) VAFA	VPLEX	\$0
VPL-08-KIT-FD-F-D	DELL VPLX VAF6 LG CONFIG KIT (FLD DEPL)	VPLEX	\$0
VPL-08-RACK	REDWOOD QUAD-ENG CONFIG RACK (TITAN)	VPLEX	\$13,010
VPL-08-RACK-D	DELL VPLX VS6 QUAD-ENG CONFIG RAC (TTN)	VPLEX	\$13,010
VPL-08-RACK-F	REDWOOD QUAD-ENG CONF RACK (TITAN) VAF	VPLEX	\$13,010
VPL-08-RACK-F-D	DELL VPLX VAF6 QUAD-ENG CONFIG RAC (TTN)	VPLEX	\$13,010
VPL-08-UPG-KIT	VPLEX QUAD-ENG UPGRADE KIT	VPLEX	\$10,000
VPL-08-UPG-KIT-F	VPLEX QUAD-ENG UPGRADE KIT VAFA	VPLEX	\$0

VPL-BM16GFC	REDWOOD BACK END I/O OPTION 16GFC	VPLEX	\$6,180
VPL-BM16GFC-F	REDWOOD BACK END I/O OPTION 16GFC VAFA	VPLEX	\$0
VPL-CM10GE	REDWOOD COM MODULE OPTION 10GE	VPLEX	\$3,855
VPL-CM10GE-F	REDWOOD COM MODULE OPTION 10GE VAFA	VPLEX	\$0
VPL-CM10GEUFD	10GB ETHERENET COM MODULES UPGRADE	VPLEX	\$5,010
VPL-CM10GEUFD-F	10GB ETHERENET COM MODULES UPGRADE VAFA	VPLEX	\$190,380
VPL-CM16GFC	REDWOOD COM MODULE OPTION 16GFC	VPLEX	\$6,095
VPL-CM16GFC-F	REDWOOD COM MODULE OPTION 16GFC VAFA	VPLEX	\$0
VPL-CM16GFCUFD	16GFC COM MODULES UPGRADE	VPLEX	\$7,925
VPL-CM16GFCUFD-F	16GFC COM MODULES UPGRADE VAFA	VPLEX	\$190,380
VPL-ENG-ADD	REDWOOD ENGINE ADD	VPLEX	\$51,820
VPL-ENG-ADD-FD	VPLEX VPL ENGINE ADD	VPLEX	\$51,820
VPL-ENG-ADD-FD-F-L	VPLEX VPL ENGINE ADD VAFA LOCAL	VPLEX	\$161,895
VPL-ENG-ADD-FD-F-M	VPLEX VPL ENGINE ADD VAFA METRO	VPLEX	\$352,275
VPL-ENG-ADD-F-L	REDWOOD ENGINE ADD VAFA LOCAL	VPLEX	\$161,895
VPL-ENG-ADD-F-M	REDWOOD ENGINE ADD VAFA METRO	VPLEX	\$352,275
VPL-ENG-ADD-QD-FD	REDWOOD ENGINE ADD QUAD	VPLEX	\$51,820
VPL-ENG-ADD-QUAD	REDWOOD ENGINE ADD QUAD	VPLEX	\$51,820
VPL-ENG-ADD-U1	VPL ENGINE UPG	VPLEX	\$67,365
VPL-ENG-ADD-U1-F	VPL ENGINE UPG VAFA	VPLEX	\$0
VPL-ENG-ADD-U1-F-L	VPL LOCAL1 ENGINE UPG VAFA	VPLEX	\$194,275
VPL-ENG-ADD-U1-F-M	VPL METRO1 ENGINE UPG VAFA	VPLEX	\$422,730
VPL-ENG-ADD-U2	VPL ENGINE UPG	VPLEX	\$67,365
VPL-ENG-ADD-U2-F	VPL ENGINE UPG VAFA	VPLEX	\$0
VPL-ENG-ADD-U2-F-L	VPL LOCAL2 ENGINE UPG VAFA	VPLEX	\$194,275
VPL-ENG-ADD-U2-F-M	VPL METRO2 ENGINE UPG VAFA	VPLEX	\$422,730
VPL-ENG-BASE	REDWOOD BASE ENGINE	VPLEX	\$61,040
VPL-ENG-BASE-FD	VPLEX VPL BASE ENGINE	VPLEX	\$61,040
VPL-ENG-BASE-F-L	REDWOOD BASE ENGINE VAFA LOCAL	VPLEX	\$161,895
VPL-ENG-BASE-F-M	REDWOOD BASE ENGINE VAFA METRO	VPLEX	\$352,275
VPL-ENG-BAS-FD-F-L	VPLEX VPL BASE ENGINE VAFA LOCAL	VPLEX	\$161,895
VPL-ENG-BAS-FD-F-M	VPLEX VPL BASE ENGINE VAFA METRO	VPLEX	\$352,275
VPLEX-LS-SN	LICENSE SOLUTION FOR VPLEX=IC	VPLEX	\$0
VPL-FDRLKT-LG-DE	VS6 DellEMC FLD DEPLOY RAIL KIT - LRG	VPLEX	\$4,945
VPL-FDRLKT-LG-E	VS6 EMC FIELD DEPLOY RAIL KIT - LRG	VPLEX	\$4,945
VPL-FDRLKT-MD-DE	VS6 DellEMC FLD DEPLOY RAIL KIT - MED	VPLEX	\$2,840
VPL-FDRLKT-MD-E	VS6 EMC FIELD DEPLOY RAIL KIT - MED	VPLEX	\$2,840
VPL-FDRLKT-SM-DE	VS6 DellEMC FLD DEPLOY RAIL KIT - SML	VPLEX	\$1,520
VPL-FDRLKT-SM-E	VS6 EMC FIELD DEPLOY RAIL KIT - SML	VPLEX	\$1,520
VPL-FM16GFC	REDWOOD FRONT END I/O OPTION 16GFC	VPLEX	\$6,180
VPL-FM16GFC-F	REDWOOD FRONT END I/O OPTION 16GFC VAFA	VPLEX	\$0
VPL-PW40 L7-30	L7-30 Single Phase	VPLEX	\$675
VPL-PW40 L7-30-F	L7-30 Single Phase VAFA	VPLEX	\$0
VPL-PW40UASTL	30A 1PH CLIPSAL 56PA332 AUS	VPLEX	\$1,410
VPL-PW40UASTL-F	30A 1PH CLIPSAL 56PA332 AUS VAFA	VPLEX	\$0
VPL-PW40UIEC3	30A 1PH IEC309-332P6 INTL	VPLEX	\$270
VPL-PW40UIEC3-F	30A 1PH IEC309-332P6 INTL VAFA	VPLEX	\$0
VPL-PW40URUS	30A 1PH RUSSELLSTOLL 3750DP	VPLEX	\$1,670
VPL-PW40URUS-F	30A 1PH RUSSELLSTOLL 3750DP VAFA	VPLEX	\$0
VPL-PW40U-US	30A 1PH L6-30P N.AMER; JAPAN	VPLEX	\$270

VPL-PW40U-US-F	30A 1PH L6-30P N.AMER; JAPAN VAFA	VPLEX	\$0
VPL-SWITCH	REDWOOD IB COM SWITCH	VPLEX	\$4,500
VPL-SWITCH-F	REDWOOD IB COM SWITCH VAFA	VPLEX	\$0
VPL-SWITCH-FD	VPLEX VPL IB COM SWITCH	VPLEX	\$4,500
VPL-SWITCH-FD-F	VPLEX VPL IB COM SWITCH VAFA	VPLEX	\$0
VPL-SWITCH-U	VPL IB COM SWITCH UPG	VPLEX	\$5,850
VPL-SWITCH-U-F	VPL IB COM SWITCH UPG VAFA	VPLEX	\$0
VPL-UPS	350VA UPS ROHS COMPLIANT UPS	VPLEX	\$770
VPL-UPS-F	350VA UPS ROHS COMPLIANT UPS VAFA	VPLEX	\$0
VPL-UPS-FD	350VA UPS ROHS COMPLIANT UPS	VPLEX	\$770
VPL-UPS-FD-F	350VA UPS ROHS COMPLIANT UPS VAFA	VPLEX	\$0
VPL-UPS-U	350VA UPS ROHS COMPLIANT UPS UPG	VPLEX	\$770
VPL-UPS-U-F	350VA UPS ROHS COMPLIANT UPS UPG VAFA	VPLEX	\$0
VPL-VCE-KIT	VPLEX VCE LAPTOP TRAY KIT	VPLEX	\$525
VPL-VCE-KIT-F	VPLEX VCE LAPTOP TRAY KIT VAFA	VPLEX	\$0
VS1-AA-PBASE	VPLEX Metro Base (incl. 10TB)	VPLEX	\$0
VS1-AA-S1BASE	VPLEX Metro Base 1 yr. (incl. 10TB)	VPLEX	\$0
VS1-AA-T10LIC	VPLEX Metro 1TB (up to 1000TB)	VPLEX	\$0
VS1-AA-T10SB1	VPLEX Metro 1TB 1 yr. (up to 1000TB)	VPLEX	\$0
VS1-AA-T11LIC	VPLEX Metro 1TB (1001TB+)	VPLEX	\$0
VS1-AA-T11SB1	VPLEX Metro 1TB 1 yr. (1001TB+)	VPLEX	\$0
VS1-AA-T1LIC	VPLEX Metro 1TB (up to 25TB)	VPLEX	\$0
VS1-AA-T1SUB1	VPLEX Metro 1TB 1 yr. (up to 25TB)	VPLEX	\$0
VS1-AA-T2LIC	VPLEX Metro 1TB (up to 50TB)	VPLEX	\$0
VS1-AA-T2SUB1	VPLEX Metro 1TB 1 yr. (up to 50TB)	VPLEX	\$0
VS1-AA-T3LIC	VPLEX Metro 1TB (up to 75TB)	VPLEX	\$0
VS1-AA-T3SUB1	VPLEX Metro 1TB 1 yr. (up to 75TB)	VPLEX	\$0
VS1-AA-T4LIC	VPLEX Metro 1TB (up to 100TB)	VPLEX	\$0
VS1-AA-T4SUB1	VPLEX Metro 1TB 1 yr. (up to 100TB)	VPLEX	\$0
VS1-AA-T5LIC	VPLEX Metro 1TB (up to 125TB)	VPLEX	\$0
VS1-AA-T5SUB1	VPLEX Metro 1TB 1 yr. (up to 125TB)	VPLEX	\$0
VS1-AA-T6LIC	VPLEX Metro 1TB (up to 150TB)	VPLEX	\$0
VS1-AA-T6SUB1	VPLEX Metro 1TB 1 yr. (up to 150TB)	VPLEX	\$0
VS1-AA-T7LIC	VPLEX Metro 1TB (up to 200TB)	VPLEX	\$0
VS1-AA-T7SUB1	VPLEX Metro 1TB 1 yr. (up to 200TB)	VPLEX	\$0
VS1-AA-T8LIC	VPLEX Metro 1TB (up to 250TB)	VPLEX	\$0
VS1-AA-T8SUB1	VPLEX Metro 1TB 1 yr. (up to 250TB)	VPLEX	\$0
VS1-AA-T9LIC	VPLEX Metro 1TB (up to 500TB)	VPLEX	\$0
VS1-AA-T9SUB1	VPLEX Metro 1TB 1 yr. (up to 500TB)	VPLEX	\$0
VS1-DM-T10LIC	VPLEX Local 1TB (up to 1000TB)	VPLEX	\$0
VS1-DM-T10SB1	VPLEX Local 1TB 1 yr. (up to 1000TB)	VPLEX	\$0
VS1-DM-T11LIC	VPLEX Local 1TB (1001TB+)	VPLEX	\$0
VS1-DM-T11SB1	VPLEX Local 1TB 1 yr. (1001TB+)	VPLEX	\$0
VS1-DM-T1LIC	VPLEX Local 1TB (up to 25TB)	VPLEX	\$0
VS1-DM-T1SUB1	VPLEX Local 1TB 1 yr. (up to 25TB)	VPLEX	\$0
VS1-DM-T2LIC	VPLEX Local 1TB (up to 50TB)	VPLEX	\$0
VS1-DM-T2SUB1	VPLEX Local 1TB 1 yr. (up to 50TB)	VPLEX	\$0
VS1-DM-T3LIC	VPLEX Local 1TB (up to 75TB)	VPLEX	\$0
VS1-DM-T3SUB1	VPLEX Local 1TB 1 yr. (up to 75TB)	VPLEX	\$0
VS1-DM-T4LIC	VPLEX Local 1TB (up to 100TB)	VPLEX	\$0

VS1-DM-T4SUB1	VPLEX Local 1TB 1 yr. (up to 100TB)	VPLEX	\$0
VS1-DM-T5LIC	VPLEX Local 1TB (up to 125TB)	VPLEX	\$0
VS1-DM-T5SUB1	VPLEX Local 1TB 1 yr. (up to 125TB)	VPLEX	\$0
VS1-DM-T6LIC	VPLEX Local 1TB (up to 150TB)	VPLEX	\$0
VS1-DM-T6SUB1	VPLEX Local 1TB 1 yr. (up to 150TB)	VPLEX	\$0
VS1-DM-T7LIC	VPLEX Local 1TB (up to 200TB)	VPLEX	\$0
VS1-DM-T7SUB1	VPLEX Local 1TB 1 yr. (up to 200TB)	VPLEX	\$0
VS1-DM-T8LIC	VPLEX Local 1TB (up to 250TB)	VPLEX	\$0
VS1-DM-T8SUB1	VPLEX Local 1TB 1 yr. (up to 250TB)	VPLEX	\$0
VS1-DM-T9LIC	VPLEX Local 1TB (up to 500TB)	VPLEX	\$0
VS1-DM-T9SUB1	VPLEX Local 1TB 1 yr. (up to 500TB)	VPLEX	\$0
VS1-ENG-ADD	VPLEX ENGINE ADD	VPLEX	\$0
VS1-ENG-ADD-U	VPLEX ADD ENGINE UPGRADE	VPLEX	\$0
VS1-ENG-BASE	VPLEX BASE ENGINE	VPLEX	\$0
VS1-SERVER	VPLEX MANAGEMENT SERVER	VPLEX	\$0
VS1-SWITCH	VPLEX FC COM SWITCH	VPLEX	\$0
VS1-SWITCH-U	VPLEX FC LOCAL COM SWITCH UPGRADE	VPLEX	\$0
VS1-UPS	350VA UPS ROHS COMPLIANT UPS	VPLEX	\$0
VS1-UPS-U	350VA UPS ROHS COMPLIANT UPS UPGRADE	VPLEX	\$0
VS2-0204-FA-U	VPLEX VS2 SING TO DUAL UPG KT (PRE-RACK)	VPLEX	\$5,250
VS2-0204-FA-U-F	VPLEX SM TO MED UPGE KIT (FACTORY) VAFA	VPLEX	\$0
VS2-0204-FD-U	VPLEX VS2 SING TO DUAL UPG KT (RACKABLE)	VPLEX	\$5,250
VS2-0204-FD-U-F	VPLEX SM TO MED UPG KIT (FIELD) VAFA	VPLEX	\$0
VS2-02-KIT-FD	VPLEX VS2 SMALL CONFIG KIT (RACKABLE)	VPLEX	\$2,470
VS2-02-KIT-FD-F	CHINOOK SMALL CONFIG RACK (TITAN) VAFA	VPLEX	\$0
VS2-02-RACK	VPLEX VS2 SINGLE CONFIG RACK (TITAN)	VPLEX	\$10,810
VS2-02-RACK-F	CHINOOK SMALL CONFIG RACK (TITAN) VAFA	VPLEX	\$10,810
VS2-02-RACK-UFD	VPLEX VS2 SINGLE-ENG CONFIG RACK (TITAN)	VPLEX	\$10,810
VS2-0408-FA-U	VPLEX VS2 DUAL TO QUAD UPG KT (PRE-RACK)	VPLEX	\$9,970
VS2-0408-FA-U-F	VPLEX MED TO LAR UPG KIT (FACTORY) VAFA	VPLEX	\$0
VS2-0408-FD-U-F	VPLEX MED TO LAR UPG KIT (FIELD) VAFA	VPLEX	\$0
VS2-04-KIT-FD	VPLEX VS2 MEDIUM CONFIG KIT (RACKABLE)	VPLEX	\$5,250
VS2-04-KIT-FD-F	CHINOOK MEDIUM CONFIG RACK (TITAN) VAFA	VPLEX	\$0
VS2-04-RACK	VPLEX VS2 DUAL CONFIG RACK (TITAN)	VPLEX	\$13,900
VS2-04-RACK-F	CHINOOK MEDIUM CONFIG RACK (TITAN) VAFA	VPLEX	\$13,900
VS2-04-RACK-UFD	VPLEX VS2 DUAL-ENG CONFIG RACK (TITAN)	VPLEX	\$13,900
VS2-08-RACK	VPLEX VS2 QUAD CONFIG RACK (TITAN)	VPLEX	\$16,060
VS2-08-RACK-F	CHINOOK LARGE CONFIG RACK (TITAN) VAFA	VPLEX	\$16,060
VS2-08-RACK-UFD	VPLEX VS2 QUAD-ENG CONFIG RACK (TITAN)	VPLEX	\$16,060
VS2-CM10GE	VPLEX VS2 10GB ETHERNET COM MODULES	VPLEX	\$3,090
VS2-CM10GE-F	CHINOOK COM MODULE OPTION (10GE) VAFA	VPLEX	\$0
VS2-CM10GEUFD	VPLEX VS2 10GB ETHERNET COM MODULES	VPLEX	\$4,010
VS2-CM10GEUFD-F	VPLEX VS2 10GB ETHERNET COM MODULES VA	VPLEX	\$114,230
VS2-CM8GFC	8 GBIT FC COM MODULES	VPLEX	\$3,090
VS2-CM8GFC-F	CHINOOK COM MODULE OPTION (8GFC) VAFA	VPLEX	\$0
VS2-CM8GFCUFD	8 GBIT FC COM MODULES UPGRADE	VPLEX	\$4,010
VS2-CM8GFCUFD-F	8GBIT FC COM MODULES VAFA	VPLEX	\$114,230
VS2-ENG-ADD	VPLEX VS2 ENGINE ADD	VPLEX	\$29,340
VS2-ENG-ADD-F-L	CHINOOK ENGINE ADD VAFA LOCAL	VPLEX	\$97,140
VS2-ENG-ADD-F-M	CHINOOK ENGINE ADD VAFA METRO	VPLEX	\$211,370

VS2-ENG-ADD-U	VS2 ENGINE UPG	VPLEX	\$38,140
VS2-ENG-ADD-U1	VS2 ENGINE UPG	VPLEX	\$38,140
VS2-ENG-ADD-U1-F-L	CHINOOK LOCAL1 ENGINE UPG VAFA	VPLEX	\$116,570
VS2-ENG-ADD-U1-F-M	CHINOOK METRO1 ENGINE UPG VAFA	VPLEX	\$253,645
VS2-ENG-ADD-U2-F-L	CHINOOK LOCAL2 ENGINE UPG VAFA	VPLEX	\$116,570
VS2-ENG-ADD-U2-F-M	CHINOOK METRO2 ENGINE UPG VAFA	VPLEX	\$253,645
VS2-ENG-ADD-U-F	CHINOOK ENGINE UPG VAFA	VPLEX	\$0
VS2-ENG-AD-FD	VPLEX VS2 ENGINE ADD (RACKABLE)	VPLEX	\$29,340
VS2-ENG-AD-FD-F-L	CHINOOK ENGINE ADD VAFA LOCAL	VPLEX	\$97,140
VS2-ENG-AD-FD-F-M	CHINOOK ENGINE ADD VAFA METRO	VPLEX	\$211,370
VS2-ENG-BASE	VPLEX VS2 BASE ENGINE	VPLEX	\$29,340
VS2-ENG-BASE-F-L	CHINOOK SM CONFIG RACK (TITAN) VAFA LOC	VPLEX	\$97,140
VS2-ENG-BASE-F-M	CHINOOK SM CONFIG RACK (TITAN) VAFA MET	VPLEX	\$211,370
VS2-ENG-BS-FD	VPLEX VS2 BASE ENGINE (RACKABLE)	VPLEX	\$29,340
VS2-ENG-BS-FD-F-L	CHINOOK BASE ENGINE VAFA LOCAL	VPLEX	\$97,140
VS2-ENG-BS-FD-F-M	CHINOOK BASE ENGINE VAFA METRO	VPLEX	\$211,370
VS2-FM10GE-F	CHINOOK FRONT END I/O OPTION (10GE) VAFA	VPLEX	\$0
VS2-FM8GFC	CHINOOK FRONT END I/O OPTION (8GFC)	VPLEX	\$3,090
VS2-FM8GFC-F	CHINOOK FRONT END I/O OPTION (8GFC) VAFA	VPLEX	\$0
VS2-PLTF-UPGR	VPLEX VS1 TO VS2 UPGRADE	VPLEX	\$0
VS2-PW40UASTL	30A 1PH CLIPSAL 56PA332 AUS	VPLEX	\$1,410
VS2-PW40UASTL-F	30A 1PH CLIPSAL 56PA332 AUS VAFA	VPLEX	\$0
VS2-PW40UIEC3	30A 1PH IEC309-332P6 INTL	VPLEX	\$270
VS2-PW40UIEC3-F	30A 1PH IEC309-332P6 INTL VAFA	VPLEX	\$0
VS2-PW40URUS	30A 1PH RUSSELLSTOLL 3750DP	VPLEX	\$1,670
VS2-PW40URUS-F	30A 1PH RUSSELLSTOLL 3750DP VAFA	VPLEX	\$0
VS2-PW40U-US	30A 1PH L6-30P N.AMER; JAPAN	VPLEX	\$270
VS2-PW40U-US-F	30A 1PH L6-30P N.AMER; JAPAN VAFA	VPLEX	\$0
VS2-SERVER	VPLEX VS2 MANAGEMENT SERVER	VPLEX	\$4,010
VS2-SERVER-F	CHINOOK MANAGEMENT SERVER VAFA	VPLEX	\$0
VS2-SERVER-FD	VPLEX VS2 MANAGEMENT SERVER (RACKABLE)	VPLEX	\$4,010
VS2-SERVER-FD-F	CHINOOK MANAGEMENT SERVER RACKABLE V	VPLEX	\$0
VS2-SWITCH	VPLEX VS2 FC COM SWITCH	VPLEX	\$4,630
VS2-SWITCH-F	CHINOOK FOC COM SWITCH VAFA	VPLEX	\$0
VS2-SWITCH-FD	VPLEX VS2 FC COM SWITCH (RACKABLE)	VPLEX	\$4,630
VS2-SWITCH-FD-F	CHINOOK FOC COM SWITCH VAFA	VPLEX	\$0
VS2-SWITCH-U	VPLEX VS2 FC COM G	VPLEX	\$6,020
VS2-SWITCH-U-F	CHINOOK FC COM SWITCH UPG VAFA	VPLEX	\$0
VS2-UPS	350VA UPS ROHS COMPLIANT UPS	VPLEX	\$770
VS2-UPS-F	350VA UPS ROHS COMPLIANT UPS VAFA	VPLEX	\$0
VS2-UPS-FD	VPLEX VS2 350VA ROHS UPS (RACKABLE)	VPLEX	\$770
VS2-UPS-FD-F	350VA UPS ROHS COMPLIANT UPS VAFA	VPLEX	\$0
VS2-UPS-U	350VA UPS ROHS COMPLIANT UPS UPG	VPLEX	\$770
VS2-UPS-U-F	350VA UPS ROHS COMPLIANT UPS UPG VAFA	VPLEX	\$0
VS-40TB	VPLEX GEOSYNCHRONY METRO 40TB LICENSE	VPLEX	\$0
VS-CUSTINST	VPLEX LOCAL CUSTOMER INSTALL	VPLEX	\$0
VS-GEO-PBASE	VPLEX GEO BASE NEW LICENSE	VPLEX	\$0
VS-GEO-T10LIC	VPLEX GEO 601-1000 TB	VPLEX	\$0
VS-GEO-T11LIC	VPLEX GEO 1001+ TB	VPLEX	\$0
VS-GEO-T1LIC	VPLEX GEO 0-14 TB	VPLEX	\$0

VS-GEO-T2LIC	VPLEX GEO 15-25 TB	VPLEX	\$0
VS-GEO-T3LIC	VPLEX GEO 26-40 TB	VPLEX	\$0
VS-GEO-T4LIC	VPLEX GEO 41-60 TB	VPLEX	\$0
VS-GEO-T5LIC	VPLEX GEO 61-100 TB	VPLEX	\$0
VS-GEO-T6LIC	VPLEX GEO 101-150 TB	VPLEX	\$0
VS-GEO-T7LIC	VPLEX GEO 151-250 TB	VPLEX	\$0
VS-GEO-T8LIC	VPLEX GEO 251-400 TB	VPLEX	\$0
VS-GEO-T9LIC	VPLEX GEO 401-600 TB	VPLEX	\$0
VS-GSN-PBASE	VPLEX GEOSYNCHRONY BASE (INCL 10TB)	VPLEX	\$0
VS-GSN-T10LIC	VPLEX GEOSYNCHRONY 1TB (601-1000 TB)	VPLEX	\$0
VS-GSN-T11LIC	VPLEX GEOSYNCHRONY 1TB (1001+ TB)	VPLEX	\$0
VS-GSN-T1LIC	VPLEX GEOSYNCHRONY 1TB (11-14TB)	VPLEX	\$0
VS-GSN-T1SCL	VPLEX GEOSYNCHRONY LARGE SCALE - TIER 1	VPLEX	\$0
VS-GSN-T2LIC	VPLEX GEOSYNCHRONY 1TB (15-25TB)	VPLEX	\$0
VS-GSN-T2SCL	VPLEX GEOSYNCHRONY LARGE SCALE - TIER 2	VPLEX	\$0
VS-GSN-T3LIC	VPLEX GEOSYNCHRONY 1TB (26-40TB)	VPLEX	\$0
VS-GSN-T3SCL	VPLEX GEOSYNCHRONY LARGE SCALE - TIER 3	VPLEX	\$0
VS-GSN-T4LIC	VPLEX GEOSYNCHRONY 1TB (41-60TB)	VPLEX	\$0
VS-GSN-T4SCL	VPLEX GEOSYNCHRONY LARGE SCALE - TIER 4	VPLEX	\$0
VS-GSN-T5LIC	VPLEX GEOSYNCHRONY 1TB (61-100TB)	VPLEX	\$0
VS-GSN-T6LIC	VPLEX GEOSYNCHRONY 1TB (101-150TB)	VPLEX	\$0
VS-GSN-T7LIC	VPLEX GEOSYNCHRONY 1TB (151-250TB)	VPLEX	\$0
VS-GSN-T8LIC	VPLEX GEOSYNCHRONY 1TB (251-400TB)	VPLEX	\$0
VS-GSN-T9LIC	VPLEX GEOSYNCHRONY 1TB (401-600TB)	VPLEX	\$0
VS-LOC-PBASE	VPLEX LOCAL BASE (INCL 10 TB)	VPLEX	\$0
VS-LOC-PUPG	VPLEX LOCAL CAPACITY UPGRADE	VPLEX	\$0
VS-LOC-T10LIC	VPLEX LOCAL 1TB (601-1000 TB)	VPLEX	\$0
VS-LOC-T11LIC	VPLEX LOCAL 1TB (1001+ TB)	VPLEX	\$0
VS-LOC-T1LIC	VPLEX LOCAL 1TB (11-14 TB)	VPLEX	\$0
VS-LOC-T1SCL	VPLEX LOCAL LARGE SCALE - TIER 1	VPLEX	\$0
VS-LOC-T2LIC	VPLEX LOCAL 1TB (15-25 TB)	VPLEX	\$0
VS-LOC-T2SCL	VPLEX LOCAL LARGE SCALE - TIER 2	VPLEX	\$0
VS-LOC-T3LIC	VPLEX LOCAL 1TB (26-40 TB)	VPLEX	\$0
VS-LOC-T3SCL	VPLEX LOCAL LARGE SCALE - TIER 3	VPLEX	\$0
VS-LOC-T4LIC	VPLEX LOCAL 1TB (41-60 TB)	VPLEX	\$0
VS-LOC-T4SCL	VPLEX LOCAL LARGE SCALE - TIER 4	VPLEX	\$0
VS-LOC-T5LIC	VPLEX LOCAL 1TB (61-100 TB)	VPLEX	\$0
VS-LOC-T6LIC	VPLEX LOCAL 1TB (101-150 TB)	VPLEX	\$0
VS-LOC-T7LIC	VPLEX LOCAL 1TB (151-250 TB)	VPLEX	\$0
VS-LOC-T8LIC	VPLEX LOCAL 1TB (251-400 TB)	VPLEX	\$0
VS-LOC-T9LIC	VPLEX LOCAL 1TB (401-600 TB)	VPLEX	\$0
VS-LOC-V51	VPLEX Base VNX5100 Frame Based Lisc =IC	VPLEX	\$0
VS-LOC-V52	VPLEX Base VNX5200 Frame Based Lisc =IC	VPLEX	\$0
VS-LOC-V53	VPLEX Base VNX5300 Frame Based Lisc =IC	VPLEX	\$0
VS-LOC-V54	VPLEX Base VNX5400 Frame Based Lisc =IC	VPLEX	\$0
VS-LOC-V55	VPLEX Base VNX5500 Frame Based Lisc =IC	VPLEX	\$0
VS-LOC-V56	VPLEX Base VNX5600 Frame Based Lisc =IC	VPLEX	\$0
VS-LOC-V57	VPLEX Base VNX5700 Frame Based Lisc =IC	VPLEX	\$0
VS-LOC-V58	VPLEX Base VNX5800 Frame Based Lisc =IC	VPLEX	\$0
VS-LOC-V75	VPLEX Base VNX7500 Frame Based Lisc =IC	VPLEX	\$0

VS-LOC-V76	VPLEX Base VNX7600 Frame Based Lisc =IC	VPLEX	\$0
VS-LOC-V80	VPLEX Base VNX8000 Frame Based Lisc =IC	VPLEX	\$0
VS-LOC-VF5	VPLEX Base VNX-F5000 Frame Base Lisc=IC	VPLEX	\$0
VS-LOC-VF7	VPLEX Base VNX-F7000 Frame Base Lisc=IC	VPLEX	\$0
VS-MEE-TBLIC	VPLEX GEOSYNCHRONY METRO 1TB UPGRADE	VPLEX	\$0
VS-MEE-UNLOCK	VPLEX GEOSYNCHRONY METRO LICENSE UNL	VPLEX	\$0
VS-METCA-V52	VPLEX 1-1 CA VNX5200 Frame TF Lisc=IC	VPLEX	\$35,000
VS-METCA-V54	VPLEX 1-1 CA VNX5400 Frame TF Lisc=IC	VPLEX	\$50,500
VS-METCA-V56	VPLEX 1-1 CA VNX5600 Frame TF Lisc=IC	VPLEX	\$112,600
VS-METCA-V58	VPLEX 1-1 CA VNX5800 Frame TF Lisc=IC	VPLEX	\$161,600
VS-MET-PBASE	VPLEX METRO BASE NEW LICENSE	VPLEX	\$0
VS-MET-T10LIC	VPLEX METRO 601-1000 TB	VPLEX	\$0
VS-MET-T11LIC	VPLEX METRO 1001+ TB	VPLEX	\$0
VS-MET-T1LIC	VPLEX METRO 0-14 TB	VPLEX	\$0
VS-MET-T2LIC	VPLEX METRO 15-25 TB	VPLEX	\$0
VS-MET-T3LIC	VPLEX METRO 26-40 TB	VPLEX	\$0
VS-MET-T4LIC	VPLEX METRO 41-60 TB	VPLEX	\$0
VS-MET-T5LIC	VPLEX METRO 61-100 TB	VPLEX	\$0
VS-MET-T6LIC	VPLEX METRO 101-150 TB	VPLEX	\$0
VS-MET-T7LIC	VPLEX METRO 151-250 TB	VPLEX	\$0
VS-MET-T8LIC	VPLEX METRO 251-400 TB	VPLEX	\$0
VS-MET-T9LIC	VPLEX METRO 401-600 TB	VPLEX	\$0
VS-MET-V51	VPLEX Metro VNX5100 Frame Based Lisc =IC	VPLEX	\$0
VS-MET-V52	VPLEX Metro VNX5200 Frame Based Lisc =IC	VPLEX	\$0
VS-MET-V53	VPLEX Metro VNX5300 Frame Based Lisc =IC	VPLEX	\$0
VS-MET-V54	VPLEX Metro VNX5400 Frame Based Lisc =IC	VPLEX	\$0
VS-MET-V55	VPLEX Metro VNX5500 Frame Based Lisc =IC	VPLEX	\$0
VS-MET-V56	VPLEX Metro VNX5600 Frame Based Lisc =IC	VPLEX	\$0
VS-MET-V57	VPLEX Metro VNX5700 Frame Based Lisc =IC	VPLEX	\$0
VS-MET-V58	VPLEX Metro VNX5800 Frame Based Lisc =IC	VPLEX	\$0
VS-MET-V75	VPLEX Metro VNX7500 Frame Based Lisc =IC	VPLEX	\$0
VS-MET-V76	VPLEX Metro VNX7600 Frame Based Lisc =IC	VPLEX	\$0
VS-MET-V80	VPLEX Metro VNX8000 Frame Based Lisc =IC	VPLEX	\$0
VS-MET-VF5	VPLEX Metro VNX-F5000 Frame Base Lisc=IC	VPLEX	\$0
VS-MET-VF7	VPLEX Metro VNX-F7000 Frame Base Lisc=IC	VPLEX	\$0
VS-MET-VNX	VPLEX 1-1 Cont Avail SW Frame TF Lisc=IC	VPLEX	\$0
VS-MIGRATION	VPLEX 180 Day Migration License =IC	VPLEX	\$0
VS-SPLIT-V3	VPLEX Splitter for VMAX3 = IC	VPLEX	\$0
VS-UPG-V52	VPLEX Metro VNX5200 Frame UPG Lisc =IC	VPLEX	\$52,660
VS-UPG-V54	VPLEX Metro VNX5400 Frame UPG Lisc =IC	VPLEX	\$57,780
VS-UPG-V56	VPLEX Metro VNX5600 Frame UPG Lisc =IC	VPLEX	\$32,140
VS-UPG-V58	VPLEX Metro VNX5800 Frame UPG Lisc =IC	VPLEX	\$11,280
VS-XIO10TBLOC	VPLEX Local License for 10TB X-Brick =ID	VPLEX	\$0
VS-XIO10TBMET	VPLEX Metro License for 10TB X-Brick =ID	VPLEX	\$0
VS-XIO20TBLOC	VPLEX Local License for 20TB X-Brick =ID	VPLEX	\$0
VS-XIO20TBMET	VPLEX Metro License for 20TB X-Brick =ID	VPLEX	\$0
VS-XIO5LOCUP	VPLEX Local 5TB X-Brick Upgrade =ID	VPLEX	\$0
VS-XIO5METUP	VPLEX Metro 5TB X-Brick Upgrade =ID	VPLEX	\$0
VS-XIO5TBLOC	VPLEX Local License for 5TB X-Brick =ID	VPLEX	\$0
VS-XIO5TBMET	VPLEX Metro License for 5TB X-Brick =ID	VPLEX	\$0

450-001-625	ViPR Suite for XIO X2-XS=CB	X2	\$980
450-001-626	ViPR Suite for XIO X2-XR=CB	X2	\$980
450-001-658	XtremIO X2/E SW Bundle for X2S=IC	X2	\$0
450-001-659	XtremIO X2/E SW Bundle for X2-R/T=IC	X2	\$0
456-112-873	XtremIO X2-S 1 X-Brick OE RTU =IC	X2	\$0
456-112-874	XtremIO X2-S 2 X-Brick OE RTU =IC	X2	\$0
456-112-875	XtremIO X2-S 3 X-Brick OE RTU =IC	X2	\$0
456-112-876	XtremIO X2-S 4 X-Brick OE RTU =IC	X2	\$0
456-112-877	XtremIO X2-R/T 1 X-Brick OE RTU =IC	X2	\$0
456-112-878	XtremIO X2-R 2 X-Brick OE RTU =IC	X2	\$0
456-112-879	XtremIO X2-R 3 X-Brick OE RTU =IC	X2	\$0
456-112-880	XtremIO X2-R 4 X-Brick OE RTU =IC	X2	\$0
456-112-979	RP/EX Local for XIO-X2 LIC=CC	X2	\$2,400
456-112-980	RP/EX Remote for XIO-X2 LIC=CC	X2	\$2,400
456-113-084	AppSync ADV For XtremIO X2S LIC = CB	X2	\$770
456-113-085	AppSync ADV For XtremIO X2-R/T LIC=CB	X2	\$770
456-113-498	XtremIO X2-T UG to X2-R OE RTU=IC	X2	\$0
458-002-048	SRM for XIO X2-XS=CB	X2	\$770
458-002-049	SRM for XIO X2-R/T=CB	X2	\$770
458-002-134	XtremIO X2-R X-Brick OE UG=IC	X2	\$0
458-002-165	RecoverPoint Basic for X2-S=ID	X2	\$11,300
458-002-166	RecoverPoint Basic X2-R/T 1TB=CB	X2	\$50,000
458-002-171	RP/EX Local for XIO-X2 =CC	X2	\$0
458-002-172	RP/EX Remote for XIO-X2 =CC	X2	\$0
458-002-190	AppSync ADV For XtremIO X2S	X2	\$0
458-002-191	AppSync ADV For XtremIO X2-R/T	X2	\$0
X2-10G-LR-KIT	XtremIO - 10GbE LR Kit	X2	\$1,500
X2-16GB-FC-LR-KIT	XtremIO - 16G FC LR Kit	X2	\$4,000
X2-1920-18SSD-BA	XtremIO X2 1.92TB SAS 18SSD BA	X2	\$0
X2-1920-6SSD	XtremIO X2 1.92TB SAS 6SSD	X2	\$99,000
X2-1920-6SSD-FD	XtremIO X2 1.92TB SAS 6SSD Fld	X2	\$99,000
X2-1920-6SSD-U	XtremIO X2 1.92TB SAS 6SSD UG	X2	\$119,000
X2-400-18SSD-BA	XtremIO X2-S 400GB SAS 18SSD Base	X2	\$0
X2-400-6SSD	XtremIO X2-S 400GB SAS 6SSD Fac	X2	\$27,500
X2-400-6SSD-FD	XtremIO X2-S 400GB SAS 6SSD Fld	X2	\$27,500
X2-400-6SSD-U	XtremIO X2-S 400GB SAS 6SSD UG	X2	\$33,000
X2-BRICK-KIT	XtremIO X2 X-Brick Instl Kit Fac	X2	\$0
X2-BRICK-KIT-EMC	XtremIO X2 X-Brick Instl Kit EMC Fac	X2	\$0
X2-BRICK-KIT-EMC-U	XtremIO X2 X-Brick Instl Kit EMC UG	X2	\$0
X2-BRICK-KIT-U	XtremIO X2 X-Brick Instl Kit UG	X2	\$0
X2-CMD	XtremIO X2 Cable Management Duct Fac	X2	\$0
X2-CMD-F	XtremIO X2 Cable Management Duct Fld	X2	\$0
X2-DAE	XtremIO X2 - Flash Drv enc fac	X2	\$0
X2-DAE-FD	XtremIO X2- Flash Drv enc Fld	X2	\$0
X2-HD-BASE	XtremIO X2-R 1.92TB Base Fac	X2	\$600,000
X2-HD-BASE-FD	XtremIO X2-R 1.92TB Base Fld	X2	\$600,000
X2-HD-CTRL	XtremIO X2-R Storage Controller Fac	X2	\$0
X2-HD-CTRL-FD	XtremIO X2-R Storage Controller Fld	X2	\$0
X2-HD-NE-TAG	XtremIO X2R 1.92TB No Encryp PSNT Fac	X2	\$0
X2-HD-NE-TAG-FD	XtremIO X2R 1.92TB No Encryp PSNT Fld	X2	\$0

X2-HD-TAG	XtremIO X2-R 1.92TB PSNT Fac	X2	\$0
X2-HD-TAG-FD	XtremIO X2-R 1.92TB PSNT Fld	X2	\$0
X2-IB-LABEL-U	XtremIO - Dispersion IB Label Kit	X2	\$0
X2-PWR-DELTA-RINT	XtremIO - 3-Phase Delta Power Intl	X2	\$3,700
X2-PWR-DELTA-RS	X2 - 3-Phase Delta Power Rus Stow NA&JP	X2	\$4,300
X2-PWR-DELTA-US	X2 - 3-Phase Delta Power NA&JP	X2	\$3,700
X2-PWR-SINGLE-ASTL	XtremIO - Single Phase Power AUS & NZ	X2	\$3,700
X2-PWR-SINGLE-IEC3	XtremIO - Single Phase Power Intl	X2	\$1,800
X2-PWR-SINGLE-RS	XtremIO- Single Phase Power RS NA & JP	X2	\$4,300
X2-PWR-SINGLE-US	XtremIO - Single Phase Power NA & JP	X2	\$1,800
X2-PWR-WYE-INT-FL	X2 3-Phase Wye Power Intl Flying Leads	X2	\$1,800
X2-PWR-WYE-INT-G	X2 3-Phase Wye Power Intl	X2	\$1,800
X2-PWR-WYE-US	XtremIO - 3-Phase Wye Power NA & JP	X2	\$1,800
X2-RACK CONV	XtremIO - Conversion to 3rd Party Rack	X2	\$700
X2-RACK-1PHASE-40U	XtremIO - 40U Deep Cabinet Single Phase	X2	\$4,700
X2-RACK-3PDELTA-40U	XtremIO - 40U Deep Cabinet Delta	X2	\$5,800
X2-RACK-3PWYE-40U	XtremIO - 40U Deep Cabinet Wye	X2	\$5,800
X2-SD-BASE	XtremIO X2-S Base Fac	X2	\$282,000
X2-SD-BASE-FD	XtremIO X2-S Base Fld	X2	\$282,000
X2-SD-CTRL	XtremIO X2-S Storage Controller Fac	X2	\$0
X2-SD-CTRL-FD	XtremIO X2-S Storage Controller Fld	X2	\$0
X2-SD-NE-TAG	XtremIO X2-S No Encryp PSNT Fac	X2	\$0
X2-SD-NE-TAG-FD	XtremIO X2-S No Encryp PSNT Fld	X2	\$0
X2-SD-TAG	XtremIO X2-S PSNT Fac	X2	\$0
X2-SD-TAG-FD	XtremIO X2-S PSNT Fld	X2	\$0
X2-T-BASE	XtremIO X2-T Base Fac	X2	\$465,000
X2-T-BASE-FD	XtremIO X2-T Base Fld	X2	\$465,000
X2-T-CTRL	XtremIO X2-T Storage Controller Fac	X2	\$0
X2-T-CTRL-FD	XtremIO X2-T Storage Controller Fld	X2	\$0
X2-T-NE-TAG	XtremIO X2-T No Encryp PSNT Fac	X2	\$0
X2-T-NE-TAG-FD	XtremIO X2-T No Encryp PSNT Fld	X2	\$0
X2-T-TAG	XtremIO X2-T PSNT Fac	X2	\$0
X2-T-TAG-FD	XtremIO X2-T PSNT Fld	X2	\$0
X2-T-UPG	XtremIO X2-T Upgrade to X2-R	X2	\$196,000
X2-VRACK-F	X2 Field Shipping Container Fld	X2	\$0
X2-XMS	XtremIO X2 Physical Mgmt Server Fac	X2	\$23,500
X2-XMS-FD	XtremIO X2 Physical Mgmt Server Fld	X2	\$23,500
X2-XMS-U	XtremIO X2 Physical Mgmt Server UG	X2	\$23,500
450-001-509	ViPR Suite XIO 5TB=ID	XT	\$6,310
450-001-510	ViPR Suite XIO 5TB UPG=ID	XT	\$4,170
450-001-511	ViPR Suite XIO 10TB=ID	XT	\$12,620
450-001-512	ViPR Suite XIO 20TB=ID	XT	\$25,240
450-001-513	ViPR Suite XIO 40TB=ID	XT	\$50,470
456-105-744	RP/EX LOC 10TB XtremIO X-BRICK=ID	XT	\$34,645
456-105-745	RP/EX LOC 20TB XtremIO X-BRICK=ID	XT	\$51,610
456-105-746	RP/EX LOC 10TB Starter X-Brick 5TB=ID	XT	\$25,000
456-105-747	RP/EX LOC 10TB Starter X-Brick 5TB UG=ID	XT	\$16,070
456-105-748	RP/EX REM 10TB XtremIO X-BRICK=ID	XT	\$41,570
456-105-749	RP/EX REM 20TB XtremIO X-BRICK=ID	XT	\$61,925
456-105-750	RP/EX REM 10TB Starter X-Brick 5TB=ID	XT	\$30,000

456-105-751	RP/EX REM 10TB Starter X-Brick 5TB UG=ID	XT	\$19,285
456-106-135	SRMSUITE XIO 10TB NODE =ID	XT	\$0
456-106-136	SRMSUITE XIO 20TB NODE =ID	XT	\$0
456-106-156	RP/EX LOC VPLEX 10TB XtremIO X-BRICK=ID	XT	\$34,645
456-106-157	RP/EX LOC VPLEX 20TB XtremIO X-BRICK=ID	XT	\$51,610
456-106-158	RP/EX REM VPLEX 10TB XtremIO X-BRICK=ID	XT	\$41,570
456-106-159	RP/EX REM VPLEX 20TB XtremIO X-BRICK=ID	XT	\$61,925
456-106-441	RP/EX LOC VPLX 10TB Strtr X-Brick 5TB=ID	XT	\$25,000
456-106-442	RP/EX LOC VPLX 10TB Strtr X-Brk 5TBUG=ID	XT	\$16,070
456-106-443	RP/EX REM VPLX 10TB Strtr X-Brick 5TB=ID	XT	\$30,000
456-106-444	RP/EX REM VPLX 10TB Strtr X-Brk 5TBUG=ID	XT	\$19,285
456-106-716	RP/EX LOC 40TB XtremIO X-BRICK=ID	XT	\$100,185
456-106-717	RP/EX REM 40TB XtremIO X-BRICK=ID	XT	\$120,205
456-106-718	RP/EX LOC VPLEX 40TB XtremIO X-BRICK=ID	XT	\$100,185
456-106-719	RP/EX REM VPLEX 40TB XtremIO X-BRICK=ID	XT	\$120,205
456-106-905	APPSYNC 5 TB X-Brick=ID	XT	\$6,850
456-106-906	APPSYNC 5 TB X-Brick UPG=ID	XT	\$4,521
456-106-907	APPSYNC 10 TB X-Brick=ID	XT	\$13,690
456-106-908	APPSYNC 20 TB X-Brick=ID	XT	\$27,380
456-106-926	RPVM Replication for XIO =IB	XT	\$0
456-107-738	XtremIO-RP REM Starter X-Brick 5TB UG=ID	XT	\$1,300
456-107-739	XtremIO-RP REM Starter X-Brick 5TB=ID	XT	\$1,200
456-107-740	XtremIO-RP REM 10TB X-BRICK=ID	XT	\$2,500
456-107-741	XtremIO-RP REM 20TB X-BRICK=ID	XT	\$8,500
456-107-742	XtremIO-RP REM 40TB X-BRICK=ID	XT	\$20,000
456-107-743	XtremIO EMC Storage Analytics Suite=IC	XT	\$0
456-107-789	SRMSUITE 40 TB X-Brick=ID	XT	\$0
456-107-790	SRMSUITE 5 TB X-Brick=ID	XT	\$0
456-107-791	SRMSUITE 5 TB X-Brick UPG=ID	XT	\$0
456-107-806	APPSYNC 40 TB X-Brick=ID	XT	\$54,760
456-107-979	RP REM for 10TB Starter X-Brick UPG=ID	XT	\$28,800
456-107-980	RP REM for 10TB XtremIO X-BRICK UPG =ID	XT	\$39,070
456-107-981	RP REM for 20TB XtremIO X-BRICK UPG =ID	XT	\$53,425
456-107-982	RP REM for 40TB XtremIO X-Brick UPG=ID	XT	\$100,205
456-109-465	APPSYNC 5TB LTD XTREMIO X-BRICK UPG=IC	XT	\$0
456-109-466	APPSYNC 5TB LTD XTREMIO X-BRICK=IC	XT	\$0
456-109-467	APPSYNC 10TB LTD XTREMIO X-BRICK=IC	XT	\$0
456-109-468	APPSYNC 20TB LTD XTREMIO X-BRICK=IC	XT	\$0
456-109-469	APPSYNC 40TB LTD XTREMIO X-BRICK=IC	XT	\$0
456-109-561	RP4VM STARTER PACK FOR XTREMIO =IB	XT	\$0
456-110-416	VS SRM XIO 5TB LIC=ID	XT	\$0
456-110-417	VS SRM XIO 5TB UPG LIC=ID	XT	\$0
456-110-418	VS SRM XIO 10TB LIC=ID	XT	\$0
456-110-419	VS SRM XIO 20TB LIC=ID	XT	\$0
456-110-420	VS SRM XIO 40TB LIC=ID	XT	\$0
456-110-427	VS VIPRC XIO 5TB LIC=ID	XT	\$0
456-110-428	VS VIPRC XIO 5TB UPG LIC=ID	XT	\$0
456-110-429	VS VIPRC XIO 10TB LIC=ID	XT	\$0
456-110-430	VS VIPRC XIO 20TB LIC=ID	XT	\$0
456-110-431	VS VIPRC XIO 40TB LIC=ID	XT	\$0

456-110-492	RP4VM FOR XTREMIO - 256 VMS =IB	XT	\$0
456-110-791	SRM XIO 10TB NODE =ID	XT	\$9,900
456-110-792	SRM XIO 20TB NODE =ID	XT	\$19,790
456-110-825	SRM XIO 40TB NODE=ID	XT	\$39,570
456-110-826	SRM XIO 5TB NODE=ID	XT	\$4,950
456-110-827	SRM XIO 5TB UPG NODE=ID	XT	\$3,270
456-111-402	RP/EX REM VPLEX VS6 10TB XIO X-BRICK=ID	XT	\$30,000
456-111-403	RP/EX REM VPLEX VS6 20TB XIO X-BRICK=ID	XT	\$41,570
456-111-404	RP/EX REM VPLEX VS6 5TB XIO X-BRICK=ID	XT	\$61,925
456-111-405	RP/EX REM VPLEX VS6 40TB XIO X-BRICK=ID	XT	\$120,205
456-111-406	RP/EX LOC VPLEX VS6 10TB XIO X-BRICK=ID	XT	\$25,000
456-111-407	RP/EX LOC VPLEX VS6 20TB XIO X-BRICK=ID	XT	\$34,645
456-111-408	RP/EX LOC VPLEX VS6 5TB XIO X-Brick=ID	XT	\$51,610
456-111-409	RP/EX LOC VPLEX VS6 40TB XIO X-BRICK=ID	XT	\$100,185
457-102-119	VS XIO 5TB=ID	XT	\$0
457-102-120	VS XIO 5TB UPG=ID	XT	\$0
457-102-121	VS XIO 10TB=ID	XT	\$0
457-102-122	VS XIO 20TB=ID	XT	\$0
457-102-123	VS XIO 40TB=ID	XT	\$0
458-000-166	SRM for XIO	XT	\$0
458-000-173	RP FOR XtremIO LOCAL PRODUCT	XT	\$0
458-000-174	RP FOR XtremIO REMOTE PRODUCT	XT	\$0
458-000-222	RP/EX VPLEX BB XIO LOCAL PRODUCT	XT	\$0
458-000-223	RP/EX VPLEX BB XIO REMOTE PRODUCT	XT	\$0
458-000-938	RECOVERPOINT FOR XIO BASIC OPTION	XT	\$0
458-000-957	RP FOR XtremIO REM UPG FROM BAS TO FULL	XT	\$0
458-000-969	XtremIO EMC Storage Analytics Suite=IC	XT	\$0
458-001-345	APPSYNC FOR XTREMIO	XT	\$0
458-001-637	VS SRM XIO=ID	XT	\$0
458-001-638	VS VIPRC XIO=ID	XT	\$0
458-001-716	RP/EX VPLEX VS6 BB XIO REMOTE PRODUCT	XT	\$0
458-001-717	RP/EX VPLEX VS6 BB XIO LOCAL PRODUCT	XT	\$0
458-001-781	VS SRM XIO 5TBU=ID	XT	\$0
458-001-782	VS VIPRC XIO 5TBU=ID	XT	\$0
458-001-783	VS SRM XIO 10TB=ID	XT	\$0
458-001-784	VS VIPRC XIO 10TB=ID	XT	\$0
458-001-785	VS SRM XIO 20TB=ID	XT	\$0
458-001-786	VS VIPRC XIO 20TB=ID	XT	\$0
458-001-787	VS SRM XIO 40TB=ID	XT	\$0
458-001-788	VS VIPRC XIO 40TB=ID	XT	\$0
ESA-XTREMIO	XtremIO EMC Storage Analytics Suite=IC	XT	\$0
ESI-ORC-XTREMIO-CF	XtremIO RTU - ESI Plugin for OracleVM=IC	XT	\$0
ESI-WIN-XTREMIO-CF	XtremIO RTU - ESI Plugin for Windows=IC	XT	\$0
ORCL-EM-XTREMIO-CF	XtremIO RTU-Oracle Ent. Mgr Plugin=IC	XT	\$0
VSI-XTREMIO-CF	XtremIO RTU - VSI Plugin=IC	XT	\$0
X01-CTRL-F	XtremIO - Storage Controller - FLD	XT	\$0
X01-CTRL-TAGF	XtremIO - Storage Controller/w tag -FLD	XT	\$0
X01-D25-400F	X-brick 25x400GB Flash Drives OE SW-FLD	XT	\$0
X01-MNGT-01	XtremIO - MGMT LICENSE QTY 1	XT	\$0
X01-MNGT-02	XtremIO - MGMT LICENSE QTY 2	XT	\$0

X01-MNGT-03	XtremIO - MGMT LICENSE QTY 3	XT	\$0
X01-MNGT-04	XtremIO - MGMT LICENSE QTY 4	XT	\$0
X01-MNGT-F	XtremIO-MGMT SERVER w/SOFTWARE-FLD	XT	\$0
X01-RTU	XtremIO Right to Use - OE	XT	\$0
X01-UPS-220F	XtremIO - UPS 220V - FLD	XT	\$0
X01-UPS-220FP	XtremIO - UPS 220V - FLD - Secondary	XT	\$0
X02-012-400-E-U	XtremIO Starter X-Brick (5TB) Exp Kit	XT	\$155,000
X02-3-6-BEZ-KIT	XtremIO Std 3 to 6 Bezel Kit	XT	\$0
X02-6U-FILLER	XtremIO Beast Six filler Kit	XT	\$0
X02-BEAST-BEZ-KIT	XtremIO Beast Bezel Kit	XT	\$0
X02-CTRL	XtremIO - Storage Controller	XT	\$0
X02-CTRL-E	XtremIO - STORAGE CONTROLLER enc	XT	\$0
X02-CTRL-E-400	XTREMIO - STORAGE CTRL ENC	XT	\$0
X02-CTRL-E-400-F	XTREMIO - STORAGE CTRL ENC FLD	XT	\$0
X02-CTRL-E-400-T	XTREMIO - STORAGE CTRL 400GB ENC TAG	XT	\$0
X02-CTRL-E-400-T-F	XTREMIO - STORAGE CTRL 400GB ENC TAG FLD	XT	\$0
X02-CTRL-E-400-U	XTREMIO - STORAGE CTRL 400GB ENC UPG	XT	\$0
X02-CTRL-E-EXP-TAG	XtremIO - STORAGE CTRL Exp tag	XT	\$0
X02-CTRL-E-EXP-T-F	XtremIO - STORAGE CTRL Exp tag fld	XT	\$0
X02-CTRL-E-F	XtremIO - STORAGE CONTROLLER enc fld	XT	\$0
X02-CTRL-E-T	XtremIO - STORAGE CTRL 800GB enc tag	XT	\$0
X02-CTRL-E-T-F	XtremIO - STORAGE CTRL 800GB enc tag fld	XT	\$0
X02-CTRL-E-U	XTREMIO - STORAGE CTRL 800GB UPGRADE	XT	\$0
X02-CTRL-F	XtremIO - STORAGE CONTROLLER - FLD	XT	\$0
X02-CTRL-TAG	XtremIO - STORAGE CONTROLLER /W TAG	XT	\$0
X02-CTRL-TAG-F	XtremIO - STORAGE CONTROLLER/W TAG - FLD	XT	\$0
X02-CTRL-U	XTREMIO - STORAGE CONTROLLER UPG	XT	\$0
X02-D13-400-E	XTREMIO -13X400GB FLASH DRV ENC OE SW	XT	\$225,000
X02-D13-400-E-F	XTREMIO 13X400GB FLASH DRV ENC FLD OE SW	XT	\$225,000
X02-D25-400	XtremIO -25x400GB Flash Drives OE SW	XT	\$0
X02-D25-400-E	XTREMIO -25X400GB FLASH DRV ENC OE SW	XT	\$345,000
X02-D25-400-E-F	XTREMIO 25X400GB FLASH DRV ENC FLD OE SW	XT	\$345,000
X02-D25-400-E-U	XTREMIO -25X400GB E FLASH DRV OE SW UPG	XT	\$345,000
X02-D25-400F	XtremIO -25x400GB Flash Drives OE SW-FLD	XT	\$0
X02-D25-400-U	XTREMIO -25X400GB FLASH DR. OE SW UPG	XT	\$335,000
X02-D25-800	XtremIO -25x800GB Flash Drives OE SW	XT	\$510,000
X02-D25-800-10T	XtremIO 25x800GB-10T FDrv enc OE SW	XT	\$0
X02-D25-800-10T-F	XtremIO 25x800GB-10T FDrv enc OE SW fld	XT	\$0
X02-D25-800-5T	XtremIO 25x800GB-5T FDrv enc OE SW	XT	\$0
X02-D25-800-5T-F	XtremIO 25x800GB-5T FDrv enc OE SW fld	XT	\$0
X02-D25-800F	XtremIO -25x800GB Flash Drives OE SW-FLD	XT	\$510,000
X02-D25-800-U	XTREMIO -25X800GB FLASH DRV OE SW UPGD	XT	\$510,000
X02-DISP-2M-KIT	XtremIO 2m Dispersion Kit	XT	\$660
X02-DISP-5M-KIT	XtremIO 5m Dispersion Kit	XT	\$1,300
X02-DUAL-BEZ-KIT	XtremIO Std Dual Bezel Kit	XT	\$0
X02-KIT-01	XtremIO BRICK 1 CONFIG KIT (FACTORY)	XT	\$0
X02-KIT-01-C	XtremIO EMC to Cust Rail conv kit single	XT	\$4,500
X02-KIT01-FD	XtremIO BRICK 1 CONFIG KIT (FIELD)	XT	\$0
X02-KIT-02	XtremIO BRICK 2 CONFIG KIT (FACTORY)	XT	\$0
X02-KIT-02-C	XtremIO EMC to Cust Rail conv kit dual	XT	\$10,500

X02-KIT02-FD	XtremIO BRICK 2 CONFIG KIT (FIELD)	XT	\$0
X02-KIT02-R-U	XtremIO BRICK 2 CONFIG KIT RACK UPG	XT	\$0
X02-KIT02-U	XTREMIO BRICK 2 CONFIG KIT UPG	XT	\$0
X02-KIT-03	XtremIO BRICK 3 CONFIG KIT (FACTORY)	XT	\$0
X02-KIT03-FD	XtremIO BRICK 3 CONFIG KIT (FIELD)	XT	\$0
X02-KIT03-R-U	XtremIO BRICK 3 CONFIG KIT RACK UPG	XT	\$0
X02-KIT03-U	XTREMIO BRICK 3 CONFIG KIT UPG	XT	\$0
X02-KIT-04	XtremIO BRICK 4 CONFIG KIT (FACTORY)	XT	\$0
X02-KIT-04-C	XtremIO EMC to Cust Rail conv kit quad	XT	\$18,500
X02-KIT04-FD	XtremIO BRICK 4 CONFIG KIT (FIELD)	XT	\$0
X02-KIT04-R-U	XtremIO BRICK 4 CONFIG KIT RACK UPG	XT	\$0
X02-KIT04-U	XTREMIO BRICK 4 CONFIG KIT UPG	XT	\$0
X02-KIT-05	XtremIO BRICK 5 CONFIG KIT (FACTORY)	XT	\$0
X02-KIT05-FD	XtremIO BRICK 5 CONFIG KIT (FIELD)	XT	\$0
X02-KIT05-R-U	XtremIO BRICK 5 CONFIG KIT RACK UPG	XT	\$0
X02-KIT05-U	XtremIO BRICK 5 CONFIG KIT UPG	XT	\$0
X02-KIT-06	XtremIO BRICK 6 CONFIG KIT (FACTORY)	XT	\$0
X02-KIT-06-C	XtremIO EMC to Cust Rail conv kit six	XT	\$24,500
X02-KIT06-FD	XtremIO BRICK 6 CONFIG KIT (FIELD)	XT	\$0
X02-KIT06-R-U	XtremIO BRICK 6 CONFIG KIT RACK UPG	XT	\$0
X02-KIT06-U	XtremIO BRICK 6 CONFIG KIT UPG	XT	\$0
X02-KIT-07	XtremIO BRICK 7 CONFIG KIT (FACTORY)	XT	\$0
X02-KIT07-FD	XtremIO BRICK 7 CONFIG KIT (FIELD)	XT	\$0
X02-KIT07-R-U	XtremIO BRICK 7 CONFIG KIT RACK UPG	XT	\$0
X02-KIT07-U	XtremIO BRICK 7 CONFIG KIT UPG	XT	\$0
X02-KIT-08	XtremIO BRICK 8 CONFIG KIT (FACTORY)	XT	\$0
X02-KIT-08-C	XtremIO EMC to Cust Rail conv kit eight	XT	\$28,500
X02-KIT08-FD	XtremIO BRICK 8 CONFIG KIT (FIELD)	XT	\$0
X02-KIT08-R-U	XtremIO BRICK 8 CONFIG KIT RACK UPG	XT	\$0
X02-KIT08-U	XtremIO BRICK 8 CONFIG KIT UPG	XT	\$0
X02-KIT-S	XtremIO SINGLE BRICK CFG KIT (FACTORY)	XT	\$0
X02-KITS-FD	XtremIO SINGLE BRICK CONFIG KIT (FIELD)	XT	\$0
X02-MNGT	XtremIO - MGMT SERVER W/ SOFTWARE	XT	\$15,480
X02-MNGT-01	XtremIO-MGMT LICENSE QTY 1	XT	\$0
X02-MNGT-01-CF	XtremIO-MGMT LICENSE QTY 1=IC	XT	\$0
X02-MNGT-02	XtremIO-MGMT LICENSE QTY 2	XT	\$0
X02-MNGT-02-CF	XtremIO-MGMT LICENSE QTY 2=IC	XT	\$0
X02-MNGT-02-U	XTREMIO-MGMT LICENSE QTY 2 UPG=IC	XT	\$0
X02-MNGT-02-U-CF	XTREMIO-MGMT LICENSE QTY 2 UPG=IC	XT	\$0
X02-MNGT-04	XtremIO-MGMT LICENSE QTY 4	XT	\$0
X02-MNGT-04-CF	XtremIO-MGMT LICENSE QTY 4=IC	XT	\$0
X02-MNGT-04-U	XTREMIO-MGMT LICENSE QTY 4 UPG=IC	XT	\$0
X02-MNGT-04-U-CF	XTREMIO-MGMT LICENSE QTY 4 UPG=IC	XT	\$0
X02-MNGT-05	XtremIO-MGMT LICENSE QTY 5	XT	\$0
X02-MNGT-06	XtremIO-MGMT LICENSE QTY 6	XT	\$0
X02-MNGT-06-CF	XtremIO-MGMT LICENSE QTY 6=IC	XT	\$0
X02-MNGT-06-U	XtremIO-MGMT LICENSE QTY 6 UPG=IC	XT	\$0
X02-MNGT-06-U-CF	XtremIO-MGMT LICENSE QTY 6 UPG=IC	XT	\$0
X02-MNGT-07	XtremIO-MGMT LICENSE QTY 7	XT	\$0
X02-MNGT-08	XtremIO-MGMT LICENSE QTY 8	XT	\$0

X02-MNGT-08-CF	XtremIO-MGMT LICENSE QTY 8=IC	XT	\$0
X02-MNGT-08-U	XtremIO-MGMT LICENSE QTY 8 UPG=IC	XT	\$0
X02-MNGT-08-U-CF	XtremIO-MGMT LICENSE QTY 8 UPG=IC	XT	\$0
X02-MNGT-F	XtremIO - MGMT SERVER W/ SOFTWARE - FLD	XT	\$15,480
X02-MNGT-U	XTREMIO - MGMT SERVER W/ SW UPG	XT	\$15,480
X02-MNGT-UFD	XMS Field Upgrade	XT	\$15,480
X02-PW-ASTL	Power cord for Australia and New Zealand	XT	\$1,530
X02-PWD-ASTL-44U	Power cord for Australia and New Zealand	XT	\$2,400
X02-PWD-IEC3S-44U	Power cord for International (not Aus.)	XT	\$1,640
X02-PWD-RSS-44U	Power cord for North America & Japan	XT	\$1,800
X02-PWD-USS-44U	Power cord for North America & Japan	XT	\$830
X02-PW-IEC3S	International (except Australia)	XT	\$800
X02-PW-RSS	For North America & Japan	XT	\$1,530
X02-PW-USS	For North America & Japan	XT	\$800
X02-RACK-40U	XtremIO - 40U Cabinet	XT	\$3,915
X02-RACK-40U-BEAST	XtremIO - 40U Cabinet Beast fillers	XT	\$6,500
X02-RACK-44U	XtremIO - 44U Cabinet std fillers	XT	\$7,350
X02-RTU	XtremIO Right to Use- OE	XT	\$0
X02-RTU-CF	XtremIO Right to Use- OE=IC	XT	\$0
X02-RTU-U	XTREMIO RIGHT TO USE- OE UPG=IC	XT	\$0
X02-RTU-U-CF	XTREMIO RIGHT TO USE- OE UPG=IC	XT	\$0
X02-SCALE-100T-RTU	XtremIO Right to Use 100TB-HW	XT	\$0
X02-SCALE-10TE-RTU	XtremIO Right to Use 10TB Exp-HW	XT	\$255,000
X02-SCALE-30T-RTU	XtremIO Right to Use 30TB-HW	XT	\$0
X02-SCALE-50T-RTU	XtremIO Right to Use 50TB-HW	XT	\$0
X02-SCALE-60T-RTU	XtremIO Right to Use 60TB-HW	XT	\$0
X02-SCALE-90T-RTU	XtremIO Right to Use 90TB-HW	XT	\$0
X02-SINGLE-BEZ-KIT	XtremIO Std single Bezel Kit	XT	\$0
X02-TRANSFMR-U-FD	1800VA ISOLATION STATION	XT	\$9,950
X02-UPS-220	XtremIO - UPS 220V	XT	\$0
X02-UPS-220F	XtremIO - UPS 220V - FLD	XT	\$0
X02-UPS-220FP	XtremIO - UPS 220V - FLD - Secondary	XT	\$3,573
X02-UPS-220P	XtremIO - UPS 220V - Secondary	XT	\$3,573
X02-UPS-220-U	XTREMIO - UPS 220V UPG	XT	\$0
X02-UPS-220-UFD	XtremIO - UPS 220V - Field Upgrade	XT	\$0
X02-VRACK-FD	XtremIO VIRTUAL RACK (FIELD)	XT	\$0
X02-VRACK-U	XTREMIO - FIELD SHIPPING CONTAINER UPG	XT	\$0
X03-CTRLE-1600	XtremIO - STORAGE CTRL enc	XT	\$0
X03-CTRLE-1600-F	XtremIO - STORAGE CTRL 1.6TB enc fld	XT	\$0
X03-CTRLE-1600-T	XtremIO - STORAGE CTRL 1.6TB enc tag	XT	\$0
X03-CTRLE-1600-T-F	XtremIO - STORAGE CTRL 1.6TB enc tag fld	XT	\$0
X03-CTRLE-1600-U	XtremIO - STORAGE CTRL enc UPG	XT	\$0
X03-D25-1.6T-10T	XtremIO 25x1.6TB-10T FDrv enc OE SW	XT	\$0
X03-D25-1.6T-10T-F	XtremIO 25x1.6TB-10T FDrv enc OE SW fld	XT	\$0
X03-D25-1.6T-30T	XtremIO 25x1.6TB-30T FDrv enc OE SW	XT	\$0
X03-D25-1.6T-30T-F	XtremIO 25x1.6TB-30T FDrv enc OE SW fld	XT	\$0
X03-D25-1600-E	XtremIO 25x1.6TB Flash Drv enc OE SW	XT	\$0
X03-D25-1600-E-F	XtremIO 25x1.6TB Flash Drv enc fld OE SW	XT	\$926,000
X03-D25-1600-E-U	XtremIO 25x1.6TB Flash Drv enc UPG OE SW	XT	\$926,000
X03-SCALE-100T-RTU	XtremIO Right to Use 100TB-HW	XT	\$0

X03-SCALE-10TE-RTU	XtremIO Right to Use 10TB Exp-HW	XT	\$0
X03-SCALE-180T-RTU	XtremIO Right to Use 180TB-HW	XT	\$0
X03-SCALE-30T-RTU	XtremIO Right to Use 30TB-HW	XT	\$0
X03-SCALE-50T-RTU	XtremIO Right to Use 50TB-HW	XT	\$0
X03-SW-40TB-ENC	XTREMIO Software 40TB ENC Xbrick=IC	XT	\$0
X03-SW-40TB-ENC-CF	XTREMIO Software 40TB ENC Xbrick=IC	XT	\$477,000
XIO-RPHWX-G6T-D	Dell RPA for XtremIO	XT	\$19,250
XTREMIO-RP-HW-G5T	XtremIO-RP appliance GEN5-TAA	XT	\$0
XTREMIO-RP-HW-G6T	XtremIO-RP appliance GEN6-TAA	XT	\$19,250

Effective August 1, 2018

Product	Part Number
AA Cloud Trx Based	AAC-TXS-S-T1
AA Cloud Trx Based	AAC-TXS-S-T2
AA Cloud Trx Based	AAC-TXS-S-T3
AA Cloud Trx Based	AAC-TXS-S-T4
AA Cloud Trx Based	AAC-TXS-S-T5
AA Cloud Trx Based	AAC-TXS-S-T6
AA Cloud Trx Based	AAC-TXS-S-T7
AA Cloud Trx Based	AAC-TXS-S-T8
AA Cloud Trx Based	AAC-TXS-S-T9
AA Cloud Trx Based	AAC-TXS-S-T10
AA Cloud Trx Based	AAC-TXS-S-T11
AA Cloud Trx Based	AAC-TXS-S-T12
AA Cloud Trx Based	AAC-TXS-S-T13
AA Cloud Trx Based	AAC-TXS-S-T14
AA ENT on Prem	AAENTOP0003000
AA ENT on Prem	AAENTOP0004000
AA ENT on Prem	AAENTOP0005000
AA ENT on Prem	AAENTOP0007500
AA ENT on Prem	AAENTOP0010000
AA ENT on Prem	AAENTOP0015000
AA ENT on Prem	AAENTOP0020000
AA ENT on Prem	AAENTOP0025000
AA ENT on Prem	AAENTOP0050000
AA ENT on Prem	AAENTOP0075000
AA ENT on Prem	AAENTOP0100000
AA ENT on Prem	AAENTOP0100000P
AA ENT on Prem	AAENTOP0003000E1
AA ENT on Prem	AAENTOP0004000E1
AA ENT on Prem	AAENTOP0005000E1
AA ENT on Prem	AAENTOP0007500E1
AA ENT on Prem	AAENTOP0010000E1
AA ENT on Prem	AAENTOP0015000E1
AA ENT on Prem	AAENTOP0020000E1
AA ENT on Prem	AAENTOP0025000E1
AA ENT on Prem	AAENTOP0050000E1
AA ENT on Prem	AAENTOP0075000E1
AA ENT on Prem	AAENTOP0100000E1
AA ENT on Prem	AAENTOP0100000PE1
AA ENT on Prem	AAENTOP0003000T
AA ENT on Prem	AAENTOP0004000T
AA ENT on Prem	AAENTOP0005000T
AA ENT on Prem	AAENTOP0007500T
AA ENT on Prem	AAENTOP0010000T
AA ENT on Prem	AAENTOP0015000T
AA ENT on Prem	AAENTOP0020000T

AA ENT on Prem	AAENTOP0025000T
AA ENT on Prem	AAENTOP0050000T
AA ENT on Prem	AAENTOP0075000T
AA ENT on Prem	AAENTOP0100000T
AA ENT on Prem	AAENTOP0100000PT
AA ENT on Prem	AAENTDF0003000
AA ENT on Prem	AAENTDF0004000
AA ENT on Prem	AAENTDF0005000
AA ENT on Prem	AAENTDF0007500
AA ENT on Prem	AAENTDF0010000
AA ENT on Prem	AAENTDF0015000
AA ENT on Prem	AAENTDF0020000
AA ENT on Prem	AAENTDF0025000
AA ENT on Prem	AAENTDF0050000
AA ENT on Prem	AAENTDF0075000
AA ENT on Prem	AAENTDF0100000
AA ENT on Prem	AAENTDF0100000P
AA ENT on Prem	AAOPENT2C0020000
AA ENT on Prem	AAOPENT2C0050000
AA ENT on Prem	AAOPENT2C0100000
AA ENT on Prem	AAOPENT2C020000E1
AA ENT on Prem	AAOPENT2C050000E1
AA ENT on Prem	AAOPENT2C100000E1
AA on Prem 13.x	AAOPVU1C-T1
AA on Prem 13.x	AAOPVU1C-T2
AA on Prem 13.x	AAOPVU1C-T3
AA on Prem 13.x	AAOPVU1C-T4
AA on Prem 13.x	AAOPVU1C-T5
AA on Prem 13.x	AAOPVU1C-T6
AA on Prem 13.x	AAOPVU1C-T7
AA on Prem 13.x	AAOPVU1C-T8
AA on Prem 13.x	AAOPVU1C-T9
AA on Prem 13.x	AAOPVU1C-T10
AA on Prem 13.x	AAOPVU1C-T11
AA on Prem 13.x	AAOPVU1C-T12
AA on Prem 13.x	AAOPVU1C-T13
AA on Prem 13.x	AAOPVU1C-T14
AA on Prem 13.x	AAOPVU1C-T1-E1
AA on Prem 13.x	AAOPVU1C-T2-E1
AA on Prem 13.x	AAOPVU1C-T3-E1
AA on Prem 13.x	AAOPVU1C-T4-E1
AA on Prem 13.x	AAOPVU1C-T5-E1
AA on Prem 13.x	AAOPVU1C-T6-E1
AA on Prem 13.x	AAOPVU1C-T7-E1
AA on Prem 13.x	AAOPVU1C-T8-E1
AA on Prem 13.x	AAOPVU1C-T9-E1
AA on Prem 13.x	AAOPVU1C-T10-E1

AA on Prem 13.x	AAOPVU1C-T11-E1
AA on Prem 13.x	AAOPVU1C-T12-E1
AA on Prem 13.x	AAOPVU1C-T13-E1
AA on Prem 13.x	AAOPVU1C-T14-E1
AA on Prem 13.x	AAOPVU2C-T1
AA on Prem 13.x	AAOPVU2C-T2
AA on Prem 13.x	AAOPVU2C-T3
AA on Prem 13.x	AAOPVU2C-T4
AA on Prem 13.x	AAOPVU2C-T5
AA on Prem 13.x	AAOPVU2C-T6
AA on Prem 13.x	AAOPVU2C-T7
AA on Prem 13.x	AAOPVU2C-T8
AA on Prem 13.x	AAOPVU2C-T9
AA on Prem 13.x	AAOPVU2C-T10
AA on Prem 13.x	AAOPVU2C-T11
AA on Prem 13.x	AAOPVU2C-T12
AA on Prem 13.x	AAOPVU2C-T13
AA on Prem 13.x	AAOPVU2C-T14
AA on Prem 13.x	AAOPVU2C-T1-E1
AA on Prem 13.x	AAOPVU2C-T2-E1
AA on Prem 13.x	AAOPVU2C-T3-E1
AA on Prem 13.x	AAOPVU2C-T4-E1
AA on Prem 13.x	AAOPVU2C-T5-E1
AA on Prem 13.x	AAOPVU2C-T6-E1
AA on Prem 13.x	AAOPVU2C-T7-E1
AA on Prem 13.x	AAOPVU2C-T8-E1
AA on Prem 13.x	AAOPVU2C-T9-E1
AA on Prem 13.x	AAOPVU2C-T10-E1
AA on Prem 13.x	AAOPVU2C-T11-E1
AA on Prem 13.x	AAOPVU2C-T12-E1
AA on Prem 13.x	AAOPVU2C-T13-E1
AA on Prem 13.x	AAOPVU2C-T14-E1
AA on Prem 13.x	AAOPVUTM-T1
AA on Prem 13.x	AAOPVUTM-T2
AA on Prem 13.x	AAOPVUTM-T3
AA on Prem 13.x	AAOPVUTM-T4
AA on Prem 13.x	AAOPVUTM-T5
AA on Prem 13.x	AAOPVUTM-T6
AA on Prem 13.x	AAOPVUTM-T7
AA on Prem 13.x	AAOPVUTM-T8
AA on Prem 13.x	AAOPVUTM-T9
AA on Prem 13.x	AAOPVUTM-T10
AA on Prem 13.x	AAOPVUTM-T11
AA on Prem 13.x	AAOPVUTM-T12
AA on Prem 13.x	AAOPVUTM-T13
AA on Prem 13.x	AAOPVUTM-T14
AA on Prem 13.x	AAOPVUTM-T1-E1

AA on Prem 13.x	AAOPVUTM-T2-E1
AA on Prem 13.x	AAOPVUTM-T3-E1
AA on Prem 13.x	AAOPVUTM-T4-E1
AA on Prem 13.x	AAOPVUTM-T5-E1
AA on Prem 13.x	AAOPVUTM-T6-E1
AA on Prem 13.x	AAOPVUTM-T7-E1
AA on Prem 13.x	AAOPVUTM-T8-E1
AA on Prem 13.x	AAOPVUTM-T9-E1
AA on Prem 13.x	AAOPVUTM-T10-E1
AA on Prem 13.x	AAOPVUTM-T11-E1
AA on Prem 13.x	AAOPVUTM-T12-E1
AA on Prem 13.x	AAOPVUTM-T13-E1
AA on Prem 13.x	AAOPVUTM-T14-E1
AA on Prem 13.x	AAOPVUTXS-T1
AA on Prem 13.x	AAOPVUTXS-T2
AA on Prem 13.x	AAOPVUTXS-T3
AA on Prem 13.x	AAOPVUTXS-T4
AA on Prem 13.x	AAOPVUTXS-T5
AA on Prem 13.x	AAOPVUTXS-T6
AA on Prem 13.x	AAOPVUTXS-T7
AA on Prem 13.x	AAOPVUTXS-T8
AA on Prem 13.x	AAOPVUTXS-T9
AA on Prem 13.x	AAOPVUTXS-T10
AA on Prem 13.x	AAOPVUTXS-T11
AA on Prem 13.x	AAOPVUTXS-T12
AA on Prem 13.x	AAOPVUTXS-T13
AA on Prem 13.x	AAOPVUTXS-T14
AA on Prem 13.x	AAOPVUTXS-T1-E1
AA on Prem 13.x	AAOPVUTXS-T2-E1
AA on Prem 13.x	AAOPVUTXS-T3-E1
AA on Prem 13.x	AAOPVUTXS-T4-E1
AA on Prem 13.x	AAOPVUTXS-T5-E1
AA on Prem 13.x	AAOPVUTXS-T6-E1
AA on Prem 13.x	AAOPVUTXS-T7-E1
AA on Prem 13.x	AAOPVUTXS-T8-E1
AA on Prem 13.x	AAOPVUTXS-T9-E1
AA on Prem 13.x	AAOPVUTXS-T10-E1
AA on Prem 13.x	AAOPVUTXS-T11-E1
AA on Prem 13.x	AAOPVUTXS-T12-E1
AA on Prem 13.x	AAOPVUTXS-T13-E1
AA on Prem 13.x	AAOPVUTXS-T14-E1
AA on Prem 13.x	AAOPVUEFN-T1
AA on Prem 13.x	AAOPVUEFN-T2
AA on Prem 13.x	AAOPVUEFN-T3
AA on Prem 13.x	AAOPVUEFN-T4
AA on Prem 13.x	AAOPVUEFN-T5
AA on Prem 13.x	AAOPVUEFN-T6

AA on Prem 13.x	AAOPVUEFN-T7
AA on Prem 13.x	AAOPVUEFN-T8
AA on Prem 13.x	AAOPVUEFN-T9
AA on Prem 13.x	AAOPVUEFN-T10
AA on Prem 13.x	AAOPVUEFN-T11
AA on Prem 13.x	AAOPVUEFN-T12
AA on Prem 13.x	AAOPVUEFN-T13
AA on Prem 13.x	AAOPVUEFN-T14
AA on Prem 13.x	AAOPVU1C-S-T1
AA on Prem 13.x	AAOPVU1C-S-T2
AA on Prem 13.x	AAOPVU1C-S-T3
AA on Prem 13.x	AAOPVU1C-S-T4
AA on Prem 13.x	AAOPVU1C-S-T5
AA on Prem 13.x	AAOPVU1C-S-T6
AA on Prem 13.x	AAOPVU1C-S-T7
AA on Prem 13.x	AAOPVU1C-S-T8
AA on Prem 13.x	AAOPVU1C-S-T9
AA on Prem 13.x	AAOPVU1C-S-T10
AA on Prem 13.x	AAOPVU1C-S-T11
AA on Prem 13.x	AAOPVU1C-S-T12
AA on Prem 13.x	AAOPVU1C-S-T13
AA on Prem 13.x	AAOPVU1C-S-T14
AA on Prem 13.x	AAOPVU2C-S-T1
AA on Prem 13.x	AAOPVU2C-S-T2
AA on Prem 13.x	AAOPVU2C-S-T3
AA on Prem 13.x	AAOPVU2C-S-T4
AA on Prem 13.x	AAOPVU2C-S-T5
AA on Prem 13.x	AAOPVU2C-S-T6
AA on Prem 13.x	AAOPVU2C-S-T7
AA on Prem 13.x	AAOPVU2C-S-T8
AA on Prem 13.x	AAOPVU2C-S-T9
AA on Prem 13.x	AAOPVU2C-S-T10
AA on Prem 13.x	AAOPVU2C-S-T11
AA on Prem 13.x	AAOPVU2C-S-T12
AA on Prem 13.x	AAOPVU2C-S-T13
AA on Prem 13.x	AAOPVU2C-S-T14
AA on Prem 13.x	AAOPVUTM-S-T1
AA on Prem 13.x	AAOPVUTM-S-T2
AA on Prem 13.x	AAOPVUTM-S-T3
AA on Prem 13.x	AAOPVUTM-S-T4
AA on Prem 13.x	AAOPVUTM-S-T5
AA on Prem 13.x	AAOPVUTM-S-T6
AA on Prem 13.x	AAOPVUTM-S-T7
AA on Prem 13.x	AAOPVUTM-S-T8
AA on Prem 13.x	AAOPVUTM-S-T9
AA on Prem 13.x	AAOPVUTM-S-T10
AA on Prem 13.x	AAOPVUTM-S-T11

AA on Prem 13.x	AAOPVUTM-S-T12
AA on Prem 13.x	AAOPVUTM-S-T13
AA on Prem 13.x	AAOPVUTM-S-T14
AA on Prem 13.x	AAOPVUTXS-S-T1
AA on Prem 13.x	AAOPVUTXS-S-T2
AA on Prem 13.x	AAOPVUTXS-S-T3
AA on Prem 13.x	AAOPVUTXS-S-T4
AA on Prem 13.x	AAOPVUTXS-S-T5
AA on Prem 13.x	AAOPVUTXS-S-T6
AA on Prem 13.x	AAOPVUTXS-S-T7
AA on Prem 13.x	AAOPVUTXS-S-T8
AA on Prem 13.x	AAOPVUTXS-S-T9
AA on Prem 13.x	AAOPVUTXS-S-T10
AA on Prem 13.x	AAOPVUTXS-S-T11
AA on Prem 13.x	AAOPVUTXS-S-T12
AA on Prem 13.x	AAOPVUTXS-S-T13
AA on Prem 13.x	AAOPVUTXS-S-T14
AA on Prem 13.x	AAOPVU1CBTM-T1
AA on Prem 13.x	AAOPVU1CBTM-T2
AA on Prem 13.x	AAOPVU1CBTM-T3
AA on Prem 13.x	AAOPVU1CBTM-T4
AA on Prem 13.x	AAOPVU1CBTM-T5
AA on Prem 13.x	AAOPVU1CBTM-T6
AA on Prem 13.x	AAOPVU1CBTM-T7
AA on Prem 13.x	AAOPVU1CBTM-T8
AA on Prem 13.x	AAOPVU1CBTM-T9
AA on Prem 13.x	AAOPVU1CBTM-T10
AA on Prem 13.x	AAOPVU1CBTM-T11
AA on Prem 13.x	AAOPVU1CBTM-T12
AA on Prem 13.x	AAOPVU1CBTM-T13
AA on Prem 13.x	AAOPVU1CBTM-T14
AA on Prem 13.x	AAOPVU1CBTMUPG-T1
AA on Prem 13.x	AAOPVU1CBTMUPG-T2
AA on Prem 13.x	AAOPVU1CBTMUPG-T3
AA on Prem 13.x	AAOPVU1CBTMUPG-T4
AA on Prem 13.x	AAOPVU1CBTMUPG-T5
AA on Prem 13.x	AAOPVU1CBTMUPG-T6
AA on Prem 13.x	AAOPVU1CBTMUPG-T7
AA on Prem 13.x	AAOPVU1CBTMUPG-T8
AA on Prem 13.x	AAOPVU1CBTMUPG-T9
AA on Prem 13.x	AAOPVU1CBTMUPG-T10
AA on Prem 13.x	AAOPVU1CBTMUPG-T11
AA on Prem 13.x	AAOPVU1CBTMUPG-T12
AA on Prem 13.x	AAOPVU1CBTMUPG-T13
AA on Prem 13.x	AAOPVU1CBTMUPG-T14
AA on Prem 13.x	AAOPVU1CBTM-T1-E1
AA on Prem 13.x	AAOPVU1CBTM-T2-E1

AA on Prem 13.x	AAOPVU1CBTM-T3-E1
AA on Prem 13.x	AAOPVU1CBTM-T4-E1
AA on Prem 13.x	AAOPVU1CBTM-T5-E1
AA on Prem 13.x	AAOPVU1CBTM-T6-E1
AA on Prem 13.x	AAOPVU1CBTM-T7-E1
AA on Prem 13.x	AAOPVU1CBTM-T8-E1
AA on Prem 13.x	AAOPVU1CBTM-T9-E1
AA on Prem 13.x	AAOPVU1CBTM-T10-E1
AA on Prem 13.x	AAOPVU1CBTM-T11-E1
AA on Prem 13.x	AAOPVU1CBTM-T12-E1
AA on Prem 13.x	AAOPVU1CBTM-T13-E1
AA on Prem 13.x	AAOPVU1CBTM-T14-E1
AA on Prem 13.x	AAOPVU1CBTM-S-T1
AA on Prem 13.x	AAOPVU1CBTM-S-T2
AA on Prem 13.x	AAOPVU1CBTM-S-T3
AA on Prem 13.x	AAOPVU1CBTM-S-T4
AA on Prem 13.x	AAOPVU1CBTM-S-T5
AA on Prem 13.x	AAOPVU1CBTM-S-T6
AA on Prem 13.x	AAOPVU1CBTM-S-T7
AA on Prem 13.x	AAOPVU1CBTM-S-T8
AA on Prem 13.x	AAOPVU1CBTM-S-T9
AA on Prem 13.x	AAOPVU1CBTM-S-T10
AA on Prem 13.x	AAOPVU1CBTM-S-T11
AA on Prem 13.x	AAOPVU1CBTM-S-T12
AA on Prem 13.x	AAOPVU1CBTM-S-T13
AA on Prem 13.x	AAOPVU1CBTM-S-T14
AA on Prem 7.3 & Lower	AAOP0020000
AA on Prem 7.3 & Lower	AAOP0050000
AA on Prem 7.3 & Lower	AAOP0100000
AA on Prem 7.3 & Lower	AAOP0200000
AA on Prem 7.3 & Lower	AAOP0400000
AA on Prem 7.3 & Lower	AAOP0600000
AA on Prem 7.3 & Lower	AAOP0800000
AA on Prem 7.3 & Lower	AAOP1000000
AA on Prem 7.3 & Lower	AAOP1500000
AA on Prem 7.3 & Lower	AAOP2000000
AA on Prem 7.3 & Lower	AAOP3000000
AA on Prem 7.3 & Lower	AAOP4000000
AA on Prem 7.3 & Lower	AAOP5000000
AA on Prem 7.3 & Lower	AAOP7500000
AA on Prem 7.3 & Lower	AAOP0020000E1
AA on Prem 7.3 & Lower	AAOP0050000E1
AA on Prem 7.3 & Lower	AAOP00100000E1
AA on Prem 7.3 & Lower	AAOP00200000E1
AA on Prem 7.3 & Lower	AAOP00400000E1
AA on Prem 7.3 & Lower	AAOP00600000E1
AA on Prem 7.3 & Lower	AAOP00800000E1

AA on Prem 7.3 & Lower	AAOP001000000E1
AA on Prem 7.3 & Lower	AAOP001500000E1
AA on Prem 7.3 & Lower	AAOP002000000E1
AA on Prem 7.3 & Lower	AAOP003000000E1
AA on Prem 7.3 & Lower	AAOP004000000E1
AA on Prem 7.3 & Lower	AAOP005000000E1
AA on Prem 7.3 & Lower	AAOP007500000E1
AA on Prem 7.3 & Lower	AAOP0020000T
AA on Prem 7.3 & Lower	AAOP0050000T
AA on Prem 7.3 & Lower	AAOP0100000T
AA on Prem 7.3 & Lower	AAOP0200000T
AA on Prem 7.3 & Lower	AAOP0400000T
AA on Prem 7.3 & Lower	AAOP0600000T
AA on Prem 7.3 & Lower	AAOP0800000T
AA on Prem 7.3 & Lower	AAOP1000000T
AA on Prem 7.3 & Lower	AAOP1500000T
AA on Prem 7.3 & Lower	AAOP2000000T
AA on Prem 7.3 & Lower	AAOP3000000T
AA on Prem 7.3 & Lower	AAOP4000000T
AA on Prem 7.3 & Lower	AAOP5000000T
AA on Prem 7.3 & Lower	AAOP7500000T
AA on Prem 7.3 & Lower	AADF0020000
AA on Prem 7.3 & Lower	AADF0050000
AA on Prem 7.3 & Lower	AADF0100000
AA on Prem 7.3 & Lower	AADF0200000
AA on Prem 7.3 & Lower	AADF0400000
AA on Prem 7.3 & Lower	AADF0600000
AA on Prem 7.3 & Lower	AADF0800000
AA on Prem 7.3 & Lower	AADF1000000
AA on Prem 7.3 & Lower	AADF1500000
AA on Prem 7.3 & Lower	AADF2000000
AA on Prem 7.3 & Lower	AADF3000000
AA on Prem 7.3 & Lower	AADF4000000
AA on Prem 7.3 & Lower	AADF5000000
AA on Prem 7.3 & Lower	AADF7500000
AA on Prem 7.3 & Lower	AAOP2C0020000T
AA on Prem 7.3 & Lower	AAOP2C0050000T
AA on Prem 7.3 & Lower	AAOP2C0100000T
AA on Prem 7.3 & Lower	AAOP2C0200000T
AA on Prem 7.3 & Lower	AAOP2C0400000T
AA on Prem 7.3 & Lower	AAOP2C0600000T
AA on Prem 7.3 & Lower	AAOP2C0800000T
AA on Prem 7.3 & Lower	AAOP2C1000000T
AA on Prem 7.3 & Lower	AAOP2C1500000T
AA on Prem 7.3 & Lower	AAOP2C2000000T
AA on Prem 7.3 & Lower	AAOP2C3000000T
AA on Prem 7.3 & Lower	AAOP2C4000000T

AA on Prem 7.3 & Lower	AAOP2C5000000T
AA on Prem 7.3 & Lower	AAOP2C7500000T
AA on Prem 7.3 & Lower	AAOP2C0020000
AA on Prem 7.3 & Lower	AAOP2C0050000
AA on Prem 7.3 & Lower	AAOP2C0100000
AA on Prem 7.3 & Lower	AAOP2C0200000
AA on Prem 7.3 & Lower	AAOP2C0400000
AA on Prem 7.3 & Lower	AAOP2C0600000
AA on Prem 7.3 & Lower	AAOP2C0800000
AA on Prem 7.3 & Lower	AAOP2C1000000
AA on Prem 7.3 & Lower	AAOP2C1500000
AA on Prem 7.3 & Lower	AAOP2C2000000
AA on Prem 7.3 & Lower	AAOP2C3000000
AA on Prem 7.3 & Lower	AAOP2C4000000
AA on Prem 7.3 & Lower	AAOP2C5000000
AA on Prem 7.3 & Lower	AAOP2C7500000
AA on Prem 7.3 & Lower	AAOP2C0020000E1
AA on Prem 7.3 & Lower	AAOP2C0050000E1
AA on Prem 7.3 & Lower	AAOP2C00100000E1
AA on Prem 7.3 & Lower	AAOP2C00200000E1
AA on Prem 7.3 & Lower	AAOP2C00400000E1
AA on Prem 7.3 & Lower	AAOP2C00600000E1
AA on Prem 7.3 & Lower	AAOP2C00800000E1
AA on Prem 7.3 & Lower	AAOP2C001000000E1
AA on Prem 7.3 & Lower	AAOP2C001500000E1
AA on Prem 7.3 & Lower	AAOP2C002000000E1
AA on Prem 7.3 & Lower	AAOP2C003000000E1
AA on Prem 7.3 & Lower	AAOP2C004000000E1
AA on Prem 7.3 & Lower	AAOP2C005000000E1
AA on Prem 7.3 & Lower	AAOP2C007500000E1
AA on Prem 7.3 & Lower	AA-SAE-P-25
AA on Prem 7.3 & Lower	AA-SAE-P-100
AA on Prem 7.3 & Lower	AA-SAE-P-150
AA on Prem 7.3 & Lower	AA-SAE-P-250
AA on Prem 7.3 & Lower	AA-SAE-P-500
AA on Prem 7.3 & Lower	AA-SAE-P-750
AA on Prem 7.3 & Lower	AA-SAE-P-1500
AA on Prem 7.3 & Lower	AA-SAE-P-2500
AA on Prem 7.3 & Lower	AA-SAE-P-5K
AA on Prem 7.3 & Lower	AA-SAE-P-10K
AA on Prem 7.3 & Lower	AA-SAE-P-50K
AA on Prem 7.3 & Lower	AA-SAE-P-100K
AA on Prem 7.3 & Lower	AA-SAE-P-1M
AA on Prem 7.3 & Lower	AA-SAE-P-25-E1
AA on Prem 7.3 & Lower	AA-SAE-P-100-E1
AA on Prem 7.3 & Lower	AA-SAE-P-150-E1
AA on Prem 7.3 & Lower	AA-SAE-P-250-E1

AA on Prem 7.3 & Lower	AA-SAE-P-500-E1
AA on Prem 7.3 & Lower	AA-SAE-P-750-E1
AA on Prem 7.3 & Lower	AA-SAE-P-1500-E1
AA on Prem 7.3 & Lower	AA-SAE-P-2500-E1
AA on Prem 7.3 & Lower	AA-SAE-P-5K-E1
AA on Prem 7.3 & Lower	AA-SAE-P-10K-E1
AA on Prem 7.3 & Lower	AA-SAE-P-50K-E1
AA on Prem 7.3 & Lower	AA-SAE-P-100K-E1
AA on Prem 7.3 & Lower	AA-SAE-P-1M-E1
AA on Prem 7.3 & Lower	AAOP-TXS-P-T1
AA on Prem 7.3 & Lower	AAOP-TXS-P-T2
AA on Prem 7.3 & Lower	AAOP-TXS-P-T3
AA on Prem 7.3 & Lower	AAOP-TXS-P-T4
AA on Prem 7.3 & Lower	AAOP-TXS-P-T5
AA on Prem 7.3 & Lower	AAOP-TXS-P-T6
AA on Prem 7.3 & Lower	AAOP-TXS-P-T7
AA on Prem 7.3 & Lower	AAOP-TXS-P-T8
AA on Prem 7.3 & Lower	AAOP-TXS-P-T9
AA on Prem 7.3 & Lower	AAOP-TXS-P-T10
AA on Prem 7.3 & Lower	AAOP-TXS-P-T11
AA on Prem 7.3 & Lower	AAOP-TXS-P-T12
AA on Prem 7.3 & Lower	AAOP-TXS-P-T13
AA on Prem 7.3 & Lower	AAOP-TXS-P-T14
AA on Prem 7.3 & Lower	AAOP-TXS-T1-E1
AA on Prem 7.3 & Lower	AAOP-TXS-T2-E1
AA on Prem 7.3 & Lower	AAOP-TXS-T3-E1
AA on Prem 7.3 & Lower	AAOP-TXS-T4-E1
AA on Prem 7.3 & Lower	AAOP-TXS-T5-E1
AA on Prem 7.3 & Lower	AAOP-TXS-T6-E1
AA on Prem 7.3 & Lower	AAOP-TXS-T7-E1
AA on Prem 7.3 & Lower	AAOP-TXS-T8-E1
AA on Prem 7.3 & Lower	AAOP-TXS-T9-E1
AA on Prem 7.3 & Lower	AAOP-TXS-T10-E1
AA on Prem 7.3 & Lower	AAOP-TXS-T11-E1
AA on Prem 7.3 & Lower	AAOP-TXS-T12-E1
AA on Prem 7.3 & Lower	AAOP-TXS-T13-E1
AA on Prem 7.3 & Lower	AAOP-TXS-T14-E1
AA on Prem 7.3 & Lower	AAOP-TXS-S-T1
AA on Prem 7.3 & Lower	AAOP-TXS-S-T2
AA on Prem 7.3 & Lower	AAOP-TXS-S-T3
AA on Prem 7.3 & Lower	AAOP-TXS-S-T4
AA on Prem 7.3 & Lower	AAOP-TXS-S-T5
AA on Prem 7.3 & Lower	AAOP-TXS-S-T6
AA on Prem 7.3 & Lower	AAOP-TXS-S-T7
AA on Prem 7.3 & Lower	AAOP-TXS-S-T8
AA on Prem 7.3 & Lower	AAOP-TXS-S-T9
AA on Prem 7.3 & Lower	AAOP-TXS-S-T10

AA on Prem 7.3 & Lower	AAOP-TXS-S-T11
AA on Prem 7.3 & Lower	AAOP-TXS-S-T12
AA on Prem 7.3 & Lower	AAOP-TXS-S-T13
AA on Prem 7.3 & Lower	AAOP-TXS-S-T14
AA on Prem 7.3 & Lower	AAOPLEGSUB
AA on Prem 7.3 & Lower	AAOPLEGSUBWEB
AA on Prem 7.3 & Lower	AAOPLEGSUBMOB
AA-TM on Prem	AATMOP0020000
AA-TM on Prem	AATMOP0050000
AA-TM on Prem	AATMOP0100000
AA-TM on Prem	AATMOP0200000
AA-TM on Prem	AATMOP0400000
AA-TM on Prem	AATMOP0600000
AA-TM on Prem	AATMOP0800000
AA-TM on Prem	AATMOP1000000
AA-TM on Prem	AATMOP1500000
AA-TM on Prem	AATMOP2000000
AA-TM on Prem	AATMOP3000000
AA-TM on Prem	AATMOP4000000
AA-TM on Prem	AATMOP5000000
AA-TM on Prem	AATMOP7500000
AA-TM on Prem	AATMOPUPG0020000
AA-TM on Prem	AATMOPUPG0050000
AA-TM on Prem	AATMOPUPG0100000
AA-TM on Prem	AATMOPUPG0200000
AA-TM on Prem	AATMOPUPG0400000
AA-TM on Prem	AATMOPUPG0600000
AA-TM on Prem	AATMOPUPG0800000
AA-TM on Prem	AATMOPUPG1000000
AA-TM on Prem	AATMOPUPG1500000
AA-TM on Prem	AATMOPUPG2000000
AA-TM on Prem	AATMOPUPG3000000
AA-TM on Prem	AATMOPUPG4000000
AA-TM on Prem	AATMOPUPG5000000
AA-TM on Prem	AATMOPUPG7500000
AA-TM on Prem	AATMOP0020000E1
AA-TM on Prem	AATMOP0050000E1
AA-TM on Prem	AATMOP00100000E1
AA-TM on Prem	AATMOP00200000E1
AA-TM on Prem	AATMOP00400000E1
AA-TM on Prem	AATMOP00600000E1
AA-TM on Prem	AATMOP00800000E1
AA-TM on Prem	AATMOP001000000E1
AA-TM on Prem	AATMOP001500000E1
AA-TM on Prem	AATMOP002000000E1
AA-TM on Prem	AATMOP003000000E1
AA-TM on Prem	AATMOP004000000E1

AA-TM on Prem	AATMOP005000000E1
AA-TM on Prem	AATMOP007500000E1
AA-TM on Prem	AADF0020000
AA-TM on Prem	AADF0050000
AA-TM on Prem	AADF0100000
AA-TM on Prem	AADF0200000
AA-TM on Prem	AADF0400000
AA-TM on Prem	AADF0600000
AA-TM on Prem	AADF0800000
AA-TM on Prem	AADF1000000
AA-TM on Prem	AADF1500000
AA-TM on Prem	AADF2000000
AA-TM on Prem	AADF3000000
AA-TM on Prem	AADF4000000
AA-TM on Prem	AADF5000000
AA-TM on Prem	AADF7500000
AA-TM on Prem	AATM0020000T
AA-TM on Prem	AATM0050000T
AA-TM on Prem	AATM0100000T
AA-TM on Prem	AATM0200000T
AA-TM on Prem	AATM0400000T
AA-TM on Prem	AATM0600000T
AA-TM on Prem	AATM0800000T
AA-TM on Prem	AATM1000000T
AA-TM on Prem	AATM1500000T
AA-TM on Prem	AATM2000000T
AA-TM on Prem	AATM3000000T
AA-TM on Prem	AATM4000000T
AA-TM on Prem	AATM5000000T
AA-TM on Prem	AATM7500000T
AA-TM on Prem	AAOP2C0020000T
AA-TM on Prem	AAOP2C0050000T
AA-TM on Prem	AAOP2C0100000T
AA-TM on Prem	AAOP2C0200000T
AA-TM on Prem	AAOP2C0400000T
AA-TM on Prem	AAOP2C0600000T
AA-TM on Prem	AAOP2C0800000T
AA-TM on Prem	AAOP2C1000000T
AA-TM on Prem	AAOP2C1500000T
AA-TM on Prem	AAOP2C2000000T

AA-TM on Prem	AAOP2C3000000T
AA-TM on Prem	AAOP2C4000000T
AA-TM on Prem	AAOP2C5000000T
AA-TM on Prem	AAOP2C7500000T
AA-TM on Prem	AAOP2C0020000
AA-TM on Prem	AAOP2C0050000
AA-TM on Prem	AAOP2C0100000
AA-TM on Prem	AAOP2C0200000
AA-TM on Prem	AAOP2C0400000
AA-TM on Prem	AAOP2C0600000
AA-TM on Prem	AAOP2C0800000
AA-TM on Prem	AAOP2C1000000
AA-TM on Prem	AAOP2C1500000
AA-TM on Prem	AAOP2C2000000
AA-TM on Prem	AAOP2C3000000
AA-TM on Prem	AAOP2C4000000
AA-TM on Prem	AAOP2C5000000
AA-TM on Prem	AAOP2C7500000
AA-TM on Prem	AAOP2C0020000E1
AA-TM on Prem	AAOP2C0050000E1
AA-TM on Prem	AAOP2C00100000E1
AA-TM on Prem	AAOP2C00200000E1
AA-TM on Prem	AAOP2C00400000E1
AA-TM on Prem	AAOP2C00600000E1
AA-TM on Prem	AAOP2C00800000E1
AA-TM on Prem	AAOP2C001000000E1
AA-TM on Prem	AAOP2C001500000E1
AA-TM on Prem	AAOP2C002000000E1
AA-TM on Prem	AAOP2C003000000E1
AA-TM on Prem	AAOP2C004000000E1
AA-TM on Prem	AAOP2C005000000E1
AA-TM on Prem	AAOP2C007500000E1
Access Manager	AXM00001000E1
Access Manager	AXM00005000E1
Access Manager	AXM00010000E1
Access Manager	AXM00025000E1
Access Manager	AXM00050000E1
Access Manager	AXM00100000E1
Access Manager	AXM00250000E1
Access Manager	AXM00500000E1

Access Manager	AXM00750000E1
Access Manager	AXM01000000E1
Access Manager	AXM05000000E1
Access Manager	AXM25000000E1
Appliance 8.3	AMABDL000010
Appliance 8.3	AMABDL000025
Appliance 8.3	AMABDL000050
Appliance 8.3	AMABDL000100
Appliance 8.3	AMABDL000300
Appliance 8.3	AMABDL000500
Appliance 8.3	AMABDL001000
Appliance 8.3	AMVBDL000010
Appliance 8.3	AMVBDL000025
Appliance 8.3	AMVBDL000050
Appliance 8.3	AMVBDL000100
Appliance 8.3	AMVBDL000300
Appliance 8.3	AMVBDL000500
Appliance 8.3	AMVBDL001000
Appliance 8.3	RBAABDL000010
Appliance 8.3	RBAABDL000025
Appliance 8.3	RBAABDL000050
Appliance 8.3	RBAABDL000100
Appliance 8.3	RBAVBDL000010
Appliance 8.3	RBAVBDL000025
Appliance 8.3	RBAVBDL000050
Appliance 8.3	RBAVBDL000100
Appliance 8.3	RSA-80020504
Appliance 8.3	RSA-80020505
Appliance 8.3	RSA-80020514
Appliance 8.3	RSA-80020515
Appliance 8.3	SIDACC-A130-A
Appliance 8.3	SIDACC-A250-A
Appliance 8.3	SIDACC-A130-A-BR
Appliance 8.3	SIDACC-A250-A-BR
Archer	AUD-USER-T-MNT
Archer	AUD-1500-T-MNT
Archer	AUD-5K-T-MNT
Archer	AUD-40K-T-MNT
Archer	AUD-100K-T-MNT
Archer	AUD-G100K-T-MNT
Archer	AUD-GT100K-T-B1
Archer	BCM-USER-T-MNT
Archer	BCM-1500-T-MNT
Archer	BCM-5K-T-MNT
Archer	BCM-40K-T-MNT
Archer	BCM-100K-T-MNT
Archer	BCM-G100K-T-MNT

Archer	BCM-GT100K-T-B1
Archer	COM-USER-T-MNT
Archer	COM-1500-T-MNT
Archer	COM-5K-T-MNT
Archer	COM-40K-T-MNT
Archer	COM-100K-T-MNT
Archer	COM-G100K-T-MNT
Archer	COM-GT100K-T-B1
Archer	ENT-USER-T-MNT
Archer	ENT-1500-T-MNT
Archer	ENT-5K-T-MNT
Archer	ENT-40K-T-MNT
Archer	ENT-100K-T-MNT
Archer	ENT-G100K-T-MNT
Archer	ENT-GT100K-T-B1
Archer	FAA-USER-T-MNT
Archer	FAA-1500-T-MNT
Archer	FAA-5K-T-MNT
Archer	FAA-40K-T-MNT
Archer	FAA-100K-T-MNT
Archer	FAA-G100K-T-MNT
Archer	FAA-GT100K-T-B1
Archer	FCM-USER-T-MNT
Archer	FCM-1500-T-MNT
Archer	FCM-5K-T-MNT
Archer	FCM-40K-T-MNT
Archer	FCM-100K-T-MNT
Archer	FCM-G100K-T-MNT
Archer	FCM-GT100K-T-B1
Archer	INC-USER-T-MNT
Archer	INC-1500-T-MNT
Archer	INC-5K-T-MNT
Archer	INC-40K-T-MNT
Archer	INC-100K-T-MNT
Archer	INC-G100K-T-MNT
Archer	INC-GT100K-T-B1
Archer	POL-USER-T-MNT
Archer	POL-1500-T-MNT
Archer	POL-5K-T-MNT
Archer	POL-40K-T-MNT
Archer	POL-100K-T-MNT
Archer	POL-G100K-T-MNT
Archer	POL-GT100K-T-B1
Archer	RSK-USER-T-MNT
Archer	RSK-1500-T-MNT
Archer	RSK-5K-T-MNT
Archer	RSK-40K-T-MNT

Archer	RSK-100K-T-MNT
Archer	RSK-G100K-T-MNT
Archer	RSK-GT100K-T-B1
Archer	THR-USER-T-MNT
Archer	THR-1500-T-MNT
Archer	THR-5K-T-MNT
Archer	THR-40K-T-MNT
Archer	THR-100K-T-MNT
Archer	THR-G100K-T-MNT
Archer	THR-GT100K-T-B1
Archer	VEN-USER-T-MNT
Archer	VEN-1500-T-MNT
Archer	VEN-5K-T-MNT
Archer	VEN-40K-T-MNT
Archer	VEN-100K-T-MNT
Archer	VEN-G100K-T-MNT
Archer	VEN-GT100K-T-B1
Archer	ODA-USER-T-MNT
Archer	ODA-1500-T-MNT
Archer	ODA-5K-T-MNT
Archer	ODA-40K-T-MNT
Archer	ODA-100K-T-MNT
Archer	ODA-G100K-T-MNT
Archer	ODA-GT100K-T-B1
Archer	AUD-USER-T-MNT-E
Archer	AUD-1500-T-MNT-E
Archer	AUD-5K-T-MNT-E
Archer	AUD-40K-T-MNT-E
Archer	AUD-100K-T-MNT-E
Archer	AUD-G100K-T-MNT-E
Archer	AUD-GT100K-T-E1
Archer	BCM-USER-T-MNT-E
Archer	BCM-1500-T-MNT-E
Archer	BCM-5K-T-MNT-E
Archer	BCM-40K-T-MNT-E
Archer	BCM-100K-T-MNT-E
Archer	BCM-G100K-T-MNT-E
Archer	BCM-GT100K-T-E1
Archer	COM-USER-T-MNT-E
Archer	COM-1500-T-MNT-E
Archer	COM-5K-T-MNT-E
Archer	COM-40K-T-MNT-E
Archer	COM-100K-T-MNT-E
Archer	COM-G100K-T-MNT-E
Archer	COM-GT100K-T-E1
Archer	ENT-USER-T-MNT-E
Archer	ENT-1500-T-MNT-E

Archer	ENT-5K-T-MNT-E
Archer	ENT-40K-T-MNT-E
Archer	ENT-100K-T-MNT-E
Archer	ENT-G100K-T-MNT-E
Archer	ENT-GT100K-T-E1
Archer	FAA-USER-T-MNT-E
Archer	FAA-1500-T-MNT-E
Archer	FAA-5K-T-MNT-E
Archer	FAA-40K-T-MNT-E
Archer	FAA-100K-T-MNT-E
Archer	FAA-G100K-T-MNT-E
Archer	FAA-GT100K-T-E1
Archer	FCM-USER-T-MNT-E
Archer	FCM-1500-T-MNT-E
Archer	FCM-5K-T-MNT-E
Archer	FCM-40K-T-MNT-E
Archer	FCM-100K-T-MNT-E
Archer	FCM-G100K-T-MNT-E
Archer	FCM-GT100K-T-E1
Archer	INC-USER-T-MNT-E
Archer	INC-1500-T-MNT-E
Archer	INC-5K-T-MNT-E
Archer	INC-40K-T-MNT-E
Archer	INC-100K-T-MNT-E
Archer	INC-G100K-T-MNT-E
Archer	INC-GT100K-T-E1
Archer	POL-USER-T-MNT-E
Archer	POL-1500-T-MNT-E
Archer	POL-5K-T-MNT-E
Archer	POL-40K-T-MNT-E
Archer	POL-100K-T-MNT-E
Archer	POL-G100K-T-MNT-E
Archer	POL-GT100K-T-E1
Archer	RSK-USER-T-MNT-E
Archer	RSK-1500-T-MNT-E
Archer	RSK-5K-T-MNT-E
Archer	RSK-40K-T-MNT-E
Archer	RSK-100K-T-MNT-E
Archer	RSK-G100K-T-MNT-E
Archer	RSK-GT100K-T-E1
Archer	THR-USER-T-MNT-E
Archer	THR-1500-T-MNT-E
Archer	THR-5K-T-MNT-E
Archer	THR-40K-T-MNT-E
Archer	THR-100K-T-MNT-E
Archer	THR-G100K-T-MNT-E
Archer	THR-GT100K-T-E1

Archer	VEN-USER-T-MNT-E
Archer	VEN-1500-T-MNT-E
Archer	VEN-5K-T-MNT-E
Archer	VEN-40K-T-MNT-E
Archer	VEN-100K-T-MNT-E
Archer	VEN-G100K-T-MNT-E
Archer	VEN-GT100K-T-E1
Archer	ODA-USER-T-MNT-E
Archer	ODA-1500-T-MNT-E
Archer	ODA-5K-T-MNT-E
Archer	ODA-40K-T-MNT-E
Archer	ODA-100K-T-MNT-E
Archer	ODA-G100K-T-MNT-E
Archer	ODA-GT100K-T-E1
Archer	AUD-USER-P-MNT
Archer	AUD-1500-P-MNT
Archer	AUD-5K-P-MNT
Archer	AUD-40K-P-MNT
Archer	AUD-100K-P-MNT
Archer	AUD-G100K-P-MNT
Archer	AUD-GT100K-P-B1
Archer	BCM-USER-P-MNT
Archer	BCM-1500-P-MNT
Archer	BCM-5K-P-MNT
Archer	BCM-40K-P-MNT
Archer	BCM-100K-P-MNT
Archer	BCM-G100K-P-MNT
Archer	BCM-GT100K-P-B1
Archer	COM-USER-P-MNT
Archer	COM-1500-P-MNT
Archer	COM-5K-P-MNT
Archer	COM-40K-P-MNT
Archer	COM-100K-P-MNT
Archer	COM-G100K-P-MNT
Archer	COM-GT100K-P-B1
Archer	ENT-USER-P-MNT
Archer	ENT-1500-P-MNT
Archer	ENT-5K-P-MNT
Archer	ENT-40K-P-MNT
Archer	ENT-100K-P-MNT
Archer	ENT-G100K-P-MNT
Archer	ENT-GT100K-P-B1
Archer	FAA-USER-P-MNT
Archer	FAA-1500-P-MNT
Archer	FAA-5K-P-MNT
Archer	FAA-40K-P-MNT
Archer	FAA-100K-P-MNT

Archer	FAA-G100K-P-MNT
Archer	FAA-GT100K-P-B1
Archer	FCM-USER-P-MNT
Archer	FCM-1500-P-MNT
Archer	FCM-5K-P-MNT
Archer	FCM-40K-P-MNT
Archer	FCM-100K-P-MNT
Archer	FCM-G100K-P-MNT
Archer	FCM-GT100K-P-B1
Archer	INC-USER-P-MNT
Archer	INC-1500-P-MNT
Archer	INC-5K-P-MNT
Archer	INC-40K-P-MNT
Archer	INC-100K-P-MNT
Archer	INC-G100K-P-MNT
Archer	INC-GT100K-P-B1
Archer	POL-USER-P-MNT
Archer	POL-1500-P-MNT
Archer	POL-5K-P-MNT
Archer	POL-40K-P-MNT
Archer	POL-100K-P-MNT
Archer	POL-G100K-P-MNT
Archer	POL-GT100K-P-B1
Archer	RSK-USER-P-MNT
Archer	RSK-1500-P-MNT
Archer	RSK-5K-P-MNT
Archer	RSK-40K-P-MNT
Archer	RSK-100K-P-MNT
Archer	RSK-G100K-P-MNT
Archer	RSK-GT100K-P-B1
Archer	THR-USER-P-MNT
Archer	THR-1500-P-MNT
Archer	THR-5K-P-MNT
Archer	THR-40K-P-MNT
Archer	THR-100K-P-MNT
Archer	THR-G100K-P-MNT
Archer	THR-GT100K-P-B1
Archer	VEN-USER-P-MNT
Archer	VEN-1500-P-MNT
Archer	VEN-5K-P-MNT
Archer	VEN-40K-P-MNT
Archer	VEN-100K-P-MNT
Archer	VEN-G100K-P-MNT
Archer	VEN-GT100K-P-B1
Archer	ODA-USER-P-MNT
Archer	ODA-1500-P-MNT
Archer	ODA-5K-P-MNT

Archer	ODA-40K-P-MNT
Archer	ODA-100K-P-MNT
Archer	ODA-G100K-P-MNT
Archer	ODA-GT100K-P-B1
Archer	AUD-USER-P-MNT-E
Archer	AUD-1500-P-MNT-E
Archer	AUD-5K-P-MNT-E
Archer	AUD-40K-P-MNT-E
Archer	AUD-100K-P-MNT-E
Archer	AUD-G100K-P-MNT-E
Archer	AUD-GT100K-P-E1
Archer	BCM-USER-P-MNT-E
Archer	BCM-1500-P-MNT-E
Archer	BCM-5K-P-MNT-E
Archer	BCM-40K-P-MNT-E
Archer	BCM-100K-P-MNT-E
Archer	BCM-G100K-P-MNT-E
Archer	BCM-GT100K-P-E1
Archer	COM-USER-P-MNT-E
Archer	COM-1500-P-MNT-E
Archer	COM-5K-P-MNT-E
Archer	COM-40K-P-MNT-E
Archer	COM-100K-P-MNT-E
Archer	COM-G100K-P-MNT-E
Archer	COM-GT100K-P-E1
Archer	ENT-USER-P-MNT-E
Archer	ENT-1500-P-MNT-E
Archer	ENT-5K-P-MNT-E
Archer	ENT-40K-P-MNT-E
Archer	ENT-100K-P-MNT-E
Archer	ENT-G100K-P-MNT-E
Archer	ENT-GT100K-P-E1
Archer	FAA-USER-P-MNT-E
Archer	FAA-1500-P-MNT-E
Archer	FAA-5K-P-MNT-E
Archer	FAA-40K-P-MNT-E
Archer	FAA-100K-P-MNT-E
Archer	FAA-G100K-P-MNT-E
Archer	FAA-GT100K-P-E1
Archer	FCM-USER-P-MNT-E
Archer	FCM-1500-P-MNT-E
Archer	FCM-5K-P-MNT-E
Archer	FCM-40K-P-MNT-E
Archer	FCM-100K-P-MNT-E
Archer	FCM-G100K-P-MNT-E
Archer	FCM-GT100K-P-E1
Archer	INC-USER-P-MNT-E

Archer	INC-1500-P-MNT-E
Archer	INC-5K-P-MNT-E
Archer	INC-40K-P-MNT-E
Archer	INC-100K-P-MNT-E
Archer	INC-G100K-P-MNT-E
Archer	INC-GT100K-P-E1
Archer	POL-USER-P-MNT-E
Archer	POL-1500-P-MNT-E
Archer	POL-5K-P-MNT-E
Archer	POL-40K-P-MNT-E
Archer	POL-100K-P-MNT-E
Archer	POL-G100K-P-MNT-E
Archer	POL-GT100K-P-E1
Archer	RSK-USER-P-MNT-E
Archer	RSK-1500-P-MNT-E
Archer	RSK-5K-P-MNT-E
Archer	RSK-40K-P-MNT-E
Archer	RSK-100K-P-MNT-E
Archer	RSK-G100K-P-MNT-E
Archer	RSK-GT100K-P-E1
Archer	THR-USER-P-MNT-E
Archer	THR-1500-P-MNT-E
Archer	THR-5K-P-MNT-E
Archer	THR-40K-P-MNT-E
Archer	THR-100K-P-MNT-E
Archer	THR-G100K-P-MNT-E
Archer	THR-GT100K-P-E1
Archer	VEN-USER-P-MNT-E
Archer	VEN-1500-P-MNT-E
Archer	VEN-5K-P-MNT-E
Archer	VEN-40K-P-MNT-E
Archer	VEN-100K-P-MNT-E
Archer	VEN-G100K-P-MNT-E
Archer	VEN-GT100K-P-E1
Archer	ODA-USER-P-MNT-E
Archer	ODA-1500-P-MNT-E
Archer	ODA-5K-P-MNT-E
Archer	ODA-40K-P-MNT-E
Archer	ODA-100K-P-MNT-E
Archer	ODA-G100K-P-MNT-E
Archer	ODA-GT100K-P-E1
Archer	AUD-USER-P-MNT-UP
Archer	AUD-1500-P-MNT-UP
Archer	AUD-5K-P-MNT-UP
Archer	AUD-40K-P-MNT-UP
Archer	AUD-100K-P-MNT-UP
Archer	AUD-G100K-P-MNT-UP

Archer	AUD-GT100K-P-UP
Archer	BCM-USER-P-MNT-UP
Archer	BCM-1500-P-MNT-UP
Archer	BCM-5K-P-MNT-UP
Archer	BCM-40K-P-MNT-UP
Archer	BCM-100K-P-MNT-UP
Archer	BCM-G100K-P-MNT-UP
Archer	BCM-GT100K-P-UP
Archer	COM-USER-P-MNT-UP
Archer	COM-1500-P-MNT-UP
Archer	COM-5K-P-MNT-UP
Archer	COM-40K-P-MNT-UP
Archer	COM-100K-P-MNT-UP
Archer	COM-G100K-P-MNT-UP
Archer	COM-GT100K-P-UP
Archer	ENT-USER-P-MNT-UP
Archer	ENT-1500-P-MNT-UP
Archer	ENT-5K-P-MNT-UP
Archer	ENT-40K-P-MNT-UP
Archer	ENT-100K-P-MNT-UP
Archer	ENT-G100K-P-MNT-UP
Archer	ENT-GT100K-P-UP
Archer	FAA-USER-P-MNT-UP
Archer	FAA-1500-P-MNT-UP
Archer	FAA-5K-P-MNT-UP
Archer	FAA-40K-P-MNT-UP
Archer	FAA-100K-P-MNT-UP
Archer	FAA-G100K-P-MNT-UP
Archer	FAA-GT100K-P-UP
Archer	FCM-USER-P-MNT-UP
Archer	FCM-1500-P-MNT-UP
Archer	FCM-5K-P-MNT-UP
Archer	FCM-40K-P-MNT-UP
Archer	FCM-100K-P-MNT-UP
Archer	FCM-G100K-P-MNT-UP
Archer	FCM-GT100K-P-UP
Archer	INC-USER-P-MNT-UP
Archer	INC-1500-P-MNT-UP
Archer	INC-5K-P-MNT-UP
Archer	INC-40K-P-MNT-UP
Archer	INC-100K-P-MNT-UP
Archer	INC-G100K-P-MNT-UP
Archer	INC-GT100K-P-UP
Archer	POL-USER-P-MNT-UP
Archer	POL-1500-P-MNT-UP
Archer	POL-5K-P-MNT-UP
Archer	POL-40K-P-MNT-UP

Archer	POL-100K-P-MNT-UP
Archer	POL-G100K-P-MNT-UP
Archer	POL-GT100K-P-UP
Archer	RSK-USER-P-MNT-UP
Archer	RSK-1500-P-MNT-UP
Archer	RSK-5K-P-MNT-UP
Archer	RSK-40K-P-MNT-UP
Archer	RSK-100K-P-MNT-UP
Archer	RSK-G100K-P-MNT-UP
Archer	RSK-GT100K-P-UP
Archer	THR-USER-P-MNT-UP
Archer	THR-1500-P-MNT-UP
Archer	THR-5K-P-MNT-UP
Archer	THR-40K-P-MNT-UP
Archer	THR-100K-P-MNT-UP
Archer	THR-G100K-P-MNT-UP
Archer	THR-GT100K-P-UP
Archer	VEN-USER-P-MNT-UP
Archer	VEN-1500-P-MNT-UP
Archer	VEN-5K-P-MNT-UP
Archer	VEN-40K-P-MNT-UP
Archer	VEN-100K-P-MNT-UP
Archer	VEN-G100K-P-MNT-UP
Archer	VEN-GT100K-P-UP
Archer	ODA-USER-P-MNT-UP
Archer	ODA-1500-P-MNT-UP
Archer	ODA-5K-P-MNT-UP
Archer	ODA-40K-P-MNT-UP
Archer	ODA-100K-P-MNT-UP
Archer	ODA-G100K-P-MNT-UP
Archer	ODA-GT100K-P-UP
Archer	BLP-1M-PE-UP
Archer	AHS-NP-1M
Archer	AHS-10-1M
Archer	AHS-25-1M
Archer	AHS-75-1M
Archer	AHS-250-1M
Archer	AHS-500-1M
Archer	AHS-1000-1M
Archer	AHS-1000P-1M
Archer	SVR-OTHER-1M
Archer	AHS-MigFromHost
Archer	AHS-MigToHost
Archer	NONUSAHS-NP-1M
Archer	NONUS-10-1M
Archer	NONUS-25-1M
Archer	NONUS-75-1M

Archer	NONUS-250-1M
Archer	NONUS-500-1M
Archer	NONUS-1000-1M
Archer	NONUS-1000P-1M
Archer	NONUS-SVR-OTHER-1M
Archer	BLP-P
Archer	PS-BAS-ARC-SMART
Archer	PS-BAS-DLP-RRM
Archer	BLP-P
Archer	PS-BAS-ARC-SMART
Archer	PS-BAS-DLP-PWM
Archer	BLP-1M-PE
Archer	AI-EXT-INST-COM
Archer	AI-EXT-INST-COM-P
Archer	AI-NP-INST-COM
Archer	AI-NP-INST-COM-P
Archer	AI-EXT-INST-COM-M
Archer	AI-EXT-INST-COM-PM
Archer	AI-NP-INST-COM-M
Archer	AI-NP-INST-COM-P-M
Archer	AI-EXT-INST-COM-E
Archer	AI-EXT-INST-COM-PE
Archer	AI-NP-INST-COM-E
Archer	AI-NP-INST-COM-P-E
Archer	AI-EXT-1P-COM-T
Archer	AI-EXT-1P-COM-P
Archer	AI-EXT-1P-COM-T-M
Archer	AI-EXT-1P-COM-P-M
Archer	AI-EXT-1P-COM-T-EM
Archer	AI-EXT-1P-COM-P-EM
Archer	MOBILE TERM
Archer	MOBILE PERP
Archer	ARC-WN-HW
Archer	ARC-SWITCH
Archer	ARC-WN-SW
Archer	ARC-WN-HW-M1
Archer	ARC-SWITCH-M1
Archer	ARC-WN-SW-M1
Archer	ARC-WN-HW-EM1
Archer	ARC-SWITCH-EM1
Archer	ARC-WN-SW-EM1
Archer - Use Cases	GRC-ISSUE-S-T1
Archer - Use Cases	GRC-ISSUE-S-T2
Archer - Use Cases	GRC-ISSUE-S-T3
Archer - Use Cases	GRC-ISSUE-S-T4
Archer - Use Cases	GRC-ISSUE-S-T5
Archer - Use Cases	GRC-ISSUE-S-T6

Archer - Use Cases	GRC-ISSUE-S-T7
Archer - Use Cases	GRC-ISSUE-S-T8
Archer - Use Cases	GRC-INCD-S-T1
Archer - Use Cases	GRC-INCD-S-T2
Archer - Use Cases	GRC-INCD-S-T3
Archer - Use Cases	GRC-INCD-S-T4
Archer - Use Cases	GRC-INCD-S-T5
Archer - Use Cases	GRC-INCD-S-T6
Archer - Use Cases	GRC-INCD-S-T7
Archer - Use Cases	GRC-INCD-S-T8
Archer - Use Cases	GRC-BIA-S-T1
Archer - Use Cases	GRC-BIA-S-T2
Archer - Use Cases	GRC-BIA-S-T3
Archer - Use Cases	GRC-BIA-S-T4
Archer - Use Cases	GRC-BIA-S-T5
Archer - Use Cases	GRC-BIA-S-T6
Archer - Use Cases	GRC-BIA-S-T7
Archer - Use Cases	GRC-BIA-S-T8
Archer - Use Cases	GRC-AUDENG-S-T1
Archer - Use Cases	GRC-AUDENG-S-T2
Archer - Use Cases	GRC-AUDENG-S-T3
Archer - Use Cases	GRC-AUDENG-S-T4
Archer - Use Cases	GRC-AUDENG-S-T5
Archer - Use Cases	GRC-AUDENG-S-T6
Archer - Use Cases	GRC-AUDENG-S-T7
Archer - Use Cases	GRC-AUDENG-S-T8
Archer - Use Cases	GRC-AUDPLN-S-T1
Archer - Use Cases	GRC-AUDPLN-S-T2
Archer - Use Cases	GRC-AUDPLN-S-T3
Archer - Use Cases	GRC-AUDPLN-S-T4
Archer - Use Cases	GRC-AUDPLN-S-T5
Archer - Use Cases	GRC-AUDPLN-S-T6
Archer - Use Cases	GRC-AUDPLN-S-T7
Archer - Use Cases	GRC-AUDPLN-S-T8
Archer - Use Cases	GRC-RESMGNT-S-T1
Archer - Use Cases	GRC-RESMGNT-S-T2
Archer - Use Cases	GRC-RESMGNT-S-T3
Archer - Use Cases	GRC-RESMGNT-S-T4
Archer - Use Cases	GRC-RESMGNT-S-T5
Archer - Use Cases	GRC-RESMGNT-S-T6
Archer - Use Cases	GRC-RESMGNT-S-T7
Archer - Use Cases	GRC-RESMGNT-S-T8
Archer - Use Cases	GRC-SUPCTLG-S-T1
Archer - Use Cases	GRC-SUPCTLG-S-T2
Archer - Use Cases	GRC-SUPCTLG-S-T3
Archer - Use Cases	GRC-SUPCTLG-S-T4
Archer - Use Cases	GRC-SUPCTLG-S-T5

Archer - Use Cases	GRC-SUPCTLG-S-T6
Archer - Use Cases	GRC-SUPCTLG-S-T7
Archer - Use Cases	GRC-SUPCTLG-S-T8
Archer - Use Cases	GRC-SUPRSK-S-T1
Archer - Use Cases	GRC-SUPRSK-S-T2
Archer - Use Cases	GRC-SUPRSK-S-T3
Archer - Use Cases	GRC-SUPRSK-S-T4
Archer - Use Cases	GRC-SUPRSK-S-T5
Archer - Use Cases	GRC-SUPRSK-S-T6
Archer - Use Cases	GRC-SUPRSK-S-T7
Archer - Use Cases	GRC-SUPRSK-S-T8
Archer - Use Cases	GRC-SUPENG-S-T1
Archer - Use Cases	GRC-SUPENG-S-T2
Archer - Use Cases	GRC-SUPENG-S-T3
Archer - Use Cases	GRC-SUPENG-S-T4
Archer - Use Cases	GRC-SUPENG-S-T5
Archer - Use Cases	GRC-SUPENG-S-T6
Archer - Use Cases	GRC-SUPENG-S-T7
Archer - Use Cases	GRC-SUPENG-S-T8
Archer - Use Cases	GRC-SUPGOV-S-T1
Archer - Use Cases	GRC-SUPGOV-S-T2
Archer - Use Cases	GRC-SUPGOV-S-T3
Archer - Use Cases	GRC-SUPGOV-S-T4
Archer - Use Cases	GRC-SUPGOV-S-T5
Archer - Use Cases	GRC-SUPGOV-S-T6
Archer - Use Cases	GRC-SUPGOV-S-T7
Archer - Use Cases	GRC-SUPGOV-S-T8
Archer - Use Cases	GRC-POLICY-S-T1
Archer - Use Cases	GRC-POLICY-S-T2
Archer - Use Cases	GRC-POLICY-S-T3
Archer - Use Cases	GRC-POLICY-S-T4
Archer - Use Cases	GRC-POLICY-S-T5
Archer - Use Cases	GRC-POLICY-S-T6
Archer - Use Cases	GRC-POLICY-S-T7
Archer - Use Cases	GRC-POLICY-S-T8
Archer - Use Cases	GRC-OBLIGS-S-T1
Archer - Use Cases	GRC-OBLIGS-S-T2
Archer - Use Cases	GRC-OBLIGS-S-T3
Archer - Use Cases	GRC-OBLIGS-S-T4
Archer - Use Cases	GRC-OBLIGS-S-T5
Archer - Use Cases	GRC-OBLIGS-S-T6
Archer - Use Cases	GRC-OBLIGS-S-T7
Archer - Use Cases	GRC-OBLIGS-S-T8
Archer - Use Cases	GRC-ITCTRL-S-T1
Archer - Use Cases	GRC-ITCTRL-S-T2
Archer - Use Cases	GRC-ITCTRL-S-T3
Archer - Use Cases	GRC-ITCTRL-S-T4

Archer - Use Cases	GRC-ITCTRL-S-T5
Archer - Use Cases	GRC-ITCTRL-S-T6
Archer - Use Cases	GRC-ITCTRL-S-T7
Archer - Use Cases	GRC-ITCTRL-S-T8
Archer - Use Cases	GRC-VULMGT-S-T1
Archer - Use Cases	GRC-VULMGT-S-T2
Archer - Use Cases	GRC-VULMGT-S-T3
Archer - Use Cases	GRC-VULMGT-S-T4
Archer - Use Cases	GRC-VULMGT-S-T5
Archer - Use Cases	GRC-VULMGT-S-T6
Archer - Use Cases	GRC-VULMGT-S-T7
Archer - Use Cases	GRC-VULMGT-S-T8
Archer - Use Cases	GRC-ITRSK-S-T1
Archer - Use Cases	GRC-ITRSK-S-T2
Archer - Use Cases	GRC-ITRSK-S-T3
Archer - Use Cases	GRC-ITRSK-S-T4
Archer - Use Cases	GRC-ITRSK-S-T5
Archer - Use Cases	GRC-ITRSK-S-T6
Archer - Use Cases	GRC-ITRSK-S-T7
Archer - Use Cases	GRC-ITRSK-S-T8
Archer - Use Cases	GRC-SECINCD-S-T1
Archer - Use Cases	GRC-SECINCD-S-T2
Archer - Use Cases	GRC-SECINCD-S-T3
Archer - Use Cases	GRC-SECINCD-S-T4
Archer - Use Cases	GRC-SECINCD-S-T5
Archer - Use Cases	GRC-SECINCD-S-T6
Archer - Use Cases	GRC-SECINCD-S-T7
Archer - Use Cases	GRC-SECINCD-S-T8
Archer - Use Cases	GRC-SECBRCH-S-T1
Archer - Use Cases	GRC-SECBRCH-S-T2
Archer - Use Cases	GRC-SECBRCH-S-T3
Archer - Use Cases	GRC-SECBRCH-S-T4
Archer - Use Cases	GRC-SECBRCH-S-T5
Archer - Use Cases	GRC-SECBRCH-S-T6
Archer - Use Cases	GRC-SECBRCH-S-T7
Archer - Use Cases	GRC-SECBRCH-S-T8
Archer - Use Cases	GRC-CTRLPRG-S-T1
Archer - Use Cases	GRC-CTRLPRG-S-T2
Archer - Use Cases	GRC-CTRLPRG-S-T3
Archer - Use Cases	GRC-CTRLPRG-S-T4
Archer - Use Cases	GRC-CTRLPRG-S-T5
Archer - Use Cases	GRC-CTRLPRG-S-T6
Archer - Use Cases	GRC-CTRLPRG-S-T7
Archer - Use Cases	GRC-CTRLPRG-S-T8
Archer - Use Cases	GRC-CTRLMON-S-T1
Archer - Use Cases	GRC-CTRLMON-S-T2
Archer - Use Cases	GRC-CTRLMON-S-T3

Archer - Use Cases	GRC-CTRLMON-S-T4
Archer - Use Cases	GRC-CTRLMON-S-T5
Archer - Use Cases	GRC-CTRLMON-S-T6
Archer - Use Cases	GRC-CTRLMON-S-T7
Archer - Use Cases	GRC-CTRLMON-S-T8
Archer - Use Cases	GRC-RSKINV-S-T1
Archer - Use Cases	GRC-RSKINV-S-T2
Archer - Use Cases	GRC-RSKINV-S-T3
Archer - Use Cases	GRC-RSKINV-S-T4
Archer - Use Cases	GRC-RSKINV-S-T5
Archer - Use Cases	GRC-RSKINV-S-T6
Archer - Use Cases	GRC-RSKINV-S-T7
Archer - Use Cases	GRC-RSKINV-S-T8
Archer - Use Cases	GRC-LSSEVNT-S-T1
Archer - Use Cases	GRC-LSSEVNT-S-T2
Archer - Use Cases	GRC-LSSEVNT-S-T3
Archer - Use Cases	GRC-LSSEVNT-S-T4
Archer - Use Cases	GRC-LSSEVNT-S-T5
Archer - Use Cases	GRC-LSSEVNT-S-T6
Archer - Use Cases	GRC-LSSEVNT-S-T7
Archer - Use Cases	GRC-LSSEVNT-S-T8
Archer - Use Cases	GRC-KEYIND-S-T1
Archer - Use Cases	GRC-KEYIND-S-T2
Archer - Use Cases	GRC-KEYIND-S-T3
Archer - Use Cases	GRC-KEYIND-S-T4
Archer - Use Cases	GRC-KEYIND-S-T5
Archer - Use Cases	GRC-KEYIND-S-T6
Archer - Use Cases	GRC-KEYIND-S-T7
Archer - Use Cases	GRC-KEYIND-S-T8
Archer - Use Cases	GRC-BTUPRSK-S-T1
Archer - Use Cases	GRC-BTUPRSK-S-T2
Archer - Use Cases	GRC-BTUPRSK-S-T3
Archer - Use Cases	GRC-BTUPRSK-S-T4
Archer - Use Cases	GRC-BTUPRSK-S-T5
Archer - Use Cases	GRC-BTUPRSK-S-T6
Archer - Use Cases	GRC-BTUPRSK-S-T7
Archer - Use Cases	GRC-BTUPRSK-S-T8
Archer - Use Cases	GRC-OPSRSK-S-T1
Archer - Use Cases	GRC-OPSRSK-S-T2
Archer - Use Cases	GRC-OPSRSK-S-T3
Archer - Use Cases	GRC-OPSRSK-S-T4
Archer - Use Cases	GRC-OPSRSK-S-T5
Archer - Use Cases	GRC-OPSRSK-S-T6
Archer - Use Cases	GRC-OPSRSK-S-T7
Archer - Use Cases	GRC-OPSRSK-S-T8
Archer - Use Cases	GRC-FEDAA-S-T1
Archer - Use Cases	GRC-FEDAA-S-T2

Archer - Use Cases	GRC-FEDAA-S-T3
Archer - Use Cases	GRC-FEDAA-S-T4
Archer - Use Cases	GRC-FEDAA-S-T5
Archer - Use Cases	GRC-FEDAA-S-T6
Archer - Use Cases	GRC-FEDAA-S-T7
Archer - Use Cases	GRC-FEDAA-S-T8
Archer - Use Cases	GRC-FEDCM-S-T1
Archer - Use Cases	GRC-FEDCM-S-T2
Archer - Use Cases	GRC-FEDCM-S-T3
Archer - Use Cases	GRC-FEDCM-S-T4
Archer - Use Cases	GRC-FEDCM-S-T5
Archer - Use Cases	GRC-FEDCM-S-T6
Archer - Use Cases	GRC-FEDCM-S-T7
Archer - Use Cases	GRC-FEDCM-S-T8
Archer - Use Cases	GRC-ODA-S-T1
Archer - Use Cases	GRC-ODA-S-T2
Archer - Use Cases	GRC-ODA-S-T3
Archer - Use Cases	GRC-ODA-S-T4
Archer - Use Cases	GRC-ODA-S-T5
Archer - Use Cases	GRC-ODA-S-T6
Archer - Use Cases	GRC-ODA-S-T7
Archer - Use Cases	GRC-ODA-S-T8
Archer - Use Cases	GRC-CYBINBR-S-T1
Archer - Use Cases	GRC-CYBINBR-S-T2
Archer - Use Cases	GRC-CYBINBR-S-T3
Archer - Use Cases	GRC-CYBINBR-S-T4
Archer - Use Cases	GRC-CYBINBR-S-T5
Archer - Use Cases	GRC-CYBINBR-S-T6
Archer - Use Cases	GRC-CYBINBR-S-T7
Archer - Use Cases	GRC-CYBINBR-S-T8
Archer - Use Cases	GRC-ISSUE-P-T1
Archer - Use Cases	GRC-ISSUE-P-T2
Archer - Use Cases	GRC-ISSUE-P-T3
Archer - Use Cases	GRC-ISSUE-P-T4
Archer - Use Cases	GRC-ISSUE-P-T5
Archer - Use Cases	GRC-ISSUE-P-T6
Archer - Use Cases	GRC-ISSUE-P-T7
Archer - Use Cases	GRC-ISSUE-P-T8
Archer - Use Cases	GRC-INCD-P-T1
Archer - Use Cases	GRC-INCD-P-T2
Archer - Use Cases	GRC-INCD-P-T3
Archer - Use Cases	GRC-INCD-P-T4
Archer - Use Cases	GRC-INCD-P-T5
Archer - Use Cases	GRC-INCD-P-T6
Archer - Use Cases	GRC-INCD-P-T7
Archer - Use Cases	GRC-INCD-P-T8
Archer - Use Cases	GRC-BIA-P-T1

Archer - Use Cases	GRC-BIA-P-T2
Archer - Use Cases	GRC-BIA-P-T3
Archer - Use Cases	GRC-BIA-P-T4
Archer - Use Cases	GRC-BIA-P-T5
Archer - Use Cases	GRC-BIA-P-T6
Archer - Use Cases	GRC-BIA-P-T7
Archer - Use Cases	GRC-BIA-P-T8
Archer - Use Cases	GRC-AUDENG-P-T1
Archer - Use Cases	GRC-AUDENG-P-T2
Archer - Use Cases	GRC-AUDENG-P-T3
Archer - Use Cases	GRC-AUDENG-P-T4
Archer - Use Cases	GRC-AUDENG-P-T5
Archer - Use Cases	GRC-AUDENG-P-T6
Archer - Use Cases	GRC-AUDENG-P-T7
Archer - Use Cases	GRC-AUDENG-P-T8
Archer - Use Cases	GRC-AUDPLN-P-T1
Archer - Use Cases	GRC-AUDPLN-P-T2
Archer - Use Cases	GRC-AUDPLN-P-T3
Archer - Use Cases	GRC-AUDPLN-P-T4
Archer - Use Cases	GRC-AUDPLN-P-T5
Archer - Use Cases	GRC-AUDPLN-P-T6
Archer - Use Cases	GRC-AUDPLN-P-T7
Archer - Use Cases	GRC-AUDPLN-P-T8
Archer - Use Cases	GRC-RESMGNT-P-T1
Archer - Use Cases	GRC-RESMGNT-P-T2
Archer - Use Cases	GRC-RESMGNT-P-T3
Archer - Use Cases	GRC-RESMGNT-P-T4
Archer - Use Cases	GRC-RESMGNT-P-T5
Archer - Use Cases	GRC-RESMGNT-P-T6
Archer - Use Cases	GRC-RESMGNT-P-T7
Archer - Use Cases	GRC-RESMGNT-P-T8
Archer - Use Cases	GRC-SUPCTLG-P-T1
Archer - Use Cases	GRC-SUPCTLG-P-T2
Archer - Use Cases	GRC-SUPCTLG-P-T3
Archer - Use Cases	GRC-SUPCTLG-P-T4
Archer - Use Cases	GRC-SUPCTLG-P-T5
Archer - Use Cases	GRC-SUPCTLG-P-T6
Archer - Use Cases	GRC-SUPCTLG-P-T7
Archer - Use Cases	GRC-SUPCTLG-P-T8
Archer - Use Cases	GRC-SUPRSK-P-T1
Archer - Use Cases	GRC-SUPRSK-P-T2
Archer - Use Cases	GRC-SUPRSK-P-T3
Archer - Use Cases	GRC-SUPRSK-P-T4
Archer - Use Cases	GRC-SUPRSK-P-T5
Archer - Use Cases	GRC-SUPRSK-P-T6
Archer - Use Cases	GRC-SUPRSK-P-T7
Archer - Use Cases	GRC-SUPRSK-P-T8

Archer - Use Cases	GRC-SUPENG-P-T1
Archer - Use Cases	GRC-SUPENG-P-T2
Archer - Use Cases	GRC-SUPENG-P-T3
Archer - Use Cases	GRC-SUPENG-P-T4
Archer - Use Cases	GRC-SUPENG-P-T5
Archer - Use Cases	GRC-SUPENG-P-T6
Archer - Use Cases	GRC-SUPENG-P-T7
Archer - Use Cases	GRC-SUPENG-P-T8
Archer - Use Cases	GRC-SUPGOV-P-T1
Archer - Use Cases	GRC-SUPGOV-P-T2
Archer - Use Cases	GRC-SUPGOV-P-T3
Archer - Use Cases	GRC-SUPGOV-P-T4
Archer - Use Cases	GRC-SUPGOV-P-T5
Archer - Use Cases	GRC-SUPGOV-P-T6
Archer - Use Cases	GRC-SUPGOV-P-T7
Archer - Use Cases	GRC-SUPGOV-P-T8
Archer - Use Cases	GRC-POLICY-P-T1
Archer - Use Cases	GRC-POLICY-P-T2
Archer - Use Cases	GRC-POLICY-P-T3
Archer - Use Cases	GRC-POLICY-P-T4
Archer - Use Cases	GRC-POLICY-P-T5
Archer - Use Cases	GRC-POLICY-P-T6
Archer - Use Cases	GRC-POLICY-P-T7
Archer - Use Cases	GRC-POLICY-P-T8
Archer - Use Cases	GRC-OBLIGS-P-T1
Archer - Use Cases	GRC-OBLIGS-P-T2
Archer - Use Cases	GRC-OBLIGS-P-T3
Archer - Use Cases	GRC-OBLIGS-P-T4
Archer - Use Cases	GRC-OBLIGS-P-T5
Archer - Use Cases	GRC-OBLIGS-P-T6
Archer - Use Cases	GRC-OBLIGS-P-T7
Archer - Use Cases	GRC-OBLIGS-P-T8
Archer - Use Cases	GRC-ITCTRL-P-T1
Archer - Use Cases	GRC-ITCTRL-P-T2
Archer - Use Cases	GRC-ITCTRL-P-T3
Archer - Use Cases	GRC-ITCTRL-P-T4
Archer - Use Cases	GRC-ITCTRL-P-T5
Archer - Use Cases	GRC-ITCTRL-P-T6
Archer - Use Cases	GRC-ITCTRL-P-T7
Archer - Use Cases	GRC-ITCTRL-P-T8
Archer - Use Cases	GRC-VULMGT-P-T1
Archer - Use Cases	GRC-VULMGT-P-T2
Archer - Use Cases	GRC-VULMGT-P-T3
Archer - Use Cases	GRC-VULMGT-P-T4
Archer - Use Cases	GRC-VULMGT-P-T5
Archer - Use Cases	GRC-VULMGT-P-T6
Archer - Use Cases	GRC-VULMGT-P-T7

Archer - Use Cases	GRC-VULMGT-P-T8
Archer - Use Cases	GRC-ITRSK-P-T1
Archer - Use Cases	GRC-ITRSK-P-T2
Archer - Use Cases	GRC-ITRSK-P-T3
Archer - Use Cases	GRC-ITRSK-P-T4
Archer - Use Cases	GRC-ITRSK-P-T5
Archer - Use Cases	GRC-ITRSK-P-T6
Archer - Use Cases	GRC-ITRSK-P-T7
Archer - Use Cases	GRC-ITRSK-P-T8
Archer - Use Cases	GRC-SECINCD-P-T1
Archer - Use Cases	GRC-SECINCD-P-T2
Archer - Use Cases	GRC-SECINCD-P-T3
Archer - Use Cases	GRC-SECINCD-P-T4
Archer - Use Cases	GRC-SECINCD-P-T5
Archer - Use Cases	GRC-SECINCD-P-T6
Archer - Use Cases	GRC-SECINCD-P-T7
Archer - Use Cases	GRC-SECINCD-P-T8
Archer - Use Cases	GRC-SECBRCH-P-T1
Archer - Use Cases	GRC-SECBRCH-P-T2
Archer - Use Cases	GRC-SECBRCH-P-T3
Archer - Use Cases	GRC-SECBRCH-P-T4
Archer - Use Cases	GRC-SECBRCH-P-T5
Archer - Use Cases	GRC-SECBRCH-P-T6
Archer - Use Cases	GRC-SECBRCH-P-T7
Archer - Use Cases	GRC-SECBRCH-P-T8
Archer - Use Cases	GRC-CTRLPRG-P-T1
Archer - Use Cases	GRC-CTRLPRG-P-T2
Archer - Use Cases	GRC-CTRLPRG-P-T3
Archer - Use Cases	GRC-CTRLPRG-P-T4
Archer - Use Cases	GRC-CTRLPRG-P-T5
Archer - Use Cases	GRC-CTRLPRG-P-T6
Archer - Use Cases	GRC-CTRLPRG-P-T7
Archer - Use Cases	GRC-CTRLPRG-P-T8
Archer - Use Cases	GRC-CTRLMON-P-T1
Archer - Use Cases	GRC-CTRLMON-P-T2
Archer - Use Cases	GRC-CTRLMON-P-T3
Archer - Use Cases	GRC-CTRLMON-P-T4
Archer - Use Cases	GRC-CTRLMON-P-T5
Archer - Use Cases	GRC-CTRLMON-P-T6
Archer - Use Cases	GRC-CTRLMON-P-T7
Archer - Use Cases	GRC-CTRLMON-P-T8
Archer - Use Cases	GRC-RSKINV-P-T1
Archer - Use Cases	GRC-RSKINV-P-T2
Archer - Use Cases	GRC-RSKINV-P-T3
Archer - Use Cases	GRC-RSKINV-P-T4
Archer - Use Cases	GRC-RSKINV-P-T5
Archer - Use Cases	GRC-RSKINV-P-T6

Archer - Use Cases	GRC-RSKINV-P-T7
Archer - Use Cases	GRC-RSKINV-P-T8
Archer - Use Cases	GRC-LSSEVNT-P-T1
Archer - Use Cases	GRC-LSSEVNT-P-T2
Archer - Use Cases	GRC-LSSEVNT-P-T3
Archer - Use Cases	GRC-LSSEVNT-P-T4
Archer - Use Cases	GRC-LSSEVNT-P-T5
Archer - Use Cases	GRC-LSSEVNT-P-T6
Archer - Use Cases	GRC-LSSEVNT-P-T7
Archer - Use Cases	GRC-LSSEVNT-P-T8
Archer - Use Cases	GRC-KEYIND-P-T1
Archer - Use Cases	GRC-KEYIND-P-T2
Archer - Use Cases	GRC-KEYIND-P-T3
Archer - Use Cases	GRC-KEYIND-P-T4
Archer - Use Cases	GRC-KEYIND-P-T5
Archer - Use Cases	GRC-KEYIND-P-T6
Archer - Use Cases	GRC-KEYIND-P-T7
Archer - Use Cases	GRC-KEYIND-P-T8
Archer - Use Cases	GRC-BTUPRSK-P-T1
Archer - Use Cases	GRC-BTUPRSK-P-T2
Archer - Use Cases	GRC-BTUPRSK-P-T3
Archer - Use Cases	GRC-BTUPRSK-P-T4
Archer - Use Cases	GRC-BTUPRSK-P-T5
Archer - Use Cases	GRC-BTUPRSK-P-T6
Archer - Use Cases	GRC-BTUPRSK-P-T7
Archer - Use Cases	GRC-BTUPRSK-P-T8
Archer - Use Cases	GRC-OPSRSK-P-T1
Archer - Use Cases	GRC-OPSRSK-P-T2
Archer - Use Cases	GRC-OPSRSK-P-T3
Archer - Use Cases	GRC-OPSRSK-P-T4
Archer - Use Cases	GRC-OPSRSK-P-T5
Archer - Use Cases	GRC-OPSRSK-P-T6
Archer - Use Cases	GRC-OPSRSK-P-T7
Archer - Use Cases	GRC-OPSRSK-P-T8
Archer - Use Cases	GRC-FEDAA-P-T1
Archer - Use Cases	GRC-FEDAA-P-T2
Archer - Use Cases	GRC-FEDAA-P-T3
Archer - Use Cases	GRC-FEDAA-P-T4
Archer - Use Cases	GRC-FEDAA-P-T5
Archer - Use Cases	GRC-FEDAA-P-T6
Archer - Use Cases	GRC-FEDAA-P-T7
Archer - Use Cases	GRC-FEDAA-P-T8
Archer - Use Cases	GRC-FEDCM-P-T1
Archer - Use Cases	GRC-FEDCM-P-T2
Archer - Use Cases	GRC-FEDCM-P-T3
Archer - Use Cases	GRC-FEDCM-P-T4
Archer - Use Cases	GRC-FEDCM-P-T5

Archer - Use Cases	GRC-FEDCM-P-T6
Archer - Use Cases	GRC-FEDCM-P-T7
Archer - Use Cases	GRC-FEDCM-P-T8
Archer - Use Cases	GRC-ODA-P-T1
Archer - Use Cases	GRC-ODA-P-T2
Archer - Use Cases	GRC-ODA-P-T3
Archer - Use Cases	GRC-ODA-P-T4
Archer - Use Cases	GRC-ODA-P-T5
Archer - Use Cases	GRC-ODA-P-T6
Archer - Use Cases	GRC-ODA-P-T7
Archer - Use Cases	GRC-ODA-P-T8
Archer - Use Cases	GRC-BAC-S-T1
Archer - Use Cases	GRC-BAC-S-T2
Archer - Use Cases	GRC-BAC-S-T3
Archer - Use Cases	GRC-BAC-S-T4
Archer - Use Cases	GRC-BAC-S-T5
Archer - Use Cases	GRC-BAC-S-T6
Archer - Use Cases	GRC-BAC-S-T7
Archer - Use Cases	GRC-BAC-S-T8
Archer - Use Cases	GRC-BAC-P-T1
Archer - Use Cases	GRC-BAC-P-T2
Archer - Use Cases	GRC-BAC-P-T3
Archer - Use Cases	GRC-BAC-P-T4
Archer - Use Cases	GRC-BAC-P-T5
Archer - Use Cases	GRC-BAC-P-T6
Archer - Use Cases	GRC-BAC-P-T7
Archer - Use Cases	GRC-BAC-P-T8
Archer - Use Cases	GRC-ITAC-S-T1
Archer - Use Cases	GRC-ITAC-S-T2
Archer - Use Cases	GRC-ITAC-S-T3
Archer - Use Cases	GRC-ITAC-S-T4
Archer - Use Cases	GRC-ITAC-S-T5
Archer - Use Cases	GRC-ITAC-S-T6
Archer - Use Cases	GRC-ITAC-S-T7
Archer - Use Cases	GRC-ITAC-S-T8
Archer - Use Cases	GRC-ITAC-P-T1
Archer - Use Cases	GRC-ITAC-P-T2
Archer - Use Cases	GRC-ITAC-P-T3
Archer - Use Cases	GRC-ITAC-P-T4
Archer - Use Cases	GRC-ITAC-P-T5
Archer - Use Cases	GRC-ITAC-P-T6
Archer - Use Cases	GRC-ITAC-P-T7
Archer - Use Cases	GRC-ITAC-P-T8
Archer - Use Cases	GRC-BCDR-S-T1
Archer - Use Cases	GRC-BCDR-S-T2
Archer - Use Cases	GRC-BCDR-S-T3
Archer - Use Cases	GRC-BCDR-S-T4

Archer - Use Cases	GRC-BCDR-S-T5
Archer - Use Cases	GRC-BCDR-S-T6
Archer - Use Cases	GRC-BCDR-S-T7
Archer - Use Cases	GRC-BCDR-S-T8
Archer - Use Cases	GRC-BCDR-P-T1
Archer - Use Cases	GRC-BCDR-P-T2
Archer - Use Cases	GRC-BCDR-P-T3
Archer - Use Cases	GRC-BCDR-P-T4
Archer - Use Cases	GRC-BCDR-P-T5
Archer - Use Cases	GRC-BCDR-P-T6
Archer - Use Cases	GRC-BCDR-P-T7
Archer - Use Cases	GRC-BCDR-P-T8
Archer - Use Cases	GRC-PCI-S-T1
Archer - Use Cases	GRC-PCI-S-T2
Archer - Use Cases	GRC-PCI-S-T3
Archer - Use Cases	GRC-PCI-S-T4
Archer - Use Cases	GRC-PCI-S-T5
Archer - Use Cases	GRC-PCI-S-T6
Archer - Use Cases	GRC-PCI-S-T7
Archer - Use Cases	GRC-PCI-S-T8
Archer - Use Cases	GRC-PCI-P-T1
Archer - Use Cases	GRC-PCI-P-T2
Archer - Use Cases	GRC-PCI-P-T3
Archer - Use Cases	GRC-PCI-P-T4
Archer - Use Cases	GRC-PCI-P-T5
Archer - Use Cases	GRC-PCI-P-T6
Archer - Use Cases	GRC-PCI-P-T7
Archer - Use Cases	GRC-PCI-P-T8
Archer - Use Cases	GRC-ISMS-S-T1
Archer - Use Cases	GRC-ISMS-S-T2
Archer - Use Cases	GRC-ISMS-S-T3
Archer - Use Cases	GRC-ISMS-S-T4
Archer - Use Cases	GRC-ISMS-S-T5
Archer - Use Cases	GRC-ISMS-S-T6
Archer - Use Cases	GRC-ISMS-S-T7
Archer - Use Cases	GRC-ISMS-S-T8
Archer - Use Cases	GRC-ISMS-P-T1
Archer - Use Cases	GRC-ISMS-P-T2
Archer - Use Cases	GRC-ISMS-P-T3
Archer - Use Cases	GRC-ISMS-P-T4
Archer - Use Cases	GRC-ISMS-P-T5
Archer - Use Cases	GRC-ISMS-P-T6
Archer - Use Cases	GRC-ISMS-P-T7
Archer - Use Cases	GRC-ISMS-P-T8
Archer - Use Cases	GRC-RISKCAT-S-T1
Archer - Use Cases	GRC-RISKCAT-S-T2
Archer - Use Cases	GRC-RISKCAT-S-T3

Archer - Use Cases	GRC-RISKCAT-S-T4
Archer - Use Cases	GRC-RISKCAT-S-T5
Archer - Use Cases	GRC-RISKCAT-S-T6
Archer - Use Cases	GRC-RISKCAT-S-T7
Archer - Use Cases	GRC-RISKCAT-S-T8
Archer - Use Cases	GRC-RISKCAT-P-T1
Archer - Use Cases	GRC-RISKCAT-P-T2
Archer - Use Cases	GRC-RISKCAT-P-T3
Archer - Use Cases	GRC-RISKCAT-P-T4
Archer - Use Cases	GRC-RISKCAT-P-T5
Archer - Use Cases	GRC-RISKCAT-P-T6
Archer - Use Cases	GRC-RISKCAT-P-T7
Archer - Use Cases	GRC-RISKCAT-P-T8
Archer - Use Cases	GRC-POAM-S-T1
Archer - Use Cases	GRC-POAM-S-T2
Archer - Use Cases	GRC-POAM-S-T3
Archer - Use Cases	GRC-POAM-S-T4
Archer - Use Cases	GRC-POAM-S-T5
Archer - Use Cases	GRC-POAM-S-T6
Archer - Use Cases	GRC-POAM-S-T7
Archer - Use Cases	GRC-POAM-S-T8
Archer - Use Cases	GRC-POAM-P-T1
Archer - Use Cases	GRC-POAM-P-T2
Archer - Use Cases	GRC-POAM-P-T3
Archer - Use Cases	GRC-POAM-P-T4
Archer - Use Cases	GRC-POAM-P-T5
Archer - Use Cases	GRC-POAM-P-T6
Archer - Use Cases	GRC-POAM-P-T7
Archer - Use Cases	GRC-POAM-P-T8
Archer - Use Cases	GRC-DATAGOV-S-T1
Archer - Use Cases	GRC-DATAGOV-S-T2
Archer - Use Cases	GRC-DATAGOV-S-T3
Archer - Use Cases	GRC-DATAGOV-S-T4
Archer - Use Cases	GRC-DATAGOV-S-T5
Archer - Use Cases	GRC-DATAGOV-S-T6
Archer - Use Cases	GRC-DATAGOV-S-T7
Archer - Use Cases	GRC-DATAGOV-S-T8
Archer - Use Cases	GRC-DATAGOV-P-T1
Archer - Use Cases	GRC-DATAGOV-P-T2
Archer - Use Cases	GRC-DATAGOV-P-T3
Archer - Use Cases	GRC-DATAGOV-P-T4
Archer - Use Cases	GRC-DATAGOV-P-T5
Archer - Use Cases	GRC-DATAGOV-P-T6
Archer - Use Cases	GRC-DATAGOV-P-T7
Archer - Use Cases	GRC-DATAGOV-P-T8
Archer - Use Cases	GRC-PRVPROG-S-T1
Archer - Use Cases	GRC-PRVPROG-S-T2

Archer - Use Cases	GRC-PRVPROG-S-T3
Archer - Use Cases	GRC-PRVPROG-S-T4
Archer - Use Cases	GRC-PRVPROG-S-T5
Archer - Use Cases	GRC-PRVPROG-S-T6
Archer - Use Cases	GRC-PRVPROG-S-T7
Archer - Use Cases	GRC-PRVPROG-S-T8
Archer - Use Cases	GRC-PRVPROG-P-T1
Archer - Use Cases	GRC-PRVPROG-P-T2
Archer - Use Cases	GRC-PRVPROG-P-T3
Archer - Use Cases	GRC-PRVPROG-P-T4
Archer - Use Cases	GRC-PRVPROG-P-T5
Archer - Use Cases	GRC-PRVPROG-P-T6
Archer - Use Cases	GRC-PRVPROG-P-T7
Archer - Use Cases	GRC-PRVPROG-P-T8
Archer - Use Cases	GRC-CYBRKQNT-BASE
Archer - Use Cases	GRC-CYBRKQNT-S-T2
Archer - Use Cases	GRC-CYBRKQNT-S-T3
Archer - Use Cases	GRC-CYBRKQNT-S-T4
Archer - Use Cases	GRC-CYBRKQNT-S-T5
Archer - Use Cases	GRC-CYBRKQNT-S-T6
Archer - Use Cases	GRC-CYBRKQNT-S-T7
Archer - Use Cases	GRC-CYBRKQNT-S-T8
Archer - Use Cases	GRC-CYBINBR-P-T1
Archer - Use Cases	GRC-CYBINBR-P-T2
Archer - Use Cases	GRC-CYBINBR-P-T3
Archer - Use Cases	GRC-CYBINBR-P-T4
Archer - Use Cases	GRC-CYBINBR-P-T5
Archer - Use Cases	GRC-CYBINBR-P-T6
Archer - Use Cases	GRC-CYBINBR-P-T7
Archer - Use Cases	GRC-CYBINBR-P-T8
Archer - Use Cases	GRC-ISSUE-P-T1-B
Archer - Use Cases	GRC-ISSUE-P-T2-B
Archer - Use Cases	GRC-ISSUE-P-T3-B
Archer - Use Cases	GRC-ISSUE-P-T4-B
Archer - Use Cases	GRC-ISSUE-P-T5-B
Archer - Use Cases	GRC-ISSUE-P-T6-B
Archer - Use Cases	GRC-ISSUE-P-T7-B
Archer - Use Cases	GRC-ISSUE-P-T8-B
Archer - Use Cases	GRC-INCD-P-T1-B
Archer - Use Cases	GRC-INCD-P-T2-B
Archer - Use Cases	GRC-INCD-P-T3-B
Archer - Use Cases	GRC-INCD-P-T4-B
Archer - Use Cases	GRC-INCD-P-T5-B
Archer - Use Cases	GRC-INCD-P-T6-B
Archer - Use Cases	GRC-INCD-P-T7-B
Archer - Use Cases	GRC-INCD-P-T8-B
Archer - Use Cases	GRC-BIA-P-T1-B

Archer - Use Cases	GRC-BIA-P-T2-B
Archer - Use Cases	GRC-BIA-P-T3-B
Archer - Use Cases	GRC-BIA-P-T4-B
Archer - Use Cases	GRC-BIA-P-T5-B
Archer - Use Cases	GRC-BIA-P-T6-B
Archer - Use Cases	GRC-BIA-P-T7-B
Archer - Use Cases	GRC-BIA-P-T8-B
Archer - Use Cases	GRC-AUDENG-P-T1-B
Archer - Use Cases	GRC-AUDENG-P-T2-B
Archer - Use Cases	GRC-AUDENG-P-T3-B
Archer - Use Cases	GRC-AUDENG-P-T4-B
Archer - Use Cases	GRC-AUDENG-P-T5-B
Archer - Use Cases	GRC-AUDENG-P-T6-B
Archer - Use Cases	GRC-AUDENG-P-T7-B
Archer - Use Cases	GRC-AUDENG-P-T8-B
Archer - Use Cases	GRC-AUDPLN-P-T1-B
Archer - Use Cases	GRC-AUDPLN-P-T2-B
Archer - Use Cases	GRC-AUDPLN-P-T3-B
Archer - Use Cases	GRC-AUDPLN-P-T4-B
Archer - Use Cases	GRC-AUDPLN-P-T5-B
Archer - Use Cases	GRC-AUDPLN-P-T6-B
Archer - Use Cases	GRC-AUDPLN-P-T7-B
Archer - Use Cases	GRC-AUDPLN-P-T8-B
Archer - Use Cases	GRC-RESMGNT-P-T1-B
Archer - Use Cases	GRC-RESMGNT-P-T2-B
Archer - Use Cases	GRC-RESMGNT-P-T3-B
Archer - Use Cases	GRC-RESMGNT-P-T4-B
Archer - Use Cases	GRC-RESMGNT-P-T5-B
Archer - Use Cases	GRC-RESMGNT-P-T6-B
Archer - Use Cases	GRC-RESMGNT-P-T7-B
Archer - Use Cases	GRC-RESMGNT-P-T8-B
Archer - Use Cases	GRC-SUPCTLG-P-T1-B
Archer - Use Cases	GRC-SUPCTLG-P-T2-B
Archer - Use Cases	GRC-SUPCTLG-P-T3-B
Archer - Use Cases	GRC-SUPCTLG-P-T4-B
Archer - Use Cases	GRC-SUPCTLG-P-T5-B
Archer - Use Cases	GRC-SUPCTLG-P-T6-B
Archer - Use Cases	GRC-SUPCTLG-P-T7-B
Archer - Use Cases	GRC-SUPCTLG-P-T8-B
Archer - Use Cases	GRC-SUPRSK-P-T1-B
Archer - Use Cases	GRC-SUPRSK-P-T2-B
Archer - Use Cases	GRC-SUPRSK-P-T3-B
Archer - Use Cases	GRC-SUPRSK-P-T4-B
Archer - Use Cases	GRC-SUPRSK-P-T5-B
Archer - Use Cases	GRC-SUPRSK-P-T6-B
Archer - Use Cases	GRC-SUPRSK-P-T7-B
Archer - Use Cases	GRC-SUPRSK-P-T8-B

Archer - Use Cases	GRC-SUPENG-P-T1-B
Archer - Use Cases	GRC-SUPENG-P-T2-B
Archer - Use Cases	GRC-SUPENG-P-T3-B
Archer - Use Cases	GRC-SUPENG-P-T4-B
Archer - Use Cases	GRC-SUPENG-P-T5-B
Archer - Use Cases	GRC-SUPENG-P-T6-B
Archer - Use Cases	GRC-SUPENG-P-T7-B
Archer - Use Cases	GRC-SUPENG-P-T8-B
Archer - Use Cases	GRC-SUPGOV-P-T1-B
Archer - Use Cases	GRC-SUPGOV-P-T2-B
Archer - Use Cases	GRC-SUPGOV-P-T3-B
Archer - Use Cases	GRC-SUPGOV-P-T4-B
Archer - Use Cases	GRC-SUPGOV-P-T5-B
Archer - Use Cases	GRC-SUPGOV-P-T6-B
Archer - Use Cases	GRC-SUPGOV-P-T7-B
Archer - Use Cases	GRC-SUPGOV-P-T8-B
Archer - Use Cases	GRC-POLICY-P-T1-B
Archer - Use Cases	GRC-POLICY-P-T2-B
Archer - Use Cases	GRC-POLICY-P-T3-B
Archer - Use Cases	GRC-POLICY-P-T4-B
Archer - Use Cases	GRC-POLICY-P-T5-B
Archer - Use Cases	GRC-POLICY-P-T6-B
Archer - Use Cases	GRC-POLICY-P-T7-B
Archer - Use Cases	GRC-POLICY-P-T8-B
Archer - Use Cases	GRC-OBLIGS-P-T1-B
Archer - Use Cases	GRC-OBLIGS-P-T2-B
Archer - Use Cases	GRC-OBLIGS-P-T3-B
Archer - Use Cases	GRC-OBLIGS-P-T4-B
Archer - Use Cases	GRC-OBLIGS-P-T5-B
Archer - Use Cases	GRC-OBLIGS-P-T6-B
Archer - Use Cases	GRC-OBLIGS-P-T7-B
Archer - Use Cases	GRC-OBLIGS-P-T8-B
Archer - Use Cases	GRC-ITCTRL-P-T1-B
Archer - Use Cases	GRC-ITCTRL-P-T2-B
Archer - Use Cases	GRC-ITCTRL-P-T3-B
Archer - Use Cases	GRC-ITCTRL-P-T4-B
Archer - Use Cases	GRC-ITCTRL-P-T5-B
Archer - Use Cases	GRC-ITCTRL-P-T6-B
Archer - Use Cases	GRC-ITCTRL-P-T7-B
Archer - Use Cases	GRC-ITCTRL-P-T8-B
Archer - Use Cases	GRC-VULMGT-P-T1-B
Archer - Use Cases	GRC-VULMGT-P-T2-B
Archer - Use Cases	GRC-VULMGT-P-T3-B
Archer - Use Cases	GRC-VULMGT-P-T4-B
Archer - Use Cases	GRC-VULMGT-P-T5-B
Archer - Use Cases	GRC-VULMGT-P-T6-B
Archer - Use Cases	GRC-VULMGT-P-T7-B

Archer - Use Cases	GRC-VULMGT-P-T8-B
Archer - Use Cases	GRC-ITRSK-P-T1-B
Archer - Use Cases	GRC-ITRSK-P-T2-B
Archer - Use Cases	GRC-ITRSK-P-T3-B
Archer - Use Cases	GRC-ITRSK-P-T4-B
Archer - Use Cases	GRC-ITRSK-P-T5-B
Archer - Use Cases	GRC-ITRSK-P-T6-B
Archer - Use Cases	GRC-ITRSK-P-T7-B
Archer - Use Cases	GRC-ITRSK-P-T8-B
Archer - Use Cases	GRC-SECINCD-P-T1-B
Archer - Use Cases	GRC-SECINCD-P-T2-B
Archer - Use Cases	GRC-SECINCD-P-T3-B
Archer - Use Cases	GRC-SECINCD-P-T4-B
Archer - Use Cases	GRC-SECINCD-P-T5-B
Archer - Use Cases	GRC-SECINCD-P-T6-B
Archer - Use Cases	GRC-SECINCD-P-T7-B
Archer - Use Cases	GRC-SECINCD-P-T8-B
Archer - Use Cases	GRC-SECBRCH-P-T1-B
Archer - Use Cases	GRC-SECBRCH-P-T2-B
Archer - Use Cases	GRC-SECBRCH-P-T3-B
Archer - Use Cases	GRC-SECBRCH-P-T4-B
Archer - Use Cases	GRC-SECBRCH-P-T5-B
Archer - Use Cases	GRC-SECBRCH-P-T6-B
Archer - Use Cases	GRC-SECBRCH-P-T7-B
Archer - Use Cases	GRC-SECBRCH-P-T8-B
Archer - Use Cases	GRC-CTRLPRG-P-T1-B
Archer - Use Cases	GRC-CTRLPRG-P-T2-B
Archer - Use Cases	GRC-CTRLPRG-P-T3-B
Archer - Use Cases	GRC-CTRLPRG-P-T4-B
Archer - Use Cases	GRC-CTRLPRG-P-T5-B
Archer - Use Cases	GRC-CTRLPRG-P-T6-B
Archer - Use Cases	GRC-CTRLPRG-P-T7-B
Archer - Use Cases	GRC-CTRLPRG-P-T8-B
Archer - Use Cases	GRC-CTRLMON-P-T1-B
Archer - Use Cases	GRC-CTRLMON-P-T2-B
Archer - Use Cases	GRC-CTRLMON-P-T3-B
Archer - Use Cases	GRC-CTRLMON-P-T4-B
Archer - Use Cases	GRC-CTRLMON-P-T5-B
Archer - Use Cases	GRC-CTRLMON-P-T6-B
Archer - Use Cases	GRC-CTRLMON-P-T7-B
Archer - Use Cases	GRC-CTRLMON-P-T8-B
Archer - Use Cases	GRC-RSKINV-P-T1-B
Archer - Use Cases	GRC-RSKINV-P-T2-B
Archer - Use Cases	GRC-RSKINV-P-T3-B
Archer - Use Cases	GRC-RSKINV-P-T4-B
Archer - Use Cases	GRC-RSKINV-P-T5-B
Archer - Use Cases	GRC-RSKINV-P-T6-B

Archer - Use Cases	GRC-RSKINV-P-T7-B
Archer - Use Cases	GRC-RSKINV-P-T8-B
Archer - Use Cases	GRC-LSSEVNT-P-T1-B
Archer - Use Cases	GRC-LSSEVNT-P-T2-B
Archer - Use Cases	GRC-LSSEVNT-P-T3-B
Archer - Use Cases	GRC-LSSEVNT-P-T4-B
Archer - Use Cases	GRC-LSSEVNT-P-T5-B
Archer - Use Cases	GRC-LSSEVNT-P-T6-B
Archer - Use Cases	GRC-LSSEVNT-P-T7-B
Archer - Use Cases	GRC-LSSEVNT-P-T8-B
Archer - Use Cases	GRC-KEYIND-P-T1-B
Archer - Use Cases	GRC-KEYIND-P-T2-B
Archer - Use Cases	GRC-KEYIND-P-T3-B
Archer - Use Cases	GRC-KEYIND-P-T4-B
Archer - Use Cases	GRC-KEYIND-P-T5-B
Archer - Use Cases	GRC-KEYIND-P-T6-B
Archer - Use Cases	GRC-KEYIND-P-T7-B
Archer - Use Cases	GRC-KEYIND-P-T8-B
Archer - Use Cases	GRC-BTUPRSK-P-T1-B
Archer - Use Cases	GRC-BTUPRSK-P-T2-B
Archer - Use Cases	GRC-BTUPRSK-P-T3-B
Archer - Use Cases	GRC-BTUPRSK-P-T4-B
Archer - Use Cases	GRC-BTUPRSK-P-T5-B
Archer - Use Cases	GRC-BTUPRSK-P-T6-B
Archer - Use Cases	GRC-BTUPRSK-P-T7-B
Archer - Use Cases	GRC-BTUPRSK-P-T8-B
Archer - Use Cases	GRC-OPSRSK-P-T1-B
Archer - Use Cases	GRC-OPSRSK-P-T2-B
Archer - Use Cases	GRC-OPSRSK-P-T3-B
Archer - Use Cases	GRC-OPSRSK-P-T4-B
Archer - Use Cases	GRC-OPSRSK-P-T5-B
Archer - Use Cases	GRC-OPSRSK-P-T6-B
Archer - Use Cases	GRC-OPSRSK-P-T7-B
Archer - Use Cases	GRC-OPSRSK-P-T8-B
Archer - Use Cases	GRC-FEDAA-P-T1-B
Archer - Use Cases	GRC-FEDAA-P-T2-B
Archer - Use Cases	GRC-FEDAA-P-T3-B
Archer - Use Cases	GRC-FEDAA-P-T4-B
Archer - Use Cases	GRC-FEDAA-P-T5-B
Archer - Use Cases	GRC-FEDAA-P-T6-B
Archer - Use Cases	GRC-FEDAA-P-T7-B
Archer - Use Cases	GRC-FEDAA-P-T8-B
Archer - Use Cases	GRC-FEDCM-P-T1-B
Archer - Use Cases	GRC-FEDCM-P-T2-B
Archer - Use Cases	GRC-FEDCM-P-T3-B
Archer - Use Cases	GRC-FEDCM-P-T4-B
Archer - Use Cases	GRC-FEDCM-P-T5-B

Archer - Use Cases	GRC-FEDCM-P-T6-B
Archer - Use Cases	GRC-FEDCM-P-T7-B
Archer - Use Cases	GRC-FEDCM-P-T8-B
Archer - Use Cases	GRC-ODA-P-T1-B
Archer - Use Cases	GRC-ODA-P-T2-B
Archer - Use Cases	GRC-ODA-P-T3-B
Archer - Use Cases	GRC-ODA-P-T4-B
Archer - Use Cases	GRC-ODA-P-T5-B
Archer - Use Cases	GRC-ODA-P-T6-B
Archer - Use Cases	GRC-ODA-P-T7-B
Archer - Use Cases	GRC-ODA-P-T8-B
Archer - Use Cases	GRC-BAC-P-T1-B
Archer - Use Cases	GRC-BAC-P-T2-B
Archer - Use Cases	GRC-BAC-P-T3-B
Archer - Use Cases	GRC-BAC-P-T4-B
Archer - Use Cases	GRC-BAC-P-T5-B
Archer - Use Cases	GRC-BAC-P-T6-B
Archer - Use Cases	GRC-BAC-P-T7-B
Archer - Use Cases	GRC-BAC-P-T8-B
Archer - Use Cases	GRC-ITAC-P-T1-B
Archer - Use Cases	GRC-ITAC-P-T2-B
Archer - Use Cases	GRC-ITAC-P-T3-B
Archer - Use Cases	GRC-ITAC-P-T4-B
Archer - Use Cases	GRC-ITAC-P-T5-B
Archer - Use Cases	GRC-ITAC-P-T6-B
Archer - Use Cases	GRC-ITAC-P-T7-B
Archer - Use Cases	GRC-ITAC-P-T8-B
Archer - Use Cases	GRC-PCI-P-T1-B
Archer - Use Cases	GRC-PCI-P-T2-B
Archer - Use Cases	GRC-PCI-P-T3-B
Archer - Use Cases	GRC-PCI-P-T4-B
Archer - Use Cases	GRC-PCI-P-T5-B
Archer - Use Cases	GRC-PCI-P-T6-B
Archer - Use Cases	GRC-PCI-P-T7-B
Archer - Use Cases	GRC-PCI-P-T8-B
Archer - Use Cases	GRC-ISMS-P-T1-B
Archer - Use Cases	GRC-ISMS-P-T2-B
Archer - Use Cases	GRC-ISMS-P-T3-B
Archer - Use Cases	GRC-ISMS-P-T4-B
Archer - Use Cases	GRC-ISMS-P-T5-B
Archer - Use Cases	GRC-ISMS-P-T6-B
Archer - Use Cases	GRC-ISMS-P-T7-B
Archer - Use Cases	GRC-ISMS-P-T8-B
Archer - Use Cases	GRC-RISKCAT-P-T1-B
Archer - Use Cases	GRC-RISKCAT-P-T2-B
Archer - Use Cases	GRC-RISKCAT-P-T3-B
Archer - Use Cases	GRC-RISKCAT-P-T4-B

Archer - Use Cases	GRC-RISKCAT-P-T5-B
Archer - Use Cases	GRC-RISKCAT-P-T6-B
Archer - Use Cases	GRC-RISKCAT-P-T7-B
Archer - Use Cases	GRC-RISKCAT-P-T8-B
Archer - Use Cases	GRC-POAM-P-T1-B
Archer - Use Cases	GRC-POAM-P-T2-B
Archer - Use Cases	GRC-POAM-P-T3-B
Archer - Use Cases	GRC-POAM-P-T4-B
Archer - Use Cases	GRC-POAM-P-T5-B
Archer - Use Cases	GRC-POAM-P-T6-B
Archer - Use Cases	GRC-POAM-P-T7-B
Archer - Use Cases	GRC-POAM-P-T8-B
Archer - Use Cases	GRC-BCDR-P-T1-B
Archer - Use Cases	GRC-BCDR-P-T2-B
Archer - Use Cases	GRC-BCDR-P-T3-B
Archer - Use Cases	GRC-BCDR-P-T4-B
Archer - Use Cases	GRC-BCDR-P-T5-B
Archer - Use Cases	GRC-BCDR-P-T6-B
Archer - Use Cases	GRC-BCDR-P-T7-B
Archer - Use Cases	GRC-BCDR-P-T8-B
Archer - Use Cases	GRC-DATAGOV-P-T1-B
Archer - Use Cases	GRC-DATAGOV-P-T2-B
Archer - Use Cases	GRC-DATAGOV-P-T3-B
Archer - Use Cases	GRC-DATAGOV-P-T4-B
Archer - Use Cases	GRC-DATAGOV-P-T5-B
Archer - Use Cases	GRC-DATAGOV-P-T6-B
Archer - Use Cases	GRC-DATAGOV-P-T7-B
Archer - Use Cases	GRC-DATAGOV-P-T8-B
Archer - Use Cases	GRC-PRVPROG-P-T1-B
Archer - Use Cases	GRC-PRVPROG-P-T2-B
Archer - Use Cases	GRC-PRVPROG-P-T3-B
Archer - Use Cases	GRC-PRVPROG-P-T4-B
Archer - Use Cases	GRC-PRVPROG-P-T5-B
Archer - Use Cases	GRC-PRVPROG-P-T6-B
Archer - Use Cases	GRC-PRVPROG-P-T7-B
Archer - Use Cases	GRC-PRVPROG-P-T8-B
Archer - Use Cases	GRC-CYBINBR-P-T1-B
Archer - Use Cases	GRC-CYBINBR-P-T2-B
Archer - Use Cases	GRC-CYBINBR-P-T3-B
Archer - Use Cases	GRC-CYBINBR-P-T4-B
Archer - Use Cases	GRC-CYBINBR-P-T5-B
Archer - Use Cases	GRC-CYBINBR-P-T6-B
Archer - Use Cases	GRC-CYBINBR-P-T7-B
Archer - Use Cases	GRC-CYBINBR-P-T8-B
Archer - Use Cases	GRC-ISSUE-P-T1-E
Archer - Use Cases	GRC-ISSUE-P-T2-E
Archer - Use Cases	GRC-ISSUE-P-T3-E

Archer - Use Cases	GRC-ISSUE-P-T4-E
Archer - Use Cases	GRC-ISSUE-P-T5-E
Archer - Use Cases	GRC-ISSUE-P-T6-E
Archer - Use Cases	GRC-ISSUE-P-T7-E
Archer - Use Cases	GRC-ISSUE-P-T8-E
Archer - Use Cases	GRC-INCD-P-T1-E
Archer - Use Cases	GRC-INCD-P-T2-E
Archer - Use Cases	GRC-INCD-P-T3-E
Archer - Use Cases	GRC-INCD-P-T4-E
Archer - Use Cases	GRC-INCD-P-T5-E
Archer - Use Cases	GRC-INCD-P-T6-E
Archer - Use Cases	GRC-INCD-P-T7-E
Archer - Use Cases	GRC-INCD-P-T8-E
Archer - Use Cases	GRC-BIA-P-T1-E
Archer - Use Cases	GRC-BIA-P-T2-E
Archer - Use Cases	GRC-BIA-P-T3-E
Archer - Use Cases	GRC-BIA-P-T4-E
Archer - Use Cases	GRC-BIA-P-T5-E
Archer - Use Cases	GRC-BIA-P-T6-E
Archer - Use Cases	GRC-BIA-P-T7-E
Archer - Use Cases	GRC-BIA-P-T8-E
Archer - Use Cases	GRC-AUDENG-P-T1-E
Archer - Use Cases	GRC-AUDENG-P-T2-E
Archer - Use Cases	GRC-AUDENG-P-T3-E
Archer - Use Cases	GRC-AUDENG-P-T4-E
Archer - Use Cases	GRC-AUDENG-P-T5-E
Archer - Use Cases	GRC-AUDENG-P-T6-E
Archer - Use Cases	GRC-AUDENG-P-T7-E
Archer - Use Cases	GRC-AUDENG-P-T8-E
Archer - Use Cases	GRC-AUDPLN-P-T1-E
Archer - Use Cases	GRC-AUDPLN-P-T2-E
Archer - Use Cases	GRC-AUDPLN-P-T3-E
Archer - Use Cases	GRC-AUDPLN-P-T4-E
Archer - Use Cases	GRC-AUDPLN-P-T5-E
Archer - Use Cases	GRC-AUDPLN-P-T6-E
Archer - Use Cases	GRC-AUDPLN-P-T7-E
Archer - Use Cases	GRC-AUDPLN-P-T8-E
Archer - Use Cases	GRC-RESMGNT-P-T1-E
Archer - Use Cases	GRC-RESMGNT-P-T2-E
Archer - Use Cases	GRC-RESMGNT-P-T3-E
Archer - Use Cases	GRC-RESMGNT-P-T4-E
Archer - Use Cases	GRC-RESMGNT-P-T5-E
Archer - Use Cases	GRC-RESMGNT-P-T6-E
Archer - Use Cases	GRC-RESMGNT-P-T7-E
Archer - Use Cases	GRC-RESMGNT-P-T8-E
Archer - Use Cases	GRC-SUPCTLG-P-T1-E
Archer - Use Cases	GRC-SUPCTLG-P-T2-E

Archer - Use Cases	GRC-SUPCTLG-P-T3-E
Archer - Use Cases	GRC-SUPCTLG-P-T4-E
Archer - Use Cases	GRC-SUPCTLG-P-T5-E
Archer - Use Cases	GRC-SUPCTLG-P-T6-E
Archer - Use Cases	GRC-SUPCTLG-P-T7-E
Archer - Use Cases	GRC-SUPCTLG-P-T8-E
Archer - Use Cases	GRC-SUPRSK-P-T1-E
Archer - Use Cases	GRC-SUPRSK-P-T2-E
Archer - Use Cases	GRC-SUPRSK-P-T3-E
Archer - Use Cases	GRC-SUPRSK-P-T4-E
Archer - Use Cases	GRC-SUPRSK-P-T5-E
Archer - Use Cases	GRC-SUPRSK-P-T6-E
Archer - Use Cases	GRC-SUPRSK-P-T7-E
Archer - Use Cases	GRC-SUPRSK-P-T8-E
Archer - Use Cases	GRC-SUPENG-P-T1-E
Archer - Use Cases	GRC-SUPENG-P-T2-E
Archer - Use Cases	GRC-SUPENG-P-T3-E
Archer - Use Cases	GRC-SUPENG-P-T4-E
Archer - Use Cases	GRC-SUPENG-P-T5-E
Archer - Use Cases	GRC-SUPENG-P-T6-E
Archer - Use Cases	GRC-SUPENG-P-T7-E
Archer - Use Cases	GRC-SUPENG-P-T8-E
Archer - Use Cases	GRC-SUPGOV-P-T1-E
Archer - Use Cases	GRC-SUPGOV-P-T2-E
Archer - Use Cases	GRC-SUPGOV-P-T3-E
Archer - Use Cases	GRC-SUPGOV-P-T4-E
Archer - Use Cases	GRC-SUPGOV-P-T5-E
Archer - Use Cases	GRC-SUPGOV-P-T6-E
Archer - Use Cases	GRC-SUPGOV-P-T7-E
Archer - Use Cases	GRC-SUPGOV-P-T8-E
Archer - Use Cases	GRC-POLICY-P-T1-E
Archer - Use Cases	GRC-POLICY-P-T2-E
Archer - Use Cases	GRC-POLICY-P-T3-E
Archer - Use Cases	GRC-POLICY-P-T4-E
Archer - Use Cases	GRC-POLICY-P-T5-E
Archer - Use Cases	GRC-POLICY-P-T6-E
Archer - Use Cases	GRC-POLICY-P-T7-E
Archer - Use Cases	GRC-POLICY-P-T8-E
Archer - Use Cases	GRC-OBLIGS-P-T1-E
Archer - Use Cases	GRC-OBLIGS-P-T2-E
Archer - Use Cases	GRC-OBLIGS-P-T3-E
Archer - Use Cases	GRC-OBLIGS-P-T4-E
Archer - Use Cases	GRC-OBLIGS-P-T5-E
Archer - Use Cases	GRC-OBLIGS-P-T6-E
Archer - Use Cases	GRC-OBLIGS-P-T7-E
Archer - Use Cases	GRC-OBLIGS-P-T8-E
Archer - Use Cases	GRC-ITCTRL-P-T1-E

Archer - Use Cases	GRC-ITCTRL-P-T2-E
Archer - Use Cases	GRC-ITCTRL-P-T3-E
Archer - Use Cases	GRC-ITCTRL-P-T4-E
Archer - Use Cases	GRC-ITCTRL-P-T5-E
Archer - Use Cases	GRC-ITCTRL-P-T6-E
Archer - Use Cases	GRC-ITCTRL-P-T7-E
Archer - Use Cases	GRC-ITCTRL-P-T8-E
Archer - Use Cases	GRC-VULMGT-P-T1-E
Archer - Use Cases	GRC-VULMGT-P-T2-E
Archer - Use Cases	GRC-VULMGT-P-T3-E
Archer - Use Cases	GRC-VULMGT-P-T4-E
Archer - Use Cases	GRC-VULMGT-P-T5-E
Archer - Use Cases	GRC-VULMGT-P-T6-E
Archer - Use Cases	GRC-VULMGT-P-T7-E
Archer - Use Cases	GRC-VULMGT-P-T8-E
Archer - Use Cases	GRC-ITRSK-P-T1-E
Archer - Use Cases	GRC-ITRSK-P-T2-E
Archer - Use Cases	GRC-ITRSK-P-T3-E
Archer - Use Cases	GRC-ITRSK-P-T4-E
Archer - Use Cases	GRC-ITRSK-P-T5-E
Archer - Use Cases	GRC-ITRSK-P-T6-E
Archer - Use Cases	GRC-ITRSK-P-T7-E
Archer - Use Cases	GRC-ITRSK-P-T8-E
Archer - Use Cases	GRC-SECINCD-P-T1-E
Archer - Use Cases	GRC-SECINCD-P-T2-E
Archer - Use Cases	GRC-SECINCD-P-T3-E
Archer - Use Cases	GRC-SECINCD-P-T4-E
Archer - Use Cases	GRC-SECINCD-P-T5-E
Archer - Use Cases	GRC-SECINCD-P-T6-E
Archer - Use Cases	GRC-SECINCD-P-T7-E
Archer - Use Cases	GRC-SECINCD-P-T8-E
Archer - Use Cases	GRC-SECBRCH-P-T1-E
Archer - Use Cases	GRC-SECBRCH-P-T2-E
Archer - Use Cases	GRC-SECBRCH-P-T3-E
Archer - Use Cases	GRC-SECBRCH-P-T4-E
Archer - Use Cases	GRC-SECBRCH-P-T5-E
Archer - Use Cases	GRC-SECBRCH-P-T6-E
Archer - Use Cases	GRC-SECBRCH-P-T7-E
Archer - Use Cases	GRC-SECBRCH-P-T8-E
Archer - Use Cases	GRC-CTRLPRG-P-T1-E
Archer - Use Cases	GRC-CTRLPRG-P-T2-E
Archer - Use Cases	GRC-CTRLPRG-P-T3-E
Archer - Use Cases	GRC-CTRLPRG-P-T4-E
Archer - Use Cases	GRC-CTRLPRG-P-T5-E
Archer - Use Cases	GRC-CTRLPRG-P-T6-E
Archer - Use Cases	GRC-CTRLPRG-P-T7-E
Archer - Use Cases	GRC-CTRLPRG-P-T8-E

Archer - Use Cases	GRC-CTRLMON-P-T1-E
Archer - Use Cases	GRC-CTRLMON-P-T2-E
Archer - Use Cases	GRC-CTRLMON-P-T3-E
Archer - Use Cases	GRC-CTRLMON-P-T4-E
Archer - Use Cases	GRC-CTRLMON-P-T5-E
Archer - Use Cases	GRC-CTRLMON-P-T6-E
Archer - Use Cases	GRC-CTRLMON-P-T7-E
Archer - Use Cases	GRC-CTRLMON-P-T8-E
Archer - Use Cases	GRC-RSKINV-P-T1-E
Archer - Use Cases	GRC-RSKINV-P-T2-E
Archer - Use Cases	GRC-RSKINV-P-T3-E
Archer - Use Cases	GRC-RSKINV-P-T4-E
Archer - Use Cases	GRC-RSKINV-P-T5-E
Archer - Use Cases	GRC-RSKINV-P-T6-E
Archer - Use Cases	GRC-RSKINV-P-T7-E
Archer - Use Cases	GRC-RSKINV-P-T8-E
Archer - Use Cases	GRC-LSSEVNT-P-T1-E
Archer - Use Cases	GRC-LSSEVNT-P-T2-E
Archer - Use Cases	GRC-LSSEVNT-P-T3-E
Archer - Use Cases	GRC-LSSEVNT-P-T4-E
Archer - Use Cases	GRC-LSSEVNT-P-T5-E
Archer - Use Cases	GRC-LSSEVNT-P-T6-E
Archer - Use Cases	GRC-LSSEVNT-P-T7-E
Archer - Use Cases	GRC-LSSEVNT-P-T8-E
Archer - Use Cases	GRC-KEYIND-P-T1-E
Archer - Use Cases	GRC-KEYIND-P-T2-E
Archer - Use Cases	GRC-KEYIND-P-T3-E
Archer - Use Cases	GRC-KEYIND-P-T4-E
Archer - Use Cases	GRC-KEYIND-P-T5-E
Archer - Use Cases	GRC-KEYIND-P-T6-E
Archer - Use Cases	GRC-KEYIND-P-T7-E
Archer - Use Cases	GRC-KEYIND-P-T8-E
Archer - Use Cases	GRC-BTUPRSK-P-T1-E
Archer - Use Cases	GRC-BTUPRSK-P-T2-E
Archer - Use Cases	GRC-BTUPRSK-P-T3-E
Archer - Use Cases	GRC-BTUPRSK-P-T4-E
Archer - Use Cases	GRC-BTUPRSK-P-T5-E
Archer - Use Cases	GRC-BTUPRSK-P-T6-E
Archer - Use Cases	GRC-BTUPRSK-P-T7-E
Archer - Use Cases	GRC-BTUPRSK-P-T8-E
Archer - Use Cases	GRC-OPSRSK-P-T1-E
Archer - Use Cases	GRC-OPSRSK-P-T2-E
Archer - Use Cases	GRC-OPSRSK-P-T3-E
Archer - Use Cases	GRC-OPSRSK-P-T4-E
Archer - Use Cases	GRC-OPSRSK-P-T5-E
Archer - Use Cases	GRC-OPSRSK-P-T6-E
Archer - Use Cases	GRC-OPSRSK-P-T7-E

Archer - Use Cases	GRC-OPSRSK-P-T8-E
Archer - Use Cases	GRC-FEDAA-P-T1-E
Archer - Use Cases	GRC-FEDAA-P-T2-E
Archer - Use Cases	GRC-FEDAA-P-T3-E
Archer - Use Cases	GRC-FEDAA-P-T4-E
Archer - Use Cases	GRC-FEDAA-P-T5-E
Archer - Use Cases	GRC-FEDAA-P-T6-E
Archer - Use Cases	GRC-FEDAA-P-T7-E
Archer - Use Cases	GRC-FEDAA-P-T8-E
Archer - Use Cases	GRC-FEDCM-P-T1-E
Archer - Use Cases	GRC-FEDCM-P-T2-E
Archer - Use Cases	GRC-FEDCM-P-T3-E
Archer - Use Cases	GRC-FEDCM-P-T4-E
Archer - Use Cases	GRC-FEDCM-P-T5-E
Archer - Use Cases	GRC-FEDCM-P-T6-E
Archer - Use Cases	GRC-FEDCM-P-T7-E
Archer - Use Cases	GRC-FEDCM-P-T8-E
Archer - Use Cases	GRC-ODA-P-T1-E
Archer - Use Cases	GRC-ODA-P-T2-E
Archer - Use Cases	GRC-ODA-P-T3-E
Archer - Use Cases	GRC-ODA-P-T4-E
Archer - Use Cases	GRC-ODA-P-T5-E
Archer - Use Cases	GRC-ODA-P-T6-E
Archer - Use Cases	GRC-ODA-P-T7-E
Archer - Use Cases	GRC-ODA-P-T8-E
Archer - Use Cases	GRC-BAC-P-T1-E
Archer - Use Cases	GRC-BAC-P-T2-E
Archer - Use Cases	GRC-BAC-P-T3-E
Archer - Use Cases	GRC-BAC-P-T4-E
Archer - Use Cases	GRC-BAC-P-T5-E
Archer - Use Cases	GRC-BAC-P-T6-E
Archer - Use Cases	GRC-BAC-P-T7-E
Archer - Use Cases	GRC-BAC-P-T8-E
Archer - Use Cases	GRC-ITAC-P-T1-E
Archer - Use Cases	GRC-ITAC-P-T2-E
Archer - Use Cases	GRC-ITAC-P-T3-E
Archer - Use Cases	GRC-ITAC-P-T4-E
Archer - Use Cases	GRC-ITAC-P-T5-E
Archer - Use Cases	GRC-ITAC-P-T6-E
Archer - Use Cases	GRC-ITAC-P-T7-E
Archer - Use Cases	GRC-ITAC-P-T8-E
Archer - Use Cases	GRC-PCI-P-T1-E
Archer - Use Cases	GRC-PCI-P-T2-E
Archer - Use Cases	GRC-PCI-P-T3-E
Archer - Use Cases	GRC-PCI-P-T4-E
Archer - Use Cases	GRC-PCI-P-T5-E
Archer - Use Cases	GRC-PCI-P-T6-E

Archer - Use Cases	GRC-PCI-P-T7-E
Archer - Use Cases	GRC-PCI-P-T8-E
Archer - Use Cases	GRC-ISMS-P-T1-E
Archer - Use Cases	GRC-ISMS-P-T2-E
Archer - Use Cases	GRC-ISMS-P-T3-E
Archer - Use Cases	GRC-ISMS-P-T4-E
Archer - Use Cases	GRC-ISMS-P-T5-E
Archer - Use Cases	GRC-ISMS-P-T6-E
Archer - Use Cases	GRC-ISMS-P-T7-E
Archer - Use Cases	GRC-ISMS-P-T8-E
Archer - Use Cases	GRC-RISKCAT-P-T1-E
Archer - Use Cases	GRC-RISKCAT-P-T2-E
Archer - Use Cases	GRC-RISKCAT-P-T3-E
Archer - Use Cases	GRC-RISKCAT-P-T4-E
Archer - Use Cases	GRC-RISKCAT-P-T5-E
Archer - Use Cases	GRC-RISKCAT-P-T6-E
Archer - Use Cases	GRC-RISKCAT-P-T7-E
Archer - Use Cases	GRC-RISKCAT-P-T8-E
Archer - Use Cases	GRC-POAM-P-T1-E
Archer - Use Cases	GRC-POAM-P-T2-E
Archer - Use Cases	GRC-POAM-P-T3-E
Archer - Use Cases	GRC-POAM-P-T4-E
Archer - Use Cases	GRC-POAM-P-T5-E
Archer - Use Cases	GRC-POAM-P-T6-E
Archer - Use Cases	GRC-POAM-P-T7-E
Archer - Use Cases	GRC-POAM-P-T8-E
Archer - Use Cases	GRC-BCDR-P-T1-E
Archer - Use Cases	GRC-BCDR-P-T2-E
Archer - Use Cases	GRC-BCDR-P-T3-E
Archer - Use Cases	GRC-BCDR-P-T4-E
Archer - Use Cases	GRC-BCDR-P-T5-E
Archer - Use Cases	GRC-BCDR-P-T6-E
Archer - Use Cases	GRC-BCDR-P-T7-E
Archer - Use Cases	GRC-BCDR-P-T8-E
Archer - Use Cases	GRC-DATAGOV-P-T1-E
Archer - Use Cases	GRC-DATAGOV-P-T2-E
Archer - Use Cases	GRC-DATAGOV-P-T3-E
Archer - Use Cases	GRC-DATAGOV-P-T4-E
Archer - Use Cases	GRC-DATAGOV-P-T5-E
Archer - Use Cases	GRC-DATAGOV-P-T6-E
Archer - Use Cases	GRC-DATAGOV-P-T7-E
Archer - Use Cases	GRC-DATAGOV-P-T8-E
Archer - Use Cases	GRC-PRVPROG-P-T1-E
Archer - Use Cases	GRC-PRVPROG-P-T2-E
Archer - Use Cases	GRC-PRVPROG-P-T3-E
Archer - Use Cases	GRC-PRVPROG-P-T4-E
Archer - Use Cases	GRC-PRVPROG-P-T5-E

Archer - Use Cases	GRC-PRVPROG-P-T6-E
Archer - Use Cases	GRC-PRVPROG-P-T7-E
Archer - Use Cases	GRC-PRVPROG-P-T8-E
Archer - Use Cases	GRC-CYBINBR-P-T1-E
Archer - Use Cases	GRC-CYBINBR-P-T2-E
Archer - Use Cases	GRC-CYBINBR-P-T3-E
Archer - Use Cases	GRC-CYBINBR-P-T4-E
Archer - Use Cases	GRC-CYBINBR-P-T5-E
Archer - Use Cases	GRC-CYBINBR-P-T6-E
Archer - Use Cases	GRC-CYBINBR-P-T7-E
Archer - Use Cases	GRC-CYBINBR-P-T8-E
Archer Focus Solutions	FST1P-MNT-1500
Archer Focus Solutions	FST1P-MNT-5K
Archer Focus Solutions	FST1P-MNT-40K
Archer Focus Solutions	FST1P-MNT-100K
Archer Focus Solutions	FST1P-MNT-G100K
Archer Focus Solutions	FST1P-GT100K-B1
Archer Focus Solutions	FST1P-MNT-E-1500
Archer Focus Solutions	FST1P-MNT-E-5K
Archer Focus Solutions	FST1P-MNT-E-40K
Archer Focus Solutions	FST1P-MNT-E-100K
Archer Focus Solutions	FST1P-MNT-E-G100K
Archer Focus Solutions	FST1P-GT100K-E1
Archer Focus Solutions	FST2P-MNT-1500
Archer Focus Solutions	FST2P-MNT-5K
Archer Focus Solutions	FST2P-MNT-40K
Archer Focus Solutions	FST2P-MNT-100K
Archer Focus Solutions	FST2P-MNT-G100K
Archer Focus Solutions	FST2P-GT100K-B1
Archer Focus Solutions	FST2P-MNT-E-1500
Archer Focus Solutions	FST2P-MNT-E-5K
Archer Focus Solutions	FST2P-MNT-E-40K
Archer Focus Solutions	FST2P-MNT-E-100K
Archer Focus Solutions	FST2P-MNT-E-G100K
Archer Focus Solutions	FST2P-GT100K-E1
Archer Focus Solutions	FST1T-MNT-1500
Archer Focus Solutions	FST1T-MNT-5K
Archer Focus Solutions	FST1T-MNT-40K
Archer Focus Solutions	FST1T-MNT-100K
Archer Focus Solutions	FST1T-MNT-G100K
Archer Focus Solutions	FST1T-GT100K-B1
Archer Focus Solutions	FST1T-MNT-E-1500
Archer Focus Solutions	FST1T-MNT-E-5K
Archer Focus Solutions	FST1T-MNT-E-40K
Archer Focus Solutions	FST1T-MNT-E-100K
Archer Focus Solutions	FST1T-MNT-E-G100K
Archer Focus Solutions	FST1T-GT100K-E1

Archer Focus Solutions	FST2T-MNT-1500
Archer Focus Solutions	FST2T-MNT-5K
Archer Focus Solutions	FST2T-MNT-40K
Archer Focus Solutions	FST2T-MNT-100K
Archer Focus Solutions	FST2T-MNT-G100K
Archer Focus Solutions	FST2T-GT100K-B1
Archer Focus Solutions	FST2T-MNT-E-1500
Archer Focus Solutions	FST2T-MNT-E-5K
Archer Focus Solutions	FST2T-MNT-E-40K
Archer Focus Solutions	FST2T-MNT-E-100K
Archer Focus Solutions	FST2T-MNT-E-G100K
Archer Focus Solutions	FST2T-GT100K-E1
Archer SECOP	SECOP-USER-T-MNT
Archer SECOP	SECOP-1500-T-MNT
Archer SECOP	SECOP-5K-T-MNT
Archer SECOP	SECOP-40K-T-MNT
Archer SECOP	SECOP-100K-T-MNT
Archer SECOP	SECOP-G100KT-MNT
Archer SECOP	SECOP-GT100K-T-B1
Archer SECOP	SECOP-USER-T-MNT-E
Archer SECOP	SECOP-1500-T-MNT-E
Archer SECOP	SECOP-5K-T-MNT-E
Archer SECOP	SECOP-40K-T-MNT-E
Archer SECOP	SECOP-100K-T-MNT-E
Archer SECOP	SECOP-G100KT-MNT-E
Archer SECOP	SECOP-GT100K-T-E1
Archer SECOP	SECOP-USER-P-MNT
Archer SECOP	SECOP-1500-P-MNT
Archer SECOP	SECOP-5K-P-MNT
Archer SECOP	SECOP-40K-P-MNT
Archer SECOP	SECOP-100K-P-MNT
Archer SECOP	SECOP-G100KP-MNT
Archer SECOP	SECOP-GT100K-P-B1
Archer SECOP	SECOP-USER-P-MNT-E
Archer SECOP	SECOP-1500-P-MNT-E
Archer SECOP	SECOP-5K-P-MNT-E
Archer SECOP	SECOP-40K-P-MNT-E
Archer SECOP	SECOP-100K-P-MNT-E
Archer SECOP	SECOP-G100KP-MNT-E
Archer SECOP	SECOP-GT100K-P-E1
Archer SECOP	SECOP-USER-P-MNTUP
Archer SECOP	SECOP-1500-P-MNTUP
Archer SECOP	SECOP-5K-P-MNTUP
Archer SECOP	SECOP-40K-P-MNTUP
Archer SECOP	SECOP-100K-P-MNTUP
Archer SECOP	SECOP-G100KP-MNTUP
Archer SECOP	SECOP-GT100K-P-UP

Archer VRM	VRM-IP-2K-T-MNT
Archer VRM	VRM-IP-5K-T-MNT
Archer VRM	VRM-IP-10K-T-MNT
Archer VRM	VRM-IP-20K-T-MNT
Archer VRM	VRM-IP-30K-T-MNT
Archer VRM	VRM-IP-40K-T-MNT
Archer VRM	VRM-IP-50K-T-MNT
Archer VRM	VRM-IP-75K-T-MNT
Archer VRM	VRM-IP-100K-T-MNT
Archer VRM	VRM-IP-G100K-T-MNT
Archer VRM	VRM-IP-2K-T-MNT-E
Archer VRM	VRM-IP-5K-T-MNT-E
Archer VRM	VRM-IP-10K-T-MNT-E
Archer VRM	VRM-IP-20K-T-MNT-E
Archer VRM	VRM-IP-30K-T-MNT-E
Archer VRM	VRM-IP-40K-T-MNT-E
Archer VRM	VRM-IP-50K-T-MNT-E
Archer VRM	VRM-IP-75K-T-MNT-E
Archer VRM	VRM-IP-100K-T-M-E
Archer VRM	VRM-IP-G100K-T-M-E
Archer VRM	VRM-IP-2K-P-MNT
Archer VRM	VRM-IP-5K-P-MNT
Archer VRM	VRM-IP-10K-P-MNT
Archer VRM	VRM-IP-20K-P-MNT
Archer VRM	VRM-IP-30K-P-MNT
Archer VRM	VRM-IP-40K-P-MNT
Archer VRM	VRM-IP-50K-P-MNT
Archer VRM	VRM-IP-75K-P-MNT
Archer VRM	VRM-IP-100K-P-MNT
Archer VRM	VRM-IP-G100K-P-MNT
Archer VRM	VRM-IP-2K-P-MNT-E
Archer VRM	VRM-IP-5K-P-MNT-E
Archer VRM	VRM-IP-10K-P-MNT-E
Archer VRM	VRM-IP-20K-P-MNT-E
Archer VRM	VRM-IP-30K-P-MNT-E
Archer VRM	VRM-IP-40K-P-MNT-E
Archer VRM	VRM-IP-50K-P-MNT-E
Archer VRM	VRM-IP-75K-P-MNT-E
Archer VRM	VRM-IP-100K-P-M-E
Archer VRM	VRM-IP-G100K-P-M-E
Archer VRM	VRM-IP-2K-P-MNTUP
Archer VRM	VRM-IP-5K-P-MNTUP
Archer VRM	VRM-IP-10K-P-MNTUP
Archer VRM	VRM-IP-20K-P-MNTUP
Archer VRM	VRM-IP-30K-P-MNTUP
Archer VRM	VRM-IP-40K-P-MNTUP
Archer VRM	VRM-IP-50K-P-MNTUP

Archer VRM	VRM-IP-75K-P-MNTUP
Archer VRM	VRM-IP-100K-P-M-UP
Archer VRM	VRM-IP-G100K-P-M-U
Certificate Mgr	RCM500B1
Certificate Mgr	RCM1000B1
Certificate Mgr	RCM5000B1
Certificate Mgr	RCM10000B1
Certificate Mgr	RCM25000B1
Certificate Mgr	RCM50000B1
Certificate Mgr	RCM100000B1
Certificate Mgr	RCM200000B1
Certificate Mgr	RCM300000B1
Certificate Mgr	RCM400000B1
Certificate Mgr	RCM500000B1
Certificate Mgr	RCM600000B1
Certificate Mgr	RCM700000B1
Certificate Mgr	RCM800000B1
Certificate Mgr	RCM900000B1
Certificate Mgr	RCM1000000B1
Certificate Mgr	RCM1MILB1
Certificate Mgr	RCM500E1
Certificate Mgr	RCM1000E1
Certificate Mgr	RCM5000E1
Certificate Mgr	RCM10000E1
Certificate Mgr	RCM25000E1
Certificate Mgr	RCM50000E1
Certificate Mgr	RCM100000E1
Certificate Mgr	RCM200000E1
Certificate Mgr	RCM300000E1
Certificate Mgr	RCM400000E1
Certificate Mgr	RCM500000E1
Certificate Mgr	RCM600000E1
Certificate Mgr	RCM700000E1
Certificate Mgr	RCM800000E1
Certificate Mgr	RCM900000E1
Certificate Mgr	RCM1000000E1
Certificate Mgr	RCM1MILE1
Data Loss	M1-SW-DLPDC-500
Data Loss	M1-SW-DLPDC-1000
Data Loss	M1-SW-DLPDC-2500
Data Loss	M1-SW-DLPDC-5000
Data Loss	M1-SW-DLPDC-10000
Data Loss	M1-SW-DLPDC-15000
Data Loss	M1-SW-DLPDC-20000
Data Loss	M1-SW-DLPDC-30000
Data Loss	M1-SW-DLPDC-40000
Data Loss	M1-SW-DLPDC-50000

Data Loss	M1-SW-DLPDC-75000
Data Loss	M1-SW-DLPDC-100000
Data Loss	M1-SW-DLPDC-100001
Data Loss	M1-SW-NWMON-500
Data Loss	M1-SW-NWMON-1000
Data Loss	M1-SW-NWMON-2500
Data Loss	M1-SW-NWMON-5000
Data Loss	M1-SW-NWMON-10000
Data Loss	M1-SW-NWMON-15000
Data Loss	M1-SW-NWMON-20000
Data Loss	M1-SW-NWMON-30000
Data Loss	M1-SW-NWMON-40000
Data Loss	M1-SW-NWMON-50000
Data Loss	M1-SW-NWMON-75000
Data Loss	M1-SW-NWMON-100000
Data Loss	M1-SW-NWMON-100001
Data Loss	M1-SW-NWENF-500
Data Loss	M1-SW-NWENF-1000
Data Loss	M1-SW-NWENF-2500
Data Loss	M1-SW-NWENF-5000
Data Loss	M1-SW-NWENF-10000
Data Loss	M1-SW-NWENF-15000
Data Loss	M1-SW-NWENF-20000
Data Loss	M1-SW-NWENF-30000
Data Loss	M1-SW-NWENF-40000
Data Loss	M1-SW-NWENF-50000
Data Loss	M1-SW-NWENF-75000
Data Loss	M1-SW-NWENF-100000
Data Loss	M1-SW-NWENF-100001
Data Loss	M1-UG-NWENF-500
Data Loss	M1-UG-NWENF-1000
Data Loss	M1-UG-NWENF-2500
Data Loss	M1-UG-NWENF-5000
Data Loss	M1-UG-NWENF-10000
Data Loss	M1-UG-NWENF-15000
Data Loss	M1-UG-NWENF-20000
Data Loss	M1-UG-NWENF-30000
Data Loss	M1-UG-NWENF-40000
Data Loss	M1-UG-NWENF-50000
Data Loss	M1-UG-NWENF-75000
Data Loss	M1-UG-NWENF-100000
Data Loss	M1-UG-NWENF-100001
Data Loss	M1-SW-DLPED-500
Data Loss	M1-SW-DLPED-1000
Data Loss	M1-SW-DLPED-2500
Data Loss	M1-SW-DLPED-5000
Data Loss	M1-SW-DLPED-10000

Data Loss	M1-SW-DLPED-15000
Data Loss	M1-SW-DLPED-20000
Data Loss	M1-SW-DLPED-30000
Data Loss	M1-SW-DLPED-40000
Data Loss	M1-SW-DLPED-50000
Data Loss	M1-SW-DLPED-75000
Data Loss	M1-SW-DLPED-100000
Data Loss	M1-SW-DLPED-100001
Data Loss	M1-SW-DLPEE-500
Data Loss	M1-SW-DLPEE-1000
Data Loss	M1-SW-DLPEE-2500
Data Loss	M1-SW-DLPEE-5000
Data Loss	M1-SW-DLPEE-10000
Data Loss	M1-SW-DLPEE-15000
Data Loss	M1-SW-DLPEE-20000
Data Loss	M1-SW-DLPEE-30000
Data Loss	M1-SW-DLPEE-40000
Data Loss	M1-SW-DLPEE-50000
Data Loss	M1-SW-DLPEE-75000
Data Loss	M1-SW-DLPEE-100000
Data Loss	M1-SW-DLPEE-100001
Data Loss	M1-SW-EDEEB-500
Data Loss	M1-SW-EDEEB-1000
Data Loss	M1-SW-EDEEB-2500
Data Loss	M1-SW-EDEEB-5000
Data Loss	M1-SW-EDEEB-10000
Data Loss	M1-SW-EDEEB-15000
Data Loss	M1-SW-EDEEB-20000
Data Loss	M1-SW-EDEEB-30000
Data Loss	M1-SW-EDEEB-40000
Data Loss	M1-SW-EDEEB-50000
Data Loss	M1-SW-EDEEB-75000
Data Loss	M1-SW-EDEEB-100000
Data Loss	M1-SW-EDEEB-100001
Data Loss	M1-SW-DCEDB-500
Data Loss	M1-SW-DCEDB-1000
Data Loss	M1-SW-DCEDB-2500
Data Loss	M1-SW-DCEDB-5000
Data Loss	M1-SW-DCEDB-10000
Data Loss	M1-SW-DCEDB-15000
Data Loss	M1-SW-DCEDB-20000
Data Loss	M1-SW-DCEDB-30000
Data Loss	M1-SW-DCEDB-40000
Data Loss	M1-SW-DCEDB-50000
Data Loss	M1-SW-DCEDB-75000
Data Loss	M1-SW-DCEDB-100000
Data Loss	M1-SW-DCEDB-100001

Data Loss	M1-SW-NMEFB-500
Data Loss	M1-SW-NMEFB-1000
Data Loss	M1-SW-NMEFB-2500
Data Loss	M1-SW-NMEFB-5000
Data Loss	M1-SW-NMEFB-10000
Data Loss	M1-SW-NMEFB-15000
Data Loss	M1-SW-NMEFB-20000
Data Loss	M1-SW-NMEFB-30000
Data Loss	M1-SW-NMEFB-40000
Data Loss	M1-SW-NMEFB-50000
Data Loss	M1-SW-NMEFB-75000
Data Loss	M1-SW-NMEFB-100000
Data Loss	M1-SW-NMEFB-100001
Data Loss	M1-SW-DLPSTE-500
Data Loss	M1-SW-DLPSTE-1000
Data Loss	M1-SW-DLPSTE-2500
Data Loss	M1-SW-DLPSTE-5000
Data Loss	M1-SW-DLPSTE-10000
Data Loss	M1-SW-DLPSTE-15000
Data Loss	M1-SW-DLPSTE-20000
Data Loss	M1-SW-DLPSTE-30000
Data Loss	M1-SW-DLPSTE-40000
Data Loss	M1-SW-DLPSTE-50000
Data Loss	M1-SW-DLPSTE-75000
Data Loss	M1-SW-DLPSTE100000
Data Loss	M1-SW-DLPSTE100001
Data Loss	M1-HW-DLP-CONT
Data Loss	M1-HW-DLP-ICAP
Data Loss	M1-HW-DLP-INT
Data Loss	M1-HW-DLP-SENS
Data Loss	M1-HW-DLP-SENS-S2
Data Loss	M1-HW-DLP-INT-S2
Data Loss	M1-HW-DLP-ICAP-S2
Data Loss	M1-HW-DLP-CONT-S2
Data Loss	M-HW-DLPEOS-CONT
Data Loss	M-HW-DLPEOS-SENS
Data Loss	M-HW-DLPEOS-ICAP
Data Loss	M-HW-DLPEOS-INT
Data Loss	EM1SW-DLPDC-500
Data Loss	EM1SW-DLPDC-1000
Data Loss	EM1SW-DLPDC-2500
Data Loss	EM1SW-DLPDC-5000
Data Loss	EM1SW-DLPDC-10000
Data Loss	EM1SW-DLPDC-15000
Data Loss	EM1SW-DLPDC-20000
Data Loss	EM1SW-DLPDC-30000
Data Loss	EM1SW-DLPDC-40000

Data Loss	EM1SW-DLPDC-50000
Data Loss	EM1SW-DLPDC-75000
Data Loss	EM1SW-DLPDC-100000
Data Loss	EM1SW-DLPDC-100001
Data Loss	EM1SW-NWMON-500
Data Loss	EM1SW-NWMON-1000
Data Loss	EM1SW-NWMON-2500
Data Loss	EM1SW-NWMON-5000
Data Loss	EM1SW-NWMON-10000
Data Loss	EM1SW-NWMON-15000
Data Loss	EM1SW-NWMON-20000
Data Loss	EM1SW-NWMON-30000
Data Loss	EM1SW-NWMON-40000
Data Loss	EM1SW-NWMON-50000
Data Loss	EM1SW-NWMON-75000
Data Loss	EM1SW-NWMON-100000
Data Loss	EM1SW-NWMON-100001
Data Loss	EM1SW-NWENF-500
Data Loss	EM1SW-NWENF-1000
Data Loss	EM1SW-NWENF-2500
Data Loss	EM1SW-NWENF-5000
Data Loss	EM1SW-NWENF-10000
Data Loss	EM1SW-NWENF-15000
Data Loss	EM1SW-NWENF-20000
Data Loss	EM1SW-NWENF-30000
Data Loss	EM1SW-NWENF-40000
Data Loss	EM1SW-NWENF-50000
Data Loss	EM1SW-NWENF-75000
Data Loss	EM1SW-NWENF-100000
Data Loss	EM1SW-NWENF-100001
Data Loss	EM1UG-NWENF-500
Data Loss	EM1UG-NWENF-1000
Data Loss	EM1UG-NWENF-2500
Data Loss	EM1UG-NWENF-5000
Data Loss	EM1UG-NWENF-10000
Data Loss	EM1UG-NWENF-15000
Data Loss	EM1UG-NWENF-20000
Data Loss	EM1UG-NWENF-30000
Data Loss	EM1UG-NWENF-40000
Data Loss	EM1UG-NWENF-50000
Data Loss	EM1UG-NWENF-75000
Data Loss	EM1UG-NWENF-100000
Data Loss	EM1UG-NWENF-100001
Data Loss	EM1SW-DLPED-500
Data Loss	EM1SW-DLPED-1000
Data Loss	EM1SW-DLPED-2500
Data Loss	EM1SW-DLPED-5000

Data Loss	EM1SW-DLPED-10000
Data Loss	EM1SW-DLPED-15000
Data Loss	EM1SW-DLPED-20000
Data Loss	EM1SW-DLPED-30000
Data Loss	EM1SW-DLPED-40000
Data Loss	EM1SW-DLPED-50000
Data Loss	EM1SW-DLPED-75000
Data Loss	EM1SW-DLPED-100000
Data Loss	EM1SW-DLPED-100001
Data Loss	EM1SW-DLP EE-500
Data Loss	EM1SW-DLP EE-1000
Data Loss	EM1SW-DLP EE-2500
Data Loss	EM1SW-DLP EE-5000
Data Loss	EM1SW-DLP EE-10000
Data Loss	EM1SW-DLP EE-15000
Data Loss	EM1SW-DLP EE-20000
Data Loss	EM1SW-DLP EE-30000
Data Loss	EM1SW-DLP EE-40000
Data Loss	EM1SW-DLP EE-50000
Data Loss	EM1SW-DLP EE-75000
Data Loss	EM1SW-DLP EE-100000
Data Loss	EM1SW-DLP EE-100001
Data Loss	EM1SW-EDEEB-500
Data Loss	EM1SW-EDEEB-1000
Data Loss	EM1SW-EDEEB-2500
Data Loss	EM1SW-EDEEB-5000
Data Loss	EM1SW-EDEEB-10000
Data Loss	EM1SW-EDEEB-15000
Data Loss	EM1SW-EDEEB-20000
Data Loss	EM1SW-EDEEB-30000
Data Loss	EM1SW-EDEEB-40000
Data Loss	EM1SW-EDEEB-50000
Data Loss	EM1SW-EDEEB-75000
Data Loss	EM1SW-EDEEB-100000
Data Loss	EM1SW-EDEEB-100001
Data Loss	EM1SW-DCEDB-500
Data Loss	EM1SW-DCEDB-1000
Data Loss	EM1SW-DCEDB-2500
Data Loss	EM1SW-DCEDB-5000
Data Loss	EM1SW-DCEDB-10000
Data Loss	EM1SW-DCEDB-15000
Data Loss	EM1SW-DCEDB-20000
Data Loss	EM1SW-DCEDB-30000
Data Loss	EM1SW-DCEDB-40000
Data Loss	EM1SW-DCEDB-50000
Data Loss	EM1SW-DCEDB-75000
Data Loss	EM1SW-DCEDB-100000

Data Loss	EM1SW-DCEDB-100001
Data Loss	EM1SW-NMEFB-500
Data Loss	EM1SW-NMEFB-1000
Data Loss	EM1SW-NMEFB-2500
Data Loss	EM1SW-NMEFB-5000
Data Loss	EM1SW-NMEFB-10000
Data Loss	EM1SW-NMEFB-15000
Data Loss	EM1SW-NMEFB-20000
Data Loss	EM1SW-NMEFB-30000
Data Loss	EM1SW-NMEFB-40000
Data Loss	EM1SW-NMEFB-50000
Data Loss	EM1SW-NMEFB-75000
Data Loss	EM1SW-NMEFB-100000
Data Loss	EM1SW-NMEFB-100001
Data Loss	EM1SW-DLPSTE-500
Data Loss	EM1SW-DLPSTE-1000
Data Loss	EM1SW-DLPSTE-2500
Data Loss	EM1SW-DLPSTE-5000
Data Loss	EM1SW-DLPSTE-10000
Data Loss	EM1SW-DLPSTE-15000
Data Loss	EM1SW-DLPSTE-20000
Data Loss	EM1SW-DLPSTE-30000
Data Loss	EM1SW-DLPSTE-40000
Data Loss	EM1SW-DLPSTE-50000
Data Loss	EM1SW-DLPSTE-75000
Data Loss	EM1SW-DLPST-100000
Data Loss	EM1SW-DLPST-100001
Data Loss	EM1-HW-DLP-CONT
Data Loss	EM1-HW-DLP-ICAP
Data Loss	EM1-HW-DLP-INT
Data Loss	EM1-HW-DLP-SENS
Data Loss	EM1-HWDLP-SENS-S2
Data Loss	EM1-HWDLP-INT-S2
Data Loss	EM1-HWDLP-ICAP-S2
Data Loss	EM1-HWDLP-CONT-S2
Data Loss	EM-HW-DLPEOS-CONT
Data Loss	EM-HW-DLPEOS-SENS
Data Loss	EM-HW-DLPEOS-ICAP
Data Loss	EM-HW-DLPEOS-INT
Data Retention	DATARETENVSM1
Data Retention	DATARETENS1
Data Retention	DATARETENMED1
Data Retention	DATARETENLG1
Data Retention	DATARETENVLG1
Ed Services	ED ARCHERCUSTOM
Ed Services	ED-ARC-AAPS-210
Ed Services	ED ARCADMIN210

Ed Services	ED ARCADVADM210
Ed Services	ED-ARC-ADM6I-210
Ed Services	ED-ARC-ADM6I-ODC
Ed Services	ED-ARC-ADM6II-210
Ed Services	ED-ARC-ADM6II-ODC
Ed Services	ED ARC EUELN 210
Ed Services	ED ARC EUILT 210
Ed Services	ED ARC EUTTT 210
Ed Services	ED-ARC-AWN6-210
Ed Services	ED-ARC-AWN6-ODC
Ed Services	ED-ARC-RNV6-210
Ed Services	ED-ARC-RNV6-ODC
Ed Services	ED-ARC-PFB6-210
Ed Services	ED-ARC-PFB6-ODC
Ed Services	ED-ARC-XTRA-210
Ed Services	ED-ARC-ODSUB-ADMIN
Ed Services	ED-ARC-ODSUB-BZUSR
Ed Services	ED-ARC-IFADM-210
Ed Services	ED-ARC-XTRA-LAB
Ed Services	ED-ARC-LAB-INSTALL
Ed Services	ED-ARC-LAB-IMBP
Ed Services	ED-ARC-LAB-SGEXPL
Ed Services	ED-ARC-TRAINCREDIT
Ed Services	ED SLCUSTOM
Ed Services	ED SW CUSTOM
Ed Services	ED-SID-TRAINCREDIT
Ed Services	ED AM CUSTOM
Ed Services	ED-SID-AEEIMPL-210
Ed Services	ED-SID-INSCFG-210
Ed Services	ED AM INS 210
Ed Services	ED-AM-INS-ODC
Ed Services	ED AM ADM 210
Ed Services	ED-AM-ADM-ODC
Ed Services	ED SIDHELPDESK210
Ed Services	ED-AM-XTRA-210
Ed Services	ED-SID-ODSUB-LVL1
Ed Services	ED-SID-ODSUB-LVL2
Ed Services	ED-SID-XTRA-LAB
Ed Services	ED-SID-LAB-COLLECT
Ed Services	ED-SID-LAB-PROVSN
Ed Services	ED-SID-LAB-AMHDP
Ed Services	ED-SID-LAB-AMMIG
Ed Services	ED-SID-LAB-AMISIC
Ed Services	ED-SID-LAB-AMPRIME
Ed Services	ED-SA-FND-210

Ed Services	ED-SA-FND-ODC
Ed Services	ED-SA-LOGS-ODC
Ed Services	ED-ECAT-FND-ODC
Ed Services	ED-ECAT-ANLY-ODC
Ed Services	ED-SA-CORADM-210
Ed Services	ED-SA-CORADM-ODC
Ed Services	ED-ASOC-HUNT-210
Ed Services	ED-ECAT-FND-210
Ed Services	ED-ECAT-ANLY-210
Ed Services	ED-SA-ANLY-210
Ed Services	ED-SA-ANLY-ODC
Ed Services	ED-SA-XTRA-210
Ed Services	ED-NW-LPADMOPS-210
Ed Services	ED-NW-LPCONCRE-210
Ed Services	ED-NW-ODSUB-LVL1
Ed Services	ED-NW-ODSUB-LVL2
Ed Services	ED-NWE-ODSUB-LVL1
Ed Services	ED-NWE-ODSUB-LVL2
Ed Services	ED-NW-XTRA-LAB
Ed Services	ED-NW-LAB-EPINS
Ed Services	ED-NW-LAB-EPTRBL
Ed Services	ED-NW-LAB-LPTUOP
Ed Services	ED-NW-LAB-PMALA
Ed Services	ED-NW-LAB-EPADM
Ed Services	ED-NW-LAB-LPREST
Ed Services	ED-NW-LAB-LOGPARS
Ed Services	ED-NW-LAB-LOGESC
Ed Services	ED-NW-TRAINCREDIT
Ed Services	ED SA CUSTOM
Ed Services	ED-VLG-ADM-210
Ed Services	ED-IGL-ADM-ODC
Ed Services	ED-IGL-LAB-INSSWRD
Ed Services	ED-IGL-LAB-INSSWCD
Ed Services	ED-IGL-LAB-INSHWLD
Ed Services	ED-IGL-LAB-INSWL
Ed Services	ED-IGL-LAB-INSWS
Ed Services	ED-IGL-LAB-QSSLC
Ed Services	ED-IGL-LAB-IMPIDC
Ed Services	ED-IGL-LAB-IMPACC
Ed Services	ED-IGL-LAB-IMPENC
Ed Services	ED-IGL-LAB-QSSGOV
Ed Services	ED-IGL-LAB-UWFEE
Ed Services	ED-IGL-LAB-ACCCERT

Ed Services	ED-IGL-ODSUB-LVL1
Ed Services	ED-IGL-ODSUB-LVL2
Ed Services	ED-IGL-TRAINCREDIT
Ed Services	ED-VLG-CUSTOM
Ed Services	ED-IST-CISSP-110
Ed Services	ED-IST-CISSP-210
Ed Services	ED-IST-CEH-110
Ed Services	ED-IST-CEH-210
Elec Enablement Soft Tokens	S820-8-60-6-A-EL
Elec Enablement Soft Tokens	S820-8-60-6-B-EL
Elec Enablement Soft Tokens	S820-8-60-6-C-EL
Elec Enablement Soft Tokens	S820-8-60-6-D-EL
Elec Enablement Soft Tokens	S820-8-60-6-E-EL
Elec Enablement Soft Tokens	S820-8-60-6-F-EL
Elec Enablement Soft Tokens	S820-8-60-6-G-EL
Elec Enablement Soft Tokens	S820-8-60-6-H-EL
Elec Enablement Soft Tokens	S820-8-60-6-I-EL
Elec Enablement Soft Tokens	S820-8-60-6-J-EL
Elec Enablement Soft Tokens	S820-8-60-12-A-EL
Elec Enablement Soft Tokens	S820-8-60-12-B-EL
Elec Enablement Soft Tokens	S820-8-60-12-C-EL
Elec Enablement Soft Tokens	S820-8-60-12-D-EL
Elec Enablement Soft Tokens	S820-8-60-12-E-EL
Elec Enablement Soft Tokens	S820-8-60-12-F-EL
Elec Enablement Soft Tokens	S820-8-60-12-G-EL
Elec Enablement Soft Tokens	S820-8-60-12-H-EL
Elec Enablement Soft Tokens	S820-8-60-12-I-EL
Elec Enablement Soft Tokens	S820-8-60-12-J-EL
Elec Enablement Soft Tokens	S820-8-60-24-A-EL
Elec Enablement Soft Tokens	S820-8-60-24-B-EL
Elec Enablement Soft Tokens	S820-8-60-24-C-EL
Elec Enablement Soft Tokens	S820-8-60-24-D-EL
Elec Enablement Soft Tokens	S820-8-60-24-E-EL
Elec Enablement Soft Tokens	S820-8-60-24-F-EL
Elec Enablement Soft Tokens	S820-8-60-24-G-EL
Elec Enablement Soft Tokens	S820-8-60-24-H-EL
Elec Enablement Soft Tokens	S820-8-60-24-I-EL
Elec Enablement Soft Tokens	S820-8-60-24-J-EL
Elec Enablement Soft Tokens	S820-8-60-36-A-EL
Elec Enablement Soft Tokens	S820-8-60-36-B-EL
Elec Enablement Soft Tokens	S820-8-60-36-C-EL
Elec Enablement Soft Tokens	S820-8-60-36-D-EL
Elec Enablement Soft Tokens	S820-8-60-36-E-EL
Elec Enablement Soft Tokens	S820-8-60-36-F-EL
Elec Enablement Soft Tokens	S820-8-60-36-G-EL
Elec Enablement Soft Tokens	S820-8-60-36-H-EL

Elec Enablement Soft Tokens	S820-8-60-36-I-EL
Elec Enablement Soft Tokens	S820-8-60-36-J-EL
Elec Enablement Soft Tokens	S820-8-60-48-A-EL
Elec Enablement Soft Tokens	S820-8-60-48-B-EL
Elec Enablement Soft Tokens	S820-8-60-48-C-EL
Elec Enablement Soft Tokens	S820-8-60-48-D-EL
Elec Enablement Soft Tokens	S820-8-60-48-E-EL
Elec Enablement Soft Tokens	S820-8-60-48-F-EL
Elec Enablement Soft Tokens	S820-8-60-48-G-EL
Elec Enablement Soft Tokens	S820-8-60-48-H-EL
Elec Enablement Soft Tokens	S820-8-60-48-I-EL
Elec Enablement Soft Tokens	S820-8-60-48-J-EL
Elec Enablement Soft Tokens	S820-8-60-60-A-EL
Elec Enablement Soft Tokens	S820-8-60-60-B-EL
Elec Enablement Soft Tokens	S820-8-60-60-C-EL
Elec Enablement Soft Tokens	S820-8-60-60-D-EL
Elec Enablement Soft Tokens	S820-8-60-60-E-EL
Elec Enablement Soft Tokens	S820-8-60-60-F-EL
Elec Enablement Soft Tokens	S820-8-60-60-G-EL
Elec Enablement Soft Tokens	S820-8-60-60-H-EL
Elec Enablement Soft Tokens	S820-8-60-60-I-EL
Elec Enablement Soft Tokens	S820-8-60-60-J-EL
Elec Enablement Soft Tokens	S820-8-60-120-A-EL
Elec Enablement Soft Tokens	S820-8-60-120-B-EL
Elec Enablement Soft Tokens	S820-8-60-120-C-EL
Elec Enablement Soft Tokens	S820-8-60-120-D-EL
Elec Enablement Soft Tokens	S820-8-60-120-E-EL
Elec Enablement Soft Tokens	S820-8-60-120-F-EL
Elec Enablement Soft Tokens	S820-8-60-120-G-EL
Elec Enablement Soft Tokens	S820-8-60-120-H-EL
Elec Enablement Soft Tokens	S820-8-60-120-I-EL
Elec Enablement Soft Tokens	S820-8-60-120-J-EL
Elec Enablement Soft Tokens	S820-8-60-S-T1-EL
Elec Enablement Soft Tokens	S820-8-60-S-T2-EL
Elec Enablement Soft Tokens	S820-8-60-S-T3-EL
Elec Enablement Soft Tokens	S820-8-60-S-T4-EL
Elec Enablement Soft Tokens	S820-8-60-S-T5-EL
Elec Enablement Soft Tokens	S820-8-60-S-T6-EL
Elec Enablement Soft Tokens	S820-8-60-S-T7-EL
Elec Enablement Soft Tokens	S820-8-60-S-T8-EL
Elec Enablement Soft Tokens	S820-8-60-S-T9-EL
Elec Enablement Soft Tokens	S820-8-60-S-T10-EL
FA & CC Intelligence	FACI-SAS-TIER1
FA & CC Intelligence	FACI-SAS-TIER2
FA & CC Intelligence	FACI-SAS-TIER3
FA & CC Intelligence	RSA-0010727
FA & CC Intelligence	RSA-0010728

FA & CC Intelligence	RSA-0010729
FA & CC Intelligence	FACI-SAS-CH-TIER1
FA & CC Intelligence	FACI-SAS-CH-TIER2
FA & CC Intelligence	FACI-SAS-CH-TIER3
FA 360 Service	FAFS-000006
FA 360 Service	FAFS-000025
FA 360 Service	FAFS-000050
FA 360 Service	FAFS-000100
FA 360 Service	FAFS-000300
FA 360 Service	FAFS-000600
FA 360 Service	FAFS-001000
FA Anti-Phishing	FAAPR0006
FA Anti-Phishing	FAAPR0012
FA Anti-Phishing	FAAPR0025
FA Anti-Phishing	FAAPR0050
FA Anti-Phishing	FAAPR0100
FA Anti-Phishing	FAAPRO006
FA Anti-Phishing	FAAPRO012
FA Anti-Phishing	FAAPRO025
FA Anti-Phishing	FAAPRO050
FA Anti-Phishing	FAAPRO100
FA Anti-Phishing	FAAPS006C1
FA Anti-Phishing	FAAPS012C1
FA Anti-Phishing	FAAPS025C1
FA Anti-Phishing	FAAPS050C1
FA Anti-Phishing	FAAPS100C1
FA Anti-Phishing	FAAPS006CE
FA Anti-Phishing	FAAPS012CE
FA Anti-Phishing	FAAPS025CE
FA Anti-Phishing	FAAPS050CE
FA Anti-Phishing	FAAPS100CE
FA Anti-Phishing	FA APSC SET UP
FA Anti-Rogue	FAARAS06DSC1
FA Anti-Rogue	FAARAS15DSC1
FA Anti-Rogue	FAARAS30DSC1
FA Anti-Rogue	FAARAS50DSC1
FA Anti-Rogue	FAARAS100DSC1
FA Anti-Rogue	FAARAS06DSCE
FA Anti-Rogue	FAARAS15DSCE
FA Anti-Rogue	FAARAS30DSCE
FA Anti-Rogue	FAARAS50DSCE
FA Anti-Rogue	FAARAS100DSCE
FA Anti-Rogue	FAARASDOC1
FA Anti-Rogue	FAARASSSC1
FA Anti-Trojan	FAATS006C1
FA Anti-Trojan	FAATS012C1
FA Anti-Trojan	FAATS025C1

FA Anti-Trojan	FAATS050C1
FA Anti-Trojan	FAATS100C1
FA Anti-Trojan	FAATS006CE
FA Anti-Trojan	FAATS012CE
FA Anti-Trojan	FAATS025CE
FA Anti-Trojan	FAATS050CE
FA Anti-Trojan	FAATS100CE
FA Anti-Trojan	FA ATSC SET UP
FIM	FIM001E1
FIM	FIM003E1
FIM	FIM010E1
FIM	FIM025E1
FIM	FIM050E1
FIM	FIM075E1
FIM	FIM100E1
FIM	FIM150E1
FIM	FIMUNLE1
FIM	FIM001E1R
FIM	FIM003E1R
FIM	FIM010E1R
FIM	FIM025E1R
FIM	FIM050E1R
FIM	FIM075E1R
FIM	FIM100E1R
FIM	FIM150E1R
FIM	FIMUNLE1R
Governance & Lifecycle	RSA-GO-S-T1
Governance & Lifecycle	RSA-GO-S-T2
Governance & Lifecycle	RSA-GO-S-T3
Governance & Lifecycle	RSA-GO-S-T4
Governance & Lifecycle	RSA-GO-S-T5
Governance & Lifecycle	RSA-GO-S-T6
Governance & Lifecycle	RSA-GO-S-T7
Governance & Lifecycle	RSA-GO-S-T8
Governance & Lifecycle	RSA-GO-S-T9
Governance & Lifecycle	RSA-GOLT-S-T1
Governance & Lifecycle	RSA-GOLT-S-T2
Governance & Lifecycle	RSA-GOLT-S-T3
Governance & Lifecycle	RSA-GOLT-S-T4
Governance & Lifecycle	RSA-GOLT-S-T5
Governance & Lifecycle	RSA-GOLT-S-T6
Governance & Lifecycle	RSA-GOLT-S-T7
Governance & Lifecycle	RSA-GOLT-S-T8
Governance & Lifecycle	RSA-GOLT-S-T9
Governance & Lifecycle	RSA-LI-S-T1
Governance & Lifecycle	RSA-LI-S-T2
Governance & Lifecycle	RSA-LI-S-T3

Governance & Lifecycle	RSA-LI-S-T4
Governance & Lifecycle	RSA-LI-S-T5
Governance & Lifecycle	RSA-LI-S-T6
Governance & Lifecycle	RSA-LI-S-T7
Governance & Lifecycle	RSA-LI-S-T8
Governance & Lifecycle	RSA-LI-S-T9
Governance & Lifecycle	RSA-LILT-S-T1
Governance & Lifecycle	RSA-LILT-S-T2
Governance & Lifecycle	RSA-LILT-S-T3
Governance & Lifecycle	RSA-LILT-S-T4
Governance & Lifecycle	RSA-LILT-S-T5
Governance & Lifecycle	RSA-LILT-S-T6
Governance & Lifecycle	RSA-LILT-S-T7
Governance & Lifecycle	RSA-LILT-S-T8
Governance & Lifecycle	RSA-LILT-S-T9
Governance & Lifecycle	RSA-BUGL-S-T1
Governance & Lifecycle	RSA-BUGL-S-T2
Governance & Lifecycle	RSA-BUGL-S-T3
Governance & Lifecycle	RSA-BUGL-S-T4
Governance & Lifecycle	RSA-BUGL-S-T5
Governance & Lifecycle	RSA-BUGL-S-T6
Governance & Lifecycle	RSA-BUGL-S-T7
Governance & Lifecycle	RSA-BUGL-S-T8
Governance & Lifecycle	RSA-BUGL-S-T9
Governance & Lifecycle	RSA-BUGLLT-S-T1
Governance & Lifecycle	RSA-BUGLLT-S-T2
Governance & Lifecycle	RSA-BUGLLT-S-T3
Governance & Lifecycle	RSA-BUGLLT-S-T4
Governance & Lifecycle	RSA-BUGLLT-S-T5
Governance & Lifecycle	RSA-BUGLLT-S-T6
Governance & Lifecycle	RSA-BUGLLT-S-T7
Governance & Lifecycle	RSA-BUGLLT-S-T8
Governance & Lifecycle	RSA-BUGLLT-S-T9
Governance & Lifecycle	RSA-BRM-S-T1
Governance & Lifecycle	RSA-BRM-S-T2
Governance & Lifecycle	RSA-BRM-S-T3
Governance & Lifecycle	RSA-BRM-S-T4
Governance & Lifecycle	RSA-BRM-S-T5
Governance & Lifecycle	RSA-BRM-S-T6
Governance & Lifecycle	RSA-BRM-S-T7
Governance & Lifecycle	RSA-BRM-S-T8
Governance & Lifecycle	RSA-BRM-S-T9
Governance & Lifecycle	RSA-BRMLT-S-T1
Governance & Lifecycle	RSA-BRMLT-S-T2
Governance & Lifecycle	RSA-BRMLT-S-T3
Governance & Lifecycle	RSA-BRMLT-S-T4
Governance & Lifecycle	RSA-BRMLT-S-T5

Governance & Lifecycle	RSA-BRMLT-S-T6
Governance & Lifecycle	RSA-BRMLT-S-T7
Governance & Lifecycle	RSA-BRMLT-S-T8
Governance & Lifecycle	RSA-BRMLT-S-T9
Governance & Lifecycle	RSA-DAG-S-T1
Governance & Lifecycle	RSA-DAG-S-T2
Governance & Lifecycle	RSA-DAG-S-T3
Governance & Lifecycle	RSA-DAG-S-T4
Governance & Lifecycle	RSA-DAG-S-T5
Governance & Lifecycle	RSA-DAG-S-T6
Governance & Lifecycle	RSA-DAG-S-T7
Governance & Lifecycle	RSA-DAG-S-T8
Governance & Lifecycle	RSA-DAG-S-T9
Governance & Lifecycle	RSA-DAGLT-S-T1
Governance & Lifecycle	RSA-DAGLT-S-T2
Governance & Lifecycle	RSA-DAGLT-S-T3
Governance & Lifecycle	RSA-DAGLT-S-T4
Governance & Lifecycle	RSA-DAGLT-S-T5
Governance & Lifecycle	RSA-DAGLT-S-T6
Governance & Lifecycle	RSA-DAGLT-S-T7
Governance & Lifecycle	RSA-DAGLT-S-T8
Governance & Lifecycle	RSA-DAGLT-S-T9
Governance & Lifecycle	RSA-IID-S-T1
Governance & Lifecycle	RSA-IID-S-T2
Governance & Lifecycle	RSA-IID-S-T3
Governance & Lifecycle	RSA-IID-S-T4
Governance & Lifecycle	RSA-IID-S-T5
Governance & Lifecycle	RSA-IID-S-T6
Governance & Lifecycle	RSA-IID-S-T7
Governance & Lifecycle	RSA-IID-S-T8
Governance & Lifecycle	RSA-IID-S-T9
Governance & Lifecycle	RSA-GO-P-T1
Governance & Lifecycle	RSA-GO-P-T2
Governance & Lifecycle	RSA-GO-P-T3
Governance & Lifecycle	RSA-GO-P-T4
Governance & Lifecycle	RSA-GO-P-T5
Governance & Lifecycle	RSA-GO-P-T6
Governance & Lifecycle	RSA-GO-P-T7
Governance & Lifecycle	RSA-GO-P-T8
Governance & Lifecycle	RSA-GO-P-T9
Governance & Lifecycle	RSA-GO-P-T1-B1
Governance & Lifecycle	RSA-GO-P-T2-B1
Governance & Lifecycle	RSA-GO-P-T3-B1
Governance & Lifecycle	RSA-GO-P-T4-B1
Governance & Lifecycle	RSA-GO-P-T5-B1
Governance & Lifecycle	RSA-GO-P-T6-B1
Governance & Lifecycle	RSA-GO-P-T7-B1

Governance & Lifecycle	RSA-GO-P-T8-B1
Governance & Lifecycle	RSA-GO-P-T9-B1
Governance & Lifecycle	RSA-GO-P-T1-E1
Governance & Lifecycle	RSA-GO-P-T2-E1
Governance & Lifecycle	RSA-GO-P-T3-E1
Governance & Lifecycle	RSA-GO-P-T4-E1
Governance & Lifecycle	RSA-GO-P-T5-E1
Governance & Lifecycle	RSA-GO-P-T6-E1
Governance & Lifecycle	RSA-GO-P-T7-E1
Governance & Lifecycle	RSA-GO-P-T8-E1
Governance & Lifecycle	RSA-GO-P-T9-E1
Governance & Lifecycle	RSA-GOLT-P-T1
Governance & Lifecycle	RSA-GOLT-P-T2
Governance & Lifecycle	RSA-GOLT-P-T3
Governance & Lifecycle	RSA-GOLT-P-T4
Governance & Lifecycle	RSA-GOLT-P-T5
Governance & Lifecycle	RSA-GOLT-P-T6
Governance & Lifecycle	RSA-GOLT-P-T7
Governance & Lifecycle	RSA-GOLT-P-T8
Governance & Lifecycle	RSA-GOLT-P-T9
Governance & Lifecycle	RSA-GOLT-P-T1-B1
Governance & Lifecycle	RSA-GOLT-P-T2-B1
Governance & Lifecycle	RSA-GOLT-P-T3-B1
Governance & Lifecycle	RSA-GOLT-P-T4-B1
Governance & Lifecycle	RSA-GOLT-P-T5-B1
Governance & Lifecycle	RSA-GOLT-P-T6-B1
Governance & Lifecycle	RSA-GOLT-P-T7-B1
Governance & Lifecycle	RSA-GOLT-P-T8-B1
Governance & Lifecycle	RSA-GOLT-P-T9-B1
Governance & Lifecycle	RSA-GOLT-P-T1-E1
Governance & Lifecycle	RSA-GOLT-P-T2-E1
Governance & Lifecycle	RSA-GOLT-P-T3-E1
Governance & Lifecycle	RSA-GOLT-P-T4-E1
Governance & Lifecycle	RSA-GOLT-P-T5-E1
Governance & Lifecycle	RSA-GOLT-P-T6-E1
Governance & Lifecycle	RSA-GOLT-P-T7-E1
Governance & Lifecycle	RSA-GOLT-P-T8-E1
Governance & Lifecycle	RSA-GOLT-P-T9-E1
Governance & Lifecycle	RSA-LI-P-T1
Governance & Lifecycle	RSA-LI-P-T2
Governance & Lifecycle	RSA-LI-P-T3
Governance & Lifecycle	RSA-LI-P-T4
Governance & Lifecycle	RSA-LI-P-T5
Governance & Lifecycle	RSA-LI-P-T6
Governance & Lifecycle	RSA-LI-P-T7
Governance & Lifecycle	RSA-LI-P-T8
Governance & Lifecycle	RSA-LI-P-T9

Governance & Lifecycle	RSA-LI-P-T1-B1
Governance & Lifecycle	RSA-LI-P-T2-B1
Governance & Lifecycle	RSA-LI-P-T3-B1
Governance & Lifecycle	RSA-LI-P-T4-B1
Governance & Lifecycle	RSA-LI-P-T5-B1
Governance & Lifecycle	RSA-LI-P-T6-B1
Governance & Lifecycle	RSA-LI-P-T7-B1
Governance & Lifecycle	RSA-LI-P-T8-B1
Governance & Lifecycle	RSA-LI-P-T9-B1
Governance & Lifecycle	RSA-LI-P-T1-E1
Governance & Lifecycle	RSA-LI-P-T2-E1
Governance & Lifecycle	RSA-LI-P-T3-E1
Governance & Lifecycle	RSA-LI-P-T4-E1
Governance & Lifecycle	RSA-LI-P-T5-E1
Governance & Lifecycle	RSA-LI-P-T6-E1
Governance & Lifecycle	RSA-LI-P-T7-E1
Governance & Lifecycle	RSA-LI-P-T8-E1
Governance & Lifecycle	RSA-LI-P-T9-E1
Governance & Lifecycle	RSA-LILT-P-T1
Governance & Lifecycle	RSA-LILT-P-T2
Governance & Lifecycle	RSA-LILT-P-T3
Governance & Lifecycle	RSA-LILT-P-T4
Governance & Lifecycle	RSA-LILT-P-T5
Governance & Lifecycle	RSA-LILT-P-T6
Governance & Lifecycle	RSA-LILT-P-T7
Governance & Lifecycle	RSA-LILT-P-T8
Governance & Lifecycle	RSA-LILT-P-T9
Governance & Lifecycle	RSA-LILT-P-T1-B1
Governance & Lifecycle	RSA-LILT-P-T2-B1
Governance & Lifecycle	RSA-LILT-P-T3-B1
Governance & Lifecycle	RSA-LILT-P-T4-B1
Governance & Lifecycle	RSA-LILT-P-T5-B1
Governance & Lifecycle	RSA-LILT-P-T6-B1
Governance & Lifecycle	RSA-LILT-P-T7-B1
Governance & Lifecycle	RSA-LILT-P-T8-B1
Governance & Lifecycle	RSA-LILT-P-T9-B1
Governance & Lifecycle	RSA-LILT-P-T1-E1
Governance & Lifecycle	RSA-LILT-P-T2-E1
Governance & Lifecycle	RSA-LILT-P-T3-E1
Governance & Lifecycle	RSA-LILT-P-T4-E1
Governance & Lifecycle	RSA-LILT-P-T5-E1
Governance & Lifecycle	RSA-LILT-P-T6-E1
Governance & Lifecycle	RSA-LILT-P-T7-E1
Governance & Lifecycle	RSA-LILT-P-T8-E1
Governance & Lifecycle	RSA-LILT-P-T9-E1
Governance & Lifecycle	RSA-BUGL-P-T1
Governance & Lifecycle	RSA-BUGL-P-T2

Governance & Lifecycle	RSA-BUGL-P-T3
Governance & Lifecycle	RSA-BUGL-P-T4
Governance & Lifecycle	RSA-BUGL-P-T5
Governance & Lifecycle	RSA-BUGL-P-T6
Governance & Lifecycle	RSA-BUGL-P-T7
Governance & Lifecycle	RSA-BUGL-P-T8
Governance & Lifecycle	RSA-BUGL-P-T9
Governance & Lifecycle	RSA-BUGL-P-T1-B1
Governance & Lifecycle	RSA-BUGL-P-T2-B1
Governance & Lifecycle	RSA-BUGL-P-T3-B1
Governance & Lifecycle	RSA-BUGL-P-T4-B1
Governance & Lifecycle	RSA-BUGL-P-T5-B1
Governance & Lifecycle	RSA-BUGL-P-T6-B1
Governance & Lifecycle	RSA-BUGL-P-T7-B1
Governance & Lifecycle	RSA-BUGL-P-T8-B1
Governance & Lifecycle	RSA-BUGL-P-T9-B1
Governance & Lifecycle	RSA-BUGL-P-T1-E1
Governance & Lifecycle	RSA-BUGL-P-T2-E1
Governance & Lifecycle	RSA-BUGL-P-T3-E1
Governance & Lifecycle	RSA-BUGL-P-T4-E1
Governance & Lifecycle	RSA-BUGL-P-T5-E1
Governance & Lifecycle	RSA-BUGL-P-T6-E1
Governance & Lifecycle	RSA-BUGL-P-T7-E1
Governance & Lifecycle	RSA-BUGL-P-T8-E1
Governance & Lifecycle	RSA-BUGL-P-T9-E1
Governance & Lifecycle	RSA-BUGLLT-P-T1
Governance & Lifecycle	RSA-BUGLLT-P-T2
Governance & Lifecycle	RSA-BUGLLT-P-T3
Governance & Lifecycle	RSA-BUGLLT-P-T4
Governance & Lifecycle	RSA-BUGLLT-P-T5
Governance & Lifecycle	RSA-BUGLLT-P-T6
Governance & Lifecycle	RSA-BUGLLT-P-T7
Governance & Lifecycle	RSA-BUGLLT-P-T8
Governance & Lifecycle	RSA-BUGLLT-P-T9
Governance & Lifecycle	RSA-BUGLLT-P-T1-B1
Governance & Lifecycle	RSA-BUGLLT-P-T2-B1
Governance & Lifecycle	RSA-BUGLLT-P-T3-B1
Governance & Lifecycle	RSA-BUGLLT-P-T4-B1
Governance & Lifecycle	RSA-BUGLLT-P-T5-B1
Governance & Lifecycle	RSA-BUGLLT-P-T6-B1
Governance & Lifecycle	RSA-BUGLLT-P-T7-B1
Governance & Lifecycle	RSA-BUGLLT-P-T8-B1
Governance & Lifecycle	RSA-BUGLLT-P-T9-B1
Governance & Lifecycle	RSA-BUGLLT-P-T1-E1
Governance & Lifecycle	RSA-BUGLLT-P-T2-E1
Governance & Lifecycle	RSA-BUGLLT-P-T3-E1
Governance & Lifecycle	RSA-BUGLLT-P-T4-E1

Governance & Lifecycle	RSA-BUGLLT-P-T5-E1
Governance & Lifecycle	RSA-BUGLLT-P-T6-E1
Governance & Lifecycle	RSA-BUGLLT-P-T7-E1
Governance & Lifecycle	RSA-BUGLLT-P-T8-E1
Governance & Lifecycle	RSA-BUGLLT-P-T9-E1
Governance & Lifecycle	RSA-BRM-P-T1
Governance & Lifecycle	RSA-BRM-P-T2
Governance & Lifecycle	RSA-BRM-P-T3
Governance & Lifecycle	RSA-BRM-P-T4
Governance & Lifecycle	RSA-BRM-P-T5
Governance & Lifecycle	RSA-BRM-P-T6
Governance & Lifecycle	RSA-BRM-P-T7
Governance & Lifecycle	RSA-BRM-P-T8
Governance & Lifecycle	RSA-BRM-P-T9
Governance & Lifecycle	RSA-BRM-P-T1-B1
Governance & Lifecycle	RSA-BRM-P-T2-B1
Governance & Lifecycle	RSA-BRM-P-T3-B1
Governance & Lifecycle	RSA-BRM-P-T4-B1
Governance & Lifecycle	RSA-BRM-P-T5-B1
Governance & Lifecycle	RSA-BRM-P-T6-B1
Governance & Lifecycle	RSA-BRM-P-T7-B1
Governance & Lifecycle	RSA-BRM-P-T8-B1
Governance & Lifecycle	RSA-BRM-P-T9-B1
Governance & Lifecycle	RSA-BRM-P-T1-E1
Governance & Lifecycle	RSA-BRM-P-T2-E1
Governance & Lifecycle	RSA-BRM-P-T3-E1
Governance & Lifecycle	RSA-BRM-P-T4-E1
Governance & Lifecycle	RSA-BRM-P-T5-E1
Governance & Lifecycle	RSA-BRM-P-T6-E1
Governance & Lifecycle	RSA-BRM-P-T7-E1
Governance & Lifecycle	RSA-BRM-P-T8-E1
Governance & Lifecycle	RSA-BRM-P-T9-E1
Governance & Lifecycle	RSA-BRMLT-P-T1
Governance & Lifecycle	RSA-BRMLT-P-T2
Governance & Lifecycle	RSA-BRMLT-P-T3
Governance & Lifecycle	RSA-BRMLT-P-T4
Governance & Lifecycle	RSA-BRMLT-P-T5
Governance & Lifecycle	RSA-BRMLT-P-T6
Governance & Lifecycle	RSA-BRMLT-P-T7
Governance & Lifecycle	RSA-BRMLT-P-T8
Governance & Lifecycle	RSA-BRMLT-P-T9
Governance & Lifecycle	RSA-BRMLT-P-T1-B1
Governance & Lifecycle	RSA-BRMLT-P-T2-B1
Governance & Lifecycle	RSA-BRMLT-P-T3-B1
Governance & Lifecycle	RSA-BRMLT-P-T4-B1
Governance & Lifecycle	RSA-BRMLT-P-T5-B1
Governance & Lifecycle	RSA-BRMLT-P-T6-B1

Governance & Lifecycle	RSA-BRMLT-P-T7-B1
Governance & Lifecycle	RSA-BRMLT-P-T8-B1
Governance & Lifecycle	RSA-BRMLT-P-T9-B1
Governance & Lifecycle	RSA-BRMLT-P-T1-E1
Governance & Lifecycle	RSA-BRMLT-P-T2-E1
Governance & Lifecycle	RSA-BRMLT-P-T3-E1
Governance & Lifecycle	RSA-BRMLT-P-T4-E1
Governance & Lifecycle	RSA-BRMLT-P-T5-E1
Governance & Lifecycle	RSA-BRMLT-P-T6-E1
Governance & Lifecycle	RSA-BRMLT-P-T7-E1
Governance & Lifecycle	RSA-BRMLT-P-T8-E1
Governance & Lifecycle	RSA-BRMLT-P-T9-E1
Governance & Lifecycle	RSA-DAG-P-T1
Governance & Lifecycle	RSA-DAG-P-T2
Governance & Lifecycle	RSA-DAG-P-T3
Governance & Lifecycle	RSA-DAG-P-T4
Governance & Lifecycle	RSA-DAG-P-T5
Governance & Lifecycle	RSA-DAG-P-T6
Governance & Lifecycle	RSA-DAG-P-T7
Governance & Lifecycle	RSA-DAG-P-T8
Governance & Lifecycle	RSA-DAG-P-T9
Governance & Lifecycle	RSA-DAG-P-T1-B1
Governance & Lifecycle	RSA-DAG-P-T2-B1
Governance & Lifecycle	RSA-DAG-P-T3-B1
Governance & Lifecycle	RSA-DAG-P-T4-B1
Governance & Lifecycle	RSA-DAG-P-T5-B1
Governance & Lifecycle	RSA-DAG-P-T6-B1
Governance & Lifecycle	RSA-DAG-P-T7-B1
Governance & Lifecycle	RSA-DAG-P-T8-B1
Governance & Lifecycle	RSA-DAG-P-T9-B1
Governance & Lifecycle	RSA-DAG-P-T1-E1
Governance & Lifecycle	RSA-DAG-P-T2-E1
Governance & Lifecycle	RSA-DAG-P-T3-E1
Governance & Lifecycle	RSA-DAG-P-T4-E1
Governance & Lifecycle	RSA-DAG-P-T5-E1
Governance & Lifecycle	RSA-DAG-P-T6-E1
Governance & Lifecycle	RSA-DAG-P-T7-E1
Governance & Lifecycle	RSA-DAG-P-T8-E1
Governance & Lifecycle	RSA-DAG-P-T9-E1
Governance & Lifecycle	RSA-DAGLT-P-T1
Governance & Lifecycle	RSA-DAGLT-P-T2
Governance & Lifecycle	RSA-DAGLT-P-T3
Governance & Lifecycle	RSA-DAGLT-P-T4
Governance & Lifecycle	RSA-DAGLT-P-T5
Governance & Lifecycle	RSA-DAGLT-P-T6
Governance & Lifecycle	RSA-DAGLT-P-T7
Governance & Lifecycle	RSA-DAGLT-P-T8

Governance & Lifecycle	RSA-DAGLT-P-T9
Governance & Lifecycle	RSA-DAGLT-P-T1-B1
Governance & Lifecycle	RSA-DAGLT-P-T2-B1
Governance & Lifecycle	RSA-DAGLT-P-T3-B1
Governance & Lifecycle	RSA-DAGLT-P-T4-B1
Governance & Lifecycle	RSA-DAGLT-P-T5-B1
Governance & Lifecycle	RSA-DAGLT-P-T6-B1
Governance & Lifecycle	RSA-DAGLT-P-T7-B1
Governance & Lifecycle	RSA-DAGLT-P-T8-B1
Governance & Lifecycle	RSA-DAGLT-P-T9-B1
Governance & Lifecycle	RSA-DAGLT-P-T1-E1
Governance & Lifecycle	RSA-DAGLT-P-T2-E1
Governance & Lifecycle	RSA-DAGLT-P-T3-E1
Governance & Lifecycle	RSA-DAGLT-P-T4-E1
Governance & Lifecycle	RSA-DAGLT-P-T5-E1
Governance & Lifecycle	RSA-DAGLT-P-T6-E1
Governance & Lifecycle	RSA-DAGLT-P-T7-E1
Governance & Lifecycle	RSA-DAGLT-P-T8-E1
Governance & Lifecycle	RSA-DAGLT-P-T9-E1
Governance & Lifecycle	RSA-DAGA-P-T1
Governance & Lifecycle	RSA-DAGA-P-T2
Governance & Lifecycle	RSA-DAGA-P-T3
Governance & Lifecycle	RSA-DAGA-P-T4
Governance & Lifecycle	RSA-DAGA-P-T5
Governance & Lifecycle	RSA-DAGA-P-T6
Governance & Lifecycle	RSA-DAGA-P-T7
Governance & Lifecycle	RSA-DAGA-P-T8
Governance & Lifecycle	RSA-DAGA-P-T9
Governance & Lifecycle	RSA-DAGA-P-T1-B1
Governance & Lifecycle	RSA-DAGA-P-T2-B1
Governance & Lifecycle	RSA-DAGA-P-T3-B1
Governance & Lifecycle	RSA-DAGA-P-T4-B1
Governance & Lifecycle	RSA-DAGA-P-T5-B1
Governance & Lifecycle	RSA-DAGA-P-T6-B1
Governance & Lifecycle	RSA-DAGA-P-T7-B1
Governance & Lifecycle	RSA-DAGA-P-T8-B1
Governance & Lifecycle	RSA-DAGA-P-T9-B1
Governance & Lifecycle	RSA-DAGA-P-T1-E1
Governance & Lifecycle	RSA-DAGA-P-T2-E1
Governance & Lifecycle	RSA-DAGA-P-T3-E1
Governance & Lifecycle	RSA-DAGA-P-T4-E1
Governance & Lifecycle	RSA-DAGA-P-T5-E1
Governance & Lifecycle	RSA-DAGA-P-T6-E1
Governance & Lifecycle	RSA-DAGA-P-T7-E1
Governance & Lifecycle	RSA-DAGA-P-T8-E1
Governance & Lifecycle	RSA-DAGA-P-T9-E1
Governance & Lifecycle	RSA-DAGW-P-T1

Governance & Lifecycle	RSA-DAGW-P-T2
Governance & Lifecycle	RSA-DAGW-P-T3
Governance & Lifecycle	RSA-DAGW-P-T4
Governance & Lifecycle	RSA-DAGW-P-T5
Governance & Lifecycle	RSA-DAGW-P-T6
Governance & Lifecycle	RSA-DAGW-P-T7
Governance & Lifecycle	RSA-DAGW-P-T8
Governance & Lifecycle	RSA-DAGW-P-T9
Governance & Lifecycle	RSA-DAGW-P-T1-B1
Governance & Lifecycle	RSA-DAGW-P-T2-B1
Governance & Lifecycle	RSA-DAGW-P-T3-B1
Governance & Lifecycle	RSA-DAGW-P-T4-B1
Governance & Lifecycle	RSA-DAGW-P-T5-B1
Governance & Lifecycle	RSA-DAGW-P-T6-B1
Governance & Lifecycle	RSA-DAGW-P-T7-B1
Governance & Lifecycle	RSA-DAGW-P-T8-B1
Governance & Lifecycle	RSA-DAGW-P-T9-B1
Governance & Lifecycle	RSA-DAGW-P-T1-E1
Governance & Lifecycle	RSA-DAGW-P-T2-E1
Governance & Lifecycle	RSA-DAGW-P-T3-E1
Governance & Lifecycle	RSA-DAGW-P-T4-E1
Governance & Lifecycle	RSA-DAGW-P-T5-E1
Governance & Lifecycle	RSA-DAGW-P-T6-E1
Governance & Lifecycle	RSA-DAGW-P-T7-E1
Governance & Lifecycle	RSA-DAGW-P-T8-E1
Governance & Lifecycle	RSA-DAGW-P-T9-E1
Governance & Lifecycle	RSA-IID-P-T1
Governance & Lifecycle	RSA-IID-P-T2
Governance & Lifecycle	RSA-IID-P-T3
Governance & Lifecycle	RSA-IID-P-T4
Governance & Lifecycle	RSA-IID-P-T5
Governance & Lifecycle	RSA-IID-P-T6
Governance & Lifecycle	RSA-IID-P-T7
Governance & Lifecycle	RSA-IID-P-T8
Governance & Lifecycle	RSA-IID-P-T9
Governance & Lifecycle	RSA-IID-P-T1-B1
Governance & Lifecycle	RSA-IID-P-T2-B1
Governance & Lifecycle	RSA-IID-P-T3-B1
Governance & Lifecycle	RSA-IID-P-T4-B1
Governance & Lifecycle	RSA-IID-P-T5-B1
Governance & Lifecycle	RSA-IID-P-T6-B1
Governance & Lifecycle	RSA-IID-P-T7-B1
Governance & Lifecycle	RSA-IID-P-T8-B1
Governance & Lifecycle	RSA-IID-P-T9-B1
Governance & Lifecycle	RSA-IID-P-T1-E1
Governance & Lifecycle	RSA-IID-P-T2-E1
Governance & Lifecycle	RSA-IID-P-T3-E1

Governance & Lifecycle	RSA-IID-P-T4-E1
Governance & Lifecycle	RSA-IID-P-T5-E1
Governance & Lifecycle	RSA-IID-P-T6-E1
Governance & Lifecycle	RSA-IID-P-T7-E1
Governance & Lifecycle	RSA-IID-P-T8-E1
Governance & Lifecycle	RSA-IID-P-T9-E1
Governance & Lifecycle	RSA-GO-T-T1
Governance & Lifecycle	RSA-GO-T-T2
Governance & Lifecycle	RSA-GO-T-T3
Governance & Lifecycle	RSA-GO-T-T4
Governance & Lifecycle	RSA-GO-T-T5
Governance & Lifecycle	RSA-GO-T-T6
Governance & Lifecycle	RSA-GO-T-T7
Governance & Lifecycle	RSA-GO-T-T8
Governance & Lifecycle	RSA-GO-T-T9
Governance & Lifecycle	RSA-GOLT-T-T1
Governance & Lifecycle	RSA-GOLT-T-T2
Governance & Lifecycle	RSA-GOLT-T-T3
Governance & Lifecycle	RSA-GOLT-T-T4
Governance & Lifecycle	RSA-GOLT-T-T5
Governance & Lifecycle	RSA-GOLT-T-T6
Governance & Lifecycle	RSA-GOLT-T-T7
Governance & Lifecycle	RSA-GOLT-T-T8
Governance & Lifecycle	RSA-GOLT-T-T9
Governance & Lifecycle	RSA-LI-T-T1
Governance & Lifecycle	RSA-LI-T-T2
Governance & Lifecycle	RSA-LI-T-T3
Governance & Lifecycle	RSA-LI-T-T4
Governance & Lifecycle	RSA-LI-T-T5
Governance & Lifecycle	RSA-LI-T-T6
Governance & Lifecycle	RSA-LI-T-T7
Governance & Lifecycle	RSA-LI-T-T8
Governance & Lifecycle	RSA-LI-T-T9
Governance & Lifecycle	RSA-LILT-T-T1
Governance & Lifecycle	RSA-LILT-T-T2
Governance & Lifecycle	RSA-LILT-T-T3
Governance & Lifecycle	RSA-LILT-T-T4
Governance & Lifecycle	RSA-LILT-T-T5
Governance & Lifecycle	RSA-LILT-T-T6
Governance & Lifecycle	RSA-LILT-T-T7
Governance & Lifecycle	RSA-LILT-T-T8
Governance & Lifecycle	RSA-LILT-T-T9
Governance & Lifecycle	RSA-BUGL-T-T1
Governance & Lifecycle	RSA-BUGL-T-T2
Governance & Lifecycle	RSA-BUGL-T-T3
Governance & Lifecycle	RSA-BUGL-T-T4
Governance & Lifecycle	RSA-BUGL-T-T5

Governance & Lifecycle	RSA-BUGL-T-T6
Governance & Lifecycle	RSA-BUGL-T-T7
Governance & Lifecycle	RSA-BUGL-T-T8
Governance & Lifecycle	RSA-BUGL-T-T9
Governance & Lifecycle	RSA-BUGLLT-T-T1
Governance & Lifecycle	RSA-BUGLLT-T-T2
Governance & Lifecycle	RSA-BUGLLT-T-T3
Governance & Lifecycle	RSA-BUGLLT-T-T4
Governance & Lifecycle	RSA-BUGLLT-T-T5
Governance & Lifecycle	RSA-BUGLLT-T-T6
Governance & Lifecycle	RSA-BUGLLT-T-T7
Governance & Lifecycle	RSA-BUGLLT-T-T8
Governance & Lifecycle	RSA-BUGLLT-T-T9
Governance & Lifecycle	RSA-BRM-T-T1
Governance & Lifecycle	RSA-BRM-T-T2
Governance & Lifecycle	RSA-BRM-T-T3
Governance & Lifecycle	RSA-BRM-T-T4
Governance & Lifecycle	RSA-BRM-T-T5
Governance & Lifecycle	RSA-BRM-T-T6
Governance & Lifecycle	RSA-BRM-T-T7
Governance & Lifecycle	RSA-BRM-T-T8
Governance & Lifecycle	RSA-BRM-T-T9
Governance & Lifecycle	RSA-BRMLT-T-T1
Governance & Lifecycle	RSA-BRMLT-T-T2
Governance & Lifecycle	RSA-BRMLT-T-T3
Governance & Lifecycle	RSA-BRMLT-T-T4
Governance & Lifecycle	RSA-BRMLT-T-T5
Governance & Lifecycle	RSA-BRMLT-T-T6
Governance & Lifecycle	RSA-BRMLT-T-T7
Governance & Lifecycle	RSA-BRMLT-T-T8
Governance & Lifecycle	RSA-BRMLT-T-T9
Governance & Lifecycle	RSA-DAG-T-T1
Governance & Lifecycle	RSA-DAG-T-T2
Governance & Lifecycle	RSA-DAG-T-T3
Governance & Lifecycle	RSA-DAG-T-T4
Governance & Lifecycle	RSA-DAG-T-T5
Governance & Lifecycle	RSA-DAG-T-T6
Governance & Lifecycle	RSA-DAG-T-T7
Governance & Lifecycle	RSA-DAG-T-T8
Governance & Lifecycle	RSA-DAG-T-T9
Governance & Lifecycle	RSA-DAGLT-T-T1
Governance & Lifecycle	RSA-DAGLT-T-T2
Governance & Lifecycle	RSA-DAGLT-T-T3
Governance & Lifecycle	RSA-DAGLT-T-T4
Governance & Lifecycle	RSA-DAGLT-T-T5
Governance & Lifecycle	RSA-DAGLT-T-T6
Governance & Lifecycle	RSA-DAGLT-T-T7

Governance & Lifecycle	RSA-DAGLT-T-T8
Governance & Lifecycle	RSA-DAGLT-T-T9
Governance & Lifecycle	RSA-DAGA-T-T1
Governance & Lifecycle	RSA-DAGA-T-T2
Governance & Lifecycle	RSA-DAGA-T-T3
Governance & Lifecycle	RSA-DAGA-T-T4
Governance & Lifecycle	RSA-DAGA-T-T5
Governance & Lifecycle	RSA-DAGA-T-T6
Governance & Lifecycle	RSA-DAGA-T-T7
Governance & Lifecycle	RSA-DAGA-T-T8
Governance & Lifecycle	RSA-DAGA-T-T9
Governance & Lifecycle	RSA-DAGW-T-T1
Governance & Lifecycle	RSA-DAGW-T-T2
Governance & Lifecycle	RSA-DAGW-T-T3
Governance & Lifecycle	RSA-DAGW-T-T4
Governance & Lifecycle	RSA-DAGW-T-T5
Governance & Lifecycle	RSA-DAGW-T-T6
Governance & Lifecycle	RSA-DAGW-T-T7
Governance & Lifecycle	RSA-DAGW-T-T8
Governance & Lifecycle	RSA-DAGW-T-T9
Governance & Lifecycle	RSA-IID-T-T1
Governance & Lifecycle	RSA-IID-T-T2
Governance & Lifecycle	RSA-IID-T-T3
Governance & Lifecycle	RSA-IID-T-T4
Governance & Lifecycle	RSA-IID-T-T5
Governance & Lifecycle	RSA-IID-T-T6
Governance & Lifecycle	RSA-IID-T-T7
Governance & Lifecycle	RSA-IID-T-T8
Governance & Lifecycle	RSA-IID-T-T9
Governance & Lifecycle	RSA-0028020
Governance & Lifecycle	RSA-0028026
Governance & Lifecycle	RSA-0028024
Governance & Lifecycle	RSA-0028027
Governance & Lifecycle	RSA-0018076
Governance & Lifecycle	RSA-0018077
Governance & Lifecycle	RSA-0028077
Governance & Lifecycle	RSA-0028078
Governance & Lifecycle	RSA-0018078
Governance & Lifecycle	RSA-0018079
Governance & Lifecycle	RSA-0028079
Governance & Lifecycle	RSA-0028080
Governance & Lifecycle	RSA-0018037
Governance & Lifecycle	RSA-0028032
Governance & Lifecycle	RSA-0028033
Hardware Authenticators	ADD-ON TOKEN FEE
Hardware Authenticators	RSA SECURID SELECT
Hardware Authenticators	KEY SHEET ARTWORK

Hardware Authenticators	SID700-6-60-24-5
Hardware Authenticators	SID700-6-60-24-10
Hardware Authenticators	SID700-6-60-24-25
Hardware Authenticators	SID700-6-60-24-50
Hardware Authenticators	SID700-6-60-24-100
Hardware Authenticators	SID700-6-60-24-250
Hardware Authenticators	SID700-6-60-24-A
Hardware Authenticators	SID700-6-60-24-B
Hardware Authenticators	SID700-6-60-24-C
Hardware Authenticators	SID700-6-60-24-D
Hardware Authenticators	SID700-6-60-24-E
Hardware Authenticators	SID700-6-60-24-F
Hardware Authenticators	SID700-6-60-24-G
Hardware Authenticators	SID700-6-60-24-H
Hardware Authenticators	SID700-6-60-24-I
Hardware Authenticators	SID700-6-60-36-5
Hardware Authenticators	SID700-6-60-36-10
Hardware Authenticators	SID700-6-60-36-25
Hardware Authenticators	SID700-6-60-36-50
Hardware Authenticators	SID700-6-60-36-100
Hardware Authenticators	SID700-6-60-36-250
Hardware Authenticators	SID700-6-60-36-A
Hardware Authenticators	SID700-6-60-36-B
Hardware Authenticators	SID700-6-60-36-C
Hardware Authenticators	SID700-6-60-36-D
Hardware Authenticators	SID700-6-60-36-E
Hardware Authenticators	SID700-6-60-36-F
Hardware Authenticators	SID700-6-60-36-G
Hardware Authenticators	SID700-6-60-36-H
Hardware Authenticators	SID700-6-60-36-I
Hardware Authenticators	SID700-6-60-48-5
Hardware Authenticators	SID700-6-60-48-10
Hardware Authenticators	SID700-6-60-48-25
Hardware Authenticators	SID700-6-60-48-50
Hardware Authenticators	SID700-6-60-48-100
Hardware Authenticators	SID700-6-60-48-250
Hardware Authenticators	SID700-6-60-48-A
Hardware Authenticators	SID700-6-60-48-B
Hardware Authenticators	SID700-6-60-48-C
Hardware Authenticators	SID700-6-60-48-D
Hardware Authenticators	SID700-6-60-48-E
Hardware Authenticators	SID700-6-60-48-F
Hardware Authenticators	SID700-6-60-48-G
Hardware Authenticators	SID700-6-60-48-H
Hardware Authenticators	SID700-6-60-48-I
Hardware Authenticators	SID700-6-60-60-5
Hardware Authenticators	SID700-6-60-60-10

Hardware Authenticators	SID700-6-60-60-25
Hardware Authenticators	SID700-6-60-60-50
Hardware Authenticators	SID700-6-60-60-100
Hardware Authenticators	SID700-6-60-60-250
Hardware Authenticators	SID700-6-60-60-A
Hardware Authenticators	SID700-6-60-60-B
Hardware Authenticators	SID700-6-60-60-C
Hardware Authenticators	SID700-6-60-60-D
Hardware Authenticators	SID700-6-60-60-E
Hardware Authenticators	SID700-6-60-60-F
Hardware Authenticators	SID700-6-60-60-G
Hardware Authenticators	SID700-6-60-60-H
Hardware Authenticators	SID700-6-60-60-I
Hardware Authenticators	SID700-6-30-24-5
Hardware Authenticators	SID700-6-30-24-10
Hardware Authenticators	SID700-6-30-24-25
Hardware Authenticators	SID700-6-30-24-50
Hardware Authenticators	SID700-6-30-24-100
Hardware Authenticators	SID700-6-30-24-250
Hardware Authenticators	SID700-6-30-24-A
Hardware Authenticators	SID700-6-30-24-B
Hardware Authenticators	SID700-6-30-24-C
Hardware Authenticators	SID700-6-30-24-D
Hardware Authenticators	SID700-6-30-24-E
Hardware Authenticators	SID700-6-30-24-F
Hardware Authenticators	SID700-6-30-24-G
Hardware Authenticators	SID700-6-30-24-H
Hardware Authenticators	SID700-6-30-24-I
Hardware Authenticators	SID700-6-30-36-5
Hardware Authenticators	SID700-6-30-36-10
Hardware Authenticators	SID700-6-30-36-25
Hardware Authenticators	SID700-6-30-36-50
Hardware Authenticators	SID700-6-30-36-100
Hardware Authenticators	SID700-6-30-36-250
Hardware Authenticators	SID700-6-30-36-A
Hardware Authenticators	SID700-6-30-36-B
Hardware Authenticators	SID700-6-30-36-C
Hardware Authenticators	SID700-6-30-36-D
Hardware Authenticators	SID700-6-30-36-E
Hardware Authenticators	SID700-6-30-36-F
Hardware Authenticators	SID700-6-30-36-G
Hardware Authenticators	SID700-6-30-36-H
Hardware Authenticators	SID700-6-30-36-I
Hardware Authenticators	SID700-6-30-48-5
Hardware Authenticators	SID700-6-30-48-10
Hardware Authenticators	SID700-6-30-48-25
Hardware Authenticators	SID700-6-30-48-50

Hardware Authenticators	SID700-6-30-48-100
Hardware Authenticators	SID700-6-30-48-250
Hardware Authenticators	SID700-6-30-48-A
Hardware Authenticators	SID700-6-30-48-B
Hardware Authenticators	SID700-6-30-48-C
Hardware Authenticators	SID700-6-30-48-D
Hardware Authenticators	SID700-6-30-48-E
Hardware Authenticators	SID700-6-30-48-F
Hardware Authenticators	SID700-6-30-48-G
Hardware Authenticators	SID700-6-30-48-H
Hardware Authenticators	SID700-6-30-48-I
Hardware Authenticators	SID700-6-30-60-5
Hardware Authenticators	SID700-6-30-60-10
Hardware Authenticators	SID700-6-30-60-25
Hardware Authenticators	SID700-6-30-60-50
Hardware Authenticators	SID700-6-30-60-100
Hardware Authenticators	SID700-6-30-60-250
Hardware Authenticators	SID700-6-30-60-A
Hardware Authenticators	SID700-6-30-60-B
Hardware Authenticators	SID700-6-30-60-C
Hardware Authenticators	SID700-6-30-60-D
Hardware Authenticators	SID700-6-30-60-E
Hardware Authenticators	SID700-6-30-60-F
Hardware Authenticators	SID700-6-30-60-G
Hardware Authenticators	SID700-6-30-60-H
Hardware Authenticators	SID700-6-30-60-I
Hardware Authenticators	SID800-6-60-24-5
Hardware Authenticators	SID800-6-60-24-10
Hardware Authenticators	SID800-6-60-24-25
Hardware Authenticators	SID800-6-60-24-50
Hardware Authenticators	SID800-6-60-24-100
Hardware Authenticators	SID800-6-60-24-250
Hardware Authenticators	SID800-6-60-24-A
Hardware Authenticators	SID800-6-60-24-B
Hardware Authenticators	SID800-6-60-24-C
Hardware Authenticators	SID800-6-60-24-D
Hardware Authenticators	SID800-6-60-24-E
Hardware Authenticators	SID800-6-60-24-F
Hardware Authenticators	SID800-6-60-24-G
Hardware Authenticators	SID800-6-60-24-H
Hardware Authenticators	SID800-6-60-24-I
Hardware Authenticators	SID800-6-60-36-5
Hardware Authenticators	SID800-6-60-36-10
Hardware Authenticators	SID800-6-60-36-25
Hardware Authenticators	SID800-6-60-36-50
Hardware Authenticators	SID800-6-60-36-100
Hardware Authenticators	SID800-6-60-36-250

Hardware Authenticators	SID800-6-60-36-A
Hardware Authenticators	SID800-6-60-36-B
Hardware Authenticators	SID800-6-60-36-C
Hardware Authenticators	SID800-6-60-36-D
Hardware Authenticators	SID800-6-60-36-E
Hardware Authenticators	SID800-6-60-36-F
Hardware Authenticators	SID800-6-60-36-G
Hardware Authenticators	SID800-6-60-36-H
Hardware Authenticators	SID800-6-60-36-I
Hardware Authenticators	SID800-6-60-48-5
Hardware Authenticators	SID800-6-60-48-10
Hardware Authenticators	SID800-6-60-48-25
Hardware Authenticators	SID800-6-60-48-50
Hardware Authenticators	SID800-6-60-48-100
Hardware Authenticators	SID800-6-60-48-250
Hardware Authenticators	SID800-6-60-48-A
Hardware Authenticators	SID800-6-60-48-B
Hardware Authenticators	SID800-6-60-48-C
Hardware Authenticators	SID800-6-60-48-D
Hardware Authenticators	SID800-6-60-48-E
Hardware Authenticators	SID800-6-60-48-F
Hardware Authenticators	SID800-6-60-48-G
Hardware Authenticators	SID800-6-60-48-H
Hardware Authenticators	SID800-6-60-48-I
Hardware Authenticators	SID800-6-60-60-5
Hardware Authenticators	SID800-6-60-60-10
Hardware Authenticators	SID800-6-60-60-25
Hardware Authenticators	SID800-6-60-60-50
Hardware Authenticators	SID800-6-60-60-100
Hardware Authenticators	SID800-6-60-60-250
Hardware Authenticators	SID800-6-60-60-A
Hardware Authenticators	SID800-6-60-60-B
Hardware Authenticators	SID800-6-60-60-C
Hardware Authenticators	SID800-6-60-60-D
Hardware Authenticators	SID800-6-60-60-E
Hardware Authenticators	SID800-6-60-60-F
Hardware Authenticators	SID800-6-60-60-G
Hardware Authenticators	SID800-6-60-60-H
Hardware Authenticators	SID800-6-60-60-I
Hardware Authenticators	SID800-6-30-24-5
Hardware Authenticators	SID800-6-30-24-10
Hardware Authenticators	SID800-6-30-24-25
Hardware Authenticators	SID800-6-30-24-50
Hardware Authenticators	SID800-6-30-24-100
Hardware Authenticators	SID800-6-30-24-250
Hardware Authenticators	SID800-6-30-24-A
Hardware Authenticators	SID800-6-30-24-B

Hardware Authenticators	SID800-6-30-24-C
Hardware Authenticators	SID800-6-30-24-D
Hardware Authenticators	SID800-6-30-24-E
Hardware Authenticators	SID800-6-30-24-F
Hardware Authenticators	SID800-6-30-24-G
Hardware Authenticators	SID800-6-30-24-H
Hardware Authenticators	SID800-6-30-24-I
Hardware Authenticators	SID800-6-30-36-5
Hardware Authenticators	SID800-6-30-36-10
Hardware Authenticators	SID800-6-30-36-25
Hardware Authenticators	SID800-6-30-36-50
Hardware Authenticators	SID800-6-30-36-100
Hardware Authenticators	SID800-6-30-36-250
Hardware Authenticators	SID800-6-30-36-A
Hardware Authenticators	SID800-6-30-36-B
Hardware Authenticators	SID800-6-30-36-C
Hardware Authenticators	SID800-6-30-36-D
Hardware Authenticators	SID800-6-30-36-E
Hardware Authenticators	SID800-6-30-36-F
Hardware Authenticators	SID800-6-30-36-G
Hardware Authenticators	SID800-6-30-36-H
Hardware Authenticators	SID800-6-30-36-I
Hardware Authenticators	SID800-6-30-48-5
Hardware Authenticators	SID800-6-30-48-10
Hardware Authenticators	SID800-6-30-48-25
Hardware Authenticators	SID800-6-30-48-50
Hardware Authenticators	SID800-6-30-48-100
Hardware Authenticators	SID800-6-30-48-250
Hardware Authenticators	SID800-6-30-48-A
Hardware Authenticators	SID800-6-30-48-B
Hardware Authenticators	SID800-6-30-48-C
Hardware Authenticators	SID800-6-30-48-D
Hardware Authenticators	SID800-6-30-48-E
Hardware Authenticators	SID800-6-30-48-F
Hardware Authenticators	SID800-6-30-48-G
Hardware Authenticators	SID800-6-30-48-H
Hardware Authenticators	SID800-6-30-48-I
Hardware Authenticators	SID800-6-30-60-5
Hardware Authenticators	SID800-6-30-60-10
Hardware Authenticators	SID800-6-30-60-25
Hardware Authenticators	SID800-6-30-60-50
Hardware Authenticators	SID800-6-30-60-100
Hardware Authenticators	SID800-6-30-60-250
Hardware Authenticators	SID800-6-30-60-A
Hardware Authenticators	SID800-6-30-60-B
Hardware Authenticators	SID800-6-30-60-C
Hardware Authenticators	SID800-6-30-60-D

Hardware Authenticators	SID800-6-30-60-E
Hardware Authenticators	SID800-6-30-60-F
Hardware Authenticators	SID800-6-30-60-G
Hardware Authenticators	SID800-6-30-60-H
Hardware Authenticators	SID800-6-30-60-I
IMG	ACM5000
IMG	ACM10000
IMG	ACM25000
IMG	ACM50000
IMG	ACM100000
IMG	ACM250000
IMG	ACM250001
IMG	ACME
IMG	ACM5000B1
IMG	ACM10000B1
IMG	ACM25000B1
IMG	ACM50000B1
IMG	ACM100000B1
IMG	ACM250000B1
IMG	ACM250001B1
IMG	ACMEB1
IMG	ACM5000E1
IMG	ACM10000E1
IMG	ACM25000E1
IMG	ACM50000E1
IMG	ACM100000E1
IMG	ACM250000E1
IMG	ACM250001E1
IMG	ACMEE1
IMG	BRM5000
IMG	BRM10000
IMG	BRM25000
IMG	BRM50000
IMG	BRM100000
IMG	BRM250000
IMG	BRM250001
IMG	BRME
IMG	BRM5000B1
IMG	BRM10000B1
IMG	BRM25000B1
IMG	BRM50000B1
IMG	BRM100000B1
IMG	BRM250000B1
IMG	BRM250001B1
IMG	BRMEB1
IMG	BRM5000E1
IMG	BRM10000E1

IMG	BRM25000E1
IMG	BRM50000E1
IMG	BRM100000E1
IMG	BRM250000E1
IMG	BRM250001E1
IMG	BRMEE1
IMG	ARM5000
IMG	ARM10000
IMG	ARM25000
IMG	ARM50000
IMG	ARM100000
IMG	ARM250000
IMG	ARM250001
IMG	ARME
IMG	ARM5000B1
IMG	ARM10000B1
IMG	ARM25000B1
IMG	ARM50000B1
IMG	ARM100000B1
IMG	ARM250000B1
IMG	ARM250001B1
IMG	ARMEB1
IMG	ARM5000E1
IMG	ARM10000E1
IMG	ARM25000E1
IMG	ARM50000E1
IMG	ARM100000E1
IMG	ARM250000E1
IMG	ARM250001E1
IMG	ARMEE1
IMG	DAG5000B1
IMG	DAG10000B1
IMG	DAG25000B1
IMG	DAG50000B1
IMG	DAG100000B1
IMG	DAG250000B1
IMG	DAG250001B1
IMG	DAGEB1
IMG	DAG5000E1
IMG	DAG10000E1
IMG	DAG25000E1
IMG	DAG50000E1
IMG	DAG100000E1
IMG	DAG250000E1
IMG	DAG250001E1
IMG	DAGEE1
IMG	DAGW5000

IMG	DAGW10000
IMG	DAGW25000
IMG	DAGW50000
IMG	DAGW100000
IMG	DAGW250000
IMG	DAGW250001
IMG	DAGWE
IMG	DAGW5000B1
IMG	DAGW10000B1
IMG	DAGW25000B1
IMG	DAGW50000B1
IMG	DAGW100000B1
IMG	DAGW250000B1
IMG	DAGW250001B1
IMG	DAGWEB1
IMG	DAGW5000E1
IMG	DAGW10000E1
IMG	DAGW25000E1
IMG	DAGW50000E1
IMG	DAGW100000E1
IMG	DAGW250000E1
IMG	DAGW250001E1
IMG	DAGWEE1
IMG	IID5000B1
IMG	IID10000B1
IMG	IID25000B1
IMG	IID50000B1
IMG	IID100000B1
IMG	IID250000B1
IMG	IID250001B1
IMG	IIDEB1
IMG	IID5000E1
IMG	IID10000E1
IMG	IID25000E1
IMG	IID50000E1
IMG	IID100000E1
IMG	IID250000E1
IMG	IID250001E1
IMG	IIDEE1
IMG	AFX5000
IMG	AFX10000
IMG	AFX25000
IMG	AFX50000
IMG	AFX100000
IMG	AFX250000
IMG	AFX250001
IMG	AFXE

IMG	AFX5000B1
IMG	AFX10000B1
IMG	AFX25000B1
IMG	AFX50000B1
IMG	AFX100000B1
IMG	AFX250000B1
IMG	AFX250001B1
IMG	AFXEB1
IMG	AFX5000E1
IMG	AFX10000E1
IMG	AFX25000E1
IMG	AFX50000E1
IMG	AFX100000E1
IMG	AFX250000E1
IMG	AFX250001E1
IMG	AFXEE1
IMG	SAAS-COMP5000
IMG	SAAS-COMP10000
IMG	SAAS-COMP25000
IMG	SAAS-COMP50000
IMG	SAAS-COMP50001
IMG	SAAS-COMP100001
IMG	SAAS-PROV-REQ5000
IMG	SAAS-PROV-REQ10000
IMG	SAAS-PROV-REQ25000
IMG	SAAS-PROV-REQ50000
IMG	SAAS-PROV-REQ50001
IMG	SAAS-PROVREQ100001
IMG	RSA-0028019
IMG	RSA-0028025
IMG	DAGAM5000B1
IMG	DAGAM10000B1
IMG	DAGAM25000B1
IMG	DAGAM50000B1
IMG	DAGAM100000B1
IMG	DAGAM250000B1
IMG	DAGAM250001B1
IMG	DAGAMEB1
IMG	DAGAM5000E1
IMG	DAGAM10000E1
IMG	DAGAM25000E1
IMG	DAGAM50000E1
IMG	DAGAM100000E1
IMG	DAGAM250000E1
IMG	DAGAM250001E1
IMG	DAGAMEE1
Key Recovery Mgr	KRMB1

Key Recovery Mgr	KRME1
NetWitness Appliance	SA-S5H-AS
NetWitness Appliance	SA-S5H-ASTR
NetWitness Appliance	SA-ANALYSTENT5
NetWitness Appliance	SA-S5H-P-DEC
NetWitness Appliance	SA-S5H-L-DEC
NetWitness Appliance	SA-S5H-P-DECTR
NetWitness Appliance	SA-S5H-L-DECTR
NetWitness Appliance	SA-S5-HYBRID-P
NetWitness Appliance	SA-S5-HYBRID-L
NetWitness Appliance	SA-S5HYBRID-PTR
NetWitness Appliance	SA-S5HYBRID-LTR
NetWitness Appliance	SA-S5H-P-CON
NetWitness Appliance	SA-S5H-L-CON
NetWitness Appliance	SA-S5H-P-CONTR
NetWitness Appliance	SA-S5H-L-CONTR
NetWitness Appliance	SA-S5H-BRO
NetWitness Appliance	SA-S5H-BROTR
NetWitness Appliance	SA-S5H-ESA
NetWitness Appliance	SA-S5H-ESA-TR
NetWitness Appliance	SA-S5H-ARCH
NetWitness Appliance	SA-S5H-ARCH-TR
NetWitness Appliance	SA-S5H-MAL
NetWitness Appliance	NW-PVHD72A-L
NetWitness Appliance	NW-PVHD144A-L
NetWitness Appliance	NW-PVHD72A-L-TR
NetWitness Appliance	NW-PVHD144A-L-TR
NetWitness Appliance	NW-PVHD72-L
NetWitness Appliance	NW-PVHD144-L
NetWitness Appliance	NW-PVHD72-L-TR
NetWitness Appliance	NW-PVHD144-L-TR
NetWitness Appliance	NW-PVHP56-L
NetWitness Appliance	NW-PVHP113-L
NetWitness Appliance	NW-PVHP56-L-TR
NetWitness Appliance	NW-PVHP113-L-TR
NetWitness Appliance	SA-HDD32-ARCH
NetWitness Appliance	SA-HDD46-ARCH
NetWitness Appliance	SA-HDD142-ARCH
NetWitness Appliance	SA-HDD32-ARCHTR
NetWitness Appliance	SA-HDD46-ARCHTR
NetWitness Appliance	SA-DACHD-P
NetWitness Appliance	SA-DACHD-PTR
NetWitness Appliance	SA-HDD22-LP
NetWitness Appliance	SA-HDD22-LPTR
NetWitness Appliance	SA-HDD32-LP
NetWitness Appliance	SA-HDD32-LPTR
NetWitness Appliance	SA-HDD142-LP

NetWitness Appliance	SA-HDD142-LPTR
NetWitness Appliance	SA-HDD180-LP
NetWitness Appliance	SA-DACHD-L
NetWitness Appliance	SA-DACHD-L TR
NetWitness Appliance	SA-HDD22-LL
NetWitness Appliance	SA-HDD22-LLTR
NetWitness Appliance	SA-HDD32-LL
NetWitness Appliance	SA-HDD32-LLTR
NetWitness Appliance	SA-HDD142-LL
NetWitness Appliance	SA-HDD142-LLTR
NetWitness Appliance	SA-HDD180-LL
NetWitness Appliance	SA-DACHP
NetWitness Appliance	SA-DACHPTR
NetWitness Appliance	SA-HPD12H1
NetWitness Appliance	SA-HPD12H1TR
NetWitness Appliance	SA-HDD22-LLH
NetWitness Appliance	SA-HDD22-LLHTR
NetWitness Appliance	SA-HDD22-LPH
NetWitness Appliance	SA-HDD22-LPHTR
NetWitness Appliance	SA-HDD32-LLH
NetWitness Appliance	SA-HDD32-LLHTR
NetWitness Appliance	SA-HDD32-LPH
NetWitness Appliance	SA-HDD32-LPHTR
NetWitness Appliance	SA-HDD46-LLH
NetWitness Appliance	SA-HDD46-LLHTR
NetWitness Appliance	SA-HDD46-LPH
NetWitness Appliance	SA-HDD46-LPHTR
NetWitness Appliance	SA-VNX2HD-SHLFU
NetWitness Appliance	SA-VNX2HP-SHLFU
NetWitness Appliance	SA-VNX2-Rack
NetWitness Appliance	SA-ULTRA-RACK
NetWitness Appliance	NWS-Unity600
NetWitness Appliance	NWS-U600-Rack
NetWitness Appliance	NWS-U6APHD-SHLF
NetWitness Appliance	NWS-U6APHP-SHLF
NetWitness Appliance	NWS-U6APHDA-SHLF
NetWitness Appliance	SA-NL400-BASE
NetWitness Appliance	SA-NL400-ADDON
NetWitness Appliance	SA-NL400S-BASE
NetWitness Appliance	SA-NL400S-ADDON
NetWitness Appliance	SA-NL400-6-BASE
NetWitness Appliance	SA-NL400-6-ADD
NetWitness Appliance	SA-SAW-CACH200
NetWitness Appliance	SA-HDD-1TB-R620
NetWitness Appliance	SA-HDD-146GB-R620
NetWitness Appliance	SA-PWR-R620
NetWitness Appliance	SA-S4H-RAILKIT

NetWitness Appliance	SA-SAW-FAN
NetWitness Appliance	SA-SAW-PWR
NetWitness Appliance	SA-S5H-PWR
NetWitness Appliance	SA-S5H-10GE-F
NetWitness Appliance	SA-S5-2M-MINI-SAS
NetWitness Appliance	SA-S5-5M-MINI-SAS
NetWitness Appliance	SA-DP-8GB-SANHBA
NetWitness Appliance	SA-DP-8GB-SANHBAB1
NetWitness Appliance	SA-DP-8GB-SANHBAE1
NetWitness Appliance	SA-S4H-ASB1
NetWitness Appliance	SA-S5H-ASB1
NetWitness Appliance	SA-ANALYSTENT5B1
NetWitness Appliance	SA-S4H-P-DECB1
NetWitness Appliance	SA-S4H-L-DECB1
NetWitness Appliance	SA-S5H-P-DECB1
NetWitness Appliance	SA-S5H-L-DECB1
NetWitness Appliance	SA-HYBRID-PB1
NetWitness Appliance	SA-HYBRID-LB1
NetWitness Appliance	SA-S5-HYBRID-PB1
NetWitness Appliance	SA-S5-HYBRID-LB1
NetWitness Appliance	SA-WN-HDDB1
NetWitness Appliance	SA-WN-SAB1
NetWitness Appliance	SA-S4H-P-CONB1
NetWitness Appliance	SA-S4H-L-CONB1
NetWitness Appliance	SA-S5H-P-CONB1
NetWitness Appliance	SA-S5H-L-CONB1
NetWitness Appliance	SA-S4H-BROB1
NetWitness Appliance	SA-S5H-BROB1
NetWitness Appliance	SA-S4H-ESAB1
NetWitness Appliance	SA-ESA-SW-B1
NetWitness Appliance	SA-S5H-ESAB1
NetWitness Appliance	NW-PVHD72A-L-B1
NetWitness Appliance	NW-PVHD144A-L-B1
NetWitness Appliance	NW-PVHD72-L-B1
NetWitness Appliance	NW-PVHD144-L-B1
NetWitness Appliance	NW-PVHP56-L-B1
NetWitness Appliance	NW-PVHP113-L-B1
NetWitness Appliance	SA-S4H-ARCHB1
NetWitness Appliance	SA-ARCH-SW-B
NetWitness Appliance	SA-S4H-ARCH-SMB1
NetWitness Appliance	SA-S4H-ARCH-MDB1
NetWitness Appliance	SA-S4H-ARCH-LGB1
NetWitness Appliance	SA-S4H-ARCH-XLB1
NetWitness Appliance	SA-HDD32-ARCH-B1
NetWitness Appliance	SA-HDD46-ARCH-B
NetWitness Appliance	SA-HDD142-ARCHB1
NetWitness Appliance	SA-S5H-ARCHB1

NetWitness Appliance	SA-HDD22-LLB1
NetWitness Appliance	SA-HDD22-LPB1
NetWitness Appliance	SA-HDD32-LLB1
NetWitness Appliance	SA-HDD32-LPB1
NetWitness Appliance	SA-DACHD-L-B
NetWitness Appliance	SA-DACHD-P-B
NetWitness Appliance	SA-HDD142-LLB1
NetWitness Appliance	SA-HDD142-LPB1
NetWitness Appliance	SA-HDD180-LLB1
NetWitness Appliance	SA-HDD180-LPB1
NetWitness Appliance	SA-HDD22-LLHB1
NetWitness Appliance	SA-HDD22-LPHB1
NetWitness Appliance	SA-HDD32-LLHB1
NetWitness Appliance	SA-HDD32-LPHB1
NetWitness Appliance	SA-HDD46-LLH-B1
NetWitness Appliance	SA-HDD46-LPH-B1
NetWitness Appliance	SA-AIO-LB1
NetWitness Appliance	SA-AIO-PB1
NetWitness Appliance	SA-HDD22-AIOLB1
NetWitness Appliance	SA-HDD22-AIOPB1
NetWitness Appliance	SA-HDD32-AIOLB1
NetWitness Appliance	SA-HDD32-AIOPB1
NetWitness Appliance	SA-S4H-MALB1
NetWitness Appliance	SA-MAL-SWB1
NetWitness Appliance	NWA200-N-32-E-UPB1
NetWitness Appliance	NWA2400-N-64MEUPB1
NetWitness Appliance	SA-S5H-MALB1
NetWitness Appliance	SA-HPD12H1B1
NetWitness Appliance	SA-HPD12H1-LB1
NetWitness Appliance	SA-DACHP-B
NetWitness Appliance	SA-SAW-CACH200B1
NetWitness Appliance	SA-SAW-SWITCHB1
NetWitness Appliance	SA-HDD-1TB-R620B1
NetWitness Appliance	SA-HDD146GB-R620B1
NetWitness Appliance	SA-PWR-R620B1
NetWitness Appliance	SA-S4H-RAILKITB1
NetWitness Appliance	SA-S5H-10GE-F-B1
NetWitness Appliance	SA-SERVER-SWB1
NetWitness Appliance	SA-P-DEC-SWB1
NetWitness Appliance	SA-L-DEC-SWB1
NetWitness Appliance	SA-HYBRID-P-SWB1
NetWitness Appliance	SA-HYBRID-L-SWB1
NetWitness Appliance	SA-AIO-L-SWB1
NetWitness Appliance	SA-AIO-P-SWB1
NetWitness Appliance	SA-WN-SA-SWB1
NetWitness Appliance	SA-30TB-WN-SWB1
NetWitness Appliance	SA-P-CON-SWB1

NetWitness Appliance	SA-L-CON-SWB1
NetWitness Appliance	SA-BRO-SWB1
NetWitness Appliance	SA-5TB-CAP-L-SWB1
NetWitness Appliance	SA-5TB-CAP-P-SWB1
NetWitness Appliance	SA-15TB-CAP-L-SWB1
NetWitness Appliance	SA-15TB-CAP-P-SWB1
NetWitness Appliance	SA-25TB-CAP-L-SWB1
NetWitness Appliance	SA-25TB-CAP-P-SWB1
NetWitness Appliance	SA-VNX2HD-5600-B1
NetWitness Appliance	SA-VNX2HD-5800-B1
NetWitness Appliance	SA-VNX2HD-7600-B1
NetWitness Appliance	SA-VNX2HD-SHLF-B1
NetWitness Appliance	SA-VNX2HP-SHLF-B1
NetWitness Appliance	SA-VNX2HD-SHLFU-B1
NetWitness Appliance	SA-VNX2HP-SHLFU-B1
NetWitness Appliance	NWS-Unity600B1
NetWitness Appliance	NWS-U6APHD-SHLFB1
NetWitness Appliance	NWS-U6APHP-SHLFB1
NetWitness Appliance	NWS-U6APHDA-SHLFB1
NetWitness Appliance	SA-NL400-BASE-B1
NetWitness Appliance	SA-NL400-ADDON-B1
NetWitness Appliance	SA-NL400S-BASE-B1
NetWitness Appliance	SA-NL400S-ADDON-B1
NetWitness Appliance	SA-NL400-6-BASE-B1
NetWitness Appliance	SA-NL400-6-ADD-B1
NetWitness Appliance	SA-S4H-ASE1
NetWitness Appliance	SA-S5H-ASE1
NetWitness Appliance	SA-ANALYSTENT5E1
NetWitness Appliance	SA-S4H-P-DECE1
NetWitness Appliance	SA-S4H-L-DECE1
NetWitness Appliance	SA-S5H-P-DECE1
NetWitness Appliance	SA-S5H-L-DECE1
NetWitness Appliance	SA-HYBRID-PE1
NetWitness Appliance	SA-HYBRID-LE1
NetWitness Appliance	SA-S5-HYBRID-PE1
NetWitness Appliance	SA-S5-HYBRID-LE1
NetWitness Appliance	SA-WN-HDDE1
NetWitness Appliance	SA-WN-SAE1
NetWitness Appliance	SA-S4H-P-CONE1
NetWitness Appliance	SA-S4H-L-CONE1
NetWitness Appliance	SA-S5H-P-CONE1
NetWitness Appliance	SA-S5H-L-CONE1
NetWitness Appliance	SA-S4H-BROE1
NetWitness Appliance	SA-S5H-BROE1
NetWitness Appliance	SA-S4H-ESAE1
NetWitness Appliance	SA-ESA-SW-E1
NetWitness Appliance	SA-S5H-ESAE1

NetWitness Appliance	NW-PVHD72A-L-E1
NetWitness Appliance	NW-PVHD144A-L-E1
NetWitness Appliance	NW-PVHD72-L-E1
NetWitness Appliance	NW-PVHD144-L-E1
NetWitness Appliance	NW-PVHP56-L-E1
NetWitness Appliance	NW-PVHP113-L-E1
NetWitness Appliance	SA-S4H-ARCHE1
NetWitness Appliance	SA-ARCH-SW-E
NetWitness Appliance	SA-S4H-ARCH-SME1
NetWitness Appliance	SA-S4H-ARCH-MDE1
NetWitness Appliance	SA-S4H-ARCH-LGE1
NetWitness Appliance	SA-S4H-ARCH-XLE1
NetWitness Appliance	SA-HDD32-ARCH-E1
NetWitness Appliance	SA-HDD46-ARCH-E
NetWitness Appliance	SA-HDD142-ARCHE1
NetWitness Appliance	SA-S5H-ARCHE1
NetWitness Appliance	SA-HDD22-LLE1
NetWitness Appliance	SA-HDD22-LPE1
NetWitness Appliance	SA-HDD32-LLE1
NetWitness Appliance	SA-HDD32-LPE1
NetWitness Appliance	SA-DACHD-P-E
NetWitness Appliance	SA-DACHD-L-E
NetWitness Appliance	SA-HDD142-LLE1
NetWitness Appliance	SA-HDD142-LPE1
NetWitness Appliance	SA-HDD180-LLE1
NetWitness Appliance	SA-HDD180-LPE1
NetWitness Appliance	SA-HDD22-LLHE1
NetWitness Appliance	SA-HDD22-LPHE1
NetWitness Appliance	SA-HDD32-LLHE1
NetWitness Appliance	SA-HDD32-LPHE1
NetWitness Appliance	SA-HDD46-LLH-E1
NetWitness Appliance	SA-HDD46-LPH-E1
NetWitness Appliance	SA-S4H-MALE1
NetWitness Appliance	SA-MAL-SWE1
NetWitness Appliance	NWA200-N-32-E-UPE1
NetWitness Appliance	NWA2400-N-64MEUPE1
NetWitness Appliance	SA-S5H-MALE1
NetWitness Appliance	SA-AIO-LE1
NetWitness Appliance	SA-AIO-PE1
NetWitness Appliance	SA-HPD12H1E1
NetWitness Appliance	SA-HPD12H1-LE1
NetWitness Appliance	SA-DACHP-E
NetWitness Appliance	SA-HDD22-AIOLE1
NetWitness Appliance	SA-HDD32-AIOLE1
NetWitness Appliance	SA-HDD22-AIOPE1
NetWitness Appliance	SA-HDD32-AIOPE1
NetWitness Appliance	SA-SAW-CACH200E1

NetWitness Appliance	SA-SAW-SWITCHE1
NetWitness Appliance	SA-HDD-1TB-R620E1
NetWitness Appliance	SA-HDD146GB-R620E1
NetWitness Appliance	SA-PWR-R620E1
NetWitness Appliance	SA-S4H-RAILKITE1
NetWitness Appliance	SA-S5H-10GE-F-E1
NetWitness Appliance	SA-SERVER-SWE1
NetWitness Appliance	SA-P-DEC-SWE1
NetWitness Appliance	SA-L-DEC-SWE1
NetWitness Appliance	SA-HYBRID-P-SWE1
NetWitness Appliance	SA-HYBRID-L-SWE1
NetWitness Appliance	SA-AIO-L-SWE1
NetWitness Appliance	SA-AIO-P-SWE1
NetWitness Appliance	SA-WN-SA-SWE1
NetWitness Appliance	SA-30TB-WN-SWE1
NetWitness Appliance	SA-P-CON-SWE1
NetWitness Appliance	SA-L-CON-SWE1
NetWitness Appliance	SA-BRO-SWE1
NetWitness Appliance	SA-5TB-CAP-L-SWE1
NetWitness Appliance	SA-5TB-CAP-P-SWE1
NetWitness Appliance	SA-15TB-CAP-L-SWE1
NetWitness Appliance	SA-15TB-CAP-P-SWE1
NetWitness Appliance	SA-25TB-CAP-L-SWE1
NetWitness Appliance	SA-25TB-CAP-P-SWE1
NetWitness Appliance	SA-VNX2HD-5600-E1
NetWitness Appliance	SA-VNX2HD-5800-E1
NetWitness Appliance	SA-VNX2HD-7600-E1
NetWitness Appliance	SA-VNX2HD-SHLF-E1
NetWitness Appliance	SA-VNX2HP-SHLF-E1
NetWitness Appliance	SA-VNX2HD-SHLFU-E1
NetWitness Appliance	SA-VNX2HP-SHLFU-E1
NetWitness Appliance	NW-VNX2-DARE-E1
NetWitness Appliance	NW-VNX25800DARE-E1
NetWitness Appliance	NW-VNX27600DARE-E1
NetWitness Appliance	NWS-Unity600E1
NetWitness Appliance	NWS-U6APHD-SHLFE1
NetWitness Appliance	NWS-U6APHP-SHLFE1
NetWitness Appliance	NWS-U6APHDA-SHLFE1
NetWitness Appliance	SA-NL400-BASE-E1
NetWitness Appliance	SA-NL400-ADDON-E1
NetWitness Appliance	SA-NL400S-BASE-E1
NetWitness Appliance	SA-NL400S-ADDON-E1
NetWitness Appliance	SA-NL400-6-BASE-E1
NetWitness Appliance	SA-NL400-6-ADD-E1
NetWitness Appliance	SA-VNX2-BASE-ARC-B
NetWitness Appliance	SA-VNX2-Shlf-ARC-B
NetWitness Appliance	SA-VNX2HD-SM-P-B

NetWitness Appliance	SA-VNX2HD-MD-P-B
NetWitness Appliance	SA-VNX2HD-LG-P-B
NetWitness Appliance	SA-VNX2HD-Shlf-P-B
NetWitness Appliance	SA-VNX2HD-SM-L-B
NetWitness Appliance	SA-VNX2HD-MD-L-B
NetWitness Appliance	SA-VNX2HD-LG-L-B
NetWitness Appliance	SA-VNX2HD-Shlf-L-B
NetWitness Appliance	SA-VNX2HP-SM-B
NetWitness Appliance	SA-VNX2HP-MD-B
NetWitness Appliance	SA-VNX2HP-LG-B
NetWitness Appliance	SA-VNX2HP-SHELF-B
NetWitness Appliance	SA-HPS25H2.1B1
NetWitness Appliance	SA-HPS25H2.1-LB1
NetWitness Appliance	SA-HPS37H3.2B1
NetWitness Appliance	SA-HPS50H4.2B1
NetWitness Appliance	SA-HPS100H8.5B1
NetWitness Appliance	SA-HPS200H17B1
NetWitness Appliance	SA-HP13H1.1SB1
NetWitness Appliance	SA-HP13H1.1S-LB1
NetWitness Appliance	SA-HDS46-LLB1
NetWitness Appliance	SA-HDS46-LPB1
NetWitness Appliance	SA-HDS75-LLB1
NetWitness Appliance	SA-HDS75-LPB1
NetWitness Appliance	SA-HDS209-LLB1
NetWitness Appliance	SA-HDS209-LPB1
NetWitness Appliance	SA-HDS395-LLB1
NetWitness Appliance	SA-HDS395-LPB1
NetWitness Appliance	SA-HDS814-LLB1
NetWitness Appliance	SA-HDS814-LPB1
NetWitness Appliance	SA-HDS1050-LLB1
NetWitness Appliance	SA-HDS1256-LLB1
NetWitness Appliance	SA-HDS1256-LPB1
NetWitness Appliance	SA-HDS1500-LLB1
NetWitness Appliance	SA-HDS1500-LPB1
NetWitness Appliance	SA-HDS23-LLB1
NetWitness Appliance	SA-HDS23-LPB1
NetWitness Appliance	SA-VNX2-BASE-ARC-E
NetWitness Appliance	SA-VNX2-Shlf-ARC-E
NetWitness Appliance	SA-VNX2HD-SM-P-E
NetWitness Appliance	SA-VNX2HD-MD-P-E
NetWitness Appliance	SA-VNX2HD-LG-P-E
NetWitness Appliance	SA-VNX2HD-Shlf-P-E
NetWitness Appliance	SA-VNX2HD-SM-L-E
NetWitness Appliance	SA-VNX2HD-MD-L-E
NetWitness Appliance	SA-VNX2HD-LG-L-E
NetWitness Appliance	SA-VNX2HD-Shlf-L-E
NetWitness Appliance	SA-VNX2HP-SM-E

NetWitness Appliance	SA-VNX2HP-MD-E
NetWitness Appliance	SA-VNX2HP-LG-E
NetWitness Appliance	SA-VNX2HP-SHELF-E
NetWitness Appliance	SA-HPS25H2.1E1
NetWitness Appliance	SA-HPS25H2.1-LE1
NetWitness Appliance	SA-HPS37H3.2E1
NetWitness Appliance	SA-HPS50H4.2E1
NetWitness Appliance	SA-HPS100H8.5E1
NetWitness Appliance	SA-HPS200H17E1
NetWitness Appliance	SA-HP13H1.1SE1
NetWitness Appliance	SA-HP13H1.1S-LE1
NetWitness Appliance	SA-HDS46-LLE1
NetWitness Appliance	SA-HDS46-LPE1
NetWitness Appliance	SA-HDS75-LLE1
NetWitness Appliance	SA-HDS75-LPE1
NetWitness Appliance	SA-HDS209-LLE1
NetWitness Appliance	SA-HDS209-LPE1
NetWitness Appliance	SA-HDS395-LLE1
NetWitness Appliance	SA-HDS395-LPE1
NetWitness Appliance	SA-HDS814-LLE1
NetWitness Appliance	SA-HDS814-LPE1
NetWitness Appliance	SA-HDS1050-LLE1
NetWitness Appliance	SA-HDS1256-LLE1
NetWitness Appliance	SA-HDS1256-LPE1
NetWitness Appliance	SA-HDS1500-LLE1
NetWitness Appliance	SA-HDS1500-LPE1
NetWitness Appliance	SA-HDS23-LLE1
NetWitness Appliance	SA-HDS23-LPE1
NetWitness Endpoint	ECAT-SW-P-T1
NetWitness Endpoint	ECAT-SW-P-T2
NetWitness Endpoint	ECAT-SW-P-T3
NetWitness Endpoint	ECAT-SW-P-T4
NetWitness Endpoint	ECAT-SW-P-T5
NetWitness Endpoint	ECAT-SW-P-T6
NetWitness Endpoint	ECAT-SW-P-T7
NetWitness Endpoint	ECAT-SW-P-T8
NetWitness Endpoint	ECAT-SW-P-T9
NetWitness Endpoint	ECAT-SW-P-T10
NetWitness Endpoint	ECAT-SW-P-T1-B1
NetWitness Endpoint	ECAT-SW-P-T2-B1
NetWitness Endpoint	ECAT-SW-P-T3-B1
NetWitness Endpoint	ECAT-SW-P-T4-B1
NetWitness Endpoint	ECAT-SW-P-T5-B1
NetWitness Endpoint	ECAT-SW-P-T6-B1
NetWitness Endpoint	ECAT-SW-P-T7-B1
NetWitness Endpoint	ECAT-SW-P-T8-B1
NetWitness Endpoint	ECAT-SW-P-T9-B1

NetWitness Endpoint	ECAT-SW-P-T10-B1
NetWitness Endpoint	ECAT-SW-P-T1-E1
NetWitness Endpoint	ECAT-SW-P-T2-E1
NetWitness Endpoint	ECAT-SW-P-T3-E1
NetWitness Endpoint	ECAT-SW-P-T4-E1
NetWitness Endpoint	ECAT-SW-P-T5-E1
NetWitness Endpoint	ECAT-SW-P-T6-E1
NetWitness Endpoint	ECAT-SW-P-T7-E1
NetWitness Endpoint	ECAT-SW-P-T8-E1
NetWitness Endpoint	ECAT-SW-P-T9-E1
NetWitness Endpoint	ECAT-SW-P-T10-E1
NetWitness Endpoint	ECAT-SUB-T1
NetWitness Endpoint	ECAT-SUB-T2
NetWitness Endpoint	ECAT-SUB-T3
NetWitness Endpoint	ECAT-SUB-T4
NetWitness Endpoint	ECAT-SUB-T5
NetWitness Endpoint	ECAT-SUB-T6
NetWitness Endpoint	ECAT-SUB-T7
NetWitness Endpoint	ECAT-SUB-T8
NetWitness Endpoint	ECAT-SUB-T9
NetWitness Endpoint	ECAT-SUB-T10
NetWitness Endpoint	NW-R730-SVR
NetWitness Endpoint	NW-R730-SVR-B1
NetWitness Endpoint	NW-R730-SVR-E1
NetWitness Legacy	SMC-SW-CAPB1
NetWitness Legacy	SMC-SW-CAPE1
NetWitness Legacy	SMC-SW-CONB1
NetWitness Legacy	SMC-SW-CONE1
NetWitness Legacy	SMC-SW-DECB1
NetWitness Legacy	SMC-SW-DECE1
NetWitness Legacy	SMC-SW-BROB1
NetWitness Legacy	SMC-SW-BROE1
NetWitness Legacy	SMC-SW-INFORMB1
NetWitness Legacy	SMC-SW-INFORME1
NetWitness Legacy	SMC-SW-CAP-SYSB1
NetWitness Legacy	SMC-SW-CAP-SYSE1
NetWitness Legacy	SMC-SW-CON-SYSB1
NetWitness Legacy	SMC-SW-CON-SYSE1
NetWitness Legacy	SMC-SW-DEC-SYSB1
NetWitness Legacy	SMC-SW-DEC-SYSE1
NetWitness Legacy	SMC-SW-BRO-SYSB1
NetWitness Legacy	SMC-SW-BRO-SYSE1
NetWitness Legacy	SMC-SW-INF-SYSB1
NetWitness Legacy	SMC-SW-INF-SYSE1
NetWitness Legacy	SMC-C32H-DB1
NetWitness Legacy	SMC-C32H-DE1
NetWitness Legacy	SMC-C32H-D-SYSB1

NetWitness Legacy	SMC-C32H-D-SYSE1
NetWitness Legacy	SMC-S4H-DECB1
NetWitness Legacy	SMC-S4H-DECE1
NetWitness Legacy	SMC-S4H-DEC-SYSB1
NetWitness Legacy	SMC-S4H-DEC-SYSE1
NetWitness Legacy	SMC-S4H-CONB1
NetWitness Legacy	SMC-S4H-CONE1
NetWitness Legacy	SMC-S4H-CON-SYSB1
NetWitness Legacy	SMC-S4H-CON-SYSE1
NetWitness Legacy	SMC-S4H-BROB1
NetWitness Legacy	SMC-S4H-BROE1
NetWitness Legacy	SMC-S4H-BRO-SYSB1
NetWitness Legacy	SMC-S4H-BRO-SYSE1
NetWitness Legacy	NW 10G CardB1
NetWitness Legacy	NW 10G CardE1
NetWitness Legacy	SMC-10GE-FB1
NetWitness Legacy	SMC-10GE-FE1
NetWitness Legacy	SMC-10GE-CB1
NetWitness Legacy	SMC-10GE-CE1
NetWitness Legacy	SMC-1GE-FB1
NetWitness Legacy	SMC-1GE-FE1
NetWitness Legacy	SMC-C46HB1
NetWitness Legacy	SMC-C46HE1
NetWitness Legacy	SMC-C209HB1
NetWitness Legacy	SMC-C209HE1
NetWitness Legacy	SMC-C395HB1
NetWitness Legacy	SMC-C395HE1
NetWitness Legacy	SMC-C814HB1
NetWitness Legacy	SMC-C814HE1
NetWitness Legacy	SMC-C1500HB1
NetWitness Legacy	SMC-C1500HE1
NetWitness Legacy	SMC-C25H2.1FB1
NetWitness Legacy	SMC-C25H2.1FE1
NetWitness Legacy	SMC-C37H3.2FB1
NetWitness Legacy	SMC-C37H3.2FE1
NetWitness Legacy	SMC-C50H4.2FB1
NetWitness Legacy	SMC-C50H4.2FE1
NetWitness Legacy	SMC-C100H8.5FB1
NetWitness Legacy	SMC-C100H8.5FE1
NetWitness Legacy	SMC-C200H17FB1
NetWitness Legacy	SMC-C200H17FE1
NetWitness Legacy	SMC-C23H-SB1
NetWitness Legacy	SMC-C23H-SE1
NetWitness Legacy	SMC-C13H1.1F-SB1
NetWitness Legacy	SMC-C13H1.1F-SE1
NetWitness Legacy	SMC-C46H-SYSB1
NetWitness Legacy	SMC-C46H-SYSE1

NetWitness Legacy	SMC-C25H2.1F-SYSB1
NetWitness Legacy	SMC-C25H2.1F-SYSE1
NetWitness Legacy	SMC-C22H-DB1
NetWitness Legacy	SMC-C22H-DE1
NetWitness Legacy	SMC-C12H1F-DB1
NetWitness Legacy	SMC-C12H1F-DE1
NetWitness Legacy	SMC-C22H-D-SYSB1
NetWitness Legacy	SMC-C22H-D-SYSE1
NetWitness Legacy	SMC-C12H1F-D-SYSB1
NetWitness Legacy	SMC-C12H1F-D-SYSE1
NetWitness Legacy	SMC-40URACKB1
NetWitness Legacy	SMC-40URACKE1
NetWitness Legacy	CS-BAS-NW-MNTP

NetWitness Legacy	SMC-S4H-DECUPB1
NetWitness Legacy	SMC-S4H-DECSYSUPB1
NetWitness Legacy	SMC-S4H-CONUPB1
NetWitness Legacy	SMC-S4H-CONSYSUPB1
NetWitness Legacy	SMC-S4H-BROUPB1
NetWitness Legacy	SMC-S4H-BROSYSUPB1
NetWitness Legacy	SMC-C22H-DUPB1
NetWitness Legacy	SMC-C22H-D-SYSUPB1
NetWitness Legacy	SMC-C23H-DUPB1
NetWitness Legacy	SMC-C46HUPB1
NetWitness Legacy	SMC-C46H-SYSUPB1
NetWitness Legacy	SMC-C209HUPB1
NetWitness Legacy	SMC-C395HUPB1
NetWitness Legacy	SMC-C814HUPB1
NetWitness Legacy	SMC-C1500HUPB1
NetWitness Legacy	SMC-C32H-DUPB1
NetWitness Legacy	SMC-C32H-DSYSDUPB1
NetWitness Legacy	SMC-SW-CONUPB1
NetWitness Legacy	SMC-SW-DECUPB1
NetWitness Legacy	SMC-SW-BROUPB1
NetWitness Legacy	SMC-SW-CON-SYSUPB1
NetWitness Legacy	SMC-SW-DEC-SYSUPB1
NetWitness Legacy	SMC-BRO-SYSUPB1
NetWitness Legacy	SMC-S4H-DECUPE1
NetWitness Legacy	SMC-S4H-DECSYSUPE1
NetWitness Legacy	SMC-S4H-CONUPE1
NetWitness Legacy	SMC-S4H-CONSYSUPE1
NetWitness Legacy	SMC-S4H-BROUPE1
NetWitness Legacy	SMC-S4H-BROSYSUPE1
NetWitness Legacy	SMC-C22H-DUPE1
NetWitness Legacy	SMC-C22H-D-SYSUPE1
NetWitness Legacy	SMC-C23H-DUPE1
NetWitness Legacy	SMC-C46HUPE1

NetWitness Legacy	SMC-C46H-SYSUPE1
NetWitness Legacy	SMC-C209HUPE1
NetWitness Legacy	SMC-C395HUPE1
NetWitness Legacy	SMC-C814HUPE1
NetWitness Legacy	SMC-C1500HUPE1
NetWitness Legacy	SMC-C32H-DUPE1
NetWitness Legacy	SMC-C32H-DSYSDUPE1
NetWitness Legacy	SMC-SW-CONUPE1
NetWitness Legacy	SMC-SW-DECUPE1
NetWitness Legacy	SMC-SW-BROUPE1
NetWitness Legacy	SMC-SW-CON-SYSUPE1
NetWitness Legacy	SMC-SW-DEC-SYSUPE1
NetWitness Legacy	SMC-BRO-SYSUPE1
NetWitness Legacy	SMC-S4H-HYBP
NetWitness Legacy	SMC-S4H-HYBL
NetWitness Legacy	SMC-S4H-HYBPB1
NetWitness Legacy	SMC-S4H-HYBPE1
NetWitness Legacy	SMC-S4H-HYBLB1
NetWitness Legacy	SMC-S4H-HYBLE1
NetWitness Legacy	SMC-VJ-VS07-020
NetWitness Legacy	SMC-VJ-VS6F-200
NetWitness Legacy	SMC-VJ-VS07-030
NetWitness Legacy	SMC-VJ-DS07-030
NetWitness Legacy	SMC-V31-DAE-N-15
NetWitness Legacy	SMC-VNX6GSDAE60F
NetWitness Legacy	SA-IPDBExt-SW
NetWitness Legacy	SMC-10GE-F
NetWitness Legacy	SMC-10GE-C
NetWitness Legacy	SMC-1GE-F
NetWitness Orchestrator	NW-OCH-PFM-4U-S
NetWitness Orchestrator	NW-OCH-ADD1U-S
NetWitness Throughput	SA-NETMON-P-T1
NetWitness Throughput	SA-NETMON-P-T2
NetWitness Throughput	SA-NETMON-P-T3
NetWitness Throughput	SA-NETMON-P-T4
NetWitness Throughput	SA-NETMON-P-T5
NetWitness Throughput	SA-NETMW-P-T1
NetWitness Throughput	SA-NETMW-P-T2
NetWitness Throughput	SA-NETMW-P-T3
NetWitness Throughput	SA-NETMW-P-T4
NetWitness Throughput	SA-NETMW-P-T5
NetWitness Throughput	SA-NETMON-P-T1-B1
NetWitness Throughput	SA-NETMON-P-T2-B1
NetWitness Throughput	SA-NETMON-P-T3-B1
NetWitness Throughput	SA-NETMON-P-T4-B1
NetWitness Throughput	SA-NETMON-P-T5-B1

NetWitness Throughput	SA-NETMW-P-T1-B1
NetWitness Throughput	SA-NETMW-P-T2-B1
NetWitness Throughput	SA-NETMW-P-T3-B1
NetWitness Throughput	SA-NETMW-P-T4-B1
NetWitness Throughput	SA-NETMW-P-T5-B1
NetWitness Throughput	SA-NETMON-P-T1-E1
NetWitness Throughput	SA-NETMON-P-T2-E1
NetWitness Throughput	SA-NETMON-P-T3-E1
NetWitness Throughput	SA-NETMON-P-T4-E1
NetWitness Throughput	SA-NETMON-P-T5-E1
NetWitness Throughput	SA-NETMW-P-T1-E1
NetWitness Throughput	SA-NETMW-P-T2-E1
NetWitness Throughput	SA-NETMW-P-T3-E1
NetWitness Throughput	SA-NETMW-P-T4-E1
NetWitness Throughput	SA-NETMW-P-T5-E1
NetWitness Throughput	SA-SIEM-P-T1
NetWitness Throughput	SA-SIEM-P-T2
NetWitness Throughput	SA-SIEM-P-T3
NetWitness Throughput	SA-SIEM-P-T4
NetWitness Throughput	SA-SIEM-P-T5
NetWitness Throughput	SA-SIEM-P-T1-B1
NetWitness Throughput	SA-SIEM-P-T2-B1
NetWitness Throughput	SA-SIEM-P-T3-B1
NetWitness Throughput	SA-SIEM-P-T4-B1
NetWitness Throughput	SA-SIEM-P-T5-B1
NetWitness Throughput	SA-SIEM-P-T1-E1
NetWitness Throughput	SA-SIEM-P-T2-E1
NetWitness Throughput	SA-SIEM-P-T3-E1
NetWitness Throughput	SA-SIEM-P-T4-E1
NetWitness Throughput	SA-SIEM-P-T5-E1
NetWitness Throughput	SA-NETMON-S-T1
NetWitness Throughput	SA-NETMON-S-T2
NetWitness Throughput	SA-NETMON-S-T3
NetWitness Throughput	SA-NETMON-S-T4
NetWitness Throughput	SA-NETMON-S-T5
NetWitness Throughput	SA-NETMON-S-T6
NetWitness Throughput	SA-NETMON-S-T7
NetWitness Throughput	SA-NETMON-S-T8
NetWitness Throughput	SA-NETMON-S-T9
NetWitness Throughput	SA-NETMON-S-T10
NetWitness Throughput	SA-NETM-S-T1-MSSPG
NetWitness Throughput	SA-NETM-S-T2-MSSPG
NetWitness Throughput	SA-NETM-S-T3-MSSPG
NetWitness Throughput	SA-NETM-S-T4-MSSPG
NetWitness Throughput	SA-NETM-S-T5-MSSPG
NetWitness Throughput	SA-NETM-S-T1-MSSPP
NetWitness Throughput	SA-NETM-S-T2-MSSPP

NetWitness Throughput	SA-NETM-S-T3-MSSPP
NetWitness Throughput	SA-NETM-S-T4-MSSPP
NetWitness Throughput	SA-NETM-S-T5-MSSPP
NetWitness Throughput	SA-NETMW-S-T1
NetWitness Throughput	SA-NETMW-S-T2
NetWitness Throughput	SA-NETMW-S-T3
NetWitness Throughput	SA-NETMW-S-T4
NetWitness Throughput	SA-NETMW-S-T5
NetWitness Throughput	SA-SIEM-S-T1
NetWitness Throughput	SA-SIEM-S-T2
NetWitness Throughput	SA-SIEM-S-T3
NetWitness Throughput	SA-SIEM-S-T4
NetWitness Throughput	SA-SIEM-S-T5
NetWitness Throughput	SA-SIEM-S-T6
NetWitness Throughput	SA-SIEM-S-T7
NetWitness Throughput	SA-SIEM-S-T8
NetWitness Throughput	SA-SIEM-S-T9
NetWitness Throughput	SA-SIEM-S-T10
NetWitness Throughput	SA-SIEM-S-T1-MSSPG
NetWitness Throughput	SA-SIEM-S-T2-MSSPG
NetWitness Throughput	SA-SIEM-S-T3-MSSPG
NetWitness Throughput	SA-SIEM-S-T4-MSSPG
NetWitness Throughput	SA-SIEM-S-T5-MSSPG
NetWitness Throughput	SA-SIEM-S-T1-MSSPP
NetWitness Throughput	SA-SIEM-S-T2-MSSPP
NetWitness Throughput	SA-SIEM-S-T3-MSSPP
NetWitness Throughput	SA-SIEM-S-T4-MSSPP
NetWitness Throughput	SA-SIEM-S-T5-MSSPP
NetWitness Throughput	NW-AWSAGENT-P
NetWitness Throughput	NW-AZUREAGENT-P
NetWitness Throughput	SA-S5H-PHYBRID-NL
NetWitness Throughput	SA-S5H-LHYBRID-NL
NetWitness Throughput	SA-S5H-ESA-NL
NetWitness Throughput	SA-S5H-AS-NL
NetWitness Throughput	SA-S5H-PDEC-NL
NetWitness Throughput	SA-S5H-LDEC-NL
NetWitness Throughput	SA-S5H-CON-NL
NetWitness Throughput	SA-S5H-BRO-NL
NetWitness Throughput	SA-S5H-ARCH-NL
NetWitness Throughput	SA-S5H-MAL-NL
NetWitness Throughput	SA-S4H-AS-A-B1
NetWitness Throughput	SA-S4H-PDEC-A-B1
NetWitness Throughput	SA-PHYBRID-A-B1
NetWitness Throughput	SA-S4H-CON-A-B1
NetWitness Throughput	SA-S4H-BRO-A-B1
NetWitness Throughput	SA-S4H-LDEC-A-B1
NetWitness Throughput	SA-LHYBRID-A-B1

NetWitness Throughput	SA-AIO-P-A-B1
NetWitness Throughput	SA-AIO-L-A-B1
NetWitness Throughput	SA-S4H-ARCH-A-B1
NetWitness Throughput	SA-S4H-ESA-A-B1
NetWitness Throughput	SA-S4H-MAL-A-B1
NetWitness Throughput	SA-S5H-PHYBRID-B1
NetWitness Throughput	SA-S5H-LHYBRID-B1
NetWitness Throughput	SA-S5H-ESA-B1
NetWitness Throughput	SA-S5H-PDEC-B1
NetWitness Throughput	SA-S5H-LDEC-B1
NetWitness Throughput	SA-S5H-CON-B1
NetWitness Throughput	SA-S5H-BRO-B1
NetWitness Throughput	SA-S5H-ARCH-B1
NetWitness Throughput	SA-S5H-MAL-B1
NetWitness Throughput	SA-S5H-AS-B1
NetWitness Throughput	SA-S4H-AS-A-E1
NetWitness Throughput	SA-S4H-PDEC-A-E1
NetWitness Throughput	SA-PHYBRID-A-E1
NetWitness Throughput	SA-S4H-CON-A-E1
NetWitness Throughput	SA-S4H-BRO-A-E1
NetWitness Throughput	SA-S4H-LDEC-A-E1
NetWitness Throughput	SA-LHYBRID-A-E1
NetWitness Throughput	SA-AIO-P-A-E1
NetWitness Throughput	SA-AIO-L-A-E1
NetWitness Throughput	SA-S4H-ARCH-A-E1
NetWitness Throughput	SA-S4H-ESA-A-E1
NetWitness Throughput	SA-S4H-MAL-A-E1
NetWitness Throughput	SA-S5H-PHYBRID-E1
NetWitness Throughput	SA-S5H-LHYBRID-E1
NetWitness Throughput	SA-S5H-ESA-E1
NetWitness Throughput	SA-S5H-AS-E1
NetWitness Throughput	SA-S5H-PDEC-E1
NetWitness Throughput	SA-S5H-LDEC-E1
NetWitness Throughput	SA-S5H-CON-E1
NetWitness Throughput	SA-S5H-BRO-E1
NetWitness Throughput	SA-S5H-ARCH-E1
NetWitness Throughput	SA-S5H-MAL-E1
NetWitness Throughput	SA-5PHYBRID-NLTR
NetWitness Throughput	SA-5LHYBRID-NLTR
NetWitness Throughput	SA-S5H-ESA-NLTR
NetWitness Throughput	SA-S5H-AS-NLTR
NetWitness Throughput	SA-S5H-PDEC-NLTR
NetWitness Throughput	SA-S5H-LDEC-NLTR
NetWitness Throughput	SA-S5H-CON-NLTR
NetWitness Throughput	SA-S5H-BRO-NLTR
NetWitness Throughput	SA-S5H-ARCH-NLTR
NetWitness Throughput	NW-PVHD72

NetWitness Throughput	NW-PVHD144
NetWitness Throughput	NW-PVHD72-TR
NetWitness Throughput	NW-PVHD144-TR
NetWitness Throughput	NW-PVHP56
NetWitness Throughput	NW-PVHP113
NetWitness Throughput	NW-PVHP56-TR
NetWitness Throughput	NW-PVHP113-TR
NetWitness Throughput	NW-PVHD72-B1
NetWitness Throughput	NW-PVHD144-B1
NetWitness Throughput	NW-PVHP56-B1
NetWitness Throughput	NW-PVHP113-B1
NetWitness Throughput	NW-PVHD72-E1
NetWitness Throughput	NW-PVHD144-E1
NetWitness Throughput	NW-PVHP56-E1
NetWitness Throughput	NW-PVHP113-E1
NetWitness Throughput	SA-HDDAC-32
NetWitness Throughput	SA-HDDAC-46
NetWitness Throughput	SA-HDUDAC-142
NetWitness Throughput	SA-HDUDAC-180
NetWitness Throughput	SA-HPDAC-12
NetWitness Throughput	SA-HPDAC-33
NetWitness Throughput	SA-HDDAC-3TB-2PK
NetWitness Throughput	SA-HDDAC-4TB-2PK
NetWitness Throughput	SA-HDDAC-3TB-2PK60
NetWitness Throughput	SA-HDDAC-4TB-2PK60
NetWitness Throughput	SA-HDDAC-32-B1
NetWitness Throughput	SA-HDDAC-46-B1
NetWitness Throughput	SA-HDUDAC-142-B1
NetWitness Throughput	SA-HDUDAC-180-B1
NetWitness Throughput	SA-HPDAC-12-B1
NetWitness Throughput	SA-HPDAC-33-B1
NetWitness Throughput	SA-HDDAC-32-E1
NetWitness Throughput	SA-HDDAC-46-E1
NetWitness Throughput	SA-HDUDAC-142-E1
NetWitness Throughput	SA-HDUDAC-180-E1
NetWitness Throughput	SA-HPDAC-12-E1
NetWitness Throughput	SA-HPDAC-33-E1
NetWitness Throughput	NWS-Unity600
NetWitness Throughput	NWS-U600-Rack
NetWitness Throughput	NWS-U6TPHD-SHLF
NetWitness Throughput	NWS-U6TPHP-SHLF
NetWitness Throughput	NWS-U6TPHDA-SHLF
NetWitness Throughput	NWS-Unity600B1
NetWitness Throughput	NWS-U6TPHD-SHLFB1
NetWitness Throughput	NWS-U6TPHP-SHLFB1
NetWitness Throughput	NWS-U6TPHDA-SHLFB1
NetWitness Throughput	NWS-Unity600E1

NetWitness Throughput	NWS-U6TPHD-SHLFE1
NetWitness Throughput	NWS-U6TPHP-SHLFE1
NetWitness Throughput	NWS-U6TPHDA-SHLFE1
NetWitness Throughput	NWS-Unity550F
NetWitness Throughput	NWS-U5FTP-80DAE
NetWitness Throughput	NWS-U5FTP-15TB5PK
NetWitness Throughput	NWS-Unity550FB1
NetWitness Throughput	NWS-U5FTP-80DAEB1
NetWitness Throughput	NW-U5FTP-15TB5PKB1
NetWitness Throughput	NWS-Unity550FE1
NetWitness Throughput	NWS-U5FTP-80DAEE1
NetWitness Throughput	NW-U5FTP-15TB5PKE1
NetWitness Throughput	SA-VNX2HD-SHLFU
NetWitness Throughput	SA-VNX2HP-SHLFU
NetWitness Throughput	SA-VNX2-Rack
NetWitness Throughput	SA-ULTRA-RACK
NetWitness Throughput	SA-VNX2HD-5600-B1
NetWitness Throughput	SA-VNX2HD-5800-B1
NetWitness Throughput	SA-VNX2HD-7600-B1
NetWitness Throughput	SA-VNX2HD-SHLF-B1
NetWitness Throughput	SA-VNX2HP-SHLF-B1
NetWitness Throughput	SA-VNX2HD-SHLFU-B1
NetWitness Throughput	SA-VNX2HP-SHLFU-B1
NetWitness Throughput	SA-VNX2HD-5600-E1
NetWitness Throughput	SA-VNX2HD-5800-E1
NetWitness Throughput	SA-VNX2HD-7600-E1
NetWitness Throughput	SA-VNX2HD-SHLF-E1
NetWitness Throughput	SA-VNX2HP-SHLF-E1
NetWitness Throughput	SA-VNX2HD-SHLFU-E1
NetWitness Throughput	SA-VNX2HP-SHLFU-E1
NetWitness Throughput	NW-VNX2-DARE-E1
NetWitness Throughput	NW-VNX25800DARE-E1
NetWitness Throughput	NW-VNX27600DARE-E1
NetWitness Throughput	SA-NL400-BASE
NetWitness Throughput	SA-NL400-ADDON
NetWitness Throughput	SA-NL400S-BASE
NetWitness Throughput	SA-NL400S-ADDON
NetWitness Throughput	SA-NL400-6-BASE
NetWitness Throughput	SA-NL400-6-ADD
NetWitness Throughput	SA-NL400-BASE-B1
NetWitness Throughput	SA-NL400-ADDON-B1
NetWitness Throughput	SA-NL400S-BASE-B1
NetWitness Throughput	SA-NL400S-ADDON-B1
NetWitness Throughput	SA-NL400-6-BASE-B1
NetWitness Throughput	SA-NL400-6-ADD-B1
NetWitness Throughput	SA-NL400-BASE-E1
NetWitness Throughput	SA-NL400-ADDON-E1

NetWitness Throughput	SA-NL400S-BASE-E1
NetWitness Throughput	SA-NL400S-ADDON-E1
NetWitness Throughput	SA-NL400-6-BASE-E1
NetWitness Throughput	SA-NL400-6-ADD-E1
NFR Kits	SA-S5H-ESANFR
NFR Kits	SA-S5H-ASNFR
NFR Kits	SA-S5H-ARCHNFR
NFR Kits	SA-S5H-P-DECNFR
NFR Kits	SA-S5H-L-DECNFR
NFR Kits	SA-S5HYBRID-PNFR
NFR Kits	SA-S5HYBRID-LNFR
NFR Kits	SA-S5H-P-CONNFR
NFR Kits	SA-S5H-L-CONNFR
NFR Kits	SA-S5H-BRONFR
NFR Kits	SA-ANALYSTENT5NFR
NFR Kits	SA-HPD12H1NFR
NFR Kits	SA-HDD22-LLNFR
NFR Kits	SA-HDD22-LPNFR
NFR Kits	SA-HDD22-LLHNFR
NFR Kits	SA-HDD22-LPHNFR
NFR Kits	SA-NETMON-P-T1-NFR
NFR Kits	SA-S5H-ASNFR-NL
NFR Kits	SA-S5H-ESANFR-NL
NFR Kits	SA-SIEM-P-T1-NFR
NFR Kits	SA-S5H-ARCHNFR-NL
NFR Kits	SA-S5H-P-DECNFR-NL
NFR Kits	SA-S5H-L-DECNFR-NL
NFR Kits	SA-S5HYBRD-PNFR-NL
NFR Kits	SA-S5HYBRD-LNFR-NL
NFR Kits	SA-S5H-P-CONNFR-NL
NFR Kits	SA-S5H-L-CONNFR-NL
NFR Kits	SA-S5H-BRONFR-NL
NFR Kits	RSA-0010810-NFR
NFR Kits	RSA-0012000-NFR
NFR Kits	RSA-80010500IN-NFR
NFR Kits	RSA-80010510IN-NFR
NFR Kits	ECAT-SW-LIC-50-NFR
NFR Kits	NW-R730-SVR-NFR
NFR Kits	NW-UEBA-P-NFR
NFR Kits	VIA-AC-S-NFR
NFR Kits	RSA-GO-P-NFR
NFR Kits	RSA-LI-P-NFR
NFR Kits	RSA-BRM-P-NFR
NFR Kits	RSA-DAG-P-NFR

NFR Kits	RSA-0018037-NFR
NW UEBA	NW-UEBA-S-T1
NW UEBA	NW-UEBA-S-T2
NW UEBA	NW-UEBA-S-T3
NW UEBA	NW-UEBA-S-T4
NW UEBA	NW-UEBA-S-T5
NW UEBA	NW-UEBA-S-T6
NW UEBA	NW-UEBA-S-T7
NW UEBA	NW-UEBA-S-T8
NW UEBA	NW-UEBA-P-T1
NW UEBA	NW-UEBA-P-T2
NW UEBA	NW-UEBA-P-T3
NW UEBA	NW-UEBA-P-T4
NW UEBA	NW-UEBA-P-T5
NW UEBA	NW-UEBA-P-T6
NW UEBA	NW-UEBA-P-T7
NW UEBA	NW-UEBA-P-T8
NW UEBA	NW-UEBA-P-T1-B1
NW UEBA	NW-UEBA-P-T2-B1
NW UEBA	NW-UEBA-P-T3-B1
NW UEBA	NW-UEBA-P-T4-B1
NW UEBA	NW-UEBA-P-T5-B1
NW UEBA	NW-UEBA-P-T6-B1
NW UEBA	NW-UEBA-P-T7-B1
NW UEBA	NW-UEBA-P-T8-B1
NW UEBA	NW-UEBA-P-T1-E1
NW UEBA	NW-UEBA-P-T2-E1
NW UEBA	NW-UEBA-P-T3-E1
NW UEBA	NW-UEBA-P-T4-E1
NW UEBA	NW-UEBA-P-T5-E1
NW UEBA	NW-UEBA-P-T6-E1
NW UEBA	NW-UEBA-P-T7-E1
NW UEBA	NW-UEBA-P-T8-E1
Personalized Support	CS-TAM-ARC-STNDRD
Personalized Support	CS-TAM-IGL-STNDRD
Personalized Support	CS-TAM-NW-STNDRD
Personalized Support	CS-TAM-SID-STNDRD
Personalized Support	PREM SUPP 3DSECURE
Personalized Support	PREM SUPP HOST AA
Personalized Support	PREM SUP ONPREM AA
Personalized Support	PREM SUPPORT STS
Personalized Support	CS-DSE-NW-STNDRD
Personalized Support	CS-DSE-ARC-STNDRD
Personalized Support	CS-DSE-SID-STNDRD
Personalized Support	CS-DSE-IGL-STNDRD
Personalized Support	CS-DSE-OAA-STNDRD
Personalized Support	CS-DSE-WTD-STNDRD

Personalized Support	DSE SUPP HOSTED AA
Personalized Support	DSE SUPP 3DSECURE
Personalized Support	SAM-PLAT-SUPP-AAH
Personalized Support	SAM-PLAT-SUPP-AAOP
Personalized Support	SAM-PLAT-SUPP-AAEC
Personalized Support	SAM-PLAT-SUPP-WTD
Personalized Support	SAM-GOLD-SUPP-AAH
Personalized Support	SAM-GOLD-SUPP-AAOP
Personalized Support	SAM-GOLD-SUPP-AAEC
Personalized Support	SAM-GOLD-SUPP-WTD
Personalized Support	SAM-SILV-SUPP-AAH
Personalized Support	SAM-SILV-SUPP-AAOP
Personalized Support	SAM-SILV-SUPP-AAEC
Personalized Support	SAM-SILV-SUPP-WTD
Professional Services	PS-BAS-SA-IMPLS
Professional Services	PS-BAS-SA-IMPLM
Professional Services	PS-BAS-SA-IMPLL
Professional Services	PS-BAS-SA-AUDIT
Professional Services	PS-BAS-SA-UDS30
Professional Services	PS-BAS-SA-OPTM
Professional Services	PS-BAS-SA-SUB3
Professional Services	PS-BAS-SA-SUB5
Professional Services	PS-BAS-SA-SUB10
Professional Services	PS-BAS-SA-EIMPL
Professional Services	PS-BAS-SA-ESUB3
Professional Services	PS-BAS-SA-ESUB5
Professional Services	PS-BAS-SA-ESUB10
Professional Services	PS-BAS-SA-RCONS1
Professional Services	PS-BAS-SA-UPGR1
Professional Services	PS-BAS-NW-PASSMNTS
Professional Services	PS-BAS-NW-UNITY1
Professional Services	PS-CUS-SA
Professional Services	PS-CUS-SA-P
Professional Services	PS-RES-SA
Professional Services	PS-BAS-SA-JUMPAI
Professional Services	PS-BAS-SA-SUB9AI
Professional Services	PS-BAS-SA-SUB9AIR
Professional Services	PS-BAS-SA-DISC
Professional Services	PS-BAS-SA-IRRAP
Professional Services	PS-BAS-SA-RETB
Professional Services	PS-BAS-SA-RETS
Professional Services	PS-BAS-SA-RETG
Professional Services	PS-BAS-SA-RETP

Professional Services	PS-BAS-CON-ACD10
Professional Services	PS-BAS-CON-ACD20
Professional Services	PS-BAS-CON-ACD40
Professional Services	PS-BAS-CON-ACD60
Professional Services	PS-BAS-CON-ACDUCD
Professional Services	PS-BAS-CON-ACDGAR
Professional Services	PS-BAS-CON-START
Professional Services	PS-BAS-CON-CTIRMAP
Professional Services	PS-BAS-CON-CARE
Professional Services	PS-CUS-IRD
Professional Services	PS-CUS-ACD
Professional Services	PS-RES-ACD
Professional Services	PS-CUS-IAP
Professional Services	PS-CUS-RMP
Professional Services	PS-BAS-ARC-OPTA
Professional Services	PS-BAS-ARC-SMART
Professional Services	PS-BAS-ARC-SMARTS
Professional Services	PS-BAS-ARC-SMARTP
Professional Services	PS-BAS-ARC-1MEOD
Professional Services	PS-BAS-ARC-UPG1
Professional Services	PS-BAS-ARC-UPGRDY
Professional Services	PS-BAS-ARC-QLFNDN
Professional Services	PS-BAS-ARC-QLMNGD
Professional Services	PS-BAS-ARC-UPG3
Professional Services	PS-BAS-ARC-UPG3RDY
Professional Services	PS-BAS-ARC-SUB5
Professional Services	PS-BAS-ARC-SUB10
Professional Services	PS-BAS-ARC-SUB20
Professional Services	PS-BAS-ARC-SUB40
Professional Services	PS-BAS-ARC-RMAPL
Professional Services	PS-BAS-ARC-RMAP
Professional Services	PS-BAS-ARC-SMARTL
Professional Services	PS-BAS-ARC-HEALTHL
Professional Services	PS-BAS-ARC-HEALTH
Professional Services	PS-BAS-ARC-DFEED
Professional Services	PS-CUS-ARC
Professional Services	PS-CUS-ARC-P
Professional Services	PS-RES-ARC
Professional Services	PS-CUS-AVK
Professional Services	PS-CUS-AVK-P
Professional Services	PS-RES-AVK
Professional Services	PS-BAS-AVK-MIGR
Professional Services	PS-BAS-AVK-PSR
Professional Services	PS-BAS-VIA-SGOVIMP
Professional Services	PS-BAS-VIA-SLIFIMP
Professional Services	PS-BAS-VIA-THC

Professional Services	PS-BAS-VIA-LGSUB10
Professional Services	PS-BAS-VIA-LGSUB30
Professional Services	PS-BAS-SID-ASMNT
Professional Services	PS-BAS-SID-HEALTH
Professional Services	PS-BAS-SID-IMPLSVC
Professional Services	PS-BAS-SID-MIGR
Professional Services	PS-BAS-SID-BEIMP
Professional Services	PS-BAS-SID-BEIMR
Professional Services	PS-BAS-SID-EEIMP
Professional Services	PS-BAS-SID-EEIMR
Professional Services	PS-BAS-SID-PEIMP
Professional Services	PS-BAS-SID-PEIMR
Professional Services	PS-BAS-SID-MFAEX
Professional Services	PS-BAS-SID-SMLEXP
Professional Services	PS-BAS-SID-SMLEXR
Professional Services	PS-CUS-SID
Professional Services	PS-RES-SID
Professional Services	PS-BAS-SID-RIMP
Professional Services	PS-APP-SID-PRM5K
Professional Services	PS-APP-SID-PRM10K
Professional Services	PS-APP-SID-PRM50K
Professional Services	PS-APP-SID-PRMUL
Professional Services	PS-CUS-AXM
Professional Services	PS-RES-AXM
Professional Services	PS-BAS-HAA-RAMGLD
Professional Services	PS-BAS-HAA-RAMSLV
Professional Services	PS-BAS-HAA-RAMBAS
Professional Services	PS-BAS-HAA-SUB12
Professional Services	PS-BAS-HAA-IMPLSVC
Professional Services	PS-BAS-HAA-RAMRUL
Professional Services	PS-BAS-HAA-RAMCRE
Professional Services	PS-BAS-HAA-CHALQ
Professional Services	PS-BAS-HAA-EVTYPE
Professional Services	PS-BAS-HAA-GENFLD
Professional Services	PS-BAS-HAA-PFOLIO
Professional Services	PS-CUS-HAA
Professional Services	PS-CUS-CAA
Professional Services	PS-RES-HAA
Professional Services	PS-BAS-OAA-ENT
Professional Services	PS-BAS-OAA-PSRBRZ
Professional Services	PS-BAS-OAA-PSRGLD
Professional Services	PS-BAS-OAA-PSRSLV
Professional Services	PS-BAS-OAA-RAMGLD
Professional Services	PS-BAS-OAA-RAMBAS
Professional Services	PS-BAS-OAA-RAMSLV
Professional Services	PS-BAS-OAA-IMPLSVC

Professional Services	PS-BAS-OAA-RAMRUL
Professional Services	PS-BAS-OAA-RAMCRE
Professional Services	PS-CUS-OAA
Professional Services	PS-RES-OAA
Professional Services	PS-BAS-EAA-SUB12
Professional Services	PS-BAS-EAA-IMPLSVC
Professional Services	PS-BAS-EAA-RAMSLV
Professional Services	PS-BAS-EAA-CONTACT
Professional Services	PS-BAS-EAA-LOGO
Professional Services	PS-BAS-EAA-TEXTFAQ
Professional Services	PS-BAS-EAA-TEXTPP
Professional Services	PS-BAS-EAA-TEXTTOU
Professional Services	PS-CUS-EAA
Professional Services	PS-RES-EAA
Professional Services	PS-BAS-SVT-SMS10
Professional Services	PS-BAS-SVT-SMS20
Professional Services	PS-BAS-SVT-IMPLSVC
Professional Services	PS-CUS-SVT
Professional Services	PS-RES-SVT
Professional Services	PS-BAS-DPM-DATACTR
Professional Services	PS-APP-DPM-MSSQL
Professional Services	PS-CUS-DCS
Professional Services	PS-RES-DCS
Professional Services	PS-CUS-DLP
Professional Services	PS-RES-DLP
Professional Services	PS-CUS-DSG
Professional Services	PS-RES-DSG
Professional Services	PS-CUS-ENV
Professional Services	PS-RES-ENV
Professional Services	PS-TRAVEXP-RSA
Protected Del Authenticators	S700E-6-60-24-5
Protected Del Authenticators	S700E-6-60-24-10
Protected Del Authenticators	S700E-6-60-24-25
Protected Del Authenticators	S700E-6-60-24-50
Protected Del Authenticators	S700E-6-60-24-100
Protected Del Authenticators	S700E-6-60-24-250
Protected Del Authenticators	S700E-6-60-24-A
Protected Del Authenticators	S700E-6-60-24-B
Protected Del Authenticators	S700E-6-60-24-C
Protected Del Authenticators	S700E-6-60-24-D
Protected Del Authenticators	S700E-6-60-24-E
Protected Del Authenticators	S700E-6-60-24-F
Protected Del Authenticators	S700E-6-60-24-G
Protected Del Authenticators	S700E-6-60-24-H
Protected Del Authenticators	S700E-6-60-24-I
Protected Del Authenticators	S700E-6-60-36-5
Protected Del Authenticators	S700E-6-60-36-10

Protected Del Authenticators	S700E-6-60-36-25
Protected Del Authenticators	S700E-6-60-36-50
Protected Del Authenticators	S700E-6-60-36-100
Protected Del Authenticators	S700E-6-60-36-250
Protected Del Authenticators	S700E-6-60-36-A
Protected Del Authenticators	S700E-6-60-36-B
Protected Del Authenticators	S700E-6-60-36-C
Protected Del Authenticators	S700E-6-60-36-D
Protected Del Authenticators	S700E-6-60-36-E
Protected Del Authenticators	S700E-6-60-36-F
Protected Del Authenticators	S700E-6-60-36-G
Protected Del Authenticators	S700E-6-60-36-H
Protected Del Authenticators	S700E-6-60-36-I
Protected Del Authenticators	S700E-6-60-48-5
Protected Del Authenticators	S700E-6-60-48-10
Protected Del Authenticators	S700E-6-60-48-25
Protected Del Authenticators	S700E-6-60-48-50
Protected Del Authenticators	S700E-6-60-48-100
Protected Del Authenticators	S700E-6-60-48-250
Protected Del Authenticators	S700E-6-60-48-A
Protected Del Authenticators	S700E-6-60-48-B
Protected Del Authenticators	S700E-6-60-48-C
Protected Del Authenticators	S700E-6-60-48-D
Protected Del Authenticators	S700E-6-60-48-E
Protected Del Authenticators	S700E-6-60-48-F
Protected Del Authenticators	S700E-6-60-48-G
Protected Del Authenticators	S700E-6-60-48-H
Protected Del Authenticators	S700E-6-60-48-I
Protected Del Authenticators	S700E-6-60-60-5
Protected Del Authenticators	S700E-6-60-60-10
Protected Del Authenticators	S700E-6-60-60-25
Protected Del Authenticators	S700E-6-60-60-50
Protected Del Authenticators	S700E-6-60-60-100
Protected Del Authenticators	S700E-6-60-60-250
Protected Del Authenticators	S700E-6-60-60-A
Protected Del Authenticators	S700E-6-60-60-B
Protected Del Authenticators	S700E-6-60-60-C
Protected Del Authenticators	S700E-6-60-60-D
Protected Del Authenticators	S700E-6-60-60-E
Protected Del Authenticators	S700E-6-60-60-F
Protected Del Authenticators	S700E-6-60-60-G
Protected Del Authenticators	S700E-6-60-60-H
Protected Del Authenticators	S700E-6-60-60-I
Protected Del Authenticators	S700E-6-30-24-5
Protected Del Authenticators	S700E-6-30-24-10
Protected Del Authenticators	S700E-6-30-24-25
Protected Del Authenticators	S700E-6-30-24-50

Protected Del Authenticators	S700E-6-30-24-100
Protected Del Authenticators	S700E-6-30-24-250
Protected Del Authenticators	S700E-6-30-24-A
Protected Del Authenticators	S700E-6-30-24-B
Protected Del Authenticators	S700E-6-30-24-C
Protected Del Authenticators	S700E-6-30-24-D
Protected Del Authenticators	S700E-6-30-24-E
Protected Del Authenticators	S700E-6-30-24-F
Protected Del Authenticators	S700E-6-30-24-G
Protected Del Authenticators	S700E-6-30-24-H
Protected Del Authenticators	S700E-6-30-24-I
Protected Del Authenticators	S700E-6-30-36-5
Protected Del Authenticators	S700E-6-30-36-10
Protected Del Authenticators	S700E-6-30-36-25
Protected Del Authenticators	S700E-6-30-36-50
Protected Del Authenticators	S700E-6-30-36-100
Protected Del Authenticators	S700E-6-30-36-250
Protected Del Authenticators	S700E-6-30-36-A
Protected Del Authenticators	S700E-6-30-36-B
Protected Del Authenticators	S700E-6-30-36-C
Protected Del Authenticators	S700E-6-30-36-D
Protected Del Authenticators	S700E-6-30-36-E
Protected Del Authenticators	S700E-6-30-36-F
Protected Del Authenticators	S700E-6-30-36-G
Protected Del Authenticators	S700E-6-30-36-H
Protected Del Authenticators	S700E-6-30-36-I
Protected Del Authenticators	S700E-6-30-48-5
Protected Del Authenticators	S700E-6-30-48-10
Protected Del Authenticators	S700E-6-30-48-25
Protected Del Authenticators	S700E-6-30-48-50
Protected Del Authenticators	S700E-6-30-48-100
Protected Del Authenticators	S700E-6-30-48-250
Protected Del Authenticators	S700E-6-30-48-A
Protected Del Authenticators	S700E-6-30-48-B
Protected Del Authenticators	S700E-6-30-48-C
Protected Del Authenticators	S700E-6-30-48-D
Protected Del Authenticators	S700E-6-30-48-E
Protected Del Authenticators	S700E-6-30-48-F
Protected Del Authenticators	S700E-6-30-48-G
Protected Del Authenticators	S700E-6-30-48-H
Protected Del Authenticators	S700E-6-30-48-I
Protected Del Authenticators	S700E-6-30-60-5
Protected Del Authenticators	S700E-6-30-60-10
Protected Del Authenticators	S700E-6-30-60-25
Protected Del Authenticators	S700E-6-30-60-50
Protected Del Authenticators	S700E-6-30-60-100
Protected Del Authenticators	S700E-6-30-60-250

Protected Del Authenticators	S700E-6-30-60-A
Protected Del Authenticators	S700E-6-30-60-B
Protected Del Authenticators	S700E-6-30-60-C
Protected Del Authenticators	S700E-6-30-60-D
Protected Del Authenticators	S700E-6-30-60-E
Protected Del Authenticators	S700E-6-30-60-F
Protected Del Authenticators	S700E-6-30-60-G
Protected Del Authenticators	S700E-6-30-60-H
Protected Del Authenticators	S700E-6-30-60-I
Protected Del Authenticators	S800E-6-60-24-5
Protected Del Authenticators	S800E-6-60-24-10
Protected Del Authenticators	S800E-6-60-24-25
Protected Del Authenticators	S800E-6-60-24-50
Protected Del Authenticators	S800E-6-60-24-100
Protected Del Authenticators	S800E-6-60-24-250
Protected Del Authenticators	S800E-6-60-24-A
Protected Del Authenticators	S800E-6-60-24-B
Protected Del Authenticators	S800E-6-60-24-C
Protected Del Authenticators	S800E-6-60-24-D
Protected Del Authenticators	S800E-6-60-24-E
Protected Del Authenticators	S800E-6-60-24-F
Protected Del Authenticators	S800E-6-60-24-G
Protected Del Authenticators	S800E-6-60-24-H
Protected Del Authenticators	S800E-6-60-24-I
Protected Del Authenticators	S800E-6-60-36-5
Protected Del Authenticators	S800E-6-60-36-10
Protected Del Authenticators	S800E-6-60-36-25
Protected Del Authenticators	S800E-6-60-36-50
Protected Del Authenticators	S800E-6-60-36-100
Protected Del Authenticators	S800E-6-60-36-250
Protected Del Authenticators	S800E-6-60-36-A
Protected Del Authenticators	S800E-6-60-36-B
Protected Del Authenticators	S800E-6-60-36-C
Protected Del Authenticators	S800E-6-60-36-D
Protected Del Authenticators	S800E-6-60-36-E
Protected Del Authenticators	S800E-6-60-36-F
Protected Del Authenticators	S800E-6-60-36-G
Protected Del Authenticators	S800E-6-60-36-H
Protected Del Authenticators	S800E-6-60-36-I
Protected Del Authenticators	S800E-6-60-48-5
Protected Del Authenticators	S800E-6-60-48-10
Protected Del Authenticators	S800E-6-60-48-25
Protected Del Authenticators	S800E-6-60-48-50
Protected Del Authenticators	S800E-6-60-48-100
Protected Del Authenticators	S800E-6-60-48-250
Protected Del Authenticators	S800E-6-60-48-A
Protected Del Authenticators	S800E-6-60-48-B

Protected Del Authenticators	S800E-6-60-48-C
Protected Del Authenticators	S800E-6-60-48-D
Protected Del Authenticators	S800E-6-60-48-E
Protected Del Authenticators	S800E-6-60-48-F
Protected Del Authenticators	S800E-6-60-48-G
Protected Del Authenticators	S800E-6-60-48-H
Protected Del Authenticators	S800E-6-60-48-I
Protected Del Authenticators	S800E-6-60-60-5
Protected Del Authenticators	S800E-6-60-60-10
Protected Del Authenticators	S800E-6-60-60-25
Protected Del Authenticators	S800E-6-60-60-50
Protected Del Authenticators	S800E-6-60-60-100
Protected Del Authenticators	S800E-6-60-60-250
Protected Del Authenticators	S800E-6-60-60-A
Protected Del Authenticators	S800E-6-60-60-B
Protected Del Authenticators	S800E-6-60-60-C
Protected Del Authenticators	S800E-6-60-60-D
Protected Del Authenticators	S800E-6-60-60-E
Protected Del Authenticators	S800E-6-60-60-F
Protected Del Authenticators	S800E-6-60-60-G
Protected Del Authenticators	S800E-6-60-60-H
Protected Del Authenticators	S800E-6-60-60-I
Protected Del Authenticators	S800E-6-30-24-5
Protected Del Authenticators	S800E-6-30-24-10
Protected Del Authenticators	S800E-6-30-24-25
Protected Del Authenticators	S800E-6-30-24-50
Protected Del Authenticators	S800E-6-30-24-100
Protected Del Authenticators	S800E-6-30-24-250
Protected Del Authenticators	S800E-6-30-24-A
Protected Del Authenticators	S800E-6-30-24-B
Protected Del Authenticators	S800E-6-30-24-C
Protected Del Authenticators	S800E-6-30-24-D
Protected Del Authenticators	S800E-6-30-24-E
Protected Del Authenticators	S800E-6-30-24-F
Protected Del Authenticators	S800E-6-30-24-G
Protected Del Authenticators	S800E-6-30-24-H
Protected Del Authenticators	S800E-6-30-24-I
Protected Del Authenticators	S800E-6-30-36-5
Protected Del Authenticators	S800E-6-30-36-10
Protected Del Authenticators	S800E-6-30-36-25
Protected Del Authenticators	S800E-6-30-36-50
Protected Del Authenticators	S800E-6-30-36-100
Protected Del Authenticators	S800E-6-30-36-250
Protected Del Authenticators	S800E-6-30-36-A
Protected Del Authenticators	S800E-6-30-36-B
Protected Del Authenticators	S800E-6-30-36-C
Protected Del Authenticators	S800E-6-30-36-D

Protected Del Authenticators	S800E-6-30-36-E
Protected Del Authenticators	S800E-6-30-36-F
Protected Del Authenticators	S800E-6-30-36-G
Protected Del Authenticators	S800E-6-30-36-H
Protected Del Authenticators	S800E-6-30-36-I
Protected Del Authenticators	S800E-6-30-48-5
Protected Del Authenticators	S800E-6-30-48-10
Protected Del Authenticators	S800E-6-30-48-25
Protected Del Authenticators	S800E-6-30-48-50
Protected Del Authenticators	S800E-6-30-48-100
Protected Del Authenticators	S800E-6-30-48-250
Protected Del Authenticators	S800E-6-30-48-A
Protected Del Authenticators	S800E-6-30-48-B
Protected Del Authenticators	S800E-6-30-48-C
Protected Del Authenticators	S800E-6-30-48-D
Protected Del Authenticators	S800E-6-30-48-E
Protected Del Authenticators	S800E-6-30-48-F
Protected Del Authenticators	S800E-6-30-48-G
Protected Del Authenticators	S800E-6-30-48-H
Protected Del Authenticators	S800E-6-30-48-I
Protected Del Authenticators	S800E-6-30-60-5
Protected Del Authenticators	S800E-6-30-60-10
Protected Del Authenticators	S800E-6-30-60-25
Protected Del Authenticators	S800E-6-30-60-50
Protected Del Authenticators	S800E-6-30-60-100
Protected Del Authenticators	S800E-6-30-60-250
Protected Del Authenticators	S800E-6-30-60-A
Protected Del Authenticators	S800E-6-30-60-B
Protected Del Authenticators	S800E-6-30-60-C
Protected Del Authenticators	S800E-6-30-60-D
Protected Del Authenticators	S800E-6-30-60-E
Protected Del Authenticators	S800E-6-30-60-F
Protected Del Authenticators	S800E-6-30-60-G
Protected Del Authenticators	S800E-6-30-60-H
Protected Del Authenticators	S800E-6-30-60-I
Registration Mgr	RRMB1
Registration Mgr	RRME1
SAE	SAE0000025
SAE	SAE0000100
SAE	SAE0000150
SAE	SAE0000250
SAE	SAE0000500
SAE	SAE0000750
SAE	SAE0001500
SAE	SAE0002500
SAE	SAE0005000
SAE	SAE0010000

SAE	SAE0050000
SAE	SAE0100000
SAE	SAE1000000
SAE	SAE0000025E1
SAE	SAE0000100E1
SAE	SAE0000150E1
SAE	SAE0000250E1
SAE	SAE0000500E1
SAE	SAE0000750E1
SAE	SAE0001500E1
SAE	SAE0002500E1
SAE	SAE0005000E1
SAE	SAE0010000E1
SAE	SAE0050000E1
SAE	SAE0100000E1
SAE	SAE1000000E1
SecurID Access	AUT0000025B8
SecurID Access	AUT0000100B8
SecurID Access	AUT0000150B8
SecurID Access	AUT0000250B8
SecurID Access	AUT0000500B8
SecurID Access	AUT0000750B8
SecurID Access	AUT0001500B8
SecurID Access	AUT0002500B8
SecurID Access	AUT0005000B8
SecurID Access	AUT0010000B8
SecurID Access	AUT0050000B8
SecurID Access	AUT0100000B8
SecurID Access	AUT1000000B8
SecurID Access	AUT0000025E8
SecurID Access	AUT0000100E8
SecurID Access	AUT0000150E8
SecurID Access	AUT0000250E8
SecurID Access	AUT0000500E8
SecurID Access	AUT0000750E8
SecurID Access	AUT0001500E8
SecurID Access	AUT0002500E8
SecurID Access	AUT0005000E8
SecurID Access	AUT0010000E8
SecurID Access	AUT0050000E8
SecurID Access	AUT0100000E8
SecurID Access	AUT1000000E8
SecurID Access	AUT0000025U8
SecurID Access	AUT0000100U8
SecurID Access	AUT0000150U8
SecurID Access	AUT0000250U8
SecurID Access	AUT0000500U8

SecurID Access	AUT0000750U8
SecurID Access	AUT0001500U8
SecurID Access	AUT0002500U8
SecurID Access	AUT0005000U8
SecurID Access	AUT0010000U8
SecurID Access	AUT0050000U8
SecurID Access	AUT0100000U8
SecurID Access	AUT1000000U8
SecurID Access	AUTRBA0000025
SecurID Access	AUTRBA0000100
SecurID Access	AUTRBA0000150
SecurID Access	AUTRBA0000250
SecurID Access	AUTRBA0000500
SecurID Access	AUTRBA0000750
SecurID Access	AUTRBA0001500
SecurID Access	AUTRBA0002500
SecurID Access	AUTRBA0005000
SecurID Access	AUTRBA0010000
SecurID Access	AUTRBA0050000
SecurID Access	BCO0000250
SecurID Access	BCO0000750
SecurID Access	BCO0001500
SecurID Access	BCO0002500
SecurID Access	BCO0005000
SecurID Access	BCO0007500
SecurID Access	BCO0010000
SecurID Access	BCO0015000
SecurID Access	BCO0025000
SecurID Access	BCO1000000
SecurID Access	AUT0000025BE1-8
SecurID Access	AUT0000100BE1-8
SecurID Access	AUT0000150BE1-8
SecurID Access	AUT0000250BE1-8
SecurID Access	AUT0000500BE1-8
SecurID Access	AUT0000750BE1-8
SecurID Access	AUT0001500BE1-8
SecurID Access	AUT0002500BE1-8
SecurID Access	AUT0005000BE1-8
SecurID Access	AUT0010000BE1-8
SecurID Access	AUT0050000BE1-8
SecurID Access	AUT0100000BE1-8
SecurID Access	AUT1000000BE1-8
SecurID Access	AUT0000025EE1-8
SecurID Access	AUT0000100EE1-8
SecurID Access	AUT0000150EE1-8
SecurID Access	AUT0000250EE1-8
SecurID Access	AUT0000500EE1-8

SecurID Access	AUT0000750EE1-8
SecurID Access	AUT0001500EE1-8
SecurID Access	AUT0002500EE1-8
SecurID Access	AUT0005000EE1-8
SecurID Access	AUT0010000EE1-8
SecurID Access	AUT0050000EE1-8
SecurID Access	AUT0100000EE1-8
SecurID Access	AUT1000000EE1-8
SecurID Access	AUT0000025UE1-8
SecurID Access	AUT0000100UE1-8
SecurID Access	AUT0000150UE1-8
SecurID Access	AUT0000250UE1-8
SecurID Access	AUT0000500UE1-8
SecurID Access	AUT0000750UE1-8
SecurID Access	AUT0001500UE1-8
SecurID Access	AUT0002500UE1-8
SecurID Access	AUT0005000UE1-8
SecurID Access	AUT0010000UE1-8
SecurID Access	AUT0050000UE1-8
SecurID Access	AUT0100000UE1-8
SecurID Access	AUT1000000UE1-8
SecurID Access	AUT0010000EEP1-8
SecurID Access	AUT0050000EEP1-8
SecurID Access	AUT0100000EEP1-8
SecurID Access	AUT1000000EEP1-8
SecurID Access	SIDACCPREM-S-T1
SecurID Access	SIDACCPREM-S-T2
SecurID Access	SIDACCPREM-S-T3
SecurID Access	SIDACCPREM-S-T4
SecurID Access	SIDACCPREM-S-T5
SecurID Access	SIDACCPREM-S-T6
SecurID Access	SIDACCPREM-S-T7
SecurID Access	SIDACCPREM-S-T8
SecurID Access	SIDACCPREM-S-T9
SecurID Access	SIDACCSSOAGENT
SecurID Access	SIDACCAGENT25
SecurID Access	SIDACCAGENT100
SecurID Access	SIDACCAGENT150
SecurID Access	SIDACCAGENT250
SecurID Access	SIDACCAGENT500
SecurID Access	SIDACCAGENT750
SecurID Access	SIDACCAGENT1500
SecurID Access	SIDACCAGENT2500
SecurID Access	SIDACCAGENT5K
SecurID Access	SIDACCAGENT10K
SecurID Access	SIDACCAGENT50K
SecurID Access	SIDACCAGENT100K

SecurID Access	SIDACCAGENT1M
SecurID Access	VIA-AC-S-EMEA
SecurID Access	VIA-AC-S-USA
SecurID Access	SIDACCENTAP-S-T1
SecurID Access	SIDACCENTAP-S-T2
SecurID Access	SIDACCENTAP-S-T3
SecurID Access	SIDACCENTAP-S-T4
SecurID Access	SIDACCENTAP-S-T5
SecurID Access	SIDACCENTAP-S-T6
SecurID Access	SIDACCENTAP-S-T7
SecurID Access	SIDACCENTAP-S-T8
SecurID Access	SIDACCENTAP-S-T9
SecurID Access	SIDACCBASE-S-T1
SecurID Access	SIDACCBASE-S-T2
SecurID Access	SIDACCBASE-S-T3
SecurID Access	SIDACCBASE-S-T4
SecurID Access	SIDACCBASE-S-T5
SecurID Access	SIDACCBASE-S-T6
SecurID Access	SIDACCBASE-S-T7
SecurID Access	SIDACCBASE-S-T8
SecurID Access	SIDACCBASE-S-T9
SecurID Access	SIDACCBASEAP-S-T1
SecurID Access	SIDACCBASEAP-S-T2
SecurID Access	SIDACCBASEAP-S-T3
SecurID Access	SIDACCBASEAP-S-T4
SecurID Access	SIDACCBASEAP-S-T5
SecurID Access	SIDACCBASEAP-S-T6
SecurID Access	SIDACCBASEAP-S-T7
SecurID Access	SIDACCBASEAP-S-T8
SecurID Access	SIDACCBASEAP-S-T9
SecurID Access	SIDACCENT-S-T1
SecurID Access	SIDACCENT-S-T2
SecurID Access	SIDACCENT-S-T3
SecurID Access	SIDACCENT-S-T4
SecurID Access	SIDACCENT-S-T5
SecurID Access	SIDACCENT-S-T6
SecurID Access	SIDACCENT-S-T7
SecurID Access	SIDACCENT-S-T8
SecurID Access	SIDACCENT-S-T9
SecurID Access	SID820-8-60-S-T1
SecurID Access	SID820-8-60-S-T2
SecurID Access	SID820-8-60-S-T3
SecurID Access	SID820-8-60-S-T4
SecurID Access	SID820-8-60-S-T5
SecurID Access	SID820-8-60-S-T6
SecurID Access	SID820-8-60-S-T7
SecurID Access	SID820-8-60-S-T8

SecurID Access	SID820-8-60-S-T9
SecurID Access	SID820-8-60-S-T10
SecurID Access	SIDMFA-S-T1
SecurID Access	SIDMFA-S-T2
SecurID Access	SIDMFA-S-T3
SecurID Access	SIDMFA-S-T4
SecurID Access	SIDMFA-S-T5
SecurID Access	SIDMFA-S-T6
SecurID Access	SIDMFA-S-T7
SecurID Access	SIDMFA-S-T8
SecurID Access	SIDMFA-S-T9
SecurID Access	SIDMFA-S-T10
SecurID Access	SIDMFA-PROMO-S
SecurID Access	SIDTELEPHONY-S
SecurID Access	SIDACCAWSAGENT-P
Software Authenticators	SID820-8-60-6-A
Software Authenticators	SID820-8-60-6-B
Software Authenticators	SID820-8-60-6-C
Software Authenticators	SID820-8-60-6-D
Software Authenticators	SID820-8-60-6-E
Software Authenticators	SID820-8-60-6-F
Software Authenticators	SID820-8-60-6-G
Software Authenticators	SID820-8-60-6-H
Software Authenticators	SID820-8-60-6-I
Software Authenticators	SID820-8-60-6-J
Software Authenticators	SID820-8-60-12-A
Software Authenticators	SID820-8-60-12-B
Software Authenticators	SID820-8-60-12-C
Software Authenticators	SID820-8-60-12-D
Software Authenticators	SID820-8-60-12-E
Software Authenticators	SID820-8-60-12-F
Software Authenticators	SID820-8-60-12-G
Software Authenticators	SID820-8-60-12-H
Software Authenticators	SID820-8-60-12-I
Software Authenticators	SID820-8-60-12-J
Software Authenticators	SID820-8-60-24-A
Software Authenticators	SID820-8-60-24-B
Software Authenticators	SID820-8-60-24-C
Software Authenticators	SID820-8-60-24-D
Software Authenticators	SID820-8-60-24-E
Software Authenticators	SID820-8-60-24-F
Software Authenticators	SID820-8-60-24-G
Software Authenticators	SID820-8-60-24-H
Software Authenticators	SID820-8-60-24-I
Software Authenticators	SID820-8-60-24-J
Software Authenticators	SID820-8-60-36-A
Software Authenticators	SID820-8-60-36-B

Software Authenticators	SID820-8-60-36-C
Software Authenticators	SID820-8-60-36-D
Software Authenticators	SID820-8-60-36-E
Software Authenticators	SID820-8-60-36-F
Software Authenticators	SID820-8-60-36-G
Software Authenticators	SID820-8-60-36-H
Software Authenticators	SID820-8-60-36-I
Software Authenticators	SID820-8-60-36-J
Software Authenticators	SID820-8-60-48-A
Software Authenticators	SID820-8-60-48-B
Software Authenticators	SID820-8-60-48-C
Software Authenticators	SID820-8-60-48-D
Software Authenticators	SID820-8-60-48-E
Software Authenticators	SID820-8-60-48-F
Software Authenticators	SID820-8-60-48-G
Software Authenticators	SID820-8-60-48-H
Software Authenticators	SID820-8-60-48-I
Software Authenticators	SID820-8-60-48-J
Software Authenticators	SID820-8-60-60-A
Software Authenticators	SID820-8-60-60-B
Software Authenticators	SID820-8-60-60-C
Software Authenticators	SID820-8-60-60-D
Software Authenticators	SID820-8-60-60-E
Software Authenticators	SID820-8-60-60-F
Software Authenticators	SID820-8-60-60-G
Software Authenticators	SID820-8-60-60-H
Software Authenticators	SID820-8-60-60-I
Software Authenticators	SID820-8-60-60-J
Software Authenticators	SID820-8-60-120-A
Software Authenticators	SID820-8-60-120-B
Software Authenticators	SID820-8-60-120-C
Software Authenticators	SID820-8-60-120-D
Software Authenticators	SID820-8-60-120-E
Software Authenticators	SID820-8-60-120-F
Software Authenticators	SID820-8-60-120-G
Software Authenticators	SID820-8-60-120-H
Software Authenticators	SID820-8-60-120-I
Software Authenticators	SID820-8-60-120-J
Technical Support	CS-API-SUPP-SID
Technical Support	CS-CAS-SUPP-SID
Technical Support	CS-CAS-SUPP-ABA
Technical Support	CS-CAS-SUPP-DCS
Technical Support	CS-CAS-SUPP-AXM
Technical Support	CS-CAS-SUPP-ENV
Technical Support	CS-ENV EOPS Y2
Technical Support	CS-CAS-SUPP-FIM
Technical Support	CS-CAS-SUPP-IPV

Technical Support	CS-CAS-SUPP-DLP
Technical Support	CS-DLP EOPS Y1
Technical Support	CS-DLP EOPS Y2
Technical Support	CS-BSAFE EOPS Y1
Technical Support	CS-BSAFE EOPS Y2
Technical Support	CS-CAS-SUPP-ARCH
Technical Support	CS-ARCH EOPS Y1
Technical Support	CS-ARCH EOPS Y2
Technical Support	CS-AM EOPS Y1
Technical Support	CS-AM EOPS Y2
Technical Support	CS-AXM EOPS Y1
Technical Support	CS-AXM EOPS Y2
Technical Support	CS-FIM EOPS Y1
Technical Support	CS-FIM EOPS Y2
Technical Support	CS-CERTMGR EOPS Y1
Technical Support	CS-CERTMGR EOPS Y2
Technical Support	CS-REGMGR EOPS Y1
Technical Support	CS-REGMGR EOPS Y2
Technical Support	CS-DPM EOPS Y1
Technical Support	CS-DPM EOPS Y2
Technical Support	CS-CAS-SUPP-RKM
Technical Support	CS-AAOP EOPS Y1
Technical Support	CS-AAOP EOPS Y2
Technical Support	MNT REINST FEE ARC
Technical Support	MNT REINST FEE IMG
Technical Support	MNT REINST FEE WTD
Technical Support	MNT REINST FEE DLP
Technical Support	MNT REINST FEE AAO
Technical Support	MNT REINST FEE AAH
Technical Support	MNT REINST FEE AAE
Technical Support	MNT REINST FEE SA
Technical Support	MAINT REINST FEE S
Technical Support	MAINT REINST FEE K
Technical Support	MAINT REINST FEE C
Technical Support	MAINT REINST FEE B
Technical Support	CS-CAS-SUPP-AVK
Technical Support	CS-CAS-SUPP-NETW
Technical Support	SA-S4SHW-EXTSPTYR1
Technical Support	SA-S4SHW-EXTSPTYR2
TM on Prem	TMOP0020000
TM on Prem	TMOP0050000
TM on Prem	TMOP0100000
TM on Prem	TMOP0200000
TM on Prem	TMOP0400000
TM on Prem	TMOP0600000
TM on Prem	TMOP0800000
TM on Prem	TMOP1000000

TM on Prem	TMOP1500000
TM on Prem	TMOP2000000
TM on Prem	TMOP3000000
TM on Prem	TMOP4000000
TM on Prem	TMOP5000000
TM on Prem	TMOP7500000
TM on Prem	TMOP0020000E1
TM on Prem	TMOP0050000E1
TM on Prem	TMOP0010000E1
TM on Prem	TMOP0020000E1
TM on Prem	TMOP0040000E1
TM on Prem	TMOP0060000E1
TM on Prem	TMOP0080000E1
TM on Prem	TMOP001000000E1
TM on Prem	TMOP001500000E1
TM on Prem	TMOP002000000E1
TM on Prem	TMOP003000000E1
TM on Prem	TMOP004000000E1
TM on Prem	TMOP005000000E1
TM on Prem	TMOP007500000E1
TM on Prem	TMOP0020000T
TM on Prem	TMOP0050000T
TM on Prem	TMOP0100000T
TM on Prem	TMOP0200000T
TM on Prem	TMOP0400000T
TM on Prem	TMOP0600000T
TM on Prem	TMOP0800000T
TM on Prem	TMOP1000000T
TM on Prem	TMOP1500000T
TM on Prem	TMOP2000000T
TM on Prem	TMOP3000000T
TM on Prem	TMOP4000000T
TM on Prem	TMOP5000000T
TM on Prem	TMOP7500000T
TM on Prem	AADF0020000
TM on Prem	AADF0050000
TM on Prem	AADF0100000
TM on Prem	AADF0200000
TM on Prem	AADF0400000
TM on Prem	AADF0600000
TM on Prem	AADF0800000
TM on Prem	AADF1000000
TM on Prem	AADF1500000
TM on Prem	AADF2000000
TM on Prem	AADF3000000
TM on Prem	AADF4000000
TM on Prem	AADF5000000

TM on Prem	AADF7500000
Trials, Evals & Promos	RSA0010810-2
Trials, Evals & Promos	AUTPRO10-8
Trials, Evals & Promos	AUTPRO25-8
Trials, Evals & Promos	SID800TRIAL2
Trials, Evals & Promos	SOFT TOKEN TRIAL
Trials, Evals & Promos	RSA0010810-AM25UT
Trials, Evals & Promos	NW-UEBA-POC
Validation Client	RVC0000500B1
Validation Client	RVC0001000B1
Validation Client	RVC0005000B1
Validation Client	RVC0010000B1
Validation Client	RVC0025000B1
Validation Client	RVC0050000B1
Validation Client	RVC0100000B1
Validation Client	RVC0200000B1
Validation Client	RVC0300000B1
Validation Client	RVC0400000B1
Validation Client	RVC0500000B1
Validation Client	RVC0600000B1
Validation Client	RVC0700000B1
Validation Client	RVC0800000B1
Validation Client	RVC0900000B1
Validation Client	RVC1000000B1
Validation Client	RVC1000001B1
Validation Client	RVC0000500E1
Validation Client	RVC0001000E1
Validation Client	RVC0005000E1
Validation Client	RVC0010000E1
Validation Client	RVC0025000E1
Validation Client	RVC0050000E1
Validation Client	RVC0100000E1
Validation Client	RVC0200000E1
Validation Client	RVC0300000E1
Validation Client	RVC0400000E1
Validation Client	RVC0500000E1
Validation Client	RVC0600000E1
Validation Client	RVC0700000E1
Validation Client	RVC0800000E1
Validation Client	RVC0900000E1
Validation Client	RVC1000000E1
Validation Client	RVC1000001E1
Validation Mgr	RVM500B1
Validation Mgr	RVM1000B1
Validation Mgr	RVM5000B1
Validation Mgr	RVM10000B1
Validation Mgr	RVM25000B1

Validation Mgr	RVM50000B1
Validation Mgr	RVM100000B1
Validation Mgr	RVM200000B1
Validation Mgr	RVM300000B1
Validation Mgr	RVM400000B1
Validation Mgr	RVM500000B1
Validation Mgr	RVM600000B1
Validation Mgr	RVM700000B1
Validation Mgr	RVM800000B1
Validation Mgr	RVM900000B1
Validation Mgr	RVM1000000B1
Validation Mgr	RVM1MILB1
Validation Mgr	RVM500E1
Validation Mgr	RVM1000E1
Validation Mgr	RVM5000E1
Validation Mgr	RVM10000E1
Validation Mgr	RVM25000E1
Validation Mgr	RVM50000E1
Validation Mgr	RVM100000E1
Validation Mgr	RVM200000E1
Validation Mgr	RVM300000E1
Validation Mgr	RVM400000E1
Validation Mgr	RVM500000E1
Validation Mgr	RVM600000E1
Validation Mgr	RVM700000E1
Validation Mgr	RVM800000E1
Validation Mgr	RVM900000E1
Validation Mgr	RVM1000000E1
Validation Mgr	RVM1MILE1
Web Threat Detection	STPLFM
Web Threat Detection	STPLFME1
Web Threat Detection	STTLFM
Web Threat Detection	STSFMOPP5000R
Web Threat Detection	STSFMOPP10000R
Web Threat Detection	STSFMOPP20000R
Web Threat Detection	STSFMOPP50000R
Web Threat Detection	STSFMOPP100000R
Web Threat Detection	STSFMOPP200000R
Web Threat Detection	STSFMOPP400000R
Web Threat Detection	STSFMOPP600000R
Web Threat Detection	STSFMOPP800000R
Web Threat Detection	STSFMOPP1000000R
Web Threat Detection	STSFMOPP1500000R
Web Threat Detection	STSFMOPP2000000R
Web Threat Detection	STSFMOPP3000000R
Web Threat Detection	STSFMOPP4000000R
Web Threat Detection	STSFMOPP5000000R

Web Threat Detection	STFSMOPP7500000R
Web Threat Detection	STFSMOPP10000000R
Web Threat Detection	STFSMOPP15000000R
Web Threat Detection	STFSMOPP20000000R
Web Threat Detection	STFSMOPP25000000R
Web Threat Detection	STFSMOPP5000RE1
Web Threat Detection	STFSMOPP10000RE1
Web Threat Detection	STFSMOPP20000RE1
Web Threat Detection	STFSMOPP50000RE1
Web Threat Detection	STFSMOPP100000RE1
Web Threat Detection	STFSMOPP200000RE1
Web Threat Detection	STFSMOPP400000RE1
Web Threat Detection	STFSMOPP600000RE1
Web Threat Detection	STFSMOPP800000RE1
Web Threat Detection	STFSMOPP1000000RE1
Web Threat Detection	STFSMOPP1500000RE1
Web Threat Detection	STFSMOPP2000000RE1
Web Threat Detection	STFSMOPP3000000RE1
Web Threat Detection	STFSMOPP4000000RE1
Web Threat Detection	STFSMOPP5000000RE1
Web Threat Detection	STFSMOPP7500000RE1
Web Threat Detection	STFSMOPP10000000RE1
Web Threat Detection	STFSMOPP15000000RE1
Web Threat Detection	STFSMOPP20000000RE1
Web Threat Detection	STFSMOPP25000000RE1
Web Threat Detection	STFSMOPP5000R
Web Threat Detection	STFSMOPP10000R
Web Threat Detection	STFSMOPP20000R
Web Threat Detection	STFSMOPP50000R
Web Threat Detection	STFSMOPP100000R
Web Threat Detection	STFSMOPP200000R
Web Threat Detection	STFSMOPP400000R
Web Threat Detection	STFSMOPP600000R
Web Threat Detection	STFSMOPP800000R
Web Threat Detection	STFSMOPP1000000R
Web Threat Detection	STFSMOPP1500000R
Web Threat Detection	STFSMOPP2000000R
Web Threat Detection	STFSMOPP3000000R
Web Threat Detection	STFSMOPP4000000R
Web Threat Detection	STFSMOPP5000000R
Web Threat Detection	STFSMOPP7500000R
Web Threat Detection	STFSMOPP10000000R
Web Threat Detection	STFSMOPP15000000R
Web Threat Detection	STFSMOPP20000000R
Web Threat Detection	STFSMOPP25000000R
Web Threat Detection	STFSMOPP5000V
Web Threat Detection	STFSMOPP10000V

Web Threat Detection	STFSMOPP20000V
Web Threat Detection	STFSMOPP50000V
Web Threat Detection	STFSMOPP100000V
Web Threat Detection	STFSMOPP200000V
Web Threat Detection	STFSMOPP400000V
Web Threat Detection	STFSMOPP600000V
Web Threat Detection	STFSMOPP800000V
Web Threat Detection	STFSMOPP1000000V
Web Threat Detection	STFSMOPP1500000V
Web Threat Detection	STFSMOPP2000000V
Web Threat Detection	STFSMOPP3000000V
Web Threat Detection	STFSMOPP4000000V
Web Threat Detection	STFSMOPP5000000V
Web Threat Detection	STFSMOPP7500000V
Web Threat Detection	STFSMOPP10000000V
Web Threat Detection	STFSMOPP15000000V
Web Threat Detection	STFSMOPP20000000V
Web Threat Detection	STFSMOPP25000000V
Web Threat Detection	STFSMOPP5000VE1
Web Threat Detection	STFSMOPP10000VE1
Web Threat Detection	STFSMOPP20000VE1
Web Threat Detection	STFSMOPP50000VE1
Web Threat Detection	STFSMOPP100000VE1
Web Threat Detection	STFSMOPP200000VE1
Web Threat Detection	STFSMOPP400000VE1
Web Threat Detection	STFSMOPP600000VE1
Web Threat Detection	STFSMOPP800000VE1
Web Threat Detection	STFSMOPP1000000VE1
Web Threat Detection	STFSMOPP1500000VE1
Web Threat Detection	STFSMOPP2000000VE1
Web Threat Detection	STFSMOPP3000000VE1
Web Threat Detection	STFSMOPP4000000VE1
Web Threat Detection	STFSMOPP5000000VE1
Web Threat Detection	STFSMOPP7500000VE1
Web Threat Detection	STFSMOPP10000000VE1
Web Threat Detection	STFSMOPP15000000VE1
Web Threat Detection	STFSMOPP20000000VE1
Web Threat Detection	STFSMOPP25000000VE1
Web Threat Detection	STFSMOPT5000V
Web Threat Detection	STFSMOPT10000V
Web Threat Detection	STFSMOPT20000V
Web Threat Detection	STFSMOPT50000V
Web Threat Detection	STFSMOPT100000V
Web Threat Detection	STFSMOPT200000V
Web Threat Detection	STFSMOPT400000V
Web Threat Detection	STFSMOPT600000V
Web Threat Detection	STFSMOPT800000V

Web Threat Detection	STSFMOPT1000000V
Web Threat Detection	STSFMOPT1500000V
Web Threat Detection	STSFMOPT2000000V
Web Threat Detection	STSFMOPT3000000V
Web Threat Detection	STSFMOPT4000000V
Web Threat Detection	STSFMOPT5000000V
Web Threat Detection	STSFMOPT7500000V
Web Threat Detection	STSFMOPT10000000V
Web Threat Detection	STSFMOPT15000000V
Web Threat Detection	STSFMOPT20000000V
Web Threat Detection	STSFMOPT25000000V
Web Threat Detection	EFNFD-WTD-SUB-T1
Web Threat Detection	EFNFD-WTD-SUB-T2
Web Threat Detection	EFNFD-WTD-SUB-T3
Web Threat Detection	EFNFD-WTD-SUB-T4
Web Threat Detection	EFNFD-WTD-SUB-T5
Web Threat Detection	EFNFD-WTD-SUB-T6
Web Threat Detection	EFNFD-WTD-SUB-T7
Web Threat Detection	EFNFD-WTD-SUB-T8
Web Threat Detection	EFNFD-WTD-SUB-T9
Web Threat Detection	EFNFD-WTD-SUB-T10
Web Threat Detection	EFNFD-WTD-SUB-T11
Web Threat Detection	EFNFD-WTD-SUB-T12
Web Threat Detection	EFNFD-WTD-SUB-T13
Web Threat Detection	EFNFD-WTD-SUB-T14
Web Threat Detection	EFNFD-WTD-SUB-T15
Web Threat Detection	EFNFD-WTD-SUB-T16
Web Threat Detection	EFNFD-WTD-SUB-T17
Web Threat Detection	EFNFD-WTD-SUB-T18
Web Threat Detection	EFNFD-WTD-SUB-T19
Web Threat Detection	EFNFD-WTD-SUB-T20
Web Threat Detection	FAFD-FA-SUB-T1
Web Threat Detection	FAFD-FA-SUB-T2
Web Threat Detection	FAFD-FA-SUB-T3
Web Threat Detection	FAFD-FA-SUB-T4
Web Threat Detection	FAFD-FA-SUB-T5
Web Threat Detection	FAFD-FA-SUB-T6
Web Threat Detection	FAFD-FA-SUB-T7
Web Threat Detection	FAFD-FA-SUB-T8
Web Threat Detection	FAFD-FA-SUB-T9
Web Threat Detection	FAFD-FA-SUB-T10
Web Threat Detection	FAFD-FA-SUB-T11
Web Threat Detection	FAFD-FA-SUB-T12
Web Threat Detection	FAFD-FA-SUB-T13
Web Threat Detection	FAFD-FA-SUB-T14
Web Threat Detection	FAFD-FA-SUB-T15
Web Threat Detection	FAFD-FA-SUB-T16

Web Threat Detection
Web Threat Detection
Web Threat Detection
Web Threat Detection

FAFD-FA-SUB-T17
FAFD-FA-SUB-T18
FAFD-FA-SUB-T19
FAFD-FA-SUB-T20

Part Description	Pricing Unit	US List
AAC TrxSign Sub 1Mo pr 1K user 10-20K	1000	\$151.85
AAC TrxSign Sub 1Mo pr 1K user 20-50K	1000	\$150.23
AAC TrxSign Sub 1Mo pr 1K user 50-100K	1000	\$147.00
AAC TrxSign Sub 1Mo pr 1K user 100K-200K	1000	\$142.14
AAC TrxSign Sub 1Mo pr 1K user 200K-400K	1000	\$135.66
AAC TrxSign Sub 1Mo pr 1K user 400K-600K	1000	\$127.56
AAC TrxSign Sub 1Mo pr 1K user 600K-800K	1000	\$115.42
AAC TrxSign Sub 1Mo pr 1K user 800K-1Mo	1000	\$103.27
AAC TrxSign Sub 1Mo pr 1K user 1Mo-1.5M	1000	\$87.78
AAC TrxSign Sub 1Mo pr 1K user 1.5M-2M	1000	\$74.62
AAC TrxSign Sub 1Mo pr 1K user 2M-3M	1000	\$63.42
AAC TrxSign Sub 1Mo pr 1K user 3M-4M	1000	\$53.91
AAC TrxSign Sub 1Mo pr 1K user 4M-5M	1000	\$45.82
AAC TrxSign Sub 1Mo pr 1K user 5M-7.5M	1000	\$38.95
RSAAA ENT On Prem for quantities between 100 - 3,000	1	\$50.00
RSAAA ENT On Prem for quantities between 3,005 - 4,000	1	\$45.00
RSAAA ENT On Prem for quantities between 4,005 - 5,000	1	\$45.00
RSAAA ENT On Prem for quantities between 5,005 - 7,500	1	\$42.00
RSAAA ENT On Prem for quantities between 7,005 - 10,000	1	\$36.00
RSAAA ENT On Prem for quantities between 10,005 - 15,000	1	\$36.00
RSAAA ENT On Prem for quantities between 15,005 - 20,000	1	\$35.00
RSAAA ENT On Prem for quantities between 20,005 - 25,000	1	\$35.00
RSAAA ENT On Prem for quantities between 25,005 - 50,000	1	\$30.00
RSAAA ENT On Prem for quantities between 50,005 - 75,000	1	\$30.00
RSAAA ENT On Prem for quantities between 75,005 - 100,000	1	\$25.00
RSAAA ENT On Prem for quantities over 100,000	1	\$23.00
RSAAA ENT On Prem MAINT-Enh-1	1	\$1.04
RSAAA ENT On Prem MAINT-Enh-1	1	\$0.94
RSAAA ENT On Prem MAINT-Enh-1	1	\$0.94
RSAAA ENT On Prem MAINT-Enh-1	1	\$0.88
RSAAA ENT On Prem MAINT-Enh-1	1	\$0.75
RSAAA ENT On Prem MAINT-Enh-1	1	\$0.75
RSAAA ENT On Prem MAINT-Enh-1	1	\$0.73
RSAAA ENT On Prem MAINT-Enh-1	1	\$0.73
RSAAA ENT On Prem MAINT-Enh-1	1	\$0.63
RSAAA ENT On Prem MAINT-Enh-1	1	\$0.63
RSAAA ENT On Prem MAINT-Enh-1	1	\$0.52
RSAAA ENT On Prem MAINT-Enh-1	1	\$0.48
RSAAA ENT On Prem Pricing per 1K Users 1MTH Term 100 - 3K	1000	\$3,055.56
RSAAA ENT On Prem Pricing per 1K Users 1MTH Term 3-4K	1000	\$2,750.00
RSAAA ENT On Prem Pricing per 1K Users 1MTH Term 4-5K	1000	\$2,750.00
RSAAA ENT On Prem Pricing per 1K Users 1MTH Term 5-7K	1000	\$2,566.67
RSAAA ENT On Prem Pricing per 1K Users 1MTH Term 7-10K	1000	\$2,200.00
RSAAA ENT On Prem Pricing per 1K Users 1MTH Term 10-15K	1000	\$2,200.00
RSAAA ENT On Prem Pricing per 1K Users 1MTH Term 15-20K	1000	\$2,138.89

RSAAA ENT On Prem Pricing per 1K Users 1MTH Term 20-25K	1000	\$2,138.89
RSAAA ENT On Prem Pricing per 1K Users 1MTH Term 25-50K	1000	\$1,833.33
RSAAA ENT On Prem Pricing per 1K Users 1MTH Term 50-75K	1000	\$1,833.33
RSAAA ENT On Prem Pricing per 1K Users 1MTH Term 75-100K	1000	\$1,527.78
RSAAA ENT On Prem Pricing per 1K Users 1MTH Term >100K	1000	\$1,214.72
eFraud Network & IP Geo Location Feeds for Enterprise On Prem for quantities between 100 - 300	1	\$7.50
eFraud Network & IP Geo Location Feeds for Enterprise On Prem for quantities between 3,005 - 4,000	1	\$6.75
eFraud Network & IP Geo Location Feeds for Enterprise On Prem for quantities between 4,005 - 5,000	1	\$6.75
eFraud Network & IP Geo Location Feeds for Enterprise On Prem for quantities between 5,005 - 7,000	1	\$6.30
eFraud Network & IP Geo Location Feeds for Enterprise On Prem for quantities between 7,005 - 10,000	1	\$5.40
eFraud Network & IP Geo Location Feeds for Enterprise On Prem for quantities between 10,005 - 15,000	1	\$5.40
eFraud Network & IP Geo Location Feeds for Enterprise On Prem for quantities between 15,005 - 20,000	1	\$5.25
eFraud Network & IP Geo Location Feeds for Enterprise On Prem for quantities between 20,005 - 25,000	1	\$5.25
eFraud Network & IP Geo Location Feeds for Enterprise On Prem for quantities between 25,005 - 50,000	1	\$4.50
eFraud Network & IP Geo Location Feeds for Enterprise On Prem for quantities between 50,005 - 75,000	1	\$4.50
eFraud Network & IP Geo Location Feeds for Enterprise On Prem for quantities between 75,005 - 100,000	1	\$3.75
eFraud Network & IP Geo Location Feeds for Enterprise On Prem for quantities over 100,000	1	\$1.15
RSAAA On Prem 2nd Channel for quantities between 10 - 20,000	1	\$10.31
RSAAA On Prem 2nd Channel for quantities between 20,005 - 50,000	1	\$7.43
RSAAA On Prem 2nd Channel for quantities between 50,005 - 100,000	1	\$4.73
AAOP ENT 2C MAINT-Enh-1	1	\$0.21
AAOP ENT 2C MAINT-Enh-1	1	\$0.15
AAOP ENT 2C MAINT-Enh-1	1	\$0.10
AAOP VU CH1 pr 1KU btw 10-20K	1000	\$4,590.00
AAOP VU CH1 pr 1KU btw 20k-50K	1000	\$2,601.00
AAOP VU CH1 pr 1KU btw 50k-100K	1000	\$1,530.00
AAOP VU CH1 pr 1KU btw 100k-200K	1000	\$1,377.00
AAOP VU CH1 pr 1KU btw 200k-400K	1000	\$1,224.00
AAOP VU CH1 pr 1KU btw 400-600K	1000	\$1,071.00
AAOP VU CH1 pr 1KU btw 600k-800k	1000	\$918.00
AAOP VU CH1 pr 1KU btw 800k-1M	1000	\$841.50
AAOP VU CH1 pr 1KU btw 1M-1.5M	1000	\$688.50
AAOP VU CH1 pr 1KU btw 1.5M-2M	1000	\$535.50
AAOP VU CH1pr 1KU btw 2M-3M	1000	\$382.50
AAOP VU CH1 pr 1KU btw 3M-4M	1000	\$336.60
AAOP VU CH1 pr 1KU btw 4M-5M	1000	\$306.00
AAOP VU CH1 pr 1KU btw 5M+	1000	\$229.50
AAOP VU CH1 EMnt 1Mo pr 1KU 10-20K	1000	\$95.63
AAOP VU CH1 EMnt 1Mo pr 1KU 20K-50K	1000	\$54.20
AAOP VU CH1 EMnt 1Mo pr 1KU 50K-100K	1000	\$31.88
AAOP VU CH1 EMnt 1Mo pr 1KU 100K-200K	1000	\$28.69
AAOP VU CH1 EMnt 1Mo pr 1KU 200K-400K	1000	\$25.50
AAOP VU CH1 EMnt 1Mo pr 1KU 400K-600K	1000	\$22.30
AAOP VU CH1 EMnt 1Mo pr 1KU 600K-800K	1000	\$19.10
AAOP VU CH1 EMnt 1Mo pr 1KU 800K-1M	1000	\$17.53
AAOP VU CH1 EMnt 1Mo pr 1KU 1M-1.5M	1000	\$14.34
AAOP VU CH1 EMnt 1Mo pr 1KU 1.5M-2M	1000	\$11.16

AAOP VU CH1 EMnt 1Mo pr 1KU 2M-3M	1000	\$7.97
AAOP VU CH1 EMnt 1Mo pr 1KU 3M-4M	1000	\$7.01
AAOP VU CH1 EMnt 1Mo pr 1KU 4M-5M	1000	\$6.38
AAOP VU CH1 EMnt 1Mo pr 1KU 5M+	1000	\$4.80
AAOP VU CH2 pr 1KU btw 10-20K	1000	\$1,380.00
AAOP VU CH2 pr 1KU btw 20k-50K	1000	\$780.00
AAOP VU CH2 pr 1KU btw 50k-100K	1000	\$460.00
AAOP VU CH2 pr 1KU btw 100k-200K	1000	\$410.00
AAOP VU CH2 pr 1KU btw 200k-400K	1000	\$370.00
AAOP VU CH2 pr 1KU btw 400-600K	1000	\$320.00
AAOP VU CH2 pr 1KU btw 600k-800k	1000	\$280.00
AAOP VU CH2 pr 1KU btw 800k-1M	1000	\$250.00
AAOP VU CH2 pr 1KU btw 1M-1.5M	1000	\$210.00
AAOP VU CH2 pr 1KU btw 1.5M-2M	1000	\$160.00
AAOP VU CH2 pr 1KU btw 2M-3M	1000	\$110.00
AAOP VU CH2 pr 1KU btw 3M-4M	1000	\$100.00
AAOP VU CH2 pr 1KU btw 4M-5M	1000	\$90.00
AAOP VU CH2 pr 1KU btw 5M+	1000	\$70.00
AAOP VU CH2 EMnt 1Mo pr 1KU 10-20K	1000	\$28.75
AAOP VU CH2 EMnt 1Mo pr 1KU 20K-50K	1000	\$16.25
AAOP VU CH2 EMnt 1Mo pr 1KU 50K-100K	1000	\$9.58
AAOP VU CH2 EMnt 1Mo pr 1KU 100K-200K	1000	\$8.54
AAOP VU CH2 EMnt 1Mo pr 1KU 200K-400K	1000	\$7.71
AAOP VU CH2 EMnt 1Mo pr 1KU 400K-600K	1000	\$6.67
AAOP VU CH2 EMnt 1Mo pr 1KU 600K-800K	1000	\$5.83
AAOP VU CH2 EMnt 1Mo pr 1KU 800K-1M	1000	\$5.21
AAOP VU CH2 EMnt 1Mo pr 1KU 1M-1.5M	1000	\$4.38
AAOP VU CH2 EMnt 1Mo pr 1KU 1.5M-2M	1000	\$3.33
AAOP VU CH2 EMnt 1Mo pr 1KU 2M-3M	1000	\$2.29
AAOP VU CH2 EMnt 1Mo pr 1KU 3M-4M	1000	\$2.08
AAOP VU CH2 EMnt 1Mo pr 1KU 4M-5M	1000	\$1.88
AAOP VU CH2 EMnt 1Mo pr 1KU 5M+	1000	\$1.46
AAOP VU TM pr 1KU btw 10-20K	1000	\$4,590.00
AAOP VU TM pr 1KU btw 20k-50K	1000	\$2,600.00
AAOP VU TM pr 1KU btw 50k-100K	1000	\$1,530.00
AAOP VU TM pr 1KU btw 100k-200K	1000	\$1,380.00
AAOP VU TM pr 1KU btw 200k-400K	1000	\$1,220.00
AAOP VU TM pr 1KU btw 400-600K	1000	\$1,070.00
AAOP VU TM pr 1KU btw 600k-800k	1000	\$920.00
AAOP VU TM pr 1KU btw 800k-1M	1000	\$840.00
AAOP VU TM pr 1KU btw 1M-1.5M	1000	\$690.00
AAOP VU TM pr 1KU btw 1.5M-2M	1000	\$540.00
AAOP VU TM pr 1KU btw 2M-3M	1000	\$380.00
AAOP VU TM pr 1KU btw 3M-4M	1000	\$340.00
AAOP VU TM pr 1KU btw 4M-5M	1000	\$310.00
AAOP VU TM pr 1KU btw 5M+	1000	\$230.00
AAOP VU TM EMnt 1Mo pr 1KU 10-20K	1000	\$95.63

AAOP VU TM EMnt 1Mo pr 1KU 20K-50K	1000	\$54.17
AAOP VU TM EMnt 1Mo pr 1KU 50K-100K	1000	\$31.88
AAOP VU TM EMnt 1Mo pr 1KU 100K-200K	1000	\$28.75
AAOP VU TM EMnt 1Mo pr 1KU 200K-400K	1000	\$25.42
AAOP VU TM EMnt 1Mo pr 1KU 400K-600K	1000	\$22.29
AAOP VU TM EMnt 1Mo pr 1KU 600K-800K	1000	\$19.17
AAOP VU TM EMnt 1Mo pr 1KU 800K-1M	1000	\$17.50
AAOP VU TM EMnt 1Mo pr 1KU 1M-1.5M	1000	\$14.38
AAOP VU TM EMnt 1Mo pr 1KU 1.5M-2M	1000	\$11.25
AAOP VU TM EMnt 1Mo pr 1KU 2M-3M	1000	\$7.92
AAOP VU TM EMnt 1Mo pr 1KU 3M-4M	1000	\$7.08
AAOP VU TM EMnt 1Mo pr 1KU 4M-5M	1000	\$6.46
AAOP VU TM EMnt 1Mo pr 1KU 5M+	1000	\$4.79
AAOP VU TXS Perp pr 1KU btw 10-20K	1000	\$3,676.00
AAOP VU TXS Perp pr 1KU btw 20K-50K	1000	\$3,636.80
AAOP VU TXS Perp pr 1KU btw 50K-100K	1000	\$3,558.40
AAOP VU TXS Perp pr 1KU btw 100K-200K	1000	\$3,440.80
AAOP VU TXS Perp pr 1KU btw 200K-400K	1000	\$3,284.00
AAOP VU TXS Perp pr 1KU btw 400K-600K	1000	\$3,088.00
AAOP VU TXS Perp pr 1KU btw 600K-800K	1000	\$2,794.00
AAOP VU TXS Perp pr 1KU btw 800K-1M	1000	\$2,500.00
AAOP VU TXS Perp pr 1KU btw 1M-1.5M	1000	\$2,125.00
AAOP VU TXS Perp pr 1KU btw 1.5M-2M	1000	\$1,806.25
AAOP VU TXS Perp pr 1KU btw 2M-3M	1000	\$1,535.31
AAOP VU TXS Perp pr 1KU btw 3M-4M	1000	\$1,305.02
AAOP VU TXS Perp pr 1KU btw 4M-5M	1000	\$1,109.26
AAOP VU TXS Perp pr 1KU btw 5M+	1000	\$942.87
AAOP VU TXS EMnt 1Mo pr 1KU 10-20K	1000	\$64.33
AAOP VU TXS EMnt 1Mo pr 1KU 20K-50K	1000	\$63.64
AAOP VU TXS EMnt 1Mo pr 1KU 50K-100K	1000	\$62.27
AAOP VU TXS EMnt 1Mo pr 1KU 100K-200K	1000	\$60.21
AAOP VU TXS EMnt 1Mo pr 1KU 200K-400K	1000	\$57.47
AAOP VU TXS EMnt 1Mo pr 1KU 400K-600K	1000	\$54.04
AAOP VU TXS EMnt 1Mo pr 1KU 600K-800K	1000	\$48.90
AAOP VU TXS EMnt 1Mo pr 1KU 800K-1M	1000	\$43.75
AAOP VU TXS EMnt 1Mo pr 1KU 1M-1.5M	1000	\$37.19
AAOP VU TXS EMnt 1Mo pr 1KU 1.5M-2M	1000	\$31.61
AAOP VU TXS EMnt 1Mo pr 1KU 2M-3M	1000	\$26.87
AAOP VU TXS EMnt 1Mo pr 1KU 3M-4M	1000	\$22.84
AAOP VU TXS EMnt 1Mo pr 1KU 4M-5M	1000	\$19.41
AAOP VU TXS EMnt 1Mo pr 1KU 5M+	1000	\$16.50
AAOP VU eFN & IP Geo 1Mo pr 1KU 10 - 20K	1000	\$57.38
AAOP VU eFN & IP Geo 1Mo pr 1KU 20K-50K	1000	\$32.51
AAOP VU eFN & IP Geo 1Mo pr 1KU 50K-100K	1000	\$19.13
AAOP VU eFN & IP Geo 1Mo pr 1KU 100K-200K	1000	\$17.21
AAOP VU eFN & IP Geo 1Mo pr 1KU 200K-400K	1000	\$15.30
AAOP VU eFN & IP Geo 1Mo pr 1KU 400K-600K	1000	\$13.39

AAOP VU eFN & IP Geo 1Mo pr 1KU 600K-800K	1000	\$11.48
AAOP VU eFN & IP Geo 1Mo pr 1KU 800K-1M	1000	\$10.52
AAOP VU eFN & IP Geo 1Mo pr 1KU 1M-1.5M	1000	\$8.61
AAOP VU eFN & IP Geo 1Mo pr 1KU 1.5M-2M	1000	\$6.69
AAOP VU eFN & IP Geo 1Mo pr 1KU 2M-3M	1000	\$4.78
AAOP VU eFN & IP Geo 1Mo pr 1KU 3M-4M	1000	\$4.21
AAOP VU eFN & IP Geo 1Mo pr 1KU 4M-5M	1000	\$3.83
AAOP VU eFN & IP Geo 1Mo pr 1KU 5M+	1000	\$2.87
AAOP VU CH1 Sub 1Mo pr 1KU 10-20K	1000	\$280.71
AAOP VU CH1 Sub 1Mo pr 1KU 20k-50K	1000	\$158.93
AAOP VU CH1 Sub 1Mo pr 1KU 50k-100K	1000	\$93.29
AAOP VU CH1 Sub 1Mo pr 1KU 100K-200K	1000	\$83.80
AAOP VU CH1 Sub 1Mo pr 1KU 200K-400K	1000	\$75.13
AAOP VU CH1 Sub 1Mo pr 1KU 400K-600K	1000	\$65.64
AAOP VU CH1 Sub 1Mo pr 1KU 600K-800K	1000	\$56.14
AAOP VU CH1 Sub 1Mo pr 1KU 800K-1M	1000	\$51.39
AAOP VU CH1 Sub 1Mo pr 1KU 1M-1.5M	1000	\$41.90
AAOP VU CH1 Sub 1Mo pr 1KU 1.5M-2M	1000	\$32.40
AAOP VU CH1 Sub 1Mo pr 1KU 2M-3M	1000	\$23.74
AAOP VU CH1 Sub 1Mo pr 1KU 3M-4M	1000	\$20.22
AAOP VU CH1 Sub 1Mo pr 1KU 4M-5M	1000	\$18.99
AAOP VU CH1 Sub 1Mo pr 1KU 5M+	1000	\$14.24
AAOP VU CH2 Sub 1Mo pr 1KU 10-20K	1000	\$124.46
AAOP VU CH2 Sub 1Mo pr 1KU 20k-50K	1000	\$70.43
AAOP VU CH2 Sub 1Mo pr 1KU 50k-100K	1000	\$41.49
AAOP VU CH2 Sub 1Mo pr 1KU 100K-200K	1000	\$37.14
AAOP VU CH2 Sub 1Mo pr 1KU 200K-400K	1000	\$33.29
AAOP VU CH2 Sub 1Mo pr 1KU 400K-600K	1000	\$28.94
AAOP VU CH2 Sub 1Mo pr 1KU 600K-800K	1000	\$25.09
AAOP VU CH2 Sub 1Mo pr 1KU 800K-1M	1000	\$22.67
AAOP VU CH2 Sub 1Mo pr 1KU 1M-1.5M	1000	\$18.81
AAOP VU CH2 Sub 1Mo pr 1KU 1.5M-2M	1000	\$14.47
AAOP VU CH2 Sub 1Mo pr 1KU 2M-3M	1000	\$10.13
AAOP VU CH2 Sub 1Mo pr 1KU 3M-4M	1000	\$9.07
AAOP VU CH2 Sub 1Mo pr 1KU 4M-5M	1000	\$8.20
AAOP VU CH2 Sub 1Mo pr 1KU 5M+	1000	\$6.27
AAOP VU TM Sub 1Mo pr 1KU 10-20K	1000	\$280.71
AAOP VU TM Sub 1Mo pr 1KU 20k-50K	1000	\$158.93
AAOP VU TM Sub 1Mo pr 1KU 50k-100K	1000	\$93.29
AAOP VU TM Sub 1Mo pr 1KU 100K-200K	1000	\$83.80
AAOP VU TM Sub 1Mo pr 1KU 200K-400K	1000	\$75.13
AAOP VU TM Sub 1Mo pr 1KU 400K-600K	1000	\$65.64
AAOP VU TM Sub 1Mo pr 1KU 600K-800K	1000	\$56.14
AAOP VU TM Sub 1Mo pr 1KU 800K-1M	1000	\$51.39
AAOP VU TM Sub 1Mo pr 1KU 1M-1.5M	1000	\$41.90
AAOP VU TM Sub 1Mo pr 1KU 1.5M-2M	1000	\$32.40
AAOP VU TM Sub 1Mo pr 1KU 2M-3M	1000	\$23.74

AAOP VU TM Sub 1Mo pr 1KU 3M-4M	1000	\$20.22
AAOP VU TM Sub 1Mo pr 1KU 4M-5M	1000	\$18.99
AAOP VU TM Sub 1Mo pr 1KU 5M+	1000	\$14.24
AAOP VU TXS Sub 1Mo pr 1KU 10-20K	1000	\$151.85
AAOP VU TXS Sub 1Mo pr 1KU 20k-50K	1000	\$150.23
AAOP VU TXS Sub 1Mo pr 1KU 50k-100K	1000	\$147.00
AAOP VU TXS Sub 1Mo pr 1KU 100K-200K	1000	\$142.14
AAOP VU TXS Sub 1Mo pr 1KU 200K-400K	1000	\$135.66
AAOP VU TXS Sub 1Mo pr 1KU 400K-600K	1000	\$127.56
AAOP VU TXS Sub 1Mo pr 1KU 600K-800K	1000	\$115.42
AAOP VU TXS Sub 1Mo pr 1KU 800K-1M	1000	\$103.27
AAOP VU TXS Sub 1Mo pr 1KU 1M-1.5M	1000	\$87.78
AAOP VU TXS Sub 1Mo pr 1KU 1.5M-2M	1000	\$74.62
AAOP VU TXS Sub 1Mo pr 1KU 2M-3M	1000	\$63.42
AAOP VU TXS Sub 1Mo pr 1KU 3M-4M	1000	\$53.91
AAOP VU TXS Sub 1Mo pr 1KU 4M-5M	1000	\$45.82
AAOP VU TXS Sub 1Mo pr 1KU 5M+	1000	\$38.95
AAOP VU CH1/TM pr 1KU btw 10-20K	1000	\$6,196.50
AAOP VU CH1/TM pr 1KU btw 20k-50K	1000	\$3,511.35
AAOP VU CH1/TM pr 1KU btw 50k-100K	1000	\$2,065.50
AAOP VU CH1/TM pr 1KU btw 100k-200K	1000	\$1,858.95
AAOP VU CH1/TM pr 1KU btw 200k-400K	1000	\$1,652.40
AAOP VU CH1/TM pr 1KU btw 400-600K	1000	\$1,445.85
AAOP VU CH1/TM pr 1KU btw 600k-800k	1000	\$1,239.30
AAOP VU CH1/TM pr 1KU btw 800k-1M	1000	\$1,136.03
AAOP VU CH1/TM pr 1KU btw 1M-1.5M	1000	\$929.48
AAOP VU CH1/TM pr 1KU btw 1.5M-2M	1000	\$722.93
AAOP VU CH1/TM pr 1KU btw 2M-3M	1000	\$516.38
AAOP VU CH1/TM pr 1KU btw 3M-4M	1000	\$454.41
AAOP VU CH1/TM pr 1KU btw 4M-5M	1000	\$413.10
AAOP VU CH1/TM pr 1KU btw 5M+	1000	\$309.83
AAOP VU CH1/TM Upg pr 1KU btw 10-20K	1000	\$1,606.50
AAOP VU CH1/TM Upg pr 1KU btw 20k-50K	1000	\$910.35
AAOP VU CH1/TM Upg pr 1KU btw 50k-100K	1000	\$535.50
AAOP VU CH1/TM Upg pr 1KU btw 100k-200K	1000	\$481.95
AAOP VU CH1/TM Upg pr 1KU btw 200k-400K	1000	\$428.40
AAOP VU CH1/TM Upg pr 1KU btw 400-600K	1000	\$374.85
AAOP VU CH1/TM Upg pr 1KU btw 600k-800k	1000	\$321.30
AAOP VU CH1/TM Upg pr 1KU btw 800k-1M	1000	\$294.53
AAOP VU CH1/TM Upg pr 1KU btw 1M-1.5M	1000	\$240.98
AAOP VU CH1/TM Upg pr 1KU btw 1.5M-2M	1000	\$187.43
AAOP VU CH1/TM Upg pr 1KU btw 2M-3M	1000	\$133.88
AAOP VU CH1/TM Upg pr 1KU btw 3M-4M	1000	\$117.81
AAOP VU CH1/TM Upg pr 1KU btw 4M-5M	1000	\$107.10
AAOP VU CH1/TM Upg pr 1KU btw 5M+	1000	\$80.33
AAOP VU CH1/TM EMnt 1Mo pr 1KU 10-20K	1000	\$129.09
AAOP VU CH1/TM EMnt 1Mo pr 1KU 20K-50K	1000	\$73.15

AAOP VU CH1/TM EMnt 1Mo pr 1KU 50K-100K	1000	\$43.03
AAOP VU CH1/TM EMnt 1Mo pr 1KU 100K-200K	1000	\$38.73
AAOP VU CH1/TM EMnt 1Mo pr 1KU 200K-400K	1000	\$34.43
AAOP VU CH1/TM EMnt 1Mo pr 1KU 400K-600K	1000	\$30.12
AAOP VU CH1/TM EMnt 1Mo pr 1KU 600K-800K	1000	\$25.82
AAOP VU CH1/TM EMnt 1Mo pr 1KU 800K-1M	1000	\$23.67
AAOP VU CH1/TM EMnt 1Mo pr 1KU 1M-1.5M	1000	\$19.36
AAOP VU CH1/TM EMnt 1Mo pr 1KU 1.5M-2M	1000	\$15.06
AAOP VU CH1/TM EMnt 1Mo pr 1KU 2M-3M	1000	\$10.76
AAOP VU CH1/TM EMnt 1Mo pr 1KU 3M-4M	1000	\$9.47
AAOP VU CH1/TM EMnt 1Mo pr 1KU 4M-5M	1000	\$8.61
AAOP VU CH1/TM EMnt 1Mo pr 1KU 5M+	1000	\$6.45
AAOP VU CH1/TM Sub 1Mo pr 1KU 10-20K	1000	\$358.67
AAOP VU CH1/TM Sub 1Mo pr 1KU 20k-50K	1000	\$203.38
AAOP VU CH1/TM Sub 1Mo pr 1KU 50k-100K	1000	\$119.83
AAOP VU CH1/TM Sub 1Mo pr 1KU 100K-200K	1000	\$107.18
AAOP VU CH1/TM Sub 1Mo pr 1KU 200K-400K	1000	\$95.37
AAOP VU CH1/TM Sub 1Mo pr 1KU 400K-600K	1000	\$83.55
AAOP VU CH1/TM Sub 1Mo pr 1KU 600K-800K	1000	\$71.73
AAOP VU CH1/TM Sub 1Mo pr 1KU 800K-1M	1000	\$65.41
AAOP VU CH1/TM Sub 1Mo pr 1KU 1M-1.5M	1000	\$53.59
AAOP VU CH1/TM Sub 1Mo pr 1KU 1.5M-2M	1000	\$41.78
AAOP VU CH1/TM Sub 1Mo pr 1KU 2M-3M	1000	\$29.96
AAOP VU CH1/TM Sub 1Mo pr 1KU 3M-4M	1000	\$26.00
AAOP VU CH1/TM Sub 1Mo pr 1KU 4M-5M	1000	\$23.63
AAOP VU CH1/TM Sub 1Mo pr 1KU 5M+	1000	\$18.14
RSAAA On Prem Pricing per 1K Users for quantities between 10 - 20,000	1000	\$4,590.00
RSAAA On Prem Pricing per 1K Users for quantities between 20,005 - 50,000	1000	\$2,601.00
RSAAA On Prem Pricing per 1K Users for quantities between 50,005 - 100,000	1000	\$1,530.00
RSAAA On Prem Pricing per 1K Users for quantities between 100,005 - 200,000	1000	\$1,377.00
RSAAA On Prem Pricing per 1K Users for quantities between 200,005 - 400,000	1000	\$1,224.00
RSAAA On Prem Pricing per 1K Users for quantities between 400,005 - 600,000	1000	\$1,071.00
RSAAA On Prem Pricing per 1K Users for quantities between 600,005 - 800,000	1000	\$918.00
RSAAA On Prem Pricing per 1K Users for quantities between 800,005 - 1,000,000	1000	\$841.50
RSAAA On Prem Pricing per 1K Users for quantities between 1,000,005 - 1,500,000	1000	\$688.50
RSAAA On Prem Pricing per 1K Users for quantities between 1,500,005 - 2,000,000	1000	\$535.50
RSAAA On Prem Pricing per 1K Users for quantities between 2,000,005 - 3,000,000	1000	\$382.50
RSAAA On Prem Pricing per 1K Users for quantities between 3,000,005 - 4,000,000	1000	\$336.60
RSAAA On Prem Pricing per 1K Users for quantities between 4,000,005 - 5,000,000	1000	\$306.00
RSAAA On Prem Pricing per 1K Users for quantities between 5,000,005 - 7,500,000	1000	\$229.50
RSAAA OnPrem Pricing per 1K Users MAINT-Enh-1	1000	\$95.63
RSAAA OnPrem Pricing per 1K Users MAINT-Enh-1	1000	\$54.20
RSAAA OnPrem Pricing per 1K Users MAINT-Enh-1	1000	\$31.88
RSAAA OnPrem Pricing per 1K Users MAINT-Enh-1	1000	\$28.69
RSAAA OnPrem Pricing per 1K Users MAINT-Enh-1	1000	\$25.50
RSAAA OnPrem Pricing per 1K Users MAINT-Enh-1	1000	\$22.30
RSAAA OnPrem Pricing per 1K Users MAINT-Enh-1	1000	\$19.10

RSAAA OnPrem Pricing per 1K Users MAINT-Enh-1	1000	\$17.53
RSAAA OnPrem Pricing per 1K Users MAINT-Enh-1	1000	\$14.34
RSAAA OnPrem Pricing per 1K Users MAINT-Enh-1	1000	\$11.16
RSAAA OnPrem Pricing per 1K Users MAINT-Enh-1	1000	\$7.97
RSAAA OnPrem Pricing per 1K Users MAINT-Enh-1	1000	\$7.01
RSAAA OnPrem Pricing per 1K Users MAINT-Enh-1	1000	\$6.38
RSAAA OnPrem Pricing per 1K Users MAINT-Enh-1	1000	\$4.80
RSAAA On Prem Consumer Pricing per 1K Users 1MTH Term 10-20K	1000	\$280.71
RSAAA On Prem Consumer Pricing per 1K Users 1MTH Term 20-50K	1000	\$158.93
RSAAA On Prem Consumer Pricing per 1K Users 1MTH Term 50-100K	1000	\$93.29
RSAAA On Prem Consumer Pricing per 1K Users 1MTH Term 100-200K	1000	\$83.80
RSAAA On Prem Consumer Pricing per 1K Users 1MTH Term 200-400K	1000	\$75.13
RSAAA On Prem Consumer Pricing per 1K Users 1MTH Term 400-600K	1000	\$65.64
RSAAA On Prem Consumer Pricing per 1K Users 1MTH Term 600-800K	1000	\$56.14
RSAAA On Prem Consumer Pricing per 1K Users 1MTH Term 800K-1M	1000	\$51.39
RSAAA On Prem Consumer Pricing per 1K Users 1MTH Term 1-1.5M	1000	\$41.90
RSAAA On Prem Consumer Pricing per 1K Users 1MTH Term 1.5-2M	1000	\$32.40
RSAAA On Prem Consumer Pricing per 1K Users 1MTH Term 2-3M	1000	\$23.74
RSAAA On Prem Consumer Pricing per 1K Users 1MTH Term 3-4M	1000	\$20.22
RSAAA On Prem Consumer Pricing per 1K Users 1MTH Term 4-5M	1000	\$18.99
RSAAA On Prem Consumer Pricing per 1K Users 1MTH Term 5-7.5M	1000	\$14.24
eFraud Network & IP Geo Location Feeds for On Prem Pricing per 1K Users for quantities betwe	1000	\$688.50
eFraud Network & IP Geo Location Feeds for On Prem Pricing per 1K Users for quantities betwe	1000	\$390.15
eFraud Network & IP Geo Location Feeds for On Prem Pricing per 1K Users for quantities betwe	1000	\$229.50
eFraud Network & IP Geo Location Feeds for On Prem Pricing per 1K Users for quantities betwe	1000	\$206.55
eFraud Network & IP Geo Location Feeds for On Prem Pricing per 1K Users for quantities betwe	1000	\$183.60
eFraud Network & IP Geo Location Feeds for On Prem Pricing per 1K Users for quantities betwe	1000	\$160.65
eFraud Network & IP Geo Location Feeds for On Prem Pricing per 1K Users for quantities betwe	1000	\$137.70
eFraud Network & IP Geo Location Feeds for On Prem Pricing per 1K Users for quantities betwe	1000	\$126.23
eFraud Network & IP Geo Location Feeds for On Prem Pricing per 1K Users for quantities betwe	1000	\$103.28
eFraud Network & IP Geo Location Feeds for On Prem Pricing per 1K Users for quantities betwe	1000	\$80.33
eFraud Network & IP Geo Location Feeds for On Prem Pricing per 1K Users for quantities betwe	1000	\$57.38
eFraud Network & IP Geo Location Feeds for On Prem Pricing per 1K Users for quantities betwe	1000	\$50.49
eFraud Network & IP Geo Location Feeds for On Prem Pricing per 1K Users for quantities betwe	1000	\$45.90
eFraud Network & IP Geo Location Feeds for On Prem Pricing per 1K Users for quantities betwe	1000	\$34.43
2Cha On Prem Consumer Pricing per 1K Users 1MTH Term 10-20K	1000	\$124.46
2Cha On Prem Consumer Pricing per 1K Users 1MTH Term 20-50K	1000	\$70.43
2Cha On Prem Consumer Pricing per 1K Users 1MTH Term 50-100K	1000	\$41.49
2Cha On Prem Consumer Pricing per 1K Users 1MTH Term 100-200K	1000	\$37.14
2Cha On Prem Consumer Pricing per 1K Users 1MTH Term 200-400K	1000	\$33.29
2Cha On Prem Consumer Pricing per 1K Users 1MTH Term 400-600K	1000	\$28.94
2Cha On Prem Consumer Pricing per 1K Users 1MTH Term 600-800K	1000	\$25.09
2Cha On Prem Consumer Pricing per 1K Users 1MTH Term 800K-1M	1000	\$22.67
2Cha On Prem Consumer Pricing per 1K Users 1MTH Term 1-1.5M	1000	\$18.81
2Cha On Prem Consumer Pricing per 1K Users 1MTH Term 1.5-2M	1000	\$14.47
2Cha On Prem Consumer Pricing per 1K Users 1MTH Term 2-3M	1000	\$10.13
2Cha On Prem Consumer Pricing per 1K Users 1MTH Term 3-4M	1000	\$9.07

2Cha On Prem Consumer Pricing per 1K Users 1MTH Term 4-5M	1000	\$8.20
2Cha On Prem Consumer Pricing per 1K Users 1MTH Term 5-7.5M	1000	\$6.27
RSAAA On Prem Pricing per 1K Users 2nd Channel for quantities between 10 - 20,000	1000	\$1,380.00
RSAAA On Prem Pricing per 1K Users 2nd Channel for quantities between 20,005 - 50,000	1000	\$780.00
RSAAA On Prem Pricing per 1K Users 2nd Channel for quantities between 50,005 - 100,000	1000	\$460.00
RSAAA On Prem Pricing per 1K Users 2nd Channel for quantities between 100,005 - 200,000	1000	\$410.00
RSAAA On Prem Pricing per 1K Users 2nd Channel for quantities between 200,005 - 400,000	1000	\$370.00
RSAAA On Prem Pricing per 1K Users 2nd Channel for quantities between 400,005 - 600,000	1000	\$320.00
RSAAA On Prem Pricing per 1K Users 2nd Channel for quantities between 600,005 - 800,000	1000	\$280.00
RSAAA On Prem Pricing per 1K Users 2nd Channel for quantities between 800,005 - 1,000,000	1000	\$250.00
RSAAA On Prem Pricing per 1K Users 2nd Channel for quantities between 1,000,005 - 1,500,000	1000	\$210.00
RSAAA On Prem Pricing per 1K Users 2nd Channel for quantities between 1,500,005 - 2,000,000	1000	\$160.00
RSAAA On Prem Pricing per 1K Users 2nd Channel for quantities between 2,000,005 - 3,000,000	1000	\$110.00
RSAAA On Prem Pricing per 1K Users 2nd Channel for quantities between 3,000,005 - 4,000,000	1000	\$100.00
RSAAA On Prem Pricing per 1K Users 2nd Channel for quantities between 4,000,005 - 5,000,000	1000	\$90.00
RSAAA On Prem Pricing per 1K Users 2nd Channel for quantities between 5,000,005 - 7,500,000	1000	\$70.00
RSAAA OnPrem Pricing per 1K Users 2C MAINT-Enh-1	1000	\$28.75
RSAAA OnPrem Pricing per 1K Users 2C MAINT-Enh-1	1000	\$16.25
RSAAA OnPrem Pricing per 1K Users 2C MAINT-Enh-1	1000	\$9.58
RSAAA OnPrem Pricing per 1K Users 2C MAINT-Enh-1	1000	\$8.54
RSAAA OnPrem Pricing per 1K Users 2C MAINT-Enh-1	1000	\$7.71
RSAAA OnPrem Pricing per 1K Users 2C MAINT-Enh-1	1000	\$6.67
RSAAA OnPrem Pricing per 1K Users 2C MAINT-Enh-1	1000	\$5.83
RSAAA OnPrem Pricing per 1K Users 2C MAINT-Enh-1	1000	\$5.21
RSAAA OnPrem Pricing per 1K Users 2C MAINT-Enh-1	1000	\$4.38
RSAAA OnPrem Pricing per 1K Users 2C MAINT-Enh-1	1000	\$3.33
RSAAA OnPrem Pricing per 1K Users 2C MAINT-Enh-1	1000	\$2.29
RSAAA OnPrem Pricing per 1K Users 2C MAINT-Enh-1	1000	\$2.08
RSAAA OnPrem Pricing per 1K Users 2C MAINT-Enh-1	1000	\$1.88
RSAAA OnPrem Pricing per 1K Users 2C MAINT-Enh-1	1000	\$1.46
RSAAA SAE Perp 10-25 users	1	\$13.80
RSAAA SAE Perp 30-100 users	1	\$12.75
RSAAA SAE Perp 105-150 users	1	\$11.10
RSAAA SAE Perp 155-250 users	1	\$9.90
RSAAA SAE Perp 255-500 users	1	\$7.80
RSAAA SAE Perp 505-750 users	1	\$6.90
RSAAA SAE Perp 755-1500 users	1	\$5.70
RSAAA SAE Perp 1505-2500 users	1	\$4.65
RSAAA SAE Perp 2505-5K users	1	\$3.90
RSAAA SAE Perp 5005-10K users	1	\$3.15
RSAAA SAE Perp 10005-50K users	1	\$2.25
RSAAA SAE Perp 50005-100K users	1	\$1.35
RSAAA SAE Perp 10K5-1M users	1	\$1.05
RSAAA SAE Perp EnhMnt 10-25 1Mo	1	\$0.24
RSAAA SAE Perp EnhMnt 30-100 1Mo	1	\$0.22
RSAAA SAE Perp EnhMnt 105-150 1Mo	1	\$0.19
RSAAA SAE Perp EnhMnt 155-250 1Mo	1	\$0.17

RSAAA SAE Perp EnhMnt 255-500 1Mo	1	\$0.14
RSAAA SAE Perp EnhMnt 505-750 1Mo	1	\$0.12
RSAAA SAE Perp EnhMnt 755-1500 1Mo	1	\$0.10
RSAAA SAE Perp EnhMnt 1505-2500 1Mo	1	\$0.08
RSAAA SAE Perp EnhMnt 2505-5K 1Mo	1	\$0.07
RSAAA SAE Perp EnhMnt 5005-10K 1Mo	1	\$0.06
RSAAA SAE Perp EnhMnt 10005-50K 1Mo	1	\$0.04
RSAAA SAE Perp EnhMnt 50005-100K 1Mo	1	\$0.03
RSAAA SAE Perp EnhMnt 10K5-1M 1Mo	1	\$0.02
AAOP TrxSign Perp pr 1KU btw 10-20K	1000	\$3,676.00
AAOP TrxSign Perp pr 1KU btw 20K-50K	1000	\$3,636.80
AAOP TrxSign Perp pr 1KU btw 50K-100K	1000	\$3,558.40
AAOP TrxSign Perp pr 1KU btw 100K-200K	1000	\$3,440.80
AAOP TrxSign Perp pr 1KU btw 200K-400K	1000	\$3,284.00
AAOP TrxSign Perp pr 1KU btw 400K-600K	1000	\$3,088.00
AAOP TrxSign Perp pr 1KU btw 600K-800K	1000	\$2,794.00
AAOP TrxSign Perp pr 1KU btw 800K-1M	1000	\$2,500.00
AAOP TrxSign Perp pr 1KU btw 1M-1.5M	1000	\$2,125.00
AAOP TrxSign Perp pr 1KU btw 1.5M-2M	1000	\$1,806.25
AAOP TrxSign Perp pr 1KU btw 2M-3M	1000	\$1,535.31
AAOP TrxSign Perp pr 1KU btw 3M-4M	1000	\$1,305.02
AAOP TrxSign Perp pr 1KU btw 4M-5M	1000	\$1,109.26
AAOP TrxSign Perp pr 1KU btw 5M-7.5M	1000	\$942.87
AAOP TrxSign EnhMnt 1Mo pr 1KU 10-20K	1000	\$64.33
AAOP TrxSign EnhMnt 1Mo pr 1KU 20K-50K	1000	\$63.64
AAOP TrxSign EnhMnt 1Mo pr 1KU 50K-100K	1000	\$62.27
AAOP TrxSign EnhMnt 1Mo pr 1KU 100K-200K	1000	\$60.21
AAOP TrxSign EnhMnt 1Mo pr 1KU 200K-400K	1000	\$57.47
AAOP TrxSign EnhMnt 1Mo pr 1KU 400K-600K	1000	\$54.04
AAOP TrxSign EnhMnt 1Mo pr 1KU 600K-800K	1000	\$48.90
AAOP TrxSign EnhMnt 1Mo pr 1KU 800K-1M	1000	\$43.75
AAOP TrxSign EnhMnt 1Mo pr 1KU 1M-1.5M	1000	\$37.19
AAOP TrxSign EnhMnt 1Mo pr 1KU 1.5M-2M	1000	\$31.61
AAOP TrxSign EnhMnt 1Mo pr 1KU 2M-3M	1000	\$26.87
AAOP TrxSign EnhMnt 1Mo pr 1KU 3M-4M	1000	\$22.84
AAOP TrxSign EnhMnt 1Mo pr 1KU 4M-5M	1000	\$19.41
AAOP TrxSign EnhMnt 1Mo pr 1KU 5M-7.5M	1000	\$16.50
AAOP TrxSign Subsc 1Mo pr 1KU 10-20K	1000	\$151.85
AAOP TrxSign Subsc 1Mo pr 1KU 20-50K	1000	\$150.23
AAOP TrxSign Subsc 1Mo pr 1KU 50-100K	1000	\$147.00
AAOP TrxSign Subsc 1Mo pr 1KU 100K-200K	1000	\$142.14
AAOP TrxSign Subsc 1Mo pr 1KU 200K-400K	1000	\$135.66
AAOP TrxSign Subsc 1Mo pr 1KU 400K-600K	1000	\$127.56
AAOP TrxSign Subsc 1Mo pr 1KU 600K-800K	1000	\$115.42
AAOP TrxSign Subsc 1Mo pr 1KU 800K-1M	1000	\$103.27
AAOP TrxSign Subsc 1Mo pr 1KU 1M-1.5M	1000	\$87.78
AAOP TrxSign Subsc 1Mo pr 1KU 1.5M-2M	1000	\$74.62

AAOP TrxSign Subsc 1Mo pr 1KU 2M-3M	1000	\$63.42
AAOP TrxSign Subsc 1Mo pr 1KU 3M-4M	1000	\$53.91
AAOP TrxSign Subsc 1Mo pr 1KU 4M-5M	1000	\$45.82
AAOP TrxSign Subsc 1Mo pr 1KU 5M-7.5M	1000	\$38.95
AA On Prem Legacy Subscription	1	\$0.00
AA On Prem Legacy Subscription Web	1	\$0.00
AA On Prem Legacy Subscription Mobile	1	\$0.00
RSAAA/TM ONPREM per 1K user btw 10-20K	1000	\$6,196.50
RSAAA/TM ONPREM per 1K user btw 20,005-50K	1000	\$3,511.35
RSAAA/TM ONPREM per 1K user btw 50,005-100K	1000	\$2,065.50
RSAAA/TM ONPREM per 1Kuser btw 100,005-200K	1000	\$1,858.95
RSAAA/TM ONPREM per 1Kuser btw 200,005-400K	1000	\$1,652.40
RSAAA/TM ONPREM per 1Kuser btw 400,005-600K	1000	\$1,445.85
RSAAA/TM ONPREM per 1Kuser btw 600,005-800K	1000	\$1,239.30
RSAAA/TM ONPREM per 1Kuser btw 800,005-1M	1000	\$1,136.03
RSAAA/TM ONPREM per 1Kuser btw 1000005-1.5M	1000	\$929.48
RSAAA/TM ONPREM per 1Kuser btw 1,500,005-2M	1000	\$722.93
RSAAA/TM ONPREM per 1Kuser btw 2,000,005-3M	1000	\$516.38
RSAAA/TM ONPREM per 1Kuser btw 3,000,005-4M	1000	\$454.41
RSAAA/TM ONPREM per 1Kuser btw 4,000,005-5M	1000	\$413.10
RSAAA/TM ONPREM per 1Kuser btw 5000005-7.5M	1000	\$309.83
RSAAA/TM ONPREM Upg 1K user btw10-20K	1000	\$1,606.50
RSAAA/TM ONPREM Upg 1K user btw 20,005-50K	1000	\$910.35
RSAAA/TM ONPREM Upg 1K user btw 50,005-100K	1000	\$535.50
RSAAA/TM ONPREM Upg 1Kuser btw 100,005-200K	1000	\$481.95
RSAAA/TM ONPREM Upg 1Kuser btw 200,005-400K	1000	\$428.40
RSAAA/TM ONPREM Upg 1Kuser btw 400,005-600K	1000	\$374.85
RSAAA/TM ONPREM Upg 1Kuser btw 600,005-800K	1000	\$321.30
RSAAA/TM ONPREM Upg 1K user btw 800,005-1M	1000	\$294.53
RSAAA/TM ONPREM Upg 1K user btw 1M,005-1.5M	1000	\$240.98
RSAAA/TM ONPREM Upg 1Kuser btw 1,500,005-2M	1000	\$187.43
RSAAA/TM ONPREM Upg 1Kuser btw 2,000,005-3M	1000	\$133.88
RSAAA/TM ONPREM Upg 1Kuser btw 3,000,005-4M	1000	\$117.81
RSAAA/TM ONPREM Upg 1Kuser btw 4,000,005-5M	1000	\$107.10
RSAAA/TM ONPREM Upg 1Kuser btw 5M,005-7.5M	1000	\$80.33
RSAAA/TM ONPREM per1KUser MAINT-Enh-1	1000	\$129.09
RSAAA/TM ONPREM per1KUser MAINT-Enh-1	1000	\$73.15
RSAAA/TM ONPREM per1KUser MAINT-Enh-1	1000	\$43.03
RSAAA/TM ONPREM per1KUser MAINT-Enh-1	1000	\$38.73
RSAAA/TM ONPREM per1KUser MAINT-Enh-1	1000	\$34.43
RSAAA/TM ONPREM per1KUser MAINT-Enh-1	1000	\$30.12
RSAAA/TM ONPREM per1KUser MAINT-Enh-1	1000	\$25.82
RSAAA/TM ONPREM per1KUser MAINT-Enh-1	1000	\$23.67
RSAAA/TM ONPREM per1KUser MAINT-Enh-1	1000	\$19.36
RSAAA/TM ONPREM per1KUser MAINT-Enh-1	1000	\$15.06
RSAAA/TM ONPREM per1KUser MAINT-Enh-1	1000	\$10.76
RSAAA/TM ONPREM per1KUser MAINT-Enh-1	1000	\$9.47

RSAAA/TM ONPREM per1KUser MAINT-Enh-1	1000	\$8.61
RSAAA/TM ONPREM per1KUser MAINT-Enh-1	1000	\$6.45
eFraud Network & IP Geo Location Feeds for On Prem Pricing per 1K Users for quantities between 10 - 20,000	1000	\$688.50
eFraud Network & IP Geo Location Feeds for On Prem Pricing per 1K Users for quantities between 20,005 - 50,000	1000	\$390.15
eFraud Network & IP Geo Location Feeds for On Prem Pricing per 1K Users for quantities between 50,005 - 100,000	1000	\$229.50
eFraud Network & IP Geo Location Feeds for On Prem Pricing per 1K Users for quantities between 100,005 - 200,000	1000	\$206.55
eFraud Network & IP Geo Location Feeds for On Prem Pricing per 1K Users for quantities between 200,005 - 400,000	1000	\$183.60
eFraud Network & IP Geo Location Feeds for On Prem Pricing per 1K Users for quantities between 400,005 - 600,000	1000	\$160.65
eFraud Network & IP Geo Location Feeds for On Prem Pricing per 1K Users for quantities between 600,005 - 800,000	1000	\$137.70
eFraud Network & IP Geo Location Feeds for On Prem Pricing per 1K Users for quantities between 800,005 - 1,000,000	1000	\$126.23
eFraud Network & IP Geo Location Feeds for On Prem Pricing per 1K Users for quantities between 1,000,005 - 1,500,000	1000	\$103.28
eFraud Network & IP Geo Location Feeds for On Prem Pricing per 1K Users for quantities between 1,500,005 - 2,000,000	1000	\$80.33
eFraud Network & IP Geo Location Feeds for On Prem Pricing per 1K Users for quantities between 2,000,005 - 3,000,000	1000	\$57.38
eFraud Network & IP Geo Location Feeds for On Prem Pricing per 1K Users for quantities between 3,000,005 - 4,000,000	1000	\$50.49
eFraud Network & IP Geo Location Feeds for On Prem Pricing per 1K Users for quantities between 4,000,005 - 5,000,000	1000	\$45.90
eFraud Network & IP Geo Location Feeds for On Prem Pricing per 1K Users for quantities between 5,000,005 - 7,500,000	1000	\$34.43
RSAAA/TM ONPREM Consumer Pricing per 1K Users 1MTH Term 10-20K	1000	\$358.67
RSAAA/TM ONPREM Consumer Pricing per 1K Users 1MTH Term 20-50K	1000	\$203.38
RSAAA/TM ONPREM Consumer Pricing per 1K Users 1MTH Term 50-100K	1000	\$119.83
RSAAA/TM ONPREM Consumer Pricing per 1K Users 1MTH Term 100-200K	1000	\$107.18
RSAAA/TM ONPREM Consumer Pricing per 1K Users 1MTH Term 200-400K	1000	\$95.37
RSAAA/TM ONPREM Consumer Pricing per 1K Users 1MTH Term 400-600K	1000	\$83.55
RSAAA/TM ONPREM Consumer Pricing per 1K Users 1MTH Term 600-800K	1000	\$71.73
RSAAA/TM ONPREM Consumer Pricing per 1K Users 1MTH Term 800K-1M	1000	\$65.41
RSAAA/TM ONPREM Consumer Pricing per 1K Users 1MTH Term 1-1.5M	1000	\$53.59
RSAAA/TM ONPREM Consumer Pricing per 1K Users 1MTH Term 1.5-2M	1000	\$41.78
RSAAA/TM ONPREM Consumer Pricing per 1K Users 1MTH Term 2-3M	1000	\$29.96
RSAAA/TM ONPREM Consumer Pricing per 1K Users 1MTH Term 3-4M	1000	\$26.00
RSAAA/TM ONPREM Consumer Pricing per 1K Users 1MTH Term 4-5M	1000	\$23.63
RSAAA/TM ONPREM Consumer Pricing per 1K Users 1MTH Term 5-7.5M	1000	\$18.14
2Cha On Prem Consumer Pricing per 1K Users 1MTH Term 10-20K	1000	\$124.46
2Cha On Prem Consumer Pricing per 1K Users 1MTH Term 20-50K	1000	\$70.43
2Cha On Prem Consumer Pricing per 1K Users 1MTH Term 50-100K	1000	\$41.49
2Cha On Prem Consumer Pricing per 1K Users 1MTH Term 100-200K	1000	\$37.14
2Cha On Prem Consumer Pricing per 1K Users 1MTH Term 200-400K	1000	\$33.29
2Cha On Prem Consumer Pricing per 1K Users 1MTH Term 400-600K	1000	\$28.94
2Cha On Prem Consumer Pricing per 1K Users 1MTH Term 600-800K	1000	\$25.09
2Cha On Prem Consumer Pricing per 1K Users 1MTH Term 800K-1M	1000	\$22.67
2Cha On Prem Consumer Pricing per 1K Users 1MTH Term 1-1.5M	1000	\$18.81
2Cha On Prem Consumer Pricing per 1K Users 1MTH Term 1.5-2M	1000	\$14.47

2Cha On Prem Consumer Pricing per 1K Users 1MTH Term 2-3M	1000	\$10.13
2Cha On Prem Consumer Pricing per 1K Users 1MTH Term 3-4M	1000	\$9.07
2Cha On Prem Consumer Pricing per 1K Users 1MTH Term 4-5M	1000	\$8.20
2Cha On Prem Consumer Pricing per 1K Users 1MTH Term 5-7.5M	1000	\$6.27
RSAAA/TM ONPREM Pricing per 1K Users 2nd Channel for quantities between 10 - 20,000	1000	\$1,380.00
RSAAA/TM ONPREM Pricing per 1K Users 2nd Channel for quantities between 20,005 - 50,000	1000	\$780.00
RSAAA/TM ONPREM Pricing per 1K Users 2nd Channel for quantities between 50,005 - 100,000	1000	\$460.00
RSAAA/TM ONPREM Pricing per 1K Users 2nd Channel for quantities between 100,005 - 200,000	1000	\$410.00
RSAAA/TM ONPREM Pricing per 1K Users 2nd Channel for quantities between 200,005 - 400,000	1000	\$370.00
RSAAA/TM ONPREM Pricing per 1K Users 2nd Channel for quantities between 400,005 - 600,000	1000	\$320.00
RSAAA/TM ONPREM Pricing per 1K Users 2nd Channel for quantities between 600,005 - 800,000	1000	\$280.00
RSAAA/TM ONPREM Pricing per 1K Users 2nd Channel for quantities between 800,005 - 1,000,000	1000	\$250.00
RSAAA/TM ONPREM Pricing per 1K Users 2nd Channel for quantities between 1,000,005 - 1,500,000	1000	\$210.00
RSAAA/TM ONPREM Pricing per 1K Users 2nd Channel for quantities between 1,500,005 - 2,000,000	1000	\$160.00
RSAAA/TM ONPREM Pricing per 1K Users 2nd Channel for quantities between 2,000,005 - 3,000,000	1000	\$110.00
RSAAA/TM ONPREM Pricing per 1K Users 2nd Channel for quantities between 3,000,005 - 4,000,000	1000	\$100.00
RSAAA/TM ONPREM Pricing per 1K Users 2nd Channel for quantities between 4,000,005 - 5,000,000	1000	\$90.00
RSAAA/TM ONPREM Pricing per 1K Users 2nd Channel for quantities between 5,000,005 - 7,500,000	1000	\$70.00
RSA RSAAA/TM ONPREM Pricing per 1K Users 2C MAINT-Enh-1	1000	\$28.75
RSA RSAAA/TM ONPREM Pricing per 1K Users 2C MAINT-Enh-1	1000	\$16.25
RSA RSAAA/TM ONPREM Pricing per 1K Users 2C MAINT-Enh-1	1000	\$9.58
RSA RSAAA/TM ONPREM Pricing per 1K Users 2C MAINT-Enh-1	1000	\$8.54
RSA RSAAA/TM ONPREM Pricing per 1K Users 2C MAINT-Enh-1	1000	\$7.71
RSA RSAAA/TM ONPREM Pricing per 1K Users 2C MAINT-Enh-1	1000	\$6.67
RSA RSAAA/TM ONPREM Pricing per 1K Users 2C MAINT-Enh-1	1000	\$5.83
RSA RSAAA/TM ONPREM Pricing per 1K Users 2C MAINT-Enh-1	1000	\$5.21
RSA RSAAA/TM ONPREM Pricing per 1K Users 2C MAINT-Enh-1	1000	\$4.38
RSA RSAAA/TM ONPREM Pricing per 1K Users 2C MAINT-Enh-1	1000	\$3.33
RSA RSAAA/TM ONPREM Pricing per 1K Users 2C MAINT-Enh-1	1000	\$2.29
RSA RSAAA/TM ONPREM Pricing per 1K Users 2C MAINT-Enh-1	1000	\$2.08
RSA RSAAA/TM ONPREM Pricing per 1K Users 2C MAINT-Enh-1	1000	\$1.88
RSA RSAAA/TM ONPREM Pricing per 1K Users 2C MAINT-Enh-1	1000	\$1.46
RSA Access Manager Maint Enh - 1	1	\$0.54
RSA Access Manager Maint Enh - 1	1	\$0.44
RSA Access Manager Maint Enh - 1	1	\$0.34
RSA Access Manager Maint Enh - 1	1	\$0.27
RSA Access Manager Maint Enh - 1	1	\$0.21
RSA Access Manager Maint Enh - 1	1	\$0.15
RSA Access Manager Maint Enh - 1	1	\$0.10
RSA Access Manager Maint Enh - 1	1	\$0.07

RSA Access Manager Maint Enh - 1	1	\$0.05
RSA Access Manager Maint Enh - 1	1	\$0.04
RSA Access Manager Maint Enh - 1	1	\$0.03
RSA Access Manager Maint Enh - 1	1	\$0.02
RSA SecurID Appliance token bundle for 10 users	1	\$3,896.00
RSA SecurID Appliance token bundle for 25 users	1	\$5,247.50
RSA SecurID Appliance token bundle for 50 users	1	\$7,050.00
RSA SecurID Appliance token bundle for 100 users	1	\$10,505.00
RSA SecurID Appliance token bundle for 300 users	1	\$23,725.00
RSA SecurID Appliance token bundle for 500 users	1	\$34,545.00
RSA SecurID Appliance token bundle for 1,000 users	1	\$60,095.00
SID Access Perp token bundle for 10u	1	\$901.00
SID Access Perp token bundle for 25u	1	\$2,252.50
SID Access Perp token bundle for 50u	1	\$4,055.00
SID Access Perp token bundle for 100u	1	\$7,510.00
SID Access Perp token bundle for 300u	1	\$20,730.00
SID Access Perp token bundle for 500u	1	\$31,550.00
SID Access Perp token bundle for 1,000u	1	\$57,100.00
AM Appliance RBAODA bundle for 10 users	1	\$3,860.22
AM Appliance RBAODA bundle for 25 users	1	\$5,159.95
AM Appliance RBAODA bundle for 50 users	1	\$6,727.10
AM Appliance RBAODA bundle for 100 users	1	\$9,914.11
SID Access Perp RBAODA bundle for 10u	1	\$866.48
SID Access Perp RBAODA bundle for 25u	1	\$2,166.21
SID Access Perp RBAODA bundle for 50u	1	\$3,733.36
SID Access Perp RBAODA bundle for 100u	1	\$6,920.37
RSA SecurID AM8 Appliance 130 Advanced Hardware Replacement Year 4	1	\$868.00
RSA SecurID AM8 Appliance 130 Advanced Hardware Replacement Year 5	1	\$928.00
RSA SecurID AM8 Appliance 250 Advanced Hardware Replacement Year 4	1	\$2,753.00
RSA SecurID AM8 Appliance 250 Advanced Hardware Replacement Year 5	1	\$2,943.00
SID Access Dell A130 Appliance	1	\$2,995.00
SID Access Dell A250 Appliance	1	\$9,495.00
SID Access Dell A130 HW-Brazil	1	\$2,995.00
SID Access Dell A250 HW-Brazil	1	\$9,495.00
Audit User Term Basic Maint [Per Month Pricing]	1	\$0.00
Audit 0-1500 Term Basic Maint [Per Month Pricing]	1	\$0.00
Audit 1501-5000 Term Basic Maint [Per Month Pricing]	1	\$0.00
Audit 5001-40000 Term Basic Maint [Per Month Pricing]	1	\$0.00
Audit 40001-100000 Term Basic Maint [Per Month Pricing]	1	\$0.00
Audit G100000 Term Basic Maint [Per Month Pricing]	1	\$0.00
AUD>100KTermBas w/1ODA cost /1Kemp /mo	1000	\$0.00
BCM User Term Basic Maint [Per Month Pricing]	1	\$0.00
BCM 0-1500 Term Basic Maint [Per Month Pricing]	1	\$0.00
BCM 1501-5000 Term Basic Maint [Per Month Pricing]	1	\$0.00
BCM 5001-40000 Term Basic Maint [Per Month Pricing]	1	\$0.00
BCM 40001-100000 Term Basic Maint [Per Month Pricing]	1	\$0.00
BCM G100000 Term Basic Maint [Per Month Pricing]	1	\$0.00

BCM>100KTermBas w/1ODA cost /1Kemp /mo	1000	\$0.00
Compliance User Term Basic Maint [Per Month Pricing]	1	\$0.00
Compliance 0-1500 Term Basic Maint [Per Month Pricing]	1	\$0.00
Compliance 1501-5000 Term Basic Maint [Per Month Pricing]	1	\$0.00
Compliance 5001-40000 Term Basic Maint [Per Month Pricing]	1	\$0.00
Compliance 40001-100000 Term Basic Maint [Per Month Pricing]	1	\$0.00
Compliance G100000 Term Basic Maint [Per Month Pricing]	1	\$0.00
COM>100KTermBas w/1ODA cost /1Kemp /mo	1000	\$0.00
Enterprise User Term Basic Maint [Per Month Pricing]	1	\$0.00
Enterprise 0-1500 Term Basic Maint [Per Month Pricing]	1	\$0.00
Enterprise 1501-5000 Term Basic Maint [Per Month Pricing]	1	\$0.00
Enterprise 5001-40000 Term Basic Maint [Per Month Pricing]	1	\$0.00
Enterprise 40001-100000 Term Basic Maint [Per Month Pricing]	1	\$0.00
Enterprise G100000 Term Basic Maint [Per Month Pricing]	1	\$0.00
ENT>100KTermBas w/1ODA cost /1Kemp /mo	1000	\$0.00
Fed Asmt Auth User Term Basic Maint	1	\$0.00
Fed Asmt Auth 0-1500 Term Basic Maint	1	\$0.00
Fed Asmt Auth 1501-5000 Term Basic Maint	1	\$0.00
Fed Asmt Auth 5001-40000 Term BasicMaint	1	\$0.00
Fed Asmt Auth 40001-100K Term BasicMaint	1	\$0.00
Fed Asmt Auth G100000 Term Basic Maint	1	\$0.00
FAA>100KTermBas w/1ODA cost /1Kemp /mo	1000	\$0.00
Fed Cont Monitor User Term Basic Maint	1	\$0.00
Fed Cont Monitor 0-1500 Term Basic Maint	1	\$0.00
Fed Cont Monitor1501-5000Term BasicMaint	1	\$0.00
Fed Cont Monitor5001-40K Term BasicMaint	1	\$0.00
Fed Cont Monitor40001-100KTermBasicMaint	1	\$0.00
Fed Cont Monitor G100000Term Basic Maint	1	\$0.00
FCM>100KTermBas w/1ODA cost /1Kemp /mo	1000	\$0.00
Incident User Term Basic Maint [Per Month Pricing]	1	\$0.00
Incident 0-1500 Term Basic Maint [Per Month Pricing]	1	\$0.00
Incident 1501-5000 Term Basic Maint [Per Month Pricing]	1	\$0.00
Incident 5001-40000 Term Basic Maint [Per Month Pricing]	1	\$0.00
Incident 40001-100000 Term Basic Maint [Per Month Pricing]	1	\$0.00
Incident G100000 Term Basic Maint [Per Month Pricing]	1	\$0.00
INC>100KTermBas w/1ODA cost /1Kemp /mo	1000	\$0.00
Policy User Term Basic Maint [Per Month Pricing]	1	\$0.00
Policy 0-1500 Term Basic Maint [Per Month Pricing]	1	\$0.00
Policy 1501-5000 Term Basic Maint [Per Month Pricing]	1	\$0.00
Policy 5001-40000 Term Basic Maint [Per Month Pricing]	1	\$0.00
Policy 40001-100000 Term Basic Maint [Per Month Pricing]	1	\$0.00
Policy G100000 Term Basic Maint [Per Month Pricing]	1	\$0.00
POL>100KTermBas w/1ODA cost /1Kemp /mo	1000	\$0.00
Risk User Term Basic Maint [Per Month Pricing]	1	\$0.00
Risk 0-1500 Term Basic Maint [Per Month Pricing]	1	\$0.00
Risk 1501-5000 Term Basic Maint [Per Month Pricing]	1	\$0.00
Risk 5001-40000 Term Basic Maint [Per Month Pricing]	1	\$0.00

Risk 40001-100000 Term Basic Maint [Per Month Pricing]	1	\$0.00
Risk G100000 Term Basic Maint [Per Month Pricing]	1	\$0.00
RSK>100KTermBas w/1ODA cost /1Kemp /mo	1000	\$0.00
Threat User Term Basic Maint [Per Month Pricing]	1	\$0.00
Threat 0-1500 Term Basic Maint [Per Month Pricing]	1	\$0.00
Threat 1501-5000 Term Basic Maint [Per Month Pricing]	1	\$0.00
Threat 5001-40000 Term Basic Maint [Per Month Pricing]	1	\$0.00
Threat 40001-100000 Term Basic Maint [Per Month Pricing]	1	\$0.00
Threat G100000 Term Basic Maint [Per Month Pricing]	1	\$0.00
THR>100KTermBas w/1ODA cost /1Kemp /mo	1000	\$0.00
Vendor User Term Basic Maint [Per Month Pricing]	1	\$0.00
Vendor 0-1500 Term Basic Maint [Per Month Pricing]	1	\$0.00
Vendor 1501-5000 Term Basic Maint [Per Month Pricing]	1	\$0.00
Vendor 5001-40000 Term Basic Maint [Per Month Pricing]	1	\$0.00
Vendor 40001-100000 Term Basic Maint [Per Month Pricing]	1	\$0.00
Vendor G100000 Term Basic Maint [Per Month Pricing]	1	\$0.00
VEN>100KTermBas w/1ODA cost /1Kemp /mo	1000	\$0.00
ODA User Term Basic Maint [Per Month Pricing]	1	\$0.00
ODA 0-1500 Term Basic Maint [Per Month Pricing]	1	\$0.00
ODA 1501-5000 Term Basic Maint [Per Month Pricing]	1	\$0.00
ODA 5001-40000 Term Basic Maint [Per Month Pricing]	1	\$0.00
ODA 40001-100000 Term Basic Maint [Per Month Pricing]	1	\$0.00
ODA G100000 Term Basic Maint [Per Month Pricing]	1	\$0.00
ODA>100KTermBas w/1ODA cost /1Kemp /mo	1000	\$0.00
Audit User Term Enh Maint [Per Month Pricing]	1	\$4.20
Audit 0-1500 Term Enh Maint [Per Month Pricing]	1	\$81.90
Audit 1501-5000 Term Enh Maint [Per Month Pricing]	1	\$233.80
Audit 5001-40000 Term Enh Maint [Per Month Pricing]	1	\$321.30
Audit 40001-100000 Term Enh Maint [Per Month Pricing]	1	\$466.90
Audit G100000 Term Enh Maint [Per Month Pricing]	1	\$641.90
AUD>100KTermEnh w/1ODA cost /1Kemp /mo	1000	\$4.67
BCM User Term Enh Maint [Per Month Pricing]	1	\$4.20
BCM 0-1500 Term Enh Maint [Per Month Pricing]	1	\$81.90
BCM 1501-5000 Term Enh Maint [Per Month Pricing]	1	\$233.80
BCM 5001-40000 Term Enh Maint [Per Month Pricing]	1	\$321.30
BCM 40001-100000 Term Enh Maint [Per Month Pricing]	1	\$466.90
BCM G100000 Term Enh Maint [Per Month Pricing]	1	\$641.90
BCM>100KTermEnh w/1ODA cost /1Kemp /mo	1000	\$4.67
Compliance User Term Enh Maint [Per Month Pricing]	1	\$4.20
Compliance 0-1500 Term Enh Maint [Per Month Pricing]	1	\$81.90
Compliance 1501-5000 Term Enh Maint [Per Month Pricing]	1	\$233.80
Compliance 5001-40000 Term Enh Maint [Per Month Pricing]	1	\$321.30
Compliance 40001-100000 Term Enh Maint [Per Month Pricing]	1	\$466.90
Compliance G100000 Term Enh Maint [Per Month Pricing]	1	\$641.90
COM>100KTermEnh w/1ODA cost /1Kemp /mo	1000	\$4.67
Enterprise User Term Enh Maint [Per Month Pricing]	1	\$4.20
Enterprise 0-1500 Term Enh Maint [Per Month Pricing]	1	\$81.90

Enterprise 1501-5000 Term Enh Maint [Per Month Pricing]	1	\$233.80
Enterprise 5001-40000 Term Enh Maint [Per Month Pricing]	1	\$321.30
Enterprise 40001-100000 Term Enh Maint [Per Month Pricing]	1	\$466.90
Enterprise G100000 Term Enh Maint [Per Month Pricing]	1	\$641.90
ENT>100KTermEnh w/1ODA cost /1Kemp /mo	1000	\$4.67
Fed Asmt Auth User Term Enh Maint	1	\$4.20
Fed Asmt Auth 0-1500 Term Enh Maint	1	\$81.90
Fed Asmt Auth 1501-5K Term Enh Maint	1	\$233.80
Fed Asmt Auth 5001-40K Term Enh Maint	1	\$321.30
Fed Asmt Auth 40001-100K Term Enh Maint	1	\$466.90
Fed Asmt Auth G100000 Term Enh Maint	1	\$641.90
FAA>100KTermEnh w/1ODA cost /1Kemp /mo	1000	\$4.67
Fed Cont Monitor User Term Enh Maint	1	\$4.20
Fed Cont Monitor 0-1500 Term Enh Maint	1	\$81.90
Fed Cont Monitor 1501-5K Term Enh Maint	1	\$233.80
Fed Cont Monitor 5001-40K Term Enh Maint	1	\$321.30
Fed Cont Monitor40001-100KTerm Enh Maint	1	\$466.90
Fed Cont Monitor G100000 Term Enh Maint	1	\$641.90
FCM>100KTermEnh w/1ODA cost /1Kemp /mo	1000	\$4.67
Incident User Term Enh Maint [Per Month Pricing]	1	\$4.20
Incident 0-1500 Term Enh Maint [Per Month Pricing]	1	\$81.90
Incident 1501-5000 Term Enh Maint [Per Month Pricing]	1	\$233.80
Incident 5001-40000 Term Enh Maint [Per Month Pricing]	1	\$321.30
Incident 40001-100000 Term Enh Maint [Per Month Pricing]	1	\$466.90
Incident G100000 Term Enh Maint [Per Month Pricing]	1	\$641.90
INC>100KTermEnh w/1ODA cost /1Kemp /mo	1000	\$4.67
Policy User Term Enh Maint [Per Month Pricing]	1	\$4.20
Policy 0-1500 Term Enh Maint [Per Month Pricing]	1	\$81.90
Policy 1501-5000 Term Enh Maint [Per Month Pricing]	1	\$233.80
Policy 5001-40000 Term Enh Maint [Per Month Pricing]	1	\$321.30
Policy 40001-100000 Term Enh Maint [Per Month Pricing]	1	\$466.90
Policy G100000 Term Enh Maint [Per Month Pricing]	1	\$641.90
POL>100KTermEnh w/1ODA cost /1Kemp /mo	1000	\$4.67
Risk User Term Enh Maint [Per Month Pricing]	1	\$4.20
Risk 0-1500 Term Enh Maint [Per Month Pricing]	1	\$81.90
Risk 1501-5000 Term Enh Maint [Per Month Pricing]	1	\$233.80
Risk 5001-40000 Term Enh Maint [Per Month Pricing]	1	\$321.30
Risk 40001-100000 Term Enh Maint [Per Month Pricing]	1	\$466.90
Risk G100000 Term Enh Maint [Per Month Pricing]	1	\$641.90
RSK>100KTermEnh w/1ODA cost /1Kemp /mo	1000	\$4.67
Threat User Term Enh Maint [Per Month Pricing]	1	\$4.20
Threat 0-1500 Term Enh Maint [Per Month Pricing]	1	\$81.90
Threat 1501-5000 Term Enh Maint [Per Month Pricing]	1	\$233.80
Threat 5001-40000 Term Enh Maint [Per Month Pricing]	1	\$321.30
Threat 40001-100000 Term Enh Maint [Per Month Pricing]	1	\$466.90
Threat G100000 Term Enh Maint [Per Month Pricing]	1	\$641.90
THR>100KTermEnh w/1ODA cost /1Kemp /mo	1000	\$4.67

Vendor User Term Enh Maint [Per Month Pricing]	1	\$4.20
Vendor 0-1500 Term Enh Maint [Per Month Pricing]	1	\$81.90
Vendor 1501-5000 Term Enh Maint [Per Month Pricing]	1	\$233.80
Vendor 5001-40000 Term Enh Maint [Per Month Pricing]	1	\$321.30
Vendor 40001-100000 Term Enh Maint [Per Month Pricing]	1	\$466.90
Vendor G100000 Term Enh Maint [Per Month Pricing]	1	\$641.90
VEN>100KTermEnh w/1ODA cost /1Kemp /mo	1000	\$4.67
ODA User Term Enh Maint [Per Month Pricing]	1	\$0.60
ODA 0-1500 Term Enh Maint [Per Month Pricing]	1	\$11.90
ODA 1501-5000 Term Enh Maint [Per Month Pricing]	1	\$33.40
ODA 5001-40000 Term Enh Maint [Per Month Pricing]	1	\$46.20
ODA 40001-100000 Term Enh Maint [Per Month Pricing]	1	\$67.20
ODA G100000 Term Enh Maint [Per Month Pricing]	1	\$91.70
ODA>100KTermEnh w/1ODA cost /1Kemp /mo	1000	\$0.67
Audit User Perp Basic Maint [Per Month Pricing]	1	\$37.80
Audit 0-1500 Perp Basic Maint [Per Month Pricing]	1	\$737.10
Audit 1501-5000 Perp Basic Maint [Per Month Pricing]	1	\$2,104.00
Audit 5001-40000 Perp Basic Maint [Per Month Pricing]	1	\$2,891.70
Audit 40001-100000 Perp Basic Maint [Per Month Pricing]	1	\$4,202.10
Audit G100000 Perp Basic Maint [Per Month Pricing]	1	\$5,777.10
AUD>100KPerpBas w/1ODA cost /1Kemp /mo	1000	\$42.02
BCM User Perp Basic Maint [Per Month Pricing]	1	\$37.80
BCM 0-1500 Perp Basic Maint [Per Month Pricing]	1	\$737.10
BCM 1501-5000 Perp Basic Maint [Per Month Pricing]	1	\$2,104.00
BCM 5001-40000 Perp Basic Maint [Per Month Pricing]	1	\$2,891.70
BCM 40001-100000 Perp Basic Maint [Per Month Pricing]	1	\$4,202.10
BCM G100000 Perp Basic Maint [Per Month Pricing]	1	\$5,777.10
BCM>100KPerpBas w/1ODA cost /1Kemp /mo	1000	\$42.02
Compliance User Perp Basic Maint [Per Month Pricing]	1	\$37.80
Compliance 0-1500 Perp Basic Maint [Per Month Pricing]	1	\$737.10
Compliance 1501-5000 Perp Basic Maint [Per Month Pricing]	1	\$2,104.00
Compliance 5001-40000 Perp Basic Maint [Per Month Pricing]	1	\$2,891.70
Compliance 40001-100000 Perp Basic Maint [Per Month Pricing]	1	\$4,202.10
Compliance G100000 Perp Basic Maint [Per Month Pricing]	1	\$5,777.10
COM>100KPerpBas w/1ODA cost /1Kemp /mo	1000	\$42.02
Enterprise User Perp Basic Maint [Per Month Pricing]	1	\$37.80
Enterprise 0-1500 Perp Basic Maint [Per Month Pricing]	1	\$737.10
Enterprise 1501-5000 Perp Basic Maint [Per Month Pricing]	1	\$2,104.00
Enterprise 5001-40000 Perp Basic Maint [Per Month Pricing]	1	\$2,891.70
Enterprise 40001-100000 Perp Basic Maint [Per Month Pricing]	1	\$4,202.10
Enterprise G100000 Perp Basic Maint [Per Month Pricing]	1	\$5,777.10
ENT>100KPerpBas w/1ODA cost /1Kemp /mo	1000	\$42.02
Fed Asmt Auth User Perp Basic Maint	1	\$37.80
Fed Asmt Auth 0-1500 Perp Basic Maint	1	\$737.10
Fed Asmt Auth 1501-5K Perp Basic Maint	1	\$2,104.00
Fed Asmt Auth 5001-40K Perp Basic Maint	1	\$2,891.70
Fed Asmt Auth 40001-100K Perp Basic Maint	1	\$4,202.10

Fed Asmt Auth G100K Perp Basic Maint	1	\$5,777.10
FAA>100KPerpBas w/1ODA cost /1Kemp /mo	1000	\$42.02
Fed Cont Monitor User Perp Basic Maint	1	\$37.80
Fed Cont Monitor 0-1500 Perp Basic Maint	1	\$737.10
Fed Cont Monitor 1501-5K Perp Basic Mnt	1	\$2,104.00
Fed Cont Monitor 5001-40K Perp Basic Mnt	1	\$2,891.70
Fed Cont Monitor40001-100K Perp BasicMnt	1	\$4,202.10
Fed Cont Monitor G100K Perp Basic Maint	1	\$5,777.10
FCM>100KPerpBas w/1ODA cost /1Kemp /mo	1000	\$42.02
Incident User Perp Basic Maint [Per Month Pricing]	1	\$37.80
Incident 0-1500 Perp Basic Maint [Per Month Pricing]	1	\$737.10
Incident 1501-5000 Perp Basic Maint [Per Month Pricing]	1	\$2,104.00
Incident 5001-40000 Perp Basic Maint [Per Month Pricing]	1	\$2,891.70
Incident 40001-100000 Perp Basic Maint [Per Month Pricing]	1	\$4,202.10
Incident G100000 Perp Basic Maint [Per Month Pricing]	1	\$5,777.10
INC>100KPerpBas w/1ODA cost /1Kemp /mo	1000	\$42.02
Policy User Perp Basic Maint [Per Month Pricing]	1	\$37.80
Policy 0-1500 Perp Basic Maint [Per Month Pricing]	1	\$737.10
Policy 1501-5000 Perp Basic Maint [Per Month Pricing]	1	\$2,104.00
Policy 5001-40000 Perp Basic Maint [Per Month Pricing]	1	\$2,891.70
Policy 40001-100000 Perp Basic Maint [Per Month Pricing]	1	\$4,202.10
Policy G100000 Perp Basic Maint [Per Month Pricing]	1	\$5,777.10
POL>100KPerpBas w/1ODA cost /1Kemp /mo	1000	\$42.02
Risk User Perp Basic Maint [Per Month Pricing]	1	\$37.80
Risk 0-1500 Perp Basic Maint [Per Month Pricing]	1	\$737.10
Risk 1501-5000 Perp Basic Maint [Per Month Pricing]	1	\$2,104.00
Risk 5001-40000 Perp Basic Maint [Per Month Pricing]	1	\$2,891.70
Risk 40001-100000 Perp Basic Maint [Per Month Pricing]	1	\$4,202.10
Risk G100000 Perp Basic Maint [Per Month Pricing]	1	\$5,777.10
RSK>100KPerpBas w/1ODA cost /1Kemp /mo	1000	\$42.02
Threat User Perp Basic Maint [Per Month Pricing]	1	\$37.80
Threat 0-1500 Perp Basic Maint [Per Month Pricing]	1	\$737.10
Threat 1501-5000 Perp Basic Maint [Per Month Pricing]	1	\$2,104.00
Threat 5001-40000 Perp Basic Maint [Per Month Pricing]	1	\$2,891.70
Threat 40001-100000 Perp Basic Maint [Per Month Pricing]	1	\$4,202.10
Threat G100000 Perp Basic Maint [Per Month Pricing]	1	\$5,777.10
THR>100KPerpBas w/1ODA cost /1Kemp /mo	1000	\$42.02
Vendor User Perp Basic Maint [Per Month Pricing]	1	\$37.80
Vendor 0-1500 Perp Basic Maint [Per Month Pricing]	1	\$737.10
Vendor 1501-5000 Perp Basic Maint [Per Month Pricing]	1	\$2,104.00
Vendor 5001-40000 Perp Basic Maint [Per Month Pricing]	1	\$2,891.70
Vendor 40001-100000 Perp Basic Maint [Per Month Pricing]	1	\$4,202.10
Vendor G100000 Perp Basic Maint [Per Month Pricing]	1	\$5,777.10
VEN>100KPerpBas w/1ODA cost /1Kemp /mo	1000	\$42.02
ODA User Perp Basic Maint [Per Month Pricing]	1	\$5.40
ODA 0-1500 Perp Basic Maint [Per Month Pricing]	1	\$105.30
ODA 1501-5000 Perp Basic Maint [Per Month Pricing]	1	\$300.60

ODA 5001-40000 Perp Basic Maint [Per Month Pricing]	1	\$413.10
ODA 40001-100000 Perp Basic Maint [Per Month Pricing]	1	\$600.30
ODA G100000 Perp Basic Maint [Per Month Pricing]	1	\$825.30
ODA>100KPerpBas w/1ODA cost /1Kemp /mo	1000	\$6.00
Audit User Perp Enh Maint [Per Month Pricing]	1	\$52.50
Audit 0-1500 Perp Enh Maint [Per Month Pricing]	1	\$1,023.75
Audit 1501-5000 Perp Enh Maint [Per Month Pricing]	1	\$2,992.50
Audit 5001-40000 Perp Enh Maint [Per Month Pricing]	1	\$4,016.25
Audit 40001-100000 Perp Enh Maint [Per Month Pricing]	1	\$5,836.25
Audit G100000 Perp Enh Maint [Per Month Pricing]	1	\$8,023.75
AUD>100KPerpEnh w/1ODA cost /1Kemp /mo	1000	\$58.36
BCM User Perp Enh Maint [Per Month Pricing]	1	\$52.50
BCM 0-1500 Perp Enh Maint [Per Month Pricing]	1	\$1,023.75
BCM 1501-5000 Perp Enh Maint [Per Month Pricing]	1	\$2,992.50
BCM 5001-40000 Perp Enh Maint [Per Month Pricing]	1	\$4,016.25
BCM 40001-100000 Perp Enh Maint [Per Month Pricing]	1	\$5,836.25
BCM G100000 Perp Enh Maint [Per Month Pricing]	1	\$8,023.75
BCM>100KPerpEnh w/1ODA cost /1Kemp /mo	1000	\$58.36
Compliance User Perp Enh Maint [Per Month Pricing]	1	\$52.50
Compliance 0-1500 Perp Enh Maint [Per Month Pricing]	1	\$1,023.75
Compliance 1501-5000 Perp Enh Maint [Per Month Pricing]	1	\$2,992.50
Compliance 5001-40000 Perp Enh Maint [Per Month Pricing]	1	\$4,016.25
Compliance 40001-100000 Perp Enh Maint [Per Month Pricing]	1	\$5,836.25
Compliance G100000 Perp Enh Maint [Per Month Pricing]	1	\$8,023.75
COM>100KPerpEnh w/1ODA cost /1Kemp /mo	1000	\$58.36
Enterprise User Perp Enh Maint [Per Month Pricing]	1	\$52.50
Enterprise 0-1500 Perp Enh Maint [Per Month Pricing]	1	\$1,023.75
Enterprise 1501-5000 Perp Enh Maint [Per Month Pricing]	1	\$2,992.50
Enterprise 5001-40000 Perp Enh Maint [Per Month Pricing]	1	\$4,016.25
Enterprise 40001-100000 Perp Enh Maint [Per Month Pricing]	1	\$5,836.25
Enterprise G100000 Perp Enh Maint [Per Month Pricing]	1	\$8,023.75
ENT>100KPerpEnh w/1ODA cost /1Kemp /mo	1000	\$58.36
Fed Asmt Auth User Perp Enh Maint	1	\$52.50
Fed Asmt Auth 0-1500 Perp Enh Maint	1	\$1,023.75
Fed Asmt Auth 1501-5K Perp Enh Maint	1	\$2,992.50
Fed Asmt Auth 5001-40K Perp Enh Maint	1	\$4,016.25
Fed Asmt Auth 40001-100K Perp Enh Maint	1	\$5,836.25
Fed Asmt Auth G100000 Perp Enh Maint	1	\$8,023.75
FAA>100KPerpEnh w/1ODA cost /1Kemp /mo	1000	\$58.36
Fed Cont Monitor User Perp Enh Maint	1	\$52.50
Fed Cont Monitor 0-1500 Perp Enh Maint	1	\$1,023.75
Fed Cont Monitor 1501-5K Perp Enh Maint	1	\$2,992.50
Fed Cont Monitor 5001-40K Perp Enh Maint	1	\$4,016.25
Fed Cont Monitor 40001-100K Perp Enh Mnt	1	\$5,836.25
Fed Cont Monitor G100000 Perp Enh Maint	1	\$8,023.75
FCM>100KPerpEnh w/1ODA cost /1Kemp /mo	1000	\$58.36
Incident User Perp Enh Maint [Per Month Pricing]	1	\$52.50

Incident 0-1500 Perp Enh Maint [Per Month Pricing]	1	\$1,023.75
Incident 1501-5000 Perp Enh Maint [Per Month Pricing]	1	\$2,992.50
Incident 5001-40000 Perp Enh Maint [Per Month Pricing]	1	\$4,016.25
Incident 40001-100000 Perp Enh Maint [Per Month Pricing]	1	\$5,836.25
Incident G100000 Perp Enh Maint [Per Month Pricing]	1	\$8,023.75
INC>100KPerpEnh w/1ODA cost /1Kemp /mo	1000	\$58.36
Policy User Perp Enh Maint [Per Month Pricing]	1	\$52.50
Policy 0-1500 Perp Enh Maint [Per Month Pricing]	1	\$1,023.75
Policy 1501-5000 Perp Enh Maint [Per Month Pricing]	1	\$2,992.50
Policy 5001-40000 Perp Enh Maint [Per Month Pricing]	1	\$4,016.25
Policy 40001-100000 Perp Enh Maint [Per Month Pricing]	1	\$5,836.25
Policy G100000 Perp Enh Maint [Per Month Pricing]	1	\$8,023.75
POL>100KPerpEnh w/1ODA cost /1Kemp /mo	1000	\$58.36
Risk User Perp Enh Maint [Per Month Pricing]	1	\$52.50
Risk 0-1500 Perp Enh Maint [Per Month Pricing]	1	\$1,023.75
Risk 1501-5000 Perp Enh Maint [Per Month Pricing]	1	\$2,992.50
Risk 5001-40000 Perp Enh Maint [Per Month Pricing]	1	\$4,016.25
Risk 40001-100000 Perp Enh Maint [Per Month Pricing]	1	\$5,836.25
Risk G100000 Perp Enh Maint [Per Month Pricing]	1	\$8,023.75
RSK>100KPerpEnh w/1ODA cost /1Kemp /mo	1000	\$58.36
Threat User Perp Enh Maint [Per Month Pricing]	1	\$52.50
Threat 0-1500 Perp Enh Maint [Per Month Pricing]	1	\$1,023.75
Threat 1501-5000 Perp Enh Maint [Per Month Pricing]	1	\$2,992.50
Threat 5001-40000 Perp Enh Maint [Per Month Pricing]	1	\$4,016.25
Threat 40001-100000 Perp Enh Maint [Per Month Pricing]	1	\$5,836.25
Threat G100000 Perp Enh Maint [Per Month Pricing]	1	\$8,023.75
THR>100KPerpEnh w/1ODA cost /1Kemp /mo	1000	\$58.36
Vendor User Perp Enh Maint [Per Month Pricing]	1	\$52.50
Vendor 0-1500 Perp Enh Maint [Per Month Pricing]	1	\$1,023.75
Vendor 1501-5000 Perp Enh Maint [Per Month Pricing]	1	\$2,992.50
Vendor 5001-40000 Perp Enh Maint [Per Month Pricing]	1	\$4,016.25
Vendor 40001-100000 Perp Enh Maint [Per Month Pricing]	1	\$5,836.25
Vendor G100000 Perp Enh Maint [Per Month Pricing]	1	\$8,023.75
VEN>100KPerpEnh w/1ODA cost /1Kemp /mo	1000	\$58.36
ODA User Perp Enh Maint [Per Month Pricing]	1	\$7.50
ODA 0-1500 Perp Enh Maint [Per Month Pricing]	1	\$146.25
ODA 1501-5000 Perp Enh Maint [Per Month Pricing]	1	\$417.50
ODA 5001-40000 Perp Enh Maint [Per Month Pricing]	1	\$573.75
ODA 40001-100000 Perp Enh Maint [Per Month Pricing]	1	\$833.75
ODA G100000 Perp Enh Maint [Per Month Pricing]	1	\$1,146.25
ODA>100KPerpEnh w/1ODA cost /1Kemp /mo	1000	\$8.34
Audit User Perp Maint Upg [Per Month Pricing]	1	\$14.70
Audit 0-1500 Perp Maint Upg [Per Month Pricing]	1	\$286.65
Audit 1501-5000 Perp Maint Upg [Per Month Pricing]	1	\$818.30
Audit 5001-40000 Perp Maint Upg [Per Month Pricing]	1	\$1,124.55
Audit 40001-100000 Perp Maint Upg [Per Month Pricing]	1	\$1,634.15
Audit G100000 Perp Maint Upg [Per Month Pricing]	1	\$2,246.65

AUD>100KPerpUpg w/1ODA cost /1Kemp /mo	1000	\$16.34
BCM User Perp Maint Upg [Per Month Pricing]	1	\$14.70
BCM 0-1500 Perp Maint Upg [Per Month Pricing]	1	\$286.65
BCM 1501-5000 Perp Maint Upg [Per Month Pricing]	1	\$818.30
BCM 5001-40000 Perp Maint Upg [Per Month Pricing]	1	\$1,124.55
BCM 40001-100000 Perp Maint Upg [Per Month Pricing]	1	\$1,634.15
BCM G100000 Perp Maint Upg [Per Month Pricing]	1	\$2,246.65
BCM>100KPerpUpg w/1ODA cost /1Kemp /mo	1000	\$16.34
Compliance User Perp Maint Upg [Per Month Pricing]	1	\$14.70
Compliance 0-1500 Perp Maint Upg [Per Month Pricing]	1	\$286.65
Compliance 1501-5000 Perp Maint Upg [Per Month Pricing]	1	\$818.30
Compliance 5001-40000 Perp Maint Upg [Per Month Pricing]	1	\$1,124.55
Compliance 40001-100000 Perp Maint Upg [Per Month Pricing]	1	\$1,634.15
Compliance G100000 Perp Maint Upg [Per Month Pricing]	1	\$2,246.65
COM>100KPerpUpg w/1ODA cost /1Kemp /mo	1000	\$16.34
Enterprise User Perp Maint Upg [Per Month Pricing]	1	\$14.70
Enterprise 0-1500 Perp Maint Upg [Per Month Pricing]	1	\$286.65
Enterprise 1501-5000 Perp Maint Upg [Per Month Pricing]	1	\$818.30
Enterprise 5001-40000 Perp Maint Upg [Per Month Pricing]	1	\$1,124.55
Enterprise 40001-100000 Perp Maint Upg [Per Month Pricing]	1	\$1,634.15
Enterprise G100000 Perp Maint Upg [Per Month Pricing]	1	\$2,246.65
ENT>100KPerpUpg w/1ODA cost /1Kemp /mo	1000	\$16.34
Fed Asmt Auth User Perp Maint Upg	1	\$14.70
Fed Asmt Auth 0-1500 Perp Maint Upg	1	\$286.65
Fed Asmt Auth 1501-5000 Perp Maint Upg	1	\$818.30
Fed Asmt Auth 5001-40000 Perp Maint Upg	1	\$1,124.55
Fed Asmt Auth 40001-100K Perp Maint Upg	1	\$1,634.15
Fed Asmt Auth G100000 Perp Maint Upg	1	\$2,246.65
FAA>100KPerpUpg w/1ODA cost /1Kemp /mo	1000	\$16.34
Fed Cont Monitor User Perp Maint Upg	1	\$14.70
Fed Cont Monitor 0-1500 Perp Maint Upg	1	\$286.65
Fed Cont Monitor 1501-5000Perp Maint Upg	1	\$818.30
Fed Cont Monitor5001-40000Perp Maint Upg	1	\$1,124.55
Fed Cont Monitor40001-100K Perp MaintUpg	1	\$1,634.15
Fed Cont Monitor G100000 Perp Maint Upg	1	\$2,246.65
FCM>100KPerpUpg w/1ODA cost /1Kemp /mo	1000	\$16.34
Incident User Perp Maint Upg [Per Month Pricing]	1	\$14.70
Incident 0-1500 Perp Maint Upg [Per Month Pricing]	1	\$286.65
Incident 1501-5000 Perp Maint Upg [Per Month Pricing]	1	\$818.30
Incident 5001-40000 Perp Maint Upg [Per Month Pricing]	1	\$1,124.55
Incident 40001-100000 Perp Maint Upg [Per Month Pricing]	1	\$1,634.15
Incident G100000 Perp Maint Upg [Per Month Pricing]	1	\$2,246.65
INC>100KPerpUpg w/1ODA cost /1Kemp /mo	1000	\$16.34
Policy User Perp Maint Upg [Per Month Pricing]	1	\$14.70
Policy 0-1500 Perp Maint Upg [Per Month Pricing]	1	\$286.65
Policy 1501-5000 Perp Maint Upg [Per Month Pricing]	1	\$818.30
Policy 5001-40000 Perp Maint Upg [Per Month Pricing]	1	\$1,124.55

Policy 40001-100000 Perp Maint Upg [Per Month Pricing]	1	\$1,634.15
Policy G100000 Perp Maint Upg [Per Month Pricing]	1	\$2,246.65
POL>100KPerpUpg w/1ODA cost /1Kemp /mo	1000	\$16.34
Risk User Perp Maint Upg [Per Month Pricing]	1	\$14.70
Risk 0-1500 Perp Maint Upg [Per Month Pricing]	1	\$286.65
Risk 1501-5000 Perp Maint Upg [Per Month Pricing]	1	\$818.30
Risk 5001-40000 Perp Maint Upg [Per Month Pricing]	1	\$1,124.55
Risk 40001-100000 Perp Maint Upg [Per Month Pricing]	1	\$1,634.15
Risk G100000 Perp Maint Upg [Per Month Pricing]	1	\$2,246.65
RSK>100KPerpUpg w/1ODA cost /1Kemp /mo	1000	\$16.34
Threat User Perp Maint Upg [Per Month Pricing]	1	\$14.70
Threat 0-1500 Perp Maint Upg [Per Month Pricing]	1	\$286.65
Threat 1501-5000 Perp Maint Upg [Per Month Pricing]	1	\$818.30
Threat 5001-40000 Perp Maint Upg [Per Month Pricing]	1	\$1,124.55
Threat 40001-100000 Perp Maint Upg [Per Month Pricing]	1	\$1,634.15
Threat G100000 Perp Maint Upg [Per Month Pricing]	1	\$2,246.65
THR>100KPerpUpg w/1ODA cost /1Kemp /mo	1000	\$16.34
Vendor User Perp Maint Upg [Per Month Pricing]	1	\$14.70
Vendor 0-1500 Perp Maint Upg [Per Month Pricing]	1	\$286.65
Vendor 1501-5000 Perp Maint Upg [Per Month Pricing]	1	\$818.30
Vendor 5001-40000 Perp Maint Upg [Per Month Pricing]	1	\$1,124.55
Vendor 40001-100000 Perp Maint Upg [Per Month Pricing]	1	\$1,634.15
Vendor G100000 Perp Maint Upg [Per Month Pricing]	1	\$2,246.65
VEN>100KPerpUpg w/1ODA cost /1Kemp /mo	1000	\$16.34
ODA User Perp Maint Upg [Per Month Pricing]	1	\$2.10
ODA 0-1500 Perp Maint Upg [Per Month Pricing]	1	\$40.95
ODA 1501-5000 Perp Maint Upg [Per Month Pricing]	1	\$116.90
ODA 5001-40000 Perp Maint Upg [Per Month Pricing]	1	\$160.65
ODA 40001-100000 Perp Maint Upg [Per Month Pricing]	1	\$233.45
ODA G100000 Perp Maint Upg [Per Month Pricing]	1	\$320.95
ODA>100KPerpUpg w/1ODA cost /1Kemp /mo	1000	\$2.33
OEM Perp Maint Upg [Per Month Pricing]	1	\$450.00
HST-NP CU10 MR250K MS25GB MTH PR	1	\$833.33
HST-P CU10 MR250K MS25GB MTH PR	1	\$1,333.33
HST-P CU25 MR500K MS50GB NP1 MTH PR	1	\$2,666.66
HST-P CU75 MR750K MS75GB NP1 MTH PR	1	\$6,666.66
HST-P CU250 MR1000K MS100GB NP2 MTH PR	1	\$12,000.00
HST-P CU500 MR1500K MS150GB NP2 MTH PR	1	\$16,666.66
HST-P CU1000 MR2000K MS200GB NP2 MTH PR	1	\$25,000.00
HST-P CU1000P MR2000K MS200GB NP2 MTH PR	1	Quoted
Federated Identity Services [Per Month Pricing]	1	\$1,500.00
Hosted to On-Prem Migration	1	\$0.00
On-Prem to Hosted Migration	1	Quoted
NUSHST-NP CU10 MR250K MS25GB MNT	1	\$1,167.00
NUSHST-P CU10 MR250K MS25GB MNT	1	\$1,867.00
NUSHST-P CU25 MR500K MS50GB NP1 MNT	1	\$3,733.00
NUSHST-P CU75 MR750K MS75GB NP1 MNT	1	\$9,333.00

NUSHST-P CU250 MR1000K MS100GB NP2 MNT	1	\$16,800.00
NUSHST-P CU500 MR1500K MS150GB NP2 MNT	1	\$23,333.00
NUSHST-P CU1000 MR2000K MS200GB NP2 MNT	1	\$35,000.00
NUSHST-P CU1000P MR2000K MS200GB NP2 MNT	1	Quoted
NonUSHost Federated Identity Service MNT	1	\$2,100.00
Solution Platform - perpetual license	1	\$30,000.00
RSA Archer Platform SmartStart Installation Services - Remote only	1	\$10,000.00
Professional Services bundle start up	1	\$27,500.00
Solution Platform - perpetual license	1	\$30,000.00
RSA Archer Platform SmartStart Installation Services - Remote only	1	\$10,000.00
Professional Services bundle start up	1	\$27,500.00
Enhanced support per month (\$625.00) [Per Month Pricing]	1	\$625.00
Additional ARC Instance 1Prod 2NP Term	1	Quoted
Additional ARC Instance 1Prod 2NP Perp	1	Quoted
Additional ARC Instance 1NP Term	1	Quoted
Additional ARC Instance 1NP Perp	1	Quoted
Additional ARC Instance 1Prod 2NP Term Mnt 1Mo	1	Quoted
Additional ARC Instance 1Prod 2NP Perp Mnt 1Mo	1	Quoted
Additional ARC Instance 1NP Term Mnt 1Mo	1	Quoted
Additional ARC Instance 1NP Perp Mnt 1Mo	1	Quoted
Additional ARC Instance 1Prod 2NP Term E Mnt 1Mo	1	Quoted
Additional ARC Instance 1Prod 2NP Perp E Mnt 1Mo	1	Quoted
Additional ARC Instance 1NP Term E Mnt 1Mo	1	Quoted
Additional ARC Instance 1NP Perp E Mnt 1Mo	1	Quoted
ADDL Archer Inst 1Prod Term	1	Quoted
ADDL Archer Inst 1Prod Perp	1	Quoted
ADDL Archer Inst 1Prod Term Mnt 1Mo	1	Quoted
ADDL Archer Inst 1Prod Perp Mnt 1Mo	1	Quoted
ADDL Archer Inst 1Prod Term E Mnt 1Mo	1	Quoted
ADDL Archer Inst 1Prod Perp E Mnt 1Mo	1	Quoted
GRC Mobile for Term License	1	\$0.00
GRC Mobile for Perpetual License	1	\$0.00
Warehouse Node H/W	1	\$85,000.00
Warehouse Switch	1	\$15,000.00
Warehouse Node w/10TB S/W	1	\$63,750.00
Warehouse Node H/W Basic Maint 1 month	1	\$1,416.76
Warehouse Switch Basic Maint 1 month	1	\$250.00
Warehouse Node w/10TB S/W BscMnt1Mo	1	\$1,062.50
Warehouse Node H/W EnhancedMaint 1 month	1	\$1,770.83
Warehouse Switch Enhanced Maint 1 month	1	\$312.50
Warehouse Node w/10TB S/W EnhMnt1Mo	1	\$1,328.13
Issues Management Sub \$/emp	1	\$2,340.63
Issues Management Sub \$/100	100	\$39.79
Issues Management Sub \$/100	100	\$23.88
Issues Management Sub \$/100	100	\$15.92
Issues Management Sub \$/100	100	\$12.73
Issues Management Sub \$/100	100	\$9.55

Issues Management Sub \$/100	100	\$7.96
Issues Management Sub \$/100	100	\$6.37
Incident Management Sub \$/emp	1	\$4,681.25
Incident Management Sub \$/100	100	\$79.58
Incident Management Sub \$/100	100	\$47.75
Incident Management Sub \$/100	100	\$31.83
Incident Management Sub \$/100	100	\$25.47
Incident Management Sub \$/100	100	\$19.10
Incident Management Sub \$/100	100	\$15.92
Incident Management Sub \$/100	100	\$12.73
Business Impact Analysis Sub \$/emp	1	\$2,340.63
Business Impact Analysis Sub \$/100	100	\$39.79
Business Impact Analysis Sub \$/100	100	\$23.88
Business Impact Analysis Sub \$/100	100	\$15.92
Business Impact Analysis Sub \$/100	100	\$12.73
Business Impact Analysis Sub \$/100	100	\$9.55
Business Impact Analysis Sub \$/100	100	\$7.96
Business Impact Analysis Sub \$/100	100	\$6.37
Audit Engage and Workpapers Sub \$/emp	1	\$4,681.25
Audit Engage and Workpapers Sub \$/100	100	\$79.58
Audit Engage and Workpapers Sub \$/100	100	\$47.75
Audit Engage and Workpapers Sub \$/100	100	\$31.83
Audit Engage and Workpapers Sub \$/100	100	\$25.47
Audit Engage and Workpapers Sub \$/100	100	\$19.10
Audit Engage and Workpapers Sub \$/100	100	\$15.92
Audit Engage and Workpapers Sub \$/100	100	\$12.73
Audit Planning and Quality Sub \$/emp	1	\$4,681.25
Audit Planning and Quality Sub \$/100	100	\$79.58
Audit Planning and Quality Sub \$/100	100	\$47.75
Audit Planning and Quality Sub \$/100	100	\$31.83
Audit Planning and Quality Sub \$/100	100	\$25.47
Audit Planning and Quality Sub \$/100	100	\$19.10
Audit Planning and Quality Sub \$/100	100	\$15.92
Audit Planning and Quality Sub \$/100	100	\$12.73
Crisis Management Sub \$/emp	1	\$4,681.25
Crisis Management Sub \$/100	100	\$79.58
Crisis Management Sub \$/100	100	\$47.75
Crisis Management Sub \$/100	100	\$31.83
Crisis Management Sub \$/100	100	\$25.47
Crisis Management Sub \$/100	100	\$19.10
Crisis Management Sub \$/100	100	\$15.92
Crisis Management Sub \$/100	100	\$12.73
Third Party Catalog Sub \$/emp	1	\$2,340.63
Third Party Catalog Sub \$/100	100	\$39.79
Third Party Catalog Sub \$/100	100	\$23.88
Third Party Catalog Sub \$/100	100	\$15.92
Third Party Catalog Sub \$/100	100	\$12.73

Third Party Catalog Sub \$/100	100	\$9.55
Third Party Catalog Sub \$/100	100	\$7.96
Third Party Catalog Sub \$/100	100	\$6.37
Third Party Risk Management Sub \$/emp	1	\$4,681.25
Third Party Risk Management Sub \$/100	100	\$79.58
Third Party Risk Management Sub \$/100	100	\$47.75
Third Party Risk Management Sub \$/100	100	\$31.83
Third Party Risk Management Sub \$/100	100	\$25.47
Third Party Risk Management Sub \$/100	100	\$19.10
Third Party Risk Management Sub \$/100	100	\$15.92
Third Party Risk Management Sub \$/100	100	\$12.73
Third Party Engagement Sub \$/emp	1	\$4,681.25
Third Party Engagement Sub \$/100	100	\$79.58
Third Party Engagement Sub \$/100	100	\$47.75
Third Party Engagement Sub \$/100	100	\$31.83
Third Party Engagement Sub \$/100	100	\$25.47
Third Party Engagement Sub \$/100	100	\$19.10
Third Party Engagement Sub \$/100	100	\$15.92
Third Party Engagement Sub \$/100	100	\$12.73
Third Party Governance Sub \$/emp	1	\$4,681.25
Third Party Governance Sub \$/100	100	\$79.58
Third Party Governance Sub \$/100	100	\$47.75
Third Party Governance Sub \$/100	100	\$31.83
Third Party Governance Sub \$/100	100	\$25.47
Third Party Governance Sub \$/100	100	\$19.10
Third Party Governance Sub \$/100	100	\$15.92
Third Party Governance Sub \$/100	100	\$12.73
Policy Program Management Sub \$/emp	1	\$4,681.25
Policy Program Management Sub \$/100	100	\$79.58
Policy Program Management Sub \$/100	100	\$47.75
Policy Program Management Sub \$/100	100	\$31.83
Policy Program Management Sub \$/100	100	\$25.47
Policy Program Management Sub \$/100	100	\$19.10
Policy Program Management Sub \$/100	100	\$15.92
Policy Program Management Sub \$/100	100	\$12.73
Corporate Obligations Mgmt Sub \$/emp	1	\$4,681.25
Corporate Obligations Mgmt Sub \$/100	100	\$79.58
Corporate Obligations Mgmt Sub \$/100	100	\$47.75
Corporate Obligations Mgmt Sub \$/100	100	\$31.83
Corporate Obligations Mgmt Sub \$/100	100	\$25.47
Corporate Obligations Mgmt Sub \$/100	100	\$19.10
Corporate Obligations Mgmt Sub \$/100	100	\$15.92
Corporate Obligations Mgmt Sub \$/100	100	\$12.73
IT Controls Assurance Sub \$/emp	1	\$4,681.25
IT Controls Assurance Sub \$/100	100	\$79.58
IT Controls Assurance Sub \$/100	100	\$47.75
IT Controls Assurance Sub \$/100	100	\$31.83

IT Controls Assurance Sub \$/100	100	\$25.47
IT Controls Assurance Sub \$/100	100	\$19.10
IT Controls Assurance Sub \$/100	100	\$15.92
IT Controls Assurance Sub \$/100	100	\$12.73
IT Sec. Vulnerabilities Prgm Sub \$/emp	1	\$4,681.25
IT Sec. Vulnerabilities Prgm Sub \$/100	100	\$79.58
IT Sec. Vulnerabilities Prgm Sub \$/100	100	\$47.75
IT Sec. Vulnerabilities Prgm Sub \$/100	100	\$31.83
IT Sec. Vulnerabilities Prgm Sub \$/100	100	\$25.47
IT Sec. Vulnerabilities Prgm Sub \$/100	100	\$19.10
IT Sec. Vulnerabilities Prgm Sub \$/100	100	\$15.92
IT Sec. Vulnerabilities Prgm Sub \$/100	100	\$12.73
IT Risk Management Sub \$/emp	1	\$4,681.25
IT Risk Management Sub \$/100	100	\$79.58
IT Risk Management Sub \$/100	100	\$47.75
IT Risk Management Sub \$/100	100	\$31.83
IT Risk Management Sub \$/100	100	\$25.47
IT Risk Management Sub \$/100	100	\$19.10
IT Risk Management Sub \$/100	100	\$15.92
IT Risk Management Sub \$/100	100	\$12.73
Sec Incident Management Sub \$/emp	1	\$2,340.63
Sec Incident Management Sub \$/100	100	\$39.79
Sec Incident Management Sub \$/100	100	\$23.88
Sec Incident Management Sub \$/100	100	\$15.92
Sec Incident Management Sub \$/100	100	\$12.73
Sec Incident Management Sub \$/100	100	\$9.55
Sec Incident Management Sub \$/100	100	\$7.96
Sec Incident Management Sub \$/100	100	\$6.37
Security Ops and Breach Mgmt Sub \$/emp	1	\$4,681.25
Security Ops and Breach Mgmt Sub \$/100	100	\$79.58
Security Ops and Breach Mgmt Sub \$/100	100	\$47.75
Security Ops and Breach Mgmt Sub \$/100	100	\$31.83
Security Ops and Breach Mgmt Sub \$/100	100	\$25.47
Security Ops and Breach Mgmt Sub \$/100	100	\$19.10
Security Ops and Breach Mgmt Sub \$/100	100	\$15.92
Security Ops and Breach Mgmt Sub \$/100	100	\$12.73
Ctrl Assurance Program Mgmt Sub \$/emp	1	\$4,681.25
Ctrl Assurance Program Mgmt Sub \$/100	100	\$79.58
Ctrl Assurance Program Mgmt Sub \$/100	100	\$47.75
Ctrl Assurance Program Mgmt Sub \$/100	100	\$31.83
Ctrl Assurance Program Mgmt Sub \$/100	100	\$25.47
Ctrl Assurance Program Mgmt Sub \$/100	100	\$19.10
Ctrl Assurance Program Mgmt Sub \$/100	100	\$15.92
Ctrl Assurance Program Mgmt Sub \$/100	100	\$12.73
Ctrl Monitoring Program Mgmt Sub \$/emp	1	\$4,681.25
Ctrl Monitoring Program Mgmt Sub \$/100	100	\$79.58
Ctrl Monitoring Program Mgmt Sub \$/100	100	\$47.75

Ctrl Monitoring Program Mgmt Sub \$/100	100	\$31.83
Ctrl Monitoring Program Mgmt Sub \$/100	100	\$25.47
Ctrl Monitoring Program Mgmt Sub \$/100	100	\$19.10
Ctrl Monitoring Program Mgmt Sub \$/100	100	\$15.92
Ctrl Monitoring Program Mgmt Sub \$/100	100	\$12.73
Top-Down Risk Assessment Sub \$/emp	1	\$4,681.25
Top-Down Risk Assessment Sub \$/100	100	\$79.58
Top-Down Risk Assessment Sub \$/100	100	\$47.75
Top-Down Risk Assessment Sub \$/100	100	\$31.83
Top-Down Risk Assessment Sub \$/100	100	\$25.47
Top-Down Risk Assessment Sub \$/100	100	\$19.10
Top-Down Risk Assessment Sub \$/100	100	\$15.92
Top-Down Risk Assessment Sub \$/100	100	\$12.73
Loss Event Management Sub \$/emp	1	\$4,681.25
Loss Event Management Sub \$/100	100	\$79.58
Loss Event Management Sub \$/100	100	\$47.75
Loss Event Management Sub \$/100	100	\$31.83
Loss Event Management Sub \$/100	100	\$25.47
Loss Event Management Sub \$/100	100	\$19.10
Loss Event Management Sub \$/100	100	\$15.92
Loss Event Management Sub \$/100	100	\$12.73
Key Indicator Management Sub \$/emp	1	\$4,681.25
Key Indicator Management Sub \$/100	100	\$79.58
Key Indicator Management Sub \$/100	100	\$47.75
Key Indicator Management Sub \$/100	100	\$31.83
Key Indicator Management Sub \$/100	100	\$25.47
Key Indicator Management Sub \$/100	100	\$19.10
Key Indicator Management Sub \$/100	100	\$15.92
Key Indicator Management Sub \$/100	100	\$12.73
Bottom-Up Risk Assessment Sub \$/emp	1	\$4,681.25
Bottom-Up Risk Assessment Sub \$/100	100	\$79.58
Bottom-Up Risk Assessment Sub \$/100	100	\$47.75
Bottom-Up Risk Assessment Sub \$/100	100	\$31.83
Bottom-Up Risk Assessment Sub \$/100	100	\$25.47
Bottom-Up Risk Assessment Sub \$/100	100	\$19.10
Bottom-Up Risk Assessment Sub \$/100	100	\$15.92
Bottom-Up Risk Assessment Sub \$/100	100	\$12.73
Operational Risk Management Sub \$/emp	1	\$4,681.25
Operational Risk Management Sub \$/100	100	\$79.58
Operational Risk Management Sub \$/100	100	\$47.75
Operational Risk Management Sub \$/100	100	\$31.83
Operational Risk Management Sub \$/100	100	\$25.47
Operational Risk Management Sub \$/100	100	\$19.10
Operational Risk Management Sub \$/100	100	\$15.92
Operational Risk Management Sub \$/100	100	\$12.73
Fed Assmnt and Authorization Sub \$/emp	1	\$4,681.25
Fed Assmnt and Authorization Sub \$/100	100	\$79.58

Fed Assmnt and Authorization Sub \$/100	100	\$47.75
Fed Assmnt and Authorization Sub \$/100	100	\$31.83
Fed Assmnt and Authorization Sub \$/100	100	\$25.47
Fed Assmnt and Authorization Sub \$/100	100	\$19.10
Fed Assmnt and Authorization Sub \$/100	100	\$15.92
Fed Assmnt and Authorization Sub \$/100	100	\$12.73
Federal Cont Monitoring Sub \$/emp	1	\$4,681.25
Federal Cont Monitoring Sub \$/100	100	\$79.58
Federal Cont Monitoring Sub \$/100	100	\$47.75
Federal Cont Monitoring Sub \$/100	100	\$31.83
Federal Cont Monitoring Sub \$/100	100	\$25.47
Federal Cont Monitoring Sub \$/100	100	\$19.10
Federal Cont Monitoring Sub \$/100	100	\$15.92
Federal Cont Monitoring Sub \$/100	100	\$12.73
On-Demand Application Sub \$/emp	1	\$668.75
On-Demand Application Sub \$/100	100	\$11.37
On-Demand Application Sub \$/100	100	\$6.82
On-Demand Application Sub \$/100	100	\$4.55
On-Demand Application Sub \$/100	100	\$3.64
On-Demand Application Sub \$/100	100	\$2.73
On-Demand Application Sub \$/100	100	\$2.27
On-Demand Application Sub \$/100	100	\$1.82
CYBINBR SUB \$ /admin /mo	1	\$4,681.25
CYBINBR SUB<5K \$ /100emp /mo	100	\$79.58
CYBINBR SUB<10K \$ /100emp /mo	100	\$47.75
CYBINBR SUB<25K \$ /100emp /mo	100	\$31.83
CYBINBR SUB<50K \$ /100emp /mo	100	\$25.47
CYBINBR SUB<75K \$ /100emp /mo	100	\$19.10
CYBINBR SUB<100K \$ /100emp /mo	100	\$15.92
CYBINBR SUB>100K \$ /100emp /mo	100	\$12.73
Issues Management Perp \$/emp	1	\$56,175.00
Issues Management Perp \$/100	100	\$955.00
Issues Management Perp \$/100	100	\$573.00
Issues Management Perp \$/100	100	\$382.00
Issues Management Perp \$/100	100	\$305.60
Issues Management Perp \$/100	100	\$229.20
Issues Management Perp \$/100	100	\$191.00
Issues Management Perp \$/100	100	\$152.80
Incident Management Perp \$/emp	1	\$112,350.00
Incident Management Perp \$/100	100	\$1,910.00
Incident Management Perp \$/100	100	\$1,146.00
Incident Management Perp \$/100	100	\$764.00
Incident Management Perp \$/100	100	\$611.20
Incident Management Perp \$/100	100	\$458.40
Incident Management Perp \$/100	100	\$382.00
Incident Management Perp \$/100	100	\$305.60
Business Impact Analysis Perp \$/emp	1	\$56,175.00

Business Impact Analysis Perp \$/100	100	\$955.00
Business Impact Analysis Perp \$/100	100	\$573.00
Business Impact Analysis Perp \$/100	100	\$382.00
Business Impact Analysis Perp \$/100	100	\$305.60
Business Impact Analysis Perp \$/100	100	\$229.20
Business Impact Analysis Perp \$/100	100	\$191.00
Business Impact Analysis Perp \$/100	100	\$152.80
Audit Engage and Workpapers Perp \$/emp	1	\$112,350.00
Audit Engage and Workpapers Perp \$/100	100	\$1,910.00
Audit Engage and Workpapers Perp \$/100	100	\$1,146.00
Audit Engage and Workpapers Perp \$/100	100	\$764.00
Audit Engage and Workpapers Perp \$/100	100	\$611.20
Audit Engage and Workpapers Perp \$/100	100	\$458.40
Audit Engage and Workpapers Perp \$/100	100	\$382.00
Audit Engage and Workpapers Perp \$/100	100	\$305.60
Audit Planning and Quality Perp \$/emp	1	\$112,350.00
Audit Planning and Quality Perp \$/100	100	\$1,910.00
Audit Planning and Quality Perp \$/100	100	\$1,146.00
Audit Planning and Quality Perp \$/100	100	\$764.00
Audit Planning and Quality Perp \$/100	100	\$611.20
Audit Planning and Quality Perp \$/100	100	\$458.40
Audit Planning and Quality Perp \$/100	100	\$382.00
Audit Planning and Quality Perp \$/100	100	\$305.60
Crisis Management Perp \$/emp	1	\$112,350.00
Crisis Management Perp \$/100	100	\$1,910.00
Crisis Management Perp \$/100	100	\$1,146.00
Crisis Management Perp \$/100	100	\$764.00
Crisis Management Perp \$/100	100	\$611.20
Crisis Management Perp \$/100	100	\$458.40
Crisis Management Perp \$/100	100	\$382.00
Crisis Management Perp \$/100	100	\$305.60
Third Party Catalog Perp \$/emp	1	\$56,175.00
Third Party Catalog Perp \$/100	100	\$955.00
Third Party Catalog Perp \$/100	100	\$573.00
Third Party Catalog Perp \$/100	100	\$382.00
Third Party Catalog Perp \$/100	100	\$305.60
Third Party Catalog Perp \$/100	100	\$229.20
Third Party Catalog Perp \$/100	100	\$191.00
Third Party Catalog Perp \$/100	100	\$152.80
Third Party Risk Management Perp \$/emp	1	\$112,350.00
Third Party Risk Management Perp \$/100	100	\$1,910.00
Third Party Risk Management Perp \$/100	100	\$1,146.00
Third Party Risk Management Perp \$/100	100	\$764.00
Third Party Risk Management Perp \$/100	100	\$611.20
Third Party Risk Management Perp \$/100	100	\$458.40
Third Party Risk Management Perp \$/100	100	\$382.00
Third Party Risk Management Perp \$/100	100	\$305.60

Third Party Engagement Perp \$/emp	1	\$112,350.00
Third Party Engagement Perp \$/100	100	\$1,910.00
Third Party Engagement Perp \$/100	100	\$1,146.00
Third Party Engagement Perp \$/100	100	\$764.00
Third Party Engagement Perp \$/100	100	\$611.20
Third Party Engagement Perp \$/100	100	\$458.40
Third Party Engagement Perp \$/100	100	\$382.00
Third Party Engagement Perp \$/100	100	\$305.60
Third Party Governance Perp \$/emp	1	\$112,350.00
Third Party Governance Perp \$/100	100	\$1,910.00
Third Party Governance Perp \$/100	100	\$1,146.00
Third Party Governance Perp \$/100	100	\$764.00
Third Party Governance Perp \$/100	100	\$611.20
Third Party Governance Perp \$/100	100	\$458.40
Third Party Governance Perp \$/100	100	\$382.00
Third Party Governance Perp \$/100	100	\$305.60
Policy Program Management Perp \$/emp	1	\$112,350.00
Policy Program Management Perp \$/100	100	\$1,910.00
Policy Program Management Perp \$/100	100	\$1,146.00
Policy Program Management Perp \$/100	100	\$764.00
Policy Program Management Perp \$/100	100	\$611.20
Policy Program Management Perp \$/100	100	\$458.40
Policy Program Management Perp \$/100	100	\$382.00
Policy Program Management Perp \$/100	100	\$305.60
Corporate Obligations Mgmt Perp \$/emp	1	\$112,350.00
Corporate Obligations Mgmt Perp \$/100	100	\$1,910.00
Corporate Obligations Mgmt Perp \$/100	100	\$1,146.00
Corporate Obligations Mgmt Perp \$/100	100	\$764.00
Corporate Obligations Mgmt Perp \$/100	100	\$611.20
Corporate Obligations Mgmt Perp \$/100	100	\$458.40
Corporate Obligations Mgmt Perp \$/100	100	\$382.00
Corporate Obligations Mgmt Perp \$/100	100	\$305.60
IT Controls Assurance Perp \$/emp	1	\$112,350.00
IT Controls Assurance Perp \$/100	100	\$1,910.00
IT Controls Assurance Perp \$/100	100	\$1,146.00
IT Controls Assurance Perp \$/100	100	\$764.00
IT Controls Assurance Perp \$/100	100	\$611.20
IT Controls Assurance Perp \$/100	100	\$458.40
IT Controls Assurance Perp \$/100	100	\$382.00
IT Controls Assurance Perp \$/100	100	\$305.60
IT Sec Vulnerabilities Prgm Perp \$/emp	1	\$112,350.00
IT Sec Vulnerabilities Prgm Perp \$/100	100	\$1,910.00
IT Sec Vulnerabilities Prgm Perp \$/100	100	\$1,146.00
IT Sec Vulnerabilities Prgm Perp \$/100	100	\$764.00
IT Sec Vulnerabilities Prgm Perp \$/100	100	\$611.20
IT Sec Vulnerabilities Prgm Perp \$/100	100	\$458.40
IT Sec Vulnerabilities Prgm Perp \$/100	100	\$382.00

IT Sec Vulnerabilities Prgm Perp \$/100	100	\$305.60
IT Risk Management Perp \$/emp	1	\$112,350.00
IT Risk Management Perp \$/100	100	\$1,910.00
IT Risk Management Perp \$/100	100	\$1,146.00
IT Risk Management Perp \$/100	100	\$764.00
IT Risk Management Perp \$/100	100	\$611.20
IT Risk Management Perp \$/100	100	\$458.40
IT Risk Management Perp \$/100	100	\$382.00
IT Risk Management Perp \$/100	100	\$305.60
Sec Incident Management Perp \$/emp	1	\$56,175.00
Sec Incident Management Perp \$/100	100	\$955.00
Sec Incident Management Perp \$/100	100	\$573.00
Sec Incident Management Perp \$/100	100	\$382.00
Sec Incident Management Perp \$/100	100	\$305.60
Sec Incident Management Perp \$/100	100	\$229.20
Sec Incident Management Perp \$/100	100	\$191.00
Sec Incident Management Perp \$/100	100	\$152.80
Sec Ops and Breach Mgmt Perp \$/emp	1	\$112,350.00
Security Ops and Breach Mgmt Perp \$/100	100	\$1,910.00
Security Ops and Breach Mgmt Perp \$/100	100	\$1,146.00
Security Ops and Breach Mgmt Perp \$/100	100	\$764.00
Security Ops and Breach Mgmt Perp \$/100	100	\$611.20
Security Ops and Breach Mgmt Perp \$/100	100	\$458.40
Security Ops and Breach Mgmt Perp \$/100	100	\$382.00
Security Ops and Breach Mgmt Perp \$/100	100	\$305.60
Contls Assurance Prgm Mgmt Perp \$/emp	1	\$112,350.00
Controls Assurance Prgm Mgmt Perp \$/100	100	\$1,910.00
Controls Assurance Prgm Mgmt Perp \$/100	100	\$1,146.00
Controls Assurance Prgm Mgmt Perp \$/100	100	\$764.00
Controls Assurance Prgm Mgmt Perp \$/100	100	\$611.20
Controls Assurance Prgm Mgmt Perp \$/100	100	\$458.40
Controls Assurance Prgm Mgmt Perp \$/100	100	\$382.00
Controls Assurance Prgm Mgmt Perp \$/100	100	\$305.60
Contls Monitoring Prgm Mgmt Perp \$/emp	1	\$112,350.00
Controls Monitoring Prgm Mgmt Perp \$/100	100	\$1,910.00
Controls Monitoring Prgm Mgmt Perp \$/100	100	\$1,146.00
Controls Monitoring Prgm Mgmt Perp \$/100	100	\$764.00
Controls Monitoring Prgm Mgmt Perp \$/100	100	\$611.20
Controls Monitoring Prgm Mgmt Perp \$/100	100	\$458.40
Controls Monitoring Prgm Mgmt Perp \$/100	100	\$382.00
Controls Monitoring Prgm Mgmt Perp \$/100	100	\$305.60
Top-Down Risk Assessment Perp \$/emp	1	\$112,350.00
Top-Down Risk Assessment Perp \$/100	100	\$1,910.00
Top-Down Risk Assessment Perp \$/100	100	\$1,146.00
Top-Down Risk Assessment Perp \$/100	100	\$764.00
Top-Down Risk Assessment Perp \$/100	100	\$611.20
Top-Down Risk Assessment Perp \$/100	100	\$458.40

Top-Down Risk Assessment Perp \$/100	100	\$382.00
Top-Down Risk Assessment Perp \$/100	100	\$305.60
Loss Event Management Perp \$/emp	1	\$112,350.00
Loss Event Management Perp \$/100	100	\$1,910.00
Loss Event Management Perp \$/100	100	\$1,146.00
Loss Event Management Perp \$/100	100	\$764.00
Loss Event Management Perp \$/100	100	\$611.20
Loss Event Management Perp \$/100	100	\$458.40
Loss Event Management Perp \$/100	100	\$382.00
Loss Event Management Perp \$/100	100	\$305.60
Key Indicator Management Perp \$/emp	1	\$112,350.00
Key Indicator Management Perp \$/100	100	\$1,910.00
Key Indicator Management Perp \$/100	100	\$1,146.00
Key Indicator Management Perp \$/100	100	\$764.00
Key Indicator Management Perp \$/100	100	\$611.20
Key Indicator Management Perp \$/100	100	\$458.40
Key Indicator Management Perp \$/100	100	\$382.00
Key Indicator Management Perp \$/100	100	\$305.60
Bottom-Up Risk Assessment Perp \$/emp	1	\$112,350.00
Bottom-Up Risk Assessment Perp \$/100	100	\$1,910.00
Bottom-Up Risk Assessment Perp \$/100	100	\$1,146.00
Bottom-Up Risk Assessment Perp \$/100	100	\$764.00
Bottom-Up Risk Assessment Perp \$/100	100	\$611.20
Bottom-Up Risk Assessment Perp \$/100	100	\$458.40
Bottom-Up Risk Assessment Perp \$/100	100	\$382.00
Bottom-Up Risk Assessment Perp \$/100	100	\$305.60
Operational Risk Management Perp \$/emp	1	\$112,350.00
Operational Risk Management Perp \$/100	100	\$1,910.00
Operational Risk Management Perp \$/100	100	\$1,146.00
Operational Risk Management Perp \$/100	100	\$764.00
Operational Risk Management Perp \$/100	100	\$611.20
Operational Risk Management Perp \$/100	100	\$458.40
Operational Risk Management Perp \$/100	100	\$382.00
Operational Risk Management Perp \$/100	100	\$305.60
Fed Assmnt and Authorization Perp \$/emp	1	\$112,350.00
Fed Assmnt and Authorization Perp \$/100	100	\$1,910.00
Fed Assmnt and Authorization Perp \$/100	100	\$1,146.00
Fed Assmnt and Authorization Perp \$/100	100	\$764.00
Fed Assmnt and Authorization Perp \$/100	100	\$611.20
Fed Assmnt and Authorization Perp \$/100	100	\$458.40
Fed Assmnt and Authorization Perp \$/100	100	\$382.00
Fed Assmnt and Authorization Perp \$/100	100	\$305.60
Federal Continuous Monitoring Perp \$/emp	1	\$112,350.00
Federal Continuous Monitoring Perp \$/100	100	\$1,910.00
Federal Continuous Monitoring Perp \$/100	100	\$1,146.00
Federal Continuous Monitoring Perp \$/100	100	\$764.00
Federal Continuous Monitoring Perp \$/100	100	\$611.20

Federal Continuous Monitoring Perp \$/100	100	\$458.40
Federal Continuous Monitoring Perp \$/100	100	\$382.00
Federal Continuous Monitoring Perp \$/100	100	\$305.60
On-Demand Application Perp \$/emp	1	\$16,099.76
On-Demand Application Perp \$/100	100	\$272.86
On-Demand Application Perp \$/100	100	\$163.71
On-Demand Application Perp \$/100	100	\$109.14
On-Demand Application Perp \$/100	100	\$87.31
On-Demand Application Perp \$/100	100	\$65.49
On-Demand Application Perp \$/100	100	\$54.57
On-Demand Application Perp \$/100	100	\$43.66
Business Asset Catalog Sub \$/emp	1	\$2,340.63
Business Asset Catalog Sub \$/100	100	\$39.79
Business Asset Catalog Sub \$/100	100	\$23.88
Business Asset Catalog Sub \$/100	100	\$15.92
Business Asset Catalog Sub \$/100	100	\$12.73
Business Asset Catalog Sub \$/100	100	\$9.55
Business Asset Catalog Sub \$/100	100	\$7.96
Business Asset Catalog Sub \$/100	100	\$6.37
Business Asset Catalog Perp \$/emp	1	\$56,175.00
Business Asset Catalog Perp \$/100	100	\$955.00
Business Asset Catalog Perp \$/100	100	\$573.00
Business Asset Catalog Perp \$/100	100	\$382.00
Business Asset Catalog Perp \$/100	100	\$305.60
Business Asset Catalog Perp \$/100	100	\$229.20
Business Asset Catalog Perp \$/100	100	\$191.00
Business Asset Catalog Perp \$/100	100	\$152.80
IT Asset Catalog Sub \$/emp	1	\$2,340.63
IT Asset Catalog Sub \$/100	100	\$39.79
IT Asset Catalog Sub \$/100	100	\$23.88
IT Asset Catalog Sub \$/100	100	\$15.92
IT Asset Catalog Sub \$/100	100	\$12.73
IT Asset Catalog Sub \$/100	100	\$9.55
IT Asset Catalog Sub \$/100	100	\$7.96
IT Asset Catalog Sub \$/100	100	\$6.37
IT Asset Catalog Perp \$/emp	1	\$56,175.00
IT Asset Catalog Perp \$/100	100	\$955.00
IT Asset Catalog Perp \$/100	100	\$573.00
IT Asset Catalog Perp \$/100	100	\$382.00
IT Asset Catalog Perp \$/100	100	\$305.60
IT Asset Catalog Perp \$/100	100	\$229.20
IT Asset Catalog Perp \$/100	100	\$191.00
IT Asset Catalog Perp \$/100	100	\$152.80
Bus. Cont. & IT Dis. Rec. Pln. Sub \$/emp	1	\$4,681.25
Bus. Cont. & IT Dis. Rec. Pln. Sub \$/100	100	\$79.58
Bus. Cont. & IT Dis. Rec. Pln. Sub \$/100	100	\$47.75
Bus. Cont. & IT Dis. Rec. Pln. Sub \$/100	100	\$31.83

Bus. Cont. & IT Dis. Rec. Pln. Sub \$/100	100	\$25.47
Bus. Cont. & IT Dis. Rec. Pln. Sub \$/100	100	\$19.10
Bus. Cont. & IT Dis. Rec. Pln. Sub \$/100	100	\$15.92
Bus. Cont. & IT Dis. Rec. Pln. Sub \$/100	100	\$12.73
Bus. Cont. & IT Dis Rec. Pln. Perp \$/emp	1	\$112,350.00
Bus. Cont. & IT Dis Rec. Pln. Perp \$/100	100	\$1,910.00
Bus. Cont. & IT Dis Rec. Pln. Perp \$/100	100	\$1,146.00
Bus. Cont. & IT Dis Rec. Pln. Perp \$/100	100	\$764.00
Bus. Cont. & IT Dis Rec. Pln. Perp \$/100	100	\$611.20
Bus. Cont. & IT Dis Rec. Pln. Perp \$/100	100	\$458.40
Bus. Cont. & IT Dis Rec. Pln. Perp \$/100	100	\$382.00
Bus. Cont. & IT Dis Rec. Pln. Perp \$/100	100	\$305.60
PCI Management Sub \$/emp	1	\$4,681.25
PCI Management Sub \$/100	100	\$79.58
PCI Management Sub \$/100	100	\$47.75
PCI Management Sub \$/100	100	\$31.83
PCI Management Sub \$/100	100	\$25.47
PCI Management Sub \$/100	100	\$19.10
PCI Management Sub \$/100	100	\$15.92
PCI Management Sub \$/100	100	\$12.73
PCI Management Perp \$/emp	1	\$112,350.00
PCI Management Perp \$/100	100	\$1,910.00
PCI Management Perp \$/100	100	\$1,146.00
PCI Management Perp \$/100	100	\$764.00
PCI Management Perp \$/100	100	\$611.20
PCI Management Perp \$/100	100	\$458.40
PCI Management Perp \$/100	100	\$382.00
PCI Management Perp \$/100	100	\$305.60
Information Sec Mgmt System Sub \$/emp	1	\$4,681.25
Information Sec Mgmt System Sub \$/100	100	\$79.58
Information Sec Mgmt System Sub \$/100	100	\$47.75
Information Sec Mgmt System Sub \$/100	100	\$31.83
Information Sec Mgmt System Sub \$/100	100	\$25.47
Information Sec Mgmt System Sub \$/100	100	\$19.10
Information Sec Mgmt System Sub \$/100	100	\$15.92
Information Sec Mgmt System Sub \$/100	100	\$12.73
Information Sec Mgmt System Perp \$/emp	1	\$112,350.00
Information Sec Mgmt System Perp \$/100	100	\$1,910.00
Information Sec Mgmt System Perp \$/100	100	\$1,146.00
Information Sec Mgmt System Perp \$/100	100	\$764.00
Information Sec Mgmt System Perp \$/100	100	\$611.20
Information Sec Mgmt System Perp \$/100	100	\$458.40
Information Sec Mgmt System Perp \$/100	100	\$382.00
Information Sec Mgmt System Perp \$/100	100	\$305.60
Risk Catalog Sub \$/emp	1	\$2,340.63
Risk Catalog Sub \$/100	100	\$39.79
Risk Catalog Sub \$/100	100	\$23.88

Risk Catalog Sub \$/100	100	\$15.92
Risk Catalog Sub \$/100	100	\$12.73
Risk Catalog Sub \$/100	100	\$9.55
Risk Catalog Sub \$/100	100	\$7.96
Risk Catalog Sub \$/100	100	\$6.37
Risk Catalog Perp \$/emp	1	\$56,175.00
Risk Catalog Perp \$/100	100	\$955.00
Risk Catalog Perp \$/100	100	\$573.00
Risk Catalog Perp \$/100	100	\$382.00
Risk Catalog Perp \$/100	100	\$305.60
Risk Catalog Perp \$/100	100	\$229.20
Risk Catalog Perp \$/100	100	\$191.00
Risk Catalog Perp \$/100	100	\$152.80
Plan of Action and Milestones Sub \$/emp	1	\$2,340.63
Plan of Action and Milestones Sub \$/100	100	\$39.79
Plan of Action and Milestones Sub \$/100	100	\$23.88
Plan of Action and Milestones Sub \$/100	100	\$15.92
Plan of Action and Milestones Sub \$/100	100	\$12.73
Plan of Action and Milestones Sub \$/100	100	\$9.55
Plan of Action and Milestones Sub \$/100	100	\$7.96
Plan of Action and Milestones Sub \$/100	100	\$6.37
Plan of Action and Milestones Perp \$/emp	1	\$56,175.00
Plan of Action and Milestones Perp \$/100	100	\$955.00
Plan of Action and Milestones Perp \$/100	100	\$573.00
Plan of Action and Milestones Perp \$/100	100	\$382.00
Plan of Action and Milestones Perp \$/100	100	\$305.60
Plan of Action and Milestones Perp \$/100	100	\$229.20
Plan of Action and Milestones Perp \$/100	100	\$191.00
Plan of Action and Milestones Perp \$/100	100	\$152.80
Data Governance Sub \$/emp	1	\$4,681.25
Data Governance Sub \$/100	100	\$79.58
Data Governance Sub \$/100	100	\$47.75
Data Governance Sub \$/100	100	\$31.83
Data Governance Sub \$/100	100	\$25.47
Data Governance Sub \$/100	100	\$19.10
Data Governance Sub \$/100	100	\$15.92
Data Governance Sub \$/100	100	\$12.73
Data Governance Perp \$/emp	1	\$112,350.00
Data Governance Perp \$/100	100	\$1,910.00
Data Governance Perp \$/100	100	\$1,146.00
Data Governance Perp \$/100	100	\$764.00
Data Governance Perp \$/100	100	\$611.20
Data Governance Perp \$/100	100	\$458.40
Data Governance Perp \$/100	100	\$382.00
Data Governance Perp \$/100	100	\$305.60
Privacy Prog Mgt Sub \$/emp	1	\$4,681.25
Privacy Prog Mgt Sub \$/100	100	\$79.58

Privacy Prog Mgt Sub \$/100	100	\$47.75
Privacy Prog Mgt Sub \$/100	100	\$31.83
Privacy Prog Mgt Sub \$/100	100	\$25.47
Privacy Prog Mgt Sub \$/100	100	\$19.10
Privacy Prog Mgt Sub \$/100	100	\$15.92
Privacy Prog Mgt Sub \$/100	100	\$12.73
Privacy Prog Mgt Perp \$/emp	1	\$112,350.00
Privacy Prog Mgt Perp \$/100	100	\$1,910.00
Privacy Prog Mgt Perp \$/100	100	\$1,146.00
Privacy Prog Mgt Perp \$/100	100	\$764.00
Privacy Prog Mgt Perp \$/100	100	\$611.20
Privacy Prog Mgt Perp \$/100	100	\$458.40
Privacy Prog Mgt Perp \$/100	100	\$382.00
Privacy Prog Mgt Perp \$/100	100	\$305.60
Cyber Risk Quant-Base Sub \$/org/mth	1	\$4,681.25
Cyber Risk Quantification Sub \$/100	100	\$119.37
Cyber Risk Quantification Sub \$/100	100	\$107.44
Cyber Risk Quantification Sub \$/100	100	\$71.62
Cyber Risk Quantification Sub \$/100	100	\$57.31
Cyber Risk Quantification Sub \$/100	100	\$52.53
Cyber Risk Quantification Sub \$/100	100	\$47.76
Cyber Risk Quantification Sub \$/100	100	\$35.01
CYBINBR PERP bas \$ /admin /mo	1	\$112,350.00
CYBINBR PERP<5K bas \$ /100emp /mo	100	\$1,910.00
CYBINBR PERP<10K bas \$ /100emp /mo	100	\$1,146.00
CYBINBR PERP<25K bas \$ /100emp /mo	100	\$764.00
CYBINBR PERP<50K bas \$ /100emp /mo	100	\$611.20
CYBINBR PERP<75K bas \$ /100emp /mo	100	\$458.40
CYBINBR PERP<100K bas \$ /100emp /mo	100	\$382.00
CYBINBR PERP>100K bas \$ /100emp /mo	100	\$305.60
Issues Management Perp Basic Maint \$/emp	1	\$936.25
Issues Management Perp Basic Maint \$/100	100	\$15.92
Issues Management Perp Basic Maint \$/100	100	\$9.55
Issues Management Perp Basic Maint \$/100	100	\$6.37
Issues Management Perp Basic Maint \$/100	100	\$5.09
Issues Management Perp Basic Maint \$/100	100	\$3.82
Issues Management Perp Basic Maint \$/100	100	\$3.18
Issues Management Perp Basic Maint \$/100	100	\$2.55
Incident Mgmt Perp Basic Maint \$/emp	1	\$1,872.50
Incident Mgmt Perp Basic Maint \$/100	100	\$31.83
Incident Mgmt Perp Basic Maint \$/100	100	\$19.10
Incident Mgmt Perp Basic Maint \$/100	100	\$12.73
Incident Mgmt Perp Basic Maint \$/100	100	\$10.19
Incident Mgmt Perp Basic Maint \$/100	100	\$7.64
Incident Mgmt Perp Basic Maint \$/100	100	\$6.37
Incident Mgmt Perp Basic Maint \$/100	100	\$5.09
Bus Impact Anlys Perp Basic Maint \$/emp	1	\$936.25

Bus Impact Anlys Perp Basic Maint \$/100	100	\$15.92
Bus Impact Anlys Perp Basic Maint \$/100	100	\$9.55
Bus Impact Anlys Perp Basic Maint \$/100	100	\$6.37
Bus Impact Anlys Perp Basic Maint \$/100	100	\$5.09
Bus Impact Anlys Perp Basic Maint \$/100	100	\$3.82
Bus Impact Anlys Perp Basic Maint \$/100	100	\$3.18
Bus Impact Anlys Perp Basic Maint \$/100	100	\$2.55
Aud Eng & Wrkprs Perp Basic Maint \$/emp	1	\$1,872.50
Aud Eng & Wrkprs Perp Basic Maint \$/100	100	\$31.83
Aud Eng & Wrkprs Perp Basic Maint \$/100	100	\$19.10
Aud Eng & Wrkprs Perp Basic Maint \$/100	100	\$12.73
Aud Eng & Wrkprs Perp Basic Maint \$/100	100	\$10.19
Aud Eng & Wrkprs Perp Basic Maint \$/100	100	\$7.64
Aud Eng & Wrkprs Perp Basic Maint \$/100	100	\$6.37
Aud Eng & Wrkprs Perp Basic Maint \$/100	100	\$5.09
Audit Pln & Qlty Perp Basic Maint \$/emp	1	\$1,872.50
Audit Pln & Qlty Perp Basic Maint \$/100	100	\$31.83
Audit Pln & Qlty Perp Basic Maint \$/100	100	\$19.10
Audit Pln & Qlty Perp Basic Maint \$/100	100	\$12.73
Audit Pln & Qlty Perp Basic Maint \$/100	100	\$10.19
Audit Pln & Qlty Perp Basic Maint \$/100	100	\$7.64
Audit Pln & Qlty Perp Basic Maint \$/100	100	\$6.37
Audit Pln & Qlty Perp Basic Maint \$/100	100	\$5.09
Crisis Mgmt Perp Basic Maint \$/emp	1	\$1,872.50
Crisis Mgmt Perp Basic Maint \$/100	100	\$31.83
Crisis Mgmt Perp Basic Maint \$/100	100	\$19.10
Crisis Mgmt Perp Basic Maint \$/100	100	\$12.73
Crisis Mgmt Perp Basic Maint \$/100	100	\$10.19
Crisis Mgmt Perp Basic Maint \$/100	100	\$7.64
Crisis Mgmt Perp Basic Maint \$/100	100	\$6.37
Crisis Mgmt Perp Basic Maint \$/100	100	\$5.09
Third Party Cat Perp Basic Maint \$/emp	1	\$936.25
Third Party Cat Perp Basic Maint \$/100	100	\$15.92
Third Party Cat Perp Basic Maint \$/100	100	\$9.55
Third Party Cat Perp Basic Maint \$/100	100	\$6.37
Third Party Cat Perp Basic Maint \$/100	100	\$5.09
Third Party Cat Perp Basic Maint \$/100	100	\$3.82
Third Party Cat Perp Basic Maint \$/100	100	\$3.18
Third Party Cat Perp Basic Maint \$/100	100	\$2.55
Thrd Pty Rsk Mgmt Perp Basic Maint \$/emp	1	\$1,872.50
Thrd Pty Rsk Mgmt Perp Basic Maint \$/100	100	\$31.83
Thrd Pty Rsk Mgmt Perp Basic Maint \$/100	100	\$19.10
Thrd Pty Rsk Mgmt Perp Basic Maint \$/100	100	\$12.73
Thrd Pty Rsk Mgmt Perp Basic Maint \$/100	100	\$10.19
Thrd Pty Rsk Mgmt Perp Basic Maint \$/100	100	\$7.64
Thrd Pty Rsk Mgmt Perp Basic Maint \$/100	100	\$6.37
Thrd Pty Rsk Mgmt Perp Basic Maint \$/100	100	\$5.09

Third Pty Engmgnt Perp Basic Maint \$/emp	1	\$1,872.50
Third Pty Engmgnt Perp Basic Maint \$/100	100	\$31.83
Third Pty Engmgnt Perp Basic Maint \$/100	100	\$19.10
Third Pty Engmgnt Perp Basic Maint \$/100	100	\$12.73
Third Pty Engmgnt Perp Basic Maint \$/100	100	\$10.19
Third Pty Engmgnt Perp Basic Maint \$/100	100	\$7.64
Third Pty Engmgnt Perp Basic Maint \$/100	100	\$6.37
Third Pty Engmgnt Perp Basic Maint \$/100	100	\$5.09
Third Party Gov Perp Basic Maint \$/emp	1	\$1,872.50
Third Party Gov Perp Basic Maint \$/100	100	\$31.83
Third Party Gov Perp Basic Maint \$/100	100	\$19.10
Third Party Gov Perp Basic Maint \$/100	100	\$12.73
Third Party Gov Perp Basic Maint \$/100	100	\$10.19
Third Party Gov Perp Basic Maint \$/100	100	\$7.64
Third Party Gov Perp Basic Maint \$/100	100	\$6.37
Third Party Gov Perp Basic Maint \$/100	100	\$5.09
Policy Prgm Mgmt Perp Basic Maint \$/emp	1	\$1,872.50
Policy Prgm Mgmt Perp Basic Maint \$/100	100	\$31.83
Policy Prgm Mgmt Perp Basic Maint \$/100	100	\$19.10
Policy Prgm Mgmt Perp Basic Maint \$/100	100	\$12.73
Policy Prgm Mgmt Perp Basic Maint \$/100	100	\$10.19
Policy Prgm Mgmt Perp Basic Maint \$/100	100	\$7.64
Policy Prgm Mgmt Perp Basic Maint \$/100	100	\$6.37
Policy Prgm Mgmt Perp Basic Maint \$/100	100	\$5.09
Corp Oblig Mgmt Perp Basic Maint \$/emp	1	\$1,872.50
Corp Oblig Mgmt Perp Basic Maint \$/100	100	\$31.83
Corp Oblig Mgmt Perp Basic Maint \$/100	100	\$19.10
Corp Oblig Mgmt Perp Basic Maint \$/100	100	\$12.73
Corp Oblig Mgmt Perp Basic Maint \$/100	100	\$10.19
Corp Oblig Mgmt Perp Basic Maint \$/100	100	\$7.64
Corp Oblig Mgmt Perp Basic Maint \$/100	100	\$6.37
Corp Oblig Mgmt Perp Basic Maint \$/100	100	\$5.09
IT Cntrls Asrn Perp Basic Maint \$/emp	1	\$1,872.50
IT Cntrls Asrn Perp Basic Maint \$/100	100	\$31.83
IT Cntrls Asrn Perp Basic Maint \$/100	100	\$19.10
IT Cntrls Asrn Perp Basic Maint \$/100	100	\$12.73
IT Cntrls Asrn Perp Basic Maint \$/100	100	\$10.19
IT Cntrls Asrn Perp Basic Maint \$/100	100	\$7.64
IT Cntrls Asrn Perp Basic Maint \$/100	100	\$6.37
IT Cntrls Asrn Perp Basic Maint \$/100	100	\$5.09
IT Sec Vuln Prog Perp Basic Maint \$/emp	1	\$1,872.50
IT Sec Vuln Prog Perp Basic Maint \$/100	100	\$31.83
IT Sec Vuln Prog Perp Basic Maint \$/100	100	\$19.10
IT Sec Vuln Prog Perp Basic Maint \$/100	100	\$12.73
IT Sec Vuln Prog Perp Basic Maint \$/100	100	\$10.19
IT Sec Vuln Prog Perp Basic Maint \$/100	100	\$7.64
IT Sec Vuln Prog Perp Basic Maint \$/100	100	\$6.37

IT Sec Vuln Prog Perp Basic Maint \$/100	100	\$5.09
IT Risk Mgmt Perp Basic Maint \$/emp	1	\$1,872.50
IT Risk Mgmt Perp Basic Maint \$/100	100	\$31.83
IT Risk Mgmt Perp Basic Maint \$/100	100	\$19.10
IT Risk Mgmt Perp Basic Maint \$/100	100	\$12.73
IT Risk Mgmt Perp Basic Maint \$/100	100	\$10.19
IT Risk Mgmt Perp Basic Maint \$/100	100	\$7.64
IT Risk Mgmt Perp Basic Maint \$/100	100	\$6.37
IT Risk Mgmt Perp Basic Maint \$/100	100	\$5.09
Sec Incdt Mgmt Perp Basic Maint \$/emp	1	\$936.25
Sec Incdt Mgmt Perp Basic Maint \$/100	100	\$15.92
Sec Incdt Mgmt Perp Basic Maint \$/100	100	\$9.55
Sec Incdt Mgmt Perp Basic Maint \$/100	100	\$6.37
Sec Incdt Mgmt Perp Basic Maint \$/100	100	\$5.09
Sec Incdt Mgmt Perp Basic Maint \$/100	100	\$3.82
Sec Incdt Mgmt Perp Basic Maint \$/100	100	\$3.18
Sec Incdt Mgmt Perp Basic Maint \$/100	100	\$2.55
Sec Ops & Brch Mgt Perp Basic Mnt \$/emp	1	\$1,872.50
Sec Ops & Brch Mgt Perp Basic Mnt \$/100	100	\$31.83
Sec Ops & Brch Mgt Perp Basic Mnt \$/100	100	\$19.10
Sec Ops & Brch Mgt Perp Basic Mnt \$/100	100	\$12.73
Sec Ops & Brch Mgt Perp Basic Mnt \$/100	100	\$10.19
Sec Ops & Brch Mgt Perp Basic Mnt \$/100	100	\$7.64
Sec Ops & Brch Mgt Perp Basic Mnt \$/100	100	\$6.37
Sec Ops & Brch Mgt Perp Basic Mnt \$/100	100	\$5.09
Ctr Asrn Prgm Mgt Perp Basic Maint \$/emp	1	\$1,872.50
Ctr Asrn Prgm Mgt Perp Basic Maint \$/100	100	\$31.83
Ctr Asrn Prgm Mgt Perp Basic Maint \$/100	100	\$19.10
Ctr Asrn Prgm Mgt Perp Basic Maint \$/100	100	\$12.73
Ctr Asrn Prgm Mgt Perp Basic Maint \$/100	100	\$10.19
Ctr Asrn Prgm Mgt Perp Basic Maint \$/100	100	\$7.64
Ctr Asrn Prgm Mgt Perp Basic Maint \$/100	100	\$6.37
Ctr Asrn Prgm Mgt Perp Basic Maint \$/100	100	\$5.09
Ctr Mon Prgm Mgmt Perp Basic Maint \$/emp	1	\$1,872.50
Ctr Mon Prgm Mgmt Perp Basic Maint \$/100	100	\$31.83
Ctr Mon Prgm Mgmt Perp Basic Maint \$/100	100	\$19.10
Ctr Mon Prgm Mgmt Perp Basic Maint \$/100	100	\$12.73
Ctr Mon Prgm Mgmt Perp Basic Maint \$/100	100	\$10.19
Ctr Mon Prgm Mgmt Perp Basic Maint \$/100	100	\$7.64
Ctr Mon Prgm Mgmt Perp Basic Maint \$/100	100	\$6.37
Ctr Mon Prgm Mgmt Perp Basic Maint \$/100	100	\$5.09
Top-Dwn Rsk Assmt Perp Basic Maint \$/emp	1	\$1,872.50
Top-Dwn Rsk Assmt Perp Basic Maint \$/100	100	\$31.83
Top-Dwn Rsk Assmt Perp Basic Maint \$/100	100	\$19.10
Top-Dwn Rsk Assmt Perp Basic Maint \$/100	100	\$12.73
Top-Dwn Rsk Assmt Perp Basic Maint \$/100	100	\$10.19
Top-Dwn Rsk Assmt Perp Basic Maint \$/100	100	\$7.64

Top-Dwn Rsk Assmt Perp Basic Maint \$/100	100	\$6.37
Top-Dwn Rsk Assmt Perp Basic Maint \$/100	100	\$5.09
Loss Event Mgmt Perp Basic Maint \$/emp	1	\$1,872.50
Loss Event Mgmt Perp Basic Maint \$/100	100	\$31.83
Loss Event Mgmt Perp Basic Maint \$/100	100	\$19.10
Loss Event Mgmt Perp Basic Maint \$/100	100	\$12.73
Loss Event Mgmt Perp Basic Maint \$/100	100	\$10.19
Loss Event Mgmt Perp Basic Maint \$/100	100	\$7.64
Loss Event Mgmt Perp Basic Maint \$/100	100	\$6.37
Loss Event Mgmt Perp Basic Maint \$/100	100	\$5.09
Key Ind Mgmt Perp Basic Maint \$/emp	1	\$1,872.50
Key Ind Mgmt Perp Basic Maint \$/100	100	\$31.83
Key Ind Mgmt Perp Basic Maint \$/100	100	\$19.10
Key Ind Mgmt Perp Basic Maint \$/100	100	\$12.73
Key Ind Mgmt Perp Basic Maint \$/100	100	\$10.19
Key Ind Mgmt Perp Basic Maint \$/100	100	\$7.64
Key Ind Mgmt Perp Basic Maint \$/100	100	\$6.37
Key Ind Mgmt Perp Basic Maint \$/100	100	\$5.09
Bot-Up Rsk Assmnt Perp Basic Maint \$/emp	1	\$1,872.50
Bot-Up Rsk Assmnt Perp Basic Maint \$/100	100	\$31.83
Bot-Up Rsk Assmnt Perp Basic Maint \$/100	100	\$19.10
Bot-Up Rsk Assmnt Perp Basic Maint \$/100	100	\$12.73
Bot-Up Rsk Assmnt Perp Basic Maint \$/100	100	\$10.19
Bot-Up Rsk Assmnt Perp Basic Maint \$/100	100	\$7.64
Bot-Up Rsk Assmnt Perp Basic Maint \$/100	100	\$6.37
Bot-Up Rsk Assmnt Perp Basic Maint \$/100	100	\$5.09
Op Risk Mgmt Perp Basic Maint \$/emp	1	\$1,872.50
Op Risk Mgmt Perp Basic Maint \$/100	100	\$31.83
Op Risk Mgmt Perp Basic Maint \$/100	100	\$19.10
Op Risk Mgmt Perp Basic Maint \$/100	100	\$12.73
Op Risk Mgmt Perp Basic Maint \$/100	100	\$10.19
Op Risk Mgmt Perp Basic Maint \$/100	100	\$7.64
Op Risk Mgmt Perp Basic Maint \$/100	100	\$6.37
Op Risk Mgmt Perp Basic Maint \$/100	100	\$5.09
Fed Asmt & Auth Perp Basic Maint \$/emp	1	\$1,872.50
Fed Asmt & Auth Perp Basic Maint \$/100	100	\$31.83
Fed Asmt & Auth Perp Basic Maint \$/100	100	\$19.10
Fed Asmt & Auth Perp Basic Maint \$/100	100	\$12.73
Fed Asmt & Auth Perp Basic Maint \$/100	100	\$10.19
Fed Asmt & Auth Perp Basic Maint \$/100	100	\$7.64
Fed Asmt & Auth Perp Basic Maint \$/100	100	\$6.37
Fed Asmt & Auth Perp Basic Maint \$/100	100	\$5.09
Federal Cont Mon Perp Basic Maint \$/emp	1	\$1,872.50
Federal Cont Mon Perp Basic Maint \$/100	100	\$31.83
Federal Cont Mon Perp Basic Maint \$/100	100	\$19.10
Federal Cont Mon Perp Basic Maint \$/100	100	\$12.73
Federal Cont Mon Perp Basic Maint \$/100	100	\$10.19

Federal Cont Mon Perp Basic Maint \$/100	100	\$7.64
Federal Cont Mon Perp Basic Maint \$/100	100	\$6.37
Federal Cont Mon Perp Basic Maint \$/100	100	\$5.09
On-Demand App Perp Basic Maint \$/emp	1	\$268.33
On-Demand App Perp Basic Maint \$/100	100	\$4.55
On-Demand App Perp Basic Maint \$/100	100	\$2.73
On-Demand App Perp Basic Maint \$/100	100	\$1.82
On-Demand App Perp Basic Maint \$/100	100	\$1.46
On-Demand App Perp Basic Maint \$/100	100	\$1.09
On-Demand App Perp Basic Maint \$/100	100	\$0.91
On-Demand App Perp Basic Maint \$/100	100	\$0.73
Business Asset Cat Perp Basic Mnt \$/emp	1	\$936.25
Business Asset Cat Perp Basic Mnt \$/100	100	\$15.92
Business Asset Cat Perp Basic Mnt \$/100	100	\$9.55
Business Asset Cat Perp Basic Mnt \$/100	100	\$6.37
Business Asset Cat Perp Basic Mnt \$/100	100	\$5.09
Business Asset Cat Perp Basic Mnt \$/100	100	\$3.82
Business Asset Cat Perp Basic Mnt \$/100	100	\$3.18
Business Asset Cat Perp Basic Mnt \$/100	100	\$2.55
IT Asset Catalog Perp Basic Maint \$/emp	1	\$936.25
IT Asset Catalog Perp Basic Maint \$/100	100	\$15.92
IT Asset Catalog Perp Basic Maint \$/100	100	\$9.55
IT Asset Catalog Perp Basic Maint \$/100	100	\$6.37
IT Asset Catalog Perp Basic Maint \$/100	100	\$5.09
IT Asset Catalog Perp Basic Maint \$/100	100	\$3.82
IT Asset Catalog Perp Basic Maint \$/100	100	\$3.18
IT Asset Catalog Perp Basic Maint \$/100	100	\$2.55
PCI Management Perp Basic Maint \$/emp	1	\$1,872.50
PCI Management Perp Basic Maint \$/100	100	\$31.83
PCI Management Perp Basic Maint \$/100	100	\$19.10
PCI Management Perp Basic Maint \$/100	100	\$12.73
PCI Management Perp Basic Maint \$/100	100	\$10.19
PCI Management Perp Basic Maint \$/100	100	\$7.64
PCI Management Perp Basic Maint \$/100	100	\$6.37
PCI Management Perp Basic Maint \$/100	100	\$5.09
Info Sec Mgmt Sys Perp Basic Maint \$/emp	1	\$1,872.50
Info Sec Mgmt Sys Perp Basic Maint \$/100	100	\$31.83
Info Sec Mgmt Sys Perp Basic Maint \$/100	100	\$19.10
Info Sec Mgmt Sys Perp Basic Maint \$/100	100	\$12.73
Info Sec Mgmt Sys Perp Basic Maint \$/100	100	\$10.19
Info Sec Mgmt Sys Perp Basic Maint \$/100	100	\$7.64
Info Sec Mgmt Sys Perp Basic Maint \$/100	100	\$6.37
Info Sec Mgmt Sys Perp Basic Maint \$/100	100	\$5.09
Risk Catalog Perp Basic Maint \$/emp	1	\$936.25
Risk Catalog Perp Basic Maint \$/100	100	\$15.92
Risk Catalog Perp Basic Maint \$/100	100	\$9.55
Risk Catalog Perp Basic Maint \$/100	100	\$6.37

Risk Catalog Perp Basic Maint \$/100	100	\$5.09
Risk Catalog Perp Basic Maint \$/100	100	\$3.82
Risk Catalog Perp Basic Maint \$/100	100	\$3.18
Risk Catalog Perp Basic Maint \$/100	100	\$2.55
Plan Action MS Perp Basic Maint \$/emp	1	\$936.25
Plan Action MS Perp Basic Maint \$/100	100	\$15.92
Plan Action MS Perp Basic Maint \$/100	100	\$9.55
Plan Action MS Perp Basic Maint \$/100	100	\$6.37
Plan Action MS Perp Basic Maint \$/100	100	\$5.09
Plan Action MS Perp Basic Maint \$/100	100	\$3.82
Plan Action MS Perp Basic Maint \$/100	100	\$3.18
Plan Action MS Perp Basic Maint \$/100	100	\$2.55
Bus Cnt IT DS Rec Pln Perp Bas Mnt \$/emp	1	\$1,872.50
Bus Cnt IT DS Rec Pln Perp Bas Mnt \$/100	100	\$31.83
Bus Cnt IT DS Rec Pln Perp Bas Mnt \$/100	100	\$19.10
Bus Cnt IT DS Rec Pln Perp Bas Mnt \$/100	100	\$12.73
Bus Cnt IT DS Rec Pln Perp Bas Mnt \$/100	100	\$10.19
Bus Cnt IT DS Rec Pln Perp Bas Mnt \$/100	100	\$7.64
Bus Cnt IT DS Rec Pln Perp Bas Mnt \$/100	100	\$6.37
Bus Cnt IT DS Rec Pln Perp Bas Mnt \$/100	100	\$5.09
Data Governance Perp Basic Maint \$/emp	1	\$1,872.50
Data Governance Perp Basic Maint \$/100	100	\$31.83
Data Governance Perp Basic Maint \$/100	100	\$19.10
Data Governance Perp Basic Maint \$/100	100	\$12.73
Data Governance Perp Basic Maint \$/100	100	\$10.19
Data Governance Perp Basic Maint \$/100	100	\$7.64
Data Governance Perp Basic Maint \$/100	100	\$6.37
Data Governance Perp Basic Maint \$/100	100	\$5.09
Privacy Prog Mgt Perp Basic Maint \$/emp	1	\$1,872.50
Privacy Prog Mgt Perp Basic Maint \$/100	100	\$31.83
Privacy Prog Mgt Perp Basic Maint \$/100	100	\$19.10
Privacy Prog Mgt Perp Basic Maint \$/100	100	\$12.73
Privacy Prog Mgt Perp Basic Maint \$/100	100	\$10.19
Privacy Prog Mgt Perp Basic Maint \$/100	100	\$7.64
Privacy Prog Mgt Perp Basic Maint \$/100	100	\$6.37
Privacy Prog Mgt Perp Basic Maint \$/100	100	\$5.09
CYBINBR PERP bas \$ /admin /mo	1	\$1,872.50
CYBINBR PERP<5K\$ bas /100emp /mo	100	\$31.83
CYBINBR PERP<10K\$ bas /100emp /mo	100	\$19.10
CYBINBR PERP<25K\$ bas /100emp /mo	100	\$12.73
CYBINBR PERP<50K\$ bas /100emp /mo	100	\$10.19
CYBINBR PERP<75K\$ bas /100emp /mo	100	\$7.64
CYBINBR PERP<100K\$ bas /100emp /mo	100	\$6.37
CYBINBR PERP>100K\$ bas /100emp /mo	100	\$5.09
Issues Management Perp Enh Maint \$/emp	1	\$1,170.31
Issues Management Perp Enh Maint \$/100	100	\$19.90
Issues Management Perp Enh Maint \$/100	100	\$11.94

Issues Management Perp Enh Maint \$/100	100	\$7.96
Issues Management Perp Enh Maint \$/100	100	\$6.37
Issues Management Perp Enh Maint \$/100	100	\$4.78
Issues Management Perp Enh Maint \$/100	100	\$3.98
Issues Management Perp Enh Maint \$/100	100	\$3.18
Incident Management Perp Enh Maint \$/emp	1	\$2,340.63
Incident Management Perp Enh Maint \$/100	100	\$39.79
Incident Management Perp Enh Maint \$/100	100	\$23.88
Incident Management Perp Enh Maint \$/100	100	\$15.92
Incident Management Perp Enh Maint \$/100	100	\$12.73
Incident Management Perp Enh Maint \$/100	100	\$9.55
Incident Management Perp Enh Maint \$/100	100	\$7.96
Incident Management Perp Enh Maint \$/100	100	\$6.37
Bus Impact Analysis Perp Enh Maint \$/emp	1	\$1,170.31
Bus Impact Analysis Perp Enh Maint \$/100	100	\$19.90
Bus Impact Analysis Perp Enh Maint \$/100	100	\$11.94
Bus Impact Analysis Perp Enh Maint \$/100	100	\$7.96
Bus Impact Analysis Perp Enh Maint \$/100	100	\$6.37
Bus Impact Analysis Perp Enh Maint \$/100	100	\$4.78
Bus Impact Analysis Perp Enh Maint \$/100	100	\$3.98
Bus Impact Analysis Perp Enh Maint \$/100	100	\$3.18
Aud Eng & Wrkpapers Perp Enh Maint \$/emp	1	\$2,340.63
Aud Eng & Wrkpapers Perp Enh Maint \$/100	100	\$39.79
Aud Eng & Wrkpapers Perp Enh Maint \$/100	100	\$23.88
Aud Eng & Wrkpapers Perp Enh Maint \$/100	100	\$15.92
Aud Eng & Wrkpapers Perp Enh Maint \$/100	100	\$12.73
Aud Eng & Wrkpapers Perp Enh Maint \$/100	100	\$9.55
Aud Eng & Wrkpapers Perp Enh Maint \$/100	100	\$7.96
Aud Eng & Wrkpapers Perp Enh Maint \$/100	100	\$6.37
Audit Pln & Quality Perp Enh Maint \$/emp	1	\$2,340.63
Audit Pln & Quality Perp Enh Maint \$/100	100	\$39.79
Audit Pln & Quality Perp Enh Maint \$/100	100	\$23.88
Audit Pln & Quality Perp Enh Maint \$/100	100	\$15.92
Audit Pln & Quality Perp Enh Maint \$/100	100	\$12.73
Audit Pln & Quality Perp Enh Maint \$/100	100	\$9.55
Audit Pln & Quality Perp Enh Maint \$/100	100	\$7.96
Audit Pln & Quality Perp Enh Maint \$/100	100	\$6.37
Crisis Mgmt Perp Enh Maint \$/emp	1	\$2,340.63
Crisis Mgmt Perp Enh Maint \$/100	100	\$39.79
Crisis Mgmt Perp Enh Maint \$/100	100	\$23.88
Crisis Mgmt Perp Enh Maint \$/100	100	\$15.92
Crisis Mgmt Perp Enh Maint \$/100	100	\$12.73
Crisis Mgmt Perp Enh Maint \$/100	100	\$9.55
Crisis Mgmt Perp Enh Maint \$/100	100	\$7.96
Crisis Mgmt Perp Enh Maint \$/100	100	\$6.37
Third Party Catalog Perp Enh Maint \$/emp	1	\$1,170.31
Third Party Catalog Perp Enh Maint \$/100	100	\$19.90

Third Party Catalog Perp Enh Maint \$/100	100	\$11.94
Third Party Catalog Perp Enh Maint \$/100	100	\$7.96
Third Party Catalog Perp Enh Maint \$/100	100	\$6.37
Third Party Catalog Perp Enh Maint \$/100	100	\$4.78
Third Party Catalog Perp Enh Maint \$/100	100	\$3.98
Third Party Catalog Perp Enh Maint \$/100	100	\$3.18
Third Pty Risk Mgmt Perp Enh Maint \$/emp	1	\$2,340.63
Third Pty Risk Mgmt Perp Enh Maint \$/100	100	\$39.79
Third Pty Risk Mgmt Perp Enh Maint \$/100	100	\$23.88
Third Pty Risk Mgmt Perp Enh Maint \$/100	100	\$15.92
Third Pty Risk Mgmt Perp Enh Maint \$/100	100	\$12.73
Third Pty Risk Mgmt Perp Enh Maint \$/100	100	\$9.55
Third Pty Risk Mgmt Perp Enh Maint \$/100	100	\$7.96
Third Pty Risk Mgmt Perp Enh Maint \$/100	100	\$6.37
Third Pty Engmnt Perp Enh Maint \$/emp	1	\$2,340.63
Third Pty Engmnt Perp Enh Maint \$/100	100	\$39.79
Third Pty Engmnt Perp Enh Maint \$/100	100	\$23.88
Third Pty Engmnt Perp Enh Maint \$/100	100	\$15.92
Third Pty Engmnt Perp Enh Maint \$/100	100	\$12.73
Third Pty Engmnt Perp Enh Maint \$/100	100	\$9.55
Third Pty Engmnt Perp Enh Maint \$/100	100	\$7.96
Third Pty Engmnt Perp Enh Maint \$/100	100	\$6.37
Third Party Gov Perp Enh Maint \$/emp	1	\$2,340.63
Third Party Gov Perp Enh Maint \$/100	100	\$39.79
Third Party Gov Perp Enh Maint \$/100	100	\$23.88
Third Party Gov Perp Enh Maint \$/100	100	\$15.92
Third Party Gov Perp Enh Maint \$/100	100	\$12.73
Third Party Gov Perp Enh Maint \$/100	100	\$9.55
Third Party Gov Perp Enh Maint \$/100	100	\$7.96
Third Party Gov Perp Enh Maint \$/100	100	\$6.37
Policy Program Mgmt Perp Enh Maint \$/emp	1	\$2,340.63
Policy Program Mgmt Perp Enh Maint \$/100	100	\$39.79
Policy Program Mgmt Perp Enh Maint \$/100	100	\$23.88
Policy Program Mgmt Perp Enh Maint \$/100	100	\$15.92
Policy Program Mgmt Perp Enh Maint \$/100	100	\$12.73
Policy Program Mgmt Perp Enh Maint \$/100	100	\$9.55
Policy Program Mgmt Perp Enh Maint \$/100	100	\$7.96
Policy Program Mgmt Perp Enh Maint \$/100	100	\$6.37
Corp Obligs Mgmt Perp Enh Maint \$/emp	1	\$2,340.63
Corp Obligs Mgmt Perp Enh Maint \$/100	100	\$39.79
Corp Obligs Mgmt Perp Enh Maint \$/100	100	\$23.88
Corp Obligs Mgmt Perp Enh Maint \$/100	100	\$15.92
Corp Obligs Mgmt Perp Enh Maint \$/100	100	\$12.73
Corp Obligs Mgmt Perp Enh Maint \$/100	100	\$9.55
Corp Obligs Mgmt Perp Enh Maint \$/100	100	\$7.96
Corp Obligs Mgmt Perp Enh Maint \$/100	100	\$6.37
IT Controls Asrn Perp Enh Maint \$/emp	1	\$2,340.63

IT Controls Asrn Perp Enh Maint \$/100	100	\$39.79
IT Controls Asrn Perp Enh Maint \$/100	100	\$23.88
IT Controls Asrn Perp Enh Maint \$/100	100	\$15.92
IT Controls Asrn Perp Enh Maint \$/100	100	\$12.73
IT Controls Asrn Perp Enh Maint \$/100	100	\$9.55
IT Controls Asrn Perp Enh Maint \$/100	100	\$7.96
IT Controls Asrn Perp Enh Maint \$/100	100	\$6.37
IT Sec Vuln Prog Perp Enh Maint \$/emp	1	\$2,340.63
IT Sec Vuln Prog Perp Enh Maint \$/100	100	\$39.79
IT Sec Vuln Prog Perp Enh Maint \$/100	100	\$23.88
IT Sec Vuln Prog Perp Enh Maint \$/100	100	\$15.92
IT Sec Vuln Prog Perp Enh Maint \$/100	100	\$12.73
IT Sec Vuln Prog Perp Enh Maint \$/100	100	\$9.55
IT Sec Vuln Prog Perp Enh Maint \$/100	100	\$7.96
IT Sec Vuln Prog Perp Enh Maint \$/100	100	\$6.37
IT Risk Management Perp Enh Maint \$/emp	1	\$2,340.63
IT Risk Management Perp Enh Maint \$/100	100	\$39.79
IT Risk Management Perp Enh Maint \$/100	100	\$23.88
IT Risk Management Perp Enh Maint \$/100	100	\$15.92
IT Risk Management Perp Enh Maint \$/100	100	\$12.73
IT Risk Management Perp Enh Maint \$/100	100	\$9.55
IT Risk Management Perp Enh Maint \$/100	100	\$7.96
IT Risk Management Perp Enh Maint \$/100	100	\$6.37
Sec Incident Mgmt Perp Enh Maint \$/emp	1	\$1,170.31
Sec Incident Mgmt Perp Enh Maint \$/100	100	\$19.90
Sec Incident Mgmt Perp Enh Maint \$/100	100	\$11.94
Sec Incident Mgmt Perp Enh Maint \$/100	100	\$7.96
Sec Incident Mgmt Perp Enh Maint \$/100	100	\$6.37
Sec Incident Mgmt Perp Enh Maint \$/100	100	\$4.78
Sec Incident Mgmt Perp Enh Maint \$/100	100	\$3.98
Sec Incident Mgmt Perp Enh Maint \$/100	100	\$3.18
Sec Ops & Brch Mgmt Perp Enh Maint \$/emp	1	\$2,340.63
Sec Ops & Brch Mgmt Perp Enh Maint \$/100	100	\$39.79
Sec Ops & Brch Mgmt Perp Enh Maint \$/100	100	\$23.88
Sec Ops & Brch Mgmt Perp Enh Maint \$/100	100	\$15.92
Sec Ops & Brch Mgmt Perp Enh Maint \$/100	100	\$12.73
Sec Ops & Brch Mgmt Perp Enh Maint \$/100	100	\$9.55
Sec Ops & Brch Mgmt Perp Enh Maint \$/100	100	\$7.96
Sec Ops & Brch Mgmt Perp Enh Maint \$/100	100	\$6.37
Ctr Asrn Prog Mgmt Perp Enh Maint \$/emp	1	\$2,340.63
Ctr Asrn Prog Mgmt Perp Enh Maint \$/100	100	\$39.79
Ctr Asrn Prog Mgmt Perp Enh Maint \$/100	100	\$23.88
Ctr Asrn Prog Mgmt Perp Enh Maint \$/100	100	\$15.92
Ctr Asrn Prog Mgmt Perp Enh Maint \$/100	100	\$12.73
Ctr Asrn Prog Mgmt Perp Enh Maint \$/100	100	\$9.55
Ctr Asrn Prog Mgmt Perp Enh Maint \$/100	100	\$7.96
Ctr Asrn Prog Mgmt Perp Enh Maint \$/100	100	\$6.37

Ctr Monit Prgm Mgmt Perp Enh Maint \$/emp	1	\$2,340.63
Ctr Monit Prgm Mgmt Perp Enh Maint \$/100	100	\$39.79
Ctr Monit Prgm Mgmt Perp Enh Maint \$/100	100	\$23.88
Ctr Monit Prgm Mgmt Perp Enh Maint \$/100	100	\$15.92
Ctr Monit Prgm Mgmt Perp Enh Maint \$/100	100	\$12.73
Ctr Monit Prgm Mgmt Perp Enh Maint \$/100	100	\$9.55
Ctr Monit Prgm Mgmt Perp Enh Maint \$/100	100	\$7.96
Ctr Monit Prgm Mgmt Perp Enh Maint \$/100	100	\$6.37
Top-Down Risk Assmt Perp Enh Maint \$/emp	1	\$2,340.63
Top-Down Risk Assmt Perp Enh Maint \$/100	100	\$39.79
Top-Down Risk Assmt Perp Enh Maint \$/100	100	\$23.88
Top-Down Risk Assmt Perp Enh Maint \$/100	100	\$15.92
Top-Down Risk Assmt Perp Enh Maint \$/100	100	\$12.73
Top-Down Risk Assmt Perp Enh Maint \$/100	100	\$9.55
Top-Down Risk Assmt Perp Enh Maint \$/100	100	\$7.96
Top-Down Risk Assmt Perp Enh Maint \$/100	100	\$6.37
Loss Event Mgmt Perp Enh Maint \$/emp	1	\$2,340.63
Loss Event Mgmt Perp Enh Maint \$/100	100	\$39.79
Loss Event Mgmt Perp Enh Maint \$/100	100	\$23.88
Loss Event Mgmt Perp Enh Maint \$/100	100	\$15.92
Loss Event Mgmt Perp Enh Maint \$/100	100	\$12.73
Loss Event Mgmt Perp Enh Maint \$/100	100	\$9.55
Loss Event Mgmt Perp Enh Maint \$/100	100	\$7.96
Loss Event Mgmt Perp Enh Maint \$/100	100	\$6.37
Key Indicator Mgmt Perp Enh Maint \$/emp	1	\$2,340.63
Key Indicator Mgmt Perp Enh Maint \$/100	100	\$39.79
Key Indicator Mgmt Perp Enh Maint \$/100	100	\$23.88
Key Indicator Mgmt Perp Enh Maint \$/100	100	\$15.92
Key Indicator Mgmt Perp Enh Maint \$/100	100	\$12.73
Key Indicator Mgmt Perp Enh Maint \$/100	100	\$9.55
Key Indicator Mgmt Perp Enh Maint \$/100	100	\$7.96
Key Indicator Mgmt Perp Enh Maint \$/100	100	\$6.37
Bot-Up Risk Assmnt Perp Enh Maint \$/emp	1	\$2,340.63
Bot-Up Risk Assmnt Perp Enh Maint \$/100	100	\$39.79
Bot-Up Risk Assmnt Perp Enh Maint \$/100	100	\$23.88
Bot-Up Risk Assmnt Perp Enh Maint \$/100	100	\$15.92
Bot-Up Risk Assmnt Perp Enh Maint \$/100	100	\$12.73
Bot-Up Risk Assmnt Perp Enh Maint \$/100	100	\$9.55
Bot-Up Risk Assmnt Perp Enh Maint \$/100	100	\$7.96
Bot-Up Risk Assmnt Perp Enh Maint \$/100	100	\$6.37
Op Risk Mgmt Perp Enh Maint \$/emp	1	\$2,340.63
Op Risk Mgmt Perp Enh Maint \$/100	100	\$39.79
Op Risk Mgmt Perp Enh Maint \$/100	100	\$23.88
Op Risk Mgmt Perp Enh Maint \$/100	100	\$15.92
Op Risk Mgmt Perp Enh Maint \$/100	100	\$12.73
Op Risk Mgmt Perp Enh Maint \$/100	100	\$9.55
Op Risk Mgmt Perp Enh Maint \$/100	100	\$7.96

Op Risk Mgmt Perp Enh Maint \$/100	100	\$6.37
Fed Asmt & Auth Perp Enh Maint \$/emp	1	\$2,340.63
Fed Asmt & Auth Perp Enh Maint \$/100	100	\$39.79
Fed Asmt & Auth Perp Enh Maint \$/100	100	\$23.88
Fed Asmt & Auth Perp Enh Maint \$/100	100	\$15.92
Fed Asmt & Auth Perp Enh Maint \$/100	100	\$12.73
Fed Asmt & Auth Perp Enh Maint \$/100	100	\$9.55
Fed Asmt & Auth Perp Enh Maint \$/100	100	\$7.96
Fed Asmt & Auth Perp Enh Maint \$/100	100	\$6.37
Federal Cont Monit Perp Enh Maint \$/emp	1	\$2,340.63
Federal Cont Monit Perp Enh Maint \$/100	100	\$39.79
Federal Cont Monit Perp Enh Maint \$/100	100	\$23.88
Federal Cont Monit Perp Enh Maint \$/100	100	\$15.92
Federal Cont Monit Perp Enh Maint \$/100	100	\$12.73
Federal Cont Monit Perp Enh Maint \$/100	100	\$9.55
Federal Cont Monit Perp Enh Maint \$/100	100	\$7.96
Federal Cont Monit Perp Enh Maint \$/100	100	\$6.37
On-Demand App Perp Enh Maint \$/emp	1	\$335.41
On-Demand App Perp Enh Maint \$/100	100	\$5.68
On-Demand App Perp Enh Maint \$/100	100	\$3.41
On-Demand App Perp Enh Maint \$/100	100	\$2.27
On-Demand App Perp Enh Maint \$/100	100	\$1.82
On-Demand App Perp Enh Maint \$/100	100	\$1.36
On-Demand App Perp Enh Maint \$/100	100	\$1.14
On-Demand App Perp Enh Maint \$/100	100	\$0.91
Business Asset Cat Perp Enh Maint \$/emp	1	\$1,170.31
Business Asset Cat Perp Enh Maint \$/100	100	\$19.90
Business Asset Cat Perp Enh Maint \$/100	100	\$11.94
Business Asset Cat Perp Enh Maint \$/100	100	\$7.96
Business Asset Cat Perp Enh Maint \$/100	100	\$6.37
Business Asset Cat Perp Enh Maint \$/100	100	\$4.78
Business Asset Cat Perp Enh Maint \$/100	100	\$3.98
Business Asset Cat Perp Enh Maint \$/100	100	\$3.18
IT Asset Catalog Perp Enh Maint \$/emp	1	\$1,170.31
IT Asset Catalog Perp Enh Maint \$/100	100	\$19.90
IT Asset Catalog Perp Enh Maint \$/100	100	\$11.94
IT Asset Catalog Perp Enh Maint \$/100	100	\$7.96
IT Asset Catalog Perp Enh Maint \$/100	100	\$6.37
IT Asset Catalog Perp Enh Maint \$/100	100	\$4.78
IT Asset Catalog Perp Enh Maint \$/100	100	\$3.98
IT Asset Catalog Perp Enh Maint \$/100	100	\$3.18
PCI Management Perp Enh Maint \$/emp	1	\$2,340.63
PCI Management Perp Enh Maint \$/100	100	\$39.79
PCI Management Perp Enh Maint \$/100	100	\$23.88
PCI Management Perp Enh Maint \$/100	100	\$15.92
PCI Management Perp Enh Maint \$/100	100	\$12.73
PCI Management Perp Enh Maint \$/100	100	\$9.55

PCI Management Perp Enh Maint \$/100	100	\$7.96
PCI Management Perp Enh Maint \$/100	100	\$6.37
Info Sec Mgmt Sys Perp Enh Maint \$/emp	1	\$2,340.63
Info Sec Mgmt Sys Perp Enh Maint \$/100	100	\$39.79
Info Sec Mgmt Sys Perp Enh Maint \$/100	100	\$23.88
Info Sec Mgmt Sys Perp Enh Maint \$/100	100	\$15.92
Info Sec Mgmt Sys Perp Enh Maint \$/100	100	\$12.73
Info Sec Mgmt Sys Perp Enh Maint \$/100	100	\$9.55
Info Sec Mgmt Sys Perp Enh Maint \$/100	100	\$7.96
Info Sec Mgmt Sys Perp Enh Maint \$/100	100	\$6.37
Risk Catalog Perp Enh Maint \$/emp	1	\$1,170.31
Risk Catalog Perp Enh Maint \$/100	100	\$19.90
Risk Catalog Perp Enh Maint \$/100	100	\$11.94
Risk Catalog Perp Enh Maint \$/100	100	\$7.96
Risk Catalog Perp Enh Maint \$/100	100	\$6.37
Risk Catalog Perp Enh Maint \$/100	100	\$4.78
Risk Catalog Perp Enh Maint \$/100	100	\$3.98
Risk Catalog Perp Enh Maint \$/100	100	\$3.18
Plan Action Milestn Perp Enh Maint \$/emp	1	\$1,170.31
Plan Action Milestn Perp Enh Maint \$/100	100	\$19.90
Plan Action Milestn Perp Enh Maint \$/100	100	\$11.94
Plan Action Milestn Perp Enh Maint \$/100	100	\$7.96
Plan Action Milestn Perp Enh Maint \$/100	100	\$6.37
Plan Action Milestn Perp Enh Maint \$/100	100	\$4.78
Plan Action Milestn Perp Enh Maint \$/100	100	\$3.98
Plan Action Milestn Perp Enh Maint \$/100	100	\$3.18
BS Cont IT DS Rec Pln Perp Enh Mnt \$/emp	1	\$2,340.63
BS Cont IT DS Rec Pln Perp Enh Mnt \$/100	100	\$39.79
BS Cont IT DS Rec Pln Perp Enh Mnt \$/100	100	\$23.88
BS Cont IT DS Rec Pln Perp Enh Mnt \$/100	100	\$15.92
BS Cont IT DS Rec Pln Perp Enh Mnt \$/100	100	\$12.73
BS Cont IT DS Rec Pln Perp Enh Mnt \$/100	100	\$9.55
BS Cont IT DS Rec Pln Perp Enh Mnt \$/100	100	\$7.96
BS Cont IT DS Rec Pln Perp Enh Mnt \$/100	100	\$6.37
Data Governance Perp Enh Maint \$/emp	1	\$2,340.63
Data Governance Perp Enh Maint \$/100	100	\$39.79
Data Governance Perp Enh Maint \$/100	100	\$23.88
Data Governance Perp Enh Maint \$/100	100	\$15.92
Data Governance Perp Enh Maint \$/100	100	\$12.73
Data Governance Perp Enh Maint \$/100	100	\$9.55
Data Governance Perp Enh Maint \$/100	100	\$7.96
Data Governance Perp Enh Maint \$/100	100	\$6.37
Privacy Prog Mgt Perp Enh Maint \$/emp	1	\$2,340.63
Privacy Prog Mgt Perp Enh Maint \$/100	100	\$39.79
Privacy Prog Mgt Perp Enh Maint \$/100	100	\$23.88
Privacy Prog Mgt Perp Enh Maint \$/100	100	\$15.92
Privacy Prog Mgt Perp Enh Maint \$/100	100	\$12.73

Privacy Prog Mgt Perp Enh Maint \$/100	100	\$9.55
Privacy Prog Mgt Perp Enh Maint \$/100	100	\$7.96
Privacy Prog Mgt Perp Enh Maint \$/100	100	\$6.37
CYBINBR PERP ENH \$ / ADMIN /MO	1	\$2,340.63
CYBINBR PERP <5K ENH \$ /100EMP /MO	100	\$39.79
CYBINBR PERP <10K ENH \$ /100EMP /MO	100	\$23.88
CYBINBR PERP <25K ENH \$ /100EMP /MO	100	\$15.92
CYBINBR PERP <50K ENH \$ /100EMP /MO	100	\$12.73
CYBINBR PERP <75K ENH \$ /100EMP /MO	100	\$9.55
CYBINBR PERP <100K ENH \$ /100EMP /MO	100	\$7.96
CYBINBR PERP >100K ENH \$ /100EMP /MO	100	\$6.37
BASIC MAINT PERP 0-1500K	1	\$367.50
BASIC MAINT PERP 1501K-5K	1	\$1,050.00
BASIC MAINT PERP 5001K-40K	1	\$1,440.00
BASIC MAINT PERP 40001K-100K	1	\$2,100.00
BASIC MAINT PERP G100K	1	\$2,887.50
FST1>100KPerpBas w/1ODA cost /1Kemp /mo	1000	\$21.00
ENH MAINT PERP 0-1500K	1	\$510.42
ENH MAINT PERP 1501K-5K	1	\$1,458.33
ENH MAINT PERP 5001K-40K	1	\$2,000.00
ENH MAINT PERP 40001K-100K	1	\$2,916.67
ENH MAINT PERP G100K	1	\$4,010.42
FST1>100KPerpEnh w/1ODA cost /1Kemp /mo	1000	\$29.17
BASIC MAINT PERP 0-1500K	1	\$183.75
BASIC MAINT PERP 1501K-5K	1	\$525.00
BASIC MAINT PERP 5001K-40K	1	\$720.00
BASIC MAINT PERP 40001K-100K	1	\$1,050.00
BASIC MAINT PERP G100K	1	\$1,443.75
FST2>100KPerpBas w/1ODA cost /1Kemp /mo	1000	\$10.50
ENH MAINT PERP 0-1500K	1	\$255.21
ENH MAINT PERP 1501K-5K	1	\$729.17
ENH MAINT PERP 5001K-40K	1	\$1,000.00
ENH MAINT PERP 40001K-100K	1	\$1,458.33
ENH MAINT PERP G100K	1	\$2,005.21
FST2>100KPerpEnh w/1ODA cost /1Kemp /mo	1000	\$14.58
BASIC MAINT TERM PER MONTH 0-1500K	1	\$0.00
BASIC MAINT TERM PER MONTH 1501K-5K	1	\$0.00
BASIC MAINT TERM PER MONTH 5001K-40K	1	\$0.00
BASIC MAINT TERM PER MONTH 40001K-100K	1	\$0.00
BASIC MAINT TERM PER MONTH G100K	1	\$0.00
FST1>100KTermBas w/1ODA cost /1Kemp /mo	1000	\$0.00
ENH MAINT TERM PER MONTH 0-1500K	1	\$40.83
ENH MAINT TERM PER MONTH 1501K-5K	1	\$116.67
ENH MAINT TERM PER MONTH 5001K-40K	1	\$160.42
ENH MAINT TERM PER MONTH 40001K-100K	1	\$233.33
ENH MAINT TERM PER MONTH G100K	1	\$320.83
FST1>100KTermEnh w/1ODA cost /1Kemp /mo	1000	\$2.33

BASIC MAINT TERM PER MONTH 0-1500K	1	\$0.00
BASIC MAINT TERM PER MONTH 1501K-5K	1	\$0.00
BASIC MAINT TERM PER MONTH 5001K-40K	1	\$0.00
BASIC MAINT TERM PER MONTH 40001K-100K	1	\$0.00
BASIC MAINT TERM PER MONTH G100K	1	\$0.00
FST2>100KTermBas w/1ODA cost /1Kemp /mo	1000	\$0.00
ENH MAINT TERM PER MONTH 0-1500K	1	\$20.42
ENH MAINT TERM PER MONTH 1501K-5K	1	\$58.33
ENH MAINT TERM PER MONTH 5001K-40K	1	\$80.21
ENH MAINT TERM PER MONTH 40001K-100K	1	\$116.67
ENH MAINT TERM PER MONTH G100K	1	\$160.42
FST2>100KTermEnh w/1ODA cost /1Kemp /mo	1000	\$1.17
SECOPMgmt User Term Basic Maint	1	\$0.00
SECOPMgmt 0-1500 Term Basic Maint	1	\$0.00
SECOPMgmt 1501-5000Term Basic Maint	1	\$0.00
SECOPMgmt5001-40000Term Basic Maint	1	\$0.00
SECOPMgmt40001-100KTerm Basic Maint	1	\$0.00
SECOPMgmt G100000 Term Basic Maint	1	\$0.00
SECOP>100KTermBas w/1ODA cost /1Kemp /mo	1000	\$0.00
SECOPMgmt User Term Enh Maint	1	\$4.20
SECOPMgmt 0-1500 Term Enh Maint	1	\$81.90
SECOPMgmt 1501-5K Term Enh Maint	1	\$233.80
SECOPMgmt 5001-40K Term Enh Maint	1	\$321.30
SECOPMgmt 40001-100K Term Enh Maint	1	\$466.90
SECOPMgmt G100000 Term Enh Maint	1	\$641.90
SECOP>100KTermEnh w/1ODA cost /1Kemp /mo	1000	\$4.67
SECOPMgmt User Perp Basic Maint	1	\$37.80
SECOPMgmt 0-1500 Perp Basic Maint	1	\$737.10
SECOPMgmt 1501-5K Perp Basic Mnt	1	\$2,104.00
SECOPMgmt 5001-40K Perp Basic Mnt	1	\$2,891.70
SECOPMgmt 40001-100K Perp Basic Mnt	1	\$4,202.10
SECOPMgmt G100K Perp Basic Maint	1	\$5,777.10
SECOP>100KPerpBas w/1ODA cost /1Kemp /mo	1000	\$42.02
SECOPMgmt User Perp Enh Maint	1	\$52.50
SECOPMgmt 0-1500 Perp Enh Maint	1	\$1,023.75
SECOPMgmt 1501-5K Perp Enh Maint	1	\$2,992.50
SECOPMgmt 5001-40K Perp Enh Maint	1	\$4,016.25
SECOPMgmt 40001-100K Perp Enh Mnt	1	\$5,836.25
SECOPMgmt G100000 Perp Enh Maint	1	\$8,023.75
SECOP>100KPerpEnh w/1ODA cost /1Kemp /mo	1000	\$58.36
SECOPMgmt User Perp Maint Upg	1	\$14.70
SECOPMgmt 0-1500 Perp Maint Upg	1	\$286.65
SECOPMgmt 1501-5000 Perp Maint Upg	1	\$818.30
SECOPMgmt 5001-40000 Perp Maint Upg	1	\$1,124.55
SECOPMgmt 40001-100K Perp Maint Upg	1	\$1,634.15
SECOPMgmt G100000 Perp Maint Upg	1	\$2,246.65
SECOP>100KPerpUpg w/1ODA cost /1Kemp /mo	1000	\$16.34

VRM 2000 Term Per Month Basic Maint	1	\$0.00
VRM 2001-5000 Term Per Month Basic Maint	100	\$0.00
VRM 5001-10000 Term Per Month Bas Maint	100	\$0.00
VRM 10001-20000 Term Per Month Bas Maint	100	\$0.00
VRM 20001-30000 Term Per Month Bas Maint	100	\$0.00
VRM 30001-40000 Term Per Month Bas Maint	100	\$0.00
VRM 40001-50000 Term Per Month Bas Maint	100	\$0.00
VRM 50001-75000 Term Per Month Bas Maint	100	\$0.00
VRM 75001-100000 Term Per Month BasMaint	100	\$0.00
VRM 100,000+ Term Per Month Bas Maint	100	\$0.00
VRM 2000 Term Per Month Enh Maint	1	\$66.67
VRM 2001-5000 Term Per Month Enh Maint	100	\$3.33
VRM 5001-10000 Term Per Month Enh Maint	100	\$2.92
VRM 10001-20000 Term Per Month Enh Maint	100	\$2.55
VRM 20001-30000 Term Per Month Enh Maint	100	\$2.23
VRM 30001-40000 Term Per Month Enh Maint	100	\$1.95
VRM 40001-50000 Term Per Month Enh Maint	100	\$1.71
VRM 50001-75000 Term Per Month Enh Maint	100	\$1.50
VRM 75001-100000 Term Per Month EnhMaint	100	\$1.31
VRM 100,000+ Term Per Month Enh Maint	100	\$1.15
VRM 2000 Perp Basic Maint Per Month	1	\$600.00
VRM 2001-5000 Perp Basic Maint Per Month	100	\$30.00
VRM 5001-10000 Perp Basic Maint PerMonth	100	\$26.25
VRM 10001-20000 Perp Bas Maint PerMonth	100	\$22.97
VRM 20001-30000 Perp Bas Maint PerMonth	100	\$20.10
VRM 30001-40000 Perp Bas Maint PerMonth	100	\$17.59
VRM 40001-50000 Perp Bas Maint PerMonth	100	\$15.39
VRM 50001-75000 Perp Bas Maint PerMonth	100	\$13.46
VRM 75001-100000 Perp Bas Maint PerMonth	100	\$11.78
VRM 100,000+ Perp Basic Maint Per Month	100	\$10.31
VRM 2000 Perp Enh Maint Per Month	1	\$833.33
VRM 2001-5000 Perp Enh Maint Per Month	100	\$41.67
VRM 5001-10000 Perp Enh Maint Per Month	100	\$36.46
VRM 10001-20000 Perp Enh Maint Per Month	100	\$31.90
VRM 20001-30000 Perp Enh Maint Per Month	100	\$27.91
VRM 30001-40000 Perp Enh Maint Per Month	100	\$24.42
VRM 40001-50000 Perp Enh Maint Per Month	100	\$21.37
VRM 50001-75000 Perp Enh Maint Per Month	100	\$18.70
VRM 75001-100000 Perp Enh Maint PerMonth	100	\$16.36
VRM 100,000+ Perp Enh Maint Per Month	100	\$14.32
VRM 2000 Perp Maint Upg Per Month	1	\$233.33
VRM 2001-5000 Perp Maint Upg Per Month	100	\$11.67
VRM 5001-10000 Perp Maint Upg Per Month	100	\$10.21
VRM 10001-20000 Perp Maint Upg Per Month	100	\$8.93
VRM 20001-30000 Perp Maint Upg Per Month	100	\$7.82
VRM 30001-40000 Perp Maint Upg Per Month	100	\$6.84
VRM 40001-50000 Perp Maint Upg Per Month	100	\$5.98

VRM 50001-75000 Perp Maint Upg Per Month	100	\$5.24
VRM 75001-100000 Perp Maint Upg PerMonth	100	\$4.58
VRM 100,000+ Perp Maint Upg Per Month	100	\$4.01
RSA Cert Mgr Basic Maint - 1	1	\$0.45
RSA Cert Mgr Basic Maint - 1	1	\$0.39
RSA Cert Mgr Basic Maint - 1	1	\$0.24
RSA Cert Mgr Basic Maint - 1	1	\$0.21
RSA Cert Mgr Basic Maint - 1	1	\$0.17
RSA Cert Mgr Basic Maint - 1	1	\$0.15
RSA Cert Mgr Basic Maint - 1	1	\$0.13
RSA Cert Mgr Basic Maint - 1	1	\$0.11
RSA Cert Mgr Basic Maint - 1	1	\$0.09
RSA Cert Mgr Basic Maint - 1	1	\$0.09
RSA Cert Mgr Basic Maint - 1	1	\$0.08
RSA Cert Mgr Basic Maint - 1	1	\$0.08
RSA Cert Mgr Basic Maint - 1	1	\$0.07
RSA Cert Mgr Basic Maint - 1	1	\$0.07
RSA Cert Mgr Basic Maint - 1	1	\$0.07
RSA Cert Mgr Basic Maint - 1	1	\$0.07
RSA Cert Mgr Basic Maint - 1	1	\$0.07
RSA Cert Mgr Enhanced Maint - 1	1	\$0.63
RSA Cert Mgr Enhanced Maint - 1	1	\$0.54
RSA Cert Mgr Enhanced Maint - 1	1	\$0.34
RSA Cert Mgr Enhanced Maint - 1	1	\$0.30
RSA Cert Mgr Enhanced Maint - 1	1	\$0.24
RSA Cert Mgr Enhanced Maint - 1	1	\$0.21
RSA Cert Mgr Enhanced Maint - 1	1	\$0.18
RSA Cert Mgr Enhanced Maint - 1	1	\$0.15
RSA Cert Mgr Enhanced Maint - 1	1	\$0.13
RSA Cert Mgr Enhanced Maint - 1	1	\$0.12
RSA Cert Mgr Enhanced Maint - 1	1	\$0.11
RSA Cert Mgr Enhanced Maint - 1	1	\$0.11
RSA Cert Mgr Enhanced Maint - 1	1	\$0.10
RSA Cert Mgr Enhanced Maint - 1	1	\$0.10
RSA Cert Mgr Enhanced Maint - 1	1	\$0.10
RSA Cert Mgr Enhanced Maint - 1	1	\$0.09
RSA Cert Mgr Enhanced Maint - 1	1	\$0.09
RSA DLP DC SW Mnt-Bas-1	1	\$0.75
RSA DLP DC SW Mnt-Bas-1	1	\$0.68
RSA DLP DC SW Mnt-Bas-1	1	\$0.61
RSA DLP DC SW Mnt-Bas-1	1	\$0.55
RSA DLP DC SW Mnt-Bas-1	1	\$0.49
RSA DLP DC SW Mnt-Bas-1	1	\$0.44
RSA DLP DC SW Mnt-Bas-1	1	\$0.40
RSA DLP DC SW Mnt-Bas-1	1	\$0.36
RSA DLP DC SW Mnt-Bas-1	1	\$0.32
RSA DLP DC SW Mnt-Bas-1	1	\$0.29

RSA DLP DC SW Mnt-Bas-1	1	\$0.26
RSA DLP DC SW Mnt-Bas-1	1	\$0.24
RSA DLP DC SW Mnt-Bas-1	1	\$0.21
RSA DLP NWMON Mnt-Bas-1	1	\$0.60
RSA DLP NWMON Mnt-Bas-1	1	\$0.56
RSA DLP NWMON Mnt-Bas-1	1	\$0.52
RSA DLP NWMON Mnt-Bas-1	1	\$0.48
RSA DLP NWMON Mnt-Bas-1	1	\$0.45
RSA DLP NWMON Mnt-Bas-1	1	\$0.42
RSA DLP NWMON Mnt-Bas-1	1	\$0.39
RSA DLP NWMON Mnt-Bas-1	1	\$0.36
RSA DLP NWMON Mnt-Bas-1	1	\$0.33
RSA DLP NWMON Mnt-Bas-1	1	\$0.31
RSA DLP NWMON Mnt-Bas-1	1	\$0.29
RSA DLP NWMON Mnt-Bas-1	1	\$0.27
RSA DLP NWMON Mnt-Bas-1	1	\$0.25
RSA DLP NWENF Mnt-BAS-1	1	\$0.60
RSA DLP NWENF Mnt-BAS-1	1	\$0.56
RSA DLP NWENF Mnt-BAS-1	1	\$0.52
RSA DLP NWENF Mnt-BAS-1	1	\$0.48
RSA DLP NWENF Mnt-BAS-1	1	\$0.45
RSA DLP NWENF Mnt-BAS-1	1	\$0.42
RSA DLP NWENF Mnt-BAS-1	1	\$0.39
RSA DLP NWENF Mnt-BAS-1	1	\$0.36
RSA DLP NWENF Mnt-BAS-1	1	\$0.33
RSA DLP NWENF Mnt-BAS-1	1	\$0.31
RSA DLP NWENF Mnt-BAS-1	1	\$0.29
RSA DLP NWENF Mnt-BAS-1	1	\$0.27
RSA DLP NWENF Mnt-BAS-1	1	\$0.25
RSA DLP NWENFUG-Mnt-Bas-1	1	\$0.30
RSA DLP NWENFUG-Mnt-Bas-1	1	\$0.28
RSA DLP NWENFUG-Mnt-Bas-1	1	\$0.26
RSA DLP NWENFUG-Mnt-Bas-1	1	\$0.24
RSA DLP NWENFUG-Mnt-Bas-1	1	\$0.22
RSA DLP NWENFUG-Mnt-Bas-1	1	\$0.21
RSA DLP NWENFUG-Mnt-Bas-1	1	\$0.19
RSA DLP NWENFUG-Mnt-Bas-1	1	\$0.18
RSA DLP NWENFUG-Mnt-Bas-1	1	\$0.17
RSA DLP NWENFUG-Mnt-Bas-1	1	\$0.16
RSA DLP NWENFUG-Mnt-Bas-1	1	\$0.14
RSA DLP NWENFUG-Mnt-Bas-1	1	\$0.13
RSA DLP NWENFUG-Mnt-Bas-1	1	\$0.12
RSA DLP ED SW-Mnt-Bas-1	1	\$0.48
RSA DLP ED SW-Mnt-Bas-1	1	\$0.45
RSA DLP ED SW-Mnt-Bas-1	1	\$0.42
RSA DLP ED SW-Mnt-Bas-1	1	\$0.39
RSA DLP ED SW-Mnt-Bas-1	1	\$0.36

RSA DLP ED SW-Mnt-Bas-1	1	\$0.34
RSA DLP ED SW-Mnt-Bas-1	1	\$0.31
RSA DLP ED SW-Mnt-Bas-1	1	\$0.29
RSA DLP ED SW-Mnt-Bas-1	1	\$0.27
RSA DLP ED SW-Mnt-Bas-1	1	\$0.25
RSA DLP ED SW-Mnt-Bas-1	1	\$0.23
RSA DLP ED SW-Mnt-Bas-1	1	\$0.22
RSA DLP ED SW-Mnt-Bas-1	1	\$0.20
RSA DLP EDEE SW-Mnt-Bas-1	1	\$0.48
RSA DLP EDEE SW-Mnt-Bas-1	1	\$0.45
RSA DLP EDEE SW-Mnt-Bas-1	1	\$0.42
RSA DLP EDEE SW-Mnt-Bas-1	1	\$0.39
RSA DLP EDEE SW-Mnt-Bas-1	1	\$0.36
RSA DLP EDEE SW-Mnt-Bas-1	1	\$0.34
RSA DLP EDEE SW-Mnt-Bas-1	1	\$0.31
RSA DLP EDEE SW-Mnt-Bas-1	1	\$0.29
RSA DLP EDEE SW-Mnt-Bas-1	1	\$0.27
RSA DLP EDEE SW-Mnt-Bas-1	1	\$0.25
RSA DLP EDEE SW-Mnt-Bas-1	1	\$0.23
RSA DLP EDEE SW-Mnt-Bas-1	1	\$0.22
RSA DLP EDEE SW-Mnt-Bas-1	1	\$0.20
RSA DLP EDEEB SW-Mnt-Bas-1	1	\$0.73
RSA DLP EDEEB SW-Mnt-Bas-1	1	\$0.68
RSA DLP EDEEB SW-Mnt-Bas-1	1	\$0.63
RSA DLP EDEEB SW-Mnt-Bas-1	1	\$0.58
RSA DLP EDEEB SW-Mnt-Bas-1	1	\$0.54
RSA DLP EDEEB SW-Mnt-Bas-1	1	\$0.50
RSA DLP EDEEB SW-Mnt-Bas-1	1	\$0.47
RSA DLP EDEEB SW-Mnt-Bas-1	1	\$0.44
RSA DLP EDEEB SW-Mnt-Bas-1	1	\$0.41
RSA DLP EDEEB SW-Mnt-Bas-1	1	\$0.38
RSA DLP EDEEB SW-Mnt-Bas-1	1	\$0.35
RSA DLP EDEEB SW-Mnt-Bas-1	1	\$0.33
RSA DLP EDEEB SW-Mnt-Bas-1	1	\$0.30
RSA DLP DCEDB SW-Mnt-Bas-1	1	\$0.93
RSA DLP DCEDB SW-Mnt-Bas-1	1	\$0.84
RSA DLP DCEDB SW-Mnt-Bas-1	1	\$0.77
RSA DLP DCEDB SW-Mnt-Bas-1	1	\$0.70
RSA DLP DCEDB SW-Mnt-Bas-1	1	\$0.64
RSA DLP DCEDB SW-Mnt-Bas-1	1	\$0.58
RSA DLP DCEDB SW-Mnt-Bas-1	1	\$0.53
RSA DLP DCEDB SW-Mnt-Bas-1	1	\$0.49
RSA DLP DCEDB SW-Mnt-Bas-1	1	\$0.45
RSA DLP DCEDB SW-Mnt-Bas-1	1	\$0.41
RSA DLP DCEDB SW-Mnt-Bas-1	1	\$0.37
RSA DLP DCEDB SW-Mnt-Bas-1	1	\$0.34
RSA DLP DCEDB SW-Mnt-Bas-1	1	\$0.31

RSA DLP NMEFB SW-Mnt-Bas-1	1	\$0.84
RSA DLP NMEFB SW-Mnt-Bas-1	1	\$0.78
RSA DLP NMEFB SW-Mnt-Bas-1	1	\$0.72
RSA DLP NMEFB SW-Mnt-Bas-1	1	\$0.67
RSA DLP NMEFB SW-Mnt-Bas-1	1	\$0.63
RSA DLP NMEFB SW-Mnt-Bas-1	1	\$0.43
RSA DLP NMEFB SW-Mnt-Bas-1	1	\$0.54
RSA DLP NMEFB SW-Mnt-Bas-1	1	\$0.50
RSA DLP NMEFB SW-Mnt-Bas-1	1	\$0.47
RSA DLP NMEFB SW-Mnt-Bas-1	1	\$0.43
RSA DLP NMEFB SW-Mnt-Bas-1	1	\$0.40
RSA DLP NMEFB SW-Mnt-Bas-1	1	\$0.38
RSA DLP NMEFB SW-Mnt-Bas-1	1	\$0.35
RSA DLP DLPSTE SW-Mnt-Bas-1	1	\$1.96
RSA DLP DLPSTE SW-Mnt-Bas-1	1	\$1.81
RSA DLP DLPSTE SW-Mnt-Bas-1	1	\$1.66
RSA DLP DLPSTE SW-Mnt-Bas-1	1	\$1.53
RSA DLP DLPSTE SW-Mnt-Bas-1	1	\$1.41
RSA DLP DLPSTE SW-Mnt-Bas-1	1	\$1.30
RSA DLP DLPSTE SW-Mnt-Bas-1	1	\$1.20
RSA DLP DLPSTE SW-Mnt-Bas-1	1	\$1.10
RSA DLP DLPSTE SW-Mnt-Bas-1	1	\$1.02
RSA DLP DLPSTE SW-Mnt-Bas-1	1	\$0.94
RSA DLP DLPSTE SW-Mnt-Bas-1	1	\$0.86
RSA DLP DLPSTE SW-Mnt-Bas-1	1	\$0.80
RSA DLP DLPSTE SW-Mnt-Bas-1	1	\$0.74
RSA DLP Cont App Mnt-Bas-1	1	\$120.00
RSA DLP ICAP Svr App Mnt-Bas-1	1	\$120.00
RSA DLP Interceptor App Mnt-Bas-1	1	\$120.00
RSA DLP Sensor App Mnt-Bas-1	1	\$180.00
1M Bas DLP Network Sensor Appl. Series 2	1	\$240.00
1M Bas DLP Network Interceptor App Ser 2	1	\$210.00
1M Bas DLP Network ICAP Srv Appl. Ser 2	1	\$210.00
1M Bas DLP Network Controller Appl Ser 2	1	\$210.00
DLP Controller Appl EOS 2014 BscMnt 1Mo	1	\$120.00
DLP Sensor Appl EOS 2014 BscMnt 1Mo	1	\$180.00
DLP ICAP Appl EOS 2014 BscMnt 1Mo	1	\$120.00
DLP Inteceptor Appl EOS 2014 BscMnt 1Mo	1	\$120.00
RSA DLP DC SW Mnt-Enh-1	1	\$1.04
RSA DLP DC SW Mnt-Enh-1	1	\$0.94
RSA DLP DC SW Mnt-Enh-1	1	\$0.84
RSA DLP DC SW Mnt-Enh-1	1	\$0.76
RSA DLP DC SW Mnt-Enh-1	1	\$0.68
RSA DLP DC SW Mnt-Enh-1	1	\$0.62
RSA DLP DC SW Mnt-Enh-1	1	\$0.55
RSA DLP DC SW Mnt-Enh-1	1	\$0.50
RSA DLP DC SW Mnt-Enh-1	1	\$0.45

RSA DLP DC SW Mnt-Enh-1	1	\$0.40
RSA DLP DC SW Mnt-Enh-1	1	\$0.36
RSA DLP DC SW Mnt-Enh-1	1	\$0.33
RSA DLP DC SW Mnt-Enh-1	1	\$0.29
RSA DLP NWMON Mnt-Enh-1	1	\$0.83
RSA DLP NWMON Mnt-Enh-1	1	\$0.77
RSA DLP NWMON Mnt-Enh-1	1	\$0.72
RSA DLP NWMON Mnt-Enh-1	1	\$0.67
RSA DLP NWMON Mnt-Enh-1	1	\$0.62
RSA DLP NWMON Mnt-Enh-1	1	\$0.58
RSA DLP NWMON Mnt-Enh-1	1	\$0.54
RSA DLP NWMON Mnt-Enh-1	1	\$0.50
RSA DLP NWMON Mnt-Enh-1	1	\$0.46
RSA DLP NWMON Mnt-Enh-1	1	\$0.43
RSA DLP NWMON Mnt-Enh-1	1	\$0.40
RSA DLP NWMON Mnt-Enh-1	1	\$0.37
RSA DLP NWMON Mnt-Enh-1	1	\$0.35
RSA DLP NWENF Mnt-Enh-1	1	\$0.83
RSA DLP NWENF Mnt-Enh-1	1	\$0.77
RSA DLP NWENF Mnt-Enh-1	1	\$0.72
RSA DLP NWENF Mnt-Enh-1	1	\$0.67
RSA DLP NWENF Mnt-Enh-1	1	\$0.62
RSA DLP NWENF Mnt-Enh-1	1	\$0.58
RSA DLP NWENF Mnt-Enh-1	1	\$0.54
RSA DLP NWENF Mnt-Enh-1	1	\$0.50
RSA DLP NWENF Mnt-Enh-1	1	\$0.46
RSA DLP NWENF Mnt-Enh-1	1	\$0.43
RSA DLP NWENF Mnt-Enh-1	1	\$0.40
RSA DLP NWENF Mnt-Enh-1	1	\$0.37
RSA DLP NWENF Mnt-Enh-1	1	\$0.35
RSA DLP NWENFUG-Mnt-Enh-1	1	\$0.41
RSA DLP NWENFUG-Mnt-Enh-1	1	\$0.39
RSA DLP NWENFUG-Mnt-Enh-1	1	\$0.36
RSA DLP NWENFUG-Mnt-Enh-1	1	\$0.33
RSA DLP NWENFUG-Mnt-Enh-1	1	\$0.31
RSA DLP NWENFUG-Mnt-Enh-1	1	\$0.29
RSA DLP NWENFUG-Mnt-Enh-1	1	\$0.27
RSA DLP NWENFUG-Mnt-Enh-1	1	\$0.25
RSA DLP NWENFUG-Mnt-Enh-1	1	\$0.23
RSA DLP NWENFUG-Mnt-Enh-1	1	\$0.22
RSA DLP NWENFUG-Mnt-Enh-1	1	\$0.20
RSA DLP NWENFUG-Mnt-Enh-1	1	\$0.19
RSA DLP NWENFUG-Mnt-Enh-1	1	\$0.17
RSA DLP ED SW-Mnt-Enh-1	1	\$0.67
RSA DLP ED SW-Mnt-Enh-1	1	\$0.63
RSA DLP ED SW-Mnt-Enh-1	1	\$0.58
RSA DLP ED SW-Mnt-Enh-1	1	\$0.54

RSA DLP ED SW-Mnt-Enh-1	1	\$0.50
RSA DLP ED SW-Mnt-Enh-1	1	\$0.47
RSA DLP ED SW-Mnt-Enh-1	1	\$0.43
RSA DLP ED SW-Mnt-Enh-1	1	\$0.40
RSA DLP ED SW-Mnt-Enh-1	1	\$0.38
RSA DLP ED SW-Mnt-Enh-1	1	\$0.35
RSA DLP ED SW-Mnt-Enh-1	1	\$0.33
RSA DLP ED SW-Mnt-Enh-1	1	\$0.30
RSA DLP ED SW-Mnt-Enh-1	1	\$0.28
RSA DLP EDEE SW-Mnt-Enh-1	1	\$0.67
RSA DLP EDEE SW-Mnt-Enh-1	1	\$0.63
RSA DLP EDEE SW-Mnt-Enh-1	1	\$0.58
RSA DLP EDEE SW-Mnt-Enh-1	1	\$0.54
RSA DLP EDEE SW-Mnt-Enh-1	1	\$0.50
RSA DLP EDEE SW-Mnt-Enh-1	1	\$0.47
RSA DLP EDEE SW-Mnt-Enh-1	1	\$0.43
RSA DLP EDEE SW-Mnt-Enh-1	1	\$0.40
RSA DLP EDEE SW-Mnt-Enh-1	1	\$0.38
RSA DLP EDEE SW-Mnt-Enh-1	1	\$0.35
RSA DLP EDEE SW-Mnt-Enh-1	1	\$0.33
RSA DLP EDEE SW-Mnt-Enh-1	1	\$0.30
RSA DLP EDEE SW-Mnt-Enh-1	1	\$0.28
RSA DLP EDEEB SW-Mnt-Enh-1	1	\$1.01
RSA DLP EDEEB SW-Mnt-Enh-1	1	\$0.94
RSA DLP EDEEB SW-Mnt-Enh-1	1	\$0.87
RSA DLP EDEEB SW-Mnt-Enh-1	1	\$0.81
RSA DLP EDEEB SW-Mnt-Enh-1	1	\$0.75
RSA DLP EDEEB SW-Mnt-Enh-1	1	\$0.70
RSA DLP EDEEB SW-Mnt-Enh-1	1	\$0.65
RSA DLP EDEEB SW-Mnt-Enh-1	1	\$0.61
RSA DLP EDEEB SW-Mnt-Enh-1	1	\$0.56
RSA DLP EDEEB SW-Mnt-Enh-1	1	\$0.52
RSA DLP EDEEB SW-Mnt-Enh-1	1	\$0.49
RSA DLP EDEEB SW-Mnt-Enh-1	1	\$0.45
RSA DLP EDEEB SW-Mnt-Enh-1	1	\$0.42
RSA DLP DCEDB SW-Mnt-Enh-1	1	\$1.29
RSA DLP DCEDB SW-Mnt-Enh-1	1	\$1.17
RSA DLP DCEDB SW-Mnt-Enh-1	1	\$1.07
RSA DLP DCEDB SW-Mnt-Enh-1	1	\$0.97
RSA DLP DCEDB SW-Mnt-Enh-1	1	\$0.89
RSA DLP DCEDB SW-Mnt-Enh-1	1	\$0.81
RSA DLP DCEDB SW-Mnt-Enh-1	1	\$0.74
RSA DLP DCEDB SW-Mnt-Enh-1	1	\$0.68
RSA DLP DCEDB SW-Mnt-Enh-1	1	\$0.62
RSA DLP DCEDB SW-Mnt-Enh-1	1	\$0.56
RSA DLP DCEDB SW-Mnt-Enh-1	1	\$0.52
RSA DLP DCEDB SW-Mnt-Enh-1	1	\$0.47

RSA DLP DCEDB SW-Mnt-Enh-1	1	\$0.43
RSA DLP NMEFB SW-Mnt-Enh-1	1	\$1.16
RSA DLP NMEFB SW-Mnt-Enh-1	1	\$1.08
RSA DLP NMEFB SW-Mnt-Enh-1	1	\$1.00
RSA DLP NMEFB SW-Mnt-Enh-1	1	\$0.93
RSA DLP NMEFB SW-Mnt-Enh-1	1	\$0.87
RSA DLP NMEFB SW-Mnt-Enh-1	1	\$0.60
RSA DLP NMEFB SW-Mnt-Enh-1	1	\$0.75
RSA DLP NMEFB SW-Mnt-Enh-1	1	\$0.70
RSA DLP NMEFB SW-Mnt-Enh-1	1	\$0.65
RSA DLP NMEFB SW-Mnt-Enh-1	1	\$0.60
RSA DLP NMEFB SW-Mnt-Enh-1	1	\$0.56
RSA DLP NMEFB SW-Mnt-Enh-1	1	\$0.52
RSA DLP NMEFB SW-Mnt-Enh-1	1	\$0.49
RSA DLP DLPSTE SW-Mnt-Enh-1	1	\$2.73
RSA DLP DLPSTE SW-Mnt-Enh-1	1	\$2.51
RSA DLP DLPSTE SW-Mnt-Enh-1	1	\$2.31
RSA DLP DLPSTE SW-Mnt-Enh-1	1	\$2.13
RSA DLP DLPSTE SW-Mnt-Enh-1	1	\$1.96
RSA DLP DLPSTE SW-Mnt-Enh-1	1	\$1.81
RSA DLP DLPSTE SW-Mnt-Enh-1	1	\$1.66
RSA DLP DLPSTE SW-Mnt-Enh-1	1	\$1.53
RSA DLP DLPSTE SW-Mnt-Enh-1	1	\$1.41
RSA DLP DLPSTE SW-Mnt-Enh-1	1	\$1.30
RSA DLP DLPSTE SW-Mnt-Enh-1	1	\$1.20
RSA DLP DLPSTE SW-Mnt-Enh-1	1	\$1.11
RSA DLP DLPSTE SW-Mnt-Enh-1	1	\$1.02
RSA DLP Cont App Mnt-Enh-1	1	\$166.67
RSA DLP ICAP Svr App Mnt-Enh-1	1	\$166.67
RSA DLP Interceptor App Mnt-Enh-1	1	\$166.67
RSA DLP Sensor App Mnt-Enh-1	1	\$250.00
1M Enh DLP Network Sensor Appl. Series 2	1	\$333.33
1M Enh DLP Network Interceptor App Ser 2	1	\$291.67
1M Enh DLP Network ICAP Srv Appl. Ser 2	1	\$291.67
1M Enh DLP Network Controller Appl Ser 2	1	\$291.67
DLP Controller Appl EOS 2014 EnhMnt 1Mo	1	\$166.67
DLP Sensor Appl EOS 2014 EnhMnt 1Mo	1	\$250.00
DLP ICAP Appl EOS 2014 EnhMnt 1Mo	1	\$166.67
DLP Inteceptor Appl EOS 2014 EnhMnt 1Mo	1	\$166.67
Data Retention Support Very Small 1Mo	1	\$25.00
Data Retention Support Small 1Mo	1	\$50.00
Data Retention Support Medium 1Mo	1	\$75.00
Data Retention Support Large 1Mo	1	\$100.00
Data Retention Support Very Large 1Mo	1	\$200.00
Archer Custom Training	1	Quoted
RSA Archer AA for Public Sector	1	\$15,000.00
RSA Archer Administration (4 day class up to 10 students)	1	\$30,000.00

RSA Archer Advanced Administration (4 day class up to 10 students)	1	\$30,000.00
RSA Archer GRC 6 Administration I	1	\$30,000.00
RSA Archer GRC 6 Admin I OD Classroom	1	\$4,000.00
RSA Archer GRC 6 Administration II	1	\$30,000.00
RSA Archer GRC 6 Admin II OD Classroom	1	\$4,000.00
Archer End User Training Services eLearning	1	\$40,000.00
Archer End User Training Services ILT	1	\$50,000.00
Archer Custom End User Training Services TTT	1	\$30,000.00
RSA Archer 6: Adv. Workflow & Navigation	1	\$7,500.00
RSA Archer Adv Workflow & Nav ODC	1	\$1,000.00
RSA Archer 6: Reporting & Navigation	1	\$7,500.00
RSA Archer Reporting & Nav. OD Classroom	1	\$1,000.00
RSA Archer 6: Plat Fund for Biz Users	1	\$7,500.00
RSA Archer Fund for Business Users ODC	1	\$1,000.00
RSA Archer Add'l Student / day - onsite	1	\$750.00
RSA Archer On-Demand (OD) Subscription (12 months) - Admin Users: includes all OD Classroom, OD Labs and OD Learning	1	\$5,000.00
RSA Archer On-Demand (OD) Subscription (12 months) - Business Users: includes Platform Fund OD Classroom; plus OD Labs & OD Learning	1	\$1,500.00
RSA Archer Infrastructure Administration	1	\$15,000.00
RSA Archer Extra Week virtual lab/pers	1	\$500.00
RSA Archer Installation	1	\$500.00
RSA Archer Infra & Maint Best Practices	1	\$500.00
RSA Archer Self-Guided Exploration Lab	1	\$500.00
RSA Archer Training Credit	1	\$1.00
Security Awareness Role-Based Custom	1	Quoted
RSA Security Awareness Assessment Custom	1	Quoted
RSA SecurID Suite Training Credit	1	\$1.00
Auth Manager Custom Training	1	Quoted
RSA SID Access EE Implementation	1	\$37,500.00
RSA SecurID Access Install & Config	1	\$22,500.00
Auth Manager Install & config dedicated	1	\$15,000.00
RSA Auth Mgr Installation & Config ODC	1	\$2,000.00
Authentication Manager Administration	1	\$15,000.00
RSA Auth Manager Admin OD Classroom	1	\$2,000.00
RSA SecurID Help Desk Basics Onsite (1 day class up to 10 students)	1	\$7,500.00
RSA AM Add'l Student / day - onsite	1	\$750.00
RSA SecurID Access On-Demand (OD) Subscription Level 1 (12 months): includes all OD Classroom, OD Labs and OD Learning	1	\$3,500.00
RSA SecurID Access On-Demand (OD) Subscription Level 2 (12 months): includes all OD Labs and ODLearning	1	\$1,500.00
RSA SecurID Extra Week virtual lab/pers	1	\$500.00
RSA IGL & AM Integration - Collecting	1	\$500.00
RSA IGL & AM Integration - Provisioning	1	\$500.00
RSA Auth Manager Help Desk Proficiency	1	\$500.00
RSA Authentication Manager Migration	1	\$500.00
RSA Authentication Manager Integration Services Installation & Configuration	1	\$500.00
RSA Authentication Manager Prime Workshop	1	\$500.00
RSA NetWitness Logs and Network Foundations	1	\$22,500.00

RSA NW L&P Foundations OD Classroom	1	\$3,000.00
RSA NetWitness for Logs OD Classroom	1	\$4,000.00
RSA NW Endpoint Foundations OD Classroom	1	\$1,000.00
RSA NW Endpoint Analysis OD Classroom	1	\$2,000.00
RSA NetWitness Logs and Network Core Administration	1	\$15,000.00
RSA NW L&P Core Admin OD Classroom	1	\$2,000.00
RSA Hunting Workshop for Analysts	1	\$15,000.00
RSA NetWitness Endpoint Foundations	1	\$7,500.00
RSA NetWitness Endpoint Analysis	1	\$15,000.00
RSA NetWitness Logs and Network Analysis	1	\$15,000.00
RSA NW L&P Analysis OD Classroom	1	\$2,000.00
RSA NetWitness Suite Add'l Student / day - onsite	1	\$750.00
RSA NetWitness L&P Admin & Operations	1	\$22,500.00
RSA NetWitness L&P Content Creation	1	\$15,000.00
RSA NetWitness Logs & Network On-Demand (OD) Subscription Level 1 (12 months): includes all OD Classroom, OD Labs and OD Learning	1	\$7,000.00
RSA NetWitness Logs & Network On-Demand (OD) Subscription Level 2 (12 months): includes all OD Labs and OD Learning	1	\$2,000.00
RSA NetWitness Endpoint On-Demand (OD) Subscription Level 1 (12 months): includes all OD Classroom, OD Labs and OD Learning	1	\$2,000.00
RSA NetWitness Endpoint On-Demand (OD) Subscription Level 2 (12 months): includes all OD Labs and OD Learning	1	\$1,000.00
RSA NW Extra Week virtual lab/pers	1	\$500.00
RSA NW Endpoint Installation	1	\$500.00
RSA NW Endpoint Troubleshooting	1	\$500.00
RSA NW Logs & Network Tuning & Optimize	1	\$500.00
RSA NW Network Malware Analysis	1	\$500.00
RSA NetWitness Endpoint Administration	1	\$500.00
RSA NW Logs & Network Using REST API	1	\$500.00
RSA NetWitness Log Parser Creation	1	\$500.00
RSA NW Logs Event Source Configuration	1	\$500.00
RSA NetWitness Platform Training Credit	1	\$1.00
RSA NetWitness Logs and Network Custom	1	Quoted
RSA Identity Governance and Lifecycle Administration	1	\$30,000.00
RSA Identity G&L Administration ODC	1	\$4,000.00
RSA Identity Governance and Lifecycle Installation Series: Software Bundle with RSA Supplied Database	1	\$500.00
RSA Identity Governance and Lifecycle Installation Series: Software Bundle with Customer Supplied Database	1	\$500.00
RSA Identity Governance and Lifecycle Installation Series: Hardware Appliance Reinstall with Local Database	1	\$500.00
RSA Identity Governance and Lifecycle Installation Series: WebLogic	1	\$500.00
RSA Identity Governance and Lifecycle Installation Series: WebSphere	1	\$500.00
RSA Identity Governance and Lifecycle Quick Start Solution - lifecycle	1	\$500.00
RSA Identity Governance and Lifecycle Implementation Scenario: Identity Collectors	1	\$500.00
RSA Identity Governance and Lifecycle Implementation Scenario: Account Collectors	1	\$500.00
RSA Identity Governance and Lifecycle Implementation Scenario: Entitlement Collectors	1	\$500.00
RSA IGL Quick Start Solution: Governance	1	\$500.00
RSA Identity Governance & Lifecycle Understanding Workflows End to End	1	\$500.00
RSA Identity Governance & Lifecycle Implementation Scenario: Access Certifications	1	\$500.00

RSA ID Governance & Lifecycle On-Demand (OD) Subscription Level 1 (12 months): includes all OD Classroom, OD Labs and OD Learning	1	\$6,000.00
RSA ID Governance & Lifecycle On-Demand (OD) Subscription Level 2 (12 months): includes all OD Labs and OD Learning	1	\$3,000.00
RSA Identity Governance and Lifecycle Training Credit	1	\$1.00
RSA Identity Governance and Lifecycle Custom	1	Quoted
RSA Certified Information Systems Security Professional (CISSP) Certification Review	1	\$3,700.00
RSA Certified Information Systems Security Professional (CISSP) Certification Review Onsite	1	\$27,500.00
RSA Certified Ethical Hacking Course	1	\$3,700.00
RSA Certified Ethical Hacking - Onsite	1	\$27,500.00
SID Soft Token E-Dlvry 6 mo 10-250	1	\$19.25
SID Soft Token E-Dlvry 6 mo 255-750	1	\$17.50
SID Soft Token E-Dlvry 6 mo 755-1500	1	\$16.50
SID Soft Token E-Dlvry 6 mo 1505-2500	1	\$15.25
SID Soft Token E-Dlvry 6 mo 2505-5K	1	\$13.25
SID Soft Token E-Dlvry 6 mo 5005-7500	1	\$11.00
SID Soft Token E-Dlvry 6 mo 7505-10K	1	\$10.00
SID Soft Token E-Dlvry 6 mo 10005-15K	1	\$9.00
SID Soft Token E-Dlvry 6 mo 15005-25K	1	\$8.00
SID Soft Token E-Dlvry 6 mo 25005-1M	1	\$6.50
SID Soft Token E-Dlvry 12 mo 10-250	1	\$25.50
SID Soft Token E-Dlvry 12 mo 255-750	1	\$23.25
SID Soft Token E-Dlvry 12 mo 755-1500	1	\$22.00
SID Soft Token E-Dlvry 12 mo 1505-2500	1	\$20.25
SID Soft Token E-Dlvry 12 mo 2505-5K	1	\$17.50
SID Soft Token E-Dlvry 12 mo 5005-7500	1	\$14.75
SID Soft Token E-Dlvry 12 mo 7505-10K	1	\$13.25
SID Soft Token E-Dlvry 12 mo 10005-15K	1	\$12.00
SID Soft Token E-Dlvry 12 mo 15005-25K	1	\$10.50
SID Soft Token E-Dlvry 12 mo 25005-1M	1	\$8.75
SID Soft Token E-Dlvry 24 mo 10-250	1	\$34.00
SID Soft Token E-Dlvry 24 mo 255-750	1	\$31.00
SID Soft Token E-Dlvry 24 mo 755-1500	1	\$29.50
SID Soft Token E-Dlvry 24 mo 1505-2500	1	\$27.00
SID Soft Token E-Dlvry 24 mo 2505-5K	1	\$23.50
SID Soft Token E-Dlvry 24 mo 5005-7500	1	\$19.50
SID Soft Token E-Dlvry 24 mo 7505-10K	1	\$17.50
SID Soft Token E-Dlvry 24 mo 10005-15K	1	\$16.00
SID Soft Token E-Dlvry 24 mo 15005-25K	1	\$14.00
SID Soft Token E-Dlvry 24 mo 25005-1M	1	\$11.50
SID Soft Token E-Dlvry 36 mo 10-250	1	\$49.50
SID Soft Token E-Dlvry 36 mo 255-750	1	\$45.50
SID Soft Token E-Dlvry 36 mo 755-1500	1	\$43.25
SID Soft Token E-Dlvry 36 mo 1505-2500	1	\$40.75
SID Soft Token E-Dlvry 36 mo 2505-5K	1	\$36.75
SID Soft Token E-Dlvry 36 mo 5005-7500	1	\$32.00
SID Soft Token E-Dlvry 36 mo 7505-10K	1	\$28.75
SID Soft Token E-Dlvry 36 mo 10005-15K	1	\$27.25

SID Soft Token E-Dlvry 36 mo 15005-25K	1	\$24.00
SID Soft Token E-Dlvry 36 mo 25005-1M	1	\$22.50
SID Soft Token E-Dlvry 48 mo 10-250	1	\$59.25
SID Soft Token E-Dlvry 48 mo 255-750	1	\$54.50
SID Soft Token E-Dlvry 48 mo 755-1500	1	\$52.00
SID Soft Token E-Dlvry 48 mo 1505-2500	1	\$48.75
SID Soft Token E-Dlvry 48 mo 2505-5K	1	\$44.00
SID Soft Token E-Dlvry 48 mo 5005-7500	1	\$38.50
SID Soft Token E-Dlvry 48 mo 7505-10K	1	\$34.50
SID Soft Token E-Dlvry 48 mo 10005-15K	1	\$32.50
SID Soft Token E-Dlvry 48 mo 15005-25K	1	\$28.75
SID Soft Token E-Dlvry 48 mo 25005-1M	1	\$26.50
SID Soft Token E-Dlvry 60 mo 10-250	1	\$68.75
SID Soft Token E-Dlvry 60 mo 255-750	1	\$62.50
SID Soft Token E-Dlvry 60 mo 755-1500	1	\$59.25
SID Soft Token E-Dlvry 60 mo 1505-2500	1	\$54.50
SID Soft Token E-Dlvry 60 mo 2505-5K	1	\$48.50
SID Soft Token E-Dlvry 60 mo 5005-7500	1	\$42.75
SID Soft Token E-Dlvry 60 mo 7505-10K	1	\$38.00
SID Soft Token E-Dlvry 60 mo 10005-15K	1	\$36.50
SID Soft Token E-Dlvry 60 mo 15005-25K	1	\$33.25
SID Soft Token E-Dlvry 60 mo 25005-1M	1	\$30.75
SID Soft Token E-Dlvry 120 mo 10-250	1	\$82.50
SID Soft Token E-Dlvry 120 mo 255-750	1	\$75.00
SID Soft Token E-Dlvry 120 mo 755-1500	1	\$71.00
SID Soft Token E-Dlvry 120 mo 1505-2500	1	\$65.50
SID Soft Token E-Dlvry 120 mo 2505-5K	1	\$58.25
SID Soft Token E-Dlvry 120 mo 5005-7500	1	\$51.25
SID Soft Token E-Dlvry 120 mo 7505-10K	1	\$45.50
SID Soft Token E-Dlvry 120 mo 10005-15K	1	\$43.80
SID Soft Token E-Dlvry 120 mo 15005-25K	1	\$40.00
SID Soft Token E-Dlvry 120 mo 25005-1M	1	\$37.00
SID Soft Tkn E-Dlvry Sub 10-250 1Mo	1	\$1.23
SID Soft Tkn E-Dlvry Sub 255-750 1Mo	1	\$1.14
SID Soft Tkn E-Dlvry Sub 755-1500 1Mo	1	\$1.08
SID Soft Tkn E-Dlvry Sub 1500-2500 1Mo	1	\$1.02
SID Soft Tkn E-Dlvry Sub 2505-5000 1Mo	1	\$0.92
SID Soft Tkn E-Dlvry Sub 5005-7500 1Mo	1	\$0.80
SID Soft Tkn E-Dlvry Sub 7505-10000 1Mo	1	\$0.72
SID Soft Tkn E-Dlvry Sub 10005-15000 1Mo	1	\$0.68
SID Soft Tkn E-Dlvry Sub 15005-25000 1Mo	1	\$0.60
SID Soft Tkn E-Dlvry Sub 25005-1Mu 1Mo	1	\$0.55
FA Cyber Intelligence SAS Tier 1 monthly	1	\$5,000.00
FA Cyber Intelligence SAS Tier 2 monthly	1	\$15,000.00
FA Cyber Intelligence SAS Tier 3 monthly	1	\$20,000.00
CCI Standard for 1 year	1	\$48,000.00
CCI Platinum Tier 1 for 1 year	1	\$180,000.00

CCI Platinum Tier 2 for 1 year	1	\$150,000.00
FA Cyber Intelligence SAS Tier 1 for 1yr	1	\$60,000.00
FA Cyber Intelligence SAS Tier 2 for 1yr	1	\$180,000.00
FA Cyber Intelligence SAS Tier 3 for 1yr	1	\$240,000.00
FA FULL SVC 6 ATTACKS MO FEE	1	\$1,270.00
FA FULL SVC 25 ATTACKS MO FEE	1	\$2,300.00
FA FULL SVC 50 ATTACKS MO FEE	1	\$3,800.00
FA FULL SVC 100 ATTACKS MO FEE	1	\$6,100.00
FA FULL SVC 300 ATTACKS MO FEE	1	\$14,000.00
FA FULL SVC 600 ATTACKS MO FEE	1	\$20,500.00
FA FULL SVC 1000 ATTACKS MO FEE	1	\$26,000.00
A-PHISH RESP ONLY 6 ATTACKS MO FEE	1	\$953.00
A-PHISH RESP ONLY 12 ATTACKS MO FEE	1	\$1,245.00
A-PHISH RESP ONLY 25 ATTACKS MO FEE	1	\$1,725.00
A-PHISH RESP ONLY 50 ATTACKS MO FEE	1	\$2,850.00
A-PHISH RESP ONLY 100 ATTACKS MO FEE	1	\$4,575.00
A-PHISH RESP ONLY 6 ATTACKS OVER FEE	1	\$3,900.00
A-PHISH RESP ONLY 12 ATTACKS OVER FEE	1	\$2,500.00
A-PHISH RESP ONLY 25 ATTACKS OVER FEE	1	\$1,700.00
A-PHISH RESP ONLY 50 ATTACKS OVER FEE	1	\$1,400.00
A-PHISH RESP ONLY 100 ATTACKS OVER FEE	1	\$1,100.00
A-PHISH FULL SVC 6 ATTACKS for 1 YEAR	1	\$15,240.00
A-PHISH FULL SVC 12 ATTACKS for 1 YEAR	1	\$19,920.00
A-PHISH FULL SVC 25 ATTACKS for 1 YEAR	1	\$27,600.00
A-PHISH FULL SVC 50 ATTACKS for 1 YEAR	1	\$45,600.00
A-PHISH FULL SVC 100 ATTACKS for 1 YEAR	1	\$73,200.00
A-PHISH FULL SVC 6 ATTACKS - EXTRA INCIDENTS	1	\$15,240.00
A-PHISH FULL SVC 12 ATTACKS - EXTRA INCIDENTS	1	\$19,920.00
A-PHISH FULL SVC 25 ATTACKS - EXTRA INCIDENTS	1	\$27,600.00
A-PHISH FULL SVC 50 ATTACKS - EXTRA INCIDENTS	1	\$45,600.00
A-PHISH FULL SVC 100 ATTACKS - EXTRA INCIDENTS	1	\$73,200.00
A-PHISH FULL SVC SETUP FEE	1	\$8,000.00
RSA FA Anti-Rogue App unlimited detection and up to 6 shutdowns for 1 year	1	\$31,920.00
RSA FA Anti-Rogue App unlimited detection and up to 12 shutdowns for 1 year	1	\$42,000.00
RSA FA Anti-Rogue App unlimited detection and up to 25 shutdowns for 1 year	1	\$50,400.00
RSA FA Anti-Rogue App unlimited detection and up to 50 shutdowns for 1 year	1	\$60,000.00
RSA FA Anti-Rogue App unlimited detection and up to 100 shutdowns for 1 year	1	\$74,400.00
RSA FA Anti-Rogue App unlimited detection and up to 6 shutdowns - EXTRA INCIDENTS	1	\$31,920.00
RSA FA Anti-Rogue App unlimited detection and up to 12 shutdowns - EXTRA INCIDENTS	1	\$42,000.00
RSA FA Anti-Rogue App unlimited detection and up to 25 shutdowns - EXTRA INCIDENTS	1	\$50,400.00
RSA FA Anti-Rogue App unlimited detection and up to 50 shutdowns - EXTRA INCIDENTS	1	\$60,000.00
RSA FA Anti-Rogue App unlimited detection and up to 100 shutdowns - EXTRA INCIDENTS	1	\$74,400.00
RSA FA Anti-Rogue App detection only for 1 year	1	\$39,000.00
RSA FA Anti-Rogue App single shutdown	1	\$900.00
A-TROJAN 6 ATTACKS for 1 YEAR	1	\$9,084.50
A-TROJAN 12 ATTACKS for 1 YEAR	1	\$11,953.31
A-TROJAN 25 ATTACKS for 1 YEAR	1	\$16,601.75

A-TROJAN 50 ATTACKS for 1 YEAR	1	\$27,216.00
A-TROJAN 100 ATTACKS for 1 YEAR	1	\$43,200.00
A-TROJAN 6 ATTACKS - EXTRA INCIDENTS	1	\$9,084.50
A-TROJAN 12 ATTACKS - EXTRA INCIDENTS	1	\$11,953.31
A-TROJAN 25 ATTACKS - EXTRA INCIDENTS	1	\$16,601.75
A-TROJAN 50 ATTACKS - EXTRA INCIDENTS	1	\$27,216.00
A-TROJAN 100 ATTACKS - EXTRA INCIDENTS	1	\$43,200.00
A-TROJAN FULL SVC SETUP FEE	1	\$8,000.00
RSA Fed Identity Mgr Enh Maint -1	1	\$520.83
RSA Fed Identity Mgr Enh Maint -1	1	\$1,041.67
RSA Fed Identity Mgr Enh Maint -1	1	\$2,083.33
RSA Fed Identity Mgr Enh Maint -1	1	\$3,098.96
RSA Fed Identity Mgr Enh Maint -1	1	\$5,000.00
RSA Fed Identity Mgr Enh Maint -1	1	\$6,640.63
RSA Fed Identity Mgr Enh Maint -1	1	\$8,020.83
RSA Fed Identity Mgr Enh Maint -1	1	\$10,000.00
RSA Fed Identity Mgr Enh Maint -1	1	\$11,458.33
RSA Fed Identity Mgr Enh Maint -1	1	\$442.71
RSA Fed Identity Mgr Enh Maint -1	1	\$885.42
RSA Fed Identity Mgr Enh Maint -1	1	\$1,770.83
RSA Fed Identity Mgr Enh Maint -1	1	\$2,634.08
RSA Fed Identity Mgr Enh Maint -1	1	\$4,250.00
RSA Fed Identity Mgr Enh Maint -1	1	\$5,644.54
RSA Fed Identity Mgr Enh Maint -1	1	\$6,817.71
RSA Fed Identity Mgr Enh Maint -1	1	\$8,500.00
RSA Fed Identity Mgr Enh Maint -1	1	\$9,739.58
RSA Gov SAAS 1-1,000 p/100u	100	\$283.00
RSA Gov SAAS 1,001-2,500 p/100u	100	\$254.00
RSA Gov SAAS 2,501-5k p/100u	100	\$239.00
RSA Gov SAAS 5,001-10k p/100u	100	\$227.00
RSA Gov SAAS 10,001-25k p/100u	100	\$216.00
RSA Gov SAAS 25,001-50k p/100u	100	\$203.00
RSA Gov SAAS 50,001-100k p/100u	100	\$193.00
RSA Gov SAAS 100,001-250k p/100u	100	\$183.00
RSA Gov SAAS >250k p/100u	100	\$172.00
RSA GovLT SAAS 1-1,000 p/100u	100	\$40.00
RSA GovLT SAAS 1,001-2,500 p/100u	100	\$36.00
RSA GovLT SAAS 2,501-5k p/100u	100	\$34.00
RSA GovLT SAAS 5,001-10k p/100u	100	\$32.00
RSA GovLT SAAS 10,001-25k p/100u	100	\$31.00
RSA GovLT SAAS 25,001-50k p/100u	100	\$29.00
RSA GovLT SAAS 50,001-100k p/100u	100	\$28.00
RSA GovLT SAAS 100,001-250k p/100u	100	\$26.00
RSA GovLT SAAS >250k p/100u	100	\$25.00
RSA Lif SAAS 1-1,000 p/100u	100	\$598.00
RSA Lif SAAS 1,001-2,500 p/100u	100	\$538.00
RSA Lif SAAS 2,501-5k p/100u	100	\$505.00

RSA Lif SAAS 5,001-10k p/100u	100	\$480.00
RSA Lif SAAS 10,001-25k p/100u	100	\$456.00
RSA Lif SAAS 25,001-50k p/100u	100	\$428.00
RSA Lif SAAS 50,001-100k p/100u	100	\$407.00
RSA Lif SAAS 100,001-250k p/100u	100	\$386.00
RSA Lif SAAS >250k p/100u	100	\$363.00
RSA LifLT SAAS 1-1,000 p/100u	100	\$85.00
RSA LifLT SAAS 1,001-2,500 p/100u	100	\$77.00
RSA LifLT SAAS 2,501-5k p/100u	100	\$72.00
RSA LifLT SAAS 5,001-10k p/100u	100	\$69.00
RSA LifLT SAAS 10,001-25k p/100u	100	\$65.00
RSA LifLT SAAS 25,001-50k p/100u	100	\$61.00
RSA LifLT SAAS 50,001-100k p/100u	100	\$58.00
RSA LifLT SAAS 100,001-250k p/100u	100	\$55.00
RSA LifLT SAAS >250k p/100u	100	\$52.00
RSA Bdl Gov&Lif SAAS 1-1,000 p/100u	100	\$837.00
RSA Bdl Gov&Lif SAAS 1,001-2,500 p/100u	100	\$752.00
RSA Bdl Gov&Lif SAAS 2,501-5k p/100u	100	\$707.00
RSA Bdl Gov&Lif SAAS 5,001-10k p/100u	100	\$671.00
RSA Bdl Gov&Lif SAAS 10,001-25k p/100u	100	\$638.00
RSA Bdl Gov&Lif SAAS 25,001-50k p/100u	100	\$600.00
RSA Bdl Gov&Lif SAAS 50,001-100k p/100u	100	\$569.00
RSA Bdl Gov&Lif SAAS 100,001-250k p/100u	100	\$541.00
RSA Bdl Gov&Lif SAAS >250k p/100u	100	\$509.00
RSA Bdl Gov&LifLT SAAS 1-1,000 p/100u	100	\$120.00
RSA Bdl Gov&LifLT SAAS 1,001-2,500 p/100u	100	\$107.00
RSA Bdl Gov&LifLT SAAS 2,501-5k p/100u	100	\$101.00
RSA Bdl Gov&LifLT SAAS 5,001-10k p/100u	100	\$96.00
RSA Bdl Gov&LifLT SAAS 10,001-25k p/100u	100	\$91.00
RSA Bdl Gov&LifLT SAAS 25,001-50k p/100u	100	\$86.00
RSA Bdl Gov&LifLT SAAS 50K1-100k p/100u	100	\$81.00
RSA Bdl Gov&LifLT SAAS 100K1-250k p/100u	100	\$77.00
RSA Bdl Gov&LifLT SAAS >250k p/100u	100	\$73.00
RSA BRM SAAS 1-1,000 p/100u	100	\$181.00
RSA BRM SAAS 1,001-2,500 p/100u	100	\$162.00
RSA BRM SAAS 2,501-5k p/100u	100	\$153.00
RSA BRM SAAS 5,001-10k p/100u	100	\$145.00
RSA BRM SAAS 10,001-25k p/100u	100	\$138.00
RSA BRM SAAS 25,001-50k p/100u	100	\$130.00
RSA BRM SAAS 50,001-100k p/100u	100	\$123.00
RSA BRM SAAS 100,001-250k p/100u	100	\$117.00
RSA BRM SAAS >250k p/100u	100	\$110.00
RSA BRMLT SAAS 1-1,000 p/100u	100	\$26.00
RSA BRMLT SAAS 1,001-2,500 p/100u	100	\$23.00
RSA BRMLT SAAS 2,501-5k p/100u	100	\$22.00
RSA BRMLT SAAS 5,001-10k p/100u	100	\$21.00
RSA BRMLT SAAS 10,001-25k p/100u	100	\$20.00

RSA BRMLT SAAS 25,001-50k p/100u	100	\$19.00
RSA BRMLT SAAS 50,001-100k p/100u	100	\$18.00
RSA BRMLT SAAS 100,001-250k p/100u	100	\$17.00
RSA BRMLT SAAS >250k p/100u	100	\$16.00
RSA DAG SAAS 1-1,000 p/100u	100	\$212.00
RSA DAG SAAS 1,001-2,500 p/100u	100	\$191.00
RSA DAG SAAS 2,501-5k p/100u	100	\$179.00
RSA DAG SAAS 5,001-10k p/100u	100	\$170.00
RSA DAG SAAS 10,001-25k p/100u	100	\$162.00
RSA DAG SAAS 25,001-50k p/100u	100	\$152.00
RSA DAG SAAS 50,001-100k p/100u	100	\$144.00
RSA DAG SAAS 100,001-250k p/100u	100	\$137.00
RSA DAG SAAS >250k p/100u	100	\$129.00
RSA DAGLT SAAS 1-1,000 p/100u	100	\$30.00
RSA DAGLT SAAS 1,001-2,500 p/100u	100	\$27.00
RSA DAGLT SAAS 2,501-5k p/100u	100	\$26.00
RSA DAGLT SAAS 5,001-10k p/100u	100	\$24.00
RSA DAGLT SAAS 10,001-25k p/100u	100	\$23.00
RSA DAGLT SAAS 25,001-50k p/100u	100	\$22.00
RSA DAGLT SAAS 50,001-100k p/100u	100	\$21.00
RSA DAGLT SAAS 100,001-250k p/100u	100	\$20.00
RSA DAGLT SAAS >250k p/100u	100	\$18.00
RSA InactiveID SAAS 1-1,000 p/100u	100	\$115.00
RSA InactiveID SAAS 1,001-2,500 p/100u	100	\$104.00
RSA InactiveID SAAS 2,501-5k p/100u	100	\$97.00
RSA InactiveID SAAS 5,001-10k p/100u	100	\$93.00
RSA InactiveID SAAS 10,001-25k p/100u	100	\$88.00
RSA InactiveID SAAS 25,001-50k p/100u	100	\$83.00
RSA InactiveID SAAS 50,001-100k p/100u	100	\$79.00
RSA InactiveID SAAS 100,001-250k p/100u	100	\$75.00
RSA InactiveID SAAS >250k p/100u	100	\$70.00
RSA Gov PERP 1-1,000 p/100u	100	\$3,107.00
RSA Gov PERP 1,001-2,500 p/100u	100	\$2,794.00
RSA Gov PERP 2,501-5k p/100u	100	\$2,625.00
RSA Gov PERP 5,001-10k p/100u	100	\$1,915.00
RSA Gov PERP 10,001-25k p/100u	100	\$1,225.00
RSA Gov PERP 25,001-50k p/100u	100	\$1,152.00
RSA Gov PERP 50,001-100k p/100u	100	\$1,094.00
RSA Gov PERP 100,001-250k p/100u	100	\$1,040.00
RSA Gov PERP >250k p/100u	100	\$977.00
RSA Gov PERP 1-1,000 p/100uBMnt	100	\$51.78
RSA Gov PERP 1,001-2,500 p/100uBMnt	100	\$46.57
RSA Gov PERP 2,501-5k p/100uBMnt	100	\$43.75
RSA Gov PERP 5,001-10k p/100uBMnt	100	\$31.92
RSA Gov PERP 10,001-25k p/100uBMnt	100	\$20.42
RSA Gov PERP 25,001-50k p/100uBMnt	100	\$19.20
RSA Gov PERP 50,001-100k p/100uBMnt	100	\$18.23

RSA Gov PERP 100,001-250k p/100uBMnt	100	\$17.33
RSA Gov PERP >250k p/100uBMnt	100	\$16.28
RSA Gov PERP 1-1,000 p/100uEMnt	100	\$64.73
RSA Gov PERP 1,001-2,500 p/100uEMnt	100	\$58.21
RSA Gov PERP 2,501-5k p/100uEMnt	100	\$54.69
RSA Gov PERP 5,001-10k p/100uEMnt	100	\$39.90
RSA Gov PERP 10,001-25k p/100uEMnt	100	\$25.52
RSA Gov PERP 25,001-50k p/100uEMnt	100	\$24.00
RSA Gov PERP 50,001-100k p/100uEMnt	100	\$22.79
RSA Gov PERP 100,001-250k p/100uEMnt	100	\$21.67
RSA Gov PERP >250k p/100uEMnt	100	\$20.35
RSA GovLT PERP 1-1,000 p/100u	100	\$444.00
RSA GovLT PERP 1,001-2,500 p/100u	100	\$399.00
RSA GovLT PERP 2,501-5k p/100u	100	\$375.00
RSA GovLT PERP 5,001-10k p/100u	100	\$274.00
RSA GovLT PERP 10,001-25k p/100u	100	\$175.00
RSA GovLT PERP 25,001-50k p/100u	100	\$165.00
RSA GovLT PERP 50,001-100k p/100u	100	\$156.00
RSA GovLT PERP 100,001-250k p/100u	100	\$149.00
RSA GovLT PERP >250k p/100u	100	\$140.00
RSA GovLT PERP 1-1,000 p/100uBMnt	100	\$7.40
RSA GovLT PERP 1,001-2,500 p/100uBMnt	100	\$6.65
RSA GovLT PERP 2,501-5k p/100uBMnt	100	\$6.25
RSA GovLT PERP 5,001-10k p/100uBMnt	100	\$4.57
RSA GovLT PERP 10,001-25k p/100uBMnt	100	\$2.92
RSA GovLT PERP 25,001-50k p/100uBMnt	100	\$2.75
RSA GovLT PERP 50,001-100k p/100uBMnt	100	\$2.60
RSA GovLT PERP 100,001-250k p/100uBMnt	100	\$2.48
RSA GovLT PERP >250k p/100uBMnt	100	\$2.33
RSA GovLT PERP 1-1,000 p/100uEMnt	100	\$9.25
RSA GovLT PERP 1,001-2,500 p/100uEMnt	100	\$8.31
RSA GovLT PERP 2,501-5k p/100uEMnt	100	\$7.81
RSA GovLT PERP 5,001-10k p/100uEMnt	100	\$5.71
RSA GovLT PERP 10,001-25k p/100uEMnt	100	\$3.65
RSA GovLT PERP 25,001-50k p/100uEMnt	100	\$3.44
RSA GovLT PERP 50,001-100k p/100uEMnt	100	\$3.25
RSA GovLT PERP 100,001-250k p/100uEMnt	100	\$3.10
RSA GovLT PERP >250k p/100uEMnt	100	\$2.92
RSA Lif PERP 1-1,000 p/100u	100	\$6,347.00
RSA Lif PERP 1,001-2,500 p/100u	100	\$5,706.00
RSA Lif PERP 2,501-5k p/100u	100	\$5,362.00
RSA Lif PERP 5,001-10k p/100u	100	\$3,910.00
RSA Lif PERP 10,001-25k p/100u	100	\$2,503.00
RSA Lif PERP 25,001-50k p/100u	100	\$2,352.00
RSA Lif PERP 50,001-100k p/100u	100	\$2,234.00
RSA Lif PERP 100,001-250k p/100u	100	\$2,123.00
RSA Lif PERP >250k p/100u	100	\$1,996.00

RSA Lif PERP 1-1,000 p/100uBMnt	100	\$105.78
RSA Lif PERP 1,001-2,500 p/100uBMnt	100	\$95.10
RSA Lif PERP 2,501-5k p/100uBMnt	100	\$89.37
RSA Lif PERP 5,001-10k p/100uBMnt	100	\$65.17
RSA Lif PERP 10,001-25k p/100uBMnt	100	\$41.72
RSA Lif PERP 25,001-50k p/100uBMnt	100	\$39.20
RSA Lif PERP 50,001-100k p/100uBMnt	100	\$37.23
RSA Lif PERP 100,001-250k p/100uBMnt	100	\$35.38
RSA Lif PERP >250k p/100uBMnt	100	\$33.27
RSA Lif PERP 1-1,000 p/100uEMnt	100	\$132.23
RSA Lif PERP 1,001-2,500 p/100uEMnt	100	\$118.88
RSA Lif PERP 2,501-5k p/100uEMnt	100	\$111.71
RSA Lif PERP 5,001-10k p/100uEMnt	100	\$81.46
RSA Lif PERP 10,001-25k p/100uEMnt	100	\$52.15
RSA Lif PERP 25,001-50k p/100uEMnt	100	\$49.00
RSA Lif PERP 50,001-100k p/100uEMnt	100	\$46.54
RSA Lif PERP 100,001-250k p/100uEMnt	100	\$44.23
RSA Lif PERP >250k p/100uEMnt	100	\$41.58
RSA LifLT PERP 1-1,000 p/100u	100	\$907.00
RSA LifLT PERP 1,001-2,500 p/100u	100	\$815.00
RSA LifLT PERP 2,501-5k p/100u	100	\$766.00
RSA LifLT PERP 5,001-10k p/100u	100	\$559.00
RSA LifLT PERP 10,001-25k p/100u	100	\$358.00
RSA LifLT PERP 25,001-50k p/100u	100	\$336.00
RSA LifLT PERP 50,001-100k p/100u	100	\$319.00
RSA LifLT PERP 100,001-250k p/100u	100	\$303.00
RSA LifLT PERP >250k p/100u	100	\$285.00
RSA LifLT PERP 1-1,000 p/100uBMnt	100	\$15.12
RSA LifLT PERP 1,001-2,500 p/100uBMnt	100	\$13.58
RSA LifLT PERP 2,501-5k p/100uBMnt	100	\$12.77
RSA LifLT PERP 5,001-10k p/100uBMnt	100	\$9.32
RSA LifLT PERP 10,001-25k p/100uBMnt	100	\$5.97
RSA LifLT PERP 25,001-50k p/100uBMnt	100	\$5.60
RSA LifLT PERP 50,001-100k p/100uBMnt	100	\$5.32
RSA LifLT PERP 100,001-250k p/100uBMnt	100	\$5.05
RSA LifLT PERP >250k p/100uBMnt	100	\$4.75
RSA LifLT PERP 1-1,000 p/100uEMnt	100	\$18.90
RSA LifLT PERP 1,001-2,500 p/100uEMnt	100	\$16.98
RSA LifLT PERP 2,501-5k p/100uEMnt	100	\$15.96
RSA LifLT PERP 5,001-10k p/100uEMnt	100	\$11.65
RSA LifLT PERP 10,001-25k p/100uEMnt	100	\$7.46
RSA LifLT PERP 25,001-50k p/100uEMnt	100	\$7.00
RSA LifLT PERP 50,001-100k p/100uEMnt	100	\$6.65
RSA LifLT PERP 100,001-250k p/100uEMnt	100	\$6.31
RSA LifLT PERP >250k p/100uEMnt	100	\$5.94
RSA Bd Gov&Lif PERP 1-1,000 p/100u	100	\$8,981.00
RSA Bd Gov&Lif PERP 1,001-2,500 p/100u	100	\$8,075.00

RSA Bd Gov&Lif PERP 2,501-5k p/100u	100	\$7,588.00
RSA Bd Gov&Lif PERP 5,001-10k p/100u	100	\$5,533.00
RSA Bd Gov&Lif PERP 10,001-25k p/100u	100	\$3,541.00
RSA Bd Gov&Lif PERP 25,001-50k p/100u	100	\$3,328.00
RSA Bd Gov&Lif PERP 50,001-100k p/100u	100	\$3,162.00
RSA Bd Gov&Lif PERP 100,001-250k p/100u	100	\$3,004.00
RSA Bd Gov&Lif PERP >250k p/100u	100	\$2,824.00
RSA Bd Gov&Lif PERP 1-1,000 p/100uBMnt	100	\$149.68
RSA Bd Gov&Lif PERP 1001-2500 p/100uBMnt	100	\$134.58
RSA Bd Gov&Lif PERP 2,501-5k p/100uBMnt	100	\$126.47
RSA Bd Gov&Lif PERP 5,001-10k p/100uBMnt	100	\$92.22
RSA Bd Gov&Lif PERP 10001-25k p/100uBMnt	100	\$59.02
RSA Bd Gov&Lif PERP 25001-50k p/100uBMnt	100	\$55.47
RSA Bd Gov&Lif PERP 50K-100k p/100uBMnt	100	\$52.70
RSA Bd Gov&Lif PERP 100K-250k p/100uBMnt	100	\$50.07
RSA Bd Gov&Lif PERP >250k p/100uBMnt	100	\$47.07
RSA Bd Gov&Lif PERP 1-1,000 p/100uEMnt	100	\$187.10
RSA Bd Gov&Lif PERP 1,001-2,500 p/100uEMnt	100	\$168.23
RSA Bd Gov&Lif PERP 2,501-5k p/100uEMnt	100	\$158.08
RSA Bd Gov&Lif PERP 5,001-10k p/100uEMnt	100	\$115.27
RSA Bd Gov&Lif PERP 10001-25k p/100uEMnt	100	\$73.77
RSA Bd Gov&Lif PERP 25001-50k p/100uEMnt	100	\$69.33
RSA Bd Gov&Lif PERP 50K-100k p/100uEMnt	100	\$65.88
RSA Bd Gov&Lif PERP 100K-250k p/100uEMnt	100	\$62.58
RSA Bd Gov&Lif PERP >250k p/100uEMnt	100	\$58.83
RSA Bd Gov&LifLT PERP 1-1,000 p/100u	100	\$1,283.00
RSA Bd Gov&LifLT PERP 1,001-2,500 p/100u	100	\$1,154.00
RSA Bd Gov&LifLT PERP 2,501-5k p/100u	100	\$1,084.00
RSA Bd Gov&LifLT PERP 5,001-10k p/100u	100	\$790.00
RSA Bd Gov&LifLT PERP 10,001-25k p/100u	100	\$506.00
RSA Bd Gov&LifLT PERP 25,001-50k p/100u	100	\$475.00
RSA Bd Gov&LifLT PERP 50,001-100k p/100u	100	\$452.00
RSA Bd Gov&LifLT PERP 100001-250k p/100u	100	\$429.00
RSA Bd Gov&LifLT PERP >250k p/100u	100	\$403.00
RSA Bd Gov&LifLT PERP 1-1,000 p/100uBMnt	100	\$21.38
RSA Bd Gov&LifLT PERP 1K-2500 p/100uBMnt	100	\$19.23
RSA Bd Gov&LifLT PERP 2501-5k p/100uBMnt	100	\$18.07
RSA Bd Gov&LifLT PERP 5K-10k p/100uBMnt	100	\$13.17
RSA Bd Gov&LifLT PERP 10K-25k p/100uBMnt	100	\$8.43
RSA Bd Gov&LifLT PERP 25K-50k p/100uBMnt	100	\$7.92
RSA Bd Gov&LifLT PERP 50K-100k 100uBMnt	100	\$7.53
RSA Bd Gov&LifLT PERP 100K-250k 100uBMnt	100	\$7.15
RSA Bd Gov&LifLT PERP >250k p/100uBMnt	100	\$6.72
RSA Bd Gov&LifLT PERP 1-1,000 p/100uEMnt	100	\$26.73
RSA Bd Gov&LifLT PERP 1K-2500 p/100uEMnt	100	\$24.04
RSA Bd Gov&LifLT PERP 2501-5k p/100uEMnt	100	\$22.58
RSA Bd Gov&LifLT PERP 5K-10k p/100uEMnt	100	\$16.46

RSA Bd Gov&LifLT PERP 10K-25k p/100uEMnt	100	\$10.54
RSA Bd Gov&LifLT PERP 25K-50k p/100uEMnt	100	\$9.90
RSA Bd Gov&LifLT PERP 50K-100k 100uEMnt	100	\$9.42
RSA Bd Gov&LifLT PERP 100K-250k 100uEMnt	100	\$8.94
RSA Bd Gov&LifLT PERP >250k p/100uEMnt	100	\$8.40
RSA BRM PERP 1-1,000 p/100u	100	\$1,954.00
RSA BRM PERP 1,001-2,500 p/100u	100	\$1,756.00
RSA BRM PERP 2,501-5k p/100u	100	\$1,651.00
RSA BRM PERP 5,001-10k p/100u	100	\$1,203.00
RSA BRM PERP 10,001-25k p/100u	100	\$770.00
RSA BRM PERP 25,001-50k p/100u	100	\$724.00
RSA BRM PERP 50,001-100k p/100u	100	\$687.00
RSA BRM PERP 100,001-250k p/100u	100	\$653.00
RSA BRM PERP >250k p/100u	100	\$614.00
RSA BRM PERP 1-1,000 p/100uBMnt	100	\$32.57
RSA BRM PERP 1,001-2,500 p/100uBMnt	100	\$29.27
RSA BRM PERP 2,501-5k p/100uBMnt	100	\$27.52
RSA BRM PERP 5,001-10k p/100uBMnt	100	\$20.05
RSA BRM PERP 10,001-25k p/100uBMnt	100	\$12.83
RSA BRM PERP 25,001-50k p/100uBMnt	100	\$12.07
RSA BRM PERP 50,001-100k p/100uBMnt	100	\$11.45
RSA BRM PERP 100,001-250k p/100uBMnt	100	\$10.88
RSA BRM PERP >250k p/100uBMnt	100	\$10.23
RSA BRM PERP 1-1,000 p/100uEMnt	100	\$40.71
RSA BRM PERP 1,001-2,500 p/100uEMnt	100	\$36.58
RSA BRM PERP 2,501-5k p/100uEMnt	100	\$34.40
RSA BRM PERP 5,001-10k p/100uEMnt	100	\$25.06
RSA BRM PERP 10,001-25k p/100uEMnt	100	\$16.04
RSA BRM PERP 25,001-50k p/100uEMnt	100	\$15.08
RSA BRM PERP 50,001-100k p/100uEMnt	100	\$14.31
RSA BRM PERP 100,001-250k p/100uEMnt	100	\$13.60
RSA BRM PERP >250k p/100uEMnt	100	\$12.79
RSA BRMLT PERP 1-1,000 p/100u	100	\$279.00
RSA BRMLT PERP 1,001-2,500 p/100u	100	\$251.00
RSA BRMLT PERP 2,501-5k p/100u	100	\$236.00
RSA BRMLT PERP 5,001-10k p/100u	100	\$172.00
RSA BRMLT PERP 10,001-25k p/100u	100	\$110.00
RSA BRMLT PERP 25,001-50k p/100u	100	\$103.00
RSA BRMLT PERP 50,001-100k p/100u	100	\$98.00
RSA BRMLT PERP 100,001-250k p/100u	100	\$93.00
RSA BRMLT PERP >250k p/100u	100	\$88.00
RSA BRMLT PERP 1-1,000 p/100uBMnt	100	\$4.65
RSA BRMLT PERP 1,001-2,500 p/100uBMnt	100	\$4.18
RSA BRMLT PERP 2,501-5k p/100uBMnt	100	\$3.93
RSA BRMLT PERP 5,001-10k p/100uBMnt	100	\$2.87
RSA BRMLT PERP 10,001-25k p/100uBMnt	100	\$1.83
RSA BRMLT PERP 25,001-50k p/100uBMnt	100	\$1.72

RSA BRMLT PERP 50,001-100k p/100uBMnt	100	\$1.63
RSA BRMLT PERP 100,001-250k p/100uBMnt	100	\$1.55
RSA BRMLT PERP >250k p/100uBMnt	100	\$1.47
RSA BRMLT PERP 1-1,000 p/100uEMnt	100	\$5.81
RSA BRMLT PERP 1,001-2,500 p/100uEMnt	100	\$5.23
RSA BRMLT PERP 2,501-5k p/100uEMnt	100	\$4.92
RSA BRMLT PERP 5,001-10k p/100uEMnt	100	\$3.58
RSA BRMLT PERP 10,001-25k p/100uEMnt	100	\$2.29
RSA BRMLT PERP 25,001-50k p/100uEMnt	100	\$2.15
RSA BRMLT PERP 50,001-100k p/100uEMnt	100	\$2.04
RSA BRMLT PERP 100,001-250k p/100uEMnt	100	\$1.94
RSA BRMLT PERP >250k p/100uEMnt	100	\$1.83
RSA DAG PERP 1-1,000 p/100u	100	\$2,326.00
RSA DAG PERP 1,001-2,500 p/100u	100	\$2,092.00
RSA DAG PERP 2,501-5k p/100u	100	\$1,966.00
RSA DAG PERP 5,001-10k p/100u	100	\$1,434.00
RSA DAG PERP 10,001-25k p/100u	100	\$917.00
RSA DAG PERP 25,001-50k p/100u	100	\$862.00
RSA DAG PERP 50,001-100k p/100u	100	\$819.00
RSA DAG PERP 100,001-250k p/100u	100	\$778.00
RSA DAG PERP >250k p/100u	100	\$732.00
RSA DAG PERP 1-1,000 p/100uBMnt	100	\$38.77
RSA DAG PERP 1,001-2,500 p/100uBMnt	100	\$34.87
RSA DAG PERP 2,501-5k p/100uBMnt	100	\$32.77
RSA DAG PERP 5,001-10k p/100uBMnt	100	\$23.90
RSA DAG PERP 10,001-25k p/100uBMnt	100	\$15.28
RSA DAG PERP 25,001-50k p/100uBMnt	100	\$14.37
RSA DAG PERP 50,001-100k p/100uBMnt	100	\$13.65
RSA DAG PERP 100,001-250k p/100uBMnt	100	\$12.97
RSA DAG PERP >250k p/100uBMnt	100	\$12.20
RSA DAG PERP 1-1,000 p/100uEMnt	100	\$48.46
RSA DAG PERP 1,001-2,500 p/100uEMnt	100	\$43.58
RSA DAG PERP 2,501-5k p/100uEMnt	100	\$40.96
RSA DAG PERP 5,001-10k p/100uEMnt	100	\$29.88
RSA DAG PERP 10,001-25k p/100uEMnt	100	\$19.10
RSA DAG PERP 25,001-50k p/100uEMnt	100	\$17.96
RSA DAG PERP 50,001-100k p/100uEMnt	100	\$17.06
RSA DAG PERP 100,001-250k p/100uEMnt	100	\$16.21
RSA DAG PERP >250k p/100uEMnt	100	\$15.25
RSA DAGLT PERP 1-1,000 p/100u	100	\$332.00
RSA DAGLT PERP 1,001-2,500 p/100u	100	\$299.00
RSA DAGLT PERP 2,501-5k p/100u	100	\$281.00
RSA DAGLT PERP 5,001-10k p/100u	100	\$205.00
RSA DAGLT PERP 10,001-25k p/100u	100	\$131.00
RSA DAGLT PERP 25,001-50k p/100u	100	\$123.00
RSA DAGLT PERP 50,001-100k p/100u	100	\$117.00
RSA DAGLT PERP 100,001-250k p/100u	100	\$111.00

RSA DAGLT PERP >250k p/100u	100	\$105.00
RSA DAGLT PERP 1-1,000 p/100uBMnt	100	\$5.53
RSA DAGLT PERP 1,001-2,500 p/100uBMnt	100	\$4.98
RSA DAGLT PERP 2,501-5k p/100uBMnt	100	\$4.68
RSA DAGLT PERP 5,001-10k p/100uBMnt	100	\$3.42
RSA DAGLT PERP 10,001-25k p/100uBMnt	100	\$2.18
RSA DAGLT PERP 25,001-50k p/100uBMnt	100	\$2.05
RSA DAGLT PERP 50,001-100k p/100uBMnt	100	\$1.95
RSA DAGLT PERP 100,001-250k p/100uBMnt	100	\$1.85
RSA DAGLT PERP >250k p/100uBMnt	100	\$1.75
RSA DAGLT PERP 1-1,000 p/100uEMnt	100	\$6.92
RSA DAGLT PERP 1,001-2,500 p/100uEMnt	100	\$6.23
RSA DAGLT PERP 2,501-5k p/100uEMnt	100	\$5.85
RSA DAGLT PERP 5,001-10k p/100uEMnt	100	\$4.27
RSA DAGLT PERP 10,001-25k p/100uEMnt	100	\$2.73
RSA DAGLT PERP 25,001-50k p/100uEMnt	100	\$2.56
RSA DAGLT PERP 50,001-100k p/100uEMnt	100	\$2.44
RSA DAGLT PERP 100,001-250k p/100uEMnt	100	\$2.31
RSA DAGLT PERP >250k p/100uEMnt	100	\$2.19
RSA DAG ActM PERP 1-1,000 p/100u	100	\$1,056.00
RSA DAG ActM PERP 1,001-2,500 p/100u	100	\$950.00
RSA DAG ActM PERP 2,501-5k p/100u	100	\$893.00
RSA DAG ActM PERP 5,001-10k p/100u	100	\$651.00
RSA DAG ActM PERP 10,001-25k p/100u	100	\$417.00
RSA DAG ActM PERP 25,001-50k p/100u	100	\$391.00
RSA DAG ActM PERP 50,001-100k p/100u	100	\$372.00
RSA DAG ActM PERP 100,001-250k p/100u	100	\$353.00
RSA DAG ActM PERP >250k p/100u	100	\$332.00
RSA DAG ActM PERP 1-1,000 p/100uBMnt	100	\$17.60
RSA DAG ActM PERP 1,001-2,500 p/100uBMnt	100	\$15.83
RSA DAG ActM PERP 2,501-5k p/100uBMnt	100	\$14.88
RSA DAG ActM PERP 5,001-10k p/100uBMnt	100	\$10.85
RSA DAG ActM PERP 10,001-25k p/100uBMnt	100	\$6.95
RSA DAG ActM PERP 25,001-50k p/100uBMnt	100	\$6.52
RSA DAG ActM PERP 50,001-100k p/100uBMnt	100	\$6.20
RSA DAG ActM PERP 100001-250k p/100uBMnt	100	\$5.88
RSA DAG ActM PERP >250k p/100uBMnt	100	\$5.53
RSA DAG ActM PERP 1-1,000 p/100uEMnt	100	\$22.00
RSA DAG ActM PERP 1,001-2,500 p/100uEMnt	100	\$19.79
RSA DAG ActM PERP 2,501-5k p/100uEMnt	100	\$18.60
RSA DAG ActM PERP 5,001-10k p/100uEMnt	100	\$13.56
RSA DAG ActM PERP 10,001-25k p/100uEMnt	100	\$8.69
RSA DAG ActM PERP 25,001-50k p/100uEMnt	100	\$8.15
RSA DAG ActM PERP 50,001-100k p/100uEMnt	100	\$7.75
RSA DAG ActM PERP 100001-250k p/100uEMnt	100	\$7.35
RSA DAG ActM PERP >250k p/100uEMnt	100	\$6.92
RSA DAGW PERP 1-1,000 p/100u	100	\$1,160.00

RSA DAGW PERP 1,001-2,500 p/100u	100	\$1,045.00
RSA DAGW PERP 2,501-5k p/100u	100	\$990.00
RSA DAGW PERP 5,001-10k p/100u	100	\$713.00
RSA DAGW PERP 10,001-25k p/100u	100	\$455.00
RSA DAGW PERP 25,001-50k p/100u	100	\$430.00
RSA DAGW PERP 50,001-100k p/100u	100	\$405.00
RSA DAGW PERP 100,001-250k p/100u	100	\$390.00
RSA DAGW PERP >250k p/100u	100	\$355.00
RSA DAGW PERP 1-1,000 p/100uBMnt	100	\$19.33
RSA DAGW PERP 1,001-2,500 p/100uBMnt	100	\$17.42
RSA DAGW PERP 2,501-5k p/100uBMnt	100	\$16.50
RSA DAGW PERP 5,001-10k p/100uBMnt	100	\$11.88
RSA DAGW PERP 10,001-25k p/100uBMnt	100	\$7.58
RSA DAGW PERP 25,001-50k p/100uBMnt	100	\$7.17
RSA DAGW PERP 50,001-100k p/100uBMnt	100	\$6.75
RSA DAGW PERP 100,001-250k p/100uBMnt	100	\$6.50
RSA DAGW PERP >250k p/100uBMnt	100	\$5.92
RSA DAGW PERP 1-1,000 p/100uEMnt	100	\$24.17
RSA DAGW PERP 1,001-2,500 p/100uEMnt	100	\$21.77
RSA DAGW PERP 2,501-5k p/100uEMnt	100	\$20.63
RSA DAGW PERP 5,001-10k p/100uEMnt	100	\$14.85
RSA DAGW PERP 10,001-25k p/100uEMnt	100	\$9.48
RSA DAGW PERP 25,001-50k p/100uEMnt	100	\$8.96
RSA DAGW PERP 50,001-100k p/100uEMnt	100	\$8.44
RSA DAGW PERP 100,001-250k p/100uEMnt	100	\$8.13
RSA DAGW PERP >250k p/100uEMnt	100	\$7.40
RSA InactiveID PERP 1-1,000 p/100u	100	\$1,268.00
RSA InactiveID PERP 1,001-2,500 p/100u	100	\$1,140.00
RSA InactiveID PERP 2,501-5k p/100u	100	\$1,071.00
RSA InactiveID PERP 5,001-10k p/100u	100	\$781.00
RSA InactiveID PERP 10,001-25k p/100u	100	\$500.00
RSA InactiveID PERP 25,001-50k p/100u	100	\$470.00
RSA InactiveID PERP 50,001-100k p/100u	100	\$447.00
RSA InactiveID PERP 100,001-250k p/100u	100	\$424.00
RSA InactiveID PERP >250k p/100u	100	\$399.00
RSA InactiveID PERP 1-1K p/100uBMnt	100	\$21.13
RSA InactiveID PERP 1001-2500 p/100uBMnt	100	\$19.00
RSA InactiveID PERP 2,501-5k p/100uBMnt	100	\$17.85
RSA InactiveID PERP 5,001-10k p/100uBMnt	100	\$13.02
RSA InactiveID PERP 10001-25k p/100uBMnt	100	\$8.33
RSA InactiveID PERP 25001-50k p/100uBMnt	100	\$7.83
RSA InactiveID PERP 50K-100k p/100uBMnt	100	\$7.45
RSA InactiveID PERP 100K-250k p/100uBMnt	100	\$7.07
RSA InactiveID PERP >250k p/100uBMnt	100	\$6.65
RSA InactiveID PERP 1-1,000 p/100uEMnt	100	\$26.42
RSA InactiveID PERP 1001-2500 p/100uEMnt	100	\$23.75
RSA InactiveID PERP 2,501-5k p/100uEMnt	100	\$22.31

RSA InactiveID PERP 5,001-10k p/100uEMnt	100	\$16.27
RSA InactiveID PERP 10001-25k p/100uEMnt	100	\$10.42
RSA InactiveID PERP 25001-50k p/100uEMnt	100	\$9.79
RSA InactiveID PERP 50K-100k p/100uEMnt	100	\$9.31
RSA InactiveID PERP 100K-250k p/100uEMnt	100	\$8.83
RSA InactiveID PERP >250k p/100uEMnt	100	\$8.31
RSA Gov SUB 1-1,000 p/100u	100	\$138.71
RSA Gov SUB 1,001-2,500 p/100u	100	\$124.73
RSA Gov SUB 2,501-5k p/100u	100	\$117.19
RSA Gov SUB 5,001-10k p/100u	100	\$85.49
RSA Gov SUB 10,001-25k p/100u	100	\$54.69
RSA Gov SUB 25,001-50k p/100u	100	\$51.43
RSA Gov SUB 50,001-100k p/100u	100	\$48.84
RSA Gov SUB 100,001-250k p/100u	100	\$46.43
RSA Gov SUB >250k p/100u	100	\$43.62
RSA GovLT SUB 1-1,000 p/100u	100	\$19.82
RSA GovLT SUB 1,001-2,500 p/100u	100	\$17.81
RSA GovLT SUB 2,501-5k p/100u	100	\$16.74
RSA GovLT SUB 5,001-10k p/100u	100	\$12.23
RSA GovLT SUB 10,001-25k p/100u	100	\$7.81
RSA GovLT SUB 25,001-50k p/100u	100	\$7.37
RSA GovLT SUB 50,001-100k p/100u	100	\$6.96
RSA GovLT SUB 100,001-250k p/100u	100	\$6.65
RSA GovLT SUB >250k p/100u	100	\$6.25
RSA Lif SUB 1-1,000 p/100u	100	\$283.35
RSA Lif SUB 1,001-2,500 p/100u	100	\$254.73
RSA Lif SUB 2,501-5k p/100u	100	\$239.38
RSA Lif SUB 5,001-10k p/100u	100	\$174.55
RSA Lif SUB 10,001-25k p/100u	100	\$111.74
RSA Lif SUB 25,001-50k p/100u	100	\$105.00
RSA Lif SUB 50,001-100k p/100u	100	\$99.73
RSA Lif SUB 100,001-250k p/100u	100	\$94.78
RSA Lif SUB >250k p/100u	100	\$89.11
RSA LifLT SUB 1-1,000 p/100u	100	\$40.49
RSA LifLT SUB 1,001-2,500 p/100u	100	\$36.38
RSA LifLT SUB 2,501-5k p/100u	100	\$34.20
RSA LifLT SUB 5,001-10k p/100u	100	\$24.96
RSA LifLT SUB 10,001-25k p/100u	100	\$15.98
RSA LifLT SUB 25,001-50k p/100u	100	\$15.00
RSA LifLT SUB 50,001-100k p/100u	100	\$14.24
RSA LifLT SUB 100,001-250k p/100u	100	\$13.53
RSA LifLT SUB >250k p/100u	100	\$12.72
RSA Bd Gov&lif SUB 1-1,000 p/100u	100	\$400.94
RSA Bd Gov&lif SUB 1,001-2,500 p/100u	100	\$360.49
RSA Bd Gov&lif SUB 2,501-5k p/100u	100	\$338.75
RSA Bd Gov&lif SUB 5,001-10k p/100u	100	\$247.01
RSA Bd Gov&lif SUB 10,001-25k p/100u	100	\$158.08

RSA Bd Gov&lif SUB 25,001-50k p/100u	100	\$148.57
RSA Bd Gov&lif SUB 50,001-100k p/100u	100	\$141.16
RSA Bd Gov&lif SUB 100,001-250k p/100u	100	\$134.11
RSA Bd Gov&lif SUB >250k p/100u	100	\$126.07
RSA Bd Gov&lifLT SUB 1-1,000 p/100u	100	\$57.28
RSA Bd Gov&lifLT SUB 1,001-2,500 p/100u	100	\$51.52
RSA Bd Gov&lifLT SUB 2,501-5k p/100u	100	\$48.39
RSA Bd Gov&lifLT SUB 5,001-10k p/100u	100	\$35.27
RSA Bd Gov&lifLT SUB 10,001-25k p/100u	100	\$22.59
RSA Bd Gov&lifLT SUB 25,001-50k p/100u	100	\$21.21
RSA Bd Gov&lifLT SUB 50,001-100k p/100u	100	\$20.18
RSA Bd Gov&lifLT SUB 100,001-250k p/100u	100	\$19.15
RSA Bd Gov&lifLT SUB >250k p/100u	100	\$17.99
RSA BRM SUB 1-1,000 p/100u	100	\$87.23
RSA BRM SUB 1,001-2,500 p/100u	100	\$78.39
RSA BRM SUB 2,501-5k p/100u	100	\$73.71
RSA BRM SUB 5,001-10k p/100u	100	\$53.71
RSA BRM SUB 10,001-25k p/100u	100	\$34.38
RSA BRM SUB 25,001-50k p/100u	100	\$32.32
RSA BRM SUB 50,001-100k p/100u	100	\$30.67
RSA BRM SUB 100,001-250k p/100u	100	\$29.15
RSA BRM SUB >250k p/100u	100	\$27.41
RSA BRMLT SUB 1-1,000 p/100u	100	\$12.46
RSA BRMLT SUB 1,001-2,500 p/100u	100	\$11.21
RSA BRMLT SUB 2,501-5k p/100u	100	\$10.54
RSA BRMLT SUB 5,001-10k p/100u	100	\$7.68
RSA BRMLT SUB 10,001-25k p/100u	100	\$4.91
RSA BRMLT SUB 25,001-50k p/100u	100	\$4.60
RSA BRMLT SUB 50,001-100k p/100u	100	\$4.38
RSA BRMLT SUB 100,001-250k p/100u	100	\$4.15
RSA BRMLT SUB >250k p/100u	100	\$3.93
RSA DAG SUB 1-1,000 p/100u	100	\$103.84
RSA DAG SUB 1,001-2,500 p/100u	100	\$93.39
RSA DAG SUB 2,501-5k p/100u	100	\$87.77
RSA DAG SUB 5,001-10k p/100u	100	\$64.02
RSA DAG SUB 10,001-25k p/100u	100	\$40.94
RSA DAG SUB 25,001-50k p/100u	100	\$38.48
RSA DAG SUB 50,001-100k p/100u	100	\$36.56
RSA DAG SUB 100,001-250k p/100u	100	\$34.73
RSA DAG SUB >250k p/100u	100	\$32.68
RSA DAGLT SUB 1-1,000 p/100u	100	\$14.82
RSA DAGLT SUB 1,001-2,500 p/100u	100	\$13.35
RSA DAGLT SUB 2,501-5k p/100u	100	\$12.54
RSA DAGLT SUB 5,001-10k p/100u	100	\$9.15
RSA DAGLT SUB 10,001-25k p/100u	100	\$5.85
RSA DAGLT SUB 25,001-50k p/100u	100	\$5.49
RSA DAGLT SUB 50,001-100k p/100u	100	\$5.22

RSA DAGLT SUB 100,001-250k p/100u	100	\$4.96
RSA DAGLT SUB >250k p/100u	100	\$4.69
RSA DAG ActM SUB 1-1000 p/100u	100	\$47.14
RSA DAG ActM SUB 1001-2500 p/100u	100	\$42.41
RSA DAG ActM SUB 2501-5k p/100u	100	\$39.87
RSA DAG ActM SUB 5001-10k p/100u	100	\$29.06
RSA DAG ActM SUB 10001-25k p/100u	100	\$18.62
RSA DAG ActM SUB 25001-50k p/100u	100	\$17.46
RSA DAG ActM SUB 50001-100k p/100u	100	\$16.61
RSA DAG ActM SUB 100001-250k p/100u	100	\$15.76
RSA DAG ActM SUB >250k p/100u	100	\$14.82
RSA DAGW SUB 1-1,000 p/100u	100	\$51.79
RSA DAGW SUB 1,001-2,500 p/100u	100	\$46.65
RSA DAGW SUB 2,501-5k p/100u	100	\$44.20
RSA DAGW SUB 5,001-10k p/100u	100	\$31.83
RSA DAGW SUB 10,001-25k p/100u	100	\$20.31
RSA DAGW SUB 25,001-50k p/100u	100	\$19.20
RSA DAGW SUB 50,001-100k p/100u	100	\$18.08
RSA DAGW SUB 100,001-250k p/100u	100	\$17.41
RSA DAGW SUB >250k p/100u	100	\$15.85
RSA InactiveID SUB 1-1,000 p/100u	100	\$56.61
RSA InactiveID SUB 1,001-2,500 p/100u	100	\$50.89
RSA InactiveID SUB 2,501-5k p/100u	100	\$47.81
RSA InactiveID SUB 5,001-10k p/100u	100	\$34.87
RSA InactiveID SUB 10,001-25k p/100u	100	\$22.32
RSA InactiveID SUB 25,001-50k p/100u	100	\$20.98
RSA InactiveID SUB 50,001-100k p/100u	100	\$19.96
RSA InactiveID SUB 100,001-250k p/100u	100	\$18.93
RSA InactiveID SUB >250k p/100u	100	\$17.81
R620 Basic Mnt 1MO	1	\$416.67
R620 Enhanced Mnt 1MO	1	\$520.83
R720 Basic Mnt 1MO	1	\$833.33
R720 Enhanced Mnt 1MO	1	\$1,041.67
RSA R630 Appliance Gov	1	\$25,000.00
RSA R630 Appliance Life	1	\$25,000.00
RSA R630 Basic Mnt 1MO	1	\$416.67
RSA R630 Enhanced Mnt 1MO	1	\$520.83
RSA R730 Appliance Gov	1	\$50,000.00
RSA R730 Appliance Life	1	\$50,000.00
RSA R730 Basic Mnt 1MO	1	\$833.33
RSA R730 Enhanced Mnt 1MO	1	\$1,041.67
Software Bundle	1	\$5,000.00
Software Bundle Basic Mnt 1MO	1	\$83.33
Software Bundle Enh Mnt 1MO	1	\$104.17
RSA SecurID Select one time fee for qty's between 1 - 999	1	\$2,000.00
RSA SecurID Select per User for qty's between 1000 - 50000	1	\$2.00
RSA SecurID Select Key Sheet Artwork	1	\$5,000.00

RSA SecurID Authenticator SID700 (24 months) 5 Pack	1	\$250.00
RSA SecurID Authenticator SID700 (24 months) 10 Pack	1	\$500.00
RSA SecurID Authenticator SID700 (24 months) 25 Pack	1	\$1,250.00
RSA SecurID Authenticator SID700 (24 months) 50 Pack	1	\$2,500.00
RSA SecurID Authenticator SID700 (24 months) 100 Pack	1	\$5,000.00
RSA SecurID Authenticator SID700 (24 months) 250 Pack	1	\$12,500.00
SID700-6-60-24 per user qtys 255-750	1	\$45.50
SID700-6-60-24 per user qtys 755-1500	1	\$43.50
SID700-6-60-24 per user qtys 1505-2500	1	\$40.50
SID700-6-60-24 per user qtys 2505-5000	1	\$36.50
SID700-6-60-24 per user qtys 5005-7500	1	\$32.00
SID700-6-60-24 per user qtys 7505-10000	1	\$29.00
SID700-6-60-24 per user qtys 10005-15000	1	\$27.50
SID700-6-60-24 per user qtys 15005-25000	1	\$24.50
SID700-6-60-24 per user qtys 25005-1,000,000	1	\$23.00
RSA SecurID Authenticator SID700 (36 months) 5 Pack	1	\$310.00
RSA SecurID Authenticator SID700 (36 months) 10 Pack	1	\$620.00
RSA SecurID Authenticator SID700 (36 months) 25 Pack	1	\$1,550.00
RSA SecurID Authenticator SID700 (36 months) 50 Pack	1	\$3,100.00
RSA SecurID Authenticator SID700 (36 months) 100 Pack	1	\$6,200.00
RSA SecurID Authenticator SID700 (36 months) 250 Pack	1	\$15,500.00
SID700-6-60-36 per user qtys 255-750	1	\$57.00
SID700-6-60-36 per user qtys 755-1500	1	\$54.00
SID700-6-60-36 per user qtys 1505-2500	1	\$51.00
SID700-6-60-36 per user qtys 2505-5000	1	\$46.00
SID700-6-60-36 per user qtys 5005-7500	1	\$40.00
SID700-6-60-36 per user qtys 7505-10000	1	\$36.00
SID700-6-60-36 per user qtys 10005-15000	1	\$34.00
SID700-6-60-36 per user qtys 15005-25000	1	\$30.00
SID700-6-60-36 per user qtys 25005-1,000,000	1	\$28.00
RSA SecurID Authenticator SID700 (48 months) 5 Pack	1	\$370.00
RSA SecurID Authenticator SID700 (48 months) 10 Pack	1	\$740.00
RSA SecurID Authenticator SID700 (48 months) 25 Pack	1	\$1,850.00
RSA SecurID Authenticator SID700 (48 months) 50 Pack	1	\$3,700.00
RSA SecurID Authenticator SID700 (48 months) 100 Pack	1	\$7,400.00
RSA SecurID Authenticator SID700 (48 months) 250 Pack	1	\$18,500.00
SID700-6-60-48 per user qtys 255-750	1	\$67.50
SID700-6-60-48 per user qtys 755-1500	1	\$64.50
SID700-6-60-48 per user qtys 1505-2500	1	\$61.00
SID700-6-60-48 per user qtys 2505-5000	1	\$55.00
SID700-6-60-48 per user qtys 5005-7500	1	\$48.00
SID700-6-60-48 per user qtys 7505-10000	1	\$43.00
SID700-6-60-48 per user qtys 10005-15000	1	\$40.50
SID700-6-60-48 per user qtys 15005-25000	1	\$36.00
SID700-6-60-48 per user qtys 25005-1,000,000	1	\$33.50
RSA SecurID Authenticator SID700 (60 months) 5 Pack	1	\$430.00
RSA SecurID Authenticator SID700 (60 months) 10 Pack	1	\$860.00

RSA SecurID Authenticator SID700 (60 months) 25 Pack	1	\$2,150.00
RSA SecurID Authenticator SID700 (60 months) 50 Pack	1	\$4,300.00
RSA SecurID Authenticator SID700 (60 months) 100 Pack	1	\$8,600.00
RSA SecurID Authenticator SID700 (60 months) 250 Pack	1	\$21,500.00
SID700-6-60-60 per user qtys 255-750	1	\$78.00
SID700-6-60-60 per user qtys 755-1500	1	\$74.00
SID700-6-60-60 per user qtys 1505-2500	1	\$68.00
SID700-6-60-60 per user qtys 2505-5000	1	\$60.50
SID700-6-60-60 per user qtys 5005-7500	1	\$53.50
SID700-6-60-60 per user qtys 7505-10000	1	\$47.50
SID700-6-60-60 per user qtys 10005-15000	1	\$45.50
SID700-6-60-60 per user qtys 15005-25000	1	\$41.50
SID700-6-60-60 per user qtys 25005-1,000,000	1	\$38.50
SID700-6-30-24 5 Pack	1	\$265.00
SID700-6-30-24 10 Pack	1	\$530.00
SID700-6-30-24 25 Pack	1	\$1,325.00
SID700-6-30-24 50 Pack	1	\$2,650.00
SID700-6-30-24 100 Pack	1	\$5,300.00
SID700-6-30-24 250 Pack	1	\$13,250.00
SID700-6-30-24 pr u qtys 255-750	1	\$48.50
SID700-6-30-24 pr u qtys 755-1500	1	\$46.50
SID700-6-30-24 pr u qtys 1505-2500	1	\$43.50
SID700-6-30-24 pr u qtys 2505-5K	1	\$39.50
SID700-6-30-24 pr u qtys 5005-7500	1	\$35.00
SID700-6-30-24 pr u qtys 7505-10K	1	\$32.00
SID700-6-30-24 pr u qtys 1K5-15K	1	\$30.50
SID700-6-30-24 pr u qtys 15005-25K	1	\$27.50
SID700-6-30-24 pr u qtys 25005-1M	1	\$26.00
SID700-6-30-36 5 Pack	1	\$325.00
SID700-6-30-36 10 Pack	1	\$650.00
SID700-6-30-36 25 Pack	1	\$1,625.00
SID700-6-30-36 50 Pack	1	\$3,250.00
SID700-6-30-36 100 Pack	1	\$6,500.00
SID700-6-30-36 250 Pack	1	\$16,250.00
SID700-6-30-36 pr u qtys 255-750	1	\$60.00
SID700-6-30-36 pr u qtys 755-1500	1	\$57.00
SID700-6-30-36 pr u qtys 1505-2500	1	\$54.00
SID700-6-30-36 pr u qtys 2505-5K	1	\$49.00
SID700-6-30-36 pr u qtys 5005-7500	1	\$43.00
SID700-6-30-36 pr u qtys 7505-10K	1	\$39.00
SID700-6-30-36 pr u qtys 1K5-15K	1	\$37.00
SID700-6-30-36 pr u qtys 15005-25K	1	\$33.00
SID700-6-30-36 pr u qtys 25005-1M	1	\$31.00
SID700-6-30-48 5 Pack	1	\$385.00
SID700-6-30-48 10 Pack	1	\$770.00
SID700-6-30-48 25 Pack	1	\$1,925.00
SID700-6-30-48 50 Pack	1	\$3,850.00

SID700-6-30-48 100 Pack	1	\$7,700.00
SID700-6-30-48 250 Pack	1	\$19,250.00
SID700-6-30-48 pr u qtys 255-750	1	\$70.50
SID700-6-30-48 pr u qtys 755-1500	1	\$67.50
SID700-6-30-48 pr u qtys 1505-2500	1	\$64.00
SID700-6-30-48 pr u qtys 2505-5K	1	\$58.00
SID700-6-30-48 pr u qtys 5005-7500	1	\$51.00
SID700-6-30-48 pr u qtys 7505-10K	1	\$46.00
SID700-6-30-48 pr u qtys 1K5-15K	1	\$43.50
SID700-6-30-48 pr u qtys 15005-25K	1	\$39.00
SID700-6-30-48 pr u qtys 25005-1M	1	\$36.50
SID700-6-30-60 5 Pack	1	\$445.00
SID700-6-30-60 10 Pack	1	\$890.00
SID700-6-30-60 25 Pack	1	\$2,225.00
SID700-6-30-60 50 Pack	1	\$4,450.00
SID700-6-30-60 100 Pack	1	\$8,900.00
SID700-6-30-60 250 Pack	1	\$22,250.00
SID700-6-30-60 pr u qtys 255-750	1	\$81.00
SID700-6-30-60 pr u qtys 755-1500	1	\$77.00
SID700-6-30-60 pr u qtys 1505-2500	1	\$71.00
SID700-6-30-60 pr u qtys 2505-5K	1	\$63.50
SID700-6-30-60 pr u qtys 5005-7500	1	\$56.50
SID700-6-30-60 pr u qtys 7505-10K	1	\$50.50
SID700-6-30-60 pr u qtys 1K5-15K	1	\$48.50
SID700-6-30-60 pr u qtys 15005-25K	1	\$44.50
SID700-6-30-60 pr u qtys 25005-1M	1	\$41.50
RSA SecurID Authenticator SID800 (24 months) 5 Pack	1	\$300.00
RSA SecurID Authenticator SID800 (24 months) 10 Pack	1	\$600.00
RSA SecurID Authenticator SID800 (24 months) 25 Pack	1	\$1,500.00
RSA SecurID Authenticator SID800 (24 months) 50 Pack	1	\$3,000.00
RSA SecurID Authenticator SID800 (24 months) 100 Pack	1	\$6,000.00
RSA SecurID Authenticator SID800 (24 months) 250 Pack	1	\$15,000.00
SID800-6-60-24 per user qtys 255-750	1	\$54.50
SID800-6-60-24 per user qtys 755-1500	1	\$52.00
SID800-6-60-24 per user qtys 1505-2500	1	\$49.00
SID800-6-60-24 per user qtys 2505-5000	1	\$47.00
SID800-6-60-24 per user qtys 5005-7500	1	\$44.00
SID800-6-60-24 per user qtys 7505-10000	1	\$41.00
SID800-6-60-24 per user qtys 10005-15000	1	\$38.00
SID800-6-60-24 per user qtys 15005-25000	1	\$35.00
SID800-6-60-24 per user qtys 25005-1,000,000	1	\$32.00
RSA SecurID Authenticator SID800 (36 months) 5 Pack	1	\$372.50
RSA SecurID Authenticator SID800 (36 months) 10 Pack	1	\$745.00
RSA SecurID Authenticator SID800 (36 months) 25 Pack	1	\$1,862.50
RSA SecurID Authenticator SID800 (36 months) 50 Pack	1	\$3,725.00
RSA SecurID Authenticator SID800 (36 months) 100 Pack	1	\$7,450.00
RSA SecurID Authenticator SID800 (36 months) 250 Pack	1	\$18,625.00

SID800-6-60-36 per user qtys 255-750	1	\$67.50
SID800-6-60-36 per user qtys 755-1500	1	\$64.50
SID800-6-60-36 per user qtys 1505-2500	1	\$61.00
SID800-6-60-36 per user qtys 2505-5000	1	\$58.00
SID800-6-60-36 per user qtys 5005-7500	1	\$55.00
SID800-6-60-36 per user qtys 7505-10000	1	\$51.00
SID800-6-60-36 per user qtys 10005-15000	1	\$48.00
SID800-6-60-36 per user qtys 15005-25000	1	\$44.00
SID800-6-60-36 per user qtys 25005-1,000,000	1	\$40.00
RSA SecurID Authenticator SID800 (48 months) 5 Pack	1	\$445.00
RSA SecurID Authenticator SID800 (48 months) 10 Pack	1	\$890.00
RSA SecurID Authenticator SID800 (48 months) 25 Pack	1	\$2,225.00
RSA SecurID Authenticator SID800 (48 months) 50 Pack	1	\$4,450.00
RSA SecurID Authenticator SID800 (48 months) 100 Pack	1	\$8,900.00
RSA SecurID Authenticator SID800 (48 months) 250 Pack	1	\$22,250.00
SID800-6-60-48 per user qtys 255-750	1	\$81.00
SID800-6-60-48 per user qtys 755-1500	1	\$77.00
SID800-6-60-48 per user qtys 1505-2500	1	\$73.00
SID800-6-60-48 per user qtys 2505-5000	1	\$69.00
SID800-6-60-48 per user qtys 5005-7500	1	\$66.00
SID800-6-60-48 per user qtys 7505-10000	1	\$61.00
SID800-6-60-48 per user qtys 10005-15000	1	\$57.00
SID800-6-60-48 per user qtys 15005-25000	1	\$53.00
SID800-6-60-48 per user qtys 25005-1,000,000	1	\$48.00
RSA SecurID Authenticator SID800 (60 months) 5 Pack	1	\$515.00
RSA SecurID Authenticator SID800 (60 months) 10 Pack	1	\$1,030.00
RSA SecurID Authenticator SID800 (60 months) 25 Pack	1	\$2,575.00
RSA SecurID Authenticator SID800 (60 months) 50 Pack	1	\$5,150.00
RSA SecurID Authenticator SID800 (60 months) 100 Pack	1	\$10,300.00
RSA SecurID Authenticator SID800 (60 months) 250 Pack	1	\$25,750.00
SID800-6-60-60 per user qtys 255-750	1	\$93.00
SID800-6-60-60 per user qtys 755-1500	1	\$88.50
SID800-6-60-60 per user qtys 1505-2500	1	\$84.00
SID800-6-60-60 per user qtys 2505-5000	1	\$79.00
SID800-6-60-60 per user qtys 5005-7500	1	\$75.00
SID800-6-60-60 per user qtys 7505-10000	1	\$70.00
SID800-6-60-60 per user qtys 10005-15000	1	\$65.00
SID800-6-60-60 per user qtys 15005-25000	1	\$60.00
SID800-6-60-60 per user qtys 25005-1,000,000	1	\$55.00
SID800-6-30-24 5 Pack	1	\$315.00
SID800-6-30-24 10 Pack	1	\$630.00
SID800-6-30-24 25 Pack	1	\$1,575.00
SID800-6-30-24 50 Pack	1	\$3,150.00
SID800-6-30-24 100 Pack	1	\$6,300.00
SID800-6-30-24 250 Pack	1	\$15,750.00
SID800-6-30-24 pr u qtys 255-750	1	\$57.50
SID800-6-30-24 pr u qtys 755-1500	1	\$55.00

SID800-6-30-24 pr u qtys 1505-2500	1	\$52.00
SID800-6-30-24 pr u qtys 2505-5K	1	\$50.00
SID800-6-30-24 pr u qtys 5005-7500	1	\$47.00
SID800-6-30-24 pr u qtys 7505-10K	1	\$44.00
SID800-6-30-24 pr u qtys 1K5-15K	1	\$41.00
SID800-6-30-24 pr u qtys 15005-25K	1	\$38.00
SID800-6-30-24 pr u qtys 25005-1M	1	\$35.00
SID800-6-30-36 5 Pack	1	\$387.50
SID800-6-30-36 10 Pack	1	\$775.00
SID800-6-30-36 25 Pack	1	\$1,937.50
SID800-6-30-36 50 Pack	1	\$3,875.00
SID800-6-30-36 100 Pack	1	\$7,750.00
SID800-6-30-36 250 Pack	1	\$19,375.00
SID800-6-30-36 pr u qtys 255-750	1	\$70.50
SID800-6-30-36 pr u qtys 755-1500	1	\$67.50
SID800-6-30-36 pr u qtys 1505-2500	1	\$64.00
SID800-6-30-36 pr u qtys 2505-5K	1	\$61.00
SID800-6-30-36 pr u qtys 5005-7500	1	\$58.00
SID800-6-30-36 pr u qtys 7505-10K	1	\$54.00
SID800-6-30-36 pr u qtys 1K5-15K	1	\$51.00
SID800-6-30-36 pr u qtys 15005-25K	1	\$47.00
SID800-6-30-36 pr u qtys 25005-1M	1	\$43.00
SID800-6-30-48 5 Pack	1	\$460.00
SID800-6-30-48 10 Pack	1	\$920.00
SID800-6-30-48 25 Pack	1	\$2,300.00
SID800-6-30-48 50 Pack	1	\$4,600.00
SID800-6-30-48 100 Pack	1	\$9,200.00
SID800-6-30-48 250 Pack	1	\$23,000.00
SID800-6-30-48 pr u qtys 255-750	1	\$84.00
SID800-6-30-48 pr u qtys 755-1500	1	\$80.00
SID800-6-30-48 pr u qtys 1505-2500	1	\$76.00
SID800-6-30-48 pr u qtys 2505-5K	1	\$72.00
SID800-6-30-48 pr u qtys 5005-7500	1	\$69.00
SID800-6-30-48 pr u qtys 7505-10K	1	\$64.00
SID800-6-30-48 pr u qtys 1K5-15K	1	\$60.00
SID800-6-30-48 pr u qtys 15005-25K	1	\$56.00
SID800-6-30-48 pr u qtys 25005-1M	1	\$51.00
SID800-6-30-60 5 Pack	1	\$530.00
SID800-6-30-60 10 Pack	1	\$1,060.00
SID800-6-30-60 25 Pack	1	\$2,650.00
SID800-6-30-60 50 Pack	1	\$5,300.00
SID800-6-30-60 100 Pack	1	\$10,600.00
SID800-6-30-60 250 Pack	1	\$26,500.00
SID800-6-30-60 pr u qtys 255-750	1	\$96.00
SID800-6-30-60 pr u qtys 755-1500	1	\$91.50
SID800-6-30-60 pr u qtys 1505-2500	1	\$87.00
SID800-6-30-60 pr u qtys 2505-5K	1	\$82.00

SID800-6-30-60 pr u qtys 5005-7500	1	\$78.00
SID800-6-30-60 pr u qtys 7505-10K	1	\$73.00
SID800-6-30-60 pr u qtys 1K5-15K	1	\$68.00
SID800-6-30-60 pr u qtys 15005-25K	1	\$63.00
SID800-6-30-60 pr u qtys 25005-1M	1	\$58.00
ACM Up to 5,000 Users	1	\$30.00
ACM 5,001 to 10,000 Users	1	\$21.88
ACM 10,001 to 25,000 Users	1	\$17.50
ACM 25,001 to 50,000 Users	1	\$14.88
ACM 50,001 to 100,000 Users	1	\$12.50
ACM 100,001 to 250,000 Users	1	\$10.50
ACM 250,001+ Users	1	\$9.64
ACM Enterprise	1	Quoted
ACM Up to 5,000 Users Basic Mnt 1MO	1	\$0.50
ACM 5,001 to 10,000 Users Basic Mnt 1MO	1	\$0.36
ACM 10,001 to 25,000 Users Basic Mnt 1MO	1	\$0.29
ACM 25,001 to 50,000 Users Basic Mnt 1MO	1	\$0.25
ACM 50,001 to 100,000 User Basic Mnt 1MO	1	\$0.21
ACM 100,001 to 250000 User Basic Mnt 1MO	1	\$0.18
ACM 250,001+ Users Basic Mnt 1MO	1	\$0.16
ACM Enterprise Basic Mnt 1MO	1	Quoted
ACM Up to 5,000 Users Enh Mnt 1MO	1	\$0.63
ACM 5,001 to 10,000 Users Enh Mnt 1MO	1	\$0.46
ACM 10,001 to 25,000 Users Enh Mnt 1MO	1	\$0.36
ACM 25,001 to 50,000 Users Enh Mnt 1MO	1	\$0.31
ACM 50,001 to 100,000 Users Enh Mnt 1MO	1	\$0.26
ACM 100,001 to 250,000 Users Enh Mnt 1MO	1	\$0.22
ACM 250,001+ Users Enh Mnt 1MO	1	\$0.20
ACM Enterprise Enh Mnt 1MO	1	Quoted
BRM Up to 5,000 Users	1	\$18.86
BRM 5,001 to 10,000 Users	1	\$13.75
BRM 10,001 to 25,000 Users	1	\$11.00
BRM 25,001 to 50,000 Users	1	\$9.35
BRM 50,001 to 100,000 User	1	\$7.86
BRM 100,001 to 250000 User	1	\$6.60
BRM 250,001+ Users	1	\$6.06
BRM Enterprise	1	Quoted
BRM Up to 5,000 Users Basic Mnt 1MO	1	\$0.31
BRM 5,001 to 10,000 Users Basic Mnt 1MO	1	\$0.23
BRM 10,001 to 25,000 Users Basic Mnt 1MO	1	\$0.18
BRM 25,001 to 50,000 Users Basic Mnt 1MO	1	\$0.16
BRM 50,001 to 100,000 User Basic Mnt 1MO	1	\$0.13
BRM 100,001 to 250000 User Basic Mnt 1MO	1	\$0.11
BRM 250,001+ Users Basic Mnt 1MO	1	\$0.10
BRM Enterprise Basic Mnt 1MO	1	Quoted
BRM Up to 5,000 Users Enh Mnt 1MO	1	\$0.39
BRM 5,001 to 10,000 Users Enh Mnt 1MO	1	\$0.29

BRM 10,001 to 25,000 Users Enh Mnt 1MO	1	\$0.23
BRM 25,001 to 50,000 Users Enh Mnt 1MO	1	\$0.19
BRM 50,001 to 100,000 Users Enh Mnt 1MO	1	\$0.16
BRM 100,001 to 250,000 Users Enh Mnt 1MO	1	\$0.14
BRM 250,001+ Users Enh Mnt 1MO	1	\$0.13
BRM Enterprise Enh Mnt 1MO	1	Quoted
ARM Up to 5,000 Users	1	\$25.71
ARM 5,001 to 10,000 Users	1	\$18.75
ARM 10,001 to 25,000 User	1	\$15.00
ARM 25,001 to 50,000 User	1	\$12.75
ARM 50,001 to 100000 User	1	\$10.71
ARM 100001 to 250000 User	1	\$9.00
ARM 250,001+ Users	1	\$8.26
ARM Enterprise	1	Quoted
ARM Up to 5,000 Users Basic Mnt 1MO	1	\$0.43
ARM 5,001 to 10,000 Users Basic Mnt 1MO	1	\$0.31
ARM 10,001 to 25,000 Users Basic Mnt 1MO	1	\$0.25
ARM 25,001 to 50,000 Users Basic Mnt 1MO	1	\$0.21
ARM 50,001 to 100,000 User Basic Mnt 1MO	1	\$0.18
ARM 100,001 to 250000 User Basic Mnt 1MO	1	\$0.15
ARM 250,001+ Users Basic Mnt 1MO	1	\$0.14
ARM Enterprise Basic Mnt 1MO	1	Quoted
ARM Up to 5,000 Users Enh Mnt 1MO	1	\$0.54
ARM 5,001 to 10,000 Users Enh Mnt 1MO	1	\$0.39
ARM 10,001 to 25,000 Users Enh Mnt 1MO	1	\$0.31
ARM 25,001 to 50,000 Users Enh Mnt 1MO	1	\$0.27
ARM 50,001 to 100,000 Users Enh Mnt 1MO	1	\$0.22
ARM 100,001 to 250,000 Users Enh Mnt 1MO	1	\$0.19
ARM 250,001+ Users Enh Mnt 1MO	1	\$0.17
ARM Enterprise Enh Mnt 1MO	1	Quoted
DAG Up to 5,000 Users Basic Mnt 1MO	1	\$0.37
DAG 5,001 to 10,000 Users Basic Mnt 1MO	1	\$0.27
DAG 10,001 to 25,000 Users Basic Mnt 1MO	1	\$0.22
DAG 25,001 to 50,000 Users Basic Mnt 1MO	1	\$0.19
DAG 50,001 to 100,000 User Basic Mnt 1MO	1	\$0.16
DAG 100,001 to 250000 User Basic Mnt 1MO	1	\$0.13
DAG 250,001+ Users Basic Mnt 1MO	1	\$0.12
DAG Enterprise Basic Mnt 1MO	1	Quoted
DAG Up to 5,000 Users Enh Mnt 1MO	1	\$0.47
DAG 5,001 to 10,000 Users Enh Mnt 1MO	1	\$0.34
DAG 10,001 to 25,000 Users Enh Mnt 1MO	1	\$0.27
DAG 25,001 to 50,000 Users Enh Mnt 1MO	1	\$0.23
DAG 50,001 to 100,000 Users Enh Mnt 1MO	1	\$0.20
DAG 100,001 to 250,000 Users Enh Mnt 1MO	1	\$0.16
DAG 250,001+ Users Enh Mnt 1MO	1	\$0.15
DAG Enterprise Enh Mnt 1MO	1	Quoted
DAGW Up to 5,000 Users	1	\$11.11

DAGW 5,001 to 10,000 Users	1	\$8.10
DAGW 10,001 to 25,000 Users	1	\$6.48
DAGW 25,001 to 50,000 Users	1	\$5.51
DAGW 50,001 to 100,000 User	1	\$4.63
DAGW 100,001 to 250000 User	1	\$3.89
DAGW 250,001+ Users	1	\$3.57
DAGW Enterprise	1	Quoted
DAGW Up to 5,000 Users Basic Mnt 1MO	1	\$0.19
DAGW 5,001 to 10,000 Users Basic Mnt 1MO	1	\$0.14
DAGW 10,001 to 25,000 User Basic Mnt 1MO	1	\$0.11
DAGW 25,001 to 50,000 User Basic Mnt 1MO	1	\$0.09
DAGW 50,001 to 100000 User Basic Mnt 1MO	1	\$0.08
DAGW 100001 to 250000 User Basic Mnt 1MO	1	\$0.06
DAGW 250,001+ Users Basic Mnt 1MO	1	\$0.06
DAGW Enterprise Basic Mnt 1MO	1	Quoted
DAGW Up to 5,000 Users Enh Mnt 1MO	1	\$0.23
DAGW 5,001 to 10,000 Users Enh Mnt 1MO	1	\$0.17
DAGW 10,001 to 25,000 Users Enh Mnt 1MO	1	\$0.14
DAGW 25,001 to 50,000 Users Enh Mnt 1MO	1	\$0.11
DAGW 50,001 to 100,000 Users Enh Mnt 1MO	1	\$0.10
DAGW 100,001 to 250,000 Users EnhMnt 1MO	1	\$0.08
DAGW 250,001+ Users Enh Mnt 1MO	1	\$0.07
DAGW Enterprise Enh Mnt 1MO	1	Quoted
IID Up to 5,000 Users Basic Mnt 1MO	1	\$0.14
IID 5,001 to 10,000 Users Basic Mnt 1MO	1	\$0.10
IID 10,001 to 25,000 Users Basic Mnt 1MO	1	\$0.08
IID 25,001 to 50,000 Users Basic Mnt 1MO	1	\$0.07
IID 50,001 to 100,000 User Basic Mnt 1MO	1	\$0.06
IID 100,001 to 250000 User Basic Mnt 1MO	1	\$0.05
IID 250,001+ Users Basic Mnt 1MO	1	\$0.05
IID Enterprise Basic Mnt 1MO	1	Quoted
IID Up to 5,000 Users Enh Mnt 1MO	1	\$0.18
IID 5,001 to 10,000 Users Enh Mnt 1MO	1	\$0.13
IID 10,001 to 25,000 Users Enh Mnt 1MO	1	\$0.10
IID 25,001 to 50,000 Users Enh Mnt 1MO	1	\$0.09
IID 50,001 to 100,000 Users Enh Mnt 1MO	1	\$0.07
IID 100,001 to 250,000 Users Enh Mnt 1MO	1	\$0.06
IID 250,001+ Users Enh Mnt 1MO	1	\$0.06
IID Enterprise Enh Mnt 1MO	1	Quoted
AFX Up to 5,000 Users	1	\$20.57
AFX 5,001 to 10,000 User	1	\$15.00
AFX 10,001 to 25000 User	1	\$12.00
AFX 25,001 to 50000 User	1	\$10.20
AFX 50001 to 100000 User	1	\$8.57
AFX 100001 - 250000 User	1	\$7.20
AFX 250,001+ Users	1	\$6.61
AFX Enterprise	1	Quoted

AFX Up to 5,000 Users Basic Mnt 1MO	1	\$0.34
AFX 5,001 to 10,000 Users Basic Mnt 1MO	1	\$0.25
AFX 10,001 to 25,000 Users Basic Mnt 1MO	1	\$0.20
AFX 25,001 to 50,000 Users Basic Mnt 1MO	1	\$0.17
AFX 50,001 to 100,000 User Basic Mnt 1MO	1	\$0.14
AFX 100,001 to 250000 User Basic Mnt 1MO	1	\$0.12
AFX 250,001+ Users Basic Mnt 1MO	1	\$0.11
AFX Enterprise Basic Mnt 1MO	1	Quoted
AFX Up to 5,000 Users Enh Mnt 1MO	1	\$0.43
AFX 5,001 to 10,000 Users Enh Mnt 1MO	1	\$0.31
AFX 10,001 to 25,000 Users Enh Mnt 1MO	1	\$0.25
AFX 25,001 to 50,000 Users Enh Mnt 1MO	1	\$0.21
AFX 50,001 to 100,000 Users Enh Mnt 1MO	1	\$0.18
AFX 100,001 to 250,000 Users Enh Mnt 1MO	1	\$0.15
AFX 250,001+ Users Enh Mnt 1MO	1	\$0.14
AFX Enterprise Enh Mnt 1MO	1	Quoted
SaaS Compliance up to 5,000 Users	1	\$7.00
SaaS Compliance 5,001 to 10,000 Users	1	\$6.50
SaaS Compliance 10,001 to 25,000 Users	1	\$5.50
SaaS Compliance 25,001 to 50,000 Users	1	\$4.00
SaaS Compliance 50,001 to 100,000 Users	1	\$3.00
SaaS Compliance 100,001 to 250,000 Users	1	\$2.00
SaaS Prov & Request up to 5,000 Users	1	\$5.00
SaaS Prov & Request 5,001 to 10,000 User	1	\$4.64
SaaS Prov & Request 10,001 to 25000 User	1	\$3.93
SaaS Prov & Request 25001 to 50000 User	1	\$2.86
SaaS Prov & Request 50001 to 100000 User	1	\$2.14
SaaS Prov & Request 100001 - 250000 User	1	\$1.43
R320 Appliance Basic Mnt 1MO	1	\$166.67
R320 Appliance Enhanced Mnt 1MO	1	\$208.33
DAG AM Up to 5K Users Basic Mnt 1MO	1	\$0.17
DAG AM 5,001 to 10K Users Basic Mnt 1MO	1	\$0.12
DAG AM 10,001 to 25K Users Basic Mnt 1MO	1	\$0.10
DAG AM 25,001 to 50K Users Basic Mnt 1MO	1	\$0.08
DAG AM 50,001 to 100K User Basic Mnt 1MO	1	\$0.07
DAG AM 100,001 to 250K User BasicMnt 1MO	1	\$0.06
DAG AM 250,001+ Users Basic Mnt 1MO	1	\$0.05
DAG AM Enterprise Basic Mnt 1MO	1	Quoted
DAG AM Up to 5K Users Enh Mnt 1MO	1	\$0.21
DAG AM 5,001 to 10K Users Enh Mnt 1MO	1	\$0.16
DAG AM 10,001 to 25K Users Enh Mnt 1MO	1	\$0.12
DAG AM 25,001 to 50K Users Enh Mnt 1MO	1	\$0.11
DAG AM 50,001 to 100K Users Enh Mnt 1MO	1	\$0.09
DAG AM 100,001 to 250K Users Enh Mnt 1MO	1	\$0.07
DAG AM 250,001+ Users Enh Mnt 1MO	1	\$0.07
DAG AM Enterprise Enh Mnt 1MO	1	Quoted
RSA Key Recovery Mgr Basic Mnt-1	1	\$300.00

RSA Key Recovery Mgr Enh Mnt -1	1	\$416.67
NW S5 Analytics Server with 10 Users	1	\$57,200.00
NW S5 Analytics Svr 10 User TR	1	\$27,500.00
NW Analyst Enterprise, 5 users or less	1	\$27,000.00
NW S5 Packet Decoder	1	\$46,800.00
NW S5 Log Decoder	1	\$46,800.00
NW S5 Packet Decoder TR	1	\$27,500.00
NW S5 Log Decoder TR	1	\$27,500.00
NW S5 Hybrid For Packets	1	\$83,100.00
NW S5 Hybrid For Logs	1	\$83,100.00
NW S5 Hybrid for Packets TR	1	\$49,100.00
NW S5 Hybrid for Logs TR	1	\$49,100.00
NW S5 Pkts Concentrator	1	\$46,800.00
NW S5 Logs Concentrator	1	\$46,800.00
NW S5 Packet Concentrator TR	1	\$27,500.00
NW S5 Log Concentrator TR	1	\$27,500.00
NW S5 Broker	1	\$46,800.00
NW S5 Broker TR	1	\$27,500.00
NW S5 Event Stream Analysis	1	\$66,000.00
NW S5 Event Stream Analysis TR	1	\$35,800.00
NW S5 HeadUnit Archiver	1	\$55,000.00
NW S5 HeadUnit Archiver TR	1	\$27,500.00
NW S5 HeadUnit Malware	1	\$46,800.00
NW PV HD 72TB Archiver w/ Lic	1	\$64,828.20
NW PV HD144TB Archiver w/ Lic	1	\$125,494.80
NW PV HD 72TB Archiver w/ Lic TR	1	\$45,379.74
NW PV HD 144TB Archiver w/ Lic TR	1	\$87,846.36
NW PV HD 72TB w/Lic	1	\$108,047.00
NW PV HD 144TB w/Lic	1	\$209,158.00
NW PV HD 72TB w/Lic TR	1	\$75,632.90
NW PV HD 144TB w/Lic TR	1	\$146,410.60
NW PV HP 56TB w/Lic	1	\$87,197.00
NW PV HP 113TB w/Lic	1	\$163,936.00
NW PV HP 56TB w/Lic TR	1	\$61,037.90
NW PV HP 113TB w/Lic TR	1	\$114,755.20
NW 32TB Archiver DAC	1	\$35,599.00
NW 46TB Archiver DAC	1	\$43,436.00
NW 142TB Archiver DAC	1	\$88,000.00
NW 32TB Archiver DAC TR	1	\$32,363.00
NW 46TB Archiver DAC TR	1	\$39,488.00
NW 46TB HDDAC Decoder 4Pkt w/Lic	1	\$83,000.00
NW 46TB HDDAC Decoder 4Pkt w/Lic TR	1	\$19,770.00
NW 22TB HDDAC Decoder 4Pkt w/Lic	1	\$36,900.00
NW 22TB HDDAC Decoder 4Pkt w/Lic TR	1	\$15,361.00
NW 32TB HDDAC Decoder 4Pkt w/Lic	1	\$58,700.00
NW 32TB HDDAC Decoder 4Pkt w/Lic TR	1	\$18,354.00
NW 142TB HDDAC Decoder 4Pkt w/Lic	1	\$238,200.00

NW 142TB HDDAC Decoder 4Pkt w/Lic TR	1	\$147,816.00
NW 180TB Hi Density UltraDAC 4Pkt w/Lic	1	\$301,950.00
NW 46TB HDDAC Decoder 4Log w/Lic	1	\$83,000.00
NW 46TB HDDAC Decoder 4Log w/LicTR	1	\$19,770.00
NW 22TB HDDAC Decoder 4Log w/Lic	1	\$36,900.00
NW 22TB HDDAC Decoder 4Log w/Lic TR	1	\$15,361.00
NW 32TB HDDAC Decoder 4Log w/Lic	1	\$58,700.00
NW 32TB HDDAC Decoder 4Log w/Lic TR	1	\$18,354.00
NW 142TB HDDAC Decoder 4Log w/Lic	1	\$238,200.00
NW 142TB HDDAC Decoder 4Log w/Lic TR	1	\$147,816.00
NW 180TB Hi Density UltraDAC 4Logs w/Lic	1	\$301,950.00
NW 33TB HP Concentrator DAC	1	\$67,230.00
NW 33TB HP Concentrator DAC TR	1	\$60,428.00
NW 12TB HP Concentrator DAC	1	\$42,353.00
NW 12TB HP Concentrator DAC TR	1	\$40,660.00
NW 22TB HD DAC 4Log Hybrid w/ lic	1	\$45,000.00
NW 22TB HD DAC 4Log Hybrid w/ lic TR	1	\$15,361.00
NW 22TB HD DAC 4Pkts Hybrid w/ lic	1	\$45,000.00
NW 22TB HD DAC 4Pkts Hybrid w/ lic TR	1	\$15,361.00
NW 32TB HD DAC 4Log Hybrid w/ lic	1	\$72,000.00
NW 32TB HD DAC 4Log Hybrid w/ lic TR	1	\$18,354.00
NW 32TB HD DAC 4Pkts Hybrid w/ lic	1	\$72,000.00
NW 32TB HD DAC 4Pkts Hybrid w/ lic TR	1	\$18,354.00
NW 46TB HDDAC 4 Log Hybrid w/ lic	1	\$83,000.00
NW 46TB HDDAC 4 Log Hybrid w/ lic TR	1	\$19,770.00
NW 46TB HDDAC 4 Pkts Hybrid w/ lic	1	\$83,000.00
NW 46TB HDDAC 4 Pkts Hybrid w/ lic TR	1	\$19,770.00
Hi Density SAN Expansion Shelf Upgrd	1	\$48,843.00
Hi Performance SAN Expansion Upgrd	1	\$70,363.00
SA VNX2 Rack	1	\$3,484.00
SA Ultra Rack	1	\$7,169.00
NW Unity 600 Base Unit	1	\$119,600.00
Unity Rack for Expansion	1	\$3,484.00
NW Storage Lic +Unity Dec Shf	1	\$137,470.00
NW Storage Lic +Unity Conc Shf	1	\$94,360.00
NW Storage Lic +Unity Archiver Shf	1	\$137,470.00
ISILON 3x144TB BASE4TB nonSED	1	\$405,586.00
ISILON 144TB ADDON 4TB nonSED	1	\$123,894.00
ISILON 3x144TB BASE4TB SED	1	\$505,408.00
ISILON 144TB ADDON 4TB SED	1	\$157,168.00
ISILON 3x210TB BASE6TB nonSED	1	\$574,624.00
ISILON 210TB ADDON 6TB nonSED	1	\$180,240.00
2 Pack SSD cache 4 SA systems	1	\$5,000.00
1TB drive for R620 (2 Pack)	1	\$1,800.00
146GB drive for R620 (2 Pack)	1	\$1,200.00
R620 Power Supply	1	\$270.00
S4 Replacement Railkit	1	\$250.00

Spare Fan Module for SAW Switch	1	\$500.00
Spare Power Supply for SAW Switch	1	\$850.00
NW S5H Series 5 Power Supply	1	\$801.00
NW S5H 10 GB NDC Fiber Add-on Card	1	\$2,105.00
NW S5H 2M Mini SAS 15 Dr DAC Cables 2 PK	1	\$554.00
NW S5H 5M Mini SAS 60 Dr DAC Cables 2 Pk	1	\$1,386.00
EMULEX 2 PORT 8GB SAN HBA	1	\$4,500.00
EMULEX 2 PORT 8GB SAN HBA BscMnt1Mo	1	\$75.00
EMULEX 2 PORT 8GB SAN HBA EnhMnt1Mo	1	\$93.75
NW S4S Analytics Svr 10U BscMnt1M	1	\$916.67
NW S5 Analytics Svr 10U BscMnt1M	1	\$953.33
NW Anlyst Entrprise 5U or less BscMnt 1M	1	\$450.00
NW S4S Pkt Decoder BscMnt1M	1	\$750.00
NW S4S Log Decoder BscMnt1M	1	\$750.00
NW S5 Pkt Decoder BscMnt1M	1	\$780.00
NW S5 Log Decoder BscMnt1M	1	\$780.00
NW S4S Hybrid for Pkts BscMnt 1M	1	\$916.67
NW S4S Hybrid for Logs BscMnt 1M	1	\$916.67
NW S5 Hybrid for Pkts BscMnt1M	1	\$1,385.00
NW S5 Hybrid for Logs BscMnt1M	1	\$1,385.00
NW Warehouse HiDen DAC w/NW Lic BMnt 1M	1	\$666.67
NW Warehouse Node w/NW Lic BscMnt 1M	1	\$1,416.67
NW S4S Pkt Concentrator BscMnt 1M	1	\$750.00
NW S4S Log Concentrator BscMnt 1M	1	\$750.00
NW S5 Pkt Concentrator BscMnt1M	1	\$780.00
NW S5 Log Concentrator BscMnt1M	1	\$780.00
NW S4S Broker BscMnt1M	1	\$750.00
NW S5 Broker BscMnt1M	1	\$780.00
NW S4SHeadUnit EvntStrmAnalysis BscMnt1M	1	\$1,000.00
NW Event Stream Analysis Sftwre BscMnt1M	1	\$750.00
NW S5SHeadUnit EvntStrmAnalysis BscMnt1M	1	\$1,100.00
NW PV HD 72TB Archiver w/ Lic BM 1Mo	1	\$1,080.47
NW PV HD144TB Archiver w/ Lic BM 1Mo	1	\$2,091.58
NW PV HD 72TB w/Lic BM 1Mo	1	\$1,800.78
NW PV HD 144TB w/Lic BM 1Mo	1	\$3,485.97
NW PV HP 56TB w/Lic BM 1Mo	1	\$1,453.28
NW PV HP 113TB w/Lic BM 1Mo	1	\$2,732.27
NW S4SHeadUnit Archiver BscMnt1M	1	\$833.33
NW Archiver Software Offering BscMnt1Mo	1	\$583.33
NW S4S HeadUnit Archiver w/32TB BscMnt1M	1	\$1,250.00
NW S4S HeadUnit Archiver w/64TB BscMnt1M	1	\$1,666.67
NW S4S HeadUnit Archiver w/96TB BscMnt1M	1	\$2,083.33
NW S4S HeadUnit Archiver w/142TB BMnt1M	1	\$2,300.00
NW 32TB Archiver DAC BscMnt1Mo	1	\$593.32
NW 46TB Archiver DAC BscMnt1Mo	1	\$723.93
NW 142TB Archiver DAC BscMnt1Mo	1	\$1,466.67
NW S5SHeadUnit Archiver BscMnt1M	1	\$916.67

NW 22TB HDDAC Decdr 4Log w/Lic BscMnt 1M	1	\$615.00
NW 22TB HDDAC Decdr 4Pkt w/Lic BscMnt 1M	1	\$615.00
NW 32TB HDDAC Decdr 4Log w/Lic BscMnt 1M	1	\$978.33
NW 32TB HDDAC Decdr 4Pkt w/Lic BscMnt 1M	1	\$978.33
NW 46TB HDDAC Decdr 4Log w/Lic BscMnt 1M	1	\$1,383.33
NW 46TB HDDAC Decdr 4Pkt w/Lic BscMnt 1M	1	\$1,383.33
NW 142TB HDDAC Decdr 4Log w/Lic BMnt 1M	1	\$3,970.00
NW 142TB HDDAC Decdr 4Pkt w/Lic BMnt 1M	1	\$3,970.00
NW 180TB Hi Den UltraDAC 4Logs BMnt 1Mo	1	\$5,032.50
NW 180TB Hi Den UltraDAC 4Pkt BMnt 1Mo	1	\$5,032.50
NW 22TB HDDAC 4Log Hybrid w/lic BMnt 1M	1	\$750.00
NW 22TB HDDAC 4Pkt Hybrid w/lic BMnt 1M	1	\$750.00
NW 32TB HDDAC 4Log Hybrid w/lic BMnt 1M	1	\$1,200.00
NW 32TB HDDAC 4Pkt Hybrid w/lic BMnt 1M	1	\$1,200.00
NW 46TB HDDAC 4Log Hybrid w/lic BMnt 1M	1	\$1,383.33
NW 46TB HDDAC 4Pkt Hybrid w/lic BMnt 1M	1	\$1,383.33
NW All-in-One4Logs BscMnt1Mo	1	\$1,250.00
NW All-in-One4Pkts BscMnt1Mo	1	\$1,250.00
NW 22TB HiDenDAC4Log All in One BMnt1Mo	1	\$750.00
NW 22TB HiDenDAC4Pkt All in One BMnt1Mo	1	\$750.00
NW 32TB HiDenDAC4Log All in One BMnt1Mo	1	\$1,200.00
NW 32TB HiDenDAC4Pkt All in One BMnt1Mo	1	\$1,200.00
NW S4S HeadUnit Malware BscMnt1M	1	\$916.67
NW Malware S/W BscMnt1M	1	\$687.50
NW S3 1U Spectrum Appliance Upg - BMnt1M	1	\$833.33
NW S3 2U Spectrum Appliance Upg - BMnt1M	1	\$1,250.00
NW S5S HeadUnit Malware BscMnt1M	1	\$780.00
NW 12TB HP Concentrator DAC BscMnt 1Mo	1	\$705.88
NW 12TB HP Concentrator DAC 4Logs BMnt 1M	1	\$705.88
NW 33TB HP Concentrator DAC BscMnt 1M	1	\$1,120.50
2 Pack SSD cache 4 SA systems BscMnt 1M	1	\$83.33
Warehouse Switch BscMnt 1M	1	\$250.00
1TB drive for R620 BscMnt 1M (2 Pack)	1	\$30.00
146GB drive for R620 BscMnt 1M (2 Pack)	1	\$20.00
R620 Power Supply BscMnt 1M	1	\$4.50
S4 Replacement Railkit BscMnt 1M	1	\$4.17
NW S5H 10GB NDC FiberAdd-onCard BMnt1Mo	1	\$17.55
NW Analytics Server - S/W Only - BscMnt1Mo	1	\$687.50
NW Pkt Decoder S/W BscMnt 1Mo	1	\$562.50
NW Log Decoder S/W BscMnt 1Mo	1	\$562.50
NW Hybrid 4Pkts S/W BscMnt1Mo	1	\$687.50
NW Hybrid4Logs S/W BscMnt1Mo	1	\$687.50
NW All-in-One for Logs S/W BscMnt1Mo	1	\$750.00
NW All-in-One for Pkts S/W BscMnt1Mo	1	\$750.00
NW Warehouse Node w/10TB S/W BscMnt1Mo	1	\$1,062.50
NW 30TB Warehouse Cpcty Add-onS/W BMnt1M	1	\$500.00
NW Pkt Concentrator S/W BscMnt1Mo	1	\$562.50

NW Log Concentrator S/W BscMnt1Mo	1	\$562.50
NW Broker S/W BscMnt1Mo	1	\$562.50
NW 5TB Capacity 4logs S/W BscMnt1Mo	1	\$150.00
NW 5TB Capacity 4Pkts S/W BscMnt1Mo	1	\$150.00
NW 15TB Capacity 4logs S/W BscMnt1Mo	1	\$375.00
NW 15TB Capacity 4Pkts S/W BscMnt1Mo	1	\$375.00
NW 25TB Capacity 4logs S/W BscMnt1Mo	1	\$500.00
NW 25TB Capacity 4Pkts S/W BscMnt1Mo	1	\$500.00
5600 SAN Base Unit BscMnt 1Mo	1	\$584.79
5800 SAN Base Unit BscMnt 1Mo	1	\$882.05
7600 SAN Base Unit BscMnt 1Mo	1	\$1,246.16
High Den SAN Exp Shelf BscMnt 1Mo	1	\$344.84
High Perf SAN Exp Shelf BscMnt 1Mo	1	\$458.31
High Den SAN Exp Shelf Upgrd BscMnt 1Mo	1	\$407.03
High Perf SAN Exp Shelf Upgrd BscMnt 1Mo	1	\$586.36
Unity 600 Base Unit Basic 1Mo	1	\$1,455.83
NW Storage Lic +Unity Dec Shf BM 1M	1	\$27,494.00
NW Storage Lic +Unity Conc Shf BM 1M	1	\$18,872.00
NW Storage Lic +Unity Arc Shf BM 1M	1	\$27,494.00
ISILON 3x144TB BASE4TB nonSED BscMnt 1Mo	1	\$3,379.88
ISILON 144TB ADDON 4TB nonSED BscMnt 1Mo	1	\$1,032.45
ISILON 3x144TB BASE4TB SED BscMnt 1Mo	1	\$4,211.73
ISILON 144TB ADDON 4TB SED BscMnt 1Mo	1	\$1,309.73
ISILON 3x210TB BASE6TB nonSED BscMnt 1Mo	1	\$4,788.53
ISILON 210TB ADDON 6TB nonSED BscMnt 1Mo	1	\$1,502.00
NW S4S Anlytics Svr 10U EnhMnt1M	1	\$1,145.83
NW S5 Anlytics Svr 10U EnhMnt1M	1	\$1,191.67
NW Analyst Entrprse 5U or less EnhMnt 1M	1	\$562.50
NW S4S Pkt Decoder EnhMnt1M	1	\$937.50
NW S4S Log Decoder EnhMnt1M	1	\$937.50
NW S5 Pkt Decoder EnhMnt1M	1	\$975.00
NW S5 Log Decoder EnhMnt1M	1	\$975.00
NW S4S Hybrid for Pkts EnhMnt 1M	1	\$1,145.83
NW S4S Hybrid for Logs EnhMnt 1M	1	\$1,145.83
NW S5 Hybrid for Pkts EnhMnt1M	1	\$1,731.25
NW S5 Hybrid for Logs EnhMnt1M	1	\$1,731.25
NW Warehouse HDDAC w/NW Lic EnhMnt 1M	1	\$833.33
NW Warehouse Node w/NW Lic EnhMnt 1M	1	\$1,770.83
NW S4S Pkt Concentrator EnhMnt 1M	1	\$937.50
NW S4S Log Concentrator EnhMnt 1M	1	\$937.50
NW S5 Pkt Concentrator EnhMnt1M	1	\$975.00
NW S5 Log Concentrator EnhMnt1M	1	\$975.00
NW S4S Broker EnhMnt1M	1	\$937.50
NW S5 Broker EnhMnt1M	1	\$975.00
NW S4SHeadUnit EvntStrmAnalysis EnhMnt1M	1	\$1,250.00
NW EvntStrmAnalysis Sftwre EnhMaint 1M	1	\$937.50
NW S5SHeadUnit EvntStrmAnalysis EnhMnt1M	1	\$1,375.00

NW PV HD 72TB Archiver w/ Lic EM 1Mo	1	\$1,350.59
NW PV HD144TB Archiver w/ Lic EM 1Mo	1	\$2,614.48
NW PV HD 72TB w/Lic EM 1Mo	1	\$2,250.98
NW PV HD 144TB w/Lic EM 1Mo	1	\$4,357.46
NW PV HP 56TB w/Lic EM 1Mo	1	\$1,816.60
NW PV HP 113TB w/Lic EM 1Mo	1	\$3,415.33
NW S4SHeadUnit Archiver EnhMnt 1M	1	\$1,041.67
NW Archiver Software Enh Maint 1M	1	\$729.17
NW HeadUnit Archiver w/32TB EnhMnt 1M	1	\$1,562.50
NW HeadUnit Archiver w/64TB EnhMnt 1M	1	\$2,083.33
NW HeadUnit Archiver w/96TB EnhMnt 1M	1	\$2,604.17
NW HeadUnit Archiver w/142TB EnhMnt 1M	1	\$2,875.00
NW 32TB Archiver DAC Enh Maint 1M	1	\$741.65
NW 46TB Archiver DAC Enh Maint 1M	1	\$904.92
NW 142TB Archiver DAC Enh Maint 1M	1	\$1,833.33
NW S5S HeadUnit Archiver EnhMnt 1M	1	\$1,145.83
NW 22TB HDDAC Decoder 4Log w/Lic EMnt1M	1	\$768.75
NW 22TB HDDAC Decoder 4Pkt w/Lic EMnt1M	1	\$768.75
NW 32TB HDDAC Decoder 4Log w/Lic EMnt1M	1	\$1,222.92
NW 32TB HDDAC Decoder 4Pkt w/Lic EMnt1M	1	\$1,222.92
NW 46TB HDDAC Decoder 4Pkt w/Lic EMnt1M	1	\$1,729.17
NW 46TB HDDAC Decoder 4Log w/Lic EMnt1M	1	\$1,729.17
NW 142TB HDDAC Decoder 4Log w/Lic EMnt1M	1	\$4,962.50
NW 142TB HDDAC Decoder 4Pkt w/Lic EMnt1M	1	\$4,962.50
NW 180TB Hi Den UltraDAC 4Logs EMnt 1Mo	1	\$6,290.63
NW 180TB Hi Den UltraDAC 4Pkt EMnt 1Mo	1	\$6,290.63
NW 22TB HDDAC 4Log Hybrid w/lic EMnt 1M	1	\$937.50
NW 22TB HDDAC 4Pkt Hybrid w/lic EMnt 1M	1	\$937.50
NW 32TB HDDAC 4Log Hybrid w/lic EMnt 1M	1	\$1,500.00
NW 32TB HDDAC 4Pkt Hybrid w/lic EMnt 1M	1	\$1,500.00
NW 46TB HDDAC 4Log Hybrid w/lic EMnt 1M	1	\$1,729.17
NW 46TB HDDAC 4Pkt Hybrid w/lic EMnt 1M	1	\$1,729.17
NW S4S HeadUnit Malware EnMnt1M	1	\$1,145.83
NW Malware S/W EnhMnt 1M	1	\$859.38
NW S3 1U Spectrum Appliance Upg - EMnt1M	1	\$1,041.67
NW S3 2U Spectrum Appliance Upg - EMnt1M	1	\$1,562.50
NW S5S HeadUnit Malware EnMnt1M	1	\$975.00
NW All-in-One4Logs EnhMnt1Mo	1	\$1,562.50
NW All-in-One4Pkts EnhMnt1Mo	1	\$1,562.50
NW 12TB HP Concentrator DAC EnhMnt 1Mo	1	\$882.35
NW 12TB HP Concentrator DAC 4Logs EMnt1M	1	\$882.35
NW 33TB HP Concentrator DAC EnhMnt 1M	1	\$1,400.63
NW 22TB HDDAC 4Log All in One EMnt1Mo	1	\$937.50
NW 32TB HDDAC 4Log All in One EMnt1Mo	1	\$1,500.00
NW 22TB HDDAC 4Pkt All in One EMnt1Mo	1	\$937.50
NW 32TB HDDAC 4Pkt All in One EMnt1Mo	1	\$1,500.00
2 Pack SSD cache 4 SA systems EnhMnt 1M	1	\$104.17

Warehouse Switch EnhMnt 1M	1	\$312.50
1TB drive for R620 EnhMnt 1M (2 Pack)	1	\$37.50
146GB drive for R620 EnhMnt 1M (2 Pack)	1	\$25.00
R620 Power Supply EnhMnt 1M	1	\$5.63
S4 Replacement Railkit EnhMnt 1M	1	\$5.21
NW S5H 10GB NDC FiberAdd-onCard EMnt1Mo	1	\$21.05
NW Analytics Server S/W Only EnhMnt1Mo	1	\$859.38
NW Pkt Decoder S/W EnhMnt1Mo	1	\$703.13
NW Log Decoder S/W EnhMnt1Mo	1	\$703.13
NW Hybrid4Pkts S/W EnhMnt1Mo	1	\$859.38
NW Hybrid4Logs S/W EnhMnt1Mo	1	\$859.38
NW All-in-One for Logs S/W EnhMnt1Mo	1	\$937.50
NW All-in-One for Pkts S/W EnhMnt1Mo	1	\$937.50
NW Warehouse Node w/NW Lic EnhMnt1Mo	1	\$1,328.13
NW 30TB Warehouse Cpcty S/WAdd-on EMnt1M	1	\$625.00
NW Pkt Cncntrtr S/W EnhMnt1Mo	1	\$703.13
NW Log Cncntrtr S/W EnhMnt1Mo	1	\$703.13
NW Broker S/W EnhMnt1Mo	1	\$703.13
NW 5TB Decoder Cpcty4logs S/W EMnt1Mo	1	\$187.50
NW 5TB Decoder Cpcty4IPkts S/W EMnt1Mo	1	\$187.50
NW 15TB Decoder Cpcty4logs S/W EMnt1Mo	1	\$468.75
NW 15TB Decoder Cpcty4Pkts S/W EMnt1Mo	1	\$468.75
NW 25TB Decoder Cpcty4logs S/W EMnt1Mo	1	\$625.00
NW 25TB Decoder Cpcty4Pkts S/W EMnt1Mo	1	\$625.00
5600 SAN Base Unit EnhMnt 1Mo	1	\$701.75
5800 SAN Base Unit EnhMnt 1Mo	1	\$1,058.46
7600 SAN Base Unit EnhMnt 1Mo	1	\$1,495.39
High Den SAN Exp Shelf EnhMnt 1Mo	1	\$413.81
High Perf SAN Exp Shelf EnhMnt 1Mo	1	\$549.97
High Den SAN Exp Shelf Upgrd EnhMnt 1Mo	1	\$488.43
High Perf SAN Exp Shelf Upgrd EnhMnt 1Mo	1	\$703.63
VNX2 5600 Ctrl Encrypt EnhMnt 1 Mo	1	\$97.73
VNX2 5800 Ctrl Encrypt EnhMnt 1 Mo	1	\$123.53
VNX2 7600 Ctrl Encrypt EnhMnt 1 Mo	1	\$151.53
Unity 600 Base Unit EnhMnt 1Mo	1	\$1,747.00
NW Storage Lic +Unity Dec Shf EM 1M	1	\$34,367.50
NW Storage Lic +Unity Conc Shf EM 1M	1	\$23,590.00
NW Storage Lic +Unity Arc Shf EM 1M	1	\$34,367.50
ISILON 3x144TB BASE4TB nonSED EnhMnt 1Mo	1	\$4,055.86
ISILON 144TB ADDON 4TB nonSED EnhMnt 1Mo	1	\$1,238.94
ISILON 3x144TB BASE4TB SED EnhMnt 1Mo	1	\$5,054.08
ISILON 144TB ADDON 4TB SED EnhMnt 1Mo	1	\$1,571.68
ISILON 3x210TB BASE6TB nonSED EnhMnt 1Mo	1	\$5,746.24
ISILON 210TB ADDON 6TB nonSED EnhMnt 1Mo	1	\$1,802.40
Primry SAN w/ 250TB Arch BscMnt1Mo	1	\$7,676.42
Primary SAN Additional Shelf BscMnt1Mo	1	\$1,107.83
5600 SAN w/4x4TBHD exp750 4Pkt BscMnt1Mo	1	\$9,558.17

5800 SAN w/4x4TB HD exp1K 4Pkt BscMnt1Mo	1	\$10,577.57
7600 SAN w/4x4TBHDexp1.5K 4Pkt BscMnt1Mo	1	\$11,701.42
46TB HD SAN Expansion Dec 4Pkt BscMnt1Mo	1	\$2,257.83
5600 SAN w/4x4TBHD exp750 4Log BscMnt1Mo	1	\$9,558.17
5800 SAN w/4x4TB HD exp1K 4Log BscMnt1Mo	1	\$10,577.57
7600 SAN w/4x4TBHDexp1.5K 4Log BscMnt1Mo	1	\$11,701.42
46TB HD SAN Expansion Dec 4Log BscMnt1Mo	1	\$2,257.83
5600 SAN HP w/ exp750 BscMnt1Mo	1	\$5,915.12
5800 SAN HP w/ exp1K BscMnt1Mo	1	\$6,660.78
7600 SAN w/4x4 HP exp1.5K BscMnt1Mo	1	\$7,611.15
HP SAN Expansion Con BscMnt1Mo	1	\$952.20
SM High Perf SAN Basic Maintenance 1 month	1	\$4,508.33
SM High Perf SAN for Logs Basic Maintenance 1 month	1	\$4,508.33
MED High Perf SAN Basic Maintenance 1 month	1	\$6,065.00
LGE High Perf SAN Basic Maintenance 1 month	1	\$7,618.33
XL High Perf SAN Basic Maintenance 1 month	1	\$14,571.67
XXL High Perf SAN Basic Maintenance 1 month	1	\$27,243.33
High Perf SAN Capacity Basic Maintenance 1 month	1	\$1,366.67
High Perf SAN Capacity for Logs Basic Maintenance 1 month	1	\$1,366.67
46TB High Den SAN 4 Log Decdr w/SA Lic Basic Maintenance 1 month	1	\$3,506.67
46TB High Den SAN 4 Packet Decdr w/SA Lic Basic Maintenance 1 month	1	\$3,506.67
75TB High Den SAN 4 Log Decdr w/SA Lic Basic Maintenance 1 month	1	\$5,717.38
75TB High Den SAN 4 Packet Decdr w/SA Lic Basic Maintenance 1 month	1	\$5,717.38
209TB High Den SAN 4 Log Decdr w/SA Lic Basic Maintenance 1 month	1	\$12,325.00
209TB High Den SAN 4 Packet Decdr w/SA Lic Basic Maintenance 1 month	1	\$12,325.00
395TB High Den SAN 4 Log Decdr w/SA Lic Basic Maintenance 1 month	1	\$22,406.67
395TB High Den SAN 4 Packet Decdr w/SA Lic Basic Maintenance 1 month	1	\$22,406.67
814TB High Den SAN 4 Log Decdr w/SA Lic Basic Maintenance 1 month	1	\$46,736.67
814TB High Den SAN 4 Packet Decdr w/SA Lic Basic Maintenance 1 month	1	\$46,736.67
2-40U Rack, HiDen 1050TB Logs BscMnt 1Mo	1	\$59,500.00
1256TB High Den SAN 4 Log Decdr w/SA Lic Basic Maintenance 1 month	1	\$72,114.57
1256TB High Den SAN 4 Packet Decdr w/SA Lic Basic Maintenance 1 month	1	\$72,114.57
1500TB High Den SAN 4 Log Decdr w/SA Lic Basic Maintenance 1 month	1	\$81,961.67
1500TB High Den SAN 4 Packet Decdr w/SA Lic Basic Maintenance 1 month	1	\$81,961.67
23TB HiDen SANCPcty AddOn 4 Log Decdr w/lic Basic Maintenance 1 month	1	\$823.33
23TB HiDen SANCPcty AddOn 4 Packet Decdr w/lic Basic Maintenance 1 month	1	\$823.33
Primry SAN w/ 250TB Arch Enh Maint	1	\$9,595.52
Primary SAN Additional Shelf Enh Maint	1	\$1,384.79
5600 SAN w/4x4TB HD exp750 4Pkt Enh Mtn	1	\$11,947.71
5800 SAN w/4x4TB HD exp1K 4Pkt Enh Mtn	1	\$13,221.96
7600 SAN w/4x4TB HD exp1.5K 4Pkt Enh Mtn	1	\$14,626.77
46TB HD SAN Expansion Dec 4Pkt Enh Mtn	1	\$2,822.29
5600 SAN w/4x4TB HD exp750 4Log Enh Mtn	1	\$11,947.71
5800 SAN w/4x4TB HD exp1K 4Log Enh Mtn	1	\$13,221.96
7600 SAN w/4x4TB HD exp1.5K 4Log Enh Mtn	1	\$14,626.77
46TB HD SAN Expansion Dec 4Log Enh Mtn	1	\$2,822.29
5600 SAN HP w/ exp750 Enh Mtn	1	\$7,393.90

5800 SAN HP w/ exp1K Enh Mtn	1	\$8,325.98
7600 SAN w/4x4 HP exp1.5K Enh Mtn	1	\$9,513.94
HP SAN Expansion Con Enh Mtn	1	\$1,190.00
SM High Perf SAN Enhanced Maintenance 1 month	1	\$5,635.42
SM High Perf SAN for Logs Enhanced Maintenance 1 month	1	\$5,635.42
MED High Perf SAN Enhanced Maintenance 1 month	1	\$7,581.25
LGE High Perf SAN Enhanced Maintenance 1 month	1	\$9,522.92
XL High Perf SAN Enhanced Maintenance 1 month	1	\$18,214.58
XXL High Perf SAN Enhanced Maintenance 1 month	1	\$34,054.17
High Perf SAN Capacity Enhanced Maintenance 1 month	1	\$1,708.33
High Perf SAN Capacity for Logs Enhanced Maintenance 1 month	1	\$1,708.33
46TB High Den SAN 4 Log Decdr w/SA Lic Enhanced Maintenance 1 month	1	\$4,383.33
46TB High Den SAN 4 Pkt Decdr w/SA Lic Enhanced Maintenance 1 month	1	\$4,383.33
75TB High Den SAN 4 Log Decdr w/SA Lic Enhanced Maintenance 1 month	1	\$7,146.73
75TB High Den SAN 4 Pkt Decdr w/SA Lic Enhanced Maintenance 1 month	1	\$7,146.73
209TB High Den SAN 4 Log Decdr w/SA Lic Enhanced Maintenance 1 month	1	\$15,406.25
209TB High Den SAN 4 Pkt Decdr w/SA Lic Enhanced Maintenance 1 month	1	\$15,406.25
395TB High Den SAN 4 Log Decdr w/SA Lic Enhanced Maintenance 1 month	1	\$28,008.33
395TB High Den SAN 4 Pkt Decdr w/SA Lic Enhanced Maintenance 1 month	1	\$28,008.33
814TB High Den SAN 4 Log Decdr w/SA Lic Enhanced Maintenance 1 month	1	\$58,420.83
814TB High Den SAN 4 Pkt Decdr w/SA Lic Enhanced Maintenance 1 month	1	\$58,420.83
2-40U Rack, HiDen 1050TB Logs EnhMnt 1Mo	1	\$74,375.00
1256TB High Den SAN 4 Log Decdr w/SA Lic Enhanced Maintenance 1 month	1	\$90,143.21
1256TB High Den SAN 4 Pkt Decdr w/SA Lic Enhanced Maintenance 1 month	1	\$90,143.21
1500TB High Den SAN 4 Log Decdr w/SA Lic Enhanced Maintenance 1 month	1	\$102,452.08
1500TB High Den SAN 4 Pkt Decdr w/SA Lic Enhanced Maintenance 1 month	1	\$102,452.08
23TB HiDen SANCpcty AddOn 4 Log Decdr w/lic Enhanced Maintenance 1 month	1	\$1,029.17
23TB HiDen SANCpcty AddOn 4 Pkt Decdr w/lic Enhanced Maintenance 1 month	1	\$1,029.17
Tier1 RNWE Perp Lic p/Host 1-250	1	\$140.75
Tier2 RNWE Perp Lic p/Host 251-500	1	\$97.00
Tier3 RNWE Perp Lic p/Host 501-1K	1	\$73.25
Tier4 RNWE Perp Lic p/Host 1001-2500	1	\$57.75
Tier5 RNWE Perp Lic p/Host 2501-5K	1	\$50.25
Tier6 RNWE Perp Lic p/Host 5001-10K	1	\$45.00
Tier7 RNWE Perp Lic p/Host 10001-25K	1	\$38.33
Tier8 RNWE Perp Lic p/Host 25001-50K	1	\$32.86
Tier9 RNWE Perp Lic p/Host 50001-100K	1	\$26.98
Tier10 RNWE Perp Lic p/Host 100K+	1	\$23.95
Tier1 RNWE BscMnt p/Host 1-250 1Mo	1	\$2.35
Tier2 RNWE BscMnt p/Host 251-500 1Mo	1	\$1.62
Tier3 RNWE BscMnt p/Host 501-1K 1Mo	1	\$1.22
Tier4 RNWE BscMnt p/Host 1001-2500 1Mo	1	\$0.96
Tier5 RNWE BscMnt p/Host 2501-5K 1Mo	1	\$0.84
Tier6 RNWE BscMnt p/Host 5001-10K 1Mo	1	\$0.75
Tier7 RNWE BscMnt p/Host 10001-25K 1Mo	1	\$0.64
Tier8 RNWE BscMnt p/Host 25001-50K 1Mo	1	\$0.55
Tier9 RNWE BscMnt p/Host 50001-100K 1Mo	1	\$0.45

Tier10 RNWE BscMnt p/Host 100K+ 1Mo	1	\$0.40
Tier1 RNWE EnhMnt p/Host 1-250 1Mo	1	\$2.93
Tier2 RNWE EnhMnt p/Host 251-500 1Mo	1	\$2.02
Tier3 RNWE EnhMnt p/Host 501-1K 1Mo	1	\$1.53
Tier4 RNWE EnhMnt p/Host 1001-2500 1Mo	1	\$1.20
Tier5 RNWE EnhMnt p/Host 2501-5K 1Mo	1	\$1.05
Tier6 RNWE EnhMnt p/Host 5001-10K 1Mo	1	\$0.94
Tier7 RNWE EnhMnt p/Host 10001-25K 1Mo	1	\$0.80
Tier8 RNWE EnhMnt p/Host 25001-50K 1Mo	1	\$0.68
Tier9 RNWE EnhMnt p/Host 50001-100K 1Mo	1	\$0.56
Tier10 RNWE EnhMnt p/Host 100K+ 1Mo	1	\$0.50
Tier1 RNWE Subsc p/Host 1-250 1Mo	1	\$6.28
Tier2 RNWE Subsc p/Host 251-500 1Mo	1	\$4.33
Tier3 RNWE Subsc p/Host 501-1K 1Mo	1	\$3.27
Tier4 RNWE Subsc p/Host 1001-2500 1Mo	1	\$2.58
Tier5 RNWE Subsc p/Host 2501-5K 1Mo	1	\$2.24
Tier6 RNWE Subsc p/Host 5001-10K 1Mo	1	\$2.01
Tier7 RNWE Subsc p/Host 10001-25K 1Mo	1	\$1.71
Tier8 RNWE Subsc p/Host25001-50K 1Mo	1	\$1.47
Tier9 RNWE Subsc p/Host 50001-100K 1Mo	1	\$1.20
Tier10 RNWE Subsc p/Host 100K+ 1Mo	1	\$1.07
NW Endpoint Server - No SW Lic	1	\$55,000.00
NW Endpoint Server BscMnt 1Mo	1	\$458.33
NW Endpoint Server EnhMnt 1Mo	1	\$550.00
CAPACITY PER TB LICENSE Maint Basic 1 Mo	1	\$50.00
CAPACITY PER TB LICENSE Maint Enhanced 1 Mo.	1	\$62.50
SMC-SW-CON Basic Maint 1 Mo.	1	\$625.00
SMC-SW-CON Enhanced Maint 1 Mo.	1	\$781.25
SMC-SW-DEC Basic Maint 1 Mo.	1	\$625.00
SMC-SW-DEC Enhanced Maint 1 Mo.	1	\$781.25
SMC-SW-BRO Basic Maint 1 Mo.	1	\$625.00
SMC-SW-BRO Enhanced Maint 1 Mo.	1	\$781.25
SMC-SW-INFORM Basic Maint 1 Mo.	1	\$583.33
SMC-SW-INFORM Enhanced Maint 1 Mo.	1	\$729.17
CAP PER TB LICENSE Logs Maint Basic 1 Mo	1	\$50.00
CAP PER TB LICENSE Logs Maint Enhanced 1 Mo.	1	\$62.50
SMC-SW-CON-SYS Basic Maint 1 Mo.	1	\$625.00
SMC-SW-CON-SYS Enhanced Maint 1 Mo.	1	\$781.25
SMC-SW-DEC-SYS Basic Maint 1 Mo.	1	\$625.00
SMC-SW-DEC-SYS Enhanced Maint 1 Mo.	1	\$781.25
SMC-SW-BRO-SYS Basic Maint 1 Mo.	1	\$625.00
SMC-SW-BRO-SYS Enhanced Maint 1 Mo.	1	\$781.25
SMC-SW-INF-SYS Basic Maint 1 Mo.	1	\$583.33
SMC-SW-INF-SYS Enhanced Maint 1 Mo.	1	\$729.17
DENSE 32TB DAC Basic Maint 1 Mo.	1	\$978.00
DENSE 32TB DAC Enhanced Maint 1 Mo.	1	\$1,222.00
DENSE 32TB DAC NWFL Basic Maint 1 Mo.	1	\$978.00

DENSE 32TB DAC NWFL Gold Maint 1 Mo.	1	\$1,222.00
SMC-S4H-DEC Basic Maint 1 Mo.	1	\$750.00
SMC-S4H-DEC Enhanced Maint 1 Mo.	1	\$937.50
SMC-S4H-DEC-SYS Basic Maint 1 Mo.	1	\$750.00
SMC-S4H-DEC-SYS Enhanced Maint 1 Mo.	1	\$937.50
SMC-S4H-CON Basic Maint 1 Mo.	1	\$750.00
SMC-S4H-CON Enhanced Maint 1 Mo.	1	\$937.50
SMC-S4H-CON-SYS Basic Maint 1 Mo.	1	\$750.00
SMC-S4H-CON-SYS Enhanced Maint 1 Mo.	1	\$937.50
SMC-S4H-BRO Basic Maint 1 Mo.	1	\$750.00
SMC-S4H-BRO Enhanced Maint 1 Mo.	1	\$937.50
SMC-S4H-BRO-SYS Basic Maint 1 Mo.	1	\$750.00
SMC-S4H-BRO-SYS Enhanced Maint 1 Mo.	1	\$937.50
NW 10G Card Basic Maint. 1 Mo.	1	\$33.33
NW 10G Card Enhanced Maint. 1 Mo.	1	\$41.67
SMC-10GE-F Basic Maint 1 Mo.	1	\$46.67
SMC-10GE-F Enhanced Maint 1 Mo.	1	\$58.33
SMC-10GE-C Basic Maint 1 Mo.	1	\$46.67
SMC-10GE-C Enhanced Maint 1 Mo.	1	\$58.33
SMC-1GE-F Basic Maint 1 Mo.	1	\$41.67
SMC-1GE-F Enhanced Maint 1 Mo.	1	\$52.08
SMC-C46H Basic Maint 1 Mo.	1	\$3,506.67
SMC-C46H Enhanced Maint 1 Mo.	1	\$4,383.33
SMC-C209H Basic Maint 1 Mo.	1	\$12,325.00
SMC-C209H Enhanced Maint 1 Mo.	1	\$15,406.25
SMC-C395H Basic Maint 1 Mo.	1	\$22,406.67
SMC-C395H Enhanced Maint 1 Mo.	1	\$28,008.33
SMC-C814H Basic Maint 1 Mo.	1	\$46,736.67
SMC-C814H Enhanced Maint 1 Mo.	1	\$58,420.83
SMC-C1500H Basic Maint 1 Mo.	1	\$81,961.67
SMC-C1500H Enhanced Maint 1 Mo.	1	\$102,452.08
SMC-C25H 2.1F Basic Maint 1 Mo.	1	\$4,508.33
SMC-C25H2.1F Enhanced Maint 1 Mo.	1	\$5,635.42
SMC-C37H 3.2F Basic Maint 1 Mo.	1	\$6,065.00
SMC-C37H3.2F Enhanced Maint 1 Mo.	1	\$7,581.25
SMC-C50H4.2F Basic Maint 1 Mo.	1	\$7,618.33
SMC-C50H4.2F Enhanced Maint 1 Mo.	1	\$9,522.92
SMC-C100H8.5F Basic Maint 1 Mo.	1	\$14,571.67
SMC-C100H8.5F Enhanced Maint 1 Mo.	1	\$18,214.58
SMC-C200H17F Basic Maint 1 Mo.	1	\$27,243.33
SMC-C200H17F Enhanced Maint 1 Mo.	1	\$34,054.16
SMC-C23H-S Basic Maint 1 Mo.	1	\$823.33
SMC-C23H-S Enhanced Maint 1 Mo.	1	\$1,029.17
SMC-C13H1.1F-S Basic Maint 1 Mo.	1	\$1,366.67
SMC-C13H1.1F-S Enhanced Maint 1 Mo.	1	\$1,708.33
SMC-C46H-SYS Basic Maint 1 Mo.	1	\$3,506.67
SMC-C46H-SYS Enhanced Maint 1 Mo.	1	\$4,383.33

SMC-C25H2.1F-SYS Basic Maint 1 Mo.	1	\$4,508.33
SMC-C25H2.1F-SYS Enhanced Maint 1 Mo.	1	\$5,635.42
SMC-C22H-D Basic Maint 1 Mo.	1	\$615.00
SMC-C22H-D Enhanced Maint 1 Mo.	1	\$768.75
SMC-C12H1F-D Basic Maint 1 Mo.	1	\$933.33
SMC-C12H1F-D Enhanced Maint 1 Mo.	1	\$1,166.66
SMC-C22H-D-SYS Basic Maint 1 Mo.	1	\$615.00
SMC-C22H-D-SYS Enhanced Maint 1 Mo.	1	\$768.75
SMC-C12H1F-D-SYS Basic Maint 1 Mo.	1	\$933.33
SMC-C12H1F-D-SYS Enhanced Maint 1 Mo.	1	\$1,166.67
SMC-40U Rack Basic Maint 1 Mo.	1	\$50.00
SMC-40U Rack Enhanced Maint 1 Mo.	1	\$62.50
1 Year Services Subscription for Remote Installation, Upgrade and Tuning Services. (All Services Remote). This is an add-on charge to the Basic maintenance level. Based on PER APPLIANCE	1	\$3,000.00
S4 Dec Upgrd BscMnt 1Mo	1	\$750.00
S4 LogDec Upgrd BscMnt 1Mo	1	\$750.00
S4 Con Upgrd BscMnt 1Mo	1	\$750.00
S4 LCon Upgrd BscMnt 1Mo	1	\$750.00
S4 Bro Upgrd BscMnt 1Mo	1	\$750.00
S4 LBro Upgrd BscMnt 1Mo	1	\$750.00
HiDen DirAttchCpcty 4 Pkts UPGBscMnt 1Mo	1	\$615.00
HiDen DirAttchCpcty 4 Logs UPGBscMnt 1Mo	1	\$615.00
HiDen DirAttchCpcty 4 Pkts UPGBscMnt 1Mo	1	\$823.33
HiDen DirAttchCpcty 4 Pkts UPGBscMnt 1Mo	1	\$3,506.67
HiDen DirAttchCpcty 4 Logs UPGBscMnt 1Mo	1	\$3,506.67
HiDen DirAttchCpcty 4 Pkts UPGBscMnt 1Mo	1	\$12,325.00
HiDen DirAttchCpcty 4 Pkts UPGBscMnt 1Mo	1	\$22,406.67
HiDen DirAttchCpcty 4 Pkts UPGBscMnt 1Mo	1	\$46,736.67
HiDen DirAttchCpcty 4 Pkts UPGBscMnt 1Mo	1	\$81,961.67
HiDen DirAttchCpcty 4 Pkts UPGBscMnt 1Mo	1	\$978.00
HiDen DirAttchCpcty 4 Logs UPGBscMnt 1Mo	1	\$978.00
Sftwre Con Upgrd BscMnt 1Mo	1	\$625.00
Sftwre Dec Upgrd BscMnt 1Mo	1	\$625.00
Sftwre Bro Upgrd BscMnt 1Mo	1	\$625.00
Softwre LCon Upgrd BscMnt 1Mo	1	\$625.00
Sftwre LDec Upgrd BscMnt 1Mo	1	\$625.00
Sftwre Bro Upgrd BscMnt 1Mo	1	\$625.00
S4 Dec Upgrd EnhMnt 1Mo	1	\$937.50
S4 LogDec Upgrd EnhMnt 1Mo	1	\$937.50
S4 Con Upgrd EnhMnt 1Mo	1	\$937.50
S4 LCon Upgrd EnhMnt 1Mo	1	\$937.50
S4 Bro Upgrd EnhMnt 1Mo	1	\$937.50
S4 LBro Upgrd EnhMnt 1Mo	1	\$937.50
HiDen DirAttchCpcty 4 Pkts UPGENhMnt 1Mo	1	\$768.75
HiDen DirAttchCpcty 4 Logs UPGENhMnt 1Mo	1	\$768.75
HiDen DirAttchCpcty 4 Pkts UPGENhMnt 1Mo	1	\$1,029.17
HiDen DirAttchCpcty 4 Pkts UPGENhMnt 1Mo	1	\$4,383.33

HiDen DirAttchCpcty 4 Logs UPGEEnhMnt 1Mo	1	\$4,383.33
HiDen DirAttchCpcty 4 Pkts UPGEEnhMnt 1Mo	1	\$15,406.25
HiDen DirAttchCpcty 4 Pkts UPGEEnhMnt 1Mo	1	\$28,008.33
HiDen DirAttchCpcty 4 Pkts UPGEEnhMnt 1Mo	1	\$58,420.83
HiDen DirAttchCpcty 4 Pkts UPGEEnhMnt 1Mo	1	\$102,452.08
HiDen DirAttchCpcty 4 Pkts UPGEEnhMnt 1Mo	1	\$1,222.00
HiDen DirAttchCpcty 4 Logs UPGEEnhMnt 1Mo	1	\$1,222.00
Sftwre Con Upgrd EnhMnt 1Mo	1	\$781.25
Sftwre Dec Upgrd EnhMnt 1Mo	1	\$781.25
Sftwre Bro Upgrd EnhMnt 1Mo	1	\$781.25
Softwre LCon Upgrd EnhMnt 1Mo	1	\$781.25
Sftwre LDec Upgrd EnhMnt 1Mo	1	\$781.25
Sftwre Bro Upgrd EnhMnt 1Mo	1	\$781.25
Series 4 Hybrid For Packets Appliance 1U - 622Mbs Network capture/metadata aggregator, 1U, 96GB RAM, 10TB, Linux, 4port copper	1	\$55,000.00
Series 4 Hybrid For Logs Appliance 1U - 10,000 EPS capture/metadata aggregator, 1U, 96GB RAM, 8.5TB, Linux, 4port copper	1	\$55,000.00
SMC-S4H-HYBP Basic Maintenance 1 month	1	\$916.67
SMC-S4H-HYBP Enhanced Maint 1 month	1	\$1,145.83
SMC-S4H-HYBL Basic Maintenance 1 month	1	\$916.67
SMC-S4H-HYBL Enhanced Maint 1 month	1	\$1,145.83
Spare 2TB SAS 7.2K HDD 3.5"DAC 15 DAE	1	\$1,150.00
Spare 200GB SAS 2.5" SSD 3.5" DAC 15 DAE	1	\$5,930.00
Spare 3TB SAS 7.2K HDD 3.5" DAC 15 DAE	1	\$1,665.00
Spare 3TB SAS 7.2K HDD 3.5" DAC 60 DAE	1	\$1,665.00
Spare 3U-DAE Drive Encl for DAC 15	1	\$3,165.00
Spare 4U-DAE Drive Encl for DAC 60	1	\$12,600.00
Virtual IPDB Extractor S/W	1	\$0.00
10 GB NIC fiber Add-on. INTEL 520 based, dual port 10G NIC, Fiber	1	\$2,800.00
10GB NIC Copper Add-on INTEL 520 based, dual port 10G NIC, Copper	1	\$2,800.00
1GB NIC Fiber Add-on INTEL 520 based, dual port 1G NIC, Fiber	1	\$2,500.00
NW Orchstor Pltfrm+4 Usr Sub Lic 1M	1	\$11,667.00
NW Orchstor Additional 1 Usr Sub Lic 1M	1	\$1,750.00
NW T1, 1-10TB/day NetM PerTB Perp Lic	1	\$48,000.00
NW T2, 11-50TB/day NetM PerTB Perp Lic	1	\$38,400.00
NW T3, 51-100TB/day NetM PerTB Perp Lic	1	\$32,600.00
NW T4, 101-250TB/day NetM PerTBPerp Lic	1	\$29,300.00
NW T5, >250TB/day NetM PerTB Perp Lic	1	\$27,800.00
NW T1, 1-10TB/day Mal PerTB Perp Lic	1	\$7,200.00
NW T2, 11-50TB/day Mal PerTB Perp Lic	1	\$5,800.00
NW T3, 51-100TB/day Mal PerTB Perp Lic	1	\$4,900.00
NW T4, 101-250TB/day Mal PerTBPerp Lic	1	\$4,400.00
NW T5, >250TB/day Mal PerTB Perp Lic	1	\$4,200.00
NW T1, Per TB NetM BscMnt 1Mo	1	\$800.00
NW T2, Per TB NetM BscMnt 1Mo	1	\$640.00
NW T3, Per TB NetM BscMnt 1Mo	1	\$543.00
NW T4, Per TB NetM BscMnt 1Mo	1	\$488.00
NW T5, Per TB NetM BscMnt 1Mo	1	\$463.00

NW T1, Per TB Mal BscMnt 1Mo	1	\$120.00
NW T2, Per TB Mal BscMnt 1Mo	1	\$97.00
NW T3, Per TB Mal BscMnt 1Mo	1	\$82.00
NW T4, Per TB Mal BscMnt 1Mo	1	\$73.00
NW T5, Per TB Mal BscMnt 1Mo	1	\$70.00
NW T1, Per TB NetM EnhMnt 1Mo	1	\$1,000.00
NW T2, Per TB NetM EnhMnt 1Mo	1	\$800.00
NW T3, Per TB NetM EnhMnt 1Mo	1	\$679.00
NW T4, Per TB NetM EnhMnt 1Mo	1	\$610.00
NW T5, Per TB NetM EnhMnt 1Mo	1	\$579.00
NW T1, Per TB Mal EnhMnt 1Mo	1	\$150.00
NW T2, Per TB Mal EnhMnt 1Mo	1	\$121.00
NW T3, Per TB Mal EnhMnt 1Mo	1	\$102.00
NW T4, Per TB Mal EnhMnt 1Mo	1	\$92.00
NW T5, Per TB Mal EnhMnt 1Mo	1	\$88.00
NW T1, 50-250GB/day SIEM Per50GBPerpLic	1	\$48,000.00
NW T2, 251GB-1TB/day SIEM Per50GBPerpLic	1	\$38,400.00
NW T3, 1-2TB/day SIEM Per50GBPerpLic	1	\$32,667.00
NW T4, 2-5TB/day SIEM Per50GBPerpLic	1	\$29,400.00
NW T5, >5TB/day SIEM Per50GBPerpLic	1	\$27,933.00
NW T1, Per 50GB SIEM BscMnt 1Mo	1	\$800.00
NW T2, Per 50GB SIEM BscMnt 1Mo	1	\$640.00
NW T3, Per 50GB SIEM BscMnt 1Mo	1	\$544.00
NW T4, Per 50GB SIEM BscMnt 1Mo	1	\$490.00
NW T5, Per 50GB SIEM BscMnt 1Mo	1	\$466.00
NW T1, Per 50GB SIEM EnhMnt 1Mo	1	\$1,000.00
NW T2, Per 50GB SIEM EnhMnt 1Mo	1	\$800.00
NW T3, Per 50GB SIEM EnhMnt 1Mo	1	\$681.00
NW T4, Per 50GB SIEM EnhMnt 1Mo	1	\$613.00
NW T5, Per 50GB SIEM EnhMnt 1Mo	1	\$582.00
NW T1, 1-10TB/day NetM PerTB Sub Lic1Mo	1	\$2,143.00
NW T2, 11-50TB/day NetM PerTB SubLic1Mo	1	\$1,714.00
NW T3, 51-100TB/day NetM PerTBSubLic1Mo	1	\$1,455.00
NW T4, 101-250TB/day NetMPerTBSubLic1Mo	1	\$1,308.00
NW T5: 250-500TB/day NetMPerTBSubLic1Mo	1	\$1,241.00
NW T6, 500-1KTB/day NetMPerTBSubLic1Mo	1	\$1,174.00
NW T7, 1K-1.5KTB/day NetMPerTBSubLic1Mo	1	\$1,109.00
NW T8, 1.5-3KTB/day NetMPerTBSubLic1Mo	1	\$1,044.00
NW T9, 3K-5KTB/day NetMPerTBSubLic1Mo	1	\$981.00
NW T10, >5KTB/day NetMPerTBSubLic1Mo	1	\$919.00
NW T1G, 1-10TB/day NetMPerTB Sub Lic1Mo	1	\$2,036.00
NW T2G, 11-50TB/day NetM PerTBSubLic1Mo	1	\$1,628.00
NW T3G, 51-100TB/day NetMPerTBSubLic1Mo	1	\$1,382.00
NW T4G, 101-250TB/dayNetMPerTBSubLic1Mo	1	\$1,243.00
NW T5G, >250TB/day NetMPerTBSubLic1Mo	1	\$1,179.00
NW T1P, 1-10TB/day NetMPerTB Sub Lic1Mo	1	\$1,929.00
NW T2P, 11-50TB/day NetM PerTBSubLic1Mo	1	\$1,543.00

NW T3P, 51-100TB/day NetMPerTBSubLic1Mo	1	\$1,310.00
NW T4P, 101-250TB/dayNetMPerTBSubLic1Mo	1	\$1,177.00
NW T5P, >250TB/day NetMPerTBSubLic1Mo	1	\$1,117.00
NW T1, 1-10TB/day Mal PerTB Sub Lic1Mo	1	\$321.00
NW T2, 11-50TB/day Mal PerTBSubLic1Mo	1	\$259.00
NW T3, 51-100TB/day Mal PerTBSubLic1Mo	1	\$219.00
NW T4, 101-250TB/dayMal PerTBSubLic1Mo	1	\$197.00
NW T5, >250TB/day Mal PerTBSubLic1Mo	1	\$188.00
NW T1, 50-250GB/daySIEMPer50GBSubLic1Mo	1	\$2,143.00
NW T2, 251GB-1TB/daySIEMPer50GBSubLic1Mo	1	\$1,714.00
NW T3, 1-2TB/daySIEMPer50GBSubLic1Mo	1	\$1,459.00
NW T4, 2-5TB/daySIEMPer50GBSubLic1Mo	1	\$1,313.00
NW T5, 5-10TB/daySIEMPer50GBSubLic1Mo	1	\$1,247.00
NW T6, 10-50TB/daySIEMPer50GBSubLic1Mo	1	\$1,181.00
NW T7, 50-100TB/daySIEMPer50GBSubLic1Mo	1	\$1,116.00
NW T8, 100-500TB/daySIEMPer50GBSubLic1Mo	1	\$1,052.00
NW T9, 500-1KTB/daySIEMPer50GBSubLic1Mo	1	\$989.00
NW T10, >1KTB/daySIEMPer50GBSubLic1Mo	1	\$928.00
NW T1G, 50-250GB/daySIEMPer50GBSubLic1Mo	1	\$2,036.00
NW T2G,251GB-1TB/daySIEMPer50GBSubLic1Mo	1	\$1,628.00
NW T3G, 1-2TB/daySIEMPer50GBSubLic1Mo	1	\$1,386.00
NW T4G, 2-5TB/daySIEMPer50GBSubLic1Mo	1	\$1,247.00
NW T5G, >5TB/daySIEMPer50GBSubLic1Mo	1	\$1,185.00
NW T1P, 50-250GB/daySIEMPer50GBSubLic1Mo	1	\$1,929.00
NW T2P, 251GB-1TB/daySIEMPer50GBSubLic1M	1	\$1,543.00
NW T3P, 1-2TB/daySIEMPer50GBSubLic1Mo	1	\$1,313.00
NW T4P, 2-5TB/daySIEMPer50GBSubLic1Mo	1	\$1,182.00
NW T5P, >5TB/daySIEMPer50GBSubLic1Mo	1	\$1,122.00
NW AWS AMI Agent SW	1	\$0.00
NW Azure Agent SW	1	\$0.00
NW S5 Hybrid for Pkt TP Appl- No SW Lic	1	\$49,100.00
NW S5 Hybrid for Logs TP Appl- No SW Lic	1	\$49,100.00
NW S5 Evt Strm Anlysis TP Appl- No SWLic	1	\$35,800.00
NW S5 Analytic Svr TP Appl- No SW Lic	1	\$27,500.00
NW S5 Pkt Decoder TP Appl- No SW Lic	1	\$27,500.00
NW S5 Log Decoder TP Appl- No SW Lic	1	\$27,500.00
NW S5 Concentrator TP Appl- No SW Lic	1	\$27,500.00
NW S5 Broker TP Appl- No SW Lic	1	\$27,500.00
NW S5 Archiver TP Appl- No SW Lic	1	\$27,500.00
NW S5 Malware TP Appl- No SW Lic	1	\$27,500.00
NW S4 Analytic Svr Appl BscMnt 1Mo	1	\$221.00
NW S4 Pkt Decoder Appl BscMnt 1Mo	1	\$221.00
NW S4 Hybrid for Pkts Appl BscMnt 1Mo	1	\$271.00
NW S4 Concentrator Appl BscMnt 1Mo	1	\$221.00
NW S4 Broker Appl BscMnt 1Mo	1	\$221.00
NW S4 Log Decoder Appl BscMnt 1Mo	1	\$221.00
NW S4 Hybrid for Logs Appl BscMnt 1Mo	1	\$271.00

NW All-in-One Pkt Appl BscMnt 1Mo	1	\$271.00
NW All-in-One Logs Appl BscMnt 1Mo	1	\$271.00
NW S4 Archiver Appl BscMnt 1Mo	1	\$221.00
NW S4 Evt Strm Anlysis Appl BscMnt 1Mo	1	\$271.00
NW S4 Malware Appl BscMnt 1Mo	1	\$271.00
NW S5 Hybrid for Pkt TP Appl BscMnt 1Mo	1	\$409.17
NW S5 Hybrid for Logs TP Appl BscMnt 1Mo	1	\$409.17
NW S5 Evt Str Analysis TP Appl BscMnt 1M	1	\$298.33
NW S5 Pkt Decoder TP Appl BscMnt 1Mo	1	\$229.17
NW S5 Log Decoder TP Appl BscMnt 1Mo	1	\$229.17
NW S5 Concentrator TP Appl BscMnt 1Mo	1	\$229.17
NW S5 Broker TP Appl BscMnt 1Mo	1	\$229.17
NW S5 Archiver TP Appl BscMnt 1Mo	1	\$229.17
NW S5 Malware TP Appl BscMnt 1Mo	1	\$229.17
NW S5 Analytic Svr TP Appl BscMnt 1Mo	1	\$229.17
NW S4 Analytic Svr Appl EnhMnt 1Mo	1	\$265.00
NW S4 Pkt Decoder Appl EnhMnt 1Mo	1	\$265.00
NW S4 Hybrid for Pkts Appl EnhMnt 1Mo	1	\$325.00
NW S4 Concentrator Appl EnhMnt 1Mo	1	\$265.00
NW S4 Broker Appl EnhMnt 1Mo	1	\$265.00
NW S4 Log Decoder Appl EnhMnt 1Mo	1	\$265.00
NW S4 Hybrid for Logs Appl EnhMnt 1Mo	1	\$325.00
NW All-in-One Pkt Appl EnhMnt 1Mo	1	\$325.00
NW All-in-One Logs Appl EnhMnt 1Mo	1	\$325.00
NW S4 Archiver Appl EnhMnt 1Mo	1	\$265.00
NW S4 Evt Str Analysis Appl EnhMnt 1Mo	1	\$325.00
NW S4 Malware Appl EnhMnt 1Mo	1	\$325.00
NW S5 Hybrid for Pkt TP Appl EnhMnt 1Mo	1	\$491.00
NW S5 Hybrid for Logs TP Appl EnhMnt 1Mo	1	\$491.00
NW S5 Evt Str Analysis TP Appl EnhMnt 1M	1	\$358.00
NW S5 Analytic Svr TP Appl EnhMnt 1Mo	1	\$275.00
NW S5 Pkt Decoder TP Appl EnhMnt 1Mo	1	\$275.00
NW S5 Log Decoder TP Appl EnhMnt 1Mo	1	\$275.00
NW S5 Concentrator TP Appl EnhMnt 1Mo	1	\$275.00
NW S5 Broker TP Appl EnhMnt 1Mo	1	\$275.00
NW S5 Archiver TP Appl EnhMnt 1Mo	1	\$275.00
NW S5 Malware TP Appl EnhMnt 1Mo	1	\$275.00
NW Series 5 Hybrid for Pkts TR	1	\$49,100.00
NW Series 5 Hybrid for Logs TR	1	\$49,100.00
NW Series 5 Evt Str Analysis TR	1	\$35,800.00
NW Series 5 -Analytics Svr 10 User TR	1	\$27,500.00
NW Series 5 Pkt Decoder TR	1	\$27,500.00
NW Series 5 Log Decoder TR	1	\$27,500.00
NW Series 5 Concentrator TR	1	\$27,500.00
NW Series 5 Broker TR	1	\$27,500.00
NW Series 5 HeadUnit Archiver TR	1	\$27,500.00
NW PV HD 72TB	1	\$18,047.00

NW PV HD 144TB	1	\$29,158.00
NW PV HD 72TB TR	1	\$18,047.00
NW PV HD 144TB TR	1	\$29,158.00
NW PV HP 56TB	1	\$24,197.00
NW PV HP 113TB	1	\$37,936.00
NW PV HP 56TB TR	1	\$24,197.00
NW PV HP 113TB TR	1	\$37,936.00
NW PV HD 72TB BM 1Mo	1	\$150.39
NW PV HD 144TB BM 1Mo	1	\$242.98
NW PV HP 56TB BM 1Mo	1	\$201.64
NW PV HP 113TB BM 1Mo	1	\$316.13
NW PV HD 72TB EM 1Mo	1	\$180.47
NW PV HD 144TB EM 1Mo	1	\$291.58
NW PV HP 56TB EM 1Mo	1	\$241.97
NW PV HP 113TB EM 1Mo	1	\$379.36
NW 32TB High Den DAC Throughput	1	\$9,939.25
NW 46TB High Den DAC Throughput	1	\$10,486.21
NW 142TB High Den UltraDAC Throughput	1	\$54,398.61
NW 180TB High Den UltraDAC Throughput	1	\$62,561.04
NW 12TB High Perform DAC Throughput	1	\$19,115.57
NW 33TB High Perform DAC Throughput	1	\$18,760.79
NW 3TB High Den DAC 2Pk for 15 drive DAE	1	\$2,430.00
NW 4TB High Den DAC 2Pk for 15 drive DAE	1	\$2,730.00
NW 3TB High Den DAC 2pk for 60 drive DAE	1	\$2,430.00
NW 4TB High Den DAC 2Pk for 60 drive DAE	1	\$2,730.00
NW 32TB High Den DAC TP BscMnt 1Mo	1	\$82.83
NW 46TB High Den DAC TP BscMnt 1Mo	1	\$87.39
NW 142TB High Den UltraDAC TP BscMnt 1M	1	\$453.32
NW 180TB High Den UltraDAC TP BscMnt 1M	1	\$521.34
NW 12TB High Perform DAC TP BscMnt 1Mo	1	\$159.30
NW 33TB High Perform DAC TP BscMnt 1Mo	1	\$156.34
NW 32TB High Den DAC TP EnhMnt 1Mo	1	\$99.39
NW 46TB High Den DAC TP EnhMnt 1Mo	1	\$104.86
NW 142TB High Den UltraDAC TP EnhMnt 1M	1	\$543.99
NW 180TB High Den UltraDAC TP EnhMnt 1M	1	\$625.61
NW 12TB High Perform DAC TP EnhMnt 1Mo	1	\$191.16
NW 33TB High Perform DAC TP EnhMnt 1Mo	1	\$187.61
NW Unity 600 Base Unit	1	\$119,600.00
Unity Rack for Expansion	1	\$3,484.00
NW Unity Decoder Shf NO Lic	1	\$29,470.00
NW Unity Conc Shf NO Lic	1	\$31,360.00
NW Unity Archiver Shf NO Lic	1	\$29,470.00
Unity 600 Base Unit Basic 1Mo	1	\$1,455.83
NW Unity Decoder Shf NO Lic BM 1M	1	\$343.83
NW Unity Conc Shf NO Lic BM 1M	1	\$365.87
NW Unity Archiver Shf NO Lic BM 1M	1	\$343.83
Unity 600 Base Unit EnhMnt 1Mo	1	\$1,747.00

NW Unity Decoder Shf NO Lic EM 1M	1	\$412.60
NW Unity Conc Shf NO Lic EM 1M	1	\$439.04
NW Unity Archiver Shf NO Lic EM 1M	1	\$412.60
Unity 550F Flash Base Unit	1	\$307,225.00
NW Unity Flash 80 drive DAE NO Lic	1	\$9,200.00
NW U Flash 5x15TB Disk Pk 80 DAE NO Lic	1	\$200,075.00
Unity 550F Flash Base Unit Basic 1Mo	1	\$3,143.30
NW Unity Flash 80 drive DAE NO Lic BM 1M	1	\$92.00
NW U Flash 5x15TB Dsk Pk 80 NO Lic BM 1M	1	\$2,000.50
Unity 550F Flash Base Unit EnhMnt 1Mo	1	\$3,772.00
NW Unity Flash 80 drive DAE NO Lic EM 1M	1	\$110.40
NW U Flash 5x15TB Dsk Pk 80 NO Lic EM 1M	1	\$2,400.50
Hi Density SAN Expansion Shelf Upgrd	1	\$48,843.00
Hi Performance SAN Expansion Upgrd	1	\$70,363.00
SA VNX2 Rack	1	\$3,484.00
SA Ultra Rack	1	\$7,169.00
5600 SAN Base Unit BscMnt 1Mo	1	\$584.79
5800 SAN Base Unit BscMnt 1Mo	1	\$882.05
7600 SAN Base Unit BscMnt 1Mo	1	\$1,246.16
High Den SAN Exp Shelf BscMnt 1Mo	1	\$344.84
High Perf SAN Exp Shelf BscMnt 1Mo	1	\$458.31
High Den SAN Exp Shelf Upgrd BscMnt 1Mo	1	\$407.03
High Perf SAN Exp Shelf Upgrd BscMnt 1Mo	1	\$586.36
5600 SAN Base Unit EnhMnt 1Mo	1	\$701.75
5800 SAN Base Unit EnhMnt 1Mo	1	\$1,058.46
7600 SAN Base Unit EnhMnt 1Mo	1	\$1,495.39
High Den SAN Exp Shelf EnhMnt 1Mo	1	\$413.81
High Perf SAN Exp Shelf EnhMnt 1Mo	1	\$549.97
High Den SAN Exp Shelf Upgrd EnhMnt 1Mo	1	\$488.43
High Perf SAN Exp Shelf Upgrd EnhMnt 1Mo	1	\$703.63
VNX2 5600 Ctrl Encrypt EnhMnt 1 Mo	1	\$97.73
VNX2 5800 Ctrl Encrypt EnhMnt 1 Mo	1	\$123.53
VNX2 7600 Ctrl Encrypt EnhMnt 1 Mo	1	\$151.53
ISILON 3x144TB BASE4TB nonSED	1	\$405,586.00
ISILON 144TB ADDON 4TB nonSED	1	\$123,894.00
ISILON 3x144TB BASE4TB SED	1	\$505,408.00
ISILON 144TB ADDON 4TB SED	1	\$157,168.00
ISILON 3x210TB BASE6TB nonSED	1	\$574,624.00
ISILON 210TB ADDON 6TB nonSED	1	\$180,240.00
ISILON 3x144TB BASE4TB nonSED BscMnt 1Mo	1	\$3,379.88
ISILON 144TB ADDON 4TB nonSED BscMnt 1Mo	1	\$1,032.45
ISILON 3x144TB BASE4TB SED BscMnt 1Mo	1	\$4,211.73
ISILON 144TB ADDON 4TB SED BscMnt 1Mo	1	\$1,309.73
ISILON 3x210TB BASE6TB nonSED BscMnt 1Mo	1	\$4,788.53
ISILON 210TB ADDON 6TB nonSED BscMnt 1Mo	1	\$1,502.00
ISILON 3x144TB BASE4TB nonSED EnhMnt 1Mo	1	\$4,055.86
ISILON 144TB ADDON 4TB nonSED EnhMnt 1Mo	1	\$1,238.94

ISILON 3x144TB BASE4TB SED EnhMnt 1Mo	1	\$5,054.08
ISILON 144TB ADDON 4TB SED EnhMnt 1Mo	1	\$1,571.68
ISILON 3x210TB BASE6TB nonSED EnhMnt 1Mo	1	\$5,746.24
ISILON 210TB ADDON 6TB nonSED EnhMnt 1Mo	1	\$1,802.40
S5 HeadUnit EvntStrmAnysis - NFR	1	\$35,800.00
S5 Analytic Server 10 Users NFR	1	\$27,500.00
S5 Archiver - NFR	1	\$27,500.00
Series 5 Packet Decoder - NFR	1	\$27,500.00
Series 5 Logs Decoder - NFR	1	\$27,500.00
Series 5 Hybrid For Packets - NFR	1	\$49,100.00
Series 5 Hybrid For Logs - NFR	1	\$49,100.00
Series 5 Packet Concentrator - NFR	1	\$27,500.00
Series 5 Logs Concentrator - NFR	1	\$27,500.00
Series 5 Broker - NFR	1	\$27,500.00
Analyst Enterprise, 5 users or less (Not for Resale)	1	\$0.00
3U, High Performance Direct Attached Appliance Capacity, 1.1T, SSD & 11T HDD Useable for DAS, 1-2TB Hot-Spares. Included Capacity license. (Not for Resale)	1	\$40,660.00
3U, High Density direct attached appliance capacity, 22TB usable, 1HS for DAS. Includes capacity license. (for Log Decoder) (Not for Resale)	1	\$15,361.00
3U, High Density direct attached appliance capacity, 22TB usable, 1HS for DAS. Includes capacity license. (for Packet Decoder) (Not for Resale)	1	\$15,361.00
22TB High Density Direct Attach Capacity for Log Hybrid w/ lic (Not for Resale)	1	\$15,361.00
22TB High Density Direct Attach Capacity for Packet Hybrid w/ lic (Not for Resale)	1	\$15,361.00
1TB/day Monitor Perp Lic NFR	1	\$2,500.00
S5 Analytic Server 10 Users NFR-NL	1	\$27,500.00
S5 EvntStrmAnysis - NFR-NL	1	\$35,800.00
Per50GB 50-250GB/day Perp Lic Logs NFR	1	\$2,500.00
S5 Archiver - NFR-NL	1	\$27,500.00
Series 5 Packet Decoder - NFR-NL	1	\$27,500.00
Series 5 Logs Decoder - NFR-NL	1	\$27,500.00
Series 5 Hybrid For Packets - NFR-NL	1	\$49,100.00
Series 5 Hybrid For Logs - NFR-NL	1	\$49,100.00
Series 5 Packet Concentrator - NFR-NL	1	\$27,500.00
Series 5 Logs Concentrator - NFR-NL	1	\$27,500.00
Series 5 Broker - NFR-NL	1	\$27,500.00
RSA Authentication Manager 50 User License, 25 SoftTokens, 25 SID700 3 yr, 5 SID800 3yr	1	\$995.00
Archer Partner NFR Bundle	1	\$5,164.00
RSA SecurID AM8 130 HW NFR Kit (includes Advanced Hardware Replacement for Years 1-3)	1	\$2,000.00
RSA SecurID AM8 250 HW NFR Kit (includes Advanced Hardware Replacement for Years 1-3)	1	\$6,000.00
RNWE 50 Count Agent Lic - Not for Resale	1	\$150.00
NW Endpoint Server - No SW Lic - NFR	1	\$27,500.00
NW UEBA 1000 User Perp Lic NFR	1	\$4.50
RSA Access (Channel)	1	\$500.00
RSA Gov P NFR u	1	\$595.00
RSA Lif P NFR u	1	\$595.00
RSA BRM P NFR u	1	\$595.00
RSA DAG P NFR u	1	\$595.00

RSA LG Software Bundle NFR	1	\$595.00
NW T1 UEBA 1000-2500User Sub Lic 1M	1	\$3.75
NW T2 UEBA 2501-5000User Sub Lic 1M	1	\$2.92
NW T3 UEBA 5001-10000User Sub Lic 1M	1	\$2.33
NW T4 UEBA 10001-25000User Sub Lic 1M	1	\$1.83
NW T5 UEBA 25001-50000User Sub Lic 1M	1	\$1.42
NW T6 UEBA 50001-100000User Sub Lic 1M	1	\$1.08
NW T7 UEBA 100001-500kUser Sub Lic 1M	1	\$0.83
NW T8 UEBA >500kUser Sub Lic 1M	1	\$0.75
NW T1 UEBA 1000-2500User Perp Lic	1	\$90.00
NW T2 UEBA 2501-5000User Perp Lic	1	\$70.00
NW T3 UEBA 5001-10000User Perp Lic	1	\$56.00
NW T4 UEBA 10001-25000User Perp Lic	1	\$44.00
NW T5 UEBA 25001-50000User Perp Lic	1	\$34.00
NW T6 UEBA 50001-100000User Perp Lic	1	\$26.00
NW T7 UEBA 100001-500kUser Perp Lic	1	\$20.00
NW T8 UEBA >500kUser Perp Lic	1	\$18.00
NW T1 UEBA PerUser BscMnt 1Mo	1	\$1.50
NW T2 UEBA PerUser BscMnt 1Mo	1	\$1.17
NW T3 UEBA PerUser BscMnt 1Mo	1	\$0.93
NW T4 UEBA PerUser BscMnt 1Mo	1	\$0.73
NW T5 UEBA PerUser BscMnt 1Mo	1	\$0.57
NW T6 UEBA PerUser BscMnt 1Mo	1	\$0.43
NW T7 UEBA PerUser BscMnt 1Mo	1	\$0.33
NW T8 UEBA PerUser BscMnt 1Mo	1	\$0.30
NW T1 UEBA PerUser EnhMnt 1Mo	1	\$1.88
NW T2 UEBA PerUser EnhMnt 1Mo	1	\$1.46
NW T3 UEBA PerUser EnhMnt 1Mo	1	\$1.17
NW T4 UEBA PerUser EnhMnt 1Mo	1	\$0.92
NW T5 UEBA PerUser EnhMnt 1Mo	1	\$0.71
NW T6 UEBA PerUser EnhMnt 1Mo	1	\$0.54
NW T7 UEBA PerUser EnhMnt 1Mo	1	\$0.42
NW T8 UEBA PerUser EnhMnt 1Mo	1	\$0.38
RSA TAM (Standard) Archer	1	\$60,000.00
RSA TAM (Standard) IGL	1	\$60,000.00
RSA TAM (Standard) NetWitness	1	\$60,000.00
RSA TAM (Standard) SecurID Access	1	\$60,000.00
3DSecure Premium Tech Acct Mgr Support	1	\$60,000.00
HostedAA Premium Tech Acct Mgr Support	1	\$60,000.00
OAA Premium Tech Acct Mgr Support	1	\$60,000.00
SilverTail Tech Acct Manager	1	\$60,000.00
RSA NetWitness DSE Standard - Annual	1	\$100,000.00
RSA Archer DSE Standard - Annual	1	\$100,000.00
RSA SecurID Access DSE Standard - Annual	1	\$90,000.00
RSA Identity G&L DSE Standard - Annual	1	\$90,000.00
RSA AA OnPrem DSE Standard - Annual	1	\$90,000.00
RSA Web Threat Det DSE Standard - Annual	1	\$90,000.00

Designated Support Engineer for Hosted Adap Auth	1	\$90,000.00
Designated Support Engineer for 3DSecure	1	\$90,000.00
1 mo Svc Acct Mgr Platinum - AA Hosted	1	\$5,000.00
1 mo Svc Acct Mgr Platinum - AA On-Prem	1	\$5,000.00
1 mo Svc Acct Mgr Platinum - AA eComm	1	\$5,000.00
1 mo Svc Acct Mgr Platinum - Web Threat	1	\$5,000.00
1 mo Svc Acct Mgr Gold - AA Hosted	1	\$3,750.00
1 mo Svc Acct Mgr Gold - AA On-Prem	1	\$3,750.00
1 mo Svc Acct Mgr Gold - AA eComm	1	\$3,750.00
1 mo Svc Acct Mgr Gold - Web Threat	1	\$3,750.00
1 mo Svc Acct Mgr Silver - AA Hosted	1	\$2,500.00
1 mo Svc Acct Mgr Silver - AA On-Prem	1	\$2,500.00
1 mo Svc Acct Mgr Silver - AA eComm	1	\$2,500.00
1 mo Svc Acct Mgr Silver - Web Threat	1	\$2,500.00
Small NW Packets &/or Logs implementation - Up to 10 components (1 NW server, other NW devices & up to 5 extended storage units)	1	\$24,000.00
Medium NW Packets &/or Logs implementation - Up to 20 components (2 NW servers, other NW devices & up to 15 extended storage units)	1	\$36,500.00
Large NW Packets &/or Logs implementation - Up to 30 components (5 NW servers, other NW devices & up to 30 extended storage units)	1	\$49,000.00
RSA NetWitness Logs UDS Audit, includes 1 trip T/E.	1	\$7,000.00
RSA NetWitness Logs UDS 30 Messages	1	\$13,000.00
RSA NetWitness Packets and Logs Optimization, includes 2 trips T/E	1	\$25,000.00
10 day Subscription Service for NW Packets & Logs, delivered at quarterly intervals, scheduled 10 days in advance. Excludes T/E.	1	\$35,000.00
20 day Subscription Service for NW Packets & Logs delivered at quarterly intervals, scheduled 10 days in advance. Excludes T/E.	1	\$65,000.00
40 day Subscription Service for NW Packets & Logs, delivered at quarterly intervals, scheduled 10 days in advance. Excludes T/E.	1	\$120,000.00
RSA NetWitness Endpoint Implementation Service	1	\$12,500.00
RSA NetWitness Endpoint 10 Day Subscription Service	1	\$36,000.00
RSA NetWitness Endpoint 20 Day Subscription Service	1	\$65,000.00
RSA NetWitness Endpoint 40 Day Subscription Service	1	\$125,000.00
Remote Consulting RSA NetWitness Suite	1	\$2,400.00
RSA NetWitness Log & Packet Upgrade Svc	1	\$27,500.00
Remote Performance Assessmants for RSA NetWitness	1	\$25,000.00
Unity Implementation for RSA NetWitness	1	\$14,130.00
RSA Prof Svcs NetWitness Packets, Logs & Endpoints	1	Quoted
RSA Prof Svcs NetWitness Packets and Logs & Endpoints - Uniquely for Strategic Partner SubContracting back to RSA	1	Quoted
RSA Residency NetWitness Packets, Logs & Endpoint	1	Quoted
RSA Jumpstart for Analytic Intelligence, excludes T/E	1	\$27,500.00
RSA Subscription Analytic Intelligence, excludes T/E	1	\$100,000.00
RSA Subscr Analytic Intellgnc w Retainer, excludes T/E	1	\$120,000.00
BASIC Incident Discovery Service, excludes T/E	1	\$55,000.00
Incident Response - Rapid Deployment to start within 10 days of receipt of PO. Excludes T/E. IR approval needed to quote.	1	\$60,000.00
RSA IR Retainer-Bronze, excludes T/E	1	\$12,000.00
RSA IR Retainer-Silver, excludes T/E	1	\$29,995.00
RSA IR Retainer-Gold, excludes T/E	1	\$49,995.00
RSA IR Retainer-Platinum, excludes T/E	1	\$79,995.00

RSA ACD Expert On Demand-Bronze	1	\$35,000.00
RSA ACD Expert On Demand-Silver	1	\$70,000.00
RSA ACD Expert On Demand-Gold	1	\$140,000.00
RSA ACD Expert On Demand-Platinum	1	\$210,000.00
RSA ACD Use Case Dvlpmnt. for NetWitness	1	\$35,000.00
RSA ACD Gap Analysis & Roadmap	1	\$72,000.00
RSA START for Incident Response Handling, excludes T/E	1	\$50,000.00
RSA ACD Roadmap - Cyber Threat Intelligence	1	\$52,500.00
RSA Controlled Attack Response Exercise	1	\$55,000.00
RSA Incident Response (IR) Practice Services	1	Quoted
RSA Custom ACD Practice Services	1	Quoted
RSA Residency Consulting ACD	1	Quoted
RSA Custom Identity Assurance Practice (IAP) Services	1	Quoted
RSA Custom Risk Management Practice (RMP) Services	1	Quoted
RSA Archer Optimization Assessment	1	\$45,500.00
RSA Archer Platform SmartStart Installation Services - Remote only	1	\$10,000.00
RSA Archer SmartStart Installation for Hosted Environment	1	\$5,000.00
RSA Archer Platform SmartStart Installation Plus Services - Customer On-site delivered (EMEA, APJ and US Federal)	1	\$15,000.00
RSA Archer Expert On Demand - One Use Case Solution (Federal Only)	1	\$72,500.00
RSA Archer Upgrade - 1 env	1	\$7,000.00
RSA Archer Upgrade Readiness	1	\$5,000.00
RSA Archer QuickLaunch: Foundation Use Case	1	\$5,000.00
RSA Archer QuickLaunch: Managed Use Case	1	\$5,000.00
RSA Archer Upgrade - 3 env	1	\$15,000.00
RSA Archer Upgrade - 3 env & Readiness	1	\$18,500.00
RSA Archer EOD Subscription - BRONZE	1	\$11,000.00
RSA Archer EOD Subscription - SILVER	1	\$21,000.00
RSA Archer EOD Subscription - GOLD	1	\$45,000.00
RSA Archer EOD Subscription - PLATINUM	1	\$88,000.00
RSA Archer Strategy Roadmap and Process Harmonization Service "LITE"	1	\$30,000.00
RSA Archer Strategy Roadmap and Process Harmonization Service	1	\$70,000.00
RSA Archer SmartStart Service "LITE" (one instance)	1	\$3,500.00
RSA Archer Hardware Sizing and Performance Health Check Service "LITE"	1	\$14,000.00
RSA Archer Hardware Sizing and Performance Health Check Service	1	\$27,000.00
RSA Archer Hosted Data Feed Configuration Add-on Service	1	\$5,000.00
RSA Prof Svcs Archer	1	Quoted
RSA Archer Partner Quoted Services	1	Quoted
RSA Archer Residency	1	Quoted
RSA Identity Governance and Lifecycle Custom PS	1	Quoted
RSA Identity Governance and Lifecycle PS - Uniquely for Strategic Partner SubContracting back to RSA	1	Quoted
RSA Identity Governance and Lifecycle Residency	1	Quoted
RSA Identity Governance and Lifecycle Migration	1	\$25,000.00
RSA Identity Governance and Lifecycle Periodic Solution Review	1	\$25,000.00
RSA Identity Governance Quick Start	1	\$25,000.00
RSA Identity Lifecycle Quick Start	1	\$35,000.00
RSA Identity Governance and Lifecycle Technical Health Check	1	\$10,000.00

RSA Identity Governance and Lifecycle 10-Day Services Subscription	1	\$20,000.00
RSA Identity Governance and Lifecycle 30-Day Services Subscription	1	\$55,000.00
RSA Assessment -SID Arch. Dsgn. & Plan.	1	\$17,500.00
RSA SecurID / Authentication Manager Health Check Service	1	\$17,500.00
RSA SecurID Implementation Assistance; ADDITIONAL services to an existing engagement.	1	\$16,000.00
RSA Assessment - SID Migr. Strat. & Plan.	1	\$17,500.00
RSA SID Access Base Edition Quick Start	1	\$12,000.00
RSA SID Access Base Edition Remote QS	1	\$5,000.00
RSA SID Access Ent. Edition Quick Start	1	\$16,000.00
RSA SID Access Ent. Edition Remote QS	1	\$8,000.00
RSA SID Access Prem. Edition Quick Start	1	\$27,000.00
RSA SID Access Prem. Edition Remote QS	1	\$13,500.00
RSA SID Access Cloud MFA Expansion	1	\$5,000.00
RSA SID Access SAML Expansion	1	\$16,000.00
RSA SID Access Remote SAML Expansion	1	\$8,000.00
RSA Prof Svcs SecurID	1	Quoted
RSA Residency SecurID	1	Quoted
RSA AM Remote Implementation Assistance	1	\$4,000.00
Auth Mgr Prime Suite 5-10k Users	1	\$4.20
Auth Mgr Prime Suite 10-50k Users	1	\$3.00
Auth Mgr Prime Suite 50-75k Users	1	\$1.80
Auth Mgr Prime Suite Unlimited Users	1	\$130,000.00
RSA Prof Svcs Access Manager	1	Quoted
RSA Residency Access Manager	1	Quoted
RSA Fraud & RiskAccMngt - HAA Gold (1 Yr)	1	\$150,000.00
RSA Fraud & RiskAccMngt - HAA Slvr (1 Yr)	1	\$100,000.00
RSA RSA Fraud & RiskAccMngt - HAA Basic (1 Y - PS-BAS-HAA-RAMBAS	1	\$75,000.00
12 Days ofAA Hosted configuration changes	1	\$25,000.00
AA Hosted 40 hours Impl. Assistance	1	\$10,000.00
AA Hosted Rule Review	1	\$45,000.00
AA Hosted Core Risk Engine Evaluation	1	\$10,000.00
RSA AA Hosted - Update Challenge Questions	1	\$7,200.00
RSA AA Hosted - Add Generic Fields	1	\$5,500.00
RSA AA Hosted- Add Client DFN Event Type	1	\$5,500.00
RSA AA Hosted- Add Portfolio-Secondary PF	1	\$5,500.00
RSA Prof SvcsAA	1	Quoted
RSA Adaptive Authentication Cloud Svcs	1	Quoted
RSA Residency HostedAA	1	Quoted
RSA Consulting-AA OnPrem Enterprise	1	\$55,000.00
AA On Premise Periodic Service Review (PSR) BRONZE; Semi-annually for one year	1	\$42,000.00
AA On Premise Periodic Service Review (PSR) GOLD; Quarterly for one year and Recommendation Implementation Support	1	\$120,000.00
AA On Premise Periodic Service Review (PSR) SILVER; Quarterly for one year	1	\$75,000.00
RSA Fraud & RiskAccMngt - OAA Gold (1 Yr)	1	\$150,000.00
RSA RSA Fraud & RiskAccMngt - OAA Basic (1 Y - PS-BAS-OAA-RAMBAS	1	\$75,000.00
RSA Fraud & RiskAccMngt - OAA Slvr (1 Yr)	1	\$100,000.00
AAoP 40 hours Implementation Assistance	1	\$10,000.00

AAoP Rule Review	1	\$45,000.00
AAoP Core Risk Engine Evaluation	1	\$10,000.00
RSA Prof SvcsAA OnPrem	1	Quoted
RSA ResidencyAA OnPrem	1	Quoted
12 Days ofAA for eCommerce changes	1	\$25,000.00
AA for eCommerce 40 hours Impl. Assist	1	\$10,000.00
RSA RiskAccMngt - EAA Silver - 1 Yr	1	\$85,000.00
RSA AA Ecommerce- 3DS Contact Info Change	1	\$5,000.00
RSA AA Ecommerce - 3DS Logo Change Service	1	\$3,000.00
RSA AA Ecommerce- 3DS FAQ Text Change SVC	1	\$5,000.00
RSA AA Ecommerce- 3DS Privacy Plcy Change	1	\$5,000.00
RSA AA Ecommerce- 3DS Terms of Use Change	1	\$5,000.00
RSA Prof SvcsAA eCommerce	1	Quoted
RSA ResidencyAA eCommerce	1	Quoted
Web Threat Detection Soln Mgmt Svcs 10 hrs/wk	1	\$45,000.00
Web Threat Detection Soln Mgmt Svcs 20 hrs/wk	1	\$82,000.00
WTD 40 hours Implementation Assistance	1	\$10,000.00
RSA Prof Svcs Web Threat Detection	1	Quoted
RSA Residency Web Threat Detection	1	Quoted
DPM Single Data Center Deployment	1	\$17,500.00
DPM EKM Crypto Provider for MS SQL - (Custom)	1	\$15,000.00
RSA Prof Svcs DCS	1	Quoted
RSA Residency DCS	1	Quoted
RSA Prof Svcs DLP	1	Quoted
RSA Residency DLP	1	Quoted
RSA Prof Svcs DSG	1	Quoted
RSA Residency DSG	1	Quoted
RSA Prof Svcs enVision	1	Quoted
RSA Residency enVision	1	Quoted
RSA Travel & Expense	1	Quoted
S700E 6 Digit 60Sec 24 Mo 5 Pack	1	\$250.00
S700E 6 Digit 60 Sec 24 Mo 10 Pack	1	\$500.00
S700E 6 Digit 60Sec 24 Mo 25 Pack	1	\$1,250.00
S700E 6 Digit 60Sec 24 Mo 50 Pack	1	\$2,500.00
S700E 6 Digit 60Sec 24 Mo 100 Pack	1	\$5,000.00
S700E 6 Digit 60Sec 24 Mo 250 Pack	1	\$12,500.00
S700E 6 Digit 60Sec 24 Mo qty 255-750	1	\$45.50
S700E 6 Digit 60Sec 24 Mo qty 755-1500	1	\$43.50
S700E 6 Digit 60Sec 24 Mo qty 1505-2500	1	\$40.50
S700E 6 Digit 60Sec 24 Mo qty 2505-5K	1	\$36.50
S700E 6 Digit 60Sec 24 Mo qty 5005-7500	1	\$32.00
S700E 6 Digit 60Sec 24 Mo qty 7505-10K	1	\$29.00
S700E 6 Digit 60Sec 24 Mo qty 10005-15K	1	\$27.50
S700E 6 Digit 60Sec 24 Mo qty 15005-25K	1	\$24.50
S700E 6 Digit 60Sec 24 Mo qty 25005-1M	1	\$23.00
S700E 6 Digit 60Sec 36 Mo 5 Pack	1	\$310.00
S700E 6 Digit 60 Sec 36 Mo 10 Pack	1	\$620.00

S700E 6 Digit 60Sec 36 Mo 25 Pack	1	\$1,550.00
S700E 6 Digit 60Sec 36 Mo 50 Pack	1	\$3,100.00
S700E 6 Digit 60Sec 36 Mo 100 Pack	1	\$6,200.00
S700E 6 Digit 60Sec 36 Mo 250 Pack	1	\$15,500.00
S700E 6 Digit 60Sec 36 Mo qty 255-750	1	\$57.00
S700E 6 Digit 60Sec 36 Mo qty 755-1500	1	\$54.00
S700E 6 Digit 60Sec 36 Mo qty 1505-2500	1	\$51.00
S700E 6 Digit 60Sec 36 Mo qty 2505-5K	1	\$46.00
S700E 6 Digit 60Sec 36 Mo qty 5005-7500	1	\$40.00
S700E 6 Digit 60Sec 36 Mo qty 7505-10K	1	\$36.00
S700E 6 Digit 60Sec 36 Mo qty 10005-15K	1	\$34.00
S700E 6 Digit 60Sec 36 Mo qty 15005-25K	1	\$30.00
S700E 6 Digit 60Sec 36 Mo qty 25005-1M	1	\$28.00
S700E 6 Digit 60Sec 48 Mo 5 Pack	1	\$370.00
S700E 6 Digit 60 Sec 48 Mo 10 Pack	1	\$740.00
S700E 6 Digit 60Sec 48 Mo 25 Pack	1	\$1,850.00
S700E 6 Digit 60Sec 48 Mo 50 Pack	1	\$3,700.00
S700E 6 Digit 60Sec 48 Mo 100 Pack	1	\$7,400.00
S700E 6 Digit 60Sec 48 Mo 250 Pack	1	\$18,500.00
S700E 6 Digit 60Sec 48 Mo qty 255-750	1	\$67.50
S700E 6 Digit 60Sec 48 Mo qty 755-1500	1	\$64.50
S700E 6 Digit 60Sec 48 Mo qty 1505-2500	1	\$61.00
S700E 6 Digit 60Sec 48 Mo qty 2505-5K	1	\$55.00
S700E 6 Digit 60Sec 48 Mo qty 5005-7500	1	\$48.00
S700E 6 Digit 60Sec 48 Mo qty 7505-10K	1	\$43.00
S700E 6 Digit 60Sec 48 Mo qty 10005-15K	1	\$40.50
S700E 6 Digit 60Sec 48 Mo qty 15005-25K	1	\$36.00
S700E 6 Digit 60Sec 48 Mo qty 25005-1M	1	\$33.50
S700E 6 Digit 60Sec 60 Mo 5 Pack	1	\$430.00
S700E 6 Digit 60 Sec 60 Mo 10 Pack	1	\$860.00
S700E 6 Digit 60Sec 60 Mo 25 Pack	1	\$2,150.00
S700E 6 Digit 60Sec 60 Mo 50 Pack	1	\$4,300.00
S700E 6 Digit 60Sec 60 Mo 100 Pack	1	\$8,600.00
S700E 6 Digit 60Sec 60 Mo 250 Pack	1	\$21,500.00
S700E 6 Digit 60Sec 60 Mo qty 255-750	1	\$78.00
S700E 6 Digit 60Sec 60 Mo qty 755-1500	1	\$74.00
S700E 6 Digit 60Sec 60 Mo qty 1505-2500	1	\$68.00
S700E 6 Digit 60Sec 60 Mo qty 2505-5K	1	\$60.50
S700E 6 Digit 60Sec 60 Mo qty 5005-7500	1	\$53.50
S700E 6 Digit 60Sec 60 Mo qty 7505-10K	1	\$47.50
S700E 6 Digit 60Sec 60 Mo qty 10005-15K	1	\$45.50
S700E 6 Digit 60Sec 60 Mo qty 15005-25K	1	\$41.50
S700E 6 Digit 60Sec 60 Mo qty 25005-1M	1	\$38.50
S700E 6 Digit 30Sec 24 Mo 5 Pack	1	\$265.00
S700E 6 Digit 30 Sec 24 Mo 10 Pack	1	\$530.00
S700E 6 Digit 30Sec 24 Mo 25 Pack	1	\$1,325.00
S700E 6 Digit 30Sec 24 Mo 50 Pack	1	\$2,650.00

S700E 6 Digit 30Sec 24 Mo 100 Pack	1	\$5,300.00
S700E 6 Digit 30Sec 24 Mo 250 Pack	1	\$13,250.00
S700E 6 Digit 30Sec 24 Mo qty 255-750	1	\$48.50
S700E 6 Digit 30Sec 24 Mo qty 755-1500	1	\$46.50
S700E 6 Digit 30Sec 24 Mo qty 1505-2500	1	\$43.50
S700E 6 Digit 30Sec 24 Mo qty 2505-5K	1	\$39.50
S700E 6 Digit 30Sec 24 Mo qty 5005-7500	1	\$35.00
S700E 6 Digit 30Sec 24 Mo qty 7505-10K	1	\$32.00
S700E 6 Digit 30Sec 24 Mo qty 10005-15K	1	\$30.50
S700E 6 Digit 30Sec 24 Mo qty 15005-25K	1	\$27.50
S700E 6 Digit 30Sec 24 Mo qty 25005-1M	1	\$26.00
S700E 6 Digit 30Sec 36 Mo 5 Pack	1	\$325.00
S700E 6 Digit 30 Sec 36 Mo 10 Pack	1	\$650.00
S700E 6 Digit 30Sec 36 Mo 25 Pack	1	\$1,625.00
S700E 6 Digit 30Sec 36 Mo 50 Pack	1	\$3,250.00
S700E 6 Digit 30Sec 36 Mo 100 Pack	1	\$6,500.00
S700E 6 Digit 30Sec 36 Mo 250 Pack	1	\$16,250.00
S700E 6 Digit 30Sec 36 Mo qty 255-750	1	\$60.00
S700E 6 Digit 30Sec 36 Mo qty 755-1500	1	\$57.00
S700E 6 Digit 30Sec 36 Mo qty 1505-2500	1	\$54.00
S700E 6 Digit 30Sec 36 Mo qty 2505-5K	1	\$49.00
S700E 6 Digit 30Sec 36 Mo qty 5005-7500	1	\$43.00
S700E 6 Digit 30Sec 36 Mo qty 7505-10K	1	\$39.00
S700E 6 Digit 30Sec 36 Mo qty 10005-15K	1	\$37.00
S700E 6 Digit 30Sec 36 Mo qty 15005-25K	1	\$33.00
S700E 6 Digit 30Sec 36 Mo qty 25005-1M	1	\$31.00
S700E 6 Digit 30Sec 48 Mo 5 Pack	1	\$385.00
S700E 6 Digit 30 Sec 48 Mo 10 Pack	1	\$770.00
S700E 6 Digit 30Sec 48 Mo 25 Pack	1	\$1,925.00
S700E 6 Digit 30Sec 48 Mo 50 Pack	1	\$3,850.00
S700E 6 Digit 30Sec 48 Mo 100 Pack	1	\$7,700.00
S700E 6 Digit 30Sec 48 Mo 250 Pack	1	\$19,250.00
S700E 6 Digit 30Sec 48 Mo qty 255-750	1	\$70.50
S700E 6 Digit 30Sec 48 Mo qty 755-1500	1	\$67.50
S700E 6 Digit 30Sec 48 Mo qty 1505-2500	1	\$64.00
S700E 6 Digit 30Sec 48 Mo qty 2505-5K	1	\$58.00
S700E 6 Digit 30Sec 48 Mo qty 5005-7500	1	\$51.00
S700E 6 Digit 30Sec 48 Mo qty 7505-10K	1	\$46.00
S700E 6 Digit 30Sec 48 Mo qty 10005-15K	1	\$43.50
S700E 6 Digit 30Sec 48 Mo qty 15005-25K	1	\$39.00
S700E 6 Digit 30Sec 48 Mo qty 25005-1M	1	\$36.50
S700E 6 Digit 30Sec 60 Mo 5 Pack	1	\$445.00
S700E 6 Digit 30 Sec 60 Mo 10 Pack	1	\$890.00
S700E 6 Digit 30Sec 60 Mo 25 Pack	1	\$2,225.00
S700E 6 Digit 30Sec 60 Mo 50 Pack	1	\$4,450.00
S700E 6 Digit 30Sec 60 Mo 100 Pack	1	\$8,900.00
S700E 6 Digit 30Sec 60 Mo 250 Pack	1	\$22,250.00

S700E 6 Digit 30Sec 60 Mo qty 255-750	1	\$81.00
S700E 6 Digit 30Sec 60 Mo qty 755-1500	1	\$77.00
S700E 6 Digit 30Sec 60 Mo qty 1505-2500	1	\$71.00
S700E 6 Digit 30Sec 60 Mo qty 2505-5K	1	\$63.50
S700E 6 Digit 30Sec 60 Mo qty 5005-7500	1	\$56.50
S700E 6 Digit 30Sec 60 Mo qty 7505-10K	1	\$50.50
S700E 6 Digit 30Sec 60 Mo qty 10005-15K	1	\$48.50
S700E 6 Digit 30Sec 60 Mo qty 15005-25K	1	\$44.50
S700E 6 Digit 30Sec 60 Mo qty 25005-1M	1	\$41.50
S800E 6 Digit 60Sec 24 Mo 5 Pack	1	\$300.00
S800E 6 Digit 60 Sec 24 Mo 10 Pack	1	\$600.00
S800E 6 Digit 60Sec 24 Mo 25 Pack	1	\$1,500.00
S800E 6 Digit 60Sec 24 Mo 50 Pack	1	\$3,000.00
S800E 6 Digit 60Sec 24 Mo 100 Pack	1	\$6,000.00
S800E 6 Digit 60Sec 24 Mo 250 Pack	1	\$15,000.00
S800E 6 Digit 60Sec 24 Mo qty 255-750	1	\$54.50
S800E 6 Digit 60Sec 24 Mo qty 755-1500	1	\$52.00
S800E 6 Digit 60Sec 24 Mo qty 1505-2500	1	\$49.00
S800E 6 Digit 60Sec 24 Mo qty 2505-5K	1	\$47.00
S800E 6 Digit 60Sec 24 Mo qty 5005-7500	1	\$44.00
S800E 6 Digit 60Sec 24 Mo qty 7505-10K	1	\$41.00
S800E 6 Digit 60Sec 24 Mo qty 10005-15K	1	\$38.00
S800E 6 Digit 60Sec 24 Mo qty 15005-25K	1	\$35.00
S800E 6 Digit 60Sec 24 Mo qty 25005-1M	1	\$32.00
S800E 6 Digit 60Sec 36 Mo 5 Pack	1	\$372.50
S800E 6 Digit 60 Sec 36 Mo 10 Pack	1	\$745.00
S800E 6 Digit 60Sec 36 Mo 25 Pack	1	\$1,862.50
S800E 6 Digit 60Sec 36 Mo 50 Pack	1	\$3,725.00
S800E 6 Digit 60Sec 36 Mo 100 Pack	1	\$7,450.00
S800E 6 Digit 60Sec 36 Mo 250 Pack	1	\$18,625.00
S800E 6 Digit 60Sec 36 Mo qty 255-750	1	\$67.50
S800E 6 Digit 60Sec 36 Mo qty 755-1500	1	\$64.50
S800E 6 Digit 60Sec 36 Mo qty 1505-2500	1	\$61.00
S800E 6 Digit 60Sec 36 Mo qty 2505-5K	1	\$58.00
S800E 6 Digit 60Sec 36 Mo qty 5005-7500	1	\$55.00
S800E 6 Digit 60Sec 36 Mo qty 7505-10K	1	\$51.00
S800E 6 Digit 60Sec 36 Mo qty 10005-15K	1	\$48.00
S800E 6 Digit 60Sec 36 Mo qty 15005-25K	1	\$44.00
S800E 6 Digit 60Sec 36 Mo qty 25005-1M	1	\$40.00
S800E 6 Digit 60Sec 48 Mo 5 Pack	1	\$445.00
S800E 6 Digit 60 Sec 48 Mo 10 Pack	1	\$890.00
S800E 6 Digit 60Sec 48 Mo 25 Pack	1	\$2,225.00
S800E 6 Digit 60Sec 48 Mo 50 Pack	1	\$4,450.00
S800E 6 Digit 60Sec 48 Mo 100 Pack	1	\$8,900.00
S800E 6 Digit 60Sec 48 Mo 250 Pack	1	\$22,250.00
S800E 6 Digit 60Sec 48 Mo qty 255-750	1	\$81.00
S800E 6 Digit 60Sec 48 Mo qty 755-1500	1	\$77.00

S800E 6 Digit 60Sec 48 Mo qty 1505-2500	1	\$73.00
S800E 6 Digit 60Sec 48 Mo qty 2505-5K	1	\$69.00
S800E 6 Digit 60Sec 48 Mo qty 5005-7500	1	\$66.00
S800E 6 Digit 60Sec 48 Mo qty 7505-10K	1	\$61.00
S800E 6 Digit 60Sec 48 Mo qty 10005-15K	1	\$57.00
S800E 6 Digit 60Sec 48 Mo qty 15005-25K	1	\$53.00
S800E 6 Digit 60Sec 48 Mo qty 25005-1M	1	\$48.00
S800E 6 Digit 60Sec 60 Mo 5 Pack	1	\$515.00
S800E 6 Digit 60 Sec 60 Mo 10 Pack	1	\$1,030.00
S800E 6 Digit 60Sec 60 Mo 25 Pack	1	\$2,575.00
S800E 6 Digit 60Sec 60 Mo 50 Pack	1	\$5,150.00
S800E 6 Digit 60Sec 60 Mo 100 Pack	1	\$10,300.00
S800E 6 Digit 60Sec 60 Mo 250 Pack	1	\$25,750.00
S800E 6 Digit 60Sec 60 Mo qty 255-750	1	\$93.00
S800E 6 Digit 60Sec 60 Mo qty 755-1500	1	\$88.50
S800E 6 Digit 60Sec 60 Mo qty 1505-2500	1	\$84.00
S800E 6 Digit 60Sec 60 Mo qty 2505-5K	1	\$79.00
S800E 6 Digit 60Sec 60 Mo qty 5005-7500	1	\$75.00
S800E 6 Digit 60Sec 60 Mo qty 7505-10K	1	\$70.00
S800E 6 Digit 60Sec 60 Mo qty 10005-15K	1	\$65.00
S800E 6 Digit 60Sec 60 Mo qty 15005-25K	1	\$60.00
S800E 6 Digit 60Sec 60 Mo qty 25005-1M	1	\$55.00
S800E 6 Digit 30Sec 24 Mo 5 Pack	1	\$315.00
S800E 6 Digit 30 Sec 24 Mo 10 Pack	1	\$630.00
S800E 6 Digit 30Sec 24 Mo 25 Pack	1	\$1,575.00
S800E 6 Digit 30Sec 24 Mo 50 Pack	1	\$3,150.00
S800E 6 Digit 30Sec 24 Mo 100 Pack	1	\$6,300.00
S800E 6 Digit 30Sec 24 Mo 250 Pack	1	\$15,750.00
S800E 6 Digit 30Sec 24 Mo qty 255-750	1	\$57.50
S800E 6 Digit 30Sec 24 Mo qty 755-1500	1	\$55.00
S800E 6 Digit 30Sec 24 Mo qty 1505-2500	1	\$52.00
S800E 6 Digit 30Sec 24 Mo qty 2505-5K	1	\$50.00
S800E 6 Digit 30Sec 24 Mo qty 5005-7500	1	\$47.00
S800E 6 Digit 30Sec 24 Mo qty 7505-10K	1	\$44.00
S800E 6 Digit 30Sec 24 Mo qty 10005-15K	1	\$41.00
S800E 6 Digit 30Sec 24 Mo qty 15005-25K	1	\$38.00
S800E 6 Digit 30Sec 24 Mo qty 25005-1M	1	\$35.00
S800E 6 Digit 30Sec 36 Mo 5 Pack	1	\$387.50
S800E 6 Digit 30 Sec 36 Mo 10 Pack	1	\$775.00
S800E 6 Digit 30Sec 36 Mo 25 Pack	1	\$1,937.50
S800E 6 Digit 30Sec 36 Mo 50 Pack	1	\$3,875.00
S800E 6 Digit 30Sec 36 Mo 100 Pack	1	\$7,750.00
S800E 6 Digit 30Sec 36 Mo 250 Pack	1	\$19,375.00
S800E 6 Digit 30Sec 36 Mo qty 255-750	1	\$70.50
S800E 6 Digit 30Sec 36 Mo qty 755-1500	1	\$67.50
S800E 6 Digit 30Sec 36 Mo qty 1505-2500	1	\$64.00
S800E 6 Digit 30Sec 36 Mo qty 2505-5K	1	\$61.00

S800E 6 Digit 30Sec 36 Mo qty 5005-7500	1	\$58.00
S800E 6 Digit 30Sec 36 Mo qty 7505-10K	1	\$54.00
S800E 6 Digit 30Sec 36 Mo qty 10005-15K	1	\$51.00
S800E 6 Digit 30Sec 36 Mo qty 15005-25K	1	\$47.00
S800E 6 Digit 30Sec 36 Mo qty 25005-1M	1	\$43.00
S800E 6 Digit 30Sec 48 Mo 5 Pack	1	\$460.00
S800E 6 Digit 30 Sec 48 Mo 10 Pack	1	\$920.00
S800E 6 Digit 30Sec 48 Mo 25 Pack	1	\$2,300.00
S800E 6 Digit 30Sec 48 Mo 50 Pack	1	\$4,600.00
S800E 6 Digit 30Sec 48 Mo 100 Pack	1	\$9,200.00
S800E 6 Digit 30Sec 48 Mo 250 Pack	1	\$23,000.00
S800E 6 Digit 30Sec 48 Mo qty 255-750	1	\$84.00
S800E 6 Digit 30Sec 48 Mo qty 755-1500	1	\$80.00
S800E 6 Digit 30Sec 48 Mo qty 1505-2500	1	\$76.00
S800E 6 Digit 30Sec 48 Mo qty 2505-5K	1	\$72.00
S800E 6 Digit 30Sec 48 Mo qty 5005-7500	1	\$69.00
S800E 6 Digit 30Sec 48 Mo qty 7505-10K	1	\$64.00
S800E 6 Digit 30Sec 48 Mo qty 10005-15K	1	\$60.00
S800E 6 Digit 30Sec 48 Mo qty 15005-25K	1	\$56.00
S800E 6 Digit 30Sec 48 Mo qty 25005-1M	1	\$51.00
S800E 6 Digit 30Sec 60 Mo 5 Pack	1	\$530.00
S800E 6 Digit 30 Sec 60 Mo 10 Pack	1	\$1,060.00
S800E 6 Digit 30Sec 60 Mo 25 Pack	1	\$2,650.00
S800E 6 Digit 30Sec 60 Mo 50 Pack	1	\$5,300.00
S800E 6 Digit 30Sec 60 Mo 100 Pack	1	\$10,600.00
S800E 6 Digit 30Sec 60 Mo 250 Pack	1	\$26,500.00
S800E 6 Digit 30Sec 60 Mo qty 255-750	1	\$96.00
S800E 6 Digit 30Sec 60 Mo qty 755-1500	1	\$91.50
S800E 6 Digit 30Sec 60 Mo qty 1505-2500	1	\$87.00
S800E 6 Digit 30Sec 60 Mo qty 2505-5K	1	\$82.00
S800E 6 Digit 30Sec 60 Mo qty 5005-7500	1	\$78.00
S800E 6 Digit 30Sec 60 Mo qty 7505-10K	1	\$73.00
S800E 6 Digit 30Sec 60 Mo qty 10005-15K	1	\$68.00
S800E 6 Digit 30Sec 60 Mo qty 15005-25K	1	\$63.00
S800E 6 Digit 30Sec 60 Mo qty 25005-1M	1	\$58.00
RSA Registration Mgr Basic Mnt-1	1	\$0.02
RSA Registration Mgr Enh Mnt-1	1	\$0.02
RSA SAE 10-25users	1	\$36.80
RSA SAE 30-100users	1	\$34.00
RSA SAE 105-150users	1	\$29.60
RSA SAE 155-250users	1	\$26.40
RSA SAE 255-500users	1	\$20.80
RSA SAE 505-750users	1	\$18.40
RSA SAE 755-1500users	1	\$15.20
RSA SAE 1505-2500users	1	\$12.40
RSA SAE 2505-5Kusers	1	\$10.40
RSA SAE 5005-10Kusers	1	\$8.40

RSA SAE 10005-50Kusers	1	\$6.00
RSA SAE 50005-100Kusers	1	\$3.60
RSA SAE 100005-1Musers	1	\$2.80
Enhanced Maint for RSA SAE-1m 10-25	1	\$0.64
Enhanced Maint for RSA SAE-1m 30-100	1	\$0.60
Enhanced Maint for RSA SAE-1m 105-150	1	\$0.52
Enhanced Maint for RSA SAE-1m 155-250	1	\$0.46
Enhanced Maint for RSA SAE-1m 255-500	1	\$0.36
Enhanced Maint for RSA SAE-1m 505-750	1	\$0.32
Enhanced Maint for RSA SAE-1m 755-1500	1	\$0.27
Enhanced Maint for RSA SAE-1m 1505-2500	1	\$0.22
Enhanced Maint for RSA SAE-1m 2505-5K	1	\$0.18
Enhanced Maint for RSA SAE-1m 5005-10K	1	\$0.15
Enhanced Maint for RSA SAE-1m 10005-50K	1	\$0.11
Enhanced Maint for RSA SAE-1m 50005-100K	1	\$0.06
Enhanced Maint for RSA SAE-1m 100005-1M	1	\$0.05
SID Access Base Perp from 10 - 25u	1	\$92.00
SID Access Base Perp from 30 - 100u	1	\$85.00
SID Access Base Perp from 105 - 150u	1	\$74.00
SID Access Base Perp from 155 - 250u	1	\$66.00
SID Access Base Perp from 255 - 500u	1	\$52.00
SID Access Base Perp from 505 - 750u	1	\$46.00
SID Access Base Perp from 755 - 1,500u	1	\$38.00
SID Access Base Perp from 1,505 - 2,500u	1	\$31.00
SID Access Base Perp from 2,505 - 5Ku	1	\$26.00
SID Access Base Perp from 5,005 - 10Ku	1	\$21.00
SID Access Base Perp from 10,005 - 50Ku	1	\$15.00
SID Access Base Perp from 50,005 - 100Ku	1	\$9.00
SID Access Base Perp from 100,005 - 1M	1	\$7.00
SID Access Ent Perp from 10 - 25u	1	\$124.00
SID Access Ent Perp from 30 - 100u	1	\$115.00
SID Access Ent Perp from 105 - 150u	1	\$100.00
SID Access Ent Perp from 155 - 250u	1	\$89.00
SID Access Ent Perp from 255 - 500u	1	\$70.00
SID Access Ent Perp from 505 - 750u	1	\$62.00
SID Access Ent Perp from 755 - 1,500u	1	\$51.50
SID Access Ent Perp from 1,505 - 2,500u	1	\$42.00
SID Access Ent Perp from 2,505 - 5Ku	1	\$35.00
SID Access Ent Perp from 5,005 - 10Ku	1	\$28.50
SID Access Ent Perp from 10,005 - 50Ku	1	\$20.50
SID Access Ent Perp from 50,005 - 100Ku	1	\$12.00
SID Access Ent Perp from 100,005 - 1M	1	\$9.50
SID Access B2Ent Upg Perp 10-25u	1	\$32.00
SID Access B2Ent Upg Perp 30-100u	1	\$30.00
SID Access B2Ent Upg Perp 105-150u	1	\$26.00
SID Access B2Ent Upg Perp 155-250u	1	\$23.00
SID Access B2Ent Upg Perp 255-500u	1	\$18.00

SID Access B2Ent Upg Perp 505-750u	1	\$16.00
SID Access B2Ent Upg Perp 755-1500u	1	\$13.50
SID Access B2Ent Upg Perp 1505-2500u	1	\$11.00
SID Access B2Ent Upg Perp 2505-5000u	1	\$9.00
SID Access B2Ent Upg Perp 5005-10Ku	1	\$7.50
SID Access B2Ent Upg Perp 10005-50Ku	1	\$5.50
SID Access B2Ent Upg Perp 50005-100Ku	1	\$3.00
SID Access B2Ent Upg Perp 100005-1Mu	1	\$2.50
SID Access RBAODA from 10 - 25u	1	\$22.00
SID Access RBAODA from 30 - 100u	1	\$20.00
SID Access RBAODA from 105 - 150u	1	\$19.00
SID Access RBAODA from 155 - 250u	1	\$18.00
SID Access RBAODA from 255 - 500u	1	\$17.00
SID Access RBAODA from 505 - 750u	1	\$16.50
SID Access RBAODA from 755 - 1,500u	1	\$16.00
SID Access RBAODA from 1,505 - 2,500u	1	\$15.00
SID Access RBAODA from 2,505 - 5Ku	1	\$13.00
SID Access RBAODA from 5,505 - 10Ku	1	\$11.00
SID Access RBAODA from 10,005 - 50Ku	1	\$10.00
SID Access 3YR BCO from 5-250u	1	\$70.00
SID Access 3YR BCO from 255-750u	1	\$51.35
SID Access 3YR BCO from 755-1,500u	1	\$41.00
SID Access 3YR BCO from 1,505-2,500u	1	\$35.60
SID Access 3YR BCO from 2,505-5Ku	1	\$30.75
SID Access 3YR BCO from 5,005-7,500u	1	\$25.50
SID Access 3YR BCO from 7,505-10Ku	1	\$23.65
SID Access 3YR BCO from 10,005-15Ku	1	\$19.60
SID Access 3YR BCO from 15,005-25Ku	1	\$18.50
SID Access 3YR BCO from 25,005-1Mu	1	\$14.50
SID Access Base EnhMnt 1Mo	1	\$2.37
SID Access Base EnhMnt 1Mo	1	\$1.49
SID Access Base EnhMnt 1Mo	1	\$1.30
SID Access Base EnhMnt 1Mo	1	\$1.16
SID Access Base EnhMnt 1Mo	1	\$0.91
SID Access Base EnhMnt 1Mo	1	\$0.81
SID Access Base EnhMnt 1Mo	1	\$0.67
SID Access Base EnhMnt 1Mo	1	\$0.54
SID Access Base EnhMnt 1Mo	1	\$0.46
SID Access Base EnhMnt 1Mo	1	\$0.37
SID Access Base EnhMnt 1Mo	1	\$0.26
SID Access Base EnhMnt 1Mo	1	\$0.16
SID Access Base EnhMnt 1Mo	1	\$0.12
SID Access Ent EnhMnt 1Mo	1	\$3.20
SID Access Ent EnhMnt 1Mo	1	\$2.01
SID Access Ent EnhMnt 1Mo	1	\$1.75
SID Access Ent EnhMnt 1Mo	1	\$1.56
SID Access Ent EnhMnt 1Mo	1	\$1.23

SID Access Ent EnhMnt 1Mo	1	\$1.08
SID Access Ent EnhMnt 1Mo	1	\$0.90
SID Access Ent EnhMnt 1Mo	1	\$0.73
SID Access Ent EnhMnt 1Mo	1	\$0.61
SID Access Ent EnhMnt 1Mo	1	\$0.50
SID Access Ent EnhMnt 1Mo	1	\$0.36
SID Access Ent EnhMnt 1Mo	1	\$0.21
SID Access Ent EnhMnt 1Mo	1	\$0.17
SID Access B2EntUP EnhMnt 1Mo	1	\$0.83
SID Access B2EntUP EnhMnt 1Mo	1	\$0.52
SID Access B2EntUP EnhMnt 1Mo	1	\$0.45
SID Access B2EntUP EnhMnt 1Mo	1	\$0.40
SID Access B2EntUP EnhMnt 1Mo	1	\$0.32
SID Access B2EntUP EnhMnt 1Mo	1	\$0.27
SID Access B2EntUP EnhMnt 1Mo	1	\$0.23
SID Access B2EntUP EnhMnt 1Mo	1	\$0.19
SID Access B2EntUP EnhMnt 1Mo	1	\$0.15
SID Access B2EntUP EnhMnt 1Mo	1	\$0.13
SID Access B2EntUP EnhMnt 1Mo	1	\$0.10
SID Access B2EntUP EnhMnt 1Mo	1	\$0.06
SID Access B2EntUP EnhMnt 1Mo	1	\$0.05
SID Access EntPI Mnt-Enh-1	1	\$0.88
SID Access EntPI Mnt-Enh-1	1	\$0.70
SID Access EntPI Mnt-Enh-1	1	\$0.56
SID Access EntPI Mnt-Enh-1	1	\$0.53
SID Acc Prem Sub from 10-500u 1Mo	1	\$4.04
SID Acc Prem Sub from 505-750u 1Mo	1	\$3.58
SID Acc Prem Sub from 755-1,500u 1Mo	1	\$2.96
SID Acc Prem Sub from 1,505-2,500u 1Mo	1	\$2.40
SID Acc Prem Sub from 2,505-5Ku 1Mo	1	\$2.03
SID Acc Prem Sub from 5,005-10Ku 1Mo	1	\$1.64
SID Acc Prem Sub from 10,005-50Ku 1Mo	1	\$1.16
SID Acc Prem Sub from 50,005-100Ku 1Mo	1	\$0.70
SID Acc Prem Sub from 100,005-1M 1Mo	1	\$0.54
SID Access SSO Agent	1	\$0.00
SID Access Standard Agent 10-25users	1	\$0.00
SID Access Standard Agent 30-100u	1	\$0.00
SID Access Standard Agent 105-150u	1	\$0.00
SID Access Standard Agent 155-250u	1	\$0.00
SID Access Standard Agent 255-500u	1	\$0.00
SID Access Standard Agent 505-750u	1	\$0.00
SID Access Standard Agent 755-1500u	1	\$0.00
SID Access Standard Agent 1505-2500u	1	\$0.00
SID Access Standard Agent 2505-5Ku	1	\$0.00
SID Access Standard Agent 5005-10Ku	1	\$0.00
SID Access Standard Agent 10005-50Ku	1	\$0.00
SID Access Standard Agent 50005-100Ku	1	\$0.00

SID Access Standard Agent 100005-1Mu	1	\$0.00
SID Access hosted in EMEA	1	\$0.00
SID Access hosted in USA	1	\$0.00
SID Acc Ent AddOn Prem Subsc 10-500u	1	\$1.35
SID Acc Ent AddOn Prem Subsc 505-750u	1	\$1.19
SID Acc Ent AddOn Prem Subsc 755-1500u	1	\$0.99
SID Acc Ent AddOn Prem Subsc 1505-2500u	1	\$0.80
SID Acc Ent AddOn Prem Subsc 2505-5000u	1	\$0.68
SID Acc Ent AddOn Prem Subsc 5005-10Ku	1	\$0.55
SID Acc Ent AddOn Prem Subsc 10005-50Ku	1	\$0.39
SID Acc Ent AddOn Prem Subsc 50005-100Ku	1	\$0.23
SID Acc Ent AddOn Prem Subsc 100005-1Mu	1	\$0.18
SID Acc Base Sub from 10-500u 1Mo	1	\$1.99
SID Acc Base Sub from 505-750u 1Mo	1	\$1.77
SID Acc Base Sub from 755-1,500u 1Mo	1	\$1.46
SID Acc Base Sub from 1,505-2,500u 1Mo	1	\$1.19
SID Acc Base Sub from 2,505-5Ku 1Mo	1	\$1.00
SID Acc Base Sub from 5,005-10Ku 1Mo	1	\$0.81
SID Acc Base Sub from 10,005-50Ku 1Mo	1	\$0.57
SID Acc Base Sub from 50,005-100Ku 1Mo	1	\$0.35
SID Acc Base Sub from 100,005-1M 1Mo	1	\$0.27
SID Acc Base AddOn Prem Subsc 10-500u	1	\$2.04
SID Acc Base AddOn Prem Subsc 505-750u	1	\$1.81
SID Acc Base AddOn Prem Subsc 755-1500u	1	\$1.50
SID Acc Base AddOn Prem Subsc 1505-2500u	1	\$1.22
SID Acc Base AddOn Prem Subsc 2505-5000u	1	\$1.03
SID Acc Base AddOn Prem Subsc 5005-10Ku	1	\$0.83
SID Acc Base AddOnPrem Subsc 10005-50Ku	1	\$0.59
SID Acc BaseAddOn Prem Subsc 50005-100Ku	1	\$0.36
SID Acc BaseAddOn Prem Subsc 100005-1Mu	1	\$0.27
SID Acc Ent Sub from 10-500u 1Mo	1	\$2.69
SID Acc Ent Sub from 505-750u 1Mo	1	\$2.39
SID Acc Ent Sub from 755-1,500u 1Mo	1	\$1.97
SID Acc Ent Sub from 1,505-2,500u 1Mo	1	\$1.60
SID Acc Ent Sub from 2,505-5Ku 1Mo	1	\$1.35
SID Acc Ent Sub from 5,005-10Ku 1Mo	1	\$1.09
SID Acc Ent Sub from 10,005-50Ku 1Mo	1	\$0.77
SID Acc Ent Sub from 50,005-100Ku 1Mo	1	\$0.47
SID Acc Ent Sub from 100,005-1M 1Mo	1	\$0.36
SecurID Soft Token Sub 10-250u 1Mo	1	\$1.23
SecurID Soft Token Sub 255-750u 1Mo	1	\$1.14
SecurID Soft Token Sub 755-1500u 1Mo	1	\$1.08
SecurID Soft Token Sub 1505-2500u 1Mo	1	\$1.02
SecurID Soft Token Sub 2505-5Ku 1Mo	1	\$0.92
SecurID Soft Token Sub 5005-7500u 1Mo	1	\$0.80
SecurID Soft Token Sub 7505-10Ku 1Mo	1	\$0.72
SecurID Soft Token Sub 10005-15Ku 1Mo	1	\$0.68

SecurID Soft Token Sub 15005-25Ku 1Mo	1	\$0.60
SecurID Soft Token Sub 25005-1Mu 1Mo	1	\$0.55
SecurID MFA Sub 10-250u 1Mo	1	\$1.38
SecurID MFA Sub 255-750u 1Mo	1	\$1.27
SecurID MFA Sub 755-1500u 1Mo	1	\$1.21
SecurID MFA Sub 1505-2500u 1Mo	1	\$1.13
SecurID MFA Sub 2505-5Ku 1Mo	1	\$1.02
SecurID MFA Sub 5005-7500u 1Mo	1	\$0.90
SecurID MFA Sub 7505-10Ku 1Mo	1	\$0.80
SecurID MFA Sub 10005-15Ku 1Mo	1	\$0.76
SecurID MFA Sub 15005-25Ku 1Mo	1	\$0.67
SecurID MFA Sub 25005-1Mu 1Mo	1	\$0.63
SecurID MFA Sub Promotion 1 Mo	1	\$0.00
SecurID SMS/Voice500x N-AMER ONLY Sub1Mo	1	\$50.00
SID Access AMI Agent SW	1	\$0.00
RSA SecurID Software Token Seeds (6 month) per User for qty's between 10 - 250	1	\$19.25
RSA SecurID Software Token Seeds (6 month) per User for qty's between 255 - 750	1	\$17.50
RSA SecurID Software Token Seeds (6 month) per User for qty's between 755 - 1,500	1	\$16.50
RSA SecurID Software Token Seeds (6 month) per User for qty's between 1,505 - 2,500	1	\$15.25
RSA SecurID Software Token Seeds (6 month) per User for qty's between 2,505 - 5,000	1	\$13.25
RSA SecurID Software Token Seeds (6 month) per User for qty's between 5,005 - 7,500	1	\$11.00
RSA SecurID Software Token Seeds (6 month) per User for qty's between 7,505 - 10,000	1	\$10.00
RSA SecurID Software Token Seeds (6 month) per User for qty's between 10,005 - 15,000	1	\$9.00
RSA SecurID Software Token Seeds (6 month) per User for qty's between 15,005 - 25,000	1	\$8.00
RSA SecurID Software Token Seeds (6 month) per User for qty's between 25,005 - 1,000,000	1	\$6.50
RSA SecurID Software Token Seeds (12 month) per User for qty's between 10 - 250	1	\$25.50
RSA SecurID Software Token Seeds (12 month) per User for qty's between 255 - 750	1	\$23.25
RSA SecurID Software Token Seeds (12 month) per User for qty's between 755 - 1,500	1	\$22.00
RSA SecurID Software Token Seeds (12 month) per User for qty's between 1,505 - 2,500	1	\$20.25
RSA SecurID Software Token Seeds (12 month) per User for qty's between 2,505 - 5,000	1	\$17.50
RSA SecurID Software Token Seeds (12 month) per User for qty's between 5,005 - 7,500	1	\$14.75
RSA SecurID Software Token Seeds (12 month) per User for qty's between 7,505 - 10,000	1	\$13.25
RSA SecurID Software Token Seeds (12 month) per User for qty's between 10,005 - 15,000	1	\$12.00
RSA SecurID Software Token Seeds (12 month) per User for qty's between 15,005 - 25,000	1	\$10.50
RSA SecurID Software Token Seeds (12 month) per User for qty's between 25,005 - 1,000,000	1	\$8.75
RSA SecurID Software Token Seeds (24 month) per User for qty's between 10 - 250	1	\$34.00
RSA SecurID Software Token Seeds (24 month) per User for qty's between 255 - 750	1	\$31.00
RSA SecurID Software Token Seeds (24 month) per User for qty's between 755 - 1,500	1	\$29.50
RSA SecurID Software Token Seeds (24 month) per User for qty's between 1,505 - 2,500	1	\$27.00
RSA SecurID Software Token Seeds (24 month) per User for qty's between 2,505 - 5,000	1	\$23.50
RSA SecurID Software Token Seeds (24 month) per User for qty's between 5,005 - 7,500	1	\$19.50
RSA SecurID Software Token Seeds (24 month) per User for qty's between 7,505 - 10,000	1	\$17.50
RSA SecurID Software Token Seeds (24 month) per User for qty's between 10,005 - 15,000	1	\$16.00
RSA SecurID Software Token Seeds (24 month) per User for qty's between 15,005 - 25,000	1	\$14.00
RSA SecurID Software Token Seeds (24 month) per User for qty's between 25,005 - 1,000,000	1	\$11.50
RSA SecurID Software Token Seeds (36 month) per User for qty's between 10 - 250	1	\$49.50
RSA SecurID Software Token Seeds (36 month) per User for qty's between 255 - 750	1	\$45.50

RSA SecurID Software Token Seeds (36 month) per User for qty's between 755 - 1,500	1	\$43.25
RSA SecurID Software Token Seeds (36 month) per User for qty's between 1,505 - 2,500	1	\$40.75
RSA SecurID Software Token Seeds (36 month) per User for qty's between 2,505 - 5,000	1	\$36.75
RSA SecurID Software Token Seeds (36 month) per User for qty's between 5,005 - 7,500	1	\$32.00
RSA SecurID Software Token Seeds (36 month) per User for qty's between 7,505 - 10,000	1	\$28.75
RSA SecurID Software Token Seeds (36 month) per User for qty's between 10,005 - 15,000	1	\$27.25
RSA SecurID Software Token Seeds (36 month) per User for qty's between 15,005 - 25,000	1	\$24.00
RSA SecurID Software Token Seeds (36 month) per User for qty's between 25,005 - 1,000,000	1	\$22.50
RSA SecurID Software Token Seeds (48 month) per User for qty's between 10 - 250	1	\$59.25
RSA SecurID Software Token Seeds (48 month) per User for qty's between 255 - 750	1	\$54.50
RSA SecurID Software Token Seeds (48 month) per User for qty's between 755 - 1,500	1	\$52.00
RSA SecurID Software Token Seeds (48 month) per User for qty's between 1,505 - 2,500	1	\$48.75
RSA SecurID Software Token Seeds (48 month) per User for qty's between 2,505 - 5,000	1	\$44.00
RSA SecurID Software Token Seeds (48 month) per User for qty's between 5,005 - 7,500	1	\$38.50
RSA SecurID Software Token Seeds (48 month) per User for qty's between 7,505 - 10,000	1	\$34.50
RSA SecurID Software Token Seeds (48 month) per User for qty's between 10,005 - 15,000	1	\$32.50
RSA SecurID Software Token Seeds (48 month) per User for qty's between 15,005 - 25,000	1	\$28.75
RSA SecurID Software Token Seeds (48 month) per User for qty's between 25,005 - 1,000,000	1	\$26.50
RSA SecurID Software Token Seeds (60 month) per User for qty's between 10 - 250	1	\$68.75
RSA SecurID Software Token Seeds (60 month) per User for qty's between 255 - 750	1	\$62.50
RSA SecurID Software Token Seeds (60 month) per User for qty's between 755 - 1,500	1	\$59.25
RSA SecurID Software Token Seeds (60 month) per User for qty's between 1,505 - 2,500	1	\$54.50
RSA SecurID Software Token Seeds (60 month) per User for qty's between 2,505 - 5,000	1	\$48.50
RSA SecurID Software Token Seeds (60 month) per User for qty's between 5,005 - 7,500	1	\$42.75
RSA SecurID Software Token Seeds (60 month) per User for qty's between 7,505 - 10,000	1	\$38.00
RSA SecurID Software Token Seeds (60 month) per User for qty's between 10,005 - 15,000	1	\$36.50
RSA SecurID Software Token Seeds (60 month) per User for qty's between 15,005 - 25,000	1	\$33.25
RSA SecurID Software Token Seeds (60 month) per User for qty's between 25,005 - 1,000,000	1	\$30.75
RSA SecurID Software Token Seeds (120 month) per User for qty's between 10 - 250	1	\$82.50
RSA SecurID Software Token Seeds (120 month) per User for qty's between 255 - 750	1	\$75.00
RSA SecurID Software Token Seeds (120 month) per User for qty's between 755 - 1,500	1	\$71.00
RSA SecurID Software Token Seeds (120 month) per User for qty's between 1,505 - 2,500	1	\$65.50
RSA SecurID Software Token Seeds (120 month) per User for qty's between 2,505 - 5,000	1	\$58.25
RSA SecurID Software Token Seeds (120 month) per User for qty's between 5,005 - 7,500	1	\$51.25
RSA SecurID Software Token Seeds (120 month) per User for qty's between 7,505 - 10,000	1	\$45.50
RSA SecurID Software Token Seeds (120 month) per User for qty's between 10,005 - 15,000	1	\$43.80
RSA SecurID Software Token Seeds (120 month) per User for qty's between 15,005 - 25,000	1	\$40.00
RSA SecurID Software Token Seeds (120 month) per User for qty's between 25,005 - 1,000,000	1	\$37.00
Advanced API Support SecurID 1 Yr	1	\$10,000.00
Support for PS Developed Solutions SID	1	Quoted
Support for PS Developed Bulk Admin 6.x	1	Quoted
Support for PS Developed Solutions DCS	1	Quoted
Support for PS Developed Solutions AXM	1	Quoted
Support for PS Developed Solutions enV	1	Quoted
enVision Extended Year 2 Maint	1	Quoted
Support for PS Developed Solutions FIM	1	Quoted
Support for PS Developed Solutions IPV	1	Quoted

Support for PS Developed Solutions DLP	1	Quoted
DLP Extended Year 1 Maint (* See notes above)	1	Quoted
DLP Extended Year 2 Maint (*See notes above)	1	Quoted
BSAFE Extended Year 1 Maint (* See notes above)	1	Quoted
BSAFE Extended Year 2 Maint (*See notes above)	1	Quoted
Support for PS Developed Solutions Archer	1	Quoted
Extended Maintenance - Year 1 (* See notes above)	1	Quoted
Extended Maintenance - Year 2 (* See notes above)	1	Quoted
Auth Mgr Extended Maintenance - Year 1	1	Quoted
Auth Mgr Extended Maintenance - Year 2	1	Quoted
AXM Extended Maintenance - Year 1	1	Quoted
AXM Extended Maintenance - Year 2	1	Quoted
FIM Extended Maintenance	1	Quoted
FIM Extended Maintenance - Year 2	1	Quoted
Cert Mgr Extended Maintenance - Year 1	1	Quoted
Cert Mgr Extended Maintenance - Year 2	1	Quoted
Registration Mgr Extended Maintenance - Year 1	1	Quoted
Registration Mgr Extended Maintenance - Year 2	1	Quoted
DPM Extended Maintenance Year 1	1	Quoted
DPM Extended Maintenance Year 2	1	Quoted
Support for PS Developed Solutions DPM	1	Quoted
AA On Prem Extended Maintenance Year 1	1	Quoted
AA On Prem Extended Maintenance Year 2	1	Quoted
Archer Maintenance Reinstatement Fee	1	Quoted
IMG Maintenance Reinstatement Fee	1	Quoted
WTD Maintenance Reinstatement Fee	1	Quoted
DLP Maintenance Reinstatement Fee	1	Quoted
AAO Maintenance Reinstatement Fee	1	Quoted
AAH Maintenance Reinstatement Fee	1	Quoted
AAEcom Maintenance Reinstatement Fee	1	Quoted
SA Maintenance Reinstatement Fee	1	Quoted
SID Maintenance Reinstatement Fee	1	Quoted
DCMS Maintenance Reinstatement Fee	1	Quoted
Access Mgr Maintenance Reinstatement Fee	1	Quoted
BSAFE Maintenance Reinstatement Fee	1	Quoted
Support for PS Developed Solutions IMG	1	Quoted
Support for PS Developed Solutions SA	1	Quoted
NW Series 4S Ext Mon Hdwr Support Yr 1	1	\$500.00
NW Series 4S Ext Mon Hdwr Support Yr 2	1	\$500.00
RSA TM ONPREM per1K users btw 10-20K	1000	\$4,590.00
RSA TM ONPREM per1K users btw 20,005-50K	1000	\$2,600.00
RSA TM ONPREM per1K users btw 50,005-100K	1000	\$1,530.00
RSA TM ONPREM per1K users btw 100,005-200K	1000	\$1,380.00
RSA TM ONPREM per1K users btw 200,005-400K	1000	\$1,220.00
RSA TM ONPREM per1K users btw 400,005-600K	1000	\$1,070.00
RSA TM ONPREM per1K users btw 600,005-800K	1000	\$920.00
RSA TM ONPREM per1K users btw 800,005-1,M	1000	\$840.00

RSA TM ONPREM per1Kusers btw 1,000,005-1,.5M	1000	\$690.00
RSA TM ONPREM per1K users btw 1,500,005-2M	1000	\$540.00
RSA TM ONPREM per1K users btw 2,000,005-3M	1000	\$380.00
RSA TM ONPREM per1K users btw 3,000,005-4M	1000	\$340.00
RSA TM ONPREM per1K users btw 4,000,005-5M	1000	\$310.00
RSA TM ONPREM per1K users btw 5,000,005-7.5M	1000	\$230.00
RSA TM ONPREM per 1K users MAINT-Enh-1	1000	\$95.63
RSA TM ONPREM per 1K users MAINT-Enh-1	1000	\$54.17
RSA TM ONPREM per 1K users MAINT-Enh-1	1000	\$31.88
RSA TM ONPREM per 1K users MAINT-Enh-1	1000	\$28.75
RSA TM ONPREM per 1K users MAINT-Enh-1	1000	\$25.42
RSA TM ONPREM per 1K users MAINT-Enh-1	1000	\$22.29
RSA TM ONPREM per 1K users MAINT-Enh-1	1000	\$19.17
RSA TM ONPREM per 1K users MAINT-Enh-1	1000	\$17.50
RSA TM ONPREM per 1K users MAINT-Enh-1	1000	\$14.38
RSA TM ONPREM per 1K users MAINT-Enh-1	1000	\$11.25
RSA TM ONPREM per 1K users MAINT-Enh-1	1000	\$7.92
RSA TM ONPREM per 1K users MAINT-Enh-1	1000	\$7.08
RSA TM ONPREM per 1K users MAINT-Enh-1	1000	\$6.46
RSA TM ONPREM per 1K users MAINT-Enh-1	1000	\$4.79
RSA TM ONPREM Consumer Pricing per 1K Users 1MTH Term 10-20K	1000	\$280.71
RSA TM ONPREM Consumer Pricing per 1K Users 1MTH Term 20-50K	1000	\$158.93
RSA TM ONPREM Consumer Pricing per 1K Users 1MTH Term 50-100K	1000	\$93.29
RSA TM ONPREM Consumer Pricing per 1K Users 1MTH Term 100-200K	1000	\$83.80
RSA TM ONPREM Consumer Pricing per 1K Users 1MTH Term 200-400K	1000	\$75.13
RSA TM ONPREM Consumer Pricing per 1K Users 1MTH Term 400-600K	1000	\$65.64
RSA TM ONPREM Consumer Pricing per 1K Users 1MTH Term 600-800K	1000	\$56.14
RSA TM ONPREM Consumer Pricing per 1K Users 1MTH Term 800K-1M	1000	\$51.39
RSA TM ONPREM Consumer Pricing per 1K Users 1MTH Term 1-1.5M	1000	\$41.90
RSA TM ONPREM Consumer Pricing per 1K Users 1MTH Term 1.5-2M	1000	\$32.40
RSA TM ONPREM Consumer Pricing per 1K Users 1MTH Term 2-3M	1000	\$23.74
RSA TM ONPREM Consumer Pricing per 1K Users 1MTH Term 3-4M	1000	\$20.22
RSA TM ONPREM Consumer Pricing per 1K Users 1MTH Term 4-5M	1000	\$18.99
RSA TM ONPREM Consumer Pricing per 1K Users 1MTH Term 5-7.5M	1000	\$14.24
eFraud Network & IP Geo Location Feeds for On Prem Pricing per 1K Users for quantities betwe	1000	\$688.50
eFraud Network & IP Geo Location Feeds for On Prem Pricing per 1K Users for quantities betwe	1000	\$390.15
eFraud Network & IP Geo Location Feeds for On Prem Pricing per 1K Users for quantities betwe	1000	\$229.50
eFraud Network & IP Geo Location Feeds for On Prem Pricing per 1K Users for quantities betwe	1000	\$206.55
eFraud Network & IP Geo Location Feeds for On Prem Pricing per 1K Users for quantities betwe	1000	\$183.60
eFraud Network & IP Geo Location Feeds for On Prem Pricing per 1K Users for quantities betwe	1000	\$160.65
eFraud Network & IP Geo Location Feeds for On Prem Pricing per 1K Users for quantities betwe	1000	\$137.70
eFraud Network & IP Geo Location Feeds for On Prem Pricing per 1K Users for quantities betwe	1000	\$126.23
eFraud Network & IP Geo Location Feeds for On Prem Pricing per 1K Users for quantities betwe	1000	\$103.28
eFraud Network & IP Geo Location Feeds for On Prem Pricing per 1K Users for quantities betwe	1000	\$80.33
eFraud Network & IP Geo Location Feeds for On Prem Pricing per 1K Users for quantities betwe	1000	\$57.38
eFraud Network & IP Geo Location Feeds for On Prem Pricing per 1K Users for quantities betwe	1000	\$50.49
eFraud Network & IP Geo Location Feeds for On Prem Pricing per 1K Users for quantities betwe	1000	\$45.90

eFraud Network & IP Geo Location Feeds for On Prem Pricing per 1K Users for quantities betwe	1000	\$34.43
RSA Authentication Manager 8.x 2 User Trial with Virtual Appliance, 2 SID700, 2 s/w tokens	1	\$0.00
10 User License, 10 SID700 and 10 s/w tokens 3yr	1	\$1,411.20
25 User License, 25 SID700 and 25 s/w tokens 3yr	1	\$2,385.50
2 User SID800 Promo Pack	1	\$0.00
3 Month Trial for Software Token - 10 User	1	\$0.00
RSA SecurID Access 25 User 90 Day Software Trial	1	\$0.00
NW UEBA Trial Software License	1	\$0.00
RSA Validation Client Mnt - Basic-1	1	\$0.15
RSA Validation Client Mnt - Basic-1	1	\$0.12
RSA Validation Client Mnt - Basic-1	1	\$0.09
RSA Validation Client Mnt - Basic-1	1	\$0.08
RSA Validation Client Mnt - Basic-1	1	\$0.06
RSA Validation Client Mnt - Basic-1	1	\$0.05
RSA Validation Client Mnt - Basic-1	1	\$0.04
RSA Validation Client Mnt - Basic-1	1	\$0.03
RSA Validation Client Mnt - Basic-1	1	\$0.03
RSA Validation Client Mnt - Basic-1	1	\$0.02
RSA Validation Client Mnt - Basic-1	1	\$0.02
RSA Validation Client Mnt - Basic-1	1	\$0.02
RSA Validation Client Mnt - Basic-1	1	\$0.02
RSA Validation Client Mnt - Basic-1	1	\$0.02
RSA Validation Client Mnt - Basic-1	1	\$0.01
RSA Validation Client Mnt - Basic-1	1	\$0.01
RSA Validation Client Mnt - Basic-1	1	\$0.01
RSA Validation Client Mnt - Enh-1	1	\$0.21
RSA Validation Client Mnt - Enh-1	1	\$0.17
RSA Validation Client Mnt - Enh-1	1	\$0.13
RSA Validation Client Mnt - Enh-1	1	\$0.10
RSA Validation Client Mnt - Enh-1	1	\$0.08
RSA Validation Client Mnt - Enh-1	1	\$0.07
RSA Validation Client Mnt - Enh-1	1	\$0.05
RSA Validation Client Mnt - Enh-1	1	\$0.04
RSA Validation Client Mnt - Enh-1	1	\$0.04
RSA Validation Client Mnt - Enh-1	1	\$0.03
RSA Validation Client Mnt - Enh-1	1	\$0.03
RSA Validation Client Mnt - Enh-1	1	\$0.03
RSA Validation Client Mnt - Enh-1	1	\$0.02
RSA Validation Client Mnt - Enh-1	1	\$0.02
RSA Validation Client Mnt - Enh-1	1	\$0.02
RSA Validation Client Mnt - Enh-1	1	\$0.02
RSA Valid Mgr Maint - Basic-1	1	\$0.30
RSA Valid Mgr Maint - Basic-1	1	\$0.24
RSA Valid Mgr Maint - Basic-1	1	\$0.18
RSA Valid Mgr Maint - Basic-1	1	\$0.15
RSA Valid Mgr Maint - Basic-1	1	\$0.12

RSA Valid Mgr Maint - Basic-1	1	\$0.10
RSA Valid Mgr Maint - Basic-1	1	\$0.08
RSA Valid Mgr Maint - Basic-1	1	\$0.06
RSA Valid Mgr Maint - Basic-1	1	\$0.05
RSA Valid Mgr Maint - Basic-1	1	\$0.05
RSA Valid Mgr Maint - Basic-1	1	\$0.04
RSA Valid Mgr Maint - Basic-1	1	\$0.04
RSA Valid Mgr Maint - Basic-1	1	\$0.03
RSA Valid Mgr Maint - Basic-1	1	\$0.03
RSA Valid Mgr Maint - Basic-1	1	\$0.03
RSA Valid Mgr Maint - Basic-1	1	\$0.03
RSA Valid Mgr Maint - Basic-1	1	\$0.02
RSA Valid Mgr Maint - Enh-1	1	\$0.42
RSA Valid Mgr Maint - Enh-1	1	\$0.33
RSA Valid Mgr Maint - Enh-1	1	\$0.25
RSA Valid Mgr Maint - Enh-1	1	\$0.21
RSA Valid Mgr Maint - Enh-1	1	\$0.17
RSA Valid Mgr Maint - Enh-1	1	\$0.14
RSA Valid Mgr Maint - Enh-1	1	\$0.10
RSA Valid Mgr Maint - Enh-1	1	\$0.08
RSA Valid Mgr Maint - Enh-1	1	\$0.07
RSA Valid Mgr Maint - Enh-1	1	\$0.06
RSA Valid Mgr Maint - Enh-1	1	\$0.06
RSA Valid Mgr Maint - Enh-1	1	\$0.05
RSA Valid Mgr Maint - Enh-1	1	\$0.05
RSA Valid Mgr Maint - Enh-1	1	\$0.04
RSA Valid Mgr Maint - Enh-1	1	\$0.04
RSA Valid Mgr Maint - Enh-1	1	\$0.04
RSA Valid Mgr Maint - Enh-1	1	\$0.03
WTD FM Base License Fee (Perpetual)	1	\$125,000.00
WTD FM Maintenance Fee [per month]	1	\$2,604.17
WTD FM Base License Fee Term [per month]	1	\$4,557.29
WTD FM OP 1-5000 Reg Users (per 1000)	1000	\$3,872.81
WTD FM OP 5-10k Reg Users (per 1000)	1000	\$3,227.34
WTD FM OP 10-20k Reg Users (per 1000)	1000	\$2,689.45
WTD FM OP 20k-50k Reg Users (per 1000)	1000	\$2,151.56
WTD FM OP 50k-100k Reg Users (per 1000)	1000	\$1,721.25
WTD FM OP 100k-200k Reg Users (per 1000)	1000	\$1,377.00
WTD FM OP 200k-400k Reg Users (per 1000)	1000	\$1,362.66
WTD FM OP 400k-600k Reg Users (per 1000)	1000	\$1,192.32
WTD FM OP 600k-800k Reg Users (per 1000)	1000	\$1,021.99
WTD FM OP 800k-1m Reg Users (per 1000)	1000	\$936.83
WTD FM OP 1m-1.5m Reg Users (per 1000)	1000	\$766.49
WTD FM OP 1.5m-2m Reg Users (per 1000)	1000	\$596.16
WTD FM OP 2m-3m Reg Users (per 1000)	1000	\$425.83
WTD FM OP 3m-4m Reg Users (per 1000)	1000	\$374.73
WTD FM OP 4m-5m Reg Users (per 1000)	1000	\$340.66

WTD FM OP 5m-7.5m Reg Users (per 1000)	1000	\$255.50
WTD FM OP 7.5m-10m Reg Users (per 1000)	1000	\$211.52
WTD FM OP 10m-15m Reg Users (per 1000)	1000	\$166.99
WTD FM OP 15m-20m Reg Users (per 1000)	1000	\$111.33
WTD FM OP 20m-25m Reg Users (per 1000)	1000	\$89.06
WTD FM 1mo MT 1-5000 Reg Use (per1000)	1000	\$80.68
WTD FM 1mo MT 5-10k Reg Use (per1000)	1000	\$67.24
WTD FM 1mo MT 10-20k Reg Use (per1000)	1000	\$56.03
WTD FM 1mo MT 20k-50k Reg Use (per1000)	1000	\$44.82
WTD FM 1mo MT 50k-100k Reg Use (per1000)	1000	\$35.86
WTD FM 1mo MT 100k-200k Reg Use (per1000)	1000	\$28.69
WTD FM 1mo MT 200k-400k Reg Use (per1000)	1000	\$28.39
WTD FM 1mo MT 400k-600k Reg Use (per1000)	1000	\$24.84
WTD FM 1mo MT 600k-800k Reg Use (per1000)	1000	\$21.29
WTD FM 1mo MT 800k-1m Reg Use (per1000)	1000	\$19.52
WTD FM 1mo MT 1m-1.5m Reg Use (per1000)	1000	\$15.97
WTD FM 1mo MT 1.5m-2m Reg Use (per1000)	1000	\$12.42
WTD FM 1mo MT 2m-3m Reg Use (per1000)	1000	\$8.87
WTD FM 1mo MT 3m-4m Reg Use (per1000)	1000	\$7.81
WTD FM 1mo MT 4m-5m Reg Use (per1000)	1000	\$7.10
WTD FM 1mo MT 5m-7.5m Reg Use (per1000)	1000	\$5.32
WTD FM 1mo MT 7.5m-10m Reg Use (per1000)	1000	\$4.41
WTD FM 1mo MT 10m-15m Reg Use (per1000)	1000	\$3.48
WTD FM 1mo MT 15m-20m Reg Use (per1000)	1000	\$2.32
WTD FM 1mo MT 20m-25m Reg Use (per1000)	1000	\$1.86
WTD FM OP Term 1-5000 RU [per mo/1000]	1000	\$141.20
WTD FM OP Term 5-10k RU [per mo/1000]	1000	\$117.66
WTD FM OP Term 10-20k RU [per mo/1000]	1000	\$98.05
WTD FM OP 20k-50k RU [per mo/1000]	1000	\$78.44
WTD FM OP 50k-100k RU [per mo/1000]	1000	\$62.75
WTD FM OP 100k-200k RU [per mo/1000]	1000	\$50.20
WTD FM OP 200k-400k RU [per mo/1000]	1000	\$49.68
WTD FM OP 400k-600k RU [per mo/1000]	1000	\$43.47
WTD FM OP 600k-800k RU [per mo/1000]	1000	\$37.26
WTD FM OP 800k-1m RU [per mo/1000]	1000	\$34.16
WTD FM OP 1m-1.5m RU [per mo/1000]	1000	\$27.95
WTD FM OP 1.5m-2m RU [per mo/1000]	1000	\$21.74
WTD FM OP 2m-3m RU [per mo/1000]	1000	\$15.53
WTD FM OP 3m-4m RU [per mo/1000]	1000	\$13.66
WTD FM OP 4m-5m RU [per mo/1000]	1000	\$12.42
WTD FM OP 5m-7.5m RU [per mo/1000]	1000	\$9.32
WTD FM OP 7.5m-10m RU [per mo/1000]	1000	\$7.71
WTD FM OP 10m-15m RU [per mo/1000]	1000	\$6.09
WTD FM OP 15m-20m RU [per mo/1000]	1000	\$4.06
WTD FM OP 20m-25m RU [per mo/1000]	1000	\$3.25
WTD FM OP 1-5000 Visitors (per 1000)	1000	\$968.20
WTD FM OP 5-10k Visitors (per 1000)	1000	\$806.84

WTD FM OP 10-20k Visitors (per 1000)	1000	\$672.36
WTD FM OP 20k-50k Visitors (per 1000)	1000	\$537.89
WTD FM OP 50k-100k Visitors (per 1000)	1000	\$430.31
WTD FM OP 100k-200k Visitors (per 1000)	1000	\$344.25
WTD FM OP 200k-400k Visitors (per 1000)	1000	\$340.66
WTD FM OP 400k-600k Visitors (per 1000)	1000	\$298.08
WTD FM OP 600k-800k Visitors (per 1000)	1000	\$255.50
WTD FM OP 800k-1m Visitors (per 1000)	1000	\$234.21
WTD FM OP 1m-1.5m Visitors (per 1000)	1000	\$191.62
WTD FM OP 1.5m-2m Visitors (per 1000)	1000	\$149.04
WTD FM OP 2m-3m Visitors (per 1000)	1000	\$106.46
WTD FM OP 3m-4m Visitors (per 1000)	1000	\$93.68
WTD FM OP 4m-5m Visitors (per 1000)	1000	\$85.17
WTD FM OP 5m-7.5m Visitors (per 1000)	1000	\$63.87
WTD FM OP 7.5m-10m Visitors (per 1000)	1000	\$52.88
WTD FM OP 10m-15m Visitors (per 1000)	1000	\$41.75
WTD FM OP 15m-20m Visitors (per 1000)	1000	\$27.83
WTD FM OP 20m-25m Visitors (per 1000)	1000	\$22.27
WTD FM 1mo MT 1-5000 Visitors(per1000)	1000	\$20.17
WTD FM 1mo MT 5-10k Visitors(per1000)	1000	\$16.81
WTD FM 1mo MT 10-20k Visitors(per1000)	1000	\$14.01
WTD FM 1mo MT 20k-50k Visitors(per1000)	1000	\$11.21
WTD FM 1mo MT 50k-100k Visitors(per1000)	1000	\$8.96
WTD FM 1mo MT 100k-200k Visitors(per1000)	1000	\$7.17
WTD FM 1mo MT 200k-400k Visitors(per1000)	1000	\$7.10
WTD FM 1mo MT 400k-600k Visitors(per1000)	1000	\$6.21
WTD FM 1mo MT 600k-800k Visitors(per1000)	1000	\$5.32
WTD FM 1mo MT 800k-1m Visitors(per1000)	1000	\$4.88
WTD FM 1mo MT 1m-1.5m Visitors(per1000)	1000	\$3.99
WTD FM 1mo MT 1.5m-2m Visitors(per1000)	1000	\$3.11
WTD FM 1mo MT 2m-3m Visitors(per1000)	1000	\$2.22
WTD FM 1mo MT 3m-4m Visitors(per1000)	1000	\$1.95
WTD FM 1mo MT 4m-5m Visitors(per1000)	1000	\$1.77
WTD FM 1mo MT 5m-7.5m Visitors(per1000)	1000	\$1.33
WTD FM 1mo MT 7.5m-10m Visitors(per1000)	1000	\$1.10
WTD FM 1mo MT 10m-15m Visitors(per1000)	1000	\$0.87
WTD FM 1mo MT 15m-20m Visitors(per1000)	1000	\$0.58
WTD FM 1mo MT 20m-25m Visitors(per1000)	1000	\$0.46
WTD FM OP TM 1-5000 Visitors[mo/1000]	1000	\$35.30
WTD FM OP TM 5-10k Visitors[mo/1000]	1000	\$29.42
WTD FM OP TM 10-20k Visitors[mo/1000]	1000	\$24.51
WTD FM OP TM 20k-50k Visitors[mo/1000]	1000	\$19.61
WTD FM OP TM 50k-100k Visitors[mo/1000]	1000	\$15.69
WTD FM OP TM 100k-200k Visitors[mo/1000]	1000	\$12.55
WTD FM OP TM 200k-400k Visitors[mo/1000]	1000	\$12.42
WTD FM OP TM 400k-600k Visitors[mo/1000]	1000	\$10.87
WTD FM OP TM 600k-800k Visitors[mo/1000]	1000	\$9.32

WTD FM OP TM 800k-1m Visitors[mo/1000]	1000	\$8.54
WTD FM OP TM 1m-1.5m Visitors[mo/1000]	1000	\$6.99
WTD FM OP TM 1.5m-2m Visitors[mo/1000]	1000	\$5.43
WTD FM OP TM 2m-3m Visitors[mo/1000]	1000	\$3.88
WTD FM OP TM 3m-4m Visitors[mo/1000]	1000	\$3.42
WTD FM OP TM 4m-5m Visitors[mo/1000]	1000	\$3.11
WTD FM OP TM 5m-7.5m Visitors[mo/1000]	1000	\$2.33
WTD FM OP TM 7.5m-10m Visitors[mo/1000]	1000	\$1.93
WTD FM OP TM 10m-15m Visitors[mo/1000]	1000	\$1.52
WTD FM OP TM 15m-20m Visitors[mo/1000]	1000	\$1.01
WTD FM OP TM 20m-25m Visitors[mo/1000]	1000	\$0.81
eFN IP for WTD per1K mo qty 1-5K	1000	\$49.97
eFN IP for WTD per1K mo qty 5K-10K	1000	\$41.48
eFN IP for WTD per1K mo qty 10K-20K	1000	\$34.43
eFN IP for WTD per1K mo qty 20K-50K	1000	\$19.51
eFN IP for WTD per1K mo qty 50K-100K	1000	\$11.48
eFN IP for WTD per1K mo qty 100K-200K	1000	\$10.33
eFN IP for WTD per1K mo qty 200K-400K	1000	\$9.18
eFN IP for WTD per1K mo qty 400K-600K	1000	\$8.03
eFN IP for WTD per1K mo qty 600K-800K	1000	\$6.89
eFN IP for WTD per1K mo qty 800K-1M	1000	\$6.31
eFN IP for WTD per1K mo qty 1M-1.5M	1000	\$5.16
eFN IP for WTD per1K mo qty 1.5M-2M	1000	\$4.02
eFN IP for WTD per1K mo qty 2M-3M	1000	\$2.87
eFN IP for WTD per1K mo qty 3M-4M	1000	\$2.52
eFN IP for WTD per1K mo qty 4M-5M	1000	\$2.30
eFN IP for WTD per1K mo qty 5M-7.5M	1000	\$1.72
eFN IP for WTD per1K mo qty 7.5M-10M	1000	\$1.43
eFN IP for WTD per1K mo qty 10M-15M	1000	\$1.19
eFN IP for WTD per1K mo qty 15M-20M	1000	\$0.98
eFN IP for WTD per1K mo qty 20M-25M	1000	\$0.82
FA Feed for WTD per1K mo qty 1-5K	1000	\$87.45
FA Feed for WTD per1K mo qty 5K-10K	1000	\$72.58
FA Feed for WTD per1K mo qty 10K-20K	1000	\$60.24
FA Feed for WTD per1K mo qty 20K-50K	1000	\$34.14
FA Feed for WTD per1K mo qty 50K-100K	1000	\$20.08
FA Feed for WTD per1K mo qty 100K-200K	1000	\$18.07
FA Feed for WTD per1K mo qty 200K-400K	1000	\$16.07
FA Feed for WTD per1K mo qty 400K-600K	1000	\$14.06
FA Feed for WTD per1K mo qty 600K-800K	1000	\$12.05
FA Feed for WTD per1K mo qty 800K-1M	1000	\$11.05
FA Feed for WTD per1K mo qty 1M-1.5M	1000	\$9.04
FA Feed for WTD per1K mo qty 1.5M-2M	1000	\$7.03
FA Feed for WTD per1K mo qty 2M-3M	1000	\$5.02
FA Feed for WTD per1K mo qty 3M-4M	1000	\$4.42
FA Feed for WTD per1K mo qty 4M-5M	1000	\$4.02
FA Feed for WTD per1K mo qty 5M-7.5M	1000	\$3.01

FA Feed for WTD per1K mo qty 7.5M-10M	1000	\$2.50
FA Feed for WTD per1K mo qty 10M-15M	1000	\$2.08
FA Feed for WTD per1K mo qty 15M-20M	1000	\$1.72
FA Feed for WTD per1K mo qty 20M-25M	1000	\$1.43

ENTERPRISE	SVC	CAT	Description	Unit
U-EC-IC-DP-BU-CRS	IaaS	CPS	Backup Restoration Request With CCS	Ea
U-EC-IC-DP-BU-NRS	IaaS	CPS	Backup Restoration Request Without CCS	Ea
U-EC-IC-SVC-DRT1-AH	IaaS	CPS	DR Test Service Tier 1 (<20 VMs)	Ea
U-EC-IC-SVC-DRT2-AH	IaaS	CPS	DR Test Service Tier 2 (<50 VMs)	Ea
U-EC-IC-SVC-DRT3-AH	IaaS	CPS	DR Test Service Tier 3 (<100 VMs)	Ea
U-EC-IC-SVC-DRT4-AH	IaaS	CPS	DR Test Service Tier 4 (<150 VMs)	Ea
U-EC-IC-SVC-DRT5-AH	IaaS	CPS	DR Test Service Tier 5 (<200VMs)	Ea
U-EC-IC-RPT-VCC-REQ	IaaS	CPS	Virtualization Custom Consumption Report	Ea
U-EC-IC-RPT-VRS-REQ	IaaS	CPS	Virtualization Right Sizing Report	Ea
U-EC-IC-RPT-VM-50	IaaS	CPS	VM Reporting (0-50 VMs)	VM
U-EC-IC-RPT-VM-150	IaaS	CPS	VM Reporting (101-150 VMs)	VM
U-EC-IC-RPT-VM-100	IaaS	CPS	VM Reporting (51-100 VMs)	VM
U-EC-IC-SVC-DRP1-AH	IaaS	CPS	DR Planning Service Tier 1 (<20 VMs)	Ea
U-EC-IC-SVC-DRP2-AH	IaaS	CPS	DR Planning Service Tier 2 (<50 VMs)	Ea
U-EC-IC-SVC-DRP3-AH	IaaS	CPS	DR Planning Service Tier 3 (<100 VMs)	Ea
U-EC-IC-SVC-DRP4-AH	IaaS	CPS	DR Planning Service Tier 4 (<150 VMs)	Ea
U-EC-IC-SVC-DRP5-AH	IaaS	CPS	DR Planning Service Tier 5 (<200 VMs)	Ea
U-EC-IC-NW-LBA-1T	IaaS	CPS	Load Balancer Setup - Advanced	Project
U-EC-CS-2F-D1-1T	IaaS	CPS	2FA Dedicated Setup	Instance
U-EC-CS-2F-D2-1T	IaaS	CPS	2FA Dedicated DR Setup	Instance
U-EC-CS-2F-DS-1T	IaaS	CPS	2FA Dedicated Self-Service Setup	Instance
U-EC-CS-2F-DT-1T	IaaS	CPS	2FA Dedicated Token Issue	User
U-EC-CS-2F-S-1T	IaaS	CPS	2FA Shared Setup	Instance
U-EC-CS-2F-SS-1T	IaaS	CPS	2FA Shared Self-Service Setup	Instance
U-EC-CS-2F-ST-1T	IaaS	CPS	2FA Shared Token Issue	User
U-EC-CS-2F-VPT-1T	IaaS	CPS	2FA Virtustream Portal Token Issue	User
U-EC-CS-ENC-AGT-1T	IaaS	CPS	Encryption Agent Setup	VM
U-EC-CS-ENC-SYSS-1T	IaaS	CPS	Encryption Management System Setup - SaaS	Ea
U-EC-CS-FA-FAE-1T	IaaS	CPS	Firewall Audit Export Setup	Firewall
U-EC-CS-FA-SYS-1T	IaaS	CPS	Firewall Audit System Setup	Account
U-EC-CS-TM-AV1-1T	IaaS	CPS	Anti-Virus Primary System Setup	Account
U-EC-CS-TM-AV2-1T	IaaS	CPS	Anti-Virus Secondary System Setup	Account
U-EC-CS-FW-FW-1T	IaaS	CPS	Firewall Configuration/Setup	Firewall
U-EC-HM-HA-PHS-1T	IaaS	CPS	HANA Appliance Installation and Setup - Physical / Appliance	Appliance
U-EC-CS-TM-FIM1-1T	IaaS	CPS	File Integrity Monitoring Primary System Setup	Account
U-EC-CS-TM-FIM2-1T	IaaS	CPS	File Integrity Monitoring Secondary System Setup	Account
U-EC-IC-ONB-SS-1T	IaaS	CPS	IaaS Onboarding - Self-Service	Account
U-EC-IC-ONB-FUL-1T	IaaS	CPS	IaaS Onboarding - Full	VM
U-EC-IC-ONB-BAS-1T	IaaS	CPS	IaaS Onboarding - Basic	VM
U-EC-CS-TM-IDFW1-1T	IaaS	CPS	Intrusion Detection and Firewall Primary System Setup	Account
U-EC-CS-TM-IDFW2-1T	IaaS	CPS	Intrusion Detection and Firewall Secondary Setup	Account
U-EC-CS-VPN-H-1T	IaaS	CPS	IPSec VPN Host-Side Configuration	Ea
U-EC-IC-NW-FLBB-1T	IaaS	CPS	F5 Load Balancer Pool Setup Charges - Basic	Each pool
U-EC-IC-NW-FLBA-1T	IaaS	CPS	F5 Load Balancer Pool Setup Charges - Advanced	Each pool
U-EC-CS-TM-VLSB1-1T	IaaS	CPS	VM-Level Security Bundle Primary System Setup	Account
U-EC-CS-TM-VLSB2-1T	IaaS	CPS	VM-Level Security Bundle Secondary System Setup	Account

U-EC-CS-IDS-NB1-1T	laaS	CPS	Network Based Intrusion Detection Primary Site S	VLAN
U-EC-CS-IDS-NB2-1T	laaS	CPS	Network Based Intrusion Detection Secondary Site	VLAN
U-EC-CS-VS-LM-1T	laaS	CPS	Log Management System Setup	Ea
U-EC-CS-VS-MLM-1T	laaS	CPS	Managed Log Management Service Setup	VM
U-EC-IC-DP-BU-1T	laaS	CPS	System Backup Setup	Account
U-EC-HM-HA-VIR-1T	laaS	CPS	vHANA Installation and Setup Charge - Virtual App	VM
U-EC-CS-VS-PSVC-1T	laaS	CPS	Policy Auditor Service Setup	VM
U-EC-CS-VS-PSYS-1T	laaS	CPS	Policy Auditor System Setup	Site
U-EC-CS-2F-D1-SYS	laaS	CPS	2FA Dedicated Base Fee	Instance
U-EC-CS-2F-D2-SYS	laaS	CPS	2FA Dedicated DR Base Fee	Instance
U-EC-CS-2F-DT-MF	laaS	CPS	2FA Dedicated Token Fee	User
U-EC-CS-2F-ST-MF	laaS	CPS	2FA Shared Token Fee	User
U-EC-CS-2F-VPT-MF	laaS	CPS	2FA Virtustream Portal Token Fee	User
U-EC-HM-HA1-SO-1TB	laaS	CPS	1 TB HANA Managed Appliance for BW (Scale-Out Appliance	
U-EC-HM-HA1-SO-15	laaS	CPS	1.5 TB HANA Managed Appliance for BW (Scale-O	Appliance
U-EC-HM-HA1-SO-2TB	laaS	CPS	2 TB HANA Managed Appliance for BW (Scale-Out Appliance	
U-EC-HM-HA1-SO-3TB	laaS	CPS	3 TB HANA Managed Appliance for BW (Scale-Out Appliance	
U-EC-HM-HA1-SO-4TB	laaS	CPS	4 TB HANA Managed Appliance for BW (Scale-Out Appliance	
U-EC-HM-HA1-SN-1TB	laaS	CPS	1 TB HANA Managed Appliance (Single Node/Scale	Appliance
U-EC-HM-HA1-SN-2TB	laaS	CPS	2 TB HANA Managed Appliance (Single Node/Scale	Appliance
U-EC-HM-HA1-SOH-1TB	laaS	CPS	1 TB HANA Managed Appliance for SoH - Primary	Appliance
U-EC-HM-HA1-SOH-15	laaS	CPS	1.5 TB HANA Managed Appliance for SoH - Primar	Appliance
U-EC-HM-HA1-SOH-2TB	laaS	CPS	2 TB HANA Managed Appliance for SoH - Primary	Appliance
U-EC-HM-HA1-SOH-3TB	laaS	CPS	3 TB HANA Managed Appliance for SoH - Primary	Appliance
U-EC-HM-HA1-SOH-4TB	laaS	CPS	4 TB HANA Managed Appliance for SoH - Primary	Appliance
U-EC-HM-HA1-SOH-6TB	laaS	CPS	6 TB HANA Managed Appliance for SoH - Primary	Appliance
U-EC-HM-HA1-SOH-8TB	laaS	CPS	8 TB HANA Managed Appliance for SoH - Primary	Appliance
U-EC-HM-HA1-SOH-9TB	laaS	CPS	9 TB HANA Managed Appliance for SoH - Primary	Appliance
U-EC-HM-HA1-SOH-12TB	laaS	CPS	12 TB HANA Managed Appliance for SoH - Primary	Appliance
U-EC-HM-HA2-SO-1TB	laaS	CPS	1 TB HANA Managed Appliance for BW (Scale-Out Appliance	
U-EC-HM-HA2-SO-15	laaS	CPS	1.5 TB HANA Managed Appliance for BW (Scale-O	Appliance
U-EC-HM-HA2-SO-2TB	laaS	CPS	2 TB HANA Managed Appliance for BW (Scale-Out Appliance	
U-EC-HM-HA2-SO-3TB	laaS	CPS	3 TB HANA Managed Appliance for BW (Scale-Out Appliance	
U-EC-HM-HA2-SO-4TB	laaS	CPS	4 TB HANA Managed Appliance for BW (Scale-Out Appliance	
U-EC-HM-HA2-SN-1TB	laaS	CPS	1 TB HANA Managed Appliance (Single Node/Scale	Appliance
U-EC-HM-HA2-SN-2TB	laaS	CPS	2 TB HANA Managed Appliance (Single Node/Scale	Appliance
U-EC-HM-HA2-SOH-1TB	laaS	CPS	1 TB HANA Managed Appliance for SoH - Seconda	Appliance
U-EC-HM-HA2-SOH-15	laaS	CPS	1.5 TB HANA Managed Appliance for SoH - Secon	Appliance
U-EC-HM-HA2-SOH-2TB	laaS	CPS	2 TB HANA Managed Appliance for SoH - Seconda	Appliance
U-EC-HM-HA2-SOH-3TB	laaS	CPS	3 TB HANA Managed Appliance for SoH - Seconda	Appliance
U-EC-HM-HA2-SOH-4TB	laaS	CPS	4 TB HANA Managed Appliance for SoH - Seconda	Appliance
U-EC-HM-HA2-SOH-6TB	laaS	CPS	6 TB HANA Managed Appliance for SoH - Seconda	Appliance
U-EC-HM-HA2-SOH-8TB	laaS	CPS	8 TB HANA Managed Appliance for SoH - Seconda	Appliance
U-EC-HM-HA2-SOH-9TB	laaS	CPS	9 TB HANA Managed Appliance for SoH - Seconda	Appliance
U-EC-HM-HA2-SOH-12TB	laaS	CPS	12 TB HANA Managed Appliance for SoH - Second	Appliance
U-EC-HM-VVM-BAS-ENT	laaS	CPS	vHANA Enterprise Basic VM Fee	VM
U-EC-HM-UVV-BAS-ENT	laaS	CPS	vHANA Enterprise Basic μ VM Variable	micro-VM

U-EC-HM-VVM-COR-ENT	IaaS	CPS	vHANA Enterprise Core VM Fee	VM
U-EC-HM-UVV-COR-ENT	IaaS	CPS	vHANA Enterprise Core μVM Variable	micro-VM
U-EC-IC-HVM-BAS-ENT	IaaS	CPS	High Memory Enterprise Basic VM Fee	VM
U-EC-IC-HVM-COR-ENT	IaaS	CPS	High Memory Enterprise Core VM Fee	VM
U-EC-HM-HVM-BASP-ENT	IaaS	CPS	vHANA Enterprise Basic Plus VM Fee	VM
U-EC-HM-UHV-BASP-ENT	IaaS	CPS	vHANA Enterprise Basic Plus μVM Variable	micro-VM
U-EC-HM-UVM-BASP-ENT	IaaS	CPS	vHANA Enterprise Basic Plus μVM	micro-VM
U-EC-IC-HVM-BASP-ENT	IaaS	CPS	High Memory Enterprise Basic Plus VM Fee	VM
U-EC-IC-UHV-BAS-ENT	IaaS	CPS	High Memory Enterprise Basic μVM	micro-VM
U-EC-IC-UHV-COR-ENT	IaaS	CPS	High Memory Enterprise Core μVM	micro-VM
U-EC-IC-UHV-BASP-ENT	IaaS	CPS	High Memory Enterprise Basic Plus μVM	micro-VM
U-EC-IC-UVM-BAS-ENT	IaaS	CPS	Enterprise Basic μVM	micro-VM
U-EC-IC-UVM-COR-ENT	IaaS	CPS	Enterprise Core μVM	micro-VM
U-EC-IC-UVM-BASP-ENT	IaaS	CPS	Enterprise Basic Plus μVM	Micro-VM
U-EC-CS-ENC-AGP-MF	IaaS	CPS	Encryption Agent per Machine - pHANA	VM
U-EC-CS-ENC-AGT-MF	IaaS	CPS	Encryption Agent per VM	VM
U-EC-CS-ENC-SYS-SYS	IaaS	CPS	Encryption Management System Fee	Account
U-EC-CS-FA-FA-SYS	IaaS	CPS	Firewall Audit System	Account
U-EC-CS-FA-MFA-SVC	IaaS	CPS	Managed Firewall Auditing Service	Firewall
U-EC-CS-TM-AV1-SYS	IaaS	CPS	Anti-Virus Primary System	Account
U-EC-CS-TM-AV2-SYS	IaaS	CPS	Anti-Virus Secondary System	Account
U-EC-CS-TM-AV-SVC	IaaS	CPS	Anti-Virus Managed Service	VM
U-EC-CS-TM-FIM1-SYS	IaaS	CPS	File Integrity Monitoring Primary System	Account
U-EC-CS-TM-FIM2-SYS	IaaS	CPS	File Integrity Monitoring Secondary System	Account
U-EC-IC-UHV-BASP-ENT	IaaS	CPS	High Memory Enterprise Basic Plus μVM	Micro-VM
U-EC-IC-HVM-BASP-ENT	IaaS	CPS	High Memory Enterprise Basic Plus VM Fee	VM
U-EC-CS-TM-IDFW1-SYS	IaaS	CPS	Intrusion Detection and Firewall Primary System	Account
U-EC-CS-TM-IDFW2-SYS	IaaS	CPS	Intrusion Detection and Firewall Secondary System	Account
U-EC-CS-VPN-DC1-NET	IaaS	CPS	IPSec VPN Bandwidth Fee - Primary	Mbps
U-EC-CS-VPN-DC2-NET	IaaS	CPS	IPSec VPN Bandwidth Fee - Secondary	Mbps
U-EC-CS-VPN-T-SVC	IaaS	CPS	IPSec VPN Tunnel Managed Service	Ea
U-EC-IC-NW-LBM-NET	IaaS	CPS	Load Balancing Bandwidth Fee (Additional to Netw	Mbps
U-EC-CS-TM-IDFW-SVC	IaaS	CPS	Intrusion Detection and Firewall Managed Service	VM
U-EC-CS-TM-VLSB1-SYS	IaaS	CPS	VM-Level Security Bundle Primary System fee	Account
U-EC-IC-NW-LBM-LB	IaaS	CPS	Managed Load Balancer Services (Per Server)	VM
U-EC-CS-TM-VLSB2-SYS	IaaS	CPS	VM-Level Security Bundle Secondary System fee	Account
U-EC-CS-FW-MPF-SVC	IaaS	CPS	Managed Perimeter Firewall	VM
U-EC-IC-SW-MSS-WIN	IaaS	CPS	Microsoft OS	Instance
U-EC-IC-SW-MQL-ENT	IaaS	CPS	Microsoft SQL Enterprise (Per 2 cores)	CPU
U-EC-IC-SW-MQL-STD	IaaS	CPS	Microsoft SQL Standard (Per 2 cores)	CPU
U-EC-CS-NW-BW1-NET	IaaS	CPS	Network Bandwidth Fee - Primary	Mbps
U-EC-CS-NW-BW2-NET	IaaS	CPS	Network Bandwidth Fee - Secondary	Mbps
U-EC-CS-IDS-NB2-SYS	IaaS	CPS	Network Based Intrusion Detection System and M VLAN	
U-EC-CS-IDS-NB1-SYS	IaaS	CPS	Network Based Intrusion Detection System and M VLAN	
U-EC-CS-TM-VLSBA-SVC	IaaS	CPS	VM-Level Security Bundle Service Fee (<101 VMs)	VM
U-EC-CS-TM-VLSBB-SVC	IaaS	CPS	VM-Level Security Bundle Service Fee (<1001 VMs)	VM
U-EC-IC-NW-IPAD-V4	IaaS	CPS	Public IP Address (IPv4)	IP

U-EC-IC-NW-IPAD-V6	IaaS	CPS	Public IP Address (IPv6)	IP
U-EC-IC-SW-RHL-ENT	IaaS	CPS	Red Hat Enterprise Linux - Enterprise (Per OS)	Instance
U-EC-IC-SW-RHL-STD	IaaS	CPS	Red Hat Enterprise Linux - Standard (Per OS)	Instance
U-EC-IC-SW-RDS-IF	IaaS	CPS	Remote Desktop Services (Per User)	User
U-EC-IC-SW-SLES-PH	IaaS	CPS	SUSE Linux Enterprise for Physical HANA	CPU
U-EC-IC-SW-SLES-MF	IaaS	CPS	vSUSE Linux Enterprise	VM
U-EC-IC-DP-BU-LOC	IaaS	CPS	System Backup - Local Only	GB
U-EC-IC-DP-BU-REP	IaaS	CPS	System Backup - Replicated	GB
U-EC-IC-STO-T0AD-LOC	IaaS	CPS	Tier 0 Block Storage - DMZ - Local Only	GB
U-EC-IC-STO-T0AD-REP	IaaS	CPS	Tier 0 Block Storage - DMZ - Replicated	GB
U-EC-IC-STO-T0AN-LOC	IaaS	CPS	Tier 0 Block Storage - HZ - Local Only	GB
U-EC-IC-STO-T0AN-REP	IaaS	CPS	Tier 0 Block Storage - HZ - Replicated	GB
U-EC-IC-STO-T0AI-LOC	IaaS	CPS	Tier 0 Block Storage - IZ - Local Only	GB
U-EC-IC-STO-T0AI-REP	IaaS	CPS	Tier 0 Block Storage - IZ - Replicated	GB
U-EC-IC-STO-T1AD-LOC	IaaS	CPS	Tier I Block Storage - DMZ - Local Only	GB
U-EC-IC-STO-T1AD-REP	IaaS	CPS	Tier I Block Storage - DMZ - Replicated	GB
U-EC-IC-STO-T1AN-LOC	IaaS	CPS	Tier I Block Storage - HZ - Local Only	GB
U-EC-IC-STO-T1AN-REP	IaaS	CPS	Tier I Block Storage - HZ - Replicated	GB
U-EC-IC-STO-T1AI-LOC	IaaS	CPS	Tier I Block Storage - IZ - Local Only	GB
U-EC-IC-STO-T1AI-REP	IaaS	CPS	Tier I Block Storage - IZ - Replicated	GB
U-EC-IC-STO-T2AD-LOC	IaaS	CPS	Tier II Block Storage - DMZ - Local Only	GB
U-EC-IC-STO-T2AD-REP	IaaS	CPS	Tier II Block Storage - DMZ - Replicated	GB
U-EC-IC-STO-T2AN-LOC	IaaS	CPS	Tier II Block Storage - HZ - Local Only	GB
U-EC-IC-STO-T2AN-REP	IaaS	CPS	Tier II Block Storage - HZ - Replicated	GB
U-EC-IC-STO-T2AI-LOC	IaaS	CPS	Tier II Block Storage - IZ - Local Only	GB
U-EC-IC-STO-T2AI-REP	IaaS	CPS	Tier II Block Storage - IZ - Replicated	GB
U-EC-IC-STO-T3AD-LOC	IaaS	CPS	Tier III Block Storage - DMZ - Local Only	GB
U-EC-IC-STO-T3AD-REP	IaaS	CPS	Tier III Block Storage – DMZ - Replicated	GB
U-EC-IC-STO-T3AN-LOC	IaaS	CPS	Tier III Block Storage - HZ - Local Only	GB
U-EC-IC-STO-T3AN-REP	IaaS	CPS	Tier III Block Storage – HZ - Replicated	GB
U-EC-IC-STO-T3AI-LOC	IaaS	CPS	Tier III Block Storage - IZ - Local Only	GB
U-EC-IC-STO-T3AI-REP	IaaS	CPS	Tier III Block Storage – IZ - Replicated	GB
U-EC-CS-TM-VLSBC-SVC	IaaS	CPS	VM-Level Security Bundle Service Fee (<10,001 VM	VM
U-EC-CS-TM-VLSBD-SVC	IaaS	CPS	VM-Level Security Bundle Service Fee (10,000+ VM	VM
U-EC-CS-VS-LM-SYS	IaaS	CPS	Log Management System Fee	Ea
U-EC-CS-VS-MLM-SVC	IaaS	CPS	Managed Log Management Service	VM
U-EC-CS-VS-PA-SVC	IaaS	CPS	Policy Auditor Service Fee	VM
U-EC-CS-VS-PA-SYS	IaaS	CPS	Policy Auditor System Fee	Site
U-EC-CS-VS-NPIP-SVC	IaaS	CPS	Vulnerability Scanning Managed Service - non Pub IP Address	
U-EC-CS-VS-NPIP-AH	IaaS	CPS	Vulnerability Scanning Remedial Ad Hoc Scan	IP Block
U-EC-CS-VS-PIP-SVC	IaaS	CPS	Vulnerability Scanning Managed Service - Public IF IP Address	
U-EC-CC-TAM-CIR-AH	IaaS	CCS	Co-Innovation Roundtables - Ad Hoc (6 months)	Ea
U-EC-CC-TAM-DMM-AH	IaaS	CCS	Demand Management Meetings - Ad Hoc (3 mont	Ea
U-EC-CC-TAM-ES-AH	IaaS	CCS	Executive Scorecards - Ad Hoc (3 months)	Ea
U-EC-CC-TAM-ITRF-AH	IaaS	CCS	IT Resource Forecast - Ad Hoc (3 months)	Ea
U-EC-CC-TAM-RBR-AH	IaaS	CCS	Reporting and Business Review - Ad Hoc (1 month	Ea
U-EC-CC-TAM-RP-AH	IaaS	CCS	Resource and Performance - Ad Hoc (1 month)	Ea

U-EC-CC-TAM-SLAR-AH	laaS	CCS	SLA Review - Ad Hoc (1 month)	Ea
U-EC-CC-TAM-WSIR-AH	laaS	CCS	Weekly Status and Incident Reporting - Ad Hoc (1	Ea
U-EC-AM-SVC-ONCC-1T	laaS	CCS	Application Managed Services Setup	VM
U-EC-CC-SAP-ONUS-1T	laaS	CCS	Onshore SAP User, Security, and Change Manager	Ea
U-EC-AM-SAP-CLAB-CO	laaS	CCS	Base - SAP Basis Support - OS & DB - Class A - Com	VM
U-EC-AM-SAP-CLBB-CO	laaS	CCS	Base - SAP Basis Support - OS & DB - Class B - Com	VM
U-EC-AM-SAP-NSDBB-CO	laaS	CCS	Base - Non-SAP DB Bolt-on Server - OS/DB/Tech A	VM
U-EC-AM-SAP-APPB-CO	laaS	CCS	Base - SAP App/Non-SAP App/Web Server - OS & I	VM
U-EC-AM-NS-OSDBC-CO	laaS	CCS	Base - OS & DB Administration - Clustered Server -	VM
U-EC-AM-NS-OSDBS-CO	laaS	CCS	Base - OS & DB Administration - Standalone Serve	VM
U-EC-AM-NS-OSCB-CO	laaS	CCS	Base - OS Administration - Clustered Server - Com	VM
U-EC-AM-NS-OSSB-CO	laaS	CCS	Base - OS Administration - Standalone Server - Co	VM
U-EC-AM-SAP-CLAS-CO	laaS	CCS	Standard - SAP Basis Support - OS & DB - Class A -	VM
U-EC-AM-SAP-CLBS-CO	laaS	CCS	Standard - SAP Basis Support - OS & DB - Class B -	VM
U-EC-AM-SAP-NSDBS-CO	laaS	CCS	Standard - Non-SAP DB Bolt-on Server - OS/DB/Te	VM
U-EC-AM-SAP-APPS-CO	laaS	CCS	Standard - SAP App/Non-SAP App/Web Server - O	VM
U-EC-AM-NS-OSDBCS-CO	laaS	CCS	Standard - OS & DB Administration - Clustered Ser	VM
U-EC-AM-NS-OSDBSS-CO	laaS	CCS	Standard - OS & DB Administration - Standalone S	VM
U-EC-AM-NS-OSCS-CO	laaS	CCS	Standard - OS Administration - Clustered Server -	VM
U-EC-AM-NS-OSSS-CO	laaS	CCS	Standard - OS Administration - Standalone Server	VM
U-EC-AM-SAP-CLAP-CO	laaS	CCS	Premium - SAP Basis Support - OS & DB - Class A -	VM
U-EC-AM-SAP-CLBP-CO	laaS	CCS	Premium - SAP Basis Support - OS & DB - Class B -	VM
U-EC-AM-SAP-NSDBP-CO	laaS	CCS	Premium - Non-SAP DB Bolt-on Server - OS/DB/Te	VM
U-EC-AM-SAP-APPP-CO	laaS	CCS	Premium - SAP App/Non-SAP App/Web Server - O	VM
U-EC-AM-NS-OSDBCP-CO	laaS	CCS	Premium - OS & DB Administration - Clustered Ser	VM
U-EC-AM-NS-OSDBSP-CO	laaS	CCS	Premium - OS & DB Administration - Standalone S	VM
U-EC-AM-NS-OSCP-CO	laaS	CCS	Premium - OS Administration - Clustered Server -	VM
U-EC-AM-NS-OSSP-CO	laaS	CCS	Premium - OS Administration - Standalone Server	VM
U-EC-AM-SAP-PRO-MT	laaS	CCS	SAP Support - Monitoring Tool	Account
U-EC-CC-TAM-OPIN-1Y	laaS	CCS	Operational Integration - 1 Year	Ea
U-EC-CC-TAM-RBR-1Y	laaS	CCS	Reporting and Business Review - 1 Year	Ea
U-EC-CC-TAM-RP-1Y	laaS	CCS	Resource and Performance - 1 Year	Ea
U-EC-CC-TAM-SLAR-1Y	laaS	CCS	SLA Review - 1 Year	Ea
U-EC-AM-TAMS-TAMSB-C	laaS	CCS	Technical Account Management Services - Base	Ea
U-EC-AM-TAMS-TAMSG-C	laaS	CCS	Technical Account Management Services - Gold	Ea
U-EC-AM-TAMS-TAMSS-C	laaS	CCS	Technical Account Management Services - Silver	Ea
U-EC-AM-TAMS-TAMSP-C	laaS	CCS	Technical Account Management Services - Platinu	Ea
U-EC-CC-TAM-WSIR-1Y	laaS	CCS	Weekly Status and Incident Reporting - 1 Year	Ea
U-EC-DC-NW1-XCC-1T	laaS	CSNS	Copper Cross Connect - Installation - Primary	Ea
U-EC-DC-NW2-XCC-1T	laaS	CSNS	Copper Cross Connect - Installation - Secondary	Ea
U-EC-DC-NW1-XCF-1T	laaS	CSNS	Fiber Cross Connect - Installation - Primary	Ea
U-EC-DC-NW2-XCF-1T	laaS	CSNS	Fiber Cross Connect - Installation - Secondary	Ea
U-EC-DC-RK1-RK-1T	laaS	CSNS	Rack Installation - Primary	Rack
U-EC-DC-RK2-RK-1T	laaS	CSNS	Rack Installation - Secondary	Rack
U-EC-DC-NW1-XCH-HA	laaS	CSNS	Cloud Connect - HA (48 ports available) - Primary	Ea
U-EC-DC-NW2-XCH-HA	laaS	CSNS	Cloud Connect - HA (48 ports available) - Seconda	Ea
U-EC-DC-NW1-XCS-STD	laaS	CSNS	Cloud Connect - Standard (24 ports available) - Pri	Ea

U-EC-DC-NW2-XCS-STD	IaaS	CSNS	Cloud Connect - Standard (24 ports available) - Secondary	Ea
U-EC-DC-NW1-XCC-MF	IaaS	CSNS	Copper Cross Connect - Primary	Ea
U-EC-DC-NW2-XCC-MF	IaaS	CSNS	Copper Cross Connect - Secondary	Ea
U-EC-DC-NW1-XCF-MF	IaaS	CSNS	Fiber Cross Connect - Primary	Ea
U-EC-DC-NW2-XCF-MF	IaaS	CSNS	Fiber Cross Connect - Secondary	Ea
U-EC-DC-RK1-RK-HR	IaaS	CSNS	Hotel Rack (1U) - Managed Colo - Primary	Rack Unit
U-EC-DC-RK2-RK-HR	IaaS	CSNS	Hotel Rack (1U) - Managed Colo - Secondary	Rack Unit
U-EC-DC-PW1-KW-42U	IaaS	CSNS	Rackpower - Per kW - Primary	Ea
U-EC-DC-PW2-KW-42U	IaaS	CSNS	Rackpower - Per kW - Secondary	Ea
U-EC-DC-SVC-RE1-AH	IaaS	CSNS	Remote eyes and hands (1 Hour) - Primary	Ea
U-EC-DC-SVC-RE2-AH	IaaS	CSNS	Remote eyes and hands (1 Hour) - Secondary	Ea
U-EC-DC-SVC-RE1-AHA	IaaS	CSNS	Remote eyes and hands (15 Minutes) - Primary	Ea
U-EC-DC-SVC-RE2-AHA	IaaS	CSNS	Remote eyes and hands (15 Minutes) - Secondary	Ea
U-EC-DC-NW1-XCC-1T	IaaS	CSNS	Copper Cross Connect - Installation - Primary	Ea
U-EC-DC-NW1-XCF-1T	IaaS	CSNS	Fiber Cross Connect - Installation - Primary	Ea
U-EC-DC-NW1-XCH-1T	IaaS	CSNS	Cloud Connect - HA (48 ports available) - Setup - Primary	Ea
U-EC-DC-NW2-XCH-1T	IaaS	CSNS	Cloud Connect - HA (48 ports available) - Setup - Secondary	Ea
U-EC-DC-RK1-DLP-1T	IaaS	CSNS	Equipment Deployment - Per equipment - Primary	Ea
U-EC-DC-RK2-DLP-1T	IaaS	CSNS	Equipment Deployment - Per equipment - Secondary	Ea
U-EC-DC-RK1-RK-1T	IaaS	CSNS	Rack Installation - Primary	Rack Unit
U-EC-DC-RK2-RK-1T	IaaS	CSNS	Rack Installation - Secondary	Rack Unit
U-EC-DC-RK1-RK-42U	IaaS	CSNS	Rackspace - 42U - Primary	Ea
U-EC-DC-RK2-RK-42U	IaaS	CSNS	Rackspace - 42U - Secondary	Ea
U-EC-DC-RK1-RK-HR	IaaS	CSNS	Hotel Rack (1U) - Managed Colo - Primary	Rack Unit
U-EC-DC-RK2-RK-HR	IaaS	CSNS	Hotel Rack (1U) - Managed Colo - Secondary	Rack Unit
U-EC-VSC-OS-STD-12-T0	VSC	VSC	SEL VTS-OS Std 12 mo. 1TB	GB
U-EC-VSC-OS-STD-12-T1	VSC	VSC	SEL VTS-OS Std 12 mo. 2-50TB	GB
U-EC-VSC-OS-STD-12-T2	VSC	VSC	SEL VTS-OS Std 12 mo. 51-500TB	GB
U-EC-VSC-OS-STD-12-T3	VSC	VSC	SEL VTS-OS Std 12 mo. 501-1000TB	GB
U-EC-VSC-OS-STD-12-T4	VSC	VSC	SEL VTS-OS Std 12 mo. Over 1000TB	GB
U-EC-VSC-OS-STD-24-T0	VSC	VSC	SEL VTS-OS Std 24 mo. 1TB	GB
U-EC-VSC-OS-STD-24-T1	VSC	VSC	SEL VTS-OS Std 24 mo. 2-50TB	GB
U-EC-VSC-OS-STD-24-T2	VSC	VSC	SEL VTS-OS Std 24 mo. 51-500TB	GB
U-EC-VSC-OS-STD-24-T3	VSC	VSC	SEL VTS-OS Std 24 mo. 501-1000TB	GB
U-EC-VSC-OS-STD-24-T4	VSC	VSC	SEL VTS-OS Std 24 mo. Over 1000TB	GB
U-EC-VSC-OS-STD-36-T0	VSC	VSC	SEL VTS-OS Std 36 mo. 1TB	GB
U-EC-VSC-OS-STD-36-T1	VSC	VSC	SEL VTS-OS Std 36 mo. 2-50TB	GB
U-EC-VSC-OS-STD-36-T2	VSC	VSC	SEL VTS-OS Std 36 mo. 51-500TB	GB
U-EC-VSC-OS-STD-36-T3	VSC	VSC	SEL VTS-OS Std 36 mo. 501-1000TB	GB
U-EC-VSC-OS-STD-36-T4	VSC	VSC	SEL VTS-OS Std 36 mo. Over 1000TB	GB
U-EC-VSC-OS-SIA-12-T0	VSC	VSC	SEL VTS-OS Std-IA 12 mo. 1TB	GB
U-EC-VSC-OS-SIA-24-T0	VSC	VSC	SEL VTS-OS Std-IA 24 mo. 1TB	GB
U-EC-VSC-OS-SIA-36-T0	VSC	VSC	SEL VTS-OS Std-IA 36 mo. 1TB	GB
U-EC-VSC-OS-PRM-12-T0	VSC	VSC	SEL VTS-OS Prm 12 mo. 1TB	GB
U-EC-VSC-OS-PRM-12-T1	VSC	VSC	SEL VTS-OS Prm 12 mo. 2-50TB	GB
U-EC-VSC-OS-PRM-12-T2	VSC	VSC	SEL VTS-OS Prm 12 mo. 51-500TB	GB
U-EC-VSC-OS-PRM-12-T3	VSC	VSC	SEL VTS-OS Prm 12 mo. 501-1000TB	GB

U-EC-VSC-OS-PRM-12-T4	VSC	VSC	SEL VTS-OS Prm 12 mo. Over 1000TB	GB
U-EC-VSC-OS-PRM-24-T0	VSC	VSC	SEL VTS-OS Prm 24 mo. 1TB	GB
U-EC-VSC-OS-PRM-24-T1	VSC	VSC	SEL VTS-OS Prm 24 mo. 2-50TB	GB
U-EC-VSC-OS-PRM-24-T2	VSC	VSC	SEL VTS-OS Prm 24 mo. 51-500TB	GB
U-EC-VSC-OS-PRM-24-T3	VSC	VSC	SEL VTS-OS Prm 24 mo. 501-1000TB	GB
U-EC-VSC-OS-PRM-24-T4	VSC	VSC	SEL VTS-OS Prm 24 mo. Over 1000TB	GB
U-EC-VSC-OS-PRM-36-T0	VSC	VSC	SEL VTS-OS Prm 36 mo. 1TB	GB
U-EC-VSC-OS-PRM-36-T1	VSC	VSC	SEL VTS-OS Prm 36 mo. 2-50TB	GB
U-EC-VSC-OS-PRM-36-T2	VSC	VSC	SEL VTS-OS Prm 36 mo. 51-500TB	GB
U-EC-VSC-OS-PRM-36-T3	VSC	VSC	SEL VTS-OS Prm 36 mo. 501-1000TB	GB
U-EC-VSC-OS-PRM-36-T4	VSC	VSC	SEL VTS-OS Prm 36 mo. Over 1000TB	GB
U-EC-VSC-OS-PIA-12-T0	VSC	VSC	SEL VTS-OS Prm-IA 12 mo. 1TB	GB
U-EC-VSC-OS-PIA-24-T0	VSC	VSC	SEL VTS-OS Prm-IA 24 mo. 1TB	GB
U-EC-VSC-OS-PIA-36-T0	VSC	VSC	SEL VTS-OS Prm-IA 36 mo. 1TB	GB

FedRAMP	SVC	CAT	Description	Unit
U-FD-IC-DP-BU-CRS	IaaS	CPS	Backup Restoration Request With CCS	Ea
U-FD-IC-DP-BU-NRS	IaaS	CPS	Backup Restoration Request Without CCS	Ea
U-FD-IC-SVC-DRT1-AH	IaaS	CPS	DR Test Service Tier 1 (<20 VMs)	Ea
U-FD-IC-SVC-DRT2-AH	IaaS	CPS	DR Test Service Tier 2 (<50 VMs)	Ea
U-FD-IC-SVC-DRT3-AH	IaaS	CPS	DR Test Service Tier 3 (<100 VMs)	Ea
U-FD-IC-SVC-DRT4-AH	IaaS	CPS	DR Test Service Tier 4 (<150 VMs)	Ea
U-FD-IC-SVC-DRT5-AH	IaaS	CPS	DR Test Service Tier 5 (<200VMs)	Ea
U-FD-IC-RPT-VCC-REQ	IaaS	CPS	Virtualization Custom Consumption Report	Ea
U-FD-IC-RPT-VRS-REQ	IaaS	CPS	Virtualization Right Sizing Report	Ea
U-FD-IC-RPT-VM-50	IaaS	CPS	VM Reporting (0-50 VMs)	VM
U-FD-IC-RPT-VM-150	IaaS	CPS	VM Reporting (101-150 VMs)	VM
U-FD-IC-RPT-VM-100	IaaS	CPS	VM Reporting (51-100 VMs)	VM
U-FD-IC-SVC-DRP1-AH	IaaS	CPS	DR Planning Service Tier 1 (<20 VMs)	Ea
U-FD-IC-SVC-DRP2-AH	IaaS	CPS	DR Planning Service Tier 2 (<50 VMs)	Ea
U-FD-IC-SVC-DRP3-AH	IaaS	CPS	DR Planning Service Tier 3 (<100 VMs)	Ea
U-FD-IC-SVC-DRP4-AH	IaaS	CPS	DR Planning Service Tier 4 (<150 VMs)	Ea
U-FD-IC-SVC-DRP5-AH	IaaS	CPS	DR Planning Service Tier 5 (<200 VMs)	Ea
U-FD-CS-2F-D1-1T	IaaS	CPS	2FA Dedicated Setup	Instance
U-FD-CS-2F-D2-1T	IaaS	CPS	2FA Dedicated DR Setup	Instance
U-FD-CS-2F-DS-1T	IaaS	CPS	2FA Dedicated Self-Service Setup	Instance
U-FD-CS-2F-DT-1T	IaaS	CPS	2FA Dedicated Token Issue	User
U-FD-CS-2F-S-1T	IaaS	CPS	2FA Shared Setup	Instance
U-FD-CS-2F-SS-1T	IaaS	CPS	2FA Shared Self-Service Setup	Instance
U-FD-CS-2F-ST-1T	IaaS	CPS	2FA Shared Token Issue	User
U-FD-CS-2F-VPT-1T	IaaS	CPS	2FA Virtustream Portal Token Issue	User
U-FD-CS-ENC-AGT-1T	IaaS	CPS	Encryption Agent Setup	VM
U-FD-CS-ENC-SYSS-1T	IaaS	CPS	Encryption Management System Setup - SaaS	Ea
U-FD-CS-FA-FAE-1T	IaaS	CPS	Firewall Audit Export Setup	Firewall
U-FD-CS-FA-SYS-1T	IaaS	CPS	Firewall Audit System Setup	Account
U-FD-CS-TM-AV1-1T	IaaS	CPS	Anti-Virus Primary System Setup	Account
U-FD-CS-TM-AV2-1T	IaaS	CPS	Anti-Virus Secondary System Setup	Account

U-FD-CS-FW-FW-1T	laaS	CPS	Firewall Configuration/Setup	Firewall
U-FD-HM-HA-PHS-1T	laaS	CPS	HANA Appliance Installation and Setup - Physical	Appliance
U-FD-CS-TM-FIM1-1T	laaS	CPS	File Integrity Monitoring Primary System Setup	Account
U-FD-CS-TM-FIM2-1T	laaS	CPS	File Integrity Monitoring Secondary System Setup	Account
U-FD-IC-ONB-SS-1T	laaS	CPS	laaS Onboarding - Self-Service	Account
U-FD-IC-ONB-FUL-1T	laaS	CPS	laaS Onboarding - Full	VM
U-FD-IC-ONB-BAS-1T	laaS	CPS	laaS Onboarding - Basic	VM
U-FD-CS-TM-IDFW1-1T	laaS	CPS	Intrusion Detection and Firewall Primary System Setup	Account
U-FD-CS-TM-IDFW2-1T	laaS	CPS	Intrusion Detection and Firewall Secondary Setup	Account
U-FD-CS-VPN-H-1T	laaS	CPS	IPSec VPN Host-Side Configuration	Ea
U-FD-IC-NW-FLBB-1T	laaS	CPS	F5 Load Balancer Pool Setup Charges - Basic	Each pool
U-FD-IC-NW-FLBA-1T	laaS	CPS	F5 Load Balancer Pool Setup Charges - Advanced	Each pool
U-FD-CS-TM-VLSB1-1T	laaS	CPS	VM-Level Security Bundle Primary System Setup	Account
U-FD-CS-TM-VLSB2-1T	laaS	CPS	VM-Level Security Bundle Secondary System Setup	Account
U-FD-CS-IDS-NB1-1T	laaS	CPS	Network Based Intrusion Detection Primary Site Setup	VLAN
U-FD-CS-IDS-NB2-1T	laaS	CPS	Network Based Intrusion Detection Secondary Site Setup	VLAN
U-FD-CS-VS-LM-1T	laaS	CPS	Log Management System Setup	Ea
U-FD-CS-VS-MLM-1T	laaS	CPS	Managed Log Management Service Setup	VM
U-FD-IC-DP-BU-1T	laaS	CPS	System Backup Setup	Account
U-FD-HM-HA-VIR-1T	laaS	CPS	vHANA Installation and Setup Charge - Virtual Appliance	VM
U-FD-CS-VS-PSVC-1T	laaS	CPS	Policy Auditor Service Setup	VM
U-FD-CS-VS-PSYS-1T	laaS	CPS	Policy Auditor System Setup	Site
U-FD-CS-2F-D1-SYS	laaS	CPS	2FA Dedicated Base Fee	Instance
U-FD-CS-2F-D2-SYS	laaS	CPS	2FA Dedicated DR Base Fee	Instance
U-FD-CS-2F-DT-MF	laaS	CPS	2FA Dedicated Token Fee	User
U-FD-CS-2F-ST-MF	laaS	CPS	2FA Shared Token Fee	User
U-FD-CS-2F-VPT-MF	laaS	CPS	2FA Virtustream Portal Token Fee	User
U-FD-HM-HA1-SO-1TB	laaS	CPS	1 TB HANA Managed Appliance for BW (Scale-Out Appliance)	Appliance
U-FD-HM-HA1-SO-15	laaS	CPS	1.5 TB HANA Managed Appliance for BW (Scale-Out Appliance)	Appliance
U-FD-HM-HA1-SO-2TB	laaS	CPS	2 TB HANA Managed Appliance for BW (Scale-Out Appliance)	Appliance
U-FD-HM-HA1-SO-3TB	laaS	CPS	3 TB HANA Managed Appliance for BW (Scale-Out Appliance)	Appliance
U-FD-HM-HA1-SO-4TB	laaS	CPS	4 TB HANA Managed Appliance for BW (Scale-Out Appliance)	Appliance
U-FD-HM-HA1-SN-1TB	laaS	CPS	1 TB HANA Managed Appliance (Single Node/Scale Appliance)	Appliance
U-FD-HM-HA1-SN-2TB	laaS	CPS	2 TB HANA Managed Appliance (Single Node/Scale Appliance)	Appliance
U-FD-HM-HA1-SOH-1TB	laaS	CPS	1 TB HANA Managed Appliance for SoH - Primary	Appliance
U-FD-HM-HA1-SOH-15	laaS	CPS	1.5 TB HANA Managed Appliance for SoH - Primary	Appliance
U-FD-HM-HA1-SOH-2TB	laaS	CPS	2 TB HANA Managed Appliance for SoH - Primary	Appliance
U-FD-HM-HA1-SOH-3TB	laaS	CPS	3 TB HANA Managed Appliance for SoH - Primary	Appliance
U-FD-HM-HA1-SOH-4TB	laaS	CPS	4 TB HANA Managed Appliance for SoH - Primary	Appliance
U-FD-HM-HA1-SOH-6TB	laaS	CPS	6 TB HANA Managed Appliance for SoH - Primary	Appliance
U-FD-HM-HA1-SOH-8TB	laaS	CPS	8 TB HANA Managed Appliance for SoH - Primary	Appliance
U-FD-HM-HA1-SOH-9TB	laaS	CPS	9 TB HANA Managed Appliance for SoH - Primary	Appliance
U-FD-HM-HA1-SOH-12TB	laaS	CPS	12 TB HANA Managed Appliance for SoH - Primary	Appliance
U-FD-HM-HA2-SO-1TB	laaS	CPS	1 TB HANA Managed Appliance for BW (Scale-Out Appliance)	Appliance
U-FD-HM-HA2-SO-15	laaS	CPS	1.5 TB HANA Managed Appliance for BW (Scale-Out Appliance)	Appliance
U-FD-HM-HA2-SO-2TB	laaS	CPS	2 TB HANA Managed Appliance for BW (Scale-Out Appliance)	Appliance
U-FD-HM-HA2-SO-3TB	laaS	CPS	3 TB HANA Managed Appliance for BW (Scale-Out Appliance)	Appliance

U-FD-HM-HA2-SO-4TB	IaaS	CPS	4 TB HANA Managed Appliance for BW (Scale-Out Appliance	
U-FD-HM-HA2-SN-1TB	IaaS	CPS	1 TB HANA Managed Appliance (Single Node/Scale Appliance	
U-FD-HM-HA2-SN-2TB	IaaS	CPS	2 TB HANA Managed Appliance (Single Node/Scale Appliance	
U-FD-HM-HA2-SOH-1TB	IaaS	CPS	1 TB HANA Managed Appliance for SoH - Seconda Appliance	
U-FD-HM-HA2-SOH-15	IaaS	CPS	1.5 TB HANA Managed Appliance for SoH - Seconda Appliance	
U-FD-HM-HA2-SOH-2TB	IaaS	CPS	2 TB HANA Managed Appliance for SoH - Seconda Appliance	
U-FD-HM-HA2-SOH-3TB	IaaS	CPS	3 TB HANA Managed Appliance for SoH - Seconda Appliance	
U-FD-HM-HA2-SOH-4TB	IaaS	CPS	4 TB HANA Managed Appliance for SoH - Seconda Appliance	
U-FD-HM-HA2-SOH-6TB	IaaS	CPS	6 TB HANA Managed Appliance for SoH - Seconda Appliance	
U-FD-HM-HA2-SOH-8TB	IaaS	CPS	8 TB HANA Managed Appliance for SoH - Seconda Appliance	
U-FD-HM-HA2-SOH-9TB	IaaS	CPS	9 TB HANA Managed Appliance for SoH - Seconda Appliance	
U-FD-HM-HA2-SOH-12TB	IaaS	CPS	12 TB HANA Managed Appliance for SoH - Seconda Appliance	
U-FD-HM-VVM-BAS-ENT	IaaS	CPS	vHANA Enterprise Basic VM Fee	VM
U-FD-HM-UVV-BAS-ENT	IaaS	CPS	vHANA Enterprise Basic μ VM Variable	micro-VM
U-FD-HM-VVM-COR-ENT	IaaS	CPS	vHANA Enterprise Core VM Fee	VM
U-FD-HM-UVV-COR-ENT	IaaS	CPS	vHANA Enterprise Core μ VM Variable	micro-VM
U-FD-IC-HVM-BAS-ENT	IaaS	CPS	High Memory Enterprise Basic VM Fee	VM
U-FD-IC-HVM-COR-ENT	IaaS	CPS	High Memory Enterprise Core VM Fee	VM
U-FD-HM-HVM-BASP-ENT	IaaS	CPS	vHANA Enterprise Basic Plus VM Fee	VM
U-FD-HM-UHV-BASP-ENT	IaaS	CPS	vHANA Enterprise Basic Plus μ VM Variable	micro-VM
U-FD-HM-UVM-BASP-ENT	IaaS	CPS	vHANA Enterprise Basic Plus μ VM	micro-VM
U-FD-IC-HVM-BASP-ENT	IaaS	CPS	High Memory Enterprise Basic Plus VM Fee	VM
U-FD-IC-UHV-BAS-ENT	IaaS	CPS	High Memory Enterprise Basic μ VM	micro-VM
U-FD-IC-UHV-COR-ENT	IaaS	CPS	High Memory Enterprise Core μ VM	micro-VM
U-FD-IC-UHV-BASP-ENT	IaaS	CPS	High Memory Enterprise Basic Plus μ VM	micro-VM
U-FD-IC-UVM-BAS-ORA	IaaS	CPS	Oracle Cluster Basic μ VM	micro-VM
U-FD-IC-UVM-COR-ORA	IaaS	CPS	Oracle Cluster Core μ VM	micro-VM
U-FD-IC-UVM-BAS-ENT	IaaS	CPS	Enterprise Basic μ VM	micro-VM
U-FD-IC-UVM-COR-ENT	IaaS	CPS	Enterprise Core μ VM	micro-VM
U-FD-IC-UVM-BASP-ENT	IaaS	CPS	Enterprise Basic Plus μ VM	Micro-VM
U-FD-CS-ENC-AGP-MF	IaaS	CPS	Encryption Agent per Machine - pHANA	VM
U-FD-CS-ENC-AGT-MF	IaaS	CPS	Encryption Agent per VM	VM
U-FD-CS-ENC-SYS-SYS	IaaS	CPS	Encryption Management System Fee	Account
U-FD-CS-FA-FA-SYS	IaaS	CPS	Firewall Audit System	Account
U-FD-CS-FA-MFA-SVC	IaaS	CPS	Managed Firewall Auditing Service	Firewall
U-FD-CS-TM-AV1-SYS	IaaS	CPS	Anti-Virus Primary System	Account
U-FD-CS-TM-AV2-SYS	IaaS	CPS	Anti-Virus Secondary System	Account
U-FD-CS-TM-AV-SVC	IaaS	CPS	Anti-Virus Managed Service	VM
U-FD-CS-TM-FIM1-SYS	IaaS	CPS	File Integrity Monitoring Primary System	Account
U-FD-CS-TM-FIM2-SYS	IaaS	CPS	File Integrity Monitoring Secondary System	Account
U-FD-IC-UHV-BASP-ENT	IaaS	CPS	High Memory Enterprise Basic Plus μ VM	Micro-VM
U-FD-IC-HVM-BASP-ENT	IaaS	CPS	High Memory Enterprise Basic Plus VM Fee	VM
U-FD-CS-TM-IDFW1-SYS	IaaS	CPS	Intrusion Detection and Firewall Primary System	Account
U-FD-CS-TM-IDFW2-SYS	IaaS	CPS	Intrusion Detection and Firewall Secondary System	Account
U-FD-CS-VPN-DC1-NET	IaaS	CPS	IPSec VPN Bandwidth Fee - Primary	Mbps
U-FD-CS-VPN-DC2-NET	IaaS	CPS	IPSec VPN Bandwidth Fee - Secondary	Mbps
U-FD-CS-VPN-T-SVC	IaaS	CPS	IPSec VPN Tunnel Managed Service	Ea

U-FD-IC-NW-LBM-NET	IaaS	CPS	Load Balancing Bandwidth Fee (Additional to Netv Mbps)	
U-FD-CS-TM-IDFW-SVC	IaaS	CPS	Intrusion Detection and Firewall Managed Service VM	
U-FD-CS-TM-VLSB1-SYS	IaaS	CPS	VM-Level Security Bundle Primary System fee	Account
U-FD-IC-NW-LBM-LB	IaaS	CPS	Managed Load Balancer Services (Per Server)	VM
U-FD-CS-TM-VLSB2-SYS	IaaS	CPS	VM-Level Security Bundle Secondary System fee	Account
U-FD-CS-FW-MPF-SVC	IaaS	CPS	Managed Perimeter Firewall	VM
U-FD-IC-SW-MSS-WIN	IaaS	CPS	Microsoft OS	Instance
U-FD-IC-SW-MQL-ENT	IaaS	CPS	Microsoft SQL Enterprise (Per 2 cores)	CPU
U-FD-IC-SW-MQL-STD	IaaS	CPS	Microsoft SQL Standard (Per 2 cores)	CPU
U-FD-CS-NW-BW1-NET	IaaS	CPS	Network Bandwidth Fee - Primary	Mbps
U-FD-CS-NW-BW2-NET	IaaS	CPS	Network Bandwidth Fee - Secondary	Mbps
U-FD-CS-IDS-NB2-SYS	IaaS	CPS	Network Based Intrusion Detection System and M VLAN	
U-FD-CS-IDS-NB1-SYS	IaaS	CPS	Network Based Intrusion Detection System and M VLAN	
U-FD-CS-TM-VLSBA-SVC	IaaS	CPS	VM-Level Security Bundle Service Fee (<101 VMs)	VM
U-FD-CS-TM-VLSBB-SVC	IaaS	CPS	VM-Level Security Bundle Service Fee (<1001 VMs)	VM
U-FD-IC-NW-IPAD-V4	IaaS	CPS	Public IP Address (IPv4)	IP
U-FD-IC-NW-IPAD-V6	IaaS	CPS	Public IP Address (IPv6)	IP
U-FD-IC-SW-RHL-ENT	IaaS	CPS	Red Hat Enterprise Linux - Enterprise (Per OS)	Instance
U-FD-IC-SW-RHL-STD	IaaS	CPS	Red Hat Enterprise Linux - Standard (Per OS)	Instance
U-FD-IC-SW-RDS-IF	IaaS	CPS	Remote Desktop Services (Per User)	User
U-FD-IC-SW-SLES-PH	IaaS	CPS	SUSE Linux Enterprise for Physical HANA	CPU
U-FD-IC-SW-SLES-MF	IaaS	CPS	vSUSE Linux Enterprise	VM
U-FD-IC-DP-BU-LOC	IaaS	CPS	System Backup - Local Only	GB
U-FD-IC-DP-BU-REP	IaaS	CPS	System Backup - Replicated	GB
U-FD-IC-STO-T0AD-LOC	IaaS	CPS	Tier 0 Block Storage - DMZ - Local Only	GB
U-FD-IC-STO-T0AD-REP	IaaS	CPS	Tier 0 Block Storage - DMZ - Replicated	GB
U-FD-IC-STO-T0AN-LOC	IaaS	CPS	Tier 0 Block Storage - HZ - Local Only	GB
U-FD-IC-STO-T0AN-REP	IaaS	CPS	Tier 0 Block Storage - HZ - Replicated	GB
U-FD-IC-STO-T0AI-LOC	IaaS	CPS	Tier 0 Block Storage - IZ - Local Only	GB
U-FD-IC-STO-T0AI-REP	IaaS	CPS	Tier 0 Block Storage - IZ - Replicated	GB
U-FD-IC-STO-T1AD-LOC	IaaS	CPS	Tier I Block Storage - DMZ - Local Only	GB
U-FD-IC-STO-T1AD-REP	IaaS	CPS	Tier I Block Storage - DMZ - Replicated	GB
U-FD-IC-STO-T1AN-LOC	IaaS	CPS	Tier I Block Storage - HZ - Local Only	GB
U-FD-IC-STO-T1AN-REP	IaaS	CPS	Tier I Block Storage - HZ - Replicated	GB
U-FD-IC-STO-T1AI-LOC	IaaS	CPS	Tier I Block Storage - IZ - Local Only	GB
U-FD-IC-STO-T1AI-REP	IaaS	CPS	Tier I Block Storage - IZ - Replicated	GB
U-FD-IC-STO-T2AD-LOC	IaaS	CPS	Tier II Block Storage - DMZ - Local Only	GB
U-FD-IC-STO-T2AD-REP	IaaS	CPS	Tier II Block Storage - DMZ - Replicated	GB
U-FD-IC-STO-T2AN-LOC	IaaS	CPS	Tier II Block Storage - HZ - Local Only	GB
U-FD-IC-STO-T2AN-REP	IaaS	CPS	Tier II Block Storage - HZ - Replicated	GB
U-FD-IC-STO-T2AI-LOC	IaaS	CPS	Tier II Block Storage - IZ - Local Only	GB
U-FD-IC-STO-T2AI-REP	IaaS	CPS	Tier II Block Storage - IZ - Replicated	GB
U-FD-IC-STO-T3AD-LOC	IaaS	CPS	Tier III Block Storage - DMZ - Local Only	GB
U-FD-IC-STO-T3AD-REP	IaaS	CPS	Tier III Block Storage – DMZ - Replicated	GB
U-FD-IC-STO-T3AN-LOC	IaaS	CPS	Tier III Block Storage - HZ - Local Only	GB
U-FD-IC-STO-T3AN-REP	IaaS	CPS	Tier III Block Storage – HZ - Replicated	GB
U-FD-IC-STO-T3AI-LOC	IaaS	CPS	Tier III Block Storage - IZ - Local Only	GB

U-FD-IC-STO-T3AI-REP	IaaS	CPS	Tier III Block Storage – IZ - Replicated	GB
U-FD-CS-TM-VLSBC-SVC	IaaS	CPS	VM-Level Security Bundle Service Fee (<10,001 VM	VM
U-FD-CS-TM-VLSBD-SVC	IaaS	CPS	VM-Level Security Bundle Service Fee (10,000+ VM	VM
U-FD-CS-VS-LM-SYS	IaaS	CPS	Log Management System Fee	Ea
U-FD-CS-VS-MLM-SVC	IaaS	CPS	Managed Log Management Service	VM
U-FD-CS-VS-PA-SVC	IaaS	CPS	Policy Auditor Service Fee	VM
U-FD-CS-VS-PA-SYS	IaaS	CPS	Policy Auditor System Fee	Site
U-FD-CS-VS-NPIP-SVC	IaaS	CPS	Vulnerability Scanning Managed Service - non Pub IP Address	
U-FD-CS-VS-NPIP-AH	IaaS	CPS	Vulnerability Scanning Remedial Ad Hoc Scan	IP Block
U-FD-CS-VS-PIP-SVC	IaaS	CPS	Vulnerability Scanning Managed Service - Public IP Address	
U-FD-CC-TAM-CIR-AH	IaaS	CCS	Co-Innovation Roundtables - Ad Hoc (6 months)	Ea
U-FD-CC-TAM-DMM-AH	IaaS	CCS	Demand Management Meetings - Ad Hoc (3 mont	Ea
U-FD-CC-TAM-ES-AH	IaaS	CCS	Executive Scorecards - Ad Hoc (3 months)	Ea
U-FD-CC-TAM-ITRF-AH	IaaS	CCS	IT Resource Forecast - Ad Hoc (3 months)	Ea
U-FD-CC-TAM-RBR-AH	IaaS	CCS	Reporting and Business Review - Ad Hoc (1 month	Ea
U-FD-CC-TAM-RP-AH	IaaS	CCS	Resource and Performance - Ad Hoc (1 month)	Ea
U-FD-CC-TAM-SLAR-AH	IaaS	CCS	SLA Review - Ad Hoc (1 month)	Ea
U-FD-CC-TAM-WSIR-AH	IaaS	CCS	Weekly Status and Incident Reporting - Ad Hoc (1	Ea
U-FD-AM-SVC-ONCC-1T	IaaS	CCS	Application Managed Services Setup	VM
U-FD-CC-SAP-ONUS-1T	IaaS	CCS	Onshore SAP User, Security, and Change Manager	Ea
U-FD-AM-SAP-PRO-MT	IaaS	CCS	SAP Support - Monitoring Tool	Account
U-FD-CC-TAM-OPIN-1Y	IaaS	CCS	Operational Integration - 1 Year	Ea
U-FD-CC-TAM-RBR-1Y	IaaS	CCS	Reporting and Business Review - 1 Year	Ea
U-FD-CC-TAM-RP-1Y	IaaS	CCS	Resource and Performance - 1 Year	Ea
U-FD-CC-TAM-SLAR-1Y	IaaS	CCS	SLA Review - 1 Year	Ea
U-FD-AM-TAMS-TAMSB-C	IaaS	CCS	Technical Account Management Services - Base	Ea
U-FD-AM-TAMS-TAMSG-C	IaaS	CCS	Technical Account Management Services - Gold	Ea
U-FD-AM-TAMS-TAMSS-C	IaaS	CCS	Technical Account Management Services - Silver	Ea
U-FD-AM-TAMS-TAMSP-C	IaaS	CCS	Technical Account Management Services - Platinu	Ea
U-FD-CC-TAM-WSIR-1Y	IaaS	CCS	Weekly Status and Incident Reporting - 1 Year	Ea
U-FD-DC-NW1-XCC-1T	IaaS	CSNS	Copper Cross Connect - Installation - Primary	Ea
U-FD-DC-NW2-XCC-1T	IaaS	CSNS	Copper Cross Connect - Installation - Secondary	Ea
U-FD-DC-NW1-XCF-1T	IaaS	CSNS	Fiber Cross Connect - Installation - Primary	Ea
U-FD-DC-NW2-XCF-1T	IaaS	CSNS	Fiber Cross Connect - Installation - Secondary	Ea
U-FD-DC-RK1-RK-1T	IaaS	CSNS	Rack Installation - Primary	Rack
U-FD-DC-RK2-RK-1T	IaaS	CSNS	Rack Installation - Secondary	Rack
U-FD-DC-NW1-XCH-HA	IaaS	CSNS	Cloud Connect - HA (48 ports available) - Primary	Ea
U-FD-DC-NW2-XCH-HA	IaaS	CSNS	Cloud Connect - HA (48 ports available) - Seconda	Ea
U-FD-DC-NW1-XCS-STD	IaaS	CSNS	Cloud Connect - Standard (24 ports available) - Pri	Ea
U-FD-DC-NW2-XCS-STD	IaaS	CSNS	Cloud Connect - Standard (24 ports available) - Se	Ea
U-FD-DC-NW1-XCC-MF	IaaS	CSNS	Copper Cross Connect - Primary	Ea
U-FD-DC-NW2-XCC-MF	IaaS	CSNS	Copper Cross Connect - Secondary	Ea
U-FD-DC-NW1-XCF-MF	IaaS	CSNS	Fiber Cross Connect - Primary	Ea
U-FD-DC-NW2-XCF-MF	IaaS	CSNS	Fiber Cross Connect - Secondary	Ea
U-FD-DC-RK1-RK-HR	IaaS	CSNS	Hotel Rack (1U) - Managed Colo - Primary	Rack Unit
U-FD-DC-RK2-RK-HR	IaaS	CSNS	Hotel Rack (1U) - Managed Colo - Secondary	Rack Unit
U-FD-DC-PW1-KW-42U	IaaS	CSNS	Rackpower - Per kW - Primary	Ea

U-FD-DC-PW2-KW-42U	laaS	CSNS	Rackpower - Per kW - Secondary	Ea
U-FD-DC-SVC-RE1-AH	laaS	CSNS	Remote eyes and hands (1 Hour) - Primary	Ea
U-FD-DC-SVC-RE2-AH	laaS	CSNS	Remote eyes and hands (1 Hour) - Secondary	Ea
U-FD-DC-SVC-RE1-AHA	laaS	CSNS	Remote eyes and hands (15 Minutes) - Primary	Ea
U-FD-DC-SVC-RE2-AHA	laaS	CSNS	Remote eyes and hands (15 Minutes) - Secondary	Ea
U-FD-DC-NW1-XCC-1T	laaS	CSNS	Copper Cross Connect - Installation - Primary	Ea
U-FD-DC-NW1-XCF-1T	laaS	CSNS	Fiber Cross Connect - Installation - Primary	Ea
U-FD-DC-NW1-XCH-1T	laaS	CSNS	Cloud Connect - HA (48 ports available) - Setup - P	Ea
U-FD-DC-NW2-XCH-1T	laaS	CSNS	Cloud Connect - HA (48 ports available) - Setup - S	Ea
U-FD-DC-RK1-DLP-1T	laaS	CSNS	Equipment Deployment - Per equipment - Primary	Ea
U-FD-DC-RK2-DLP-1T	laaS	CSNS	Equipment Deployment - Per equipment - Second	Ea
U-FD-DC-RK1-RK-1T	laaS	CSNS	Rack Installation - Primary	Rack Unit
U-FD-DC-RK2-RK-1T	laaS	CSNS	Rack Installation - Secondary	Rack Unit
U-FD-DC-RK1-RK-42U	laaS	CSNS	Rackspace - 42U - Primary	Ea
U-FD-DC-RK2-RK-42U	laaS	CSNS	Rackspace - 42U - Secondary	Ea
U-FD-DC-RK1-RK-HR	laaS	CSNS	Hotel Rack (1U) - Managed Colo - Primary	Rack Unit
U-FD-DC-RK2-RK-HR	laaS	CSNS	Hotel Rack (1U) - Managed Colo - Secondary	Rack Unit

ITAR	SVC	CAT	Description	Unit
U-IT-IC-DP-BU-CRS	laaS	CPS	Backup Restoration Request With CCS	Ea
U-IT-IC-DP-BU-NRS	laaS	CPS	Backup Restoration Request Without CCS	Ea
U-IT-IC-SVC-DRT1-AH	laaS	CPS	DR Test Service Tier 1 (<20 VMs)	Ea
U-IT-IC-SVC-DRT2-AH	laaS	CPS	DR Test Service Tier 2 (<50 VMs)	Ea
U-IT-IC-SVC-DRT3-AH	laaS	CPS	DR Test Service Tier 3 (<100 VMs)	Ea
U-IT-IC-SVC-DRT4-AH	laaS	CPS	DR Test Service Tier 4 (<150 VMs)	Ea
U-IT-IC-SVC-DRT5-AH	laaS	CPS	DR Test Service Tier 5 (<200VMs)	Ea
U-IT-IC-RPT-VCC-REQ	laaS	CPS	Virtualization Custom Consumption Report	Ea
U-IT-IC-RPT-VRS-REQ	laaS	CPS	Virtualization Right Sizing Report	Ea
U-IT-IC-RPT-VM-50	laaS	CPS	VM Reporting (0-50 VMs)	VM
U-IT-IC-RPT-VM-150	laaS	CPS	VM Reporting (101-150 VMs)	VM
U-IT-IC-RPT-VM-100	laaS	CPS	VM Reporting (51-100 VMs)	VM
U-IT-IC-SVC-DRP1-AH	laaS	CPS	DR Planning Service Tier 1 (<20 VMs)	Ea
U-IT-IC-SVC-DRP2-AH	laaS	CPS	DR Planning Service Tier 2 (<50 VMs)	Ea
U-IT-IC-SVC-DRP3-AH	laaS	CPS	DR Planning Service Tier 3 (<100 VMs)	Ea
U-IT-IC-SVC-DRP4-AH	laaS	CPS	DR Planning Service Tier 4 (<150 VMs)	Ea
U-IT-IC-SVC-DRP5-AH	laaS	CPS	DR Planning Service Tier 5 (<200 VMs)	Ea
U-IT-CS-2F-D1-1T	laaS	CPS	2FA Dedicated Setup	Instance
U-IT-CS-2F-D2-1T	laaS	CPS	2FA Dedicated DR Setup	Instance
U-IT-CS-2F-DS-1T	laaS	CPS	2FA Dedicated Self-Service Setup	Instance
U-IT-CS-2F-DT-1T	laaS	CPS	2FA Dedicated Token Issue	User
U-IT-CS-2F-S-1T	laaS	CPS	2FA Shared Setup	Instance
U-IT-CS-2F-SS-1T	laaS	CPS	2FA Shared Self-Service Setup	Instance
U-IT-CS-2F-ST-1T	laaS	CPS	2FA Shared Token Issue	User
U-IT-CS-2F-VPT-1T	laaS	CPS	2FA Virtustream Portal Token Issue	User
U-IT-CS-ENC-AGT-1T	laaS	CPS	Encryption Agent Setup	VM
U-IT-CS-ENC-SYSS-1T	laaS	CPS	Encryption Management System Setup - SaaS	Ea

U-IT-CS-FA-FAE-1T	laaS	CPS	Firewall Audit Export Setup	Firewall
U-IT-CS-FA-SYS-1T	laaS	CPS	Firewall Audit System Setup	Account
U-IT-CS-TM-AV1-1T	laaS	CPS	Anti-Virus Primary System Setup	Account
U-IT-CS-TM-AV2-1T	laaS	CPS	Anti-Virus Secondary System Setup	Account
U-IT-CS-FW-FW-1T	laaS	CPS	Firewall Configuration/Setup	Firewall
U-IT-HM-HA-PHS-1T	laaS	CPS	HANA Appliance Installation and Setup - Physical	Appliance
U-IT-CS-TM-FIM1-1T	laaS	CPS	File Integrity Monitoring Primary System Setup	Account
U-IT-CS-TM-FIM2-1T	laaS	CPS	File Integrity Monitoring Secondary System Setup	Account
U-IT-IC-ONB-SS-1T	laaS	CPS	laaS Onboarding - Self-Service	Account
U-IT-IC-ONB-FUL-1T	laaS	CPS	laaS Onboarding - Full	VM
U-IT-IC-ONB-BAS-1T	laaS	CPS	laaS Onboarding - Basic	VM
U-IT-CS-TM-IDFW1-1T	laaS	CPS	Intrusion Detection and Firewall Primary System Setup	Account
U-IT-CS-TM-IDFW2-1T	laaS	CPS	Intrusion Detection and Firewall Secondary System Setup	Account
U-IT-CS-VPN-H-1T	laaS	CPS	IPSec VPN Host-Side Configuration	Ea
U-IT-IC-NW-FLBB-1T	laaS	CPS	F5 Load Balancer Pool Setup Charges - Basic	Each pool
U-IT-IC-NW-FLBA-1T	laaS	CPS	F5 Load Balancer Pool Setup Charges - Advanced	Each pool
U-IT-CS-TM-VLSB1-1T	laaS	CPS	VM-Level Security Bundle Primary System Setup	Account
U-IT-CS-TM-VLSB2-1T	laaS	CPS	VM-Level Security Bundle Secondary System Setup	Account
U-IT-CS-IDS-NB1-1T	laaS	CPS	Network Based Intrusion Detection Primary Site Setup	VLAN
U-IT-CS-IDS-NB2-1T	laaS	CPS	Network Based Intrusion Detection Secondary Site Setup	VLAN
U-IT-CS-VS-LM-1T	laaS	CPS	Log Management System Setup	Ea
U-IT-CS-VS-MLM-1T	laaS	CPS	Managed Log Management Service Setup	VM
U-IT-IC-DP-BU-1T	laaS	CPS	System Backup Setup	Account
U-IT-HM-HA-VIR-1T	laaS	CPS	vHANA Installation and Setup Charge - Virtual Appliance	VM
U-IT-CS-VS-PSVC-1T	laaS	CPS	Policy Auditor Service Setup	VM
U-IT-CS-VS-PSYS-1T	laaS	CPS	Policy Auditor System Setup	Site
U-IT-CS-2F-D1-SYS	laaS	CPS	2FA Dedicated Base Fee	Instance
U-IT-CS-2F-D2-SYS	laaS	CPS	2FA Dedicated DR Base Fee	Instance
U-IT-CS-2F-DT-MF	laaS	CPS	2FA Dedicated Token Fee	User
U-IT-CS-2F-ST-MF	laaS	CPS	2FA Shared Token Fee	User
U-IT-CS-2F-VPT-MF	laaS	CPS	2FA Virtustream Portal Token Fee	User
U-IT-HM-HA1-SO-1TB	laaS	CPS	1 TB HANA Managed Appliance for BW (Scale-Out Appliance)	Appliance
U-IT-HM-HA1-SO-15	laaS	CPS	1.5 TB HANA Managed Appliance for BW (Scale-Out Appliance)	Appliance
U-IT-HM-HA1-SO-2TB	laaS	CPS	2 TB HANA Managed Appliance for BW (Scale-Out Appliance)	Appliance
U-IT-HM-HA1-SO-3TB	laaS	CPS	3 TB HANA Managed Appliance for BW (Scale-Out Appliance)	Appliance
U-IT-HM-HA1-SO-4TB	laaS	CPS	4 TB HANA Managed Appliance for BW (Scale-Out Appliance)	Appliance
U-IT-HM-HA1-SN-1TB	laaS	CPS	1 TB HANA Managed Appliance (Single Node/Scale Appliance)	Appliance
U-IT-HM-HA1-SN-2TB	laaS	CPS	2 TB HANA Managed Appliance (Single Node/Scale Appliance)	Appliance
U-IT-HM-HA1-SOH-1TB	laaS	CPS	1 TB HANA Managed Appliance for SoH - Primary	Appliance
U-IT-HM-HA1-SOH-15	laaS	CPS	1.5 TB HANA Managed Appliance for SoH - Primary	Appliance
U-IT-HM-HA1-SOH-2TB	laaS	CPS	2 TB HANA Managed Appliance for SoH - Primary	Appliance
U-IT-HM-HA1-SOH-3TB	laaS	CPS	3 TB HANA Managed Appliance for SoH - Primary	Appliance
U-IT-HM-HA1-SOH-4TB	laaS	CPS	4 TB HANA Managed Appliance for SoH - Primary	Appliance
U-IT-HM-HA1-SOH-6TB	laaS	CPS	6 TB HANA Managed Appliance for SoH - Primary	Appliance
U-IT-HM-HA1-SOH-8TB	laaS	CPS	8 TB HANA Managed Appliance for SoH - Primary	Appliance
U-IT-HM-HA1-SOH-9TB	laaS	CPS	9 TB HANA Managed Appliance for SoH - Primary	Appliance
U-IT-HM-HA1-SOH-12TB	laaS	CPS	12 TB HANA Managed Appliance for SoH - Primary	Appliance

U-IT-HM-HA2-SO-1TB	laaS	CPS	1 TB HANA Managed Appliance for BW (Scale-Out Appliance	
U-IT-HM-HA2-SO-15	laaS	CPS	1.5 TB HANA Managed Appliance for BW (Scale-Out Appliance	
U-IT-HM-HA2-SO-2TB	laaS	CPS	2 TB HANA Managed Appliance for BW (Scale-Out Appliance	
U-IT-HM-HA2-SO-3TB	laaS	CPS	3 TB HANA Managed Appliance for BW (Scale-Out Appliance	
U-IT-HM-HA2-SO-4TB	laaS	CPS	4 TB HANA Managed Appliance for BW (Scale-Out Appliance	
U-IT-HM-HA2-SN-1TB	laaS	CPS	1 TB HANA Managed Appliance (Single Node/Scale Appliance	
U-IT-HM-HA2-SN-2TB	laaS	CPS	2 TB HANA Managed Appliance (Single Node/Scale Appliance	
U-IT-HM-HA2-SOH-1TB	laaS	CPS	1 TB HANA Managed Appliance for SoH - Seconda Appliance	
U-IT-HM-HA2-SOH-15	laaS	CPS	1.5 TB HANA Managed Appliance for SoH - Seconda Appliance	
U-IT-HM-HA2-SOH-2TB	laaS	CPS	2 TB HANA Managed Appliance for SoH - Seconda Appliance	
U-IT-HM-HA2-SOH-3TB	laaS	CPS	3 TB HANA Managed Appliance for SoH - Seconda Appliance	
U-IT-HM-HA2-SOH-4TB	laaS	CPS	4 TB HANA Managed Appliance for SoH - Seconda Appliance	
U-IT-HM-HA2-SOH-6TB	laaS	CPS	6 TB HANA Managed Appliance for SoH - Seconda Appliance	
U-IT-HM-HA2-SOH-8TB	laaS	CPS	8 TB HANA Managed Appliance for SoH - Seconda Appliance	
U-IT-HM-HA2-SOH-9TB	laaS	CPS	9 TB HANA Managed Appliance for SoH - Seconda Appliance	
U-IT-HM-HA2-SOH-12TB	laaS	CPS	12 TB HANA Managed Appliance for SoH - Seconda Appliance	
U-IT-HM-VVM-BAS-ENT	laaS	CPS	vHANA Enterprise Basic VM Fee	VM
U-IT-HM-UVV-BAS-ENT	laaS	CPS	vHANA Enterprise Basic μVM Variable	micro-VM
U-IT-HM-VVM-COR-ENT	laaS	CPS	vHANA Enterprise Core VM Fee	VM
U-IT-HM-UVV-COR-ENT	laaS	CPS	vHANA Enterprise Core μVM Variable	micro-VM
U-IT-IC-HVM-BAS-ENT	laaS	CPS	High Memory Enterprise Basic VM Fee	VM
U-IT-IC-HVM-COR-ENT	laaS	CPS	High Memory Enterprise Core VM Fee	VM
U-IT-HM-HVM-BASP-ENT	laaS	CPS	vHANA Enterprise Basic Plus VM Fee	VM
U-IT-HM-UHV-BASP-ENT	laaS	CPS	vHANA Enterprise Basic Plus μVM Variable	micro-VM
U-IT-HM-UVM-BASP-ENT	laaS	CPS	vHANA Enterprise Basic Plus μVM	micro-VM
U-IT-IC-HVM-BASP-ENT	laaS	CPS	High Memory Enterprise Basic Plus VM Fee	VM
U-IT-IC-UHV-BAS-ENT	laaS	CPS	High Memory Enterprise Basic μVM	micro-VM
U-IT-IC-UHV-COR-ENT	laaS	CPS	High Memory Enterprise Core μVM	micro-VM
U-IT-IC-UHV-BASP-ENT	laaS	CPS	High Memory Enterprise Basic Plus μVM	micro-VM
U-IT-IC-UVM-BAS-ORA	laaS	CPS	Oracle Cluster Basic μVM	micro-VM
U-IT-IC-UVM-COR-ORA	laaS	CPS	Oracle Cluster Core μVM	micro-VM
U-IT-IC-UVM-BAS-ENT	laaS	CPS	Enterprise Basic μVM	micro-VM
U-IT-IC-UVM-COR-ENT	laaS	CPS	Enterprise Core μVM	micro-VM
U-IT-IC-UVM-BASP-ENT	laaS	CPS	Enterprise Basic Plus μVM	Micro-VM
U-IT-CS-ENC-AGP-MF	laaS	CPS	Encryption Agent per Machine - pHANA	VM
U-IT-CS-ENC-AGT-MF	laaS	CPS	Encryption Agent per VM	VM
U-IT-CS-ENC-SYS-SYS	laaS	CPS	Encryption Management System Fee	Account
U-IT-CS-FA-FA-SYS	laaS	CPS	Firewall Audit System	Account
U-IT-CS-FA-MFA-SVC	laaS	CPS	Managed Firewall Auditing Service	Firewall
U-IT-CS-TM-AV1-SYS	laaS	CPS	Anti-Virus Primary System	Account
U-IT-CS-TM-AV2-SYS	laaS	CPS	Anti-Virus Secondary System	Account
U-IT-CS-TM-AV-SVC	laaS	CPS	Anti-Virus Managed Service	VM
U-IT-CS-TM-FIM1-SYS	laaS	CPS	File Integrity Monitoring Primary System	Account
U-IT-CS-TM-FIM2-SYS	laaS	CPS	File Integrity Monitoring Secondary System	Account
U-IT-IC-UHV-BASP-ENT	laaS	CPS	High Memory Enterprise Basic Plus μVM	Micro-VM
U-IT-IC-HVM-BASP-ENT	laaS	CPS	High Memory Enterprise Basic Plus VM Fee	VM
U-IT-CS-TM-IDFW1-SYS	laaS	CPS	Intrusion Detection and Firewall Primary System	Account

U-IT-CS-TM-IDFW2-SYS	IaaS	CPS	Intrusion Detection and Firewall Secondary System Account	
U-IT-CS-VPN-DC1-NET	IaaS	CPS	IPSec VPN Bandwidth Fee - Primary	Mbps
U-IT-CS-VPN-DC2-NET	IaaS	CPS	IPSec VPN Bandwidth Fee - Secondary	Mbps
U-IT-CS-VPN-T-SVC	IaaS	CPS	IPSec VPN Tunnel Managed Service	Ea
U-IT-IC-NW-LBM-NET	IaaS	CPS	Load Balancing Bandwidth Fee (Additional to Netv	Mbps
U-IT-CS-TM-IDFW-SVC	IaaS	CPS	Intrusion Detection and Firewall Managed Service VM	
U-IT-CS-TM-VLSB1-SYS	IaaS	CPS	VM-Level Security Bundle Primary System fee	Account
U-IT-IC-NW-LBM-LB	IaaS	CPS	Managed Load Balancer Services (Per Server)	VM
U-IT-CS-TM-VLSB2-SYS	IaaS	CPS	VM-Level Security Bundle Secondary System fee	Account
U-IT-CS-FW-MPF-SVC	IaaS	CPS	Managed Perimeter Firewall	VM
U-IT-IC-SW-MSS-WIN	IaaS	CPS	Microsoft OS	Instance
U-IT-IC-SW-MQL-ENT	IaaS	CPS	Microsoft SQL Enterprise (Per 2 cores)	CPU
U-IT-IC-SW-MQL-STD	IaaS	CPS	Microsoft SQL Standard (Per 2 cores)	CPU
U-IT-CS-NW-BW1-NET	IaaS	CPS	Network Bandwidth Fee - Primary	Mbps
U-IT-CS-NW-BW2-NET	IaaS	CPS	Network Bandwidth Fee - Secondary	Mbps
U-IT-CS-IDS-NB2-SYS	IaaS	CPS	Network Based Intrusion Detection System and M VLAN	
U-IT-CS-IDS-NB1-SYS	IaaS	CPS	Network Based Intrusion Detection System and M VLAN	
U-IT-CS-TM-VLSBA-SVC	IaaS	CPS	VM-Level Security Bundle Service Fee (<101 VMs)	VM
U-IT-CS-TM-VLSBB-SVC	IaaS	CPS	VM-Level Security Bundle Service Fee (<1001 VMs)	VM
U-IT-IC-NW-IPAD-V4	IaaS	CPS	Public IP Address (IPv4)	IP
U-IT-IC-NW-IPAD-V6	IaaS	CPS	Public IP Address (IPv6)	IP
U-IT-IC-SW-RHL-ENT	IaaS	CPS	Red Hat Enterprise Linux - Enterprise (Per OS)	Instance
U-IT-IC-SW-RHL-STD	IaaS	CPS	Red Hat Enterprise Linux - Standard (Per OS)	Instance
U-IT-IC-SW-RDS-IF	IaaS	CPS	Remote Desktop Services (Per User)	User
U-IT-IC-SW-SLES-PH	IaaS	CPS	SUSE Linux Enterprise for Physical HANA	CPU
U-IT-IC-SW-SLES-MF	IaaS	CPS	vSUSE Linux Enterprise	VM
U-IT-IC-DP-BU-LOC	IaaS	CPS	System Backup - Local Only	GB
U-IT-IC-DP-BU-REP	IaaS	CPS	System Backup - Replicated	GB
U-IT-IC-STO-T0AD-LOC	IaaS	CPS	Tier 0 Block Storage - DMZ - Local Only	GB
U-IT-IC-STO-T0AD-REP	IaaS	CPS	Tier 0 Block Storage - DMZ - Replicated	GB
U-IT-IC-STO-T0AN-LOC	IaaS	CPS	Tier 0 Block Storage - HZ - Local Only	GB
U-IT-IC-STO-T0AN-REP	IaaS	CPS	Tier 0 Block Storage - HZ - Replicated	GB
U-IT-IC-STO-T0AI-LOC	IaaS	CPS	Tier 0 Block Storage - IZ - Local Only	GB
U-IT-IC-STO-T0AI-REP	IaaS	CPS	Tier 0 Block Storage - IZ - Replicated	GB
U-IT-IC-STO-T1AD-LOC	IaaS	CPS	Tier I Block Storage - DMZ - Local Only	GB
U-IT-IC-STO-T1AD-REP	IaaS	CPS	Tier I Block Storage - DMZ - Replicated	GB
U-IT-IC-STO-T1AN-LOC	IaaS	CPS	Tier I Block Storage - HZ - Local Only	GB
U-IT-IC-STO-T1AN-REP	IaaS	CPS	Tier I Block Storage - HZ - Replicated	GB
U-IT-IC-STO-T1AI-LOC	IaaS	CPS	Tier I Block Storage - IZ - Local Only	GB
U-IT-IC-STO-T1AI-REP	IaaS	CPS	Tier I Block Storage - IZ - Replicated	GB
U-IT-IC-STO-T2AD-LOC	IaaS	CPS	Tier II Block Storage - DMZ - Local Only	GB
U-IT-IC-STO-T2AD-REP	IaaS	CPS	Tier II Block Storage - DMZ - Replicated	GB
U-IT-IC-STO-T2AN-LOC	IaaS	CPS	Tier II Block Storage - HZ - Local Only	GB
U-IT-IC-STO-T2AN-REP	IaaS	CPS	Tier II Block Storage - HZ - Replicated	GB
U-IT-IC-STO-T2AI-LOC	IaaS	CPS	Tier II Block Storage - IZ - Local Only	GB
U-IT-IC-STO-T2AI-REP	IaaS	CPS	Tier II Block Storage - IZ - Replicated	GB
U-IT-IC-STO-T3AD-LOC	IaaS	CPS	Tier III Block Storage - DMZ - Local Only	GB

U-IT-IC-STO-T3AD-REP	laaS	CPS	Tier III Block Storage – DMZ - Replicated	GB
U-IT-IC-STO-T3AN-LOC	laaS	CPS	Tier III Block Storage - HZ - Local Only	GB
U-IT-IC-STO-T3AN-REP	laaS	CPS	Tier III Block Storage – HZ - Replicated	GB
U-IT-IC-STO-T3AI-LOC	laaS	CPS	Tier III Block Storage - IZ - Local Only	GB
U-IT-IC-STO-T3AI-REP	laaS	CPS	Tier III Block Storage – IZ - Replicated	GB
U-IT-CS-TM-VLSBC-SVC	laaS	CPS	VM-Level Security Bundle Service Fee (<10,001 VM	VM
U-IT-CS-TM-VLSBD-SVC	laaS	CPS	VM-Level Security Bundle Service Fee (10,000+ VM	VM
U-IT-CS-VS-LM-SYS	laaS	CPS	Log Management System Fee	Ea
U-IT-CS-VS-MLM-SVC	laaS	CPS	Managed Log Management Service	VM
U-IT-CS-VS-PA-SVC	laaS	CPS	Policy Auditor Service Fee	VM
U-IT-CS-VS-PA-SYS	laaS	CPS	Policy Auditor System Fee	Site
U-IT-CS-VS-NPIP-SVC	laaS	CPS	Vulnerability Scanning Managed Service - non Pub IP Address	
U-IT-CS-VS-NPIP-AH	laaS	CPS	Vulnerability Scanning Remedial Ad Hoc Scan	IP Block
U-IT-CS-VS-PIP-SVC	laaS	CPS	Vulnerability Scanning Managed Service - Public IP Address	
U-IT-CC-TAM-CIR-AH	laaS	CCS	Co-Innovation Roundtables - Ad Hoc (6 months)	Ea
U-IT-CC-TAM-DMM-AH	laaS	CCS	Demand Management Meetings - Ad Hoc (3 mont	Ea
U-IT-CC-TAM-ES-AH	laaS	CCS	Executive Scorecards - Ad Hoc (3 months)	Ea
U-IT-CC-TAM-ITRF-AH	laaS	CCS	IT Resource Forecast - Ad Hoc (3 months)	Ea
U-IT-CC-TAM-RBR-AH	laaS	CCS	Reporting and Business Review - Ad Hoc (1 month	Ea
U-IT-CC-TAM-RP-AH	laaS	CCS	Resource and Performance - Ad Hoc (1 month)	Ea
U-IT-CC-TAM-SLAR-AH	laaS	CCS	SLA Review - Ad Hoc (1 month)	Ea
U-IT-CC-TAM-WSIR-AH	laaS	CCS	Weekly Status and Incident Reporting - Ad Hoc (1	Ea
U-IT-AM-SVC-ONCC-1T	laaS	CCS	Application Managed Services Setup	VM
U-IT-CC-SAP-ONUS-1T	laaS	CCS	Onshore SAP User, Security, and Change Manager	Ea
U-IT-AM-SAP-PRO-MT	laaS	CCS	SAP Support - Monitoring Tool	Account
U-IT-CC-TAM-OPIN-1Y	laaS	CCS	Operational Integration - 1 Year	Ea
U-IT-CC-TAM-RBR-1Y	laaS	CCS	Reporting and Business Review - 1 Year	Ea
U-IT-CC-TAM-RP-1Y	laaS	CCS	Resource and Performance - 1 Year	Ea
U-IT-CC-TAM-SLAR-1Y	laaS	CCS	SLA Review - 1 Year	Ea
U-IT-AM-TAMS-TAMSB-C	laaS	CCS	Technical Account Management Services - Base	Ea
U-IT-AM-TAMS-TAMSG-C	laaS	CCS	Technical Account Management Services - Gold	Ea
U-IT-AM-TAMS-TAMSS-C	laaS	CCS	Technical Account Management Services - Silver	Ea
U-IT-AM-TAMS-TAMSP-C	laaS	CCS	Technical Account Management Services - Platinu	Ea
U-IT-CC-TAM-WSIR-1Y	laaS	CCS	Weekly Status and Incident Reporting - 1 Year	Ea
U-IT-DC-NW1-XCC-1T	laaS	CSNS	Copper Cross Connect - Installation - Primary	Ea
U-IT-DC-NW2-XCC-1T	laaS	CSNS	Copper Cross Connect - Installation - Secondary	Ea
U-IT-DC-NW1-XCF-1T	laaS	CSNS	Fiber Cross Connect - Installation - Primary	Ea
U-IT-DC-NW2-XCF-1T	laaS	CSNS	Fiber Cross Connect - Installation - Secondary	Ea
U-IT-DC-RK1-RK-1T	laaS	CSNS	Rack Installation - Primary	Rack
U-IT-DC-RK2-RK-1T	laaS	CSNS	Rack Installation - Secondary	Rack
U-IT-DC-NW1-XCH-HA	laaS	CSNS	Cloud Connect - HA (48 ports available) - Primary	Ea
U-IT-DC-NW2-XCH-HA	laaS	CSNS	Cloud Connect - HA (48 ports available) - Seconda	Ea
U-IT-DC-NW1-XCS-STD	laaS	CSNS	Cloud Connect - Standard (24 ports available) - Pri	Ea
U-IT-DC-NW2-XCS-STD	laaS	CSNS	Cloud Connect - Standard (24 ports available) - Se	Ea
U-IT-DC-NW1-XCC-MF	laaS	CSNS	Copper Cross Connect - Primary	Ea
U-IT-DC-NW2-XCC-MF	laaS	CSNS	Copper Cross Connect - Secondary	Ea
U-IT-DC-NW1-XCF-MF	laaS	CSNS	Fiber Cross Connect - Primary	Ea

U-IT-DC-NW2-XCF-MF	IaaS	CSNS	Fiber Cross Connect - Secondary	Ea
U-IT-DC-RK1-RK-HR	IaaS	CSNS	Hotel Rack (1U) - Managed Colo - Primary	Rack Unit
U-IT-DC-RK2-RK-HR	IaaS	CSNS	Hotel Rack (1U) - Managed Colo - Secondary	Rack Unit
U-IT-DC-PW1-KW-42U	IaaS	CSNS	Rackpower - Per kW - Primary	Ea
U-IT-DC-PW2-KW-42U	IaaS	CSNS	Rackpower - Per kW - Secondary	Ea
U-IT-DC-SVC-RE1-AH	IaaS	CSNS	Remote eyes and hands (1 Hour) - Primary	Ea
U-IT-DC-SVC-RE2-AH	IaaS	CSNS	Remote eyes and hands (1 Hour) - Secondary	Ea
U-IT-DC-SVC-RE1-AHA	IaaS	CSNS	Remote eyes and hands (15 Minutes) - Primary	Ea
U-IT-DC-SVC-RE2-AHA	IaaS	CSNS	Remote eyes and hands (15 Minutes) - Secondary	Ea
U-IT-DC-NW1-XCC-1T	IaaS	CSNS	Copper Cross Connect - Installation - Primary	Ea
U-IT-DC-NW1-XCF-1T	IaaS	CSNS	Fiber Cross Connect - Installation - Primary	Ea
U-IT-DC-NW1-XCH-1T	IaaS	CSNS	Cloud Connect - HA (48 ports available) - Setup - P	Ea
U-IT-DC-NW2-XCH-1T	IaaS	CSNS	Cloud Connect - HA (48 ports available) - Setup - S	Ea
U-IT-DC-RK1-DLP-1T	IaaS	CSNS	Equipment Deployment - Per equipment - Primary	Ea
U-IT-DC-RK2-DLP-1T	IaaS	CSNS	Equipment Deployment - Per equipment - Second	Ea
U-IT-DC-RK1-RK-1T	IaaS	CSNS	Rack Installation - Primary	Rack Unit
U-IT-DC-RK2-RK-1T	IaaS	CSNS	Rack Installation - Secondary	Rack Unit
U-IT-DC-RK1-RK-42U	IaaS	CSNS	Rackspace - 42U - Primary	Ea
U-IT-DC-RK2-RK-42U	IaaS	CSNS	Rackspace - 42U - Secondary	Ea
U-IT-DC-RK1-RK-HR	IaaS	CSNS	Hotel Rack (1U) - Managed Colo - Primary	Rack Unit
U-IT-DC-RK2-RK-HR	IaaS	CSNS	Hotel Rack (1U) - Managed Colo - Secondary	Rack Unit

Commercial

U-EC-CC-LAB-ONPG-MAN	IaaS	Onshor	Onshore Program Manager (Onb)	PS
U-EC-CC-LAB-ONPJ-MAN	IaaS	Onshor	Onshore Project Manager (Onb)	PS
U-EC-CC-LAB-ONSB-MAN	IaaS	Onshor	Onshore SAP Basis Manager (Onb)	PS
U-EC-CC-LAB-ONSB-SRC	IaaS	Onshor	Onshore SAP Basis Senior Consultant (Onb)	PS
U-EC-CC-LAB-ONBH-MAN	IaaS	Onshor	Onshore Basis / HANA Manager (Onb)	PS
U-EC-CC-LAB-ONBR-MAN	IaaS	Onshor	Onshore Backup and Recovery Manager (Onb)	PS
U-EC-CC-LAB-ONOB-SRC	IaaS	Onshor	Onshore Onboarding Senior Consultant (Onb)	PS
U-EC-AD-LAB-ONCP-ENG	CAS	Onshor	Onshore Cloud Platform Engineer (Advisor)	PS
U-EC-CC-LAB-OFBH-MAN	IaaS	Offshor	Offshore Basis / HANA Manager (Onb)	PS
U-EC-CC-LAB-OFOB-SRC	IaaS	Offshor	Offshore Onboarding Senior Consultant (Onb)	PS
U-EC-CC-LAB-OFBH-CON	IaaS	Offshor	Offshore SAP Basis Senior Consultant (Onb)	PS
U-EC-CC-LAB-OFSB-MAN	IaaS	Offshor	Offshore SAP Basis Manager (Onb)	PS

FedRAMP

U-FD-CC-LAB-ONPG-MAN	IaaS	Onshor	Onshore Program Manager (Onb)	PS
U-FD-CC-LAB-ONPJ-MAN	IaaS	Onshor	Onshore Project Manager (Onb)	PS
U-FD-CC-LAB-ONSB-MAN	IaaS	Onshor	Onshore SAP Basis Manager (Onb)	PS
U-FD-CC-LAB-ONSB-SRC	IaaS	Onshor	Onshore SAP Basis Senior Consultant (Onb)	PS
U-FD-CC-LAB-ONBH-MAN	IaaS	Onshor	Onshore Basis / HANA Manager (Onb)	PS
U-FD-CC-LAB-ONBR-MAN	IaaS	Onshor	Onshore Backup and Recovery Manager (Onb)	PS
U-FD-CC-LAB-ONOB-SRC	IaaS	Onshor	Onshore Onboarding Senior Consultant (Onb)	PS

U-FD-AD-LAB-ONCP-ENG	CAS	Onshor Onshore Cloud Platform Engineer (Advisor)	PS
U-FD-CC-LAB-OFBH-MAN	IaaS	Offshor Offshore Basis / HANA Manager (Onb)	PS
U-FD-CC-LAB-OFOB-SRC	IaaS	Offshor Offshore Onboarding Senior Consultant (Onb)	PS
U-FD-CC-LAB-OFBH-CON	IaaS	Offshor Offshore SAP Basis Senior Consultant (Onb)	PS
U-FD-CC-LAB-OFSB-MAN	IaaS	Offshor Offshore SAP Basis Manager (Onb)	PS
U-FD-CC-LAB-OFPJ-MAN	IaaS	Offshor Offshore Project Manager (Onb)	PS

ITAR

U-IT-CC-LAB-ONPG-MAN	IaaS	Onshor Onshore Program Manager (Onb)	PS
U-IT-CC-LAB-ONPJ-MAN	IaaS	Onshor Onshore Project Manager (Onb)	PS
U-IT-CC-LAB-ONSB-MAN	IaaS	Onshor Onshore SAP Basis Manager (Onb)	PS
U-IT-CC-LAB-ONSB-SRC	IaaS	Onshor Onshore SAP Basis Senior Consultant (Onb)	PS
U-IT-CC-LAB-ONBH-MAN	IaaS	Onshor Onshore Basis / HANA Manager (Onb)	PS
U-IT-CC-LAB-ONBR-MAN	IaaS	Onshor Onshore Backup and Recovery Manager (Onb)	PS
U-IT-CC-LAB-ONOB-SRC	IaaS	Onshor Onshore Onboarding Senior Consultant (Onb)	PS
U-IT-AD-LAB-ONCP-ENG	CAS	Onshor Onshore Cloud Platform Engineer (Advisor)	PS
U-IT-CC-LAB-OFBH-MAN	IaaS	Offshor Offshore Basis / HANA Manager (Onb)	PS
U-IT-CC-LAB-OFOB-SRC	IaaS	Offshor Offshore Onboarding Senior Consultant (Onb)	PS
U-IT-CC-LAB-OFBH-CON	IaaS	Offshor Offshore SAP Basis Senior Consultant (Onb)	PS
U-IT-CC-LAB-OFSB-MAN	IaaS	Offshor Offshore SAP Basis Manager (Onb)	PS
U-IT-CC-LAB-OFPJ-MAN	IaaS	Offshor Offshore Project Manager (Onb)	PS

List Price

\$ 125.00
\$ 250.00
\$ 13,883.82
\$ 19,610.68
\$ 26,552.59
\$ 33,494.49
\$ 40,436.40
\$ 1,950.00
\$ 1,350.00
\$ 13.00
\$ 9.00
\$ 11.00
\$ 8,940.42
\$ 12,622.86
\$ 16,994.85
\$ 21,563.29
\$ 26,131.72
\$ 750.00
\$ 1,750.00
\$ 1,025.00
\$ 1,025.00
\$ 70.00
\$ 1,000.00
\$ 270.00
\$ 100.00
\$ 125.00
\$ 180.00
\$ 2,150.00
\$ 1,250.00
\$ 3,000.00
\$ 214.29
\$ 214.29
\$ 1,875.00
\$ 2,000.00
\$ 214.29
\$ 214.29
\$ 1,500.00
\$ 1,120.00
\$ 560.00
\$ 642.86
\$ 214.29
\$ 156.25
\$ 1,030.00
\$ 3,300.00
\$ 1,071.43
\$ 214.29

\$ 1,280.00
\$ 640.00
\$ 500.00
\$ 100.00
\$ 500.00
\$ 1,000.00
\$ 62.50
\$ 1,500.00
\$ 150.00
\$ 45.00
\$ 9.00
\$ 11.00
\$ 9.00
\$ 5,000.00
\$ 5,300.00
\$ 6,000.00
\$ 6,500.00
\$ 8,700.00
\$ 5,000.00
\$ 6,000.00
\$ 4,476.00
\$ 5,300.00
\$ 6,000.00
\$ 6,500.00
\$ 8,500.00
\$ 16,000.00
\$ 21,000.00
\$ 22,500.00
\$ 25,500.00
\$ 5,000.00
\$ 5,300.00
\$ 6,000.00
\$ 6,500.00
\$ 8,700.00
\$ 5,000.00
\$ 6,000.00
\$ 4,476.00
\$ 5,300.00
\$ 6,000.00
\$ 6,500.00
\$ 8,500.00
\$ 16,000.00
\$ 21,000.00
\$ 22,500.00
\$ 25,500.00
\$ 900.00
\$ 13.00

\$ 1,150.00
\$ 20.00
\$ 900.00
\$ 1,150.00
\$ 1,025.00
\$ 16.50
\$ 20.50
\$ 1,025.00
\$ 13.00
\$ 20.00
\$ 16.50
\$ 39.15
\$ 52.20
\$ 45.68
\$ 105.00
\$ 105.00
\$ 850.00
\$ 675.00
\$ 270.00
\$ 25.00
\$ 25.00
\$ 24.99
\$ 25.00
\$ 25.00
\$ 16.50
\$ 1,025.00
\$ 203.57
\$ 25.00
\$ 31.25
\$ 31.25
\$ 50.00
\$ 22.50
\$ 73.74
\$ 190.18
\$ 75.00
\$ 56.25
\$ 25.00
\$ 50.00
\$ 575.00
\$ 150.00
\$ 28.75
\$ 28.75
\$ 477.00
\$ 957.00
\$ 116.14
\$ 105.92
\$ 25.00

\$ 5.00
\$ 100.00
\$ 50.00
\$ 7.50
\$ 200.00
\$ 73.00
\$ 0.85
\$ 1.25
\$ 0.84
\$ 1.70
\$ 0.84
\$ 1.70
\$ 0.84
\$ 1.70
\$ 0.40
\$ 0.88
\$ 0.40
\$ 0.88
\$ 0.40
\$ 0.88
\$ 0.28
\$ 0.64
\$ 0.28
\$ 0.64
\$ 0.28
\$ 0.64
\$ 0.12
\$ 0.32
\$ 0.12
\$ 0.32
\$ 0.12
\$ 0.32
\$ 99.00
\$ 88.72
\$ 2,000.00
\$ 60.00
\$ 73.00
\$ 125.00
\$ 30.00
\$ 450.00
\$ 150.00
\$ 5,850.00
\$ 3,217.50
\$ 3,510.00
\$ 7,020.00
\$ 4,638.75
\$ 4,203.75

\$ 1,755.00
\$ 3,330.00
\$ 155.00
\$ 2,750.00
\$ 963.11
\$ 692.13
\$ 579.24
\$ 396.61
\$ 300.21
\$ 248.50
\$ 206.00
\$ 191.92
\$ 1,382.92
\$ 1,197.34
\$ 828.76
\$ 655.18
\$ 376.76
\$ 312.29
\$ 263.61
\$ 232.16
\$ 2,038.05
\$ 1,669.72
\$ 1,148.24
\$ 786.18
\$ 453.03
\$ 394.74
\$ 311.58
\$ 276.84
\$ 334.10
\$ 1,950.00
\$ 3,092.50
\$ 2,802.50
\$ 1,170.00
\$ 3,000.00
\$ 12,000.00
\$ 6,000.00
\$ 24,000.00
\$ 2,220.00
\$ 682.94
\$ 682.94
\$ 902.00
\$ 902.00
\$ 9,455.00
\$ 9,455.00
\$ 531.25
\$ 531.25
\$ 250.00

\$ 250.00
\$ 554.55
\$ 554.55
\$ 454.55
\$ 454.55
\$ 540.00
\$ 540.00
\$ 429.00
\$ 429.00
\$ 273.00
\$ 273.00
\$ 68.25
\$ 68.25
\$ 682.94
\$ 902.00
\$ 2,415.00
\$ 2,415.00
\$ 545.00
\$ 545.00
\$ 9,455.00
\$ 9,455.00
\$ 1,636.00
\$ 1,636.00
\$ 540.00
\$ 540.00
\$ 0.03
\$ 0.03
\$ 0.03
\$ 0.03
\$ 0.03
\$ 0.03
\$ 0.03
\$ 0.03
\$ 0.03
\$ 0.03
\$ 0.03
\$ 0.03
\$ 0.03
\$ 0.03
\$ 0.03
\$ 0.03
\$ 0.03
\$ 0.03
\$ 0.03
\$ 0.01
\$ 0.01
\$ 0.01
\$ 0.06
\$ 0.06
\$ 0.06
\$ 0.06

\$ 0.06
\$ 0.06
\$ 0.06
\$ 0.06
\$ 0.06
\$ 0.06
\$ 0.06
\$ 0.06
\$ 0.06
\$ 0.06
\$ 0.06
\$ 0.03
\$ 0.03
\$ 0.03

List Price

\$ 125.00
\$ 250.00
\$ 17,700.88
\$ 25,127.90
\$ 33,978.35
\$ 42,828.79
\$ 51,679.23
\$ 1,950.00
\$ 1,350.00
\$ 13.00
\$ 9.00
\$ 11.00
\$ 9,024.80
\$ 12,759.33
\$ 17,152.84
\$ 21,784.13
\$ 26,415.42
\$ 1,750.00
\$ 1,025.00
\$ 1,025.00
\$ 70.00
\$ 1,000.00
\$ 270.00
\$ 100.00
\$ 125.00
\$ 180.00
\$ 2,150.00
\$ 1,250.00
\$ 3,000.00
\$ 214.29
\$ 214.29

\$ 1,875.00
\$ 2,200.00
\$ 214.29
\$ 214.29
\$ 1,500.00
\$ 1,120.00
\$ 560.00
\$ 642.86
\$ 214.29
\$ 156.25
\$ 1,030.00
\$ 3,300.00
\$ 1,071.43
\$ 214.29
\$ 1,280.00
\$ 640.00
\$ 500.00
\$ 100.00
\$ 500.00
\$ 1,000.00
\$ 62.50
\$ 1,500.00
\$ 150.00
\$ 45.00
\$ 9.00
\$ 11.00
\$ 9.00
\$ 7,228.04
\$ 7,093.87
\$ 16,379.79
\$ 18,700.00
\$ 19,800.00
\$ 6,147.80
\$ 17,040.85
\$ 6,277.91
\$ 7,093.87
\$ 7,616.63
\$ 8,749.42
\$ 17,660.99
\$ 25,976.50
\$ 42,900.00
\$ 45,650.00
\$ 49,500.00
\$ 7,228.04
\$ 7,093.87
\$ 16,379.79
\$ 18,700.00

\$ 19,800.00
\$ 6,147.80
\$ 17,040.85
\$ 6,277.91
\$ 7,093.87
\$ 7,616.63
\$ 8,749.42
\$ 17,660.99
\$ 25,976.04
\$ 42,900.00
\$ 45,650.00
\$ 49,500.00
\$ 1,075.00
\$ 20.40
\$ 1,486.00
\$ 28.80
\$ 1,075.00
\$ 1,486.00
\$ 1,230.00
\$ 19.80
\$ 24.60
\$ 1,230.00
\$ 20.40
\$ 28.80
\$ 19.80
\$ 159.60
\$ 297.60
\$ 46.98
\$ 62.64
\$ 54.81
\$ 105.00
\$ 105.00
\$ 850.00
\$ 675.00
\$ 270.00
\$ 25.00
\$ 25.00
\$ 24.99
\$ 25.00
\$ 25.00
\$ 19.80
\$ 1,230.00
\$ 203.57
\$ 25.00
\$ 31.25
\$ 31.25
\$ 50.00

\$ 22.50
\$ 73.74
\$ 190.18
\$ 100.00
\$ 56.25
\$ 25.00
\$ 50.00
\$ 575.00
\$ 150.00
\$ 28.75
\$ 28.75
\$ 477.00
\$ 957.00
\$ 116.14
\$ 105.92
\$ 25.00
\$ 5.00
\$ 100.00
\$ 50.00
\$ 7.50
\$ 200.00
\$ 73.00
\$ 0.89
\$ 1.31
\$ 0.88
\$ 1.78
\$ 0.88
\$ 1.78
\$ 0.88
\$ 1.78
\$ 0.42
\$ 0.92
\$ 0.42
\$ 0.92
\$ 0.42
\$ 0.92
\$ 0.29
\$ 0.67
\$ 0.29
\$ 0.67
\$ 0.29
\$ 0.67
\$ 0.13
\$ 0.42
\$ 0.13
\$ 0.42
\$ 0.13

\$ 0.42
\$ 99.00
\$ 88.72
\$ 2,000.00
\$ 60.00
\$ 73.00
\$ 125.00
\$ 100.00
\$ 450.00
\$ 500.00
\$ 5,850.00
\$ 3,217.50
\$ 3,510.00
\$ 7,020.00
\$ 4,638.75
\$ 4,203.75
\$ 1,755.00
\$ 3,330.00
\$ 155.00
\$ 2,750.00
\$ 334.10
\$ 1,950.00
\$ 3,092.50
\$ 2,802.50
\$ 1,170.00
\$ 3,000.00
\$ 12,000.00
\$ 6,000.00
\$ 24,000.00
\$ 2,220.00
\$ 717.09
\$ 717.09
\$ 947.10
\$ 947.10
\$ 9,927.75
\$ 9,927.75
\$ 557.81
\$ 557.81
\$ 262.50
\$ 262.50
\$ 582.28
\$ 582.28
\$ 477.28
\$ 477.28
\$ 567.00
\$ 567.00
\$ 450.45

\$ 450.45
\$ 286.65
\$ 286.65
\$ 71.66
\$ 71.66
\$ 717.09
\$ 947.10
\$ 2,535.75
\$ 2,535.75
\$ 572.25
\$ 572.25
\$ 9,927.75
\$ 9,927.75
\$ 1,717.80
\$ 1,717.80
\$ 567.00
\$ 567.00

List Price

\$ 125.00
\$ 250.00
\$ 17,700.88
\$ 25,127.90
\$ 33,978.35
\$ 42,828.79
\$ 51,679.23
\$ 1,950.00
\$ 1,350.00
\$ 13.00
\$ 9.00
\$ 11.00
\$ 9,024.80
\$ 12,759.33
\$ 17,152.84
\$ 21,784.13
\$ 26,415.42
\$ 1,750.00
\$ 1,025.00
\$ 1,025.00
\$ 70.00
\$ 1,000.00
\$ 270.00
\$ 100.00
\$ 125.00
\$ 180.00
\$ 2,150.00

\$ 1,250.00
\$ 3,000.00
\$ 214.29
\$ 214.29
\$ 1,875.00
\$ 2,200.00
\$ 214.29
\$ 214.29
\$ 1,500.00
\$ 1,120.00
\$ 560.00
\$ 642.86
\$ 214.29
\$ 156.25
\$ 1,030.00
\$ 3,300.00
\$ 1,071.43
\$ 214.29
\$ 1,280.00
\$ 640.00
\$ 500.00
\$ 100.00
\$ 500.00
\$ 1,000.00
\$ 62.50
\$ 1,500.00
\$ 150.00
\$ 45.00
\$ 9.00
\$ 11.00
\$ 9.00
\$ 7,228.04
\$ 7,093.87
\$ 16,379.79
\$ 18,700.00
\$ 19,800.00
\$ 6,147.80
\$ 17,040.85
\$ 6,277.91
\$ 7,093.87
\$ 7,616.63
\$ 8,749.42
\$ 17,660.99
\$ 25,976.50
\$ 42,900.00
\$ 45,650.00
\$ 49,500.00

\$ 7,228.04
\$ 7,093.87
\$ 16,379.79
\$ 18,700.00
\$ 19,800.00
\$ 6,147.80
\$ 17,040.85
\$ 6,277.91
\$ 7,093.87
\$ 7,616.63
\$ 8,749.42
\$ 17,660.99
\$ 25,976.04
\$ 42,900.00
\$ 45,650.00
\$ 49,500.00
\$ 1,075.00
\$ 20.40
\$ 1,486.00
\$ 28.80
\$ 1,075.00
\$ 1,486.00
\$ 1,230.00
\$ 19.80
\$ 24.60
\$ 1,230.00
\$ 20.40
\$ 28.80
\$ 19.80
\$ 159.60
\$ 297.60
\$ 46.98
\$ 62.64
\$ 54.81
\$ 105.00
\$ 105.00
\$ 850.00
\$ 675.00
\$ 270.00
\$ 25.00
\$ 25.00
\$ 24.99
\$ 25.00
\$ 25.00
\$ 19.80
\$ 1,230.00
\$ 203.57

\$ 25.00
\$ 31.25
\$ 31.25
\$ 50.00
\$ 22.50
\$ 73.74
\$ 190.18
\$ 100.00
\$ 56.25
\$ 25.00
\$ 50.00
\$ 575.00
\$ 150.00
\$ 28.75
\$ 28.75
\$ 477.00
\$ 957.00
\$ 116.14
\$ 105.92
\$ 25.00
\$ 5.00
\$ 100.00
\$ 50.00
\$ 7.50
\$ 200.00
\$ 73.00
\$ 0.89
\$ 1.31
\$ 0.88
\$ 1.78
\$ 0.88
\$ 1.78
\$ 0.88
\$ 1.78
\$ 0.42
\$ 0.92
\$ 0.42
\$ 0.92
\$ 0.42
\$ 0.92
\$ 0.29
\$ 0.67
\$ 0.29
\$ 0.67
\$ 0.29
\$ 0.67
\$ 0.13

\$ 0.42
\$ 0.13
\$ 0.42
\$ 0.13
\$ 0.42
\$ 99.00
\$ 88.72
\$ 2,000.00
\$ 60.00
\$ 73.00
\$ 125.00
\$ 100.00
\$ 450.00
\$ 500.00
\$ 5,850.00
\$ 3,217.50
\$ 3,510.00
\$ 7,020.00
\$ 4,638.75
\$ 4,203.75
\$ 1,755.00
\$ 3,330.00
\$ 155.00
\$ 2,750.00
\$ 334.10
\$ 1,950.00
\$ 3,092.50
\$ 2,802.50
\$ 1,170.00
\$ 3,000.00
\$ 12,000.00
\$ 6,000.00
\$ 24,000.00
\$ 2,220.00
\$ 717.09
\$ 717.09
\$ 947.10
\$ 947.10
\$ 9,927.75
\$ 9,927.75
\$ 557.81
\$ 557.81
\$ 262.50
\$ 262.50
\$ 582.28
\$ 582.28
\$ 477.28

\$ 477.28
\$ 567.00
\$ 567.00
\$ 450.45
\$ 450.45
\$ 286.65
\$ 286.65
\$ 71.66
\$ 71.66
\$ 717.09
\$ 947.10
\$ 2,535.75
\$ 2,535.75
\$ 572.25
\$ 572.25
\$ 9,927.75
\$ 9,927.75
\$ 1,717.80
\$ 1,717.80
\$ 567.00
\$ 567.00

\$ 324.25
\$ 337.22
\$ 298.31
\$ 285.34
\$ 337.22
\$ 168.61
\$ 220.49
\$ 402.08
\$ 90.79
\$ 57.07
\$ 64.85
\$ 90.79

\$ 324.25
\$ 337.22
\$ 298.31
\$ 285.34
\$ 337.22
\$ 168.61
\$ 220.49

\$ 402.08
\$ 90.79
\$ 57.07
\$ 64.85
\$ 90.79
\$ 62.26

\$ 324.25
\$ 337.22
\$ 298.31
\$ 285.34
\$ 337.22
\$ 168.61
\$ 220.49
\$ 402.08
\$ 90.79
\$ 57.07
\$ 64.85
\$ 90.79
\$ 62.26

PEPPM 2019 Product Line Bid – California # 528899

AWARDED VENDOR AGREEMENT

BETWEEN

Kern County Superintendent of Schools (“Agency”)

AND

EMC Corporation

(Bidder's legal name referred to throughout this agreement as "Awarded Vendor")

For Bid Product Line:

Boomi, Inc.

(Product Line Name within PEPPM 2019 Product Line Bid – California # 528899)

This Agreement is made and entered into as of the date this Agreement is fully executed by the Kern County Superintendent of Schools (Agency) after an initial signature from the Awarded Vendor. This date of final execution shall be known as the “Effective Date.”

Whereas, Agency issued a Request for Bids for PEPPM 2019 Product Line Bid – California (“RFB”); and

Whereas that RFB is incorporated into this Agreement by reference and made a part hereof;

Whereas, the Awarded Vendor submitted a Bid in response to the Agency’s RFB for the Product Line referenced above;

Whereas, the Agency determined that Awarded Vendor was the lowest responsive and responsible bidder for the Product Line referenced above; and

Whereas, Awarded Vendor signs and executes this Awarded Vendor Agreement to indicate its acceptance of the terms and conditions of the Contract as defined below;

Now, therefore in consideration of the mutual covenants contained herein and other good and valuable consideration, the sufficiency of which is expressly acknowledged by both parties, and intending to be legally bound hereby, the parties mutually agree as follows:

1. This Agreement is a Contract and Contract Documents consist of the Request for Bids, bid Terms and Conditions, any applicable state-specific terms and conditions, all information incorporated into the electronic bid form by Agency or Bidder, the Bidder’s responses to Questions, the Bidder’s PEPPM Bid Quote Sheet(s), the Bidder’s pricing spreadsheet, the Bidder’s PEPPM State Selection Form, the Bidder’s Ancillary Services Form, this Agreement, all other attachments and exhibits to the request for bids, all addenda to the request for bids issued prior to the Bid Opening Date, and all subsequent written amendments to the Agreement (e.g. adding state-specific terms and conditions). The Contract Documents form the “Contract” between Agency for the Contract term, and during any authorized extensions.
2. Awarded Vendor agrees to furnish products and services related to the RFB in accordance with the RFB Terms and Conditions and Contract.

3. The Contract shall commence on January 1, 2019 and end on December 31, 2021. Agency and Awarded Vendor may elect to extend the term of the Contract as set forth in the Terms and Conditions.
4. Awarded Vendor agrees to honor submitted bid prices and pricing formulas according to all terms and conditions of the Contract Documents to all eligible buying organizations in California as authorized to purchase the products included in the Awarded Vendor's bid.
5. Where Awarded Vendor agreed to extend its quoted price formulas and effective prices to eligible LEAs in states and territories outside of California, Awarded Vendor agrees to extend those quoted bid prices and formulas according to all terms and conditions of the Contract Documents to those other LEAs and eligible agencies.
6. Awarded Vendor agrees to remit the Transaction Fee in accordance with the terms and conditions set forth in the Contract.
7. This Agreement shall be governed by and construed under the laws of the state of California, any disputes shall be determined in the court of general jurisdiction in the County of Kern.

IN WITNESS WHEREOF, the parties, intending to be legally bound, have caused their hands to be affixed.

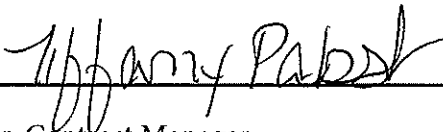
Vendor Signature 
 Signatory Title Sr. Contract Manager
 Vendor Name Tiffany Pabst
 Address 3017 Douglas Blvd. Suite 300
 City, State, Zip Roseville, CA 95661
 Date October 1, 2018

KCSOS Signature *For Mary C. Barlow, Kern County Superintendent of Schools*
 Signatory Title _____
 Agency Name Kern County Superintendent of Schools
 Address 1300 17th Street
 City, State, Zip Bakersfield, CA 93301
 Date _____

PEPPM 2019 Product Line Bid – California # 528899

AWARDED VENDOR AGREEMENT

BETWEEN

Kern County Superintendent of Schools (“Agency”)

AND

EMC Corporation

(Bidder's legal name referred to throughout this agreement as "Awarded Vendor")

For Bid Product Line:

Dell EMC

(Product Line Name within PEPPM 2019 Product Line Bid – California # 528899)

This Agreement is made and entered into as of the date this Agreement is fully executed by the Kern County Superintendent of Schools (Agency) after an initial signature from the Awarded Vendor. This date of final execution shall be known as the “Effective Date.”

Whereas, Agency issued a Request for Bids for PEPPM 2019 Product Line Bid – California (“RFB”); and

Whereas that RFB is incorporated into this Agreement by reference and made a part hereof;

Whereas, the Awarded Vendor submitted a Bid in response to the Agency's RFB for the Product Line referenced above;

Whereas, the Agency determined that Awarded Vendor was the lowest responsive and responsible bidder for the Product Line referenced above; and

Whereas, Awarded Vendor signs and executes this Awarded Vendor Agreement to indicate its acceptance of the terms and conditions of the Contract as defined below;

Now, therefore in consideration of the mutual covenants contained herein and other good and valuable consideration, the sufficiency of which is expressly acknowledged by both parties, and intending to be legally bound hereby, the parties mutually agree as follows:

1. This Agreement is a Contract and Contract Documents consist of the Request for Bids, bid Terms and Conditions, any applicable state-specific terms and conditions, all information incorporated into the electronic bid form by Agency or Bidder, the Bidder's responses to Questions, the Bidder's PEPPM Bid Quote Sheet(s), the Bidder's pricing spreadsheet, the Bidder's PEPPM State Selection Form, the Bidder's Ancillary Services Form, this Agreement, all other attachments and exhibits to the request for bids, all addenda to the request for bids issued prior to the Bid Opening Date, and all subsequent written amendments to the Agreement (e.g. adding state-specific terms and conditions). The Contract Documents form the “Contract” between Agency for the Contract term, and during any authorized extensions.
2. Awarded Vendor agrees to furnish products and services related to the RFB in accordance with the RFB Terms and Conditions and Contract.

3. The Contract shall commence on January 1, 2019 and end on December 31, 2021. Agency and Awarded Vendor may elect to extend the term of the Contract as set forth in the Terms and Conditions.
4. Awarded Vendor agrees to honor submitted bid prices and pricing formulas according to all terms and conditions of the Contract Documents to all eligible buying organizations in California as authorized to purchase the products included in the Awarded Vendor's bid.
5. Where Awarded Vendor agreed to extend its quoted price formulas and effective prices to eligible LEAs in states and territories outside of California, Awarded Vendor agrees to extend those quoted bid prices and formulas according to all terms and conditions of the Contract Documents to those other LEAs and eligible agencies.
6. Awarded Vendor agrees to remit the Transaction Fee in accordance with the terms and conditions set forth in the Contract.
7. This Agreement shall be governed by and construed under the laws of the state of California, any disputes shall be determined in the court of general jurisdiction in the County of Kern.

IN WITNESS WHEREOF, the parties, intending to be legally bound, have caused their hands to be affixed.

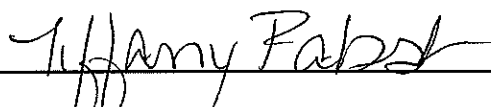
Vendor Signature 
 Signatory Title Sr. Contract Manager
 Vendor Name Tiffany Pabst
 Address 3017 Douglas Blvd. Suite 300
 City, State, Zip Roseville, CA 95661
 Date October 1, 2018

KCSOS Signature For Mary C. Barlow, Kern County Superintendent of Schools
 Signatory Title _____
 Agency Name Kern County Superintendent of Schools
 Address 1300 17th Street
 City, State, Zip Bakersfield, CA 93301
 Date _____

PEPPM 2019 Product Line Bid – California # 528899

AWARDED VENDOR AGREEMENT

BETWEEN

Kern County Superintendent of Schools (“Agency”)

AND

EMC Corporation

(Bidder's legal name referred to throughout this agreement as "Awarded Vendor")

For Bid Product Line:

RSA Security

(Product Line Name within PEPPM 2019 Product Line Bid – California # 528899)

This Agreement is made and entered into as of the date this Agreement is fully executed by the Kern County Superintendent of Schools (Agency) after an initial signature from the Awarded Vendor. This date of final execution shall be known as the “Effective Date.”

Whereas, Agency issued a Request for Bids for PEPPM 2019 Product Line Bid – California (“RFB”); and

Whereas that RFB is incorporated into this Agreement by reference and made a part hereof;

Whereas, the Awarded Vendor submitted a Bid in response to the Agency's RFB for the Product Line referenced above;

Whereas, the Agency determined that Awarded Vendor was the lowest responsive and responsible bidder for the Product Line referenced above; and

Whereas, Awarded Vendor signs and executes this Awarded Vendor Agreement to indicate its acceptance of the terms and conditions of the Contract as defined below;

Now, therefore in consideration of the mutual covenants contained herein and other good and valuable consideration, the sufficiency of which is expressly acknowledged by both parties, and intending to be legally bound hereby, the parties mutually agree as follows:

1. This Agreement is a Contract and Contract Documents consist of the Request for Bids, bid Terms and Conditions, any applicable state-specific terms and conditions, all information incorporated into the electronic bid form by Agency or Bidder, the Bidder's responses to Questions, the Bidder's PEPPM Bid Quote Sheet(s), the Bidder's pricing spreadsheet, the Bidder's PEPPM State Selection Form, the Bidder's Ancillary Services Form, this Agreement, all other attachments and exhibits to the request for bids, all addenda to the request for bids issued prior to the Bid Opening Date, and all subsequent written amendments to the Agreement (e.g. adding state-specific terms and conditions). The Contract Documents form the “Contract” between Agency for the Contract term, and during any authorized extensions.
2. Awarded Vendor agrees to furnish products and services related to the RFB in accordance with the RFB Terms and Conditions and Contract.

3. The Contract shall commence on January 1, 2019 and end on December 31, 2021. Agency and Awarded Vendor may elect to extend the term of the Contract as set forth in the Terms and Conditions.
4. Awarded Vendor agrees to honor submitted bid prices and pricing formulas according to all terms and conditions of the Contract Documents to all eligible buying organizations in California as authorized to purchase the products included in the Awarded Vendor's bid.
5. Where Awarded Vendor agreed to extend its quoted price formulas and effective prices to eligible LEAs in states and territories outside of California, Awarded Vendor agrees to extend those quoted bid prices and formulas according to all terms and conditions of the Contract Documents to those other LEAs and eligible agencies. -
6. Awarded Vendor agrees to remit the Transaction Fee in accordance with the terms and conditions set forth in the Contract.
7. This Agreement shall be governed by and construed under the laws of the state of California, any disputes shall be determined in the court of general jurisdiction in the County of Kern.

IN WITNESS WHEREOF, the parties, intending to be legally bound, have caused their hands to be affixed.

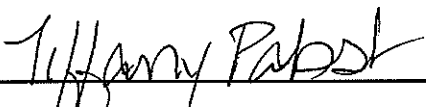
Vendor Signature 
 Signatory Title Sr. Contract Manager
 Vendor Name Tiffany Pabst
 Address 3017 Douglas Blvd. Suite 300
 City, State, Zip Roseville, CA 95661
 Date October 1, 2018

KCSOS Signature *For Mary C. Barlow, Kern County Superintendent of Schools*
 Signatory Title _____
 Agency Name Kern County Superintendent of Schools
 Address 1300 17th Street
 City, State, Zip Bakersfield, CA 93301
 Date _____

PEPPM 2019 Product Line Bid – California # 528899

AWARDED VENDOR AGREEMENT

BETWEEN

Kern County Superintendent of Schools (“Agency”)

AND

EMC Corporation

(Bidder's legal name referred to throughout this agreement as "Awarded Vendor")

For Bid Product Line:

Virtustream

(Product Line Name within PEPPM 2019 Product Line Bid – California # 528899)

This Agreement is made and entered into as of the date this Agreement is fully executed by the Kern County Superintendent of Schools (Agency) after an initial signature from the Awarded Vendor. This date of final execution shall be known as the “Effective Date.”

Whereas, Agency issued a Request for Bids for PEPPM 2019 Product Line Bid – California (“RFB”); and

Whereas that RFB is incorporated into this Agreement by reference and made a part hereof;

Whereas, the Awarded Vendor submitted a Bid in response to the Agency’s RFB for the Product Line referenced above;

Whereas, the Agency determined that Awarded Vendor was the lowest responsive and responsible bidder for the Product Line referenced above; and

Whereas, Awarded Vendor signs and executes this Awarded Vendor Agreement to indicate its acceptance of the terms and conditions of the Contract as defined below;

Now, therefore in consideration of the mutual covenants contained herein and other good and valuable consideration, the sufficiency of which is expressly acknowledged by both parties, and intending to be legally bound hereby, the parties mutually agree as follows:

1. This Agreement is a Contract and Contract Documents consist of the Request for Bids, bid Terms and Conditions, any applicable state-specific terms and conditions, all information incorporated into the electronic bid form by Agency or Bidder, the Bidder’s responses to Questions, the Bidder’s PEPPM Bid Quote Sheet(s), the Bidder’s pricing spreadsheet, the Bidder’s PEPPM State Selection Form, the Bidder’s Ancillary Services Form, this Agreement, all other attachments and exhibits to the request for bids, all addenda to the request for bids issued prior to the Bid Opening Date, and all subsequent written amendments to the Agreement (e.g. adding state-specific terms and conditions). The Contract Documents form the “Contract” between Agency for the Contract term, and during any authorized extensions.
2. Awarded Vendor agrees to furnish products and services related to the RFB in accordance with the RFB Terms and Conditions and Contract.

3. The Contract shall commence on January 1, 2019 and end on December 31, 2021. Agency and Awarded Vendor may elect to extend the term of the Contract as set forth in the Terms and Conditions.
4. Awarded Vendor agrees to honor submitted bid prices and pricing formulas according to all terms and conditions of the Contract Documents to all eligible buying organizations in California as authorized to purchase the products included in the Awarded Vendor's bid.
5. Where Awarded Vendor agreed to extend its quoted price formulas and effective prices to eligible LEAs in states and territories outside of California, Awarded Vendor agrees to extend those quoted bid prices and formulas according to all terms and conditions of the Contract Documents to those other LEAs and eligible agencies.
6. Awarded Vendor agrees to remit the Transaction Fee in accordance with the terms and conditions set forth in the Contract.
7. This Agreement shall be governed by and construed under the laws of the state of California, any disputes shall be determined in the court of general jurisdiction in the County of Kern.

IN WITNESS WHEREOF, the parties, intending to be legally bound, have caused their hands to be affixed.

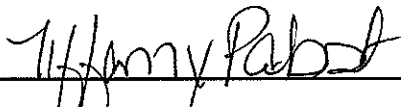
Vendor Signature 
 Signatory Title Sr. Contract Manager
 Vendor Name Tiffany Pabst
 Address 3017 Douglas Blvd. Suite 300
 City, State, Zip Roseville, CA 95661
 Date October 1, 2018

KCSOS Signature _____
For Mary C. Barlow, Kern County Superintendent of Schools
 Signatory Title _____
 Agency Name Kern County Superintendent of Schools
 Address 1300 17th Street
 City, State, Zip Bakersfield, CA 93301
 Date _____



October 1, 2018

PEPPM California
Kern County Superintendent of Schools (KCSOS)
1300 17th Street
Bakersfield, California 93301

RFP: PEPPM 2019 Product Line Bid – California
Electronic Bid Number: 528899

We are pleased to provide a response for the above referenced RFP for PEPPM.

When many organizations examine their TCO (total cost of ownership) for technology, they discover their habits may be costing them - the burden of maintaining older technology, reporting losses due to “upside-down” asset values, mid-life upgrades and productivity losses from downtime.

Dell Financial Services (DFS) has lease and financing options to help you free up capital, meet your equipment replacement goals and shift costs between capital and expense budgets. Your DFS financial specialist can find the right solution based upon your specific technology and budget needs.

We appreciate this opportunity and look forward to discussing this in further detail. Should you have any questions or need clarifications, please do not hesitate to contact me at 925-216-2779.

Sincerely,

Robert Kraft
Dell Financial Services L.L.C.
Account Executive Southern California- Education
Robert.Kraft@dell.com



Dell Financial Services Overview

DFS is a dedicated financial services entity focused on the financial and technology management needs of DellEMC's customers. Obtaining computer equipment is only the beginning. Information technology, its acquisition, management and disposition, is an emerging challenge that requires state of the art tools for successful administration. DFS in its mission to relate directly to the customer and the customer's individual needs is ready, willing and capable of assisting PEPPM –CA with the acquisition of information technology.

Over the past twenty-one years, DFS has originated over \$76 billion in leases, an unprecedented performance in the leasing industry. A direct result of this success is DFS' ability to structure the contractual leasing relationship in a fashion that is mutually satisfactory to the parties. DFS looks forward to meeting with you and establishing a leasing program, tailored around your specific needs.

DFS has grown by contributing to the success of our customers. By accessing DellEMC's online business model, we're able to offer complete technology acquisition and management solutions, featuring:

Helping your institution get the technology it needs and expand acquisition opportunities within current budget allocations — that's our mission at DFS. You'll find a wide range of flexible programs all aimed at making acquisition easy and affordable, whether you're on a regular rotation program, unsure of your long-term plans or seeking an affordable method of financing equipment ownership. Founded with Dell customers in mind, DFS delivers a unique focus on the complete customer experience. At DFS we're with you every step of the way — from dedicated sales team introductions to an easy end-of-term process.

Here are just a few ways we are working to make your financing experience easier:

- **Dedicated Sales Team.** No phone queue to dial in. You have direct access to your DFS sales team members, from your DFS field executive to your end-of-lease coordinator.
- **DFS Online Services.** Dell customers can access DFS Online Services from their Premier portal, allowing virtually anytime access to critical information and an easy way to handle routine tasks to make asset management and your end-of-lease process more efficient.

The Lease vs. Own Decision

Conservation of capital

Leasing allows a company to conserve capital for investment in its business rather than in the infrastructure.

Payment flexibility

Provides payment flexibility tailored to specific cash flow or budgetary requirements.

Operational flexibility

Maximize your IT investments by matching your lease term to the useful life of the asset in your organization's environment.

Residual value risk

Help reduce the risk of ownership, liability and cost usually associated with asset disposal and re-marketing.

Proper equipment disposal

The requirement to properly dispose of surplus equipment, both for ethical and regulatory reasons, places the responsibility on the legal owner for its proper disposal.

No Escrow

DFS does not utilize escrow accounts for any of their lease options. Leasing with DFS alleviates concerns of sudden non-funding due to changes in the global economy that are out of your control. DFS guarantees payment to your vendors as long as your credit has no substantial changes and all documents have been received by DFS.

Lease Program Overview

DFS' leasing programs offer flexible end-of lease options designed to suit each entity's unique needs. Lease terms are generally from 24 through 60 months and are tailored to match the essential useful life of the leased equipment to the lease term. Lease payments can be billed monthly, quarterly, semi-annually or annual, in advance.

Master Lease Program

For large-scale acquisitions (in excess of \$250,000 in leased equipment over the next 12 months) and/or the ability to upgrade PC-related equipment continually, with minimal additional paperwork, the Master Lease Program is the most efficient choice.

Rotation Programs	Ideal for	Term	Advantages
Dell Flex	Customers on a Technology rotation program	Exercise the option to purchase the products at XX% (desktops and notebooks) or XX% (printers and servers) of the equipment's original value	<ul style="list-style-type: none"> • It allows you to migrate to the latest technology prior to the end of the lease term through a simple, streamlined process. • It provides your organization with an integrated asset disposal mechanism. This may eliminate property bidding which has an associated cost. • It provides you with a hedge against technology obsolescence.
Fair Market Value (FMV)		At the end of the lease term, return to upgrade on a new lease or purchase the equipment for its then current Fair Market Value.	<ul style="list-style-type: none"> • Maximizes useful life of equipment. • Helps reduce IT costs by ensuring regular equipment upgrades on a new lease. • Deferred payment option may apply for qualified customers.
Ownership Programs	Ideal for	Term	Advantages
Tax Exempt Lease Purchase (TELP)	Customers planning to keep their equipment but desire a lease financing solution	Purchase leased equipment at end of the lease term for \$1.	<ul style="list-style-type: none"> • The TELP is only available to states and their political subdivisions (most public K-12 and Higher Education institutions generally qualify). • Equipment may qualify for standard depreciation schedule (consult your tax advisor) • Deferred payment option may apply for qualified customers.
\$1 Buyout		Purchase leased equipment at end of the lease term for \$1.	<ul style="list-style-type: none"> • Offers end-of-lease ownership option with cost-effective solution for cash flow management • Equipment may qualify for standard depreciation schedule (consult your tax advisor) • Deferred payment option may apply for qualified customers.



Online Tools

At DFS, we know that acquiring Dell equipment is just one element of your extensive asset management program. So we have created DFS Online Services, the web-based asset management system that places access to information regarding your leased assets right at your fingertips.

With DFS Online Services, qualified customers will be able to search for contract and asset data, request location and cost center changes, accept lease schedules online and much more. Just access DFS Online Services through your Dell Premier site and you will be on your way to achieving greater control over your Dell leased assets program.

Review and Manage Your Contracts. We've given you one place to view your assets. You can search by contracts, contract number, commencement date or termination date. If you need more information, you can sort by a variety of fields, from equipment cost to payment amount to payment schedules. Most importantly, all information is available for download in either CSV or XML formats for easy import into your current asset management program.

Streamline End-of-Lease Tasks. No more phone calls when it comes to end-of-lease requests.² Packing slips, buyout quotes, early termination quotes and renewal/extension quotes can now be obtained online. Your request will be reviewed by our service representatives and posted on the Requested End-of-Lease Documents page.

Immediately Access Your Documents. Eliminate the paper chase. With DFS Online Services, the documents associated with your lease agreements are now online. Think of it as an online filing system. Through our Online Schedule Acceptance feature, you can access your lease schedules. Reviewing and accepting lease schedules has never been easier.

Generate Custom Reports. Perhaps the most important feature of DFS Online Services is your ability to create various reports and download them for later review and use.

- Active Asset Report – an overview of your assets by contract number or by date
- Disposed Asset Report – contract level detail on assets received by DFS and removed from our billing cycle
- Received Asset Report – confirm assets returned at the end of the lease
- Custom Report – build your own report from the wide range of lease asset fields

Reports are available for download and will be accessible for a period of seven days. You can check the status of your online requests easily by referring to the dashboard on the home page.



End of Lease

DFS recognizes that an ineffective end-of-term process can diminish the potential benefits of leasing. This is why DFS has incorporated direct customer feedback into our end-of-lease approach to deliver the best customer experience possible. Our relationship with Dell aligns our approach to technology refresh with your interest in taking advantage of the technological and financial benefits of replacing equipment on a timely basis. DFS understands that the elimination of obsolete systems promotes the continued mission of your business and the role of the technology department. Accordingly, your dedicated DFS sales team will work with you to provide the tools to help you make the right decisions at lease termination.

Following are some of the valuable benefits to our end-of-lease program.

No Lengthy Automatic Renewal Periods - Automatic lease renewals of 6 and 12 months can put a kink in the total cost of ownership savings you hoped to gain from leasing. Under our MLA, the automatic renewal period is simply month-to-month at the end-of-term until you are ready to make your decision to refresh, renew or purchase your existing leased assets.

End-of-Lease Administration - DFS feels that one of the keys to an efficient end-of-lease process is a clear customer understanding of the roles and responsibilities of the end-of-lease process. DFS maintains resources specifically to assist you with management of leased equipment coming out of the leasing cycle.

DFSOS - DFSOS helps reduce the time and costs associated with the lease process and it is user-friendly. This web-enabled tool will help you generate leased asset reports and end-of-lease requests. As a special feature, Dell customers can access DFSOS from their Premier portal, allowing anytime access to critical information and an easy way to handle routine tasks to make asset management and your end-of-lease process more efficient.

Fewer Damage Charge Categories - DFS offers a simple and easy returns process with only a limited number of missing, wrong, and damaged categories. We do not bill MWD in excess of a system's Fair Market Value and all charges below assume at least 80% of the items are returned without other damages or missing items. The following chart shows DFS' MWD categories and pricing.

DFS Missing, Wrong & Damage Charges	
Broken/ Damaged Latches	\$50.00
Excessive Physical Damage	\$150.00*
LCD Cracked Beyond Repair	\$150.00
Missing/Damaged Hard Drive	\$0.60/Gb
Missing/Damaged Memory	\$0.05/Mb
Missing/Damaged Keys (Notebook)	\$50.00
Failure to Boot	\$150.00



Lease Return Services

Packing and Transportation

Focused on improving your internal efficiencies, our Lease Return Services provide you with competitive pricing, and the ability to pre-pay costs. Below are just some of the benefits of choosing this service:

- Enjoy the convenience of having your packing materials and labor included at the pick-up
- Reduce your financial exposure with coverage for in-transit damage
- Spend less time arranging complex transportation logistics and more time focused on day-to-day activities

Data Wipe Certification

In today's environment, taking the right steps to help you protect data is paramount. Your institution can use this service and receive a DFS Data Wipe Certification which will provide you with a certificate of data removal for your returned DFS leased assets that have reached lease conclusion.

Using our United States based asset returns facility, DFS will perform a three-pass overwrite of the data on the hard drive. The three-pass overwrite will remove drive partitions, drive partition tables, and master boot records. Hard drives that fail the three-pass process will be destroyed and disposed of to meet all applicable local, county and state regulatory laws and requirements. The chart below shows pricing for our data wipe service.

Data Wipe Certification Pricing	
Description	Charge
All Products (Dell and Non-Dell)	\$15.00

Minority Solution

Through a strategic arrangement with Pharos Financial Services L.P. (PFS), DFS can help facilitate ownership and rotation financing programs to customers desiring a Minority Business Enterprise (MBE) or Historically Underutilized Business (HUB) lessor. Available in the United States only.

These programs can benefit customers in a number of ways:

- Demonstrate public policy support
- May provide bidding advantages on government contracts
- Cultivate greater customer loyalty



The collaboration between PFS and DFS also offers a number of advantages:

- Access to DFS financing program benefits including customized payment structures, electronic invoicing, asset reporting and a flexible end-of-lease process
- Single-source contact for equipment and leasing needs
- One-stop shopping for service
- Speed to production and delivery
- Easy equipment upgrades and enhancements

Unlike a complete outsourcing solution, you remain in total control of key strategic decisions with PFS minority financing solutions.

Response to Specific RFP Provisions

Many of the terms and conditions presented in the RFP are applicable to straight procurement/purchase transactions and not to leasing. The leasing arrangement will establish a long-term (beyond net 30 days) financial relationship between DFS (the Lessor) and PEPPM's Eligible Entity (the Lessee). **Therefore, the terms and conditions of a mutually beneficial and duly executed DFS Lease Agreement shall take precedence over any other terms and conditions.**

DFS Sales Team

DFS Account Executive- Education for Southern California

Robert Kraft	Office Phone	925-216-2779
	Email	Robert.Kraft@Dell.com

DFS Financial Services Representative- Education and State and Local Government for Southern California

Andre Williams	Office Phone	512-728-4037
	Email	Andre.D.Williams@Dell.com

DFS Account Executive- Education for Northern California

Gary Albright	Office Phone	503-367-0631
	Email	Gary.Albright@Dell.com

DFS Financial Services Representative- Education and State and Local Government for Northern California

Tiffany Collins	Office Phone	512-723-7225
	Email	Tiffany.Collins@Dell.com



Dell Financial Services Master Lease Agreement



**EFFECTIVE DATE:
MASTER LEASE AGREEMENT NO.**

LESSOR: DELL FINANCIAL SERVICES L.L.C.	LESSEE:
<u>Payment Address:</u> Payment Processing Center 4319 Collection Center Dr. Chicago, IL 60693	<u>Principal Address:</u> _____ _____ _____
	Fax: _____ Attention: _____

This Master Lease Agreement (this "Agreement"), effective as of the Effective Date set forth above, is between the Lessor and Lessee named above. Capitalized terms have the meaning set forth in this Agreement.

1. LEASE.

(a) Lessor hereby leases to Lessee and Lessee hereby leases the equipment ("Products"), Software (defined below), and services or fees, where applicable, as described in any lease schedule ("Schedule"). Each Schedule shall incorporate by reference the terms and conditions of this Agreement and contain such other terms as are agreed to by Lessee and Lessor. Each Schedule shall constitute a separate lease of Products ("Lease"). In the event of any conflict between the terms of a Schedule and the terms of this Agreement, the terms of the Schedule shall prevail. Lessor reserves all rights to the Products not specifically granted to Lessee in this Agreement or in a Schedule. Execution of this Agreement does not create an obligation of either party to lease to or from the other.

2. ACCEPTANCE DATE; SCHEDULE.

(a) Subject to any right of return provided by the Product seller ("Seller") named on the Schedule, Products are deemed to have been irrevocably accepted by Lessee upon delivery to Lessee's ship to location ("Acceptance Date"). Lessee shall be solely responsible for unpacking, inspecting and installing the Products.

(b) Lessor shall deliver to Lessee a Schedule for Products. Lessee agrees to sign or otherwise authenticate (as defined under the Uniform Commercial Code, "UCC") and return each Schedule by the later of the Acceptance Date or five (5) days after Lessee receives a Schedule from Lessor. If the Schedule is not signed or otherwise authenticated by Lessee within the time provided in the prior sentence, then upon written notice from Lessor and Lessee's failure to cure within five (5) days of such notice, Lessor may require the Lessee to purchase the Products by paying the Product Cost charged by the Seller, plus any shipping charges, Taxes or Duties (defined below) and interest at the Overdue Rate accruing from the date the Products are shipped through the date of payment. If Lessee returns any leased Products in accordance with the Seller's return policy, it will notify Lessor. When Lessor receives a credit from the Seller for the returned Product, the Schedule will be deemed amended to reflect the return of the Product and Lessor will adjust its billing records and Lessee's invoice for the applicable Lease. In addition, Lessee and Lessor agree that a signed Schedule may be amended by written notice from Lessor to Lessee provided such notice is (i) to correct the serial (or service tag) number of Products or (ii) to adjust the related Rent (defined below) on the Schedule (any increase up to 15% or any decrease) caused by any change made by Lessee in Lessee's order with the Seller.

3. TERM.

The initial term (the "Primary Term") for each Lease shall begin on the date set forth on the Schedule as the Commencement Date (the

"Commencement Date"). The period beginning on the Acceptance Date and ending on the last day of the Primary Term, together with any renewals or extensions thereof, is defined as the "Lease Term. The Lease is non-cancelable by Lessee, except as expressly provided in Section 5.

4. RENT; TAXES; PAYMENT OBLIGATION.

(a) The rental payment amount ("Rent"), and the payment period for each installment of Rent ("Payment Period") shall be stated in the Schedule. A prorated portion of Rent calculated based on a 30-day month, 90-day quarter or 360-day year (as appropriate) for the period from the Acceptance Date to the Commencement Date shall be added to the first payment of Rent. All Rent and other amounts due and payable under this Agreement or any Schedule shall be paid to Lessor in lawful funds of the United States of America at the payment address for Lessor set forth above or at such other address as Lessor may designate in writing from time to time. Whenever Rent and other amounts payable under a Lease are not paid when due, Lessee shall pay interest on such amounts at a rate equal to the lesser of 1% per month or the highest such rate permitted by applicable law ("Overdue Rate"). Rent shall be due and payable whether or not Lessee has received an invoice showing such Rent is due. Late charges and reasonable attorney's fees necessary to recover Rent and other amounts owed hereunder are considered an integral part of this Agreement.

(b) EACH LEASE SHALL BE A NET LEASE. In addition to Rent, Lessee shall pay sales, use, excise, purchase, property, added value or other taxes, fees, levies or assessments lawfully assessed or levied against Lessor or with respect to the Products and the Lease ("collectively "Taxes"), and customs, duties or surcharges on imports or exports (collectively, "Duties"), plus all expenses incurred in connection with Lessor's purchase and Lessee's use of the Products, including but not limited to shipment, delivery, installation, and insurance. Unless Lessee provides Lessor with a tax exemption certificate acceptable to the relevant taxing authority prior to Lessor's payment of such Taxes, Lessee shall pay to Lessor all Taxes and Duties upon demand by Lessor. Lessor may, at its option, invoice Lessee for estimated personal property tax with the Rent Payment. Lessee shall pay all utility and other charges incurred in the use and maintenance of the Products.

(c) EXCEPT AS EXPRESSLY PROVIDED IN SECTION 5, LESSEE'S OBLIGATION TO PAY ALL RENT AND OTHER AMOUNTS WHEN DUE AND TO OTHERWISE PERFORM AS REQUIRED UNDER THIS AGREEMENT AND EACH SCHEDULE SHALL BE ABSOLUTE AND UNCONDITIONAL, AND SHALL NOT BE SUBJECT TO ANY ABATEMENT, REDUCTION, SET-OFF, DEFENSE, COUNTERCLAIM, INTERRUPTION, DEFERMENT OR RECOUPMENT FOR ANY REASON WHATSOEVER WHETHER ARISING OUT OF ANY CLAIMS BY LESSEE AGAINST LESSOR, LESSOR'S ASSIGNS, THE SELLER, OR THE SUPPLIER OR MANUFACTURER OF THE PRODUCTS, TOTAL OR PARTIAL LOSS OF THE PRODUCTS OR THEIR USE OR POSSESSION, OR OTHERWISE. If any Product is unsatisfactory for any reason, Lessee shall make its claim solely against the Seller of such Product (or the Licensor in the case of Software, as defined

below) and shall nevertheless pay Lessor or its assignee all amounts due and payable under the Lease.

5. APPROPRIATION OF FUNDS.

(a) Lessee intends to continue each Schedule for the Primary Term and to pay the Rent and other amounts due thereunder. Lessee reasonably believes that legally available funds in an amount sufficient to pay all Rent during the Primary Term can be obtained and agrees to do all things lawfully within its power to obtain and maintain funds from which the Rent and other amounts due may be paid.

(b) Lessee may terminate a Schedule in whole, but not in part by giving at least sixty (60) days notice prior to the end of the then current Fiscal Period (as defined in the Lessee's Secretary/Clerk's Certificate provided to Lessor) certifying that: (1) sufficient funds were not appropriated and budgeted by Lessee's governing body or will not otherwise be available to continue the Lease beyond the current Fiscal Period; and (2) that the Lessee has exhausted all funds legally available for payment of the Rent beyond the current Fiscal Period. Upon termination of the Schedule, Lessee's obligations under the Schedule (except those that expressly survive the end of the Lease Term) and any interest in the Products shall cease and Lessee shall surrender the Products in accordance with Section 8. Notwithstanding the foregoing, Lessee agrees that, without creating a pledge, lien or encumbrance upon funds available to Lessee in other than its current Fiscal Period, it will use its best efforts to take all action necessary to avoid termination of a Schedule, including making budget requests for each Fiscal Period during each applicable Lease Term for adequate funds to meet its Lease obligations and to continue the Schedule in force.

(c) Lessor and Lessee intend that the obligation of Lessee to pay Rent and other amounts due under a Lease constitutes a current expense of Lessee and is not to be construed to be a debt in contravention of any applicable constitutional or statutory limitation on the creation of indebtedness or as a pledge of funds beyond Lessee's current Fiscal Period.

6. LICENSED MATERIALS.

Software means any operating system software or computer programs included with the Products (collectively, "Software"). "Licensed Materials" are any manuals and documents, end user license agreements, evidence of licenses, including without limitation, any certificate of authenticity and other media provided in connection with such Software, all as delivered with or affixed as a label to the Products. Lessee agrees that this Agreement and any Lease (including the sale of any Product pursuant to any purchase option) does not grant any title or interest in Software or Licensed Materials. Any use of the terms "sell," "purchase," "license," "lease," and the like in this Agreement or any Schedule with respect to Licensed Materials shall be interpreted in accordance with this Section 6.

7. USE; LOCATION; INSPECTION.

Lessee shall (a) comply with all terms and conditions of any Licensed Materials and (b) possess and operate the Products only (i) in accordance with the Seller's supply contract and any service provider maintenance and operating manuals, documentation and applicable laws; and (ii) for the business purposes of Lessee. Lessee agrees not to move Products from the location(s) specified in the Schedule without providing Lessor with at least 30 days prior written notice, and then only to a location within the continental United States and at Lessee's expense. Without notice to Lessor, Lessee may temporarily use laptop computers at other locations, including outside the United States, provided Lessee complies with the United States Export Control Administration Act of 1979 and the Export Administration Act of 1985, as those Acts are amended from time to time (or any successor or similar legislation). Provided Lessor complies with Lessee's reasonable security requirements, Lessee shall allow Lessor to inspect the premises where the Products are located from time to time during reasonable hours after reasonable notice in order to confirm Lessee's compliance with its obligations under this Agreement.

8. RETURN.

At the expiration or earlier termination of any Schedule, and except for Products purchased pursuant to any purchase option under the Lease, if any, Lessee will (a) remove all proprietary data from the Products; and (b) return

them to Lessor at a place within the contiguous United States designated by Lessor. Upon return of the Products, Lessee's right to the operating system Software in returned Products will terminate and Lessee will return the Products with the original certificate of authenticity (attached and unaltered) for the original operating system Software. Lessee agrees to deinstall and package the Products for return in a manner which will protect them from damage. Lessee shall pay all costs associated with the packaging and return of the Products and shall promptly reimburse Lessor for all costs and expenses for missing or damaged Products or operating system Software. If Lessee fails to return all of the Products at the expiration of the Lease Term or earlier termination (other than for non-appropriation) in accordance with this Section, the Lease Term with respect to the Products that are not returned shall continue to be renewed as described in the Schedule.

9. RISK OF LOSS; MAINTENANCE; INSURANCE.

(a) From the time the Products are delivered to Lessee's ship to location until the Products are returned to Lessor's designated return location or purchased by Lessee, Lessee agrees: (i) to assume the risk of loss or damage to the Products; (ii) to maintain the Products in good operating condition and appearance, ordinary wear and tear excepted, (iii) to comply with all requirements necessary to enforce all warranty rights; and (iv) to promptly repair any repairable damage to the Products. For the Lease Term, Lessee shall ensure that the Products are covered by a manufacturer approved maintenance agreement or, with Lessor's prior consent, are self-maintained in accordance with the standards set forth herein. At all times, Lessee shall provide the following insurance: (x) casualty loss insurance for the Products for no less than the Stipulated Loss Value (defined below) naming Lessor as a loss payee; (y) liability insurance with respect to the Products for no less than an amount as required by Lessor, with Lessor named as an additional insured; and (z) such other insurance as may be required by law which names Lessee as an insured and Lessor as an additional insured. Upon Lessor's prior written consent, Lessee may provide this insurance pursuant to Lessee's existing self insurance policy or as provided for under state law. Lessee shall provide Lessor with either an annual certificate of third party insurance or a written description of its self insurance policy or relevant law, as applicable. The certificate of insurance will provide that Lessor shall receive at least ten (10) days prior written notice of any material change to or cancellation of the insurance policy or Lessee's self-insurance program, if previously approved by Lessor. If Lessee does not give Lessor evidence of insurance in accordance with the standards herein, Lessor has the right, but not the obligation, to obtain such insurance covering Lessor's interest in the Products for the Lease Term, including renewals. If Lessor obtains such insurance, Lessor will add a monthly, quarterly or annual charge (as appropriate) to the Rent to reimburse Lessor for the insurance premium and Lessor's then current insurance administrative fee.

(b) If the Products are lost, stolen, destroyed, damaged beyond repair or in the event of any condemnation, confiscation, seizure or expropriation of such Products ("Casualty Products"), Lessee shall promptly (i) notify Lessor of the same and (ii) pay to Lessor the Stipulated Loss Value for the Casualty Products. The Stipulated Loss Value is an amount equal to the sum of (a) all Rent and other amounts then due and owing (including interest at the Overdue Rate from the due date until payment is received) under the Lease, plus (b) the present value of all future Rent to become due under the Lease during the remainder of the Lease Term, plus (c) the present value of the estimated in place Fair Market Value of the Product at the end of the Primary Term as determined by Lessor; plus (d) all other amounts to become due and owing during the remaining Lease Term. Unless priced as a tax-exempt Schedule, each of (b) and (c) shall be calculated using the federal funds rate target reported in the Wall Street Journal on the Commencement Date of the applicable Schedule. The discount rate applicable to tax-exempt Schedules shall be federal funds rate target reported in the Wall Street Journal on the Commencement Date of the applicable Schedule less 100 basis points.

10. ALTERATIONS.

Lessee shall, at its expense, make such alterations to the Products during the Lease Term as are legally required or provided at no charge by Seller. Lessee may make other alterations, additions or improvements to the Products provided that any alteration, addition or improvement shall be readily removable and shall not materially impair the value or utility of the Products. Upon the return of any Product to Lessor, any alteration, addition or improvement that is not removed by Lessee shall become the property of

Lessor free and clear of all liens and encumbrances.

11. REPRESENTATIONS AND WARRANTIES OF LESSEE.

Lessee represents, warrants and covenants to Lessor and will provide to Lessor at Lessor's request all documents deemed necessary or appropriate by Lessor, including Certificates of Insurance, financial statements, Secretary or Clerk Certificates, essential use information or documents (such as affidavits, notices and similar instruments in a form satisfactory to Lessor) and Opinions of Counsel (in substantially such form as provided to Lessee by Lessor and otherwise satisfactory to Lessor) to the effect that, as of the time Lessee enters into this Agreement and each Schedule that:

(a) Lessee is an entity duly organized and existing under and by virtue of the authorizing statute or constitutional provisions of its state and is a state or political subdivision thereof as described in Section 103(a) of the Internal Revenue Code of 1986, as amended, and the regulations promulgated thereunder as in effect and applicable to the Agreement or any Schedule, with full power and authority to enter into this Agreement and any Schedules and perform all of its obligations under the Leases;

(b) This Agreement and each Schedule have been duly authorized, authenticated and delivered by Lessee by proper action of its governing board at a regularly convened meeting and attended by the requisite majority of board members, or by other appropriate official authentication, as applicable, and all requirements have been met and procedures have occurred in order to ensure the validity and enforceability of this Agreement against Lessee;

(c) This Agreement and each Schedule constitute the valid, legal and binding obligations of Lessee, enforceable in accordance with their terms;

(d) No other approval, consent or withholding of objection is required from any federal, state or local governmental authority or instrumentality with respect to the entering into or performance by Lessee of the Agreement or any Schedule and the transactions contemplated thereby;

(e) Lessee has complied with such public bidding requirements and other state and federal laws as may be applicable to the Agreement and any Schedule and the acquisition by Lessee of the Products;

(f) The entering into and performance of the Agreement or any Schedule will not (i) violate any judgment, order, law or regulation applicable to Lessee; (ii) result in any breach of, or constitute a default under, any instrument to which the Lessee is a party or by which it or its assets may be bound; or (iii) result in the creation of any lien, charge, security interest or other encumbrance upon any assets of the Lessee or on the Products, other than those created pursuant to this Agreement;

(g) There are no actions, suits, proceedings, inquiries or investigations, at law or in equity, before or by any court, public board or body, pending or threatened against or affecting Lessee, nor to the best of Lessee's knowledge and belief is there any basis therefor, which if determined adversely to Lessee will have a material adverse effect on the ability of Lessee to fulfill its obligations under the Agreement or any Schedule;

(h) The Products are essential to the proper, efficient and economic operation of Lessee or to the services which Lessee provides to its citizens. Lessee expects to make immediate use of the Products, for which it has an immediate need that is neither temporary nor expected to diminish during the applicable Lease Term. The Products will be used for the sole purpose of performing one or more of Lessee's governmental or proprietary functions consistent within the permissible scope of Lessee's authority; and

(i) Lessee has, in accordance with the requirements of law, fully budgeted and appropriated sufficient funds to make all Rent payments and other obligations under this Agreement and any Schedule during the current Fiscal Period, and such funds have not been expended for other purposes.

12. WARRANTY ASSIGNMENT; EXCLUSION OF WARRANTIES; LIMITATIONS ON LIABILITY; FINANCE LEASE.

(a) Provided no Event of Default has occurred and is continuing, Lessor assigns to Lessee for the Lease Term the benefit of any Product warranty and right of return provided by any Seller.

(b) LESSEE ACKNOWLEDGES THAT LESSOR DID NOT SELECT,

MANUFACTURE, SUPPLY OR LICENSE ANY PRODUCT AND THAT LESSEE HAS MADE THE SELECTION OF PRODUCTS BASED UPON ITS OWN JUDGMENT AND EXPRESSLY DISCLAIMS ANY RELIANCE ON STATEMENTS MADE BY LESSOR OR ITS AGENTS. LESSOR LEASES THE PRODUCTS AS-IS AND MAKES NO WARRANTY, EXPRESS, IMPLIED, OR OTHERWISE, INCLUDING, BUT NOT LIMITED TO, ANY WARRANTIES OF DESIGN, MERCHANTABILITY, OR FITNESS FOR A PARTICULAR PURPOSE. LESSEE HEREBY WAIVES ANY CLAIM IT MIGHT HAVE AGAINST LESSOR OR ITS ASSIGNEE FOR ANY LOSS, DAMAGE OR EXPENSE CAUSED BY OR WITH RESPECT TO ANY PRODUCTS.

(c) IN NO EVENT SHALL LESSOR BE LIABLE FOR ANY ACTUAL, SPECIAL, INDIRECT, INCIDENTAL OR CONSEQUENTIAL DAMAGES ARISING OUT OF OR RELATED TO THIS AGREEMENT, ANY SCHEDULE OR THE SALE, LEASE OR USE OF ANY PRODUCTS EVEN IF LESSOR IS ADVISED IN ADVANCE OF THE POSSIBILITY OR CERTAINTY OF SUCH DAMAGES AND EVEN IF LESSEE ASSERTS OR ESTABLISHES A FAILURE OF ESSENTIAL PURPOSE OF ANY LIMITED REMEDY PROVIDED IN THIS AGREEMENT.

(d) Lessee agrees that it is the intent of both parties that each lease qualify as a statutory finance lease under Article 2A of the UCC. Lessee acknowledges either (i) that Lessee has reviewed and approved any written supply contract covering the Products purchased from the Seller for lease to Lessee or (ii) that Lessor has informed or advised Lessee, in writing, either previously or by this Agreement, that Lessee may have rights under the supply contract evidencing the purchase of the Products and that Lessee should contact the Seller for a description of any such rights. TO THE FULLEST EXTENT PERMITTED BY APPLICABLE LAW, LESSEE HEREBY WAIVES ALL RIGHTS AND REMEDIES CONFERRED UPON A LESSEE BY ARTICLE 2A OF THE UCC.

13. EVENTS OF DEFAULT.

It shall be an event of default hereunder and under any Schedule ("Event of Default") if:

(a) Lessee fails to pay any Rent or other amounts payable under this Agreement or any Schedule within 15 days after the date such payment is due;

(b) Any representation or warranty made by Lessee to Lessor in connection with this Agreement, any Schedule or any other Documents is at the time made materially untrue or incorrect;

(c) Lessee fails to comply with any other obligation or provision of this Agreement or any Schedule and such failure shall have continued for 30 days after notice from Lessor;

(d) Lessee (i) is generally not paying its debts as they become due or (ii) takes action for the purpose of invoking the protection of any bankruptcy or insolvency law, or any such law is invoked against or with respect to Lessee or its property and such petition is not dismissed within 60 days;

(e) Any provision of this Agreement ceases to be valid and binding on Lessee, is declared null and void, or its validity or enforceability is contested by Lessee or any governmental agency or authority whereby the loss of such provision would materially adversely affect the rights or security of Lessor, or Lessee denies any further liability or obligation under this Agreement; or

(f) Lessee is in default under any other lease, contract, or obligation now existing or hereafter entered into with Lessor or Seller or any assignee of Lessor.

14. REMEDIES; TERMINATION.

(a) Upon an Event of Default under any Schedule, all of Lessee's rights (including its rights to the Products), but not its obligations thereunder, shall automatically be canceled without notice and Lessor may exercise one or more of the following remedies in its sole discretion:

(i) require Lessee to return any and all such Products in accordance with Section 8, or if requested by Lessor, to assemble the Products in a single location designated by Lessor and to grant Lessor the right to enter the premises where such Products are located (regardless of where assembled) for the purpose of repossession;

(ii) sell, lease or otherwise dispose of any or all Products (as agent and attorney-in-fact for Lessee to the extent necessary) upon such terms and in such manner (at public or private sale) as Lessor deems advisable in its sole discretion ("Disposition");

(iii) declare immediately due and payable as a pre-estimate of liquidated damages for loss of bargain and not as a penalty, the Stipulated Loss Value of the Products in lieu of any further Rent, in which event Lessee shall pay such amount to Lessor within 10 days after the date of Lessor's demand; or

(iv) proceed by appropriate court action either at law or in equity (including action for specific performance) to enforce the performance by Lessee or recover damages associated with such Event of Default or exercise any other remedy available to lessor in law or in equity.

(b) Lessee shall pay all costs and expenses arising or incurred by Lessor, including reasonable attorney fees, in connection with or related to an Event of Default or the repossession, transportation, re-furbishing, storage and Disposition of any or all Products ("Default Expenses"). In the event Lessor recovers proceeds (net of Default Expenses) from its Disposition of the Products, Lessor shall credit such proceeds against the owed Stipulated Loss Value. Lessee shall remain liable to Lessor for any deficiency. With respect to this Section, to the extent the proceeds of the Disposition (net of Default Expenses) exceed the Stipulated Loss Value owed under the Lease, or Lessee has paid Lessor the Stipulated Loss Value, the Default Expenses and all other amounts owing under the Lease, Lessee shall be entitled to such excess and shall have no further obligations with respect to such Lease. All rights of Lessor are cumulative and not alternative and may be exercised by Lessor separately or together.

15. QUIET ENJOYMENT.

Lessor shall not interfere with Lessee's right to possession and quiet enjoyment of Products during the relevant Lease Term, provided no Event of Default has occurred or is continuing. Lessor represents and warrants that as of the Commencement Date of the applicable Schedule, Lessor has the right to lease the Products to Lessee.

16. INDEMNIFICATION.

Without waiving the doctrines of sovereign immunity and immunity from suit, and to the extent allowed by the laws and Constitution of the State of Texas, Lessee assumes all risks and liabilities, whether or not covered by insurance, for loss or damage to any Products and for injury to or death of any person, or damage to any property, whether such injury or death be with respect to agents or employees of Lessee or of third parties, and whether such property damage be to Lessee's property or the property of others, which is proximately caused by the negligent conduct of Lessee, its officers or employees.

17. OWNERSHIP; LIENS AND ENCUMBRANCES; LABELS.

As between Lessor and Lessee, title to the Products (other than the Licensed Materials) is and shall remain with Lessor. Products are considered personal property and Lessee shall, at Lessee's expense, keep the Products free and clear of liens and encumbrances of any kind (except those arising through the acts of Lessor) and shall immediately notify Lessor if Lessor's interest is subject to compromise. Lessee shall not remove, cover, or alter plates, labels, or other markings upon Products by Lessor, Seller or any other supplier.

18. NON-PERFORMANCE BY LESSEE.

If Lessee shall fail to perform any of its obligations hereunder or under any Schedule, Lessor shall have the right but not the obligation to effect such performance and Lessee shall promptly reimburse Lessor for all out of pocket and other reasonable expenses incurred in connection with such performance, with interest at the Overdue Rate.

19. NOTICES.

All notices shall be given in writing and, except for billings and communications in the ordinary course of business, shall be delivered by overnight courier service, delivered personally or sent by certified mail, return receipt requested, and shall be effective on the date of receipt unless mailed, in which case the effective date will be four (4) Business Days after the date of mailing. Notices

to Lessor by Lessee shall be sent to: Dell Financial Services L.P., Legal Department, One Dell Way, Round Rock, TX 78682, or such other mailing address designated in writing by Lessor. Notice to Lessee shall be to the address on the first page of this Agreement or such other mailing address designated in writing by Lessee.

20. ASSIGNMENT.

(a) LESSEE MAY ASSIGN THIS AGREEMENT OR ANY SCHEDULE, OR SUBLEASE ANY PRODUCT(S) WITH THE PRIOR WRITTEN CONSENT OF LESSOR (SUCH CONSENT NOT TO BE UNREASONABLY WITHHELD). LESSOR, AT ITS SOLE DISCRETION, MAY ASSESS AN ADMINISTRATIVE FEE FOR ANY APPROVED ASSIGNMENT OR SUBLEASE. No assignment or sublease shall in any way discharge Lessee's obligations to Lessor under this Agreement or Schedule.

(b) Lessor may at any time without notice to Lessee, but subject to the rights of Lessee, transfer, assign, or grant a security interest in any Product, this Agreement, any Schedule, or any rights and obligations hereunder or thereunder in whole or in part. Lessee hereby consents to such assignments, agrees to comply fully with the terms thereof, and agrees to execute and deliver promptly such acknowledgments, opinions of counsel and other instruments reasonably requested to effect such assignment.

(c) Subject to the foregoing, this Agreement and each Schedule shall be binding upon and inure to the benefit of Lessor, Lessee and their successors and assigns.

21. GOVERNING LAW; JURISDICTION AND VENUE; WAIVER OF JURY TRIAL; STATE CLAIMS PROCESS.

(a) THIS AGREEMENT AND EACH SCHEDULE SHALL BE GOVERNED BY TEXAS LAW WITHOUT REGARD TO ITS CONFLICTS OF LAW PRINCIPLES AND, TO THE EXTENT APPLICABLE, THE ELECTRONIC SIGNATURES IN GLOBAL AND NATIONAL COMMERCE ACT. EXCEPT FOR LESSEES TO WHOM SECTION 21(b) HEREIN APPLIES, LESSEE CONSENTS TO THE JURISDICTION OF ANY FEDERAL COURT LOCATED IN DALLAS COUNTY, TEXAS AND WAIVES ANY OBJECTION TO VENUE IN SUCH COURT, AND FURTHER WAIVES ANY RIGHT TO A TRIAL BY JURY.

(b) This sub-section applies only to Lessees designated a State, agency, department, commission, bureau, board, office, council, court, or other entity that is in any branch of state government and that is created by the constitution or a statute of the State of Texas, including a university system or institution of higher education.

(1) To the extent that Chapter 2260 of the *Texas Government Code*, as it may be amended from time to time ("Chapter 2260"), is applicable to this Agreement and is not preempted by other applicable law, the dispute resolution process provided for in Chapter 2260 shall be used, as further described herein, by the Lessee and Lessor to attempt to resolve any claim for breach of contract made by Lessor:

(A) Lessor's claims for breach of this Agreement that the parties cannot resolve pursuant to other provisions of this Agreement or in the ordinary course of business shall be submitted to the negotiation process provided in subchapter B of Chapter 2260. To initiate the process, Lessor shall submit written notice, as required by subchapter B of Chapter 2260, to Lessee in accordance with the notice provisions in this Agreement. Lessor's notice shall specifically state that the provisions of subchapter B of Chapter 2260 are being invoked, the date and nature of the event giving rise to the claim, the specific contract provision that Lessee allegedly breached, the amount of damages Lessor seeks, and the method used to calculate the damages. Compliance by Lessor with subchapter B of Chapter 2260 is a required prerequisite to Lessor's filing of a contested case proceeding under subchapter C of Chapter 2260. The chief business officer of Lessee, or such other officer of Lessee as may be designated from time to time by Lessee by written notice thereof to Lessor in accordance with the notice provisions in this Agreement, shall examine Lessor's claim and any counterclaim and negotiate with Lessor in an effort to resolve such claims.

(B) If the parties are unable to resolve their disputes under subparagraph (A) of this subsection, the contested case process provided in subchapter C of Chapter 2260 is Lessor's sole and exclusive

process for seeking a remedy for any and all of Lessor's claims for breach of this Agreement by Lessee.

(C) Compliance with the contested case process provided in subchapter C of Chapter 2260 is a required prerequisite to seeking consent to sue from the Legislature under Chapter 107 of the Texas Civil Practices and Remedies Code. The parties hereto specifically agree that (i) neither the execution of this Agreement by Lessee nor any other conduct, action or inaction of any representative of Lessee relating to this Agreement constitutes or is intended to constitute a waiver of Lessee's or the State's sovereign immunity to suit and (ii) Lessee has not waived its right to seek redress in the courts.

(2) (A) If the Lessee against whom Lessor makes a claim does not have rulemaking authority, the submission, processing and resolution of Lessor's claim is governed by the published rules adopted by the Office of the Attorney General pursuant to Chapter 2260, Government Code as currently effective, hereafter enacted or subsequently amended.

(B) If the Lessee against whom Lessor makes a claim has rulemaking authority, and has adopted rules governing the alternative dispute resolution process, the submission, processing and resolution of Lessor's claim shall be governed by such rules, as such rules are then effective, hereafter enacted or subsequently amended. If the Lessee against whom Lessor makes a claim has rulemaking authority, but has not yet adopted rules governing the alternative dispute resolution process, Lessee's claim shall be governed by the rules adopted by the Office of the Attorney General pursuant to Subsection 2260.052 (c), Subchapter B, Government Code.

(3) Neither the occurrence of an event giving rise to a breach of contract claim nor the pendency of a claim constitute grounds for the suspension of performance by Lessor, in whole or in part. Lessee and Lessor agree that any periods set forth in this Agreement for notice and cure of defaults are not waived, delayed, or suspended by Chapter 2260 or this subsection.

22. MISCELLANEOUS .

(a) The headings used in this Agreement are for convenience only and shall have no legal effect. This Agreement shall be interpreted without any strict construction in favor of or against either party.

(b) The provisions of Sections 6, 8, 11, 12(b), 12(c), 12(d), 16, 21 and 22 shall continue in full force and effect even after the termination or expiration of this Agreement or any Schedule.

(c) Failure of Lessor at any time to require Lessee's performance of any obligation shall not affect the right to require performance of that obligation. No term, condition or provision of this Agreement or any Schedule shall be waived or deemed to have been waived by Lessor unless it is in writing and signed by a duly authorized representative of Lessor. A valid waiver is limited to the specific situation for which it was given.

(d) Lessee shall furnish such financial statements of Lessee (prepared in accordance with generally accepted accounting principles) and other information as Lessor may from time to time reasonably request.

(e) If any provision(s) of this Agreement is deemed invalid or unenforceable to any extent (other than provisions going to the essence of this Agreement) the same shall not in any respect affect the validity, legality or enforceability (to the fullest extent permitted by law) of the remainder of this Agreement and the parties shall use their best efforts to replace such illegal, invalid or unenforceable provision with an enforceable provision approximating, to the extent possible, the original intent of the parties.

(f) Unless otherwise provided, all obligations hereunder shall be performed or observed at the respective party's expense.

(g) Lessee shall take any action reasonably requested by Lessor for the purpose of fully effectuating the intent and purposes of this Agreement or any Schedule. If any Lease is determined to be other than a true lease, Lessee hereby grants to Lessor a first priority security interest in the Products and all proceeds thereof. Lessee acknowledges that by signing this Agreement,

Lessee has authorized Lessor to file any financing statements or related filings as Lessor may reasonably deem necessary or appropriate. Lessor may file a copy of this Agreement or any Schedule in lieu of a financing statement.

(h) This Agreement and any Schedule may be signed in any number of counterparts each of which when so executed or otherwise authenticated and delivered shall be an original but all counterparts shall together constitute one and the same instrument. To the extent each Schedule would constitute chattel paper as that term is defined in the UCC, no security interest may be created through the transfer or control or possession, as applicable, of a counterpart of a Schedule other than the original in Lessor's possession marked by Lessor as either "original" or "Counterpart Number 1".

(i) This Agreement and the Schedules hereto between Lessor and Lessee set forth all of the understandings and agreements between the parties and supersede and merge all prior written or oral communications, understandings, or agreements between the parties relating to the subject matter contained herein. Except as permitted herein, this Agreement and any Schedule may be amended only by a writing duly signed or otherwise authenticated by Lessor and Lessee.

(j) If Lessee delivers this Agreement, a signed Schedule, amendment or other document related to the Master Lease or a Schedule (each a "Document") to Lessor by facsimile transmission, and Lessor does not receive all of the pages of that Document, Lessee agrees that, except for any pages which require a signature, Lessor may supply the missing pages to the Document from Lessor's database which conforms to the version number at the bottom of the page. If Lessee delivers a signed Document to Lessor as an e-mail attachment, facsimile transmission or by U.S. mail, Lessee acknowledges that Lessor is relying on Lessee's representation that the Document has not been altered. Lessee further agrees that, notwithstanding any rule of evidence to the contrary, in any hearing, trial or proceeding of any kind with respect to a Document, Lessor may produce a tangible copy of the Document transmitted by Lessee to Lessor by facsimile or as an e-mail attachment and such signed copy shall be deemed to be the original of the Document. To the extent (if any) that the Document constitutes chattel paper under the Uniform Commercial Code, the authoritative copy of the Document shall be the copy designated by Lessor or its assignee, from time to time, as the copy available for access and review by Lessee, Lessor of its assignee. All other copies are deemed identified as copies of the authoritative copy. In the event of inadvertent destruction of the authoritative copy, or corruption of the authoritative copy for any reason or as the result of any cause, the authoritative copy may be restored from a backup or archive copy, and the restored copy shall become the authoritative copy. At Lessor's option, this electronic record may be converted into paper form. At such time, such paper copy will be designated or marked as the authoritative copy of the Document.

EXECUTED by the undersigned on the dates set forth below, to be effective as of the Effective Date.

"Lessee"
BY: _____
NAME: _____
TITLE: _____
DELL FINANCIAL SERVICES L.L.C.
"Lessor"
BY: _____
NAME: _____
TITLE: _____

Lease Schedules:

Fair Market Value Lease

\$1 Out Purchase Option Lease

Tax Exempt Lease Purchase Lease



**TRUE LEASE SCHEDULE NO.
MASTER LEASE AGREEMENT SCHEDULE NO.**

THIS SCHEDULE IS SUBJECT TO AND INCORPORATES THE TERMS AND CONDITIONS OF MASTER LEASE AGREEMENT NO. ("Agreement") DATED BETWEEN DELL FINANCIAL SERVICES L.L.C. ("Lessor") AND ("Lessee").

Lessor hereby agrees to lease and/or make available to Lessee subject to the terms, conditions and provisions set forth in this Schedule and in the Agreement, the Products described below. Any capitalized term used herein and not defined herein shall have the meaning ascribed to it in the Agreement.

PRODUCT DESCRIPTION AND LOCATION: See below or Exhibit "A" attached to and made a part hereof.

PRODUCT SELLER:

<u>Product Description</u>	<u>Product Location</u>	<u>Lessee Purchase Order No.</u>	<u>Rent*</u>	<u>Primary Term (Mos.)</u>	<u>Commencement Date**</u>
See Exhibit 'A'	See Exhibit 'A'				

Total Product Acquisition Cost:

Rent is payable: in

Payment Period:

*Lessee is responsible for applicable taxes, shipping and other amounts as described in the Agreement, and, with the first payment of Rent, any prorated Rent if applicable. Such amounts are further described in Exhibit "A".

**The Commencement Date may be extended for one Payment Period until the Schedule is returned in accordance with the terms in the Agreement. Lessor may charge Lessee prorated Rent accruing from the Acceptance Date to the Commencement Date, as such date is finally determined.

TRUE LEASE PROVISIONS

The following provisions shall apply with respect to this Schedule in addition to those provisions in the Agreement:

1. **TRUE LEASE:** The parties intend for this lease to constitute a true lease of Products under the UCC and all applicable laws. If this Lease is determined to be a lease intended as security, in no event shall Lessee be obligated to pay any time price balance differential in excess of the maximum amount permitted by applicable law (as specified herein or the state where the Products are located, whichever law permits the greater amount). In the event Lessor shall receive anything of value under a Lease that is deemed interest which would exceed the maximum amount of interest allowed under the law, the excess amount shall be applied to the reduction of the unpaid time price balance or shall be refunded to Lessee. In order to reduce the unpaid time price balance, any amount deemed interest shall, to the fullest extent permitted by applicable law, be amortized and spread uniformly throughout the Lease Term."

2. **END OF LEASE OPTIONS.**

(a) Provided that no Event of Default has occurred and is continuing, and at least 90 days but no more than 180 days prior to the expiration of the Primary Term (the "Expiration Date"), Lessee will give irrevocable written notice to Lessor of its intention to either:

- (i) purchase all of the Products at the Fair Market Value (as defined below);
- (ii) renew the Lease Term for a minimum of six (6) months at a rate and for a term agreed upon by both parties; or
- (iii) return all of the Products in accordance with the Agreement.

(b) If Lessee exercises the option to purchase the Products then, upon receipt of payment of the "Fair Market Value" (defined below), plus applicable taxes, Lessor will sell the Products to Lessee AS IS-WHERE IS, WITHOUT

WARRANTY OR RECOURSE, EXPRESS, IMPLIED OR OTHERWISE, INCLUDING ANY WARRANTIES OF DESIGN, MERCHANTABILITY, FITNESS FOR A PARTICULAR PURPOSE, OR AGAINST INFRINGEMENT. The Fair Market Value purchase price shall be paid on or before the last day of the Primary Term. "Fair Market Value" means the price of the Products, installed, in use and in the condition required by the Agreement as determined by Lessor in its reasonable judgment. If Lessee disagrees with the Fair Market Value, Lessee shall notify Lessor in writing within 60 days prior to the Expiration Date and, upon Lessee's request, and within ten (10) days after receipt of Lessee's notice, Lessor shall appoint a qualified appraiser reasonably acceptable to Lessee to appraise the retail value of the Products. The amount determined by such appraiser shall be the final Fair Market Value. Lessor and Lessee shall share the expense of such appraisal equally.

(c) If Lessee desires to renew a lease, Lessee and Lessor shall enter into a supplement to this Schedule describing the length of the renewal Lease Term and the renewal Rent provided, however, all other terms of this Schedule and the Agreement shall remain in full force and effect.

(d) Whether or not Lessee has given Lessor notice of its intent as described above, if Lessee does not return or purchase the Products or renew the Lease as required above, the Lease Term shall automatically extend on a month-to-month basis at the Rent in effect on the Expiration Date (prorated on a monthly basis if the Payment Period was other than monthly during the Primary Term). Such extension shall continue until Lessee: (i) provides thirty (30) days prior written notice of its intention to return or purchase the Products (to take effect on the next Rent payment date that is at least 30 days after the notice is received by Lessor) and (ii) either returns or purchases all of the Products in accordance with the End of Lease options above. Payments of Rent during the month-to-month extension are due and payable monthly as specified in Lessor's invoice. If Lessee fails to return or purchase any Products, the Schedule and associated Rent for the Products that have not been returned or purchased shall extend on a month-to-month basis in accordance with the prior sentence.

3. COMPLETION OF SCHEDULE. Lessee hereby authorizes Lessor to insert or update the serial numbers of the Products from time to time if necessary.

If Lessee delivers this signed Schedule, any amendment or other document related to this Schedule or the Master Lease (each a "Document") to Lessor by facsimile transmission, and Lessor does not receive all of the pages of that Document, Lessee agrees that, except for any pages which require a signature, Lessor may supply the missing pages to the Document from Lessor's database which conforms to the version number at the bottom of the page. If Lessee delivers a signed Document to Lessor as an e-mail attachment, facsimile transmission or by U.S. mail, Lessee acknowledges that Lessor is relying on Lessee's representation that the Document has not been altered. Lessee further agrees that, notwithstanding any rule of evidence to the contrary, in any hearing, trial or proceeding of any kind with respect to a Document, Lessor may produce a tangible copy of the Document transmitted by Lessee to Lessor by facsimile or as an e-mail attachment and such signed copy shall be deemed to be the original of the Document. To the extent (if any) that the Document constitutes chattel paper under the Uniform Commercial Code, the authoritative copy of the Document shall be the copy designated by Lessor or its assignee, from time to time, as the copy available for access and review by Lessee, Lessor or its assignee. All other copies are deemed identified as copies of the authoritative copy. In the event of inadvertent destruction of the authoritative copy, or corruption of the authoritative copy for any reason or as the result of any cause, the authoritative copy may be restored from a backup or archive copy, and the restored copy shall become the authoritative copy. At Lessor's option, this electronic record may be converted into paper form. At such time, such paper copy will be designated or marked as the authoritative copy of the Document.

By signing below, each of the parties hereto agrees to be bound by the terms of the Agreement, this Schedule and the attached Exhibit "A".

"Lessee"	DELL FINANCIAL SERVICES L.L.C. "Lessor"
By: _____	By: _____
Name: _____	Name: _____
Title: _____	Title: _____
Date: _____	Date: _____



**LEGAL COMPANY NAME
LEASE PURCHASE SCHEDULE NO. CONTRACT NUMBER
TO MASTER LEASE AGREEMENT NO. MLA NUMBER**

THIS SCHEDULE IS SUBJECT TO AND INCORPORATES THE TERMS AND CONDITIONS OF MASTER LEASE AGREEMENT NO. MLA NUMBER ("Agreement") DATED MLA EFFECTIVE DATE BETWEEN DELL FINANCIAL SERVICES L.L.C. ("Lessor") AND LEGAL COMPANY NAME ("Lessee").

Lessor hereby agrees to lease and/or make available to Lessee subject to the terms, conditions and provisions set forth in this Schedule and in the Agreement, the Products described below. Any capitalized term used herein and not defined herein shall have the meaning ascribed to it in the Agreement.

PRODUCT DESCRIPTION AND LOCATION: See below or Exhibit "A" attached to and made a part hereof.

PRODUCT SELLER:

<u>Product Description</u>	<u>Product Location</u>	<u>Lessee Purchase Order No.</u>	<u>Primary Term (Mos.)</u>	<u>Commencement Date*</u>
See Exhibit 'A'	See Exhibit 'A'	TBD	TERM	TBD

Rent is payable: in Advance

Payment Period:

*The Commencement Date may be extended for one Payment Period until the Schedule is returned in accordance with the terms in the Agreement. Lessor may charge Lessee prorated Rent accruing from the Acceptance Date to the Commencement Date, as such date is finally determined.

LEASE PURCHASE PROVISIONS

The following provisions shall apply with respect to this Schedule in addition to those provisions in the Agreement:

1. SECTION 4. RENT; TAXES; PAYMENT OBLIGATION.

Insert as a new last sentence to subsection (a) the following:

"For the purposes of this Schedule, the Rent and Purchase Price (as of the applicable Purchase Date) are shown in the chart below or on Exhibit "B", attached to and made a part hereof.

<u>Payment Number</u>	<u>Purchase Date</u>	<u>Rent</u>	<u>Interest Portion</u>	<u>Principal Portion</u>	<u>Purchase Price</u>
See Exhibit 'B'					

2. PURCHASE OPTION.

Provided that no Event of Default has occurred and is continuing, and at least 60 days but no more than 180 days before the purchase date ("Purchase Date") selected by Lessee, Lessee will give irrevocable written notice to Lessor of its intention to:

- (i) purchase the Products for \$1.00 at the end of the Primary Term;
- (ii) purchase the Products at the Purchase Price as stated in Paragraph (i) above or as listed on Exhibit B, so long as all other amounts due on the Purchase Date have been paid in full; or
- (iii) return the Products in accordance with the Agreement for a fee agreed upon by both parties.

Upon satisfaction by Lessee of such conditions, Lessee shall be entitled to Lessor's interest in the Products, AS IS, WHERE IS, WITHOUT WARRANTY OR RECOURSE, EXPRESS, IMPLIED OR OTHERWISE, BY OR AGAINST LESSOR,

INCLUDING ANY WARRANTIES OF DESIGN, MERCHANTABILITY, FITNESS FOR A PARTICULAR PURPOSE, OR AGAINST INFRINGEMENT, other than the absence of any liens by, through, or under Lessor.

As continuing security for Lessee's obligations hereunder, Lessee hereby grants to Lessor, a first-priority security interest in all of Lessee's rights and interest in and to the Products and all proceeds thereof, free and clear of all security interests, liens or encumbrances whatsoever.

3. **COMPLETION OF SCHEDULE.** Lessee hereby authorizes Lessor to insert or update the serial numbers of the Products from time to time as necessary.

By signing below, each of the parties hereto agrees to be bound by the terms of the Agreement, this Schedule and the attached Exhibits "A" and "B".

LEGAL COMPANY NAME
"Lessee"

DELL FINANCIAL SERVICES L.L.C.
"Lessor"

By: _____

By: _____

Name: _____

Name: _____

Title: _____

Title: _____

Date: _____

Date: _____



**SAMPLE
LEASE PURCHASE SCHEDULE NO.
TO MASTER LEASE AGREEMENT SCHEDULE NO.**

THIS SCHEDULE IS SUBJECT TO AND INCORPORATES THE TERMS AND CONDITIONS OF MASTER LEASE AGREEMENT NO. _____ ("Agreement") DATED _____ BETWEEN DELL FINANCIAL SERVICES L.L.C. ("Lessor") AND _____ ("Lessee").

Lessor hereby agrees to lease and/or make available to Lessee subject to the terms, conditions and provisions set forth in this Schedule and in the Agreement, the Products described below. Any capitalized term used herein and not defined herein shall have the meaning ascribed to it in the Agreement.

PRODUCT DESCRIPTION AND LOCATION: See below or Exhibit "A" attached to and made a part hereof.

PRODUCT SELLER:

<u>Product Description</u>	<u>Product Location</u>	<u>Lessee Purchase Order No.</u>	<u>Primary Term (Mos.)</u>	<u>Commencement Date</u>
See Exhibit 'A'	See Exhibit 'A'			

Rent is payable: in _____

Payment Period: _____

LEASE PURCHASE PROVISIONS

The following provisions shall apply with respect to this Schedule in addition to those provisions in the Agreement:

1. SECTION 4. RENT; TAXES; PAYMENT OBLIGATION.

Insert as a new last sentence to subsection (a) the following:

"For the purposes of this Schedule, the Rent, as well as the principal and interest portions of each Rent payment and the Purchase Price as of the applicable Purchase Date are shown in the chart provided on Exhibit "B", attached to and made a part hereof.

Add as a new last sentence to subsection (b) the following:

"Because the Products will be used for a governmental or proprietary purpose of Lessee, they are exempt from all sales, use and property taxes."

2. SECTION 11. REPRESENTATIONS AND WARRANTIES OF LESSEE.

For purposes of this Schedule, add paragraphs (j) through (t) as follows:

(j) Lessee will comply with the information reporting requirements of Section 149(e) of the Code, including but not limited to, the execution and delivery to Lessor of information statements requested by Lessor;

(k) Lessee will not do, cause to be done or fail to do any act if such act or failure to act will cause this Agreement, or any transaction hereunder, to be an Arbitrage Bond within the meaning of Section 148 of the Code or a Private Activity Bond within the meaning of Section 141 of the Code;

(l) The total cost of the Products listed in this Schedule will not be less than the total Principal Portion of the Rent listed in this Schedule; :

(m) The Products listed in this Schedule have or will be ordered within six months of the date hereof in order to commence such Schedule;

(n) The Products listed in this Schedule are expected to be delivered and installed, and the Seller fully paid, within one year from the date hereof;

(o) No fund or account which secures or otherwise relates to the Rent has been established;

(p) Lessee will not sell, encumber or otherwise dispose of any property comprising this Schedule prior to the final maturity or termination of such Schedule without a written opinion of nationally recognized bond counsel to the effect that any such disposition will not adversely affect the exclusion of interest on the Rent from gross income for federal income tax purposes;

(q) Lessee agrees to execute, deliver and provide Lessor with satisfactory evidence of the filing of such documentation, as may be required for the purposes of properly reporting this Schedule, including, without limitation, IRS forms 8038-G or 8038-GC, as required under the Code;

(r) It is expected that Rent under this Schedule will be paid from periodic appropriations of the Lessee deposited into the general fund of the Lessee, that such appropriations will equal the Rent due during each Fiscal Period of Lessee, and that all amounts paid for Rent will be from an appropriation made by the Lessee during the Fiscal Period in which such Rent is made;

(s) To the best of Lessee's knowledge, information and belief, the above expectations are reasonable; and

(t) Lessee will comply with all applicable provisions of the Code, including without limitation Sections 103, 141 and 148 thereof, and the applicable regulations of the Treasury Department to maintain the exclusion of the interest components of Rent from gross income for purposes of federal income taxation.

Without limiting the generality of the foregoing, Lessor hereby gives notice to Lessee that, upon execution of this Schedule by Lessor, Lessor shall assign all of its right, title and interest in, to and under this Schedule, including all Products and all payments owing under such Schedule, to Dell Equipment Funding L.P. ("DEF") pursuant to a purchase agreement between the Lessor and DEF. Lessee hereby acknowledges and consents to such assignment and shall keep, or cause to be kept, a complete and accurate record of all such assignments in a manner and form necessary to comply with Section 149(a) of the Code and the Treasury Regulations promulgated thereunder. Lessor hereby directs Lessee to continue to make any and all payments required to be made under this Schedule directly to Lessor, as servicing agent for DEF, at the same address to which Lessee is currently making payments unless and until Lessor is directed by DEF to make such payments to a different address or payee."

TO THE EXTENT PERMITTED BY LAW, AND IN ADDITION TO LESSEE'S OBLIGATION UNDER SECTION 16 OF THE AGREEMENT AND ANY AMENDMENTS THERETO, LESSEE HEREBY ASSUMES LIABILITY FOR, AND SHALL PAY WHEN DUE, AND SHALL DEFEND LESSOR AND ITS SUCCESSORS AND ASSIGNS AGAINST, ANY AND ALL LIABILITIES, LOSSES, DAMAGES, CLAIMS AND EXPENSES (INCLUDING REASONABLE ATTORNEY FEES) RELATING TO OR ARISING OUT OF LESSEE'S BREACH OF ANY OF ITS REPRESENTATIONS, WARRANTIES, OR COVENANTS CONTAINED IN SECTION 11 OF THE AGREEMENT AS SUPPLEMENTED HEREIN.

3. SECTION 12. WARRANTY ASSIGNMENT; EXCLUSION OF WARRANTIES; LIMITATIONS ON LIABILITY; FINANCE LEASE.

For purposes of this Schedule, delete "FINANCE LEASE" in the title of this Section and delete the first and last sentences of paragraph (d).

4. SECTION 17. OWNERSHIP; LIENS AND ENCUMBRANCES; LABELS.

Insert at the end of this paragraph the following: "Notwithstanding the first sentence of this Section, upon Lessee's acceptance of the Products under this Schedule, title to the Products shall vest in Lessee subject to Lessor's rights under the Agreement; provided that, upon an Event of Default or any termination of this Schedule, other than by Lessee's purchase of the Products, title to the Products shall immediately and without any action by either party vest in Lessor, and Lessee shall immediately surrender possession of the Products to Lessor. Any such transfer of title shall occur automatically without the necessity of any bill of sale, certificate of title or other instrument of conveyance. Lessee shall, nevertheless, execute and deliver any such instruments as Lessor may request to evidence such transfer.

5. PURCHASE OPTION.

Provided that no Event of Default has occurred and is continuing, and upon satisfaction of all payment obligations herein by Lessee, Lessee shall be entitled to Lessor's interest in the Products, AS IS, WHERE IS, WITHOUT WARRANTY OR RECOURSE, EXPRESS, IMPLIED OR OTHERWISE, BY OR AGAINST LESSOR, INCLUDING ANY WARRANTIES OF

DESIGN, MERCHANTABILITY, FITNESS FOR A PARTICULAR PURPOSE, OR AGAINST INFRINGEMENT, other than the absence of any liens by, through, or under Lessor.

As continuing security for Lessee's obligations hereunder, Lessee hereby grants to Lessor, a first-priority security interest in all of Lessee's rights and interest in and to the Products and all proceeds thereof, free and clear of all security interests, liens or encumbrances whatsoever.

6. COMPLETION OF SCHEDULE: Lessee hereby authorizes Lessor to insert or update the serial numbers of the Products from time to time as necessary.

If Lessee delivers this signed Schedule, any amendment or other document related to this Schedule or the Master Lease (each a "Document") to Lessor by facsimile transmission, and Lessor does not receive all of the pages of that Document,

By signing below, each of the parties hereto agrees to be bound by the terms of the Agreement, this Schedule and the attached Exhibits "A" and "B".

"Lessee"	DELL FINANCIAL SERVICES L.L.C. "Lessor"
By: _____	By: _____
Name: _____	Name: _____
Title: _____	Title: _____
Date: _____	Date: _____

Ancillary Documents:

Validity Opinion

8038G

8038GC

**SAMPLE OPINION LETTER
TO BE EXECUTED ON COUNSEL'S LETTERHEAD**

To: Dell Financial Services L.L.C.
One Dell Way
Round Rock, TX 78682

Ladies and Gentlemen:

We are counsel to the _____ (the "Lessee") and, in that capacity, we have examined Master Lease Agreement No. _____ dated as of _____ 2018, and the Lease Purchase Schedule No. _____ to Master Lease Agreement No. _____ thereto, dated as of _____, 2018 (collectively the "Agreement"), between the Lessee and Dell Financial Services L.L.C. (the "Lessor").

Based on our examination of the Agreement and such other examinations as we have deemed appropriate, we are of the opinion as follows:

(a) The Lessee is an entity duly organized and existing under and by virtue of the authorizing statute or constitutional provisions of the State of _____ and is a state or political subdivision thereof as described in Section 103(a) of the Internal Revenue Code of 1986, as amended, with full power and authority to enter into the Agreement and the transactions contemplated thereby and to perform all of its obligations thereunder;

(b) The Agreement has been duly authorized, executed and delivered by _____*, _____ of the Lessee by proper action of its governing board at a meeting duly called, regularly convened and attended throughout by the requisite majority of the members thereof or by other appropriate official approval, and all requirements have been met and procedures have occurred in order to ensure the validity and enforceability of the Agreement against the Lessee;

(c) The Agreement constitutes the valid, legal and binding obligation of the Lessee, enforceable in accordance with its terms;

(d) No approval, consent or withholding of objection is required from any federal, state or local governmental authority or instrumentality with respect to the entering into or performance by the Lessee of the Agreement and the transactions contemplated thereby;

(e) Lessee has complied with any applicable public bidding requirements and other applicable state and federal laws in connection with the Agreement and the transactions contemplated thereby;

(f) The entering into and performance of the Agreement will not violate any judgment, order, law or regulation applicable to the Lessee or result in any breach of, or constitute a default under, any instrument to which the Lessee is a party or by which it or its assets may be bound, or result in the creation of any lien, charge, security interest or other encumbrance upon any assets of the Lessee or on the Products, other than those created by the Agreement;

(g) The Products are tangible personal property and when subject to use by the Lessee will not be or become fixtures or real property under the laws of the State of _____;

(h) There are no actions, suits, proceedings, inquiries or investigations, at law or in equity, before or by any court, public board or body, pending or threatened against or affecting, nor to the best of our knowledge and belief is there any basis therefor, which, if determined adversely to Lessee, will have a material adverse effect on the ability of the Lessee to fulfill its obligations under the Agreement; and

(i) Lessee has, in accordance with the requirements of law, fully budgeted and appropriated sufficient funds for Lessee's current Fiscal Period to make the Rent payments scheduled to come due during Lessee's current Fiscal Period and to meet its other obligations under the Agreement for the current Fiscal Period, and such funds have not been expended for other purposes.

This opinion is delivered to the addressee for its benefit and the benefit of its assigns for the purpose contemplated by the Agreement.

Very truly yours,

*Authorized Signatory of Lessee under the Agreement.

Information Return for Tax-Exempt Governmental Obligations

► Under Internal Revenue Code section 149(e)
 ► See separate instructions.
Caution: If the issue price is under \$100,000, use Form 8038-GC.

Part I Reporting Authority		If Amended Return, check here <input type="checkbox"/>
1 Issuer's name		2 Issuer's employer identification number (EIN)
3a Name of person (other than issuer) with whom the IRS may communicate about this return (see instructions)		3b Telephone number of other person shown on 3a
4 Number and street (or P.O. box if mail is not delivered to street address)	Room/suite	5 Report number (For IRS Use Only)
6 City, town, or post office, state, and ZIP code		7 Date of issue
8 Name of issue		9 CUSIP number
10a Name and title of officer or other employee of the issuer whom the IRS may call for more information (see instructions)		10b Telephone number of officer or other employee shown on 10a

Part II Type of Issue (enter the issue price). See the instructions and attach schedule.

11 Education	11		
12 Health and hospital	12		
13 Transportation	13		
14 Public safety	14		
15 Environment (including sewage bonds)	15		
16 Housing	16		
17 Utilities	17		
18 Other. Describe ►	18		
19 If obligations are TANs or RANs, check only box 19a		<input type="checkbox"/>	
If obligations are BANs, check only box 19b		<input type="checkbox"/>	
20 If obligations are in the form of a lease or installment sale, check box		<input type="checkbox"/>	

Part III Description of Obligations. Complete for the entire issue for which this form is being filed.

	(a) Final maturity date	(b) Issue price	(c) Stated redemption price at maturity	(d) Weighted average maturity	(e) Yield
21		\$	\$	years	%

Part IV Uses of Proceeds of Bond Issue (including underwriters' discount)

22 Proceeds used for accrued interest	22		
23 Issue price of entire issue (enter amount from line 21, column (b))	23		
24 Proceeds used for bond issuance costs (including underwriters' discount)	24		
25 Proceeds used for credit enhancement	25		
26 Proceeds allocated to reasonably required reserve or replacement fund	26		
27 Proceeds used to currently refund prior issues	27		
28 Proceeds used to advance refund prior issues	28		
29 Total (add lines 24 through 28)	29		
30 Nonrefunding proceeds of the issue (subtract line 29 from line 23 and enter amount here)	30		

Part V Description of Refunded Bonds. Complete this part only for refunding bonds.

31 Enter the remaining weighted average maturity of the bonds to be currently refunded	►	_____ years
32 Enter the remaining weighted average maturity of the bonds to be advance refunded	►	_____ years
33 Enter the last date on which the refunded bonds will be called (MM/DD/YYYY)	►	_____
34 Enter the date(s) the refunded bonds were issued (MM/DD/YYYY)	►	_____

Part VI Miscellaneous

35 Enter the amount of the state volume cap allocated to the issue under section 141(b)(5)	35		
36a Enter the amount of gross proceeds invested or to be invested in a guaranteed investment contract (GIC) (see instructions)	36a		
b Enter the final maturity date of the GIC ▶ _____			
c Enter the name of the GIC provider ▶ _____			
37 Pooled financings: Enter the amount of the proceeds of this issue that are to be used to make loans to other governmental units	37		
38a If this issue is a loan made from the proceeds of another tax-exempt issue, check box ▶ <input type="checkbox"/> and enter the following information:			
b Enter the date of the master pool obligation ▶ _____			
c Enter the EIN of the issuer of the master pool obligation ▶ _____			
d Enter the name of the issuer of the master pool obligation ▶ _____			
39 If the issuer has designated the issue under section 265(b)(3)(B)(i)(III) (small issuer exception), check box ▶ <input type="checkbox"/>			
40 If the issuer has elected to pay a penalty in lieu of arbitrage rebate, check box ▶ <input type="checkbox"/>			
41a If the issuer has identified a hedge, check here ▶ <input type="checkbox"/> and enter the following information:			
b Name of hedge provider ▶ _____			
c Type of hedge ▶ _____			
d Term of hedge ▶ _____			
42 If the issuer has superintegrated the hedge, check box ▶ <input type="checkbox"/>			
43 If the issuer has established written procedures to ensure that all nonqualified bonds of this issue are remediated according to the requirements under the Code and Regulations (see instructions), check box ▶ <input type="checkbox"/>			
44 If the issuer has established written procedures to monitor the requirements of section 148, check box ▶ <input type="checkbox"/>			
45a If some portion of the proceeds was used to reimburse expenditures, check here ▶ <input type="checkbox"/> and enter the amount of reimbursement ▶ _____			
b Enter the date the official intent was adopted ▶ _____			

Signature and Consent	Under penalties of perjury, I declare that I have examined this return and accompanying schedules and statements, and to the best of my knowledge and belief, they are true, correct, and complete. I further declare that I consent to the IRS's disclosure of the issuer's return information, as necessary to process this return, to the person that I have authorized above.			
Paid Preparer Use Only	Print/Type preparer's name	Preparer's signature	Date	Check <input type="checkbox"/> if self-employed
	Firm's name ▶			Firm's EIN ▶
	Firm's address ▶			Phone no.

**Information Return for Small Tax-Exempt
Governmental Bond Issues, Leases, and Installment Sales**

▶ **Under Internal Revenue Code section 149(e)**

Caution: If the issue price of the issue is \$100,000 or more, use Form 8038-G.

Part I Reporting Authority Check box if **Amended Return**

1 Issuer's name		2 Issuer's employer identification number (EIN)	
3 Number and street (or P.O. box if mail is not delivered to street address)			Room/suite
4 City, town, or post office, state, and ZIP code		5 Report number (For IRS Use Only)	
6 Name and title of officer or other employee of issuer or designated contact person whom the IRS may call for more information		7 Telephone number of officer or legal representative	

Part II Description of Obligations Check one: a single issue or a consolidated return

8a Issue price of obligation(s) (see instructions)	8a	
b Issue date (single issue) or calendar date (consolidated). Enter date in mm/dd/yyyy format (for example, 01/01/2009) (see instructions) ▶		
9 Amount of the reported obligation(s) on line 8a that is:		
a For leases for vehicles	9a	
b For leases for office equipment	9b	
c For leases for real property	9c	
d For leases for other (see instructions)	9d	
e For bank loans for vehicles	9e	
f For bank loans for office equipment	9f	
g For bank loans for real property	9g	
h For bank loans for other (see instructions)	9h	
i Used to refund prior issue(s)	9i	
j Representing a loan from the proceeds of another tax-exempt obligation (for example, bond bank)	9j	
k Other	9k	
10 If the issuer has designated any issue under section 265(b)(3)(B)(i)(III) (small issuer exception), check this box ▶		<input type="checkbox"/>
11 If the issuer has elected to pay a penalty in lieu of arbitrage rebate, check this box (see instructions) ▶		<input type="checkbox"/>
12 Vendor's or bank's name:	
13 Vendor's or bank's employer identification number:	

Signature and Consent

Under penalties of perjury, I declare that I have examined this return and accompanying schedules and statements, and to the best of my knowledge and belief, they are true, correct, and complete. I further declare that I consent to the IRS's disclosure of the issuer's return information, as necessary to process this return, to the person(s) that I have authorized above.

Signature of issuer's authorized representative _____ Date _____ Type or print name and title _____

Paid Preparer Use Only	Print/Type preparer's name	Preparer's signature	Date	Check <input type="checkbox"/> if self-employed	PTIN
	Firm's name ▶	Firm's EIN ▶			
	Firm's address ▶	Phone no.			

General Instructions

Section references are to the Internal Revenue Code unless otherwise noted.

What's New

The IRS has created a page on IRS.gov for information about the Form 8038 series and its instructions, at www.irs.gov/form8038. Information about any future developments affecting the Form 8038 series (such as legislation enacted after we release it) will be posted on that page.

Purpose of Form

Form 8038-GC is used by the issuers of tax-exempt governmental obligations to provide the IRS with the information required by section 149(e) and to monitor the requirements of sections 141 through 150.

Who Must File

Issuers of tax-exempt governmental obligations with issue prices of less than \$100,000 must file Form 8038-GC.

Issuers of a tax-exempt governmental obligation with an issue price of \$100,000 or more must file Form 8038-G, Information Return for Tax-Exempt Governmental Obligations.

Filing a separate return for a single issue. Issuers have the option to file a separate Form 8038-GC for any tax-exempt governmental obligation with an issue price of less than \$100,000.

An issuer of a tax-exempt bond used to finance construction expenditures must file a separate Form 8038-GC for each issue to give notice to the IRS that an election was made to

pay a penalty in lieu of arbitrage rebate (see the line 11 instructions).

Filing a consolidated return for multiple issues. For all tax-exempt governmental obligations with issue prices of less than \$100,000 that are not reported on a separate Form 8038-GC, an issuer must file a consolidated information return including all such issues issued within the calendar year.

Thus, an issuer may file a separate Form 8038-GC for each of a number of small issues and report the remainder of small issues issued during the calendar year on one consolidated Form 8038-GC. However, if the issue is a construction issue, a separate Form 8038-GC must be filed to give the IRS notice of the election to pay a penalty in lieu of arbitrage rebate.

When To File

To file a separate return for a single issue, file Form 8038-GC on or before the 15th day of the second calendar month after the close of the calendar quarter in which the issue is issued.

To file a consolidated return for multiple issues, file Form 8038-GC on or before February 15th of the calendar year following the year in which the issue is issued.

Late filing. An issuer may be granted an extension of time to file Form 8038-GC under section 3 of Rev. Proc. 2002-48, 2002-37 I.R.B. 531, if it is determined that the failure to file on time is not due to willful neglect. Type or print at the top of the form, "Request for Relief under section 3 of Rev. Proc. 2002-48." Attach to the Form 8038-GC a letter briefly stating why the form was not submitted to the IRS on time. Also indicate whether the obligation in question is under examination by the IRS. Do not submit copies of any bond documents, leases, or installment sale documents. See *Where To File* next.

Where To File

File Form 8038-GC, and any attachments, with the Department of the Treasury, Internal Revenue Service Center, Ogden, UT 84201.

Private delivery services. You can use certain private delivery services designated by the IRS to meet the "timely mailing as timely filing/paying" rule for tax returns and payments. These private delivery services include only the following:

- DHL Express (DHL): DHL Same Day Service.
- Federal Express (FedEx): FedEx Priority Overnight, FedEx Standard Overnight, FedEx 2Day, FedEx International Priority, and FedEx International First.
- United Parcel Service (UPS): UPS Next Day Air, UPS Next Day Air Saver, UPS 2nd Day Air, UPS 2nd Day Air A.M., UPS Worldwide Express Plus, and UPS Worldwide Express.

The private delivery service can tell you how to get written proof of the mailing date.

Other Forms That May Be Required

For rebating arbitrage (or paying a penalty in lieu of arbitrage rebate) to the Federal Government, use Form 8038-T, Arbitrage Rebate, Yield Reduction and Penalty in Lieu of Arbitrage Rebate. For private activity bonds, use Form 8038, Information Return for Tax-Exempt Private Activity Bond Issues.

For a tax-exempt governmental obligation with an issue price of \$100,000 or more, use Form 8038-G.

Rounding to Whole Dollars

You may show the money items on this return as whole-dollar amounts. To do so, drop any amount less than 50 cents and increase any amount from 50 to 99 cents to the next higher dollar.

Definitions

Obligations. This refers to a single tax-exempt governmental obligation if Form 8038-GC is used for separate reporting or to

multiple tax-exempt governmental obligations if the form is used for consolidated reporting.

Tax-exempt obligation. This is any obligation including a bond, installment purchase agreement, or financial lease, on which the interest is excluded from income under section 103.

Tax-exempt governmental obligation. A tax-exempt obligation that is not a private activity bond (see below) is a tax-exempt governmental obligation. This includes a bond issued by a qualified volunteer fire department under section 150(e).

Private activity bond. This includes an obligation issued as part of an issue in which:

- More than 10% of the proceeds are to be used for any private activity business use, and
- More than 10% of the payment of principal or interest of the issue is either (a) secured by an interest in property to be used for a private business use (or payments for such property) or (b) to be derived from payments for property (or borrowed money) used for a private business use.

It also includes a bond, the proceeds of which (a) are to be used to make or finance loans (other than loans described in section 141(c)(2)) to persons other than governmental units and (b) exceeds the lesser of 5% of the proceeds or \$5 million.

Issue. Generally, obligations are treated as part of the same issue only if they are issued by the same issuer, on the same date, and as part of a single transaction, or a series of related transactions. However, obligations issued during the same calendar year (a) under a loan agreement under which amounts are to be advanced periodically (a "draw-down loan") or (b) with a term not exceeding 270 days, may be treated as part of the same issue if the obligations are equally and ratably secured under a single indenture or loan agreement and are issued under a common financing arrangement (for example, under the same official statement periodically updated to reflect changing factual circumstances). Also, for obligations issued under a draw-down loan that meets the requirements of the preceding sentence, obligations issued during different calendar years may be treated as part of the same issue if all of the amounts to be advanced under the draw-down loan are reasonably expected to be advanced within 3 years of the date of issue of the first obligation. Likewise, obligations (other than private activity bonds) issued under a single agreement that is in the form of a lease or installment sale may be treated as part of the same issue if all of the property covered by that agreement is reasonably expected to be delivered within 3 years of the date of issue of the first obligation.

Arbitrage rebate. Generally, interest on a state or local bond is not tax-exempt unless the issuer of the bond rebates to the United States arbitrage profits earned from investing proceeds of the bond in higher yielding nonpurpose investments. See section 148(f).

Construction issue. This is an issue of tax-exempt bonds that meets both of the following conditions:

1. At least 75% of the available construction proceeds of the issue are to be used for construction expenditures with respect to property to be owned by a governmental unit or a 501(c)(3) organization, and

2. All of the bonds that are part of the issue are qualified 501(c)(3) bonds, bonds that are not private activity bonds, or private activity bonds issued to finance property to be owned by a governmental unit or a 501(c)(3) organization.

In lieu of rebating any arbitrage that may be owed to the United States, the issuer of a construction issue may make an irrevocable election to pay a penalty. The penalty is equal to 1-1/2% of the amount of construction proceeds that do not meet certain spending requirements. See section 148(f)(4)(C) and the Instructions for Form 8038-T.

Specific Instructions

In general, a Form 8038-GC must be completed on the basis of available information and reasonable expectations as of the date of issue. However, forms that are filed on a consolidated basis may be completed on the basis of information readily available to the issuer at the close of the calendar year to which the form relates, supplemented by estimates made in good faith.

Part I—Reporting Authority

Amended return. An issuer may file an amended return to change or add to the information reported on a previously filed return for the same date of issue. If you are filing to correct errors or change a previously filed return, check the "Amended Return" box in the heading of the form.

The amended return must provide all the information reported on the original return, in addition to the new corrected information. Attach an explanation of the reason for the amended return and write across the top "Amended Return Explanation."

Line 1. The issuer's name is the name of the entity issuing the obligations, not the name of the entity receiving the benefit of the financing. In the case of a lease or installment sale, the issuer is the lessee or purchaser.

Line 2. An issuer that does not have an employer identification number (EIN) should apply for one on Form SS-4, Application for Employer Identification Number. You can get this form on the IRS website at IRS.gov or by calling 1-800-TAX-FORM (1-800-829-3676). You may receive an EIN by telephone by following the instructions for Form SS-4.

Lines 3 and 4. Enter the issuer's address or the address of the designated contact person listed on line 6. If the issuer wishes to use its own address and the issuer receives its mail in care of a third party authorized representative (such as an accountant or attorney), enter on the street address line "C/O" followed by the third party's name and street address or P.O. box. Include the suite, room, or other unit number after the street address. If the post office does not deliver mail to the street address and the issuer has a P.O. box, show the box number instead of the

street address. If a change in address occurs after the return is filed, use Form 8822, Change of Address, to notify the IRS of the new address.

Note. The address entered on lines 3 and 4 is the address the IRS will use for all written communications regarding the processing of this return, including any notices. By authorizing a person other than an authorized officer or other employee of the issuer to communicate with the IRS and whom the IRS may contact about this return, the issuer authorizes the IRS to communicate directly with the individual listed on line 6, whose address is entered on lines 3 and 4 and consents to disclose the issuer's return information to that individual, as necessary, to process this return.

Line 5. This line is for IRS use only. Do not make any entries in this box.

Part II—Description of Obligations

Check the appropriate box designating this as a return on a single issue basis or a consolidated return basis.

Line 8a. The issue price of obligations is generally determined under Regulations section 1.148-1(b). Thus, when issued for cash, the issue price is the price at which a substantial amount of the obligations are sold to the public. To determine the issue price of an obligation issued for property, see sections 1273 and 1274 and the related regulations.

Line 8b. For a single issue, enter the date of issue (for example, 03/15/2010 for a single issue issued on March 15, 2010), generally the date on which the issuer physically exchanges the bonds that are part of the issue for the underwriter's (or other purchaser's) funds; for a lease or installment sale, enter the date interest starts to accrue. For issues reported on a consolidated basis, enter the first day of the calendar year during which the obligations were issued (for example, for calendar year 2010, enter 01/01/2010).

Lines 9a through 9h. Complete this section if property other than cash is exchanged for the obligation, for example, acquiring a police car, a fire truck, or telephone equipment through a series of monthly payments. (This type of obligation is sometimes referred to as a "municipal lease.") Also complete this section if real property is directly acquired in exchange for an obligation to make periodic payments of interest and principal.

Do not complete lines 9a through 9d if the proceeds of an obligation are received in the form of cash even if the term "lease" is used in the title of the issue. For lines 9a through 9d, enter the amount on the appropriate line that represents a lease or installment purchase. For line 9d, enter the type of item that is leased. For lines 9e through 9h, enter the amount on the appropriate line that represents a bank loan. For line 9h, enter the type of bank loan.

Lines 9i and 9j. For line 9i, enter the amount of the proceeds that will be used to pay principal, interest, or call premium on any other issue of bonds, including proceeds that will be used to fund an escrow account for this purpose. Several lines may apply to a particular obligation. For example, report on lines 9i and 9j obligations used to refund prior issues which represent loans from the proceeds of another tax-exempt obligation.

Line 9k. Enter on line 9k the amount on line 8a that does not represent an obligation described on lines 9a through 9j.

Line 10. Check this box if the issuer has designated any issue as a "small issuer exception" under section 265(b)(3)(B)(i)(III).

Line 11. Check this box if the issue is a construction issue and an irrevocable election to pay a penalty in lieu of arbitrage rebate has been made on or before the date the bonds were issued. The penalty is payable with a Form 8038-T for each 6-month period after the date the bonds are issued. Do not make any payment of penalty in lieu of rebate with Form 8038-GC. See Rev. Proc. 92-22, 1992-1 C.B. 736, for rules regarding the "election document."

Line 12. Enter the name of the vendor or bank who is a party to the installment purchase agreement, loan, or financial lease. If there are multiple vendors or banks, the issuer should attach a schedule.

Line 13. Enter the employer identification number of the vendor or bank who is a party to the installment purchase agreement, loan, or financial lease. If there are multiple vendors or banks, the issuer should attach a schedule.

Signature and Consent

An authorized representative of the issuer must sign Form 8038-GC and any applicable certification. Also print the name and title of the person signing Form 8038-GC. The authorized representative of the issuer signing this form must have the authority to consent to the disclosure of the issuer's return information, as necessary to process this return, to the person(s) that has been designated in this form.

Note. If the issuer authorizes in line 6 the IRS to communicate with a person other than an officer or other employee of the issuer, (such authorization shall include contact both in writing regardless of the address entered in lines 3 and 4, and by telephone) by signing this form, the issuer's authorized representative consents to the disclosure of the issuer's return information, as necessary to process this return, to such person.

Paid Preparer

If an authorized representative of the issuer filled in its return, the paid preparer's space should remain blank. Anyone who prepares the return but does not charge the organization should not sign the return. Certain others who prepare the return should not sign. For example, a regular, full-time employee of the issuer, such as a clerk, secretary, etc., should not sign.

Generally, anyone who is paid to prepare a return must sign it and fill in the other blanks in the *Paid Preparer Use Only* area of the return. A paid preparer cannot use a social security number in the *Paid Preparer Use Only* box. The paid preparer must use a preparer tax identification number (PTIN). If the paid preparer is self-employed, the preparer should enter his or her address in the box.

The paid preparer must:

- Sign the return in the space provided for the preparer's signature, and
- Give a copy of the return to the issuer.

Paperwork Reduction Act Notice

We ask for the information on this form to carry out the Internal Revenue laws of the United States. You are required to give us the information. We need it to ensure that you are complying with these laws.

You are not required to provide the information requested on a form that is subject to the Paperwork Reduction Act unless the form displays a valid OMB control number. Books or records relating to a form or its instructions must be retained as long as their contents may become material in the administration of any Internal Revenue law. Generally, tax returns and return information are confidential, as required by section 6103.

The time needed to complete and file this form will vary depending on individual circumstances. The estimated average time is:

Learning about the law or the form	4 hr., 46 min.
Preparing the form	2 hr., 22 min.
Copying, assembling, and sending the form to the IRS	2 hr., 34 min.

If you have comments concerning the accuracy of these time estimates or suggestions for making this form simpler, we would be happy to hear from you. You can write to the Internal Revenue Service, Tax Products Coordinating Committee, SE:W:CAR:MP:T:M:S, 1111 Constitution Ave. NW, IR-6526, Washington, DC 20224. Do not send the form to this address. Instead, see *Where To File*.

Additional Leasing Information:

End of Lease Guide

Dell Financial Services Online Services Guide (DFSOS)

Dell Financial Services
End-of-Lease
Guide



End-of-Lease Guide

Introduction	2
Roles and Responsibilities	3
End-of-Lease Timeline	4
End-of-Lease Options	5
Returning Your Equipment	6
Lease Return Services	14
Frequently Asked Questions	15

Introduction

As the end of your lease approaches, Dell Financial Services (DFS) wants to thank you for being a valued customer.

At DFS, we understand how important a successfully executed end of lease decision is to our customers. With that in mind, the End-of-Lease Guide is designed to provide you with the necessary information to assist you in preparing for your lease expiration.

This guide will walk you through the following:

- Roles and Responsibilities
- End-of-Lease Timeline
- End-of-Lease Options
- Returning your Equipment
- End-of-Lease Services
- Frequently Asked Questions

Again, we want to thank you for utilizing DFS, for your leasing and financing needs and we look forward to your continued business.

Roles and Responsibilities

At DFS, we feel that one of the keys to an efficient end-of-lease process is a clear customer understanding of the process. To facilitate this understanding, we have developed the following “Roles & Responsibilities” matrix. The following definitions will provide you with the necessary information so that we may deliver a positive end-of-lease experience.

Dell Financial Services

- Provide timely and accurate renewal and/or buyout information.
- Provide timely and accurate return shipping information.
- Provide timely and accurate invoicing for missing and/or damaged items.
 - Offer and explain the benefits of DFS value added service programs (e.g., Return Logistics).

Customer

- Provide DFS notice of end-of-lease plans by agreed upon date in Master Lease Agreement and/or Lease Schedule. Must notify DFS prior to return of any product to avoid delays in receiving.
- If you decide to return your equipment, prepare and return your equipment to DFS by the lease expiration date:
 - Arrange for Dell’s replacement equipment to be delivered to your location.
 - Migrate information to replacement equipment.
 - Remove proprietary information and tags from all systems.
 - Arrange for transportation to DFS returns processing center. *NOTE: COD deliveries will not be accepted.*
 - Erase and destroy sensitive data located on hard drives. *NOTE: If you remove the hard drive to perform a data wipe, please be sure to reinstall to avoid being charged for a missing hard drive.*
- Package equipment properly to guard against in-transit damage. *NOTE: See packaging guidelines detailed later in this guide.*
- Ensure equipment arrives at DFS processing center by Lease Schedule termination date.

Note that the information contained in this guide is intended to help create a more effective and efficient relationship between DFS and your company. However, it does not change or supplement the terms and conditions of your lease agreement. In the event of a conflict, the terms and conditions of your lease agreement shall control.

End-of-Lease Timeline

DFS recommends, as a “best practice”, to begin end-of-lease planning at least 90 days prior to your required lease notification date. To establish your end-of-lease strategy, consider your specific technology needs, financial needs and operational capabilities. To help guide you through this process, we have provided a timeline below detailing specific activities and questions that will help facilitate your decision making process. Since each customer’s environment is unique, we encourage you to involve all stakeholders in the decision making process.

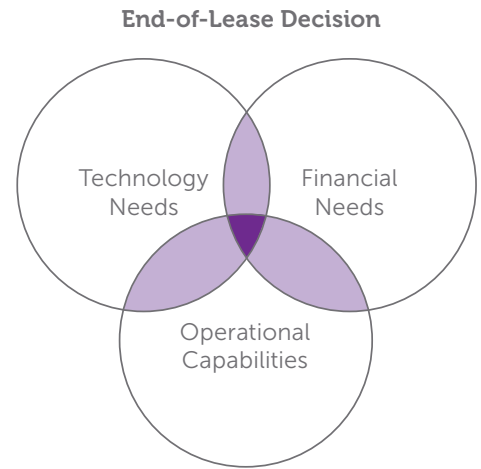

Account Planning (T-180 days)

During the account planning process, you should begin to consider:

Equipment Location and Condition

- Can the equipment be located?
- Is it in good working condition?

Equipment Viability

- Does it still satisfy end-user needs?

Organizational Characteristics?

- Do you want to continue using the equipment?
- How long do you need for a technology transition?

Notification Date (T-90 days)

Date customer must notify DFS of their end-of-lease intention. (Generally 90 days before the end of the lease)

For items you have notified us that you will be returning, DFS will mail a “packing” slip of items to be returned and the return location information. As a best practice, we recommend that you reconcile the packing slip with your records.

You should plan returned equipment arrival at the DFS specified location on or before the end-of-lease date to avoid additional rental or fees.

End-of-Lease (T: Term Date)

Lease reconciliation period

Upon receipt of equipment by DFS, we will audit the equipment for the following:

- Receipt of all items
- Cosmetic damage
- Functionality
- Configuration

DFS will invoice for missing or damaged items in accordance with your lease agreement. Reconciliation is generally completed within 30 days of receiving equipment.

Note that the information contained in this guide is intended to help create a more effective and efficient relationship between DFS and your company. However, it does not change or supplement the terms and conditions of your lease agreement. In the event of a conflict, the terms and conditions of your lease agreement shall control.

End-of-Lease Options

Our Fair Market Value Program generally offers three (3) end-of-lease options to meet the needs of your organization's unique structure, capabilities, and needs.

Renew or Extend your Lease

If you are not ready to make a decision when your lease expires or wish to continue using the equipment, you can choose to renew month-to-month or extend for a fixed term renewal rate. Either renewal option provides the benefit of continued use of equipment while maintaining the built in disposal capability provided by leasing.

When renewing your lease on a month-to-month basis, we will continue to invoice you at your contracted amount for use of the equipment until you notify us that you intend to purchase or return and do so.

Fixed Term Extension requires written end-of-lease notification and a signed extension addendum. Contact your end-of-lease Coordinator for fixed extended terms and prices. *NOTE: Unless otherwise stated in your Master Lease Agreement, partial lease schedule renewal requests require purchase or return of the non-renewal equipment before the renewal will be processed.*

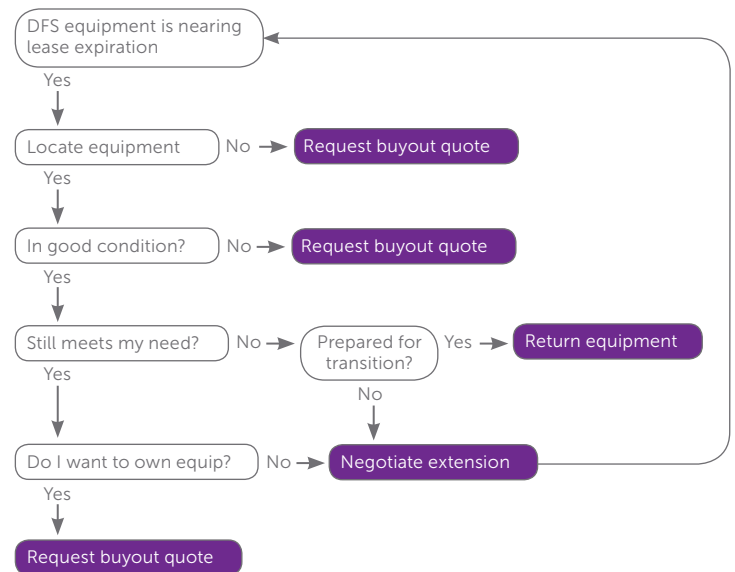

Purchase the Equipment

If your technology environment does not require upgraded equipment for the next 12 to 24 months, purchasing equipment may be the best choice. The purchase price is generally determined by your specific lease, but is typically the equipment's current fair market value at end-of-lease or a fixed buyout amount that was negotiated at lease inception. Contact your end-of-lease Coordinator for details.

Return the Equipment

If all or a part of your leased equipment is no longer meeting your technology needs, contact your DFS end-of-lease Coordinator to help guide you through this process. DFS provides packing and transportation services at a reasonable cost to help alleviate many of the administrative issues associated with returning leased equipment. *NOTE: Contact your end-of-lease coordinator for details and to request a quote.*

Tip: Monitors generally have a long useful life. Purchasing existing monitors may save you money on the return freight and purchase of new monitors.

Note that the information contained in this guide is intended to help create a more effective and efficient relationship between DFS and your company. However, it does not change or supplement the terms and conditions of your lease agreement. In the event of a conflict, the terms and conditions of your lease agreement shall control.

Returning Your Equipment

With our Fair Market Value leases, DFS makes a financial investment in your leased equipment that may not be fully recovered through your lease payments. We make this investment with the understanding that the equipment will be returned in good working and cosmetic condition for remarketing purposes. Our ability to remarket and recover our up front financial investment in the leased equipment is critical to our ability to offer competitive future lease rates. We understand that even though our customers may use best efforts to maintain their equipment, "Normal Wear & Tear" does occur. It is not DFS' intention to invoice customers for "Normal Wear & Tear" damage to equipment. Below is information that will help you in determining what is considered "Normal Wear & Tear".

Normal Wear & Tear¹

Normal "Wear and Tear" describes the expected cosmetic wear that may generally appear on a system used under Normal Circumstances during the lease term.

- Faded lettering on keyboards
- Minor surface scratches on plastics or metal base
- Slight plastic color fading
- Faded manufacturer's logo
- Removable labels and stickers

Beyond Normal Wear & Tear²

- Removal of OEM serial number identification, FCC product tags, or Microsoft COA
- Cracked and/or chipped plastics
- Bent metal frames
- Broken and/or missing hinges and latch catches
- Scratched monitor glass and/or LCD panels
- Missing keycaps from keyboards
- Broken and/or missing panels, cover plates or media doors
- Batteries that do not hold an electrical charge
- Character burns in monitors or LCD panels
- Systems' passwords that prohibit diagnostic level program execution or testing
- Major equipment discoloration, blood or radioactive substances requiring more than light cleaning for safe handling and process for resale

Cosmetic Condition Descriptions

Broken/Damaged Latches: A broken or damaged latch that holds the CRU devices in place on a notebook. Examples: Battery, Floppy Drive, CD/DVD Drive

LCD: LCD cracked beyond repair

Keys: Missing or damaged keys on a notebook

Excessive Physical Damage: Extensive physical damage that prevents the system from being remarketed

¹ DFS Reserves the right, in its' sole discretion to determine what constitutes "Normal Wear & Tear".

² This information is intended as an example and may not be reflective of all items considered to be "Beyond Normal Wear & Tear". Additionally, items listed under "Normal Wear & Tear" may be considered "Beyond Normal Wear & Tear" based on severity.

Note that the information contained in this guide is intended to help create a more effective and efficient relationship between DFS and your company. However, it does not change or supplement the terms and conditions of your lease agreement. In the event of a conflict, the terms and conditions of your lease agreement shall control.

Functional Testing Descriptions

System Failed to Boot: Occurs when system is completely inoperable and will not boot from the floppy disk drive or network drive.

Missing/Damaged Hard Drive: Occurs when hard drive is missing, inoperable or has any portion of damaged sectors. All hardware incryption password locks must be removed prior to return of the asset.

Missing/Damaged Memory: Occurs when memory is inoperable or missing in any denomination below what was present at lease inception.

As the lessee, you are responsible for returning your leased equipment to DFS unless you have purchased our Equipment Return Services. This responsibility includes packing, shipping and adherence to DFS Packing Guidelines (described below). When you notify DFS of your intention to return equipment, we will generate a Returns Material Authorization (RMA) on your behalf and send you a packing slip of items to be returned. Typically, one RMA will constitute one returning lease schedule.

DFS Packing Guidelines

- Ensure only those items related to the specific terminating Lease or Lease Schedule are returned to DFS.
 - Due to automated processing and remarketing, DFS may not be able to return to you items shipped to us in error.
- Every box must be identifiable to a specific customer in case of box separation or pallet breakdown
 - All peripheral items (keyboards, mice, cords, adapters, docking stations, etc.) may be returned together within the same box(es). *NOTE: Monitors are not peripheral items.*
 - Failure to comply with these guidelines may result in an irreconcilable RMA and related billings for missing items.
- Affix the Return Materials Authorization (RMA) Number on the outside of each box (the RMA will be found on the packing slip provided by DFS).
- Pack your equipment in a manner that will avoid in-transit damage.
 - Container and packaging materials are left to your discretion, however you will be invoiced for any damaged items outside of "Normal Wear and Tear".
 - See "Suggested Packing Guidelines". *NOTE: Do not double stack pallets.*
- Carrier must come in a truck with standard dock height of 48 inches (4 feet).

Tip: Inquire about DFS' Equipment Return Services. You could save money and time on packaging and logistics.

We recommend following these suggested guidelines when returning equipment to reduce or eliminate in-transit damage.

Packing Systems

Notebooks/Laptops

Single Pack:

Use a sturdy box large enough to surround the unit with packing material. Double wrap completely with 1/2" or larger bubble wrap to protect the system and it's components. If returning a leased notebook bag, use this for your bubble wrap. This gives an added measure of protection. Include all peripheral items such as the mouse, keyboard, power cords, adapters, docking stations etc. Fill in gaps with packing paper or crumpled newspaper. *NOTE: Packaging peanuts are not suitable.*

Multi-pack:

1. Always transport vertically using a sturdy box & pallet.
2. Place box on pallet.
3. Double wrap each notebook completely with 1/2" or larger bubble wrap to protect the system and it's components.
4. Place in box on its edge.
5. Place a corrugated cardboard between layers.
6. Do not stack more than 2 layers high.
7. Seal box with tape.
8. Shrink wrap to pallet.

Desktop CPU

Single Pack:

Use a sturdy box large enough to surround the unit with packing material. Double wrap completely with 1/2" or larger bubble wrap to protect the system and it's components. Be sure to include peripheral items such as mice, keyboards, cords etc. These can be packed loosely in the box with the CPU, as long as the CPU is completely wrapped and will not rub against the components. Fill in gaps with packing paper or crumpled newspaper. *NOTE: Packaging peanuts are not suitable.*

Desktop CPU

Multi-pack:

1. Use a sturdy pallet. Damaged pallets can break in transit.
2. Place a layer of corrugated cardboard on pallet.
3. Double wrap each CPU with 1/2" or larger bubble wrap to protect the system and it's components.
4. Lay flat on pallet making sure CPUs do not hang off the sides of the pallet.
5. Stack no more than 60" high to avoid potential pallet tipping & weight damage to the systems on the lower levels.
6. Use corrugated cardboard or foam sheets between layers.
7. Shrink wrap to pallet to prevent movement of desktops on the pallet.
8. Use banding whenever possible.
9. Return all peripheral items i.e. mouse, keyboard, power cords, etc.

Flat Panel Monitors

Single Pack:

Use a sturdy box large enough to surround the monitor with packing material. Double wrap monitor with 1/2" or larger bubble wrap. Insert in box lying on its side (not on its base/pedestal). Make sure base is securely attached. Wrap video & power cords around the monitor base. Fill in gaps with packing paper or crumpled newspaper. *NOTE: Packaging peanuts are not suitable.*

Multi-pack:

1. Use a sturdy pallet. Damaged pallets can break in transit.
2. Place a layer of corrugated cardboard on pallet.
3. Place two layers of large bubble wrap at the bottom of the pallet to minimize damage to LCD screen.
4. Wrap video & power cords around the monitor base making sure base is securely attached.
5. Double wrap each monitor with 1/2" or larger bubble wrap.
6. Lay monitor face down with the base towards the outside of the pallet.
7. Make sure monitors do not hang off the side of the pallet.
 - a. 15 & 17" monitor
 - i. Standard size pallet can hold 6 monitors per level
 - ii. Do not stack more than 3 layers high
 - b. 19" monitor & larger
 - i. Standard size pallet can hold 4 monitors per level
 - ii. Do not stack more than 2 layers high
8. Place one layer of corrugated cardboard & 2 layers of large bubble wrap between layers.
9. Shrink wrap to pallet to prevent movement on the pallet.

CRT Monitors

Single Pack:

Use a sturdy box large enough to surround the monitor with packing material. Double wrap monitor with 1/2" or larger bubble wrap. Insert in box lying on its side (not on its base/ pedestal). Make sure base is securely attached. Wrap video & power cords around the monitor base. Fill in gaps with packing paper or crumpled newspaper. *NOTE: Packaging peanuts are not suitable.*

Multi-pack:

1. Use a sturdy pallet. Damaged pallets can break in transit.
2. Place a layer of corrugated cardboard on pallet.
3. Wrap video & power cords around the monitor base making sure base is securely attached.
4. Double wrap each monitor with 1/2" or larger bubble wrap to protect the monitor & screen.
5. Lay monitor on its side making sure they do not hang off the sides of the pallet.
 - a. 15 & 17" monitor
 - i. Standard size pallet can hold 6 monitors per level
 - ii. Do not stack more than 3 layers high
 - b. 19 inch monitor & larger
 - i. Standard size pallet can hold 4 monitors per level
 - ii. Do not stack more than 2 layers high
6. Use corrugated cardboard between layers.
7. Shrink wrap to pallet to prevent movement on the pallet.

Printers

Single Pack:

Use a sturdy box large enough to surround the printer with packing material. Remove toner/ink cartridge, place in a plastic bag & seal. Use tape to secure paper drawers/trays and other door openings. Double wrap printer with 1/2" or larger bubble wrap. Place in box with video and power cables. Fill in gaps with packing paper or crumpled newspaper. *NOTE: Packaging peanuts are not suitable. Seal box & ship.*

Multi-pack:

1. Use a sturdy pallet. Damaged pallets can break in transit.
2. Place a layer of corrugated cardboard at bottom of pallet.
3. Remove toner/ink cartridges. Place each in its own plastic bag and seal.
4. Double wrap each printer with 1/2" or larger bubble wrap and include the video and power cables.
5. Place printers of the same size on pallets evenly distributing the weight.
6. Make sure product does not overhang off the sides of the pallet.
7. Place corrugated cardboard between layers.
8. Do not stack more than 3 layers.
9. Shrink wrap to pallet to prevent movement.
10. Use banding whenever possible.

Projectors

Single Pack:

Use a sturdy box large enough to surround the projector with packing material. Double wrap with 1/2" or larger bubble wrap. Place in box with projector bag, remote, video and power cables. Fill in gaps with packing paper or crumpled newspaper. *NOTE: Packaging peanuts are not suitable. Seal box & ship.*

Multi-pack:

1. Use a sturdy pallet. Damaged pallets can break in transit.
2. Place a layer of corrugated cardboard at bottom of pallet.
3. Return with projector bag, remote, video and power cables.
4. Double wrap each projector with 1/2" or larger bubble wrap.
5. Place projectors evenly distributing the weight on the pallet.
6. Make sure product does not overhang off the sides of the pallet.
7. Place corrugated cardboard between layers.
8. Do not stack more than 6 layers.
9. Shrink wrap to pallet to prevent movement.
10. Use banding whenever possible.

Servers, Rack Servers, Racks, Storage

Floor or Free Standing Servers and Storage Devices:

- Floor standing servers should be palletized.
- Wrapped in bubble wrap or some protective material to prevent damaged during transportation.
- They may be stacked 2 high if they are the same size.
- Use triple layer cardboard and bubble wrap between the layers to prevent damage.
- Banding to the pallet is preferred to prevent moving and falling off the pallet during transportation.
- Shrink wrap the entire pallet insuring the equipment is wrapped to the pallet.
- Insure that there is no overhang to prevent any damages.

Rack Mounted Servers and Storage Devices:

- Rack mounted servers and storage devices must be removed from the racks
- Rails may be left on the servers as long as they do not protrude past the pallet edge.
- Servers and storage devices should be wrapped with bubble wrap to prevent damages.
- Devices may be stacked on a pallet insuring there is no overhang to prevent damages.
- Use triple layer cardboard and bubble wrap between the layers to prevent damage.
- They may be stacked up to 4 feet high with no over hang of the pallet. (weight limits for handling must be considered).
- Banding to the pallet is preferred to prevent moving and falling off the pallet during transportation.
- Shrink wrap the entire pallet insuring the equipment is wrapped to the pallet securely.

Server Racks:

- Everything, including UPS devices, switches and routers should be removed from the racks and shipped separately.
- Wrap the rack in some protective bubble wrap or other protective wrap to prevent damage.
- Empty racks should be placed on a pallet and banded to the pallet to prevent falling over during transportation.
- Shrink wrap the entire pallet insuring the rack is wrapped to the pallet securely.

Blade and Brick Servers:

- Blade and/or Brick servers should be removed from the Enclosure.
- Enclosures must be removed from the Rack.
- Blade and Brick individual servers can be reinstalled into the enclosure before palletizing.
- Palletize but, do not stack.
- Wrap each unit with bubble wrap or other protective wrap to prevent damage.
- Banding to the pallet is preferred to prevent moving during transportation.
- Shrink wrap the entire pallet insuring the equipment is wrapped to the pallet securely.

Large Self Contained Storage Equipment:

(Examples: EMC Symmetrix, EMC Clarion, Dell Power Vault 160T, Teradata, etc.)

- These are self contained complete units and may be left together.
- Special handling and special transportation equipment is required for these units.
- They must be wrapped extensively to prevent damage during transportation.
- They must be securely strapped inside the truck when transporting to prevent damage.

Follow these guidelines when palletizing your returning equipment.

When to Palletize

- When pieces fit squarely within the edges of a pallet.
- When height and width of shipment pieces are similar.
- When individual pieces in a load exceed 100 lbs.
- When individual pieces are less than 60" high.
- Do not stack pallets.
- Place equipment on pallets for transportation whenever possible to minimize in-transit damage and processing delays.

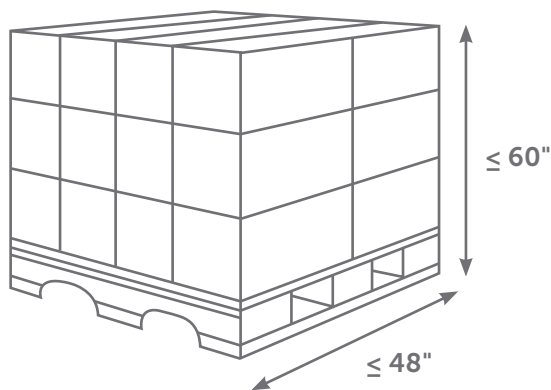

How to correctly Palletize

- Place lighter pieces toward the top of the pallet or on the top layer of the pallet secured by shrink-wrap to eliminate or reduce movement.
- Shrink-wrap containers to eliminate or reduce movement when a shipment is not large enough to fill the surface of a pallet.
- Place items on pallet so that the sides of the containers do not overhang the sides of the pallet.
- Do not stack pallets.
- Ensure that the pallet is balanced and properly weighted to eliminate or reduce chances of pallet tipping over during transit.
- Vertically align the edges of boxes.
- Make sure the top is flat.
- Secure items by shrink wrapping to pallet and use banding whenever possible.

Building your Pallet

- Avoid pre-used, old or moisture-exposed fiberboard cartons.
- Do not nail into the end grain of lumber.
- Use three-way locking corners and diagonals to help form a structurally sound open-frame crate.

A Packing Slip will be provided to you once you notify DFS of your intent to return your equipment. The Packing Slip contains the Returns Material Authorization Number (RMA), which is required to assure quick reconciliation of your equipment.

		Financial Services		Packing Slip		MM/DD/YY	
				Ship To		Dell Financial Services Processing Center Street Address1 Street Address2 City, State, Zip Code	
RMA Number		XXXX		Contract Number		001XXXXXX001	
Expected Return Date		MM/DD/YYYY					
Order Number	Customer PO Number	Service Tag	Item Number	Description	Quantity	Substitute Tag	
160431334	PF111222	GGQQ7	220-2815	550K GX1/T+INT NIC BASE W/512	1		
			310-0019	MICROSOFT SYSTEM MOUSE			
			310-0038	KYBD, PERFORMANCE MECH, 10			
			310-2268	REDUCED DOCUMENTATION, GX1			
			311-0513	129MB ECC, SDRAM, 100MHZ, 1 DIMM			
			311-0519	128MB, ECC, RAM, 100 MHZ, 1DIMM, GX			
			311-0555	17/40x, EIDE, CD, GX1 M/T W/INTSN			
			340-0701	3.5 1.44 MB, FACT, MT			
			340-0740	6.4 GB, IDE, 5400 RPM, GX1, M/T 350			
			340-0746	6.4 GB, EIDE, GX1 M/T, 350+ MHZ, 2N			
			365-1000	DPW, ING SVC, STAND, TAG OPTI			
			420-0387	NT4 SERVICE PACK 4, OPTIPLEX, EN			
			430-0118	7 SLOT RISER, FX 1T, WOL, ACTIVE, F			
			67020-52	2940 CONTROLLER KIT PNP PCI-	1		
				Number of Tags	1		
				Number of Items	2		

Lease Return Services

Packing and Transportation

Focused on improving your internal efficiencies, our Lease Return Services provide you with competitive pricing, and the ability to pre-pay costs. Enjoy the convenience of having your packing materials and labor included at the pick-up. Reduce your financial exposure with coverage for in-transit damage.* Spend less time arranging complex transportation logistics and more time focused on your day-to-day activities.

Data Wipe Certification

In today's environment, taking the right steps to help protect data is paramount. Choosing Dell Financial Services' (DFS) Data Wipe Certification will provide you with a certificate of data removal for your returned DFS leased assets which have reached lease conclusion. Using our U.S. based asset returns facility, DFS will perform a three-pass overwrite of the data on the hard drive,** removing drive partitions, drive partition tables, and master boot records. Hard drives that fail the 3x process will be destroyed and disposed in such a manner as to meet all applicable local, country and state regulatory laws and requirements.

Contact your DFS representative to learn more or visit us at www.dell.com/financenow

All rights, obligations, representations and warranties regarding any and all Lease Return Services will be contained in an agreement between the customer and Dell Financial Services L.L.C. Such agreement will set forth the full and final agreement between the parties. Leasing and financing provided by Dell Financial Services L.L.C. to qualified US Public and Large Enterprise customers. All terms subject to credit approval and availability and can change without notice. Dell and the Dell logo are trademarks of Dell Inc.

*DFS performs visual inspection of equipment at pick-up. Customer remains responsible for pre-existing damage to equipment prior to pick-up.

**No data wipe process leaves a hard drive as free from unreadable residual data as a comparable new hard drive. DFS makes no (i) recommendations regarding the customer's data removal requirements or (ii) representations regarding the effectiveness of one method of data removal over another. All representations and warranties regarding the data wipe process will be contained in a Data Wipe Services Agreement between the customer and DFS. Such Agreement will set forth the full and final agreement between the parties.

FAQ's

These most frequently asked questions should help guide you through a successful end-of-lease process.

Please refer to your Lease agreement for specific lease information.

Q What happens at end of my lease?

A At the end of your lease term, you generally have three end-of-lease options. You may:

- Purchase the equipment for the purchase option price in your Lease;
- Return the equipment; or
- Renew your Lease.

Q When do I notify DFS of my End-of-Lease intent?

A A 90-day written notification prior to your lease expiration date is required unless otherwise specified in your Lease agreement.

Q Where do I send my written notice of intent?

A Mail to:	Contact:	Call:
Dell Financial Services L.L.C.	DFS EOL Coordinator	1.800.955.3355 and reference
Attention: CSG-End-of-Lease	For e-mail address or	your lease schedule and
One Dell Way, MS 5300	fax number	company's name
Austin, TX 78728		

Q What if I cannot make an End-of-Lease decision by my lease expiration?

A DFS will continue to bill you monthly (or your applicable billing period) at your current rent payment until we receive written end-of-lease notification as required by your lease agreement and the equipment is returned.

Q What is my purchase price at end-of-lease?

A Depending on the type of Lease agreement signed and its terms, you may be eligible to purchase your equipment at its Fair Market Value (FMV), a pre-determined fixed purchase amount (usually 10% of original equipment cost) or \$1.00 (full payout lease purchase).

Q How do I receive my End-of-Lease purchase or renewal price?

A In order to obtain your end-of-lease purchase or renewal price, forward your request to your End-of-Lease Coordinator.

Q How do I return my equipment?

A To return your equipment, contact your End-of-Lease Coordinator. Your coordinator will provide you with a Returns Material Authorization (RMA) number, packing instructions and return address. To avoid additional rental invoices, your equipment must be received at the specified DFS return location on or before your lease expiration date.

Q What happens if the asset cannot be located?

A If you cannot locate an asset that is to be returned to DFS, please consult your Lease agreement for your specific information regarding this event. Most Lease agreements contain a Stipulated Loss table or definition outlining your required obligation.

Note that the information contained in this guide is intended to help create a more effective and efficient relationship between DFS and your company. However, it does not change or supplement the terms and conditions of your lease agreement. In the event of a conflict, the terms and conditions of your lease agreement shall control.

Q Who will pay for return shipping?

A You are responsible for the cost of shipping the equipment back to DFS.

Q Do I need to keep the original boxes?

A Keeping the original boxes is not required.

Q What if items are missing with the returned equipment?

A You will be invoiced for the fair market value for any items damaged or not returned at end-of-lease.

Q Can DFS arrange for the return of equipment?

A Yes, in most cases. DFS offers fee-based equipment return services that include the packing of the equipment and shipping back to DFS. Contact your End-of-Lease Coordinator for an Equipment Return Services quote.

Note that the information contained in this guide is intended to help create a more effective and efficient relationship between DFS and your company. However, it does not change or supplement the terms and conditions of your lease agreement. In the event of a conflict, the terms and conditions of your lease agreement shall control.

Leasing and financing provided by Dell Financial Services, L.L.C. to qualified customers. All terms are subject to credit approval and availability. Contact your DFS representative for further details. Terms are subject to change without notice. Valid for qualified Dell customers in the United States only. Dell and the DELL logo are trademarks of Dell Inc.



DFS Online Services offers access to lease management information anytime, anywhere.

Welcome to Dell Financial Services Online Services (DFSOS), a web-based asset management system that puts information about your leased assets at your fingertips. DFSOS provides you with quick access to information through your Dell Premier site so that you can more effectively manage all phases of your IT product ownership, including asset management, document administration and reporting. With DFSOS, qualified customers will be able to search for contract and asset data, request location changes, accept lease schedules online and much more.¹

DFSOS Quick Reference Guide

Gaining access to DFSOS starts with your Premier page. If you do not have a Premier page, please contact your Dell sales representative. In the meantime, take a test drive of our DFSOS demo available at http://dfsos.us.dell.com/dfsosdemo/tutorial/setup_html.htm to experience how easily and efficiently you can manage your IT assets online.

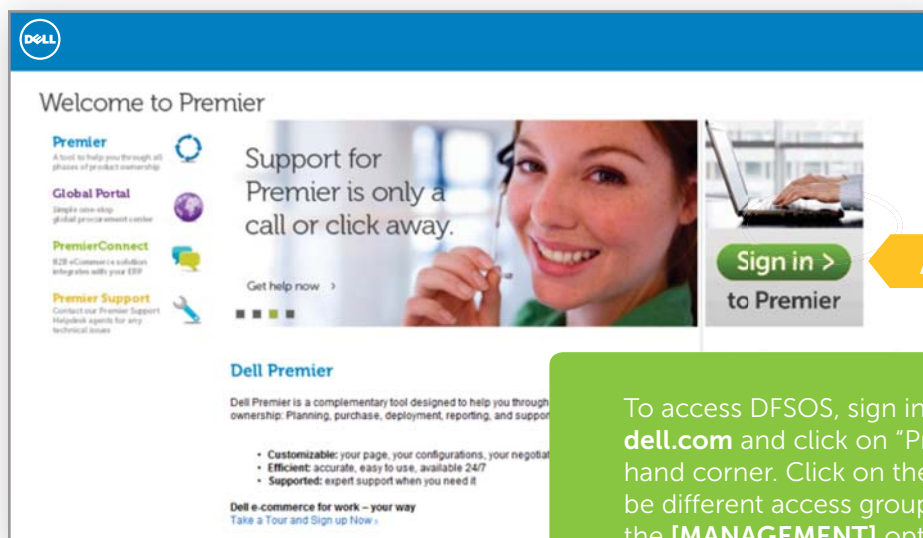

To access DFSOS, sign in to premier.dell.com or go to dell.com and click on "Premier Login" in the upper right hand corner. Click on the green "Sign in" link. There may be different access groups available to you. If so, select the **[MANAGEMENT]** option which gives the appropriate level of access to view DFSOS.

¹In order to accept lease schedules online, customers must have a valid DFS Master Lease Agreement and have signed the accompanying Electronic Lease Order Agreement.

Premier Home Page

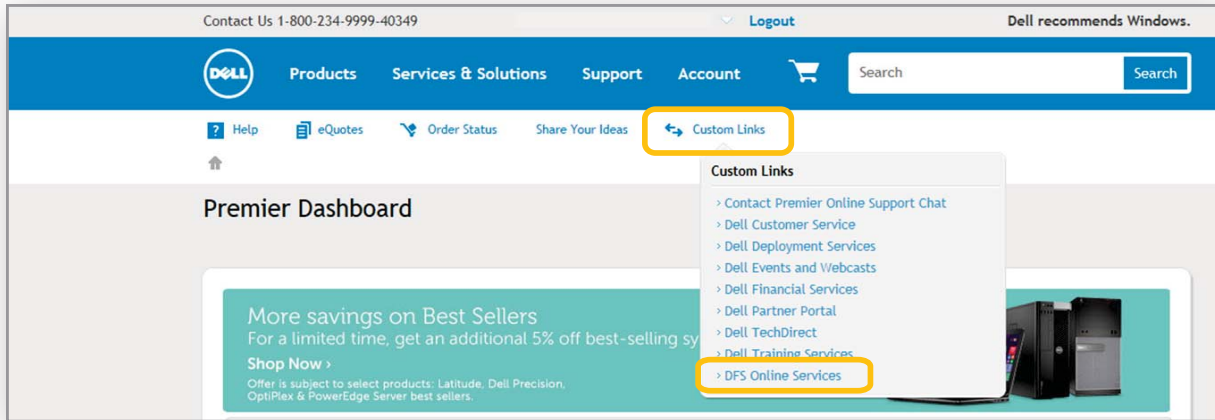

From your Dell Premier home page, navigate to the "Custom Links" menu. Click on "DFS Online Services", which is listed at the bottom of the menu.

Your DFSOS experience begins here.

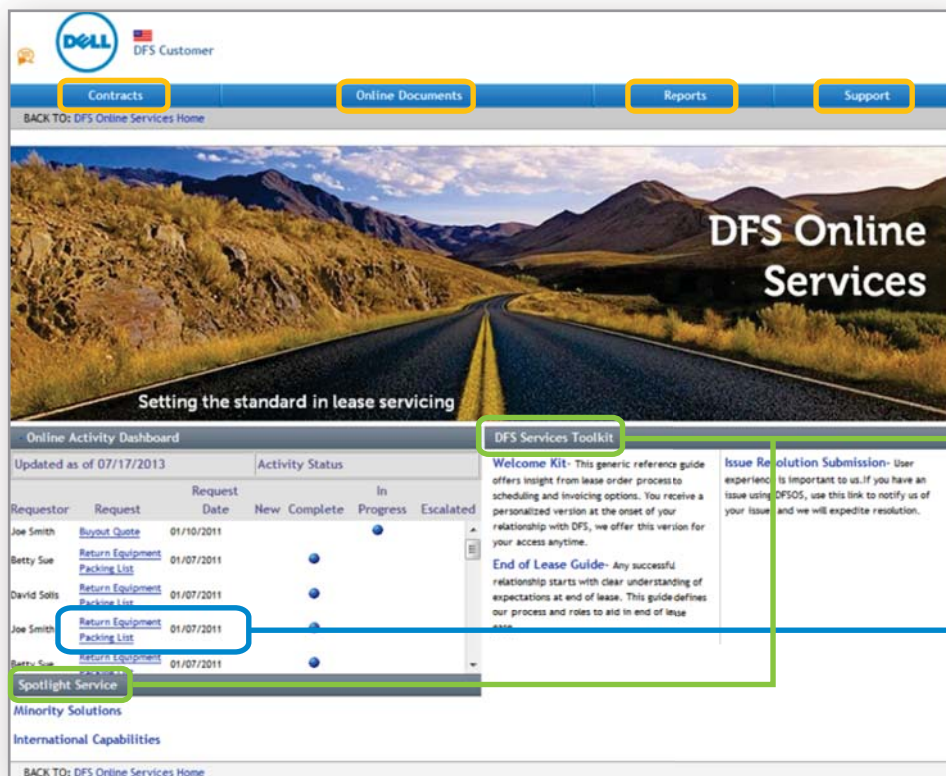

Navigation

The navigation toolbar at the top of the home page is divided into four key functional topics.

You can also find links to additional DFS information and services under the Toolkit and Spotlight sections.

The Online Activity Dashboard feature allows you to easily check the status of your online requests.

Let's take a look at each of the functional topics in greater detail.

Contracts

Under the **Contracts Option** you can:

- Browse all your contracts and search for a specific contract by Contract Number, Commencement Date, Termination Date or Purchase Order
- Identify specific contracts or assets to easily perform the following online tasks:

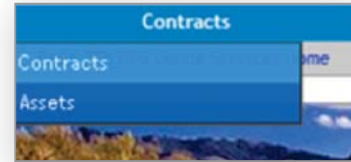

See more detailed information regarding your contract

Print the page being viewed

Download the results in Excel²

Results Per Page: 10 | 25 | 50 | 100 | 500 (Items 1 - 10 of 10) Data as of: 07/24/2013

Details	Customer Bill to Name	Contract Number ▲	Commencement Date	Term	Termination Date	Assets	Equipment Cost	Contract Tasks
	Company A	099-030-025	07/24/2011	48	07/24/2015	2	\$1,910.00	
	Company B	199-131-125	03/10/2012	24	07/24/2014	2	\$1,450.00	
	Company A	299-232-225	08/14/2011	48	07/24/2015	2	\$3,080.00	
	Company B	399-333-325	08/08/2012	24	07/24/2014	2	\$3,910.00	
	Company A	499-434-425	10/04/2011	48	07/24/2015	2	\$3,180.00	
	Company B	599-535-525	02/19/2012	24	07/24/2014	2	\$2,430.00	
	Company A	699-636-625	07/07/2011	48	07/24/2015	2	\$2,760.00	
	Company B	799-737-725	09/01/2012	24	07/24/2014	2	\$2,910.00	
	Company A	899-838-825	07/19/2011	48	07/24/2015	2	\$2,910.00	
	Company B	999-939-925	05/15/2012	24	07/24/2014	2	\$4,220.00	

BACK TO: DFS Online Services Home > End of Lease Documents > Custom Invoices > Contracts

Help
Open a window with a tutorial to help guide you through the page



View the assets for an individual contract in order to make asset level requests



Submit end of lease requests for an individual contract



Request an update to the billing address of the selected contract



View invoice statements for the selected contract

²Excel and the logo are registered trademarks of the Microsoft Corporation.

Under the **Assets Option** you can:

- Browse all your leased assets and search for **specific assets** by Asset ID, Contract Number, Service Tag, Dell Order Number, Purchase Order, Cost Center or Equipment Location Zip Code
- Identify **specific assets** to easily submit an online form for the following end-of-lease requests³:

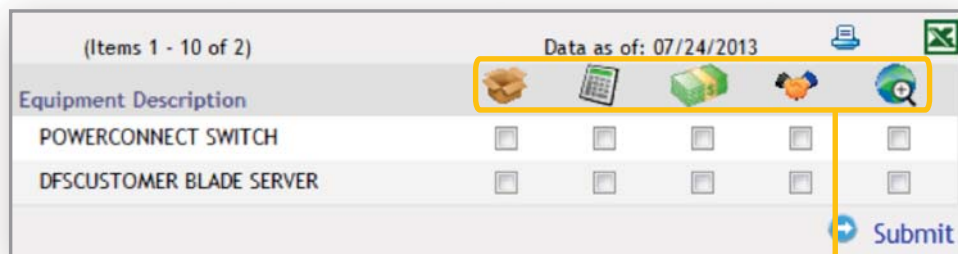

Select **Packing Slip** for assets you want to return



Request a **Buyout Quote** for assets you want to keep



Select **Early Termination Quote** for assets that are lost, stolen or damaged during the lease



Select **Renewal/Extension** for assets you want to continue using after the lease expires



Select **Change Asset Location** to change the address on specific service tags

Online Documents

Under the **Online Documents** tab, you can:

- Access, review and accept your lease schedules electronically via **Online Schedule Acceptance (OSA)**⁴. It is also a depository for your previously accepted schedules
- Request **Autopay**, which provides you with documentation to set up electronic payments
- Retrieve **Requested End of Lease (EOL) Documents**, including packing slips and quotes for buyout, early termination and renewal/extension options



³End of Lease Request features do not replace any written notification required pursuant to the terms and conditions of your Master Lease Agreement.

⁴Customers must first sign DFS's Electronic Lease Order Agreement to take advantage of Online Schedule Acceptance. This option is not available for governmental entities.

Reports

Under the **Reports Tab**, you can:

- Access and customize reports in .CSV or .XML formats for easy import into your current asset management system (reports are available for download for 14 days)
- Create an **All Asset Report** including active, disposed and received assets
- Pull an **Active Asset Report** (aka Leased Asset Report or LAR) that provides an overview of your active leased assets by contract and date including assets in renewal or month-to-month
- Run a **Disposed Asset Report** with details of disposed assets for the last three years
- Obtain a **Received Asset Report** to confirm returned assets were received at end of lease
- Build your own **Custom Report** from a wide range of available data fields
 - To position the data in the order you desire, simply select **Add Custom** within the All, Active, Disposed, or Received Asset Reports menus
 - Schedule a report to be run on a regular basis by selecting **Add Schedule** and choosing the time frame, search criteria and format you prefer
- View **Custom Reports** you previously scheduled after receiving email notification of its availability
- Request Account Reconciliation or Personal Property Tax reports from the **Request a Report** option
- View the **Requested Report** (available for viewing/download for seven days) after receiving email notification that the report is posted



Support

Under the **Support Tab**, you can:

- Find your DFS Account Team's contact information by clicking on the **DFS Contacts** option
- Review answers to **Frequently Asked Questions** regarding Online Schedule Acceptance, Senate Bill 20 and End of Lease options

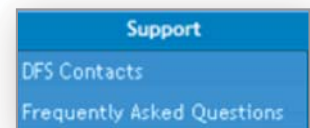

With DFS Online Services, DFS has put the power of managing your leased assets right at your fingertips. From simple tasks such as reviewing your assets, to more complex tasks such as getting information regarding your end-of-lease options, DFS Online Services makes your job easier.

For more information on how DFSOS can work for you, contact your DFS representative today.



Note that the information contained in this guide is intended to help create a more effective and efficient relationship between DFS and your organization. However, it does not change or supplement the terms and conditions of your lease agreement. In the event of a conflict, the terms and conditions of your Master Lease Agreement shall control.

Thank you for considering

