

Applied Systems

Product catalogue 2023



High performance and reliability for comfort and process applications

Follow us on



AHUs

CHILLERS

PROJECTS

SERVICE

Our promise...

... is to ensure that customers can depend on Daikin for the ultimate in comfort, so that they are free to focus on their own working and home lives.

We promise to dedicate ourselves to technological excellence, a design focus and the highest quality standards so that our customers can trust and rely on the comfort we deliver.

Our promise to the planet is absolute. Our products are at the forefront of low energy-usage and we will innovate to further reduce the environmental impact of HVAC-R (Heating, Ventilation, Air conditioning, Refrigeration) solutions. We lead where others follow.

We will continue our global leadership in HVAC-R solutions as our specialist expertise in all market sectors combined with 90 years' experience enable us to deliver added value in long-lasting relationships based on trust, respect and credibility.

We promise to continue our forward-thinking ethos, treating challenges as opportunities to produce ever-better solutions.

We will drive innovation and go the extra distance for our customers and our company.

We will be smart and ready to do things differently.

We will deliver on these core values of our brand and enjoy sustainable success with continued growth.

Table of content

Daikin, your partner of choice	4	Air handling units	133
Tools and platforms	5	Fan coil units	151
The best partner for your BREEAM project	6	Control systems	185
Chiller and AHU modernisation	8	Service & Maintenance	215
Day-to-day reliability and efficiency	10	Daikin PROtect maintenance solutions	217
What's new in 2023	12	Daikin on Site active remote monitoring	218
Chillers	14	IEQ Sensor	219
Daikin chillers, the best choice	14	Refrigerant leak detection	220
Why choose Daikin chillers?	16	Vibration analysis	220
Products overview	20	Oil analysis	221
Air cooled chillers	25	Rental services	222
Air cooled chillers (Cooling only)	25	Chiller modernisation	224
Air cooled chillers (Heat pump)	70	AHU refurbishment	225
Multipurpose unit	86	F-Gas regulations	226
Condensing unit	90	Spare parts	227
Water cooled chillers	92		
Condenserless chillers	114		
Centrifugal chillers	122		
Accessories	130		

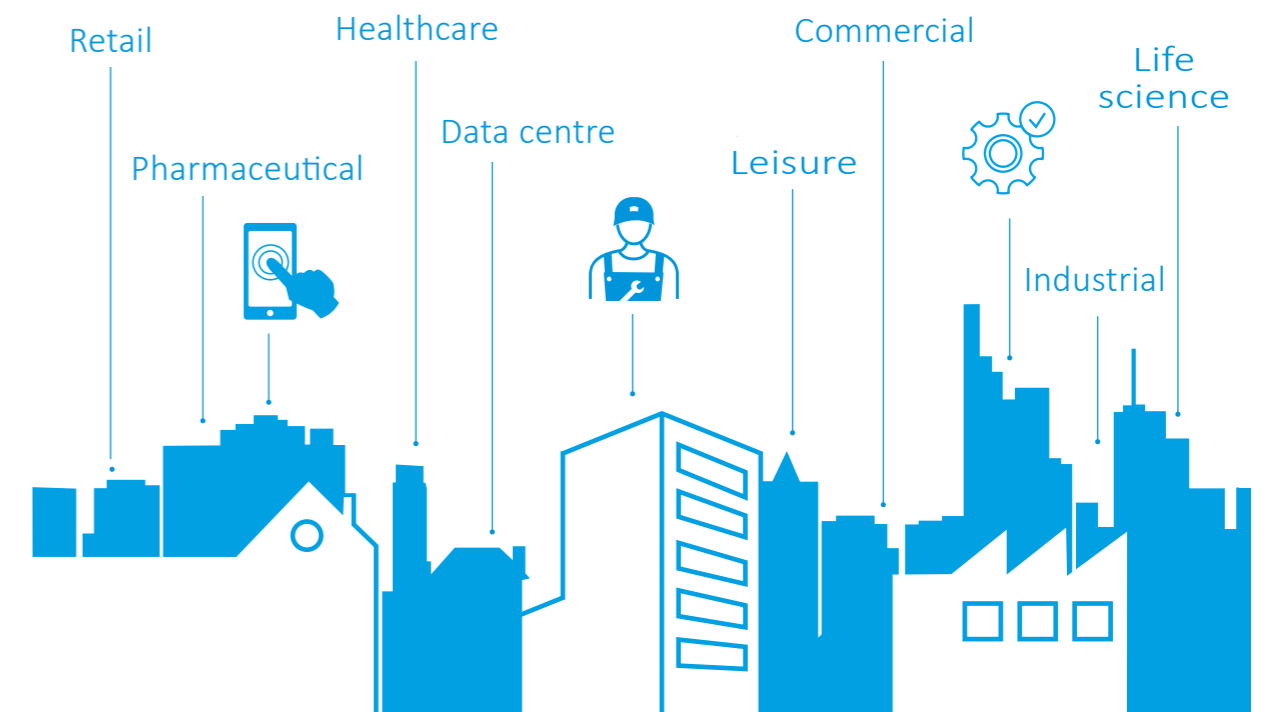



Forged under severe conditions around the world, Daikin chillers, fan coil units & air handling units provide high quality, operation efficiency and energy savings. Various applications are possible including air conditioning applications, industry-type process cooling and heating, and large-scale district cooling and heating.

A partner of choice

Daikin is Europe's leading manufacturer and global n°1 of highly energy-efficient heating, cooling, ventilation and refrigeration solutions for residential, commercial and industrial applications. Daikin is a leader in using technologies that help preserve the environment, such as those that conserve energy and deliver high reliability to its customers. Daikin's flexible applied systems deliver high efficiency for commercial, institutional and industrial buildings.

The comfort of reliability

Nobody is really looking for complexity in business. Because complexity often leads to mistakes, delays or losses. Unfortunately, the world we are all doing business in, is sometimes quite complex. When looking for further business development, we all expand our national and international operations. And that doesn't make things easy.

As a small scale business or multinational company, you deserve the best partners. Partners that can take away the headaches and make you feel comfortable again. With Daikin, you have found such a partner. Because Daikin would like things to be easy ... for you.

Daikin quality

Daikin's much envied quality quite simply stems from the close attention paid to design, production and testing as well as aftersales support. To this end, every component is carefully selected and rigorously tested to verify its contribution to product quality and reliability.

Staff who understands you

Daikin and its staff of devoted engineers, consultants and analysts are ready to assist you on a daily basis in setting up nationwide or international agreements, providing advice on equipment selection and monitoring regulations. Our goal is to help you carry out your plans with confidence, using custom-designed systems that meet your needs (for comfort, performance levels, support and service).

Daikin Applied Development Center

Opened in May 2009, the Daikin Applied Development Center is the world's most advanced facility for heating, ventilation and air conditioning (HVAC) research and development. The purpose of the center is to develop and test advanced chiller, compressor and other HVAC technologies to reduce energy consumption and, ultimately the carbon footprint of the buildings where they will be used.

Find out more about the Daikin Applied Europe in the video below:

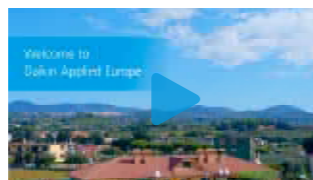

Witness Testing Chiller and AHU testing facilities

The performance of your chiller or AHU can be simulated and tested through witness tests.

During witness testing even the toughest design conditions can be simulated. Customers and consultants can appreciate product performance before its delivery, ensuring peace of mind.

We have specific competencies and state of the art testing facilities to ensure comprehensive and accurate testing. Our Chiller testing facilities are at our Chiller factory in Rome, and our AHU testing facilities are in our UK factory in Northumberland.

Find out more about our testing facilities in the video below:

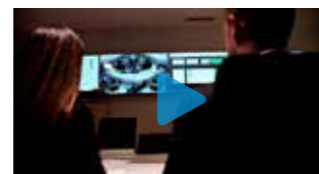

Tools and platforms

Have a question, looking for specific software applications, need detailed product information or looking for any other marketing tools? This overview gives you an idea of what we can offer.

Selection software

Daikin Europe offers you a variety of building modelling, selection, simulation and quotation software tools to support your sales.

Web-based chiller selection software

A user-friendly interface allows users to quickly create new projects, open and change existing projects or simply do a quick selection.

Technical selection reports can be printed or downloaded in several formats. To make life easier, the tool is accessible everywhere, via any device. No matter where you are, projects can be consulted.

Create now a new account on:
 › <http://tools.daikinapplied.eu/>



Online support

Daikin on Site

A new remote monitoring and control for chillers and air handling units has been developed by Daikin to give peace of mind to the end-customer.

Using this new tool results in optimum use and costs over the system's entire lifetime:

- › enhanced control and measuring
- › monitors the system
- › reduces risks at the earliest possible moment
- › keeps the system running as it was intended to

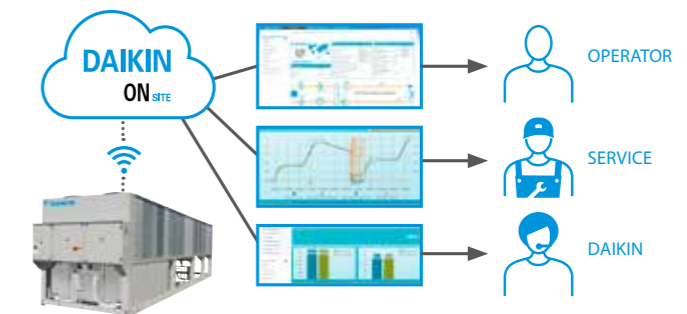

ASTRA Web

- › Quick AHU selection that will save you precious time, drastically reducing selection time through the new software interface.
- › Very competitive solution available within the Wizard thanks to pre-uploaded parameters.
- › High selection quality, thanks to the intelligence embedded within the software core.

Daikin, your partner for your BREEAM project

What is BREEAM?

BREEAM (British Research Establishment Environmental Assessment Method) is a certification system that recognises sustainable buildings that exceed national standards. As an internationally leading quality label, it provides investors and building owners the guidelines to focus sustainability in building design as well as the environmental impact of products in buildings.

The BREEAM label assesses the overall building concept in **10 different categories**. Credits are awarded and weighted for each category in order to generate the **final score for the building**, in levels from 'pass' to 'outstanding'. The final BREEAM building score recognises the effort the investor or building owner have done and result in increased property, leasing or renting value.

Daikin contributes in 6 BREEAM categories:

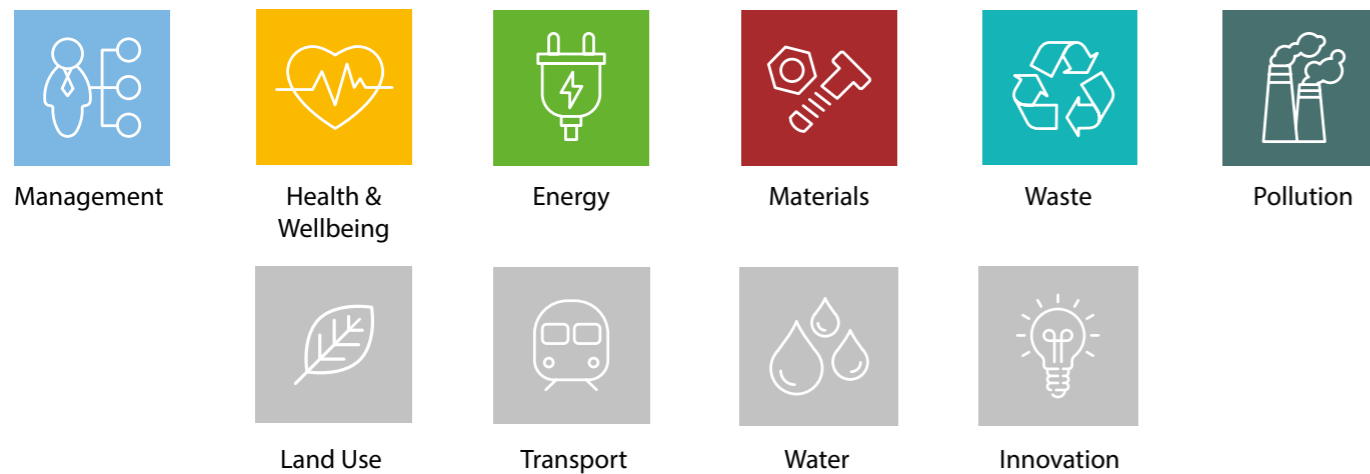

Daikin heat pumps can contribute in

6 out of 10 BREEAM categories

and achieve

up to **30** BREEAM credits*



Why Daikin?

to maximize your BREEAM rating

1. Team up with our own **accredited professionals (AP's)** assisting you to achieve your green building certification.
2. A global leader with local manufacturing service infrastructure and resources to provide **outstanding aftercare support**, advanced commissioning and hand-over.
3. Daikin Cloud Service ensures a **pro-active aftercare**, by detecting excessive energy use or potential issues before they occur to maximise system lifetime and minimize operational costs.
4. **First class Indoor Air Quality** thanks to low VOC emission, optimal thermal zoning and a low acoustic performance.
5. **Responsible sourcing and waste reduction**: BES6001 and ISO14001 certification delivers extra credits for the project.
6. Low carbon heating, cooling, ventilation and refrigeration thanks to **market-leading seasonal efficiency**.
7. Reduced environmental impact thanks to **refrigerant leak detection** systems and reuse of existing refrigerant through the **L∞P by Daikin** program.
8. High quality and performant products result in a **positive life cycle analysis**.
9. Our system are designed to be **easily adaptable** and upgradable to meet future building demands



Scan the code to download

Save time by using our in-depth BREEAM assessment sheet, created by our team of experts, as base of evidence towards assessors when applying for BREEAM credits.



System modernisation

Be smart – replace components, not systems



'If equipment is more than 10 years old, it is likely not running as efficiently as it could'

Chiller Modernisation

Even if the R-22 chiller has been maintained well and is still in good condition, R-22 is no longer allowed to be used. That's why Daikin offers chiller modernisation packages. Not only is the chiller made compliant with the latest legislation, the technology upgrade also revives your system, increasing reliability and efficiency.

Main benefits

- › Convert R-22 to be compliant with legislation
- › Limit capital
- › Save money for future equipment thanks to the chiller's longer lifetime, increased reliability, and improved maintenance efficiency
- › Enhance energy efficiency up to +20% ESEER by manufacturer pre-engineered upgrade

Benefits for budget and risk management

- › No chiller removal
- › No water pipe work
- › No electrical modifications
- › Low logistic expenses (transport, crantage, permissions ...)
- › Quick delivery
- › Government-sponsored subsidies may be available

Lower GWP refrigerants

With ever reducing F-Gas quota targets, new equipment can be supplied with low GWP refrigerants. Options for Retrofit to lower GWP solutions are also feasible to reduce potential long term maintenance costs.

- Soft starter
- Inverter



Controller box upgrade



Compressor upgrade



* EU directive: Regulation (EC) No.2037/2000

AHU Refurbishment

AHU refurbishment offers a cost effective, streamlined solution to improve the performance of existing AHUs and aid with compliance to the latest HVAC regulations. Our engineers at Daikin Applied UK can refurbish ANY BRAND of air handling unit.

By refurbishing your AHU, you could increase the life expectancy of the system by a further **10-15 years**.

What services can we offer?



Fan upgrades to EC fan arrays

- › Benefits - Higher efficiencies, significant energy and CO2 savings, additional redundancy and easy maintenance.

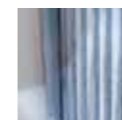

Filters

- › Update from BS EN 779 to ISO 16890 means more effective filter solutions to the market.
- › Benefits - Significant impact on IAQ and system pressure drop.



Coil replacement where damaged or worn

- › Benefits - Re-establish optimal performance. DX coils can offer significant cost savings. Over-time, set point parameters can change which can require the implementation of new coils.



Damper repair or replacement

- › Benefits - airflow set-points are re-established at the lowest pressure drop.



Panel replacement where damaged

- › Benefits - Improve casing leakage and thermal performance and help align to the latest specifications such as HTM-03-01 with the requirements for BS EN 1886 T2/TB2 and Euroclass A insulation.



Other

- › Site surveys of controls often highlight areas where control set-up is sub-optimal for desired performance.
- › We can offer individual component or full system upgrades and re-commissioning.
- › This can also reduce overall energy consumption, performance.

Benefits

- › Improved efficiency
- › Energy savings
- › Reduced CO2
- › Improved IAQ
- › Maintainability
- › Extended lifecycle
- › Redundancy
- › Compliance to regulations
- › Low upfront cost

Day-to-day reliability and efficiency

Whatever the requirements of the customer - large systems requiring constant capacity or small systems for flexibility - Daikin always provides a reliable and efficient solution.

Inhouse development and manufacturing of compressors

Unlike many other air conditioning manufacturers, Daikin manufactures its own compressors. This is important because the compressor is the very heart of the air conditioning system, increasing the pressure and temperature of the refrigerant vapour, effectively concentrating the heat as it passes around the system. Daikin has always been at the forefront of developing compressor technology and now offers a comprehensive range of swing, scroll, screw and centrifugal compressors. As a result, inverter compressor control is applied throughout our product range, delivering enhanced comfort and system efficiency.

Swing compressor

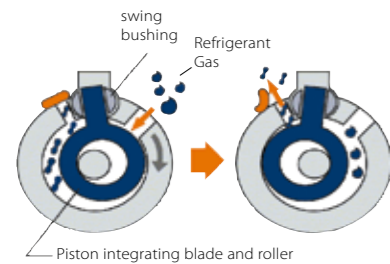

The mini chiller series EWAQ005-007ADVP & EWYQ005-007ADVP are equipped with a swing inverter compressor. This innovative design by Daikin has fewer moving parts allowing a smoother, more reliable operation with low vibration and low noise levels. The high-efficiency motor reduces energy consumption, resulting in energy cost savings.

Scroll compressor for controlled capacity

Being compact, the Daikin scroll compressor is used with R-407C and R-410A to provide constant reliability and high efficiency throughout its service life. Designed for small and medium capacities, the scroll compressors are used with air cooled and water cooled chillers.

Characteristics:

- › Compact, simple yet robust design
- › Absence of valves and oscillating connecting mechanisms providing maximum reliability
- › Constant compression guaranteeing low energy consumption
- › Increased compression efficiency thanks to the absence of volumetric re-expansion
- › Low sound level
- › Low starting current

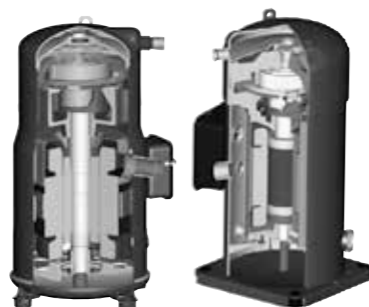

Innovative frictionless centrifugal compressor

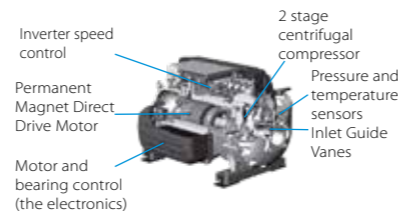

The innovative frictionless centrifugal compressor has an integrated VFD, as well as magnetic bearings, and delivers high levels of unit efficiency and reliability. The compressor's only moving part - the rotor shaft and impellers - are powered by the permanent magnetic direct-drive motor and kept levitated by a digitally controlled magnetic bearing system. This reduction in moving parts significantly increases unit reliability and reduces maintenance costs. As the condensing temperature and/or cooling load reduces, the speed of rotation reduces and movable inlet guide vanes, activated by the step motor, redirect gas flow into the first stage impeller once the compressor has reached its minimum speed. This delivers increased efficiency and cost savings during part-load operations.

The single-screw stepless compressor for high capacity

At the heart of the larger Daikin chillers is a semi hermetic single screw compressor, designed, tested and manufactured in Daikin's own factories, in order to meet the highest capacity, performance and maintenance specifications. This compressor has been especially developed for operation with R-410A or R-134a refrigerants, guaranteeing unequalled reliability and many years of efficient operation. The bearing life is 100,000hrs with inspection and maintenance intervals every 40,000hrs.

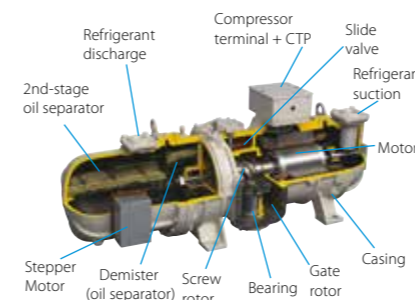

Characteristics:

- › Optimal performance through stepless capacity control chilled water temperatures. The unit capacity is infinitely variable from 30 - 100% on single circuit units and 15 - 100 % on dual circuit units.
- › Compact, simple yet robust construction.
- › Using a main single screw and two gate rotors, axial and radial forces are balanced, thanks to the symmetrical compression guaranteeing low bearing loads.
- › Gate rotors made of polymer material result in closer tolerances with the main screw and reduced friction greatly improves compressor efficiency and lifetime.
- › No oil pump necessary - lubrication based on the differential pressure principle.
- › Easy access to both compressor and safety devices.
- › Star-Delta starter with low starting current as standard.

Screw compressor with integrated inverter

Characteristics:

- › Compressor and inverter fully designed by Daikin
- › Inverter integral to the compressor body
- › Inverter refrigerant cooled
- › VVR = Variable Volume Ratio for optimized efficiency
- › Enlarged discharge port and suction side for reduced refrigerant pressure drop
- › New optimized compressor motors

Main benefits:

- › Better ESEER & EER values
- › 30% more compact than single-screw compressor
- › Rapid payback time
- › Silent operations
- › Optimal comfort levels

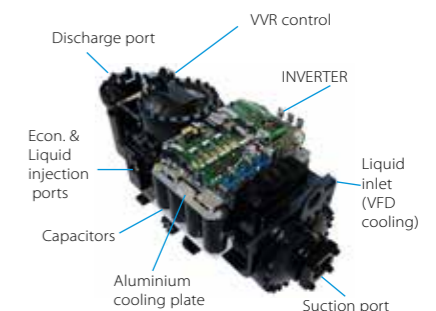

What's new in **NEW** 2023

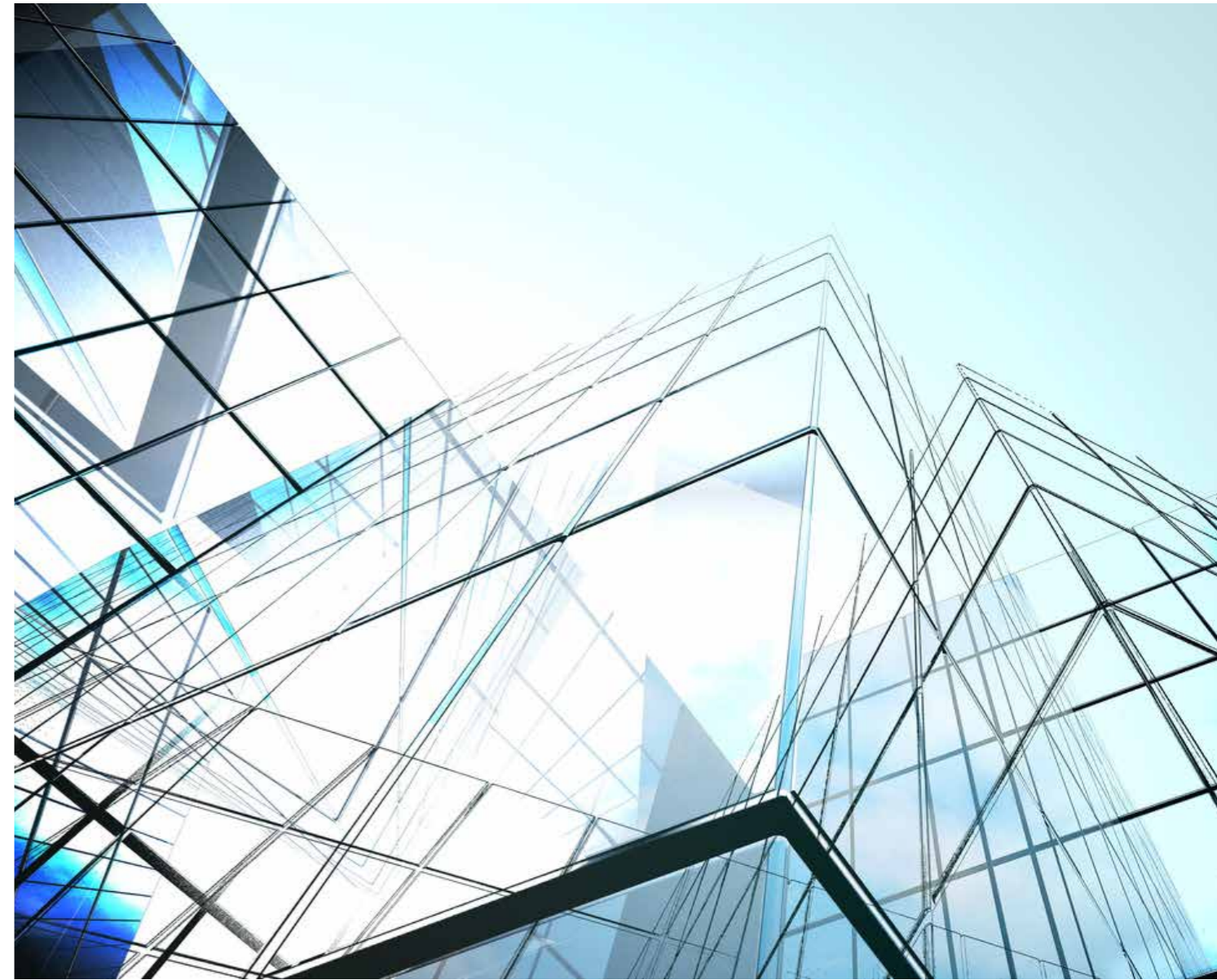

COMING SOON



Air Cooled VFD Screw Chillers

NEW

- > 4 efficiency tiers available in 3 sound configurations for max flexibility
- > Available with 3 refrigerants: R1234ze, R513A, R134a
- > Single and dual circuit
- > Compact footprint
- > New performance monitoring option
- > New Daikin mobile App
- > Suitable for Data Center application thanks to the:
 - New hydronic free cooling version available
 - Extended operating range with chilled water up to 30 °C
 - New rapid re-start option

COMING SOON



Air Cooled Scroll Chillers

NEW

- > Extended capacity range up to **1.012 kW cooling capacity** at nominal conditions
- > Improved full load efficiency
- > Silver and Gold efficiency versions combinable with standard or reduced noise execution
- > Standard unit operating down to 5°C ambient without fan speed control
- > New performance monitoring option
- > New Daikin mobile App
- > Suitable for Data Center application thanks to the:
 - New hydronic free cooling version available
 - Extended operating range with chilled water up to 30 °C
 - New rapid re-start option



Daikin chillers offer the ultimate in reliability and flexibility — a reflection of the advanced technology inherent within them. Daikin chillers represent the sure and safe route to a comfortable environment and a process cooling solution that is clean and consistent.

Table of content Chillers

Why choose Daikin chillers	16		
Why choose Daikin Applied Service	17		
Products Overview - Air cooled chillers, condensing units and Multipurpose units	20		
Products Overview - Water cooled and condenserless chillers	22		
Air cooled chillers cooling only	25		
NEW EWAA-DV3P	25		
EWAA-DW1P	26		
EWAA-DV3P-H	27		
EWAA-DW1P-H	28		
EWAT-CZ	29		
EWYT-CZ	32		
EWAD-CF	35		
EWAD-TZS	40		
EWAD-TZX	42		
EWAD-TZP	44		
EWAH-TZS	46		
EWAH-TZX	48		
EWAH-TZP	50		
EWAD-TZSSC2/SLC2	52		
EWAD-TZSRC2	53		
EWAD-TZXSC2	54		
EWAD-TZXRC2	55		
EWAH-TZSSC2/SLC2	56		
EWAH-TZSRC2	57		
EWAH-TZXSC2/XLC2	58		
EWAH-TZXRC2	59		
EWAD-T-SSC/SLC	60		
EWAD-T-XSC/XLC	61		
EWAD-T-XRC	62		
EWAT-B-SSB/SLB	66		
EWAT-B-SRB	67		
EWAT-B-XSB/XLB	68		
EWAT-B-XRB	69		
Air cooled chillers Heat pump	70		
NEW EWYA-DV3P	70		
EWYA-DW1P	72		
EWYA-DW1P-H	73		
		EWYA-DV3P-H	74
		EWYT-B-SS/SL	78
		EWYT-B-SR	79
		EWYT-B-XS/XL	80
		EWYT-B-XR	81
		NEW EWYT-CZ I / EWYT-CZ O	82
		EWYD-BZSS	84
		EWYD-BZSL	85
		Multipurpose unit	86
		EWYD-4ZXS2	87
		EWYD-4ZXR2	88
		Air cooled condensing unit	90
		ERAD-E-SS	90
		ERAD-E-SL	91
		Water cooled chillers	92
		NEW EWWQ-KC	92
		EWHQ-G-SS	94
		EWWQ-G-SS	95
		EWWQ-L-SS	96
		EWWD-J-SS	97
		EWWH-J-SS	98
		EWWS-J-SS	99
		EWWD-VZ	102
		EWWH-VZ	106
		EWWS-VZ	110
		Condenserless chillers	114
		EWLQ-G-SS	114
		EWLQ-L-SS	115
		EWLD-J-SS	116
		EWLH-J-SS	117
		EWLS-J-SS	118
		EWLD-I-SS	119
		NEW EWLQ-KC	120
		Water cooled centrifugal chillers	122
		EWWD-DZ	122
		EWWH-DZ	124
		EWWS-DZ	126
		NEW DWSC C Series	128
		NEW DWDC C Series	129
		Accessories	130



Why choose Daikin chillers?

Daikin chillers are the perfect bridge between project requirements and customer satisfaction. From the smallest chillers to the very largest, our quality control and attention detail is absolute. Our systems have the **most advanced technologies**, deliver **the highest energy efficiencies** and **lowest running costs**, and are the gold standard for reliability and performance.

The widest and most flexible chiller portfolio

- › From the smallest mini chiller for residential use to the largest chiller for district cooling
- › Tailor made solutions based on the most advanced technologies
- › Wide range of options and accessories

Worldwide experience in chiller design and manufacturing

- › World's most advanced facilities for air conditioning research and development: the Applied Development Center in Minneapolis, Minnesota
- › Inhouse development and manufacturing of chiller main components (compressors, fans, condenser coils, software, etc...)
- › Chillers produced in European factories, in Milan and Ostend

The highest efficiency for every installation

- › Inverter technology over the whole capacity range
- › The lowest total cost of ownership and fast payback time

Quality and reliability

- › Daikin's integrated zero defect policy ensures quality of components and finished products
- › Each Daikin chiller is factory run-tested and subjected to quality audit before shipment

Benefits for installers

- › Plug & play solutions
- › Maximum serviceability
- › Ideal solutions for retrofit projects

Benefits for consultants

- › Energy efficient solutions without compromising on reliability and performance
- › Latest technology embedded in all our products

Benefits for end users

- › Remarkable savings on running costs
- › Easy to customise the chiller to your application, environment and need thanks to more than 150 different options.





Products overview

	Refrigerant type*	Refrigerant circuits	Inverter	Free cooling	Compressor			Water heat exchanger		Efficiency version			Sound version			Cooling capacity (kW)	Heating capacity (kW)				
					Swing	Scroll	Screw	Plate**	Single pass shell and tube	Standard	High	Premium	Standard	Low	Reduced						
Cooling only																0	17.5	200	500	1,000	2,000
EWAA-DV3P	R-32	1	●		●			●	BPHE	●			●			4.5~5.4					
EWAA-DV3P-H/ DW1P-H	R-32	1	●		●			●	BPHE	●			●			11.0~14.0					
EWAT~CZN/P/H	R-32	1-2	●			●		●	BPHE	●			●			16.0~90.0					
EWAD~CF	R-134a	2		●			●	●		●			●	●			602~1,555				
EWAD-TZ B	R-134a	1-2	●				●	●		●	●	●	●	●			170~1,100				
EWAH-TZ B	R-1234ze(E)	1-2	●				●	●		●	●	●	●	●			170~620				
EWAD-TZ C	R-134a	1-2	●				●	●		●	●	●	●	●			1,200~2,000				
EWAH-TZ C	R-1234ze(E)	1-2	●				●	●		●	●	●	●	●			670~1,600				
EWAD-T-	R-134a	2					●	●		●	●	●	●	●			291~1,456				
EWAT-B	R-32	1-2				●		●		●	●		●	●			76.3~701				
Heat pump																0	17.5	200	500	1,000	2,000
EWYA-DV3P	R-32	1	●		●			●	BPHE	●			●			4.5~5.4					
EWYA-DV3P-H/ DW1P-H	R-32	1	●		●			●	BPHE	●			●			4.6~7.8					
EWYT~CZN/P/H	R-32	1-2	●			●		●	BPHE	●			●			9.0~14.0					
EWYT-B	R-32	1-2				●		●	BPHE	●	●		●	●		16.0~90.0					
EWYT-CZI EWYT-CZO	R-32	1-2	●			●		●	BPHE	●			●			21.1~64.4					
EWYD~BZ	R-134a	2-3	●				●	●		●			●	●		19.9~61.8					
Condensing unit																0	17.5	200	500	1,000	2,000
ERAD~E-	R-134a	1				●		●					●	●			116~488				
Multipurpose unit																0	17.5	200	500	1,000	2,000
EWYD-4Z	R-134a	2	●				●	●		●			●	●			358~786				
																	358~800				

* (GWP): R-410A (2,087.5), R-134a (1,430) - ** BPHE: Brazed plate heat exchanger

Products overview

Refrigerant Type *	Refrigerant circuits	Inverter	Compressor			Water heat exchanger			Efficiency version			Sound version	Cooling capacity (kW)	Heating capacity (kW)					
			Scroll	Screw	Centrifugal	Plate **	Single pass shell and tube	Shell and tube	Standard	High	Premium	Standard							
Water cooled chillers (Cooling only and Heat Pump)													0	17.5	200	500	1,000	2,000	21,800
EWQK-KCWIN	R-410a	1-2	•			•			•			•	12~183	15~209					
EWQK-G-	R-410A	1	•			•			•			•	87.3~352	118~462					
EWQK-G-	R-410A	1	•			•			•			•	93.7~370	118~468					
EWQK-L-	R-410A	2	•			•			•			•	187~400	234~400					
EWWD-J-	R-134a	1		•		•			•			•	120~284	148~354					
EWWH-J-	R1234ze	1		•		•			•			•	89~200	107~245					
EWWS-J-	R-513A	1		•		•			•			•	115~272	142~388					
EWWD-VZ	R-134a	1-2	•	•			Flooded		•	•	•	•			449~2,100				
EWWH-VZ	R-1234ze(E)	1-2	•	•			Flooded		•	•	•	•			329 - 1,540				
EWWS-VZ	R-513A	1-2	•	•			Flooded		•	•	•	•			440~2,050				
Condenserless chillers													0	17.5	200	500	1,000	2,000	21,800
EWLQ-KCWIN	R-410A	1-2				•	BPHE		•			•	13.25~61						
EWLQ-G-	R-410A	1	•			•			•			•	86.5~346						
EWLQ-L-	R-410A	2	•			•			•			•	173~676						
EWLD-J-	R-134a	1		•		•			•			•	109~264						
EWLD-I-	R-134a	1-2-3				•			•			•	315~1,433						
EWLH-J-	R1234ze	1		•		•			•			•	84~193						
EWLS-J-	R-513A	1		•		•			•			•	111~268						
Water cooled centrifugal chillers													0	17.5	200	500	1,000	2,000	21,800
EWWD-DZ	R-134a	1			•			•	•			•	320 - 1,478						
EWWH-DZ	R-1234ze(E)	1			•			•	•			•	227 - 945						
DWSCC / DWDC NEW	R-134a, R-513A and R-1234ze	1	optional		•		Flooded		•			•	1,050~4,500			2,100~9,000			
6,000 RT CENTRIFUGAL	R-134a	2 per chiller			•		Flooded		•			•			[2 x 10,900]	21,800			

* (GWP): R-410A (2,087.5), R-134a (1,430), R-407C (1,773.9) - ** BPHE: Brazed plate heat exchanger

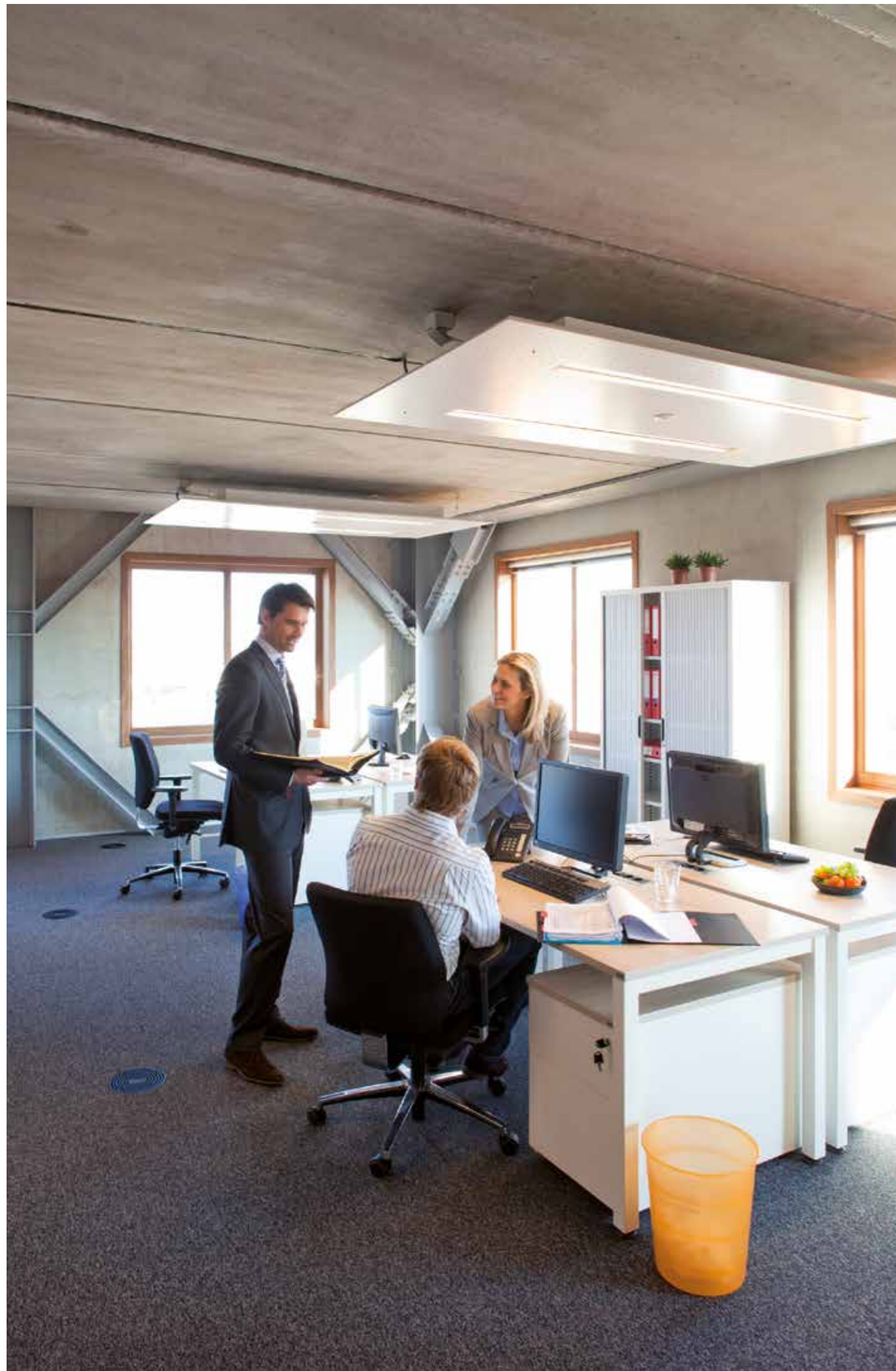

EWAA-DV3P



BLUEEVOLUTION

Air cooled mini inverter chiller

- › Choosing for an R-32 product, reduces the environmental impact with 68% compared to R-410A and leads directly to lower energy consumption thanks to its high energy efficiency
- › Inverter chiller
- › Hermetically sealed swing inverter compressor
- › New casing for the outdoor units
- › Separate MMI-2 controller for indoor installation



Cooling Only				EWAA-DV3P	004	006	008
Cooling capacity	Nom.		kW	4.86 (1) / 4.52 (2)	5.83 (1) / 5.09 (2)	6.18 (1) / 5.44 (2)	
Power input	Cooling	Nom.	kW	0.820 (1) / 1.36 (2)	1.08 (1) / 1.55 (2)	1.19 (1) / 1.73 (2)	
Capacity control	Method				Variable (inverter)		
EER				5.91 (1) / 3.32 (2)	5.40 (1) / 3.28 (2)	5.19 (1) / 3.14 (2)	
Dimensions	Unit	Height	mm	770			
		Width	mm	1,250			
		Depth	mm	362			
Weight	Unit		kg	88.0			
Water heat exchanger	Type			Plate heat exchanger			
	Water volume		l	1			
Compressor	Type			Hermetically sealed swing compressor			
	Quantity			1			
Fan	Type			Propeller fan			
	Quantity			1			
Sound power level	Cooling	Nom.	dB(A)	61.0 (1)	62.0 (1)		
Sound pressure level	Cooling	Nom.	dB(A)	48.0 (1)	49.0 (1)	50.0 (1)	
Operation range	Air side	Cooling	Min.~Max.	°CDB			10 (3)~43
	Water side	Cooling	Min.~Max.	°CDB			5 (3)~22
Refrigerant	Type/GWP			R-32/675.0			
	Charge		kg	1.35			
Power supply	Phase/Frequency/Voltage		Hz/V	1~/50 /230 +/-10%			

(1)Condition 1: cooling Ta 35°C - LWE 18°C (DT = 5°C); heating Ta DB/WB 7°C/6°C - LWC 35°C (DT = 5°C) | (2)Condition 2: cooling Ta 35°C - LWE 7°C (DT = 5°C); heating Ta DB/WB 7°C/6°C - LWC 45°C (DT = 5°C) | (3)For more details, see operation range drawing

Air cooled mini inverter chiller

- › Choosing for an R-32 product, reduces the environmental impact with 68% compared to R-410A and leads directly to lower energy consumption thanks to its high energy efficiency
- › Inverter chiller
- › Daikin swing compressor
- › New casing for the outdoor units
- › Separate MMI-2 controller for indoor installation



Air cooled mini inverter chiller

- › Choosing for an R-32 product, reduces the environmental impact with 68% compared to R-410A and leads directly to lower energy consumption thanks to its high energy efficiency
- › Inverter chiller
- › Daikin swing compressor
- › New casing for the outdoor units
- › Separate MMI-2 controller for indoor installation



Cooling Only					EWAA	011DW1P	014DW1P	016DW1P	
Space cooling	A Condition 35°C Pdc				kW	11.6	12.8	14.0	
	ηs,c				%	229	226	221	
SEER						5.79	5.71	5.59	
Cooling capacity	Nom.				kW	11.6 (1) / 11.5 (2)	12.8 (1) / 12.7 (2)	14.0 (1) / 15.3 (2)	
Power input	Cooling Nom.				kW	3.56 (1) / 2.17 (2)	4.06 (1) / 2.51 (2)	4.58 (1) / 3.24 (2)	
Capacity control	Method				Variable (inverter)				
EER						3.26 (1) / 5.31 (2)	3.16 (1) / 5.04 (2)	3.06 (1) / 4.74 (2)	
Dimensions	Unit	Height		mm	870				
		Width		mm	1,380				
		Depth		mm	460				
Weight	Unit				kg	147			
Water heat exchanger	Type				Plate heat exchanger				
	Water volume				l	2			
Air heat exchanger	Type				High efficiency fin and tube type with integral subcooler				
Compressor	Type				Hermetically sealed swing inverter compressor				
	Quantity					1			
Fan	Type				Propeller fan				
	Quantity					1			
Sound power level	Cooling	Nom.	Air flow rate		m³/min	70	85		
			Cooling		dB(A)	67.0	69.0		
			Sound pressure level		dB(A)	47.7	50.8	51.0	
Operation range	Air side	Cooling	Min.~Max.		°CDB	10~43			
			Water side	Cooling	Min.~Max.		°CDB	5~22	
Refrigerant	Type/GWP				R-32/675.0				
	Control				Electronic expansion valve				
	Circuits		Quantity			1			
Refrigerant charge	Per circuit				kg	3.80			
	Per circuit				TCO ₂ eq	2.6			
Unit	Running current	Max		A	14.0				
		Power supply				Hz/V	3~/50/400		

(1)Cooling: EW 12°C; LW 7°C; ambient conditions: 35°CDB | (2)Cooling: EW 23°C; LW 18°C; ambient conditions: 35°CDB

Cooling Only					EWAA	011DV3P-H-	014DV3P-H-	016DV3P-H-	
Space cooling	A Condition 35°C Pdc				kW	11.6	12.8	14.0	
	ηs,c				%	229	226	221	
SEER						5.79	5.71	5.59	
Cooling capacity	Nom.				kW	11.6 (1) / 11.5 (2)	12.8 (1) / 12.7 (2)	14.0 (1) / 15.3 (2)	
Power input	Cooling Nom.				kW	3.56 (1) / 2.17 (2)	4.06 (1) / 2.51 (2)	4.58 (1) / 3.24 (2)	
Capacity control	Method				Variable (inverter)				
EER						3.26 (1) / 5.31 (2)	3.16 (1) / 5.04 (2)	3.06 (1) / 4.74 (2)	
Dimensions	Unit	Height		mm	870				
		Width		mm	1,380				
		Depth		mm	460				
Weight	Unit				kg	147			
Water heat exchanger	Type				Plate heat exchanger				
	Water volume				l	2			
Air heat exchanger	Type				High efficiency fin and tube type with integral subcooler				
Compressor	Type				Hermetically sealed swing inverter compressor				
	Quantity					1			
Fan	Type				Propeller fan				
	Quantity					1			
Sound power level	Cooling	Nom.	Air flow rate		m³/min	70	85		
			Cooling		dB(A)	67.0	69.0		
			Sound pressure level		dB(A)	47.7	50.8	51.0	
Operation range	Air side	Cooling	Min.~Max.		°CDB	10~43			
			Water side	Cooling	Min.~Max.		°CDB	5~22	
Refrigerant	Type/GWP				R-32/675.0				
	Control				Electronic expansion valve				
	Circuits		Quantity			1			
Refrigerant charge	Per circuit				kg	3.80			
	Per circuit				TCO ₂ eq	2.6			
Unit	Running current	Max		A	30.8				
		Power supply				Hz/V	1~/50/230		

(1)Cooling: EW 12°C; LW 7°C; ambient conditions: 35°CDB | (2)Cooling: EW 23°C; LW 18°C; ambient conditions: 35°CDB

Air cooled mini inverter chiller

- › Choosing for an R-32 product, reduces the environmental impact with 68% compared to R-410A and leads directly to lower energy consumption thanks to its high energy efficiency
- › Inverter chiller
- › Daikin swing compressor
- › New casing for the outdoor units
- › Separate MMI-2 controller for indoor installation



Cooling Only		EWAA	011DW1P-H-	014DW1P-H-	016DW1P-H-
Space cooling	A Condition 35°C Pdc	kW	11.6	12.8	14.0
	ηs,c	%	229	226	221
SEER			5.79	5.71	5.59
Cooling capacity	Nom.	kW	11.6 (1) / 11.5 (2)	12.8 (1) / 12.7 (2)	14.0 (1) / 15.3 (2)
	Cooling Nom.	kW	3.56 (1) / 2.17 (2)	4.06 (1) / 2.51 (2)	4.58 (1) / 3.24 (2)
Capacity control	Method		Variable (inverter)		
EER			3.26 (1) / 5.31 (2)	3.16 (1) / 5.04 (2)	3.06 (1) / 4.74 (2)
Dimensions	Unit	Height	mm		
		Width	mm		
		Depth	mm		
			mm		
Weight	Unit	kg	147		
Water heat exchanger	Type		Plate heat exchanger		
	Water volume	l	2		
Air heat exchanger	Type		High efficiency fin and tube type with integral subcooler		
Compressor	Type		Hermetically sealed swing inverter compressor		
	Quantity		1		
Fan	Type		Propeller fan		
	Quantity		1		
Air flow rate	Cooling Nom.	m ³ /min	70	85	
	Sound power level	Cooling Nom.	67.0	69.0	
Sound pressure level	Cooling Nom.	dB(A)	47.7	50.8	51.0
	Operation range	Air side Cooling Min.~Max.	°CDB	10~43	
Water side Cooling Min.~Max.		°CDB	5~22		
Refrigerant	Type/GWP		R-32/675.0		
	Control		Electronic expansion valve		
	Circuits Quantity		1		
Refrigerant charge	Per circuit	kg	3.80		
	Per circuit	TCO ₂ eq	2.6		
Unit	Running Max current	A	14.0		
	Power supply	Phase/Frequency/Voltage	Hz/V 3~/50/400		

(1)Cooling: EW 12°C; LW 7°C; ambient conditions: 35°CDB | (2)Cooling: EW 23°C; LW 18°C; ambient conditions: 35°CDB

Air cooled scroll inverter chiller

- › Inverter chiller
- › High part load efficiency for low running cost
- › Minimal starting currents
- › No buffertank required for standard applications
- › Daikin scroll compressor
- › Wide operation range
- › Integrated hydronic module on request



Cooling Only		EWAT	016CZN-A1	021CZN-A1	025CZN-A1	032CZN-A1	040CZN-A1	040CZN-A2	050CZN-A2	064CZN-A2	090CZN-A2	
Space cooling	A Condition Pdc 35°C	kW	15.9	20.9	25.6	32.4	39.6	41.4	50.8	64.0	88.3	
	ηs,c	%	197		200	205	201	213	210	205	198	
SEER			5.00		5.06	5.21	5.09	5.41	5.33	5.21	5.03	
Cooling capacity	Nom.	kW	15.9	20.9	25.6	32.4	39.6	41.4	50.8	64.0	88.3	
Power input	Cooling Nom.	kW	5.50	6.60	8.50	10.3	13.4	13.2	17.0	21.8	31.0	
Capacity control	Method		Inverter controlled									
	Minimum capacity	%	18	14	12	19	15	14	12	15	14	
EER			2.90	3.16	3.00	3.13	2.95	3.12	2.98	2.93	2.84	
IPLV			5.83	6.29	6.05	6.25	5.87	6.37	5.92	5.88	5.61	
Dimensions	Unit	Height	mm									
		Width	mm		mm		mm		mm		mm	
		Depth	mm			mm		mm		mm		
			mm			mm		mm		mm		
Weight	Unit	kg	222	245	340	339	480	574	672			
	Operation weight	kg	223	247	343	342	486	580	680			
Water heat exchanger	Type		Braze plate heat exchanger									
	Water volume	l	1	2		5		8				
	Water flow rate	Cooling Nom.	l/s	0.8	1.0	1.2	1.6	1.9	2.0	2.4	3.1	4.2
		Water pressure drop	nom.	kPa	20	11	16	19	28	10	14	22
Air heat exchanger	Type		High efficiency fin and tube type – Copper Aluminum									
Compressor	Type		Scroll compressor									
	Quantity		1			2		3		4		
Fan	Type		Axial									
	Quantity		1		2		3		4			
Sound power level	Cooling Nom.	dB(A)	800	900	700	900	700	900	800	900		
	Sound pressure level	Cooling Nom.	dB(A)	76.0	78.0	79.0	80.0	81.0	83.0	85.0		
Refrigerant	Type/GWP		R-32/675									
	Charge	kg	3.00	5.50	7.00	8.00	12.0	13.0	16.0			
Piping connections	Evaporator water inlet/outlet (OD)		1			2		2				
			1"1/4			2"		2"				

Cooling: EW 12°C; LW 7°C; ambient conditions: 35°CDB | Cooling: EW 23°C; LW 18°C; ambient conditions: 35°CDB | Condition: Ta DB/WB 7°C/6°C - LWC 35°C (DT = 5°C) | Condition: Ta DB/WB 7°C/6°C - LWC 45°C (Dt=5°C) | According to EN14825 | Depends on operation mode, refer to installation manual. | For more details, see operation range drawing



Air cooled scroll inverter chiller

- › Inverter chiller
- › High part load efficiency for low running cost
- › Minimal starting currents
- › No buffertank required for standard applications
- › Daikin scroll compressor
- › Wide operation range
- › Integrated hydronic module on request



Cooling Only				EWAT	016CZP-A1	021CZP-A1	025CZP-A1	032CZP-A1	040CZP-A1	040CZP-A2	050CZP-A2	064CZP-A2	090CZP-A2			
Space cooling	A Condition Pdc 35°C			kW	16.0	21.0	25.7	32.6	39.8	41.6	51.0	64.3	88.6			
	ηs,c			%	209	213	225	211	228	216	211	204				
SEER					5.30	5.41	5.70	5.36	5.76	5.48	5.34	5.18				
Cooling capacity	Nom.			kW	16.1	21.1	25.9	32.7	39.9	41.7	51.1	64.4	88.8			
Power input	Cooling Nom.			kW	5.45	6.56	8.48	10.3	13.3	13.2	16.9	21.9	31.1			
Capacity control	Method			Inverter controlled												
	Minimum capacity			%	18	14	12	19	15	14	12	15	14			
EER					2.96	3.22	3.05	3.18	3.00	3.17	3.03	2.95	2.85			
IPLV					5.83	6.29	6.05	6.25	5.87	6.37	5.92	5.88	5.61			
Dimensions	Unit	Height		mm	1,878											
		Width		mm	1,152			1,752		2,306		2,906		3,506		
		Depth		mm	802				814							
Weight	Unit			kg	256	278	383	382	531	630	727					
	Operation weight			kg	257	280	386	385	537	636	735					
Water heat exchanger	Type			Braze plate heat exchanger												
	Water volume			l	1	2				5				8		
	Water flow rate	Cooling	Nom.	l/s	0.8	1.0	1.2	1.6	1.9	2.0	2.4	3.1	4.2			
				kPa	20	11	16	19	28	10	14	22	20			
Air heat exchanger	Type			High efficiency fin and tube type – Copper Aluminum												
Compressor	Type			Scroll compressor												
	Quantity				1				2							
Fan	Type			Axial												
	Quantity				1		2		3		4					
	Speed	rpm	800													
Cooling			Nom.	dBa	76.0	78.0	79.0	80.0	81.0	-	-	-	-	-		
	Sound pressure level	Cooling		Nom.	dBa	59.7	61.7	62.2	63.2	62.8	63.8	-	-	-	-	
Type/GWP			R-32/675													
Refrigerant	Charge			kg	3.00	5.50	7.00	8.00	12.0	13.0	16.0					
	Circuits				1				2							
	Quantity				1				2							
Piping connections Evaporator water inlet/outlet (OD)					1"1/4				2"							

Cooling: EW 12°C; LW 7°C; ambient conditions: 35°CDB | Cooling: EW 23°C; LW 18°C; ambient conditions: 35°CDB | Condition: Ta DB/WB 7°C/6°C - LWC 35°C (DT = 5°C) | Condition: Ta DB/WB 7°C/6°C - LWC 45°C (Dt=5°C) | According to EN14825 | Depends on operation mode, refer to installation manual. | For more details, see operation range drawing



Air cooled scroll inverter chiller

- › Inverter chiller
- › High part load efficiency for low running cost
- › Minimal starting currents
- › No buffertank required for standard applications
- › Daikin scroll compressor
- › Wide operation range
- › Integrated hydronic module on request



Cooling Only				EWAT	016CZH-A1	021CZH-A1	025CZH-A1	032CZH-A1	040CZH-A1	040CZH-A2	050CZH-A2	064CZH-A2	090CZH-A2			
Space cooling	A Condition Pdc 35°C			kW	16.1	21.1	25.8	32.7	39.9	41.7	51.1	64.3	88.7			
	ηs,c			%	205	210	211	224	210	227	213	208	202			
SEER					5.30	5.41	5.70	5.36	5.76	5.48	5.34	5.18				
Cooling capacity	Nom.			kW	16.2	21.2	25.9	32.8	40.1	41.8	51.3	64.5	88.9			
Power input	Cooling Nom.			kW	5.60	6.70	8.70	10.4	13.5	13.3	17.0	22.0	31.2			
Capacity control	Method			Inverter controlled												
	Minimum capacity			%	18	14	12	19	15	14	12	15	14			
EER					2.89	3.15	2.98	3.14	2.97	3.15	3.02	2.93	2.85			
IPLV					5.83	6.29	6.05	6.25	5.87	6.37	5.92	5.88	5.61			
Dimensions	Unit	Height		mm	1,878											
		Width		mm	1,152			1,752		2,306		2,906		3,506		
		Depth		mm	802				814							
Weight	Unit			kg	256	278	383	382	531	630	727					
	Operation weight			kg	257	280	386	385	537	636	735					
Water heat exchanger	Type			Braze plate heat exchanger												
	Water volume			l	1	2				5				8		
	Water flow rate	Cooling	Nom.	l/s	0.8	1.0	1.2	1.6	1.9	2.0	2.4	3.1	4.20			
				kPa	20	11	16	19	28	10	14	22	20			
Air heat exchanger	Type			High efficiency fin and tube type – Copper Aluminum												
Compressor	Type			Scroll compressor												
	Quantity				1				2							
Fan	Type			Axial												
	Quantity				1		2		3		4					
	Speed	rpm	800													
Cooling			Nom.	dBa	76.0	78.0	79.0	80.0	81.0	-	-	-	-			
	Sound pressure level	Cooling		Nom.	dBa	59.7	61.7	62.2	63.2	62.8	63.8	-	-	-		
Type/GWP			R-32/675													
Refrigerant	Charge			kg	3.00	5.50	7.00	8.00	12.0	13.0	16.0					
	Circuits				1				2							
	Quantity				1				2							
Piping connections Evaporator water inlet/outlet (OD)					1"1/4				2"							

Cooling: EW 12°C; LW 7°C; ambient conditions: 35°CDB | Cooling: EW 23°C; LW 18°C; ambient conditions: 35°CDB | Condition: Ta DB/WB 7°C/6°C - LWC 35°C (DT = 5°C) | Condition: Ta DB/WB 7°C/6°C - LWC 45°C (Dt=5°C) | According to EN14825 | Depends on operation mode, refer to installation manual. | For more details, see operation range drawing



Air cooled scroll inverter heat pump

- › Inverter chiller
- › High part load efficiency for low running cost
- › Minimal starting currents
- › No buffertank required for standard applications
- › Daikin scroll compressor
- › Wide operation range
- › Integrated hydronic module on request



Heating & Cooling				EWYT	016CZN-A1	021CZN-A1	025CZN-A1	032CZN-A1	040CZN-A1	040CZN-A2	050CZN-A2	064CZN-A2	090CZN-A2
Space cooling	A Condition	Pdc	kW	15.9	20.9	25.6	32.4	39.6	41.4	50.8	64.0	88.3	
	35°C												
	ηs,c		%	197	200	205	201	213	210	205	198		
SEER				5.00	5.06	5.21	5.09	5.41	5.33	5.21	5.03		
Space heating	Average climate water outlet 35°C	General	SCOP	3.89	4.00	4.07	4.06	4.07	4.02	4.00	3.98	4.00	
			Seasonal space heating eff. class	A++									
Cooling capacity	Nom.		kW	15.9	20.9	25.6	32.4	39.6	41.4	50.8	64.0	88.3	
Heating capacity	Nom.		kW	15.9	20.2	24.8	32.4	39.4	40.3	49.8	61.9	85.8	
Power input	Cooling	Nom.	kW	5.50	6.60	8.50	10.3	13.4	13.2	17.0	21.8	31.0	
	Heating	Nom.	kW	4.70	5.80	7.50	9.40	11.8	11.9	15.4	19.1	27.2	
Capacity control	Method			Inverter controlled									
	Minimum capacity		%	18	14	12	19	15	14	12	15	14	
EER				2.90	3.16	3.00	3.13	2.95	3.12	2.98	2.93	2.84	
COP				3.41	3.46	3.33	3.45	3.33	3.38	3.24	3.23	3.16	
IPLV				5.83	6.29	6.05	6.25	5.87	6.37	5.92	5.88	5.61	
Dimensions	Unit	Height	mm	1,878									
		Width	mm	1,152			1,752			2,306		2,906	3,506
		Depth	mm	802				814					
Weight	Unit		kg	227	252	350	349	494	588	693			
	Operation weight		kg	228	254	353	352	500	594	701			
Water heat exchanger	Type			Braze plate heat exchanger									
	Water volume		l	1	2				5			8	
	Water flow rate	Cooling	Nom.	l/s	0.8	1.0	1.2	1.6	1.9	2.0	2.4	3.1	4.2
		Heating	Nom.	l/s	0.8	1.0	1.2	1.5	1.9		2.4	3.0	4.1
	Water pressure drop	Cooling	Nom.	kPa	20	11	16	19	28	10	14	22	20
Heating		Nom.	kPa	19.6	10.6	15.4	19.1	27.1	9.4	13.8	20.4	19.1	
Air heat exchanger	Type			High efficiency fin and tube type – Copper Aluminum									
Compressor	Type			Scroll compressor									
	Quantity			1				2					
Fan	Type			Axial									
	Quantity			1			2			3	4		
	Speed		rpm	800	900	700	900	700	900	800	900		
Sound power level	Cooling	Nom.	dBA	76.0	78.0	79.0	80.0	81.0	83.0	85.0			
Sound pressure level	Cooling	Nom.	dBA	59.7	61.7	62.2	63.2	62.8	63.8	65.4	67.0		
Refrigerant	Type/GWP			R-32/675									
	Charge		kg	3.00	5.50	7.00	8.00	12.0	13.0	16.0			
	Circuits	Quantity		1				2					
Piping connections	Evaporator water inlet/outlet (OD)			1"1/4				2"					

Cooling: EW 12°C; LW 7°C; ambient conditions: 35°CDB | Cooling: EW 23°C; LW 18°C; ambient conditions: 35°CDB | Condition: Ta DB/WB 7°C/6°C - LWC 35°C (DT = 5°C) | Condition: Ta DB/WB 7°C/6°C - LWC 45°C (Dt=5°C) | According to EN14825 | Depends on operation mode, refer to installation manual. | For more details, see operation range drawing



Air cooled scroll inverter heat pump

- › Inverter chiller
- › High part load efficiency for low running cost
- › Minimal starting currents
- › No buffertank required for standard applications
- › Daikin scroll compressor
- › Wide operation range
- › Integrated hydronic module on request



Heating & Cooling				EWYT	016CZP-A1	021CZP-A1	025CZP-A1	032CZP-A1	040CZP-A1	040CZP-A2	050CZP-A2	064CZP-A2	090CZP-A2
Space cooling	A Condition	Pdc	kW	16.0	21.0	25.7	32.6	39.8	41.6	51.0	64.3	88.6	
	35°C												
	ηs,c		%	209	213	225	211	228	216	211	204		
SEER				5.30	5.41	5.70	5.36	5.76	5.48	5.34	5.18		
Space heating	Average climate water outlet 35°C	General	SCOP	4.03	4.19	4.18	4.19	4.12	4.01	4.04			
			Seasonal space heating eff. class	A++									
Cooling capacity	Nom.		kW	16.1	21.1	25.9	32.7	39.9	41.7	51.1	64.4	88.8	
Heating capacity	Nom.		kW	15.6	19.9	24.6	32.1	39.0	40.0	49.5	61.4	85.3	
Power input	Cooling	Nom.	kW	5.45	6.56	8.48	10.3	13.3	13.2	16.9	21.9	31.1	
	Heating	Nom.	kW	4.63	5.81	7.42	9.32	11.7	11.8	15.3	19.2	27.3	
Capacity control	Method			Inverter controlled									
	Minimum capacity		%	18	14	12	19	15	14	12	15	14	
EER				2.96	3.22	3.05	3.18	3.00	3.17	3.03	2.95	2.85	
COP				3.37	3.43	3.31	3.44	3.33	3.38	3.23	3.20	3.13	
IPLV				5.83	6.29	6.05	6.25	5.87	6.37	5.92	5.88	5.61	
Dimensions	Unit	Height	mm	1,878									
		Width	mm	1,152			1,752			2,306		2,906	3,506
		Depth	mm	802				814					
Weight	Unit		kg	261	286	393	392	546	644	749			
	Operation weight		kg	262	288	396	395	551	650	757			
Water heat exchanger	Type			Braze plate heat exchanger									
	Water volume		l	1	2				5			8	
	Water flow rate	Cooling	Nom.	l/s	0.8	1.0	1.2	1.6	1.9	2.0	2.4	3.1	4.2
		Heating	Nom.	l/s	0.8	1.0	1.2	1.5	1.9		2.4	3.0	4.1
	Water pressure drop	Cooling	Nom.	kPa	20	11	16	19	28	10	14	22	20
Heating		Nom.	kPa	19.6	10.6	15.4	19.1	27.1	9.4	13.8	20.4	19.1	
Air heat exchanger	Type			High efficiency fin and tube type – Copper Aluminum									
Compressor	Type			Scroll compressor									
	Quantity			1				2					
Fan	Type			Axial									
	Quantity			1			2			3	4		
	Speed		rpm	800	900	700	900	700	900	800	900		
Sound power level	Cooling	Nom.	dBA	76.0	78.0	79.0	80.0	81.0	83.0	85.0			
Sound pressure level	Cooling	Nom.	dBA	59.7	61.7	62.2	63.2	62.8	63.8	65.4	67.0		
Refrigerant	Type/GWP			R-32/675									
	Charge		kg	3.00	5.50	7.00	8.00	12.0	13.0	16.0			
	Circuits	Quantity		1				2					
Piping connections	Evaporator water inlet/outlet (OD)			1"1/4				2"					

Cooling: EW 12°C; LW 7°C; ambient conditions: 35°CDB | Cooling: EW 23°C; LW 18°C; ambient conditions: 35°CDB | Condition: Ta DB/WB 7°C/6°C - LWC 35°C (DT = 5°C) | Condition: Ta DB/WB 7°C/6°C - LWC 45°C (Dt=5°C) | According to EN14825 | Depends on operation mode, refer to installation manual. | For more details, see operation range drawing



Air cooled scroll inverter heat pump

- › Inverter chiller
- › High part load efficiency for low running cost
- › Minimal starting currents
- › No buffertank required for standard applications
- › Daikin scroll compressor
- › Wide operation range
- › Integrated hydronic module on request



Heating & Cooling			EWYT	016CZH-A1	021CZH-A1	025CZH-A1	032CZH-A1	040CZH-A1	040CZH-A2	050CZH-A2	064CZH-A2	090CZH-A2			
Space cooling	A Condition 35°C	Pdc	kW	16.1	21.1	25.8	32.7	39.9	41.7	51.1	64.3	88.7			
		ηs,c	%	205	210	211	224	210	227	213	208	202			
SEER				5.20	5.32	5.34	5.67	5.34	5.76	5.40	5.27	5.12			
Space heating	Average climate water outlet 35°C	General	SCOP	3.88	4.06	4.08	4.11	4.13	4.14	4.09	3.94	4.00			
			Seasonal space heating eff. class	A++											
Cooling capacity	Nom.		kW	16.2	21.2	25.9	32.8	40.1	41.8	51.3	64.5	88.9			
Heating capacity	Nom.		kW	15.5	19.8	24.5	32.0	38.9	39.9	49.4	61.3	85.2			
Power input	Cooling	Nom.	kW	5.60	6.70	8.70	10.4	13.5	13.3	17.0	22.0	31.2			
	Heating	Nom.	kW	4.80	6.00	7.60	9.50	11.9	12.0	15.4	19.3	27.4			
Capacity control	Method			Inverter controlled											
	Minimum capacity		%	18	14	12	19	15	14	12	15	14			
EER				2.89	3.15	2.98	3.14	2.97	3.15	3.02	2.93	2.85			
COP				3.24	3.31	3.22	3.37	3.28	3.33	3.20	3.17	3.12			
IPLV				5.83	6.29	6.05	6.25	5.87	6.37	5.92	5.88	5.61			
Dimensions	Unit	Height	mm	1,878											
		Width	mm	1,152			1,752			2,306		2,906		3,506	
		Depth	mm	802				814							
Weight	Unit	Operation weight	kg	261	286	393	392	546	644	749					
			kg	262	288	396	395	551	650	757					
Water heat exchanger	Type			Braze plate heat exchanger											
	Water volume		l	1	2				5			8			
	Water flow rate	Cooling	Nom.	l/s	0.8	1.0	1.2	1.6	1.9	2.4	3.1	4.2			
		Heating	Nom.	l/s	0.8	1.0	1.2	1.5	1.9	2.4	3.0	4.1			
	Water pressure drop	Cooling	Nom.	kPa	20	11	16	19	28	10	14	22	20		
Heating		Nom.	kPa	19.6	10.6	15.4	19.1	27.1	9.4	13.8	20.4	19.1			
Air heat exchanger	Type			High efficiency fin and tube type – Copper Aluminum											
Compressor	Type			Scroll compressor											
	Quantity			1				2							
Fan	Type			Axial											
	Quantity			1			2			3		4			
	Speed		rpm	800	900	700	900	700	900	800	900				
Sound power level	Cooling	Nom.	dBA	76.0	78.0	79.0	80.0	81.0	83.0	85.0					
Sound pressure level	Cooling	Nom.	dBA	59.7	61.7	62.2	63.2	62.8	63.8	65.4	67.0				
Refrigerant	Type/GWP			R-32/675											
	Charge		kg	3.00	5.50	7.00	8.00	12.0	13.0	16.0					
Piping connections	Evaporator water inlet/outlet (OD)			1				2							
				1"1/4				2"							

Cooling: EW 12°C; LW 7°C; ambient conditions: 35°CDB | Cooling: EW 23°C; LW 18°C; ambient conditions: 35°CDB | Condition: Ta DB/WB 7°C/6°C - LWC 35°C (DT = 5°C) | Condition: Ta DB/WB 7°C/6°C - LWC 45°C (Dt=5°C) | According to EN14825 | Depends on operation mode, refer to installation manual. | For more details, see operation range drawing

Air cooled screw chiller with free cooling, high efficiency, standard/low sound

- › Free cooling chiller for space cooling and industrial processes
- › Stepless single-screw compressor
- › Greater energy savings and reduced CO₂ emissions during cold season
- › Wide operating range: NEW OPTION 187 (high evaporator leaving temperature up to 25°C)
- › MicroTech 4 controller with superior control logic and easy interface



Cooling only			EWAD-CFXS/XL	640	770	850	900	C10	C11	C12	C13	C14	C15	C16	
Cooling capacity	Nom.		kW	640 (1) / 415 (2)	772 (1) / 510 (2)	852 (1) / 583 (2)	902 (1) / 612 (2)	1,027 (1) / 701 (2)	1,089 (1) / 734 (2)	1,269 (1) / 902 (2)	1,349 (1) / 957 (2)	1,435 (1) / 963 (2)	1,493 (1) / 1,013 (2)	1,555 (1) / 1,039 (2)	
Power input	Cooling	Nom.	kW	257 (1) / 53.7 (2)	272 (1) / 62.0 (2)	293 (1) / 64.7 (2)	324 (1) / 69.8 (2)	360 (1) / 75.7 (2)	399 (1) / 83.4 (2)	397 (1) / 86.4 (2)	439 (1) / 92.8 (2)	454 (1) / 101 (2)	492 (1) / 109 (2)	530 (1) / 115 (2)	
	Capacity control	Method		Stepless											
	Minimum capacity		%	12.5											
EER				2.49 (1) / 11.91 (2)	2.84 (1) / 12.44 (2)	2.90 (1) / 13.17 (2)	2.78 (1) / 12.93 (2)	2.85 (1) / 13.56 (2)	2.73 (1) / 13.05 (2)	3.19 (1) / 14.68 (2)	3.08 (1) / 14.55 (2)	3.16 (1) / 14.21 (2)	3.04 (1) / 13.72 (2)	2.93 (1) / 13.50 (2)	
IPLV				3.86	4.03	4.10	4.05	4.00	3.95	4.36	4.25	4.36	4.35	4.26	
Dimensions	Unit	Height	mm	2,565											
		Width	mm	2,480											
		Length	mm	6,300	7,200	8,100	9,000			10,800					
Weight (XS)	Unit	Operation weight	kg	7,760	8,340	8,900	10,160	10,420	11,900	12,540	12,620	12,670			
			kg	8,515	9,100	9,705	11,169	11,429	13,276	14,516	14,596	14,646			
Weight (XL)	Unit	Operation weight	kg	8,050	8,620	9,190	10,450	10,710	12,190	12,830	12,910	12,960			
			kg	8,795	9,390	9,995	11,459	11,719	13,566	14,806	14,886	14,936			
Water heat exchanger	Type			Single pass shell & tube											
	Water flow rate	Cooling	Nom.	l/s	27.8 (1) / 27.8 (2)	33.5 (1) / 33.5 (2)	37.0 (1) / 37.0 (2)	39.2 (1) / 39.2 (2)	44.6 (1) / 44.6 (2)	47.3 (1) / 47.3 (2)	55.1 (1) / 55.1 (2)	58.6 (1) / 58.6 (2)	62.4 (1) / 62.4 (2)	64.9 (1) / 64.9 (2)	67.6 (1) / 67.6 (2)
		Water pressure drop	Cooling	Nom.	kPa	85 (1) / 128 (2)	105 (1) / 172 (2)	90 (1) / 178 (2)	101 (1) / 198 (2)	111 (1) / 245 (2)	124 (1) / 272 (2)	98 (1) / 232 (2)	110 (1) / 259 (2)	139 (1) / 305 (2)	150 (1) / 328 (2)
	Water volume		l	741	771	808		1,012		1,372		1,965			
Air heat exchanger	Type			High efficiency fin and tube type											
Compressor	Type			Asymmetric single screw compressor											
	Quantity			2											
Fan	Type			Direct propeller											
	Air flow rate	Nom.	l/s	50,368	60,441	70,515		80,588			95,253				
Sound power level (XS)	Cooling	Nom.	dBA	100		101			102			103			
Sound power level (XL)	Cooling	Nom.	dBA	96	97			98			99				
Sound pressure level (XS)	Cooling	Nom.	dBA	79	80			81			80				
Sound pressure level (XL)	Cooling	Nom.	dBA	76		77									
Operation range	Air side	Cooling	Min.-Max.	-20~-45											
	Water side	Cooling	Min.-Max.	-8~-25											
Refrigerant	Type/GWP			R-134a/1,430											
	Circuits	Quantity		2											
Refrigerant charge		kg/TCO2Eq		64.0/91.5	73.0/104.4	81.0/115.8		91.0/130.1		107.0/153.0		112.5/160.9	124.0/177.3		
Piping connections	Evaporator water inlet/outlet (OD)			168.3mm				219.1mm				273mm			
	Unit	Starting current	Max	A	605	619	658		924	971	1,030		1,073	1,086	
	Running current	Cooling	Nom.	A	404	430	467	515	568	628	636	701	720	773	
	Max		A	476	510	561	605	672	731	811	875		929	982	
Power supply	Phase/Frequency/Voltage		Hz/V	3~/50/400											

(1) Cooling: entering evaporator water temp. 16°C; leaving evaporator water temp. 10°C; ambient air temp. 35°C; full load operation. (2) Data is calculated at ambient air temperature 5°C, inlet water temperature 16°C.

Air cooled screw chiller with free cooling, high efficiency, reduced sound

- › Free cooling chiller for space cooling and industrial processes
- › Stepless single-screw compressor
- › Greater energy savings and reduced CO₂ emissions during cold season
- › Wide operating range: NEW OPTION 187 (high evaporator leaving temperature up to 25°C)
- › MicroTech 4 controller with superior control logic and easy interface

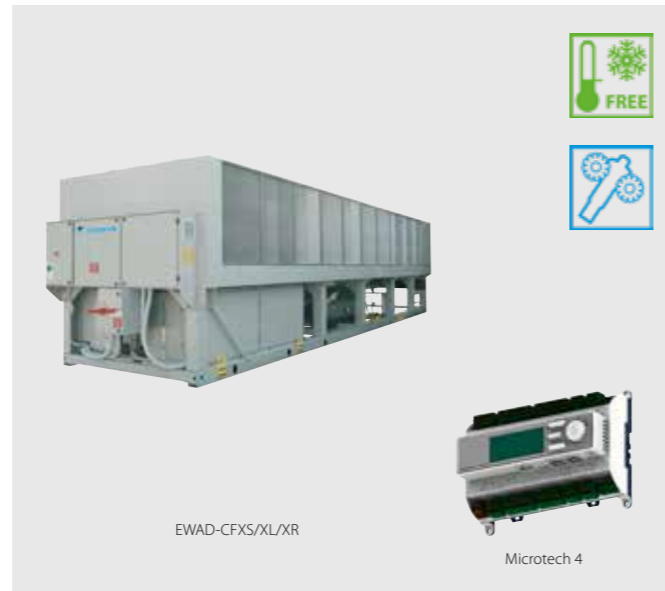

Cooling Only				EWAD-CFXR	600	740	820	870	980	C10	C11	C12	C13	C14	C15	
Cooling capacity	Nom.		kW		602 (1) / 374 (2)	739 (1) / 468 (2)	821 (1) / 539 (2)	866 (1) / 562 (2)	981 (1) / 644 (2)	1,034 (1) / 670 (2)	1,229 (1) / 825 (2)	1,302 (1) / 866 (2)	1,374 (1) / 889 (2)	1,424 (1) / 909 (2)	1,476 (1) / 929 (2)	
Power input	Cooling	Nom.	kW		263 (1) / 46.6 (2)	278 (1) / 56.2 (2)	299 (1) / 58.5 (2)	334 (1) / 63.1 (2)	368 (1) / 68.5 (2)	412 (1) / 74.4 (2)	403 (1) / 80.0 (2)	450 (1) / 87.5 (2)	466 (1) / 93.4 (2)	511 (1) / 103 (2)	556 (1) / 109 (2)	
Capacity control	Method				Stepless											
	Minimum capacity		%		12.5											
EER					2.29 (1) / 12.91 (2)	2.66 (1) / 13.17 (2)	2.75 (1) / 14.04 (2)	2.59 (1) / 13.71 (2)	2.67 (1) / 14.33 (2)	2.51 (1) / 13.89 (2)	3.05 (1) / 15.36 (2)	2.90 (1) / 14.87 (2)	2.95 (1) / 14.7 (2)	2.79 (1) / 13.85 (2)	2.66 (1) / 13.56 (2)	
IPLV					4.09	4.15	4.16	4.20	4.10	4.08	4.42	4.37	4.42	4.28	4.28	
Dimensions	Unit	Height	mm		2,565											
		Width	mm		2,480											
		Depth	mm		6,300	7,200	8,100	9,000	9,000	10,710	12,190	12,830	14,806	14,886	14,936	
Weight	Unit		kg		8,050	8,620	9,190	10,450	10,710	12,190	12,830	14,806	14,886	14,936		
	Operation weight		kg		8,795	9,390	9,995	11,459	11,719	13,566	14,806	14,886	14,936			
Water heat exchanger	Type				Single pass shell & tube											
	Water	Cooling	Nom.	l/s	26.2 (1) / 26.2 (2)	32.1 (1) / 32.1 (2)	35.7 (1) / 35.7 (2)	37.6 (1) / 37.6 (2)	42.6 (1) / 42.6 (2)	44.9 (1) / 44.9 (2)	53.4 (1) / 53.4 (2)	56.6 (1) / 56.6 (2)	59.7 (1) / 59.7 (2)	61.9 (1) / 61.9 (2)	64.1 (1) / 64.1 (2)	
	Water	Cooling	Nom.	kPa	76 (1) / 115 (2)	97 (1) / 159 (2)	84 (1) / 167 (2)	93 (1) / 184 (2)	102 (1) / 225 (2)	113 (1) / 248 (2)	92 (1) / 219 (2)	103 (1) / 243 (2)	128 (1) / 282 (2)	137 (1) / 301 (2)	146 (1) / 321 (2)	
	Water volume		l		741	771	808	808	1,012	1,012	1,372	1,372	1,965	1,965		
Air heat exchanger	Type				High efficiency fin and tube type											
Compressor	Type				Asymm single screw											
	Quantity				2											
Fan	Type				Direct propeller											
	Quantity				10	12	14	16	16	20	20	20	20	20		
	Air flow rate Nom.		l/s		38,935	46,722	54,508	62,295	62,295	73,011	73,011	73,011	73,011	73,011		
Speed		rpm		715												
Sound power level	Cooling	Nom.	dB(A)		92				94				95			
Sound pressure level	Cooling	Nom.	dB(A)		71	72				73				73		
Operation range	Air side	Cooling	Min.~Max.	°CDB	-20~-45											
	Water side	Cooling	Min.~Max.	°CDB	-8~-25											
Refrigerant	Type/GWP				R-134a/1,430											
	Circuits	Quantity			2											
Refrigerant charge	Per circuit		kg		64.0	73.0	81.0	91.0	91.0	107.0	112.5	124.0	124.0	124.0		
	Per circuit		TCO2Eq		91.5	104.4	115.8	130.1	130.1	153.0	160.9	177.3	177.3	177.3		
Piping connections	Evaporator water inlet/outlet (OD)				168.3mm				219.1mm				273mm			
	Unit	Starting current	Max	A	598	611	648	912	960	960	1,016	1,059	1,072			
	Running current	Cooling	Nom.	A	411	439	473	526	580	647	645	717	738	800	862	
		Max		A	462	493	542	585	649	708	783	847	901	954		
Power supply	Phase/Frequency/Voltage		Hz/V		3~/50/400											

(1) Cooling: entering evaporator water temp. 16°C; leaving evaporator water temp. 10°C; ambient air temp. 35°C; full load operation.
 (2) Data is calculated at ambient air temperature 5°C, inlet water temperature 16°C.

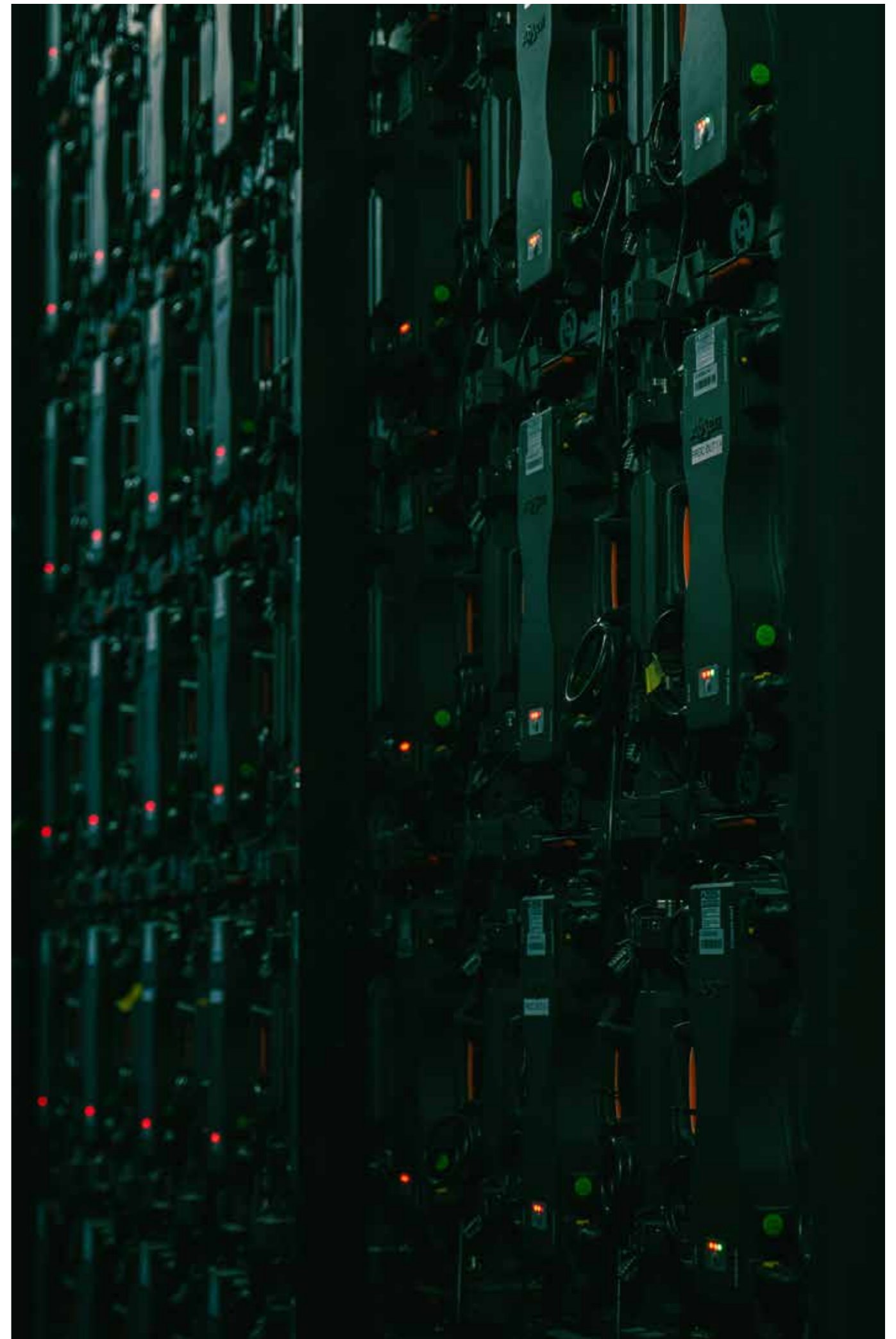



Over 1,000 sites around the world with screw chillers installed is demonstrating that we will never stop developing the most advanced technology with highest quality level to offer the best chiller experience to our customers.

EWA(H)(D)-TZB/C at a glance

- › Full inverter air cooled chiller
- › Capacity range from 190kW to 2,000kW for series with R134a
- › Capacity range from 170kW to 1,500kW for series with R1234ze
- › Daikin single screw compressor with integrated inverter
- › Best efficiency at full load and part load conditions

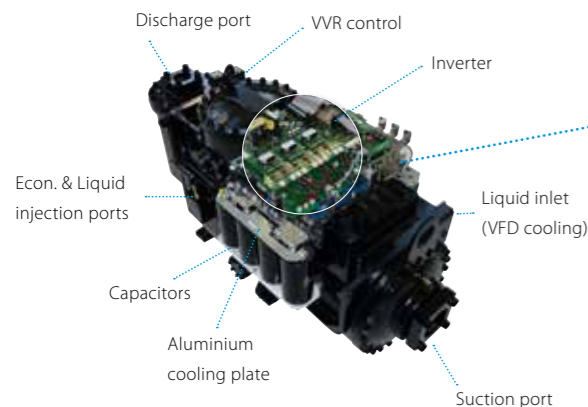
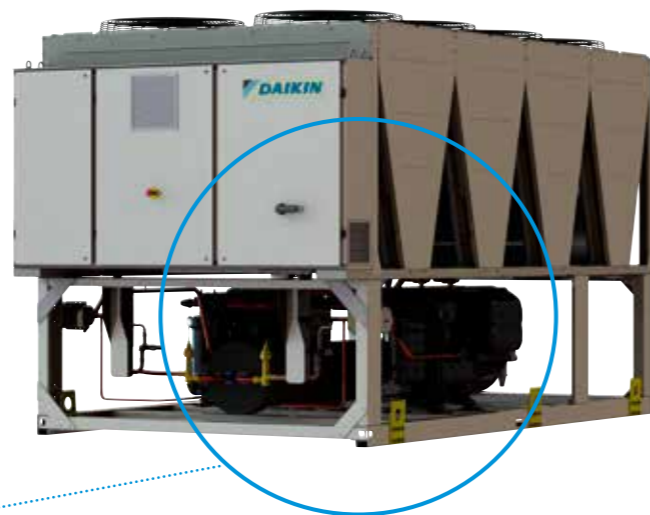

› Daikin EWAD-TZB Screw Inverter Chiller

Check on
YouTube
www.youtube.com/
DaikinEurope



Web-based chiller selection software

A user-friendly interface allows users to quickly create new projects, open and change existing projects or simply do a quick selection.

Technical selection reports can be printed or downloaded in several formats.

To make life easier, the tool is accessible everywhere, via any device. No matter where you are, projects can be consulted.

Create now a new account on:
<http://tools.daikinapplied.eu/>

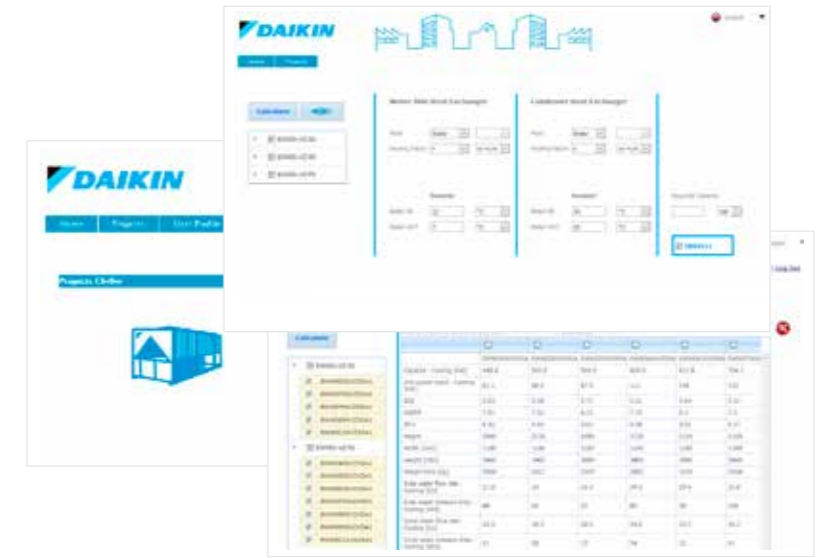

Why choose EWA(H)(D)-TZB/C?

High efficiencies both at full load and part load:

- › Daikin compressor with in-built inverter for optimized efficiency
- › In-house developed software with dynamic condensing pressure management and innovative economizer control logic

Rapid return on investment

- › Payback of three years, compared to a non-inverter unit for comfort cooling applications
- › Less than one year a for process cooling applications

Perfect comfort level

- › Infinitely variable load regulation
- › Precise leaving water temperature control thanks to stepless regulation

Compact design

- › More compact heat exchanger with superior efficiencies
- › Reduced electrical panel dimensions thanks to the inverter compressor mounted

Lowest sound levels

- › Down to 87 dB(A) sound power at full load and even lower at part load thanks to fans and compressors variable speed
- › Quiet compressor thanks to special acoustic executions
- › Unique Daikin fans design with reduced noise impact and vibrations

Unrivalled and proven reliability

- › Extensive testing of chillers and components in laboratories, Daikin factories and selected job sites - even at extreme working conditions
- › Reduced energy demand without compromising on reliability and performance

Extensive option list

More than 60 different options are available to fit the EWA(H)(D)-TZB/C chiller to fit to your requirements:

- › Rapid restart after power failure
- › Variable speed water pumps to optimise the working efficiency
- › Total heat recovery: 80 to 85% of the total heat rejection of the chiller can be recovered
- › Partial heat recovery: 15 to 20% of the total heat rejection of the chiller can be recovered
- › Refrigerant leak detection



Performance monitoring

With MT4, advanced algorithm implementation in the unit controller are possible, such as the **Performance Monitoring** (Option 186). This sensor-less algorithm calculates the unit cooling capacity by using refrigerant pressure and temperature readings. Electrical power is calculated either from compressor VFD power and fan, or directly measured through optional energy meter. As a standard(*), **no extra-hardware is required**.

(*): For TZ-B units an additional sub-cooling temperature sensor is required.



Air cooled screw inverter chiller, standard efficiency, standard/low sound

- › Optimized energy efficiency both at full and part load conditions
- › Inverter stepless single-screw compressor
- › Advanced compressor technology featuring integrated inverter and variable volume ratio (VVR)
- › Compact design for small footprint and minimized installation space
- › Low operating sound levels are achieved by the latest compressor and fan design
- › One or two truly independent refrigerant circuits for outstanding reliability



Cooling Only		EWAD-TZSSB/SLB		160	190	240	270	300	360	380	455	500	570	610	660	700	820	900	990	C10	C11																						
Space cooling	A Condition 35°C Pdc	kW		169.1	200.88	235.29	268.82	305.99	351.41	394.74	455.64	499.81	569.52	612.22	660.72	700.94	815.92	889.95	987.19	1,045.39	1,103.99																						
	ηs,c	%		168.2	172.6	169.4	175.4	177	183	172.6	171.4	175	180.2	189.8	182.6	185.4	197.4	194.2	200.6	200.2	200.6	200.6																					
SEER				4.28	4.39	4.31	4.46	4.5	4.65	4.39	4.63	4.65	4.58	4.82	4.64	4.71	5.01	4.93	5.09	5.08	5.09																						
Cooling capacity	Nom.	kW		169.1	200.9	235.3	268.8	306	351.4	394.7	455.6	499.8	569.5	612.2	660.7	700.9	816	890	987	1,045	1,104																						
Power input	Cooling Nom.	kW		56.48	69.9	82.99	89.94	108.6	118	139.4	163.8	174.6	198.1	217.6	239	249.1	257.9	296.1	321.3	346.4	366.2																						
Capacity control	Minimum capacity	%		37	31	34	29	25	24	16	17	16	14	13	12																												
EER				2.995	2.874	2.835	2.989	2.817	2.954	2.832	2.783	2.862	2.876	2.813	2.764	2.813	3.164	3.005	3.072	3.017	3.015																						
ESEER				4.37	4.46	4.3	4.4	4.42	4.5	4.46	4.44	4.49	4.54	4.59	4.63	4.7	4.43		4.44		4.51																						
IPLV				5.3	5.27	5.04	5.19	5.37	5.53	5.34	5.3	5.46	5.64	5.62	5.7	5.29	5.26	5.25	5.26	5.27	5.27																						
Dimensions	Unit	Height	mm	2,540																																							
	Width	mm	2,282																																								
	Depth	mm	2,330																																								
Weight (SSB)	Unit	kg	2,066	2,091	2,149	2,375	2,422	2,771	4,044	4,060	4,317	4,603	4,780	4,804	5,074	6,282	6,382	6,777	7,132	7,410	7,410																						
	Operation weight	kg	2,086	2,117	2,187	2,401	2,460	2,821	4,202	4,224	4,475	4,761	5,050	5,059	5,329	6,532	6,632	7,027	7,382	7,660	7,660																						
Weight (SLB)	Unit	kg	2,081	2,106	2,164	2,390	2,437	2,786	4,074	4,090	4,347	4,633	4,810	4,834	5,104	6,282	6,382	6,777	7,132	7,410	7,410																						
	Operation weight	kg	2,101	2,132	2,202	2,416	2,475	2,836	4,232	4,254	4,505	4,791	5,080	5,089	5,359	6,532	6,632	7,027	7,382	7,660	7,660																						
Water heat exchanger	Type			Plate heat exchanger									Shell and tube																														
	Water volume	l	20.25	26.1	37.35	26.1	37.35	49.5	158	164	158	270	255	283	485	453																											
	Water flow rate	Cooling Nom.	l/s	8.1	9.6	11.2	12.9	14.6	16.8	18.9	21.8	23.9	27.3	29.3	31.6	33.5	39.1	42.6	47.2	50	52.8	52.8																					
	Water pressure drop	Cooling Nom.	kPa	25	19.3	15.4	32.6	25.2	25.9	32.4	44	55.7	38.8	32.3	36	52.6	36.9	42.2	46.6	37.3	37.3	37.3																					
Air heat exchanger	Type			Microchannel																																							
Compressor	Type			Driven vapour compression																																							
	Quantity			1									2																														
Fan	Type			Direct propeller																																							
	Quantity			4				6				8				10				12				14				16				18				20							
	Air flow rate	Cooling Nom.	l/s	15,109				22,664				30,219				37,774				45,328				52,883				69,177				79,060				88,942				98,825			
	Speed	rpm	700																																								
Sound power level (SSB)	Cooling Nom.	dBA	96				97				98				99				100				101				102				105				102				103				
Sound power level (SLB)	Cooling Nom.	dBA	90				91				92				93				94				95				96				97				99				100				
Sound pressure level (SSB)	Cooling Nom.	dBA	77				78				79				80				82				84				81				81				81								
Sound pressure level (SLB)	Cooling Nom.	dBA	71				72				73				74				75				76				77				78				78								
Operation range	Air side	Cooling	Min.~Max.	°CDB																																							
	Water side	Cooling	Min.~Max.	°CDB																																							
Refrigerant	Type/GWP			R-134a/1,430																																							
	Charge	kg	27	29	33	38	41	52	58	59	68	75	77	83	90	91	104	117	130	130	130																						
	Circuits	Quantity	1																																								
Refrigerant charge	Per circuit	TCO2Eq	38.6	41.5	47.2	54.3	58.6	74.4	41.5	42.2	48.6	53.6	55.1	59.3	64.4	65.1	74.4	83.7	93.0	93.0	93.0																						
Piping connections	Evaporator water inlet/outlet (OD)			3"				4"				5"				6"				168.3 mm				219.1mm																			
Unit	Running current	Cooling	Nom.	A	102	123	188	177	188	200	246	372	366	361	377	396	414	429	501	528	563	597																					
	Max	A	130	149	160	187	220	246	298	320	350	374	439	466	486	537	599	652	708	768	768																						
Power supply	Phase/Frequency/Voltage	Hz/V	3~/50/400																																								

performances according to CSS software 10.27



Air cooled screw inverter chiller, standard efficiency, reduced sound

- › Optimized energy efficiency both at full and part load conditions
- › Inverter stepless single-screw compressor
- › Advanced compressor technology featuring integrated inverter and variable volume ratio (VVR)
- › Compact design for small footprint and minimized installation space
- › Low operating sound levels are achieved by the latest compressor and fan design
- › One or two truly independent refrigerant circuits for outstanding reliability



Cooling Only		EWAD-TZSRB		160	190	240	270	300	360	380	455	500	570	610	660	700	820	900	990	C10	C11																						
Space cooling	A Condition 35°C Pdc	kW		169.1	200.88	235.29	268.82	305.99	351.41	394.01	454.57	499.14	568.6	610.43	658.99	699.87	799.95	894.94	956.14	1,013.27	1,067.02																						
	ηs,c	%		168.2	172.6	169.4	175.4	177	183	172.2	170.6	174.2	179.4	188.6	181.8	184.6	215	213.4	213.8	216.2	217.8	217.8																					
SEER				4.28	4.39	4.31	4.46	4.5	4.65	4.38	4.63	4.64	4.56	4.79	4.62	4.69	5.45	5.41	5.42	5.48	5.52																						
Cooling capacity	Nom.	kW		169.1	200.9	235.3	268.8	306	351.4	394	454.6	499.1	568.6	610.4	659	699.9	800	895	956	1,013	1,067																						
Power input	Cooling Nom.	kW		56.48	69.9	82.99	89.94	108.6	118	140.2	164.8	175.4	199.1	218.4	240.3	250.3	247.8	294.1	316	335.6	358.9																						
Capacity control	Minimum capacity	%		37	31	34	29	25	24	16	17	16	14	13	12																												
EER				2.995	2.874	2.835	2.989	2.817	2.954	2.81	2.759	2.846	2.856	2.795	2.742	2.796	3.229	3.043	3.016	3.018	2.973																						
ESEER				4.37	4.46	4.3	4.4	4.42	4.5	4.44	4.43	4.47	4.53	4.61	4.6	4.68	4.8	4.85	4.83	4.98	4.98																						
IPLV				5.3	5.27	5.04	5.19	5.37	5.53	5.3	5.26	5.43	5.6	5.61	5.6	5.67	5.92	5.74	5.77	5.75	5.86																						
Dimensions	Unit	Height	mm	2,540																																							
	Width	mm	2,282																																								
	Length	mm	2,330																																								
Weight	Unit	kg	2,166	2,191	2,249	2,475	2,522	2,871	4,244	4,260	4,517	4,803	4,980	5,274	6,997	7,097	7,452	7,730	8,023	8,023	8,023																						
	Operation weight	kg	2,186	2,217	2,287	2,501	2,560	2,921	4,402	4,424	4,675	4,961	5,250	5,259	5,529	7,247	7,347	7,702	7,980	8,273	8,273																						
Water heat exchanger	Type			Plate heat exchanger									Shell and tube																														
	Water volume	l	20.25	26.1	37.35	26.1	37.35	49.5	158	164	158	270	255	283	485	453																											
	Water flow rate	Cooling Nom.	l/s	8.1	9.6	11.2	12.9	14.6	16.8	18.9	21.8	23.9	27.3	29.3	31.6	33.5	39.1	42.6	47.2	50	52.8																						
	Water pressure drop	Cooling Nom.	kPa	25	19.3	15.4	32.6	25.2	25.9	32.4	44	55.7	38.8	32.3	36	52.6	36.9	42.2	46.6	37.3	37.3																						
Air heat exchanger	Type			Microchannel																																							
Compressor	Type			Driven vapour compression																																							
	Quantity			1									2																														
Fan	Type			Direct propeller																																							
	Quantity			4				6				8				10				12				14				16				18				20				22			
	Air flow rate	Cooling Nom.	l/s	15,109				22,664				30,219				37,774				45,328				52,883				69,177				79,060				88,942				98,825			
	Speed	rpm	700																																								
Sound power level	Cooling Nom.	dBA	86				87				88				90				91				92				94				95												
Sound pressure level	Cooling Nom.	dBA	67				68				69				70				71				73				73																
Operation range	Air side	Cooling	Min.~Max.	°CDB																																							
	Water side	Cooling	Min.~Max.	°CDB																																							
Refrigerant	Type/GWP			R-134a/1,430																																							
	Charge	kg	27	29	33	38	41	52	58	59	68	75	77	83	90	91	104	117	130	143	143																						
	Circuits	Quantity	1																																								
Refrigerant charge	Per circuit	TCO2Eq	38.6	41.5	47.2	54.3	58.6	74.4	41.5	42.2	48.6	53.6	55.1	59.3	64.4	65.1	74.4	83.7	93.0	93.0	93.0																						
Piping connections	Evaporator water inlet/outlet (OD)			3"				4"				5"				6"				168.3 mm				219.1mm																			
Unit	Running current	Cooling	Nom.	A	102	123	188	177	188	200	246	372	366	361	377	396	414	429	501	528	563	597																					
	Max	A	130	149	160	187	220	246	298	320	350	374	439	466	486	537	599	652	708	768	768																						
Power supply	Phase/Frequency/Voltage	Hz/V	3~/50/400																																								

performances according to CSS software 10.27



Air cooled screw inverter chiller, high efficiency, standard/low sound

- › High energy efficiency both at full and part load conditions
- › Inverter stepless single-screw compressor with DC electrical motor
- › Advanced compressor technology featuring integrated inverter and variable volume ratio (VVR)
- › Continuous fans speed modulation thanks to inverter driven fans to improve part load efficiency
- › Compact design for small footprint and minimized installation space
- › Low operating sound levels are achieved by the latest compressor and fan design
- › One or two truly independent refrigerant circuits for outstanding reliability



Cooling Only		EWAD-TZXS/XLB																	
		190	220	240	290	320	360	420	450	540	570	610	660	680	770	850	910	C10	C11
Space cooling (XSB)	A Condition 35°C Pdc	kW																	
	ηs,c	%																	
Space cooling (XLB)	A Condition 35°C Pdc	kW																	
	ηs,c	%																	
SEER		4.95 5.04 4.96 5.15 5.14 4.96 5.03 5.07 5.1 5.04 5.17 5.23 5.21 5.79 5.74 5.91 6.15 6																	
Cooling capacity	Nom.	kW																	
Power input	Cooling Nom.	kW																	
Capacity control	Minimum capacity	%																	
EER		3.46 3.343 3.304 3.3 3.127 3.304 3.156 3.261 3.236 3.111 3.127 3.164 3.085 3.374 3.195 3.306 3.3 3.265																	
ESEER		5.11 5.06 4.99 5.09 5.13 5.14 5.09 5 5.07 5.11 5.15 5.09 5.13 5.15 5.22																	
IPLV		6.26 6.15 6.19 6.17 6.4 6.3 6.22 6.29 6.31 6.25 6.21 6.26 6.08 6.19 6.29 6.24																	
Dimensions	Unit																		
	Height	mm																	
	Width	mm																	
Weight (XSB)	Unit	kg																	
	Operation weight	kg																	
	Weight (XLB)	Unit	kg																
Water heat exchanger	Type	Plate heat exchanger																	
	Water volume	l																	
	Water flow rate Cooling Nom.	l/s																	
Air heat exchanger	Type	Microchannel																	
	Compressor	Driven vapour compression																	
	Fan	Direct propeller																	
Sound power level (XSB)	Cooling Nom.	dBA																	
	Sound power level (XLB)	dBA																	
	Sound pressure level (XSB)	dBA																	
Operation range	Air side Cooling Min.~Max.	°CDB																	
	Water side Cooling Min.~Max.	°CDB																	
	Refrigerant	R-134a/1,430																	
Refrigerant charge	Type/GWP (XSB)	R-134a/1,430																	
	Charge	kg																	
	Circuits Quantity																		
Piping connections	Evaporator water inlet/outlet (OD)	mm																	
Unit	Running current	A																	
	Cooling Nom. Max	A																	
Power supply	Phase/Frequency/Voltage	Hz/V																	

performances according to CSS software 10.27



Air cooled screw inverter chiller, high efficiency, reduced sound

- › High energy efficiency both at full and part load conditions
- › Inverter stepless single-screw compressor with DC electrical motor
- › Advanced compressor technology featuring integrated inverter and variable volume ratio (VVR)
- › Continuous fans speed modulation thanks to inverter driven fans to improve part load efficiency
- › Compact design for small footprint and minimized installation space
- › Low operating sound levels are achieved by the latest compressor and fan design
- › One or two truly independent refrigerant circuits for outstanding reliability



Cooling Only		EWAD-TZXR																	
		190	220	240	290	320	360	420	450	540	570	610	660	680	770	850	910	C10	C11
Space cooling	A Condition 35°C Pdc	kW																	
	ηs,c	%																	
SEER		4.95 5.04 4.96 5.15 5.14 4.96 5.03 5.07 5.1 5.04 5.17 5.23 5.21 5.79 5.74 5.91 6.15 6																	
Cooling capacity	Nom.	kW																	
Power input	Cooling Nom.	kW																	
Capacity control	Minimum capacity	%																	
EER		3.46 3.343 3.304 3.3 3.127 3.304 3.156 3.261 3.236 3.111 3.127 3.164 3.085 3.374 3.195 3.306 3.3 3.265																	
ESEER		5.11 5.06 4.99 5.09 5.13 5.14 5.09 5 5.07 5.11 5.15 5.09 5.13 5.15 5.22																	
IPLV		6.26 6.15 6.19 6.17 6.4 6.3 6.22 6.29 6.31 6.25 6.21 6.26 6.08 6.19 6.29 6.24																	
Dimensions	Unit																		
	Height	mm																	
	Width	mm																	
Weight	Unit	kg																	
	Operation weight	kg																	
	Water heat exchanger	Type	Plate heat exchanger																
Air heat exchanger	Type	Microchannel																	
	Compressor	Driven vapour compression																	
	Fan	Direct propeller																	
Sound power level (XSB)	Cooling Nom.	dBA																	
	Sound power level (XLB)	dBA																	
	Sound pressure level (XSB)	dBA																	
Operation range	Air side Cooling Min.~Max.	°CDB																	
	Water side Cooling Min.~Max.	°CDB																	
	Refrigerant	R-134a/1,430																	
Refrigerant charge	Type/GWP	R-134a/1,430																	
	Charge	kg																	
	Circuits Quantity																		
Piping connections	Evaporator water inlet/outlet (OD)	mm																	
Unit	Running current	A																	
	Cooling Nom. Max	A																	
Power supply	Phase/Frequency/Voltage	Hz/V																	

performances according to CSS software 10.27



Air cooled screw inverter chiller, premium efficiency, standard/low sound

- › Premium energy efficiency both at full and part load conditions
- › Inverter stepless single-screw compressor with DC electrical motor
- › Advanced compressor technology featuring integrated inverter and variable volume ratio (VVR)
- › Continuous fans speed modulation with EC fans for even higher part load efficiency
- › Compact design for small footprint and minimized installation space
- › Low operating sound levels are achieved by the latest compressor and fan design
- › One or two truly independent refrigerant circuits for outstanding reliability



Cooling Only		EWAD-TZPSB/PLB												
		190	220	240	290	300	350	420	495	550	620	720	820	950
Space cooling	A Condition 35°C Pdc	kW												
	ηs,c	%												
SEER		5.19	5.33	5.29	5.3	5.5	5.25	5.36	5.62	5.55	6.11	6.22	6.3	6.31
Cooling capacity	Nom.	kW												
Power input	Cooling Nom.	kW												
Capacity control	Minimum capacity	%												
EER		3.637	3.559	3.555	3.379	3.372	3.623	3.502	3.603	3.586	3.468	3.933	3.78	3.763
ESEER		5.54	5.51	5.42	5.4	5.35	5.48	5.45	5.5	5.42	5.59	5.54	5.55	
IPLV		6.49	6.35	6.41	6.35	6.21	6.52	6.58	6.55	6.51	6.47	6.73	6.6	6.64
Dimensions	Unit													
	Height	mm												
	Width	mm												
Weight (PSB)	Unit	kg												
	Operation weight	kg												
	Weight (PLB)	kg												
Water heat exchanger	Type	Plate heat exchanger						Shell and tube						
	Water volume	l						l						
	Water flow rate Cooling Nom.	l/s						l/s						
Air heat exchanger	Type	Microchannel												
	Compressor	Driven vapour compression												
	Fan	Direct propeller												
Sound power level (PSB)	Cooling Nom.	dBA												
	Sound pressure level (PSB)	dBA												
	Sound pressure level (PLB)	dBA												
Operation range	Air side Cooling Min.~Max.	°CDB												
	Water side Cooling Min.~Max.	°CDB												
Refrigerant	Type/GWP	R-134a/1,430												
	Charge	kg												
Refrigerant charge	Per circuit	TCO2Eq												
	Piping connections	Evaporator water inlet/outlet (OD)												
Unit	Running current	A												
	Cooling current Max	A												
Power supply	Phase/Frequency/Voltage	Hz/V												

performances according to CSS software 10.27



Air cooled screw inverter chiller, premium efficiency, reduced sound

- › Premium energy efficiency both at full and part load conditions
- › Inverter stepless single-screw compressor with DC electrical motor
- › Advanced compressor technology featuring integrated inverter and variable volume ratio (VVR)
- › Continuous fans speed modulation with EC fans for even higher part load efficiency
- › Compact design for small footprint and minimized installation space
- › Low operating sound levels are achieved by the latest compressor and fan design
- › One or two truly independent refrigerant circuits for outstanding reliability



Cooling Only		EWAD-TZPRB												
		190	220	240	290	300	350	420	495	550	620	720	820	950
Space cooling	A Condition 35°C Pdc	kW												
	ηs,c	%												
SEER		5.29	5.38	5.34	5.25	5.38	5.28	5.33	5.6	5.53	5.57	6.29	6.31	6.35
Cooling capacity	Nom.	kW												
Power input	Cooling Nom.	kW												
Capacity control	Minimum capacity	%												
EER		3.71	3.594	3.59	3.347	3.308	3.637	3.486	3.618	3.59	3.473	3.935	3.783	3.764
ESEER		5.55	5.52	5.16	5.2	5.32	5.32	5.21	5.38	5.5	5.42	5.59	5.54	5.55
IPLV		6.49	6.35	6.23	6.07	6.04	6.3	6.27	6.47	6.53	6.47	6.73	6.6	6.64
Dimensions	Unit													
	Height	mm												
	Width	mm												
Weight	Unit	kg												
	Operation weight	kg												
	Water heat exchanger	kg												
Water heat exchanger	Type	Plate heat exchanger						Shell and tube						
	Water volume	l						l						
	Water flow rate Cooling Nom.	l/s						l/s						
Air heat exchanger	Type	Microchannel												
	Compressor	Driven vapour compression												
	Fan	Direct propeller												
Sound power level (PSB)	Cooling Nom.	dBA												
	Sound pressure level (PSB)	dBA												
	Sound pressure level (PLB)	dBA												
Operation range	Air side Cooling Min.~Max.	°CDB												
	Water side Cooling Min.~Max.	°CDB												
Refrigerant	Type/GWP	R-134a/1,430												
	Charge	kg												
Refrigerant charge	Per circuit	TCO2Eq												
	Piping connections	Evaporator water inlet/outlet (OD)												
Unit	Running current	A												
	Cooling current Max	A												
Power supply	Phase/Frequency/Voltage	Hz/V												

performances according to CSS software 10.27

Air cooled screw inverter chiller, standard efficiency, standard/low sound

- › Optimized energy efficiency both at full and part load conditions
- › Inverter stepless single-screw compressor
- › Advanced compressor technology featuring integrated inverter and variable volume ratio (VVR)
- › HFO R1234zeE Refrigerant with Ozone Depletion Potential equal to zero and extremely low Global Warming Potential
- › Low operating sound levels are achieved by the latest compressor and fan design
- › One or two truly independent refrigerant circuits for outstanding reliability
- › Compact design for small footprint and minimized installation space



Air cooled screw inverter chiller, standard efficiency, reduced sound

- › Optimized energy efficiency both at full and part load conditions
- › Inverter stepless single-screw compressor
- › Advanced compressor technology featuring integrated inverter and variable volume ratio (VVR)
- › HFO R1234zeE Refrigerant with Ozone Depletion Potential equal to zero and extremely low Global Warming Potential
- › Low operating sound levels are achieved by the latest compressor and fan design
- › One or two truly independent refrigerant circuits for outstanding reliability
- › Compact design for small footprint and minimized installation space



Cooling Only		EWAH-TZSSB/SLB										
		170	200	240	290	330	390	420	490	530	600	
Space cooling	A Condition 35°C Pdc	kW										
	ηs,c	%										
SEER		4.245	4.311	4.567	4.742	4.589	4.602	4.589	4.751	4.743	4.842	
Cooling capacity	Nom.	kW										
Power input	Cooling	kW										
	Nom.	kW										
Capacity control	Method	Variable										
	Minimum capacity	%										
EER		3.08	2.88	2.89	3.02	2.82	2.99	2.88	2.8	2.8	2.82	
IPLV		5.19	5.22	5.5	5.73	5.52	5.18	5.16	5.4	5.31	5.41	
Dimensions	Unit											
	Height	mm										
	Width	mm										
Weight	Unit	kg										
	Operation weight	kg										
	Type	mm										
Water heat exchanger	Type	Plate heat exchanger					Shell and tube					
	Water volume	l										
	Water flow rate	Cooling	l/s									
	Water pressure drop	Cooling	kPa									
Air heat exchanger	Type	Microchannel										
Compressor	Type	Driven vapour compression										
	Quantity	1					2					
Fan	Type	Direct propeller										
	Quantity	4				6		10		12		
	Air flow rate	l/s										
	Speed	rpm										
Sound power level (SSB)	Cooling	dB(A)										
	Nom.	dB(A)										
Sound pressure level (SLB)	Cooling	dB(A)										
	Nom.	dB(A)										
Operation range	Air side	°CDB										
	Water side	°CDB										
Refrigerant	Type/GWP	R-1234(ze)/7										
	Charge	kg										
	Circuits	1					2					
Piping connections	Evaporator water inlet/outlet (OD)	88.9mm		114.3mm		139.7mm		168.3mm				
Unit	Running current	A										
	Cooling current	A										
Power supply	Phase/Frequency/Voltage	Hz/V										

Cooling Only		EWAH-TZSRB										
		170	200	240	290	330	390	420	490	530	600	
Space cooling	A Condition 35°C Pdc	kW										
	ηs,c	%										
SEER		4.245	4.311	4.567	4.742	4.589	4.576	4.609	4.76	4.714	4.815	
Cooling capacity	Nom.	kW										
Power input	Cooling	kW										
	Nom.	kW										
Capacity control	Method	Variable										
	Minimum capacity	%										
EER		3.08	2.88	2.89	3.02	2.82	2.98	2.87	2.86	2.78	2.79	
IPLV		5.19	5.22	5.5	5.73	5.52	5.13	5.22	5.38	5.29	5.38	
Dimensions	Unit											
	Height	mm										
	Width	mm										
Weight	Unit	kg										
	Operation weight	kg										
	Type	mm										
Water heat exchanger	Type	Plate heat exchanger					Shell and tube					
	Water volume	l										
	Water flow rate	Cooling	l/s									
	Water pressure drop	Cooling	kPa									
Air heat exchanger	Type	Microchannel										
Compressor	Type	Driven vapour compression										
	Quantity	1					2					
Fan	Type	Direct propeller										
	Quantity	4				6		10		12		
	Air flow rate	l/s										
	Speed	rpm										
Sound power level (SSB)	Cooling	dB(A)										
	Nom.	dB(A)										
Sound pressure level (SLB)	Cooling	dB(A)										
	Nom.	dB(A)										
Operation range	Air side	°CDB										
	Water side	°CDB										
Refrigerant	Type/GWP	R-1234(ze)/7										
	Charge	kg										
	Circuits	1					2					
Piping connections	Evaporator water inlet/outlet (OD)	88.9mm		114.3mm		139.7mm		168.3mm				
Unit	Running current	A										
	Cooling current	A										
Power supply	Phase/Frequency/Voltage	Hz/V										

Air cooled screw inverter chiller, high efficiency, standard/low sound

- › High energy efficiency both at full and part load conditions
- › Inverter stepless single-screw compressor with DC electrical motor
- › Advanced compressor technology featuring integrated inverter and variable volume ratio (VVR)
- › HFO R1234zeE Refrigerant with Ozone Depletion Potential equal to zero and extremely low Global Warming Potential
- › Compact design for small footprint and minimized installation space
- › Low operating sound levels are achieved by the latest compressor and fan design
- › One or two truly independent refrigerant circuits for outstanding reliability
- › Continuous fans speed modulation thanks to inverter driven fans to improve part load efficiency



Air cooled screw inverter chiller, high efficiency, reduced sound

- › High energy efficiency both at full and part load conditions
- › Inverter stepless single-screw compressor with DC electrical motor
- › Advanced compressor technology featuring integrated inverter and variable volume ratio (VVR)
- › HFO R1234zeE Refrigerant with Ozone Depletion Potential equal to zero and extremely low Global Warming Potential
- › Compact design for small footprint and minimized installation space
- › Low operating sound levels are achieved by the latest compressor and fan design
- › One or two truly independent refrigerant circuits for outstanding reliability
- › Continuous fans speed modulation thanks to inverter driven fans to improve part load efficiency



Cooling Only		EWAH-TZXS/XLB		180	220	270	300	350	390	430	480	580	620	
Space cooling	A Condition 35°C Pdc		kW	180.38	224.67	270.66	300.22	355	392	427.64	481.86	574.38	619.88	
	ηs,c		%	188.68	195.84	194.04	203.08	196.16	196.4	203.28	206.2	214.96	217.88	
SEER				4.792	4.971	4.926	5.152	4.979	4.985	5.157	5.23	5.449	5.522	
Cooling capacity	Nom.		kW	180	225	271	300	355	392	428	482	574	620	
Power input	Cooling	Nom.	kW	51.8	66.3	79	89.6	103	114	125	144	164	181	
	Capacity control	Method		Variable										
	Minimum capacity		%	33.4	26.7	21.6	18.7	16.7	15.4	14.3	12.5	10.8	10	
EER				3.49	3.39	3.43	3.35	3.44	3.42	3.33	3.5	3.41		
IPLV				6.05	6.09	5.92	6.2	5.8	5.81	5.9	6	6.01	6.2	
Dimensions	Unit	Height	mm	2,540										
		Width	mm	2,282										
		Length	mm	3,230	4,130	3,230	4,130	5,887		6,786	7,684	6,877	7,778	
Weight	Unit		kg	2,447	2,813	2,557	2,923	4,445.2	4,629.2	5,004.6	5,748.6	5,720	6,364.8	
	Operation weight		kg	2,484.35	2,862.5	2,606.5	2,972.5	4,598.2	4,870.2	5,237.6	5,981.6	6,021	6,656.8	
Water heat exchanger	Type			Plate heat exchanger				Shell and tube						
	Water volume		l	37	50			153	241	233			301	292
	Water flow rate	Cooling	Nom.	l/s	8.6	10.7	12.9	14.3	17	18.7	20.4	23	27.4	29.6
	Water pressure drop	Cooling	Nom.	kPa	10.2	11.2	15.7	18.9	23.2	16.7	34.2	26.3	24.7	31.1
Air heat exchanger	Type			Microchannel										
Compressor	Type			Driven vapour compressor										
	Quantity			1					2					
Fan	Type			Direct propeller										
	Quantity			6	8	6	8	12		14	16	14	16	
	Air flow rate	Nom.	l/s	26,172	34,896	26,172	34,896	52,344		61,068	69,792	61,068	69,792	
	Speed		rpm	760										
Sound power level (XSB)	Cooling	Nom.	dB(A)	97.19	98.16	101.14	96.57	100.19	100.4	100.7	101.94	99.44	104.19	
Sound power level (XLB)				92.14	93.15	96.44	96.57	95.14	95.3	95.68	96.78	99.44	99.57	
Sound pressure level (XSB)	Cooling	Nom.	dB(A)	77.7	78.20	81.70	76.60	79.40	79.60	80.40	78.70	82.70		
Sound pressure level (XLB)				72.65	73.19	76.96	76.62	74.36	74.53	74.55	75.29	78.67	78.12	
Operation range	Air side	Cooling	Min.~Max.	°CDB -18~55										
	Water side	Cooling	Min.~Max.	°CDB -8~18										
Refrigerant	Type/GWP			R-1234(ze)/7										
	Charge		kg	39	52	39	52	73.2		84.6	97.6	102	116.8	
Piping connections	Evaporator water inlet/outlet (OD)			1			2							
	Unit	Running current	Cooling Nom. Max	A	88.5	113.05	131.55	147.5	176.4	193.47	208.66	243.65	272.5	298.67
Power supply	Phase/Frequency/Voltage		Hz/V	3~/50/400										

Cooling Only		EWAH-TZXR		180	220	270	300	350	390	430	480	580	620	
Space cooling	A Condition 35°C Pdc		kW	180.38	224.67	270.66	300.22	354.75	391.7	427.42	481.53	573.98	619.32	
	ηs,c		%	188.68	195.84	194.04	203.08	195.44	195.76	202.72	205.68	213.64	217.16	
SEER				4.792	4.971	4.926	5.152	4.961	4.969	5.143	5.217	5.416	5.504	
Cooling capacity	Nom.		kW	180	225	271	300	355	392	427	482	574	619	
Power input	Cooling	Nom.	kW	51.8	66.3	79	89.6	103	115	125	145	164	182	
	Capacity control	Method		Variable										
	Minimum capacity		%	33.4	26.7	21.6	18.7	16.7	15.4	14.3	12.5	10.8	10	
EER				3.49	3.39	3.43	3.35	3.42	3.41	3.32	3.48	3.39		
IPLV				6.05	6.09	5.92	6.2	5.78	5.77	5.88	5.97	5.98	6.17	
Dimensions	Unit	Height	mm	2,540										
		Width	mm	2,282										
		Length	mm	3,230	4,130	3,230	4,130	5,887		6,786	7,684	6,877	7,778	
Weight	Unit		kg	2,547	2,913	2,717	3,083	4,645.2	4,829.2	5,204.6	5,948.6	6,040	6,684.8	
	Operation weight		kg	2,584.35	2,962.5	2,766.5	3,132.5	4,798.2	5,070.2	5,437.6	6,181.6	6,341	6,976.8	
Water heat exchanger	Type			Plate heat exchanger				Shell and tube						
	Water volume		l	37	50			153	241	233			301	292
	Water flow rate	Cooling	Nom.	l/s	8.6	10.7	12.9	14.3	16.9	18.7	20.4	23	27.4	29.6
	Water pressure drop	Cooling	Nom.	kPa	10.2	11.2	15.7	18.9	23.2	16.6	34.1	26.3	24.7	31.1
Air heat exchanger	Type			Microchannel										
Compressor	Type			Driven vapour compressor										
	Quantity			1					2					
Fan	Type			Direct propeller										
	Quantity			6	8	6	8	12		14	16	14	16	
	Air flow rate	Nom.	l/s	26,172	34,896	26,172	34,896	51,324		59,709	68,433	59,709	68,433	
	Speed		rpm	760										
Sound power level	Cooling	Nom.	dB(A)	88.63	89.73	92.27	92.6	91.63	91.73	92.25	93.09	95.27	95.6	
Sound pressure level	Cooling	Nom.	dB(A)	69.20	69.80	72.80	72.60	70.90	71.00	71.10	71.6	74.5	74.20	
Operation range	Air side	Cooling	Min.~Max.	°CDB -18~55										
	Water side	Cooling	Min.~Max.	°CDB -8~18										
Refrigerant	Type/GWP			R-1234(ze)/7										
	Charge		kg	39	52	39	52	73.2		84.6	97.6	102	116.8	
Piping connections	Evaporator water inlet/outlet (OD)			1			2							
	Unit	Running current	Cooling Nom. Max	A	88.5	113.05	131.55	147.5	176.9	194.09	209.13	244.41	273.41	299.81
Power supply	Phase/Frequency/Voltage		Hz/V	3~/50/400										

Air cooled screw inverter chiller, premium efficiency, standard/low sound

- › Premium energy efficiency both at full and part load conditions
- › Inverter stepless single-screw compressor with DC electrical motor
- › Advanced compressor technology featuring integrated inverter and variable volume ratio (VVR)
- › HFO R1234zeE Refrigerant with Ozone Depletion Potential equal to zero and extremely low Global Warming Potential
- › Compact design for small footprint and minimized installation space
- › Low operating sound levels are achieved by the latest compressor and fan design
- › One or two truly independent refrigerant circuits for outstanding reliability
- › Continuous fans speed modulation with EC fans for even higher part load efficiency



Air cooled screw inverter chiller, premium efficiency, reduced sound

- › Premium energy efficiency both at full and part load conditions
- › Inverter stepless single-screw compressor with DC electrical motor
- › Advanced compressor technology featuring integrated inverter and variable volume ratio (VVR)
- › HFO R1234zeE Refrigerant with Ozone Depletion Potential equal to zero and extremely low Global Warming Potential
- › Compact design for small footprint and minimized installation space
- › Low operating sound levels are achieved by the latest compressor and fan design
- › One or two truly independent refrigerant circuits for outstanding reliability
- › Continuous fans speed modulation with EC fans for even higher part load efficiency



Cooling Only		EWAH-TZPSB/PLB		370	440	530	610
Space cooling	A Condition 35°C Pdc	kW		371.15	435.24	532.06	606.43
	ηs,c	%		206.56	213.68	220.48	224.96
SEER				5.239	5.417	5.587	5.699
Cooling capacity	Nom.	kW		371	435	532	606
Power input	Cooling Nom.	kW		102	121	137	163
Capacity control	Method	Variable					
	Minimum capacity	%		16.7	14.3	11.7	10
EER				3.62	3.58	3.86	3.7
IPLV				6.15	6.35	6.36	6.35
Dimensions	Unit	Height	mm	2,540			
		Width	mm	2,282			
		Length	mm	7,684	9,480	7,778	8,687
Weight	Unit		kg	5,741.4	6,722	6,364.8	7,140.2
		Operation weight	kg	5,982.4	7,023	6,656.8	7,636.2
Water heat exchanger	Type	Shell and tube					
	Water volume		l	241	301	292	496
	Water flow rate	Cooling Nom.	l/s	17.7	20.8	25.4	29
	Water pressure drop	Cooling Nom.	kPa	24.4	15	15.3	18
Air heat exchanger	Type	Microchannel					
Compressor	Type	Driven vapour compression					
	Quantity	2					
Fan	Type	Direct propeller					
	Quantity			16	20	16	18
	Air flow rate	Nom.	l/s	251,251.0	314,064	251,251.0	282,658.0
	Speed			760			
Sound power level (PSB)	Cooling Nom.	dB(A)		100.3	100.8	103.24	104.21
	Cooling Nom.	dB(A)		95.48	96	98.71	99.63
Sound pressure level (PSB)	Cooling Nom.	dB(A)		78.80		81.80	82.40
	Cooling Nom.	dB(A)		74.03	73.96	77.25	77.86
Operation range	Air side Cooling	Min.~Max.	°CDB	-18~55			
	Water side Cooling	Min.~Max.	°CDB	-8~18			
Refrigerant	Type/GWP	R-1234(ze)/7					
	Circuits	Quantity	2				
Refrigerant circuit	Charge	kg		90.4	113	116.8	131.2
Refrigerant charge	Per circuit	kg		316.4	395.5	408.8	459.2
Piping connections	Evaporator water inlet/outlet (OD)	168.3mm					
Unit	Running current	Cooling Nom.	A	175.85	205.4	233.82	272.98
	current Max	A		272	319	350	424
Power supply	Phase/Frequency/Voltage	Hz/V		3~/50/400			

Cooling Only		EWAH-TZPRB		370	440	530	610
Space cooling	A Condition 35°C Pdc	kW		370.96	435.06	531.76	606.09
	ηs,c	%		206.04	213.28	219.28	223.8
SEER				5.226	5.407	5.557	5.67
Cooling capacity	Nom.	kW		371	435	532	606
Power input	Cooling Nom.	kW		102	122	138	164
Capacity control	Method	Variable					
	Minimum capacity	%		16.7	14.3	11.7	10
EER				3.61	3.57	3.84	3.69
IPLV				6.12	6.32	6.32	6.32
Dimensions	Unit	Height	mm	2,540			
		Width	mm	2,282			
		Length	mm	7,684	9,480	7,778	8,687
Weight	Unit		kg	5,941.4	6,922	6,684.8	7,460.2
		Operation weight	kg	6,182.4	7,223	6,976.8	7,956.2
Water heat exchanger	Type	Shell and tube					
	Water volume		l	241	301	292	496
	Water flow rate	Cooling Nom.	l/s	17.7	20.8	25.4	28.9
	Water pressure drop	Cooling Nom.	kPa	24.4	14.9	15.3	18
Air heat exchanger	Type	Microchannel					
Compressor	Type	Driven vapour compression					
	Quantity	2					
Fan	Type	Direct propeller					
	Quantity			16	20	16	18
	Air flow rate	Nom.	l/s	246,359.0	307,948.0	246,359.0	276,541.0
	Speed			760			
Sound power level	Cooling Nom.	dB(A)		92.37	92.94	94.94	95.73
	Cooling Nom.	dB(A)		70.90		73.50	74.00
Sound pressure level	Cooling Nom.	dB(A)		70.90		73.50	74.00
	Cooling Nom.	dB(A)		70.90		73.50	74.00
Operation range	Air side Cooling	Min.~Max.	°CDB	-18~55			
	Water side Cooling	Min.~Max.	°CDB	-8~18			
Refrigerant	Type/GWP	R-1234(ze)/7					
	Circuits	Quantity	2				
Refrigerant circuit	Charge	kg		90.4	113	116.8	131.2
Refrigerant charge	Per circuit	kg		316.4	395.5	408.8	459.2
Piping connections	Evaporator water inlet/outlet (OD)	168.3mm					
Unit	Running current	Cooling Nom.	A	176.22	205.83	234.54	273.8
	current Max	A		272	319	350	424
Power supply	Phase/Frequency/Voltage	Hz/V		3~/50/400			



Air cooled screw inverter chiller, standard efficiency, standard/low sound

- › Optimized energy efficiency both at full and part load conditions
- › New single screw compressor geometry allowing performance optimization
- › Refrigerant cooled inverter mounted on compressor all across the range
- › New generation of air-cooled inverter series with extension of capacity range: Nominal capacity up to 1,600 kW
- › Includes new generation Daikin MicroTech 4 controller with higher memory capacity and faster microprocessor
- › Microchannel coils



Air cooled screw inverter chiller, standard efficiency, reduced sound

- › High energy efficiency both at full and part load conditions
- › New single screw compressor geometry allowing performance optimization
- › Refrigerant cooled inverter mounted on compressor all across the range
- › New generation of air-cooled inverter series with extension of capacity range: Nominal capacity up to 1,600 kW
- › Includes new generation Daikin MicroTech 4 controller with higher memory capacity and faster microprocessor
- › Microchannel coils



Cooling Only		EWAD-TZSSC2/SLC2		H11	H12	H13	C15	C16	H17	H18	H19										
Space cooling	A Condition 35°C Pdc	kW		1,189	1,259	1,355	1,508	1,644	1,766	1,875	1,965										
	ηs,c	%		184.5	182.4	182.9	190.1	191.8	191.4	190.1	184.2										
SEER		kW		4.69	4.64	4.65	4.83	4.87	4.86	4.83	4.68										
Cooling capacity	Nom.	kW		1,189	1,259	1,355	1,508	1,644	1,766	1,875	1,965										
Power input	Cooling	kW		380.9	413.4	438.6	485	532.8	581.8	636.4	709.3										
	Nom.	kW																			
Capacity control	Method	Variable																			
	Minimum capacity	%		12.5																	
EER		kW		3.12	3.05	3.09	3.11	3.09	3.04	2.95	2.77										
IPLV		%		4.85	4.8	4.78	5.14	5.11	5.07	5.04	4.99										
Dimensions	Unit	Height	mm	2,540																	
		Width	mm	2,282																	
		Length	mm	10,510	11,404		12,302	13,202	14,102												
Weight	Unit	kg		9,322	10,112	10,716	11,134	11,564	12,037												
	Operation weight	kg		9,879	11,123	11,727	12,145	12,575	13,048												
Water heat exchanger	Type	Shell and tube																			
	Water volume	l		557		1,011															
	Water pressure drop	Cooling	Nom.	kPa	57.1	63.3	40.5	49.1	57.4	65.2	72.7	79									
Air heat exchanger	Type	Microchannel																			
Compressor	Type	Inverter driven single screw compressor																			
	Quantity	2																			
Fan	Type	Direct propeller																			
	Quantity	22		24		26		28		30											
	Air flow rate	Nom.	l/s		112,259		122,464		132,670		142,876		153,081								
	Speed	rpm		900																	
Sound power level (SSC2)	Cooling	Nom.	dBA		100		101		102		103										
	Nom.	dBA		102		103		104		105		106		107							
Sound pressure level (SSC2)	Cooling	Nom.	dBA		77		78		79		80										
	Nom.	dBA		80		81		82		83		84									
Refrigerant	Type/GWP	R-134a/1,430																			
	Charge	kg		175		200		220		250		270									
	Circuits	Quantity		2																	
Piping connections	Evaporator water inlet/outlet (OD)	219.1mm				273mm															
	Unit	Running current	Cooling Max	Nom.	A		646.5		691.1		733.0		813.9		884.0		962.8		1,044		1,149
Power supply	Phase/Frequency/Voltage	Hz/V		3~/50 /400																	

performances according to CSS software 10.27

Cooling Only		EWAD-TZSRC2		H11	H12	H13	C15	C16	H17	H18	H19										
Space cooling	A Condition 35°C Pdc	kW		1,164	1,229	1,323	1,463	1,595	1,712	1,812	1,876										
	ηs,c	%		206.8	201.6	203.1	204.1	205.3	205.0		201.4										
SEER		kW		5.24	5.12	5.15	5.18	5.21	5.20		5.11										
Cooling capacity	Nom.	kW		1,164	1,229	1,323	1,463	1,595	1,712	1,812	1,876										
Power input	Cooling	kW		384.6	423.1	446	513.9	564.5	611.2	663.5	741.2										
	Nom.	kW																			
Capacity control	Method	Variable																			
	Minimum capacity	%		12.5																	
EER		kW		3.03	2.91	2.97	2.85	2.83	2.80	2.73	2.53										
IPLV		%		5.43	5.29	5.34	5.53		5.5	5.51	5.36										
Dimensions	Unit	Height	mm	2,540																	
		Width	mm	2,282																	
		Length	mm	10,510	11,404		12,302	13,202	14,102												
Weight	Unit	kg		9,322	10,112	10,716	11,134	11,564	12,037												
	Operation weight	kg		9,879	11,123	11,727	12,145	12,575	13,048												
Water heat exchanger	Type	Shell and tube																			
	Water volume	l		557		1,011															
	Water pressure drop	Cooling	Nom.	kPa	54	60.6	38.8	46.5	54.3	61.6	68.3	72.7									
Air heat exchanger	Type	Microchannel																			
Compressor	Type	Inverter driven single screw compressor																			
	Quantity	2																			
Fan	Type	Direct propeller																			
	Quantity	22		24		26		28		30											
	Air flow rate	Nom.	l/s		81,518		89,145		96,375		104,002		111,232								
	Speed	rpm		700																	
Sound power level (SSC2)	Cooling	Nom.	dBA		93		94		95		96										
	Nom.	dBA		70		71		72		73											
Refrigerant	Type/GWP	R-134a/1,430																			
	Charge	kg		175		200		220		250		270									
	Circuits	Quantity		2																	
Piping connections	Evaporator water inlet/outlet (OD)	219.1mm				273mm															
	Unit	Running current	Cooling Max	Nom.	A		659.2		708.5		748.1		853.7		922.8		1,000		1,080		1,194
Power supply	Phase/Frequency/Voltage	Hz/V		3~/50 /400																	

performances according to CSS software 10.27



Air cooled screw inverter chiller, high efficiency, standard sound

- › High energy efficiency both at full and part load conditions
- › New single screw compressor geometry allowing performance optimization
- › Refrigerant cooled inverter mounted on compressor all across the range
- › New generation of air-cooled inverter series with extension of capacity range: Nominal capacity up to 1,600 kW
- › Includes new generation Daikin MicroTech 4 controller with higher memory capacity and faster microprocessor
- › Microchannel coils



Air cooled screw inverter chiller, high efficiency, reduced sound

- › High energy efficiency both at full and part load conditions
- › New single screw compressor geometry allowing performance optimization
- › Refrigerant cooled inverter mounted on compressor all across the range
- › New generation of air-cooled inverter series with extension of capacity range: Nominal capacity up to 1,600 kW
- › Includes new generation Daikin MicroTech 4 controller with higher memory capacity and faster microprocessor
- › Microchannel coils



Cooling Only		EWAD-TZXSC2		C11	C12	H12	C14	C15	H16	H17	
Space cooling	A Condition 35°C Pdc	kW	1,124.00	1,280	1,206	1,399	1,539	1,667	1,780		
	ηs,c	%	211.5	210.8	211.1	211.9	212.6	214.2	212.6		
SEER			5.36		5.35		5.37	5.39	5.43	5.39	
Cooling capacity	Nom.	kW	1,124	1,280	1,206	1,399	1,539	1,667	1,780		
Power input	Cooling Nom.	kW	354	401.6	375.9	431.7	478.8	524.7	575.4		
Capacity control	Method		Variable								
	Minimum capacity	%	12.5								
EER			3.17	3.19	3.21	3.24	3.22	3.18	3.09		
IPLV			5.54		5.58	5.79	5.7	5.66	5.65		
Dimensions	Unit										
	Height	mm	2,540								
	Width	mm	2,282								
Weight	Unit										
	Operation weight	kg	10,510	12,302	11,402		12,302	13,202	14,104		
		kg	9,322	10,515	10,112	10,716	11,134	11,564	12,037	13,048	
Water heat exchanger	Type		Shell and tube								
	Water volume	l	557	1,011							
	Water pressure drop	Cooling Nom. kPa	51.6	36.6	32.8	42.9	50.9	58.8	66.1		
Air heat exchanger	Type		Microchannel								
Compressor	Type		Inverter driven single screw compressor								
	Quantity		2								
Fan	Type		Direct propeller								
	Quantity		22	26	24	26	28	30			
	Air flow rate	Nom. l/s	83,897	99,151	91,524	122,464	132,670	142,876	153,081		
	Speed	rpm	900								
Sound power level	Cooling Nom. dBA		95	97	96	101		102			
Sound pressure level	Cooling Nom. dBA		73	74	73	78		79			
Refrigerant	Type/GWP		R-134a/1,430								
	Charge	kg	175	220	200	220	250	270			
	Circuits	Quantity	2								
Piping connections	Evaporator water inlet/outlet (OD)		219.1mm			273mm					
Unit	Starting current	A	0.0								
	Running current	Cooling Nom. A	608.8	686.1	647.1	735.8	806.6	874.7	957.5		
	Max	A	918	994	939	1,085	1,124	1,218	1,313		
Power supply	Phase/Frequency/Voltage	Hz/V	3~/50 /400								

performances according to CSS software 10.27

Cooling Only		EWAD-TZXR2		C11	C12	H12	C14	C15	H16	H17	
Space cooling	A Condition 35°C Pdc	kW	1,122	1,204	1,279	1,362	1,499	1,625	1,735		
	ηs,c	%	208.8	210.2	209.8	207.8	209.4	209.3	209.7		
SEER			5.30	5.33	5.32	5.27		5.31	5.32		
Cooling capacity	Nom.	kW	1,122	1,204	1,279	1,362	1,499	1,625	1,735		
Power input	Cooling Nom.	kW	356.3	377.3	403	450.1	501.4	547.6	598.6		
Capacity control	Method		Variable								
	Minimum capacity	%	12.5								
EER			3.15	3.19	3.17	3.03	2.99	2.97	2.90		
IPLV			5.51	5.55	5.49	5.64	5.65	5.64	5.6		
Dimensions	Unit										
	Height	mm	2,540								
	Width	mm	2,282								
Weight	Unit										
	Operation weight	kg	10,510	11,402	12,302	11,402	12,302	13,202	14,104		
		kg	9,322	10,112	10,515	10,716	11,134	11,564	12,037	13,048	
Water heat exchanger	Type		Shell and tube								
	Water volume	l	557	1,011							
	Water pressure drop	Cooling Nom. kPa	51.4	32.7	36.5	40.8	48.5	56.1	63.2		
Air heat exchanger	Type		Microchannel								
Compressor	Type		Inverter driven single screw compressor								
	Quantity		2								
Fan	Type		Direct propeller								
	Quantity		22	24	26	24	26	28	30		
	Air flow rate	Nom. l/s	81,518	89,145	96,375	89,145	96,375	104,002	111,232		
	Speed	rpm	700								
Sound power level	Cooling Nom. dBA		92	93	94	93	94		95		
Sound pressure level	Cooling Nom. dBA		70			71			72		
Refrigerant	Type/GWP		R-134a/1,430								
	Charge	kg	175	200	220	200	220	250	270		
	Circuits	Quantity	2								
Piping connections	Evaporator water inlet/outlet (OD)		219.1mm	273mm	219.1mm		273mm				
Unit	Starting current	A	0.0								
	Running current	Cooling Nom. A	612.3	651.0	689.6	762.5	834.0	901.3	982.6		
	Max	A	918	939	994	1,085	1,124	1,218	1,313		
Power supply	Phase/Frequency/Voltage	Hz/V	3~/50 /400								

performances according to CSS software 10.27



Air cooled screw inverter chiller, standard efficiency, standard/low sound

- › Optimized energy efficiency both at full and part load conditions
- › New single screw compressor geometry allowing performance optimization
- › HFO R-1234ze(E) Refrigerant with Ozone Depletion Potential equal to zero and extremely low Global Warming Potential
- › Refrigerant cooled inverter mounted on compressor all across the range
- › New generation of air-cooled inverter series with extension of capacity range: Nominal capacity up to 1,600 kW
- › Includes new generation Daikin MicroTech 4 controller with higher memory capacity and faster microprocessor
- › Microchannel coils



Air cooled screw inverter chiller, standard efficiency, reduced sound

- › Optimized energy efficiency both at full and part load conditions
- › New single screw compressor geometry allowing performance optimization
- › HFO R-1234ze(E) Refrigerant with Ozone Depletion Potential equal to zero and extremely low Global Warming Potential
- › Refrigerant cooled inverter mounted on compressor all across the range
- › New generation of air-cooled inverter series with extension of capacity range: Nominal capacity up to 1,600 kW
- › Includes new generation Daikin MicroTech 4 controller with higher memory capacity and faster microprocessor
- › Microchannel coils



Cooling Only		EWAH-TZSSC2/SLC2		710	770	880	940	990	H10	C11	C12	C13	C14	C15	C16
Space cooling	A Condition 35°C Pdc	kW		712.28	765.6	879.39	942.78	990.5	1,055.51	1,117.22	1,230.93	1,301.55	1,431.96	1,518.61	1,603.34
	ηs,c	%		181.52	183.08	182.16	181.72	182.84	181.4	182.24	179.28	193.88	192.32	190.76	188.92
SEER				4.613	4.652	4.629	4.618	4.646	4.61	4.631	4.557	4.922	4.883	4.844	4.798
Cooling capacity	Nom.	kW		712.3	765.6	879.4	942.8	990.5	1,056	1,117	1,231	1,302	1,432	1,519	1,603
Power input	Cooling Nom.	kW		230.7	246.6	284.9	303.9	318.9	339.4	357.4	396	418.4	465.3	510.4	567.4
Capacity control	Method	Inverter controlled													
	Minimum capacity	%		12.5											
EER				3.088	3.104	3.087	3.102	3.107	3.11	3.126	3.109	3.111	3.077	2.975	2.826
IPLV				4.79	4.85	4.8	4.74	4.78	4.71	4.73	4.63	5.17	5.08	5.07	4.98
Dimensions	Unit	Height	mm	2,540											
		Width	mm	2,280											
		Length	mm	6,909	7,809	8,709	9,602	10,510	11,402	12,302	11,402	12,302	13,202	13,202	14,102
Weight	Unit		kg	7,033	7,660	8,093	8,900	9,288	10,073	10,475	10,716	11,134	11,564	12,037	
	Operation weight		kg	7,313	8,152	8,585	9,483	9,871	11,116	11,518	11,727	12,145	12,575	13,048	
Water heat exchanger	Type	Shell and tube													
	Water volume		l	280		492		583		1,043		1,011			
	Water flow rate	Cooling Nom.	l/s	33.97	36.51	41.94	44.96	47.24	50.34	53.27	58.70	62.06	68.28	72.41	76.45
	Water pressure drop	Cooling Nom.	kPa	44.6	50.8	59.7	67.7	59.9	67.2	44.3	52.7	38.7	45.9	51	56.3
Air heat exchanger	Type	Microchannel													
Compressor	Type	Inverter driven single screw compressor													
	Quantity	2													
Fan	Type	Direct propeller, on/off fans													
	Quantity	14													
	Air flow rate	Nom.	l/s	71,438	81,644	91,849	102,054	112,259	122,464	132,670	122,464	132,670	142,876	153,081	
	Speed		rpm	900											
Sound power level (SSC2)	Cooling Nom.	dB(A)	98	99	100	101	102	103	102	103	102	103	103	104	
Sound power level (SLC2)	Cooling Nom.	dB(A)	101	102	103	104	105	106	107	105	106	107	107	108	
Sound pressure level (SSC2)	Cooling Nom.	dB(A)	77		78		79		80		80				
Sound pressure level (SLC2)	Cooling Nom.	dB(A)	80		81		82		83		84		85		
Refrigerant	Type/GWP	R-1234(ze)/7													
	Charge		kg	120	130	141	150	175	200	220	200	220	250	270	
	Circuits	Quantity	2												
Piping connections	Evaporator water inlet/outlet (OD)	mm		168.3mm		219.1mm				273mm					
	Unit	Starting current	A	0											
	Running current	Cooling Nom.	A	408.6	433.3	493.5	521.5	549.9	579.6	612.7	668.8	718.8	780.9	848.9	934.8
	Max	A	609.0	640.0	717.0	763.0	811.0	869.0	924.0	1,032.0	1,029.0	1,119.0	1,198.0	1,226.0	
Power supply	Phase/Frequency/Voltage	Hz/V	3~/50/400												

performances according to CSS software 10.27

Cooling Only		EWAH-TZSRC2		710	770	880	940	990	H10	C11	C12	C13	C14	C15	C16
Space cooling	A Condition 35°C Pdc	kW		696.3	749.16	859.56	922.06	970.53	1,034.22	1,095.25	1,204.39	1,273.47	1,399.7	1,484.25	1,551.82
	ηs,c	%		204.76	202.64	202.68	204.16	209.88	207.24	210.36	207.08	216.56	213.72	213.96	213.16
SEER				5.194	5.141	5.142	5.179	5.322	5.256	5.334	5.252	5.489	5.418	5.424	5.404
Cooling capacity	Nom.	kW		696.3	749.2	859.6	922.1	970.5	1,034	1,095	1,204	1,273	1,400	1,484	1,552
Power input	Cooling Nom.	kW		232.1	253	290.9	309.1	318.8	340.5	354	396.4	424.2	479.7	524.7	581
Capacity control	Method	Inverter controlled													
	Minimum capacity	%		12.5											
EER				3.001	2.962	2.955	2.983	3.044	3.038	3.094	3.038	3.002	2.918	2.829	2.671
IPLV				5.43	5.4	5.36	5.37	5.52	5.46	5.49	5.35	5.79	5.73	5.71	
Dimensions	Unit	Height	mm	2,540											
		Width	mm	2,280											
		Length	mm	6,909	7,809	8,709	9,602	10,510	11,402	12,302	11,402	12,302	13,202	13,202	14,102
Weight	Unit		kg	7,033	7,660	8,093	8,900	9,288	10,073	10,475	10,716	11,134	11,564	12,037	
	Operation weight		kg	7,313	8,152	8,585	9,483	9,871	11,116	11,518	11,727	12,145	12,575	13,048	
Water heat exchanger	Type	Shell and tube													
	Water volume		l	280		492		583		1,043		1,011			
	Water flow rate	Cooling Nom.	l/s	33.21	35.73	41.00	43.98	46.29	49.32	52.23	57.43	60.72	66.74	70.77	73.99
	Water pressure drop	Cooling Nom.	kPa	42.8	48.9	57.3	64	57.8	64.8	42.7	50.7	37.2	44.1	48	53.1
Air heat exchanger	Type	Microchannel													
Compressor	Type	Inverter driven single screw compressor													
	Quantity	2													
Fan	Type	Direct propeller, on/off fans													
	Quantity	14													
	Air flow rate	Nom.	l/s	51,803	59,430	66,660	74,287	81,518	89,145	96,375	89,145	96,375	104,002	111,232	
	Speed		rpm	700											
Sound power level	Cooling Nom.	dB(A)	91	92	93	94	95	96	95	96	95	96	96	97	
Sound pressure level	Cooling Nom.	dB(A)	70		71		72		73		72		73		74
Refrigerant	Type/GWP	R-1234(ze)/7													
	Charge		kg	120	130	141	150	175	200	220	200	220	250	270	
	Circuits	Quantity	2												
Piping connections	Evaporator water inlet/outlet (OD)	mm		168.3mm		219.1mm				273mm					
	Unit	Starting current	A	0											
	Running current	Cooling Nom.	A	414.9	446.8	505.2	529.7	554.4	581.0	611.1	667.2	736.4	796.5	863.9	952.0
	Max	A	609.0	640.0	717.0	763.0	811.0	869.0	924.0	1,032.0	1,029.0	1,119.0	1,198.0	1,226.0	
Power supply	Phase/Frequency/Voltage	Hz/V	3~/50/400												

performances according to CSS software 10.27



Air cooled screw inverter chiller, high efficiency, standard/low sound

- › High energy efficiency both at full and part load conditions
- › New single screw compressor geometry allowing performance optimization
- › HFO R-1234ze(E) Refrigerant with Ozone Depletion Potential equal to zero and extremely low Global Warming Potential
- › Refrigerant cooled inverter mounted on compressor all across the range
- › New generation of air-cooled inverter series with extension of capacity range: Nominal capacity up to 1,600 kW
- › Includes new generation Daikin MicroTech 4 controller with higher memory capacity and faster microprocessor
- › Microchannel coils



Air cooled screw inverter chiller, high efficiency, reduced sound

- › High energy efficiency both at full and part load conditions
- › New single screw compressor geometry allowing performance optimization
- › HFO R-1234ze(E) Refrigerant with Ozone Depletion Potential equal to zero and extremely low Global Warming Potential
- › Refrigerant cooled inverter mounted on compressor all across the range
- › New generation of air-cooled inverter series with extension of capacity range: Nominal capacity up to 1,600 kW
- › Includes new generation Daikin MicroTech 4 controller with higher memory capacity and faster microprocessor
- › Microchannel coils



Cooling Only		EWAH-TZXSC2/XLC2												
		670	780	840	950	C10	C11	C12	C13	C14	C15			
Space cooling	A Condition 35°C Pdc	kW	669.32	783.42	840.22	947.7	1,014.01	1,119.73	1,236.7	1,347.06	1,442.56	1,526.76		
	ηs,c	%	209.96	211.56	212.8	215.88	216.72	213.16	219.2	218.36	217.48	216.32		
SEER			5.324	5.364	5.395	5.472	5.493	5.404	5.555	5.534	5.512	5.483		
Cooling capacity	Nom.	kW	669.3	783.4	840.2	947.7	1,014	1,120	1,237	1,347	1,443	1,527		
Power input	Cooling	Nom.	kW	206	242	260.2	292.4	310.6	351.7	380.1	420.4	460.7	507.5	
	Method		Inverter controlled											
Capacity control	Minimum capacity	%	12.5											
EER			3.249	3.237	3.229	3.241	3.264	3.184	3.253	3.204	3.131	3.009		
IPLV			5.59		5.6	5.64	5.66	5.53	5.86	5.8	5.76	5.7		
	Unit	Height	2,540											
Dimensions	Width	mm	2,280											
	Length	mm	6,909	7,809	8,709	10,510	11,402	12,302	11,402	12,302	13,202	14,102		
	Weight	kg	7,033	7,660	8,093	9,288	10,073	10,475	10,716	11,134	11,564	12,037		
Water heat exchanger	Type		Shell and tube											
	Water volume	l	280	492		583	1,043		1,011					
Air heat exchanger	Water flow rate	Cooling	Nom.	l/s	31.92	37.36	40.07	45.20	48.35	53.39	58.97	64.23	68.78	72.80
	Water pressure drop	Cooling	Nom.	kPa	39.9	48.5	54	55.3	37.2	44.5	35.3	41.1	46.5	51.5
Compressor	Type		Inverter driven single screw compressor											
Fan	Quantity		2											
	Type		Direct propeller, on/off fans											
Sound power level (XSC2)	Cooling	Nom.	98	99	100	101	103	105	104	105	106	107		
	Cooling	Nom.	93	95		96	98	99	101	102		103		
Sound pressure level (XLC2)	Cooling	Nom.	76	78		79	80	82		83		84		
	Cooling	Nom.	72	73		74	75	76	79		80			
Refrigerant	Type/GWP		R-1234ze/7											
	Charge	kg	120	130	141	175	200	220	200	220	250	270		
Piping connections	Evaporator water inlet/outlet (OD)		168.3mm	219.1mm				273mm						
	Unit	Starting current	A	0										
Power supply	Running current	Cooling	Nom.	A	373.9	431.3	459.1	513.1	544.2	604.8	660.3	717.4	778.2	848.9
	Phase/Frequency/Voltage	Max	A	588.0	625.0	693.0	754.0	836.0	936.0	967.0	1,042.0	1,132.0	1,157.0	

performances according to CSS software 10.27

Cooling Only		EWAH-TZXR2												
		670	780	840	950	C10	C11	C12	C13	C14	C15			
Space cooling	A Condition 35°C Pdc	kW	669.17	783.17	840	947.47	1,013.69	1,119.41	1,212.9	1,321.24	1,415.52	1,497.21		
	ηs,c	%	208.32	211.4	212.68	215.84	216.12	212.64	219.4	220.16	218.84	217.44		
SEER			5.283	5.36	5.392	5.471	5.478	5.391	5.56	5.579	5.546	5.511		
Cooling capacity	Nom.	kW	669.2	783.2	840	947.5	1,014	1,119	1,213	1,321	1,416	1,497		
Power input	Cooling	Nom.	kW	206.2	243.3	261.9	292.6	310.8	351.9	382.2	426	467.4	514.6	
	Method		Inverter controlled											
Capacity control	Minimum capacity	%	12.5											
EER			3.246	3.219	3.207	3.238	3.261	3.181	3.174	3.101	3.029	2.91		
IPLV			5.58		5.59	5.63	5.65	5.52	5.94	5.86	5.81	5.79		
	Unit	Height	2,540											
Dimensions	Width	mm	2,280											
	Length	mm	6,909	7,809	8,709	10,510	11,402	12,302	11,402	12,302	13,202	14,102		
	Weight	kg	7,033	7,660	8,093	9,288	10,073	10,475	10,716	11,134	11,564	12,037		
Water heat exchanger	Type		Shell and tube											
	Water volume	l	280	492		583	1,043		1,011					
Air heat exchanger	Water flow rate	Cooling	Nom.	l/s	31.91	37.35	40.06	45.19	48.34	53.38	57.83	63.00	67.49	71.39
	Water pressure drop	Cooling	Nom.	kPa	39.9	48.4	54	55.3	37.2	44.4	34.1	39.7	44	49.7
Compressor	Type		Inverter driven single screw compressor											
Fan	Quantity		2											
	Type		Direct propeller, on/off fans											
Sound power level (XSC2)	Cooling	Nom.	90	91	92	93	94	95	94	95	96			
	Cooling	Nom.	69	70		71	72		73					
Refrigerant	Type/GWP		R-1234ze/7											
	Charge	kg	120	130	141	175	200	220	200	220	250	270		
Piping connections	Evaporator water inlet/outlet (OD)		168.3mm	219.1mm				273mm						
	Unit	Starting current	A	0										
Power supply	Running current	Cooling	Nom.	A	374.9	432.6	460.2	514.2	545.4	606.0	670.1	725.0	783.7	853.8
	Phase/Frequency/Voltage	Max	A	588.0	625.0	693.0	754.0	836.0	936.0	967.0	1,042.0	1,132.0	1,157.0	

performances according to CSS software 10.27

Air Cooled Screw Chiller - fix speed

- › Optimised for use with R-134a
- › Large operation range (ambient temperature down to -18°C)
- › Low operating cost and extended operating life thanks to the careful design aimed to optimize the energy efficiency of the chillers and to improve installation profitability, effectiveness and economical management
- › 2 or 3 independent refrigerant circuits for outstanding reliability and maximum safety for maintenance
- › Extremely wide range from 290kW to over 2 MW
- › Units with stepless regulation offer the benefit of following the system energy demand at any time with high efficiency if compared to the units with step regulation. Each unit has infinitely variable capacity control from 100% down to 12.5%
- › Advanced compressor and fans design that operate at very low sound levels
- › MicroTech 4 controller: sophisticated adaptive software logic for stable operating conditions



Air Cooled Screw Chiller - fix speed

- › Optimised for use with R-134a
- › Large operation range (ambient temperature down to -18°C)
- › Low operating cost and extended operating life thanks to the careful design aimed to optimize the energy efficiency of the chillers and to improve installation profitability, effectiveness and economical management
- › 2 or 3 independent refrigerant circuits for outstanding reliability and maximum safety for maintenance
- › Extremely wide range from 290kW to over 2 MW
- › Units with stepless regulation offer the benefit of following the system energy demand at any time with high efficiency if compared to the units with step regulation. Each unit has infinitely variable capacity control from 100% down to 12.5%
- › Advanced compressor and fans design that operate at very low sound levels
- › MicroTech 4 controller: sophisticated adaptive software logic for stable operating conditions



Cooling Only		EWAD-T-SSC/SLC																					
		290	330	370	510	520	580	700	800	940	C10	C11	C17	C19	C20	C21	H10	H12	H13	H14	H15	H16	H18
Cooling capacity	Nom.	kW																					
Power input	Cooling Nom.	kW																					
Capacity control	Method	Stepless																					
	Minimum capacity	%																					
SEPR		5.14	5.1	5.16	5.5	5.51	5.56	5.51	5.52	5.51	5.42	5.38	5.51	5.5	5.52	5.5	5.54	5.56	5.5				
EER		3.15	2.94	3.1	3.02	3.07	3.03	3.01	3.03	2.85	2.87	2.88	2.84	2.87	2.8	2.85	2.88	2.92	2.98	2.8			
IPLV		4.31	4.22	4.35	4.9	4.78	5.04	4.63	4.56	4.63	4.65	4.67	4.6	4.5	4.46	4.57	4.64	4.62	4.63	4.64	4.6	4.63	
Dimensions	Unit	mm																					
	Height	2,540																					
	Width	2,282																					
Weight	Unit	kg																					
	Operation weight	3,062	4,104	4,724	4,860	5,316	5,663	5,950	6,468	11,277	11,808	11,999	6,490	7,062	7,362	7,654	10,157	11,277	11,385				
		3,162	4,274	4,894	5,030	5,402	5,903	6,240	6,768	12,148	12,761	13,034	7,002	7,554	7,842	8,134	10,657	12,148	12,338				
Water heat exchanger	Type	Shell and tube																					
	Water volume	l																					
	Water flow rate Cooling Nom.	l/s																					
Air heat exchanger	Type	Microchannel																					
	Compressor	Asymm single screw																					
	Fan	Direct propeller, on/off fans																					
Sound power level (SSC)	Cooling Nom.	dBA																					
	Sound pressure level (SSC)	dBA																					
	Sound power level (SLC)	dBA																					
Refrigerant	Type	R-134a																					
	Charge	kg																					
	Circuits	Quantity																					
Piping connections	Evaporator water inlet/outlet (OD)	mm																					
	Unit	A																					
	Running current	A																					
Power supply	Phase/Frequency/Voltage	Hz/V																					

performances according to CSS software 10.27

Cooling Only		EWAD-T-XSC/XLC																						
		350	380	400	420	440	490	540	570	730	820	950	C10	C13	C14	C17	C19	C20	H10	H11	H13	H15	H16	H18
Cooling capacity	Nom.	kW																						
Power input	Cooling Nom.	kW																						
Capacity control	Method	Stepless																						
	Minimum capacity	%																						
SEPR		5.18	5.52	5.54	5.51	5.51	5.5	5.55	5.52	5.61	5.52	5.56	5.55	5.59	5.57	5.52	5.56	5.58	5.57	5.57	5.58	5.58	5.58	
EER		3.32	3.29	3.24	3.16	3.09	3.26	3.19	3.01	3.02	3.15	3.02	3.1	3	3.13	3.05	2.96	3.1	3.11	3.12	3.09	3.14		
IPLV		4.15	4.34	4.6	4.77	4.46	4.82	4.88	4.97	4.68	4.54	4.76	4.69	4.56	4.62	4.67	4.6	4.65	4.69	4.7	4.6	4.62		
Dimensions	Unit	mm																						
	Height	2,540																						
	Width	2,282																						
Weight	Unit	kg																						
	Operation weight	4,064	4,360	4,860	5,398	5,316	5,663	6,376	7,654	8,020	11,581	11,999	7,362	7,392	8,020	11,277	11,684	11,672						
		4,234	4,530	5,030	5,568	5,402	5,903	6,676	8,134	8,470	12,511	13,034	7,842	7,872	8,470	12,148	12,555	12,602						
Water heat exchanger	Type	Shell and tube																						
	Water volume	l																						
	Water flow rate Cooling Nom.	l/s																						
Air heat exchanger	Type	Microchannel																						
	Compressor	Asymm single screw																						
	Fan	Direct propeller, on/off fans																						
Sound power level (XSC)	Cooling Nom.	dBA																						
	Sound pressure level (XSC)	dBA																						
	Sound power level (XLC)	dBA																						
Refrigerant	Type	R-134a																						
	Charge	kg																						
	Circuits	Quantity																						
Piping connections	Evaporator water inlet/outlet (OD)	mm																						
	Unit	A																						
	Running current	A																						
Power supply	Phase/Frequency/Voltage	Hz/V																						

performances according to CSS software 10.27

Air Cooled Screw Chiller - fix speed

- › Optimised for use with R-134a
- › Large operation range (ambient temperature down to -18°C)
- › Low operating cost and extended operating life thanks to the careful design aimed to optimize the energy efficiency of the chillers and to improve installation profitability, effectiveness and economical management
- › 2 or 3 independent refrigerant circuits for outstanding reliability and maximum safety for maintenance
- › Extremely wide range from 290kW to over 2 MW
- › Units with stepless regulation offer the benefit of following the system energy demand at any time with high efficiency if compared to the units with step regulation. Each unit has infinitely variable capacity control from 100% down to 12.5%
- › Advanced compressor and fans design that operate at very low sound levels
- › MicroTech 4 controller: sophisticated adaptive software logic for stable operating conditions



		EWAD-T-XRC																					
		350	380	400	420	440	490	540	570	730	820	950	C10	C13	C17	C19	C20	H10	H11	H13	H15	H16	H18
Cooling capacity	Nom.	kW																					
Power input	Cooling Nom.	kW																					
Capacity control	Method	Stepless																					
	Minimum capacity	12.5																					
SEPR		5.16	5.14	5.51	5.52	5.5	5.5	5.5	5.5	5.5	5.52	5.5	5.52	5.55	5.56	5.5	5.55	5.56	5.53	5.53	5.54	5.55	
EER		3.19	3.17	3.12	3.04	2.96	3.14	3.07	2.81	2.79	2.95	2.77	2.89	2.93	2.82	2.69	2.92	2.93	2.89	2.87	2.9	2.95	
IPLV		4.25	4.3	4.93	4.73	4.75	4.97	5.06	4.98	4.53	4.64	4.65	4.63	4.54	4.72	4.66	4.68	4.56	4.65	4.52	4.64	4.61	4.7
Dimensions	Unit																						
	Height	mm																					
	Width	mm																					
	Length	mm																					
Weight	Unit	kg																					
	Operation weight	kg																					
Water heat exchanger	Type	Shell and tube																					
	Water volume	l																					
	Water flow rate	Cooling	Nom.																				
	Water pressure drop	Cooling	Nom.																				
Air heat exchanger	Type	Microchannel																					
	Compressor	Type	Asymm single screw																				
Fan	Quantity	2																					
	Type	Direct propeller, on/off fans																					
	Quantity	8																					
	Air flow rate	Nom.	l/s																				
Sound power level	Cooling	Nom.																					
	Sound pressure level	Cooling	Nom.																				
Refrigerant	Type	R-134a																					
	Charge	kg																					
	Circuits	Quantity																					
Piping connections	Evaporator water inlet/outlet (OD)	139.7																					
	Unit	A																					
	Starting current	Max																					
Power supply	Phase/Frequency/Voltage	Hz/V																					

performances according to CSS software 10.27

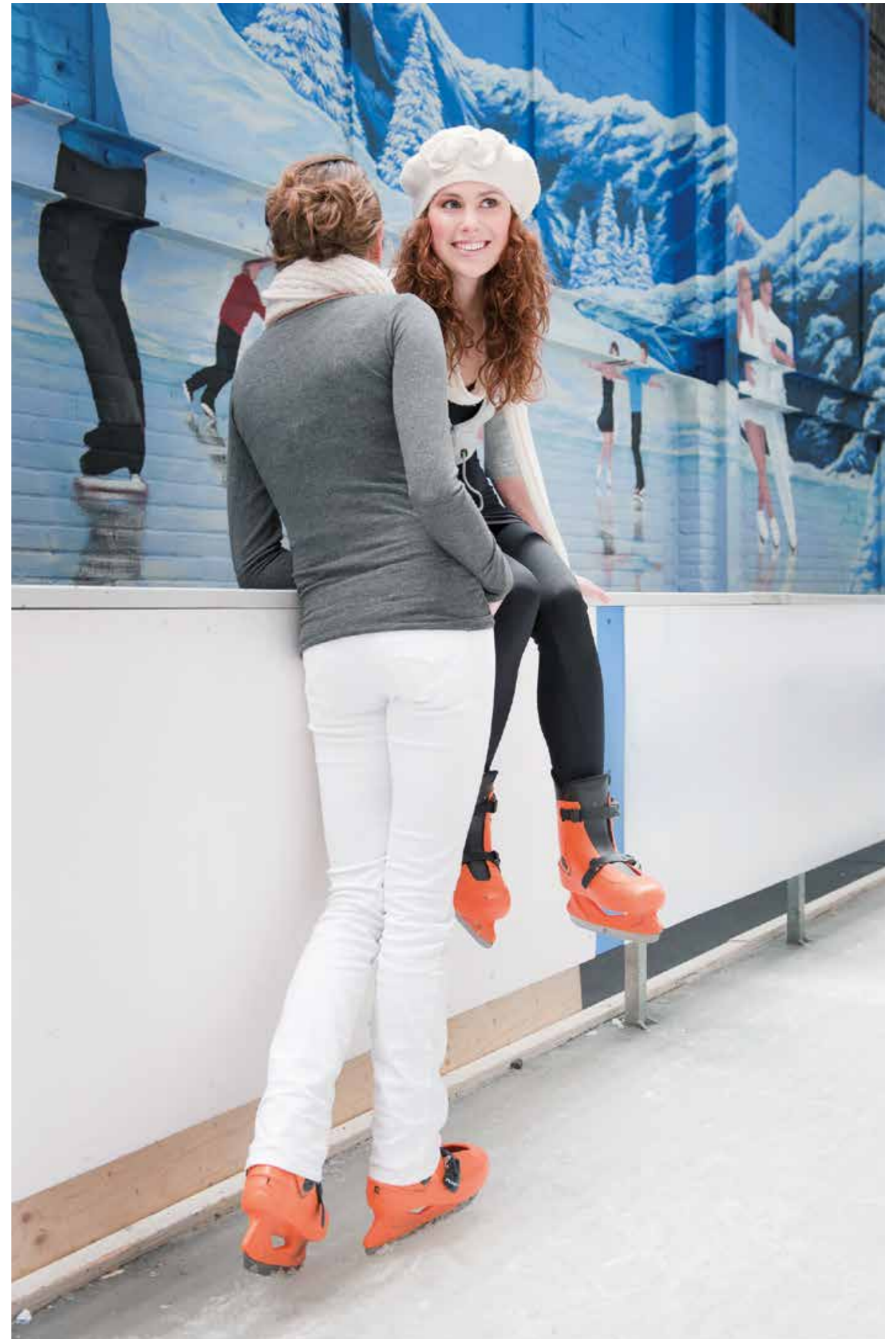



Daikin, world's first company introducing a new generation of air cooled scroll chiller series with refrigerant R-32.

EWAT-B

Multi scroll chiller with R-32 refrigerant

BLUEvolution

R-32

- ✓ Top class efficiency, SEER up to 4.84. Overcoming 2021 Eco-design requirements!
- ✓ Environmental friendly refrigerant → First in the market
- ✓ New R-32 optimized scroll compressors and heat exchangers
- ✓ The Global Warming Potential (GWP) of R-32 refrigerant is 675, which is only one third compared to commonly used refrigerant R-410
- ✓ The low GWP R-32 refrigerant falls into category class A2L in ISO817 and it can be safely used in many applications including chilled water systems
- ✓ As a single component refrigerant, R-32 is also easier to recycle and reuse another environmental plus in its favour
- ✓ Wide capacity range: 80 – 700 kW
- ✓ Microchannel condensing coil, for reduced refrigerant charge
- ✓ Silver and Gold efficiency versions
- ✓ 3 sound configurations
- ✓ Full compatibility with Daikin on Site
- ✓ New Hydronic Kit configurations (single and twin pump, inertial tank, VFD)
- ✓ Single and dual circuit version overlapping between 150 kW and 350 kW
 - › Single circuit units fits 2 or 3 compressors
 - › Dual circuit units fits 4 or 5 or 6 compressors
- ✓ Extensive option lists
- ✓ Fan speed modulation option (VFD)

Extensive options list

Including new options:

- › Partial heat recovery
- › Buffer tank
- › VFD pumps and variable flow control
- › Master/Slave supplied standard
- › Fan Silent Mode



Single-V Layout

- › Slim layout
- › Higher flexibility: new intermediate sound configuration for both Silver and Gold versions

Modular-V Layout:

- › Brand new layout
- › Better part load efficiency (SEER) vs. previous generation:
 - › +4% with standard arrangement
 - › +7% with VFD fan option



Free-cooling options

It's the capability of a system/equipment to cool air or water by taking advantage of the favorable outdoor conditions when ambient temperature is reducing, for example during winter or intermediate season or even during night time operation. Free cooling operation allows to reduce the power consumption generated by traditional mechanical cooling (e.g. Compressors).

The use of the outdoor ambient as a source for cooling is the perfect way to answer to the new "EPBD Directive" (Energy Performance of Buildings Directive):

Free-cooling - Light

Refrigerant migration system allowing to recover up to 25% of normal unit capacity.

Free-cooling - Full

Refrigerant migration system allowing to recover up to 25% of normal unit capacity.

Benefits

- › Glycol free solution
- › No refrigerant pump required
- › No extra footprint vs standard unit
- › No extra pressure drops on water side

Daikin on Site

Fully compatible with Daikin on Site cloud based platform that allows a number of advanced functionalities including:

- › Remote monitoring
- › System optimization
- › Preventive maintenance
- › Remote access with one click via LAN or GSM modem



Connection to Intelligent Chiller Manager

In case of more complex installations Daikin can offer the Intelligent Chiller Manager option, allowing energy optimisation of the system and, when necessary, full customization of the control solutions to the specific installation's needs:

- › High number of units
- › Peripheral controls

Air cooled scroll chiller, standard efficiency, standard/low sound

- › First R-32 air cooled chiller with Scroll compressors in the market
- › Choosing for an R-32 product, reduces the environmental impact with 68% compared to R-410A and leads directly to lower energy consumption thanks to its high energy efficiency
- › One or two truly independent refrigerant circuits for outstanding reliability
- › MicroTech 4 controller with superior control logic and easy interface
- › Low operating cost and extended operating life thanks to the careful design aimed to optimize the energy efficiency of the chillers and to improve installation profitability, effectiveness and economical management
- › Fan speed modulation to ensure precise airflow control and optimized condensing temperature
- › Possible to set up detailed time bands to reduce fan rotation speed and therefore sound emission
- › Thanks to the Dynamic Condensing Pressure Management, the chiller controller adjusts the condensing pressure set-point to minimize the overall chiller power input



Cooling Only		EWAT-B-SSB/SLB																				
		085	115	135	155	175	195	205	215	240	260	290	310	330	340	350	420	460	510	570	610	670
Space cooling	A Condition 35°C Pdc	kW																				
	ηs,c	%																				
	ηs,c + VFDFAN	%																				
SEER		4.1	4.4	4.1	4.48	4.34	4.4	4.1	4.37	4.14	4.42	4.52	4.33	4.44	4.24	4.56	4.56	4.56	4.56	4.56	4.56	4.55
SEER + VFDFAN		-																				
SEER + VFDFAN		4.46 4.21 4.52 4.64 4.41 4.66 4.31 4.57 4.63 4.62 4.56 4.58 4.67																				
Cooling capacity	Nom.	kW																				
Power input	Cooling Nom.	kW																				
Capacity control	Method	Step																				
	Minimum capacity	%																				
EER		2.55	2.83	2.64	2.55	2.58	2.75	2.63	2.53	2.83	2.73	2.62	2.72	2.71	2.94	2.65	2.84	2.73	2.76	2.63	2.66	2.8
IPLV		4.65 4.92 4.46 4.68 4.78 4.84 4.86 4.7																				
EER + VFDFAN		2.83 2.73 2.62 2.72 2.7 2.93 2.65 2.83 2.73 2.76 2.62 2.66 2.8																				
IPLV + VFDFAN		4.81 4.27 4.55 5.02 4.75 5 4.7 4.91 4.89 4.9 4.93 4.89 5																				
Dimensions	Unit	1,801																				
	Height	1,822																				
	Width	1,204																				
Weight (SSB)	Unit	2,120																				
	Operation weight	681																				
	Weight (SLB)	691																				
Water heat exchanger	Type	Brazed plate																				
	Water volume	l																				
	Water flow rate Cooling Nom.	l/s																				
Air heat exchanger	Type	Microchannel																				
	Compressor	Scroll compressor																				
	Fan	Direct propeller																				
Sound power level (SSB)	Cooling Nom.	84.8																				
	Sound power level (SLB)	83.7																				
	Sound pressure level (SSB)	67.4																				
Refrigerant	Type/GWP	R-32/675																				
	Charge (SSB)	kg																				
	Circuits	Quantity																				
Piping connections	Evaporator water inlet/outlet (OD)	76.1																				
	Unit	A																				
	Power supply	3~50																				

Air cooled scroll chiller, standard efficiency, reduced sound

- › First R-32 air cooled chiller with Scroll compressors in the market
- › Choosing for an R-32 product, reduces the environmental impact with 68% compared to R-410A and leads directly to lower energy consumption thanks to its high energy efficiency
- › One or two truly independent refrigerant circuits for outstanding reliability
- › MicroTech 4 controller with superior control logic and easy interface
- › Low operating cost and extended operating life thanks to the careful design aimed to optimize the energy efficiency of the chillers and to improve installation profitability, effectiveness and economical management
- › Fan speed modulation to ensure precise airflow control and optimized condensing temperature
- › Possible to set up detailed time bands to reduce fan rotation speed and therefore sound emission
- › Thanks to the Dynamic Condensing Pressure Management, the chiller controller adjusts the condensing pressure set-point to minimize the overall chiller power input



Cooling Only		EWAT-B-SRB																				
		085	115	135	155	175	195	205	215	240	260	290	310	330	340	350	420	460	510	570	610	670
Space cooling	A Condition 35°C Pdc	kW																				
	ηs,c	%																				
	SEER	4.1																				
Cooling capacity	Nom.	kW																				
Power input	Cooling Nom.	kW																				
Capacity control	Method	Step																				
	Minimum capacity	%																				
EER		2.27	2.61	2.34	2.28	2.26	2.48	2.37	2.21	2.6	2.49	2.31	2.44	2.41	2.7	2.35	2.71	2.45	2.48	2.32	2.37	2.55
IPLV		4.67 4.97 4.5 4.63 4.74 4.64 4.91 4.66 4.93 4.27 4.51 4.82 4.7 5 4.72 4.81 4.92 4.93 5.04 5.03 5.01																				
Dimensions	Unit	1,801																				
	Height	1,822																				
	Width	1,204																				
Weight	Unit	2,120																				
	Operation weight	691																				
	Water heat exchanger	Brazed plate																				
Air heat exchanger	Type	Microchannel																				
	Compressor	Scroll compressor																				
	Fan	Direct propeller																				
Sound power level	Cooling Nom.	78.6																				
	Sound pressure level	61.2																				
	Refrigerant	R-32/675																				
Piping connections	Evaporator water inlet/outlet (OD)	76.1																				
	Unit	A																				
	Power supply	3~50																				

Air cooled scroll chiller, high efficiency, standard/low sound

- › First R-32 air cooled chiller with Scroll compressors in the market
- › Choosing for an R-32 product, reduces the environmental impact with 68% compared to R-410A and leads directly to lower energy consumption thanks to its high energy efficiency
- › One or two truly independent refrigerant circuits for outstanding reliability
- › MicroTech 4 controller with superior control logic and easy interface
- › Low operating cost and extended operating life thanks to the careful design aimed to optimize the energy efficiency of the chillers and to improve installation profitability, effectiveness and economical management
- › Fan speed modulation to ensure precise airflow control and optimized condensing temperature
- › Possible to set up detailed time bands to reduce fan rotation speed and therefore sound emission
- › Thanks to the Dynamic Condensing Pressure Management, the chiller controller adjusts the condensing pressure set-point to minimize the overall chiller power input



Air cooled scroll chiller, high efficiency, reduced sound

- › First R-32 air cooled chiller with Scroll compressors in the market
- › Choosing for an R-32 product, reduces the environmental impact with 68% compared to R-410A and leads directly to lower energy consumption thanks to its high energy efficiency
- › One or two truly independent refrigerant circuits for outstanding reliability
- › MicroTech 4 controller with superior control logic and easy interface
- › Low operating cost and extended operating life thanks to the careful design aimed to optimize the energy efficiency of the chillers and to improve installation profitability, effectiveness and economical management
- › Fan speed modulation to ensure precise airflow control and optimized condensing temperature
- › Possible to set up detailed time bands to reduce fan rotation speed and therefore sound emission
- › Thanks to the Dynamic Condensing Pressure Management, the chiller controller adjusts the condensing pressure set-point to minimize the overall chiller power input



Cooling Only		EWAT-B-XSB/XLB																				
		085	115	145	180	185	200	220	230	250	280	300	310	320	360	370	430	470	540	600	660	700
Space cooling	A Condition 35°C Pdc	kW																				
	ηs,c	%																				
	ηs,c + VFDFAN	%																				
SEER		4.25 4.65 4.45 4.38 4.47 4.4 4.5 4.31 4.47 4.59 4.6 4.5 4.34 4.48 4.56 4.55 4.56 4.61 4.64 4.58																				
SEER + VFDFAN		-																				
Cooling capacity	Nom.	kW																				
Power input	Cooling Nom.	kW																				
Capacity control	Method	Step																				
	Minimum capacity	%																				
EER		3.05 3.12 3.23 3.14 2.87 3.06 3.03 3.21 3.12 3.2 3.13 3.313 3.06 3.11 3.06 3.11 3.09 3.07 3.12 3.14 3.1																				
IPLV		4.83 5 4.82 4.65 4.74 4.67 4.72 4.6 4.69 4.78 4.86 4.77 4.79 4.38 4.7 4.8 4.9 4.8 4.79 4.82 4.77																				
EER + VFDFAN		-																				
IPLV + VFDFAN		-																				
Dimensions	Unit																					
	Height	mm																				
	Width	mm																				
Weight (XSB)	Unit	kg																				
	Operation weight	kg																				
Weight (XLB)	Unit	kg																				
	Operation weight	kg																				
Water heat exchanger	Type	Brazed plate																				
	Water volume	l																				
	Water flow rate Cooling Nom.	l/s																				
	Water pressure drop	kPa																				
Air heat exchanger	Type	Microchannel																				
Compressor	Type	Scroll compressor																				
	Quantity	2 4 2 4 2 4 3 4 3 4 5 6																				
Fan	Type	Direct propeller																				
	Quantity	6 8 10 4 10 4 5 6 7 8 9 10 12 13 14																				
	Air flow rate Nom.	l/s																				
Sound power level (XSB)	Cooling Nom.	dB(A)																				
	Cooling Nom.	dB(A)																				
	Cooling Nom.	dB(A)																				
Sound pressure level (XSB)	Cooling Nom.	dB(A)																				
	Cooling Nom.	dB(A)																				
	Cooling Nom.	dB(A)																				
Refrigerant	Type/GWP	R-32/675																				
	Charge (XSB)	kg																				
	Charge (XLB)	kg																				
	Circuits Quantity	1 2 1 2 1 2 1 2 1 2 1 2																				
Piping connections	Evaporator water inlet/outlet (OD)	76.1 88.9 76.1 88.9 76.1 88.9 76.1 88.9 76.1 88.9 76.1 88.9 76.1 88.9 76.1 88.9 76.1 88.9 76.1 88.9 76.1 88.9																				
Unit	Starting current Max	A																				
	Running current Cooling Nom.	A																				
	Running current Max	A																				
Power supply	Phase/Frequency	Hz																				

Cooling Only		EWAT-B-VRB																				
		085	115	145	180	185	200	220	230	250	280	300	310	320	360	370	430	470	540	600	660	700
Space cooling	A Condition 35°C Pdc	kW																				
	ηs,c	%																				
	ηs,c + VFDFAN	%																				
SEER		4.13 4.56 4.24 4.5 4.19 4.74 4.55 4.3 4.5 4.74 4.72 4.65 4.42 4.59 4.48 4.62 4.55 4.65 4.76 4.71																				
Cooling capacity	Nom.	kW																				
Power input	Cooling Nom.	kW																				
Capacity control	Method	Step																				
	Minimum capacity	%																				
EER		2.66 2.79 2.89 2.84 2.36 2.69 2.58 2.84 2.73 2.87 2.72 2.76 2.63 2.71 2.67 2.69 2.64 2.76 2.77 2.72																				
IPLV		4.74 5.1 4.76 5.04 4.72 5.05 4.97 4.86 4.91 5.08 4.78 4.94 4.62 5.04 4.95 4.88 4.72 4.96 5.04 5.07 5.08																				
Dimensions	Unit																					
	Height	mm																				
	Width	mm																				
Weight	Unit	kg																				
	Operation weight	kg																				
Water heat exchanger	Type	Brazed plate																				
	Water volume	l																				
	Water flow rate Cooling Nom.	l/s																				
	Water pressure drop	kPa																				
Air heat exchanger	Type	Microchannel																				
Compressor	Type	Scroll compressor																				
	Quantity	2 4 2 4 2 4 3 4 3 4 5 6																				
Fan	Type	Direct propeller																				
	Quantity	6 8 10 4 10 4 5 6 7 8 9 10 12 13 14																				
	Air flow rate Nom.	l/s																				
Sound power level (XSB)	Cooling Nom.	dB(A)																				
	Cooling Nom.	dB(A)																				
	Cooling Nom.	dB(A)																				
Sound pressure level (XSB)	Cooling Nom.	dB(A)																				
	Cooling Nom.	dB(A)																				
	Cooling Nom.	dB(A)																				
Refrigerant	Type/GWP	R-32/675																				
	Charge	kg																				
	Charge	kg																				
	Circuits Quantity	1 2 1 2 1 2 1 2 1 2 1 2																				
Piping connections	Evaporator water inlet/outlet (OD)	76.1 88.9 76.1 88.9 76.1 88.9 76.1 88.9 76.1 88.9 76.1 88.9 76.1 88.9 76.1 88.9 76.1 88.9 76.1 88.9 76.1 88.9																				
Unit	Starting current Max	A																				
	Running current Cooling Nom.	A																				
	Running current Max	A																				
Power supply	Phase/Frequency	Hz																				

Air cooled mini inverter heat pump

- › Choosing for an R-32 product, reduces the environmental impact with 68% compared to R-410A and leads directly to lower energy consumption thanks to its high energy efficiency
- › Inverter chiller
- › Hermetically sealed swing inverter compressor
- › New casing for the outdoor units
- › Separate MMI-2 controller for indoor installation



Heating & Cooling					EWYA-D	004DV3P	006DV3P	008DV3P
Space heating	Average climate water outlet 35°C	General	SCOP	Seasonal space heating eff. class		4.54	4.52	4.61
							A+++	
Cooling capacity	Nom.				kW	4.86 (1) / 4.52 (2)	5.83 (1) / 5.09 (2)	6.18 (1) / 5.44 (2)
Heating capacity	Nom.				kW	4.30 (1) / 4.60 (2)	6.00 (1) / 5.90 (2)	7.50 (1) / 7.80 (2)
Power input	Cooling	Nom.			kW	0.820 (1) / 1.36 (2)	1.08 (1) / 1.55 (2)	1.19 (1) / 1.73 (2)
	Heating	Nom.			kW	0.840 (1) / 1.26 (2)	1.24 (1) / 1.69 (2)	1.63 (1) / 2.23 (2)
EER						5.91 (1) / 3.32 (2)	5.40 (1) / 3.28 (2)	5.19 (1) / 3.14 (2)
COP						5.10 (1) / 3.65 (2)	4.85 (1) / 3.50 (2)	4.60 (1) / 3.50 (2)
Dimensions	Unit	Height			mm	770		
		Width			mm	1,250		
		Depth			mm	362		
Weight	Unit				kg	88.0		
Water heat exchanger	Type					Plate heat exchanger		
	Water volume				l	1		
Compressor	Type					Hermetically sealed swing compressor		
	Quantity					1		
Fan	Type					Propeller fan		
	Quantity					1		
Sound power level	Cooling	Nom.			dB(A)	61.0 (1)	62.0 (1)	
	Heating	Nom.			dB(A)	58.0 (1)	60.0 (1)	62.0 (1)
Sound pressure level	Cooling	Nom.			dB(A)	48.0 (1)	49.0 (1)	50.0 (1)
	Heating	Nom.			dB(A)	44.0 (1)	47.0 (1)	49.0 (1)
Operation range	Air side	Cooling	Min.~Max.	°CDB		10 (3)~43		
		Heating	Min.~Max.	°CDB		-25 ~25		
	Water side	Cooling	Min.~Max.	°CDB		5 (3)~22		
		Heating	Min.~Max.	°CDB		9 (3)~65 (3)		
Refrigerant	Type/GWP				R-32/675.0			
	Control				Electronic expansion valve			
	Circuits	Quantity				1		
Refrigerant charge	Per circuit				kg	3.80		
					TCO2Eq	2.6		
Unit	Running current	Max			A	30.8		
Power supply	Phase/Frequency/Voltage				Hz/V	1~/50 /230 +/-10%		

(1)Condition 1: cooling Ta 35°C - LWE 18°C (DT = 5°C); heating Ta DB/WB 7°C/6°C - LWC 35°C (DT = 5°C) | (2)Condition 2: cooling Ta 35°C - LWE 7°C (DT = 5°C); heating Ta DB/WB 7°C/6°C - LWC 45°C (DT = 5°C) | (3)For more details, see operation range drawing

Air cooled mini inverter heat pump

- › Choosing for an R-32 product, reduces the environmental impact with 68% compared to R-410A and leads directly to lower energy consumption thanks to its high energy efficiency
- › Inverter chiller
- › Hermetically sealed swing inverter compressor
- › New casing for the outdoor units
- › Separate MMI-2 controller for indoor installation



Heating & Cooling		EWYA-D	009DV3P	011DV3P	014DV3P	016DV3P	
Space cooling	A Condition 35°C Pdc	kW	9.35	11.6	12.8	14.0	
	ηs,c	%	222	229	226	221	
SEER			5.62 (6)	5.79 (6)	5.71 (6)	5.59 (6)	
Space heating	Average climate water outlet 35°C	General	4.82	4.73	4.70	4.69	
	SCOP	Seasonal space heating eff. class	A+++				
Cooling capacity	Nom.	kW	9.35 (2) / 9.10 (3)	11.6 (2) / 11.5 (3)	12.8 (2) / 12.7 (3)	14.0 (2) / 15.3 (3)	
Heating capacity	Nom.	kW	9.37 (4) / 9.00 (5)	10.6 (4) / 9.82 (5)	12.0 (4) / 12.5 (5)	16.0 (4) / 16.0 (5)	
Power input	Cooling	Nom.	2.79 (2) / 1.71 (3)	3.56 (2) / 2.17 (3)	4.06 (2) / 2.51 (3)	4.58 (2) / 3.24 (3)	
	Heating	Nom.	1.91 (4) / 2.43 (5)	2.18 (4) / 2.68 (5)	2.46 (4) / 3.42 (5)	3.53 (4) / 4.56 (5)	
Capacity control	Method		Variable (inverter)				
EER			3.35 (2) / 5.34 (3)	3.26 (2) / 5.31 (3)	3.16 (2) / 5.04 (3)	3.06 (2) / 4.74 (3)	
COP			4.91 (4) / 3.71 (5)	4.83 (4) / 3.66 (5)	4.87 (4) / 3.64 (5)	4.53 (4) / 3.51 (5)	
Dimensions	Unit	Height	mm				
		Width	mm				
		Depth	mm				
Weight	Unit		kg				
Water heat exchanger	Type		Plate heat exchanger				
	Water volume	l	2				
Air heat exchanger	Type		High efficiency fin and tube type with integral subcooler				
Compressor	Type		Hermetically sealed swing inverter compressor				
	Quantity		1				
Fan	Type		Propeller fan				
	Quantity		1				
Air flow rate	Cooling	Nom.	m³/min	63	70	85	
	Heating	Nom.	m³/min	48.0	55.8	70.4	
Sound power level	Cooling	Nom.	dB(A)	65.5	67.0	69.0	
	Heating	Nom.	dB(A)	44.0	47.7	50.8	
Operation range	Air side	Cooling	Min.~Max.	°CDB	10 ~43		
		Heating	Min.~Max.	°CDB	-25 ~25		
	Water side	Cooling	Min.~Max.	°CDB	5 ~22		
		Heating	Min.~Max.	°CDB	9 (1)~60 (1)		
Refrigerant	Type/GWP		R-32/675.0				
	Control		Electronic expansion valve				
	Circuits	Quantity		1			
Refrigerant charge	Per circuit		kg	3.80			
			TCO2Eq	2.6			
Unit	Running current	Max				30.8	
Power supply	Phase/Frequency/Voltage					1~/50 /230	

(1)For more details, see operation range drawing | (2)Cooling: EW 12°C; LW 7°C; ambient conditions: 35°CDB | (3)Cooling: EW 23°C; LW 18°C; ambient conditions: 35°CDB | (4)Condition: Ta DB/WB 7°C/6°C - LWC 35°C (DT = 5°C) | (5)Condition: Ta DB/WB 7°C/6°C - LWC 45°C (Dt=5°C) | (6)According to EN14825 | Depends on operation mode, refer to installation manual.

Air cooled mini inverter heat pump

- › Choosing for an R-32 product, reduces the environmental impact with 68% compared to R-410A and leads directly to lower energy consumption thanks to its high energy efficiency
- › Inverter chiller
- › Daikin swing compressor
- › New casing for the outdoor units
- › Separate MMI-2 controller for indoor installation



Heating & Cooling				EWYA-D	009DW1P	011DW1P	014DW1P	016DW1P	
Space cooling	A Condition 35°C Pdc			kW	9.35	11.6	12.8	14.0	
	ηs,c			%	222	229	226	221	
SEER					5.62	5.79	5.71	5.59	
Space heating	Average climate water outlet 35°C	General	SCOP Seasonal space heating eff. class		4.82	4.73	4.70	4.69	
				A+++					
Cooling capacity	Nom.			kW	9.35 (1) / 9.10 (2)	11.6 (1) / 11.5 (2)	12.8 (1) / 12.7 (2)	14.0 (1) / 15.3 (2)	
Heating capacity	Nom.			kW	9.37 (3) / 9.00 (4)	10.6 (3) / 9.82 (4)	12.0 (3) / 12.5 (4)	16.0 (3) / 16.0 (4)	
Power input	Cooling	Nom.			kW	2.79 (1) / 1.71 (2)	3.56 (1) / 2.17 (2)	4.06 (1) / 2.51 (2)	4.58 (1) / 3.24 (2)
	Heating	Nom.			kW	1.91 (3) / 2.43 (4)	2.18 (3) / 2.68 (4)	2.46 (3) / 3.42 (4)	3.53 (3) / 4.56 (4)
Capacity control	Method			Variable (inverter)					
EER					3.35 (1) / 5.34 (2)	3.26 (1) / 5.31 (2)	3.16 (1) / 5.04 (2)	3.06 (1) / 4.74 (2)	
COP					4.91 (3) / 3.71 (4)	4.83 (3) / 3.66 (4)	4.87 (3) / 3.64 (4)	4.53 (3) / 3.51 (4)	
Dimensions	Unit	Height			mm				
		Width			mm				
		Length			mm				
Weight	Unit			kg					
Water heat exchanger	Type			Plate heat exchanger					
	Water volume			l					
Air heat exchanger	Type			High efficiency fin and tube type with integral subcooler					
Compressor	Type			Hermetically sealed swing inverter compressor					
	Quantity			1					
Fan	Type			Propeller fan					
	Quantity			1					
	Air flow rate	Cooling	Nom.			m³/min			
Sound power level	Cooling	Nom.			dB(A)				
		Heating	Nom.			dB(A)			
Sound pressure level	Cooling	Nom.			dB(A)				
		Heating	Nom.			dB(A)			
Operation range	Air side	Cooling	Min.~Max.			°CDB			
		Heating	Min.~Max.			°CDB			
	Water side	Cooling	Min.~Max.			°CDB			
		Heating	Min.~Max.			°CDB			
Refrigerant	Type/GWP			R-32/675.0					
	Control			Electronic expansion valve					
	Circuits	Quantity			1				
Refrigerant charge	Per circuit			kg					
	Per circuit			TCO2Eq					
Unit	Running	Max			A				
	current								
Power supply	Phase/Frequency/Voltage			Hz/V					
				3~/50/400					

(1)Cooling: EW 12°C; LW 7°C; ambient conditions: 35°CDB | (2)Cooling: EW 23°C; LW 18°C; ambient conditions: 35°CDB | (3)Condition: Ta DB/WB 7°C/6°C - LWC 35°C (DT = 5°C) | (4)Condition: Ta DB/WB 7°C/6°C - LWC 45°C (Dt=5°C)

Air cooled mini inverter heat pump

- › Choosing for an R-32 product, reduces the environmental impact with 68% compared to R-410A and leads directly to lower energy consumption thanks to its high energy efficiency
- › Inverter chiller
- › Daikin swing compressor
- › New casing for the outdoor units
- › Separate MMI-2 controller for indoor installation



Heating & Cooling				EWYA-D	009DW1P-H-	011DW1P-H-	014DW1P-H-	016DW1P-H-	
Space cooling	A Condition 35°C Pdc			kW	9.35	11.6	12.8	14.0	
	ηs,c			%	222	229	226	221	
SEER					5.62	5.79	5.71	5.59	
Space heating	Average climate water outlet 35°C	General	SCOP Seasonal space heating eff. class		4.82	4.73	4.70	4.69	
				A+++					
Cooling capacity	Nom.			kW	9.35 (1) / 9.10 (2)	11.6 (1) / 11.5 (2)	12.8 (1) / 12.7 (2)	14.0 (1) / 15.3 (2)	
Heating capacity	Nom.			kW	9.37 (3) / 9.00 (4)	10.6 (3) / 9.82 (4)	12.0 (3) / 12.5 (4)	16.0 (3) / 16.0 (4)	
Power input	Cooling	Nom.			kW	2.79 (1) / 1.71 (2)	3.56 (1) / 2.17 (2)	4.06 (1) / 2.51 (2)	4.58 (1) / 3.24 (2)
	Heating	Nom.			kW	1.91 (3) / 2.43 (4)	2.18 (3) / 2.68 (4)	2.46 (3) / 3.42 (4)	3.53 (3) / 4.56 (4)
Capacity control	Method			Variable (inverter)					
EER					3.35 (1) / 5.34 (2)	3.26 (1) / 5.31 (2)	3.16 (1) / 5.04 (2)	3.06 (1) / 4.74 (2)	
COP					4.91 (3) / 3.71 (4)	4.83 (3) / 3.66 (4)	4.87 (3) / 3.64 (4)	4.53 (3) / 3.51 (4)	
Dimensions	Unit	Height			mm				
		Width			mm				
		Length			mm				
Weight	Unit			kg					
Water heat exchanger	Type			Plate heat exchanger					
	Water volume			l					
Air heat exchanger	Type			High efficiency fin and tube type with integral subcooler					
Compressor	Type			Hermetically sealed swing inverter compressor					
	Quantity			1					
Fan	Type			Propeller fan					
	Quantity			1					
	Air flow rate	Cooling	Nom.			m³/min			
Sound power level	Cooling	Nom.			dB(A)				
		Heating	Nom.			dB(A)			
Sound pressure level	Cooling	Nom.			dB(A)				
		Heating	Nom.			dB(A)			
Operation range	Air side	Cooling	Min.~Max.			°CDB			
		Heating	Min.~Max.			°CDB			
	Water side	Cooling	Min.~Max.			°CDB			
		Heating	Min.~Max.			°CDB			
Refrigerant	Type/GWP			R-32/675.0					
	Control			Electronic expansion valve					
	Circuits	Quantity			1				
Refrigerant charge	Per circuit			kg					
	Per circuit			TCO2Eq					
Unit	Running	Max			A				
	current								
Power supply	Phase/Frequency/Voltage			Hz/V					
				3~/50/400					

(1)Cooling: EW 12°C; LW 7°C; ambient conditions: 35°CDB | (2)Cooling: EW 23°C; LW 18°C; ambient conditions: 35°CDB | (3)Condition: Ta DB/WB 7°C/6°C - LWC 35°C (DT = 5°C) | (4)Condition: Ta DB/WB 7°C/6°C - LWC 45°C (Dt=5°C)

Air cooled mini inverter heat pump

- › Choosing for an R-32 product, reduces the environmental impact with 68% compared to R-410A and leads directly to lower energy consumption thanks to its high energy efficiency
- › Inverter chiller
- › Daikin swing compressor
- › New casing for the outdoor units
- › Separate MMI-2 controller for indoor installation



Heating & Cooling				EWYA-D	009DV3P-H-	011DV3P-H-	014DV3P-H-	016DV3P-H-		
Space cooling	A Condition 35°C Pdc			kW	9.35	11.6	12.8	14.0		
	ηs,c			%	222	229	226	221		
SEER					5.62	5.79	5.71	5.59		
Space heating	Average climate water outlet 35°C	General	SCOP Seasonal space heating eff. class		4.82	4.73	4.70	4.69		
				A+++						
Cooling capacity	Nom.		kW	9.35 (1) / 9.10 (2)		11.6 (1) / 11.5 (2)		12.8 (1) / 12.7 (2)		
Heating capacity	Nom.		kW	9.37 (3) / 9.00 (4)		10.6 (3) / 9.82 (4)		12.0 (3) / 12.5 (4)		
Power input	Cooling	Nom.	kW	2.79 (1) / 1.71 (2)		3.56 (1) / 2.17 (2)		4.06 (1) / 2.51 (2)		
		Heating	Nom.	kW	1.91 (3) / 2.43 (4)		2.18 (3) / 2.68 (4)		2.46 (3) / 3.42 (4)	
Capacity control	Method			Variable (inverter)						
EER				3.35 (1) / 5.34 (2)		3.26 (1) / 5.31 (2)		3.16 (1) / 5.04 (2)		
COP				4.91 (3) / 3.71 (4)		4.83 (3) / 3.66 (4)		4.87 (3) / 3.64 (4)		
Dimensions	Unit	Height	mm	870						
		Width	mm	1,380						
		Length	mm	460						
Weight	Unit		kg	147						
Water heat exchanger	Type			Plate heat exchanger						
	Water volume			l						
Air heat exchanger	Type			High efficiency fin and tube type with integral subcooler						
Compressor	Type			Hermetically sealed swing inverter compressor						
	Quantity			1						
Fan	Type			Propeller fan						
	Quantity			1						
	Air flow rate	Cooling	Nom.	m ³ /min	63		70		85	
Heating			Nom.	m ³ /min	48.0		55.8		70.4	
Sound power level	Cooling		Nom.	dB(A)	65.5		67.0		69.0	
Sound pressure level	Cooling		Nom.	dB(A)	44.0		47.7		50.8	
Operation range	Air side	Cooling	Min.~Max.	°CDB	10~43					
			Heating	Min.~Max.	°CDB	-25~25				
	Water side	Cooling	Min.~Max.	°CDB	5~22					
			Heating	Min.~Max.	°CDB	9~60				
Refrigerant	Type/GWP			R-32/675.0						
	Control			Electronic expansion valve						
Refrigerant charge	Circuits	Quantity			1					
		Per circuit	kg			3.80				
Unit	Running current	Max			A					
		current			30.8					
Power supply	Phase/Frequency/Voltage			Hz/V						
				1~/50/230						

(1)Cooling: EW 12°C; LW 7°C; ambient conditions: 35°CDB | (2)Cooling: EW 23°C; LW 18°C; ambient conditions: 35°CDB | (3)Condition: Ta DB/WB 7°C/6°C - LWC 35°C (DT = 5°C) | (4)Condition: Ta DB/WB 7°C/6°C - LWC 45°C (Dt=5°C)





EWYT-B

Multi scroll heat pumps with R-32 refrigerant

- ✓ Top class efficiency, SEER up to 4.92 and SCOP up to 4.06
- ✓ Low environmental impact thanks to R-32 refrigerant
- ✓ Dedicated Scroll Compressors for hot water production up to 60°C
- ✓ The Global Warming Potential (GWP) of R-32 refrigerant is 675, which is only one third compared to commonly used refrigerant R-410
- ✓ The low GWP R-32 refrigerant falls into category class A2L in ISO817 and it can be safely used in many applications including chilled water systems
- ✓ As a single component refrigerant, R-32 is also easier to recycle and reuse another environmental plus in its favour
- ✓ Wide capacity range: 80 – 650 kW
- ✓ Optimized Copper -Aluminium Coils improving performances and de-frosting operation
- ✓ Silver and Gold efficiency versions
- ✓ 3 sound configurations
- ✓ 2 different layouts: Parallel Coil and Double V Coil
- ✓ One or Two independent refrigerant circuits
- ✓ Full compatibility with Daikin on Site
- ✓ Extensive option lists
- ✓ Fan speed modulation option (VFD)

Connectivity

Daikin on Site
Fully compatible with Daikin on Site cloud based platform that allows a number of advanced functionalities including:

- › Remote monitoring
- › System optimization
- › Preventive maintenance
- › Remote access with one click via LAN or 4G LTE router

Connection to Intelligent Chiller Manager
Daikin can offer the Intelligent Chiller Manager option, allowing energy optimisation of the system and, when necessary, full customization of the control solutions to the specific installation's needs even in case of more complex installation.

- › High number of units
- › Cooling and Heating mode
- › Peripheral controls



Layouts & Range overview

Parallel coils



Silver Efficiency	75-193 kW 82-213 kW	1 circuit
Gold Efficiency	80-206 kW 86-218 kW	
Silver Efficiency	189-230 kW 209-256 kW	2 circuits
Gold Efficiency	206-250 kW 215-261 kW	

Double-V coils



Silver Efficiency	270-570 kW 300-627 kW	2 circuits
Gold Efficiency	294-630 kW 306-650 kW	

Extensive option lists Including new options:

Partial heat recovery

Introduction of condensation control allowing to maintain heat recovery capacity at lower ambient temperatures with unit operating at full capacity

Buffer tank

Unit mounted buffer tank available all across the range for plug and play solution.

VFD pumps and variable flow control

- › Variable pump speed control via external 0-10 volt signal
- › "Thermostat on" and "thermostat off" pump speed management
- › Variable primary flow control

Master/Slave supplied as standard

Master/Slave functionality allowing to manage up to 4 units on the same system without the need of external control devices.

Fan Silent Mode

The parallel coil units and units with VFD option are standardly equipped with Fan Silent Mode, which reduces fan velocity and therefore unit sound emission on scheduled time bands, enhancing comfort during night operation.

Pumping energy

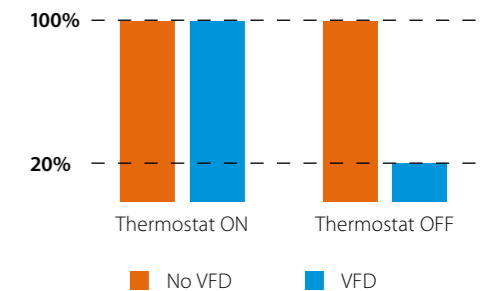



Air cooled scroll inverter heat pump, split version

- › Inverter Heat Pump in Split version
- › Daikin scroll compressor
- › High part load efficiency for low running cost
- › Glycol free application
- › Wide operation range and hot water production up to 60°C
- › Integrated hydronic module as standard



EWYT-CZI

Indoor Unit		EWYT		021CZI-A1	032CZI-A1	040CZI-A1	064CZI-A2
Casing	Colour	Ivory white					
	Material	Galvanized and painted steel sheet					
Dimensions	Unit	HeightxWidthxDepth	mm	700x1,120x830			
Weight	Unit		kg	133	144		172
Operation range	Heating	Ambient	Min.~Max.	-20 ~35			
		Water side	Min.~Max.	20 ~60			
	Cooling	Ambient	Min.~Max.	-20 ~45			
		Water side	Min.~Max.	4 ~20			
Sound power level	Nom.		dBA	63.0	64.5		66.0



Air cooled scroll inverter heat pump, split version

- › Inverter Heat Pump in Split version
- › Daikin scroll compressor
- › High part load efficiency for low running cost
- › Glycol free application
- › Wide operation range and hot water production up to 60°C
- › Integrated hydronic module as standard



EWYT-CZO

Outdoor Unit		EWYT		021CZO-A1	032CZO-A1	040CZO-A1	064CZO-A2
Dimensions	Unit	HeightxWidthxDepth	mm	1,878x1,152x802	1,878x1,752x802		1,878x2,906x814
Weight	Unit		kg	265	357		620
Compressor	Quantity	1					
	Type	Scroll compressor					
Refrigerant	Type	R-32					
	GWP	675.0					
	Charge	kg	7.3	9.5	9.8	16.6	
Sound power level	Cooling	Nom.	dBA	76.0	79.0	80.0	83.0
			dBA	59.6	62.2	63.2	65.4
Sound pressure level	Cooling	Nom.					
Power supply	Phase/Frequency/Voltage		Hz/V	3N~/50 /400			





Air cooled screw inverter heat pump, standard efficiency, standard sound

- › Ideal solution for commercial comfort cooling and/or heating applications
- › Optimum ESEER values
- › 2-3 truly independent refrigerant circuits
- › Low starting current
- › DX shell and tube evaporator – one pass refrigerant side to minimize pressure drops
- › Standard electronic expansion valve
- › Optimised defrost cycles
- › Partial and total heat recovery option available
- › Power factor up to 0.95
- › PID microprocessor control



Heating & Cooling				EWYD-BZSS																						
				250	270	290	320	340	370	380	410	440	460	510	530	570										
SEER				3.21			3.20			3.21			3.20			4.57		4.55								
Space heating	Average climate water outlet 35°C	General	SCOP	3.21			3.20			3.21			3.20			-		-								
Cooling capacity	Nom.	kW		253	272	291	323	337	363	380	411	433	455	515	533	569										
Heating capacity	Nom.	kW		271	298	325	334	350	380	412	445	465	477	532.86	560.55	618.33										
Power input	Cooling	Nom.	kW	91.3	101	110	117	125	135	144	154	165	163	183	189	217										
	Heating	Nom.	kW	91.4	100	108	118	126	133	143	157	167	165	177.37	184.84	208.14										
Capacity control	Method	Stepless																								
	Minimum capacity	%		13.0										9.0		9										
EER				2.77	2.70	2.65	2.75	2.69	2.68	2.63	2.66	2.62	2.79	2.81		2.62										
ESEER				3.93	3.92	3.89	3.95	3.89	3.90	3.82	3.91	3.89	4.18	-												
COP				2.96	2.97	3.00	2.82	2.78	2.85	2.88	2.83	2.79	2.88	3.004	3.033	2.971										
IPLV				4.58	4.62		4.75	4.64	4.71	4.67	4.73	4.69	4.85	4.89	4.85	4.77										
Dimensions	Unit	Height	mm	2,335										2,280												
	Width	mm	2,254																							
	Length	mm	3,547			4,428			5,329			6,659			6,659											
	Weight	Unit	kg	3,410	3,455	3,500	3,870	3,940	4,010	4,390	5,015	5,495	5,735													
Water heat exchanger	Type	Single pass shell & tube																								
	Water volume	l		138			133			128			240		229		218									
	Water flow rate	Cooling	Nom.	l/s	12.1	13.0	13.9	15.5	16.2	17.4	18.2	19.7	20.8	21.8	24.7	25.5	27.3									
		Heating	Nom.	l/s	13.1	14.4	15.7	16.1	16.9	18.3	19.8	21.4	22.4	23.0	-											
Water pressure drop	Cooling	Nom.	kPa	40	46	44	50	55	60	65	74	80	47	68.4	46.5	52.4										
	Heating	Nom.	kPa	30	35	52	37	40	45	51	59	64	42	-												
Air heat exchanger	Type	High efficiency fin and tube type with integral subcooler																								
Compressor	Type	Single screw compressor																								
	Quantity	2										3		3												
Fan	Type	Direct propeller																								
	Quantity	6			8			10			12			12												
	Air flow rate	Nom.	l/s	31,729	31,422	31,115	42,306	42,337	41,487	52,882	63,458	62,640	61,652	48,191												
	Speed	rpm	900																							
Sound power level	Cooling	Nom.	dBA	101			102			104			103.6													
Sound pressure level	Cooling	Nom.	dBA	82			83			84			83.7													
Operation range	Air side	Cooling	Min.~Max.	-10~45																						
		Heating	Min.~Max.	-10~20																						
	Water side	Cooling	Min.~Max.	-8~15																						
		Heating	Min.~Max.	35~55																						
Refrigerant	Type/GWP	R-134a/1,430																								
	Charge	kg		-										141		147										
Refrigerant charge	Circuits	Quantity	2										3		3											
	Per circuit	kg	43.0	44.0	43.0	46.0	46.5	47.0	50.0	47.0	-															
	Per circuit	TCO2eq	61.5	62.9	61.5	65.8	66.5	67.2	71.5	67.2	-															
Piping connections	Evaporator water inlet/outlet (OD)	139.7mm												219.1mm												
Unit	Starting current	Max	A	150			181			204			224			238			245		327		355		344	
	Running current	Cooling	Nom.	A	137	150	164	176	188	202	214	229	244	246	298	310	349									
		Max	A	211	212	254	288			316	336	329	433	474	458											
Power supply	Phase/Frequency/Voltage	Hz/V	3~/50/400												3~/50/400											



Air cooled screw inverter heat pump, standard efficiency, low sound

- › Ideal solution for commercial comfort cooling and/or heating applications
- › Optimum ESEER values
- › 2-3 truly independent refrigerant circuits
- › Low starting current
- › DX shell and tube evaporator – one pass refrigerant side to minimize pressure drops
- › Standard electronic expansion valve
- › Optimised defrost cycles
- › Partial and total heat recovery option available
- › Power factor up to 0.95
- › PID microprocessor control



Heating & Cooling				EWYD-BZSL																					
				250	270	290	320	330	360	370	400	430	450	510	530	570									
SEER				3.21			3.20			3.21			3.20			4.56		4.6		4.55					
Space heating	Average climate water outlet 35°C	General	SCOP	3.21			3.20			3.21			3.20			-		-							
Cooling capacity	Nom.	kW		247	265	290	315	330	353	370	401	423	446	503	519	569									
Heating capacity	Nom.	kW		271	298	325	334	350	380	412	445	465	477	532.86	560.55	618.33									
Power input	Cooling	Nom.	kW	89.5	99.5	110	115	123	134	144	151	163	158	178	185	217									
	Heating	Nom.	kW	91.4	100	108	118	126	133	143	157	167	165	177.37	184.84	208.14									
Capacity control	Method	Stepless																							
	Minimum capacity	%		13.0										9.0		9									
EER				2.76	2.66	2.62	2.75	2.68	2.64	2.57	2.66	2.59	2.83	2.82	2.8	2.62									
ESEER				4.06	4.04	4.03	4.17	4.09	4.04	4.01	4.06	4.02	4.18	-											
COP				2.96	2.97	3.00	2.82	2.78	2.85	2.88	2.83	2.79	2.88	3.004	3.033	2.971									
IPLV				4.90	4.96	4.91	5.17	5.08	5.12	5.06	5.22	5.13	5.07	5.03	4.99	4.89									
Dimensions	Unit	Height	mm	2,335												2,280									
	Width	mm	2,254																						
	Length	mm	3,547			4,428			5,329			6,659			6,659										
Weight	Unit	kg	3,750	3,795	3,840	4,210		4,280	4,350	4,730	5,525	6,005	6,245												
	Operation weight	kg	3,888	3,933	3,978	4,343		4,408	4,478	4,858	5,765	6,234	6,474	6,463											
Water heat exchanger	Type	Single pass shell & tube																							
	Water volume	l		138			133			128			240		229		218								
	Water flow rate	Cooling	Nom.	l/s	11.8	12.7	13.9	15.1	15.8	16.9	17.7	19.2	20.3	21.4	24.1	24.9	27.3								
		Heating	Nom.	l/s	13.1	14.4	15.7	16.1	16.9	18.3	19.8	21.4	22.4	23.0	-										
Water pressure drop	Cooling	Nom.	kPa	38	44	42	48	53	57	62	71	77	45	65.5	44.4	52.4									
	Heating	Nom.	kPa	30	35	52	37	40	45	51	59	64	42	-											
Air heat exchanger	Type	High efficiency fin and tube type with integral subcooler																							
Compressor	Type	Single screw compressor																							
	Quantity	2										3		3											
Fan	Type	Direct propeller																							
	Quantity	6			8			10			12			12											
	Air flow rate	Nom.	l/s	-																					
	Speed	rpm	700																						
Sound power level	Cooling	Nom.	dBA	94			95			97			97												
Sound pressure level	Cooling	Nom.	dBA	76			77			77.2															
Operation range	Air side	Cooling	Min.~Max.	-10~45																					
		Heating	Min.~Max.	-10~20																					
	Water side	Cooling	Min.~Max.	-8~15																					
		Heating	Min.~Max.	35~55																					
Refrigerant	Type/GWP	R-134a/1,430																							
	Charge	kg		-										141		147									
Refrigerant charge	Circuits	Quantity	2										3		3										
	Per circuit	kg	43.0	44.0	43.0	46.0	46.5	47.0	50.0	47.0	-														
	Per circuit	TCO2eq	61.5	62.9	61.5	65.8	66.5	67.2	71.5	67.2	-														
Piping connections	Evaporator water inlet/outlet (OD)	139.7mm												219.1mm											
Unit	Starting current	Max	A	145			146			176			199			217		231		234		316		344	
	Running current	Cooling	Nom.	A	134	148	163	171	184	199	212	224	240	238	291	305	349								
		Max	A	202	203	243	277			302	322	313	416	458											
Power supply	Phase/Frequency/Voltage	Hz/V	3~/50/400												3~/50/400										

EWYD-4Z Air to water Multipurpose unit



4-pipe system solution with full inverter technology
For independent and simultaneous cooling and heating all year round

1
Top class efficiency
Total Energy Ratio up to 8.8

Full inverter technology:
the best choice for
every application

2
Easy part load calculation
via the tool CSS WEB

3
Best solution for simultaneous
cooling and heating
Big multipurpose buildings, hotels, hospital are just
a few examples of application for multipurpose units

Daikin single screw compressor with integrated inverter and Variable Volume Ratio Technology

The inverter integrated in the compressor is refrigerant cooled:

- › Safe and robust cooling system, totally independent from outdoor ambient conditions and air quality.
- › Suitable even for aggressive installation such as industrial or desert application.

The volume ratio will change by moving the sliding valves.

VVR changes the point at which the gas leaves the compressor, and therefore changes the pressures at discharge which will be optimal at any condition.

Upon defining the design condition in the unit selection page it is possible to calculate the unit performances in every in-between condition with a different load

Check on
YouTube
www.youtube.com/
DaikinEurope

› Daikin EWYD-4Z
Multipurpose Unit



› Daikin EWYD-4Z
Multipurpose Unit –
Behind the scenes



EWYD-4ZXS2

Air to Water Multipurpose unit

- › Best solution for independent and simultaneous cooling and heating all year round
- › Daikin single screw compressor with integrated inverter and Variable Volume Ratio Technology
- › High Efficiency Inverter fans with optimized geometry ensures the best ratio between airflow and power input.
- › Wide operating envelope for cooling and heating with extra capacity in Boosted operation and Rapid Restart functionality

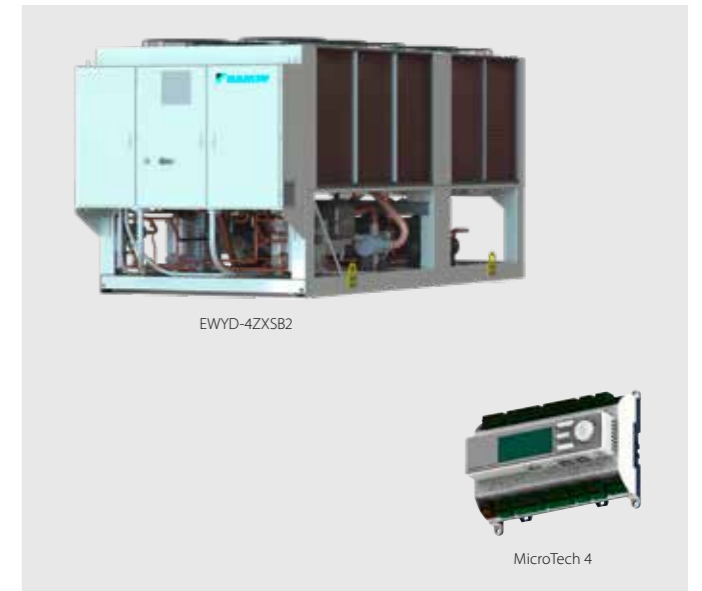

Multipurpose		EWYD-4ZXS2	400	450	500	550	600	650	700	800	
Air to water – cooling only (1)	Nominal Rated Capacity – Net	kW	402.4	438.4	502.8	523.4	602.4	653.7	702.9	785.7	
	EER – Net		3.17	3.15	3.25	3.08	3.25	3.19	3.37	3.29	
Air to water – heating only (2)	Nom. Rated Capacity – Net	kW	402.7	439.7	503.5	545.2	600.9	654.7	702.4	803.0	
	COP – Net		3.33	3.41	3.45	3.44	3.45	3.38	3.55	3.54	
Water to water – Cooling + heating (3)	Nom. Rated Capacity COOLNG – Net	kW	313.2	351.6	393.9	430.4	479.4	516	553.3	634.4	
	Nom. Rated Capacity HEATING – Net	kW	402.4	449.3	503.4	549.4	608.8	658.3	707.1	808.9	
	TER – Net		8.03	8.19	8.2	8.24	8.4	8.25	8.2	8.27	
Dimensions	Height	mm	2,465								
	Width	mm	2,285								
	Length	mm	5,825		6,725		7,625	8,525			
Weight	Unit Weight	kg	6,075	6,095	6,870	6,870	7,850	8,435	9,405	9,430	
	Operating Weight	kg	6,540	6,560	7,560	7,560	8,935	9,540	10,785	10,820	
	Cold/Hot side water connections	mm	219.1								
Sound level	Sound Power – Cooling (4)	dB(A)	99	98	99		100		102		
	Sound Pressure – Cooling at 1 m (5)	dB(A)	78	77		78		79	80		
Water heat exchangers	Cold Side	Water Volume	l	126	126	214	214	369	361	468	468
		Water flow rate (1)	l/s	19.3	21.0	24.1	25.1	28.8	31.3	33.6	37.6
		Water pressure drop (1)	kPa	42.0	50.8	40.1	47.8	48.0	34.2	40.7	37.1
	Hot Side	Water Volume	l	126	126	214	214	369	361	468	468
		Water flow rate (2)	l/s	9.1	9.1	13.4	13.4	14.6	19.5	20.8	26.1
		Water pressure drop (2)	kPa	19.4	21.146	24.3	26.334	29	31.6	33.9	38.7
Fan	Quantity	n	10		12		14		16		
	Nominal air flow (1)	l/s	56,550		67,860		79,170		90,480		
Compressor	Type		Single screw								
	Oil charge	l	28							38	
	Quantity	n.	2								
Refrigerant circuit	Refrigerant type		R134a								
	Refrigerant charge	kg	198	207	200	219	247	260	328	354	
	Circuits	n.	2								
Power Supply	Phase/Frequency/Voltage	Hz/V	3~/50/400								

Fluid: Water; Fouling factor = 0

(1) Operation in Air to water "Cooling only" mode rated at 35°C ambient temperature, 50% R.H.; Entering water temperature 12°C, Outlet water temperature 7°C.

(2) Operation in Air to water "Heating only" mode rated at 7°C ambient temperature, 85% R.H.; Entering water temperature 40°C, Outlet water temperature 45°C.

(3) Operation in Water to water "Cooling + Heating" mode rated with water flowing on cold and hot heat exchangers determined respectively at conditions (1) and (2) - Chilled water outlet temperature 7°C, Hot water outlet temperature 45°C.

(4) Sound power level are referred to condition (1) for Cooling and (2) for Heating. The data are measured in accordance with ISO 9614 and Eurovent 8/1 for Eurovent certified units.

The certification refers only to the overall sound power level.

(5) Sound pressure is calculated from the sound power level and it is for information only and not considered binding.

All the above data are referred to standard units without options and are subject to change without notice.

Air to Water Multipurpose unit

- › Best solution for independent and simultaneous cooling and heating all year round
- › Daikin single screw compressor with integrated inverter and Variable Volume Ratio Technology
- › High Efficiency Inverter fans with optimized geometry ensures the best ratio between airflow and power input.
- › Wide operating envelope for cooling and heating with extra capacity in Boosted operation and Rapid Restart functionality



Multipurpose		EWYD-4ZXR82	400	450	500	550	600	650	700	800	
Air to water – cooling only (1)	Nominal Rated Capacity – Net	kW	357.9	400.4	451.9	496.2	548.0	596.5	619.1	690.0	
	EER – Net		3.05	3.06	3.12	3.06	3.11	3.07	3.19	3.08	
Air to water – heating only (2)	Nom. Rated Capacity – Net	kW	358.3	398.7	452.2	493.4	550.7	601	620.9	690.8	
	COP – Net		3.48	3.65	3.65	3.63	3.59	3.55	3.67	3.71	
Water to water – Cooling + heating (3)	Nom. Rated Capacity COOLING – Net	kW	281.5	312.7	351.1	383.1	435.2	473.1	489.3	543.8	
	Nom. Rated Capacity HEATING – Net	kW	361.4	399.5	448.1	487.9	550.5	602.1	625.3	693.3	
	TER – Net		8.04	8.20	8.24	8.31	8.55	8.33	8.19	8.27	
Dimensions	Height	mm	2,465								
	Width	mm	2,285								
	Length	mm	5,825		6,725		7,625		8,525		
Weight	Unit Weight	kg	6,240	6,260	7,035	7,035	8,015	8,600	9,690	9,715	
	Operating Weight	kg	6,705	6,725	7,725	7,725	9,100	9,705	11,075	11,110	
	Cold/Hot side water connections	mm	219.1								
Sound level	Sound Power – Cooling (4)	dB(A)	87	86	87		88		90		
	Sound Pressure – Cooling at 1 m (5)	dB(A)			66				68	69	
Water heat exchangers	Cold Side	Water Volume	126		214		369		468		
		Water flow rate (1)	l/s	17.1	19.2	21.6	23.7	26.2	28.5	29.6	33.0
		Water pressure drop (1)	kPa	31.8	37.1	31.7	38.7	39	27	33.7	28.1
	Hot Side	Water Volume	l	126	126	214	214	369	361	468	468
		Water flow rate (2)	l/s	17.3	19.2	21.8	23.8	26.6	29.0	30.0	33.3
		Water pressure drop (2)	kPa	31.8	38.5	27.7	33.6	32	23.8	28.5	24.4
Fan	Quantity	n	10		12		14		16		
	Nominal air flow (1)	l/s	36,110		43,332		50,554		57,776		
Compressor	Type		Single screw								
	Oil charge	l	28								
	Quantity	n.	2								
Refrigerant circuit	Refrigerant type		R134a								
	Refrigerant charge	kg	206	207	224	226	248	260	320	348	
	Circuits	n.	2								
Power Supply	Phase/Frequency/Voltage	Hz/V	3~/50/400								

Fluid: Water; Fouling factor = 0
 (1) Operation in Air to water "Cooling only" mode rated at 35°C ambient temperature, 50% R.H.; Entering water temperature 12°C, Outlet water temperature 7°C.
 (2) Operation in Air to water "Heating only" mode rated at 7°C ambient temperature, 85% R.H.; Entering water temperature 40°C, Outlet water temperature 45°C.
 (3) Operation in Water to water "Cooling + Heating" mode rated with water flowing on cold and hot heat exchangers determined respectively at conditions (1) and (2) - Chilled water outlet temperature 7°C, Hot water outlet temperature 45°C.
 (4) Sound power level are referred to condition (1) for Cooling and (2) for Heating. The data are measured in accordance with ISO 9614 and Eurovent 8/1 for Eurovent certified units. The certification refers only to the overall sound power level.
 (5) Sound pressure is calculated from the sound power level and it is for information only and not considered binding.
 All the above data are referred to standard units without options and are subject to change without notice.

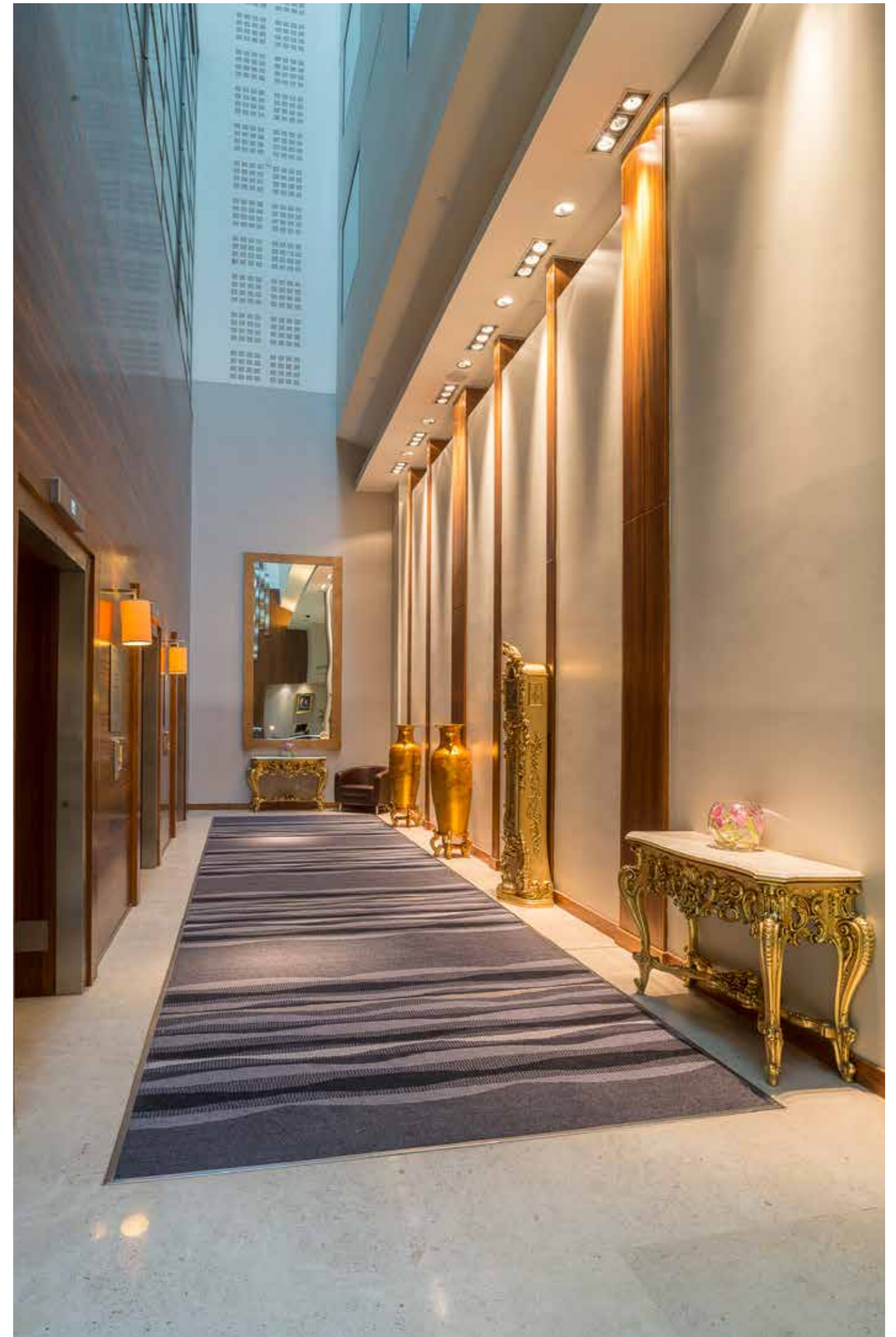

Air cooled screw condensing unit, standard efficiency, standard sound

- › One refrigerant circuit with single screw compressor
- › Compact design
- › Large operation range (ambient temperature down to -18°C)
- › Extensive option list (heat recovery option available)



Cooling only		ERAD-E-SS												
		120	140	170	200	220	250	310	370	440	490			
Cooling capacity	Nom.	kW		121	144	165	196	219	251	309	370	435	488	
Power input	Cooling	kW		42.1	51.2	57.7	65.6	74.2	77.0	93.8	123	148	161	
Capacity control	Method	Stepless												
	Minimum capacity	25.0												
EER		2.88	2.82	2.86	2.99	2.95	3.27	3.30	3.02	2.95	3.02			
Dimensions	Unit	Height	mm		2,273				2,223					
		Width	mm		1,292				2,236					
		Length	mm		2,165		3,065		3,965		3,070			
			mm											
Weight	Unit	kg		1,584		1,741		1,936		2,679				
	Operation weight	kg		1,617		1,781		1,981		2,756				
Air heat exchanger	Type	High efficiency fin and tube type with integral subcooler												
Compressor	Type	Single screw compressor												
	Quantity	1												
Fan	Type	Direct propeller												
		Air flow rate	Nom.	l/s		10,924	10,576	16,386	15,865	21,848	21,153	32,772	31,729	
		Quantity			2		3		4		6			
		Speed	Cooling	Nom.	rpm		900							
Sound power level	Cooling	Nom.		dB(A)		92.0		93.0		94.0		95.0		
Sound pressure level	Cooling	Nom.		dB(A)		74.0				75.0		76.0		
Operation range	Saturated suction temp.	°C		-9~12										
	Condenser inlet temp.	°C		-18~48										
Refrigerant	Type / GWP	R-134a / 1,430												
	Circuits	Quantity		1										
Piping connections	Evaporator water inlet/outlet (OD)	76mm												
Unit	Maximum starting current	A		151		195		288		330		410		
	Nominal running current (RLA)	Cooling	A		72	88	98	110	125	129	158	204	244	266
	Maximum running current	A		86	103	119	132	157	164	198	242	284	298	
Power supply	Phase/Frequency/Voltage	Hz/V		3~/50/400										

Air cooled screw condensing unit, standard efficiency, low sound

- › One refrigerant circuit with single screw compressor
- › Compact design
- › Large operation range (ambient temperature down to -18°C)
- › Extensive option list (heat recovery option available)



Cooling only		ERAD-E-SL													
		120	140	160	190	210	240	300	350	410	460				
Cooling capacity	Nom.	kW		116	137	159	187	209	243	298	352	409	462		
Power input	Cooling	kW		42.4	52.5	57.7	66.3	73.9	78.1	91.9	122	150	167		
Capacity control	Method	Stepless													
	Minimum capacity	25.0													
EER		2.74	2.61	2.75	2.83	3.11	3.24	2.88	2.73	2.76					
Dimensions	Unit	Height	mm		2,273				2,223						
		Width	mm		1,292				2,236						
		Length	mm		2,165		3,065		3,965		3,070				
			mm												
Weight	Unit	kg		1,684		1,841		2,036		2,789					
	Operation weight	kg		1,717		1,881		2,081		2,886					
Air heat exchanger	Type	High efficiency fin and tube type with integral subcooler													
Compressor	Type	Single screw compressor													
	Quantity	1													
Fan	Type	Direct propeller													
		Air flow rate	Nom.	l/s		8,373	8,144	12,560	12,216	16,747	16,288	25,120	24,432		
		Quantity			2		3		4		6				
		Speed	Cooling	Nom.	rpm		700								
Sound power level	Cooling	Nom.		dB(A)		89.0		90.0		91.0		92.0		93.0	
Sound pressure level	Cooling	Nom.		dB(A)		71.0				73.0		74.0			
Operation range	Saturated suction temp.	°C		-9~12											
	Condenser inlet temp.	°C		-18~48											
Refrigerant	Type / GWP	R-134a / 1,430													
	Circuits	Quantity		1											
Piping connections	Evaporator water inlet/outlet (OD)	76mm													
Unit	Maximum starting current	A		151		195		288		330		410			
	Nominal running current (RLA)	Cooling	A		73	90	98	112	125	131	155	204	249	275	
	Maximum running current	A		83	100	115	128	151	158	189	234	276	290		
Power supply	Phase/Frequency/Voltage	Hz/V		3~/50/400											



Water cooled scroll heat pump

- › One of the most compact units on the market: 600mm x 600mm x 600mm
- › Low energy consumption
- › Low operating sound level
- › Low refrigerant volume
- › Stainless steel plate heat exchanger
- › Extension possible to 183kW
- › Easy installation and maintenance
- › Remote cooling or heating selection
- › Water/water heat pump, with water reversibility
- › Standard integrated: water filter, flow switch, air purge, pressure ports
- › Advanced $\mu\text{C}^2\text{SE}$ controller for direct connection to a Modbus based BMS or to a remote user interface



Cooling & Heating only				EWVQ-KC		014	025	033	049	064		
SEER				4.02		4.23		3.63	4.48	3.88		
Space heating	Average climate water outlet 55°C	General	SCOP	3.64		3.63		3.71	3.58	3.87		
			Seasonal space heating eff. class					A++				
Space heating	Average climate water outlet 35°C	General	SCOP	4.76		4.73		4.52	4.87	4.91		
			Seasonal space heating eff. class		A+++		A++		A+++			
Cooling capacity	Nom.			kW		12.09/13.25	19.87/23.89	28.90/30.47	39.35/47.15	57.84/61.00		
Heating capacity	Nom.			kW		14.98	27.30	34.74	54.13	69.51		
Power input	Cooling	Nom.			kW		3.20/3.74	5.70/6.11	7.30/8.43	11.4/12.03	14.6/16.41	
	Heating	Nom.			kW		3.90	7.10	8.70	14.4	17.5	
Capacity control	Method							Fixed				
	Minimum capacity									50		
EER							3.237/4.20	3.254/4.18	3.429/4.16	3.27/4.13	3.524/4.18	
COP							3.84	3.83	3.98	3.77	3.98	
IPLV							4.68	4.85	4.28	4.97	4.44	
Dimensions	Unit	Height			mm				600			
		Width			mm				600			
		Depth			mm				1,200			
Weight	Unit			kg		68.0	132	141	257	265		
	Operation weight			kg		70/74	129/136	135/145	247/266	258/282		
Water heat exchanger - evaporator	Type							Braze plate				
	Water volume			l		1.47	1.96	2.74	4.47	5.88		
	Water flow rate	Cooling	Nom.			l/s		0.63	1.14	1.45	2.25	2.91
		Heating	Nom.			l/s		0.88	1.6	2.07	3.2	4.13
	Water pressure drop	Cooling	Nom.			kPa		9.71/11.7	16.4/28.7	21.3/21.6	20.5/27.6	34.8/44.8
Heating		Nom.			kPa		23.70	60.20	59.60	56.70	94.60	
Compressor	Type							Scroll compressor				
	Quantity							1	2			
Sound power level	Cooling	Nom.			dBA		69	76	72	79		
Sound pressure level	Cooling	Nom.			dBA		55.2	62.1	57.6	64.6		
Operation range	Evaporator	Cooling	Min.-Max.			°CDB		-10 ~20				
	Condenser	Heating	Min.-Max.			°CDB		20 ~55				
Refrigerant	Type/GWP							R-410A/2,088.0				
	Charge			kg		0.0/1.30	0.0/1.90	0.0/2.70	0.0/4.60	0.0/6.80		
	Circuits	Quantity							1	2		
Piping connections	Evaporator water inlet/outlet (OD)							G1"		G1" 1/2		
Space heating	Average climate water outlet 55°C	General	SCOP	3.64		3.63		3.71	3.58	3.87		
			Seasonal space heating eff. class					A++				
Space heating	Average climate water outlet 55°C	A Condition (-7°CDB/-8°CWB)	Cdh (Degradation heating)					0.9				
				Seasonal space heating eff. class		A+++		A++		A+++		
Unit	Starting current	Max			A		57.4	109.3	124.3	124.8	143.6	
	Running current	Cooling	Nom.			A		6.0/6.57	9.0/10.5	13.0/14.1	19.0/20.9	26.0/28.1
		Max			A		9.16	15.5/15.53	19.3/19.33	31.0/31.05	38.65/38.7	
Power supply	Phase/Frequency/Voltage			Hz/V				3N~/50/400				

Cooling: EW 12°C, LW 7°C, ambient conditions: 35°CDB | Cooling: EW 23°C, LW 18°C, ambient conditions: 35°CDB | Condition: Ta DB/WB 7°C/6°C - LWC 35°C (DT = 5°C) | Condition: Ta DB/WB 7°C/6°C - LWC 45°C (Dt=5°C) | According to EN14825 | Depends on operation mode, refer to installation manual. | For more details, see operation range drawing



Water cooled multi-scroll chiller reversing on refrigerant side, standard efficiency, standard sound

- › Single refrigerant circuit (2 scroll compressors) with single evaporator
- › Heat pump version with reversibility on refrigerant side available, ideal for geothermal applications
- › Compact design to allow easy indoor installation or retrofit operations
- › Conceived for stacked installation of two single circuit units to reduce the footprint
- › High efficiency and reliable scroll compressor
- › High flexibility for a wide variety of applications
- › Allows sequencing control (up to 4 units) without any external device
- › Stainless steel plate heat exchanger
- › Pump (low 100 kPa and high 200 kPa lift) available for evaporator and condenser
- › MicroTech 4 controller with superior control logic and easy interface



Water cooled multi-scroll chiller, standard efficiency, standard sound

- › Single refrigerant circuit (2 scroll compressors) with single evaporator
- › Heat pump version available
- › Compact design to allow easy indoor installation or retrofit operations
- › Conceived for stacked installation of two single circuit units to reduce the footprint
- › High efficiency and reliable scroll compressor
- › High flexibility for a wide variety of applications
- › Allows sequencing control (up to 4 units) without any external device
- › Stainless steel plate heat exchanger
- › Pump (low 100 kPa and high 200 kPa lift) available for evaporator and condenser
- › MicroTech 4 controller with superior control logic and easy interface



Heating & Cooling				EWHQ-G-SS												
				100	120	130	150	160	190	210	240	270	340	400		
Cooling capacity	Nom.	kW		87.3	100.0	111	127	141	160	181	208	232	291	352		
Heating capacity	Nom.	kW		112	128	144	162	179	205	233	266	299	375	454		
Capacity control	Method	Step														
	Minimum capacity	%		50.0	43.0	50.0	44.0	50.0	45.0	50.0	43.0	50.0	40.0	50.0		
Power input	Cooling	Nom.	kW	22.4	25.3	28.5	32.0	35.6	41.1	46.0	53.3	59.1	73.7	88.4		
	Heating	Nom.	kW	27.0	30.9	35.2	39.3	43.6	50.4	56.6	64.7	72.2	90.3	109		
EER				3.90	3.95	3.91	3.96	3.95	3.90	3.93	3.90	3.92	3.95	3.98		
COP				4.15	4.16	4.09	4.12	4.11	4.07	4.11	4.10	4.14	4.16	4.18		
ESEER				4.70	4.84	4.65	4.86	4.80	4.89	4.86	4.83	4.79	4.90	4.83		
IPLV				6.02	6.14	5.66	5.84	5.73	5.84	5.81	5.87	5.71	5.86	5.79		
Dimensions	Unit	HeightxWidthxLength	mm	1,066x928x2,432			1,066x928x2,264			1,066x928x2,432			1,186x928x2,432			
Weight	Unit			kg		519	608	728	770	808	838	880	930	941	1,090	1,203
	Operation weight			kg		558	654	782	830	873	908	995	1,019	1,031	1,202	1,334
Water heat exchanger - evaporator	Type	Plate heat exchanger														
	Water flow rate	Cooling	Nom.	l/s	4.2	4.8	5.3	6.1	6.7	7.7	8.7	10.0	11.1	13.9	16.9	
		Heating	Nom.	l/s	4.1	4.7	5.2	5.9	6.5	7.4	8.5	9.6	10.9	13.7	16.6	
	Water pressure drop	Cooling	Nom.	kPa	44		35	30	29	31	33	31	38	42	43	
	Heating	Nom.	kPa	42		33	28	27	29	32	29	37	41	42		
Water heat exchanger - condenser	Type	Plate heat exchanger														
	Water volume			l	6	8	10	12	13	15	17	27	34			
	Water flow rate	Cooling	Nom.	l/s	5.2	6.0	6.7	7.7	8.5	9.7	10.9	13.7	13.9	17.4	21.1	
		Heating	Nom.	l/s	5.4	6.2	7.0	7.8	8.7	9.9	11.2	12.5	14.3	18.0	21.8	
	Cooling	Nom.	kPa	69		55	49	48	51	54	32	39	66	69		
	Heating	Nom.	kPa	73		59	51	50	53	57	33	42	70	73		
Compressor	Type	Scroll compressor														
	Quantity	2														
Sound power level	Cooling	Nom.	dBA	80.0	83.0	85.0	87.0	88.0		90.0	92.0	93.0				
Sound pressure level	Cooling	Nom.	dBA	64.0	67.0	69.0	70.0	72.0		74.0	76.0		77.0			
Operation range	Evaporator	Cooling	Min.~Max.	°CDB	-8~-15											
		Heating	Min.~Max.	°CDB	-8~-15											
	Condenser	Cooling	Min.~Max.	°CDB	25~55											
		Heating	Min.~Max.	°CDB	25~55											
Refrigerant	Type/GWP	R-410A/2,087.5														
	Circuits	Quantity	1													
Refrigerant charge			kg/TCO2Eq	9.0/18.8	10.0/20.9	13.0/27.1	11.0/23.0	13.0/27.1	15.0/31.3	19.0/39.7						
Piping connections	Evaporator water inlet/outlet (OD)			2" 1/2		2" 1/2		2" 1/2		3"						
	Condenser water inlet/outlet (OD)			1" 1/2		2" 1/2		2" 1/2		3"						
Power supply	Phase/Frequency/Voltage			3~/50/400												
Unit	Starting current	Max	A	204	255	261	308	316	354	368	466	481	640	677		
	Running current	Cooling	Nom.	A	43	46	50	56	63	71	78	88	97	123	148	
		Max	A	59	66	72	80	88	102	116	131	145	183	221		

Cooling Only				EWWQ-G-SS											
				090	100	120	130	150	170	190	210	240	300	360	
Space cooling	A Condition 35°C Pdc ηs,c	kW		93.7	105.6	119	135.9	150	172.1	193.8	220.7	246.1	314.3	370.4	
		%		209.08	215.32	233.52	227.68	233.04	233.36	220.32	235.56	231.84	236.64	211.36	
SEER				5.427	5.583	6.038	5.892	6.026	6.034	5.708	6.089	5.996	6.116	5.484	
Cooling capacity	Nom.	kW		93.7	105.6	119	135.9	150	172.1	193.8	220.7	246.1	314.3	370.4	
Power input	Cooling	Nom.	kW	21.3	24	26.9	30.5	33.9	38.9	43.8	50.74	56.1	70.2	84	
Capacity control	Method	Fixed													
	Minimum capacity	%		50	43	50	44	50	45	50	43	50	40	50	
EER				4.399	4.4	4.424	4.456	4.425	4.424	4.425	4.349	4.387	4.477	4.41	
ESEER				5.51	5.52	5.51	5.53	5.51	5.53	5.52					
IPLV				6.71	6.79	6.22	6.36	6.22	6.32	6.3	6.31	6.1	6.28	6.16	
Dimensions	Unit	Height	mm	1,066											
		Width	mm	928											
		Length	mm	2,432	2,264		2,432		1,186						
Weight	Unit	kg		516	606	728	762	795	832	871	921	934	1,083	1,181	
	Operation weight	kg		554.9	652.4	781.6	821.4	859	901.4	945.9	1,009.6	1,023.2	1,194.7	1,311.1	
Water heat exchanger - evaporator	Type	Plate heat exchanger													
	Water volume			l	6	8	10	12	13	15	17	27	34		
	Water flow rate	Cooling	Nom.	l/s	4.5	5.07	5.7	6.51	7.18	8.24	9.28	10.57	11.79	15.06	17.4
	Water pressure drop	Cooling	Nom.	kPa	48.8	49	39.1	33	32.6	34.5	36.7	33.8	41.8	46.8	
Water heat exchanger - condenser	Type	Plate heat exchanger													
	Water volume			l	6	8	10	12	13	15	17	27	34		
	Water flow rate	Cooling	Nom.	l/s	5.52	6.23	7.05	8.04	8.87	10.17	11.43	13.02	14.53	18.46	21.81
	Water pressure drop	Cooling	Nom.	kPa	72	73	60	50	50	52	56	46	57	69	71
Compressor	Type	Driven vapour compression													
	Quantity	2													
Sound power level	Cooling	Nom.	dBA	80.0	83.0	85.0	87.0	88.0		90.0	92.0	93.0			
Sound pressure level	Cooling	Nom.	dBA	64.0	67.0	69.0	70.0	72.0		74.0	76.0		77.0		
Operation range	Evaporator	Cooling	Min.~Max.	°CDB	-10~-15										
		Heating	Min.~Max.	°CDB	-10~-15										
	Condenser	Cooling	Min.~Max.	°CDB	25~55										
		Heating	Min.~Max.	°CDB	25~55										
Refrigerant	Type/GWP	R-410A/2,087.5													
	Circuits	Quantity	1												
Refrigerant charge			kg/TCO2Eq	20.88	22.96	25.05	31.31	33.40	35.49	39.66	41.75				
Piping connections	Evaporator water inlet/outlet (OD)			1" 1/2		2" 1/2		2" 1/2		3"					
	Condenser water inlet/outlet (OD)			1" 1/2		2" 1/2		2" 1/2		3"					
Power supply	Phase/Frequency/Voltage			3~/50/400											
Unit	Starting current	Max	A	204	255	261	308	316	354	368	466	481	640	677	
	Running current	Cooling	Nom.	A	42	45	48	54	61	68	76	86	95	118	143
		Max	A	59	66	72	80	88	102	116	131	145	183	221	

Water cooled multi-scroll chiller, standard efficiency, standard sound

- › Dual refrigerant circuit (4 scroll compressors) with single evaporator
- › Heat pump version available
- › Compact design to allow easy indoor installation or retrofit operations
- › High efficiency and reliable scroll compressor
- › Stainless steel plate heat exchanger
- › High flexibility for a wide variety of applications
- › Allows sequencing control (up to 4 units) without any external device
- › Pump (low 100 kPa and high 200 kPa lift) available for evaporator and condenser
- › MicroTech 4 controller with superior control logic and easy interface



Cooling only/Heating only				EWVQ-L-SS	180	205	230	260	290	330	380
Space cooling	A Condition 35°C Pdc		kW	187.4	215.1	244.3	272.6	303.2	344.5	386.8	
	ηs,c		%	211.72	222.72	232.76	230.32	236.76	233.32	224.84	
SEER				5.493	5.768	6.019	5.958	6.119	6.033	5.821	
Cooling capacity	Nom.		kW	187.4	215.1	244.3	272.6	303.2	344.5	386.8	
Power input	Cooling	Nom.	kW	41.7	47.3	53.1	60.2	67.1	77.1	87	
Capacity control	Method			Fixed							
	Minimum capacity		%	25	21	25	22	25	23	25	
EER				4.494	4.548	4.601	4.528	4.519	4.468	4.446	
ESEER				5.54		5.52	5.53	5.54	5.53	5.54	
IPLV				6.77	6.84	6.35	6.38	6.31	6.32	6.36	
Dimensions	Unit	Height	mm	1,970							
		Width	mm	928							
		Length	mm	2,801							
Weight	Unit		kg	877	1,062	1,285	1,347	1,439	1,498	1,559	
	Operation weight		kg	957	1,156	1,401	1,469	1,575	1,641	1,723	
Water heat exchanger - evaporator	Type			Plate heat exchanger							
	Water volume		l	35	41	53		65		76	
	Water flow rate	Nom.	l/s	8.97	10.29	11.69	13.04	14.5	16.48	18.51	
	Water pressure drop	Cooling	Nom.	kPa	28	27.6	22.6	28	25.1	32.2	31.9
Water heat exchanger - condenser	Type			Plate heat exchanger							
	Water volume		l	19	22	29		35		41	
	Water flow rate	Nom.	l/s	11.02	12.66	14.4	16.12	17.9	20.38	22.8	
	Water pressure drop	Cooling	Nom.	kPa	72	73	61	49	50	51	55
Compressor	Type			Driven vapour compression							
	Quantity			4							
Sound power level	Cooling	Nom.	dBA	83.0	86.0	88.0	90.0		91.0		
Sound pressure level	Cooling	Nom.	dBA	65.0	68.0	70.0	72.0		74.0		73.0
Operation range	Evaporator	Cooling	Min.~Max.	°CDB -10~-15							
		Heating	Min.~Max.	°CDB -10~-15							
	Condenser	Cooling	Min.~Max.	°CDB 25~55							
		Heating	Min.~Max.	°CDB 25~55							
Refrigerant	Type/GWP			R-410A/2,087.5							
	Charge		kg	20		22		24		30	
	Circuits	Quantity		2							
Refrigerant charge			kg/TCO2Eq	10.0/20.9		11.0/23.0		12.0/25.1		15.0/31.3	
Piping connections	Evaporator water inlet/outlet (OD)			3"							
	Condenser water inlet/outlet (OD)			1" 1/2				2" 1/2			
Unit	Starting current	Max	A	263	320	333	388	403	456	484	
		Running current	Cooling	Nom.	A	83	89	96	109	121	137
	Running current	Max	A	118	131	144	160	175	205	232	
		Phase/Frequency/Voltage		Hz/V	3~/50/400						

performances according to CSS software 10.27

Water to water screw heat pump, standard efficiency, standard sound

- › Compact design to allow easy indoor installation or retrofit operations
- › Daikin semi-hermetic single screw stepless compressor
- › High energy efficiency both at full and part load conditions
- › Chilled water temperatures down to -10°C on standard unit
- › Optimised for use with R-134a
- › MicroTech 4 controller with superior control logic and easy interface



Cooling & Heating				EWVJ-SS	120	140	150	180	210	250	280	
Space heating	Average climate water outlet 55°C	General	SCOP	4.03	4.11	4.16	4.17	4.17	4.23	3.83		
	Cooling capacity	Nom.	kW	119.7	145.7	154.3	177.3	207.3	255.3	284.1		
Heating capacity	Nom.	kW	144.2	175.4	189.8	217.8	252.2	308.4	347.4			
Power input	Cooling	Nom.	kW	28.0	34.0	39.5	45.3	50.4	59.9	70.0		
Capacity control	Method			Stepless								
	Minimum capacity		%	25.0								
EER				4.28	4.28	3.91	3.92	4.11	4.26	4.06		
COP				5.20		4.84	4.85	5.04	5.17	4.98		
IPLV				5.18	5.06		5.05	5.16	5.70	4.88		
Dimensions	Unit	Height	mm	1,020								
		Width	mm	913								
		Length	mm	2,684								
Weight	Unit		kg	1,177	1,233	1,334	1,366	1,416	1,600	1,607		
	Operation weight		kg	1,211	1,276	1,378	1,415	1,473	1,663	1,675		
Water heat exchanger - evaporator	Type			Plate heat exchanger								
	Water volume		l	14	18	14	17	20		26		
	Water flow rate	Cooling	Nom.	l/s	5.7	7.0	7.4	8.5	9.9	12.2	13.6	
	Water pressure drop	Heating	Nom.	l/s	9.3	11.3	12	13.8	16.1	19.8	22.1	
Water heat exchanger - condenser	Type			Single pass shell and tube								
	Water volume		l	20		23	25	29		32		
	Water flow rate	Cooling	Nom.	l/s	7.1	8.64	9.32	10.7	12.4	15.2	17.0	
	Water pressure drop	Heating	Nom.	l/s	6.93	8.44	9.13	10.5	12.1	14.8	16.7	
Compressor	Type	Cooling	Nom.	kPa	20	13	11		15	17	27	
		Heating	Nom.	kPa	19	12	11		15	16	26	
	Quantity			Single screw compressor								
					1							
Sound power level	Cooling	Nom.	dBA	89								
Sound pressure level	Cooling	Nom.	dBA	79								
Operation range	Evaporator	Cooling	Min.~Max.	°CDB -10~-15								
	Condenser	Cooling	Min.~Max.	°CDB 23~60								
Refrigerant	Type/GWP			R-134a/1,430								
	Charge		kg	1								
	Circuits	Quantity		1								
Refrigerant charge	Per circuit		kg/TCO2Eq	18.0/25.7	35.0/50.1	34.0/48.6	37.0/52.9		38.0/54.3			
Piping connections			mm	76.2								
Unit	Starting current	Max	A	2" 1/2		4"		197				290
		Running current	Cooling	Nom.	A	48	57	67	74	83	97	109
	Running current	Max	A	85	103	114	130	154	178	201		
		Phase/Frequency/Voltage		Hz/V	3~/50/400							

performances according to CSS software 10.34

Fluid: Water; Fouling factor = 0 m²/C/W

Cooling performances: evaporator 12.0/7.0°C, condenser 30.0/35.0°C; Heating performances (Low temperature application): evaporator 10.0/7.0°C, condenser 30.0/35.0°C.

Water to water screw heat pump, standard efficiency, standard sound

- › HFO R-1234ze(E) Refrigerant with Ozone Depletion Potential equal to zero and extremely low Global Warming Potential
- › Daikin semi-hermetic single screw compressor
- › Direct expansion plate to plate evaporator
- › Shell and tube condenser
- › Silver efficiency and standard sound
- › Upgrade to new MicroTech 4 controller



Water to water screw heat pump, standard efficiency, standard sound

- › Refrigerant R-513A
- › Daikin semi-hermetic single screw compressor
- › Direct expansion plate to plate evaporator
- › Shell and tube condenser
- › Silver efficiency and standard sound
- › Upgrade to new MicroTech 4 controller



				EWWH-J-SS		090	110	120	130	150	180	200
Space heating	Average climate water outlet 55°C	General	SCOP		3.91	3.92	3.78	3.77	3.80	3.90	3.84	
	Cooling capacity	Nom.		kW	88.77	107.1	115.1	133.5	150.1	181.6	200.6	
Heating capacity	Nom.			kW	107.2	129.2	140.9	162.3	182.2	220.5	245	
Power input	Cooling	Nom.		kW	30	36.3	41.7	47.8	54.2	65.7	74.4	
Capacity control	Method				Stepless							
	Minimum capacity			%	25							
EER					3.85	3.75	3.72	3.78	3.82	3.67	3.66	
COP					4.69	4.57	4.52	4.59	4.67	4.46	4.46	
IPLV					4.1	4.11	4.09	4.11	4.12	4.64	4.59	
Dimensions	Unit	Height		mm	1,020							
		Width		mm	913							
		Length		mm	2,684							
	Weight	Unit		kg	1,177	1,233	1,334	1,366	1,416	1,600	1,607	
	Operation weight		kg	1,211	1,276	1,378	1,415	1,473	1,663	1,675		
Water heat exchanger - evaporator	Type				Plate heat exchanger							
	Water volume			l	14	18	14	17	20	26		
	Water flow rate	Cooling	Nom.	l/s	4.24	5.11	5.49	6.37	7.16	8.66	9.57	
		Heating	Nom.	l/s	6.8	8.3	8.9	10.2	11.8	13.9	15.4	
	Water pressure drop	Cooling	Nom.	kPa	10.7	10.9	19.3	19.3	17.8	16.8	20.1	
Heating		Nom.	kPa	24.9	25.9	45.6	44.9	43.7	39.2	47.4		
Water heat exchanger - condenser	Type				Single pass shell and tube							
	Water volume			l	20	20	23	25	29	32		
	Water flow rate	Cooling	Nom.	l/s	5.18	6.31	6.79	7.84	9.1	10.7	11.9	
		Heating	Nom.	l/s	6.77	8.27	8.86	10.2	11.8	13.9	15.4	
	Water pressure drop	Cooling	Nom.	kPa	9.1	9.7	8.7	9.1	9.3	12.3	12.1	
Heating		Nom.	kPa	24.9	25.9	45.6	44.9	43.7	39.2	47.4		
Compressor	Type				Single screw compressor							
	Quantity				1							
Sound power level	Cooling	Nom.		dB(A)	89							
Sound pressure level	Cooling	Nom.		dB(A)	79							
Refrigerant	Type				R-1234(ze)							
	Charge			kg	18	35	34	37	38			
	Circuits	Quantity			1							
Piping connections				mm	76.2							
	Condenser water inlet/outlet			inch	2" 1/2						4	
Unit	Starting current	Max		A	153		197			290		
	Running current	Cooling	Nom.	A	39	44	55	60	65	76	84	
		Max		A	75	90	100	114	143	158	178	
Power supply	Phase/Frequency/Voltage			Hz/V	3~/50 /400							

performances according to CSS software 10.34
 Fluid: Water; Fouling factor = 0 m²/C/W
 Cooling performances: evaporator 12.0/7.0°C, condenser 30.0/35.0°C; Heating performances (Low temperature application): evaporator 10.0/7.0°C, condenser 30.0/35.0°C.

				EWWS-J-SS		120	140	150	180	210	240	270
Space heating	Average climate water outlet 55°C	General	SCOP		3.63	3.54	3.56	3.59	3.62	3.54	3.58	
	Cooling capacity	Nom.		kW	115.2	136.3	154.7	180.6	207.3	241	272.2	
Heating capacity	Nom.			kW	141.7	167.5	191.3	223	256.9	297	338.2	
Power input	Cooling	Nom.		kW	30	36.3	41.7	47.8	54.2	65.7	74.4	
Capacity control	Method				Stepless							
	Minimum capacity			%	25							
EER					3.85	3.75	3.72	3.78	3.82	3.67	3.66	
COP					4.69	4.57	4.52	4.59	4.67	4.46	4.46	
IPLV					4.1	4.11	4.09	4.11	4.12	4.64	4.59	
Dimensions	Unit	Height		mm	1,020							
		Width		mm	913							
		Length		mm	2,684							
	Weight	Unit		kg	1,177	1,233	1,334	1,366	1,416	1,600	1,607	
	Operation weight		kg	1,211	1,276	1,378	1,415	1,473	1,663	1,675		
Water heat exchanger - evaporator	Type				Plate heat exchanger							
	Water volume			l	14	18	14	17	20	26		
	Water flow rate	Cooling	Nom.	l/s	5.5	6.5	7.38	8.62	9.89	11.5	13	
		Heating	Nom.	l/s	8.8	10.8	12.1	13.8	15.5	19	21.1	
	Water pressure drop	Cooling	Nom.	kPa	17.1	16.8	32.8	33.4	31.8	27.9	34.8	
Heating		Nom.	kPa	40.1	41.7	79.4	78.1	71.5	68.9	83.3		
Water heat exchanger - condenser	Type				Single pass shell and tube							
	Water volume			l	20	20	23	25	29	32		
	Water flow rate	Cooling	Nom.	l/s	6.87	8.38	9.39	10.8	12.1	14.8	16.5	
		Heating	Nom.	l/s	6.72	8.2	9.2	10.6	11.9	14.5	16.2	
	Water pressure drop	Cooling	Nom.	kPa	15	16.1	15.4	15.9	15.4	22	21.6	
Heating		Nom.	kPa	14.4	15.5	14.8	15.3	14.8	21.2	20.8		
Compressor	Type				Single screw compressor							
	Quantity				1							
Sound power level	Cooling	Nom.		dB(A)	89							
Sound pressure level	Cooling	Nom.		dB(A)	79							
Refrigerant	Type				R-513A							
	Charge			kg	18	35	34	37	38			
	Circuits	Quantity			1							
Piping connections				mm	76.2							
Piping connections	Condenser water inlet/outlet			inch	2" 1/2						4	
Unit	Starting current	Max		A	154		198			291		
	Running current	Cooling	Nom.	A	50	60	70	78	87	104	117	
		Max		A	81	96	108	122	141	164	185	
Power supply	Phase/Frequency/Voltage			Hz/V	3~/50 /400							

performances according to CSS software 10.34
 Fluid: Water; Fouling factor = 0 m²/C/W
 Cooling performances: evaporator 12.0/7.0°C, condenser 30.0/35.0°C; Heating performances (Low temperature application): evaporator 10.0/7.0°C, condenser 30.0/35.0°C.



The highest peak in chiller technology

The VZ chiller series were developed and manufactured to answer the growing market demands on high efficient chiller series. Thanks to the continuous evolution in components' technology, we are the first to reach the highest peak in chiller efficiency and technology.

EWW(H)(D)(S)-VZ at a glance

Single compressor



Dual compressor & dual circuit unit

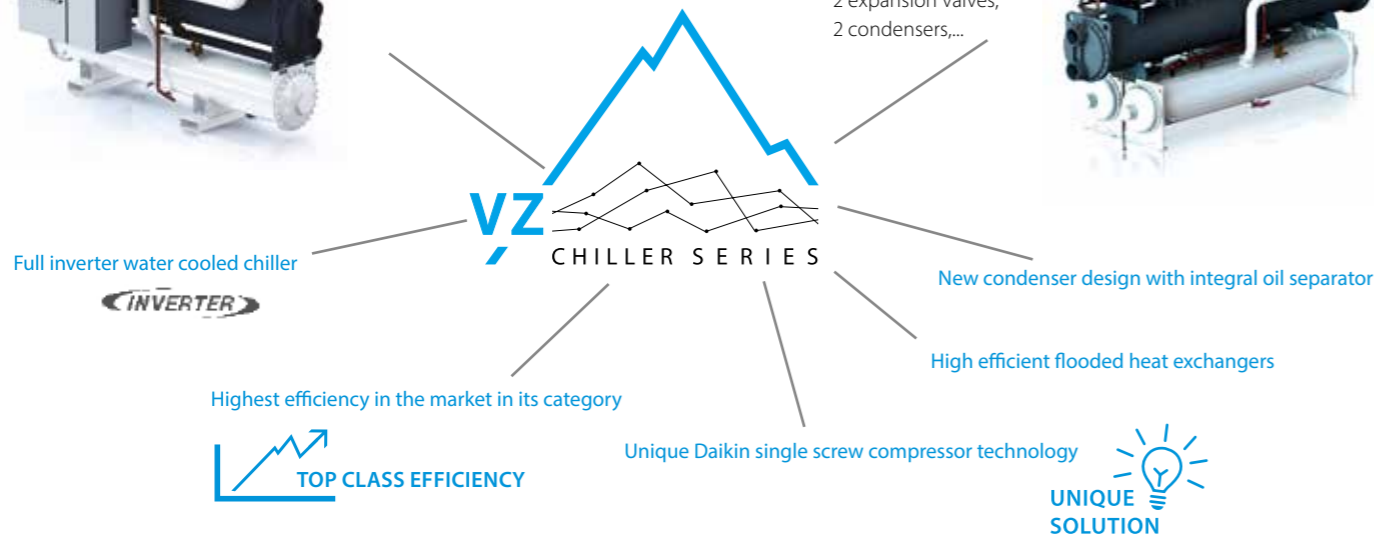

Performance monitoring

With MT4, advanced algorithm implementation in the unit controller are possible, such as the **Performance Monitoring** (Option 186). This sensor-less algorithm calculates the unit cooling capacity by using refrigerant pressure and temperature readings. Electrical power is calculated either from compressor VFD power and fan, or directly measured through optional energy meter. As a standard(*), **no extra-hardware is required**.

(*) For TZ-B units an additional sub-cooling temperature sensor is required.

Why choose EWW(H)(D)(S)-VZ at a glance chiller series?

- 1 Top class efficiency**
Thanks to:
 - > New generation Daikin inverter screw compressors
 - > New generation high efficiency heat exchangers
 - > Variable volume ratio technology
 - > Optimized refrigerant circuit design
- 2 Compact unit: 40% footprint reduction**
Thanks to:
 - > New single pass condenser technology
 - > New integrated oil separator technology
 - > Optional knock down panel which reduces the unit width
- 3 Application flexibility: widest operating envelope in its range**
- 4 Connectivity: Daikin on site cloud platform**
- 5 Future readiness: Choose for today's best solution and be ready for the future!**



Supporting tools

Product video



Check on
YouTube
www.youtube.com/
DaikinEurope



Marketing material

All marketing material can be downloaded from the business portal. Asset finder > Campaign > VZ chiller series

DAIKIN

The highest peak in chiller technology

www.daikin.eu

DAIKIN

The highest peak in chiller technology

AT A GLANCE

TOP CLASS EFFICIENCY

New generation high efficiency heat exchangers

Flooded type technology allowing maximizing unit performances.

Latest technology enhanced surface tubes

DAIKIN

VZ Chiller series

Water cooled inverter chiller

Product profile

Want to know more about this product? Have a look at our website and download the product profile:

www.daikineurope.com/vzchillerseries

Water cooled screw inverter chiller, standard efficiency, standard sound

- › Optimized energy efficiency both at full and part load conditions
- › Compact footprint through stacked heat exchanger lay-out
- › Heat pump version with reversibility on water side (up to 65°C hot water production)
- › Multiple options available: sound proof cabinet, rapid restart, removable electrical panel, etc. to adapt the unit to your specific application and need
- › Thanks to a large operating envelope, the unit is suitable for all possible process and comfort applications
- › High efficient flooded type heat exchanger allowing maximum unit performances
- › One or two truly independent refrigerant circuits for outstanding reliability



Cooling only/Heating only				EWWD-VZSS											
				600	700	760	890	C10	C12	C13	C14	C16	C17	C19	C21
Space cooling	A Condition Pdc (35°C - 27/19)			kW											
	ηs,c			%											
SEER	Nom.			kW											
Power input	Cooling	Nom.		kW											
Capacity control	Method			Variable											
	Minimum capacity			%											
EER				20											
IPLV				10											
Dimensions	Unit	Height	mm	2,123											
		Width	mm	1,178											
		Length	mm	3,722											
	Weight	Unit	kg	2,892											
Water heat exchanger - evaporator	Type			Flooded shell and tube											
	Water volume			l											
	Water flow rate	Cooling	Nom.	l/s											
	Water pressure drop	Cooling	Nom.	kPa											
Water heat exchanger - condenser	Type			Shell and tube											
	Water volume			l											
	Water flow rate	Cooling	Nom.	l/s											
	Water pressure drop	Cooling	Nom.	kPa											
Compressor	Type			Driven vapour compressor											
	Quantity			1											
Sound power level	Cooling	Nom.		dBA											
Sound pressure level	Cooling	Nom.		dBA											
Operation range	Evaporator	Min.~Max.		°CDB											
	Condenser	Min.~Max.		°CDB											
Refrigerant	Type/GWP			R-134a/1,430											
	Charge			kg											
	Circuits	Quantity		1											
Piping connections	mm			139.7											
	Condenser water inlet/outlet (OD)			168.3											
Running current	Running	Cooling	Nom.	A											
	Unit	Running	Max	A											
Power supply	Phase/Frequency/Voltage			Hz/V											

performances according to CSS software 10.33

Water cooled screw inverter chiller, high efficiency, standard sound

- › High energy efficiency both at full and part load conditions
- › Compact footprint through stacked heat exchanger lay-out
- › Heat pump version with reversibility on water side (up to 65°C hot water production)
- › Multiple options available: sound proof cabinet, rapid restart, removable electrical panel, etc. to adapt the unit to your specific application and need
- › Thanks to a large operating envelope, the unit is suitable for all possible process and comfort applications
- › High efficient flooded type heat exchanger allowing maximum unit performances
- › One or two truly independent refrigerant circuits for outstanding reliability

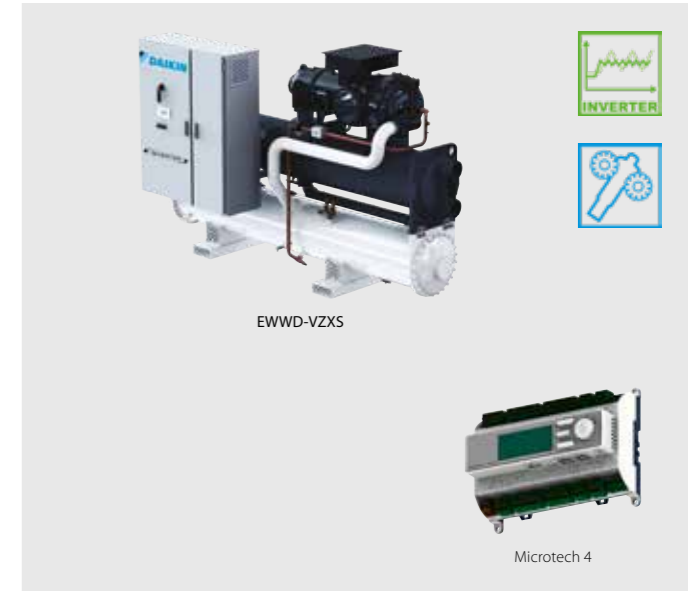

Cooling only/Heating only				EWWD-VZXS													
				450	500	610	710	800	900	C11	C12	C13	C14	C16	C17	C19	C21
Space cooling	A Condition Pdc (35°C - 27/19)			kW													
	ηs,c			%													
SEER	Nom.			kW													
Power input	Cooling	Nom.		kW													
Capacity control	Method			Variable													
	Minimum capacity			%													
EER				20													
IPLV				10													
Dimensions	Unit	Height	mm	2,135													
		Width	mm	1,178													
		Length	mm	3,722													
	Weight	Unit	kg	2,968													
Water heat exchanger - evaporator	Type			Flooded shell and tube													
	Water volume			l													
	Water flow rate	Cooling	Nom.	l/s													
	Water pressure drop	Cooling	Nom.	kPa													
Water heat exchanger - condenser	Type			Shell and tube													
	Water volume			l													
	Water flow rate	Cooling	Nom.	l/s													
	Water pressure drop	Cooling	Nom.	kPa													
Compressor	Type			Driven vapour compressor													
	Quantity			1													
Sound power level	Cooling	Nom.		dBA													
Sound pressure level	Cooling	Nom.		dBA													
Operation range	Evaporator	Min.~Max.		°CDB													
	Condenser	Min.~Max.		°CDB													
Refrigerant	Type/GWP			R-134a/1,430													
	Charge			kg													
	Circuits	Quantity		1													
Piping connections	mm			139.7													
	Condenser water inlet/outlet (OD)			168.3													
Running current	Running	Cooling	Nom.	A													
	Unit	Running	Max	A													
Power supply	Phase/Frequency/Voltage			Hz/V													

performances according to CSS software 10.33

Water cooled screw inverter chiller, premium efficiency, standard sound

- › Premium energy efficiency both at full and part load conditions
- › Compact footprint through stacked heat exchanger lay-out
- › Heat pump version with reversibility on water side (up to 65°C hot water production)
- › Multiple options available: sound proof cabinet, rapid restart, removable electrical panel, etc. to adapt the unit to your specific application and need
- › Thanks to a large operating envelope, the unit is suitable for all possible process and comfort applications
- › High efficient flooded type heat exchanger allowing maximum unit performances
- › One or two truly independent refrigerant circuits for outstanding reliability

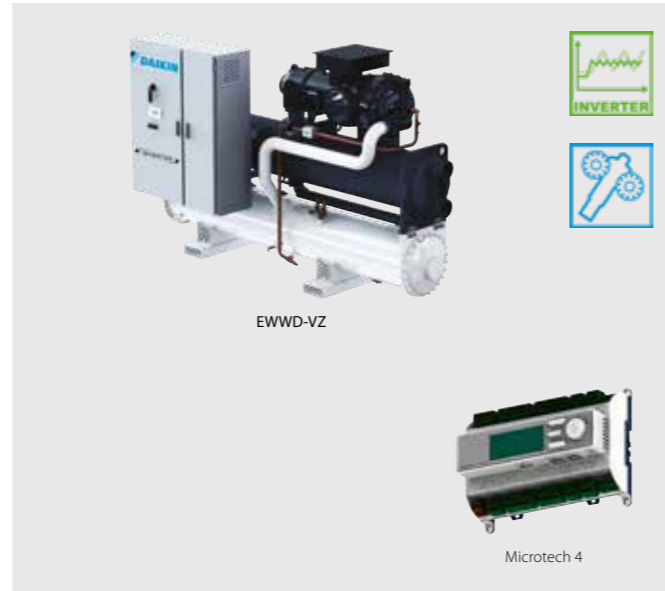

Cooling only/ Heating only				EWWD-VZPS	505	715	910	C12	C16	C18
Space cooling	A Condition Pdc (35°C - 27/19)			kW	505.02	717.71	908.11	1,201.02	1,604.03	1,757.01
	ηs,c			%	339.6	355.2	344.4	353.6	354	350
SEER					8.69	9.08	8.81	9.04	9.05	8.95
Cooling capacity	Nom.			kW	505	718	908	1,201	1,604	1,757
Power input	Cooling	Nom.		kW	85.1	124	153	218	291	326
Capacity control	Method			Variable						
	Minimum capacity			%	20			10		
EER					5.93	5.77	5.91	5.49	5.5	5.39
IPLV					9.61	9.68	9.57	9.79	9.82	9.92
Dimensions	Unit	Height	mm	2,108	2,430	2,487	2,302	2,500	2,493	
		Width	mm	1,179	1,287	1,303	1,579	1,610	1,769	
		Length	mm	3,750	3,822		4,508	4,750	4,874	
Weight	Unit			kg	3,247	4,082	4,346	6,310	7,530	8,250
	Operation weight				kg	3,375	4,349	4,660	6,900	8,300
Water heat exchanger - evaporator	Type			Flooded shell and tube						
	Water volume			l	96	168	199	320	380	480
	Water flow rate	Cooling	Nom.	l/s	24.2	34.3	43.4	57.4	76.7	84
	Water pressure drop	Cooling	Nom.	kPa	55	42	44	38	49	41
Water heat exchanger - condenser	Type			Shell and tube						
	Water volume			l	126	217	241	270	390	470
	Water flow rate	Cooling	Nom.	l/s	29.4	41.3	52.1	69.9	93.4	102
	Water pressure drop	Cooling	Nom.	kPa	16	17	19	21		28
Compressor	Type			Driven vapour compressor						
	Quantity			1			2			
Sound power level	Cooling	Nom.		dBA	99	105		106	107	109
Sound pressure level	Cooling	Nom.		dBA	80	86		87	88	89
Operation range	Evaporator	Min.~Max.		°CDB	-12~20					
	Condenser	Min.~Max.		°CDB	19~65					
Refrigerant	Type/GWP			R-134a/1,430						
	Charge			kg	120	195	185	305	320	350
	Circuits	Quantity			1			2		
Piping connections				mm	139.7	219.1			273	
	Condenser water inlet/outlet (OD)				219.1mm			219.1 / 219.1 mm		
Running current	Cooling	Nom.		A	138	200	247	338	447	497
	Unit	Max		A	191	280	342	470	621	696
Power supply	Phase/Frequency/Voltage			Hz/V	3~/50/400					

performances according to CSS software 10.33



Water cooled screw inverter chiller, standard efficiency, standard sound

- › Optimized energy efficiency both at full and part load conditions
- › Compact footprint through stacked heat exchanger lay-out
- › Heat pump version with reversibility on water side (up to 75°C hot water production)
- › Multiple options available: sound proof cabinet, rapid restart, removable electrical panel, etc. to adapt the unit to your specific application and need
- › Thanks to a large operating envelope, the unit is suitable for all possible process and comfort applications
- › High efficient flooded type heat exchanger allowing maximum unit performances
- › One or two truly independent refrigerant circuits for outstanding reliability

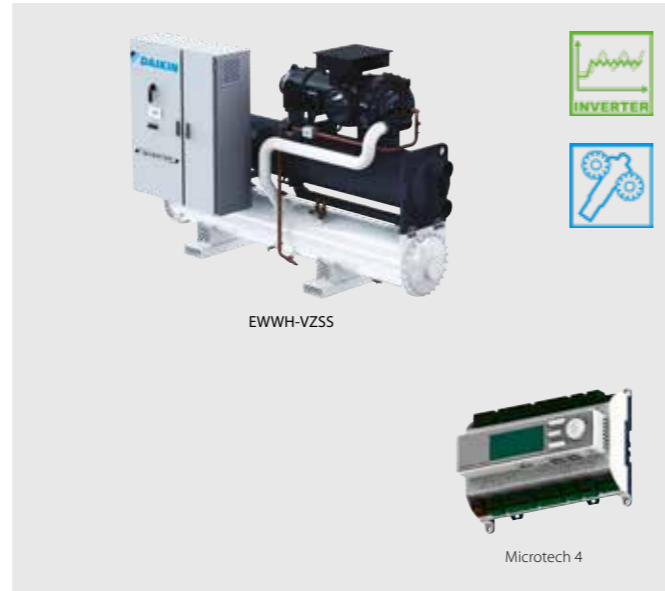

Water cooled screw inverter chiller, high efficiency, standard sound

- › High energy efficiency both at full and part load conditions
- › Compact footprint through stacked heat exchanger lay-out
- › Heat pump version with reversibility on water side (up to 75°C hot water production)
- › Multiple options available: sound proof cabinet, rapid restart, removable electrical panel, etc. to adapt the unit to your specific application and need
- › Thanks to a large operating envelope, the unit is suitable for all possible process and comfort applications
- › High efficient flooded type heat exchanger allowing maximum unit performances
- › One or two truly independent refrigerant circuits for outstanding reliability

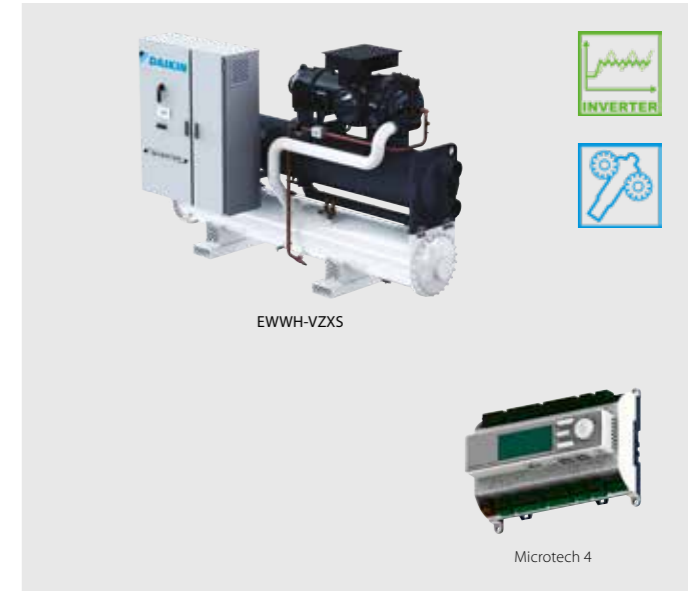

Cooling only/Heating only		EWWH-VZSS		445	515	550	660	770	860	940	C10	C12	C13	C14	C15					
Space cooling	A Condition Pdc (35°C - 27/19) ηs,c	kW	443	512	548.51	657.51	767.8	865.2	940.6	1,011.7	1,142.46	1,271.38	1,396.11	1,524.83						
SEER		%	336.4	338.4	336.8	348.4	345.2	318.4	327.2	339.6	331.2	340	345.6	353.2						
Cooling capacity	Nom.	kW	443	512	549	658	768	865	941	1,012	1,142	1,271	1,396	1,525						
Power input	Cooling Nom.	kW	82.8	98.1	107	123	149	172	188	205	235	254	282	302						
Capacity control	Method		Variable																	
	Minimum capacity	%	20					10												
EER			5.35	5.22	5.15	5.34	5.14	5.02	5	4.93	4.87	5.01	4.95	5.04						
IPLV			9.25																	
Dimensions	Unit	Height	2,123																	
		Width	1,178						1,179			1,233			1,303			1,484		
		Length	3,722						3,750			3,690			3,822			4,792		
																		4,508		
Weight	Unit	kg	2,892	2,928	2,941	3,451	4,237	5,570	5,790	5,820	6,220	6,890	7,260	8,260						
	Operation weight	kg	2,977	3,033	3,053	3,611	4,488	5,980	6,220	6,290	6,690	7,480	7,830	9,070						
Water heat exchanger - evaporator	Type		Flooded shell and tube																	
	Water volume	l	88		96		134		156		230		270		320		380			
	Water flow rate	Cooling Nom.	l/s	21.2	24.5	26.2	31.5	36.8	41.4	45	48.4	54.6	60.8	66.8	72.9					
	Water pressure drop	Cooling Nom.	kPa	46	61	52	59	64	39	46	39	50	44	53	45					
Water heat exchanger - condenser	Type		Shell and tube																	
	Water volume	l	81		102		126		217		200		270		250		430			
	Water flow rate	Cooling Nom.	l/s	25.5	29.6	31.8	38.1	44.8	50.3	54.8	59	66.8	74	81.4	88.7					
	Water pressure drop	Cooling Nom.	kPa	19	17	20	19	17	25	22	25	38	25	32	18					
Compressor	Type		Driven vapour compression																	
	Quantity		1						2											
Sound power level	Cooling Nom.	dBA	101			105			107			108			110					
Sound pressure level	Cooling Nom.	dBA	82			86			88			87			89					
Refrigerant	Type/GWP		R-1234(ze)/7																	
	Charge	kg	125	124	105	145	190	210	230	250	220	280		320						
	Circuits	Quantity	1						2											
Piping connections		mm	139.7			168.3			219.1											
	Condenser water inlet/outlet (OD)		168.3mm			219.1mm			168.3 / 168.3 mm			219.1 / 219.1 mm								
Unit	Running current	A	131.0	153.0	167.0	188.0	227.0	264.0	287.0	312.0	353.0	385.0	426.0	458.0						
	Cooling Max	A	183	226	235	268	324	374	402	451	493	549	591	647						
Power supply	Phase/Frequency/Voltage	Hz/V	3~/50/400																	

performances according to CSS software 10.33

Cooling only/Heating only		EWWH-VZXS		335	365	450	525	580	670	800	875	950	C11	C12	C13	C14	C15					
Space cooling	A Condition Pdc (35°C - 27/19) ηs,c	kW	329.01	364.52	448	520.61	579.19	665.41	788.2	877.36	952.01	1,028.81	1,169.3	1,288.48	1,421.75	1,540.03						
SEER		%	296	307.2	343.6	347.2	343.2	356	354.4	326	334		346.8		358	356.8						
SEER		%	7.6	7.88	8.79	8.88	8.78	9.1	9.06	8.35	8.55		8.87		9.15	9.12						
Cooling capacity	Nom.	kW	329	365	448	521	579	665	788	877	952	1,029	1,169	1,288	1,422	1,540						
Power input	Cooling Nom.	kW	60.5	66.6	81	96	109	121	147	168	185	198	224	248	276	298						
Capacity control	Method		Variable																			
	Minimum capacity	%	20					10														
EER			5.44	5.48	5.53	5.42	5.29	5.49	5.37	5.23	5.16	5.19	5.22	5.19	5.16							
IPLV			8.51																			
Dimensions	Unit	Height	2,135																			
		Width	1,178			1,179			1,233			1,484			1,580			1,627				
		Length	3,722			3,750			3,690			3,822			4,792			4,508				
																		4,874				
Weight	Unit	kg	2,968	2,911	3,102	3,470	3,451	4,257	4,552	5,860	6,240	6,520	6,920	7,530	7,790	8,670						
	Operation weight	kg	3,098	3,006	3,274	3,648	3,611	4,518	4,860	6,370	6,760	7,130	7,530	8,300	8,560	9,630						
Water heat exchanger - evaporator	Type		Flooded shell and tube																			
	Water volume	l	70		88		136		134		168		199		270		320		380		480	
	Water flow rate	Cooling Nom.	l/s	15.8	17.5	21.4	24.9	27.7	31.8	37.7	41.9	45.5	49.1	55.9	61.6	67.9	73.6					
	Water pressure drop	Cooling Nom.	kPa	54	38	35	37	31	39	36	29	34	28	37	32	28	33					
Water heat exchanger - condenser	Type		Shell and tube																			
	Water volume	l	81		92		126		145		126		241		240		290		390		480	
	Water flow rate	Cooling Nom.	l/s	18.9	20.9	25.7	30	33.5	38.4	45.7	50.7	55.1	59.6	67.6	74.6	82.3	89.3					
	Water pressure drop	Cooling Nom.	kPa	19	16	13	12	15	13		16		13	19	16	23	16					
Compressor	Type		Driven vapour compression																			
	Quantity		1						2													
Sound power level	Cooling Nom.	dBA	97			99			101			105			107			106				
Sound pressure level	Cooling Nom.	dBA	78			80			82			86			88			87				
Refrigerant	Type/GWP		R-1234(ze)/7																			
	Charge	kg	124	110	125	140	130	200	185	250	220	270	255	305	320	346						
	Circuits	Quantity	1						2													
Piping connections		mm	139.7			168.3			219.1													
	Condenser water inlet/outlet (OD)		168.3mm			219.1mm			168.3 / 219.1 mm			219.1 / 219.1 mm										
Unit	Running current	A	96.0	106.0	129.0	151.0	173.0	187.0	226.0	259.0	284.0	304.0	341.0	379.0	421.0	454.0						
	Cooling Max	A	134	149	183	226	247	268	324	374	402	451	493	549	591	647						
Power supply	Phase/Frequency/Voltage	Hz/V	3~/50/400																			

performances according to CSS software 10.33

Water cooled screw inverter chiller, premium efficiency, standard sound

- › Premium energy efficiency both at full and part load conditions
- › Compact footprint through stacked heat exchanger lay-out
- › Heat pump version with reversibility on water side (up to 75°C hot water production)
- › Multiple options available: sound proof cabinet, rapid restart, removable electrical panel, etc. to adapt the unit to your specific application and need
- › Thanks to a large operating envelope, the unit is suitable for all possible process and comfort applications
- › High efficient flooded type heat exchanger allowing maximum unit performances
- › One or two truly independent refrigerant circuits for outstanding reliability

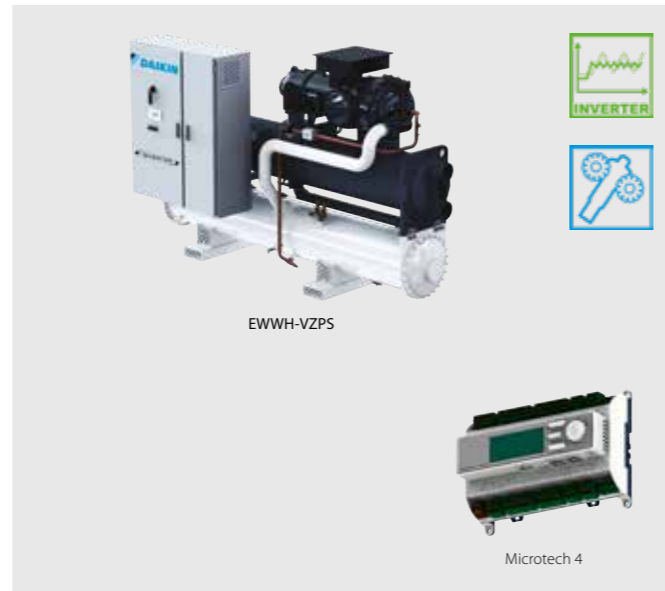

Cooling only/Heating only		EWWH-VZPS		370	530	680	880	C12	C13	
Space cooling	A Condition Pdc (35°C - 27/19)	kW		369.3	525.1	677.11	883.79	1,180.43	1,295.36	
	ηs,c	%		316.8	352.8	363.6	334.4	352.4	348.8	
SEER				8.12	9.02	9.29	8.56	9.01	8.92	
Cooling capacity	Nom.	kW		369	525	677	884	1,180	1,295	
Power input	Cooling	Nom.	kW	64.7	94.9	119	166	221	247	
	Method			Variable						
Capacity control	Minimum capacity	%		20			10			
				5.71	5.53	5.67	5.34	5.35	5.25	
EER				9.13	9.68	9.96	9.37	9.56	9.61	
	IPLV			2,108	2,430	2,487	2,302	2,500	2,493	
Dimensions	Unit	Height	mm	1,179	1,287	1,303	1,579	1,610	1,769	
		Width	mm	3,750	3,822		4,508	4,750	4,874	
		Length	mm	3,247	4,082	4,346	6,310	7,530	8,250	
Weight	Unit	kg		3,375	4,349	4,660	6,900	8,300	9,200	
	Operation weight	kg								
Water heat exchanger - evaporator	Type			Flooded shell and tube						
	Water volume	l		96	168	199	320	380	480	
	Water flow rate	Cooling	Nom.	l/s	17.7	25.1	32.3	42.2	56.4	61.9
	Water pressure drop	Cooling	Nom.	kPa	32	25	27	20	26	23
Water heat exchanger - condenser	Type			Shell and tube						
	Water volume	l		126	217	241	270	390	470	
	Water flow rate	Cooling	Nom.	l/s	21.1	30.1	38.9	50.9	68	74.9
	Water pressure drop	Cooling	Nom.	kPa	9		12	13	12	16
Compressor	Type			Driven vapour compression						
	Quantity			1			2			
Sound power level	Cooling	Nom.	dBA	99	105		106	107	109	
Sound pressure level	Cooling	Nom.	dBA	80	86		87	88	89	
Refrigerant	Type/GWP			R-1234(ze)/7						
	Charge	kg		120	190	185	305	288	350	
	Circuits	Quantity		1			2			
Piping connections		mm		139.7	219.1			273		
	Condenser water inlet/outlet (OD)			219.1mm			219.1 / 219.1 mm			
Unit	Running current	Cooling	Nom.	A	104.0	150.0	185.0	257.0	338.0	378.0
		Max	A	149	226	268	374	493	549	
Power supply	Phase/Frequency/Voltage	Hz/V		3~/50/400						

performances according to CSS software 10.33

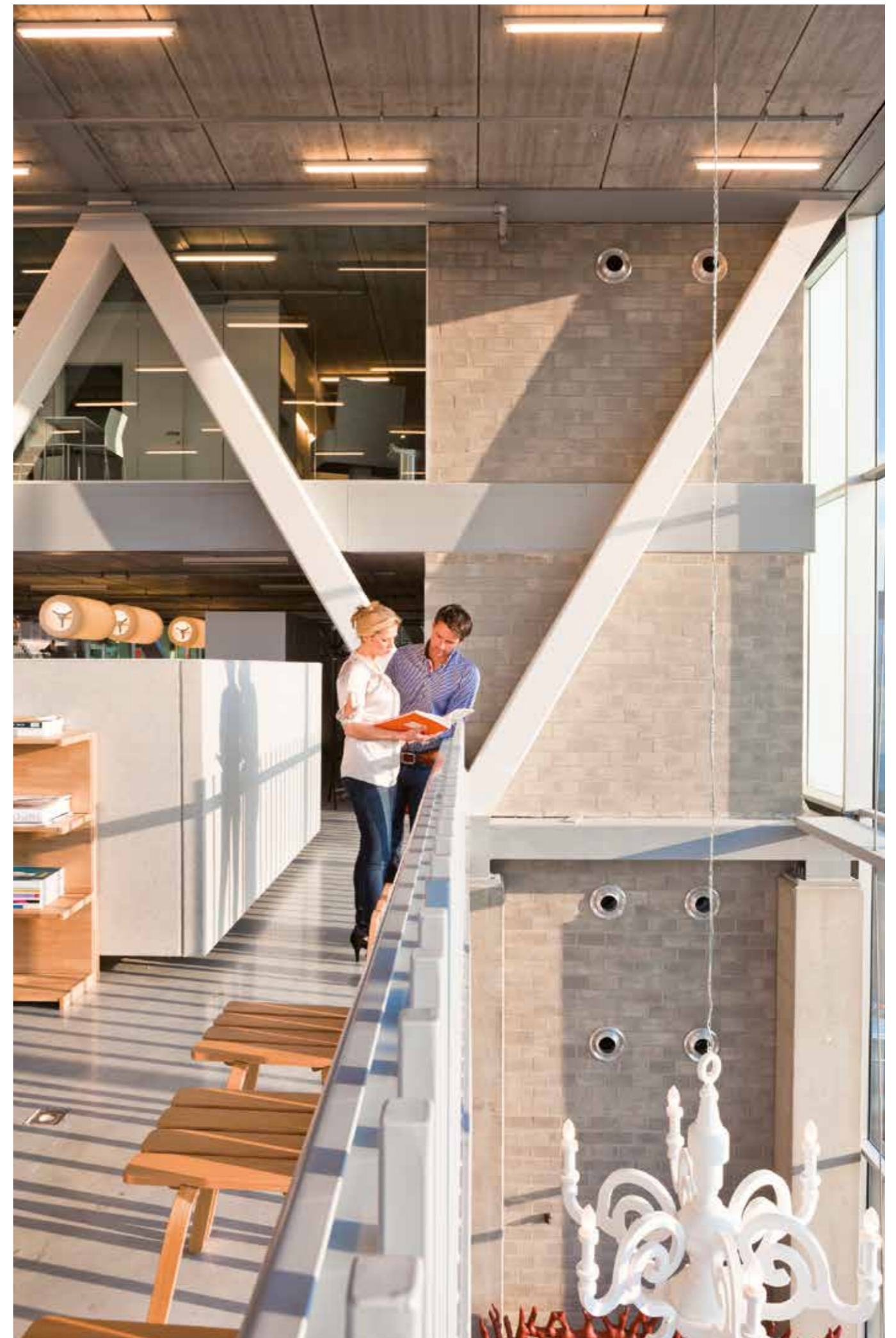



Water to water screw inverter chiller, standard efficiency, standard sound

- › Optimized energy efficiency both at full and part load conditions
- › Compact footprint through stacked heat exchanger lay-out
- › Heat pump version with reversibility on water side (up to 60°C hot water production)
- › Multiple options available: sound proof cabinet, rapid restart, removable electrical panel, etc. to adapt the unit to your specific application and need
- › Thanks to a large operating envelope, the unit is suitable for all possible process and comfort applications
- › High efficient flooded type heat exchanger allowing maximum unit performances
- › One or two truly independent refrigerant circuits for outstanding reliability



EWWS-VZ

Cooling only/Heating only		EWWS-VZSS		600	700	740	880	C10	C12	C13	C14	C15	C17	C18	C20	
Space cooling	A Condition Pdc (35°C - 27/19)	kW		599.51	693.51	743.53	879.64	1,020.09	1,148.76	1,263.41	1,351.54	1,514.87	1,689.58	1,831.98	2,013.41	
	ηs,c	%		316	314.4	313.2	320	313.2	321.2	314.8	312	297.6	313.6	304	318.4	
SEER				8.1	8.06	8.03	8.2	8.03	8.23	8.07	8	7.64	8.04	7.8	8.16	
Cooling capacity	Nom.	kW		600	694	744	880	1,020	1,149	1,263	1,352	1,515	1,690	1,832	2,013	
Power input	Cooling Nom.	kW		120.1	143.3	154.7	175.2	212.7	251.8	273.9	301	343	367.4	413.5	437.2	
Capacity control	Method	Variable														
	Minimum capacity	%		20				Variable				10				
EER				4.99	4.84	4.81	5.02	4.8	4.56	4.61	4.49	4.42	4.6	4.43	4.61	
IPLV				9.02	9.15	8.84	8.88	9.06	9.31	9.23	8.9	9.18	8.88	9.05		
Dimensions	Unit	Height	mm	2,123		2,292	2,487	2,296		2,350	2,338	2,498				
		Width	mm	1,178	1,179	1,233	1,303	1,484	1,487	1,484	1,580	1,627	1,753			
		Depth	mm	3,722	3,750	3,690	3,822	4,792		4,508	4,750					
			mm	3,722	3,750	3,690	3,822	4,792		4,508	4,750					
Weight	Unit	Operation weight	kg	2,892	2,928	2,941	3,451	4,237	5,570	5,790	5,820	6,220	6,890	7,260	8,260	
			kg	2,977	3,033	3,053	3,611	4,488	5,980	6,220	6,290	6,690	7,480	7,830	9,070	
Water heat exchanger - evaporator	Type	Flooded shell and tube														
		Water volume	l	88	96	134	156	230	270	320	380					
		Water flow rate	l/s	28.7	33.3	35.7	42.2	48.9	55	60.6	64.7	72.6	80.9	87.8	96.4	
		Water pressure drop	kPa	80	108	89	100	103	69	85	70	89	79	92	81	
Water heat exchanger - condenser	Type	Flooded Shell & Tube														
		Water volume	l	81	102	126	217	180	200	270	250	430				
		Water flow rate	l/s	34.5	40.1	43.2	50.6	59.3	67.1	73.7	79.2	89	98.7	107	117	
		Water pressure drop	kPa	31	29	32	29	33	43	38	44	64	41	53	36	
Compressor	Type	Driven vapour compressor														
		Quantity	1							2						
Sound power level	Cooling Nom.	dB(A)	101	105	107	106	107	108	110							
Sound pressure level	Cooling Nom.	dB(A)	82	86	88	87	88	89	90							
Refrigerant	Type/GWP	R-513A/631														
		Charge	kg	100	110	170	180	250	260	270	290	295	320	350		
Piping connections	Circuits	Quantity	1													
			mm							2						
		mm	139.7	168.3	219.1		168.3		219.1		219.1					
		mm	168.3	219.1		168.3		219.1		219.1		219.1				

performances according to CSS software 10.33



Water to water screw inverter chiller, high efficiency, standard sound

- › High energy efficiency both at full and part load conditions
- › Compact footprint through stacked heat exchanger lay-out
- › Heat pump version with reversibility on water side (up to 62°C hot water production)
- › Multiple options available: sound proof cabinet, rapid restart, removable electrical panel, etc. to adapt the unit to your specific application and need
- › Thanks to a large operating envelope, the unit is suitable for all possible process and comfort applications
- › High efficient flooded type heat exchanger allowing maximum unit performances
- › One or two truly independent refrigerant circuits for outstanding reliability



EWWS-VZ

Cooling only/Heating only		EWWS-VZXS		450	490	600	700	780	890	C10	C12	C13	C14	C16	C17	C19	C20	
Space cooling	A Condition Pdc (35°C - 27/19)	kW		441.23	493.3	605.32	704.66	783.15	888.89	1,038.67	1,178.53	1,287.26	1,390.42	1,570.18	1,725.3	1,876.17	2,045.66	
	ηs,c	%		306.4	313.6	328.4	329.2	328	328.4	328.8	331.2	326.4	329.2	331.2	326.4	323.2	326.8	
SEER				7.86	8.04	8.41	8.43	8.4	8.41	8.42	8.48	8.36	8.43	8.48	8.36	8.28	8.37	
Cooling capacity	Nom.	kW		441	493	605	705	783	889	1,039	1,179	1,287	1,390	1,570	1,725	1,876	2,046	
Power input	Cooling Nom.	kW		87.8	96.8	116.8	138.6	157.7	171.3	207.8	239.2	263.6	282.6	319.6	354.3	396.6	425.5	
Capacity control	Method	Variable																
		Minimum capacity	%		20				Variable				10					
EER				5.02	5.1	5.18	5.09	4.97	5.19	5	4.93	4.88	4.92	4.91	4.87	4.73	4.81	
IPLV				8.87	9.01	9.29	9.43	9.39	8.96	9.27	9.24	9.48	9.43	9.39	9.29	9.15		
Dimensions	Unit	Height	mm	2,135	2,123	2,235	2,487	2,296		2,301	2,350	2,500	2,469	2,493				
		Width	mm	1,178	1,179	1,189	1,303	1,484	1,639	1,579	1,580	1,610	1,704	1,769				
		Depth	mm	3,722	3,750	3,690	3,822	4,792		4,508	4,750	4,874						
			mm	3,722	3,750	3,690	3,822	4,792		4,508	4,750	4,874						
Weight	Unit	Operation weight	kg	2,968	2,911	3,102	3,470	3,451	4,257	4,552	5,860	6,240	6,520	6,920	7,530	7,790	8,670	
			kg	3,098	3,006	3,274	3,648	3,611	4,518	4,860	6,370	6,760	7,130	7,530	8,300	8,560	9,630	
Water heat exchanger - evaporator	Type	Flooded shell and tube																
		Water volume	l	70	88	136	134	168	199	270	320	380	480					
		Water flow rate	l/s	21.2	23.6	29	33.7	37.5	42.6	49.7	56.4	61.6	66.5	75.2	82.6	89.7	97.9	
		Water pressure drop	kPa	91	64	61	65	57	69	60	53	64	53	68	59	50	60	
Water heat exchanger - condenser	Type	Flooded Shell & Tube																
		Water volume	l	81	92	126	145	126	217	241	240	250	290	390	290	480		
		Water flow rate	l/s	25.8	28.7	34.5	40.4	45.1	50.8	59.8	68	74.4	80.2	90.7	99.8	108	118	
		Water pressure drop	kPa	31	27	22	20	24	25	28	21	32	27	36	27			
Compressor	Type	Driven vapour compressor																
		Quantity	1								2							
Sound power level	Cooling Nom.	dB(A)	97	99	101	105	107	106	107	108	109	110						
Sound pressure level	Cooling Nom.	dB(A)	78	80	82	86	88	87	88	89	90							
Refrigerant	Type/GWP	R-513A/631																
		Charge	kg	95	130	110	170	210	185	250	260	290	320	350				
Piping connections	Circuits	Quantity	1															
			mm								2							
		mm	139.7	168.3	219.1		168.3		219.1		219.1		219.1					
		mm	168.3	219.1		168.3		219.1		219.1		219.1		219.1				

performances according to CSS software 10.33



Water to water screw inverter chiller, premium efficiency, standard sound

- › Premium energy efficiency both at full and part load conditions
- › Compact footprint through stacked heat exchanger lay-out
- › Heat pump version with reversibility on water side (up to 62°C hot water production)
- › Multiple options available: sound proof cabinet, rapid restart, removable electrical panel, etc. to adapt the unit to your specific application and need
- › Thanks to a large operating envelope, the unit is suitable for all possible process and comfort applications
- › High efficient flooded type heat exchanger allowing maximum unit performances
- › One or two truly independent refrigerant circuits for outstanding reliability



Cooling only/Heating only				EWWS-VZPS	500	710	900	C12	C16	C17
Space cooling	A Condition Pdc (35°C - 27/19)		kW	500.08	710.08	898.24	1,187.65	1,585.78	1,735.47	
	ηs,c		%	321.6	334	335.2	336.4		330	
SEER				8.24	8.55	8.58	8.61		8.45	
Cooling capacity	Nom.		kW	500	710	898	1,188	1,586	1,735	
Power input	Cooling Nom.		kW	91.3	133.8	165.1	235.4	313.7	350.7	
Capacity control	Method			Variable						
	Minimum capacity		%	20			10			
EER				5.48	5.31	5.44	5.05		4.95	
IPLV				9.13	9.48	9.17	9.36	9.48	9.4	
Dimensions	Unit	Height	mm	2,108	2,430	2,487	2,302	2,500	2,493	
		Width	mm	1,179	1,287	1,303	1,579	1,610	1,769	
		Depth	mm	3,750	3,822		4,508	4,750	4,874	
Weight	Unit		kg	3,247	4,082	4,346	6,310	7,530	8,250	
	Operation weight		kg	3,375	4,349	4,660	6,900	8,300	9,200	
Water heat exchanger - evaporator	Type			Flooded shell and tube						
	Water volume		l	96	168	199	320	380	480	
	Water flow rate	Cooling Nom.	l/s	23.9	34	43	56.8	75.8	83	
	Water pressure drop	Cooling Nom.	kPa	57	44	46	39	50	42	
Water heat exchanger - condenser	Type			Flooded Shell & Tube						
	Water volume		l	126	217	241	270	390	470	
	Water flow rate	Cooling Nom.	l/s	28.9	40.6	51.1	68.3	91.1	100	
	Water pressure drop	Cooling Nom.	kPa	16	17	19	21		27	
Compressor	Type			Driven vapour compressor						
	Quantity			1			2			
Sound power level	Cooling Nom.		dB(A)	99	105		106	107	109	
	Sound pressure level		dB(A)	80	86		87	88	89	
Refrigerant	Type/GWP			R-513A/631						
	Charge		kg	130	180	190	320	350		
	Circuits	Quantity		1			2			
Piping connections			mm	139.7	219.1			273		
			mm	219.1						

performances according to CSS software 10.33

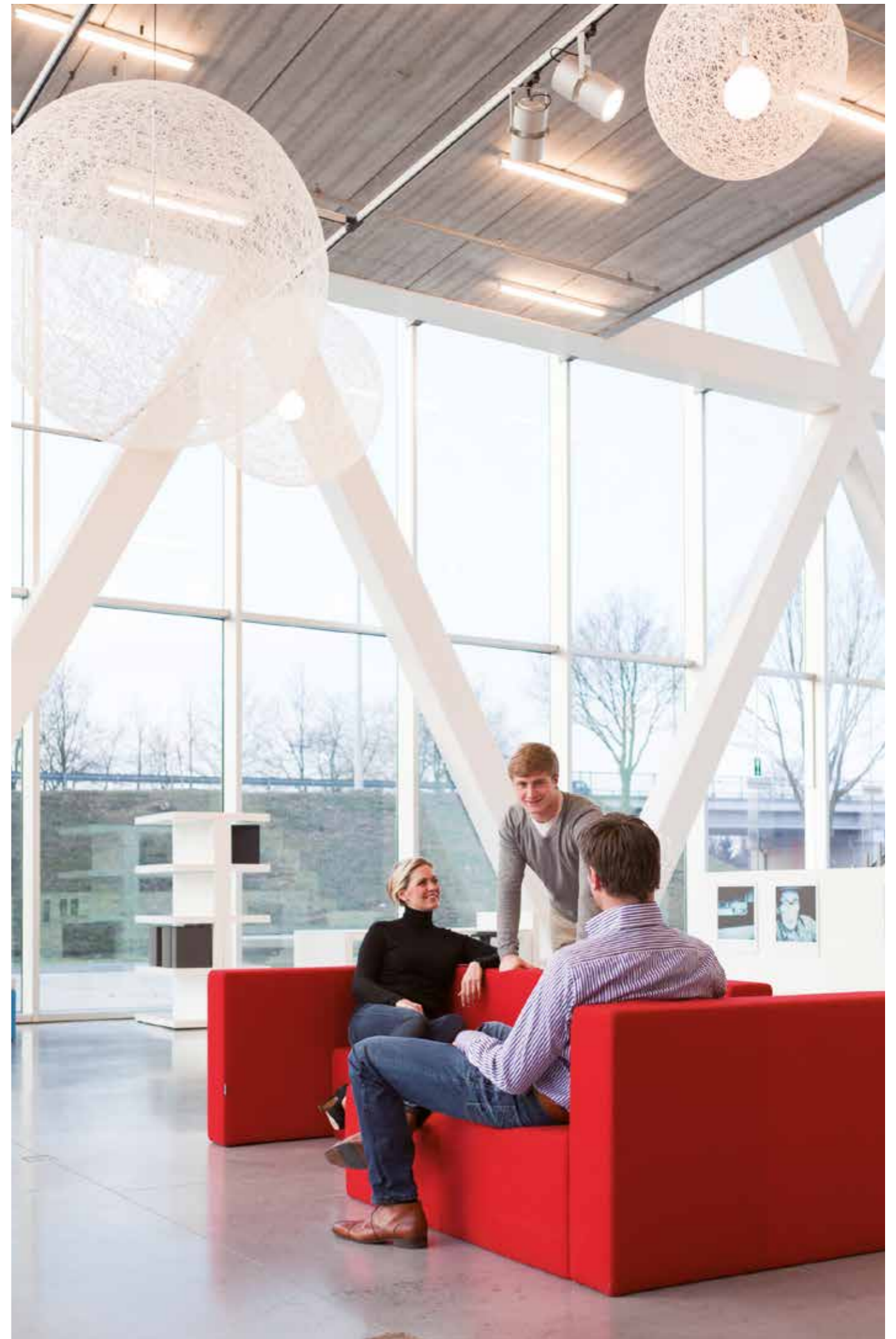

Condenserless multi-scroll chiller, standard efficiency, standard sound

- › Single refrigerant circuit (2 scroll compressors) with single evaporator
- › For chilled water production, to be combined with a remote condensing unit
- › Compact design to allow easy indoor installation or retrofit operations
- › Conceived for stacked installation of two single circuit units to reduce the footprint
- › High efficiency and reliable scroll compressor
- › Stainless steel plate heat exchanger



Cooling only		EWLQ-G-SS		090	100	120	130	150	170	190	210	240	300	360			
Cooling capacity	Nom.	kW		86.5	98.4	110	125	139	160	181	206	231	290	346			
Power input	Cooling	kW		22.4	25.8	29.2	33.0	36.8	42.0	47.0	54.2	59.9	75.6	91.8			
Capacity control	Method	Step															
	Minimum capacity	%		50.0	43.0	50.0	44.0	50.0	45.0	50.0	43.0	50.0	40.0	50.0			
EER			3.86	3.81	3.78	3.79	3.80	3.86	3.80	3.80	3.85	3.84	3.77				
Dimensions	Unit	Height	1,066											1,186			
		Width	928														
		Length	2,743														
Weight	Unit	kg															
	Operation weight	kg		494	578	686	714	742	773	807	838	852	967	1,046			
Water heat exchanger - evaporator	Type	Plate heat exchanger															
	Water volume	l		6	8	10	12	13	15	17	27	34					
	Water flow rate	Nom.	l/s		4.2	4.7	5.3	6.0	6.7	7.7	8.7	9.8	11.1	13.9	16.6		
Compressor	Type	Cooling	Nom.	kPa		44	35	29	31	33	30	38	41				
				Quantity	2												
Sound power level	Cooling	Nom.		dBA		80.0	83.0	85.0	87.0	88.0	90.0	92.0	93.0				
Sound pressure level	Cooling	Nom.		dBA		64.0	67.0	69.0	70.0	72.0	74.0	76.0	77.0				
Operation range	Evaporator	Cooling	Min.~Max.		°CDB		-10~15										
	Condenser	Cooling	Min.~Max.		°CDB		30~60										
Refrigerant	Type / GWP	R-410A / 2,087.5															
Piping connections	Evaporator water inlet/outlet (OD)	Quantity		1"			2"			3"							
		Unit	Starting current	Max		A		204	255	261	308	316	354	368	466	481.0	640
Power supply	Phase/Frequency/Voltage	Hz/V	3~/50/400		A		39	42	45	51	57	64	70	81	88	111	135
			Max		A		59	66	72	80	88	102	116	131	145	183	221

Condenserless multi-scroll chiller, standard efficiency, standard sound

- › Dual refrigerant circuit (4 scroll compressors) with single evaporator
- › For chilled water production, to be combined with a remote condensing unit
- › Compact design to allow easy indoor installation or retrofit operations
- › High efficiency and reliable scroll compressor
- › Stainless steel plate heat exchanger



Cooling only		EWLQ-L-SS		180	205	230	260	290	330	380	430	480	540	600	660	720			
Cooling capacity	Nom.	kW		173	197	224	249	279	317	361	409	459	511	571	624	676			
Power input	Cooling	kW		44.3	51.1	57.9	65.6	73.2	83.8	93.5	108	119	135	152	168	184			
Capacity control	Method	Step																	
	Minimum capacity	%		25.0	21.0	25.0	22.0	25.0	23.0	25.0	21.0	25.0	22.0	20.0	18.0	25.0			
EER			3.91	3.86	3.87	3.79	3.81	3.78	3.86	3.79	3.84	3.78	3.76	3.71	3.67				
Dimensions	Unit	Height	1,970											2,090	2,210				
		Width	928																
		Length	2,801																
Weight	Unit	kg																	
	Operation weight	kg		832	1,007	1,202	1,252	1,333	1,380	1,432	1,511	1,560	1,609	1,694	1,833	1,957			
Water heat exchanger - evaporator	Type	Plate heat exchanger																	
	Water volume	l		19	22	29	35	41	49	62									
	Water flow rate	Nom.	l/s		8.3	9.5	10.7	11.9	13.4	15.2	17.3	19.6	21.9	24.5	27.3	29.9	32.4		
Compressor	Type	Cooling	Nom.	kPa		25	20	25	22	29	36	45	44	52	62				
				Quantity	4														
Sound power level	Cooling	Nom.		dBA		83.0	86.0	88.0	90.0	91.0	93.0	95.0	96.0						
Sound pressure level	Cooling	Nom.		dBA		65.0	68.0	70.0	72.0	74.0	73.0	76.0	77.0	78.0					
Operation range	Evaporator	Cooling	Min.~Max.		°CDB		-10~15												
	Condenser	Cooling	Min.~Max.		°CDB		30~60												
Refrigerant	Type / GWP	R-410A / 2,087.5																	
Piping connections	Evaporator water inlet/outlet (OD)	Quantity		2"			3"												
		Unit	Starting current	Max		A		263	320	333	388	403	456	484	597	626	785	822	860
Power supply	Phase/Frequency/Voltage	Hz/V	3~/50/400		A		78	84	90	102	114	128	141	161	176	199	223	246	269
			Max		A		118	131	144	160	175	205	232	262	290	328	366	403	441

Condenserless screw chiller, standard efficiency, standard sound

- › Compact design to allow easy indoor installation or retrofit operations
- › Daikin semi-hermetic single screw stepless compressor
- › High energy efficiency both at full and part load conditions
- › Chilled water temperatures down to -10°C on standard unit
- › Optimised for use with R-134a
- › MicroTech 4 controller with superior control logic and easy interface

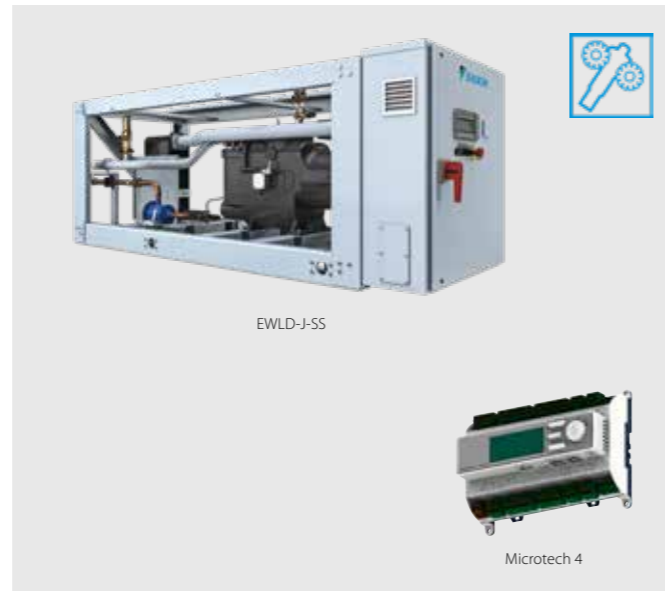

Cooling only		EWLD-J-SS		110	130	145	165	195	235	265	
Cooling capacity	Nom.	kW		110	128	142	163	191	236	264	
Power input	Cooling	Nom. kW		31.2	38.4	43.8	50.4	56.0	66.0	75.3	
Capacity control	Method	Stepless									
	Minimum capacity	%		25.0							
EER				3.51	3.33	3.25	3.24	3.42	3.58	3.51	
Dimensions	Unit	Height	mm	1,020							
		Width	mm	913							
		Length	mm	2,684							
Weight	Unit	kg		1,124	1,141	1,237	1,263	1,305	1,489	1,489	
		Operation weight		1,138	1,159	1,253	1,281	1,327	1,518	1,518	
Water heat exchanger - evaporator	Type	Plate heat exchanger									
	Water volume	l		14	18	14	17	20	26	26	
	Water flow rate	Nom.	l/s	5.2	6.1	6.8	7.8	9.2	11.3	12.6	
Compressor	Water pressure drop	Cooling	Nom. kPa	14	13	39	37	33	26	32	
	Type	Single screw compressor									
	Quantity	1									
Sound power level	Cooling	Nom. dBA		89.0							
Sound pressure level	Cooling	Nom. dBA		79.0							
Operation range	Evaporator	Cooling	Min.~Max. °CDB	-10~15							
	Condenser	Cooling	Min.~Max. °CDB	25~60							
Refrigerant	Type / GWP	R-134a / 1,430									
	Circuits	Quantity		1							
Piping connections	Evaporator water inlet/outlet (OD)			76.2 mm							
Unit	Maximum starting current	A		153		197		197		290	
	Nominal running current (RLA)	Cooling	A	52	62	72	81	91	107	120	
	Maximum running current	A		85	103	114	130	154	168	201	
Power supply	Phase/Frequency/Voltage		Hz/V	3~/50/400							

performances according to CSS software 10.34

Condenserless screw chiller, standard efficiency, standard sound

- › HFO R-1234ze(E) Refrigerant with Ozone Depletion Potential equal to zero and extremely low Global Warming Potential
- › Daikin semi-hermetic single screw compressor
- › Direct expansion plate to plate evaporator
- › Shell and tube condenser
- › Silver efficiency and standard sound
- › Upgrade to new MicroTech 4 controller

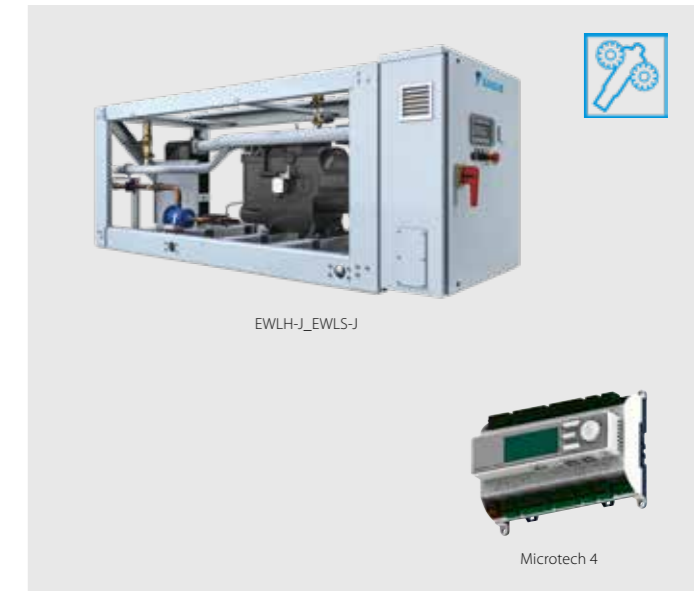

Cooling only		EWLH-J-SS		080	100	110	130	140	170	190
Cooling capacity	Nom.	kW		84	102	109	127	143	174	193
Power input	Cooling	Nom. kW		23.3	28.1	31.8	37	41.5	49.6	56.3
Capacity control	Method	Stepless								
	Minimum capacity	%		25						
EER				3.62	3.43	3.42	3.43	3.51	3.43	
Dimensions	Unit	Height	mm	1,020						
		Width	mm	913						
		Length	mm	2,684						
Weight	Unit	kg		1,124	1,141	1,237	1,263	1,305	1,489	
		Operation weight		1,138	1,159	1,253	1,281	1,327	1,518	
Water heat exchanger - evaporator	Type	Plate heat exchanger								
	Water volume	l		14	18	14	17	20	26	
	Water flow rate	Cooling	Nom. l/s	4	4.9	5.2	6	6.8	8.3	9.2
Compressor	Water pressure drop	Cooling	Nom. kPa	9.7	9.9	17.5	17.6	16.2	15.5	18.7
	Type	Single screw compressor								
	Quantity	1								
Sound power level	Cooling	Nom. dBA		88.9						
Sound pressure level	Cooling	Nom. dBA		79						
Refrigerant	Type	R-1234(ze)								
	Circuits	Quantity		1						
Piping connections	Evaporator water inlet/outlet (OD)			76.2 mm						
Unit	Starting current	Max	A	153		197		290		
	Running current	Cooling	Nom. A	42	48	59	65	72	84	92
		Max	A	75	90	100	114	143	158	178
Power supply	Phase/Frequency/Voltage		Hz/V	3~/50 /400						

performances according to CSS software 10.34

Condenserless screw chiller, standard efficiency, standard sound

- › Refrigerant R-513A
- › Daikin semi-hermetic single screw compressor
- › Direct expansion plate to plate evaporator
- › Shell and tube condenser
- › Silver efficiency and standard sound
- › Upgrade to new MicroTech 4 controller



Condenserless screw chiller, standard efficiency, standard sound

- › DX shell and tube evaporator – one pass refrigerant side for easy oil circulation and return
- › Stepless single-screw compressor
- › Standard electronic expansion valve
- › Optimised for use with R-134a



			EWLS-J-SS		110	130	150	170	200	240	270
Cooling capacity	Nom.	kW	111	132	150	175	200	236	268		
Power input	Cooling	Nom. kW	32.2	38.7	44.8	51.2	58.2	69.4	78.8		
Capacity control	Method		Stepless								
	Minimum capacity	%	25								
EER			3.44	3.4	3.35	3.41	3.44	3.41	3.4		
Dimensions	Unit										
	Height	mm	1,020								
	Width	mm	913								
Weight	Unit										
	Operation weight	kg	1,124	1,141	1,237	1,263	1,305	1,489			
		kg	1,138	1,159	1,253	1,281	1,327	1,518			
Water heat exchanger - evaporator	Type		Plate heat exchanger								
	Water volume	l	14	18	14	17	20	26			
	Water flow rate	Cooling	Nom. l/s	5.3	6.3	7.2	8.4	9.6	11.3	12.8	
	Water pressure drop	Cooling	Nom. kPa	16	15.8	31.1	31.5	30	27	33.8	
Compressor	Type		Single screw compressor								
	Quantity		1								
Sound power level	Cooling	Nom. dBA	88.9								
Sound pressure level	Cooling	Nom. dBA	79								
Refrigerant	Type		R-513A								
	Circuits	Quantity	1								
Piping connections		mm	76.2								
Unit	Starting current	A	154			198			291		
	Running current	Cooling	Nom. A	54	65	75	84	94	111	125	
	Max	A	81	96	108	122	141	164	185		
Power supply	Phase/Frequency/Voltage	Hz/V	3~/50 /400								

performances according to CSS software 10.34

			EWLD-I-SS		320	400	420	500	600	650	750	800	850	900	950	C10	C11	C12	C13	C14	C15	C16	C17			
Cooling capacity	Nom.	kW	315	374	437	509	607	670	740	802	865	935	975	1,029	1,097	1,144	1,210	1,278	1,330	1,381	1,433					
Power input	Cooling	Nom. kW	80.3	96.0	113	134	160	175	192	208	224	246	264	283	286	302	318	336	356	375	395					
Capacity control	Method		Stepless																							
	Minimum capacity	%	25.0						12.5						8.3											
EER			3.93	3.89	3.88	3.79	3.80	3.82	3.86	3.81	3.69	3.64	3.83	3.79	3.80	3.74	3.68	3.63								
Dimensions	Unit																									
	Height	mm	1,899						2,325						2,415											
	Width	mm	1,464						2,135						4,426											
Weight	Unit																									
	Operation weight	kg	1,861	1,869	1,884	3,331	3,339	3,347	3,356	3,364	3,412	5,146	5,167	5,188	5,208											
		kg	2,054	2,052	2,056	3,602	3,603	3,605	3,645	5,667	5,671	5,677	5,680													
Water heat exchanger - evaporator	Type		Single pass shell and tube																							
	Water volume	l	193	183	172	271	263	256	248	241	233	504	489	472	504	489	472									
	Water flow rate	Cooling	Nom. l/s	15.1	17.9	20.9	24.4	29.1	32.1	35.4	38.4	41.4	44.8	46.7	49.3	52.5	54.8	57.9	61.2	63.7	66.1	68.6				
	Water pressure drop	Cooling	Total kPa	34	46	49	56	50	40	52	49	40	49	36	54	47	51	43	53	57	61	65				
Compressor	Type		Single screw compressor																							
	Quantity		1						2						3											
Sound power level	Cooling	Nom. dBA	94.0	97.0	98.0	99.0	100.0	101.0	103.0																	
Sound pressure level	Cooling	Nom. dBA	75.0	76.0	78.0	79.0	80.0	81.0	80.0	81.0	83.0															
Operation range	Evaporator	Cooling	Min.~Max. °CDB	-8~-15																						
	Condenser	Cooling	Min.~Max. °CDB	25~60																						
Refrigerant	Type / GWP		R-134a / 1,430																							
	Circuits	Quantity	1						2						3											
Piping connections	Evaporator water inlet/outlet (OD)	mm	42mm																							
Unit	Maximum starting current	A	330	464	493	627	650	681	703	836	867	898	920	942												
	Nominal running current (RLA)	Cooling	A	131	157	181	214	260	287	313	338	361	391	420	448	470	493	517	542	571	601	631				
	Maximum running current	A	204	233	271	299	407	436	465	504	542	570	597	670	698	737	775	814	841	868	896					
Power supply	Phase/Frequency/Voltage	Hz/V	3~/50/400																							



Water cooled scroll heat pump

- › One of the most compact units on the market: 600mm x 600mm x 600mm
- › Low energy consumption
- › Low operating sound level
- › Easy installation and maintenance
- › Stainless steel plate heat exchanger
- › Low refrigerant volume
- › Standard integrated: pressure ports, flow switch, filter, shut-off valves and air purge
- › Advanced μ C²SE controller for direct connection to a Modbus based BMS or to a remote user interface



EWLQ-KC_EWWQ-KC_hydracube_modulo_03

Cooling Only				EWLQ-KC	014	025	033	049	064
Cooling capacity	Nom.		kW	12.09	19.87	28.90	39.35	57.84	
Power input	Cooling	Nom.	kW	3.74	6.11	8.43	12.03	16.41	
Capacity control	Method			Fixed					
	Minimum capacity		%		100			50	
EER				3.237	3.254	3.429	3.27	3.524	
Dimensions	Unit	Height	mm	600					
		Width	mm	600					
		Depth	mm	1,200					
Weight	Unit		kg	62	124	130	238	249	
	Operation weight		kg	70	129	135	247	258	
Water heat exchanger - evaporator	Type			Braze plate					
	Water volume		l	1.47	1.96	2.74	4.47	5.88	
	Water	Cooling	Nom.	l/s	0.576	0.947	1.378	1.876	2.757
	Water	Cooling	Nom.	kPa	9.71	16.4	21.6	20.5	34.8
Compressor	Type			Scroll compressor					
	Quantity			1			2		
Sound power level	Cooling	Nom.	dBA	69.0		76.0	72.0	79.0	
Sound pressure level	Cooling	Nom.	dBA	55.2		62.1	57.6	64.6	
Operation range	Evaporator	Cooling	Min.-Max.	°CDB					
	Condenser	Heating	Min.-Max.	°CDB					
Refrigerant	Type/GWP			R-410A/2,088.0					
	Charge		kg	0.0					
	Circuits	Quantity		1			2		
Piping connections	Evaporator water inlet/outlet (OD)			G1"					
Unit	Starting	Max	A	57.4	109.3	124.3	124.8	143.6	
	Running	Cooling	Nom.	A	6.57	10.5	14.1	20.9	28.1
	Running	Max	A	9.16	15.5	19.3	31.0	38.7	
Power supply	Phase/Frequency/Voltage		Hz/V	3N~/50 /400					





Water cooled centrifugal chiller, high efficiency, standard sound

- › No friction loss, no oil contamination, no additional oil management systems and an increased equipment life thanks to the magnetic bearing technology
- › Excellent part load efficiency
- › Totally oil-free operation resulting in reduced maintenance costs and increased reliability
- › Compact footprint through stacked heat exchanger lay-out
- › Increased installation flexibility thanks to limited dimensions
- › Easy handling: thanks to its compact size, it can easily pass through the doorway
- › MicroTech 4 controller with superior control logic and easy interface
- › A wide portfolio of options is available to meet different requirements.
- › The compressor vibration levels are extremely low as a result of the high-speed design
- › Optimized for highly efficient R134a refrigerant and compatible with next generation refrigerants



Cooling Only		EWWD-DZXS		320	440	530	610	640	700	880	C10	C13	C14	C15	C21				
Space cooling	A Condition Pdc (35°C - 27/19) ηs,c	kW	320.01	443.01	528	610.02	638.01	699.97	883.01	1,056	1,325.26	1,402	1,564.57	2,070.42					
SEER		%	334	314	324	344	349	342	350	363	349.8	362	360.6	365.4					
Cooling capacity	Nom.	kW	320	443	528	610	638	700	883	1,056	1,325	1,402	1,565	2,070					
Power input	Cooling Nom.	kW	66.5	88.5	102	124.7	131	126	176	205	272	256	310	391					
Capacity control	Method		Variable																
	Minimum capacity	%	30	21	16	15	18	11	7	9	8	6							
EER			4.81	5	5.14	4.89	4.85	5.53	5.01	5.15	4.88	5.46	5.04	5.3					
ESEER			7.94	7.92	8.2	7.78	8.16	8.08	8.09	8.39	-	8.29	-	-					
IPLV			9.38	9.33	9.7	9.41	9.5	9.86	9.52	9.91	9.18	10.1	9.5	9.42					
Dimensions	Unit	Height	1,865			1,985			2,200		2,083		2,200		2,225		2,290		
		Width	1,055			1,160			1,270		1,510		1,270		1,510				
		Length	3,625			3,585			3,580		4,793		3,580		4,768		4,812		
Weight	Unit		1,700	1,900	2,000	2,850		2,600		2,900		3,600		4,350		4,750		5,500	
	Operation weight	kg	1,973	2,216	2,347	3,197	3,344	3,102	3,458	4,292	5,020	4,579	5,540	6,570					
Water heat exchanger - evaporator	Type		Flooded shell and tube																
	Water volume	l	70	96	107		134		156	199	271.8	229	317.4	444.3					
	Water flow rate	Nom. l/s	15.3	21.2	25.3	29.1	30.5	33.5	42.3	50.6	-	67.2	-	-					
	Water pressure drop	Cooling Nom. kPa	47.4	40.6	45	59.1	51	61.3	64	60.4	60.1	74	61.1	71.9					
Water heat exchanger - condenser	Type		Shell and tube										Flooded Shell & Tube	Shell and tube	Flooded Shell & Tube				
	Water volume	l	83	100	120		170	188	211	263	359.9	320	442.6	603.6					
	Water flow rate	Nom. l/s	18.3	25.3	30.1	35.1	36.7	39.4	50.5	60.1	-	79.1	-	-					
	Water pressure drop	Cooling Nom. kPa	49.2	59.5	54.5	74	46.2	41.6	50.9	50.3	56	52.9	43	57					
Compressor	Type		Driven vapour compressor																
	Quantity		1		2		1		2		3		2		3				
Sound power level	Cooling Nom.	dB(A)	87.9	88.9	89.9	91.1	91	92	93.3	99	94.3	100	101						
Sound pressure level	Cooling Nom.	dB(A)	69.6	70.6	71.6	72.6		73.6		74.6	80	75.6	81	82					
Operation range	Evaporator Cooling	Min.~Max. °CDB	4~20																
	Condenser Cooling	Min.~Max. °CDB	20~55	20~42	20~55	20~42	20~55	20~42	20~55	20~42	20~55	20~42	20~55	20~42					
Refrigerant	Type/GWP		R-134a/1,430																
	Charge	kg	120			180		230	320	230	340	390							
Refrigerant charge	Circuits		1																
	Quantity	TCO2Eq	172			257		329	-	329	-								
Piping connections		mm	139.7			168.3		219.1											
Unit	Running current	Cooling Nom. A	100.55	138.22	155.23	203.41	200.56	190.23	274.86	309.17	445	383.87	471.7	588					
	Max	A	134	208	166	267	196	417	331	631	392	511	589						
Power supply	Phase/Frequency/Voltage	Hz/V	3~/50/400																

performances according to CSS software 10.27



Water cooled centrifugal chiller, high efficiency, standard sound

- › No friction loss, no oil contamination, no additional oil management systems and an increased equipment life thanks to the magnetic bearing technology
- › Excellent part load efficiency
- › Totally oil-free operation resulting in reduced maintenance costs and increased reliability
- › Compact footprint through stacked heat exchanger lay-out
- › Increased installation flexibility thanks to limited dimensions
- › Easy handling: thanks to its compact size, it can easily pass through the doorway
- › MicroTech 4 controller with superior control logic and easy interface
- › A wide portfolio of options is available to meet different requirements.
- › The compressor vibration levels are extremely low as a result of the high-speed design
- › Optimized for highly efficient R134a refrigerant and compatible with next generation refrigerants



Cooling Only		EWWD-DZXE		340	470	570	670	680	740	950	C10	C11	C14	C15	C17	C22			
Space cooling	A Condition Pdc (35°C - 27/19) ηs,c	kW	341.01	474.02	566	670	682	741.96	946	1,038.18	1,130	1,436.52	1,477.93	1,684.76	2,172.91				
SEER		%	335	316	326	345	349	346	352	339.8	365	350.6	366	359	370.2				
Cooling capacity	Nom.	kW	341	474	566	670	682	742	946	1,038	1,130	1,437	1,478	1,685	2,173				
Power input	Cooling Nom.	kW	69.9	93.5	108	138.4	138	131	186	210	216	288	263	329	393				
Capacity control	Method		Variable																
	Minimum capacity	%	29	20	15	17	10	7	9	7	6								
EER			4.88	5.07	5.22	4.84	4.91	5.65	5.08	4.94	5.23	4.98	5.6	5.12	5.53				
ESEER			7.81	7.83	8.11	7.52	8	8.09	7.96	-	8.26	-	8.22	-	-				
IPLV			9.29	9.3	9.71	9.22	9.37	9.9	9.46	9.33	9.86	9.2	10.1	9.49	9.52				
Dimensions	Unit	Height	1,865			1,985			2,082		2,083		2,200		2,225		2,290		
		Width	1,055			1,160			1,510		1,270		1,510						
		Length	3,625			3,585			4,688		3,580		4,793		3,580		4,768		4,812
Weight	Unit		1,750	1,950	2,050	2,850		2,650		3,000		4,400		4,700		5,100		5,900	
	Operation weight	kg	2,033	2,276	2,407	3,197	3,354	3,162	3,568	4,970	4,412	5,370	4,699	5,890	6,920				
Water heat exchanger - evaporator	Type		Flooded shell and tube																
	Water volume	l	70	96	107		134		156	199	271.8	229	317.4	444.3					
	Water flow rate	Nom. l/s	16.4	22.7	27.1	32	32.7	35.6	45.3	-	54.1	-	70.9	-	-				
	Water pressure drop	Cooling Nom. kPa	54.2	46.5	51.5	71.4	58.3	68.7	73.2	61.4	68.9	70.7	82	70.7	78.9				
Water heat exchanger - condenser	Type		Shell and tube										Flooded Shell & Tube	Shell and tube	Flooded Shell & Tube	Shell and tube	Flooded Shell & Tube		
	Water volume	l	83	100	120		170	188	211	263	326.4	263	359.9	320	442.6	603.6			
	Water flow rate	Nom. l/s	19.6	27	32.1	38.6	39.1	41.6	53.9	-	64.1	-	83	-	-				
	Water pressure drop	Cooling Nom. kPa	56.4	68.4	62.4	90	52.9	46.7	58.3	44	57.6	66	58.5	50	62				
Compressor	Type		Driven vapour compressor																
	Quantity		1		2		1		2		3		2		3				
Sound power level	Cooling Nom.	dB(A)	87.9	88.9	89.9	91.1	91	92	98	93.3	99	94.3	100	101					
Sound pressure level	Cooling Nom.	dB(A)	69.6	70.6	71.6	72.6		73.6		74.6	80	75.6	81	82					
Operation range	Evaporator Cooling	Min.~Max. °CDB	4~20																
	Condenser Cooling	Min.~Max. °CDB	20~55	20~42	20~55	20~42	20~55	20~42	20~55	20~42	20~55	20~42	20~55	20~42					
Refrigerant	Type/GWP		R-134a/1,430																
	Charge	kg	130			120	200	190	200	350	250	400	250	420	470				
Refrigerant charge	Circuits		1																
	Quantity	TCO2Eq	186			172	286	272	286	-	358	-	358	-					
Piping connections		mm	139.7			168.3		219.1											
Unit	Running current	Cooling Nom. A	105.42	144.7	162.48	212.9	210.15	196	287.44	318.3	323.53	425.9	392	496	588				
	Max	A	134	208	166	267	196	417	406	331	631	392	511	589					
Power supply	Phase/Frequency/Voltage	Hz/V	3~/50/400																

performances according to CSS software 10.27



Water cooled centrifugal chiller, high efficiency, standard sound

- › No friction loss, no oil contamination, no additional oil management systems and an increased equipment life thanks to the magnetic bearing technology
- › Excellent part load efficiency
- › Totally oil-free operation resulting in reduced maintenance costs and increased reliability
- › Compact footprint through stacked heat exchanger lay-out
- › HFO R1234zeE Refrigerant with Ozone Depletion Potential equal to zero and extremely low Global Warming Potential
- › Increased installation flexibility thanks to limited dimensions
- › Easy handling: thanks to its compact size, it can easily pass through the doorway
- › MicroTech 4 controller with superior control logic and easy interface
- › A wide portfolio of options is available to meet different requirements.
- › The compressor vibration levels are extremely low as a result of the high-speed design



Cooling Only		EWWH-DZXS											
		230	320	380	430	455	460	640	755	920	945	C11	C13
Space cooling	A Condition Pdc (35°C - 27/19)	227.08	318.33	376.33	455.13	454.66	474.48	637.15	752.27	917.79	945.8	1,126	1,352
	ηs,c	330	346		342	339	352	354	353	360.2	359.4	364.2	
SEER		8.78	8.66	8.67	8.8	8.78	8.32	9.04	9.07	9.06	9.02	9.04	9.13
Cooling capacity	Nom.	227	318	376	455	461	637	752	918	945.8	1,126	1,352	
Power input	Cooling Nom.	45.6	60.5	71.4	93.3	90.6	79.3	120.5	142.1	158.8	181	216.5	237.7
Capacity control	Method	Variable											
	Minimum capacity	24	21	20	13	12	20	11	10	Stepless			
EER		4.98	5.27		4.88	5.02	5.81	5.29	5.78	5.22	5.2	5.69	
ESEER		7.78	7.97	7.98	7.89	8.06	7.76	8.26	8.3	8.16			
IPLV		9.37	9.52	9.56	9.44	9.5	9.74	9.78	9.74	9.54	9.57	9.71	
Dimensions	Unit	1,865											
	Height	1,985											
	Width	2,200											
Weight	Unit	1,700											
	Operation weight	1,973											
	Water heat exchanger - evaporator	Type	Flooded shell and tube										
Water heat exchanger - evaporator	Water volume	70	96	107	134	156	199	229	271.8	317.4	444.3		
	Water flow rate	10.8	15.2	18	20.5	21.7	22	30.4	35.9	43.9	45.2	53.8	64.6
	Water pressure drop	28.2	24.6	26.8	31.7	27.8	28.6	35.9	33	34.3	30	31	
Water heat exchanger - condenser	Type	Shell and tube											
	Water volume	83	100	120	170	188	211	263	320	359.9	442.6	603.6	
	Water flow rate	13	18.1	21.4	24.5	26.1	25.8	36.2	42.7	51.4	53.8	64.2	76
Compressor	Type	Driven vapour compressor											
	Quantity	1	2	1	2	3							
	Sound power level	87.9	88.9	89.9	91.1	91	92	93.3	94.3	99	100	101	
Operation range	Evaporator Cooling	20~55	20~42	20~55	20~42	20~55	20~42	20~55	20~42	20~55	20~42		
	Condenser Cooling	20~55	20~42	20~55	20~42	20~55	20~42	20~55	20~42	20~55	20~42		
	Refrigerant	Type/GWP	R-1234(ze)/7										
Refrigerant charge	Charge	120	180	230	320	340	390						
	Circuits	1											
Piping connections	mm	139.7											
	mm	168.3											
Unit	Running current	72	99	112	133	144	125	198	222	249	297.8	339.2	374.1
	Running current Max	95	150	123	190	142	300	246	284	451	370	448	
Power supply	Phase/Frequency/Voltage	3~/50/400											

performances according to CSS software 10.27



Water cooled centrifugal chiller, high efficiency, standard sound

- › No friction loss, no oil contamination, no additional oil management systems and an increased equipment life thanks to the magnetic bearing technology
- › Excellent part load efficiency
- › Totally oil-free operation resulting in reduced maintenance costs and increased reliability
- › Compact footprint through stacked heat exchanger lay-out
- › HFO R1234zeE Refrigerant with Ozone Depletion Potential equal to zero and extremely low Global Warming Potential
- › Increased installation flexibility thanks to limited dimensions
- › Easy handling: thanks to its compact size, it can easily pass through the doorway
- › MicroTech 4 controller with superior control logic and easy interface
- › A wide portfolio of options is available to meet different requirements.
- › The compressor vibration levels are extremely low as a result of the high-speed design



Cooling Only		EWWH-DZXE												
		245	345	405	470	480	490	685	740	810	955	C10	C12	C14
Space cooling	A Condition Pdc (35°C - 27/19)	241.98	339.33	401.93	460.88	483.83	486.57	678.69	741	802.77	944.73	1,033	1,226	2,172.91
	ηs,c	331	350	335	345	344	356	344.6	358	356	364.2	371.8		
SEER		8.85	8.75	8.79	8.94	8.4	8.9	9.18	8.8	9.22	9.15	9.17	9.35	
Cooling capacity	Nom.	242	339	402	487	474	484	679	741	803	945	1,033	1,226	1,417
Power input	Cooling Nom.	47.9	63.4	75.1	98.7	79.5	95.1	126.3	144.6	149.4	159.2	192.9	229.5	238.3
Capacity control	Method	Variable												
	Minimum capacity	24	20	19	12	20	12	10	12	9	10	Stepless		
EER		5.05	5.35	4.93	5.97	5.09	5.37	5.13	5.37	5.93	5.35	5.34	5.94	
ESEER		7.78	8.02	8	7.75	7.83	8.04	8.22	-	8.27	8.23			
IPLV		9.33	9.54	9.58	9.36	9.56	9.43	9.74	9.44	9.79	9.8	9.62	9.65	9.72
Dimensions	Unit	1,865												
	Height	1,985												
	Width	2,082												
Weight	Unit	1,750												
	Operation weight	2,033												
	Water heat exchanger - evaporator	Type	Flooded shell and tube											
Water heat exchanger - evaporator	Water volume	70	96	107	134	156	207.3	199	229	317.4	444.3			
	Water flow rate	11.6	16.2	19.2	22.4	22.6	23.1	32.4	34.9	38.4	45.2	48.7	57.9	67
	Water pressure drop	29.7	28.4	37.8	30.8	32	41.3	31	38.1	36.9	37	38	33	
Water heat exchanger - condenser	Type	Shell and tube												
	Water volume	83	100	120	188	170	211	326.4	263	320	359.9	442.6	603.6	
	Water flow rate	13.9	19.2	22.8	26.7	26.4	27.7	38.5	41.8	45.5	52.8	57.8	68.8	78.4
Compressor	Type	Driven vapour compressor												
	Quantity	1	2	1	2	3	2	3	2	3				
	Sound power level	87.9	88.9	89.9	91.1	91	92	93.3	94.3	99	100	101		
Operation range	Evaporator Cooling	20~55	20~42	20~55	20~42	20~55	20~42	20~55	20~42	20~55	20~42			
	Condenser Cooling	20~55	20~42	20~55	20~42	20~55	20~42	20~55	20~42	20~55	20~42			
	Refrigerant	Type/GWP	R-1234(ze)/7											
Refrigerant charge	Charge	130	120	190	200	350	250	400	420	470				
	Circuits	1												
Piping connections	mm	139.7												
	mm	168.3												
Unit	Running current	75	103	117	142	125	150	205	277	232	249	311	249	
	Running current Max	95	150	123	190	142	300	286	246	284	451	370	448	
Power supply	Phase/Frequency/Voltage	3~/50/400												

performances according to CSS software 10.27



Water cooled centrifugal chiller, high efficiency, standard sound

- › No friction loss, no oil contamination, no additional oil management systems and an increased equipment life thanks to the magnetic bearing technology
- › Excellent part load efficiency
- › Totally oil-free operation resulting in reduced maintenance costs and increased reliability
- › Compact footprint through stacked heat exchanger lay-out
- › Increased installation flexibility thanks to limited dimensions
- › Easy handling: thanks to its compact size, it can easily pass through the doorway
- › MicroTech 4 controller: sophisticated adaptive software logic for stable operating conditions
- › A wide portfolio of options is available to meet different requirements.
- › The compressor vibration levels are extremely low as a result of the high-speed design
- › Optimized for highly efficient R-513A refrigerant and compatible with next generation refrigerants



Water cooled centrifugal chiller, high efficiency, standard sound

- › No friction loss, no oil contamination, no additional oil management systems and an increased equipment life thanks to the magnetic bearing technology
- › Excellent part load efficiency
- › Totally oil-free operation resulting in reduced maintenance costs and increased reliability
- › Compact footprint through stacked heat exchanger lay-out
- › Increased installation flexibility thanks to limited dimensions
- › Easy handling: thanks to its compact size, it can easily pass through the doorway
- › MicroTech 4 controller: sophisticated adaptive software logic for stable operating conditions
- › A wide portfolio of options is available to meet different requirements.
- › The compressor vibration levels are extremely low as a result of the high-speed design
- › Optimized for highly efficient R-513A refrigerant and compatible with next generation refrigerants



Cooling Only		EWWS-DZXS											
		320	440	530	610	640	700	880	C10	C13	C14	C15	C21
Space cooling	A Condition Pdc (35°C - 27/19)	kW											
	ηs,c	%											
SEER													
Cooling capacity	Nom.	kW											
Power input	Cooling Nom.	kW											
Capacity control	Method	Variable											
	Minimum capacity	%											
EER													
IPLV													
Dimensions	Unit	mm											
	Height	1,865											
	Width	1,055											
	Depth	3,625											
Weight	Unit	kg											
	Operation weight	kg											
Water heat exchanger - evaporator	Type	Flooded shell and tube											
	Water volume	l											
	Water flow rate	l/s											
	Water pressure drop	kPa											
Water heat exchanger - condenser	Type	Flooded Shell & Tube											
	Water volume	l											
	Water flow rate	l/s											
	Water pressure drop	kPa											
Compressor	Type	Driven vapour compressor											
	Quantity												
Sound power level	Cooling Nom.	dBA											
Sound pressure level	Cooling Nom.	dBA											
Refrigerant	Type/GWP	R-513A/631											
	Charge	kg											
	Circuits	Quantity											
Piping connections		mm											
		mm											

Cooling Only		EWWS-DZXE													
		340	470	570	670	680	740	950	C10	C11	C14	C15	C17	C22	
Space cooling	A Condition Pdc (35°C - 27/19)	kW													
	ηs,c	%													
SEER															
Cooling capacity	Nom.	kW													
Power input	Cooling Nom.	kW													
Capacity control	Method	Variable													
	Minimum capacity	%													
EER															
IPLV															
Dimensions	Unit	mm													
	Height	1,865													
	Width	1,055													
	Depth	3,625													
Weight	Unit	kg													
	Operation weight	kg													
Water heat exchanger - evaporator	Type	Flooded shell and tube													
	Water volume	l													
	Water flow rate	l/s													
	Water pressure drop	kPa													
Water heat exchanger - condenser	Type	Flooded Shell & Tube													
	Water volume	l													
	Water flow rate	l/s													
	Water pressure drop	kPa													
Compressor	Type	Driven vapour compressor													
	Quantity														
Sound power level	Cooling Nom.	dBA													
Sound pressure level	Cooling Nom.	dBA													
Refrigerant	Type/GWP	R-513A/631													
	Charge	kg													
	Circuits	Quantity													
Piping connections		mm													
		mm													

Water cooled centrifugal chiller, high efficiency, standard sound

- › Single Compressor chiller
- › High part load efficiency with Daikin VFD Unit Mounted - Refrigerant Cooled
- › Low Harmonics VFD option
- › Excellent Full Load performance
- › Unloading down to 10% without Hot Gas By Pass
- › Refrigerant flexibility with R-134a, R-1234ze and R-513A
- › Reduced refrigerant quantity
- › Touch screen operator panel
- › Unit mounted control panel
- › Rapid restart for fast start-up after power loss
- › Heat pump mode

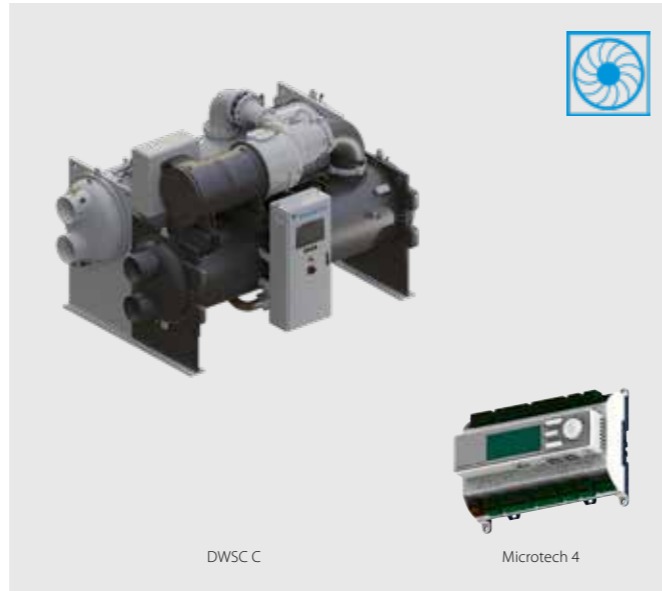

Water cooled centrifugal chiller, high efficiency, standard sound

- › Lower equipment, installation and annual operating costs than two single compressor chillers
- › Main components can be removed or repaired without shutting down the unit as the chiller has two of everything (compressors, lubrication systems, control systems and starters)
- › Compact design for small footprint and minimized installation space
- › Unloading to 5% of full load provides improved stability of the chilled water temperature and less harmful cycling of compressors
- › High efficiency flooded type shell and tube evaporator/condensers



Daikin Centrifugal Compressor

- › No compromises in application flexibility
- › Proven compressor technology (Daikin centrifugal compressor design)



Free cooling operation

Allows to reduce the power consumption generated by traditional mechanical cooling.



Touch screen operator panel



Touch screen operator panel is graphically intuitive and easy to use for enhanced operator productivity. Important status and control information is available at a glance or a touch.

Unit mounted control panel



Cooling Only		DWSC C	DWSC C	DWSC C
Cooling capacity	Min./Max.	kW	1,050 (1)/4,500 (1)	700 (1)/3,300 (1)
Compressor	Type		Single stage centrifugal compressor	Single stage centrifugal compressor
Refrigerant	Type		R-134a / R-513A	R-1234(ze)
Power supply	Frequency	Hz	50/60	50/60

(1) AHRI conditions

Cooling Only		DWDC C	DWDC C
Cooling capacity	Min./Max.	kW	2,100 (1)/9,000 (1)
Compressor	Type		Single stage centrifugal compressor
Refrigerant	Type		R-134a / R-513A / R-1234(ze)
Power supply	Frequency	Hz	50/60

(1)AHRI conditions

Panels			Air-cooled chillers										Water-cooled chillers							Centrifugals				
			EWAA~BVP EWYA~BVP	EWAA~DA EWYA~DA	EWYD~BZ	EWYD~4Z	EWYT~B-	EWAH~TZB & C	EWAD~TZB & C	EWAD~T-C	ERAD~E-	EWAT~B-	EWAD~CF	EWQ~KC	EWLQ~KC	EW_Q-G EW_Q-L	EWLD~I-	EWWS/H/ D~J/ EWLS/H/ D~J-	EWVH~VZ	EWVW~VZ	EWVH~DZ	EWVW~DZ	DWSC & DWDC	
EKDIMPAB	(a) (b) (c)	ICM Primary Basic																						
EKDIMPAL	(a) (b) (c)	ICM Primary for evaporator peripherals Light																						
EKDIMPAL	(a) (b) (c)	ICM Primary for evaporator peripherals Full																						
EKDIMPWL	(a) (b) (c)	ICM primary Evaporator/Condenser Light																						
EKDIMPWF	(a) (b) (c)	ICM primary Evaporator/Condenser Full																						
EKDICTL	(a) (b)	ICM Cooling towers Light																						
EKDICTF	(a) (b)	ICM Cooling towers Full																						
EKDIMPABIO	(a) (b)	ICM Primary Basic with IO third party chiller																						
EKDIMPALIO	(a) (b)	ICM Primary Evaporator Light with IO third party chiller																						
EKTSMS		Temperature sensor for master/slave configuration																						
EKRUMCL1		User Interface																						

Serial Cards & Communication Modules			Air-cooled chillers										Water-cooled chillers							Centrifugals				
			EWAA~BVP EWYA~BVP	EWAA~DA EWYA~DA	EWYD~BZ	EWYD~4Z	EWYT~B-	EWAH~TZB & C	EWAD~TZB & C	EWAD~T-C	ERAD~E-	EWAT_B- (single)	EWAD~CF	EWQ~KC	EWLQ~KC	EW_Q-G EW_Q-L	EWLD~I-	EWVW~J- EWLD~J-	EWVH~VZ A	EWVW~VZ A	EWVH~DZ	EWVW~DZ	DWSC & DWDC	
EKAC200J		Serial Card RS485/Modbus																						
EKACBAC		Ethernet Card BACnet																						
EKACLONP		Serial Card LON FTT 10																						
EKACRS232		Serial Card RS232 Modem Interface (single unit only)																						
EKACWEB		Web Server Card																						
EKACBACMSTP		Serial Card BACnet MSTP																						
EKACBACCERT		Serial Card BACnet pre-loaded IP/Ethernet (centrifugal chillers)																						
EKACMSTPCERT		Serial Card BACnet pre-loaded MSTP (centrifugal chillers)																						
EKCM200J		ModBus RTU communication module																						
EKCLON		LON communication module																						
EKCMBACMSTP		BACnet/MSTP communication module																						
EKCMBACIP		BACnet/IP communication module																						
EKDOSMWO		Daikin on Site Modem without M2M card																						

Other Systems & Accessories			Air-cooled chillers										Water-cooled chillers							Centrifugals				
			EWAA~BVP EWYA~BVP	EWAA~DA EWYA~DA	EWYD~BZ	EWYD~4Z	EWYT~B-	EWAH~TZB & C	EWAD~TZB & C	EWAD~T-C	ERAD~E-	EWAT_B- (single)	EWAD~CF	EWQ~KC	EWLQ~KC	EW_Q-G EW_Q-L	EWLD~I-	EWVW~J- EWLD~J-	EWVH~VZ A	EWVW~VZ A	EWVH~DZ	EWVW~DZ	DWSC & DWDC	
EKCON		Converter RS485 to RS232																						
EKCONUSB		Converter RS485 to USB																						
EKMODEM		Fixed modem																						
EKGSMOD		GSM modem																						
EKRUPCJ		Remote display kit																						
EKRUPCS		Local/remote display HMI																						
EKPWPROEXT		PlantWatchPro I/O extension module for hardwiring and retrofit																						
EKGWWEB		Gateway web (Ethernet LAN SNMP)																						
EKGWMODEM		Gateway for modem																						
EKAC10C		Address card for connection to BMS or Remote user interface																						
EKRUMCA		Remote installed user interface																						
EKLS2	(d)	Low noise kit 22/28/35/45/55/65 Hp-units																						
ECB2MUCW	(e)	Controller kit																						
ECB3MUCW	(e)	Controller kit																						
EKRPIAHT	(g)	Digital input/output PCB																						
EKRUAHTB	(g)	Remote user interface																						
DTA104A62	(f)	External control adapter																						
BHGP26A1	(f)	Digital pressure gauge kit																						
EKQDP2M016	(g)	Differential Pressure Sensor 4-20 mA 0-160 kPa																						
EKQDP2M020	(g)	Differential Pressure Sensor 4-20 mA 0-250 kPa																						
EKQDP2M040	(g)	Differential Pressure Sensor 4-20 mA 0-400 kPa																						
EKQDP2M060	(g)	Differential Pressure Sensor 4-20 mA 0-600 kPa																						
EKDAPCONT		Containerization of one unit																						
EKDAPSTF		Containerization of additional units in the same container																						

Notes:
 (a) Price does not include commissioning of panel; if commissioning is required please refer to RN17-041
 (b) ICM panels work in cooling mode only; heat pump versions, total heat recovery and Free cooling options on A/C and W/C chillers are not compatible
 (c) In case you are ordering ICM panels please add corresponding modbus RTU communication module (EKCM200J or EKAC200J) for each chiller unit controller
 (d) For 45/55/65 Hp-units 2 pieces are needed
 (e) Only available for modular units (EWWP~KAW1M)
 (f) Price available in SAP system
 (g) Differential pressure sensor are specific for ICM panels in variable primary flow management



Table of content

Air handling units

Why choose Daikin air handling units?	134
Products overview	138
Software and Eurovent certification	139
The working principle at a glance	140
Professional and Digital Controls	142
Modular R	144
Modular P	145
Modular L	146
NEW Modular T	147
Daikin fresh air package	148

Daikin air handling units



Why choose Daikin air handling units?

- › Maximum energy efficiency and indoor air quality
- › Wide range of functions and options
- › **High quality** components
- › **Innovative** technology: Unique features and state of the art technology for short payback
- › Operation **efficiency** and **energy savings**
- › Outstanding **reliability** and **performance**
- › Various applications are possible including air conditioning applications, industry-type process cooling, and large-scale district heat source systems
- › Plug and play concept for easy installation and commissioning
- › Unique Daikin fresh air package available for connection of AHU to VRV or ERQ

Certifications

- › Eurovent certified performances
- › Exceeding 2018 ErP – ECODSIGN requirements
- › Certified according to the Hygiene Directive VDI 6022 (Modular L and Professional ranges)
- › Certified according to the Hygiene Directive DIN 1946 (Professional range)
- › RLT certified performances



The unique quality of Daikin AHU is accomplished by:

Panels

- › The outer panel is Pre-painted with Corrosion Class RC5
- › The inner panel is made of Aluzinc with Corrosion Class RC4

Gasket

- › Liquid gasket technology drastically reduces unit air leakage

Frame

- › All anodized aluminium which has the highest corrosion resistance compared to natural aluminium
- › Unique Daikin thermal break (35 mm or 27 mm thermal break). Polyamide bars design to enhance thermal break unit performances
- › Distinctive Section to section thermal break profile to ensure thermal break design on the whole unit
- › Rounded profile for increased ease of cleaning

IAQ

- › Flush internal surface and rounded corner flush surface to avoid the retention of dirt and to be easily cleanable
- › Wide filtration possibility to reduce pollution

Plug & Play Controls

- › Pre-commissioned and Factory-tested control for quicker on site commissioning
- › Sole manufacturer to provide a complete AHU DX solution from a single manufacturer available for connection of AHU to VRV or ERQ (everything factory-mounted)

Marketing tools

- › Watch the time-lapse video of a Daikin AHU construction on www.youtube.com/daikineurope
- › Watch the Modular L promotional video on www.youtube.com/daikineurope
- › Download the Modular L “Daikin Air Design” App on the App stores for iOS and Android



BIM models

- › Get the Modular L and T BIM models on bim.daikin.eu
- › Get the BIM tool plugin for Revit for Professional and Modular R/P series

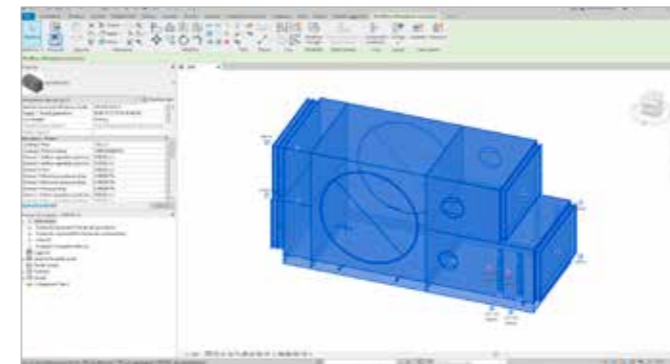

Benefits for the installer

Plug and play design

- › Pre-programmed and factory-tested controls for an easier and fast commissioning
- › Low voltage fast connectors between AHU sections
- › Flush mounted or external electrical control panel

Daikin Fresh air package

- › Plug & Play connection of Professional or Modular AHU to Daikin VRV and ERQ
- › Factory-mounted package contains expansion valves, electronic interface and sensors

Benefits for the consultant

Quick selection tool

- › In-house developed web software with improved user interface and preset parameters ensure that you can always find the optimum and most energy efficient product for your application
- › Extremely flexible design
- › Infinite variable sizes (increments of 1 cm)

BIM models

- › Regardless if your AHU is standard or fully customized, BIM models are available and can be downloaded with just a few clicks

Benefits for the end user

Customized or standard

- › Amazing tailor-made capability to meet the specific customer needs with the Professional range or fast availability thanks to the “make to stock” standard Modular L and T range

Efficient control logic

- › Open communication protocols (BACnet and Modbus) that guarantee BMS, and iTM compatibility
- › Energy efficient controls with reduced energy and operating cost
- › Highest efficiency ensure savings on energy consumption costs



SMART CONTROLS



D-AHU MODULAR R
INSTALLATION



DAMPER AND EC FAN



HEAT RECOVERY
WHEEL AND FILTER



COMFORTABLE
INDOOR CLIMATE

Products overview

Centralised ventilation

D-AHU Professional	D-AHU Modular R	D-AHU Modular P
<ul style="list-style-type: none"> > Infinite variable sizes > Tailored to the individual customer 	<ul style="list-style-type: none"> > Pre-configured sizes > Plug and play concept > EC Fan technology > Heat recovery wheel (sorption and sensible technology) > Compact design 	<ul style="list-style-type: none"> > Pre-configured sizes > Plug and play concept > EC Fan technology > High efficiency aluminium counter flow PHE > Compact design
0.21 m³/s up to 40 m³/s	0.14m³/s up to 6.94 m³/s	0.14m³/s up to 6.94 m³/s
MADE IN BRITAIN	MADE IN BRITAIN	MADE IN BRITAIN

Decentralised ventilation

Modular L	Modular T
<ul style="list-style-type: none"> > Pre-configured sizes > Plug and play concept > EC Fan technology > High efficiency aluminium counter flow PHE > Low height unit > For false ceiling applications 	<ul style="list-style-type: none"> > Pre-configured sizes > Plug and play concept > EC Fan technology > Small footprint > Compact design > High efficiency aluminium counter flow PHE > Top connected unit
42 l/s up to 944 l/s	56 l/s up to 1,167 l/s

Centralized ventilation

Professional **Modular R & P**

Decentralized ventilation

Modular T **Modular L**

Eurovent certification

Daikin Applied Europe S.p.A. participates in the Eurovent Certified Performance programme for Air Handling Units. Check ongoing validity of certificate: www.eurovent-certification.com or www.certiflash.com



Result Energy TermiC° S2&F2		Eurovent Classification according to EN1886				
D1	Casing strength class	D1	D2	D3		
	Max. relative deflection mm x m ⁻¹	4.00	10.00	Exceeding10		
L1	Casing air leakage class at -400 Pa	L1	L2	L3		
	Max. leakage rate (f ₄₀₀) l x s ⁻¹ x m ⁻²	0.15	0.44	1.32		
L1	Casing air leakage lass at +700 Pa	L1	L2	L3		
	Max. leakage rate (f ₇₀₀) l x s ⁻¹ x m ⁻²	0.22	0.63	1.90		
ePM, 80% (F9)	Filter bypass leakage class	ePM ₁ 80% (F9)	ePM ₁ 70% (F8)	ePM ₁ 50% (F7)	ePM _{2.5} 50% (M6)	ISO Coarse
	Max. filter bypass leakage rate k in % of the volume flow rate	0.50	1	2	4	6
T2	Thermal transmittance	T1	T2	T3	T4	T5
	(U) W x m ² x K ⁻¹	U <= 0.5	0.5 < U <= 1	1 < U <= 1.4	1.4 < U <= 2	No requirements
TB2	Thermal bridging factor	TB1	TB2	TB3	TB4	TB5
	(kb)	0.75 < K _b <= 1	0.6 < K _b <= 0.75	0.45 < K _b <= 0.6	0.3 < K _b <= 0.45	No requirements

Selection software

ASTRA Web

- > Quick AHU selection software interface, drastically reducing selection time.
- > Very competitive solution available within the Wizard thanks to pre-uploaded parameters.
- > High selection quality, thanks to the intelligence embedded within the software core.

Quickly select your air handling unit by following the wizard:

- 1 Select the series: D-AHU Professional, D-AHU Modular R/P, Modular L and Modular T
- 2 Insert the air flow supply and return
- 3 Insert the summer/winter air supply setpoint
- 4 Insert the summer/winter outdoor and extract temperature

You will get immediately your 3D result. Now, you will be able to modify your unit (adding or changing components) in order to have a product that meets all your needs.

When finished a technical report, price list, fan curve chart can be generated. These final reports can be downloaded in different formats.

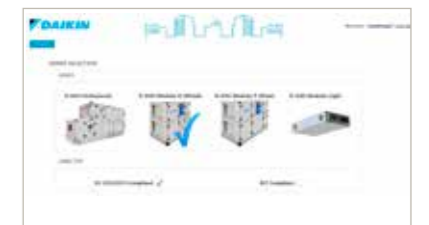

The working principle at a glance

Typical configurations for Daikin air handling units provide a versatile range of functions. Our system offers numerous options for customisation through an extensive range of variations and added functionality.

Supply side

- › Damper section including ventilation grilles, factory-mounted actuators
- › Premium efficiency filters with factory-mounted differential pressure manometer
- › Heat recovery system (cross flow and counter flow plate heat exchanger or rotary heat exchanger)
- › Mixing box with damper and factory-mounted actuators
- › Heating/cooling coil section with stainless steel condensate tray and drip protection
- › Supply air fan, EC technology (with hinged door, opening drive monitoring, mounted and cabled lighting and ON/OFF switch)

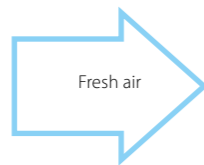

Return side

- › Premium efficiency filters with factory-mounted differential pressure manometer
- › Exhaust air fan, EC technology (with hinged door, opening drive monitoring, mounted and cabled lighting and ON/OFF switch)
- › Mixing box with damper and factory-mounted actuators
- › Heat recovery system (cross flow and counter flow plate heat exchanger or rotary heat exchanger)
- › Damper section including ventilation grilles, factory-mounted actuators

Plug and Play control solution

- › Air flow control
- › Air temperature control
- › Chilled water and DX cooling system control
- › Free cooling
- › CO₂ automatic control
- › Air temperature control (supply, return, ambient)
- › Variable Air Volume (VAV) and Constant Air Volume (CAV) systems

Unique section to section thermal break profile

- › Thermal bridge free for the entire AHU
- › Smooth interior surface with improved IAQ (Indoor Air Quality)

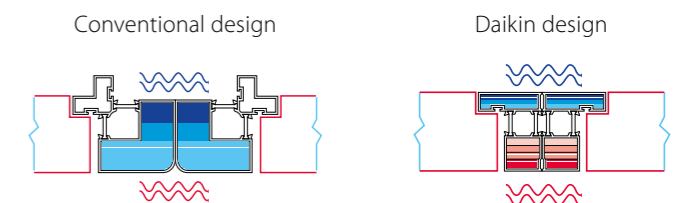

Fans

- › EC plug fan
- › Forward curved fan
- › Backward curved fan
- › Backward airfoil blades fan
- › Plug fan

Exchangers

- › Water coils
- › Steam coils
- › Direct expansion coil
- › Superheated water coils
- › Electric coils

Humidifiers

- › Evaporative humidifier without pump (loss water)
- › Evaporative humidifier with re-circulating pump
- › Steam humidifier with direct steam production
- › Steam humidifier with local distributor
- › Atomized water spray humidifier

Heat recovery systems

- › Heat wheel, sensible or sorption
- › Cross flow and Counter flow plate heat exchangers
- › Run-around coils

Other section

- › Attenuator section
- › Mixing box section with actuators or manual controlled dampers
- › Empty section

Filters

- › Synthetic pleated filter
- › Flat filter aluminium mesh
- › Rigid bag filter
- › Soft bag filter
- › High efficiency filter
- › Carbon absorption filter
- › Carbon deodorizing filter

Accessories

- › Control features
- › Frost protection
- › Manometers
- › Drive guard
- › Roof
- › ...

Professional



Flexible solution for custom applications



Highlights

- › Air flow from 0.21 m³/s up to 40 m³/s, for all customer needs
- › Indoor and outdoor versions
- › Custom designed to facilitate the transport and the assembly on site
- › Smooth interior surface with improved IAQ (Indoor Air Quality)
- › DX cooling system integration (VRV IV and ERQ coupling capability)
- › Daikin Digital Control compatible
- › Different heat recovery systems: heat wheel (sensible, enthalpy or sorption), cross flow and counter flow plate heat exchangers, run-around coils
- › Wide range of fans selectable: EC, AC plug, belt driven (forward curved, backward curved and backward airfoil blades)
- › Heating/cooling coil section with stainless steel condensate tray and drip protection
- › Different humidifiers available depending on customer needs
- › Premium efficiency filters with factory mounted differential pressure manometer
- › Profile in anodized aluminum with or without thermal break
- › Base frame in Galvanized steel, Aluminium, Stainless Steel 430 or 316
- › Panel insulation in polyurethane foam or mineral wool
- › Different material options selectable for internal, external panel skin: Pre-coated, Aluzinc, Aluminium, Stainless Steel 304 or 316
- › Wide range of accessories
- › Possibility to import BIM objects in Autodesk® Revit, thanks to a dedicated free plug-in available for [download](#)



Daikin Digital Control

Plug and play control system



Highlights

- › Free cooling/free heating management
- › VRV direct expansion systems management
- › Chilled water system control
- › Eco and reduced night modes
- › Up to 310 I/O (inputs/outputs)
- › All components internally wired
- › Fast connection between sections
- › Programming schedule
- › Indoor Air Quality (IAQ) controlled by CO₂ Probe
- › Regulation logic: Temperature Supply, Return, Ambient
- › Preloaded control parameters simplify the field commissioning
- › Unit delivered tested and programmed in the factory ensuring high quality level
- › Time and cost savings thanks to easy assembly on site
- › Minimum maintenance required
- › No involvement of external company or need of a third-party warranty thanks to integration of low and high voltage
- › User friendly control interface
- › Supervision and Control management local, remote options (Modbus, Bacnet)
- › Maximum flexibility in selecting the product and control feature directly from selection software

Daikin On Site

Control everywhere

The Daikin On Site platform offers different features and functions to monitor and control the unit. The monitoring system makes available dashboards, remote access, scheduling, online graphics, diagnostics, software upgrade.



Modular R

Side connected rotary heat recovery air handling unit



Highlights

- › 10 predefined sizes
- › Airflow from 0.14m³/s up to 6.94 m³/s (ErP 2018)
- › Rotary heat recovery (Sensible or Sorption)
- › Compact design (only 720 mm depth)
- › Indoor and outdoor versions
- › Thermal bridge free for the entire AHU
- › Smooth interior surface with improved IAQ (Indoor Air Quality)
- › Indoor air quality compliant with VDI 6022 hygiene guideline
- › Chilled water system control
- › DX cooling system integration (VRV IV and ERQ coupling capability)
- › Advanced control features
- › Monitoring and control through Daikin iTM
- › Nominal air flow programmed at factory
- › Air flow or pressure control (Variable Air Volume - Constant Air Volume)
- › Free cooling capability
- › Economy and Night mode operation
- › Possibility to import BIM objects in Autodesk® Revit



Modular R

Air flow range

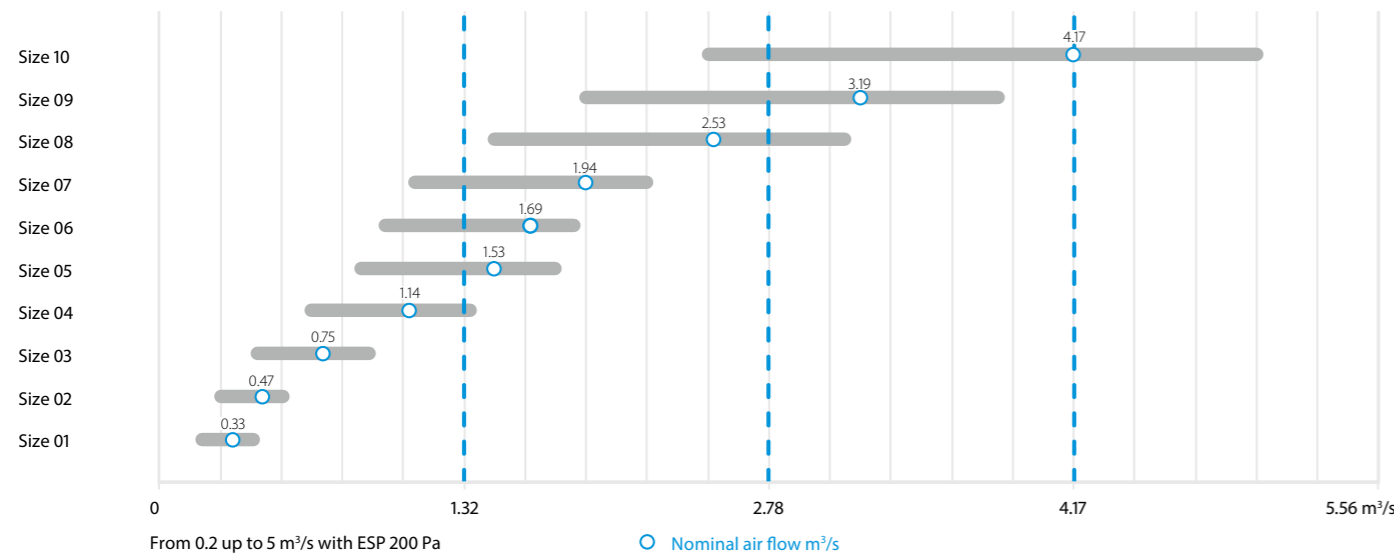

Technical details

Now available with plug fan

Modular R			1	2	3	4	5	6	7	8	9	10
Airflow	m³/s		0.33	0.47	0.75	1.14	1.53	1.69	1.94	2.53	3.19	4.17
Temp. efficiency winter	%		76.9	76.7	77	77.2	78.5	77	78.4	78.7	77.9	78.2
External static pressure	Nom. Pa		200									
Current ¹	Nom. A		2.6	3.65	2.24	3.27	4.23	5.14	5.79	6.92	9.39	12.56
Power input ¹	Nom. kW		0.6	0.84	1.36	1.98	2.56	3.11	3.51	4.19	5.69	7.61
SFPv ²	kW/m³/s		1.553	1.507	1.451	1.521	1.387	1.549	1.525	1.432	1.487	1.551
Electrical supply	Phase	ph	1			3						
	Frequency	Hz	50									
	Voltage	V	230		400							
Dimensions unit	Width	mm	720	820	990	1,200	1,400	1,600	1,940		2,300	
	Height	mm	1,320		1,540	1,740		1,920	1,600	1,940	2,300	
	Length	mm	1,700	1,800	1,920	2,080	2,280	2,400	2,180	2,460	2,570	
Weight unit	kg	325	350	475	575	750	790	950	1,330	1,410	1,750	

1. Measured with dirty filters | 2. SFPv is a parameter that quantifies the fan efficiency (the lower it is the better will be). This reduces if airflow decreases.

Modular P

Side connected plate heat recovery air handling unit



Highlights

- › 10 predefined sizes
- › Airflow from 0.14m³/s up to 6.94 m³/s (ErP 2018)
- › Counterflow plate heat recovery
- › Compact design (only 720 mm depth)
- › Indoor and outdoor versions
- › Thermal bridge free for the entire AHU
- › Smooth interior surface with improved IAQ (Indoor Air Quality)
- › Indoor air quality compliant with VDI 6022 hygiene guideline
- › Chilled water system control
- › DX cooling system integration (VRV IV and ERQ coupling capability)
- › Advanced control features
- › Monitoring and control through Daikin iTM
- › Nominal air flow programmed at factory
- › Air flow or pressure control (Variable Air Volume - Constant Air Volume)
- › Free cooling capability
- › Economy and Night mode operation
- › Possibility to import BIM objects in Autodesk® Revit, thanks to a dedicated free plug-in available for [download](#)



Modular P

Air flow range

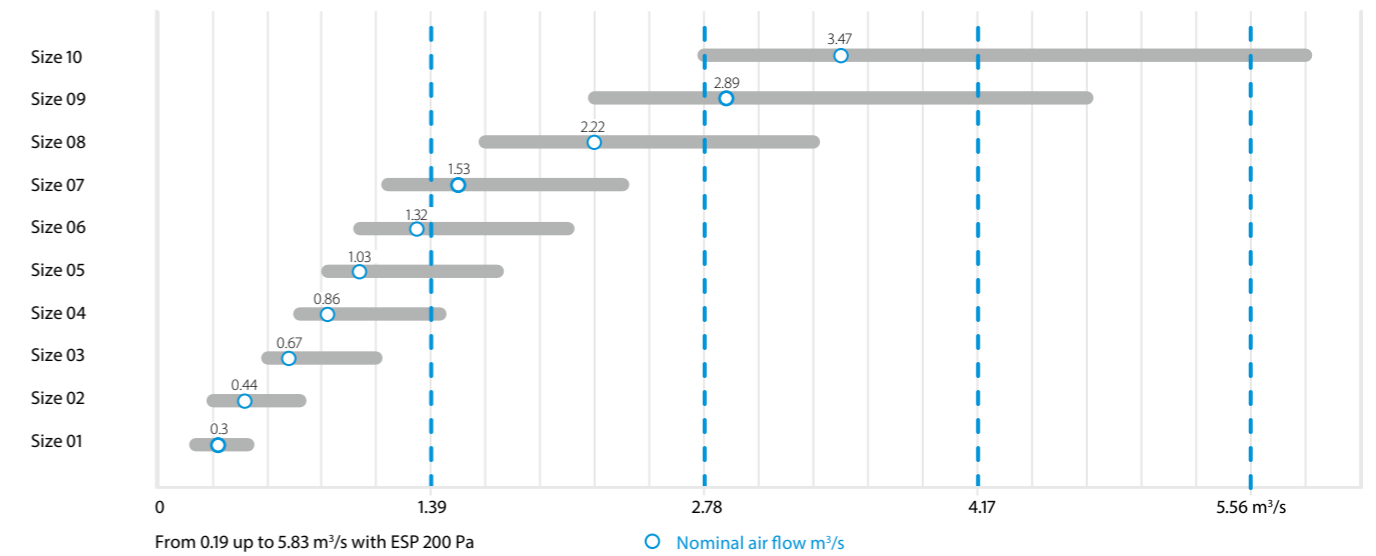

Technical details

Now available with plug fan

Modular P			1	2	3	4	5	6	7	8	9	10
Airflow	m³/s		0.3	0.44	0.67	0.86	1.03	1.32	1.53	2.22	2.89	3.47
Heat exchanger thermal efficiency ¹	%		88.1	87	87.2	87.1		92.1		91.8	92.9	
External static pressure	Nom. Pa		200									
Current ²	Nom. A		1.78	2.48	2.08	2.73	3.45	4.58	5.25	7.53	9.55	11.55
Power input ²	Nom. kW		0.41	0.57	0.83	1.09	1.38	1.83	2.10	3.01	3.82	4.62
SFPv ³	kW/m³/s		1.183	1.092	1.090	1.113	1.118	1.210	1.207	1.216	1.148	1.166
Electrical supply	Phase	ph	1			3						
	Frequency	Hz	50									
	Voltage	V	230		400							
Dimensions unit	Width	mm	720	820	990	1,200	1,400	1,400	1,600	1,940	1,940	2,300
	Height	mm	1,320		1,540	1,740		1,920	1,600	1,940	2,180	2,570
	Length	mm	2,030	2,200	2,610	2,660	2,800	3,210	3,340	3,840	4,060	4,190
Weight unit	kg	343	358	512	604	785	852	964	1,449	1,700	2,071	

1. Winter design condition: Outdoor: -10°C, 90% Indoor: 22°C, 50% | 2. Measured with dirty filters | 3. SFPv is a parameter that quantifies the fan efficiency (the lower it is, the better will be). This reduces if airflow decreases.

Modular L

False ceiling heat recovery unit



Highlights

- › 6 Predefined sizes
- › Plug & Play control solution
- › Compact unit from 280 mm height (for air flow up to 153 l/s)
- › Wide air flow coverage from 42 to 944 l/s
- › Right and left configuration
- › Pro (open control platform) and Smart (Daikin control platform) version
- › Excellent indoor air quality (IAQ). Up to ePM1 80% (F9) filtration level with possibility to have a prefilter up to ePM1 50% (F7) for the best IAQ
- › VDI 6022 Certified
- › BIM file available at www.daikin.eu/BIM

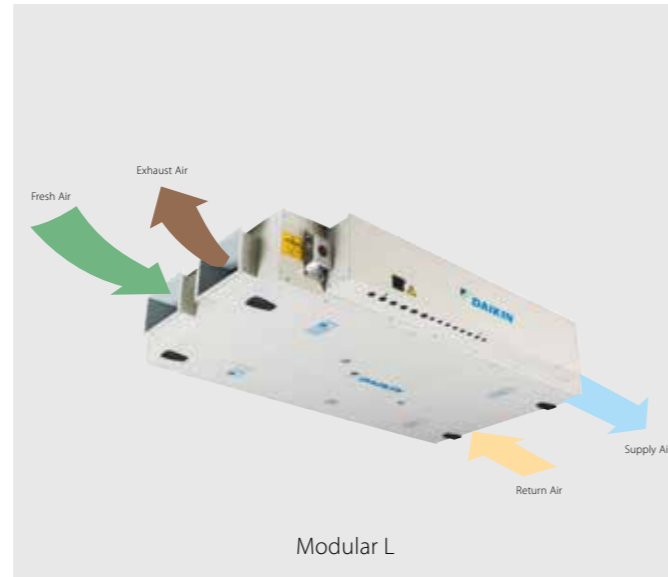

Air flow range

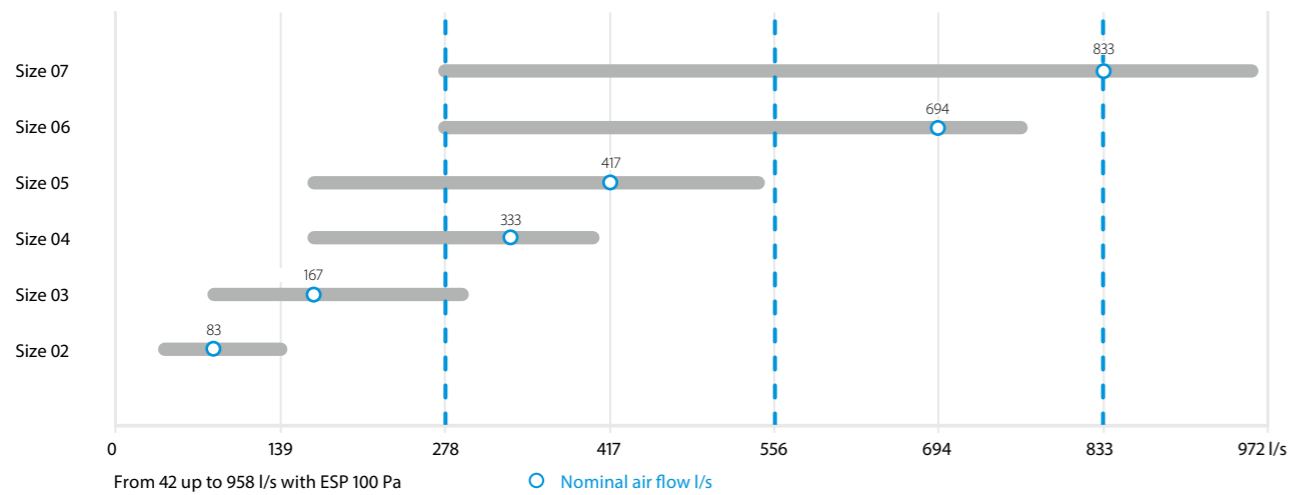

Technical details

Modular L		ALB02*B	ALB03*B	ALB04*B	ALB05*B	ALB06*B	ALB07*B
Airflow	l/s	83	167	333	417	694	833
Heat exchanger thermal efficiency ¹	%	90					
External static pressure	Nom. Pa	100					
Current	Nom. A	0.61	1.39	2.26	2.87	5.17	6.26
Power input	Nom. kW	0.14	0.32	0.52	0.66	1.19	1.44
SFPv ²	kW/m ³ /s	1.27	1.55	1.32	1.38	1.49	1.54
Electrical supply	Phase	ph					
	Frequency	Hz					
	Voltage	V					
Main unit dimensions	Width	920	1,100	1,600		2,000	
	Height	280	350	415		500	
	Length	1,660	1,800	2,000			
	Rectangular duct flange	Width	250	400	500		700
	Height	150	200	300		400	
Weight unit	kg	125	180	270	280	355	360

1. Winter design condition: Outdoor: -10°C, 90% Indoor: 22°C, 50% | 2. SFPv is a parameter that quantifies the fan efficiency (the lower it is the better will be). This reduces if airflow decreases.
3. Electrical current is based on 230V | 4. All data in the table refer to Modular L Pro. For Modular L Smart can be different. Please refer to Databook or Astra selection software for more details.

Modular T

Top connected heat recovery unit

Highlights

- › 5 Predefined sizes
- › Plug & Play control solution
- › Compact unit from 550 mm width (for unit up to 306 l/s)
- › Wide air flow coverage from 200 to 4,200 m³/h
- › Right and left configuration
- › Pro (open control platform) and Smart (Daikin control platform) version
- › Excellent indoor air quality (IAQ). Up to three filtration stages: more than 90% PM1 in outdoor air are deleted achieving the best IAQ
- › DX and water coil available as option
- › Recirculation mixing damper (option)
- › BIM file available at www.daikin.eu/BIM



Air flow range

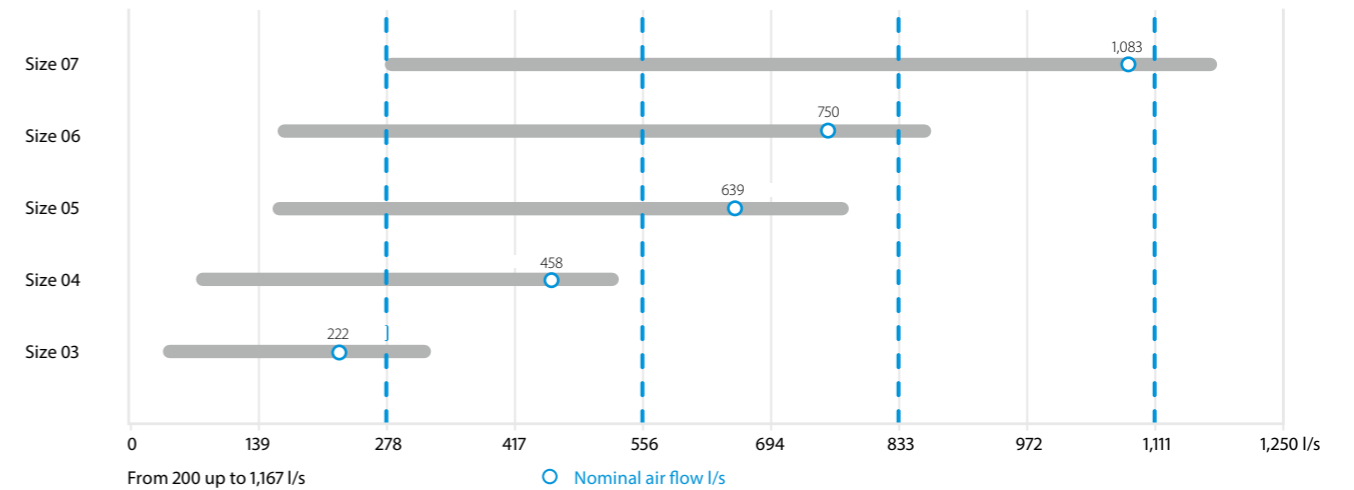

Technical details

Modular T		ATB03*A*	ATB04*A*	ATB05*A*	ATB06*A*	ATB07*A*
Size ¹		03	04	05	06	07
Airflow	l/s	222	458	639	750	1,083
Heat exchanger thermal efficiency ²	%	89.3	88.3	85.1	85.5	90.8
External static pressure	Pa	100				
Current	A	1.70	3.39	4.61	5.17	7.87
Power input	kW	0.39	0.78	1.06	1.19	1.81
SFPv ⁵	kW/m ³ /s	1.47	1.5	1.49	1.41	1.5
Electrical supply	Phase	ph				
	Frequency	Hz				
	Voltage	V				
Main unit dimensions	Width	550	790	790	790	890
	Height	1,600		1,900	1,850	2,050
	Length	1,580	1,650	2,170 ⁴	2,620 ⁵	2,950 ⁵
	Circular duct flange	Diameter	255	315	355	400
Unit sound power level	dBA	57	52	55		58
Unit sound pressure level ⁶	dBA	50	45	48		51
Weight Unit	Kg	200	250	400	500	620

1. All size available in Smart or Pro version and right or left handing | 2. Outdoor condition: -5°C, 90% Indoor condition: 25°C, 50% | 3. Including feet and duct connections | 4. Size 05 is provided in two sections
5. Size 06 and 07 are provided in three sections | 6. Simple source reference value at 1 meter, directivity factor Q=4 (quarter sphere) and non-reverberant field. Allowances on declared values: +/- 3dB

Daikin fresh air package



Plug and play connection of AHU to Daikin VRV and ERQ

The Daikin fresh air package provides a complete solution, including all unit controls (expansion valve, control box and AHU controller) and sensors factory mounted and configured.

Higher efficiency

Daikin heat pumps are renowned for their high energy efficiency. Integrating the AHU with a heat recovery system is even more effective since an office system can frequently be in cooling mode while the outdoor air is too cold to be brought inside in an unconditioned state. In this case heat from the offices is merely transferred to heat up the cold incoming fresh air.

High comfort levels

Daikin ERQ and VRV units respond rapidly to fluctuations in supply air temperature, resulting in a steady indoor temperature and resulting in high comfort levels for the end user. The ultimate is the VRV range which improves comfort even more by offering continuous heating, also during defrost.

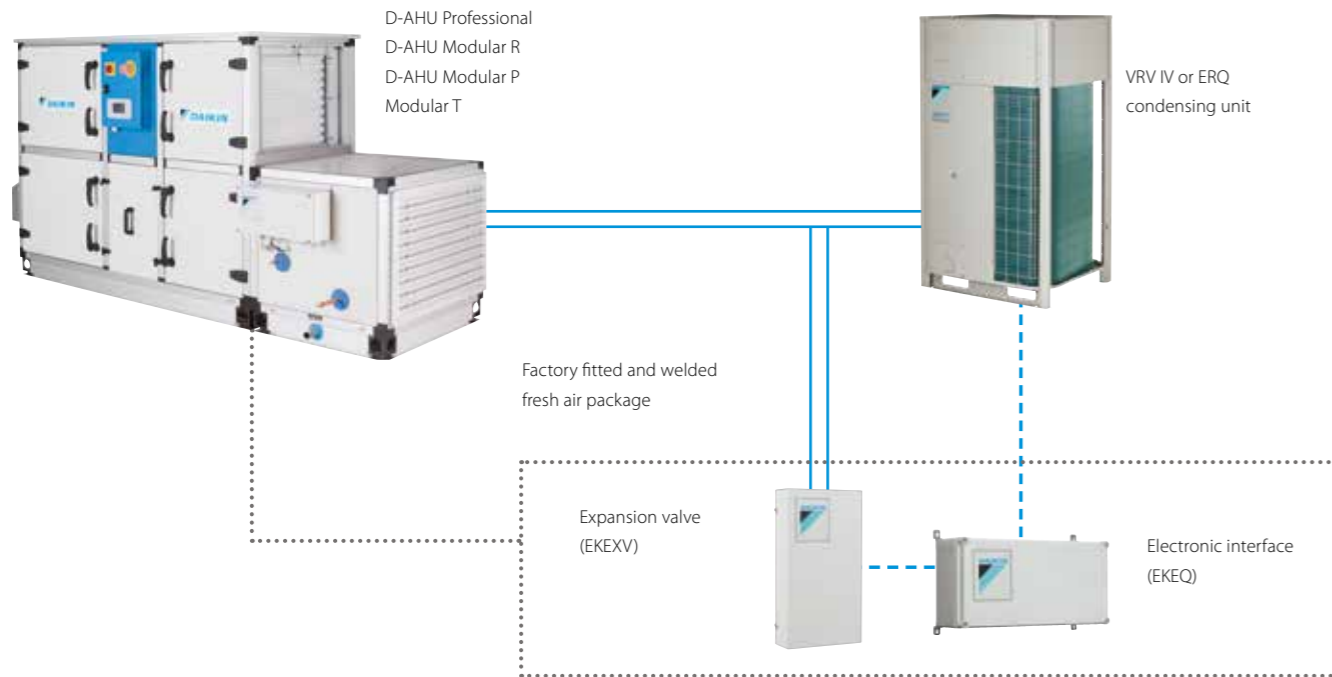

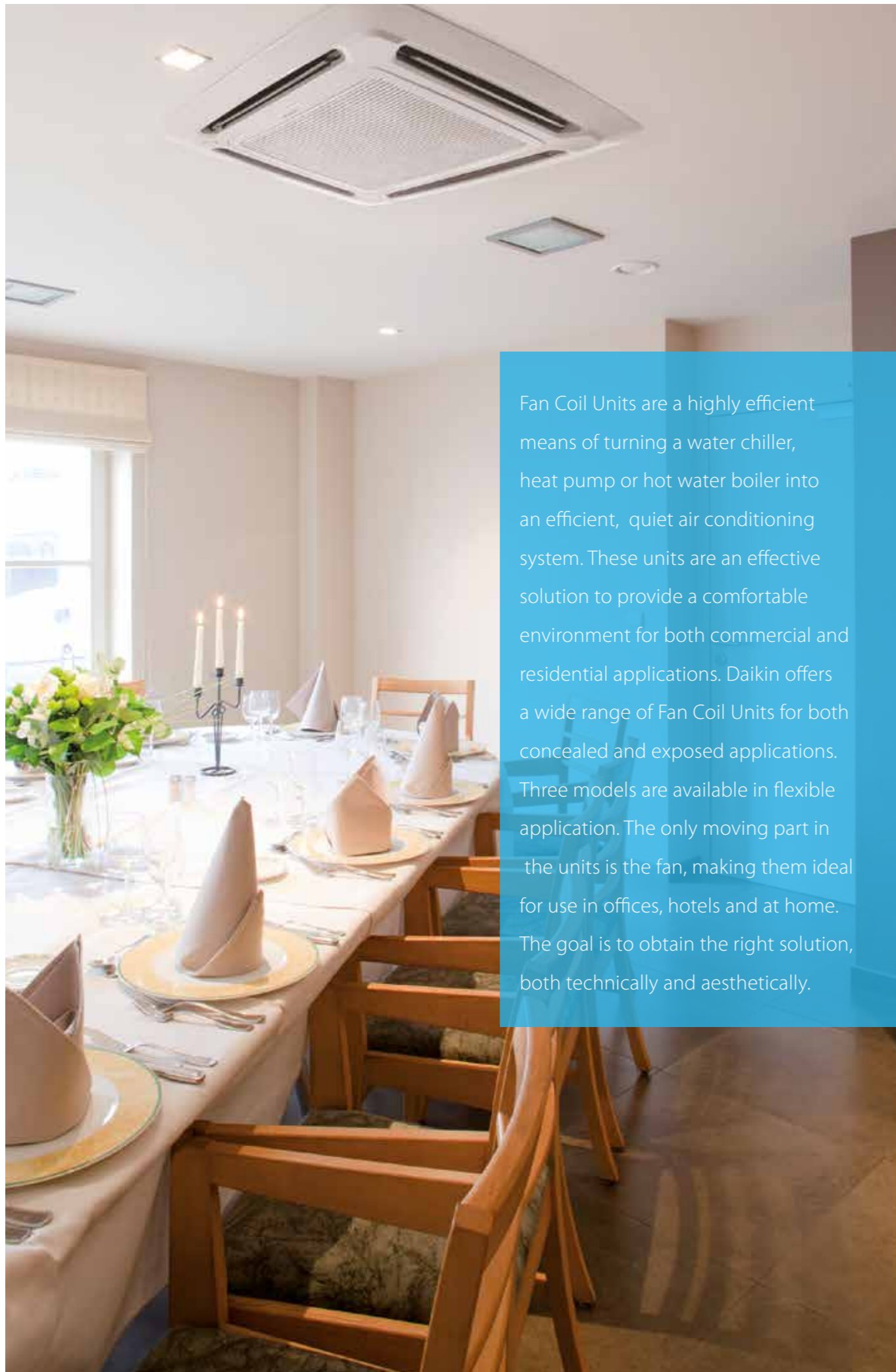

Fan Coil Units are a highly efficient means of turning a water chiller, heat pump or hot water boiler into an efficient, quiet air conditioning system. These units are an effective solution to provide a comfortable environment for both commercial and residential applications. Daikin offers a wide range of Fan Coil Units for both concealed and exposed applications. Three models are available in flexible application. The only moving part in the units is the fan, making them ideal for use in offices, hotels and at home. The goal is to obtain the right solution, both technically and aesthetically.

Table of content

Fan coil units

Why choose Daikin fan coil units?	152
Products overview	156
Round flow cassette	158
FWC-BT/BF	158
4-way blow ceiling mounted cassette	159
FWF-BT/BF	159
Open protocol cassette	160
NEW FWI-AT/AF	160
NEW FWH-AT/AF	161
Floor standing units	162
FWZ-AT/AF	162
FWW-DAT/DAF	163
Flexi type units	164
FWR-AT/AF	164
FWL-DAT/DAF	165
FWS-AT/AF	166
FWM-DAT/DAF	167
FWE-DT/DF	168
Ducted units	169
FWE-CT/CF	low ESP 169
FWP-CT/CF	medium ESP 170
FWB-CT/CF	medium ESP 171
FWN-AT/AF	high ESP 172
FWD-AT/AF	high ESP 173
Wall mounted unit	174
FWT-GT	174
Options & accessories	176



Fan coil units with BLDC motor

As more buildings undergo renovation, the need to be able to deliver high indoor air quality in a specific space in an **efficient and cost-effective way** without having to do a radical re-fit of the entire HVAC system has made fan coil technology an obvious solution.

Daikin has a full capacity range of **aesthetically pleasing** fan coil units with advanced controls that reliably deliver **excellent comfort levels**. And by using a refined range of advanced DC fan motors, we are able to offer flexibility while maintaining very low noise levels.

Why choose Daikin fan coil units?

- The new brushless DC ranges reflect Daikin's commitment to developing highly efficient fan coil units that help to reduce energy consumption, without compromising on reliability and performance.
- High level quality is written large for us and we are pleased to offer high technology solutions to the market.

Benefits for the installer

- › Reduced amount of sizes: less stock space needed
- › Modular designs for multiple configurations
- › Easy integration in BMS system via modbus protocol

Benefits for the consultant

- › Best solution in the market in order to have top efficiency, best comfort and lowest sound levels
- › Product flexibility: wide range of options, accessories and controls

Benefits for the end user

- › High comfort level
- › Up to 70% savings on running costs with a BLDC fan motor
- › Controller with timer programmed operating mode
- › FWECSPA controller that can satisfy all customer requirements in terms of FCU management

New generation web-based fan coil selection software

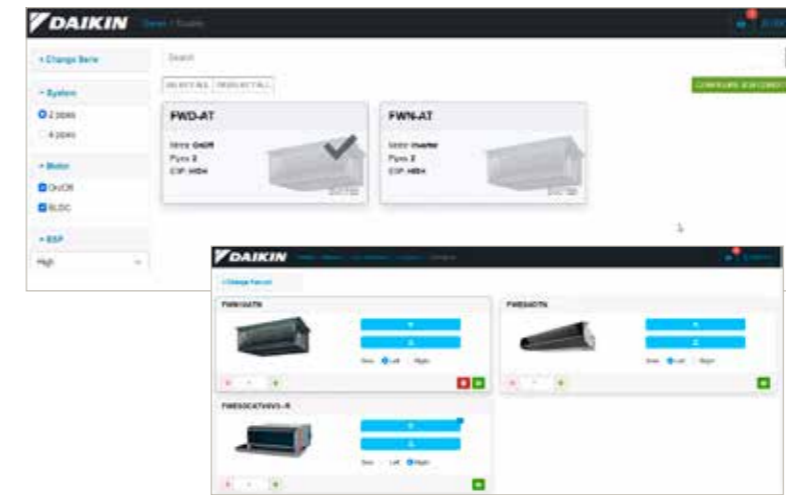

Select your FCU via our new web-based selection software:

- › Selection logic is based on the performance conditions requested and filtered by the user
- › The unit is completely configurable by the user with all the options/accessories available
- › A modular report with certified technical specifications and project summary can be printed

BIM objects

Our Fan Coils units are available as BIM objects in Revit format, which means they can be used in Autodesk REVIT MEP and in AutoCAD 2D files.

Visit our [BIM Application Suite](#) 

BLDC fan motors Video

Learn more on the advantages of BLDC fan motors in Fan coil units:

- Higher efficiency than AC motor**
- High comfort level**
- Low sound levels**
- High flexibility level**



Check on 
www.youtube.com/
DaikinEurope



Expanded FCU Controller Lineup

FWTOUCH
Touch interface



Full capacitive 2.8" colour touchscreen interface to use in combination with the FWECSPA control board

FWEC2T/4T/10
Simplified electronic controller



Wired wall controller available in 3 models: 2 pipe, 4 pipe, BLDC (with automatic speed function)



FWH-A (AC) & FWI-A (BLDC)

New "open protocol" cassette

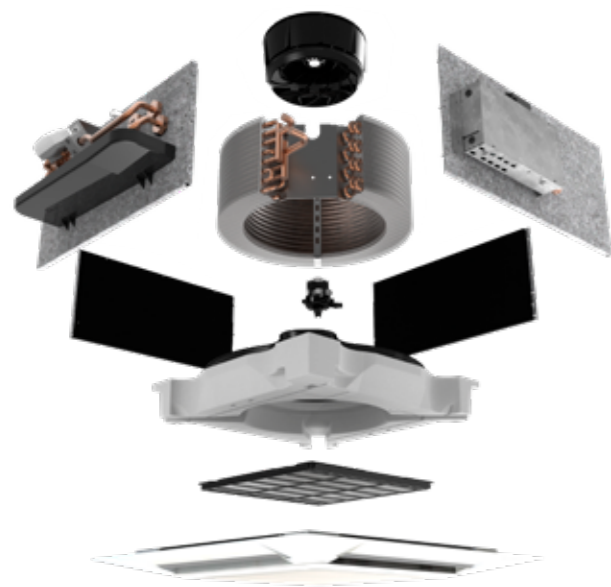

Structure

- > 600x600 (02 up to 04 size)
- > 900x900 (06 up to 08 size)
- > Condensate drainage pump operates up to 0.9m
- > 4-way air discharge with RAL9003 ABS panel

Performance

- > BLDC fan-motor technology
- > Low noise level and optimized comfort
- > up to 5 kW for 600x600 models
- > up to 10 kW for 900x900 models

Control

- > The "Open protocol" feature allows 3rd party BMS integration through the ModBus protocol
- > Can be used in combination with the Daikin "split-controller" and the FWTOUCH interface
- > Compatible with the Daikin wired room controllers

Options



















- > Pressure Independent Control valve kit
- > ON/OFF and proportional valve kit
- > Ready to be combined with spigot for fresh air introduction and air distribution plenum



Coanda effect decoration panel
for FWH/FWI-A cassette



Products overview

Type	Model	Product name	Fan motor type	Capacity	1	15	2	25	3	35	4	5	6	7	8	9	10	11	12	15	16	17	18		
Round flow cassette	Round flow cassette - 900 x 900 cassette - 360° air discharge ensures uniform air flow - Integrated fresh air intake - Easy installation in corners - Standard drain pump with 850 mm lift		FWC-BT/BF		BLDC																				
	4-way blow ceiling mounted cassette - 600 x 600 cassette - Integrated fresh air intake - Horizontal auto swing - Easy installation in corners - Standard drain pump with 750 mm lift		FWF-BT/BF		AC																				
Open protocol cassette	FWI-A - 600 x 600 and 900 x 900 cassette - BLDC motor with low energy consumption up to 75% - 4-way air discharge - Open protocol for control - Condensate drainage pump up to 900 mm lift		FWI-A		BLDC																				
	FWH-A - 600 x 600 and 900 x 900 cassette - ON/OFF 3-speed motor - 4-way air discharge - Open protocol for control - Condensate drainage pump up to 900 mm lift		FWH-A		AC																				
Floor standing units	Floor standing unit - For vertical mounting - Continuous air flow regulation and fan speed modulation - Up to 70% energy savings - Low sound levels		FWZ-AT/AF		BLDC																				
	Floor standing unit - For horizontal or vertical concealed mounting - Insulated valve packages, no extra drain pan required - Fast-on connections for electrical options: no tools needed - Easy maintenance		FWV-DAT/DAF		AC																				
Flexi type units	Flexi type unit - For horizontal or vertical mounting - Continuous air flow regulation and fan speed modulation - Up to 70% energy savings - Low sound levels		FWR-AT/AF		BLDC																				
	Flexi type unit - For horizontal or vertical concealed mounting - Insulated valve packages, no extra drain pan required - Fast-on connections for electrical options: no tools needed - Easy maintenance		FWL-DAT/DAF		AC																				
	Concealed flexi type unit - For horizontal or vertical concealed mounting - Continuous air flow regulation and fan speed modulation - Up to 70% energy savings - Low sound levels		FWS-AT/AF		BLDC																				
	Concealed flexi type unit - For horizontal or vertical concealed mounting - Insulated valve packages, no extra drain pan required - Fast-on connections for electrical options: no tools needed - Easy maintenance		FWM-DAT/DAF		AC																				
	Concealed flexi type - For horizontal or vertical concealed mounting - Available static pressure up to 30 Pa - Easy installation and maintenance - 5/6 speed fan motor - High power air flow		FWE-DT/DF		AC																				
	Ducted unit with low ESP - For horizontal concealed mounting - Available static pressure up to 30 Pa - Easy installation and maintenance - 4-speed fan motor - High power air flow		FWE-CT/CF		AC																				
Ducted units	Ducted unit with medium ESP - For horizontal concealed mounting - Instant adjustment to temperature and relative humidity changes - Available static pressure up to 70 Pa - Low sound levels		FWP-CT/CF		BLDC																				
	Ducted unit with medium ESP - For horizontal concealed mounting - Available static pressure up to 60 Pa - 7-speed electrical motors (thermal protection on windings) - Easy maintenance		FWB-CT/CF		AC																				
	Ducted unit with high ESP - For horizontal or vertical concealed mounting - Available static pressure up to 70 Pa - Easy maintenance		FWN-AT/AF		BLDC																				
	Ducted unit with high ESP - For horizontal or vertical concealed mounting - Available static pressure from 60 up to 145 Pa - Easy maintenance		FWD-AT/AF		AC																				
Wall mounted unit	Wall mounted unit - High aesthetic cabinet design - Optimum air distribution - Easy installation - 3-speed fan motor		FWT-GT		AC																				



Round flow cassette

BLDC fan motor unit for ceiling mounting.
360° air discharge

- › 360° air discharge ensures uniform air flow and temperature distribution
- › Modern style decoration panel in white (RAL9010)
- › Optional fresh air intake
- › Comfortable horizontal air discharge ensures draughtfree operation and prevents ceiling soiling



- › Possibility to shut 1 or 2 flaps for easy installation in corners
- › Standard drain pump with 850mm lift increases flexibility and installation speed

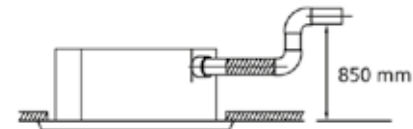

More details and final information can be found by scanning or clicking the QR codes.



FWC-BT



FWC-BF

Indoor unit				FWC-BT/BF		06	07	08	09	06	07	08	09
				2-pipe				4-pipe					
Cooling capacity (standard conditions)	Total capacity	High	kW	5.5	6.1	7.2	8.1	5.9	6.3	7.2	8.3		
		Medium	kW	4.7	5.3	5.9	6.8	5.1	5.6	6.2	6.9		
		Low	kW	3.9	4.5	4.8	5.4	4.3	4.6	4.8	5.7		
	Sensible capacity	High	kW	4.2	4.7	5.7	6.5	4.2	4.6	5.4	6.4		
Medium		kW	3.5	4.0	4.5	5.3	3.6	4.0	4.5	5.2			
Low		kW	2.8	3.3	3.5	4.1	3.1	3.3	3.5	4.0			
Heating capacity (standard conditions)	High	kW	6.8	7.7	9.2	10.6	6.9	7.8	9.2	10.4			
	Medium	kW	5.8	6.6	7.6	8.8	6.1	6.7	7.6	8.7			
	Low	kW	4.8	5.5	5.8	7.0	5.2	5.5	5.8	6.8			
Power input	High	kW	0.045	0.054	0.077	0.107	0.046	0.055	0.077	0.107			
	Medium	kW	0.040	0.046	0.058	0.076	0.041	0.047	0.059	0.077			
	Low	kW	0.034	0.037	0.039	0.045	0.035	0.038	0.040	0.046			
FCEER			116	119	113	104	124	120	112	106			
FCCOP			143	147	141	137	149	144	138	131			
Dimensions	Unit	HeightxWidthxLength	mm	288x840x840									
Weight	Unit		kg	26				29					
Fan	Type			Turbo fan									
	Quantity			1									
Air flow rate	High	m³/h	1,068	1,236	1,518	1,776	1,032	1,200	1,476	1,746			
		Medium	m³/h	894	1,038	1,200	1,410	864	1,002	1,164	1,374		
		Low	m³/h	720	834	888	1,044	708	804	852	1,014		
Total sound power level	High	dBA	43.0	47.0	53.0	57.0	43.0	47.0	53.0	57.0			
	Medium	dBA	36.0	39.0	44.0	49.0	36.0	39.0	44.0	49.0			
	Low	dBA	31.0	33.0	36.0	40.0	33.0	36.0	38.0	40.0			
Sound pressure level	High	dBA	29.0	33.0	39.0	43.0	29.0	33.0	39.0	43.0			
	Medium	dBA	24.0	28.0	32.0	37.0	24.0	28.0	32.0	37.0			
	Low	dBA	21.0	22.0	24.0	28.0	21.0	22.0	24.0	28.0			
Piping connections	Drain	OD	mm	VP25 (External dia.32 / internal dia. 25)									
Power supply	Phase/Frequency/Voltage		Hz/V	1~/50/220-240									
Control systems	Infrared remote control			BRC7E532F / BRC7E533F									
	Wired remote control			BRC315D7									

For standard conditions refer to Measuring Conditions table, at the end of this catalogue

4-way blow ceiling mounted cassette

AC fan motor unit for ceiling mounting.
Possibility to shut 1 or 2 flaps

- › Modern style decoration panel in white (RAL9010)
- › Compact casing (570mm in width and Length) enables unit to fit flush into ceilings and match standard architectural modules, without cutting ceiling tiles
- › Comfortable horizontal auto swing ensures draughtfree operation and prevents ceiling soiling
- › Optional fresh air intake
- › Possibility to shut 1 or 2 flaps for easy installation in corners
- › Standard drain pump with 750mm lift increases flexibility and installation speed

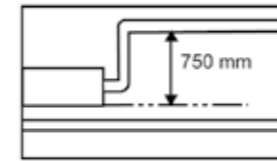

More details and final information can be found by scanning or clicking the QR codes.



FWF-BT



FWF-BF

Indoor unit				FWF-BT/BF		02	03	04	05	02	03	04	05
				2-pipe				4-pipe					
Cooling capacity (standard conditions)	Total capacity	High	kW	1.7	3.0	4.0	4.9	1.8	2.9	3.8	4.6		
		Medium	kW	1.5	2.7	3.1	4.0	1.5	2.4	3.1	3.8		
		Low	kW	1.3	2.4	2.8	3.5	1.3	2.1	2.8	3.5		
	Sensible capacity	High	kW	1.4	2.0	2.7	3.5	1.5	1.8	2.5	3.2		
Medium		kW	1.2	1.7	2.0	2.7	1.2	1.5	1.9	2.5			
Low		kW	1.0	1.4	1.8	2.4	1.0	1.3	1.7	2.3			
Heating capacity (standard conditions)	High	kW	2.4	3.3	4.5	5.6	3.3	3.6	4.7	5.7			
	Medium	kW	2.1	2.9	3.5	4.4	2.9	3.1	3.7	4.7			
	Low	kW	1.9	2.7	3.0	3.8	2.4	2.6	3.2	4.0			
Power input	High	kW	0.074	0.090	0.118	0.148	0.074	0.094	0.121				
	Medium	kW	0.067	0.070	0.089	0.107	0.067	0.074	0.093				
	Low	kW	0.060	0.055	0.062	0.060	0.055	0.062	0.066				
FCEER			22	40	44	45	22	33	34	40			
FCCOP			32	45	49	41	48	49					
Dimensions	Unit	HeightxWidthxLength	mm	285x575x575									
Weight	Unit		kg	19				20					
Fan	Type			Turbo fan									
	Quantity			1									
Air flow rate	High	m³/h	456	468	660	876	468	438	618	822			
		Medium	m³/h	384	390	486	648	390	366	456	612		
		Low	m³/h	300	318	420	504	318	300	390	504		
Total sound power level	High	dBA	44.0	44.0	50.0	55.0	44.0	46.0	52.0	57.0			
	Medium	dBA	40.0	40.0	44.0	49.0	40.0	42.0	46.0	51.0			
	Low	dBA	36.0	38.0	42.0	46.0	36.0	38.0	41.0	44.0			
Sound pressure level	High	dBA	31.0	31.0	39.0	45.0	31.0	33.0	42.0	47.0			
	Medium	dBA	27.0	27.0	33.0	39.0	27.0	29.0	35.0	41.0			
	Low	dBA	26.0	26.0	30.0	36.0	26.0	27.0	32.0	38.0			
Piping connections	Drain	OD	mm	VP20 (External dia.26 / Internal dia. 20)									
Power supply	Phase/Frequency/Voltage		Hz/V	1~/50/220-440									
Control systems	Infrared remote control			BRC7E530 / BRC7E531									
	Wired remote control			BRC315D7									

For standard conditions refer to the Measuring Conditions table, at the end of this catalogue

Open Protocol BLDC Cassette

BLDC fan motor for a precise control of operation
4-way air discharge

- › Two dimensional frames (600x600mm and 900x900mm)
- › Modern style ABS air intake diffusion grille
- › Low operating sound level
- › Up to 70% energy savings with brushless DC motor technology compared to traditional technology
- › Condensate drainage pump up to 900mm lift
- › Available with mounted control board or in naked version to be combinable with any controller
- › Reduced installation and commissioning time with the availability of 2-way or 3-way valves, with ON-OFF or modulating actuator, and also pressure-independent control valves



Indoor unit		FWI-AT/FWI-AF		02	03	04	06	07	08	02	04	06	08		
		2-pipe						4-pipe							
Cooling capacity (standard conditions)	Total capacity	High	kW	2.63	4.39	5.23	6.39	9.04	10.5	2.6	3.61	6.61	9.5		
		Medium	kW	2.24	3.4	3.95	5.36	7.26	8.37	2.18	2.8	5.34	7.62		
		Low	kW	1.93	2.68	2.76	4.8	5.92	6.7	1.85	2.05	4.61	6.09		
	Sensible capacity	High	kW	2.2	3.41	4.11	4.75	6.78	7.97	2.23	3.31	5.03	7.56		
		Medium	kW	1.81	2.54	2.96	3.92	5.31	6.15	1.79	2.38	3.94	5.82		
		Low	kW	1.51	1.94	1.98	3.8	4.24	4.8	1.46	1.62	3.34	4.5		
Heating capacity (standard conditions)	High	kW	3.25	4.58	5.55	7.30	10.20	12.20	3.86	4.98	9.53	12.90			
	Medium	kW	2.70	3.48	4.09	6.00	7.99	9.35	3.34	4.06	7.96	10.80			
	Low	kW	2.27	2.69	2.77	5.50	6.33	7.23	2.90	3.14	7.01	8.96			
Power input	High	kW	0.018	0.037	0.067	0.036	0.067	0.15	0.018	0.067	0.036	0.15			
	Medium	kW	0.01	0.015	0.022	0.018	0.036	0.06	0.01	0.022	0.018	0.06			
	Low	kW	0.007	0.009	0.009	0.013	0.018	0.025	0.007	0.009	0.014	0.025			
Dimensions	Unit	Height	mm	298				350				298		350	
		Width	mm	577				793				577		793	
		Depth	mm	577				793				577		793	
Weight	Unit	kg	23				43				23		43		
Casing	Material		Galvanised steel												
Decoration panel	Dimensions	Height	mm	41				75				41		75	
		Width	mm	730				860				730		860	
		Depth	mm	730				860				730		860	
		Weight	kg	2.5				5				2.5		5	
		Air Filter	Type		Honeycomb polypropylene										
Fan	Type		Backward Centrifugal												
	Quantity		1												
	Air flow rate	High	m³/h	583	796	980	1,276	1,554	1,831	610	982	1,137	1,823		
Total sound power level	High	dBA	46	54	61	45	53	58	46	61	45	58			
	Medium	dBA	40	44	49	39	45	50	40	49	39	50			
	Low	dBA	35	37	38	35	39	43	35	38	35	43			
Sound pressure level	High	dBA	38	46	61	37	45	50	46	61	45	58			
	Medium	dBA	33	36	49	31	37	42	40	49	39	50			
	Low	dBA	27	29	38	27	31	35	38	35	43				
Water flow	Cooling	High	l/h	452	754	898	1,097	1,545	1,805	447	620	1,135	1,631		
		Medium	l/h	385	584	687	921	1,245	1,436	374	480	917	1,307		
		Low	l/h	331	460	473	833	1,015	1,150	317	352	792	1,045		
	Heating	High	l/h	565	797	965	1,269	1,779	2,116	338	435	834	1,133		
		Medium	l/h	470	605	711	1,043	1,390	1,625	292	356	697	947		
		Low	l/h	395	468	481	953	1,100	1,257	254	275	613	785		
Allowed water temperature	Cooling	Min	°C	5											
	Heating	Max	°C	70											
Piping connections	Water	Inlet		1/2"				3/4"				1/2"		3/4"	
		Outlet		1/2"				3/4"				1/2"		3/4"	
	Drain	OD	mm	10											
Power supply	Phase/Frequency/Voltage	Hz/V	1~/50/230												
Maximum absorbed current	A		0.64				1.20				0.64		1.20		
Control systems	Wired remote control		FWEC3A / FWEC3A / FWTOUCH / FWEC10												

For standard conditions refer to the Measuring Conditions table, at the end of this catalogue

Open Protocol BLDC Cassette

AC fan motor unit for ceiling mounting
4-way air discharge

- › Two dimensional frames (600x600mm and 900x900mm)
- › Modern style ABS air intake diffusion grille
- › Reliability and sturdiness in a compact design
- › Condensate drainage pump up to 900mm lift
- › Available with mounted control board or in naked version to be combinable with any controller
- › Reduced installation and commissioning time with the availability of 2-way or 3-way valves with ON-OFF or modulating actuator



Indoor unit		FWH-AT/FWH-AF		02	03	04	06	07	08	02	03	04	06	08				
		2-pipe						4-pipe										
Cooling capacity (standard conditions)	Total capacity	High	kW	2.53	4.31	5	7.01	8.24	9.73	2.35	3.38	3.62	7.45	9				
		Medium	kW	1.97	3.55	4.61	5.36	6.11	8.61	1.85	2.83	3.38	6.6	8.48				
		Low	kW	1.7	2.39	3.4	4.64	5.16	6.34	1.56	2.01	2.58	4.73	5.83				
	Sensible capacity	High	kW	2.14	3.18	3.79	5.29	6.1	7.35	1.94	3.38	3.02	5.81	6.98				
		Medium	kW	1.6	2.53	3.44	3.99	4.37	6.4	1.49	2.22	2.77	5.04	6.56				
		Low	kW	1.33	1.66	2.43	3.42	3.68	4.59	1.24	1.49	2	3.47	4.29				
Heating capacity (standard conditions)	High	kW	3.1	4.3	5.35	8.17	9.18	11.1	3.55	4.22	4.81	10.6	12.4					
	Medium	kW	2.33	3.44	4.92	6.06	6.53	9.53	2.88	3.62	4.54	9.6	11.7					
	Low	kW	1.97	2.29	3.49	5.16	5.22	6.71	2.53	2.75	3.67	7.20	8.64					
Power input	High	kW	0.04	0.05	0.09	0.11		0.15	0.04	0.05	0.09	0.11	0.15					
	Medium	kW	0.02	0.04	0.07	0.06		0.11	0.02	0.04	0.07	0.06	0.11					
	Low	kW	0.02	0.03	0.06	0.05		0.06	0.02	0.03	0.06	0.05	0.06					
Dimensions	Unit	Height	mm	298				350				298		350				
		Width	mm	577				793				577		793				
		Depth	mm	577				793				577		793				
Weight	Unit	kg	23				43				23		43					
Casing	Material		Galvanised steel															
Decoration panel	Dimensions	Height	mm	41				75				41		75				
		Width	mm	730				860				730		860				
		Depth	mm	730				860				730		860				
		Weight	kg	2.5				5				2.5		5				
		Air Filter	Type		Honeycomb polypropylene													
Fan	Type		Backward Centrifugal															
	Quantity		1															
	Air flow rate	High	m³/h	557	640	805	1,494	1,380	1,651	533	640	805	1,380	1,651				
Total sound power level	High	dBA	45	50	58	51		56	45	50	58	51	56					
	Medium	dBA	37	44	55	40		51	37	44	55	40	51					
	Low	dBA	33	40	47	35		40	33	40	47	35	40					
Sound pressure level	High	dBA	37	42	50	43		48	37	42	50	43	48					
	Medium	dBA	29	36	47	32		43	29	36	47	32	43					
	Low	dBA	25	32	39	27		32	25	32	39	27	32					
Water flow	Cooling	High	l/h	441	749	873	1,223	1,434	1,696	410	589	637	1,299	1,571				
		Medium	l/h	342	616	803	930	1,060	1,498	321	493	593	1,148	1,477				
		Low	l/h	295	416	593	805	893	1,097	271	351	453	822	1,010				
	Heating	High	l/h	539	747	930	1,420	1,596	1,930	311	369	421	929	1,083				
		Medium	l/h	404	597	855	1,053	1,136	1,656	258	317	398	840	1,026				
		Low	l/h	342	399	607	897	908	1,167	222	241	322	634	757				
Allowed water temperature	Cooling	Min	°C	5														
	Heating	Max	°C	70														
Piping connections	Water	Inlet		1/2"				3/4"				1/2"		3/4"				
		Outlet		1/2"				3/4"				1/2"		3/4"				
	Drain	OD	mm	10														
Power supply	Phase/Frequency/Voltage	Hz/V	1~/50/230															
Maximum absorbed current	A		0.2				0.4				0.7		0.2		0.4		0.7	
Control systems	Wired remote control		FWEC1A / FWEC2A / FWEC3A / FWEC3A / FWTOUCH / FWTOUCH / FWEC2T / FWEC4T															

For standard conditions refer to the Measuring Conditions table, at the end of this catalogue

Floor standing unit

BLDC fan motor unit for vertical mounting. Continuous air flow regulation and fan speed modulation

- › Up to 70% energy savings with brushless DC motor technology compared to traditional technology
- › Instant adjustment to temperature and relative humidity changes
- › Low operating sound level
- › Highly flexible solutions: multiple sizes, piping topologies and connection valves
- › Requires very little installation space



More details and final information can be found by scanning or clicking the QR codes.



Indoor unit		FWZ-AT/AF		02		03		06		08		
				2-pipe				4-pipe				
Cooling capacity (standard conditions)	Total capacity	High	kW	1.94	2.91	4.48	7.93	1.77	2.86	4.64	7.79	
		Medium	kW	1.69	2.37	3.64	6.2	1.55	2.32	3.79	6.12	
		Low	kW	1.35	1.75	2.99	4.1	1.25	1.72	3.10	4.06	
	Sensible capacity	High	kW	1.49	2.09	3.62	5.87	1.44	2.06	3.54	5.76	
	Medium	kW	1.30	1.69	2.90	4.59	1.21	1.65	2.85	4.54		
	Low	kW	1.04	1.25	2.31	3.04	0.97	1.23	2.27	3.01		
Heating capacity (standard conditions)	High	kW	2.15	2.94	4.88	8.37	1.76	2.68	4.64	7.35		
	Medium	kW	1.81	2.37	4.11	6.53	1.56	2.31	4.07	6.29		
	Low	kW	1.50	1.76	3.36	4.39	1.36	1.88	3.55	4.85		
Power input	High	kW	0.019	0.016	0.033	0.087	0.019	0.016	0.033	0.087		
	Medium	kW	0.01		0.02	0.038	0.01		0.02	0.038		
	Low	kW	0.01		0.013		0.01		0.013			
FCEER			B	A				B	A			
FCCOP			B	A				B	A			
Dimensions	Unit	HeightxWidthxLength	mm	564x774x226	564x984x226	564x1,190x226	564x1,404x251	564x774x226	564x984x226	564x1,190x226	564x1,404x251	
Weight	Unit		kg	20.6	26.7	32.3	41.6	20.6	26.7	32.3	41.6	
Casing	Colour			White - RAL9010								
Air filter	Type			Polypropylene net								
Fan	Type			Centrifugal								
	Quantity			1		2		1		2		
Air flow rate	High	m³/h	344	442	785	1,393	327	431	763	1,362		
	Medium	m³/h	271	341	605	1,022	261	332	593	1,007		
	Low	m³/h	211	241	470	642	205	237	460	636		
Total sound power level	High	dBA	50.0	48.0	56.0	67.0	50.0	47.0	58.0	66.0		
	Medium	dBA	44.0	42.0	49.0	60.0	44.0	41.0	53.0	58.0		
	Low	dBA	40.0	36.0	43.0	49.0	38.0	33.0	48.0			
Sound pressure level	High	dBA	45.0	43.0	51.0	62.0	45.0	42.0	54.0	61.0		
	Medium	dBA	39.0	37.0	44.0	55.0	39.0	36.0	48.0	53.0		
	Low	dBA	35.0	31.0	38.0	44.0	33.0	28.0	43.0			
Electric heater	Power input (Optional)	kW	1.5	1.6	2.0	-	1.5	1.6	2.0	-		
Piping connections	Drain OD	mm	16									
Power supply	Phase/Frequency/Voltage	Hz/V	1~/50/230									
Control systems	Wired remote control		FWEC3A / FWEC3A / FWTOUCH / FWEC10									

For standard conditions refer to the Measuring Conditions table, at the end of this catalogue

Floor standing unit

AC fan motor unit for vertical mounting

- › Quick fixing system for wall mounted installation
- › Pre-assembled 3-way/4-port on/off valves are available
- › Valve packages are insulated, no extra drain pan required
- › Valve packages contain balancing valves and sensor pocket
- › Fast-on connections for electrical options: no tools needed
- › The air filter can easily be removed for cleaning
- › Electric heater: no relay up to 2kW capacity
- › Electric heater: equipped with two overheat cut-out thermostats



More details and final information can be found by scanning or clicking the QR codes.



Indoor unit		FWV-DAT/DAF		01		15		02		25		03		35		04		06		08		10		01		15		02		25		03		35		04		06		08		10	
				2-pipe										4-pipe																													
Cooling capacity (standard conditions)	Total capacity	High	kW	1.50	1.69	1.91	2.36	2.87	3.45	4.23	4.41	6.53	7.78	1.42	1.64	1.74	2.32	2.81	3.36	4.16	4.57	6.46	7.64																				
		Medium	kW	1.21	1.48	1.66	1.99	2.34	2.58	3.21	3.59	5.14	6.07	1.11	1.44	1.52	1.96	2.29	2.54	3.17	3.74	5.10	5.99																				
		Low	kW	1.02	1.24	1.34	1.57	1.73	1.94	2.47	2.95	3.88	4.00	0.97	1.22	1.24	1.55	1.70	1.92	2.44	3.06	3.84	3.96																				
	Sensible capacity	High	kW	1.16	1.25	1.37	1.82	2.05	2.69	3.05	3.55	4.73	5.72	1.10	1.22	1.41	1.79	2.01	2.61	2.99	3.47	4.67	5.61																				
	Medium	kW	0.94	1.10	1.20	1.53	1.66	1.99	2.39	2.85	3.70	4.46	0.87	1.07	1.18	1.50	1.62	1.96	2.36	2.80	3.67	4.40																					
	Low	kW	0.77	0.93	0.98	1.15	1.23	1.41	1.76	2.27	2.75	2.94	0.73	0.91	0.96	1.14	1.21	1.40	1.74	2.23	2.73	2.91																					
Heating capacity (standard conditions)	High	kW	1.82	1.84	2.15	2.70	2.94	4.05	4.24	4.98	6.49	8.37	1.66	1.76	2.53	2.68	4.20	3.82	4.64	6.97	7.35																						
	Medium	kW	1.48	1.72	1.81	2.26	2.37	3.13	3.24	4.08	5.17	6.53	1.49	1.56	2.18	2.31	3.47	3.22	4.07	6.02	6.29																						
	Low	kW	1.21	1.45	1.50	1.74	1.76	2.39	2.47	3.31	3.97	4.39	1.31	1.36	1.78	1.88	2.82	2.73	3.55	5.02	4.85																						
Power input	High	kW	0.037	0.053	0.057	0.056	0.065	0.098	0.182	0.244	0.037	0.053	0.057	0.056	0.065	0.098	0.182	0.244																									
	Medium	kW	0.03	0.04		0.05	0.06	0.07	0.13	0.17	0.03	0.04		0.05	0.06	0.07	0.13	0.17																									
	Low	kW	0.02	0.03	0.02	0.03	0.04	0.05	0.09	0.11	0.02	0.03	0.02	0.03	0.04	0.05	0.09	0.11																									
Dimensions	Unit	HeightxWidthxLength	mm	564x774x226	564x984x226	564x1,190x226	564x1,400x251	564x774x226	564x984x226	564x1,190x226	564x1,400x251																																
Weight	Unit		kg	19.7	20.6	25.5	26.7	31.0	30.4	32.3	41.4	41.6	19.7	20.6	25.5	26.7	31.0	30.4	32.3	41.4	41.6																						
Casing	Colour			White - RAL9010																																							
Air filter	Type			Polypropylene net																																							
Fan	Type			Centrifugal																																							
	Quantity			1		2		1		2																																	
Air flow rate	High	m³/h	319	344	442	640	706	785	1,011	1,393	307	330	327	432	431	628	690	763	998	1,362																							
	Medium	m³/h	233	271	341	450	497	605	771	1,022	225	261	334	332	444	490	593	765	1,007																								
	Low	m³/h	178	211	241	320	361	470	570	642	174	205	238	237	316	356	460	565	636																								
Total sound power level	High	dBA	47.0	49.0	50.0	48.0	52.0	53.0	56.0	61.0	67.0	45.0	49.0	50.0	48.0	47.0	53.0	56.0	58.0	60.0	66.0																						
	Medium	dBA	42.0	44.0	43.0	42.0	43.0	49.0	54.0	60.0	39.0	44.0	43.0	41.0	45.0	46.0	53.0	54.0	58.0																								
	Low	dBA	37.0	38.0	40.0	35.0	36.0	35.0	43.0	47.0	49.0	33.0	40.0	38.0	34.0	33.0	36.0	39.0	48.0	46.0	48.0																						
Sound pressure level	High	dBA	42.0	44.0	45.0	43.0	47.0	48.0	51.0	56.0	62.0	40.0	44.0	45.0	43.0	42.0	46.0	51.0	54.0	55.0	61.0																						
	Medium	dBA	37.0	39.0	38.0	37.0	38.0	44.0	49.0	55.0	34.0	39.0	38.0	36.0	38.0	41.0	48.0	49.0	53.0																								
	Low	dBA	32.0	33.0	35.0	30.0	31.0	30.0	38.0	42.0	44.0	28.0	33.0	29.0	28.0	29.0	32.0	43.0	41.0	43.0																							
Electric heater	Power input (Optional)	kW	1.0	1.5	1.6	2.0	3.0	1.0	1.5	1.6	2.0	3.0																															
Piping connections	Drain OD	mm	16																																								
Power supply	Phase/Frequency/Voltage	Hz/V	1~/50/230																																								
Control systems	Wired remote control		FWEC1A / FWEC2A / FWEC3A / FWEC3A / ECFWMB6 / FWTOUCH / FWEC2T / FWEC4T																																								

For standard conditions refer to the Measuring Conditions table, at the end of this catalogue

Flexi type unit

BLDC fan motor unit for horizontal or vertical mounting.
Continuous air flow regulation and fan speed modulation

- › For wall or ceiling mounted installation: ideal solution for spaces with no false ceilings
- › Up to 70% energy savings with brushless DC motor technology compared to traditional technology
- › Instant adjustment to temperature and relative humidity changes
- › Low operating sound level
- › Highly flexible solutions: multiple sizes, piping topologies and connection valves
- › Requires very little installation space



More details and final information can be found by scanning or clicking the QR codes.



Indoor unit		FWR-AT/AF		2-pipe				4-pipe			
		02	03	06	08	02	03	06	08		
Cooling capacity (standard conditions)	Total capacity	High	1.94	2.91	4.48	7.93	1.77	2.86	4.64	7.79	
		Medium	1.69	2.37	3.64	6.20	1.55	2.32	3.79	6.12	
		Low	1.35	1.75	2.99	4.10	1.25	1.72	3.10	4.06	
	Sensible capacity	High	1.49	2.09	3.62	5.87	1.44	2.06	3.54	5.76	
	Medium	1.30	1.69	2.90	4.59	1.21	1.65	2.85	4.54		
	Low	1.04	1.25	2.31	3.04	0.97	1.23	2.27	3.01		
Heating capacity (standard conditions)	High	2.15	2.94	4.88	8.37	1.76	2.68	4.64	7.35		
	Medium	1.81	2.37	4.11	6.53	1.56	2.31	4.07	6.29		
	Low	1.50	1.76	3.36	4.39	1.36	1.88	3.55	4.85		
Power input	High	0.019	0.016	0.033	0.087	0.019	0.016	0.033	0.087		
	Medium	0.01		0.02	0.038	0.01		0.02	0.038		
	Low	0.01		0.013		0.01		0.013			
FCEER		B	A				B	A			
FCCOP		B	A				B	A			
Dimensions	Unit	HeightxWidthxLength	mm	564x774x246	564x984x246	564x1,190x246	564x1,404x271	564x774x246	564x984x246	564x1,190x246	564x1,404x271
Weight	Unit	kg	21.2	27.5	33.6	43.1	21.2	27.5	33.6	43.1	
Casing	Colour		White - RAL9010								
Air filter	Type		Polypropylene net								
Fan	Type		Centrifugal								
	Quantity		1				2				
Air flow rate	High	m³/h	344	442	785	1,393	327	431	763	1,362	
	Medium	m³/h	271	341	605	1,022	261	332	593	1,007	
	Low	m³/h	211	241	470	642	205	237	460	636	
Total sound power level	High	dBA	50.0	48.0	56.0	67.0	50.0	47.0	58.0	66.0	
	Medium	dBA	44.0	42.0	49.0	60.0	44.0	41.0	53.0	58.0	
	Low	dBA	40.0	36.0	43.0	49.0	38.0	33.0	48.0		
Sound pressure level	High	dBA	45.0	43.0	51.0	62.0	45.0	42.0	54.0	61.0	
	Medium	dBA	39.0	37.0	44.0	55.0	39.0	36.0	48.0	53.0	
	Low	dBA	35.0	31.0	38.0	44.0	33.0	28.0	43.0		
Electric heater	Power input (Optional)	kW	1.5	1.6	2.0	-	1.5	1.6	2.0	-	
Piping connections	Drain OD	mm	16								
Power supply	Phase/Frequency/Voltage	Hz/V	1~/50/230								
Control systems	Wired remote control		FWEC3A / FWECSA / FWTOUCH / FWEC10								

For standard conditions refer to the Measuring Conditions table, at the end of this catalogue

Flexi type unit

AC fan motor unit for horizontal or vertical mounting

- › Quick fixing system for wall or ceiling mounted installation
- › Pre-assembled 3-way/4-port on/off valves are available
- › Valve packages are insulated, no extra drain pan required
- › Valve packages contain balancing valves and sensor pocket
- › Fast-on connections for electrical options: no tools needed
- › The air filter can easily be removed for cleaning
- › Electric heater: no relay up to 2kW capacity
- › Electric heater: equipped with two overheat cut-out thermostats



More details and final information can be found by scanning or clicking the QR codes.



Indoor unit		FWL-DAT/DAF		2-pipe										4-pipe									
		01	15	02	25	03	35	04	06	08	10	01	15	02	25	03	35	04	06	08	10		
Cooling capacity (standard conditions)	Total capacity	High	1.50	1.69	1.91	2.36	2.87	3.45	4.23	4.41	6.53	7.78	1.42	1.64	1.74	2.32	2.81	3.36	4.16	4.57	6.46	7.64	
		Medium	1.21	1.48	1.66	1.99	2.34	2.58	3.21	3.59	5.14	6.07	1.11	1.44	1.52	1.96	2.29	2.54	3.17	3.74	5.10	5.99	
		Low	1.02	1.24	1.34	1.57	1.73	1.94	2.47	2.95	3.88	4.00	0.97	1.22	1.24	1.55	1.70	1.92	2.44	3.06	3.84	3.96	
	Sensible capacity	High	1.16	1.25	1.37	1.82	2.05	2.69	3.05	3.55	4.73	5.72	1.10	1.22	1.41	1.79	2.01	2.61	2.99	3.47	4.67	5.61	
	Medium	0.94	1.10	1.20	1.53	1.66	1.99	2.39	2.85	3.70	4.46	0.87	1.07	1.18	1.50	1.62	1.96	2.36	2.80	3.67	4.40		
	Low	0.77	0.93	0.98	1.15	1.23	1.41	1.76	2.27	2.75	2.94	0.73	0.91	0.96	1.14	1.21	1.40	1.74	2.23	2.73	2.91		
Heating capacity (standard conditions)	High	1.82	1.84	2.15	2.70	2.94	4.05	4.24	4.98	6.49	8.37	1.66	1.76	2.53	2.68	4.20	3.82	4.64	6.97	7.35			
	Medium	1.48	1.72	1.81	2.26	2.37	3.13	3.24	4.08	5.17	6.53	1.49	1.56	2.18	2.31	3.47	3.22	4.07	6.02	6.29			
	Low	1.21	1.45	1.50	1.74	1.76	2.39	2.47	3.31	3.97	4.39	1.31	1.36	1.78	1.88	2.82	2.73	3.55	5.02	4.85			
Power input	High	0.037	0.053	0.057	0.056	0.065	0.098	0.182	0.244	0.037	0.053	0.057	0.056	0.065	0.098	0.182	0.244	0.037	0.053	0.057	0.056		
	Medium	0.03	0.04		0.05	0.06	0.07	0.13	0.17	0.03	0.04		0.05	0.06	0.07	0.13	0.17	0.03					
	Low	0.02	0.03	0.02	0.03	0.04	0.05	0.09	0.11	0.02	0.03	0.02	0.03	0.04	0.05	0.09	0.11	0.02	0.03	0.04	0.05		
Dimensions	Unit	HeightxWidthxLength	mm	564x774x246	564x984x246	564x1,190x246	564x1,400x271	564x774x246	564x984x246	564x1,190x246	564x1,400x271	564x774x246	564x984x246	564x1,190x246	564x1,400x271								
Weight	Unit	kg	20.6	21.2	26.5	27.5	32.5	33.5	33.6	43.1	20.6	21.2	26.5	27.5	32.5	33.5	33.6	43.1					
Casing	Colour		White - RAL9010																				
Air filter	Type		Polypropylene net																				
Fan	Type		Centrifugal																				
	Quantity		1					2					1					2					
Air flow rate	High	m³/h	319	344	442	640	706	785	1,011	1,393	307	330	327	432	431	628	690	763	998	1,362			
	Medium	m³/h	233	271	341	450	497	605	771	1,022	225	261	334	332	444	490	593	765	1,007				
	Low	m³/h	178	211	241	320	361	470	570	642	174	205	238	237	316	356	460	565	636				
Total sound power level	High	dBA	47.0	49.0	50.0	48.0	52.0	53.0	56.0	61.0	67.0	45.0	49.0	50.0	48.0	47.0	53.0	56.0	58.0	60.0	66.0		
	Medium	dBA	42.0	44.0	43.0	43.0	42.0	43.0	49.0	54.0	60.0	39.0	44.0	43.0	41.0	45.0	46.0	53.0	54.0	58.0			
	Low	dBA	37.0	38.0	40.0	35.0	36.0	35.0	43.0	47.0	49.0	33.0	40.0	38.0	34.0	33.0	36.0	39.0	48.0	46.0	48.0		
Sound pressure level	High	dBA	42.0	44.0	45.0	43.0	47.0	48.0	51.0	56.0	62.0	40.0	44.0	45.0	43.0	42.0	46.0	51.0	54.0	55.0	61.0		
	Medium	dBA	37.0	39.0	38.0	37.0	38.0	37.0	38.0	44.0	49.0	55.0	34.0	39.0	38.0	36.0	38.0	41.0	48.0	49.0	53.0		
	Low	dBA	32.0	33.0	35.0	30.0	31.0	30.0	38.0	42.0	44.0	28.0	33.0	29.0	28.0	29.0	32.0	43.0	41.0	43.0			
Electric heater	Power input (Optional)	kW	1.0	1.5	1.6	2.0	3.0	1.0	1.5	1.6	2.0	3.0											
Piping connections	Drain OD	mm	16																				
Power supply	Phase/Frequency/Voltage	Hz/V	1~/50/230																				
Control systems	Wired remote control		FWEC1A / FWEC2A / FWEC3A / FWECSA / ECFWMB6 / FWTOUCH / FWEC2T / FWEC4T																				

For standard conditions refer to the Measuring Conditions table, at the end of this catalogue

Concealed flexi type unit

BLDC fan motor unit for horizontal or vertical concealed mounting. Continuous air flow regulation and fan speed modulation

- › Blends unobtrusively with any interior décor: only the suction and discharge grilles are visible
- › Up to 70% energy savings with brushless DC motor technology compared to traditional technology
- › Instant adjustment to temperature and relative humidity changes
- › Low operating sound level
- › Highly flexible solutions: multiple sizes, piping topologies and connection valves
- › Available static pressure up to 50Pa at maximum speed



More details and final information can be found by scanning or clicking the QR codes.



Indoor unit			FWS-AT/AF				FWS-AF				
			02	03	06	08	02	03	06	08	
			2-pipe				4-pipe				
Cooling capacity (standard conditions)	Total capacity	High	kW	1.94	2.91	4.48	7.93	1.77	2.86	4.64	7.79
		Medium	kW	1.69	2.37	3.64	6.2	1.55	2.32	3.79	6.12
	Sensible capacity	High	kW	1.35	1.75	2.99	4.1	1.25	1.72	3.10	4.06
		Medium	kW	1.49	2.09	3.62	5.87	1.44	2.06	3.54	5.76
Heating capacity (standard conditions)	High	kW	1.30	1.69	2.90	4.59	1.21	1.65	2.85	4.54	
	Medium	kW	1.04	1.25	2.31	3.04	0.97	1.23	2.27	3.01	
	Low	kW	2.15	2.94	4.88	8.37	1.76	2.68	4.64	7.35	
Power input	High	kW	1.81	2.37	4.11	6.53	1.56	2.31	4.07	6.29	
	Medium	kW	1.50	1.76	3.36	4.39	1.36	1.88	3.55	4.85	
	Low	kW	0.019	0.016	0.033	0.087	0.019	0.016	0.033	0.087	
FCEER			0.01		0.02		0.01		0.038		
FCCOP			0.01		0.013		0.01		0.013		
Dimensions	Unit	HeightxWidthxLength	mm	535x584x224	535x794x224	535x1,000x224	535x1,214x249	535x584x224	535x794x224	535x1,000x224	535x1,214x249
Weight	Unit		kg	16.9	22.1	26.6	35.4	16.9	22.1	26.6	35.4
Air filter	Type			Polypropylene net							
Fan	Type			Centrifugal							
Total sound power level	Air flow rate	High	m³/h	344	442	785	1,393	327	431	763	1,362
		Medium	m³/h	271	341	605	1,022	261	332	593	1,007
		Low	m³/h	211	241	470	642	205	237	460	636
		High	dBA	50.0	48.0	56.0	67.0	50.0	47.0	58.0	66.0
Sound pressure level	Medium	dBA	44.0	42.0	49.0	60.0	44.0	41.0	53.0	58.0	
	Low	dBA	40.0	36.0	43.0	49.0	38.0	33.0	48.0	53.0	
	High	dBA	45.0	43.0	51.0	62.0	45.0	42.0	54.0	61.0	
Electric heater	Medium	dBA	39.0	37.0	44.0	55.0	39.0	36.0	48.0	53.0	
	Low	dBA	35.0	31.0	38.0	44.0	33.0	28.0	43.0	43.0	
	Power input (Optional)	kW	1.5	1.6	2.0	-	1.5	1.6	2.0	-	
Piping connections	Drain OD	mm	16								
Power supply	Phase/Frequency/Voltage	Hz/V	1~/50/230								
Control systems	Wired remote control		FWEC3A / FWEC3A / FWTOUCH / FWEC10								

For standard conditions refer to the Measuring Conditions table, at the end of this catalogue

Concealed flexi type unit

AC fan motor unit for horizontal or vertical concealed mounting

- › Quick fixing system for wall or ceiling mounted installation
- › Pre-assembled 3-way/4-port on/off valves are available
- › Valve packages are insulated, no extra drain pan required
- › Valve packages contain balancing valves and sensor pocket
- › Fast-on connections for electrical options: no tools needed
- › The air filter can easily be removed for cleaning
- › Electric heater: no relay up to 2kW capacity
- › Electric heater: equipped with two overheat cut-out thermostats
- › Available static pressure up to 50Pa at maximum speed



More details and final information can be found by scanning or clicking the QR codes.



Indoor unit			FWM-DAT/DAF																				
			01	15	02	25	03	35	04	06	08	10	01	15	02	25	03	35	04	06	08	10	
			2-pipe								4-pipe												
Cooling capacity (standard conditions)	Total capacity	High	kW	1.50	1.69	1.91	2.36	2.87	3.45	4.23	4.41	6.53	7.78	1.42	1.64	1.74	2.32	2.81	3.36	4.16	4.57	6.46	7.64
		Medium	kW	1.21	1.48	1.66	1.99	2.34	2.58	3.21	3.59	5.14	6.07	1.11	1.44	1.52	1.96	2.29	2.54	3.17	3.74	5.10	5.99
	Sensible capacity	High	kW	1.02	1.24	1.34	1.57	1.73	1.94	2.47	2.95	3.88	4.00	0.97	1.22	1.24	1.55	1.70	1.92	2.44	3.06	3.84	3.96
		Medium	kW	1.16	1.25	1.37	1.82	2.05	2.69	3.05	3.55	4.73	5.72	1.10	1.22	1.41	1.79	2.01	2.61	2.99	3.47	4.67	5.61
Heating capacity (standard conditions)	High	kW	0.94	1.10	1.20	1.53	1.66	1.99	2.39	2.85	3.70	4.46	0.87	1.07	1.18	1.50	1.62	1.96	2.36	2.80	3.67	4.40	
	Medium	kW	0.77	0.93	0.98	1.15	1.23	1.41	1.76	2.27	2.75	2.94	0.73	0.91	0.96	1.14	1.21	1.40	1.74	2.23	2.73	2.91	
	Low	kW	1.48	1.72	1.81	2.26	2.37	3.13	3.24	4.08	5.17	6.53	1.49	1.56	2.18	2.31	3.47	3.22	4.07	6.02	6.29		
Power input	High	kW	1.21	1.45	1.50	1.74	1.76	2.39	2.47	3.31	3.97	4.39	1.31	1.36	1.78	1.88	2.82	2.73	3.55	5.02	4.85		
	Medium	kW	0.037	0.053	0.057	0.056	0.065	0.098	0.182	0.244	0.037	0.053	0.057	0.056	0.065	0.098	0.182	0.244	0.037	0.053	0.057	0.056	
	Low	kW	0.02	0.03	0.02	0.03	0.04	0.05	0.09	0.11	0.02	0.03	0.02	0.03	0.04	0.05	0.09	0.11	0.02	0.03	0.02	0.03	
Dimensions	Unit	HeightxWidthxLength	mm	535x584x224	535x794x224	535x1,000x224	535x1,210x249	535x584x224	535x794x224	535x1,000x224	535x1,210x249	535x584x224	535x794x224	535x1,000x224	535x1,210x249	535x584x224	535x794x224	535x1,000x224	535x1,210x249	535x584x224	535x794x224	535x1,000x224	
Weight	Unit		kg	16.5	16.9	21.4	22.1	26.3	26.4	26.6	35.4	16.5	16.9	21.4	22.1	26.3	26.4	26.6	35.4	16.5	16.9	21.4	
Air filter	Type			Polypropylene net																			
Fan	Type			Centrifugal																			
Total sound power level	Air flow rate	High	m³/h	319	344	442	640	706	785	1,011	1,393	307	330	327	432	431	628	690	763	998	1,362		
		Medium	m³/h	233	271	341	450	497	605	771	1,022	225	261	334	332	444	490	593	765	1,007			
		Low	m³/h	178	211	241	320	361	470	570	642	174	205	238	237	316	356	460	565	636			
		High	dBA	47.0	49.0	50.0	48.0	52.0	53.0	56.0	61.0	67.0	45.0	49.0	50.0	48.0	47.0	53.0	56.0	58.0	60.0	66.0	
Sound pressure level	Medium	dBA	42.0	44.0	44.0	43.0	42.0	43.0	49.0	54.0	60.0	39.0	44.0	43.0	41.0	45.0	46.0	53.0	54.0	58.0			
	Low	dBA	37.0	38.0	40.0	35.0	36.0	35.0	43.0	47.0	48.0	33.0	40.0	38.0	34.0	33.0	36.0	39.0	48.0	46.0			
	High	dBA	42.0	44.0	45.0	43.0	47.0	48.0	51.0	56.0	62.0	40.0	44.0	45.0	43.0	42.0	46.0	51.0	54.0	55.0			
Electric heater	Medium	dBA	37.0	39.0	39.0	38.0	37.0	38.0	44.0	49.0	55.0	34.0	39.0	38.0	36.0	38.0	41.0	48.0	49.0	53.0			
	Low	dBA	32.0	33.0	35.0	30.0	31.0	30.0	38.0	42.0	44.0	28.0	33.0	29.0	28.0	29.0	32.0	43.0	41.0	43.0			
	Power input (Optional)	kW	1.0	1.5	1.6	2.0	3.0	1.0	1.5	1.6	2.0	3.0											
Piping connections	Drain OD	mm	16																				
Power supply	Phase/Frequency/Voltage	Hz/V	1~/50/230																				
Control systems	Wired remote control		FWEC1A / FWEC2A / FWEC3A / FWEC3A / FWTOUCH / FWEC2T / FWEC4T																				

For standard conditions refer to the Measuring Conditions table, at the end of this catalogue

Concealed flexi type unit with low ESP

AC fan motor unit for horizontal or vertical concealed mounting

- › Low unit casing height of 200mm
- › Sirocco Fan leading to low noise operation
- › Open control
- › Factory mounted valve combinations
- › Increased flexibility of capacity setting in the field
- › The air filter can easily be removed for cleaning



More details and final information can be found by scanning or clicking the QR codes.



Indoor unit			FWE-DT/FWE-DF																					
			03	04	05	06	07	08	10	11	03	04	05	06	07	08	10	11						
Cooling capacity (standard conditions)	Total capacity	High	2-pipe											4-pipe										
		Medium																						
	Fan speed 1	High																						
		Medium																						
		Low																						
	Sensible capacity	High																						
		Medium																						
		Low																						
	Latent capacity	High																						
		Medium																						
Low																								
Heating capacity (standard conditions)	Capacity	High																						
	Medium																							
	Low																							
	Fan speed 1																							
Power input	High																							
	Medium																							
	Low																							
	Fan speed 1																							
Dimensions	Unit	Height																						
		Width																						
		Depth																						
	Packed unit	Height																						
		Width																						
		Depth																						
Weight	Unit																							
	Packed unit																							
Casing	Colour																							
	Material																							
Air filter	Type																							
	Material																							
Fan	Quantity	High																						
		Medium																						
	Air flow rate	High																						
		Medium																						
		Low																						
	Total sound power level	High																						
Medium																								
Low																								
Sound pressure level	High																							
	Medium																							
	Low																							
Water flow	Cooling	High																						
		Medium																						
		Low																						
	Heating	High																						
		Medium																						
		Low																						
Piping connections	Drain																							
	OD																							
Power supply	Phase/Frequency/Voltage																							
	High																							
	Medium																							
Current input	High																							
	Medium																							
	Low																							
Control systems	Wired remote control																							
	Wired remote control																							

Heating: indoor temp. 20°CDB, 15°CWB; entering water temp. 65°C, water temperature drop 10K. | Heating: indoor temp. 20°CDB, 15°CWB; entering water temp. 45°C, water temperature drop 5K. | Inlet/outlet water temperature 7/12 °C; inlet air temperature 27°C DB 19°C WB

Concealed ceiling unit with low ESP

AC fan motor unit for horizontal concealed mounting

- › Easy installation and maintenance
- › 4-speed fan motor
- › High power air flow
- › Wired electronic controllers range
- › Available static pressure up to 50Pa
- › Wide operating range
- › Standard left and right side water connection
- › Extended drain pan as standard
- › Factory mounted valve (both left and right side)
- › Nylon filter G2 class
- › Polyethylene insulation



More details and final information can be found by scanning or clicking the QR codes.



Indoor unit			FWE-CT/CF																					
			02	03	04	06	07	08	10	02	03	04	06	07	08	10								
Cooling capacity (standard conditions)	Total capacity	Super high	2-pipe											4-pipe										
		High																						
	Sensible capacity	High																						
		Medium																						
		Low																						
	Latent capacity	High																						
		Medium																						
		Low																						
	Heating capacity (standard conditions)	Super high																						
		High																						
Medium																								
Low																								
Power input	Super high																							
	High																							
	Medium																							
	Low																							
Dimensions	Unit	Height																						
		Width																						
		Depth																						
	Packed unit	Height																						
		Width																						
		Depth																						
Weight	Unit																							
	Packed unit																							
Casing	Colour																							
	Material																							
Air filter	Type																							
	Material																							
Fan	Quantity	High																						
		Medium																						
	Air flow rate	High																						
		Medium																						
		Low																						
	Total sound power level	High																						
Medium																								
Low																								
Sound pressure level	High																							
	Medium																							
	Low																							
Water flow	Cooling	Super high																						
		High																						
		Medium																						
	Heating	Super high																						
		High																						
		Medium																						
Piping connections	Drain																							
	OD																							
Power supply	Phase/Frequency/Voltage																							
	High																							
	Medium																							
Current input	High																							
	Medium																							
	Low																							
Control systems	Wired remote control																							
	Wired remote control																							

Concealed ceiling unit with high ESP

BLDC fan motor unit for horizontal or vertical mounting.
Continuous air flow regulation and fan speed modulation

- › Up to 70% energy savings with brushless DC motor technology compared to traditional technology
- › Instant adjustment to temperature and relative humidity changes
- › Low operating sound level
- › Highly flexible solutions: multiple sizes, piping topologies and connection valves
- › The air filter can easily be removed for cleaning
- › Straight duct connector mounted to discharge side
- › Available static pressure up to 120Pa at maximum speed



More details and final information can be found by scanning or clicking the QR codes.



Indoor unit			FWN-AT/AF		04	05	06	07	08	10	04	05	06	07	08	10
			2-pipe						4-pipe							
Cooling capacity (standard conditions)	Total capacity	High	kW	3.80	4.65	6.01	6.65	7.57	8.49	3.76	4.61	5.91	6.55	7.46	8.35	
		Medium	kW	3.47	4.20	5.65	6.25	6.84	7.62	3.44	4.17	5.58	6.17	6.75	7.52	
	Sensible capacity	High	kW	2.83	3.38	5.22	5.78	6.20	6.84	2.82	3.36	5.17	5.71	6.14	6.77	
		Medium	kW	2.70	3.19	4.20	4.73	5.60	6.07	2.68	3.17	4.15	4.66	5.52	5.98	
Heating capacity (standard conditions)	High	kW	2.19	2.54	3.90	4.35	5.01	5.40	2.18	2.52	3.84	4.30	4.96	5.34		
	Medium	kW	4.05	4.83	6.42	7.26	7.88	8.93	3.91	3.89	5.72	5.65	7.99	7.94		
	Low	kW	3.69	4.36	6.03	6.80	7.11	8.04	3.68	3.66	5.51	5.45	7.47	7.44		
Power input	High	kW	0.112		0.152		0.248		0.112		0.152		0.248			
	Medium	kW	0.07		0.13		0.17		0.07		0.13		0.17			
	Low	kW	0.04		0.10		0.12		0.45	0.40	0.10		0.12			
FCEER			C	B			C			B			C			
FCCOP			B	A			C			B			C			
Dimensions	Unit	HeightxWidthxLength	mm	559x754x280	559x964x280	559x1,170x280	559x754x280	559x964x280	559x1,170x280							
Weight	Unit		kg	32.5	33.3	40.6	41.7	47.3	48.7	34.7	35.5	43.2	44.4	50.3	51.7	
Air filter	Type			Acrylic - Filtering class EU2												
Fan	Type			Centrifugal												
Air flow rate	Quantity	High	m³/h	802	791	1,238	1,203	1,606	1,581	793	783	1,211	1,182	1,576	1,550	
		Medium	m³/h	700	692	1,134	1,107	1,384	1,371	694	686	1,115	1,088	1,362	1,349	
		Low	m³/h	534	532	1,019	1,000	1,207	1,198	531	529	1,005	985	1,192	1,184	
Total sound power level	High	dBA	66.0		69.0		72.0		66.0		69.0		72.0			
	Medium	dBA	61.0		63.0		67.0		61.0		63.0		67.0			
	Low	dBA	54.0		59.0	61.0	62.0		54.0	59.0	61.0		62.0			
Sound pressure level	High	dBA	61.0		64.0		67.0		61.0		64.0		67.0			
	Medium	dBA	56.0		58.0		62.0		56.0		58.0		62.0			
	Low	dBA	49.0		54.0	56.0	57.0		49.0	54.0	56.0		57.0			
Electric heater	Power input (Optional)	kW	2.0		6.0		9.0		2.0		6.0		9.0			
Piping connections	Drain OD	mm	17													
Power supply	Phase/Frequency/Voltage	Hz/V	1~/50/230													
Control systems	Wired remote control		FWEC3A / FWECSA / FWTOUCH / FWEC10													

For standard conditions refer to the Measuring Conditions table, at the end of this catalogue

Concealed ceiling unit with high ESP

AC fan motor unit for horizontal or vertical concealed mounting

- › Quick fixing system for wall or ceiling mounted installation
- › Straight duct connector mounted to discharge side
- › The air filter can easily be removed for cleaning
- › Available static pressure up to 180Pa at maximum speed



More details and final information can be found by scanning or clicking the QR codes.



Indoor unit			FWD-AT/AF		04	06	08	10	12	16	18	04	06	08	10	12	16	18
			2-pipe						4-pipe									
Cooling capacity (standard conditions)	Total capacity	High	kW	3.65	5.71	7.33	8.25	11.86	15.92	17.74	3.62	5.60	7.20	8.10	11.66	15.84	17.66	
		Medium	kW	3.36	5.39	6.63	7.41	10.12	13.83	15.36	3.33	5.32	6.54	7.31	10.00	13.77	15.29	
	Sensible capacity	High	kW	2.74	4.99	6.03	6.68	8.42	11.63	12.92	2.73	4.92	5.97	6.61	8.33	11.59	12.87	
		Medium	kW	2.83	4.16	6.04	6.58	9.22	12.21	13.49	2.80	4.08	5.94	6.46	9.06	12.14	13.41	
Heating capacity (standard conditions)	High	kW	2.59	3.94	5.39	5.86	7.75	10.43	11.40	2.57	3.89	5.31	5.77	7.66	10.38	11.34		
	Medium	kW	2.10	3.66	4.84	5.23	6.35	8.61	9.37	2.09	3.60	4.79	5.17	6.29	8.58	9.34		
	Low	kW	4.05	6.42	7.88	8.93	12.72	17.29	19.05	3.91	5.72	7.99	7.94	14.43	19.30	19.20		
Power input	High	kW	0.265	0.460	0.505	0.750	1.300	0.265	0.460	0.505	0.750	1.300						
	Medium	kW	0.19	0.39	0.38	0.54	1.09	0.19	0.39	0.38	0.54	1.09						
	Low	kW	0.14	0.35	0.29	0.37	0.87	0.14	0.35	0.29	0.37	0.87						
Dimensions	Unit	HeightxWidthxLength	mm	559x754x280	559x964x280	559x1,170x280	718x1,170x353	718x1,380x353	559x754x280	559x964x280	559x1,170x280	718x1,170x353	718x1,380x353					
Weight	Unit		kg	32.5	40.6	47.3	48.7	65.3	77.0	79.5	34.7	43.2	50.3	51.7	70.9	83.4	85.9	
Air filter	Type			Acrylic fiber - Filtering class G2 (G4 on request)														
Fan	Type			Centrifugal														
Air flow rate	Quantity	High	m³/h	802	1,241	1,609	1,584	2,380	3,206	3,175	794	1,212	1,573	1,550	2,328	3,186	3,155	
		Medium	m³/h	700	1,134	1,384	1,371	1,898	2,641	2,604	694	1,115	1,362	1,349	1,871	2,626	2,590	
		Low	m³/h	534	1,021	1,208	1,200	1,485	2,092	2,073	532	1,004	1,194	1,186	1,466	2,084	2,065	
Total sound power level	High	dBA	66.0	69.0	72.0	74.0	78.0	66.0	69.0	72.0	74.0	78.0						
	Medium	dBA	61.0	63.0	67.0	73.0	61.0	64.0	67.0	73.0								
	Low	dBA	54.0	59.0	62.0	60.0	69.0	54.0	61.0	62.0	60.0	69.0						
Sound pressure level	High	dBA	61.0	64.0	67.0	69.0	73.0	61.0	64.0	67.0	69.0	73.0						
	Medium	dBA	56.0	58.0	62.0	68.0	56.0	59.0	62.0	68.0								
	Low	dBA	49.0	54.0	57.0	55.0	64.0	49.0	56.0	57.0	55.0	64.0						
Electric heater	Power input (Optional)	kW	2.0	6.0	9.0	12.0	2.0	6.0	9.0	12.0								
Piping connections	Drain OD	mm	17															
Power supply	Phase/Frequency/Voltage	Hz/V	1~/50/230															
Control systems	Wired remote control		FWEC1A / FWEC2A / FWEC3A / FWECSA / FWTOUCH / FWEC2T / FWEC4T															

For standard conditions refer to the Measuring Conditions table, at the end of this catalogue

Wall mounted unit

AC fan motor unit for wall mounting

- › High aesthetic cabinet design
- › Optimum air distribution
- › Easy to install
- › Wireless remote control up to 9 m distance
- › 3-speed fan motor
- › Wide operating range
- › Low operating sound level thanks to tangential fan
- › Insulated with self-extinguishing class 1 heat insulation
- › Removable washable air filter (self-extinguishing class 1)



More details and final information can be found by scanning or clicking the QR codes.



Indoor unit			FWT-GT	02	03	04	05	06
			2-pipe					
Cooling capacity (standard conditions)	Total capacity	High	kW	2.40	2.67	3.27	4.49	5.21
		Medium	kW	2.20	2.23	2.79	4.02	4.32
		Low	kW	1.94	2.02	2.52	3.76	4.04
Sensible capacity		High	kW	1.82	1.99	2.60	3.38	4.03
		Medium	kW	1.73	1.69	2.21	3.00	3.52
		Low	kW	1.50	1.49	1.91	2.77	3.22
Heating capacity (standard conditions)		High	kW	2.71	2.96	3.71	5.07	6.23
		Medium	kW	2.41	2.62	3.29	4.51	5.38
		Low	kW	2.06	2.25	2.75	4.03	4.83
Power input	High		kW	0.031	0.032	0.042	0.053	0.072
	Medium		kW		0.03	0.04	0.05	0.07
	Low		kW		0.03		0.04	0.06
FCEER				D		C		D
FCCOP						C		
Dimensions	Unit	HeightxWidthxLength	mm	288x800x206			310x1,070x224	
Weight	Unit		kg	9.00			14.0	
Casing	Colour			White				
Air filter	Type			Washable Saranet				
Fan	Type			Cross flow fan				
	Quantity			1				
Air flow rate	High		m³/h	442	476	629	866	1,053
	Medium		m³/h	391	425	544	765	883
	Low		m³/h	340	374	442	663	782
Total sound power level	High		dB(A)	45.0	48.0	55.0		59.0
	Medium		dB(A)	41.0	44.0	50.0	51.0	54.0
	Low		dB(A)	36.0	39.0	45.0	47.0	51.0
Sound pressure level	High		dB(A)	34.0	35.0	42.0		46.0
	Medium		dB(A)	29.0	30.0	39.0	38.0	42.0
	Low		dB(A)		25.0	32.0	34.0	39.0
Piping connections	Drain OD		mm	19				
Power supply	Phase/Frequency/Voltage		Hz/V	1N~/50/220-240				
Control systems	Infrared remote control			WRC-HPC				
	Wired remote control			MERCA / SRC-HPA				

For standard conditions refer to the Measuring Conditions table, at the end of this catalogue



INDOOR UNITS	FWC-BT/BF	FWF-BT/BF	FWH-AT/AF	FWI-AT/AF	FWZ-AT/AF	FWV-DAT/DAF	FWR-AT/AF	FWL-DAT/DAF
ON/OFF valves 230V	3-ways 230V ON/OFF valve kit (2-pipe)	EKMV3C09B	EKMV3C09B	E2C3V02A (2 up to 4 class) E2C3V06A (6 up to 8 class)	E2C3V02A (2 up to 4 class) E2C3V06A (6 up to 8 class)	E2MV03A6 (2, 3 & 6 class) E2MV06A6 (4 & 6 class) E2MV10A6 (8 class)	E2MV03A6 (1 up to 35 class) E2MV06A6 (4 & 6 class) E2MV10A6 (8 & 10 class)	E2MV03A6 (1 up to 35 class) E2MV06A6 (4 & 6 class) E2MV10A6 (8 & 10 class)
	3-ways 230V ON/OFF valve kit (4-pipe)	EKMV3C09B x2	EKMV3C09B x2	E4C3V02A (2 up to 4 class) E4C3V06A (6 up to 8 class)	E4C3V02A (2 up to 4 class) E4C3V06A (6 up to 8 class)	E4MV03A6 (2, 3 & 6 class) E4MV10A6 (8 class)	E4MV03A6 (2, 3 & 6 class) E4MV10A6 (8 class)	E4MV03A6 (1 up to 35 class) E4MV06A6 (4 & 6 class) E4MV10A6 (8 & 10 class)
	2-ways 230V ON/OFF valve kit (2-pipe)	EKMV2C09B	EKMV2C09B	E2C2V02A (2 up to 4 class) E2C2V06A (6 up to 8 class)	E2C2V02A (2 up to 4 class) E2C2V06A (6 up to 8 class)			
	2-ways 230V ON/OFF valve kit (4-pipe)	EKMV2C09B x2	EKMV2C09B x2	E4C2V02A (2 up to 4 class) E4C2V06A (6 up to 8 class)	E4C2V02A (2 up to 4 class) E4C2V06A (6 up to 8 class)			
	2-ways 230V ON/OFF valve kit (cooling heat exchanger)					E2MV2B07A6 (2, 3 & 6 class) E2MV2B10A6 (8 class)	E2MV2B07A6 (1 up to 6 class) E2MV2B10A6 (8 class)	E2MV2B07A6 (1 up to 6 class) E2MV2B10A6 (8 & 10 class)
	2-ways 230V ON/OFF valve kit (additional heat exchanger)					E2MV2B07A6	E2MV2B07A6	E2MV2B07A6
	3-ways 230V ON/OFF valve kit (additional heat exchanger)							
	Simplified 3-ways 230V ON/OFF valve kit (2-pipe)					E2MVD03A6 (2 & 3 class) E2MVD06A6 (6 class) E2MVD10A6 (8 class)	E2MVD03A6 (1 up to 35 class) E2MVD06A6 (4 & 6 class) E2MVD10A6 (8 & 10 class)	E2MVD03A6 (1 up to 35 class) E2MVD06A6 (4 & 6 class) E2MVD10A6 (8 & 10 class)
	Simplified 3-ways 230V ON/OFF valve kit (4-pipe)					E4MVD03A6 (2 & 3 class) E4MVD06A6 (6 class) E4MVD10A6 (8 class)	E4MVD03A6 (1 up to 35 class) E4MVD06A6 (4 & 6 class) E4MVD10A6 (8 & 10 class)	E4MVD03A6 (1 up to 35 class) E4MVD06A6 (4 & 6 class) E4MVD10A6 (8 & 10 class)
ON/OFF valves 24V	3-ways 24V ON/OFF valve kit (cooling heat exchanger)			E2C324V02A (2 up to 4 class) E2C324V06A (6 up to 8 class)	E2C324V02A (2 up to 4 class) E2C324V06A (6 up to 8 class)	E2M2V03A6 (2 & 3 class) E2M2V06A6 (4 & 6 class) E2M2V10A6 (8 class)	E2M2V03A6 (1 up to 35 class) E2M2V06A6 (4 & 6 class) E2M2V10A6 (8 class)	E2M2V03A6 (1 up to 35 class) E2M2V06A6 (4 & 6 class) E2M2V10A6 (8 & 10 class)
	3-ways 24V ON/OFF valve kit (4-pipe)			E4C324V02A (2 up to 4 class) E4C324V06A (6 up to 8 class)	E4C324V02A (2 up to 4 class) E4C324V06A (6 up to 8 class)	E4M2V03A6 (2 & 3 class) E4M2V06A6 (4 & 6 class) E4M2V10A6 (8 class)	E4M2V03A6 (1 up to 35 class) E4M2V06A6 (4 & 6 class) E4M2V10A6 (8 & 10 class)	E4M2V03A6 (1 up to 35 class) E4M2V06A6 (4 & 6 class) E4M2V10A6 (8 & 10 class)
	2-ways 24V ON/OFF valve kit (cooling heat exchanger)			E2C224V02A (2 up to 4 class) E2C224V06A (6 up to 8 class)	E2C224V02A (2 up to 4 class) E2C224V06A (6 up to 8 class)	E2M2V207A6 (2, 3 & 6 class) E2M2V210A6 (8 class)	E2M2V207A6 (1 up to 6 class) E2M2V210A6 (8 & 10 class)	E2M2V207A6 (1 up to 6 class) E2M2V210A6 (8 & 10 class)
	2-ways 24V ON/OFF valve kit (additional heat exchanger)			E4C224V02A (2 up to 4 class) E4C224V06A (6 up to 8 class)	E4C224V02A (2 up to 4 class) E4C224V06A (6 up to 8 class)	E2M2V207A6	E2M2V207A6	E2M2V207A6
	2-ways 24V ON/OFF valve kit (4-pipe)							

FWS-AT/AF	FWM-DAT/DAF	FWE-DT/DF	FWE-CT/CF	FWP-CT/CF	FWB-CT/CF	FWD-AT/AF	FWN-AT/AF	FWT-GT
E2MV03A6 (2, 3 & 6 class) E2MV10A6 (8 class)	E2MV03A6 (1 up to 35 class) E2MV06A6 (4 & 6 class) E2MV10A6 (8 & 10 class)	E3V2VN02V3WA	EK2MV3B10C5	E4V2N05OV3WA (4 & 5 class) E4V2N08OV3WA (6 & 8 class) E2MV10B6 (10 up to 17 class)	E4V2N05OV3WA (4 & 5 class) E4V2N08OV3WA (6 & 8 class) E2MV10B6 (10 up to 17 class)	ED2MV04A6 (4 class) ED2MV10A6 (6, 8 & 10 class) ED2MV12A6 (12 class) ED2MV18A6 (16 & 18 class)	ED2MV04A6 (4 & 5 class) ED2MV10A6 (6 up 10 class)	
E4MV03A6 (2, 3 & 6 class) E4MV10A6 (8 class)	E4MV03A6 (1 up to 35 class) E4MV06A6 (4 & 6 class) E4MV10A6 (8 & 10 class)	E3V4VN02V3WA	EK4MV3B10C5	E4V2N05OV3WA + E4VHN08OV3WA (4 up to 5 class) E4V2N08OV3WA + E4VHN08OV3WA (6 up to 8 class) E2MV10B6 + E4VHN17OV3WA (10 up to 17 class)	E4V2N05OV3WA + E4VHN08OV3WA (4 up to 5 class) E4V2N08OV3WA + E4VHN08OV3WA (6 up to 8 class) E2MV10B6 + E4VHN17OV3WA (10 up to 17 class)	ED4MV04A6 (4 class) ED4MV10A6 (6, 8 & 10 class) ED4MV12A6 x2 (12 class) ED4MV18A6 x2 (16 & 18 class)	ED4MV04A6 (4 & 5 class) ED4MV10A6 (6 up 10 class)	
		E2V2VN01V3WA	EK2MV2B10C5					
		E2V4VN01V3WA	EK4MV2B10C5	E2MV2B07A6 + E2MV2B07A6 (4 up to 8 class) E2MV2B10A6 + E2MV2B07A6 (10 up to 17 class)	E2MV2B07A6 + E2MV2B07A6 (4 up to 8 class) E2MV2B10A6 + E2MV2B07A6 (10 up to 17 class)			
E2MV2B07A6 (2 up to 6 class) E2MV2B10A6 (8 class)	E2MV2B07A6 (1 up to 6 class) E2MV2B10A6 (8 & 10 class)			E2MV2B07A6 (4 up to 8 class) E2MV2B10A6 (10 up to 17 class)	E2MV2B07A6 (4 up to 8 class) E2MV2B10A6 (10 up to 17 class)			
E2MV2B07A6	E2MV2B07A6			E2MV2B07A6	E2MV2B07A6			
				E4VHN08OV3WA (4 up to 8 class) E4VHN17OV3WA (10 up to 17 class)	E4VHN08OV3WA (4 up to 8 class) E4VHN17OV3WA (10 up to 17 class)			
E2MVD03A6 (2 & 3 class) E2MVD06A6 (6 class) E2MVD10A6 (8 class)	E2MVD03A6 (1 up to 35 class) E2MVD06A6 (4 & 6 class) E2MVD10A6 (8 class)							
E4MVD03A6 (2 & 3 class) E4MVD06A6 (4 & 6 class) E4MVD10A6 (8 & 10 class)	E4MVD03A6 (1 up to 35 class) E4MVD06A6 (4 & 6 class) E4MVD10A6 (8 & 10 class)							
E2M2V03A6 (2 & 3 class) E2M2V06A6 (4 & 6 class) E2M2V10A6 (8 class)	E2M2V03A6 (1 up to 35 class) E2M2V06A6 (4 & 6 class) E2M2V10A6 (8 class)			E4V2N05O24WA (4 & 5 class) E4V2N08O24WA (6 & 8 class) E4V2N17O24WA (10 up to 17 class)	E4V2N05O24WA (4 & 5 class) E4V2N08O24WA (6 & 8 class) E4V2N17O24WA (10 up to 17 class)			
E4M2V03A6 (2 & 3 class) E4M2V06A6 (4 & 6 class) E4M2V10A6 (8 class)	E4M2V03A6 (1 up to 35 class) E4M2V06A6 (4 & 6 class) E4M2V10A6 (8 class)							
E2M2V207A6 (2, 3 & 6 class) E2M2V210A6 (8 class)	E2M2V207A6 (1 up to 6 class) E2M2V210A6 (8 & 10 class)			E2M2V207A6 (4 up to 8 class) E2M2V210A6 (10 up to 17 class)	E2M2V207A6 (4 up to 8 class) E2M2V210A6 (10 up to 17 class)			
E2M2V207A6	E2M2V207A6			E2M2V207A6	E2M2V207A6			
				E2M2V207A6 + E2M2V210A6 (4 up to 8 class) E2M2V210A6 + E2M2V207A6 (10 up to 17 class)	E2M2V207A6 + E2M2V210A6 (4 up to 8 class) E2M2V210A6 + E2M2V207A6 (10 up to 17 class)			

INDOOR UNITS	FWC-BT/BF	FWF-BT/BF	FWH-AT/AF	FWI-AT/AF	FWZ-AT/AF	FWV-DAT/DAF	FWR-AT/AF	FWL-DAT/DAF
Fresh air intake kit (direct installation type)		KDDQ44XA60						
Fresh air intake					EFA02A6 (2 class) EFA03A6 (3 class) EFA06A6 (6 class) EFA10A6 (8 class)	EFA02A6 (1, 15 & 2 class) EFA03A6 (25 & 3 class) EFA06A6 (35, 4 & 6 class) EFA10A6 (8 & 10 class)		
Electrical box with earth terminal (2 blocks)	KJB212A	KJB212A						
Electrical box with earth terminal (3 blocks)	KJB311A	KJB311A						
Electrical box with earth terminal	KJB411A	KJB411A						
Electric heater (standard)					EEH02A6 (2 class) EEH03A6 (3 class) EEH06A6 (6 class) EEH10A6 (8 class)	EEH01A6 (1 class) EEH02A6 (15 & 2 class) EEH03A6 (25 & 3 class) EEH06A6 (35, 4 & 6 class) EEH10A6 (8 & 10 class)	EEH02A6 (2 class) EEH03A6 (3 class) EEH06A6 (6 class) EEH10A6 (8 class)	EEH01A6 (1 class) EEH02A6 (15 & 2 class) EEH03A6 (25 & 3 class) EEH06A6 (35, 4 & 6 class) EEH10A6 (8 & 10 class)
Electric heater (big)								
Additional heat exchanger					ESRH02A6 (2 class) ESRH03A6 (3 class) ESRH06A6 (6 class) ESRH10A6 (8 class)	ESRH02A6 (1, 15 & 2 class) ESRH03A6 (25 & 3 class) ESRH06A6 (35, 4 & 6 class) ESRH10A6 (8 & 10 class)	ESRH02A6 (2 class) ESRH03A6 (3 class) ESRH06A6 (6 class) ESRH10A6 (8 class)	ESRH02A6 (1, 15 & 2 class) ESRH03A6 (25 & 3 class) ESRH06A6 (35, 4 & 6 class) ESRH10A6 (8 & 10 class)
Supporting feet					ESFV06A6 (2, 3 & 6 class) ESFV10A6 (8 class)	ESFV06A6 (1 up to 6 class) ESFV10A6 (8 & 10 class)	ESFV06A6 (2, 3 and 6 class) ESFV10A6 (8 class)	ESFV06A6 (1 up to 6 class) ESFV10A6 (8 & 10 class)
Supporting feet and grille					ESFVG02A6 (2 class) ESFVG03A6 (3 class) ESFVG06A6 (6 class) ESFVG10A6 (8 class)	ESFVG02A6 (1, 15 & 2 class) ESFVG03A6 (25 & 3 class) ESFVG06A6 (35, 4 & 6 class) ESFVG10A6 (8 & 10 class)		
Plenum box with rectangular connections								
Plenum box with circular connections								
Plenum box (not insulated) with circular connections (supply side)								
Plenum box (insulated) with circular connections (supply side)								
Plenum box (insulated) with circular connections (intake side)								
Cover box for electric connections								
G4 Filter								
Vertical auxiliary drain pan					EDPVB6	EDPVB6	EDPVB6	EDPVB6
Horizontal auxiliary drain pan					EDPHB6	EDPHB6	EDPHB6	EDPHB6
Drain pump	included	included			CDRP1A	CDRP1A	CDRP1A (only vertical installation)	CDRP1A (only vertical installation)
Vertical installation kit (Wall Mounted)								

Others

FWS-AT/AF	FWM-DAT/DAF	FWE-DT/DF	FWE-CT/CF	FWP-CT/CF	FWB-CT/CF	FWD-AT/AF	FWN-AT/AF	FWT-GT
						EDMFA04A6 (4 class) EDMFA06A6 (6 class) EDMFA10A6 (8 & 10 class) EDMFA12A6 (12 class) EDMFA18A6 (16 & 18 class)	EDMFA04A6 (4 & 5 class) EDMFA06A6 (6 & 7 class) EDMFA10A6 (8 & 10 class)	
EEH02A6 (2 class) EEH03A6 (3 class) EEH06A6 (6 class) EEH10A6 (8 class)	EEH01A6 (1 class) EEH02A6 (15 & 2 class) EEH03A6 (25 & 3 class) EEH06A6 (35, 4 & 6 class) EEH10A6 (8 & 10 class)			EH060V3A (4 & 5 class) EH100V36A (6 & 8 class) EH200V36A (10 up to 17 class)	EH060V3A (4 & 5 class) EH100V36A (6 & 8 class) EH200V36A (10 up to 17 class)	EDEH04A6 (4 class) EDEHS06B6 (6 class) EDEHS10B6 (8 & 10 class) EDEHS12B6 (12 class) EDEHS18B6 (16 & 18 class)	EDEH04A6 (4 & 5 class) EDEHS06B6 (6 & 7 class) EDEHS10B6 (8 & 10 class)	
						EDEH04A6 (4 class) EDEHB06A6 (6 class) EDEHB10A6 (8 & 10 class) EDEHB12A6 (12 class) EDEHB18A6 (16 & 18 class)	EDEH04A6 (4 & 5 class) EDEHB06A6 (6 & 7 class) EDEHB10A6 (8 & 10 class)	
ESRH02A6 (2 class) ESRH03A6 (3 class) ESRH06A6 (6 class) ESRH10A6 (8 class)	ESRH02A6 (1, 15 & 2 class) ESRH03A6 (25 & 3 class) ESRH06A6 (35, 4 & 6 class) ESRH10A6 (8 & 10 class)			EAHD04A (4 & 5 class) EAHD06A (6 & 8 class) EAHD10A (10 up to 17 class)	EAHD04A (4 & 5 class) EAHD06A (6 & 8 class) EAHD10A (10 up to 17 class)			
ESFV06A6 (2, 3 & 6 class) ESFV10A6 (8 class)	ESFV06A6 (1 up to 6 class) ESFV10A6 (8 & 10 class)	ESFH01D5 (installation leg for vertical application)						
						PRD04A6 (4 class) PRD06A6 (6 class) PRD08A6 (8 & 10 class) PRD12A6 (12 class) PRD16A6 (16 & 18 class)	PRD04A6 (4 & 5 class) PRD06A6 (6 & 7 class) PRD08A6 (8 & 10 class)	
						PCIC04A6 (4 class) PCIC06A6 (6 class) PCIC08A6 (8 & 10 class) PCIC12A6 (12 class) PCIC16A6 (16 & 18 class)	PCIC04A6 (4 & 5 class) PCIC06A6 (6 & 7 class) PCIC08A6 (8 & 10 class)	
				PLT1NAA (4 & 5 class) PLT2NAA (6 & 8 class) PLT3NAA (10 up to 17 class)	PLT1NAA (4 & 5 class) PLT2NAA (6 & 8 class) PLT3NAA (10 up to 17 class)			
EPCC02A6 (2 class) EPCC03A6 (3 class) EPCC06A6 (6 class) EPCC10A6 (8 class)	EPCC02A6 (1,15 & 2 class) EPCC03A6 (25 & 3 class) EPCC06A6 (35, 4 & 6 class) EPCC10A6 (8 & 10 class)			PLT1CAA (4 & 5 class) PLT2CAA (6 & 8 class) PLT3CAA (10 up to 17 class)	PLT1CAA (4 & 5 class) PLT2CAA (6 & 8 class) PLT3CAA (10 up to 17 class)			
EICC02A6 (2 class) EICC03A6 (3 class) EICC06A6 (6 class) EICC10A6 (8 class)	EICC02A6 (1,15 & 2 class) EICC03A6 (25 & 3 class) EICC06A6 (35, 4 & 6 class) EICC10A6 (8 & 10 class)							
				FWBOX	FWBOX			
				FG4T1AA (4 & 5 class) FG4T2AA (6 & 8 class) FG4T3AA (10 up to 17 class)	FG4T1AA (4 & 5 class) FG4T2AA (6 & 8 class) FG4T3AA (10 up to 17 class)	FSDG404A (4 class) FSDG406A (6 class) FSDG408A (8 & 10 class) FSDG412A (12 class) FSDG416A (16 & 18 class)	FSDG404A (4 & 5 class) FSDG406A (6 & 7 class) FSDG408A (8 & 10 class)	
EDPVB6	EDPVB6	ESFD01D6				EDDPV10A6 (4, 6, 8, 10 class) EDDPV18A6 (12, 16 & 18 class)	EDDPV10A6	
EDPHB6	EDPHB6			EDPD7 (4 up to 8 class) EDPD9 (10 up to 17 class)	EDPD7 (4 up to 8 class) EDPD9 (10 up to 17 class)	EDDPH10A6 (4, 6, 8, 10 class) EDDPH18A6 (12, 16 & 18 class)	EDDPH10A6	
CDRP1A	CDRP1A			CDRP1A	CDRP1A	CDRP1A	CDRP1A	
		ESFH02D5						

Connect with Daikin

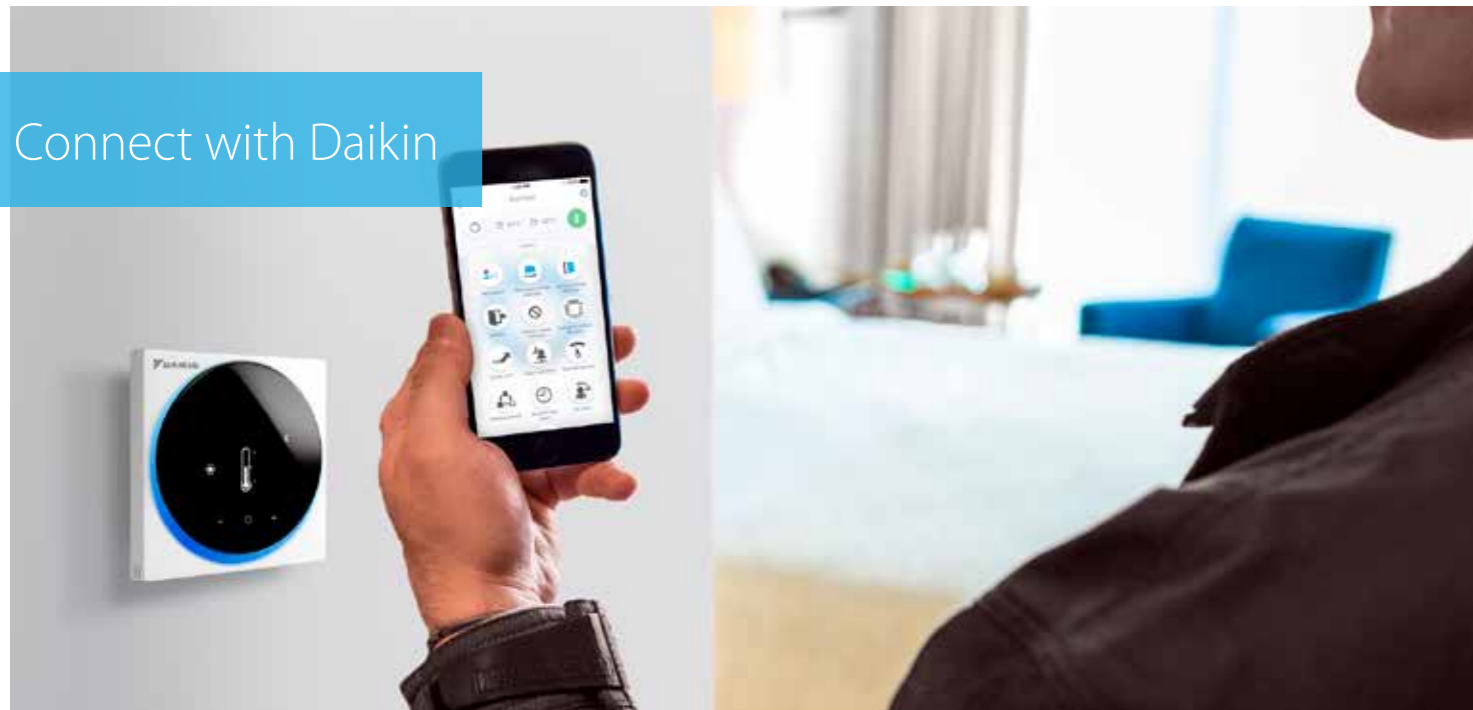

If you are a user or installer it is important you can **interact with our systems** in the easiest way, from **anywhere you are**. For any user our interfaces create **peace of mind** that their system is running in the best possible way.

Depending on the type of user and application Daikin develops controls and cloud services to ensure the best experience.

- › For home owners it means **app and voice control** of their home comfort.
- › For hotel owners it means easy and stylish **personal control for guests**, with an integration in hotel booking software for central control
- › For technical managers it means **cloud access** to all sites, with the possibility to benchmark, optimize performance
- › For installers it means **easy transfer of settings during commissioning**, remote retrieval of errors and preventive alerts to save time on maintenance or interventions

Our controls enable you to **connect with your customer**, save time, improve your comfort intelligently and reduce energy bills.



Table of content Control Systems

Application overview	186
Individual control systems	188
NEW Daikin mAP	188
Centralised control systems	190
Intelligent Controller	190
Intelligent Manager	192
Intelligent Manager	198
Standard protocol interfaces	202
Modbus interface	202
BACnet Interface	204
LonWorks Interface	205
Daikin on Site for Applied systems 	206
Indoor Environmental Sensor	208

Remote monitoring



Control solutions summary

Daikin offers various control solution adapted to the requirements of even the most demanding commercial application.

- › Basic control solutions for those customers with few requirements and limited budget
- › Integrating control solutions for those customers that would like to integrate Daikin units into their existing BMS system
- › Advanced control solutions for those customers that expect Daikin to deliver a mini BMS solution, including advance energy management

Shop

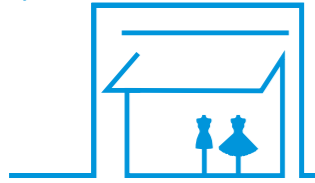

	Unit control		Integrating control			Advanced control		
	BRP069*	BRC1H52W/S/K	RTD-20	RTD-Net	KLIC DI V2	EKMBDXA	DCC601A51	DCM601B51
	Smartphone control for up to 50 indoor units	1 remote controller for 1 indoor unit (group)	1 gateway for 1 indoor unit (group)	1 gateway for 1 indoor unit (group)	Two additional probes can be connected	1 gateway for max. 64 indoor unit(s) & 10 outdoors	1 unit for 32 indoor unit(s) (5)	1 iTM for 64 indoor unit(s) (groups) (1)
Automatic control of A/C	•	•	•	•	•	•	•	•
Limit control possibilities for shop staff	•	•	•	•	•	•	•	•
Create zones within the shop			•				•	•
Interlock with eg. Alarm, PIR sensor			•				(limited)	•
Integration into smart home systems	• (7)							
Integrate Daikin units into existing BMS via Modbus				•		•		
Integrate Daikin units into existing BMS via KNX					•			
Integrate Daikin units into existing BMS via HTTP								•
Monitor energy consumption	• (4)	• (4)					• (2)	•
Advanced energy management							• (2)	• (6)
Allows free cooling								•
Voice control	• (6)							
Integrate Daikin products cross pillars into Daikin BMS								•
Integrate third party products into Daikin BMS							•	•
Online control	•						• (2)	• (3)
Manage multiple sites							• (2)	• (3)

(1) 7 iTM plus adapters (DCM601A52) can be added to have 512 indoor groups and 80 outdoor (systems) (2) Via Daikin cloud service (3) Through own IT set-up (not Daikin cloud sever) (4) Not available on all indoors (5) Up to 10 DCC601A51 can be combined as a single site on Daikin Cloud Service (6) Only for BRP069C51, connection to Google Assistant and Amazon Alexa; (7) only for BRP069C51, contact your local sales representative for an overview of available services.

Hotel

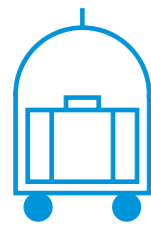

	Unit control		Integrating control		Advanced control	
	BRC1H52W/S/K	RTD-HO	KLIC DI V2	DCM010A51	DCM601B51	
	1 remote controller for 1 indoor unit (group)	1 gateway for 1 indoor unit (group)	Two additional probes can be connected	1 interface for up to 2,500 indoor units	1 iTM for 64 indoor unit(s) (groups) (1)	
Hotel guest can control & monitor basic functionalities from his room	•	•	• (3)		•	
Limit control possibilities for hotel guests	•	•	•	•	•	
Interlock with window contact	• (2)	•			•	
Interlock with key-card	• (2)	•			•	
Integrate Daikin units into existing BMS via Modbus		•				
Integrate Daikin units into existing BMS via KNX			•			
Integrate Daikin units into existing BMS via HTTP						•
Integrate Daikin unit control in hotel booking software				•		
				Oracle Opera PMS		
Monitor energy consumption						•
Advanced energy management						•
Integrate Daikin products cross pillars into Daikin BMS						•
Integrate third party products into Daikin BMS						•
Online control						•

(1) 7 iTM plus adapters (DCM601A52) can be added to have 512 indoor groups and 80 outdoor (systems) (2) Via BRP7A51 adapter (3) requires KNX compatible controller

Office



	Unit control		Integrating control		Advanced control	
	BRC1H52W/S/K	EKMBDXB	DMS504B51	DMS502A51	DCC601A51	DCM601B51
	1 remote controller for 1 indoor unit (group)	1 gateway for max. 64 indoor unit(s) (groups) & 10 outdoors	1 gateway for 64 indoor unit(s) (groups)	1 gateway for 128 indoor unit(s) (groups), 20 outdoors (2)	1 unit for 32 indoor unit(s) (groups) (5)	1 iTM for 64 indoor unit(s) (groups) (1)
Automatic control of A/C	•	•	•	•	•	•
Centralised control for management		•	•	•	•	•
Local control for office staff	•				• (4)	• through Web Remote management
Limit control possibilities for office staff	•	•	•	•	•	•
Integrate Daikin units into existing BMS via Modbus		•				
Integrate Daikin units into existing BMS via HTTP						•
Integrate Daikin units into existing BMS via LonTalk			•			
Integrate Daikin units into existing BMS via BACnet				•		
Energy consumption read out	• (3)					
Monitor energy consumption					• (4)	•
Advanced energy management					• (4)	•
PPD software to distribute used kWh/indoor unit				• (6)		• (7)
Integrate Daikin cross pillar products into Daikin BMS						•
Integrate third party products into Daikin BMS					•	•
Online control					• (4)	•
Manage multiple sites					• (4)	• (5)

(1) 7 iTM plus adapters (DCM601A52) can be added to have 512 indoor groups and 80 outdoor (systems) (2) extension (DAM41B51) needed to have up to 256 indoor unit(s) (groups), 40 outdoors (3) Not available on all indoor units (4) Via Daikin cloud service (5) Through own IT set-up (not Daikin cloud sever) (6) Up to 10 DCC601A51 can be combined as a single site on Daikin Cloud Service (7) via DAM41B51 option (7) via DCM002A51 option

Infrastructure cooling



	Unit	Integrating	Advanced
	BRC1H52W/S/K	RTD-10	DCM601B51
	1 remote controller for 1 indoor unit (group) (2)	1 gateway for 1 indoor unit (group) Up to 8 gateways can be linked together	1 iTM for 64 indoor unit(s) (groups) (1)
Automatic control of A/C	•	•	•
Back-up operation	•	•	•
Duty rotation	•	•	•
Limit control possibilities in the technical cooling room	•	•	•
If room temperature above max., then show alarm & start standby unit.		•	•
If an error occurs, an alarm will be shown.	•	•	•
If an error occurs, activate an alarm output	• Via KRP2/4A option (3)	•	• Via WAGO I/O

(1) 7 iTM plus adapters (DCM601A52) can be added to have 512 indoor groups and 80 outdoor (systems) (2) Infrastructure cooling functions only compatible with indoor units connected to RZQG*/RZAG* outdoor units. (3) See option list of indoor unit



Daikin mAP

Digital interface for your HVAC equipment



The Daikin mAP is the brand-new Digital HMI solution for all Daikin Applied products, designed to let end-users and technician operate easily and effectively from their smartphone or tablet while performing field activities.



Daikin mAP

NEW
Digital Interface

The Daikin mAP is the brand-new Digital HMI solution for all Daikin Applied products, designed to let end-users and technician operate easily and effectively from their smartphone or tablet while performing field activities.

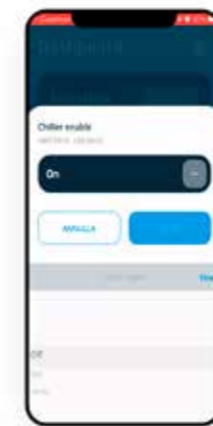
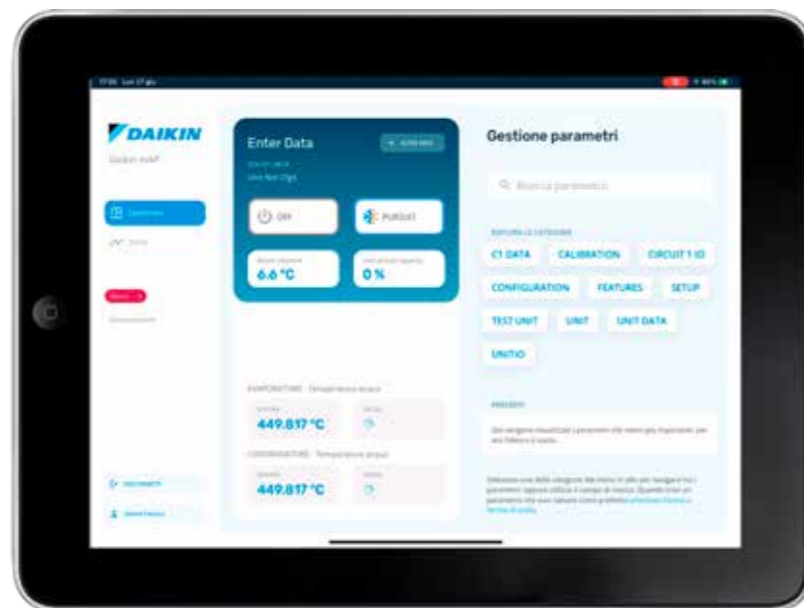

Control

Change settings and control parameters with more flexibility.

- Up to 4 user levels with different privileges
- Improved unit access security

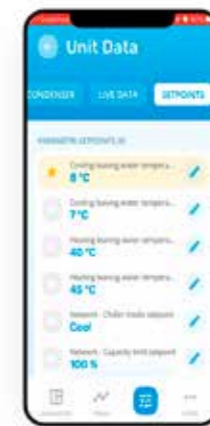

Select

Explore and search for a specific unit parameter.

- Search bar to easily find the desired parameter
- Select & change and pin in the dashboard your preferred parameters

Monitor

Start a live monitoring and trending of your preferred parameters

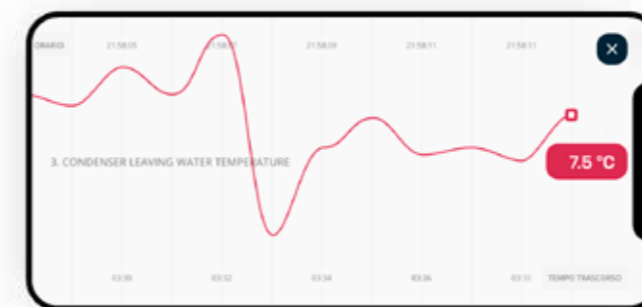

- Background monitoring for a non-stop operations
- Export and share monitoring data in .CSV file
- Up to 20 live trends and monitoring

DCC601A51

Intelligent **Tablet** Controller

Advanced centralised controller with Cloud connection

- Intuitive and user-friendly interface
- Flexible concept for stand alone and multi site applications
- Total solution thanks to integration of 3rd party equipment
- Monitor & control your small commercial building, no matter where you are

2 solutions:

Local solution

- › Offline centralised control
- › Stylish optional screen fits any interior

Cloud solution

- › Flexible online control from any device (Laptop, tablet...)
- › Monitor & control one or multiple sites
- › Benchmark the energy consumption of different installations (1)
- › Energy consumption follow-up to comply with local regulations

System layout

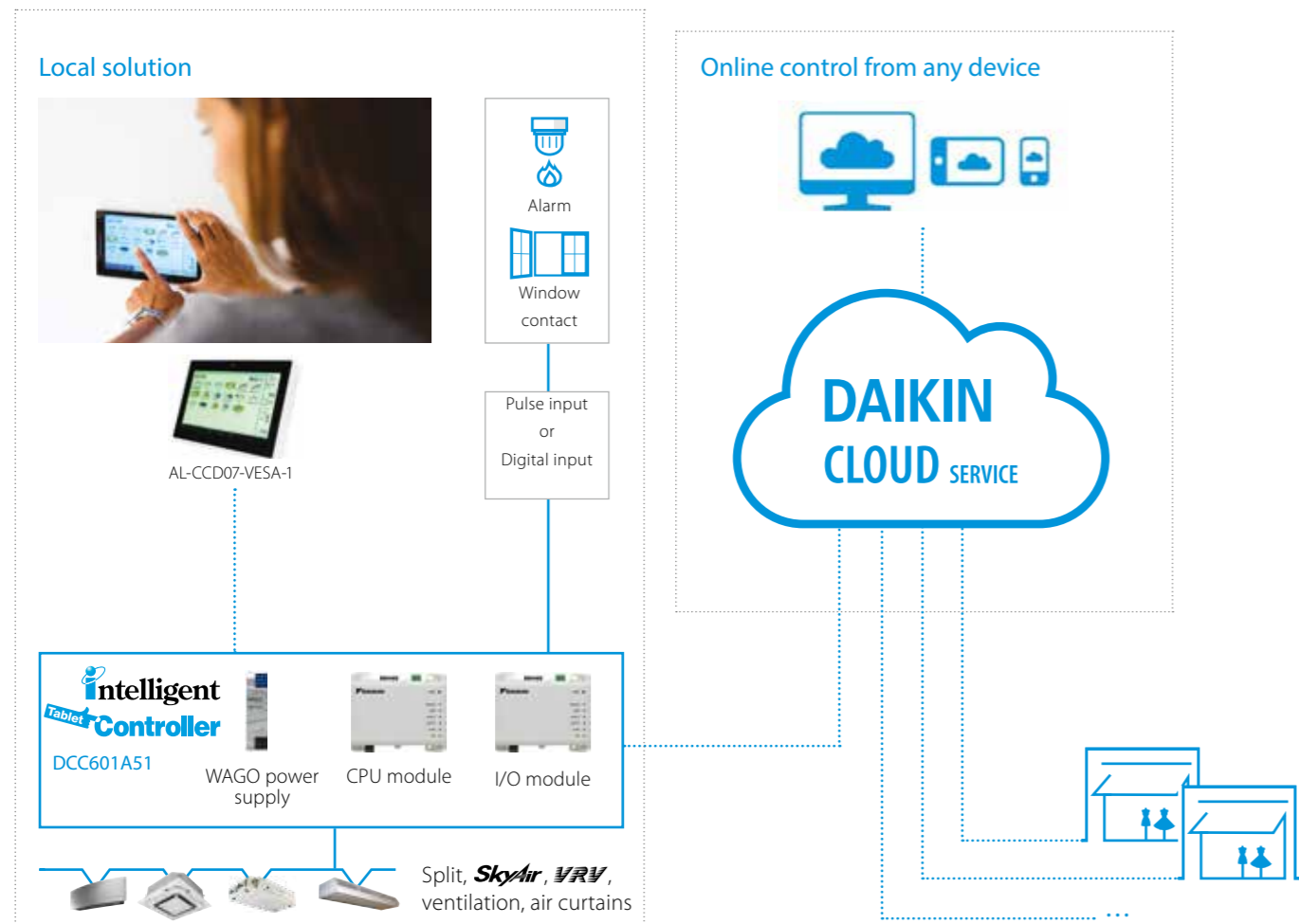

(1) For VRV and Sky Air R-32 ranges the consumption data is integrated; for other (HVAC) systems, field supplied kWh meters will be required

Total solution

- › Total solution thanks to a large integration of Daikin products and 3rd party equipment
- › Connect a wide range of units (Split, Sky Air, VRV, Ventilation, Biddle air curtains)
- › Simply control your entire building centrally
- › Increased customer shopping experience by better management of your shop comfort level

Daikin Cloud Services

- › Control your building no matter where you are
- › Monitor and control multiple sites
- › Installer or technical manager can remotely login to the cloud for first troubleshooting
- › Benchmark the energy consumption of different installations (1)
- › Manage & track your energy use

User friendly touch control

- › Stylish Daikin supplied optional screen for local control fits any interior
- › Intuitive and user-friendly interface
- › Full solution with simple control
- › Easy commissioning

Flexible

- › Pulse/digital inputs for 3rd party equipment such as kWh meters, emergency input, window contact, ...
- › Modular concept allows your cloud to grow with your business
- › Control up to 32 indoor units per controller and 320 units per site

(1) only available in combination with certain indoor units

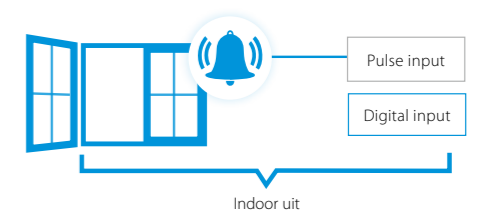
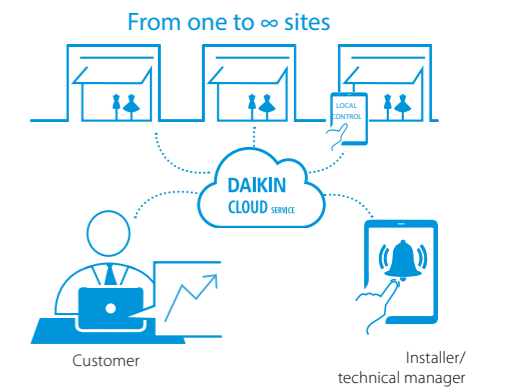

Functions overview

	Local solution	Cloud solution
Languages	Depends on local device	EN, DE, FR, NL, ES, IT, EL, PT, RU, TR, DA, SV, NO, FI, CS, HR, HU, PL, RO, SL, BG, SK
System layout	N° of connectable indoor units	
	Multiple sites control	
Monitoring & control	Basic control functions (ON/OFF, mode, filter sign, setpoint, fan speed, ventilation mode, room temperature, ...)	
	Remote control prohibition	
	All devices ON/OFF	
	Zone control	
	Group control	
	Weekly schedule	
	Yearly schedule	
	Interlock control	
	Set point limitation	
	Visualisation of energy use per operation mode	
Connectable to	DX split, Sky Air, VRV	
	Modular L Smart, VAM, VKM ventilation	
	Air curtains	

For available Daikin Cloud Service options refer to the option list



Mini BMS

with full integration across all product pillars

DCM601B51



- Price competitive mini BMS
- Cross-pillar integration of Daikin products
- Integration of third party equipment



Download the WAGO selection tool from my.daikin.eu

- › Easy selection of WAGO materials
- › Material list creation
- › Time saving
 - Includes wiring schemes
 - Contains commissioning/preset data for iTM



Check on **YouTube**

<https://www.youtube.com/DaikinEurope>



System overview

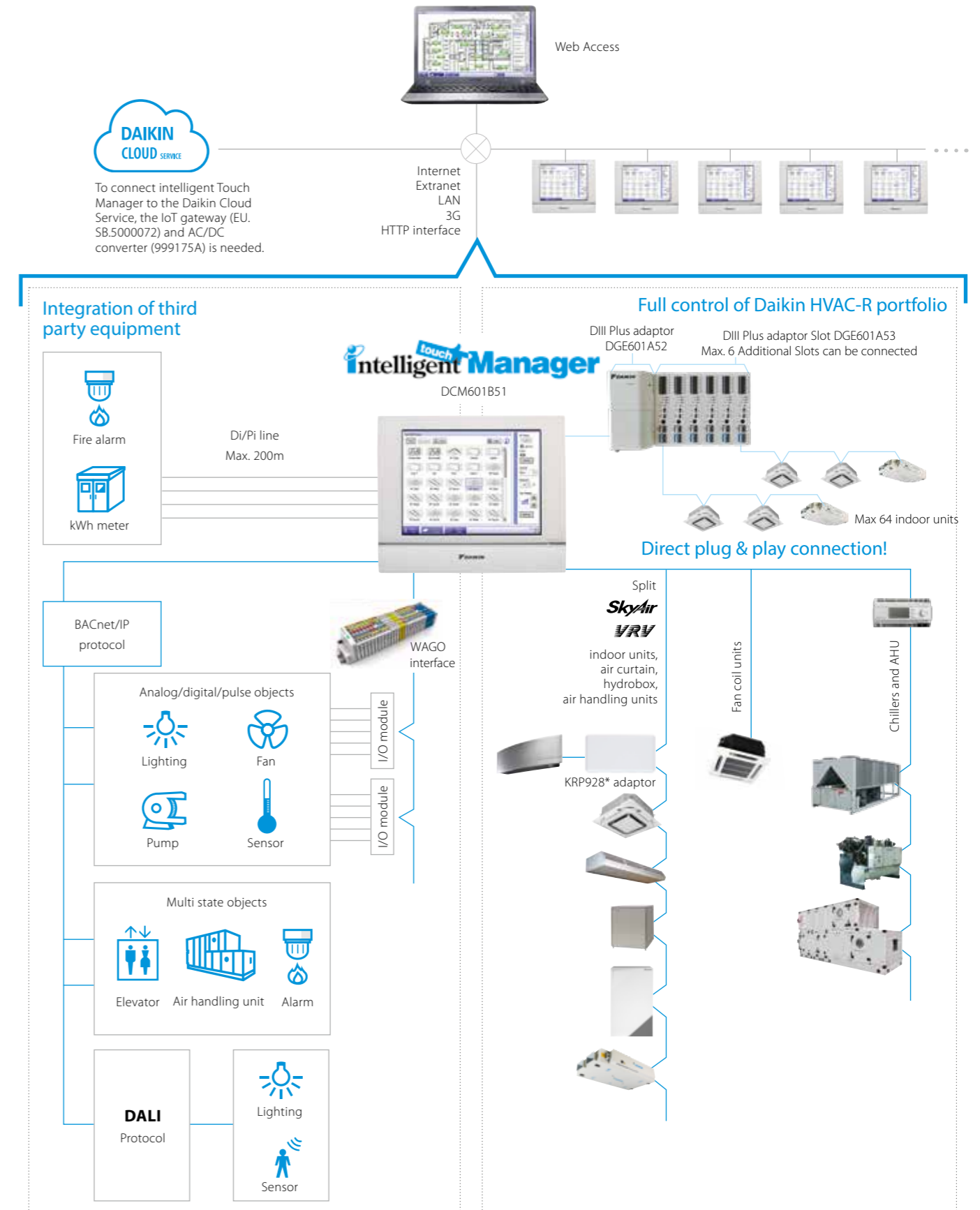



User friendliness

- › Intuitive user interface
- › Visual lay out view and direct access to indoor unit main functions
- › All functions direct accessible via touch screen or via web interface
- › Simplified electrical wiring, only one power supply & one connection wiring required

Smart energy management

- › Monitoring if energy use is according to plan
- › Helps to detect origins of energy waste
- › Powerful schedules guarantee correct operation throughout the year
- › Save energy by interlocking A/C operation with other equipment such as heating
- › Peak Power Cut off Control: Activating this feature in schedule function allows users to operate the outdoor unit in 4 settings i.e. 100%,70%, 40% and 0%

Flexibility

- › Cross-pillar integration (heating, air conditioning, applied systems, refrigeration, air handling units)
- › BACnet protocol for 3rd party products integration
- › I/O for integration of equipment such as lights, pumps... on WAGO modules
- › Modular concept for small to large applications
- › Control up to 512 indoor unit groups via one ITM and combine multiple ITM via web interface

Easy servicing and commissioning

- › Remote refrigerant containment check reducing on site visit
- › Simplified troubleshooting
- › Save time on commissioning thanks to the pre-commissioning tool
- › Auto registration of indoor units

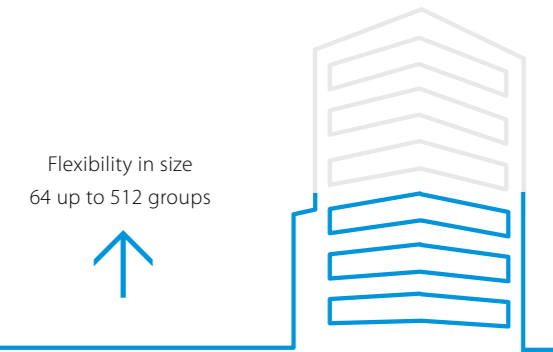

Plug & play

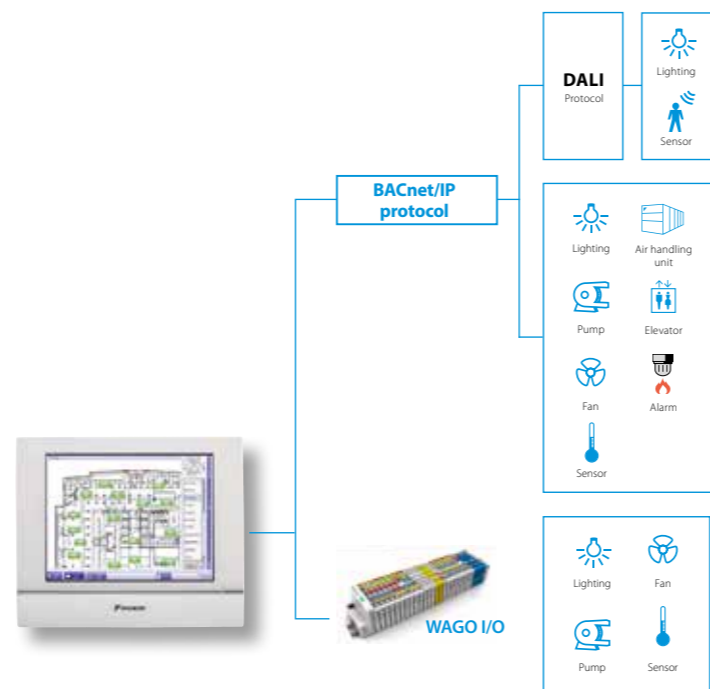

Functions overview

Languages

- › English
- › French
- › German
- › Italian
- › Spanish
- › Dutch
- › Portuguese

Management

- › Web access via html 5
- › Power Proportional Distribution (option)
- › Operational history (malfunctions, ...)
- › Smart energy management
 - monitor if energy use is according to plan
 - detect origins of energy waste
- › Setback function
- › Sliding temperature

WAGO Interface

- › Modular integration of 3rd party equipment
- › Large variety of input and outputs available. For more details refer to the options list

Open http interface

- › Communication to any third party controller (domotics, BMS, etc.) is possible via http open interface (http option DCM007A51)

System layout

- › Up to 512 unit groups can be controlled (ITM + 7 ITM Plus adapters)

Control

- › Individual control (512 groups)
- › Schedule setting (Weekly schedule, yearly calendar, seasonal schedule)
- › Interlock control
- › Setpoint limitation
- › Temperature limit
- › Schedule function to activate quiet operation mode on outdoor unit

DALI integration

- › Control and monitor the lights
- › Easier facility management: receive error signal when light or light controller has a malfunction
- › Flexible approach and less wiring needed, compared to classic light scheme
- › Easier to make groups and control scenes
- › Connection between intelligent Touch Manager and DALI through WAGO BACnet / IP interface

Connectable to

- › DX Split, Sky Air, VRV
- › HRV
- › Chillers (via MT3-EKCBACIP controller)
- › Daikin AHU (via MT3-EKCBACIP controller)
- › Fan coils
- › LT and HT hydroboxes
- › Biddle Air curtains
- › WAGO I/O
- › BACnet/IP protocol
- › Daikin PMS interface (option DCM010A51)



Daikin Applied Control Solutions



The intelligent Chiller Manager is a factory-engineered control solution to manage a chiller plant room. It is responsible for the **optimal sequencing and staging** of Chillers, Heat Pumps and Multipurpose units even in a **mixed plant configuration** and in both Heating and Cooling modes. The extended control solution integrated the management of Cooling Towers and manifolded Pumps for air and water cooled chiller plant. By reaching higher plant performance and efficiency levels, the intelligent Chiller Manager is the best and qualified solution for your HVAC equipment in a wide range of **Applications**.

Key Benefits

- > High performance
- > Lower energy & Maintenance Costs
- > Increase reliability & lifetime
- > Remote control and monitoring through Daikin on Site
- > **No additional installation required**



Daikin on Site

Daikin on Site is the unique solution for remote monitoring and smart maintenance. It allows a complete remote operation of every unit with different users and levels of access.

Daikin on site is fully compatible with All Daikin Applied Europe products and it can integrate **third-party products** like **IoT devices** (i.e. IAQ sensors).

Daikin has developed two offers called Daikin on Site: Partner and Daikin on Site: Premium.

- REMOTE MONITORING
- REPORTING
- ALARM TROUBLESHOOTING
- ENERGY ANALYSIS
- REFRIGERANT LEAKAGE DETECTION

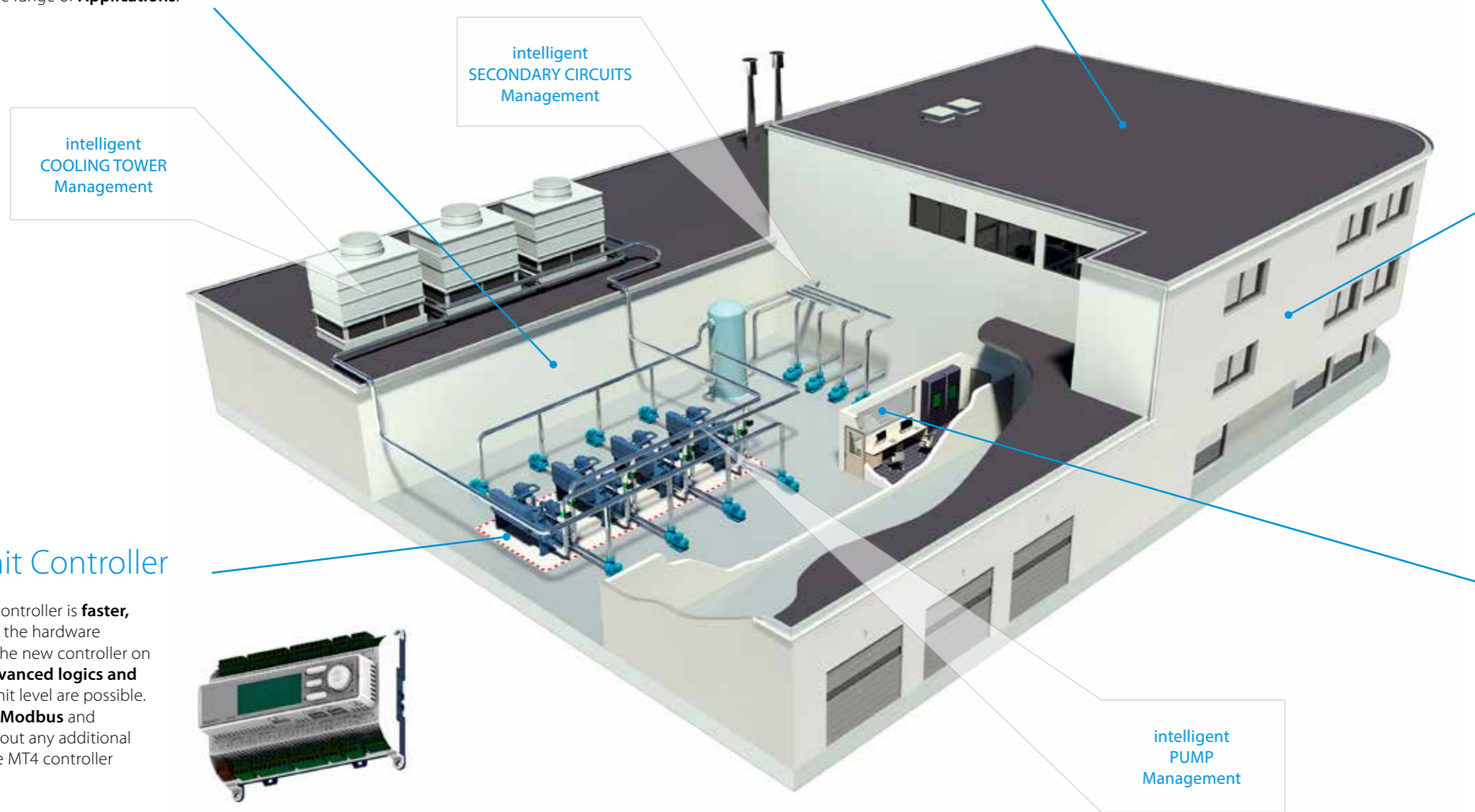

Microtech® 4 Unit Controller

The new **Microtech® 4 (MT4)** controller is **faster, smarter and connected**. With the hardware improvements introduced by the new controller on all air/water cooled chillers, **advanced logics and algorithms** development at unit level are possible. Communication protocols like **Modbus** and **BACNet** are also available without any additional hardware required because the MT4 controller supports them natively.



Building management system Integration

With MT4 unit the communication protocols such as **Modbus** and **BACNet** are available directly from the controller and activated from Factory when ordered or through the after-sales channel.



Performance Monitoring

With MT4, advanced algorithms implementation in the unit controller are possible, such as the **Performance Monitoring** (Option 186). This **sensor-less algorithm** calculates the unit cooling capacity by using refrigerant pressure and temperature readings. Electrical power is calculated either from compressor VFD power and fan, or directly measured through optional energy meter. As a standard, **no extra-hardware is required**.



Factory-engineered system control to manage a chiller plant room

Thus optimising its performance and increasing its reliability by:

- › Optimal start-up, sequencing & staging of chillers
- › Matching chiller capacity to load demand

iCM's main functionalities:

Availability

Determines whether chillers are available or not, based on:

- › Inputs from the chiller unit controllers
- › Modbus communication status
- › Pump status

Sequencing

Optimises the order in which available chillers are turned on and off depending on operating hours, energy efficiency, etc.



Staging

Calculates **energy-optimal stage-up/stage-down** of the chiller by determining the increased capacity demand by capacity control, compensation of temperature and rotation. This function aims at providing the most energy-efficient combination of chillers on a continuous basis.

Stopping Last Chiller/Recycling

Captures a rise in demand when the **last chiller is staged down**, by operating the pump dedicated to the next ON chiller at a minimum VFD frequency.

Min/Max Operating Chiller Setting

Ensures that the number of operating chillers always **stays within a certain range**, regardless of changes in demand.

Primary Pump control

Primary evaporator and condenser pump control for dedicated and manifolded pumps thanks to iPM panel

Secondary Pump Control

Control of up to 12 secondary circuits thanks to iSM panel extension

Cooling Tower Optimization

Control and Optimization of Cooling Tower systems thanks to iCT extension modules.

Remote Connection through Daikin on Site

24/7 monitoring and control of iCM plants through Daikin on Site cloud service.

Daikin is the best qualified partner to optimise the operation of a Daikin chiller plant room.

Why choose iCM?

- › Optimise performance
- › Increase reliability
- › Reduce energy costs
- › Reduce maintenance costs
- › Factory-engineered and tested
- › Remote control and monitoring. From one-time commissioning to real-time commissioning

Remote control and monitoring possibilities

(valid for both Standard and Customised versions)

- › **Connectivity to Daikin's remote monitoring and control system (www.daikinonsite.com)** for remote monitoring and service providing Internet connection to the main controller
- › **Integration with general BAS/BMS** offered through BACnet or Modbus Modules based on BACnet/IP or Modbus RTU/RS-485 protocols
- › **Built-in HMI, Remote HMI, Web HMI and daikinonsite.com** are available for control and configuration

Integrated logics for Plant Management



Key Benefits

- › High performance
- › Lower energy & Maintenance Costs
- › Increase reliability & lifetime
- › Remote control and monitoring through Daikin on Site
- › **No additional installation required**

Control strategies

Advanced control strategies can be chosen to optimise units life time and the energy efficiency of a chillers plant:

- › by sequencing it is decided which unit must start or stop
- › by staging the unit shares the load based on a threshold specified by the user

Control options

iCM can manage:

- › Up to 16 units Heating/Cooling mode, with iCM expanded kit
- › Up to 8 units Heating/Cooling mode
- › Special control options such as: VPF, Demand Limit, Rapid Restart are managed by iCM in a multiple unit system
- › Heat recovery option management
- › Free cooling option management
- › Manifolded pumps management (evaporator/condenser) – iPM control panel is required
- › Cooling tower system management – iCT control panel is required
- › Secondary circuits management - iSM control panel is required

What are the main differences between Master/Slave and iCM?

For Daikin unit equipped with MT4, iCM are set of functions embedded directly in the unit controller. In addition for those applications not covered by the embedded functions, iCM customized are also available.

While Master/Slave can manage systems composed by units model of the same type, iCM can manage cooling, heating and plants made of different kind of units

Feature	Master/Slave	New iCM
Number of chillers	UP TO 4	UP TO 16
Plants with All Chillers	same models	YES
Plants with all Heat Pumps	same models	YES
Plants with Multipurpose	YES	YES
Mix of Chillers (max 2 circuits) + Multipurpose	NO	YES
Mix of Chillers + Heat Pumps	NO	YES
Chillers with Heat Recovery	NO	YES
Chillers with free cooling	NO	YES
Units with modulable capacity control	YES	YES
Units with step capacity control	YES	YES

Product line-up



iCM as unit option 184 (up to 16 with iCM expanded kit):

- › Up to 8 daikin chillers
- › Mixed systems (Chiller + heat pumps or chillers + multipurpose)
- › Heating/cooling operating modes
- › Heat recovery and Free cooling management
- › Units with modifiable and step capacity control

Intelligent Pump Manager:

- › Up to 5 dedicated or manifolded pumps (evaporator or condenser)
- › Up to 10 dedicated or manifolded pumps (evaporator or condenser)

Intelligent Cooling Tower Manager:

- › Up to 10 manifolded cooling towers (available with Pump Manager at the condenser side)

intelligent Secondary Circuits Manager:

- › Up to 8 pumps divided in up to 4 pump groups (up to 3 ism can be connected for a total of 12 pump groups and 24 secondary pumps)

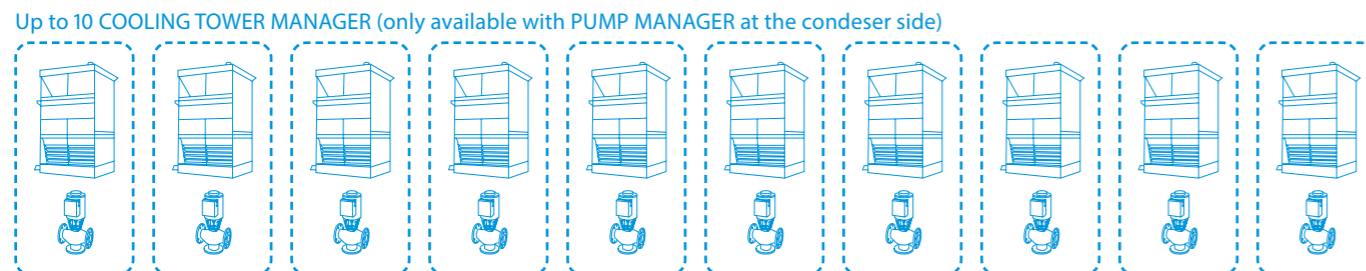
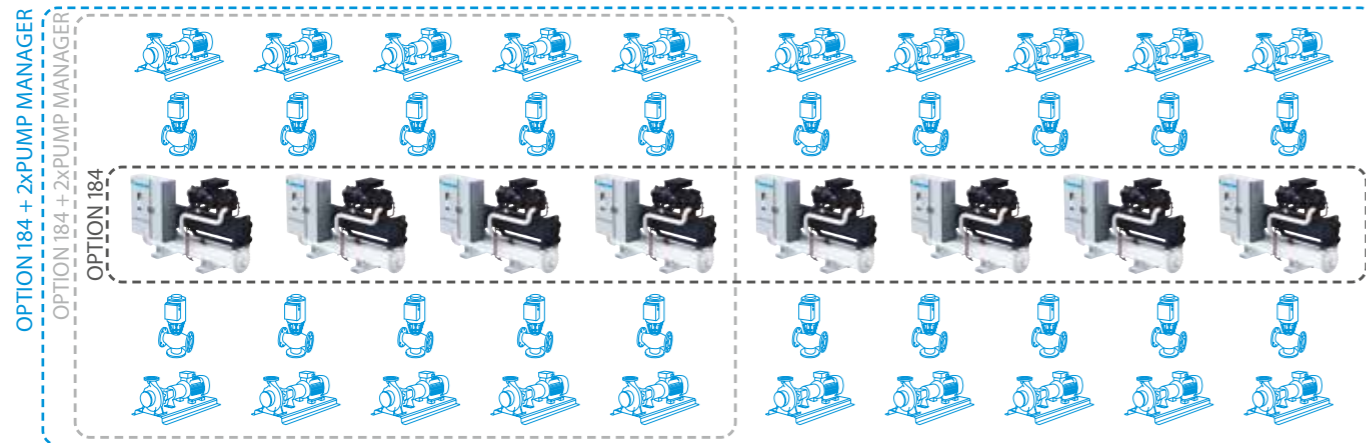
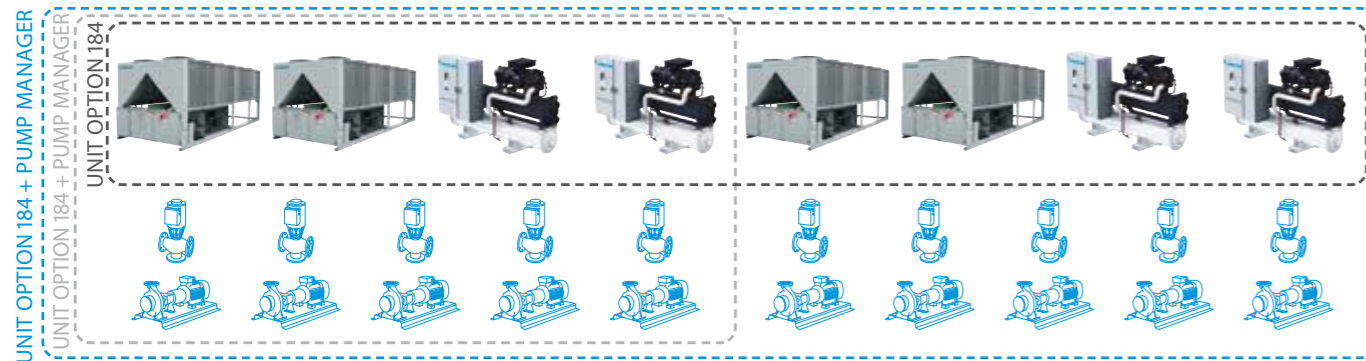

EKMBDXB

DIII-net Modbus interface

Integrated control system for seamless connection between Split, Sky Air, VRV and small inverter chillers and BMS systems

- > Communication via Modbus RS485 protocol
- > Detailed monitoring and control of the VRV total solution
- > Easy and fast installation via DIII-net protocol
- > As the Daikin DIII-net protocol is being used, only one modbus interface is needed for a group of Daikin systems (up to 10 outdoor units systems).



		EKMBDXB7V1	
Maximum number of connectable indoor units		64	
Maximum number of connectable outdoor units		10	
Communication	DIII-NET - Remark	DIII-NET (F1F2)	
	Protocol - Remark	2 wire; communication speed: 9,600 bps or 19,200 bps	
	Protocol - Type	RS485 (modbus)	
	Protocol - Max. Wiring length	m	500
Dimensions	HeightxWidthxDepth	mm	124x379x87
Weight		kg	2.1
Ambient temperature - operation	Max.	°C	60
	Min.	°C	0
Installation		Indoor installation	
Power supply	Frequency	Hz	50
	Voltage	V	220-240

Modbus interface

Integrate chillers, fan coil units and air handling units in BMS systems via modbus protocol

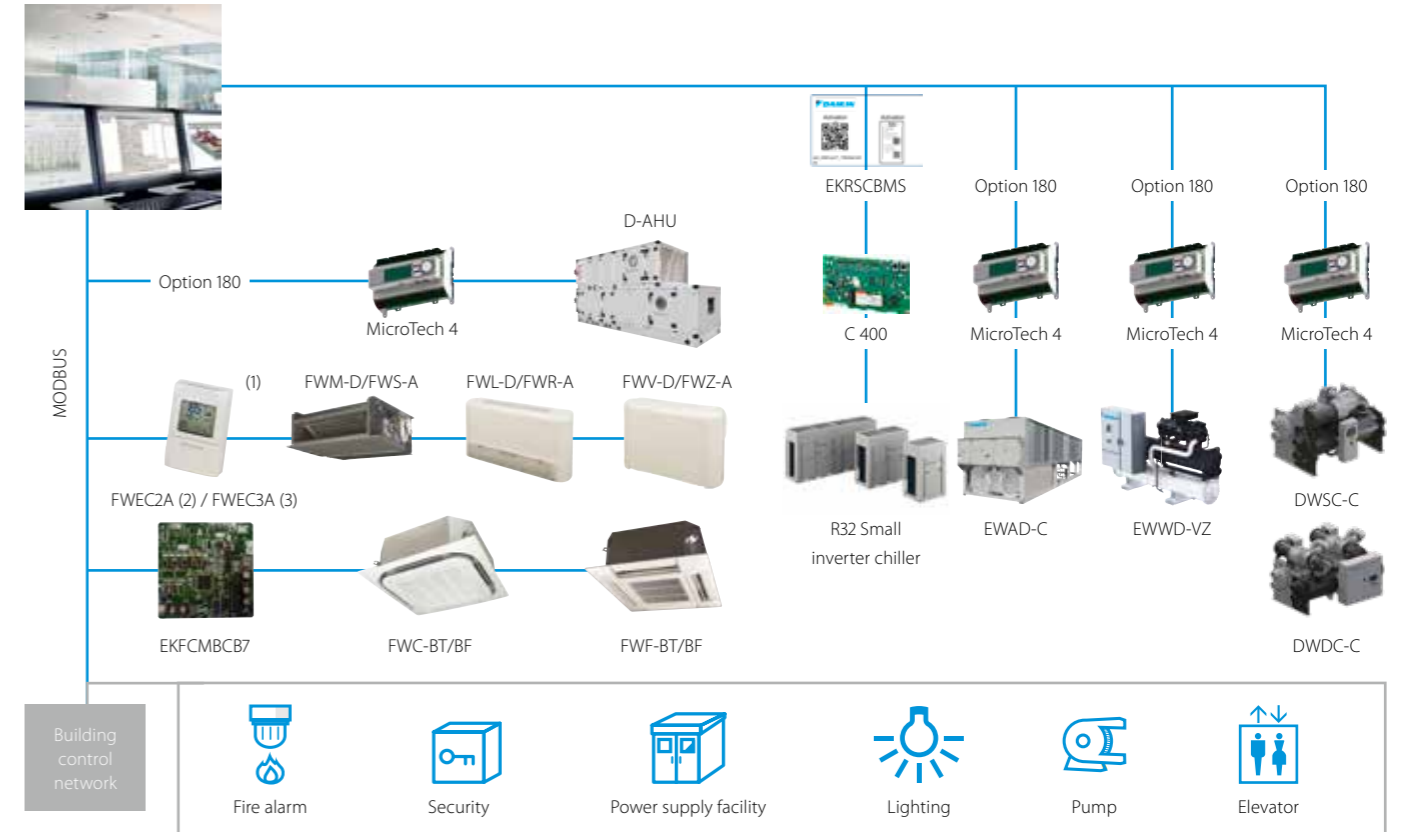

(1) The communication module is integrated in the controller (2) Connection to FWV-D, FWL-D & FWM-D (3) Connection to FWV-D, FWL-D, FWM-D and to FWZ-A, FWR-A, FWS-A

Integrate Refrigeration units in BMS systems via modbus protocol

BRR9A1V1



* For all connectable indoor units and Biddle air curtains please refer to the Conveni-pack pages in this catalogue

DMS502A51 / EKACBACMSTP / EKCBACIP / EKCBACMSTP

BACnet Interface

Integrated control system for seamless connection between VRV, applied systems, air handling units and BMS systems

- > Interface for BMS system
- > Communication via BACnet protocol (connection via Ethernet)
- > Unlimited site size
- > Easy and fast installation
- > PPD data is available on BMS system (only for VRV)

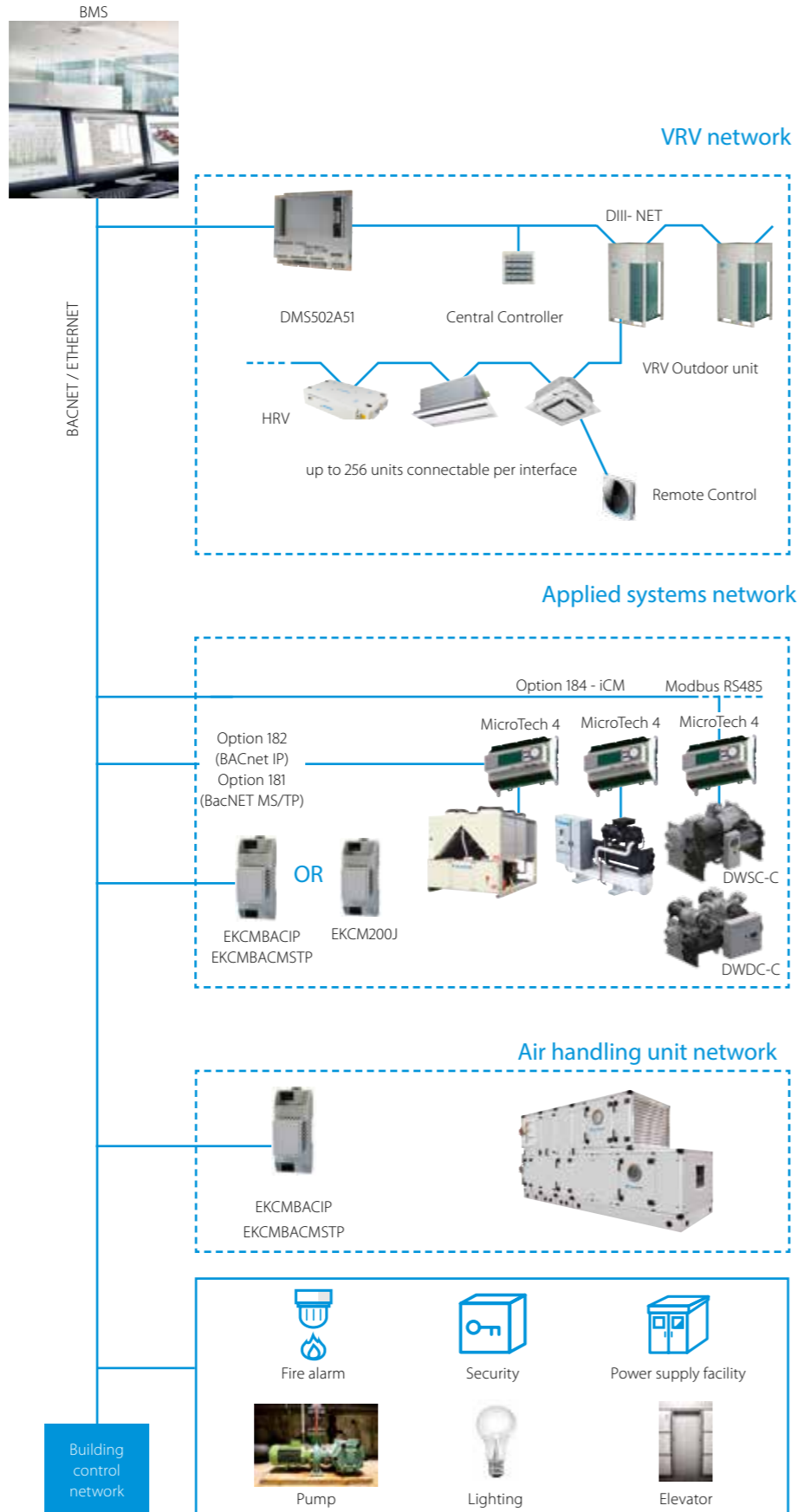

DMS504B51

LonWorks Interface

Open network integration of VRV monitoring and control functions into LonWorks networks

- > Interface for Lon connection to LonWorks networks
- > Communication via Lon protocol (twisted pair wire)
- > Unlimited sitesize
- > Quick and easy installation

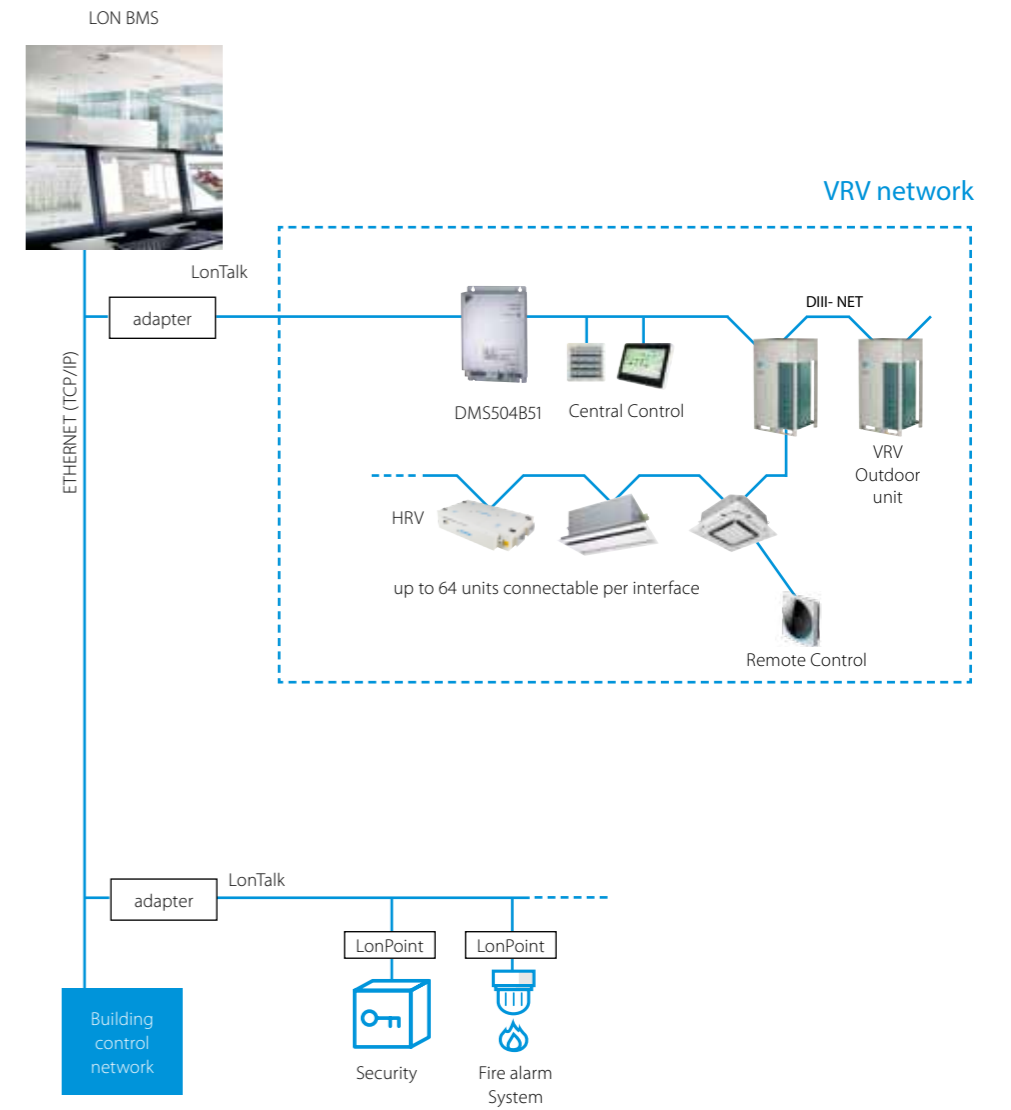

Daikin on Site

Why Daikin on Site?

Operating costs like energy and maintenance typically account for 85% of the system's total lifetime cost. Undiscovered energy waste and incorrect operation will increase costs and can even lead to unscheduled interruptions.

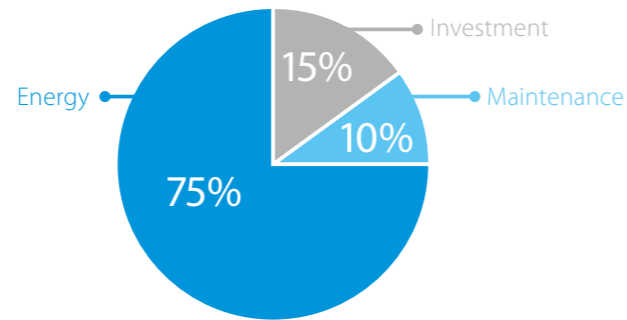

Typical Life cycle Cost of a chiller (15 years)

Using Daikin on Site monitoring results in optimum use and costs over the system's entire lifetime:

- › Enhanced control and measuring
- › Monitors the system
- › Reduces risks at the earliest possible moment
- › Keeps the system running as it was intended to
- › Controls your IEQ by connecting our sensor

What is Daikin on Site?

A solution for customer specific needs

The Daikin on Site cloud server collects operational data from the control system of a Daikin chiller or air handling unit plant. Daikin's Smartcentre then turns this data into useful information on a web user interface. Daikin on Site has predefined user roles like:

- › operator
- › service provider
- › Daikin specialists

The Daikin on Site platform's features are designed to:

- › Increase uptime, reduce unscheduled interruptions
- › Optimise efficiency and reduce energy waste
- › Increase lifetime and avoid wear by misuse
- › Give insight into the optimum use of equipment, including advice from a Daikin expert

We will combine Daikin on Site remote monitoring with the complementary service programme best suited to your needs.

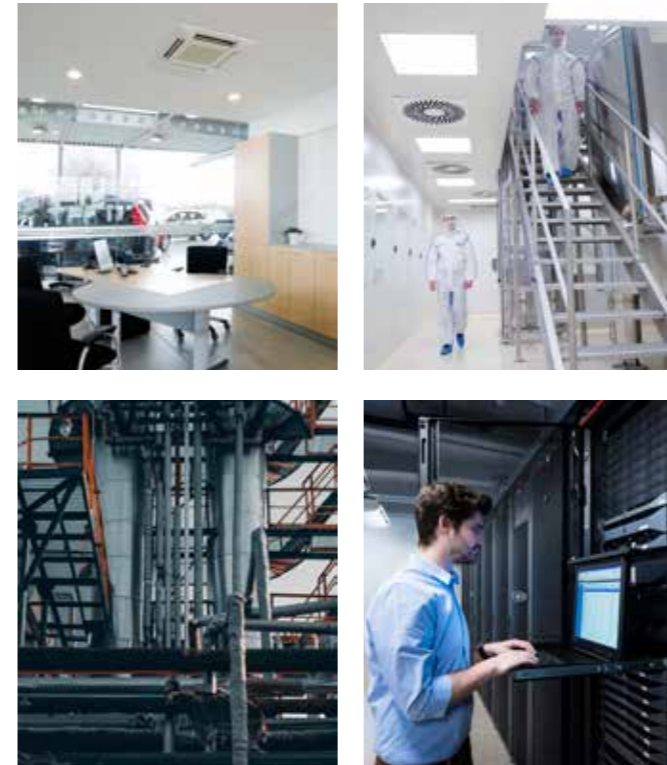

The remote monitoring for Daikin products

Let's enter in Daikin connected HVAC with Daikin on Site cloud solution. An enriched offer meeting every needs. From a basic control up to a full and advanced monitoring of your HVAC equipment directly from your desk. A wide variety of HVAC application can benefit from Daikin on Site and its connected services.

With Daikin on Site, your HVAC equipment will reach high reliability and efficiency levels. No more stops and long waiting time for Alarm troubleshooting. Thanks to a continuous monitoring and advanced tools, Daikin on Site helps to improve the overall system lifetime. A Daikin expert is ready to help and keep monitored your plant, suggesting actions and system improvements.

Daikin on Site is the best solution to improve your HVAC efficiency.

SOON AVAILABLE

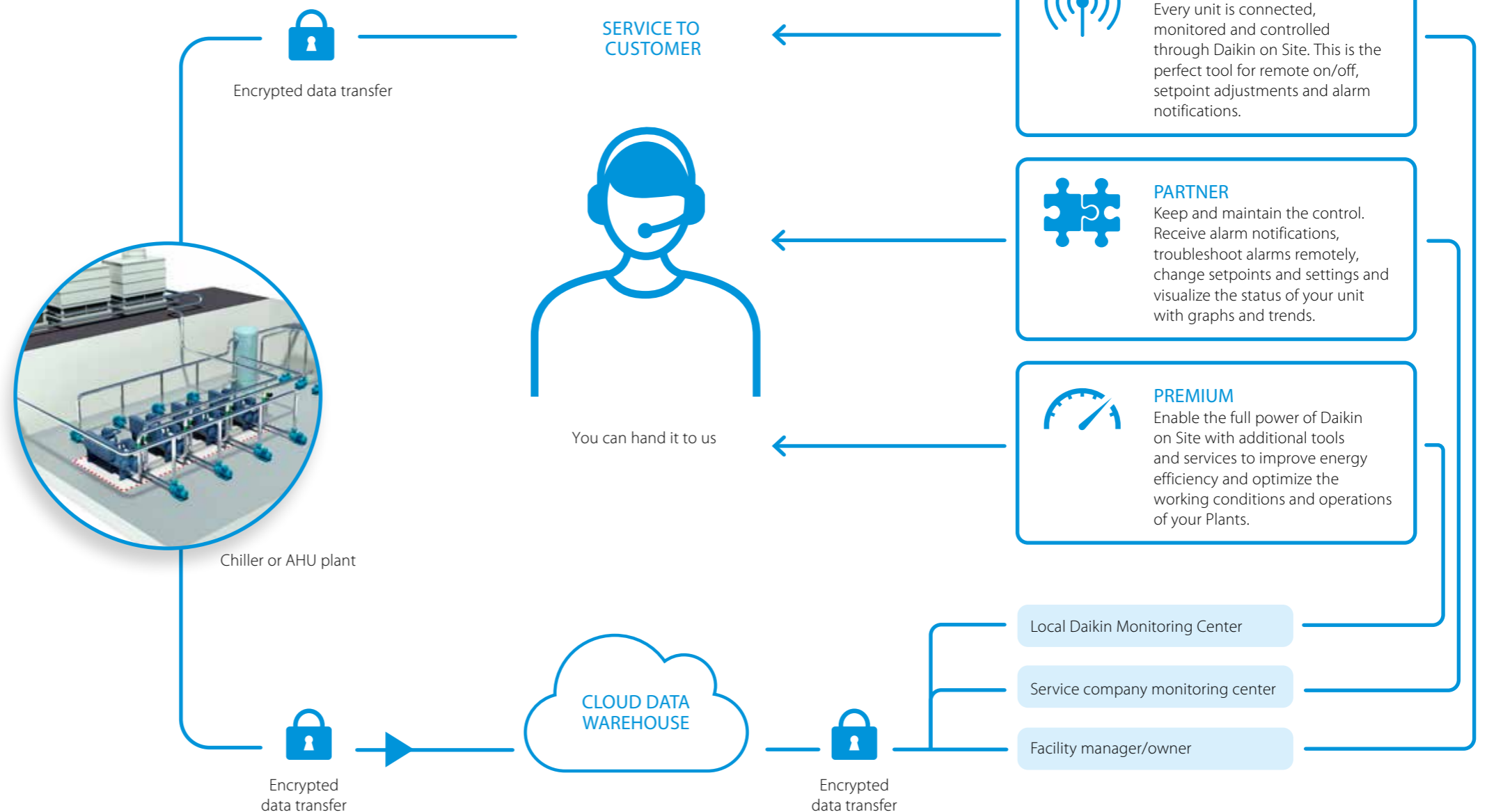

IEQ Sensor

Our New Indoor Environmental Quality Sensor



Daikin's newest device measures and analyses your indoor environment to improve your well-being

Why Indoor Air Quality Matters

✓ Indoor Air Quality

Indoor Air Quality (IAQ) refers to the quality of the air in indoor environments, which affects building's occupants during their everyday lives. When designing HVAC systems for residential buildings, schools, offices, or light commercial buildings, many things must be considered. While it is important to meet the cooling and heating demand, we should also consider aspects such as ventilation, air filtration, and indoor air quality.

Did you know that breathing indoor air, whether it is at home, at the office, or in a hotel room, can be much more polluted than outdoor air? Remember that 90% of our life is spent indoors, and indoor air quality can be 2 to 5 times worse than outdoor air.

✓ Ventilation

Ventilation systems ensure optimal climate conditions by providing a fresh, healthy, and comfortable environment for buildings of all sizes, as well as for different applications.

In a completely closed room, air cannot easily enter or leave, causing air pollutants to accumulate which could affect the health of the people who use the room. Ventilation is essential for diluting and removing these air pollutants.

A well-maintained ventilation system with an adequate air-exchange rate have been demonstrated to be an effective solution to protect people from contaminants, including viruses.

✓ Indoor Air Quality components

Indoor Environment Quality (IEQ) is broader than IAQ, and includes lighting, noise, and electromagnetic fields.

1. Ventilation

Ensures the provision of fresh and clean air

2. Energy recovery

Delivers energy savings by transferring heat and moisture between airflows

3. Air processing

Ensures clean and healthy air by filtering out pollen, dust, and odours that are harmful to our health

4. Humidification

Ensures the desired moisture level in the conditioned space

✓ Monitoring Indoor Air Quality

Nowadays, most things that surround us can be monitored and tracked, even Indoor Air Quality (IAQ). Monitoring and tracking IAQ values can help us to understand how our surrounding environment affects our well-being, and then take action to improve the quality of the environment in which we live, whether this is our homes, the office, a restaurant, schools, or shops.

Features

The Daikin IEQ Sensor measures your well-being by tracking indoor air quality values, environmental comfort, and electromagnetic pollution. It is available with 12 sensors and 15 parameter measures, and connects through your Wi-Fi network or via NB-IoT technology.

✔ Complete Standalone Installation

The Daikin IEQ Sensor does not have to be paired with another product, for an extremely easy and completely standalone installation that takes about a minute. The device can be powered up with microUSB power supply (included). The material code is AIRSENSEPROPLUS.

✔ Caelum Monitoring Platform

The device connects to Caelum, Daikin's monitoring platform, at www.daikiniaq.com. This enables you to easily monitor Indoor Air Quality levels and create regular reports based on the data detected by the sensor. You can even use the platform to show your indoor air quality levels to your visitors.

✔ Mobile App

The configuration app is available as Daikin AirSense on both the App Store and Play Store. Once installed on your mobile device and logged in, scan the QR code on the IEQ sensor and the app will guide you through the entire configuration process. Once your sensor is configured, you will have access to the entire set of functions from your mobile.

✔ Connectivity

The IEQ sensor ensures perfect integration with Daikin on Site and Daikin Cloud Service, Daikin's remote monitoring and smart maintenance platform. It gives you perfect control over the entire heating, ventilation and air conditioning system installed in your building. You can use interlock function between IAQ sensor and AHUs.

✔ Available ReFilter tools

Product Hierarchy

- › Material – Product hierarchy: Accessory
- › Material name: AIRSENSEPROPLUS
- › Business Pillar: SERVICES

✔ Green Building Certification

Installing the Daikin IEQ sensor can help you achieve better sustainability ratings and green building projects certified with LEED and WELL certification thanks to Indoor Environmental Quality credits.

✔ Video wall

The video wall is a great tool to have a general overview of the measurements conducted by the device. This screen can be shared with the occupants of the buildings to show in each moment the Indoor Air Quality status.

✔ Communication capability

NB-IoT: This technology can reach devices in areas where reception is poor or difficult to reach. Complete standalone installation. This is a perfect solution for service purposes where access to local Wi-Fi is not allowed or not available.

Wi-Fi: Easy and complete standalone installation.

✔ Sensor characteristics

Fine Dust (PM10/PM2.5)

Range: 0 to 1,000 µg/m³
 Precision: (from 0 µg/m³ to 100 µg/m³): ±15 µg/m³
 Precision: (from 100 µg/m³ to 1,000 µg/m³): ±15%
 Resolution: 1 µg/m³

Temperature

Range: -40 °C a 85 °C
 Precision: ±1 °C (between 0 °C and 65 °C)
 Resolution: 0.1 °C

Humidity

Range: 0 to 100% RH
 Precision: ±3% RH
 Resolution: 0.1% RH

Ambient Light

Range: 0 lux to 120,000 lux
 Precision: ±10%
 Resolution: 0.1 lux

Air Pressure hPa

Range: 300 to 1,100 mbar (hPa)
 Precision: 0.1 mbar (hPa)
 Resolution: 0.1 mbar (hPa)

Electrosmog

LF Range: 0 - 20.000 nT - Range: 5 Hz - 120 Hz
 Precision: ±5% - Resolution: 25nT
 HF Range: 0 to -10 V/m - Range: 50 MHz - 300 GHz
 Precision: ±10% - Resolution: 0.1 V/m
 Measurements performed on 3 axes

CO₂

Range: 0 to 5,000 ppm
 Precision: ±30 ppm (between 0 and 1,000 ppm)
 ±3% (over 1,000 ppm)
 Resolution: 1 ppm

TVOC

Range: 0 ppb to 1,187 ppb
 Resolution: 1 ppb
 Precision: ±10%

Air quality

Range: 0 to 500
 Precision: ±15%
 Resolution: 0.1

Sound Pressure

Range: 28 to 120 dBspl
 Frequency: from 50 Hz to 20 KHz
 Precision: ±1 dBspl
 Resolution: 0.1 dBspl

CO₂e

Range: 400 to 6,000 ppm
 Precision: 20%
 Resolution: 1 ppm

Wi-Fi networks & signal intensity (2.4GHz band)/(PM10-PM2.5)

Detects Access Point n° in band 2.4Ghz and overall signal level (from 0 to -100 dBm)

Daikin IEQ Sensor kit

The IEQ sensor kit comes in a carton box containing the following items:

- › Power Supply plug
- › USB - Micro USB Cables
- › Wall fixing kit
- › Quick installation guides



NB-IoT or WiFi?

Communication is either Wifi or NB-IoT network (mobile network). The NB-IoT services is available in the following 18 countries: Austria, Belgium, Czech Republic, Denmark, Estonia, Germany, Greece, Hungary, Ireland, Italy, the Netherlands, Norway, Portugal, Romania, Spain, Switzerland, United Kingdom. NB-IoT services carry a fee (invoiced after the first year of usage).

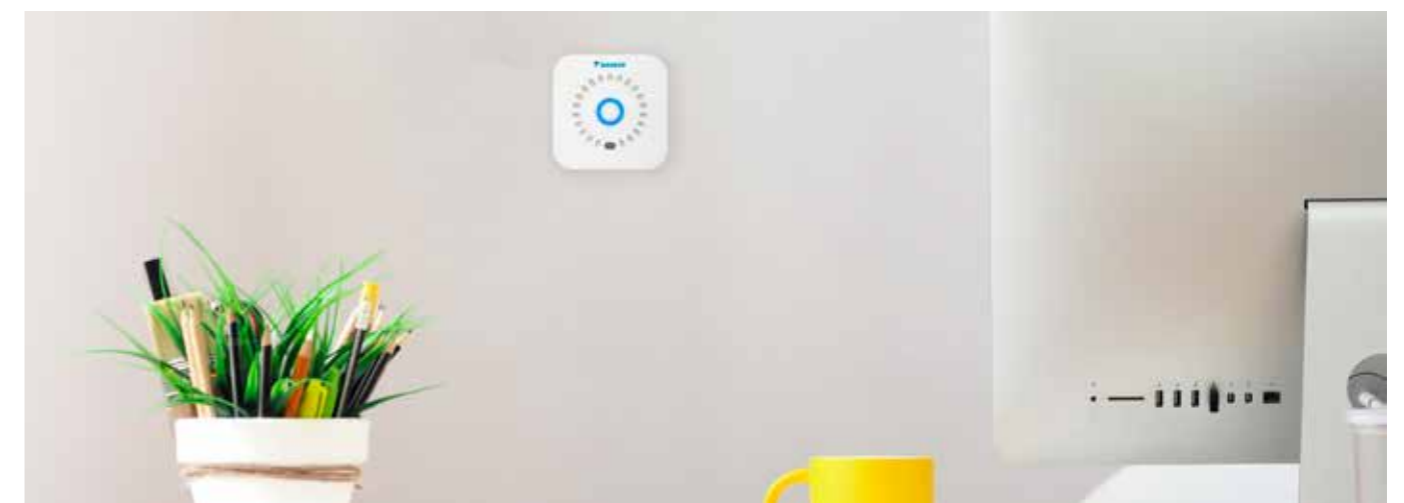
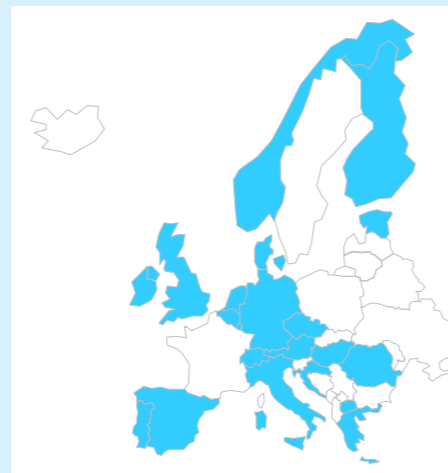

Power supply

T1	=	3~, 220V, 50Hz
V1	=	1~, 220-240V, 50Hz
VE	=	1~, 220-240V/220V, 50Hz/60Hz*
V3	=	1~, 230V, 50Hz
VM	=	1~, 220~240V/220~230V, 50Hz/60Hz
W1	=	3N~, 400V, 50Hz
Y1	=	3~, 400V, 50Hz

* For VE power supply only 1~, 220-240V, 50Hz data is displayed in this catalogue.

Conversion table refrigerant piping

inch	mm
1/4"	6.4 mm
3/8"	9.5 mm
1/2"	12.7 mm
5/8"	15.9 mm
3/4"	19.1 mm
7/8"	22.2 mm
1 1/8"	28.5 mm
1 3/8"	34.9 mm
1 5/8"	41.3 mm
1 3/4"	44.5 mm
2"	50.8 mm
2 1/8"	54 mm
2 5/8"	66.7 mm

F-gas regulation

Any refrigeration system that contains fluorinated greenhouse gases is in scope of the F-gas regulations.

For fully/partially pre-charged equipment: contains fluorinated greenhouse gases. Actual refrigerant charge depends on the final unit construction, details can be found on the unit labels and in the notes underneath the specification tables in this catalogue.

For non pre-charged equipment (including, but not limited to racks): its functioning relies on fluorinated greenhouse gases.

The F-gas regulations do not apply to systems that contain only natural refrigerants such as propane or carbon dioxide.

Measuring conditions

Air conditioning

1) Nominal cooling capacities are based on:	
Indoor temperature	27°CDB/19°CWB
Outdoor temperature	35°CDB
Refrigerant piping length	7.5m - 8/5m VRV
Level difference	0m
2) Nominal heating capacities are based on:	
Indoor temperature	20°CDB
Outdoor temperature	7°CDB/6°CWB
Refrigerant piping length	7.5m - 8/5m VRV
Level difference	0m

Applied systems

Air cooled	Cooling only	Evaporator: 12°C/7°C	Ambient: 35°CDB
	Heat pump	Evaporator: 12°C/7°C Condenser: 40°C/45°C	Ambient: 35°C Ambient: 7°CDB/6°CWB
Water cooled	Cooling only	Evaporator: 12°C/7°C Condenser: 30°C/35°C	
	Heating only	Evaporator: 12°C/7°C Condenser: 40°C/45°C	
Condenserless chiller		Evaporator: 12°C/7°C Condensing temperature: 45°C / liquid temperature: 40°C	
Fan coil units	Cooling	Indoor temperature 27°CDB, 19°CWB; entering water temperature 7°C, water temperature rise 5K	
	Heating	2-pipe	Indoor temperature 20°CDB, 15°CWB; entering water temperature 45°C, water temperature drop 5K
		4-pipe	Indoor temperature 20°CDB, 15°CWB; entering water temperature 65°C, water temperature drop 10K
Air Handling Units		Temperature and humidity conditions: Extract air 22°C / 50%; Fresh air -10°C / 90%	

The sound pressure level is measured via a microphone at a certain distance from the unit. It is a relative value, depending on the distance and acoustic environment (for measuring conditions: please refer to the technical databooks). The sound power level is an absolute value indicating the "power" which a sound source generates. For more detailed information please consult our technical databooks.



Table of content

Service and Maintenance

Why choose Daikin Applied Service ?	216
Daikin PROtect maintenance solutions	217
Daikin on Site active remote monitoring	218
IEQ Sensor	219
Refrigerant leak detection	220
Vibration analysis	220
Oil analysis	221
Rental services	222
Chiller modernisation	224
AHU refurbishment	225
F-Gas regulations	226
Spare parts	227



Daikin Applied Service

Why choose Daikin Applied Service?

Daikin Applied Service is one of the leading specialists in the maintenance and refurbishment of **all brands of HVAC equipment**. Operating across the UK offering rapid response and specialist solutions to your maintenance needs. Our service is further enhanced by **Daikin On Site - active remote monitoring**, proactive monitoring and diagnosis of AHUs and chillers, 24/7/365, supported by a reliable network of technical and on-site personnel, helping you to optimise your system efficiency.

Service capabilities

- › Flexible maintenance contracts tailored to your business needs
- › Maintenance of ALL brands of HVAC equipment
- › 24/7 emergency call out service
- › Up to four hour response time
- › Qualified site service engineers (F-Gas Registered)
- › Remote monitoring with Daikin On Site (DOS)
- › On site training for front-line personnel
- › Tailored Service Level Agreement (SLA)
- › Full chiller running logs taken on every service visit
- › Comprehensive spare parts availability & support on all brands
- › Retrofitting & refurbishment

Benefits of a maintained system

- › Lower operation costs and energy usage
- › Extended life-cycle of assets
- › Fast and reliable remote diagnostics with Daikin On Site
- › Reduced equipment downtime and costly repairs
- › Improved indoor air quality



Daikin PROtect

Maintenance solutions

Daikin PROtect is your long term economical and sustainable maintenance solution, direct from the manufacturer.

We offer a three year maintenance package (option to extend to five years) designed to protect and optimise your HVAC equipment. Because your maintenance is directly from the manufacturer, you can have peace of mind knowing that your assets are in the hands of the experts.

With the Daikin PROtect maintenance package we can offer you:

- ✓ Fast and reliable remote diagnostics with Daikin On Site active monitoring
- ✓ Rapid fault identification and resolution
- ✓ Protected three year parts warranty (option to extend to five years) plus labour in the first year
- ✓ Up to four hour response time for emergency callouts
- ✓ Factory trained technicians (F-gas registered)



What you get with Daikin PROtect:

Conforms to SFG20 maintenance standard	✓
F-Gas leak test	✓
Oil Analysis	✓
Daikin on Site active monitoring	✓
Four visits per annum (1 major / 3 minor)	✓
3 years parts warranty	✓
1 point vibration analysis	Optional extra

Daikin on Site

Active remote monitoring

What is Daikin on Site?

Daikin on Site (DoS) is a web-based 24/7/365 active remote monitoring system that collects complex operational data from the AHU or chiller control system.

Daikin's Smart Centre turns the operational data into useful information that allows the user to remotely monitor performance. It also allows Daikin professionals to remotely optimise and maintain the equipment.

Lifetime cost of your system

Energy costs and maintenance typically account for 85% of the system's total lifetime cost. With DoS we can provide a preventative maintenance schedule to ensure maximum efficiency and reliability of your equipment, preventing costly downtime and major repairs and keeping your energy costs to a minimum.

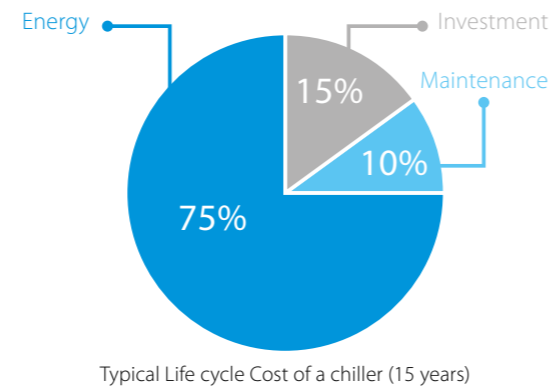

What you get with Daikin on Site

Active monitoring and assistance

- › 24/7/365 automated alarm via email
- › Remote diagnostic support from Daikin experts
- › Quick site assessment
- › Smart mobilisation of service personnel to site if necessary

User friendly

- › Access to DoS web app
- › Remote software upgrades
- › Interactive personalised dashboards

Control and measuring

- › Master / slave functionality
- › Real time operational data and trend insights 24/7/365
- › Lifecycle data log
- › Automated and tailored reports

Efficiency and reliability

- › Reduced operational costs
- › Optimised energy efficiency
- › Reduced waste
- › Reduced carbon footprint
- › Enhanced system reliability
- › Reduced system downtime

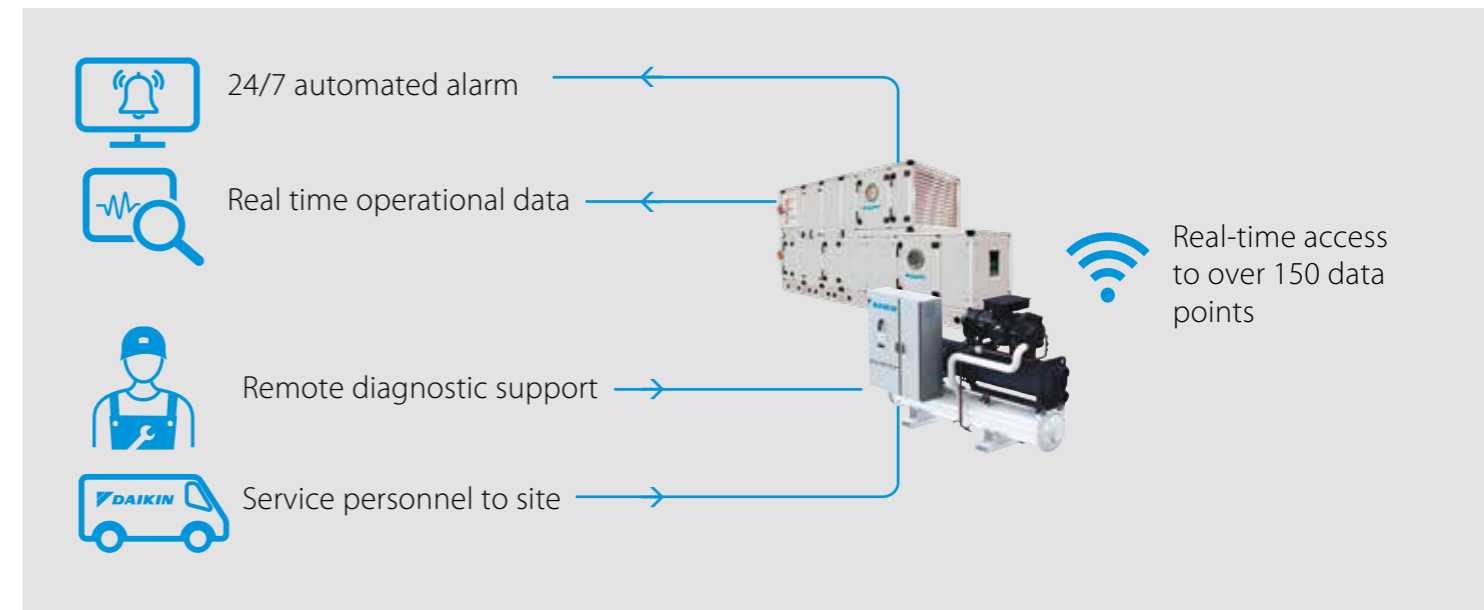

How it works

Cloud technology to hand

Using cloud technology, process data is collected automatically in real time and stored centrally.

Simple, effective connection

Most Daikin Applied Chiller and AHU controllers allow connection through LAN or with a wireless modem.

Insight into operational data for enhanced control and reliability

Through enhanced operational data, Daikin engineers are able to remotely monitor system performance, run diagnostics and software upgrades. If an on-site visit is required, the service engineer will arrive already informed of the issue, reducing system downtime.

High security

Secure in all aspects such as data privacy, data storage security and data transport.

- › All connections are encrypted (HTTPS) to prevent wiretapping and man-in-the-middle (MITM) attacks
- › CSA security attestation - security level 2.
- › EU General Data Protection GDPR compliant
- › Geo-redundant data storage in Northern Europe



Daikin IEQ sensor

[see page 208 for more details](#)

Daikin IEQ sensor is an IoT device measuring your well-being, recording various values relating to indoor air quality, environmental comfort and electromagnetic pollution. It has 12 embedded sensors that monitor 15 different parameters.



Caelum monitoring and reporting platform
 Integration with remote monitoring Daikin on Site
 Get green building projects certified with LEED thanks to Indoor Environmental Quality credits

Refrigerant leak detection

with active remote monitoring

New technology to the market, remote monitoring can now detect potential gas losses. An alarm is triggered, notifying the operator and allowing rapid response to the machinery to prevent further gas loss. This feature can detect losses that are in a range of 0-15% of the total amount of gas. (Automatically available on Daikin on Site with units equipped with liquid temperature sensor). Users can view leak detection data through the DoS dashboard.

Assumption: 100% refrigerant charge=30kg

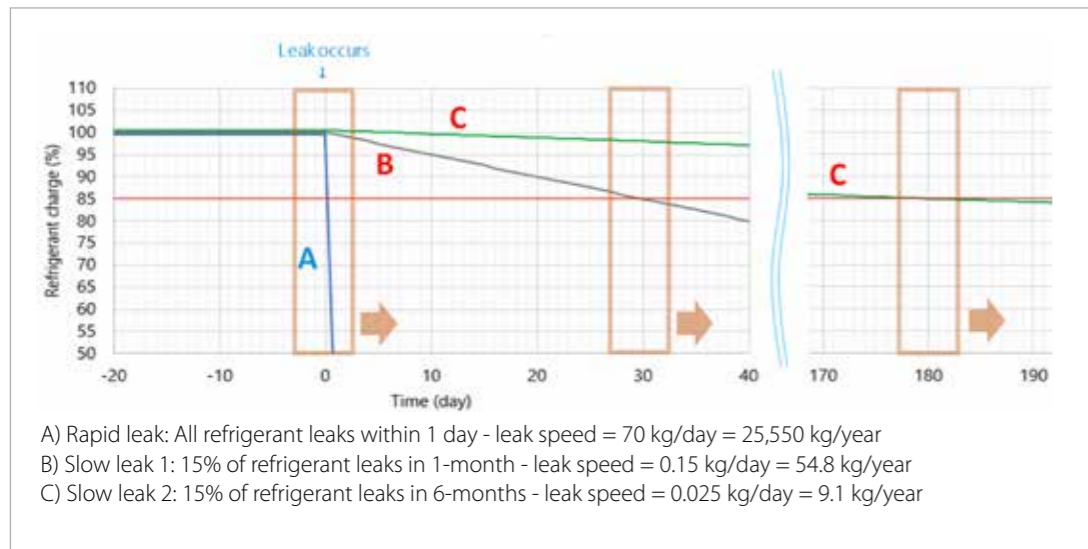

Since your HVAC-R equipment contains fluorinated greenhouse gases (F-gases) such as hydrofluorocarbons (HFCs), you must comply with a series of requirements adopted in the European Union to ensure emission prevention and containment; and hence reduce the environmental impact of refrigerants. **For more details see page 226.**

Oil Analysis

diagnostic and predictive maintenance

Oil comes in contact with many important internal components and therefore holds valuable information about a chiller's condition. The presence of harmful acids, corrosion causing water and abnormal metal wear particles can all be detected.

What you get

- › Expert comments and corrective recommendations
- › History and trend lines of chemicals, contamination, wear, acidity and moisture

Oil analysis can identify

- › Lubricant condition
- › Internal contamination
- › Abnormal wear and mechanical condition

Benefits

Reduced downtime

Prevent chiller failures and eliminate the cost of unexpected shutdowns.

Minimise costly repairs

Identify and remedy problems early before they become bigger problems that are more expensive to repair.

Environment

Extending oil lifetime reduces handling of oil waste. It is a win-win for the environment and it is cost saving.



Vibration analysis

All HVAC equipment with rotating components has its own vibration signature. Any deviation from this signature can be used to accurately predict developing problems such as bearing wear, shaft unbalancing and degrading compressor rotor tolerances.

Benefits

Reduced downtime

Vibration analysis when used as part of a condition based monitoring programme can prevent catastrophic failures and equipment downtime.

Minimise costly repairs

Early detection of potential failures allows corrective action to take place preventing a major component failure.

Environment

Non-intrusive diagnostics minimises internal mechanical inspections and subsequent waste.

What you get

- › Expert knowledge of compressor kinematics.
- › A detailed report identifying equipment trends and corrective action required.
- › Improved reliability and reduced lifecycle costs.

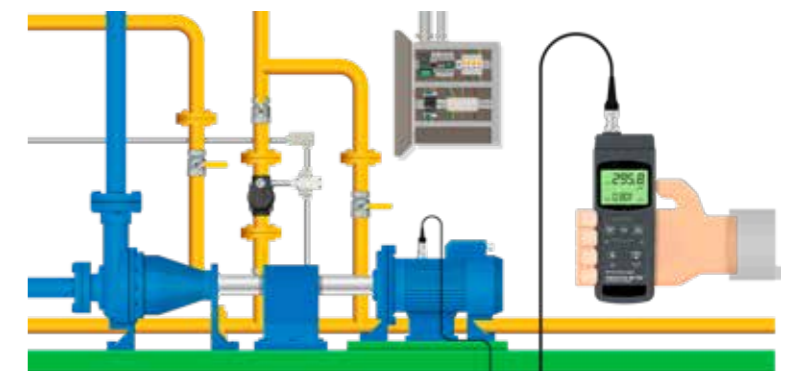

Rental Services

keeping you up and running

Daikin Rental provides rental chillers, heat pumps, air handling, heat, power and services to meet your temporary cooling needs while reducing CAPEX and optimizing your OPEX.

Wide range of unit capacity



Acoustic comfort

- › Extra-low noise versions: compressor soundproofing
- › Modulating fans

Rapidity of intervention

- › Extensive presence of service centres
- › Accessories for "plug & play" installations



Reliability:

- › Remote monitoring
- › Units with multiple circuits and multiple compressors

High seasonal efficiencies:

Operating costs reduction

- › Heat pumps: SCOP up to 3.65
- › Chillers: SEER up to 5.03

Daikin and partners stock most capacity units. If the requested unit is not available, Daikin commits to find the suitable solution for you.

Wide operating ranges:

Flexibility of application

- › **Hot water** produced up to +60°C
- › Heating up to -15°C outside air temp
- › **Chilled water** produced down to -13°C
- › Air conditioning up to 43°C outside air temperature



1. Daikin on Site, a solution for customer specific needs

Your cooling unit will reach high reliability and efficiency levels. No more stops and long waiting time for alarm troubleshooting. Thanks to a continuous monitoring and advanced tools, Daikin on Site helps to improve the overall system lifetime. A Daikin expert is ready to help and keep monitoring your plant, analysing your energy consumption, suggesting actions and system improvements.

2. Solutions for cooling emergencies

Whether a natural disaster and/or an equipment failure takes your cooling system down, Daikin temporary cooling can get you up and running again fast!

3. Standby cooling for critical applications and processes

A temporary cooling system is sometimes used to back-up manufacturing, and chemical processes, or when a hospital's required system redundancy has been reduced.

4. Special events

We can support you with creating a comfortable climate for your special events and parties by putting together the right equipment for your specialty cooling requirements. Quick and easy solutions for fairs, trade shows, festivals, events in temporary structures, etc.

5. Solutions for cooling load fluctuations

During facility expansions there is a need to test equipment and process areas but not sufficient load to keep new or large chillers running. A simple rental solution ensures the correct load and energy efficiency while the expansion new build is being finalized.

6. Cooling supply during planned shutdowns and outages

Daikin temporary cooling is an excellent way to supply cooling during planned equipment maintenance, which elevates the time pressure to get your primary cooling system back on line. This way, the work can be completed correctly the first time, and avoid costly overtime. In addition to the cooling solutions, we also have the same rental solutions available for heating.

Daikin temporary cooling makes it possible for your facility to maintain full cooling capabilities during retrofit, renovation, or replacement

Why use Daikin rental?

System modernisation

Be smart – replace components, not systems



Chiller Modernisation

Even if the R-22 chiller has been maintained well and is still in good condition, R-22 is no longer allowed to be used. That's why Daikin offers chiller modernisation packages. Not only is the chiller made compliant with the latest legislation, the technology upgrade also revives your system, increasing reliability and efficiency.

Main benefits

- › Convert R-22 to be compliant with legislation
- › Limit capital
- › Save money for future equipment thanks to the chiller's longer lifetime, increased reliability, and improved maintenance efficiency
- › Enhance energy efficiency up to +20% ESEER by manufacturer pre-engineered upgrade

Benefits for budget and risk management

- › No chiller removal
- › No water pipe work
- › No electrical modifications
- › Low logistic expenses (transport, crantage, permissions ...)
- › Quick delivery
- › Government-sponsored subsidies may be available

Lower GWP refrigerants

With ever reducing F-Gas quota targets, new equipment can be supplied with low GWP refrigerants. Options for Retrofit to lower GWP solutions are also feasible to reduce potential long term maintenance costs.

- Soft starter
- Inverter

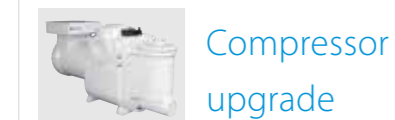
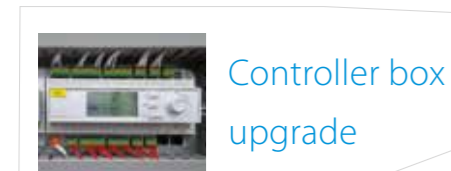

AHU Refurbishment

AHU refurbishment offers a cost effective, streamlined solution to improve the performance of existing AHUs and aid with compliance to the latest HVAC regulations. Our engineers at Daikin Applied UK can refurbish ANY BRAND of air handling unit.

By refurbishing your AHU, you could increase the life expectancy of the system by a further **10-15 years**.

What services can we offer?



Fan upgrades to EC fan arrays

- › Benefits - Higher efficiencies, significant energy and CO2 savings, additional redundancy and easy maintenance.

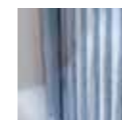

Filters

- › Update from BS EN 779 to ISO 16890 means more effective filter solutions to the market.
- › Benefits - Significant impact on IAQ and system pressure drop.



Coil replacement where damaged or worn

- › Benefits - Re-establish optimal performance. DX coils can offer significant cost savings. Over-time, set point parameters can change which can require the implementation of new coils.



Damper repair or replacement

- › Benefits - airflow set-points are re-established at the lowest pressure drop.



Panel replacement where damaged

- › Benefits - Improve casing leakage and thermal performance and help align to the latest specifications such as HTM-03-01 with the requirements for BS EN 1886 T2/TB2 and Euroclass A insulation.



Other

- › Site surveys of controls often highlight areas where control set-up is sub-optimal for desired performance.
- › We can offer individual component or full system upgrades and re-commissioning.
- › This can also reduce overall energy consumption, performance.

Benefits

- › Improved efficiency
- › Energy savings
- › Reduced CO2
- › Improved IAQ
- › Maintainability
- › Extended lifecycle
- › Redundancy
- › Compliance to regulations
- › Low upfront cost



F-Gas Regulations

Reduce the environmental impact of your equipment

Since your HVAC-R equipment contains fluorinated greenhouse gases (F-gases) such as hydrofluorocarbons (HFCs), you must comply with a series of requirements adopted in the European Union to ensure emission prevention and containment; and hence reduce the environmental impact of refrigerants.

Why conduct F-gas leak checks?

HVAC-R equipment that contains fluorinated greenhouse gases in quantities of 5 tonnes of CO₂ equivalent or more must be checked for F-gas leakage by certified personnel only.

During these checks, precautionary measures are taken to prevent leakages.

In case a leak is detected, it is repaired without undue delay.

We can manage your F-gas requirements for you

All commercial, industrial and public sector organisations must comply with obligations under the government's environmental policy on F-Gas and Ozone-Depleting Substances.

Our F-Gas registered site service engineers can help you carry out different tasks such as regular leak checks, installation of leakage detection systems and diligent on-site record keeping with supporting templates. As well as recovery and/or destruction of gases before the equipment is discarded.

You can also combine the required F-gas inspections with one of our service plans.

How often to conduct leak checks?

The frequency of your equipment's leak inspections depends on its F-gas charge size measured in CO₂ equivalents as shown in the table.

The installation of a leakage detection system is mandatory for equipment that contains 500 t CO₂ or more. The proper functioning of the system should be checked at least once every 12 months.

If the equipment has a leakage detection system, the required frequency of leak checks is reduced by half.

For more details on leak detection see page 226.

Spare parts

With next day delivery

Replacement parts for Daikin and McQuay products

If your cooling equipment is running 24/7 throughout the year, it is inevitable that components may wear over time.

Daikin Applied UK offers genuine replacement spare parts and components for Daikin and McQuay products.

Benefit from the support and expertise of our qualified engineers

Our engineers can conduct a site visit to discuss any critical components you may require at short notice, in the event of an unexpected breakdown.

Need your parts in a hurry?

We offer next day delivery from our dedicated stock stored at our factory in Cramlington, Northumberland.

Additional Services

Retrofit kits
Compressor upgrades
VFD upgrades
Controls software upgrades: Micro Tech®/Siemens/Carel



Our Range of Spares

Compressors
Condensers
Controls
Software
Critical spares list
Electricals
Evaporators
Fans
Gaskets
Sensors
Transducers
Valves
And many more!



For more information email info@daikinapplied.uk or visit www.daikinapplied.uk

For all Daikin Applied UK,
Daikin Applied Service &
Spares enquiries call us on:
0345 565 2700



Daikin Europe NV participates in the Eurovent Certified Performance programme for Liquid Chilling Packages and Hydronic Heat Pumps, Fan Coil Units and Variable Refrigerant Flow systems. Check ongoing validity of certificate: www.eurovent-certification.com

The present publication is drawn up by way of information only and does not constitute an offer binding upon Daikin Europe NV. Daikin Europe NV has compiled the content of this publication to the best of its knowledge. No express or implied warranty is given for the completeness, accuracy, reliability or fitness for particular purpose of its content and the products and services presented therein. Specifications are subject to change without prior notice. Daikin Europe NV explicitly rejects any liability for any direct or indirect damage, in the broadest sense, arising from or related to the use and/or interpretation of this publication. All content is copyrighted by Daikin Europe NV.

