

Data Sheet

E300

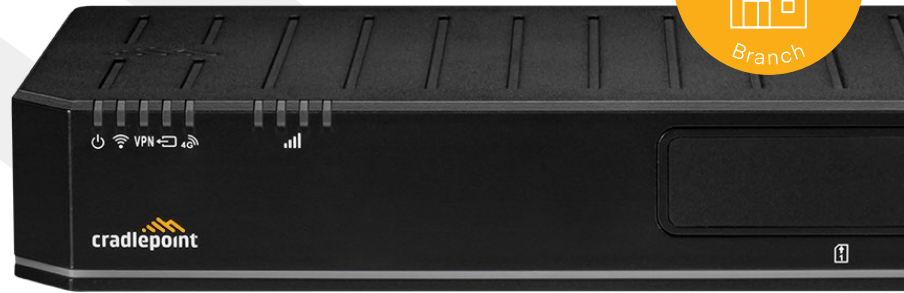

The Cradlepoint NetCloud Enterprise Branch Service with E300 Series Router is ideally suited for pop-up temporary locations, branches, stores, and restaurants. The all-in-one form factor includes full featured routing, security, and Wi-Fi, making it easy to connect branches to the Internet and critical applications without the need for extra hardware or complicated configurations. And the embedded LTE modem means that connectivity is always available from day 1 without waiting for a wired connection.

Notable Features

- Take advantage of embedded Cat 4 or Cat 18 LTE modem for fast day-1 or primary connectivity.
- Terminate a primary wired broadband link with LTE as failover for highly resilient hybrid connectivity.
- Open temporary locations without compromising security or reliability with an all-in-one design and compact form factor.
- Integrate into your existing network with standards-based dynamic routing and VPN tunnel support.
- Define policies through centralized, cloud-based management for easy deployment at scale.
- Add a second cellular modem for dual LTE connectivity.
- 5G Ready acting as Captive Modem controller for Cradlepoint 5G Wideband Adapters.

Ideal for Wireless WAN

For organizations moving to a Wireless WAN, the E300 offers the ability to pair LTE with a wired link and use LTE as a failover connection or a primary connection. For an all wireless WAN, the E300 offers Gigabit-class LTE performance, which can support the throughput needs of a small or medium sized branch with the ability to add a second LTE connection to increase available bandwidth and reliability.

5G Ready for Upward Compatibility

The E300 Enterprise Branch Router is 5G Ready and can act as a controller for a Cradlepoint 5G Wideband Adapter. This capability ensures upward compatibility for 5G, while still allowing optimal placement of the 5G adapter. The unique capability of Cradlepoint to operate the adapter in captive mode means that the two separate, Ethernet-connected, appliances can be managed as a single entity.

Performance

Stateful Firewall Throughput:	940 Mbps
IPS Throughput:	940 Mbps
Application Aware Services & Analytics:	940 Mbps

IPSec VPN Throughput:	400 Mbps
Concurrent Sessions (TCP):	130,000
Typical Client Count:	50

Performance testing was conducted based on requirements as defined in RFC2544 using fixed-frame 1518 byte packets. Throughput results reflect uni-directional UDP traffic with less than 1% packet loss as tested with wired connections.

Results do not reflect performance of the cellular wireless operator networks.

Key Software Capabilities

Cradlepoint NetCloud Service for the E300 provides everything needed to unlock the power of LTE at the network edge and connect users and IoT to critical applications and services. The NetCloud Service package for the E300 includes router software for optimizing routing, VPN, SD-WAN, and security capabilities. The cloud capabilities include group policy definition, reports, troubleshooting and analytics dashboards. And the service includes a warranty for as long as an active subscription on the router, online training, live and online support, and all software and firmware updates.

Router Services

Next generation hardware provides local processing power to handle demanding router-delivered services, such as support for VPN tunneling encryption including DMVPN, IPsec, GRE, and other tunneling technologies.

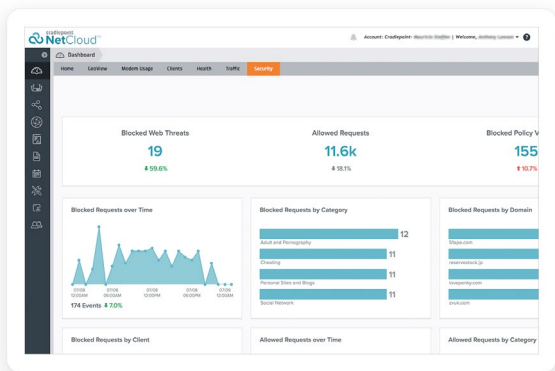
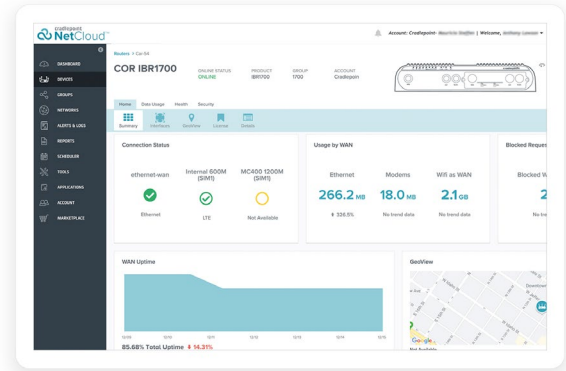

Security Services

NetCloud Service includes security features and options to optimize the E300 to meet the evolving security needs of distributed environments. The service includes stateful zone-based firewall enhancement capability to Application Aware with the Advanced package.

Connection Manager

Connection Manager provides the ability to manage all WAN connections types, both wireless and wired, from a single software-defined policy. Our custom-built modem software ensures users establish Wireless WAN connectivity faster while maintaining the highest level of resiliency.

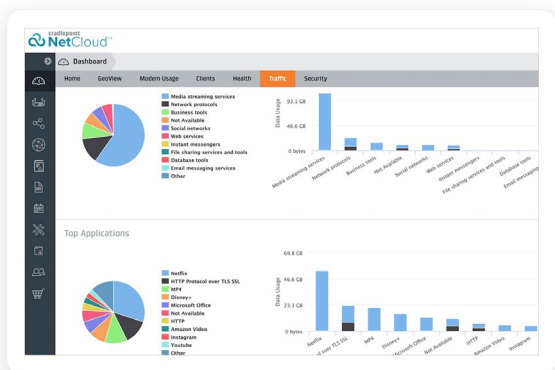
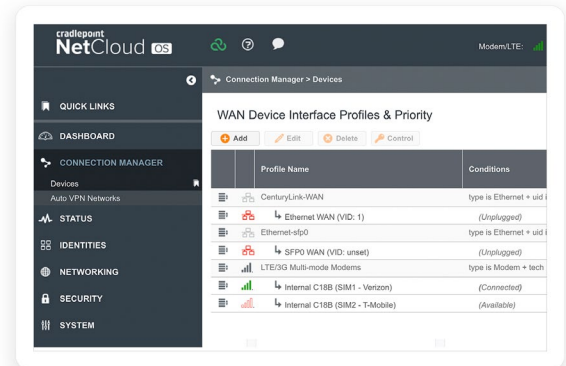

Cloud Services

NetCloud Manager delivers true zero-touch deployment with the ability to define and deliver policy across entire groups of endpoints. Users can create a cloud-orchestrated hub and spoke VPN network and gain insights and analytics required for rapid troubleshooting and diagnostic workflows.

Hardware Specifications

The following features are delivered through the hardware.

INTERFACES

- Modem:** One of the following:
- Embedded C18B modem
 - 4 x SMA cellular antenna connectors
 - Embedded C4D modem
 - 2 x SMA cellular antenna connectors

- Optional dual modem:
- Modular MC400 modem

- Ethernet:** 5 x GbE RJ45 (LAN/WAN switchable)
- 1 x 10GbE SFP+ (LAN/WAN switchable)
- SFP: Finisar FTLF8519P3BNL, FTLF1318P3BTL
 - SFP+: Finisar FTLX8574D3BCL, FTLX1475D3BCL, FCBG110SD1Cxx

- Wi-Fi:** Dual-radio, dual-band, concurrent operation (2.4 GHz and 5 GHz)
- 2x2 MU-MIMO 802.11ax Wi-Fi 6 with DFS
 - 574 Mbps (2.4 GHz) and 1,200 Mbps (5 GHz)
 - Internal 2x2 antenna
 - Global Optimized Wi-Fi
 - WPA/WPA2/WPA3 Personal, WPA2/WPA3 Enterprise, WEP auto
 - 802.11k, 802.11v

- Expansion:** 1 x USB 2.0 Type A (OOBM)
- 1 x Expansion (future exp. modules)

- GNSS/
GPS:** 1 x SMA GNSS antenna connector

TEMPERATURE

- Operating:** 0 °C to 45 °C (32 °F to 113 °F)

- Storage:** -20 °C to 70 °C (-4 °F to 158 °F)

HUMIDITY

- Operating:** 5% to 95%

- Storage:** 5% to 95%

POWER

- Power Required:** Powered by external DC power supply, 100-240 VAC input, 12 VDC 2A output (included)

PHYSICAL

- Size:** 5.3 x 10.6 x 1.7 in (135 x 270 x 44 mm)

- Weight:** 1 lb 13 oz (.82kg)

CERTIFICATIONS

- Safety:** UL/CUL, CB Scheme, EN60950-1, EN 62368

- Materials:** WEEE, RoHS, REACH, California Prop 65

WI-FI POWER:

- FCC:**
- 2402–2483.5 MHz (2.4 GHz band): 33.14 dBm conducted
 - 5150–5250 MHz (5 GHz band 1): 32.94 dBm conducted
 - 5725–5850 MHz (5 GHz band 3): 32.81 dBm conducted

- Europe/
Rest of
World**
- 2.4 GHz band: 19.93 dBm EIRP
 - 5150-5250 MHz: 22.76 dBm EIRP
 - 5250-5350 MHz: 22.92 dBm EIRP
 - 5500-5700 MHz: 29.08 dBm EIRP

- Australia/
New
Zealand**
- 2.4 GHz band: 19.93 dBm EIRP
 - 5150-5250 MHz: 22.98 dBm EIRP
 - 5250-5350 MHz: 22.98 dBm EIRP
 - 5500-5700 MHz: 29.82 dBm EIRP
 - 5475-5825 MHz: 32.81 dBm EIRP

LEDs

Refer to the [E300 Series Enterprise Branch Router Quick Start Guide](#)

Enterprise-Class Modem Specifications

SPECIFICATION	E300-C18B	E300-C4D
Technology:	Cat 18 LTE Advanced Pro (3GPP Rel. 12) <ul style="list-style-type: none"> — Dual SIM slots, mini 2FF form factor — SIM-based auto-carrier selection 	Cat 4 LTE (3GPP Rel. 11) <ul style="list-style-type: none"> — Dual SIM slots, mini 2FF form factor — SIM-based auto-carrier selection
Fallback:	WCDMA/UMTS/HSPA+	WCDMA/UMTS/HSPA+
Carrier Aggregation:	Up to 5 x CA downlink, 2 x CA uplink Refer to modem carrier aggregations article	N/A
Peak Downlink Rates:	LTE: 1.2 Gbps WCDMA: 42.2 Mbps	LTE: 150 Mbps WCDMA: 42.2 Mbps
Peak Uplink Rates:	LTE 150 Mbps WCDMA: 5.76 Mbps	LTE 50 Mbps WCDMA: 5.76 Mbps
MIMO:	2x2 MIMO or 4x4 MIMO	2x2 MIMO
QAM:	256	64
LTE Bands:	LTE FDD <ul style="list-style-type: none"> — B1, B2(B25), B3, B4(B66), B5(B26/B18/B19), B7, B8, B12, B13, B14, B20, B28, B29, B30, B32, B71 LTE TDD <ul style="list-style-type: none"> — B38, B39, B40, B41, B42, B43, B46, B48 	LTE FDD <ul style="list-style-type: none"> — B2, B4, B5, B12, B13, B14, B66, B71
WCDMA Bands:	B1, B2, B4, B5(B19), B8	B2, B4, B5
Power:	LTE 23 dBm ± 1, DC-HSPA+ 23 dBm ± 1 (typical conducted)	LTE 23 dBm ± 1; HSPA+ 23 dBm ± 1 (typical conducted)
Antennas:	SMA female connectors, external 600 MHz - 6 GHz cellular paddle antennas (qty 4. included)	SMA female connectors, external 600 MHz - 6 GHz cellular paddle antennas (qty 2. included)
GNSS/GPS:	Active GNSS <ul style="list-style-type: none"> — GPS, GLONASS, BeiDou, Galileo — DC voltage bias supplied (typical 3.1v) 	Passive GNSS <ul style="list-style-type: none"> — GPS, GLONASS, BeiDou, Galileo
SMS:	Yes	Yes
Regulatory:	FCC, IC, CE, RCM	FCC, IC
Telecom:	PTCRB, GCF	PTCRB
Carrier Approvals:	AT&T, Verizon	AT&T, Verizon
Public Safety Network Approvals:	N/A	N/A
Private LTE:	Yes, includes FCC Part 96 (CBRS Band 48)	N/A

Cellular carriers and operators throughout the world may only require telecom industry certifications, like PTCRB or GCF, to operate on their network. Some carriers require additional testing and approval, beyond telecom certifications, to operate on their network. A carrier listed in the approvals section means Cradlepoint completed additional testing and acquired technical approval for that given carrier. Any carrier not listed may not require additional testing or approval beyond telecom industry certifications to operate on their network.

Hardware

Physical Measurements

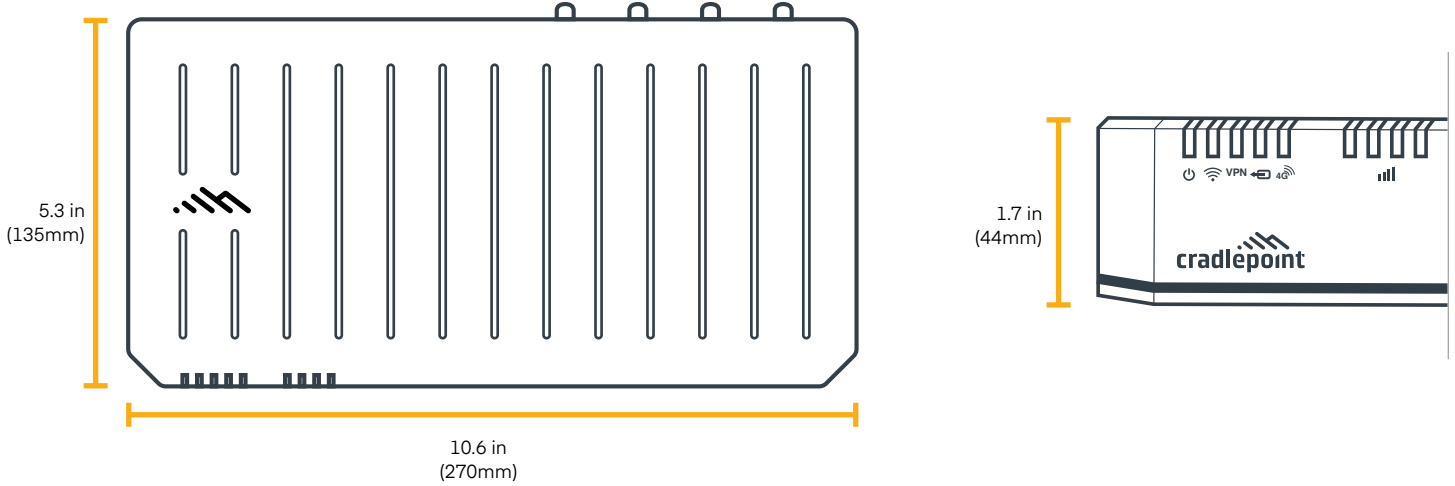

Front View

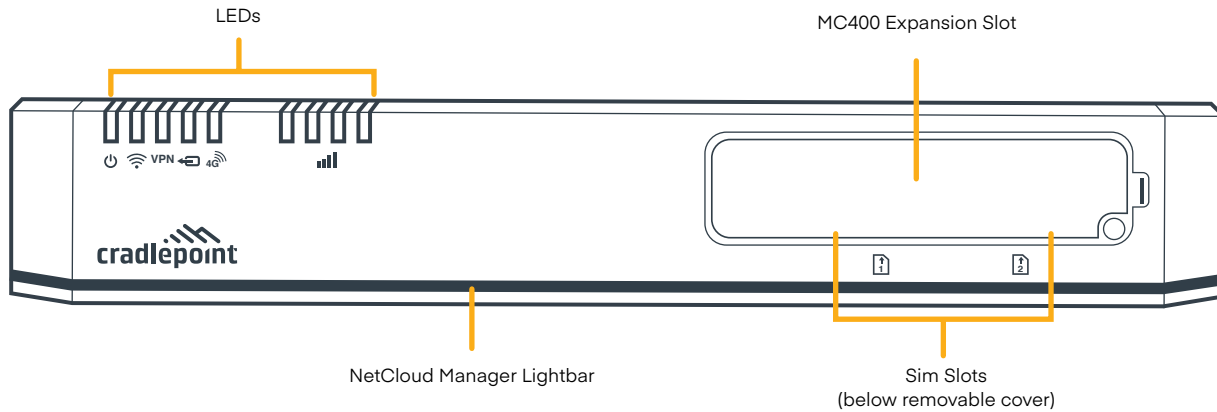

Rear View (Cat 18)

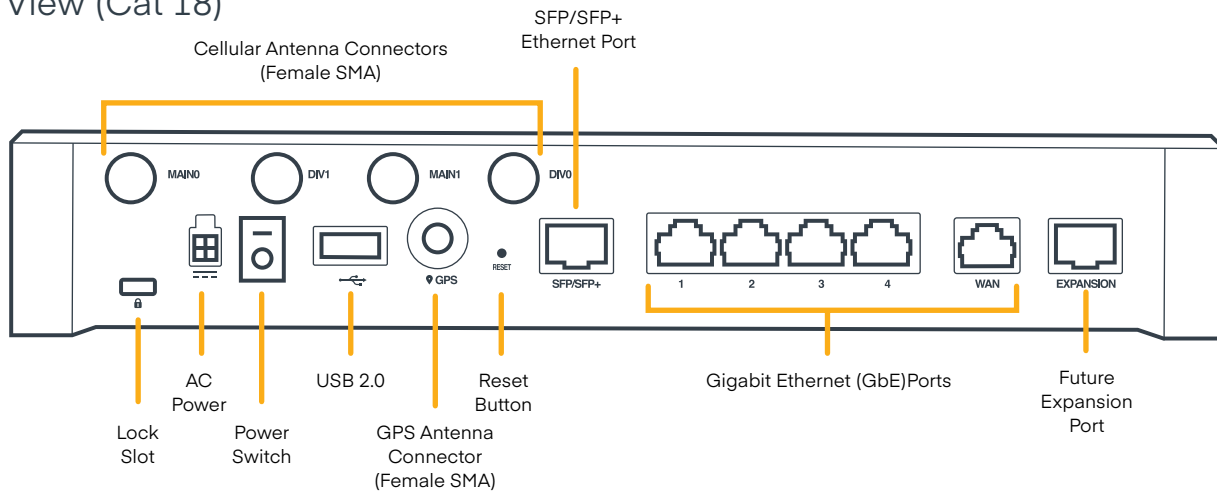

Ordering Guide

NetCloud Enterprise Branch Essentials packages and plans contain all the features and capabilities required for small to mid-sized branch applications. Essentials Packages include 24x7 support (phone support: 24 hour weekdays with emergency response on weekends, web: 24x7, chat: 24x5) and a limited lifetime warranty.

For additional capabilities, a **NetCloud Enterprise Branch Advanced Plan** can be added to the NetCloud Enterprise Branch Essentials Package at any time.

See additional details of what is included in the Essential and Advanced NetCloud software: cradlepoint.com/netcloud-manager

For more details on the E300 series of routers, included with the NetCloud Enterprise Branch Packages, see below.

NetCloud Packages and Plans

REGION	DESCRIPTION	PART NUMBER
North America: U.S. & Canada	NetCloud Enterprise Branch Essentials + Advanced Package with E300-C18B	BFAx-0300C18B-GN
	NetCloud Enterprise Branch Essentials Package with E300-C18B	BF0x-0300C18B-GN
	NetCloud Enterprise Branch Essentials + Advanced Package with E300-C4D	BFAx-0300C4D-NN
	NetCloud Enterprise Branch Essentials Package with E300-C4D	BF0x-0300C4D-NN
Worldwide: European Union (EU), United Kingdom (UK), Asia-Pacific, Australia (AP) & New Zealand (NZ)	NetCloud Enterprise Branch Essentials + Advanced Package with E300-C18B	BFAx-0300C18B-GM
	NetCloud Enterprise Branch Essentials Package with E300-C18B	BF0x-0300C18B-GM
All Regions	NetCloud Enterprise Branch Advanced Plan	BF0x-NCADV
	NetCloud Enterprise Branch Essentials + Advanced Plan Renewal	BFAx-NCEA-R
	NetCloud Enterprise Branch Essentials Plan Renewal	BF0x-NCESS-R

x = 1, 3, or 5 years

Accessories

INCLUDED	PART NUMBER
Power Supply, 12VDC 2A, 2M, North America	170716-000
Antenna, Cell 600MHZ - 6GHZ SMA Gray (Qty. 2 or 4)	170801-000
One of the following:	
— Cat 4 Cell Antenna Alignment Tool	N/A
— Cat 18 Cell Antenna Alignment Tool	N/A
Wall Mount Screw Pack	N/A
Rubber Feet for Desktop Mounting	N/A
OPTIONAL	PART NUMBER
Power Supply, 12VDC 3A, 2M, International	170717-000
Enterprise Branch E300 Cat 18 LTE Advanced Pro Modular Modem Kit	BF-MC400-1200M-B
— MC400-1200M-B Cat 18 LTE Advanced Pro Modular Modem	N/A
— E300 MC400-1200M-B Modem Door with Screw	N/A
— Antenna, Cell 600MHZ - 6GHZ SMA Gray (Qty. 4)	170801-000
Enterprise Branch E300 Cat 6 LTE Advanced Modular Modem Kit	BF-MC400LP6
— MC400LP6 Cat 6 LTE Advanced Pro Modular Modem	N/A
— Antenna, Cell 600MHZ - 6GHZ SMA Gray (Qty. 2)	170801-000
Refer to the Cradlepoint MC400 Modular Modem webpage for more information of modular modems	

Support & Warranty

The E300 is only sold as a component of NetCloud Branch Packages.

- NetCloud Packages include support for the full subscription term.
- All Cradlepoint hardware products are covered by a limited lifetime warranty for as long as they have a subscription license to an active NetCloud Service Plan.