

Project		Catalog #		Type	
Prepared by		Notes		Date	



Portfolio

LSR8B EC8B 8L

High Bay / Low Bay Ceiling, Pendant or Wall Mount

Typical Applications

Office • Education • Healthcare • Hospitality

Interactive Menu

- Order Information [page 2](#)
- Product Specification [page 5](#)
- Energy Data [page 6](#)
- Photometric Data [page 7](#)
- Connected Systems [page 9](#)
- Product Warranty

Product Certification



Product Features



Top Product Features

- 1,000 to 17,500 lumens; Surface, wall or optional pendant mount
- Offered in narrow beam, medium beam and wide beam distributions; 80, 90 or 97 CRI
- 2700K, 3000K, 3500K, 4000K, 5000K; D2W™ option from 3000K to 1850K
- W2N tunable white CCT range from 2700K to 6500K or 2000K to 5000K
- Two-stage reflector system produces smooth beam

Dimensional and Mounting Details

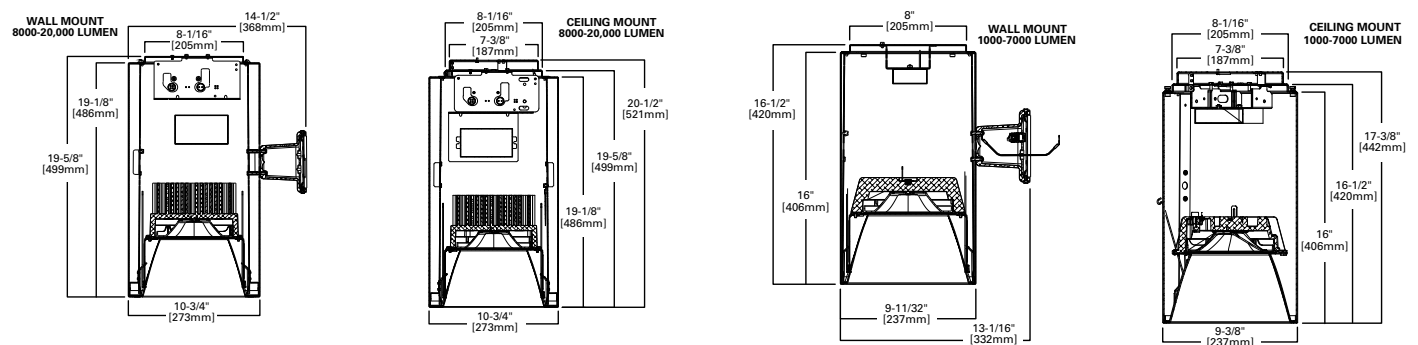

Order Information

SAMPLE ORDER NUMBER: **LSR8B20D010MB**

Housing	Lumens	Voltage	Driver	
Housing	Lumens ⁽¹⁾	Voltage	1 Driver	2 and 3 Drivers
LSR8B =Surface Ceiling Mount Cylinder LSRWM8B =Wall Mount Cylinder	10 =1000 lumens 15 =1500 lumens 20 =2000 lumens 30 =3000 lumens 40 =4000 lumens 50 =5000 lumens 60 =6000 lumens 70 =7000 lumens 80 =8000 lumens 90 =9000 lumens 100 =10000 lumens 120 =12000 lumens 150 =15000 lumens 175 =17500 lumens remote driver only	blank =120-277V 3 =347V ⁽²⁾	1000-4000 Lumen⁽⁴⁾ D010 =0-10V Dimming, 1% to 100%, 120V-277V D010TR =0-10V 120-277V or 120V Line Voltage Dimming, 1% to 100% DE010 =0-10V Linear Dimming, 0% to 100%, 120V-277V D5LT =Fifth Light® DALI DT6 Logarithmic Dimming, 0% to 100%, 120V-277V DMX =DMX/RDM Logarithmic Dimming, 0% to 100%, 120V-277V ⁽³⁾ DMXC5 =DMX/RDM Logarithmic Dimming, 0% to 100%, 120V-277V, with RJ45 connection ⁽⁵⁾ DLE =Lutron Ecosystem dimming 1% to 100% DLV =Low Voltage System ⁽⁶⁾ 5000, 6000, and 7000 Lumen⁽⁵⁾ D010TE =0-10V or Trailing Edge Dimming, 5% to 100%, 120V-277V (120V Only for Trailing Edge Dimming) Tunable white 1000-2000 DE010W2N =0-10V dimming, 0% to 100%, 120V D5LTW2N =Fifth Light (DALI) Logarithmic Dimming, 0% to 100% DE010W2N2765 = 0-10V dimming, 0% to 100%, 120-277V, 2700K-6500K DE010W2N2050 = 0-10V dimming, 0% to 100%, 120-277V, 2000K-5000K D5LTW2N2765 = Fifth Light DALI DT6 Logarithmic Dimming, 0% to 100%, 120V-277V, 2700K-6500K D5LTW2N2050 =Fifth Light DALI DT6 Logarithmic Dimming, 0% to 100%, 120V-277V, 2000K-5000K	4000 and 6000 Lumen D2W (2 Drivers) 6000, 8000 and 9000 Lumen (2 Drivers) 9000 Lumen D2W (3 Drivers) 12,000 Lumen (3 Drivers) D010 =0-10V, 120V-277V Dimming, 1% to 100% D010TR =0-10V, 120V-277V or 120V Line Voltage Dimming, 1% to 100% DE010 =0-10V, 120V-277V Linear Dimming, 0% to 100% D5LT =Fifth Light® DALI DT6 Logarithmic Dimming, 0% to 100%, 120V-277V DMX =120V-277V, DMX/RDM Logarithmic Dimming, 0% to 100% ⁽³⁾ DMXC5 =120V-277V, DMX/RDM Logarithmic Dimming 0% to 100% with RJ45 connection ⁽⁵⁾ DL2 =120V Lutron® Hi-Lume Forward Phase Dimming, 1% to 100% DLE =120V-277V, Lutron Ecosystem dimming 1% to 100% 10,000, 12,000, 15,000, 17,500 Lumen D010TE =0-10V or Trailing Edge Dimming, 5% to 100%, 120V-277V Tunable white 3000-4000 1DE010W2N =0-10V dimming, 0% to 100%, 120V-277V 1D5LTW2N =120V-277V, Fifth Light (DALI) Logarithmic Dimming, 0% to 100% DE010W2N2765 = 0-10V dimming, 0% to 100%, 120-277V, 2700K-6500K DE010W2N2050 = 0-10V dimming, 0% to 100%, 120-277V, 2000K-5000K D5LTW2N2765 = Fifth Light DALI DT6 Logarithmic Dimming, 0% to 100%, 120V-277V, 2700K-6500K D5LTW2N2050 =Fifth Light DALI DT6 Logarithmic Dimming, 0% to 100%, 120V-277V, 2000K-5000K
Notes	Notes	Notes	Notes	
	(1) Nominal Lumens will vary depending on selected color, driver and reflector finish.	(2) 347V integral D010 only.	(3) DMX fixtures default to full on upon loss of DMX signal. (4) For D2W up to 3000 lumens. (5) Not for use with D2W. (6) Limited to 3000 Lumens	

Dim to Warm	Remote	Finish
Dim to Warm	Remote	Finish ⁽⁸⁾
blank = For 3000 and below D2W = For 4000, 6000 and 9000	blank = Integral driver R = Remote driver ⁽⁷⁾	P =White MB =Matte Black SL =Silver BZ =Bronze
Notes	Notes	Notes
	(7) Order remote driver separately. See below to order.	(8) Consult factory for custom finishes

SAMPLE ORDER NUMBER: **ER8B30408035**

Power Module	Lumen Levels	Color	
Power Module	Lumen Levels ⁽¹⁾	Color	
EC8B =8" LED Module for 7000 lumen and below ER8B =8" LED Module for 8000 lumen and above, and with multiple drives	1 Driver 1020 =1000, 1500, or 2000 Lumens 3040 =3000 or 4000 Lumens 5070 =5000, 6000, or 7000 lumens 2 Drivers 60 =6000 lumens, 2 LEDs 80120 =8000, 9000, 10000, or 12000 lumens 3 Drivers 120 =12000 lumens, 3 LEDs 150200 =15000, or 17500	80 CRI 8027 = 80CRI, 2700K 8030 = 80CRI, 3000K 8035 = 80CRI, 3500K 8040 = 80CRI, 4000K 8050 = 80CRI, 5000K Dim 2 Warm 1 Driver 109030D2W =1000 Lumen, 90 CRI, Dim 2 Warm, IC Rated 159030D2W =1500 Lumen, 90 CRI, Dim 2 Warm, IC Rated 209030D2W =2000 Lumen, 90 CRI, Dim 2 Warm, IC Rated 309030D2W =3000 Lumen, 90 CRI, Dim 2 Warm Dim 2 Warm 2 Drivers 409030D2W =4000 Lumen, 90 CRI, Dim 2 Warm 609030D2W =6000 Lumen, 90 CRI, Dim 2 Warm Dim 2 Warm 3 Drivers 909030D2W =9000 Lumen, 90 CRI, Dim 2 Warm	90 CRI 9024 = 90CRI, 2400K 9027 = 90CRI, 2700K 9030 = 90CRI, 3000K 9035 = 90CRI, 3500K 9040 = 90CRI, 4000K 9050 = 90CRI, 5000K W2N Tunable White 1 Driver 10W2N902050 =1000 lumens, 90 CRI, Tunable white 2000K - 5000K 10W2N902765 =1000 lumens, 90 CRI, Tunable white 2700K - 6500K 15W2N902050 =1500 lumens, 90 CRI, Tunable white 2000K - 5000K 15W2N902765 =1500 lumens, 90 CRI, Tunable white 2700K - 6500K 20W2N902050 =2000 lumens, 90 CRI, Tunable white 2000K - 5000K 20W2N902765 =2000 lumens, 90 CRI, Tunable white 2700K - 6500K W2N Tunable White 2 Drivers 30W2N902050 =3000 lumens, 90 CRI, Tunable white 2000K - 5000K 30W2N902765 =3000 lumens, 90 CRI, Tunable white 2700K - 6500K 40W2N902050 =4000 lumens, 90 CRI, Tunable white 2000K - 5000K 40W2N902765 =4000 lumens, 90 CRI, Tunable white 2700K - 6500K
Notes	Notes	Notes	
(1) Nominal Lumens will vary depending on selected color, driver and reflector finish.			

Order Information

REQUIRED if Remote Driver (R) is specified on Cylinder

Remote Drivers	Lumens	Voltage	Driver	
Remote Drivers ⁽⁹⁾	Lumens	Voltage	Driver	
			1 Driver	2 and 3 Drivers
R100 =Remote 100 ft R75 = Remote 75ft R50 = Remote 50 ft R25 = Remote 25ft R15 = Remote 15ft R5 = Remote 5ft R2 = Remote 2 ft	10 =1000 lumens 15 =1500 lumens 20 =2000 lumens 30 =3000 lumens 40 =4000 lumens 50 =5000 lumens 60 =6000 lumens 70 =7000 lumens 80 =8000 lumens 90 =9000 lumens 100 =10000 lumens 120 =12000 lumens 150 =15000 lumens 175 = 17500 lumens	blank =120-277V ⁽¹⁰⁾ 1 =120V 2 =277V 3 =347V	1000-4000 Lumen⁽⁴⁾ D010 =0-10V Dimming, 1% to 100%, 120V-277V D010TR =0-10V 120-277V or 120V Line Voltage Dimming, 1% to 100% DE010 =0-10V Linear Dimming, 0% to 100%, 120V-277V DSL =Fifth Light® DALI DT6 Logarithmic Dimming, 0% to 100%, 120V-277V DMX =DMX/RDM Logarithmic Dimming, 0% to 100%, 120V-277V ⁽³⁾ DMXC5 =DMX/RDM Logarithmic Dimming, 0% to 100%, 120V-277V, with RJ45 connection ⁽⁵⁾ DLE =Lutron Ecosystem dimming 1% to 100% DLV =Low Voltage System ⁽⁶⁾ 5000, 6000, and 7000 Lumen⁽⁴⁾ D010TE =0-10V or Trailing Edge Dimming, 5% to 100%, 120V-277V (120V Only for Trailing Edge Dimming) Tunable white 1000-2000 DE010W2N =0-10V dimming, 0% to 100%, 120V DSLW2N =Fifth Light (DALI) Logarithmic Dimming, 0% to 100% DE010W2N2765 = 0-10V dimming, 0% to 100%, 120-277V, 2700K-6500K DE010W2N2050 = 0-10V dimming, 0% to 100%, 120-277V, 2000K-5000K DSLW2N2765 = Fifth Light DALI dimming, 0% to 100%, 120-277V, 2700K-6500K DSLW2N2050 =Fifth Light DALI dimming, 0% to 100%, 120-277V, 2000K-5000K	4000 and 6000 Lumen D2W (2 Drivers) 6000, 8000 and 9000 Lumen (2 Drivers) 9000 Lumen D2W (3 Drivers) 12,000 Lumen (3 Drivers) D010 =0-10V, 120V-277V Dimming, 1% to 100% D010TR =0-10V, 120V-277V or 120V Line Voltage Dimming, 1% to 100% 1DE010 =0-10V, 120V-277V Linear Dimming, 0% to 100% DSL =120V-277V Fifth Light® (DALI) Logarithmic Dimming, 0% to 100% DMX =120V-277V, DMX/RDM Logarithmic Dimming, 0% to 100% ⁽³⁾ DMXC5 =120V-277V, DMX/RDM Logarithmic Dimming 0% to 100% with RJ45 connection ⁽⁵⁾ DL2 =120V Lutron® Hi-Lume Forward Phase Dimming, 1% to 100% DLE =120V-277V, Lutron Ecosystem dimming 1% to 100% 10,000, 12,000, 15,000, 17,500 Lumen D010TE =0-10V or Trailing Edge Dimming, 5% to 100%, 120V-277V
Notes (9) Lutron driver limited to 25'	Notes	Notes (10) 3000 and below. Up to 3000 lumens does not need voltage specified.	Notes (3) DMX fixtures default to full on upon loss of DMX signal. (4) For D2W up to 3000 lumens. (5) Not for use with D2W. (6) Limited to 3000 Lumens	

Options	Controls
EM7 =7W emergency module with remote test switch EM14 =14W emergency module with remote test switch EMB0D =Bodine® Emergency Module with Remote Test Switch EMV7 =7W emergency module for use with DLV driver with remote test switch EMV14 =14W emergency module for use with DLV driver with remote test switch	WTA = Factory installed WaveLinX sensor Kit ^{(12) (16)} WTK = Factory installed WaveLinX Lite Sensor Kit ^{(12) (17)}
Notes	Notes (12) Refer to system specifications for additional information, features, and benefits. Order either factory installed option or accessory. (16) WTA = WaveLinX wireless sensor kit for daylight dimming, PIR motion sensing, and optional RLTS - Real Time Location Services, use with 0-10V only. (17) WTK = WaveLinX Lite tile mount sensor kit for daylight dimming, PIR motion sensing, use with D010 only (Refer to WaveLinX Lite system specifications)

SAMPLE ORDER NUMBER: **8LBM3LI**

Trim	Distribution	Flange	Finish
8LB =8" Reflector	N =Narrow Spun Aluminum M =Medium Spun Aluminum W =Wide Spun Aluminum S =Shallow Spun Aluminum SW =Single Wall Wash, Spun Aluminum DW =Double Wall Wash, Spun Aluminum	3 =Rimless	LI =Specular Clear H =Semi-Specular Clear WMH =Warm Haze WH =Wheat GPH =Graphite Haze B =Specular Black MW =Matte White
Notes (13) Beam angles are nominal with LI finish trims.	Notes	Notes	Notes

	NOMINAL BEAM ANGLES WITH LI FINISH			
	Narrow	Medium	Wide	Shallow
1000-7000	15	40	73	86
8000-12000	30	44	73	86
15000-20000	34	46	73	86

Order Information

Accessories	Type	Lengths
Pendant Kit⁽¹⁵⁾ P836P =White pendant stem kit P836BZ =Bronze pendant stem kit P836MB =Matte black pendant stem kit P836SL =Silver pendant stem kit	Blank =5 conductor for use with 0-10V driver 3C =3 conductor for use with 120 or 277V 5C = 5 conductor for use with D5LT drivers DMX =No conductors for use with DMX RM = for Remote drivers	Blank =36" SP *=* Specify 6" to 144" in 1" increments
Conduit Pendant Kit PMRCC6P = Round pendant stem kit with conduit knockout cover, white PMRCC6MB = Round pendant stem kit with conduit knockout cover, black PMRCC6BZ = Round pendant stem kit with conduit knockout cover, bronze PMRCC6SL = Round pendant stem kit with conduit knockout cover, silver		Blank =36" SP *=* Specify 6" to 144" in 1" increments
Aircraft cable AC120P =120" white aircraft cable kit AC48P =48" white aircraft cable kit AC120MB =120" black aircraft cable kit AC48MB =48" black aircraft cable kit	Blank =5 conductor DMXC5 =DMX/RDM logarithmic Dimming with RJ45 connection	
Connected Lighting Systems⁽¹²⁾ WTA = Field installed WaveLinX sensor Kit ⁽¹⁶⁾ WTK = Field installed WaveLinX Lite Sensor Kit ⁽¹⁷⁾		
Notes (12) Refer to system specifications for additional information, features, and benefits. Order either factory installed option or accessory. (15) 0-45° slope (16) WTA = WaveLinX wireless sensor kit for daylight dimming, PIR motion sensing, and optional RLTS - Real Time Location Services, use with 0-10V only. (17) WTK = WaveLinX Lite tile mount sensor kit for daylight dimming, PIR motion sensing, use with D010 only (Refer to WaveLinX Lite system specifications)	Notes	Notes

Product Specifications

Lower Reflector

- Self-flanged, spun 0.062" thick aluminum lower reflector with a lensed upper optical chamber provides superior lumen output with minimal source brightness

Trim Retention

- Two torsion springs hold flange tightly to the cylinder lip

Housing

- Round seamless .060" thick spun aluminum housing
- White, bronze, silver or matte black. Consult factory for custom finishes
- Available in standard and shallow heights

Mounting

- Ceiling mounting plate installs to mounted junction box
- Cylinder mounts to plate with easy twist and lock hooks for ceiling mount
- For wall mount, mounting bracket plate attaches directly to wall-mounted junction box
- Optional pendant kits allow unit to be stem hung on ceilings with up to 45° slope

LED System

- Contains a plurality of high brightness white LED's combined with high reflectance upper reflector and convex transitional lens producing even distribution with no pixilation
- Lumen output shall not decrease by more than 10% over the minimum life of 55,000 hours (L90 > 55,000 hours)
- Color variation within 2-step MacAdam ellipses
- Flexible disconnect allows for tool-less replacement of LED engine from below ceiling
- Available in 2700K, 3000K, 3500K, 4000K and 5000K correlated color temperature (CCT)
- Available in 80, 90 or 97 color rendering index (CRI)

VividTune™ Color Tuning Solutions

- D2W™ – Dim-to-Warm shifts CCT from 3000K to 1850K as fixture dims, mimicking halogen sources
- W2N – Tunable white CCT range from 2700K to 6500K or 2000K to 5000K; 90 CRI

Driver

- Combination 0-10V trailing edge driver provides flicker-free dimming from 100% to 10%
- Optional 1% 0-10V, Fifth Light, DMX or Lutron® Ecosystem
- 1,000 - 7,000 lumens utilize one driver; 8,000 - 12,000 lumens utilize two drivers; 15,000 lumens utilize three drivers; reference ordering information for other variations
- Remote driver option up to 100' based on driver selection
- Distributed low voltage power system combines power, lighting, and controls with ease of installation.

Connected Lighting System Options

Two WaveLinX connected systems to choose from. Refer to WaveLinX system specifications and application guides for details.

WaveLinX Wireless System Tilemount Sensor Kit

- WaveLinX Wireless WTA tile mount sensor kit offers daylight dimming, PIR motion sensing, scene and zone configuration, automatic commissioning; and optional RLTS - Real Time Location Services available.

WaveLinX Lite System Tilemount Sensor Kit

- WaveLinX Lite WTK tile mount sensor kit offers daylight dimming and PIR motion sensing, scene and grouping configuration.

WaveLinX Tilemount Kits Application

- The WTA and WTK tilemount kits include a control module mounted on the luminaire junction box via 1/2" knock-out, and a tilemount sensor on 54-inch whip; for ceiling installation by direct-mount spring clips or via mounting bracket in octagon ceiling boxes.

- The WTA and WTK tilemount kits may be ordered as factory installed on the luminaire, or ordered separately as a field installed accessory kit.

Compliance

- Pendant and wall mount and 15,000 lumen cylinder cULus Listed for damp locations
- Ceiling surface mount cULus Listed for protected wet locations with covered ceiling
- EMI/RFI emissions per FCC 47CFR Part 18 Class B consumer limits
- RoHS compliant
- Photometric testing completed in accordance with IES LM-79
- Lumen maintenance projections in accordance with IES LM-80-08 and TM-21-11

Warranty

- Five-year warranty

Color Metric Summary

8027		8030		8035		8040		8050	
R _f	93.2	R _f	83.4	R _f	83.7	R _f	83.3	R _f	82.5
R _g	94.1	R _g	94.4	R _g	94.8	R _g	94	R _g	94.3
CRI	81.3	CRI	82.4	CRI	83.1	CRI	83.7	CRI	94.2
R ₉	0.7	R ₉	4.5	R ₉	9.1	R ₉	9.9	R ₉	11.9

9027		9030		9035		9040		9050	
R _f	92	R _f	91.6	R _f	90.9	R _f	89.4	R _f	88.4
R _g	98.4	R _g	98.6	R _g	98.3	R _g	96.6	R _g	96.8
CRI	93.4	CRI	93.2	CRI	93.3	CRI	91.8	CRI	91
R ₉	59.3	R ₉	60.2	R ₉	63.1	R ₉	58	R ₉	55.2

9727		9730	
R _f	95	R _f	94.2
R _g	100.1	R _g	99.6
CRI	98	CRI	98.5
R ₉	93.9	R ₉	94.7

Energy Data

ENERGY DATA
Sound Rating: Class A standards
(Values at non-dimming line voltage)
Minimum Starting Temperature: -20°C (-4°F)
EMI/RFI: FCC Title 47 CFR, Part 15, Class B (Consumer)
Power Factor: >0.90
Input Frequency: 50/60Hz

1000 Lumen D010	
Input Power: 11W	THD <14%
Input Current: 0.09A	277V Input Current: 0.04A

1500 Lumen D010	
Input Power: 15.5W	THD <13%
Input Current: 0.13A	277V Input Current: 0.06A

2000 Lumen D010	
Input Power: 21.2 W	THD <9%
Input Current: 0.18A	277V Input Current: 0.08A

3000 Lumen D010	
Input Power: 27.6 W	THD <10%
Input Current: 0.23A	277V Input Current: 0.10A

4000 Lumen D010	
Input Power: 41.6 W	THD <13%
Input Current: 0.35A	277V Input Current: 0.15A

5000 Lumen D010TE	
Input Power: 52.5 W	THD <12%
Input Current: 0.44A	277V Input Current: 0.19A

6000 Lumen D010TE	
Input Power: 59.7W	THD <14%
Input Current: 0.50A	277V Input Current: 0.22A

7000 Lumen D010TE	
Input Power: 75.8 W	THD <13%
Input Current: 0.64A	277V Input Current: 0.29A

8000 Lumen D010	
Input Power: 73.8 W	THD <13%
Input Current: 0.62A	277V Input Current: 0.26A

9000 Lumen D010	
Input Power: 86.9 W	THD <13%
Input Current: 0.72A	277V Input Current: 0.32A

10000 Lumen D010TE	
Input Power: 115.4 W	THD <13%
Input Current: 0.96A	277V Input Current: 0.42A





12000 Lumen D010TE	
Input Power: 119.4 W	THD <13%
Input Current: 1.0A	277V Input Current: 0.43A

15000 Lumen D010TE	
Input Power: 173.7 W	THD <13%
Input Current: 1.45A	277V Input Current: 0.63A

17500 Lumen D010TE	
Input Power: 179.1 W	THD <13%
Input Current: 1.49A	277V Input Current: 0.65A

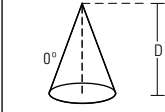
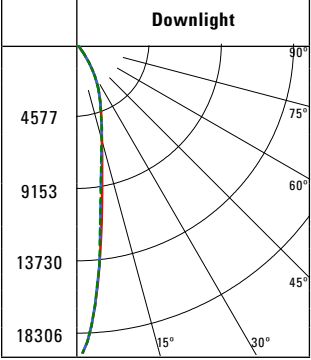
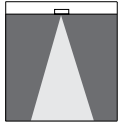
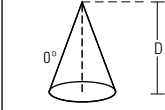
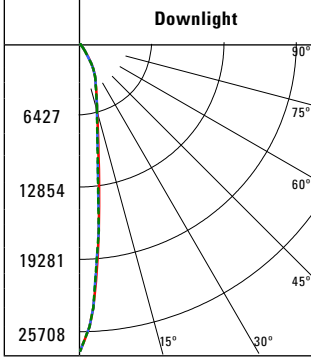
 View IES files

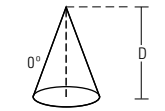
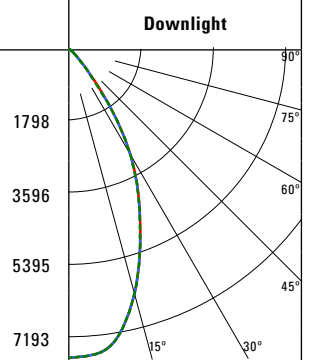
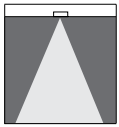
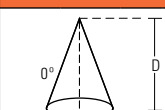
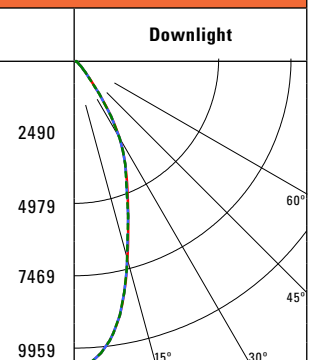
Photometric Data

NARROW (30° BEAM)		CANDLEPOWER DISTRIBUTION		CONE OF LIGHT		CANDELA TABLE		ZONAL LUMEN SUMMARY			LUMINANCE	
Test Number		Downlight				Degrees Vertical	Candela	Zone	Lumens	% Fixture	Average Candela Degrees	Average 0° Luminance
Housing	LSR8B50D010					0	18310	0-30	4214	84.5	45	4330
Module	ER8B50835					5	14091	0-40	4883	97.9	55	253
Trim	8LBN0H					15	5762	0-60	4983	99.9	65	88
Lumens	4986					25	3117	0-90	4986	100	75	143
Efficacy	94.1 Lm/W					35	1021	90-180	0	0	85	0
SC	0.32					45	99	0-180	4986	100		
						55	5					
						65	1					
						75	1					
						85	0					
						90	0					
Test Number		Downlight				Degrees Vertical	Candela	Zone	Lumens	% Fixture	Average Candela Degrees	Average 0° Luminance
Housing	LSR8B50D010					0	25712	0-30	4514	86	45	4422
Module	ER8B50835					5	17790	0-40	5134	97.8	55	382
Trim	8LBN0LI					15	5743	0-60	5238	99.8	65	518
Lumens	5248					25	3148	0-90	5248	100	75	429
Efficacy	99 Lm/W					35	879	90-180	0	0	85	0
SC	0.25					45	101	0-180	5248	100		
						55	7					
						65	7					
						75	4					
						85	0					
						90	0					
Test Number		Downlight				Degrees Vertical	Candela	Zone	Lumens	% Fixture	Average Candela Degrees	Average 0° Luminance
Housing	LSR8B50D010					0	7197	0-30	4078	75.2	45	10619
Module	ER8B50835					5	7141	0-40	5174	95.4	55	887
Trim	8LBM0H					15	5914	0-60	5422	99.9	65	175
Lumens	5426					25	3883	0-90	5426	100	75	143
Efficacy	102.4 Lm/W					35	1774	90-180	0	0	85	0
SC	0.8					45	244	0-180	5426	100		
						55	16					
						65	2					
						75	1					
						85	0					
						90	0					
Test Number		Downlight				Degrees Vertical	Candela	Zone	Lumens	% Fixture	Average Candela Degrees	Average 0° Luminance
Housing	LSR8B50D010					0	9963	0-30	4491	78.6	45	9546
Module	ER8B50835					5	9498	0-40	5481	96	55	1435
Trim	8LBM0LI					15	6587	0-60	5702	99.8	65	518
Lumens	5711					25	3908	0-90	5711	100	75	214
Efficacy	107.8 Lm/W					35	1559	90-180	0	0	85	0
SC	0.63					45	219	0-180	5711	100		
						55	27					
						65	7					
						75	2					
						85	0					
						90	0					

Photometric Data

 View IES files

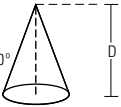
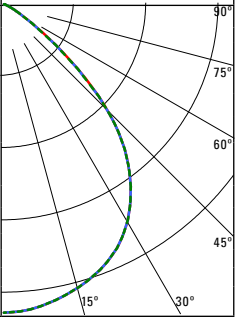
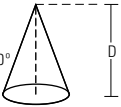
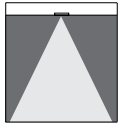
SHALLOW (75° BEAM)		CANDLEPOWER DISTRIBUTION		CONE OF LIGHT		CANDELA TABLE		ZONAL LUMEN SUMMARY			LUMINANCE			
Test Number		Downlight				Degrees Vertical	Candela	Zone	Lumens	% Fixture	Average Candela Degrees	Average 0° Luminance		
Housing	LSR8B50D010			MH	FC	L	W	0	3502	0-30	2670	44.2	45	71087
Module	ER8B50835			4'	218.9	4.6	4.6	5	3477	0-40	4240	70.2	55	24682
Trim	8LBS0H			7'	71.5	8.2	8.2	15	3322	0-60	5920	98.1	65	6100
Lumens	6035			9'	43.2	10.6	10.6	25	3056	0-90	6035	100	75	2121
Efficacy	113.9 Lm/W			13'	20.7	15.4	15.4	35	2525	90-180	0	0	85	1274
SC	1.2	16'	13.7	19	19	45	1630	0-180	6035	100				
														

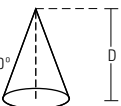
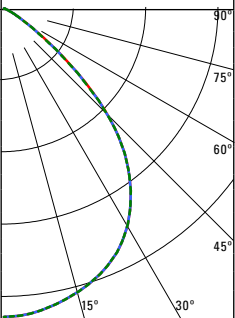
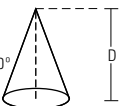
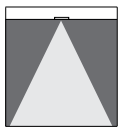
SHALLOW (75° BEAM)		CANDLEPOWER DISTRIBUTION		CONE OF LIGHT		CANDELA TABLE		ZONAL LUMEN SUMMARY			LUMINANCE			
Test Number		Downlight				Degrees Vertical	Candela	Zone	Lumens	% Fixture	Average Candela Degrees	Average 0° Luminance		
Housing	LSR8B50D010			MH	FC	L	W	0	3460	0-30	2850	45.9	45	69395
Module	ER8B50835			4'	216.3	5	5	5	3462	0-40	4513	72.7	55	22488
Trim	8LBS0LI			7'	70.6	8.8	8.8	15	3498	0-60	6132	98.8	65	4159
Lumens	6206			9'	42.7	11.4	11.4	25	3343	0-90	6206	100	75	631
Efficacy	117.1 Lm/W			13'	20.5	16.6	16.6	35	2681	90-180	0	0	85	637
SC	1.28	16'	13.5	20.4	20.4	45	1591	0-180	6206	100				
														

Nominal Scaling From 80 CRI 3500K		
CRI	CCT	Lumen Mult
80	2700	0.938
80	3000	0.962
80	3500	1.000
80	4000	0.993
80	5000	1.013
90	2700	0.784
90	3000	0.826
90	3500	0.853
90	4000	0.891
90	5000	0.922
97	2700	0.696
97	3000	0.737

Nominal Scaling From 5000 lumen package	
LUMEN PACKAGE	LUMEN MULT
1000 LUMEN	0.207
1500 LUMEN	0.280
2000 LUMEN	0.398
3000 LUMEN	0.562
4000 LUMEN	0.799
5000 LUMEN	1.000
6000 LUMEN	1.133
7000 LUMEN	1.368
8000 LUMEN	1.535
9000 LUMEN	1.729
10,000 LUMEN	1.994
12,000 LUMEN	2.261
15,000 LUMEN	2.949
17,500 LUMEN	3.329
20,000 LUMEN	3.924

Connected Systems

WaveLinx Lite - WTK Tilemount Sensor



- Intuitive Android™ or Apple® iOS® app for basic system code compliant set up and configuration via Bluetooth
- Up to 28 unique areas per project site (WaveLinx Lite Bluetooth network)
- Up to 50 devices for an area, any one of 16 control zones, up to 6 occupancy sets, and custom lighting scenes
- Automatic occupancy or vacancy, sensor sensitivity, daylight dimming, etc. configurable through the app
- Refer to the WaveLinx system specifications for details



WaveLinx Lite WTK Tilemount Wiring Diagram

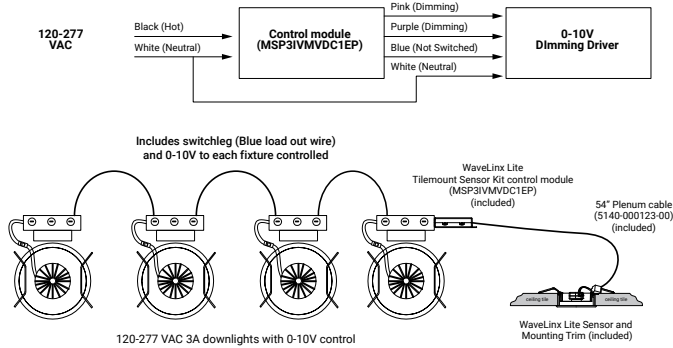

WaveLinx Lite Bluetooth Enabled System

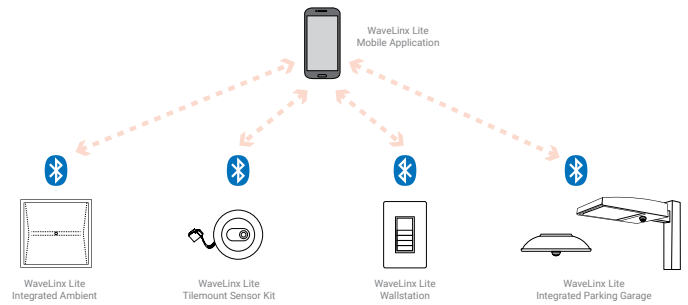

WaveLinx Wireless – WTA Tilemount Sensor



- WaveLinx Wireless functionality configures zones and customizes settings from one secure mobile app
- Automatic code commissioning that meets the strictest codes
- Fixtures and sensors integrate with Wireless Area Controller, Wall Stations, and Control Devices
- Stand-Alone Offices or Entire Building Network Installations



WaveLinx mobile app settings

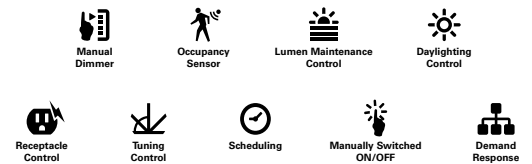

WaveLinx Lite WTA Tilemount Wiring Diagram

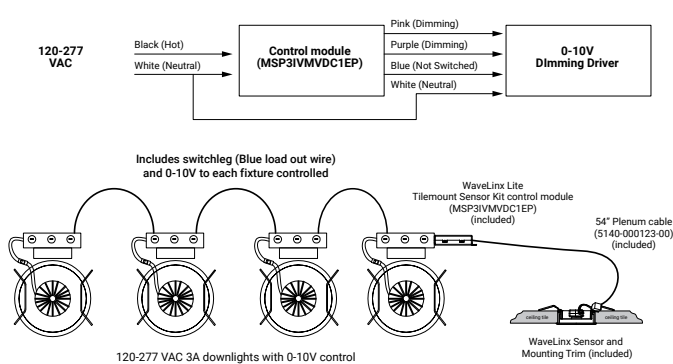

WaveLinx Wireless Trellix Building Management Integration

