



# POWER DISTRIBUTION UNIT (PDU) MODELS AND SPECIFICATIONS

Updated April 2014

## Basic PDUs



Reliable Power  
Distribution

Model	Nominal AC Voltage (50/60 Hz)	Max Input Current (at 230 V)	Meters/ Output Banks	Nominal Load Capacity <sup>(A)</sup>	Input Type	Input Cord Length	Outlets (Quantity & Type)	Rack Size <sup>(E)</sup>
<b>SINGLE-PHASE HORIZONTAL BASIC PDUs</b>								
PDU12IEC	230 V (100-240 V)	16 A	0/1	3,7 kW	C20 inlet <sup>(B)</sup>	N/A <sup>(D)</sup>	14 (12 C13 + 2 C19)	1U or 0U (44,45 cm)
PDU1NV	230 V (100-240 V)	16 A	0/1	3,7 kW	C20 plug (with 6 options) <sup>(B,C)</sup>	3 m	14 (12 C13 + 2 C19)	1U or 0U (44,45 cm)
PDUH20DV	230 V (100-240 V)	16 A	0/1	3,7 kW	C20 inlet to L6-20P plug <sup>(B)</sup>	3,7 m	14 (12 C13 + 2 C19)	1U or 0U (44,45 cm)

Certifications vary by model. **(A)** Load capacity varies with voltage and applicable derating. **(B)** Connect the inlet to a user-supplied input cord with a region-specific plug. **(C)** Includes fixed input cord terminating in C20, plus adapters for C14, 5-15P, 5-20P, L5-20P and L6-20P. **(D)** User-supplied cord. **(E)** 1U and 2U represent horizontal rack installation. 0U represents vertical rack installation. Included brackets also support surface mounting. Select 1U models also support vertical installation with optional PDU5IDBRKT accessory.

Complete, up-to-date specifications available at [www.tripplite.com/all-pdu](http://www.tripplite.com/all-pdu)



## Metered PDUs



Reliable Power  
Distribution



Current  
Monitoring

Model	Nominal AC Voltage (50/60 Hz)	Max Input Current (at 230 V) <sup>(A)</sup>	Meters/ Output Banks	Nominal Load Capacity <sup>(B,C)</sup>	Input Type	Input Cord Length	Outlets (Quantity & Type)	Rack Size <sup>(F)</sup>
<b>SINGLE-PHASE HORIZONTAL METERED PDUs</b>								
PDUH20HV	230 V (208/240 V)	16 A	1/1	3,7 kW (at 230 V)	C20 inlet to L6-20P plug <sup>(D)</sup>	3,7 m	10 (8 C13 + 2 C19)	1U
PDUH32HV	230 V	32 A	2/2	7,4 kW	IEC-309 Blue 32 A (2P+E) <sup>(E)</sup>	3,7 m	18 (16 C13 + 2 C19)	2U
<b>SINGLE-PHASE VERTICAL METERED PDUs</b>								
PDUV20HV	230 V (208/240 V)	16 A	1/1	3,7 kW (at 230 V)	C20 inlet to L6-20P plug <sup>(D)</sup>	3 m	38 (32 C13 + 6 C19)	0U (162 cm)
<b>3-PHASE VERTICAL METERED PDUs (3Φ IN, 1Φ OUT)</b>								
PDU3XMV6G20	400 V 3Φ In, 230 V Out	16 A	3/3	11 kW	IEC-309 Red 16 A (3P+N+E) <sup>(E)</sup>	1,8 m	45 (36 C13 + 9 C19)	0U (178 cm)
PDU3XMV6L2220	400 V 3Φ In, 230 V Out	16 A	3/3	11 kW	L22-20P	1,8 m	45 (36 C13 + 9 C19)	0U (178 cm)

Certifications vary by model. **(A)** 3-phase input current is limited by plug type and/or agency derating. **(B)** Load capacity varies with voltage and applicable derating. **(C)** Balanced load (3-phase models). **(D)** Connect the inlet to a user-supplied input cord with a region-specific plug. **(E)** Splash-proof IEC 60309 plug with IP44 protection rating. **(F)** 1U and 2U represent horizontal rack installation. 0U represents vertical rack installation. Included brackets also support surface mounting. Select 1U models also support vertical installation with optional PDU5IDBRKT accessory.

Complete, up-to-date specifications available at [www.tripplite.com/all-pdu](http://www.tripplite.com/all-pdu)



Basic PDUs	1
Metered PDUs	1
Monitored PDUs	2

Switched PDUs	2
ATS PDUs	3
Hot-Swap PDUs	3

Power Cords	4
Plug and Outlet Guide	5
PDU Accessories	6

# Monitored PDUs



Reliable Power Distribution



Current Monitoring



Network Interface

Model	Nominal AC Voltage (50/60 Hz)	Max Input Current (at 230 V) <sup>(A)</sup>	Meters/Output Banks	Nominal Load Capacity <sup>(B,C)</sup>	Input Type	Input Cord Length	Outlets (Quantity & Type)	Rack Size <sup>(F)</sup>
<b>SINGLE-PHASE HORIZONTAL MONITORED PDUs</b>								
PDUMNH20HV	230 V (208/240 V)	16 A	1/1	3,7 kW	C20 inlet to L6-20P plug <sup>(D)</sup> 	2,6 m	8 (C13)	1U
PDUMNH32HV	230 V	32 A	1/2	7,4 kW	IEC-309 Blue 32 A (2P+E) <sup>(E)</sup>	3,7 m	16 (12 C13 + 4 C19)	2U
<b>SINGLE-PHASE VERTICAL MONITORED PDUs</b>								
PDUMNV20HV	230 V (208/240 V)	16 A	1/1	3,7 W	C20 inlet to L6-20P plug <sup>(D)</sup> 	3 m	24 (20 C13 + 4 C19)	0U (178 cm)
PDUMNV20HV2	230 V (208/240 V)	16 A	1/1	3,7 kW	C20 inlet to L6-20P plug <sup>(D)</sup> 	3 m	20 (18 C13 + 2 C19)	0U (90 cm)
<b>3-PHASE VERTICAL MONITORED PDUs (3Φ IN, 1Φ OUT)</b>								
PDU3XVN10G16	400 V 3Φ In, 230 V Out	16 A	1/3	11 kW	IEC-309 Red 16 A (3P+N+E) <sup>(E)</sup>	3 m	36 (30 C13 + 6 C19)	0U (178 cm)
PDU3XVN3G16	400 V 3Φ In, 230 V Out	16 A	1/3	11 kW	IEC-309 Red 16 A (3P+N+E) <sup>(E)</sup>	0,9 m	36 (30 C13 + 6 C19)	0U (178 cm)

Certifications vary by model. (A) 3-phase input current is limited by plug type and/or agency derating. (B) Load capacity varies with voltage and applicable derating. (C) Balanced load (3-phase models). (D) Connect the inlet to a user-supplied input cord with a region-specific plug. (E) Splash-proof IEC 60309 plug with IP44 protection rating. (F) 1U and 2U represent horizontal rack installation. 0U represents vertical rack installation. Included brackets also support surface mounting.

# Switched PDUs



Reliable Power Distribution



Current Monitoring



Network Interface



Individual Outlet Control

Model	Nominal AC Voltage (50/60 Hz)	Max Input Current (at 230 V) <sup>(A)</sup>	Meters/Output Banks	Nominal Load Capacity <sup>(B,C)</sup>	Input Type	Input Cord Length	Outlets (Quantity & Type)	Rack Size <sup>(F)</sup>
<b>SINGLE-PHASE HORIZONTAL SWITCHED PDUs</b>								
PDUMH15HVNET	230 V (208/240 V)	10 A	1/1	2,3 kW	C14 inlet <sup>(D)</sup>	2 m	8 (C13)	1U
PDUMH20HVNET	230 V (208/240 V)	16 A	1/1	3,7 kW	C20 inlet to L6-20P plug <sup>(D)</sup>	2,6 m	8 (C13)	1U
PDUMH32HVNET	230 V	32 A	1/2	7,4 kW	IEC-309 Blue 32 A (2P+E) <sup>(E)</sup>	3,6 m	16 (C13)	2U
<b>SINGLE-PHASE VERTICAL SWITCHED PDUs</b>								
PDUMV20HVNET	230 V (208/240 V)	16 A	1/1	3,7 kW	C20 inlet to L6-20P plug <sup>(D)</sup>	3 m	24 (20 C13 + 4 C19)	0U (99 cm)
PDUMV20HVNET2	230 V (208/240 V)	16 A	1/1	3,7 kW	C20 inlet to L6-20P plug <sup>(D)</sup>	3 m	8 (7 C13 + 1 C19)	0U (99 cm)
PDUMV32HVNET	230V	32 A	1/2	7,4 kW	IEC-309 Blue 32 A (2P+E) <sup>(E)</sup>	3 m	24 (20 C13 + 4 C19)	0U (99 cm)
<b>3-PHASE VERTICAL SWITCHED PDUs (3Φ IN, 1Φ OUT)</b>								
PDU3XVSR10G16	400 V 3Φ In, 230 V Out	16 A	1/3 <sup>(G)</sup>	11 kW	IEC-309 Red 16 A (3P+N+E) <sup>(E)</sup>	3 m	24 (21 C13 + 3 C19)	0U (178 cm)
PDU3XVSR3G16	400 V 3Φ In, 230 V Out	16 A	1/3 <sup>(G)</sup>	11 kW	IEC-309 Red 16 A (3P+N+E) <sup>(E)</sup>	0,9 m	24 (21 C13 + 3 C19)	0U (178 cm)
PDU3XVSR6G32A	380/400 V 3Φ In, 220/230 V Out	32 A	1/6 <sup>(G)</sup>	22,1 kW	IEC-309 Red 32 A (3P+N+E) <sup>(E)</sup>	1,8 m	24 (12 C13 + 12 C19)	0U (178 cm)
PDU3XVSR6G32B	400 V 3Φ In, 230 V Out	32 A	1/6 <sup>(G)</sup>	22,1 kW	IEC-309 Red 32 A (3P+N+E) <sup>(E)</sup>	1,8 m	30 (24 C13 + 6 C19)	0U (178 cm)
PDU3XVSR6G33A	380/400 V 3Φ In, 220/230 V Out	40 A	1/6 <sup>(G)</sup>	27,6 kW	IEC-309 Red 63 A (3P+N+E) <sup>(E)</sup>	1,8 m	24 (12 C13 + 12 C19)	0U (178 cm)
PDU3XVSR6G33B	400 V 3Φ In, 230 V Out	40 A	1/6 <sup>(G)</sup>	27,6 kW	IEC-309 Red 63 A (3P+N+E) <sup>(E)</sup>	1,8 m	30 (24 C13 + 6 C19)	0U (178 cm)
PDU3XVSRHWA	400 V 3Φ In, 230 V Out	40 A	1/6 <sup>(G)</sup>	27,6 kW	Hardwire 40 A (3P+N+E) <sup>(E)</sup>	N/A	24 (12 C13 + 12 C19)	0U (178 cm)
PDU3XVSRHWB	400 V 3Φ In, 230 V Out	40 A	1/6 <sup>(G)</sup>	27,6 kW	Hardwire 40 A (3P+N+E) <sup>(E)</sup>	N/A	30 (24 C13 + 6 C19)	0U (178 cm)

Certifications vary by model. (A) 3-phase input current is limited by plug type and/or agency derating. (B) Load capacity varies with voltage and applicable derating. (C) Balanced load (3-phase models). (D) Connect the inlet to a user-supplied input cord with a region-specific plug. (E) Splash-proof IEC 60309 plug with IP44 protection rating. (F) 1U and 2U represent horizontal installation. 0U represents vertical installation. Included brackets also support surface mounting. (G) Model provides outlet-level metering.

# ATS PDUs



**Automatic Transfer Switch**



**Reliable Power Distribution**



**Current Monitoring**



**Network Interface (Switched Models)**



**Individual Outlet Control (Switched Models)**

Model	Nominal AC Voltage (50/60 Hz)	Max Input Current (at 230 V)	Meters/Output Banks	Load Capacity <sup>(A)</sup>	Input Type	Input Cord Length	Outlets (Quantity & Type)	Rack Size <sup>(D)</sup>
<b>SINGLE-PHASE HORIZONTAL METERED ATS PDUs</b>								
<b>PDUH20HVAT</b>	230 V (208/240 V)	16 A	1/1	3,7 kW	2 x C20 (C20 inlets)	2 x 3,6 m <sup>(B)</sup>	10 (8 C13 + 2 C19)	1U
<b>SINGLE-PHASE HORIZONTAL SWITCHED ATS PDUs</b>								
<b>PDUH20HVATNET</b>	230 V (208/240 V)	16 A	1/1	3,7 kW	2 x C20 (C20 inlets)	2 x 3,7 m <sup>(B)</sup>	10 (8 C13 + 2 C19) <sup>(C)</sup>	1U

Certifications vary by model. (A) Load capacity varies with voltage and applicable derating. (B) Both input cords are detachable. (C) The C19 outlets do not support individual outlet control. (D) 1U and 2U represent horizontal rack installation. Included brackets also support surface mounting.

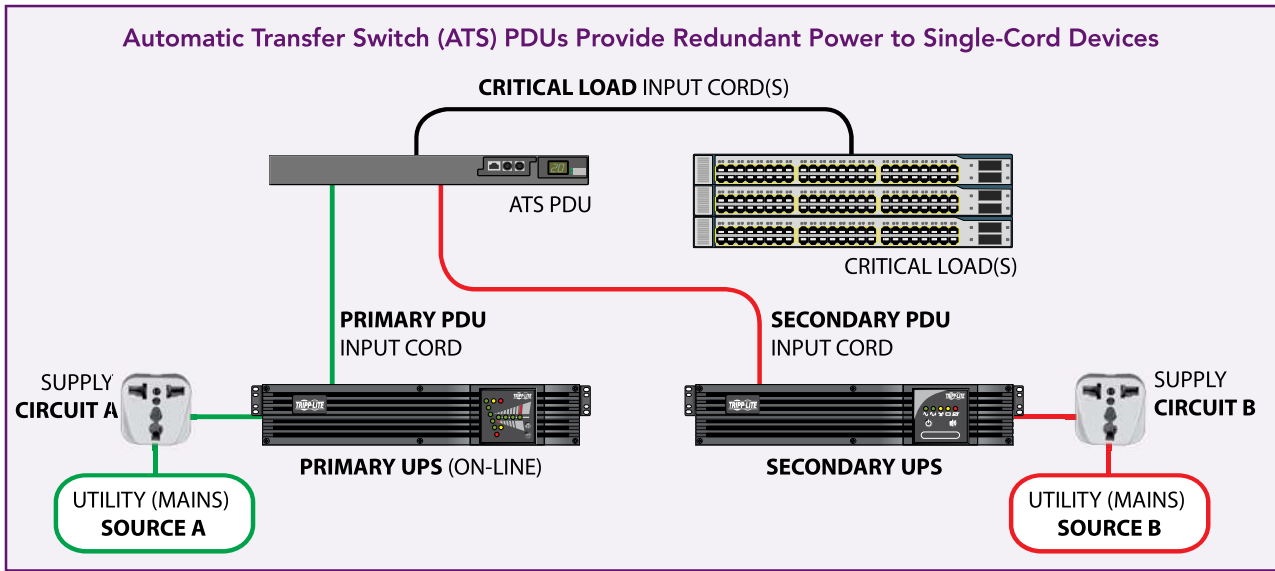

Complete, up-to-date specifications available at [www.tripplite.com/all-pdu](http://www.tripplite.com/all-pdu)



# Hot-Swap PDUs



**Manual Transfer Switch**



**Reliable Power Distribution**

Model	Nominal AC Voltage (50/60 Hz)	Max Input Current (at 230 V)	Load Capacity <sup>(A)</sup>	Recommended UPS Size	Input Type	Input Cord Length (UPS/Utility)	Equipment Outlets <sup>(C)</sup> (Quantity & Type)	UPS Connection Outlet Type <sup>(C)</sup>	Rack Size
<b>SINGLE-PHASE HORIZONTAL HOT-SWAP PDUs</b>									
<b>PDUHV10</b>	230 V (208/240 V)	10 A	2,3 kW	Up to 1,5 kVA	2 x C14 inlet <sup>(B)</sup>	1,8 m/1,8 m	8 (C13)	C13	2U
<b>PDUHV20</b>	230V (208/240 V)	16 A	3,7 kW	2,0 to 3,0 kVA	2 x C20 inlet <sup>(B)</sup>	1,8 m/1,5 m	8 (6 C13 + 2 C19)	C19	2U

Certifications vary by model. (A) Load capacity varies with voltage. (B) Connect the inlets to the included input cords or user-supplied input cords with region-specific plugs. (C) In addition to the equipment outlets, the PDU includes a single UPS connection outlet. The UPS system's input plug must be compatible with the PDU's UPS connection outlet.

Complete, up-to-date specifications available at [www.tripplite.com/all-pdu](http://www.tripplite.com/all-pdu)



# Power Cords

Model	Input-Side Connector	Output-Side Connector	Length	Rated Current/Voltage	Wire Gauge
<b>CORDS WITH IEC OR EUROPEAN INPUT</b>					
P004-002-13LA	C14	C13	0,6 m	10 A / 100-250 V	0,8 mm <sup>2</sup>
P004-002-13RA	C14	C13	0,6 m	10 A / 100-250 V	0,8 mm <sup>2</sup>
P004-002-5 <sup>(A)</sup>	C14	C13	0,6 m	10 A / 100-250 V	0,8 mm <sup>2</sup>
P004-004	C14	C13	1,2 m	10 A / 100-250 V	0,8 mm <sup>2</sup>
P004-004-BL <sup>(B)</sup>	C14	C13	1,2 m	10 A / 100-250 V	0,8 mm <sup>2</sup>
P004-004-GN <sup>(B)</sup>	C14	C13	1,2 m	10 A / 100-250 V	0,8 mm <sup>2</sup>
P004-004-RD <sup>(B)</sup>	C14	C13	1,2 m	10 A / 100-250 V	0,8 mm <sup>2</sup>
P004-004-YW <sup>(B)</sup>	C14	C13	1,2 m	10 A / 100-250 V	0,8 mm <sup>2</sup>
P004-006	C14	C13	1,8 m	10 A / 100-250 V	0,8 mm <sup>2</sup>
P004-010	C14	C13	3 m	10 A / 100-250 V	0,8 mm <sup>2</sup>
P005-002	C14	C13	0,6 m	15 A / 100-250 V	2,1 mm <sup>2</sup>
P005-006	C14	C13	1,8 m	15 A / 100-250 V	2,1 mm <sup>2</sup>
P005-006-BL <sup>(B)</sup>	C14	C13	1,8 m	15 A / 100-250 V	2,1 mm <sup>2</sup>
P005-006-GN <sup>(B)</sup>	C14	C13	1,8 m	15 A / 100-250 V	2,1 mm <sup>2</sup>
P005-006-RD <sup>(B)</sup>	C14	C13	1,8 m	15 A / 100-250 V	2,1 mm <sup>2</sup>
P005-006-YW <sup>(B)</sup>	C14	C13	1,8 m	15 A / 100-250 V	2,1 mm <sup>2</sup>
P005-010	C14	C13	3 m	15 A / 100-250 V	2,1 mm <sup>2</sup>
P005-18N	C14	C13	0,5 m	15 A / 100-250 V	2,1 mm <sup>2</sup>
P047-002	C14	C19	0,6 m	15 A / 100-250 V	2,1 mm <sup>2</sup>
P047-004	C14	C19	1,2 m	15 A / 100-250 V	2,1 mm <sup>2</sup>
P047-006	C14	C19	1,8 m	15 A / 100-250 V	2,1 mm <sup>2</sup>
P047-010	C14	C19	3 m	15 A / 100-250 V	2,1 mm <sup>2</sup>
P036-002	C20	C19	0,6 m	20 A / 100-250 V	3,3 mm <sup>2</sup>
P036-002-19LA	C20	C19	0,6 m	20 A / 100-250 V	3,3 mm <sup>2</sup>
P036-002-19RA	C20	C19	0,6 m	20 A / 100-250 V	3,3 mm <sup>2</sup>
P036-002-20LA	C20	C19	0,6 m	20 A / 100-250 V	3,3 mm <sup>2</sup>
P036-002-20RA	C20	C19	0,6 m	20 A / 100-250 V	3,3 mm <sup>2</sup>
P036-006	C20	C19	1,8 m	20 A / 100-250 V	3,3 mm <sup>2</sup>
P032-007	C20	C13	2,1 m	15 A / 100-250 V	3,3 mm <sup>2</sup>
P056-006	BS1363	C13	1,8 m	5 A / 200-250 V	1,0 mm <sup>2</sup>
P052-008	BS1363	C19	2,4 m	13 A / 200-250 V	1,5 mm <sup>2</sup>
P054-006	CEE 7/7	C13	1,8 m	10 A / 200-250 V	1,0 mm <sup>2</sup>
P050-008	CEE 7/7	C19	2,4 m	16 A / 200-250 V	1,5 mm <sup>2</sup>
P070-010	IEC-309 Blue (2P+E)	C19	3 m	16 A / 200-250 V	1,5 mm <sup>2</sup>
UNIPLUGINT	C14	Wonpro <sup>(C)</sup>	N/A	10 A / 100-250 V	N/A

## IEC PLUG-LOCK INSERTS

<b>PLC13BK</b>	100-pack of black inserts to secure C13/C14 connections.
<b>PLC13BL</b>	100-pack of blue inserts to secure C13/C14 connections.
<b>PLC13RD</b>	100-pack of red inserts to secure C13/C14 connections.
<b>PLC19BK</b>	100-pack of black inserts to secure C19/C20 connections.
<b>PLC19BL</b>	100-pack of blue inserts to secure C19/C20 connections.
<b>PLC19RD</b>	100-pack of red inserts to secure C19/C20 connections.

Certifications vary by model. **(A)** 5-pack. **(B)** The cord has color-coded connectors (BL=Blue, GN=Green, RD=Red, YW=Yellow). **(C)** The Wonpro universal outlet is compatible with most household AC plugs worldwide.



Complete, up-to-date specifications available at [www.tripplite.com/all-pdu](http://www.tripplite.com/all-pdu)

# Plug and Outlet Guide

## IEC 60320 INPUT-SIDE CONNECTORS

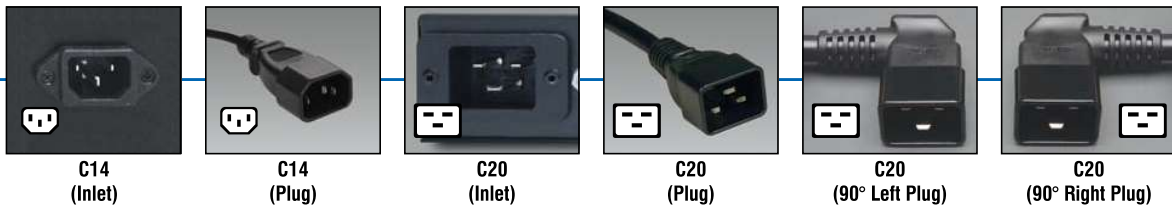

## IEC 60320 OUTPUT-SIDE CONNECTORS

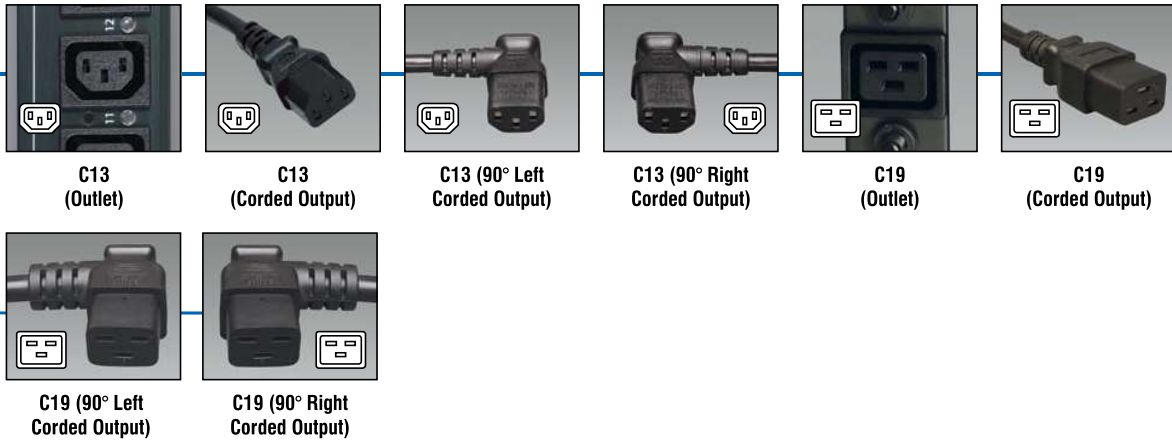

## IEC 60309 INPUT-SIDE CONNECTORS

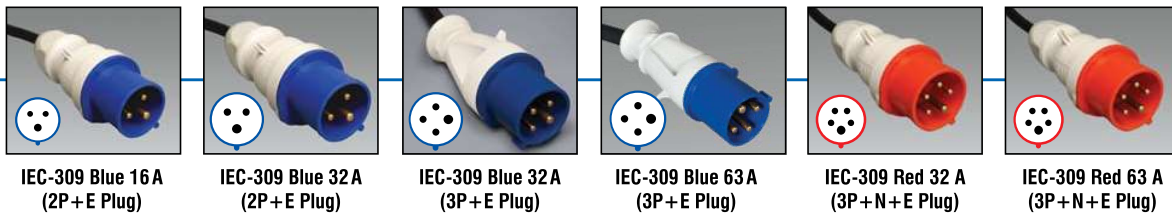

## OTHER CONNECTORS

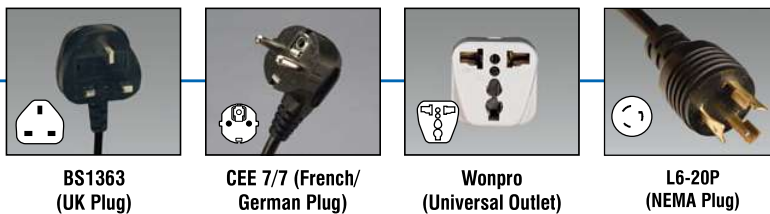

Complete, up-to-date specifications available at [www.tripplite.com/all-pdu](http://www.tripplite.com/all-pdu)



# PDU Accessories

Model	Description
<b>REMOTE MANAGEMENT ACCESSORIES</b>	
<b>ENVIROSENSE</b>	Remote environmental sensor for Monitored and Switched PDUs. 3,7 m connection cord allows flexible placement inside or outside racks. Measures ambient temperature and humidity. Can monitor and control alarm, security and telecom devices through contact closure communications. Can monitor up to three additional sensors. Can monitor optional SRSWITCH magnetic entry detection switch kit.
<b>POWERALERT</b>	PowerAlert software allows IT managers to monitor and control hundreds of Monitored and Switched PDUs over the network through a single interface. Included on CD-ROM with select models and freely downloadable from <a href="http://www.tripplite.com/poweralert">www.tripplite.com/poweralert</a> .
<b>SRSWITCH</b>	Kit includes two magnetic entry detection switches for rack doors or other access points. Requires ENVIROSENSE.
<b>MOUNTING ACCESSORIES</b>	
<b>P350-10N-10</b>	10-pack of reusable black cable ties with hook-and-loop (Velcro®) fasteners. 254 x 16 mm
<b>PDUMVROTATEBRKT</b>	Enables vertical PDU placement with outlets facing the rear in button-mount equipped racks for improved airflow and equipment cabling access. Included with most vertical PDU models.
<b>PDUSIDEBRKT</b>	Enables vertical installation of select 1U PDUs, power strips and surge suppressors. The included mounting brackets support toolless installation in the keyhole mounting slots of most Tripp Lite rack enclosures and open frame racks. The brackets can also connect to mounting rails with the included mounting hardware.

Looking for power cords? See page 4 or visit [www.tripplite.com](http://www.tripplite.com).

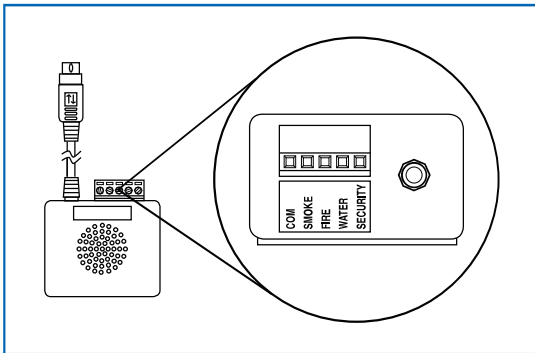

ENVIROSENSE with Contact Closure Interface



PowerAlert Software (PDU Status Overview)

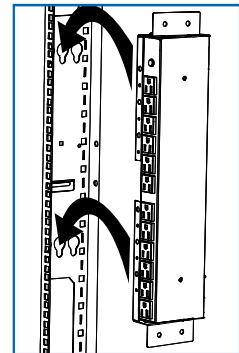

PDUSIDEBRKT with 1U PDU

Go to [www.tripplite.com](http://www.tripplite.com) for Tripp Lite's complete line of data center solutions, including PDUs, UPS systems, rack enclosures, close-coupled cooling, cables, KVM switches, console servers, surge suppressors and custom products.

## ABOUT TRIPP LITE

Since 1922, Tripp Lite has established a global reputation for quality manufacturing, superior value and excellent service. Tripp Lite makes more than 2,500 products to power, protect and connect electronic equipment. Learn more at [www.tripplite.com](http://www.tripplite.com).



**Tripp Lite World Headquarters:** 1111 W. 35th Street, Chicago, IL 60609 USA +1.773.869.1212

**Tripp Lite Middle East:** +971.4.887.1633 [infome@tripplite.com](mailto:infome@tripplite.com) • **Tripp Lite Asia Pacific:** +972.54.2057646 [infoap@tripplite.com](mailto:infoap@tripplite.com)

**Tripp Lite Eastern Europe:** +36.1.203.7941 [infoeeu@tripplite.com](mailto:infoeeu@tripplite.com) • **Tripp Lite East/West Africa:** +254.731.137.202 [infoa@tripplite.com](mailto:infoa@tripplite.com)

**Tripp Lite South Africa:** +27.82.8099.043 [infosaa@tripplite.com](mailto:infosaa@tripplite.com) • **Tripp Lite Western Europe:** +33.1.70.61.77.85 [infoeu@tripplite.com](mailto:infoeu@tripplite.com)

**Tripp Lite United Kingdom:** +44.01635.887396 [info-uk@tripplite.com](mailto:info-uk@tripplite.com)

# Plug and Outlet Guide

## IEC 60320 INPUT-SIDE CONNECTORS

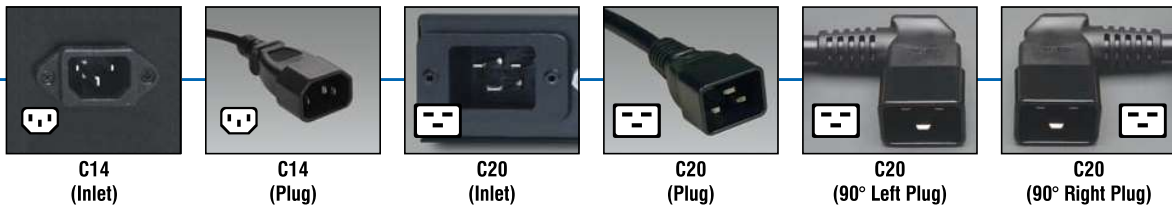

## IEC 60320 OUTPUT-SIDE CONNECTORS

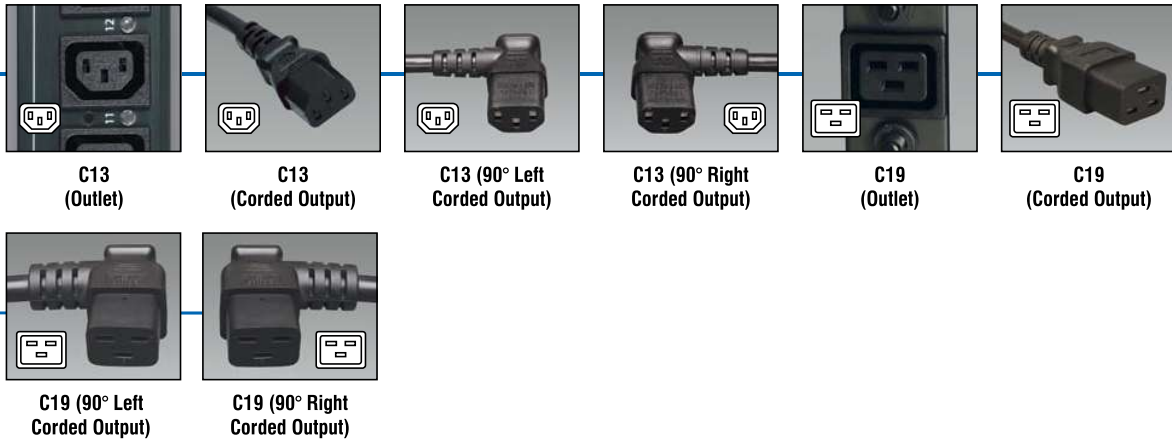

## IEC 60309 INPUT-SIDE CONNECTORS

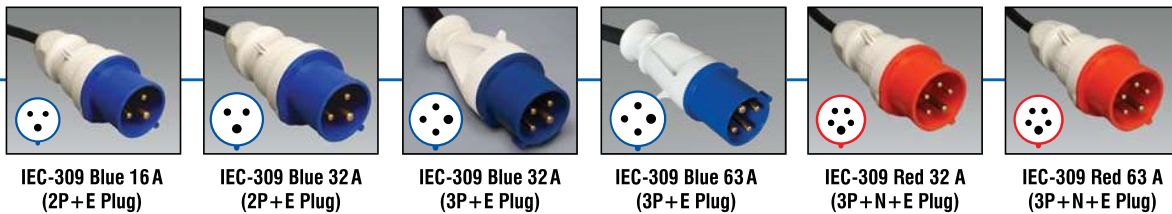

## OTHER CONNECTORS

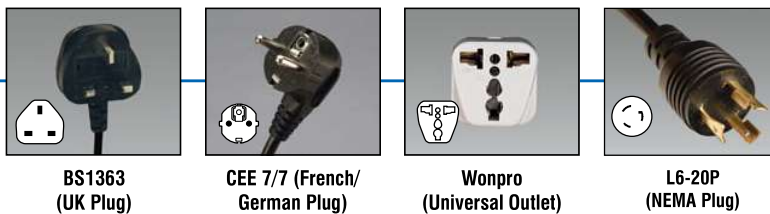

Complete, up-to-date specifications available at [www.tripplite.com/all-pdu](http://www.tripplite.com/all-pdu)

