



Mellanox Spectrum® 1U Switch Systems Hardware User Manual

10/25/40/50/100GbE Open Ethernet Switch Systems Models: SN2700, SN2740, SN2410,
SN2100, SN2010

Table of Contents

Ordering Information	6
SN2700 Ordering Part Numbers	6
SN2410 Ordering Part Numbers	7
SN2100 Ordering Part Numbers	8
SN2010 Ordering Part Numbers	8
Introduction.....	10
Speed and Switching Capabilities	12
Management Interfaces, PSUs and Fans	12
Features	13
Certifications	13
Installation.....	14
System Installation and Initialization	14
Safety Warnings	14
Air Flow.....	17
Package Contents	18
19” System Mounting Options.....	19
SN2700 Static Rail Kit	19
Removing the System from the Rack.....	23
SN2700 Telescopic Rail Kit	23
Removing the System from the Rack.....	26
SN2740/SN2410 Static Rail Kit	27
SN2100/SN2010 Side by Side Mounting Rail Kit.....	30
SN2100/SN2010 Static Single Switch Rail Kit	35
Cable Installation	37
Splitter (Breakout) Cables and Adapters	39
Initial Power On	41
System Bring-Up.....	42
Configuring Network Attributes Using Mellanox Onyx (MLNX-OS)	42
Configuring Network Attributes Using Cumulus Linux.....	46
FRU Replacements	46
Power Supply	46
Fans	47

Interfaces	49
Data Interfaces.....	49
Supported Passive Cables in SN2010bM.....	50
Speed	50
RS232 (Console)	50
Management	51
USB	51
Reset Button	51
Status and Port LEDs.....	52
LED Notifications.....	52
System Status LED	52
Fan Status LED.....	54
Power Supply Status LEDs.....	56
Unit Identification LED	58
Bad Port LED	58
Port LEDs	58
Inventory Information	59
Software Management	62
Upgrading Software.....	62
Mellanox Onyx (MLNX-OS) Software Upgrade.....	62
Switch Firmware Update.....	62
Cumulus Linux Software Upgrade	62
Troubleshooting	63
Specifications.....	65
SN2700 Series.....	65
SN2740 Series.....	66
SN2410 Series.....	67
SN2100 Series.....	68
SN2010 Series.....	69
Appendixes.....	70
Accessory and Replacement Parts.....	70
Thermal Threshold Definitions.....	71
Interface Specifications.....	72
QSFP28 Pin Description	72

SFP28 Pin Description	74
RJ45 to DB9 Harness Pinout	75
RJ45 to RJ45 Harness.....	76
Disassembly and Disposal	76
Disassembly Procedure	76
Disposal.....	77
Document Revision History	78

Relevant for Models: SN2700, SN2740, SN2410, SN2100 and SN2010

About this Manual

This manual describes the installation and basic use of Mellanox Ethernet switches based on the Mellanox Spectrum IC device.

Ordering Information

See [Ordering Information](#).

Intended Audience

This manual is intended for IT managers and system administrators.

Related Documentation

Document	Description
<i>Mellanox Onyx (MLNX-OS) User Manual</i>	This document contains information regarding the configuration and management of the Mellanox Onyx (MLNX-OS) software. See http://www.mellanox.com/page/mlnx_onyx .
<i>Cumulus Linux User Guide</i>	This document contains information regarding the configuration and management of the Cumulus® Linux® software. See https://docs.cumulusnetworks.com .
<i>Open Network Install Environment (ONIE) Quick Start Guide</i>	See https://github.com/opencomputeproject/onie/wiki/Quick-Start-Guide/ .
Hands-on workshops	Cumulus on-site/remote training: https://academy.mellanox.com/en/cumulus-linux/ Mellanox Onyx on-site/remote training: https://academy.mellanox.com/en/network-pro-private/
On-site/remote services	http://www.mellanox.com/globalservices/index.php/project-delivery-services-on-site-ethernet-kick-start-package/ For any tailor-made service, contact services-sales@mellanox.com .

Revision History

A list of the changes made to this document are provided in [Document Revision History](#).

Ordering Information

The following table lists ordering information for the available systems.

Please pay attention to the airflow direction when ordering your system. For more details, see [Air Flow](#).

SN2700 Ordering Part Numbers

OPN	Marketing Description
MSN2700-BS2F	Mellanox Spectrum based 40GbE, 1U Open Ethernet Switch with Mellanox Onyx (MLNX-OS), 32 QSFP28 ports, 2 Power Supplies (AC), x86 CPU, Standard depth, P2C airflow, Rail Kit, RoHS6
MSN2700-BS2FC	Mellanox Spectrum 40GbE 1U switch w/Cumulus Linux, 32 QSFP28 ports, 2 AC PSUs, x86 2-core, standard depth, P2C airflow, Rail Kit, RoHS6, (Cumulus License Key is required)
MSN2700-BS2FO	Mellanox Spectrum based 40GbE 1U Open Switch with ONIE, 32 QSFP28 ports, 2 Power Supplies (AC), Standard depth, x86 CPU, P2C airflow, Rail Kit, RoHS6
MSN2700-BS2R	Mellanox Spectrum based 40GbE, 1U Open Ethernet Switch with Mellanox Onyx (MLNX-OS), 32 QSFP28 ports, 2 Power Supplies (AC), x86 CPU, Standard depth, C2P airflow, Rail Kit, RoHS6
MSN2700-BS2RC	Mellanox Spectrum 40GbE 1U switch w/Cumulus Linux, 32 QSFP28 ports, 2 AC PSUs, x86 2-core, standard depth, C2P airflow, Rail Kit, RoHS6, (Cumulus License Key is required)
MSN2700-CS2F	Mellanox Spectrum based 100GbE, 1U Open Ethernet Switch with Mellanox Onyx (MLNX-OS), 32 QSFP28 ports, 2 Power Supplies (AC), x86 CPU, Standard depth, P2C airflow, Rail Kit, RoHS6
MSN2700-CS2FC	Mellanox Spectrum 100GbE 1U switch w/Cumulus Linux, 32 QSFP28 ports, 2 AC PSUs, x86 2-core, standard depth, P2C airflow, Rail Kit, RoHS6, (Cumulus License Key is required)
MSN2700-CS2FO	Mellanox Spectrum based 100GbE 1U Open Switch with ONIE, 32 QSFP28 ports, 2 Power Supplies (AC), Standard depth, x86 CPU, P2C airflow, Rail Kit, RoHS6
MSN2700-CS2R	Mellanox Spectrum based 100GbE, 1U Open Ethernet Switch with Mellanox Onyx (MLNX-OS), 32 QSFP28 ports, 2 Power Supplies (AC), x86 CPU, Standard depth, C2P airflow, Rail Kit, RoHS6
MSN2700-CS2RC	Mellanox Spectrum 100GbE 1U switch w/Cumulus Linux, 32 QSFP28 ports, 2 AC PSUs, x86 2-core, standard depth, C2P airflow, Rail Kit, RoHS6, (Cumulus License Key is required)
MSN2700-CS2RO	Mellanox Spectrum based 100GbE 1U Open Ethernet switch with ONIE, 32 QSFP28 ports, 2 power supplies (AC), x86 CPU, standard depth, C2P airflow, Rail Kit
MSN2700-CBBFO	Mellanox Spectrum based 100GbE, 1U Open Ethernet Switch with ONIE, 32 QSFP28 ports, 2 power-supplies (DC), x86 CPU, short depth, P2C airflow, Rail Kit

SN2410 Ordering Part Numbers

OPN	Marketing Description
MSN2410-BB2FC	Mellanox Spectrum 10GbE/100GbE switch w/Cumulus Linux, 48 SFP28 ports + 8 QSFP28 ports, 2 AC PSUs, x86 2-core, short depth, P2C air flow, Rail Kit, (Cumulus License Key is required)
MSN2410-BB2FO	Mellanox Spectrum based 10GbE/100GbE 1U Open Ethernet switch with ONIE, 48 SFP28 ports, 8 QSFP28 ports, 2 power supplies (AC), x86 dual core, Short depth, P2C airflow, Rail Kit, RoHS6
MSN2410-BB2R	Mellanox Spectrum based 10GbE/100GbE 1U Open Ethernet switch with Mellanox Onyx (MLNX-OS), 48 SFP28 ports, 8 QSFP28 ports, 2 power supplies (AC), x86 dual core, Short depth, C2P airflow, Rail Kit, RoHS6
MSN2410-BB2RO	Mellanox Spectrum based 10GbE/100GbE 1U Open Ethernet switch with ONIE, 48 SFP28 ports and 8 QSFP28 ports, 2 power supplies (AC), x86 CPU, short depth, C2P airflow, Rail Kit
MSN2410-BB2RC	Mellanox Spectrum based 10GbE/100GbE 1U Open Ethernet switch with Cumulus Linux, 48 SFP28 ports and 8 QSFP28 ports, 2 power supplies (AC), x86 CPU, short depth, C2P airflow, Rail Kit
MSN2410-BBBFC	Mellanox Spectrum based 10GbE/100GbE 1U Open Ethernet switch with Cumulus Linux, 48 SFP28 ports and 8 QSFP28 ports, 2 power supplies (DC), x86 CPU, short depth, P2C airflow, Rail Kit
MSN2410-CB2F	Mellanox Spectrum based 25GbE/100GbE 1U Open Ethernet switch with Mellanox Onyx (MLNX-OS), 48 SFP28 ports, 8 QSFP28 ports, 2 power supplies (AC), x86 dual core, Short depth, P2C airflow, Rail Kit, RoHS6
MSN2410-CB2FC	Mellanox Spectrum 25GbE/100GbE switch w/Cumulus Linux, 48 SFP28 ports + 8 QSFP28 ports, 2 AC PSUs, x86 2 core, short depth, P2C air flow, Rail Kit, (Cumulus License Key is required)
MSN2410-CB2FO	Mellanox Spectrum based 25GbE/100GbE 1U Open Ethernet switch with ONIE, 48 SFP28 ports, 8 QSFP28 ports, 2 power supplies (AC), x86 dual core, Short depth, P2C airflow, Rail Kit, RoHS6
MSN2410-CB2R	Mellanox Spectrum based 25GbE/100GbE 1U Open Ethernet switch with Mellanox Onyx (MLNX-OS), 48 SFP28 ports, 8 QSFP28 ports, 2 power supplies (AC), x86 dual core, Short depth, C2P airflow, Rail Kit, RoHS6
MSN2410-CB2RC	Mellanox Spectrum 25GbE/100GbE switch w/Cumulus Linux, 48 SFP28 ports + 8 QSFP28 ports, 2 AC PSUs, x86 2 core, short depth, C2P air flow, Rail Kit, (Cumulus License Key is required)
MSN2410-CB2RO	Mellanox Spectrum based 25GbE/100GbE 1U Open Ethernet switch with ONIE, 48 SFP28 ports, 8 QSFP28 ports, 2 power supplies (AC), x86 dual core, Short depth, C2P airflow, Rail Kit, RoHS6
MSN2410-CBBRC	Mellanox Spectrum based 25GbE/100GbE 1U Open Ethernet switch with Cumulus Linux, 48 SFP28 ports and 8 QSFP28 ports, 2 power supplies (DC), x86 CPU, short depth, C2P airflow, Rail Kit

SN2100 Ordering Part Numbers

OPN	Marketing Description
MSN2100-BB2FC	Mellanox Spectrum 40GbE 1U switch w/Cumulus Linux, 16 QSFP28 ports, 2 AC PSUs, x86 2 core, short depth, P2C airflow, Rails to be purchased separately, (Cumulus License Key is required)
MSN2100-BB2FO	Mellanox Spectrum based 40GbE 1U Open Switch with ONIE, 16 QSFP28 ports, 2 AC PSUs, x86 2-core, short depth, P2C airflow, Rail Kit must be purchased separately, RoHS6
MSN2100-BB2R	Mellanox Spectrum based 40GbE, 1U Open Ethernet Switch with Mellanox Onyx (MLNX-OS), 16 QSFP28 ports, 2 AC PSUs, x86 2-core, short depth, C2P airflow, Rail Kit must be purchased separately, RoHS6
MSN2100-BB2RC	Mellanox Spectrum 40GbE 1U switch w/Cumulus Linux, 16 QSFP28 ports, 2 AC PSUs, x86 2-core, short depth, C2P airflow, Rails to be purchased separately, (Cumulus License Key is required)
MSN2100-BB2RO	Mellanox Spectrum based 40GbE 1U Open Ethernet switch with ONIE, 16 QSFP28 ports, 2 power supplies (AC), x86 CPU, short depth, C2P airflow. Rail Kit must be purchased separately
MSN2100-CB2F	Mellanox Spectrum based 100GbE, 1U Open Ethernet Switch with Mellanox Onyx (MLNX-OS), 16 QSFP28 ports, 2 AC PSUs, x86 2-core, short depth, P2C airflow, Rail Kit must be purchased separately, RoHS6
MSN2100-CB2FC	Mellanox Spectrum 100GbE 1U switch w/Cumulus Linux, 16 QSFP28 ports, 2 AC PSUs, x86 2-core, short depth, P2C airflow, Rails to be purchased separately, (Cumulus License Key is required)
MSN2100-CB2FO	Mellanox Spectrum based 100GbE 1U Open Switch with ONIE, 16 QSFP28 ports, 2 AC PSUs, x86 2-core, short depth, P2C airflow, Rail Kit must be purchased separately, RoHS6
MSN2100-CB2R	Mellanox Spectrum based 100GbE, 1U Open Ethernet Switch with Mellanox Onyx (MLNX-OS), 16 QSFP28 ports, 2 AC PSUs, x86 2-core, short depth, C2P airflow, Rail Kit must be purchased separately, RoHS6
MSN2100-CB2RC	Mellanox Spectrum 100GbE 1U switch w/Cumulus Linux, 16 QSFP28 ports, 2 AC PSUs, x86 2-core, short depth, C2P airflow, Rails to be purchased separately, (Cumulus License Key is required)
MSN2100-CB2RO	Mellanox Spectrum based 100GbE 1U Open Ethernet switch with ONIE, 16 QSFP28 ports, 2 power supplies (AC), x86 CPU, short depth, C2P airflow. Rail Kit must be purchased separately

SN2010 Ordering Part Numbers

OPN	Marketing Description
MSN2010-CB2F	Mellanox Spectrum-based 25GbE/100GbE, 1U Open Ethernet Switch with Mellanox Onyx, 18 SFP28 and 4 QSFP28 ports, 2 Power Supplies (AC), short depth, x86 quad core, P2C airflow, Rail Kit must be purchased separately
MSN2010-CB2FC	Mellanox Spectrum-based 25GbE/100GbE 1U switch w/Cumulus Linux, 18 SFP28 and 4 QSFP28 ports, 2 AC PSUs, x86 4-core, short depth, P2C airflow, Rails to be purchased separately, (Cumulus License is provided at no cost with purchase of SUP-SN2010-CL-XX)

OPN	Marketing Description
MSN2010-CB2F3C	Mellanox Spectrum based 25GbE/100GbE, 1U Open Ethernet switch with Cumulus Linux, 18 SFP28 and 4 QSFP28 ports, 2 power supplies (AC), x86 CPU, 32G RAM and 30G SSD, short depth, P2C airflow, Rail Kit must be purchased separately
MSN2010-CB2FO	Mellanox Spectrum-based 25GbE/100GbE, 1U Open Ethernet Switch with ONIE, 18 SFP28 ports and 4 QSFP28 ports, 2 Power Supplies (AC), x86 quad core, short depth, P2C airflow, Rail Kit must be purchased separately
MSN2010-CB2R	Mellanox Spectrum-based 25GbE/100GbE, 1U Open Ethernet Switch with Mellanox Onyx, 18 SFP28 ports and 4 QSFP28 ports, 2 Power Supplies (AC), short depth, x86 quad core, C2P airflow, Rail Kit must be purchased separately
MSN2010-CB2RC	Spectrum-based 25GbE/100GbE 1U switch w/Cumulus Linux, 18 SFP28 and 4 QSFP28 ports, 2 AC PSUs, x86 4-core, short depth, C2P airflow, Rails to be purchased separately, (Cumulus License is provided at no cost with purchase of SUP-SN2010-CL-XX)
MSN2010- CB2RO	Mellanox Spectrum based 25GbE/100GbE 1U Open Ethernet switch with ONIE, 18 SFP28 ports and 4 QSFP28 ports, 2 power supplies (AC), x86 CPU, short depth, C2P airflow. Rail Kit must be purchased separately

Introduction

Mellanox Spectrum® based 1U switch systems are an ideal spine and Top of Rack (ToR) solution, allowing maximum flexibility, with port speeds spanning from 10Gb/s to 100Gb/s per port, and port density that enables full rack connectivity to any server at any speed. The uplink ports allow a variety of blocking ratios that suit any application requirement. Powered by the Mellanox Spectrum ASIC, the systems carry whopping switching and processing capacities in a compact 1U form factor.

Keeping with the Mellanox tradition of setting performance record switch systems, the Mellanox Spectrum-based systems introduce the world's lowest latency for 100GbE switching and routing elements, and do so while having the lowest power consumption in the market. They enable the use of 10, 25, 40, 50 and 100GbE in a large scale without changing power infrastructure facilities.

The Mellanox Spectrum-based 1U switch systems are a part of Mellanox's complete end-to-end solution, which provides 10GbE through 100GbE interconnectivity within the data center. Other devices in this solution include ConnectX®-4 based network interface cards, and LinkX® copper or fiber cabling/transceivers. This end-to-end solution is topped with NEO, a management application that relieves some of the major obstacles standing in the way when deploying a network. NEO enables a fully certified and interoperable design, speeds up time to service and RoI. The systems introduce hardware capabilities for multiple tunneling protocols that enable increased reachability and scalability for today's data centers. Implementing MPLS, NVGRE and VXLAN tunneling encapsulations in the network layer of the data center allows more flexibility for terminating a tunnel by the network, in addition to termination on the server endpoint.

While Mellanox Spectrum provides the thrust and acceleration that powers the switch systems, they get yet another angle of capabilities, running with a powerful x86-based processor, which allows them to not only be the highest performing switch fabric elements, but also grants them the ability to incorporate a Linux running server into the same device. This opens up multiple application aspects of utilizing the high CPU processing power and the best switching fabric, to create a powerful machine with unique appliance capabilities that can improve numerous network implementation paradigms. The Mellanox Spectrum-based 1U switch systems support the Open Network Install Environment (ONIE) for zero touch installations of network operating systems. While all Ethernet systems can be purchased preloaded with Mellanox Onyx (MLNX-OS), the SN2000 switches (in both the 100GbE and the 40GbE versions) are offered, in addition, with Cumulus Linux support, as an alternative operating system. For a full list of all available ordering options, see [Ordering Information](#).

SN2700 Front View



SN2740 Front View



SN2410 Front View

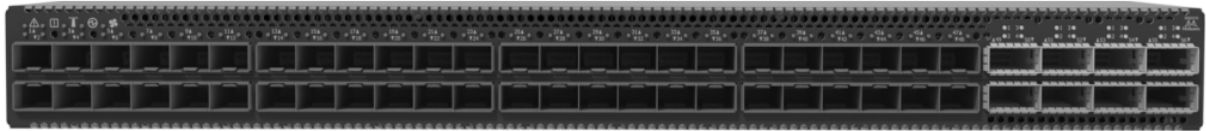

SN2100 Front View

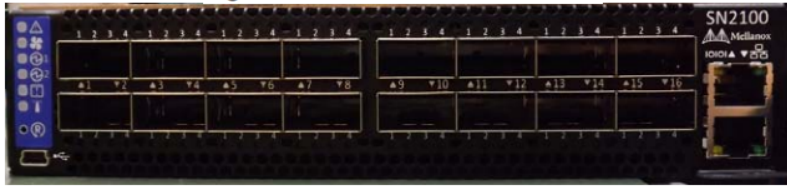

SN2010 Front View



SN2700 and SN2410 Rear View



SN2740 Rear View

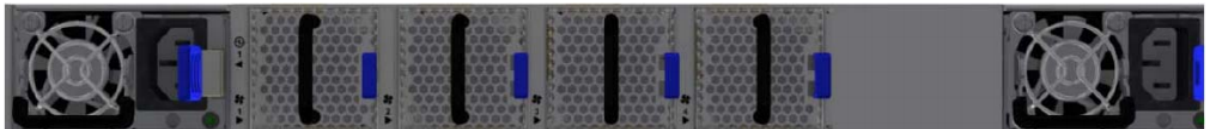

SN2100 Rear View



SN2010 Rear View



Speed and Switching Capabilities

The table below describes maximum throughput and interface speed per system model.

System Model	10/25GbE SFP28 Interfaces*	40/50/56/100GbE QSFP28 Interfaces*	Max Throughput
SN2700	64 (using QSFP to SFP splitter cables)	32	6.4Tb/s
SN2740	64 (using QSFP to SFP splitter cables)	32	6.4Tb/s
SN2410	Total 64, 48SFP+16 (using QSFP to SFP splitter cables)	8	4Tb/s
SN2100	64 (using QSFP to SFP splitter cables)	16 (or 32 50GbE interfaces when using QSFP to 2xQSFP splitter cables)	3.2Tb/s
SN2010	34 (using QSFP to SFP splitter cables)	4 (or 8 50GbE interfaces when using QSFP to 2xQSFP splitter cables)	1.7Tb/s

*The system can support different interfaces and speed rates using QSFP+ to SFP+ adapters or hybrid cables. For further information, see [Splitter \(Breakout\) Cables and Adapters](#).

Management Interfaces, PSUs and Fans

The table below lists the various management interfaces, PSUs and fans per system model.

System Model	USB	MGT	Console	PSU	Fan
SN2700	Rear	Rear (2 ports)	Rear	2 units	4 units
SN2740	Front	Front (1 port)	Front	2 units	4 units
SN2410	Rear	Rear (2 ports)	Rear	2 units	4 units
SN2100	Front (mini USB)	Front (1 port)	Front	2 units (non-replaceable)	4 units (non-replaceable)
SN2010	Front	Front (1 port)	Front	2 units (non-replaceable)	4 units (non-replaceable)

Features

For a full feature list, please refer to the system's product brief. Go to <http://www.mellanox.com>. In the main menu, click on Products > Ethernet Switch Systems, and select the desired product page.

Certifications

The list of certifications (such as EMC, Safety and others) per system for different regions of the world is located on the Mellanox website at http://www.mellanox.com/page/environmental_compliance.

Installation

System Installation and Initialization

Installation and initialization of the system require attention to the normal mechanical, power, and thermal precautions for rack-mounted equipment.

 The rack mounting holes conform to the EIA-310 standard for 19-inch racks. Take precautions to guarantee proper ventilation in order to maintain good airflow at ambient temperature.

 Unless otherwise specified, Mellanox products are designed to work in an environmentally controlled data center with low levels of gaseous and dust (particulate) contamination. The operation environment should meet severity level G1 as per ISA 71.04 for gaseous contamination and ISO 14644-1 class 8 for cleanliness level.

The installation procedure for the system involves the following phases:

Step	Procedure	See
1	Follow the safety warnings	Safety Warnings
2	Pay attention to the air flow consideration within the system and rack	Air Flow
3	Make sure that none of the package contents is missing or damaged	Package Contents
4	Mount the system into a rack enclosure	19" System Mounting Options
5	Power on the system	Initial Power On
6	Perform system bring-up	System Bring-Up
7	[Optional] FRU replacements	FRU Replacements

Safety Warnings

Prior to the installation, please review the safety warnings. Note that not all warnings may apply to all models.

 Safety warnings are provided here in the English language. For safety warnings in other languages, refer to the [1U Switch Installation Safety Instructions](#) document available on mellanox.com.

Safety Warnings (English)

 [Installation Instructions](#)

Read all installation instructions before connecting the equipment to the power source.

 **Bodily Injury Due to Weight**

Use enough people to safely lift this product.

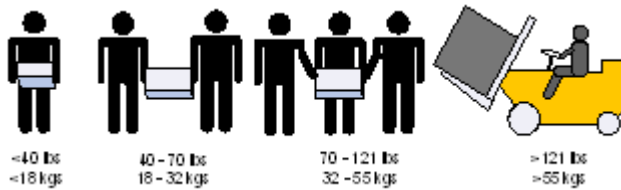

 **Heavy Equipment**

This equipment is heavy and should be moved using a mechanical lift to avoid injuries.

 **Risk of Electric Shock!**

- With the fan module removed power pins are accessible within the module cavity. Do not insert tools or body parts into the fan module cavity.
- For AC powered switch systems: Disconnecting one power supply only disconnects one module. To isolate the unit completely, all connected power supplies must be disconnected.



 **Over-temperature**

This equipment should not be operated in an area with an ambient temperature exceeding the maximum recommended: 45°C (113°F). Moreover, to guarantee proper ventilation, allow at least 8 cm (3 inches) of clearance around the ventilation openings.

 **Stacking the Chassis**

The chassis should not be stacked on any other equipment. If the chassis falls, it can cause bodily injury and equipment damage.

 **Redundant Power Supply Connection—Electrical Hazard**

This product includes a redundant power or a blank in its place. In case of a blank power supply, do not operate the product with the blank cover removed or not securely fastened.

 **Double Pole/Neutral Fusing**

This system has double pole/neutral fusing. Remove all power cords before opening the cover of this product or touching any internal parts.

 **Multiple Power Inlets**

Risk of electric shock and energy hazard. The PSUs are all independent. Disconnect all power supplies to ensure a powered down state inside of the switch platform.

 During Lightning—Electrical Hazard

During periods of lightning activity, do not work on the equipment or connect or disconnect cables.

 Copper Cable Connecting/Disconnecting

Copper cables are heavy and not flexible, as such they should be carefully attached to or detached from the connectors. Refer to the cable manufacturer for special warnings/instructions.

 Rack Mounting and Servicing

When this product is mounted or serviced in a rack, special precautions must be taken to ensure that the system remains stable. In general, the rack should be filled with equipment starting from the bottom to the top.

 Equipment Installation

This equipment should be installed, replaced, and/or serviced only by trained and qualified personnel.

 Equipment Disposal

Disposal of this equipment should be in accordance to all national laws and regulations.

 Local and National Electrical Codes

This equipment should be installed in compliance with local and national electrical codes.

 Installation Codes

This device must be installed according to the latest version of the country national electrical codes. For North America, equipment must be installed in accordance to the applicable requirements in the US National Electrical Code and the Canadian Electrical Code.

 Battery Replacement

Warning: Replace only with UL Recognized battery, certified for maximum abnormal charging current not less than 4mA. There is a risk of explosion should the battery be replaced with a battery of an incorrect type. Dispose of used batteries according to the instructions.

 UL Listed and CSA Certified Power Supply Cord

For North American power connection, select a power supply cord that is UL Listed and CSA Certified, 3 - conductor, [16 AWG], terminated with a molded plug rated at 125 V, [13 A], with a minimum length of 1.5m [six feet] but no longer than 4.5m.

For European connection, select a power supply cord that is internationally harmonized and marked “<HAR>”, 3 - conductor, minimum 1.0 mm² wire, rated at 300 V, with a PVC insulated jacket. The cord must have a molded plug rated at 250 V, 10 A.

 Installation Codes

This device must be installed according to the latest version of the country's national electrical codes. For North America, equipment must be installed in accordance to the applicable requirements in the US National Electrical Code and the Canadian Electrical Code.

! Interconnection of Units

Cables for connecting to the unit RS232 and Ethernet Interfaces must be UL certified type DP-1 or DP-2. (Note: when residing in non LPS circuit.)

! Overcurrent Protection

A readily accessible Listed branch circuit overcurrent protective device rated 20 A must be incorporated in the building wiring.



Do Not Use the Switch as a Shelf or Work Space

Caution: Slide/rail mounted equipment is not to be used as a shelf or a work space. The rails are not intended for sliding the unit away from the rack. It is for permanent installation at final resting place only, not used for service and maintenance.



WEEE Directive

According to the WEEE Directive 2002/96/EC, all waste electrical and electronic equipment (EEE) should be collected separately and not disposed of with regular household waste. Dispose of this product and all of its parts in a responsible and environmentally-friendly way.

! Country of Norway Power Restrictions

This unit is intended for connection to a TN power system and an IT power system of Norway only.

Air Flow

⚠ The following information does not apply to SN2100/SN2010. In the SN2100/SN2010 systems, the fan units are non-replaceable.

Mellanox systems are offered with two air flow patterns:

- Power (rear) side inlet to connector side outlet - marked with blue power supplies/fans FRUs' handles.

Air Flow Direction Marking - Power Side Inlet to Connector Side Outlet



- Connector (front) side inlet to power side outlet - marked with red power supplies/fans FRUs' handles.

Air Flow Direction Marking - Connector Side Inlet to Power Side Outlet



- ❗ All servers and systems in the same rack should be planned with the same airflow direction. All FRU components need to have the same air flow direction. A mismatch in the air flow will affect the heat dissipation.

The table below provides an air flow color legend and respective OPN designation.

Direction	Description and OPN Designation
	Connector side inlet to power side outlet. Red latches are placed on the power inlet side. OPN designation is “-R”.
	Power side inlet to connector side outlet. Blue latches are placed on the power inlet side. OPN designation is “-F”.

Package Contents

Before installing your new system, unpack it and check against the parts list below that all the parts have been sent. Check the parts for visible damage that may have occurred during shipping.

The SN2700 and SN2410 package content is as follows:

- 1 - System
- 1 - Rail kit
- 1 - Power cable for each power supply unit - Type C13-C14
- 1 - Cable retainer for each power supply unit
- 1 - DB9 to RJ-45 2m harness
- 1 - RJ-45 to RJ-45 2m harness

The SN2100/SN2010 package content is as follows:

- 1 - System
- 1 - Power cable for each power supply unit - Type C13-C14

- 1 - DB9 to RJ-45 2m harness

⚠ A designated rail kit for the SN2100/SN2010 systems can be purchased separately.

⚠ If anything is damaged or missing, contact your sales representative at support@mellanox.com.

19” System Mounting Options

- By default, the SN2700 systems are shipped with the static rail kit described [SN2700 Static Rail Kit](#).
- The SN2410 and SN2740 systems are shipped with the static rail kit described in [SN2740/SN2410 Static Rail Kit](#).
- For the telescopic rail kit installation instructions (can be used with SN2700 only), see [SN2700 Telescopic Rail Kit](#).
- The SN2100/SN2010 system is shipped without a rail kit and a designated rail kit can be purchased separately. For installation instructions, see [SN2100/SN2010 Side by Side Mounting Rail Kit](#).
- [SN2100/SN2010 Static Single Switch Rail Kit](#)

SN2700 Static Rail Kit

Kit OPN	Rack Size and Rack Depth Range
MTEF-KIT-A	Short (17”-24”) or Standard (24”-34”)

The following parts are included in the static rail kit (see figure below):

- 2x Rack mount rails (A)
- 2x Rack mount brackets (B)
- 2x Rack mount blades (C)
- 8x M6 Standard cage nuts^{1 2} and 8x M6 Standard pan-head Phillips screws¹ (D)
- 4x Phillips100 DEG F.H TYPE-I ST.ST 6-32 X 1/4 screws with a round patch (E)

¹ Other threads are available by special order: M5, 10-32, 12-24. ² G-type cage-nut is available by special order.

Rack Rail Kit Parts

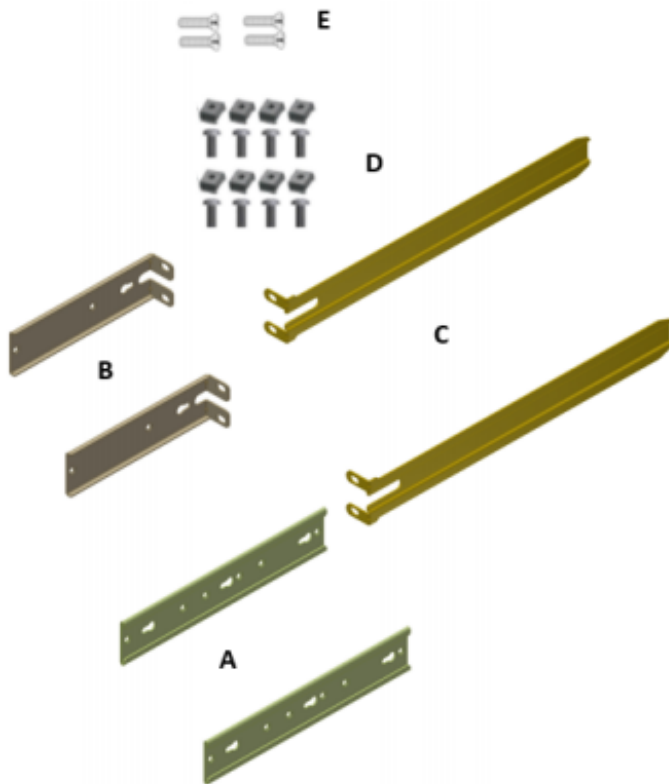

Prerequisites:

Before mounting the system to the rack, select the way you wish to place the system. Pay attention to the airflow within the rack cooling, connector and cabling options.

While planning how to place the system, consider the two installation options shown in the figure below, and review the following points:

- Make sure the system air flow is compatible with your installation selection. It is important to keep the airflow within the rack in the same direction.
- Note that the part of the system to which you choose to attach the rails (the front panel direction, as demonstrated in Option 1 or the FRUs direction, as demonstrated in Option 2) will determine the system's adjustable side. The system's part to which the brackets are attached will be adjacent to the cabinet.
- The FRU side is extractable. Mounting the rack brackets inverted to the FRU side (Option 2) will allow you to slide the FRUs, in and out.

Installation Option 1 & Option 2

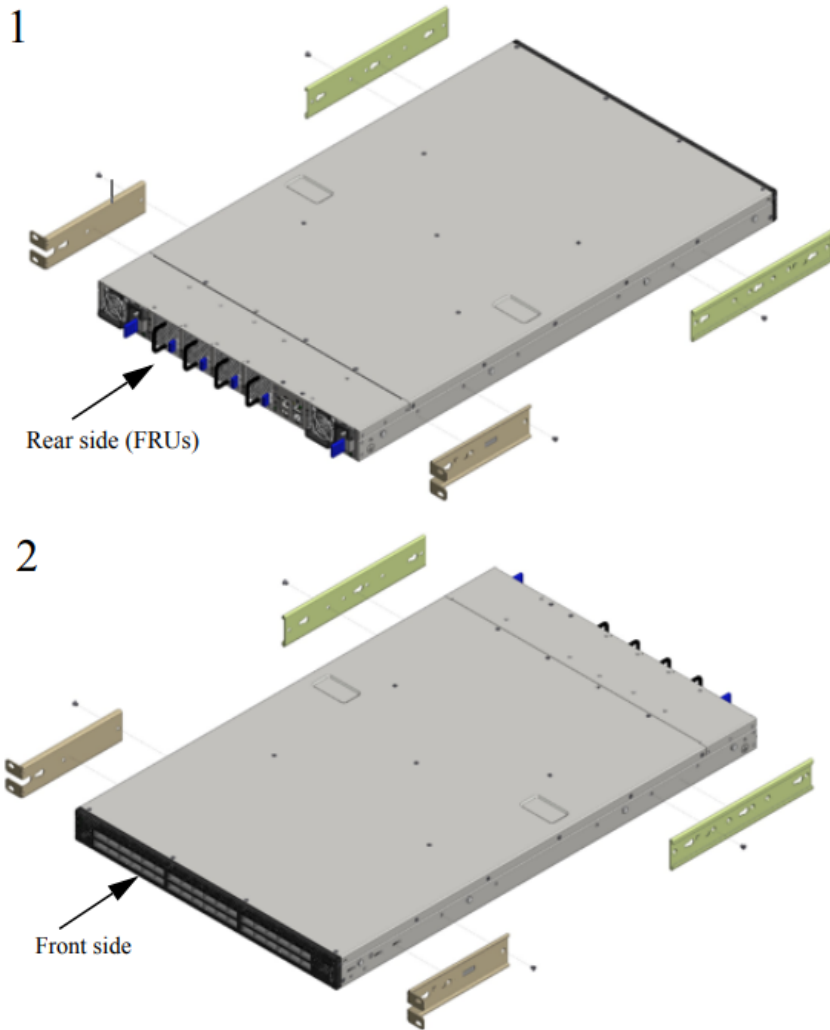

To mount the system into the rack:

⚠ At least two people are required to safely mount the system in the rack.

1. Attach the left and right rack mount rails (A) to the switch chassis' pins through the slider key holes, until locking occurs.
2. Secure the chassis in the rails by screwing 2 flat head Phillips screws (E) in the designated points with a torque of 1.5 ± 0.2 Nm.

Attaching the Rails to the Chassis

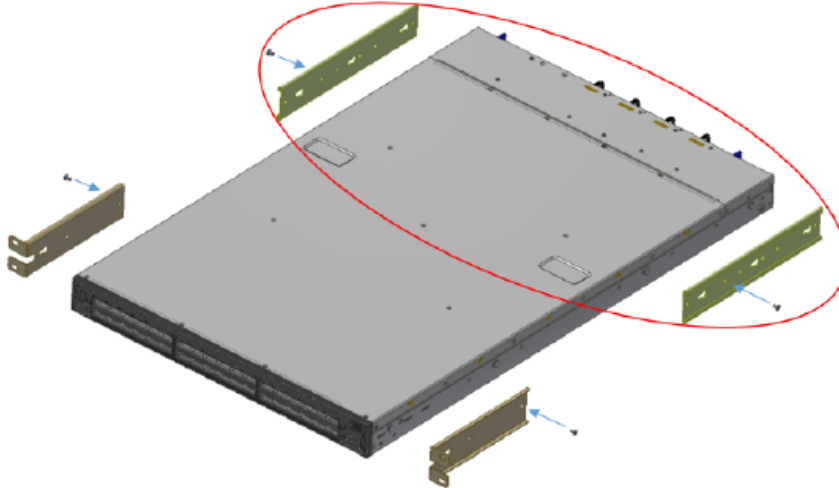

3. Attach the left and right rack mount brackets (B) to the switch, by gently pushing the switch chassis' pins through the slider key holes, until locking occurs. Secure the system in the brackets by screwing the remaining 2 flat head Phillips screws (E) in the designated points with a torque of 1.5 ± 0.2 Nm.

Attaching the Brackets to the Chassis

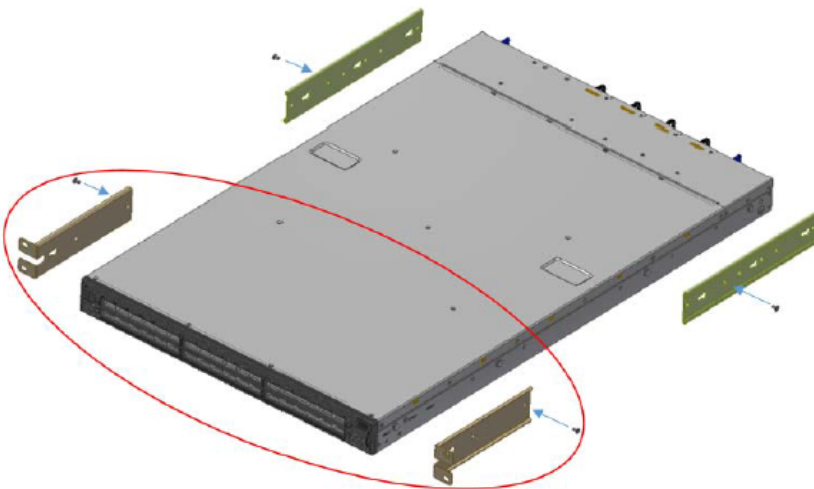

4. Install 8 cage nuts in the desired slots of the rack: 4 cage nuts in the non-extractable side (in the top and bottom holes only) and 4 cage nuts in the extractable side.

Installing the Cage Nuts



⚠ While each rack U (unit) consists of three holes, the cage nut should be installed vertically with its ears engaging the top and bottom holes only.

While your installation partner is supporting the system's weight, perform the following steps:

5. Mount the system into the rack enclosure, and attach the brackets installed on the system to the rack's posts. Secure the brackets to the rack's posts by inserting four M6 screws in the designated cage nuts, as described in the figure below. Do not tighten the screws yet.

Attaching the Brackets to the Rack

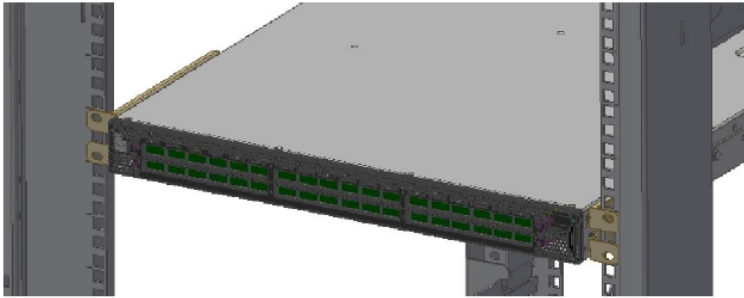

6. Slide the two blades into the left and right rails, and adjust them to fit your rack's depth. Use four M6 screws (D) to fix the blades into the rack. Do not tighten the screws yet.

Sliding the Blades in the Rails

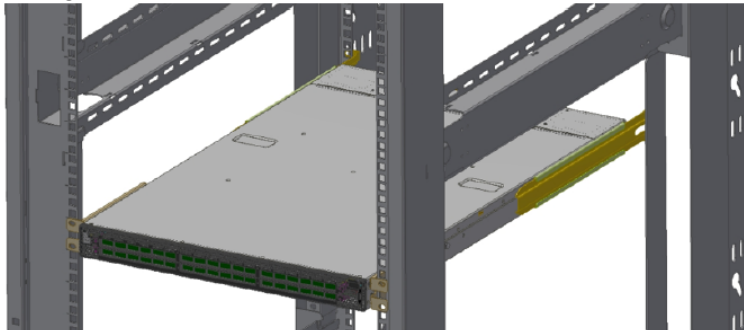

7. Secure the system in the rack by tightening the 8 screws inserted in Step 5 and Step 6 with a torque of 4.5 ± 0.5 Nm.

Removing the System from the Rack

To remove a unit from the rack:

1. Turn off the system and disconnect it from peripherals and from the electrical outlet. While your installation partner is supporting the system's weight:
2. Loosen the screws attaching the brackets to the rack. Do not remove them yet.
3. Loosen the screws attaching the blades to the rack, and pull the blades towards you, while your partner is holding the system.
4. Extract the loosened screws from Step 2 and dismount the system from the rack.
5. Remove the rails and brackets from the chassis by unscrewing 8 screws.

SN2700 Telescopic Rail Kit

 The telescopic rail kit is not included in the system's package, and can be purchased separately.

There are two installation kit options:

- Standard depth systems should be mounted using the standard rail kit.
- Short depth systems can be mounted using either of the rail kits.

Kit OPN	Rack Size and Rack Depth Range
MTEF-KIT-B	Short: 17"-24" (43.1 to 61 cm)
MTEF-KIT-S	Standard: 24"-34" (61 to 86.3 cm)

The following parts are included in the rail kit package (see figure below):

- 1x Right inner rail (A) +2x Outer rails (C) - Bundled
- 1x Left inner rail (B) + 2x Outer rails (D) - Bundled
- 10x M6 Standard cage nuts¹ ² and 10x M6 Standard pan-head Phillips screws¹ (E)
- 2x Phillips100 DEG F.H TYPE-I ST.ST 6-32 X 1/4 screw with a round patch (F)

¹ Other threads are available by special order: M5, 10-32, 12-24. ² G-type cage-nut is available by special order.

Rack Rail Kit Parts

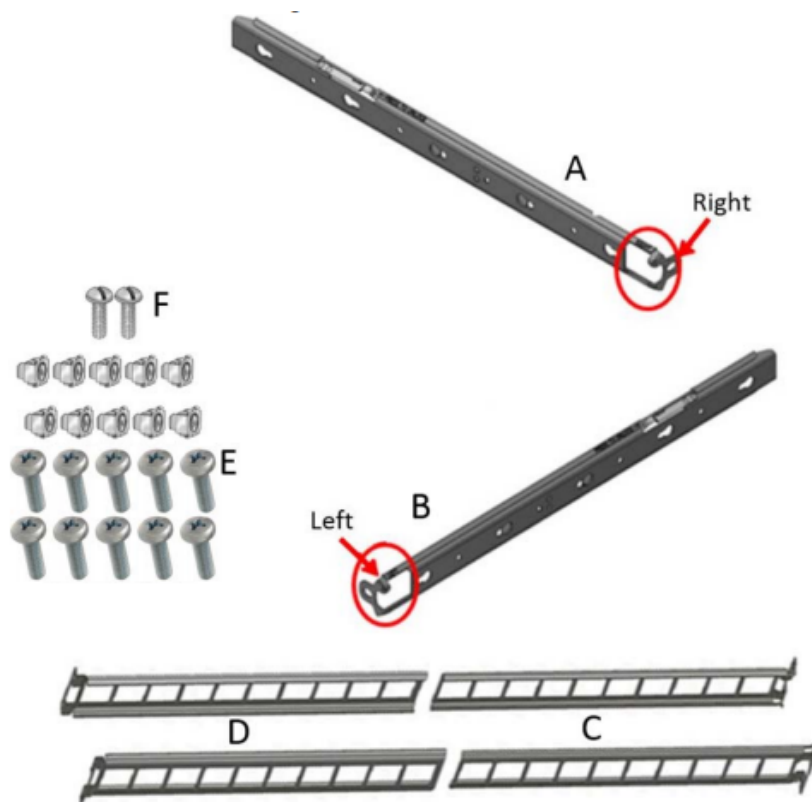

Prerequisites

⚠ The rails must be separated prior to the installation procedure.

To separate the rails:

1. Extend the rail assembly by pulling the extension outwards (D).
2. Extract rail A from rail C by pushing it outside from the rear part of the assembly. To allow complete separation of rail A from rail C, press the quick-release latch.

Rails Separation

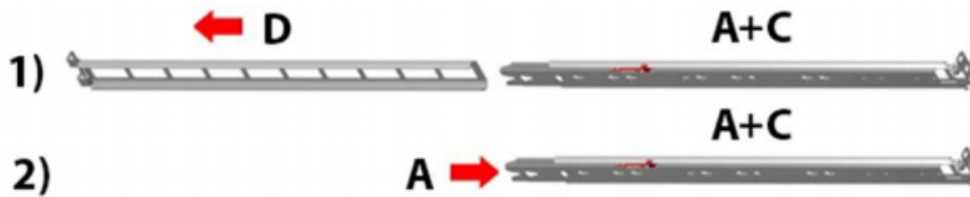

Before mounting the system to the rack, select the way you wish to place the system. Pay attention to the airflow within the rack cooling, connector and cabling options.

While planning how to place the system, review the following points:

- Make sure the system air flow is compatible with your installation selection. It is important to keep the airflow within the rack in the same direction.
- In case there are cables that cannot bend within the rack, or in case more space is needed for cable bending radius, it is possible to recess the connector side or the FRU side by 3” or 4” (7.62 or 10.16cm) by optional placement of the system’s rails.
- The FRU side is extractable. Mounting the sliding rail inverted to the system will allow you to slide the FRU side of the system, in and out.

To mount the system into the rack:

1. Insert 10 cage nuts into the desired slots of the rack: 4 cage nuts in the non-extractable side and 6 cage nuts in the extractable side.

Installing the Cage Nuts



2. Mount both of the outer rails (C+D) into the rack (as illustrated below), and use 8 standard pan-head screws (E) to fix them to the rack. Do not tighten the screws yet.

Mounting the Outer Rails into the Rack

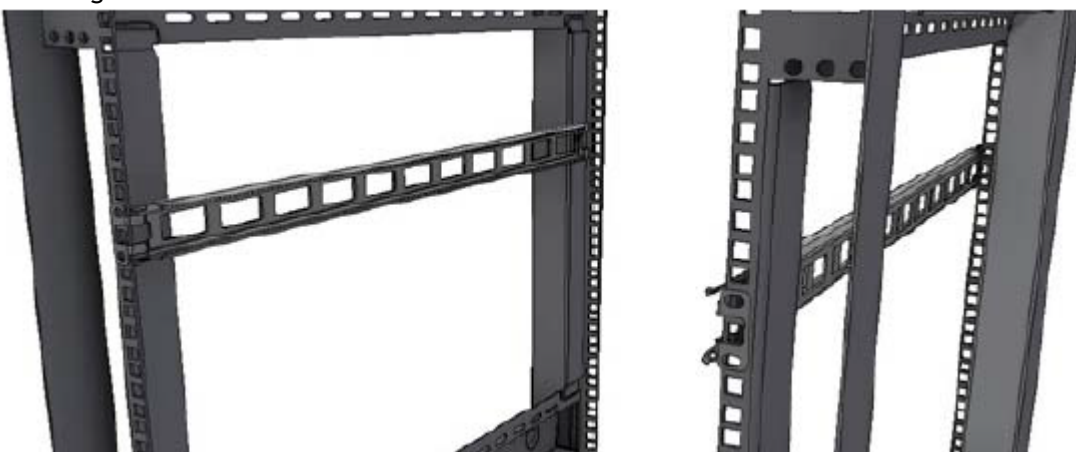

3. If cable accommodation is required, route the power cable and/or Eth cable through either of the outer rails.
4. Attach left and right inner rails (A+B) to the switch sides, by gently pushing the switch chassis’ pins through the slider key holes, until locking occurs.

Attaching the Inner Rails

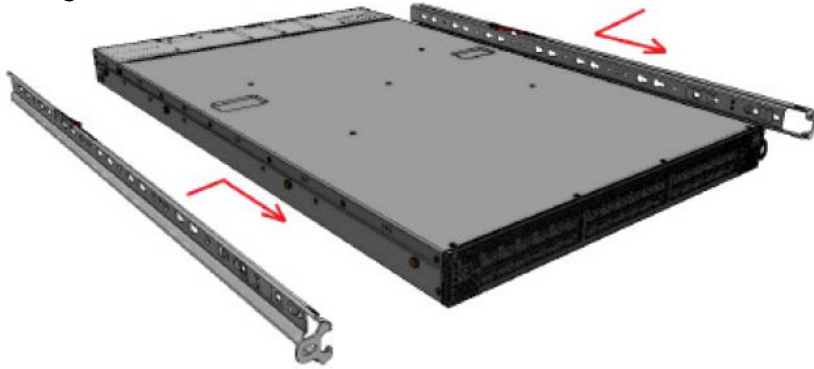

5. Secure the chassis in the inner rails by screwing the 2 flat head Phillips screws (F) in the designated points with a torque of 1.5 ± 0.2 Nm.
Securing the Chassis in the Inner Rails



6. Slide the switch into the rack by carefully pushing the inner rails into the outer rails installed on the rack.
Sliding the Switch into the Rack

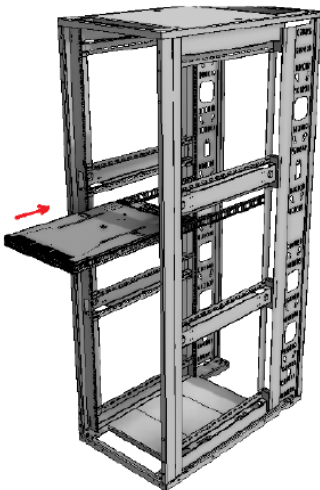

7. When fully inserted, fix the switch by closing the remaining 2 screws in the middle and tightening the 8 screws inserted in Step 2 with a torque of 4.5 ± 0.5 Nm.

Removing the System from the Rack

To remove a unit from the rack:

1. Turn off the system and disconnect it from peripherals and from the electrical outlet.
2. Unscrew the two M6 screws securing the front of the inner rails' ears to the outer rails and to the rack.

3. Pull the unit out until braking is felt. For safety purposes, the locking mechanism will not allow a complete removal of the unit at this stage.

Pulling the Unit Outwards

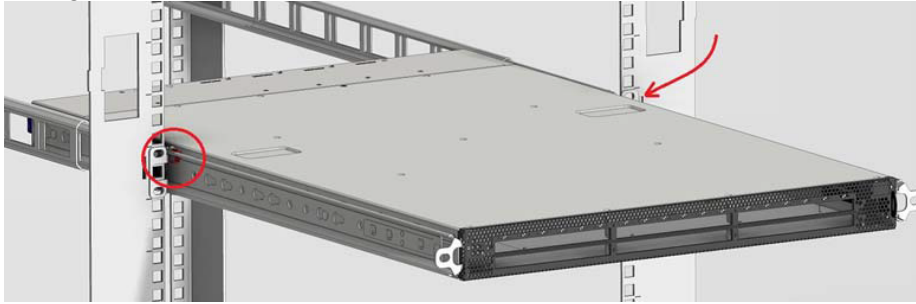

4. Press on the locking spring (appears in red in the figure below) on both sides simultaneously, and continue pulling the unit towards you until it is fully removed.

Locking Mechanism

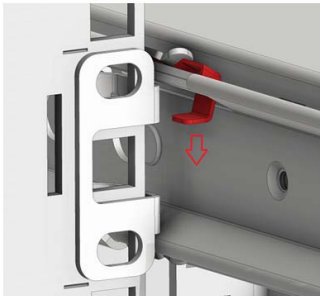

SN2740/SN2410 Static Rail Kit

⚠ By default, the system is sold with the standard-depth rail kit. The short-depth rail kit can be supplied upon request.

Kit OPN	Rack Size and Rack Depth Range
MTEF-KIT-BP	Short: 19.7"-23.6" (50 to 60 cm)
MTEF-KIT-SP	Standard: 23.6"-31.5" (60 to 80 cm)

The following parts are included in the static rail kit (see figure below):

- 2x Rack mount rails (A)
- 2x Rack mount blades (B)
- 8x M6 Standard cage nuts¹ ² and 8x M6 Standard pan-head Phillips screws¹ (C)
- 4x Phillips100 DEG F.H TYPE-I ST.ST 6-32 X 1/4 screw with around patch (D).

¹ Other threads are available by special order: M5, 10-32, 12-24. ² G-type cage-nut is available by special order.

Rack Rail Kit Parts

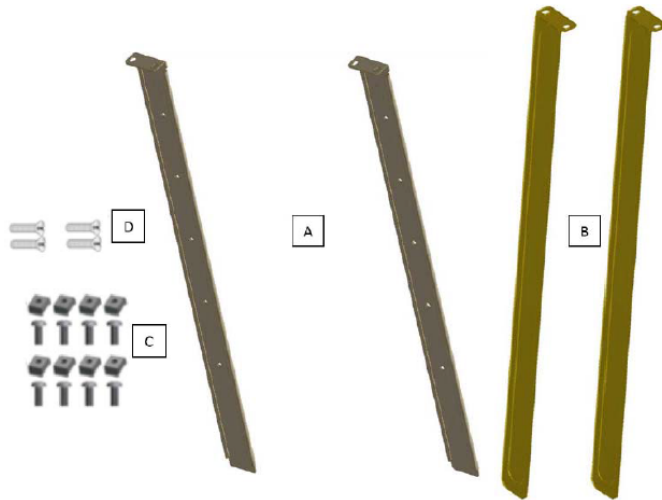

Prerequisites

Before mounting the system to the rack, select the way you wish to place the system. Pay attention to the airflow within the rack cooling, connector and cabling options.

While planning how to place the system, consider the two installation options shown in the Installation Options figure below, and review the following points:

- Make sure the system air flow is compatible with your installation selection. It is important to keep the airflow within the rack in the same direction.
- Note that the part of the system to which you choose to attach the rails (the front panel direction, as demonstrated in Option 1 or the FRUs direction, as demonstrated in Option 2) will determine the system's adjustable side. The system's part to which the blades are attached, will be adjacent to the cabinet.
- In case there are cables that cannot bend within the rack, or in case more space is needed for cable bending radius, it is possible to recess the connector side or the FRU side by 3.5" (8.9 cm), by optional placement of the system's rails.
- The FRU side is extractable. Mounting the rack blades inverted to the FRU side (Option 2) will allow you to slide the FRUs, in and out.

Installation Options

Option 1:

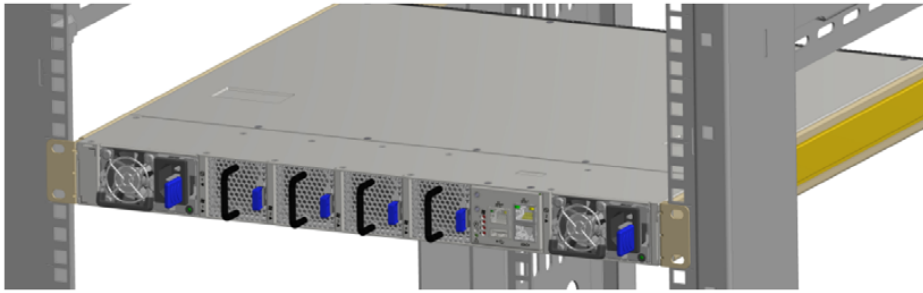

Option 2:

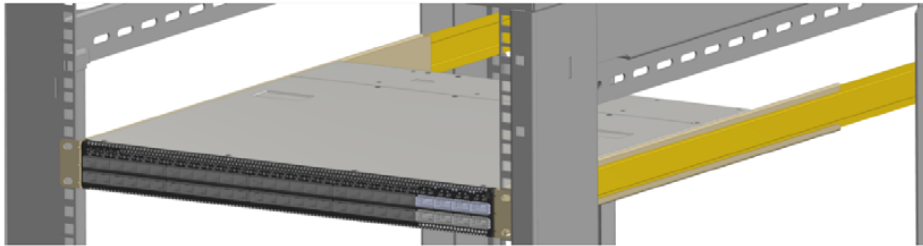

To mount the system into the rack:

⚠ At least two people are required to safely mount the system in the rack.

1. Attach the left and right rack mount rails (A) to the switch, and secure the chassis in the rails by screwing 2 flat head Phillips screws (D) in the designated points on each side (a total of 4 screws). To tighten the screws, use a torque of 1.5 ± 0.2 Nm.

Attaching the Rails to the Chassis

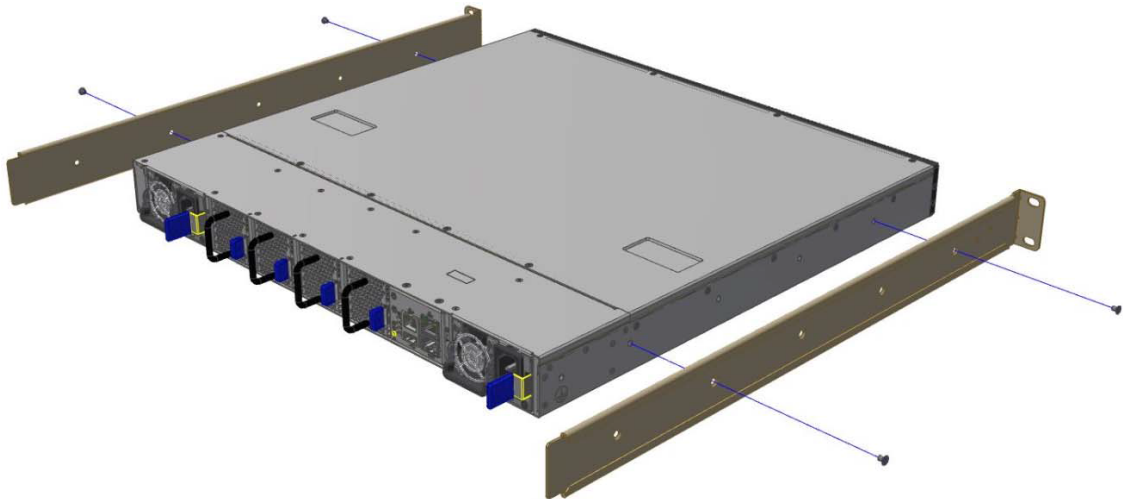

2. Install 8 cage nuts (C) in the desired slots of the rack: 4 cage nuts in the non-extractable side and 4 cage nuts in the extractable side. Note that while each rack U (unit) consists of three holes, the cage nut should be installed vertically with its ears engaging the top and bottom holes only.

Installing the Cage Nuts



While your installation partner is supporting the system's weight, perform steps 3, 4 and 5:

3. On the rear side of the cabinet, install the two blades (B) in the selected rack unit, using four M6 screws (C). Do not tighten the screws yet.

Attaching the Rails to the Rack

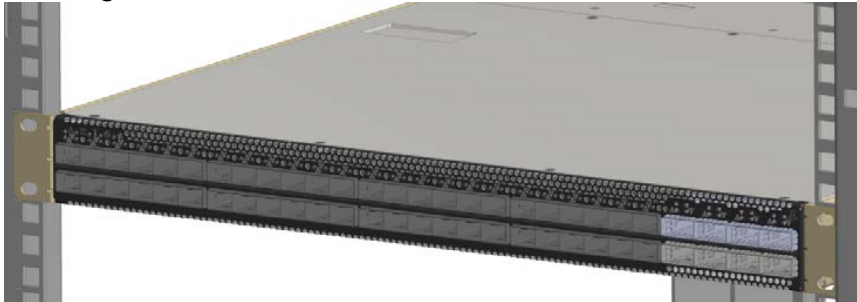

4. Slide the two blades into the left and right rails, and adjust them to fit your rack's depth. Use four M6 screws (D) to fix the blades into the rack. Do not tighten the screws yet.

Sliding the Blades in the Rails

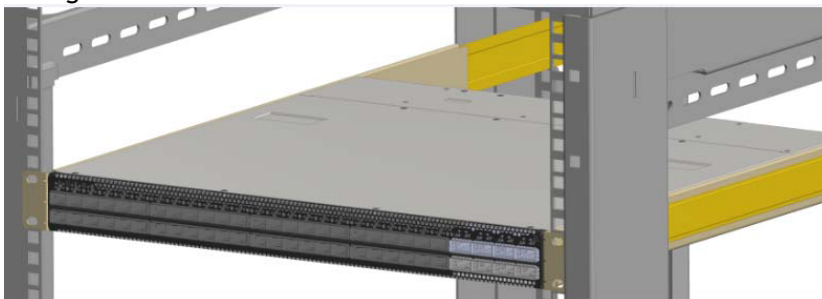

5. Secure the system in the rack by tightening the 8 screws inserted in Step 3 and Step 4 with a torque of 4.5 ± 0.5 Nm.

SN2100/SN2010 Side by Side Mounting Rail Kit

⚠ The installation process is demonstrated on an SN2100 system, but applies to the SN2010 series as well.

A designated rail kit for the SN2100/SN2010 systems can be purchased separately.

This section is relevant to short-depth systems that allow such a form of installation only.

Kit OPN	Rack Size and Rack Depth Range
MTEF-KIT-D	Rack installation kit for SN2100/SN2010 series short depth 1U switches, allows installation of one or two switches side-by-side into standard depth racks.

The following parts are included in the rail kit (see figure below):

- 1 metal frame for two systems (A)
- 2 system mounting blades with 8 screw holes - the kit contains enough rails to install 2 systems (B)
- 2 system mounting blades with 7 screw holes - the kit contains enough rails to install 2 systems (C)
- 2 blank (installed) covers (D)
- 30 flat head 4-40 screws - the kit contains enough screws to install 2 systems (E)
- 2 frame rail slides (F)
- 10 (+2 spare units) M6 pan head screws (G)
- 10 (+2 spare units) M6 spring washers (H)
- 10 (+2 spare units) M6 spring steel cage nuts (I)
- 6 (+2 spare units) cable-ties (J)

Rack Rail Kit Parts

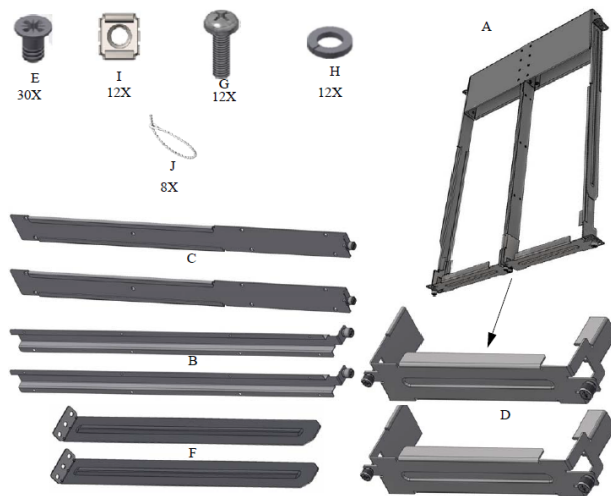

Prerequisites

Before mounting the system to the rack, select the way you wish to place the system. Pay attention to the airflow within the rack cooling, connector and cabling options.

- The installation kits come with enough system mounted rails and flat head screws to install two systems.
- The 2 system metal frame will fit into racks with from 23.6" (600mm) to 31.5" (800mm) space between the vertical supports.
- You may choose to install your system in the right or in the left part of the metal frame. The following instructions apply to installation in the right part. For installation in the frame's left part, follow the same instructions, while replacing "right" with "left", and vice versa.

To mount the system into the rack:

! At least two people are required to safely mount the system in the rack.

1. Insert the SE (single ended) plugs to the dedicated inlets in the system's rear panel.
2. Carefully position the SE (single ended) cables one on top of the other, and use three cable ties to pair them together (shown in figure).

! While pairing the cables, make sure the cables are paired in symmetry to the switch, in order to avoid damaging the cables.

Coupling the Cables with Cable-ties

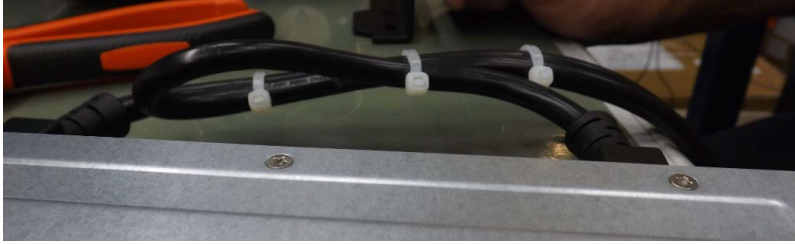

Coupled Cables - Rear View

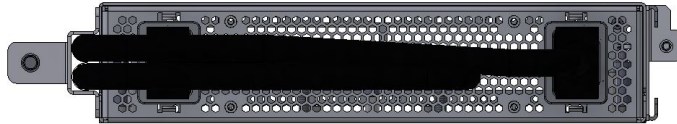

3. Place the coupled cables in the designated area within the right flat blade (the blade with 7 screw holes).

Cables within the Rail



 In the next step you will be attaching the mounting rails to the switch sides. Before doing that, make sure the cables are laid properly within them. Avoid using excessive pressure, as it can damage the cables.

4. While holding the cables stably together in the blade's rail with one hand, use your other hand to secure the blades to the chassis. Screw the right blade with eight 4-40 flathead screws, and the left blade with seven 4-40 flathead screws. The recommended torque is 0.49-0.54 Nm.

Attach the Blades to the System

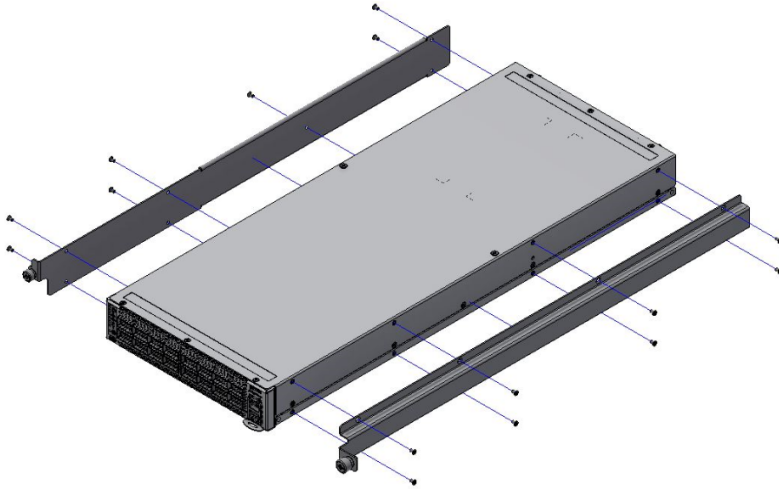

Attached Rail with Threaded Cables - Top View



5. Slide the two frame sliders into the dedicated rails in the metal frame. Sliding the Frame Sliders into the Rails

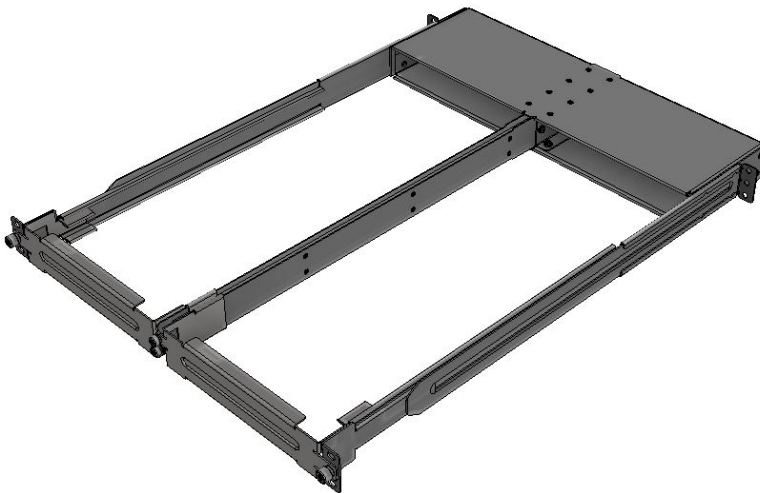

- Step 6. Install ten cage nuts in the desired slots of the rack: three cage nuts in the front part of each cabinet post, and two cage nuts in the rear part of each cabinet post.

Installing the Cage Nuts



- Attach the frame to the rack by using ten spacer cage nuts, and screw ten M6 pan head screws - four in the front part of the rack, and 6 in its rear part. The recommended torque is 6.55-7.35 Nm. See figure above.
- Place the frame in the cabinet.

Attaching the Frame to the Rack

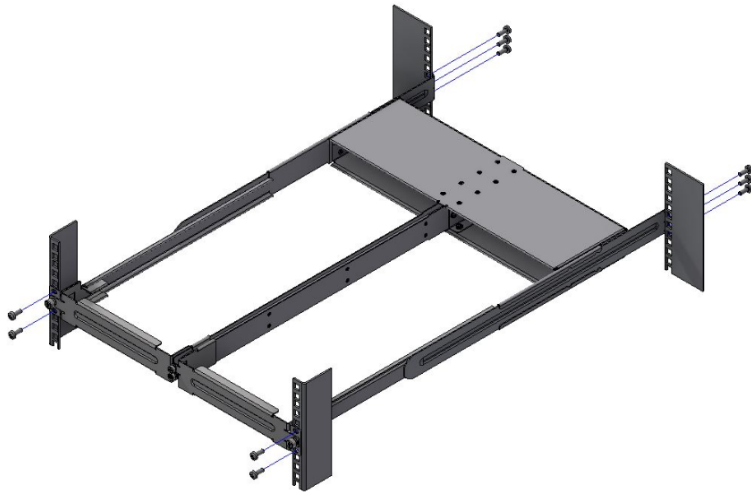

! Do not remove both of the blank covers at the same time. When no system is installed, at least one of them should be present to support the frame's partition.

- Remove the blank cover from the selected slot in the frame, and mount the system by sliding its mounting blades into the frame. Repeat this step to install an additional system in the other side of the frame, if needed.
- Tighten the capture nuts to secure the system in the frame. The recommended torque on the right screw is 3.0-3.36 Nm while on the left screw recommended torque is 0.89-0.98 Nm.

Sliding the System's Blades in the Rails

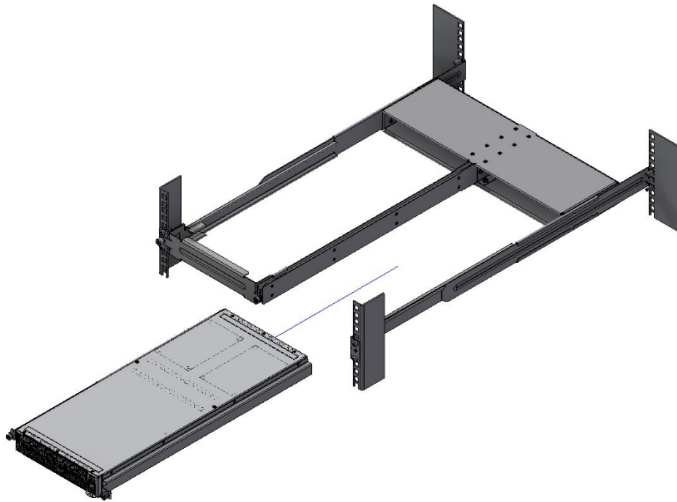

SN2100/SN2010 Static Single Switch Rail Kit

⚠ The installation process is demonstrated on an SN2100 system, but applies to the SN2010 series as well.

This rail kit is not included with the SN2100/SN2010 systems, and can be purchased separately.

This section is relevant to short-depth systems that allow such form of installation only.

Kit OPN	Rack Size and Rack Depth Range
MTEF-KIT-E	Rack installation static kit for SN2100/SN2010 systems short depth 1U half-width switches, allows installation of a single switch into standard depth racks.

The following parts are included in the rail kit (see figure below):

- 16 flat head 4-40 screws (A)
- 8 M6 spring steel cage nuts (B)
- 8 M6 pan head screws (C)
- 8 M6 spring washers (D)
- 8 M6 flat washers (E)
- 2 rack mount blades (F)
- 2 system brackets (G)

Rack Rail Kit Parts

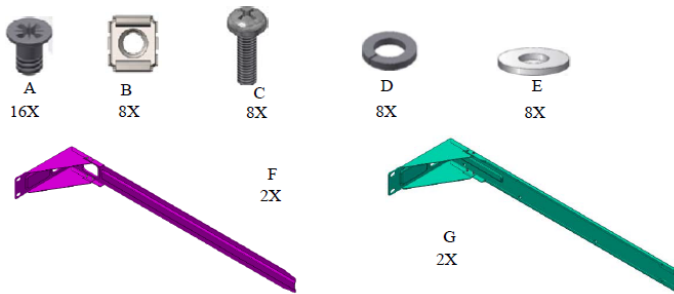

To mount the system into the rack:

⚠ At least two people are required to safely mount the system in the rack.

1. Attach the 2 system rails to the system's sides using 8 flat head 4-40 screws (A) in each side. Attaching the Brackets to the System's Sides

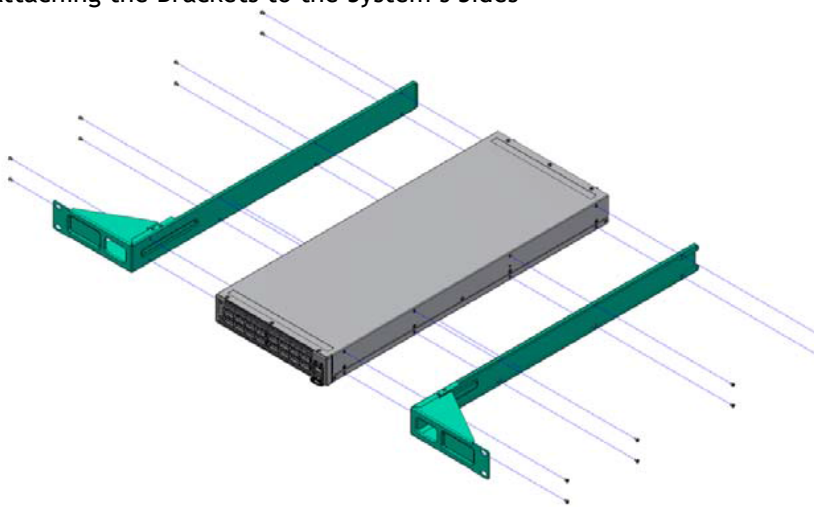

2. Install 8 cage nuts of the relevant type - square or round holes, according to your rack type. Installing the Cage Nuts



While your installation partner is supporting the system's weight, perform steps 3 and 4:

3. On the rear side of the cabinet, install the two blades (F) in the selected rack unit, using four M6 screws and washers (C+D+E). Do not tighten the screws yet.

Attaching the Blades to the Rack

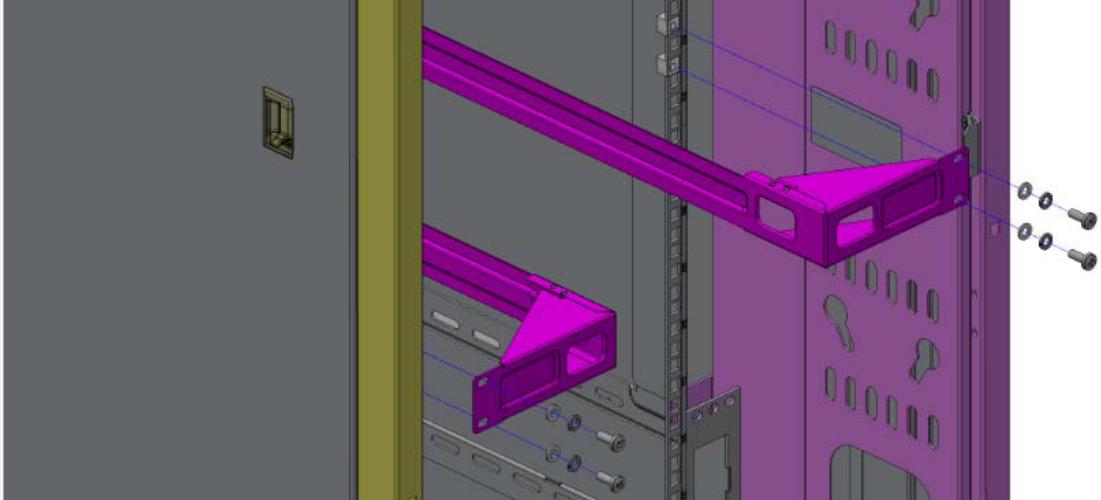

4. Mount the system into the rack enclosure by sliding the rails in the rack. Secure the brackets to the rack's posts by inserting four M6 screws and washers (C+D+E) in the designated cage nuts - 2 in each side. Tighten all screws.

Attaching the Brackets to the Rack

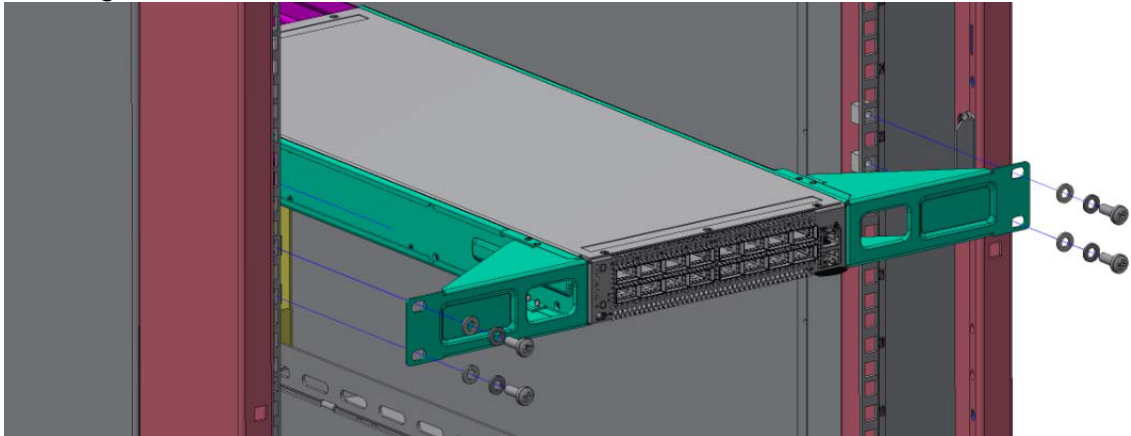

Cable Installation

All cables can be inserted or removed with the unit powered on.

To insert a cable, press the connector into the port receptacle until the connector is firmly seated. The LED indicator, corresponding to each data port, will light when the physical connection is established. When a logical connection is made, the relevant port LED will turn on.

To remove a cable, disengage the locks and slowly pull the connector away from the port receptacle. The LED indicator for that port will turn off when the cable is unseated.

For full cabling guidelines, ask your Mellanox representative for a copy of *Mellanox Cable Management Guidelines and FAQs Application Note*.

For more information about port LEDs, refer to [Port LEDs](#).

- ⚠ Do not force the cable into the cage with more than 40 newtons / 9.0 pounds / 4kg force. Greater insertion force may cause damage to the cable or to the cage.

SN2700, SN2100 and SN2010 QSFP Cable Orientation

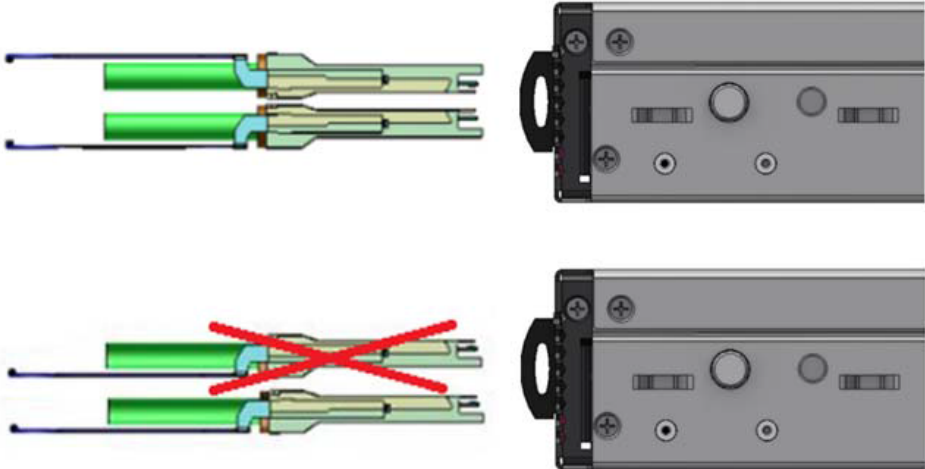

SN2010 SFP Cable Orientation

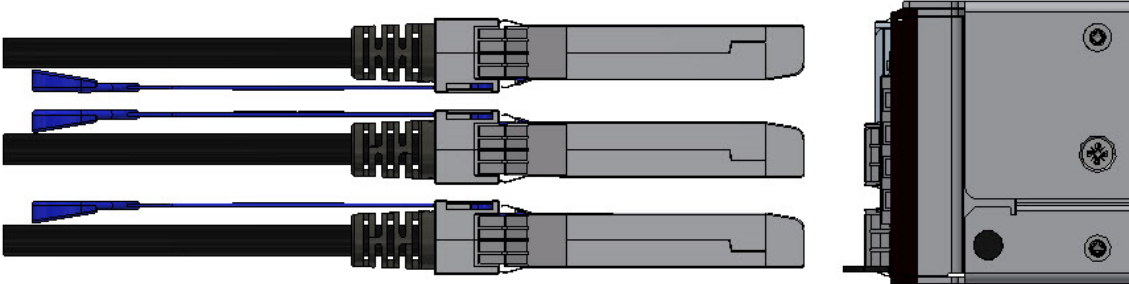

SN2740 Cable Orientation

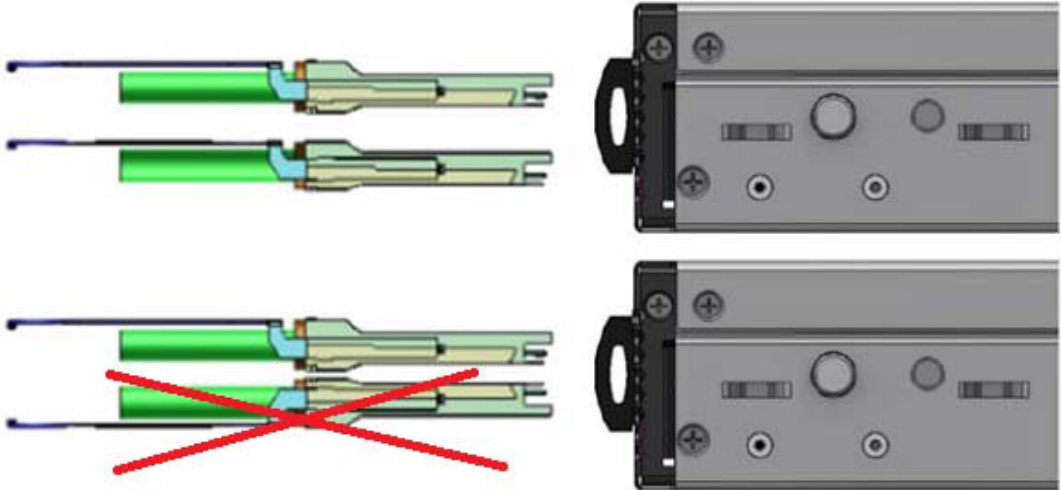

SN2410 Cable Orientation



⚠ The SN2410 system includes ports of different types. The figure above does not apply to the SFP28 ports; see "SN2410 Splitting Options" below.

Splitter (Breakout) Cables and Adapters

A 100GbE port can be split to two 50GbE ports, or to four (or less) 25GbE ports, using a Mellanox splitter cable.

Splitting a 100GbE QSFP28 port to 4 separate 25GbE ports (using a splitter cable) disables (unmaps) the 100GbE port below it. See "SN2700 and SN2740 Splitting Options" below.

Using Splitter (Breakout) Cables with Mellanox Onyx (MLNX-OS)

When using this feature, you should log into the Mellanox Onyx (MLNX-OS) CLI and configure the individual ports to be 'split-2' or 'split-4'. For further information on Mellanox's cable, visit http://www.mellanox.com/page/interconnect_overview.

Using Splitter (Breakout) Cables with Cumulus Linux

If you are using 4x10G direct attach copper cables or active optical cables, edit the `/etc/cumulus/ports.conf` to enable support for these cables, then restart the switchd service using the `sudo systemctl restart switchd` command. For more details, see [Layer 1 and Switch Port Attributes](#) in the [Cumulus Linux User Guide](#).

Examples of Splitter (Breakout or Fanout) Cables

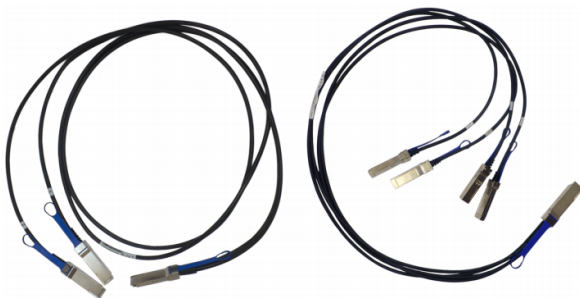

SN2700 and SN2740 Splitting Options

The top QSFP28 ports marked in green are splittable to 4 SFP28 ports, each.
 The bottom QSFP28 ports (gray) are blocked when the upper ports are in split mode.
 All QSFP28 ports can be split to 2 QSFP28 ports.



SN2410 Splitting Options

The top QSFP28 ports - 49, 51, 53, 55 (green) - are splittable to 4 SFP28 ports each.
 The bottom QSFP28 ports - 50, 52, 54, 56 (gray) - are blocked when the upper ports are in 4 SFP28 split mode.
 All QSFP28 ports can be split into two QSFP28 ports.



SN2100 Splitting Options

All QSFP28 ports are splittable. Each port can be split into 4xSFP28 (10/25G) or 2xQSFP28 (50G) ports. There are no blocking requirements.

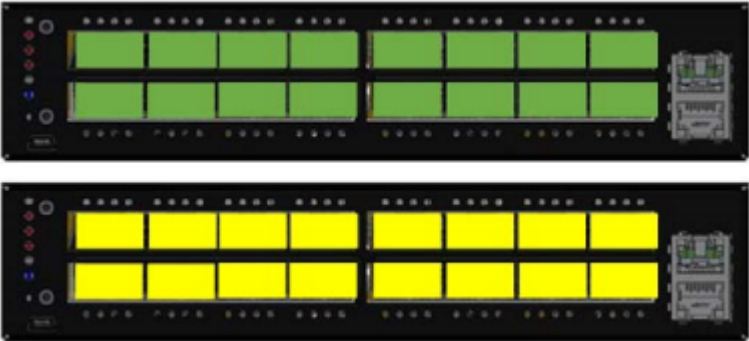

SN2010 Splitting Options

All QSFP28 ports are splittable. Each port can be split into 4xSFP28 (10/25G) or 2xQSFP28 (50G) ports each. There are no blocking requirements.



Initial Power On

Each system's input voltage is specified in the [Specifications](#) chapter.



The power cords should be standard 3-wire AC power cords including a safety ground and rated for 15A or higher.

⚠ The system platform will automatically power on when AC power is applied. There is no power system. Check all boards, power supplies, and fan tray modules for proper insertion before plugging in a power cable.

1. Plug in the first power cable.
2. Plug in the second power cable.
3. Wait for the System Status LED to turn green.

⚠ It may take up to five minutes to turn on the system. If the System Status LED shows red after five minutes, unplug the system and call your Mellanox representative for assistance.

4. Check the System Status LEDs and confirm that all of the LEDs show status lights consistent with normal operation (initially flashing, and then moving to a steady color) as shown in the figures below. For more information, refer to [LED Notifications](#).

System Status LEDs 5 Minutes After Power On in SN2700	System Status LEDs 5 Minutes After Power On in SN2740	System Status LEDs 5 Minutes After Power On in SN 2410
		

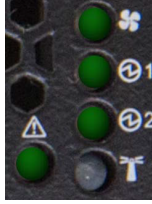
System Status LEDs 5 Minutes After Power On in SN2100	System Status LEDs 5 Minutes After Power On in SN2010
	

- ⚠ After inserting a power cable and confirming the green System Status LED light is on, make sure that the Fan Status LED shows green. If the Fan Status LED is not green, unplug the power connection and check that the fan module is inserted properly and that the mating connector of the fan unit is free of any dirt and/or obstacles. If no obstacles were found and the problem persists, call your Mellanox representative for assistance.

Two Power Inlets - Electric Caution Notifications:

- ⚠
- Risk of electric shock and energy hazard. The two power supply units are independent. Disconnect all power supplies to ensure a powered down state inside of the switch platform.
 - ACHTUNG Gefahr des elektrischen Schocks. Entfernen des Netzsteckers eines Netzteils spannungsfrei. Um alle Einheiten spannungsfrei zu machen sind die Netzstecker aller Netzteile zu entfernen.
 - ATTENTION Risque de choc et de danger e'lectriques. Le de'branchment d'une seule alimentation stabilise'e ne de'branch uniquement qu'un module "Alimentation Stabilise'e". Pour isoler completement le module en cause, Il faut de'brancher toutes les alimentations stabilise'es.

System Bring-Up

For bring-up of a switch system with Mellanox Onyx (MLNX-OS) operating system installed, see [Configuring Network Attributes Using Mellanox Onyx \(MLNX-OS\)](#).



For bring-up of a switch system with Cumulus Linux operating system installed, see [Configuring Network Attributes Using Cumulus Linux](#).

Configuring Network Attributes Using Mellanox Onyx (MLNX-OS)

The procedures described in this chapter assume that you have already installed and powered on the system according to the instructions in this document. The system comes with a pre-configured DHCP. If you wish to disable it, refer to [Disable Dynamic Host Configuration Protocol \(DHCP\)](#). In case a manual configuration is required, please refer to the instructions in [Manual Host Configuration](#).

Manual Host Configuration

To perform initial configuration of the system:

Step 1. Connect a host PC to the Console RJ45 () port of the system, using the supplied harness cable (DB9 to RJ45). Make sure to connect to the Console RJ45 port and not to the (Ethernet) MGT () port.

Step 2. Configure a serial terminal program (for example, HyperTerminal, minicom, or Tera Term) on your host PC with the settings described in the table below. Once you perform that, you should get the CLI prompt of the system.

Serial Terminal Program Configuration

Parameter	Setting
Baud Rate	115200
Data bits	8
Stop bits	1
Parity	None
Flow Control	None

Step 3. Login as admin and use admin as password. On the first login, the Mellanox Onyx (MLNX-OS) configuration wizard will start.

Step 4. To configure network attributes and other initial parameters to the system, follow the configuration wizard as shown in the Configuration Wizard Session table below.

Configuration Wizard Session

Wizard Session Display	Comments
Mellanox configuration wizard Do you want to use the wizard for initial configuration? yes	You must perform this configuration the first time you operate the system or after resetting the system. Type 'y' and then press <Enter>.
Step 1: Hostname? [switch-1]	If you wish to accept the default hostname, press <Enter>. Otherwise, type a different hostname and press <Enter>.
Step 2: Use DHCP on mgmt0 interface? [no] yes	Perform this step to obtain an IP address for the system. (mgmt0 is the management port of the system). If you wish the DHCP server to assign the IP address, type 'yes' and press <Enter>. If you type 'no' (no DHCP), then you will be asked whether you wish to use the 'zeroconf' configuration or not. If you enter 'no' (no Zeroconf), you must enter a static IP, and the session will continue.

Wizard Session Display	Comments
Step 3: Enable IPv6? [yes]	The management interface will be able to use IPv6 addresses. If you enter "no" (no IPv6), you will automatically be referred to Step 6.
Step 4: Enable IPv6 auto-config (SLAAC) on mgmt0 interface? [no]	This turns on auto-configuration of the IPv6 addresses. This is unsuitable for DHCPv6.
Step 5: Enable DHCPv6 on mgmt0 interface? [no]	To enable DHCPv6 on the MGMT0 interface.
Step 6: Admin password (Press <Enter> to leave unchanged)? <new_password> Step 6: Confirm admin password? <new_password>	To avoid illegal access to the machine, please type a password and then press <Enter>. Then confirm the password by re-entering it. Note that password characters are not printed.
You have entered the following information: <A summary of the configuration is now displayed.> To change an answer, enter the step number to return to or hit <enter> to save changes and exit. Choice: <Enter> Configuration changes saved.	The wizard displays a summary of your choices and then asks you to confirm the choices or to re-edit them. Either press <Enter> to save changes and exit, or enter the configuration step number that you wish to return to. <i>Note: To re-run the configuration wizard, run the command "configuration jump-start" in Config mode.</i>

The table below shows an example of static IP configuration for mgmt0 interface.

Configuration Wizard Session - Static IP Configuration

```
Mellanox configuration wizard

Do you want to use the wizard for initial configuration? yes

Step 1: Hostname? []
Step 2: Use DHCP on mgmt0 interface? [yes] no
Step 3: Use zeroconf on mgmt0 interface? [no]
Step 4: Primary IP address? [for example 192.168.10.4] 10.10.10.10
Mask length may not be zero if address is not zero (interface eth0)
Step 5: Netmask? [0.0.0.0] 255.255.255.0
Step 6: Default gateway? [for example 192.168.10.1] 10.10.10.255
Step 7: Primary DNS server?
Step 8: Domain name?
Step 9: Enable IPv6? [yes]
Step 10: Enable IPv6 autoconfig (SLAAC) on mgmt0 interface? [no]
Step 11: Admin password (Enter to leave unchanged)?

To change an answer, enter the step number to return to.
Otherwise hit <enter> to save changes and exit.
Choice:
Configuration changes saved.

To return to the wizard from the CLI, enter the "configuration jump-start"
command from configure mode. Launching CLI...
```

Step 5. Before attempting a remote (for example, SSH) connection to the system, check the mgmt0 interface configuration. Specifically, verify the existence of an IP address. To check the current mgmt0 configuration, enter the following command:

```

switch01 (config) # show interfaces mgmt0
Interface mgmt0 status:
Comment:
Admin up:          yes
Link up:          yes
DHCP running:     yes
IP address:       192.168.1.100
Netmask:          255.255.255.0
IPv6 enabled:     yes
Autoconf enabled: no
Autoconf route:  yes
Autoconf privacy: no
DHCPv6 running:  no
IPv6 addresses:  1
IPv6 address:     fe80::202:c9ff:fe63:b55a/64
Speed:            1000Mb/s (auto)
Duplex:           full (auto)
Interface type:   ethernet
Interface source: physical
MTU:              1500
HW address:       00:02:C9:63:B5:5A

RX bytes:          968810197      TX bytes:          1172590194
RX packets:        10982099      TX packets:        10921755
RX mcast packets: 0          TX discards:       0
RX discards:       0          TX errors:          0
RX errors:         0          TX overruns:        0
RX overruns:       0          TX carrier:         0
RX frame:          0          TX collisions:      0
                                TX queue len:      1000

switch01 (config) #

```

Step 6. Check the software version embedded in your system, using the command ‘show version’. Compare this version to the latest version that can be retrieved from Mellanox support site. To upgrade software, please refer to the *Mellanox Onyx (MLNX-OS) User Manual*.

Disable Dynamic Host Configuration Protocol (DHCP)

DHCP is used for automatic retrieval of management IP addresses.

If a user connects through SSH, runs the wizard and turns off DHCP, the connection is immediately terminated, as the management interface loses its IP address. In such a case, the serial connection should be used.



```
<localhost># ssh admin@<ip-address>
```

```
Mellanox Onyx (MLNX-OS) Switch Management
```

```
Password:
```

```
Mellanox Switch
```

```
Mellanox configuration wizard
```

```
Do you want to use the wizard for initial configuration? yes
```

```
Step 1: Hostname? [my-switch]
```

```
Step 2: Use DHCP on mgmt0 interface? [yes] no
```

```
<localhost>#
```

Remote Connection with Mellanox Onyx (MLNX-OS)

Once the network attributes are set, you can access the CLI via SSH or the WebUI via HTTP/ HTTPS.

To access the CLI, perform the following steps:

1. Set up an Ethernet connection between the system and a local network machine using a standard RJ45 connector.
2. Start a remote secured shell (SSH) using the command: `ssh -l <username> <IP_address>`

```
# ssh -l <username> <ip_address>
Mellanox Onyx (MLNX-OS) Switch Management
Password:
```

3. Login as admin (default username is *admin*, password is *admin*).
4. Once you get the CLI prompt, you are ready to use the system.

For additional information about Mellanox Onyx (MLNX-OS), refer to the *Mellanox Onyx (MLNX-OS) User Manual* located on the Mellanox support web.

Configuring Network Attributes Using Cumulus Linux

For Cumulus Linux initial configuration instructions, see Configuring Cumulus Linux in the [Cumulus Linux Quick Start Guide](https://docs.cumulusnetworks.com/display/DOCS/Quick+Start+Guide) (at <https://docs.cumulusnetworks.com/display/DOCS/Quick+Start+Guide>).

Remote Connection with Cumulus Linux

Cumulus Linux uses the OpenSSH package to provide SSH functionality. To securely access a Cumulus Linux switch remotely, please follow the instructions on the [SSH for Remote Access](#) page in the [Cumulus Linux User Guide](#).

FRU Replacements

 The following information does not apply to the SN2100/SN2010 series. The SN2100/SN2010 systems include two non-replaceable power supply units and four non-replaceable fan units.

Power Supply

Mellanox systems that are equipped with two replaceable power supply units work in a redundant configuration. Either unit may be extracted without bringing down the system.

 Make sure that the power supply unit that you are NOT replacing is showing green for the power supply unit LED.

 Power supply units have directional air flows similar to the fan module. The fan module airflow must coincide with the airflow of all of the power supply units. If the power supply unit airflow direction is different from the fan module airflow direction, the system's internal temperature will be affected. For power supply unit air flow direction, refer to [Air Flow](#).

To extract a power supply unit:

 The power supply slots of SN2740 and SN2410 should not be left empty for more than 5 minutes.

1. Remove the power cord from the power supply unit.

2. Grasping the handle with your hand, push the latch release with your thumb while pulling the handle outward. As the power supply unit unseats, the power supply unit status LEDs will turn off.
3. Remove the power supply unit.
PS Unit Pulled Out

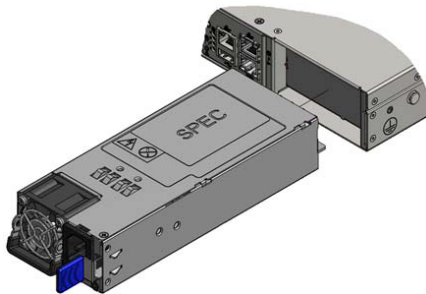

To insert a power supply unit:

1. Make sure the mating connector of the new unit is free of any dirt and/or obstacles.

❗ Do not attempt to insert a power supply unit with a power cord connected to it.

2. Insert the power supply unit by sliding it into the opening, until a slight resistance is felt.
3. Continue pressing the power supply unit until it seats completely. The latch will snap into place, confirming the proper installation.
4. Insert the power cord into the supply connector.
5. Insert the other end of the power cord into an outlet of the correct voltage.

❗ The green power supply unit indicator should light. If it does not, repeat the whole procedure to extract the power supply unit and re-insert it.

Fans

The system can fully operate if one fan FRU is dysfunctional. Failure of more than one fan is not supported.

❗ Make sure that the fans have the air flow that matches the model number. An air flow opposite to the system design will cause the system to operate at a higher (less than optimal) temperature. For power supply unit air flow direction, refer to [Air Flow](#).

To remove a fan unit:

1. Grasping the handle with your right hand, push the latch release with your thumb while pulling the handle outward. As the fan unit unseats, the fan unit status LEDs will turn off.
2. Remove the fan unit.

To insert a fan unit:

1. Make sure the mating connector of the new unit is free of any dirt and/or obstacles.
2. Insert the fan unit by sliding it into the opening until slight resistance is felt. Continue pressing the fan unit until it seats completely.

⚠ The green Fan Status LED should light. If not, extract the fan unit and reinsert it. After two unsuccessful attempts to install the fan unit, power off the system before attempting any system debug.

Fan Module Latches

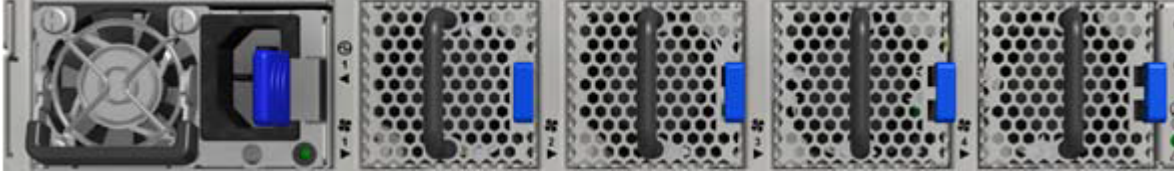

Interfaces

The systems support the following interfaces:

- Data interfaces - Ethernet: 1/10/25/40/50/56/100GbE
- USB port (mini USB in SN2100)
- RS232 Console port
- Management interface(s) (Eth. RJ45) - 100MbE/1GbE
- Reset button
- Status and Port LEDs

In order to review the full configuration options matrix, refer to [Management Interfaces, PSUs and Fans](#).

Data Interfaces

The data interfaces use QSFP28 connectors. The full list of interfaces per system is provided in [Speed and Switching Capabilities](#).

Each QSFP28 port can be connected with a QSFP28 cable or connector for 25/40/50/56/100GbE, or 1/10/25GbE when connecting through Mellanox QSFP28 to SFP28 (Dynamix QSA™) adapters, hybrid or split cables. The systems offer support of up to 3.5W transceivers in all QSFP28 ports, and support of up to 1.5W in all SFP28 ports.

Some QSFP28 ports and SFP28 ports support higher power consumption transceivers, as detailed in the following table:

High Power/LR4 Transceivers Support

Model Family	Ports	Maximum High Power Support
SN2700	1, 2, 31, 32	5.0W ^(b)
SN2740	1, 2, 31, 32	2.5W
SN2410	1, 2, 47, 48 ^(c)	4.5W ^(a)
	49, 50, 55, 56	5.0W ^(b)
SN2100	1, 2, 15, 16	4.5W ^(a)
SN2010	19, 20, 21, 22	4.5W ^(a)
	1, 2, 17, 18 ^(c)	2.5W

Notes:

- a. 4.5W high power modules are supported on Mellanox Onyx (MLNX-OS) from version 3.6.3004 onwards.
- b. 5.0W high power modules are supported on Mellanox Onyx (MLNX-OS) from version 3.x.1xxx onwards for 100GbE Fiber Optics up to 80km.
- c. SFP28 ports.

Using 5.0W Modules on Ports 49, 50, 55, 56 in SN2410M/SN2410bM

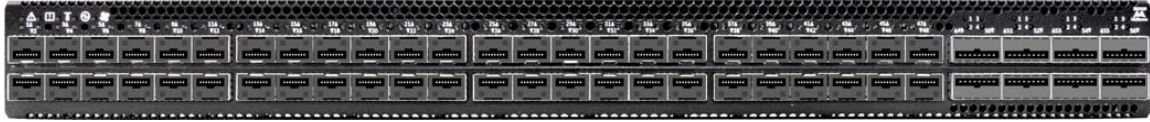

Supported Passive Cables in SN2010bM

- For server ports:
 - 25GbE cables (all ports can be used):
 - 1m-1.5m: any DAC
 - 2m: MCP2M00-A002E30N
 - 2.5m: MCP2M00-A02AE26N
 - 3m: MCP2M00-A003E26N
 - 10GbE cables (all ports can be used):
 - 0.5m to 5m: any DAC
- For IPL ports (SN2010 to SN2010 connection):
 - 40/100GbE cables (all ports can be used):
 - No limitations
 - 25GbE cables (only ports 3, 6, 9, 12, 15, 18 can be used)
 - Up to 2m: any DAC
 - 10GbE cables (all ports can be used):
 - 0.5m to 5m: any DAC
- For connections with other switches:
 - AOCs/Transceivers only

Supported 25GbE and 40/100GbE Cables on IPL Ports (SN2010 to SN2010 Connection)

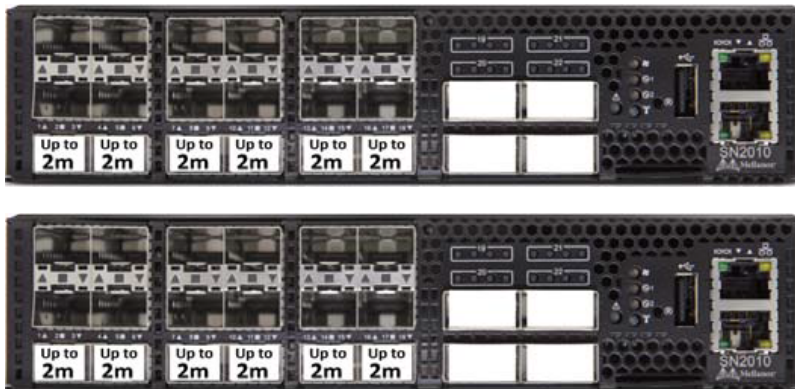

Speed

Ethernet speed must be set manually. The system's ports can be manually configured to run at speeds ranging from 10GbE to 100GbE (for more details, see [Specifications](#)). To change the port speed configuration, use the command “speed” under interface configuration mode. Refer to the *Mellanox Onyx (MLNX-OS) User Manual* for instructions on port speed re-configuration.

RS232 (Console)

The port labeled “Console” is an RS232 serial port on the back side of the chassis in SN2700 and SN2410, and on the front side in SN2740 and SN2100/SN2010. It is used for initial configuration and

debugging. Upon first installation of the system, you need to connect a PC to this interface and configure network parameters for remote connections. Refer to [Configuring Network Attributes Using Mellanox Onyx \(MLNX-OS\)](#) to view the full procedure.

Management

The RJ45 Ethernet ports labeled “MGT ” provide access for remote management. The management ports are configured with auto-negotiation capabilities by default (100MbE to 1GbE). The management ports’ network attributes (such as IP address) need to be pre-configured via the RS232 serial console port or by DHCP before use. Refer to [Configuring Network Attributes Using Mellanox Onyx \(MLNX-OS\)](#) to view the full procedure.

 In the SN2100/SN2010 systems there is only one MGT port.

 Make sure you use only FCC compliant Ethernet cables.

USB

The USB interface is USB 2.0 (mini USB in SN2100) compliant (USB 1.0 is not supported) and can be used by Mellanox Onyx (MLNX-OS) software to connect to an external disk for software upgrade or file management. The connector comes in a standard USB shape.

To view the full matrix of the USB configuration options, refer to [Management Interfaces, PSUs and Fans](#).

 Do not use excessive force when inserting or extracting the USB disk to and from the connector.

Reset Button

The reset button is located on the rear side of the system next to the fan status LEDs in SN2700 and SN2410, and on the front side in SN2740 and SN2100/SN2010. This reset button requires a tool to be pressed.

 Do not use a sharp pointed object such as a needle or a push pin for pressing the reset button. Use a flat object to push the reset button.

To reset the system and the CPU of its management board, push the reset button and keep it pressed for up to 15 seconds.

To reset the system, the CPU of its management board, and the “admin” password, push the reset button and keep it pressed for at least 15 seconds. When using a Mellanox Onyx (MLNX-OS) based system, this should allow you to enter without a password and set a new password for the user “admin”.

For Cumulus Linux password reset instructions, please refer to the [Single User Mode - Boot Recovery](#) section in the [Cumulus Linux User Guide](#).





Status and Port LEDs

See [LED Notifications](#).

LED Notifications

The system's LEDs are an important tool for hardware event notification and troubleshooting.

LEDs Symbols

Symbol	Name	Description	Normal Conditions
	System Status LED	Shows the health of the system.	Green/Flashing green when booting
	Fan Status LED	Shows the health of the fans.	Green
a 	Power Supply Units LEDs	Shows the health of the power supply units.	Green
b 	Bad Port LED	Lights up when a symbol error is detected on one of the ports.	Off
	Unit Identifier LED	Lights up on command through the CLI.	Off or blue when identifying a port



a. There are two PSU LEDs in SN2100/SN2010.

b. This LED does not exist in SN2740.

System Status LED

Both of the System Status LEDs (front and back, if exist) supply identical information.

System Status LEDs - Front and Rear Sides in SN2700

Front Panel	Description	Rear Panel
	<p>Both of these LEDs in the red ovals show the system's status.</p>	

System Status LEDs - Front Side in SN2740

<p>Both of these LEDs in the red ovals show the system's status.</p>	
--	---

System Status LEDs - Front and Rear Sides in SN2410

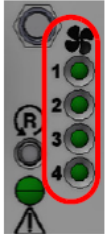
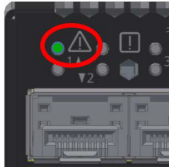
	<p>Both of these LEDs in the red ovals show the system's status.</p>	
---	--	---

System Status LED in SN2100

	<p>The LED in the read oval is located on the front panel of SN2100. There are no LEDs in the rear panel of SN2100.</p>
---	---

System Status LED in SN2010



The LED in the red oval is located on the front panel of SN2010. There are no LEDs in the rear panel of SN2010.

⚠ It may take up to five minutes to turn on the system. If the System Status LED shows red after five minutes, unplug the system and call your Mellanox representative for assistance.

System Status LED Assignments

LED Behavior	Description	Action Required
Solid Green	The system is up and running normally.	N/A
Flashing Green	The system is booting up.	Wait up to five minutes for the end of the booting process.
Solid Red	Major error has occurred. For example, corrupted firmware, system is overheated etc.	If the System Status LED shows red five minutes after starting the system, unplug the system and call your Mellanox representative for assistance.

Fan Status LED

Fan Status LED in SN2700 - Front and Rear Sides



Both of these LEDs in the red ovals show the fans' status.





System Status LEDs - Front Side in SN2740

The LED in the red oval shows the fans' status.

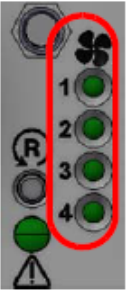

Fan Status LED in SN2410 - Front and Rear Sides

	<p>Both of these LEDs in the red ovals show the fans' status.</p>	
---	---	---

Fan Status LED in SN2100

<p>The SN2100 systems have a front fan LED only.</p>	
--	---

Fan Status LED in SN2010

<p>The SN2010 systems have a front fan LED only.</p>	
--	--

Fan Status Front LED Assignments

LED Behavior	Description	Action Required
Solid Green	All fans are up and running.	N/A
Solid Red	Error, one or more fans are not operating properly.	The faulty FRUs should be replaced.
Off	System boot	N/A

Fan Status Rear LED Assignments (One LED per Fan)

LED Behavior	Description	Action Required
Solid Green	A specific fan unit is operating.	N/A
Solid Red	A specific fan unit is missing or not operating properly.	The fan unit should be replaced.
Off	System boot	N/A

⚠ The table above - Fan Status Rear LED Assignments (One LED per Fan) - does not apply to the SN2100/SN2010 systems.

⚠ Risk of Electric Shock! With the fan module removed, power pins are accessible within the module cavity. Do not insert tools or body parts into the fan module cavity.

Power Supply Status LEDs

⚠ The following information does not apply to the SN2100/SN2010 systems. In these systems, the power supply units are non-replaceable, and there is a designated LED for each unit in the system's front panel. (Front panel figures are located in the [Introduction](#).)

Power Status LED



There are two power supply inlets in the system (for redundancy). The system can operate with only one power supply connected. In case the power supply is an FRU, a second power supply unit can be added to support hot-swap ability. Each power supply unit has a single 2 color LED on the right side of the unit, that indicates the status of the unit.

SN2700 and SN2410 Rear Side Panel

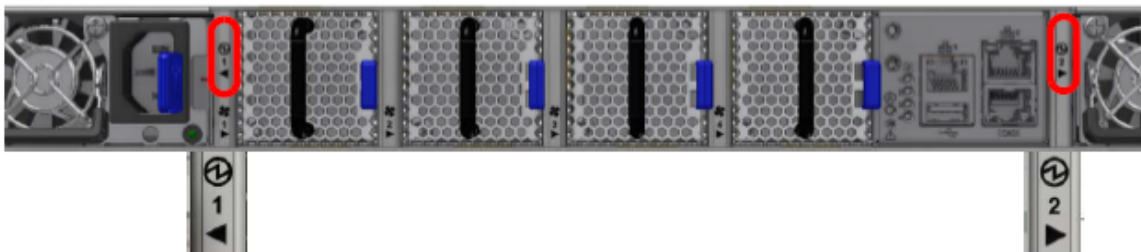

SN2740 Side Panel

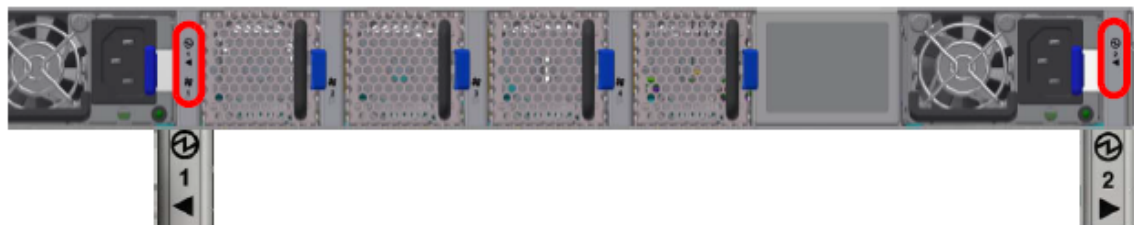

The primary power supply (PS) unit is located on the left side, and the secondary unit is located on the right side.

Power Supply Unit Status Front LED Assignments for SN2700, SN2740 and SN2410

LED Behavior	Description	Action Required
Solid Green	All plugged (one or two) power supplies are running normally.	N/A
Solid Red	PSU is faulty or disconnected.	Make sure the AC cable is plugged in and active. If the problem resumes, the FRUs might be faulty, and should then be replaced.
Off	N/A	N/A

Power Supply Unit Status Front LED Assignments for SN2100/SN2010

LED Behavior	Description	Action Required
Solid Green	Power supply is running normally.	N/A
Solid Red	PSU is faulty or disconnected.	Make sure the AC cable is plugged in and active. If the problem resumes, the PSU might be faulty.
Off	PSU not present	N/A

The power supply status LEDs on the rear side of the system (in SN2700, SN2740 and SN2410 only) are located on the PSUs themselves. Each PSU has one LED of its own.

Power Supply Unit Status Rear LED Assignments

LED Behavior	Description	Action Required
Solid Green	The PSU is running normally.	N/A
Flashing Green 1Hz	AC present / Only 12VSB on (PSU off) or PSU in Smart-on state.	Call your Mellanox representative for assistance.
Amber	AC cord unplugged or AC power lost while the second power supply still has AC input power.	Plug in the AC cord of the faulty PSU.
	PS failure (including voltage out of range and power cord disconnected).	Check voltage. If OK, call your Mellanox representative for assistance.
Flashing Amber	Power supply warning events where the power supply continues to operate; high temp, high power, high current, slow fan.	Call your Mellanox representative for assistance.
Off	No AC power to all power supplies.	Call your Mellanox representative for assistance.

 The table above (Power Supply Unit Status Rear LED Assignments) does not apply to the SN2100/SN2010 systems.

Unit Identification LED

The UID LED is a debug feature, that the user can use to find a particular system within a cluster by turning on the UID blue LED.

To activate the UID LED on a switch system, run:

```
switch (config) # led MGMT uid on
```

To verify the LED status, run:

```
switch (config) # show leds
Module LED Status
-----
MGMT UID Blues
```

To deactivate the UID LED on a switch system, run:

```
switch (config) # led MGMT uid off
```





Bad Port LED

The Bad Port LED indicator is used to indicate symbol errors in one or more system ports.

Bad Port LED Assignments

LED Behavior	Description	Action Required
Off	No symbol errors have been received in last few seconds (normal condition).	N/A
Flashing Amber	Error, one or more ports have received symbol errors. Possible causes are: <ul style="list-style-type: none"> • Bad cable • Bad connection • Bad connector 	Check symbol error counters on the system UI to identify the ports. Replace the cable on these ports.

Port LEDs

SN2740 Port LEDs 	SN2410 SFP28 Port LEDs 	SN2410 QSFP28 Port LEDs 	SN2010 QSFP Port LEDs 
SN2010 SFP Port LEDs	SN2100 Port LEDs		

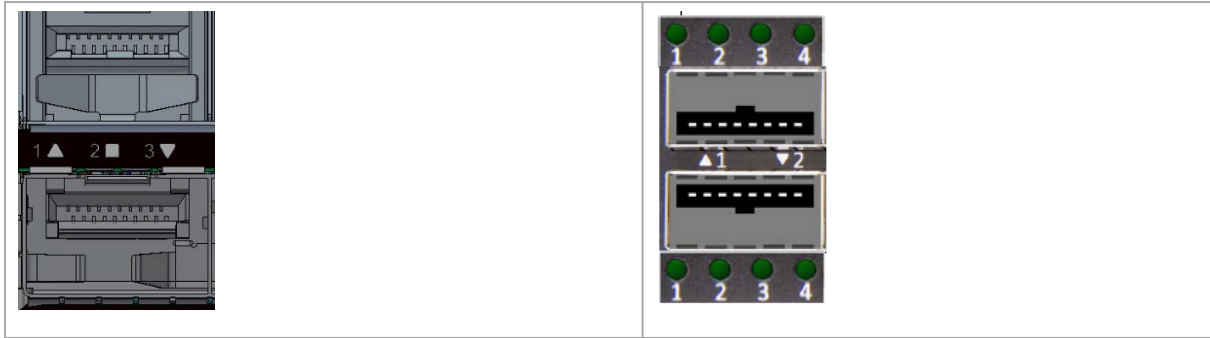

In the SN2410 systems, the status of each pair of adjacent QSFP28 ports is indicated by four LEDs, as shown in the picture above:

- While the bottom LEDs signify the port status in regular condition, the upper LEDs operate only when the port is split.
- When one port is split to two, a connection of 100GbE can be utilized in its adjacent port.
- When one port is split to four, its adjacent port is canceled.
- If the ports run at a 100GbE/40GbE speed each, the two lower LEDs (2 and 4) will light green.
- If the ports run at a 50GbE speed each, the left LEDs (1 and 2) will light green for the upper port, and the right LEDs (3 and 4) will light green for the lower port.
- If the ports run at a 25GbE/10GbE speed each, all LEDs may light green, according to the selected lane.

Port LEDs in Ethernet System Mode

LED Behavior	Description	Action Required
Off	Link is down.	Check the cable
Solid Green	Link is up with no traffic.	N/A
Flashing Green	Link is up with traffic.	N/A
Flashing Amber	A problem with the link.	Check the cable, and replace it if needed.

Inventory Information

The system's inventory parameters (such as Serial Number, Part Number, GUID and MAC address) can be extracted from the inventory pull-out tab on the lower right side of the front panel.

In some systems, there is no pull-out tab, and the information is provided on labels in several locations.

SN2700 Pull-out Tab

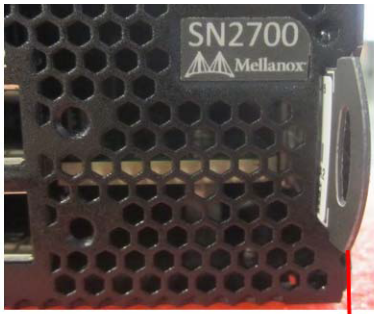

SN2740 Inventory Information Illustration

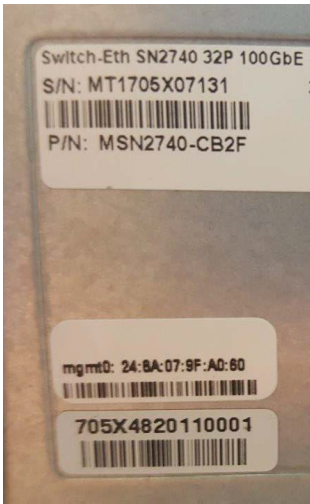

SN2410 Inventory Information Illustration



SN2100 Pull-out Tab



SN2010 Pull-out Tab



Software Management

The system includes an embedded management CPU card that runs Mellanox Onyx® (MLNX-OS®) management software. This system includes a CLI, WebUI, SNMP, system management software, Ethernet protocols and IB management software (OpenSM).

- For Mellanox Onyx (MLNX-OS) systems management package and related documentation, visit the product page at http://www.mellanox.com/page/mlnx_os.
- For Cumulus® Linux® software management instructions, refer to the [Cumulus Linux User Guide](#).

 The Ethernet ports for remote management connect to Ethernet systems. These systems must be configured to 100Mb/1Gb auto-negotiation.

 No more than two subnet managers are recommended for any single fabric.

Upgrading Software

Mellanox Onyx (MLNX-OS) Software Upgrade

Software and firmware updates are available from the Mellanox Support website. Check that your current revision is the latest one available on the Mellanox Support website. If you do not have the latest revision, upgrade your software using the CLI or the GUI. Copy the updated software to a known location on a remote server within the user's LAN.

For further information please refer to the *Mellanox Onyx (MLNX-OS) Software User Manual* in the "Upgrading Onyx (MLNX-OS) Software" section.

Prior to updating, read and follow all of the instructions regarding the updating of the software on your system.

Switch Firmware Update

The systems do not require firmware updating. Firmware updating is done through the Mellanox Onyx (MLNX-OS) management software.

Cumulus Linux Software Upgrade

For Cumulus Linux software upgrade instructions, see [Upgrading Cumulus Linux](#) in the [Cumulus Linux User Guide](#).

Troubleshooting

Problem Indicator	Symptoms	
LEDs	System Status LED is blinking for more than 5 minutes	Cause: Mellanox Onyx (MLN-OS) Solution: Connect to the system console and run the command <code>show system status</code> . If the status is <code>FAIL</code> , contact an FAE if the Mellanox Onyx (MLN-OS) is not supported.
	System Status LED is red	Cause: <ul style="list-style-type: none"> • Critical system failure • Over temperature Solution: <ul style="list-style-type: none"> • Check environment
	Fan Status LED is red	Cause: Possible fan issue Solution: <ul style="list-style-type: none"> • Check that the fan is working • Replace the fan if necessary
	PSU Status LED is red	Cause: Possible PSU issue Solution: <ul style="list-style-type: none"> • Check/replace the PSU if necessary • Replace the PSU if necessary
System boot failure while using Mellanox Onyx (MLNX-OS)	Software upgrade failed on x86 based systems	Solution: <ul style="list-style-type: none"> • Connect the RS232 console • Push the system's reset button • Press the ArrowUp or ArrowDown key to select the previous image <pre> Default image: 'SX_X86_64' Press enter to boot this image Booting default image in 10 seconds Boot Menu ----- 0: SX_X86_64 SX_3.4.0008 1: SX_X86_64 SX_3.4.0007 ----- Use the ArrowUp and ArrowDown keys Press enter to boot the selected image Highlighted entry is 0: " </pre> <ul style="list-style-type: none"> • Select previous image
System boot failure while using Cumulus Linux	Software upgrade failed on x86 based systems	See Monitoring and Troubleshooting

Problem Indicator	Symptoms	
System date and time reset	The date and time settings were reset to the default configuration following an AC power loss	<p>Cause: Date and time are reconfi</p> <p>Solution:</p> <ul style="list-style-type: none"> To set the system's da <pre data-bbox="1362 450 1596 510"># clock set <hh:mm:ss></pre> <ul style="list-style-type: none"> To verify the configur <pre data-bbox="1362 573 1596 633"># show clock</pre> <ul style="list-style-type: none"> It is recommended to that, run: <pre data-bbox="1362 757 1596 846">> enable # config terminal (config)# ntp server</pre> <ul style="list-style-type: none"> To verify NTP time syn <pre data-bbox="1362 909 1596 969"># show ntp</pre> <p>For full configuration inst</p>

Specifications

SN2700 Series

Feature		Value
Mechanical	Size:	Standard depth - 1.72" (H) x 16.84" (W) x 27" (D). 43.8mm (H) x 427.83mm (W) x 686.8mm (D).
		Short depth - 1.72" (H) x 16.84" (W) x 17" (D). 43.9mm (H) x 428mm (W) x 432mm (D).
	Mounting:	19" Rack mount
	Weight:	1 PSU: 10.23kg, 2 PSUs: 11.1kg
	Speed:	10/25/40/50/56/100GbE per port
	Connector cage:	32 QSFP28
Environmental	Temperature:	Operational: 0° to 40°C Non-Operational: -40° to 70°C
	Humidity:	Operational: 10% - 85% non-condensing Non-Operational: 10% - 90% non-condensing
	Altitude:	3050m
	Noise level:	71.6 dB(A)
Regulatory	Safety/ EMC:	CB, cTUVus, CE, CU, S_Mark, CE, FCC, VCCI, ICES, RCM, BSMI, KCC, CCC
	RoHS:	RoHS complaint
Power Supply AC and DC	Input Voltage:	100-127VAC; 50/60Hz 3.5A; 200-240 50/60Hz 2.9A/ 192-288VDC (not certified)
		48VDC (Input voltage 40-72 VDC)
	Global Power Consumption:	40GbE Models - Typical power with passive cables (ATIS): 150W (same as the 100GbE models) Max power with optical cables (assuming 2W per port): 308.5W 100GbE Models - Typical power with passive cables (ATIS): 150W Max power with optical cables (assuming 3.5W per port): 398W
Main Devices	CPU:	Intel x86 1.40GHz Dual Core
	PCIe:	4x Gen2.0
	Switch:	Mellanox Spectrum

Feature		Value
	Memory:	8GB DDR3 RAM, 32G SSD for systems based on Switch rev. B1 and earlier 8GB DDR3 RAM, 16G SSD for systems based on Switch rev. B2 and higher
Throughput		6.4Tb/s

SN2740 Series

Feature		Value
Mechanical	Size:	Standard - 1.72" (H) x 16.84" (W) x 27" (D). 43.8mm (H) x 427.83mm (W) x 686.8mm (D)
	Mounting:	19" Rack mount
	Weight:	1 PSU: 10.23kg, 2 PSUs: 11.1kg
	Speed:	10/25/40/50/56/100GbE per port
	Connector cage:	32 QSFP28
Environmental	Temperature:	Operational: 0° to 40°C Non-Operational: -40° to 70°C
	Humidity:	Operational: 10% - 85% non-condensing Non-Operational: 10% - 90% non-condensing
	Altitude:	3050m
	Noise level:	71.6 dB(A)
Regulatory	Safety/ EMC:	CB, cTUVus, CE, CU, S_Mark, CE, FCC, VCCI, ICES, RCM, BSMI, KCC, CCC
	RoHS:	RoHS complaint
Power	Input Voltage:	100-127VAC; 50/60Hz 3.5A; 200-240 50/60Hz 2.9A/ 192-288VDC (not certified)
	Global Power Consumption:	40GbE Models - Typical power with passive cables (ATIS): 140.4W (same as the 100GbE models) Max power with optical cables (assuming 2W per port): 266W 100GbE Models - Typical power with passive cables (ATIS): 140.4W Max power with optical cables (assuming 3.5W per port): 335W
Main Devices	CPU:	Intel x86 2.40GHz Quad Core
	PCIe:	4x Gen2.0
	Switch:	Mellanox Spectrum
	Memory:	8GB DDR3 RAM, 16G SSD
Throughput		6.4Tb/s

SN2410 Series

Feature		Value
Mechanical	Size:	43.9mm (H) x 438mm (W) x 394mm (D) 1.72"(H) x 17.24"(W) x 15.5"(D)
	Mounting:	19" Rack mount
	Weight:	1 PSU weight 6.726kg (14.8 lb) 2 PSU weight 7.526kg (16.6 lb)
	Speed:	10/25GbE per port (ports 1-48), 10/25/40/50/56/100GbE per port (ports 49-56)
	Connector cage:	48xSFP28 and 8xQSFP28
Environmental	Temperature:	Operational: 0° to 40°C Non-Operational: -40° to 70°C
	Humidity:	Operational: 10% - 85% non-condensing Non-Operational: 10% - 90% non-condensing
	Altitude:	3050m
	Noise level:	70.9 dB(A)
Regulatory	Safety/ EMC:	CB, cTUVus, CE, CU, S_Mark, CE, FCC, VCCI, ICES, RCM, BSMI, KCC, CCC
	RoHS:	RoHS complaint
Power Supply AC and DC	Input Voltage:	100-127VAC 50/60Hz 4.5A; 200-240 50/60Hz 2.9A/ 192-288VDC (not certified) 48VDC (Input voltage 40-72 VDC)
	Global Power Consumption:	40GbE Models - Typical power with passive cables (ATIS): 165W (same as the 100GbE models) Max power with optical cables (assuming 2W per each QSFP28 port, and 1W per each SFP28 port): 295.1W 100GbE Models - Typical power with passive cables (ATIS): 165W Max power with optical cables (assuming 3.5W per each QSFP28 port, and 1.5W per each SFP28 port): 362W
Main Devices	CPU:	Intel x86 1.40GHz Dual Core
	PCIe:	4x Gen2.0
	Switch:	Mellanox Spectrum
	Memory:	8GB DDR3 RAM, 32G SSD for systems based on Switch rev. B1 and earlier 8GB DDR3 RAM, 16G SSD for systems based on Switch rev. B2 and higher
Throughput		4Tb/s

SN2100 Series

Feature		Value
Mechanical	Size:	43.8mm (H) x 200mm (W) x 508mm (D) 1.72" (H) x 7.87" (W) x 20" (D)
	Mounting:	19" Rack mount
	Weight:	4.540kg
	Speed:	10/25/40/50/56/100GbE per port
	Connector cage:	16xQSFP28
Environmental	Temperature:	Operational: 0° to 40° C Non-Operational: -40° to 70° C
	Humidity:	Operational: 10% - 85% non-condensing Non-Operational: 10% - 90% non-condensing
	Altitude:	3050m
	Noise level:	73.7 dB(A)
Regulatory	Safety/ EMC:	CB, cTUVus, CE, CU, S_Mark, CE, FCC, VCCI, ICES, RCM, BSMI, KCC, CCC
	RoHS:	RoHS complaint
Power	Input Voltage:	100-127VAC 50/60Hz 4.5A; 200-240 50/60Hz 2.9A
	Global Power Consumption:	40GbE Models - Typical power with passive cables (ATIS): 94.3W (same as the 100GbE models) Max power with SR4 cables (assuming 1.5W per each QSFP28 port): 216.6W 100GbE Models - Typical power with passive cables (ATIS): 94.3W Max power with optical cables (assuming 3.5W per each QSFP28 port): 248.6W
Main Devices	CPU:	Intel x86 2.40GHz Quad Core
	PCIe:	4x Gen2.0
	Switch:	Mellanox Spectrum
	Memory:	SDRAM: 8GB DDR3L 1600 MT/s SO-DIMM Storage: 16GB Dual Channel MLC M.2-SATA SSD
Throughput		3.2Tb/s

SN2010 Series

Feature		Value
Mechanical	Size:	43.8mm (H) x 200mm (W) x 508mm (D) 1.72" (H) x 7.87" (W) x 20" (D)
	Mounting:	19" Rack mount
	Weight:	4.500kg
	Speed:	10/25/40/50/56/100GbE per port
	Connector cage:	18 ports of 10/25GbE and 4 splittable ports of 40/100GbE
Environmental	Temperature:	Operational: 0° to 40° C Non-Operational: -40° to 70° C
	Humidity:	Operational: 10% - 85% non-condensing Non-Operational: 10% - 90% non-condensing
	Altitude:	3050m
	Noise level:	73.7 dB(A)
Regulatory	Safety/ EMC:	CB, cTUVus, CE, CU, S_Mark, CE, FCC, VCCI, ICES, RCM, BSMI, KCC, CCC
	RoHS:	RoHS complaint
Power	Input Voltage:	100-127VAC 50/60Hz 4.5A; 200-240 50/60Hz 2.9A
	Global Power Consumption:	Typical power with passive cables (ATIS): 57W Max power with optical cables (assuming 3.5W per each QSFP28 port): 250W
Main Devices	CPU:	Intel x86 2.40GHz Quad Core
	PCIe:	4x Gen2.0
	Switch:	Mellanox Spectrum
	Memory:	SDRAM: 8GB DDR3L 1600 MT/s SO-DIMM Storage: 16GB Dual Channel MLC M.2-SATA SSD
Throughput		1.7Tb/s

Appendixes

The document contains the following appendixes:

- [Accessory and Replacement Parts](#)
- [Thermal Threshold Definitions](#)
- [Interface Specifications](#)
- [Disassembly and Disposal](#)

Accessory and Replacement Parts

Ordering Part Numbers for Replacement Parts

OPN	Part Description	Supported Systems	Notes
MTEF-KIT-A	Rack installation kit for 1U systems to be mounted into short or standard depth racks	SN2700	Included in the SN2700 package.
MTEF-KIT-S	Rack installation kit for standard depth 1U systems to be mounted into standard depth racks	SN2700	--
MTEF-KIT-BP	Rack installation kit for 1U wide systems to be mounted into short depth racks	SN2410, SN2740	--
MTEF-KIT-SP	Rack installation kit for 1U wide systems to be mounted into standard depth racks	SN2410, SN2740	Included in the SN2410 and SN2740 packages.
MTEF-KIT-D	Rack installation kit for SN2100 series short depth 1U switches, allows installation of one or two switches side-by-side into standard depth racks	SN2010, SN2100	--
MTEF-PSF-AC-A	460W AC Power Supply w/ P2C air flow (front to rear)	SN2740, SN2700, SN2410	This item is discontinued. It is replaced by MTEF-PSF-AC-I.
MTEF-PSR-AC-A	460W AC Power Supply w/ C2P air flow (rear to front)	SN2700, SN2740, SN2410	This item is discontinued. It is replaced by MTEF-PSR-AC-I.
MTEF-PSF-AC-I	Mellanox Power-Supply Unit, 550W AC, P2C Airflow, For SB7700, SB7800, SB7890, SN2410, SN2700, SX6710, SN2740, SX1410, SX1710 switches, Power cord included	SN2700, SN2740, SN2410	The Network operating system identifies this module as a 460W PSU.
MTEF-PSR-AC-I	Mellanox Power-Supply Unit, 550W AC, C2P Airflow, For SB7700, SB7800, SB7890, SN2410, SN2700, SX6710, SN2740, SX1410, SX1710 switches, Power cord included	SN2700, SN2740, SN2410	The Network operating system identifies this module as a 460W PSU.
HAR000028	Harness RS232 2M cable - DB9 to RJ-45	SN2700, SN2740, SN2410, SN2010, SN2100	--

OPN	Part Description	Supported Systems	Notes
ACC000501	Power cord Type C13-C14	SN2700, SN2740, SN2410, SN2010, SN2100	--
MTEF-FANF-A	FAN MODULE W/ P2C air flow (front to rear)	SN2700, SN2410	--
MTEF-FANR-A	FAN MODULE W/ C2P air flow (rear to front)	SN2700, SN2410	--

Thermal Threshold Definitions

Three thermal threshold definitions are measured by the Spectrum ASICs, and impact the overall switch system operation state as follows:

- Warning - 105°C: On managed systems only: When the ASIC device crosses the 100°C threshold, a Warning Threshold message will be issued by the management software, indicating to system administration that the ASIC has crossed the Warning threshold. Note that this temperature threshold does not require nor lead to any action by hardware (such as switch shutdown).
- Critical - 120°C: When the ASIC device crosses this temperature, the switch firmware will automatically shut down the device.
- Emergency - 130°C: In case the firmware fails to shut down the ASIC device upon crossing its Critical threshold, the device will auto-shutdown upon crossing the Emergency (130°C) threshold.

For thermal threshold definitions in Cumulus Linux, see [Configuring Net-SNMP Event Notification Traps](#) in the [Cumulus Networks Help Center](#).

Interface Specifications

QSFP28 Pin Description



QSFP Pin Description

Connector Pin Number	Symbol	Signal Description
1	GND	Ground
2	Tx2n	Connected to Port 2 lane Rx Inverted Data
3	Tx2p	Connected to Port 2 lane Rx Non-Inverted Data
4	GND	Ground
5	Tx4n	Connected to Port 4 lane Rx Inverted Data
6	Tx4p	Connected to Port 4 lane Rx Non-Inverted Data
7	GND	Ground
8	Mod-Sell	Cable/Module Select
9	ResetL	Cable/Module Reset
10	Vcc Rx	+3.3 V Power supply receiver

Connector Pin Number	Symbol	Signal Description
11	SCL	2-wire serial interface clock
12	SDA	2-wire serial interface data
13	GND	Ground
14	Rx3p	Connected to Port 3 lane Tx Non-Inverted Data
15	Rx3n	Connected to Port 3 lane Tx Inverted Data
16	GND	Ground
17	Rx1p	Connected to Port 1 lane Tx Non-Inverted Data
18	Rx1n	Connected to Port 1 lane Tx Inverted Data
19	GND	Ground
20	GND	Ground
21	Rx2n	Connected to Port 2 lane Tx Inverted Data
22	Rx2p	Connected to Port 2 lane Tx Non-Inverted Data
23	GND	Ground
24	Rx4n	Connected to Port 4 lane Tx Inverted Data
25	Rx4p	Connected to Port 4 lane Tx Non-Inverted Data
26	GND	Ground
27	ModPrsL	Module/cable Present
28	IntL	Interrupt
29	Vcc Tx	+3.3 V Power supply transmitter
30	Vcc 1	+3.3 V Power Supply
31	LPMode	Low Power Mode
32	GND	Ground
33	Tx3p	Connected to Port 3 lane Rx Non-Inverted Data
34	Tx3n	Connected to Port 3 lane Rx Inverted Data
35	GND	Ground
36	Tx1p	Connected to Port 1 lane Rx Non-Inverted Data
37	Tx1n	Connected to Port 1 lane Rx Inverted Data
38	GND	Ground

SFP28 Pin Description

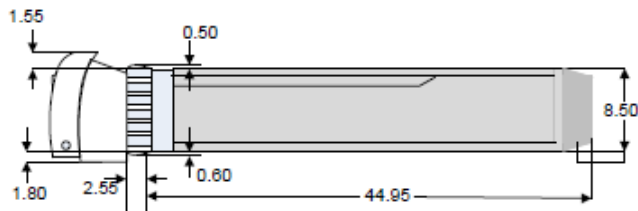
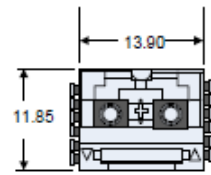
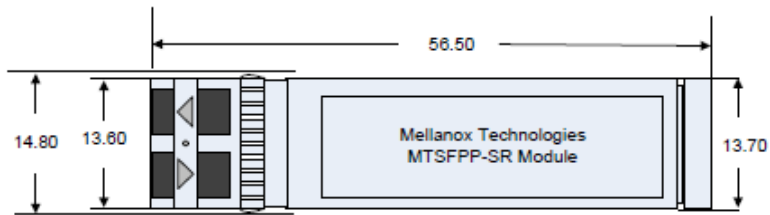

Rear View of Module with Pin Placement

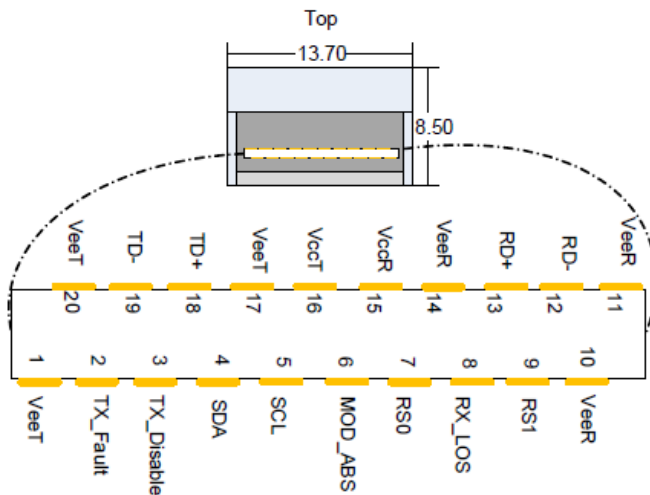

SFP Pin Description

Pin	Symbol Name	Description	Note
1	VeeT	Module Transmitter Ground	--
2	TX_Fault	Module Transmitter Fault	a
3	TX_Disable	Transmitter Disable. Turns off transmitter laser output	b
4	SDA	2-wire Serial Interface Data Line	c
5	SCL	2-wire Serial Interface Clock Line	d
6	MOD_ABS	Module Absent. Grounded within the module	d
7	RS0	No connection required	--
8	Rx_LOS	Loss of Signal indication. Logic 0 indicates normal operation.	d
9	RS1	No connection required	--

Pin	Symbol Name	Description	Note
10	VeeR	Receiver Ground (Common with Transmitter Ground)	a
11	VeeR	Receiver Ground (Common with Transmitter Ground)	a
12	RD-	Receiver Inverted DATA out. AC Coupled	--
13	RD+	Receiver Non-inverted DATA out. AC Coupled	--
14	VeeR	Receiver Ground (Common with Transmitter Ground)	a
15	VccR	Receiver Power Supply	--
16	VccT	Transmitter Power Supply	--
17	VeeT	Transmitter Ground (Common with Receiver Ground)	a
18	TD+	Transmitter Non-Inverted DATA in. AC Coupled	--
19	TD-	Transmitter Inverted DATA in. AC Coupled	--
20	VeeT	Transmitter Ground (Common with Receiver Ground)	a

Notes:

- a. TFAULT is an open collector/drain output, which should be pulled up with a 4.7k-10k Ohms resistor on the host board if intended for use. Pull up voltage should be between 2.0V to Vcc + 0.3V. A high output indicates a transmitter fault caused by either the TX bias current or the TX output power exceeding the preset alarm thresholds. A low output indicates normal operation. In the low state, the output is pulled to <0.8V.
- b. Laser output disabled on TDIS >2.0V or open, enabled on TDIS <0.8V
- c. Should be pulled up with 4.7kΩ-10kΩ on host board to a voltage between 2.0V and 3.6V. MOD_ABS pulls line low to indicate module is plugged in.
- d. LOS is open collector output. Should be pulled up with 4.7kΩ-10kΩ on host board to a voltage between 2.0V and 3.6V. Logic 0 indicates normal operation; logic 1 indicates loss of signal.

RJ45 to DB9 Harness Pinout

The RS232 harness cable (DB9 to RJ45) is provided within the package to connect a host PC to the system's Console RJ45 port.

RJ45 to DB9 Harness Pinout

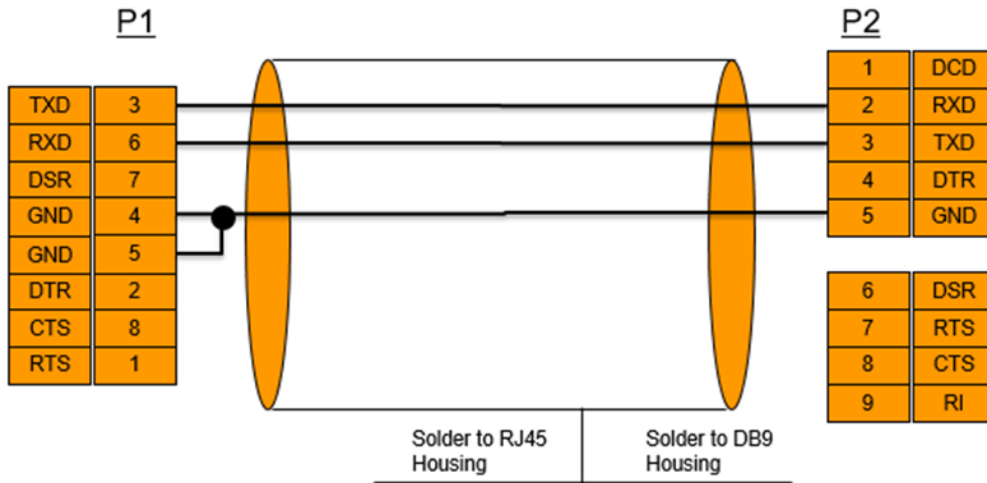

RJ45 to RJ45 Harness

2m RJ45-to-RJ45 serial port cable is provided in the SN2410 and SN2700 packages.

The harness must be used when connecting the switch serial port with the terminal server/console server.

⚠ The new harness can be extended by an ordinary flat 1-to-1 RJ45 cable.

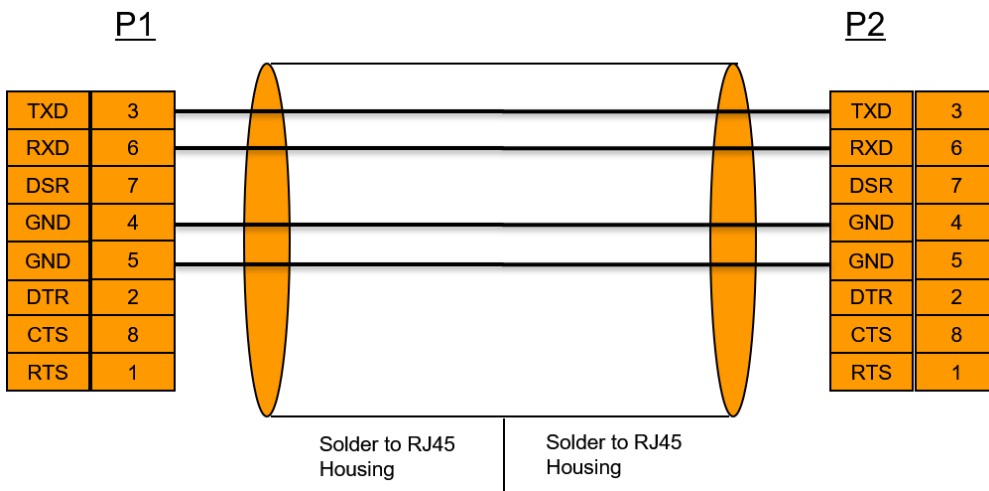

Disassembly and Disposal

Disassembly Procedure

To disassemble the system from the rack:

1. Unplug and remove all connectors.
2. Unplug all power cords.
3. Remove the ground wire.
4. Unscrew the center bolts from the side of the system with the bracket.

⚠ Support the weight of the system when you remove the screws so that the system does not fall.

5. Slide the system from the rack.
6. Remove the rail slides from the rack.
7. Remove the caged nuts.

Disposal

According to the WEEE Directive 2002/96/EC, all waste electrical and electronic equipment (EEE) should be collected separately and not disposed of with regular household waste. Dispose of this product and all of its parts in a responsible and environmentally friendly way.

Follow the instructions found at http://www.mellanox.com/page/dismantling_procedures for proper disassembly and disposal of the switch, according to the WEEE directive.



Document Revision History

Date	Revision	Description
November 29, 2020	3.2	Updated Accessory and Replacement Parts .
May 26, 2020	3.1	Added MSN2010-CB2F3C to the SN2100 Ordering Part Numbers (OPNs) table under Ordering Information .
May 3, 2020	3.0	Updated: <ul style="list-style-type: none"> • Cable Installation
March 29, 2020	2.9	Updated Thermal Threshold Definitions
December 2019	2.8	Updated: <ul style="list-style-type: none"> • Ordering Information • Installation
August 2019	2.7	Updated: <ul style="list-style-type: none"> • Ordering Information • Interfaces • Specifications • Interface Specifications • Mellanox Spectrum is a registered trademark; logo updated.
March 2019	2.6	Updated: <ul style="list-style-type: none"> • Interfaces • Management
December 2018	2.5	Migrated to online format; minor reorganization
October 2018	2.4	Updated High Power/LR4 Transceivers Support in the Interfaces chapter
August 2018	2.3	Added Static Single Switch Rail Kit for SN2100/SN2010
July 2018	2.2	Updated “Data Interfaces” and its sub-sections.
March 2018	2.1	Added SN2010 Updated “MLNX-OS” to “Onyx (MLNX-OS)” throughout the document
December 2017	2.0	Minor format updates Updated “High Power/LR4 Transceivers Support”
October 2017	1.9	Added SN2740 Updated: <ul style="list-style-type: none"> • “Installation Kit” • “System Installation and Initialization” • “SN2410 Splitting Options”
February 2017	1.8	Updated “Unit Identification LED”
	1.7	Updated: <ul style="list-style-type: none"> • “Data Interfaces” • “Specifications” • “RJ45 to DB9 Harness Pinout”

Date	Revision	Description
November 2016	1.6	Updated "Specifications"
September 2016	1.5	Added "Noise Level" to "Specifications" Updated: <ul style="list-style-type: none"> • "Reset Button" • "Status and Port LEDs"
June 2016	1.4	Updated: <ul style="list-style-type: none"> • "Introduction to Mellanox SN2000 Spectrum™ Ethernet Switch Systems" • "Ordering Information" • "Side by Side Mounting for SN2100/SN2010 Rail Kit"
May 2016	1.3	Added SX1012 to the following sections: <ul style="list-style-type: none"> • "Introduction to Mellanox SN2000 Spectrum™ Ethernet Switch Systems" • "Installation" • "Interfaces" • "Specifications" • "Accessory and Replacement Parts"
March 2016	1.2	Added "Taiwan BSMI Class A Statement in Safety Warnings" Updated: <ul style="list-style-type: none"> • "Introduction to Mellanox SN2000 Spectrum™ Ethernet Switch Systems" • "Software Management" • "Troubleshooting Instructions" • "Specifications" • "Accessory and Replacement Parts"
December 2015	1.1	Added SN2410
August 2015	1.0	First revision

Notice

This document is provided for information purposes only and shall not be regarded as a warranty of a certain functionality, condition, or quality of a product. Neither NVIDIA Corporation nor any of its direct or indirect subsidiaries (collectively: "NVIDIA") make any representations or warranties, expressed or implied, as to the accuracy or completeness of the information contained in this document and assumes no responsibility for any errors contained herein. NVIDIA shall have no liability for the consequences or use of such information or for any infringement of patents or other rights of third parties that may result from its use. This document is not a commitment to develop, release, or deliver any Material (defined below), code, or functionality.

NVIDIA reserves the right to make corrections, modifications, enhancements, improvements, and any other changes to this document, at any time without notice.

Customer should obtain the latest relevant information before placing orders and should verify that such information is current and complete.

NVIDIA products are sold subject to the NVIDIA standard terms and conditions of sale supplied at the time of order acknowledgement, unless otherwise agreed in an individual sales agreement signed by authorized representatives of NVIDIA and customer ("Terms of Sale"). NVIDIA hereby expressly objects to applying any customer general terms and conditions with regards to the purchase of the NVIDIA product referenced in this document. No contractual obligations are formed either directly or indirectly by this document.

NVIDIA products are not designed, authorized, or warranted to be suitable for use in medical, military, aircraft, space, or life support equipment, nor in applications where failure or malfunction of the NVIDIA product can reasonably be expected to result in personal injury, death, or property or environmental damage. NVIDIA accepts no liability for inclusion and/or use of NVIDIA products in such equipment or applications and therefore such inclusion and/or use is at customer's own risk. NVIDIA makes no representation or warranty that products based on this document will be suitable for any specified use. Testing of all parameters of each product is not necessarily performed by NVIDIA. It is customer's sole responsibility to evaluate and determine the applicability of any information contained in this document, ensure the product is suitable and fit for the application planned by customer, and perform the necessary testing for the application in order to avoid a default of the application or the product. Weaknesses in customer's product designs may affect the quality and reliability of the NVIDIA product and may result in additional or different conditions and/or requirements beyond those contained in this document. NVIDIA accepts no liability related to any default, damage, costs, or problem which may be based on or attributable to: (i) the use of the NVIDIA product in any manner that is contrary to this document or (ii) customer product designs. No license, either expressed or implied, is granted under any NVIDIA patent right, copyright, or other NVIDIA intellectual property right under this document. Information published by NVIDIA regarding third-party products or services does not constitute a license from NVIDIA to use such products or services or a warranty or endorsement thereof. Use of such information may require a license from a third party under the patents or other intellectual property rights of the third party, or a license from NVIDIA under the patents or other intellectual property rights of NVIDIA.

Reproduction of information in this document is permissible only if approved in advance by NVIDIA in writing, reproduced without alteration and in full compliance with all applicable export laws and regulations, and accompanied by all associated conditions, limitations, and notices.

THIS DOCUMENT AND ALL NVIDIA DESIGN SPECIFICATIONS, REFERENCE BOARDS, FILES, DRAWINGS, DIAGNOSTICS, LISTS, AND OTHER DOCUMENTS (TOGETHER AND SEPARATELY, "MATERIALS") ARE BEING PROVIDED "AS IS." NVIDIA MAKES NO WARRANTIES, EXPRESSED, IMPLIED, STATUTORY, OR OTHERWISE WITH RESPECT TO THE MATERIALS, AND EXPRESSLY DISCLAIMS ALL IMPLIED WARRANTIES OF NONINFRINGEMENT, MERCHANTABILITY, AND FITNESS FOR A PARTICULAR PURPOSE. TO THE EXTENT NOT PROHIBITED BY LAW, IN NO EVENT WILL NVIDIA BE LIABLE FOR ANY DAMAGES, INCLUDING WITHOUT LIMITATION ANY DIRECT, INDIRECT, SPECIAL, INCIDENTAL, PUNITIVE, OR CONSEQUENTIAL DAMAGES, HOWEVER CAUSED AND REGARDLESS OF THE THEORY OF LIABILITY, ARISING OUT OF ANY USE OF THIS DOCUMENT, EVEN IF NVIDIA HAS BEEN ADVISED OF THE POSSIBILITY OF SUCH DAMAGES. Notwithstanding any damages that customer might incur for any reason whatsoever, NVIDIA's

aggregate and cumulative liability towards customer for the products described herein shall be limited in accordance with the Terms of Sale for the product.

Trademarks

NVIDIA, the NVIDIA logo, and Mellanox are trademarks and/or registered trademarks of Mellanox Technologies Ltd. and/or NVIDIA Corporation in the U.S. and in other countries. Other company and product names may be trademarks of the respective companies with which they are associated. For the complete and most updated list of Mellanox trademarks, visit <http://www.mellanox.com/page/trademarks>

Copyright

© 2021 Mellanox Technologies Ltd. All rights reserved.