

CISCO *Live!*

ALL IN

#CiscoLive



The bridge to possible

# Webex Desk Series Deep Dive

David Scott CCIE, Technical Marketing Engineer

BRKCOL-2390

CISCO *Live!*

#CiscoLive

# Cisco Webex App

## Questions?

Use Cisco Webex App to chat with the speaker after the session

## How

- 1 Find this session in the Cisco Live Mobile App
- 2 Click “Join the Discussion”
- 3 Install the Webex App or go directly to the Webex space
- 4

Enter messages/questions in the Webex space

Webex spaces will be moderated by the speaker until June 17, 2022.

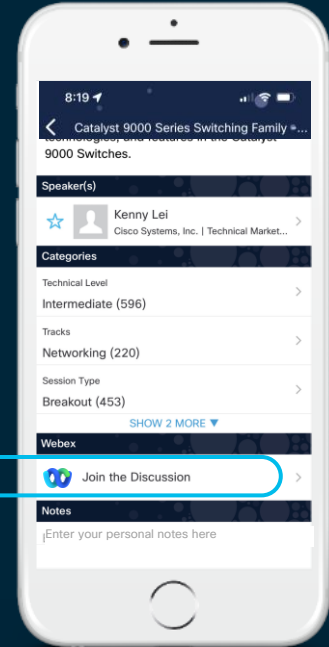

<https://cislive.ciscoevents.com/cislivebot/#BRKCOL-2390>

# Agenda

- Introduction
- Webex Desk Pro
- Webex Desk
- Webex Desk Mini
- Webex Desk Hub
- Cisco Desk Cameras
- RoomOS Platform Features
- Vertical Deployment Scenarios

# The Webex Desk family



Desk  
Camera  
1080p

Desk  
Camera  
4k

Desk Hub

Desk Mini

Desk

Desk Pro

# Evolution of the Webex Desk Series

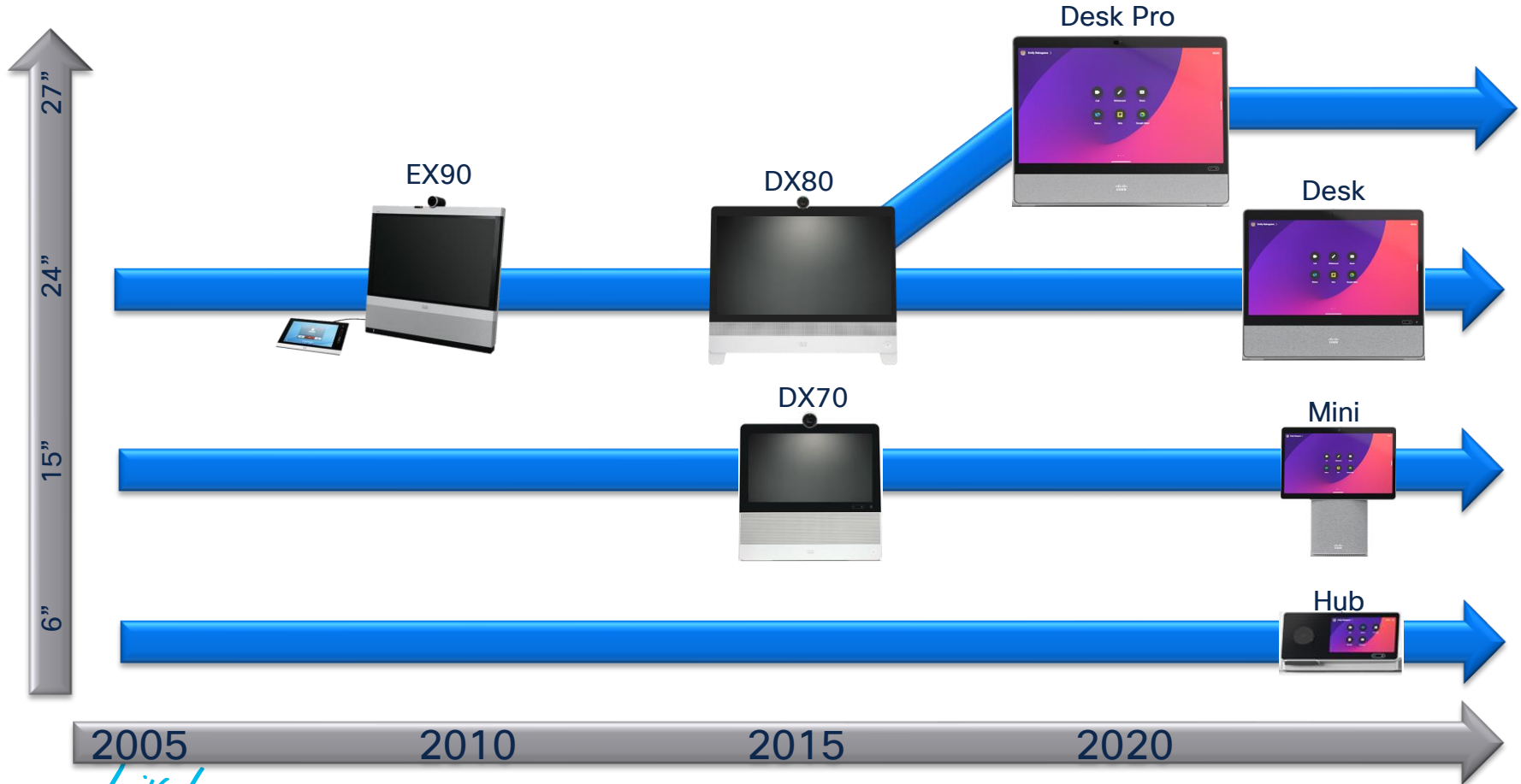

# Webex Desk Pro



# Introduction to the Webex Desk Pro

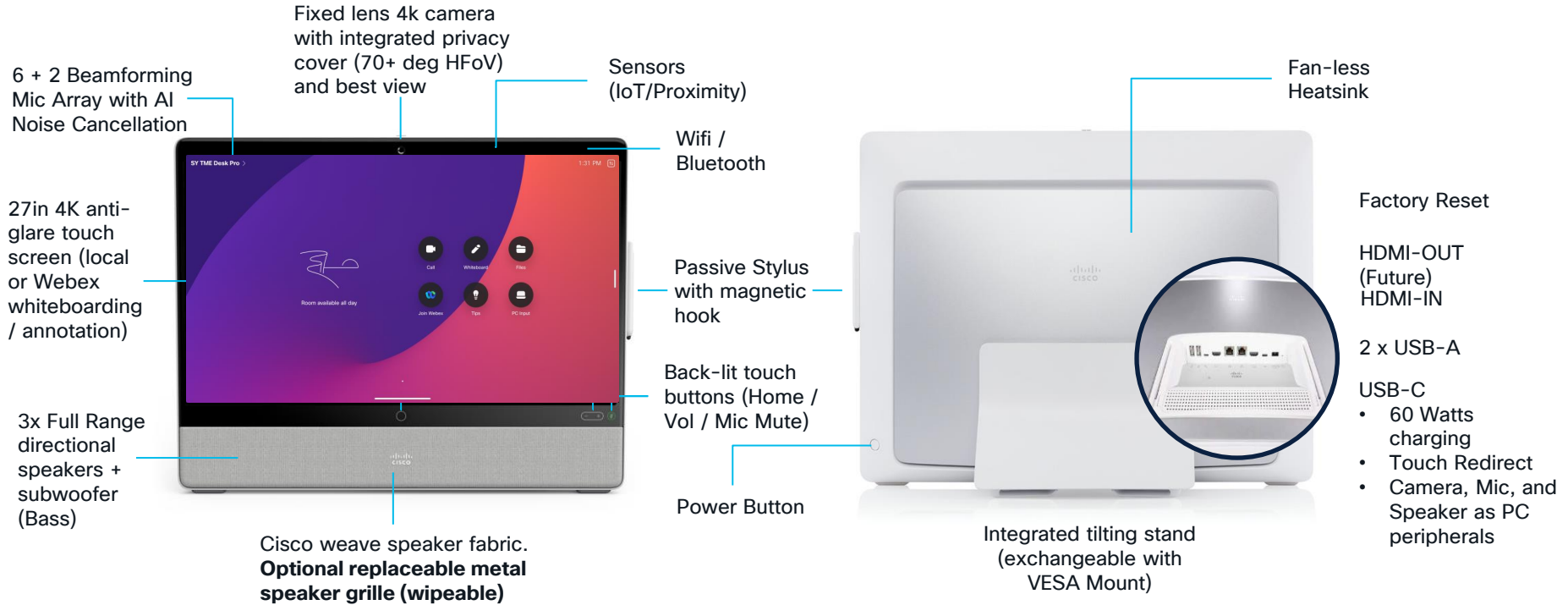



# Key Features

- Calling and Sharing
- Whiteboard
- Webex Meetings
- Noise suppression
- Immersive Share
- Virtual Backgrounds
- Webex Assistant



Whiteboard in a call  
and share to Webex®

# Easy installation – desk stand, wall mount, grille

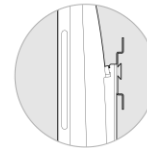
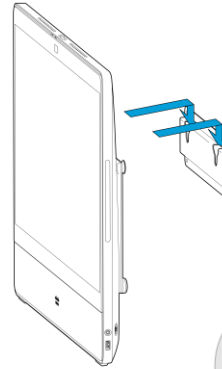
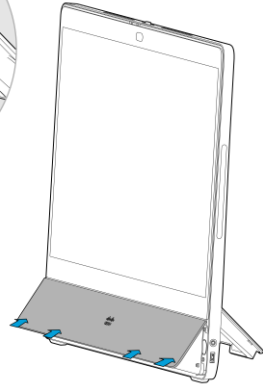
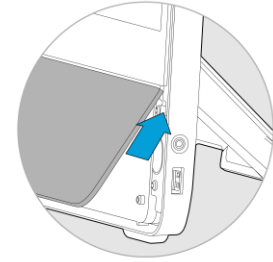
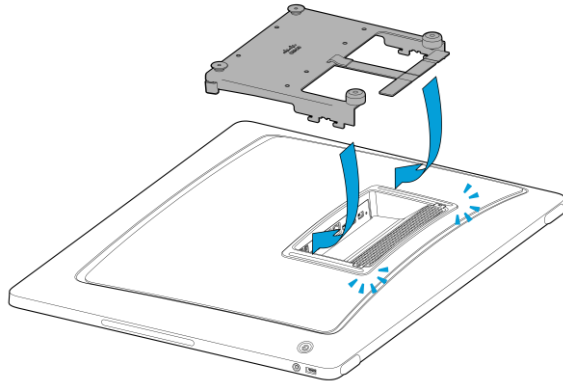
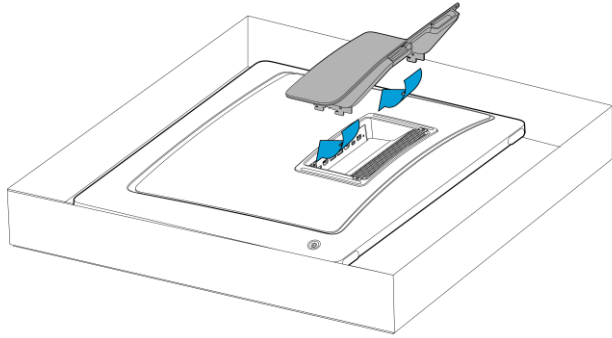

# Webex Desk

# Key Features of the Webex Desk

- Calling and Sharing
- Whiteboard
- Webex Meetings
- Noise suppression
- Immersive Share
- Virtual Backgrounds
- Webex Assistant
- Wireless sharing



- 24" Screen & 1080p
- One center speaker
- 4 beamforming array
- 64 degrees FOV
- Virtual backgrounds
- USB-C forwarding
- Optional metal grille
- Rear Power Button

# Comparison of ports – Webex Desk Pro vs Desk

## Webex Desk Pro

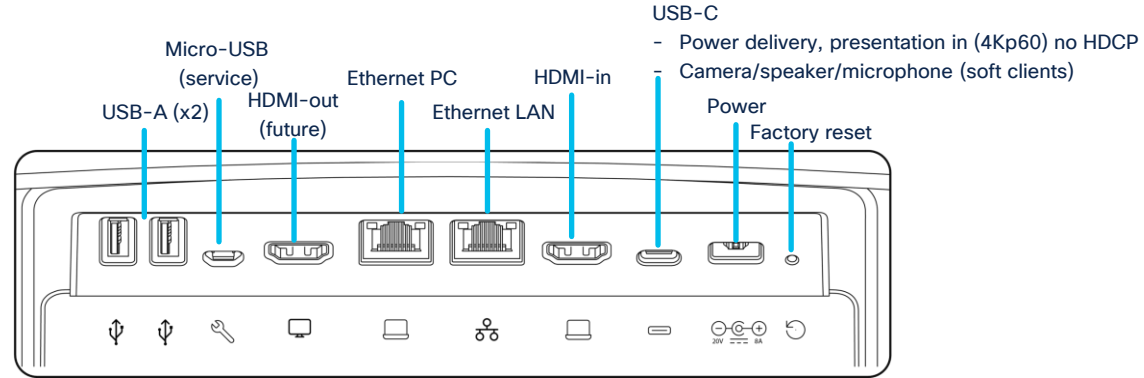

## Webex Desk

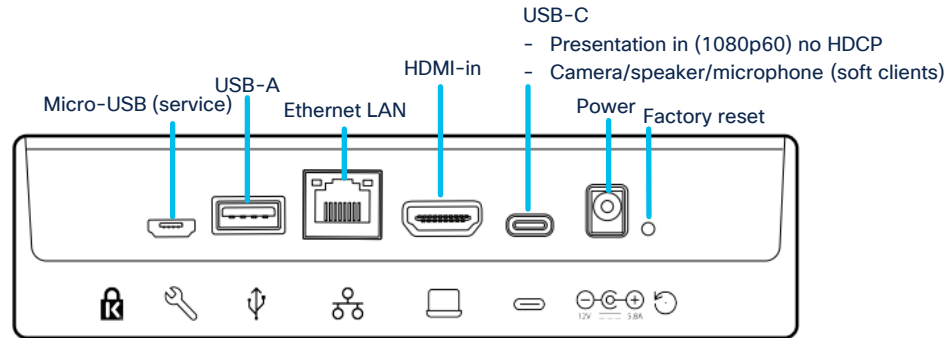

# Webex Desk – Color Options



In addition to our familiar First Light (White), you can choose the dramatically deep Carbon Black, as well as three new limited-edition colors formulated to complement spaces and lifestyles: Desert Sand, Nordic Blue, and Woodland Green.

# Stand for Webex Desk

- A 15- or 11-degree tilt angle depending upon screw placement
- Screws positioned at the top results in 11-degree tilt
- Screws positioned at the bottom results in 15-degree tilt
- Stand includes L shaped Allen wrench
- Arrow on stand indicates degree of tilt

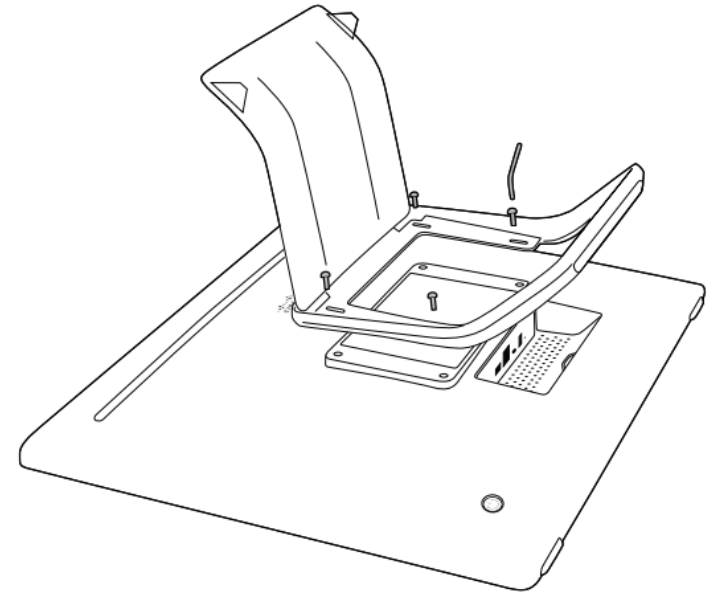
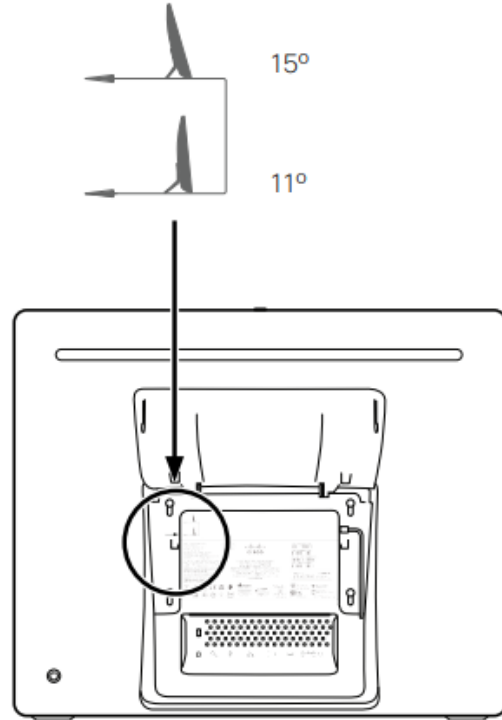

# Wall Mount for Webex Desk

- The VESA bracket is not needed for Webex Desk
- 4 bumpers are added to the back of unit
- Top two bumpers go into the wall mount
- Bumper feet can be removed at the bottom of the unit

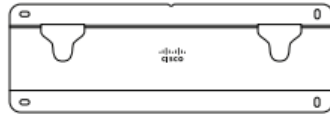

<https://www.cisco.com/c/dam/en/us/td/docs/telepresence/endpoint/desk-series/installation-guide/cisco-webex-desk-installation-guide-multilingual.pdf>



# The Webex Desk Pro compared with Webex Desk

	<b>Desk Pro</b>	<b>Desk</b>
Size	27"	24"
Resolution	4k	1080p
Audio	Stereo speakers 3.1 6+2 beamforming mic array, 3.5mm mini jack	One center speaker 4 beamforming mic array
Camera	4K Ultra HD, HFOV 71° Automatic tilt, 2 x digital zoom	8MP HD, HFOV 64° Automatic tilt, 2 x digital zoom
Virtual background support	Yes	Yes
USB-C Capabilities	Screen share; Windows touch forwarding; Camera, Mic, and Speaker as PC peripherals; laptop power (up to 60W)	Screen share; Windows touch forwarding; Camera, Mic, and Speaker as PC peripherals
Changeable speaker grille	Yes (default is fabric)	Yes (default is fabric)

# Webex Desk Mini

# Webex Desk Mini

## Hardware at a glance

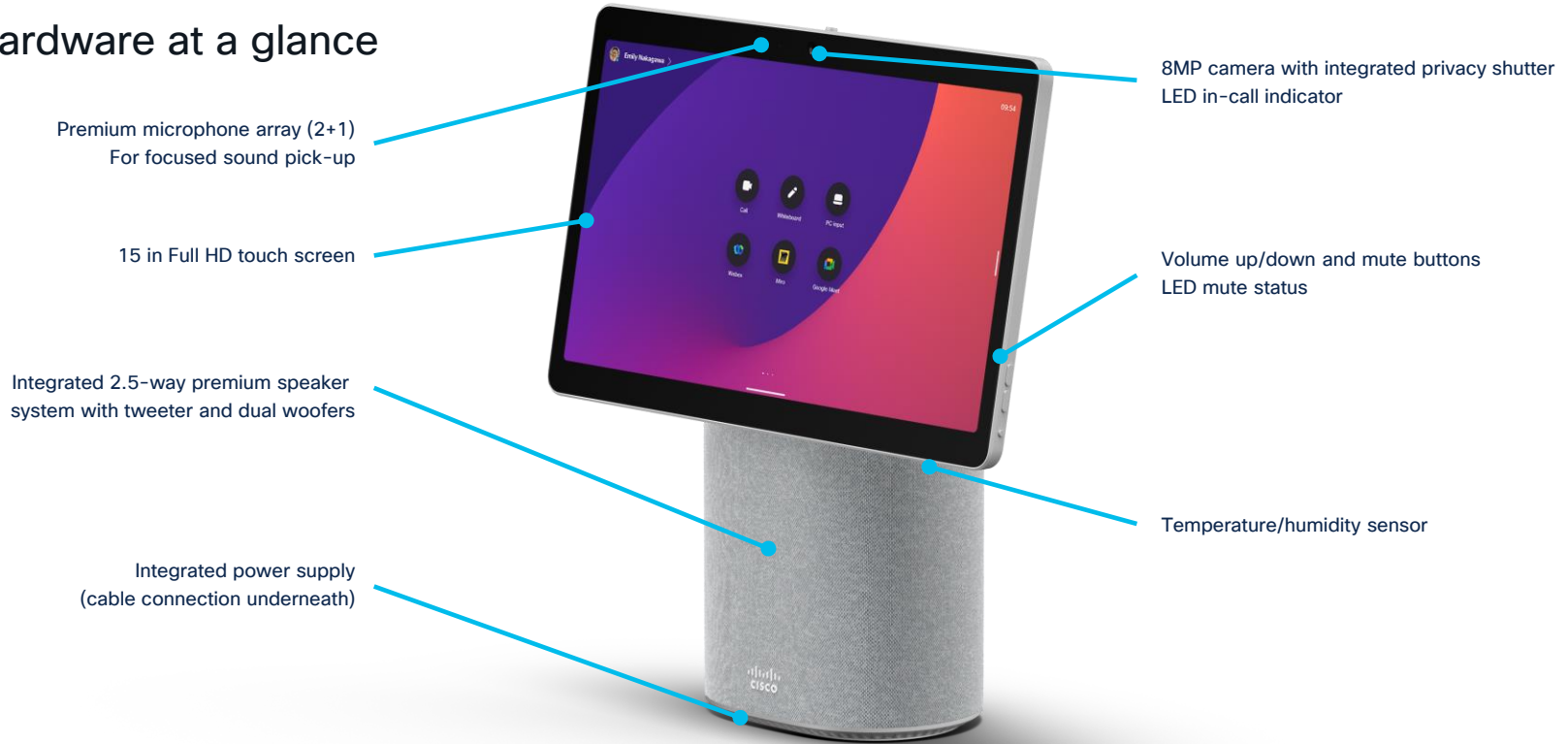



# Portability

- Desk Mini is equipped with an integrated handle for easy transportation.
- All you need is to connect the power cable, switch on and you can work from wherever you like.
- Integrated power supply
- Wi-Fi support for:
  - 802.11a/b/g/n/ac
  - 2.4 GHz/5 GHz
  - 2x2 MIMO

# Connectivity Ports and Slots



- 1** • USB Type A
- 2** • Ethernet (10/100/1000)
- 3** • USB Type C
  - Audio and video (1080p60 input)
  - Camera (4kp30)/mic/touch output
  - 7.5W max PD

- 4** • Service (micro USB)
- 5** • Port cover (magnetic)
- 6** • Power connection (underneath Desk Mini)

# Webex Desk Mini – Color Options



In addition to our familiar First Light (White), you can choose the dramatically deep Carbon Black, as well as three new limited-edition colors formulated to complement spaces and lifestyles: Desert Sand, Nordic Blue, and Woodland Green.

# Webex Desk Hub



# Webex Desk Hub Features

- Hotdesking via smartphone or laptop
- Personal Mode Calendar and OBTJ
- Cisco Desk Camera/Audio Redirect for 3rd party meetings
- Wireless Smartphone Charging
- 2 x RJ-45 or Wireless Networking
- 3 x USB-C ports and 1 x USB-A port
- Attachable 730 Headset cradle
- Bring your own monitor support
- Platinum Color: CD-DSKH-HUB-P-K9
- Carbon Color: CD-DSKH-HUB-C-K9

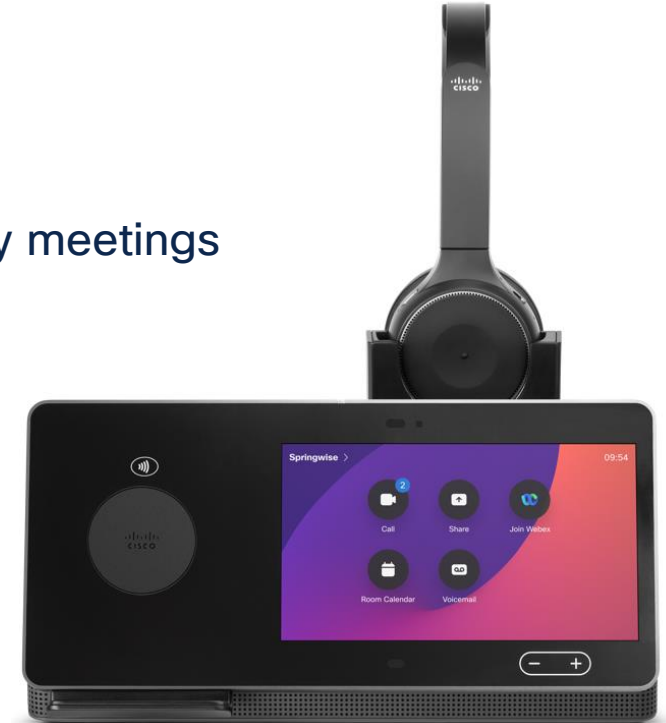



# User Experience

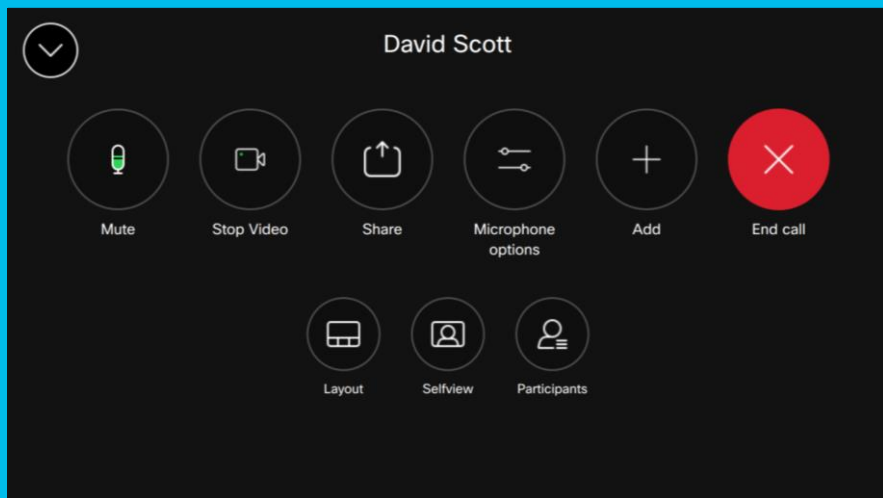
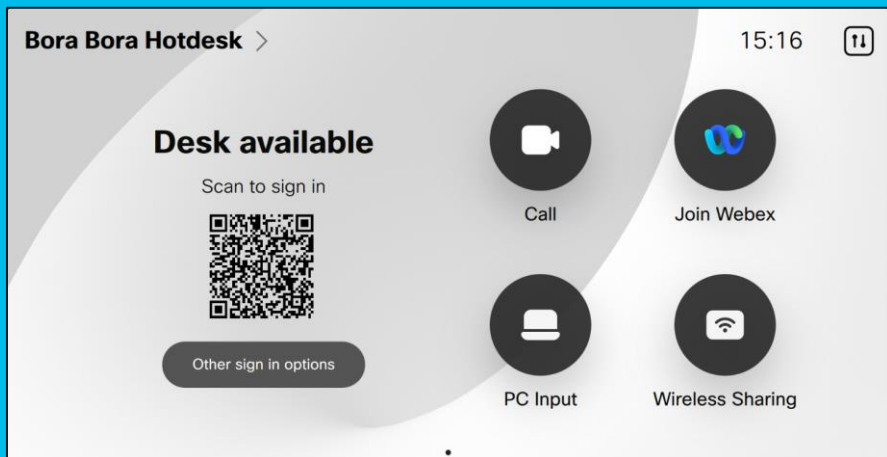

# Accessory Requirements

	Desk Hub
Monitor with HDMI or USB-C port *	Required
Desk Camera 4K or 1080p	Required
Third Party Cameras	Not supported
Headset (Wired or Wireless)	Optional - 730 Recommended

# Webex Desk Hub Cabling (Scenario 1)

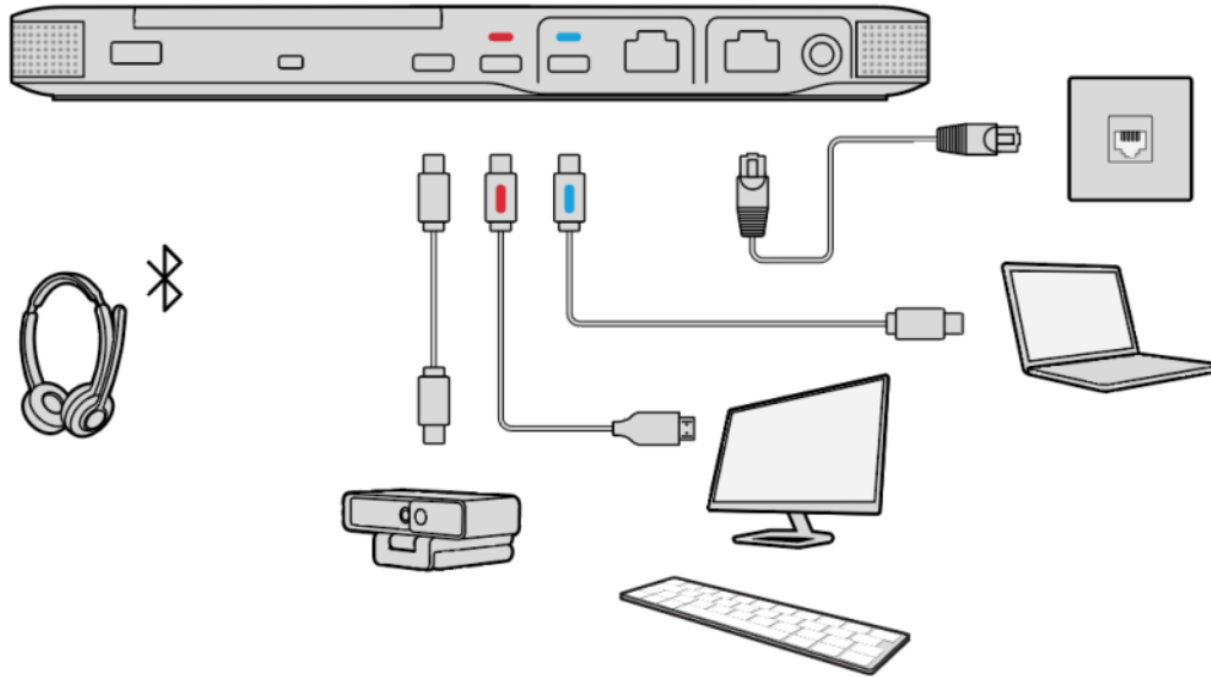

# Webex Desk Hub - Cabling

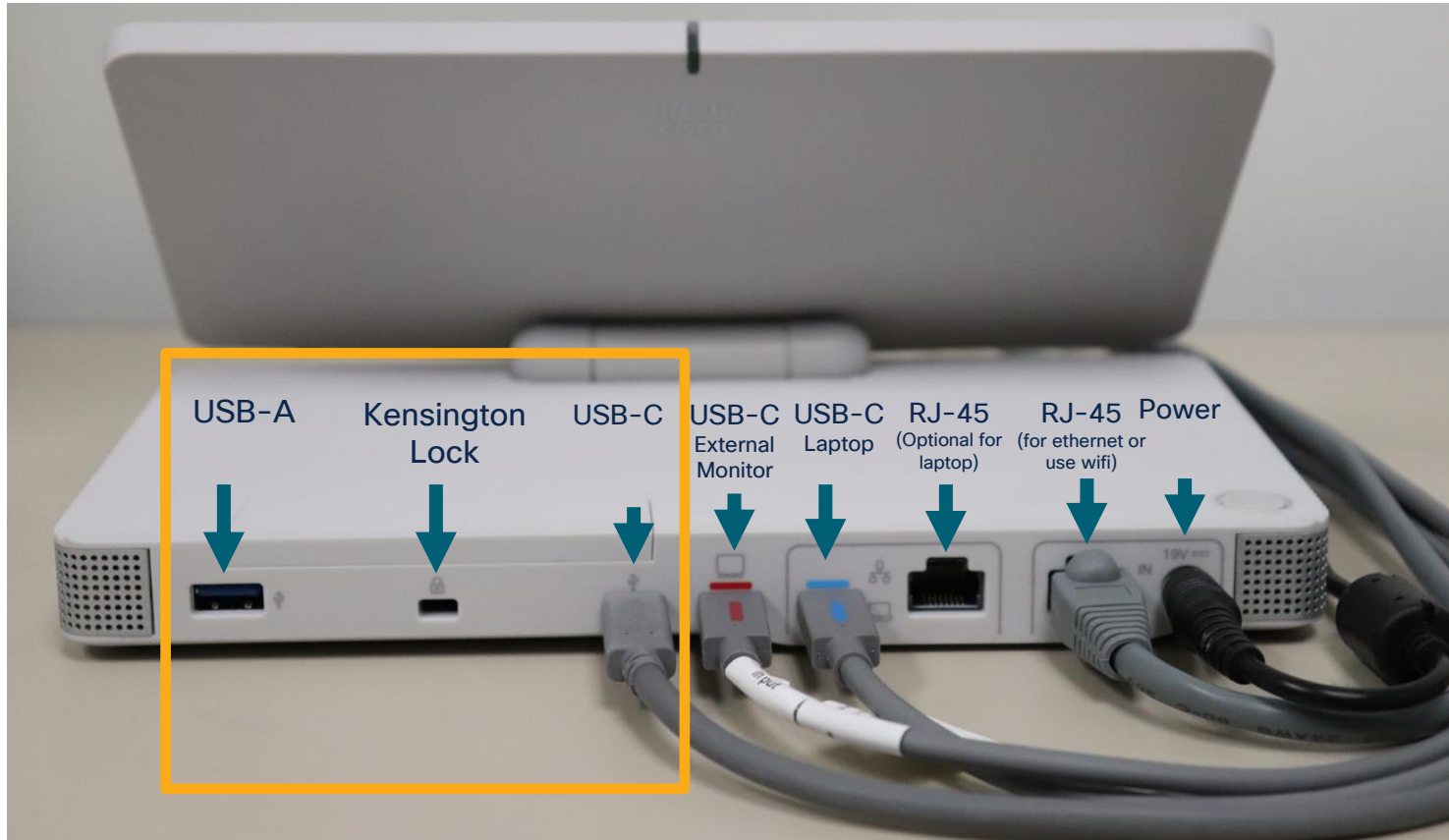

# Webex Desk Hub (Scenario 2: USB Routing)

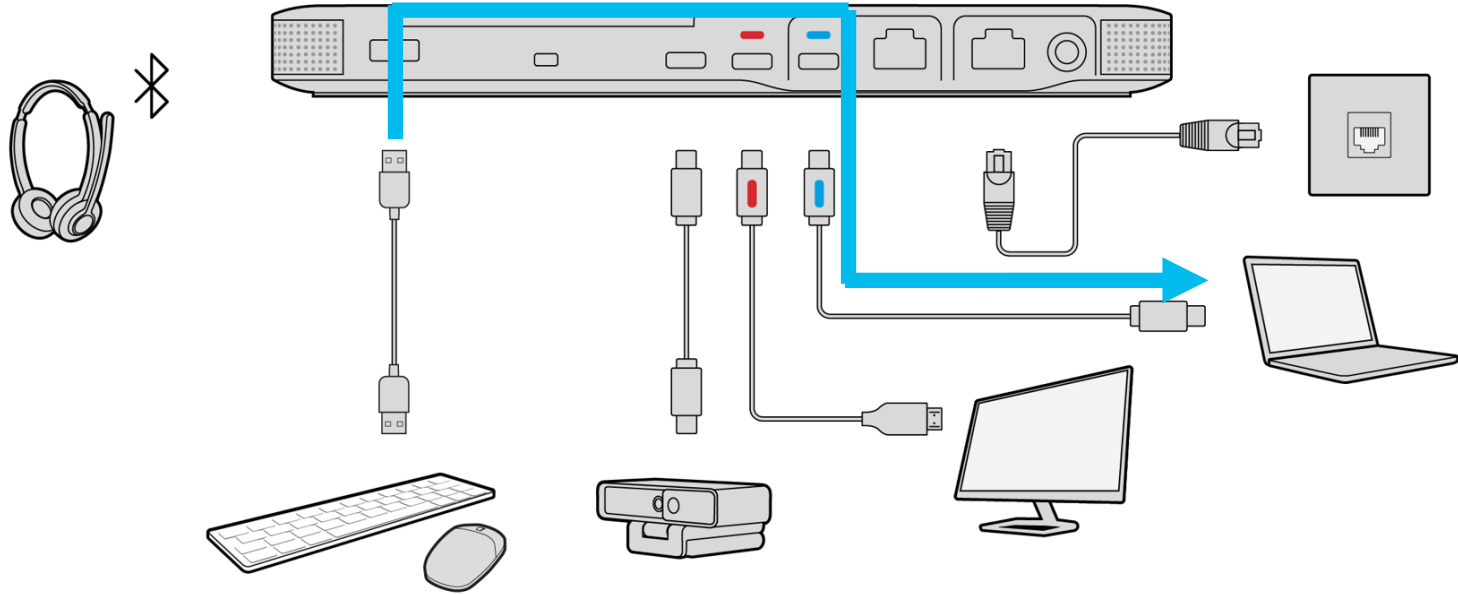

## USBForwarding

USBA Enabled

False

USBC Enabled

False

# Cisco Desk Cameras



# Introducing the Cisco Desk Camera Series

- Cisco Desk Camera 1080p



- Cisco Desk Camera 4K



# Cisco Desk Camera 4k



# Cisco Desk Camera 1080p

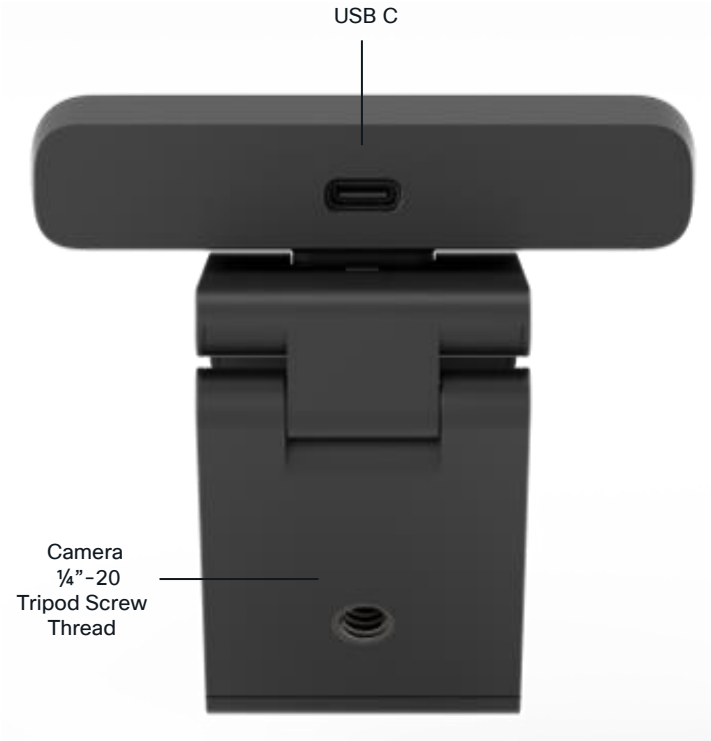
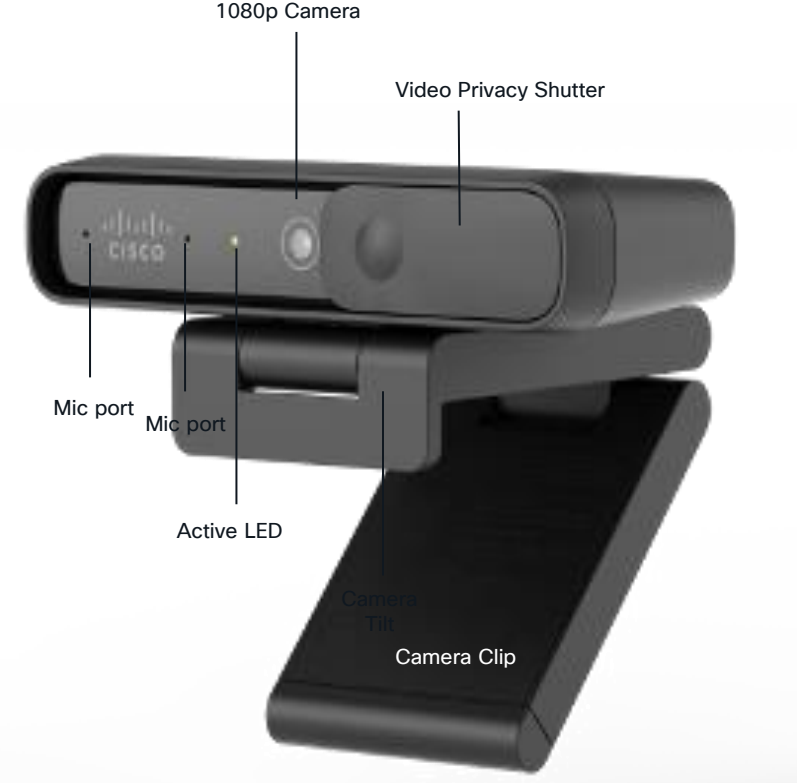



# Comparing Cameras

	<b>Desk Camera 1080p</b>	<b>Desk Camera 4k</b>
Color	Carbon Black	Carbon Black, Platinum
Material	Plastic	Aluminum
Max resolution	1080p	4k
Best Overview	No	Yes
Image Sensor	8MP	13MP
Digital zoom	4x	10x

## Cisco Desk Camera App

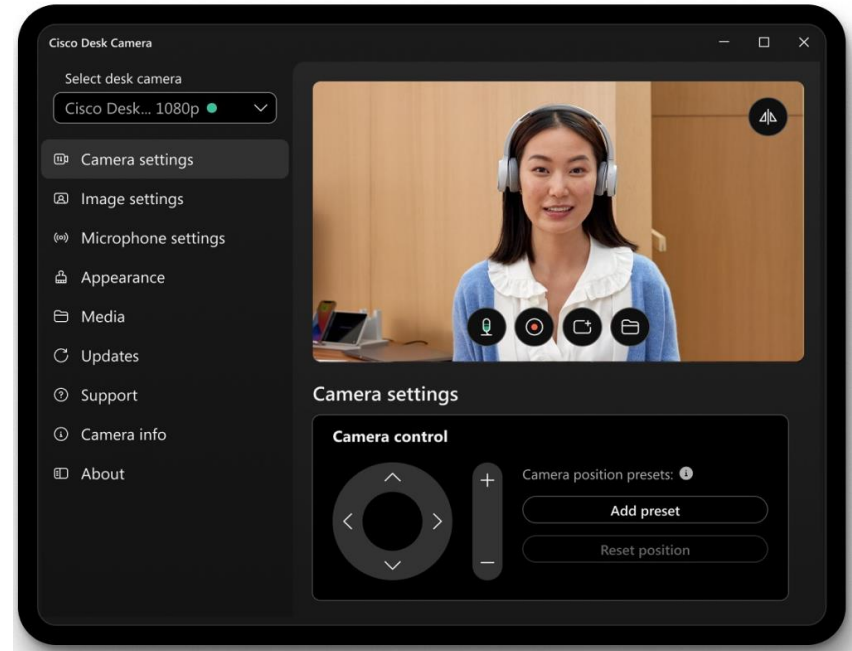

To manually upgrade go to [upgrade.cisco.com/accessories](https://upgrade.cisco.com/accessories) or use app.  
Note: Webex app and Desk Hub can automatically upgrade

# Desk portfolio – key features comparison

	<b>Desk Hub + Camera</b>	<b>Desk Mini</b>	<b>Desk</b>	<b>Desk Pro</b>
Size	6" touch control panel - requires external display	15-inch	24-inch	27-inch
Resolution	up to 4k external display support	1080p	1080p	4k
Audio	Wideband speakerphone Directional microphone	2.5 loudspeaker system with dual woofers and tweeter Dual mic array + single mic	Full-range mono loudspeaker 4 mic array	Stereo speakers 3.1 6+2 beamforming mic array
Camera	4K (Ultra HD)	8MP Automatic tilt Digital zoom	8MP Automatic tilt Digital zoom	4K (Ultra HD) Automatic tilt Digital zoom
Virtual background support	Yes	Yes	Yes	Yes

Check compliance class and local regulations before deploying devices in homes

# Desk portfolio – key BYOD feature support

	Desk Hub + Camera	Desk Mini	Desk	Desk Pro
USB-C capabilities	Screen share Client agnostic Windows touch forwarding Laptop charging (65 watts)	Screen share Client agnostic Windows touch forwarding	Screen share Client agnostic Windows touch forwarding	Screen share Client agnostic Windows touch forwarding Laptop charging (60 watts)
Smartphone wireless charging	Yes	No	No	No
Bluetooth®	Yes	Yes	Yes	Yes
USB Headset support	Yes	Yes	Yes	Yes
3.5 mm mini jack	No	No	No	Yes
Dual Display	No	No	No	Yes (HMD! out – roadmap feature)

The Bluetooth® word mark and logos are registered trademarks owned by Bluetooth SIG, Inc. and any use of such marks by Cisco Systems, Inc. is under license. Other trademarks and trade names are those of their respective owners.

# RoomOS Platform Features



# Tutorials

- Registration
- Noise Removal
- OBTP and Sharing
- Layouts
- Webex Assistant
- Whiteboard
- Touch Redirect
- Immersive Share
- Virtual Background
- Adjust Camera View

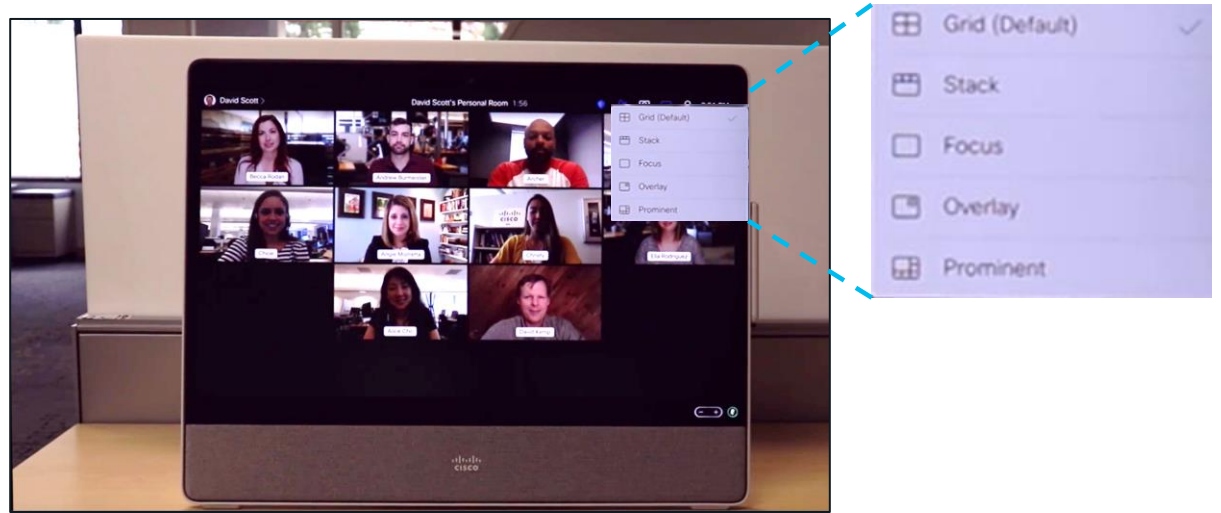

<https://resources.webex.com/webex-essentials/webex-devices-users>

- Click “Videos” section
- Tutorials localized in different languages

# RoomOS Hotdesking Options

## USB-C

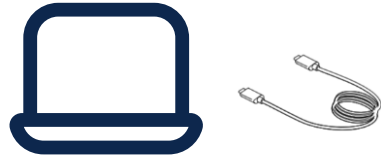

## QR



	Desk Pro	Desk	Desk Mini	Desk Hub
USB-C + laptop	Yes	Yes	Yes	Yes
QR Code	Yes	Yes	Yes	Yes
NFC	No	No	No	Yes

# End User Workflow – Before and After Sign-in

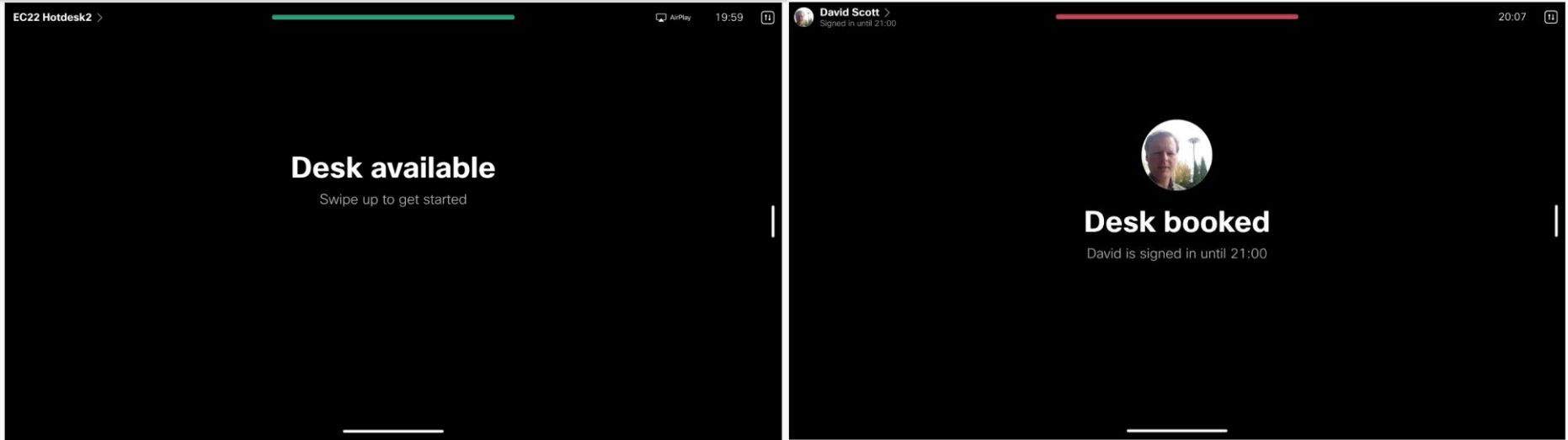

# End User Workflow – Book the Desk

- Choose one hour booking slots
- Defaulted to 5 pm local time
- Can book all the way until end of the day – 11:59PM
- Use left arrow to choose an earlier time to end booking

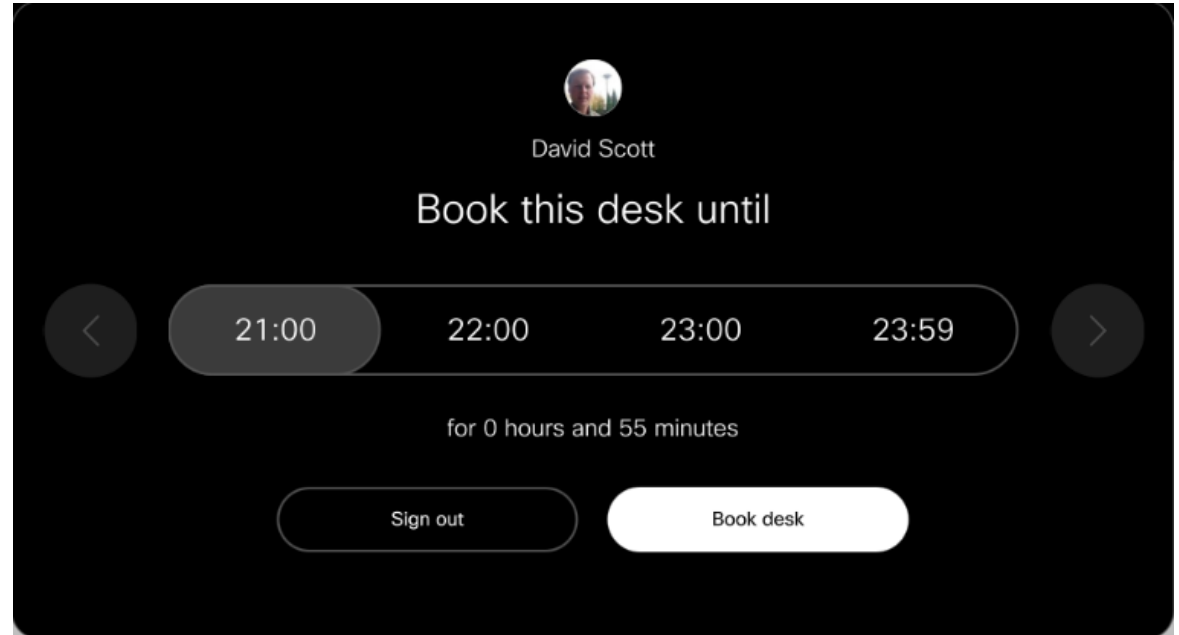



# End User Workflow – Sign-out

- You can wait for booking session to expire. Desk Hub will then automatically sign out the user
- Manually sign out by clicking name in the upper left corner and then choosing Sign out
- You can also sign out from the Webex app by selecting “Sign out”

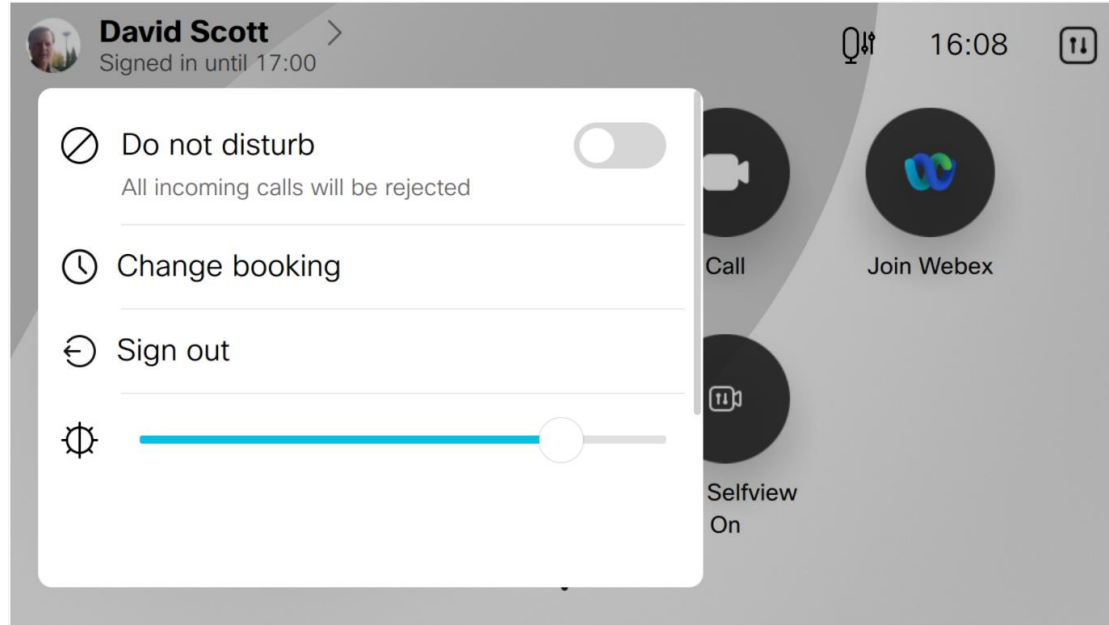

# Admin Hotdesking Enablement Overview

1. Create a new Workspace in Webex Control Hub and enable Hotdesking capability for that Workspace. Issue an activation code for Webex Desk Series in that Workspace
2. Opt-in to QR or NFC Hotdesking
3. Disable Standby on Desk Series and decrease Ultrasound (optional)
4. Validate that Smartphones and/or Laptops have the latest version of Webex installed

# Step 1 – Add Workspace with Hot Desking support

### Add Workspace

Which services are needed in this Workspace?

**Calling**

- Call on Webex (1:1 call, non-PSTN) (default)
- Cisco Webex Calling  
Free Calling features with additional PSTN service provided through Webex.
- Hybrid Calling  
Free Calling features with additional PSTN service from existing premises, using Unified CM or an HCS partner.

---

**Workspace Scheduling**

- None  
The workspace will be available without the following Room Scheduling services.
- Calendar  
Calendar service enables One Button To Push for this Workspace.
- Hot Desking  
Enabled Hot Desking automatically configures Desk Hub and Desk Pro series devices in the workspace to be in Hot Desk mode.

[Back](#) [Next](#)

# Step 2 - Opt-in to QR Hotdesking

- QR and/or NFC Hotdesking via Smartphone is disabled by default
- Desk Series will automatically have Hotdesking enabled with USB-C support
- Smartphone or laptop must run latest version of Webex app

The screenshot displays the Cisco Webex Settings application. At the top left, the word "Settings" is prominently displayed. Below it, there are four navigation tabs: "Configurations" (selected), "Statuses", "Send Whiteboard to Email", and "Audio and Video". A search bar is located below the tabs. On the left side, there is a vertical menu with several options: "Audio", "Bluetooth", "Bookings", "BYOD" (highlighted in blue), "CallHistory", and "Camera". The main content area is titled "Configuration / BYOD" and includes "Collapse All" and "Expand All" buttons. The configuration list shows two items: "QRCodePairing" set to "Enabled" and "TouchForwarding Enabled" set to "True". Each item has an information icon (i) to its left.

# Step 3 – Disable Standby for Perpetual Availability Status (Optional) and set Ultrasound to zero (Optional)

- By default, the Desk Series will go into standby and turn off monitor
- Unless standby is disabled, the end users will be unable to see the availability status
- Set Ultrasound to zero to disable it. This avoids wireless pairing in an office that has an open seating area

The screenshot shows the 'Settings' page with three tabs: 'Configurations', 'Statuses', and 'Audio and Video'. The 'standby control' search filter is active in the left sidebar. The 'Configuration' section is expanded, showing the 'Standby' category. Under 'Standby', the 'Control' setting is set to 'Off' via a dropdown menu. There are also 'Collapse All' and 'Expand All' buttons in the top right of the configuration area.

# Step 4 – Run latest version of Webex

- Make sure the Webex Client is up to date
- For NFC, make sure NFC support is enabled on the Webex client. This is on by default.
- For NFC, make sure NFC support is enabled on the device via Webex Control Hub (see step 2).
- For USB-C, make sure the Webex client is running the latest build. Make sure the USB-C cable is plugged into the correct port on the Desk Hub and that the USB-C cable being used is the one that came with the device.

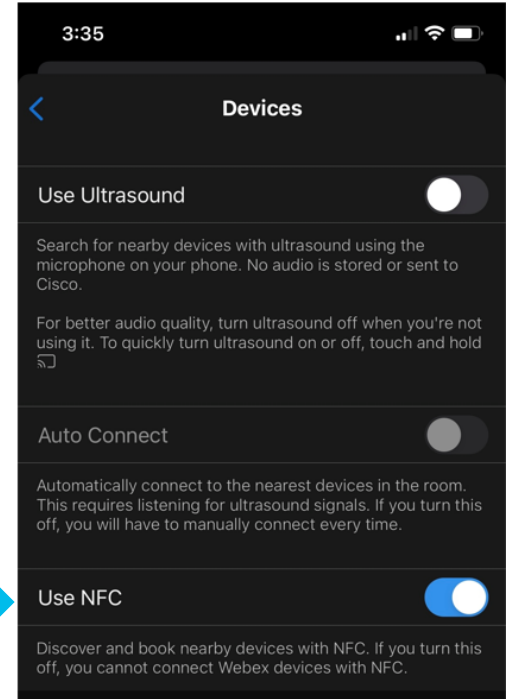
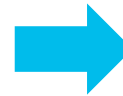

# Webex Control Hub

Control Hub is your single pane of glass for

- Workspace management
- Device Management
- User Management
- Services Management

The screenshot displays the Webex Control Hub interface for a workspace named 'Springwise'. The interface is organized into several sections:

- Overview:** Shows 'Desk - Capacity: 2 people - Device idle - Vacant'.
- Devices:** Lists 'Cisco Webex Desk Pro' with a status of 'Online today at 17:24'. It also shows a 'Software Upgrade Channel' set to 'Latest' and 'Lock Settings on Touch Devices' set to 'Off'. Action buttons include 'Pair device', 'Edit API Access', and 'Add Device'.
- Real-Time Utilisation Metrics:** A table showing current status: Devices: 2 (1 idle, 1 occupied), Occupied: No, Occupants: 0, Booked: No, Paired apps: 1. A 'View Details' button is present.
- Real-Time Environmental Metrics:** Shows 'Sound Level' at 34 dBA, 'Ambient Noise' at 32 dBA, 'Temperature' at 15/59 °C/°F, 'Relative Humidity' at 57%, and 'Air quality (TVOC)' as 'Not available'. A 'View Details' button is present.
- Calling:** Shows 'Call on Webex (1:1 call, non-PSTN)' and 'Cisco Webex SIP Address' as 'springwise@medemo.rooms.webex.com'.
- Scheduling:** Shows 'Office 365' as 'Activated - since last Friday at 12:11' with a 'See history' link. It also lists 'Email Address' as 'dp@medemo.com' and 'In-room booking' as 'Off'. A 'View Scheduled Meetings' button is present.
- Location:** Shows 'Charlie Lab' with a small video thumbnail of a person working at a computer.

# RoomOS 11 UI

- Currently available on Board and Desk Series
  - Cloud-registered or Webex Edge for Devices
- Org-level Enablement
  - Control Hub – Devices – Settings – Enable RoomOS 11 UI Experience as default
- Device Level Enablement
  - Control Hub – Devices – <Select Device> – All Configurations
    - UserInterface > Concept > Tablet > Compositor (From Desktop)
    - Device needs to have Cloud Upgrade Mode enabled
- Software release will still show RoomOS 10.x.x.x
  - Will move to 11.x.x.x once Room systems are added

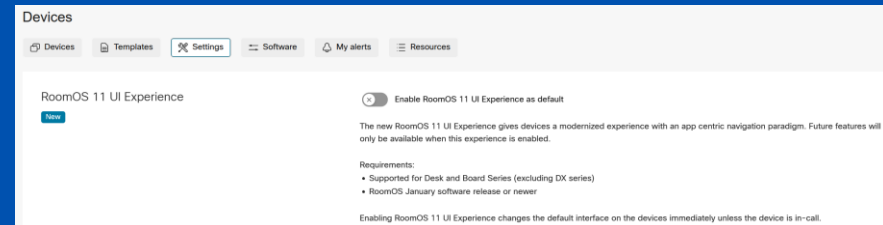



# Virtual backgrounds

- Create a virtual office by replacing your background in real time.
- Choose to blur your current background or select from pre-loaded images.
  - Webex Desk Pro
  - Webex Desk
  - Webex Mini
  - Webex Desk Hub

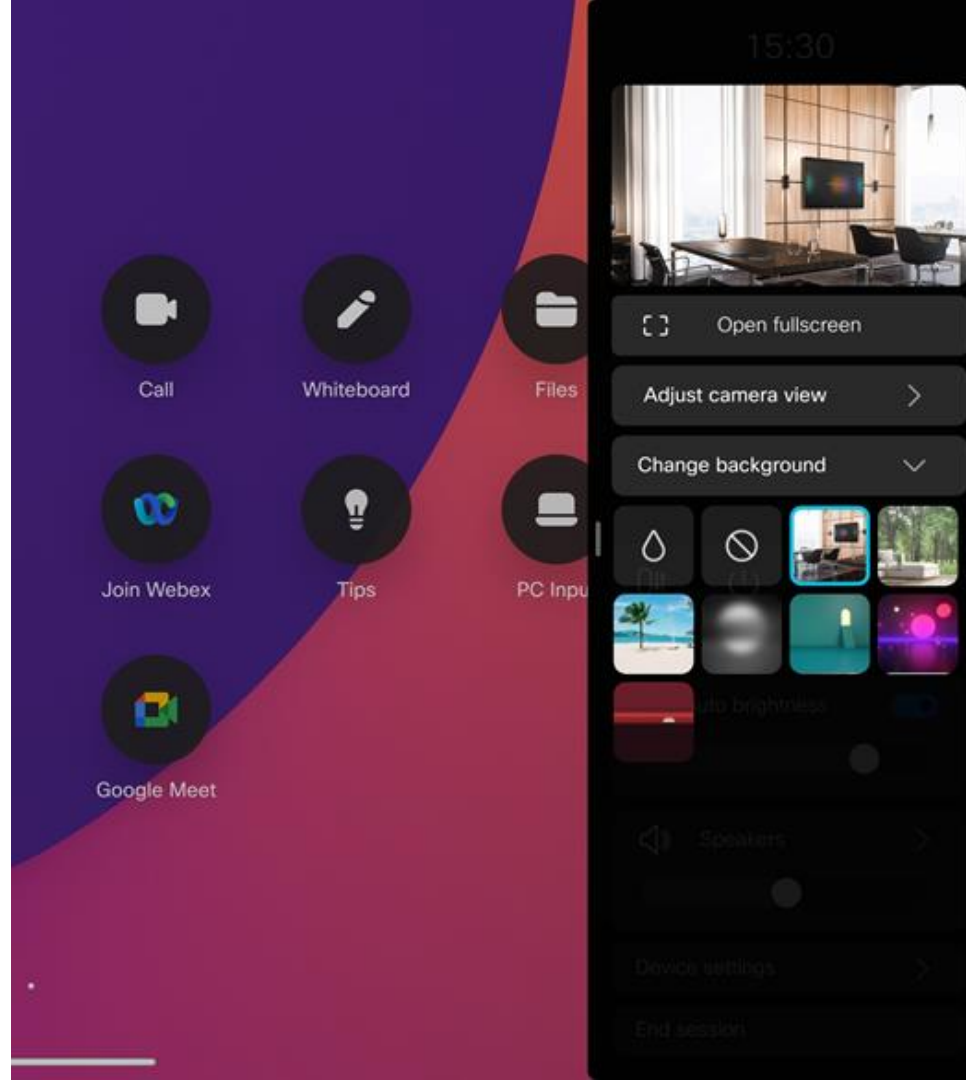

'Yes'



Webex® Assistant

# Noise Removal

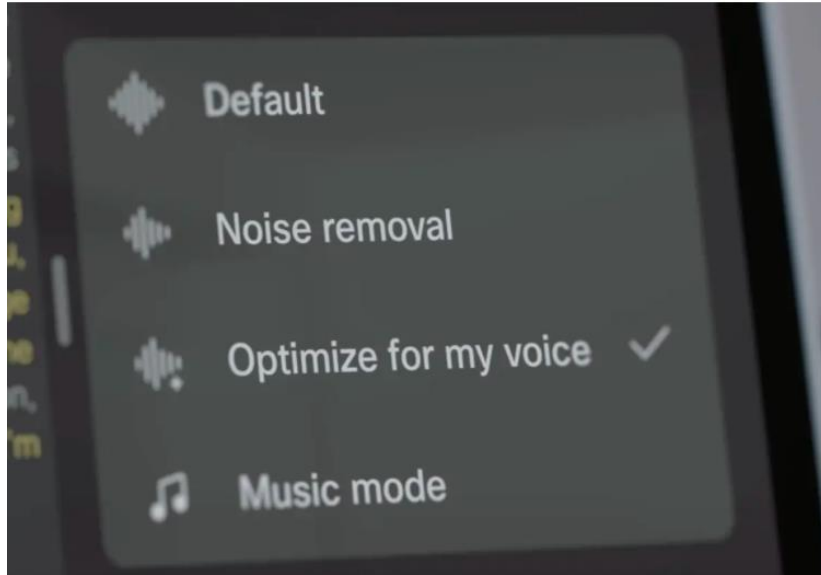

Webex Desk Series comes with advanced AI capabilities built in, like noise removal and video backgrounds to keep you productive no matter your surroundings.

# Sharing Support

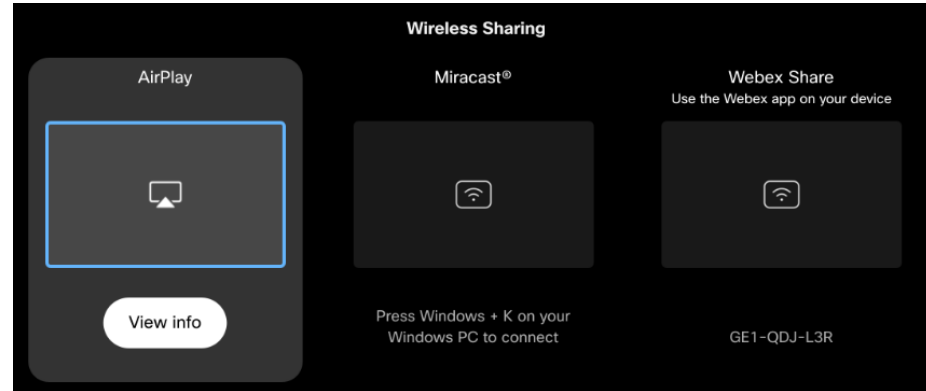
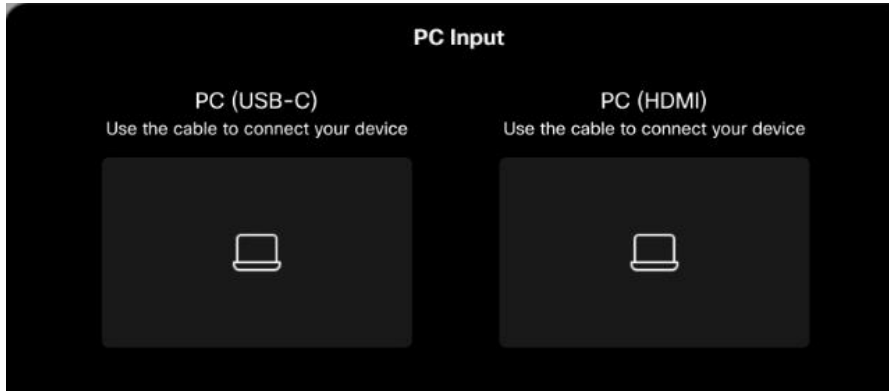

# Miracast® Support

## Windows Button + K on a PC

- Miracast® provides a wireless content sharing solution without the need for a client or a connection to the guest/enterprise network as a direct network connection is established from the Windows PC/Android device to the Webex device using Wi-Fi Direct.
- Requires RoomOS 11 UI
- Webex device must be on ethernet connection (not wireless)
- Senders hardware must support Wi-Fi Direct
- Webex devices support Wi-Fi Direct receiver on 2.4Ghz frequency band
- Share resolution up to 1080p60 with H.264 video
- Admin Controlled  
xConfiguration Video Input Miracast Mode: On
- User Controlled  
xConfiguration Video Input Miracast Mode: Manual
- There are two versions of the Wi-Fi Display Technical Specification, R1 and R2.
  - Webex devices currently only support R1
  - Webex Desk Hub does not support Miracast
  - Webex devices do not support HDCP over Miracast. Some Android devices require HDCP support.
- Webex devices use TCP port 7236 for Miracast signaling
  - Miracast will not work if this port is blocked
- Devices with built-in Miracast support:
  - Windows 8.1 and above
  - Android 4.2 and above (not supported by Google Pixel)
  - Device must support Wi-Fi Direct

# AirPlay Support

- Available soon on Webex Desk and Room Series products
- Wirelessly share content from iPhone, iPad, or MAC

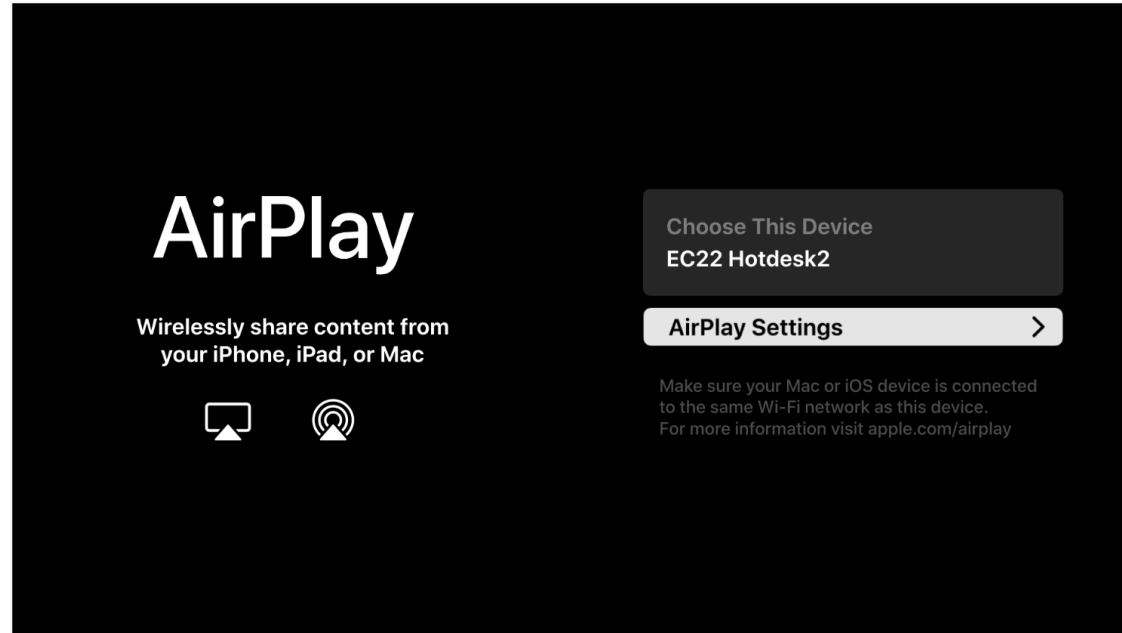

<https://blog.webex.com/hybrid-work/making-hybrid-work-more-magical/>

# Webex Guest Share -> share.webex.com

- Share wirelessly to any Webex registered room device from your browser.
- Guest share works on the latest versions of Firefox and Chrome on Windows, Mac OS, and Linux.
- Closing the browser or the tab where share.webex.com is open stops the share.
- Audio plays through your laptop but not through the display screen. You can't start a share when someone else is sharing.
- Personal Mode not supported.

<https://help.webex.com/en-us/article/nrp8zym/Wireless-Guest-Share>

# Vertical Deployment Scenarios

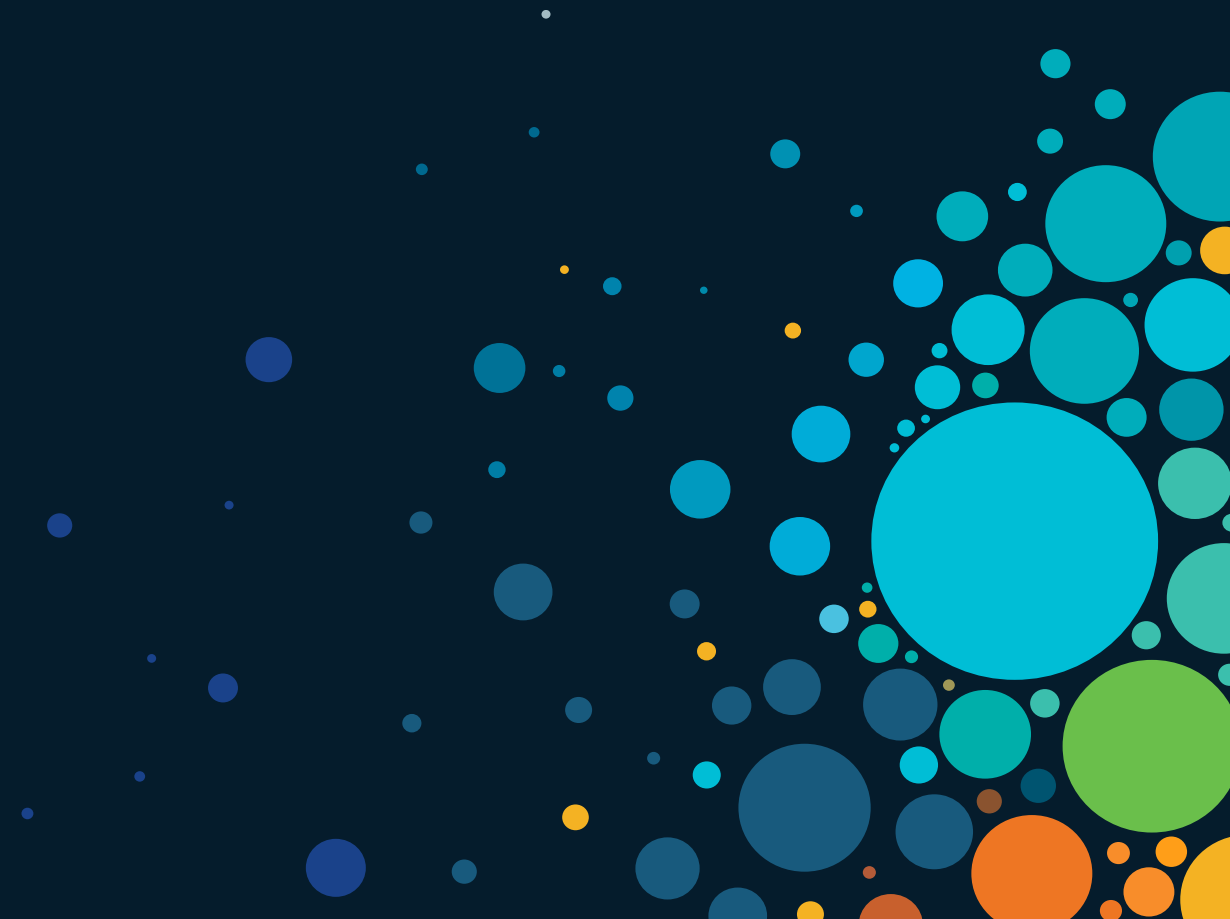



# Call a Virtual Receptionist using Facial Detection

- Uses near field “Close Proximity” detection to avoid triggering based upon people from a distance (people count)
  - “People count” runs the risk of triggering workflows when people are walking by at a distance
  - More responsive (less delay) than people count
- Close Proximity is available on the Webex Desk Pro, Desk, Desk Mini, Webex Board, and Webex Room Kits
- Works with a face mask
  - Minimize exposure to viruses by encouraging social distancing

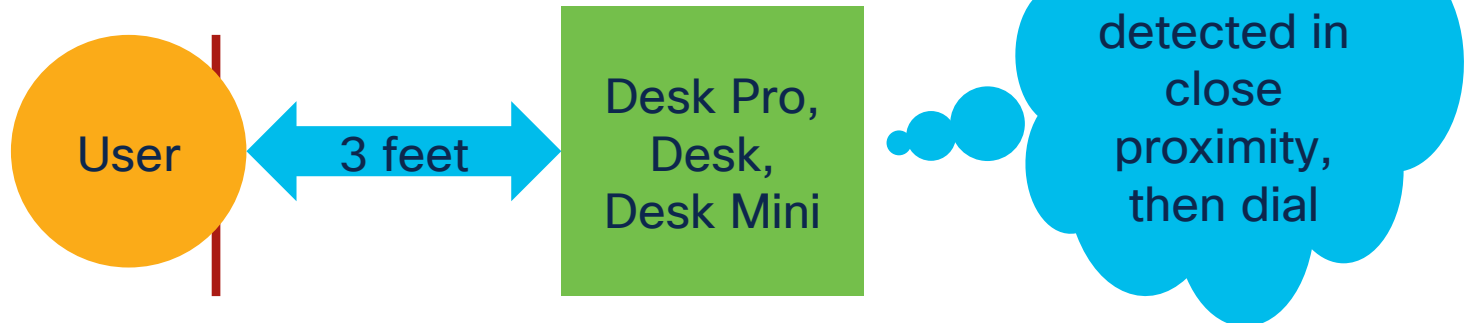

# More Vertical Use Programmability Examples

Refer to this Cisco Live 2020 Digital Session BRKCOL-2032



## Facial Detection – Minimal Configuration

This is the core logic we will plug this into the Desk Pro Macro Editor

```
xapi.status.on('RoomAnalytics Engagement CloseProximity', (newstate) => {  
  if(newstate === 'True'){  
    xapi.status.get('SystemUnit State NumberOfActiveCalls')  
      .then(callIfNotInCall);  
  }  
});
```

**Core Logic**

```
function callIfNotInCall(callCount) {  
  if (callCount < 1) {  
    xapi.command('Dial', { Number: '1091' });  
  }  
  xapi.Config.Video.Selfview.Default.Mode.set("On");  
}
```

**Secondary Logic**

<https://www.ciscolive.com/on-demand/on-demand-library.html?search=BRKCOL-2032#/session/16360602738220017FLJ>

# RoomOS Kiosk Mode

- New feature that addresses most Kiosk-type use cases
- Customizable click-to-call interface
- No 3<sup>rd</sup> party requirements other than a generic web server
- Sample configuration:  
<https://cisco-ce.github.io/roomos-samples/kiosk-example/>
- Source code on GitHub:  
<https://github.com/cisco-ce/roomos-samples/tree/main/kiosk-example>

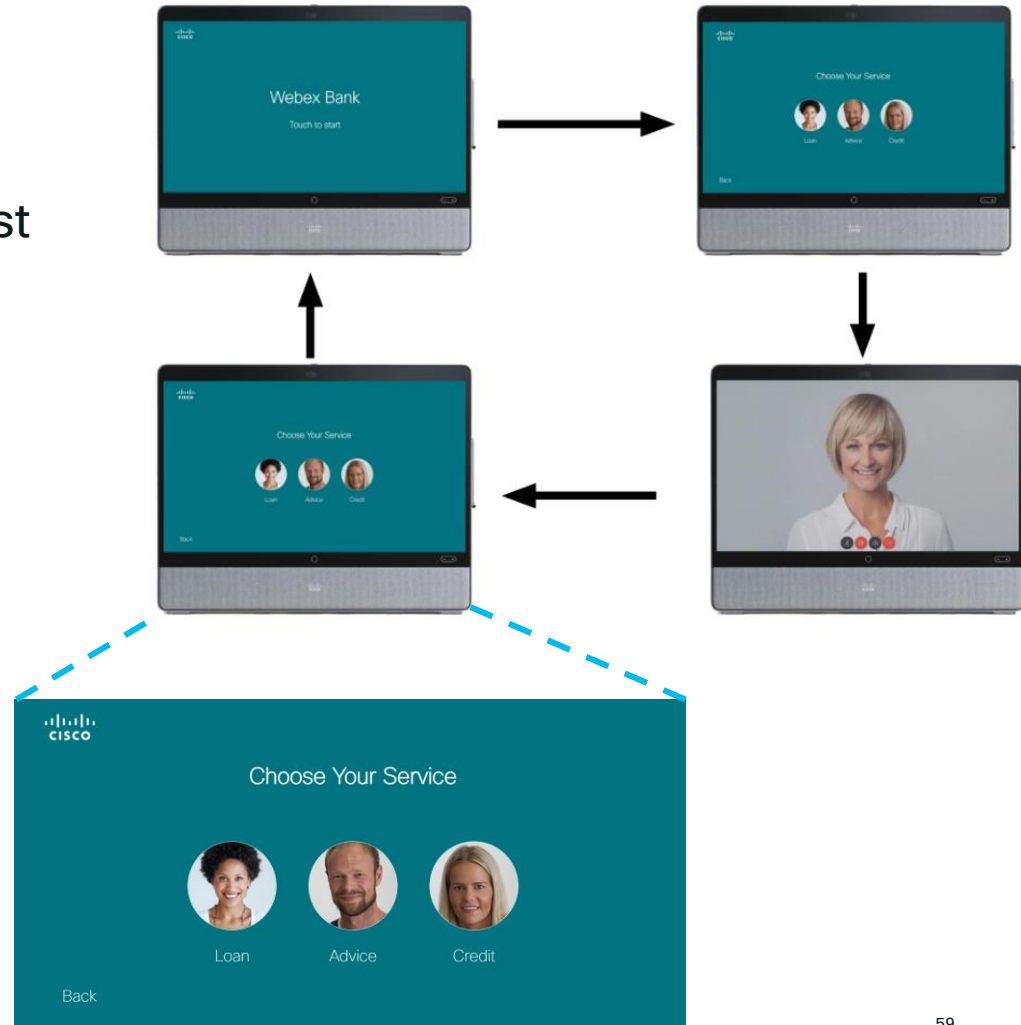

# Kiosk Mode – How to Configure

## 1. Enable minimal configuration from the following URL

<https://help.webex.com/en-us/article/ol1th3/Configure-Kiosk-mode-on-Board-and-Desk-Series-devices>

xConfiguration WebEngine Mode: On

xConfiguration UserInterface Kiosk URL: *www.my\_web\_server.com*

xConfiguration UserInterface Kiosk Mode: On

xConfiguration WebEngine Features SipUrlHandler: On

## 2. (Optional) Enable lock down and other features such as:

xConfiguration UserInterface SettingsMenu Mode: Locked

xConfiguration UserInterface Security Mode: Strong

## 3. Customize calling URLs (in main.js):

```
services: [  
  { url: 'mymeeting@go.webex.com', name: 'Loan' },  
  { url: 'erica@cisco.com', name: 'Advice' },  
  { url: 'bob@cisco.com', name: 'Credit' },],
```

## 4. Customize HTML/CSS and add your own photo images

# Call to Action



# Call to Action

- Head down to the World of Solutions to learn more!
  - Visit the Home office to see the 27” Desk Pro
  - Visit the Nook to see the Desk Mini
  - Visit the Hotdesk area to see the Desk Hub and 24” Desk
- Evaluate Hotdesking on RoomOS
- Explore customizing RoomOS with Macros
- Keep learning!

# Related Sessions

- PSOCOL-1016 Design, Deploy, and Manage Smart Hybrid Workspaces with Webex Devices
- BRKCOL-2029 Journey to Cloud - Webex Edge for Devices
- BRKCOL-2750 Understanding the new call flows and meeting type for Video Mesh Solution
- BRKCOL-2895 Collaboration Security and Cloud Transitions
- BRKCOL-2057 Understanding Network Requirements for Webex Traffic
- BRKCOL-3014 Troubleshooting Webex Cloud Registered and Cloud Aware Endpoints
- BRKCOL-2184 Webex Video Interoperability with Microsoft Teams
- BRKCOL-2058 Troubleshooting the Cisco Webex Video Integration for Microsoft Teams

# Technical Session Surveys

- Attendees who fill out a minimum of four session surveys and the overall event survey will get Cisco Live branded socks!
- Attendees will also earn 100 points in the Cisco Live Game for every survey completed.
- These points help you get on the leaderboard and increase your chances of winning daily and grand prizes.





# Cisco Learning and Certifications

From technology training and team development to Cisco certifications and learning plans, let us help you empower your business and career. [www.cisco.com/go/certs](http://www.cisco.com/go/certs)

Pay for Learning with  
Cisco Learning Credits

(CLCs) are prepaid training  
vouchers redeemed directly  
with Cisco.



## Learn



### Cisco U.

IT learning hub that guides teams and learners toward their goals

### Cisco Digital Learning

Subscription-based product, technology, and certification training

### Cisco Modeling Labs

Network simulation platform for design, testing, and troubleshooting

### Cisco Learning Network

Resource community portal for certifications and learning



## Train



### Cisco Training Bootcamps

Intensive team & individual automation and technology training programs

### Cisco Learning Partner Program

Authorized training partners supporting Cisco technology and career certifications

### Cisco Instructor-led and Virtual Instructor-led training

Accelerated curriculum of product, technology, and certification courses



## Certify



### Cisco Certifications and Specialist Certifications

Award-winning certification program empowers students and IT Professionals to advance their technical careers

### Cisco Guided Study Groups

180-day certification prep program with learning and support

### Cisco Continuing Education Program

Recertification training options for Cisco certified individuals

Here at the event? Visit us at **The Learning and Certifications lounge at the World of Solutions**

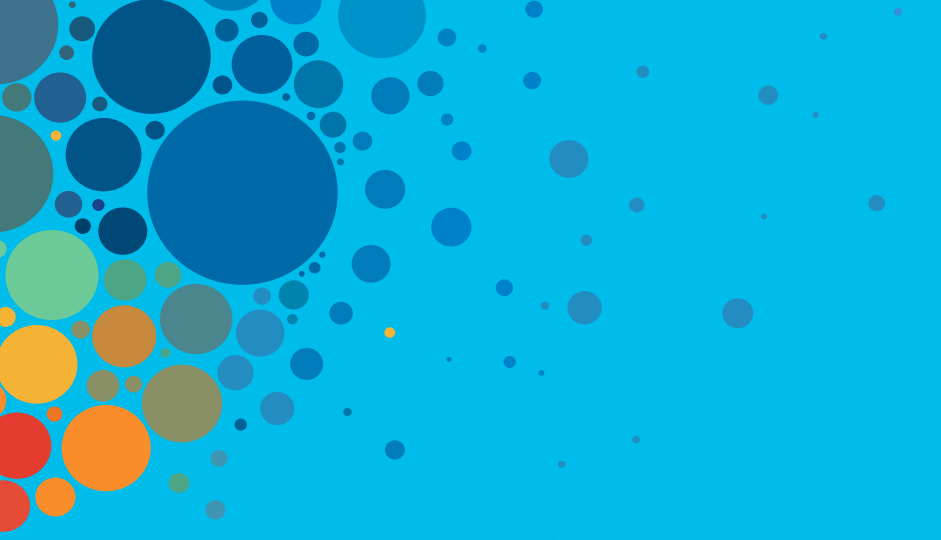

# Continue your education

- Visit the Cisco Showcase for related demos
- Book your one-on-one Meet the Engineer meeting
- Attend the interactive education with DevNet, Capture the Flag, and Walk-in Labs
- Visit the On-Demand Library for more sessions at [www.CiscoLive.com/on-demand](http://www.CiscoLive.com/on-demand)



The bridge to possible

# Thank you

CISCO *Live!*

#CiscoLive

CISCO *Live!*

ALL IN

#CiscoLive