



You make **possible**



# Cisco Unified Communications Manager Serviceability and Troubleshooting

Paul Giralt, @PaulGiralt  
Baha Akman, @mbakman

TECUCC-3000

**CISCO** *Live!*

Barcelona | January 27-31, 2020



# Cisco Webex Teams

## Questions?

Use Cisco Webex Teams to chat with the speaker after the session

## How

- 1 Find this session in the Cisco Events Mobile App
- 2 Click “Join the Discussion”
- 3 Install Webex Teams or go directly to the team space
- 4 Enter messages/questions in the team space

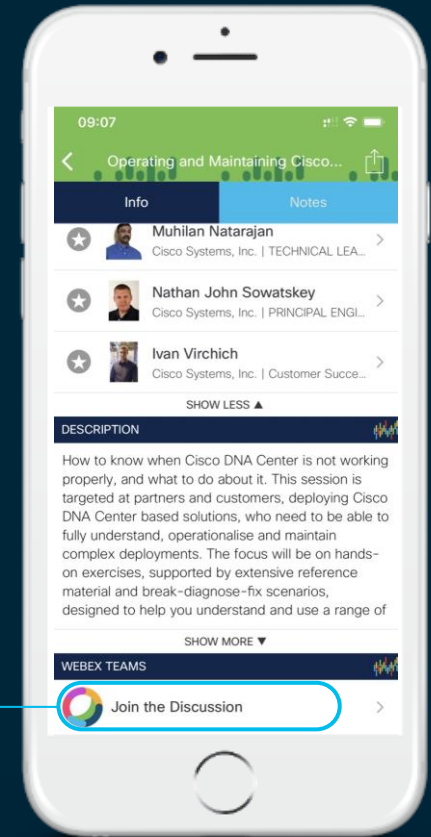

# Session Objectives

- Become familiarized with the various serviceability tools available in Unified CM to assist in data gathering and analysis
- Learn how to set trace levels to provide sufficient trace data to troubleshoot issues
- Understand what data to collect to troubleshoot various Cisco IP telephony problems
- Use collected data to find root cause of some real-world problems

# What You Should Know

- Cisco Unified Communications Manager configuration and operation
- Cisco IOS® voice gateway configuration and operation
- Basic understanding of:
  - Session Initiation Protocol (SIP)
  - Integrated Services Digital Network (ISDN)
  - Skinny Client Control Protocol (SCCP)
  - H.323

# Agenda

- Serviceability Tools Overview
  - Real-Time Monitoring Tool (RTMT)
  - Cisco Unified Operating System GUI
  - Cisco Unified Operating System CLI
  - Cisco Serviceability Reports
  - Cisco Unified Reporting
  - Serviceability APIs
- Troubleshooting Methodology
  - Problem Description
  - Information Collection
- Troubleshooting Case Studies
  - Dropped Call
  - No One Answers the Phone
  - Unable to Place Calls
  - Call Drops After Answering
  - Video Encryption Not Working
  - One-Way Audio
  - ActiveControl Not Working on Jabber 12.5
  - Video Call Immediately Drops
- Understanding and Troubleshooting Unified CM Throttling Events
- Troubleshooting Database Replication

# Today's Schedule

- 08:30 – 10:30
- 10:30 – 11:00 – Break
- 11:00 – 13:00
- 13:00 – 14:15 – Lunch
- 14:15 – 16:15
- 16:15 – 16:45 – Break
- 16:45 – 18:45

# Agenda

- **Serviceability Tools Overview**

  - Real-Time Monitoring Tool (RTMT)

  - Cisco Unified Operating System GUI

  - Cisco Unified Operating System CLI

  - Cisco Serviceability Reports

  - Cisco Unified Reporting

  - Serviceability APIs

- Troubleshooting Methodology

  - Problem Description

  - Information Collection

- Troubleshooting Case Studies

  - Dropped Call

  - Video Encryption Not Working

  - No One Answers the Phone

  - One-Way Audio

  - Unable to Place Calls

  - ActiveControl Not Working on Jabber 12.5

  - Call Drops After Answering

  - Video Call Immediately Drops

- Understanding and Troubleshooting Unified CM Throttling Events

- Troubleshooting Database Replication



# Unified CM Serviceability Introduction

- Three primary serviceability interfaces into UC manager: Real-Time Monitoring Tool (RTMT), OS admin GUI, and OS admin CLI
- RTMT essential to serviceability and monitoring
  - Precanned alerts, perfmon, trace and log central
- Some serviceability functionality is duplicated between Cisco unified OS administration GUI and CLI and RTMT
  - Provides redundancy and resiliency
- Appliance model impacts
  - Access to console
  - Install and upgrades
  - Disk partitioning



```
Command Line Interface is starting up, please wait ...

Welcome to the Platform Command Line Interface

VMware Installation:
  2 vCPU: Intel(R) Xeon(R) CPU           X5680 @ 3.33GHz
  Disk 1: 80GB, Partitions aligned
  Disk 2: 160GB, Partitions aligned
  6144 Mbytes RAM

admin: █
```

# Cisco Unified OS Administration CLI vs. GUI vs. RTMT

CLI (SSH2 or Console Access)	GUI (Including Serviceability and Platform DRS and CU Reporting)	RTMT
<p>No Dependency to Other Services – just OS</p> <p>Platform Status Summary and Details</p> <p>See all Services' Status and <u>Control</u> <u>Some</u></p> <p>Set all Platform Configuration</p> <p>Diagnose Hardware Problems</p> <p>Component Utilities i.e. Database</p> <p>Tech Support Commands</p> <p>DRS Backup/Restore</p> <p>View / Search / Collect Trace / Log Files</p> <p>Upgrades and Option Installs</p> <p>NTP Status &amp; Configuration</p>	<p>Depends on Cisco Tomcat Service and Database</p> <p>Platform Status Summary</p> <p>See All Services' Status and <u>Control All</u></p> <p><u>Service Activation/Deactivation</u></p> <p>Set Some Platform Configuration</p> <p>IPSEC Configuration</p> <p><u>Certificate Management</u></p> <p>Upgrades and Option Installs</p> <p>DRS Backup/Restore</p> <p>System Reports</p> <p>NTP Status &amp; Configuration</p>	<p>Depends on Various Services</p> <p>Platform Status + CCM Application Summary and Details</p> <p>See All Services' Status</p> <p>Precanned Monitoring Screens</p> <p>Performance Counter Collection and Graphing</p> <p><u>Alert Central</u></p> <p>Syslog Viewer</p> <p>View / Search / Collect Trace / Log Files</p> <p>Session Trace</p> <p>SIP Trunk Status</p>

# Unified CM Management Interfaces Overview

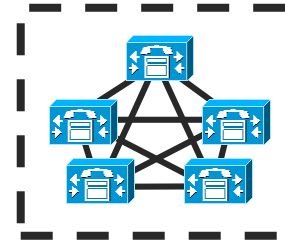

Platform CLI

GUI Web Pages

AMC Service

Services/Syslog

CDR/CMR  
Trace & Logs  
Backup

# Agenda

- Serviceability Tools Overview

  - Real-Time Monitoring Tool (RTMT)

    - Cisco Unified Operating System GUI

    - Cisco Unified Operating System CLI

    - Cisco Serviceability Reports

    - Cisco Unified Reporting

    - Serviceability APIs

- Troubleshooting Methodology

  - Problem Description

  - Information Collection

- Troubleshooting Case Studies

  - Dropped Call

  - Video Encryption Not Working

  - No One Answers the Phone

  - One-Way Audio

  - Unable to Place Calls

  - ActiveControl Not Working on Jabber 12.5

  - Call Drops After Answering

  - Video Call Immediately Drops

- Understanding and Troubleshooting Unified CM Throttling Events

- Troubleshooting Database Replication

# Real-Time Monitoring Tool: Overview

- RTMT is the primary serviceability interface for Unified CM
- Linux or Windows-based client
  - Downloaded via CCMAdmin → Application → Plugins
-  RTMT 12.0+ Requires JRE 1.8+
- Unsupported macOS version see Paul & Baha
- Provides the following serviceability functionality
  - Monitor performance counters
    - Includes OS & Unified CM Applications Telemetry
    - Both live and historical counter data
  - Alert central
  - Trace and log central
  - Pre-canned screens
  - Syslog viewer
  - Device search
  - Analysis Manager
  - Session Trace (SIP)

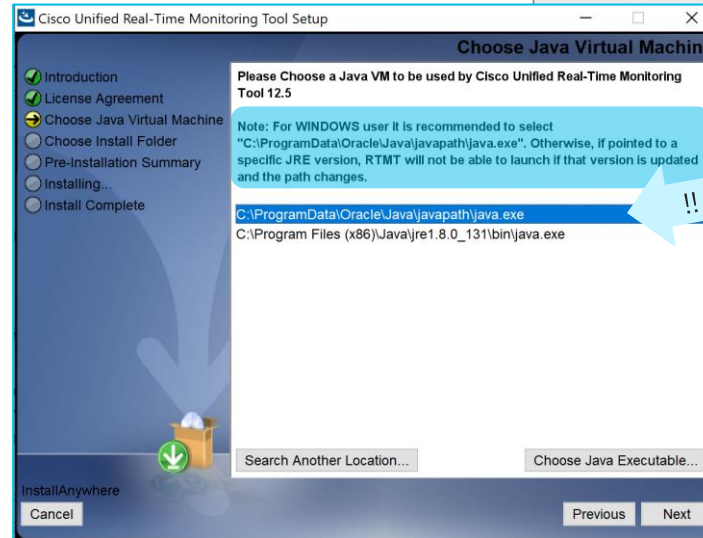
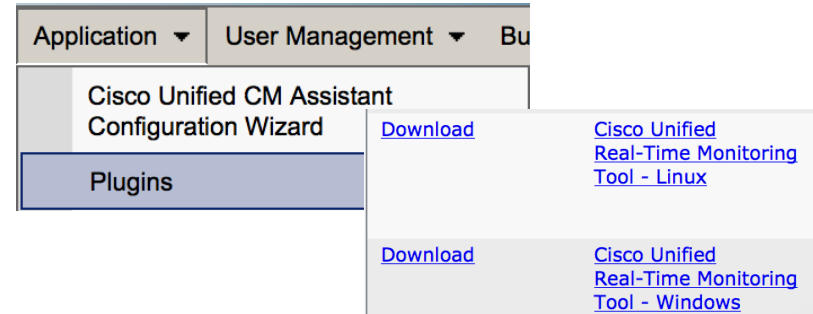

# Real-Time Monitoring Tool: Dependencies

- A Cisco DB
- Cisco RIS Data Collector (RISDC)
- Cisco AMC Service (Alert Manager Collector)
- Cisco Tomcat
- Cisco CallManager Serviceability RTMT

# Real-Time Monitoring Tool: Performance Counters

- Performance counters have classes, counters, and instances per node
- Counters can be viewed in table view or in graph view
- Polling rate can be adjusted as low as 5 sec. - Default is 10 sec
- Counter descriptions can be accessed by right clicking on them
- Profiles can be used to save performance categories and counters created
- Custom alerts could be set up against any performance counter given a threshold

The image shows the Real Time Monitoring Tool interface for Cisco Unified Communications Solutions. The main window displays a tree view of performance categories: System Summary, Server (CPU and Memory, Process, Disk Usage, Critical Services), and Performance (Performance, Performance Log Viewer). A red arrow points to the 'Performance' category. A 'Counter Property' dialog box is open, showing details for the 'IOAwait' counter on host 'vnt-cm1a.cisco.com'. The dialog includes a description: 'This represents the average time, in milliseconds, for I/O requests issued to all devices to be served. This includes the time spent by the requests in queue and the time spent servicing the requests.' Below the dialog is a table view of performance data.

Host	Counter	Value	Min.	Max.	Ave.
10.3.90.6	\Processor(_Total)\IOawait	0	0	1	0.0104166...

A context menu is open over the table row, with options: Alert/Threshold..., Remove Alert..., Remove, and Properties.

# Real-Time Monitoring Tool: Performance Counters

## Default Graph View

- ✓ 6 Graph Panes per Category / Tab

- ✓ Drag Drop Up to 3 Counters in a Graph Pane

- ✓ Monitoring Properties Can be adjusted

- ✓ More Data Points shown in a Graph Pane

The screenshot displays the Cisco Unified Real Time Monitoring Tool interface. The main window shows a tree view of performance counters on the left, a central area with six graph panes, and a right-hand pane with a configuration dialog. A context menu is open over one of the graphs, and a blue callout box points to it with the text "Select a Graph Pane with Left Click First". Another callout box points to the configuration dialog with the text "Can Stack Up to 3 Counters". A third callout box points to the bottom of the interface with the text "Category / Tab".

Right Click

Select a Graph Pane with Left Click First

Can Stack Up to 3 Counters

Category / Tab

Counter Property

Description	Data Sample
Number of samples:	
No. of data samples:	1000
No. of data points shown on chart:	50

View value as:

- Absolute (i.e. as is)
- Delta (i.e. current - previous)
- % Delta (i.e. (current - previous)/previous)

OK



# Real-Time Monitoring Tool: Performance Counters

**TIP** Save your Performance Counters and other RTMT Tabs in Profiles via (Ctrl+Alt+P)

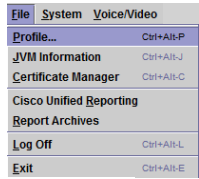

Profile Configuration window showing a list of configurations (Default, SF-UC1-ELBCAC) and buttons for Restore, Save, and Delete. A red arrow points from the 'Save...' button to a database icon labeled 'DB'.

Cisco Unified Real Time Monitoring Tool (Currently Logged into: vnt-cm1a.cisco.com)

File System Voice/Video AnalysisManager IM and Presence Edit Window Application Help

Real Time Monitoring Tool For Cisco Unified Communications Solutions

System Summary

System

- System Summary
- Server
  - CPU and Memory
  - Process
  - Disk Usage
  - Critical Services
- Performance
  - Performance
  - Performance Log Viewer
- Tools
  - Alert Central
  - Trace & Log Central
  - Job Status
  - SysLog Viewer
  - VLT
  - AuditLog Viewer

Voice/Video

AnalysisManager

IM and Presence

System Summary Trunk Activity Database Summary Performance

Performance

Host	Counter	Value	Min.	Max.	Ave.
vnt-cm1b.cisco.com	ICisco SIP(IT-SME-SJC)ICallsInProgress	2	2	5	3.4333333...
vnt-cm1b.cisco.com	ICisco SIP(IT-SME-RTP)ICallsInProgress	5	2	5	3.3
vnt-cm1b.cisco.com	ICisco SIP(IT-SME-EMEAR-APAC)ICallsInProgress	0	0	0	0.0
vnt-cm1c.cisco.com	ICisco SIP(IT-SME-RTP)ICallsInProgress	3	1	3	1.7977528...
vnt-cm1c.cisco.com	ICisco SIP(IT-SME-EMEAR-APAC)ICallsInProgress	0	0	0	0.0
vnt-cm1c.cisco.com	ICisco SIP(IT-SME-SJC)ICallsInProgress	4	1	4	2.4545454...

Tools

- New Category
- Remove Category
- Rename Category
- Polling Rate
- Start Counter(s) Logging

Right Click

Create New Categories / Tabs to Monitor Group of Performance Counters

# Real-Time Monitoring Tool: Performance Counter-Based Alerting

1

Right Click

Alert Properties: General

Name: \wnt-cm1a.cisco.com\Processor(\_Total)\IOwait Percentage

Enable Alert Severity: Warning

Description: Custom IOwait Monitor Alert

Recommended Action:

2

Can be Changed

Determines EMAIL Destination(s)

Alert Properties: Threshold & Duration

Threshold: Trigger alert when following condition is met. Value:  Over  OR  Under

Value Calculated As:

Absolute

Delta (curr - prev)

Delta Percentage ((curr - prev)/prev)

Duration:

Trigger alert only when value constantly below or over threshold for  seconds

Trigger alert immediately

3

Alert Properties: Frequency & Schedule

Frequency

When value exceed/below configured threshold:

Trigger alert on every poll

Trigger alert up to  alerts within  minutes

Schedule

Alert will be triggered in following period:

Trigger Alert when it occurs. (Non-Stop Monitoring)

Trigger Alert everyday (Scheduled Monitoring) between:

Start Time:  and End Time:

4

Alert Properties: Email Notification

Enable Email

Trigger Alert Action:

User-defined email text:

5

# Real-Time Monitoring Tool: Performance Counter-Based Alerting

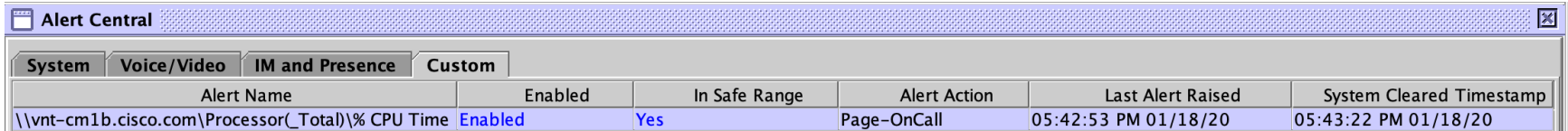

Alert Name	Enabled	In Safe Range	Alert Action	Last Alert Raised	System Cleared Timestamp
\\vnt-cm1b.cisco.com\Processor(_Total)\% CPU Time	Enabled	Yes	Page-OnCall	05:42:53 PM 01/18/20	05:43:22 PM 01/18/20



Alert Name	Enabled	In Safe Range	Alert Action	Last Alert Raised	System Cleared Timestamp
\\vnt-cm1b.cisco.com\Processor(_Total)\% CPU Time	Enabled	No	Page-OnCall	11:59:14 AM 01/26/20	05:43:22 PM 01/18/20

- Once the threshold is reached at the time of AMC Polling Interval (30sec) Alert is raised

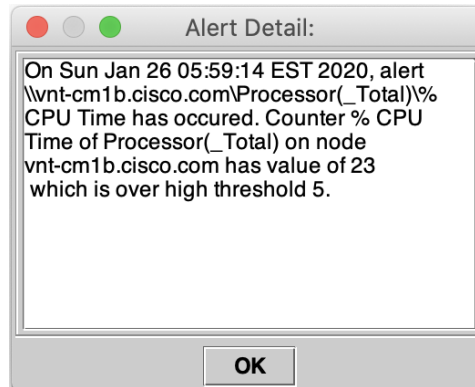

- Alert Details are emailed when
  - ✓ Enable email option is checked
  - ✓ SMTP server is configured
  - ✓ Configured Alert action includes email destinations

# Real-Time Monitoring Tool: Performance Counter Collection

Host	Counter	Value	Min.
10.3.90.6	Number of Replicates Created and State of Replication(ReplicateCount)\Number of Replicates Created	342	342
10.3.90.5	Number of Replicates Created and State of Replication(ReplicateCount)\Number of Replicates Created	342	342
10.3.90.5	Number of Replicates Created and State of Replication(ReplicateCount)\Replicate_State	2	2
10.3.90.6	Number of Replicates Created and State of Replication(ReplicateCount)\Replicate_State	2	2

Counter Logging Configuration

Log File Name : PerfmonCountersScreen

HostName and File extension (.csv) will be appended to the Log File Name specified

Log Files will be saved in C:\Users\makman\jrtmtlog

Ok Cancel

Do This before  
Starting  
Counter Logging

System Voice/Video AnalysisManager IM and Presence

System Summary

Server

Performance

Tools

System Summary

Open Performance Monitoring

Open Performance Log Viewer

Counter Logging Configuration...

Counter Logging Configuration

Max Log File Count : 10 Max Log File Size in KB : 5000

Ok Cancel

increase ↑

increase ↑

- Right click on each category (tab) and select “Start Counter(s) Logging”
- Single CSV file is created logging all counters collected per host
- System → Performance → Counter Logging Configuration controls file size and count
- RTMT must be running for collection to take place

# Performance Counter Collection Without RTMT

- Cisco RIS Data Collector Troubleshooting Perfmon Data Logging
- Enabled by default
- Under RIS data collector service parameters [on each server](#)
- Default Polling rate is every 15 seconds , min 5 seconds
- File size can be adjusted to cover longer periods of time in each file
- Logs are saved under active/inactive logs [cm/log/ris/csv/](#) on each server
- RTMT Trace & Log Central can collect these files
- Select service name: [Cisco RIS Data Collector PerfMonLog](#)

Cisco Unified CM Administration  
For Cisco Unified Communications Solutions

System ▾

Service Parameters

Select Server and Service

Server\* vnt-cm1a.cisco.com--CUCM Voice/Video (Active) ▾

Service\* Cisco RIS Data Collector (Active) ▾

## Cisco RIS Data Collector (Active) Parameters on server vnt-cm1a.cisco.com--CUCM Voice/Video (Active)

### Troubleshooting Perfmon Data Logging

<a href="#">Enable Logging</a> *	True	True
<a href="#">Polling Rate</a> *	15	15
<a href="#">Maximum No. of Files</a> *	100	50
<a href="#">Maximum File Size (MB)</a> *	10	5

Maximize  
it to 100

Increase to  
10MB

# Real-Time Monitoring Tool: Performance Log Viewer

- RTMT performance log viewer can load CSV log files from
  - RISDC Perfmon Data from any cluster node
  - Saved files from other clusters
- Add/remove multiple counters from **single file**
- Zoom in/out
- Limitations/caveats
  - Can only view files one at a time and from one server at a time
  - Hard to highlight counters
    - Don't add too many
    - Change Colors

The screenshot shows the Cisco Unified Real Time Monitoring Tool (RTMT) Performance Log Viewer. The interface includes a sidebar with navigation options, a main performance chart, and a file selection dialog. The chart displays a line graph of performance data over time. The file selection dialog lists several log files with their names and modified dates. A tooltip is visible over the chart area, indicating that a right-click action can be performed to change the color or highlight the data.

File Names	Modified Date
PerfMon_vnt-cm1b.cisco.com_06_21_2017_08_1...	06/21/2017 Wed 09:52:20 EDT
PerfMon_vnt-cm1b.cisco.com_06_23_2017_06_5...	06/23/2017 Fri 08:35:39 EDT
PerfMon_vnt-cm1b.cisco.com_06_24_2017_11_3...	06/24/2017 Sat 13:14:41 EDT
PerfMon_vnt-cm1b.cisco.com_06_22_2017_15_4...	06/22/2017 Thu 17:30:08 EDT
PerfMon_vnt-cm1b.cisco.com_06_21_2017_23_0...	06/22/2017 Thu 00:47:21 EDT
PerfMon_vnt-cm1b.cisco.com_06_24_2017_06_2...	06/24/2017 Sat 08:09:41 EDT
PerfMon_vnt-cm1b.cisco.com_06_23_2017_05_1...	06/23/2017 Fri 06:56:24 EDT
PerfMon_vnt-cm1b.cisco.com_06_23_2017_18_4...	06/23/2017 Fri 20:23:25 EDT
PerfMon_vnt-cm1b.cisco.com_06_21_2017_13_0...	06/21/2017 Wed 14:47:36 EDT

# Unified CM Appliance Physical Memory and CPU Utilization via RTMT

LowAvailableVirtualMemory Alert – Raised at 85%

Memory Utilization % =  
 (Total KBytes - Free Kbytes -  
 Buffers Kbytes - Cached  
 KBytes + Shared KBytes) /  
 (Total KBytes + Total Swap  
 KBytes)

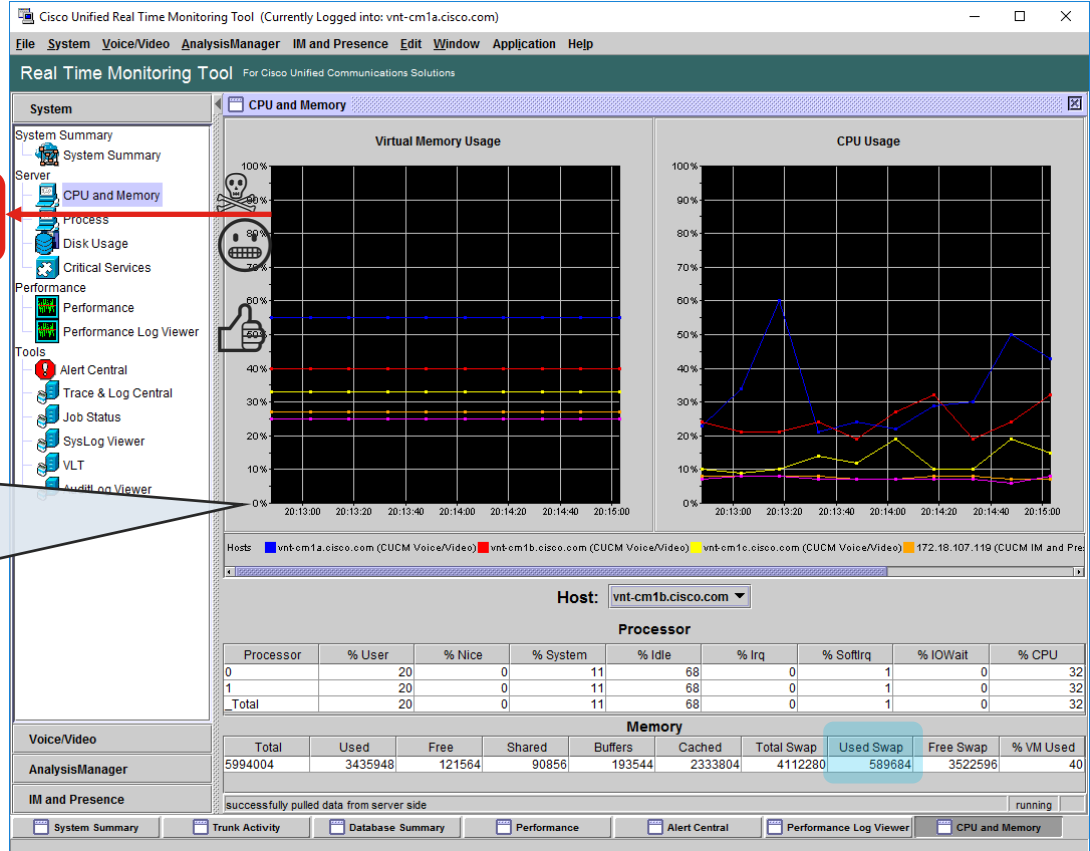

# CPU & Memory Monitoring

	7.5k ova 2 Cores		10k ova 4 Cores	
Total CPU Usage _Total → % CPU Time	< 68%	Good	< 68%	Good
	68-79%	Warning	68-79%	Warning
	> 80%	Bad	> 80%	Bad
Process ccm ccm → % CPU Time	< 44 %	Good	< 22%	Good
IOWait _Total → IOWait Percentage	< 20%	Good	< 20%	Good
	20-40%	Warning	20-40%	Warning
	> 41%	Bad	> 41%	Bad
Process ccm VmSize ccm → VmSize	< 2.1 GB	Good	< 2.1 GB	Good
	3GB	Warning	3GB	Warning
	4GB	Max Limit	4GB	Max Limit



# Unified CM Alarms vs. Alerts

## Alarms

- Generated by Applications or Services or Platform
- Alarm library embedded in to the Services /Applications forwards them to destinations
- Alarm definitions and severities are predefined
  - Available in the Alarm Catalog
- Admin can adjust the Alarm notification destinations and filter them based on severity
- ⚠ Alarms can trigger alerts and these alerts can be logged as alarms 👍

## Alerts

- They are only generated by the Alert Manager Collector (AMC) Service
  - Primary or Secondary ← Best Practice
- Triggers from
  - Alarm(s)
  - Perfmon Counter(s) State/Value
  - System Performance and conditions
    - CPU, Memory
  - Linux OS Syslog messages

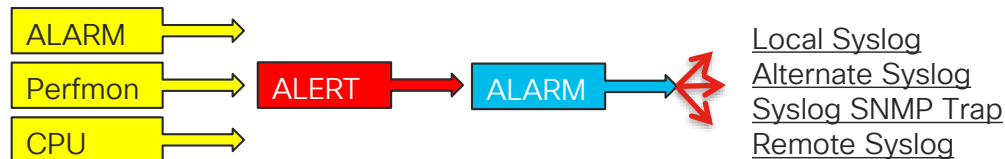

# Alarm and Alert System Flow

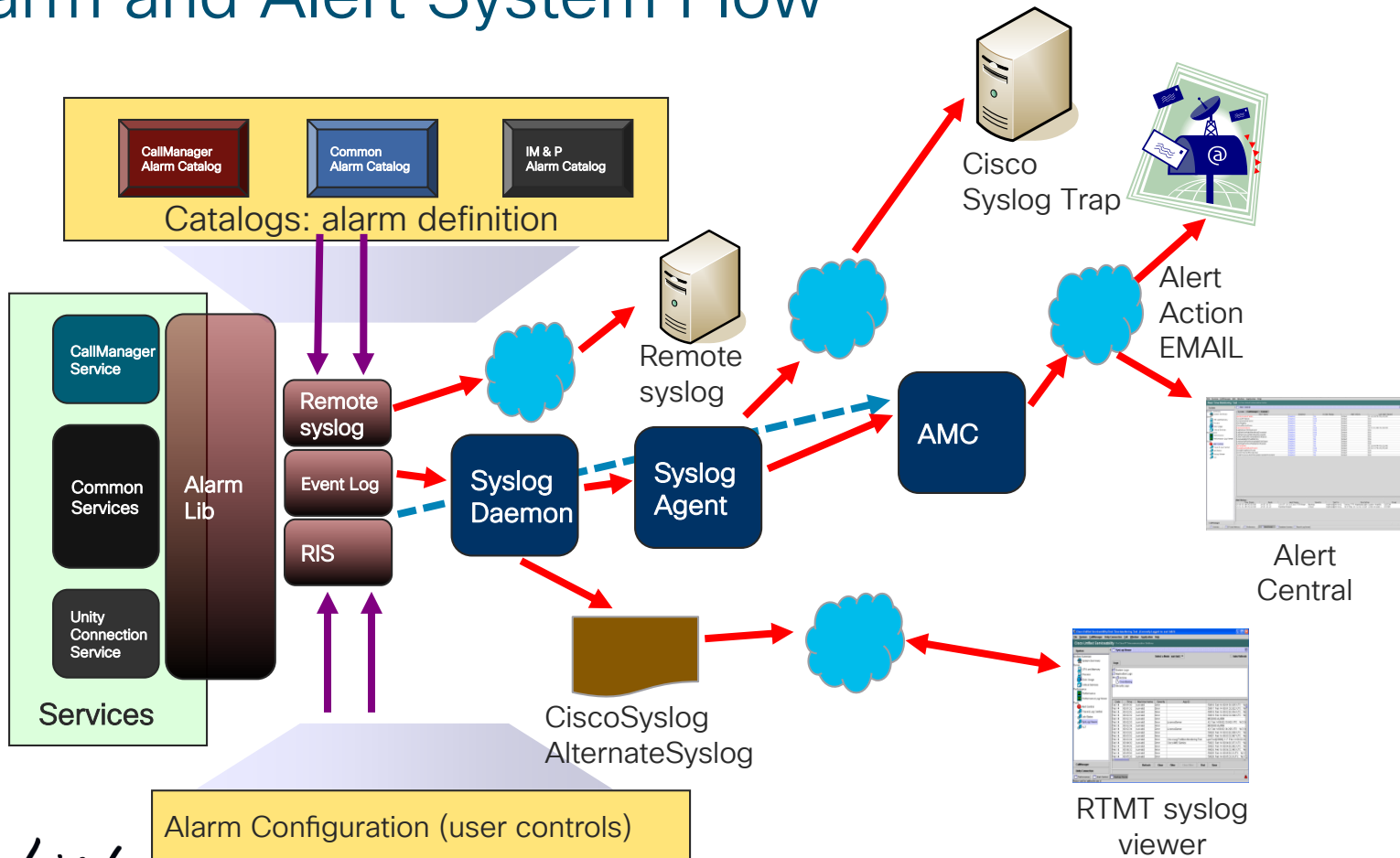

# Unified CM Serviceability Alarm Configuration and Definitions

- Alarm configuration
  - Alarm event level (Filter)
    - Emergency ↔ Debug
  - Alarm destination
    - Local Syslog → activelog syslog/CiscoSyslog
    - Alternate Syslog → activelog syslog/AlternateSyslog
    - Remote Syslogs
    - SDL Trace Files
- Alarm definitions catalog
  - Provides enum definitions for reason codes, description, explanation, and most importantly **recommended action**

The screenshot displays the Cisco Unified Serviceability web interface. At the top, there is a navigation menu with options: Alarm, Trace, Tools, Snmp, CallHome, and Help. Below this, there are tabs for Configuration and Definition. The main content area is titled "Alarm Information" and includes a "Related Links" section with a button for "Back to Find/List Alarms" and a "Go" button. There are also "Save" and "Clear All" buttons. The "Status" section shows "Ready". The main content is divided into two columns: "Catalog" and "Definition".

Catalog	Definition												
<b>Name</b>	CallManagerFailure												
<b>Description</b>	Indicates an internal failure in Unified CM												
<b>Severity</b>	CRITICAL_ALARM												
<b>Explanation</b>	This alarm indicates that an internal failure occurred in the Cisco CallManager service. The service should restart in an attempt to clear the failure.												
<b>Recommended Action</b>	Monitor for other alarms and restart Cisco CallManager service, if necessary. Collect the core file if available, SDL and CCM/SDI trace files (you can gather these from Trace and Log Central in RTMT using the Collect Files feature) and contact the Cisco Technical Assistance Center (TAC).												
<b>Routing List</b>	SDL SDI Sys Log Event Log SNMP Traps												
<b>Parameter(s)</b>	Additional Text(String) Host Name of Hosting Node(String) Host Node IP Address(String) Reason code(Enum)												
<b>Enum Definitions - Reason code</b>	<table border="1"><thead><tr><th>Value</th><th>Definition</th></tr></thead><tbody><tr><td>1</td><td>Unknown - Unified CM has failed for an unknown reason</td></tr><tr><td>2</td><td>HeartBeatStopped - An internal heart beat has stopped after the preceding heart beat interval</td></tr><tr><td>3</td><td>RouterThreadDied - An internal thread has failed</td></tr><tr><td>4</td><td>TimerThreadDied - An internal thread has failed</td></tr><tr><td>5</td><td>CriticalThreadDied - An internal thread has failed</td></tr></tbody></table>	Value	Definition	1	Unknown - Unified CM has failed for an unknown reason	2	HeartBeatStopped - An internal heart beat has stopped after the preceding heart beat interval	3	RouterThreadDied - An internal thread has failed	4	TimerThreadDied - An internal thread has failed	5	CriticalThreadDied - An internal thread has failed
Value	Definition												
1	Unknown - Unified CM has failed for an unknown reason												
2	HeartBeatStopped - An internal heart beat has stopped after the preceding heart beat interval												
3	RouterThreadDied - An internal thread has failed												
4	TimerThreadDied - An internal thread has failed												
5	CriticalThreadDied - An internal thread has failed												
<b>User Defined Text</b>													

# Unified CM Serviceability Alarm Destinations

**Alarm Configuration**

Save Set to Default

**Select Server, Service Group and Service**

Server\* 172.18.106.59 Go

Service Group\* CM Services Go

Service\* Cisco CallManager (Active) Go

Apply to All Nodes

**Local Syslogs**

Enable Alarm Alarm Event Level Informational

**Remote Syslogs**

Enable Alarm Alarm Event Level Informational

Remote Syslog Servers<sup>1</sup>

Server Name 1 1.2.3.4

Server Name 2 1.2.3.5

Server Name 3

Server Name 4

Server Name 5

Exclude End Point Alarms

**SDI Trace**

Enable Alarm Alarm Event Level Informational

**SDL Trace**

Enable Alarm Alarm Event Level Informational

- Save Set to Default



- CLI - activelog syslog/CiscoSyslog & AlternateSyslog
- RTMT - Event Viewer-Application log

- Cannot send to another Unified CM server
- Defaults to local7 facility, cannot change it

# Real-Time Monitoring Tool: Alert Central

- Alert Central → Alert History
- Displays last 100 or last 30 minutes worth of alerts
- Archived to CSV and logged to Syslog

## Real Time Monitoring Tool For Cisco Unified Communications Solutions

### System

#### System Summary

#### Server

#### Performance

#### Tools

#### Alert

#### Trace

#### SysLog Viewer

#### Plugins

#### AuditLog Viewer

#### Alert Central

#### Set Alert/Properties...

#### Remove Alert

#### Enable Alert

#### Disable Alert

#### Suspend Cluster/Node Alerts...

#### Clear Alert

#### Clear all Alerts

#### Reset all Alerts to Default Config

#### Alert Detail

#### Config Email Server...

#### Config Alert Action...

Cisco Unified Real Time Monitoring Tool (Currently Logged into: vnt-cm1a.cisco.com)

Real Time Monitoring Tool For Cisco Unified Communications Solutions

Alert Central

Alert Name	Enabled	In Safe Range	Alert Action	Last Alert Raised	System Cleared Timestamp
AuditLogOverflowDueToLogRotation	Enabled	N/A	Default	04:54:07 PM 06/08/19	N/A
AuditLogOverflowDueToLPM Purge	Enabled	N/A	Default	N/A	N/A
AuditLogExceedConfiguredThreshold	Enabled	N/A	Default	N/A	N/A
AuthenticationFailed	Enabled	Yes	Default	07:44:51 AM 06/08/19	07:45:21 AM 06/08/19
CCMEncryptionErrorDetected	Enabled	N/A	Default	N/A	N/A
CiscoDRFailure	Enabled	N/A	Default	N/A	N/A
CoreDumpFileFound	Enabled	N/A	Default	N/A	N/A
CpuPeering	Enabled	Yes	Default	N/A	N/A
CriticalServiceDown	Enabled	Yes	Default	N/A	N/A
DBChangeNotifyFailure	Enabled	Yes	Default	N/A	N/A
DBReplicationFailure	Enabled	Yes	Default	N/A	N/A
DBReplicationTableOutOfSync	Enabled	N/A	Default	N/A	N/A
HardwareFailure	Enabled	N/A	Default	N/A	N/A
LogFileSearchStringFound	Enabled	N/A	Default	02:42:21 PM 06/07/19	N/A
LogPartitionHighWaterMarkExceeded	Enabled	N/A	Default	N/A	N/A
LogPartitionLowWaterMarkExceeded	Enabled	N/A	Default	N/A	N/A
LowActivePartitionAvailableDiskSpace	Enabled	Yes	Default	N/A	N/A
LowAvailableVirtualMemory	Enabled	Yes	Default	N/A	N/A
LowInactivePartitionAvailableDiskSpace	Enabled	Yes	Default	N/A	N/A
LowSwapPartitionAvailableDiskSpace	Enabled	Yes	Default	N/A	N/A
ServerDown	Enabled	Yes	Default	N/A	N/A
SparePartitionHighWaterMarkExceeded	Enabled	N/A	Default	N/A	N/A
SparePartitionLowWaterMarkExceeded	Enabled	N/A	Default	N/A	N/A
SyslogSeverityMismatchFound	Enabled	N/A	Default	N/A	N/A
SyslogStringMatchFound	Enabled	N/A	Default	N/A	N/A
SystemVersionMismatched	Enabled	Yes	Default	N/A	N/A
TCPRemoteSyslogDeliveryFailed	Enabled	N/A	Default	N/A	N/A
TLSRemoteSyslogDeliveryFailed	Enabled	N/A	Default	N/A	N/A
TotalProcessesAndThreadsExceededThreshold	Enabled	Yes	Default	N/A	N/A
UnreachableRemoteSyslogServer	Enabled	N/A	Default	02:06:52 PM 06/08/19	N/A

Alert History

Time Stamp	Node	Alert Name	Severity	Sent to	Description	Group
------------	------	------------	----------	---------	-------------	-------

# Real-Time Monitoring Tool: Alert Central

- Can be sent out via email
  - Primary then secondary AMC service in charge
  - Must configure and have access to a SMTP mail server ①
    - RTMT → System → Tools → Alert → Config Email Server
  - Destinations can be controlled via **Alert Actions** ② & ③
    - RTMT → System → Tools → Alert → Config Alert Action
- Alerts can be suspended or disabled per node or clusterwide ④
  - RTMT → System → Tools → Alert → Suspend Cluster/Node Alerts
- Thresholds, alert notification interval & **severity** can be adjusted
  - Set alert properties...
  - Can be reset back to default Config
    - RTMT → System → Tools → Alert → Reset all Alerts to Default Config

① Mail Server Configuration

Configure Mail Server to send Email alert:

Mail Server: outbound.cisco.com

Port: 25

Sender User Id: RTMT\_Admin@cisco.com

OK Cancel Reset

② Alert Action

Action List

- Default
- Page-OnCall
- Test

Add... Edit Delete

Description:

Close

③ Action Configuration

Name: Page-OnCall

Description: Baha's Pager

Recipients:

Recipient	Enable
makman@epage.ci...	<input checked="" type="checkbox"/>

Add... Delete

OK Cancel

④ Suspend/Resume Alert

Cluster Wide  suspend all alerts

Per Server

Server	Suspend
172.18.107.119	<input type="checkbox"/>
172.18.107.120	<input type="checkbox"/>
vnt-cm1a.cisco...	<input type="checkbox"/>
vnt-cm1b.cisco...	<input type="checkbox"/>
vnt-cm1c.cisco...	<input type="checkbox"/>

OK Cancel

# RTMT / AMC Alert Redundancy

- Alert Manager Collector (AMC) service in charge of Built-in and Custom Alerting
- By default, the AMC service Polls Counters, Alarms, Events every 30 sec
  - Polling rate is every 30 seconds by default can go down to 15
- AMC has primary and failover collector
  - By default, publisher becomes primary collector and **failover collector is NOT** configured and it should be for RTMT, and AMC/alerting redundancy

Cisco AMC Service (Active) Parameters on server vnt-cm1a.cisco.com--CUCM Voice/Video (Active)

Parameter Name	Parameter Value	Suggested Value
Clusterwide Parameters (Parameters that apply to all servers)		
Primary Collector *	vnt-cm1a.cisco.com	
Failover Collector	vnt-cm1b.cisco.com	
Data Collection Enabled *	True	True
Data Collection Polling Rate *	30	30



SET THIS!!!

• Failover Problem  
• See Workaround

CSCve51537



# Real-Time Monitoring Tool: Alert Central Alert Email Process

- AMC Service is responsible for mailing out Alert
  - !!! Don't Forget to set AMC Failover Collector !!!
- Alert Emails will be from RTMT\_Admin@<domainname>
  - Can be changed using RTMT Client
  - RTMT → System → Tools → Alert → Config Email Server
- Domain name is retrieved from the Platform's Domain Name configuration

```
show network eth0 detail
```

```
DNS
Primary       : 172.18.106.25      Secondary   :
Options      : timeout:5 attempts:2
Domain       : cisco.com
Gateway     : 172.18.106.1 on Ethernet bond0
```

- No SMTP Authentication support

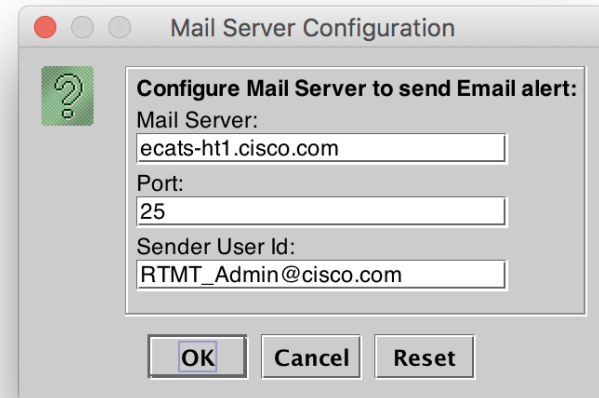

## TIP Config Email Server via Platform CLI

```
run sql update scratch set content='<EmailConfig><EmailServer Name="ecats-ht1.cisco.com" Port="25"/><DefaultSender Name="RTMT_Admin"/><DefaultDomain Name="cisco.com"/></EmailConfig>' where name == 'RisGenConfigCatalog=EmailConfig'
```



# Real-Time Monitoring Tool: Alert Central

## Trace Download

- CodeYellow, CoreDumpFileFound, CriticalServiceDown alerts' properties have ability to download traces upon trigger
- Trace Download Parameters allows you to download traces at the time of the alert raising and upload to a SFTP/FTP server
- Traces collected at the time of an alert could be essential for troubleshooting

**1** Alert Properties: General

Name: CoreDumpFileFound  
 Enable Alert Severity: Critical

Server	Enable
172.18.107.119	<input checked="" type="checkbox"/>
172.18.107.120	<input checked="" type="checkbox"/>
vnt-cm1a.cisco.com	<input checked="" type="checkbox"/>
vnt-cm1b.cisco.com	<input checked="" type="checkbox"/>
vnt-cm1c.cisco.com	<input checked="" type="checkbox"/>

Description:  
 This alert occurs when the CoreDumpFileFound event is generated. This indicates that a core dump file has been found in the system.

Recommended Action:

**2** Alert Properties: Threshold

Threshold:  
 Trigger alert when following condition is met  
 CoreDumpFileFound event is generated.

**3** Alert Properties: Frequency & Schedule

Frequency  
 When value exceed/below configured threshold:  
 Trigger alert on every poll **Check**  
 Trigger up to 3 (3) alerts within 30 (30) m

Schedule  
 Alert will be triggered in following period:  
 Trigger Alert when it occurs. (Non-Stop Monitoring)  
 Trigger Alert everyday (Scheduled Monitoring) b

Start Time: 09:29 PM and End Time: 09:2

**4** Alert Properties: Trace Download

Trace Download Parameters  
 Enable Trace Download

3 (3) Downloads every

**5** Trace Download Configuration

Localhost  
 SFTP/FTP Server

SFTP/FTP Options

Protocol: FTP  
 Host IP Address: 1.2.3.4  
 User Name: cse  
 Password: .....  
 Port: 22  
 Download Directory Path: /Traces/

**6** SFTP/FTP Response

Connection Summary:  
 Success while connecting from ecats-cups1a.cisco.com  
 Success while connecting from vnt-cm1c.cisco.com  
 Success while connecting from ecats-cups1b.cisco.com  
 Success while connecting from vnt-cm1a.cisco.com  
 Success while connecting from vnt-cm1b.cisco.com

**7** Alert Properties: Email Notification

Enable Email  
 Trigger Alert Action:  
 Page-On-Call

# Cisco AMC Service Alert Logs

- AMC service is responsible for raising alerts
  - Primary AMC server (publisher) monitors the whole cluster
  - If primary is down secondary AMC server takes over
  - Depends on AMC and RISDC service from all nodes
- AMC keeps track of alerts as they are raised in a CSV file
  - Duration is hard coded to seven days
- Alert history can be downloaded via OS administration CLI or RTMT trace and log central
  - From the primary AMC collector (defaults to publisher node)
  - From the failover AMC collector when primary is down (default not set)
  - Active/inactive logs [cm\log\amc\AlertLog\](#)
  - RTMT trace and log collector collect files or remote browse
  - Select service name: [Cisco AMC Service AlertLog](#)
- You must convert time stamp column (in UTC msec) to Excel datetime stamp



= B2/(24\*60\*60\*1000) + DATE(1970,1,1)

A	B	C	D	E	F	G	H	I	J	K
1	Time Stamp	Alert Type	Alert Name	Alert Message	Monitored O	Severity	PollValue	Action	Node ID	Group ID
2	6/7/18 2:40 AM	1.5283E+12	0	CriticalServiceDown	Service operational status is DOWN.		2	0	makman-rtmt@ecats-ht1.cisco.com;pgiralt@vnt-cm1b.cisco.com	System

# Cisco AMC Service Alert Logs



- All alerts raised by AMC AlertMgr are also logged in to application logs as alarms
  - `activelog syslog/CiscoSyslog`
- The logged Alarms have matching Severity as set in the Alert's Properties

## Local Syslogs

Enable Alarm

Change This

Alarm Event Level

Informational

```
admin:file search activelog syslog/CiscoSyslog RTMT
```

```
Jun 6 22:14:04 vnt-cmla local7 0 : 76: vnt-cmla.cisco.com: Jun 07 2019 02:14:04.496 UTC : %UC_RTMT-0-RTMT_ALERT:
%[AlertName=CallProcessingNodeCpuPegging][AlertDetail= Processor load over configured threshold for configured duration of
time . Configured high threshold is 91 %012ilsd (31 percent) uses most of the CPU. #012 #015#012Processor_Info:
#015#012#012#015 For processor instance 1: %CPU= 99, %User= 88, %System= 11, %Nice= 1, %Idle= 0, %IOWait= 0, %softirq= 0,
%irq= 0. #015#012#012#015 For processor instance _Total: %CPU= 99, %User= 87, %System= 12, %Nice= 1, %Idle= 0, %IOWait= 0,
%softirq= 0, %irq= 0. #015#012#012#015 For processor instance 0: %CPU= 99, %User= 85, %System= 13, %Nice= 1, %Idle= 0,
%IOWait= 0, %softirq= 0, %irq= 0. #015#012#012The alert is generated on Wed Jun 06 22:14:04 EDT 2019 on node vnt-
cmla.cisco.com. #012 #015#012 Memory_Info: %Mem Used= 60, %VM Used= 35. #012#015#012 Partition_Info: #015#012Swap: %Disk
Used=0. #012Active: %Disk Used=67. #012Common: %Disk Used=63. #012 #015#012 Process_I][AppID=Cisco AMC
Service][ClusterID=][NodeID=vnt-cmla]: RTMT Alert
```

# Cisco AMC Service Alert Logs

```
%UC_RTMT-0-RTMT_ALERT: %[AlertName=CallProcessingNodeCpuPegging]
[AlertDetail= Processor load over configured threshold for configured duration of
time . Configured high threshold is 91 %
```

**ilsd (31 percent)** uses most of the CPU.

Processor\_Info:

```
For processor instance 0: %CPU= 99, %User= 85, %System= 13, %Nice= 1, %Idle= 0,
%IOWait= 0, %softirq= 0, %irq= 0.
```

```
For processor instance 1: %CPU= 99, %User= 88, %System= 11, %Nice= 1, %Idle= 0,
%IOWait= 0, %softirq= 0, %irq= 0.
```

```
For processor instance Total: %CPU= 99, %User= 87, %System= 12, %Nice= 1, %Idle=
0, %IOWait= 0, %softirq= 0, %irq= 0.
```

The alert is generated on Wed Jun 06 22:14:04 EDT 2018 on node vnt-cmla.cisco.com.

**Memory\_Info: %Mem Used= 60, %VM Used= 35.**

Partition\_Info:

**Swap: %Disk Used=0.**

Active: %Disk Used=67.

Common: %Disk Used=63.

# Cisco AMC Service Alert Logs (Cont.)

- AMC Service by default sends Syslog/Alarms at Error Level to Local Syslog
- Some Pre-canned Alerts' Default Severity is Warning or Below
  - LogFileSearchStringFound
  - LowCallManagerHeartbeatRate
  - LowTFTPServerHeartbeatRate
  - MediaListExhausted
  - **RouteListExhausted**

**Cisco Unified Serviceability**  
For Cisco Unified Communications Solutions

Navigation Cisco Unified Serviceability Go

makman About Logout

Alarm Trace Tools Snmp CallHome Help

**Alarm Configuration**

Save Set to Default

**Select Server, Service Group and Service**

Server\* vnt-cm1a.cisco.com--CUCM Voice/Video Go

Service Group\* Performance and Monitoring Services Go

Service\* Cisco AMC Service (Active) Go

Apply to All Nodes

**Local Syslogs**

Enable Alarm Alarm Event Level Informational

**Remote Syslogs**

Enable Alarm Alarm Event Level Informational

Remote Syslog Servers<sup>1</sup>

Server Name 1 172.18.106.64

Server Name 2

Server Name 5

Save Set to Default

Change to Informational Level

Check

Save

## TIP Config Service Alarm Level via Platform CLI

```
run sql update alarmconfig set tkalarmseverity = '6' where fkprocessnodeservice IN (select pkid from processnodeservice where tkservice = '24') and tkmonitor = '0'
```

# Sending All Syslog Messages to Remote Servers

- Enterprise parameter for Cisco Syslog agent ← Runs on All Nodes by Default ✓
- Covers Platform OS Alarms or Syslogs ✓
  - Event Viewer–System log (messages)
- Can forward up to 5 Remote Syslog Servers
- Syslog Messages sent via UDP by default
  - TCP Support added as of Unified CM 11.5 → `utils remotesyslog set protocol tcp`
- NEW • TLS Support added as of Unified CM 11.5(1)SU3 & 12.0 → `utils remotesyslog set protocol tls`
- ! • Potential to duplicate alarms sent to remote syslog server
  - If you have also configured remote syslog destinations via alarm configuration
  - Event Viewer–Application log (CiscoSyslog/AlternateSyslog)

splunk &gt;

graylog

Elastic Stack

TIP Config Remote Syslog via Platform CLI

TIP Config Remote Severity via Platform CLI

## Cisco Syslog Agent

Remote Syslog Server Name 1	syslog-receiver.com
Remote Syslog Server Name 2	1.2.3.4
Remote Syslog Server Name 3	
Remote Syslog Server Name 4	
Remote Syslog Server Name 5	
Syslog Severity For Remote Syslog messages *	Informational

```
run sql update processconfig set paramvalue='1.2.3.4' where paramname == 'RemoteSyslogServerName'
```

Rows: 1

```
run sql update processconfig set paramvalue='6' where paramname == 'RemoteSyslogSeverity'
```

Rows: 1

# Sending Unified CM Alarms to Remote Servers via SNMP Traps

- Alarms that route to local syslogs can be sent out via SNMP traps utilizing **CISCO-SYSLOG-MIB** and notification destinations configured under serviceability GUI
- Configuration steps need to be performed on all servers/nodes
  1. Configure SNMP V1/V2 or V3 notification destination
  2. Configure alarm's to ensure local syslog is enabled and set the alarm event level to the desired level
  3. Use SNMP SET to enable clogNotificationsEnabled
    - Object = clogNotificationsEnabled
    - OID = 1.3.6.1.4.1.9.9.41.1.1.2
    - snmpset -v1 -c <write string> <host-ip> 1.3.6.1.4.1.9.9.41.1.1.2.0 i 1
  4. Use SNMP SET to configure clogMaxSeverity to the desired level
    - Object = clogMaxSeverity
    - OID = 1.3.6.1.4.1.9.9.41.1.1.3
    - snmpset -v1 -c <write string> <host-ip> 1.3.6.1.4.1.9.9.41.1.1.3.0 i <level>

# Real-Time Monitoring Tool: Sample Alerts

- SDLLinkOutOfService  
SDLLinkOOS for CTI or CCM
- **SyslogSeverityMatchFound**  
Severity 2 or above

Pay Attention ⓘ

- ServerDown  
Depends on AMC services  
Utilizes server list
- **DBReplicationTableOutOfSync**  
⚠ NOT enabled by default ⚠

Enabled by Cisco Database Layer Monitor Service Parameter Configuration

[Table Out of Sync Detection](#) \*

On

Turn This ON

Off

- DBChangeNotifyFailure  
Depends on DBMON service  
Monitors DB CN queues, collect *show tech notify* when received
- SyslogStringMatchFound  
Event Viewer – Application and System Logs are search for a given list of Strings configurable within Alert Properties
- SystemVersionMismatched  
Raised during upgrades/switchover



# Real-Time Monitoring Tool: SyslogSeverityMatchFound Examples

- **NTP Sync Failure → %UC\_RTMT-2-RTMT\_ALERT: %[AlertName=SyslogSeverityMatchFound]**  
 [AlertDetail= At Fri Jan 18 18:55:33 EST 2019 on node , the following SyslogSeverityMatchFound events generated: #012SeverityMatch :  
 Critical#012MatchedEvent : Jan 18 18:48:16 localhost user 2 platform: **None of the external NTP servers (172.18.106.3 72.163.32.43 10.81.254.202) responded. Verify the network connectivity, delay and jitter to the external NTP servers, that the NTP servers are operational, and that their strata are <= 5.**#012AppID : Cisco Syslog Agent#012ClusterID : #012NodeID : vnt-cm1a.cisco.com#012 TimeStamp : Fri Jan 18 18:55:23 EST 2019][AppID=Cisco AMC Service][ClusterID=][NodeID=vnt-cm1a.cisco.com]: RTMT Alert
- **Signal Congestion Entry → %UC\_RTMT-2-RTMT\_ALERT: %[AlertName=SyslogSeverityMatchFound]**  
 [AlertDetail= At Tue Jun 05 12:03:01 EDT 2019 on node 1.2.3.4, the following SyslogSeverityMatchFound events generated: #012SeverityMatch :  
 Critical#012MatchedEvent : Jun 5 12:02:29 cucm-sub1 local7 2 ccm: 6838: cucm-sub1: Jun 05 2019 16:02:29.795 UTC : **%UC\_CALLMANAGER-2-SignalCongestionEntry:** %[Thread=SIP Handler Thread] [AverageDelay=22] [EntryLatency=20] [ExitLatency=8] [SampleSize=10]  
 [TotalSignalCongestionEntry=6752][HighPriorityQueueDepth=0][NormalPriorityQueueDepth=1][LowPriorityQueueDepth=0][AppID=Cisco CallManager][ClusterID=UCMCluster1][NodeID=cucm-sub1]: Unified CM has detected signal congestion in an internal thread and has throttled activities for that thread#012AppID : Cisco Syslog Agent#012ClusterID : #012NodeID : cucm-sub1#012 TimeStamp : Tue Jun 05 12:02:02 EDT 2019][AppID=Cisco AMC Service][ClusterID=][NodeID=cucm-pub]: RTMT Alert
- **Certificate Validation Expiration → %UC\_RTMT-2-RTMT\_ALERT: %[AlertName=SyslogSeverityMatchFound]**  
 [AlertDetail= At Fri Jun 17 01:00:10 EDT 2019 on node cucm-pub, the following SyslogSeverityMatchFound events generated: #012SeverityMatch :  
 Alert#012MatchedEvent : Jun 17 01:00:00 cucm-pub local7 1 : 19: cucm-pub: Jun 17 2019 05:00:00 AM.128 UTC : **%UC\_CERT-1-CertValidLessthanADay:** %[Message=Certificate expiration Notification. Certificate name:ecats-uc-test-exp-c-1a.vnt.cisco.com.der Unit:CallManager-trust Type:own-ce][AppID=Cisco Certificate Monitor][ClusterID=][NodeID=cucm-pub]: Certificate is about to Expire in less than 24 hours or has Expired  
 #012AppID : Cisco Syslog Agent#012ClusterID : #012NodeID : cucm-pub#012 TimeStamp : Fri Jun 17 01:00:00 EDT 2019][AppID=Cisco AMC Service][ClusterID=][NodeID=cucm-pub]: RTMT Alert

# Service Manager: Feature vs. Network Services

- Feature services
  - Services that can be **activated/deactivated**
  - e.g., CallManager, TFTP
- Network services
  - Services that are always activated can **not** be deactivated
- Servm Started by initrd and maintained by inittab
  - Can **not** stop/start/restart it
- Each service has its own restart limit

## ServM Logs

- file get activelog platform/servm\_startup.log
- file get activelog platform/log/servm\*.log

**CISCO** Live!

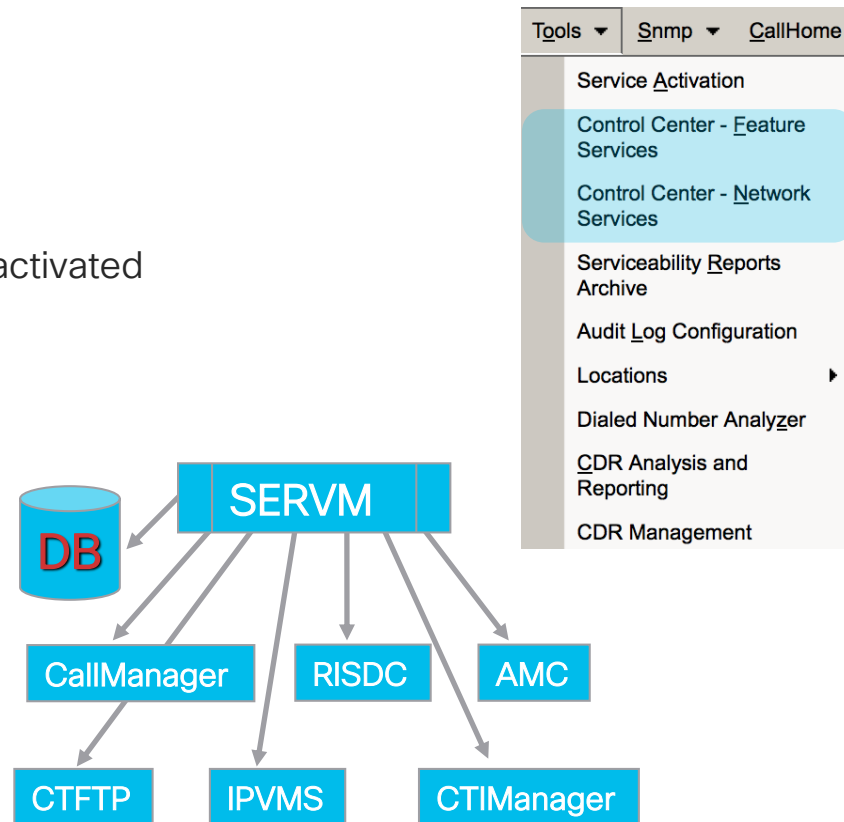

# Service Manager Alarms and Alerts

- Service Manager has its own Alarm Catalog
  - See Unified CM Serviceability
    - Alarm → Definitions → System Alarm Catalog → Service Manager Alarm Catalog

---

```
Nov 25 16:11:21 makman-vmcm1 local7 6 : 30: Nov 25 21:11:21.986 UTC :  
%UC_GENERIC-6-ServiceStopped: %[ServiceName=Cisco Tftp][AppID=Cisco Service  
Manager][ClusterID=][NodeID=makman-vmcm1]
```

```
Nov 25 16:12:17 makman-vmcm1 local7 3 : 35: Nov 25 21:12:17.173 UTC :  
%CCM_SERVICEMANAGER-SERVICEMANAGER-3-ServiceExceededMaxRestarts: Service exceeded  
maximum allowed restarts. Service Name:Cisco Tftp Reason:3 App ID:Cisco Service Manager Cluster  
ID: Node ID:makman-vmcm1
```

```
Nov 25 16:12:20 makman-vmcm1 local7 3 : 0: Nov 25 21:12:20.831 UTC : %CCM_RTMT-RTMT-3-  
RTMT-ERROR-ALERT: RTMT Alert Name:CriticalServiceDown Detail: Service status is DOWN. Cisco  
Tftp. The alert is generated on Sun Nov 25 16:12:20 EST 2019 on node 192.168.1.9. App ID:Cisco  
AMC Service Cluster ID: Node ID:makman-vmcm1
```

# Real-Time Monitoring Tool: Trace and Log Central

- Remote browse
  - Allows you to browse trace/log files for services/applications and system logs
  - Can download selected files from the browse window
- Collect files
  - Allows you to collect log/trace files for service/application and system logs matching the given time range
- Query wizard
  - Allows you to query log/trace files for service/application and system logs given a match string and time range

# Real-Time Monitoring Tool: Trace and Log Central

- Schedule collection
  - Allows you to create scheduled collection job's for service/application log/trace files given the time range and collection interval
- Real-time trace
  - View real-time data allows you to see log/trace files for service/application and system logs in real time and give basic search functionality
  - Monitor user event allows you to monitor an event in log/trace files for service/application and system logs given a monitoring time range. Upon a match several actions can be taken such as raise an alert, local syslog, remote syslog, download file.
- Collect crash dump
  - Allows you to collect core dump files for a given service/application and matched time range

# Real-Time Monitoring Tool: Trace and Log Central → Remote Browse

Use to See Files on Server(s)

Service Logs  
System Logs  
Audit Logs  
Crash Dump Files  
Download or Delete

The screenshot displays the Real Time Monitoring Tool interface. The main window is titled "Trace & Log Central" and shows a tree view of nodes under "vnt-cm1b.cisco.com". The "Remote Browse" dialog is open, showing a list of files with columns for Name, Size, and Modified. The files are listed in a table format.

Name	Size	Modified
SDL002_100_001119.txt.gz	1689102	Thu Jan 24 00:37:24 EST 2019
1692735		Thu Jan 24 00:39:04 EST 2019
SDL002_100_001121.txt.gz	1702194	Thu Jan 24 00:40:37 EST 2019
1677454		Thu Jan 24 00:42:16 EST 2019
SDL002_100_001122.txt.gz	1697364	Thu Jan 24 00:43:54 EST 2019
1731950		Thu Jan 24 00:45:27 EST 2019
SDL002_100_001124.txt.gz	1750698	Thu Jan 24 00:46:51 EST 2019
1750698		Thu Jan 24 00:48:29 EST 2019
SDL002_100_001126.txt.gz	1692729	Thu Jan 24 00:50:04 EST 2019
1708724		Thu Jan 24 00:51:44 EST 2019
SDL002_100_001128.txt.gz	1675842	Thu Jan 24 00:53:16 EST 2019
1708693		Thu Jan 24 00:54:37 EST 2019
SDL002_100_001129.txt.gz	1691459	Thu Jan 24 00:56:11 EST 2019
1687082		Thu Jan 24 00:57:48 EST 2019
SDL002_100_001132.txt.gz	1709922	Thu Jan 24 00:59:26 EST 2019
1704439		Thu Jan 24 01:00:59 EST 2019
SDL002_100_001133.txt.gz	1717002	Thu Jan 24 01:02:35 EST 2019
1712572		Thu Jan 24 01:04:06 EST 2019
SDL002_100_001134.txt.gz	1713209	Thu Jan 24 01:05:46 EST 2019
1696479		Thu Jan 24 01:07:24 EST 2019
SDL002_100_001135.txt.gz	1684048	Thu Jan 24 01:09:02 EST 2019
1711155		Thu Jan 24 01:10:37 EST 2019
SDL002_100_001136.txt.gz	1678847	Thu Jan 24 01:12:14 EST 2019
1702224		Thu Jan 24 01:13:46 EST 2019
SDL002_100_001142.txt.gz	1671592	Thu Jan 24 01:15:24 EST 2019
1707246		Thu Jan 24 01:16:57 EST 2019
SDL002_100_001143.txt.gz	1703833	Thu Jan 24 01:18:33 EST 2019
1720126		Thu Jan 24 01:20:05 EST 2019
SDL002_100_001144.txt.gz	1671891	Thu Jan 24 01:21:44 EST 2019
1687709		Thu Jan 24 01:23:19 EST 2019
SDL002_100_001147.txt.gz	1676217	Thu Jan 24 01:24:56 EST 2019
1689850		Thu Jan 24 01:26:34 EST 2019
SDL002_100_001149.txt.gz	1722691	Thu Jan 24 01:28:09 EST 2019
1716727		Thu Jan 24 01:29:43 EST 2019
SDL002_100_001152.txt.gz	1750003	Thu Jan 24 01:31:02 EST 2019
1776183		Thu Jan 24 01:32:13 EST 2019
SDL002_100_001153.txt.gz	1769334	Thu Jan 24 01:33:31 EST 2019
1754424		Thu Jan 24 01:34:58 EST 2019
SDL002_100_001154.txt.gz	1717947	Thu Jan 24 01:36:27 EST 2019
1702379		Thu Jan 24 01:38:04 EST 2019
SDL002_100_001157.txt.gz	1687382	Thu Jan 24 01:39:44 EST 2019
1688116		Thu Jan 24 01:41:24 EST 2019
SDL002_100_001158.txt.gz	1684300	Thu Jan 24 01:43:00 EST 2019
1706873		Thu Jan 24 01:44:36 EST 2019
SDL002_100_001161.txt.gz	1721512	Thu Jan 24 01:46:06 EST 2019
1724260		Thu Jan 24 01:47:34 EST 2019
SDL002_100_001162.txt.gz	1695731	Thu Jan 24 01:49:08 EST 2019
1692205		Thu Jan 24 01:50:43 EST 2019
SDL002_100_001163.txt.gz	1703048	Thu Jan 24 01:52:19 EST 2019

# Real-Time Monitoring Tool: Trace and Log Central → Collect Files

- Can collect logs/traces from multiple nodes on demand
- Collection done over HTTPS and can be cancelled

Unified CM  
10+ RTMT

①

②

③

Name	All Servers
Cisco CAR Scheduler	<input type="checkbox"/>
Cisco CAR Web Service	<input type="checkbox"/>
Cisco CAR Agent	<input type="checkbox"/>
Cisco CDR Repository Manager	<input type="checkbox"/>
Cisco CDR files on CM server	<input type="checkbox"/>
Cisco CDR files on Publisher Processed	<input type="checkbox"/>
Cisco CTManager	<input checked="" type="checkbox"/>
Cisco CTL Provider	<input type="checkbox"/>
Cisco CallManager	<input checked="" type="checkbox"/>
Cisco CallManager SNMP Service	<input type="checkbox"/>
Cisco Certificate Authority Proxy Function	<input type="checkbox"/>
Cisco Change Credential Application	<input type="checkbox"/>
Cisco DHCP Monitor Service	<input type="checkbox"/>
Cisco Dialed Number Analyzer	<input type="checkbox"/>
Cisco Dialed Number Analyzer Server	<input type="checkbox"/>
Cisco Directory Number Alias Lookup	<input type="checkbox"/>
Cisco Directory Number Alias Sync	<input type="checkbox"/>
Cisco Extended Functions	<input type="checkbox"/>
Cisco Extended Functions Report	<input type="checkbox"/>
Cisco Extension Mobility	<input type="checkbox"/>
Cisco Extension Mobility Application	<input type="checkbox"/>
Cisco IP Manager Assistant	<input type="checkbox"/>
Cisco IP Voice Media Streaming App	<input type="checkbox"/>
Cisco Intercluster Lookup Service	<input type="checkbox"/>
Cisco Location Bandwidth Manager	<input type="checkbox"/>
Cisco Management Agent Service	<input type="checkbox"/>
Cisco Push Notification Service	<input type="checkbox"/>

Warning

There were no service logs for following services.  
Files for Cisco CallManager on server cit-leaf-023-rtp.ecatsrtp.cisco.com are not available for the selected time

Close

Collect File Options:

Collection Time

Absolute Range

Select Reference Server Time Zone: Client:(GMT-5:0)Eastern Daylight Time-AmericaNew\_York

From Date/Time: 6/9/18 - 11:09 AM

To Date/Time: 6/9/18 - 12:09 PM

Relative Range

Files Generated in the last: 5 Minutes

Download File Options

Select Partition: Active Partition

Download File Directory: C:\Users\lmakman Browse

Zip Files

Do Not Zip Files

Uncompress Log Files

Delete Collected Log Files from Server

Note: The result file can be found in the directory named <Node Name> created under the user specified directory structure. The File Name is as specified by the user.

< Back Next > Finish Cancel

DO NOT ZIP HERE

cisco *Live!*

# Real-Time Monitoring Tool: Trace and Log Central → Query Wizard

- Same selection process as in collect files
- Can save queries for future use
- Can set call processing impact level
- Once query completes, matching file names are displayed similar to Remote Browse
- Equivalent to platform CLI command file search

④

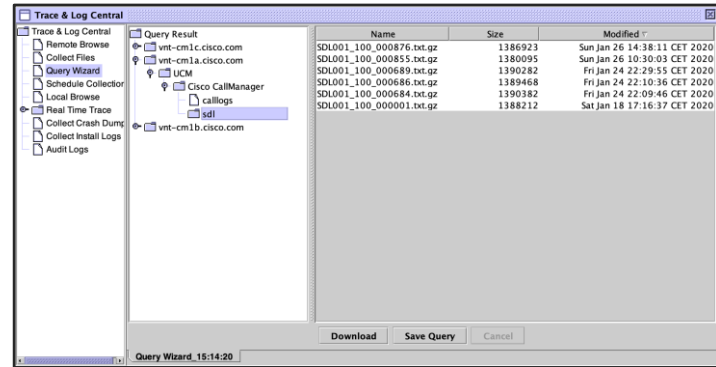

①

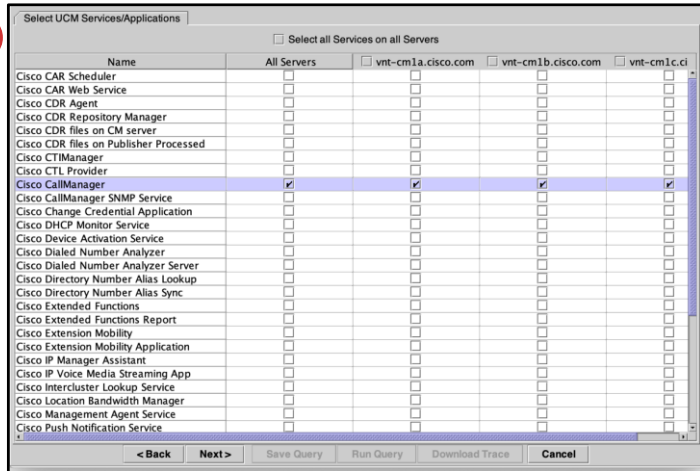

②

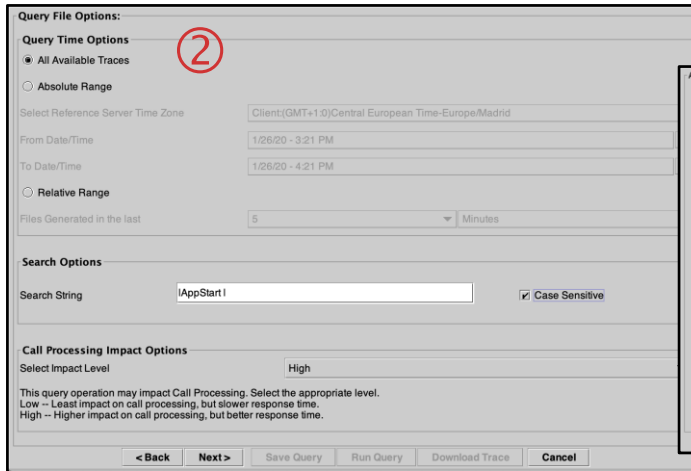

③

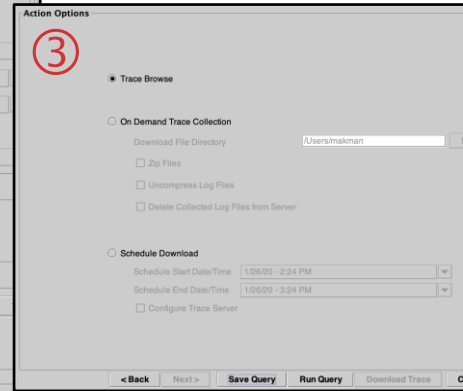



# Real-Time Monitoring Tool: Trace and Log Central → Schedule Collection

- Same selection process as in collect files
- Can choose to collect all files or collect matching ones to a query string
- Zip files option is done on the server side
- Use job status to monitor current jobs
- Upload to SFTP/FTP Servers
- “Collect files generated in the last” only applies to the first collection

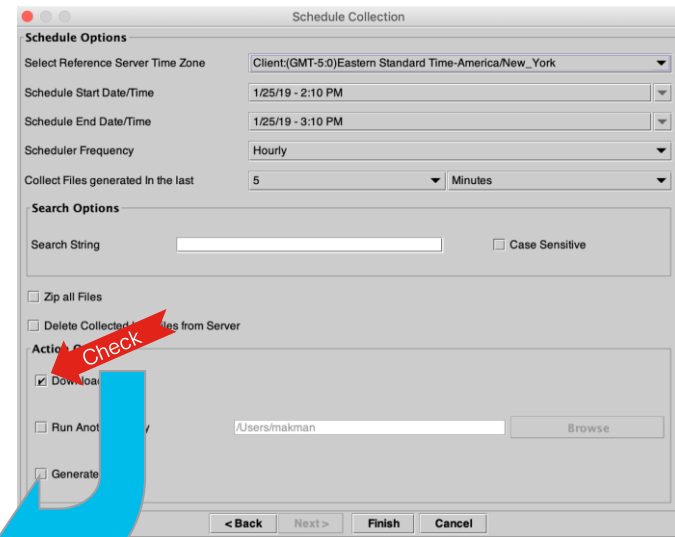
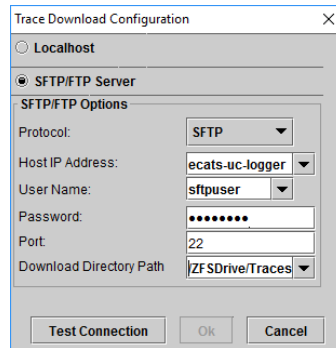

File System CallManager Edit Window Application Help

Real Time Monitoring Tool For Cisco Unified Communications Solution

System Job Status

Select a Node vnt-cm1b.cisco.com

Job Id	Status	Job Type	Query String
1202140494896	PENDING	ScheduleTask	<Partition> Active </Partition> <Ser...
1202140494910	COMPLETED	OnDemand	<Partition> Active </Partition> <Ser...
1202140494912	COMPLETED	OnDemand	<Partition> Active </Partition> <Ser...
1202140494913	COMPLETED	OnDemand	<Partition> Active </Partition> <Ser...
1202140494914	COMPLETED	OnDemand	<Partition> Active </Partition> <Ser...
1202140494898	COMPLETED	OnDemand	<Partition> Active </Partition> <Ser...

# Trace & Log Central → Schedule Collection Recommendations

## Publisher

- Cisco Serviceability Reporter
  - AlertReport
  - CallActivitiesReport
  - DeviceReport
  - PPRReport
  - ServerReport
  - ServiceReport

## CallProcessing Subscriber

- Prog Logs
- Cisco CallManager
- CTI Manager

## TFTP/MOH

- Cisco TFTP
- Cisco IP Voice Media Streaming App

## All Nodes

- Cisco Database Layer Monitor
- Cisco Database Library Trace
- Cisco Database Notification Service
- Cisco Database Replicator Trace
- Cisco RIS Data Collector PerfMonLog
- Service Manager
- Event Viewer-Application Log
- Event Viewer-System Log
- SAR Logs
- Cisco Audit Logs

# Real-Time Monitoring Tool: Trace and Log Central → Schedule Collection

- If trace collection server is down and a scheduled job fails there will be an error-level alarm raised at the local server which experienced the problem
- When the collection job resumes it will not go back and collect the trace files since the first failed job, it will only go back up to the scheduled interval

```
Jun  5 04:49:57 sjc-rfd-pub-1 local17 3 : 2: Jun 05
11:49:57.93 UTC : %CCM_TCT-LPMTCT-3-
ScheduledCollectionError: An error occurred while
executing scheduled collection. JobID:1180808534704
Reason:SFTP server 10.3.2.149 not reachable. Scheduled
run #62 App ID:Cisco Trace Collection Service Cluster ID:
Node ID:sjc-rfd-pub-1
```

# Real-Time Monitoring Tool: Trace and Log Central → Real-Time Trace → View Real-Time Data

**Real Time Trace Option**

Category:

Services:

Trace File Type:

- Select a Trace File Type
- calllogs
- dbl
- dbnotify
- sdl**

If trace compression is enabled, the data seen in this window can be bursty due to buffering of data.

Enter a Search String    Match case

**File Content**

```
08381144.027 |06:47:48.509 |AppInfo |//SIP/Stack/Info/0x0xcc1b8d98/sipSIPAddContextToTable: Added context(0xcb2108f0) with key=[67
08381144.028 |06:47:48.509 |AppInfo |//SIP/Stack/Info/0x0xcc1b8d98/sipSIPSendOptionsRequest: Associated container=0xcda
08381144.029 |06:47:48.509 |AppInfo |//SIP/Stack/Transport/0x0xcc1b8d98/sipSIPTransportSendMessage: msg=0xcda08520, a
08381144.030 |06:47:48.509 |AppInfo |//SIP/Stack/Transport/0x0/sipInstanceGetConnectionId: Registering gcb=0xcc1b8d98 with
08381144.031 |06:47:48.509 |AppInfo |//SIP/Stack/Transport/0x0xcc1b8d98/sipTransportLogicSendMessage: Set to send the msg=0x
08381144.032 |06:47:48.509 |AppInfo |//SIP/Stack/Transport/0x0xcc1b8d98/sipTransportPostSendMessage: Posting send for ms
08381144.033 |06:47:48.509 |AppInfo |//SIP/SIPHandler/ccblid=0/scblid=0/sip_stop_timer: timerContext=0xcc1b9d80 type=SIP_
08381144.034 |06:47:48.509 |AppInfo |//SIP/SIPHandler/ccblid=0/scblid=0/sip_start_timer: timerContext=0xcc1b9d80 type=SIP_
08381145.000 |06:47:48.509 |SdISig |SIPSPISignal |wait |SIPHandler(2,100,191,1) |SIPHand
08381145.001 |06:47:48.509 |AppInfo |SIPtcp - wait_SdISIPSignal: Outgoing SIP TCP message to 171.70.146.235 on port 5060 in
[15121507,NET]
OPTIONS sip:171.70.146.235:5060 SIP/2.0
Via: SIP/2.0/TCP 172.18.106.59:5060;branch=z9hG4bK338da533310f7b
From: <sip:172.18.106.59>;tag=861358828
To: <sip:171.70.146.235>
Date: Sun, 26 Jan 2020 11:47:48 GMT
Call-ID: ab4a0f80-1eb15e34-32e2ea-3b6a12ac@172.18.106.59
User-Agent: Cisco-CUCM12.5
CSeq: 101 OPTIONS
Contact: <sip:172.18.106.59:5060;transport=tcp>
Max-Forwards: 0
Content-Length: 0

08381146.000 |06:47:48.509 |SdISig |SIPpingReq |wait |SIPHandler(2,100,183,1) |SIPD
08381147.000 |06:47:48.509 |AppInfo |SIPSocketProtocol(2,100,251,56)::handleWriteComplete
08381146.001 |06:47:48.509 |AppInfo |//SIP/Stack/Info/0x0/sipSIPAddContextToTable: Added context(0xcb2108f0) with key=[67
08381146.002 |06:47:48.509 |AppInfo |DET-SDPMsg- sBandwidth:: enabledMask=0x0 as=0 ct=0 tias=0 maxprate=0
08381146.003 |06:47:48.509 |AppInfo |DET-SDPMsg- ngroups 0
08381146.004 |06:47:48.509 |AppInfo |DET-SDPMsg- No Session level unrecognized attributes list.
08381146.005 |06:47:48.509 |AppInfo |DET-SDPMsg- nAudio=0, mDTMFP.PayloadNum=0
08381146.006 |06:47:48.509 |AppInfo |DET-SDPMsg- nVideo=0
08381146.007 |06:47:48.509 |AppInfo |DET-SDPMsg- nApp=0
```

Enable Auto-Scrolling



# Real-Time Monitoring Tool: Trace and Log Central → Real-Time Trace → Monitor User Event

1

Monitor User Event

Real Time Trace Option

Nodes: vnt-cm1b.cisco.com-CUCM Voice/Video

Category: UCM

Services: Cisco CallManager

Trace File Type: sdl

< Back Next > Finish Cancel

2

3

Monitor User Event Options

Search Options

Search String: Cnf

Monitoring Time

Select Reference Server Time Zone: Client:(GMT-5.0)Eastern Standard Time-America/New\_York

From Date/Time: 1/25/19 - 2:26 PM

To Date/Time: 1/25/20 - 3:26 PM

Action Options

Alert

Local Syslog

Remote Syslog Server Name: 1.2.3.4

Download File

Warning

Warning:

1. If trace compression is enabled, there might be a delay in catching the event after it occurs, due to buffering of data.

2. Configure the Remote Syslogs for Cisco Trace Collection Service from Alarm Configuration page in Cisco Unified Serviceability to send the alarms to Remote Syslog server.

< Back Next > Finish Cancel

4

Alert Description:

At Fri Jan 25 14:35:15 EST 2019 on node vnt-cm1b.cisco.com; the following LogFileSearchStringFound events generated: SearchString : Cnf string encountered in file SDL002\_100\_001159.txt.gzo AppID : Cisco Trace Collection Service ClusterID : NodeID : vnt-cm1b.cisco.com TimeStamp : Fri Jan 25 14:34:52 EST 2019

```
Jan 25 14:35:45 vnt-cm1a local7 7 : 3: vnt-cm1a.cisco.com: Jan 25 2019 20:35:45.695 UTC : %UC_RTMT-4-RTMT_ALERT:
%[AlertName=LogFileSearchStringFound][AlertDetail=#012 At Sun Jan 25 14:34:52 EST 2019 on node , the following LogFileSearchStringFound events generated:
#012SearchString : Cnf string encountered in file SDL002_100_001159.txt.gzo#012AppID : Cisco Trace Collection Service#012ClusterID : #012NodeID : vnt-
cm1b.cisco.com#012 TimeStamp : Sun Jan 25 14:35:45 EST 2019][AppID=Cisco AMC Service][ClusterID=][NodeID=vnt-cm1a.cisco.com]: RTMT Alert
```

# Real-Time Monitoring Tool: Monitor User Event → Use Case Example

- **Problem Statement:** I have very crafty UC Admins who manage to create call routing loops via our SIP Trunks between our SME & Leaf Clusters. How can I detect these call routing loops and get notified?

 **Solution:** The Q.850 Cause Code of **25** could be used to detect such conditions. This code is used when a SIP Call is rejected with a 483 Response upon depleting the Max-Forwards count.

```
SIP/2.0 483 Too Many Hops
```

```
Via: SIP/2.0/TCP 10.122.224.65:5060;branch=z9hG4bK2638a1fb46f12
```

```
From: "Baha Akman" <sip:89915628@10.122.224.65>;tag=172381~7098c01f-c01f-4579-bc5b-6146a650f424-110041506
```

```
To: <sip:89915700@172.18.106.59>;tag=13471639
```

```
Call-ID: 42b42100-8a41c8f3-2638b-41e07a0a@10.122.224.65
```

```
CSeq: 101 INVITE
```

**Reason: Q.850;cause=25**

We can setup a Monitor User Event job against the CallManager Traces to detect it and notify Admins via an Alert Email / Syslog

# Real-Time Monitoring Tool: Monitor User Event → Use Case Example

The image displays three sequential screenshots of the Real-Time Monitoring Tool interface, illustrating the process of creating a monitoring job. The screenshots are labeled with red circled numbers 1, 2, and 3.

**Screenshot 1 (Monitor User Event Option):** Shows the initial configuration screen. The "Create Events" radio button is selected. A "Nodes" dropdown menu is visible, showing "vnt-cm1b.cisco.com--CUCM Voice/Video". A blue callout box points to this dropdown with the text: "Need to Create the Monitoring Job ONE Node at a time".

**Screenshot 2 (Real Time Trace Option):** Shows the "Real Time Trace Option" screen. The "Nodes" dropdown menu is still visible, showing "vnt-cm1b.cisco.com--CUCM Voice/Video".

**Screenshot 3 (Real Time Trace Option):** Shows the "Real Time Trace Option" screen with configuration options: "Category" (UCM), "Services" (Cisco CallManager), and "Trace File Type" (sdl).

Blue curved arrows indicate the flow from Screenshot 1 to Screenshot 2, and from Screenshot 2 to Screenshot 3. Navigation buttons (< Back, Next >, Finish, Cancel) are visible at the bottom of each screenshot.

# Real-Time Monitoring Tool: Monitor User Event → Use Case Example

Monitor User Event

**Monitor User Event Options**

**Search Options**

Search String: Reason: Q.850;cause=25  Case Sensitive

**Monitoring Time**

Select Reference Server Time Zone: Client:(GMT-5:0)Eastern Standard Time-America/New\_York

From Date/Time: 2/15/17 - 4:58 PM

To Date/Time: 2/15/18 - 5:58 PM

**Action Options**

Alert

Local Syslog

Remote Syslog Server Name:

Download File

**Warning**

Warning:

1. If trace compression is enabled, there might be a delay in catching the event after it occurs, due to buffering of data.
2. Configure the Remote Syslogs for Cisco Trace Collection Service from Alarm Configuration page in Cisco Unified Serviceability to send the alarms to Remote Syslog server.

< Back Next > Finish Cancel

Jan 26 08:33:59 vnt-cm1a local7 4 : 1094: vnt-cm1a.cisco.com: Jan 26 2020 13:33:59.620 UTC : %UC\_RTMT-4-RTMT\_ALERT: %[AlertName=LogFileSearchStringFound][AlertDetail=#012 At Sun Jan 26 08:33:59 EST 2020 on node vnt-cm1b.cisco.com, the following LogFileSearchStringFound events generated: #012SearchString : Reason: Q.850; cause=25 string encountered in file SDL002\_100\_001369.txt.gzo#012AppID : Cisco Trace Collection Service#012ClusterID : #012NodeID : vnt-cm1b.cisco.com#012 TimeStamp : Sun Jan 26 08:33:48 EST 2020][AppID=Cisco AMC Service][ClusterID=][NodeID=vnt-cm1a.cisco.com]: RTMT Alert



# Real-Time Monitoring Tool: Trace and Log Central IOWait Throttling

- Customized via clusterwide RISDC service parameters
- Warning is displayed on all on-demand operations

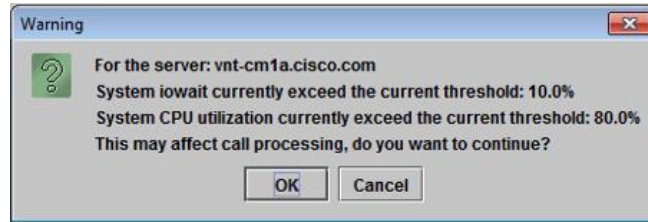

**Select Server and Service**

Server\*

Service\*

All parameters apply only to the current server except parameters that are in the Clusterwide group(s).

<a href="#">TLC Throttling Enabled</a> *	<input type="text" value="True"/>	True
<a href="#">TLC Throttling IOWait Goal</a> *	<input type="text" value="50"/>	55
<a href="#">TLC Throttling CPU Goal</a> *	<input type="text" value="50"/>	80
<a href="#">TLC Throttling Polling Delay</a> *	<input type="text" value="250"/>	250
<a href="#">TLC Throttling SFTP Maximum Delay</a> *	<input type="text" value="5000"/>	5000

# Unified CM Serviceability Trace Configuration

- Cannot change the Trace Destinations

Each service/application has fixed destination under activelogs partition

RTMT trace and log central uses the service's name to access trace/log files

Virtualized Unified CM Disk Size can be increased via `ciscocm.vmware-disk-size-reallocation-1.0.cop.sgn`

**Required for Unified CM 8.6 & 9.1 NOT required for Unified CM 10+**

- Log partition monitor service monitors the common partition where trace/log files are placed

You can configure the following information parameters in alert central in RTMT:

**LogPartitionLowWaterMarkExceeded** – disk space utilization level at which log partition monitoring stops purging log files; level ranges exist from 10 – 90 percent; **default equals 90 percent**; configuration must be lower than high watermark

**LogPartitionHighWaterMarkExceeded** – disk space utilization level at which log partition monitoring starts purging log files; level ranges exist from 15 – 95 percent; **default equals 95 percent**

- In order to minimize unnecessary IO impact avoid hitting the LogPartitionHighWaterMark

Control the maximum number files and maximum file size trace configuration

Alert Central			
System Voice/Video IM and Presence Custom			
Alert Name	Enabled	In Safe Range	Alert Action
LogPartitionHighWaterMarkExceeded	Enabled	N/A	Default
LogPartitionLowWaterMarkExceeded	Enabled	N/A	Default

# Real-Time Monitoring Tool: Syslog Viewer

- System logs
  - messages log file contains OS logs, platform agents logs
- Application logs
  - CiscoSyslog log file contains Alarms from most Cisco Unified CallManager Alarm Catalogs
  - AlternateSyslog (8.6+) log file contains certain Unified CM Alarm Catalogs such as Phones
- Security logs
  - secure log file contains security-related messages such as all login attempts to the platform and other internal process executions at privileged level
- OS syslogd will drop messages if the system is overloaded. Unified CM 10.X+ utilizes rsyslogd
  - Jun 8 17:38:54 azo-cm-uc syslog 1 nbslogpd[4456]: 104 messages were dropped
  - Feb 16 04:02:01 vnt-cm1c syslog 6 rsyslogd-2177:imuxsock begins to drop messages from pid 16915 due to rate-limiting



File Rotation Settings



Each File Can Grow Up to 5 MB and Rotated 4 Times

# Real-Time Monitoring Tool: Syslog Viewer

Cisco Unified Real Time Monitoring Tool (Currently Logged into: vnt-cm1a.cisco.com)

File System Voice/Video AnalysisManager IM and Presence Edit Window Application Help

Real Time Monitoring Tool For Cisco Unified Communications Solutions

System SysLog Viewer

Select a Node vnt-cm1b.cisco.com

Logs

Date	Machine Name	Severity	Process	Message
Feb 14 21:30:02	vnt-cm1b	Error	platform	: The domain name server is now reachable. The DNS watch dog
Feb 14 22:30:17	vnt-cm1b	Error	platform	: Domain name server is unreachable
Feb 14 23:00:02	vnt-cm1b	Error	platform	: The domain name server is now reachable. The DNS watch dog automatically restarts NSCD service when DNS goes from not reachable to re
Feb 15 08:00:17	vnt-cm1b	Error	platform	: Domain name server is unreachable
Feb 15 08:30:02	vnt-cm1b	Error	platform	: The domain name server is now reachable. The DNS watch dog automatically restarts NSCD service when DNS goes from not reachable to re
Feb 15 15:00:17	vnt-cm1b	Error	platform	: Domain name server is unreachable
Feb 15 15:30:02	vnt-cm1b	Error	platform	: The domain name server is now reachable. The DNS watch dog automatically restarts NSCD service when DNS goes from not reachable to re

Filter Options

Filter Inverse:

Severity: All

Process: platform

Machine Name: All

Message: All

From Date/Time:

To Date/Time:

OK Apply Clear Can

Show Detail

Log

Date: Feb 15 15:30:02

Machine Name: vnt-cm1b

Severity: Error

Process: platform

Message: : The domain name server is now reachable. The DNS watch dog automatically restarts NSCD service when DNS goes from not reachable to reachable

↑ ↓ Print Close

Refresh Clear Filter Clear Filter Find Save

Trace & Log Central Alert Central Real Time Data SysLog Viewer

# Real-Time Monitoring Tool: AuditLog Viewer

- AuditApp Logs
  - Application Level Audit Logs
    - activelog audit/AuditApp/Audit\*.log
  - Enabled via Cisco Unified Serviceability
    - Tools → Audit Log Configuration
  - Can send to Dedicated Remote Syslog

The screenshot shows the 'Audit Log Configuration' web interface. At the top, there are 'Save' and 'Set to Default' buttons. Below that, the 'Status' is 'Ready'. The 'Select Server' section shows a dropdown menu with 'vnt-cm1a.cisco.com--CUCM Voice/Video' selected and a 'Go' button. There is an 'Apply to All Nodes' checkbox. The 'Application Audit Log Settings' section includes 'Filter Settings' with four checked options: 'Enable Audit Log', 'Enable Purging', 'Enable Log Rotation', and 'Detailed Audit Logging'. The 'Remote Syslog' section has a 'Server Name' input field and a 'Remote Syslog Audit Event Level' dropdown set to 'Error'. The 'Output Settings' section has 'Maximum No. of Files\*' set to 250 and 'Maximum File Size (MB)\*' set to 2. The 'Notification Settings' section has a 'Warning Threshold for Approaching Log Rotation Overwrite (%)' set to 80.

- vos Logs
  - Operating System Level Audit Logs
    - activelog audit/vos/vos-audit.log\*
  - Enabled via Admin CLI
    - utils auditd enable
- OS Level Audit Logs are also forwarded to syslog/messages file
  - No Flooding in
    - 11.5(1)SU7
    - 12.5(1)SU2



# Real-Time Monitoring Tool: AuditLog Viewer

**AuditLog Viewer**

Select a Node: **vnt-cm1a.cisco.com** Auto Refresh

**Logs**

- Audit00000084.log
- Audit00000085.log
- Audit00000086.log
- Audit00000087.log
- Audit00000088.log
- Audit00000089.log
- Cisco Unified OS Logs

Date	UserID	ClientAddress	Severity	Event	Resource	EventStatus	CompulsoryEvent	AuditCategory	ComponentID	CorrelationID	AuditDetails	App ID	Cluster ID	Node ID
06/09/2019 17:40:19.311	axl	2001:420:27c2:106:b1ac:81a4:90d3:3520	Error	UserLogg										
06/09/2019 17:40:19.314	axl	2001:420:27c2:106:b1ac:81a4:90d3:3520	Info	UserAcce										
06/09/2019 17:40:19.369	axl	2001:420:27c2:106:b1ac:81a4:90d3:3520	Error	UserLogg										
06/09/2019 17:40:19.370	axl	2001:420:27c2:106:b1ac:81a4:90d3:3520	Info	UserAcce										
06/09/2019 17:40:19.427	axl	2001:420:27c2:106:b1ac:81a4:90d3:3520	Error	UserLogg										
06/09/2019 17:40:19.429	axl	2001:420:27c2:106:b1ac:81a4:90d3:3520	Info	UserAcce										
06/09/2019 17:40:19.503	axl	2001:420:27c2:106:b1ac:81a4:90d3:3520	Error	UserLogg										
06/09/2019 17:40:19.505	axl	2001:420:27c2:106:b1ac:81a4:90d3:3520	Info	UserAcce										
06/09/2019 17:40:19.560	axl	2001:420:27c2:106:b1ac:81a4:90d3:3520	Error	UserLogg										
06/09/2019 17:40:19.561	axl	2001:420:27c2:106:b1ac:81a4:90d3:3520	Info	UserAcce										
06/09/2019 17:40:19.620	axl	2001:420:27c2:106:b1ac:81a4:90d3:3520	Error	UserLogg										
06/09/2019 17:40:19.629	axl	2001:420:27c2:106:b1ac:81a4:90d3:3520	Info	UserAcce										
06/09/2019 17:40:24.212	spark-call-connect	10.122.249.100	Info	UserAcce										
06/09/2019 17:40:29.260	makman	2001:420:c0c8:1001:0:0:0:cd	Info	UserAcce										
06/09/2019 17:40:30.384	CCMAdministrator	172.18.107.119	Info	UserAccess	Cisco AXL	Success	No	AdministrativeEvent						
06/09/2019 17:40:30.459	makman	2001:420:c0c8:1001:0:0:0:cd	Notice	DeviceUpdate	CUCMAdmin	Success	No	AdministrativeEvent						
06/09/2019 17:40:30.505	makman	2001:420:c0c8:1001:0:0:0:cd	Notice	GeneralConfigurationUpdate	CUCMAdmin	Success	No	AdministrativeEvent						
06/09/2019 17:40:30.505	makman	2001:420:c0c8:1001:0:0:0:cd	Notice	GeneralConfigurationUpdate	CUCMAdmin	Success	No	AdministrativeEvent						
06/09/2019 17:40:30.505	makman	2001:420:c0c8:1001:0:0:0:cd	Notice	GeneralConfigurationUpdate	CUCMAdmin	Success	No	AdministrativeEvent						
06/09/2019 17:40:30.505	makman	2001:420:c0c8:1001:0:0:0:cd	Notice	GeneralConfigurationUpdate	CUCMAdmin	Success	No	AdministrativeEvent						
06/09/2019 17:40:30.505	makman	2001:420:c0c8:1001:0:0:0:cd	Notice	GeneralConfigurationUpdate	CUCMAdmin	Success	No	AdministrativeEvent						
06/09/2019 17:40:30.506	makman	2001:420:c0c8:1001:0:0:0:cd	Notice	GeneralConfigurationUpdate	CUCMAdmin	Success	No	AdministrativeEvent						
06/09/2019 17:40:30.506	makman	2001:420:c0c8:1001:0:0:0:cd	Notice	GeneralConfigurationUpdate	CUCMAdmin	Success	No	AdministrativeEvent						
06/09/2019 17:40:30.677	makman	2001:420:c0c8:1001:0:0:0:cd	Info	UserAccess	CUCMAdmin	Success	No	AdministrativeEvent						
06/09/2019 17:40:30.743	CCMAdministrator	172.18.107.119	Info	UserAccess	Cisco AXL	Success	No	AdministrativeEvent						
06/09/2019 17:41:11.707	axl	2001:420:27c2:106:b1ac:81a4:90d3:3520	Info	UserLogging	Cisco Tomcat	Success	No	CriticalEvent						
06/09/2019 17:41:11.709	axl	2001:420:27c2:106:b1ac:81a4:90d3:3520	Info	UserLogging	Cisco Tomcat	Success	No	CriticalEvent						
06/09/2019 17:41:11.709	axl	2001:420:27c2:106:b1ac:81a4:90d3:3520	Info	UserLogging	Cisco Tomcat	Success	No	CriticalEvent						
06/09/2019 17:41:11.710	axl	2001:420:27c2:106:b1ac:81a4:90d3:3520	Info	UserLogging	Cisco Tomcat	Success	No	CriticalEvent						
06/09/2019 17:41:11.711	axl	2001:420:27c2:106:b1ac:81a4:90d3:3520	Info	UserLogging	Cisco Tomcat	Success	No	CriticalEvent						

Refresh Clear Filter Clear Filter Find Save

Date: 06/09/2019 17:40:30.459  
 UserID: makman  
 ClientAddress: 2001:420:c0c8:1001:0:0:0:cd  
 Severity: Notice  
 EventType: DeviceUpdate  
 ResourceAccessed: CUCMAdmin  
 EventStatus: Success  
 CompulsoryEvent: No  
 AuditCategory: AdministrativeEvent  
 ComponentID: Cisco CUCM Administration CorrelationID :  
 AuditDetails: CAL mode or CAL value of Phone with MAC  
 address=00506004F5BE has not been modified  
 App ID: Cisco Tomcat  
 Cluster ID:  
 Node ID: vnt-cm1a.cisco.com

# Real-Time Monitoring Tool: Device Search

- Use device search to find out last activities of devices
  - When they last registered, failed over, failed back, unregistered

The screenshot illustrates the 'Device Search' workflow in the Real-Time Monitoring Tool. The main interface shows a tree view of system components, with 'Device Search' highlighted under the 'Device' section. Overlaid on this are several dialog boxes that guide the user through the search process:

- Select Device with Status:** Allows filtering by status (Registered, Unregistered, Partial Registered, Rejected, Any Status, Device only Configured in).
- Select Device with Download Status:** Allows filtering by download status (Any Status, Successful, Downloading, Failed).
- Search By Device Model:** Allows searching by Protocol (Any) and Model (Any Model or Device Model).
- Search with Name:** Allows searching by Name/Address, Directory Number, Device Name, Device Description, IP Address, IP Subnet, or IPv6 Address.
- Monitor following attributes:** Allows selecting specific attributes to monitor, such as Name, Status, DirNumber, Description, Model, StatusReason, Protocol, InactiveLoadId, DownloadStatus, DownloadServer, ActiveLoadId, RequestedLoadId, and DownloadFailureReason.

# Real-Time Monitoring Tool: Device Search

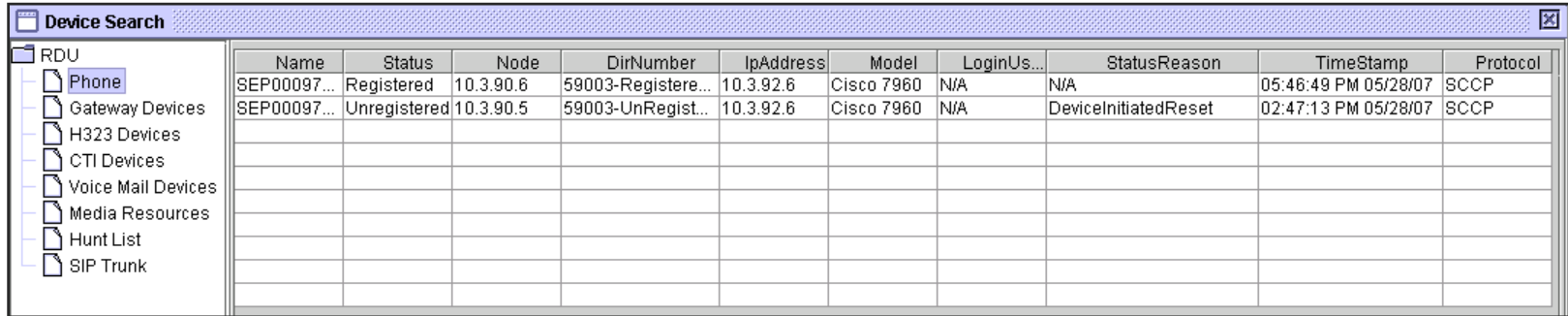

Name	Status	Node	DirNumber	IpAddress	Model	LoginUs...	StatusReason	TimeStamp	Protocol
SEP00097...	Registered	10.3.90.6	59003-Registere...	10.3.92.6	Cisco 7960	N/A	N/A	05:46:49 PM 05/28/07	SCCP
SEP00097...	Unregistered	10.3.90.5	59003-UnRegist...	10.3.92.6	Cisco 7960	N/A	DeviceInitiatedReset	02:47:13 PM 05/28/07	SCCP

- Same information about devices can be found via platform CLI commands  
show risdb query or show risdb list
- RISDB query can be saved in to a file and can be downloaded or viewed via “file view platform/cli/<filename>” command
- Timestamp is in RTMT client’s timezone



# Real-Time Monitoring Tool: Device Search

## SIP Trunk Detailed Service Status

Device Search											
VNT-CM1A-Cluster											
	Name	Status	Node	IpAddress	Ipv6Addr...	Model	Descripti...	StatusR...	% Of Ser...	Duration	
Phone	IT-SME-EMEAR-APAC	Full Service	vnt-cm1c.ci...	172.18.106...	N/A	SIP Trunk	Cisco-IT S...	N/A	100 %	Time In-Full-Service: 0 day 10 hours 43 minutes	
Gateway Devices	IT-SME-RTP	Partial Serv...	vnt-cm1c.ci...	172.18.106...	N/A	SIP Trunk	Cisco IT S...	N/A	75 %	Time not in Full Service: 25 days 2 hours 23 minutes	
H323 Devices	IT-SME-SJC	Full Service	vnt-cm1c.ci...	172.18.106...	N/A	SIP Trunk	Cisco-IT S...	N/A	100 %	Time In-Full-Service: 2 days 6 hours 22 minutes	
CTI Devices	IT-SME-EMEAR-APAC	No Service	vnt-cm1a.ci...	172.18.106...	N/A	SIP Trunk	Cisco IT S...	N/A	0 %	Time not in Full Service: 65 days 11 hours 16 minutes	
Voice Mail Devices	IT-SME-SJC	No Service	vnt-cm1a.ci...	172.18.106...	N/A	SIP Trunk	Cisco IT S...	N/A	0 %	Time not in Full Service: 65 days 11 hours 16 minutes	
Media Resources	IT-SME-EMEAR-APAC	Full Service	vnt-cm1b.ci...	172.18.106...	N/A	SIP Trunk	Cisco-IT S...	N/A	100 %	Time In-Full-Service: 0 day 10 hours 43 minutes	
Hunt List	IT-SME-RTP	Partial Serv...	vnt-cm1b.ci...	172.18.106...	N/A	SIP Trunk	Cisco IT S...	N/A	75 %	Time not in Full Service: 25 days 2 hours 23 minutes	
SIP Trunk	IT-SME-SJC	Full Service	vnt-cm1b.ci...	172.18.106...	N/A	SIP Trunk	Cisco-IT S...	N/A	100 %	Time In-Full-Service: 1 day 2 hours 52 minutes	

Destination IP Address	Destination Status	Destination StatusReason	Destination Time UP/DOWN
64.100.24.219	UP		Time Up: 0 day 2 hours 37 minutes
64.100.36.182	UP		Time Up: 0 day 2 hours 37 minutes
64.100.36.183	UP		Time Up: 0 day 12 hours 47 minutes
64.100.24.220	DOWN	local=2	Time Down: 0 day 2 hours 37 minutes

The only way to see a SIP Trunk's Real Time Service Status per node

- Click on a Trunk running on a Node to see Detailed Status
  - Status Shown per destination from a Unified CM node's perspective
  - StatusReason maps to [SIPTrunkOOS Alarm](#) Definition Reasons
    - Local=2 → local SIP stack is not able to create a socket connection with the remote peer
    - Remote=503 → "503 Service Unavailable" a standard SIP RFC error code received

- Applicable only to SIP Trunks where **OPTIONS Ping** is enabled
- Historical SIP Trunk Status available via CallManager Alarms
  - SIPTrunkOOS, SIPTrunkISV, SIPTrunkPartiallyISV

# Real-Time Monitoring Tool: Analysis Manager Overview

- A Client Application in the Real Time Monitoring Tool (RTMT)
- Provides a Single User Interface for Troubleshooting Functions Across the following UC Products:
  - Cisco Unified Communications Manager
  - Cisco Unified Communications Manager Business Edition
  - Cisco Unified Unity Connection
  - Cisco Unified Presence
  - Cisco Unified Contact Center Express
  - Cisco Unified Voice Portal
  - Cisco Unified Contact Center Enterprise
  - Cisco IOS Voice Gateways via ACS

# Agenda

- **Serviceability Tools Overview**

  - Real-Time Monitoring Tool (RTMT)

  - Cisco Unified Operating System GUI

  - Cisco Unified Operating System CLI

  - Cisco Serviceability Reports

  - Cisco Unified Reporting

  - Serviceability APIs

- Troubleshooting Methodology

  - Problem Description

  - Information Collection

- Troubleshooting Case Studies

  - Dropped Call

  - Video Encryption Not Working

  - No One Answers the Phone

  - One-Way Audio

  - Unable to Place Calls

  - ActiveControl Not Working on Jabber 12.5

  - Call Drops After Answering

  - Video Call Immediately Drops

- Understanding and Troubleshooting Unified CM Throttling Events

- Troubleshooting Database Replication

# Cisco Unified OS GUI

- Displays basic OS-level information
  - List cluster nodes
  - Show hardware information (CPU type, installed memory, RAID controller status)
  - View IP addressing and network statistics
  - List installed software (including all COP files)—shows active and inactive versions
  - Display system-level statistics (CPU/memory/disk utilization)
  - Displays TCP/IP Port usage (IP Preferences)

# Cisco Unified OS GUI

- Allows configuration of platform-level settings
  - IP addressing or Hostname information
  - NTP server and time configuration
  - SMTP server address (used for OS-level notifications such as certificate expirations)
  - Reset, restart, and switch version of the server
- Configuration of platform security settings
  - Manage certificates (upload, download, generate)
    - [Bulk Certificate Management](#) (Import, Export, Consolidate)
  - Configure certificate monitor notifications
  - Certificate Revocation Setting (OCSP)
  - Configure IPSEC policies
  - Upload Customized Logon Message

# Cisco Unified OS GUI

- Software Installation
  - Install COP files or upgrade unified CM software
  - **CUCM 12.5+ Install/Upgrade Cluster (aka Simple Upgrades)** 👍
- TFTP file management
  - Upload or delete files from the TFTP directory (e.g., RingList.xml)
  - Device Load Management available in 11.X+
    - Allows easy clean up of Device Loads that are Not In Use
- Ping from the server
  - Useful for troubleshooting IP connectivity issues from the server
  - Can validate IPSEC connections

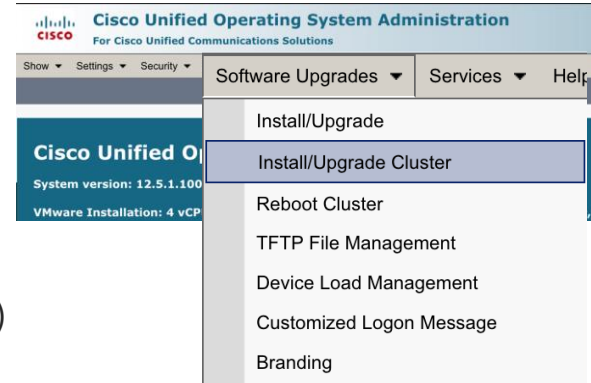

# Introduction to CUCM 12.5 Simple Upgrades

## Simple Upgrades

Pre/Post Upgrade COP  
For 10/11/12x to 12.5

One-Touch Cluster wide  
Software Download

One-Touch Cluster wide  
Upgrade

One-Touch Cluster wide  
Reboot / Switchover

!! Only for 12.5+ DSU !!

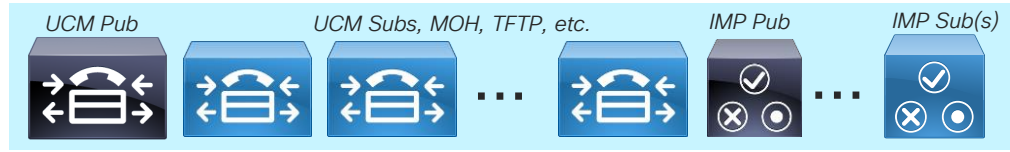

→ Pre/Post Upgrade COP File that can detect common Problems  
PASS  / WARNING  / FAIL

→ Use Download Credentials From Publisher  
→ Download without kicking off Upgrade

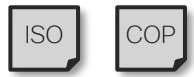

→ Mini PCD Built-in to CUCM Publisher OS Admin GUI  
→ Pre-Reboot CUCM & IM&P Database Replication  
→ Pre-Reboot IM&P ← → CUCM Database Sync



→ Batch & Control Cluster wide Switchover Sequence

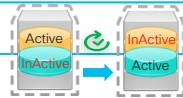

# Pre / Post Upgrade Check COP Files aka. Upgrade Readiness COP file

- “Living” COP Files Posted on CCO
- Automate several pre/post Upgrade checklist tasks
  - Source CUCM 10.X,11.X, 12.X
  - Targeted for CUCM 12.5
- ciscocm.preUpgradeCheck-00XXX.cop.sgn
- ciscocm.postUpgradeCheck-00XXX.cop.sgn
- Checks are executed at the time of COP Installation on each node.

```
admin:file dump install PreUpgradeReport.txt
```

```
=====
                        Pre Upgrade Test                        Date: 01/26/2020 12:46:03
=====
Active Version: 12.5.1.12900-112
Server: vnt-cmla.cisco.com , CUCM Publisher
=====

Result Test
-----
1.1 PASS Test dataBase Sanity
1.2 WARN Filesystem Checks

*) This server is using an older filesystem type (ext3).
Recommend reinstall-and-restore or PCD Migration before upgrading to move
to newer/more efficient ext4 for increased performance and reliability.

1.3 PASS SLM License Status
1.4 WARN Deprecated Phone Models
Deprecated Phones in the system for CUCM 12.x and above are :
- Phone XYZ

1.5 PASS Common Security Password Length
System not in FIPS mode, Common Security Password's Minimum length
requirement not enforced

1.6 PASS DRS backup status
1.7 PASS Network status (NTP, DNS & Cluster node connectivity)
1.8 PASS Cluster Database Status
1.9 PASS Network Adapter Type
```



# Pre / Post Upgrade Check COP Files

```
=====  
System Status List  
-----
```

```
2.1 Version          VMTools Type (PASS)  
    10.1.5.59732     open-vm-tools
```

```
2.2 Cops Installed (PASS)  
    No Installed Software Options Found.
```

```
2.3 Upgrade Checks (PASS)  
  
    No issues Found
```

```
2.4 Count          Phone Status (PASS)  
    1              Registered  
    0              Unregistered
```

```
=====  
Summary:
```

```
Total Test Run : 13  
Total Passed   : 11  
Total Warnings : 2  
Total Failed   : 0
```

```
Note: Please refer to the readme of Pre Upgrade cop for test  
details and  
      pass/fail/warn/criteria
```

```
Duration for running tests: 0:04:06  
=====
```

# Pre / Post Upgrade Check COP Files

```
admin:file dump install PostUpgradeReport.txt
```

```
=====
                          Post Upgrade Test                Date: 01/26/2020 13:02:26
=====
```

```
Active Version: 12.5.1.12900-112
Inactive Version: 12.5.1.12900-108
Server: vnt-cmla.cisco.com , CUCM Publisher
Pre Upgrade Date: 01/26/2020 12:50:28
=====
```

```
Result Test
```

```
-----
1.1 PASS Test dataBase Sanity
1.2 PASS SLM License Status
1.3 PASS Network status (NTP, DNS & Cluster node connectivity)
1.4 PASS Cluster Database Status
1.5 PASS Network Adapter Type
=====
```

```
System Status List
```

```
-----
2.1 Version VMTools Type (PASS)
    10.1.5.59732 open-vm-tools

2.2 Cops Installed (PASS)
    ciscocm.preUpgradeCheck-00022.cop
=====
```

```
=====
Summary:
```

```
Total Test Run : 12
Total Passed : 12
Total Warnings : 0
Total Failed : 0
```

```
Note: Please refer to the readme of Post Upgrade cop for test
details and
```

```
pass/fail/warn/criteria
```

```
Phones and services take time finish setting up.
Rerunning the COP will give latest status.
```

```
Some values may be truncated due to column width size.
Please refer the
```

```
pre_upgrade_readiness_cmds.log/post_upgrade_readiness_cmds.log
for exact values.
```

```
Use "file view install pre_upgrade_readiness_cmds.log/
post_upgrade_readiness_cmds.log" to view the command
output with
```

```
exact values.
```

```
Duration for running tests: 0:02:59
=====
```

- ✓ Wait until DB Replication Setup is complete
- ✓ Re-Run as needed
- ✓ Work with TAC if you can't address Failures

# Examples of Pre-upgrade Checks

(Work in Progress & subject to change)

- ✓ Check Network services/connectivity (NTP, DNS, intra-cluster)
- ✓ Check FIPS-mode password length restriction
- ✓ Check License sync vs. PLM/SLM
- ✓ Check VMware Tools version compatibility vs. destination release.
- ✓ Check enough disk space in critical locations
- ✓ Compare SIP & H.323 trunk registration status
- ✓ Check ClusterManager authentication & Database replication status of all nodes
- ✓ Check DB contains “sane” source data
- ✓ Check that DRS backup is configured, and date of last backup.
- ✓ Compare Services status
- ✓ Compare Installed COPs & Locales
- ✓ Compare Device Registration status count
- ✓ Compare CTI Endpoint registration status
- ✓ Compare Enterprise Service Parameters
- ✓ Compare TFTP Max Service Count service parameter values
- ✓ Display Active/Inactive Versions
- ✓ For destination release, suggest any COPS that should be installed or services that won't be there (e.g. deprecated endpoints)

# Agenda

- **Serviceability Tools Overview**

  - Real-Time Monitoring Tool (RTMT)

  - Cisco Unified Operating System GUI

  - Cisco Unified Operating System CLI**

  - Cisco Serviceability Reports

  - Cisco Unified Reporting

  - Serviceability APIs

- Troubleshooting Methodology

  - Problem Description

  - Information Collection

- Troubleshooting Case Studies

  - Dropped Call

  - Video Encryption Not Working

  - No One Answers the Phone

  - One-Way Audio

  - Unable to Place Calls

  - ActiveControl Not Working on Jabber 12.5

  - Call Drops After Answering

  - Video Call Immediately Drops

- Understanding and Troubleshooting Unified CM Throttling Events

- Troubleshooting Database Replication

# Cisco Unified OS Administration CLI (Platform CLI) Overview

- Command line interface access

SSH2 client remotely

Local keyboard/mouse console access or via VMWare Console



- CLI gives wrapped and controlled interface to several OS/appliance/application functions
- Provides several “show tech” commands
- Provides low level platform/appliance health status and monitoring
- Multiple sessions can be opened at the same time via SSH2 remote connections
- Duplicates some functionality that is available in RTMT
  - Check services status, performance counter access, RISDB search, etc.
  - utils service, show perf, show risdb**
- All activities are logged with auditing support
- Context-sensitive command syntax help is provided with “?”

```
admin:set timezone ?
```

```
Syntax:
```

```
set timezone zone
```

```
zone mandatory
```

```
This is the new timezone. Enter the appropriate string  
or zone index id to uniquely identify the timezone.
```

```
A list of valid timezones can be obtained via the  
following CLI command: show timezone list.
```

# Sample CLI Commands: Trace and Logs

- **file list**

Lists files similar to Linux “ls” command

```
file list activelog
file list inactivelog
file list install
file list partBsalog
file list salog
file list tftp
```

- **file search**

Searches files for a given regular expression similar to Linux “grep” command

```
admin:file search activelog ?
```

Syntax:

```
file search activelog file-spec reg-exp [options]
```

file-spec mandatory file to view

reg-exp mandatory regular expression which is to be searched.

To include "s escape them with \.

options optional reltime days|hours|minutes timevalue

abstime hh:mm:ss mm/dd/yyyy hh:mm:ss mm/dd/yyyy

ignorecase, recurs

- **file tail**

Tails a given file similar to Linux “tail” command. Has regular expression support. Use ‘recent’ to tail the newest file in the directory

- **file get**

[Uploads](#) a file from the node where command is issued to a remote SFTP server

- **file dump**

[Cats](#) a file to the screen. Enable “set cli pagination off” prior to get a quick dump of an entire file

# Sample CLI Commands: Network

- **set network**

Allows admin to set IP address, DNS, domain name, MTU, PMTUD, NIC speed/duplex, default gateway, NIC teaming, etc.

```
admin:set network
    set network cluster publisher
    set network dhcp*
    set network dns*
    set network domain
    set network gateway
    set network hostname
    set network ip eth0
    set network ipv6*
    set network max_ip_contrack
    set network mtu
    set network name-service ← Controls Name Service Caching Daemon
    set network nic*
    set network ntp option
    set network pmtud
    set network restore
    set network status*
```

# Sample CLI Commands: Network

- **show network**

Allows admin to see the following network information

```
show network all
show network cluster
show network dhcp
show network eth0 detail (MAC address)
show network ip_conntrack
show network ipprefs*
show network ipv6*
show network max_ip_conntrack
show network name-service*
show network ntp*
show network route
show network status
```

Syntax: show network status [options]

options      optional      detail,listen,process,all,nodns,search stext

options are:

detail	- Display additional information
listen	- Display only Listening Sockets
process	- Display the process ID and name of the program to which each socket belongs
all	- Display both Listening and Non-Listening Sockets
nodns	- Displays Numerical Addresses without any DNS information
search stext	- Search for the "stext" in the output



# Sample CLI Commands: Network

- **utils firewall ipv4/ipv6 list**

- Shows the Internal firewall rules that is in place. Each node has to authenticate in to the cluster to get allowed to connect to certain applications. After successful authentication firewall rules are adjusted to allow connection. Starting with Unified CM 7.X `All ports are denied by Default. If a Service is not activated ports are not allowed.

- **show open ports all/regex**

- Used to see which TCP/UDP and application has open or established ports

```
admin:show open ports regex "2000"
```

```
Executing.. please wait.
```

```
ccm 31097 ccbase 256u IPv4 43464284 TCP 10.9.30.5:2000 (LISTEN)
ccm 31097 ccbase 260u IPv4 43464297 TCP 10.9.30.5:2000->10.9.36.204:49516 (ESTABLISHED)
```

- **utils network capture**

- Allows admin to sniff network traffic similar to Linux command “tcpdump”
- Can save to a file under activelog platform/cli/\*.cap

- **utils network capture-rotate**

- Enhanced network capture command to allow Local File Rotation

- **utils network host**

- Allows admin to perform DNS name lookups including SRV records similar to Linux command “dig”. Can specify which external server to use for lookup.

- **utils network name-service hosts/services cache invalidate**

- Clears Hosts or Services Entries out of the Name Caching Daemon



# Sample CLI Commands Network

- **utils network connectivity**

- Used only on the subscriber nodes. [Performs a Network Connectivity test between the Subscriber node and Publisher](#). Utilizes Cluster Manager and ensures TCP/UDP port 8500 communication is intact. If there is a failure the following alarm will be logged in the Event Viewer - Application Log.

```
May 21 13:49:50 bldr-ccm97 local7 6 : 7: May 21 19:49:50.533 UTC
: %CCM_CLUSTERMANAGER-CLUSTERMANAGER-6-CLM_ConnectivityTest: CLM
Connectivity Test Failed. Node's IP:10.94.150.99 Error description
:CLM_TEST_UNABLE_UDP_DATAGRAM App ID:Cisco Cluster Manager Cluster ID:
Node ID:bldr-ccm97
```

- The same Connectivity test is also ran automatically by the Cluster Manager Service every 3 minutes to proactively detect major intracluster communication problems.

- **utils network connectivity [hostname]**

- Can be run on any node against any other node. Used to check Intracluster communication.

# Sample CLI Commands: Platform/OS

- **show status**

Shows the current platform status information such as datetime, timezone, active version, [uptime](#), CPU, memory, and disk usage summary



- **license management system remove**

Removes the Local License Management System (PLM) installation, if you are utilizing a Standalone PLM or Smart Software Manager Satellite

Not Applicable to CUCM 12.0+

- **utils vmtools refresh**

Performs Interactive VMware Tools Installation when the Vmtools Installation ISO is mounted

**Requires Reboot** after successful Install / Update of Vmtools



- **utils vmtools switch open**

CUCM 12.5+ only.. Uninstalls Existing VMware tools and installs open-vm-tools (Guest Managed)

**Requires Reboot** after successful switch to open-vm-tools

# Sample CLI Commands: Platform/OS

- **show process list**

- Lists processes currently running similar to Linux “ps” command with or without details such as threads, file descriptors, memory usage, etc. Can search for processes using process id, name or userid

- **show process using-most cpu/memory**

- Shows the top 5 Processes using the most CPU or memory.

- **show process load**

- Lists top CPU processes currently running similar to Linux “top” command. Top process sort order can be adjusted using memory, CPU, time. [noidle option can indicate which processes are waiting on IOWait](#)

# Sample CLI Commands: Platform/OS



## • `utils os kerneldump`

- Replaces “utils netdump” functionality. Used to collect debug information in the event of a kernel panic. In case there is catastrophic hardware failure debug information can be sent to a remote SSH server.

```
admin:utils os kerneldump
      utils os kerneldump disable
      utils os kerneldump enable
      utils os kerneldump ssh*
      utils os kerneldump status
```

Best Practice

```
admin:file list install crash/* date detail
09 Jun,2012 14:22:20      <dir>      127.0.0.1-2012-06-09-14:20:03
dir count = 1, file count = 0
admin:file list install crash/127.0.0.1-2012-06-09-14:20:03/ detail
09 Jun,2012 14:20:14    70,926,328  vmcore
dir count = 0, file count = 1
```

# Sample CLI Commands: Platform/OS

- **utils system**

- Utility to shutdown, restart or switch versions on the system



- **utils os secure**

- Utility to switch SELinux mode from enforce (default) to permissive

- **utils core active/inactive analyze**

- Analyzes a coredump file and records the backtrace information. Essential to pass on to TAC in the unlikely event you experience a CoreDumpFile found alert. Use file list activelog core first to find out the core filename. IOwait warning

# Sample CLI Commands: Platform/OS



## • **utils create report security**

- Collects SELinux Security related logs, including VOS audit logs

```
admin:utils create report security
```

```
Collecting files...
```

```
Security Diagnostic files have been collected: security-diagnostics.tar.gz
```

```
To retrieve the security-diagnostic.tar.gz, use CLI command: file get activelog syslog/security-diagnostics.tar.gz
```

```
To delete the security-diagnostic.tar.gz, use CLI command: file delete activelog syslog/security-diagnostics.tar.gz
```

## • **utils filebeat**

- Allows Export of Platform Audit Logs, Remote Access Logs or Bulk Admin Logs to a LogStash Server

```
utils filebeat config
```

```
utils filebeat disable
```

```
utils filebeat enable
```

```
utils filebeat status
```

```
utils filebeat tls*
```

# Sample CLI Commands: Platform/OS IOWAIT

- **utils fior**

- File IO reporting is used to periodically capture IO stats for each process.
- Polling occurs every 10 min. So data is not as granular.
- You must first enable FIOR then start it. Once enabled it will remain enabled through restarts.

```
admin:utils fior
      utils fior disable
      utils fior enable
      utils fior list
      utils fior start
      utils fior status
      utils fior stop
      utils fior top
```

- **utils iostat**

- Equivalent of Linux iostat command

```
admin:utils iostat
```

Syntax:

```
utils iostat
```

```
interval          optional          (seconds) Interval
between two iostat readings - mandatory if
iterations is being used
```

```
iterations        optional          The number of
iostat iterations to be performed - mandatory if
interval is being used
```

```
filename          optional          Redirect the output
to a file
```



# Cisco Unified OS Administration CLI Tips

- Only CBC Based Ciphers are supported for outbound SFTP Connections prior to Unified CM 10.5(2)SU4, 11.5
  - SFTP Server Side “/etc/ssh/sshd\_config” can be modified to allow older CBC based Ciphers

 Ciphers `chacha20-poly1305@openssh.com, aes128-ctr, aes192-ctr, aes256-ctr, aes128-gcm@openssh.com, aes256-gcm@openssh.com, aes256-cbc, 3des-cbc`

- Some operations will cause increased CPU utilization and IOWait state. Use with caution

`file get, file search, utils dbreplication, etc.`

- Watch out for impact of show tech commands. Read documentation first before trying them

`show tech all, show tech database, show tech routeplan, etc.`

- CTRL + C can break out of many commands

- Some characters are not legal. When pressed you won't see anything on the screen

Semicolon (;) or backtick (`) or pipe (|) or ampersand (&)

- DNS Reverse Lookup failure or Very high IOWait conditions could significantly delay CLI login times or prevent logins

- Watch out for **CSCuy82773** while logging in to Platform CLI via Vsphere Virtual Machine Console

- Fixed as of 10.5(2)SU3+, 11.0(1)SU2+, 11.5(1)+

-  • Reset CCMAdministrator/CallManager application password using CLI command

`utils reset_application_ui_administrator_name`

`utils reset_application_ui_administrator_password`

# Agenda

- **Serviceability Tools Overview**

  - Real-Time Monitoring Tool (RTMT)

  - Cisco Unified Operating System GUI

  - Cisco Unified Operating System CLI

- Troubleshooting Methodology

  - Problem Description

- Troubleshooting Case Studies

  - Dropped Call

  - No One Answers the Phone

  - Unable to Place Calls

  - Call Drops After Answering

- Understanding and Troubleshooting Unified CM Throttling Events

- Troubleshooting Database Replication

  - Cisco Serviceability Reports**

  - Cisco Unified Reporting

  - Serviceability APIs

  - Information Collection

  - Video Encryption Not Working

  - One-Way Audio

  - ActiveControl Not Working on Jabber 12.5

  - Video Call Immediately Drops

# Unified CM Serviceability Reports Archive

- Data collected by primary/failover [AMC service](#)
- Reports are generated by [Cisco Serviceability Reporter Service](#)
  - Should be activated on the **Publisher node Only**
- Reports are generated daily and each covers last 24 hours
  - Accessible via Cisco Unified Serviceability → Tools → Serviceability Reports Archive
  - Reports are generated at 12:30am by default. Set by Cisco Serviceability Reporter Service Parameter **RTMT Report Report Generation Time\***
- Reports can be collected via RTMT or CLI
  - Cisco Serviceability Reporter AlertReport, CallActivitiesReport, DeviceReport, PPRReport, ServerReport, ServiceReport
  - file get activelog cm/report/rtmtreporter/\* recurs
- Archive can keep up to 30 days
  - Set by Cisco Serviceability Reporter Service Parameter RTMT Report Deletion Age\*

## Performance and Monitoring Services

	Service Name	Activation Status
<input checked="" type="checkbox"/>	Cisco Serviceability Reporter	Activated
<input checked="" type="checkbox"/>	Cisco CallManager SNMP Service	Activated

The screenshot shows the Cisco Unified Serviceability web interface. The top navigation bar includes 'Alarm', 'Trace', 'Tools', 'Snmp', 'CallHome', and 'Help'. The 'Tools' menu is expanded, showing 'Serviceability Reports Archive' as the selected option. Below the menu, there are sections for 'Month-Year' (May 2019, Jun 2019) and 'Jun' (1 2 3 4). A section titled 'Files for 06 04 2019' lists several report files, including AlertRep, CallActivitiesRep, DeviceRep, PerformanceRep, and ServiceRep.

**cisco** *Live!*

# Unified CM Serviceability Reports – Call Activities Report

- Call activity for the cluster
  - Calls attempted
  - Calls completed
- H323 gateways call activity for the cluster
  - Calls attempted
  - Calls completed
- MGCP gateways call activity for the cluster
  - T1 CAS–calls completed
  - PRI–calls completed
  - FXS–calls completed
  - FXO–calls completed
- MGCP gateways
  - FXO–ports In Service
  - FXO–ports active
  - FXS–ports In service
  - FXS–ports active
  - PRI–spans In service
  - PRI–channels active
  - T1 CAS–spans In service
  - T1 CAS–channels active
- Trunk call activity for the cluster
  - H323 trunks–calls attempted
  - H323 trunks–calls completed
  - SIP trunk–calls attempted
  - SIP trunk–calls completed

# Unified CM Serviceability Reports – Alert Summary Report

- Number of alerts per severity for the cluster
  - Severity–number of alerts
- Number of alerts per server
  - Server–number of alerts
- Top 10 alerts in the cluster
  - Alerts

# Unified CM Serviceability Reports – Device Statistics Report

- Number of registered phones per server
  - Servers, clusterwide
- Number of partially registered phones per server
  - Servers, clusterwide
- Number of MGCP gateways registered in the cluster
  - Cisco MGCP FXO gateways
  - Cisco MGCP FXS gateways
  - Cisco MGCP PRI gateways
  - Cisco MGCP T1CAS gateways
- Number of H323 gateways in the cluster
- Number of trunks in the cluster
  - H323 Trunks
  - SIP Trunks

# Unified CM Serviceability Reports – Performance Protection Statistics (1 of 2)

- Call activity for 172.18.106.58
  - Calls attempted \* hourly rate
  - Calls completed \* hourly rate
  - Calls In progress
- Number of registered phones, MGCP gateway for 172.18.106.58
  - Phones
  - MGCP gateways
- System resource utilization for 172.18.106.58
  - % CPU usage
  - % Virtual memory usage
  - % Hard disk usage of the common partition
  - % Hard disk usage of the swap partition
  - % Hard disk usage of the active partition
  - % Hard disk usage of the inactive partition

 This Report Is Generated per Server and Includes Last Seven Days of Performance Data

# Unified CM Serviceability Reports – Performance Protection Statistics (2 of 2)

- Devices
  - Number of IP phones 7212
  - Number of unity connection ports 241
  - Number of CTI ports 16
  - Number of CTI route points 14
  - Number of H323 clients 1
  - Number of H323 gateways 4
  - Number of MGCP gateways 12
  - Number of MOH resources 3
  - Number of MTP resources 12
  - Number of CFB resources 14
- Dial plan
  - Number of directory numbers/lines 2609
  - Number of route patterns 57
  - Number of translation patterns 34



# Unified CM Serviceability Reports – Service Statistics Report

- Cisco CTI manager: number of open devices
  - Servers
- Cisco CTI manager: number of open lines
  - Servers
- Cisco TFTP: number of requests
  - Server
- Cisco TFTP: number of aborted requests
  - Server

# Unified CM Serviceability Reports – Server Report

- % CPU per server
  - Servers
- % Virtual memory usage per server
  - Servers
- %Hard disk usage of the common partition per server
  - Server

# Unified CM Serviceability Reports Archive

## Sample Alert Summary Report

### RTMT Reporter Alert Summary

Date : Jun 4 , 2019

Page : 1 of 3

Number of Alerts per Severity for the Cluster

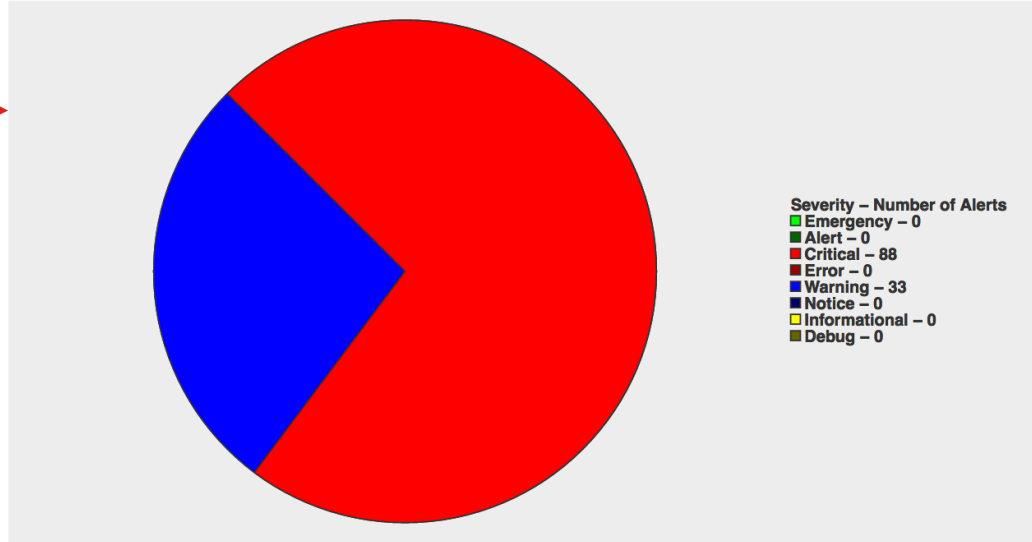

- Files for 06 04 2019
- AlertRep\_06\_04\_2019.pdf
  - CallActivitiesRep\_06\_04\_2019.pdf
  - DeviceRep\_06\_04\_2019.pdf
  - PerformanceRep\_vnt-cm1a.cisco.com\_06\_04\_2019.pdf
  - PerformanceRep\_vnt-cm1b.cisco.com\_06\_04\_2019.pdf
  - PerformanceRep\_vnt-cm1c.cisco.com\_06\_04\_2019.pdf
  - ServerRep\_06\_04\_2019.pdf
  - ServiceRep\_06\_04\_2019.pdf

# Unified CM Serviceability Reports Archive

## Sample Alert Summary Report

Date : Jun 4 , 2019

Page : 2 of 3

Number of Alerts per Server

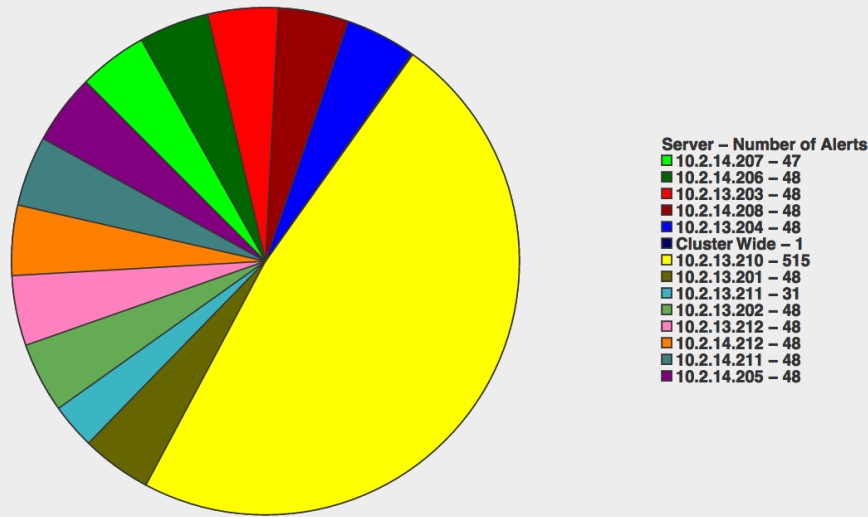

Files for 06 04 2019

- AlertRep\_06\_04\_2019.pdf
- CallActivitiesRep\_06\_04\_2019.pdf
- DeviceRep\_06\_04\_2019.pdf
- PerformanceRep\_vnt-cm1a.cisco.com\_06\_04\_2019.pdf
- PerformanceRep\_vnt-cm1b.cisco.com\_06\_04\_2019.pdf
- PerformanceRep\_vnt-cm1c.cisco.com\_06\_04\_2019.pdf
- ServerRep\_06\_04\_2019.pdf
- ServiceRep\_06\_04\_2019.pdf

# Unified CM Serviceability Reports Archive

## Sample Alert Summary Report

Date : Jun 4 , 2019

Page : 3 of 3

Top 10 Alerts in the Cluster

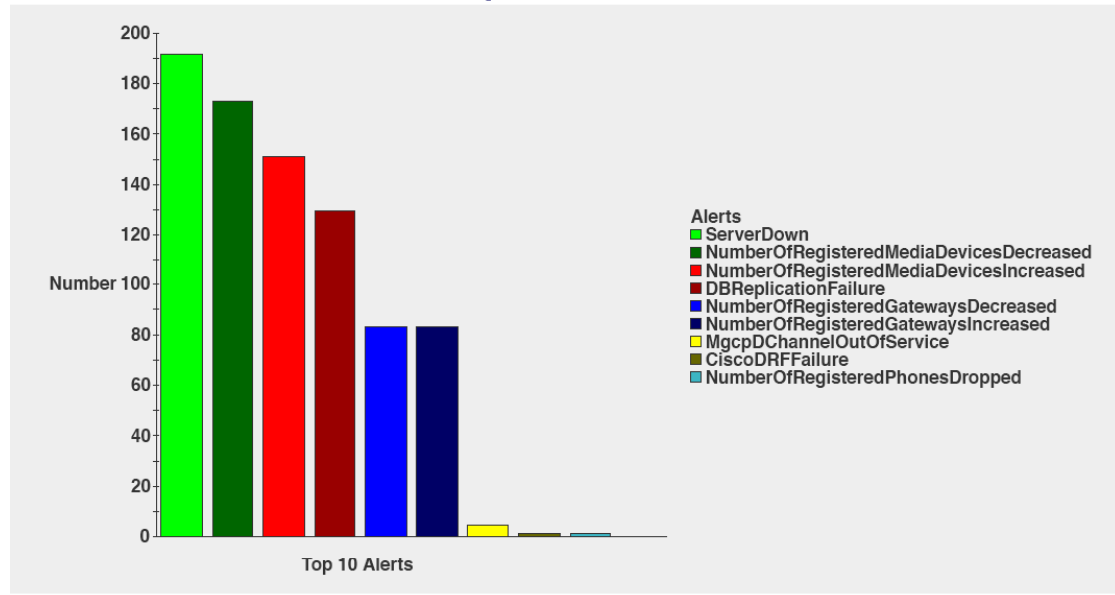

- Files for 06 04 2019
- [AlertRep\\_06\\_04\\_2019.pdf](#)
  - [CallActivitiesRep\\_06\\_04\\_2019.pdf](#)
  - [DeviceRep\\_06\\_04\\_2019.pdf](#)
  - [PerformanceRep\\_vnt-cm1a.cisco.com\\_06\\_04\\_2019.pdf](#)
  - [PerformanceRep\\_vnt-cm1b.cisco.com\\_06\\_04\\_2019.pdf](#)
  - [PerformanceRep\\_vnt-cm1c.cisco.com\\_06\\_04\\_2019.pdf](#)
  - [ServerRep\\_06\\_04\\_2019.pdf](#)
  - [ServiceRep\\_06\\_04\\_2019.pdf](#)



# Unified CM Serviceability Reports Archive

## Sample Call Activities Report

### RTMT Reporter Call Activities

Date : Jun 4 , 2019

Page : 1 of 5

Call Activity for the Cluster

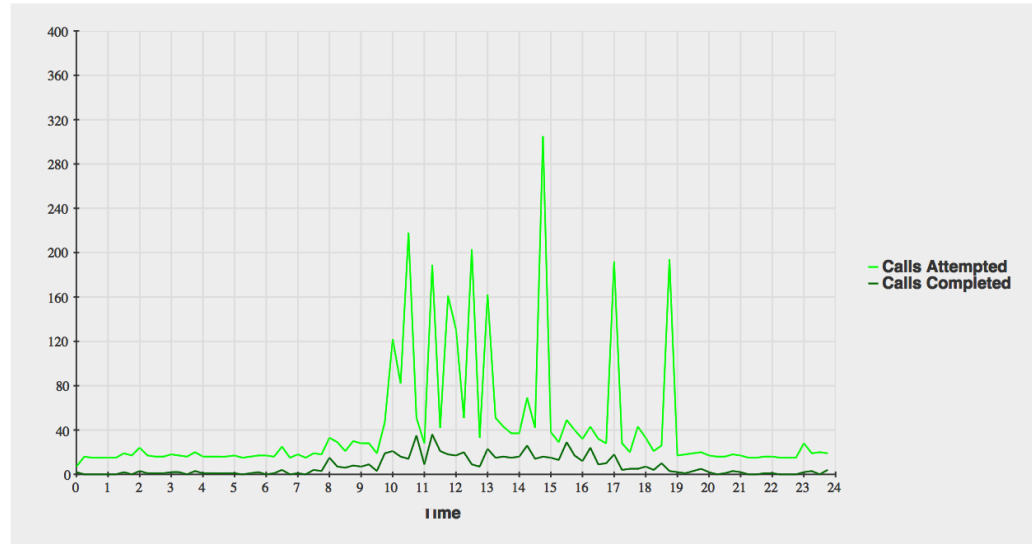

- Files for 06 04 2019
- [AlertRep\\_06\\_04\\_2019.pdf](#)
  - [CallActivitiesRep\\_06\\_04\\_2019.pdf](#)
  - [DeviceRep\\_06\\_04\\_2019.pdf](#)
  - [PerformanceRep\\_vnt-cm1a.cisco.com\\_06\\_04\\_2019.pdf](#)
  - [PerformanceRep\\_vnt-cm1b.cisco.com\\_06\\_04\\_2019.pdf](#)
  - [PerformanceRep\\_vnt-cm1c.cisco.com\\_06\\_04\\_2019.pdf](#)
  - [ServerRep\\_06\\_04\\_2019.pdf](#)
  - [ServiceRep\\_06\\_04\\_2019.pdf](#)



# Unified CM Serviceability Reports Archive

## Sample Call Activities Report

Date : Jun 4 , 2019

Page : 5 of 5

Trunk Call Activity for the Cluster

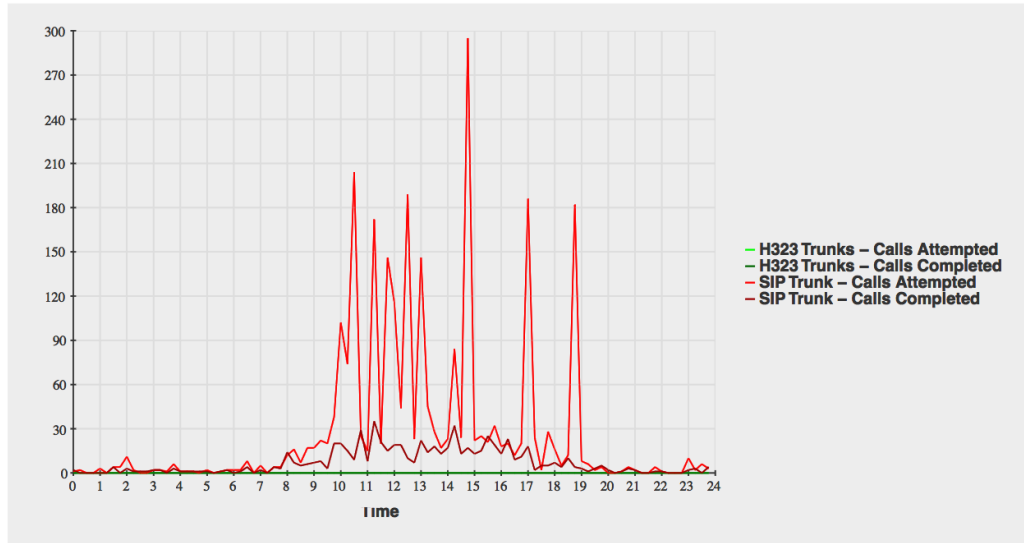

Files for 06 04 2019

- [AlertRep\\_06\\_04\\_2019.pdf](#)
- [CallActivitiesRep\\_06\\_04\\_2019.pdf](#)
- [DeviceRep\\_06\\_04\\_2019.pdf](#)
- [PerformanceRep\\_vnt-cm1a.cisco.com\\_06\\_04\\_2019.pdf](#)
- [PerformanceRep\\_vnt-cm1b.cisco.com\\_06\\_04\\_2019.pdf](#)
- [PerformanceRep\\_vnt-cm1c.cisco.com\\_06\\_04\\_2019.pdf](#)
- [ServerRep\\_06\\_04\\_2019.pdf](#)
- [ServiceRep\\_06\\_04\\_2019.pdf](#)

**CISCO** Live!

# Unified CM Serviceability Reports Archive

## Sample Server Reports

- Files for 06 04 2019
- [AlertRep\\_06\\_04\\_2019.pdf](#)
  - [CallActivitiesRep\\_06\\_04\\_2019.pdf](#)
  - [DeviceRep\\_06\\_04\\_2019.pdf](#)
  - [PerformanceRep\\_vnt-cm1a.cisco.com\\_06\\_04\\_2019.pdf](#)
  - [PerformanceRep\\_vnt-cm1b.cisco.com\\_06\\_04\\_2019.pdf](#)
  - [PerformanceRep\\_vnt-cm1c.cisco.com\\_06\\_04\\_2019.pdf](#)
  - [ServerRep\\_06\\_04\\_2019.pdf](#)
  - [ServiceRep\\_06\\_04\\_2019.pdf](#)

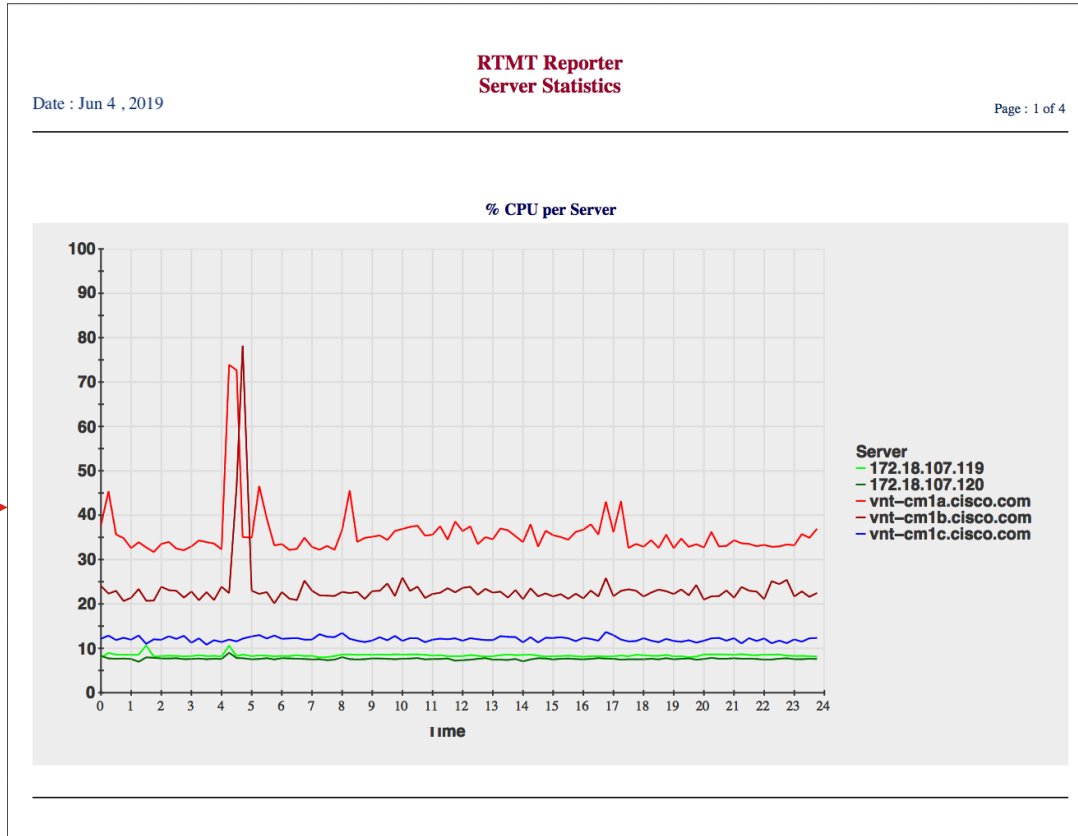



# Unified CM Serviceability Reports Archive

## Sample Server Reports

Date : Jun 4 , 2019

Page : 2 of 4

% Virtual Memory Usage per Server

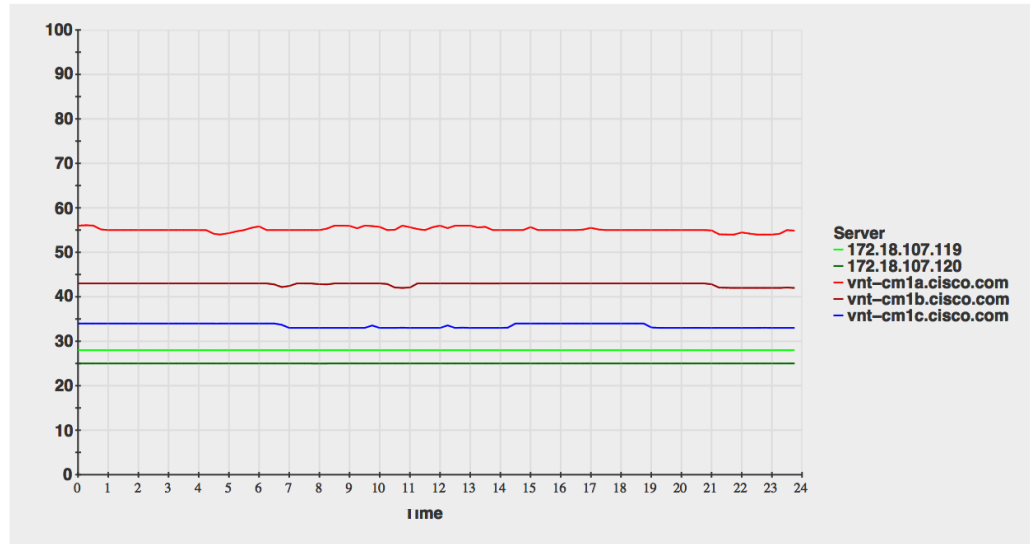

- Files for 06 04 2019
- [AlertRep\\_06\\_04\\_2019.pdf](#)
  - [CallActivitiesRep\\_06\\_04\\_2019.pdf](#)
  - [DeviceRep\\_06\\_04\\_2019.pdf](#)
  - [PerformanceRep\\_vnt-cm1a.cisco.com\\_06\\_04\\_2019.pdf](#)
  - [PerformanceRep\\_vnt-cm1b.cisco.com\\_06\\_04\\_2019.pdf](#)
  - [PerformanceRep\\_vnt-cm1c.cisco.com\\_06\\_04\\_2019.pdf](#)
  - [ServerRep\\_06\\_04\\_2019.pdf](#)
  - [ServiceRep\\_06\\_04\\_2019.pdf](#)



# Unified CM Serviceability Reports Archive

## Sample Server Performance Protection Statistics

### RTMT Reporter Performance Protection Statistics

Date : Jun 4 , 2019

Page : 1 of 5

Call Activity for vnt-cm1b.cisco.com

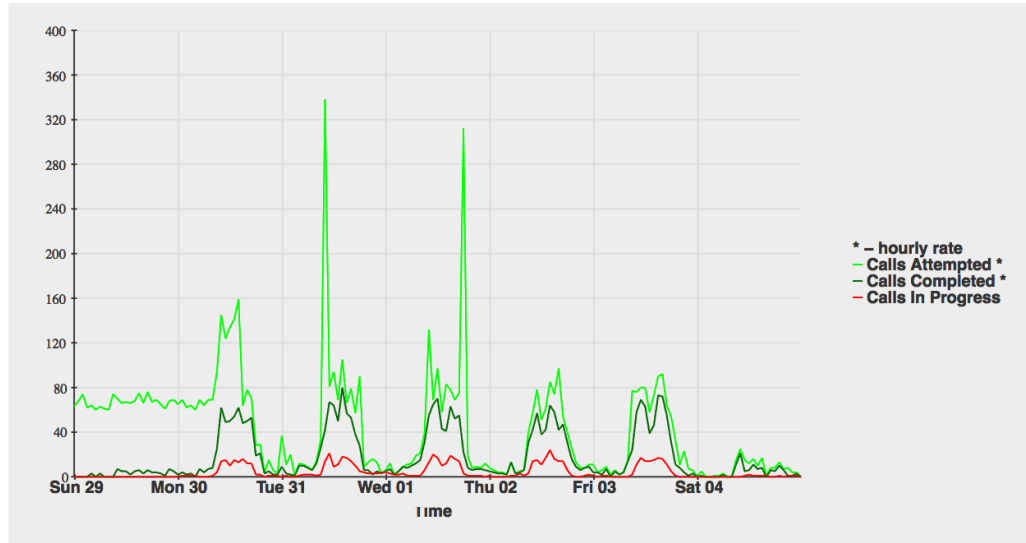

#### Files for 06 04 2019

- [AlertRep\\_06\\_04\\_2019.pdf](#)
- [CallActivitiesRep\\_06\\_04\\_2019.pdf](#)
- [DeviceRep\\_06\\_04\\_2019.pdf](#)
- [PerformanceRep\\_vnt-cm1a.cisco.com\\_06\\_04\\_2019.pdf](#)
- [PerformanceRep\\_vnt-cm1b.cisco.com\\_06\\_04\\_2019.pdf](#)
- [PerformanceRep\\_vnt-cm1c.cisco.com\\_06\\_04\\_2019.pdf](#)
- [ServerRep\\_06\\_04\\_2019.pdf](#)
- [ServiceRep\\_06\\_04\\_2019.pdf](#)

**CISCO** *Live!*

# Agenda

- **Serviceability Tools Overview**

  - Real-Time Monitoring Tool (RTMT)

  - Cisco Unified Operating System GUI

  - Cisco Unified Operating System CLI

- Troubleshooting Methodology

  - Problem Description

- Troubleshooting Case Studies

  - Dropped Call

  - No One Answers the Phone

  - Unable to Place Calls

  - Call Drops After Answering

- Understanding and Troubleshooting Unified CM Throttling Events

- Troubleshooting Database Replication

  - Cisco Serviceability Reports

  - Cisco Unified Reporting**

  - Serviceability APIs

  - Information Collection

  - Video Encryption Not Working

  - One-Way Audio

  - ActiveControl Not Working on Jabber 12.5

  - Video Call Immediately Drops

# Cisco Unified Reporting

- Run reports from publisher node to quickly diagnose common problems
  - Reports to run before and after upgrades
    - Unified CM Data Inventory Summary
    - Unified CM Data Summary
    - Unified CM Cluster Overview
    - Unified CM Database Status
    - Unified CM Phones with Mismatched Load
- Unified CM data summary
  - Could be used to take cluster size snapshot
- Traces to collect if there is a problem
  - Cisco Unified Reporting Web Service
  - Cisco Tomcat

The screenshot displays the Cisco Unified Reporting interface. At the top, there is a navigation bar with a search box containing 'Cisco Unified Reporting' and a 'Go' button. Below the navigation bar, the user 'makman' is logged in. The main content area is titled 'System Reports' and contains a list of reports under the heading 'Report Descriptions'. The reports are listed in two columns. The first column includes: Security Diagnostic Tool, Stale LSCs, UCM Users with out-of-date credential algorithm, Unified CM Cluster Overview, Unified CM Data Summary, Unified CM Database Replication Debug, Unified CM Database Status, Unified CM Device Counts Summary, Unified CM Device Distribution Summary, Unified CM Directory URI and GDPR Duplicates, Unified CM Extension Mobility, Unified CM GeoLocation Policy, and Unified CM GeoLocation Policy with Filter. The second column includes: Unified CM Lines Without Phones, Unified CM Multi-Line Devices, Unified CM Phone Category, Unified CM Phone Feature List, Unified CM Phone Locale Installers, Unified CM Phones With Mismatched Load (highlighted), Unified CM Phones Without Lines, Unified CM Shared Lines, Unified CM Table Count Summary, Unified CM User Device Count, Unified CM Users Sharing Primary Extensions, Unified CM VG2XX Gateway, Unified CM Voice Mail, and Unified Confidential Access Level Matrix.

# Cisco Unified Reporting

- Samples From CM Cluster Overview Report:

## Unified CM Provisioned Servers

Name ▲▼	Description ▲▼	IP Address ▲▼	Server Type ▲▼
vnt-cm1a.cisco.com	VNT-CM1A (Publisher)	172.18.106.58	CUCM Voice/Video
vnt-cm1b.cisco.com	VNT-CM1B	172.18.106.59	CUCM Voice/Video
vnt-cm1c.cisco.com	VNT-CM1C	172.18.106.60	CUCM Voice/Video
ecats-cups1a.cisco.com	ecats-cups1a.cisco.com	172.18.107.119	CUCM IM and Presence
ecats-cups1b.cisco.com	ecats-cups1b.cisco.com	172.18.107.120	

## Unified CM Hardware Summary

### Summary

component ▲▼	MCS Model ▲▼	CPU Speed ▲▼	RAM ▲▼	Partition Total ▲▼
<b>vnt-cm1a.cisco.com</b>	VMware	2270	8G	192G
<b>vnt-cm1b.cisco.com</b>	VMware	2270	8G	192G
<b>vnt-cm1c.cisco.com</b>	VMware	2400	8G	115G
<b>ecats-cups1a.cisco.com</b>	VMware	2270	8G	116G
<b>ecats-cups1b.cisco.com</b>	VMware	2270	8G	116G

## Unified CM Hosts

All servers have equivalent host files

[View Details](#)

# Cisco Unified Reporting

- Samples From CM Device Distribution Summary Report:

## Primary Unified CM Device Distribution Summary

Shows distribution of devices to their primary Unified CM.

Unified CM Name ▲▼	Primary Device Count ▲▼
CM_VNT-CM1A	13
CM_VNT-CM1B	8967
CM_VNT-CM1C	1045

## Unified CM Device Distribution Summary

Shows distribution of devices by summing the primary, secondary and tertiary Unified CM. Since devices count towards each Unified CM to which they may register, the totals will be more that the number of devices. If all other Unified CM are off line, this represents the devices that will register to this Unified CM.

Unified CM Name ▲▼	Device Count ▲▼
CM_VNT-CM1A	13
CM_VNT-CM1B	10010
CM_VNT-CM1C	10008

# Cisco Unified Reporting

- Samples From CM Database Status Report:

The screenshot displays a web-based reporting interface for Cisco Unified Communications Manager (CM) database status. It is organized into several sections:

- Unified CM Database Status:** Contains RTMT Counter Information, a green checkmark indicating all servers have a replication count of 541, a red 'X' icon indicating that not all servers have a good replication status, and several warning icons with instructions to view details or run CLI commands.
- Unified CM Hosts:** Shows a green checkmark indicating all servers have equivalent host files, with a 'View Details' link.
- Unified CM Rhosts:** A list of 15 green checkmarks indicating all servers have equivalent rhosts files, with a 'View Details' link at the bottom.
- Unified CM Connectivity:** A list of 6 green checkmarks indicating connectivity success for various IP addresses.
- Unified CM ONCONFIG.CCM:** A large section on the right containing a list of 15 'lent sqlhosts files.' entries, each followed by a 'nconfig.ccm files.' entry.



# Splunk Demo



# Agenda

- **Serviceability Tools Overview**

  - Real-Time Monitoring Tool (RTMT)

  - Cisco Unified Operating System GUI

  - Cisco Unified Operating System CLI

- Troubleshooting Methodology

  - Problem Description

- Troubleshooting Case Studies

  - Dropped Call

  - No One Answers the Phone

  - Unable to Place Calls

  - Call Drops After Answering

- Understanding and Troubleshooting Unified CM Throttling Events

- Troubleshooting Database Replication

  - Cisco Serviceability Reports

  - Cisco Unified Reporting

  - Serviceability APIs**

  - Information Collection

  - Video Encryption Not Working

  - One-Way Audio

  - ActiveControl Not Working on Jabber 12.5

  - Video Call Immediately Drops

# Unified CM APIs

- Serviceability APIs
  - Real-Time Information
  - Performance Monitoring
  - CDR on Demand
  - Service Control
  - Log Collection
- Platform API - Platform Administrative Web Services (PAWS)
- Configuration API - Administrative XML (AXL)

# SOAP APIs

- The specification formerly known as Simple Object Access Protocol
- Exchange of structured and typed information based on XML
- SOAP specification defines
  - SOAP message format
  - How to send and receive messages
  - Data encoding
- Web Services Description Language (WSDL)
  - XML-based format (grammar) to describe web services
  - Defines four pieces of data:
    - Publicly available methods; interface description, formats
    - Data type information for requests and responses
    - Binding; which transport protocol
    - Address information – where to find the service

# Unified CM Serviceability APIs

<https://developer.cisco.com/site/sxml/>

- **Real-Time Information** (RisPort) – Provides the current connection status of phones, devices, and applications connected to Cisco Unified Communications Manager (Unified CM).
  - <https://<server>:8443/realtimeservice2/services/RISService70?wsdl>
- **Performance Monitoring** (PerfMon) – Provides real-time event feeds to monitor the status and health of Cisco Unified CM.
  - <https://<server>:8443/perfmonservice2/services/PerfmonService?wsdl>
- **CDRonDemand** – SOAP/HTTPS interface to query the Unified CM Call Detail Records (CDR) Repository.
  - <https://<server>:8443/realtimeservice2/services/CDRonDemandService?wsdl>
- **Log Collection** – Retrieval of trace files and logs
  - <https://<server>:8443/logcollectionservice2/services/LogCollectionPortTypeService?wsdl>
- **Service Control** – Activate / Deactivate / Start / Stop Services
  - <https://<server>:8443/controlcenterservice2/services/ControlCenterServices?wsdl>

# Unified CM Serviceability APIs

<https://developer.cisco.com/site/sxml/>

The screenshot shows the Cisco DevNet website navigation. The top navigation bar includes the Cisco logo, 'DEVNET', and links for 'Discover', 'Technologies', 'Community', and 'Support'. Below this is a secondary navigation bar with 'Serviceability', 'Discover', 'Learn', 'Documents', 'Downloads', 'Tools', 'Help', and 'Archive'. The 'Documents' menu is expanded, showing a list of items: 'API Reference', 'Operations by Release', 'Real-Time Information (RisPort)', 'Call Detail Records (CDRonDemand)', 'Performance Monitoring (PerfMon)', 'Service Control (ControlCenter)', and 'Log Collection (LogCollection, DimeGetFile)'. The 'API Reference' item is highlighted with a red box, and the entire expanded menu is also enclosed in a red box.

DEVNET Discover Technologies Community Support

Serviceability Discover Learn Documents Downloads Tools Help Archive

Sxml

- API Reference
- Operations by Release
- Real-Time Information (RisPort)
- Call Detail Records (CDRonDemand)
- Performance Monitoring (PerfMon)
- Service Control (ControlCenter)
- Log Collection (LogCollection, DimeGetFile)

Overview

Sample App ▶

Communities ▶

Sandbox ▶

You have

Click here to

# Real-Time Information API

<https://developer.cisco.com/site/sxml/documents/api-reference/risport/>

- SelectCmDevice / SelectCmDeviceExt: Real-time Registration Status Information

```
<soapenv:Envelope xmlns:soapenv="http://schemas.xmlsoap.org/soap/envelope/" xmlns:soap="http://schemas.cisco.com/ast/soap">
  <soapenv:Header/>
  <soapenv:Body>
    <soap:selectCmDevice>
      <soap:StateInfo></soap:StateInfo>
      <soap:CmSelectionCriteria>
        <soap:MaxReturnedDevices>1000</soap:MaxReturnedDevices>
        <soap:DeviceClass>Any</soap:DeviceClass>
        <soap:Model>255</soap:Model>
        <soap:Status>Any</soap:Status>
        <soap:NodeName></soap:NodeName>
        <soap:SelectBy>DirNumber</soap:SelectBy>
        <soap:SelectItems>
          <!--Zero or more repetitions:-->
          <soap:item>
            <soap:Item>6961</soap:Item>
          </soap:item>
        </soap:SelectItems>
        <soap:Protocol>Any</soap:Protocol>
        <soap:DownloadStatus>Any</soap:DownloadStatus>
      </soap:CmSelectionCriteria>
    </soap:selectCmDevice>
  </soapenv:Body>
</soapenv:Envelope>
```

```
<ns1:CmDevices>
  <ns1:item>
    <ns1:Name>SEPE8B7480316D6</ns1:Name>
    <ns1:DirNumber>6961-Registered</ns1:DirNumber>
    <ns1:DeviceClass>Phone</ns1:DeviceClass>
    <ns1:Model>497</ns1:Model>
    <ns1:Product>384</ns1:Product>
    <ns1:BoxProduct>0</ns1:BoxProduct>
    <ns1:Httpd>Yes</ns1:Httpd>
    <ns1:RegistrationAttempts>0</ns1:RegistrationAttempts>
    <ns1:IsCt...>
    <ns1:Logi...>
    <ns1:Stat...>
    <ns1:Stat...>
    <ns1:Perf...>
    <ns1:DCha...>
    <ns1:Desc...>
    <ns1:ActiveLoadID>SCCP69xx.9-4-1-3SR1</ns1:ActiveLoadID>
    <ns1:InactiveLoadID xsi:nil="1"
    org/2001/XMLSchema-instance"/>
    <ns1:DownloadStatus>Unknown</ns1:DownloadStatus>
    <ns1:DownloadFailureReason xsi:nil="1"
    org/2001/XMLSchema-instance"/>
    <ns1:DownloadServer xsi:nil="1"
    org/2001/XMLSchema-instance"/>
    <ns1:IPAddress>
      <ns1:item>
        <ns1:IP>192.168.168.186</ns1:IP>
        <ns1:IPAddrType>ipv4</ns1:IPAddrType>
        <ns1:Attribute>AdministrativeAndSignaling</ns1:Attribute>
      </ns1:item>
    </ns1:IPAddress>
```

# PerfMon API

<https://developer.cisco.com/site/sxml/documents/api-reference/perfmon/>

- Programmatic way to access RTMT Performance Counters
- Session-Based – Steps to Get Data:
  - perfmonOpenSession
  - perfmonAddCounter
  - perfmonRemoveCounter
  - perfmonCollectSessionData (can do this periodically while session is open)
  - perfmonCloseSession

# CDR on Demand API

<https://developer.cisco.com/site/sxml/documents/api-reference/cdr-on-demand/>

- Alternative to using CDR Repository Manager
- `get_file_list` - API Request to get list of CDR files
- `get_file` - API Request to retrieve specific file (via FTP/SFTP)

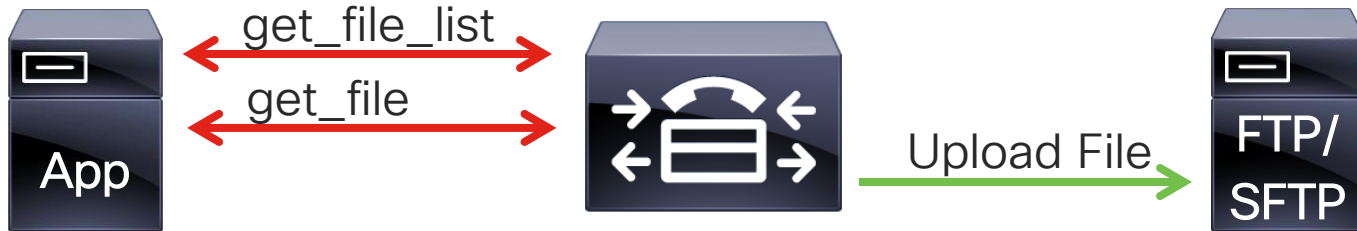



# Service Control API

<https://developer.cisco.com/site/sxml/documents/api-reference/service-control/>

- Check and Control Services

**Select Server**  
Server\*  Go

**Performance and Monitoring Services**

Service Name	Status	Activation Status	Start Time
<input type="radio"/> Cisco Serviceability Reporter	Started	Activated	Fri Oct 13 22:1
<input type="radio"/> Cisco CallManager SNMP Service	Started	Activated	Fri Oct 13 22:1

**CM Services**

Service Name	Status	Activation Status	Start Time
<input type="radio"/> Cisco CallManager	Started	Activated	Thu Nov 9 17:4
<input type="radio"/> Cisco IP Voice Media Streaming App	Started	Activated	Fri Oct 13 22:1
<input type="radio"/> Cisco CTIManager	Started	Activated	Fri Oct 13 22:1
<input type="radio"/> Cisco Extension Mobility	Started	Activated	Fri Oct 13 22:3
<input type="radio"/> Cisco DHCP Monitor Service	Not Running	Deactivated	
<input type="radio"/> Cisco Location Bandwidth Manager	Not Running	Deactivated	
<input type="radio"/> Cisco Directory Number Alias Lookup	Not Running	Deactivated	
<input type="radio"/> Cisco Dialed Number Analyzer Server	Not Running	Deactivated	
<input type="radio"/> Cisco Dialed Number Analyzer	Not Running	Deactivated	
<input type="radio"/> Cisco Tftp	Started	Activated	Fri Oct 13 22:1

**Select Server**  
Server\*  Go

Check All Services

**CM Services**

Service Name	Activation Status
<input checked="" type="checkbox"/> Cisco CallManager	Activated
<input checked="" type="checkbox"/> Cisco IP Voice Media Streaming App	Activated
<input checked="" type="checkbox"/> Cisco CTIManager	Activated
<input checked="" type="checkbox"/> Cisco Extension Mobility	Activated
<input type="checkbox"/> Cisco Extended Functions	Deactivated
<input type="checkbox"/> Cisco DHCP Monitor Service	Deactivated
<input type="checkbox"/> Cisco Location Bandwidth Manager	Deactivated
<input type="checkbox"/> Cisco Directory Number Alias Lookup	Deactivated
<input type="checkbox"/> Cisco Dialed Number Analyzer Server	Deactivated
<input type="checkbox"/> Cisco Dialed Number Analyzer	Deactivated
<input checked="" type="checkbox"/> Cisco Tftp	Activated

**CTI Services**

Service Name	Activation Status
<input type="checkbox"/> Cisco IP Manager Assistant	Deactivated
<input checked="" type="checkbox"/> Cisco WebDialer Web Service	Activated

# Log Collection API

<https://developer.cisco.com/site/sxml/documents/api-reference/log-collection/>

- Retrieve Log files from a UCM Server
  - `listNodeServiceLogs` – Get list of services
  - `selectLogFiles` – Search for Specific Files
- Files can be sent to SFTP Destination or Retrieved via **getOneFile**
- `getOneFile` – Download a specific file from the server

```
<!--DIME Get File - getOneFile API Request-->
<soapenv:Envelope xmlns:xsi="http://www.w3.org/2001/XMLSchema-instance"
xmlns:xsd="http://www.w3.org/2001/XMLSchema"
xmlns:soapenv="http://schemas.xmlsoap.org/soap/envelope/"
xmlns:soap="http://schemas.cisco.com/ast/soap/">
  <soapenv:Header/>
  <soapenv:Body>
    <soap:GetOneFile soapenv:encodingStyle="http://schemas.xmlsoap.org/soap/encoding/">
      <FileName>/var/log/active/syslog/messages</FileName>
    </soap:GetOneFile>
  </soapenv:Body>
</soapenv:Envelope>
```

# Platform API - Platform Administrative Web Services (PAWS)

<https://developer.cisco.com/site/paws/>

- Various Platform-related services
  - Cluster Status
  - Upgrade Platform
  - Change Network Settings
  - Administer Backups
  - Import / Export Platform Configuration
  - Hardware Information
  - Installed Product Information
  - Restart / Switch Versions
  - Certificate / CSR Operations
- Uses Platform Administration Credentials

# Platform API - Platform Administrative Web Services (PAWS)

<https://developer.cisco.com/site/paws/>

- List Available Platform Web Services:  
`https://<server>/platform-services/services/listServices`
- Get WSDL for Services:  
`https://<server>/platform-services/services/<Service Name>?wsdl`

## ClusterNodesService

**Service EPR :** `https://vnt-cm1a.cisco.com/platform-services/services/ClusterNodesService`

### **Service Description : ClusterNodesService**

*Service Status : Active*  
*Available Operations*

- `getClusterStatus`
- `isClusterReplicationOK`
- `getClusterNodes`
- `getMyClusterNode`
- `isNodeReplicationOK`

## VersionService

**Service EPR :** `https://vnt-cm1a.cisco.com/platform-services/services/VersionService`

### **Service Description : VersionService**

*Service Status : Active*  
*Available Operations*

- `getInactiveVersion`
- `getActiveVersion`

# PAWS Example - VersionService

```
<?xml version="1.0" encoding="utf-8"?>
<soap-env:Envelope xmlns:soap-env="http://www.w3.org/2003/05/soap-envelope">
  <soap-env:Header xmlns:wsa="http://www.w3.org/2005/08/addressing"
    <wsa:Action>urn:getActiveVersion</wsa:Action>
    <wsa:MessageID>urn:uuid:e46055fd-4cdc-43c7-81d5-7c225639a25b</wsa:MessageID>
  </soap-env:Header>
  <soap-env:Body>
    <ns0:getActiveVersion xmlns:ns0="http://services.api.platform.vos.cisco.com"/>
  </soap-env:Body>
</soap-env:Envelope>
```

# PAWS Example - VersionService

```
<?xml version="1.0" encoding="utf-8"?>
<soapenv:Envelope xmlns:soapenv="http://www.w3.org/2003/05/soap-envelope">
  <soapenv:Header xmlns:wsa="http://www.w3.org/2005/08/addressing">
    <wsa:Action>urn:getActiveVersionResponse</wsa:Action>
    <wsa:RelatesTo>urn:uuid:e46055fd-4cdc-43c7-81d5-7c225639a25b</wsa:RelatesTo>    </soapenv:Header>
  <soapenv:Body>
    <ns:getActiveVersionResponse xmlns:ns="http://services.api.platform.vos.cisco.com">
      <ns:return xmlns:ax221="http://element.services.api.platform.vos.cisco.com/xsd"
        xmlns:ax222="http://api.platform.vos.cisco.com/xsd" xmlns:xsi="http://www.w3.org/2001/XMLSchema-instance"
        xsi:type="ax221:VersionResponse">
        <ax221:remoteMessages xsi:nil="true"/>
        <ax221:result>internal.request.complete</ax221:result>
        <ax221:version>12.5.1.12900-112</ax221:version>
      </ns:return>
    </ns:getActiveVersionResponse>
  </soapenv:Body>
</soapenv:Envelope>
```

# PAWS Example - VersionService

```
{
  'remoteMessages': [
    {
      'error': None,
      'info': None,
      'messageKey': None,
      'messageType': None,
      'warning': None,
      'messageParams': []
    }
  ],
  'result': 'internal.request.complete',
  'version': '12.5.1.12900-112'
}
```

# AXL API Introduction

- The **Administrative XML Web Service (AXL)** is an XML/SOAP based interface that provides a mechanism for inserting, retrieving, updating and removing data from the Unified Communication configuration database.
- <https://developer.cisco.com/site/axl/>
- Thick AXL – API defines specific objects that can be created, removed, queried, or updated
- Thin AXL – Provides a mechanism to perform direct SQL queries / updates



# Administrative XML Configuration API

- Read/modify UCM Configuration Database
- Methods for All Database Objects
  - list\*
  - add\*
  - update\*
  - get\*
  - remove\*
- Thin AXL methods:
  - ExecuteSQLupdate
  - ExecuteSQLquery
- Service port: `https://<server>:8443/axl/`
- Authentication:
  - Member of group with **AXL API Access** Role for Read/Write
  - Member of group with **Standard AXL Read Only API Access** Role for Read Only

# Documentation

- AXL Schema Reference
  - <https://developer.cisco.com/docs/axl-schema-reference/>
- AXL Developer Guide
  - <https://developer.cisco.com/docs/axl/#12-0-axl-developer-guide>
- UCM Data Dictionary
  - <https://developer.cisco.com/docs/axl/#12-0-cucm-data-dictionary>

# Programming Languages & SOAP Toolkits

- Python
  - zeep – <http://docs.python-zeep.org/>
  - suds – poorly maintained
- PHP
  - SoapClient – <http://php.net/manual/en/book.soap.php>
- Java }  
• .NET } – Various options to generate wrapper classes



# Serviceability API Demo

# Agenda

- Serviceability Tools Overview

  - Real-Time Monitoring Tool (RTMT)

  - Cisco Unified Operating System GUI

  - Cisco Unified Operating System CLI

  - Cisco Serviceability Reports

  - Cisco Unified Reporting

  - Serviceability APIs

- Troubleshooting Methodology

  - Problem Description

  - Information Collection

- Troubleshooting Case Studies

  - Dropped Call

  - No One Answers the Phone

  - Unable to Place Calls

  - Call Drops After Answering

  - Video Encryption Not Working

  - One-Way Audio

  - ActiveControl Not Working on Jabber 12.5

  - Video Call Immediately Drops

- Understanding and Troubleshooting Unified CM Throttling Events

- Troubleshooting Database Replication

# Problem Description

- First step: understand the problem you are troubleshooting
- Make the problem description as detailed as possible
- Stick to factual data and don't jump to conclusions
- If multiple problems are reported, try to narrow your focus to one problem at a time

# Problem Description

## Some Questions to Ask

- What happened?
- Who did it happen to?
- When did it happen?
- What were you doing when it happened?
- What device were you using?
- What changed?
- Is it plugged in?

# Problem Description

- **Egon**: Don't cross the streams.
- Venkman: Why?
- **Egon**: It would be bad.
- Venkman: I'm fuzzy on the whole good/bad thing. What do you mean "bad"?
- **Egon**: Try to imagine all life as you know it stopping instantaneously, and every molecule in your body exploding at the speed of light.



# Problem Description

- **Bad:** “I was talking to someone and then the call went away”
- **Good:** “I received an audio call from Chuck Robbins at 1:52 p.m. on my Cisco DX80 and about five minutes into the call, I could not hear him, but the call still appeared to be connected. I hung up after about 30 seconds and called him back. He said he could hear me talking the whole time before I hung up.

# Agenda

- Serviceability Tools Overview

  - Real-Time Monitoring Tool (RTMT)

  - Cisco Unified Operating System GUI

  - Cisco Unified Operating System CLI

  - Cisco Serviceability Reports

  - Cisco Unified Reporting

  - Serviceability APIs

- Troubleshooting Methodology

  - Problem Description

  - Information Collection

- Troubleshooting Case Studies

  - Dropped Call

  - Video Encryption Not Working

  - No One Answers the Phone

  - One-Way Audio

  - Unable to Place Calls

  - ActiveControl Not Working on Jabber 12.5

  - Call Drops After Answering

  - Video Call Immediately Drops

- Understanding and Troubleshooting Unified CM Throttling Events

- Troubleshooting Database Replication

# Information Collection

- Time synchronization
- Trace configuration
- Trace collection

# Time Synchronization

- Ensure all network devices and applications are using an authoritative time source (NTP server)
- All Unified CM subscribers are synced to the clock of the publisher
- Sync the publisher to an NTP server from the Cisco Unified OS administration GUI (Settings > NTP Servers)

```
admin:utils ntp status
```

```
ntpd (pid 20175) is running...
```

remote	refid	st	t	when	poll	reach	delay	offset	jitter
*172.18.106.1	72.163.32.43	2	u	860	1024	377	0.571	0.111	0.089

```
synchronised to NTP server (172.18.106.1) at stratum 3
```

```
time correct to within 48 ms
```

```
polling server every 1024 s
```

```
Current time in UTC is : Wed Jun 29 17:55:13 UTC 2016
```

```
Current time in America/New_York is : Wed Jun 29 13:55:13 EDT 2016
```

# Trace Configuration

- Unified CM 9.0 and later combine SDI and SDL traces into the SDL traces and sets the Default trace level to Detailed (on new installations)
- **Cisco CallManager** service trace files (SDL traces) are needed for the majority of issues
- Trace levels must be set properly before a problem occurs
- Configured from **Cisco Unified Serviceability > Trace > Configuration**
- For pre-9.x systems, look in SDI trace files, not SDL.

# Trace Configuration

The screenshot shows the Cisco Unified Serviceability interface for Trace Configuration. At the top, there is a navigation menu with options: Alarm, Trace, Tools, Snmp, CallHome, and Help. Below the navigation is a header for 'Trace Configuration' with 'Save' and 'Set Default' buttons. The main content area is divided into sections: 'Status' (Ready), 'Select Server, Service Group and Service' (with dropdowns for Server, Service Group, and Service, each with a 'Go' button), 'Apply to All Nodes' (checkbox), 'Trace On' (checkbox), and 'Trace Filter Settings' (checkbox). Three callout boxes are present: 'Select the Server' points to the Server dropdown, 'Select Service Group' points to the Service Group dropdown, and 'Select the Service on Which Trace Needs to Be Enabled' points to the Service dropdown.

**Cisco Unified Serviceability**  
For Cisco Unified Communications Solutions

Alarm ▾ Trace ▾ Tools ▾ Snmp ▾ CallHome ▾ Help ▾

**Trace Configuration**

Save Set Default

**Status:**  
Ready

**Select Server, Service Group and Service**

Server\* vnt-cm1a.cisco.com--CUCM Voice/Video Go

Service Group\* CM Services Go

Service\* Cisco CallManager (Active) Go

Apply to All Nodes

Trace On

**Trace Filter Settings**

Select the Server

Select Service Group

Select the Service on Which Trace Needs to Be Enabled

# Trace Configuration

**Trace Configuration** Related Links: [SDL Configuration](#)

1. Press Set Default

**Status:**  
 Ready

**Select Server, Service Group and Service**

Server\*

Service Group\*  Updates All Servers in this cluster with these settings

Service\*

Apply to All Nodes

Trace On

**Trace Filter Settings**

Debug Trace Level  2. Set to Detailed

Enable H245 Message Trace  Enable CDR Trace

# Trace Configuration

## Trace Filter Settings

Debug Trace Level

- |                                                                                  |                                                                          |
|----------------------------------------------------------------------------------|--------------------------------------------------------------------------|
| <input checked="" type="checkbox"/> Enable H245 Message Trace                    | <input checked="" type="checkbox"/> Enable CDR Trace                     |
| <input checked="" type="checkbox"/> Enable DT-24+/DE-30+ Trace                   | <input checked="" type="checkbox"/> Enable Analog Trunk Trace            |
| <input checked="" type="checkbox"/> Enable PRI Trace                             | <input checked="" type="checkbox"/> Enable All Phone Device Trace        |
| <input checked="" type="checkbox"/> Enable ISDN Translation Trace                | <input checked="" type="checkbox"/> Enable MTP Trace                     |
| <input checked="" type="checkbox"/> Enable H225 & Gatekeeper Trace               | <input type="checkbox"/> Enable All GateWay Trace                        |
| <input type="checkbox"/> Enable Miscellaneous Trace                              | <input checked="" type="checkbox"/> Enable Forward & Miscellaneous Trace |
| <input checked="" type="checkbox"/> Enable Conference Bridge Trace               | <input checked="" type="checkbox"/> Enable MGCP Trace                    |
| <input checked="" type="checkbox"/> Enable Music On Hold Trace                   | <input checked="" type="checkbox"/> Enable Media Resource Manager Trace  |
| <input checked="" type="checkbox"/> Enable CM Real-Time Information Server Trace | <input checked="" type="checkbox"/> Enable SIP Call Processing Trace     |
| <input checked="" type="checkbox"/> Enable SIP Stack Trace                       | <input type="checkbox"/> Enable SCCP Keep Alive Trace                    |
| <input checked="" type="checkbox"/> Enable Annunciator Trace                     | <input type="checkbox"/> Enable SpeedDial Trace                          |
| <input type="checkbox"/> Enable SoftKey Trace                                    | <input type="checkbox"/> Enable SIP Keep Alive (REGISTER Refresh) Trace  |
| <input type="checkbox"/> Enable Route or Hunt List Trace                         | <input checked="" type="checkbox"/> Enable IVR Trace                     |



# Trace Configuration

- Can Also Use the **Troubleshooting Trace Settings** Page in Cisco Unified Serviceability (Trace > Troubleshooting Trace Settings)

<b>Select Server</b> Server* <input type="text" value="vnt-cm1b.cisco.com--CUCM Voice/Video"/> <input type="button" value="Go"/>	
<input type="checkbox"/> Check All Services <input type="checkbox"/> Check Selected Services on All Nodes <input type="checkbox"/> Check All Services on All Nodes	
<b>CM Services</b>	
Cisco CallManager	<input type="checkbox"/>
Cisco Trtp	<input type="checkbox"/>
Cisco Messaging Interface	N/A
Cisco IP Voice Media Streaming App	<input type="checkbox"/>
Cisco CTIManager	<input type="checkbox"/>
Cisco Intercluster Lookup Service	N/A
Cisco Location Bandwidth Manager	N/A
Cisco User Data Services	<input type="checkbox"/>
Cisco External Call Control Service	<input type="checkbox"/>
Cisco E911 Service	<input type="checkbox"/>
Cisco Directory Number Alias Sync	N/A
Cisco Directory Number Alias Lookup	N/A
Cisco Extended Functions	N/A
Cisco Extension Mobility Application	<input type="checkbox"/>
Cisco Extension Mobility	<input type="checkbox"/>
Cisco CallManager Cisco IP Phone Services	<input type="checkbox"/>
Cisco Unified Mobile Voice Access Service	N/A
Cisco DHCP Monitor Service	N/A
Cisco Dialed Number Analyzer	N/A
Cisco Dialed Number Analyzer Server	N/A
Cisco Change Credential Application	<input type="checkbox"/>
<b>CTI Services</b>	
Self Provisioning IVR	<input type="checkbox"/>
Cisco IP Manager Assistant	N/A
Cisco WebDialer Web Service	<input type="checkbox"/>
<b>CDR Services</b>	
Cisco CDR Repository Manager	<input type="checkbox"/>
Cisco CAR Scheduler	<input type="checkbox"/>
Cisco CAR Web Service	N/A
Cisco CDR Agent	<input type="checkbox"/>
<b>Database and Admin Services</b>	
Cisco Database Layer Monitor	<input type="checkbox"/>
Cisco CCMUser Web Service	<input type="checkbox"/>
SOAP - Diagnostic Portal Database Service	<input type="checkbox"/>
Cisco GRT Communication Web Service	<input type="checkbox"/>
Cisco Unified Reporting Web Service	<input type="checkbox"/>
Cisco CCMAdmin Web Service	<input type="checkbox"/>
Cisco CCM DBL Web Library	<input type="checkbox"/>
Cisco AXL Web Service	<input type="checkbox"/>
Cisco Bulk Provisioning Service	N/A
Cisco UXL Web Service	<input type="checkbox"/>
Cisco TAPS Service	N/A
Cisco Role-based Security	<input type="checkbox"/>
<b>Performance and Monitoring Services</b>	
Cisco RIS Data Collector	<input type="checkbox"/>
Cisco Log Partition Monitoring Tool	<input type="checkbox"/>
Cisco CallManager SNMP Service	<input type="checkbox"/>
Cisco Audit Event Service	<input type="checkbox"/>
Cisco CCM PD Web Service	<input type="checkbox"/>
Cisco CCM NCS Web Library	<input type="checkbox"/>
Cisco RTMT Web Service	<input type="checkbox"/>
Cisco RisBean Library	<input type="checkbox"/>
Cisco AMC Service	<input type="checkbox"/>
<b>Security Services</b>	
Cisco Certificate Authority Proxy Function	N/A
Cisco Trust Verification Service	<input type="checkbox"/>
Cisco Certificate Change Notification Service	<input type="checkbox"/>
Cisco CTL Provider	<input type="checkbox"/>
<b>Directory Services</b>	
Cisco DirSync	N/A
<b>Backup and Restore Services</b>	
Cisco DRF Master	<input type="checkbox"/>
Cisco DRF Local	<input type="checkbox"/>
<b>System Services</b>	
Cisco Common User Interface	<input type="checkbox"/>
Cisco Trace Collection Service	<input type="checkbox"/>
Cisco CCMService Web Service	<input type="checkbox"/>
Cisco CCMRealm Web Service	<input type="checkbox"/>
<b>Soap Services</b>	
Cisco SOAP Web Service	<input type="checkbox"/>
Cisco SOAPMessage Service	<input type="checkbox"/>
<b>Platform Services</b>	
Platform Administrative Web Service	<input type="checkbox"/>
Cisco Unified OS Admin Web Service	<input type="checkbox"/>
<b>Location based Tracking Services</b>	
Cisco Wireless Controller Synchronization Service	N/A



# Trace Collection

## Various Ways to Collect Trace Files

- RTMT Collect Files
- RTMT Analysis Manager
- RTMT Remote Browse
- RTMT Query Wizard
- OS CLI (file get or file tail)  
ex: file tail activelog cm/trace/ccm/sdl recent

# Working with TAC: Data collection, transfer and analysis

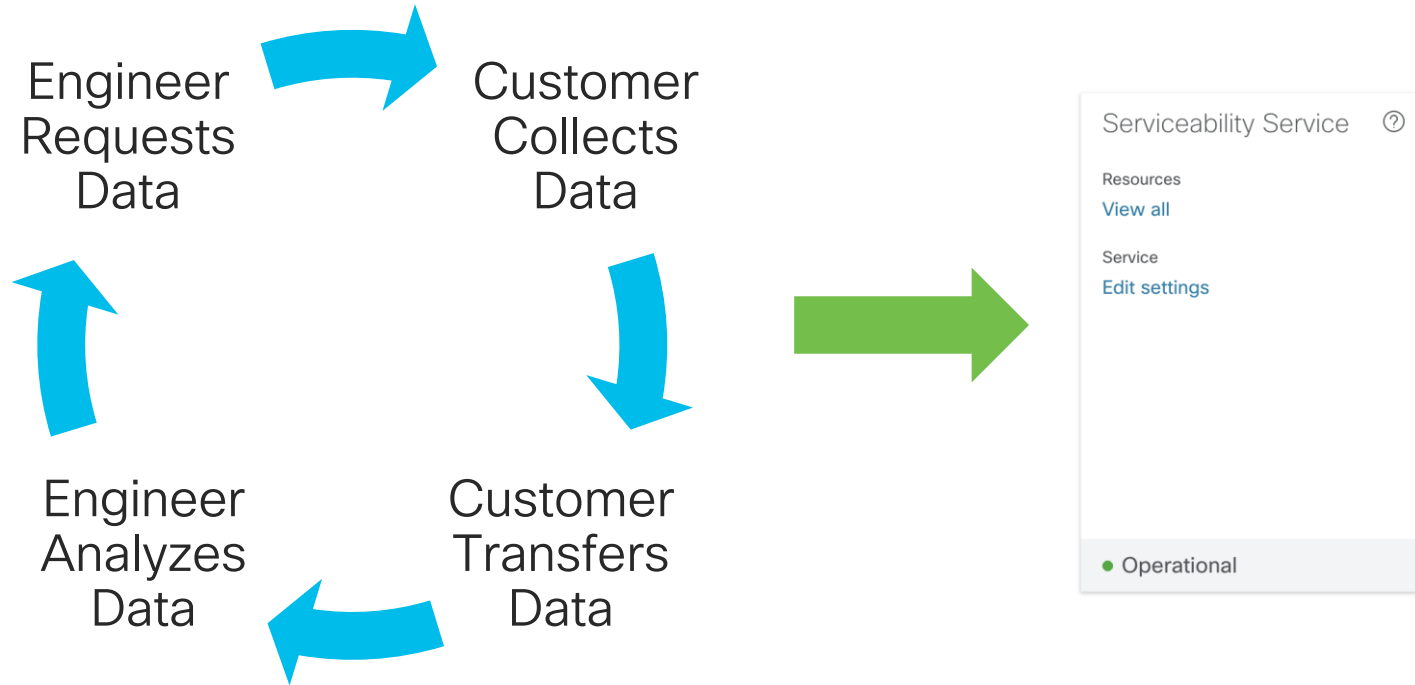

# Webex Serviceability Connector

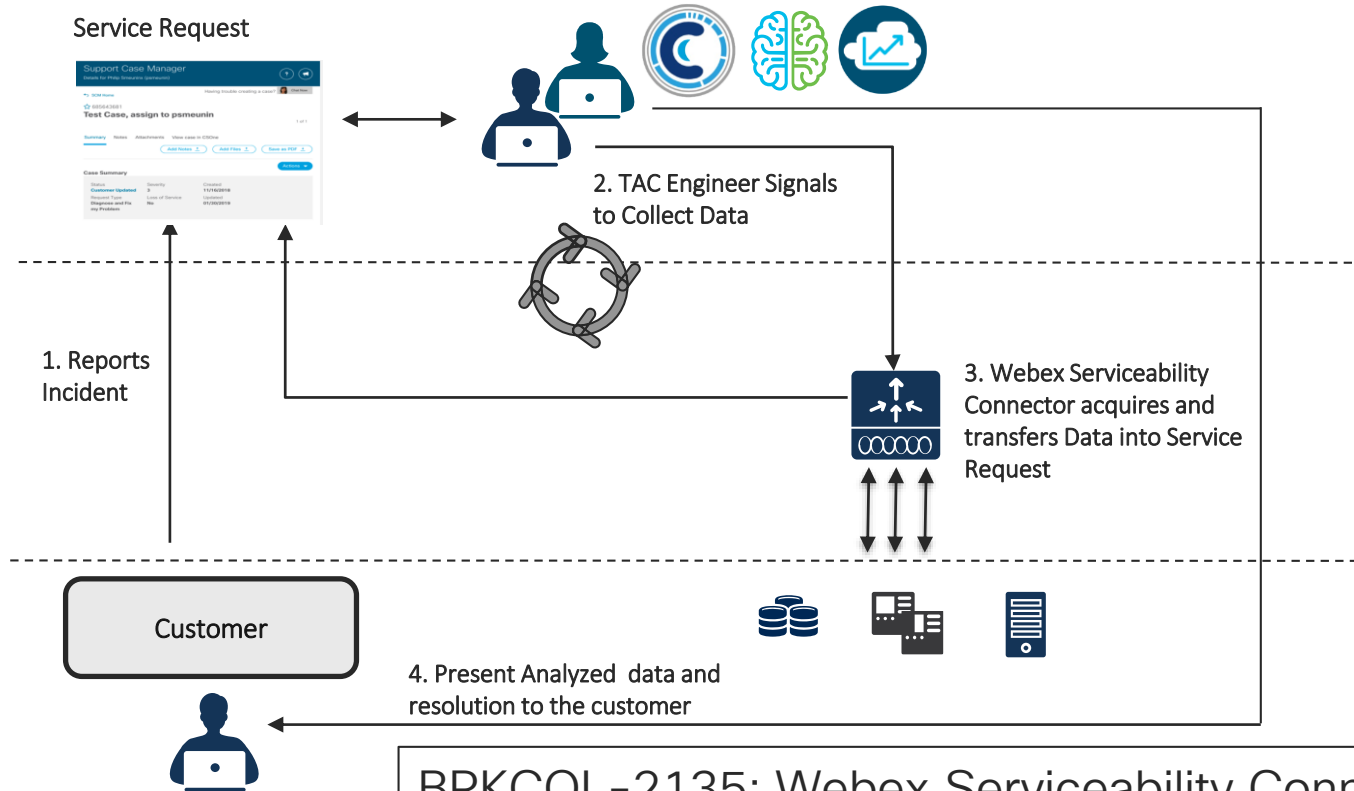

# Agenda

- Serviceability Tools Overview
  - Real-Time Monitoring Tool (RTMT)
  - Cisco Unified Operating System GUI
  - Cisco Unified Operating System CLI
  - Cisco Serviceability Reports
  - Cisco Unified Reporting
  - Serviceability APIs
- Troubleshooting Methodology
  - Problem Description
  - Information Collection
- Troubleshooting Case Studies
  - Dropped Call
    - No One Answers the Phone
    - Unable to Place Calls
    - Call Drops After Answering
    - Video Encryption Not Working
    - One-Way Audio
    - ActiveControl Not Working on Jabber 12.5
    - Video Call Immediately Drops
- Understanding and Troubleshooting Unified CM Throttling Events
- Troubleshooting Database Replication

# Case Study 1: Dropped Call

## Problem Description

- “A user’s call was dropped”
- What kind of questions would you ask to get additional data?

# Case Study 1: Questions to Ask

## Questions to Ask About “A User’s Call Was Dropped”

- Who was the user?
  - **Chuck Robbins**
- What is the directory number on their phone?
  - **85551001**
- What is the MAC address / device name of their phone?
  - **SEP00270DBF5B58**
- What time did the dropped call occur?
  - **At 11:43 a.m.**

# Case Study 1: Questions to Ask

## Questions to Ask About “A User’s Call Was Dropped”

- Who was the user speaking on the call that was dropped (internal vs. external)?
  - External—phone number (919) 555-7285
- Was the call inbound or outbound?
  - Inbound
- What time was the call placed/received?
  - About two minutes before the call was dropped



# Case Study 1: Problem Description

## Formulate a Problem Description

- Chuck Robbins received a call around 11:41 a.m. on June 29 from (919) 555-7285. He received the call on extension 85551001 on the phone identified as SEP00270DBF5B58. About two minutes into the call, the call was dropped.

# Case Study 1: Finding the Dropped Call

## How Do We Find this Call in the Trace Files?

- Options to search:
  - Search for everything that happened on device SEP00270DBF5B58 at the time of the problem
  - Search for calls to extension 85551001
  - Search for calls from (919) 555-7285
- We will be searching only through the CallManager Service SDL trace files
  - `activelog cm/trace/ccm/sdl`

# Case Study 1: SCCP Trace Data

## SCCP Trace Data in a CCM Trace

39912282.001 | 11:40:23.128 | AppInfo | StationInit: (0000005) SoftKeyEvent  
softKeyEvent=11 (Answer) lineInstance=1 callReference=63664372.

Field Name	Description
Line Number	SDL Trace Line Number (and sub-line number)
Timestamp	Time the Event Occurred
SCCP Message Direction	StationInit = SCCP Device → Unified CM StationD = Unified CM → SCCP Device
TCP Handle	Unique Identifier for a Device Registered to a Unified CM Server
SCCP Message Name	The type of message being sent/received
SCCP Message Data	Additional data related to the message

# Case Study 1: Device Name to TCP Handle

## Correlating a Device Name to TCP Handle

- In SDL trace, look at the correlation data for a **StationInit** signal:

```
39912282 000 |11:40:23.128 |SdISig |SdIDataInd |wait
|StationInit(1,100,62,1) |SdITCPConnection(1,100,14,1062195)
|1,100,14,1062195.2333^172.18.159.160^SEP00270DBF5B58
|*TraceFlagOverrode
39912282 001 |11:40:23.128 |AppInfo |StationInit: (0000005) SoftKeyEvent
softKeyEvent=11(Answer) lineInstance=1 callReference=63664372.
```

# Case Study 1: Digit Analysis Results

## Finding a Call in an SDL Trace

- Look for a digit analysis result:

```
00172610.007 |11:40:19.950 |AppInfo |Digit analysis: analysis results
00172610.008 |11:40:19.950 |AppInfo ||PretransformCallingPartyNumber=9195557285
|CallingPartyNumber=9195557285
|DialingPartition=1stLine
|DialingPattern=85551001
|FullyQualifiedCalledPartyNumber=+14085264000
|DialingPatternRegularExpression=(85551001)
|DialingWhere=
|PatternType=Enterprise
|PotentialMatches=NoPotentialMatchesExist
|DialingSdlProcessId=(0,0,0)
|PretransformDigitString=85551001
|PretransformTagsList=SUBSCRIBER
|PretransformPositionalMatchList=85551001
|CollectedDigits=85551001
|UnconsumedDigits=
```

# Case Study 1: Trace Searching Tools

## What Do You Use to Search Through Files?

- Platform CLI 'file search' command
- RTMT query wizard
- WinGREG (Windows) (<http://www.wingrep.com/>)
- Notepad++ (Windows)
- BBEdit / TextWrangler (MacOS X) (Apple App Store or barebones.com)
- grep / zgrep
- TranslatorX (<https://translatorx.org>)
- Collaboration Solutions Analyzer (<https://cway.cisco.com/csa/>)

# Case Study 1: TranslatorX

Cisco Unified Communications Trace Translator

Filters Enabled    New Filter    Filters...    Clear Filters    3 Filters Configured    Call List...    Search    Clear

Timestamp	Node/Interface	Remote Device	Direction	Protocol	Message Name	TCP Handle/From Tag	Call Ref / ID
06/29/2016 11:40:19.943	10.122.249.15	172.18.106.231	In	H.225	SETUP		0x000A
06/29/2016 11:40:19.951	10.122.249.15	172.18.106.231	Out	H.225	CALL_PROC		0x800A
06/29/2016 11:40:19.954	10.81.98.205	172.18.159.160	Out	SCCP	CallState	(0000005)	63664372
06/29/2016 11:40:19.954	10.81.98.205	172.18.159.160	Out	SCCP	SelectSoftKeys	(0000005)	63664372
06/29/2016 11:40:19.954	10.81.98.205	172.18.159.160	Out	SCCP	DisplayPromptStatus	(0000005)	63664372
06/29/2016 11:40:19.954	10.81.98.205	172.18.159.160	Out	SCCP	DisplayPriNotify	(0000005)	
06/29/2016 11:40:19.954	10.81.98.205	172.18.159.160	Out	SCCP	CallInfo	(0000005)	63664372
06/29/2016 11:40:19.954	10.81.98.205	172.18.159.160	Out	SCCP	SetLamp	(0000005)	
06/29/2016 11:40:19.954	10.81.98.205	172.18.159.160	Out	SCCP	SetRinger	(0000005)	
06/29/2016 11:40:19.956	10.122.249.15	172.18.106.231	Out	H.225	ALERTING		0x800A
06/29/2016 11:40:19.957	10.122.249.15	172.18.106.231	Out	H.225	NOTIFY		0x800A
06/29/2016 11:40:20.071	10.122.249.15	172.18.106.231	In	H.225	FACILITY		0x000A
06/29/2016 11:40:23.128	10.81.98.205	172.18.159.160	In	SCCP	SoftKeyEvent	(0000005)	63664372
06/29/2016 11:40:23.128	10.81.98.205	172.18.159.160	Out	SCCP	SetRinger	(0000005)	
06/29/2016 11:40:23.128	10.81.98.205	172.18.159.160	Out	SCCP	SetSpeakerMode	(0000005)	
06/29/2016 11:40:23.128	10.81.98.205	172.18.159.160	Out	SCCP	SetLamp	(0000005)	
06/29/2016 11:40:23.128	10.81.98.205	172.18.159.160	Out	SCCP	CallState	(0000005)	63664372
06/29/2016 11:40:23.128	10.81.98.205	172.18.159.160	Out	SCCP	ActivateCallPlane	(0000005)	
06/29/2016 11:40:23.129	10.81.98.205	172.18.159.160	Out	SCCP	SetRinger	(0000005)	

Inbound H.225 SETUP message from 172.18.106.231 at timestamp 06/29/2016 11:40:19.943

SETUP, pd = 8, callref = 0x000A, Message Size = 662 bytes

Bearer Capability i = 0x08090A3, ITU-T standard, Speech, Circuit mode, 64k, A-law  
 Calling Party Number i = '9195557285' - Plan: ISDN, Type: National, Presentation Allowed, Network provided  
 Called Party Number i = '85551001' - Plan: ISDN, Type: Subscriber  
 User-User, i =  
 0x052080060008914A00042800B500001240013C050100009E8C979A3D4611E6B68DC47D4FB61B0000CD1D82800700AC126AE7455A11009E8D33C23D4611E68732C  
 5E7C300170680E708130000000C6013800B05000100AC126AE75917001E40000060401004C6013801215000100AC126AE7591600AC126AE7591700130000010C20  
 13800B05000100AC126AE75917001E400001060401004C2013801215000100AC126AE7591600AC126AE7591700200000020E180D200005000801010B01001300148  
 00B05000100AC126AE75917002B4000002060401004E180D200005000801010B0100130014801215000100AC126AE7591600AC126AE7591700130000030D401800B  
 05000100AC126AE75917001E400003060401004D4001801215000100AC126AE7591600AC126AE7591700010001000180018001000642035053544E10A8018081030  
 140B500001280FB60010200010480F304038090A21803A183971C159F8B0100A10F02010106072A8648CE1500040A01006C0C2183393139363234373238357008C1  
 393934343438321C889E81000367746400000AD49414D2C0D0A50524E2C6973646E2A2C2C4E492A2A2C0D0A5553492C726174652C632C732C632C310D0A55534  
 92C66179312756C61770D0A544D522C30300D0A43504E2C30322C2C312C393934343438320D0A43474E2C30342C2C312C792C342C393139363234373238350D0A  
 4350432C30390D0A643492C2C2C2C2C792C0D0A4743492C3965386339373961336434363131653662363864633437643466623631623030D0A0D0A80B5420

Lines Processed: 246449     SCCP     H.245     Exclude SCCP and MGCP Keepalives    Generate Diagram

Msgs Processed: 4287     SIP     MGCP     Exclude SIP REGISTER     Exclude SIP OPTIONS    Export List

Msgs Displayed: 69     Q.931 / H.225     MGCP BH     Exclude SIP SUBSCRIBE / NOTIFY / PUBLISH    Export Details



# Case Study 1: Downloading Tools

- To download TranslatorX, go to <https://translatorx.org> and click Downloads





# Case Study 1: Collaboration Solutions Analyzer

<https://www.cisco.com/c/en/us/support/web/tools-catalog.html>

The screenshot displays the Cisco Collaboration Solutions Analyzer interface, showing a sequence diagram on the left and a log view on the right.

**Sequence Diagram:**

- Participants: 10.0.251.126 and CUCM 10.0.130.82.
- 20:21:32.761: 200 OK (green arrow from CUCM to 10.0.251.126).
- 20:21:33.079: Invite (blue arrow from 10.0.251.126 to CUCM). SDP ver.: 0.
- 20:21:33.080: 100 Trying (black arrow from CUCM to 10.0.251.126).
- 20:21:33.248: 180 Ringing (black arrow from CUCM to 10.0.251.126).
- 20:21:33.267: 200 OK (green arrow from CUCM to 10.0.251.126).

**Log View:**

- [20:21:33.249] cucm1b: **Outgoing SIP TCP 180 Ringing** response for CSeq:101 INVITE and Call-ID: 00059a3c-7a0000c-00003ee1-00005df3@10.0.251.126
- [20:21:33.255] cucm1b: **Incoming SIP TCP 200 OK** response for CSeq:101 INVITE and Call-ID: 7867ca00-c481cccd-39f2-528200a@10.0.130.82
- [20:21:33.257] cucm1b: **RouteListCdr** stopped hunting for Route List
- [20:21:33.257] cucm1b: Remote party with CI 34411856 answered the call and provided called party name
- [20:21:33.258] cucm1b: MediaConnect Request for CI (34411855, 34411856) in Regions (Default,Default) with Media Requirements('NoRequirements', 'NoRequirements'), DTMF Capabilities (Configured, Supported, RFC2833 PayloadType, Wants to Receive DTMF, Can Do OOB) are ('BestEffort', 'OOB\_RFC2833', '101', 'No', 'No') and ('BestEffort', 'RFC2833', '101', 'Yes', 'Yes')
- [20:21:33.259] cucm1b: SIPInterface sending offer with audio caps ('OPUS' 'G722 64k' 'G7221 32k' 'G7221 24k' 'G711mu-law 64k' 'G711Alaw 64k' 'G729' 'G729AnnexA' 'H264\_FEC'), video caps ('H264' 'H264' 'H264\_FEC') and app caps ('H224')
- [20:21:33.262] cucm1b: Media is established on 'SIP Trunk' with CI 34411855 in 'OPUS' codec on IP:10.0.251.126 Port:22262
- [20:21:33.264] cucm1b: Media is established on 'SIP Trunk' with CI 34411856 in 'OPUS' codec on IP:10.0.130.51 Port:51310
- [20:21:33.266] cucm1b: **Outgoing SIP TCP ACK** request with CSeq:101 ACK and Call-ID: 7867ca00-c481cccd-39f2-528200a@10.0.130.82



# Case Study 1: Finding the Call

Find the TCP Handle for Chuck Robbins' Phone SEP0012431EB746

- Pick any trace file **from the server the phone is registered to** and search for SEP00270DBF5B58 looking for a **StationInit** message
- Found the following lines:

```
39912282.000 |11:40:23.128 |SdISig |SdIDataInd |wait  
|StationInit(1,100,62,1) |SdITCPConnection(1,100,14,1062195)  
|1,100,14,1062195.2333^172.18.159.160^SEP00270DBF5B58 |*TraceFlagOverrode
```

```
39912282.001 |11:40:23.128 |AppInfo |StationInit: (0000005) SoftKeyEvent  
softKeyEvent=11(Answer) lineInstance=1 callReference=63664372.
```

- TCP handle is (0000005)

# Case Study 1: SCCP Messages

39912240.001 | 11:40:19.954 | ApplInfo | StationD: (0000005) CallState callState=4 lineInstance=1 callReference=63664372...  
39912241.001 | 11:40:19.954 | ApplInfo | StationD: (0000005) SelectSoftKeys instance=1 reference=63664372...  
39912242.001 | 11:40:19.954 | ApplInfo | StationD: (0000005) DisplayPromptStatus timeOut=0 Status='?9195557285'...  
39912243.001 | 11:40:19.954 | ApplInfo | StationD: (0000005) DisplayPriNotify timeOutValue=10 pri=5 notify='?9195557285'...  
39912244.001 | 11:40:19.954 | ApplInfo | StationD: (0000005) CallInfo callingPartyName="" callingParty=9195557285 ...  
39912245.001 | 11:40:19.954 | ApplInfo | StationD: (0000005) SetLamp mode=5, stim=9 stimInst=1.  
39912249.001 | 11:40:19.954 | ApplInfo | StationD: (0000005) SetRinger ringMode=3(OutsideRing).  
39912282.001 | 11:40:23.128 | ApplInfo | StationInit: (0000005) SoftKeyEvent softKeyEvent=11(Answer) lineInstance=1 ...  
39912285.001 | 11:40:23.128 | ApplInfo | StationD: (0000005) SetRinger ringMode=1(RingOff).  
39912286.001 | 11:40:23.128 | ApplInfo | StationD: (0000005) SetSpeakerMode speakermode=1(On).  
39912288.001 | 11:40:23.128 | ApplInfo | StationD: (0000005) SetLamp mode=2, stim=9 stimInst=1.  
39912292.001 | 11:40:23.128 | ApplInfo | StationD: (0000005) CallState callState=1 lineInstance=1 callReference=63664372...  
39912295.001 | 11:40:23.128 | ApplInfo | StationD: (0000005) ActivateCallPlane lineInstance=1.  
39912299.001 | 11:40:23.129 | ApplInfo | StationD: (0000005) SetRinger ringMode=1(RingOff).  
39912312.001 | 11:40:23.136 | ApplInfo | StationD: (0000005) StopTone.  
39912313.001 | 11:40:23.136 | ApplInfo | StationD: (0000005) CallState callState=5 lineInstance=1 callReference=63664372...  
39912314.001 | 11:40:23.136 | ApplInfo | StationD: (0000005) SelectSoftKeys instance=1 reference=63664372...  
39912315.001 | 11:40:23.136 | ApplInfo | StationD: (0000005) DisplayPromptStatus timeOut=0 Status='?' content='Connected'...  
39912326.001 | 11:40:23.153 | ApplInfo | StationD: (0000005) StopTone.  
39912327.002 | 11:40:23.153 | ApplInfo | StationD: (0000005) OpenReceiveChannel conferenceID=63664372...  
39912330.001 | 11:40:23.155 | ApplInfo | StationD: (0000005) startMediaTransmission conferenceID=63664372...  
39912331.001 | 11:40:23.236 | ApplInfo | StationInit: (0000005) OpenReceiveChannelAck Status=0, IpAddr=IpAddr.type:0...  
39912339.001 | 11:40:23.240 | ApplInfo | StationD: (0000005) CallInfo callingPartyName="" callingParty=9195557285...

# Case Study 1: SCCP Call States

1–Off hook

2–On hook

3–Ring out

4–Ring in

5–Connected

6–Busy

7–Congestion

8–Hold

9–Call waiting

10–Call transfer

11–Call park

12–Proceed

13–Call remote multiline

14–Invalid number

# Case Study 1: Finding the Call

- Find all activity around 11:41 a.m. for TCP Handle (0000005)
- Once you have found a message, click on it and filter by TCP handle (Control-T)

The screenshot shows the Cisco Unified Communications Trace Translator interface. At the top, there is a search bar with the text "Search (0000005)" and a "Clear" button. Below the search bar is a table with the following columns: Timestamp, Node/Interface, Remote Device, Direction, Protocol, Message Name, TCP Handle/From Tag, and Call Ref / ID. The table contains 20 rows of data, all filtered by the search term "0000005". At the bottom of the interface, there are several checkboxes for filtering options:  SCCP,  H.245,  Exclude SCCP and MGCP Keepalives,  SIP,  MGCP,  Exclude SIP REGISTER,  Exclude SIP OPTIONS,  Q.931 / H.225,  MGCP BH,  Exclude SIP SUBSCRIBE / NOTIFY / PUBLISH. There are also buttons for "Generate Diagram", "Export List", and "Export Details".

Timestamp	Node/Interface	Remote Device	Direction	Protocol	Message Name	TCP Handle/From Tag	Call Ref / ID
06/29/2016 10:48:37.470	10.81.98.205	172.18.159.160	Out	SCCP	CallState	(0000005)	63664360
06/29/2016 10:48:37.470	10.81.98.205	172.18.159.160	Out	SCCP	SelectSoftKeys	(0000005)	63664360
06/29/2016 10:48:37.470	10.81.98.205	172.18.159.160	Out	SCCP	DisplayPromptStatus	(0000005)	63664360
06/29/2016 10:48:37.470	10.81.98.205	172.18.159.160	Out	SCCP	DisplayPriNotify	(0000005)	
06/29/2016 10:48:37.471	10.81.98.205	172.18.159.160	Out	SCCP	CallInfo	(0000005)	63664360
06/29/2016 10:48:37.471	10.81.98.205	172.18.159.160	Out	SCCP	SetLamp	(0000005)	
06/29/2016 10:48:37.472	10.81.98.205	172.18.159.160	Out	SCCP	SetRinger	(0000005)	
06/29/2016 10:48:41.660	10.81.98.205	172.18.159.160	In	SCCP	SoftKeyEvent	(0000005)	63664360
06/29/2016 10:48:41.678	10.81.98.205	172.18.159.160	Out	SCCP	SetRinger	(0000005)	
06/29/2016 10:48:41.741	10.81.98.205	172.18.159.160	Out	SCCP	SetSpeakerMode	(0000005)	
06/29/2016 10:48:41.805	10.81.98.205	172.18.159.160	Out	SCCP	SetLamp	(0000005)	
06/29/2016 10:48:41.844	10.81.98.205	172.18.159.160	Out	SCCP	CallState	(0000005)	63664360
06/29/2016 10:48:41.890	10.81.98.205	172.18.159.160	Out	SCCP	ActivateCallPlane	(0000005)	
06/29/2016 10:48:41.949	10.81.98.205	172.18.159.160	Out	SCCP	SetRinger	(0000005)	
06/29/2016 10:48:42.226	10.81.98.205	172.18.159.160	Out	SCCP	StopTone	(0000005)	
06/29/2016 10:48:42.227	10.81.98.205	172.18.159.160	Out	SCCP	CallState	(0000005)	63664360
06/29/2016 10:48:42.241	10.81.98.205	172.18.159.160	Out	SCCP	SelectSoftKeys	(0000005)	63664360
06/29/2016 10:48:42.242	10.81.98.205	172.18.159.160	Out	SCCP	DisplayPromptStatus	(0000005)	63664360
06/29/2016 10:48:42.256	10.81.98.205	172.18.159.160	Out	SCCP	CallInfo	(0000005)	63664360

# Case Study 1: Finding the Call

- Find all activity around 11:41 a.m. for device SEP00270DBF5B58
- Once you have found a message, click on it and filter by TCP handle (Control-T)

The screenshot shows the Cisco Unified Communications Trace Translator interface. At the top, there is a search bar with the text "SEP00270DBF5B58" entered and highlighted by a red circle. Below the search bar is a table of messages with columns: Timestamp, Node/Interface, Remote Device, Direction, Protocol, Message Name, TCP Handle/From Tag, and Call Ref / ID. The table contains several rows of data, with the last row highlighted in grey. Below the table, there is a detailed view of the selected message, showing the following text:

```
Outbound SCCP message to SEP00270DBF5B58 (172.18.159.160) at 06/29/2016 10:48:37.470
StationD: (0000005) CallState callState=4 lineInstance=1 callReference=63664360 privacy=0 sccp_precedenceLv=4 precedenceDm=0
Source Filename: SDL001_100_000845.txt.gz
```

At the bottom of the interface, there are several checkboxes for filtering options, including "SCCP", "SIP", "Q.931 / H.225", "H.245", "MGCP", "MGCP BH", "Exclude SCCP and MGCP Keepalives", "Exclude SIP REGISTER", "Exclude SIP SUBSCRIBE / NOTIFY / PUBLISH", "Exclude SIP OPTIONS", and "Generate Diagram", "Export List", and "Export Details" buttons.

# Case Study 1: Finding the Call

Message Filters

Device IP  Protocol  Call ID

TCP Handle (0000005)  Message  Call Ref

From Tag  Direction  Node ID 10.81.98.205

Correlation Tag  Session ID

Timestamp Start Time End Time

Search Text

Active Filters - All items on a single line are AND'd together and each line is OR'd with other lines.

Device IP	Node/Interface	Direction	Message	TCP Handle	Call Ref	From Tag	SIP Call ID	SIP Session ID	Protocol
0	10.81.98.205			(0000005)					

# Case Study 1: SCCP CallInfo Message

## Use Call Info Message to Find Information About This Call

```
39912339.001 | 11:40:23.240 |AppInfo |StationD: (0000005) CallInfo callingPartyName=""  
callingParty=9195557285 cgpnVoiceMailbox= alternateCallingParty= 9195557285  
calledPartyName='Chuck Robbins' calledParty=85551001 cdpnVoiceMailbox=  
originalCalledPartyName='Chuck Robbins' originalCalledParty=85551001 originalCdpnVoiceMailbox=  
originalCdpnRedirectReason=0 lastRedirectingPartyName='Chuck Robbins'  
lastRedirectingParty=85551001 lastRedirectingVoiceMailbox= lastRedirectingReason=0  
callType=1(InBound) lineInstance=1 callReference=63664372. version: 8570000c
```

- Inbound Call
- To Chuck Robbins
- Extension 85551001
- Calling Party Number is 9195557285
- At around 11:41 a.m.



# Case Study 1: Searching for Calling Number

Can also find the call by searching for 9195557285

The screenshot shows the Cisco Unified Communications Trace Translator interface. At the top, there are buttons for 'Filters Enabled', 'New Filter', 'Filters...', 'Clear Filters', '1 Filter Configured', 'Call List...', 'Search 9195557285', and 'Clear'. The search field is highlighted with a red circle. Below the buttons is a table with columns: Timestamp, Node/Interface, Remote Device, Direction, Protocol, Message Name, TCP Handle/From Tag, and Call Ref / ID. The table contains several rows of call data. The row for timestamp '06/29/2016 11:40:19.954' is highlighted in blue. Below the table, there is a text area showing the details of the selected call, including the Station ID, calling party name, and various call parameters. At the bottom, there are statistics for lines and messages processed, and a set of checkboxes for filtering options like SCCP, SIP, Q.931, H.245, MGCP, and BPH, along with buttons for 'Generate Diagram', 'Export List', and 'Export Details'.

Timestamp	Node/Interface	Remote Device	Direction	Protocol	Message Name	TCP Handle/From Tag	Call Ref / ID
06/29/2016 11:30:51.928	10.81.98.205	172.18.159.160	Out	SCCP	DisplayPromptStatus	(0000005)	63664366
06/29/2016 11:30:51.929	10.81.98.205	172.18.159.160	Out	SCCP	DisplayPriNotify	(0000005)	
06/29/2016 11:30:51.962	10.81.98.205	172.18.159.160	Out	SCCP	CallInfo	(0000005)	63664366
06/29/2016 11:35:51.242	10.81.98.205	172.18.159.160	Out	SCCP	DisplayPromptStatus	(0000005)	63664370
06/29/2016 11:35:51.242	10.81.98.205	172.18.159.160	Out	SCCP	DisplayPriNotify	(0000005)	
06/29/2016 11:35:51.242	10.81.98.205	172.18.159.160	Out	SCCP	CallInfo	(0000005)	63664370
06/29/2016 11:35:56.250	10.81.98.205	172.18.159.160	Out	SCCP	CallInfo	(0000005)	63664370
06/29/2016 11:35:56.359	10.81.98.205	172.18.159.160	Out	SCCP	CallInfo	(0000005)	63664370
06/29/2016 11:40:19.954	10.81.98.205	172.18.159.160	Out	SCCP	DisplayPromptStatus	(0000005)	63664372
06/29/2016 11:40:19.954	10.81.98.205	172.18.159.160	Out	SCCP	DisplayPriNotify	(0000005)	
06/29/2016 11:40:19.954	10.81.98.205	172.18.159.160	Out	SCCP	CallInfo	(0000005)	63664372
06/29/2016 11:40:23.136	10.81.98.205	172.18.159.160	Out	SCCP	CallInfo	(0000005)	63664372
06/29/2016 11:40:23.240	10.81.98.205	172.18.159.160	Out	SCCP	CallInfo	(0000005)	63664372

Outbound SCCP message to 172.18.159.160 at 06/29/2016 11:40:19.954

```
StationD: (0000005) (1,100,14,1062195) CallInfo callingPartyName='' callingParty=9195557285 cgnVoiceMailbox=
alternateCallingParty= 9195557285
calledPartyName='Chuck Robbins' calledParty=85551001 cdpnVoiceMailbox=
originalCalledPartyName='Chuck Robbins' originalCalledParty=85551001 originalCdpnVoiceMailbox=
originalCdpnRedirectReason=0 lastRedirectingPartyName='Chuck Robbins' lastRedirectingParty=85551001
lastRedirectingVoiceMailbox= lastRedirectingReason=0
callType=1(InBound) lineInstance=1 callReference=63664372. version: 8570000c

Source Filename: SDL001_100_000845.txt.gz
```

Lines Processed: 246449  
Msgs Processed: 4287  
Msgs Displayed: 13

SCCP  H.245  Exclude SCCP and MGCP Keepalives  
 SIP  MGCP  Exclude SIP REGISTER  Exclude SIP OPTIONS  
 Q.931 / H.225  MGCP BH  Exclude SIP SUBSCRIBE / NOTIFY / PUBLISH

Generate Diagram  
Export List  
Export Details

# Case Study 1: Finding Originating Device

## Where Did This Call Come From?

- Look immediately above the first messages sent to the phone in relation to this call to see if there is an inbound gateway call
- If you do not see the digit analysis results for this call in the trace file, the call must have originated from some other node in the cluster – Can use Call Reference ID (CI) to find incoming call.
- Look for SdISig-O in same SDL trace file
- NOTE: SIP Session-ID can help correlate SIP calls – more on this later.

```
39912339.001 | 11:40:23.240 |AppInfo |StationD: (0000005) CallInfo callingPartyName=""  
callingParty=9195557285 cgpnVoiceMailbox= alternateCallingParty= 9195557285  
calledPartyName='Chuck Robbins' calledParty=85551001 cdpnVoiceMailbox=  
originalCalledPartyName='Chuck Robbins' originalCalledParty=85551001 originalCdpnVoiceMailbox=  
originalCdpnRedirectReason=0 lastRedirectingPartyName='Chuck Robbins' lastRedirectingParty=85551001  
lastRedirectingVoiceMailbox= lastRedirectingReason=0 callType=1(InBound) lineInstance=1  
callReference=63664372. version: 8570000c
```

# Case Study 1: Finding Originating Node

## Searching SDL Trace to find Originating Node

- Search for Call Reference ID (CI) to find where call originated.

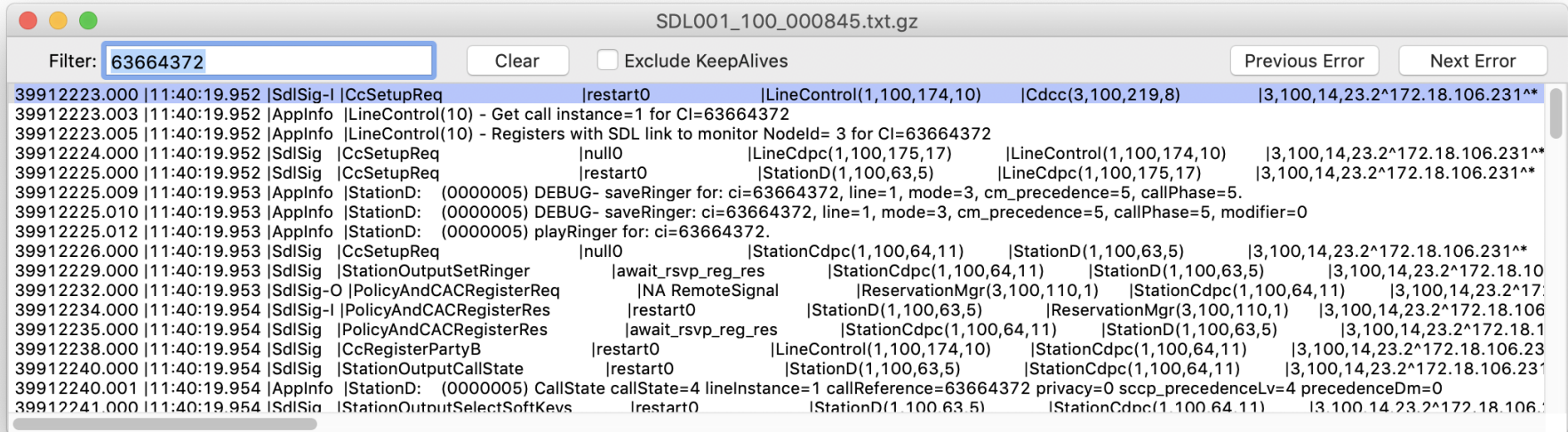

SDL001\_100\_000845.txt.gz

Filter:    Exclude KeepAlives

```
39912223.000 |11:40:19.952 |SdlSig-I |CcSetupReq |restart0 |LineControl(1,100,174,10) |Cdcc(3,100,219,8) |3,100,14,23.2^172.18.106.231**
39912223.003 |11:40:19.952 |AppInfo |LineControl(10) - Get call instance=1 for CI=63664372
39912223.005 |11:40:19.952 |AppInfo |LineControl(10) - Registers with SDL link to monitor NodeId= 3 for CI=63664372
39912224.000 |11:40:19.952 |SdlSig |CcSetupReq |null0 |LineCdpc(1,100,175,17) |LineControl(1,100,174,10) |3,100,14,23.2^172.18.106.231**
39912225.000 |11:40:19.952 |SdlSig |CcSetupReq |restart0 |StationD(1,100,63,5) |LineCdpc(1,100,175,17) |3,100,14,23.2^172.18.106.231**
39912225.009 |11:40:19.953 |AppInfo |StationD: (0000005) DEBUG- saveRinger for: ci=63664372, line=1, mode=3, cm_precedence=5, callPhase=5.
39912225.010 |11:40:19.953 |AppInfo |StationD: (0000005) DEBUG- saveRinger: ci=63664372, line=1, mode=3, cm_precedence=5, callPhase=5, modifier=0
39912225.012 |11:40:19.953 |AppInfo |StationD: (0000005) playRinger for: ci=63664372.
39912226.000 |11:40:19.953 |SdlSig |CcSetupReq |null0 |StationCdpc(1,100,64,11) |StationD(1,100,63,5) |3,100,14,23.2^172.18.106.231**
39912229.000 |11:40:19.953 |SdlSig |StationOutputSetRinger |await_rsvp_reg_res |StationCdpc(1,100,64,11) |StationD(1,100,63,5) |3,100,14,23.2^172.18.10
39912232.000 |11:40:19.953 |SdlSig-O |PolicyAndCACRegisterReq |NA RemoteSignal |ReservationMgr(3,100,110,1) |StationCdpc(1,100,64,11) |3,100,14,23.2^17
39912234.000 |11:40:19.954 |SdlSig-I |PolicyAndCACRegisterRes |restart0 |StationD(1,100,63,5) |ReservationMgr(3,100,110,1) |3,100,14,23.2^172.18.106
39912235.000 |11:40:19.954 |SdlSig |PolicyAndCACRegisterRes |await_rsvp_reg_res |StationCdpc(1,100,64,11) |StationD(1,100,63,5) |3,100,14,23.2^172.18.1
39912238.000 |11:40:19.954 |SdlSig |CcRegisterPartyB |restart0 |LineControl(1,100,174,10) |StationCdpc(1,100,64,11) |3,100,14,23.2^172.18.106.23
39912240.000 |11:40:19.954 |SdlSig |StationOutputCallState |restart0 |StationD(1,100,63,5) |StationCdpc(1,100,64,11) |3,100,14,23.2^172.18.106.23
39912240.001 |11:40:19.954 |AppInfo |StationD: (0000005) CallState callState=4 lineInstance=1 callReference=63664372 privacy=0 sccp_precedenceLv=4 precedenceDm=0
39912241.000 |11:40:19.954 |SdlSig |StationOutputSelectSoftKeys |restart0 |StationD(1,100,63,5) |StationCdpc(1,100,64,11) |3,100,14,23.2^172.18.106
```

# Case Study 1: SDL Trace File Definitions

## SDL Signal Trace Line Example:

```
39912223.000 |11:40:19.952 |SdISig-I |CcSetupReq |restart0  
|LineControl(1,100,174,10) |Cdcc(3,100,219,8) |3,100,14,23.2^172.18.106.231^*  
|[R:N-H:0,N:0,L:0,V:0,Z:0,D:0] CI=63664372...
```

Field Name	Description
Line Number	Line Number Continuously Incremented Across Files. Related trace lines increment number after decimal point.
Date and Time	Date and Time the Event Occurred
SDL Operation	Indicates if the Signal Is Local to the Server (SdISig), Inbound from Another Node in the Cluster (SdISig-I), or Out to Another Node in the Cluster (SdISig-O) AppInfo indicates SDI trace data in the SDL trace
SDL Signal Name	The Signal that Is Being Sent from Source Process to Destination Process
Destination Process State	Current State of the Destination Process
Destination Process	The Name and Process ID of the Destination Process
Source Process	The Name and Process ID of the Source Process

# Case Study 1: SDL Trace File Definitions



What Does Cdcc(3,100,219,8) Mean?

Field Name	Description
Node ID	Node in the cluster where this process exists
Application ID	100 = CallManager, 200 = CTIManager
Process ID	In this case 219 means Cdcc. Process IDs are assigned at runtime and may not be the same from one CallManager Service restart to another.
Process Instance	The Instance ID of this Process. In this Case this Is the 8th Cdcc Process that has been created on this server.

# Case Study 1: Finding SDL Node ID

Node ID Is Found Under System > Cisco Unified CM

### Cisco Unified CM Configuration

 Save  Reset  Apply Config

---

#### Status

 Status: Ready

---

#### Cisco Unified Communications Manager Information

Cisco Unified Communications Manager: CM\_10.122.249.15 (used by 4 devices)

---

#### Server Information

CTI ID	3
Cisco Unified Communications Manager Server*	10.122.249.15
Cisco Unified Communications Manager Name*	<input type="text" value="CM_10.122.249.15"/>
Description	<input type="text" value="10.122.249.15"/>
Location Bandwidth Manager Group	<input type="text" value=" &lt; None &gt;"/>

# Case Study 1: Finding SDL Node ID

## Can Run an SQL Query to Find Node ID

```
admin:run sql select name, description, ctiid from callmanager order by ctiid
name          description          ctiid
=====
CM_VNT-CM1A  VNT-CM1A - Publisher  1
CM_VNT-CM1B  VNT-CM1B              2
CM_VNT-CM1C  VNT-CM1C              3
```

# Case Study 1: Finding Originating Node

## Going Back to the SDL Trace Line

```
39912223.000 |11:40:19.952 |SdlSig-I |CcSetupReq |restart0  
|LineControl(1,100,174,10) |Cdcc(3,100,219,8)
```

- Cdcc instance 8 on node 3 sent LineControl instance 10 on Node 1 a CCSetupReq signal
- This means the call originated on node 3
- Look in the SDL trace on node 3 to find the matching trace line

```
00172622.000 |11:40:19.951 |SdlSig-O |CcSetupReq |NA  
RemoteSignal |LineControl(1,100,174,10)  
|Cdcc(3,100,219,8)
```

- Search for CI in new trace to see where it originated



# Case Study 1: Found Digit Analysis Results

SDL003\_100\_000008.txt.gz

Filter: 63664372    Clear     Exclude KeepAlives    Previous Error    Next Error

00172615.000	11:40:19.950	SdlSig	PolicyAndCACAssociateReq	wait	ReservationMgr(3,100,110,1)	Cdcc(3,100,219,8)	3,100,14,23.2^172.18.106.231^*
00172617.000	11:40:19.950	SdlSig	CACAssociateReq	connecting	LBMInterface(3,100,176,1)	ReservationMgr(3,100,110,1)	3,100,14,23.2^172.18.106.231^*
00172617.001	11:40:19.950	AppInfo	LBMIF: Ci: 63664371 ASSOC	63664372			
00172617.002	11:40:19.950	AppInfo	LBMIF: Ci: 63664372 ASSOC'	63664371			
00172618.000	11:40:19.950	SdlSig	CACAssociateReq	await_associate	RSVPSession(3,100,107,8)	ReservationMgr(3,100,110,1)	3,100,14,23.2^172.18.106.231^*
00172619.000	11:40:19.950	SdlSig	PolicyAndCACAssociateRes	wait	Cc(3,100,220,1)	ReservationMgr(3,100,110,1)	3,100,14,23.2^172.18.106.231^*
00172620.000	11:40:19.951	SdlSig	PolicyAndCACAssociateRes	tcc_register_party_b	Cdcc(3,100,219,8)	Cc(3,100,220,1)	3,100,14,23.2^172.18.106.231^*
00172622.000	11:40:19.951	SdlSig-O	CcSetupReq	NA RemoteSignal	LineControl(1,100,174,10)	Cdcc(3,100,219,8)	3,100,14,23.2^172.18.106.231^*
00172623.000	11:40:19.953	SdlSig-I	PolicyAndCACRegisterReq	wait	ReservationMgr(3,100,110,1)	StationCdpc(1,100,64,11)	3,100,14,23.2^172.18.106.231^*
00172624.000	11:40:19.953	SdlSig	LBMRegisterReq	connecting	LBMInterface(3,100,176,1)	ReservationMgr(3,100,110,1)	3,100,14,23.2^172.18.106.231^*
00172624.001	11:40:19.953	AppInfo	LBMIF: Ci: 63664372 REGISTER 1,100,63,5 dev 0xcec2840				
00172624.004	11:40:19.954	AppInfo	LBMIF: Ci: 63664372 BW RSV>	dev 0xcec2840 10938327537272487944 audio 272			
00172624.005	11:40:19.954	AppInfo	LBMIF: Ci: 63664372 BW RSV<S	10938327537272487944			
00172625.000	11:40:19.954	SdlSig	LBMRegisterRes	wait	ReservationMgr(3,100,110,1)	LBMInterface(3,100,176,1)	3,100,14,23.2^172.18.106.231^*
00172626.000	11:40:19.954	SdlSig	RSVPRegisterReq	wait	RSVPSession(3,100,107,8)	ReservationMgr(3,100,110,1)	3,100,14,23.2^172.18.106.231^*
00172627.000	11:40:19.954	SdlSig	RSVPRegisterRes	wait	ReservationMgr(3,100,110,1)	RSVPSession(3,100,107,8)	3,100,14,23.2^172.18.106.231^*
00172628.000	11:40:19.954	SdlSig-O	PolicyAndCACRegisterRes	NA RemoteSignal	StationD(1,100,63,5)	ReservationMgr(3,100,110,1)	3,100,14,23.2^172.18.106.231^*
00172629.000	11:40:19.956	SdlSig-I	CcRegisterPartyB	wait	Cc(3,100,220,1)	LineCdpc(1,100,175,17)	3,100,14,23.2^172.18.106.231^*
00172630.000	11:40:19.956	SdlSig-I	CcAlertInd	wait	Cc(3,100,220,1)	LineCdpc(1,100,175,17)	3,100,14,23.2^172.18.106.231^*

00172615.000 |11:40:19.950 |SdlSig |PolicyAndCACAssociateReq |wait  
 |ReservationMgr(3,100,110,1) |Cdcc(3,100,219,8) |3,100,14,23.2^172.18.106.231^\*  
 |[R:N-H:0,N:1,L:0,V:0,Z:0,D:0] Ci= 63664371 aCI=63664371 bCI=63664372 isASerCI=F isBSerCI=F  
 sendResp=T mcNodeId=0 sideAnp=F sideBnp=F



# Case Study 1: Found Digit Analysis Results

CCM trace at 09:38:13.406

```
00172610.007 |11:40:19.950 |AppInfo |Digit analysis: analysis results
00172610.008 |11:40:19.950 |AppInfo
||PretransformCallingPartyNumber=9195557285
|CallingPartyNumber=9195557285
|DialingPartition=1stLine
|DialingPattern=85551001
|FullyQualifiedCalledPartyNumber=+14085264000
|DialingPatternRegularExpression=(85551001)
|DialingWhere=
|PatternType=Enterprise
|PotentialMatches=NoPotentialMatchesExist
|DialingSdIProcessId=(0,0,0)
|PretransformDigitString=85551001
|PretransformTagsList=SUBSCRIBER
|PretransformPositionalMatchList=85551001
|CollectedDigits=85551001
|UnconsumedDigits=
```

# Case Study 1: Found Originating SETUP

- Look just before the digit analysis match and you see:

```
00172588.002 |11:40:19.943 |AppInfo |In Message -- H225SetupMsg -- Protocol= H225Protocol
00172588.003 |11:40:19.943 |AppInfo |le - H225BearerCapability -- IEData= 04 03 80 90 A3
00172588.004 |11:40:19.943 |AppInfo |le - H225CallingPartyle -- IEData= 6C 0C 21 83 39 31 39 35 35 35 37 32 38 35
00172588.005 |11:40:19.943 |AppInfo |le - Q931CalledPartyle -- IEData= 70 09 C1 38 35 35 35 31 30 30 31
00172588.006 |11:40:19.943 |AppInfo |le - H225UserUserle -- IEData= 7E 03 00 05 20 80 06 00 08 91 4A 00 04 28 00 B5
00 00 12 40 01 3C 05 01 00 00 9E 8C 97 9A 3D 46 11 E6 B6 8D C4 7D 4F B6 1B 00 00 CD 1D 82 80 07 00 AC 12 6A E7 45
5A 11 00 9E 8D 33 C2 3D 46 11 E6 87 32 C5 E7 C3 00 17 06 80 E7 08 13 00 00 00 0C 60 13 80 0B 05 00 01 00 AC...
00172588.007 |11:40:19.943 |AppInfo |MMan_Id= 0. (iep= 0 dsl= 0 sapi= 0 ces= 0 IpAddr=e76a12ac IpPort=17754)
```

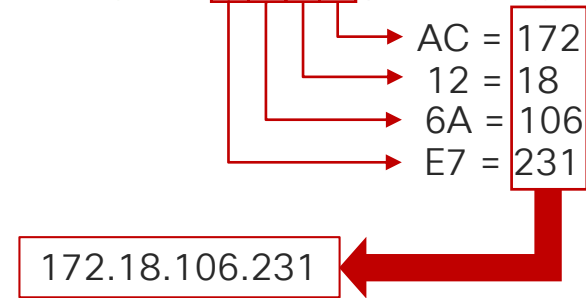

# Case Study 1: Decoding H.225 Messages

Open the Trace Files from Node 3 in TranslatorX

The screenshot shows the Cisco Unified Communications Trace Translator interface. At the top, there are menu options: "Filters Enabled", "New Filter", "Filters...", "Clear Filters", "1 Filter Configured", "Call List...", "Search", and "Clear". Below this is a table of message logs. The first row is highlighted in blue and shows a SETUP message at 11:40:19.943 from 10.122.249.15 to 172.18.106.231. Below the table, there is a detailed view of the selected message, showing its structure and content. At the bottom, there are statistics for lines and messages processed, and a set of checkboxes for filtering and generating diagrams.

Timestamp	Node/Interface	Remote Device	Direction	Protocol	Message Name	TCP Handle/From Tag	Call Ref / ID
06/29/2016 11:40:19.943	10.122.249.15	172.18.106.231	In	H225	SETUP		0x000A
06/29/2016 11:40:19.951	10.122.249.15	172.18.106.231	Out	H225	CALL_PROC		0x800A
06/29/2016 11:40:19.956	10.122.249.15	172.18.106.231	Out	H225	ALERTING		0x800A
06/29/2016 11:40:19.957	10.122.249.15	172.18.106.231	Out	H225	NOTIFY		0x800A
06/29/2016 11:40:20.071	10.122.249.15	172.18.106.231	In	H225	FACILITY		0x000A
06/29/2016 11:40:23.138	10.122.249.15	172.18.106.231	Out	H225	CONNECT		0x800A
06/29/2016 11:40:23.139	10.122.249.15	172.18.106.231	Out	H225	NOTIFY		0x800A
06/29/2016 11:40:23.145	10.122.249.15	172.18.106.231	In	H245	terminalCapabilitySet	(5)	0x800A
06/29/2016 11:40:23.147	10.122.249.15	172.18.106.231	In	H245	masterSlaveDeterminat...	(5)	0x800A
06/29/2016 11:40:23.151	10.122.249.15	172.18.106.231	Out	H245	terminalCapabilitySet	(5)	0x800A
06/29/2016 11:40:23.151	10.122.249.15	172.18.106.231	Out	H245	terminalCapabilitySetAck	(5)	0x800A
06/29/2016 11:40:23.152	10.122.249.15	172.18.106.231	In	H245	terminalCapabilitySetAck	(5)	0x800A
06/29/2016 11:40:23.152	10.122.249.15	172.18.106.231	Out	H245	masterSlaveDeterminat...	(5)	0x800A
06/29/2016 11:40:23.153	10.122.249.15	172.18.106.231	In	H245	masterSlaveDeterminat...	(5)	0x800A
06/29/2016 11:40:23.153	10.122.249.15	172.18.106.231	In	H245	openLogicalChannel	(5)	0x800A
06/29/2016 11:40:23.154	10.122.249.15	172.18.106.231	Out	H245	openLogicalChannel	(5)	0x800A
06/29/2016 11:40:23.155	10.122.249.15	172.18.106.231	In	H245	openLogicalChannelAck	(5)	0x800A
06/29/2016 11:40:23.239	10.122.249.15	172.18.106.231	Out	H245	openLogicalChannelAck	(5)	0x800A
06/29/2016 11:43:05.268	10.122.249.15	172.18.106.231	Out	H245	closeLogicalChannel	(5)	0x800A

Inbound H225 SETUP message from 172.18.106.231 at timestamp 06/29/2016 11:40:19.943

SETUP, pd = 8, callref = 0x000A, Message Size = 662 bytes

Bearer Capability i = 0x8090A3, ITU-T standard, Speech, Circuit mode, 64k, A-law  
Calling Party Number i = '919557285' - Plan: ISDN, Type: National, Presentation Allowed, Network provided  
Called Party Number i = '85551001' - Plan: ISDN, Type: Subscriber  
User-User, i =  
0x502080060008914A00042800B500001240013C050100009E8C979A3D4611E6B68DC47D4FB61B0000CD1D82800700AC126AE7455A11009E8D33C23D4611E68732C5E7C300170680E708130000000C601380B05000100AC126AE75917001E40000060401004C6013801215000100AC126AE7591600AC126AE7591700130000010C201380B05000100AC126AE75917001E400001060401004C2013801215000100AC126AE7591600AC126AE7591700200000020E180D200005000801010B0100130014800B05000100AC126AE75917002B400002060401004E180D200005000801010B0100130014801215000100AC126AE7591600AC126AE7591700130000030D4001800B05000100AC126AE75917001E400003060401004D4001801215000100AC126AE7591600AC126AE7591700010001000180018001000642035053544E10A801800103140B500001280FB60010200010480F304038090A21803A183971C159FB0100A10F02010106072A8648CE1500040A01006C0C2183393139363234373238357008C13939343438321CB89E810003677644000000AD49414D2C0D0A50524E2C6973646E2A2C2C4E492A2A2AC0D0A5553492C7261746522C632C732C632C310D0A5553492C6C6179312C756C61770D0A544D522C3030D0A43504E2C30322C2C312C393934343438320D0A43474E2C30342C2C312C792C342C393139363234373238350D0A4350432C3039D0A4643492C2C2C2C2C2C2C792C0D0A4743492C3965386339373961336434363131653662363864633437643466623631623030D0A0D0A80B5420

Lines Processed: 246449     SCCP     H.245     Exclude SCCP and MGCP Keepalives      
Msgs Processed: 4287     SIP     MGCP     Exclude SIP REGISTER     Exclude SIP OPTIONS      
Msgs Displayed: 24     Q.931 / H.225     MGCP BH     Exclude SIP SUBSCRIBE / NOTIFY / PUBLISH   



# Case Study 1: Decoding H.225 Messages

Open the Trace Files from Node 3 in TranslatorX

Inbound H225 SETUP message from **172.18.106.231** at timestamp 06/29/2016  
11:40:19.943

SETUP, pd = 8, callref = 0x000A, Message Size = 662 bytes

Bearer Capability i = 0x8090A3, ITU-T standard, Speech, Circuit mode, 64k, A-law  
Calling Party Number i = '**9195557285**' - Plan: ISDN, Type: National,  
Presentation Allowed, Network provided

Called Party Number i = '**85551001**' - Plan: ISDN, Type: Subscriber  
User-User, i =

0x052080060008914A00042800B500001240013C050100009E8C979A3D4611E6B68DC  
47D4FB61B0000CD1D82800700AC126AE7455A11009E8D33C23D4611E68732C5E7C30  
0170680E708130000000C6013800B05000100AC126AE75917001E400000060401004C6  
013801215...

# Case Study 1: Call Setup

## Call Setup Signaling

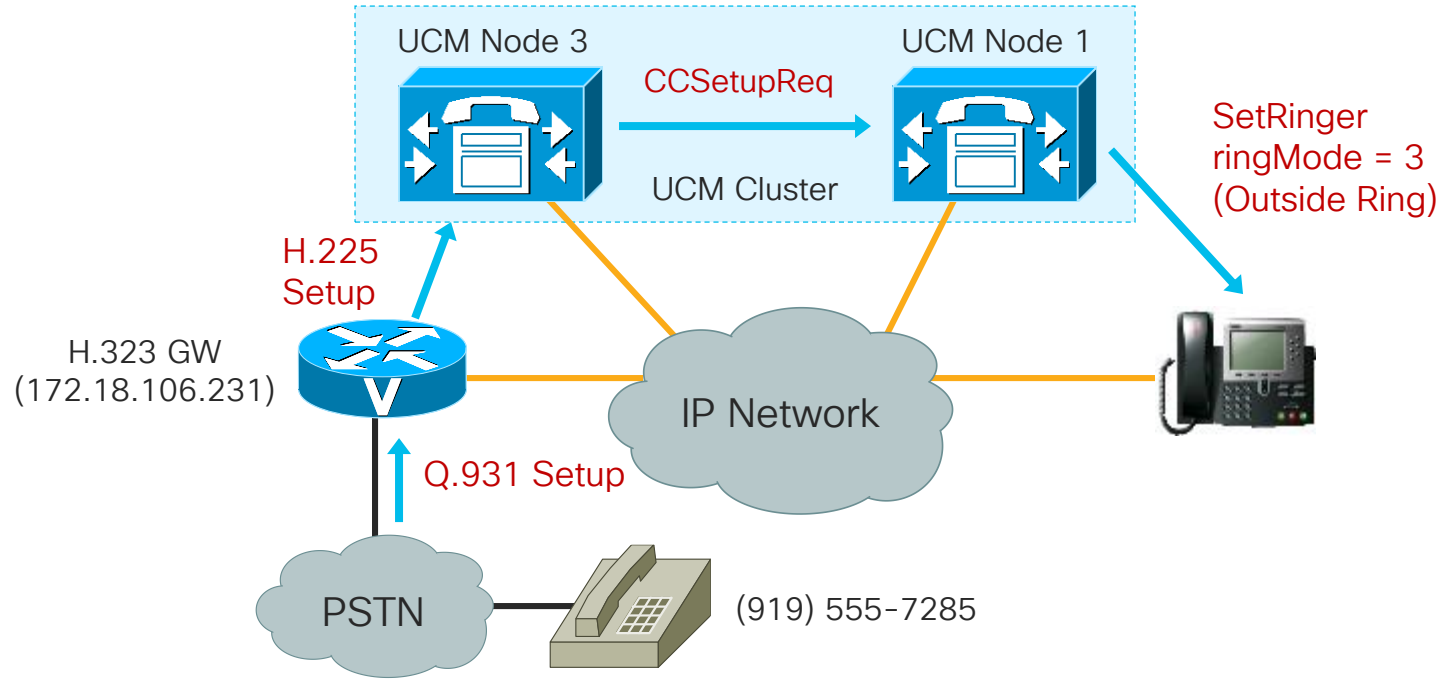

# Case Study 1: Call Disconnected at Gateway

Filter the Call by Call Reference to see all messages about this call

Timestamp	Node/Interface	Remote Device	Direction	Protocol	Message Name	TCP Handle/From Tag	Call Ref / ID
06/29/2016 11:40:19.943	10.122.249.15	172.18.106.231	In	H225	SETUP		0x000A
06/29/2016 11:40:19.951	10.122.249.15	172.18.106.231	Out	H225	CALL_PROC		0x800A
06/29/2016 11:40:19.956	10.122.249.15	172.18.106.231	Out	H225	ALERTING		0x800A
06/29/2016 11:40:19.957	10.122.249.15	172.18.106.231	Out	H225	NOTIFY		0x800A
06/29/2016 11:40:20.071	10.122.249.15	172.18.106.231	In	H225	FACILITY		0x000A
06/29/2016 11:40:23.138	10.122.249.15	172.18.106.231	Out	H225	CONNECT		0x800A
06/29/2016 11:40:23.139	10.122.249.15	172.18.106.231	Out	H225	NOTIFY		0x800A
06/29/2016 11:43:05.269	10.122.249.15	172.18.106.231	Out	H225	RELEASE_COMP		0x800A
06/29/2016 11:43:05.278	10.122.249.15	172.18.106.231	In	H225	RELEASE_COMP		0x000A

- Inbound call originated at 11:40:19.943 and connected at 11:40:23.138
- Call was disconnected at 11:43:05.269

RELEASE\_COMP, pd = 8, callref = 0x800A, Message Size = 46 bytes  
Cause i = **0x80A9 - Temporary failure**

- Now we know Unified CM sent a disconnect with a cause code of temporary failure at 11:43:05.269, but why?

# Case Study 1: Call Dropped on IP Phone

Go Back to the IP Phone to See What Happened From the User's Perspective

- Unified CM sends a SelectSoftKeys and DisplayPromptStatus message at 11:42:57.606. Click on DisplayPromptStatus to see what the message sent to the phone was.

Timestamp	Node/Interface	Remote Device	Direction	Protocol	Message Name	TCP Handle/From Tag	Call Ref / ID
06/29/2016 11:40:41.135	10.81.98.205	172.18.159.160	Out	SCCP	SetRinger	(0000005)	
06/29/2016 11:42:57.606	10.81.98.205	172.18.159.160	Out	SCCP	SelectSoftKeys	(0000005)	63664372
06/29/2016 11:42:57.606	10.81.98.205	172.18.159.160	Out	SCCP	DisplayPromptStatus	(0000005)	63664372
06/29/2016 11:42:57.606	10.81.98.205	172.18.159.160	Out	SCCP	StationOutputDisplayText	(0000005)	
06/29/2016 11:42:57.606	10.81.98.205	172.18.159.160	Out	SCCP	SelectSoftKeys	(0000005)	63664372
06/29/2016 11:42:57.606	10.81.98.205	172.18.159.160	Out	SCCP	DisplayPromptStatus	(0000005)	63664372
06/29/2016 11:42:57.606	10.81.98.205	172.18.159.160	Out	SCCP	StationOutputDisplayText	(0000005)	
06/29/2016 11:43:54.562	10.81.98.205	172.18.159.160	In	SCCP	SoftKeyEvent	(0000005)	63664372
06/29/2016 11:43:54.562	10.81.98.205	172.18.159.160	Out	SCCP	StopTone	(0000005)	
06/29/2016 11:43:54.562	10.81.98.205	172.18.159.160	Out	SCCP	ConnectionStatisticsReq	(0000005)	63664372

StationD: (0000005) DisplayPromptStatus timeOut=0 Status='#'  
content='Temporary failure' line=1 CI=63664372 ver=8570000c.



# Case Study 1: Call Disconnected

## Call Being Disconnected

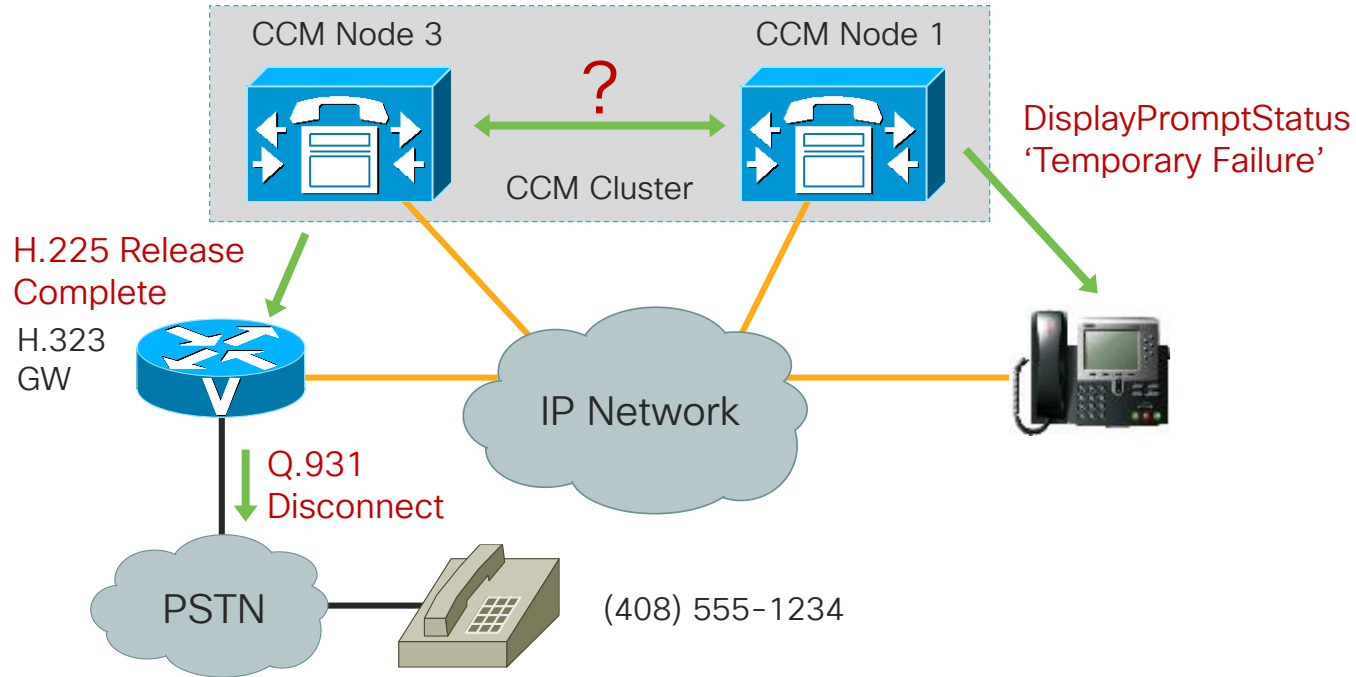

# Case Study 1: SDL Link OOS

## What Happened Between Node 1 and Node 3?

- Look at the SDL trace on Node 1 right before Unified CM tells the phone about the failure at 11:42:57.606

39913061.003 |11:42:57.602 |AppInfo |SDLLinkOOS - **SDL link to remote application is out of service**  
Local Node ID:1 Local Application ID:100 Remote Application IP Address:10.122.249.15 Remote Node ID:3 Remote Application ID:100 Unique Link ID:1:100:3:100 App ID:Cisco CallManager Cluster ID:StandAloneCluster Node ID:collab-ccie-cm2a

39913061.004 |11:42:57.603 |AlarmErr |AlarmClass: CallManager, AlarmName: SDLLinkOOS, AlarmSeverity: Alert, AlarmMessage: , AlarmDescription: **SDL link to remote application is out of service**, AlarmParameters: LocalNodId:1, LocalApplicationID:100, RemoteIPAddress:10.122.249.15, RemoteNodeID:3, RemoteApplicationID:100, LinkID:1:100:3:100, AppID:Cisco CallManager, ClusterID:StandAloneCluster, NodeID:collab-ccie-cm2a,

# Case Study 1: SDL Link OOS

## What Happened Between Node 1 and Node 3?

- Look at the SDL trace on node 3 right before Unified CM sends the RELEASE COMPLETE to the gateway at 11:43:05.269

00173311.003 |11:43:05.262 |AppInfo |SDLLinkOOS - **SDL link to remote application is out of service** Local Node ID:3 Local Application ID:100 Remote Application IP Address:10.81.98.205 Remote Node ID:1 Remote Application ID:100 Unique Link ID:3:100:1:100 App ID:Cisco CallManager Cluster ID:StandAloneCluster Node ID:collab-ccie-cm2c

00173311.004 |11:43:05.262 |AlarmErr |AlarmClass: CallManager, AlarmName: SDLLinkOOS, AlarmSeverity: Alert, AlarmMessage: , AlarmDescription: **SDL link to remote application is out of service**, AlarmParameters: LocalNodeID:3, LocalApplicationID:100, RemoteIPAddress:10.81.98.205, RemoteNodeID:1, RemoteApplicationID:100, LinkID:3:100:1:100, AppID:Cisco CallManager, ClusterID:StandAloneCluster, NodeID:collab-ccie-cm2c,

# Case Study 1: SDL Links

## What Is an SDL Link?

- Fully-meshed TCP connections between all nodes in a Unified CM cluster
- Each server establishes a TCP connection to other nodes with a lower node ID than itself on port 8002

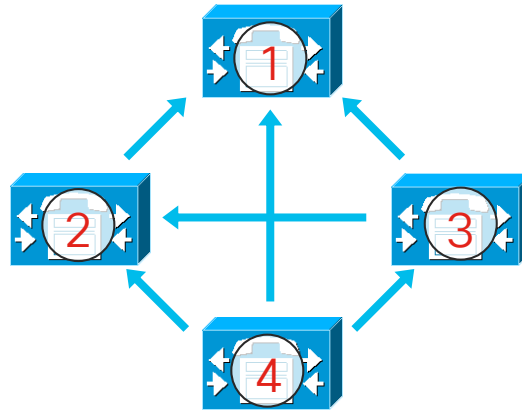

# Case Study 1: SDL Link OOS

## Why Would an SDL Link Go Out of Service?

- Server Hardware Failure / Power / CallManager Service restart
- IP connectivity issues
  - Duplex mismatch between Unified CM Server NIC and switch
  - Router or switch failure between Unified CM nodes / Routing problems
  - Cabling issues
  - Network congestion / Errors / Packet Loss
- CallManager Service blocked from processing signals on SDL Link
  - Overloaded Unified CM Node
  - High CPU due to other process on the system
  - High disk I/O / SAN Failure
  - Low memory (causing memory to swap to/from disk)
  - Hypervisor Host overloaded / Hypervisor blocking VM

# Case Study 1: Proactive Alerts

## Leverage Syslog / RTMT Alerts to receive Alerts / Alarms

- Alerts generated in Syslog on Node 1:

```
11:42:57.604 |SyslogSeverityMatchFound - The configured Syslog Alarm/message severity had
matched SeverityMatch:Alert MatchedEvent:Jun 29 11:42:57 collab-ccie-cm2a local7 1 ccm: 12:
collab-ccie-cm2a.cisco.com: Jun 29 2016 15:42:57.600 UTC : %UC_CALLMANAGER-1-
SDLLinkOOS:%[LocalNodeID=1][LocalApplicationID=100][RemoteIPAddress=10.122.249.15]
[RemoteNodeID=3][RemoteApplicationID=100][LinkID=1:100:3:100][AppID=Cisco
CallManager][ClusterID=StandAloneCluster][NodeID=collab-ccie-cm2a]: SDL link to remote application
is out of service App ID:Cisco Syslog Agent Cluster ID: Node ID:collab-ccie-cm2a
```

# Case Study 1: Proactive Alerts

## Leverage Syslog / RTMT Alerts to receive Alerts / Alarms

- Alerts generated in Syslog on Node 2:

```
11:43:03.850 |SyslogSeverityMatchFound - The configured Syslog Alarm/message severity had
matched SeverityMatch:Alert MatchedEvent:Jun 29 11:43:03 collab-ccie-cm2b local7 1 ccm: 12:
collab-ccie-cm2b.cisco.com: Jun 29 2016 15:43:03.792 UTC : %UC_CALLMANAGER-1-
SDLLinkOOS:%[LocalNodeId=2][LocalApplicationID=100][RemoteIPAddress=10.122.249.15]
[RemoteNodeID=3][RemoteApplicationID=100][LinkID=2:100:3:100][AppID=Cisco
CallManager][ClusterID=StandAloneCluster][NodeID=collab-ccie-cm2b]: SDL link to remote application
is out of service App ID:Cisco Syslog Agent Cluster ID: Node ID:collab-ccie-cm2b
```

# Case Study 1: Proactive Alerts

## Leverage Syslog / RTMT Alerts to receive Alerts / Alarms

- Alerts generated in Syslog on Node 3:

11:43:05.261 |SyslogSeverityMatchFound - The configured Syslog Alarm/message severity had matched  
SeverityMatch:Alert MatchedEvent:Jun 29 11:43:05 collab-ccie-cm2c local7 1 ccm: 9: collab-ccie-cm2c.cisco.com:  
Jun 29 2016 15:43:05.259 UTC : %UC\_CALLMANAGER-1-SDLLinkOOS:  
%[LocalNodeID=3][LocalApplicationID=100][RemoteIPAddress=10.81.98.206][RemoteNodeID=2][RemoteApplicationID=  
100][LinkID=3:100:2:100][AppID=Cisco CallManager][ClusterID=StandAloneCluster][NodeID=collab-ccie-cm2c]: SDL  
link to remote application is out of service App ID:Cisco Syslog Agent Cluster ID: Node ID:collab-ccie-cm2c

11:43:06.362 |SyslogSeverityMatchFound - The configured Syslog Alarm/message severity had matched  
SeverityMatch:Alert MatchedEvent:Jun 29 11:43:05 collab-ccie-cm2c local7 1 ccm: 10: collab-ccie-cm2c.cisco.com:  
Jun 29 2016 15:43:05.263 UTC : %UC\_CALLMANAGER-1-SDLLinkOOS:  
%[LocalNodeID=3][LocalApplicationID=100][RemoteIPAddress=10.81.98.205][RemoteNodeID=1][RemoteApplicationID=  
100][LinkID=3:100:1:100][AppID=Cisco CallManager][ClusterID=StandAloneCluster][NodeID=collab-ccie-cm2c]: SDL  
link to remote application is out of service App ID:Cisco Syslog Agent Cluster ID: Node ID:collab-ccie-cm2c



# Case Study 1: SDL Link OOS

How do you prevent the call from being dropped?

- Enable “Allow Peer to Preserve H.323 Calls”

## Clusterwide Parameters (Device - H323)

<a href="#">Accept Unknown TCP Connection</a> *	False	False
<a href="#">Allow TCP KeepAlives For H323</a> *	False	True
<a href="#">BRQ Enabled</a> *	False	False
<a href="#">Call Present Disconnect Flag</a> *	False	False
<a href="#">Allow Peer to Preserve H.323 Calls</a> *	True	False

- Enable Call Preservation & Media Inactivity detection on the IOS gateway

voice service voip

h323

call preserve

gateway

timer receive-rtcp 1200

# Agenda

- Serviceability Tools Overview
  - Real-Time Monitoring Tool (RTMT)
  - Cisco Unified Operating System GUI
  - Cisco Unified Operating System CLI
  - Cisco Serviceability Reports
  - Cisco Unified Reporting
  - Serviceability APIs
- Troubleshooting Methodology
  - Problem Description
  - Information Collection
- Troubleshooting Case Studies
  - Dropped Call
  - Video Encryption Not Working
  - No One Answers the Phone**
  - One-Way Audio
  - Unable to Place Calls
  - ActiveControl Not Working on Jabber 12.5
  - Call Drops After Answering
  - Video Call Immediately Drops
- Understanding and Troubleshooting Unified CM Throttling Events
- Troubleshooting Database Replication

# Case Study 2: No One Answers the Phone

## Problem Description

- A user reports that every time they call a specific phone number, no one answers the call, but if they call from their cell phone, the call is answered immediately every time.
- Calling phone is extension 89919236.
- Called number is 1 (877) 288-8362

# Case Study 2: No One Answers the Phone

## Collect Traces

- Problem is reproducible, so generate a test call and then collect traces.

The screenshot displays the 'Real Time Monitoring Tool' interface for Cisco Unified Communications. The left sidebar shows a tree view with 'Trace & Log Central' selected. The main window shows a 'Collect Files' dialog box with a table of services and their collection options. The 'Cisco CallManager' service is selected, and the 'Collect File Options' dialog is open, showing the 'Relative Range' collection method and the 'Download File Directory' set to '/Users/pgiralt'. Red arrows highlight the 'Trace & Log Central' menu item, the 'Cisco CallManager' service in the table, the 'Relative Range' radio button, the 'Browse' button for the download directory, and the 'Finish' button at the bottom of the dialog.

**System**

- System Summary
- Server
  - CPU and Memory
  - Process
  - Disk Usage
  - Critical Services
- Performance
  - Performance
  - Performance Log Viewer
- Tools
  - Alert Central
  - Trace & Log Central**
  - Job Status
  - SysLog Viewer
  - VLT
  - AuditLog Viewer

**Trace & Log Central**

- Trace & Log Central
  - Remote Browse
  - Collect Files
  - Query Wizard
  - Schedule Collection
  - Local Browse
  - Real Time Trace
  - Collect Crash Dump
  - Collect Install Logs
  - Audit Logs

**Collect Files**

Name	All Servers
Cisco CAR Scheduler	<input type="checkbox"/>
Cisco CAR Web Service	<input type="checkbox"/>
Cisco CDR Agent	<input type="checkbox"/>
Cisco CDR Repository Manager	<input type="checkbox"/>
Cisco CDR files on CM server	<input type="checkbox"/>
Cisco CDR files on Publisher Processed	<input type="checkbox"/>
Cisco CTIManager	<input type="checkbox"/>
Cisco CTL Provider	<input type="checkbox"/>
<b>Cisco CallManager</b>	<input checked="" type="checkbox"/>
Cisco CallManager SNMP Service	<input type="checkbox"/>
Cisco Certificate Authority Proxy Function	<input type="checkbox"/>
Cisco Change Credential Application	<input type="checkbox"/>
Cisco DHCP Monitor Service	<input type="checkbox"/>
Cisco Device Activation Service	<input type="checkbox"/>
Cisco Dialed Number Analyzer	<input type="checkbox"/>
Cisco Dialed Number Analyzer Server	<input type="checkbox"/>
Cisco Directory Number Alias Lookup	<input type="checkbox"/>
Cisco Directory Number Alias Sync	<input type="checkbox"/>
Cisco Extended Functions	<input type="checkbox"/>
Cisco Extended Functions Report	<input type="checkbox"/>
Cisco Extension Mobility	<input type="checkbox"/>
Cisco Extension Mobility Application	<input type="checkbox"/>
Cisco Headset Service	<input type="checkbox"/>
Cisco IP Manager Assistant	<input type="checkbox"/>
Cisco IP Voice Media Streaming App	<input type="checkbox"/>
Cisco Intercluster Lookup Service	<input type="checkbox"/>

**Collect File Options:**

**Collection Time**

Absolute Range

Select Reference Server Time Zone: Client:(GMT-5:0)Eastern Standard Time-America/New\_York

From Date/Time: 1/24/20 - 10:32 PM

To Date/Time: 1/24/20 - 11:32 PM

Relative Range

Files Generated in the last: 10 Minutes

**Download File Options**

Select Partition: Active Partition

Download File Directory: /Users/pgiralt **Browse**

Zip Files

Do Not Zip Files

Uncompress Log Files

Delete Collected Log Files from Server

Note: The result file can be found in the directory named <Node Name> created under the user specified directory structure. The File Name is as specified by the user.

**Finish**

# Case Study 2: No One Answers the Phone

## Use TranslatorX to Analyze Traces

- Problem is reproducible, so generate a test call and then collect traces. Drag and Drop folder into TranslatorX

The screenshot shows the Cisco Unified Communications Trace Translator application window. A blue folder icon is on the left, with a blue arrow pointing to a grey box in the center of the application window that says "Drag and Drop a File or Folder or Paste text from the Clipboard to begin". To the right, a "Processing Files" dialog box is open, displaying a progress bar, the text "Opening file 6 of 11", "Current File: SDL002\_100\_000204.txt.gz", and "Time Remaining: 3 seconds". The application window has a menu bar with "Filters Enabled", "New Filter", "Filters...", "Clear Filters", "0 Filters Configured", "Call List...", "Search", and "Clear". Below the menu bar is a table with columns: "Timestamp", "Node/Interface", "Remote Device", "Direction", "Protocol", "Message Name", "TCP Handle/From Tag", and "Call Ref / ID". The table is currently empty. At the bottom of the application window, there are statistics: "Lines Processed: 0", "Msgs Processed: 0", and "Msgs Displayed: 0". There are also several checkboxes for filtering: "SCCP", "H.245", "Exclude SCCP and MGCP Keepalives", "SIP", "MGCP", "Exclude SIP REGISTER", "Exclude SIP OPTIONS", "Q.931 / H.225", "MGCP BH", and "Exclude SIP SUBSCRIBE / NOTIFY / PUBLISH". There are buttons for "Generate Diagram", "Export List", and "Export Details".

# Case Study 2: No One Answers the Phone

## Use TranslatorX to Analyze Traces

- Try to find call in Call List

The screenshot shows two overlapping windows of the 'Call List' application. The foreground window is titled 'Call List' and features a search bar with the following fields: 'Calling Number' (empty), 'Called Number' (containing '1877'), and a dropdown menu set to 'All Calls'. Below the search bar, there is a text instruction: 'Double-click calls below to view Call Detail Record details. Select and click 'Generate Filter' to add a filter for the call.' A table with the following columns is displayed: 'Originate Time', 'Calling Party', 'Orig Called Party', 'Final Called Party', 'Orig Cause', 'Dest Cause', 'In Call Ref', and 'Out Call Ref'. The table is currently empty. At the bottom of the window, there are four buttons: 'View Details', 'Export To Text File', 'Generate Filter', and 'Clear All Filters'. The background window is partially obscured and shows a similar search interface with a 'View Details' button.

# Case Study 2: No One Answers the Phone

## Use TranslatorX to Analyze Traces

- Search for called party number

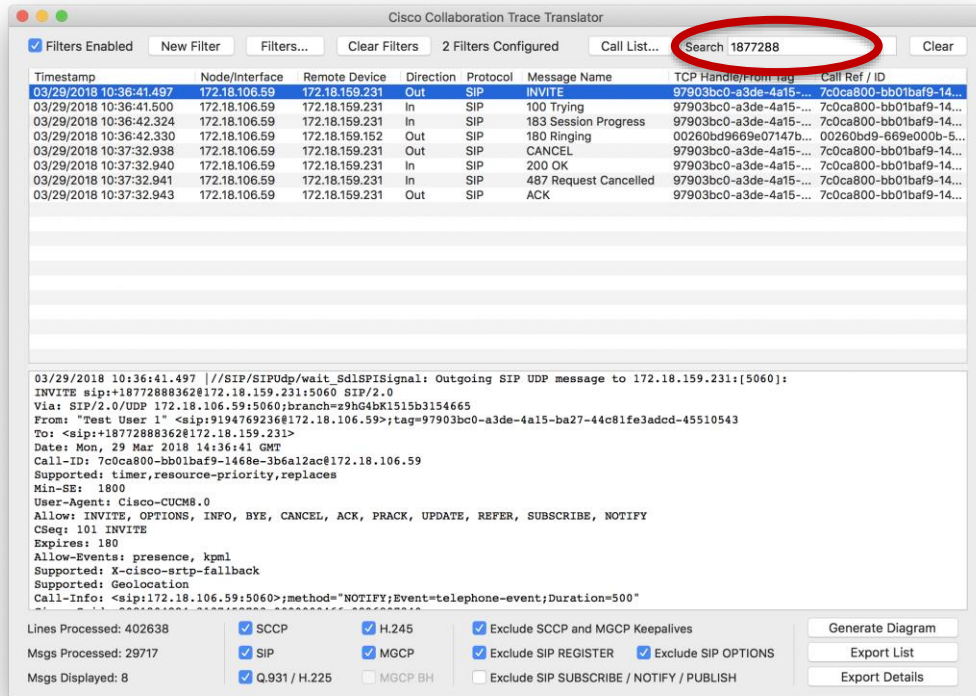

The screenshot shows the Cisco Collaboration Trace Translator interface. At the top, there is a search bar with the text "Search 1877288" highlighted by a red circle. Below the search bar, there is a table with columns: Timestamp, Node/Interface, Remote Device, Direction, Protocol, Message Name, TCP Handle/From Tag, and Call Ref / ID. The table contains several rows of SIP messages, including INVITE, Trying, Session Progress, Ringing, CANCEL, OK, Request Cancelled, and ACK. Below the table, there is a detailed view of a specific message (timestamp 03/29/2018 10:36:41.497) showing the SIP message content, including headers like Via, From, To, Date, Call-ID, Supported, Min-SE, User-Agent, Allow, CSeq, Expires, Allow-Events, Supported, and Call-Info. At the bottom of the interface, there are statistics and filtering options. The statistics show: Lines Processed: 402638, Msgs Processed: 29717, and Msgs Displayed: 8. The filtering options include checkboxes for SCCP, SIP, Q.931 / H.225, H.245, MGCP, and MGCP BH, as well as options to exclude various SIP messages like REGISTER, OPTIONS, SUBSCRIBE / NOTIFY / PUBLISH, and Keepalives.

Timestamp	Node/Interface	Remote Device	Direction	Protocol	Message Name	TCP Handle/From Tag	Call Ref / ID
03/29/2018 10:36:41.497	172.18.106.59	172.18.159.231	Out	SIP	INVITE	97903bc0-a3de-4a15-...	7c0ca800-bb01baf9-14...
03/29/2018 10:36:41.500	172.18.106.59	172.18.159.231	In	SIP	100 Trying	97903bc0-a3de-4a15-...	7c0ca800-bb01baf9-14...
03/29/2018 10:36:42.324	172.18.106.59	172.18.159.231	In	SIP	183 Session Progress	97903bc0-a3de-4a15-...	7c0ca800-bb01baf9-14...
03/29/2018 10:36:42.330	172.18.106.59	172.18.159.152	Out	SIP	180 Ringing	00260bd9-669e07147b...	00260bd9-669e00b-5...
03/29/2018 10:37:32.938	172.18.106.59	172.18.159.231	Out	SIP	CANCEL	97903bc0-a3de-4a15-...	7c0ca800-bb01baf9-14...
03/29/2018 10:37:32.940	172.18.106.59	172.18.159.231	In	SIP	200 OK	97903bc0-a3de-4a15-...	7c0ca800-bb01baf9-14...
03/29/2018 10:37:32.941	172.18.106.59	172.18.159.231	In	SIP	487 Request Cancelled	97903bc0-a3de-4a15-...	7c0ca800-bb01baf9-14...
03/29/2018 10:37:32.943	172.18.106.59	172.18.159.231	Out	SIP	ACK	97903bc0-a3de-4a15-...	7c0ca800-bb01baf9-14...

```
03/29/2018 10:36:41.497 //SIP/SIPUdp/wait_sd1SPISignal: Outgoing SIP UDP message to 172.18.159.231:[5060]:
INVITE sip:+18772888362@172.18.159.231:5060 SIP/2.0
Via: SIP/2.0/UDP 172.18.106.59:5060;branch=9b04b1515b3154665
From: "Test User 1" <sip:9194769236@172.18.106.59>;tag=97903bc0-a3de-4a15-ba27-44c81fe3adcd-45510543
To: <sip:+18772888362@172.18.159.231>
Date: Mon, 29 Mar 2018 14:36:41 GMT
Call-ID: 7c0ca800-bb01baf9-1468e-3b6a2ac@172.18.106.59
Supported: timer,resource-priority,replaces
Min-SE: 1800
User-Agent: Cisco-CUCM8.0
Allow: INVITE, OPTIONS, INFO, BYE, CANCEL, ACK, PRACK, UPDATE, REFER, SUBSCRIBE, NOTIFY
CSeq: 101 INVITE
Expires: 180
Allow-Events: presence, kpml
Supported: X-cisco-srtp-fallback
Supported: Geolocation
Call-Info: <sip:172.18.106.59:5060;method=NOTIFY;Event=telephone-event;Duration=500>
```

Lines Processed: 402638     SCCP     H.245     Exclude SCCP and MGCP Keepalives      
Msgs Processed: 29717     SIP     MGCP     Exclude SIP REGISTER     Exclude SIP OPTIONS      
Msgs Displayed: 8     Q.931 / H.225     MGCP BH     Exclude SIP SUBSCRIBE / NOTIFY / PUBLISH

# Case Study 2: No One Answers the Phone

## Use TranslatorX to Analyze Traces

- Disable Filters
- Select the INVITE
- Filter by SIP Call ID (control/command – S)

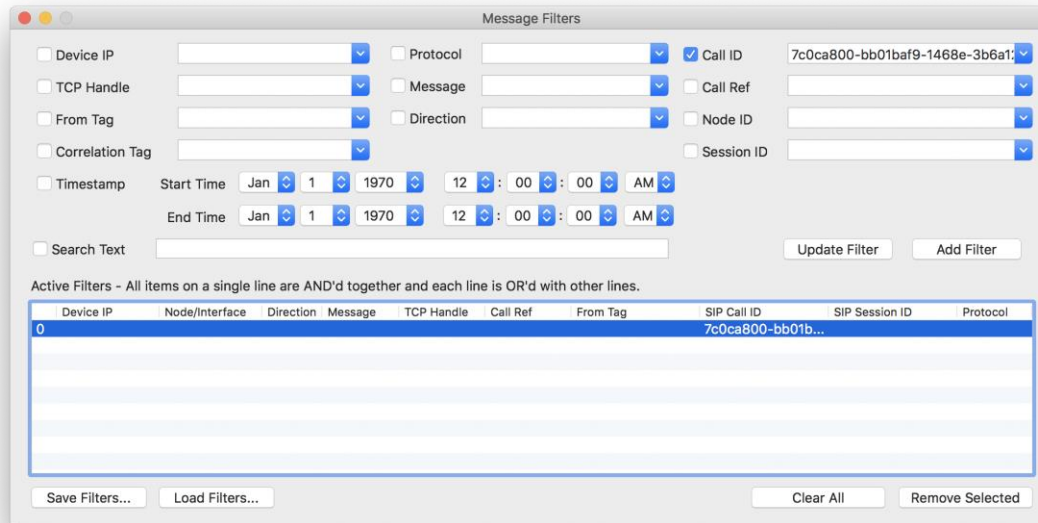



# Case Study 2: No One Answers the Phone

## Use TranslatorX to Analyze Traces

10:36:41.497 |//SIP/SIPUdp/wait\_SdISPISignal: Outgoing SIP UDP message to 172.18.159.231:[5060]:  
INVITE sip:+18772888362@172.18.159.231:5060 SIP/2.0  
Via: SIP/2.0/UDP 172.18.106.59:5060;branch=z9hG4bK1515b3154665  
**From: "Test User 1" <sip:9194769236@172.18.106.59>;**tag=97903bc0-a3de-4a15-ba27-44c81fe3adcd-45510543  
**To: <sip:+18772888362@172.18.159.231>**  
Date: Mon, 29 Mar 2018 14:36:41 GMT  
**Call-ID: 7c0ca800-bb01baf9-1468e-3b6a12ac@172.18.106.59**  
Supported: timer,resource-priority,replaces  
Min-SE: 1800  
User-Agent: Cisco-CUCM11.5  
Allow: INVITE, OPTIONS, INFO, BYE, CANCEL, ACK, PRACK, UPDATE, REFER, SUBSCRIBE, NOTIFY  
CSeq: 101 INVITE  
Expires: 180  
Allow-Events: presence, kpml  
Supported: X-cisco-srtp-fallback  
Supported: Geolocation  
Call-Info: <sip:172.18.106.59:5060>;method="NOTIFY;Event=telephone-event;Duration=500"  
Cisco-Guid: 2081204224-3137452793-0000000466-0996807340  
Session-Expires: 1800  
P-Asserted-Identity: "Test User 1" <sip:9194769236@172.18.106.59>  
Contact: <sip:9194769236@172.18.106.59:5060>;video;audio  
Max-Forwards: 69  
Content-Length: 0

# Case Study 2: No One Answers the Phone

## Use TranslatorX to Analyze Traces

- Where did the call originate? Try searching for the calling party number

The screenshot shows the Cisco Collaboration Trace Translator interface. A search bar at the top right contains the number "89919236", which is circled in red. Below the search bar, a table lists SIP messages. The following table represents the data from the screenshot:

Timestamp	Node/Interface	Remote Device	Directi...	Protocol	Message Name	TCP Handsh...	Call Ref / ID
03/29/2018 10:35:37.184	172.18.106.59	172.18.159.152	In	SIP	NOTIFY	00260bd9669e070e33...	0920d68b-644e82e1@...
03/29/2018 10:35:37.188	172.18.106.59	172.18.159.152	Out	SIP	200 OK	00260bd9669e070e33...	0920d68b-644e82e1@...
03/29/2018 10:35:38.714	172.18.106.59	172.18.159.152	In	SIP	NOTIFY	00260bd9669e070f12...	458c4fa6-6eb9b221@1...
03/29/2018 10:35:38.718	172.18.106.59	172.18.159.152	Out	SIP	200 OK	00260bd9669e070f12...	458c4fa6-6eb9b221@1...
03/29/2018 10:36:32.175	172.18.106.59	172.18.159.152	In	SIP	NOTIFY	00260bd9669e07150e...	19bdc1a1-7d0c8896@1...
03/29/2018 10:36:32.179	172.18.106.59	172.18.159.152	Out	SIP	200 OK	00260bd9669e07150e...	19bdc1a1-7d0c8896@1...
03/29/2018 10:36:33.771	172.18.106.59	172.18.159.152	In	SIP	INVITE	00260bd9669e07147b...	00260bd9-669e000b-...
03/29/2018 10:36:33.773	172.18.106.59	172.18.159.152	Out	SIP	100 Trying	00260bd9669e07147b...	00260bd9-669e000b-...
03/29/2018 10:36:33.780	172.18.106.59	172.18.159.152	Out	SIP	REFER	2144536187	77471400-bb01baf1-14...
03/29/2018 10:36:33.781	172.18.106.59	172.18.159.152	Out	SIP	SUBSCRIBE	1976165806	77471400-bb01baf1-14...
03/29/2018 10:36:33.802	172.18.106.59	172.18.159.152	In	SIP	200 OK	2144536187	77471400-bb01baf1-14...
03/29/2018 10:36:33.843	172.18.106.59	172.18.159.152	In	SIP	200 OK	1976165806	77471400-bb01baf1-14...
03/29/2018 10:36:33.844	172.18.106.59	172.18.159.152	In	SIP	NOTIFY	00260bd9669e07177e...	77471400-bb01baf1-14...
03/29/2018 10:36:33.846	172.18.106.59	172.18.159.152	Out	SIP	200 OK	00260bd9669e07177e...	77471400-bb01baf1-14...
03/29/2018 10:36:34.350	172.18.106.59	172.18.159.152	In	SIP	NOTIFY	00260bd9669e07177e...	77471400-bb01baf1-14...
03/29/2018 10:36:34.352	172.18.106.59	172.18.159.152	Out	SIP	200 OK	00260bd9669e07177e...	77471400-bb01baf1-14...
03/29/2018 10:36:34.353	172.18.106.59	172.18.159.152	Out	SIP	REFER	1574166193	77e08a80-bb01baf2-14...
03/29/2018 10:36:34.402	172.18.106.59	172.18.159.152	In	SIP	200 OK	1574166193	77e08a80-bb01baf2-14...
03/29/2018 10:36:34.944	172.18.106.59	172.18.159.152	In	SIP	NOTIFY	00260bd9669e07177e...	77471400-bb01baf1-14...

Below the table, the selected message (INVITE) is expanded to show details:

```
03/29/2018 10:36:33.771 //SIP/SIPtcp/wait_sdReadRep: Incoming SIP TCP message from 172.18.159.152 on port 51682 index 2321 with 1717 bytes:
INVITE sip:98172.18.106.59;user=phone SIP/2.0
Via: SIP/2.0/TLS 172.18.159.152:51682;branch=9hG4bR1636ab61
From: "Test User 1" <sip:89919236@172.18.106.59>;tag=00260bd9669e07147bcb3aac-3cda8f0c
To: <sip:98172.18.106.59;user=phone>
Call-ID: 00260bd9-669e000b-588c0c2b-2193e2a3@172.18.159.152
Max-Forwards: 70
Date: Mon, 29 Mar 2018 14:36:33 GMT
CSeq: 101 INVITE
User-Agent: Cisco-CP9951/9.0.1
Contact: <sip:4a8a8f91-609e-d655-19ea-44eedcd7bd06@172.18.159.152:51682;transport=tls>
Expires: 180
Accept: application/sdp
Allow: ACK,BYE,CANCEL,INVITE,NOTIFY,OPTIONS,REFER,REGISTER,UPDATE,SUBSCRIBE,INFO
Remote-Party-ID: "Test User 1" <sip:89919236@172.18.106.59>;party=calling;id-type=subscriber;privacy=off;screen=yes
Supported: replaces,join,sdp-angat,norefersub,extended-refer,X-cisco-callinfo,X-cisco-serviceuri,X-cisco-escapecodes,X-cisco-
```

At the bottom of the interface, there are statistics and filtering options:

- Lines Processed: 402638
- Msgs Processed: 29717
- Msgs Displayed: 49
- Filters:  SCCP,  SIP,  Q.931 / H.225
- Filters:  H.245,  MGCP,  MGCP BH
- Filters:  Exclude SCCP and MGCP Keepalives,  Exclude SIP REGISTER,  Exclude SIP OPTIONS,  Exclude SIP SUBSCRIBE / NOTIFY / PUBLISH
- Buttons: Generate Diagram, Export List, Export Details

# Case Study 2: No One Answers the Phone

## Use TranslatorX to Analyze Traces

- Select the INVITE
- Create New Filter (control/command-N)
- Filter by IP Address (control/command - I)
- Re-enable Filters

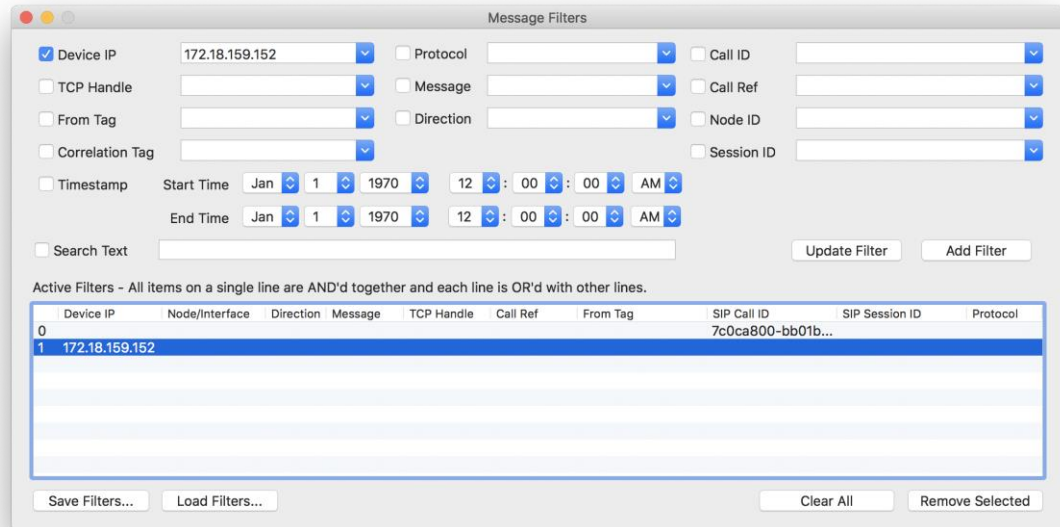

# Case Study 2: No One Answers the Phone

## Use TranslatorX to Analyze Traces

The screenshot displays the Cisco Collaboration Trace Translator application. At the top, there are controls for filters and search, including a search bar with the value '89919236'. Below this is a table of trace entries with columns for Timestamp, Node/Interface, Remote Device, Direction, Protocol, Message Name, TCP Handle/From Tag, and Call Ref / ID. The selected entry is a SIP INVITE message from 172.18.159.152 to 172.18.106.59.

Timestamp	Node/Interface	Remote Device	Directi...	Protocol	Message Name	TCP Handle/From Tag	Call Ref / ID
03/29/2018 10:36:33.771	172.18.106.59	172.18.159.152	In	SIP	INVITE	00260bd9669e07147b...	00260bd9-669e000b-...
03/29/2018 10:36:33.773	172.18.106.59	172.18.159.152	Out	SIP	100 Trying	00260bd9669e07147b...	00260bd9-669e000b-...
03/29/2018 10:36:33.780	172.18.106.59	172.18.159.152	Out	SIP	REFER	2144536187	7747f400-bb01baf1-14...
03/29/2018 10:36:33.781	172.18.106.59	172.18.159.152	Out	SIP	SUBSCRIBE	1976165806	7747f400-bb01baf1-14...
03/29/2018 10:36:33.802	172.18.106.59	172.18.159.152	In	SIP	200 OK	2144536187	7747f400-bb01baf1-14...
03/29/2018 10:36:33.843	172.18.106.59	172.18.159.152	In	SIP	200 OK	1976165806	7747f400-bb01baf1-14...
03/29/2018 10:36:33.844	172.18.106.59	172.18.159.152	In	SIP	NOTIFY	00260bd9669e07177e...	7747f400-bb01baf1-14...
03/29/2018 10:36:33.846	172.18.106.59	172.18.159.152	Out	SIP	200 OK	00260bd9669e07177e...	7747f400-bb01baf1-14...
03/29/2018 10:36:34.350	172.18.106.59	172.18.159.152	In	SIP	NOTIFY	00260bd9669e07177e...	7747f400-bb01baf1-14...
03/29/2018 10:36:34.352	172.18.106.59	172.18.159.152	Out	SIP	200 OK	00260bd9669e07177e...	7747f400-bb01baf1-14...
03/29/2018 10:36:34.353	172.18.106.59	172.18.159.152	Out	SIP	REFER	1574166193	77e08a80-bb01baf2-14...
03/29/2018 10:36:34.402	172.18.106.59	172.18.159.152	In	SIP	200 OK	1574166193	77e08a80-bb01baf2-14...
03/29/2018 10:36:34.944	172.18.106.59	172.18.159.152	In	SIP	NOTIFY	00260bd9669e07177e...	7747f400-bb01baf1-14...
03/29/2018 10:36:34.947	172.18.106.59	172.18.159.152	Out	SIP	200 OK	00260bd9669e07177e...	7747f400-bb01baf1-14...
03/29/2018 10:36:36.118	172.18.106.59	172.18.159.152	In	SIP	NOTIFY	00260bd9669e07177e...	7747f400-bb01baf1-14...
03/29/2018 10:36:36.120	172.18.106.59	172.18.159.152	Out	SIP	200 OK	00260bd9669e07177e...	7747f400-bb01baf1-14...
03/29/2018 10:36:36.504	172.18.106.59	172.18.159.152	In	SIP	NOTIFY	00260bd9669e07177e...	7747f400-bb01baf1-14...
03/29/2018 10:36:36.506	172.18.106.59	172.18.159.152	Out	SIP	200 OK	00260bd9669e07177e...	7747f400-bb01baf1-14...
03/29/2018 10:36:37.368	172.18.106.59	172.18.159.152	In	SIP	NOTIFY	00260bd9669e07177e...	7747f400-bb01baf1-14...

The detailed view of the selected message shows the following SIP INVITE details:

```
03/29/2018 10:36:33.771 ||//SIP/SIPTcp/wait_sd1ReadResp: Incoming SIP TCP message from 172.18.159.152 on port 51682 index 2321 with 1717 bytes:
INVITE sip:9@172.18.106.59;user=phone SIP/2.0
Via: SIP/2.0/TLS 172.18.159.152:51682;branch=z9hG4bK1636ab61
From: "Test User 1" <sip:89919236@172.18.106.59>;tag=00260bd9669e07147bcb3aac-3cda8f0c
To: <sip:9@172.18.106.59;user=phone>
Call-ID: 00260bd9-669e000b-5880c2b-2193e2a3@172.18.159.152
Max-Forwards: 70
Date: Mon, 29 Mar 2018 14:36:33 GMT
CSeq: 101 INVITE
User-Agent: Cisco-CP9951/9.0.1
Contact: <sip:4a8af91-609e-d655-19ea-44eedcd7b0d6@172.18.159.152:51682>;transport=tls
Expires: 180
Accept: application/sdp
Allow: ACK,BYE,CANCEL,INVITE,OPTIONS,REFER,REGISTER,UPDATE,SUBSCRIBE,INFO
Remote-Party-ID: "Test User 1" <sip:89919236@172.18.106.59>;party=calling;id-type=subscriber;privacy=off;screen=yes
Supported: replaces,join,sdp-anat,norefersub,extended-refer,X-cisco-callinfo,X-cisco-serviceuri,X-cisco-escapecodes,X-cisco-
```

At the bottom, there are summary statistics and filter options:

- Lines Processed: 402638
- Msgs Processed: 29717
- Msgs Displayed: 49
- Filters:  SCCP,  H.245,  Exclude SCCP and MGCP Keepalives,  SIP,  MGCP,  Exclude SIP REGISTER,  Exclude SIP OPTIONS,  Q.931 / H.225,  MGCP BH,  Exclude SIP SUBSCRIBE / NOTIFY / PUBLISH
- Buttons: Generate Diagram, Export List, Export Details

# Case Study 2: No One Answers the Phone

## INVITE from IP Phone w/ SDP

10:36:33.771 |//SIP/SIPTcp/wait\_SdlReadRsp: Incoming SIP TCP message from 172.18.159.152 on port 51682 index 2321 with 1717 bytes:

**INVITE sip:9@172.18.106.59;user=phone SIP/2.0**

Via: SIP/2.0/TLS 172.18.159.152:51682;branch=z9hG4bK1636ab61

**From: "Test User 1" <sip:89919236@172.18.106.59>**;tag=00260bd9669e07147bcb3aac-3cda8f0c

**To: <sip:9@172.18.106.59;user=phone>**

**Call-ID: 00260bd9-669e000b-588c0c2b-2193e2a3@172.18.159.152**

Max-Forwards: 70

Date: Mon, 29 Mar 2018 14:36:33 GMT

CSeq: 101 INVITE

User-Agent: Cisco-CP9951/9.0.1

Contact: <sip:4a8a8f91-609e-d655-19ea-44eedcd7b0d6@172.18.159.152:51682;transport=tls>

Expires: 180

Accept: application/sdp

Allow: ACK,BYE,CANCEL,INVITE,NOTIFY,OPTIONS,REFER,REGISTER,UPDATE,SUBSCRIBE,INFO

Remote-Party-ID: "Test User 1" <sip:89919236@172.18.106.59>;party=calling;id-type=subscriber;privacy=off;screen=yes

Supported: replaces,join,sdp-anat,norefersub,extended-refer,X-cisco-callinfo,X-cisco-serviceuri,X-cisco-escapecodes,X-cisco-service-control,X-cisco-srtp-fallback,X-cisco-monrec,X-cisco-config,X-cisco-sis-5.0.0,X-cisco-xsi-9.0.1

Allow-Events: kpml,dialog

Content-Length: 632

Content-Type: application/sdp

Content-Disposition: session;handling=optional

# Case Study 2: No One Answers the Phone

```
v=0
o=Cisco-SIPUA 26964 0 IN IP4 172.18.159.152
s=SIP Call
t=0 0
m=audio 29254 RTP/SAVP 0 8 18 102 9 116 124 101
c=IN IP4 172.18.159.152
a=crypto:XXXXXXXXXXXXXXXXXXXXXXXXXXXXXXXXXXXXXXXXXXXXXXXXXXXXXXXXXXXXXXXXXXXX
a=rtpmap:0 PCMU/8000
a=rtpmap:8 PCMA/8000
a=rtpmap:18 G729/8000
a=fmtp:18 annexb=no
a=rtpmap:102 L16/16000
a=rtpmap:9 G722/8000
a=rtpmap:116 iLBC/8000
a=fmtp:116 mode=20
a=rtpmap:124 ISAC/16000
a=rtpmap:101 telephone-event/8000
a=fmtp:101 0-15
a=sendrecv
m=video 25466 RTP/AVP 97
c=IN IP4 172.18.159.152
b=TIAS:1000000
a=rtpmap:97 H264/90000
a=fmtp:97 profile-level-id=42801E
a=recvonly
```

# Case Study 2: No One Answers the Phone

## Unified CM Sends a 100 Trying

10:36:33.773 |||SIP/SIPTcp/wait\_SdISPISignal: Outgoing SIP TCP message to 172.18.159.152 on port 51682  
index 2321

SIP/2.0 100 Trying

Via: SIP/2.0/TLS 172.18.159.152:51682;branch=z9hG4bK1636ab61

From: "Test User 1" <sip:89919236@172.18.106.59>;tag=00260bd9669e07147bcb3aac-3cda8f0c

To: <sip:9@172.18.106.59;user=phone>

Date: Mon, 29 Mar 2018 14:36:33 GMT

Call-ID: 00260bd9-669e000b-588c0c2b-2193e2a3@172.18.159.152

CSeq: 101 INVITE

Allow-Events: presence

Content-Length: 0

# Case Study 2: No One Answers the Phone

## Unified CM Sends a REFER to play Outside Dialtone

10:36:33.780 ||//SIP/SIPTcp/wait\_SdISPISignal: Outgoing SIP TCP message to 172.18.159.152 on port 51682  
index 2321

**REFER sip:89919236@172.18.159.152:51682 SIP/2.0**

Via: SIP/2.0/TLS 172.18.106.59:5061;branch=z9hG4bK151511c5f04bf

**From: <sip:89919236@172.18.106.59>;tag=2144536187**

**To: <sip:89919236@172.18.159.152>**

**Call-ID: 7747f400-bb01baf1-14685-3b6a12ac@172.18.106.59**

CSeq: 101 REFER

Max-Forwards: 70

Contact: <sip:89919236@172.18.106.59:5061;transport=tls>

User-Agent: Cisco-CUCM11.5

Expires: 0

Refer-To: cid:1234567890@172.18.106.59

Content-Id: <1234567890@172.18.106.59>

Require: norefersub

**Content-Type: application/x-cisco-remotecc-request+xml**

Referred-By: <sip:89919236@172.18.106.59>

Content-Length: 409



# Case Study 2: No One Answers the Phone

```
<x-cisco-remotecc-request>  
  <playtonereq>  
    <dialogid>  
      <callid>00260bd9-669e000b-588c0c2b-2193e2a3@172.18.159.152</callid>  
      <localtag>97903bc0-a3de-4a15-ba27-44c81fe3adcd-45510542</localtag>  
      <remotetag>00260bd9669e07147bcb3aac-3cda8f0c</remotetag>  
    </dialogid>  
    <tonetype>DtOutsideDialTone</tonetype>  
    <direction>user</direction>  
  </playtonereq>  
</x-cisco-remotecc-request>
```

# Case Study 2: No One Answers the Phone

## Unified CM Sends a SUBSCRIBE for KPML

10:36:33.781 //SIP/SIPTcp/wait\_SdISPISignal: Outgoing SIP TCP message to 172.18.159.152 on port 51682 index 2321  
**SUBSCRIBE sip:89919236@172.18.159.152:51682 SIP/2.0**  
Via: SIP/2.0/TLS 172.18.106.59:5061;branch=z9hG4bK1515232b4e84f  
**From: <sip:9@172.18.106.59>;tag=1976165806**  
**To: <sip:89919236@172.18.159.152>**  
**Call-ID: 7747f400-bb01baf1-14686-3b6a12ac@172.18.106.59**  
CSeq: 101 SUBSCRIBE  
Date: Mon, 29 Mar 2018 14:36:33 GMT  
User-Agent: Cisco-CUCM11.5  
Event: kpml; call-id=00260bd9-669e000b-588c0c2b-2193e2a3@172.18.159.152; from-tag=00260bd9669e07147bcb3aac-3cda8f0c  
Expires: 7200  
Contact: <sip:9@172.18.106.59:5061;transport=tls>  
Accept: application/kpml-response+xml  
Max-Forwards: 70  
Content-Type: application/**kpml-request+xml**  
Content-Length: 424  
<?xml version="1.0" encoding="UTF-8" ?>  
<**kpml-request** xmlns="urn:ietf:params:xml:ns:kpml-request" xmlns:xsi="http://www.w3.org/2001/XMLSchema-instance"  
  xsi:schemaLocation="urn:ietf:params:xml:ns:kpml-request kpml-request.xsd" version="1.0">  
  <pattern criticaldiggittimer="1000" extradiggittimer="500" interdigittimer="10000" persist="persist">  
    <regex tag="Backspace OK">[x#\*+]]bs</regex>  
  </pattern>  
</kpml-request>

# Case Study 2: No One Answers the Phone

## Phone Sends 200 OK for the REFER and SUBSCRIBE

10:36:33.802 //SIP/SIPTcp/wait\_SdlReadRsp: Incoming SIP TCP message from 172.18.159.152 on port 51682 index 2321 with 453 bytes:  
SIP/2.0 200 OK  
Via: SIP/2.0/TLS 172.18.106.59:5061;branch=z9hG4bK151511c5f04bf  
From: <sip:89919236@172.18.106.59>;tag=2144536187  
To: <sip:89919236@172.18.159.152>;tag=00260bd9669e07167c743311-343ee3af  
Call-ID: 7747f400-bb01baf1-14685-3b6a12ac@172.18.106.59  
Date: Mon, 29 Mar 2018 14:36:33 GMT  
CSeq: 101 REFER  
Server: Cisco-CP9951/9.0.1  
Contact: <sip:4a8a8f91-609e-d655-19ea-44eedcd7b0d6@172.18.159.152:51682;transport=TLS>  
Content-Length: 0

---

10:36:33.843 //SIP/SIPTcp/wait\_SdlReadRsp: Incoming SIP TCP message from 172.18.159.152 on port 51682 index 2321 with 465 bytes:  
SIP/2.0 200 OK  
Via: SIP/2.0/TLS 172.18.106.59:5061;branch=z9hG4bK1515232b4e84f  
From: <sip:9@172.18.106.59>;tag=1976165806  
To: <sip:89919236@172.18.159.152>;tag=00260bd9669e07177ee0d51d-14f56f89  
Call-ID: 7747f400-bb01baf1-14686-3b6a12ac@172.18.106.59  
Date: Mon, 29 Mar 2018 14:36:33 GMT  
CSeq: 101 SUBSCRIBE  
Server: Cisco-CP9951/9.0.1  
Contact: <sip:4a8a8f91-609e-d655-19ea-44eedcd7b0d6@172.18.159.152:51682;transport=TLS>  
Expires: 7200  
Content-Length: 0

# Case Study 2: No One Answers the Phone

IP Phone  
(172.18.159.152)

Unified CM  
(172.18.159.152)

SIP Gateway  
(172.18.159.231)

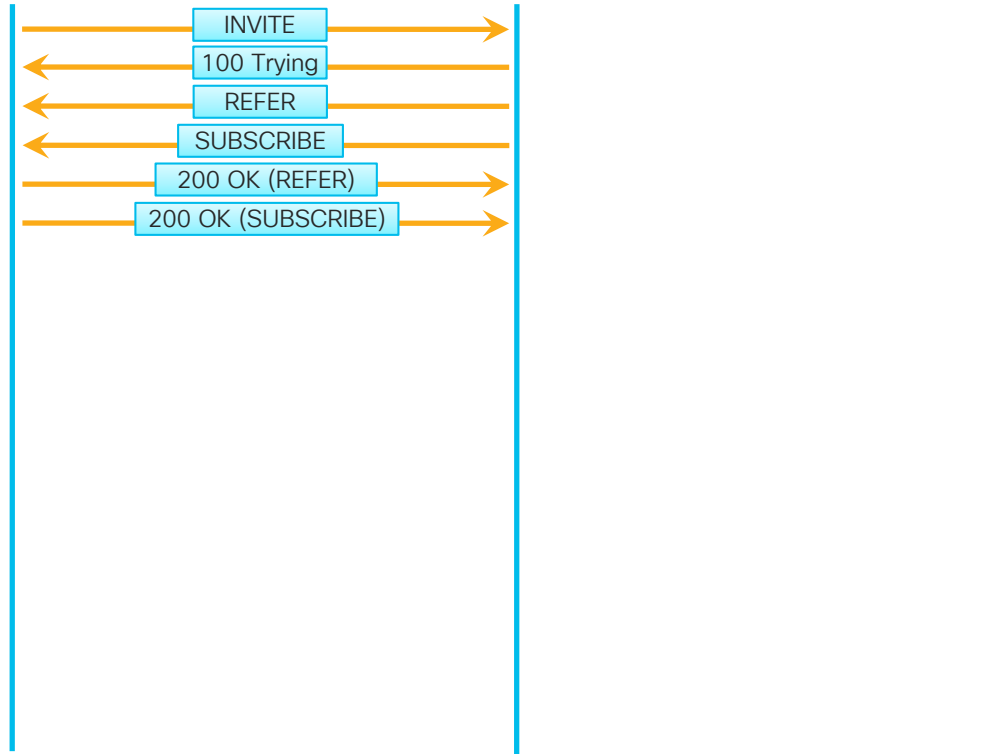

# Case Study 2: No One Answers the Phone

## User Dials a '1'

10:36:34.350 |//SIP/SIPTcp/wait\_SdIReadRsp: Incoming SIP TCP message from 172.18.159.152 on port 51682 index 2321 with 896 bytes:

NOTIFY sip:9@172.18.106.59:5061 SIP/2.0

Via: SIP/2.0/TLS 172.18.159.152:51682;branch=z9hG4bK1cd529ba

To: <sip:9@172.18.106.59>;tag=1976165806

From: <sip:89919236@172.18.159.152>;tag=00260bd9669e07177ee0d51d-14f56f89

Call-ID: 7747f400-bb01baf1-14686-3b6a12ac@172.18.106.59

Date: Mon, 29 Mar 2018 14:36:33 GMT

CSeq: 1001 NOTIFY

Event: kpml

Subscription-State: active; expires=7200

Max-Forwards: 70

Contact: <sip:4a8a8f91-609e-d655-19ea-44eedcd7b0d6@172.18.159.152:51682;transport=TLS>

Allow: ACK,BYE,CANCEL,INVITE,NOTIFY,OPTIONS,REFER,REGISTER,UPDATE,SUBSCRIBE

Content-Length: 209

Content-Type: application/kpml-response+xml

Content-Disposition: session;handling=required

<?xml version="1.0" encoding="UTF-8"?>

<kpml-response xmlns="urn:ietf:params:xml:ns:kpml-response" version="1.0" code="200" text="OK" suppressed="false" forced\_flush="false" digits="1" tag="Backspace OK"/>

# Case Study 2: No One Answers the Phone

## Unified CM Replies to NOTIFY With a 200 OK

10:36:34.352 |//SIP/SIPTcp/wait\_SdISPISignal: Outgoing SIP TCP message to 172.18.159.152 on port 51682 index 2321

SIP/2.0 200 OK

Via: SIP/2.0/TLS 172.18.159.152:51682;branch=z9hG4bK1cd529ba

From: <sip:89919236@172.18.159.152>;tag=00260bd9669e07177ee0d51d-14f56f89

To: <sip:9@172.18.106.59>;tag=1976165806

Date: Mon, 29 Mar 2018 14:36:34 GMT

Call-ID: 7747f400-bb01baf1-14686-3b6a12ac@172.18.106.59

CSeq: 1001 NOTIFY

Content-Length: 0

# Case Study 2: No One Answers the Phone

## Unified CM Replies Sends a REFER to Disable Outside Dialtone

10:36:34.353 ||//SIP/SIPTcp/wait\_SdISPISignal: Outgoing SIP TCP message to 172.18.159.152 on port 51682 index 2321  
**REFER sip:89919236@172.18.159.152:51682 SIP/2.0**  
Via: SIP/2.0/TLS 172.18.106.59:5061;branch=z9hG4bK151536ea86ab0  
**From: <sip:89919236@172.18.106.59>;tag=1574166193**  
**To: <sip:89919236@172.18.159.152>**  
**Call-ID: 77e08a80-bb01baf2-14687-3b6a12ac@172.18.106.59**  
CSeq: 101 REFER  
Max-Forwards: 70  
Contact: <sip:89919236@172.18.106.59:5061;transport=tls>  
User-Agent: Cisco-CUCM11.5  
Expires: 0  
Refer-To: cid:1234567890@172.18.106.59  
Content-Id: <1234567890@172.18.106.59>  
Require: norefersub  
Content-Type: application/x-cisco-remotecc-request+xml  
Referred-By: <sip:89919236@172.18.106.59>  
Content-Length: 401

# Case Study 2: No One Answers the Phone

```
<x-cisco-remotecc-request>  
  <playtonereq>  
    <dialogid>  
      <callid>00260bd9-669e000b-588c0c2b-2193e2a3@172.18.159.152</callid>  
      <localtag>97903bc0-a3de-4a15-ba27-44c81fe3adcd-45510542</localtag>  
      <remotetag>00260bd9669e07147bcb3aac-3cda8f0c</remotetag>  
    </dialogid>  
    <tonetype>Dt_NoTone</tonetype>  
    <direction>user</direction>  
  </playtonereq>  
</x-cisco-remotecc-request>
```



# Case Study 2: No One Answers the Phone

## Phone Replies With 200 OK to REFER

10:36:34.402 ||//SIP/SIPTcp/wait\_SdIReadRsp: Incoming SIP TCP message from 172.18.159.152 on port 51682 index 2321 with 453 bytes:

**SIP/2.0 200 OK**

Via: SIP/2.0/TLS 172.18.106.59:5061;branch=z9hG4bK151536ea86ab0

**From: <sip:89919236@172.18.106.59>;tag=1574166193**

**To: <sip:89919236@172.18.159.152>;tag=00260bd9669e07184b08b96b-796ab86f**

**Call-ID: 77e08a80-bb01baf2-14687-3b6a12ac@172.18.106.59**

Date: Mon, 29 Mar 2018 14:36:33 GMT

CSeq: **101 REFER**

Server: Cisco-CP9951/9.0.1

Contact: <sip:4a8a8f91-609e-d655-19ea-44eedcd7b0d6@172.18.159.152:51682;transport=TLS>

Content-Length: 0

# Case Study 2: No One Answers the Phone

IP Phone  
(172.18.159.152)

Unified CM  
(172.18.159.152)

SIP Gateway  
(172.18.159.231)

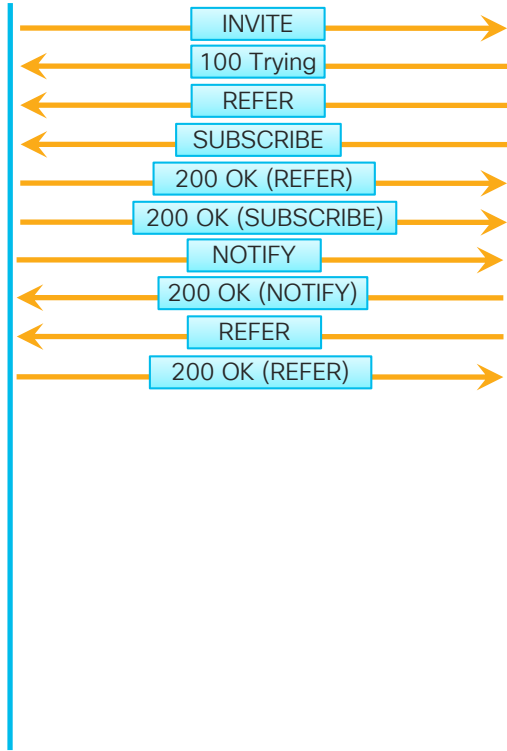

# Case Study 2: No One Answers the Phone

## User Dials a '8'

10:36:34.944 |//SIP/SIPTcp/wait\_SdlReadRsp: Incoming SIP TCP message from 172.18.159.152 on port 51682  
index 2321 with 896 bytes:

**NOTIFY sip:9@172.18.106.59:5061 SIP/2.0**

Via: SIP/2.0/TLS 172.18.159.152:51682;branch=z9hG4bK647d03c1

To: <sip:9@172.18.106.59>;tag=1976165806

From: <sip:89919236@172.18.159.152>;tag=00260bd9669e07177ee0d51d-14f56f89

Call-ID: 7747f400-bb01baf1-14686-3b6a12ac@172.18.106.59

Date: Mon, 29 Mar 2018 14:36:34 GMT

CSeq: 1002 NOTIFY

Event: kpml

Subscription-State: active; expires=7195

Max-Forwards: 70

Contact: <sip:4a8a8f91-609e-d655-19ea-44eedcd7b0d6@172.18.159.152:51682;transport=TLS>

Allow: ACK,BYE,CANCEL,INVITE,NOTIFY,OPTIONS,REFER,REGISTER,UPDATE,SUBSCRIBE

Content-Length: 209

Content-Type: application/kpml-response+xml

Content-Disposition: session;handling=required

<?xml version="1.0" encoding="UTF-8"?>

<kpml-response xmlns="urn:ietf:params:xml:ns:kpml-response" version="1.0" code="200" text="OK"  
suppressed="false" forced\_flush="false" digits="8" tag="Backspace OK"/>

# Case Study 2: No One Answers the Phone

## Unified CM Replies to NOTIFY With a 200 OK

10:36:34.352 |//SIP/SIPTcp/wait\_SdISPISignal: Outgoing SIP TCP message to 172.18.159.152 on port 51682 index 2321

SIP/2.0 200 OK

Via: SIP/2.0/TLS 172.18.159.152:51682;branch=z9hG4bK1cd529ba

From: <sip:89919236@172.18.159.152>;tag=00260bd9669e07177ee0d51d-14f56f89

To: <sip:9@172.18.106.59>;tag=1976165806

Date: Mon, 29 Mar 2018 14:36:34 GMT

Call-ID: 7747f400-bb01baf1-14686-3b6a12ac@172.18.106.59

CSeq: 1001 NOTIFY

Content-Length: 0

# Case Study 2: No One Answers the Phone

## User Dials Remaining Digits

03/29/2018 10:36:34.944	172.18.106.59	172.18.159.152	In	SIP	NOTIFY	00260bd9669e07177e...	7747f400-bb01baf1-14...
03/29/2018 10:36:34.947	172.18.106.59	172.18.159.152	Out	SIP	200 OK	00260bd9669e07177e...	7747f400-bb01baf1-14...
03/29/2018 10:36:36.118	172.18.106.59	172.18.159.152	In	SIP	NOTIFY	00260bd9669e07177e...	7747f400-bb01baf1-14...
03/29/2018 10:36:36.120	172.18.106.59	172.18.159.152	Out	SIP	200 OK	00260bd9669e07177e...	7747f400-bb01baf1-14...
03/29/2018 10:36:36.504	172.18.106.59	172.18.159.152	In	SIP	NOTIFY	00260bd9669e07177e...	7747f400-bb01baf1-14...
03/29/2018 10:36:36.506	172.18.106.59	172.18.159.152	Out	SIP	200 OK	00260bd9669e07177e...	7747f400-bb01baf1-14...
03/29/2018 10:36:37.368	172.18.106.59	172.18.159.152	In	SIP	NOTIFY	00260bd9669e07177e...	7747f400-bb01baf1-14...
03/29/2018 10:36:37.370	172.18.106.59	172.18.159.152	Out	SIP	200 OK	00260bd9669e07177e...	7747f400-bb01baf1-14...
03/29/2018 10:36:37.886	172.18.106.59	172.18.159.152	In	SIP	NOTIFY	00260bd9669e07177e...	7747f400-bb01baf1-14...
03/29/2018 10:36:37.888	172.18.106.59	172.18.159.152	Out	SIP	200 OK	00260bd9669e07177e...	7747f400-bb01baf1-14...
03/29/2018 10:36:38.459	172.18.106.59	172.18.159.152	In	SIP	NOTIFY	00260bd9669e07177e...	7747f400-bb01baf1-14...
03/29/2018 10:36:38.461	172.18.106.59	172.18.159.152	Out	SIP	200 OK	00260bd9669e07177e...	7747f400-bb01baf1-14...
03/29/2018 10:36:38.909	172.18.106.59	172.18.159.152	In	SIP	NOTIFY	00260bd9669e07177e...	7747f400-bb01baf1-14...
03/29/2018 10:36:38.910	172.18.106.59	172.18.159.152	Out	SIP	200 OK	00260bd9669e07177e...	7747f400-bb01baf1-14...
03/29/2018 10:36:39.956	172.18.106.59	172.18.159.152	In	SIP	NOTIFY	00260bd9669e07177e...	7747f400-bb01baf1-14...
03/29/2018 10:36:39.959	172.18.106.59	172.18.159.152	Out	SIP	200 OK	00260bd9669e07177e...	7747f400-bb01baf1-14...
03/29/2018 10:36:40.893	172.18.106.59	172.18.159.152	In	SIP	NOTIFY	00260bd9669e07177e...	7747f400-bb01baf1-14...
03/29/2018 10:36:40.895	172.18.106.59	172.18.159.152	Out	SIP	200 OK	00260bd9669e07177e...	7747f400-bb01baf1-14...
03/29/2018 10:36:41.483	172.18.106.59	172.18.159.152	In	SIP	NOTIFY	00260bd9669e07177e...	7747f400-bb01baf1-14...
03/29/2018 10:36:41.485	172.18.106.59	172.18.159.152	Out	SIP	200 OK	00260bd9669e07177e...	7747f400-bb01baf1-14...

# Case Study 2: No One Answers the Phone

IP Phone  
(172.18.159.152)

Unified CM  
(172.18.159.152)

SIP Gateway  
(172.18.159.231)

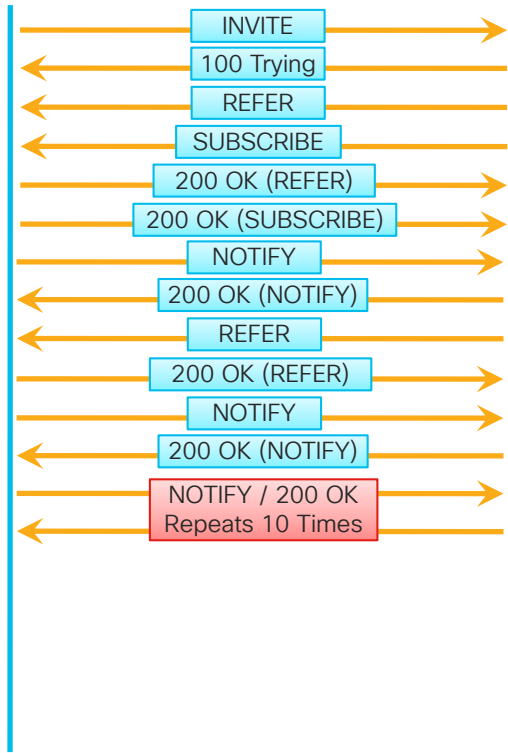

# Case Study 2: No One Answers the Phone

## Unified CM Unsubscribes From KPML

10:36:41.490 ||//SIP/SIPTcp/wait\_SdISPISignal: Outgoing SIP TCP message to 172.18.159.152 on port 51682  
index 2321

**SUBSCRIBE sip:4a8a8f91-609e-d655-19ea-44eedcd7b0d6@172.18.159.152:51682;transport=TLS SIP/2.0**

Via: SIP/2.0/TLS 172.18.106.59:5061;branch=z9hG4bK1515a5e1d5a4c

**From: <sip:9@172.18.106.59>;tag=1976165806**

**To: <sip:89919236@172.18.159.152>;tag=00260bd9669e07177ee0d51d-14f56f89**

**Call-ID: 7747f400-bb01baf1-14686-3b6a12ac@172.18.106.59**

CSeq: 102 SUBSCRIBE

Date: Mon, 29 Mar 2018 14:36:41 GMT

User-Agent: Cisco-CUCM11.5

**Event: kpml; call-id=00260bd9-669e000b-588c0c2b-2193e2a3@172.18.159.152; from-  
tag=00260bd9669e07147bcb3aac-3cda8f0c**

Expires: 0

Contact: <sip:9@172.18.106.59:5061;transport=tls>

Max-Forwards: 70

Content-Length: 0

# Case Study 2: No One Answers the Phone

## Digit Analysis Match

```
10:36:41.486 |Digit analysis: match(pi="2", fqcn="+19194769236", cn="89919236", plv="5", pss="1stLine:RTP_AbbrDial:Cisco:US
  Local:US RTP Local:US Long Distance:US International:VMPilotPartition", TodFilteredPss="1stLine:RTP_AbbrDial:Cisco:US Local:US
  RTP Local:US Long Distance:US International:VMPilotPartition", dd="918772888362", dac="1")
10:36:41.486 |Digit analysis: analysis results
10:36:41.486 ||PretransformCallingPartyNumber=+19194769236
|CallingPartyNumber=+19194769236
|DialingPartition=GDP_GlobalE164_PSTN
|DialingPattern=\\+1.[2-9]XX[2-9]XXXXXX
|FullyQualifiedCalledPartyNumber=+18772888362
|DialingPatternRegularExpression=(+1)([2-9][0-9][0-9][2-9][0-9][0-9][0-9][0-9][0-9][0-9])
|DialingWhere=
|PatternType=Enterprise
|PotentialMatches=NoPotentialMatchesExist
|DialingSdIProcessId=(0,0,0)
|PretransformDigitString=+18772888362
|PretransformTagsList=ACCESS-CODE:SUBSCRIBER
|PretransformPositionalMatchList=+1:8772888362
|CollectedDigits=+18772888362
|UnconsumedDigits=
|TagsList=ACCESS-CODE:SUBSCRIBER
|PositionalMatchList=+1:8772888362
|VoiceMailbox=
|VoiceMailCallingSearchSpace=1stLine:RTP_AbbrDial
```



# Case Study 2: No One Answers the Phone

## Digit Analysis Match

```
|VoiceMailPilotNumber=89944444  
|RouteBlockFlag=RouteThisPattern  
|RouteBlockCause=0  
|AlertingName=  
|UnicodeDisplayName=  
|DisplayNameLocale=1  
|OverlapSendingFlagEnabled=0  
|WithTags=  
|WithValues=  
|CallingPartyNumberPi=NotSelected  
|ConnectedPartyNumberPi=NotSelected  
|CallingPartyNamePi=NotSelected  
|ConnectedPartyNamePi=NotSelected  
|CallManagerDeviceType=NoDeviceType  
|PatternPrecedenceLevel=Routine  
|CallableEndPointName=[23146446-6606-7227-3882-75d07dd6fdef]  
|PatternNodeId=[9badd465-d20a-5bc7-1077-8edee47e8caf]  
|AARNeighborhood=[]  
|AARDestinationMask=[]  
|AARKeepCallHistory=true  
|AARVoiceMailEnabled=false  
|NetworkLocation=OffNet
```

# Case Study 2: No One Answers the Phone

## Digit Analysis Match

```
|Calling Party Number Type=Cisco Unified CallManager
|Calling Party Numbering Plan=Cisco Unified CallManager
|Called Party Number Type=Cisco Unified CallManager
|Called Party Numbering Plan=Cisco Unified CallManager
|ProvideOutsideDialtone=false
|AllowDeviceOverride=false
|AlternateMatches=
{
|Partition=US Long Distance
{
<
|Pattern=9.1[2-9]XX[2-9]XXXXXX
|PatternType=Translation
|TranslationPartition=[a6bd708e-ac4d-ae55-3134-b90b987e5ad9]
|CallManagerDeviceType=NoDeviceType
|PatternPrecedenceLevel=PIDefault
|PatternRouteClass=RouteClassDefault
|RouteNextHopByCgpn=false
>
}
}
```



# Case Study 2: No One Answers the Phone

## Digit Analysis Match

[Digit Analysis Complexity](#) \*

TranslationAndAlternatePatternAnalysis

|TranslationPatternDetails=

|PretransformCallingPartyNumber=89919236

|CallingPartyNumber=+19194769236

|DialingPartition=US Local

|DialingPattern=9.1877[2-9]XXXXXX

|FullyQualifiedCalledPartyNumber=918772888362

|DialingPatternRegularExpression=(9)(1877[2-9][0-9][0-9][0-9][0-9][0-9][0-9])

|DialingWhere=

|PatternType=Translation

|PotentialMatches=NoPotentialMatchesExist

|DialingSdlProcessId=(0,0,0)

|PretransformDigitString=918772888362

|PretransformTagsList=ACCESS-CODE:SUBSCRIBER

|PretransformPositionalMatchList=9:18772888362

|CollectedDigits=+18772888362

|UnconsumedDigits=

|TagsList=SUBSCRIBER

|PositionalMatchList=18772888362

|VoiceMailbox=

|VoiceMailCallingSearchSpace=

|VoiceMailPilotNumber=

|RouteBlockFlag=RouteThisPattern

|RouteBlockCause=1



Set this!

# Case Study 2: No One Answers the Phone

## Digit Analysis Match

```
|UnicodeDisplayName=  
|DisplayNameLocale=1  
|OverlapSendingFlagEnabled=0  
|WithTags=  
|WithValues=  
|CallingPartyNumberPi=NotSelected  
|ConnectedPartyNumberPi=NotSelected  
|CallingPartyNamePi=NotSelected  
|ConnectedPartyNamePi=NotSelected  
|CallManagerDeviceType=NoDeviceType  
|PatternPrecedenceLevel=Routine  
|CallableEndPointName=[bb6f140a-5fd4-179a-2cad-2a1d5eacca7e]  
|PatternNodeId=[bb6f140a-5fd4-179a-2cad-2a1d5eacca7e]  
|AARNeighborhood=[]  
|AARDestinationMask=[]  
|AARKeepCallHistory=true  
|AARVoiceMailEnabled=false  
|NetworkLocation=OnNet  
|ProvideOutsideDialtone=true  
|AllowDeviceOverride=false  
|AlternateMatches=
```

# Case Study 2: No One Answers the Phone

## Route List Match

```
RouteListControl::idle_CcSetupReq - RouteList(UDP LRG - Cisco GK), numberSetup=3 numberMember=1 vmEnabled=0
RoutePlanServer::getRouteList() - RouteListName(23146446-6606-7227-3882-75d07dd6fdef),
  fRealLocalRouteGroup(16512c76-e145-8101-9977-952696a53137)
RoutePlanServer::getRouteGroup: standardLocalRG = 00000000-1111-0000-0000-000000000000, input routeGP =00000000-
  1111-0000-0000-000000000000
RoutePlanServer::getRouteGroup: LRG flag = 1, lRouteGroupName = 00000000-1111-0000-0000-000000000000
RoutePlanServer::getRouteGroup: standardLocalRG = 00000000-1111-0000-0000-000000000000, input routeGP =16512c76-
  e145-8101-9977-952696a53137
RoutePlanServer::getRouteGroup: mDeviceInfoList size =678
RoutePlanServer::getRouteGroup: standardLocalRG = 00000000-1111-0000-0000-000000000000, input routeGP =2bdffebe-
  b414-489b-906a-44d16dce30c3
RoutePlanServer::getRouteGroup: LRG flag = 0, lRouteGroupName = 2bdffebe-b414-489b-906a-44d16dce30c3
RoutePlanServer::getRouteGroup: mDeviceInfoList size =678
RouteList - RouteGroup count="2"
RouteListCdrcc::algorithmCategorization -- CDRC_SERIAL_DISTRIBUTION type=2
RoutePlanServer::updateStartingIndex - RouteGroupName(16512c76-e145-8101-9977-952696a53137)
```

# Case Study 2: No One Answers the Phone

## Finding the Route Group Names

```
admin:run sql select name, pkid from routegroup where pkid = '16512c76-e145-8101-9977-952696a53137'
```

```
name          pkid
=====
vnt-3945-gw1-sip 16512c76-e145-8101-9977-952696a53137
```

```
admin:run sql select name, pkid from routegroup where pkid = '2bdf febe-b414-489b-906a-44d16dce30c3'
```

```
name  pkid
=====
RTP-GK 2bdf febe-b414-489b-906a-44d16dce30c3
```

# Case Study 2: No One Answers the Phone

## Unified CM Sends an INVITE to the PSTN Gateway

10:36:41.497 |//SIP/SIPUdp/wait\_SdISPISignal: Outgoing SIP UDP message to 172.18.159.231:[5060]:  
**INVITE sip:+18772888362@172.18.159.231:5060 SIP/2.0**  
Via: SIP/2.0/UDP 172.18.106.59:5060;branch=z9hG4bK1515b3154665  
**From: "Test User 1" <sip:9194769236@172.18.106.59>;tag=97903bc0-a3de-4a15-ba27-44c81fe3adcd-45510543**  
**To: <sip:+18772888362@172.18.159.231>**  
Date: Mon, 29 Mar 2018 14:36:41 GMT  
**Call-ID: 7c0ca800-bb01baf9-1468e-3b6a12ac@172.18.106.59**  
Supported: timer,resource-priority,replaces  
Min-SE: 1800  
User-Agent: Cisco-CUCM11.5  
Allow: INVITE, OPTIONS, INFO, BYE, CANCEL, ACK, PRACK, UPDATE, REFER, SUBSCRIBE, NOTIFY  
CSeq: 101 INVITE  
Expires: 180  
Allow-Events: presence, kpml  
Supported: X-cisco-srtp-fallback  
Supported: Geolocation  
Call-Info: <sip:172.18.106.59:5060>;method="NOTIFY;Event=telephone-event;Duration=500"  
Cisco-Guid: 2081204224-3137452793-0000000466-0996807340  
Session-Expires: 1800  
P-Asserted-Identity: "Test User 1" <sip:9194769236@172.18.106.59>  
Contact: <sip:9194769236@172.18.106.59:5060>;video;audio  
Max-Forwards: 69  
Content-Length: 0

# Case Study 2: No One Answers the Phone

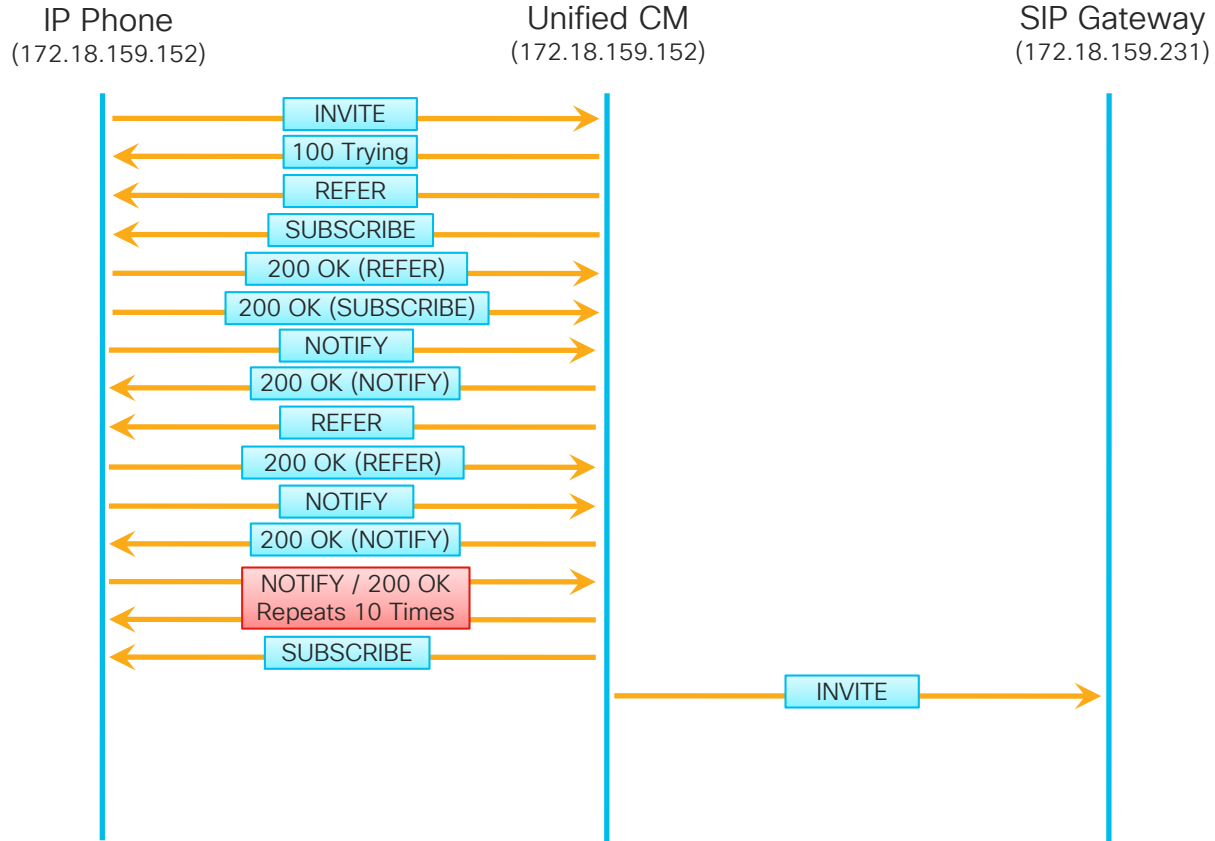



# Case Study 2: No One Answers the Phone

## Gateway Replies With a 100 Trying

10:36:41.500 [//SIP/SIPUdp/wait\_UdpDataIhd: Incoming SIP UDP message size 424 from  
172.18.159.231:[5060]:

SIP/2.0 100 Trying

Via: SIP/2.0/UDP 172.18.106.59:5060;branch=z9hG4bK1515b3154665

From: "Test User 1" <sip:9194769236@172.18.106.59>;tag=97903bc0-a3de-4a15-ba27-  
44c81fe3adcd-45510543

To: <sip:+18772888362@172.18.159.231>

Date: Mon, 29 Mar 2018 14:37:23 GMT

Call-ID: 7c0ca800-bb01baf9-1468e-3b6a12ac@172.18.106.59

CSeq: 101 INVITE

Allow-Events: telephone-event

Server: Cisco-SIPGateway/IOS-12.x

Content-Length: 0

# Case Study 2: No One Answers the Phone

## Phone Replies With 200 OK for the SUBSCRIBE

10:36:41.534 |||SIP/SIPTcp/wait\_SdlReadRsp: Incoming SIP TCP message from **172.18.159.152**  
on port 51682 index 2321 with 462 bytes:

**SIP/2.0 200 OK**

Via: SIP/2.0/TLS 172.18.106.59:5061;branch=z9hG4bK1515a5e1d5a4c

**From: <sip:9@172.18.106.59>;tag=1976165806**

**To: <sip:89919236@172.18.159.152>;tag=00260bd9669e07177ee0d51d-14f56f89**

**Call-ID: 7747f400-bb01baf1-14686-3b6a12ac@172.18.106.59**

Date: Mon, 29 Mar 2018 14:36:41 GMT

**CSeq: 102 SUBSCRIBE**

Server: Cisco-CP9951/9.0.1

Contact: <sip:4a8a8f91-609e-d655-19ea-  
44eedcd7b0d6@172.18.159.152:51682;transport=TLS>

Expires: 0

Content-Length: 0

# Case Study 2: No One Answers the Phone

## Gateway Replies With a 183 Session Progress W/ SDP

10:36:42.324 ||//SIP/SIPUdp/wait\_UdpDataIn: Incoming SIP UDP message size 1568 from  
172.18.159.231:[5060]:

SIP/2.0 183 Session Progress

Via: SIP/2.0/UDP 172.18.106.59:5060;branch=z9hG4bK1515b3154665

From: "Test User 1" <sip:9194769236@172.18.106.59>;tag=97903bc0-a3de-4a15-ba27-44c81fe3adcd-45510543

To: <sip:+18772888362@172.18.159.231>;tag=DE1EFF8-0

Date: Mon, 29 Mar 2018 14:37:23 GMT

Call-ID: 7c0ca800-bb01baf9-1468e-3b6a12ac@172.18.106.59

CSeq: 101 INVITE

Allow: INVITE, OPTIONS, BYE, CANCEL, ACK, PRACK, UPDATE, REFER, SUBSCRIBE, NOTIFY, INFO, REGISTER

Allow-Events: telephone-event

Remote-Party-ID: <sip:+18772888362@172.18.159.231>;party=called;screen=no;privacy=off

Contact: <sip:+18772888362@172.18.159.231:5060>

Supported: sdp-anat

Server: Cisco-SIPGateway/IOS-12.x

Content-Type: multipart/mixed;boundary=uniqueBoundary

Mime-Version: 1.0

Content-Length: 788

--uniqueBoundary

# Case Study 2: No One Answers the Phone

## Gateway Replies With a 183 Session Progress W/ SDP

```
Content-Type: application/sdp
Content-Disposition: session;handling=required
v=0
o=CiscoSystemsSIP-GW-UserAgent 0 7954 IN IP4 172.18.159.231
s=SIP Call
c=IN IP4 172.18.159.231
t=0 0
m=audio 27980 RTP/AVP 0 8 116 18 100 101
c=IN IP4 172.18.159.231
a=rtpmap:0 PCMU/8000
a=rtpmap:8 PCMA/8000
a=rtpmap:116 iLBC/8000
a=fmtp:116 mode=20
a=rtpmap:18 G729/8000
a=fmtp:18 annexb=no
a=rtpmap:100 X-NSE/8000
a=fmtp:100 192-194
a=rtpmap:101 telephone-event/8000
a=fmtp:101 0-16
--uniqueBoundary
Content-Type: application/x-q931
Content-Disposition: signal;handling=optional
Content-Length: 11
```

# Case Study 2: No One Answers the Phone

## Unified CM Sends a 180 Ringing to the IP Phone

10:36:42.330 ||//SIP/SIPTcp/wait\_SdISPISignal: Outgoing SIP TCP message to **172.18.159.152** on port 51682  
index 2321

### SIP/2.0 180 Ringing

Via: SIP/2.0/TLS 172.18.159.152:51682;branch=z9hG4bK1636ab61

From: "Test User 1" <sip:89919236@172.18.106.59>;tag=00260bd9669e07147bcb3aac-3cda8f0c

To: <sip:9@172.18.106.59;user=phone>;tag=97903bc0-a3de-4a15-ba27-44c81fe3adcd-45510542

Date: Mon, 29 Mar 2018 14:36:33 GMT

Call-ID: 00260bd9-669e000b-588c0c2b-2193e2a3@172.18.159.152

CSeq: 101 INVITE

Allow: INVITE, OPTIONS, INFO, BYE, CANCEL, ACK, PRACK, UPDATE, REFER, SUBSCRIBE, NOTIFY

Allow-Events: presence

Contact: <sip:9@172.18.106.59:5061;transport=tls>

Call-Info: <urn:x-cisco-remotecallinfo>; security= NotAuthenticated; orientation= to; ui-state= ringout; gci= 2-305505; call-instance= 1

Send-Info: conference

Remote-Party-ID: <sip:+18772888362@172.18.106.59>;party=called;screen=no;privacy=off

Content-Length: 0

# Case Study 2: No One Answers the Phone

IP Phone  
(172.18.159.152)

Unified CM  
(172.18.159.152)

SIP Gateway  
(172.18.159.231)

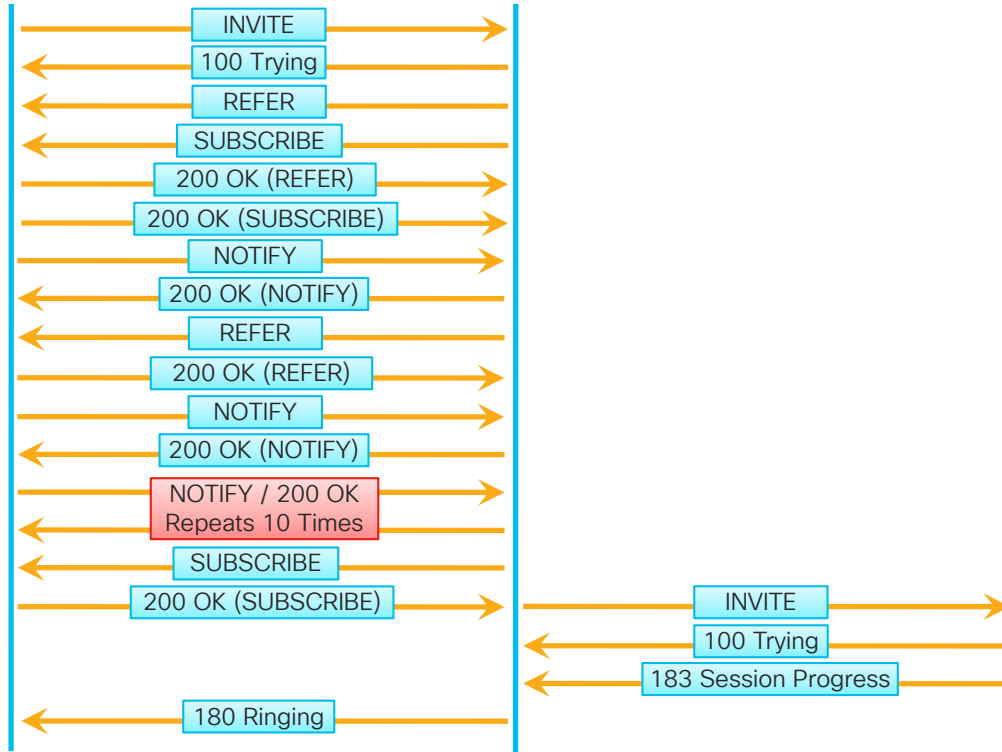

# Case Study 2: No One Answers the Phone

- Phone Keeps Ringing
  - Timestamps jump from 10:36:42 to 10:37:32
  - No SIP Signaling for 50 seconds

03/29/2018	10:36:42.330	172.18.106.59	172.18.159.152	Out	SIP	180 Ringing	00260bd9669e07147b...	00260bd9-669e000b-...
03/29/2018	10:37:32.931	172.18.106.59	172.18.159.152	In	SIP	NOTIFY	00260bd9669e071979...	0fab4815-3637406f@1...
03/29/2018	10:37:32.934	172.18.106.59	172.18.159.152	Out	SIP	200 OK	00260bd9669e071979...	0fab4815-3637406f@1...
03/29/2018	10:37:32.934	172.18.106.59	172.18.159.152	In	SIP	CANCEL	00260bd9669e07147b...	00260bd9-669e000b-...
03/29/2018	10:37:32.935	172.18.106.59	172.18.159.152	Out	SIP	200 OK	00260bd9669e07147b...	00260bd9-669e000b-...
03/29/2018	10:37:32.939	172.18.106.59	172.18.159.152	Out	SIP	487 Request Cancelled	00260bd9669e07147b...	00260bd9-669e000b-...
03/29/2018	10:37:32.947	172.18.106.59	172.18.159.152	In	SIP	ACK	00260bd9669e07147b...	00260bd9-669e000b-...

# Case Study 2: No One Answers the Phone

## IP Phone Sends a NOTIFY

10:37:32.931 |//SIP/SIPTcp/wait\_SdlReadRsp: Incoming SIP TCP message from 172.18.159.152 on port 51682 index 2321 with 1015 bytes:

NOTIFY sip:89919236@172.18.106.59 SIP/2.0

Via: SIP/2.0/TLS 172.18.159.152:51682;branch=z9hG4bK13e00d69

To: <sip:89919236@172.18.106.59>

From: <sip:89919236@172.18.106.59>;tag=00260bd9669e0719795cb162-12870e0b

Call-ID: 0fab4815-3637406f@172.18.159.152

Date: Mon, 29 Mar 2018 14:37:32 GMT

CSeq: 4 NOTIFY

Event: dialog

Subscription-State: active

Max-Forwards: 70

Contact: <sip:4a8a8f91-609e-d655-19ea-44eedcd7b0d6@172.18.159.152:51682;transport=TLS>

Allow: ACK,BYE,CANCEL,INVITE,NOTIFY,OPTIONS,REFER,REGISTER,UPDATE,SUBSCRIBE

Content-Length: 366

Content-Type: application/dialog-info+xml

Content-Disposition: session;handling=required

<?xml version="1.0" encoding="UTF-8" ?>

<dialog-info xmlns:call="urn:x-cisco:parmams:xml:ns:dialog-info:dialog:callinfo-dialog" version="1" state="partial" entity="sip:89919236@172.18.159.152">

<dialog id="22" call-id="00260bd9-669e000b-588c0c2b-2193e2a3@172.18.159.152" local-tag="00260bd9669e07147bcb3aac-3cda8f0c"><state>terminated</state></dialog></dialog-info>



# Case Study 2: No One Answers the Phone

## Unified CM Replies With 200 OK for the NOTIFY

10:37:32.934 |///SIP/SIPTcp/wait\_SdISPISignal: Outgoing SIP TCP message to 172.18.159.152 on port 51682 index 2321

SIP/2.0 200 OK

Via: SIP/2.0/TLS 172.18.159.152:51682;branch=z9hG4bK13e00d69

From: <sip:89919236@172.18.106.59>;tag=00260bd9669e0719795cb162-12870e0b

To: <sip:89919236@172.18.106.59>;tag=322772766

Date: Mon, 29 Mar 2018 14:37:32 GMT

Call-ID: 0fab4815-3637406f@172.18.159.152

CSeq: 4 NOTIFY

Content-Length: 0

# Case Study 2: No One Answers the Phone

## Phone Sends a CANCEL

10:37:32.934 |||SIP/SIPTcp/wait\_SdlReadRsp: Incoming SIP TCP message from 172.18.159.152 on port 51682 index 2321 with 422 bytes:

CANCEL sip:9@172.18.106.59;user=phone SIP/2.0

Via: SIP/2.0/TLS 172.18.159.152:51682;branch=z9hG4bK1636ab61

From: "Test User 1" <sip:89919236@172.18.106.59>;tag=00260bd9669e07147bcb3aac-3cda8f0c

To: <sip:9@172.18.106.59;user=phone>

Call-ID: 00260bd9-669e000b-588c0c2b-2193e2a3@172.18.159.152

Max-Forwards: 70

Date: Mon, 29 Mar 2018 14:37:32 GMT

CSeq: 101 CANCEL

User-Agent: Cisco-CP9951/9.0.1

Content-Length: 0

# Case Study 2: No One Answers the Phone

## Unified CM Sends a 200 OK for the CANCEL

10:37:32.935 |||SIP/SIPTcp/wait\_SdISPISignal: Outgoing SIP TCP message to 172.18.159.152 on port 51682 index 2321

SIP/2.0 200 OK

Via: SIP/2.0/TLS 172.18.159.152:51682;branch=z9hG4bK1636ab61

From: "Test User 1" <sip:89919236@172.18.106.59>;tag=00260bd9669e07147bcb3aac-3cda8f0c

To: <sip:9@172.18.106.59;user=phone>

Date: Mon, 29 Mar 2018 14:37:32 GMT

Call-ID: 00260bd9-669e000b-588c0c2b-2193e2a3@172.18.159.152

CSeq: 101 CANCEL

Content-Length: 0

# Case Study 2: No One Answers the Phone

## Unified CM Sends CANCEL to Gateway

10:37:32.938 [//SIP/SIPUdp/wait\_SdlSPISignal: Outgoing SIP UDP message to  
172.18.159.231:[5060]:

CANCEL sip:+18772888362@172.18.159.231:5060 SIP/2.0

Via: SIP/2.0/UDP 172.18.106.59:5060;branch=z9hG4bK1515b3154665

From: "Test User 1" <sip:9194769236@172.18.106.59>;tag=97903bc0-a3de-4a15-ba27-  
44c81fe3adcd-45510543

To: <sip:+18772888362@172.18.159.231>

Date: Mon, 29 Mar 2018 14:36:41 GMT

Call-ID: 7c0ca800-bb01baf9-1468e-3b6a12ac@172.18.106.59

CSeq: 101 CANCEL

Max-Forwards: 70

Content-Length: 0

# Case Study 2: No One Answers the Phone

Unified CM Sends 487 in response to INVITE

10:37:32.939 |||SIP/SIPTcp/wait\_SdISPISignal: Outgoing SIP TCP message to 172.18.159.152 on port 51682 index 2321

SIP/2.0 487 Request Cancelled

Via: SIP/2.0/TLS 172.18.159.152:51682;branch=z9hG4bK1636ab61

From: "Test User 1" <sip:89919236@172.18.106.59>;tag=00260bd9669e07147bcb3aac-3cda8f0c

To: <sip:9@172.18.106.59;user=phone>;tag=97903bc0-a3de-4a15-ba27-44c81fe3adcd-45510542

Date: Mon, 29 Mar 2018 14:37:32 GMT

Call-ID: 00260bd9-669e000b-588c0c2b-2193e2a3@172.18.159.152

CSeq: 101 INVITE

Allow-Events: presence

Content-Length: 0

# Case Study 2: No One Answers the Phone

## Unified CM Sends 200 OK for CANCEL to Gateway

10:37:32.940 [//SIP/SIPUdp/wait\_UdpDataInd: Incoming SIP UDP message size 354 from  
172.18.159.231:[5060]:

SIP/2.0 200 OK

Via: SIP/2.0/UDP 172.18.106.59:5060;branch=z9hG4bK1515b3154665

From: "Test User 1" <sip:9194769236@172.18.106.59>;tag=97903bc0-a3de-4a15-ba27-  
44c81fe3adcd-45510543

To: <sip:+18772888362@172.18.159.231>

Date: Mon, 29 Mar 2018 14:38:15 GMT

Call-ID: 7c0ca800-bb01baf9-1468e-3b6a12ac@172.18.106.59

CSeq: 101 CANCEL

Content-Length: 0

# Case Study 2: No One Answers the Phone

## Gateway Sends 487 in response to INVITE

10:37:32.941 [//SIP/SIPUdp/wait\_UdpDataInd: Incoming SIP UDP message size 473 from  
172.18.159.231:[5060]:

SIP/2.0 487 Request Cancelled

Via: SIP/2.0/UDP 172.18.106.59:5060;branch=z9hG4bK1515b3154665

From: "Test User 1" <sip:9194769236@172.18.106.59>;tag=97903bc0-a3de-4a15-ba27-  
44c81fe3adcd-45510543

To: <sip:+18772888362@172.18.159.231>;tag=DE1EFF8-0

Date: Mon, 29 Mar 2018 14:38:15 GMT

Call-ID: 7c0ca800-bb01baf9-1468e-3b6a12ac@172.18.106.59

CSeq: 101 INVITE

Allow-Events: telephone-event

Server: Cisco-SIPGateway/IOS-12.x

Reason: Q.850;cause=16

Content-Length: 0

# Case Study 2: No One Answers the Phone

## Gateway sends ACK

10:37:32.943 [//SIP/SIPUdp/wait\_SdlSPISignal: Outgoing SIP UDP message to  
172.18.159.231:[5060]:

ACK sip:+18772888362@172.18.159.231:5060 SIP/2.0

Via: SIP/2.0/UDP 172.18.106.59:5060;branch=z9hG4bK1515b3154665

From: "Test User 1" <sip:9194769236@172.18.106.59>;tag=97903bc0-a3de-4a15-ba27-  
44c81fe3adcd-45510543

To: <sip:+18772888362@172.18.159.231>;tag=DE1EFF8-0

Date: Mon, 29 Mar 2018 14:36:41 GMT

Call-ID: 7c0ca800-bb01baf9-1468e-3b6a12ac@172.18.106.59

Max-Forwards: 70

CSeq: 101 ACK

Allow-Events: presence, kpml

Content-Length: 0



# Case Study 2: No One Answers the Phone

## Unified CM Sends ACK

10:37:32.947 |//SIP/SIPTcp/wait\_SdlReadRsp: Incoming SIP TCP message from 172.18.159.152 on port 51682 index 2321 with 416 bytes:

ACK sip:9@172.18.106.59;user=phone SIP/2.0

Via: SIP/2.0/TLS 172.18.159.152:51682;branch=z9hG4bK1636ab61

From: "Test User 1" <sip:89919236@172.18.106.59>;tag=00260bd9669e07147bcb3aac-3cda8f0c

To: <sip:9@172.18.106.59;user=phone>;tag=97903bc0-a3de-4a15-ba27-44c81fe3adcd-45510542

Call-ID: 00260bd9-669e000b-588c0c2b-2193e2a3@172.18.159.152

Date: Mon, 29 Mar 2018 14:37:32 GMT

CSeq: 101 ACK

Content-Length: 0

# Case Study 2: No One Answers the Phone

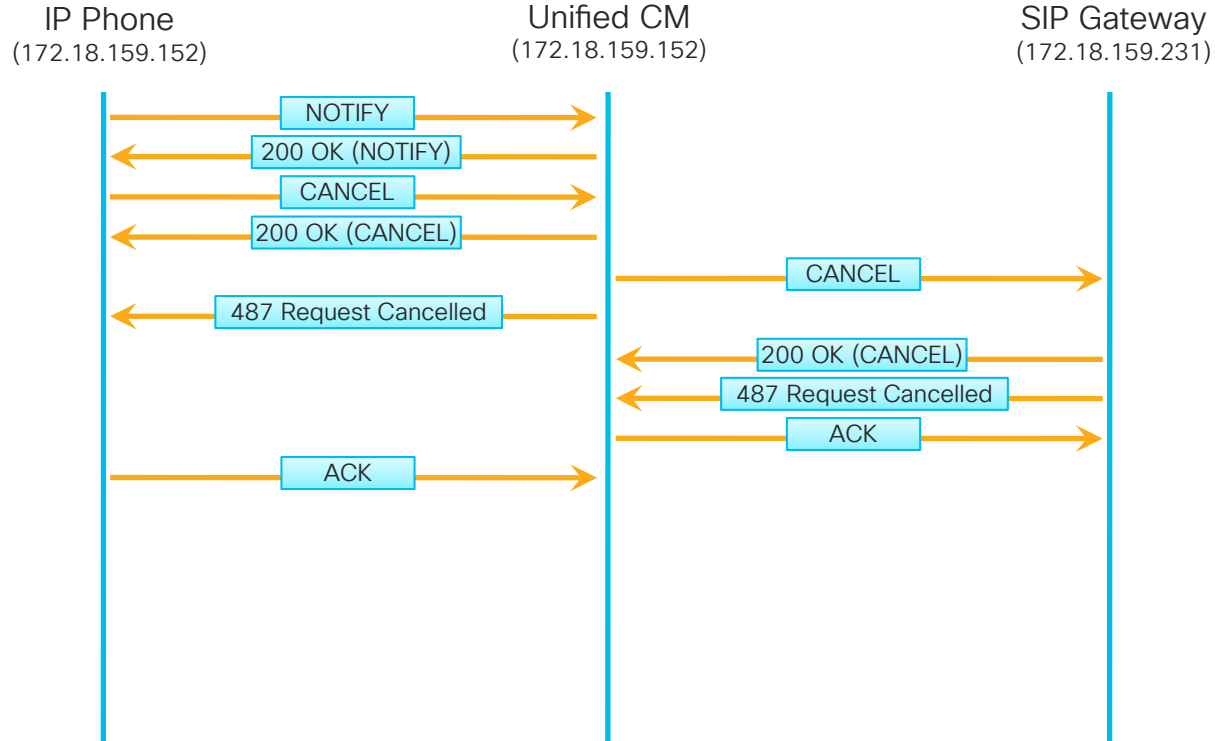

# Case Study 2: No One Answers the Phone

## Debugging Calls in IOS

- Enable Q.931 ISDN Debugs:
  - `debug isdn q931`
- Enable SIP Debugs:
  - `debug ccsip messages`

# Case Study 2: No One Answers the Phone

## INVITE From Unified CM to Gateway

\*Mar 29 14:37:23.635: //-1/xxxxxxxxxxxx/SIP/Msg/ccsipDisplayMsg:

Received:

INVITE sip:+18772888362@172.18.159.231:5060 SIP/2.0

Via: SIP/2.0/UDP 172.18.106.59:5060;branch=z9hG4bK1515b3154665

From: "Test User 1" <sip:9194769236@172.18.106.59>;tag=97903bc0-a3de-4a15-ba27-44c81fe3adcd-45510543

To: <sip:+18772888362@172.18.159.231>

Date: Mon, 29 Mar 2018 14:36:41 GMT

Call-ID: 7c0ca800-bb01baf9-1468e-3b6a12ac@172.18.106.59

Supported: timer,resource-priority,replaces

Min-SE: 1800

User-Agent: Cisco-CUCM11.5

Allow: INVITE, OPTIONS, INFO, BYE, CANCEL, ACK, PRACK, UPDATE, REFER, SUBSCRIBE, NOTIFY

CSeq: 101 INVITE

Expires: 180

Allow-Events: presence, kpml

Supported: X-cisco-srtp-fallback

Supported: Geolocation

Call-Info: <sip:172.18.106.59:5060>;method="NOTIFY;Event=telephone-event;Duration=500"

Cisco-Guid: 2081204224-3137452793-0000000466-0996807340

Session-Expires: 1800

P-Asserted-Identity: "Test User 1" <sip:9194769236@172.18.106.59>

Contact: <sip:9194769236@172.18.106.59:5060>;video;audio

Max-Forwards: 69

Content-Length: 0

# Case Study 2: No One Answers the Phone

## ISDN SETUP Message

\*Mar 29 2018 14:37:23.639: ISDN Se0/0/0:23 Q931: TX -> SETUP pd = 8 callref = 0x008B

Bearer Capability i = 0x8090A2

Standard = CCITT

Transfer Capability = Speech

Transfer Mode = Circuit

Transfer Rate = 64 kbit/s

Channel ID i = 0xA98381

Exclusive, Channel 1

Calling Party Number i = 0x2181, '9194769236'

Plan:ISDN, Type:National

Called Party Number i = 0x80, '18772888362'

Plan:Unknown, Type:Unknown

\*Mar 29 2018 14:37:23.667: ISDN Se0/0/0:23 Q931: RX <- CALL\_PROC pd = 8 callref = 0x808B

Channel ID i = 0xA98381

Exclusive, Channel 1

\*Mar 29 2018 14:37:24.463: ISDN Se0/0/0:23 Q931: RX <- PROGRESS pd = 8 callref = 0x808B

Progress Ind i = 0x8281 - Call not end-to-end ISDN, may have in-band info

# Case Study 2: No One Answers the Phone

## Gateway Sends 183 in Response to ISDN PROGRESS Message

\*Mar 29 2018 14:37:24.463: //-1/xxxxxxxxxxxx/SIP/Msg/ccsipDisplayMsg:

Sent:

SIP/2.0 183 Session Progress

Via: SIP/2.0/UDP 172.18.106.59:5060;branch=z9hG4bK1515b3154665

From: "Test User 1" <sip:9194769236@172.18.106.59>;tag=97903bc0-a3de-4a15-ba27-44c81fe3adcd-45510543

To: <sip:+18772888362@172.18.159.231>;tag=DE1EFF8-0

Date: Mon, 29 Mar 2018 14:37:23 GMT

Call-ID: 7c0ca800-bb01baf9-1468e-3b6a12ac@172.18.106.59

CSeq: 101 INVITE

Allow: INVITE, OPTIONS, BYE, CANCEL, ACK, PRACK, UPDATE, REFER, SUBSCRIBE, NOTIFY, INFO, REGISTER

Allow-Events: telephone-event

Remote-Party-ID: <sip:+18772888362@172.18.159.231>;party=called;screen=no;privacy=off

Contact: <sip:+18772888362@172.18.159.231:5060>

Supported: sdp-anat

Server: Cisco-SIPGateway/IOS-12.x

Content-Type: multipart/mixed;boundary=uniqueBoundary

Mime-Version: 1.0

Content-Length: 788

--uniqueBoundary

Content-Type: application/sdp

# Case Study 2: No One Answers the Phone

- How do we get the gateway to cut through audio on the PROGRESS message?
- RFC 3262: Reliability of Provisional Responses in the Session Initiation Protocol (SIP)
- Provides a way to acknowledge the 183 Session Progress message – PRACK
- Unified CM SIP Profile Setting “SEP Rel1XX Options”
  - Disabled
  - Send PRACK for all 1xx Messages
  - Send PRACK if 1xx Contains SDP

SIP Rel1XX Options\*

Send PRACK for all 1xx Messages



# Case Study 2: No One Answers the Phone

## IP Phone Sends INVITE When User Presses “Redial”

10:38:47.085 |//SIP/SIPTcp/wait\_SdlReadRsp: Incoming SIP TCP message from 172.18.159.152 on port 51682 index 2321 with 1717 bytes:

INVITE sip:918772888362@172.18.106.59 SIP/2.0

Via: SIP/2.0/TLS 172.18.159.152:51682;branch=z9hG4bK3d7f770b

From: "Test User 1" <sip:89919236@172.18.106.59>;tag=00260bd9669e071b177eda32-75cc7dfe

To: <sip:918772888362@172.18.106.59>

Call-ID: 00260bd9-669e000c-418d9a4e-16aced08@172.18.159.152

Max-Forwards: 70

Date: Mon, 29 Mar 2018 14:38:46 GMT

CSeq: 101 INVITE

User-Agent: Cisco-CP9951/9.0.1

Contact: <sip:4a8a8f91-609e-d655-19ea-44eedcd7b0d6@172.18.159.152:51682;transport=tls>

Expires: 180

Accept: application/sdp

Allow: ACK,BYE,CANCEL,INVITE,NOTIFY,OPTIONS,REFER,REGISTER,UPDATE,SUBSCRIBE,INFO

Remote-Party-ID: "Test User 1" <sip:89919236@172.18.106.59>;party=calling;id-type=subscriber;privacy=off;screen=yes

Supported: replaces,join,sdp-anat,norefersub,extended-refer,X-cisco-callinfo,X-cisco-serviceuri,X-cisco-escapecodes,X-cisco-service-control,X-cisco-srtp-fallback,X-cisco-monrec,X-cisco-config,X-cisco-sis-5.0.0,X-cisco-xsi-9.0.1

Allow-Events: kpml,dialog

Content-Length: 632

Content-Type: application/sdp

Content-Disposition: session;handling=optional



# Case Study 2: No One Answers the Phone

```
v=0
o=Cisco-SIPUA 21482 0 IN IP4 172.18.159.152
s=SIP Call
t=0 0
m=audio 30308 RTP/SAVP 0 8 18 102 9 116 124 101
c=IN IP4 172.18.159.152
a=crypto:XXXXXXXXXXXXXXXXXXXXXXXXXXXXXXXXXXXXXXXXXXXXXXXXXXXXXXXXXXXXXXXXXXXX
a=rtpmap:0 PCMU/8000
a=rtpmap:8 PCMA/8000
a=rtpmap:18 G729/8000
a=fmtp:18 annexb=no
a=rtpmap:102 L16/16000
a=rtpmap:9 G722/8000
a=rtpmap:116 iLBC/8000
a=fmtp:116 mode=20
a=rtpmap:124 ISAC/16000
a=rtpmap:101 telephone-event/8000
a=fmtp:101 0-15
a=sendrecv
m=video 26760 RTP/AVP 97
c=IN IP4 172.18.159.152
b=TIAS:1000000
a=rtpmap:97 H264/90000
a=fmtp:97 profile-level-id=42801E
a=recvonly
```



# Case Study 2: No One Answers the Phone

## Unified CM Sends a 100 Trying to the Phone

10:38:47.088 |//SIP/SIPTcp/wait\_SdISPISignal: Outgoing SIP TCP message to 172.18.159.152 on port 51682 index 2321

SIP/2.0 100 Trying

Via: SIP/2.0/TLS 172.18.159.152:51682;branch=z9hG4bK3d7f770b

From: "Test User 1" <sip:89919236@172.18.106.59>;tag=00260bd9669e071b177eda32-75cc7dfe

To: <sip:918772888362@172.18.106.59>

Date: Mon, 29 Mar 2018 14:38:47 GMT

Call-ID: 00260bd9-669e000c-418d9a4e-16aced08@172.18.159.152

CSeq: 101 INVITE

Allow-Events: presence

Content-Length: 0

# Case Study 2: No One Answers the Phone

## Unified CM Sends an INVITE to the PSTN Gateway

10:38:47.102 [//SIP/SIPUdp/wait\_SdlSPISignal: Outgoing SIP UDP message to 172.18.159.231:[5060]:  
INVITE sip:+18772888362@172.18.159.231:5060 SIP/2.0  
Via: SIP/2.0/UDP 172.18.106.59:5060;branch=z9hG4bK151894fb5e17  
From: "Test User 1" <sip:9194769236@172.18.106.59>;tag=97903bc0-a3de-4a15-ba27-44c81fe3adcd-45510549  
To: <sip:+18772888362@172.18.159.231>  
Date: Mon, 29 Mar 2018 14:38:47 GMT  
Call-ID: c726bb00-bb01bb77-146b7-3b6a12ac@172.18.106.59  
Supported: 100rel,timer,resource-priority,replaces  
Min-SE: 1800  
User-Agent: Cisco-CUCM11.5  
Allow: INVITE, OPTIONS, INFO, BYE, CANCEL, ACK, PRACK, UPDATE, REFER, SUBSCRIBE, NOTIFY  
CSeq: 101 INVITE  
Expires: 180  
Allow-Events: presence, kpml  
Supported: X-cisco-srtp-fallback  
Supported: Geolocation  
Call-Info: <sip:172.18.106.59:5060>;method="NOTIFY;Event=telephone-event;Duration=500"  
Cisco-Guid: 3341204224-3137452919-0000000467-0996807340  
Session-Expires: 1800  
P-Asserted-Identity: "Test User 1" <sip:9194769236@172.18.106.59>  
Contact: <sip:9194769236@172.18.106.59:5060>;video;audio  
Max-Forwards: 69  
Content-Length: 0

# Case Study 2: No One Answers the Phone

## Unified CM Sends an 100 Trying to IP Phone

10:38:47.107 ||//SIP/SIPUdp/wait\_UdpDataIn: Incoming SIP UDP message size 424 from 172.18.159.231:[5060]:

SIP/2.0 100 Trying

Via: SIP/2.0/UDP 172.18.106.59:5060;branch=z9hG4bK151894fb5e17

From: "Test User 1" <sip:9194769236@172.18.106.59>;tag=97903bc0-a3de-4a15-ba27-44c81fe3adcd-45510549

To: <sip:+18772888362@172.18.159.231>

Date: Mon, 29 Mar 2018 14:39:29 GMT

Call-ID: c726bb00-bb01bb77-146b7-3b6a12ac@172.18.106.59

CSeq: 101 INVITE

Allow-Events: telephone-event

Server: Cisco-SIPGateway/IOS-12.x

Content-Length: 0

# Case Study 2: No One Answers the Phone

## Gateway sends 183 Session Progress to Unified CM

10:38:47.972 |//SIP/SIPUdp/wait\_UdpDataIhd: Incoming SIP UDP message size 1601 from 172.18.159.231:[5060]:

SIP/2.0 183 Session Progress

Via: SIP/2.0/UDP 172.18.106.59:5060;branch=z9hG4bK151894fb5e17

From: "Test User 1" <sip:9194769236@172.18.106.59>;tag=97903bc0-a3de-4a15-ba27-44c81fe3adcd-45510549

To: <sip:+18772888362@172.18.159.231>;tag=DE3DAC4-1E12

Date: Mon, 29 Mar 2018 14:39:29 GMT

Call-ID: c726bb00-bb01bb77-146b7-3b6a12ac@172.18.106.59

CSeq: 101 INVITE

Require: 100rel

RSeq: 42

Allow: INVITE, OPTIONS, BYE, CANCEL, ACK, PRACK, UPDATE, REFER, SUBSCRIBE, NOTIFY, INFO, REGISTER

Allow-Events: telephone-event

Remote-Party-ID: <sip:+18772888362@172.18.159.231>;party=called;screen=no;privacy=off

Contact: <sip:+18772888362@172.18.159.231:5060>

Supported: sdp-anat

Server: Cisco-SIPGateway/IOS-12.x

Content-Type: multipart/mixed;boundary=uniqueBoundary

Mime-Version: 1.0

Content-Length: 791

--uniqueBoundary

# Case Study 2: No One Answers the Phone

## Gateway sends 183 Session Progress to Unified CM

```
Content-Type: application/sdp
Content-Disposition: session;handling=required
v=0
o=CiscoSystemsSIP-GW-UserAgent 1896 8548 IN IP4 172.18.159.231
s=SIP Call
c=IN IP4 172.18.159.231
t=0 0
m=audio 17784 RTP/AVP 0 8 116 18 100 101
c=IN IP4 172.18.159.231
a=rtpmap:0 PCMU/8000
a=rtpmap:8 PCMA/8000
a=rtpmap:116 iLBC/8000
a=fmtp:116 mode=20
a=rtpmap:18 G729/8000
a=fmtp:18 annexb=no
a=rtpmap:100 X-NSE/8000
a=fmtp:100 192-194
a=rtpmap:101 telephone-event/8000
a=fmtp:101 0-16
--uniqueBoundary
Content-Type: application/x-q931
Content-Disposition: signal;handling=optional
Content-Length: 11
```

# Case Study 2: No One Answers the Phone

## Unified CM Sends PRACK to Gateway with SDP

```
10:38:47.983 |//SIP/SIPUdp/wait_SdISPISignal: Outgoing SIP UDP message to 172.18.159.231:[5060]:
PRACK sip:+18772888362@172.18.159.231:5060 SIP/2.0
Via: SIP/2.0/UDP 172.18.106.59:5060;branch=z9hG4bK1518c3e52a9ef
From: "Test User 1" <sip:9194769236@172.18.106.59>;tag=97903bc0-a3de-4a15-ba27-44c81fe3adcd-45510549
To: <sip:+18772888362@172.18.159.231>;tag=DE3DAC4-1E12
Date: Mon, 29 Mar 2018 14:38:47 GMT
Call-ID: c726bb00-bb01bb77-146b7-3b6a12ac@172.18.106.59
CSeq: 102 PRACK
RAck: 42 101 INVITE
Allow-Events: presence, kpml
Max-Forwards: 70
Content-Type: application/sdp
Content-Length: 215
v=0
o=CiscoSystemsCCM-SIP 2000 1 IN IP4 172.18.106.59
s=SIP Call
c=IN IP4 172.18.159.152
t=0 0
m=audio 30308 RTP/AVP 0 101
a=rtpmap:0 PCMU/8000
a=ptime:20
a=rtpmap:101 telephone-event/8000
a=fmtp:101 0-15
```

# Case Study 2: No One Answers the Phone

## Unified CM Sends 183 with SDP to IP Phone

10:38:47.989 ||//SIP/SIPTcp/wait\_SdISPISignal: Outgoing SIP TCP message to 172.18.159.152 on port 51682 index 2321

SIP/2.0 183 Session Progress

Via: SIP/2.0/TLS 172.18.159.152:51682;branch=z9hG4bK3d7f770b

From: "Test User 1" <sip:89919236@172.18.106.59>;tag=00260bd9669e071b177eda32-75cc7dfe

To: <sip:918772888362@172.18.106.59>;tag=97903bc0-a3de-4a15-ba27-44c81fe3adcd-45510548

Date: Mon, 29 Mar 2018 14:38:47 GMT

Call-ID: 00260bd9-669e000c-418d9a4e-16aced08@172.18.159.152

CSeq: 101 INVITE

Allow: INVITE, OPTIONS, INFO, BYE, CANCEL, ACK, PRACK, UPDATE, REFER, SUBSCRIBE, NOTIFY

Allow-Events: presence

Contact: <sip:918772888362@172.18.106.59:5061;transport=tls>

Call-Info: <urn:x-cisco-remotecc:callinfo>; security= NotAuthenticated; orientation= to; gci= 2-305508; call-instance= 1

Send-Info: conference

Remote-Party-ID: <sip:918772888362@172.18.106.59>;party=called;screen=yes;privacy=off

Content-Type: application/sdp



# Case Study 2: No One Answers the Phone

## Unified CM Sends 183 with SDP to IP Phone

Content-Length: 633

v=0

o=CiscoSystemsCCM-SIP 2000 1 IN IP4 172.18.106.59

s=SIP Call

t=0 0

m=audio 17784 RTP/AVP 0 101

c=IN IP4 172.18.159.231

a=rtpmap:0 PCMU/8000

a=ptime:20

a=rtpmap:101 telephone-event/8000

a=fmtp:101 0-15

m=video 0 RTP/AVP 31 34 96 97

c=IN IP4 0.0.0.0

a=rtpmap:31 H261/90000

a=fmtp:31 MAXBR=128

a=rtpmap:34 H263/90000

a=fmtp:34 BPP=12092;F=1

a=rtpmap:96 H263-1998/90000

a=fmtp:96 BPP=27745;F=1;I=1;J=1;T=1;K=1;P=2,4

a=rtpmap:97 H264/90000

a=fmtp:97 sprop-interleaving-depth=21838;sprop-deint-buf-req=1801858876;sprop-max-don-diff=1701606770;max-fs=1767992687;max-br=164213620;deint-buf-cap=1715224179

a=inactive



# Case Study 2 Live Demo

# Agenda

- Serviceability Tools Overview
  - Real-Time Monitoring Tool (RTMT)
  - Cisco Unified Operating System GUI
  - Cisco Unified Operating System CLI
  - Cisco Serviceability Reports
  - Cisco Unified Reporting
  - Serviceability APIs
- Troubleshooting Methodology
  - Problem Description
  - Information Collection
- Troubleshooting Case Studies
  - Dropped Call
  - No One Answers the Phone
  - Unable to Place Calls
  - Call Drops After Answering
  - Video Encryption Not Working
  - One-Way Audio
  - ActiveControl Not Working on Jabber 12.5
  - Video Call Immediately Drops
- Understanding and Troubleshooting Unified CM Throttling Events
- Troubleshooting Database Replication

# Case Study 3: Unable to Place Calls

## Problem Description

- Some users report getting a message saying “We're sorry. It is not necessary to dial a 1 when calling this number. Will you please hang up and try your call again”
- User who reported the issue indicates they did not dial a 1; they dial 9 637 0000.
- User reports the problem is reproducible – every time they call that number the problem happens.

# Case Study 3: Unable to Place Calls

## Problem Description

- Reproduce and search for the call in AnalysisManager

The screenshot displays the Cisco Unified Real Time Monitoring Tool interface. The main window is titled 'Analyze Call Path' and contains a 'Search Criteria' section with the following fields:

- Calling Number/URI: \*
- Called Number/URI: \*6370000
- Termination Cause: All
- Start Time: 2019-Jan-26 19:20:44
- Duration\*: 60 mins
- Time Zone: (GMT+0:0)Greenwich Mean Time-Ame...

Below the search criteria is a table with columns for 'Node', 'Call Record Server', and 'Noc'. The table contains three rows of data:

Node	Call Record Server	Noc
<input checked="" type="checkbox"/> vnt-cm1b.cisco.com	vnt-cm1a.cisco.com	CUCM Voice/Vid...
<input checked="" type="checkbox"/> vnt-cm1c.cisco.com	vnt-cm1a.cisco.com	CUCM Voice/Vid...
<input checked="" type="checkbox"/> vnt-cm1a.cisco.com	vnt-cm1a.cisco.com	CUCM Voice/Vid...

Buttons for 'Select All', 'Clear All', and 'Refresh' are located below the table. A 'Run' button is positioned below the table. At the bottom of the window, there are buttons for 'View Full Path', 'View Record Details', 'Save Results', and 'Abort'. The status bar at the bottom indicates 'vnt-cm1a.cisco.com: Retrieved 0 call records'.

# Case Study 3: Unable to Place Calls

- No calls found...



- Why? Must set CDR Log Calls with Zero Duration Flag to “True”

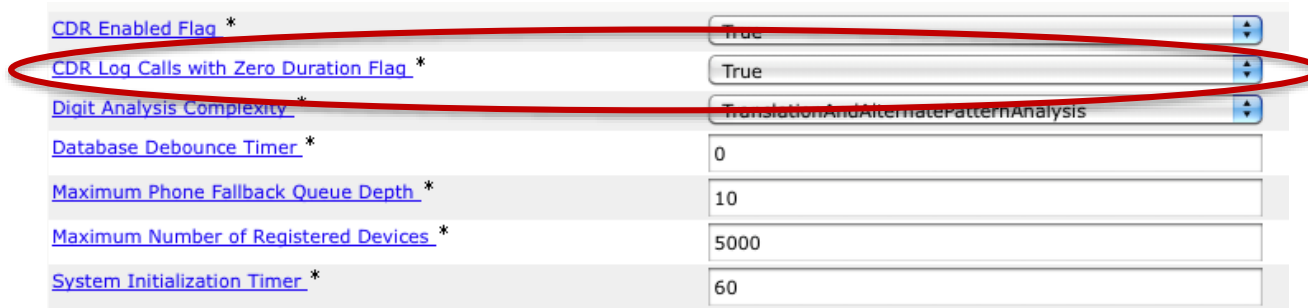

# Case Study 3: Unable to Place Calls

## Problem Description

- Reproduce the problem at 2:19 p.m. on 4/16
- Search again for the call in AnalysisManager

**Search Criteria**

Calling Number/URI: \*

Called Number/URI: \*6370000

Termination Cause: All

Start Time: 2019-Jan-26 19:20:44

Duration\*: 60 mins

Time Zone: (GMT+0:0)Greenwich Mean Time-Ame...

Filter Nodes by Group: AllNodes  
and Node Type: All

Node	Call Record Server	Noc
<input checked="" type="checkbox"/> vnt-cm1b.cisco.com	vnt-cm1a.cisco.com	CUCM Voice/Vid
<input checked="" type="checkbox"/> vnt-cm1c.cisco.com	vnt-cm1a.cisco.com	CUCM Voice/Vid
<input checked="" type="checkbox"/> vnt-cm1a.cisco.com	vnt-cm1a.cisco.com	CUCM Voice/Vid

Select All Clear All Refresh

**Run**

vnt-cm1a.cisco.com

**Nodes:** vnt-cm1b.cisco.com, vnt-cm1c.cisco.com, vnt-cm1a.cisco.com

Caller ID	Orig Called ID	Final Called ID	Originating Time	Connect Time	Disconnect Time	Orig Cause	Dest Cause	Pro
89915644	+18656370000	+18656370000	2019-Jan-26 20:0...		2019-Jan-26 20:0...	( 16 ) Normal call cl...	( 0 ) No error	UCM

# Case Study 3: Unable to Place Calls

No Connect Time

Caller ID	Orig Called ID	Final Called ID	Originating Time	Connect Time	Disconnect Time
89915644	+18656370000	+18656370000	2019-Jan-26 20:0...		2019-Jan-26 20:0...

Orig Cause	Dest Cause	Product Type	Cluster ID	Hostname*	Node ID
( 16 ) Normal call cl...	( 0 ) No error	UCM	VNT-CM1A-Cluster		2

Normal Call Clearing  
Caused by Originator



# Case Study 3: Unable to Place Calls

Click on “View Record Details”

Record Details - vnt-cm1a.cisco.com - 0

Field	Value
cdrrecordtype	1
globalcallid_callmanagerid	2
globalcallid_callid	4966486
origlegcallidentifier	34222748
datetimeorigination	1548533374
orignodeid	2
origspan	0
origipaddr	-1028304374
callingpartynumber	89915644
callingpartyunicodeloginuserid	pgiral
origcause_location	0
origcause_value	16
origprecedencelevel	4
origmediatransportaddress_ip	-1028304374
origmediatransportaddress_port	24618
origmediacap_payloadcapability	4
origmediacap_maxframesperpacket	20
origmediacap_g723bitrate	0
origvideocap_codec	0
origvideocap_bandwidth	0
origvideocap_resolution	0
origvideotransportaddress_ip	0
origvideotransportaddress_port	0
origsvpaudiostat	0
origsvpvideostat	0
destlegidentifier	34222749
destnodeid	2
destspan	34222749
destipaddr	-337681344

Save Results Close

Record Details - vnt-cm1a.cisco.com - 0

Field	Value
destipaddr	-337681344
originalcalledpartynumber	+18656370000
finalcalledpartynumber	+18656370000
finalcalledpartyunicodeloginuserid	
destcause_location	0
destcause_value	0
destprecedencelevel	4
destmediatransportaddress_ip	-337681344
destmediatransportaddress_port	10822
destmediacap_payloadcapability	4
destmediacap_maxframesperpacket	20
destmediacap_g723bitrate	0
destvideocap_codec	0
destvideocap_bandwidth	0
destvideocap_resolution	0
destvideotransportaddress_ip	0
destvideotransportaddress_port	0
destrsvpaudiostat	0
destrsvpvideostat	0
datetimeconnect	0
datetimedisconnect	1548533384
lastredirectdn	+18656370000
pkid	6e103e0c-ced3-4e7d-9a8c-22fa5d959d6c
originalcalledpartynumberpartition	GDP_GlobalE164_PSTN
callingpartynumberpartition	1stLine
finalcalledpartynumberpartition	GDP_GlobalE164_PSTN
lastredirectdnpartition	GDP_GlobalE164_PSTN
duration	0
origdeviceName	CSEPCIRAIT

Save Results Close

# Case Study 3: Unable to Place Calls

Click on “Record Details”

Field	Value
origdeviceid	CCPCIRALIT
destdeviceid	knv-3845-gw1
origcallterminationbehavior	12
destcallterminationbehavior	0
origcalledpartydirectionbehavior	0
lastredirectedirectionbehavior	0
origcalledpartydirectreason	0
lastredirectedirectreason	0
destconversationid	0
globalcallid_clusterid	VNT-CM1A-Cluster
joinbehavior	0
comment	
authcodeid	
authorizationlevel	0
clientmattercode	
origdtmfmethod	3
destdtmfmethod	3
callsecuredstatus	0
origconversationid	0
origmediacap_bandwidth	64
destmediacap_bandwidth	64
authorizationcodevalue	
outpulsedcallingpartynumber	9199915644
outpulsedcalledpartynumber	918656370000
origipv4v6addr	10.82.181.194
destipv4v6addr	64.100.223.235
origvideocap_codec_channel2	0
origvideocap_bandwidth_channel2	0
origvideocap_resolution_channel2	0

To Import into TranslatorX,  
click “Save Results”

# Case Study 3: Unable to Place Calls

## Importing CDR into TranslatorX

- Open Text File that was exported from Analysis Manager

```
ReportType:Raw
```

```
SCTVersion:1.0
```

```
Caller ID,Orig Called ID,Final Called ID,Originating Time,Connect Time,Disconnect Time,Orig Cause,Dest Cause,Product Type,Cluster ID,Hostname*,N  
89915644,+18656370000,+18656370000,2019-Jan-26 20:09:34.000 UTC,null,2019-Jan-26 20:09:44.000 UTC,( 16 ) Normal call clearing. Explanation: The
```

- Delete All Text up to the first number shown in Quotes (should be “1”)

```
timeorigination,orignodeid,origspan,origipaddr,callingpartynumber,callingpartyunicodeloginuserid,origcause_location,origcause_value,origprecedenc  
l be cleared. ,( 0 ) No error ,UCM,VNT-CM1A-Cluster,null,2,"1","2","4966486","34222748","1548533374","2","0","-1028304374","89915644","pgiralt","
```

```
"1","2","4966486","34222748","1548533374","2","0","-1028304374","89915644","pgiralt","0","16","4","-1028304374","24618","4","20","0","0","0","0"
```

# Case Study 3: Unable to Place Calls

## Importing CDR into TranslatorX

- Open the Call List Window in TranslatorX

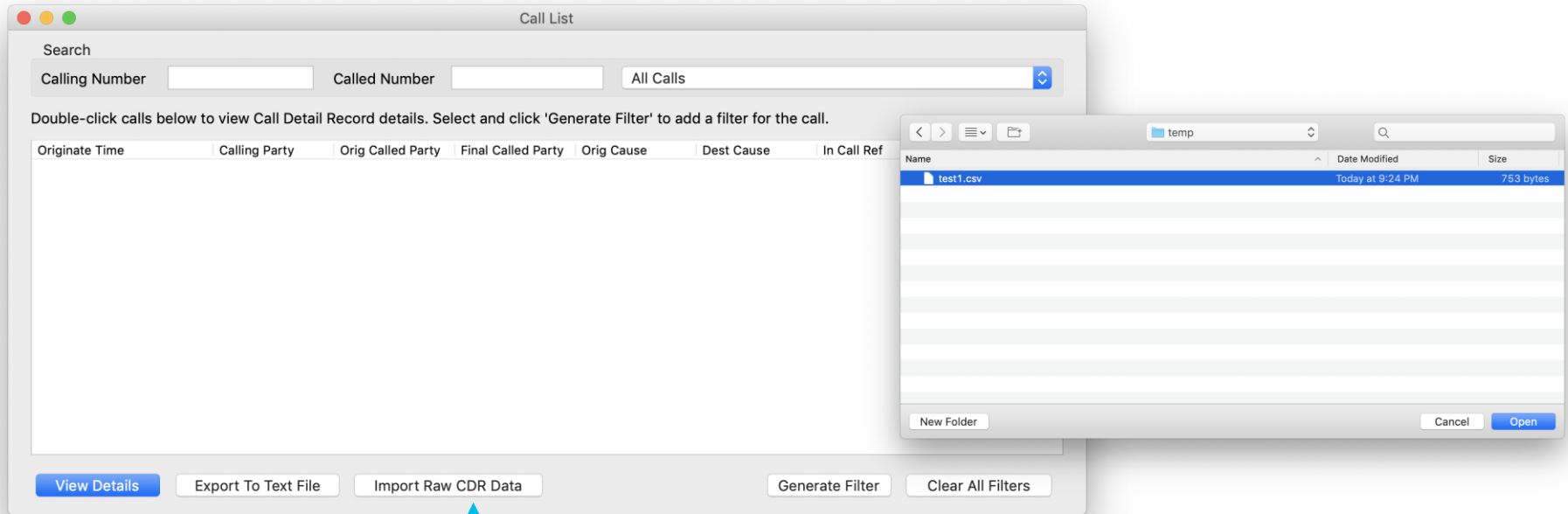

Click "Input Raw CDR Data" and select file

# Case Study 3: Unable to Place Calls

## Importing CDR into TranslatorX

- Open the Call List Window in TranslatorX

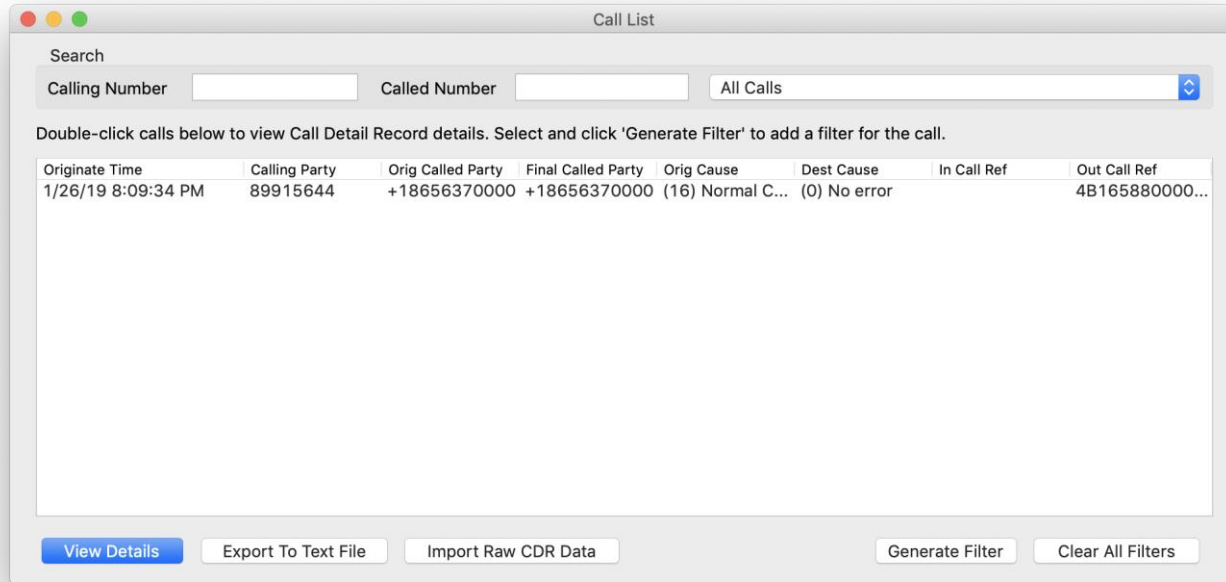

Double-click record or click row and “View Details”

# Case Study 3: Unable to Place Calls

## Importing CDR into TranslatorX

CDR Details

Node ID	2	Calling Party Number	89915644	Last Redirect Number	+18656370000
Global Call ID	4966486	Calling Party URI		Last Redirect Partition	GDP_GlobalE164_PSTN
Cluster ID	VNT-CM1A-Cluster	Calling Party Partition	1stLine	Original Called Party Redirect On Behalf Of	(0) Unknown
Origination Time	1/26/19 8:09:34 PM	Calling Party User ID	pgiral	Original Called Party Redirect Reason	(0) Unknown
Connect Time	n/a	Original Called Party	+18656370000	Last Redirect On Behalf Of	(0) Unknown
Disconnect Time	1/26/19 8:09:44 PM	Original Called Party URI		Last Redirect Redirect Reason	(0) Unknown
Duration	0	Original Called Partition	GDP_GlobalE164_PSTN	Current Routing Reason	0
Join On Behalf Of	(0) Unknown	Final Called Party	+18656370000	Original Routing Reason	0
Security Status	0	Final Called Party URI		Last Redirecting Routing Reason	0
Authorization Level	0	Final Called Partition	GDP_GlobalE164_PSTN		
Auth Code Desc		Called Party User ID			
Auth Code Value		Outpulsed Calling Party	9199915644		
Client Matter Code		Outpulsed Called Party	918656370000		
Hunt Pilot DN					
Hunt Pilot Partition					
Comment					

# Case Study 3: Unable to Place Calls

## Importing CDR into TranslatorX

CDR Details

Origination Details		Destination Details	
Device Name	CSFPGIRALT	Device Name	knv-3845-gw1
IP Address	10.82.181.194	IP Address	64.100.223.235
IPv4/v6 IP Address	10.82.181.194	IPv4/v6 IP Address	64.100.223.235
Protocol	Unknown	Protocol	SIP
Call Reference		Call Reference	4B16588000010000000005533B6A12AC
Disconnect Cause	(16) Normal Call Clearing	Disconnect Cause	(0) No error
Cause Location	0	Node ID	2
Call Identifier	34222748	TDM Span	0
Term on Behalf Of	(12) Device	Term on Behalf Of	(0) Unknown
Conversation ID	0	Conversation ID	0
Audio Media Information		Audio Media Information	
IP Address	10.82.181.194	Port	24618
Codec	G.711 mu-law 64k (4)	Packetization	20
Video Media Information		Video Media Information	
IP Address	0.0.0.0	Port	0

# Case Study 3: Unable to Place Calls

## Importing CDR into TranslatorX

CDR Details

IP Address	10.82.181.194	Port	24618	IP Address	64.100.223.235	Port	10822
Codec	G.711 mu-law 64k (4)	Packetization	20	Codec	G.711 mu-law 64k (4)	Packetization	20
Video Media Information				Video Media Information			
IP Address	0.0.0.0	Port	0	IP Address	0.0.0.0	Port	0
Codec	0			Codec	0		
Resolution	0	Bandwidth	0	Resolution	0	Bandwidth	0
Video Media Information (Channel 2)				Video Media Information (Channel 2)			
IP Address	0.0.0.0	Port	0	IP Address	0.0.0.0	Port	0
Codec	0			Codec	0		
Resolution	0	Bandwidth	0	Resolution	0	Bandwidth	0
Role	0			Role	0		
RSVP Audio Status	(0) No Reservation			RSVP Audio Status	(0) No Reservation		
RSVP Video Status	(0) No Reservation			RSVP Video Status	(0) No Reservation		
DTMF Method	(3) Out of Band and RFC2833			DTMF Method	(3) Out of Band and RFC2833		
Precedence Level	(4) Routine			Precedence Level	(4) Routine		



# Case Study 3: Unable to Place Calls

- Use Dialed Number Analyzer:
  - [https://publisher\\_ip\\_address:8443/dna](https://publisher_ip_address:8443/dna)
- Make sure the Cisco DNA service is activated on the publisher:

<input checked="" type="checkbox"/>	Cisco Dialed Number Analyzer Server	Activated
<input checked="" type="checkbox"/>	Cisco Dialed Number Analyzer	Activated

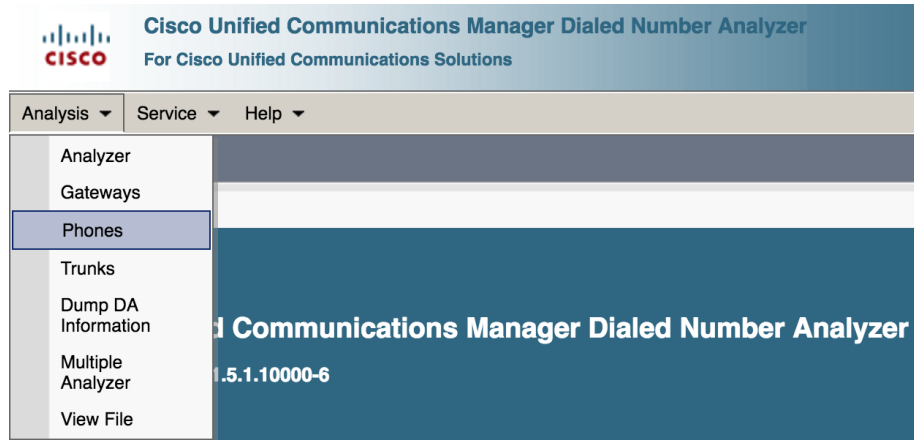

# Case Study 3: Unable to Place Calls

## Search for the phone

### Status



6 records found

### Search Options

Find Phone where      Search Within Results

### Search Results

	Device Name(Line)	Description	Device Pool	Device Protocol	Status	IP Address
	<a href="#">CSFPGIRALT</a>	pgiralt-csf	KNV BCD Unicast 711 Unrestricted Video CST_CDT	SIP	Registered	10.82.181.194

# Case Study 3: Unable to Place Calls

## Device Information (Model = Cisco Unified Client Services Framework)

Registration	Registered with Cisco Unified CallManager vnt-cm1b.cisco.com
IP Address	10.82.181.194
MAC Address	CSFPGIRALT
Device Name	CSFPGIRALT
Description	pgiralt-csf
Owner User ID	pgiralt
Device Pool	KNV BCD Unicast 711 Unrestricted Video CST_CDT
Call Classification	OnNet
Calling Search Space	KNV Unrestricted
AAR Calling Search Space	None
Media Resource Group List	Video List - Conductor
Device Time Zone	America/Chicago

## Association Information

 Line [1] - 89915644 in 1stLine

# Case Study 3: Unable to Place Calls

**Analyzer Input**

**Dialed Digit Settings**

Directory URI

Dialed Digits

Pattern Analysis  SIP Analysis

Domain Route

IP Route

**Date and Time Settings**

Time Zone

Date  -  -  (YYYY - MMM - DD)

Time  -  -  -  (HH : MM : SS : MS)

 \* - indicates required item

# Case Study 3: Unable to Place Calls

## Results Summary

### Calling Party Information

- **Calling Party** = +19199915644
- **Partition** = 1stLine
- **Device CSS** = KNV Unrestricted
- **Line CSS** = Temp-Test
- **AAR Group Name** = VNT
- **AAR CSS** =
- **Dialed Digits** = 96375411
- **Match Result** = RouteThisPattern

### Matched Pattern Information

- **Pattern** = +1.[2-9]XX[2-9]XXXXXX
- **Partition** = GDP\_GlobalE164\_PSTN
- **Time Schedule** =
- **Called Party Number** = +18656375411
- **Time Zone** = Etc/GMT
- **End Device** = Triad - LRG - Cisco SME
- **Call Classification** = OnNet
- **InterDigit Timeout** = NO
- **Device Override** = Disabled
- **Outside Dial Tone** = NO

## Call Flow

### TranslationPattern :Pattern= 9.[2-9]XXXXXX

- **Partition** = US KNV Local
- **Positional Match List** = +1:8656375411
- **Calling Party Number** = +19199915644
- **PreTransform Calling Party Number** = 89915644
- **PreTransform Called Party Number** = 96375411

### Calling Party Transformations

- **External Phone Number Mask** = YES
- **Calling Party Mask** =
- **Prefix** =
- **CallingLineId Presentation** = Default
- **CallingName Presentation** = Default
- **Calling Party Number** = +19199915644

### ConnectedParty Transformations

- **ConnectedLineId Presentation** = Default
- **ConnectedName Presentation** = Default

### Called Party Transformations

- **Called Party Mask** = +1865XXXXXXX
- **Discard Digits Instruction** = None
- **Prefix** =
- **Called Number** = +18656375411

# Case Study 3: Unable to Place Calls

- ▼ **Route Pattern** :Pattern= +1.[2-9]XX[2-9]XXXXXX
  - Positional Match List = +1:8656375411
  - DialPlan =
  - ▼ **Route Filter**
    - Filter Name =
    - Filter Clause =
  - Require Forced Authorization Code = No
  - Authorization Level = 0
  - Require Client Matter Code = No
  - Call Classification =
  - PreTransform Calling Party Number = +19199915644
  - PreTransform Called Party Number = +18656375411
  - ▼ **Calling Party Transformations**
    - External Phone Number Mask = NO
    - Calling Party Mask =
    - Prefix =
    - CallingLineId Presentation =
    - CallingName Presentation =
    - Calling Party Number = +19199915644
  - ▼ **ConnectedParty Transformations**
    - ConnectedLineId Presentation =
    - ConnectedName Presentation =
  - ▼ **Called Party Transformations**
    - Called Party Mask =
    - Discard Digits Instruction =
    - Prefix =
    - Called Number = +18656375411

- ▼ **Route List** :Route List Name= Triad - LRG - Cisco SME
  - ▼ **RouteGroup** :RouteGroup Name= Local PSTN Route (knv-3845-gw1)
    - PreTransform Calling Party Number = +19199915644
    - PreTransform Called Party Number = +18656375411
    - ▼ **Calling Party Transformations**
      - External Phone Number Mask = Default
      - Calling Party Mask =
      - Prefix =
      - Calling Party Number = +19199915644
    - ▼ **Called Party Transformations**
      - Called Party Mask =
      - Discard Digits Instructions =
      - Prefix =
      - Called Number = +18656375411
    - ▼ **Device** :Type= SIPTrunk
      - **Transformed Called Party = 918656375411**
      - End Device Name = knv-3845-gw1
      - PortNumber = 0
      - Device Status = UnKnown
      - AAR Group Name =
      - AAR Calling Search Space =
      - AAR Prefix Digits =
      - Call Classification = Use System Default
      - Calling Party Selection = Originator
      - CallingLineId Presentation = Allowed
      - CallerID DN =

# Case Study 3: Unable to Place Calls

- Use `show dialplan number` to see call routing in IOS

```
ciscolive-gw1#show dialplan number 918656375411 timeout  
Macro Exp.: 918656375411
```

## **VoiceEncapPeer901**

```
peer type = voice, system default peer = FALSE,  
  information type = voice, description = `',  
tag = 901, destination-pattern = `9T',  
voice reg type = 0, corresponding tag = 0,  
allow watch = FALSE  
answer-address = `', preference=0,  
  -- snip --  
session-target = `', voice-port = `0/0/0:23',  
direct-inward-dial = enabled,  
digit_strip = enabled,
```

# Case Study 3: Unable to Place Calls

- Check the dial peer configuration

```
ciscolive-gw1#sh run | beg dial-peer voice 901  
dial-peer voice 901 pots  
  translation-profile incoming KNV_DID  
  destination-pattern 9T  
  incoming called-number .  
  direct-inward-dial  
  port 0/0/0:23  
!
```



# Case Study 3: Unable to Place Calls

- Run debug isdn q931 to see the outgoing call

Jan 26 08:09:34.791: ISDN Se0/0/0:23 Q931: TX -> SETUP pd = 8 callref = 0x0111

Bearer Capability i = 0x8090A2

Standard = CCITT

Transfer Capability = Speech

Transfer Mode = Circuit

Transfer Rate = 64 kbit/s

Channel ID i = 0xA98397

Exclusive, Channel 23

Calling Party Number i = 0x2181, '9199915644'

Plan:ISDN, Type:National

Called Party Number i = 0x80, '18656370000'

Plan:Unknown, Type:Unknown

Jan 26 08:09:35.282: ISDN Se0/0/0:23 Q931: RX <- CALL\_PROC pd = 8 callref = 0x8111

Channel ID i = 0xA98397

Exclusive, Channel 23

Jan 26 08:09:35.458: ISDN Se0/0/0:23 Q931: RX <- PROGRESS pd = 8 callref = 0x8111

Cause i = 0x829F - Normal, unspecified

Progress Ind i = 0x8288 - In-band info or appropriate now available

# Case Study 3: Unable to Place Calls

- Need to remove the 1 for local calls
- Transform either in Unified CM or on the gateway

**Pattern Definition**

Pattern*	\+1.865[2-9]XXXXXX
Partition	CalledTransform_US_KNV_prefix9
Description	PSTN calls to +1865 - strip +1
Numbering Plan	< None >
Route Filter	< None >
<input checked="" type="checkbox"/> Urgent Priority	
<input type="checkbox"/> MLPP Preemption Disabled	

**Called Party Transformations**

Discard Digits	PreDot
Called Party Transformation Mask	
Prefix Digits	9
Called Party Number Type*	Cisco CallManager
Called Party Numbering Plan*	Cisco CallManager

# Agenda

- Serviceability Tools Overview
  - Real-Time Monitoring Tool (RTMT)
  - Cisco Unified Operating System GUI
  - Cisco Unified Operating System CLI
  - Cisco Serviceability Reports
  - Cisco Unified Reporting
  - Serviceability APIs
- Troubleshooting Methodology
  - Problem Description
  - Information Collection
- Troubleshooting Case Studies
  - Dropped Call
  - No One Answers the Phone
  - Unable to Place Calls
  - Call Drops After Answering
  - Video Encryption Not Working
  - One-Way Audio
  - ActiveControl Not Working on Jabber 12.5
  - Video Call Immediately Drops
- Understanding and Troubleshooting Unified CM Throttling Events
- Troubleshooting Database Replication

# Case Study 4: Call Drops after Answering

## Problem Description

- When a user (89915644) dials another user (89915724), the call drops immediately after being answered.
- User reports the problem is reproducible – every time they call that number the problem happens.

# Case Study 4: Call Drops after Answering

## Collect Traces

- Problem is reproducible, so generate a test call and then collect traces.

**Collect Files**

**Collect File Options:**

**Collection Time**

Absolute Range

Select Reference Server Time Zone: Client:(GMT-5:0)Eastern Standard Time-America/New\_York

From Date/Time: 1/24/20 - 10:32 PM

To Date/Time: 1/24/20 - 11:32 PM

Relative Range

Files Generated in the last: 10 Minutes

**Download File Options**

Select Partition: Active Partition

Download File Directory: /Users/pgiralt

Zip Files

Do Not Zip Files

Uncompress Log Files

Delete Collected Log Files from Server

Note: The result file can be found in the directory named <Node Name> created under the user specified directory structure. The File Name is as specified by the user.

< Back   Next >   Finish   Cancel

DO NOT ZIP HERE

# Case Study 4: Call Drops after Answering

## Use TranslatorX to Analyze Traces

- Problem is reproducible, so generate a test call and then collect traces. Drag and Drop folder into TranslatorX

The screenshot shows the Cisco Unified Communications Trace Translator application window. A blue folder icon is being dragged from the left into the application window. A grey box with the text "Drag and Drop a File or Folder or Paste text from the Clipboard to begin" is overlaid on the application window. A "Processing Files" dialog box is open on the right, showing a progress bar, "Opening file 6 of 11", "Current File: SDL002\_100\_000204.txt.gz", and "Time Remaining: 3 seconds".

The application window has a menu bar with "Filters Enabled", "New Filter", "Filters...", "Clear Filters", "0 Filters Configured", "Call List...", "Search", and "Clear". Below the menu bar is a table with columns: "Timestamp", "Node/Interface", "Remote Device", "Direction", "Protocol", "Message Name", "TCP Handle/From Tag", and "Call Ref / ID".

The application window also has a status bar at the bottom with the following information:

- Lines Processed: 0
- Msgs Processed: 0
- Msgs Displayed: 0
- SSCP
- SIP
- Q.931 / H.225
- H.245
- MGCP
- MGCP BH
- Exclude SSCP and MGCP Keepalives
- Exclude SIP REGISTER
- Exclude SIP SUBSCRIBE / NOTIFY / PUBLISH
- Exclude SIP OPTIONS

Buttons at the bottom right include "Generate Diagram", "Export List", and "Export Details".

# Case Study 4: Call Drops after Answering

## Use TranslatorX to Analyze Traces

- Open Call List Window

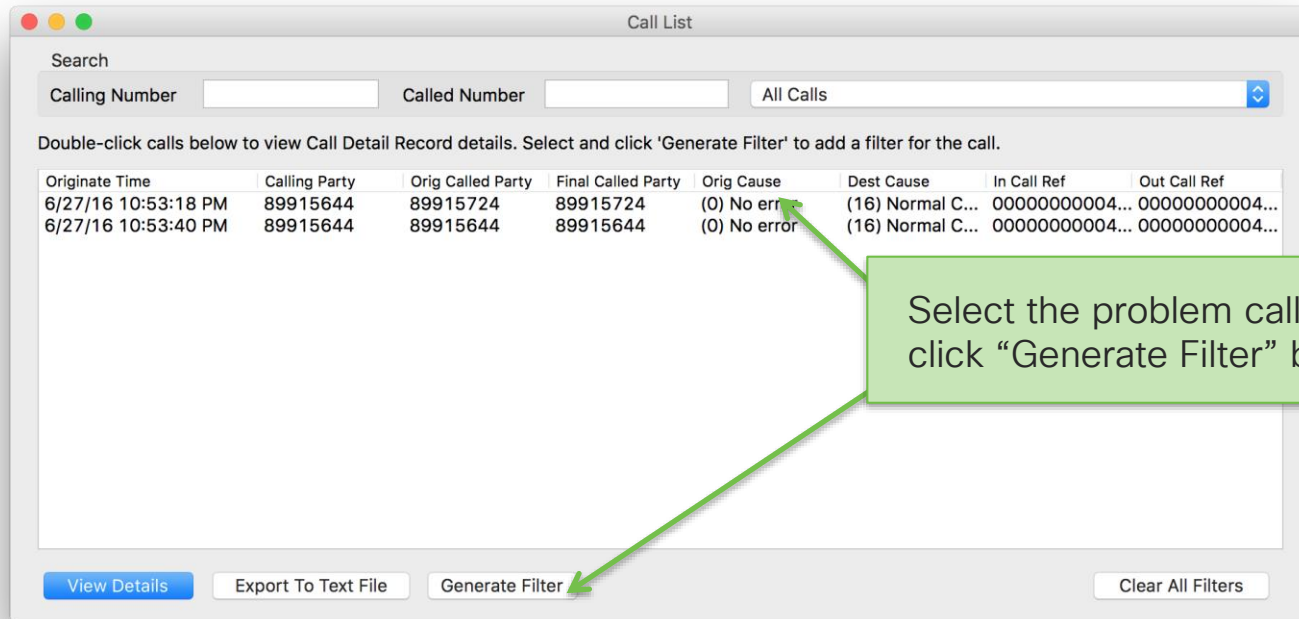
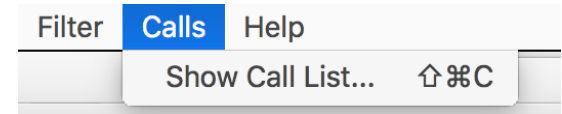
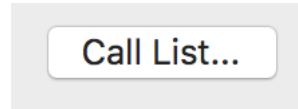

Call List

Search

Calling Number  Called Number  All Calls

Double-click calls below to view Call Detail Record details. Select and click 'Generate Filter' to add a filter for the call.

Originate Time	Calling Party	Orig Called Party	Final Called Party	Orig Cause	Dest Cause	In Call Ref	Out Call Ref
6/27/16 10:53:18 PM	89915644	89915724	89915724	(0) No error	(16) Normal C...	00000000004...	00000000004...
6/27/16 10:53:40 PM	89915644	89915644	89915644	(0) No error	(16) Normal C...	00000000004...	00000000004...

View Details Export To Text File Generate Filter Clear All Filters

Select the problem call and click "Generate Filter" button

# Case Study 4: Call Drops after Answering

## Use TranslatorX to Analyze Traces

- Can double-click a call to see CDR details

The screenshot shows a 'CDR Details' window with the following data:

Field	Value
Node ID	2
Global Call ID	4398648
Cluster ID	VNT-CM1A-Cluster
Origination Time	6/27/16 10:53:18 PM
Connect Time	6/27/16 10:53:21 PM
Disconnect Time	6/27/16 10:53:21 PM
Duration	0
Join On Behalf Of	(0) Unknown
Security Status	2
Authorization Level	0
Auth Code Desc	
Auth Code Value	
Client Matter Code	
Hunt Pilot DN	
Hunt Pilot Partition	
Comment	
Calling Party Number	89915644
Calling Party URI	
Calling Party Partition	1stLine
Calling Party User ID	pgiralt
Original Called Party	89915724
Original Called Party URI	
Original Called Party Partition	1stLine
Final Called Party	89915724
Final Called Party URI	
Final Called Party Partition	1stLine
Called Party User ID	asharma
Outpulsed Calling Party	
Outpulsed Called Party	
Last Redirect Number	89915724
Last Redirect Partition	1stLine
Original Called Party Redirect On Behalf Of	(0) Unknown
Original Called Party Redirect Reason	(0) Unknown
Last Redirect On Behalf Of	(0) Unknown
Last Redirect Redirect Reason	(0) Unknown
Current Routing Reason	0
Original Routing Reason	0
Last Redirecting Routing Reason	0
Origination Details	
Device Name	SEP881DFC610185
IP Address	10.116.123.205
Destination Details	
Device Name	SEPAC7E8AB699C8
IP Address	10.116.123.197



# Case Study 4: Call Drops after Answering

## Use TranslatorX to Analyze Traces

- Can double-click a call to see CDR details

The screenshot shows a window titled "CDR Details" with two main sections: "Origination Details" and "Destination Details". Each section contains fields for device information, call reference, and media details.

Origination Details		Destination Details	
Device Name	SEP881DFC610185	Device Name	SEPAC7E8AB699C8
IP Address	10.116.123.205	IP Address	10.116.123.197
IPv4/v6 IP Address	10.116.123.205	IPv4/v6 IP Address	10.116.123.197
Protocol	CTI/JTAPI	Protocol	CTI/JTAPI
Call Reference	000000000431E3802C36B1400000000	Call Reference	000000000431E3802C36B1500000000
Disconnect Cause	(0) No error	Disconnect Cause	(16) Normal Call Clearing
Cause Location	0	Cause Location	0
Node ID	2	Node ID	2
Call Identifier	46361364	Call Identifier	46361365
TDM Span	0	TDM Span	0
Term on Behalf Of	(0) Unknown	Term on Behalf Of	(12) Device
Conversation ID	0	Conversation ID	0
Audio Media Information		Audio Media Information	
IP Address	10.116.123.205	IP Address	10.116.123.197
Port	19630	Port	22674
Codec	G.722 64k (6)	Codec	G.722 64k (6)
Packetization	20	Packetization	20
Video Media Information		Video Media Information	
IP Address	10.116.123.205	IP Address	10.116.123.197
Port	16836	Port	26048
Codec	103	Codec	103
Resolution	(10) Unknown	Resolution	(11) Unknown
Bandwidth	4000	Bandwidth	4000

# Case Study 4: Call Drops after Answering

## Use TranslatorX to Analyze Traces

- Can look at the Filters that were automatically generated

Message Filters

Device IP 10.116.123.205  Protocol  Call ID  
 TCP Handle  Message  Call Ref  
 From Tag  Direction  Node ID  
 Correlation Tag  Session ID

Timestamp Start Time Jun 27, 2016 10:53:18 PM End Time Jun 27, 2016 10:53:23 PM  
 Search Text Update Filter Add Filter

Active Filters - All items on a single line are AND'd together and each line is OR'd with other lines.

	Device IP	Node/Interf...	Direction	Message	TCP Handle	Call Ref	From Tag	SIP Call ID	SIP Session ID	Protocol
0	10.116.123.205									
1	10.116.123.197									

Save Filters... Load Filters... Clear All Remove Selected

# Case Study 4: Call Drops after Answering

Cisco Unified Communications Trace Translator

Filters Enabled    New Filter    Filters...    Clear Filters    2 Filters Configured    Call List...    Search    Clear

Timestamp	Node/Interface	Remote Device	Direction	Protocol	Message Name	TCP Handle/From Tag	Call Ref / ID
06/27/2016 22:53:18.087	172.18.106.59	10.116.123.205	In	SIP	NOTIFY	881dfc6101852a906e...	44304155-025f55bc@...
06/27/2016 22:53:18.089	172.18.106.59	10.116.123.205	Out	SIP	200 OK	881dfc6101852a906e...	44304155-025f55bc@...
06/27/2016 22:53:18.111	172.18.106.59	10.116.123.205	In	SIP	INVITE	881dfc6101852a8f24...	881dfc61-0185000e-0...
06/27/2016 22:53:18.112	172.18.106.59	10.116.123.205	Out	SIP	100 Trying	881dfc6101852a8f24...	881dfc61-0185000e-0...
06/27/2016 22:53:18.133	172.18.106.59	10.116.123.197	Out	SIP	INVITE	45642980-0d0d25d7...	762d2880-7711e69e-...
06/27/2016 22:53:18.139	172.18.106.59	10.116.123.205	Out	SIP	180 Ringing	881dfc6101852a8f24...	881dfc61-0185000e-0...
06/27/2016 22:53:18.177	172.18.106.59	10.116.123.197	In	SIP	100 Trying	45642980-0d0d25d7...	762d2880-7711e69e-...
06/27/2016 22:53:18.362	172.18.106.59	10.116.123.197	In	SIP	180 Ringing	45642980-0d0d25d7...	762d2880-7711e69e-...
06/27/2016 22:53:21.059	172.18.106.59	10.116.123.197	In	SIP	200 OK	45642980-0d0d25d7...	762d2880-7711e69e-...
06/27/2016 22:53:21.073	172.18.106.59	10.116.123.197	Out	SIP	ACK	45642980-0d0d25d7...	762d2880-7711e69e-...
06/27/2016 22:53:21.077	172.18.106.59	10.116.123.205	Out	SIP	200 OK	881dfc6101852a8f24...	881dfc61-0185000e-0...
06/27/2016 22:53:21.081	172.18.106.59	10.116.123.197	Out	SIP	UPDATE	45642980-0d0d25d7...	762d2880-7711e69e-...
06/27/2016 22:53:21.162	172.18.106.59	10.116.123.197	In	SIP	200 OK	45642980-0d0d25d7...	762d2880-7711e69e-...
06/27/2016 22:53:21.162	172.18.106.59	10.116.123.205	In	SIP	ACK	881dfc6101852a8f24...	881dfc61-0185000e-0...
06/27/2016 22:53:21.163	172.18.106.59	10.116.123.205	Out	SIP	UPDATE	45642965-0d0d25d7...	881dfc61-0185000e-0...
06/27/2016 22:53:21.189	172.18.106.59	10.116.123.205	In	SIP	200 OK	45642965-0d0d25d7...	881dfc61-0185000e-0...
06/27/2016 22:53:21.253	172.18.106.59	10.116.123.197	In	SIP	BYE	ac7e8ab699c82f4027...	762d2880-7711e69e-...
06/27/2016 22:53:21.256	172.18.106.59	10.116.123.205	Out	SIP	BYE	45642965-0d0d25d7...	881dfc61-0185000e-0...
06/27/2016 22:53:21.257	172.18.106.59	10.116.123.197	Out	SIP	200 OK	ac7e8ab699c82f4027...	762d2880-7711e69e-...

Lines Processed: 1329901     SCCP     H.245     Exclude SCCP and MGCP Keepalives

Msgs Processed: 26358     SIP     MGCP     Exclude SIP REGISTER     Exclude SIP OPTIONS

Msgs Displayed: 22     Q.931 / H.225     MGCP BH     Exclude SIP SUBSCRIBE / NOTIFY / PUBLISH

Click 'Generate Diagram' button to generate a Message Sequence Diagram

# Case Study 4: Call Drops after Answering

Can rename headers to make viewing diagram easier

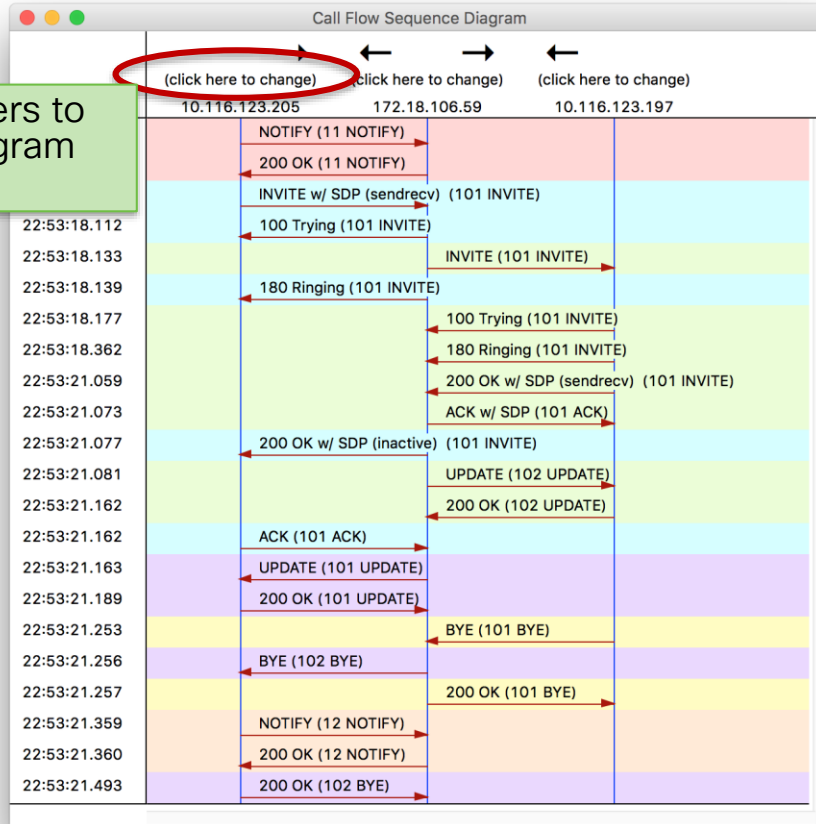

# Case Study 4: Call Drops after Answering

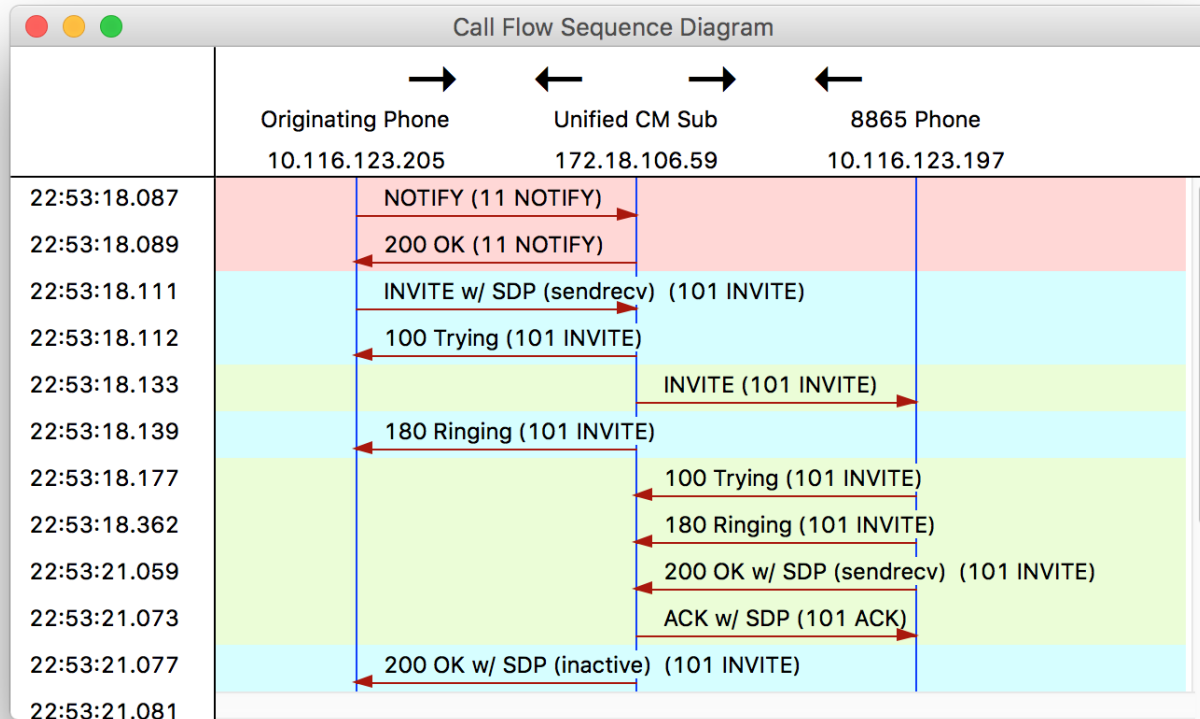

# Case Study 4: Call Drops after Answering

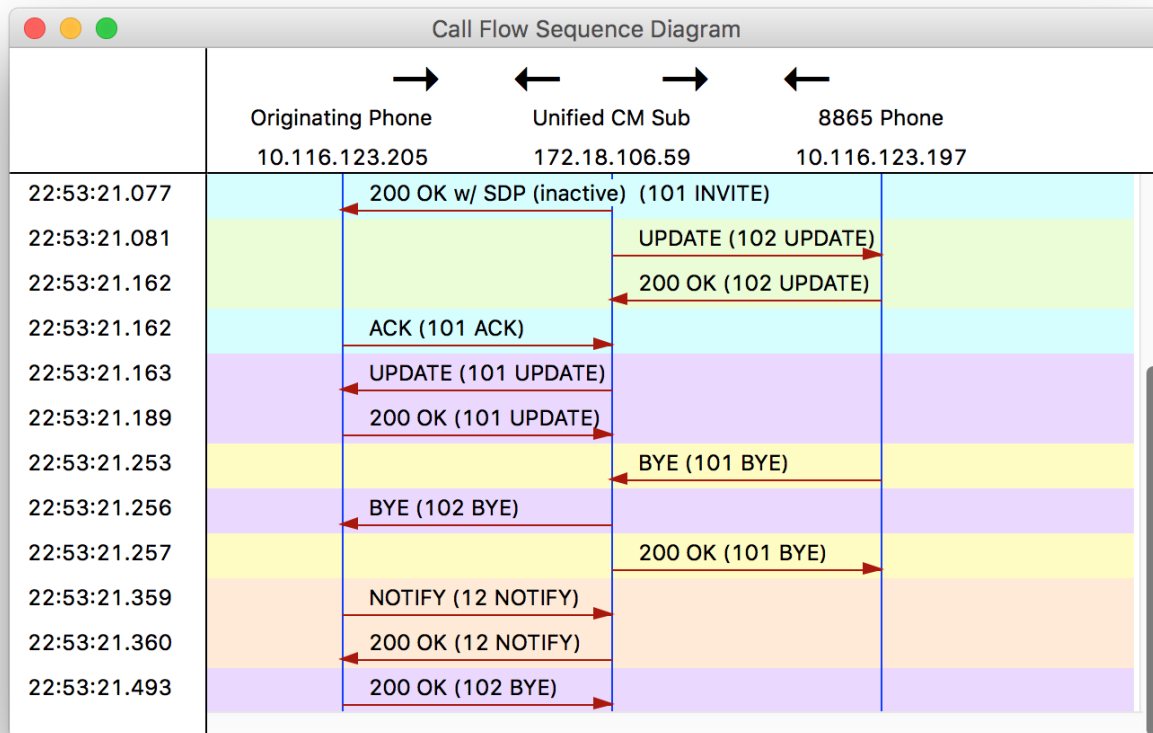

# Case Study 4: Call Drops after Answering

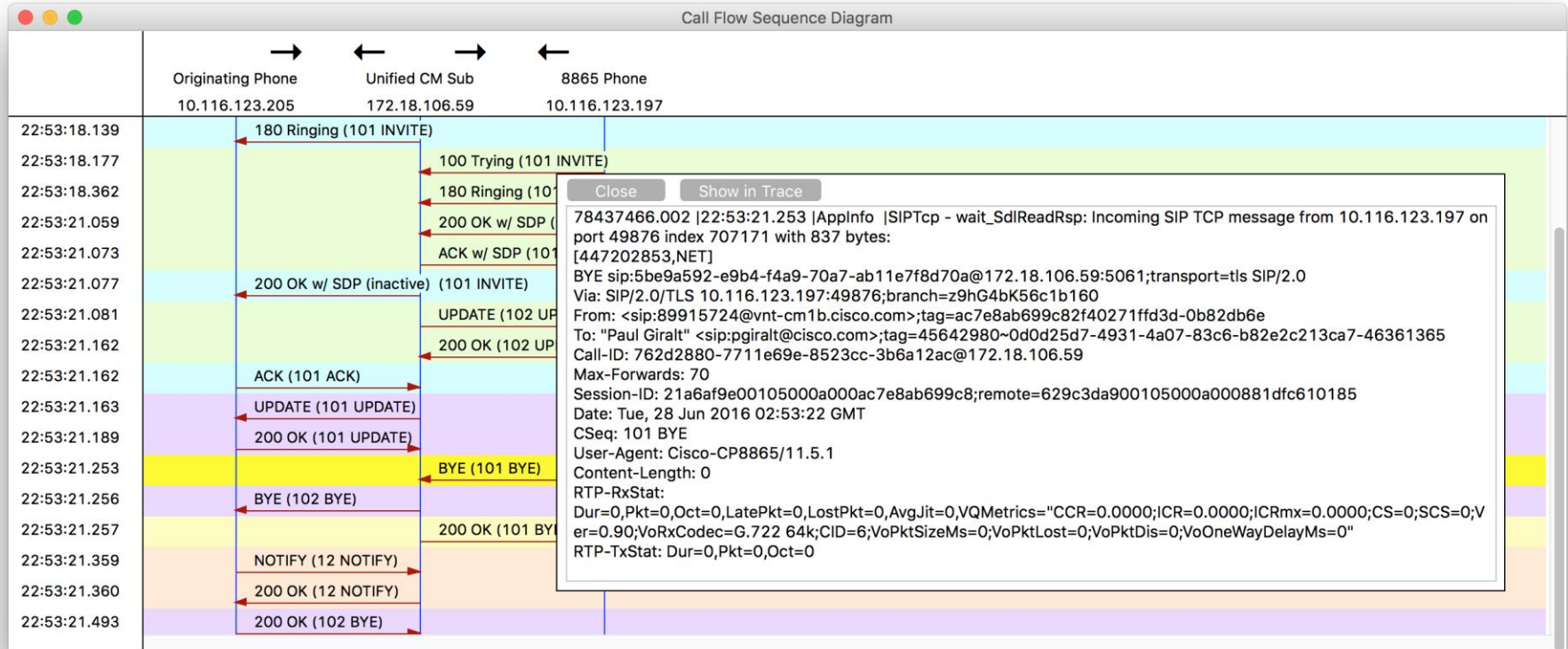

# Case Study 4: Call Drops after Answering

BYE sip:5be9a592-e9b4-f4a9-70a7-ab11e7f8d70a@172.18.106.59:5061;transport=tls SIP/2.0  
Via: SIP/2.0/TLS 10.116.123.197:49876;branch=z9hG4bK56c1b160  
From: <sip:89915724@vnt-cm1b.cisco.com>;tag=ac7e8ab699c82f40271ffd3d-0b82db6e  
To: "Paul Giralt" <sip:pgiralt@cisco.com>;tag=45642980~0d0d25d7-4931-4a07-83c6-b82e2c213ca7-46361365  
Call-ID: 762d2880-7711e69e-8523cc-3b6a12ac@172.18.106.59  
Max-Forwards: 70  
Session-ID: 21a6af9e00105000a000ac7e8ab699c8;remote=629c3da900105000a000881dfc610185  
Date: Tue, 28 Jun 2016 02:53:22 GMT  
CSeq: 101 BYE  
User-Agent: Cisco-CP8865/11.5.1  
Content-Length: 0  
RTP-RxStat:  
Dur=0,Pkt=0,Oct=0,LatePkt=0,LostPkt=0,AvgJit=0,VQMetrics="CCR=0.0000;ICR=0.0000;ICRmx=0.0000;CS=0;SCS=0;Ver=0.90;VoRxCodec=G.722 64k;CID=6;VoPktSizeMs=0;VoPktLost=0;VoPktDis=0;VoOneWayDelayMs=0"  
RTP-TxStat: Dur=0,Pkt=0,Oct=0



# Case Study 4: Call Drops after Answering

- Why did phone send a BYE?

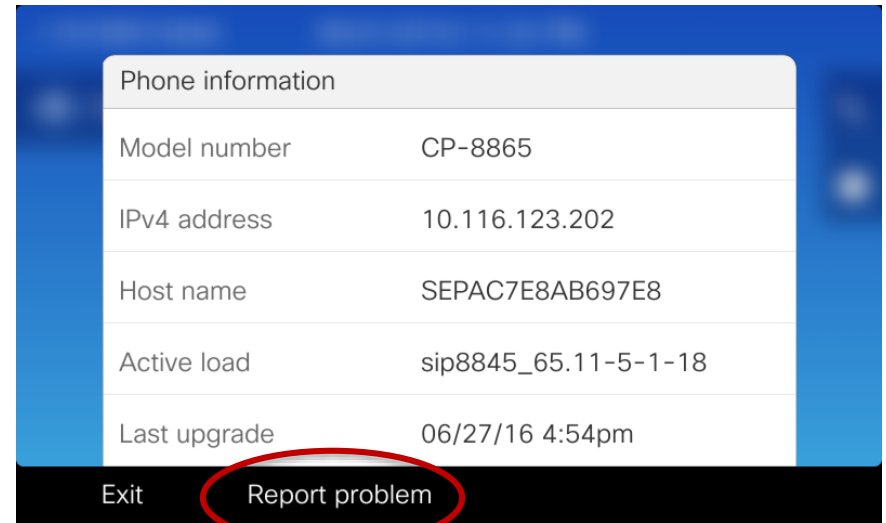
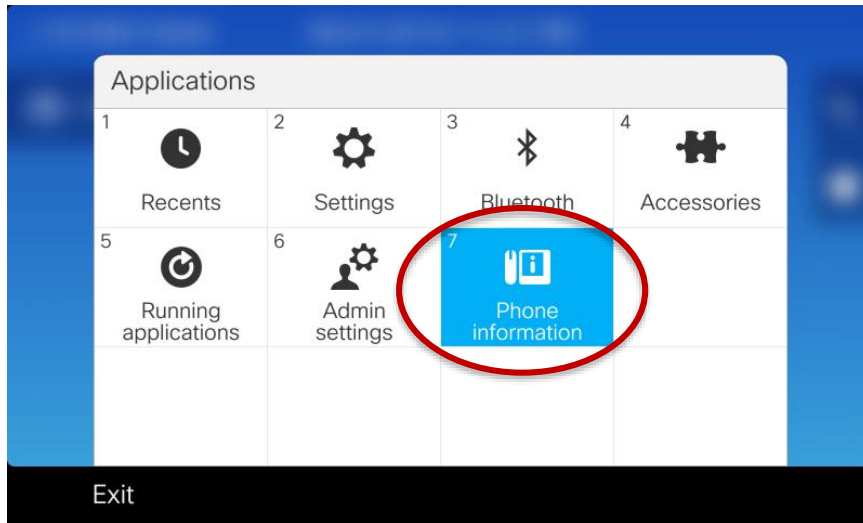

# Case Study 4: Call Drops after Answering

- Generate a Problem Report

Problem reporting tool

1 Date of problem 06/27/2016

2 Time of problem 10:53 PM

3 Problem description Failed to place a call

Exit Submit

Problem reporting tool

1 Date of problem 06/27/2016

2 Time of problem 10:53 PM

3 Problem description Failed to place a call

Error: -1

Failed to upload data, but the report can be accessed from the phone directly:  
<http://10.116.123.202/FS/prt-20160627-232254-AC7E8AB697E8.tar.gz>

Ok

# Case Study 4: Call Drops after Answering

- Retrieve Problem Report from Phone
- Must have Web access enabled on Unified CM configuration page for phone.

Web Access*	Enabled
HTTPS Server*	http and https Enabled

- Download Logs from phone web page

The screenshot shows the Cisco IP Phone web interface. On the left is a navigation menu with options like Device information, Network setup, Network statistics, Ethernet information, Access, Network, Device logs, Console logs, Core dumps, Status messages, Debug display, Streaming statistics, Stream 1, Stream 2, Stream 3, Stream 4, and Stream 5. The main content area is titled 'Console logs' for 'Cisco IP Phone CP-8865 (SEPAC7E8AB699C8)'. It displays a list of log files under 'Current logs in /var/log:' (messages, messages.0, messages.1) and 'Archived logs in /cisco/logsave/main:'. Below that, it shows 'Archived logs in /cisco/logsave/lastimage:' and 'Archived logs in /cisco/logsave/lasthour:'. At the bottom, 'Problem Report Tool Logs:' is highlighted with a red oval, showing a file named 'prt-20160627-231917-AC7E8AB699C8.tar.gz'.

# Case Study 4: Call Drops after Answering

- prt-20190124-134833-74A02FC0EC18
  - 74A02FC0EC18.cnf.xml ← Phone Configuration File
  - data
    - brcm\_vc4.log
    - logsave
      - backtraces
      - crash
      - lastimage
      - main ← Historical Log Files
      - miniprt
    - usrlog\_ms.2.txt
  - description-20190124-134833.log
  - logcat-20190124-134833.log ← Log File
  - resetstatus-20190124-134833.log
  - show-output-20190124-134833.log ← Various Diagnostic Commands

# Case Study 4: Call Drops after Answering

- Open logcat file in TranslatorX and filter by the SIP Call-ID from the BYE we saw come from the 8865
- Try to look for errors that might have triggered the BYE
- Double-click the BYE to find the BYE in the actual trace file

The screenshot shows the Cisco Unified Communications Trace Translator interface. At the top, there are controls for filters: "Filters Enabled", "New Filter", "Filters...", "Clear Filters", "1 Filter Configured", "Call List...", "Search", and "Clear". Below this is a table of SIP messages:

Timestamp	Node/Interface	Remote Device	Direction	Protocol	Message Name	TCP Handle/From Tag	Call Ref / ID
06/27/2016 22:53:19.582	10.116.123.197	172.18.106.59	In	SIP	INVITE	45642980-0d0d25d7-...	762d2880-7711e69e-...
06/27/2016 22:53:19.585	10.116.123.197	172.18.106.59	Out	SIP	100 Trying	45642980-0d0d25d7-...	762d2880-7711e69e-...
06/27/2016 22:53:19.599	10.116.123.197	172.18.106.59	Out	SIP	180 Ringing	45642980-0d0d25d7-...	762d2880-7711e69e-...
06/27/2016 22:53:22.327	10.116.123.197	172.18.106.59	Out	SIP	200 OK	45642980-0d0d25d7-...	762d2880-7711e69e-...
06/27/2016 22:53:22.518	10.116.123.197	172.18.106.59	In	SIP	ACK	45642980-0d0d25d7-...	762d2880-7711e69e-...
06/27/2016 22:53:22.530	10.116.123.197	172.18.106.59	In	SIP	UPDATE	45642980-0d0d25d7-...	762d2880-7711e69e-...
06/27/2016 22:53:22.533	10.116.123.197	172.18.106.59	Out	SIP	200 OK	45642980-0d0d25d7-...	762d2880-7711e69e-...
06/27/2016 22:53:22.580	10.116.123.197	172.18.106.59	Out	SIP	BYE	ac7e8ab699c82f4027...	762d2880-7711e69e-...
06/27/2016 22:53:22.696	10.116.123.197	172.18.106.59	In	SIP	200 OK	ac7e8ab699c82f4027...	762d2880-7711e69e-...

Below the table, the selected message (BYE) is expanded to show its details:

```
SIP/2.0 200 OK
Via: SIP/2.0/TLS 172.18.106.59:5061;branch=z9hG4bK58b3d0aa2789f2
From: "Paul Giralt" <sip:pgiralt@cisco.com>;tag=45642980-0d0d25d7-4931-4a07-83c6-b82e2c213ca7-46361365
To: <sip:89915724@vnt-cmlb.cisco.com>;tag=ac7e8ab699c82f40271ffd3d-0b82db6e
Call-ID: 762d2880-7711e69e-8523cc-3b6a12ac@172.18.106.59
Session-ID: 21a6af9e00105000a000ac7e8ab699c8;remote=629c3da900105000a000881dfc610185
Date: Tue, 28 Jun 2016 02:53:22 GMT
CSeq: 102 UPDATE
Server: Cisco-CP8865/11.5.1
Contact: <sip:38dc3aed-5f98-8095-009e-eb6ff64d67495810.116.123.197:49876;transport=tls>;+u.sip!
devicename.ccm.cisco.com="SEPACTE8AB699C8";video
Allow: ACK,BYE,CANCEL,INVITE,NOTIFY,OPTIONS,REFER,REGISTER,UPDATE,SUBSCRIBE,INFO
Content-Length: 0
```

At the bottom, there are statistics and filter options:

Lines Processed: 21719  
Msgs Processed: 283  
Msgs Displayed: 9

Filters:  SCCP  H.245  Exclude SCCP and MGCP Keepalives  
 SIP  MGCP  Exclude SIP REGISTER  Exclude SIP OPTIONS  
 Q.931 / H.225  MGCP BH  Exclude SIP SUBSCRIBE / NOTIFY / PUBLISH

Buttons: Generate Diagram, Export List, Export Details

# Case Study 4: Call Drops after Answering

```
logcat-20160627-231917.log
Filter:  Clear  Exclude KeepAlives Previous Error Next Error
0814 DEB Jun 27 22:53:22.580065 (20145:20301) JAVA-SIPCC-SIP_SESSION_ID: sipAddSessionIdHeader: local_uuid: 21a6af9e00105000a000ac7e8;
0815 DEB Jun 27 22:53:22.580131 (20145:20301) JAVA-SIPCC-SIP_ROUTE: SIPSPIAddRouteHeaders: Route info not available; will not add Route head
0816 DEB Jun 27 22:53:22.580180 (20145:20301) JAVA-SIP : sipTransportCreateSendMessage : sippmh_write() with message size=[837]
0817 NOT Jun 27 22:53:22.580223 (20145:20301) JAVA-SIPCC-SIP_MSG_SEND: ccsip_dump_send_msg_info: <172.18.106.59:5061>:BYE sip: "Paul G
0818 DEB Jun 27 22:53:22.580268 (20145:20301) JAVA-SIPCC-SIP_TRANS: sipTransportSendMessage: Sip msg sent handle=<96>,length=<837>, me
0819 DEB Jun 27 22:53:22.580436 (20145:20301) JAVA-sipio-sent---> BYE sip:5be9a592-e9b4-f4a9-70a7-ab11e7f8d70a@172.18.106.59:5061;tr
Via: SIP/2.0/TLS 10.116.123.197:49876;branch=z9hG4bK56c1b160^M
From: <sip:89915724@vnt-cm1b.cisco.com>;tag=ac7e8ab699c82f40271ffd3d-0b82db6e^M
To: "Paul Giralt" <sip:pgiralt@cisco.com>;tag=45642980~0d0d25d7-4931-4a07-83c6-b82e2c213ca7-46361365^M
Call-ID: 762d2880-7711e69e-8523cc-3b6a12ac@172.18.106.59^M
Max-Forwards: 70^M
Session-ID: 21a6af9e00105000a000ac7e8ab699c8;remote=629c3da900105000a000881dfc610185^M
Date: Tue, 28 Jun 2016 02:53:22 GMT^M
CSeq: 101 BYE^M
User-Agent: Cisco-CP8865/11.5.1^M
Content-Length: 0^M
RTP-RxStat: Dur=0,Pkt=0,Oct=0,LatePkt=0,LostPkt=0,AvgJit=0,VQMetrics="CCR=0.0000;ICR=0.0000;ICRmx=0.0000;CS=0;SCS=0;Ver=0.90;VoR
RTP-TxStat: Dur=0,Pkt=0,Oct=0^M
^M
0820 DEB Jun 27 22:53:22.580470 (20145:20301) JAVA-::End-Of-Sip-Message::
0821 DEB Jun 27 22:53:22.580496 (20145:20301) JAVA-SIPCC-ENTRY: LINE 0/1: sipTransportSendMessage : Stopping reTx timer
0822 DEB Jun 27 22:53:22.580521 (20145:20301) JAVA-[[MESSAGE_1.0]]: [SIPCC] --> BYE sip:5be9a592-e9b4-f4a9-70a7-ab11e7f8d70a@172.18
0823 DEB Jun 27 22:53:22.580698 (20145:20301) JAVA-SIPCC-SIP_MSG_SEND: ccsip_store_send_msg_for_alarm: local_uuid:21a6af9e00105000a000
0824 DEB Jun 27 22:53:22.580731 (20145:20301) JAVA-SIPCC-SIP_MSG_SEND: ccsip_store_send_msg_for_alarm: Sent:BYE sip:5be9a592-e9b4-f4a9
0825 DEB Jun 27 22:53:22.580789 (20145:20301) JAVA-SIPCC-SIP_STATE: 1/55, sip_sm_change_state: Change state SIP_STATE_ACTIVE -> SIP_STATE
0826 DEB Jun 27 22:53:22.580811 (20145:20301) JAVA-sip_platform_supervision_disconnect_timer_stop for ccb-index=0
0827 NOT Jun 27 22:53:22.581887 (20135:20175) ms-ACOLUSTICAFEC::aecProcessCmdQue: Aec mute [value= 11 [result = 0]
```

# Case Study 4: Call Drops after Answering





```
logcat-20160627-231917.log
Filter: ERR
Clear
Exclude KeepAlives
Previous Error
Next Error
9877 ERR Jun 27 22:53:22.303063 (20145:20263) JAVA-mediacontrolui MQThread|cip.msui.MediaControl:? - MediaManager: featureInvoked: cip.mmgr.InputFeature@c7
9914 ERR Jun 27 22:53:22.321568 (20135:20135) ms_msDispatch: msapi function error: retv = -1, errno 1116, len 24, MSAPI opcode = 9(opMS_stopSession)
9915 ERR Jun 27 22:53:22.321651 (20145:20303) JAVA-libms: doorCallFunc - (null)- IPC doorcall detects a return value -1 with errno 1116 ***
9924 ERR Jun 27 22:53:22.321883 (20135:20135) ms_msDispatch: msapi function error: retv = -1, errno 1116, len 24, MSAPI opcode = 10(opMS_deallocateSession)
9925 ERR Jun 27 22:53:22.321938 (20145:20303) JAVA-libms: doorCallFunc - (null)- IPC doorcall detects a return value -1 with errno 1116 ***
0077 ERR Jun 27 22:53:22.433157 (20145:20263) JAVA-mediacontrolui MQThread|cip.msui.MediaControl:in the buttonSpeaker - The keyActions iscip.app.KeyAction@44
0078 ERR Jun 27 22:53:22.516944 (356:356) SECUREAPP-SSL_READ error 2
0305 ERR Jun 27 22:53:22.534696 (20145:20303) JAVA-SIPCC-ICEMGR: iceAddRemoteCandidates: cannot find ice session for handle=65591
0322 ERR Jun 27 22:53:22.535563 (20145:20303) JAVA-SIPCC-PLAT_API: jGetCameraShutterState:
0353 ERR Jun 27 22:53:22.537293 (20145:20303) JAVA-SIPCC-PLAT_API: jGetCameraShutterState:
0417 ERR Jun 27 22:53:22.539236 (20145:20303) JAVA-SIPCC-ICEMGR: iceAddRemoteCandidates: cannot find ice session for handle=65591
0442 ERR Jun 27 22:53:22.540269 (20145:20303) JAVA-SIPCC-PLAT_API: jGetCameraShutterState:
0520 ERR Jun 27 22:53:22.544324 (20145:20303) JAVA-SIPCC-MSP: get_session_handle: Session handle not found: sid[805306400]
0615 ERR Jun 27 22:53:22.554197 (20145:20303) JAVA-SIPCC-PLAT_API: jSessionGetVideoMuteState: call_id=55_line=1
0687 ERR Jun 27 22:53:22.575429 (20135:20135) ms-WLANMGR.wlanm_getClassifier NO more classifier element !
0688 ERR Jun 27 22:53:22.575445 (20135:20135) ms-RTPSESSION.createRTPSession RTP Dual session could not be created since no available classifier in wlanmgr!
0692 ERR Jun 27 22:53:22.575510 (20135:20135) ms_msDispatch: msapi function error: retv = -1, errno 1116, len 24, MSAPI opcode = 59(opMS_createRTPSession)
0693 ERR Jun 27 22:53:22.575566 (20145:20303) JAVA-libms: doorCallFunc - (null)- IPC doorcall detects a return value -1 with errno 1116 ***
0695 ERR Jun 27 22:53:22.575670 (20145:20303) JAVA-VCM : vcmRxStart : ms_createRTPSession failed.. error=-1116
0709 ERR Jun 27 22:53:22.575912 (20145:20303) JAVA-SIPCC-PLAT_API: jSessionGetVideoMuteState: call_id=55_line=1
0719 ERR Jun 27 22:53:22.577225 (20135:20135) ms-WLANMGR.wlanm_getClassifier NO more classifier element !
0720 ERR Jun 27 22:53:22.577240 (20135:20135) ms-RTPSESSION.createRTPSession RTP Dual session could not be created since no available classifier in wlanmgr!
0724 ERR Jun 27 22:53:22.577305 (20135:20135) ms_msDispatch: msapi function error: retv = -1, errno 1116, len 24, MSAPI opcode = 59(opMS_createRTPSession)
0725 ERR Jun 27 22:53:22.577359 (20145:20303) JAVA-libms: doorCallFunc - (null)- IPC doorcall detects a return value -1 with errno 1116 ***
0731 ERR Jun 27 22:53:22.577470 (20145:20303) JAVA-VCM : vcmTxStart : ms_createRTPSession failed.. error=-1116
0747 ERR Jun 27 22:53:22.578096 (20145:20303) JAVA-VCM : remove_from_ring_queue : Stop Ringing line 1 does not exist in queue.
0910 ERR Jun 27 22:53:22.645346 (20135:20135) ms-VIDEO_MUTE video_muteVideo [sinkType=0x00001001 - 0x00001002] [name=local - remote] sinks not found
```



SIP  
BYE



# Case Study 4: Call Drops after Answering

<https://bst.cloudapps.cisco.com/bugsearch/>





 Save Search  Load Saved Search  Clear Search  Email Current Search

Search For:   

Examples: CSCta04879, router crash, etc...

Product:    *Select*

Releases:  

Modified Date:   Status:   Severity:   Rating:   Support Cases:  



# Case Study 4: Call Drops after Answering

<https://bst.cloudapps.cisco.com/bugsearch/bug/CSCva25320>

phone fail to answer call and reboot

CSCva25320

## ▼ Description

### Symptom:

Video call is terminated immediately after answering.

### Conditions:

Occurs if 8865 IP Phone is on WiFi and places a Video call

### Workaround:

Downgrade to 11.0 load or upgrade to load with the fix.

### Further Problem Description:

The logcat file from the phone report will contain the following error:

RTP Dual session could not be created since no available classifier in wlanmgr!

Was the description about this Bug Helpful? ☆☆☆☆☆ (0)

## ▼ Details

Last Modified: Feb 19,2017

Status: Fixed

Severity: 3 Moderate

Product: (1)

Cisco IP Phone 8800 Series

Known Affected Releases: (1)

11.7(1)

Known Fixed Releases: (4)

11.5(1)ES2

11.5(1)OD52

11.5(1)OD53

11.7(1)MN297

[Download software for Cisco IP Phone 8800 Series](#)

# Agenda

- Serviceability Tools Overview

  - Real-Time Monitoring Tool (RTMT)

  - Cisco Unified Operating System GUI

  - Cisco Unified Operating System CLI

  - Cisco Serviceability Reports

  - Cisco Unified Reporting

  - Serviceability APIs

- Troubleshooting Methodology

  - Problem Description

  - Information Collection

- Troubleshooting Case Studies

  - Dropped Call

  - Video Encryption Not Working

  - No One Answers the Phone

  - One-Way Audio

  - Unable to Place Calls

  - ActiveControl Not Working on Jabber 12.5

  - Call Drops After Answering

  - Video Call Immediately Drops

- Understanding and Troubleshooting Unified CM Throttling Events

- Troubleshooting Database Replication

# Case Study 5: Video Encryption Not Working

## Problem Description

- Video call from a Cisco DX70 to a Cisco Meeting Server is not being encrypted
- Problem is easily reproducible
- Calls are destined to the CMS Server at extension 80029999

# Case Study 5: Video Encryption Not Working

## Leverage Session Trace feature in RTMT

The screenshot displays the Cisco Unified Real Time Monitoring Tool (RTMT) interface. The main window is titled "Real Time Data" and contains a search criteria section with the following fields:

- Calling Number/URI: \*
- Called Number/URI: \*80029999
- Start Time: 2016-Jul-02 01:30:00
- Duration: 30 mins
- Time Zone: (GMT-5:0)Eastern Daylight Time-America...

A "Run" button is located below the search criteria. Below the search criteria is a table with the following data:

Start Time	Calling DN	Orig Called DN	Final Called DN	Calling Device Name	Called Device Name	Termination Cause...
2016/07/02 01:3...	89915644	80029999	80029999	SEP881DFC610185	ecats-uc-conducto...	( 16 ) Normal call ...

At the bottom of the interface, there are two checkboxes: "Include SIP Message" (checked) and "Trace Call".

# Case Study 5: Video Encryption Not Working

## Session Trace Features

- Session trace only traces SIP sessions in detail
- Can show full SIP messages
- Uses correlation tags to include all call legs related to the call selected

# Case Study 5: Video Encryption Not Working

Click on INVITE from DX70

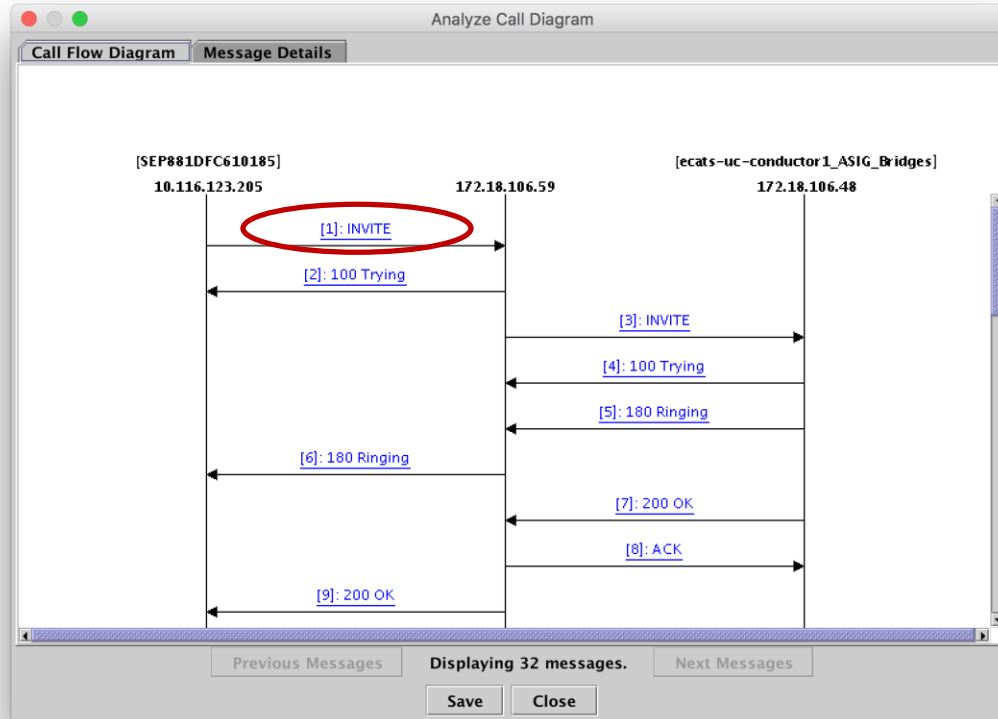

# Case Study 5: Video Encryption Not Working

## INVITE from DX70

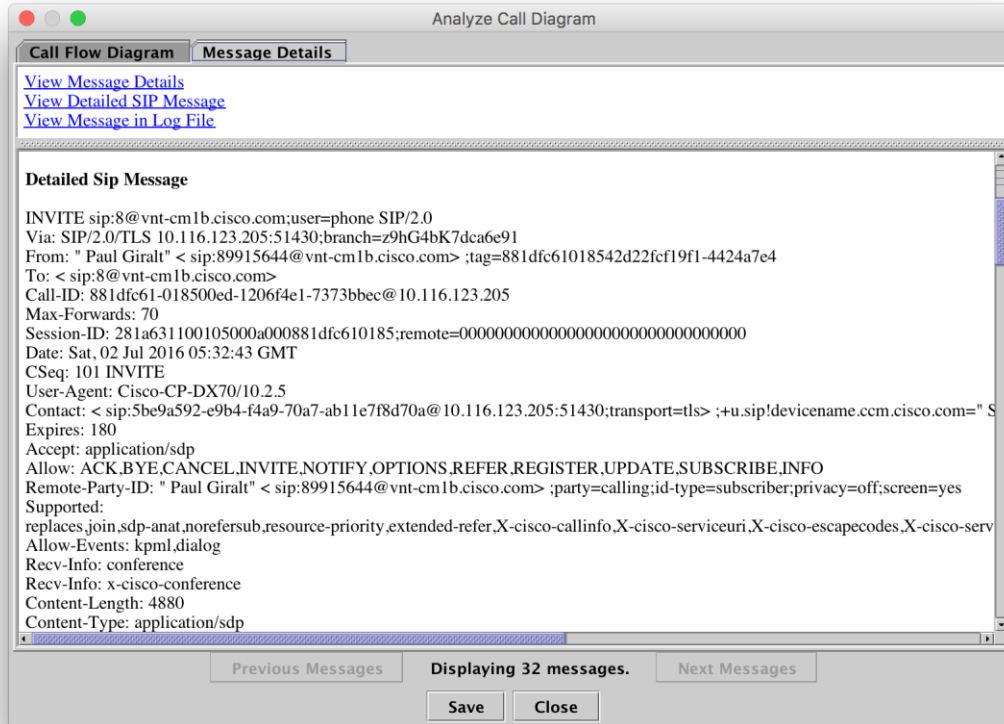

Analyze Call Diagram

Call Flow Diagram Message Details

[View Message Details](#)  
[View Detailed SIP Message](#)  
[View Message in Log File](#)

**Detailed Sip Message**

```
INVITE sip:8@vnt-cm1b.cisco.com;user=phone SIP/2.0
Via: SIP/2.0/TLS 10.116.123.205:51430;branch=z9hG4bK7dcafe91
From: " Paul Giralt" < sip:89915644@vnt-cm1b.cisco.com> ;tag=881dfc61018542d22fcf19f1-4424a7e4
To: < sip:8@vnt-cm1b.cisco.com>
Call-ID: 881dfc61-018500ed-1206f4e1-7373bbec@10.116.123.205
Max-Forwards: 70
Session-ID: 281a631100105000a000881dfc610185;remote=00000000000000000000000000000000
Date: Sat, 02 Jul 2016 05:32:43 GMT
CSeq: 101 INVITE
User-Agent: Cisco-CP-DX70/10.2.5
Contact: < sip:5be9a592-e9b4-f4a9-70a7-ab11e7f8d70a@10.116.123.205:51430;transport=tlsv;+u.sip/devicename.ccm.cisco.com=" S
Expires: 180
Accept: application/sdp
Allow: ACK,BYE,CANCEL,INVITE,NOTIFY,OPTIONS,REFER,REGISTER,UPDATE,SUBSCRIBE,INFO
Remote-Party-ID: " Paul Giralt" < sip:89915644@vnt-cm1b.cisco.com> ;party=calling;id-type=subscriber;privacy=off;screen=yes
Supported:
replaces,join,sdp-anat,norefersub,resource-priority,extended-refer,X-cisco-callinfo,X-cisco-serviceuri,X-cisco-escapecodes,X-cisco-serv
Allow-Events: kpml,dialog
Recv-Info: conference
Recv-Info: x-cisco-conference
Content-Length: 4880
Content-Type: application/sdp
```

Previous Messages    Displaying 32 messages.    Next Messages

Save    Close

# Case Study 5: Video Encryption Not Working

## Audio m-line in SDP contained in INVITE from DX70

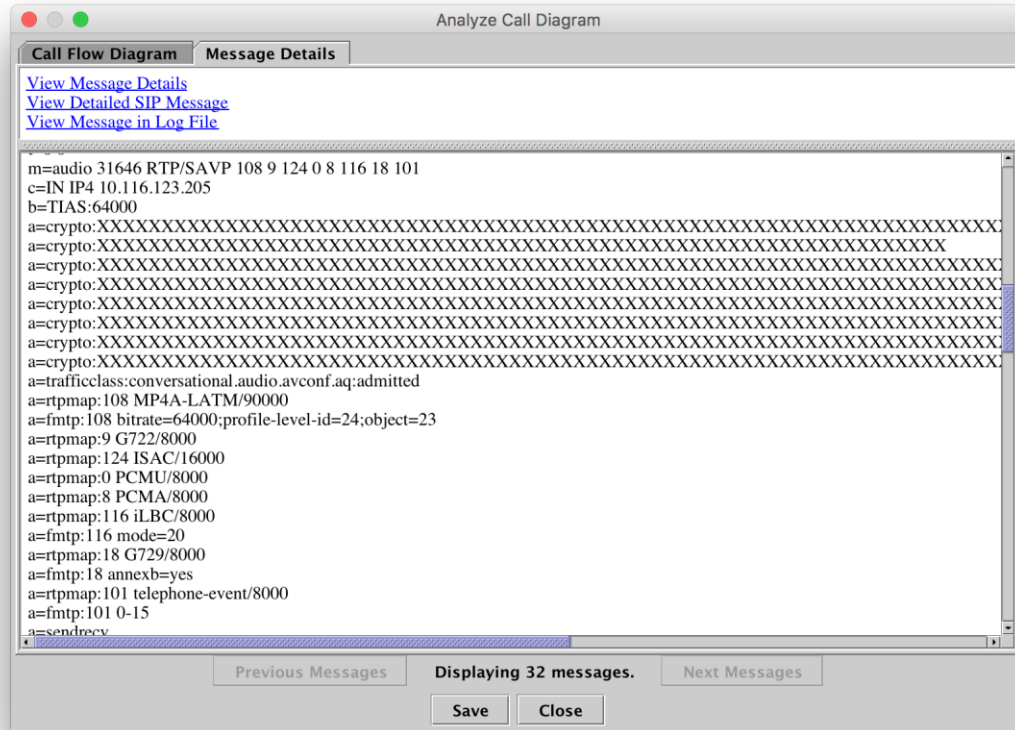

```
m=audio 31646 RTP/SAVP 108 9 124 0 8 116 18 101
c=IN IP4 10.116.123.205
b=TIAS:64000
a=crypto:XXXXXXXXXXXXXXXXXXXXXXXXXXXXXXXXXXXXXXXXXXXXXXXXXXXXXXXXXXXXXXXXXXXX
a=crypto:XXXXXXXXXXXXXXXXXXXXXXXXXXXXXXXXXXXXXXXXXXXXXXXXXXXXXXXXXXXXXXXXXXXX
a=crypto:XXXXXXXXXXXXXXXXXXXXXXXXXXXXXXXXXXXXXXXXXXXXXXXXXXXXXXXXXXXXXXXXXXXX
a=crypto:XXXXXXXXXXXXXXXXXXXXXXXXXXXXXXXXXXXXXXXXXXXXXXXXXXXXXXXXXXXXXXXXXXXX
a=crypto:XXXXXXXXXXXXXXXXXXXXXXXXXXXXXXXXXXXXXXXXXXXXXXXXXXXXXXXXXXXXXXXXXXXX
a=crypto:XXXXXXXXXXXXXXXXXXXXXXXXXXXXXXXXXXXXXXXXXXXXXXXXXXXXXXXXXXXXXXXXXXXX
a=crypto:XXXXXXXXXXXXXXXXXXXXXXXXXXXXXXXXXXXXXXXXXXXXXXXXXXXXXXXXXXXXXXXXXXXX
a=trafficclass:conversational.audio.avconf.aq:admitted
a=rtpmap:108 MP4A-LATM/90000
a=fmtp:108 bitrate=64000;profile-level-id=24;object=23
a=rtpmap:9 G722/8000
a=rtpmap:124 ISAC/16000
a=rtpmap:0 PCMU/8000
a=rtpmap:8 PCMA/8000
a=rtpmap:116 iLBC/8000
a=fmtp:116 mode=20
a=rtpmap:18 G729/8000
a=fmtp:18 annexb=yes
a=rtpmap:101 telephone-event/8000
a=fmtp:101 0-15
a=sendrecv
```



# Case Study 5: Video Encryption Not Working

Now look at 200 OK from CMS

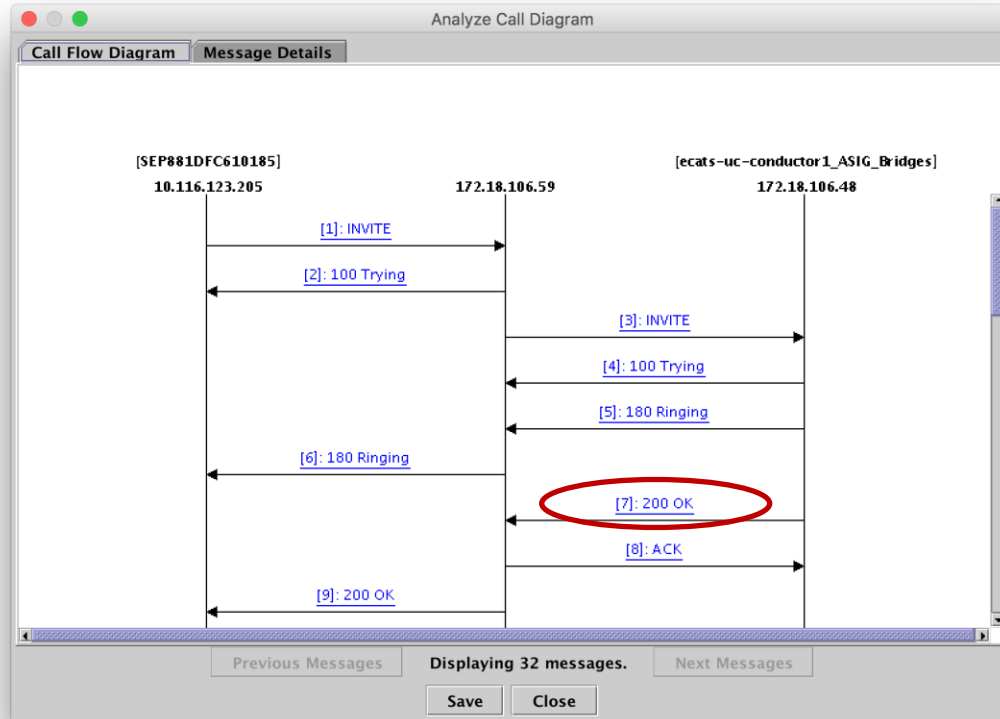

# Case Study 5: Video Encryption Not Working

## 200 OK from CMS

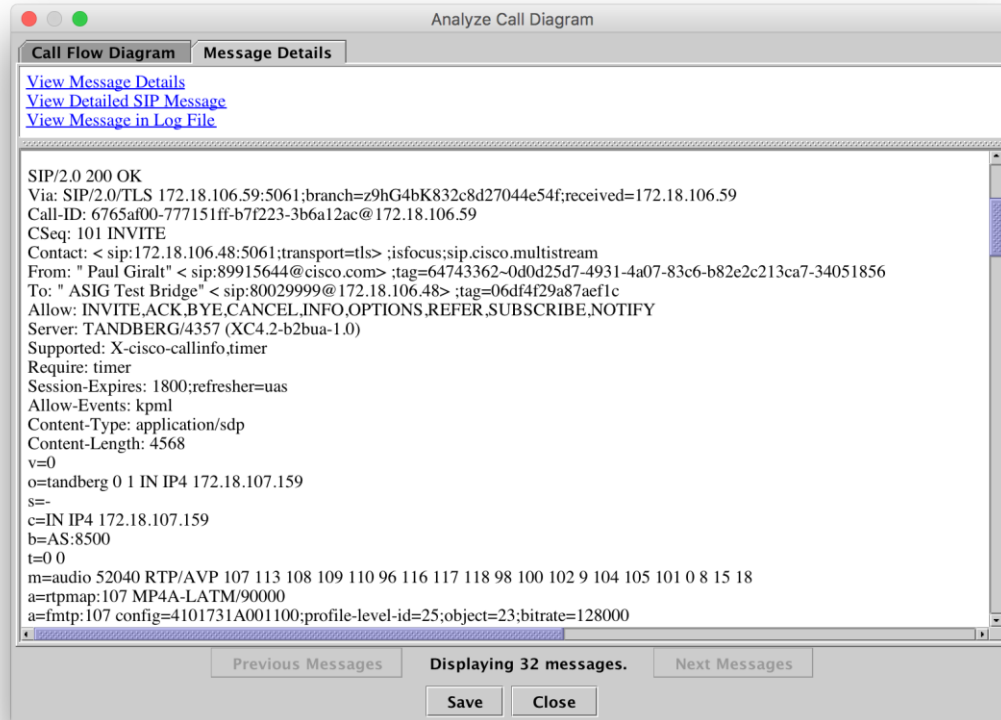



# Case Study 5: Video Encryption Not Working

Look at ACK from UCM to CMS

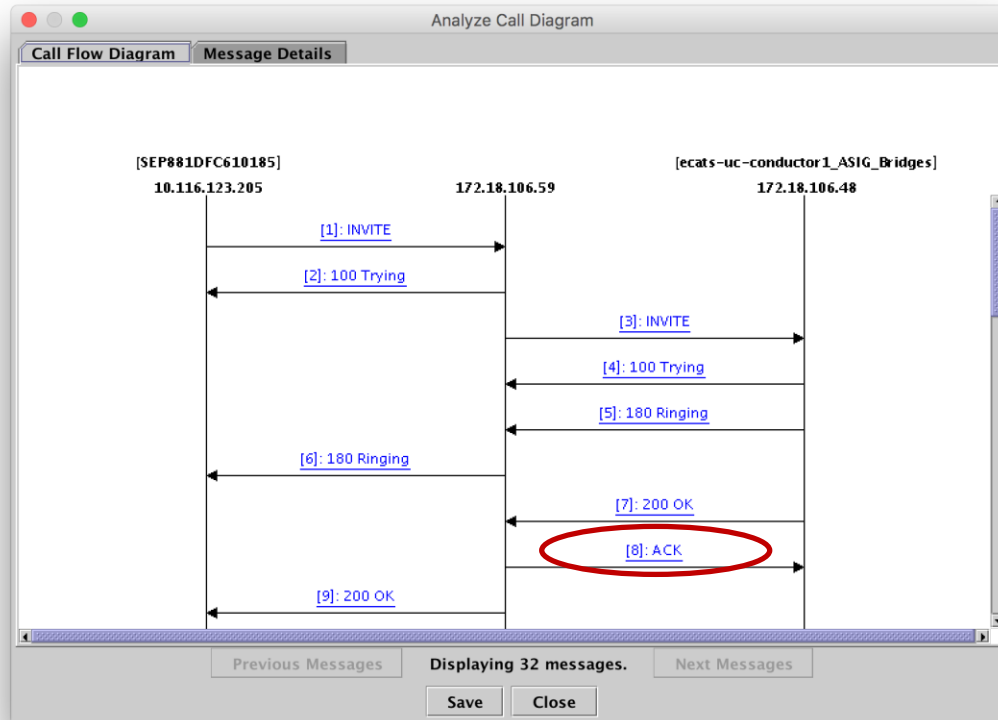

# Case Study 5: Video Encryption Not Working

## ACK from UCM to CMS

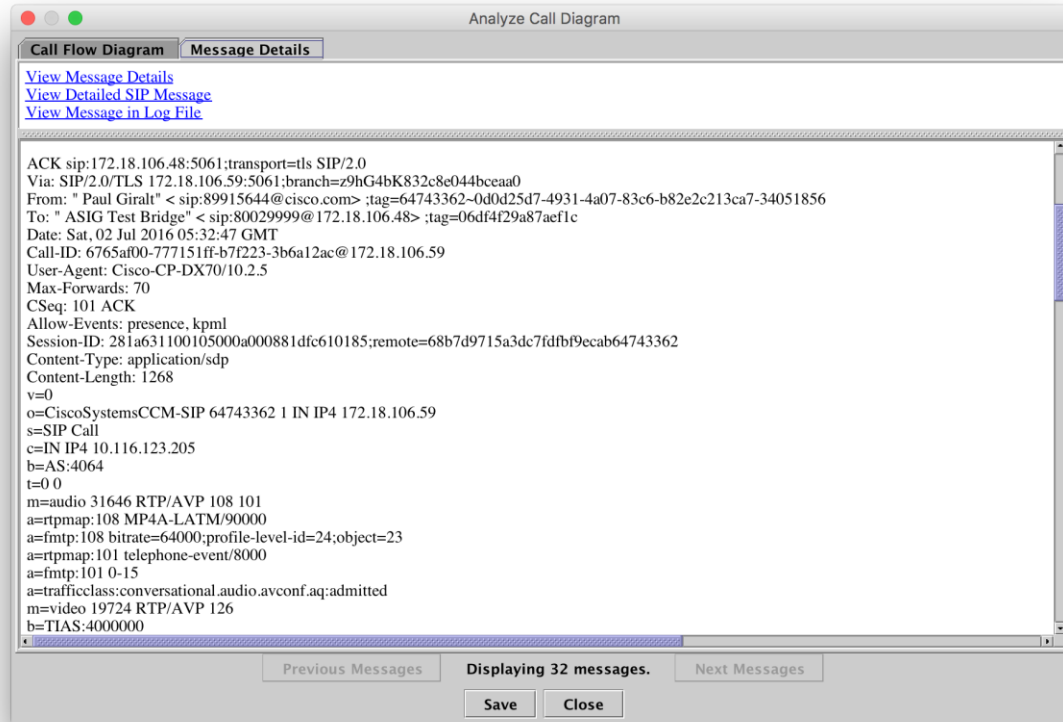

# Case Study 5: Video Encryption Not Working

## Audio m-line in SDP contained in ACK from UCM to CMS

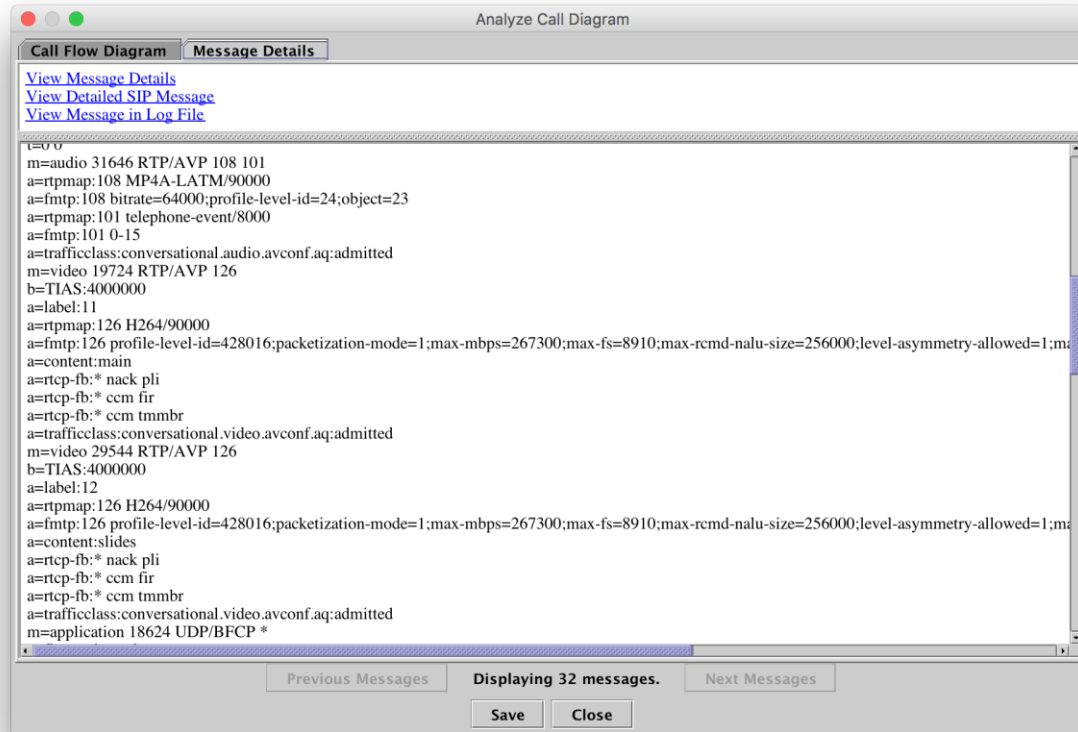

```
View Message Details
View Detailed SIP Message
View Message in Log File

t=0 0
m=audio 31646 RTP/AVP 108 101
a=rtpmap:108 MP4A-LATM/90000
a=fmtp:108 bitrate=64000;profile-level-id=24;object=23
a=rtpmap:101 telephone-event/8000
a=fmtp:101 0-15
a=trafficclass:conversational.audio.avconf.aq:admitted
m=video 19724 RTP/AVP 126
b=TIAS:4000000
a=label:11
a=rtpmap:126 H264/90000
a=fmtp:126 profile-level-id=428016;packetization-mode=1;max-mbps=267300;max-fs=8910;max-rcmd-nalu-size=256000;level-asymmetry-allowed=1;max-
a=content:main
a=rtp-fb:* nack pli
a=rtp-fb:* ccm fir
a=rtp-fb:* ccm tmmb
a=trafficclass:conversational.video.avconf.aq:admitted
m=video 29544 RTP/AVP 126
b=TIAS:4000000
a=label:12
a=rtpmap:126 H264/90000
a=fmtp:126 profile-level-id=428016;packetization-mode=1;max-mbps=267300;max-fs=8910;max-rcmd-nalu-size=256000;level-asymmetry-allowed=1;max-
a=content:slides
a=rtp-fb:* nack pli
a=rtp-fb:* ccm fir
a=rtp-fb:* ccm tmmb
a=trafficclass:conversational.video.avconf.aq:admitted
m=application 18624 UDP/BFCP *
```

# Case Study 5: Video Encryption Not Working

Look at 200 OK from UCM to DX70

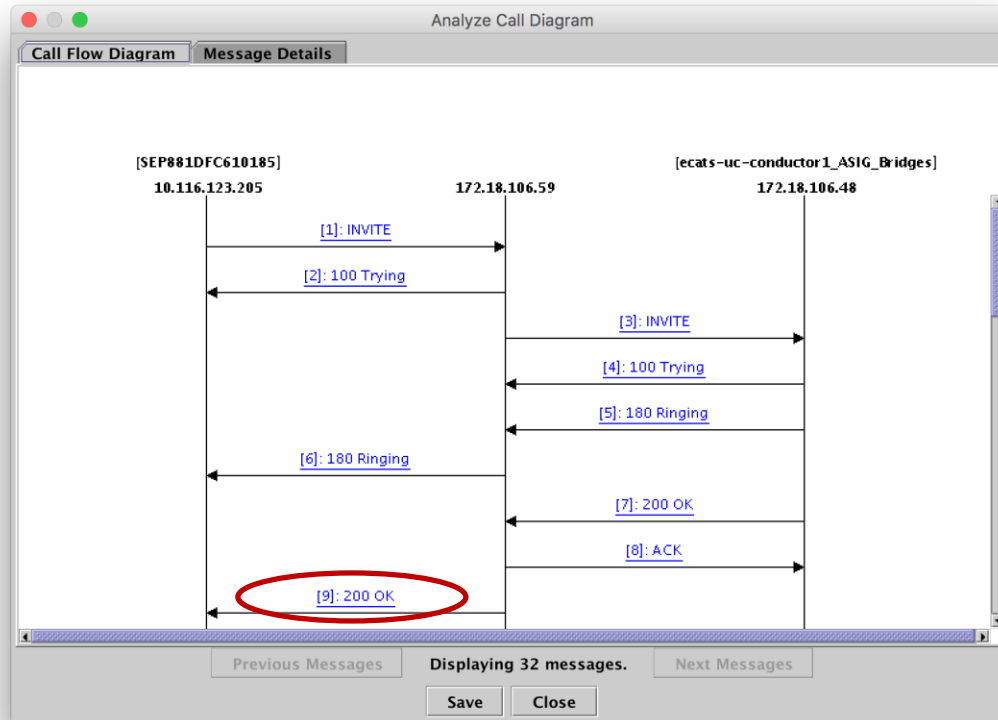

# Case Study 5: Video Encryption Not Working

## 200 OK from UCM to DX70

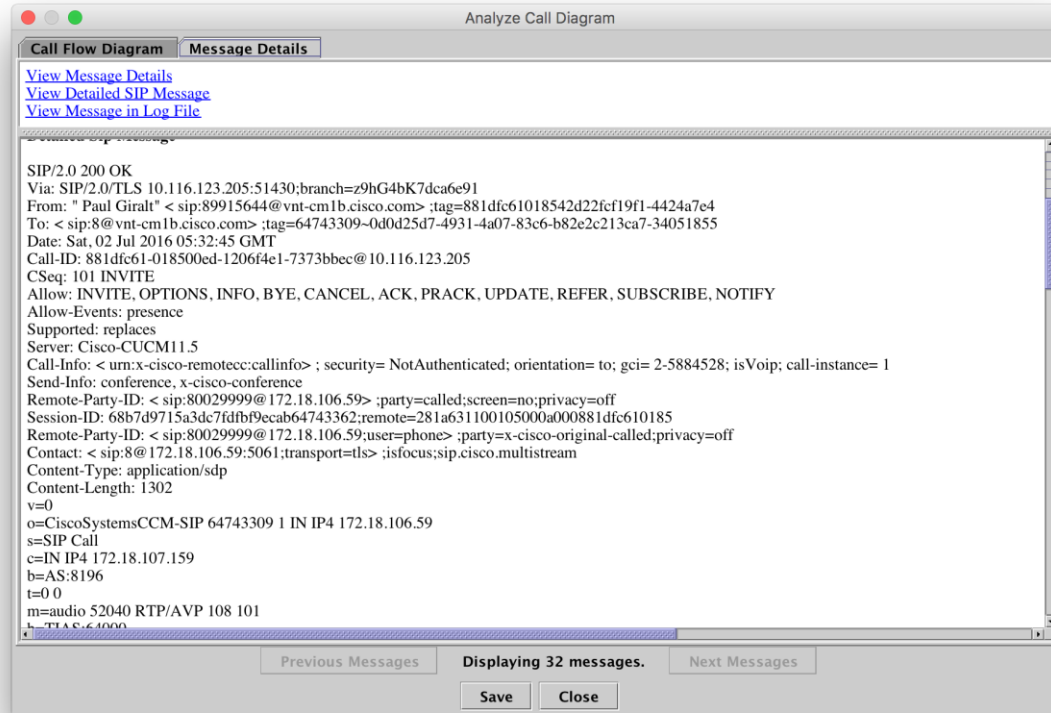



# Case Study 5: Video Encryption Not Working

Audio m-line in SDP contained in 200 OK from UCM to DX70

```
Call Flow Diagram | Message Details
View Message Details
View Detailed SIP Message
View Message in Log File
b=AS:8196
t=0
m=audio 52040 RTP/AVP 108 101
b=TIAS:64000
a=rtpmap:108 MP4A-LATM/90000
a=fmtp:108 bitrate=64000;profile-level-id=24;object=23
a=rtpmap:101 telephone-event/8000
a=fmtp:101 0-15
a=trafficclass:conversational.audio.avconf.aq:admitted
a=rtcp:52041 IN IP4 172.18.107.159
m=video 53638 RTP/AVP 126
b=TIAS:3250000
a=label:11
a=rtpmap:126 H264/90000
a=fmtp:126 profile-level-id=42E014;packetization-mode=1;max-mbps=244800;max-fs=8160;max-cpb=130;max-dpb=12240;max-br=3250;max-rcmd-nal
a=content:main
a=rtcp-fb:* nack pli
a=rtcp-fb:* ccm fir
a=rtcp-fb:* ccm tmmbr
a=trafficclass:conversational.video.avconf.aq:admitted
a=rtcp:53639 IN IP4 172.18.107.159
m=video 49652 RTP/AVP 126
b=TIAS:768000
a=label:12
a=rtpmap:126 H264/90000
a=fmtp:126 profile-level-id=42E00D;packetization-mode=1;max-mbps=18000;max-fs=9000;max-dpb=3375;max-rcmd-nalu-size=196608;max-fps=6000
a=content:slides
a=rtcp-fb:* nack pli
```

Previous Messages | **Displaying 32 messages.** | Next Messages

Save | Close

# Case Study 5: Video Encryption Not Working

Look carefully at audio and video m-lines

- SDP from Phone to UCM (Offer) w/ Crypto attributes:

```
m=audio 31646 RTP/SAVP 108 9 124 0 8 116 18 101  
m=video 19724 RTP/SAVP 100 126 97
```

- SDP from Conductor to UCM (Offer) w/ Crypto attributes:

```
m=audio 52040 RTP/AVP 107 113 108 109 110 96 116 117 118 98 100 102 9 104 105 101 0 8 15 18  
m=video 53638 RTP/AVP 126 97 99 34 31
```

- SDP from UCM to Conductor (Answer):

```
m=audio 31646 RTP/AVP 108 101  
m=video 19724 RTP/AVP 126
```

- SDP from UCM to Phone (Answer):

```
m=audio 52040 RTP/AVP 108 101  
m=video 53638 RTP/AVP 126
```

# Case Study 5: Video Encryption Not Working

## Root Cause Analysis

- Root Cause is Incompatibility between how UCM / Endpoints and Cisco Meeting Server negotiate best-effort Encryption
- Must enable cisco-meeting-server-interop Normalization Script

### Normalization Script

Normalization Script

Enable Trace

Parameter Name

Parameter Value

1



- Converts AVP w/ Crypto to SAVP w/ x-cisco-srtp-fallback

# Agenda

- Serviceability Tools Overview
  - Real-Time Monitoring Tool (RTMT)
  - Cisco Unified Operating System GUI
  - Cisco Unified Operating System CLI
  - Cisco Serviceability Reports
  - Cisco Unified Reporting
  - Serviceability APIs
- Troubleshooting Methodology
  - Problem Description
  - Information Collection
- **Troubleshooting Case Studies**
  - Dropped Call
  - No One Answers the Phone
  - Unable to Place Calls
  - Call Drops After Answering
  - Video Encryption Not Working
  - One-Way Audio**
  - ActiveControl Not Working on Jabber 12.5
  - Video Call Immediately Drops
- Understanding and Troubleshooting Unified CM Throttling Events
- Troubleshooting Database Replication

# Case Study 6: One-Way Audio

## Problem Description

- All calls from a specific MRA-registered 8865 always gets one-way audio

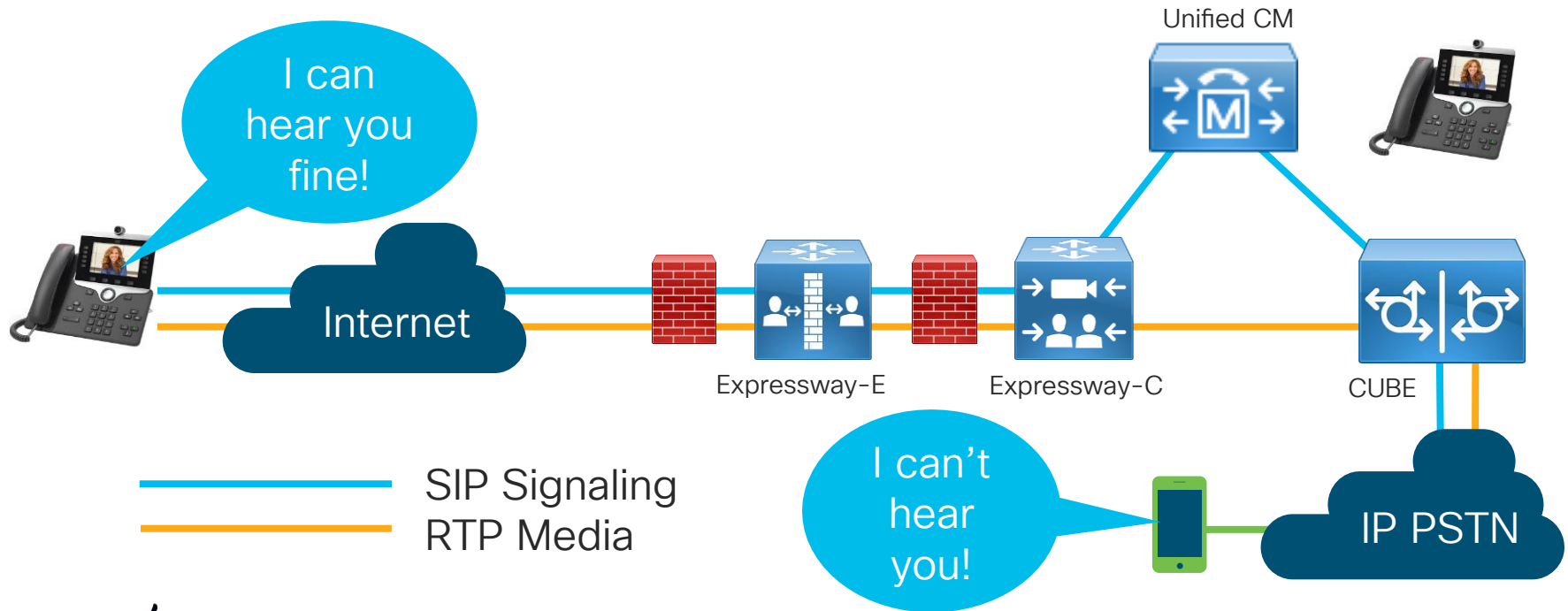

# Case Study 6: One-Way Audio

## Examine Signaling

- Gather logs from Phone, Expressway-E, Expressway-C, UCM, and CUBE
- Open in TranslatorX
- Search for Calling/Called Number
- Find INVITE
- Filter by SIP Session ID

# Case Study 8: Video Call Immediately Drops

The screenshot shows the Wireshark interface with a list of SIP messages. A context menu is open over the 'SIP Session' field of the selected message. The menu items include Protocol, Direction, IP Address, Message Name, Node ID, Correlation Tag, Q.931/H225 Call Reference, SCCP TCP Handle, SIP Call ID, SIP Session (highlighted), SIP Local Session ID, SIP Remote Session ID, and SIP From Tag. The background table shows various SIP messages with their timestamps, directions, and session IDs.

Timestamp	Source IP	Destination IP	Direction	Protocol	Message Name	Node ID	Correlation Tag	Q.931/H225 Call Reference	SCCP TCP Handle	SIP Call ID	SIP Session	SIP Local Session ID	SIP Remote Session ID	SIP From Tag
01/22/2020 13:56:39.579	172.18.106.59	173.36.37.136	In	SIP										
01/22/2020 13:56:39.581	172.18.106.59	173.36.37.136	Out	SIP										
01/22/2020 18:56:39.600	172.18.106.225	172.18.106.59	In	SIP										
01/22/2020 13:56:39.600	172.18.106.59	172.18.106.225	Out	SIP										
01/22/2020 18:56:39.605	172.18.106.225	172.18.106.59	Out	SIP										
01/22/2020 13:56:39.607	172.18.106.59	172.18.106.225	In	SIP										
01/22/2020 18:56:39.646	172.18.106.225	64.102.250.10	Out	SIP										
01/22/2020 18:56:39.650	64.102.250.10	172.18.106.225	In	SIP										
01/22/2020 18:56:39.657	64.102.250.10	172.18.106.225	Out	SIP										
01/22/2020 18:56:39.774	172.18.106.225	64.102.250.10	In	SIP										
01/22/2020 18:56:39.947	64.102.250.10	162.255.36.11	Out	SIP										
01/22/2020 18:56:39.980	64.102.250.10	162.255.36.11	In	SIP										
01/22/2020 18:56:39.982	64.102.250.10	172.18.106.225	Out	SIP										
01/22/2020 18:56:39.983	172.18.106.225	64.102.250.10	In	SIP										
01/22/2020 18:56:39.984	172.18.106.225	172.18.106.59	Out	SIP										
01/22/2020 13:56:39.985	172.18.106.59	172.18.106.225	In	SIP										
01/22/2020 13:56:39.991	172.18.106.59	173.36.37.136	Out	SIP										
01/22/2020 18:56:40.159	64.102.250.10	162.255.36.11	In	SIP										
01/22/2020 18:56:40.169	64.102.250.10	172.18.106.225	Out	SIP	200 OK			3630903~0d0d25d7-4...						
01/22/2020 18:56:40.171	172.18.106.225	64.102.250.10	In	SIP	200 OK			3630903~0d0d25d7-4...						
01/22/2020 18:56:40.177	172.18.106.225	172.18.106.59	Out	SIP	200 OK			3630903~0d0d25d7-4...						
01/22/2020 13:56:40.179	172.18.106.59	172.18.106.225	In	SIP	200 OK			3630903~0d0d25d7-4...						
01/22/2020 18:56:40.196	172.18.106.225	172.18.106.59	In	SIP	ACK			3630903~0d0d25d7-4...						
01/22/2020 13:56:40.196	172.18.106.59	172.18.106.225	Out	SIP	ACK			3630903~0d0d25d7-4...						
01/22/2020 13:56:40.198	172.18.106.59	173.36.37.136	Out	SIP	200 OK			2086966398						
01/22/2020 18:56:40.218	172.18.106.225	64.102.250.10	Out	SIP	ACK			3630903~0d0d25d7-4...						
01/22/2020 18:56:40.221	64.102.250.10	172.18.106.225	In	SIP	ACK			3630903~0d0d25d7-4...						
01/22/2020 18:56:40.241	64.102.250.10	162.255.36.178	Out	SIP	ACK			3630903~0d0d25d7-4...						

# Case Study 6: One-Way Audio

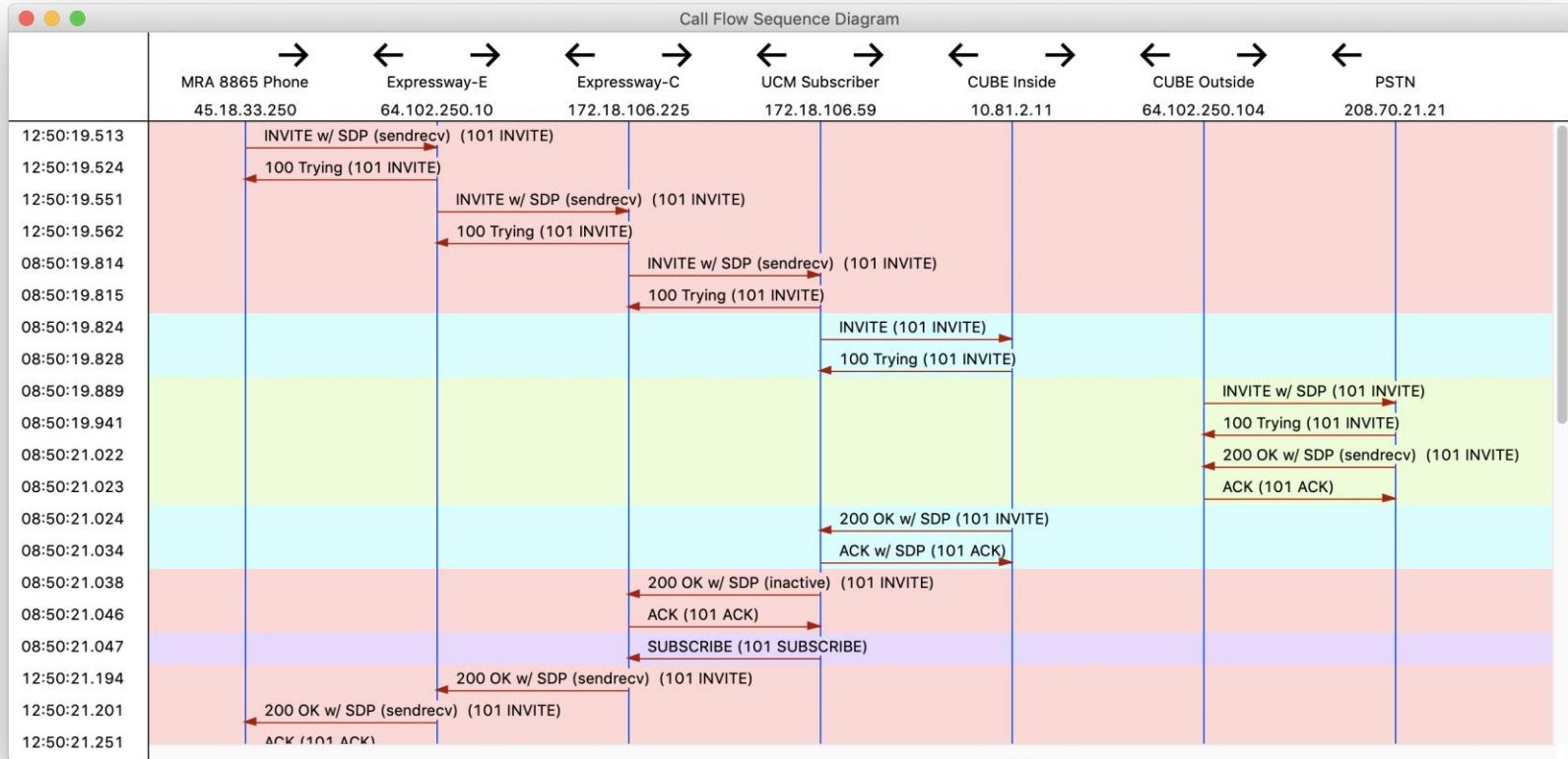



# Case Study 6: One-Way Audio

— SIP Signaling  
— RTP Media

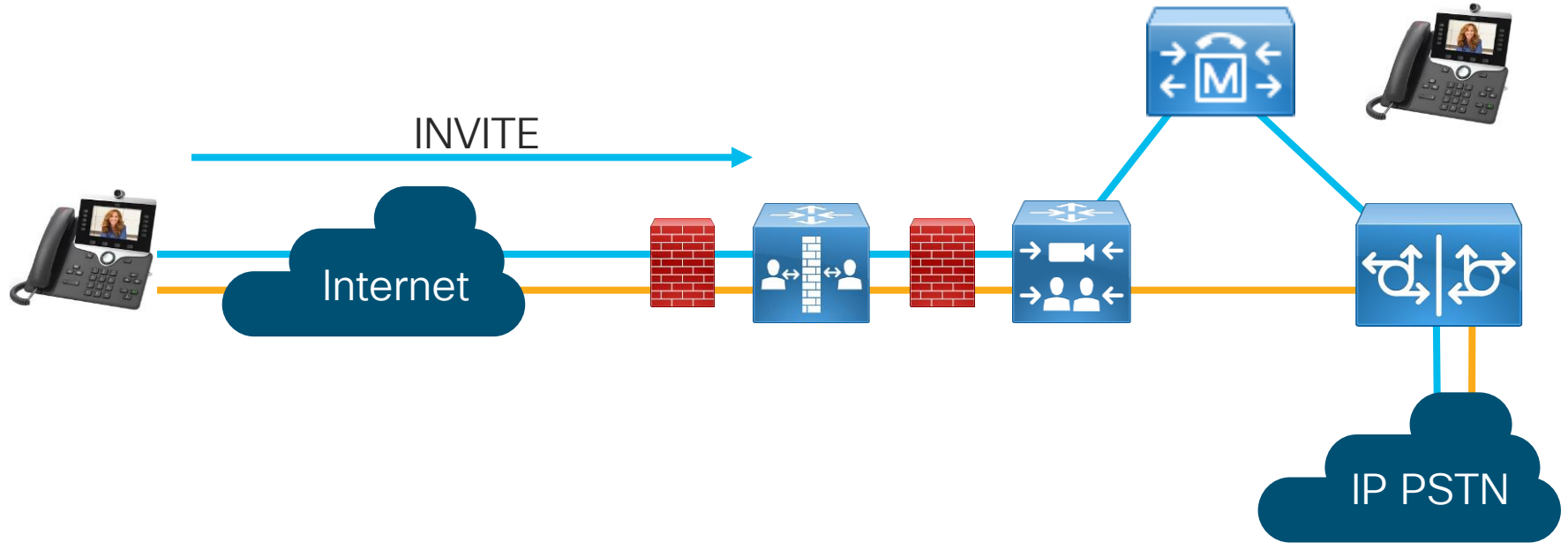

# Case Study 6: One-Way Audio

```
INVITE sip:99196277285@vnt-cmlb.cisco.com;user=phone SIP/2.0
Via: SIP/2.0/TLS 192.168.1.100:52204;branch=z9hG4bK26c16e4b
Call-ID: ac7e8ab6-99c800ac-1c9c635a-62cd8207@192.168.1.100
CSeq: 101 INVITE
Call-Info: <urn:x-cisco-remotecallinfo>;gci=1-634013
Remote-Party-ID: "Archana Sharma" <sip:89915724@vnt-cmlb.cisco.com>;party=calling;id-
type=subscriber;privacy=off;screen=yes
Contact: <sip:38dc3aed-5f98-8095-009e-
eb6f64d67495@192.168.1.100:52204;transport=tls>;+u.sip!devicename.ccm.cisco.com="SEPAC7E8AB699C8";video
From: "Archana Sharma" <sip:89915724@vnt-cmlb.cisco.com>;tag=ac7e8ab699c82a1717efbf5a-78ec7e86
To: <sip:99196277285@vnt-cmlb.cisco.com>
Max-Forwards: 70
Route: <sip:ecatlab-vcse1.ecatlab.com;transport=tls;lr>,<sip:172.18.106.225:5061;transport=tls;zone-
id=1;directed;lr>,<sip:vnt-cmlb.cisco.com;transport=tcp;lr>
Allow: ACK,BYE,CANCEL,INVITE,NOTIFY,OPTIONS,REFER,REGISTER,UPDATE,SUBSCRIBE,INFO
User-Agent: Cisco-CP8865/12.5.1
Expires: 180
Date: Sat, 08 Jun 2019 12:50:20 GMT
Proxy-Authorization: Digest username="asharma", realm="ecatlab-vcse1.ecatlab.com",
uri="sip:99196277285@vnt-cmlb.cisco.com;user=phone", response="2d56e87dc82b2777a5d17cf905dcceff",
nonce="4006fff2810efdf243bff957bf09c1f68cd9d60b0ac9e1d4044003d8e3657",
opaque="AQAAAAj8Ym6d90Ktn68XglUvg/mgqEWa", cnonce="18d871fa", qop=auth, nc=00000004, algorithm=MD5
```

# Case Study 6: One-Way Audio

```
Supported: replaces,join,sdp-anat,norefersub,resource-priority,extended-refer,X-cisco-callinfo,X-cisco-  
serviceuri,X-cisco-escapecodes,X-cisco-service-control,X-cisco-srtp-fallback,X-cisco-monrec,X-cisco-  
config,X-cisco-sis-7.0.0,X-cisco-xsi-8.5.1  
Accept: application/sdp  
Allow-Events: kpml,dialog  
Recv-Info: conference  
Recv-Info: x-cisco-conference  
Content-Disposition: session;handling=optional  
Session-ID: 660fbbdb00105000a000ac7e8ab699c8;remote=00000000000000000000000000000000  
Content-Type: application/sdp  
Content-Length: 2401
```

# Case Study 6: One-Way Audio

```
v=0
o=Cisco-SIPUA 22854 0 IN IP4 192.168.1.100
s=SIP Call
b=AS:4064
t=0 0
m=audio 22330 RTP/SAVP 114 9 124 113 115 0 8 116 18 101
c=IN IP4 192.168.1.100
b=TIAS:64000
a=crypto:1 AES_CM_128_HMAC_SHA1_80 inline:.....
a=crypto:2 AES_CM_128_HMAC_SHA1_32 inline:.....
a=crypto:3 AES_CM_128_HMAC_SHA1_80 inline:..... UNENCRYPTED_SRTCP
a=crypto:4 AES_CM_128_HMAC_SHA1_32 inline:..... UNENCRYPTED_SRTCP
a=trafficclass:conversational.audio.avconf.aq:admitted
a=rtpmap:114 opus/48000/2
a=fmtp:114 maxplaybackrate=16000;sprop-maxcapture=16000;maxaveragebitrate=64000;stereo=0;sprop-
stereo=0;usedtx=0
a=rtpmap:9 G722/8000
a=rtpmap:124 ISAC/16000
a=rtpmap:113 AMR-WB/16000
a=fmtp:113 octet-align=0;mode-change-capability=2
a=rtpmap:115 AMR-WB/16000
a=fmtp:115 octet-align=1;mode-change-capability=2
```

# Case Study 6: One-Way Audio

```
a=rtpmap:0 PCMU/8000
a=rtpmap:8 PCMA/8000
a=rtpmap:116 iLBC/8000
a=fmtp:116 mode=20
a=rtpmap:18 G729/8000
a=fmtp:18 annexb=yes
a=rtpmap:101 telephone-event/8000
a=fmtp:101 0-15
a=sendrecv
```

# Case Study 6: One-Way Audio

```
m=video 23556 RTP/SAVP 100 126 97
c=IN IP4 192.168.1.100
b=TIAS:4000000
a=crypto:1 AES_CM_128_HMAC_SHA1_80 inline:.....
a=crypto:2 AES_CM_128_HMAC_SHA1_32 inline:.....
a=crypto:3 AES_CM_128_HMAC_SHA1_80 inline:..... UNENCRYPTED_SRTCP
a=crypto:4 AES_CM_128_HMAC_SHA1_32 inline:..... UNENCRYPTED_SRTCP
a=trafficclass:conversational.video.avconf.aq:admitted
a=rtpmap:100 H264/90000
a=fmtp:100 profile-level-id=640C16;packetization-mode=1;level-asymmetry-allowed=1;max-
fs=3600;max-rcmd-nalu-size=256000
a=imageattr:* recv [x=800,y=480,q=0.60] [x=1280,y=720,q=0.50]
a=rtpmap:126 H264/90000
a=fmtp:126 profile-level-id=428016;packetization-mode=1;level-asymmetry-allowed=1;max-
fs=3600;max-rcmd-nalu-size=256000
a=imageattr:* recv [x=800,y=480,q=0.60] [x=1280,y=720,q=0.50]
a=rtpmap:97 H264/90000
a=fmtp:97 profile-level-id=428016;packetization-mode=0;level-asymmetry-allowed=1;max-
fs=3600;max-rcmd-nalu-size=256000
a=imageattr:* recv [x=800,y=480,q=0.60] [x=1280,y=720,q=0.50]
a=rtcp-fb:* nack pli
a=rtcp-fb:* ccm tmmbr
a=sendrecv
```

# Case Study 6: One-Way Audio

— SIP Signaling  
— RTP Media

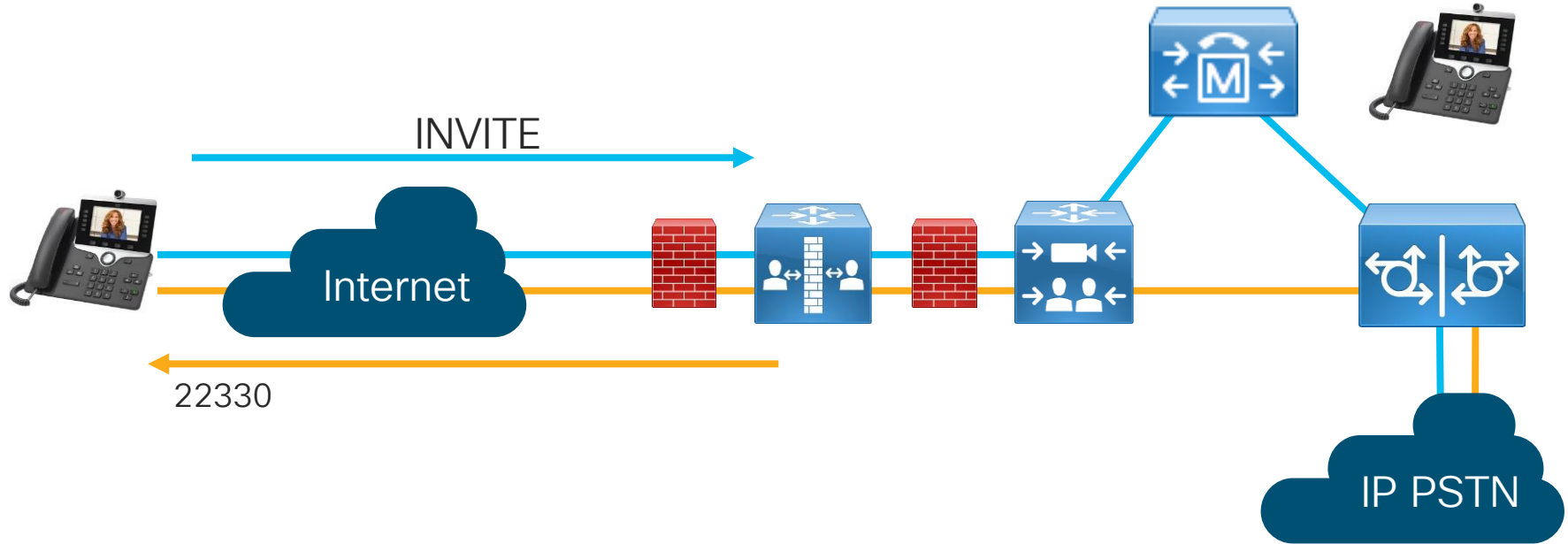

# Case Study 6: One-Way Audio

— SIP Signaling  
— RTP Media

```
m=audio 50000 RTP/SAVP 114 9 124 113 115 0 8 116 18 101  
c=IN IP4 64.102.250.10
```

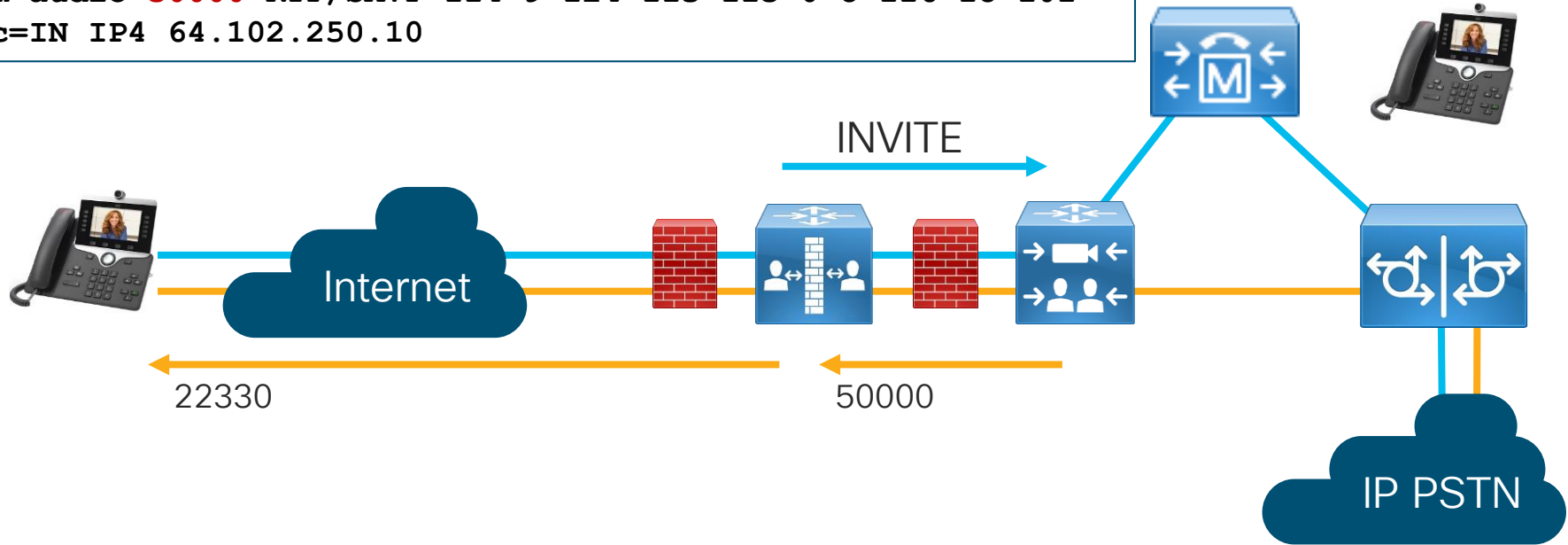



# Case Study 6: One-Way Audio

— SIP Signaling  
— RTP Media

```
m=audio 55396 RTP/AVP 114 9 124 113 0 8 116 18 101  
c=IN IP4 172.18.106.225
```

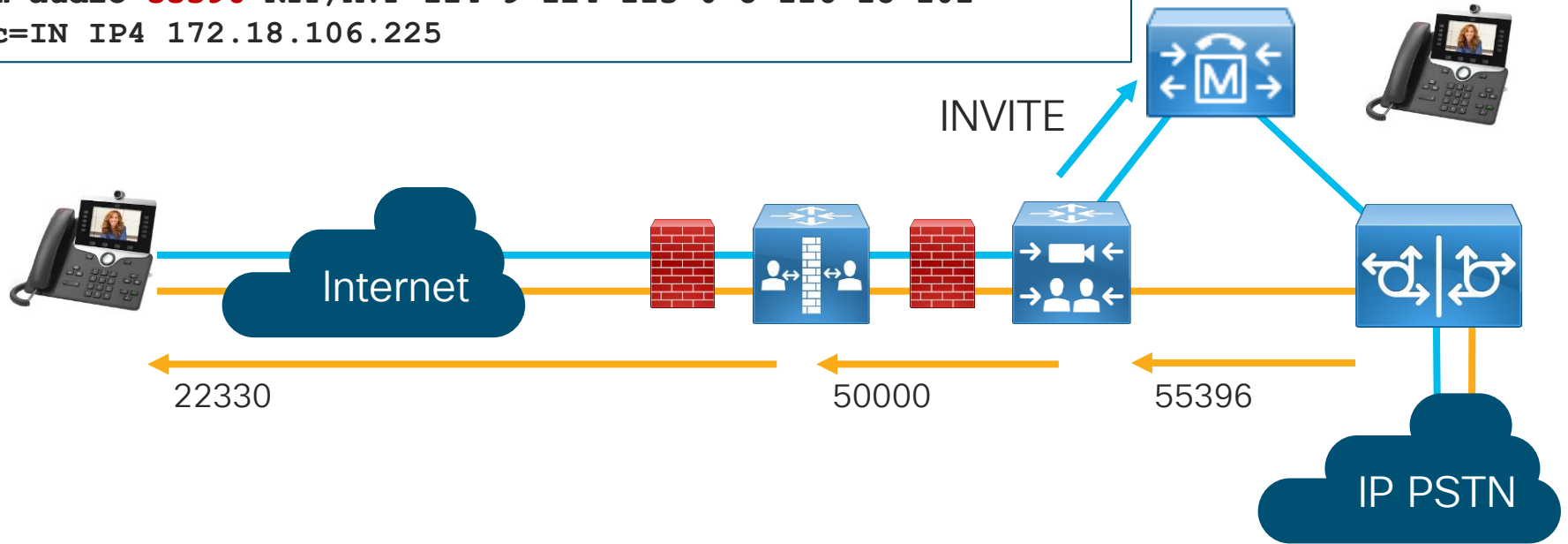

# Case Study 6: One-Way Audio

— SIP Signaling  
— RTP Media

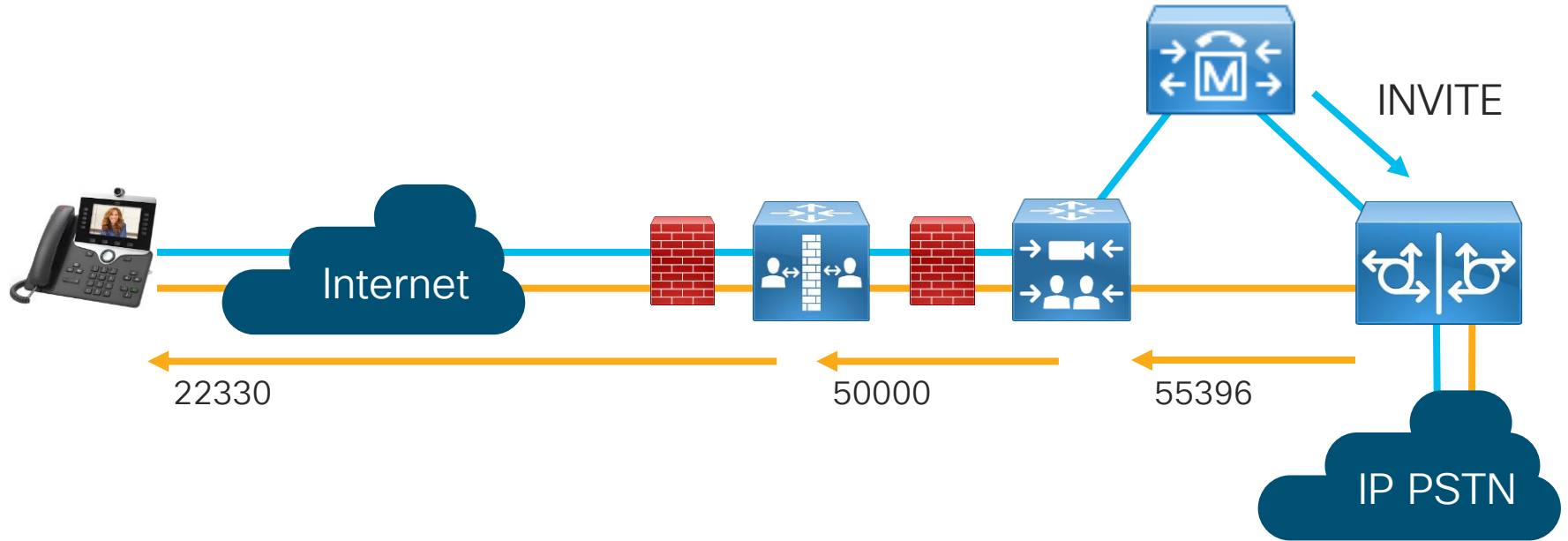

# Case Study 6: One-Way Audio

— SIP Signaling  
— RTP Media

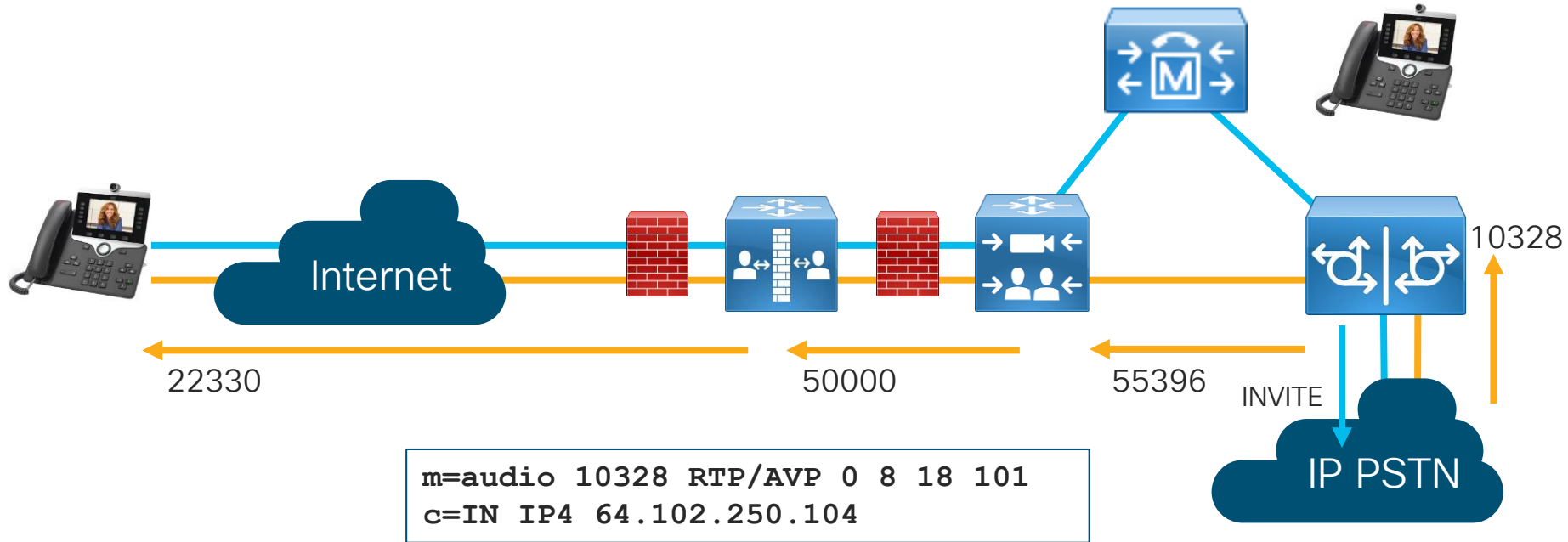

# Case Study 6: One-Way Audio

— SIP Signaling  
— RTP Media

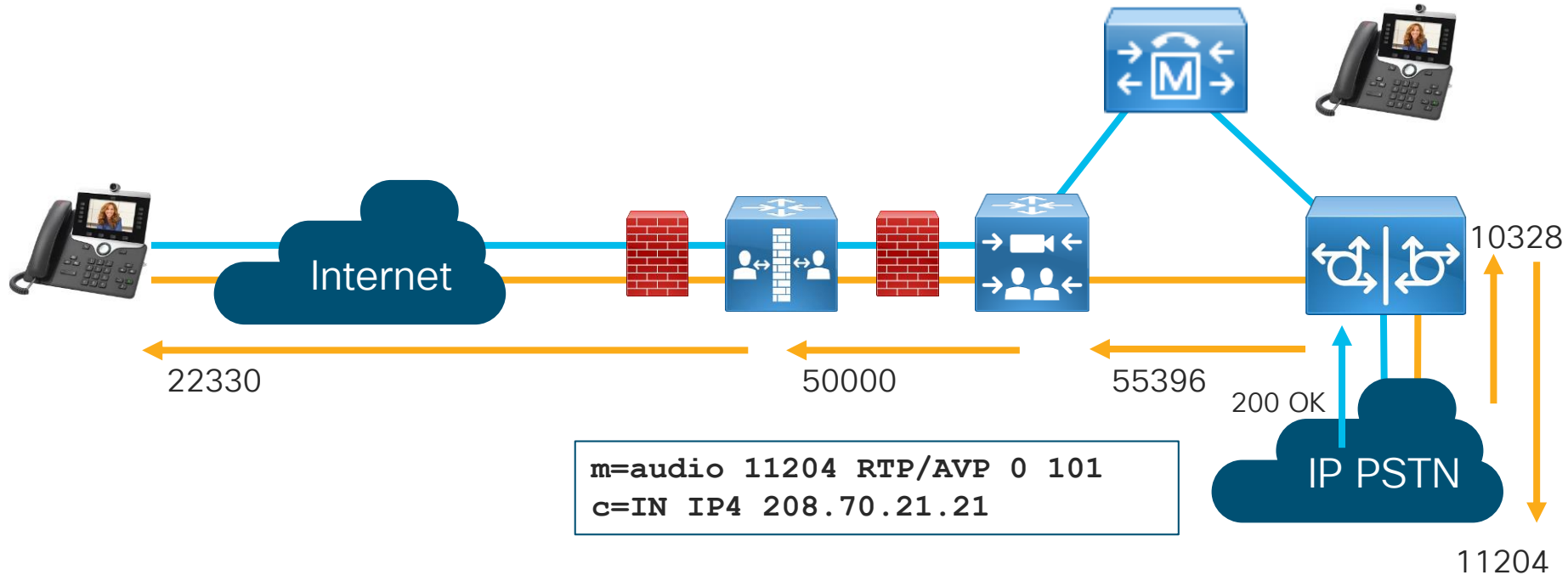

# Case Study 6: One-Way Audio

— SIP Signaling  
— RTP Media

```
m=audio 10326 RTP/AVP 0 8 18 101  
c=IN IP4 10.81.2.11
```

```
m=audio 10326 RTP/AVP 0 101  
c=IN IP4 10.81.2.11
```

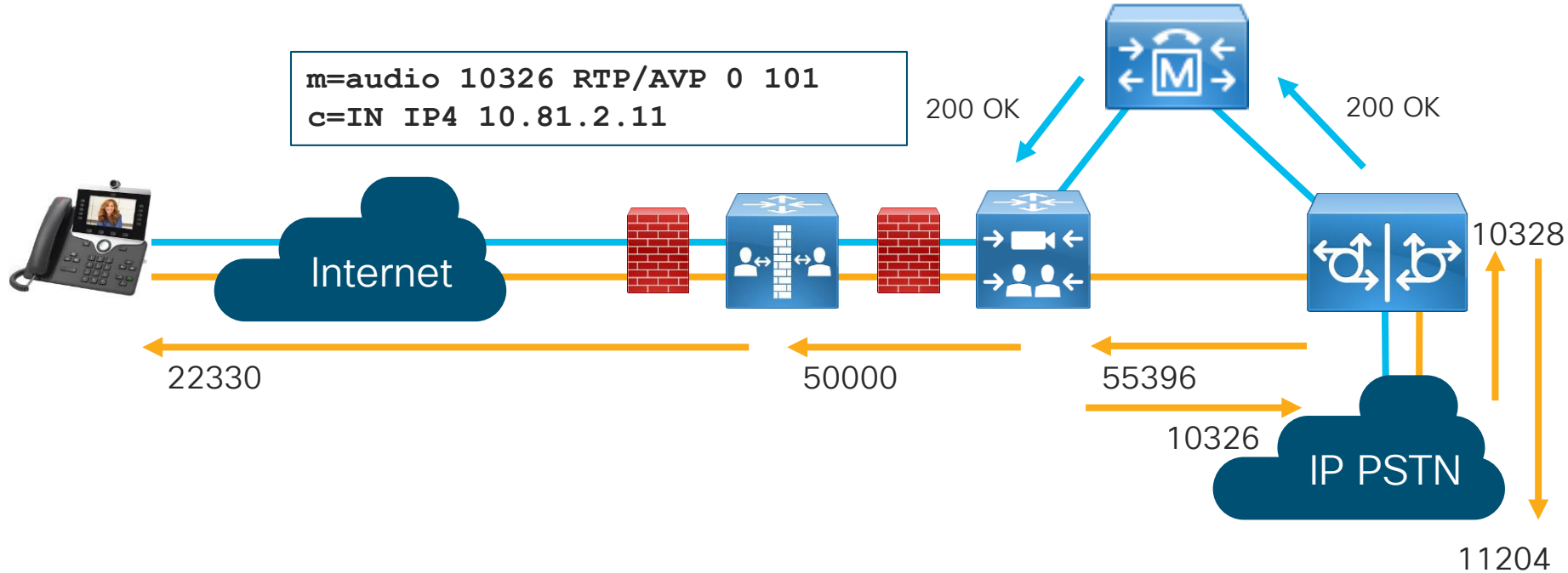

# Case Study 6: One-Way Audio

— SIP Signaling  
— RTP Media

```
m=audio 55392 RTP/SAVP 0 101  
c=IN IP4 172.18.106.225
```

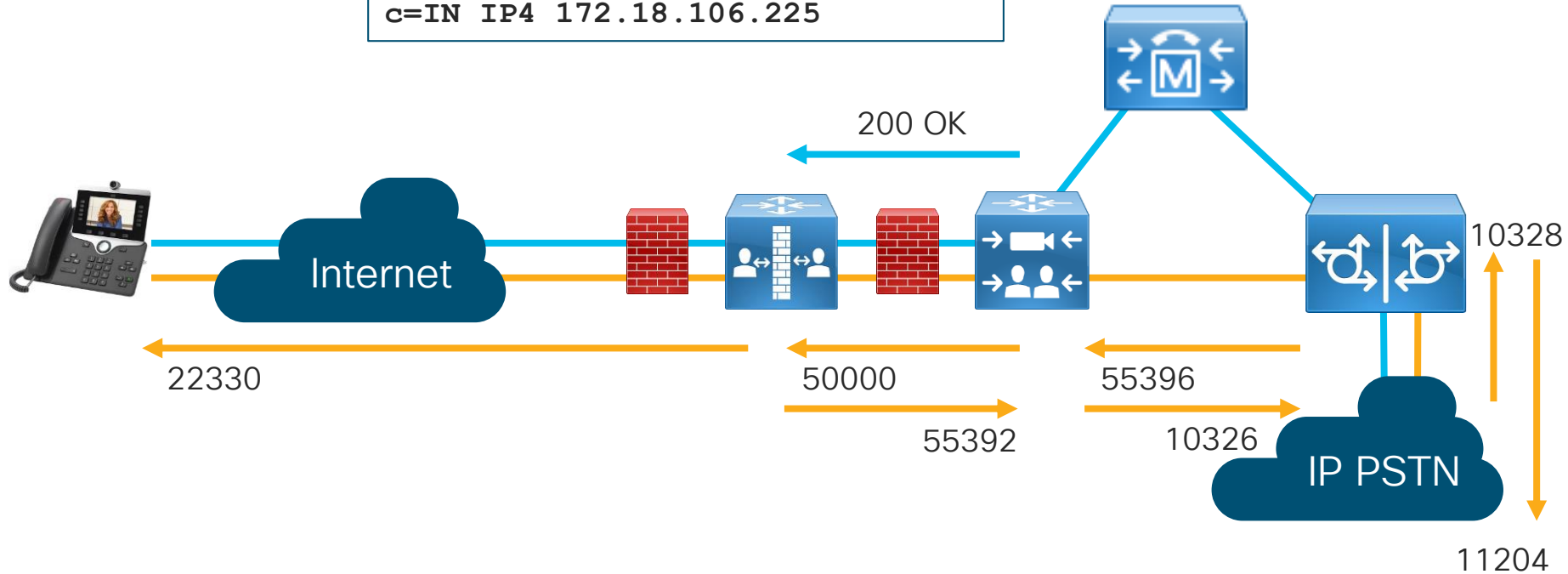

# Case Study 6: One-Way Audio

— SIP Signaling  
— RTP Media

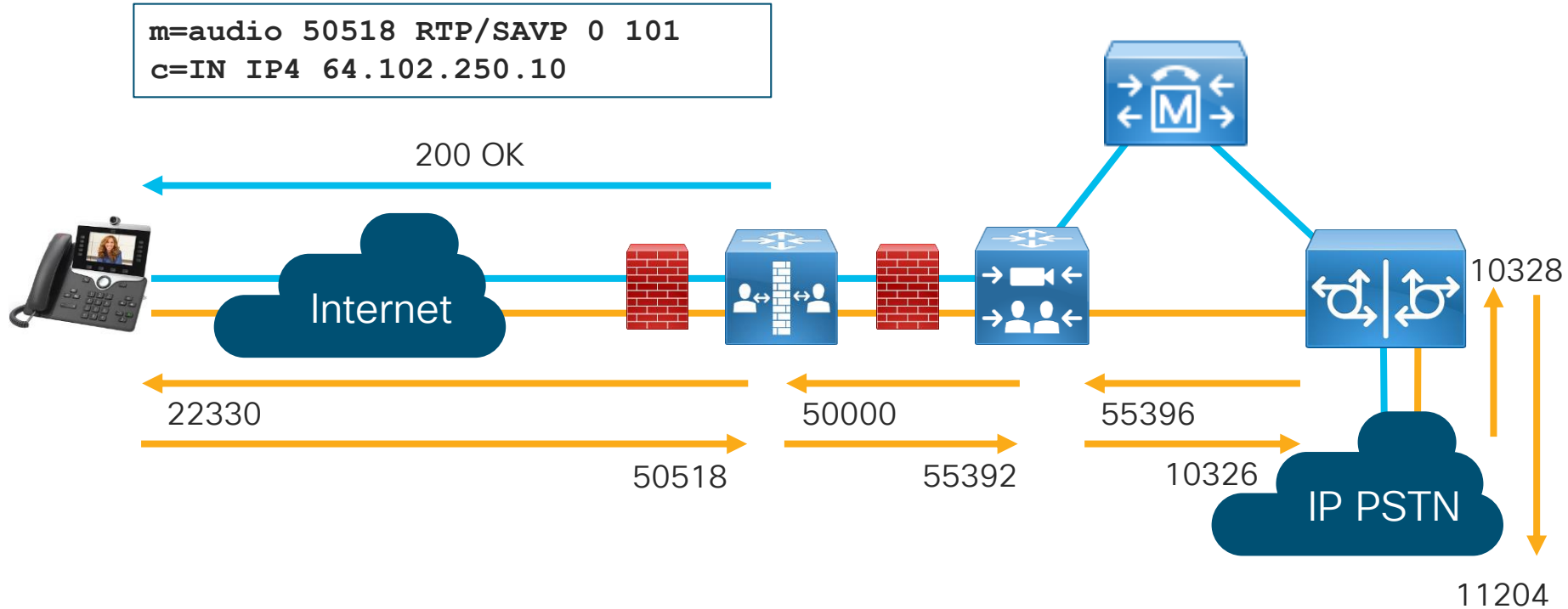

# Case Study 6: One-Way Audio

— SIP Signaling  
— RTP Media

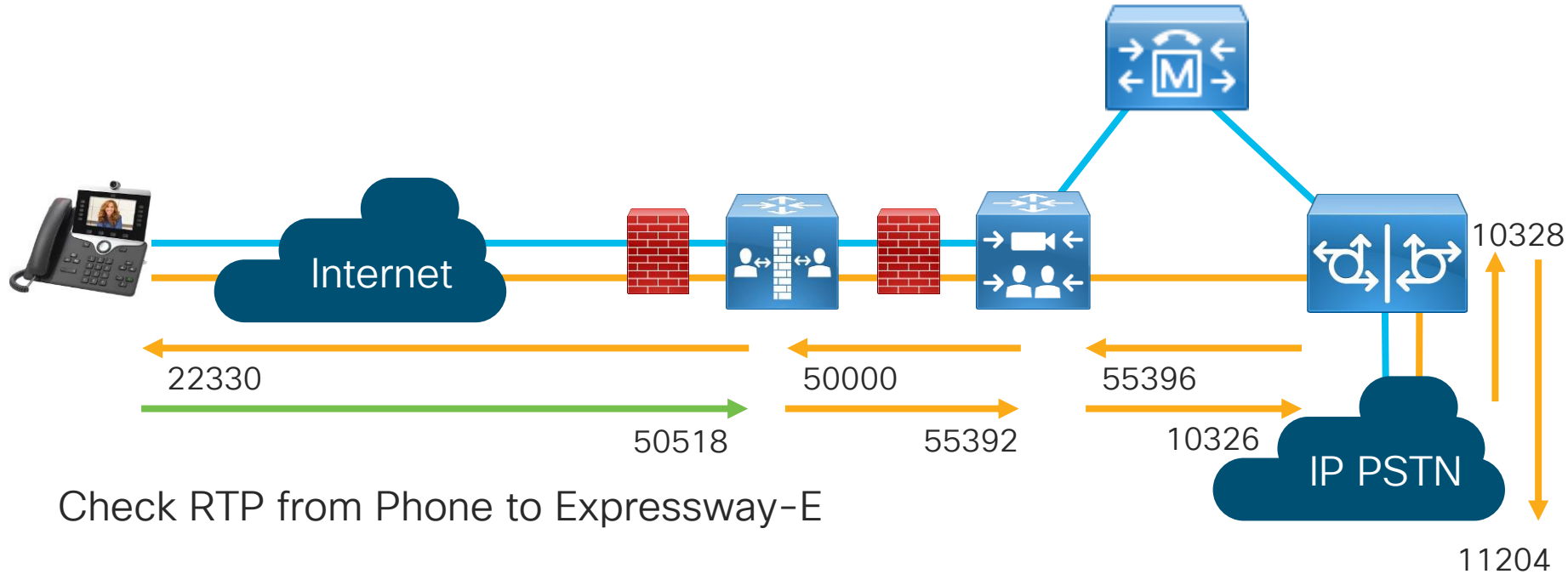

Check RTP from Phone to Expressway-E



# Case Study 6: One-Way Audio



## Streaming statistics

Cisco IP Phone CP-8865 ( SEPAC7E8AB699C8 )

Remote address	64.102.250.10/50518
Local address	192.168.1.100/22330
Start time	7:22:38am
Stream status	Active
Host name	SEPAC7E8AB699C8
Sender packets	2999
Sender octets	479840
Sender codec	G.711u
Sender reports sent	11
Sender report time sent	7:23:37am
Rcvr lost packets	0
Avg jitter	0
Receiver codec	G.711u
Receiver reports sent	0
Receiver report time sent	00:00:00
Rcvr packets	3000
Rcvr octets	421916

- [Device information](#)
- [Network setup](#)
- [Network statistics](#)
- [Ethernet information](#)
- [Access](#)
- [Network](#)
- [Device logs](#)
- [Console logs](#)
- [Core dumps](#)
- [Status messages](#)
- [Debug display](#)
- [Streaming statistics](#)
  - [Stream 1](#)
  - [Stream 2](#)
  - [Stream 3](#)
  - [Stream 4](#)
  - [Stream 5](#)

# Case Study 6: One-Way Audio

**Cisco TelePresence** Video Communication Server Expressway

**This system has 6 alarms**

**Status** System Configuration Applications Users Maintenance ? Help Logout

### Call status

You are here: [Status](#) > [Calls](#) > [Calls](#)

Records: 1 Page 1 of 1

Start time ^	Duration	Source	Destination	Type	Protocol	SIP variant	Peer	Actions
<input type="checkbox"/> <a href="#">2019-06-08 07:22:36</a>	1 minute 27 seconds	sip:89915724@vnt-cm1b.cisco.com	sip:99196277285@vnt-cm1b.cisco.com	Traversal	SIP <-> SIP	Standards-based	This system	<a href="#">View</a>

[Disconnect](#) [Select all](#) [Unselect all](#)

### Call status

You are here: [Status](#) > [Calls](#) > [Calls](#) > [View](#)

<b>Status</b>	Connected			
Status	Connected			
Tag	4daa6656-69e2-484e-b2b2-411bc37d0f7f			
Box-unique call serial number	89412524-3ae4-43ff-96e1-bc1fb4ade74f			
Source alias	sip:89915724@vnt-cm1b.cisco.com			
Destination alias	sip:99196277285@vnt-cm1b.cisco.com			
Start time	2019-06-08 07:22:36			
Duration	1 minute 36 seconds			
<b>Call components</b>				
<b>Local call serial number</b>	<b>Source alias</b>	<b>Destination alias</b>	<b>Protocol</b>	<b>Type</b>
<a href="#">051f9772-1de0-4b29-bd9e-5a6e6846ca41</a>	sip:89915724@vnt-cm1b.cisco.com	sip:99196277285@vnt-cm1b.cisco.com	SIP <-> SIP	VCS

# Case Study 6: One-Way Audio

## Call details

You are here: [Status](#) > [Calls](#) > [Calls](#) > Call details

### Call information

State	Connected
Start time	2019-06-08 07:22:36
Duration	1 minute 44 seconds
Tag	4daa6656-69e2-484e-b2b2-411bc37d0f7f
Serial number	051f9772-1de0-4b29-bd9e-5a6e6846ca41
Type	Audio
SIP variant	Standards-based

### Bandwidth

Requested	4064 kbps
Allocated	80 kbps
Route	CollaborationEdgeZone -> CollaborationEdgeZToTraversalSZ -> TraversalSubZone -> Zone001ToTraversalSZ -> TraversalZone

# Case Study 6: One-Way Audio

## Leg 1

Bandwidth node	CollaborationEdgeZone
Source alias 1	sip:89915724@vnt-cm1b.cisco.com (Url)
Target alias 1	sip:99196277285@vnt-cm1b.cisco.com;user=phone (Url)
Protocol	SIP
Address	45.18.33.250:52204
Transport	TLS
Encryption type	AES

## Leg 2

Bandwidth node	TraversalZone
Target alias 1	sip:99196277285@vnt-cm1b.cisco.com (Url)
Protocol	SIP
Address	172.18.106.225:25005
Transport	TLS
Encryption type	AES

# Case Study 6: One-Way Audio

## Session 1

Status	Connected
Media routed	True
Call routed	True
Participant 1	Leg 1
Participant 2	Leg 2
Bandwidth allocated	80 kbps
Bandwidth requested	4064 kbps
Route	CollaborationEdgeZone -> CollaborationEdgeZToTraversalSZ -> TraversalSubZone -> Zone001ToTraversalSZ -> TraversalZone

### Related tasks

[View summary of this call](#)

[View media statistics for this call component](#)

[View search details for this call component](#)

[View all events associated with this call](#)

# Case Study 6: One-Way Audio

Call media		You
<b>Session Information</b>		
Status	Connected	
Media routed	True	
Call routed	True	
Participant 1	Leg 1	
Participant 2	Leg 2	
Bandwidth allocated	80 kbps	
Bandwidth requested	4064 kbps	
Route	CollaborationEdgeZone -> CollaborationEdgeZToTraversalSZ -> TraversalSubZone -> Zone001ToTraversalSZ -> TraversalZone	

Channel 1: 2 -> 1	
Type	Audio
Protocol	PCMU
Rate	72800 bps
Packets forwarded	4473
Keepalives	8
Errors	0
Duplicate packets	0
Lost packets	0
Out of order packets	0
Unexpected packets	0
Jitter	0 ms
From	sip:99196277285@vnt-cm1b.cisco.com

Channel 2: 1 -> 2	
Type	Audio
Protocol	PCMU
Rate	0 bps
Packets forwarded	23
Keepalives	0
Errors	0
Duplicate packets	0
Lost packets	0
Out of order packets	0
Unexpected packets	0
Jitter	0 ms
From	sip:89915724@vnt-cm1b.cisco.com

# Case Study 6: One-Way Audio

— SIP Signaling  
— RTP Media

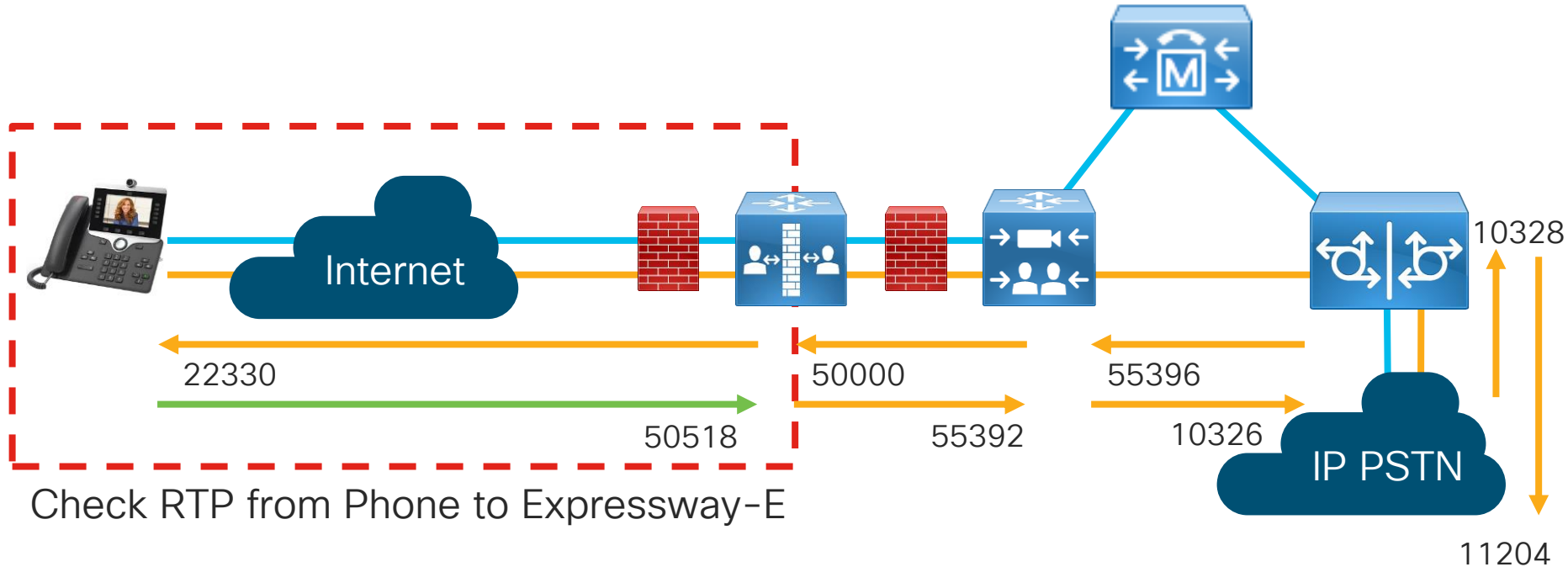

# Case Study 6: One-Way Audio

— SIP Signaling  
— RTP Media

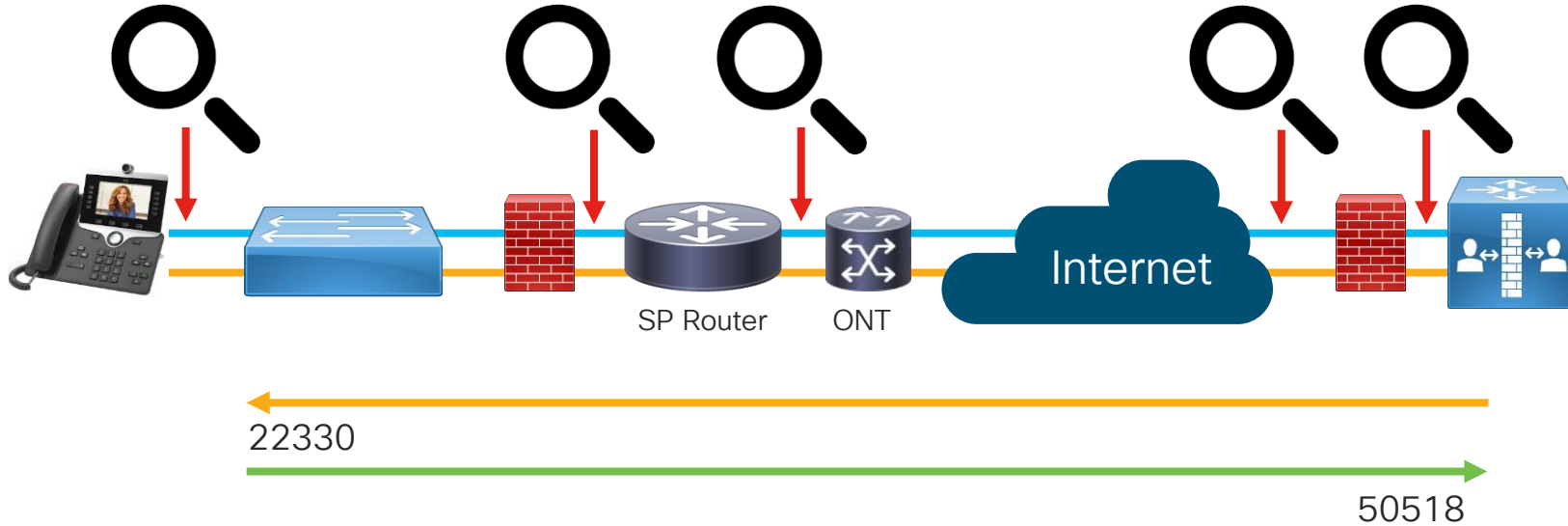



# Case Study 6: One-Way Audio

— SIP Signaling  
— RTP Media

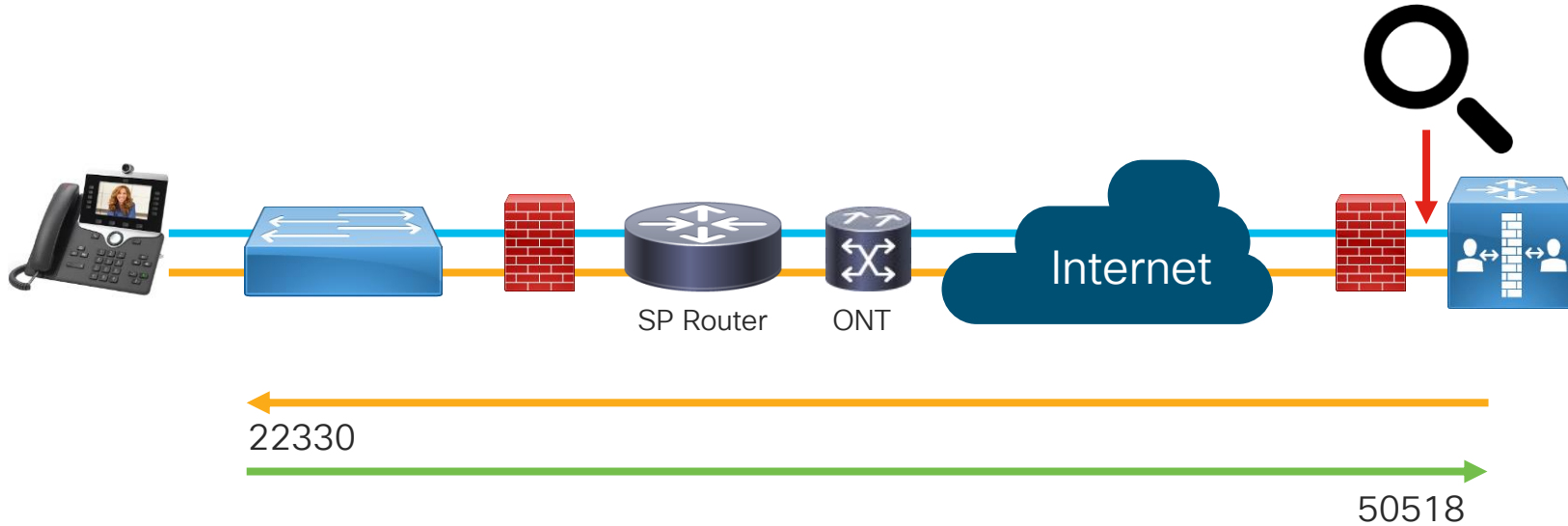

# Case Study 6: One-Way Audio

The screenshot shows a Wireshark interface with a packet capture of RTP traffic. The top toolbar includes various navigation and analysis tools. The filter bar at the top shows the filter `ip.addr == 45.18.33.250`. The main packet list pane displays 85 packets, all of which are RTP packets from source 64.102.250.10 to destination 45.18.33.250. Packet 18 is highlighted in grey. The packet details pane for packet 18 shows the Real-Time Transport Protocol (RTCP) structure:

```
▼ Real-Time Transport Protocol
  10.. .... = Version: RFC 1889 Version (2)
  ..0. .... = Padding: False
  ...0 .... = Extension: False
  .... 0000 = Contributing source identifiers count: 0
  0... .... = Marker: False
  Payload type: ITU-T G.711 PCMU (0)
  Sequence number: 131
  Timestamp: 20960
```

The status bar at the bottom indicates: Packets: 13568 · Displayed: 1026 (7.6%) · Load time: 0:0:303 Profile: Default

# Case Study 6: One-Way Audio

The image shows a Wireshark interface displaying a network traffic capture. The filter bar at the top is set to 'ip.addr == 45.18.33.250'. The main display area shows a list of packets, with the 'Destination' column highlighted in red. The packets are RTP (Real-time Transport Protocol) packets of type ITU-T G.711 PCMU, sent from source IP 64.102.250.10 to destination IP 45.18.33.250. The sequence numbers range from 131 to 166. The bottom pane shows the details of the selected RTP packet, including its version (RFC 1889), padding status, extension status, source identifiers count, marker status, and payload type (ITU-T G.711 PCMU).

No.	Time	Timestamp	Source	Destination	Protocol	Length	Info
199	0.419768	23:14:57.804613	64.102.250.10	45.18.33.250	RTP	224	PT=ITU-T G.711 PCMU, SSRC=0xDA837442, Seq=150, Time=24000
204	0.427887	23:14:57.812732	45.18.33.250	64.102.250.10	RTP	224	PT=ITU-T G.711 PCMU, SSRC=0x334EC4A1, Seq=24545, Time=4115640899
207	0.439753	23:14:57.824598	64.102.250.10	45.18.33.250	RTP	224	PT=ITU-T G.711 PCMU, SSRC=0xDA837442, Seq=151, Time=24160
212	0.447897	23:14:57.832742	45.18.33.250	64.102.250.10	RTP	224	PT=ITU-T G.711 PCMU, SSRC=0x334EC4A1, Seq=24546, Time=4115641059
215	0.459754	23:14:57.844599	64.102.250.10	45.18.33.250	RTP	224	PT=ITU-T G.711 PCMU, SSRC=0xDA837442, Seq=152, Time=24320
223	0.479929	23:14:57.864774	64.102.250.10	45.18.33.250	RTP	224	PT=ITU-T G.711 PCMU, SSRC=0xDA837442, Seq=153, Time=24480
245	0.499981	23:14:57.884826	64.102.250.10	45.18.33.250	RTP	224	PT=ITU-T G.711 PCMU, SSRC=0xDA837442, Seq=154, Time=24640
251	0.519903	23:14:57.904748	64.102.250.10	45.18.33.250	RTP	224	PT=ITU-T G.711 PCMU, SSRC=0xDA837442, Seq=155, Time=24800
257	0.539701	23:14:57.924546	64.102.250.10	45.18.33.250	RTP	224	PT=ITU-T G.711 PCMU, SSRC=0xDA837442, Seq=156, Time=24960
263	0.559719	23:14:57.944564	64.102.250.10	45.18.33.250	RTP	224	PT=ITU-T G.711 PCMU, SSRC=0xDA837442, Seq=157, Time=25120
269	0.579814	23:14:57.964659	64.102.250.10	45.18.33.250	RTP	224	PT=ITU-T G.711 PCMU, SSRC=0xDA837442, Seq=158, Time=25280
275	0.599738	23:14:57.984583	64.102.250.10	45.18.33.250	RTP	224	PT=ITU-T G.711 PCMU, SSRC=0xDA837442, Seq=159, Time=25440
281	0.619899	23:14:58.004744	64.102.250.10	45.18.33.250	RTP	224	PT=ITU-T G.711 PCMU, SSRC=0xDA837442, Seq=160, Time=25600
287	0.639759	23:14:58.024604	64.102.250.10	45.18.33.250	RTP	224	PT=ITU-T G.711 PCMU, SSRC=0xDA837442, Seq=161, Time=25760
293	0.659791	23:14:58.044636	64.102.250.10	45.18.33.250	RTP	224	PT=ITU-T G.711 PCMU, SSRC=0xDA837442, Seq=162, Time=25920
299	0.679830	23:14:58.064675	64.102.250.10	45.18.33.250	RTP	224	PT=ITU-T G.711 PCMU, SSRC=0xDA837442, Seq=163, Time=26080
305	0.699874	23:14:58.084719	64.102.250.10	45.18.33.250	RTP	224	PT=ITU-T G.711 PCMU, SSRC=0xDA837442, Seq=164, Time=26240
311	0.720003	23:14:58.104848	64.102.250.10	45.18.33.250	RTP	224	PT=ITU-T G.711 PCMU, SSRC=0xDA837442, Seq=165, Time=26400
317	0.739934	23:14:58.124779	64.102.250.10	45.18.33.250	RTP	224	PT=ITU-T G.711 PCMU, SSRC=0xDA837442, Seq=166, Time=26560

▼ Real-Time Transport Protocol

- 10.. .... = Version: RFC 1889 Version (2)
- ..0. .... = Padding: False
- ...0 .... = Extension: False
- ... 0000 = Contributing source identifiers count: 0
- 0... .... = Marker: False

Payload type: ITU-T G.711 PCMU (0)  
Sequence number: 131  
Timestamp: 20960

Frame (frame), 224 bytes      Packets: 13568 · Displayed: 1026 (7.6%) · Load time: 0:0.303      Profile: Default

# Case Study 6: One-Way Audio

— SIP Signaling  
— RTP Media

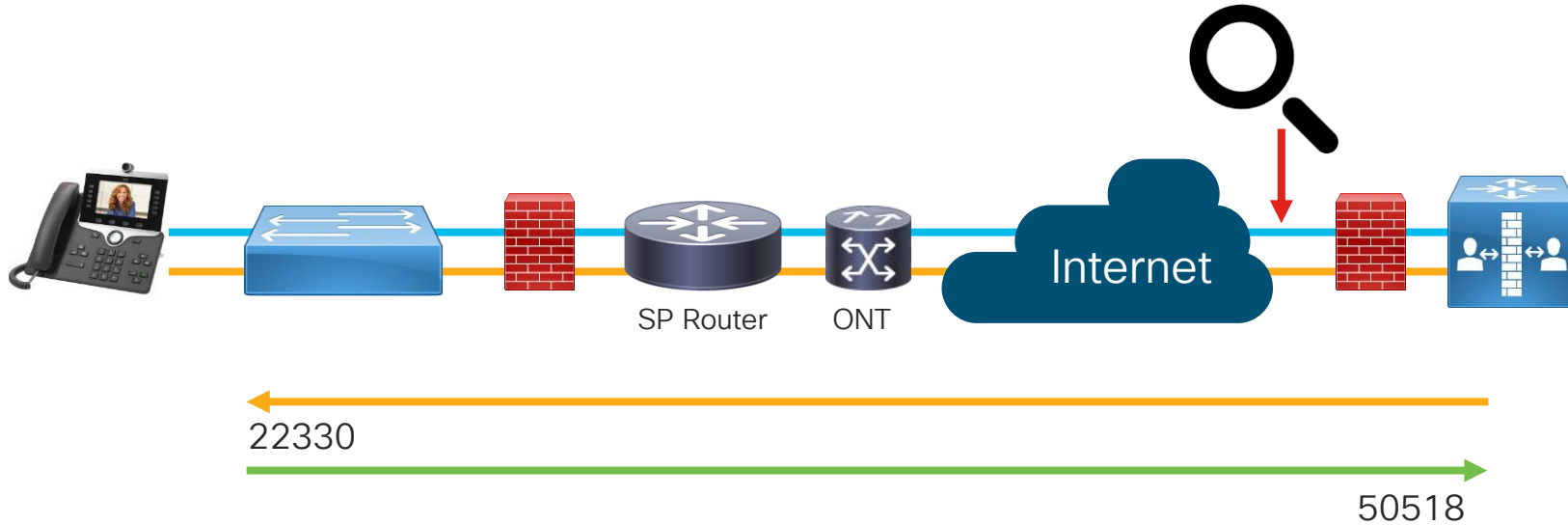

# Case Study 6: One-Way Audio



- Enable Span to PC Port on Phone

Span to PC Port\* Enabled

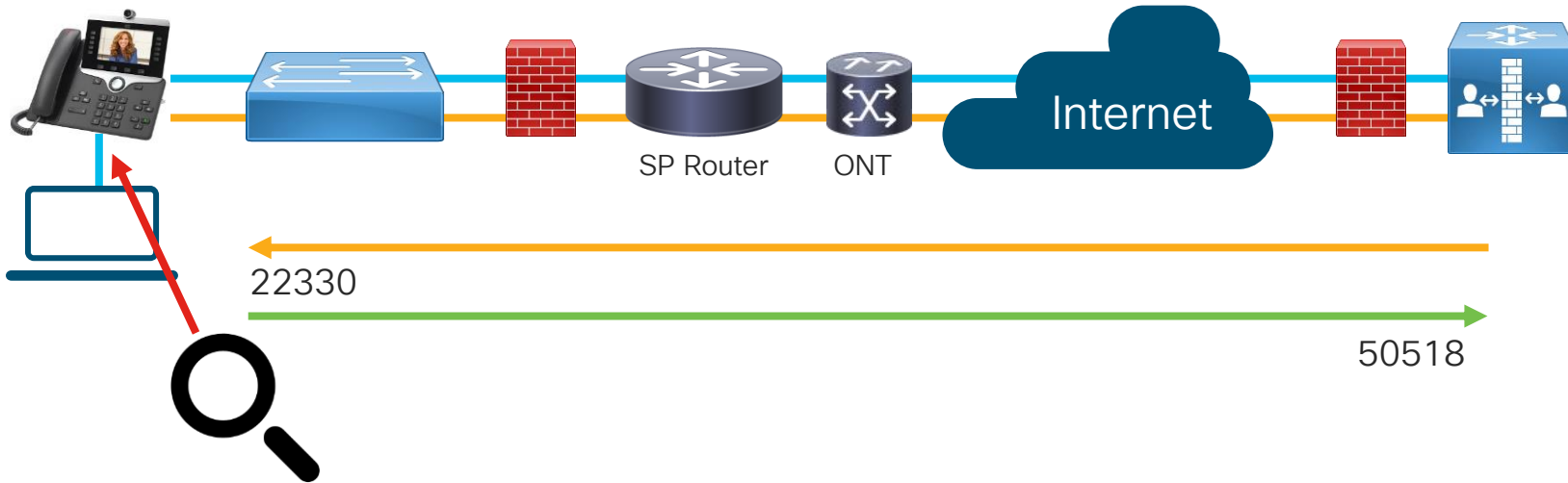

# Case Study 6: One-Way Audio

The image shows a Wireshark packet capture window titled "back\_of\_phone.pcap". The filter bar is set to "ip.addr == 192.168.1.100". The main display area shows a list of 17 packets, all of which are RTP packets. The packets are numbered 459 through 477. Each packet has a time, timestamp, source IP (64.102.250.10), destination IP (192.168.1.100), and protocol (RTP). The info column for each packet shows "PT=ITU-T G.711 PCMU, SSRC=0x6DFC3A6E, Seq=267, Time=42720" (with the sequence number and time increasing by 1 for each subsequent packet). Below the packet list, the packet details pane shows the structure of packet 116: Ethernet II, Internet Protocol Version 4, User Datagram Protocol, and Real-Time Transport Protocol.

No.	Time	Timestamp	Source	Destination	Protocol	Length	Info
459	6.351889	04:20:27.404763	64.102.250.10	192.168.1.100	RTP	224	PT=ITU-T G.711 PCMU, SSRC=0x6DFC3A6E, Seq=267, Time=42720
460	6.354097	04:20:27.406971	192.168.1.100	64.102.250.10	RTP	224	PT=ITU-T G.711 PCMU, SSRC=0xC27FE2F2, Seq=26227, Time=96647561
461	6.371752	04:20:27.424626	64.102.250.10	192.168.1.100	RTP	224	PT=ITU-T G.711 PCMU, SSRC=0x6DFC3A6E, Seq=268, Time=42880
462	6.374101	04:20:27.426975	192.168.1.100	64.102.250.10	RTP	224	PT=ITU-T G.711 PCMU, SSRC=0xC27FE2F2, Seq=26228, Time=96647721
463	6.392036	04:20:27.444910	64.102.250.10	192.168.1.100	RTP	224	PT=ITU-T G.711 PCMU, SSRC=0x6DFC3A6E, Seq=269, Time=43040
464	6.394255	04:20:27.447129	192.168.1.100	64.102.250.10	RTP	224	PT=ITU-T G.711 PCMU, SSRC=0xC27FE2F2, Seq=26229, Time=96647881
465	6.411607	04:20:27.464481	64.102.250.10	192.168.1.100	RTP	224	PT=ITU-T G.711 PCMU, SSRC=0x6DFC3A6E, Seq=270, Time=43200
466	6.414128	04:20:27.467002	192.168.1.100	64.102.250.10	RTP	224	PT=ITU-T G.711 PCMU, SSRC=0xC27FE2F2, Seq=26230, Time=96648041
467	6.431899	04:20:27.484773	64.102.250.10	192.168.1.100	RTP	224	PT=ITU-T G.711 PCMU, SSRC=0x6DFC3A6E, Seq=271, Time=43360
468	6.434198	04:20:27.487072	192.168.1.100	64.102.250.10	RTP	224	PT=ITU-T G.711 PCMU, SSRC=0xC27FE2F2, Seq=26231, Time=96648201
469	6.452116	04:20:27.504990	64.102.250.10	192.168.1.100	RTP	224	PT=ITU-T G.711 PCMU, SSRC=0x6DFC3A6E, Seq=272, Time=43520
470	6.454313	04:20:27.507187	192.168.1.100	64.102.250.10	RTP	224	PT=ITU-T G.711 PCMU, SSRC=0xC27FE2F2, Seq=26232, Time=96648361
471	6.471990	04:20:27.524864	64.102.250.10	192.168.1.100	RTP	224	PT=ITU-T G.711 PCMU, SSRC=0x6DFC3A6E, Seq=273, Time=43680
472	6.474212	04:20:27.527086	192.168.1.100	64.102.250.10	RTP	224	PT=ITU-T G.711 PCMU, SSRC=0xC27FE2F2, Seq=26233, Time=96648521
473	6.491925	04:20:27.544799	64.102.250.10	192.168.1.100	RTP	224	PT=ITU-T G.711 PCMU, SSRC=0x6DFC3A6E, Seq=274, Time=43840
474	6.494079	04:20:27.546953	192.168.1.100	64.102.250.10	RTP	224	PT=ITU-T G.711 PCMU, SSRC=0xC27FE2F2, Seq=26234, Time=96648681
475	6.511544	04:20:27.564418	64.102.250.10	192.168.1.100	RTP	224	PT=ITU-T G.711 PCMU, SSRC=0x6DFC3A6E, Seq=275, Time=44000
476	6.514093	04:20:27.566967	192.168.1.100	64.102.250.10	RTP	224	PT=ITU-T G.711 PCMU, SSRC=0xC27FE2F2, Seq=26235, Time=96648841
477	6.531682	04:20:27.584556	64.102.250.10	192.168.1.100	RTP	224	PT=ITU-T G.711 PCMU, SSRC=0x6DFC3A6E, Seq=276, Time=44160

▶ Frame 116: 224 bytes on wire (1792 bits), 224 bytes captured (1792 bits)  
▶ Ethernet II, Src: CiscoInc\_d0:39:08 (e4:d3:f1:d0:39:08), Dst: CiscoInc\_b6:99:c8 (ac:7e:8a:b6:99:c8)  
▶ Internet Protocol Version 4, Src: 64.102.250.10, Dst: 192.168.1.100  
▶ User Datagram Protocol, Src Port: 50486 (50486), Dst Port: 18172 (18172)  
▶ Real-Time Transport Protocol

back\_of\_phone Packets: 496 - Displayed: 496 (100.0%) · Load time: 0:0.69 Profile: Default

# Case Study 6: One-Way Audio

— SIP Signaling  
— RTP Media

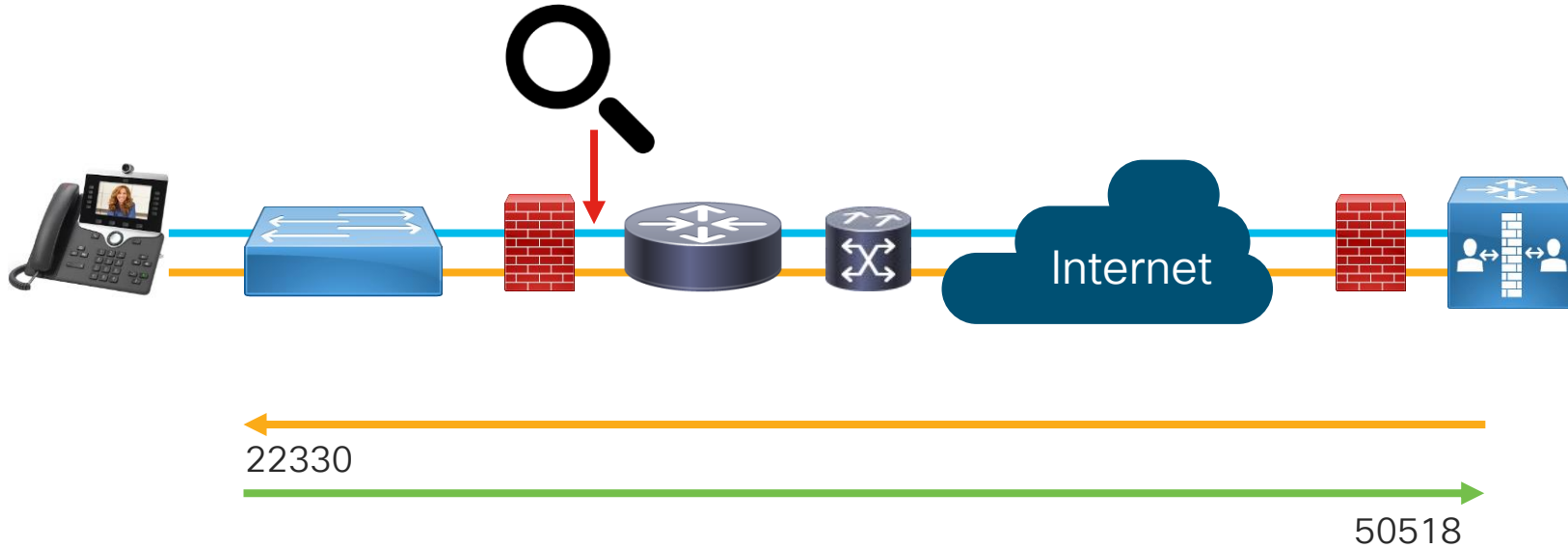

# Case Study 6: One-Way Audio

The screenshot shows a Wireshark interface with a packet capture named 'asharma\_phone\_capture-2018-12-01 12:22:24.pcapng'. The main display area shows a list of 24 RTP packets. The selected packet (No. 224) is expanded to show its structure:

No.	Time	Timestamp	Source	Destination	Protocol	Length	Info
390	7.606660	17:20:10.364506	45.18.33.250	64.102.250.10	RTP	224	PT=ITU-T G.711 PCMU, SSRC=0x603AF522, Seq=1409, Time=955105327
391	7.608318	17:20:10.366164	64.102.250.10	45.18.33.250	RTP	224	PT=ITU-T G.711 PCMU, SSRC=0xCB0745A3, Seq=148, Time=23680
392	7.626505	17:20:10.384351	45.18.33.250	64.102.250.10	RTP	224	PT=ITU-T G.711 PCMU, SSRC=0x603AF522, Seq=1410, Time=955105487
393	7.628413	17:20:10.386259	64.102.250.10	45.18.33.250	RTP	224	PT=ITU-T G.711 PCMU, SSRC=0xCB0745A3, Seq=149, Time=23840
394	7.646621	17:20:10.404467	45.18.33.250	64.102.250.10	RTP	224	PT=ITU-T G.711 PCMU, SSRC=0x603AF522, Seq=1411, Time=955105647
395	7.648370	17:20:10.406216	64.102.250.10	45.18.33.250	RTP	224	PT=ITU-T G.711 PCMU, SSRC=0xCB0745A3, Seq=150, Time=24000
396	7.666556	17:20:10.424402	45.18.33.250	64.102.250.10	RTP	224	PT=ITU-T G.711 PCMU, SSRC=0x603AF522, Seq=1412, Time=955105807
397	7.668339	17:20:10.426185	64.102.250.10	45.18.33.250	RTP	224	PT=ITU-T G.711 PCMU, SSRC=0xCB0745A3, Seq=151, Time=24160
398	7.686561	17:20:10.444407	45.18.33.250	64.102.250.10	RTP	224	PT=ITU-T G.711 PCMU, SSRC=0x603AF522, Seq=1413, Time=955105967
399	7.688173	17:20:10.446019	64.102.250.10	45.18.33.250	RTP	224	PT=ITU-T G.711 PCMU, SSRC=0xCB0745A3, Seq=152, Time=24320
400	7.706548	17:20:10.464394	45.18.33.250	64.102.250.10	RTP	224	PT=ITU-T G.711 PCMU, SSRC=0x603AF522, Seq=1414, Time=955106127
401	7.708238	17:20:10.466084	64.102.250.10	45.18.33.250	RTP	224	PT=ITU-T G.711 PCMU, SSRC=0xCB0745A3, Seq=153, Time=24480
402	7.726495	17:20:10.484341	45.18.33.250	64.102.250.10	RTP	224	PT=ITU-T G.711 PCMU, SSRC=0x603AF522, Seq=1415, Time=955106287
403	7.728207	17:20:10.486053	64.102.250.10	45.18.33.250	RTP	224	PT=ITU-T G.711 PCMU, SSRC=0xCB0745A3, Seq=154, Time=24640
404	7.746523	17:20:10.504369	45.18.33.250	64.102.250.10	RTP	224	PT=ITU-T G.711 PCMU, SSRC=0x603AF522, Seq=1416, Time=955106447
405	7.748450	17:20:10.506296	64.102.250.10	45.18.33.250	RTP	224	PT=ITU-T G.711 PCMU, SSRC=0xCB0745A3, Seq=155, Time=24800
406	7.766540	17:20:10.524386	45.18.33.250	64.102.250.10	RTP	224	PT=ITU-T G.711 PCMU, SSRC=0x603AF522, Seq=1417, Time=955106607
407	7.768349	17:20:10.526195	64.102.250.10	45.18.33.250	RTP	224	PT=ITU-T G.711 PCMU, SSRC=0xCB0745A3, Seq=156, Time=24960
408	7.786555	17:20:10.544401	45.18.33.250	64.102.250.10	RTP	224	PT=ITU-T G.711 PCMU, SSRC=0x603AF522, Seq=1418, Time=955106767

▼ Frame 284: 224 bytes on wire (1792 bits), 224 bytes captured (1792 bits) on interface 0  
▶ Ethernet II, Src: CiscoInc\_b6:99:c8 (ac:7e:8a:b6:99:c8), Dst: 14:ed:bb:52:04:4d (14:ed:bb:52:04:4d)  
▶ Internet Protocol Version 4, Src: 45.18.33.250, Dst: 64.102.250.10  
▶ User Datagram Protocol, Src Port: 22330 (22330), Dst Port: 50518 (50518)  
▼ Real-Time Transport Protocol  
    10.. .... = Version: RFC 1889 Version (2)  
    ..0. .... = Padding: False  
    ...0 .... = Extension: False  
    ... 0000 = Contributing source identifiers count: 0

asharma\_phone\_capture-2018-12-01 12:22:24      Packets: 10476 · Displayed: 10476 (100.0%) · Load time: 0:0.234      Profile: Default



# Case Study 6: One-Way Audio

— SIP Signaling  
— RTP Media

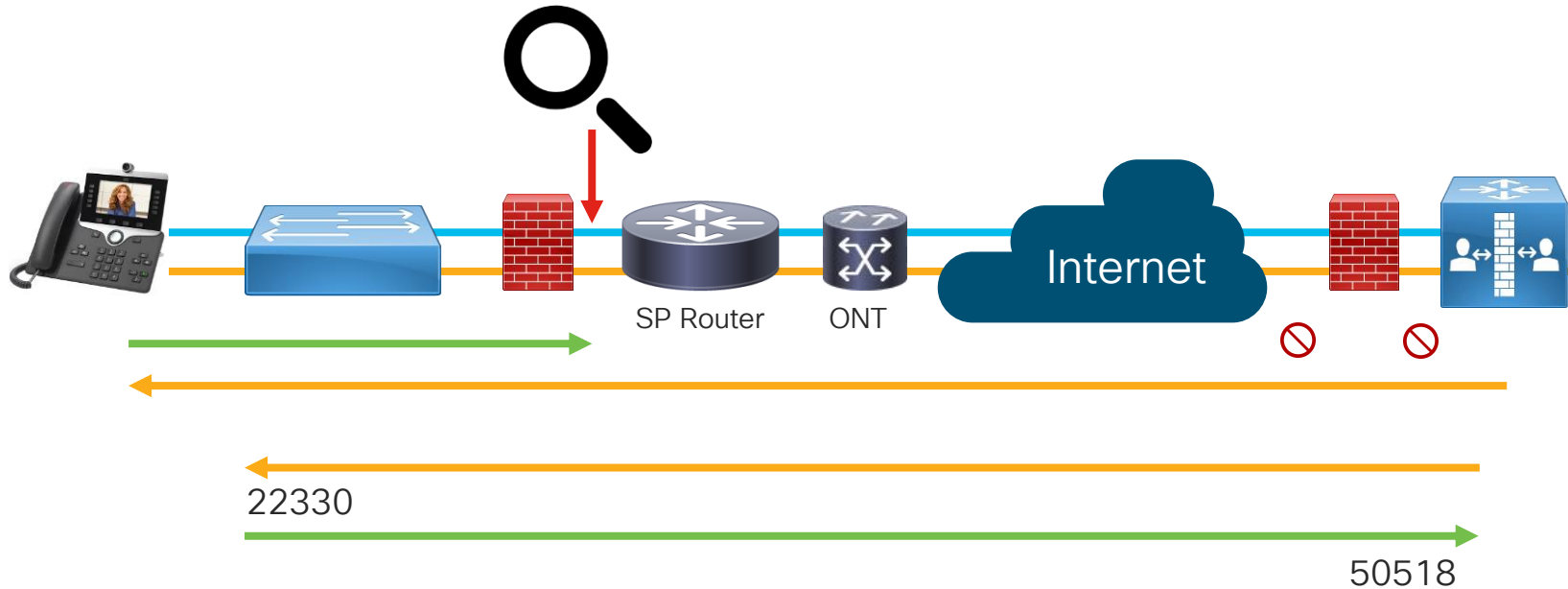

# Case Study 6: One-Way Audio

— SIP Signaling  
— RTP Media

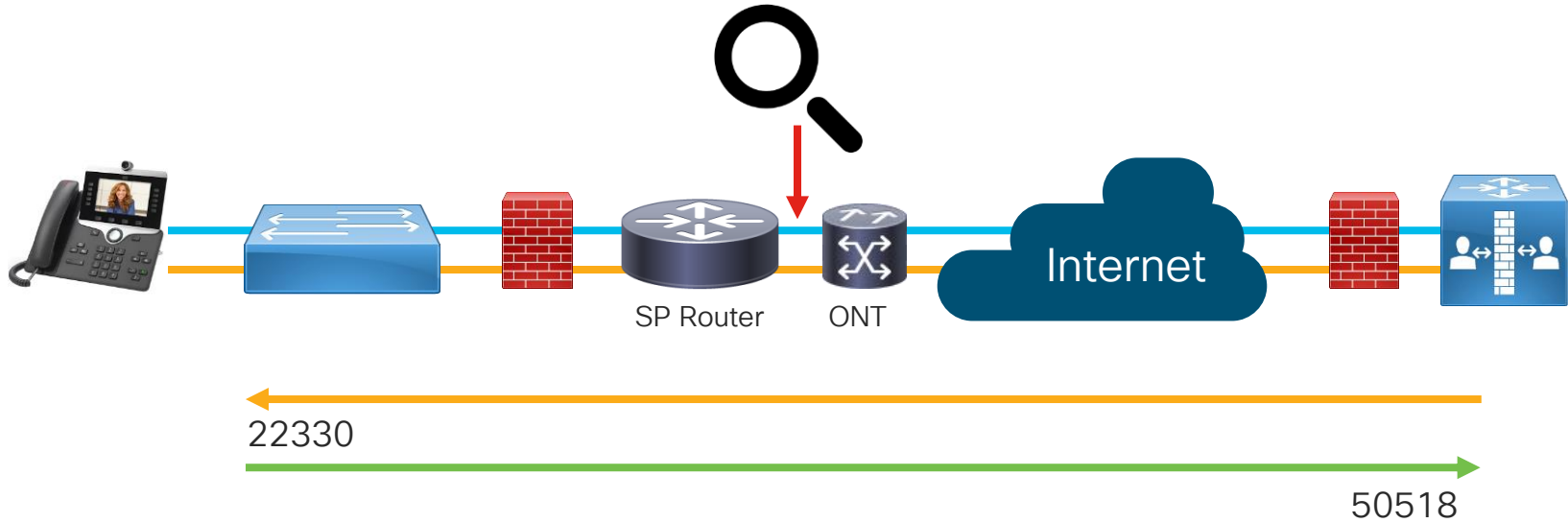

# Agenda

- Serviceability Tools Overview

  - Real-Time Monitoring Tool (RTMT)

  - Cisco Unified Operating System GUI

  - Cisco Unified Operating System CLI

  - Cisco Serviceability Reports

  - Cisco Unified Reporting

  - Serviceability APIs

- Troubleshooting Methodology

  - Problem Description

  - Information Collection

- Troubleshooting Case Studies

  - Dropped Call

  - Video Encryption Not Working

  - No One Answers the Phone

  - One-Way Audio

  - Unable to Place Calls

  - ActiveControl Not Working on Jabber 12.5

  - Call Drops After Answering

  - Video Call Immediately Drops

- Understanding and Troubleshooting Unified CM Throttling Events

- Troubleshooting Database Replication

# Case Study 7: ActiveControl not working

## Participants Pane and Layout Control Button Missing

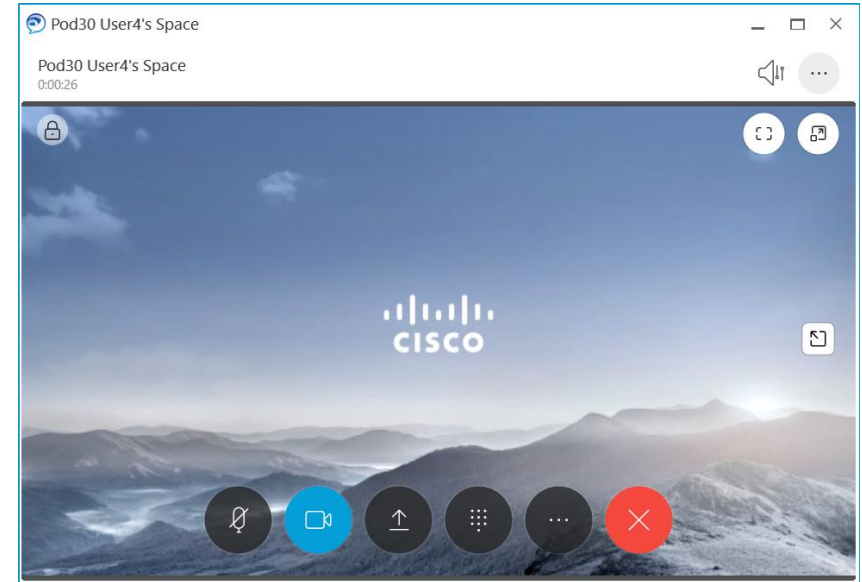
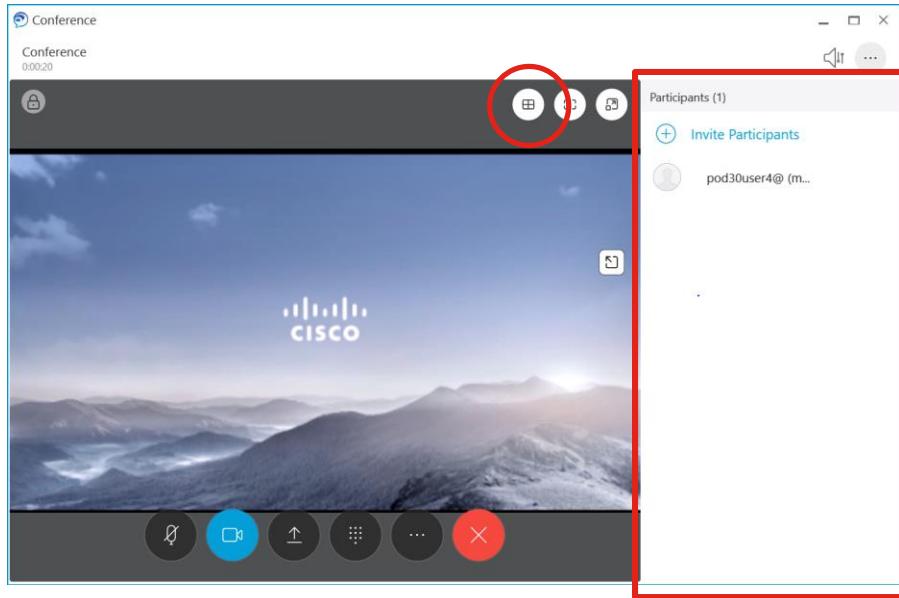



# Case Study 7: Troubleshooting Live Demo

# Agenda

- Serviceability Tools Overview
  - Real-Time Monitoring Tool (RTMT)
  - Cisco Unified Operating System GUI
  - Cisco Unified Operating System CLI
  - Cisco Serviceability Reports
  - Cisco Unified Reporting
  - Serviceability APIs
- Troubleshooting Methodology
  - Problem Description
  - Information Collection
- **Troubleshooting Case Studies**
  - Dropped Call
  - No One Answers the Phone
  - Unable to Place Calls
  - Call Drops After Answering
  - Video Encryption Not Working
  - One-Way Audio
  - ActiveControl Not Working on Jabber 12.5
  - Video Call Immediately Drops**
- Understanding and Troubleshooting Unified CM Throttling Events
- Troubleshooting Database Replication

# Case Study 8: Video Call Immediately Drops

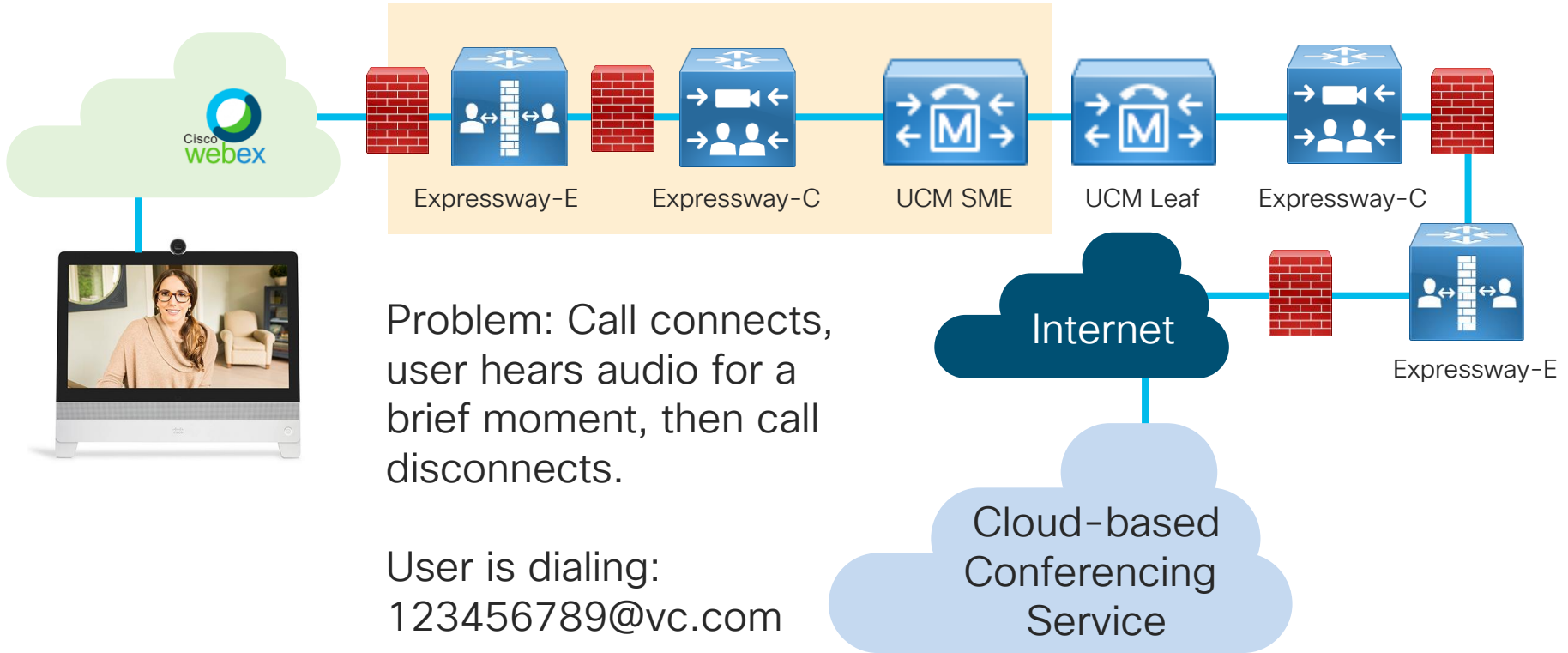

# Case Study 8: Video Call Immediately Drops

<https://www.cisco.com/c/en/us/support/web/tools-catalog.html>

Collaboration Solutions Analyzer

 Suite of tools to assist you in the day to day operations of your Collaboration infrastructure. It simplifies the most complex...

[Learn More >](#)



Tools Catalog / Cisco TAC Tool Paul Giralte

## Upload log files

Click or drop files here

Upload files

**1** Files are being uploaded to the same storage used and controlled by a service request and hence meets the same security requirements. For analysis the files are fetched in a sandbox unique and only accessible by the cco id and kept there for 8 hours after which they are automatically removed.

## About the tool

This tool analyzes the log files from multiple products in collaboration space and displays details about great amount of communications flows (calls, MRA logins, RTP/TCP/UDP streams, XMPP, STUN, etc.), configuration overview and diagnostic signatures highlighting known issues found and next action plan to resolve them. [More info](#)

## When to use

Use this tool when troubleshooting any issue on your collaboration servers or endpoints. Diagnostic signatures will suggest next action plan in case any known issues were found. Alternatively, use the tool output to visualize and better understand the communication flows and configuration to troubleshoot the issue further. [More info](#)





# Case Study 8: Video Call Immediately Drops

 Upload log files

 vc\_call...  
26.1 MB

 diagno...  
256.9 KB

 diagno...  
256.3 KB

 diagno...  
363.3 KB

 diagno...  
343.4 KB

 UCM.zip  
24.9 MB

6 Selected (Total: 52.2 MB)

[Upload files](#)











IN\_PROGRESS

Total Files	6
Completed Files	1
Failed/Cancelled Files	0
Total Elapsed Time	19.6s

513.5 KB / 52.2 MB Completed

### 5 Files In Progress

 829df506019cc607917659fa8b...		▼
(256.9 KB / 256.9 KB) (100.0%) 9.1s		
 62c704c81f086854519535fa36...		▼
(0 B / 343.4 KB) (0.0%) 0s		
 89d9121a5b8c9c6968c91ef2f3...		▼
(0 B / 363.3 KB) (0.0%) 0s		
 514b8a673e4ca9555fc578345d...		▼
(0 B / 24.9 MB) (0.0%) 0s		

# Case Study 8: Video Call Immediately Drops

Select	Filename	Size	Product type	
<input type="checkbox"/>	vc_call_2.zip	27.393 MB	VCS	
<input checked="" type="checkbox"/>	diagnostic_log_ecatslab-vcse2_2020-01-22_18:58:04.zip	351.593 KB	VCS	
<input checked="" type="checkbox"/>	diagnostic_log_ecats-uc-vcs2b_2020-01-22_18:58:01.zip	262.451 KB	VCS	
<input checked="" type="checkbox"/>	UCM.zip	26.137 MB	CUCM	
<input checked="" type="checkbox"/>	diagnostic_log_ecatslab-vcse1_2020-01-22_18:58:04.zip	372.054 KB	VCS	
<input checked="" type="checkbox"/>	diagnostic_log_ecats-uc-vcs2a_2020-01-22_18:58:01.zip	263.097 KB	VCS	

Select all      Run Analysis      Delete all

# Case Study 8: Video Call Immediately Drops

From DN / URI	To DN / URI	Call-Id	CI A	CI B	Call initiated (UTC)	Last timestamp (UTC)	Duration (sec)	Disconnect reason	Node	Within SDL With SDL Only
	12345678									<input type="checkbox"/>
89915644 / pgiralt@cisco.com	123456789 / 123456789@vc.com	07b85a2500e419fc6712d72394f2e545@127.0.0.1^f5215bc900255000a0000ce1eeac0000^b16d11be615d1cd96e0fc5ce7b77cad2	42802679	42802680	2020-01-22 18:30:22	2020-01-22 18:30:28	6	47 ⓘ	vnt-cm1b.cisco.com	✖
89915644 / pgiralt@cisco.com	123456789 / 123456789@vc.com	e8349e6a44bfb3dd5f04dda78d48d840@127.0.0.1^b8ab8cbd00255000a0000ce1eeac0000^68fd171ff85d8151e6dc6b1cb4e91515	42802687	42802688	2020-01-22 18:30:42	2020-01-22 18:30:47	5	47 ⓘ	vnt-cm1b.cisco.com	✖



# Case Study 8: Video Call Immediately Drops

Search:

From DN / URI	To DN / URI	Call-Id	CI A	CI B	Call initiated (UTC)	Last timestamp (UTC)	Duration (sec)	Disconnect reason	Node	Within SDL With SDL Only
<input type="text"/>	12345678	<input type="text"/>	<input type="text"/>	<input type="text"/>	<input type="text"/>	<input type="text"/>	<input type="text"/>	<input type="text"/>	<input type="text"/>	<input checked="" type="checkbox"/>

89915644 / pgiralt@cisco.com	123456789 / 123456789@vc.com	b8bc074f31cc0654 5d3620f056a5c24c @127.0.0.1^2cda0 27300255000a000 0ce1eeac0000^2fd 1039c8d930b25f21 7a3a9cffb9072	42802871	42802872	2020-01- 22 18:56:39	2020-01-22 18:56:45	6	47 ⓘ	vnt- cm1b.cisco.com	<input checked="" type="checkbox"/>
---------------------------------	---------------------------------	--------------------------------------------------------------------------------------------------------------------------------------	----------	----------	-------------------------	------------------------	---	------	------------------------	-------------------------------------

Showing 1 to 1 of 1 entries

Previous 1 Next



# Case Study 8: Video Call Immediately Drops

## Call detail

From: pgiralt@cisco.call.ciscospark.com To: 123456789@vc.com

Call leg info | Signaling | Ladder diagram | Annotated logs

Download pcap | Download filtered SDL traces

### SIP - incoming Use for signaling and ladder

#### General information

SIP call leg type	Call
From	pgiralt@cisco.call.ciscospark.com
To	123456789@vc.com
Signaling source	173.36.37.136 : 25238
Signaling destination	172.18.106.59 : 0
Call-ID	b8bc074f31cc06545d3620f056a5c24c@127.0.0.1
Call leg connects	✓ 2020-01-22 18:56:40 UTC

#### CUCM CI 42802871

Reception Preference	BestEffort
DTMF Capabilities	OOB_RFC2833
RFC2833 payload number	(101:8000
Endpoint receive DTMF	✓
Endpoint provide OOB DTMF	✓
Region	Telepresence H.265

#### Associated CIs

CI	MTP required	Transcoder required	E2E region bandwidth
42802872	✗	✗	Audio:256 Video:3128 Immersive:3128

# Case Study 8: Video Call Immediately Drops

SIP - outgoing  Use for signaling and ladder

---

### General information

SIP call leg type	Call
From	pgiralt@cisco.com
To	123456789@vc.com
Signaling source	172.18.106.59 : 5071
Signaling destination	172.18.106.225 : 5061
Call-ID	ea821300-1eb15b4b-1add54-3b6a12ac@172.18.106.59
Call leg connects	✓ 2020-01-22 18:56:40 UTC

### CUCM CI 42802872

Reception Preference	BestEffort
DTMF Capabilities	RFC2833
RFC2833 payload number	(101:8000)
Endpoint receive DTMF	✓
Endpoint provide OOB DTMF	✓
Region	Telepresence

---

### Associated CIs

CI	MTP required	Transcoder required	E2E region bandwidth
42802871	✗	✗	Audio:256 Video:3128 Immersive:3128

ⓘ No RTP streams linked for this call leg

# Case Study 8: Video Call Immediately Drops

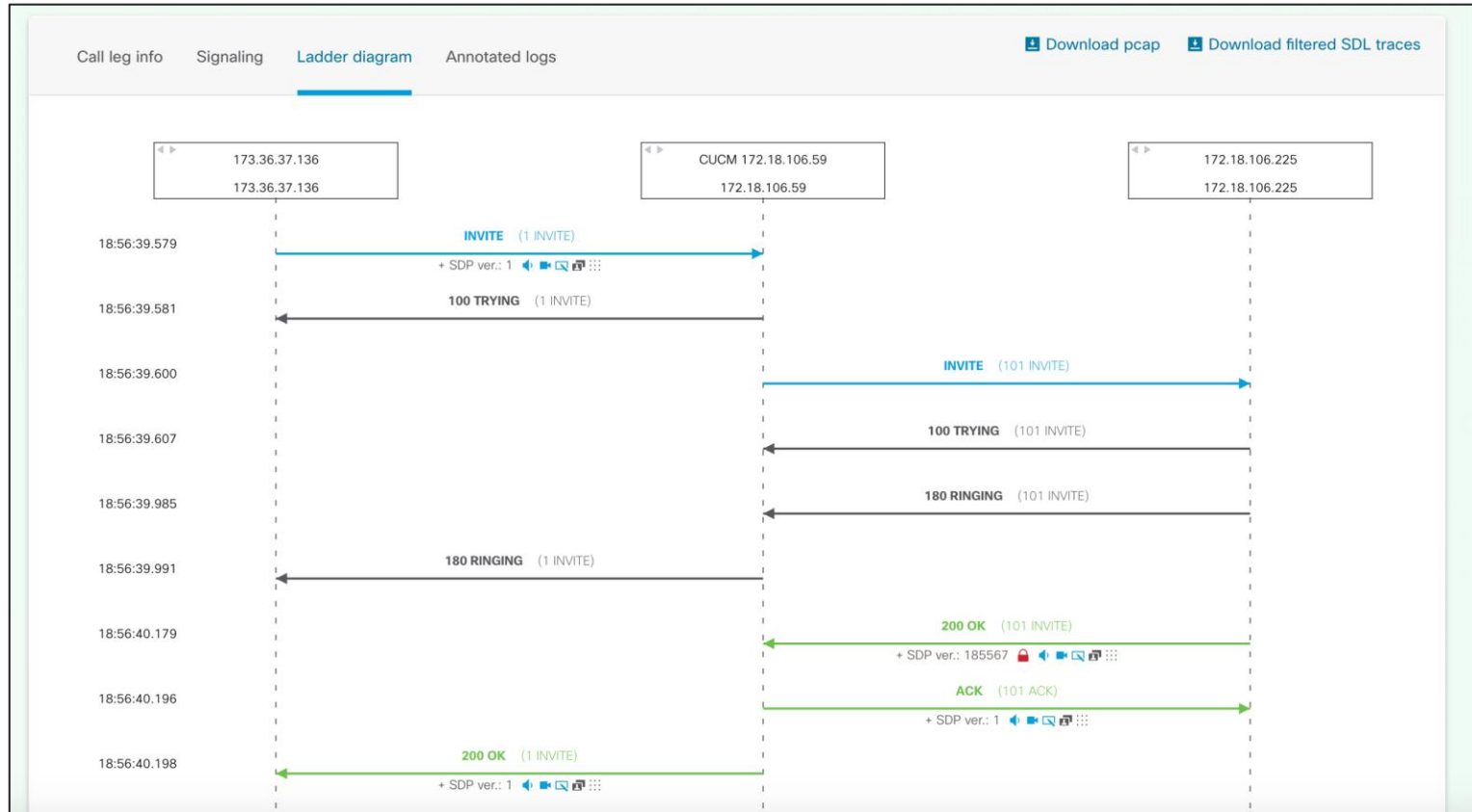

# Case Study 8: Video Call Immediately Drops

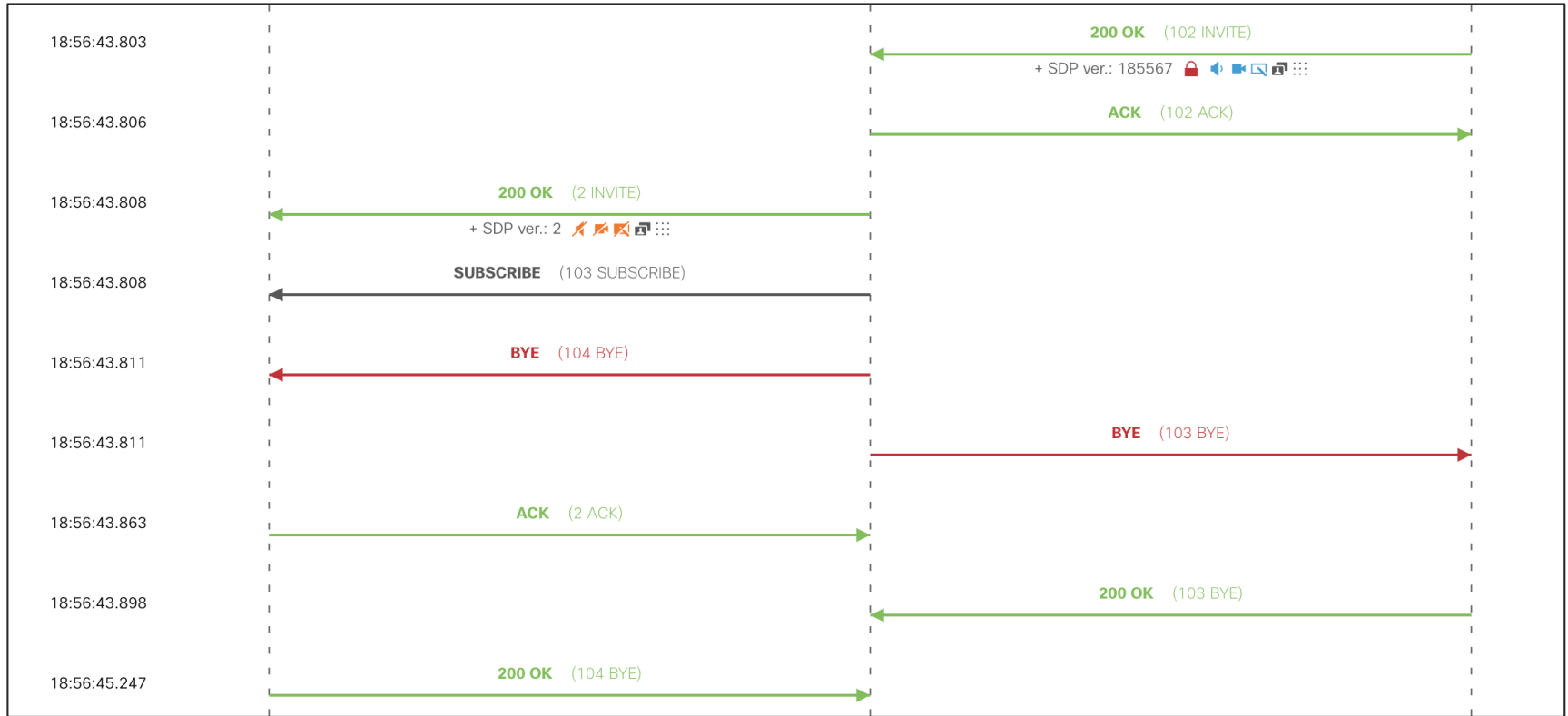



# Case Study 8: Video Call Immediately Drops

Message

✕

Message detail

---

📎 42802871\_node\_id\_2\_app\_CCM.txt

Message body

```
BYE sip:173.36.37.136:5073;transport=tls SIP/2.0
Via: SIP/2.0/TCP 172.18.106.59:5060;branch=z9hG4bK1b094f53b66417
From: <sip:123456789@vc.com>;tag=3630890~0d0d25d7~4931~4a07~83c6~b82e2c213ca7~42802871
To: "Paul Giralt" <sip:pgiralt@cisco.call.ciscopark.com>;tag=2086966398
Date: Wed, 22 Jan 2020 18:56:43 GMT
Call-ID: b8bc074f31cc06545d3620f056a5c24c@127.0.0.1
User-Agent: Cisco-CUCM12.5
Max-Forwards: 70
Route: <sip:proxy-call-id=50ad989e-cb24-4a44-b9a9-82a89bc0517b@173.36.37.136:5060;transport=tcp;lr>, <sip:proxy-call-id=50ad989e-cb24-4a44-b9a9-82a89bc0517b@173.36.37.136:5061;transport=tls;lr>
CSeq: 104 BYE
Reason: Q.850;cause=47
Session-ID: 2cda027300255000a0000ce1eeac0000;remote=2fd1039c8d930b25f217a3a9cffb9072
Content-Length: 0
```

# Case Study 8: Video Call Immediately Drops

Media

[18:56:43.806] vnt-cm1b.cisco.com The call media path failed to be established due to **unknown failure case** with reason

```
56264448.000 |13:56:43.806 |SdlSig |MXErrorReport |interfacesEstablished |MediaExchange(2,100,114,1003) |SIPInterface(2,100,186,1556) |2,100,247,6.5970^172.18.106.225**  
[[R:N-H:0,N:2,L:0,V:0,Z:0,D:0] error=0 CallMediaFailureCause=unknown failure case Reason=
```

 [Download filtered SDL traces](#)

# Case Study 8: Video Call Immediately Drops

Open files in TranslatorX and open Call List -> Filter for Abnormal Call Clearing

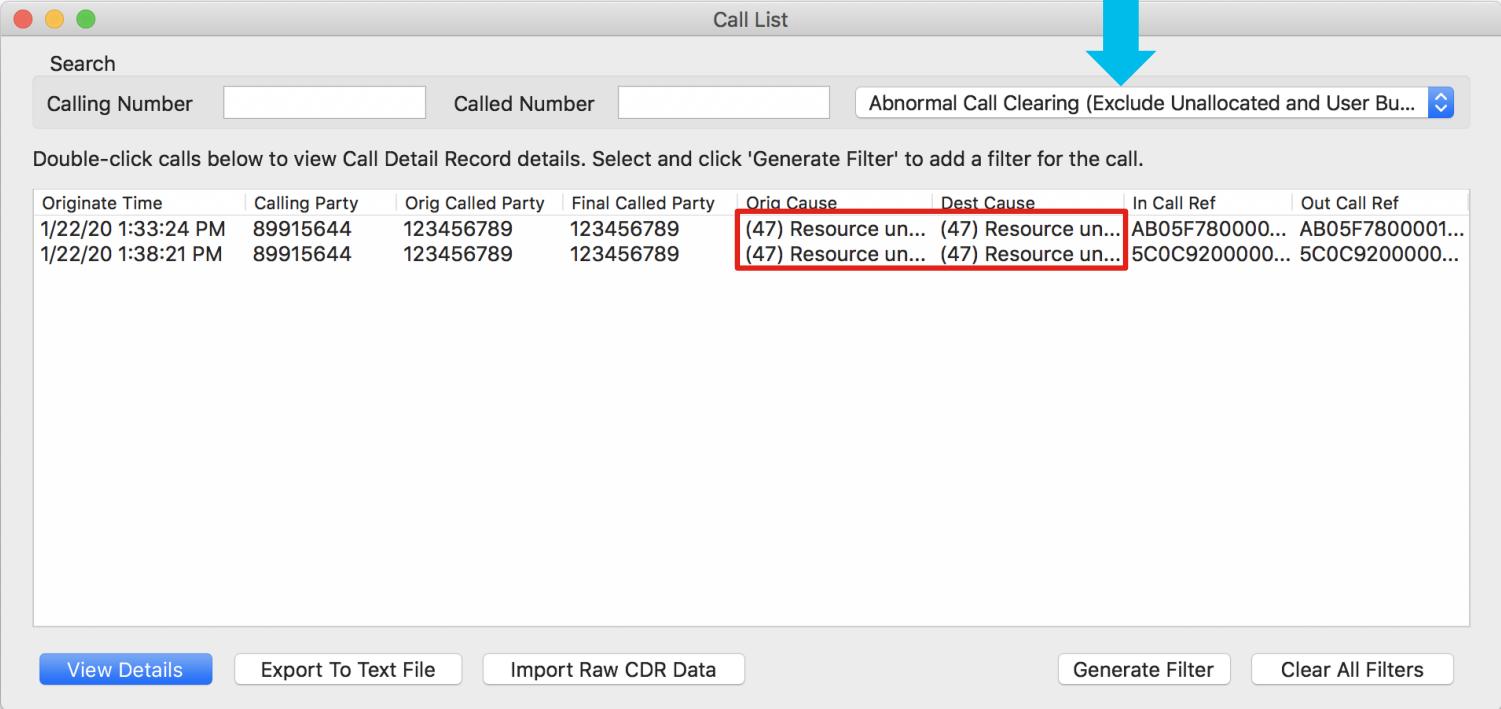

Call List

Search

Calling Number  Called Number  Abnormal Call Clearing (Exclude Unallocated and User Bu... ▾)

Double-click calls below to view Call Detail Record details. Select and click 'Generate Filter' to add a filter for the call.

Originate Time	Calling Party	Orig Called Party	Final Called Party	Orig Cause	Dest Cause	In Call Ref	Out Call Ref
1/22/20 1:33:24 PM	89915644	123456789	123456789	(47) Resource un...	(47) Resource un...	AB05F780000...	AB05F7800001...
1/22/20 1:38:21 PM	89915644	123456789	123456789	(47) Resource un...	(47) Resource un...	5C0C9200000...	5C0C9200000...

View Details Export To Text File Import Raw CDR Data Generate Filter Clear All Filters

# Case Study 8: Video Call Immediately Drops

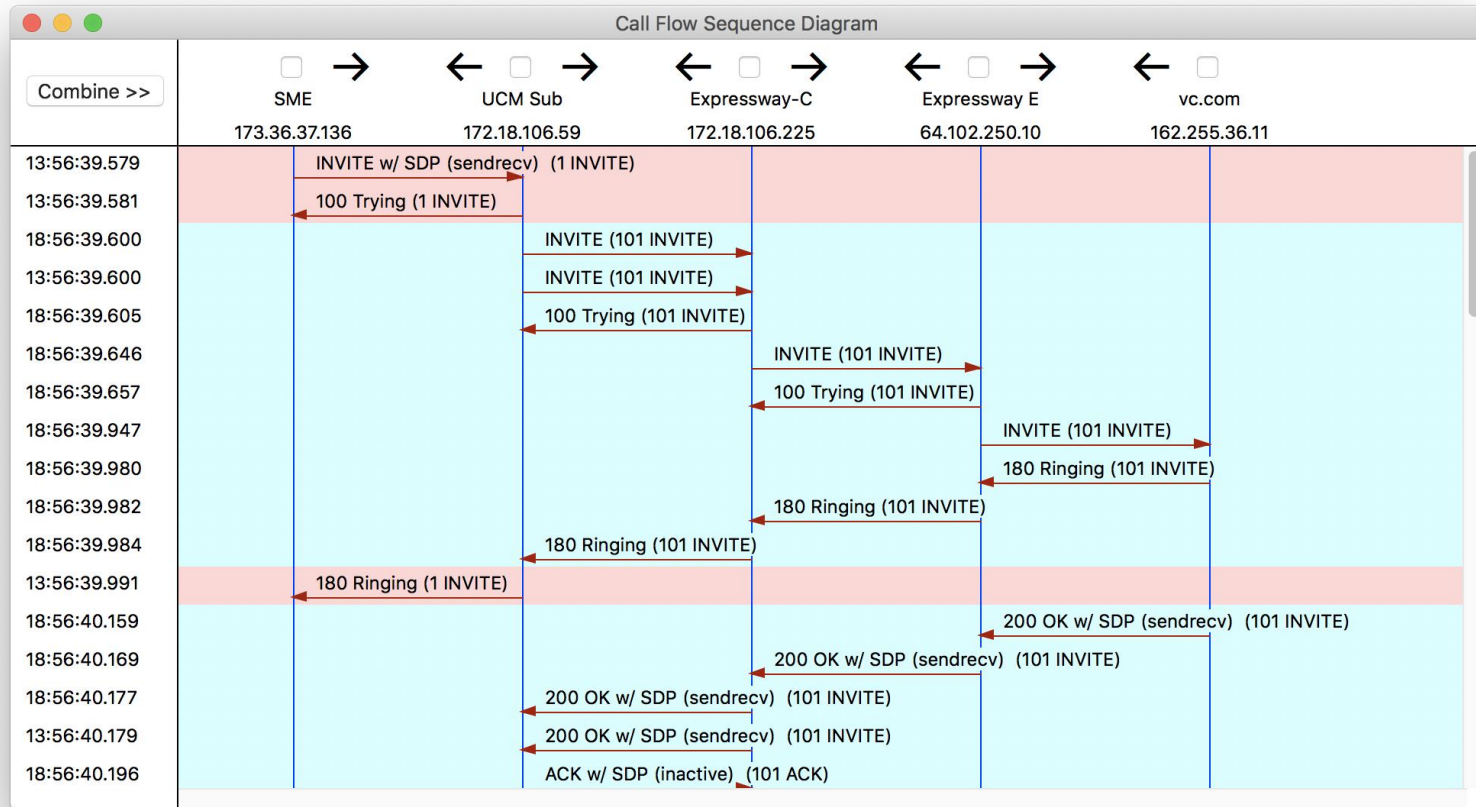

# Case Study 8: Video Call Immediately Drops

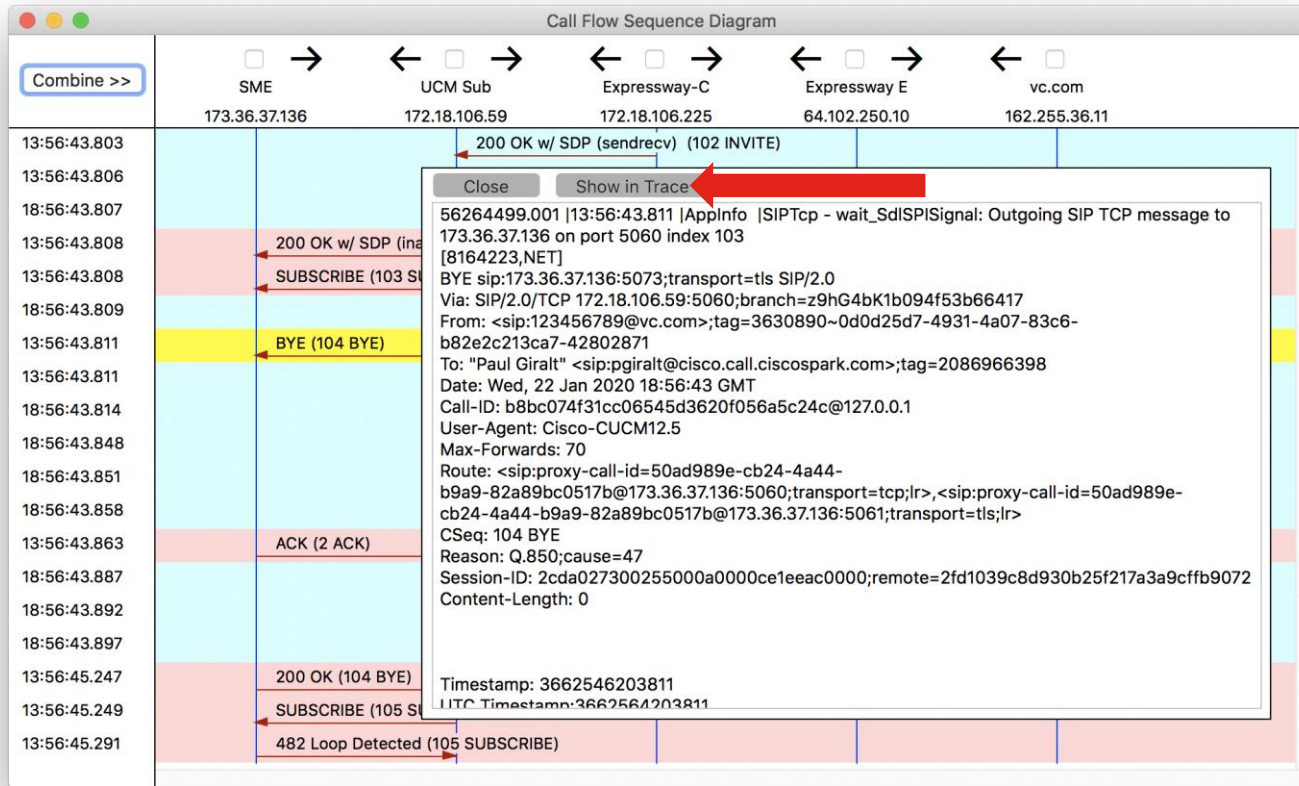

# Case Study 8: Video Call Immediately Drops

```
Trace
Filter: [ ] Clear [ ] Exclude KeepAlives Previous Error Next Error
56264498.001 [13:56:43.809 |AppInfo |//SIP/Stack/Info/0x0/ccsip_process_sipspl_queue_event: ccsip_spl_get_msg_type returned: 3 (SIP_APPLICATION_MSG), for event 8 (SIPSPLEV_CC_CALL_DISCONNECT)
56264498.002 [13:56:43.809 |AppInfo |//SIP/Stack/States/0x0xcc1eaad0/sipSPICheckState: 0xcc1eaad0 : State change from (STATE_MIDCALL_LOCAL_RESP_PENDING, SUBSTATE_NONE) to (STATE_ACTIVE, SUBSTATE_NONE)
56264498.003 [13:56:43.809 |AppInfo |//SIP/Stack/Info/0x0xcc1eaad0/sipSPIStopHoldTimer: Stopping hold timer
56264498.004 [13:56:43.809 |AppInfo |//SIP/Stack/Info/0x0xcc1eaad0/sipSPISendRequestContainerIntoHolder: Request Container Holder is above threshold...tr
56264498.005 [13:56:43.809 |AppInfo |//SIP/Stack/Info/0x0xcc1eaad0/sipSPIStopHoldTimer: Stopping hold timer
56264498.006 [13:56:43.809 |AppInfo |//SIP/Stack/Info/0x0xcc1eaad0/sipSPISendViaParams: inserted z9hG4bK1b094f53b66417 into via branch list
56264498.007 [13:56:43.809 |AppInfo |//SIP/Stack/Info/0x0/sipSPIAddRouteHeaders: status = TRUE Route: <sip:proxy-call-id=50ad989e-cb24-4a44-b9a9-82a89bc0517b@173.36.37.136:5060;transport=tcp;lr>, <sip:proxy-call-id=50ad989e-cb24-4a44-b9a9-82a89bc0517b@173.36.37.136:5060;transport=tcp;lr>
56264498.008 [13:56:43.809 |AppInfo |//SIP/Stack/Info/0x0xcc1eaad0/sipSPISendBye: Associated container=0xcafb93c8 to Bye
56264498.009 [13:56:43.809 |AppInfo |//SIP/Stack/Transport/0x0xcc1eaad0/sipSPISendBye: Sending BYE to the transport layer
56264498.010 [13:56:43.809 |AppInfo |//SIP/Stack/Transport/0x0xcc1eaad0/sipSPITransportSendMessage: msg=0xd1566910, addr=173.36.37.136, port=5060, sentBy_port=0, is_req=1, tran
56264498.011 [13:56:43.809 |AppInfo |//SIP/Stack/Transport/0x0/sipInstanceGetConnectionId: gcb=0xcc1eaad0 is already on connection=0xd125b688 context_list
56264498.012 [13:56:43.809 |AppInfo |//SIP/Stack/Transport/0x0xcc1eaad0/sipTransportLogicSendMsg: Set to send the msg=0xd1566910
56264498.013 [13:56:43.809 |AppInfo |//SIP/Stack/Transport/0x0xcc1eaad0/sipTransportPostSendMessage: Posting send for msg=0xd1566910, addr=173.36.37.136, port=5060, connId=103 for
56264498.014 [13:56:43.809 |AppInfo |//SIP/Stack/Info/0x0xcc1eaad0/sentByeDisconnecting: Sent Bye Request, starting DisconnectTimer
56264498.015 [13:56:43.809 |AppInfo |//SIP/Stack/States/0x0xcc1eaad0/sipSPICheckState: 0xcc1eaad0 : State change from (STATE_ACTIVE, SUBSTATE_NONE) to (STATE_DISCONNECTING, SUBSTATE_NONE)
56264498.016 [13:56:43.809 |AppInfo |//SIP/SIPHandler/ccblid=0/scblid=0/sip_stop_timer: timerContext=0xcc1ebab8 type=SIP_TIMER_DISCONNECT value=500 retries=10
56264498.017 [13:56:43.809 |AppInfo |//SIP/SIPHandler/ccblid=0/scblid=0/sip_start_timer: timerContext=0xcc1ebab8 type=SIP_TIMER_DISCONNECT value=500 retries=10
56264499.000 [13:56:43.811 |SdISig |SIPSPISignal |wait |SIPTcp(2,100,191,1) |SIPHandler(2,100,183,1) |2,100,247,6.5970*172.18.106.225** |*TraceFlagOverrode
56264499.001 [13:56:43.811 |AppInfo |SIPTcp - wait_SdISIPISignal: Outgoing SIP TCP message to 173.36.37.136 on port 5060 index 103
[8164223,NET]
BYE sip:173.36.37.136:5073;transport=tls SIP/2.0
Via: SIP/2.0/TCP 172.18.106.59:5060;branch=z9hG4bK1b094f53b66417
From: <sip:123456789@vc.com>;tag=3630890-0d0d25d7-4931-4a07-83c6-b82e2c13ca7-42802871
To: "Paul Giralt" <sip:pgiralt@cisco.call.ciscospark.com>;tag=2086966398
Date: Wed, 22 Jan 2020 18:56:43 GMT
Call-ID: b8bc074f31cc06545d3620f056a5c24c@127.0.0.1
User-Agent: Cisco-CUCM12.5
Max-Forwards: 70
Route: <sip:proxy-call-id=50ad989e-cb24-4a44-b9a9-82a89bc0517b@173.36.37.136:5060;transport=tcp;lr>, <sip:proxy-call-id=50ad989e-cb24-4a44-b9a9-82a89bc0517b@173.36.37.136:5061;transport=tls;lr>
CSeq: 104 BYE
Reason: Q.850;cause=47
Session-ID: 2cda027300255000a0000ce1eac0000;remote=2fd1039c8d930b25f217a39c8ff9072
Content-Length: 0

56264500.000 [13:56:43.811 |AppInfo |SIPSocketProtocol(2,100,251,67)::handleWriteComplete
56264501.000 [13:56:43.811 |SdISig |SIPSPISignal |wait |SIPTcp(2,100,191,1) |SIPHandler(2,100,183,1) |2,100,247,6.5970*172.18.106.225** |*TraceFlagOverrode
56264501.001 [13:56:43.811 |AppInfo |SIPTcp - wait_SdISIPISignal: Outgoing SIP TCP message to 172.18.106.225 on port 5061 index 115
[8164222,NET]
BYE sip:123456789@162.255.36.178:5061;transport=tls SIP/2.0
Via: SIP/2.0/TLS 172.18.106.59:5071;branch=z9hG4bK1b094eb686e3f
```

# Case Study 8: Video Call Immediately Drops

Trace

Filter:  Clear  Exclude KeepAlives Previous Error Next Error

```
56264464.016 [13:56:43.807] |AppInfo |//SIP/SIPHandler/ccbid=0/scbid=0/insertBFCPFloorCtrlAttr: BFCP floorctrl -- setting floorctrl
56264464.017 [13:56:43.807] |AppInfo |//SIP/SIPHandler/ccbid=0/scbid=0/insertBFCPFloorCtrlAttr: BFCP floorctrl -- successfully set floorctrl role 0 at index 0
56264464.018 [13:56:43.807] |AppInfo |//SIP/SIPHandler/ccbid=0/scbid=0/insertBFCPFloorCtrlAttr: BFCP floorid -- setting floorid
56264470.000 [13:56:43.807] |SdISig |MXInterfaceStoppedStreaming |waitStopped |MediaExchange(2,100,114,1003) |SIPInterface(2,100,186,1556) |2,100,247,6.5970*172.18.106.225** |[R:N-H:0,N:3,L:0,V:0,Z:0,D:0]
56264471.000 [13:56:43.807] |SdISig |MXInterfaceStoppedStreaming |waitStopped |MediaExchange(2,100,114,1003) |SIPInterface(2,100,186,1556) |2,100,247,6.5970*172.18.106.225** |[R:N-H:0,N:2,L:0,V:0,Z:0,D:0]
56264464.019 [13:56:43.807] |AppInfo |//SIP/Stack/Info/0x0/ccsip_process_sipsip_queue_event: ccsip_sip_get_msg_type returned: 3 (SIP_APPLICATION_MSG), for event 30 (SIPSPI_EV_CC_MEDIA_EVENT)
56264464.020 [13:56:43.807] |AppInfo |//SIP/Stack/Info/0x0xcc1eaaad0/act_handle_app_media_event: method = 102 state = 16
56264464.021 [13:56:43.807] |AppInfo |//SIP/Stack/Info/0x0xcc1eaaad0/act_handle_app_media_event: Received media sip event SIP_RESPONSE_ANSWER
56264472.000 [13:56:43.807] |SdISig |CcUpdateRegistration |call_active |RouteListCdrcc(2,100,173,66) |RouteListControl(2,100,173,66) |2,100,247,6.5970*172.18.106.225** |[R:N-H:0,N:3,L:0,V:0,Z:0,D:0] CI=42802872
56264464.022 [13:56:43.807] |AppInfo |//SIP/Stack/Info/0x0xcc1eaaad0/sipSPIPushSubsTransMsgContainerIntoHolder: Response Container Holder is above threshold..
56264473.000 [13:56:43.807] |SdISig |MediaConnectErrorInd |tcc_call_active7 |Cdccc(2,100,39,7876) |MatrixControl(2,100,117,1985) |2,100,247,6.5970*172.18.106.225** |[R:N-H:0,N:3,L:0,V:0,Z:0,D:0] CI1=42802871
56264464.023 [13:56:43.807] |AppInfo |//SIP/Stack/Info/0x0xcc1eaaad0/sipSPISendInviteResponse: Associated container=0xcac08130 to Invite Response 200
56264464.024 [13:56:43.807] |AppInfo |//SIP/Stack/Transport/0x0xcc1eaaad0/sipSPISendInviteResponse: Sending 200OK Response to the Transport Layer
56264464.025 [13:56:43.807] |AppInfo |//SIP/Stack/Transport/0x0xcc1eaaad0/sipSPITransportSendMessage: msg=0xd115dd60, addr=173.36.37.136, port=25238, sentBy_port=5060, is_req=0, tran
56264464.026 [13:56:43.807] |AppInfo |//SIP/Stack/Transport/0x0xcc1eaaad0/sipSPITransportPostSendMessage: Posting send for msg=0xd115dd60, addr=173.36.37.136, port=25238, connId=267 for
```

```
5 56264473.000 |13:56:43.807 |SdISig |MediaConnectErrorInd
5 |tcc_call_active7 |Cdccc(2,100,39,7876)
5 |MatrixControl(2,100,117,1985) |2,100,247,6.5970^172.18.106.225^*
5 |[R:N-H:0,N:3,L:0,V:0,Z:0,D:0] CI1=42802871 CI2=42802872 clearType=0
5 Cause=0
```

```
56264474.012 [13:56:43.808] |AppInfo |//SIP/Stack/Transport/0x0/sipSPIUpdateTCBRequestInfo: Dialog Transaction Address 173.36.37.136,Port 5060, Port Present: TRUE, Transport
56264474.013 [13:56:43.808] |AppInfo |//SIP/Stack/Info/0x0xcb2b5160/sipSPIPutSCBInClientTable: SCB with key b8bc074f31cc06545d3620f056a5c24c@127.0.0.13630890~0d0d25d7-4931-4a07-83c6-b82e2c213ca7-42802871 already in ClientTa
56264476.000 [13:56:43.808] |SdISig |MXCloseSession |restart |SIPInterface(2,100,186,1556) |MediaExchange(2,100,114,1003) |2,100,247,6.5970*172.18.106.225** |[R:N-H:0,N:6,L:0,V:0,Z:0,D:0]
56264476.001 [13:56:43.808] |Stopping | |SIPInterface(2,100,186,1556) |SIPInterface(2,100,186,1556) | |NumOfCurrentInstances: 40
56264474.014 [13:56:43.808] |AppInfo |//SIP/Stack/Info/0x0xcb2b5160/sipSPICreateSubscribe: Value of scb->incoming and direction flag 0, 0
56264474.015 [13:56:43.808] |AppInfo |//SIP/Stack/Info/0x0/sipSPIAddRouteHeaders: status = TRUE Route: <sip:proxy-call-id=50ad989e-cb24-4a44-b9a9-82a89bc0517b@173.36.37.136:5060;transport=tcp;|>,<sip:proxy-call-id=50ad989e-cb24-
56264474.016 [13:56:43.808] |AppInfo |//SIP/Stack/Info/0x0/sipSPIUpdateTCBMethod: TCB 0xd1238390's method is 112
56264474.017 [13:56:43.808] |AppInfo |//SIP/Stack/Info/0x0/sipSPIUpdateTCBClientMarker: Client TCB's Marker Updated to: z9hG4bK1b094d6bdac3cd
```



# Case Study 8: Video Call Immediately Drops

Trace

Filter:  Clear  Exclude KeepAlives Previous Error Next Error

```
56264448.000 |13:56:43.806 |SdlSig |MXErrorReport |interfacesEstablished |MediaExchange(2,100,114,1003) |SIPInterface(2,100,186,1556) |2,100,247,6.5970^172.18.106.225** |[R:N-H:0,N:2,L:0,V:0,Z:0,D:0] error=0 Ca
56264449.000 |13:56:43.806 |SdlSig |SdlWriteReq |active |SdSSLTCPConnection(2,100,247,6) |SIPInterface(2,100,186,1556) |2,100,247,6.5970^172.18.106.225** |*TraceFlagOve
56264449.001 |13:56:43.806 |AppInfo |SIPSocketProtocol(2,100,247,6)::handleWriteComplete
56264450.000 |13:56:43.806 |SdlSig |SIPMediaToUpdateCcc |waitStopped |MediaExchange(2,100,114,1003) |SIPInterface(2,100,186,1556) |2,100,247,6.5970^172.18.106.225** |[R:N-H:0,N:4,L:0,V:0,Z:0,D:0] flushIns=1
56264451.000 |13:56:43.806 |SdlSig |CcUpdateRegistration |call_active |RouteListCdcrc(2,100,172,598) |RouteListControl(2,100,173,66) |2,100,247,6.5970^172.18.106.225** |[R:N-H:0,N:4,L:0,V:0,Z:0,D:0] CI=42802872
56264452.000 |13:56:43.806 |SdlSig |MediaConnectErrorInd |waitDisconnect |MediaManager(2,100,119,998) |MediaExchange(2,100,114,1003) |2,100,247,6.5970^172.18.106.225** |[R:N-H:0,N:4,L:0,V:0,Z:0,D:0] CI1=421
56264452.001 |13:56:43.806 |AppInfo |!!!ERROR!! -MediaManager-(998)::handle_MediaConnectErrorInd, mCleanupPreallocatedMTP=0
56264452.002 |13:56:43.806 |AppInfo |!!!ERROR!! -MediaManager-(998)::handle_MediaConnectErrorInd, send disconnect to 1 MXs
56264452.003 |13:56:43.806 |AppInfo |!!!ERROR!! -MediaManager-(998)::handle_MediaConnectErrorInd, mediaConnectRequestMsg party video capable (1=1, 2=1), ConnecterrorInd party capable (1=1, 2=1)
56264452.004 |13:56:43.806 |AppInfo |DET -MediaManager-(998)::processRetainedAndReparentToMC(), retainingPartryCI=0
56264452.005 |13:56:43.806 |AppInfo |!!!ERROR!! -MediaManager-(998)::handle_MediaConnectErrorInd, ERROR:remain mConnCount=1
56264452.006 |13:56:43.806 |AppInfo |!!!ERROR!! -MediaManager-(998)::handle_MediaConnectErrorInd, ERROR:only 1 MX reported error...going away.
56264452.007 |13:56:43.806 |Stopping | |MediaManager(2,100,119,998) |MediaManager(2,100,119,998) | |NumOfCurrentInstances: 17
56264453.000 |13:56:43.806 |SdlSig |MXInterfaceStopStreaming |sessionEstablished |SIPInterface(2,100,186,1556) |MediaExchange(2,100,114,1003) |2,100,247,6.5970^172.18.106.225** |[R:N-H:0,N:4,L:0,V:0,Z:0,D:0] ClearT
56264453.019 |13:56:43.806 |AppInfo |DET-MediaMlinesList::resetRtcpBWModifiersinMlinesList: TEXOMA_ICE: Rtcp BW modifiers removed in mlines
56264453.020 |13:56:43.806 |AppInfo |DET-SDPMsg-resetRtcpBWModifiersinSDP:: TEXOMA_ICE: TEXOMA_ICE: Rtcp BW modifiers in entire SDP reset
56264454.000 |13:56:43.806 |SdlSig |MXInterfaceStopStreaming |sessionEstablished |SIPInterface(2,100,186,1556) |MediaExchange(2,100,114,1003) |2,100,247,6.5970^172.18.106.225** |[R:N-H:0,N:5,L:0,V:0,Z:0,D:0] ClearT
56264455.000 |13:56:43.806 |SdlError |SIPMediaToUpdateCcc |INA |MediaManager(2,100,119,998) |MediaExchange(2,100,114,1003) |2,100,247,6.5970^172.18.106.225** |Destination process does not exist
56264456.000 |13:56:43.806 |SdlSig |SdlProcessNE |waitStopped |MediaExchange(2,100,114,1003) |MediaManager(2,100,119,998) |2,100,247,6.5970^172.18.106.225** |*TraceFlagOverride
56264456.001 |13:56:43.806 |SdlError |SdlProcessNE |waitStopped |MediaExchange(2,100,114,1003) | | |Error: Description: A transition is not defined for the input signal. Chec
56264457.000 |13:56:43.806 |SdlSig |CcUpdateRegistration |wait |Cc(2,100,38,1) |RouteListCdcrc(2,100,172,598) |2,100,247,6.5970^172.18.106.225** |[R:N-H:0,N:4,L:0,V:0,Z:0,D:0] CI=42802872 CI=branci
```

```
56264448.000 |13:56:43.806 |SdlSig |MXErrorReport
|interfacesEstablished |MediaExchange(2,100,114,1003)
|SIPInterface(2,100,186,1556) |2,100,247,6.5970^172.18.106.225^*
|[R:N-H:0,N:2,L:0,V:0,Z:0,D:0] error=0 CallMediaFailureCause=unknown failure
case Reason=
```

```
56264453.019 |13:56:43.806 |AppInfo |DET-MediaMlinesList::resetRtcpBWModifiersinMlinesList: TEXOMA_ICE: Rtcp BW modifiers removed in mlines
56264453.020 |13:56:43.806 |AppInfo |DET-SDPMsg-resetRtcpBWModifiersinSDP:: TEXOMA_ICE: TEXOMA_ICE: Rtcp BW modifiers in entire SDP reset
56264454.000 |13:56:43.806 |SdlSig |MXInterfaceStopStreaming |sessionEstablished |SIPInterface(2,100,186,1556) |MediaExchange(2,100,114,1003) |2,100,247,6.5970^172.18.106.225** |[R:N-H:0,N:5,L:0,V:0,Z:0,D:0] ClearT
56264455.000 |13:56:43.806 |SdlError |SIPMediaToUpdateCcc |INA |MediaManager(2,100,119,998) |MediaExchange(2,100,114,1003) |2,100,247,6.5970^172.18.106.225** |Destination process does not exist
56264456.000 |13:56:43.806 |SdlSig |SdlProcessNE |waitStopped |MediaExchange(2,100,114,1003) |MediaManager(2,100,119,998) |2,100,247,6.5970^172.18.106.225** |*TraceFlagOverride
56264456.001 |13:56:43.806 |SdlError |SdlProcessNE |waitStopped |MediaExchange(2,100,114,1003) | | |Error: Description: A transition is not defined for the input signal. Chec
56264457.000 |13:56:43.806 |SdlSig |CcUpdateRegistration |wait |Cc(2,100,38,1) |RouteListCdcrc(2,100,172,598) |2,100,247,6.5970^172.18.106.225** |[R:N-H:0,N:4,L:0,V:0,Z:0,D:0] CI=42802872 CI=branci
```



# Case Study 8: Video Call Immediately Drops

Trace

Filter:  Clear  Exclude KeepAlives Previous Error Next Error

```
56264444.033 |13:56:43.805 |AppInfo |DET-SDPMsg-():setBWforVideo, video bandwidth mask = 4
56264444.034 |13:56:43.805 |AppInfo |DET-SDPMsg-():setBWforVideo, video bandwidth mask = 4
56264444.035 |13:56:43.805 |AppInfo |DET-SDPMsg-():setBWforVideo, sessionBW=1920000, calMainVideoobps=1792000, calSecVideoobps=960000
56264444.036 |13:56:43.805 |AppInfo |DET-SDPMsg-():setSessionBandwidthModifiers(bw=1920000, action=0) - session(bitmask=0x1,tias=0,as=1920,ct=0)
56264444.037 |13:56:43.805 |AppInfo |!!ERROR!! -SIPInterface-(1556)::answerProfilesConformWithOffer, mx-offer profile mis-match, posting MxError and dropping call, RTP(0,1), sRTP(1,0)
56264445.000 |13:56:43.806 |SdISig |sessionEstablished |SIPInterface(2,100,186,1556) |SIPcdpc(2,100,180,3378) |2,100,247,6.5970*172.18.106.225** |[R:N-H:0,N:3,L:0,V:0,Z:0,D:0] flushIns=0
56264446.000 |13:56:43.806 |SdISig |CcUpdateRegistration |idle |RouteListControl(2,100,173,66) |SIPcdpc(2,100,180,3378) |2,100,247,6.5970*172.18.106.225** |[R:N-H:0,N:3,L:0,V:0,Z:0,D:0] Cl=42802872 ClI=
56264447.000 |13:56:43.806 |SdISig |SIPSPISignal |wait |SIPTcp(2,100,191,1) |SIPHandler(2,100,183,1) |2,100,247,6.5970*172.18.106.225** |*TraceFlagOverride
56264447.001 |13:56:43.806 |AppInfo |SIPTcp - wait_SdISIPISignal: Outgoing SIP TCP message to 172.18.106.225 on port 5061 index 115
[8164219,NET]
ACK sip:123456789@162.255.36.178:5061;transport=tls SIP/2.0
V
F
T
D
C
U
R
M
C
A
C
```

56264444.037 |13:56:43.805 |AppInfo |!!ERROR!! -SIPInterface-(1556)::answerProfilesConformWithOffer, mx-offer profile mis-match, posting MxError and dropping call, RTP(0,1), sRTP(1,0)

```
56264448.000 |13:56:43.806 |SdISig |MXErrorReport |interfacesEstablished |MediaExchange(2,100,114,1003) |SIPInterface(2,100,186,1556) |2,100,247,6.5970*172.18.106.225** |[R:N-H:0,N:2,L:0,V:0,Z:0,D:0] error=0 Ca
56264449.000 |13:56:43.806 |SdISig |SdISslWriteReq |active |SdISslTCPConnection(2,100,247,6) |SIPTcp(2,100,191,1) |2,100,247,6.5970*172.18.106.225** |*TraceFlagOve
56264449.001 |13:56:43.806 |AppInfo |SIPSocketProtocol(2,100,247,6)::handleWriteComplete |waitStopped |MediaExchange(2,100,114,1003) |SIPInterface(2,100,186,1556) |2,100,247,6.5970*172.18.106.225** |[R:N-H:0,N:4,L:0,V:0,Z:0,D:0] flushIns=1
56264450.000 |13:56:43.806 |SdISig |SIPMediaToUpdateCc |call_active |RouteListCdrcc(2,100,172,598) |RouteListControl(2,100,173,66) |2,100,247,6.5970*172.18.106.225** |[R:N-H:0,N:4,L:0,V:0,Z:0,D:0] Cl=42802872
56264451.000 |13:56:43.806 |SdISig |MediaConnectErrorInd |waitDisconnect |MediaManager(2,100,119,998) |MediaExchange(2,100,114,1003) |2,100,247,6.5970*172.18.106.225** |[R:N-H:0,N:4,L:0,V:0,Z:0,D:0] Cl1=421
56264452.001 |13:56:43.806 |AppInfo |!!ERROR!! -MediaManager-(998)::handle_MediaConnectErrorInd, mCleanupPreallocatedMTP=0
56264452.002 |13:56:43.806 |AppInfo |!!ERROR!! -MediaManager-(998)::handle_MediaConnectErrorInd, send disconnect to 1 MXs
56264452.003 |13:56:43.806 |AppInfo |!!ERROR!! -MediaManager-(998)::handleMediaConnectErrorInd, mediaConnectRequestMsg party video capable (1=1, 2=1), Connecterrorind party capable (1=1, 2=1)
56264452.004 |13:56:43.806 |AppInfo |DET-MediaManager-(998)::processRetainedAndReparentToMC(), retainingPartryCl=0
56264452.005 |13:56:43.806 |AppInfo |!!ERROR!! -MediaManager-(998)::handle_MediaConnectErrorInd, ERROR:remain mConnCount=1
56264452.006 |13:56:43.806 |AppInfo |!!ERROR!! -MediaManager-(998)::handle_MediaConnectErrorInd, ERROR:only 1 MX reported error...going away.
56264452.007 |13:56:43.806 |Stopping | |MediaManager(2,100,119,998) |MediaManager(2,100,119,998) | |NumOfCurrentInstances: 17
56264453.000 |13:56:43.806 |SdISig |MXInterfaceStopStreaming |sessionEstablished |SIPInterface(2,100,186,1555) |MediaExchange(2,100,114,1003) |2,100,247,6.5970*172.18.106.225** |[R:N-H:0,N:4,L:0,V:0,Z:0,D:0] ClearT
56264453.001 |13:56:43.806 |AppInfo |SIPInterface::resetRemotelpAddressForMLines
56264453.002 |13:56:43.806 |AppInfo |DET-SIPInterface-(1555)::prepareAndSendSDPAnswer, preSDP(aud=1,vid=2,app=0,bfcp=1,ix=0),nLines(aud=1,vid=2,app=0,bfcp=1,ix=0)
56264453.003 |13:56:43.806 |AppInfo |DET-SIPInterface-(1555)::adjustLineStackIdxForMatchLines MLINE_AUDIO lineStackIdx=1
```

# Case Study 8: Video Call Immediately Drops

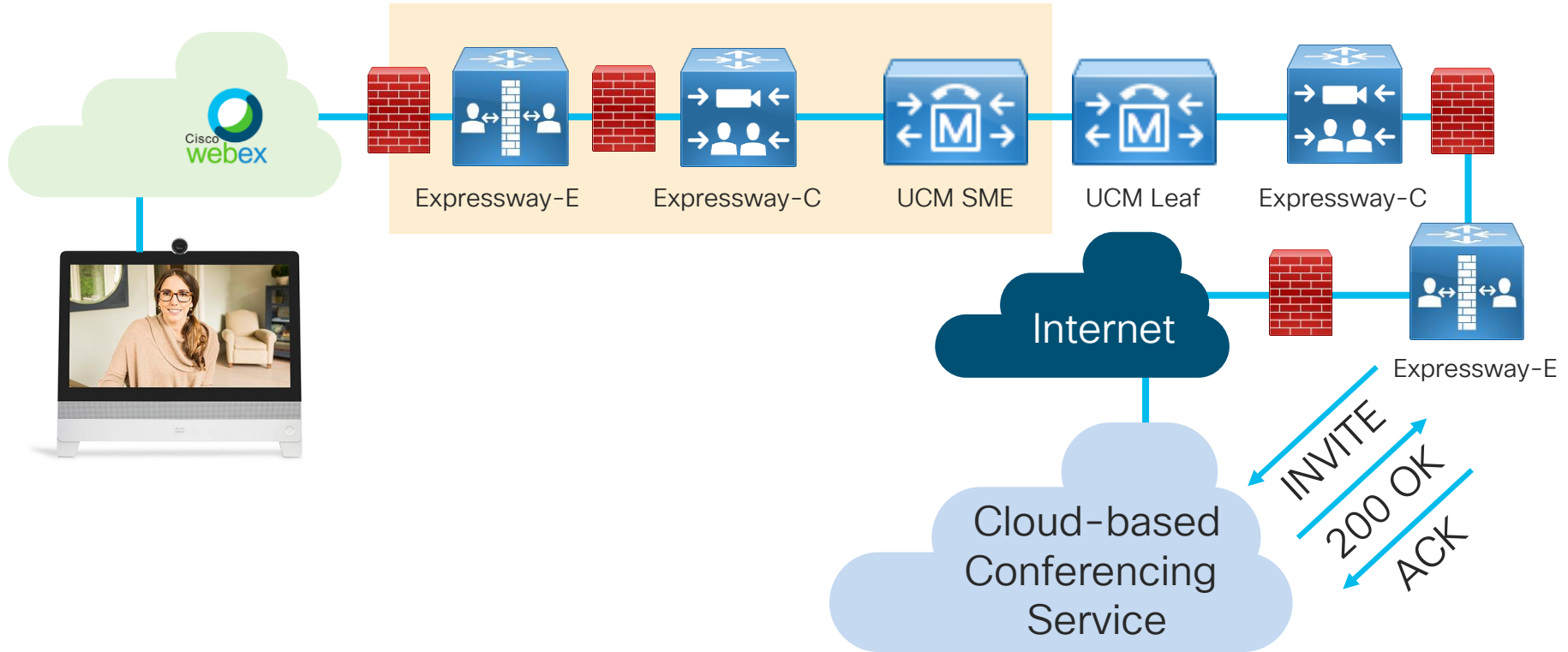

# Case Study 8: Video Call Immediately Drops

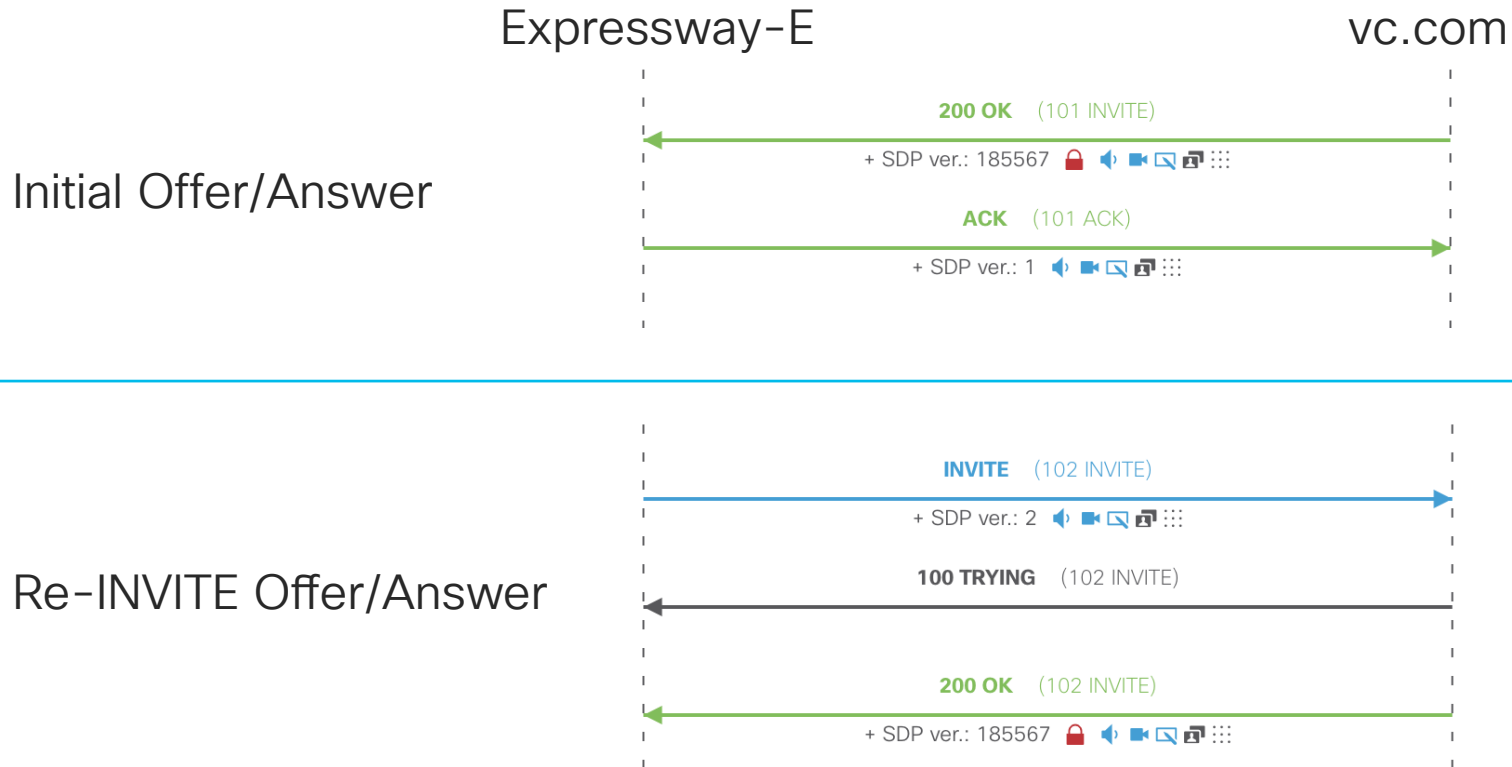

# Case Study 8: Video Call Immediately Drops

Fix: Allow Expressway-E to interwork between encrypted and unencrypted

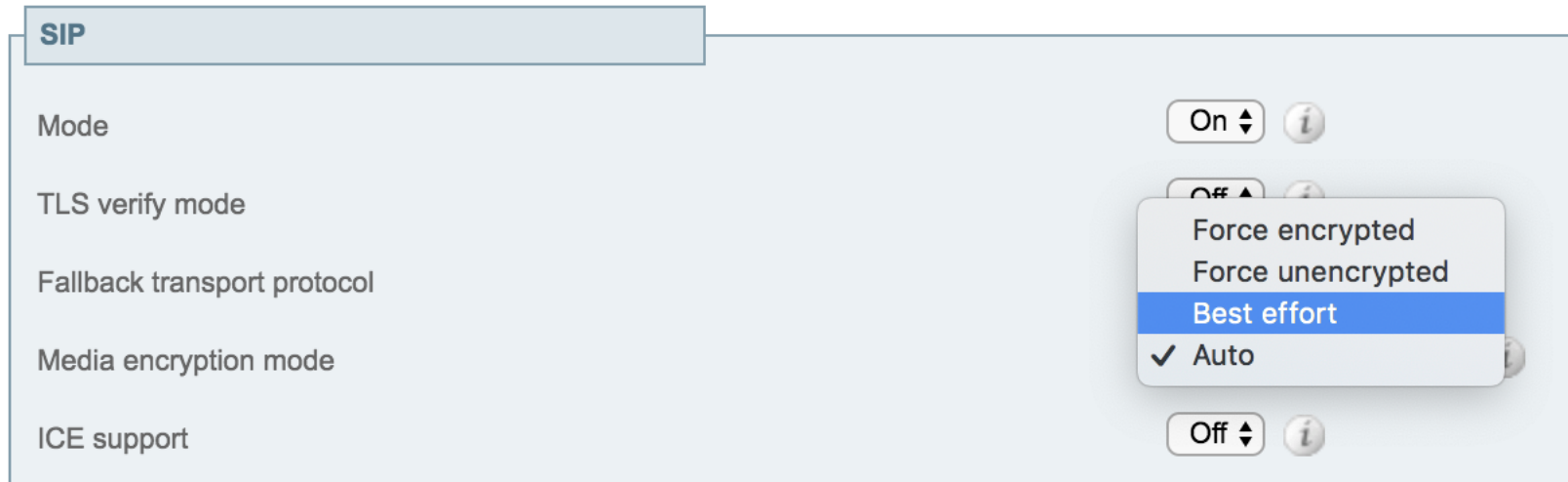

The image shows a configuration interface for SIP. A dropdown menu is open for the 'Mode' setting, displaying the following options: 'Force encrypted', 'Force unencrypted', 'Best effort' (highlighted in blue), and 'Auto' (with a checkmark). The 'Mode' setting is currently set to 'On'. Other settings visible include 'TLS verify mode', 'Fallback transport protocol', 'Media encryption mode', and 'ICE support', all of which are currently set to 'Off'.

# Agenda

- Serviceability Tools Overview
  - Real-Time Monitoring Tool (RTMT)
  - Cisco Unified Operating System GUI
  - Cisco Unified Operating System CLI
  - Cisco Serviceability Reports
  - Cisco Unified Reporting
  - Serviceability APIs
- Troubleshooting Methodology
  - Problem Description
  - Information Collection
- Troubleshooting Case Studies
  - Dropped Call
  - No One Answers the Phone
  - Unable to Place Calls
  - Call Drops After Answering
  - Video Encryption Not Working
  - One-Way Audio
  - ActiveControl Not Working on Jabber 12.5
  - Video Call Immediately Drops
- **Understanding and Troubleshooting Unified CM Throttling Events**
- Troubleshooting Database Replication

# CallManager built-in Monitoring & Throttling

## ProcMon

- Internal CCM Thread that monitors Itself & Other threads
- Runs every 2 Seconds
- Could Trigger %UC\_CALLMANAGER-2-TimerThreadSlowed Alarm
- Could Intentionally Abort CallManager Service as a Last Resort



## CodeYellow

- Triggered against SDL Router Thread congestion only
- Throttles this Main Call Processing Thread
- All New Calls Rejected on the Node in CodeYellow



## SignalCongestionEntry

- Triggered against other CallManager Sub Threads
- Such as SIP Handler Thread
- Could Trigger %UC\_CALLMANAGER-2-SignalCongestionEntry



# Understanding ProcMon TimerThreadSlowed

- ProcMon SDL Router Thread Verification expects to run every 2 seconds
- > 1sec Delay **TimerThreadSlowed** Alarm is raised as a forewarning to Throttling (CodeYellow / Signal Congestion)
- Usually induced due to IOWait conditions
- Could be Correlated to CallManager RISDC Performance Counter
  - \\cucm\System\IOServiceTime
  - \\cucm\System\IOAwait

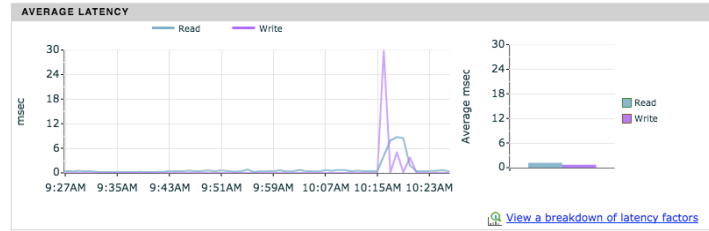

Clusterwide Parameters (System - SDL)		
SDL Listening Port Number *	8002	
SDL Max Router Latency *	20	in seconds

↳ 3 X Max Router Latency 60 secs → Intentional Abort

```

backtrace - CUCM
=====
#0 0xf77430 in __kernel_vsyscall ()
#1 0xf691a871 in raise () from /lib/libc.so.6
#2 0xf691c14a in abort () from /lib/libc.so.6
#3 0x083a008e in IntentionalAbort () at ProcessCMProcMon.cpp:88
#4 CMProcMon::verifySdlRouterServices () at ProcessCMProcMon.cpp:748
#5 0x083a04da in CMProcMon::callManagerMonitorThread (cmProcMon=0xe3a7ff70)
#6 0xf6c3d398 in ACE_OS_Thread_Adapter::invoke (this=0xd93687d8) at OS_Th
#7 0xf6bfd491 in ace_thread_adapter (args=0xd93687d8) at Base_Thread_Ada
#8 0xf68d1bc9 in start_thread () from /lib/libpthread.so.0#9 0xf69d2c9e
    
```

• Alarm is missing from Local Syslog (CiscoSyslog)

• CUCM → Serviceability → Alarm Configuration → CallManager Service → Remote Syslog ONLY

• Fixed in 10.5(2)SU4, 11.5(1)SU1+

CSCty06667



Feb 10 10:15:33 cucm-sub5 local7 2 ccm: 14: cucm-sub5.domain.com : Feb 10 2017 15:15:33.193 UTC : **%UC\_CALLMANAGER-2-TimerThreadSlowed:** %[AppID=Cisco CallManager][ClusterID=StandAloneCluster][NodeID=cucm-sub5]: Timer thread has slowed beyond acceptable limits

# Investigating TimerThreadSlowed Events

Feb 10 10:15:33 cucm-sub5 local7 2 ccm: 14: cucm-sub5.domain.com : Feb 10 2017 15:15:33.193 UTC : %UC\_CALLMANAGER-2-TimerThreadSlowed: %[AppID=Cisco CallManager][ClusterID=StandAloneCluster][NodeID=cucm-sub5]: Timer thread has slowed beyond acceptable limits

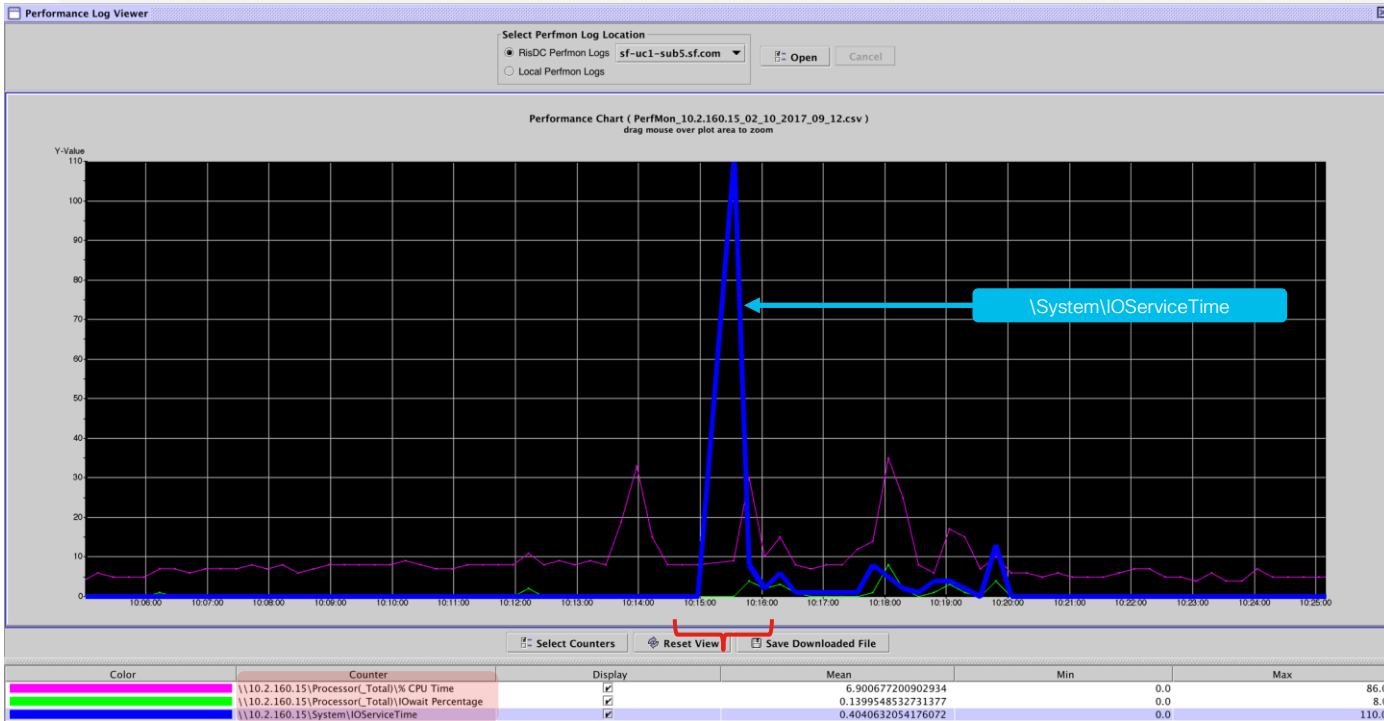

Evidence first seen in  
RisDC Perfmon Logs  
- Counter IOServiceTime

The Counter Property dialog box shows the following details for the counter '\System\IOServiceTime':

- Host: vnt-cm1b.cisco.com
- Object: System
- Counter: IOServiceTime
- Desc: This represents the average service time, in milliseconds, for I/O requests that were issued to all devices on this server.



# Investigating TimerThreadSlowed Events

Feb 10 10:15:33 cucm-sub5 local7 2 ccm: 14: cucm-sub5.domain.com : Feb 10 2017 15:15:33.193 UTC : %UC\_CALLMANAGER-2-TimerThreadSlowed: % [AppID=Cisco CallManager][ClusterID=StandAloneCluster][NodeID=cucm-sub5]: Timer thread has slowed beyond acceptable limits

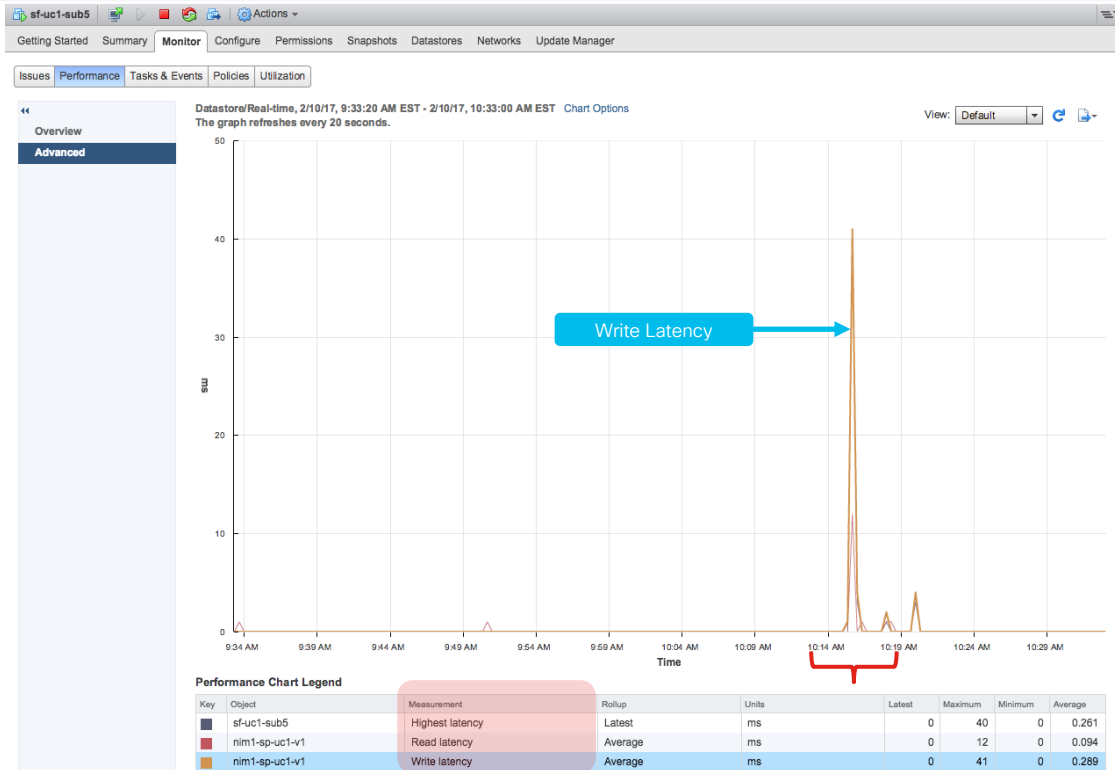

Next Evidence seen in  
VWware VM Performance  
Disk Counters

- Highest Latency
  - Read Latency
  - Write Latency

# Investigating TimerThreadSlowed Events

Feb 10 10:15:33 cucm-sub5 local7 2 ccm: 14: cucm-sub5.domain.com : Feb 10 2017 15:15:33.193 UTC : %UC\_CALLMANAGER-2-TimerThreadSlowed: % [AppID=Cisco CallManager][ClusterID=StandAloneCluster][NodeID=cucm-sub5]: Timer thread has slowed beyond acceptable limits

## Performance

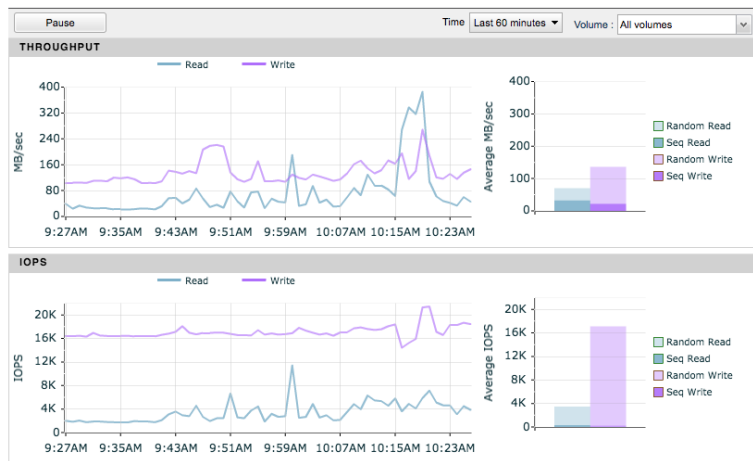

Finally Evidence can be seen in your SAN's Performance Counters

- Average Latency

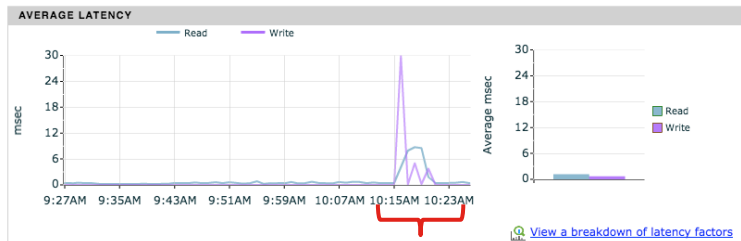

# Investigating TimerThreadSlowed Events

Cisco UCS C-Series  
BE6/7k



ESXi Performance  
Monitoring

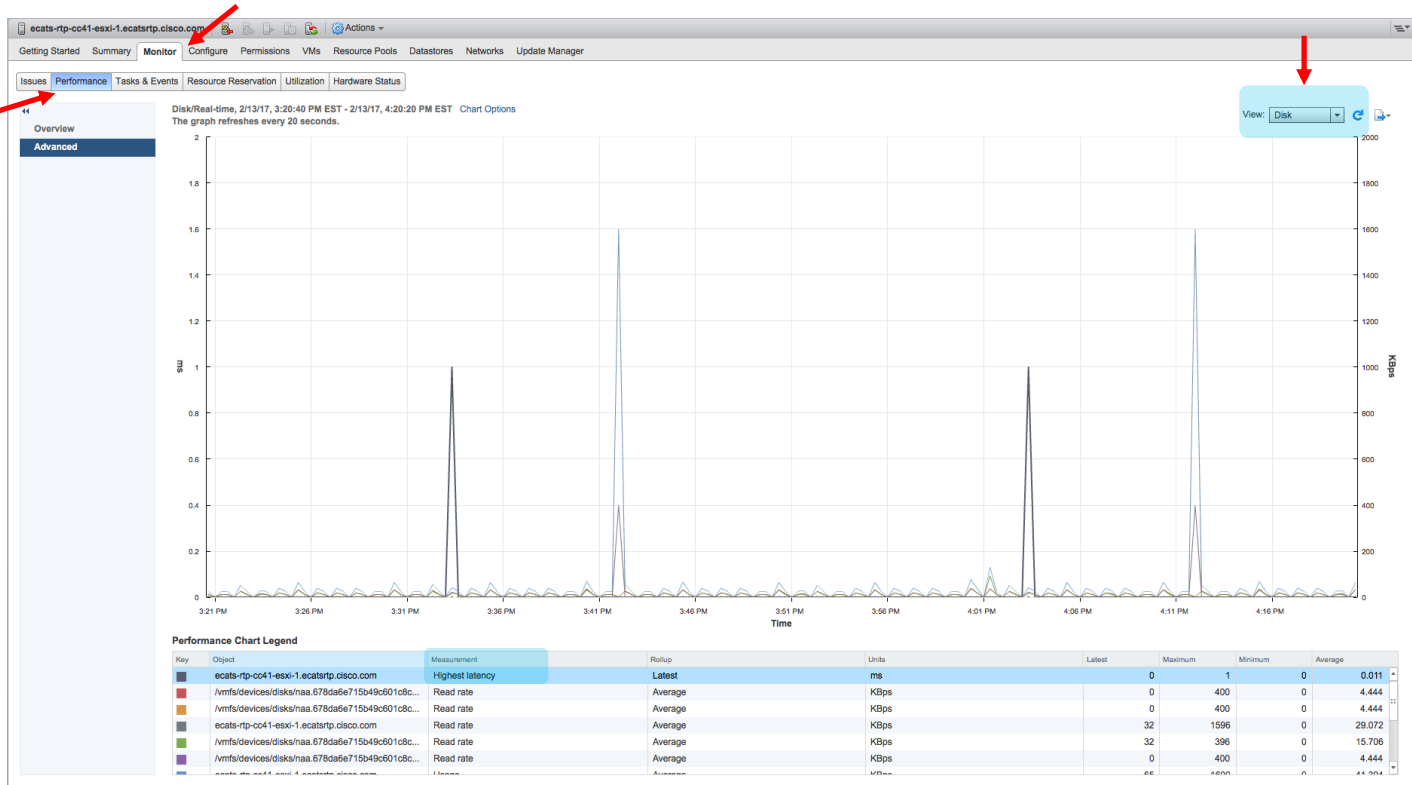

# Unified CM on UCS Storage IO Requirements

## TRC C-Series



- IOPS pre spec'd out with Raid5 and number of Disks required
- ✓ Good BBU = **Write Back** Cache Mode
- ✗ Bad BBU = **Write Through** Mode

## B-Series w/ SAN



- Host Level Kernel Disk Command Latency Requirement < 4ms
- Physical Device Command Latency Requirement < 20ms
- Min IOPS Requirements

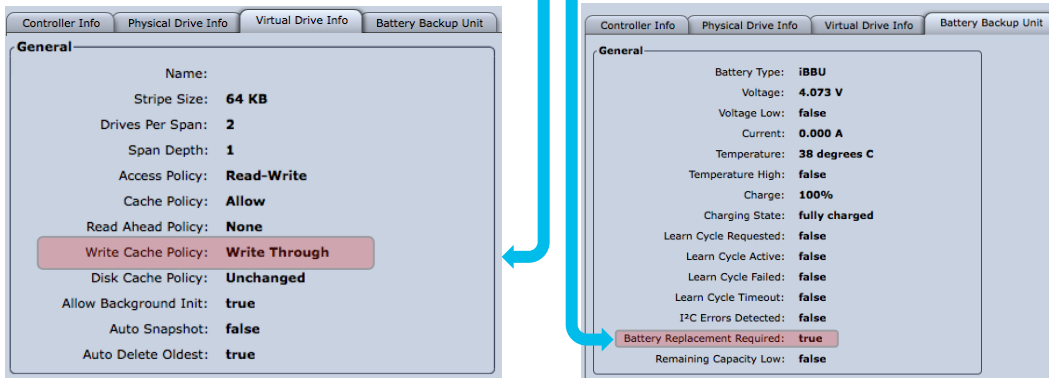

## Unified CM IOPS Requirements (<https://bit.ly/2sVhceK>)

BHCA 10k – 100K = 35 – 150 IOPS

Software Upgrades 800-1200 IOPS

Continuous CDR loading to CAR 300 IOPS

Trace collection 100 IOPS

Backups 50 IOPS

# C220 / 240 M3S or M4 Tested Reference Configurations with Super Cap

Cisco Integrated Management Controller

CIMC Hostname: C240-FCH1733V1PN  
Logged in as: admin@10.81.96.40  
Log Out

Overall Server Status: Good

Storage Adapters

Server Admin Storage CPUs Memory Power Supplies PCI Adapters Cisco VIC Adapters Network Adapters Storage Adapters

**LSI MegaRAID SAS 9266-8i**

Controller: **SLOT-4** Product ID: **LSI Logic**  
PCI Slot: **SLOT-4** Battery Status: **capacitor**  
Product Name: **LSI MegaRAID SAS 9266-8i** Cache Memory Size: **877 MB**  
Serial Number: **SV33517375** Health: Good  
Firmware Package Build: **23.12.0-0021**

[Details](#)

**LSI MegaRAID SAS 9266-8i (SLOT-4)**

Controller Info Physical Drive Info Virtual Drive Info Battery Backup Unit Storage Log

**Virtual Drives**

Virtual Drive Number	Name	Status	Health	Size	RAID Level	Boot Drive
0		Optimal	<span>Good</span>	1996036 MB	RAID 5	true
1		Optimal	<span>Good</span>	1996036 MB	RAID 5	false

**LSI MegaRAID SAS 9266-8i (SLOT-4)**

Controller Info Physical Drive Info Virtual Drive Info Battery Backup Unit Storage Log

**Actions**

- Disable Auto Learn Mode
- Start Learn Cycle

**General**

Name:

Strip Size: **128 KB**

Drives Per Span: **8**

Span Depth: **1**

Access Policy: **Read-Write**

Cache Policy: **Direct**

Read Ahead Policy: **Always**

Requested Write Cache Policy: **Write Back**

Current Write Cache Policy: **Write Back**

Disk Cache Policy: **Unchanged**

Allow Background Init: **true**

Auto Snapshot: **false**

Auto Delete Oldest: **true**

Boot Drive: **true**

**General**

Controller: **SLOT-4**

Battery Type: **TMM-C SuperCap**

Health: Good

Status: **Optimal**

Battery Present: **true**

Temperature: **31 degrees C**

Capacitance: **102 %**

Charging Status: **capacitor**

Temperature High: **false**

Temperature High: **false**

*Cisco Live!*

# Understanding CallManager Code Yellow

- New call requests are throttled if expected delay to handle signals are very high

All interfaces, SIP, SCCP, MGCP, CTI, H.323 clients + trunks

Call reject reason code will be 42 (SWITCHING EQUIPMENT CONGESTION)

-  New calls originating on other nodes are still allowed

ICT calls, PSTN gateways, IP to IP, etc. (incoming calls)

- The depth of SDL queues in conjunction with the sample size is used to calculate average expected delay to process a signal

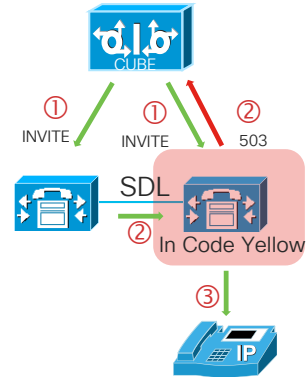

Parameter Name	Parameter Value	Suggested Value
<b>Call Throttling</b>		
<a href="#">Code Yellow Entry Latency</a> *	<input type="text" value="20"/> ms	20
<a href="#">Code Yellow Exit Latency Calculation</a> *	<input type="text" value="40"/> %	40
<a href="#">Code Yellow Duration</a> *	<input type="text" value="5"/> min	5
<a href="#">Max Events Allowed</a> *	<input type="text" value="2000"/>	2000
<a href="#">System Throttle Sample Size</a> *	<input type="text" value="10"/>	10

This is Code Red  
CallManager Service Self Aborts  
CoreDumpFileFound ↑

# Code-Yellow Entry/Exit

- **Entry criteria**

Once a node exceeds the code yellow entry latency (**20 ms by Default**) it enters code yellow

- Rejected new calls should reduce system load and average expected delay should drop
- IP phones attempting to get dial tone will get reorder and display a message saying “too much traffic, try again later”

- **Exit criteria**

Once delay drops below code yellow entry latency \* code yellow exit latency calculation (example  $20 * .4 = 8 \text{ ms to exit}$ ) the node exits code yellow

# CallManager Code-Yellow Alarms and Alerts

## Alarms

Dec 8 14:57:15 sjc-rfd-sub-1 local7 3 : 2244: Dec 08 22:57:15.641 UTC :

 %CCM\_CALLMANAGER-CALLMANAGER-3-CodeYellowEntry: CodeYellowEntry Expected Average Delay:214 Entry Latency:20 Exit Latency:8 Sample Size:10 Total Code Yellow Entry:1 High Priority Queue Depth:0 Normal Priority Queue Depth:0 Low Priority Queue Depth:1285 App ID:Cisco CallManager Cluster ID:SJC-RFD Node ID:sjc-rfd-sub-1

 Dec 8 14:57:23 sjc-rfd-sub-1 local7 3 : 2245: Dec 08 22:57:23.721 UTC : %CCM\_CALLMANAGER-CALLMANAGER-3-CodeYellowExit: CodeYellowExit Expected Average Delay:0 Entry Latency:20 Exit Latency:8 Sample Size:10 Time Spent in Code Yellow:8 Number of Calls Rejected Due to Call Throttling:238 Total Code Yellow Exit:1 High Priority Queue Depth:0 Normal Priority Queue Depth:0 Low Priority Queue Depth:0 App ID:Cisco CallManager Cluster ID:SJC-RFD Node ID:sjc-rfd-sub-1

## Alert

Dec 8 14:57:29 sjc-rfd-pub-1 local7 3 : 106: Dec 08 22:57:29.33 UTC : %CCM\_RTMT-RTMT-3-RTMT-ERROR-ALERT: RTMT Alert Name:CodeYellow Detail: From Fri Dec 07 11:04:39 PST 2007 to Sat Dec 08 14:57:28 PST 2007 on node sjc-rfd-sub-1, there are 1 CodeYellowEntry alarm(s) and 0 CodeYellowExit alarm(s) received. On Sat Dec 08 14:57:15 PST 2007, the last CodeYellowEntry alarm generated: CodeYellowEntry AverageDelay : 214 EntryLatency : 20 ExitLatency : 8 SampleSize : 10 TotalCodeYellowEntry : 1 HighPriorityQueueDepth : 0 NodeID : sjc-rfd-sub-1 App ID:Cisco AMC Service Cluster ID: Node ID:sjc-rfd-pub-1



# Sample CodeYellowEntry Reasons: High IOWait

1. Due to tracing or disk fragmentation
  - Excessive # of trace files
  - Disk spacers are overwritten due to core files or other application traces
2. Due to swap activity
  - System is running out of memory
  - Memory leak condition
3. Due to other processes starving ccm out of CPU Resources
  - Trace collection or trace searching for events
4. Due to hard disk or raid array failure
  - Array accelerator is disabled due to battery failure

# Sample CodeYellowEntry Reasons: CCM Process Runs Out of CPU

## 1. CCM process runs out of CPU

- SDLRouter thread which runs most of call processing **is single threaded**
- For example on a 4 Core Server, the SDLRouter thread can only utilize **25% of total CPU**
- Inspect **Proglogs** along with RISDC performance data

## 2. Other process starves ccm out of CPU

- Inspect RISDC performance data for process %CPU usage

```
admin:file dump activelog cm/trace/ccm/Proglogs/ccm001_100_008.ProgLog
ProgramStarted - 01/24/2017-08:40:28.823
  ProgramInfo
    Internal Name      : (null)
    Parent Process ID : 1
    Process ID        : 28710
    Program Name       : ccm
  Thread Monitor Log
  .....
  01/24/2017-08:42:12.288 | Started | 23080 | SDLRouter
  .....
```

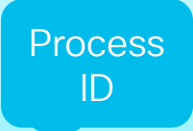

# CodeYellowEntry Due to SDLRouter Thread Out of CPU

- Due to tracing or disk fragmentation ☒

- ✓ IOWait is nominal
- ✓ No trace collection
- ✓ Disk fragmentation is nominal

- Application logs (CiscoSyslog/CallManager) is inspected to find out exactly when CodeYellowEntry occurred

Feb 11 12:27:58 vnt-cm1b local7 2 ccm: 85855: vnt-cm1b.cisco.com: Feb 11 2017 17:27:58.325 UTC : %UC\_CALLMANAGER-2-CodeYellowEntry: %**[AverageDelay=83]**[EntryLatency=20][ExitLatency=8][SampleSize=10][TotalCodeYellowEntry=16][HighPriorityQueueDepth=0][NormalPriorityQueueDepth=0][LowPriorityQueueDepth=1112][AppID=Cisco CallManager][ClusterID=VNT-CM1A-Cluster][NodeID=vnt-cm1b]: Unified CM has entered Code Yellow state

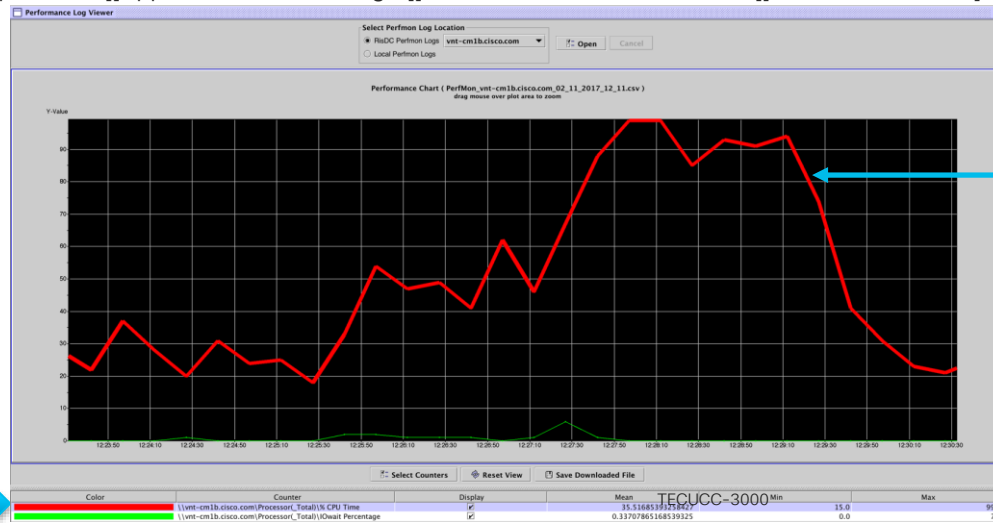
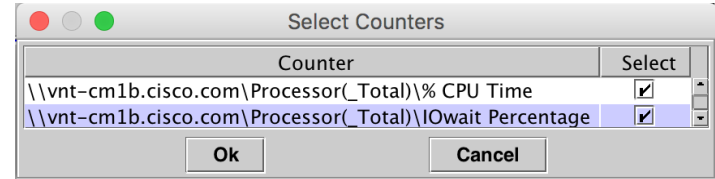

\\Processor(\_Total)\% CPU Time

# CodeYellowEntry Due to SDLRouter Thread Out of CPU

- Proglogs inspected

01/24/2017-08:42:12.288 | Started | 23080 | SDLRouter

- RISDC performance data inspected closer
  - Thread counter class

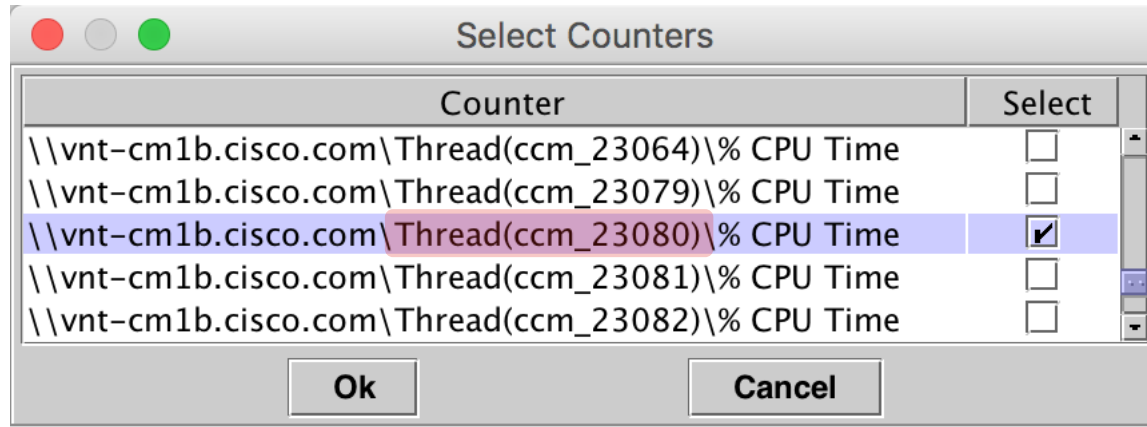

# CodeYellowEntry Due to SDLRouter Thread Out of CPU

Feb 11 12:27:58 vnt-cm1b local7 2 ccm: 85855: vnt-cm1b.cisco.com: Feb 11 2017 17:27:58.325 UTC : %UC\_CALLMANAGER-2-CodeYellowEntry: % [AverageDelay=83][EntryLatency=20][ExitLatency=8][SampleSize=10][TotalCodeYellowEntry=16][HighPriorityQueueDepth=0][NormalPriorityQueueDepth=0][LowPriorityQueueDepth=1112][AppID=Cisco CallManager][ClusterID=VNT-CM1A-Cluster][NodeID=vnt-cm1b]: Unified CM has entered Code Yellow state

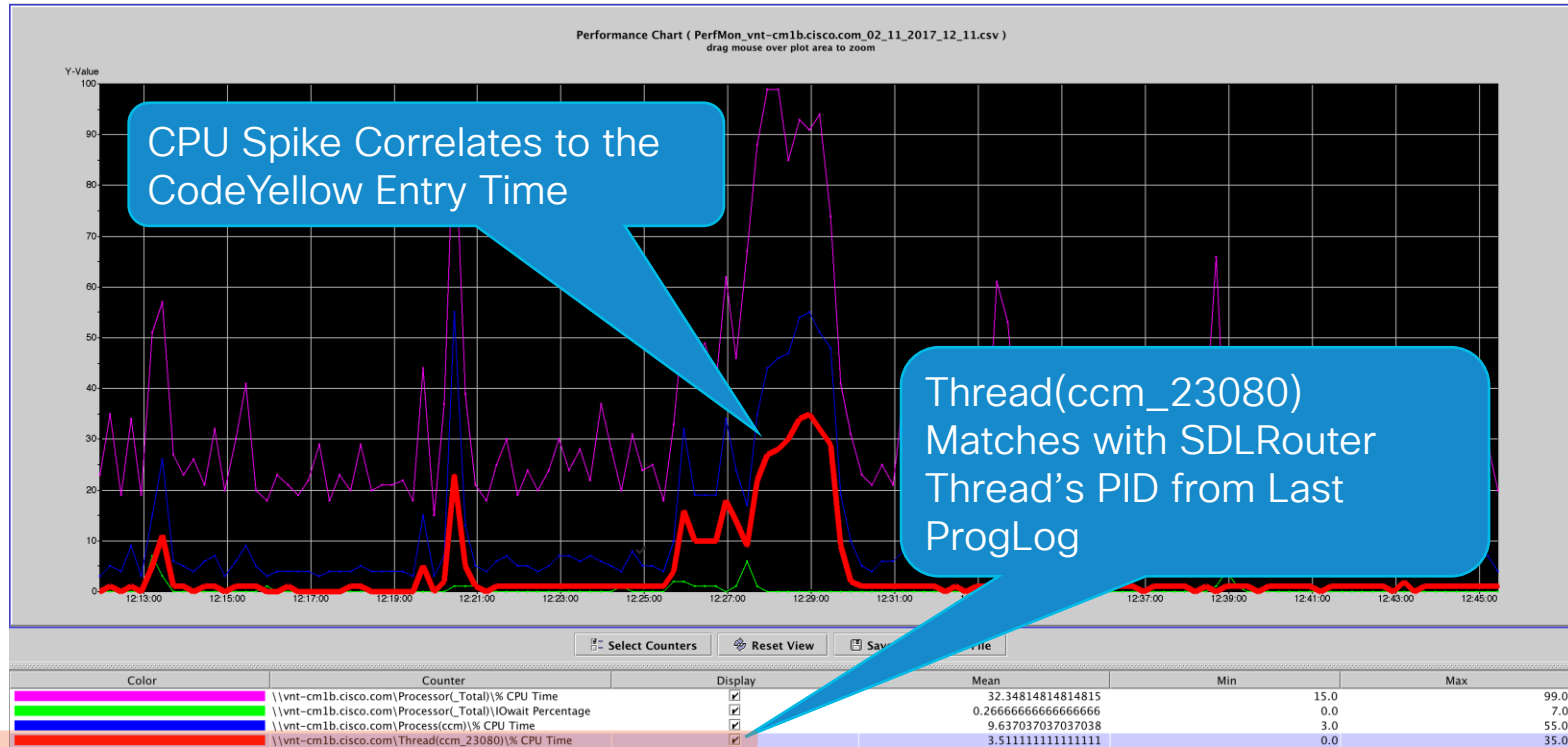

# Understanding CallManager SignalCongestion

- Very Similar to Code Yellow Entry / Exit Criteria
  - Same Service Parameters are used
- Impacts SIP Signaling Only processed via SIP Handler Thread
  - New Calls & Options Pings are rejected with 503 Service Unavailable, Q.850 Cause Code = 42
- The depth of SDL queues in conjunction with the sample size is used to calculate average expected delay to process a signal within the SIP Handler Thread

71623913.000 |15:02:58.567 |AppInfo |CMPProcMon - TotalDelay = 653 for SIP Handler Thread

Parameter Name	Parameter Value	Suggested Value
<b>Call Throttling</b>		
<a href="#">Code Yellow Entry Latency</a> *	20 ms	20
<a href="#">Code Yellow Exit Latency Calculation</a> *	40 %	40
<a href="#">Code Yellow Duration</a> *	5 min	5
<a href="#">Max Events Allowed</a> *	2000	2000
<a href="#">System Throttle Sample Size</a> *	10	10

# SignalCongestion Alarms and Alerts

## Alarms



Feb 11 17:31:34 vnt-cm1b local7 2 ccm: 88012: vnt-cm1b.cisco.com: Feb 11 2017 22:31:34.484 UTC :  
%UC\_CALLMANAGER-2-SignalCongestionEntry: %[Thread=SIP Handler Thread][AverageDelay=2184][EntryLatency=20][ExitLatency=8]  
[SampleSize=10][TotalSignalCongestionEntry=9][HighPriorityQueueDepth=2][NormalPriorityQueueDepth=0][LowPriorityQueueDepth=0]  
[AppID=Cisco CallManager][ClusterID=VNT-CM1A-Cluster][NodeID=vnt-cm1b]: Unified CM has detected signal congestion in an internal  
thread and has throttled activities for that thread



Feb 11 17:31:38 vnt-cm1b local7 5 ccm: 88014: vnt-cm1b.cisco.com: Feb 11 2017 22:31:38.496 UTC :  
%UC\_CALLMANAGER-5-SignalCongestionExit: %[Thread=SIP Handler Thread][AverageDelay=0][EntryLatency=20][ExitLatency=8]  
[SampleSize=10][TimeSpentInSignalCongestion=4][NumberOfCallsRejected=15054][TotalSignalCongestionExit=9]  
[HighPriorityQueueDepth=0][NormalPriorityQueueDepth=0][LowPriorityQueueDepth=0][AppID=Cisco CallManager][ClusterID=VNT-  
CM1A-Cluster][NodeID=vnt-cm1b]: Unified CM has exited throttling caused by a previous signal congestion condition

## Alert

Feb 11 17:31:44 vnt-cm1a local7 2 : 92: vnt-cm1a.cisco.com: Feb 11 2017 22:31:44.565 UTC :  
%UC\_RTMT-2-RTMT\_ALERT: %[AlertName=SyslogSeverityMatchFound][AlertDetail= At Sat Feb 11 17:31:34 EST 2017 on node vnt-  
cm1b.cisco.com, the following SyslogSeverityMatchFound events generated: #012SeverityMatch : Critical#012MatchedEvent : Feb 11  
17:31:34 vnt-cm1b local7 2 ccm: 87037: vnt-cm1b.cisco.com: Feb 11 2017 22:31:34.568 UTC : %UC\_CALLMANAGER-2-  
SignalCongestionEntry: %[Thread=SIP Handler Thread][AverageDelay=2184][EntryLatency=20][ExitLatency=8][SampleSize=10]  
[TotalSignalCongestionEntry=9][HighPriorityQueueDepth=2][NormalPriorityQueueDepth=0][LowPriorityQueueDepth=0][AppID=Cisco  
CallManager][ClusterID=VNT-CM1A-Cluster][NodeID=vnt-cm1b]: Unified CM has detected signal congestion in an internal thread and  
has throttled activities for that thread #012AppID : Cisco Syslog Agent#012ClusterID : #012NodeID : vnt-cm1b#012 TimeStamp : Sat  
Feb 11 17:31:34][AppID=Cisco AMC Service][ClusterID=][NodeID=vnt-cm1a]: RTMT Alert

# SignalCongestion Entry Due to VM CPU Contention

- Proglogs inspected

01/24/2017-08:42:12.562 | Started | 23089 | SdlThreadedProcess: SIPHandler(2,100,80,1)

- RISDC performance data inspected closer
  - Thread counter class

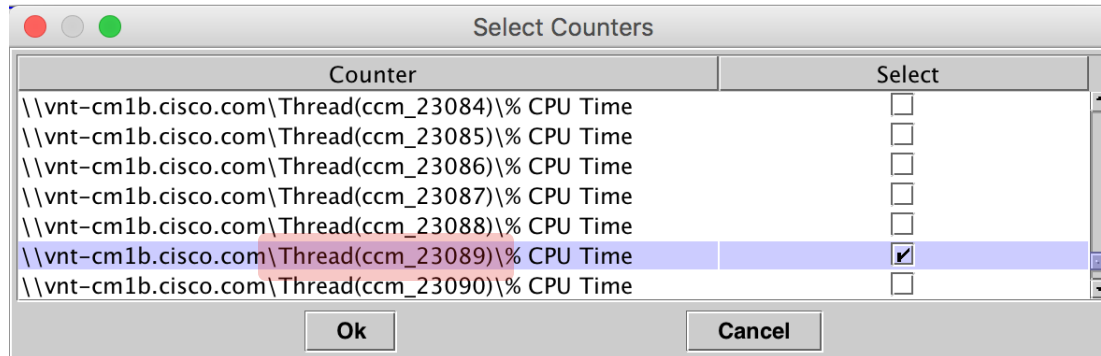



# SignalCongestion Entry Due to VM CPU Contention

Feb 11 17:31:34 vnt-cm1b local7 2 ccm: 88012: vnt-cm1b.cisco.com: Feb 11 2017 22:31:34.484 UTC : %UC\_CALLMANAGER-2-SignalCongestionEntry:

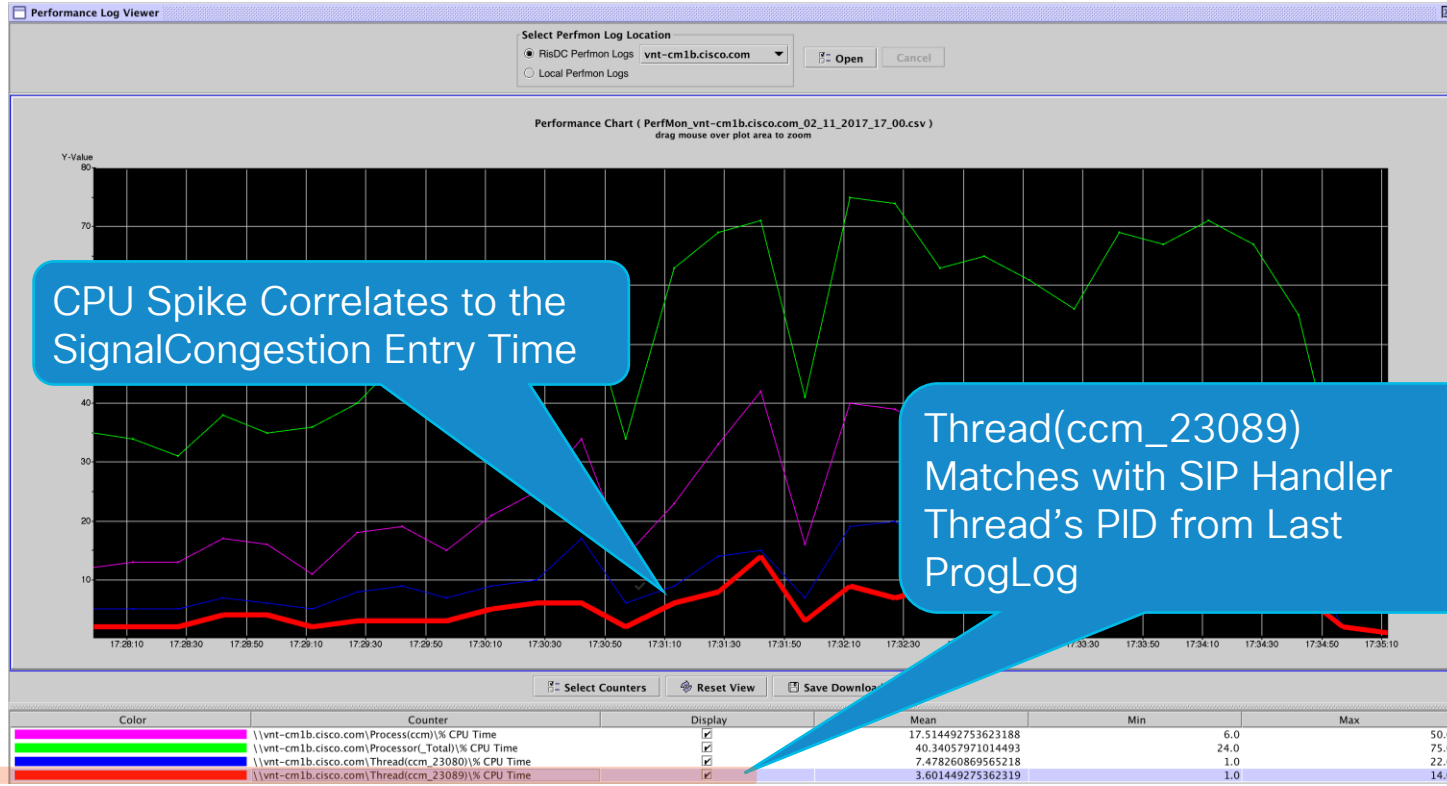

# SignalCongestion Entry Due to VM CPU Contention

Feb 11 17:31:34 vnt-cm1b local7 2 ccm: 88012: vnt-cm1b.cisco.com: Feb 11 2017 22:31:34.484 UTC : %UC\_CALLMANAGER-2-SignalCongestionEntry:

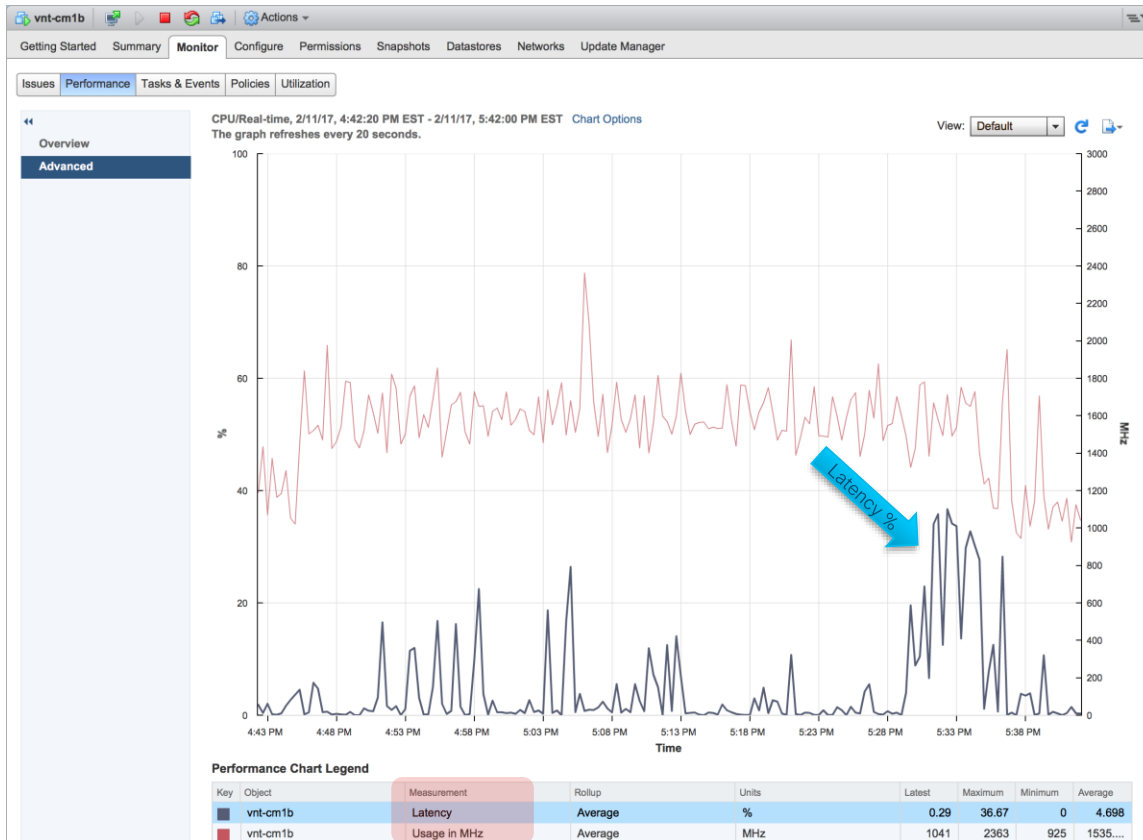

First Evidence seen in VMware VM Performance Counter

- Latency
  - Percent of time the VM is unable to run because it is contending for access to the physical CPU

# Unified CM on UCS Performance Monitoring w/ vSphere CPU

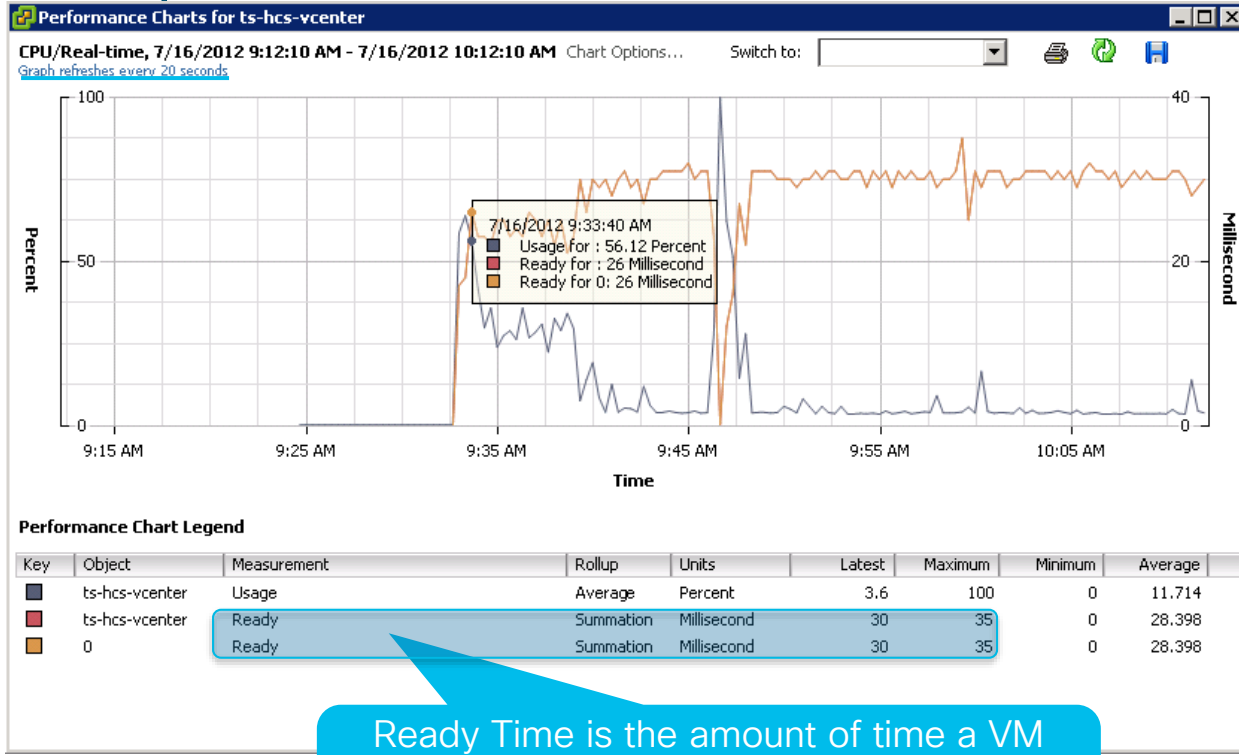

Ready Time is the amount of time a VM wants to run but could not because Physical CPU Resources could not be scheduled

- vSphere Client Refresh Rate = 20 sec
- 35 msec / 20000 msec = 0.175 %
- Above 5% is **BAD** ☠

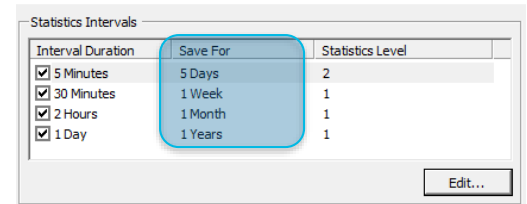
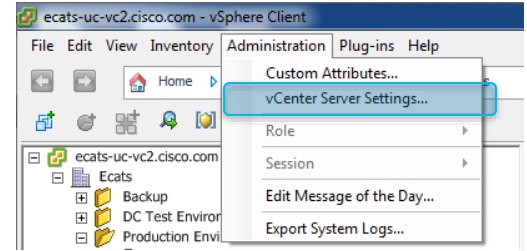

# SignalCongestion Entry Due to VM CPU Contention



# UC on UCS or 3rd Party Infrastructure vCenter Specs-based → Performance Statistics Level



ecats-uc-vc2.cisco.com - Edit vCenter

**Statistics**

- Database
- Runtime settings
- User directory
- Mail
- SNMP receivers
- Ports
- Timeout settings
- Logging settings
- SSL settings

**Settings**

- General
- Licensing
- Message of the Day
- Advanced Settings
- Auto Deploy

**vCenter Server Settings**

Statistics

Statistics intervals

Enabled	Interval Duration	Save For	Statistics Level
Yes	5 minutes	5 days	Level 4
Yes	30 minutes	1 week	Level 4
Yes	2 hours	1 month	Level 4
Yes	1 day	1 year	Level 4

**Database size**

Based on the current vCenter Server inventory size, the vCenter Server database can be estimated. Enter the expected number of hosts and virtual machines in the inventory to calculate an estimate.

500 Physical hosts Estimated space required: 579.35 GB

2000 Virtual machines

Monitor vCenter database consumption and disk partition in Appliance Management UI

OK Cancel

# Virtualized Unified CM Performance Reservations Memory & CPU

Consider Increasing under Shared Environments (B-Series) with Vmware DRS enabled. As long as all CPUs in the Cluster have same clock speed. Match to ESXi Hosts' CPU speed X vCPU required for Unified CM

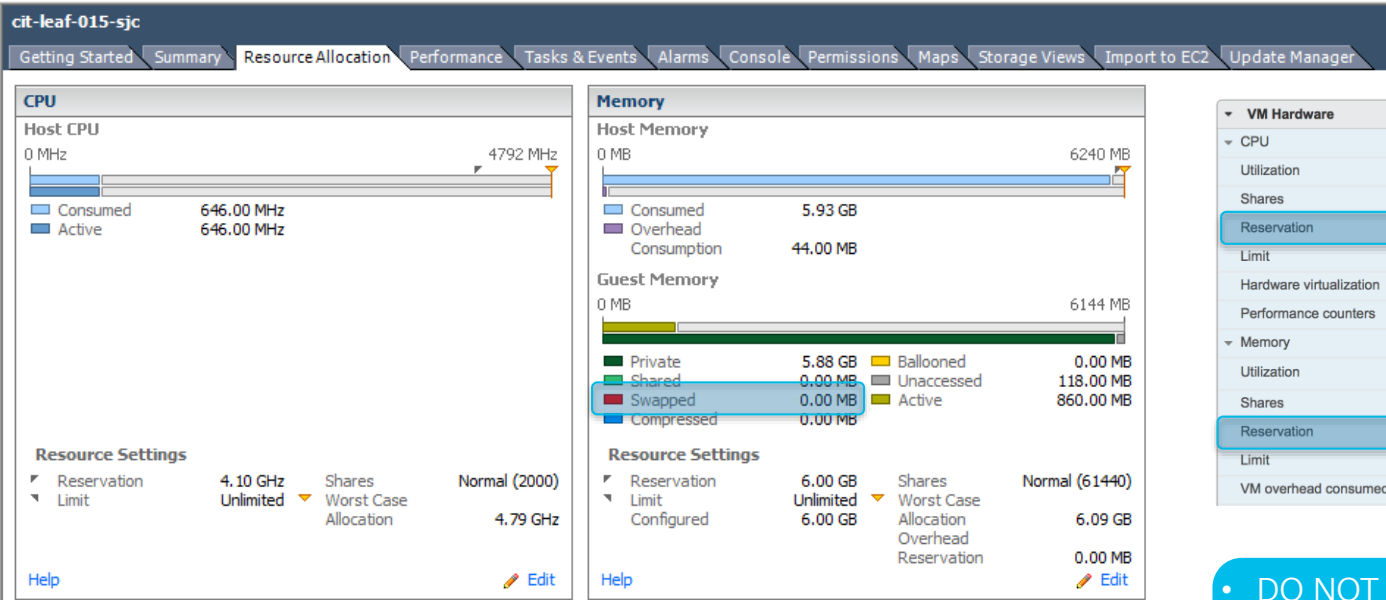

VM Hardware		Processor Type:
CPU		VMware ESXi, 6.0.0, 4600944
Utilization	2 CPU(s), 4281 Hz	Cisco Systems Inc B230-BASE-M2
Shares	2000 (Normal)	Processor Type: Intel(R) Xeon(R) CPU E7- 2830 @ 2.13GHz
Reservation	3600 MHz	
Limit	Unlimited	
Hardware virtualization	Disabled	
Performance counters	Disabled	Reservation 4259 MHz
Memory		
Utilization	6144 MB, 1474 MB memory active	
Shares	61440 (Normal)	
Reservation	6144 MB	
Limit	Unlimited	
VM overhead consumed	64 MB	

UCM and IMP Caveated Support for VMware CPU Reservations  
[http://www.cisco.com/c/dam/en/us/td/docs/voice\\_ip\\_comm/uc\\_system/virtualization/cucm-vmware-support.html](http://www.cisco.com/c/dam/en/us/td/docs/voice_ip_comm/uc_system/virtualization/cucm-vmware-support.html)

- DO NOT reduce OVA Reservations
- Follow Collaboration VM Placement Tool (VMPT)
- Hypervisor (ESXi) Swapping **BAD** ☠️



# Unified CM on UCS Performance Monitoring w/ Vsphere VMware Support Log Collection

The process involves the following steps:

- Source Selection:** In the vSphere Client, the 'Export System Logs...' option is selected under the Administration menu. The dialog prompts to specify where system logs should be gathered from.
- Select System Logs:** The user selects the source (ecats-uc-vc2.cisco.com) and chooses which system logs to export, including options like FaultTolerance, System, Storage, Userworld, VirtualMachines, Configuration, Logs, hostProfiles, and ActiveDirectory.
- Performance Data:** The user can choose to gather performance data, setting a duration of 300 seconds and an interval of 5 seconds.
- Ready to Complete:** A summary screen shows the download location (Z:\Traces\Vmware-System-Logs-Test), hosts (ecats-uc-vc2.cisco.com), and the selected logs.
- Download Location:** The user specifies the destination path for the logs, such as Z:\Traces\Vmware-System-Logs-Test.

The final output is a table of downloaded log bundles:

Source	Status	Details
ecats-uc-vc2.cisco.com	Complete	
ecats-uc-vc2.cisco.com	Complete	
VMware vSphere Client	Complete	

Download Details:  
 File: ecats-uc-vc2.cisco.com-vm-support-2014-01-25@15-19-43  
 Folder: Z:\Traces\Vmware-System-Logs-Test\VMware-vCenter-support-2014-01-25@15-19-43  
 Error:

# Agenda

- Serviceability Tools Overview
  - Real-Time Monitoring Tool (RTMT)
  - Cisco Unified Operating System GUI
  - Cisco Unified Operating System CLI
  - Cisco Serviceability Reports
  - Cisco Unified Reporting
  - Serviceability APIs
- Troubleshooting Methodology
  - Problem Description
  - Information Collection
- Troubleshooting Case Studies
  - Dropped Call
  - No One Answers the Phone
  - Unable to Place Calls
  - Call Drops After Answering
  - Video Encryption Not Working
  - One-Way Audio
  - ActiveControl Not Working on Jabber 12.5
- Understanding and Troubleshooting Unified CM Throttling Events
- Troubleshooting Database Replication



# Database Replication Setup and Status Monitoring With RTMT

- Key performance counters to monitor for replication status

\Number of Replicates Created and State of Replication(ReplicateCount)\Replicate\_State

Look for 2 (Good) on all nodes

\Number of Replicates Created and State of Replication(ReplicateCount)\Replicates\_Created

- All nodes should have the same replicates created number as the publisher node
  - DBReplicationFailure alert
    - AMC monitors Replicate\_State Counter
    - Raised when counter is at
      - 3 – Replication Data Transfer is bad in the cluster
      - 4 – Replication setup did not succeed
- By default it will raise one alert every 60 min from each Node

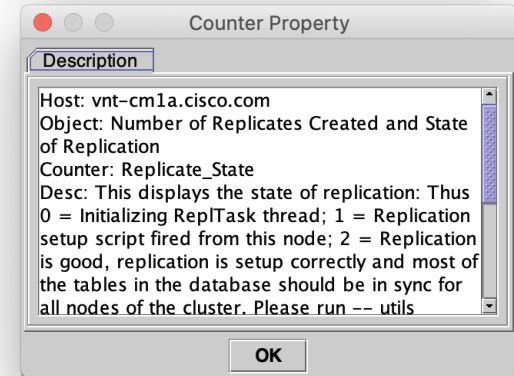
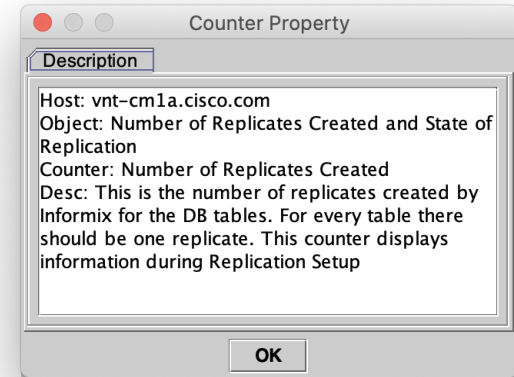

# Replicate\_State How Does It Work?

- DBMON updates every 1.5 min a single local table named “[replicationdynamic](#)” and puts its node id with a timestamp.
- This replicationdynamic table is replicated across the cluster. All nodes after updating the local replicationdynamic table also check for other nodes’ updates and their timestamps.
- If any node that completed replication setup fails to update this table for 1800 sec ([30min](#)) DBMON will detect this and that node will change Replicate\_State to 3
- Because each node checks for all other nodes that have completed replication setup. You may see all nodes report 3 around the same time and one node shows 0 or 4
- DBMON traces
  - MaintenanceTask::displayRealTimeReplicationCounter

```
admin:file search activelog cm/trace/dbl/sdi/dbmon*.txt "MaintenanceTask::checkRTMT" reltime
minutes 30
```

# Database CLI Commands



- **utils dbreplication status**

- Runs a background script to check database replication setup. This utility compares each node's tables to publisher's. Output goes in to a file like "activelog cm/trace/dbl/sdi/ReplicationStatus.113133.out"

- **utils dbreplication repair all/nodename**

- Runs a background script to repair replication setup on a given nodename or all nodes. Nodename = hostname

- **utils dbreplication reset all/nodename** ⚠

- Runs a background script to reset and setup replication on a given nodename or all nodes. Nodename = hostname

- **utils dbreplication stop** ⚠

- Stops all dbreplication setup/repair/reset processes. Could take long on publisher

- **utils dbreplication dropadmindb** ⚠

- This command is used to drop the Informix syscdr database on any server in the cluster
- It should only be run if replication reset or cluster reset fails and replication cannot be restarted

# Database CLI Commands

- **utils dbreplication setrepltimeout**

Increase on  
Large Scale  
Clusters

- Sets the timeout to start automatic DB replication setup after the first subscriber node contacts the publisher after a switchover following an upgrade or after a fresh install.
- Defaults to 5 minutes
- Preserved across reboots & upgrades
- Remember to return it back to 5 min default pre Unified CM 10.X
- Remember to set it prior to starting your Upgrade
- Unified CM 10.X + Replication Setup Timeout is more intelligent

- **show tech repltimeout**

- Shows the current Database Replication Setup Timeout value

- **utils dbreplication stop all**

Stops all dbreplication setup/repair/reset processes on all nodes. Executed on Publisher as long as Database Replicator Service (DBLRPC) is functional it will work on all nodes.

- **utils create report database**

- Generates a detailed database status and replication report

Collect the output  
when you  
experience  
Database Problems



# Database CLI Commands

- **utils dbreplication runtimestate**

What replication setup is doing, its progress, and error indication

Checks for TCP, RPC, and IDS-ER connectivity between nodes

Checks if actual data is being replicated between nodes

Compares DB version and tables across nodes



Collect the output from ALL NODES when you experience Database Replication Problems

- **utils dbreplication quickaudit**

This command is a quick alternative, but not a replacement, to the existing “utils dbreplication status” command.

It executes some smart counts on selected dynamic tables to determine if a node’s DB is out of sync.

- **utils dbreplication repairtable**

This command can resync a single table if it is out of sync.

# Database CLI Commands



- **utils dbreplication forcedatasyncsub**

- Use when utils dbreplication repair or reset fails to successfully complete.
- Should be preceded with utils dbreplication stop all on Publisher
- All local data on the subscriber will be overwritten with the data currently on the Publisher
- Could take a significant amount of time depending on Clustering Over Wan delay, bandwidth and # of subscribers
- Subscriber(s) must be rebooted after completion of force data sync
- Automated Database Replication setup will start after reboot

# Database CLI Commands

- **utils dbreplication rebuild [nodename |nodename1, nodename2,..., nodenameN | all ]**
  - This command will run a combination of the following commands on the specified servers
    - utils dbreplication stop [all] ⚠
    - utils dbreplication dropadmindb or dropadmindbforce ⚠
    - utils dbreplication reset ⚠

# Database CLI Commands

- **utils dbreplication setprocess**

- This command will increase the parallel processing thread count of certain DB Replication Setup Tasks.
- Maximum Thread count we can set is 40
- Significant improvements to DB Replication Setup time in Large Clusters with Clustering Over WAN Delay
- Setting larger PROCESS option may consume more system resources especially in Large Clusters **with little to NO Delay in between Cluster nodes**
- If Set prior to Upgrade the setting is persistent just like “utils dbreplication setrepltimeout”



# Database CLI Commands

- **show tech notify**

- Show DB change notify subscription details.

Collect the output if you receive DBChangeNotifyFailure Alert in addition to DBMON Traces

```
admin:show tech notify
----- show tech notify -----
Database Change Notify Monitor
Msg I 0/2 P 8902 DB 0
 0 I  0 P  6 H  6 T  6 S  5 DbTraceMon
 1 I  0 P  0 H  0 T  0 S  2 DbIPsecMon
 2 I  0 P  0 H  0 T  0 S  5 SERVICE_TOMCAT[127.0.0.1]:32798
 3 I  0 P 11 H 11 T 11 S  2 LpmTool
 4 I  0 P  0 H  0 T  0 S  2 License Manager Trace[127.0.0.1]:32931
 5 I  0 P  0 H  0 T  0 S  2 DRF Local Trace[127.0.0.1]:32937
 6 I  0 P  0 H  0 T  0 S  2 DRF Master Trace[127.0.0.1]:32940
284 I  0 P  0 H  0 T  0 S 58 ccm:Client_PID=30282[10.9.40.8]:36959
```

```
MSG I <inuse count/max inuse has ever been> P <processed> DB <count in DB>
<client index> I <inuse count/not consumed> H <head ptr> T <tail ptr> S <tables subscribed> <client name>
```

- **run sql sql\_statement**

- Run a given SQL statement against the LOCAL database. SQL statement can not include any stored procedures
- Example run sql to run against a different DB

```
run sql select sum(seg_blkfree) as blkfree, sum(seg_blkused) as blkused from sysmaster:syssegments
```

# Database Replication Setup and Status Monitoring With CLI

```
admin:utils dbreplication runtimestate
```

```
Server Time: Sun Jan 26 07:51:33 EST 2020
```

```
Cluster Replication State: BROADCAST SYNC ended at: 2020-01-17-20-32
```

```
Sync Result: SYNC COMPLETED on 737 tables out of 737
```

```
Sync Status: All Tables are in sync
```

```
Use CLI to see detail: 'file view activelog cm/trace/dbl/20200117_203115_dbl_repl_output_Broadcast.log'
```

```
DB Version: ccm12_5_1_12900_112
```

```
Repltimeout set to: 300s
```

```
PROCESS option set to: 40
```

```
Cluster Detailed View from vnt-cmla.cisco.com (3 Servers):
```

SERVER-NAME	IP ADDRESS	PING (msec)	DB/RPC/ DbMon?	REPL. QUEUE	Replication Group ID
vnt-cmla	172.18.106.58	0.031	Y/Y/Y	0	(g_4)
vnt-cmlb	172.18.106.59	0.515	Y/Y/Y	656	(g_5)
vnt-cmlc	172.18.106.60	0.422	Y/Y/Y	656	(g_6)

```
REPLICATION SETUP  
(RTMT) & Details
```

```
(2) Setup Completed  
(2) Setup Completed  
(2) Setup Completed
```

# Database Replication Setup and Status Monitoring With CLI

```
admin:utils dbreplication status
```

```
----- utils dbreplication status -----
```

```
Replication status check is now running in background.
```

```
Use command 'utils dbreplication rntimestate' to check its progress
```

```
The final output will be in file cm/trace/dbl/sdi/ReplicationStatus.2009_06_28_16_10_14.out
```

```
Please use "file view activelog cm/trace/dbl/sdi/ReplicationStatus.2009_06_28_16_10_14.out "  
command to see the output
```

- This command will check CDR (Continuous Data Replication) connectivity as well as compares all tables' content to the one in publisher.
- It could take a long time (hours) to complete in large clusters use `utils dbreplication quickaudit first`
- This Database Status check runs in the background and its progress can be monitored via `utils dbreplication rntimestate`
- Replicationdynamic table could be out of sync all the time. **It Can be ignored** 

# Database Replication Setup and Status Monitoring With CLI – Good Case

```
admin:file view activelog cm/trace/db1/sdi/ReplicationStatus.144821.out
```

```
SERVER                ID STATE   STATUS   QUEUE  CONNECTION CHANGED
-----
g_blldr_ccm4_ccm      2 Active  Local   0
g_blldr_ccm5_ccm      3 Active  Connected 0 Sep  6 16:27:15
-----
```

```
utils dbreplication status output
```

To determine if replication is suspect, look for the following:

- (1) Number of rows in a table do not match on all nodes.
- (2) Non-zero values occur in any of the other output columns for a table
- (3) \*\*\*\*\* PLEASE IGNORE MISMATCHES IN ReplicationDynamic TABLE \*\*\*\*\*

First a summary of replication servers and their server status is provided

```
----- Statistics for ccmbdtemplate_blldr_ccm4_ccm_1_3_alarmusertext -----
Node                Rows      Extra   Missing  Mismatch  Processed
-----
g_blldr_ccm4_ccm      0         0       0        0         0
g_blldr_ccm5_ccm      0         0       0        0         0
```

- This command views replication status output file. The replication status on this cluster is good, because all servers are either local or connected, and no tables show up as suspect.

# Database Replication Setup and Status Monitoring With CLI – Servers Out of Sync

```
admin:file view activelog cm/trace/dbl/sdi/ReplicationStatus.144821.out
```

```
SERVER                ID STATE    STATUS    QUEUE  CONNECTION CHANGED
-----
g_blldr_ccm4_ccm      2 Active   Local    0
g_blldr_ccm5_ccm      3 Active   Connected 0 Sep  6 16:27:15
```

## ~~----- Suspect Replication Summary -----~~

```
For table: ccmdbtemplate_blldr_ccm4_ccm_1_27_processnode replication is suspect for
node(s):
```

```
g_blldr_ccm5_ccm
```

```
For table: ccmdbtemplate_blldr_ccm4_ccm_1_34_replicationdynamic replication is suspect for
node(s):
```

```
g_blldr_ccm5_ccm
```

Note: processnode table and replicationdynamic tables are suspect. Process node is a problem but remember replicationdynamic can be ignored.

# Database Replication Setup Monitoring Logs

- Cisco database replicator service logs
  - file list `activelog cm/trace/dbl/*` date detail
- During the first CDR define phase of replication setup you should see logs for each node in the cluster that establishes communication with Publisher DBMON
  - ① 20170124\_084901\_vnt-cm1b\_g\_5\_ccm11\_5\_1\_12900\_21\_dbl\_repl\_cdr\_define.log
- During the CDR realize template followed by sync/check phase of replication setup you should see logs for the group of nodes
  - ② 20170124\_085553\_dbl\_repl\_cdr\_Broadcast.log
- Once replication setup is complete look for this file
  - ③ 20170124\_085553\_dbl\_repl\_output\_Broadcast.log

In this file you will find how long the replication setup took

You will also find the exact commands used to setup replication.

This can tell you which nodes' replication was in fact setup in this batch attempt...

# Database Replication Logs to Collect

## Traces and Output to collect if you suspect a DB Replication problem

1. Event Viewer–Application log – all nodes  
file get activelog syslog/CiscoSyslog\*
2. Cisco Database Replicator Trace – publisher only  
file get activelog cm/trace/dbl/dbl\_repl\*  
file get activelog cm/trace/dbl/sdi/startrpc.log  
file get activelog  
cm/trace/dbl/sdi/replication\_scripts\_output.log
3. Cisco Informix database service – all nodes  
file get activelog cm/log/informix/ccm.log\*
4. Cisco Database Layer Monitor – all nodes  
file get activelog cm/trace/dbl/sdi/dbmon\*.txt
5. Cisco Abort Transaction Spooling – all nodes  
file get activelog cm/log/informix/ats/\*.\*
6. Cisco Row Information Spooling – all nodes  
file get activelog cm/log/informix/ris/\*.\*
7. Output of “utils dbreplication runtimestate” – all nodes
8. Output of “utils dbreplication status” – publisher only
  - Performs a comparison of all tables from all nodes in the cluster. Identifies if any of the tables are have a mismatch.
  - Could take a long time on clustering over wan or large databases (over 1 hour)
9. Output of “show tech dbstateinfo” – all nodes
  - Generates a report that details the current Database status
10. Output of “show tech activesql” – all nodes
  - Generates a report on all Active SQL Traces
11. Output of “utils create report database” – all nodes
  - Generates a report that collects all relevant Database Logs/Traces
  - [Unified CM 9.X +](#)

# Database Replication Reports to Run

- Cisco Unified Reporting
- Unified CM Database Status
  - Replication status similar to RTMT
  - Replication config files check across the cluster hosts/rhosts/sqlhosts/service
- Unified CM database replication debug
  - cdr list repl
- Reports can be downloaded in xml format and sent to TAC

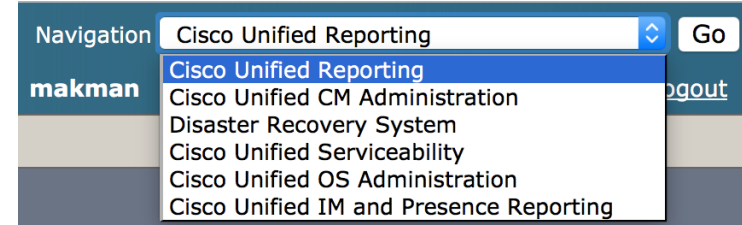

 INFO: A local copy of report with name Unified CM Database Status already exists.

## Unified CM Database Status

Report Name	Time Generated
<a href="#">Unified CM Database Status</a>	Fri Jan 24 15:58:53 EST 2020





# Database Replication Service Dependencies

Check the Following Services to Ensure They Are Still Running on All Nodes

- **A Cisco DB[STARTED] ✓**

```
admin:show process name cmoninit detail
```

PID	PPID	TID	%CPU	%MEM	S	USER	MINFL	MAJFL	RSS	VSZ	STARTED	COMMAND
6292	1	-	1.7	4.6	S	informix	335	127155	189876	282252	Wed Feb 13 09:57:45 2008	/usr/local/cm/bin/cmoninit

- **A Cisco DB Replicator[STARTED] ✓**

```
admin:show process search python
```

root	6596	1	0	Feb13	?	00:00:00	/usr/bin/python	/usr/local/cm/bin/dblrpc
root	6596	1	0	Feb13	?	00:00:00	/usr/bin/python	/usr/local/cm/bin/dblrpc

- **Cisco Database Layer Monitor[STARTED] ✓**

```
admin:show process name dbmon detail
```

PID	PPID	TID	%CPU	%MEM	S	USER	MINFL	MAJFL	RSS	VSZ	STARTED	COMMAND
6674	4886	-	0.2	0.2	S	database	1764	3110	11188	476012	Wed Feb 13 09:58:29 2008	/usr/local/cm/bin/dbmon

- **Cluster Manager[STARTED] ✓**

```
admin:show process name clm detail
```

PID	PPID	TID	%CPU	%MEM	S	USER	MINFL	MAJFL	RSS	VSZ	STARTED	COMMAND
13436	1	-	0.0	0.1	S	root	4746	1679	7012	44288	Wed May 14 11:19:28 2008	/usr/local/platform/bin/clm/clm

- Look for core files as well as TCP/IP port usage through firewalls

# Database Replication Service Dependencies

- Database Replication also depends on communication between all nodes in the Cluster  
Internal Firewalls Rules managed by Cluster Manager

- Look for the following messages on each node

```
admin:file search activelog syslog/CiscoSyslog INJECTED
```

```
Jun  2 15:44:03 sme-pub local7 1 : 14: sme-pub: Jun 02 2018 19:44:03.853 UTC : %UC_CLUSTERMANAGER-1-  
CLM_PeerState: %[NodeName=sme-sub03][NodeState=POLICY_INJECTED][AppID=Cisco Cluster  
Manager][ClusterID=SME][NodeID=sme-pub]: Current ClusterMgr session state.
```

- To test connectivity between Subscriber and Publisher use

```
admin:utils network connectivity
```

```
This command can take up to 3 minutes to complete.
```

```
Continue (y/n)?y
```

```
Running test, please wait ...
```

```
Network connectivity test with the publisher completed successfully.
```

```
admin:
```

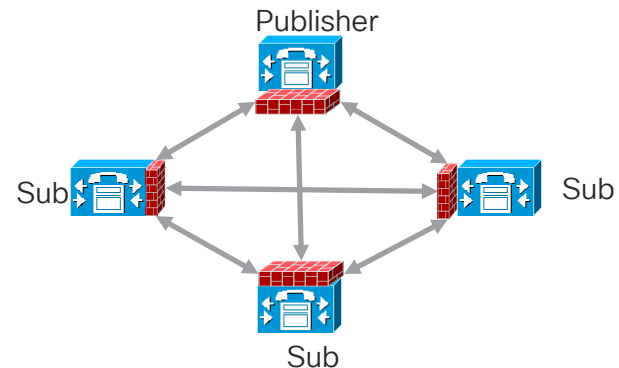

# Database Replication Service Dependencies

- You can query real time ClusterManager Authentication State

```
admin:show network cluster
```

```
1.2.3.4 cmlb.cisco.com cmlb Subscriber callmanager DBSub authenticated using TCP since Mon Feb 16 12:13:40 2016
```

```
1.2.3.5 cmlc.cisco.com cmlc Subscriber callmanager DBSub authenticated using TCP since Wed Jun 3 19:17:56 2016
```

```
1.2.3.6 cmla.cisco.com cmla Publisher callmanager DBPub authenticated
```

```
1.2.3.7 cups1b.cisco.com cups1b Subscriber cups DBSub authenticated using TCP since Wed Jun 3 19:18:17 2016
```

```
1.2.3.8 cups1a.cisco.com cups1a Subscriber cups DBPub authenticated using TCP since Thu Mar 5 22:47:49 2016
```

```
Server Table (processnode) Entries
```

```
-----
```

```
cmla.cisco.com
```

```
cmlb.cisco.com
```

```
cmlc.cisco.com
```

```
1.2.3.7
```

```
1.2.3.8
```

```
admin:
```

# Database Replication Recovery

- DB replication setup is Automated
  - Check “*utils dbreplication runtimestate*” output first
    - Ensure DBLRPC Connectivity is Good
  - Observe the Database Replicator Logs
    - *file list activelog cm/trace/dbl/\* date detail*
  - Check Unified CM Database Status Report
    - Ensure Config Files are all in sync. Try Rebooting Node/Cluster first if they are out of sync
  - **⚠ ONLY Take manual action If you observe an Automated Setup failure**
    - Repeated `cdr_define` logs
    - Repeated errors in the `output_Broadcast` log

## Publisher

```
admin: utils dbreplication rebuild [nodename | nodename1,nodename2,..,nodenameN | all ]
```



# Continue your education



Demos in the  
Cisco campus



Walk-in labs



Meet the engineer  
1:1 meetings



Related sessions



Thank you





You make **possible**





You make **possible**