



China

Korea

Japan

Hong Kong

Vietnam

Taiwan

Thailand

Philippines

India

Malaysia

Bangladesh

Singapore

Indonesia

Version 6.02

Australia

New Zealand



# Cisco Start Catalog for APJC

March - July, 2019

**Table of Contents**

**Start Portfolio**

**Start Website**

**For Partners**

**Getting Started**

Cisco Start Portfolio  
Cisco Start Website  
What's in It for Partners

**What's New**

4 New Product Portfolio & 2 New Solutions  
Find Out Our Promotions for Partners  
Cisco Start Portfolio Promotion Buying Method

**Feature Story**

Cisco SD-WAN  
Cisco Smart Accounts

**Collaborate**

Cisco Webex Meetings  
Cisco Webex Teams  
Cisco Webex DX80  
Cisco Webex Room Kit Series  
Cisco Webex Share  
Cisco Webex Board  
Cisco TelePresence SX10 Quick Set  
Cisco Business Edition 4000  
Cisco IP Phone 7800/8800 Series  
Cisco IP Phone 7800/8800 Series with Multiplatform Phone Firmware  
Cisco Headset 500 Series

**Connect**

**Switches**

Cisco SF/SG Switches  
Cisco Catalyst Switches  
Cisco Catalyst 2960-L Series  
Cisco Catalyst 2960-X Series  
Cisco Catalyst 3650/3850 Series  
Cisco Catalyst 9200 Series  
Cisco Meraki MS Cloud Managed Switches

**Wireless**

Cisco Wireless Access Points  
Cisco Aironet Access Points  
Cisco Wireless Controllers  
Cisco Meraki MR Cloud Managed Access Points

**Routers**

Cisco RV Series  
Cisco ISR 800 Series  
Cisco ISR 900 Series  
Cisco ISR 1100 Series  
Cisco ISR 4000 Series

**Compute**

Cisco UCS C-Series Rack Servers  
Cisco HyperFlex HX-Series  
Cisco Nexus 9348GC-FXP Switch  
Cisco Intersight

**Security**

Cisco ASA 5500-X Series  
Cisco Firepower 2100 Series  
Cisco AnyConnect Secure Mobility Client  
Cisco Advanced Malware Protection for Endpoints  
Cisco Umbrella  
Cisco Meraki MX Cloud Managed Security Appliances  
Cisco Meraki Z Cloud Managed Teleworker Gateway  
Cisco Meraki MV Cloud Managed Security Cameras

**Services**

Cisco Support Essentials  
Cisco Smart Net Total Care  
Cisco Software Support Service

Getting Started

Start Portfolio

Start Website

For Partners

What's New

Feature Story

Collaborate

Compute

Security

Connect

Switches

Wireless

Routers

Services



Table of Contents

Start Portfolio

Start Website

For Partners

Cisco Start Portfolio Overview



Support Essentials

Cisco Webex



Collaborate

Secure the endpoint



Security



Secure the cloud



Compute

Secure the network



Meraki

SM



Connect

Getting Started  
Start Portfolio

Start Website  
For Partners

What's New

Feature Story

Collaborate

Compute

Security

Connect

Switches

Wireless

Routers

Services

Getting Started

Start Portfolio

Start Website

For Partners

What's New

Feature Story

Collaborate

Compute

Security

Connect

Switches

Wireless

Routers

Services

Table of Contents

Start Portfolio

Start Website

For Partners

Cisco Start Website

Visit our website for your country, simply by typing "cisco start" on the search engines such as Google.

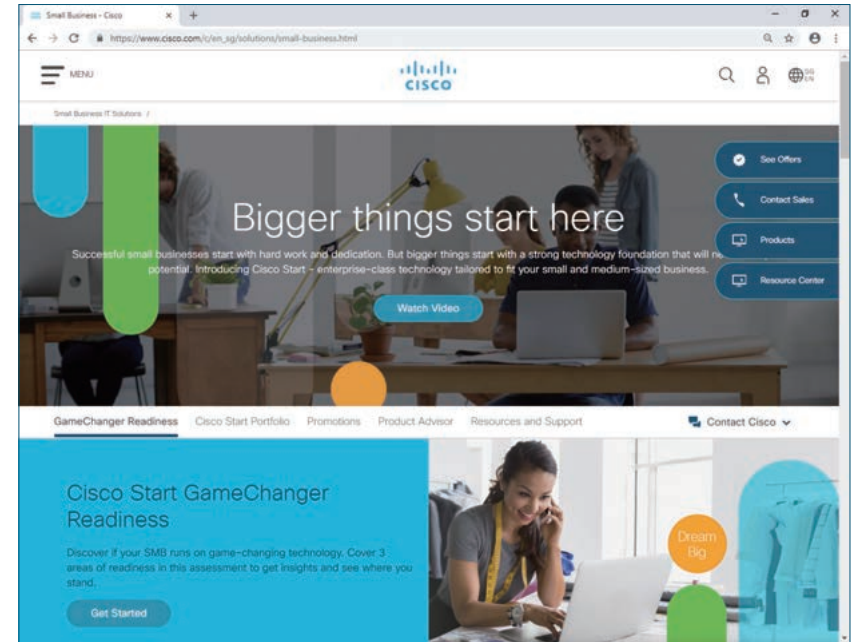

Cisco Start Helpline by Country

Country	Website	Email	Direct Line 9 AM to 6 PM Local Time	Toll Free Number 9 AM to 6 PM Local Time
Australia	<a href="https://www.cisco.com/c/m/en_au/cisco-start.html">https://www.cisco.com/c/m/en_au/cisco-start.html</a>	csg-au@cisco.com	61284463050	1800 134 349 (Press 5 then 2 then 1)
India	<a href="https://www.cisco.com/c/m/en_in/cisco-start.html">https://www.cisco.com/c/m/en_in/cisco-start.html</a>	csg-in@cisco.com	918042501535	000 800 100 1364 (Press 7)
Indonesia	<a href="https://www.cisco.com/c/m/en_id/cisco-start.html">https://www.cisco.com/c/m/en_id/cisco-start.html</a>	csg-id@cisco.com	622127546455	001 803 61 838 (Press 7)
Japan	<a href="http://www.cisco.com/jp/go/start">http://www.cisco.com/jp/go/start</a>	-	-	-
Korea	<a href="https://www.cisco.com/c/m/ko_kr/cisco-start.html">https://www.cisco.com/c/m/ko_kr/cisco-start.html</a>	csg-kr@cisco.com	82234298295	0803 77 0880 (Press 5 then 2 then 1)
Malaysia	<a href="https://www.cisco.com/c/m/en_my/cisco-start.html">https://www.cisco.com/c/m/en_my/cisco-start.html</a>	csg-my@cisco.com	60320811595	1800 88 1292 (Press 5 then 2 then 1)
New Zealand	<a href="https://www.cisco.com/c/m/en_au/cisco-start.html">https://www.cisco.com/c/m/en_au/cisco-start.html</a>	csg-nz@cisco.com	6444982465	0800 291 129 (Press 5 then 2 then 1)
Philippines	<a href="https://www.cisco.com/c/m/en_ph/cisco-start.html">https://www.cisco.com/c/m/en_ph/cisco-start.html</a>	csg-ph@cisco.com	6328653411	1800 1441 0466 (Press 5 then 2 then 1)
Singapore	<a href="https://www.cisco.com/c/m/en_sg/cisco-start.html">https://www.cisco.com/c/m/en_sg/cisco-start.html</a>	csg-sg@cisco.com	6563177048	800 4481627 (Press 5 then 2 then 1)
Thailand	<a href="https://www.cisco.com/c/m/th_th/cisco-start.html">https://www.cisco.com/c/m/th_th/cisco-start.html</a>	csg-th@cisco.com	6622637099	001 800 611 0754 (Press 7)
Vietnam	<a href="https://www.cisco.com/c/m/en_vn/cisco-start.html">https://www.cisco.com/c/m/en_vn/cisco-start.html</a>	csg-vn@cisco.com	84439746990	1800 585 809 (Press 5 then 2 then 1)



Getting Started

Start Portfolio

Start Website

For Partners

What's New

Feature Story

Collaborate

Compute

Security

Connect

Switches

Wireless

Routers

Services

Why Cisco Start?

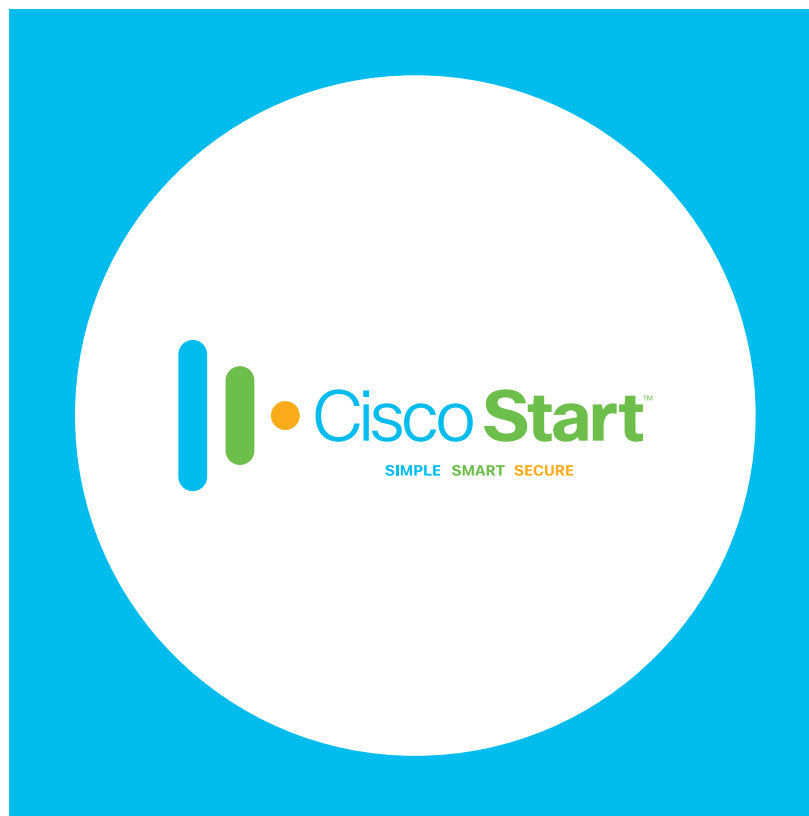

Successful small businesses start with hard work and dedication.

But bigger things start with a strong foundation that will never limit your potential.

That's what Cisco Start provides to SMBs.

A strong technology foundation so that they can focus on bigger things.

Because bigger things start here.



Getting Started

Start Portfolio

Start Website

**For Partners**

What's New

Feature Story

Collaborate

Compute

Security

Connect

Switches

Wireless

Routers

Services

## Why Bigger Things Start Here?



### Best of Breed Portfolio

- Solutions and services to meet any customer need and grow your Cisco business
- Market leadership across 'Collaborate,' 'Compute,' 'Secure,' 'Connect'
- Simple, smart and secure



### Increased Profitability

- Best available competitive and dynamic pricing
- Programs & incentives that grow your bottom line
- Capitalize on Cisco Start marketing investments

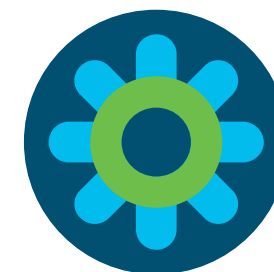

### Ease of Doing Business

- Simplified pricing and ordering with promotion codes from distributors
- Assets, training and support to help you sell
- Dedicated Cisco support specialists





Table of Contents

Start Portfolio

Start Website

For Partners

Getting Started

Start Portfolio

Start Website

For Partners

What's New

Feature Story

Collaborate

Compute

Security

Connect

Switches

Wireless

Routers

Services

### Best of Breed Portfolio

In today's demanding business landscape, SMBs are constantly on the lookout for ways to differentiate and get ahead of the competition via technology. We anticipate their needs, guide them through challenges, and help them grow their businesses. When it comes to the business and IT priorities of SMBs, no one knows better than Cisco.

As a new partner to Cisco, you can get started by selling Cisco Start — enterprise-class technology tailored for SMBs.



Getting Started

Start Portfolio

Start Website

For Partners

What's New

Feature Story

Collaborate

Compute

Security

Connect

Switches

Wireless



Routers

Services

## Increased Profitability



Earn rewards for new business and high-volume sales. Find discounts for our products.

- **Fast Track** (Registered & above partners - SKU based): Fast-track your sales by taking advantage of increased SKU based discounts for high-volume product sales. 
- **NFR - Not for Resale** (Registered & above partners - conditions apply): Buy our products and software at discount to use for internal testing and training. 
- **Deal Registration** (Select Certified & above partners): Bring in new business, or partner with us on presale deals. Get discount advantage and program benefits for hunting and teaming by registering deals with us. 



Earn rewards when you sell our technologies, support customers and more.

- **Cisco Commercial Xcelerate** (Registered & above partners - Commercial segment only): Cisco is enriching the incentive program to better recognize and reward our Commercial partners. As our Commercial partners, the more you invest in the Cisco partnership and deliver on the business goals, the more you will be rewarded for your success. 





Earn rebates when you help sell our products and grow the midmarket.

- **VIP - Value Incentive Program** (Registered & above partners - requires track based specialisations and other conditions apply): Sell our products in key growth areas and gain rebates to increase your earnings or reinvest in your business. 



Market like you mean it. We help you reach new customers.

- **Partner Marketing Central**: Create more demand for your solutions with our marketing tools. 
- **Marketing Velocity**: Learn new skills; connect with experts. Get what you need for success. 
- **Logo & Banners**: Use our brand to promote your success. Our visuals help you stand out. 





Ease of Doing Business

Everyday Low Prices (Fast Track)

- Single products and services



Purchase Programs  
Special Promotions





Limited Time Offers

- Bundles
- Other types of promotions



Before a Sale

During a Sale

After a Sale

- Hunting Incentive (OIP) 
- Teaming Incentive (TIP) 
- Solution Incentive Program (SIP) - Solution Led Selling 
- Technology Migration Program (TMP) 
- JMF or ASAP for Marketing
- Big Bet or Quick Bets for Business Growth

- Standard Not for Resale Program (NFR)
- Fast Track Promotion Pricing
- Architecture Specific Promotions

- Value Incentive Program (VIP) - Architecture Led Selling Rebate 
- Commercial Sales Rewards Program "Commercial Xcelerate" 
- Partner Sales Competition "Commercial Champs"

Getting Started

Start Portfolio

Start Website

For Partners

What's New

Feature Story

Collaborate

Compute

Security

Connect

Switches

Wireless

Routers

Services



Partner Journey to Value Portfolio

Partner Registration

Ensure partner is completes registration with Cisco

Increased Focus on Cisco Start

Simplified portfolio and offers tailored for Small Businesses

Aspire for Partner Plus\*1

Learn and prepare to meet eligibility criteria for the flagship program in commercial segment



Familiarise with Commercial Offer

Register for CX Rewards, learn about commercial landscape, start portfolio and offerings

Certification and Incentives

Did you know that a Select Partner is more profitable and eligible for larger incentives than a registered partner?

\*1 Entry into Partner Plus is by invite only and this journey can only help them meet the eligibility criteria, not guarantee an invite. Other criteria on bookings, YOY growth and commercial share of business need to be satisfied to be invited for the program.

Getting Started

Start Portfolio

Start Website

For Partners

What's New

Feature Story

Collaborate

Compute

Security

Connect

Switches

Wireless

Routers

Services





# 4 New Product Portfolio & 2 New Solutions to Check Out

Products

Promotions

Buying Method

Introduce Cisco Webex Room Kit Mini



Introduce Cisco Webex Room Kit Plus PTZ



Introduce Cisco ISR 900 Series



Introduce Cisco Catalyst 9200 Series



Introduce Cisco SD-WAN

Viptela Meraki

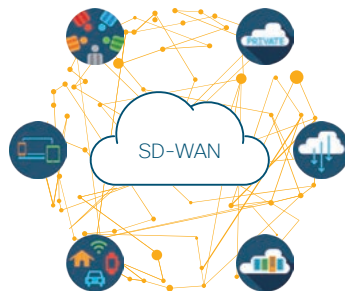

Introduce Cisco Smart Accounts

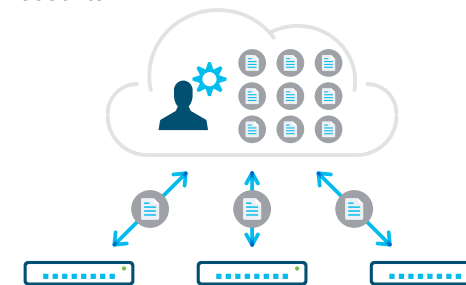

Getting Started

What's New

Products

Promotions

Buying Method

Feature Story

Collaborate

Compute

Security

Connect

Switches

Wireless

Routers

Services

Products

Promotions

Buying Method

Cisco Start Promotion Guide for Cisco Partners Q3 FY19

Increase your profitability and win competitive deals by taking advantage of short-term promotions. For details, download our full promotion guide, "Cisco Start Promotion Guide for Cisco Partners Q3 FY19."

Download Available from Here!!



APJ Promo Summary | ANZ | ASEAN | GREATER CHINA | INDIA | JAPAN | KOREA | How to Buy

Guide customers to pick what suits them

	Analog type	Tech centric type	Digital native type
SMB customer characteristic	Cost-conscious, simply must use IT	IT adds value to my business	IT is my business driver
WAN	SBTG RV series (Linux)	ISR600 series (IOS)/ISR1100 series for connectivity	ISR1100 series (IOSXE) with SD-WAN/SD-WAN security
LAN	SBTG 95-500 series of Switching (Linux)	Catalyst 2960X/L series (IOS)	Catalyst 9200 series (IOSXE)
Customer type to Cisco	New logo	Sustain cisco install base	Upsell cisco install base
How to serve	Primary perpetual, subscription license on FindIT, UMB and Sec Lic, as options	Perpetual, do NOT require end user SA&SL, no term based license	Recurring, must require SA&SL (register and manage) at the point and after sale
Simplest solution	Meraki full stack solutions Recurring		

© 2019 Cisco and/or its affiliates. All rights reserved.

APJ Promo Summary | ANZ | ASEAN | GREATER CHINA | INDIA | JAPAN | KOREA | How to Buy

Introduce SD-WAN ready and SD-WAN Security platforms -the branches use and SMB customers

**New** C1111-4P/8P-DNA  
C1111-4P/SPLTELA-DNA  
Compact fixed branch platform with rich services, integrated Wi-Fi and LTE

**New** C1111X-8P-DNA-PM  
Highest performing and scalable fixed routing platform with SD-WAN security capabilities

Optimized for Office 365 performance

Meraki MX | ENCS 5000 | Public Cloud | vEdge | ISR 1000 | ISR 4000 | ASR 1000

Microsoft Azure | Amazon | Google Cloud

© 2019 Cisco and/or its affiliates. All rights reserved.

APJ Promo Summary | ANZ | ASEAN | GREATER CHINA | INDIA | JAPAN | KOREA | How to Buy

Catalyst access switching T2 channel positioning: sell both

Well known product line Best for fast in fast orders and transactions



Catalyst 2960X/XR

&

Superior product line Best for competition take out



Catalyst 9200L/9200 With Cisco DNA-E&A

<b>1</b>	No.1 proven and recognized switching brand of its class for decades	<b>1</b>	Provide automation, assurance, telemetry and network visibility on top of superior switching capabilities
<b>2</b>	No product EoS plan on Cat2960X product line	<b>2</b>	Recurring license handle to access to rich feature set, customer requires Smart Account and Smart License
<b>3</b>	Perpetual license, best use for fast in fast orders	<b>3</b>	Ready to sell using a recurring revenue model and prepared to seek Cisco sales support if guidance is required

© 2019 Cisco and/or its affiliates. All rights reserved.

APJ Promo Summary | ANZ | ASEAN | GREATER CHINA | INDIA | JAPAN | KOREA | How to Buy

Introducing Webex Room Kit mini for huddle space



USD \$5,990 (CS-KIT-MINI-K9)

World-class superior conference experience starting from only

FTB Promotion Price US\$2,216 (63%off) | Purchase with cloud device registration: A-SPK-SH-ND-SR at 27% off

© 2019 Cisco and/or its affiliates. All rights reserved.

Getting Started

What's New

Products

Promotions

Buying Method

Feature Story

Collaborate

Compute

Security

Connect

Switches

Wireless

Routers

Services



Products

Promotions

**Buying Method**

## Collaborate

### FTx Promotion

— Buy X for more X —

#### Calling

- IP Phone 7800/8800 Series
- IP Phone 7800/8800 Series with MPP
- Headset 500 Series

#### Meetings

- Webex DX80
- Webex Room Kit Mini
- Webex Room Kit
- Webex Room Kit Plus PTZ

#### Team Collaboration

- Webex Share\*1
- Webex Board

### Collaboration Flex Plan

#### Named User <250

- Webex Meetings
- Webex Teams

1

Take  
Small Deal Accelerator  
add 10 %

2

Take  
Named User Meetings Promotion  
add up to 16 %  
● Promotional SKU:  
A-FLEX-NUCM-MC

Getting Started

What's New

Products

Promotions

**Buying Method**

Feature Story

Collaborate

Compute

Security

Connect

Switches

Wireless

Routers

Services



Products

Promotions

**Buying Method**

## Compute

### FTx Promotion

— Buy X for more X —

UCS

UCS C220/240 M5

Nexus

Nexus 9348GC-FXP

### Dynamic Bundle

— Buy X with Y for better price —

HyperFlex

HX220c/240c M5

UCS

UCS C220/240 M5

### Base Edition Free

Unified Management

Intersight

(Essentials edition available under subscription)

Getting Started

What's New

Products

Promotions

**Buying Method**

Feature Story

Collaborate

Compute

Security

Connect

Switches

Wireless

Routers

Services

Products

Promotions

**Buying Method**

## Security

### FTx Promotion

— Buy X for more X —

#### Endpoint

- AnyConnect
- AMP for Endpoints

#### Network

- Firepower 2110
- ASA 5506/5508/5516-X with FTD

#### Cloud

- Umbrella

### Dynamic Bundle

— Buy X with Y for better price —

#### Cloud

- Umbrella

Getting Started

What's New

Products

Promotions

**Buying Method**

Feature Story

Collaborate

Compute

Security

Connect

Switches

Wireless

Routers

Services



Getting Started

What's New

Products

Promotions

Buying Method

Feature Story

Collaborate

Compute

Security

Connect

Switches

Wireless

Routers

Services

Products

Promotions

Buying Method

## Connect

 Security Dynamic Bundle available  
Buy with Umbrella for better price

### Meraki Full Stack Promotion

#### Security/UTM

- MX64/65
- MX67/68
- MX84
- vMX100



#### Wireless

- MR20
- MR33
- MR42

#### Teleworker Gateway

- Z3

#### Switches

- MS120 Series
- MS210 Series
- MS220-8
- MS225 Series

#### Security Cameras

- MV12
- MV21
- MV71

#### Endpoint Management

- SM

### FTx Promotion

— Buy X for more X —

#### Wireless

- 100/300/500 Series Wireless Access Points (WAP)
- Aironet 1800/2800/3800 Series with Mobility Express
- 3504 Wireless Controller



#### Routers

- RV 160/260/340 Series
- ISR 900 Series
- ISR 1100 Series
- ISR 4200/4300 Series

#### Switches

- SF/SG Switches
- Catalyst 2960-L/X Series
- Catalyst 3650/3850 Series
- Catalyst 9200 Series

### 10-Device License Free

#### Network Management

- FindIT Network Manager  
(15-, 25-, 50-device licenses available under subscription)







Getting Started

What's New

Feature Story

SD-WAN

Smart Accounts

Collaborate

Compute

Security

Connect

Switches

Wireless

Routers

Services

## SD-WAN: the New Landscape of Networking

More users, more apps, more devices —

An influx of data and devices is pushing the limits of traditional WAN architectures, making it nearly impossible for networks to keep up. IT is trying to increase bandwidth and improve connectivity, but they can't do it alone.

Cisco SD-WAN can help.

With the power of software-defined networking on the WAN, businesses can improve performance, reduce costs, and stay secure.

It's a cloud-first, software-driven approach that routes traffic, maintains application performance, and adapts to changing conditions — all without direct IT oversight.



## What is SD-WAN?

SD-WAN (Software-Defined WAN) is a software-defined approach to managing the WAN (Wide Area Network).

### Why Now for SD-WAN?

Today's networks are consuming more cloud based applications and this is challenging the traditional WANs which have been designed using Multiprotocol Label Switching (MPLS) for connectivity, and where the majority of branch office traffic flows through a central location, usually the data center to get out to the Internet. This change creates new requirements for security, application performance, cloud connectivity, WAN management, and operations and IT is struggling to do all this at scale and across locations.

### What are the Benefits of SD-WAN?

- **Simplify Management:** As a centralized, cloud-delivered WAN architecture, SD-WAN makes it easy to scale across thousands of endpoints, whether they are in the branch, campus, or cloud. IT has the ability to automate zero-touch deployment globally, using a single management interface.
- **Improve User Experiences:** WAN optimization delivers optimal cloud application performance from multiple clouds to users anywhere. In the event of link failure or link degradation, application-aware routing can dynamically route traffic between dedicated circuits and secure Internet connections to drive constant delivery of business-critical applications.
- **Increase Security:** Threat prevention is enforced at the right place. SD-WAN architecture features distributed security at the branch level. Data does not have to travel back to the headquarters or data center for advanced security protection (such as a firewall, DNS enforcement, or intrusion prevention).

### Why Cisco SD-WAN?

Only Cisco offers a comprehensive network solution that includes SD-WAN along with powerful security architecture and the ability to scale at your own pace. Cisco SD-WAN solutions integrate cloud optimization, security, and advanced analytics to transform your enterprise for digital and cloud.

### Today's IT challenges

- Applications moved to not one cloud, but many

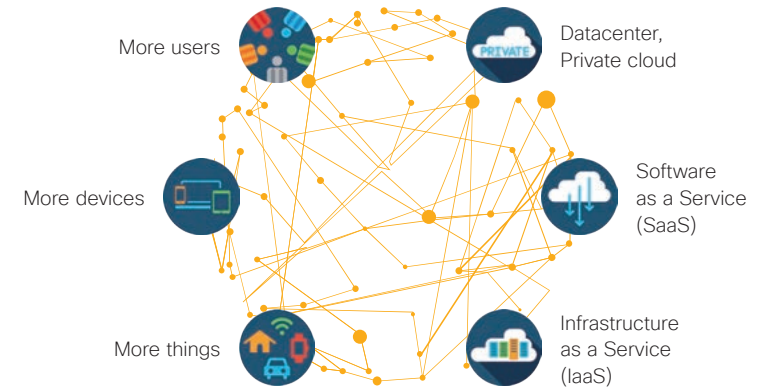

### Cisco SD-WAN provides



Simplified Management



Improved User Experiences



Increased Security

Cisco SD-WAN portfolio is powered by

Viptela

For sophisticated IT teams, Viptela extends intent-based networking across the branch, WAN, and cloud. Deploy SD-WAN on Cisco Cisco ISR/ASR

Meraki

For lean IT teams, Meraki simplifies branch management and integrates threat management. Deploy SD-WAN on Cisco Meraki MX

Overview

What is SD-WAN?

Powered by Viptela

Powered by Meraki

■ Cisco SD-WAN powered by Viptela

Cisco SD-WAN (powered by Viptela) is a centrally managed, orchestrated, and operated solution with a cloud-hosted **Cisco vManage** GUI management and provisioning platform, **Cisco vSmart** controller, and **Cisco vBond** orchestration layer at the heart of the solution.

Through the Cisco vManage console, you can quickly establish an SD-WAN overlay fabric to connect data centers, branches, campuses, colocation facilities, and clouds to improve network speed, security, and efficiency. After setting your preferred templates and policies, Cisco SD-WAN identifies connectivity and contextual issues to determine optimal paths for users to get to their destination, regardless of the connectivity they are using.

Whether hosted in the cloud or on-premises, Cisco vBond and vSmart orchestration and controller platforms authenticate and provision network infrastructure, making certain that the devices connecting to your SD-WAN are authorized. Once connected, the SD-WAN platforms find the best path to bring users closer to the applications they need, managing overlay routing efficiency, adjusting in real time to reflect policy updates, and handling key exchanges in Cisco's full-mesh, encrypted delivery.

■ Cisco SD-WAN Capability can be Enabled on Cisco ISR 1100

● Better User Experience

The ability to deploy applications in minutes, on any platform, with a consistent user experience. Deliver predictable performance for applications residing in the data center or in the cloud.

● Greater Agility

Faster, easier deployment and operation of your WAN, and get faster performance using less bandwidth. Add new revenue generating services in minutes not months.

● Advanced Threat Protection: SD-WAN Security

Securely connect your users to applications in minutes and protect your data from the WAN edge to the cloud. Secure segmentation for critical assets and multi-layer, robust security that encrypts all data.

Single Management Dashboard:  
One console for SD-WAN and network security



Zero Touch Deployment:  
Agility in provisioning and deployment

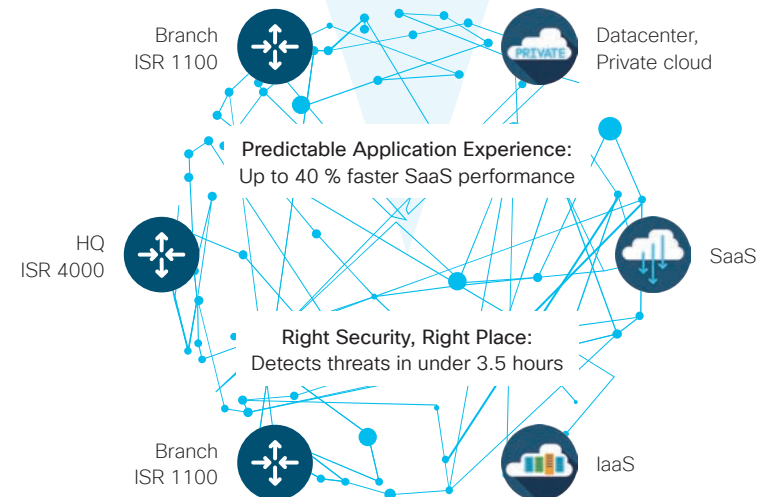

- Getting Started
- What's New
- Feature Story
- SD-WAN
- Smart Accounts
- Collaborate
- Compute
- Security
- Connect
- Switches
- Wireless
- Routers
- Services



Getting Started

What's New

Feature Story  
SD-WAN

Smart Accounts

Collaborate

Compute

Security

Connect

Switches

Wireless

Routers

Services

## ■ Cisco SD-WAN powered by Meraki

Cisco SD-WAN (powered by Meraki) is ideal for lean IT environments in which full stack management of WAN, LAN, and security is valued, along with simple management, orchestration, and automation, or where Meraki is the predominant architecture.

All Cisco Meraki MX Cloud Managed Security & SD-WAN Appliances are equipped with SD-WAN capabilities that enable administrators to use available bandwidth more efficiently and ensure the highest possible level of performance for critical applications without sacrificing security or data privacy.

### ■ Meraki MX SD-WAN Features

The following features can lower your operational costs and improve resource usage:

#### ● Dual-Active VPN Uplinks

In addition to supporting dual WAN uplinks and automatic VPN failover, the Meraki MX also has the ability to build multiple VPN tunnels that are active simultaneously on both uplinks, whether they are Internet or MPLS connections. Traffic can then be load-balanced across these tunnels to make optimal use of available bandwidth.

#### ● Policy-based Routing (PbR)

PbR functionality allows administrators to assign traffic to a particular VPN path based on criteria such as traffic protocol, source, destination, or application.

#### ● Dynamic Path Selection

Dynamic path selection allows administrators to set performance thresholds for different types of traffic, in order to ensure that critical applications and data transfers always use the best path based on the loss, latency, and jitter over the available VPN tunnels.

#### ● Meraki Insight WAN Health

The WAN Health feature is specifically designed to monitor ISP connections, and it will help with troubleshooting and reporting for these connections. In addition to active/primary ISP uplinks, WAN Health will also monitor secondary/failover connections (such as WAN2 and LTE connections).

#### Meraki Dashboard: Intuitive Centralized Management



#### Zero-Touch Cloud Provisioning: Can be remotely deployed in minutes

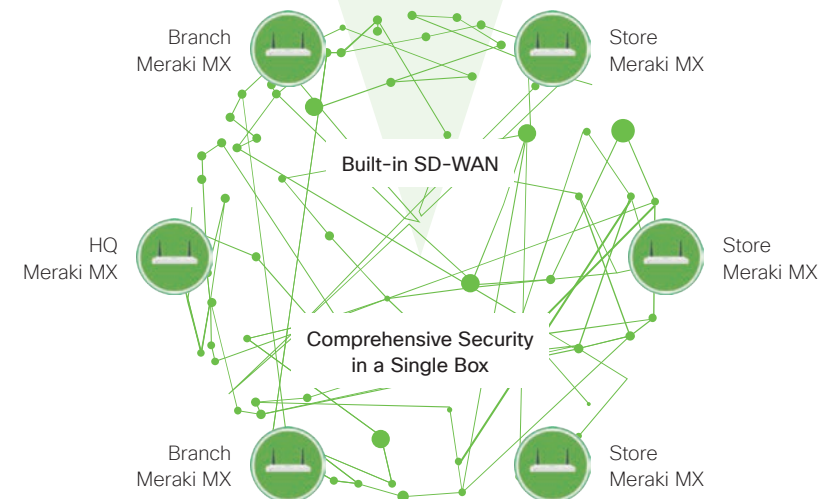



## Simplify Your Software License Management

Cisco understands that purchasing, deploying, managing and tracking software licenses can be extremely complex. As a result, we are introducing Cisco Smart Licensing, a standardized licensing paradigm that helps you understand how Cisco software is used across your network, thereby reducing administrative overhead and saving on operating expenses.

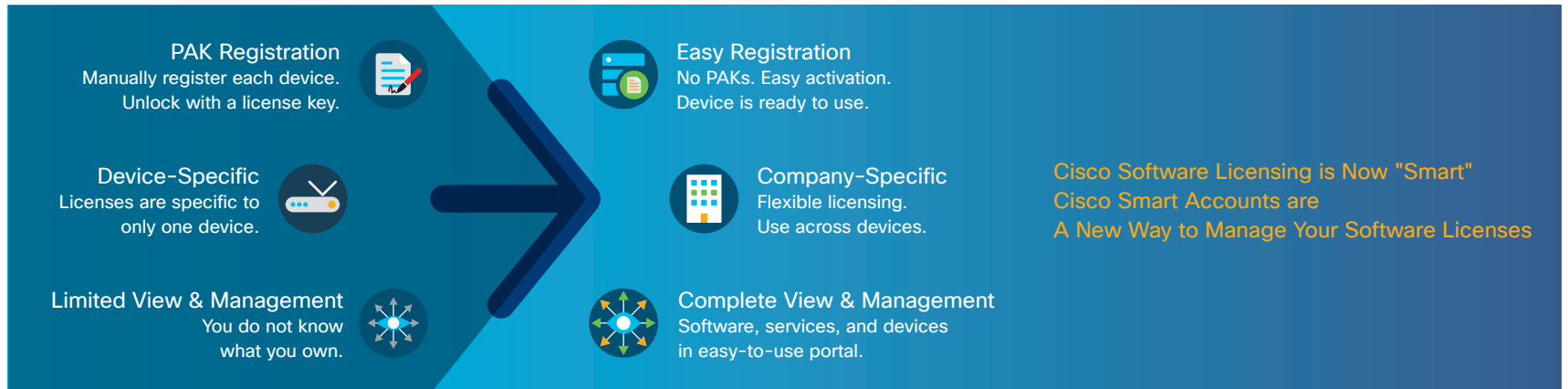

When Cisco Smart Licenses are linked to a Cisco Smart Account, you can manage licenses for greater visibility, flexibility, and productivity.

Enhanced Visibility



- You will have a single view of licenses you currently own and are using, which will simplify communications between procurement and IT.

Maximize Software ROI



- Of all your owned licenses, only your active ones will be counted as consumed and license records cannot be lost or misplaced.
- Available licenses are easily transferred around your network as needs evolve.

Increase Productivity



- Effectively delegate access levels and efficiently manage your Cisco Software assets.
- Reduce operating expense when processing Return Material Authorizations.
- Activate new products without license files.

Getting Started

What's New

Feature Story

SD-WAN

Smart Accounts

Collaborate

Compute

Security

Connect

Switches

Wireless

Routers

Services

## Gain Enterprisewide Visibility into Your Cisco Software Licensing Assets

Cisco Smart Accounts offer a simple-to-use, centralized and organized solution to license management. Serving as a central repository, Cisco Smart Accounts give full visibility into your Cisco software assets across your organization. You can view, store, manage, and move Cisco software assets to where they are needed, when they are needed. And getting a Cisco Smart Account is fast and free. It takes just minutes to activate an account.

When your Cisco Smart Account is combined with Cisco Smart Licensing, you get real-time, enterprise-wide visibility into your license utilization, providing insights to inform purchase decisions, lower operational costs and ensure compliance. This allows your operations to continue without delay or downtime and can help reduce unneeded license purchases. Comprehensively, a Cisco Smart Account gives you access to your software licenses, hardware and subscriptions.

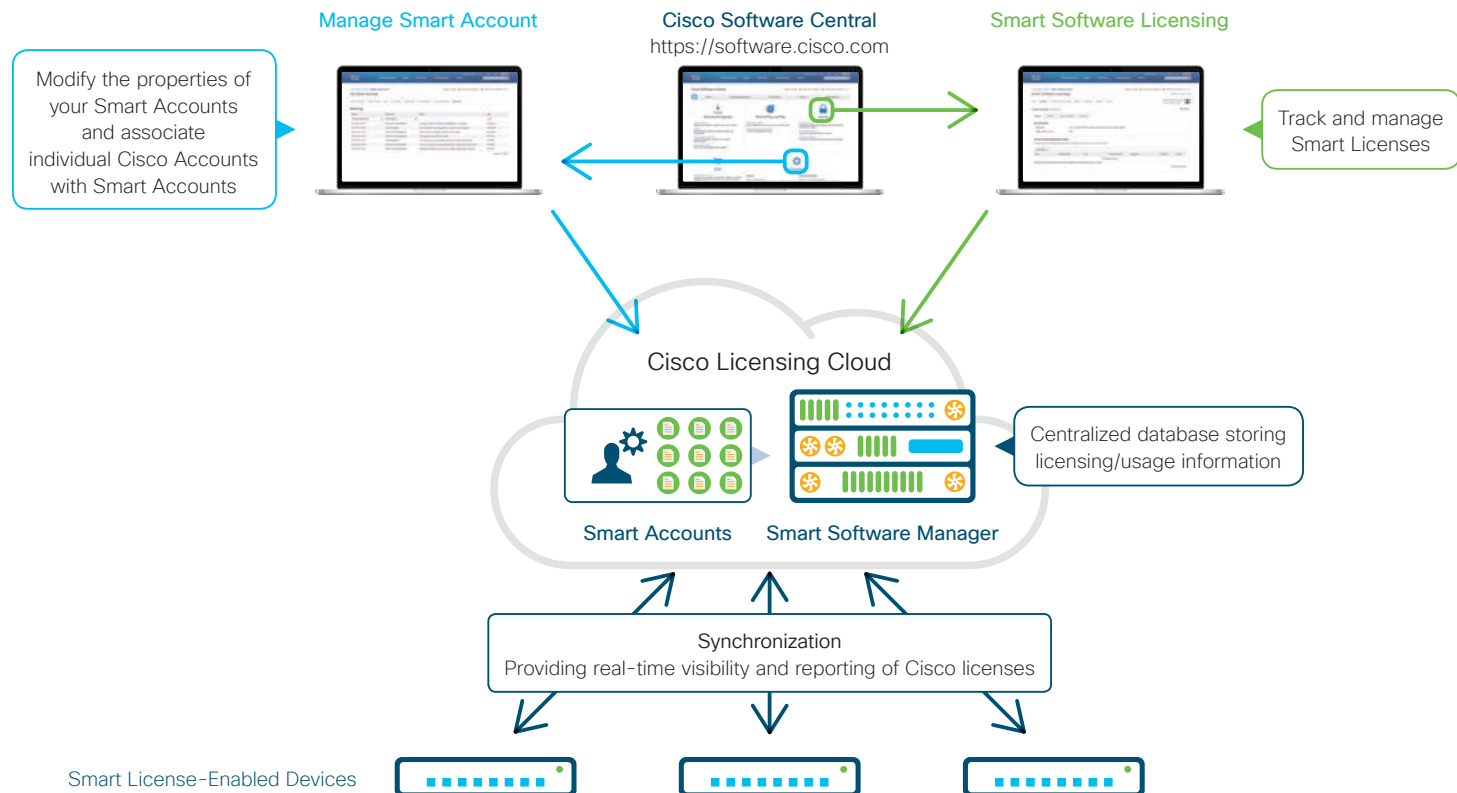

For details on Cisco Smart Licensing Enabled Product Families, go to: [community.cisco.com/t5/licensing-enterprise-agreements/smart-license-enabled-product-families/ta-p/3652497?attachment-id=163614](https://community.cisco.com/t5/licensing-enterprise-agreements/smart-license-enabled-product-families/ta-p/3652497?attachment-id=163614)

Getting Started

What's New

Feature Story

SD-WAN

Smart Accounts

Collaborate

Compute

Security

Connect

Switches

Wireless

Routers

Services



### License Portability

License portability is a key services-enabled benefit offered by the Cisco Smart Licensing model. Previously, software application licenses were node-locked to a specific device. With license portability, when a customer needs to move to a different device within the same product family, they are entitled to move their software licenses to that new device.

This means, the customer can now use the available smart licenses across devices within the enterprise in the same product family. For example, if you remove a device from your network, the license can be released and re-assigned to another device within your enterprise where-ever required.

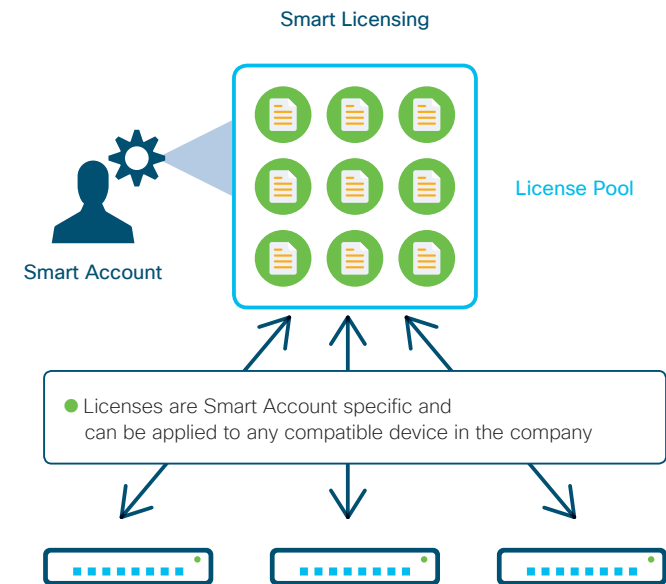
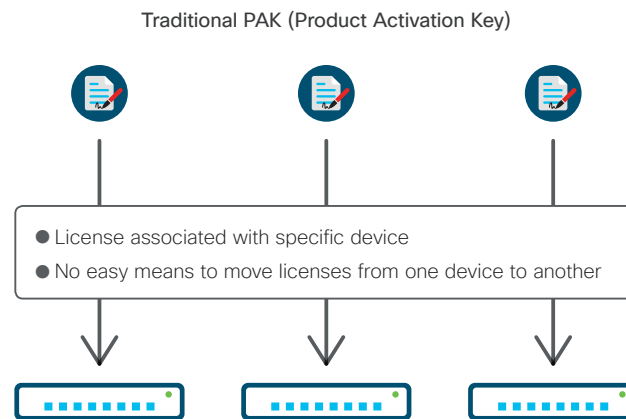

Getting Started

What's New

Feature Story

SD-WAN

Smart Accounts

Collaborate

Compute

Security

Connect

Switches

Wireless

Routers

Services



## Virtual Accounts

After creating a Cisco Smart Account, you have the flexibility to create sub-accounts (called **Virtual Accounts**) to organize and manage your users and licenses by department, product, geography, project, or other designation — whatever makes the most sense for your organization. Licenses can be pooled within Virtual Accounts as needed. Cisco Smart Accounts have role-based user access controls, which allow the delegation of authority to account administrators at the Smart Account level or at the Virtual Account level. In addition, you can manage partner visibility and management rights to your virtual or enterprise-level accounts.

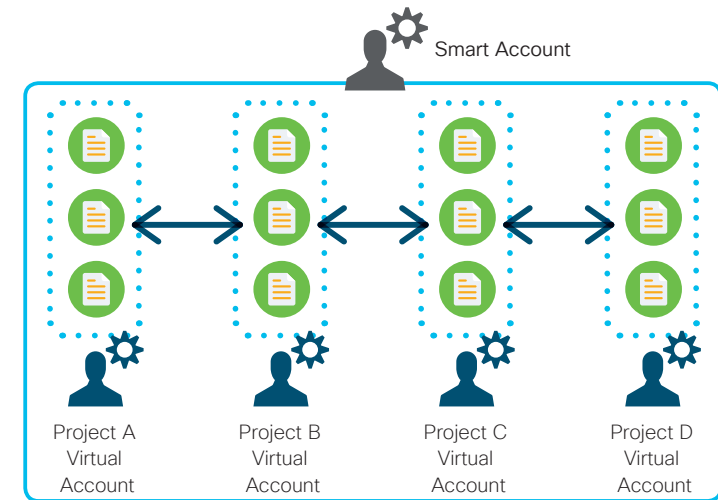

### TIP 5 Roles for Smart Accounts

#### 1 Smart Account Approver

The approver is able to edit Smart Account (SA) properties, view all users, accept agreements, and view event logs. The approver cannot perform any license management activities.

#### 2 Smart Account Administrator

The administrator is able to edit SA properties, add and edit users, add and edit Virtual Account (VA), accept agreements and view event logs. The SA administrator can perform license management activities for the entire SA.

#### 3 Smart Account User

Similar to a SA administrator, this role allows access to all VA. A SA user can perform licensing activities but cannot create new VA or perform user management activities.

#### 4 Virtual Account Administrator

Similar to the SA administrator, except that this administrator is limited to assigned VA. This role allows the administrator to add and edit users to assigned VA, view event logs for assigned VA, and view account agreements. The VA administrator can perform all license management activities for the assigned VA.

#### 5 Virtual Account User

Similar to a SA user, except that this user is limited to the VA the user is assigned to. They can perform licensing activities for the selected VA, but they cannot add new users.

Getting Started

What's New

Feature Story

SD-WAN

Smart Accounts

Collaborate

Compute

Security

Connect

Switches

Wireless

Routers

Services



Getting Started

What's New

Feature Story

SD-WAN

Smart Accounts

Collaborate

Compute

Security

Connect

Switches

Wireless

Routers

Services

**Cisco Smart Software Manager**

You can self-manage license deployment throughout your company using the **Cisco Smart Software Manager**. Cisco Smart Software Manager is a cloud-based tool that maintains a record of your Smart Licenses. The system maintains real-time status of license usage after products are registered and activated.

There are various options available to connect the devices to Smart Account including direct Internet connectivity, through a HTTPS Proxy, on-premise **Cisco Smart Software Manager satellite**, etc. For any customer who can not connect to the cloud for acquiring licenses due to security reasons such as defense, federal customers (military, navy, submarines, tanks, etc.) — there are provisions to deliver permanent licenses on request. However please note that they are not generally available to all customers.

**Direct Access**

Cisco products send usage information directly over the Internet. No additional components are needed.

**Access through an HTTPS Proxy**

Cisco products send usage information directly over the Internet via a proxy server — Smart Call Home Transport Gateway (Free VM Download) or off-the-shelf proxy (such as Apache).

**Access through an On-Premise License Management**

Cisco products send usage information to a locally installed satellite. Periodically, exchange information with Cisco to keep satellite sync. This synchronization can occur automatically in connected environments or manually in disconnected environments

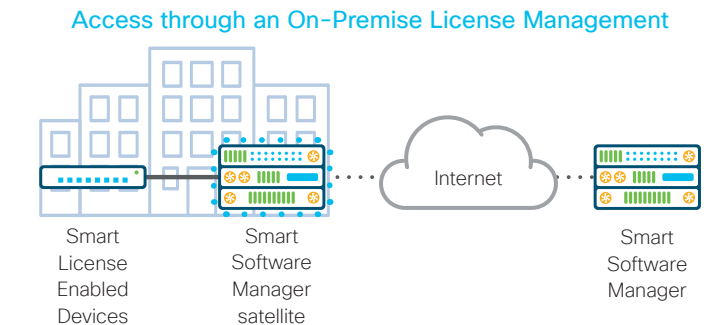
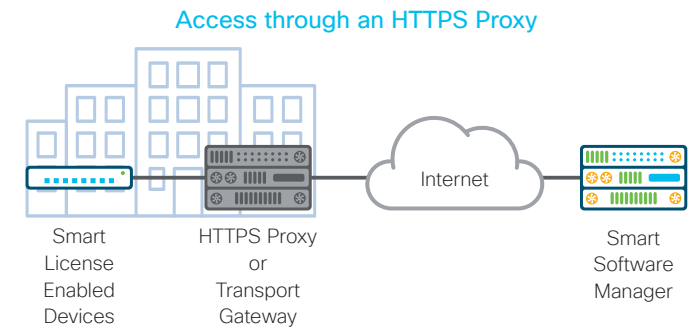
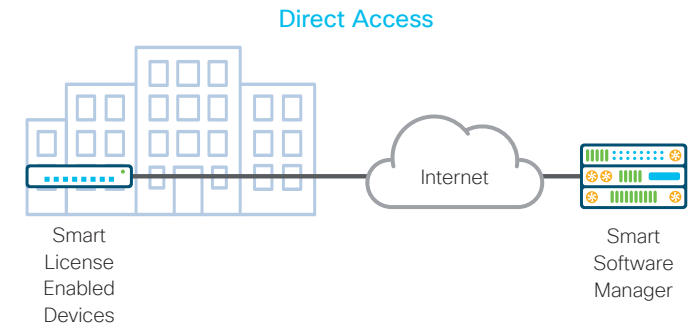

## Overview

## Features and Benefits

## FAQ

### Myths and Facts Revealed (for Customers & Partners)



I don't need SA while ordering. Its required only for deployment.



Customer SA (or) Partner Holding Account needs to be entered to complete the booking.



Setting up SA is a lot of effort.



Setting up SA takes only 2-3 minutes. Customer receives email to approve the SA, and it will be fully active post the approval.



SA is required only for Catalyst 9K.



SA is required for all IOS XE 16.9.1 release. Any old switches with Cisco DNA or Network PNP licenses will require SA.



Smart License shows the details of customer business interactions, data, type of network, traffic, innovations, etc.



No. With Smart Licensing, Cisco only receives the serial # of device, the account #, and product ID. Customer configurations are not sent to SA.



When the lifecycle of the device hits Last-Day-of-Support (LDOS), Cisco has the keys and can turn off functionality.



Smart Licensing operates under a Do-No-Harm premise. All communication is always device-initiated and there is no capability Cisco has put in place to disable the device.



If a device does not check in with Cisco within 30 days it will lose functionality.



If a device has not communicated with Cisco within 30 days, an alert is sent notifying the user that the device has not been used. After 90 days with no communication, the license usage is released, however, the device itself will continue to run in an 'Authorization Expired' state until the ID certificate is revoked, which is one year after the last communication.



With Smart Licensing, you hand over the keys of functionality to Cisco. This increases the risk of network outages.



Smart Licensing operates under a Do-No-Harm premise. All communication is always device-initiated and there is no capability Cisco has put in place to disable the device.



With Smart Licenses, devices must connect to the Internet daily for entitlement validation, which introduces security risks.



Devices typically connect to the Internet monthly, not daily. The primary reason for this is to detect devices that have been removed from service, but the license is still active. This retrieval service ensures that customers are only consuming licenses on active devices.



Smart Licensing will eliminate residual value on your hardware purchases.



Smart Licensing does not shorten the lifespan or change the resell value of hardware. As before, software remains non-transferable.

Getting Started

What's New

Feature Story

SD-WAN

Smart Accounts

Collaborate

Compute

Security

Connect

Switches

Wireless

Routers

Services



**Myths and Facts Revealed (for Partners)**



I need to have Customer SA to book a deal.



You can book a deal with Partner Holding Account, and the licenses are delivered to partner. Partner needs to work with customer to complete license fulfillment sooner than later as the subscription is set to start up to 60 days from HW ship date.



Partner Holding Account are where Partners can manage customer's Smart Licenses.



Smart Licenses must be in Customer SA to be activated & consumed. Best practice for partners to deposit Smart Licenses directly to Customer SA.



With SA, partners can see all customer licenses including licenses sold by other partners.



Customers have the option to restrict or grant access to partners as they see fit. Partners can not access Customer SA without access from customer.



My customer don't allow cloud connectivity. Therefore SA is not possible.



There are various options available to connect to SA including proxy, Smart Software Manager satellite, Permanent License Reservation (PLR), etc.



My customer has several locations & complex org structure. Single SA is difficult.



SA Virtual Account provides various options to build hierarchy for an enterprise and assign administrator privileges to each virtual account.

For more FAQs for distributors & partners, download our guide, "Cisco Smart Licensing & Cisco Smart Accounts: Quick Guide for Distributors & Partners."



Getting Started

What's New

Feature Story

SD-WAN

Smart Accounts

Collaborate

Compute

Security

Connect

Switches

Wireless

Routers

Services



# Cisco Webex Room Kit Mini

Artificial Intelligence (AI)-Powered Video Conferencing System in a Box, Bringing More Intelligence to Modern Huddle Spaces

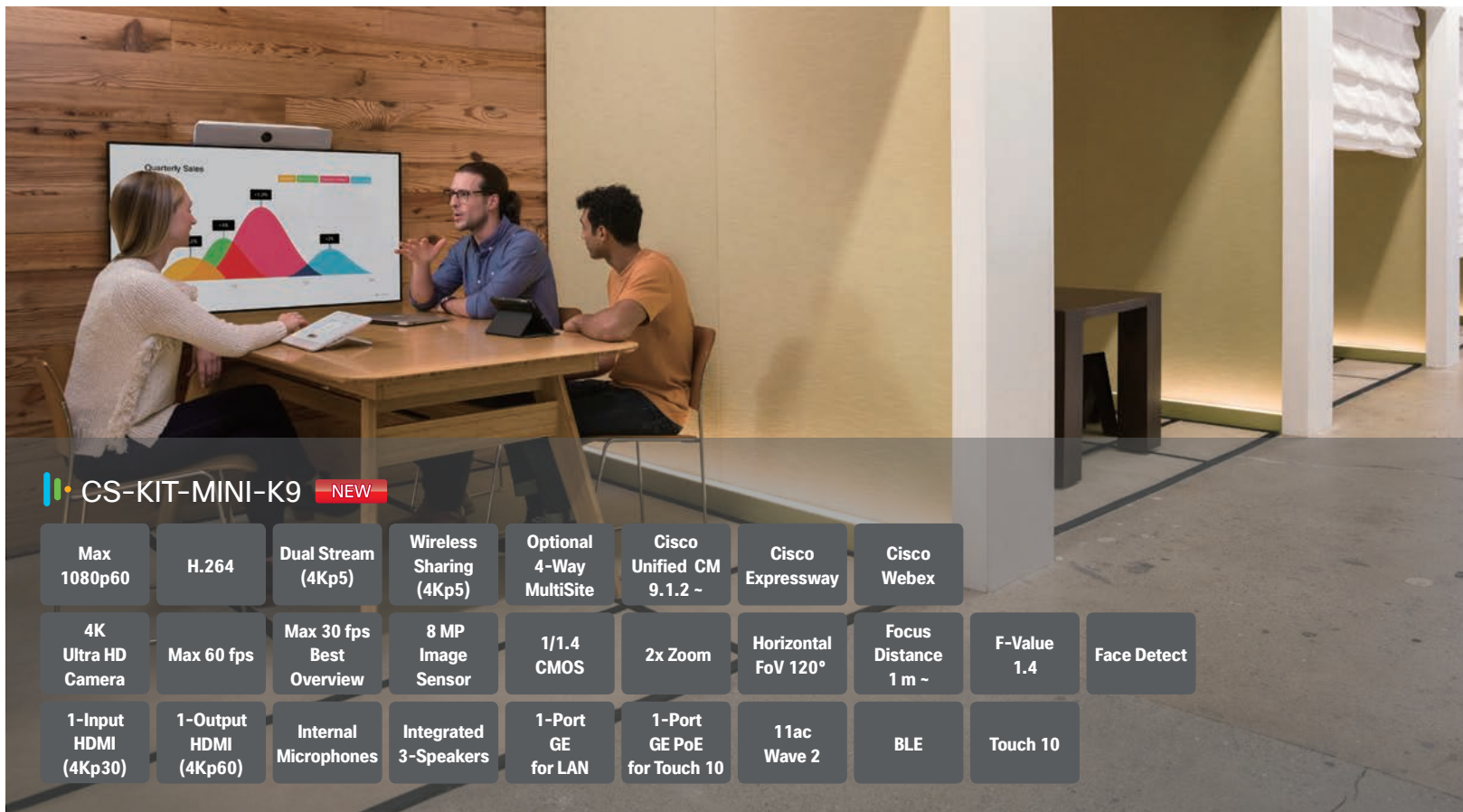

**CS-KIT-MINI-K9** NEW

Max 1080p60	H.264	Dual Stream (4Kp5)	Wireless Sharing (4Kp5)	Optional 4-Way MultiSite	Cisco Unified CM 9.1.2 ~	Cisco Expressway	Cisco Webex			
4K Ultra HD Camera	Max 60 fps	Max 30 fps Best Overview	8 MP Image Sensor	1/1.4 CMOS	2x Zoom	Horizontal FoV 120°	Focus Distance 1 m ~	F-Value 1.4	Face Detect	
1-Input HDMI (4Kp30)	1-Output HDMI (4Kp60)	Internal Microphones	Integrated 3-Speakers	1-Port GE for LAN	1-Port GE PoE for Touch 10	11ac Wave 2	BLE	Touch 10		

Getting Started

What's New

Feature Story

**Collaborate**

Webex Meetings

Webex Teams

Webex DX80

NEW Webex Room Kit

Webex Share

Webex Board

SX10 Quick Set

Business Edition 4000

IP Phone 7800/8800

IP Phone 7800/8800 MPP

Headset 500

Compute

Security

Connect

Switches

Wireless

Routers

Services







# Cisco Webex Room Kit Plus PTZ

Bringing More Intelligence and Versatility to Any Rooms,  
Where You Need Special Camera Flexibility



CS-KIT-PTZ12-K9 **NEW**

Max 1080p60	H.264	H.265	Dual Stream (4Kp5)	Wireless Sharing (4Kp5)	Optional 4-Way MultiSite	Cisco Unified CM 10.5.2 ~	Cisco Expressway	Cisco Webex		
Full HD Camera	12x Optical Zoom	12x Digital Zoom	Pan Range +/- 100°	Tilt Range +/- 25°	Horizontal FoV 71°	Focus Distance 0.5 m ~	F-Value 1.8 ~ 2.0			
1-Input HDMI (1080p60)	2-Input HDMI (4Kp30)	2-Output HDMI (4Kp60)	3-Input Mini-Jack	1-Output Mini-Jack	1-Port GE for LAN	1-Port GE for Camera	1-Port GE PoE for Touch 10	11ac Wave 2	BLE	Touch 10

Getting Started

What's New

Feature Story

Collaborate

Webex Meetings

Webex Teams

Webex DX80

**NEW** Webex Room Kit

Webex Share

Webex Board

SX10 Quick Set

Business Edition 4000

IP Phone 7800/8800

IP Phone 7800/8800 MPP

Headset 500

Compute

Security

Connect

Switches

Wireless

Routers

Services





# Cisco Headset 500 Series

A Professional Range of Wired and Wireless Headsets  
Optimized for Cisco IP Phones and Soft Clients

## CP-HS-WL-561-S-xx=

Single Earpiece	Vibrant Audio	Powerful Noise Isolation	Audio Shaping	Uni-directional Microphone	Microphone Tuning
On-Ear Controls	Music Mode	Multi-Mode Audio	Lightweight Ergonomic Design	Standard Base Station	Enhanced Mobility Wireless

## CP-HS-WL-562-S-xx=

Dual Earpiece	Vibrant Audio	Powerful Noise Isolation	Audio Shaping	Uni-directional Microphone	Microphone Tuning
On-Ear Controls	Music Mode	Multi-Mode Audio	Lightweight Ergonomic Design	Standard Base Station	Enhanced Mobility Wireless



Getting Started

What's New

Feature Story

### Collaborate

Webex Meetings

Webex Teams

Webex DX80

**NEW** Webex Room Kit

Webex Share

Webex Board

SX10 Quick Set

Business Edition 4000

IP Phone 7800/8800

IP Phone 7800/8800 MPP

Headset 500

Compute

Security

Connect

Switches

Wireless

Routers

Services





# Cisco Webex Meetings & Cisco Webex Teams

From meeting, to brainstorming, to sharing with the whole team, work progresses with Webex. It's how millions do their best teamwork



## A-FLEX-NUCM-MC

Webex Meetings	1,025 + Participants per Meeting	Screen Sharing	Video Call Back	Background Noise Detection	Record Meetings	Schedule Meetings	One-Button Join	Personal Rooms
Webex Teams	Messaging	File Sharing	Native Browser Support	Integration with Mobile App	Integration with Calendars	Multiple Devices Support	Standard App/Device Support	End-to-End Encryption

Getting Started

What's New

Feature Story

### Collaborate

Webex Meetings

Webex Teams

Webex DX80

**NEW** Webex Room Kit

Webex Share

Webex Board

SX10 Quick Set

Business Edition 4000

IP Phone 7800/8800

IP Phone 7800/8800 MPP

Headset 500

Compute

Security

Connect

Switches

Wireless

Routers

Services



Featured Products

Portfolio



# Cisco IP Phone 7800/8800 Series with Multiplatform Phone (MPP) Firmware

Enjoy Cisco's Superior Phone Design, Quality, and Features while Using an Approved Third-Party Cloud-Hosted Platform



CP-7841-3PCC-K9=

CP-8845-3PCC-K9=

4 Lines	White Backlit Grayscale Display	396 x 162 Pixel Resolution	Wideband Audio	Full Duplex Speaker-phone	
2-port GE	PoE Class 1	Ergonomic Design	Replaceable Bezel	Wall Mount	Third-Party Call Control

10 Lines	24-bit Color Display	800 x 480 Pixel Resolution	720p HD Video	Wideband Audio	Full Duplex Speaker-phone
2-port GE	PoE Class 2	Ergonomic Design	Replaceable Bezel	Wall Mount	Third-Party Call Control

Getting Started

What's New

Feature Story

Collaborate

Webex Meetings

Webex Teams

Webex DX80

**NEW** Webex Room Kit

Webex Share

Webex Board

SX10 Quick Set

Business Edition 4000

IP Phone 7800/8800

IP Phone 7800/8800 MPP

Headset 500

Compute

Security

Connect

Switches

Wireless

Routers

Services





Featured Products

Portfolio

Getting Started

What's New

Feature Story

Collaborate

Webex Meetings

Webex Teams

Webex DX80

**NEW** Webex Room Kit

Webex Share

Webex Board

SX10 Quick Set

Business Edition 4000

IP Phone 7800/8800

IP Phone 7800/8800 MPP

Headset 500

Compute

Security

Connect

Switches

Wireless

Routers

Services

Calling

Meetings

Team Collaboration



Cisco IP Phone 7800/8800 Series



Cisco Webex Meetings



Cisco Webex Teams



Cisco Webex DX80



Cisco Webex Share



Cisco Webex Room Kit Series



Cisco TelePresence SX10 Quick Set



Cisco Webex Board

Cisco Webex



Cisco Business Edition 4000



Cisco IP Phone 7800/8800 Series MPP



compatible with



Cisco Headset 500 Series



## Overview

## Licenses (Flex Plan)

## Why Webex Meetings?

## Comparison

## Meet with Anyone, Anywhere, on Any Device

### Use People-Centric Web Conferencing Collaboration

Take advantage of industry-leading web conferencing capabilities to facilitate compelling, productive team meetings. With the **Cisco Webex Meetings**, organizations of any size can:

- Promote collaboration with anyone globally, anywhere, anytime, on any device
- Increase productivity with an engaging, interactive web conferencing meeting experience
- Improve day-to-day efficiency and streamline meeting activities
- Save time and money by reducing the need to travel

### Reduce Costs, Optimize Investments

Cisco Webex Meetings helps reduce costs and optimize IT resources. Delivered through the **Cisco Webex Cloud**, these solutions are easy to implement and scale throughout your organization. Cisco Webex Meetings:

- Require no large, up-front investment, and offer a predictable cost and licensing model
- Offer quick global deployment and easy adoption for users inside or outside firewalls
- Help you cut costs on hardware, software, and maintenance
- Give you the time to focus on strategic business projects instead of conferencing operations
- Integrate web conferencing with existing Cisco investments such as Cisco Jabber, Cisco TelePresence, and new **Cisco Webex Teams**

### Meetings Available for Anyone at Any Time on Any Device

Your customers, partners, and other peers can easily join you in a meeting from their own video system at any time without requiring cumbersome codes, including Microsoft Skype for Business.

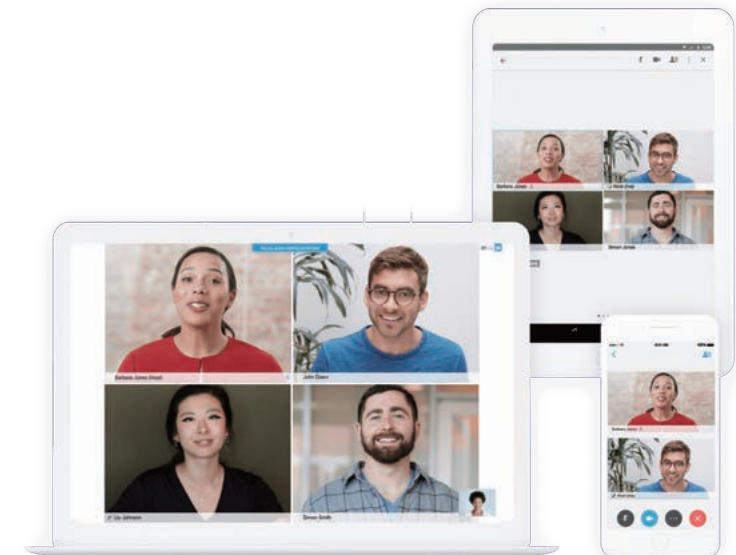
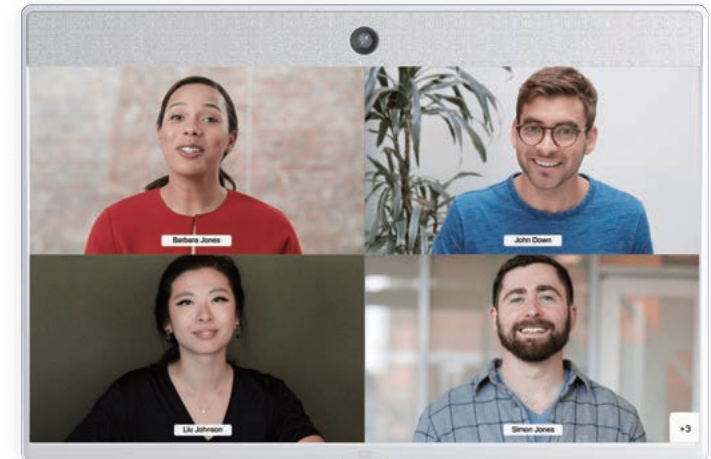

Getting Started

What's New

Feature Story

Collaborate

Webex Meetings

Webex Teams

Webex DX80

**NEW** Webex Room Kit

Webex Share

Webex Board

SX10 Quick Set

Business Edition 4000

IP Phone 7800/8800

IP Phone 7800/8800 MPP

Headset 500

Compute

Security

Connect

Switches

Wireless

Routers

Services



**Cisco Collaboration Flex Plan**

The Cisco Collaboration Flex Plan is a single subscription that gives you access to Cisco's collaboration services and software and allows you to mix and match buying models and deployment models depending on your needs at any given time. One subscription covers software and technical support for Cisco Webex services, Cisco Unified Communications Manager software, and Cisco Meeting Server software.

With Cisco Collaboration Flex Plan, you choose a buying model for Meetings and/or Calling services. There are three buying models available: Enterprise Agreement, Active User, and Named User.

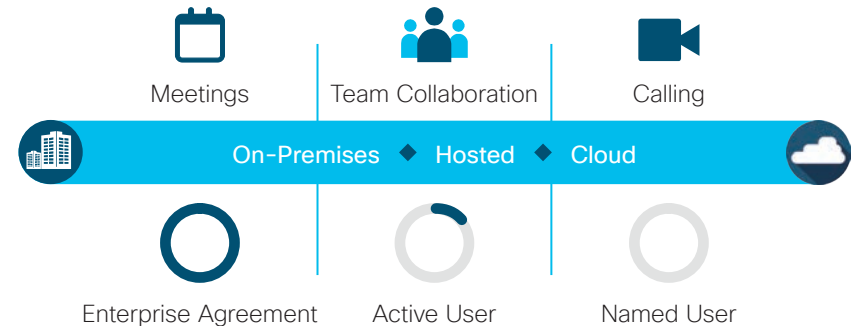

**Cisco Collaboration Flex Plan Meetings - Named User : The Best Way to Buy Cisco Webex Meetings for Your Designated Users**

The Cisco Collaboration Flex Plan Meetings - Named User is designed for organizations that want the simplest possible approach to buying the Cisco Webex Meetings applications. Team Collaboration (the Cisco Webex Teams) is included for each user.

Under the Named User buying model, you are charged based on the quantity of Named User accounts that you order, regardless of usage. A "Named User" is an Employee that you register and provision to access the specified Cisco service or Cisco collaboration software. Your Named Users will receive a unique account that may not be shared or used by anyone other than the designated Employee.

Offer	Meetings	Meetings Suite
Product SKU <sup>*1</sup>	A-FLEX-NUCM-MC	A-FLEX-NUCM-EE
Meetings Capabilities	Webex Meetings with capacity of 1,000 attendees/session	Webex Meetings with capacity of 1,000 attendees/session Webex Training with capacity of 1,000 attendees/session Webex Events with capacity of 1,000 attendees/session Webex Support with capacity of 5 attendees/session
Network Based Recording (NBR) Storage	10 GB/site, Optional Unlimited NBR storage is available	
Audio Services	Toll Dial-in Audio or Cloud Connected Audio Service Provider (CCA SP), Optional fix rate monthly plans (bridge Country callback and global callback) and per minute usage plans (committed and uncommitted billing) are available	
Cisco Webex Teams File Storage	20 GB/user	
Cloud Device Registration	Optional add-on is available	
Pro Pack for Cisco Webex Control Hub	Optional add-on is available, With Pro Pack for Cisco Webex Control Hub, administrators can provision, manage, and analyze the entire Cisco Webex experience	

\*1 A-FLEX is required in CCW. See [Ordering Guide](#) for details.

Getting Started

What's New

Feature Story

Collaborate

Webex Meetings

Webex Teams

Webex DX80

**NEW** Webex Room Kit

Webex Share

Webex Board

SX10 Quick Set

Business Edition 4000

IP Phone 7800/8800

IP Phone 7800/8800 MPP

Headset 500

Compute

Security

Connect

Switches

Wireless

Routers

Services



Overview

Licenses (Flex Plan)

Why Webex Meetings?

Comparison

Effective Web Meetings are a Priority

Strong business starts with strong relationships. Today it's not about where you work, but about how you work. And meeting, effectively, is a priority. Cisco Webex provides you with a proven, simple, and innovative solution that helps you achieve effective virtual meetings.

27.9 M



27.9 M mobile downloads

18



Meet in one of 18 local languages

91 %



91% of people say they use virtual meetings more today than in the past.

New Webex Meetings Experiences

Cisco Webex Meetings provides new meeting experiences with more intelligent and intuitive tools.

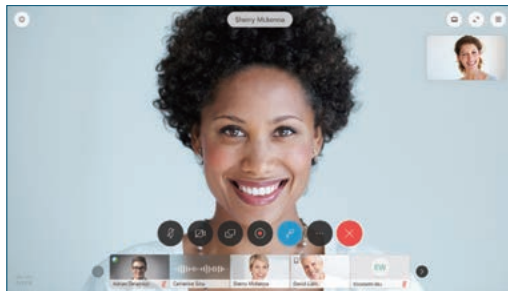

Improved navigation with centralized control bar for easy access to meeting controls



Grid view layouts for up to 25 participants in one full-screen mode



Greater flexibility around content sharing, mixed with video layout options

Getting Started

What's New

Feature Story

Collaborate

Webex Meetings

Webex Teams

Webex DX80

NEW Webex Room Kit

Webex Share

Webex Board

SX10 Quick Set

Business Edition 4000

IP Phone 7800/8800

IP Phone 7800/8800 MPP

Headset 500

Compute

Security

Connect

Switches

Wireless

Routers

Services



Overview

Licenses (Flex Plan)

Why Webex Meetings?

Comparison

Online Meetings Products Comparison: Service Capability

	Webex	Zoom	Microsoft Skype for Business	Microsoft Teams
Meeting Capacity	1,025 + Up to 1,025 concurrent users in a single meeting; 3,000 for events	500	250	250
Webcast Capacity	40,000 +	100-10,000 Capacity depends on license	10,000 with E5	10,000 with Azure
Multiple Meeting Types	Webex Meetings, Webex Training, Webex Support, Webex Events, Webex Webcasting, plus optional white glove services	No tailored offerings for specialty meetings and no white glove services available	-	-
Cloud, On-Premises, and Hybrid Deployment	Fully Supported	Cloud or on-premises only	Cloud or on-premises only	Cloud only
MPEG 4 Recording	Fully Supported	Fully Supported	Windows Media, local recording	Windows Media, local recording
Content Storage Integration	Box, Dropbox, IBM Connections, Google, OneDrive	Box, Dropbox, IBM Connections, Google, OneDrive	Skype for Business, OneDrive, Box, Dropbox	Skype for Business, OneDrive, Box, Dropbox
Join via H.323 or SIP Video Devices without Added Cost	Webex video conferencing is included and connects your video devices into a Webex meeting. Also includes interoperability with Microsoft Skype for Business.	Must pay for extra for rooms or for interoperability	Microsoft Skype for Business certified endpoints only	Microsoft Teams certified endpoints only
Personal Rooms with Advanced features	Auto lock/unlock, allow user entrance into personal room, and more	Personal meeting ID and personal link	Needs to be an admin setting	Needs to be an admin setting

Getting Started

What's New

Feature Story

Collaborate

Webex Meetings

Webex Teams

Webex DX80

**NEW** Webex Room Kit

Webex Share

Webex Board

SX10 Quick Set

Business Edition 4000

IP Phone 7800/8800

IP Phone 7800/8800 MPP

Headset 500

Compute

Security

Connect

Switches

Wireless

Routers

Services







Overview

Licenses (Flex Plan)

Why Webex Meetings?

Comparison

Online Meetings Products Comparison: Innovation

	Webex	Zoom	Microsoft Skype for Business	Microsoft Teams
Team Collaboration Features	Includes Cisco Webex Teams for persistent messaging, file sharing, and white boarding with anyone on any device	-	-	Fully Supported
Video Call Back	Users can have Webex dial their video devices to simplify the join experience	-	-	-
Background Noise Detection	Helps reduce distractions from background noise	-	-	-
Augmented Reality (AR) Capabilities	via iOS only	-	-	-
No Downloads/Plug-ins Needed to Participate	Native browser-based fast join using WebRTC. Host or attend video rich meetings with screen & application sharing. No Downloads or plug-ins needed.	No downloads/plug-ins needed to join meeting. Basic meeting functionality only. No video, sharing, or hosting capabilities.	-	-

Getting Started

What's New

Feature Story

Collaborate

Webex Meetings

Webex Teams

Webex DX80

**NEW** Webex Room Kit

Webex Share

Webex Board

SX10 Quick Set

Business Edition 4000

IP Phone 7800/8800

IP Phone 7800/8800 MPP

Headset 500

Compute

Security

Connect

Switches

Wireless

Routers

Services

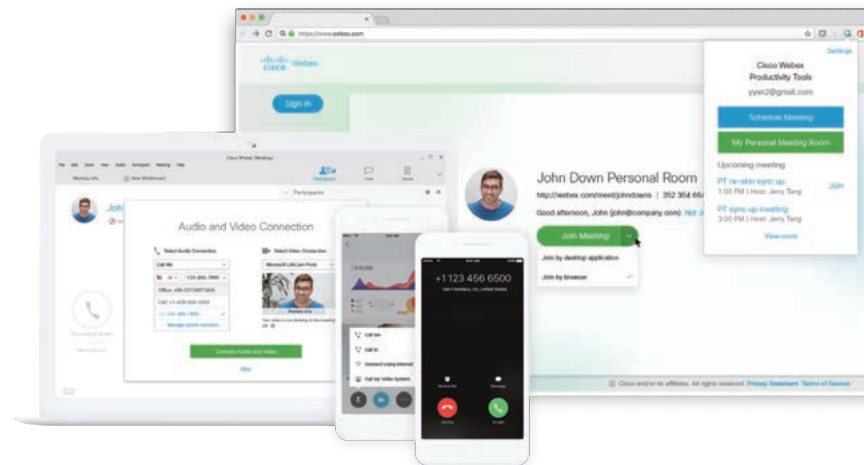





Overview

Licenses (Flex Plan)

Why Webex Meetings?

Comparison

### Online Meetings Products Comparison: Mobile Features

	Webex	Zoom	Microsoft Skype for Business	Microsoft Teams
Simplified Scheduling from Mobile Devices	Add @Webex to the meeting location field to automatically populate the join information. No download or plug-in required.	Multistep process requires Zoom app on mobile device	Requires Skype for Business and Outlook apps on mobile device	Requires desktop device
Native Sharing from Mobile Devices	Fully Supported	Fully Supported	Share from content stores	-
Automatic Dial in and Call-Back Options	Fully Supported	No ability for callback	-	-

Getting Started

What's New

Feature Story

Collaborate

Webex Meetings

Webex Teams

Webex DX80

**NEW** Webex Room Kit

Webex Share

Webex Board

SX10 Quick Set

Business Edition 4000

IP Phone 7800/8800

IP Phone 7800/8800 MPP

Headset 500

Compute

Security

Connect

Switches

Wireless

Routers

Services





Overview

Licenses (Flex Plan)

Why Webex Meetings?

Comparison

Online Meetings Products Comparison: Security

	Webex	Zoom	Microsoft Skype for Business	Microsoft Teams
FedRAMP Authorized	Webex meets the stringent requirements set forth by the U.S. Federal Government	-	Fully Supported	-
Prevent Unauthorized Meeting Attendees	Simple option to lock a room to require attendees to be admitted by host. Hosts can set option to prevent unauthenticated users from entering Personal Room or "lobby".	-	-	-
Auto-Lock Personal Room	Host can set room to automatically lock after meeting begins	-	-	-
Securing Meeting Content	Content or messaging shared during a meeting goes away after the meeting ends unless host specifically saves it	Fully Supported	Content continues to be stored in the Microsoft cloud even after the meeting has ended	Content continues to be stored in the Microsoft cloud even after the meeting has ended

Getting Started

What's New

Feature Story

Collaborate

Webex Meetings

Webex Teams

Webex DX80

**NEW** Webex Room Kit

Webex Share

Webex Board

SX10 Quick Set

Business Edition 4000

IP Phone 7800/8800

IP Phone 7800/8800 MPP

Headset 500

Compute

Security

Connect

Switches

Wireless

Routers

Services





Overview

Licenses (Flex Plan)

Why Webex Meetings?

Comparison

Online Meetings Products Comparison: Scheduling and Joining Meetings

	Webex	Zoom	Microsoft Skype for Business	Microsoft Teams
Fast Scheduling in Standard Apps	Microsoft Outlook, Google Calendar, Lotus Notes	Microsoft Outlook, Google Calendar, Lotus Notes	Microsoft Outlook	Microsoft Outlook
Simplified Scheduling	With Hybrid Calendar Service enabled, simply add @Webex to meeting location field to automatically populate join information. Works from mobile or desktop device.	-	-	-
Customizable Personal Room Address	Fully Supported	Fully Supported	-	-
One-Button Join	Push the "green button" to join from mobile, desktop, phone, or video devices	Requires middleware setup	Microsoft Skype for Business certified endpoints only	Microsoft Teams certified endpoints only
Pair Mobile Device with Room System to Simplify Join	Cisco Intelligent Proximity is integrated into Webex	Fully Supported	-	-
Optimized Join from Apple Devices	Siri Kit, Face ID for iPhone X, Touch ID sign in from Apple iOS devices	Fully Supported	-	-

Getting Started

What's New

Feature Story

Collaborate

Webex Meetings

Webex Teams

Webex DX80

**NEW** Webex Room Kit

Webex Share

Webex Board

SX10 Quick Set

Business Edition 4000

IP Phone 7800/8800

IP Phone 7800/8800 MPP

Headset 500

Compute

Security

Connect

Switches

Wireless

Routers

Services





Overview

Licenses (Flex Plan)

Why Webex Meetings?

Comparison

Online Meetings Products Comparison: Video Quality

	Webex	Zoom	Microsoft Skype for Business	Microsoft Teams
Global Data Center Support	Webex leverages a global architecture of data centers purpose-built for meetings. Attendees automatically connect through the closest data center, which improves meeting speed and performance.	Limited	Leverages Azure backbone built for email and non-real-time content	Leverages Azure backbone built for email and non-real-time content
Best-in-Class Video Endpoints	Cisco has the broadest video endpoint portfolio in the industry with award-winning design	Zoom does not offer endpoints	-	-
Integration of Codecs, Software, Hardware	Cisco Video Experience combines award winning design and ease of use to increase user adoption by optimizing video and providing detailed analytics for utilization	-	-	-
Support for Multiple Devices in a Single Meeting	Supports users on web browsers, webcams, mobile devices, and standards-based SIP video endpoints, going up to 720p high definition in a single video conference	Requires video interoperability licenses	-	-

Getting Started

What's New

Feature Story

Collaborate

Webex Meetings

Webex Teams

Webex DX80

**NEW** Webex Room Kit

Webex Share

Webex Board

SX10 Quick Set

Business Edition 4000

IP Phone 7800/8800

IP Phone 7800/8800 MPP

Headset 500

Compute

Security

Connect

Switches

Wireless

Routers

Services



## Overview

## Why Webex Teams?

## Comparison

## Gallery

## A Better Way for People to Create Together

The Cisco Webex Teams is an app for continuous teamwork. With this solution, create secure virtual work spaces with anyone where you can work on projects from start to finish, solve problems, and create stronger relationships.

Get things started with messaging and file sharing. Express your ideas on whiteboards that others can add to. Seamlessly use high-quality video meetings and make calls. Even keep up to date with what is happening in other apps. Anytime, anywhere, on virtually any device.



### Highlights

- Promotes Growth:** Cisco Webex Teams app provides a solution for innovation and growth. It helps connect and engage employees, customers, and partners to keep work moving forward anytime, anywhere with a complete set of tools.
- Accelerates Decision Making:** Start a meeting with another person or with a whole group from wherever you are to accelerate decision making. Share what's on your screen for fast alignment. Annotate on screens. Escalate to white boarding for an immersive tool to visualize the ideas you and your team are discussing. You can join the meeting from virtually any device.
- Simplifies How People Work Together:** The Cisco Webex Teams app holds your teams' ideas, conversations, and files for future reference. Everyone is always looped in. You'll be notified of any new activity in your secure virtual spaces, and see when people have viewed what you've shared.
- Secures Your information:** You can work confidently with end-to-end encryption. When the content is sensitive, room moderators can lock their spaces and decide who can be added.
- Provides Cloud Simplicity:** The included Webex as-a-service cloud approach reduces complexity for IT while enabling new collaboration apps for users who want to be more productive. You can scale up apps and users as needed. And there is little to no infrastructure to buy or maintain—everything is hosted in Webex cloud and managed by Cisco.

Getting Started

What's New

Feature Story

Collaborate

Webex Meetings

Webex Teams

Webex DX80

**NEW** Webex Room Kit

Webex Share

Webex Board

SX10 Quick Set

Business Edition 4000

IP Phone 7800/8800

IP Phone 7800/8800 MPP

Headset 500

Compute

Security

Connect

Switches

Wireless

Routers

Services



Simple Provisioning

You can join a meeting from the Cisco Webex Teams app, but also from any device registered to Cisco Webex. Setting up Cisco Webex Devices only takes a couple of easy steps.

- Register a Cisco Webex device to the Webex cloud

1 Sign in to the Cisco Webex Control Hub



2 Register the device



3 Get an activation code



- Activate the Cisco Webex device in the setup wizard

1 Launch the setup wizard

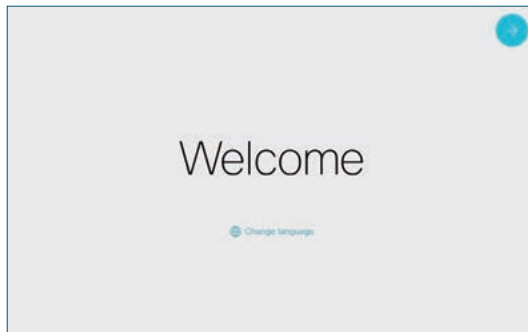

2 Choose Cisco Webex

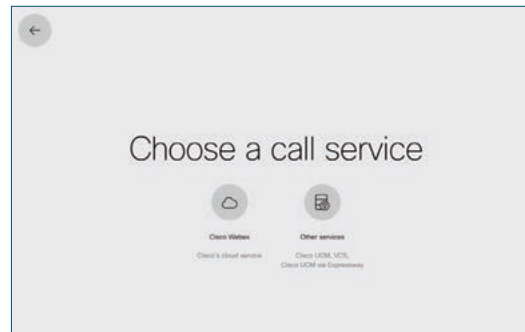

3 Enter the activation code

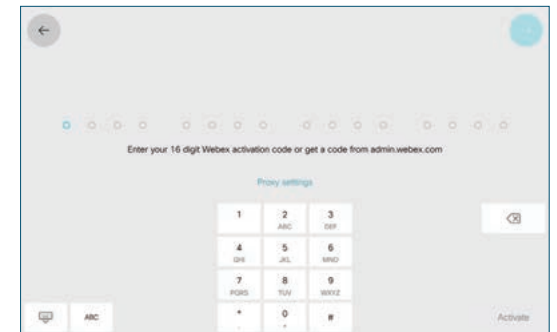

Getting Started

What's New

Feature Story

Collaborate

Webex Meetings

Webex Teams

Webex DX80

**NEW** Webex Room Kit

Webex Share

Webex Board

SX10 Quick Set

Business Edition 4000

IP Phone 7800/8800

IP Phone 7800/8800 MPP

Headset 500

Compute

Security

Connect

Switches

Wireless

Routers

Services



Overview

Why Webex Teams?

Comparison

Gallery

Team Collaboration Products Comparison: Teamwork

	Webex	Microsoft Teams	Slack
End-to-End Encryption	Encrypts messages, files, and whiteboards from your device to theirs, and everywhere in between—even when it's being processed (data in use). This makes attempted attacks or intercepts useless.	-	-
All Teams in One View	One list includes all the teams or spaces you're in—whether built by you, your co-workers, or people outside your organization	Must manually switch accounts to see each team that is outside your organization	Must manually create shared workspaces or switch tabs to see all the workspaces and channels of which you are a member
Search Across All Work	Search keywords, messages, and people across all your spaces	Search only for the account you're in	Search only across your own company's teams when using Slack Grid
Automatically Keep Work Going Anywhere	Consistent UI from mobile apps to meeting rooms. Automatically pair user devices with Cisco Webex devices to instantly collaborate on and save whiteboards, control meetings, share screens, and more.	No native support/UI on room devices	No native support/UI on room devices
Automatically Get Whiteboard Drawings	Users paired to a Webex Board automatically receive saved whiteboard drawings	Saving whiteboards takes several manual steps	-
Add Users with Any Email Address	Fully Supported	Requires Office 365 work or school ID, or must add user to host Azure domain	Fully Supported
Embed Workspaces in Third-Party Applications	Developers can use Webex Teams widgets to quickly embed messaging and calling in thirdparty apps, or customize with a full set of APIs and SDKs	APIs and SDKs only	-
Integrate Capabilities within Mobile Applications	SDKs for iOS and Android	-	-

Getting Started

What's New

Feature Story

Collaborate

Webex Meetings

Webex Teams

Webex DX80

**NEW** Webex Room Kit

Webex Share

Webex Board

SX10 Quick Set

Business Edition 4000

IP Phone 7800/8800

IP Phone 7800/8800 MPP

Headset 500

Compute

Security

Connect

Switches

Wireless

Routers

Services





Overview

Why Webex Teams?

Comparison

Gallery

Team Collaboration Products Comparison: Meetings

	Webex	Microsoft Teams	Slack
Democratized Meeting Capabilities	Anyone in a space can schedule, start, record, mute others, and admit guests—no need to rely on a single host to get work done	-	-
One-Button to Push to Join Meetings on Any Device	One button to push to join support on the app, Cisco Webex devices, even iOS calendar notifications and events	-	-
Native Audio and Video Experience in Browser	Uses Web RTC to allow for audio, video, and screen sharing in browsers without requiring a plug-in	Requires plug-in	Chrome only with limited features
Screen Share from iOS and Android Devices	Fully Supported	-	-
Everyone can View Meeting RSVPs	Fully Supported	Only available for host	-
Join External Meetings	Stay right in the app to simply join or host your Webex meetings and SIP-based meetings	-	-
Support External Video Users	Skype for Business and standards-based SIP users can join meetings	-	-
Preview Participant Lists	See who is participating in meetings before you join	During meetings only	During meetings only
Native Calendar Integration for Scheduling	Support for Microsoft Exchange, Office 365, and Google Calendar without download or plug-in: Simply add text to the Location field on any device	Requires plug-ins or downloads	-
Record Meetings	Fully Supported	-	-
Embed Communications in Third-Party Applications	Voice and video calling, screen sharing, and more	-	-

Getting Started

What's New

Feature Story

Collaborate

Webex Meetings

Webex Teams

Webex DX80

**NEW** Webex Room Kit

Webex Share

Webex Board

SX10 Quick Set

Business Edition 4000

IP Phone 7800/8800

IP Phone 7800/8800 MPP

Headset 500

Compute

Security

Connect

Switches

Wireless

Routers

Services





Overview

Why Webex Teams?

Comparison

Gallery

Team Collaboration Products Comparison: Purpose-Built Collaboration Devices

	Webex	Microsoft Teams	Slack
Use Third-Party USB Cameras	Fully Supported	Fully Supported	Fully Supported
Single Experience for Hardware, Software, Services	In addition to the Webex Board, Webex Teams is compatible with award-winning Cisco desk and room devices for advantages such as automatic pairing for wireless meeting controls, consistent user interface on all devices, streamlined feature updates, and unified support	Microsoft Surface Hub and room devices do not natively support Microsoft Teams	-
Pair and Share for Local Meetings	Users can pair with Cisco Webex devices for sharing content in local meetings	-	-
Intelligent Views for Any Meeting	Cisco intelligent views for room devices automatically frame speaker(s) and present best views to remote viewers, even in meetings that interoperate with third-party services	-	-
Automatic Noise Suppression	When certain non-voice noises are detected, microphone sound is lowered until voices are detected again	-	-
Meeting Room Usage Information	Cisco Webex-enabled video devices can detect and count faces to integrate with resource allocation and operations applications	-	-

Getting Started

What's New

Feature Story

Collaborate

Webex Meetings

Webex Teams

Webex DX80

**NEW** Webex Room Kit

Webex Share

Webex Board

SX10 Quick Set

Business Edition 4000

IP Phone 7800/8800

IP Phone 7800/8800 MPP

Headset 500

Compute

Security

Connect

Switches

Wireless

Routers

Services





Overview

Why Webex Teams?

Comparison

Gallery

Team Collaboration Products Comparison: Enterprise-Grade IT Features

	Webex	Microsoft Teams	Slack
Always Maintain Corporate Data Policies	Configurable data retention policy, archiving, eDiscovery, and integrations with most top dataloss prevention (DLP) systems, including Cisco Cloudlock	Teams adheres to your policy only for messages and files shared by internal users. Data is no longer discoverable when users share content as a guest in another organization's channels.	-
Store Content Encryption Keys On-Premises without Functionality Loss	Install key server on your premises or in a private cloud without losing functionality (e-Discovery, search, etc.)	Can use Hold Your Own Key through Active Directory Rights Management Services, but cannot index or search information	-
Use Cloud Services for On-Premises Meetings Overflow	Maintain on-premises quality and use Hybrid Media Services to move to the cloud when needed to scale	-	-
Extend Your Enterprise Telephony Services	Use Webex Hybrid Call Service to connect Webex Teams app with your on-premise or partner-managed enterprise telephony capabilities	-	-
Improve Application QoS	Prioritize applications with Fast Lane to whitelist iOS and MacOS applications for better performance even when the network is congested	-	-
Mobile Pin Lock Enforcement	Fully Supported	Requires MDM bundle	-

Getting Started

What's New

Feature Story

Collaborate

Webex Meetings

Webex Teams

Webex DX80

**NEW** Webex Room Kit

Webex Share

Webex Board

SX10 Quick Set

Business Edition 4000

IP Phone 7800/8800

IP Phone 7800/8800 MPP

Headset 500

Compute

Security

Connect

Switches

Wireless

Routers

Services





Overview

Why Webex Teams?

Comparison

Gallery

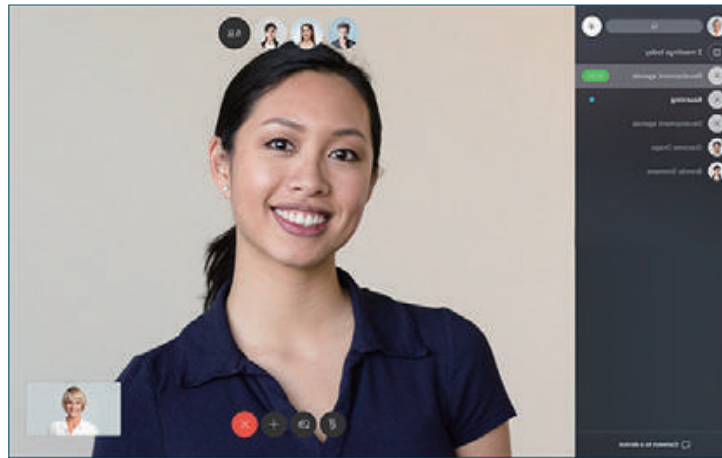

Video Meeting (Desktop)

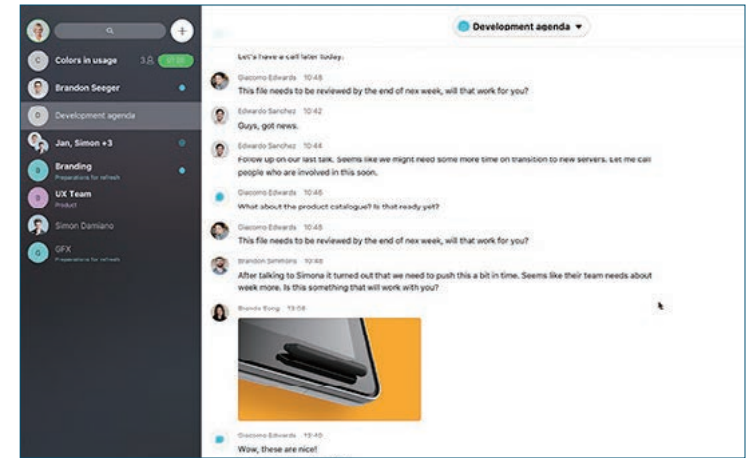

Webex Teams Space (Desktop)

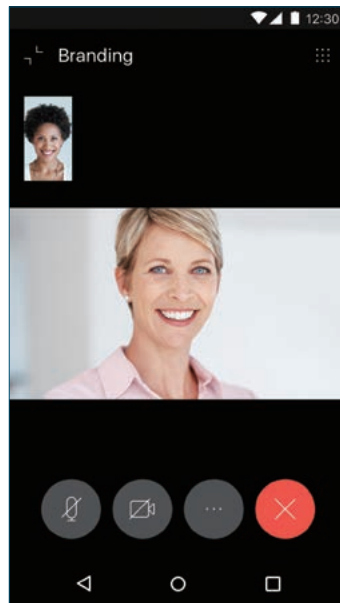

Video Calling (Mobile)

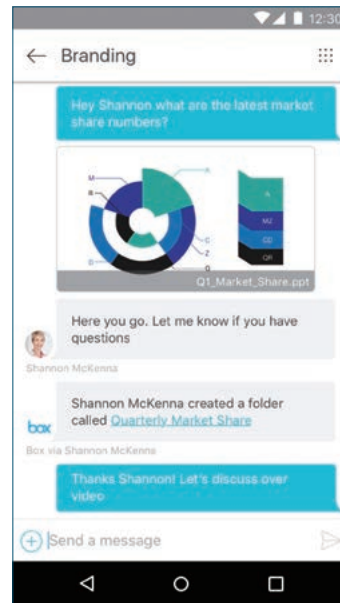

Message Thread (Mobile)

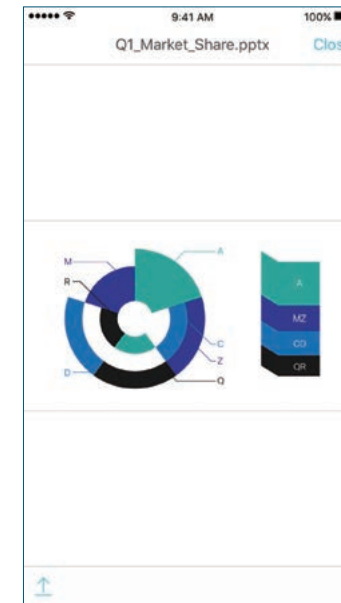

File Preview (Mobile)

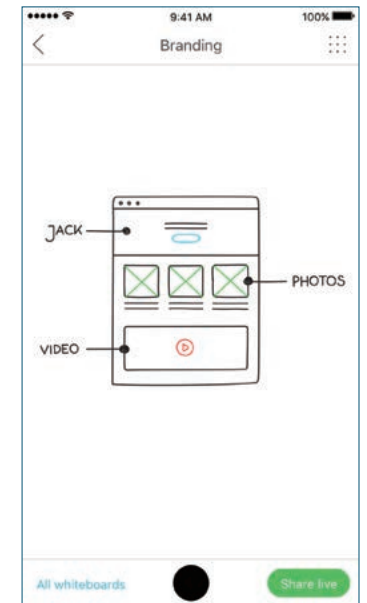

White Board (Mobile)

Getting Started

What's New

Feature Story

Collaborate

Webex Meetings

Webex Teams

Webex DX80

**NEW** Webex Room Kit

Webex Share

Webex Board

SX10 Quick Set

Business Edition 4000

IP Phone 7800/8800

IP Phone 7800/8800 MPP

Headset 500

Compute

Security

Connect

Switches

Wireless

Routers

Services

Getting Started

What's New

Feature Story

Collaborate

Webex Meetings

Webex Teams

Webex DX80

**NEW** Webex Room Kit

Webex Share

Webex Board

SX10 Quick Set

Business Edition 4000

IP Phone 7800/8800

IP Phone 7800/8800 MPP

Headset 500

Compute

Security

Connect

Switches

Wireless

Routers

Services

## All-in-One Desktop Collaboration

The Cisco Webex DX80 is all-in-one units designed to video-enable small collaboration spaces. This innovative set of multifunction touchscreen device suits people who spend a lot of time collaborating and want a no-compromise experience at their fingertips. Launch lifelike HD video meetings with any stan-

dards-based H.264 AVC device, including smartphones, Cisco TelePresence systems, and Cisco Webex applications. Use it to replace your desktop IP phone. Integrate with your PC for content sharing and much more, all with a single, easy-touse device.



## Highlights

- Dedicated, always-on HD video communication system
- IP phone that provides essential features for knowledge workers
- High-quality audio system for speakerphone
- 23-inch 16:9 screen that provides an engaging experience for video calls
- Multitouch capacitive touchscreen that provides an elegant and powerful user interface
- Self-provisioning device that is simple for users to take out of the box and start using quickly
- Easy "One-Button-To-Push" (OBTP) calling that integrates with common calendaring programs
- Flexible registration models on-premises and in the cloud



Overview

Platform Spec

Licenses & Accessories

Gallery

Cisco Webex DX Series

Model	Display			Camera	Video			Audio	GE Ports	Wireless		Call Control		
	Resolution	PC Input	Touch Screen		Resolution	Content Sharing	Standards	Standards		Wi-Fi	Blue tooth	SIP	H.323	Webex
 DX80	23-inch 1,920 x 1,080	Up to 1080p30	•	Integrated Up to 1080p30	Up to 1080p30	Up to 1080p5	H.263 H.263+ H.264 AVC	G.711a G.711mu G.722 G.722.1 G.729 G.729ab AAC-LD OPUS	2	11n	•	•	•	•

Cisco Webex DX80

Product SKU	Description
CS-DX80-K9=	Subscription Pricing Model (MSRP)*1
CP-DX80-K9=	Upfront Pricing Model (GPL)
CP-DX80-NR-K9=	Upfront Pricing Model (GPL, No Radio)

\*1 A-SPK-SH-RMS is required in CCW. See [Ordering Guide](#) for details.

Getting Started

What's New

Feature Story

Collaborate

Webex Meetings

Webex Teams

Webex DX80

**NEW** Webex Room Kit

Webex Share

Webex Board

SX10 Quick Set

Business Edition 4000

IP Phone 7800/8800

IP Phone 7800/8800 MPP

Headset 500

Compute

Security

Connect

Switches

Wireless

Routers

Services

Cisco Webex DX80 Licenses

Product SKU*1	Description
A-SPK-SH-RMS	Webex Registration for MSRP Model (Monthly or 1-, 2-, 3-, 4-, or 5-year options)
A-SPK-SH-ND-SR	Webex Registration for GPL Model (Monthly or 1-, 2-, 3-, 4-, or 5-year options)

\*1 A-SPK-SH is required in CCW. See [Ordering Guide](#) for details.

Cisco Webex DX80 Accessory

Product SKU*1	Description
CP-DX80-VESA=	Cisco VESA Adapter and Wall Mount Kit



Getting Started

What's New

Feature Story

Collaborate

Webex Meetings

Webex Teams

Webex DX80

**NEW** Webex Room Kit

Webex Share

Webex Board

SX10 Quick Set

Business Edition 4000

IP Phone 7800/8800

IP Phone 7800/8800 MPP

Headset 500

Compute

Security

Connect

Switches

Wireless

Routers

Services



Overview

Platform Spec

Licenses & Accessories

Gallery

Getting Started

What's New

Feature Story

Collaborate

Webex Meetings

Webex Teams

Webex DX80

**NEW** Webex Room Kit

Webex Share

Webex Board

SX10 Quick Set

Business Edition 4000

IP Phone 7800/8800

IP Phone 7800/8800 MPP

Headset 500

Compute

Security

Connect

Switches

Wireless

Routers

Services





[Getting Started](#)[What's New](#)[Feature Story](#)

## Collaborate

[Webex Meetings](#)[Webex Teams](#)[Webex DX80](#)**NEW** [Webex Room Kit](#)[Webex Share](#)[Webex Board](#)[SX10 Quick Set](#)[Business Edition 4000](#)[IP Phone 7800/8800](#)[IP Phone 7800/8800 MPP](#)[Headset 500](#)[Compute](#)[Security](#)[Connect](#)[Switches](#)[Wireless](#)[Routers](#)[Services](#)

## Turn Your Flat Panel Display into a Smart Video Conferencing System

The Cisco Webex Room Kit Series is powerful collaboration solutions that integrate with flat panel displays to bring more intelligence and usability to your small to large-sized meeting rooms.

These newest integrator solutions deliver the unmatched video and audio experience that customers have come to expect from Cisco. In addition, new capabilities enable even smarter meetings, smarter presentations, and smarter room and device integrations — further removing the barriers to usage and deployment of video collaboration.

### Highlights

- **Powerful Collaboration Solutions:** Integrate with flat panel displays to bring more intelligence and usability to your small to large-sized meeting rooms
- **Smart Meetings:** Intelligent, integrated cameras deliver intelligent viewing capabilities, such as automatic framing (Room Kit Mini & Room Kit) and speaker tracking (Room Kit)
- **Smart Presentations:** Dual screens, dual content sources, wireless sharing, and 4K content make for great presentations
- **Smart Integrations:** People count for usage metrics and resource allocation; tight integrations with screens to enhance user interactions
- **Registration Flexibility:** Built for both on-premises and cloud deployment, protecting your investment

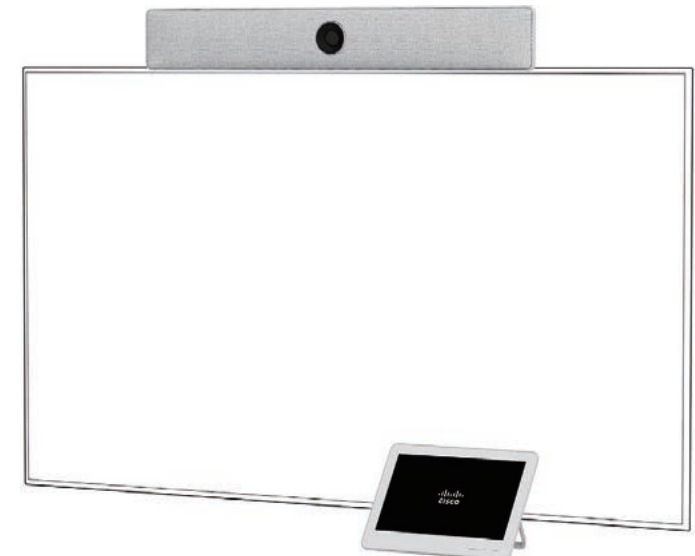



Overview



Platform Spec

Licenses & Accessories

Why Room Kit?

Gallery

Cisco Webex Room Kit Series

Model	Camera	Video				Audio Standards	GE Ports			Wireless		Call Control		
		Output Resolution	Input Resolution	Content Sharing	Standards		LAN	Camera	Touch 10	Wi-Fi	Blue tooth	SIP	H.323	Webex
<b>Webex Room Kit Mini</b> 	Integrated Up to 4Kp60	Up to 4Kp60	Up to 4Kp30	Up to 4Kp30 (Local) 4Kp5 (Remote)	H.264	G.711 G.722 G.722.1 G.729 AAC-LD Opus	1	-	1	11ac	•	•	•	•
<b>Webex Room Kit</b> 	Integrated Up to 5Kp60	Up to 4Kp60	Up to 4Kp30	Up to 4Kp30 (Local) 4Kp5 (Remote)	H.264 H.265	G.711 G.722 G.722.1 G.729 AAC-LD Opus	1	-	1	11ac	•	•	•	•
<b>Webex Room Kit Plus PTZ</b> 	PTZ12 Camera Up to 1080p60	Up to 4Kp60	Up to 4Kp30	Up to 4Kp30 (Local) 4Kp5 (Remote)	H.264 H.265	G.711 G.722 G.722.1 G.729 AAC-LD Opus	1	1	1	11ac	•	•	•	•

Cisco Webex Room Kit Mini NEW

Product SKU	Description
CS-KIT-MINI-K9	Upfront Pricing Model (GPL)
CS-KIT-MINI-NR-K9	Upfront Pricing Model (GPL, No Radio)

Cisco Webex Room Kit Plus PTZ NEW

Product SKU	Description
CS-KIT-PTZ12-K9	Upfront Pricing Model (GPL)

Cisco Webex Room Kit

Product SKU	Description
CS-KIT-MSRP-K9	Subscription Pricing Model (MSRP)**1
CS-KIT-K9	Upfront Pricing Model (GPL)
CS-KIT-NR-K9	Upfront Pricing Model (GPL, No Radio)

\*1 A-SPK-SH-RMK is required in CCW. See [Ordering Guide](#) for details.

Getting Started

What's New

Feature Story

Collaborate

Webex Meetings

Webex Teams

Webex DX80

NEW Webex Room Kit

Webex Share

Webex Board

SX10 Quick Set

Business Edition 4000

IP Phone 7800/8800

IP Phone 7800/8800 MPP

Headset 500

Compute

Security

Connect

Switches

Wireless

Routers

Services



Overview

**Platform Spec**

Licenses & Accessories

Why Room Kit?

Gallery

Cisco Webex Room Kit Series Cameras Comparison: Choose the Room Kit Optimized for Your Space

	Room Kit Mini	Room Kit	Room Kit Plus PTZ
Sample Scenario			
Zoom	2x zoom	3x zoom	12x optical zoom, 12x digital zoom
Camera Features	Best Overview PeopleCount	Speaker Tracking Best Overview PeopleCount	-
Video Resolution	1080p60	1080p60*1	1080p60
Speakers	85 dB	86 dB	-
Content Sharing	1 x HDMI input (1080p60 + 4Kp5)	1 x HDMI input (1080p60 + 4Kp5)	2 x HDMI input (1080p60 + 4Kp5)
Microphone	1 internal	2 x mic input + 1 internal	3 x mic input

\*1 1080p30 with Speaker Tracking enabled.

Getting Started

What's New

Feature Story

Collaborate

Webex Meetings

Webex Teams

Webex DX80

**NEW** Webex Room Kit

Webex Share

Webex Board

SX10 Quick Set

Business Edition 4000

IP Phone 7800/8800

IP Phone 7800/8800 MPP

Headset 500

Compute

Security

Connect

Switches

Wireless

Routers

Services





## Overview

## Platform Spec

## Licenses &amp; Accessories

## Why Room Kit?

## Gallery

## Cisco Webex Room Kit Series Licenses

Product SKU	Description
A-SPK-SH-RMK <sup>*1</sup>	Webex Registration for MSRP Model (Monthly or 1-, 2-, 3-, 4-, or 5-year options)
A-SPK-SH-ND-SR <sup>*1</sup>	Webex Registration for GPL Model (Monthly or 1-, 2-, 3-, 4-, or 5-year options)
L-ROOM-RM <sup>*2</sup>	Remote Monitoring License
L-KITMINI-MS <sup>*3</sup>	MultiSite (Embedded Multipoint) License for Webex Room Kit Mini
L-KIT-MS <sup>*3</sup>	MultiSite (Embedded Multipoint) License for Webex Room Kit
L-KITPLUS-MS <sup>*3</sup>	MultiSite (Embedded Multipoint) License for Webex Room Kit Plus PTZ

\*1 A-SPK-SH is required in CCW. See [Ordering Guide](#) for details.

\*2 L-TP-RM is required in CCW. . \*3 L-ROOM-PAK is required in CCW.

## Cisco Webex Room Kit Series Accessories

Product SKU	Description
CTS-MIC-TABL20	Table Microphone 20
CAB-MIC20-EXT	Extension Cable for Table Microphone 20
CTS-MIC-CLNG-G2	Ceiling Microphone
CAB-ETHRSHLD-10M	Shielded Cable for Ceiling Microphone (Non-Plenum Rated)
CAB-2HDMI-1.5M-GR	HDMI 2.0 Second Screen Certified Cable (1.5 m)
CAB-2HDMI-3M-GR	HDMI 2.0 Second Screen Certified Cable (3 m)
CAB-PRES-2HDMI-GR	Presentation Certified Cable (8 m)
CAB-USBC-4M-GR	USB Cable (Type A Connector)
CAB-ETH-1.5M-GR	Grey Ethernet Cable (1.5 m)
CAB-ETH-3M-GR	Grey Ethernet Cable (3 m)
CAB-ETH-5M-GR	Grey Ethernet Cable (5 m)
CS-KIT-MINI-SMK	Screen Mount Kit for Room Kit Mini
CS-KITPLUS-WMK	Wall Mount Kit for Codec Plus

Getting Started

What's New

Feature Story

Collaborate

Webex Meetings

Webex Teams

Webex DX80

**NEW** Webex Room Kit

Webex Share

Webex Board

SX10 Quick Set

Business Edition 4000

IP Phone 7800/8800

IP Phone 7800/8800 MPP

Headset 500

Compute

Security

Connect

Switches

Wireless

Routers

Services



Overview

Platform Spec

Licenses & Accessories

Why Room Kit?

Gallery

Best Overview

Automatically detects meeting participants and provides ideal framing

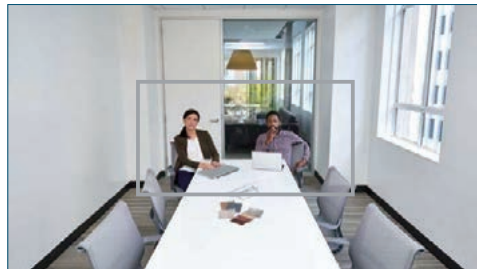

Auto-detects people in room

Speaker Tracking

Detects and switches between active speakers and provides ideal framing



Auto-detects person speaking

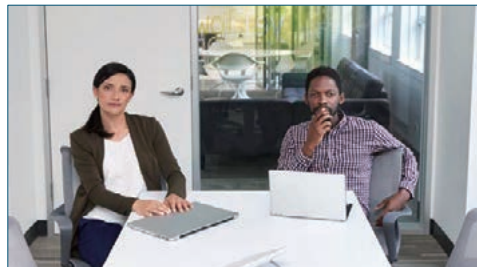

Selects best framing



Selects best framing for speaker

People Count

For usage metrics and resource allocation; tight integrations with screens for enhanced functionalities



Auto-counts people in room

Getting Started

What's New

Feature Story

Collaborate

Webex Meetings

Webex Teams

Webex DX80

**NEW** Webex Room Kit

Webex Share

Webex Board

SX10 Quick Set

Business Edition 4000

IP Phone 7800/8800

IP Phone 7800/8800 MPP

Headset 500

Compute

Security

Connect

Switches

Wireless

Routers

Services





Overview

Platform Spec

Licenses & Accessories

Why Room Kit?

Gallery



Getting Started

What's New

Feature Story

Collaborate

Webex Meetings

Webex Teams

Webex DX80

**NEW** Webex Room Kit

Webex Share

Webex Board

SX10 Quick Set

Business Edition 4000

IP Phone 7800/8800

IP Phone 7800/8800 MPP

Headset 500

Compute

Security

Connect

Switches

Wireless

Routers

Services







Overview

Platform Spec

Licenses & Accessories

Why Room Kit?

Gallery



Getting Started

What's New

Feature Story

Collaborate

Webex Meetings

Webex Teams

Webex DX80

**NEW** Webex Room Kit

Webex Share

Webex Board

SX10 Quick Set

Business Edition 4000

IP Phone 7800/8800

IP Phone 7800/8800 MPP

Headset 500

Compute

Security

Connect

Switches

Wireless

Routers

Services



# Cisco Webex Share

Overview

Device & Accessories

Why Webex Share?

Gallery

## Quickly Enable Every Corner of Your Business for Collaboration

The **Cisco Webex Share** brings high quality collaboration to every corner of your business with a simple and consistent enterprise grade wireless content sharing experience.

Cisco Webex Share is a palm-sized affordable device that plugs into any HD TV or monitor to instantly turn it into a wireless presentation screen when used with a Cisco Webex Teams app.

It provides incredibly simple wireless content sharing for huddle spaces. No longer is there a need for users to connect any cables or dongles, or adjust any AV settings to share content onto a screen. The wireless content sharing experience is consistent with other Cisco Webex devices such as the Cisco Webex Board and the Cisco Webex Room Series, enabling ease of use wherever people meet.

### Highlights

- Simple user experience with **automatic pairing** and **one-click to share**
- Share a specific application or your whole screen
- Enable virtual team members to see what's being shared
- Keep work moving forward anytime, anywhere in secure **Cisco Webex Teams** spaces
- No Learning Curve: Consistent wireless sharing experience across all **Cisco Webex Room Series** devices for ease of use wherever people meet
- Instant Productivity: No cables to connect or settings to adjust - it just works
- Simple and Affordable: Priced for every huddle room or shared office space
- Business Class: Integrates with enterprise calendars and single pane of glass management and analytics. Enables users to reserve huddle spaces in advance and see upcoming events on the monitor to know when the space will be used next. Analytics provide system usage details, helping resources planners optimize future investments. Delivers end to end encryption security using the **Cisco Webex** platform
- Built for Teams: Use the **Cisco Webex Teams** app to instantly share work with others



Getting Started

What's New

Feature Story

Collaborate

Webex Meetings

Webex Teams

Webex DX80

**NEW** Webex Room Kit

**Webex Share**

Webex Board

SX10 Quick Set

Business Edition 4000

IP Phone 7800/8800

IP Phone 7800/8800 MPP

Headset 500

Compute

Security

Connect

Switches

Wireless

Routers

Services

# Cisco Webex Share

Overview

**Device & Accessories**

Why Webex Share?

Gallery

## Cisco Webex Share

Product SKU	Description
SPK-SHARE-K9	Webex Share Wireless Screen-Sharing Adapter

## Cisco Webex Share Accessories

Product SKU	Description
PWR18W-WW	18 W Power Adapter
POE-WW	12 W Device PoE Adapter
PWR18W-ETH-WW	18 W Ethernet Power Adapter

### TIP Deployment Options

Cisco Webex Share may be deployed in three different modes. They include:

- **Wi-Fi:** An 18-Watt wall-power adapter connects to Webex Share through a USB-C cable
- **Power over Ethernet (PoE):** The adapter sits in between the wall PoE port and Webex Share. It is connected to a PoE port via an RJ45 cable and to Webex Share via a USB-C cable.
- **Ethernet:** An 18-Watt wall power adapter, which includes an Ethernet board, provides wired connectivity. It plugs into the wall outlet and is connected via an RJ45 cable to the wall Ethernet port, and via a USB-C cable to Webex Share.



Wi-Fi



Ethernet



PoE

Getting Started

What's New

Feature Story

**Collaborate**

Webex Meetings

Webex Teams

Webex DX80

**NEW** Webex Room Kit

**Webex Share**

Webex Board

SX10 Quick Set

Business Edition 4000

IP Phone 7800/8800

IP Phone 7800/8800 MPP

Headset 500

Compute

Security

Connect

Switches

Wireless

Routers

Services

# Cisco Webex Share

Overview

Device & Accessories

Why Webex Share?

Gallery

## Simple Wireless Content Sharing

The Cisco Webex Share plugs into the HDMI port of any screen.



Simply walk into a room, pair with the system using the Cisco Webex Teams app on your laptop or and immediately start sharing a single application or your entire screen. You can use Cisco Webex Teams app to navigate your experience.

- 1 Open the Cisco Webex Teams app on your computer (Windows or Mac). Automatic pairing starts.



- 2 Click [Share Screen]. You can share a specific application or the entire screen.



Getting Started

What's New

Feature Story

Collaborate

Webex Meetings

Webex Teams

Webex DX80

**NEW** Webex Room Kit

Webex Share

Webex Board

SX10 Quick Set

Business Edition 4000

IP Phone 7800/8800

IP Phone 7800/8800 MPP

Headset 500

Compute

Security

Connect

Switches

Wireless

Routers

Services



# Cisco Webex Share

Overview

Device & Accessories

Why Webex Share?

Gallery

Getting Started

What's New

Feature Story

## Collaborate

Webex Meetings

Webex Teams

Webex DX80

**NEW** Webex Room Kit

## Webex Share

Webex Board

SX10 Quick Set

Business Edition 4000

IP Phone 7800/8800

IP Phone 7800/8800 MPP

Headset 500

Compute

Security

Connect

Switches

Wireless

Routers

Services



Getting Started

What's New

Feature Story

Collaborate

Webex Meetings

Webex Teams

Webex DX80

**NEW** Webex Room Kit

Webex Share

Webex Board

SX10 Quick Set

Business Edition 4000

IP Phone 7800/8800

IP Phone 7800/8800 MPP

Headset 500

Compute

Security

Connect

Switches

Wireless

Routers

Services

## All-in-One Device for Team Collaboration

The **Cisco Webex Board**, like no other, is a new team collaboration device that combines **wireless presentation**, **digital whiteboarding**, and **video conferencing**. It is a cloud- and touch-based system that securely connects teams and their content in physical rooms with virtual teams and meeting spaces.

The Cisco Webex Board resides in physical meeting rooms but is connected to the Cisco Webex service to facilitate continuous workflow before and during the meeting, and even after everyone has left the physical room. Through the Cisco Webex Teams app, team members both in the physical conference room and attending remotely can meet, message, call, and white board from anywhere through their Cisco Webex Teams app-enabled device of choice.

### Highlights

- **Wireless Presentation:** Share your presentation, locally in the room or remotely, without any need for wires, dongles, adapters, or typing in PIN codes.
- **Digital Whiteboarding:** Easily white board with the Cisco Webex Pen or your finger and automatically save content to a Cisco Webex Teams virtual space; multiple people can white board — in the room or remotely on any Cisco Webex Teams app-enabled device.
- **Video Conferencing:** Make your high-definition video or high-fidelity audio calls directly on the Cisco Webex Board.
- **Continuous Workflow:** Connect the Cisco Webex Board to a virtual Cisco Webex Teams space and your whiteboard creations and other shared documents will live there persistently and securely, to be reviewed and edited by any member of the team from another Cisco Webex Board or any Cisco Webex Teams app-enabled device



reddot design award  
best of the best 2017





Overview

Platform Spec

Licenses & Accessories

Gallery

Cisco Webex Board

Model	Display			Camera	Video			Audio Standards	GE Ports	Wireless		Call Control		
	Resolution	PC Input	Touch Screen		Resolution	Content Sharing	Standards			Wi-Fi	Blue tooth	SIP	H.323	Webex
Webex Board 55S 	55-inch 1,920 x 1,080	Up to 1080p30	●	Integrated Up to 4Kp60	Up to 1080p30	Up to 1080p30	H.263 H.263+ H.264	G.711 G.722 G.722.1 G.728 G.729 AAC-LD OPUS	1	11ac	●	-	-	●
Webex Board 70S 	70-inch 1,920 x 1,080	Up to 1080p30	●	Integrated Up to 4Kp60	Up to 1080p30	Up to 1080p30	H.263 H.263+ H.264	G.711 G.722 G.722.1 G.728 G.729 AAC-LD OPUS	1	11ac	●	-	-	●

Cisco Webex Board 55S

Product SKU	Description
CS-BOARD55S-M-K9	Subscription Pricing Model (MSRP)*1
CS-BOARD55S-G-K9	Upfront Pricing Model (GPL)

\*1 A-SPK-SH-ND-BRD is required in CCW. See [Ordering Guide](#) for details.

Cisco Webex Board 70S

Product SKU	Description
CS-BOARD70S-M-K9	Subscription Pricing Model (MSRP)*1
CS-BOARD70S-G-K9	Upfront Pricing Model (GPL)

\*1 A-SPK-SH-ND-BRD is required in CCW. See [Ordering Guide](#) for details.

Getting Started

What's New

Feature Story

Collaborate

Webex Meetings

Webex Teams

Webex DX80

**NEW** Webex Room Kit

Webex Share

**Webex Board**

SX10 Quick Set

Business Edition 4000

IP Phone 7800/8800

IP Phone 7800/8800 MPP

Headset 500

Compute

Security

Connect

Switches

Wireless

Routers

Services

## Overview

## Platform Spec

## Licenses &amp; Accessories

## Gallery

## Cisco Webex Board Licenses

Product SKU*1	Description
A-SPK-SH-ND-BRD	Webex Registration for MSRP Model (Monthly or 1-, 2-, 3-, 4-, or 5-year options)
A-SPK-SH-ND-SR	Webex Registration for GPL Model (Monthly or 1-, 2-, 3-, 4-, or 5-year options)

\*1 A-SPK-SH is required in CCW. See [Ordering Guide](#) for details.

## Cisco Webex Board Accessories

Product SKU	Description
CS-BOARD55-M-FS	Floor Stand Kit for Webex Board 55S (MSRP Model)
CS-BOARD55-G-FS	Floor Stand Kit for Webex Board 55S (GPL Model)
CS-BOARD55-M-WS	Wall Stand Kit for Webex Board 55S (MSRP Model)
CS-BOARD55-G-WS	Wall Stand Kit for Webex Board 55S (GPL Model)
CS-BOARD70-M-FS	Floor Stand Kit for Webex Board 70S (MSRP Model)
CS-BOARD70-G-FS	Floor Stand Kit for Webex Board 70S (GPL Model)
CS-BOARD70-M-WS	Wall Stand Kit for Webex Board 70S (MSRP Model)
CS-BOARD70-G-WS	Wall Stand Kit for Webex Board 70S (MSRP Model)



Getting Started

What's New

Feature Story

## Collaborate

Webex Meetings

Webex Teams

Webex DX80

**NEW** Webex Room Kit

Webex Share

## Webex Board

SX10 Quick Set

Business Edition 4000

IP Phone 7800/8800

IP Phone 7800/8800 MPP

Headset 500

Compute

Security

Connect

Switches

Wireless

Routers

Services





Overview

Platform Spec

Licenses & Accessories

Gallery

Getting Started

What's New

Feature Story

Collaborate

Webex Meetings

Webex Teams

Webex DX80

**NEW** Webex Room Kit

Webex Share

**Webex Board**

SX10 Quick Set

Business Edition 4000

IP Phone 7800/8800

IP Phone 7800/8800 MPP

Headset 500

Compute

Security

Connect

Switches

Wireless

Routers

Services

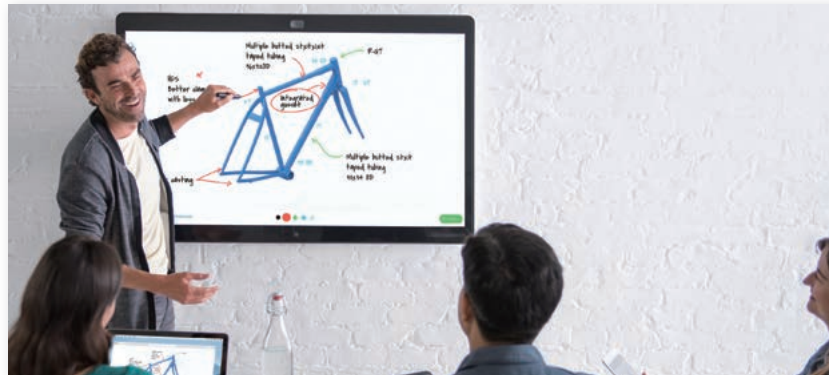



## Overview

## Platform Spec

## Licenses &amp; Accessories

## Gallery

## Face-to-Face Collaboration in Small Workspaces

The Cisco TelePresence SX10 Quick Set is an all-in-one unit designed to video-enable your small collaboration spaces, offering great affordability for small-to-medium businesses just starting out with telepresence. With the SX10, you can also extend telepresence pervasively throughout your enterprise. The SX10 supports cloud registration to Cisco Webex for even faster and more cost effective deployment

This low-cost, high-quality unit combines camera and codec into a single, compact device that is mounted over your standard flat-panel display and connects through a discreet single-cable system for Power over Ethernet (PoE). High-definition video is enabled with 1080p30 resolution, while an industry-leadership wide-angle field of view provides the best overview even in small spaces. Support for Cisco Intelligent Proximity allows you to use your iOS and Android devices to wirelessly control the SX10 as well as receive shared content for richer collaboration. Wireless content sharing is also possible from your laptop or PC.



### Highlights

- Optimal definition up to 1080p30 with content sharing at 1080p5
- Wide-angle 83° horizontal FOV with 5x zoom
- Supports Cisco Intelligent Proximity for content sharing to mobile devices and wireless sharing from laptops
- Wireless control of the system is also enabled with Cisco Intelligent Proximity
- Easily control room peripherals such as lights, room dividers, curtains, directly from the Cisco TelePresence Touch 10 (optional) through customizable API (requires external third-party control system processor)
- Ready-to-use unit with Power over Ethernet (PoE)
- Integrated microphone
- Energy efficient with low consumption (EU Class B)

Getting Started

What's New

Feature Story

### Collaborate

Webex Meetings

Webex Teams

Webex DX80

**NEW** Webex Room Kit

Webex Share

Webex Board

### SX10 Quick Set

Business Edition 4000

IP Phone 7800/8800

IP Phone 7800/8800 MPP

Headset 500

Compute

Security

Connect

Switches

Wireless

Routers

Services



Overview

Platform Spec

Licenses & Accessories

Gallery

Cisco TelePresence SX Series

Model	Camera	Video				Audio Standards	FE Ports			Wireless		Call Control		
		Output Resolution	Input Resolution	Content Sharing	Standards		LAN	Camera	Touch 10	Wi-Fi	Blue tooth	SIP	H.323	Webex
 SX10 Quick Set	Integrated Up to 1080p30	Up to 1080p60	Up to 1080p30	Up to 1080p5	H.263 H.263+ H.264	G.711 G.711mu G.722 G.722.1 G.729 G.729ab AAC-LD Opus	1*1	-	-	-	-	•	•	•

\*1 Powered via 802.3af PoE.

Cisco TelePresence SX10 Quick Set

Product SKU	Description
CS-SX10N-MSRP-K9	Subscription Pricing Model (MSRP)*1
CTS-SX10N-K9	Upfront Pricing Model (GPL)

\*1 A-SPK-SH-RMS is required in CCW. See [Ordering Guide](#) for details.

Getting Started

What's New

Feature Story

Collaborate

Webex Meetings

Webex Teams

Webex DX80

**NEW** Webex Room Kit

Webex Share

Webex Board

**SX10 Quick Set**

Business Edition 4000

IP Phone 7800/8800

IP Phone 7800/8800 MPP

Headset 500

Compute

Security

Connect

Switches

Wireless

Routers

Services



## Overview

## Platform Spec

## Licenses &amp; Accessories

## Gallery

## Cisco TelePresence SX10 Quick Set Licenses

Product SKU*1	Description
A-SPK-SH-RMS	Webex Registration for MSRP Model (Monthly or 1-, 2-, 3-, 4-, or 5-year options)
A-SPK-SH-ND-SR	Webex Registration for GPL Model (Monthly or 1-, 2-, 3-, 4-, or 5-year options)

\*1 A-SPK-SH is required in CCW. See [Ordering Guide](#) for details.

## Cisco TelePresence SX10 Quick Set Accessories

Product SKU	Description
CTS-MIC-TABL20	Table Microphone 20
CAB-PRESO-2HDMI	HDMI to HDMI Presentation Cable (8 m)
CAB-VGA-8M	VGA to VGA Presentation Cable (8 m)
CAB-HDMI-MULT-9M	HDMI to Multi Presentation Cable (9 m)
CS-TOUCH10=	Cisco TelePresence Touch 10 Control Device
CTS-PWR-AIR-INJ5=	Power Injector for Cisco TelePresence Touch 10
BRKT-SX10-SMK	Screen Mount Kit

Getting Started

What's New

Feature Story

Collaborate

Webex Meetings

Webex Teams

Webex DX80

**NEW** Webex Room Kit

Webex Share

Webex Board

SX10 Quick Set

Business Edition 4000

IP Phone 7800/8800

IP Phone 7800/8800 MPP

Headset 500

Compute

Security

Connect

Switches

Wireless

Routers

Services



Overview

Platform Spec

Licenses & Accessories

Gallery



Getting Started

What's New

Feature Story

Collaborate

Webex Meetings

Webex Teams

Webex DX80

**NEW** Webex Room Kit

Webex Share

Webex Board

**SX10 Quick Set**

Business Edition 4000

IP Phone 7800/8800

IP Phone 7800/8800 MPP

Headset 500

Compute

Security

Connect

Switches

Wireless

Routers

Services



## Overview

## Platform Spec

## Licenses &amp; Accessories

## Simple, Cloud-Managed Office Communications

The Cisco Business Edition 4000 (BE4000) is a dedicated voice appliance for small to midsize businesses, providing IP telephony and voicemail services for up to 200 phones. Unlike competing solutions, it is completely cloud-managed, featuring simple and intuitive management capabilities that make it easy to deploy, manage, and use.



### Highlights

- **Reduce the Cost of Communications.** Lower call charges and consolidate networking overheads with an affordable IP phone system, optimized for small and midsize businesses
- **Respond Quickly.** Preconfigure and deploy a BE4000 system in less than one day
- **Simplify Administration** with intuitive cloud-hosted management for IT admins and end-user preferences
- **Strengthen Relationships** with reliable VoIP telephony, offering superior clarity that supports a host of calling features
- **Be More Flexible** with support for the latest Cisco IP phones for a range of use cases and budgets
- **Invest with Confidence.** Plan for technology migrations ahead of time, with flexible, term-based licensing plans and hardware investment protection as you migrate to cloud or hybrid collaboration with Cisco Webex
- **High-Quality Telephony and Voicemail:** Supports the latest Cisco IP Phone 7800 and 8800 Series phones, delivering wideband audio with superior clarity
- **Comprehensive Calling Features:** Call park, hold, and transfer, plus hunt groups, conference, auto attendant, and much more
- **Quick to Deploy:** Cisco partners can preconfigure settings and deploy a new system in less than a day
- **Easy to Manage:** A simple dashboard for administrators keeps key status information close to hand and makes everyday additions of users and phones a breeze
- **Easy to Own:** One-, three-, or five-year term-based license plans make it easy to plan for future investments and provide access to telephony features, the management portal, and award-winning 24x7 Cisco support
- **Starting at Just 10 Users:** Competitively priced solution for small-business budgets

Getting Started

What's New

Feature Story

### Collaborate

Webex Meetings

Webex Teams

Webex DX80

**NEW** Webex Room Kit

Webex Share

Webex Board

SX10 Quick Set

### Business Edition 4000

IP Phone 7800/8800

IP Phone 7800/8800 MPP

Headset 500

Compute

Security

Connect

Switches

Wireless

Routers

Services



Overview

Platform Spec

Licenses & Accessories

Cisco Business Edition 4000

Product SKU	Supported Users		Maximum IP Phones	Analog Device	Voicemail		Ports		Expansion Slots		Supported Voice Modules via NIM				Power Supply	Rack Mount
	Minimum	Maximum			Mailboxes	Storage (Hours)	GE	GE/SFP	NIM	PVDM	T1/E1	FXS	FXO	BRI		
BE4S-V-K9	10	200	200	●	200	120	1	1	2	1	●	●	●	●	External	1 RU

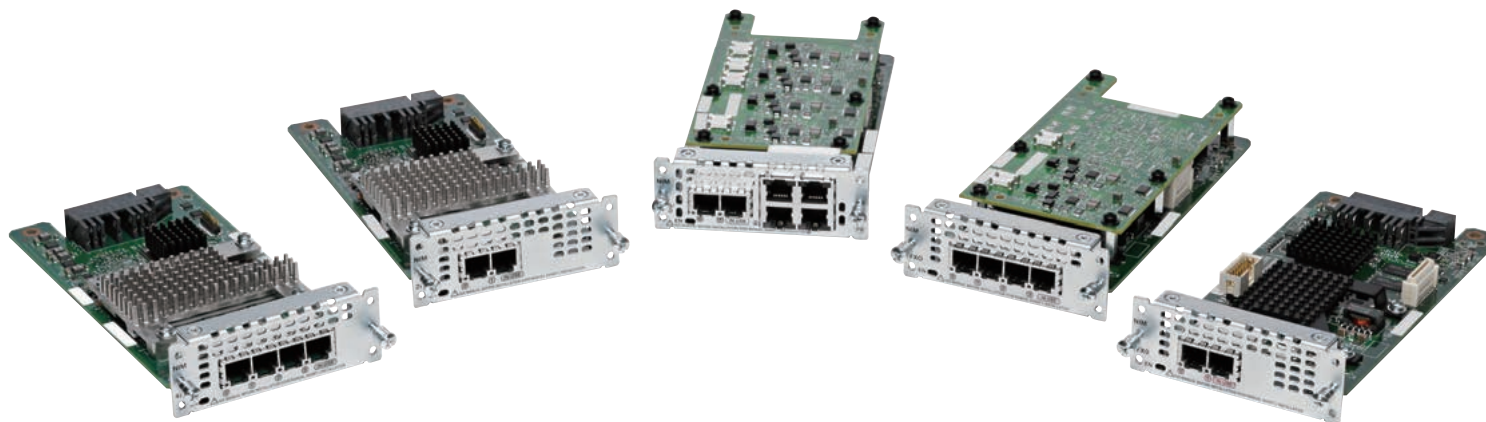

Getting Started

What's New

Feature Story

Collaborate

Webex Meetings

Webex Teams

Webex DX80

**NEW** Webex Room Kit

Webex Share

Webex Board

SX10 Quick Set

Business Edition 4000

IP Phone 7800/8800

IP Phone 7800/8800 MPP

Headset 500

Compute

Security

Connect

Switches

Wireless

Routers

Services

## Overview

## Platform Spec

## Licenses &amp; Accessories

## Cisco Business Edition 4000 Licenses

Product SKU			Description
1-Year <sup>*1</sup>	3-Years <sup>*2</sup>	5-Years <sup>*3</sup>	
A-BE4K-1YR-SEAT	A-BE4K-3YR-SEAT	A-BE4K-5YR-SEAT	Per User License

\*1 A-BE4K-1YR-K9 is required in CCW. See [Ordering Guide](#) for details.

\*2 A-BE4K-3YR-K9 is required in CCW. See [Ordering Guide](#) for details.

\*3 A-BE4K-5YR-K9 is required in CCW. See [Ordering Guide](#) for details.

## Cisco T1/E1 Voice and WAN Network Interface Modules (NIMs)

Product SKU	Description
NIM-1MFT-T1/E1	Voice/WAN Module (1-port T1/E1) <sup>*1</sup>
NIM-2MFT-T1/E1	Voice/WAN Module (2-port T1/E1) <sup>*2</sup>
NIM-4MFT-T1/E1	Voice/WAN Module (4-port T1/E1) <sup>*3</sup>

\*1 PVDM4-32 is required. \*2 PVDM4-64 is required.

\*3 PVDM4-128 is required.

## Cisco Analog Voice Network Interface Modules (NIMs)

Product SKU	Description
NIM-2FXSP	Voice Module (2-port FXS)
NIM-4FXSP	Voice Module (4-port FXS)
NIM-2FXO	Voice Module (2-port FXO)
NIM-4FXO	Voice Module (4-port FXO)
NIM-2FXS/4FXOP	Voice Module (2-port FXS and 4-port FXO)
NIM-2BRI-NT/TE	Voice Module (2-port BRI)
NIM-4BRI-NT/TE	Voice Module (4-port BRI)

## Cisco Packet Voice Digital Signal Processor Modules (PVDMs)

Product SKU	Description
PVDM4-32	High-density Voice DSP Module (16-channel)
PVDM4-64	High-density Voice DSP Module (32-channel)

Getting Started

What's New

Feature Story

Collaborate

Webex Meetings

Webex Teams

Webex DX80

**NEW** Webex Room Kit

Webex Share

Webex Board

SX10 Quick Set

Business Edition 4000

IP Phone 7800/8800

IP Phone 7800/8800 MPP

Headset 500

Compute

Security

Connect

Switches

Wireless

Routers

Services

## VoIP and Video Phones to Meet a Range of Needs

The Cisco IP Phones empower your business with a new collaboration experience that connects you with the right people, with the right information at the right time, so you can accelerate team performance and maximize your business results.

The Cisco IP Phone portfolio includes an impressive range of user-friendly, full-featured VoIP and HD video phones that can meet the needs of your entire organization.



### Cisco IP Phone 7800 Series Highlights

- Affordable Voice Communications Solution with cost-effective, feature-rich models that can be flexibly deployed on-premises or in the cloud via Cisco Webex, along with multiplatform support with select Cisco approved third-party UC-as-a-Service (UCaaS) providers
- Superior Audio Experience with full wideband audio support on select models (handset, headset, and speaker) for crystal-clear audio performance
- Energy Efficient and Eco-Friendly with low power consumption, recyclable plastics in the hardware design and Cisco EnergyWise on most models delivers energy savings
- Ease of Use with backlit displays to enhance viewing and navigation, headset and speakerphone support on most models for added flexibility, and ergonomically rounded keys for superior tactile experience

### Cisco IP Phone 8800 Series Highlights

- Affordable Entry to HD 720p Video, helping you bring teams closer together for faster decision making
- Enhance Collaboration with advanced VoIP features and crystal-clear audio performance
- Increase Productivity by importing contacts and call history from personal mobile devices to select 8800 Series phones. Even move audio during active calls between these devices!
- Expand Return on Investment with additional line and feature keys available through optional software features and new key expansion modules
- Gain Flexibility with a variety of deployment options, including on-premises, in the cloud with Cisco Webex, or through Cisco preapproved third-party UCaaS providers

Getting Started

What's New

Feature Story

Collaborate

Webex Meetings

Webex Teams

Webex DX80

**NEW** Webex Room Kit

Webex Share

Webex Board

SX10 Quick Set

Business Edition 4000

IP Phone 7800/8800

IP Phone 7800/8800 MPP

Headset 500

Compute

Security

Connect

Switches

Wireless

Routers

Services



Getting Started

What's New

Feature Story

Collaborate

Webex Meetings

Webex Teams

Webex DX80

**NEW** Webex Room Kit

Webex Share

Webex Board

SX10 Quick Set

Business Edition 4000

**IP Phone 7800/8800**

IP Phone 7800/8800 MPP

Headset 500

Compute

Security

Connect

Switches

Wireless

Routers





Services

Overview

**Portfolio**

Platform Spec

Gallery

	3900 Series	6900 Series	7800 Series	7900 Series	8800 Series
					
Occasional Use (Common Areas)	●	●	●	-	-
Knowledge Workers (On-Campus)	-	-	●	●	●
Knowledge Workers (Remote)	-	-	●	-	●
Manager, Executives, Administrative Staff, Receptionists	-	-	●	●	●
In-Campus Mobile Workers	-	-	-	-	●
Conference Rooms	-	-	●	-	●
Hospitality Guest Rooms	-	●	●	-	-
High-Resolution Color Displays	-	-	-	●	●
HD Video Collaboration	-	-	-	-	●
Bluetooth (mobile device integration, 3rd-party headsets)	-	-	-	-	●
Latest Security Enhancements	-	-	●	-	●
GE Switch Ports (for co-located PC)	-	-	●	●	●
Reduced Power Consumption (PoE Class)	●	●	●	-	-
Cisco Webex	-	-	●	-	●
Cisco Business Edition 4000	-	-	●	-	●











Overview

Portfolio

Platform Spec

Gallery

Cisco IP Phone 7800 Series

Product SKU		Display			Audio			Line Keys	Ethernet Ports			Wireless			Call Control	
Charcoal	White	Resolution	Color	HD Video	Wide band	Speaker phone	Headset Port		FE	GE	PoE Class	Wi-Fi	Blue tooth	DECT	BE4K	Webex
 <p>CP-7811-K9=</p>	-	3.28 inch 384 x 106	-	-	-**	•	-	-	2	-	1	-	-	-	•	•
 <p>CP-7821-K9=</p>	 <p>CP-7821-W-K9=</p>	3.5 inch 396 x 162	-	-	•	•	•	2	2	-	1	-	-	-	•	•
 <p>CP-7841-K9=</p>	 <p>CP-7841-W-K9=</p>	3.5 inch 396 x 162	-	-	•	•	•	4	-	2	1	-	-	-	•	•
 <p>CP-7861-K9=</p>	 <p>CP-7861-W-K9=</p>	3.5 inch 396 x 162	-	-	•	•	•	16	2	-	1	-	-	-	•	•
 <p>CP-7832-K9=</p>	 <p>CP-7832-W-K9=</p>	384 x 128	-	-	•	•	-	-	1	-	2	-	-	-	-	•

Getting Started

What's New

Feature Story

Collaborate

Webex Meetings

Webex Teams

Webex DX80

**NEW** Webex Room Kit

Webex Share

Webex Board

SX10 Quick Set

Business Edition 4000

IP Phone 7800/8800

IP Phone 7800/8800 MPP

Headset 500

Compute

Security

Connect

Switches

Wireless

Routers

Services



Getting Started

What's New

Feature Story

Collaborate

Webex Meetings

Webex Teams

Webex DX80

**NEW** Webex Room Kit

Webex Share

Webex Board

SX10 Quick Set

Business Edition 4000

**IP Phone 7800/8800**

IP Phone 7800/8800 MPP

Headset 500

Compute

Security

Connect

Switches

Wireless

Routers

Services

Overview

Portfolio

Platform Spec

Gallery

Cisco IP Phone 8800 Series

Product SKU		Display			Audio			Line Keys	Ethernet Ports			Wireless			Call Control	
Charcoal	White	Resolution	Color	HD Video	Wide band	Speaker phone	Headset Port		FE	GE	PoE Class	Wi-Fi	Blue tooth	DECT	BE4K	Webex
 CP-8811-K9=	 CP-8811-W-K9=	5 inch 800 x 480	-	-	•	•	•	5	-	2	2	-	-	-	•	•
 CP-8841-K9=	 CP-8841-W-K9=	5 inch 800 x 480	•	-	•	•	•	5	-	2	2	-	-	-	•	•
 CP-8845-K9=	 CP-8845-W-K9=	5 inch 800 x 480	•	•	•	•	•	5	-	2	2	-	•	-	•	•
 CP-8851NR-K9=	-	5 inch 800 x 480	•	-	•	•	•	5	-	2	3	-	-	-	•	•
 CP-8851-K9=	 CP-8851-W-K9=	5 inch 800 x 480	•	-	•	•	•	5	-	2	3	-	•	-	•	•
 CP-8861-K9=	 CP-8861-W-K9=	5 inch 800 x 480	•	-	•	•	•	5	-	2	4	11ac	•	-	•	•
 CP-8865NR-K9=	-	5 inch 800 x 480	•	•	•	•	•	5	-	2	4	-	-	-	•	•
 CP-8865-K9=	 CP-8865-W-K9=	5 inch 800 x 480	•	•	•	•	•	5	-	2	4	11ac	•	-	•	•







Overview

Portfolio

Platform Spec

Gallery

Cisco IP Phone 8800 Series

Product SKU		Display			Audio			Line Keys	Ethernet Ports			Wireless			Call Control	
Charcoal	White	Resolution	Color	HD Video	Wide band	Speaker phone	Headset Port		FE	GE	PoE Class	Wi-Fi	Blue tooth	DECT	BE4K	Webex
CP-8831-NR-K9=	-	3.5 inch 396 x 162	-	-	•	•	-	1	-	1	3	-	-	-	•	-
	-	3.5 inch 396 x 162	-	-	•	•	-	1	-	1	3	-	-	•	•	-
CP-8831-x-K9=	-	3.5 inch 396 x 162	-	-	•	•	-	1	-	1	3	-	-	•	•	-
	-	3.5 inch 396 x 162	-	-	•	•	-	1	-	1	3	-	-	•	•	-
CP-8832-NR-K9	-	3.9 inch 480 x 128	•	-	•	•	-	1	1	-	3	-	-	-	-	-
	-	3.9 inch 480 x 128	•	-	•	•	-	1	1	-	3	-	-	-	-	-
CP-8832-x-K9	CP-8832-x-W-K9	3.9 inch 480 x 128	•	-	•	•	-	1	1	-	3	-	-	•	-	-
		3.9 inch 480 x 128	•	-	•	•	-	1	1	-	3	-	-	•	-	-

Getting Started

What's New

Feature Story

Collaborate

Webex Meetings

Webex Teams

Webex DX80

**NEW** Webex Room Kit

Webex Share

Webex Board

SX10 Quick Set

Business Edition 4000

IP Phone 7800/8800

IP Phone 7800/8800 MPP

Headset 500

Compute

Security

Connect

Switches

Wireless

Routers

Services





Overview

Portfolio

Platform Spec

Gallery

Getting Started

What's New

Feature Story

Collaborate

Webex Meetings

Webex Teams

Webex DX80

**NEW** Webex Room Kit

Webex Share

Webex Board

SX10 Quick Set

Business Edition 4000

**IP Phone 7800/8800**

IP Phone 7800/8800 MPP

Headset 500

Compute

Security

Connect

Switches

Wireless

Routers

Services





## Overview

## Platform Spec

## ■ Cisco IP Phone for Third-Party Call Control Systems

Enhance business agility with affordable, reliable, secure, and high-quality VoIP communications using the **Cisco IP Phone 7800/8800 Series with Multiplatform Phone (MPP) Firmware**. Select models provide affordable entry to HD video.

These multiplatform IP phones are the very same endpoints that customers of Cisco infrastructure solutions take advantage of today. They are supported on-premises and in the cloud on Cisco-approved service provider offerings, where the providers have certified the Cisco IP Phone 7800/8800 Series.

### ■ Supported Platforms

- Asterisk
- Broadsoft
- Centile
- Metaswitch

### ■ Supported Session Border Controllers

- EdgeMarc
- Metaswitch Perimeter
- Oracle/Acme
- Sonus 5100

### ■ Full DN Lines Supported (SIP Registration)

- |                  |                  |
|------------------|------------------|
| ● 7811: 1 line   | ● 8811: 10 lines |
| ● 7821: 2 lines  | ● 8841: 10 lines |
| ● 7832: 1 line   | ● 8845: 10 lines |
| ● 7841: 4 lines  | ● 8851: 10 lines |
| ● 7861: 16 lines | ● 8861: 10 lines |
|                  | ● 8865: 10 lines |

### ■ Codecs

- |                      |        |
|----------------------|--------|
| ● G.711 a, $\mu$ law | ● ILBC |
| ● G.722*1            | ● iSAC |
| ● G.722.2*1          | ● OPUS |
| ● G.729 a, b, ab     |        |



Getting Started

What's New

Feature Story

### Collaborate

Webex Meetings

Webex Teams

Webex DX80

**NEW** Webex Room Kit

Webex Share

Webex Board

SX10 Quick Set

Business Edition 4000

IP Phone 7800/8800

IP Phone 7800/8800 MPP

Headset 500

Compute

Security

Connect

Switches

Wireless

Routers

Services











\*1 On headset, handset, and speakerphone; not supported on 7811, speakerphone only on 8831.



Overview

Platform Spec

Cisco IP Phone 7800 Series with Multiplatform Phone (MPP) Firmware

Product SKU		Display			Audio			Line Keys	Ethernet Ports			Wireless		
-	For Remote Configuration	Resolution	Color	HD Video	Wide band	Speaker phone	Headset Port		FE	GE	PoE Class	Wi-Fi	Blue tooth	DECT
CP-7811-3PCC-K9= 	CP-7811-3PC-RC-K9= 	3.28 inch 384 x 106	-	-	-*	•	-	-	2	-	1	-	-	-
CP-7821-3PCC-K9= 	CP-7821-3PC-RC-K9= 	3.5 inch 396 x 162	-	-	•	•	•	2	2	-	1	-	-	-
CP-7832-3PCC-K9= 	CP-7832-3PC-RC-K9= 	384 x 128	-	-	•	•	-	-	1	-	2	-	-	-
CP-7841-3PCC-K9= 	CP-7841-3PC-RC-K9= 	3.5 inch 396 x 162	-	-	•	•	•	4	-	2	1	-	-	-
CP-7861-3PCC-K9= 	CP-7861-3PC-RC-K9= 	3.5 inch 396 x 162	-	-	•	•	•	16	2	-	1	-	-	-

Getting Started

What's New

Feature Story

Collaborate

Webex Meetings

Webex Teams

Webex DX80

**NEW** Webex Room Kit

Webex Share

Webex Board

SX10 Quick Set

Business Edition 4000

IP Phone 7800/8800

IP Phone 7800/8800 MPP

Headset 500

Compute

Security

Connect

Switches

Wireless

Routers

Services















Overview

Platform Spec

Cisco IP Phone 8800 Series with Multiplatform Phone (MPP) Firmware

Product SKU		Display			Audio			Line Keys	Ethernet Ports			Wireless		
-	For Remote Configuration	Resolution	Color	HD Video	Wide band	Speaker phone	Headset Port		FE	GE	PoE Class	Wi-Fi	Blue tooth	DECT
CP-8811-3PCC-K9= 	CP-8811-3PC-RC-K9= 	5 inch 800 x 480	-	-	•	•	•	5	-	2	2	-	-	-
CP-8841-3PCC-K9= 	CP-8841-3PC-RC-K9= 	5 inch 800 x 480	•	-	•	•	•	5	-	2	2	-	-	-
CP-8845-3PCC-K9= 	-	5 inch 800 x 480	•	•	•	•	•	5	-	2	2	-	•	-
CP-8851-3PCC-K9= 	CP-8851-3PC-RC-K9= 	5 inch 800 x 480	•	-	•	•	•	5	-	2	3	-	•	-
CP-8861-3PCC-K9= 	CP-8861-3PC-RC-K9= 	5 inch 800 x 480	•	-	•	•	•	5	-	2	4	11ac	•	-
CP-8865-3PCC-K9= 	-	5 inch 800 x 480	•	•	•	•	•	5	-	2	4	11ac	•	-
CP-8831-3P-x-K9= 	-	3.5 inch 396 x 162	-	-	•	•	-	1	-	1	3	-	-	•

Getting Started

What's New

Feature Story

Collaborate

Webex Meetings

Webex Teams

Webex DX80

**NEW** Webex Room Kit

Webex Share

Webex Board

SX10 Quick Set

Business Edition 4000

IP Phone 7800/8800

IP Phone 7800/8800 MPP

Headset 500

Compute

Security

Connect

Switches

Wireless

Routers

Services



## Overview

## Spec &amp; Accessories

## Gallery

## Surprisingly Vibrant Sound for Open Workspaces

The Cisco Headset 500 Series is a professional range of wired and wireless headsets optimized for Cisco IP phones and soft clients. It delivers surprisingly vibrant sound for open workspaces. Now users can stay focused in noisy environments with rich sound, exceptional comfort, and proven reliability.

It offers a lightweight form factor that is comfortable to wear, even for an entire workday. It's designed for workers who spend a lot of time wearing headsets for voice communications and listening to music.



### Highlights

- **Vibrant Audio:** Experience bold sound while listening to music or during meetings, and be heard loud and clear with unidirectional microphones that hone in on your voice.
- **Stay Productive:** Maintain focus in busy open work environments with exceptional noise isolation in a sleek form factor for all-day comfort. A range of wired and wireless models in single and dual earpiece configurations offers the perfect fit for any user.
- **A Magical Experience:** Get up and running with an easy and intuitive setup experience. Automatic software upgrades, diagnostics, and metrics help make device management easier for IT.
- **Work Where You Want:** Wireless models offer crystal-clear sound over a DECT connection with a range exceeding 300 feet from the base. Optional multibase allows switching between up to four audio devices with USB or Bluetooth.
- **Proven Reliability:** Say goodbye to compatibility issues. Cisco headsets are designed with deep integrations for Cisco IP phones, Cisco Webex DX80, Cisco Webex Meetings, and Cisco Webex Teams and offer a single-panel administration experience for IT.

Getting Started

What's New

Feature Story

### Collaborate

Webex Meetings

Webex Teams

Webex DX80

**NEW** Webex Room Kit

Webex Share

Webex Board

SX10 Quick Set

Business Edition 4000

IP Phone 7800/8800

IP Phone 7800/8800 MPP

### Headset 500

Compute

Security

Connect

Switches

Wireless

Routers

Services





Overview

Spec & Accessories

Gallery

Cisco Headset 500 Series

Product SKU	CP-HS-W-521-USB=	CP-HS-W-522-USB=	CP-HS-W-531-RJ=	CP-HS-W-531-USBA=	CP-HS-W-532-RJ=	CP-HS-W-532-USBA=	CP-HS-WL-561-N-xx=	CP-HS-WL-561-S-xx=	CP-HS-WL-562-N-xx=	CP-HS-WL-562-S-xx=
Earpiece	Single	Dual	Single		Dual		Single		Dual	
Default Cabling Option	USB		RJ9	USB	RJ9	USB	Wireless (DECT 6.0 or region-specific)			
Hearing Protection	•	•	-*1	•	-*1	•	•	•	•	•
Microphone Type	Electret condenser/ECM									
Microphone Directionality	Unidirectional									
Microphone Frequency Response	150 to 6,800 Hz									
Speaker Impedance	~ 90 ohms									
Earpiece Bandwidth	50 Hz to 18 kHz									
Maximum Sound Pressure 118 db SPL(A)	•	•	-*1	•	-*1	•	•	•	•	•
In-Call Presence Indicator on Ear Plate	•	•	-*1	•	-*1	•	•	•	•	•
Wireless Base Included	-	-	-	-	-	-	-	•	-	•
Wireless Range	-						100 meters			
Wireless Battery Life	-						Storage: 200 days; Standby: 60 hours; Active use: 10 hours			
Wireless Audio Bandwidth	-						Narrowband (8 kHz), Wideband (16 kHz), Full band (48 kHz)			

\*1 USB Headset Adapter (CP-HS-W-USBA=) is required.

Cisco Headset 500 Series Accessories

Product SKU	Description
CP-HS-W-RJ=	QD RJ Headset Cable
CP-HS-W-USBA=	USB Headset Adapter

Getting Started

What's New

Feature Story

Collaborate

Webex Meetings

Webex Teams

Webex DX80

**NEW** Webex Room Kit

Webex Share

Webex Board

SX10 Quick Set

Business Edition 4000

IP Phone 7800/8800

IP Phone 7800/8800 MPP

Headset 500

Compute

Security

Connect

Switches

Wireless

Routers

Services

Overview

Spec & Accessories

Gallery

Getting Started

What's New

Feature Story

Collaborate

Webex Meetings

Webex Teams

Webex DX80

**NEW** Webex Room Kit

Webex Share

Webex Board

SX10 Quick Set

Business Edition 4000

IP Phone 7800/8800

IP Phone 7800/8800 MPP

Headset 500

Compute

Security

Connect

Switches

Wireless

Routers

Services



Featured Products

Portfolio



# Cisco HyperFlex HX-Series

Next-Generation, Multicloud Hyperconvergence is Here  
Unify Compute, Storage, and Networking with Cloud Management



## HX-E-220M5SX

Hybrid Node	Intel Xeon Scalable	Max 28 Cores per Socket	2 CPU Sockets	Max 3 TB Memory	24 Memory Slots
Max 800 GB Cache	Max 14.4 TB Capacity	10 2.5 inch SFF Slots	VMware vSphere 6 & 6.5	HXDP Edge Software	



## HXAF240C-M5SX

All-Flash Node	Intel Xeon Scalable	Max 28 Cores per Socket	2 CPU Sockets	Max 3 TB Memory	24 Memory Slots
Max 1.6 TB Cache	Max 87.4 TB Capacity	24 + 2 2.5 inch SFF Slots	VMware vSphere 6 & 6.5	Microsoft Hyper-V	HXDP Std/Ent Software

Getting Started

What's New

Feature Story

Collaborate

Compute

UCS C-Series

HyperFlex

Nexus 9348

Intersight

Security

Connect

Switches

Wireless

Routers

Services



Getting Started

What's New

Feature Story

Collaborate

Compute

UCS C-Series

HyperFlex

Nexus 9348

Intersight

Security

Connect

Switches

Wireless

Routers

Services

# Cisco Intersight

Intelligent Cloud-Powered Management for Cisco UCS

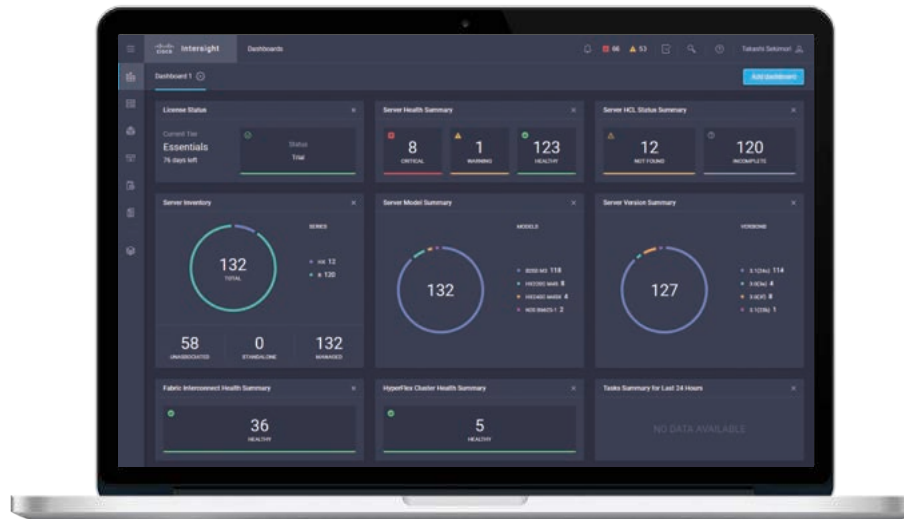

DC-MGT-SAAS-EST-C

- Cloud-based Management
- Manage UCS
- Manage HyperFlex
- Monitoring Server Alerts
- Monitoring Server Health
- User Customizable Dashboard
- Tagging & Basic Search
- Element Managers
- Policy-based Configuration
- Remote Management & vKVM
- Firmware Management
- HCL Compliance Check





Featured Products

Portfolio

Getting Started

What's New

Feature Story

Collaborate

Compute

UCS C-Series

HyperFlex

Nexus 9348

Intersight

Security

Connect

Switches

Wireless

Routers

Services

Cisco Nexus 9348GC-FXP Switch

Cisco HyperFlex HX220c Edge M5

Cisco UCS C220 M5 Rack Server

Cisco UCS C240 M5 Rack Server

Any Other Type of UCS

3rd Vendor Servers/Systems

Cloud Managed  
Computing

Free Version Available!!



Cisco Intersight

Getting Started

What's New

Feature Story

Collaborate

Compute

UCS C-Series

HyperFlex

Nexus 9348

Intersight

Security

Connect

Switches

Wireless

Routers

Services

## Superior Multilayered Protection

The Cisco UCS C-Series Rack Servers provide a rack-server entry point to Cisco UCS. With world-record-setting performance for 2- and 4-socket servers, Cisco UCS C-Series Rack Servers can integrate into Cisco UCS through a single set of cables. Cisco UCS C-Series Rack Servers provide a wide range of I/O, memory, internal disk, and solid-state disk (SSD) drive capacity, enabling you to easily match servers to workloads.

### Highlights: Cisco UCS C-Series M5 Rack Servers

Designed to provide your computing infrastructure now and into the future, Cisco UCS C-Series M5 Rack Servers give you the benefits of the latest Intel Xeon Scalable processors:

- More Cores to accelerate parallelized virtualized and bare-metal workloads
- Larger Memory Capacity for better performance and larger in-memory databases
- Higher Memory Bandwidth to accelerate the flow of information to and from the CPU
- Ready for Intel 3D XPoint nonvolatile memory
- Up to 6 PCIe GPU Accelerators for a smooth user experience in virtual desktop environments
- Cloud Managed by Cisco Intersight



Overview

**Positioning Map**

Platform Spec

SmartPlay Rack Paks

Why UCS?

**Massive Storage Capacity**  
for Data-intensive Workloads

**Performance and Expandability**  
for Enterprise-class Workloads

**Superior Performance**  
for Mission-Critical Workloads

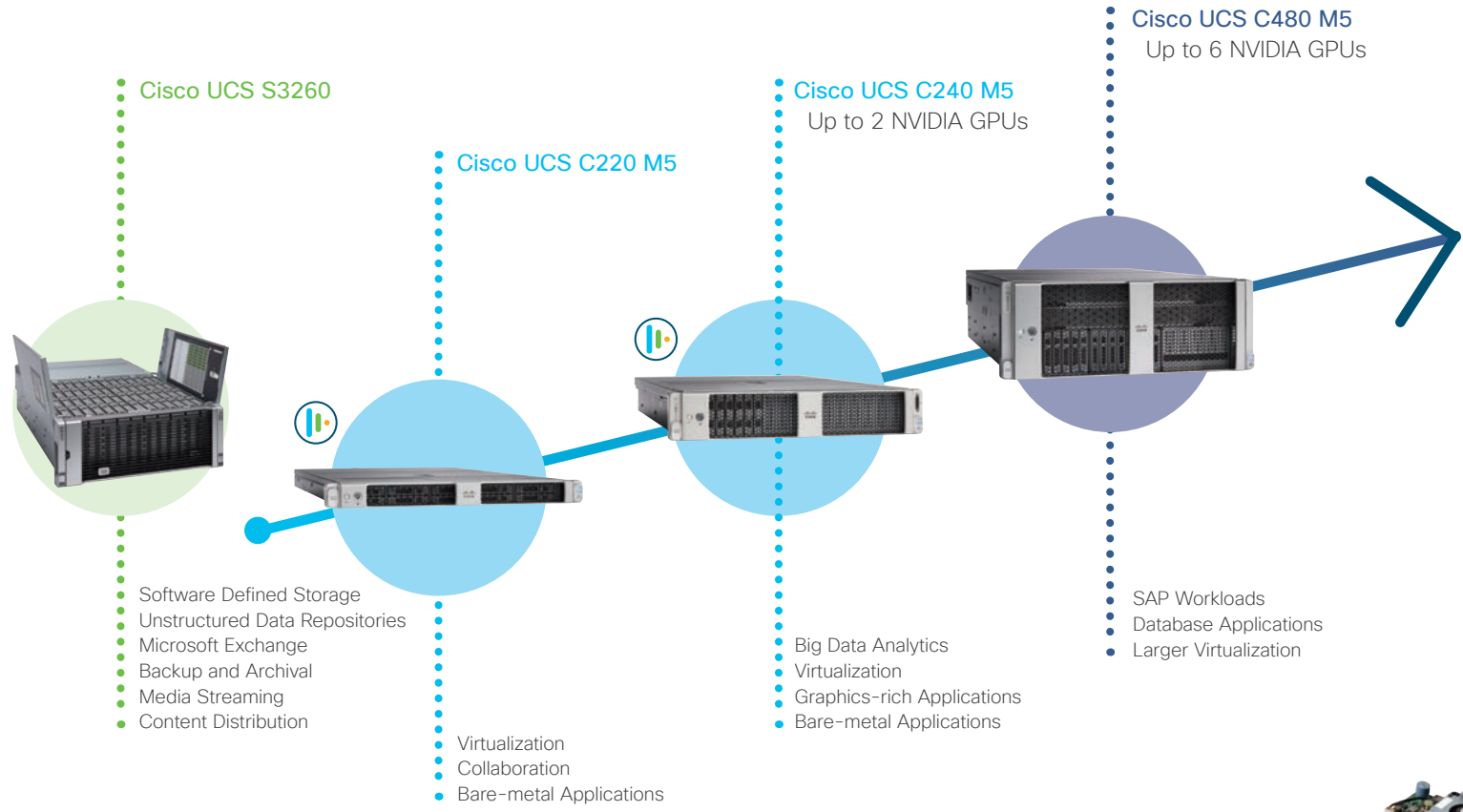

All models support  
**Cisco UCS Virtual Interface Card (VIC)**  
in PCIe or MLOM form factor



Getting Started

What's New

Feature Story

Collaborate

Compute

UCS C-Series

HyperFlex

Nexus 9348

Intersight

Security

Connect

Switches

Wireless

Routers

Services

Overview

Positioning Map

Platform Spec

SmartPlay Rack Paks

Why UCS?

## Cisco UCS C-Series M5 Rack Servers

Product SKU	Processor			Memory		Internal Storage						PCIe Gen3		mLOM Slots	Ports		Rack Mount
	Sockets	Processor Supported	Max Cores per Socket	Slots	Max Memory	2.5 inch SFF Slots	3.5 inch LFF Slots	Max Internal Storage				Slots	Max GPUs		10GB-T	Mgmt GE	
								HDD	SSD	Self-Encrypted HDD/SDD	PCIe NVMe						
UCSC-C220-M5L	2	Intel Xeon Scalable	28	24	3 TB	-	4	48 TB	7.6 TB	24 TB	6.4 TB	2	1	1	2	1	1 RU
UCSC-C220-M5SX	2	Intel Xeon Scalable	28	24	3 TB	10	-	20 TB	76 TB	38 TB	15.4 TB	2	1	1	2	1	1 RU
UCSC-C220-M5SN	2	Intel Xeon Scalable	28	24	3 TB	10	-	-	-	-	76 TB	2	1	1	2	1	1 RU
UCSC-C240-M5S	2	Intel Xeon Scalable	28	24	3 TB	8 + 2	-	20 TB	76 TB	38 TB	15.2 TB	6	2	1	2	1	2 RU
UCSC-C240-M5L	2	Intel Xeon Scalable	28	24	3 TB	2	12	168 TB	38 TB	79.6 TB	21.6 TB	6	2	1	2	1	2 RU
UCSC-C240-M5SX	2	Intel Xeon Scalable	28	24	3 TB	24 + 2	-	52 TB	197.6 TB	98.8 TB	30.4TB	6	2	1	2	1	2 RU
UCSC-C240-M5SN	2	Intel Xeon Scalable	28	24	3 TB	24 + 2	-	32.0 TB	121.6 TB	60.8 TB	197.6 TB	6	2	1	2	1	2 RU

Getting Started

What's New

Feature Story

Collaborate

Compute

UCS C-Series

HyperFlex

Nexus 9348

Intersight

Security

Connect

Switches

Wireless

Routers

Services





Overview

Positioning Map

Platform Spec

SmartPlay Rack Paks

Why UCS?

Cisco UCS C220 M5 SFF Rack Server SmartPlay Rack Paks

Product SKU	Bundle					
	Processor	Memory	RAID Controller	PCIe Riser	Additional Storage	Power Supply
UCS-SPR-C220M5-B3	1 x Intel Xeon Bronze 3106 8 Cores, 1.70 GHz, 11 MB L3, 85 W	1 x 16 GB DDR4 2,666 MHz	12G SAS RAID Controller with 2 GB FBWC	-	32 GB SD Card	1 x 770 W AC
UCS-SPR-C220M5-B4	2 x Intel Xeon Bronze 3106 8 Cores, 1.70 GHz, 11 MB L3, 85 W	2 x 16 GB DDR4 2,666 MHz	12G SAS RAID Controller with 2 GB FBWC	-	32 GB SD Card	2 x 770 W AC
UCS-SPR-C220M5-S3	1 x Intel® Xeon Silver 4110 8 Cores, 2.10 GHz, 11 MB L3, 85 W	1 x 16 GB DDR4 2,666 MHz	12G SAS RAID Controller with 2 GB FBWC	-	32 GB SD Card	1 x 770 W AC
UCS-SPR-C220M5-S4	2 x Intel® Xeon Silver 4110 8 Cores, 2.10 GHz, 11 MB L3, 85 W	2 x 16 GB DDR4 2,666 MHz	12G SAS RAID Controller with 2 GB FBWC	-	32 GB SD Card	2 x 770 W AC
UCS-SPR-C220M5-EP2	2 x Intel Xeon Silver 4114 10 Cores, 2.20 GHz, 13.75 MB L3, 85 W	2 x 16 GB DDR4 2,666 MHz	12G SAS RAID Controller with 2 GB FBWC	-	32 GB SD Card	2 x 770 W AC
UCS-SPR-C220M5-A4	2 x Intel Xeon Silver 4116 12 Cores, 2.10 GHz, 16.5 MB L3, 85 W	2 x 16 GB DDR4 2,666 MHz	12G SAS RAID Controller with 2 GB FBWC	-	32 GB SD Card	2 x 770 W AC
UCS-SPR-C220M5-A2	2 x Intel Xeon Silver 4116 12 Cores, 2.10 GHz, 16.5 MB L3, 85 W	2 x 32 GB DDR4 2,666 MHz	12G SAS RAID Controller with 2 GB FBWC	-	32 GB SD Card	2 x 770 W AC
UCS-SPR-C220M5-A5	2 x Intel Xeon Gold 5120 14 Cores, 2.20 GHz, 19.25 MB L3, 105 W	2 x 16 GB DDR4 2,666 MHz	12G SAS RAID Controller with 2 GB FBWC	-	32 GB SD Card	2 x 770 W AC
UCS-SPR-C220M5-C1	2 x Intel Xeon Gold 5120 14 Cores, 2.20 GHz, 19.25 MB L3, 105 W	2 x 32 GB DDR4 2,666 MHz	12G SAS RAID Controller with 2 GB FBWC	-	32 GB SD Card	2 x 770 W AC
UCS-SPR-C220M5-C2	2 x Intel Xeon Gold 6130 16 Cores, 2.10 GHz, 22 MB L3, 125 W	2 x 32 GB DDR4 2,666 MHz	12G SAS RAID Controller with 2 GB FBWC	-	32 GB SD Card	2 x 770 W AC

Getting Started

What's New

Feature Story

Collaborate

Compute

UCS C-Series

HyperFlex

Nexus 9348

Intersight

Security

Connect

Switches

Wireless

Routers

Services



Overview

Positioning Map

Platform Spec

SmartPlay Rack Paks

Why UCS?

## Cisco UCS C240 M5 SFF Rack Server SmartPlay Rack Paks

Product SKU	Bundle					
	Processor	Memory	RAID Controller	PCIe Riser	Additional Storage	Power Supply
UCS-SPR-C240M5-B2	1 x Intel Xeon Bronze 3106 8 Cores, 1.70 GHz, 11 MB L3, 85 W	1 x 16 GB DDR4 2,666 MHz	12G SAS RAID Controller with 4 GB FBWC	Riser Card 1B 3 PCIe Slots (x8, x8, x8)	32 GB SD Card	1 x 1,100 W AC
UCS-SPR-C240M5-S4	1 x Intel® Xeon Silver 4110 8 Cores, 2.10 GHz, 11 MB L3, 85 W	1 x 16 GB DDR4 2,666 MHz	12G SAS RAID Controller with 4 GB FBWC	Riser Card 1B 3 PCIe Slots (x8, x8, x8)	32 GB SD Card	2 x 1,100 W AC
UCS-SPR-C240M5-S5	2 x Intel® Xeon Silver 4110 8 Cores, 2.10 GHz, 11 MB L3, 85 W	2 x 16 GB DDR4 2,666 MHz	12G SAS RAID Controller with 4 GB FBWC	Riser Card 1 3 PCIe Slots (x8, x16, x8)	32 GB SD Card	2 x 1,100 W AC
UCS-SPR-C240M5-S6	2 x Intel Xeon Silver 4114 10 Cores, 2.20 GHz, 13.75 MB L3, 85 W	2 x 16 GB DDR4 2,666 MHz	12G SAS RAID Controller with 4 GB FBWC	Riser Card 1 3 PCIe Slots (x8, x16, x8)	32 GB SD Card	2 x 1,100 W AC
UCS-SPR-C240M5-A1	1 x Intel Xeon Gold 5120 14 Cores, 2.20 GHz, 19.25 MB L3, 105 W	1 x 32 GB DDR4 2,666 MHz	12G SAS RAID Controller with 4 GB FBWC	Riser Card 1B 3 PCIe Slots (x8, x8, x8)	32 GB SD Card	1 x 1,100 W AC
UCS-SPR-C240M5-C1	2 x Intel Xeon Gold 5120 14 Cores, 2.20 GHz, 19.25 MB L3, 105 W	2 x 32 GB DDR4 2,666 MHz	12G SAS RAID Controller with 4 GB FBWC	Riser Card 1 3 PCIe Slots (x8, x16, x8)	32 GB SD Card	2 x 1,100 W AC
UCS-SPR-C240M5-C2	2 x Intel Xeon Gold 6130 16 Cores, 2.10 GHz, 22 MB L3, 125 W	2 x 32 GB DDR4 2,666 MHz	12G SAS RAID Controller with 4 GB FBWC	Riser Card 1 3 PCIe Slots (x8, x16, x8)	32 GB SD Card	2 x 1,100 W AC

Getting Started

What's New

Feature Story

Collaborate

Compute

UCS C-Series

HyperFlex

Nexus 9348

Intersight

Security

Connect

Switches

Wireless

Routers

Services

Overview

Positioning Map

Platform Spec

SmartPlay Rack Paks

Why UCS?

## Cisco UCS C220/240 M5 SFF Rack Server SmartPlay Rack Paks Accessories

Product Category	Product SKU	Description	Compatible Models	
			C220 M5 SFF	C240 M5 SFF
DDR4 DIMM	UCS-MR-X16G1RS-H	16 GB, DDR4, 2,666 MHz RDIMM, PC4-21300, Dual Rank, x4, 1.2 v	•	•
	UCS-MR-X32G2RS-H	32 GB, DDR4, 2,666 MHz RDIMM, PC4-21300, Dual Rank, x4, 1.2 v	•	•
SSD	UCS-SD150G61X-EV	150 GB, 6G SATA, SFF SSD	•	•
HDD	UCS-HD300G10K12N	300 GB, 12G SAS, 10K RPM, SFF HDD	•	•
	UCS-HD600G10K12N	600 GB, 12G SAS, 10K RPM, SFF HDD	•	•
	UCS-HD1T7K12N	1 TB, 12G SAS, 7.2K RPM, SFF HDD	•	•
	UCS-HD300G15K12N	300 GB, 12G SAS, 15K RPM, SFF HDD	•	•
PCIe	UCSC-PCIE-IRJ45	Intel i350 Quad Port 1GE Adapter	•	•
	N2XX-AIPCI01	Intel X520 Dual Port 10GE SFP+ Adapter	•	•
	UCSC-PCIE-C40Q-03	Cisco VIC 1385 Dual Port 40GE QSFP+, CNA, RDMA	•	•
	UCSC-PCIE-BD32GF	Broadcom LPe32002 Dual-Port 32GE FC, HBA	•	•
PCIe MLOM	UCSC-MLOM-C40Q-03	Cisco VIC 1387 Dual Port 40GE QSFP+, CNA, MLOM	•	•
PCIe Riser 2	UCSC-PCI-2A-240M5	Riser Card 2A, 3 x PCIe Slots (x8, x16, x16) Supports GPU	-	•
	UCSC-PCI-2B-240M5	Riser Card 2B, 3 x PCIe Slots (x8, x16, x8) Supports GPU + Rear NVMe	-	•
	UCSC-PCI-2C-240M5	Riser Card 2C, 3 x PCIe Slots (x8, x8, x8) Supports Front + Rear NVMe	-	•

Getting Started

What's New

Feature Story

Collaborate

Compute

UCS C-Series

HyperFlex

Nexus 9348

Intersight

Security

Connect

Switches

Wireless

Routers

Services

Simple, Flexible, and Powerful Management Capabilities: Cisco Integrated Management Controller (IMC)

The Cisco Integrated Management Controller (IMC) is a baseboard management controller that provides embedded server management for the Cisco UCS C-Series Rack Servers. The Cisco IMC enables system management in the datacenter and across distributed branch-office locations. Cisco IMC supports multiple management interfaces, including a web user interface (Web UI), a command-line interface (CLI), and an XML API that is consistent with the one used by the Cisco UCS Manager. Cisco IMC also supports industry-standard management protocols, including Simple Network Management Protocol Version 3 (SNMPv3) and Intelligent Platform Management Interface Version 2.0 (IPMIv2.0). Cisco IMC is available in Chinese, English, Japanese, Korean, Russian, and Spanish.



Dedicated Management Port for Cisco IMC



Getting Started

What's New

Feature Story

Collaborate

Compute

UCS C-Series

HyperFlex

Nexus 9348

Intersight

Security

Connect

Switches

Wireless

Routers

Services





**Powerful and Configurable Networking: Cisco Virtual Interface Cards (VIC)**

The Cisco Virtual Interface Cards (VIC) is PCIe-compliant interfaces that support up to 256 PCIe devices with dynamically configured type (NIC or HBA), identity [MAC address or worldwide name (WWN)], fabric failover policy, bandwidth, and QoS policy settings. With Cisco VICs, server configuration — including I/O configuration — becomes configurable on demand, making servers stateless resources that can be deployed to meet any workload need at any time, without any physical reconfiguration or recabling required.

**Cisco UCS Virtual Interface Card (VIC)**

	UCS VIC 1385	UCS VIC 1387
Form Factor	PCIExpress (half height)	Modular LOM
Connectivity	PCIe 3.0 x 16 form factor	PCIe 3.0 x 8 form factor
Network Throughput	80 GB	80 GB
VXLAN/NVGRE	•	•
SMB Direct	•	•
RDMA	•	•
usNIC	•	•

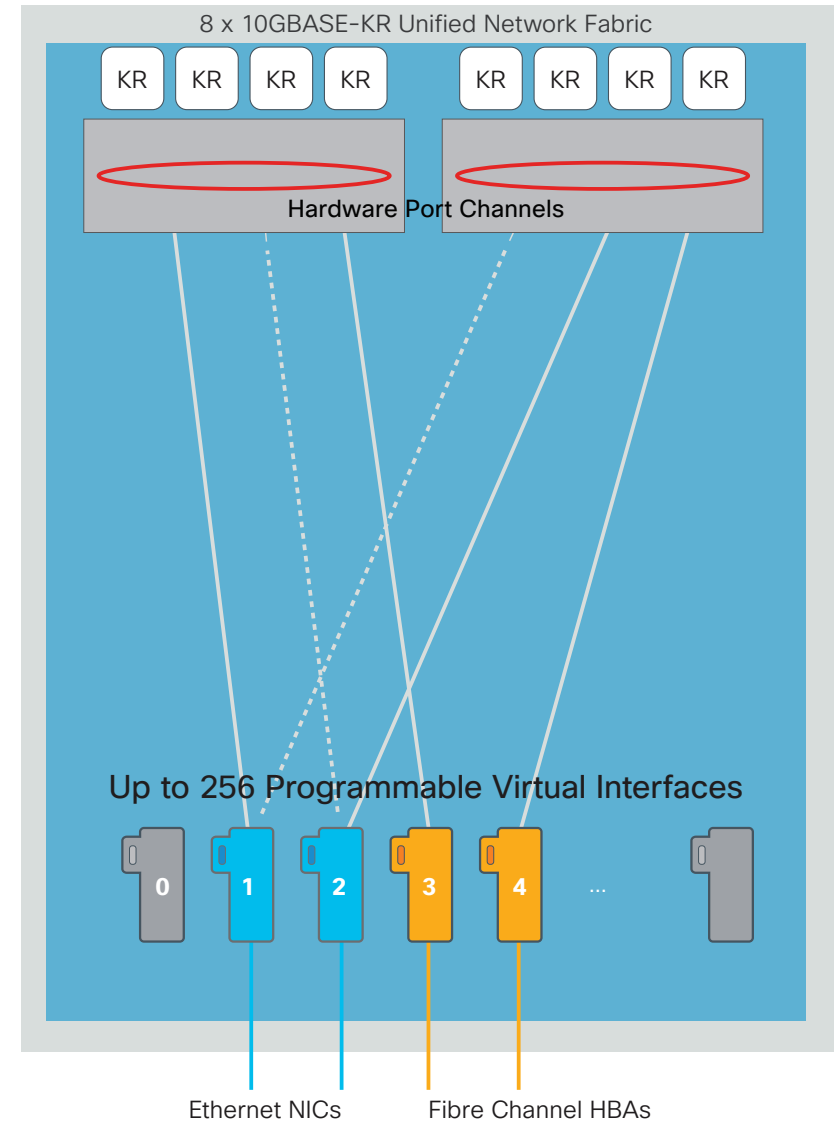

Getting Started

What's New

Feature Story

Collaborate

Compute

UCS C-Series

HyperFlex

Nexus 9348

Intersight

Security

Connect

Switches

Wireless

Routers

Services



Ability to Integrate into a Fully Managed Environment: Cisco UCS Manager & Cisco UCS Fabric Interconnects

The Cisco UCS Manager integrates blade and rack servers into a single self-aware, self-integrating, unified system. It quickly and accurately configures computing, network, storage, and storage-access resources to increase compliance and reduce the chance of errors that can cause downtime. It uses a role- and policy-based approach that helps organizations more easily align policies and configurations with workloads, and it automates system configuration through a “create once, deploy many” approach. Cisco UCS Manager acts as a single point of management and monitoring for the entire system. It is embedded software that runs on the system’s fabric interconnects, typically in a redundant, high-availability configuration. It can be accessed through an intuitive GUI, command-line interface (CLI), or XML API. The Cisco UCS Fabric Interconnects provide a single point of connectivity and management for the entire system. Typically deployed as an active-active pair, the system’s fabric interconnects integrate all components into a single, highly

available management domain controlled by Cisco UCS Manager. The fabric interconnects manage all I/O efficiently and securely at a single point, resulting in deterministic I/O latency regardless of a server or virtual machine’s topological location in the system.

- Cisco UCS 6200 Series Fabric Interconnects support line-rate, lossless 10 Gigabit Ethernet and FCoE connectivity
- Cisco UCS 6200 Series Fabric Interconnects can be used to create Cisco UCS domains containing blade or rack servers
- Cisco UCS 6300 Series Fabric Interconnects support line-rate, lossless 40 Gigabit Ethernet and FCoE connectivity
- Cisco UCS 6324 Fabric Interconnects can be used to create a self-contained Cisco UCS Mini solution for branch offices and remote locations

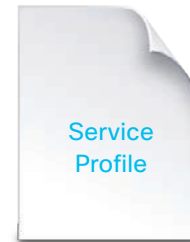

Server Deployment with Service Profiles Takes Only Minutes



UCS Manager Embedded in UCS Fabric Interconnect

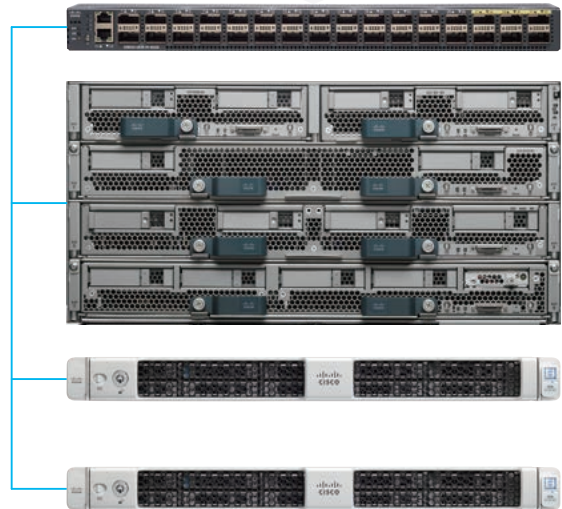
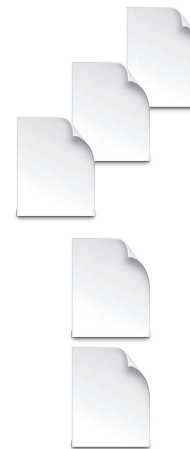

Getting Started

What's New

Feature Story

Collaborate

Compute

UCS C-Series

HyperFlex

Nexus 9348

Intersight

Security

Connect

Switches

Wireless

Routers

Services





## ■ Cisco HyperFlex Systems: Hyperconverged Multicloud Platform

You need infrastructure that can adapt to match the speed of your business—whether deploying enterprise applications or containers in multicloud environments. The **Cisco HyperFlex Systems** with Intel Xeon Scalable processors deliver hyperconvergence with the power and simplicity for **any application**,

on **any cloud**, and at **any scale**. Engineered on the Cisco Unified Computing System (UCS), Cisco HyperFlex Systems deliver the agility, scalability, and pay-as-you-grow economics of the cloud with the benefits of onpremises infrastructure.



### ■ Cisco HyperFlex HX-Series

The **Cisco HyperFlex HX-Series** provides unified compute, storage, and networking with cloud management. Physically, the Cisco HyperFlex System is delivered as a cluster of the Cisco HyperFlex HX-Series nodes.

A HyperFlex cluster requires a minimum of three homogeneous nodes (with disk storage). Data is replicated across at least two of these nodes, and a third node is required for continuous operation in the event of a single-node failure. Each node is equipped with at least one high-performance SSD drive for data caching and rapid acknowledgment of write requests.

- Hybrid nodes use SSD drives for caching and HDDs for the capacity layer
- All Flash nodes use SSD drives or NVMe storage for caching, and SSD drives for the capacity layer

#### ● Cisco HyperFlex HX220c Edge M5 Nodes

These nodes are designed to work in simplified three-node clusters using existing Gigabit Ethernet networks. Cisco HyperFlex Edge systems offer the same easy deployment and management as all Cisco HyperFlex systems.

#### ● Cisco HyperFlex HX220c M5 Hybrid and All-Flash Nodes

These nodes balance up to 8 drives of disk capacity in a 2-socket, 1-rack-unit (1RU) package ideal for small-footprint environments.

#### ● Cisco HyperFlex HX240c M5 Hybrid and All-Flash Nodes

These nodes balance high disk capacity (up to 23 drives) in a 2-socket, 2RU package ideal for storage-intensive applications.

Getting Started

What's New

Feature Story

Collaborate

Compute

UCS C-Series

HyperFlex

Nexus 9348

Intersight

Security

Connect

Switches

Wireless

Routers

Services



Overview

Positioning Map

Platform Spec

SmartPlay HyperFlex

Why HyperFlex?

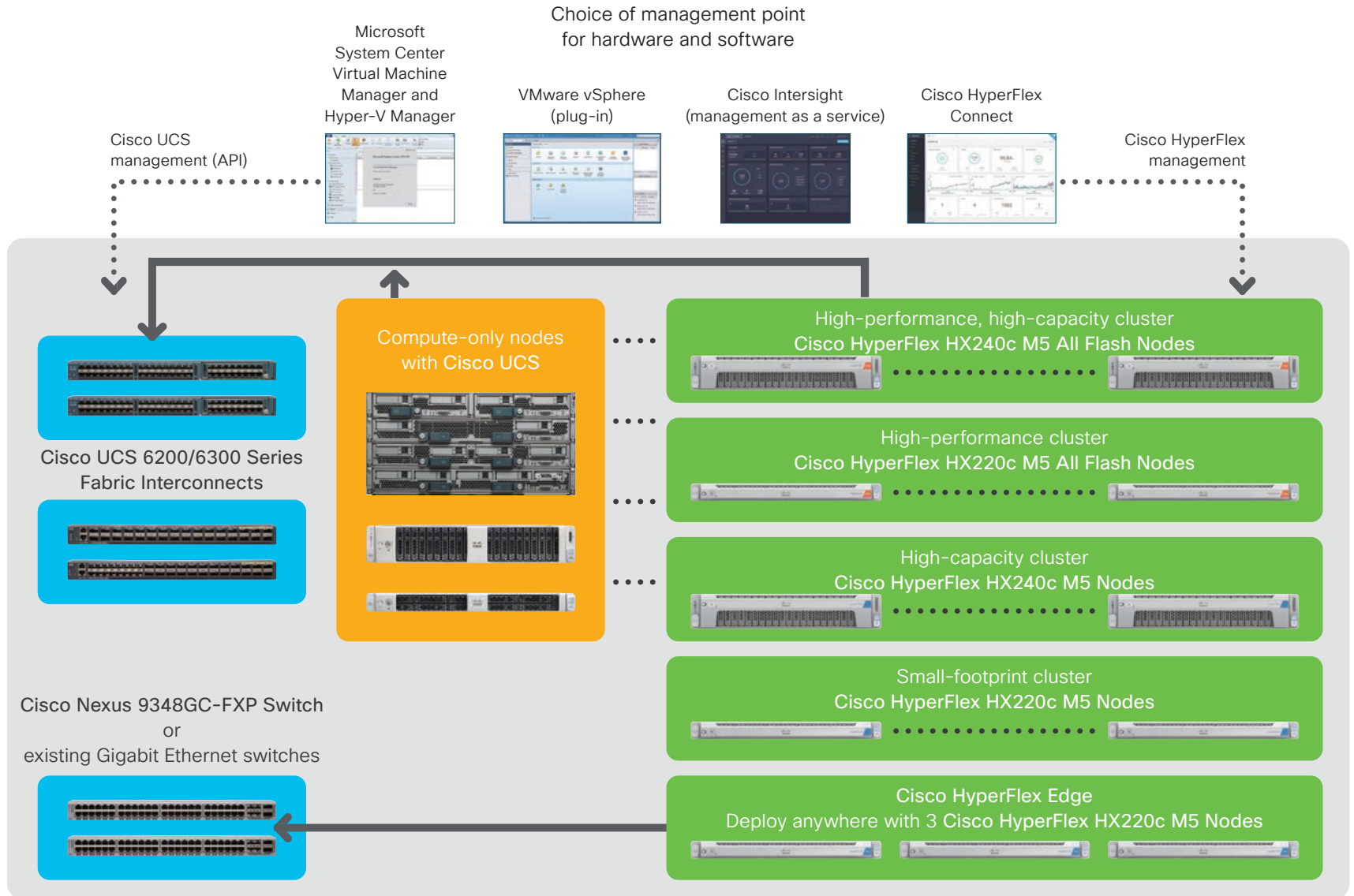

Getting Started

What's New

Feature Story

Collaborate

Compute

UCS C-Series

HyperFlex

Nexus 9348

Intersight

Security

Connect

Switches

Wireless

Routers

Services





Overview

Positioning Map

Platform Spec

SmartPlay HyperFlex

Why HyperFlex?

Cisco HyperFlex HX-Series

Product SKU	Processor			Memory		Internal Storage						PCIe Gen3		Ports		Rack Mount		
	Sockets	Processor Supported	Max Cores per Socket	Slots	Max Memory	2.5 inch SFF Slots	3.5 inch LFF Slots	Max Cache		Max Capacity			Slots	Max GPUs	mLOM Slots		Ports	
								SSD	PCIe NVMe	HDD	SSD	Self-Encrypted HDD/SDD					10 GB-T	Mgmt GE
HX-E-220M5SX <sup>*1</sup>	2	Intel Xeon Scalable	28	24	3 TB	10	-	800 GB	-	14.4 TB	-	-	2	1	1	2	1	1 RU
HXAF-E-220M5SX <sup>*1</sup>	2	Intel Xeon Scalable	28	24	3 TB	10	-	400 GB	-	-	30.4 TB	-	2	1	1	2	1	1 RU
HX220C-M5SX <sup>*2</sup>	2	Intel Xeon Scalable	28	24	3 TB	10	-	800 GB	-	14.4 TB	-	14.4 TB	2	1	1	2	1	1 RU
HXAF220C-M5SX <sup>*3</sup>	2	Intel Xeon Scalable	28	24	3 TB	10	-	800 GB	1.6 TB	-	30.4 TB	30.4 TB	2	1	1	2	1	1 RU
HX240C-M5L <sup>*2</sup>	2	Intel Xeon Scalable	28	24	3 TB	2	12	3.2 TB	-	96 TB	-	-	6	2	1	2	1	2 RU
HX240C-M5SX <sup>*2</sup>	2	Intel Xeon Scalable	28	24	3 TB	24 + 2	-	1.6 TB	-	41.4 TB	-	27.6 TB	6	2	1	2	1	2 RU
HXAF240C-M5SX <sup>*3</sup>	2	Intel Xeon Scalable	28	24	3 TB	24 + 2	-	800 GB	1.6 TB	-	87.4 TB	87.4 TB	6	2	1	2	1	2 RU

\*1 HX-E-M5S-HXDP is required in CCW. See [Ordering Guide](#) for details. \*2 HX-M5S-HXDP is required in CCW. See [Ordering Guide](#) for details. \*3 HXAF-M5S-HXDP is required in CCW. See [Ordering Guide](#) for details.

Cisco HyperFlex HX Data Platform (HXDP) Licenses for Cisco HyperFlex HX220c Edge M5 Nodes

Product SKU <sup>*1</sup>					Description
1-Year	2-Years	3-Years	4-Years	5-Years	
HXDP-E001-1YR=	HXDP-E001-2YR=	HXDP-E001-3YR=	HXDP-E001-4YR=	HXDP-E001-5YR=	Cisco HyperFlex Data Platform Edge Edition

\*1 HX-E-M5S-HXDP is required in CCW. See [Ordering Guide](#) for details.

Cisco HyperFlex HX Data Platform (HXDP) Licenses for Cisco HyperFlex HX220c/240c M5 Hybrid and All-Flash Nodes

Product SKU <sup>*1</sup>					Description
1-Year	2-Years	3-Years	4-Years	5-Years	
HXDP-S001-1YR=	HXDP-S001-2YR=	HXDP-S001-3YR=	HXDP-S001-4YR=	HXDP-S001-5YR=	Cisco HyperFlex Data Platform Standard Edition
HXDP-P001-1YR=	HXDP-P001-2YR=	HXDP-P001-3YR=	HXDP-P001-4YR=	HXDP-P001-5YR=	Cisco HyperFlex Data Platform Enterprise Edition

\*1 HX-M5S-HXDP or HXAF-M5S-HXDP is required in CCW. See [Ordering Guide](#) for details.

Getting Started

What's New

Feature Story

Collaborate

Compute

UCS C-Series

HyperFlex

Nexus 9348

Intersight

Security

Connect

Switches

Wireless

Routers

Services



Overview

Positioning Map

Platform Spec

SmartPlay HyperFlex

Why HyperFlex?

Cisco HyperFlex HX220c M5 Nodes Hybrid SmartPlay HyperFlex

Product SKU*1	Bundle					
	Processor	Memory	RAID Controller	PCIe Option Card	Additional Storage	Power Supply
HX-SP-220M5SX-E	2 x Intel Xeon Bronze 3106 8 Cores, 1.70 GHz, 11 MB L3, 85 W	8 x 16 GB DDR4 2,666 MHz	Cisco 12G SAS HBA	Cisco VIC 1387 Dual Port 40 GB QSFP CNA MLOM	32 GB SD Card 240 GB SATA M.2 SSD	2 x 770 W AC

\*1 HX-SP-220M5-E is required in CCW.

Cisco HyperFlex HX220c M5 Nodes All-Flash SmartPlay HyperFlex

Product SKU*1	Bundle					
	Processor	Memory	RAID Controller	PCIe Option Card	Additional Storage	Power Supply
HXAF-SP-220M5SX-V	2 x Intel Xeon Silver 4114 10 Cores, 2.20 GHz, 13.75 MB L3, 85 W	12 x 16 GB DDR4 2,666 MHz	Cisco 12G SAS HBA	Cisco VIC 1387 Dual Port 40 GB QSFP CNA MLOM	32 GB SD Card 240 GB SATA M.2 SSD	2 x 770 W AC

\*1 HXAF-SP-220M5-V is required in CCW.

Cisco HyperFlex HX240c M5 Nodes Hybrid SmartPlay HyperFlex

Product SKU*1	Bundle					
	Processor	Memory	RAID Controller	PCIe Option Card	Additional Storage	Power Supply
HX-SP-240M5SX-P	2 x Intel Xeon Gold 6140 18 Cores, 2.30 GHz, 24.75 MB L3, 140 W	12 x 32 GB DDR4 2,666 MHz	Cisco 12G SAS HBA	Cisco VIC 1387 Dual Port 40 GB QSFP CNA MLOM	32 GB SD Card 240 GB SATA M.2 SSD	2 x 1,600 W AC

\*1 HX-SP-240M5-P is required in CCW.

Cisco HyperFlex HX240c M5 Nodes All-Flash SmartPlay HyperFlex

Product SKU*1	Bundle					
	Processor	Memory	RAID Controller	PCIe Option Card	Additional Storage	Power Supply
HXAF-SP-240M5SX-V	2 x Intel Xeon Silver 4114 10 Cores, 2.20 GHz, 13.75 MB L3, 85 W	12 x 32 GB DDR4 2,666 MHz	Cisco 12G SAS HBA	Cisco VIC 1387 Dual Port 40 GB QSFP CNA MLOM	32 GB SD Card 240 GB SATA M.2 SSD	2 x 1,600 W AC

\*1 HXAF-SP-240M5-V is required in CCW.

Getting Started

What's New

Feature Story

Collaborate

Compute

UCS C-Series

HyperFlex

Nexus 9348

Intersight

Security

Connect

Switches

Wireless

Routers

Services





Overview

Positioning Map

Platform Spec

SmartPlay HyperFlex

Why HyperFlex?

Cisco HyperFlex HX-Series SmartPlay HyperFlex Accessories

Product Category	Product SKU	Description	Compatible Models			
			HX220c M5		HX240c M5	
			Hybrid	All-Flash	Hybrid	All-Flash
Fabric Interconnect	UCS-HX-FI48P	Cisco UCS 6248UP 48-Port Fabric Interconnect, 12-port License, 2 x Power Supply 4 x Cisco 10GBASE-SR SFP+, 4 x Cisco Fibre Channel Shortwave SFP+	●	●	●	●
	UCS-HX-FI96P	Cisco UCS 6296UP 96-Port Fabric Interconnect, 18-port License, 2 x Power Supply 4 x Cisco 10GBASE-SR SFP+, 4 x Cisco Fibre Channel Shortwave SFP+	●	●	●	●
	HX-SP-FI6332	Cisco UCS 6332 Fabric Interconnect 4 x Cisco 40GBASE-SR QSFP+, 2 x Power Supply	●	●	●	●
	HX-SP-FI6332-16UP	Cisco UCS 6332-16UP Fabric Interconnect 4 x Cisco 40GBASE-SR QSFP+, 2 x Power Supply	●	●	●	●
DDR4 DIMM	HX-SP-M16G1-RSH	16 GB, DDR4, 2,666 MHz RDIMM, PC4-21300, Single Rank, x4, 1.2 v	●	●	●	●
	HX-SP-M32G2-RSH	32 GB, DDR4, 2,666 MHz RDIMM, PC4-21300, Dual Rank, x4, 1.2 v	●	●	●	●
HDD Pack (Standard)	HX-STD-01	1 x 480 GB SAS (Cache), 1 x 240 GB SATA (Log), 6 x 1.2 TB SAS (Capacity)	●	-	-	-
	HX-STD-02	1 x 480 GB SATA (Cache), 1 x 240 GB SATA (Log), 6 x 1.8 TB SAS (Capacity)	●	-	-	-
	HX-STD-03	1 x 400 GB SAS (Cache), 1 x 240 GB SATA (Log), 6 x 960 GB SATA (Capacity)	-	●	-	-
	HX-STD-04	1 x 400 GB SAS (Cache), 1 x 240 GB SATA (Log), 6 x 3.8 TB SATA (Capacity)	-	●	-	●
	HX-STD-05	1 x 400 GB SAS (Cache), 1 x 240 GB SATA (Log), 11 x 3.8 TB SATA (Capacity)	-	-	-	●
	HX-STD-06	1 x 1.6 TB SAS (Cache), 1 x 240 GB SATA (Log), 15 x 1.8 TB SAS (Capacity)	-	-	●	-
	HX-STD-07	1 x 1.6 TB SAS (Cache), 1 x 240 GB SATA (Log), 15 x 1.2 TB SAS (Capacity)	-	-	●	-
	HX-STD-08	1 x 400 GB SAS (Cache), 1 x 240 GB SATA (Log), 11 x 960 GB SATA (Capacity)	-	-	-	●
HDD Pack (Encrypted)	HX-ENCR-01	1 x 800 GB SAS (Cache), 1 x 240 GB SATA (Log), 6 x 1.2 TB SAS (Capacity)	●	-	-	-
	HX-ENCR-03	1 x 800 GB SAS (Cache), 1 x 240 GB SATA (Log), 6 x 960 GB SATA (Capacity)	-	●	-	-
	HX-ENCR-04	1 x 800 GB SAS (Cache), 1 x 240 GB SATA (Log), 6 x 3.8 TB SATA (Capacity)	-	●	-	●
	HX-ENCR-05	1 x 800 GB SAS (Cache), 1 x 240 GB SATA (Log), 11 x 3.8 TB SATA (Capacity)	-	-	-	●
	HX-ENCR-06	1 x 1.6 TB SAS (Cache), 1 x 240 GB SATA (Log), 15 x 1.2 TB SAS (Capacity)	-	-	●	-
	HX-ENCR-07	1 x 800 GB SAS (Cache), 1 x 240 GB SATA (Log), 11 x 960 GB SATA (Capacity)	-	-	-	●

Getting Started

What's New

Feature Story

Collaborate

Compute

UCS C-Series

HyperFlex

Nexus 9348

Intersight

Security

Connect

Switches

Wireless

Routers

Services





Overview

Positioning Map

Platform Spec

SmartPlay HyperFlex

Why HyperFlex?

Performance Matters

The Cisco HyperFlex's HX Data Platform (HXDP) is engineered to deploy mission-critical applications on hyperconverged infrastructure, providing simplified installation and management, reduced storage footprint, reduction in IOPS variability, reduced read/write latency, and lower TCO.

3 x

Higher Virtual Machine Density

3 x

Reduced Read/Write Latency

7:1

Reduction in IOPS Variability

Independent Resource Scaling

The Cisco HyperFlex Systems include a purpose-built, high-performance distributed file system that expands the boundaries of hyperconverged infrastructure. You can scale your environment simply by adding nodes to the configuration.

Unlike with any other hyperconverged product, you can choose to independently scale computing or storage capacity to meet the specific needs of your applications. Our predefined networking resources expand to incorporate the new nodes.

HDD SSD

Network CPU Memory

Network CPU Memory

Scale up with Cisco HyperFlex nodes  
Add storage

Scale out with Cisco HyperFlex nodes  
Add more nodes with computing and storage

Scale computing capacity  
with Cisco UCS blade and rack servers

Getting Started

What's New

Feature Story

Collaborate

Compute

UCS C-Series

HyperFlex

Nexus 9348

Intersight

Security

Connect

Switches

Wireless

Routers

Services



## ■ Gigabit Ethernet ToR Switch with Proven Performance and Density

The Cisco Nexus 9348GC-FXP Switch is a 1RU switch that supports 696 Gbps of bandwidth and over 250 mpps. The 48 1GBASE-T downlink ports on the switch can be configured to work as 100-Mbps, 1-Gbps ports. The 4 ports of SFP28 can be configured as 1/10/25-Gbps and the 2 ports of QSFP28 can be configured as 40- and 100-Gbps ports.

Cisco Nexus 9348GC-FXP Switch is designed to meet the changing needs of data centers, big data applications, and automated cloud environments.



### ■ Highlights

- Powered by Cisco Cloud Scale ASIC technology
- Support for Cisco NX OS Software and Cisco ACI (Application Centric Infrastructure) architecture
- High-performance, Layer 2 and 3 non-blocking architecture
- Easily deployed into either a hot-aisle or cold-aisle configuration
- Cisco Tetration Analytics Platform support with built-in hardware sensors for rich traffic flow telemetry and line-rate data collection
- Cisco Nexus Data Broker support for network traffic monitoring and analysis
- Robust hardware system specifications feature 4-core CPU, 24 GB of system memory, and respectively 128-GB SSD drive
- The 40-MB buffer supporting highly scalable data centers and big data applications
- 696 Gbps of bandwidth and over 250 mpps
- Fixed downlinks with 48 x FE/GE
- Fixed uplinks with 4 x 25GE SFP28, 2 x 100GE QSFP28

Getting Started

What's New

Feature Story

Collaborate

Compute

UCS C-Series

HyperFlex

Nexus 9348

Intersight

Security

Connect

Switches

Wireless

Routers

Services

Overview

Platform Spec

Licenses & Accessories

Cisco Nexus 9348GC-FXP Switch

Product SKU	System Buffer	Switching Capacity (Bandwidth)	Downlinks	Uplinks		Power Supply				Fan		Rack Mount
			FE/GE	SFP/ SFP+ / SFP28	QSFP+ / QSFP28	Default PS	Dual PS	Port Side Exhaust	Port Side Intake	Port Side Exhaust	Port Side Intake	
N9K-C9348GC-FXP	40 MB	696 Gbps	48	4	2	350 W AC	●	●	●	●	●	1 RU

Cisco Nexus 9348GC-FXP Switch Bundle

Product SKU	Bundle		
	Switch	QSFP+	QSFP28
N9K-C9348-FX-B14Q	2 x N9K-C9348GC-FXP	4 x QSFP-40G-SR-BD	-
N9K-C9348-FX-B24C	2 x N9K-C9348GC-FXP	-	4 x QSFP-100G-SR4-S or QSFP-100G-PSM4-S



Getting Started

What's New

Feature Story

Collaborate

Compute

UCS C-Series

HyperFlex

Nexus 9348

Intersight

Security

Connect

Switches

Wireless

Routers

Services

## Overview

## Platform Spec

## Licenses &amp; Accessories

## Cisco Nexus 9348GC-FXP Switch Licenses for ACI

Product SKU	Description
ACI-ES-GF	ACI Essentials License
ACI-AD-GF	ACI Advantage License
ACI-SEC-GF	Security License
ACI-STRG	Storage License

## Cisco Nexus 9348GC-FXP Switch Accessories

Product SKU	Description
NXK-ACC-KIT-2P	Fixed Accessory Kit with 2-Post Rack Mount Kit

## Cisco Nexus 9348GC-FXP Switch Licenses for NX-OS

Product SKU	Description
NXOS-ES-GF	NX-OS Essentials License
NXOS-AD-GF	NX-OS Advantage License
NXOS-SEC-GF	Security License
NXOS-STRG-GF	Storage License
NXOS-NDB	Nexus Data Broker License

Getting Started

What's New

Feature Story

Collaborate

Compute

UCS C-Series

HyperFlex

Nexus 9348

Intersight

Security

Connect

Switches

Wireless

Routers

Services

## Adaptive Computing with Cloud-Powered Intelligence

The Cisco Intersight delivers a new era of computing for Cisco UCS and HyperFlex systems. This adaptive, cloud-powered management platform enables you to be anywhere and act everywhere. It delivers pervasive simplicity at a global level with connected technical support, so daily activities are easier for everyone.

Intersight provides actionable intelligence based on insights gained from analytics and best practices to enable faster, proactive operations. Intersight is an open platform that will be integrated with Cisco and third party tools and infrastructure to enable agile delivery, so IT can empower the business to respond quickly to change.

### Highlights

#### Pervasive Simplicity

Use a GUI or API to meet the needs of your development teams.

Simplify the user experience with the capability to manage your infrastructure regardless of where it is installed.

#### Actionable Intelligence

Use best practices to enable faster, proactive operations.

Gain actionable insight for ongoing improvement and problem avoidance.

#### Agile Delivery

Respond quickly to new requests and manage the unpredictable.

Deploy edge clusters as quickly as you deploy virtual machines in your data center.

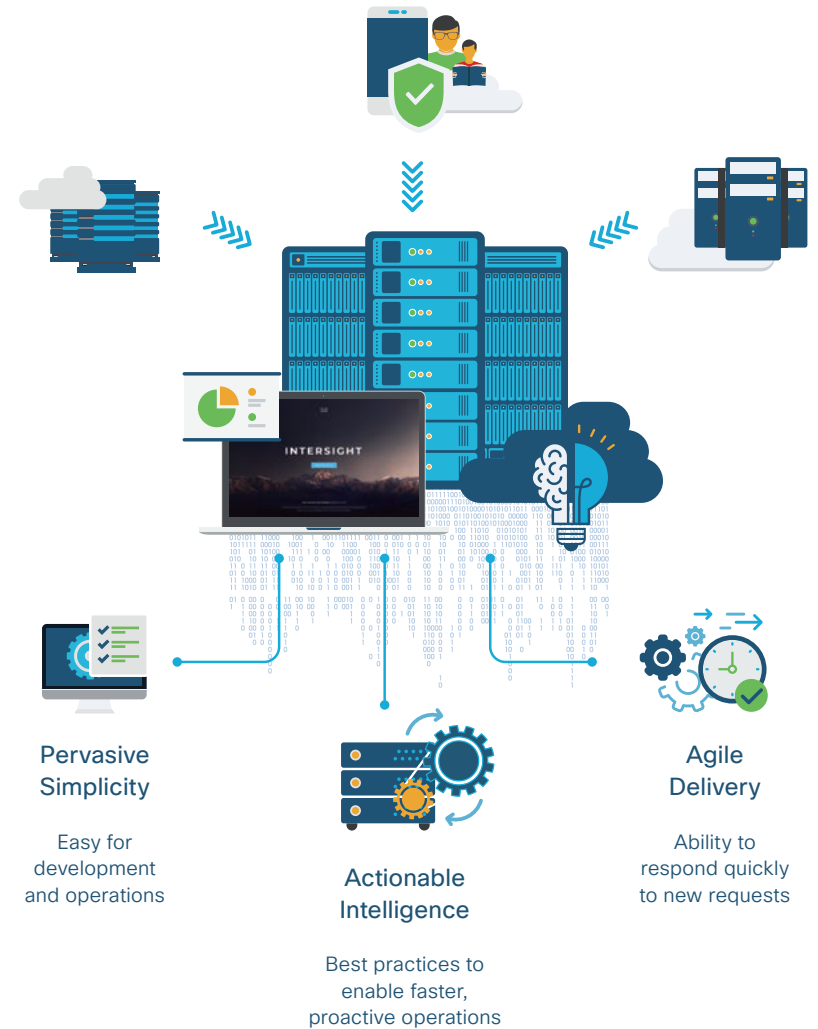

Getting Started

What's New

Feature Story

Collaborate

Compute

UCS C-Series

HyperFlex

Nexus 9348

Intersight

Security

Connect

Switches

Wireless

Routers

Services

### ■ Cisco Intersight Editions (Licenses)

The Cisco Intersight uses a subscription-based license with multiple editions. Customers can purchase a Subscription duration of one, three, or five years and choose the Cisco UCS server volume tier they need for the selected subscription duration.

Each Cisco UCS server or Cisco HyperFlex system automatically includes a Cisco Intersight Base edition at no additional cost when the customer accesses the Cisco Intersight portal and claims the device. In addition, customers can purchase the Cisco Intersight Essentials edition using the Cisco ordering tool.

#### ● Base

The Cisco Intersight Base offering is available at no cost to customers with platforms enabled to support Cisco Intersight. Enabled platforms are those Cisco UCS and Cisco HyperFlex systems with a Cisco Intersight device connector, including eligible Cisco UCS Manager, Cisco IMC, and Cisco HyperFlex software.

Cisco Intersight Base provides access to a portal that delivers centralized monitoring and basic inventory of managed systems, organizational capabilities including tagging and search, and the capability to launch native end-point management interfaces including Cisco UCS Manager.

#### ● Essentials

The Cisco Intersight Essentials offering builds on the functions provided in the Base edition. It includes centralized setup and configuration capabilities through a policy engine, firmware management, compliance tool integration, and other features.

Cisco Intersight Essentials enables customers to centralize configuration management through a unified policy engine, determine compliance with the Cisco UCS Hardware Compatibility List (HCL), and initiate firmware updates. The Essentials edition provides a single interface for monitoring, management, and operations, with the capability to launch the virtual keyboard, video, and mouse (vKVM) console directly from Cisco Intersight.

Editions	Base	Essentials
Product SKU <sup>*1</sup>	-	DC-MGT-SAAS-EST-C
Free version, supports Cisco UCS and HyperFlex	●	●
Global monitoring of health and inventory status	●	●
User customizable dashboard	●	●
Tagging and basic search	●	●
Context launch of element managers	●	●
Policy-based configuration with service profiles	-	●
Remote management and vKVM	-	●
Firmware management with scheduled updates	-	●
HCL compliance check and upgrade recommendations	-	●

\*1 DC-MGT-SAAS is required in CCW.

Getting Started

What's New

Feature Story

Collaborate

Compute

UCS C-Series

HyperFlex

Nexus 9348

Intersight

Security

Connect

Switches

Wireless

Routers

Services



Overview

Features & Licenses

Gallery

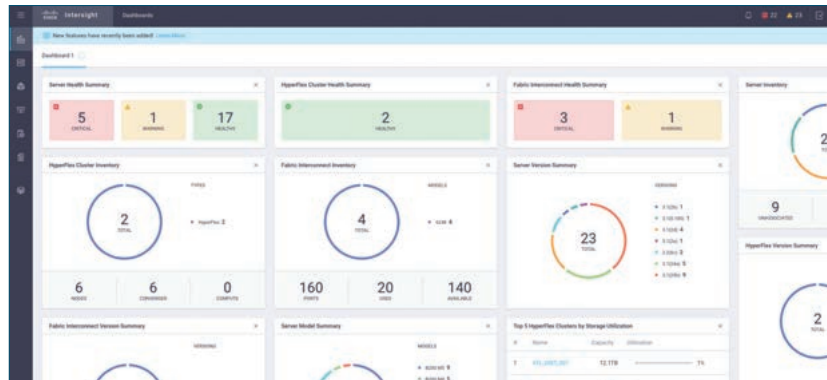

- Customizable dashboard to show overall faults/health/inventory for all managed infrastructure
- Can create unique dashboards for individual Intersight users
- Can add/remove widgets as desired
- Can move (drag and drop) widgets to desired positions
- Can click on various widgets for more detailed information

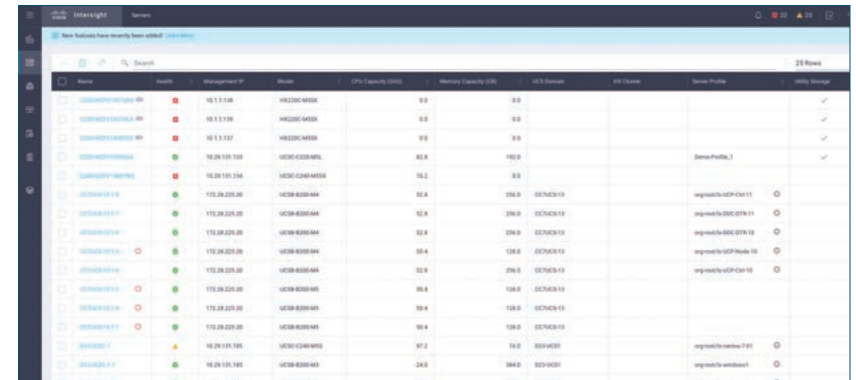

- Main server tab shows all servers managed by Cisco Intersight, and provides basic Health/Model/IP information
- Desired column details can be added/removed as user sees fit
- Clicking on any server name dials in to that server – detailed server overview/inventory information

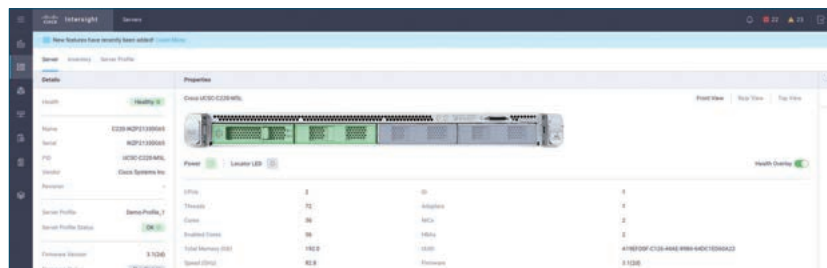

- Server name, model, serial number, and other basic properties are displayed
- Health overlay for front/back/top views can be turned on/off as needed
- Alarms/faults visible on right hand side
- Server actions available as well — IMC cross-launch, vKVM, power operations, tagging

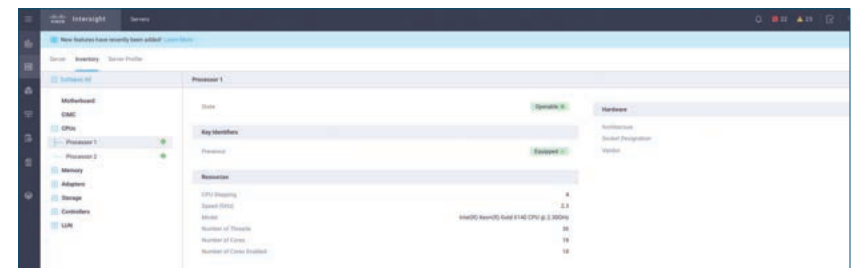

- Detailed information for all server peripherals — CPUs, memory, adapters, storage, etc.
- Can dial in to specific peripheral for additional component information
- Server actions tab available here as well

Getting Started

What's New

Feature Story

Collaborate

Compute

UCS C-Series

HyperFlex

Nexus 9348

Intersight

Security

Connect

Switches

Wireless

Routers

Services

Featured Products



# Cisco Meraki MX67/68 Cloud Managed Security Appliances

Comprehensive Security in a Single Box  
Secure a Site in Minutes, Right Out of the Box



## MX67-HW

450 Mbps FW Throughput	300 Mbps Adv. Security Throughput	200 Mbps VPN Throughput	50 VPN Peers	
Default AVC	Optional NGIPS	Optional AMP	Optional URL Filtering	
1-port GE-WAN	1-port GE-WAN/LAN	4-port GE-LAN	11ac Wave 2 AP	USB for 4G

## MX68CW-HW-WW

450 Mbps FW Throughput	300 Mbps Adv. Security Throughput	200 Mbps VPN Throughput	50 VPN Peers	
Default AVC	Optional NGIPS	Optional AMP	Optional URL Filtering	
2-port GE-WAN	8-port GE-LAN	2-port GE-LAN PoE+	11ac Wave 2 AP	300 Mbps Internal LTE Modem
				USB for 4G

Getting Started

What's New

Feature Story

Collaborate

Compute

Security

ASA 5500-X

Firepower 2100

AnyConnect

AMP for Endpoints

Umbrella

Meraki MX

Meraki Z

Meraki MV

Connect

Switches

Wireless

Routers

Services





Featured Products

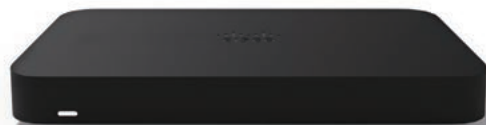

# Cisco Meraki Z Cloud Managed Teleworker Gateway

Comprehensive Security in a Single Box  
Secure a Site in Minutes, Right Out of the Box



 Z3C-HW-WW

100 Mbps FW Throughput	50 Mbps VPN Throughput	1-port GE-WAN	3-port GE-LAN	1-port GE-LAN PoE	11ac Wave 2 AP	100 Mbps Internal LTE Modem	USB for 4G	Optional Desk Stand
------------------------------	------------------------------	------------------	------------------	-------------------------	----------------------	-----------------------------------	---------------	------------------------

Getting Started

What's New

Feature Story

Collaborate

Compute

Security

ASA 5500-X

Firepower 2100

AnyConnect

AMP for Endpoints

Umbrella

Meraki MX

Meraki Z

Meraki MV

Connect

Switches

Wireless

Routers

Services



Featured Products



# Cisco Firepower 2100 Series

Gain Business Resiliency through Superior Security with Threat-Focused Next-Generation Firewall



## FPR2110-NGFW-K9

Dual Multicore CPU	2 Gbps FW + AVC Throughput	2 Gbps AVC + IPS Throughput	750 Mbps VPN Throughput	1,500 VPN Peers	Default AVC	Optional NGIPS	Optional AMP	Optional URL Filtering
12-port GE	4-port SFP	Firepower Device Manager						

Getting Started

What's New

Feature Story

Collaborate

Compute

Security

ASA 5500-X

Firepower 2100

AnyConnect

AMP for Endpoints

Umbrella

Meraki MX

Meraki Z

Meraki MV

Connect

Switches

Wireless

Routers

Services



Featured Products

Getting Started

What's New

Feature Story

Collaborate

Compute

Security

ASA 5500-X

Firepower 2100

AnyConnect

AMP for Endpoints

Umbrella

Meraki MX

Meraki Z

Meraki MV

Connect

Switches

Wireless

Routers

Services

# Cisco Advanced Malware Protection for Endpoints

Replace Your Legacy Anti-Virus with Next-Generation Endpoint Security



FP-AMP-LIC=

- Powered by Talos
- 1.6 million Global Sensors
- 1.5 million Samples per Day
- 100 TB Data per Day
- 13 Billion Web Requests
- 24-Hour Operations
- Windows
- macOS
- Linux Red Hat Enterprise
- Linux CentOS
- Android
- iOS





## Overview

## Positioning Map

## Platform Spec

## Licenses

## Bundles

## Superior Multilayered Protection

The Cisco ASA 5500-X Series is not only the world's most widely deployed, enterprise-class stateful firewall, but also the industry's first adaptive, threat-focused Next-Generation FireWall (NGFW). It provides comprehensive protection from known and advanced threats, including protection against targeted and persistent malware attacks.

With Cisco ASA, you consolidate multiple security layers in a single platform, eliminating the cost of buying and managing multiple solutions. This integrated approach combines best-in-class security technology with multilayer protection integrated in a single device that's less costly than piecemeal security solutions.



## Highlights

- Site-to-site and remote access VPN and advanced clustering provide highly secure, high-performance access and high availability to help ensure business continuity.
- Granular Application Visibility and Control (AVC) supports more than 3,000 application-layer and risk-based controls that can launch tailored intrusion prevention system (IPS) threat detection policies to optimize security effectiveness.
- The industry-leading Cisco Firepower Next-Generation IPS (NGIPS) provides highly effective threat prevention and full contextual awareness of users, infrastructure, applications, and content to detect multivector threats and automate defense response.
- Cisco Advanced Malware Protection (AMP) provides industry-leading breach detection effectiveness, sandboxing, a low total cost of ownership, and superior protection value that helps you discover, understand, and stop malware and emerging threats missed by other security layers.
- Reputation- and category-based URL Filtering offer comprehensive alerting and control over suspicious web traffic and enforce policies on hundreds of millions of URLs in more than 80 categories.

Getting Started

What's New

Feature Story

Collaborate

Compute

Security

ASA 5500-X

Firepower 2100

AnyConnect

AMP for Endpoints

Umbrella

Meraki MX

Meraki Z

Meraki MV

Connect

Switches

Wireless

Routers

Services



Overview

**Positioning Map**

Platform Spec

Licenses

Bundles



Getting Started

What's New

Feature Story

Collaborate

Compute

Security

ASA 5500-X

Firepower 2100

AnyConnect

AMP for Endpoints

Umbrella

Meraki MX

Meraki Z

Meraki MV

Connect

Switches

Wireless

Routers

Services



Overview

Positioning Map

Platform Spec

Licenses

Bundles

Product SKU	Service (CSE) SKU	Throughput			AVC Sessions		VPN Peers	GE Ports	11n Wireless AP	Power Supply	Fanless	Rack Mount
		FW AVC	FW AVC IPS	VPN	Concurrent Sessions	New Connections per Second						
ASA5506-FTD-K9	CON-SMBS-ASAK506F	250 Mbps	125 Mbps	100 Mbps	20,000	3,000	50	8	-	External	●	- <sup>*1</sup>
ASA5506W-x-FTD-K9	CON-SMBS-ASAxxxxW	250 Mbps	125 Mbps	100 Mbps	20,000	3,000	50	8	●	External	●	- <sup>*1</sup>
ASA5506H-FTD-K9	CON-SMBS-ASAD506H	250 Mbps	125 Mbps	100 Mbps	20,000	3,000	50	4	-	External	●	- <sup>*2</sup>
ASA5508-FTD-K9	CON-SMBS-ASD5508F	450 Mbps	250 Mbps	175 Mbps	100,000	7,000	100	8	-	External	-	1 RU
ASA5516-FTD-K9	CON-SMBS-ASA5K16F	850 Mbps	450 Mbps	250 Mbps	250,000	8,000	300	8	-	External	-	1 RU

\*1 Rack Mount Kit (ASA5506-RACK-MNT=) is required. Optional Wall Mount Kit (ASA5506-WALL-MNT=) is available.

\*2 Rack Mount Kit (ASA5506-RACK-MNT=) is required. Optional Wall Mount Kit (ASA5506-WALL-MNT=) and DIN Rail Mount Kit (ASA5506H-DIN-MNT=) are available.

Getting Started

What's New

Feature Story

Collaborate

Compute

Security

ASA 5500-X

Firepower 2100

AnyConnect

AMP for Endpoints

Umbrella

Meraki MX

Meraki Z

Meraki MV

Connect

Switches

Wireless

Routers

Services





**Cisco Firepower Threat Defense Software Image & Licenses**

The Cisco ASA 5500-X Series ships with the Cisco Firepower Threat Defense software image. It includes Application Visibility and Control (AVC), and optional Next-Generation IPS (NGIPS), Cisco Advanced Malware Protection (AMP) for Networks, and URL Filtering.

● **Application Visibility and Control (AVC)**

Supports more than 3,000 application-layer and risk-based controls that can launch tailored intrusion prevention system (IPS) threat detection policies to optimize security effectiveness.

One-year, 3-year, and 5-year subscriptions below are available.

● **Next-Generation IPS (NGIPS)**

Provides highly effective threat prevention and full contextual awareness of users, infrastructure, applications, and content to detect multivector threats and automate defense response. The NGIPS licenses can be added alone to the base licenses, or bundled with AMP, or with AMP and URL licenses.

● **Cisco Advanced Malware Protection (AMP) for Networks**

Delivers inline network protection against sophisticated malware and Cisco Threat Grid sandboxing. The AMP licenses can be added alone to the base licenses, or bundled with NGIPS, or with NGIPS and URL licenses.

● **URL Filtering (URL)**

Adds the capability to filter more than 280 million top-level domains by risk level and more than 82 categories. The URL licenses can be added alone to the base licenses, or bundled with NGIPS, or with NGIPS and AMP licenses.

**Cisco Firepower Threat Defense License Comparison**

Licenses	Characters Included in Product SKU	Next-Generation IPS (NGIPS)	Advanced Malware Protection (AMP)	URL Filtering (URL)
NGIPS License	T	●	-	-
AMP License	AMP	-	●	-
URL License	URL	-	-	●
NGIPS & AMP License	TM	●	●	-
NGIPS & URL License	TC	●	-	●
NGIPS & AMP & URL License	TMC	●	●	●

Getting Started

What's New

Feature Story

Collaborate

Compute

Security

ASA 5500-X

Firepower 2100

AnyConnect

AMP for Endpoints

Umbrella

Meraki MX

Meraki Z

Meraki MV

Connect

Switches

Wireless

Routers

Services



## Cisco Firepower Threat Defense NGIPS Licenses for Cisco ASA 5500-X Series

Product SKU <sup>*1</sup>			Compatible Models
1-Year	3-Years	5-Years	
L-ASA5506T-T-1Y	L-ASA5506T-T-3Y	L-ASA5506T-T-5Y	ASA 5506
L-ASA5506WT-T-1Y	L-ASA5506WT-T-3Y	L-ASA5506WT-T-5Y	ASA 5506W
L-ASA5506HT-T-1Y	L-ASA5506HT-T-3Y	L-ASA5506HT-T-5Y	ASA 5506H
L-ASA5508T-T-1Y	L-ASA5508T-T-3Y	L-ASA5508T-T-5Y	ASA 5508
L-ASA5516T-T-1Y	L-ASA5516T-T-3Y	L-ASA5516T-T-5Y	ASA 5516

\*1 L-ASAxxxxT-T= is required in CCW. See [Ordering Guide](#) for details.  
(The "xxxx" corresponds to the supported models.)

## Cisco Firepower Threat Defense AMP Licenses for Cisco ASA 5500-X Series

Product SKU <sup>*1</sup>			Compatible Models
1-Year	3-Years	5-Years	
L-ASA5506T-AMP-1Y	L-ASA5506T-AMP-3Y	L-ASA5506T-AMP-5Y	ASA 5506
L-ASA5506WT-AMP-1Y	L-ASA5506WT-AMP-3Y	L-ASA5506WT-AMP-5Y	ASA 5506W
L-ASA5506HT-AMP-1Y	L-ASA5506HT-AMP-3Y	L-ASA5506HT-AMP-5Y	ASA 5506H
L-ASA5508T-AMP-1Y	L-ASA5508T-AMP-3Y	L-ASA5508T-AMP-5Y	ASA 5508
L-ASA5516T-AMP-1Y	L-ASA5516T-AMP-3Y	L-ASA5516T-AMP-5Y	ASA 5516

\*1 L-ASAxxxxT-AMP= is required in CCW. See [Ordering Guide](#) for details.  
(The "xxxx" corresponds to the supported models.)

## Cisco Firepower Threat Defense URL Licenses for Cisco ASA 5500-X Series

Product SKU <sup>*1</sup>			Compatible Models
1-Year	3-Years	5-Years	
L-ASA5506T-URL-1Y	L-ASA5506T-URL-3Y	L-ASA5506T-URL-5Y	ASA 5506
L-ASA5506WT-URL-1Y	L-ASA5506WT-URL-3Y	L-ASA5506WT-URL-5Y	ASA 5506W
L-ASA5506HT-URL-1Y	L-ASA5506HT-URL-3Y	L-ASA5506HT-URL-5Y	ASA 5506H
L-ASA5508T-URL-1Y	L-ASA5508T-URL-3Y	L-ASA5508T-URL-5Y	ASA 5508
L-ASA5516T-URL-1Y	L-ASA5516T-URL-3Y	L-ASA5516T-URL-5Y	ASA 5516

\*1 L-ASAxxxxT-URL= is required in CCW. See [Ordering Guide](#) for details.  
(The "xxxx" corresponds to the supported models.)

Getting Started

What's New

Feature Story

Collaborate

Compute

Security

ASA 5500-X

Firepower 2100

AnyConnect

AMP for Endpoints

Umbrella

Meraki MX

Meraki Z

Meraki MV

Connect

Switches

Wireless

Routers

Services





## Cisco Firepower Threat Defense NGIPS &amp; AMP Licenses for Cisco ASA 5500-X Series

Product SKU <sup>*1</sup>			Compatible Models
1-Year	3-Years	5-Years	
L-ASA5506T-TM-1Y	L-ASA5506T-TM-3Y	L-ASA5506T-TM-5Y	ASA 5506
L-ASA5506WT-TM-1Y	L-ASA5506WT-TM-3Y	L-ASA5506WT-TM-5Y	ASA 5506W
L-ASA5506HT-TM-1Y	L-ASA5506HT-TM-3Y	L-ASA5506HT-TM-5Y	ASA 5506H
L-ASA5508T-TM-1Y	L-ASA5508T-TM-3Y	L-ASA5508T-TM-5Y	ASA 5508
L-ASA5516T-TM-1Y	L-ASA5516T-TM-3Y	L-ASA5516T-TM-5Y	ASA 5516

\*1 L-ASAxxxxT-TM= is required in CCW. See [Ordering Guide](#) for details.  
(The "xxxx" corresponds to the supported models.)

## Cisco Firepower Threat Defense NGIPS &amp; URL Licenses for Cisco ASA 5500-X Series

Product SKU <sup>*1</sup>			Compatible Models
1-Year	3-Years	5-Years	
L-ASA5506T-TC-1Y	L-ASA5506T-TC-3Y	L-ASA5506T-TC-5Y	ASA 5506
L-ASA5506WT-TC-1Y	L-ASA5506WT-TC-3Y	L-ASA5506WT-TC-5Y	ASA 5506W
L-ASA5506HT-TC-1Y	L-ASA5506HT-TC-3Y	L-ASA5506HT-TC-5Y	ASA 5506H
L-ASA5508T-TC-1Y	L-ASA5508T-TC-3Y	L-ASA5508T-TC-5Y	ASA 5508
L-ASA5516T-TC-1Y	L-ASA5516T-TC-3Y	L-ASA5516T-TC-5Y	ASA 5516

\*1 L-ASAxxxxT-TC= is required in CCW. See [Ordering Guide](#) for details.  
(The "xxxx" corresponds to the supported models.)

## Cisco Firepower Threat Defense NGIPS &amp; AMP &amp; URL Licenses for Cisco ASA 5500-X Series

Product SKU <sup>*1</sup>			Compatible Models
1-Year	3-Years	5-Years	
L-ASA5506T-TMC-1Y	L-ASA5506T-TMC-3Y	L-ASA5506T-TMC-5Y	ASA 5506
L-ASA5506WT-TMC-1Y	L-ASA5506WT-TMC-3Y	L-ASA5506WT-TMC-5Y	ASA 5506W
L-ASA5506HT-TMC-1Y	L-ASA5506HT-TMC-3Y	L-ASA5506HT-TMC-5Y	ASA 5506H
L-ASA5508T-TMC-1Y	L-ASA5508T-TMC-3Y	L-ASA5508T-TMC-5Y	ASA 5508
L-ASA5516T-TMC-1Y	L-ASA5516T-TMC-3Y	L-ASA5516T-TMC-5Y	ASA 5516

\*1 L-ASAxxxxT-TMC= is required in CCW. See [Ordering Guide](#) for details.  
(The "xxxx" corresponds to the supported models.)

Getting Started

What's New

Feature Story

Collaborate

Compute

Security

ASA 5500-X

Firepower 2100

AnyConnect

AMP for Endpoints

Umbrella

Meraki MX

Meraki Z

Meraki MV

Connect

Switches

Wireless

Routers

Services



## Overview

## Positioning Map

## Platform Spec

## Licenses

## Bundles

## Cisco ASA 5500-X Series Bundles

1. Select the bundle SKU for the desired appliance model.
2. Next select the matching software licensing subscription SKU.

	ASA5506-FTD-BUN	ASA5506W-FTD-BUN	ASA5506H-FTD-BUN	ASA5508-FTD-BUN	ASA5516-FTD-BUN
ASA 5500-X Series with Firepower Threat Defense	ASA5506-FTD-K9	ASA5506H-FTD-K9	ASA5506W-x-FTD-K9	ASA5508-FTD-K9	ASA5516-FTD-K9
Firepower Threat Defense NGIPS License	L-ASA5506T-T=	L-ASA5506HT-T=	L-ASA5506WT-T=	L-ASA5508T-T=	L-ASA5516T-T=
Firepower Threat Defense AMP License	L-ASA5506T-AMP=	L-ASA5506HT-AMP=	L-ASA5506WT-AMP=	L-ASA5508T-AMP=	L-ASA5516T-AMP=
Firepower Threat Defense URL License	L-ASA5506T-URL=	L-ASA5506HT-URL=	L-ASA5506WT-URL=	L-ASA5508T-URL=	L-ASA5516T-URL=
Firepower Threat Defense NGIPS & AMP License	L-ASA5506T-TM=	L-ASA5506HT-TM=	L-ASA5506WT-TM=	L-ASA5508T-TM=	L-ASA5516T-TM=
Firepower Threat Defense NGIPS & URL License	L-ASA5506T-TC=	L-ASA5506HT-TC=	L-ASA5506WT-TC=	L-ASA5508T-TC=	L-ASA5516T-TC=
Firepower Threat Defense NGIPS & AMP & URL License	L-ASA5506T-TMC=	L-ASA5506HT-TMC=	L-ASA5506WT-TMC=	L-ASA5508T-TMC=	L-ASA5516T-TMC=

Getting Started

What's New

Feature Story

Collaborate

Compute

Security

ASA 5500-X

Firepower 2100

AnyConnect

AMP for Endpoints

Umbrella

Meraki MX

Meraki Z

Meraki MV

Connect

Switches

Wireless

Routers

Services

## Overview

## Positioning Map

## Platform Spec

## Licenses

## Business Resiliency through Superior Threat Defense

The Cisco Firepower 2100 Series is the industry's first fully integrated, threat-focused Next-Generation Firewall (NGFW) with unified management. It delivers business resiliency through superior security with sustained performance—provides sustained network performance when threat inspection features are activated to keep your business running securely. And It is now simpler to manage for improved IT efficiency and a lower total cost of ownership.

The Firepower 2100 NGFWs sustain its throughput performance as threat services are added. They do this by uniquely incorporating an innovative dual multi-core CPU architecture that optimizes firewall, cryptographic, and threat inspection functions simultaneously. They won't become a network bottleneck or lose effectiveness like competitors when threat inspection is turned on. Now, achieving security doesn't come at the expense of network performance.



### Highlights

- **Stop more threats:** Contain known and unknown malware with leading Cisco AMP and sandboxing.
- **Gain more insight:** Gain superior visibility into your environment with Cisco Firepower NGIPS. Automated risk rankings and impact flags identify priorities for your team.
- **Detect earlier, act faster:** The Cisco Annual Security Report identifies a 100-day median time from infection to detection, across enterprises. Cisco reduces this time to less than a day.
- **Reduce complexity:** Get unified management and automated threat correlation across tightly integrated security functions, including application firewalling, NGIPS, and AMP.
- **Get more from your network:** Enhance security, and take advantage of your existing investments, with optional integration of other Cisco and third-party networking and security solutions.

Getting Started

What's New

Feature Story

Collaborate

Compute

Security

ASA 5500-X

Firepower 2100

AnyConnect

AMP for Endpoints

Umbrella

Meraki MX

Meraki Z

Meraki MV

Connect

Switches

Wireless

Routers

Services



Overview

**Positioning Map**

Platform Spec

Licenses

Getting Started

What's New

Feature Story

Collaborate

Compute

**Security**

ASA 5500-X

**Firepower 2100**

AnyConnect

AMP for Endpoints

Umbrella

Meraki MX

Meraki Z

Meraki MV

Connect

Switches

Wireless

Routers

Services

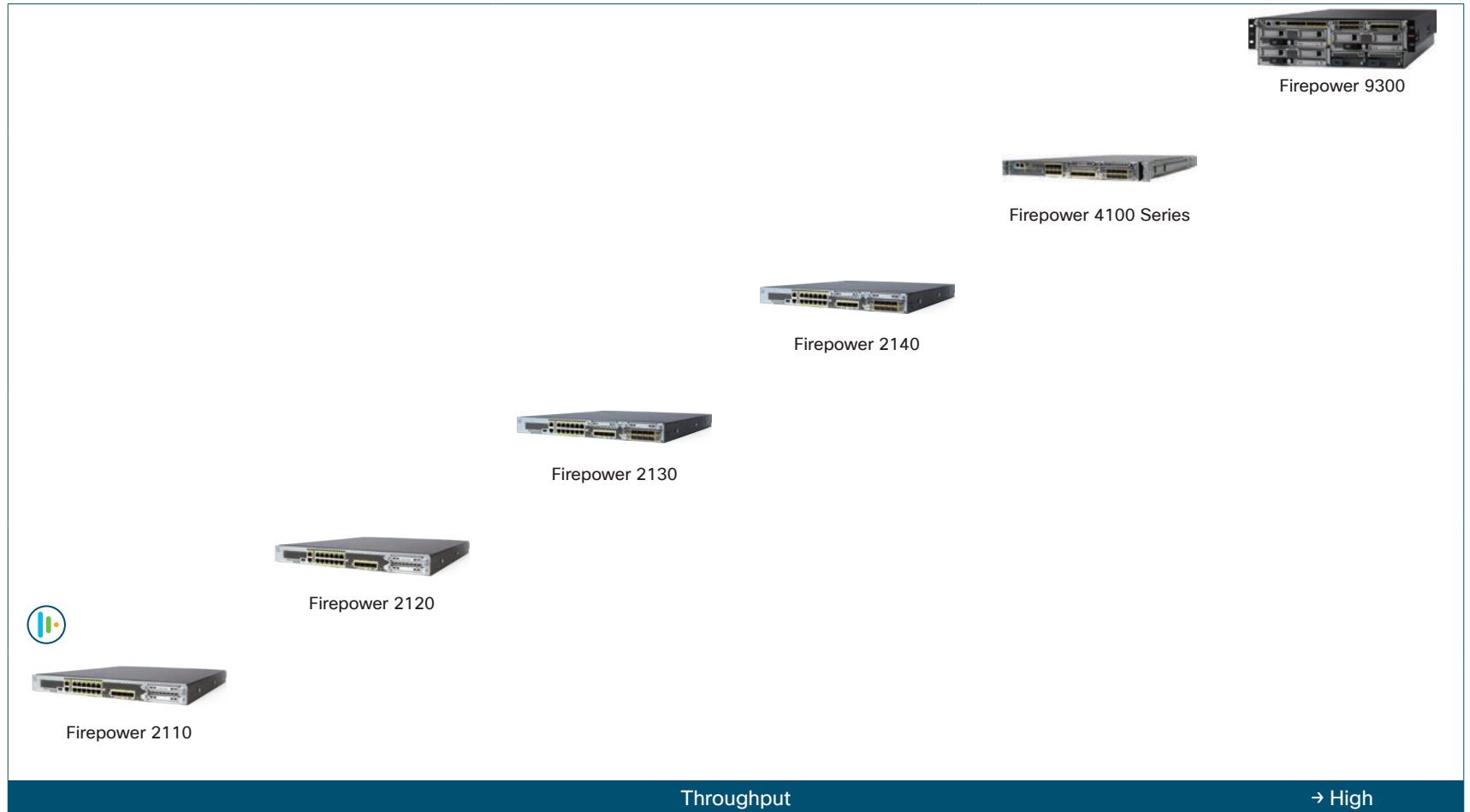

Firepower 9300



Firepower 4100 Series



Firepower 2140



Firepower 2130



Firepower 2120



Firepower 2110



Overview

Positioning Map

Platform Spec

Licenses

Cisco Firepower 2110 Firepower Threat Defense (FTD) Software Image

Product SKU*1	Service (CSE) SKU	Throughput			AVC Sessions		VPN Peers	Ports		Power Supply	Rack Mount
		FW AVC	FW AVC IPS	VPN	Concurrent Sessions	New Connections per Second		GE	SFP		
FPR2110-NGFW-K9	-	2 Gbps	2 Gbps	250 Mbps	1,000,000	12,000	1,500	12	4	Internal	1 RU

\*1 FPR2110-BUN is recommended in CCW.

Cisco Firepower 2110 Adaptive Security Appliance (ASA) Software Image

Product SKU*1	Service (CSE) SKU	Throughput			FW Sessions		VPN Peers	Ports		Power Supply	Rack Mount
		FW	FW AVC IPS	VPN	Concurrent Sessions	New Connections per Second		GE	SFP		
FPR2110-ASA-K9	-	3 Gbps	-	500 Mbps	1,000,000	18,000	1,500	12	4	Internal	1 RU

\*1 FPR2110-BUN is recommended in CCW.



Getting Started

What's New

Feature Story

Collaborate

Compute

Security

ASA 5500-X

Firepower 2100

AnyConnect

AMP for Endpoints

Umbrella

Meraki MX

Meraki Z

Meraki MV

Connect

Switches

Wireless

Routers

Services



## Overview

## Positioning Map

## Platform Spec

## Licenses

## Cisco Firepower Threat Defense NGIPS Licenses for Cisco Firepower 2110

Product SKU <sup>*1</sup>			Compatible Models
1-Year	3-Years	5-Years	
L-FPR2110T-T-1Y	L-FPR2110T-T-3Y	L-FPR2110T-T-5Y	Firepower 2110 FTD

\*1 L-FPR2110T-T= is required, FPR2110-BUN is recommended, in CCW. See [Ordering Guide](#) for details.

## Cisco Firepower Threat Defense AMP Licenses for Cisco Firepower 2110

Product SKU <sup>*1</sup>			Compatible Models
1-Year	3-Years	5-Years	
L-FPR2110T-AMP-1Y	L-FPR2110T-AMP-3Y	L-FPR2110T-AMP-5Y	Firepower 2110 FTD

\*1 L-FPR2110T-T= is required, FPR2110-BUN is recommended, in CCW. See [Ordering Guide](#) for details.

## Cisco Firepower Threat Defense URL Licenses for Cisco Firepower 2110

Product SKU <sup>*1</sup>			Compatible Models
1-Year	3-Years	5-Years	
L-FPR2110T-URL-1Y	L-FPR2110T-URL-3Y	L-FPR2110T-URL-5Y	Firepower 2110 FTD

\*1 L-FPR2110T-T= is required, FPR2110-BUN is recommended, in CCW. See [Ordering Guide](#) for details.

## Cisco Firepower Threat Defense NGIPS &amp; AMP Licenses for Cisco Firepower 2110

Product SKU <sup>*1</sup>			Compatible Models
1-Year	3-Years	5-Years	
L-FPR2110T-TM-1Y	L-FPR2110T-TM-3Y	L-FPR2110T-TM-5Y	Firepower 2110 FTD

\*1 L-FPR2110T-T= is required, FPR2110-BUN is recommended, in CCW. See [Ordering Guide](#) for details.

## Cisco Firepower Threat Defense NGIPS &amp; URL Licenses for Cisco Firepower 2110

Product SKU <sup>*1</sup>			Compatible Models
1-Year	3-Years	5-Years	
L-FPR2110T-TC-1Y	L-FPR2110T-TC-3Y	L-FPR2110T-TC-5Y	Firepower 2110 FTD

\*1 L-FPR2110T-T= is required, FPR2110-BUN is recommended, in CCW. See [Ordering Guide](#) for details.

## Cisco Firepower Threat Defense NGIPS &amp; AMP &amp; URL Licenses for Cisco Firepower 2110

Product SKU <sup>*1</sup>			Compatible Models
1-Year	3-Years	5-Years	
L-FPR2110T-TMC-1Y	L-FPR2110T-TMC-3Y	L-FPR2110T-TMC-5Y	Firepower 2110 FTD

\*1 L-FPR2110T-T= is required, FPR2110-BUN is recommended, in CCW. See [Ordering Guide](#) for details.

Getting Started

What's New

Feature Story

Collaborate

Compute

Security

ASA 5500-X

Firepower 2100

AnyConnect

AMP for Endpoints

Umbrella

Meraki MX

Meraki Z

Meraki MV

Connect

Switches

Wireless

Routers

Services

Overview

Features

Licenses

Easy to Use, Highly Secure, Much More than a VPN

The industry-leading Cisco AnyConnect Secure Mobility Client is a modular endpoint software product. It not only provides VPN access through Secure Sockets Layer (SSL) and IPsec IKEv2 but also offers enhanced security through various built-in modules. These modules provide services such as compliance through the VPN with Cisco ASA or through wired, wireless, and VPN with Cisco Identity Services Engine (ISE), web security along side Cisco Cloud Web Security (CWS), network visibility into endpoint flows within Cisco Stealthwatch, or off-network roaming protection with Cisco Umbrella.

Cisco AnyConnect clients are available across a broad set of platforms, including Windows, macOS, Linux, iOS, Android, Windows Phone/Mobile, BlackBerry, and ChromeOS.



AnyConnect Features



Integration with Other Cisco Solutions



ASA

ISR/RV

ASR/CSR

ISE

CWS/WSA

Catalyst/WC

NetFlow Collectors

AMP

Umbrella

Getting Started

What's New

Feature Story

Collaborate

Compute

Security

ASA 5500-X

Firepower 2100

AnyConnect

AMP for Endpoints

Umbrella

Meraki MX

Meraki Z

Meraki MV

Connect

Switches

Wireless

Routers

Services



## Overview

## Features

## Licenses

Feature	Description
<b>Unified Endpoint Compliance</b>	The Cisco AnyConnect ISE Posture Module in Cisco ISE deployments provides unified endpoint posture checks and automated remediation across wired, wireless, and VPN environments. This module serves as the main source of endpoint posture checking for OS levels, latest antivirus/spyware/malware updates, application and hardware inventory and other endpoint checks to determine compliance state and strengthen endpoint security. For VPN only environments, the Cisco ASA provides endpoint posture using Cisco AnyConnect Hostscan Module.
<b>Highly Secure Network Access</b>	The Cisco AnyConnect Network Access Manager provides superior connectivity features. Administrators can control which networks or resources for endpoints to connect. It provides an IEEE 802.1X supplicant that can be provisioned as part of authentication, authorization, and accounting (AAA) capabilities along with some unique encryption technologies such as MACsec IEEE 802.1AE.
<b>Web Security</b>	A built-in Cisco AnyConnect module implements web security either through the on-premise Cisco Web Security Appliance (WSA) or the cloud-based Cisco Cloud Web Security (CWS) offering. Combining web security with VPN access, administrators can provide comprehensive, highly secure mobility to all end users, which is vital for bring-your-own-device (BYOD) deployments. Enterprises have a choice of deployments to defend the network against web malware and to control and safeguard web usage.
<b>Network Visibility</b>	The Cisco AnyConnect Network Visibility Module on Windows, macOS, Linux, and Samsung Knox-enabled devices gives administrators the ability to monitor endpoint application usage to uncover potential behavior anomalies and to make more informed network design decisions. Usage data can be shared with NetFlow analysis tools such as Cisco Stealthwatch.
<b>Off-Network Protection (DNS-Layer Security)</b>	Cisco Umbrella Roaming is a cloud-delivered security service that protects devices when they are off the corporate network. Whether users turn off the VPN or forget to turn it on, Umbrella Roaming enforces security at the DNS layer to protect against malware, phishing, and command-and-control callbacks over any port or protocol.
<b>Mobile Device Support</b>	Administrators need to support end-user productivity by providing personal mobile devices with remote access to the company network. Cisco AnyConnect services can be deployed on the most popular devices used by today's diverse workforce. Highly secure remote access can either be device-based or through select per-application VPN, which eliminates unapproved applications from accessing confidential business resources further reducing malware intrusion risks and bandwidth costs for remote access.
<b>Servers and Platforms</b>	Cisco AnyConnect services are used in conjunction with numerous Cisco head server platforms, including but not limited to the Cisco ASA (physical and virtual), Cisco Firepower Next-Generation Firewalls (physical and virtual/ASA and FTD operating systems), Cisco Identity Services Engine (ISE), Cisco Aggregation Services Routers (ASR), Cisco Cloud Web Security (CWS), and Cisco IOS software on Cisco ISR. Headend termination devices and cloud services, along with the associated service costs and support contracts, are purchased separately.

Getting Started

What's New

Feature Story

Collaborate

Compute

Security

ASA 5500-X

Firepower 2100

AnyConnect

AMP for Endpoints

Umbrella

Meraki MX

Meraki Z

Meraki MV

Connect

Switches

Wireless

Routers

Services

## Overview

## Features

## Licenses

### Cisco AnyConnect Licenses

The Cisco AnyConnect offers simplified licensing to meet the needs of the broad enterprise IT community as it adapts to growing end-user mobility demands. The current AnyConnect 4.x collapses the formerly complex AnyConnect licensing model into two simple tiers: the first is AnyConnect Plus and the second is AnyConnect Apex.

#### ● Cisco AnyConnect Plus License

Includes basic VPN services such as device and per-application VPN (including third-party IKEv2 remote access VPN headend support), trusted network detection, basic device context collection, and Federal Information Processing Standards (FIPS) compliance. AnyConnect Plus also includes other non-VPN services such as the AnyConnect Network Access Manager 802.1X supplicant, the Cisco Cloud Web Security (CWS) module, and the Cisco Umbrella Roaming module. Existing AnyConnect customers should think of AnyConnect Plus as similar to the previous AnyConnect Essentials.

#### ● Cisco AnyConnect Apex License

Includes more advanced services such as endpoint posture checks (Host-scan through ASA VPN, or ISE Posture through the Cisco Identity Services Engine), network visibility, next-generation VPN encryption (including Suite B), and clientless remote access VPN as well as all the capabilities of AnyConnect Plus. Existing AnyConnect customers should think of AnyConnect Apex as similar to previous AnyConnect Premium and Premium Shared Licenses.

AnyConnect Plus and Apex licenses offer a set of features and deployment flexibility to meet a wide range of your enterprise's requirements. For enterprises that want only AnyConnect for remote access use cases, there is also the Cisco AnyConnect VPN Only License.

### Cisco AnyConnect Plus & Apex License Comparison

	Plus	Apex
Device or System VPN (Including Cisco Phone VPN)	●	●
Third-Party IPsec IKEv2 Remote Access VPN Clients (Non-AnyConnect Client)	●	●
Per-Application VPN	●	●
Cloud Web Security and Web Security Appliance	●	●
Cisco Umbrella Roaming <sup>*1</sup>	●	●
Network Access Manager	●	●
AMP for Endpoints Enabler <sup>*2</sup>	●	●
Network Visibility Module	-	●
Unified Endpoint Compliance and Remediation (Posture) <sup>*3</sup>	-	●
Suite B or Next-Generation Encryption (Including Third-Party IPsec IKEv2 Remote VPN Clients)	-	●
Clientless (Browser-based) VPN Connectivity	-	●
ASA Multicontext-mode Remote Access	-	●
SAML authentication <sup>*4</sup>	-	●

<sup>\*1</sup> Cisco Umbrella Roaming License is required.

<sup>\*2</sup> Cisco AMP for Endpoints License is required.

<sup>\*3</sup> Cisco ISE Apex License is required.

<sup>\*4</sup> Cisco ASA 9.7.1 or later is required.

Getting Started

What's New

Feature Story

Collaborate

Compute

Security

ASA 5500-X

Firepower 2100

AnyConnect

AMP for Endpoints

Umbrella

Meraki MX

Meraki Z

Meraki MV

Connect

Switches

Wireless

Routers

Services

## Overview

## Features

## Licenses

## Cisco AnyConnect Plus Licenses

Product SKU <sup>*1 *2</sup>			User Range
1-Year	3-Years	5-Years	
L-AC-PLS-1Y-S1	L-AC-PLS-3Y-S1	L-AC-PLS-5Y-S1	25 to 99
L-AC-PLS-1Y-S2	L-AC-PLS-3Y-S2	L-AC-PLS-5Y-S2	100 to 249
L-AC-PLS-1Y-S3	L-AC-PLS-3Y-S3	L-AC-PLS-5Y-S3	250 to 499

\*1 See [Ordering Guide](#) for a full list of SKUs supporting over 500 users.

\*2 L-AC-PLS-LIC= is required in CCW. See [Ordering Guide](#) for details.

Product SKU <sup>*1 *2</sup>	Users
Perpetual	
AC-PLS-P-25-S	25
AC-PLS-P-50-S	50
AC-PLS-P-100-S	100
AC-PLS-P-250-S	250
AC-PLS-P-500-S	500

\*\*1 See [Ordering Guide](#) for a full list of SKUs supporting over 500 users.

\*2 L-AC-PLS-P-G is required in CCW. See [Ordering Guide](#) for details.

## Cisco AnyConnect Apex Licenses

Product SKU <sup>*1 *2</sup>			User Range
1-Year	3-Years	5-Years	
L-AC-APX-1Y-S1	L-AC-APX-3Y-S1	L-AC-APX-5Y-S1	25 to 99
L-AC-APX-1Y-S2	L-AC-APX-3Y-S2	L-AC-APX-5Y-S2	100 to 249
L-AC-APX-1Y-S3	L-AC-APX-3Y-S3	L-AC-APX-5Y-S3	250 to 499

\*1 See [Ordering Guide](#) for a full list of SKUs supporting over 500 users.

\*2 L-AC-APX-LIC= is required in CCW. See [Ordering Guide](#) for details.

## Cisco AnyConnect VPN Only Licenses

Product SKU <sup>*1 *2</sup>	Simultaneous Connections
Perpetual	
L-AC-VPNO-25=	25
L-AC-VPNO-50=	50
L-AC-VPNO-100=	100
L-AC-VPNO-250=	250
L-AC-VPNO-500=	500

\*1 See [Ordering Guide](#) for a full list of SKUs supporting over 500 users.

Getting Started

What's New

Feature Story

Collaborate

Compute

Security

ASA 5500-X

Firepower 2100

AnyConnect

AMP for Endpoints

Umbrella

Meraki MX

Meraki Z

Meraki MV

Connect

Switches

Wireless

Routers

Services



## Overview

## Licenses

## AMP Everwhere

## Cloud-Managed Next-Generation Endpoint Security

The Cisco Advanced Malware Protection (AMP) for Endpoints is a cloud-managed endpoint security solution that provides the visibility, context, and control to prevent breaches, but also rapidly detect, contain, and remediate threats if they evade front-line defenses and get inside, all cost-effectively and without affecting operational efficiency.

- **Prevent:** Strengthen defenses using the best global threat intelligence and block malware in real time
- **Detect:** Continuously monitor and record all file activity to quickly detect stealthy malware
- **Respond:** Accelerate investigations and automatically remediate malware across PCs, Macs, Linux, servers and mobile devices (Android and iOS)

## Threat Intelligence and Dynamic Malware Analysis

The Cisco AMP is built on an extensive collection of real-time threat intelligence and dynamic malware analytics supplied by the Cisco Talos Security Intelligence Group, and Cisco Threat Grid intelligence feeds.

Organizations benefit from:

- 1.5 million incoming malware samples per day
- 1.6 million global sensors
- 100 terabytes of data per day
- 13 billion web requests
- Team of engineers, technicians, and researchers
- 24-hour operations

Cisco AMP for Endpoints is managed through an easy-to-use, web-based console. It is deployed through AMP's lightweight endpoint connector, with no performance impact on users. Analysis is done in the cloud, not on the endpoint. The solution is offered as a subscription on endpoints, including coverage for Windows, Macs, Linux, servers and mobile devices (Android and iOS).

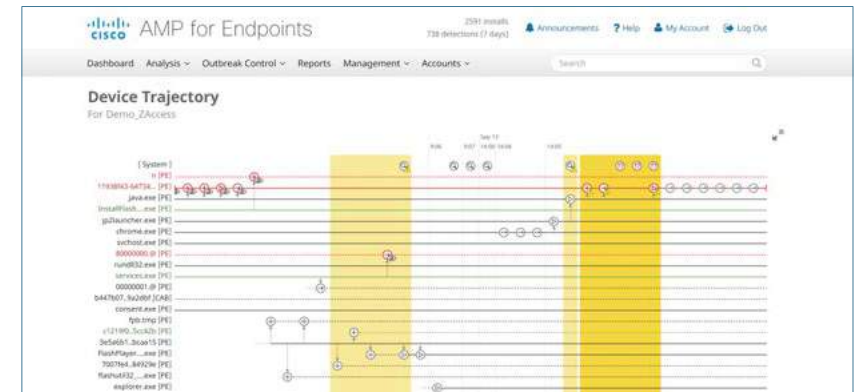

Managed through an easy-to-use, web-based console



Visibility

Context

Control

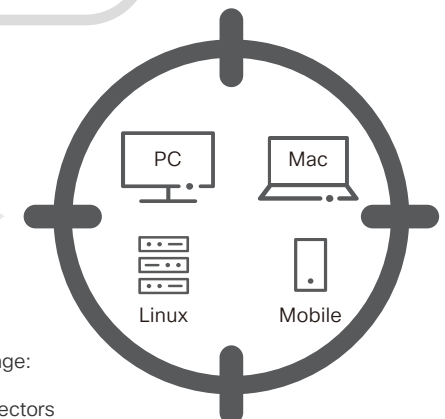

Broad Endpoint Coverage:  
Lightweight  
AMP for Endpoints Connectors

Getting Started

What's New

Feature Story

Collaborate

Compute

Security

ASA 5500-X

Firepower 2100

AnyConnect

AMP for Endpoints

Umbrella

Meraki MX

Meraki Z

Meraki MV

Connect

Switches

Wireless

Routers

Services



Overview

Licenses

AMP Everwhere

Cisco AMP for Endpoints Connector Licenses

Product SKU <sup>1</sup> <sup>2</sup>			Connector Range
1-Year	3-Years	5-Years	
FP-AMP-1Y-S1	FP-AMP-3Y-S1	FP-AMP-5Y-S1	50 to 99
FP-AMP-1Y-S2	FP-AMP-3Y-S2	FP-AMP-5Y-S2	100 to 499

\*1 See [Ordering Guide](#) for a full list of SKUs supporting over 500 users.

\*2 FP-AMP-LIC= is required in CCW. See [Ordering Guide](#) for details.

Cisco AMP Virtual Private Cloud Appliance

Product SKU <sup>1</sup>	Max Connectors
FP-AMP-CLOUD-SW	10,000

\*1 FP-AMP-CLOUD-BUN is recommended in CCW. See [Ordering Guide](#) for details.

Cisco AMP Virtual Private Cloud Appliance Licenses

Product SKU <sup>1</sup> <sup>2</sup>		
1-Year	3-Years	5-Years
FP-AMP-CLOUD-1Y	FP-AMP-CLOUD-3Y	FP-AMP-CLOUD-5Y

\*1 FP-AMP-CLOUD= is required, FP-AMP-CLOUD-BUN is recommended, in CCW. See [Ordering Guide](#) for details.

Software Requirements

Connector	Supported OS
Cisco AMP Windows Connector	<ul style="list-style-type: none"> <li>● Microsoft Windows 7</li> <li>● Microsoft Windows 8 and 8.1</li> <li>● Microsoft Windows 10</li> <li>● Microsoft Windows Server 2008</li> <li>● Microsoft Windows Server 2012</li> </ul>
Cisco AMP Mac Connector	<ul style="list-style-type: none"> <li>● Mac OS X 10.7 and later</li> </ul>
Cisco AMP Linux Connector	<ul style="list-style-type: none"> <li>● Linux Red Hat Enterprise 6.5, 6.6, 6.7, 6.8, 7.2, and 7.3</li> <li>● Linux CentOS 6.4, 6.5, 6.6, 6.7, 6.8, 7.2 and 7.3</li> </ul>
Cisco AMP Mobile	<ul style="list-style-type: none"> <li>● Android version 2.1 and later</li> <li>● MDM supervised iOS version 11</li> </ul>

Getting Started

What's New

Feature Story

Collaborate

Compute

Security

ASA 5500-X

Firepower 2100

AnyConnect

AMP for Endpoints

Umbrella

Meraki MX

Meraki Z

Meraki MV

Connect

Switches

Wireless

Routers

Services

Overview

Licenses

AMP Everywhere

### Find the Best AMP Deployment for You

The **Cisco Advanced Malware Protection (AMP)** is subscription-based, managed through a web-based management console, and deployed on a variety of platforms.

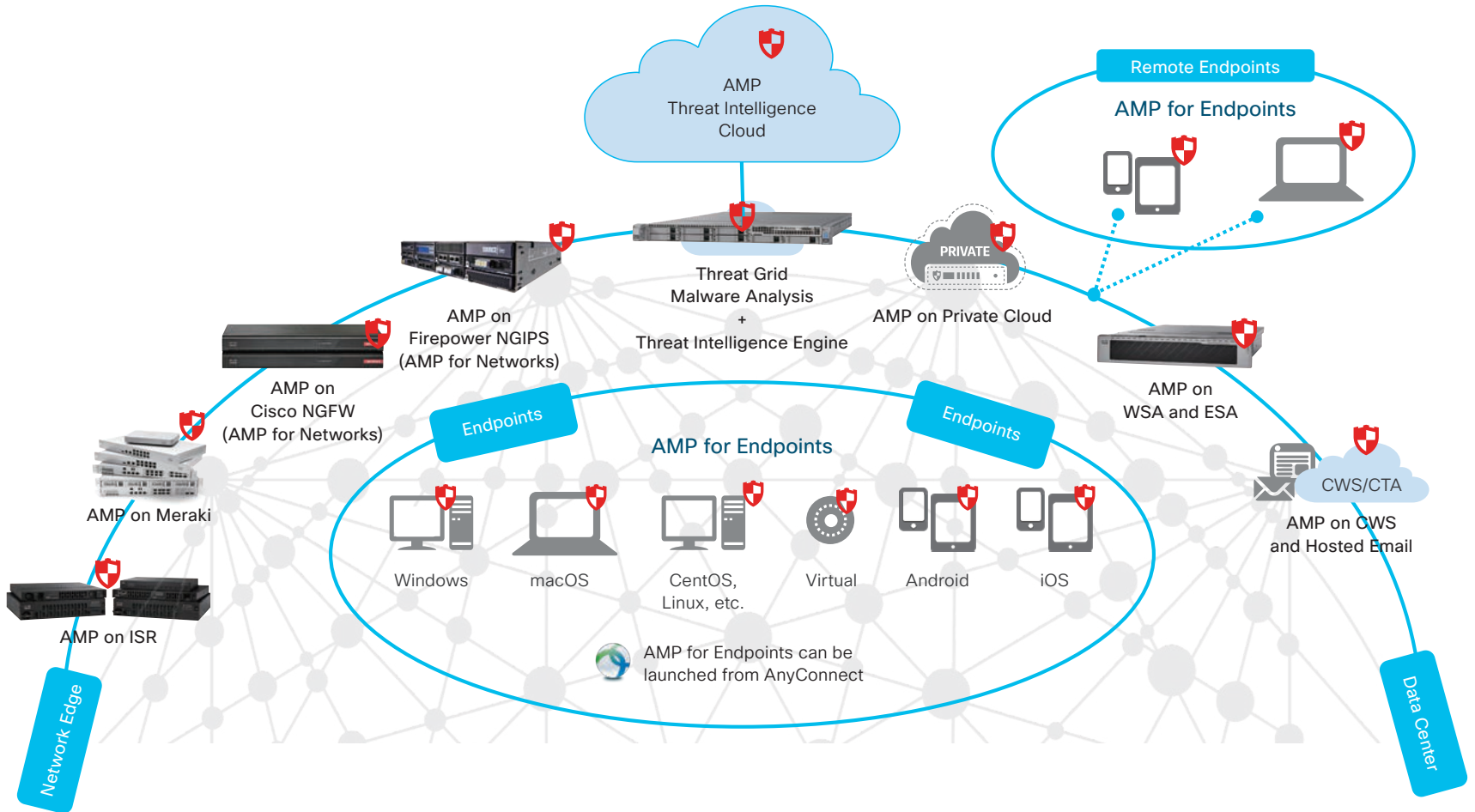

Getting Started

What's New

Feature Story

Collaborate

Compute

Security

ASA 5500-X

Firepower 2100

AnyConnect

AMP for Endpoints

Umbrella

Meraki MX

Meraki Z

Meraki MV

Connect

Switches

Wireless

Routers

Services



Overview

Features

Licenses

Why Umbrella?

14-Day Trial

### The Fastest and Easiest Way to Protect All of Your Users in Minutes

The Cisco Umbrella is the industry's first Secure Internet Gateway (SIG) that provides the first line of defense against threats on the internet wherever users go. Umbrella delivers complete visibility into internet activity across all locations, devices, and users, and blocks threats before they ever reach your network or endpoints. As a cloud-delivered, open platform, Umbrella integrates easily with your existing security stack and delivers live threat intelligence about current and emerging threats.

By analyzing and learning from internet activity patterns, Umbrella automatically uncovers attacker infrastructure staged for attacks, and proactively blocks requests to malicious destinations before a connection is even established — without adding any latency for users.

With Umbrella, you can stop phishing and malware infections earlier, identify already infected devices faster, and prevent data exfiltration.

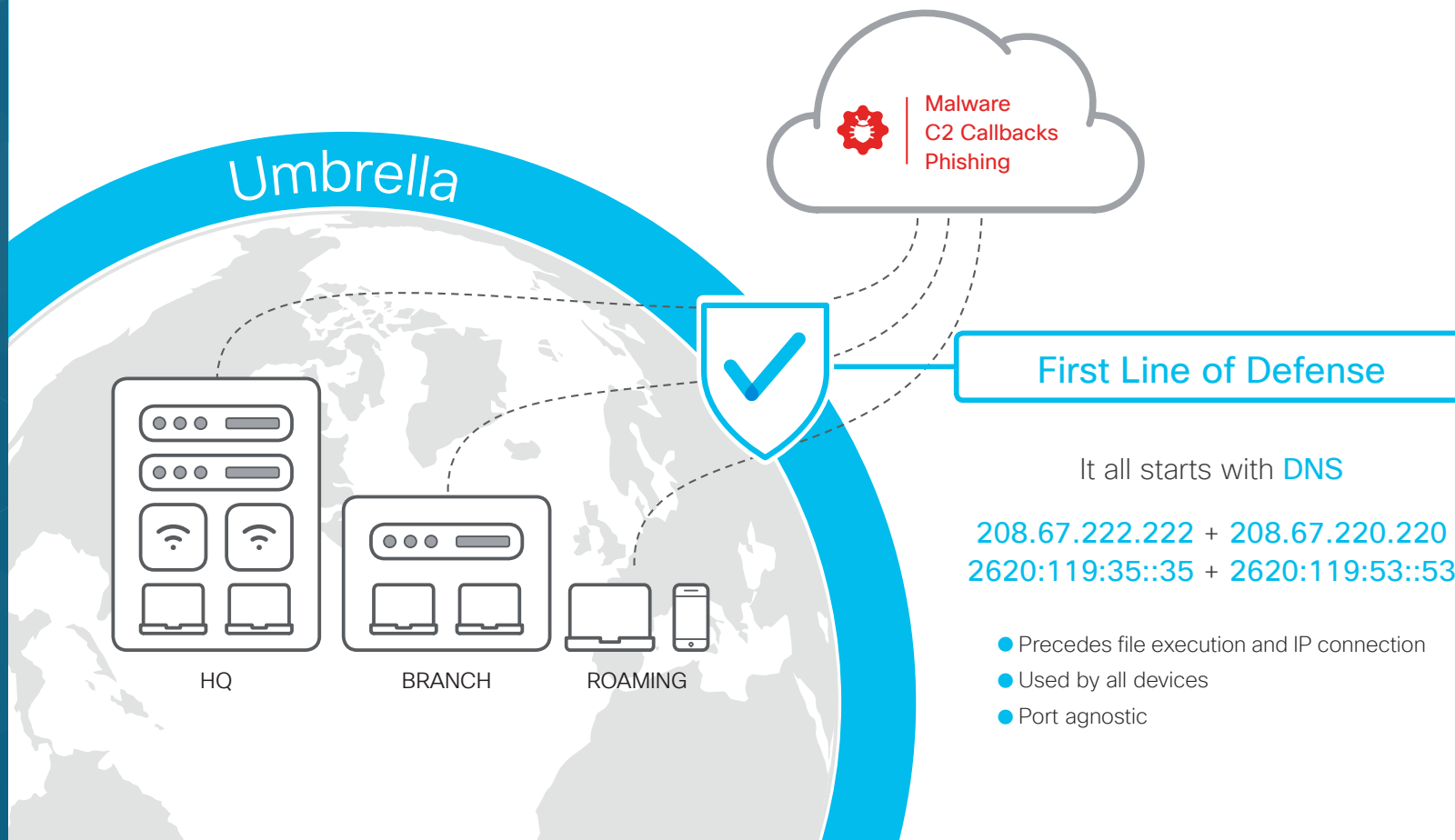

Getting Started

What's New

Feature Story

Collaborate

Compute

Security

ASA 5500-X

Firepower 2100

AnyConnect

AMP for Endpoints

**Umbrella**

Meraki MX

Meraki Z

Meraki MV

Connect

Switches

Wireless

Routers

Services



Getting Started

What's New

Feature Story

Collaborate

Compute

Security

ASA 5500-X

Firepower 2100

AnyConnect

AMP for Endpoints

**Umbrella**

Meraki MX

Meraki Z

Meraki MV

Connect

Switches

Wireless

Routers

Services

Overview

Features

Licenses

Why Umbrella?

14-Day Trial

Package		Roaming	Branch	WLAN	Professional	Insights	Platform
Best for		AnyConnect NGFW	RV 340 ISR 1K/4K	Wireless AP/Controllers	Small Companies	Mid-sized Companies	Advanced Security Teams
Performance	100 % Cloud: No Hardware to Install or Software to Maintain	●	●	●	●	●	●
	100 % Uptime: Resolves 80 B+ Requests Daily with No Added Latency	●	●	●	●	●	●
	7 M+ Unique Malicious Destinations Enforced Concurrently across 25 Data Centers	●	●	●	●	●	●
Protection	Add a New Layer of Predictive Security for Any Device, Anywhere	● <sup>*1</sup>	● <sup>*3</sup>	● <sup>*3</sup>	●	●	●
	Prevent Malware, Phishing, and C2 Callbacks over Any Port	●	●	●	●	●	●
	Enforce Acceptable Use Policies Using 80+ Content Categories	-	●	●	●	●	●
Enforcement	Block Malicious Domain Requests & IP Responses at the DNS-Layer	●	●	●	●	●	●
	Block Malicious URL Paths & Direct IP Connections at the IP-Layer	-	-	-	-	●	●
Visibility	Real-Time, Enterprise-Wide Activity Search & Scheduled Reports	●	●	●	●	●	●
	Identify Targeted Attacks by Comparing Local vs. Global Activity	-	-	-	-	●	●
	Identify Cloud & IoT Usage Risks by Reporting on 1800+ Services (App Discovery)	-	-	-	● <sup>*6</sup>	●	●
Management	Custom Block/Allow Lists, Built-in Block Pages, and Bypass Options	● <sup>*2</sup>	●	●	●	●	●
	Enforcement & Visibility per Internal Network or AD User/Group	-	● <sup>*4</sup>	● <sup>*5</sup>	-	●	●
	Retain Logs Forever by Integrating with Your Amazon S3 Bucket	-	-	-	-	●	●
Platform Package Exclusive	API-based Integrations to Enforce & Manage 3rd-party Block Lists	-	-	-	-	-	●
	Investigate Console: Threat Intelligence on All Domains, IPs, & File Hashes	-	-	-	-	-	●

\*1 Off-network only. \*2 Only has allow list and 1 built-in block page. \*3 On-network only.

\*4 Only per internal network (no Active Directory). \*5 Per SSID, access point, AP group, and user group (no Active Directory).

\*6 Umbrella App Discovery for Professional License is required.





## Overview

## Features

## Licenses

## Why Umbrella?

## 14-Day Trial

## Cisco Umbrella Roaming License

Product SKU <sup>*1</sup>	Description
UMB-ROAM	Umbrella Roaming per User License

\*1 UMBRELLA-SUB is required in CCW. See [Ordering Guide](#) for details.

## Cisco Umbrella Branch Licenses

Product SKU	Description
UMB-BRAN-RV <small>NEW</small>	Umbrella Branch License for Cisco RV 340 Series
UMB-BRAN-1100	Umbrella Branch License for Cisco ISR 1100 Series
UMB-BRAN-4221	Umbrella Branch License for Cisco ISR 4321
UMB-BRAN-4321	Umbrella Branch License for Cisco ISR 4321
UMB-BRAN-4331	Umbrella Branch License for Cisco ISR 4331
UMB-BRAN-4351	Umbrella Branch License for Cisco ISR 4351
UMB-BRAN-4431	Umbrella Branch License for Cisco ISR 4431
UMB-BRAN-4451	Umbrella Branch License for Cisco ISR 4451

\*1 UMBRELLA-SUB is required in CCW. See [Ordering Guide](#) for details.

## Cisco Umbrella WLAN License

Product SKU <sup>*1</sup>	Description
UMB-WLAN	Umbrella WLAN per Access Point License

\*1 UMBRELLA-SUB is required in CCW. See [Ordering Guide](#) for details.

## Cisco Umbrella Professional Licenses

Product SKU <sup>*1</sup>	Description
UMB-PROFESSIONAL	Umbrella Professional per User License
UMB-APP-DISC	Umbrella App Discovery for Professional License

\*1 UMBRELLA-SUB is required in CCW. See [Ordering Guide](#) for details.

## Cisco Umbrella Insights License

Product SKU <sup>*1</sup>	Description
UMB-INSIGHTS-K9	Umbrella Insights per User License

\*1 UMBRELLA-SUB is required in CCW. See [Ordering Guide](#) for details.

## Cisco Umbrella Platform License

Product SKU <sup>*1</sup>	Description
UMB-PLATFORM-K9	Umbrella Platform per User License

\*1 UMBRELLA-SUB is required in CCW. See [Ordering Guide](#) for details.

Getting Started

What's New

Feature Story

Collaborate

Compute

Security

ASA 5500-X

Firepower 2100

AnyConnect

AMP for Endpoints

Umbrella

Meraki MX

Meraki Z

Meraki MV

Connect

Switches

Wireless

Routers

Services



### Enterprise-wide Deployment in Minutes

Cisco Umbrella is the fastest and easiest way to protect all of your users in minutes. Because it is delivered from the cloud, there is no hardware to install or software to manually update.

You can provision all on-network devices — including BYOD and IoT — in minutes and use your existing Cisco footprint — RV 340, ISR 1100/4000, Mobility Express, Wireless Controller 3540, and Meraki MR — to quickly provision thousands of network egresses and roaming laptops.

Additionally, with the Cisco Security Connector app, you can use the Umbrella extension to protect supervised iOS 11.3 or higher devices.

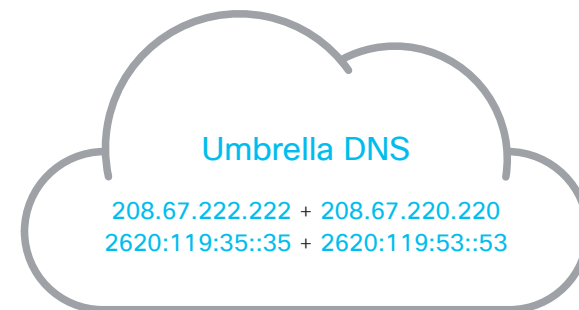

### How Easy Is It to Deploy Umbrella?

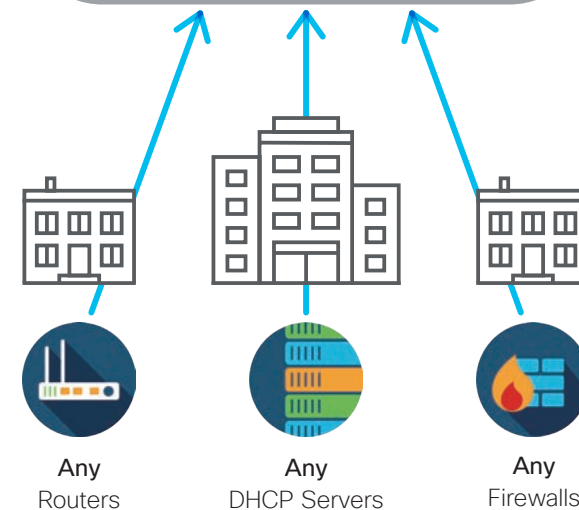
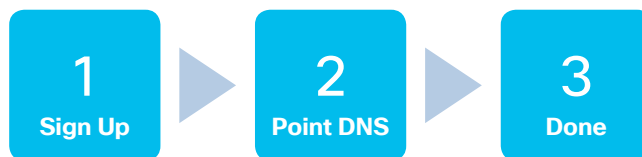

Getting Started

What's New

Feature Story

Collaborate

Compute

Security

ASA 5500-X

Firepower 2100

AnyConnect

AMP for Endpoints

Umbrella

Meraki MX

Meraki Z

Meraki MV

Connect

Switches

Wireless

Routers

Services





Overview

Features

Licenses

Why Umbrella?

14-Day Trial

**Off-Network Security without VPN**

Cisco Umbrella protects employees when they are off the VPN by blocking malicious domain requests and IP responses as DNS queries are resolved. By enforcing security at the DNS-layer, connections are never established and files are never downloaded. Malware will not infect laptops and command & control (C2) callbacks or phishing will not exfiltrate data over any port. Plus, you gain real-time visibility of infected laptops with C2 activity.

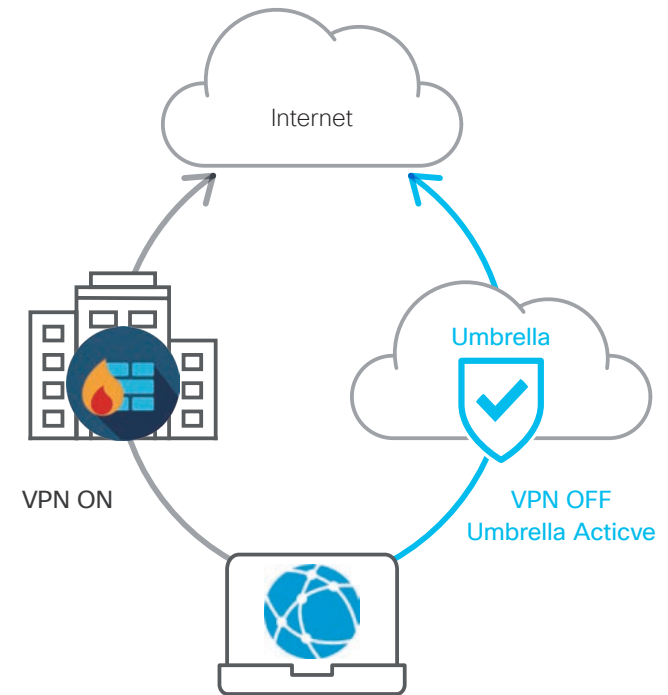

**Roaming Devices**  
Windows/macOS (Umbrella Roaming Client)  
Chromebook (Umbrella Chromebook Client)  
iOS (Security Connector)

**TIP The Way Your Employees Work Has Changed**

82% of your workers admit to not always using the VPN\*1

Employees are using more cloud apps for work and leveraging their work laptops for personal use—the reality is that not every connection goes through the VPN. Your network extends beyond the perimeter, and your security must too.

49 % of your workforce is mobile and under defended\*2

Zero-day malware spikes at night and on weekends when we're roaming and attackers know we're vulnerable. In fact, 22 % of malicious email links are clicked when roaming.\*3 While security may never stop 100 % of the threats, it must work 100 % of the time.

\*1 cs.co/IDG-survey \*2 cs.co/sans-survey \*3 cs.co/proofpoint-report

Getting Started

What's New

Feature Story

Collaborate

Compute

Security

ASA 5500-X

Firepower 2100

AnyConnect

AMP for Endpoints

**Umbrella**

Meraki MX

Meraki Z

Meraki MV

Connect

Switches

Wireless

Routers

Services



Overview

Features

Licenses

Why Umbrella?

14-Day Trial

Manage Flexible, Location-aware Policies

Cisco Umbrella's 80+ content categories cover millions of domains (and billions of web pages) to give you control over which sites can be accessed by users on your network and by roaming users. The easy-to-use, cloud-delivered administration console enables you to quickly set up, manage, and test different acceptable use policies per network, group, user, device, or IP address, giving you greater control of your organization's internet usage. You even have the flexibility to set up different policies depending on whether users are on or off the corporate network.

Umbrella enables you to customize our category-based filtering to meet each network's specific needs, particularly to help you meet compliance requirements. Quickly create exceptions to allow or block specific domains, regardless of whether it is in a category that is allowed or blocked. Our 80+ content categories empower you to enforce acceptable web use to comply with internal policies or external regulations such as CIPA. We are also a member of the Internet Watch Foundation (IWF), enabling you to block their list of child sexual abuse sites.

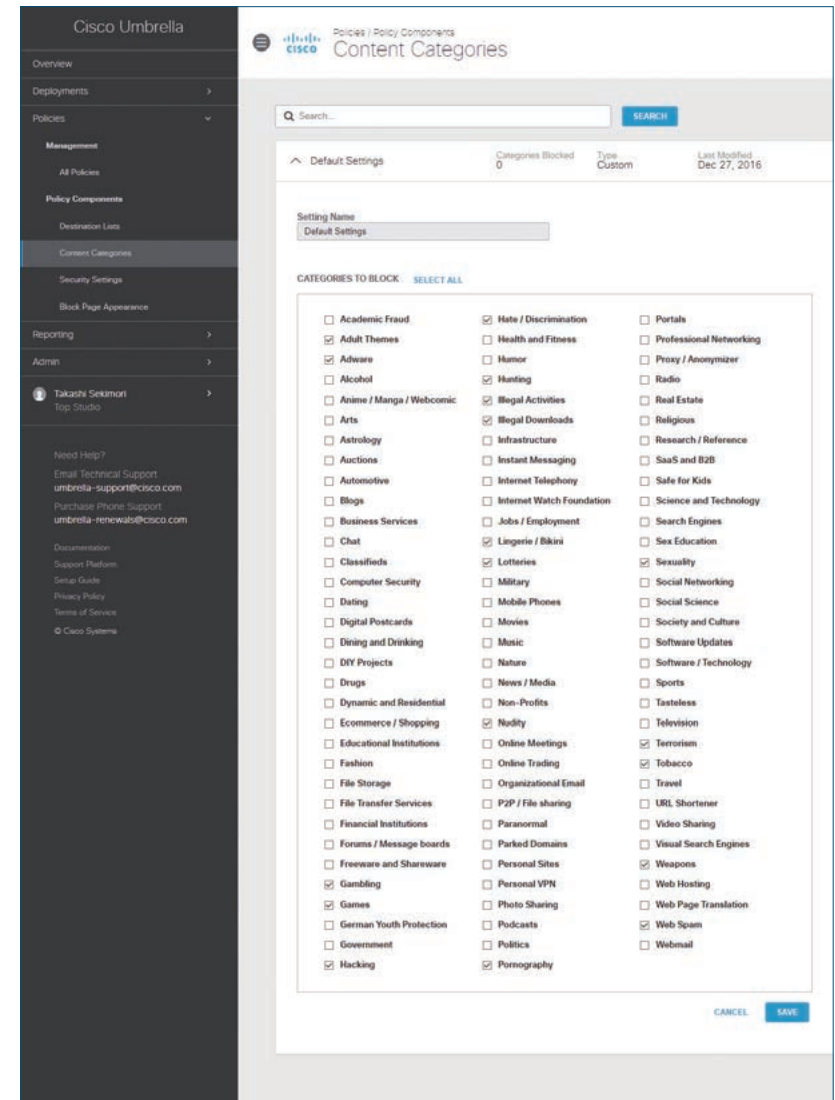

Getting Started

What's New

Feature Story

Collaborate

Compute

Security

ASA 5500-X

Firepower 2100

AnyConnect

AMP for Endpoints

Umbrella

Meraki MX

Meraki Z

Meraki MV

Connect

Switches

Wireless

Routers

Services





Overview

Features

Licenses

Why Umbrella?

14-Day Trial

Expose Shadow IT and Manage Cloud Adoption

Cloud usage is continuing to expand as end users and departments become more comfortable acquiring cloud services. The typical organization is only aware of a small fraction of its overall cloud activity. The lack of a coordinated cloud enablement strategy leads to a broad set of productivity, expense, security, and support issues.

The **App Discovery** report of Cisco Umbrella provides full visibility and risk information to manage cloud adoption in a secure and organized fashion. Once decisions are made about specific apps, you can block access to applications that are not approved to reduce the risk of sensitive data loss, account compromise and malware infection.

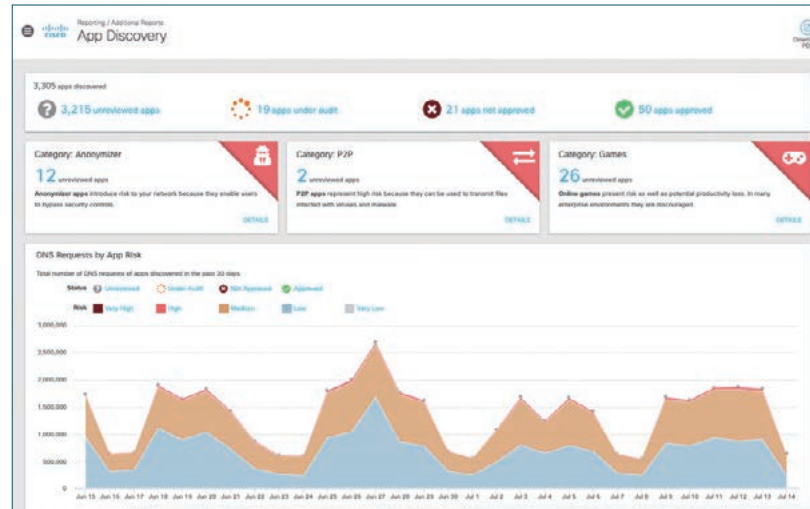

The App Discovery dashboard provides an overview of the number of app requests by date and risk level to show patterns and changes over time. The most recent set of discovered and unreviewed apps are highlighted for easy access and a chart showing the number of apps in each major category is provided with a breakdown by risk level. These summary charts allow point and click access to more detailed information on the category or individual application to simplify common administrator tasks.

The screenshot shows a table of "Unreviewed Apps (39 Found)".

Application	Vendor	Weighted Risk	Identities	DNS Requests	Blocked	Label
123RF Cloud Storage	123RF	Medium	3	11	Unreviewed	Block this app
4mat Cloud Storage	4mat	Medium	1	4	Unreviewed	Block this app
Amazon Drive Cloud Storage	Amazon	Low	1	2	Unreviewed	Block this app
Amazon S3 Cloud Storage	Amazon	Medium	8	35,385	Unreviewed	Block this app
Amazon S3 Transfer Acceleration Cloud Storage	Amazon	Low	3	610	Unreviewed	Block this app
Apple iCloud Cloud Storage	Apple	Medium	4	66,187	Unreviewed	Block this app
Box Cloud Storage	Box	Medium	3	29,736	Unreviewed	Block this app

The Apps Grid report provides key details on all applications that have been discovered including the app and vendor name, category, weighted risk level, number of users, number of requests and current status. This report can be segmented and filtered into groups for deeper analysis by category, risk level or number of users to provide views that assist with the organization and management of cloud adoption.

Getting Started

What's New

Feature Story

Collaborate

Compute

Security

ASA 5500-X

Firepower 2100

AnyConnect

AMP for Endpoints

Umbrella

Meraki MX

Meraki Z

Meraki MV

Connect

Switches

Wireless

Routers

Services







Overview

Features

Licenses

Why Umbrella?

14-Day Trial

Simple and Effective Protection for Corporate and Guest Wi-Fi

The Cisco Umbrella Wireless LAN (WLAN) package provides the first line of defense against threats for Wi-Fi connections. It offers the simplest, fastest way to protect every user on your Wi-Fi network.

Umbrella WLAN protects employees and guests who are accessing the internet from wireless access points. By enforcing security at the DNS layer, connections to unsafe sites are never established and malicious files are never downloaded. This prevents malware from infecting devices and stops attacks from exfiltrating data over any port and protocol. Umbrella WLAN also brings a simple-to-use content filtering solution to your Wi-Fi network. It stops guests and corporate users from accessing inappropriate content, based on company policy. This keeps users happy with safe internet access, while also protecting your business.

Umbrella WLAN is the simplest way to protect any device accessing your wireless network — there's no action required from end users for protection. Whether it's a corporate device, employee-owned, or customer-owned device, Umbrella WLAN adds an easy, but very effective layer of protection. Umbrella WLAN works across a broad portfolio of wireless controllers and access points. Built-in integrations with the Cisco WAP125/WAP581, Cisco Aironet Access Points with Mobility Express, Cisco Wireless Controllers, and Cisco Meraki MR Cloud Managed Access Points provides additional ease of use and granularity.

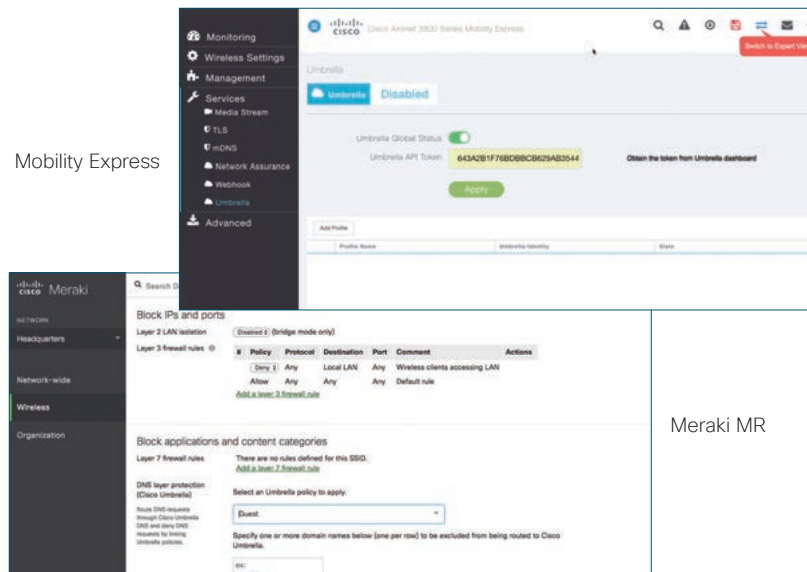

You can deploy Umbrella in minutes across your access points. Simply input the API key and secret from Umbrella into the AP's GUI.

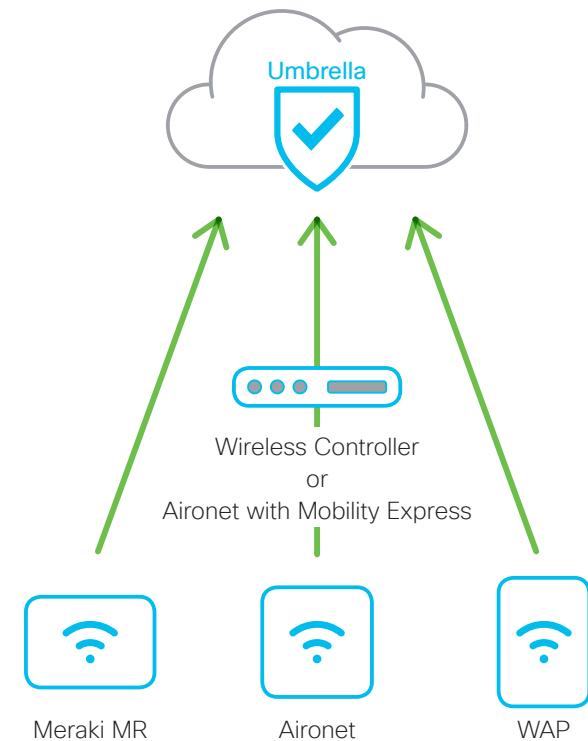

Getting Started

What's New

Feature Story

Collaborate

Compute

Security

ASA 5500-X

Firepower 2100

AnyConnect

AMP for Endpoints

Umbrella

Meraki MX

Meraki Z

Meraki MV

Connect

Switches

Wireless

Routers

Services



Overview

Features

Licenses

Why Umbrella?

14-Day Trial

The Simplest and Fastest Way to Secure DIA from Branch

The traditional WAN was built to give branch offices and roaming users access to IT resources within private data centers. But today, as networks become more decentralized and users connect directly to SaaS applications, backhauling traffic to apply security policies just isn't efficient. And that's not the only problem. Backhauling internet-bound traffic is expensive, and it adds latency. So users get frustrated – and thwarted – in their attempt to get work done. That's why so many branch offices are migrating to direct internet access (DIA).

The Cisco Umbrella Branch package is a cloud-delivered security service for the Cisco RV 340 Series and Cisco ISR 1100/4000 Series routers. It provides the first layer of defense against threats at branch offices. And it offers the simplest, fastest way to protect every device on your branch network. You gain visibility and enforcement at the DNS-layer, so you can block requests to malicious domains and IPs before a connection is ever made. Umbrella Branch protects employees and guests in distributed branch offices — like those in retail, finance, hospitality, and education. By enforcing security at the DNS-layer, connections are never established and files are never downloaded. This prevents malware from infecting devices and stops attacks from exfiltrating data over any port.

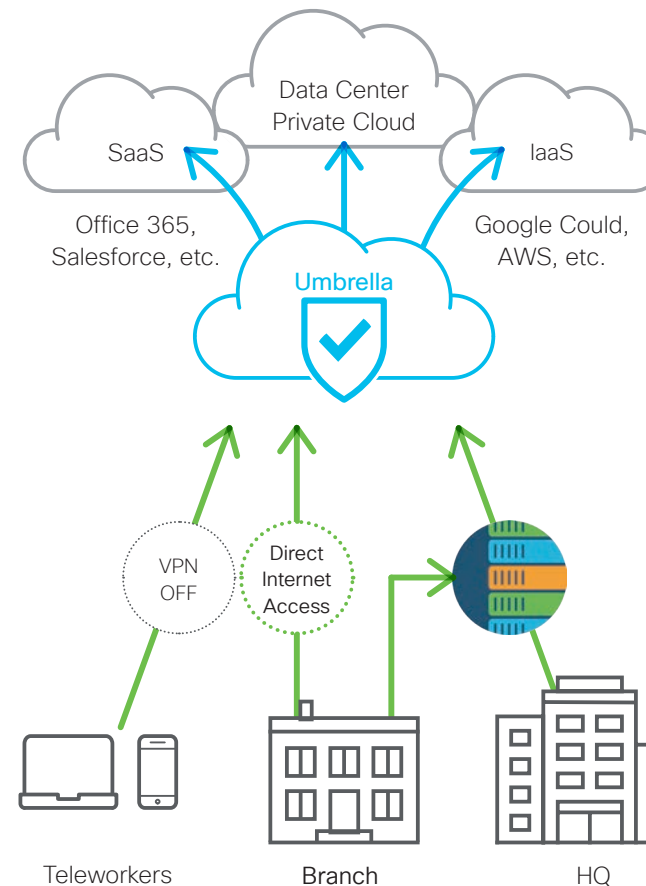

RV 340

You can deploy Umbrella in minutes on your RV 340 series router. Simply input the API key and secret from Umbrella into the router's GUI.

Getting Started

What's New

Feature Story

Collaborate

Compute

Security

ASA 5500-X

Firepower 2100

AnyConnect

AMP for Endpoints

Umbrella

Meraki MX

Meraki Z

Meraki MV

Connect

Switches

Wireless

Routers

Services



Overview

Features

Licenses

Why Umbrella?

14-Day Trial

### Promotion Prices & Trial

OpenDNS  
Home

**FREE**

Our classic, free service with customizable filtering and identity theft protection

OpenDNS  
Home VIP

**US\$ 19.95/year**

OpenDNS Home package plus one year of usage stats and optional white-list mode

Umbrella  
14 Day Trial

**FREE**

Get start in 30 seconds  
No credit card or phone call required

Umbrella  
Professional

**US\$ 38/year**

Per user (10 to 90 users)

Cisco Promotion Price

### Free Umbrella 14-Day Trial

If you want to add an additional layer of DNS security to your router or firewall, try our free trial—you can set it up yourself in less than five minutes, no credit card or phone call required.

 [signup.umbrella.com](https://signup.umbrella.com)

### Umbrella Professional: Best for Small Companies

This is Cisco's direct sale promotion price via on-line credit card settlement. Cisco authorized distributors are also offering even more attractive promotion pricing for various umbrella packages. Actual purchase price will be determined between purchaser & reseller of your choice.

 [umbrella.cisco.com/products/small-teams](https://umbrella.cisco.com/products/small-teams)

Getting Started

What's New

Feature Story

Collaborate

Compute

Security

ASA 5500-X

Firepower 2100

AnyConnect

AMP for Endpoints

Umbrella

Meraki MX

Meraki Z

Meraki MV

Connect

Switches

Wireless

Routers

Services

## Overview

## Positioning Map

## Platform Spec

## Licenses &amp; Accessories

## 100 % Centralized Cloud Management for Security, Networking, and Application Control

The **Cisco Meraki MX Cloud Managed Security Appliances** are ideal for organizations considering a Unified Threat Management (UTM) solution, for distributed sites, campuses or datacenter VPN concentration. Since the MX is 100 % cloud managed, installation and remote management is simple. The MX has a comprehensive suite of network services, eliminating the need for multiple appliances.

These services include SD-WAN capabilities, application-based firewalling, content filtering, web search filtering, SNORT based intrusion detection and prevention, Cisco Advanced Malware Protection (AMP), web caching, 4G cellular failover and more. Auto VPN and SD-WAN features are available on our hardware and virtual appliances, configurable in Amazon Web Services.



### Highlights

- **Identity-Based Firewall:** Automatically assigns firewall and traffic shaping rules, VLAN tags, and bandwidth limits to enforce the right policies for each class of users
- **Intrusion Prevention:** Protects critical network resources from the latest security threats and vulnerabilities
- **Auto VPN:** Securely connects branch locations using mesh or hub-and-spoke topologies. Provides simple VPN access into Amazon Web Services
- **Content Filtering:** Block undesirable web content across 70+ categories, and leverage cloud lookups to filter billions of URLs
- **Advanced Malware Protection:** Protect your network against malware using the latest threat intelligence, and identify previously unknown malicious files with retrospective detection
- **High Availability & Failover:** Provides device and connection integrity through multiple uplinks, warm spare failover, and self-healing VPN
- **Application Visibility & Control:** Identify which applications are being used, and then prioritize critical apps while limiting recreational apps
- **Centralized Management:** Seamlessly manage campus-wide Wi-Fi deployments and distributed multi-site networks from a single pane-of-glass

Getting Started

What's New

Feature Story

Collaborate

Compute

Security

ASA 5500-X

Firepower 2100

AnyConnect

AMP for Endpoints

Umbrella

**Meraki MX**

Meraki Z

Meraki MV

Connect

Switches

Wireless

Routers







Services

Overview

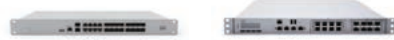
**Positioning Map**

Platform Spec

Licenses & Accessories

<p>Large Branch, Campus, Concentrator</p>	 <p>MX600      MX450</p>  <p>MX250      MX400</p>
<p>Virtual Appliances</p>	 <p>vMX100</p>
<p>Medium Branch</p>	 <p>MX84      MX100</p>
<p>Small Branch</p>	 <p>MX67C      MX68CW</p>  <p>MX64W/65W      MX67W      MX68W</p>  <p>MX64/65      MX67      MX68</p>

Throughput

→ High

Getting Started

What's New

Feature Story

Collaborate

Compute

**Security**

ASA 5500-X

Firepower 2100

AnyConnect

AMP for Endpoints

Umbrella

**Meraki MX**

Meraki Z

Meraki MV

Connect

Switches

Wireless

Routers

Services





## Overview

## Positioning Map

## Platform Spec

## Licenses &amp; Accessories

Product SKU	Recommended Clients	Throughput			Concurrent VPN Tunnels	Web Caching	WAN Ports		LAN Ports			Wireless		Power Supply	Rack Mount
		Stateful Firewall	Advanced Security	VPN			GE	GE	GE	GE PoE+	SFP	11ac AP	4G LTE		
MX64-HW	50	250 Mbps	200 Mbps	100 Mbps	50	-	1	1	4	-	-	-	- <sup>*1</sup>	External	- <sup>*2</sup>
MX64W-HW	50	250 Mbps	200 Mbps	100 Mbps	50	-	1	1	4	-	-	●	- <sup>*1</sup>	External	- <sup>*2</sup>
MX65-HW	50	250 Mbps	200 Mbps	100 Mbps	50	-	2	-	8	2	-	-	- <sup>*1</sup>	External	- <sup>*2</sup>
MX65W-HW	50	250 Mbps	200 Mbps	100 Mbps	50	-	2	-	8	2	-	●	- <sup>*1</sup>	External	- <sup>*2</sup>
MX67-HW	50	450 Mbps	300 Mbps	200 Mbps	50	-	1	1	4	-	-	-	- <sup>*1</sup>	External	- <sup>*2</sup>
MX67W-HW	50	450 Mbps	300 Mbps	200 Mbps	50	-	1	1	4	-	-	●	- <sup>*1</sup>	External	- <sup>*2</sup>
MX67C-HW-WW	50	450 Mbps	300 Mbps	200 Mbps	50	-	1	1	4	-	-	-	●	External	- <sup>*2</sup>
MX68-HW	50	450 Mbps	300 Mbps	200 Mbps	50	-	2	-	8	2	-	-	- <sup>*1</sup>	External	- <sup>*2</sup>
MX68W-HW	50	450 Mbps	300 Mbps	200 Mbps	50	-	2	-	8	2	-	●	- <sup>*1</sup>	External	- <sup>*2</sup>
MX68CW-HW-WW	50	450 Mbps	300 Mbps	200 Mbps	50	-	2	-	8	2	-	●	●	External	- <sup>*2</sup>
MX84-HW	200	500 Mbps	320 Mbps	250 Mbps	100	1 TB	2	-	8	-	2	-	- <sup>*1</sup>	Internal	1 RU
vMX100	-	-	-	500 Mbps	-	-	-	-	-	-	-	-	-	-	-

\*1 Cellular Modem is required.

\*2 Desktop or Wall mountable with included mount hardware.

Getting Started

What's New

Feature Story

Collaborate

Compute

Security

ASA 5500-X

Firepower 2100

AnyConnect

AMP for Endpoints

Umbrella

Meraki MX

Meraki Z

Meraki MV

Connect

Switches

Wireless

Routers

Services

## Overview

## Positioning Map

## Platform Spec

## Licenses &amp; Accessories

## Cisco Meraki Licensing for Cisco Meraki MX Series

The Cisco Meraki MX Cloud Managed Security Appliances have licenses on a per-model basis, so every Meraki MX model has a corresponding license. Please note that these licenses are non-transferrable between appliance models. For example, an MX64 will not be covered by an MX84 license; it will require an MX64 license.

The Cisco Meraki MX has multiple license editions: **Enterprise** and **Advanced Security**. Please note that the Meraki MX licensing edition is uniform across the Organization. For example, you can have all 25 appliances using Enterprise edition or Advanced Security edition, but you cannot have 20 appliances using one edition and 5 using the other edition. If you wish to use Enterprise edition for some appliances and Advanced Security edition for other appliances, you need to create two Organizations, one for your appliances with the Enterprise edition, and another for the appliances with the Advanced Security edition.

## Cisco Meraki License Comparison

	Enterprise	Advanced Security
Next-Generation Firewalls (NGFW)	●	●
VLAN to VLAN Routing	●	●
Link Bonding and Failover	●	●
3G/4G Failover via USB Modem	●	●
Traffic Shaping and Prioritization	●	●
Auto VPN Self-Configuring Site-to-Site VPN	●	●
Client VPN	●	●
MPLS to VPN Failover	●	●
Splash Pages	●	●
Configuration Templates	●	●
HTTP Content Caching (Web Caching)	●	●
Group Policies	●	●
Client Connectivity Alerts	●	●
Active/Passive High Availability <sup>*1</sup>	●	●
SD-WAN	●	●
Geography-based Firewall Rules	-	●
Cisco Snort IDS/IPS	-	●
Content Filtering (with Google SafeSearch)	-	●
Anti-Virus and Anti-Phishing	-	●
Youtube for Schools	-	●
Web Search Filtering	-	●
Cisco Advanced Malware Protection (AMP)	-	●
Cisco Threat Grid <sup>*2</sup>	-	●

\*1 No license required for Meraki MX deployed as Warm Spares.

\*2 Cisco Threat Grid License is required.

Getting Started

What's New

Feature Story

Collaborate

Compute

Security

ASA 5500-X

Firepower 2100

AnyConnect

AMP for Endpoints

Umbrella

Meraki MX

Meraki Z

Meraki MV

Connect

Switches

Wireless

Routers

Services



Overview

Positioning Map

Platform Spec

Licenses & Accessories

Cisco Meraki Enterprise Licenses for Cisco Meraki MX Series

Product SKU					Compatible Models
1-Year	3-Years	5-Years	7-Years	10-Years	
LIC-MX64-ENT-1YR	LIC-MX64-ENT-3YR	LIC-MX64-ENT-5YR	LIC-MX64-ENT-7YR	LIC-MX64-ENT-10YR	MX64
LIC-MX64W-ENT-1YR	LIC-MX64W-ENT-3YR	LIC-MX64W-ENT-5YR	LIC-MX64W-ENT-7YR	LIC-MX64W-ENT-10YR	MX64W
LIC-MX65-ENT-1YR	LIC-MX65-ENT-3YR	LIC-MX65-ENT-5YR	LIC-MX65-ENT-7YR	LIC-MX65-ENT-10YR	MX65
LIC-MX65W-ENT-1YR	LIC-MX65W-ENT-3YR	LIC-MX65W-ENT-5YR	LIC-MX65W-ENT-7YR	LIC-MX65W-ENT-10YR	MX65W
LIC-MX67-ENT-1YR	LIC-MX67-ENT-3YR	LIC-MX67-ENT-5YR	LIC-MX67-ENT-7YR	LIC-MX67-ENT-10YR	MX67
LIC-MX67W-ENT-1YR	LIC-MX67W-ENT-3YR	LIC-MX67W-ENT-5YR	LIC-MX67W-ENT-7YR	LIC-MX67W-ENT-10YR	MX67W
LIC-MX67C-ENT-1YR	LIC-MX67C-ENT-3YR	LIC-MX67C-ENT-5YR	LIC-MX67C-ENT-7YR	LIC-MX67C-ENT-10YR	MX67C
LIC-MX68-ENT-1YR	LIC-MX68-ENT-3YR	LIC-MX68-ENT-5YR	LIC-MX68-ENT-7YR	LIC-MX68-ENT-10YR	MX68
LIC-MX68W-ENT-1YR	LIC-MX68W-ENT-3YR	LIC-MX68W-ENT-5YR	LIC-MX68W-ENT-7YR	LIC-MX68W-ENT-10YR	MX68W
LIC-MX68CW-ENT-1YR	LIC-MX68CW-ENT-3YR	LIC-MX68CW-ENT-5YR	LIC-MX68CW-ENT-7YR	LIC-MX68CW-ENT-10YR	MX68CW
LIC-MX84-ENT-1YR	LIC-MX84-ENT-3YR	LIC-MX84-ENT-5YR	LIC-MX84-ENT-7YR	LIC-MX84-ENT-10YR	MX84

Cisco Meraki Advanced Security Licenses for Cisco Meraki MX Series

Product SKU					Compatible Models
1-Year	3-Years	5-Years	7-Years	10-Years	
LIC-MX64-SEC-1YR	LIC-MX64-SEC-3YR	LIC-MX64-SEC-5YR	LIC-MX64-SEC-7YR	LIC-MX64-SEC-10YR	MX64
LIC-MX64W-SEC-1YR	LIC-MX64W-SEC-3YR	LIC-MX64W-SEC-5YR	LIC-MX64W-SEC-7YR	LIC-MX64W-SEC-10YR	MX64W
LIC-MX65-SEC-1YR	LIC-MX65-SEC-3YR	LIC-MX65-SEC-5YR	LIC-MX65-SEC-7YR	LIC-MX65-SEC-10YR	MX65
LIC-MX65W-SEC-1YR	LIC-MX65W-SEC-3YR	LIC-MX65W-SEC-5YR	LIC-MX65W-SEC-7YR	LIC-MX65W-SEC-10YR	MX65W
LIC-MX67-SEC-1YR	LIC-MX67-SEC-3YR	LIC-MX67-SEC-5YR	LIC-MX67-SEC-7YR	LIC-MX67-SEC-10YR	MX67
LIC-MX67W-SEC-1YR	LIC-MX67W-SEC-3YR	LIC-MX67W-SEC-5YR	LIC-MX67W-SEC-7YR	LIC-MX67W-SEC-10YR	MX67W
LIC-MX67C-SEC-1YR	LIC-MX67C-SEC-3YR	LIC-MX67C-SEC-5YR	LIC-MX67C-SEC-7YR	LIC-MX67C-SEC-10YR	MX67C
LIC-MX68-SEC-1YR	LIC-MX68-SEC-3YR	LIC-MX68-SEC-5YR	LIC-MX68-SEC-7YR	LIC-MX68-SEC-10YR	MX68
LIC-MX68W-SEC-1YR	LIC-MX68W-SEC-3YR	LIC-MX68W-SEC-5YR	LIC-MX68W-SEC-7YR	LIC-MX68W-SEC-10YR	MX68W
LIC-MX68CW-SEC-1YR	LIC-MX68CW-SEC-3YR	LIC-MX68CW-SEC-5YR	LIC-MX68CW-SEC-7YR	LIC-MX68CW-SEC-10YR	MX68CW
LIC-MX84-SEC-1YR	LIC-MX84-SEC-3YR	LIC-MX84-SEC-5YR	LIC-MX84-SEC-7YR	LIC-MX84-SEC-10YR	MX84

Getting Started

What's New

Feature Story

Collaborate

Compute

Security

ASA 5500-X

Firepower 2100

AnyConnect

AMP for Endpoints

Umbrella

Meraki MX

Meraki Z

Meraki MV

Connect

Switches

Wireless

Routers

Services



Overview

Positioning Map

Platform Spec

Licenses &amp; Accessories

## Cisco Meraki Advanced Security Licenses for Cisco Meraki vMX100

Product SKU			Compatible Models
1-Year	3-Years	5-Years	
LIC-VMX100-1YR	LIC-VMX100-3YR	LIC-VMX100-5YR	vMX100

## Cisco Meraki 1000BASE Small Form-Factor Pluggable (SFP) Modules

SKU	Description	Max Distance	Compatible Series					
			MX64	MX64W	MX65	MX65W	MX84	vMX100
MA-SFP-1GB-TX	1000BASE-T SFP Module	100 m	-	-	-	-	●	-
MA-SFP-1GB-SX	1000BASE-SX SFP Module	550 m	-	-	-	-	●	-
MA-SFP-1GB-LX10	1000BASE-LX10 Module	10 km	-	-	-	-	●	-

Getting Started

What's New

Feature Story

Collaborate

Compute

Security

ASA 5500-X

Firepower 2100

AnyConnect

AMP for Endpoints

Umbrella

Meraki MX

Meraki Z

Meraki MV

Connect

Switches

Wireless

Routers

Services



## Overview

## Platform Spec

## Licenses &amp; Accessories

## Offering Fast, Reliable Connectivity for the Modern Teleworker

The **Cisco Meraki Z Cloud Managed Teleworker Gateway** is an enterprise class firewall, VPN gateway and router. Each model offers five gigabit ethernet ports and wireless for connectivity. Each model is designed to securely extend the power of Meraki cloud managed networking to employees, IT staff, and executives working from home.

Using Meraki's proven and highly scalable Auto VPN technology, administrators can deploy network services including VoIP and remote endpoints with automatic, zero-touch provisioning. All models feature a high-performance stateful firewall, support for VLANs, inter-VLAN routing, and isolation to segregate corporate data from recreational traffic.



### Highlights

- Self-configuring, plug-and-play deployment
- Auto VPN for intelligent site-to-site VPN connectivity
- Layer 7 application traffic shaping and prioritization
- Layer 3 firewall to separate corporate data from personal traffic
- IEEE 802.1x port authentication for wired devices
- Built-in 100 Mbps CAT 3 LTE connectivity (**Z3C**)
- USB port for 3G/4G connectivity
- GE downlinks for printers, phones and other wired devices
- PoE output for VoIP phones and other powered devices
- Built-in IEEE 802.11n/ac-compatible wireless access point
- Up to 4 SSIDs with integrated enterprise security and personal/guest access
- Sleek, low profile design
- Optional desk stand

Getting Started

What's New

Feature Story

Collaborate

Compute

Security

ASA 5500-X

Firepower 2100

AnyConnect

AMP for Endpoints

Umbrella

Meraki MX

**Meraki Z**

Meraki MV

Connect

Switches

Wireless

Routers

Services



Overview

Platform Spec

Licenses & Accessories

Product SKU	Recommended Clients	Throughput		WAN Ports	LAN Ports		Wireless			Power Supply	Rack Mount
		Stateful Firewall	VPN	GE	GE	GE PoE	11n AP	11ac AP	4G LTE		
Z3-HW	5	100 Mbps	50 Mbps	1	3	1	●	●	-*1	External	-*2
Z3C-HW-WW	5	100 Mbps	50 Mbps	1	3	1	●	●	●	External	-*2

\*1 Cellular Modem is required.

\*2 Desktop or Wall mountable with included mount hardware. Vertical Desk Stand (MA-STND-1) is available.

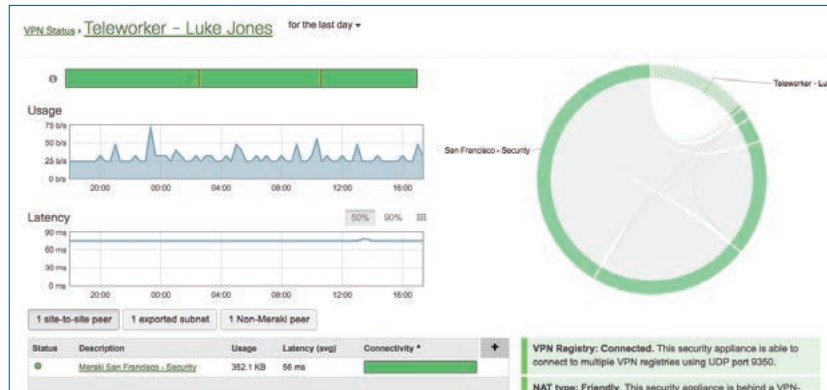

Auto Configuring Site-to-Site VPN

Multi-Site Management via the Meraki Cloud

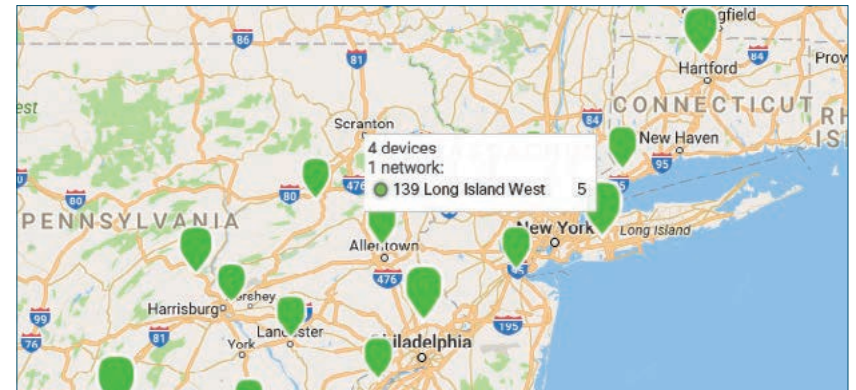

Getting Started

What's New

Feature Story

Collaborate

Compute

Security

ASA 5500-X

Firepower 2100

AnyConnect

AMP for Endpoints

Umbrella

Meraki MX

Meraki Z

Meraki MV

Connect

Switches

Wireless

Routers

Services

Overview

Platform Spec

Licenses & Accessories

Cisco Meraki Enterprise Licenses for Cisco Meraki Z Series

Product SKU					Compatible Models
1-Year	3-Years	5-Years	7-Years	10-Years	
LIC-Z3-ENT-1YR	LIC-Z3-ENT-3YR	LIC-Z3-ENT-5YR	LIC-Z3-ENT-7YR	LIC-Z3-ENT-10YR	Z3
LIC-Z3C-ENT-1YR	LIC-Z3C-ENT-3YR	LIC-Z3C-ENT-5YR	LIC-Z3C-ENT-7YR	LIC-Z3C-ENT-10YR	Z3C

Cisco Meraki Vertical Desk Stand for Cisco Meraki Z3

Product SKU	Description
MA-STND-1	Vertical Desk Stand



Getting Started

What's New

Feature Story

Collaborate

Compute

Security

ASA 5500-X

Firepower 2100

AnyConnect

AMP for Endpoints

Umbrella

Meraki MX

**Meraki Z**

Meraki MV

Connect

Switches

Wireless

Routers

Services

## Overview

## Platform Spec

## Licenses &amp; Accessories

## Bringing Meraki Magic to the Video Security World

The **Cisco Meraki MV Cloud Managed Security Cameras** are exceptionally simple to deploy and configure. Their integration into the Meraki dashboard, ease of deployment, and use of cloud-augmented edge storage, eliminate the cost and complexity required by traditional security camera solutions.

Like all Meraki products, MV cameras provide zero-touch deployment. Using just serial numbers, an administrator can add devices to the Meraki dashboard and begin configuration before the hardware even arrives on site. In the Meraki dashboard, users can easily stream video and create video walls for monitoring key areas across multiple locations without ever configuring an IP or installing a plugin.



### Highlights

- **Centralized Cloud Management:** The Meraki dashboard provides secure monitoring and management of all your cameras from anywhere in the world
- **Edge Storage:** 128 or 256 GB of high write endurance solid state storage on each camera eliminates the need for an NVR
- **Optimized Retention:** Use motion-based retention and scheduled recording to customize video storage plans for every deployment
- **Advanced Analytics:** Industry-leading analytics and machine learning capabilities onboard each MV12
- **Motion Search:** Dynamically and retroactively select areas of interest in a video stream to find that missing laptop, then export clips directly from the dashboard
- **Encrypted By Default:** Video is encrypted at rest and during transport by default, with automated TLS certificate provisioning
- **Granular Access Controls:** Easily define who can see which video streams, view historical footage, and export video, all from the dashboard
- **Firmware Always Up-to-Date:** Feature releases, firmware updates, and bug fixes are always pushed automatically and at no additional cost with active license

Getting Started

What's New

Feature Story

Collaborate

Compute

Security

ASA 5500-X

Firepower 2100

AnyConnect

AMP for Endpoints

Umbrella

Meraki MX

Meraki Z

Meraki MV

Connect

Switches

Wireless

Routers

Services

## Overview

## Platform Spec

## Licenses &amp; Accessories

Model	Indoor			Outdoor	
Product SKU	MV12N-HW	MV12W-HW	MV12WE-HW	MV21-HW	MV71-HW
Camera	1/3", 4 MP (2,688 × 1,520) progressive CMOS image sensor			1/3.2", 5 MP (2,560 × 1,920) progressive CMOS image sensor	
	3.8 mm focal length f/1.8 minimum aperture	2.8 mm focal length f/1.8 minimum aperture		3 - 10 mm vari-focal lens f/1.3 - 2.5 variable aperture	
	Field of view 73° horizontal 44° vertical 86° diagonal	Field of view 114° horizontal 61° vertical 132° diagonal		Variable field of view 28 - 82° (horizontal) 21 - 61° (vertical) 37 - 107° (diagonal)	
	1/32,000 to 1/30 sec. shutter speed			1/5 to 1/32,000 sec. shutter speed	
	Minimum illumination 0.18 Lux (standard recording) and 0.01 Lux (night mode)			Minimum illumination 0.27 Lux (F1.3, color) and 0.001 Lux (F1.3, B&W)	
	S/N Ratio 52.9 dB			S/N Ratio exceeding 62 dB - Dynamic Range 69 dB	
	Built-in IR illuminators, effective up to 15 m (49 ft)			Built-in IR illuminators, effective up to 30 m (98 feet)	
Video	1080p HD video recording (1,920 × 1,080) with H.264 encoding			720p HD video recording (1,280 × 720) with H.264 encoding	
Storage	256 GB high endurance SSD		128 GB high endurance SSD	128 GB high endurance SSD	
Interface	1 x GE, Dual band IEEE 802.11 a/b/g/n/ac, Bluetooth 4.X (BR/EDR/BLE)			1 x FE	
Power	Power consumption 12.95 W maximum via IEEE 802.3af PoE			Power consumption 10.94 W maximum via IEEE 802.3af PoE	
Dimensions	106 mm x 74 mm (diameter × height)			166 mm x 116.5 mm (diameter × height)	173.3 mm x 115 mm (diameter × height)
Weight	286 g			1,028 g (including mounting plate)	1,482 g (including mounting plate)
Lens Adjustment Range	Fixed			65° Tilt, 350° Rotation, 350° Pan	
Weather-Proof IP66	-			-	•
Vandal-Proof IK10	-			-	•

Getting Started

What's New

Feature Story

Collaborate

Compute

Security

ASA 5500-X

Firepower 2100

AnyConnect

AMP for Endpoints

Umbrella

Meraki MX

Meraki Z

Meraki MV

Connect

Switches

Wireless

Routers

Services

Overview

Platform Spec

Licenses & Accessories

Cisco Meraki Enterprise Licenses for Cisco Meraki MV Series

Product SKU					Compatible Models
1-Year	3-Years	5-Years	7-Years	10-Years	
LIC-MV-1YR	LIC-MV-3YR	LIC-MV-5YR	LIC-MV-7YR	LIC-MV-10YR	All MV

Cisco Meraki Power Injector for Cisco Meraki MV Series

Product SKU	Description	Compatible Models
MA-INJ-4-xx	PoE Injector (802.3at)	All MV

Cisco Meraki Mount Kits for Cisco Meraki MV Series

Product SKU	Description	Compatible Models				
		MV12N	MV12W	MV12WE	MV21	MV71
MA-MNT-MV-1	Wall Mount Arm	-	-	-	●	●
MA-MNT-MV-2	Pole Mount	-	-	-	-	●
MA-MNT-MV-3	L-Shape Wall Mount Bracket	-	-	-	●	●



Getting Started

What's New

Feature Story

Collaborate

Compute

Security

ASA 5500-X

Firepower 2100

AnyConnect

AMP for Endpoints

Umbrella

Meraki MX

Meraki Z

Meraki MV

Connect

Switches

Wireless

Routers

Services



Featured Products

Portfolio

Transceiver Modules

Multigigabit



# Cisco Catalyst 9200 Series

**NEW**

Extend the Power of Intent-Based Networking Everywhere — It's Highly Secure and Always On, and It Provides IT Simplicity



## C9200L-24P-4X-E

UADP 2.0 Mini ASIC	Network Essentials (Perpetual)	Cisco DNA Essentials (3/5/7-Years)	Web UI CPC	Over-the-Air via Bluetooth	Blue Beacon
24-port GE PoE+ Up to 370 W	Perpetual PoE	4-port SFP+	Optional StackWise 80 Gbps	Optional Dual PS (FRU)	1 RU Rack Mount

## C9200-48T-A

UADP 2.0 Mini ASIC	Network Advantage (Perpetual)	Cisco DNA Advantage (3/5/7-Years)	Web UI CPC	Over-the-Air via Bluetooth	Blue Beacon
48-port GE	Optional Network Module	Optional StackWise 160 Gbps	Optional Dual PS/Fan (FRU)	1 RU Rack Mount	

- Getting Started
- What's New
- Feature Story
- Collaborate
- Compute
- Security
- Connect
  - Switches
    - SF/SG
    - Catalyst
      - 2960-L
      - 2960-X
      - 3650/3850
      - 9200 **NEW**
    - Meraki MS
  - Wireless
  - Routers
  - Services





# Cisco Catalyst 2960-L Series

Entry-level, Fixed-Configuration, Layer 2 Gigabit Ethernet Switches  
Powering Small Networks with Quietness & Ease



## WS-C2960L-24PQ-LL

IOS Enhanced LAN Lite	Static Routing	RIP	Virtual Stacking	Web UI CPC	Over-the-Air via Bluetooth
24-port GE PoE+ Up to 195 W	Perpetual PoE	4-port SFP+	1 RU Rack Mount		

## WS-C2960L-48PQ-LL

IOS Enhanced LAN Lite	Static Routing	RIP	Virtual Stacking	Web UI CPC	Over-the-Air via Bluetooth
48-port GE PoE+ Up to 370 W	Perpetual PoE	4-port SFP+	1 RU Rack Mount		

Getting Started

What's New

Feature Story

Collaborate

Compute

Security

Connect

Switches

SF/SG

Catalyst

2960-L

2960-X

3650/3850

9200 **NEW**

Meraki MS

Wireless

Routers

Services





# Cisco 250/350/350X Series Switches

Now Cisco provides new models to the existing family of Cisco 250/350/350X Series Switches Including Multigigabit Ethernet models to support 11ac Wave 2 and beyond



## SG350-8PD-K9-xx

- Advanced Managed Features
- IPv4/v6 Static Routing
- sFlow RSPAN
- 2R3C Policing
- Web UI
- Smart Network Application
- 6-port GE PoE+
- 2-port 2.5GE PoE+
- PoE Power Up to 124 W
- 2-port 10GB-T/SFP+
- Desktop

## SG350X-24PD-K9-xx

- Advanced Managed Features
- IPv4/v6 Static Routing
- sFlow RSPAN
- 2R3C Policing
- Web UI
- Smart Network Application
- 20-port GE PoE+
- 4-port 2.5GE 60 W PoE
- PoE Power Up to 375 W
- 2-port SFP+
- 2-port 10GB-T/SFP+
- Hardware Stacking
- 1 RU Rack Mount

Getting Started

What's New

Feature Story

Collaborate

Compute

Security

Connect

Switches

SF/SG

Catalyst

2960-L

2960-X

3650/3850

9200 **NEW**

Meraki MS

Wireless

Routers

Services



Getting Started

What's New

Feature Story

Collaborate

Compute

Security

Connect

Switches

SF/SG

Catalyst

2960-L

2960-X

3650/3850

9200 NEW

Meraki MS

Wireless

Routers

Services

Featured Products

Portfolio

Transceiver Modules

Multigigabit

	Access, Distribution, and Core Switches			Data Center Switches
	On-Premises Managed		Cloud Managed	
Overview	 <p>SF/SG Switches</p>	 <p>Catalyst Switches</p>	 <p>Meraki MS Switches</p>	 <p>Nexus Switches</p>
Highlights	<ul style="list-style-type: none"> <li>● Ideal for small and medium businesses</li> <li>● Easy network management with Cisco FindIT Network Management</li> </ul>	<ul style="list-style-type: none"> <li>● Ideal for small and medium businesses, and organizations seeking to implement digital transformation</li> <li>● Cisco Digital Network Architecture (Cisco DNA)-ready</li> </ul>	<ul style="list-style-type: none"> <li>● Provides unified visibility and control of the entire network via a single dashboard: not only switching, but also wireless, and security appliances</li> </ul>	<ul style="list-style-type: none"> <li>● Ideal for both traditional and fully automated software-defined data center deployments</li> </ul>
Cisco Start Products	<ul style="list-style-type: none"> <li>● Cisco 95 Series Unmanaged Switches</li> <li>● Cisco 110 Series Unmanaged Switches</li> <li>● Cisco 220 Series Smart Switches</li> <li>● Cisco 250 Series Smart Switches</li> <li>● Cisco 350 Series Managed Switches</li> <li>● Cisco 350X Series Stackable Managed Switches</li> <li>● Cisco 550X Series Stackable Managed Switches</li> </ul>	<ul style="list-style-type: none"> <li>● Cisco Catalyst 2960-L Series</li> <li>● Cisco Catalyst 2960-X Series</li> <li>● Cisco Catalyst 3650 Series</li> <li>● Cisco Catalyst 3850 Series</li> <li>● Cisco Catalyst 9200 Series</li> </ul>	<ul style="list-style-type: none"> <li>● Cisco Meraki MS120 Series</li> <li>● Cisco Meraki MS210 Series</li> <li>● Cisco Meraki MS220 Series</li> <li>● Cisco Meraki MS225 Series</li> </ul>	<ul style="list-style-type: none"> <li>● Cisco Nexus 9348GC-FXP</li> </ul>

Getting Started

What's New

Feature Story

Collaborate

Compute

Security

Connect

Switches

SF/SG

Catalyst

2960-L

2960-X

3650/3850

9200 NEW

Meraki MS

Wireless

Routers

Services

Featured Products

Portfolio

Transceiver Modules

Multigigabit

Cisco 100BASE Small Form-Factor Pluggable (SFP) Modules

SKU	Description	Max Distance	Compatible Series												
			SF/SG						Catalyst				Nexus		
			95/110	220	250	350	350X	550X	2960-L	2960-X	3650	3850	9200	9348	
GLC-GE-100FX	100BASE-FX SFP	2 km	-	-	-	-	-	-	-	-	•	•	•	•	-

Cisco 1000BASE Small Form-Factor Pluggable (SFP) Modules

SKU	Description	Max Distance	Compatible Series												
			SF/SG						Catalyst				Nexus		
			95/110	220	250	350	350X	550X	2960-L	2960-X	3650	3850	9200	9348	
MGBT1	1000BASE-T SFP	100 m	•	•	•	•	•	•	-	-	-	-	-	-	-
MGBSX1	1000BASE-SX SFP	500 m	•	•	•	•	•	•	-	-	-	-	-	-	-
MGBLX1	1000BASE-LX SFP	10 km	•	•	•	•	•	•	-	-	-	-	-	-	-
MGBLH1	1000BASE-LH SFP	40 km	•	•	•	•	•	•	-	-	-	-	-	-	-
GLC-TE	1000BASE-T SFP	100 m	-	-	-	-	-	-	•	•	•	•	•	•	•
GLC-SX-MMD	1000BASE-SX SFP	1 km	-	-	-	-	-	-	•	•	•	•	•	•	•
GLC-LH-SMD	1000BASE-LX SFP	10 km	•	•	•	•	•	•	•	•	•	•	•	•	•
GLC-BX-D	1000BASE-BX SFP	10 km	-	-	-	-	-	-	•	•	•	•	•	•	-
GLC-BX-U	1000BASE-BX SFP	10 km	•	•	•	•	•	•	•	•	•	•	•	•	-
GLC-EX-SMD	1000BASE-EX SFP	40 km	-	-	-	-	-	-	•	•	•	•	•	•	-
GLC-ZX-SMD	1000BASE-ZX SFP	70 km	-	-	-	-	-	-	•	•	•	•	•	•	-





Getting Started

What's New

Feature Story

Collaborate

Compute

Security

Connect

Switches

SF/SG

Catalyst

2960-L

2960-X

3650/3850

9200 NEW

Meraki MS

Wireless

Routers

Services

Featured Products

Portfolio

Transceiver Modules

Multigigabit

Cisco 10GBASE Small Form-Factor Pluggable Plus (SFP+) Modules

SKU	Description	Max Distance	Compatible Series											
			SF/SG						Catalyst				Nexus	
			95/110	220	250	350	350X	550X	2960-L	2960-X	3650	3850	9200	9348
SFP-10G-SR-S	S-class 10GBASE-SR SFP+	400 m	-	-	●*1	●*2	●	●	-	●	●	●	●*3	●
SFP-10G-SR	10GBASE-SR SFP+	400 m	-	-	●*1	●*2	●	●	-	●	●	●	●*3	●
SFP-10G-LRM	10GBASE-LRM SFP+	300 m	-	-	-	-	-	-	-	●	●	●	●*3	-
SFP-10G-LR-S	S-class 10GBASE-LR SFP+	10 km	-	-	●*1	●*2	●	●	-	●	●	●	●*3	●
SFP-10G-LR	10GBASE-LR SFP+	10 km	-	-	●*1	●*2	●	●	-	●	●	●	●*3	●
SFP-10G-BXD-I	10GBASE-BX SFP+	10 km	-	-	-	-	-	-	-	-	●	●	●*3	-
SFP-10G-BXU-I	10GBASE-BX SFP+	10 km	-	-	-	-	-	-	-	-	●	●	●*3	-
SFP-10G-BX40D-I	10GBASE-BX SFP+	40 km	-	-	-	-	-	-	-	-	●	●	●*3	-
SFP-10G-BX40U-I	10GBASE-BX SFP+	40 km	-	-	-	-	-	-	-	-	●	●	●*3	-
SFP-10G-ER-S	S-class 10GBASE-ER SFP+	40 km	-	-	-	-	-	-	-	●	●	●	●*3	●
SFP-10G-ER	10GBASE-ER SFP+	40 km	-	-	-	-	-	-	-	●	●	●	●*3	●
SFP-10G-ZR-S	S-class 10GBASE-ZR SFP+	80 km	-	-	-	-	-	-	-	●	●	●	●*3	●
SFP-10G-ZR	10GBASE-ZR SFP+	80 km	-	-	-	-	-	-	-	●	●	●	●*3	●
SFP-H10GB-CU1M	10GBASE-CU SFP+	1 m	-	-	●*1	●*2	●	●	-	●	●	●	●*3	●
SFP-H10GB-CU1-5M	10GBASE-CU SFP+	1.5 m	-	-	-	-	-	-	-	●	●	●	●*3	-
SFP-H10GB-CU2M	10GBASE-CU SFP+	2 m	-	-	-	-	-	-	-	●	●	●	●*3	●
SFP-H10GB-CU2-5M	10GBASE-CU SFP+	2.5 m	-	-	-	-	-	-	-	●	●	●	●*3	-
SFP-H10GB-CU3M	10GBASE-CU SFP+	3 m	-	-	●*1	●*2	●	●	-	●	●	●	●*3	●
SFP-H10GB-CU5M	10GBASE-CU SFP+	5 m	-	-	●*1	●*2	●	●	-	●	●	●	●*3	●
SFP-H10GB-ACU7M	10GBASE-ACU SFP+	7 m	-	-	-	-	-	-	-	●	●	●	●*3	●
SFP-H10GB-ACU10M	10GBASE-ACU SFP+	10 m	-	-	-	-	-	-	-	●	●	●	●*3	●
SFP-10G-AOC1M	10GBASE-AOC SFP+	1 m	-	-	-	-	-	-	-	●	●	●	●*3	●
SFP-10G-AOC2M	10GBASE-AOC SFP+	2 m	-	-	-	-	-	-	-	●	●	●	●*3	●
SFP-10G-AOC3M	10GBASE-AOC SFP+	3 m	-	-	-	-	-	-	-	●	●	●	●*3	●
SFP-10G-AOC5M	10GBASE-AOC SFP+	5 m	-	-	-	-	-	-	-	●	●	●	●*3	●
SFP-10G-AOC7M	10GBASE-AOC SFP+	7 m	-	-	-	-	-	-	-	●	●	●	●*3	●
SFP-10G-AOC10M	10GBASE-AOC SFP+	10 m	-	-	-	-	-	-	-	●	●	●	●*3	●

\*1 Cisco 250X Series only. \*2 SG350-8PD only. \*3 10GE models & 10GE Network Module only.



Cisco 40GBASE Quad Small Form-Factor Pluggable (QSFP+) Modules

SKU	Description	Max Distance	Compatible Series											
			SF/SG						Catalyst				Nexus	
			95/110	220	250	350	350X	550X	2960-L	2960-X	3650	3850	9200	9348
QSFP-40G-SR-BD	40GBASE-SR QSFP+	150 m	-	-	-	-	-	-	-	-	-	●	-	●
QSFP-40G-SR4-S	S-class 40GBASE-SR4 QSFP+	150 m	-	-	-	-	-	-	-	-	-	●	-	●
QSFP-40G-SR4	40GBASE-SR4 QSFP+	150 m	-	-	-	-	-	-	-	-	-	●	-	●
QSFP-40G-CSR4	40GBASE-CSR4 QSFP+	400 m	-	-	-	-	-	-	-	-	-	●	-	●
WSP-Q40GLR4L	40GBASE-LR4L QSFP+	2 km	-	-	-	-	-	-	-	-	-	●	-	●
QSFP-40G-LR4-S	S-class 40GBASE-LR4 QSFP+	10 km	-	-	-	-	-	-	-	-	-	●	-	●
QSFP-40G-LR4	40GBASE-LR4 QSFP+	10 km	-	-	-	-	-	-	-	-	-	●	-	●
QSFP-40G-ER4	40GBASE-ER4 QSFP+	40 km	-	-	-	-	-	-	-	-	-	●	-	●
QSFP-H40G-CU1M	40GBASE-CU QSFP+	1 m	-	-	-	-	-	-	-	-	-	●	-	●
QSFP-H40G-CU3M	40GBASE-CU QSFP+	3 m	-	-	-	-	-	-	-	-	-	●	-	●
QSFP-H40G-CU5M	40GBASE-CU QSFP+	5 m	-	-	-	-	-	-	-	-	-	●	-	●
QSFP-H40G-ACU7M	40GBASE-ACU QSFP+	7 m	-	-	-	-	-	-	-	-	-	●	-	●
QSFP-H40G-ACU10M	40GBASE-ACU QSFP+	10 m	-	-	-	-	-	-	-	-	-	●	-	●
QSFP-H40G-AOC1M	40GBASE-AOC QSFP+	1 m	-	-	-	-	-	-	-	-	-	-	-	●
QSFP-H40G-AOC2M	40GBASE-AOC QSFP+	2 m	-	-	-	-	-	-	-	-	-	-	-	●
QSFP-H40G-AOC3M	40GBASE-AOC QSFP+	3 m	-	-	-	-	-	-	-	-	-	-	-	●
QSFP-H40G-AOC5M	40GBASE-AOC QSFP+	5 m	-	-	-	-	-	-	-	-	-	-	-	●
QSFP-H40G-AOC7M	40GBASE-AOC QSFP+	7 m	-	-	-	-	-	-	-	-	-	-	-	●
QSFP-H40G-AOC10M	40GBASE-AOC QSFP+	10 m	-	-	-	-	-	-	-	-	-	-	-	●
QSFP-H40G-AOC15M	40GBASE-AOC QSFP+	15 m	-	-	-	-	-	-	-	-	-	-	-	●
QSFP-H40G-AOC20M	40GBASE-AOC QSFP+	20 m	-	-	-	-	-	-	-	-	-	-	-	●
QSFP-H40G-AOC25M	40GBASE-AOC QSFP+	25 m	-	-	-	-	-	-	-	-	-	-	-	●
QSFP-H40G-AOC30M	40GBASE-AOC QSFP+	30 m	-	-	-	-	-	-	-	-	-	-	-	●

Getting Started

What's New

Feature Story

Collaborate

Compute

Security

Connect

Switches

SF/SG

Catalyst

2960-L

2960-X

3650/3850

9200 NEW

Meraki MS

Wireless

Routers

Services



Cisco 100GBASE Quad Small Form-Factor Pluggable (QSFP+) Modules

SKU	Description	Max Distance	Compatible Series												
			SF/SG						Catalyst				Nexus		
			95/110	220	250	350	350X	550X	2960-L	2960-X	3650	3850	9200	9348	
QSFP-100G-SR4-S	100GBASE-SR4 QSFP+	100 m	-	-	-	-	-	-	-	-	-	-	-	-	●
QSFP-40/100-SRBD	40/100GBASE-SR-BiDi QSFP+	100 m	-	-	-	-	-	-	-	-	-	-	-	-	●
QSFP-100G-PSM4-S	100GBASE-PSM4 QSFP+	500 m	-	-	-	-	-	-	-	-	-	-	-	-	●
QSFP-100G-SM-SR	100GBASE-CWDM4 Lite QSFP+	2 km	-	-	-	-	-	-	-	-	-	-	-	-	●
QSFP-100G-CWDM4-S	100GBASE-CWDM4 QSFP+	2 km	-	-	-	-	-	-	-	-	-	-	-	-	●
QSFP-100G-LR4-S	100GBASE-LR4 QSFP+	10 km	-	-	-	-	-	-	-	-	-	-	-	-	●
QSFP-100G-CU1M	100GBASE-CU QSFP+	1 m	-	-	-	-	-	-	-	-	-	-	-	-	●
QSFP-100G-CU2M	100GBASE-CU QSFP+	2 m	-	-	-	-	-	-	-	-	-	-	-	-	●
QSFP-100G-CU3M	100GBASE-CU QSFP+	3 m	-	-	-	-	-	-	-	-	-	-	-	-	●
QSFP-100G-CU5M	100GBASE-CU QSFP+	5 m	-	-	-	-	-	-	-	-	-	-	-	-	●
QSFP-100G-AOC1M	100GBASE-AOC QSFP+	1 m	-	-	-	-	-	-	-	-	-	-	-	-	●
QSFP-100G-AOC2M	100GBASE-AOC QSFP+	2 m	-	-	-	-	-	-	-	-	-	-	-	-	●
QSFP-100G-AOC3M	100GBASE-AOC QSFP+	3 m	-	-	-	-	-	-	-	-	-	-	-	-	●
QSFP-100G-AOC5M	100GBASE-AOC QSFP+	5 m	-	-	-	-	-	-	-	-	-	-	-	-	●
QSFP-100G-AOC7M	100GBASE-AOC QSFP+	7 m	-	-	-	-	-	-	-	-	-	-	-	-	●
QSFP-100G-AOC10M	100GBASE-AOC QSFP+	10 m	-	-	-	-	-	-	-	-	-	-	-	-	●
QSFP-100G-AOC15M	100GBASE-AOC QSFP+	15 m	-	-	-	-	-	-	-	-	-	-	-	-	●
QSFP-100G-AOC20M	100GBASE-AOC QSFP+	20 m	-	-	-	-	-	-	-	-	-	-	-	-	●
QSFP-100G-AOC25M	100GBASE-AOC QSFP+	25 m	-	-	-	-	-	-	-	-	-	-	-	-	●
QSFP-100G-AOC30M	100GBASE-AOC QSFP+	30 m	-	-	-	-	-	-	-	-	-	-	-	-	●

- Getting Started
- What's New
- Feature Story
- Collaborate
- Compute
- Security
- Connect
  - Switches
    - SF/SG
    - Catalyst
      - 2960-L
      - 2960-X
      - 3650/3850
      - 9200 NEW
    - Meraki MS
  - Wireless
  - Routers
  - Services



Getting Started

What's New

Feature Story

Collaborate

Compute

Security

Connect

Switches

SF/SG

Catalyst

2960-L

2960-X

3650/3850

9200 NEW

Meraki MS

Wireless

Routers

Services

Featured Products

Portfolio

Transceiver Modules

Multigigabit

## Cisco Meraki 1000BASE Small Form-Factor Pluggable (SFP) Modules

SKU	Description	Max Distance	Compatible Series			
			MS120	MS210	MS220	MS225
MA-SFP-1GB-TX	1000BASE-T SFP	100 m	●	●	●	●
MA-SFP-1GB-SX	1000BASE-SX SFP	550 m	●	●	●	●
MA-SFP-1GB-LX10	1000BASE-LX10 SFP	10 km	●	●	●	●

## Cisco Meraki 10GBASE Small Form-Factor Pluggable Plus (SFP+) Modules

SKU	Description	Max Distance	Compatible Series			
			MS120	MS210	MS220	MS225
MA-SFP-10GB-SR	10GBASE-SR SFP+	400 m	-	-	-	●
MA-SFP-10GB-LRM	10GBASE-LRM SFP+	220 m	-	-	-	●
MA-SFP-10GB-LR	10GBASE-LR SFP+	10 km	-	-	-	●



Getting Started

What's New

Feature Story

Collaborate

Compute

Security

Connect

Switches

SF/SG

Catalyst

2960-L

2960-X

3650/3850

9200 NEW

Meraki MS

Wireless

Routers

Services

Featured Products

Portfolio

Transceiver Modules

Multigigabit

Challenges for Wired LAN Posed by 11ac “Gigabit Wireless LAN”

IEEE 802.11ac is a super high-speed wireless standard that delivers a theoretical maximum throughput of up to 6.9 Gbps. Wireless LAN is literally entering the “Gigabit era,” but the migration to 11ac is presenting wired LAN with “old and new” challenges. In other words, these are the same old challenges that were experienced during the migration from 11a/g to 11n.

During the migration from 11a/g to 11n, it was obvious that Fast Ethernet switches (max 100 Mbps) had insufficient capacity to server as access switches for accommodating the access points. Similarly today, it is obvious that 1-Gigabit Ethernet switches (1GE, max 1000 Mbps) have insufficient capacity when migrating from 11n to 11ac. Specifically:

- A bottleneck will occur if the uplink port of the access switches accommodating multiple 11ac compatible access points is 1GE.
- A bottleneck will occur if the downlink port of the access switches accommodating 11ac Wave compatible access points is 1GE.

Therefore, as was during the migration from 11a/g to 11n, replacement of access switches is therefore indispensable in order to unleash the full potential of 11ac.

The only current IEEE standard that is faster than 1 GE is 10 Gigabit Ethernet (10GE) with copper or optical fiber cables. However, there are some difficulties associated with the deployment of 10GE-compatible switches.

- Cable re-installation is required in many cases: Category 5e accounts for 46 % and Category 6 accounts for 28 % of the copper cables currently installed in corporations around the world, respectively. 10GE via copper is not supported for Category 5e cables and is limited to a length of 55 meters for Category 6 cables. Installations of optical fiber cables and copper wire cables both require huge costs.
- Current 10GE does not support PoE: Power supply units and power cables would be required for the access points.

Cisco Catalyst Multigigabit Technology (mGig)

Cisco’s innovative Cisco Catalyst Multigigabit Technology (mGig) has been developed to address all of these challenges posed by the deployment of 11ac. Largely, mGig offers the following three advantages:

- **Multi-Speed:** Category 5e cables support 100 Mbps, 1 Gbps, 2.5 Gbps and 5 Gbps; and category 6a cables support 10 Gbps, respectively.
- **Cable Type:** A wide variety of cable types are supported including Category 5e, Category 6, and Category 6a.
- **PoE:** PoE (15.4 W), PoE+ (30 W), and UPOE (60 W) are supported unlike the current 10GE.

mGig is based on the technology of the NBASE-T Alliance established by Cisco in October 2014. A large number of vendors are participating in the NBASE-T Alliance; and IEEE standardization is currently being promoted for 2.5GBASE-T for 5GBASE-T.

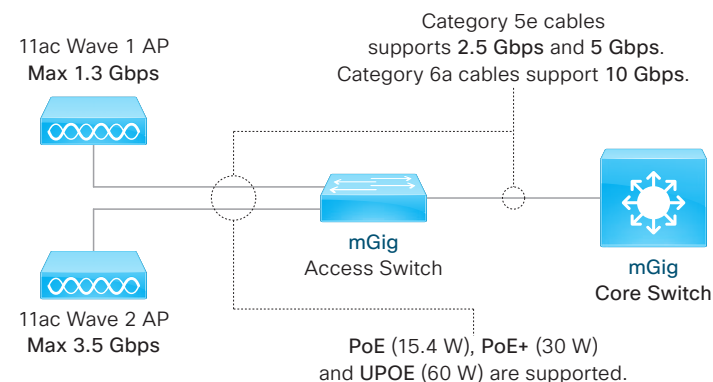

Cisco Catalyst Multigigabit Technology (mGig): Speeds and Cables

Cable Type	1 Gbps	2.5 Gbps	5 Gbps	10 Gbps
Cat 5e	●	●	●	-
Cat 6	●	●	●	●  55m
Cat 6a	●	●	●	●



## Easy-to-Use Switches that Provide the Ideal Combination of Features and Affordability

The Cisco SF/SG Switches provide nonblocking, wire-speed switching for 10-, 100-, and 1000-Mbps network clients. These switches can be used to replace the current workgroup hub or switch and to deliver full 1- and 10-Gbps speeds to high-requirement workstations as necessary while continuing to serve other clients at their current speeds.

The switches can also be used to create a local area network within the business, with appropriate link speeds for each user's requirements. Either way, they're perfect for graphics, videos, and other applications that have to move large files across the network quickly.

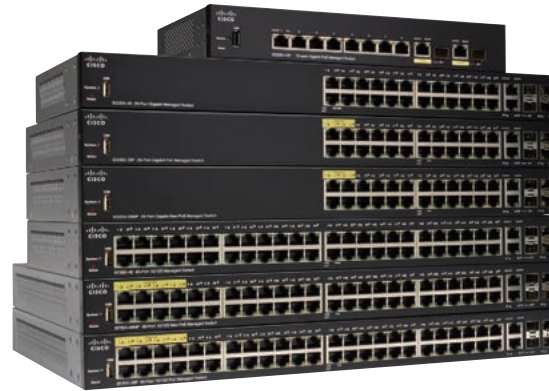

### Lineup

- **Cisco 95/110 Series Unmanaged Switches**

Get highly affordable Gigabit, Fast Ethernet, and PoE. No setup is required for QoS, network diagnostics, power-saving mode, and loop detection.

- **Cisco 220 Series Smart Switches**

Get the powerful features, security, and performance of a managed switch with the affordability that's closer to smart switches.

- **Cisco 250 Series Smart Switches**

Entry-level managed switch features and easy management at a great price. Build a business-class network with the features you need.

- **Cisco 350 Series Managed Switches**

The ideal combination of affordability and advanced network features for small business, these easy to use fully managed switches are the cornerstone of your network.

- **Cisco 350X Series Stackable Managed Switches**

Our managed switches deliver an ideal combination of affordability and advanced features with 10-Gigabit Ethernet and stacking.

- **Cisco 550X Series Stackable Managed Switches**

These next-generation stackable managed switches offer 10-Gigabit Ethernet and advanced capabilities to accelerate your business growth.

Getting Started

What's New

Feature Story

Collaborate

Compute

Security

Connect

Switches

SF/SG

Catalyst

2960-L

2960-X

3650/3850

9200 **NEW**

Meraki MS

Wireless

Routers

Services

Overview

Positioning Map

Platform Spec

FindIT

Managed



350 Series Managed Switches

- SNA, PnP client
- IPv6 static routing
- sFlow, RSPAN
- 2R3C policing
- PoE+ and 60 W PoE
- PSE/PD models



350X Series Stackable Managed Switches

- 10GE uplink
- all 10GE models
- 4 units true stacking
- PoE+ and 60 W PoE



550X Series Stackable Managed Switches

- Redundant power and fan
- 10GE uplink
- all 10GE models
- 8 unit true stacking
- PoE+ and 60 W PoE

Smart



220 Series Smart Switches

- Enhanced smart features
- All ports PoE+



250 Series Smart Switches

- Advanced smart features
- Static routing, ACL, CLI
- All ports PoE+

Unmanaged



95/110 Series Unmanaged Switches

- Basic connectivity
- 1/2 ports PoE

Getting Started

What's New

Feature Story

Collaborate

Compute

Security

Connect

Switches

SF/SG

Catalyst

2960-L

2960-X

3650/3850

9200 NEW

Meraki MS

Wireless

Routers

Services



Overview

Positioning Map

Platform Spec

FindIT

Cisco 95 Series Unmanaged Switches

Product SKU	Service (CSE) SKU	Ports								PoE					AC Power	Fan less	Stack able	Rack Mount	
		FE	GE	SFP	GE/SFP	2.5G mGig	10 GB-T	SFP+	10GB-T /SFP+	Ports	60 W Ports	Power Budget	IEEE 802.3	Input Ports					Pass through
SF95D-05-xx	CON-SMBS-F95D05xx	5	-	-	-	-	-	-	-	-	-	-	-	-	-	External	●	-	-
SF95D-08-xx	CON-SMBS-F95D08xx	8	-	-	-	-	-	-	-	-	-	-	-	-	-	External	●	-	-
SF95D-16-xx	CON-SMBS-F95D16xx	16	-	-	-	-	-	-	-	-	-	-	-	-	-	External	●	-	-
SF95-24-xx	CON-SMBS-SF9524xx	24	-	-	-	-	-	-	-	-	-	-	-	-	-	Internal	●	-	1 RU
SG95D-05-xx	CON-SMBS-G95D05xx	-	5	-	-	-	-	-	-	-	-	-	-	-	-	External	●	-	-
SG95D-08-xx	CON-SMBS-G95D08xx	-	8	-	-	-	-	-	-	-	-	-	-	-	-	External	●	-	-
SG95-16-xx	CON-SMBS-SG9516xx	-	16	-	-	-	-	-	-	-	-	-	-	-	-	Internal	●	-	-
SG95-24-xx	CON-SMBS-SG9524xx	-	22	-	2	-	-	-	-	-	-	-	-	-	-	Internal	●	-	1 RU

Cisco 110 Series Unmanaged Switches

Product SKU	Service (CSE) SKU	Ports								PoE					AC Power	Fan less	Stack able	Rack Mount	
		FE	GE	SFP	GE/SFP	2.5G mGig	10 GB-T	SFP+	10GB-T /SFP+	Ports	60 W Ports	Power Budget	IEEE 802.3	Input Ports					Pass through
SF110D-05-xx <sup>*1</sup>	CON-SMBS-SF0D05xx	5	-	-	-	-	-	-	-	-	-	-	-	-	-	External	●	-	-
SF110D-08-xx	CON-SMBS-SF0D08xx	8	-	-	-	-	-	-	-	-	-	-	-	-	-	External	●	-	-
SF110D-08HP-xx	CON-SMBS-0D08HPxx	8	-	-	-	-	-	-	-	4	-	32 W	af	-	-	External	●	-	-
SF110D-16-xx <sup>*1</sup>	CON-SMBS-SF0D16xx	16	-	-	-	-	-	-	-	-	-	-	-	-	-	External	●	-	-
SF110D-16HP-xx <sup>*1</sup>	CON-SMBS-0D16HPxx	16	-	-	-	-	-	-	-	8	-	64 W	af	-	-	External	●	-	-
SF110-16-xx <sup>*1</sup>	CON-SMBS-S1F016xx	16	-	-	-	-	-	-	-	-	-	-	-	-	-	Internal	●	-	1 RU
SF110-24-xx	CON-SMBS-S1F024xx	24	-	-	-	-	-	-	-	-	-	-	-	-	-	Internal	●	-	1 RU
SF112-24-xx	CON-SMBS-S1F224xx	24	-	-	2	-	-	-	-	-	-	-	-	-	-	Internal	●	-	1 RU
SG110D-05-xx	CON-SMBS-SG0D05xx	-	5	-	-	-	-	-	-	-	-	-	-	-	-	External	●	-	-
SG110D-08-xx	CON-SMBS-SG0D08xx	-	8	-	-	-	-	-	-	-	-	-	-	-	-	External	●	-	-
SG110D-08HP-xx	CON-SMBS-xxxxxxx	-	8	-	-	-	-	-	-	4	-	32 W	af	-	-	External	●	-	-
SG110-16-xx	CON-SMBS-S1G016xx	-	16	-	-	-	-	-	-	-	-	-	-	-	-	Internal	●	-	1 RU
SG110-16HP-xx	CON-SMBS-G016HPxx	-	16	-	-	-	-	-	-	8	-	64 W	af	-	-	Internal	●	-	1 RU
SG110-24-xx	CON-SMBS-S1G024xx	-	22	-	2	-	-	-	-	-	-	-	-	-	-	Internal	●	-	1 RU
SG110-24HP-xx	CON-SMBS-xxxxxxx	-	22	-	2	-	-	-	-	12	-	100 W	af	-	-	Internal	-	-	1 RU
SG112-24-xx	CON-SMBS-S1G224xx	-	22	-	2	-	-	-	-	-	-	-	-	-	-	Internal	●	-	1 RU

\*1 The "-AU" SKUs have reached end-of-life status.

Getting Started

What's New

Feature Story

Collaborate

Compute

Security

Connect

Switches

SF/SG

Catalyst

2960-L

2960-X

3650/3850

9200 NEW

Meraki MS

Wireless

Routers

Services





Overview

Positioning Map

Platform Spec

FindIT

Cisco 220 Series Smart Switches

Product SKU	Service (CSE) SKU	Ports								PoE					AC Power	Fan less	Stack able	Rack Mount
		FE	GE	SFP	GE/SFP	2.5G mGig	10 GB-T	SFP+	10GB-T /SFP+	Ports	60 W Ports	Power Budget	IEEE 802.3	Input Ports				
SF220-24-K9-xx*1	CON-SMBS-F2029xx1	24	-	-	2	-	-	-	-	-	-	-	-	-	Internal	●	-	1 RU
SF220-24P-K9-xx*1	CON-SMBS-F2029xx2	24	-	-	2	-	-	-	-	24	-	180 W	af/at	-	Internal	-	-	1 RU
SF220-48-K9-xx*1	CON-SMBS-F2049xx1	48	-	-	2	-	-	-	-	-	-	-	-	Internal	●	-	1 RU	
SF220-48P-K9-xx*1	CON-SMBS-F2049xx2	48	-	-	2	-	-	-	-	48	-	375 W	af/at	-	Internal	-	-	1 RU
SG220-26-K9-xx	CON-SMBS-G2029xx1	-	24	-	2	-	-	-	-	-	-	-	-	Internal	●	-	1 RU	
SG220-26P-K9-xx	CON-SMBS-G2029xx2	-	24	-	2	-	-	-	-	24	-	180 W	af/at	-	Internal	-	-	1 RU
SG220-50-K9-xx	CON-SMBS-G2059xx1	-	48	-	2	-	-	-	-	-	-	-	-	Internal	-	-	1 RU	
SG220-50P-K9-xx	CON-SMBS-G2059xx2	-	48	-	2	-	-	-	-	48	-	375 W	af/at	-	Internal	-	-	1 RU

\*1 The "-AU" SKUs have reached end-of-life status.

Cisco 250 Series Smart Switches

Product SKU	Service (CSE) SKU	Ports								PoE					AC Power	Fan less	Stack able	Rack Mount
		FE	GE	SFP	GE/SFP	2.5G mGig	10 GB-T	SFP+	10GB-T /SFP+	Ports	60 W Ports	Power Budget	IEEE 802.3	Input Ports				
SF250-24-K9-xx	CON-SMBS-SF2502xx	24	-	2	2	-	-	-	-	-	-	-	-	-	Internal	●	-	1 RU
SF250-24P-K9-xx	CON-SMBS-SF25024x	24	-	2	2	-	-	-	-	24	-	185 W	af/at	-	Internal	-	-	1 RU
SF250-48-K9-xx	CON-SMBS-SFxxxxxx	48	-	2	2	-	-	-	-	-	-	-	-	Internal	●	-	1 RU	
SF250-48HP-K9-xx	CON-SMBS-SF25xxxx	48	-	2	2	-	-	-	-	48	-	195 W	af/at	-	Internal	-	-	1 RU
SG250-08-K9-xx	CON-SMBS-SG2500xx	-	8	-	-	-	-	-	-	-	-	-	1	External	●	-	1 RU	
SG250-08HP-K9-xx	CON-SMBS-SG25008x	-	8	-	-	-	-	-	-	8	-	45 W	af/at	-	External	●	-	1 RU
SG250-10P-K9-xx	CON-SMBS-xxxxxx	-	8	-	2	-	-	-	-	8	-	62 W	af/at	2	External	●	-	1 RU
SG250-18-K9-xx	CON-SMBS-SG25018x	-	16	-	2	-	-	-	-	-	-	-	-	Internal	●	-	1 RU	
SG250-26-K9-xx	CON-SMBS-xxxxxx	-	24	-	2	-	-	-	-	-	-	-	-	Internal	●	-	1 RU	
SG250-26HP-K9-xx	CON-SMBS-xxxxxx	-	24	-	2	-	-	-	-	24	-	100 W	af/at	-	Internal	-	-	1 RU
SG250-26P-K9-xx	CON-SMBS-xxxxxx	-	24	-	2	-	-	-	-	24	-	195 W	af/at	-	Internal	-	-	1 RU
SG250-50-K9-xx	CON-SMBS-SG250xxx	-	48	-	2	-	-	-	-	-	-	-	-	Internal	-	-	1 RU	
SG250-50HP-K9-xx	CON-SMBS-SG2505xx	-	48	-	2	-	-	-	-	48	-	192 W	af/at	-	Internal	-	-	1 RU
SG250-50P-K9-xx	CON-SMBS-SG2505xx	-	48	-	2	-	-	-	-	48	-	375 W	af/at	-	Internal	-	-	1 RU
SG250X-24-K9-xx	CON-SMBS-SG25xxxx	-	24	-	-	-	2	2	-	-	-	-	-	Internal	-	-	1 RU	
SG250X-24P-K9-xx	CON-SMBS-xxxxxx	-	24	-	-	-	2	2	-	24	-	195 W	af/at	-	Internal	-	-	1 RU
SG250X-48-K9-xx	CON-SMBS-SG25xxxx	-	48	-	-	-	2	2	-	-	-	-	-	Internal	-	-	1 RU	
SG250X-48P-K9-xx	CON-SMBS-SG25xxxx	-	48	-	-	-	2	2	-	48	-	382 W	af/at	-	Internal	-	-	1 RU

Getting Started

What's New

Feature Story

Collaborate

Compute

Security

Connect

Switches

SF/SG

Catalyst

2960-L

2960-X

3650/3850

9200 NEW

Meraki MS

Wireless

Routers

Services





Overview

Positioning Map

Platform Spec

FindIT

Cisco 350 Series Managed Switches

Product SKU	Service (CSE) SKU	Ports								PoE					AC Power	Fan less	Stack able	Rack Mount	
		FE	GE	SFP	GE/SFP	2.5G mGig	10 GB-T	SFP+	mGig/SFP+	Ports	60 W Ports	Power Budget	IEEE 802.3	Input Ports					Pass through
SF350-08-K9-xx	CON-SMBS-SF3xxxxx	8	-	-	-	-	-	-	-	-	-	-	-	-	External	●	-	1 RU	
SF352-08-K9-xx	CON-SMBS-SF3xxxxx	8	-	-	2	-	-	-	-	-	-	-	-	-	External	●	-	1 RU	
SF352-08P-K9-xx	CON-SMBS-xxxxxxx	8	-	-	2	-	-	-	-	8	-	62 W	af/at	-	External	●	-	1 RU	
SF352-08MP-K9-xx	CON-SMBS-SFxxxxxx	8	-	-	2	-	-	-	-	8	-	128 W	af/at	-	External	●	-	1 RU	
SF350-24-K9-xx	CON-SMBS-SF35xxxx	24	-	2	2	-	-	-	-	-	-	-	-	-	Internal	●	-	1 RU	
SF350-24P-K9-xx	CON-SMBS-SF3xxxxx	24	-	2	2	-	-	-	-	24	4	185 W	af/at	-	Internal	-	-	1 RU	
SF350-24MP-K9-xx	CON-SMBS-SFxxxxxx	24	-	2	2	-	-	-	-	24	4	375 W	af/at	-	Internal	-	-	1 RU	
SF350-48-K9-xx	CON-SMBS-xxxxxxx	48	-	2	2	-	-	-	-	-	-	-	-	-	Internal	●	-	1 RU	
SF350-48P-K9-xx	CON-SMBS-SF35xxxx	48	-	2	2	-	-	-	-	48	8	382 W	af/at	-	Internal	-	-	1 RU	
SF350-48MP-K9-xx	CON-SMBS-SF35xxxx	48	-	2	2	-	-	-	-	48	8	740 W	af/at	-	Internal	-	-	1 RU	
SG350-8PD-K9-xx	CON-SMBS-SG3xxxxx	-	6	-	-	2	-	-	2	8	-	124 W	af/at	-	Internal	●	-	1 RU	
SG350-10-K9-xx	CON-SMBS-SG3xxxxx	-	8	-	2	-	-	-	-	-	-	-	-	2	●	External	●	-	1 RU
SG350-10P-K9-xx	CON-SMBS-SG35xxxx	-	8	-	2	-	-	-	-	8	-	62 W	af/at	2	●	External	●	-	1 RU
SG350-10MP-K9-xx	CON-SMBS-SG3xxxxx	-	8	-	2	-	-	-	-	8	-	124 W	af/at	2	●	External	●	-	1 RU
SG355-10P-K9-xx	CON-SMBS-SG35xxxx	-	8	-	2	-	-	-	-	8	-	62 W	af/at	2	●	Internal	●	-	1 RU
SG350-10SFP-K9-xx	CON-SMBS-SG3501	-	-	8	2	-	-	-	-	-	-	-	-	-	External	●	-	1 RU	
SG350-20-K9-xx	CON-SMBS-SG3xxxxx	-	16	2	2	-	-	-	-	-	-	-	-	-	Internal	●	-	1 RU	
SG350-28-K9-xx	CON-SMBS-xxxxxxx	-	24	2	2	-	-	-	-	-	-	-	-	-	Internal	●	-	1 RU	
SG350-28P-K9-xx	CON-SMBS-xxxxxxx	-	24	2	2	-	-	-	-	24	4	195 W	af/at	-	Internal	-	-	1 RU	
SG350-28MP-K9-xx	CON-SMBS-xxxxxxx	-	24	2	2	-	-	-	-	24	4	382 W	af/at	-	Internal	-	-	1 RU	
SG350-28SFP-K9-xx	CON-SMBS-SG3xxxxx	-	-	26	2	-	-	-	-	-	-	-	-	-	Internal	-	-	1 RU	
SG350-52-K9-xx	CON-SMBS-SG3xxxxx	-	48	2	2	-	-	-	-	-	-	-	-	-	Internal	-	-	1 RU	
SG350-52P-K9-xx	CON-SMBS-SG35052x	-	48	2	2	-	-	-	-	48	8	375 W	af/at	-	Internal	-	-	1 RU	
SG350-52MP-K9-xx	CON-SMBS-SG3xxxxx	-	48	2	2	-	-	-	-	48	8	740 W	af/at	-	Internal	-	-	1 RU	

Getting Started

What's New

Feature Story

Collaborate

Compute

Security

Connect

Switches

SF/SG

Catalyst

2960-L

2960-X

3650/3850

9200 NEW

Meraki MS

Wireless

Routers

Services







Overview

Positioning Map

Platform Spec

FindIT

Cisco 350X Series Stackable Managed Switches

Product SKU	Service (CSE) SKU	Ports								PoE					AC Power	Fan less	Stack able	Rack Mount	
		FE	GE	SFP	GE/SFP	2.5G mGig	10 GB-T	SFP+	10GB-T /SFP+	Ports	60 W Ports	Power Budget	IEEE 802.3	Input Ports					Pass through
SG350X-8PMD-K9-xx	CON-SMBS-SG3xxxxx	-	-	-	-	8	-	-	2	8	4	240 W	af/at	-	-	Internal	-	●	1 RU
SG350X-24-K9-xx	CON-SMBS-xxxxxxx	-	24	-	-	-	-	2	2	-	-	-	-	-	-	Internal	-	●	1 RU
SG350X-24P-K9-xx	CON-SMBS-xxxxxxx	-	24	-	-	-	-	2	2	24	4	195 W	af/at	-	-	Internal	-	●	1 RU
SG350X-24MP-K9-xx	CON-SMBS-xxxxxxx	-	24	-	-	-	-	2	2	24	4	382 W	af/at	-	-	Internal	-	●	1 RU
SG350X-24PD-K9-xx	CON-SMBS-SGxxxxxx	-	20	-	-	4	-	2	2	24	4	375 W	af/at	-	-	Internal	-	●	1 RU
SG350X-48-K9-xx	CON-SMBS-xxxxxxx	-	48	-	-	-	-	2	2	-	-	-	-	-	-	Internal	-	●	1 RU
SG350X-48P-K9-xx	CON-SMBS-xxxxxxx	-	48	-	-	-	-	2	2	48	8	382 W	af/at	-	-	Internal	-	●	1 RU
SG350X-48MP-K9-xx	CON-SMBS-xxxxxxx	-	48	-	-	-	-	2	2	48	8	740 W	af/at	-	-	Internal	-	●	1 RU
SG350XG-2F10-K9-xx	CON-SMBS-SGxxxxxx	-	-	-	-	-	10	2	-	-	-	-	-	-	-	Internal	-	●	1 RU
SG350XG-24T-K9-xx	CON-SMBS-SGxxxxxx	-	-	-	-	-	22	-	2	-	-	-	-	-	-	Internal	-	●	1 RU
SG350XG-24F-K9-xx	CON-SMBS-SGxxxxxx	-	-	-	-	-	-	22	2	-	-	-	-	-	-	Internal	-	●	1 RU
SG350XG-48T-K9-xx	CON-SMBS-SGxxxxxx	-	-	-	-	-	46	-	2	-	-	-	-	-	-	Internal	-	●	1 RU

Getting Started

What's New

Feature Story

Collaborate

Compute

Security

Connect

Switches

SF/SG

Catalyst

2960-L

2960-X

3650/3850

9200 NEW

Meraki MS

Wireless

Routers

Services





Overview

Positioning Map

Platform Spec

FindIT

Cisco 550X Series Stackable Managed Switches

Product SKU	Service (CSE) SKU	Ports								PoE					AC Power	Fan less	Stack able	Rack Mount	
		FE	GE	SFP	GE/SFP	2.5G mGig	10 GB-T	SFP+	10GB-T /SFP+	Ports	60 W Ports	Power Budget	IEEE 802.3	Input Ports					Pass through
SF550X-24-K9-xx	CON-SMBS-SFxxxxxx	24	-	-	-	-	-	2	2	-	-	-	-	-	-	Internal	-	●	1 RU
SF550X-24P-K9-xx	CON-SMBS-SFxxxxxx	24	-	-	-	-	-	2	2	24	8	195 W	af/at	-	-	Internal	-	●	1 RU
SF550X-24MP-K9-xx	CON-SMBS-Sxxxxxxx	24	-	-	-	-	-	2	2	24	8	382 W	af/at	-	-	Internal	-	●	1 RU
SF550X-48-K9-xx	CON-SMBS-SFxxxxxx	48	-	-	-	-	-	2	2	-	-	-	-	-	-	Internal	-	●	1 RU
SF550X-48P-K9-xx	CON-SMBS-SFxxxxxx	48	-	-	-	-	-	2	2	48	16	382 W	af/at	-	-	Internal	-	●	1 RU
SF550X-48MP-K9-xx	CON-SMBS-xxxxxxx	48	-	-	-	-	-	2	2	48	16	740 W	af/at	-	-	Internal	-	●	1 RU
SG550X-24-K9-xx	CON-SMBS-SGxxxxxx	-	24	-	-	-	-	2	2	-	-	-	-	-	-	Internal	-	●	1 RU
SG550X-24P-K9-xx	CON-SMBS-SG55xxxx	-	24	-	-	-	-	2	2	24	8	195 W	af/at	-	-	Internal	-	●	1 RU
SG550X-24MP-K9-xx	CON-SMBS-Sxxxxxxx	-	24	-	-	-	-	2	2	24	8	382 W	af/at	-	-	Internal	-	●	1 RU
SG550X-24MPP-K9-xx	CON-SMBS-SGxxxxxx	-	24	-	-	-	-	2	2	24	8	740 W	af/at	-	-	Internal	-	●	1 RU
SG550X-48-K9-xx	CON-SMBS-xxxxxxx	-	48	-	-	-	-	2	2	-	-	-	-	-	-	Internal	-	●	1 RU
SG550X-48P-K9-xx	CON-SMBS-SG5xxxxx	-	48	-	-	-	-	2	2	48	16	382 W	af/at	-	-	Internal	-	●	1 RU
SG550X-48MP-K9-xx	CON-SMBS-SG55xxxx	-	48	-	-	-	-	2	2	48	16	740 W	af/at	-	-	Internal	-	●	1 RU
SG550XG-8F8T-K9-xx	CON-SMBS-SGxxxxxx	-	-	-	-	-	8	8	-	-	-	-	-	-	-	Internal	-	●	1 RU
SG550XG-24T-K9-xx	CON-SMBS-SGxxxxxx	-	-	-	-	-	22	-	2	-	-	-	-	-	-	Internal	-	●	1 RU
SG550XG-24F-K9-xx	CON-SMBS-SGxxxxxx	-	-	-	-	-	-	22	2	-	-	-	-	-	-	Internal	-	●	1 RU
SG550XG-48T-K9-xx	CON-SMBS-SGxxxxxx	-	-	-	-	-	46	-	2	-	-	-	-	-	-	Internal	-	●	1 RU

Getting Started

What's New

Feature Story

Collaborate

Compute

Security

Connect

Switches

SF/SG

Catalyst

2960-L

2960-X

3650/3850

9200 NEW

Meraki MS

Wireless

Routers

Services



## ■ Cisco FindIT Network Management: Manage a Network, Not a Collection of Devices

Maintaining a business network is difficult without the right tools. The Cisco FindIT Network Management is purpose-built for managing networks of Cisco SF/SG Switches, Cisco Wireless Access Points (WAP), and Cisco RV Series Routers. It lets you proactively manage the network instead of just reacting to events. Cisco FindIT Network Management is the perfect addition to your business's network.

Cisco FindIT Network Management supports two deployment models: full-time network management with the Cisco FindIT Network Manager and discovering and managing the network on the go with the Cisco FindIT Network Discovery Utility.

### ● Cisco FindIT Network Manager

Full-time network management tool designed to manage Cisco SF/SG Switches, Cisco Wireless Access Points (WAP), and Cisco RV Series Routers. You can configure system information, wireless networks, virtual LANs, and Ethernet switching in a single interface.

### ● Cisco FindIT Network Discovery Utility

Simple toolbar on your web browser to discover Cisco devices on the network and display basic device information, inventory, and new firmware updates to aid in the configuration and speed the deployment of Cisco SF/SG Switches, Cisco Wireless Access Points (WAP), and Cisco RV Series Routers.

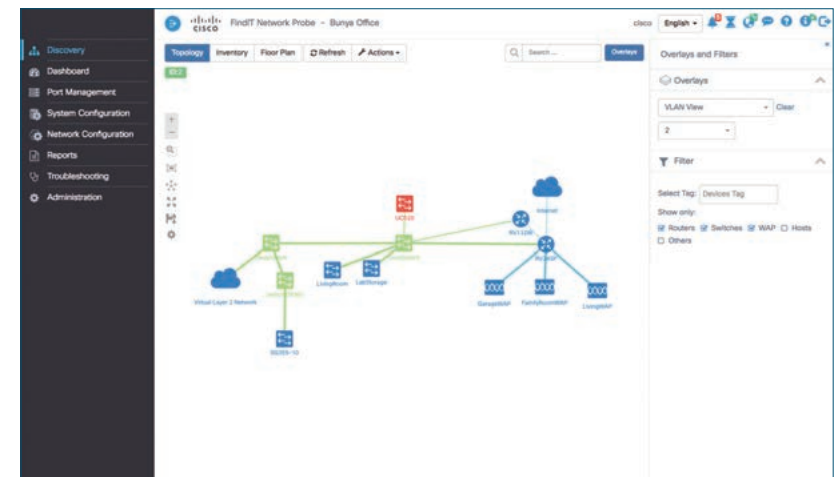
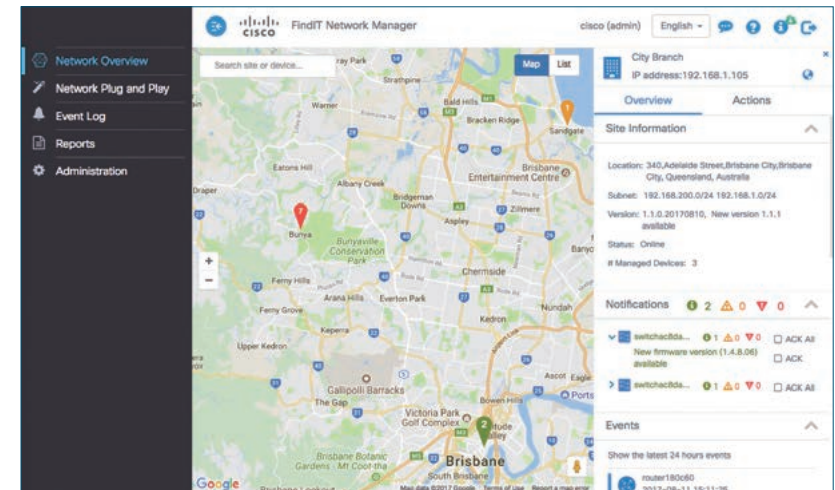

Getting Started

What's New

Feature Story

Collaborate

Compute

Security

Connect

Switches

SF/SG

Catalyst

2960-L

2960-X

3650/3850

9200 NEW

Meraki MS

Wireless

Routers

Services

## ■ Cisco FindIT Network Management: Manage a Network, Not a Collection of Devices

The Cisco FindIT Network Manager is designed to manage Cisco SF/SG Switches, Cisco Wireless Access Points (WAP), and Cisco RV Series Routers. You can configure system information, wireless networks, virtual LANs, and Ethernet switching in a single interface. And you can monitor network performance with a customizable dashboard. Automatic network discovery comes with a topology diagram and an inventory report. In addition, you get:

- Automatic firmware updates for network devices
- Detailed lifecycle reports showing maintenance status and end-of-life bulletins
- Integration with Cisco Active Advisor
- Remote access to sites without requiring a VPN
- One-click collection of diagnostic data for technical support

The Cisco FindIT Network Manager comprises two components:

- **Cisco FindIT Network Probe**  
Installed at each site and discovers and directly manages the network devices at that site.
- **Cisco FindIT Network Manager**  
Provides a summary view and alerts for each site in the network

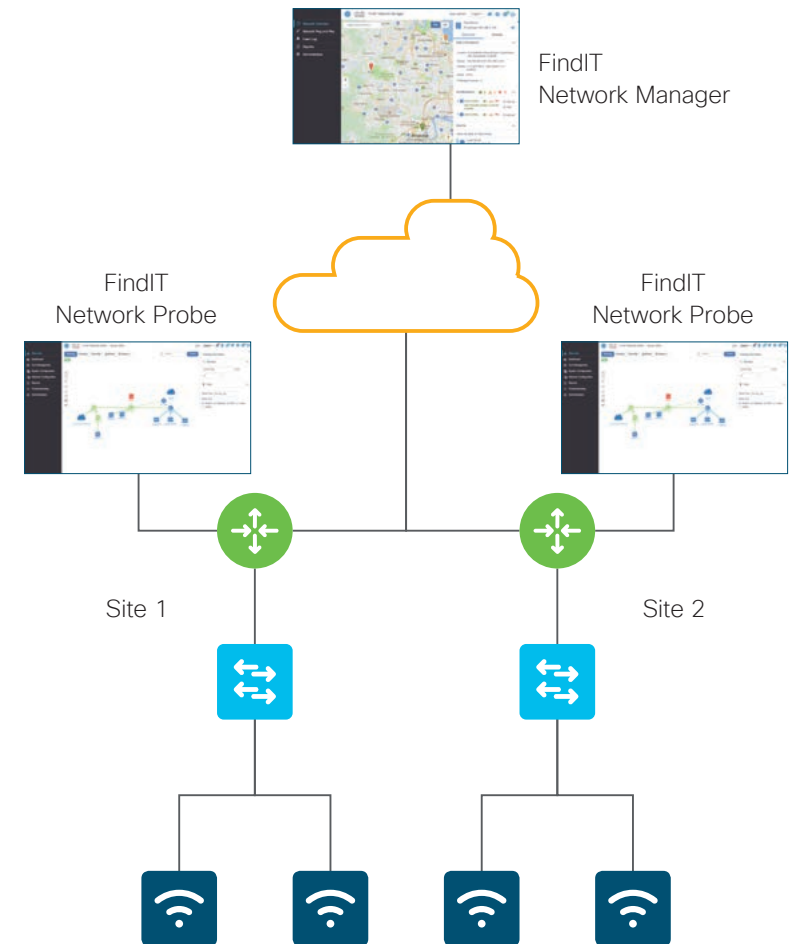

Getting Started

What's New

Feature Story

Collaborate

Compute

Security

Connect

Switches

SF/SG

Catalyst

2960-L

2960-X

3650/3850

9200 NEW

Meraki MS

Wireless

Routers

Services

## ■ Cisco FindIT Network Manager: Ordering and Licensing Guide

To place an order for Cisco FindIT Network Manager licenses, the following steps are required:

- Identify the number of licenses and type required
- Obtain a Cisco Smart Account if you do not already have one
- Place an order with your preferred supplier, and provide the supplier with your Cisco Smart Account details

### ■ Licensing

Cisco FindIT Network Manager is licensed based on the number of infrastructure devices in your network. Device licenses are required only for the Cisco SF/SG Switches products in your network.

You may manage up to 10 Cisco SF/SG Switches devices for evaluation purposes without a license.

To download the software, visit the following web site:

 [www.cisco.com/go/findit-sw](http://www.cisco.com/go/findit-sw)

### ■ Obtaining a Cisco Smart Account

Cisco Smart Account is a new solution that provides a central location to manage Cisco software licenses across an entire organization, allowing partners and customers to optimize their software management.

To obtain a Cisco Smart account, visit Cisco Software Central and select the Request a Smart Account option under the Administration heading.

 [software.cisco.com](http://software.cisco.com)

### ■ Ordering information

You can order Cisco FindIT Network Manager licenses in three different ways:

- As standalone license packs that will expire at the end of the term
- As a subscription with automatic invoicing and renewal at the end of the term
- By selecting the metered option for Cisco FindIT Network Manager for AWS and obtaining licenses through your AWS account (No Cisco Smart Account required)

Not all Cisco resellers offer the subscription option, so check with your reseller prior to making a selection.

### ■ Cisco FindIT Network Manager Device Licenses (Standalone)

Product SKU	Description
LS-FINDITNM-15-1Y=	15-device license pack- 1 year
LS-FINDITNM-25-1Y=	25-device license pack - 1 year
LS-FINDITNM-50-1Y=	50-device license pack - 1 year

### ■ Cisco FindIT Network Manager Device Licenses (Subscription)\*1

Product SKU	Description
LS-FINDITNM-DEV	Device subscription license

\*1 LS-FINDITNM-SUB is required in CCW. See [Ordering Guide](#) for details.

Getting Started

What's New

Feature Story

Collaborate

Compute

Security

Connect

Switches

SF/SG

Catalyst

2960-L

2960-X

3650/3850

9200 

Meraki MS

Wireless

Routers

Services





## ■ Cisco FindIT Network Discovery Utility: Handy Plug-In

The Cisco FindIT Network Discovery Utility can be used by network administrators on the go. It integrates with your web browser and allows you to easily discover Cisco SF/SG Switches and Cisco Wireless Access Points (WAP), display detailed information about devices, and click to download firmware updates.

The Cisco FindIT Network Discovery Utility runs on Apple Safari, Google Chrome, Microsoft Internet Explorer, and Mozilla Firefox browsers on Microsoft Windows and Apple OS X. It provides:

- Automatic discovery and information display for Cisco SF/SG Switches and Cisco Wireless Access Points (WAP)
- Automatic discovery and one-click downloads for firmware updates
- Support and maintenance information for discovered devices
- Integration with the Cisco Active Advisor
- Direct access to the Small Business Support Center

To download the software, visit the following web site:



<http://www.cisco.com/go/findit>

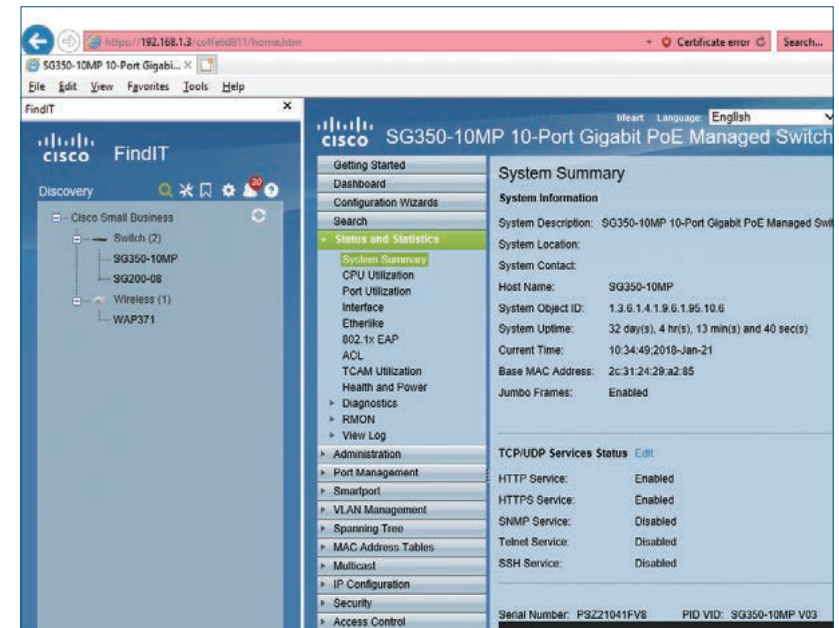

Getting Started

What's New

Feature Story

Collaborate

Compute

Security

Connect

Switches

SF/SG

Catalyst

2960-L

2960-X

3650/3850

9200 NEW

Meraki MS

Wireless

Routers

Services



Getting Started

What's New

Feature Story

Collaborate

Compute

Security

Connect

Switches

SF/SG

Catalyst

2960-L

2960-X

3650/3850

9200 **NEW**

Meraki MS

Wireless

Routers

Services

## Enterprise Networks Switching

The Cisco Catalyst Switches provide the performance and features required for nearly any deployment, from traditional small workgroups, wiring closets, and network cores, to highly virtualized and converged corporate data centers.

Working together, they are the building blocks of an integrated network that delivers scalable and intelligent services protecting, optimizing, and growing your network as your business needs evolve.

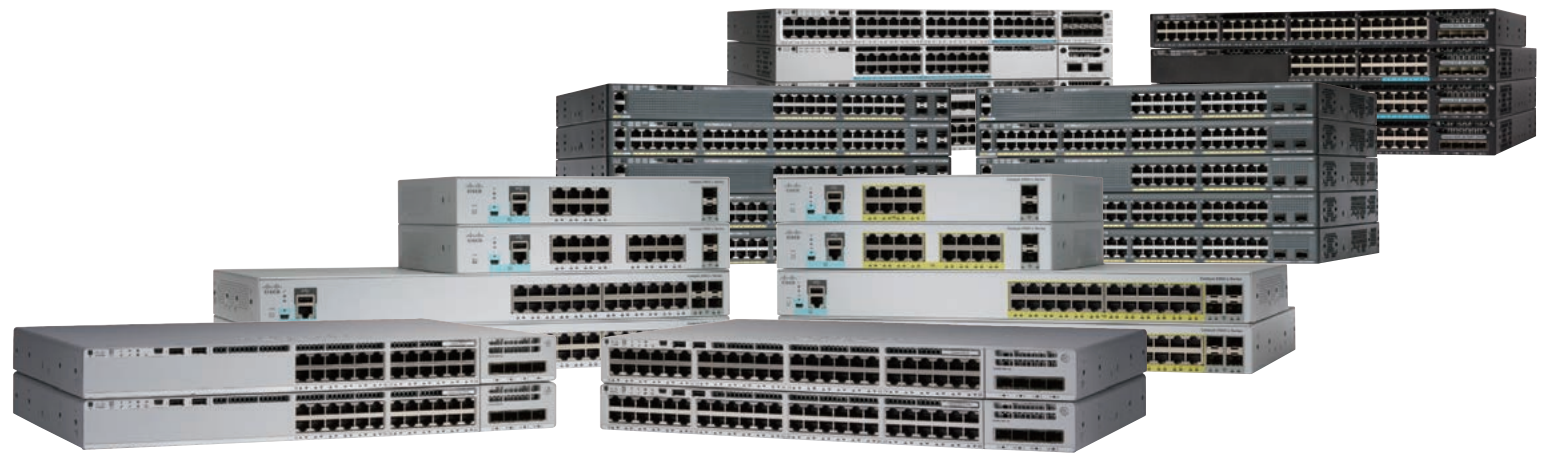

### Lineup (in this catalog)

#### ● Cisco Catalyst 2960-L Series

High value layer 2 access switches that provide enhanced network security, network reliability, and operational efficiency.

#### ● Cisco Catalyst 2960-X Series

Stackable layer 2 and layer 3 access switches that provide smart, simple, scalable, and secure services for enterprise-class networks.

#### ● Cisco Catalyst 3650/3850 Series

Stackable layer 2 and layer 3 access switches that provide the foundation for full wired and wireless convergence on a single platform.

#### ● Cisco Catalyst 9200 Series **NEW**

Stackable layer 2 and layer 3 access switches that provide the foundational building blocks for the Cisco Digital Network Architecture (Cisco DNA).













- Getting Started
- What's New
- Feature Story
- Collaborate
- Compute
- Security
- Connect
  - Switches
    - SF/SG
    - Catalyst
      - 2960-L
      - 2960-X
      - 3650/3850
      - 9200 NEW
    - Meraki MS
  - Wireless
  - Routers
  - Services

Overview

**Positioning Map**

Cisco IOS (C2K/C3K)

Cisco IOS (C9K)

Modular Core	 <p>Catalyst 6500/6800</p>		
Fixed Core	 <p>Catalyst 3850 Fiber</p>	 <p>Catalyst 4500-X</p>	 <p>Catalyst 9500</p>
Modular Access	 <p>Catalyst 4500E      Catalyst 9400</p>		
Fixed Access	 <p>Catalyst 3650/3850</p>		 <p>Catalyst 9300</p>
	 <p>Catalyst 2960-Plus</p>	 <p>Catalyst 2960-X</p>	 <p>Catalyst 9200 <span style="color: red; font-weight: bold;">NEW</span></p>
Access/ Compact	 <p>Catalyst 2960-L</p>		
Compact	 <p>Catalyst 2960-CX</p>	 <p>Catalyst 3560-CX</p>	

Performance & Scalability

→ High

Getting Started

What's New

Feature Story

Collaborate

Compute

Security

Connect

Switches

SF/SG

Catalyst

2960-L

2960-X

3650/3850

9200 NEW

Meraki MS

Wireless

Routers

Services

Overview

Positioning Map

Cisco IOS (C2K/C3K)

Cisco IOS (C9K)

The Cisco Catalyst 2000/3000 Series incorporates the Cisco IOS (Inter-network Operating System), which is a high-performance network infrastructure software. LAN Lite and LAN Base feature sets provide the L2 level features, IP Lite, IP Base, and IP Services feature sets provide the L3 level features, respectively.

Cisco IOS provided with the Cisco Catalyst 3650/3850 Series is delivered in a single universal image. The universal image contains the entire Cisco IOS feature sets that can be activated via the Cisco IOS Upgrade License.

Cisco IOS Compatibility

Supported Series Name	LAN Lite (LL)	LAN Base (LB)	IP Lite (IPL)	IP Base (IPB)	IP Services (IPS)
Catalyst 2960-L	●	-	-	-	-
Catalyst 2960-X	●	●	●*1	-	-
Catalyst 3650	-	●	-	●	●
Catalyst 3850	-	●	-	●	●

\*1 Catalyst 2960-XR Series only.

Cisco IOS L2 Features

Feature	LL	LB	IPL	IPB	IPS
IEEE 802.1Q Trunking	●	●	●	●	●
DTP	●	●	●	●	●
UDLD	●	●	●	●	●
VTP	●	●	●	●	●
CDP	●	●	●	●	●
LLDP	●	●	●	●	●
LLDP-MED	●*1	●	●	●	●
STP (Spanning Tree Protocol)	●	●	●	●	●
Flex Link	-	●	●	●	●
EtherChannel	●	●	●	●	●
LACP	●	●	●	●	●
Link State Tracking	●*2	●	●	●	●
Resilient Ethernet Protocol (REP)	-	-	-	●*3	●*3
Per-Port Storm Control	●	●	●	●	●

\*1 Catalyst 2960-L Series only.

\*2 Catalyst 2960-L Series are to be supported in future software release.

\*3 Catalyst 3650/3850 Series are to be supported in future software release.

Cisco IOS L3 Features

Feature	LL	LB	IPL	IPB	IPS
Static Routing	●*1	●	●	●	●
RIP	●*1	-	●	●	●
EIGRP Stub	-	-	●	●	●
EIGRP	-	-	-	-	●
OSPF for Routed Access	-	-	●	●	●
OSPF v2/v3	-	-	-	-	●
BGP	-	-	-	-	●
IS-IS	-	-	-	-	●
Policy Based Routing (PBR)	-	-	●	●	●
VRF-Lite	-	-	-	-	●
PIM Stub	-	-	●	●	●
PIM	-	-	-	-	●
WCCP	-	-	●	●	●
SSO	-	●	-	●*2	●*2
NSF	-	-	-	●	●
MPLS	-	-	-	-	●*2

\*1 Catalyst 2960-L Series only. \*2 Catalyst 3650/3850 Series are not supported.





Getting Started

What's New

Feature Story

Collaborate

Compute

Security

Connect

Switches

SF/SG

Catalyst

2960-L

2960-X

3650/3850

9200 NEW

Meraki MS

Wireless

Routers

Services

Overview

Positioning Map

Cisco IOS (C2K/C3K)

Cisco IOS (C9K)

Cisco IOS Managability Features

Feature	LL	LB	IPL	IPB	IPS
SNMP	●	●	●	●	●
RMON	●	●	●	●	●
SPAN	●	●	●	●	●
RSPAN	-	●	●	●	●
TDR	●	●	●	●	●
Smart Ports	●	●	●	●	●
Smart Install (client)	●	●	●	●	●
Smart Install (director)	-	● <sup>*1</sup>	-	●	●
Cisco IOS IP SLA (responder)	-	●	●	●	●
Cisco IOS IP SLA (initiator)	-	-	-	●	●
Cisco IOS EEM	-	-	-	●	●
Wireshark	-	-	-	●	●
Netflow-Lite	-	●	●	●	●
Flexible Netflow	-	-	-	●	●
EnergyWise	●	●	●	●	●
GOLD (GOLD-Lite)	●	●	●	●	●
OBFL	●	●	●	●	●

\*1 Catalyst 2960-X Series are not supported.

Cisco IOS QoS Features

Feature	LL	LB	IPL	IPB	IPS
SRR	●	●	●	●	●
Priority Queue	●	●	●	●	●
Auto QoS	● <sup>*1</sup>	●	●	●	●
DSCP	● <sup>*1</sup>	●	●	●	●
Weighted Tail Drop (WTD)	● <sup>*2</sup>	● <sup>*3</sup>	-	● <sup>*3</sup>	●
Dynamic Buffer Limiting (DBL)	-	-	-	-	-
Control Plane Policing (CoPP)	-	● <sup>*4</sup>	-	●	●
Per VLAN Policy	-	-	●	●	●

\*1 Cisco Catalyst 2960-L Series are to be supported in future software release.

\*2 Catalyst 2960-L Series only. \*3 Catalyst 3560/3850 Series only.

\*4 Catalyst 2960-X Series are not supported.

Cisco IOS Security Features

Feature	LL	LB	IPL	IPB	IPS
SSH	●	●	●	●	●
SSL	●	●	●	●	●
SCP	●	●	●	●	●
HTTPS	●	●	●	●	●
TACACS+	●	●	●	●	●
RADIUS	●	●	●	●	●
Port Security	●	●	●	●	●
DHCP Snooping	● <sup>*1</sup>	●	●	●	●
Dynamic ARP Inspection (DAI)	● <sup>*1</sup>	●	●	●	●
IP Source Guard	-	●	●	●	●
MAC Authentication Bypass for Voice	●	●	●	●	●
Private VLAN Edge	●	●	●	●	●
Private VLAN	-	-	●	●	●
Layer 2 - 4 ACL	-	●	●	●	●
Router ACL	-	● <sup>*2</sup>	●	●	●
VLAN ACL	● <sup>*1</sup>	-	●	●	●
Time Range ACL	-	●	●	●	●
Web Authentication	● <sup>*1</sup>	●	●	●	●
TrustSec SXP	-	●	●	●	●
TrustSec SGT/SGACL	-	● <sup>*2</sup>	●	●	●
MACsec	-	-	-	●	●
NEAT	-	●	●	●	●

\*1 Catalyst 2960-L Series only.

\*2 Catalyst 3650/3850 Series are not supported.





Getting Started

What's New

Feature Story

Collaborate

Compute

Security

Connect

Switches

SF/SG

Catalyst

2960-L

2960-X

3650/3850

9200 NEW

Meraki MS

Wireless

Routers

Services

Overview

Positioning Map

Cisco IOS (C2K/C3K)

Cisco IOS (C9K)

The **Cisco Catalyst 9000 Series** is the next generation of our best-selling Cisco Catalyst line of enterprise LAN switches and operates with the same feature-rich Cisco IOS XE 16 and field-reprogrammable UADP ASIC technology already widely deployed with the Cisco Catalyst 3650/3850 Series. Cisco Catalyst 9000 Series also takes advantage of a shared DevOps toolkit for open programmability, analytics, and telemetry. This means you can expect to have all of the advanced Layer 2 and Layer 3 capabilities that you have come to expect and more, at twice the capacity. One key difference, however, is the new subscription licensing model that helps make ordering easy. Rather than the multiple, perhaps confusing, licensing options, Cisco Catalyst 9000 Series is offered with three options — **Cisco DNA Essentials**, **Cisco DNA Advantage**, and **Cisco DNA Premier**. Each of these are offered in 3, 5, and 7 year options.

- **Cisco DNA Essentials** delivers base automation, monitoring, and management. This solution includes Cisco DNA Essentials and embedded Cisco Software Support. With this solution, customers can enable basic automation and monitoring.
- **Cisco DNA Advantage** delivers policy-based automation with SD-Access, monitoring, and Cisco DNA Assurance. This solution includes Cisco DNA Essentials and Cisco DNA Advantage, with embedded Cisco Software Support. Customers need to buy ISE Base, ISE Plus, and Stealthwatch to enable all Cisco DNA use cases..
- **Cisco DNA Premier** delivers policy-based automation with SD-Access, Cisco DNA Assurance, and enhanced security. This solution includes Cisco DNA Essentials, Cisco DNA Advantage, ISE Base, ISE Plus, and Stealthwatch, along with embedded Cisco Software Support. Customers can enable all Cisco DNA use cases with Cisco DNA Premier. Offered as a single SKU.

- Must attach Cisco DNA Essentials, Advantage, or Premier, as subscription with Catalyst 9K
- Single SKU, 3, 5, or 7-year term subscriptions
- Cisco Software Support Service (SWSS) included in all subscriptions

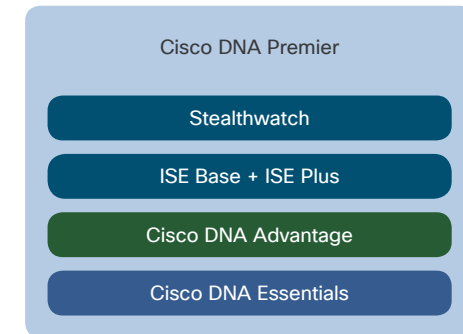
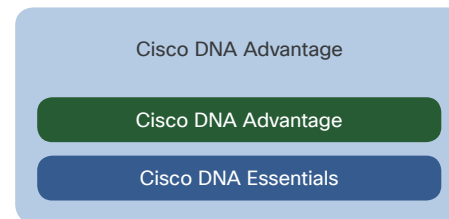
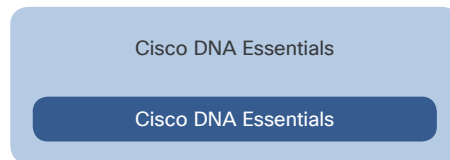



Overview

Positioning Map

Cisco IOS (C2K/C3K)

Cisco IOS (C9K)

Network Essentials and Advantage Package Features (Cisco Catalyst 9200 Series)

Feature		Network Essentials	Network Advantage
Switch Fundamentals	Layer 2	●	●
	RIP	●	●
	EIGRP Stub	●	●
	OSPF	●	●
	PIM Stub Multicast	●	●
	PVLAN	●	●
	VRRP	●	●
	PBR	●	●
	CDP	●	●
	QoS	●	●
	802.1X	●	●
	CoPP	●	●
	SXP	●	●
IP SLA Responder	●	●	

Feature		Network Essentials	Network Advantage
Advanced Switch Capabilities and Scale	EIGRP	-	●
	HSRP	-	●
	IS-IS	-	●
	BSR	-	●
	MSDP	-	●
	IP SLA	-	●
	OSPF	-	●
Network Segmentation	VRF	-	●
	VXLAN	-	●
	LISP	-	●
	SGT	-	●
Automation	NETCONF	●	●
	RESTCONF	●	●
	YANG	●	●
	PnP Agent	●	●
	PnP	●	●
Telemetry and Visibility	Model-Driven Telemetry	●	●
	Sampled NetFlow	●	●
	SPAN	●	●
	RSPAN	●	●
Security	MACsec-128	●	●

Getting Started

What's New

Feature Story

Collaborate

Compute

Security

Connect

Switches

SF/SG

Catalyst

2960-L

2960-X

3650/3850

9200 NEW

Meraki MS

Wireless

Routers

Services



Overview

Positioning Map

Cisco IOS (C2K/C3K)

Cisco IOS (C9K)

Cisco DNA Essentials, Advantage, and Premier Package Features (Cisco Catalyst 9200 Series)

Feature		Cisco DNA Essentials	Cisco DNA Advantage	Cisco DNA Premier
Switch Features	<b>Advanced Telemetry and Visibility</b> Full Flexible NetFlow, EEM	•	•	•
	<b>Day-0 Network Bring-up Automation</b> Cisco Network Plug-and-Play application, network settings, device credentials, LAN automation, host onboarding	•	•	•
Cisco DNA Center Features	<b>Element Management</b> Discovery, inventory, topology, software image, licensing, and configuration management	•	•	•
	<b>Element Management</b> Patch management	-	•	•
	<b>Basic Assurance</b> Health dashboards - Network, Client, Application; switch and wired client health monitoring	•	•	•
	<b>SD-Access</b> Policy-based automation and assurance for wired and wireless	-	•	•
	<b>Network Assurance and Analytics</b> Global insights, trends, compliance, custom reports; switch 360, wired client 360; fabric and non-fabric insights; app health, app 360, app performance (loss, latency, jitter)	-	•	•

- Getting Started
- What's New
- Feature Story
- Collaborate
- Compute
- Security
- Connect
  - Switches
    - SF/SG
    - Catalyst
      - 2960-L
      - 2960-X
      - 3650/3850
      - 9200 NEW
    - Meraki MS
  - Wireless
  - Routers
  - Services



## Overview

## Platform Spec

## Why 2960-L?

## Build Your Enterprise-Class Network with Simplicity and Value

The Cisco Catalyst 2960-L Series switches are fixed-configuration, Gigabit Ethernet switches that provide enterprise-class access switching for branch offices, out-of-the-wiring-closet applications, and critical Internet of Things (IoT) deployments, as well as small and medium-sized businesses. They operate on Cisco IOS Software and support simple device management as well as network management.

The Catalyst 2960-L Series provides easy device onboarding, configuration, monitoring, and troubleshooting. These fully managed switches offer advanced Layer 2 and basic Layer 3 features as well as Power over Ethernet Plus (PoE+) power. Catalyst 2960-L Series delivers enhanced network security, network reliability, and operational efficiency.

### Highlights

- Cisco IOS Enhanced LAN Lite Image: Supports basic layer 3 features with static routing and Routing Information Protocol (RIP), and security with 802.1X support for connected devices, Switched Port Analyzer (SPAN), and Bridge Protocol Data Unit (BPDU) Guard
- PoE+ output (PSE models)
- Perpetual PoE for powering a powered device even when the device is booting
- Fanless operation with operating temperature up to 45 °C (select models)
- Compact design with a depth of less than 11.5 inches
- Device management support with: Intuitive web UI via Cisco Configuration Professional for Catalyst, over-the-air access via Bluetooth, Command-Line Interface (CLI), Simple Network Management Protocol (SNMP), RJ-45 or USB console access, and virtual stacking

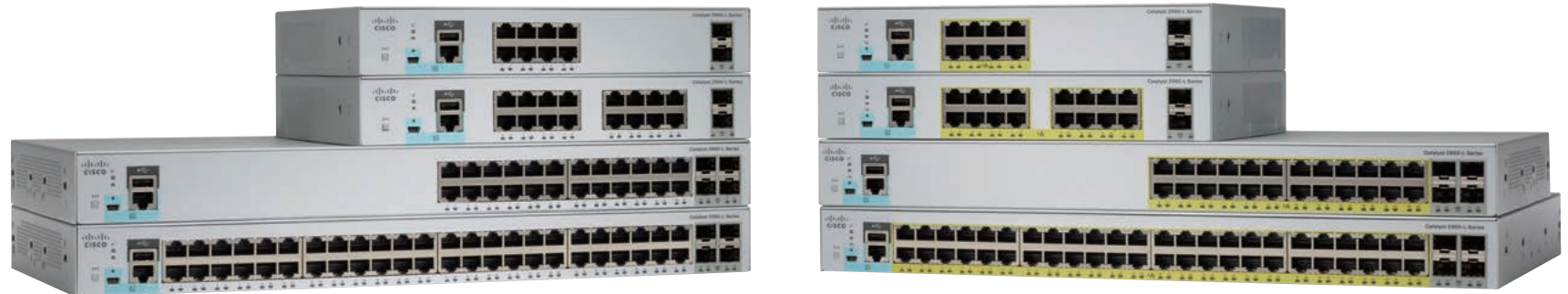

Getting Started

What's New

Feature Story

Collaborate

Compute

Security

Connect

Switches

SF/SG

Catalyst

2960-L

2960-X

3650/3850

9200 NEW

Meraki MS

Wireless

Routers

Services



## Overview

## Platform Spec

## Why 2960-L?

Product SKU <sup>*1</sup>	Service (CSE) SKU	Cisco IOS	Downlinks	Uplinks			PoE			AC Power	Fanless	Rack Mount
			GE	GE	SFP	SFP/SFP+	Ports	Power Budget	IEEE 802.3			
WS-C2960L-8TS-LL	CON-SMBS-WSC296TW	LAN Lite	8	-	2	-	-	-	-	Internal	●	- <sup>*2</sup>
WS-C2960L-8PS-LL	CON-SMBS-WSC29606	LAN Lite	8	-	2	-	8	67 W	af/at	Internal	●	- <sup>*2</sup>
WS-C2960L-16TS-LL	CON-SMBS-WSC2966L	LAN Lite	16	-	2	-	-	-	-	Internal	●	- <sup>*2</sup>
WS-C2960L-16PS-LL	CON-SMBS-WSC2969S	LAN Lite	16	-	2	-	16	120 W	af/at	Internal	●	- <sup>*2</sup>
WS-C2960L-24TS-AP	CON-SMBS-WSC296LT	LAN Lite	24	-	4	-	-	-	-	Internal	●	1 RU
WS-C2960L-24PS-AP	CON-SMBS-WSC296LA	LAN Lite	24	-	4	-	24	195 W	af/at	Internal	●	1 RU
WS-C2960L-24TQ-LL	CON-SMBS-WSQC296L	LAN Lite	24	-	-	4	-	-	-	Internal	●	1 RU
WS-C2960L-24PQ-LL	CON-SMBS-WSCP296L	LAN Lite	24	-	-	4	24	195 W	af/at	Internal	●	1 RU
WS-C2960L-48TS-AP	CON-SMBS-WSC298LS	LAN Lite	48	-	4	-	-	-	-	Internal	●	1 RU
WS-C2960L-48PS-AP	CON-SMBS-WSC2P6LA	LAN Lite	48	-	4	-	48	370 W	af/at	Internal	-	1 RU
WS-C2960L-48TQ-LL	CON-SMBS-WSTQ296L	LAN Lite	48	-	-	4	-	-	-	Internal	●	1 RU
WS-C2960L-48PQ-LL	CON-SMBS-WSC9296L	LAN Lite	48	-	-	4	48	370 W	af/at	Internal	-	1 RU

\*1 Not orderable in Australia and New Zealand.

\*2 Optional Magnet and Mounting Tray (CMPCT-MGNT-TRAY=) is available.

Getting Started

What's New

Feature Story

Collaborate

Compute

Security

Connect

Switches

SF/SG

Catalyst

2960-L

2960-X

3650/3850

9200 NEW

Meraki MS

Wireless

Routers

Services





Getting Started

What's New

Feature Story

Collaborate

Compute

Security

Connect

Switches

SF/SG

Catalyst

2960-L

2960-X

3650/3850

9200 NEW

Meraki MS

Wireless

Routers

Services

Overview

Platform Spec

Why 2960-L?

Why Catalyst 2960-L?

The Cisco Catalyst 2960-L Series leads the competition with:

- **Noiseless, flexible deployment** in a “fanless” design of not only the 8-port model, but also the 16-, 24- and 48-port models, with the only exception being the 48-port PoE units, the Catalyst 2960-L can be installed in meeting rooms, classrooms, retail stores, and office spaces, which are no-go areas for a traditional switch relying on one or more noisy fans to keep it cool. Additionally, because there are no fans to suck in dust and lint, it can be tucked away in a cupboard or ceiling space, without the need for periodic cleaning, making it even more flexible to deploy.
- **Persistent PoE** reduces the wait time and improves network availability by providing PoE power to IP phones, cameras, and wireless access points, even while the switch is booting up with a new software image.
- **Runs Cisco IOS Software** and supports a rich set of Cisco IOS Software networking features in IPv6, security, and manageability. It also offers unsurpassed energy efficiency and Cisco enhanced limited lifetime warranty, offering lower TCO.

	Catalyst 2960-L	Competitor A	Competitor B	Why Cisco?
<b>No Fans</b>	More deployment flexibility, less cleaning and preventive maintenance, and higher reliability and uptime.	The switch has fans that suck in dust, resulting in limited deployment options and more cleaning and maintenance.	Some of the models have 3 fans.	The Cisco Catalyst switch can be housed in cupboards and cavities with no risk of fans sucking in failure-causing dust.
	People-friendly operation.	Not designed to coexist with people: the warmer it gets, the faster and noisier the fans get.		Allows the switch to share office space with people without being intrusive; ideal for small retail, classrooms, offices.
<b>Persistent PoE/PoE+</b>	Maintains PoE power to attached devices when the switch is rebooted after a software upgrade or other reason.	Ethernet switches can reboot quickly after a software upgrade, in an effort to minimize downtime, but what about the attached IP phone, camera, or access point? Without persistent PoE, they will reboot as well, and only after the switch has finished.		More network uptime: IP phones, cameras, and access points stay powered on when the switch is rebooted after a software upgrade.
<b>Bluetooth and USB</b>	Innovations such as Bluetooth console access and USB type-A slot supporting memory cards for software and configuration transfer.	While offering a USB console port, these switches still require a PC to physically connect. This is not always practical in branch locations, where the switch might be installed in a difficult-to-reach location.		Innovations that provide out-of-band management without requiring a traditional PC to be physically connected; improve uptime and problem resolution time.

## Enterprise Ready: Cost-Effective Access Switches that Scale

The Cisco Catalyst 2960-X Series switches are stackable fixed configuration Gigabit Ethernet switches offering network connectivity for enterprise, mid-market, and branch locations.

They enable reliable and secure business operations with lower total cost of ownership through a range of innovative features, including Cisco FlexStack-Plus and FlexStack-Extended, application visibility and control, Power over Ethernet Plus (PoE+), innovative power management, and Smart Operations.

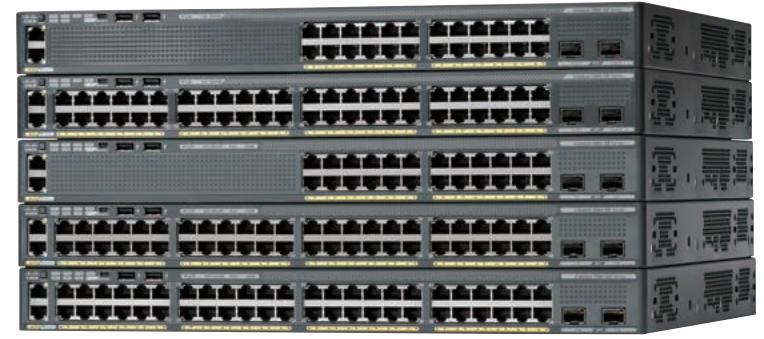
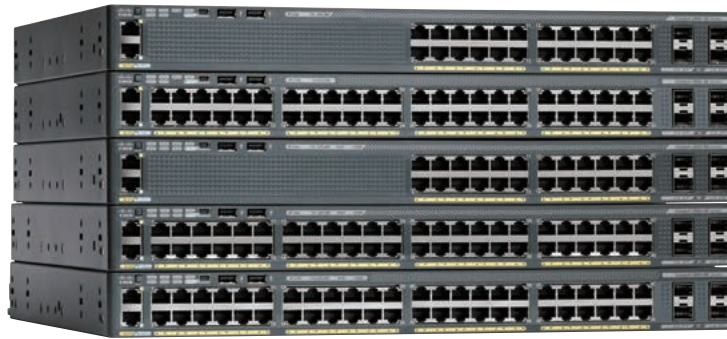

### Highlights

- Cisco IOS LAN Lite/LAN Base Image (Catalyst 2960-X)
- Cisco IOS IP Lite Image (Catalyst 2960-XR): Supports layer 3 features including Open Shortest Path First OSPF and Virtual Router Redundancy Protocol (VRRP)
- 10 GB SFP+ uplinks (select models)
- PoE+ output (PSE models)
- Perpetual PoE for powering a powered device even when the device is booting
- Resiliency with optional an external redundant power supply (LAN Base models) and dual redundant power supplies (IP Lite models)
- Stacking with Cisco FlexStack-Plus and FlexStack-Extended (LAN Base/IP Lite models)
- Device management support with: Intuitive web UI via Cisco Configuration Professional for Catalyst, over-the-air access via Bluetooth, Command-Line Interface (CLI), Simple Network Management Protocol (SNMP), RJ-45 or USB console access
- Cisco Digital Network Architecture (Cisco DNA)-ready: Supports Cisco NetFlow Lite and Cisco Flexible NetFlow\*1 for application visibility at the access network, and so on (LAN Base/IP Lite models)

\*1 Cisco ONE Foundation License or Cisco DNA Essentials License is required.

Getting Started

What's New

Feature Story

Collaborate

Compute

Security

Connect

Switches

SF/SG

Catalyst

2960-L

2960-X

3650/3850

9200 NEW

Meraki MS

Wireless

Routers

Services

## Overview

## Platform Spec

## Modules &amp; Accessories

Product SKU <sup>1</sup>	Service (CSE) SKU	Cisco IOS	Downlinks		Uplinks			PoE			Power Supply			Fanless	Flex Stack	Rack Mount
			GE	GE	SFP	SFP/SFP+	Ports	Power Budget	IEEE 802.3	Default PS	Ext RPS	Dual PS				
WS-C2960X-24TS-LL	CON-SMBS-WSC296X2	LAN Lite	24	-	2	-	-	-	-	Fixed AC	-	-	-	-	1 RU	
WS-C2960X-48TS-LL	CON-SMBS-WSC296X4	LAN Lite	48	-	2	-	-	-	-	Fixed AC	-	-	-	-	1 RU	
WS-C2960X-24TS-L	CON-SMBS-WSC296XT	LAN Base	24	-	4	-	-	-	-	Fixed AC	●	-	-	●	1 RU	
WS-C2960X-24TD-L	CON-SMBS-WSC24TDL	LAN Base	24	-	-	2	-	-	-	Fixed AC	●	-	-	●	1 RU	
WS-C2960X-24PSQ-L	CON-SMBS-WSC224QL	LAN Base	24	2	2	-	8	110 W	af/at	Fixed AC	-	-	●	-	1 RU	
WS-C2960X-24PS-L	CON-SMBS-WSC224SL	LAN Base	24	-	4	-	24	370 W	af/at	Fixed AC	●	-	-	●	1 RU	
WS-C2960X-24PD-L	CON-SMBS-WSC604DL	LAN Base	24	-	-	2	24	370 W	af/at	Fixed AC	●	-	-	●	1 RU	
WS-C2960X-48TS-L	CON-SMBS-WSC248TS	LAN Base	48	-	4	-	-	-	-	Fixed AC	●	-	-	●	1 RU	
WS-C2960X-48TD-L	CON-SMBS-WSC298DL	LAN Base	48	-	-	2	-	-	-	Fixed AC	●	-	-	●	1 RU	
WS-C2960X-48LPS-L	CON-SMBS-WSC248SL	LAN Base	48	-	4	-	48	370 W	af/at	Fixed AC	●	-	-	●	1 RU	
WS-C2960X-48LPD-L	CON-SMBS-WSC48LPD	LAN Base	48	-	-	2	48	370 W	af/at	Fixed AC	●	-	-	●	1 RU	
WS-C2960X-48FPS-L	CON-SMBS-WSC294SL	LAN Base	48	-	4	-	48	740 W	af/at	Fixed AC	●	-	-	●	1 RU	
WS-C2960X-48FPD-L	CON-SMBS-WSC296XL	LAN Base	48	-	-	2	48	740 W	af/at	Fixed AC	●	-	-	●	1 RU	
WS-C2960XR-24TS-I	CON-SMBS-WS296X24	IP Lite	24	-	4	-	-	-	-	250 W AC	-	●	-	●	1 RU	
WS-C2960XR-24TD-I	CON-SMBS-WSC296TD	IP Lite	24	-	-	2	-	-	-	250 W AC	-	●	-	●	1 RU	
WS-C2960XR-24PS-I	CON-SMBS-WSC296PS	IP Lite	24	-	4	-	24	370 W	af/at	640 W AC	-	●	-	●	1 RU	
WS-C2960XR-24PD-I	CON-SMBS-WSC296PD	IP Lite	24	-	-	2	24	370 W	af/at	640 W AC	-	●	-	●	1 RU	
WS-C2960XR-48TS-I	CON-SMBS-WS296X48	IP Lite	48	-	4	-	-	-	-	250 W AC	-	●	-	●	1 RU	
WS-C2960XR-48TD-I	CON-SMBS-WSC2968T	IP Lite	48	-	-	2	-	-	-	250 W AC	-	●	-	●	1 RU	
WS-C2960XR-48LPS-I	CON-SMBS-WSC29648	IP Lite	48	-	4	-	48	370 W	af/at	640 W AC	-	●	-	●	1 RU	
WS-C2960XR-48LPD-I	CON-SMBS-W296X48L	IP Lite	48	-	-	2	48	370 W	af/at	640 W AC	-	●	-	●	1 RU	
WS-C2960XR-48FPS-I	CON-SMBS-WSC296FP	IP Lite	48	-	4	-	48	740 W	af/at	1025 W AC	-	●	-	●	1 RU	
WS-C2960XR-48FPD-I	CON-SMBS-W296X48F	IP Lite	48	-	-	2	48	740 W	af/at	1025 W AC	-	●	-	●	1 RU	

Getting Started

What's New

Feature Story

Collaborate

Compute

Security

Connect

Switches

SF/SG

Catalyst

2960-L

2960-X

3650/3850

9200 NEW

Meraki MS

Wireless

Routers

Services

Getting Started

What's New

Feature Story

Collaborate

Compute

Security

Connect

Switches

SF/SG

Catalyst

2960-L

2960-X

3650/3850

9200 NEW

Meraki MS

Wireless

Routers

Services

Overview

Platform Spec

Modules & Accessories

Cisco Redundant Power System (RPS) 2300

Product SKU	Description
PWR-RPS2300	Cisco RPS 2300 Chassis (No Power Supply)
C3K-PWR-750WAC	Cisco RPS 2300 750 W AC Power Supply
CAB-RPS2300-E=	Cisco RPS 2300 cable

Power Supply Modules

Product SKU	Description
PWR-C2-250WAC	250 W AC Power Supply Module
PWR-C2-640WAC	640 W AC Power Supply Module
PWR-C2-1025WAC	1025 W AC Power Supply Module

Cisco FlexStack Modules

Product SKU	Description
C2960X-STACK	Cisco FlexStack-Plus Module
C2960X-FIBER-STK	Cisco FlexStack-Extended Fiber Module
C2960X-HYBRID-STK	Cisco FlexStack-Extended Hybrid Module



**TIP** Cisco FlexStack-Plus & FlexStack-Extended

The Cisco FlexStack-Plus provides stacking of up to eight Cisco Catalyst 2960-X or 2960-XR Series switches with the optional Cisco FlexStack-Plus Module.

The Cisco FlexStack-Extended enables a long-distance out-of-the wiring-closet stack option (floor to floor). It provides stacking of up to eight Cisco Catalyst 2960-X or 2960-XR Series switches with the optional Cisco FlexStack-Extended Module.

Cisco FlexStack-Plus Supported Combinations\*1

Stack Member	Catalyst 2960-X LAN Base	Catalyst 2960-XR IP Lite
Catalyst 2960-X LAN Base	●	-
Catalyst 2960-XR IP Lite	-	●

Cisco FlexStack-Extended Supported Combinations

Stack Member	Catalyst 2960-X LAN Base	Catalyst 2960-XR IP Lite
Catalyst 2960-X LAN Base	●	-
Catalyst 2960-XR IP Lite	-	●

Cisco FlexStack-Plus Scalability & Performance\*1

Stack Member	Stack Bandwidth	Stack Limit
Catalyst 2960-X LAN Base	80 Gbps	8
Catalyst 2960-XR IP Lite	80 Gbps	8

Cisco FlexStack-Extended Scalability & Performance

Stack Member	Stack Bandwidth	Stack Limit
Catalyst 2960-X LAN Base	40 Gbps	8
Catalyst 2960-XR IP Lite	40 Gbps	8

\*1 FlexStack-Plus is backward compatible with FlexStack. Up to four Catalyst 2960-X LAN Base switches and Catalyst 2960-S/SF LAN Base switches can be stacked.



## Overview

## Platform Spec (3650)

## Platform Spec (3850)

## Licenses &amp; Accessories

## Bundles

## Converged Wired and Wireless Access on A Single Platform

The Cisco Catalyst 3650/3850 Series switches are the next generation of enterprise-class stackable access and aggregation layer switches that provide the foundation for full convergence between wired and wireless on a single platform.

The new Cisco Unified Access Data Plane (UADP) Application-Specific Integrated Circuit (ASIC) powers the switch and enables uniform wired-wireless policy enforcement, application visibility, flexibility, and application optimization. This convergence is built on the resilience of the new and improved Cisco StackWise-160/480 technology.



### Highlights

- Cisco IOS XE Universal Image (LAN Base/IP Base/IP Services)
- Cisco Unified Access Data Plane (UADP) Application-Specific Integrated Circuit (ASIC)
- Integrated wireless controller capability with: Up to 20 or 40 Gbps of wireless capacity per switch, support for up to 50 access points and 1,000 wireless clients (Catalyst 3650) or 100 access points and 2,000 wireless clients (Catalyst 3850) on each switching entity (switch or stack)
- Multigigabit downlinks (select models)
- Fixed uplinks with 4 x 1GE, 2 x 10GE SFP+, 4 x 10GE SFP+, 8 x 10GE SFP+, or 2 x 40GE QSFP (Catalyst 3650)
- Optional uplink modules with 4 x 1GE SFP, 2 x 10GE SFP+, 4 x 10GE SFP+, 8 x 10GE SFP+, or 2 x 40GE QSFP (Catalyst 3850, all copper models & most fiber models)
- Fixed uplinks with 40GE QSFP (Catalyst 3850, select fiber models)
- PoE+ output (PSE models)
- 60 W PoE output (select PSE models)
- Resiliency with optional an external redundant power supply (Catalyst 3850, mini models) and dual redundant power supplies (Catalyst 3650/3850, except mini models)
- Cisco StackPower technology provides power stacking among stack members for power redundancy (Catalyst 3850)
- Stacking with Cisco StackWise-160 (Catalyst 3650) and Cisco StackWise-480 (Catalyst 3850)
- authenticating and encrypting packets between switches and endpoints: MACsec-128 (all models) and MACsec-256 (Catalyst 3850, Multigigabit and 10GE fiber models)
- Cisco Digital Network Architecture (Cisco DNA)-ready: Cisco DNA services can be delivered through Cisco ONE or Cisco DNA Licenses

Getting Started

What's New

Feature Story

Collaborate

Compute

Security

Connect

Switches

SF/SG

Catalyst

2960-L

2960-X

3650/3850

9200 NEW

Meraki MS

Wireless

Routers

Services



## Overview

## Platform Spec (3650)

## Platform Spec (3850)

## Licenses &amp; Accessories

## Bundles

Product SKU	Service (CSE) SKU	Cisco IOS	Downlinks				Fixed Uplinks			PoE				Power Supply			Rack Mount	
			GE	mGig	SFP	SFP/SFP+	SFP	SFP/SFP+	QSFP	Ports	60 W Ports	Power Budget	IEEE 802.3	Default PS	Ext RPS	Dual PS		
WS-C3650-24TS-L	CON-SMBS-WSC3652TS	LAN Base	24	-	-	-	4	-	-	-	-	-	-	-	250 W AC	-	●	1 RU
WS-C3650-24TS-S	CON-SMBS-WS6524SS	IP Base	24	-	-	-	4	-	-	-	-	-	-	-	250 W AC	-	●	1 RU
WS-C3650-24TS-E	CON-SMBS-WS5024SE	IP Services	24	-	-	-	4	-	-	-	-	-	-	-	250 W AC	-	●	1 RU
WS-C3650-24TD-L	CON-SMBS-WSC3652L	LAN Base	24	-	-	-	2	2	-	-	-	-	-	-	250 W AC	-	●	1 RU
WS-C3650-24TD-S	CON-SMBS-WSC365BU	IP Base	24	-	-	-	2	2	-	-	-	-	-	-	250 W AC	-	●	1 RU
WS-C3650-24TD-E	CON-SMBS-WSC365TE	IP Services	24	-	-	-	2	2	-	-	-	-	-	-	250 W AC	-	●	1 RU
WS-C3650-24PS-L	CON-SMBS-WSC365SL	LAN Base	24	-	-	-	4	-	-	24	-	390 W	af/at	640 W AC	-	●	1 RU	
WS-C3650-24PS-S	CON-SMBS-WSC3652S	IP Base	24	-	-	-	4	-	-	24	-	390 W	af/at	640 W AC	-	●	1 RU	
WS-C3650-24PS-E	CON-SMBS-WS6524PS	IP Services	24	-	-	-	4	-	-	24	-	390 W	af/at	640 W AC	-	●	1 RU	
WS-C3650-24PDM-L	CON-SMBS-WSC365ML	LAN Base	24	-	-	-	2	2	-	24	-	390 W	af/at	640 W AC	●	-	1 RU	
WS-C3650-24PDM-S	CON-SMBS-WSC365PS	IP Base	24	-	-	-	2	2	-	24	-	390 W	af/at	640 W AC	●	-	1 RU	
WS-C3650-24PDM-E	CON-SMBS-WSC365ME	IP Services	24	-	-	-	2	2	-	24	-	390 W	af/at	640 W AC	●	-	1 RU	
WS-C3650-24PD-L	CON-SMBS-WSC364DL	LAN Base	24	-	-	-	2	2	-	24	-	390 W	af/at	640 W AC	-	●	1 RU	
WS-C3650-24PD-S	CON-SMBS-WSC365PDS	IP Base	24	-	-	-	2	2	-	24	-	390 W	af/at	640 W AC	-	●	1 RU	
WS-C3650-24PD-E	CON-SMBS-WSC3652DE	IP Services	24	-	-	-	2	2	-	24	-	390 W	af/at	640 W AC	-	●	1 RU	

Getting Started

What's New

Feature Story

Collaborate

Compute

Security

Connect

Switches

SF/SG

Catalyst

2960-L

2960-X

3650/3850

9200 NEW

Meraki MS

Wireless

Routers

Services



Overview

Platform Spec (3650)

Platform Spec (3850)

Licenses & Accessories

Bundles

Product SKU	Service (CSE) SKU	Cisco IOS	Downlinks				Fixed Uplinks			PoE				Power Supply			Rack Mount
			GE	mGig	SFP	SFP/SFP+	SFP	SFP/SFP+	QSFP	Ports	60 W Ports	Power Budget	IEEE 802.3	Default PS	Ext RPS	Dual PS	
WS-C3650-48TS-L	CON-SMBS-WSC36TSL	LAN Base	48	-	-	-	4	-	-	-	-	-	af/at	250 W AC	-	●	1 RU
WS-C3650-48TS-S	CON-SMBS-WSC3654T	IP Base	48	-	-	-	4	-	-	-	-	-	af/at	250 W AC	-	●	1 RU
WS-C3650-48TS-E	CON-SMBS-WS5048SE	IP Services	48	-	-	-	4	-	-	-	-	-	af/at	250 W AC	-	●	1 RU
WS-C3650-48TD-L	CON-SMBS-WS6548DL	LAN Base	48	-	-	-	2	2	-	-	-	-	af/at	250 W AC	-	●	1 RU
WS-C3650-48TD-S	CON-SMBS-WSC368TD	IP Base	48	-	-	-	2	2	-	-	-	-	af/at	250 W AC	-	●	1 RU
WS-C3650-48TD-E	CON-SMBS-WC3654UA	IP Services	48	-	-	-	2	2	-	-	-	-	af/at	250 W AC	-	●	1 RU
WS-C3650-48TQ-L	CON-SMBS-WC365T48	LAN Base	48	-	-	-	-	4	-	-	-	-	af/at	250 W AC	-	●	1 RU
WS-C3650-48TQ-S	CON-SMBS-WS3654QS	IP Base	48	-	-	-	-	4	-	-	-	-	af/at	250 W AC	-	●	1 RU
WS-C3650-48TQ-E	CON-SMBS-WSC36TQE	IP Services	48	-	-	-	-	4	-	-	-	-	af/at	250 W AC	-	●	1 RU
WS-C3650-48PS-L	CON-SMBS-WS6548SL	LAN Base	48	-	-	-	4	-	-	48	-	390 W	af/at	640 W AC	-	●	1 RU
WS-C3650-48PS-S	CON-SMBS-WSC36PSS	IP Base	48	-	-	-	4	-	-	48	-	390 W	af/at	640 W AC	-	●	1 RU
WS-C3650-48PS-E	CON-SMBS-WSC3654SE	IP Services	48	-	-	-	4	-	-	48	-	390 W	af/at	640 W AC	-	●	1 RU
WS-C3650-48PD-L	CON-SMBS-WS365048	LAN Base	48	-	-	-	2	2	-	48	-	390 W	af/at	640 W AC	-	●	1 RU
WS-C3650-48PD-S	CON-SMBS-WC3654PS	IP Base	48	-	-	-	2	2	-	48	-	390 W	af/at	640 W AC	-	●	1 RU
WS-C3650-48PD-E	CON-SMBS-WSC365DE	IP Services	48	-	-	-	2	2	-	48	-	390 W	af/at	640 W AC	-	●	1 RU
WS-C3650-48PQ-L	CON-SMBS-WSC365QL	LAN Base	48	-	-	-	-	4	-	48	-	390 W	af/at	640 W AC	-	●	1 RU
WS-C3650-48PQ-S	CON-SMBS-WSC36PQS	IP Base	48	-	-	-	-	4	-	48	-	390 W	af/at	640 W AC	-	●	1 RU
WS-C3650-48PQ-E	CON-SMBS-WSC365QE	IP Services	48	-	-	-	-	4	-	48	-	390 W	af/at	640 W AC	-	●	1 RU
WS-C3650-48FS-L	CON-SMBS-WSC3654	LAN Base	48	-	-	-	4	-	-	48	-	775 W	af/at	1025 W AC	-	●	1 RU
WS-C3650-48FS-S	CON-SMBS-WSC654	IP Base	48	-	-	-	4	-	-	48	-	775 W	af/at	1025 W AC	-	●	1 RU
WS-C3650-48FS-E	CON-SMBS-WS5048FS	IP Services	48	-	-	-	4	-	-	48	-	775 W	af/at	1025 W AC	-	●	1 RU
WS-C3650-48FD-L	CON-SMBS-WS6548FD	LAN Base	48	-	-	-	2	2	-	48	-	775 W	af/at	1025 W AC	-	●	1 RU
WS-C3650-48FD-S	CON-SMBS-WSC365FD	IP Base	48	-	-	-	2	2	-	48	-	775 W	af/at	1025 W AC	-	●	1 RU
WS-C3650-48FD-E	CON-SMBS-WS3654UA	IP Services	48	-	-	-	2	2	-	48	-	775 W	af/at	1025 W AC	-	●	1 RU
WS-C3650-48FQM-L	CON-SMBS-WSC365FQ	LAN Base	48	-	-	-	-	4	-	48	-	775 W	af/at	975 W AC	●	-	1 RU
WS-C3650-48FQM-S	CON-SMBS-WSC365QS	IP Base	48	-	-	-	-	4	-	48	-	775 W	af/at	975 W AC	●	-	1 RU
WS-C3650-48FQM-E	CON-SMBS-WSC3658Q	IP Services	48	-	-	-	-	4	-	48	-	775 W	af/at	975 W AC	●	-	1 RU
WS-C3650-48FQ-L	CON-SMBS-WS3654FQ	LAN Base	48	-	-	-	-	4	-	48	-	775 W	af/at	1025 W AC	-	●	1 RU
WS-C3650-48FQ-S	CON-SMBS-WSC354QS	IP Base	48	-	-	-	-	4	-	48	-	775 W	af/at	1025 W AC	-	●	1 RU
WS-C3650-48FQ-E	CON-SMBS-WC3654	IP Services	48	-	-	-	-	4	-	48	-	775 W	af/at	1025 W AC	-	●	1 RU

Getting Started

What's New

Feature Story

Collaborate

Compute

Security

Connect

Switches

SF/SG

Catalyst

2960-L

2960-X

3650/3850

9200 NEW

Meraki MS

Wireless

Routers

Services





Overview

Platform Spec (3650)

Platform Spec (3850)

Licenses & Accessories

Bundles

Product SKU	Service (CSE) SKU	Cisco IOS	Downlinks				Fixed Uplinks			PoE				Power Supply			Rack Mount
			GE	mGig	SFP	SFP/SFP+	SFP	SFP/SFP+	QSFP	Ports	60 W Ports	Power Budget	IEEE 802.3	Default PS	Ext RPS	Dual PS	
WS-C3650-8X24PD-L	CON-SMBS-WSDC3658	LAN Base	24	8	-	-	-	2	-	24	-	435 W	af/at	715 W AC	-	●	1 RU
WS-C3650-8X24PD-S	CON-SMBS-SWC3DPX2	IP Base	24	8	-	-	-	2	-	24	-	435 W	af/at	715 W AC	-	●	1 RU
WS-C3650-8X24PD-E	CON-SMBS-WSEC3658	IP Services	24	8	-	-	-	2	-	24	-	435 W	af/at	715 W AC	-	●	1 RU
WS-C3650-8X24UQ-L	CON-SMBS-WSC365SU	LAN Base	24	8	-	-	-	4	-	24	24	820 W	af/at	1100 W AC	-	●	1 RU
WS-C3650-8X24UQ-S	CON-SMBS-WSC3656Q	IP Base	24	8	-	-	-	4	-	24	24	820 W	af/at	1100 W AC	-	●	1 RU
WS-C3650-8X24UQ-E	CON-SMBS-WSC3656U	IP Services	24	8	-	-	-	4	-	24	24	820 W	af/at	1100 W AC	-	●	1 RU
WS-C3650-12X48FD-L	CON-SMBS-WSLC3651	LAN Base	48	12	-	-	-	2	-	48	-	660 W	af/at	1100 W AC	-	●	1 RU
WS-C3650-12X48FD-S	CON-SMBS-WSC36FDX	IP Base	48	12	-	-	-	2	-	48	-	660 W	af/at	1100 W AC	-	●	1 RU
WS-C3650-12X48FD-E	CON-SMBS-WSFC3651	IP Services	48	12	-	-	-	2	-	48	-	660 W	af/at	1100 W AC	-	●	1 RU
WS-C3650-12X48UQ-L	CON-SMBS-WSC3653W	LAN Base	48	12	-	-	-	4	-	48	48	660 W	af/at	1100 W AC	-	●	1 RU
WS-C3650-12X48UQ-S	CON-SMBS-WS36513C	IP Base	48	12	-	-	-	4	-	48	48	660 W	af/at	1100 W AC	-	●	1 RU
WS-C3650-12X48UQ-E	CON-SMBS-WSC3658E	IP Services	48	12	-	-	-	4	-	48	48	660 W	af/at	1100 W AC	-	●	1 RU
WS-C3650-12X48UR-L	CON-SMBS-WSC3654X	LAN Base	48	12	-	-	-	8	-	48	48	660 W	af/at	1100 W AC	-	●	1 RU
WS-C3650-12X48UR-S	CON-SMBS-WSC3653X	IP Base	48	12	-	-	-	8	-	48	48	660 W	af/at	1100 W AC	-	●	1 RU
WS-C3650-12X48UR-E	CON-SMBS-WSC3653R	IP Services	48	12	-	-	-	8	-	48	48	660 W	af/at	1100 W AC	-	●	1 RU
WS-C3650-12X48UZ-L	CON-SMBS-WSC3658W	LAN Base	48	12	-	-	-	-	2	48	48	660 W	af/at	1100 W AC	-	●	1 RU
WS-C3650-12X48UZ-S	CON-SMBS-WSC3658U	IP Base	48	12	-	-	-	-	2	48	48	660 W	af/at	1100 W AC	-	●	1 RU
WS-C3650-12X48UZ-E	CON-SMBS-WSC3655X	IP Services	48	12	-	-	-	-	2	48	48	660 W	af/at	1100 W AC	-	●	1 RU

Getting Started

What's New

Feature Story

Collaborate

Compute

Security

Connect

Switches

SF/SG

Catalyst

2960-L

2960-X

3650/3850

9200 NEW

Meraki MS

Wireless

Routers

Services





Getting Started

What's New

Feature Story

Collaborate

Compute

Security

Connect

Switches

SF/SG

Catalyst

2960-L

2960-X

3650/3850

9200 NEW

Meraki MS

Wireless

Routers

Services

Overview

Platform Spec (3650)

Platform Spec (3850)

Licenses & Accessories

Bundles

Product SKU	Service (CSE) SKU	Cisco IOS	Downlinks				Fixed Uplinks			PoE				Power Supply			Rack Mount
			GE	mGig	SFP	SFP/SFP+	SFP	SFP/SFP+	QSFP	Ports	60 W Ports	Power Budget	IEEE 802.3	Default PS	Ext RPS	Dual PS	
WS-C3850-24T-L	CON-SMBS-WSC384TL	LAN Base	24	-	-	-	-	-	-	-	-	-	-	350 W AC	-	●	1 RU
WS-C3850-24T-S	CON-SMBS-WSC384TS	IP Base	24	-	-	-	-	-	-	-	-	-	-	350 W AC	-	●	1 RU
WS-C3850-24T-E	CON-SMBS-WSC384TE	IP Services	24	-	-	-	-	-	-	-	-	-	-	350 W AC	-	●	1 RU
WS-C3850-24P-L	CON-SMBS-WSC384PL	LAN Base	24	-	-	-	-	-	-	24	-	435 W	af/at	715 W AC	-	●	1 RU
WS-C3850-24P-S	CON-SMBS-WS-C384PS	IP Base	24	-	-	-	-	-	-	24	-	435 W	af/at	715 W AC	-	●	1 RU
WS-C3850-24P-E	CON-SMBS-WSC384PE	IP Services	24	-	-	-	-	-	-	24	-	435 W	af/at	715 W AC	-	●	1 RU
WS-C3850-24U-L	CON-SMBS-WSC8524U	LAN Base	24	-	-	-	-	-	-	24	24	800 W	af/at	1100 W AC	-	●	1 RU
WS-C3850-24U-S	CON-SMBS-WS8524US	IP Base	24	-	-	-	-	-	-	24	24	800 W	af/at	1100 W AC	-	●	1 RU
WS-C3850-24U-E	CON-SMBS-WS8524UE	IP Services	24	-	-	-	-	-	-	24	24	800 W	af/at	1100 W AC	-	●	1 RU
WS-C3850-48T-L	CON-SMBS-WSC388TL	LAN Base	48	-	-	-	-	-	-	-	-	-	-	350 W AC	-	●	1 RU
WS-C3850-48T-S	CON-SMBS-WSC388TS	IP Base	48	-	-	-	-	-	-	-	-	-	-	350 W AC	-	●	1 RU
WS-C3850-48T-E	CON-SMBS-WSC388TE	IP Services	48	-	-	-	-	-	-	-	-	-	-	350 W AC	-	●	1 RU
WS-C3850-48P-L	CON-SMBS-WSC388PL	LAN Base	48	-	-	-	-	-	-	48	-	435 W	af/at	715 W AC	-	●	1 RU
WS-C3850-48P-S	CON-SMBS-WSC388PS	IP Base	48	-	-	-	-	-	-	48	-	435 W	af/at	715 W AC	-	●	1 RU
WS-C3850-48P-E	CON-SMBS-WSC388PE	IP Services	48	-	-	-	-	-	-	48	-	435 W	af/at	715 W AC	-	●	1 RU
WS-C3850-48F-L	CON-SMBS-WSC388FL	LAN Base	48	-	-	-	-	-	-	48	-	800 W	af/at	1100 W AC	-	●	1 RU
WS-C3850-48F-S	CON-SMBS-WSC388FS	IP Base	48	-	-	-	-	-	-	48	-	800 W	af/at	1100 W AC	-	●	1 RU
WS-C3850-48F-E	CON-SMBS-WSC388FE	IP Services	48	-	-	-	-	-	-	48	-	800 W	af/at	1100 W AC	-	●	1 RU
WS-C3850-48U-L	CON-SMBS-WS5048UL	LAN Base	48	-	-	-	-	-	-	48	48	800 W	af/at	1100 W AC	-	●	1 RU
WS-C3850-48U-S	CON-SMBS-WS3548US	IP Base	48	-	-	-	-	-	-	48	48	800 W	af/at	1100 W AC	-	●	1 RU
WS-C3850-48U-E	CON-SMBS-WS3848UE	IP Services	48	-	-	-	-	-	-	48	48	800 W	af/at	1100 W AC	-	●	1 RU





Overview

Platform Spec (3650)

Platform Spec (3850)

Licenses & Accessories

Bundles

Product SKU	Service (CSE) SKU	Cisco IOS	Downlinks				Fixed Uplinks			PoE				Power Supply			Rack Mount
			GE	mGig	SFP	SFP/SFP+	SFP	SFP/SFP+	QSFP	Ports	60 W Ports	Power Budget	IEEE 802.3	Default PS	Ext RPS	Dual PS	
WS-C3850-24XU-L	CON-SMBS-WSC3852L	LAN Base	-	24	-	-	-	-	-	24	24	580 W	af/at	1100 W AC	-	●	1 RU
WS-C3850-24XU-S	CON-SMBS-WSC3852X	IP Base	-	24	-	-	-	-	-	24	24	580 W	af/at	1100 W AC	-	●	1 RU
WS-C3850-24XU-E	CON-SMBS-WSC385XE	IP Services	-	24	-	-	-	-	-	24	24	580 W	af/at	1100 W AC	-	●	1 RU
WS-C3850-12X48U-L	CON-SMBS-WSC3851L	LAN Base	36	12	-	-	-	-	-	48	48	630 W	af/at	1100 W AC	-	●	1 RU
WS-C3850-12X48U-S	CON-SMBS-WSC385US	IP Base	36	12	-	-	-	-	-	48	48	630 W	af/at	1100 W AC	-	●	1 RU
WS-C3850-12X48U-E	CON-SMBS-WSC385UE	IP Services	36	12	-	-	-	-	-	48	48	630 W	af/at	1100 W AC	-	●	1 RU
WS-C3850-12S-S	CON-SMBS-WSC3851S	LAN Base	-	-	12	-	-	-	-	-	-	-	-	350 W AC	-	●	1 RU
WS-C3850-12S-E	CON-SMBS-WSC385SE	IP Base	-	-	12	-	-	-	-	-	-	-	-	350 W AC	-	●	1 RU
WS-C3850-24S-S	CON-SMBS-WSC3854S	IP Base	-	-	24	-	-	-	-	-	-	-	-	350 W AC	-	●	1 RU
WS-C3850-24S-E	CON-SMBS-WSC3852E	IP Services	-	-	24	-	-	-	-	-	-	-	-	350 W AC	-	●	1 RU
WS-C3850-12XS-S	CON-SMBS-WSC3851X	IP Services	-	-	-	12	-	-	-	-	-	-	-	350 W AC	-	●	1 RU
WS-C3850-12XS-E	CON-SMBS-WSC3851E	LAN Base	-	-	-	12	-	-	-	-	-	-	-	350 W AC	-	●	1 RU
WS-C3850-24XS-S	CON-SMBS-WSCX3852	IP Services	-	-	-	24	-	-	-	-	-	-	-	715 W AC	-	●	1 RU
WS-C3850-24XS-E	CON-SMBS-WS850XSE	LAN Base	-	-	-	24	-	-	-	-	-	-	-	715 W AC	-	●	1 RU
WS-C3850-48XS-S	CON-SMBS-WSC08XSS	IP Services	-	-	-	48	-	-	4	-	-	-	-	750 W AC	-	●	1 RU
WS-C3850-48XS-E	CON-SMBS-WS508XSE	LAN Base	-	-	-	48	-	-	4	-	-	-	-	750 W AC	-	●	1 RU
WS-C3850-48XS-F-S	CON-SMBS-WS50XSFS	IP Base	-	-	-	48	-	-	4	-	-	-	-	750 W AC	-	●	1 RU
WS-C3850-48XS-F-E	CON-SMBS-WSC3854E	IP Services	-	-	-	48	-	-	4	-	-	-	-	750 W AC	-	●	1 RU

Getting Started

What's New

Feature Story

Collaborate

Compute

Security

Connect

Switches

SF/SG

Catalyst

2960-L

2960-X

3650/3850

9200 NEW

Meraki MS

Wireless

Routers

Services





## Overview

## Platform Spec (3650)

## Platform Spec (3850)

## Licenses &amp; Accessories

## Bundles

## Cisco IOS XE Upgrade License for Cisco Catalyst 3650 Series\*1

Product SKU	Description
L-C3650-24-L-S	LAN Base to IP Base RTU License for 24-port models
L-C3650-24-S-E	IP Base to IP Services RTU License for 24-port models
L-C3650-24-L-E	LAN Base to IP Services RTU License for 24-port models
L-C3650-48-L-S	LAN Base to IP Base RTU License for 48-port models
L-C3650-48-S-E	IP Base to IP Services RTU License for 48-port models
L-C3650-48-L-E	LAN Base to IP Services RTU License for 48-port models

\*1 L-C3650-RTU= is required in CCW.

## Cisco IOS XE Upgrade License for Cisco Catalyst 3850 Series\*1

Product SKU	Description
L-C3850-24-L-S	LAN Base to IP Base RTU License for 24-port models
L-C3850-24-S-E	IP Base to IP Services RTU License for 24-port models
L-C3850-24-L-E	LAN Base to IP Services RTU License for 24-port models
L-C3850-48-L-S	LAN Base to IP Base RTU License for 48-port models
L-C3850-48-S-E	IP Base to IP Services RTU License for 48-port models
L-C3850-48-L-E	LAN Base to IP Services RTU License for 48-port models
L-C3850-12-S-E	IP Base to IP Services RTU License for 12-port models

\*1 L-C3850-RTU= is required in CCW.

## Access Point License for Cisco Catalyst 3650/3850 Series\*1

Product SKU	Description
L-LIC-CTIOS-1A	1 Access Point Adder License

\*1 L-LIC-CT3650-UPG is required in CCW for Catalyst 3650.  
L-LIC-CT3850-UPG is required in CCW for Catalyst 3850.

Getting Started

What's New

Feature Story

Collaborate

Compute

Security

Connect

Switches

SF/SG

Catalyst

2960-L

2960-X

3650/3850

9200 NEW

Meraki MS

Wireless

Routers

Services



Getting Started

What's New

Feature Story

Collaborate

Compute

Security

Connect

Switches

SF/SG

Catalyst

2960-L

2960-X

3650/3850

9200 NEW

Meraki MS

Wireless

Routers

Services

Overview

Platform Spec (3650)

Platform Spec (3850)

Licenses & Accessories

Bundles

Power Supply Modules for Cisco Catalyst 3650 Series

Product SKU	Description
PWR-C2-250WAC	250 W AC Power Supply Module
PWR-C2-640WAC	640 W AC Power Supply Module
PWR-C2-1025WAC	1025 W AC Power Supply Module
PWR-C2-640WDC	640 W DC Power Supply Module
PWR-C1-715WAC	715 W AC Power Supply Module
PWR-C1-1100WAC	1100 W AC Power Supply Module
PWR-C1-440WDC	440 W DC Power Supply Module

Cisco Redundant Power System (RPS) 2300

Product SKU	Description
PWR-RPS2300	Cisco RPS 2300 Chassis (No Power Supply)
C3K-PWR-750WAC	Cisco RPS 2300 750 W AC Power Supply
CAB-RPS2300-E=	Cisco RPS 2300 cable

Cisco StackWise-160 Module for Cisco Catalyst 3650 Series

Product SKU	Description
C3650-STACK-KIT	Cisco StackWise-160 Module



Power Supply Modules for Cisco Catalyst 3850 Series

Product SKU	Description
PWR-C1-350WAC	250 W AC Power Supply Module
PWR-C1-715WAC	640 W AC Power Supply Module
PWR-C1-1100WAC	1025 W AC Power Supply Module
PWR-C1-440WDC	640 W DC Power Supply Module
PWR-C3-750WAC-R	750 W AC Front-to-Back Airflow Power Supply Module for Catalyst 3850-48XS
PWR-C3-750WAC-F	750 W AC Back-to-Front Airflow Power Supply Module for Catalyst 3850-48XS
PWR-C3-750WDC-R	750 W DC Front-to-Back Airflow Power Supply Module for Catalyst 3850-48XS
PWR-C3-750WDC-F	750 W DC Back-to-Front Airflow Power Supply Module for Catalyst 3850-48XS

Network Modules for Cisco Catalyst 3850 Series

Product SKU	Description
C3850-NM-4-1G	4 x SFP Network Module for copper models, 1GE fiber models
C3850-NM-2-10G	2 x SFP & 2 x SFP/SFP+ Network Module for copper models, 1GE fiber models
C3850-NM-4-10G	4 x SFP/SFP+ Network Module for 48-port copper models, mGig models, 10GE fiber models
C3850-NM-8-10G	8 x SFP/SFP+ Network Module for mGig models, 24-port 10GE fiber models
C3850-NM-2-40G	2 x QSFP Network Module for mGig models, 24-port 10GE fiber models



Overview

Platform Spec (3650)

Platform Spec (3850)

Licenses &amp; Accessories

Bundles

## Cisco Catalyst 3650 Series Bundles

Product SKU	Service (CSE) SKU	Bundle		
		Model	Access Point Licenses	Cisco IOS
WS-C3650-24PWS-S	CON-SMBS-WSC365WS	WS-C3650-24PS-S	5	IP Base
WS-C3650-24PWD-S	CON-SMBS-WSC3652WD	WS-C3650-24PD-S	5	IP Base
WS-C3650-48PWS-S	CON-SMBS-WSC36548	WS-C3650-48PS-S	5	IP Base
WS-C3650-48PWD-S	CON-SMBS-WS8W654S	WS-C3650-48PD-S	5	IP Base
WS-C3650-48PWQ-S	CON-SMBS-WSCQ3654	WS-C3650-48PQ-S	5	IP Base
WS-C3650-48FWS-S	CON-SMBS-WSC3654W	WS-C3650-48FS-S	5	IP Base
WS-C3650-48FWD-S	CON-SMBS-WSC3654D	WS-C3650-48FD-S	5	IP Base
WS-C3650-48FWQ-S	CON-SMBS-WSC3654Q	WS-C3650-48FQ-S	5	IP Base

## Cisco Catalyst 3650 Series Bundles

Product SKU	Service (CSE) SKU	Bundle			
		Model	Network Module	Access Point Licenses	Cisco IOS
WS-C3850-24PW-S	CON-SMBS-WSC24PWS	WS-C3850-24P-S	-	5	IP Base
WS-C3850-24UW-S	CON-SMBS-WSC38524	WS-C3850-24U-S	-	5	IP Base
WS-C3850-24XUW-S	CON-SMBS-WSC382XS	WS-C3850-24XU-S	-	5	IP Base
WS-C3850-48W-S	CON-SMBS-WSC385WS	WS-C3850-48P-S	-	5	IP Base
WS-C3850-48PW-S	CON-SMBS-WSC48PWS	WS-C3850-48F-S	-	5	IP Base
WS-C3850-48UW-S	CON-SMBS-WSC38548	WS-C3850-48U-S	-	5	IP Base
WS-C3850-12X48UW-S	CON-SMBS-WSC3851W	WS-C3850-12X48U-S	-	5	IP Base
WS-C3850-16XS-S	CON-SMBS-WS3850XS	WS-C3850-12XS-S	C3850-NM-4-10G	5	IP Base
WS-C3850-16XS-E	CON-SMBS-WSC3858X	WS-C3850-12XS-E	C3850-NM-4-10G	5	IP Services
WS-C3850-32XS-S	CON-SMBS-WSC385X2	WS-C3850-24XS-S	C3850-NM-8-10G	5	IP Base
WS-C3850-32XS-E	CON-SMBS-WSC3853X	WS-C3850-24XS-E	C3850-NM-8-10G	5	IP Services

Getting Started

What's New

Feature Story

Collaborate

Compute

Security

Connect

Switches

SF/SG

Catalyst

2960-L

2960-X

3650/3850

9200 NEW

Meraki MS

Wireless

Routers

Services

## Overview

## Platform Spec

## Licenses &amp; Accessories

## Transition Guide

## Extend Intent-Based Networking Everywhere

The Cisco Catalyst 9200 Series switches are Cisco's latest addition to the fixed enterprise switching access platform, and are built for security, resiliency, and programmability. These switches play an integral role as entry-level switches in Cisco Software-Defined Access (SD-Access), Cisco's lead enterprise architecture.

Cisco Catalyst 9200 Series provides enterprise-level resiliency and keeps your business up and running seamlessly with FRU power supplies and fans, modular uplinks, cold patching, perpetual Power over Ethernet (PoE), and the industry's highest Mean Time Between Failures (MTBF).



### Highlights

- Cisco IOS XE: A Common Licensing based operating system for the enterprise Cisco Catalyst 9000 product family with support for model-driven programmability and streaming telemetry
- Cisco UADP 2.0 Mini with integrated CPU offers customers optimized scale with better cost structure
- Fixed uplinks with 4 x 1GE SFP or 4 x 10GE SFP+ (Catalyst 9200L)
- Optional uplink modules with 4 x 1GE SFP or 4 x 10GE SFP+ (Catalyst 9200)
- PoE+ output (PSE models)
- Resiliency with Field-Replaceable Units (FRU) and redundant power supply, fans (Catalyst 9200), and modular uplinks (Catalyst 9200)
- Operational efficiency with optional backplane stacking, supporting stacking bandwidth up to 80 Gbps with Cisco StackWise-80 (Catalyst 9200L) or up to 160 Gbps with Cisco StackWise-160 (Catalyst 9200)
- Layer 3 capabilities, including OSPF, EIGRP, ISIS, RIP, and routed access
- Enhanced security with AES-128 MACsec encryption, policy-based segmentation, and trustworthy systems
- Advanced network monitoring using Full Flexible NetFlow
- Cisco Software-Defined Access (SD-Access):
  - Simplified operations and deployment with policy-based automation from edge to cloud managed with Cisco Identity Services Engine (ISE)
  - Network assurance and improved resolution time through Cisco DNA Center
- Plug and Play (PnP) enabled: A simple, secure, unified, and integrated offering to ease new branch or campus device rollouts or updates to an existing network

Getting Started

What's New

Feature Story

Collaborate

Compute

Security

Connect

Switches

SF/SG

Catalyst

2960-L

2960-X

3650/3850

9200 NEW

Meraki MS

Wireless

Routers

Services

## Overview

## Platform Spec

## Licenses &amp; Accessories

## Transition Guide

## Cisco Catalyst 9200 Series

Product SKU	Service (CSE) SKU	Software Package	Downlinks		Uplinks		PoE		Power Supply		Stack-Wise	Rack Mount	
			GE	SFP	SFP/SFP+	Network Module Slot	Ports	Power Budget		Default			Max
								Default	Max				
C9200L-24T-4G-E	-	Essentials	24	4	-	-	-	-	125 W AC x 1	125 W AC x 2	80	1 RU	
C9200L-24T-4G-A	-	Advantage	24	4	-	-	-	-	125 W AC x 1	125 W AC x 2	80	1 RU	
C9200L-24P-4G-E	-	Essentials	24	4	-	-	24	370 W	740 W	600 W AC x 1	600 W AC x 2	80	1 RU
C9200L-24P-4G-A	-	Advantage	24	4	-	-	24	370 W	740 W	600 W AC x 1	600 W AC x 2	80	1 RU
C9200L-48T-4G-E	-	Essentials	48	4	-	-	-	-	-	125 W AC x 1	125 W AC x 2	80	1 RU
C9200L-48T-4G-A	-	Advantage	48	4	-	-	-	-	-	125 W AC x 1	125 W AC x 2	80	1 RU
C9200L-48P-4G-E	-	Essentials	48	4	-	-	48	740 W	1,440 W	1,000 W AC x 1	1,000 W AC x 2	80	1 RU
C9200L-48P-4G-A	-	Advantage	48	4	-	-	48	740 W	1,440 W	1,000 W AC x 1	1,000 W AC x 2	80	1 RU
C9200L-24T-4X-E	-	Essentials	24	-	4	-	-	-	-	125 W AC x 1	125 W AC x 2	80	1 RU
C9200L-24T-4X-A	-	Advantage	24	-	4	-	-	-	-	125 W AC x 1	125 W AC x 2	80	1 RU
C9200L-24P-4X-E	-	Essentials	24	-	4	-	24	370 W	740 W	600 W AC x 1	600 W AC x 2	80	1 RU
C9200L-24P-4X-A	-	Advantage	24	-	4	-	24	370 W	740 W	600 W AC x 1	600 W AC x 2	80	1 RU
C9200L-48T-4X-E	-	Essentials	48	-	4	-	-	-	-	125 W AC x 1	125 W AC x 2	80	1 RU
C9200L-48T-4X-A	-	Advantage	48	-	4	-	-	-	-	125 W AC x 1	125 W AC x 2	80	1 RU
C9200L-48P-4X-E	-	Essentials	48	-	4	-	48	740 W	1,440 W	1,000 W AC x 1	1,000 W AC x 2	80	1 RU
C9200L-48P-4X-A	-	Advantage	48	-	4	-	48	740 W	1,440 W	1,000 W AC x 1	1,000 W AC x 2	80	1 RU
C9200-24T-E	-	Essentials	24	-	-	1	-	-	-	125 W AC x 1	125 W AC x 2	160	1 RU
C9200-24T-A	-	Advantage	24	-	-	1	-	-	-	125 W AC x 1	125 W AC x 2	160	1 RU
C9200-24P-E	-	Essentials	24	-	-	1	24	370 W	740 W	600 W AC x 1	600 W AC x 2	160	1 RU
C9200-24P-A	-	Advantage	24	-	-	1	24	370 W	740 W	600 W AC x 1	600 W AC x 2	160	1 RU
C9200-48T-E	-	Essentials	48	-	-	1	-	740 W	-	125 W AC x 1	125 W AC x 2	160	1 RU
C9200-48T-A	-	Advantage	48	-	-	1	-	740 W	-	125 W AC x 1	125 W AC x 2	160	1 RU
C9200-48P-E	-	Essentials	48	-	-	1	48	740 W	1,440 W	1,000 W AC x 1	1,000 W AC x 2	160	1 RU
C9200-48P-A	-	Advantage	48	-	-	1	48	740 W	1,440 W	1,000 W AC x 1	1,000 W AC x 2	160	1 RU

Getting Started

What's New

Feature Story

Collaborate

Compute

Security

Connect

Switches

SF/SG

Catalyst

2960-L

2960-X

3650/3850

9200 NEW

Meraki MS

Wireless

Routers

Services



## Overview

## Platform Spec

## Licenses &amp; Accessories

## Transition Guide

## Cisco DNA Licenses for Cisco Catalyst 9200 Series (Catalyst 9200L)

Software Package	Product SKU			Compatible Models
	3-Years	5-Years	7-Years	
Cisco DNA Essentials	C9200L-DNA-E-24-3Y	C9200L-DNA-E-24-5Y	C9200L-DNA-E-24-7Y	24-port Catalyst 9200L (-E, Network Essentials) <sup>*1</sup>
	C9200L-DNA-E-48-3Y	C9200L-DNA-E-48-5Y	C9200L-DNA-E-48-7Y	48-port Catalyst 9200L (-E, Network Essentials) <sup>*2</sup>
Cisco DNA Advantage	C9200L-DNA-A-24-3Y	C9200L-DNA-A-24-5Y	C9200L-DNA-A-24-7Y	24-port Catalyst 9200L (-A, Network Advantage) <sup>*3</sup>
	C9200L-DNA-A-48-3Y	C9200L-DNA-A-48-5Y	C9200L-DNA-A-48-7Y	48-port Catalyst 9200L (-A, Network Advantage) <sup>*4</sup>

\*1 C9200L-DNA-E-24 is required in CCW. \*2 C9200L-DNA-E-48 is required in CCW.

\*3 C9200L-DNA-A-24 is required in CCW. \*4 C9200L-DNA-A-48 is required in CCW.

## Cisco DNA Licenses for Cisco Catalyst 9200 Series (Catalyst 9200)

Software Package	Product SKU			Compatible Models
	3-Years	5-Years	7-Years	
Cisco DNA Essentials	C9200-DNA-E-24-3Y	C9200-DNA-E-24-5Y	C9200-DNA-E-24-7Y	24-port Catalyst 9200 (-E, Network Essentials) <sup>*1</sup>
	C9200-DNA-E-48-3Y	C9200-DNA-E-48-5Y	C9200-DNA-E-48-7Y	48-port Catalyst 9200 (-E, Network Essentials) <sup>*2</sup>
Cisco DNA Advantage	C9200-DNA-A-24-3Y	C9200-DNA-A-24-5Y	C9200-DNA-A-24-7Y	24-port Catalyst 9200 (-A, Network Advantage) <sup>*3</sup>
	C9200-DNA-A-48-3Y	C9200-DNA-A-48-5Y	C9200-DNA-A-48-7Y	48-port Catalyst 9200 (-A, Network Advantage) <sup>*4</sup>

\*1 C9200-DNA-E-24 is required in CCW. \*2 C9200-DNA-E-48 is required in CCW.

\*3 C9200-DNA-A-24 is required in CCW. \*4 C9200-DNA-A-48 is required in CCW.

 **Ordering and Licensing Guide**

You must order a Cisco DNA License in order to purchase a switch.

A Cisco Smart Account is mandatory when ordering a Cisco DNA License.

The Cisco Smart Account is a new solution that provides a central location to manage Cisco software licenses across an entire organization, allowing partners and customers to optimize their software management.

To obtain a Cisco Smart Account, visit [Cisco Software Central](#) and select the [Request a Smart Account] option under the [Administration] heading.

Getting Started

What's New

Feature Story

Collaborate

Compute

Security

Connect

Switches

SF/SG

Catalyst

2960-L

2960-X

3650/3850

9200 NEW

Meraki MS

Wireless

Routers

Services



Getting Started

What's New

Feature Story

Collaborate

Compute

Security

Connect

Switches

SF/SG

Catalyst

2960-L

2960-X

3650/3850

**9200** NEW

Meraki MS

Wireless

Routers

Services

Overview

Platform Spec

**Licenses & Accessories**

Transition Guide

**Power Supply Modules for Cisco Catalyst 9200 Series**

Product SKU	Description
PWR-C5-125WAC/2	125 W AC Power Supply Module
PWR-C5-600WAC/2	600 W AC Power Supply Module
PWR-C5-1KWAC/2	1,100 W AC Power Supply Module

**Network Modules for Cisco Catalyst 9200 Series**

Product SKU	Description
C9200-NM-4G	4 x 1GE SFP Network Module
C9200-NM-4X	4 x 10GE SFP+ Network Module

**Cisco StackWise-80/160 Modules for Cisco Catalyst 9200 Series**

Product SKU	Description
C9200L-STACK-KIT	StackWise-80 Module for Catalyst 9200L
C9200-STACK-KIT	StackWise-160 Module for Catalyst 9200



**TIP Cisco StackWise-80/160**

The Cisco StackWise-80/160 provides stacking of up to eight Cisco Catalyst 9200 Series switches with the optional Cisco StackWise-80/160 Modules.

Mixed stacking is not supported. You cannot stack fixed (Catalyst 9200L) with modular (Catalyst 9200) models, or other Catalyst switches, e.g., Cisco Catalyst 2960-X and 2960-XR Series.

**Cisco StackWise-80/160 Scalability & Performance**

Stack Member	Stack Bandwidth	Stack Limit
Catalyst 9200L (Fixed Models) with Same License Level	80 Gbps	4
Catalyst 9200 (Modular Models) with Same License Level	160 Gbps	8



Overview

Platform Spec

Licenses & Accessories

**Transition Guide**

Benefits of Upgrading to Cisco Catalyst 9200 Series

Feature	Catalyst 2960-X	Catalyst 2960-XR	Catalyst 9200	Benefits	
<p>Scale and Performance</p>	Bandwidth per Stack	80 Gbps	80 Gbps	80 Gbps 160 Gbps	Twice the density at nearly the same price
	1/10GE Uplinks	4 x 1GE 2 x 10 GE	4 x 1GE 2 x 10 GE	4 x 1GE 4 x 10 GE	
<p>Advanced Security</p>	Full Flexible NetFlow	-	-	●	Orchestrate role-based access to corporate resources
	TrustSec and SGT	●	●	●	
	Trustworthy Systems	●*1	●*1	●	
<p>Simplicity and Automation</p>	Native MACsec	-	-	●	AES-128, MACsec-128
	IOS XE OS	-	-	●	Single common network OS across switching, routing, wireless, and IoT
	Model-Driven Programmability	-	-	●	Standards-based programmable interfaces
	Streaming Telemetry	-	-	●	Rich contextual insights
	SD-Access Programmability	-	-	●	Automation and Assurance

\*1 Except some models.

Getting Started

What's New

Feature Story

Collaborate

Compute

Security

Connect

Switches

SF/SG

Catalyst

2960-L

2960-X

3650/3850

**9200** NEW

Meraki MS

Wireless

Routers

Services





Overview

Platform Spec

Licenses & Accessories

**Transition Guide**

**Transition Map**

Existing Model		New Model	
Catalyst 2960-X	Catalyst 2960-XR	Catalyst 9200	Description
WS-C2960X-24TS	-	<b>C9200L-24T-4G</b>	24 x GE, 4 x SFP
WS-C2960X-24PS WS-C2960X-24PSQ	-	<b>C9200L-24P-4G</b>	24 x GE PoE+, 4 x SFP
WS-C2960X-48TS	-	<b>C9200L-48T-4G</b>	48 x GE, 4 x SFP
WS-C2960X-48LPS WS-C2960X-48FPS	-	<b>C9200L-48P-4G</b>	48 x GE PoE+, 4 x SFP
WS-C2960X-24TD	-	<b>C9200L-24T-4X</b>	24 x GE, 4 x SFP+
WS-C2960X-24PD	-	<b>C9200L-24P-4X</b>	24 x GE PoE+, 4 x SFP+
WS-C2960X-48TD	-	<b>C9200L-48T-4X</b>	48 x GE, 4 x SFP+
WS-C2960X-48LPD WS-C2960X-48FPD	-	<b>C9200L-48P-4X</b>	48 x GE PoE+, 4 x SFP+
-	WS-C2960XR-24TS WS-C2960XR-24TD	<b>C9200-24T</b>	24 x GE 4 x SFP or 4 x SFP+ Network Modules are supported
-	WS-C2960XR-24PS WS-C2960XR-24PD	<b>C9200-24P</b>	24 x GE PoE+ 4 x SFP or 4 x SFP+ Network Modules are supported
-	WS-C2960XR-48TS WS-C2960XR-48TD	<b>C9200-48T</b>	48 x GE 4 x SFP or 4 x SFP+ Network Modules are supported
-	WS-C2960XR-48LPS WS-C2960XR-48FPS WS-C2960XR-48LPD WS-C2960XR-48FPD	<b>C9200-48P</b>	48 x GE PoE+ 4 x SFP or 4 x SFP+ Network Modules are supported

Getting Started

What's New

Feature Story

Collaborate

Compute

Security

**Connect**

**Switches**

SF/SG

Catalyst

2960-L

2960-X

3650/3850

**9200** NEW

Meraki MS

Wireless

Routers

Services



## Overview

## Positioning Map

## Platform Spec

## Licenses &amp; Accessories

## True Zero-Touch Cloud Provisioning, Network Visibility, and Remote Troubleshooting

The Cisco Meraki MS Cloud Managed Switches offer true zero-touch provisioning, can be pre-staged and configured entirely from a web browser. The Meraki management experience accelerates and simplifies the work of the network engineer.

Troubleshooting network issues, especially on remote locations, can significantly add to the cost of running this mission critical service. Meraki MS switches provide groundbreaking tools for remote troubleshooting, so that scaling a Meraki network need not mean scaling complexity.

The Meraki MS switches include features for streamlining the work of the network engineer, from deployment to security to troubleshooting.

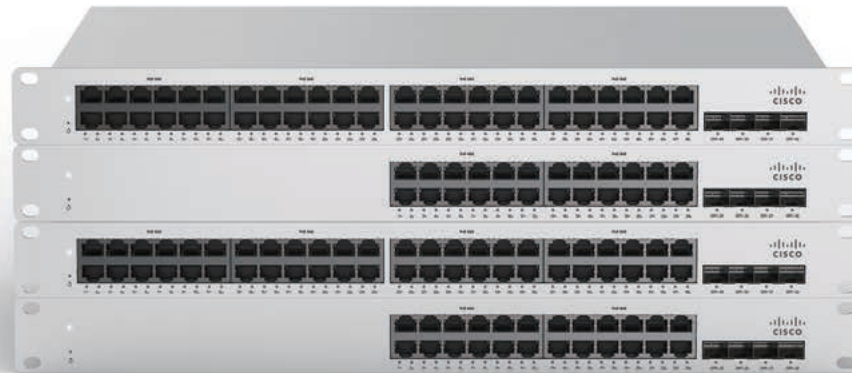

### Highlights

- **Multigigabit Ethernet:** Provide the higher performance demanded by the latest access points over existing cabling.
- **Voice & Video QoS:** Give latency sensitive applications the priority and bandwidth they deserve with configurable QoS.
- **Flexible Stacking:** Simultaneously configure thousands of ports across standalone and physically stacked switches, regardless of location.
- **Network Topology:** View the network in real-time, showing devices and their connections and even monitor network-wide health.
- **Layer 7 Visibility:** Meraki MS switches make it easy to understand how valuable network resources are being used.
- **Remote Live Tools:** Powerful tools for identifying and correcting issues, even from thousands of miles away.
- **Layer 3 Scalability:** Build large, resilient networks using dynamic routing protocols and warm spare technology.
- **Enterprise Security:** Protect the wired network from both external and internal threats.

Getting Started

What's New

Feature Story

Collaborate

Compute

Security

Connect

Switches

SF/SG

Catalyst

2960-L

2960-X

3650/3850

9200 NEW

Meraki MS

Wireless

Routers

Services



Overview

**Positioning Map**

Platform Spec

Licenses & Accessories

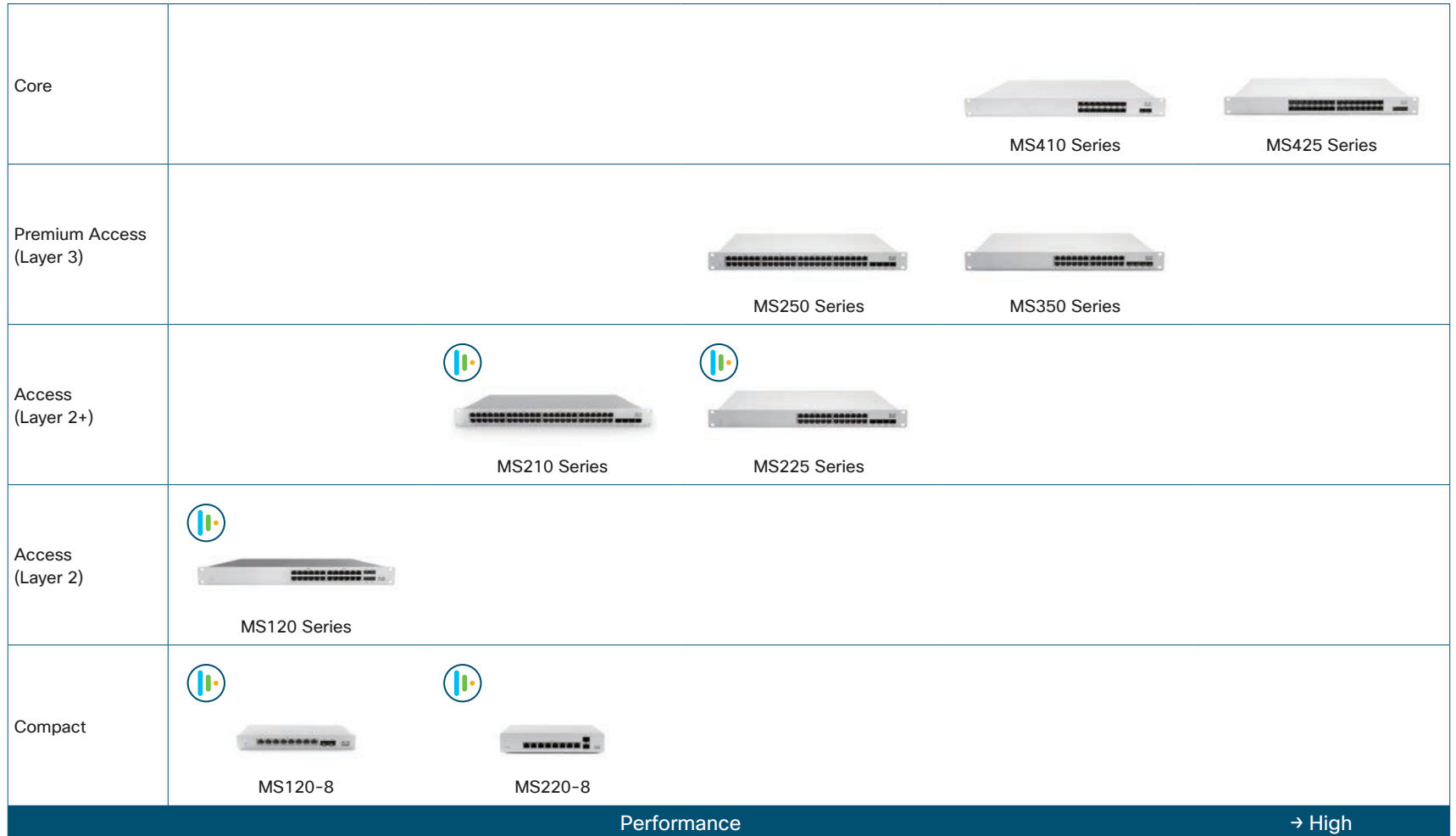

Getting Started

What's New

Feature Story

Collaborate

Compute

Security

**Connect**

**Switches**

SF/SG

Catalyst

2960-L

2960-X

3650/3850

9200 NEW

**Meraki MS**

Wireless

Routers

Services

Overview

Positioning Map

Platform Spec

Licenses & Accessories

Cisco Meraki MS120 Compact Series

Product SKU	Switching Capacity	Downlinks			Uplinks		PoE			Power Supply			Fan less	Stackable		Rack Mount
		GE	SFP	SFP+	Ports	Power Budget	IEEE 802.3	Default PS	Ext RPS	Dual PS	Virtual	Physical				
MS120-8-HW	20 Gbps	8	2	-	-	-	-	External	-	-	●	●	-	-*1		
MS120-8LP-HW	20 Gbps	8	2	-	8	67 W	af/at	External	-	-	●	●	-	-*1		
MS120-8FP-HW	20 Gbps	8	2	-	8	124 W	af/at	Internal	-	-	●	●	-	-*1		

\*1 Wall or utility board mountable with included mount hardware.

Cisco Meraki MS220 Compact Series

Product SKU	Switching Capacity	Downlinks			Uplinks		PoE			Power Supply			Fan less	Stackable		Rack Mount
		GE	SFP	SFP+	Ports	Power Budget	IEEE 802.3	Default PS	Ext RPS	Dual PS	Virtual	Physical				
MS220-8-HW	20 Gbps	8	2	-	-	-	-	Internal	-	-	●	●	-	-*1		
MS220-8P-HW	20 Gbps	8	2	-	8	124 W	af/at	Internal	-	-	●	●	-	-*1		

\*1 Wall or utility board mountable with included mount hardware.



Getting Started

What's New

Feature Story

Collaborate

Compute

Security

Connect

Switches

SF/SG

Catalyst

2960-L

2960-X

3650/3850

9200 NEW

Meraki MS

Wireless

Routers

Services



## Overview

## Positioning Map

## Platform Spec

## Licenses &amp; Accessories

## Cisco Meraki MS120 Series

Product SKU	Switching Capacity	Downlinks			Uplinks		PoE			Power Supply			Fan less	Stackable		Rack Mount
		GE	SFP	SFP+	Ports	Power Budget	IEEE 802.3	Default PS	Ext RPS	Dual PS	Virtual	Physical				
MS120-24-HW	56 Gbps	24	4	-	-	-	-	Internal	-	-	●	●	-	●		
MS120-24P-HW	56 Gbps	24	4	-	24	370 W	af/at	Internal	-	-	-	●	-	●		
MS120-48-HW	104 Gbps	48	4	-	-	-	-	Internal	-	-	●	●	-	●		
MS120-48LP-HW	104 Gbps	48	4	-	48	370 W	af/at	Internal	-	-	-	●	-	●		
MS120-48FP-HW	104 Gbps	48	4	-	48	740 W	af/at	Internal	-	-	-	●	-	●		

## Cisco Meraki MS210 Series

Product SKU	Switching Capacity	Downlinks			Uplinks		PoE			Power Supply			Fan less	Stackable		Rack Mount
		GE	SFP	SFP+	Ports	Power Budget	IEEE 802.3	Default PS	Ext RPS	Dual PS	Virtual	Physical				
MS210-24-HW	128 Gbps	24	4	-	-	-	-	Internal	●	-	●	●	80 Gbps	●		
MS210-24P-HW	128 Gbps	24	4	-	24	370 W	af/at	Internal	●	-	-	●	80 Gbps	●		
MS210-48-HW	176 Gbps	48	4	-	-	-	-	Internal	●	-	●	●	80 Gbps	●		
MS210-48LP-HW	176 Gbps	48	4	-	48	370 W	af/at	Internal	●	-	-	●	80 Gbps	●		
MS210-48FP-HW	176 Gbps	48	4	-	48	740 W	af/at	Internal	●	-	-	●	80 Gbps	●		

## Cisco Meraki MS225 Series

Product SKU	Switching Capacity	Downlinks			Uplinks		PoE			Power Supply			Fan less	Stackable		Rack Mount
		GE	SFP	SFP+	Ports	Power Budget	IEEE 802.3	Default PS	Ext RPS	Dual PS	Virtual	Physical				
MS225-24-HW	128 Gbps	24	-	4	-	-	-	Internal	●	-	●	●	80 Gbps	●		
MS225-24P-HW	128 Gbps	24	-	4	24	370 W	af/at	Internal	●	-	●	●	80 Gbps	●		
MS225-48-HW	176 Gbps	48	-	4	-	-	-	Internal	●	-	●	●	80 Gbps	●		
MS225-48LP-HW	176 Gbps	48	-	4	48	370 W	af/at	Internal	●	-	●	●	80 Gbps	●		
MS225-48FP-HW	176 Gbps	48	-	4	48	740 W	af/at	Internal	●	-	●	●	80 Gbps	●		

Getting Started

What's New

Feature Story

Collaborate

Compute

Security

Connect

Switches

SF/SG

Catalyst

2960-L

2960-X

3650/3850

9200 NEW

Meraki MS

Wireless

Routers

Services

## Overview

## Positioning Map

## Platform Spec

## Licenses &amp; Accessories

## Cisco Meraki Enterprise Licenses for Cisco Meraki MS120 Compact Series

Product SKU					Compatible Models
1-Year	3-Years	5-Years	7-Years	5-Years	
LIC-MS120-8-1YR	LIC-MS120-8-3YR	LIC-MS120-8-5YR	LIC-MS120-8-7YR	LIC-MS120-8-10YR	MS120-8
LIC-MS120-8LP-1YR	LIC-MS120-8LP-3YR	LIC-MS120-8LP-5YR	LIC-MS120-8LP-7YR	LIC-MS120-8LP-10YR	MS120-8LP
LIC-MS120-8FP-1YR	LIC-MS120-8FP-3YR	LIC-MS120-8FP-5YR	LIC-MS120-8FP-7YR	LIC-MS120-8FP-10YR	MS120-8FP

## Cisco Meraki Enterprise Licenses for Cisco Meraki MS220 Compact Series

Product SKU					Compatible Models
1-Year	3-Years	5-Years	7-Years	5-Years	
LIC-MS220-8-1YR	LIC-MS220-8-3YR	LIC-MS220-8-5YR	LIC-MS220-8-7YR	LIC-MS220-8-10YR	MS220-8
LIC-MS220-8P-1YR	LIC-MS220-8P-3YR	LIC-MS220-8P-5YR	LIC-MS220-8P-7YR	LIC-MS220-8P-10YR	MS220-8P

## Cisco Meraki Enterprise Licenses for Cisco Meraki MS120 Series

Product SKU					Compatible Models
1-Year	3-Years	5-Years	7-Years	5-Years	
LIC-MS120-24-1YR	LIC-MS120-24-3YR	LIC-MS120-24-5YR	LIC-MS120-24-7YR	LIC-MS120-24-10YR	MS120-24
LIC-MS120-24P-1YR	LIC-MS120-24P-3YR	LIC-MS120-24P-5YR	LIC-MS120-24P-7YR	LIC-MS120-24P-10YR	MS120-24P
LIC-MS120-48-1YR	LIC-MS120-48-3YR	LIC-MS120-48-5YR	LIC-MS120-48-7YR	LIC-MS120-48-10YR	MS120-48
LIC-MS120-48LP-1YR	LIC-MS120-48LP-3YR	LIC-MS120-48LP-5YR	LIC-MS120-48LP-7YR	LIC-MS120-48LP-10Y	MS120-48LP
LIC-MS120-48FP-1YR	LIC-MS120-48FP-3YR	LIC-MS120-48FP-5YR	LIC-MS120-48FP-7YR	LIC-MS120-48FP-10Y	MS120-48FP

Getting Started

What's New

Feature Story

Collaborate

Compute

Security

Connect

Switches

SF/SG

Catalyst

2960-L

2960-X

3650/3850

9200 NEW

Meraki MS

Wireless

Routers

Services

## Overview

## Positioning Map

## Platform Spec

## Licenses &amp; Accessories

## Cisco Meraki Enterprise Licenses for Cisco Meraki MS210 Series

Product SKU					Compatible Models
1-Year	3-Years	5-Years	7-Years	5-Years	
LIC-MS210-24-1YR	LIC-MS210-24-3YR	LIC-MS210-24-5YR	LIC-MS210-24-7YR	LIC-MS210-24-10YR	MS210-24
LIC-MS210-24P-1YR	LIC-MS210-24P-3YR	LIC-MS210-24P-5YR	LIC-MS210-24P-7YR	LIC-MS210-24P-10YR	MS210-24P
LIC-MS210-48-1YR	LIC-MS210-48-3YR	LIC-MS210-48-5YR	LIC-MS210-48-7YR	LIC-MS210-48-10YR	MS210-48
LIC-MS210-48FP-1YR	LIC-MS210-48FP-3YR	LIC-MS210-48FP-5YR	LIC-MS210-48FP-7YR	LIC-MS210-48FP-10Y	MS210-48LP
LIC-MS210-48LP-1YR	LIC-MS210-48LP-3YR	LIC-MS210-48LP-5YR	LIC-MS210-48LP-7YR	LIC-MS210-48LP-10Y	MS210-48FP

## Cisco Meraki Enterprise Licenses for Cisco Meraki MS225 Series

Product SKU					Compatible Models
1-Year	3-Years	5-Years	7-Years	5-Years	
LIC-MS225-24-1YR	LIC-MS225-24-3YR	LIC-MS225-24-5YR	LIC-MS225-24-7YR	LIC-MS225-24-10YR	MS225-24
LIC-MS225-24P-1YR	LIC-MS225-24P-3YR	LIC-MS225-24P-5YR	LIC-MS225-24P-7YR	LIC-MS225-24P-10YR	MS225-24P
LIC-MS225-48-1YR	LIC-MS225-48-3YR	LIC-MS225-48-5YR	LIC-MS225-48-7YR	LIC-MS225-48-10YR	MS225-48
LIC-MS225-48FP-1YR	LIC-MS225-48FP-3YR	LIC-MS225-48FP-5YR	LIC-MS225-48FP-7YR	LIC-MS225-48FP-10Y	MS225-48LP
LIC-MS225-48LP-1YR	LIC-MS225-48LP-3YR	LIC-MS225-48LP-5YR	LIC-MS225-48LP-7YR	LIC-MS225-48LP-10Y	MS225-48FP

## Cisco Redundant Power System (RPS) 2300

Product SKU	Description
PWR-RPS2300	Cisco RPS 2300 Chassis (No Power Supply)
C3K-PWR-750WAC	Cisco RPS 2300 750 W AC Power Supply
CAB-RPS2300-E=	Cisco RPS 2300 cable

Getting Started

What's New

Feature Story

Collaborate

Compute

Security

Connect

Switches

SF/SG

Catalyst

2960-L

2960-X

3650/3850

9200 NEW

Meraki MS

Wireless

Routers

Services





## Cisco 3504 Wireless Controller

Compact, Highly Scalable, Service-Rich, Resilient, and Flexible Platform  
Enables Next-Generation Wireless Networks for Small to Medium-sized Enterprises



 AIR-CT3504-K9

Optimized for 11ac Wave 2	4 Gbps Max Throughput	150 Max APs	3,000 Max Clients	Central Mode	FlexConnect	Mesh	FlexConnect + Mesh	OfficeExtend
1-port mGig	2-port GE PoE+	2-port GE	Fanless	Desktop	Optional Side-by-Side Rack Mount			

Getting Started

What's New

Feature Story

Collaborate

Compute

Security

Connect

Switches

Wireless

WAP

Aironet

Controllers

Meraki MR

Routers

Services

Featured Products

Portfolio

Management Platform	Access Points		Switches	Controllers	Cloud
	Single Point Setup	Mobility Express			
Components	<p>Wireless Access Points (WAP)</p>	<p>Aironet Access Points</p>	<p>Catalyst Switches</p> <p>Aironet Access Points</p>	<p>Wireless Controllers</p> <p>Aironet Access Points</p>	<p>Meraki MR Cloud Managed Access Points</p>
Highlights	<ul style="list-style-type: none"> <li>Supports 16 APs (500 Series WAP)</li> <li>No license requirement</li> </ul>	<ul style="list-style-type: none"> <li>Supports 100 APs, 2,000 clients (Aironet 2800/3800)</li> <li>No license requirement</li> </ul>	<ul style="list-style-type: none"> <li>Supports 100 APs, 2,000 clients (Catalyst 3850)</li> <li>Converged wired and wireless access for operational simplicity and scale</li> </ul>	<ul style="list-style-type: none"> <li>Supports 150 APs, 3,000 clients (WC 3504)</li> <li>Supports various deployment modes: central, distributed, and mesh</li> </ul>	<ul style="list-style-type: none"> <li>Provides unified visibility and control of the entire network via a single dashboard: not only wireless, but also switching, and security appliances</li> </ul>
Cisco Start Products	<ul style="list-style-type: none"> <li>Cisco 100 Series Wireless Access Points (WAP)*1</li> <li>Cisco 300 Series Wireless Access Points (WAP)</li> <li>Cisco 500 Series Wireless Access Points (WAP)</li> </ul>	<ul style="list-style-type: none"> <li>Cisco Aironet 1800 Series*2</li> <li>Cisco Aironet 2800 Series</li> <li>Cisco Aironet 3800 Series</li> </ul>	<ul style="list-style-type: none"> <li>Cisco Catalyst 3650 Series</li> <li>Cisco Catalyst 3850 Series</li> </ul>	<ul style="list-style-type: none"> <li>Cisco 3504 Wireless Controller</li> <li>Cisco Aironet 1800 Series</li> <li>Cisco Aironet 2800 Series</li> <li>Cisco Aironet 3800 Series</li> </ul>	<ul style="list-style-type: none"> <li>Cisco Meraki MR20</li> <li>Cisco Meraki MR30H</li> <li>Cisco Meraki MR33</li> <li>Cisco Meraki MR42</li> <li>Cisco Meraki MR42E</li> </ul>

\*1 Cisco WAP125/131 do not support Single Point Setup.

\*2 Cisco Aironet 1815t does not support Mobility Express.

Getting Started

What's New

Feature Story

Collaborate

Compute

Security

Connect

Switches

Wireless

WAP

Aironet

Controllers

Meraki MR

Routers

Services

## Overview

## Positioning Map

## Platform Spec

## High-Performance, Easy-to-Deploy, and Highly Secure Business-Class Wireless

Today Wi-Fi is the primary way for mobile access; small to medium-sized businesses are now looking for simple, yet easy-to-deploy Wi-Fi networks where they can provide the best experience to their employees and customers. To stay productive, they need dependable, business-class access to network applications throughout the office.

The **Cisco Wireless Access Points (WAP)** provide a simple, cost-effective way to extend highly secure, high-performance mobile networking to your employees and guests, so they can stay connected anywhere in the office, regardless of what mobile devices they use.



### Highlights

- IEEE 802.11ac Wave 2-compatible (WAP581)
- IEEE 802.11ac Wave 1-compatible (most models)
- Multigigabit uplink (WAP581)
- Dual GE uplinks (WAP571/581)
- PoE/PoE+ input (all models)
- PoE output (WAP361)
- Built-in managed switch (WAP361)
- Integrated wireless spectrum analysis tool (WAP581)
- Single Point Setup for easy, cost-effective deployment of multiple access points (most models)
- Easy to set up and use with wizard-based configuration (all models)

Getting Started

What's New

Feature Story

Collaborate

Compute

Security

Connect

Switches

Wireless

WAP

Aironet

Controllers

Meraki MR









Routers

Services

Overview

**Positioning Map**

Platform Spec

1.7 Gbps			 WAP581
1.3 Gbps		 WAP571  WAP571E  WAP371	
867 Mbps		 WAP125  WAP361  WAP150	
300 Mbps	 WAP121  WAP131		
	11n	11ac Wave 1	11ac Wave 2

Getting Started

What's New

Feature Story

Collaborate

Compute

Security

**Connect**

Switches

Wireless

WAP

Aironet

Controllers

Meraki MR

Routers

Services

## Overview

## Positioning Map

## Platform Spec

## Cisco 100 Series Wireless Access Points (WAP)

Product SKU	Service (CSE) SKU	IEEE 802			2.4 GHz	5 GHz	Concurrent Radios	Active Clients per Radio	APs per Cluster (SPS)	Ports			PoE (PD) <sup>*1</sup>		AC Power
		11n	11ac Wave 1	11ac Wave 2						FE	GE	mGig	802.3af	802.3at	
WAP121-x-K9-xx	-	●	-	-	●	-	-	16	4	1	-	-	●	●	External
WAP125-x-K9-xx	CON-SMBS-WAP12K9x	●	●	-	●	●	-	16	-	-	1	-	●	●	External
WAP131-x-K9-xx	CON-SMBS-WAP131AK	●	-	-	●	●	●	16	-	-	1	-	●	●	External
WAP150-x-K9-xx	CON-SMBS-WAP159xx	●	●	-	●	●	●	16	4	-	1	-	●	●	External

\*1 Power Adapter (included) or Power Injector is required when not using PoE receiving.

## Cisco 300 Series Wireless Access Points (WAP)

Product SKU	Service (CSE) SKU	IEEE 802			2.4 GHz	5 GHz	Concurrent Radios	Active Clients per Radio	APs per Cluster (SPS)	Ports			PoE (PD) <sup>*1</sup>		AC Power
		11n	11ac Wave 1	11ac Wave 2						FE	GE	mGig	802.3af	802.3at	
WAP361-x-K9	CON-SMBS-WAP361xK	●	●	-	●	●	●	32	8	-	5 <sup>*2</sup>	-	● <sup>*3</sup>	●	External
WAP371-x-K9	CON-SMBS-WAP71xK9	●	●	-	●	●	●	32	8	-	1	-	● <sup>*3</sup>	●	External

\*1 Power Adapter or Power Injector is required when not using PoE receiving.

\*2 GE PoE (PSE) x 1 is included. \*3 Some features are disabled when powered via 802.3af PoE.

## Cisco 500 Series Wireless Access Points (WAP)

Product SKU	Service (CSE) SKU	IEEE 802			2.4 GHz	5 GHz	Concurrent Radios	Active Clients per Radio	APs per Cluster (SPS)	Ports			PoE (PD) <sup>*1</sup>		AC Power
		11n	11ac Wave 1	11ac Wave 2						FE	GE	mGig	802.3af	802.3at	
WAP571-x-K9	CON-SMBS-WAP57xK9	●	●	-	●	●	●	64	16	-	2	-	● <sup>*2</sup>	●	-
WAP571E-x-K9	CON-SMBS-WAP571Ex	●	●	-	●	●	●	64	16	-	2	-	● <sup>*2</sup>	●	-
WAP581-x-K9	CON-SMBS-WAP581xK	●	●	●	●	●	●	64	16	-	1	1	● <sup>*2</sup>	●	-

\*1 Power Adapter or Power Injector is required when not using PoE receiving.

\*2 Some features are disabled when powered via 802.3af PoE.

Getting Started

What's New

Feature Story

Collaborate

Compute

Security

Connect

Switches

Wireless

WAP

Aironet

Controllers

Meraki MR

Routers

Services



## Industry-Leading Wireless Performance

Ideal for small and medium-sized networks, the Cisco Aironet Access Points deliver industry-leading wireless performance with support for the latest Wi-Fi standard, IEEE's new 802.11ac Wave 2 specification, and meet the growing requirements of wireless networks by delivering a better user experience. For organizations paving the way for the new 11ac Wave 2 standard, the Cisco Aironet Access Points are the perfect solution. The access points go beyond getting ready for the new standard, providing the ultimate in flexibility and versatility.

### Highlights

- IEEE 802.11ac Wave 2-compatible (all models)
- Dual 5-GHz radios allowing an industry-leading 5.2 Gbps (2 x 2.6 Gbps) over-the-air speeds (Aironet 2800/3800)
- Cisco High Density Experience (HDX) including features such as custom hardware in 11ac Wave 2 radios, Cisco CleanAir, Cisco ClientLink 4.0, cross-access point noise reduction, and an optimized client roaming experience (Aironet 2800/3800)
- Multigigabit uplink (Aironet 3800)
- Dual GE uplinks (Aironet 1850/2800/3800)
- PoE/PoE+ input (all models)
- PoE output (Aironet 1815t/w)
- Built-in managed switch (Aironet 1815t/w)
- Cisco Mobility Express for easy, cost-effective deployment of multiple access points (most models)



Getting Started

What's New

Feature Story

Collaborate

Compute

Security

Connect

Switches

Wireless

WAP

Aironet

Controllers

Meraki MR

Routers

Services

Overview

**Positioning Map**

Platform Spec

Accessories

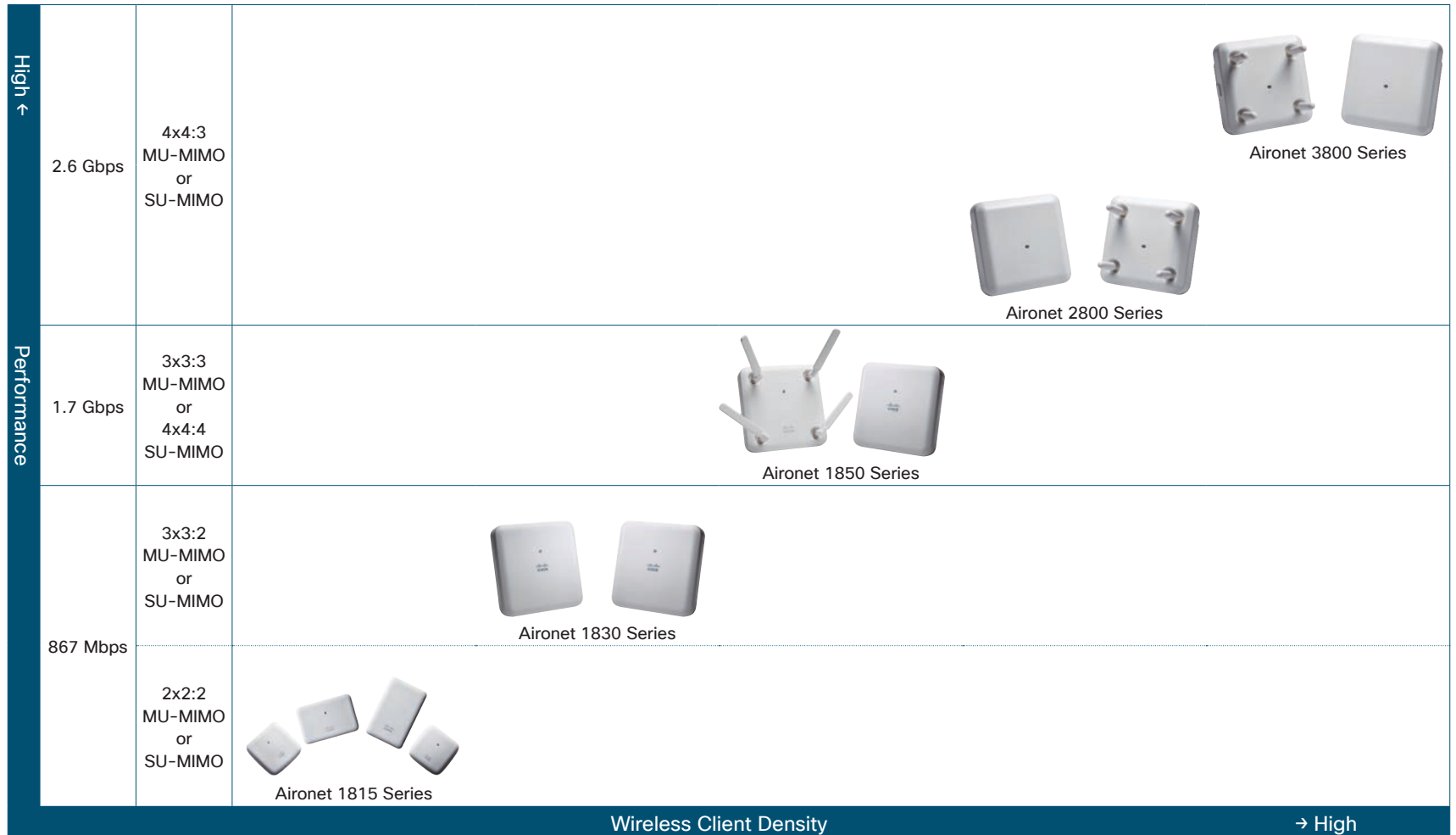

Getting Started

What's New

Feature Story

Collaborate

Compute

Security

**Connect**

Switches

**Wireless**

WAP

**Aironet**

Controllers

Meraki MR

Routers

Services

## Overview

## Positioning Map

## Platform Spec

## Accessories

## Cisco Aironet 1815 Series

Product SKU	Service (CSE) SKU	Default Mode <sup>*1</sup>		IEEE 802			HDX	Maximum Clients		Ports		PoE (PD) <sup>*2</sup>		Antenna
		ME Master	Controller based	11n	11ac Wave 1	11ac Wave 2		w/o ClientLink	with ClientLink	GE	mGig	802.3af	802.3at	
AIR-AP1815I-x-K9C	CON-SMBS-xxxx	●	-	●	●	●	-	400	-	1	-	●	●	Internal
AIR-AP1815I-x-K9	CON-SMBS-xxxx	-	●	●	●	●	-	400	-	1	-	●	●	Internal
AIR-AP1815M-x-K9C	CON-SMBS-xxxx	●	-	●	●	●	-	400	-	1	-	●	●	Internal
AIR-AP1815M-x-K9	CON-SMBS-xxxx	-	●	●	●	●	-	400	-	1	-	●	●	Internal
AIR-AP1815T-x-K9	CON-SMBS-xxxx	-	● <sup>*3</sup>	●	●	●	-	400	-	4 <sup>*4</sup>	-	-	-	Internal
AIR-AP1815W-x-K9C	CON-SMBS-xxxx	●	-	●	●	●	-	400	-	4 <sup>*4</sup>	-	● <sup>*5</sup>	●	Internal
AIR-AP1815W-x-K9	CON-SMBS-xxxx	-	●	●	●	●	-	400	-	4 <sup>*4</sup>	-	● <sup>*5</sup>	●	Internal

\*1 Mode migration is supported. \*2 Power Adapter or Power Injector is required when not using PoE receiving.

\*3 Mode migration is not supported. \*4 Local GE x 2 and PoE power supplying local GE x 1 are included.

\*5 Some features are disabled when powered via 802.3af PoE.

## Cisco Aironet 1830 Series

Product SKU	Service (CSE) SKU	Default Mode <sup>*1</sup>		IEEE 802			HDX	Maximum Clients		Ports		PoE (PD) <sup>*2</sup>		Antenna
		ME Master	Controller based	11n	11ac Wave 1	11ac Wave 2		w/o ClientLink	with ClientLink	GE	mGig	802.3af	802.3at	
AIR-AP1832I-x-K9C	CON-SMBS-xxxx	●	-	●	●	●	-	400	-	1	-	● <sup>*3</sup>	●	Internal
AIR-AP1832I-x-K9	CON-SMBS-xxxx	-	●	●	●	●	-	400	-	1	-	● <sup>*3</sup>	●	Internal

\*1 Mode migration is supported. \*2 Power Adapter or Power Injector is required when not using PoE receiving.

\*3 Some features are disabled when powered via 802.3af PoE.

## Cisco Aironet 1850 Series

Product SKU	Service (CSE) SKU	Default Mode <sup>*1</sup>		IEEE 802			HDX	Maximum Clients		Ports		PoE (PD) <sup>*2</sup>		Antenna
		ME Master	Controller based	11n	11ac Wave 1	11ac Wave 2		w/o ClientLink	with ClientLink	GE	mGig	802.3af	802.3at	
AIR-AP1852I-x-K9C	CON-SMBS-xxxx	●	-	●	●	●	-	400	-	2	-	● <sup>*3</sup>	●	Internal
AIR-AP1852I-x-K9	CON-SMBS-xxxx	-	●	●	●	●	-	400	-	2	-	● <sup>*3</sup>	●	Internal
AIR-AP1852E-x-K9C	CON-SMBS-xxxx	●	-	●	●	●	-	400	-	2	-	● <sup>*3</sup>	●	External
AIR-AP1852E-x-K9	CON-SMBS-xxxx	-	●	●	●	●	-	400	-	2	-	● <sup>*3</sup>	●	External

\*1 Mode migration is supported. \*2 Power Adapter or Power Injector is required when not using PoE receiving.

\*3 Some features are disabled when powered via 802.3af PoE.

Getting Started

What's New

Feature Story

Collaborate

Compute

Security

Connect

Switches

Wireless

WAP

Aironet

Controllers

Meraki MR

Routers

Services



Overview

Positioning Map

Platform Spec

Accessories

Cisco Aironet 2800 Series

Product SKU	Service (CSE) SKU	Default Mode <sup>*1</sup>		IEEE 802			HDX	Maximum Clients		Ports		PoE (PD) <sup>*2</sup>		Antenna
		ME Master	Controller based	11n	11ac Wave 1	11ac Wave 2		w/o ClientLink	with ClientLink	GE	mGig	802.3af	802.3at	
AIR-AP2802I-x-K9C	-	●	-	●	●	●	●	400	256	2	-	● <sup>*3</sup>	●	Internal
AIR-AP2802I-x-K9	-	-	●	●	●	●	●	400	256	2	-	● <sup>*3</sup>	●	Internal
AIR-AP2802E-x-K9C	-	●	-	●	●	●	●	400	256	2	-	● <sup>*3</sup>	●	External
AIR-AP2802E-x-K9	-	-	●	●	●	●	●	400	256	2	-	● <sup>*3</sup>	●	External

\*1 Mode migration is supported. \*2 Power Injector is required when not using PoE receiving.  
\*3 Some features are disabled when powered via 802.3af PoE.

Cisco Aironet 3800 Series

Product SKU	Service (CSE) SKU	Default Mode <sup>*1</sup>		IEEE 802			HDX	Maximum Clients		Ports		PoE (PD) <sup>*2</sup>		Antenna
		ME Master	Controller based	11n	11ac Wave 1	11ac Wave 2		w/o ClientLink	with ClientLink	GE	mGig	802.3af	802.3at	
AIR-AP3802I-x-K9C	-	●	-	●	●	●	●	400	256	1	1	● <sup>*3</sup>	●	Internal
AIR-AP3802I-x-K9	-	-	●	●	●	●	●	400	256	1	1	● <sup>*3</sup>	●	Internal
AIR-AP3802E-x-K9C	-	●	-	●	●	●	●	400	256	1	1	● <sup>*3</sup>	●	External
AIR-AP3802E-x-K9	-	-	●	●	●	●	●	400	256	1	1	● <sup>*3</sup>	●	External
AIR-AP3802P-x-K9C	-	●	-	●	●	●	●	400	256	1	1	● <sup>*3</sup>	●	External
AIR-AP3802P-x-K9	-	-	●	●	●	●	●	400	256	1	1	● <sup>*3</sup>	●	External

\*1 Mode migration is supported. \*2 Power Injector is required when not using PoE receiving.  
\*3 Some features are disabled when powered via 802.3af PoE.

**TIP** What is Meant by a "x" Included in the SKU

Country <sup>*1</sup>	Australia	Brunei	China	Fiji	Hong Kong	India	Indonesia	Japan	Korea	Macau
x (Regulatory Domain)	Z	S	H	N	N, S	D, N	F	Q	K	C, S

Country <sup>*1</sup>	Malaysia	Mongolia	New Zealand	Pakistan	Philippines	Singapore	Sri Lanka	Taiwan	Thailand	Vietnam
x (Regulatory Domain)	C, K	E, H	Z	C, G	A	S	E	T	E, S	E, S

\*1 Customers are responsible for verifying approval for use in their individual countries.

To verify approval that corresponds to a particular country, or the regulatory domain used in a specific country, see <http://www.cisco.com/go/aironet/compliance>. Not all models available for all regulatory domains. Not all regulatory domains have been approved. As they are approved, the SKU will be available on the Global Price List.

- Getting Started
- What's New
- Feature Story
- Collaborate
- Compute
- Security
- Connect
  - Switches
  - Wireless
    - WAP
    - Aironet
      - Controllers
      - Meraki MR
    - Routers
  - Services



## Overview

## Positioning Map

## Platform Spec

## Accessories

## Cisco Aironet Power Injectors &amp; Power Supplies

Product SKU	Description	Compatible Models											
		1815i	1815m	1815t	1815w	1830i	1850i	1850e	2800i	2800e	3800i	3800e	3800p
AIR-PWRINJ5=	Power Injector (802.3af)	●	●	-	●	●*1	●*1	●*1	-	-	-	-	-
AIR-PWRINJ6=	Power Injector (802.3af)	●	●	-	●	●	●	●	●	●	●	●	●
AIR-PWR-C=	Power Supply (Black)	-	-	-	-	●	●	●	-	-	-	-	-
AIR-PWR-D=	Power Supply (White)	-	-	●	-	●	●	●	-	-	-	-	-
AIR-PWR-50=	Power Supply (White)	-	-	-	-	-	-	-	-	-	●	●	●

\*1 Some features are disabled.

## Cisco Aironet Antennas

Product SKU	Description	Compatible Models											
		1815i	1815m	1815t	1815w	1830i	1850i	1850e	2800i	2800e	3800i	3800e	3800p
AIR-ANT2524DB-R	Dual-Band Dipole Antenna (Black)	-	-	-	-	-	-	●	-	●	-	●	●
AIR-ANT2524DG-R	Dual-Band Dipole Antenna (Gray)	-	-	-	-	-	-	●	-	●	-	●	●
AIR-ANT2524DW-R	Dual-Band Dipole Antenna (White)	-	-	-	-	-	-	●	-	●	-	●	●
AIR-ANT2535SDW-R	Short Dual-Band Omni Antenna (White)	-	-	-	-	-	-	●	-	●	-	●	●
AIR-ANT2524V4C-R	Dual-Band Ceiling Mount Omnidirectional Antenna	-	-	-	-	-	-	●	-	●	-	●	●
AIR-ANT2544V4M-R	Dual-Band Wall-Mounted Omnidirectional Antenna	-	-	-	-	-	-	●	-	●	-	●	●
AIR-ANT2566P4W-R	Dual-Band Patch Antenna	-	-	-	-	-	-	●	-	●	-	●	●
AIR-ANT2566D4M-R	Dual-Band Polarization-Diverse Directional Array Antenna	-	-	-	-	-	-	●	-	●	-	●	●
AIR-ANT2513P4M-N	Dual-Band Polarization-Diverse Array Antenna	-	-	-	-	-	-	-	-	-	-	-	●

Getting Started

What's New

Feature Story

Collaborate

Compute

Security

Connect

Switches

Wireless

WAP

Aironet

Controllers

Meraki MR

Routers

Services



## Centralized Control, Management, and Troubleshooting for Small to Medium-Sized Wireless Networks

The Cisco Wireless Controllers provide centralized control, management, and troubleshooting for small to medium-sized enterprises and branch offices. They offer flexibility to support multiple deployment modes in the same controller—a centralized mode for campus environments, Cisco FlexConnect mode for lean branches managed over the WAN, and a mesh (bridge) mode for deployments in which full Ethernet cabling is unavailable.

### Highlights

- Flexibility to configure wireless policy, management or security settings at any time
- Faster response to business needs by centrally managing wireless networks
- Standardized access point configuration for software versioning
- Networkwide quality of service (QoS) for voice and video across wired and wireless networks
- Networkwide centralized security policies across wired and wireless networks













Overview

**Positioning Map**

Platform Spec

Licenses & Accesories

<p>Appliance</p>	    <p>3504 Wireless Controller      5520 Wireless Controller      8540 Wireless Controller</p>		
<p>Virtual Machine</p>	 <p>Virtual Wireless Controller</p>		
<p>Switch</p>	  <p>Catalyst 3650 Series      Catalyst 3850 Series</p>		
<p>Access Point Mobility Express</p>	    <p>Aironet 1815/1830/1850 Series      Aironet 2800/3800 Series</p> <p>Maximum Access Points</p>		

→ More

Getting Started

What's New

Feature Story

Collaborate

Compute

Security

**Connect**

Switches

**Wireless**

WAP

Aironet

**Controllers**

Meraki MR

Routers

Services



Overview

Positioning Map

Platform Spec

Licenses &amp; Accessories

## Cisco Aironet 1815/1830/1850/2800/3800 Series Access Points

Series Name	Deployment Mode						Managed Access Points		Clients	RF Tags	Through-put	Ports <sup>*1</sup>		Rack Mount
	Central	Flex Connect	Mesh	Flex Connect + Mesh	Office Extend	Mobility Express	Default	Maximum				GE	mGig	
Aironet 1815/1830/1850	-	-	-	-	-	●	50	50	1,000	-	1 Gbps	-	-	-
Aironet 2800/3800	-	-	-	-	-	●	100	100	2,000	-	1 Gbps	-	-	-

\*1 Depends on models.

## Cisco 3504 Wireless Controller

Product SKU	Service (CSE) SKU	Deployment Mode						Managed Access Points		Clients	RF Tags	Through-put	Ports		Rack <sup>*1</sup> Mount
		Central	Flex Connect	Mesh	Flex Connect + Mesh	Office Extend	Mobility Express	Default	Maximum				GE	mGig	
AIR-CT3504-K9	-	●	●	●	●	●	-	0	150	3,000	1,500	4 Gbps	4	1	1 RU

\*1 Rack Mount Bracket (AIR-3504-RMNT=) is required.

Getting Started

What's New

Feature Story

Collaborate

Compute

Security

Connect

Switches

Wireless

WAP

Aironet

Controllers

Meraki MR

Routers

Services

Overview

Positioning Map

Platform Spec

Licenses & Accessories

Cisco 3504 Wireless Controller License\*1

Product SKU	Description
LIC-CT3504-1A	1 Access Point Adder License

\*1 LIC-CT3504-UPG is required in CCW.

Cisco 3504 Wireless Controller Rack Mount Bracket

Product SKU	Description
AIR-3504-RMNT=	Rack Mount Bracket



Getting Started

What's New

Feature Story

Collaborate

Compute

Security

Connect

Switches

Wireless

WAP

Aironet

Controllers

Meraki MR

Routers

Services



## Overview

## Positioning Map

## Platform Spec

## Licenses &amp; Accessories

## 100 % Cloud Managed for Faster Deployment, Simplified Administration, and Richer Visibility

The Cisco Meraki MR Cloud Managed Access Points are built from the highest grade components and carefully optimized for a seamless user experience. The outcome: faster connections, greater user capacity, more coverage, and fewer support calls.

The Cisco Meraki wireless solution includes a complete, robust feature set right out of the box. No additional purchase required.

### Highlights

- **Centralized Management:** Seamlessly manage campus-wide Wi-Fi deployments and distributed multi-site networks from a single pane-of-glass.
- **Multigigabit Ethernet:** Pass 2.5Gbps of traffic over a single cable in order to take full advantage of high speed 802.11ac Wave 2 wireless.
- **Location Analytics:** Reveal powerful metrics such as visitor capture rate, user visit time, and repeat visits by listening for wireless devices.
- **Application Visibility & Control:** Identify which applications are being used, and then prioritize critical apps while limiting recreational apps.
- **High Capacity 802.11ac:** RF optimization with real-time spectrum analysis enables high performance wireless in dense, demanding environments.
- **Automatic RF Optimization:** Automatically optimize Wi-Fi by measuring channel utilization, signal strength, throughput, and interference.
- **Dedicated Security Radio:** Instantly detects interference, vulnerabilities, and attacks on all channels.
- **Identity-Based Firewall:** Automatically assigns firewall and traffic shaping rules, VLAN tags, and bandwidth limits to enforce the right policies for each class of users.



Getting Started

What's New

Feature Story

Collaborate

Compute

Security

Connect

Switches

Wireless

WAP

Aironet

Controllers

Meraki MR

Routers

Services











Overview

Positioning Map

Platform Spec

Licenses & Accessories

High ←	1,733 Mbps (5 GHz) + 800 Mbps (2.4 GHz)	4x4:4 MU-MIMO or SU-MIMO	 <p>MR53 MR53E</p>	
			 <p>MR52</p>	
	Performance	1,300 Mbps (5 GHz) + 600 Mbps (2.4 GHz)	3x3:3 MU-MIMO or SU-MIMO	 <p>MR42</p>
866 Mbps (5 GHz) + 400 Mbps (2.4 GHz)		2x2:2 MU-MIMO or SU-MIMO	 <p>MR30H</p>	
			 <p>MR33</p>	
	 <p>MR20</p>			
Wireless Client Density → High				

Getting Started

What's New

Feature Story

Collaborate

Compute

Security

Connect

Switches

Wireless

WAP

Aironet

Controllers

Meraki MR

Routers

Services



## Overview

## Positioning Map

## Platform Spec

## Licenses &amp; Accessories

Product SKU	Cloud Management	IEEE 802			2.4 GHz	5 GHz	Concurrent Radios	WIDS/WIPS	Bluetooth Low Energy	Ports		PoE (PD) <sup>*1</sup>		Antenna
		11n	11ac Wave 1	11ac Wave 2						GE	mGig	802.3af	802.3at	
MR20-HW	●	●	●	●	●	●	●	-	-	1	-	●	●	Internal
MR30H-HW	●	●	●	●	●	●	●	●	-	5 <sup>*1</sup>	-	● <sup>*2</sup>	●	Internal
MR33-HW	●	●	●	●	●	●	●	●	●	1	-	●	●	Internal
MR42-HW	●	●	●	●	●	●	●	●	●	1	-	● <sup>*2</sup>	●	Internal
MR42E-HW	●	●	●	●	●	●	●	●	●	1	-	● <sup>*2</sup>	●	External

\*1 Local GE x 3 and PoE power supplying local GE x 1 are included.

\*2 Some features are disabled when powered via 802.3af PoE.

Getting Started

What's New

Feature Story

Collaborate

Compute

Security

Connect

Switches

Wireless

WAP

Aironet

Controllers

Meraki MR

Routers

Services



## Overview

## Positioning Map

## Platform Spec

## Licenses &amp; Accessories

## Cisco Meraki MR Cloud Managed Access Points Enterprise Licenses

Product SKU	Description	Compatible Models				
		MR20	MR30H	MR33	MR42	MR42E
LIC-ENT-1YR	License and Support, 1-Year	●	●	●	●	●
LIC-ENT-3YR	License and Support, 3-Years	●	●	●	●	●
LIC-ENT-5YR	License and Support, 5-Years	●	●	●	●	●
LIC-ENT-7YR	License and Support, 7-Years	●	●	●	●	●
LIC-ENT-10YR	License and Support, 10-Years	●	●	●	●	●

## Cisco Meraki MR Cloud Managed Access Points Injectors &amp; Power Supplies

Product SKU	Description	Compatible Models				
		MR20	MR30H	MR33	MR42	MR42E
MA-INJ-4-xx	PoE Injector (802.3at)	●	●	●	●	-
MA-INJ-5-xx	Multigigabit PoE Injector (802.3at)	-	-	-	-	●
MA-PWR-30W-xx	Power Supply	●	-	●	●	●

## Cisco Meraki MR Cloud Managed Access Points Antennas

Product SKU	Description	Compatible Models				
		MR20	MR30H	MR33	MR42	MR42E
MA-ANT-3-A5	Dipole Antenna	-	-	-	-	●
MA-ANT-3-B5	Dipole Antenna (Bendable)	-	-	-	-	●
MA-ANT-3-C5	Panel Omni Antenna	-	-	-	-	●
MA-ANT-3-D5	Downtilt Panel Omni Antenna	-	-	-	-	●
MA-ANT-3-E5	Wide Patch Antenna	-	-	-	-	●
MA-ANT-3-F5	Narrow Patch Antenna	-	-	-	-	●

Getting Started

What's New

Feature Story

Collaborate

Compute

Security

Connect

Switches

Wireless

WAP

Aironet

Controllers

Meraki MR

Routers

Services



# Cisco ISR 900 Series

**NEW**

Create a Highly Secure, Enterprise-class Network with A Router Fit for Small and Medium-sized Businesses



## C927-4P

150 Mbps Max Crypto Throughput	IOS IP Base	x86 2.2 GHz CPU	1 GB DRAM	2 GB Flash	1-port GE-WAN	1-port VADSL Annex A	4-port GE Managed Switch	1-port USB 2.0 Type A	External Power Adapter	Optional 1 RU Rack Mount	Optional Under Desk Mount
--------------------------------	-------------	-----------------	-----------	------------	---------------	----------------------	--------------------------	-----------------------	------------------------	--------------------------	---------------------------

## C931-4P

250 Mbps Max Crypto Throughput	IOS IP Base	x86 2.2 GHz CPU	1 GB DRAM	2 GB Flash	2-port GE-WAN	4-port GE Managed Switch	1-port USB 2.0 Type A	Internal Power Supply	Optional 1 RU Rack Mount	Optional Under Desk Mount
--------------------------------	-------------	-----------------	-----------	------------	---------------	--------------------------	-----------------------	-----------------------	--------------------------	---------------------------

Getting Started

What's New

Feature Story

Collaborate

Compute

Security

Connect

Switches

Wireless

Routers

RV

ISR 800

**NEW** ISR 900

ISR 1100

ISR 4000

Services



Featured Products

Portfolio

 Cisco ISR 1100 Series

Provides Internet Access, Comprehensive Security, and Wireless Services in A Single, High-Performance Device



 C1101-4PLTEP

150 Mbps Max Crypto Throughput	IOS XE IP Base	Multicore CPU	4 GB DRAM	4 GB Flash
1-port GE-WAN	LTE Advanced Pluggable	4-port GE Managed Switch	1-port USB 2.0 Type A	

 C1111X-8P-DNA-PM NEW

250 Mbps Max Crypto Throughput	SD-WAN IOS XE	Multicore CPU	8 GB DRAM	8 GB Flash	
1-port GE-WAN	1-port GE/SFP-WAN	8-Port GE Managed Switch	Optional PoE/PoE+	1-port USB 2.0 Type A	Optional 1 RU Rack Mount
Cisco DNA E or A or P Subscription	Application Aware Firewall	Snort IPS	URL Filtering	Umbrella Integration	Network Plug-n-Play License

Getting Started

What's New

Feature Story

Collaborate

Compute

Security

Connect

Switches

Wireless

Routers

RV

ISR 800

NEW ISR 900

ISR 1100

ISR 4000

Services







# Cisco RV160/260 Series

With Powerful Performance and Features at an Attractive Price  
Keep Your Business and Your Employees Productive and Effective



## RV160W-x-K9-xx

- 600 Mbps Firewall Throughput
- 50 Mbps IPsec VPN Throughput
- 10 IPsec VPN Tunnels
- 1-port GE/SFP-WAN
- 4-port GE-LAN
- 11ac Wave 2
- 11n
- Dual Radio
- 1-port USB
- External Power Adapter
- Desktop

## RV260P-K9-xx

- 800+ Mbps Firewall Throughput
- 75+ Mbps IPsec VPN Throughput
- 20 IPsec VPN Tunnels
- 1-Year Web Filtering
- 1-port GE/SFP-WAN
- 4-port GE-LAN
- 4-port GE PoE LAN
- 1-port USB
- External Power Adapter
- Desktop
- 1 RU Rack Mount

Getting Started

What's New

Feature Story

Collaborate

Compute

Security

Connect

Switches

Wireless

Routers

RV

ISR 800

**NEW** ISR 900

ISR 1100

ISR 4000

Services



Featured Products

Portfolio

High →

Performance, Function, Flexibility, Scalability



RV Series

- Custom Linux
- Basic Routing
- Basic Security
- Max 650 Mbps Crypto Throughput



ISR 800 Series

- Classic IOS
- Advanced Routing
- Advanced Security
- Max 100 Mbps Crypto Throughput



ISR 900 Series

- Classic IOS
- Advanced Routing
- Advanced Security
- Max 250 Mbps Crypto Throughput



ISR 1100 Series

- IOS XE
- SD-WAN
- SD-WAN Security
- Max 350 Mbps Crypto Throughput



ISR 4200 Series

- IOS XE
- SD-WAN
- SD-WAN Security
- Max 75 Mbps Crypto Throughput



ISR 4300 Series

- IOS XE
- SD-WAN
- SD-WAN Security
- Max 500 Mbps Crypto Throughput



ISR 4400 Series

- IOS XE
- SD-WAN
- SD-WAN Security
- Max 7 Gbps Crypto Throughput

Fixed Platforms

Modular Platforms

Getting Started

What's New

Feature Story

Collaborate

Compute

Security

Connect

Switches

Wireless

Routers

RV

ISR 800

**NEW** ISR 900

ISR 1100

ISR 4000

Services

## Overview

## Positioning Map

## Platform Spec

## Secure, Flexible Connectivity for Small Business

The Cisco RV Series are affordable, highly secure network access devices, designed and built for small businesses. Cisco offers a broad range of small business routers to meet any requirement from basic Internet connectivity to high-capacity, business-critical networking.

### Highlights

- Dual Gigabit Ethernet WAN ports for load balancing and/or business continuity (select models)
- Dual USB ports for storage and 3G/4G modem failover (select models)
- Site-to-site and remote access VPN enable highly secure connectivity, making Cisco RV Series perfect for multiple offices and remote employees.
- Strong security by proven stateful packet inspection (SPI) firewall
- Built-in managed switch (all models)
- Built-in IEEE 802.11n/ac-compatible wireless access point (wireless models)
- Easy to set up and use with wizard-based configuration



Getting Started

What's New

Feature Story

Collaborate

Compute

Security

Connect

Switches

Wireless

Routers

RV

ISR 800

**NEW** ISR 900

ISR 1100

ISR 4000



















Services



Overview

Positioning Map

Platform Spec

GE WAN	 RV134W	 RV130W	 RV160W	 RV260W	 RV340W	 RV260P   RV345P   RV130   RV160   RV260   RV340   RV345   RV042G   RV320   RV325
FE WAN	 RV132W	 RV215W	 RV042			

- Getting Started
- What's New
- Feature Story
- Collaborate
- Compute
- Security
- Connect
  - Switches
  - Wireless
  - Routers**
  - RV
  - ISR 800
  - NEW ISR 900
  - ISR 1100
  - ISR 4000
- Services



Overview

Positioning Map

Platform Spec

Product SKU	Service (CSE) SKU	WAN Ports					LAN Ports		PoE			IPsec Through-put	IPsec VPN Tunnels		Web Filtering	Wireless				AC Power
		FE	GE	GE/SFP	xDSL	3G/4G	FE	GE	Ports	Power Budget	IEEE 802.3		Site-to-Site	Remote Access		11n	11ac	2.4 GHz	5 GHz	
RV042-xx	CON-SMBS-V02xxxxx	2	-	-	-	-	4	-	-	-	-	59 Mbps	50	50	-	-	-	-	-	External
RV042G-K9-xx	CON-SMBS-RV02G9xx	-	2	-	-	-	-	4	-	-	-	75 Mbps	50	50	-	-	-	-	-	External
RV130-K9-xx	CON-SMBS-xxxxxxx	-	1	-	-	1**	-	4	-	-	-	50 Mbps	10	10	-	-	-	-	-	External
RV130-WB-K9-xx	CON-SMBS-xxxxxxx	-	1	-	-	1**	-	4	-	-	-	50 Mbps	10	10	●	-	-	-	-	External
RV130W-x-K9-xx	CON-SMBS-V10W9xxx	-	1	-	-	1**	-	4	-	-	-	50 Mbps	10	10	-	●	-	●	-	External
RV130W-x-WB-K9-xx	-	-	1	-	-	1**	-	4	-	-	-	50 Mbps	10	10	●	●	-	●	-	External
RV132W-x-K9-xx	CON-SMBS-RV13K9xx	1	-	-	1	1**	3	-	-	-	-	3 Mbps	5	5	-	●	-	●	-	External
RV134W-x-K9-xx	CON-SMBS-RV134Wxx	-	1	-	1	1**	-	4	-	-	-	20 Mbps	5	5	-	●	●	●	●	External
RV160-K9-xx	CON-SMBS-RV16xxxx	-	-	1	-	-	-	4	-	-	-	50 Mbps	10	10	-	-	-	-	-	External
RV160W-x-K9-xx	CON-SMBS-RV16xxxx	-	-	1	-	-	-	4	-	-	-	50 Mbps	10	10	-	●	●	●	●	External
RV215W-x-K9-xx	CON-SMBS-RV25W9xx	1	-	-	-	1**	4	-	-	-	-	5 Mbps	1	5	-	●	-	●	-	External
RV260-K9-xx	CON-SMBS-RV260xxx	-	-	1	-	1**	-	8	-	-	-	75 Mbps	20	20	●*2	-	-	-	-	External
RV260P-K9-xx	CON-SMBS-RV260xxx	-	-	1	-	1**	-	8	4	60 W	af	75 Mbps	20	20	●*2	-	-	-	-	External
RV260W-x-K9-xx	CON-SMBS-RVxxxxxx	-	-	1	-	1**	-	8	-	-	-	75 Mbps	20	20	●*2	●	●	●	●	External
RV320-K9-xx	CON-SMBS-RV3xxxxx	-	2	-	-	1**	-	4	-	-	-	100 Mbps	25	25	-	-	-	-	-	External
RV325-K9-xx	CON-SMBS-RV35K9xx	-	2	-	-	1**	-	14	-	-	-	100 Mbps	25	25	-	-	-	-	-	External
RV340-K9-xx	CON-SMBS-RV340Kxx	-	2	-	-	1**	-	4	-	-	-	650 Mbps	50	50	●*3	-	-	-	-	External
RV340W-x-K9-xx	-	-	2	-	-	1**	-	4	-	-	-	650 Mbps	50	50	●*3	●	●	●	●	External
RV345-K9-xx	CON-SMBS-V345K9xx	-	2	-	-	1**	-	16	-	-	-	650 Mbps	50	50	●*3	-	-	-	-	External
RV345P-K9-xx	CON-SMBS-RV345Pxx	-	2	-	-	1**	-	16	8	120 W	af/at	650 Mbps	50	50	●*3	-	-	-	-	External

\*1 3G/4G modem is required. \*2 Available for one year. \*3 Security License (LS-RV34X-SEC-1YR=) is required.

Getting Started

What's New

Feature Story

Collaborate

Compute

Security

Connect

Switches

Wireless

Routers

RV

ISR 800

**NEW** ISR 900

ISR 1100

ISR 4000

Services



## Overview

## Platform Spec

## Licenses &amp; Accessories

## Small but Mighty Business-class Routers

Do you have limited space, but need best-in-class routing, voice and video, security, application performance, cloud connection, and wireless capabilities? The **Cisco ISR 800 Series** routers offer all that in a single device. They are well suited for customer premises and priced for small and midsize businesses.

### Highlights

- Cisco IOS Universal Image (IP Base/Advanced Security/Advanced IP Services)
- Dual WAN ports for load balancing and/or business continuity (select models)
- 4G LTE wireless WAN (select models)
- Built-in managed switch (all models)
- Built-in IEEE 802.11n-compatible wireless access point (wireless models)
- Easy to set up and use with wizard-based configuration (Cisco Configuration Professional Express)



Getting Started

What's New

Feature Story

Collaborate

Compute

Security

Connect

Switches

Wireless

Routers

RV

ISR 800

**NEW** ISR 900

ISR 1100

ISR 4000

Services



## Overview

## Platform Spec

## Licenses &amp; Accessories

Product SKU	Service (CSE) SKU	Cisco IOS	WAN Ports						LAN Ports		Wireless		AppX	Security		Rack mount	
			FE	GE	GE/SFP	ISDN	xDSL	Voice	FE	GE	AP	4G LTE		FW	VPN		
C819H-K9	CON-SMBS-C819HK9	Advanced IP Services	-	1	-	-	-	-	-	4	-	-	-	●	●	●	_* <sup>3</sup>
C819G-LTE-LA-K9	CON-SMBS-C819TEK9	Advanced IP Services	-	1	-	-	-	-	-	4	-	-	●	●	●	●	_* <sup>4</sup>
C819GW-LTE-LA-xK9 <sup>*1</sup>	CON-SMBS-C8QT9GWL	Advanced IP Services	-	1	-	-	-	-	-	4	-	●	●	●	●	●	_* <sup>4</sup>
C841M-4X/K9	CON-SMBS-C841M4XK	Advanced IP Services	-	2	-	-	-	-	-	4	-	-	-	-	●	●	_* <sup>5</sup>
C841M-8X/K9	CON-SMBS-C841M8XK	Advanced IP Services	-	2	-	-	-	-	-	4	-	-	-	-	●	●	_* <sup>5</sup>
C867VAE	CON-SMBS-C867VAE	IP Base	-	1	-	-	1	-	-	3	2	-	-	-	-	-	-
C867VAE-K9	CON-SMBS-C867VAK9	Advanced Security	-	1	-	-	1	-	-	3	2	-	-	-	●	●	-
C881W-x-K9	CON-SMBS-C881WxK9	Advanced Security	1	-	-	-	-	-	-	4	-	●	-	-	●	●	-
C891F-K9	CON-SMBS-C891F8BB	Advanced IP Services	1	-	1	1	-	-	-	8	-	-	● <sup>*2</sup>	●	●	●	_* <sup>6</sup>
C891-24X/K9	CON-SMBS-C89124K9	Advanced IP Services	-	-	2	-	-	-	-	24	-	-	-	-	●	●	_* <sup>7</sup>
C892FSP-K9	CON-SMBS-C892FSPK	Advanced IP Services	-	1	1	-	-	-	-	8	-	-	● <sup>*2</sup>	●	●	●	_* <sup>6</sup>
C897VA-K9	CON-SMBS-C897VAK9	Advanced IP Services	-	-	1	1	1	-	-	8	-	-	● <sup>*2</sup>	●	●	●	_* <sup>6</sup>
C897VAG-LTE-LA-K9	CON-SMBS-CLTEAGK9	Advanced IP Services	-	-	1	-	1	-	-	8	-	●	● <sup>*2</sup>	●	●	●	_* <sup>6</sup>
C898EAG-LTE-LA-K9	CON-SMBS-C898EAGA	Advanced IP Services	-	-	1	-	1	-	-	8	-	●	● <sup>*2</sup>	●	●	●	_* <sup>6</sup>
C899G-LTE-LA-K9	CON-SMBS-C89LKEGL	Advanced IP Services	-	1	1	-	-	-	-	8	-	●	● <sup>*2</sup>	●	●	●	_* <sup>6</sup>

\*1 The "x" corresponds to the supported domain. \*2 Feature License is required.

\*3 Optional Floor/Wall Mounting Kit (ACS-810-FWM) and Flat Floor/Wall Mounting Kit (ACS-810-RFWM) are available.

\*4 Optional Floor/Wall Mounting Kit (ACS-810-FWM), Flat Floor/Wall Mounting Kit (ACS-810-RFWM), and Din Rail Mounting Kit (ACS-810-DM) are available.

\*5 ACS-800M-RM-19 is required. \*6 ACS-890-RM-19 is required. \*7 ACS-2901-RM-19 is required.

Getting Started

What's New

Feature Story

Collaborate

Compute

Security

Connect

Switches

Wireless

Routers

RV

ISR 800

**NEW** ISR 900

ISR 1100

ISR 4000

Services

## Overview

## Platform Spec

## Licenses &amp; Accessories

## Cisco IOS Advanced IP Services Licenses

Product SKU	Description
SL-880-AIS	Cisco IOS Advanced IP Services License for Cisco 881W
L-880-AIS=	Cisco IOS Advanced IP Services License for Cisco 881W (eDelivery)

## Cisco IOS Feature Licenses

Product SKU	Description
L-FL-C800-APP=	Cisco IOS APP License for Cisco ISR 891F/892FSP/897VA/899G

## Cisco WAN Interface Modules for Cisco ISR 841M

Product SKU	Description
WIM-1T	Serial WAN Module (1-port)
WIM-3G	Multi Mode 3G WAN Module (Dual SIM)
WIM-LTE-AS	4G LTE WAN Module (Single SIM, Bands Supported: B1, B3, B5, B8, B40, B41)

## PoE-capable Power Supply Module

Product SKU	Description
800-IL-PM-4	4-port PoE-capable Power Supply Module for Cisco ISR 891F/897VA/897VAG/898EAG/899G

Getting Started

What's New

Feature Story

Collaborate

Compute

Security

Connect

Switches

Wireless

Routers

RV

ISR 800

NEW ISR 900

ISR 1100

ISR 4000

Services

Getting Started

What's New

Feature Story

Collaborate

Compute

Security

Connect

Switches

Wireless

Routers

RV

ISR 800

NEW ISR 900

ISR 1100

ISR 4000

Services

## Enterprise-class Routing for Small and Home Offices

The Cisco ISR 900 Series combines WAN and comprehensive security in a compact, fanless platform. The routers are designed to provide enterprise-class security and connectivity for small to medium-sized businesses.

The ISRs come with a 4-port managed switch, providing LAN ports to connect multiple devices and up to **250 Mbps** of VPN throughput for high performance. These small yet powerful fixed configuration routers provide secure broadband, Metro Ethernet, and DSL connectivity. The ISRs deliver integrated security and threat defense, protecting networks from both known and new Internet vulnerabilities and attacks. The ISRs offer easy management and provisioning capabilities through Cisco Configuration Professional Express, Cisco DNA Center, and Cisco IOS Software, with full visibility into and control of network configurations and applications.

### Highlights

- Cisco IOS Universal Image (IP Base/SEC/APP)
- High-performance Intel x86 2.2 GHz CPU
- Dual WAN ports for load balancing and/or business continuity
- 4G LTE wireless WAN (Roadmap)
- Built-in managed switch (all models)
- Noiseless, flexible deployment in a fanless design
- Easy to set up and use with wizard-based configuration (Cisco Configuration Professional Express)



Overview

**Platform Spec**

Licenses

Transition Guide

Cisco ISR 900 Series

Product SKU	Service (CSE) SKU	Cisco IOS	Crypto Throughput*1	WAN Ports			LAN Ports		Wireless		AppX	Security		DRAM	Power Supply	Rack Mount
				GE	SFP	xDSL	GE	AP	4G LTE	FW		VPN				
C921-4P	-	IP Base*2	150 Mbps	2	-	-	4	-	-	-*6	-*7	-*7	1 GB	Internal	-*8	
C926-4P	-	IP Base*2	150 Mbps	1	-	1*3	4	-	-	-*6	-*7	-*7	1 GB	External	-*8	
C927-4P	-	IP Base*2	150 Mbps	1	-	1*4	4	-	-	-*6	-*7	-*7	1 GB	External	-*8	
C927-4PM	-	IP Base*2	150 Mbps	1	-	1*5	4	-	-	-*6	-*7	-*7	1 GB	External	-*8	
C931-4P	-	IP Base*2	250 Mbps	2	-	-	4	-	-	-*6	-*7	-*7	1 GB	Internal	-*8	

\*1 Cisco IOS SEC License are required. \*2 Cisco IOS SEC License and Cisco IOS APP License can be added.  
 \*3 VDSL/ADSL2+ (Annex B/J). \*4 VDSL/ADSL2+ (Annex A). \*5 VDSL/ADSL2+ (Annex M).  
 \*6 Cisco IOS APP License is required. \*7 Cisco IOS SEC License is required.  
 \*8 ACS-900-RM-19 is required. Optional Under-the-Desk Mounting Kit (ACS-900-DM) is available.



C921-4P, C931-4P



C926-4P, C927-4P, C927-4PM



Getting Started

What's New

Feature Story

Collaborate

Compute

Security

**Connect**

Switches

Wireless

**Routers**

RV

ISR 800

NEW **ISR 900**

ISR 1100

ISR 4000

Services



## Cisco IOS Technology Package Licenses

Product SKU	Description
SL-900-SEC	Cisco IOS SEC License for Cisco ISR 900
SL-900-APP	Cisco IOS APP License for Cisco ISR 900



## Cisco IOS Software Licensing and Packaging

A single Cisco IOS universal image encompassing all functions is delivered with Cisco ISR 900 Series. Advanced features can be enabled simply by activating a software license on the Universal image. The following licenses are available:

- IP Base

Available as the default: Routing protocols, Access Control Lists (ACL), Network Address Translation (NAT), Quality of Service (QoS), Bidirectional Forwarding Detection (BFD), Virtual Routing and Forwarding (VRF) Lite, IP SLA Responder

- Security (SEC)

Includes features for securing network infrastructure: Zone-based firewall, IPsec VPN, Dynamic Multipoint VPN (DMVPN), FlexVPN, Group Encrypted Transport (GET) VPN, Secure Sockets Layer (SSL) VPN

- Application Experience (APP)

Includes data and application performance features: Layer 2 Tunneling Protocol (L2TP) v3, Multiprotocol Label Switching (MPLS), Performance Routing (PfR) v3, Next-Generation Network-Based Application Recognition (NBAR2), Application Visibility and Control (AVC), IP SLA Initiator, LISP, Virtual Private LAN Services (VPLS), Ethernet over MPLS

APP

SEC

IP Base

Getting Started

What's New

Feature Story

Collaborate

Compute

Security

Connect

Switches

Wireless

Routers

RV

ISR 800

NEW ISR 900

ISR 1100

ISR 4000

Services

## Overview

## Platform Spec

## Licenses

## Transition Guide

## Transition Map

EoS Model	Existing Model	New Model	Description
CISCO881-K9 CISCO881-SEC-K9 CISCO881C-K9 CISCO881GC-K9	C881-K9	C921-4P  C931-4P	2 x GE-WAN, 4 x GE-LAN managed switch, 1 GB DRAM and 2 GB Flash, Internal power supply, Cisco IOS IP Base, Max 150 Mbps crypto throughput (Cisco IOS SEC License is required)  2 x GE-WAN, 4 x GE-LAN managed switch, 1 GB DRAM and 2 GB Flash, Internal power supply, Cisco IOS IP Base, Max 250 Mbps crypto throughput (Cisco IOS SEC License is required)
CISCO886-K9 CISCO886-SEC-K9 CISCO886VA-K9 CISCO886VA-SEC-K9	C886VA-K9 C886VAJ-K9	C926-4P	1 x GE-WAN, 1 x VDSL/ADSL2+ (Annex B/J), 4 x GE-LAN managed switch, 1 GB DRAM and 2 GB Flash, External power supply, Cisco IOS IP Base, Max 150 Mbps crypto throughput (Cisco IOS SEC License is required)
CISCO887-K9 CISCO887-SEC-K9 CISCO887V-K9 CISCO887V-SEC-K9 CISCO887VA-K9 CISCO887VA-SEC-K9	C887VA-K9	C927-4P	1 x GE-WAN, 1 x VDSL/ADSL2+ (Annex A), 4 x GE-LAN managed switch, 1 GB DRAM and 2 GB Flash, External power supply, Cisco IOS IP Base, Max 150 Mbps crypto throughput (Cisco IOS SEC License is required)
CISCO887M-K9 CISCO887VA-M-K9	C887VAM-K9	C927-4PM	1 x GE-WAN, 1 x VDSL/ADSL2+ (Annex M), 4 x GE-LAN managed switch, 1 GB DRAM and 2 GB Flash, External power supply, Cisco IOS IP Base, Max 150 Mbps crypto throughput (Cisco IOS SEC License is required)

Getting Started

What's New

Feature Story

Collaborate

Compute

Security

Connect

Switches

Wireless

Routers

RV

ISR 800

**NEW** ISR 900

ISR 1100

ISR 4000

Services

## Overview

## Platform Spec

## Licenses &amp; Accessories

## Bundles for SD-WAN

## Fixed, High-Performance Routers

The Cisco ISR 1100 Series routers are best suited for small and midsize businesses, enterprise branches, and as customer premises equipment in managed services environments. The routers come with 4 or 8 LAN ports in various model options. There are multiple combinations to choose from, including LAN, WLAN, WAN, DSL, LTE, and pluggable, depending on your branch needs. They can be used in ATMs, retail stores, and kiosks, as well as for various other purposes.

## Highlights

- Cisco IOS XE Universal Image (IP Base/SEC/APP)
- High-performance multicore processors for high-speed WAN connections and multiple services
- Dual WAN ports for load balancing and/or business continuity
- 4G LTE wireless WAN (select models)
- Built-in managed switch (all models)
- Optional integrated power supply for distribution of PoE/PoE+
- Built-in IEEE 802.11ac Wave 2-compatible wireless access point (wireless models)
- Cisco Mobility Express for flexible deployment



Getting Started

What's New

Feature Story

Collaborate

Compute

Security

Connect

Switches

Wireless

Routers

RV

ISR 800

NEW ISR 900

ISR 1100

ISR 4000

Services



Overview

Platform Spec

Licenses & Accessories

Bundles for SD-WAN

Product SKU	Service (CSE) SKU	Cisco IOS	Crypto Throughput		WAN Ports			LAN Ports	Wireless		AppX	Security		DRAM	Rack Mount
			Default	Upgradable*1	GE	GE/SFP	xDSL	GE	AP	4G LTE		FW	VPN		
C1101-4P	-	IP Base*3	50 Mbps	250 Mbps	1	-	-	4	-	-	-*8	-*9	-*9	4 GB	-
C1101-4PLTEP	-	IP Base*3	50 Mbps	250 Mbps	1	-	-	4	-	-*7	-*8	-*9	-*9	4 GB	-
C1101-4PLTEPWx*2	-	IP Base*3	50 Mbps	250 Mbps	1	-	-	4	●	-*7	-*8	-*9	-*9	4 GB	-
C1109-4PLTE2P <small>NEW</small>	-	IP Base*3	50 Mbps	200 Mbps	1	-	-	4	-	-*7	-*8	-*9	-*9	4 GB	-
C1111-4P	CON-SMBS-C11114P	IP Base*3	50 Mbps	250 Mbps	1	1	-	4	-	-	-*8	-*9	-*9	4 GB	-*10
C1111-8P	CON-SMBS-C11118P	IP Base*3	50 Mbps	350 Mbps	1	1	-	8	-	-	-*8	-*9	-*9	4 GB	-*10
C1111X-8P	CON-SMBS-C11118P	IP Base*3	50 Mbps	350 Mbps	1	1	-	8	-	-	-*8	-*9	-*9	8 GB	-*10
C1111-4PWx*2	CON-SMBS-C111xW4P*2	IP Base*3	50 Mbps	250 Mbps	1	1	-	4	●	-	-*8	-*9	-*9	4 GB	-*10
C1111-8PWx*2	CON-SMBS-C111xW8P*2	IP Base*3	50 Mbps	350 Mbps	1	1	-	8	●	-	-*8	-*9	-*9	4 GB	-*10
C1111-4PLTELA	CON-SMBS-C1114PAL	IP Base*3	50 Mbps	250 Mbps	1	1	-	4	-	●	-*8	-*9	-*9	4 GB	-*10
C1111-4PLTEEA <small>NEW</small>	-	IP Base*3	50 Mbps	250 Mbps	1	1	-	4	-	●	-*8	-*9	-*9	4 GB	-*10
C1111-8PLTELA	CON-SMBS-C1118PAL	IP Base*3	50 Mbps	350 Mbps	1	1	-	8	-	●	-*8	-*9	-*9	4 GB	-*10
C1111-8PLTELAWx*2	CON-SMBS-C11118PW	IP Base*3	50 Mbps	350 Mbps	1	1	-	8	●	●	-*8	-*9	-*9	4 GB	-*10
C1113-8P <small>NEW</small>	-	IP Base*3	50 Mbps	250 Mbps	-	1	1*4	4	-	-	-*8	-*9	-*9	4 GB	-*10
C1117-4P	CON-SMBS-C11174P1	IP Base*3	50 Mbps	250 Mbps	-	1	1*5	4	-	-	-*8	-*9	-*9	4 GB	-*10
C1117-4PWx*2	CON-SMBS-C111xxxx	IP Base*3	50 Mbps	250 Mbps	-	1	1*6	4	●	-	-*8	-*9	-*9	4 GB	-*10
C1117-4PLTELA	CON-SMBS-C1114PLE	IP Base*3	50 Mbps	250 Mbps	-	1	1*6	4	-	●	-*8	-*9	-*9	4 GB	-*10
C1117-4PLTELAWx*2	CON-SMBS-C111Wx4P	IP Base*3	50 Mbps	250 Mbps	-	1	1*6	4	●	●	-*8	-*9	-*9	4 GB	-*10

\*1 Cisco IOS IPsec Performance License and Cisco IOS HSEC License are required. \*2 The "x" corresponds to the supported domain.  
 \*3 Cisco IOS SEC License, Cisco IOS APP License, Cisco IOS IPsec Performance License, and Cisco IOS HSEC License can be added.  
 \*4 1 G.FAST (Annex A). \*5 VA-DSL (Annex A). \*6 ADSL2/VDLSL2+ (Annex A). \*7 Cisco LTE Advanced Pluggable is required.  
 \*8 Cisco IOS APP License is required. \*9 Cisco IOS SEC License is required. \*10 ACS-1100-RM-19 is required.

Getting Started

What's New

Feature Story

Collaborate

Compute

Security

Connect

Switches

Wireless

Routers

RV

ISR 800

NEW ISR 900

ISR 1100

ISR 4000

Services

## Overview

## Platform Spec

## Licenses &amp; Accessories

## Bundles for SD-WAN

## Cisco IOS Technology Package Licenses

Product SKU	Description
SL-1100-4P-SEC	Cisco IOS SEC License for Cisco ISR 1100 (4-port Model)
SL-1100-8P-SEC	Cisco IOS SEC License for Cisco ISR 1100 (8-port Model)
SL-1100-4P-APP	Cisco IOS APP License for Cisco ISR 1100 (4-port Model)
SL-1100-8P-APP	Cisco IOS APP License for Cisco ISR 1100 (8-port Model)

## Cisco IOS Feature Licenses

Product SKU	Description
FL-VPERF-4P-100	Cisco IOS VPERF License for Cisco ISR 1100 (4-port Model)
FL-VPERF-8P-200	Cisco IOS VPERF License for Cisco ISR 1100 (8-port Model)
FL-1100-4P-HSEC	Cisco IOS HSEC License for Cisco ISR 1100 (4-port Model)
FL-1100-8P-HSEC	Cisco IOS HSEC License for Cisco ISR 1100 (8-port Model)

## Cisco LTE Advanced Pluggable for Cisco ISR 1101-4PLTEP/4PLTEPWx

Product SKU	Description
P-LTEA-LA	LTE Advanced (3GPP Category 6) Pluggable

## PoE-capable Power Supply Module for Cisco ISR 111x

Product SKU	Description
ISR-1100-POE2	2-port PoE-capable (2 PoE or 1 PoE+) 115 W Power Supply Module for Cisco 111x (4-port Model)
ISR-1100-POE4	4-port PoE-capable (4 PoE or 2 PoE+) 150 W Power Supply Module for Cisco 111x (8-port Model)

 Cisco IOS Software Licensing and Packaging

A single Cisco IOS XE universal image encompassing all functions is delivered with the platform. Advanced features can be enabled simply by activating a software license on the Universal image. The following licenses are available:

- IP Base: Available as the default.
- Security (SEC): Includes features for securing network infrastructure.
- Application Experience (APP): Includes data and application performance features.
- Performance (VPERF): Provides additional IPsec performance 100 Mbps for ISR 1100-4P and 200 Mbps for ISR 1100-8P.
- High Performance Security (HSEC): Provides High IPsec maximum performance security.

VPERF

HSEC

APP

SEC

IP Base

Getting Started

What's New

Feature Story

Collaborate

Compute

Security

Connect

Switches

Wireless

Routers

RV

ISR 800

 ISR 900

ISR 1100

ISR 4000

Services



## Overview

## Platform Spec

## Licenses &amp; Accessories

## Bundles for SD-WAN

Cisco ISR 1100 Series Cisco DNA Bundles NEW

Product SKU	Description	SD-WAN Security			
		App Aware FW	IPS	URL Filtering	Umbrella Integration
C1111-4P-DNA	Cisco 1111-4P with Cisco DNA Support	●	-	-	●
C1111-8P-DNA	Cisco 1111-8P with Cisco DNA Support	●	-	-	●
C1111X-8P-DNA-PM	Cisco 1111X-8P with Cisco DNA Support	●	●	●	●
C1111-4PLTELA-DNA	Cisco 1111-4PLTELA with Cisco DNA Support	●	-	-	●
C1111-8PLTELA-DNA	Cisco 8PLTELA with Cisco DNA Support	●	-	-	●

Cisco DNA Licenses for Cisco ISR 1100 Series NEW

- Cloud Management: Provides simplicity of management with Cisco vManage; recommended for all SD-WAN deployments.
- On-Premises Management: Manages WAN using Cisco DNA Center or Cisco vManage on-premises.  
Cisco DNA Center requires an additional appliance purchase.

Software Package	Bandwidth	Product SKU (Cloud Management)		Product SKU (On-Premises Management)	
		3-Years	5-Years	3-Years	5-Years
Cisco DNA Essentials	10 Mbps	DNA-C-10M-E-3Y	DNA-C-10M-E-5Y	DNA-P-10M-E-3Y	DNA-P-10M-E-5Y
	20 Mbps	DNA-C-20M-E-3Y	DNA-C-20M-E-5Y	DNA-P-20M-E-3Y	DNA-P-20M-E-5Y
	50 Mbps	DNA-C-50M-E-3Y	DNA-C-50M-E-5Y	DNA-P-50M-E-3Y	DNA-P-50M-E-5Y
	100 Mbps	DNA-C-100M-E-3Y	DNA-C-100M-E-5Y	DNA-P-100M-E-3Y	DNA-P-100M-E-5Y
Cisco DNA Advantage	10 Mbps	DNA-C-10M-A-3Y	DNA-C-10M-A-5Y	DNA-P-10M-A-3Y	DNA-P-10M-A-5Y
	20 Mbps	DNA-C-20M-A-3Y	DNA-C-20M-A-5Y	DNA-P-20M-A-3Y	DNA-P-20M-A-5Y
	50 Mbps	DNA-C-50M-A-3Y	DNA-C-50M-A-5Y	DNA-P-50M-A-3Y	DNA-P-50M-A-5Y
	100 Mbps	DNA-C-100M-A-3Y	DNA-C-100M-A-5Y	DNA-P-100M-A-3Y	DNA-P-100M-A-5Y

Getting Started

What's New

Feature Story

Collaborate

Compute

Security

Connect

Switches

Wireless

Routers

RV

ISR 800

NEW ISR 900

ISR 1100

ISR 4000

Services

## Meet All Your Needs with One Device

The Cisco ISR 4000 Series routers consolidate many must-have IT functions, including network, security, compute, storage, and unified communications. So you get everything you need in a single platform.

The platform is modular and upgradable, so you can add new services without changing equipment. It supports multiple application-aware services concurrently while maintaining WAN performance of up to 4 Gbps, even during heavy traffic loads. The backplane architecture supports high-bandwidth, module-to-module communication at speeds up to 10 Gbps.

### Highlights

- Cisco IOS Universal Image (IP Base/SEC/UC/APP)
- High-performance multicore processors for high-speed WAN connections and multiple services
- Separates control- and data-plane operations (Cisco 4431/4451: the default control-plane memory is 4 GB, upgradable to 16 GB, and the default data-plane memory is 2 GB)
- Cisco Enhanced Services Module (SM-X) and Cisco Network Interface Module (NIM) integrate networking, services, computing, and storage into a single form factor

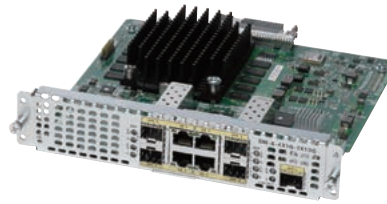
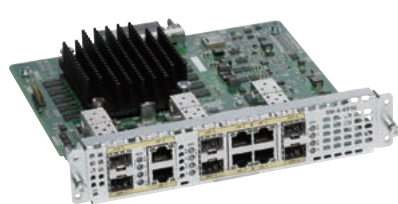

Getting Started

What's New

Feature Story

Collaborate

Compute

Security

Connect

Switches

Wireless

Routers

RV

ISR 800

**NEW** ISR 900

ISR 1100

ISR 4000

Services



Getting Started

What's New

Feature Story

Collaborate

Compute

Security

Connect

Switches

Wireless

Routers

RV

ISR 800

**NEW** ISR 900

ISR 1100

ISR 4000

Services

Overview

Platform Spec

Licenses & Accessories

Bundles

Transition Guide

Product SKU	Service (CSE) SKU	Cisco IOS	Throughput		Ports			Expansion Slots			Default Power Supply	Power Redundancy	Rack Mount
			Default	Max*1	GE	SFP	GE/SFP	NIM	SM-X	PVDM			
ISR4221/K9	CON-SMBS-ISR4221K	IP Base*2	35 Mbps	1.2 Gbps	1	-	1	2	-	-	External AC	-	1 RU
ISR4321/K9	CON-SMBS-ISR4321K	IP Base*2	50 Mbps	2 Gbps ~	1	-	1	2	-	1	External AC	-	1 RU
ISR4331/K9	-	IP Base*2	100 Mbps	2 Gbps ~	1	1	1	2	1	1	Internal AC	-	1 RU
ISR4351/K9	-	IP Base*2	200 Mbps	2 Gbps ~	-	-	3	3	2	1	Internal AC	-	2 RU
ISR4431/K9	-	IP Base*2	500 Mbps	4 Gbps ~	-	-	4	3	-	1	Internal AC	●	1 RU
ISR4451-X/K9	-	IP Base*2	1 Gbps	4 Gbps ~	-	-	4	3	2	1	Internal AC	●	2 RU

\*1 Cisco IOS Booster Performance License is required.

\*2 Cisco IOS SEC License, Cisco IOS UC License, and Cisco IOS APP License can be added.



Overview

Platform Spec

Licenses &amp; Accessories

Bundles

Transition Guide

## Cisco IOS Technology Package Licenses

Product SKU	Description	Compatible Models					
		4221	4321	4331	4351	4431	4451
SL-4220-SEC-K9	Cisco IOS SEC License for Cisco ISR 4221	●	-	-	-	-	-
SL-4320-SEC-K9	Cisco IOS SEC License for Cisco ISR 4321	-	●	-	-	-	-
SL-4330-SEC-K9	Cisco IOS SEC License for Cisco ISR 4331	-	-	●	-	-	-
SL-4350-SEC-K9	Cisco IOS SEC License for Cisco ISR 4351	-	-	-	●	-	-
SL-44-SEC-K9	Cisco IOS SEC License for Cisco ISR 4400 Series	-	-	-	-	●	●
SL-4320-UC-K9	Cisco IOS UC License for Cisco ISR 4321	-	●	-	-	-	-
SL-4330-UC-K9	Cisco IOS UC License for Cisco ISR 4331	-	-	●	-	-	-
SL-4350-UC-K9	Cisco IOS UC License for Cisco ISR 4351	-	-	-	●	-	-
SL-44-UC-K9	Cisco IOS UC License for Cisco ISR 4400 Series	-	-	-	-	●	●
SL-4220-APP-K9	Cisco IOS APP License for Cisco ISR 4221	●	●	-	-	-	-
L-SL-4320-APP-K9	Cisco IOS APP License for Cisco ISR 4321	-	●	-	-	-	-
L-SL-4330-APP-K9	Cisco IOS APP License for Cisco ISR 4331	-	-	●	-	-	-
L-SL-4350-APP-K9	Cisco IOS APP License for Cisco ISR 4351	-	-	-	●	-	-
L-SL-44-APP-K9	Cisco IOS APP License for Cisco ISR 4400 Series	-	-	-	-	●	●

Getting Started

What's New

Feature Story

Collaborate

Compute

Security

Connect

Switches

Wireless

Routers

RV

ISR 800

NEW ISR 900

ISR 1100

ISR 4000

Services



## Overview

## Platform Spec

## Licenses &amp; Accessories

## Bundles

## Transition Guide

## Cisco IOS Feature Licenses

Product SKU	Description	Compatible Models					
		4221	4321	4331	4351	4431	4451
FL-4320-HSEC-K9	Cisco IOS HSEC License for Cisco ISR 4321 <sup>*1</sup>	-	●	-	-	-	-
FL-4330-HSEC-K9	Cisco IOS HSEC License for Cisco ISR 4331 <sup>*1</sup>	-	-	●	-	-	-
FL-4350-HSEC-K9	Cisco IOS HSEC License for Cisco ISR 4351 <sup>*1</sup>	-	-	-	●	-	-
FL-44-HSEC-K9	Cisco IOS HSEC License for Cisco ISR 4400 Series <sup>*1</sup>	-	-	-	-	●	●
SW-CCME-UL-ESS	Cisco Unified CME Phone License - Essential	-	●	●	●	●	●
SW-CCME-UL-BASIC	Cisco Unified CME Phone License - Basic	-	●	●	●	●	●
SW-CCME-UL-ENH	Cisco Unified CME Phone License - Enhanced	-	●	●	●	●	●
L-FL-CME-SRST-5	Cisco Unified CME or SRST 5 License <sup>*2</sup>	-	●	●	●	●	●
L-FL-CME-SRST-25	Cisco Unified CME or SRST 25 License <sup>*2</sup>	-	●	●	●	●	●
L-FL-CME-SRST-100	Cisco Unified CME or SRST 100 License <sup>*2</sup>	-	-	●	●	●	●
FL-CUBEE-5-RED	Cisco Unified BEe 5 Redundant Configuration License <sup>*2</sup>	-	●	●	●	●	●
FL-CUBEE-25-RED	Cisco Unified BEe 25 Redundant Configuration License <sup>*2</sup>	-	●	●	●	●	●
FL-CUBEE-100-RED	Cisco Unified BEe 100 Redundant Configuration License <sup>*2</sup>	-	●	●	●	●	●
SL-200-AKC	Cisco IWAN with Akamai Connect 200 Connections License <sup>*3</sup>	●	●	●	-	-	-
SL-750-AKC	Cisco IWAN with Akamai Connect 200 Connections License <sup>*3</sup>	-	-	●	●	●	-
SL-1300-AKC	Cisco IWAN with Akamai Connect 1,300 Connections License <sup>*3</sup>	-	-	●	●	●	●
SL-2500-AKC	Cisco IWAN with Akamai Connect 2,500 Connections License <sup>*3</sup>	-	-	●	●	-	●
SL-6K-AKC	Cisco IWAN with Akamai Connect 6,000 Connections License <sup>*3</sup>	-	-	●	●	-	●
FL-4220-PERF-K9	Cisco IOS Performance-on-Demand License for Cisco ISR 4221	●	-	-	-	-	-
FL-4320-PERF-K9	Cisco IOS Performance-on-Demand License for Cisco ISR 4321	-	●	-	-	-	-
FL-4330-PERF-K9	Cisco IOS Performance-on-Demand License for Cisco ISR 4331	-	-	●	-	-	-
FL-4350-PERF-K9	Cisco IOS Performance-on-Demand License for Cisco ISR 4351	-	-	-	●	-	-
FL-44-PERF-K9	Cisco IOS Performance-on-Demand License for Cisco ISR 4400 Series	-	-	-	-	●	●
FL-4220-BOOST-K9	Cisco IOS Booster Performance License for Cisco ISR 4221	●	-	-	-	-	-
FL-4320-BOOST-K9	Cisco IOS Booster Performance License for Cisco ISR 4321	-	●	-	-	-	-
FL-4330-BOOST-K9	Cisco IOS Booster Performance License for Cisco ISR 4331	-	-	●	-	-	-
FL-4350-BOOST-K9	Cisco IOS Booster Performance License for Cisco ISR 4351	-	-	-	●	-	-
FL-4430-BOOST-K9	Cisco IOS Booster Performance License for Cisco ISR 4431	-	-	-	-	●	-
FL-44-BOOST-K9	Cisco IOS Booster Performance License for Cisco ISR 4451	-	-	-	-	-	●

\*1 Cisco IOS SEC License is required. \*2 Cisco IOS UC License is required. \*3 Cisco IOS APP License is required.

Getting Started

What's New

Feature Story

Collaborate

Compute

Security

Connect

Switches

Wireless

Routers

RV

ISR 800

NEW ISR 900

ISR 1100

ISR 4000

Services



## Overview

## Platform Spec

## Licenses &amp; Accessories

## Bundles

## Transition Guide

## Cisco Layer 2/3 EtherSwitch Modules

Product SKU	Description	Slot	Compatible Models					
			4221	4321	4331	4351	4431	4451
NIM-ES2-4	EtherSwitch Module (L2, 4-port GE)	NIM	●	●	●	●	●	●
NIM-ES2-8	EtherSwitch Module (L2, 8-port GE)	NIM	●	●	●	●	●	●
NIM-ES2-8-P	EtherSwitch Module (L2, 8-port GE/PoE+)	NIM	-	●	●	●	●	●
SM-X-ES3-16-P	EtherSwitch Service Module (L2/L3, 16-port GE/PoE+)	SM-X	-	-	●	●	-	●
SM-X-ES3-24-P	EtherSwitch Service Module (L2/L3, 24-port GE/PoE+)	SM-X	-	-	●	●	-	●
SM-X-ES3D-48-P	EtherSwitch Service Module (L2/L3, 48-port GE/PoE+)	SM-X	-	-	-	●	-	●

## Cisco Gigabit Ethernet WAN Modules

Product SKU	Description	Slot	Compatible Models					
			4221	4321	4331	4351	4431	4451
NIM-1GE-CU-SFP	GE/SFP Module (1-port)	NIM	●	●	●	●	●	●
NIM-2GE-CU-SFP	GE/SFP Module (2-port)	NIM	-	●	●	●	●	●
SM-X-6X1G	GE/SFP Service Module (6-port)	SM-X	-	-	●	●	-	●
SM-X-4X1G-1X10G	GE/SFP (4-port) or SFP+ (1-port) Service Module	SM-X	-	-	●	●	-	●

## Cisco Serial WAN Interface Modules

Product SKU	Description	Slot	Compatible Models					
			4221	4321	4331	4351	4431	4451
NIM-1T	Serial WAN Module (1-port)	NIM	●	●	●	●	●	●
NIM-2T	Serial WAN Module (2-port)	NIM	●	●	●	●	●	●
NIM-4T	Serial WAN Module (4-port)	NIM	-	●	●	●	●	●
SM-X-1T3/E3	T3/E3 Service Module (1 port)	SM-X	-	-	●	●	-	●

## Cisco Async WAN Interface Modules

Product SKU	Description	Slot	Compatible Models					
			4221	4321	4331	4351	4431	4451
NIM-16A	Asynchronous Module (16-port)	NIM	●	●	●	●	●	●
NIM-24A	Asynchronous Module (24-port)	NIM	●	●	●	●	●	●

Getting Started

What's New

Feature Story

Collaborate

Compute

Security

Connect

Switches

Wireless

Routers

RV

ISR 800

NEW ISR 900

ISR 1100

ISR 4000

Services

## Overview

## Platform Spec

## Licenses &amp; Accessories

## Bundles

## Transition Guide

## Cisco Multimode VDSL2 and ADSL2/2+ Network Interface Modules

Product SKU	Description	Slot	Compatible Models					
			4221	4321	4331	4351	4431	4451
NIM-VAB-A	Multi Mode VDSL2/ADSL2/2+ (Annex A)	NIM	●	●	●	●	●	●
NIM-VA-B	Multi Mode VDSL2/ADSL2/2+ (Annex B)	NIM	●	●	●	●	●	●
NIM-VAB-M	Multi Mode VDSL2/ADSL2/2+ (Annex M)	NIM	●	●	●	●	●	●

## Cisco 4G LTE Network Interface Modules

Product SKU	Description	Slot	Compatible Models					
			4221	4321	4331	4351	4431	4451
NIM-4G-LTE-GA	4G LTE Module for Global	NIM	●	●	●	●	●	●
NIM-4G-LTE-NA	4G LTE Module for North America	NIM	●	●	●	●	●	●
NIM-4G-LTE-ST	4G LTE Module for Sprint	NIM	●	●	●	●	●	●
NIM-4G-LTE-VZ	4G LTE Module for Verizon	NIM	●	●	●	●	●	●
NIM-4G-LTE-LA	4G LTE Module for Asia Pacific, Australia and Latam	NIM	●	●	●	●	●	●
NIM-LTEA-EA	LTE Advanced Module for Europe and North America	NIM	●	●	●	●	●	●
NIM-LTEA-LA	LTE Advanced Module for Asia Pacific, Australia and Latam	NIM	●	●	●	●	●	●

## Cisco T1/E1 Voice and WAN Network Interface Modules

Product SKU	Description	Slot	Compatible Models					
			4221	4321	4331	4351	4431	4451
NIM-1MFT-T1/E1	Voice/WAN Module (1-port T1/E1)	NIM	●	●	●	●	●	●
NIM-2MFT-T1/E1	Voice/WAN Module (2-port T1/E1)	NIM	●	●	●	●	●	●
NIM-4MFT-T1/E1	Voice/WAN Module (4-port T1/E1)	NIM	-	●	●	●	●	●
NIM-8MFT-T1/E1	Voice/WAN Module (8-port T1/E1)	NIM	-	●	●	●	●	●
NIM-1CE1T1-PRI	Voice/WAN Module (1-port T1/E1/G.703)	NIM	-	●	●	●	●	●
NIM-2CE1T1-PRI	Voice/WAN Module (2-port T1/E1/G.703)	NIM	-	●	●	●	●	●
NIM-8CE1T1-PRI	Voice/WAN Module (8-port T1/E1/G.703)	NIM	-	●	●	●	●	●
SM-X-1T3/E3	T3/E3 Service Module (1 port)	SM-X	-	-	●	●	-	●

Getting Started

What's New

Feature Story

Collaborate

Compute

Security

Connect

Switches

Wireless

Routers

RV

ISR 800

NEW ISR 900

ISR 1100

ISR 4000

Services

## Overview

## Platform Spec

## Licenses &amp; Accessories

## Bundles

## Transition Guide

## Cisco Analog Voice Network Interface Modules

Product SKU	Description	Slot	Compatible Models					
			4221	4321	4331	4351	4431	4451
NIM-2FXSP	Voice Module (2-port FXS)	NIM	-	●	●	●	●	●
NIM-4FXSP	Voice Module (4-port FXS)	NIM	-	●	●	●	●	●
NIM-2FXO	Voice Module (2-port FXO)	NIM	-	●	●	●	●	●
NIM-4FXO	Voice Module (4-port FXO)	NIM	-	●	●	●	●	●
NIM-2FXS/4FXOP	Voice Module (2-port FXS and 4-port FXO)	NIM	-	●	●	●	●	●
NIM-4E/M	Voice Module (4-port E/M)	NIM	-	●	●	●	●	●
NIM-2BRI-NT/TE	Voice Module (2-port BRI)	NIM	-	●	●	●	●	●
NIM-4BRI-NT/TE	Voice Module (4-port BRI)	NIM	-	●	●	●	●	●

## Cisco Packet Voice Digital Signal Processor Modules (PVDMs)

Product SKU	Description	Slot	Compatible Models					
			4221	4321	4331	4351	4431	4451
PVDM4-32	High-density Voice DSP Module (16-channel)	PVDM4	-	●	●	●	●	●
PVDM4-64	High-density Voice DSP Module (32-channel)	PVDM4	-	●	●	●	●	●
PVDM4-128	High-density Voice DSP Module (64-channel)	PVDM4	-	●	●	●	●	●
PVDM4-256	High-density Voice DSP Module (128-channel)	PVDM4	-	●	●	●	●	●
SM-X-PVDM-500	High-density Voice DSP Service Module (768-channel)	SM-X	-	-	●	●	-	●
SM-X-PVDM-1000	High-density Voice DSP Service Module (1,024-channel)	SM-X	-	-	●	●	-	●
SM-X-PVDM-2000	High-density Voice DSP Service Module (2,048-channel)	SM-X	-	-	-	● <sup>*1</sup>	-	●
SM-X-PVDM-3000	High-density Voice DSP Service Module (3,080-channel)	SM-X	-	-	-	● <sup>*1</sup>	-	●

\*1 Supports up to 1,024 channels.

## Cisco UCS E Series Servers

Product SKU	CPU Cores	Memory		Internal Drive Slots	RAID	Slot	Compatible Models					
		Default	Maximum				4221	4321	4331	4351	4431	4451
UCS-EN140N-M2/K9	4	8 GB	8 GB	1	-	NIM	-	●	●	●	●	●
UCS-EN120S-M2/K9	2	4 GB	16 GB	2	0/1	SM-X	-	-	●	●	-	●
UCS-E140S-M2/K9	4	8 GB	16 GB	2	0/1	SM-X	-	-	●	●	-	●
UCS-E160S-M3/K9	6	8 GB	32 GB	2	0/1	SM-X	-	-	●	●	-	●
UCS-E160D-M2/K9	6	8 GB	96 GB	3	0/1/5	SM-X	-	-	-	●	-	●
UCS-E180D-M2/K9	8	8 GB	96 GB	3	0/1/5	SM-X	-	-	-	●	-	●
UCS-E180D-M3/K9	8	16 GB	128 GB	3	0/1/5/10	SM-X	-	-	-	●	-	●
UCS-E1120D-M3/K9	12	16 GB	128 GB	4	0/1/5/10	SM-X	-	-	-	●	-	●

Getting Started

What's New

Feature Story

Collaborate

Compute

Security

Connect

Switches

Wireless

Routers

RV

ISR 800

NEW ISR 900

ISR 1100

ISR 4000

Services



Getting Started

What's New

Feature Story

Collaborate

Compute

Security

Connect

Switches

Wireless

Routers

RV

ISR 800

**NEW** ISR 900

ISR 1100

ISR 4000

Services

Overview

Platform Spec

Licenses & Accessories

**Bundles**

Transition Guide

Cisco ISR 4000 Series Bundles

Platform	Product SKU	Service (CSE) SKU
Cisco ISR 4221	ISR4221-SEC/K9	CON-SMBS-ISR4221S
	ISR4221-AX/K9	-
Cisco ISR 4321	ISR4321-SEC/K9	-
	ISR4321-V/K9	-
	ISR4321-VSEC/K9	-
	ISR4321-AX/K9	-
Cisco ISR 4331	ISR4331-AXV/K9	-
	ISR4331-SEC/K9	-
	ISR4331-V/K9	-
	ISR4331-VSEC/K9	-
Cisco ISR 4351	ISR4331-AX/K9	-
	ISR4331-AXV/K9	-
	ISR4351-SEC/K9	-
	ISR4351-V/K9	-
Cisco ISR 4351	ISR4351-VSEC/K9	-
	ISR4351-AX/K9	-
	ISR4351-AXV/K9	-
	ISR4351-AXV/K9	-

Platform	Product SKU	Service (CSE) SKU
Cisco ISR 4431	ISR4431-SEC/K9	-
	ISR4431-V/K9	-
	ISR4431-VSEC/K9	-
	ISR4431-AX/K9	-
Cisco ISR 4451	ISR4431-AXV/K9	-
	ISR4451-X-SEC/K9	-
	ISR4451-X-V/K9	-
	ISR4451-X-VSEC/K9	-
Cisco ISR 4451	ISR4451-X-AX/K9	-
	ISR4451-X-AXV/K9	-
	ISR4451-X-AXV/K9	-
	ISR4451-X-AXV/K9	-

Cisco ISR 4000 Series Bundles Comparison

Bundles	Characters Included in SKU	Bundled Licenses/Modules			
		IOS SEC	IOS UC	IOS APP	PVDM4
Security Bundles	SEC	●	-	-	-
Voice Bundles	V	-	●	-	●
Voice Security Bundles	VSEC	●	●	-	●
Application Experience Bundles	AX	●	-	●	-
Application Experience Voice Bundles	AXV	●	●	●	●



Overview

Platform Spec

Licenses & Accessories

**Bundles**

Transition Guide

Cisco ISR 4000 Series Cisco DNA Bundles NEW

Product SKU	Description	SD-WAN Bandwidth					
		10 Mbps	20 Mbps	50 Mbps	100 Mbps	500 Mbps	1 Gbps
ISR4331-DNA	Cisco 4331 with Cisco DNA Support	●	●	●	●	●	-
ISR4351-DNA	Cisco 4351 with Cisco DNA Support	●	●	●	●	●	-
ISR4451-DNA	Cisco 4451 with Cisco DNA Support	-	-	-	●	●	●

Cisco DNA Licenses for Cisco ISR 4000 Series NEW

- Cloud Management: Provides simplicity of management with Cisco vManage; recommended for all SD-WAN deployments.
- On-Premises Management: Manages WAN using Cisco DNA Center or Cisco vManage on-premises.  
Cisco DNA Center requires an additional appliance purchase.

Software Package	Bandwidth	Product SKU (Cloud Management)		Product SKU (On-Premises Management)	
		3-Years	5-Years	3-Years	5-Years
Cisco DNA Essentials	10 Mbps	DNA-C-10M-E-3Y	DNA-C-10M-E-5Y	DNA-P-10M-E-3Y	DNA-P-10M-E-5Y
	20 Mbps	DNA-C-20M-E-3Y	DNA-C-20M-E-5Y	DNA-P-20M-E-3Y	DNA-P-20M-E-5Y
	50 Mbps	DNA-C-50M-E-3Y	DNA-C-50M-E-5Y	DNA-P-50M-E-3Y	DNA-P-50M-E-5Y
	100 Mbps	DNA-C-100M-E-3Y	DNA-C-100M-E-5Y	DNA-P-100M-E-3Y	DNA-P-100M-E-5Y
	500 Mbps	DNA-C-500M-E-3Y	DNA-C-500M-E-5Y	DNA-P-500M-E-3Y	DNA-P-500M-E-5Y
	1 Gbps	DNA-C-1G-E-3Y	DNA-C-1G-E-5Y	DNA-P-1G-E-3Y	DNA-P-1G-E-5Y
Cisco DNA Advantage	10 Mbps	DNA-C-10M-A-3Y	DNA-C-10M-A-5Y	DNA-P-10M-A-3Y	DNA-P-10M-A-5Y
	20 Mbps	DNA-C-20M-A-3Y	DNA-C-20M-A-5Y	DNA-P-20M-A-3Y	DNA-P-20M-A-5Y
	50 Mbps	DNA-C-50M-A-3Y	DNA-C-50M-A-5Y	DNA-P-50M-A-3Y	DNA-P-50M-A-5Y
	100 Mbps	DNA-C-100M-A-3Y	DNA-C-100M-A-5Y	DNA-P-100M-A-3Y	DNA-P-100M-A-5Y
	500 Mbps	DNA-C-500M-A-3Y	DNA-C-500M-A-5Y	DNA-P-500M-A-3Y	DNA-P-500M-A-5Y
	1 Gbps	DNA-C-1G-A-3Y	DNA-C-1G-A-5Y	DNA-P-1G-A-3Y	DNA-P-1G-A-5Y

- Getting Started
- What's New
- Feature Story
- Collaborate
- Compute
- Security
- Connect**
  - Switches
  - Wireless
  - Routers**
    - RV
    - ISR 800
    - NEW ISR 900
    - ISR 1100
    - ISR 4000**
  - Services





## Overview

## Platform Spec

## Licenses &amp; Accessories

## Bundles

## Transition Guide

## Benefits of Upgrading to Cisco ISR 4000 Series

Features		ISR 1800/2800/3800	ISR 1900/2900/3900	ISR 4000	Benefits
 Insights and Experiences	Maximum throughput	Up to 50 Mbps	Up to 350 Mbps	Up to 4 Gbps	4 to 10 times greater performance than ISR G2 at lower price
	Cisco Application Visibility and Control (AVC)	-	●	●	Visibility into 1000+ applications for capacity planning and prioritization
	Intelligent path selection (Cisco Performance Routing [Pfr] v3)	-	●	●	Real-time analytics to help ensure application experience and lower costs with path selection
	WAN optimization (Cisco Wide Area Application Services [WAAS] and Akamai)	-	●	●	Improved application performance and WAN offload with Layer 4 through 7 optimization and intelligent caching
 Automation and Assurance	Pay-as-you-grow performance and services	-	-	●	Ability to buy what you need today and upgrade anytime without a complete equipment upgrade
	Cisco ONE Software Suites	-	●	●	Predictable OpEx, license portability, and investment protection
	Cisco Intelligent WAN app with Application Policy Infrastructure Controller Enterprise Module (APIC-EM)	-	●	●	Automated provisioning for faster SD-WAN deployments
 Security and Compliance	Cisco Firepower Threat Defense for ISR	-	●	●	Industry-leading advanced threat defense
	Cisco Umbrella Branch (OpenDNS)	-	-	●	Protection from malware, botnets, phishing, and targeted online attacks using real-time threat intelligence
	Cisco Stealthwatch Learning Network License	-	●	●	Branch network visibility and device-level incident response with packet capture and machine learning (ISR 2900/3900 Series requires UCS E-Series blade)
	Multicore hardware VPN acceleration	-	-	●	High-performance encryption for secure WAN
 Virtualization	Enterprise Network Functions Virtualization	-	-	●	Simplified operations and deployment of virtual network services on any platform
	Native Application Hosting	-	-	●	No need for additional network devices in the branch
	Integrated compute with Cisco UCS E-Series servers	-	●	●	Local compute resources for applications, data backup, and analytics
	Cisco IOS XE operating system			●	Multi-core processing increases network services performance and availability

Getting Started

What's New

Feature Story

Collaborate

Compute

Security

Connect

Switches

Wireless

Routers

RV

ISR 800

NEW ISR 900

ISR 1100

ISR 4000

Services

## Overview

## Results at the Speed of Business

Operational inefficiencies can cause quality and performance issues that directly affect your users. You need to anticipate, detect, and resolve incidents quickly to minimize any risk to the business. A few minutes of downtime can be extremely costly.

That's where **Cisco Services** come in. A reliable partner to help you improve your IT operations and reduce risk.

## Services: Protection Beyond Warranty

The hardware warranty included with Cisco products protects the customer in the case of hardware defects. However, many customers and partners mistakenly believe that warranty coverage is all they need and do not realize where warranty ends.

To successfully position services over hardware warranty, help your customers understand the differences and incorporate them into your key customer talking points.

A service contract provides the following primary benefits that warranty does not:

- 24x7 TAC Access
- Premium Software Images
- Part Ships to Customer Site vs. Original Ship-to Location

## Technical Support Service Offering Comparison between the Different Product Warranties and a Service Contract

Warranty	Standard Warranty	Limited Lifetime Warranty	Enhanced Limited Lifetime Warranty	Service Support Contract
24 x 7 TAC Support	No access for TAC support; TAC access for RMA only	No access for TAC support; TAC access for RMA only	90 days support from date of purchase (access only during business hours)	● <sup>*1</sup>
Cisco OS Updates and Upgrades	-	-	-	● <sup>*2</sup>
Application Software Updates and Upgrades	-	-	-	● <sup>*3</sup>
Online Technical Resources (Cisco.com)	Guest access only	Guest access only	Guest access only	●
Hardware Replacement in as Little as 2 Hours	10 business days	10 business days	Next business day ship to original address	● <sup>*4</sup>
Proactive Diagnostics and Alerts	-	-	-	● <sup>*5</sup>
Renewable Contracts	-	-	-	●

\*1 Cisco Support Essentials supports 8 x 5 (Callback). \*2 Cisco Support Essentials supports maintenance release update only.

\*3 Cisco Software Support Service (SWSS) contract is required. \*4 24 x 7 x 2 Service Level contract is required. \*5 Cisco Smart Call Home contract is required.

Getting Started

What's New

Feature Story

Collaborate

Compute

Security

Connect

Switches

Wireless

Routers

Services

Support Essentials

Smart Net Total Care

Software Support

## Essential Technical Support Designed for Cost-Conscious Businesses

The Cisco Support Essentials is designed for customers with business networks that utilize basic Cisco routers, switches and wireless access points. Their network is important to their business but not mission critical. They do not need premium support options like 2-hour hardware replacement, onsite support, or around-the clock TAC access. This service provides non-urgent callback TAC support that is accessible only during normal business hours (8 x 5, Monday through Friday), and next-business-day hardware replacement.

Cisco Support Essentials help you:

- Improves operational reliability of the business network with the technical expertise and responsiveness needed to minimize downtime
- Increases productivity by helping to reduce the effects of a potential network problem and allows IT staff to quickly resolve any issues and focus on the company's core business
- Protects network investment by extending the life of Cisco network solutions
- Provides support above and beyond product warranties
- Reduces costs, since a single uncovered service transaction can cost more than a one-year Cisco Support Essentials contract

### Support from Cisco Technical Assistance Center (TAC) Engineers

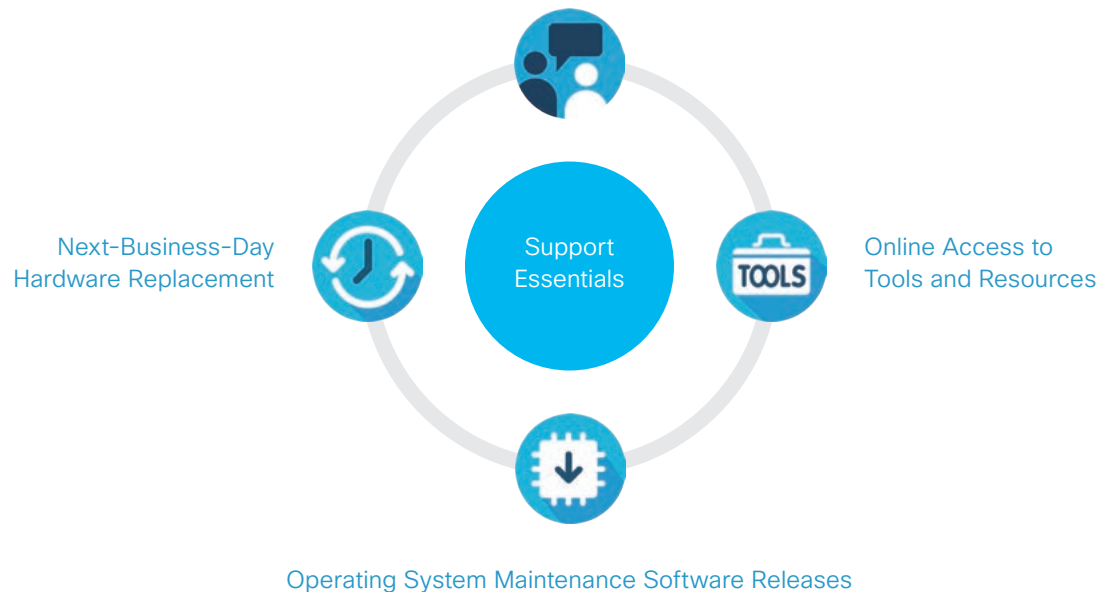

Getting Started

What's New

Feature Story

Collaborate

Compute

Security

Connect

Switches

Wireless

Routers

Services

Support Essentials

Smart Net Total Care

Software Support

## Overview

## Features

## For Partners

## Services &amp; Warranty Comparison

The Cisco Support Essentials is part of a broader Cisco Services portfolio. Be sure to consider the Cisco Smart Net Total Care (SNTC) as an alternative product support offer if your customer has more critical technical service needs.

If your customer is looking for support for their software products, introduce them to the Cisco Software Support Service (SWSS).

Premium Services such as the Cisco Solution Support and the Cisco Technical Services (TS) Advantage may also be useful to your customer.

	Equipment Covered	Duration	Hardware Replacement	Software Updates	TAC Support
Smart Net Total Care	All <sup>*1</sup>	Renewable Contracts	Advance Replacement: <ul style="list-style-type: none"> <li>● 24 x 7 x 2-hours</li> <li>● 24 x 7 x 4-hours</li> <li>● 8 x 5 x 4-hours</li> <li>● 8 x 5 x Next Business Day (NBD)</li> <li>● Onsite Options</li> </ul>	Minor and Maintenance Releases	24 x 7
Support Essentials	Commercial Focused	Renewable Contracts	8 x 5 x NBD	Maintenance Releases	8 x 5 (Callback)
Warranty	All <sup>*1</sup>	90 Days <sup>*2</sup>	Advance Replacements (10 Days) <sup>*2</sup>	-	- <sup>*3</sup>

<sup>\*1</sup> Some equipment exclusions may apply. Consult a service sales representative for more details.

<sup>\*2</sup> This table refers to Cisco's standard hardware warranty. Additional Cisco warranties are referenced at <http://www.cisco.com/go/warranty>.

<sup>\*3</sup> Hardware fault identification/return materials authorization (RMA) validation only.

Getting Started

What's New

Feature Story

Collaborate

Compute

Security

Connect

Switches

Wireless

Routers

Services

Support Essentials

Smart Net Total Care

Software Support

How Should I Address Common Objections?



Why do I need services? Doesn't my warranty cover me?



Your warranty protects against defects in Cisco hardware or software. But if an issue does arise, it will more likely be because of the way the solution has been configured or used and will be outside the scope of the warranty.



I have never had any problems with the equipment.



Any new network application or service could affect your network operability, so it is important to have a plan in case issues do arise. The cost of uncovered service and the harm to your business of a delay resolving an outage can be significant.



I do not have the budget for services.



Cisco Support Essentials is priced specifically for companies that do not have significant resources to devote to network support services. The small annual fee is much lower than the cost of even a single uncovered support event.



I have in-house staff who can handle any network issues.



Is servicing network equipment the best use of your in-house resources? Cisco Support Essentials can help your staff more quickly diagnose and resolve any problem and get back to focusing on your business. If your staff does need to call for help, they will have the support of Cisco experts who have the most up-to-date knowledge about covered products.



I use spares when I need hardware replacement.



Can you adequately determine the number of spares you need? What if something happens to the spare? If the piece of equipment experiencing an issue is not covered by a service contract, you run the risk of costly network downtime by not having the ability to provide a timely resolution to the problem.

Getting Started

What's New

Feature Story

Collaborate

Compute

Security

Connect

Switches

Wireless

Routers

Services

Support Essentials

Smart Net Total Care

Software Support





Overview

Features

For Partners

Manage Risks to Business Continuity, Resolve Problems Faster, and Operate More Efficiently





Your IT infrastructure is the lifeline that connects your business to customers and suppliers. Business success requires maintaining high service levels for your network while reducing costs and expanding your network as your business grows. The **Cisco Smart Net Total Care (SNTC)** can help you meet these objectives by providing technical services and smart capabilities that:

- **Resolve Problems Faster**  
Identify issues quickly and streamline your incident management processes to reduce network downtime and improve IT service levels.
- **Reduce Risk**  
Access to Cisco technical experts combined with smart, proactive tools and capabilities minimizes risks to business continuity.
- **Increase Operational Efficiency**  
Proactive management and automated processes mean fewer support resource requirements and lower costs for managing your network.

Cisco SNTC helps reduce downtime with fast, expert technical support and flexible hardware coverage provided by the **Cisco Technical Assistance Center (TAC)**. It also offers integrated smart capabilities, providing current information about your installed base, contracts, and security alerts to enhance the efficiency of your support workflows.

The Cisco TAC is staffed by Cisco experts and is accessible 24 hours a day, 365 days per year. Technical services available through the TAC are backed by advance hardware replacement options and fast response time, including 2-hour, 4-hour, and next-business-day options (where available). Online self-help tools include our extensive knowledge library, software downloads, and support tools designed to help you resolve network issues quickly without opening a case.

Smart capabilities are delivered through the Cisco Smart Net Total Care portal, providing actionable information and automation to support your Cisco products. Customizable screens show you up-to-date information about the service coverage, product lifecycles, and security and product alerts that apply to your network.

	Faster Problem Resolution	Risk Mitigation	Operational Efficiency
 <p><b>Technical Service and Incident Management</b></p> <ul style="list-style-type: none"> <li>● Fast expert technical support from Cisco TAC</li> <li>● Advance hardware replacement</li> <li>● Automated streamlined processes for incident management</li> </ul>	●	●	●
 <p><b>Security and Product Alerts</b></p> <ul style="list-style-type: none"> <li>● Actionable security alerts</li> <li>● Relevant product notices (Hardware and software)</li> <li>● Service availability alerts (Hardware and software)</li> </ul>	-	●	●
 <p><b>Service Coverage Management</b></p> <ul style="list-style-type: none"> <li>● Covered/uncovered, right coverage</li> <li>● Renewal preparation and planning</li> <li>● Budget planning</li> </ul>	-	●	●
 <p><b>Product Lifecycle Management</b></p> <ul style="list-style-type: none"> <li>● Up-to-date installed base information</li> <li>● EoS/EoL, software version mismatches</li> <li>● Automation to reduce cost and risk of manual processes</li> </ul>	-	●	●

Getting Started

What's New

Feature Story

Collaborate

Compute

Security

Connect

Switches

Wireless

Routers

Services

Support Essentials

Smart Net Total Care

Software Support

## Overview

## Features

## For Partners

### Technical Service

When a network problem affects business-critical systems, it requires fast response and a deep understanding of the technology to resolve the incident quickly. Cisco SNTC offers the following capabilities for device-level support to help you reduce the risk of business interruptions caused by network issues. These capabilities help ensure that you get rapid response for service and can quickly identify your devices and their service coverage information in order to streamline your interaction with Cisco TAC support representatives.

### Advance Hardware Replacement Service Levels

Service Level	Description
24 x 7 x 2	2-hour response, 24 hours a day, 7 days per week, including holidays
24 x 7 x 4	4-hour response, 24 hours a day, 7 days a week, including holidays
8 x 5 x 4	4-hour response, local business hours based on depot time, 5 days a week
8 x 5 x NBD	Next-business-day delivery, local business hours based on depot time, 5 days a week

### Onsite Support Service Levels

Service Level	Description
24 x 7 x 2	2-hour response, 24 hours a day, 7 days per week, including holidays
24 x 7 x 4	4-hour response, 24 hours a day, 7 days a week, including holidays
8 x 5 x 4	Based on depot time. 4-hour response, 9 a.m. to 5 p.m., if the request is received before 1 p.m., the service (including parts, labor, and materials) will be provided the same day. For requests received after 1 p.m., the service will be provided the following business day.
8 x 5 x NBD	Based on depot time. Next business day, 9 a.m. to 5 p.m., if the request is received before 3 p.m., the service (including parts, labor, and materials) will be provided the next business day. After 3 p.m., the service (including parts, labor, and materials) will be provided the following business day.

### Cisco TAC

The Cisco TAC is staffed by Cisco professionals certified in a broad range of Cisco products and technologies and service provider architectures. We provide you with access by phone, fax, or email 24 hours a day, 365 days a year and can assist you with product use, configuration, and troubleshooting issues. Cisco TAC objectives for response times are:

- Severity 1 and 2: Cisco will respond within one hour.
- Severity 3 and 4: Cisco will respond no later than one business day.

### Advance Hardware Replacement

With our customized hardware support service plans, you can have confidence knowing that your hardware can support your ongoing business needs. Cisco offers multiple service levels with different shipment options.

### Onsite Support

Cisco is committed to providing professional, customer-focused support services in person at your location. The Cisco Smart Net Total Care On-site service includes installation of advance replacement parts.

### Software Updates

Cisco provides OS software updates for your licensed feature set. Software releases and any supporting documentation are available through the [Cisco Software Central](#).

### Online Self-Help Support

Cisco provides access to the Cisco Support website, which includes Cisco's extensive knowledge library, software downloads, and support tools designed to help users resolve network issues quickly without opening a case.

- You can manage problems according to the [Cisco Severity and Escalation Guidelines](#).
- Access to the [Cisco Support & Downloads](#) provides helpful technical and general information on Cisco products.

Getting Started

What's New

Feature Story

Collaborate

Compute

Security

Connect

Switches

Wireless

Routers

Services

Support Essentials

Smart Net Total Care

Software Support



## Overview

## Features

## For Partners

## Incident Management

All support customers are entitled to smart capabilities, including access to the Cisco SNTC portal, the mobile app, and the Cisco collector software. Support for these smart capabilities is provided through an online community monitored by Cisco and peer experts. Proactive smart capabilities are integrated with foundational support capabilities and work to help resolve problems more quickly and provide the visibility and insight you need to improve the efficiency of your support operations.

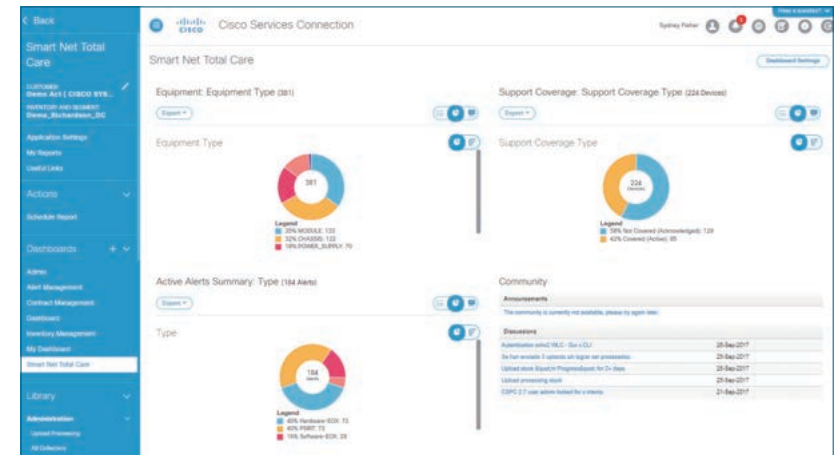

Smart Net Total Care Portal

- Portal and Interactive Dashboard

Cisco SNTC portal provides secure access to your detailed device data and an interactive dashboard that delivers the information you need to speed up the problem resolution process. The dashboard offers in-depth information to open and manage a Cisco TAC case, including configuration status, serial number, contract number, service level, and unresolved alerts. The Cisco SNTC portal allows you to manage user access and configure and generate reports and workflows. It provides access to security and product alerts, product lifecycles, and Cisco service coverage.

- Collector Software

The Cisco Common Services Platform Collector (CSPC) automatically gathers device support information for Cisco products, including serial numbers, installed memory, product IDs (PIDs), and more. This saves time and provides a more current view compared with manual efforts. The collector also identifies hardware or software versions and configuration files for your Cisco network devices.

- Smart Device Diagnostics

The Cisco Smart Call Home provides continuous self-monitoring of critical devices and automated remediation recommendations if a problem arises. It offers automatic notification to both you and the Cisco TAC to help expedite problem resolution. Customers who have enabled a qualified collector in their network can also enjoy the benefits of SmartData Advantage, which provides secure and automatic transmission of device details and support information for case creation. These capabilities work to speed time to resolution.

- Mobile App

Use your smartphone or tablet to get access to the Cisco TAC and support information from wherever you are. The information you need to manage service coverage, problem resolution, alerts, and more is at your fingertips from your mobile device.

Getting Started

What's New

Feature Story

Collaborate

Compute

Security

Connect

Switches

Wireless

Routers

Services

Support Essentials

Smart Net Total Care

Software Support

## Security and Product Alerts

Staying current about Cisco alerts regarding security recommendations, device updates, and software updates can be challenging. Cisco SNTC helps preempt network disruption by allowing you to identify and manage relevant alerts for your devices. It proactively identifies which devices are affected by Cisco published product alerts and security advisories and enables you to document alert-related activity. For example, you can flag a device for immediate action, ignore an alert for a device, or enter status information for future reference.

### ● Hardware Alerts

Hardware alerts inform you about devices that have reached or are approaching end of life in your network.

### ● Software Alerts

Software alerts inform you about end-of-life issues with specific software versions you are using.

### ● Security Alerts

Security alerts are Product Security Incident Response Team (PSIRT) alerts that inform you about security vulnerabilities associated with specific devices in your network.

### ● Field Notices

Field notices inform you about significant issues (other than security vulnerability issues) with a hardware device or software version. A field notice often requires customer action such as an RMA.

An alert management workflow helps you more efficiently manage alerts by allowing you to assign status information to alerts. It then filters future alerts so that you receive only those that still require your attention. For example, an alert can be closed, or its status can be changed to “action taken.” In either case, you will not be distracted by that alert in the future. Alert status information also makes it easy for supervisors to monitor their team’s progress toward desired goals as they work on reviewing alerts and performing the required actions.

[Getting Started](#)[What's New](#)[Feature Story](#)[Collaborate](#)[Compute](#)[Security](#)[Connect](#)[Switches](#)[Wireless](#)[Routers](#)[Services](#)[Support Essentials](#)[Smart Net Total Care](#)[Software Support](#)

### Service Coverage Management

Without good visibility into your service coverage, there is a risk that an uncovered device will have an outage, and then you'll be scrambling to find a solution while your network is compromised. Cisco SNTC helps you ensure that your business-critical assets have the necessary service coverage to meet business needs and comply with corporate policies.

Cisco SNTC provides automated installed base and contract management functionality to help you streamline the process of ensuring proper coverage for your Cisco devices. Whereas manual methods of tracking service coverage for large or complex networks can be time consuming and prone to error, Cisco SNTC uses automation to save time and reduce risk. Regular installed base collection and flexible reporting capabilities help you manage your Cisco installed base and service contracts, identifying and tracking what's new, what's changed, what's covered, and what's not.

Maintaining up-to-date records about the coverage of your installed base also simplifies your renewal and budget planning processes. Cisco SNTC enables you to quickly identify service contracts that will be expiring at various intervals so that you can plan for renewals and identify budget requirements.

#### Service Coverage Reports

Device data from installed base collections can be matched against service contracts and purchase orders to identify coverage gaps. View all service contracts and coverage levels, including 24-month advance visibility into upcoming renewal dates. Reviewing coverage information can help ensure that devices in your network have the right kind of coverage for their intended use.

#### Service Coverage and Renewal Management Workflow

This feature gives you the ability to document and annotate those devices that do not require service coverage and why. You can also assign tasks to people responsible for architectural or budget planning to ask for recommendations about renewing coverage versus replacing specific devices before their service contracts expire.

Getting Started

What's New

Feature Story

Collaborate

Compute

Security

Connect

Switches

Wireless

Routers

Services

Support Essentials

Smart Net Total Care

Software Support





Getting Started

What's New

Feature Story

Collaborate

Compute

Security

Connect

Switches

Wireless

Routers

Services

Support Essentials

Smart Net Total Care

Software Support

### Product Lifecycle Management

Maintaining up-to-date installed base data in Cisco SNTC can provide dramatic efficiencies over manual methods while also reducing the risk of errors. Cisco SNTC can help you maintain a current view of your Cisco installed base, including device and configuration details such as serial number, product ID, Cisco IOS Software version, installed memory and firmware, IP address, hostname, and more.

By providing enhanced visibility into your installed base, Cisco SNTC allows you to:

- Quickly identify Cisco products that are reaching end of life, end of sale, or end of support
- Easily see what has been moved, added, or changed in your network
- Verify that your Cisco hardware is running current, consistent, and supported software versions
- Mitigate risk and plan for upgrades for equipment that is no longer supported

Smart capabilities within Cisco SNTC portal can enhance and control product and lifecycle visibility.

### Role-based Access Control (RBAC)

Cisco SNTC portal gives you control over the types of data that users can see. User views within the portal are based on the user's role, allowing administrators to assign roles and designate network device data visibility for portal users, including partners. For example, a certain group of network administrators may be given access to data for a specific segment of the network, and other groups of users may be restricted to specific types of information such as device configuration data or security alerts.

### Device Data File Uploads

In addition to data uploads from the Cisco collector, data can be uploaded using manual file uploads (such as from a spreadsheet) or third-party collection mechanisms. After data is uploaded into the portal, it can be analyzed and enriched with Cisco support information.



## Overview

## Features

## For Partners

## How Should I Address Common Objections?



Why should I purchase Cisco SNTC when I have the Cisco warranty?



Cisco SNTC is much more than just a warranty. Our services provide expert troubleshooting support, advanced hardware replacement options, and extensive self-help, along with smart capabilities that empower your network operations and support staff to work more efficiently.



Why is the installed base process necessary? Don't you already know what is covered and not covered in my network?



Customers have complete freedom to purchase equipment and services through any number of channel partners, or they might have obtained equipment through acquisitions. Network devices are constantly moved to different locations or reconfigured to meet changing business needs. The collection process helps to reconcile equipment with contract records and invoicing, providing an up-to-date baseline from which contract status and coverage can be managed more effectively.



Doesn't Cisco publish security alerts on the web?



Yes, but determining which ones apply to the devices in your network is challenging. Cisco SNTC can show you the specific alerts and updates that are relevant to the devices in your network and provide a workflow to help you manage them.



I have a good handle on my Cisco inventory.



Cisco SNTC installations have 90+ percent visibility, with smart capabilities that correlate installed base, contracts, and alerts into actionable information. Customers can benefit from this information to plan and budget contracts and device lifecycles, manage alerts, and improve incident management. In addition, the automated methods of collecting and managing information about your inventory can create substantial savings by eliminating the need for manual processes.



Doesn't Cisco publish hardware and software alerts that tell me which devices have reached end of life?



Yes, but determining which ones apply to the devices in your network is challenging. Cisco SNTC can show you lifecycle-related information so you can easily see if you have these devices in your network. This also includes devices that are scheduled to reach end of service or end of life, aiding in budget planning and helping to minimize surprises.

Getting Started

What's New

Feature Story

Collaborate

Compute

Security

Connect

Switches

Wireless

Routers

Services

Support Essentials

Smart Net Total Care

Software Support

Overview

Features

For Partners

Complete Software Support Keeps Your Systems Running Smoothly

The Cisco Software Support Service (SWSS) offers comprehensive coverage for the software application products and suites that keep your systems and your business running smoothly.

Cisco SWSS is a single offer that provides end-to-end support for your Cisco software products. Entitlement to software maintenance, minor, and major release updates helps increase business value and ROI for your Cisco software products. Cisco SWSS is required for a minimum of 12 months to help you reduce network disruptions and application availability.

Access Cisco technical experts and online resources 24 hours a day, 365 days a year. Take advantage of multiyear discounts to keep your network performing as needed.

The following options are available under the Cisco SWSS framework:

Basic

Provides TAC support, software release updates, and online access to Cisco resources. When sold as a subscription, the support is embedded in the product purchase price.

Enhanced

Provides proactive software support and technical adoption with faster response times

Premium

Prescriptive software support, designated service management, advanced technical adoption, and the fastest response times.



Seamless Support Experience across Hybrid Deployments



Faster Deployment and Adoption of Your Software



Improved Time to Detect and Solve Incidents



Accelerated Business Outcomes



Advice and Support on Specific, Business Impactful Software Features



Increased Return on Your Technology Investment



Higher Levels of Proactive Customized Support to Achieve Your Business Objectives



Increased Security Posture

Getting Started

What's New

Feature Story

Collaborate

Compute

Security

Connect

Switches

Wireless

Routers

Services

Support Essentials

Smart Net Total Care

Software Support

## Services - Cisco Technical Services

# Cisco Software Support Service



## Overview

## Features

## For Partners

Deliverable		Software Support Options		
		Basic	Enhanced	Premium
Software Technical Support	24 x 7 case submission and technical assistance.	●	●	●
Initial Response	Response-time service-level objective for every 1 and 2 cases.	60 minutes	30 minutes	15 minutes
Software Updates	Access to available software maintenance and to minor and major updates to the supported product.	●	●	●
Knowledge Base and Online Resources	Online access to standard adoption materials, marketing materials, all support tools, and product knowledge.	●	●	●
Prioritized Case Handling	Priority handling of cases by software support option.	-	Prioritized case handling over Basic tier	Prioritized case handling over Basic tier
Software Configuration Guidance	Support and guidance for software deployment, updates, migration, and performance maintenance.	-	●	●
Direct Access to Experts	Direct access to technical support experts.	-	●	●
User Adoption	Identification of customer adoption priorities by product, with use cases based on customer business processes and practices. Creation of user adoption plan with periodic plan reviews.	- <sup>*1</sup>	●	●
Technical Adoption Support for Software Integration	Support for integrating and deploying software into the IT environment. Includes initial training on best practices for interacting with Cisco technical support, ongoing guidance for supporting internal users, and periodic system risk evaluations.	-	●	●
Learning and Training	Recommendations for pertinent learning and training available on Cisco.com or the Cisco learning services website.	-	●	●
Advanced Technical Adoption Business Reviews	Review of the customer's business against the adoption plan to see how the customer is tracking against Key Performance Indicators (KPIs), plus feature usage, training, and creation of a plan for the next quarter.	-	2x/year	4x/year
Designated Service Management	Assigned expert with specialized technical knowledge of the customer's Cisco software solution. Product-level expert providing incident management, case escalation management, and change management. Provides product-level support geared toward the customer's specific environment, including proactive consultation for integrating software features into customer workflows; advice on upgrades, migrations, and expansions; and software configuration reviews and recommendations to reduce service disruptions.	-	-	●
Advanced Support Analytics	Support case analysis for Severity 1 and 2 issues, with best practices to reduce support cases. Periodic technical reviews of overall operational performance.	-	-	●

\*1 User adoption services are provided with some subscriptions. Entitlement may vary.

Getting Started

What's New

Feature Story

Collaborate

Compute

Security

Connect

Switches

Wireless

Routers

Services

Support Essentials

Smart Net Total Care

Software Support

Overview

Features

For Partners

How Should I Address Common Objections?

No budget

- Flexible options to fit your needs and budget
- Cisco Capital Financing can help

Why purchase?

- Investment protection
- Faster time to resolve issues
- Software updates

Why should I buy Enhanced?

- Achieve better product usage
- Reduces risks and complexities
- Accelerate business outcomes
- Faster ROI

Why should I buy Premium?

- Optimize use
- Speed issue resolution
- Fastest time to value and ROI
- Alignment to business outcomes

I already have SWSS

- SWSS is a great foundational offer and is the equivalent of the Basic option of Cisco Software Support Service

I have Cisco Smart Net Total Care Doesn't it cover my software?

- Cisco Smart Net Total Care only covers the base operating system not the applications

Getting Started

What's New

Feature Story

Collaborate

Compute

Security

Connect

Switches

Wireless

Routers

Services

Support Essentials

Smart Net Total Care

Software Support





---

**Americas Headquarters**  
Cisco Systems, Inc.  
San Jose, CA

**Asia Pacific Headquarters**  
Cisco Systems (USA) Pte. Ltd.  
Singapore

**Europe Headquarters**  
Cisco Systems International BV Amsterdam,  
The Netherlands

Cisco has more than 200 offices worldwide. Addresses, phone numbers, and fax numbers are listed on the Cisco Website at [www.cisco.com/go/offices](http://www.cisco.com/go/offices).

---

 Cisco and the Cisco logo are trademarks or registered trademarks of Cisco and/or its affiliates in the U.S. and other countries. To view a list of Cisco trademarks, go to this URL: [www.cisco.com/go/trademarks](http://www.cisco.com/go/trademarks). Third party trademarks mentioned are the property of their respective owners. The use of the word partner does not imply a partnership relationship between Cisco and any other company. (1110R)