



This product has been discontinued

Cisco UCS C480 ML M5 Purpose Built Server for Deep Learning



CISCO SYSTEMS
170 WEST TASMAN DR.
SAN JOSE, CA, 95134
WWW.CISCO.COM

PUBLICATION HISTORY

REV A.29 SEPTEMBER 28, 2021

CONTENTS

OVERVIEW	5
DETAILED VIEWS	6
Chassis Front View	6
UCS C480 ML M5 Server Rear Panel Features	8
BASE SERVER STANDARD CAPABILITIES and FEATURES	9
CONFIGURING the SERVER	12
STEP 1 VERIFY BASE SKU	13
STEP 2 CHOOSE CPU(S)	14
STEP 3 CHOOSE MEMORY	16
STEP 4 CHOOSE DRIVE MODULES and DRIVES (OPTIONAL)	25
STEP 5 CHOOSE RAID CONFIGURATION	29
STEP 6 CHOOSE PCIe OPTION CARD(S)	31
STEP 7 ORDER OPTIONAL PCIe OPTION CARD ACCESSORIES	32
STEP 8 ORDER OPTICAL DRIVE (OPTIONAL)	33
STEP 9 ORDER SECURE DIGITAL CARDS or M.2 DEVICES (OPTIONAL)	34
STEP 10 ORDER INTERNAL MICRO-SD CARD MODULE (OPTIONAL)	37
STEP 11 ORDER POWER SUPPLIES	38
STEP 12 SELECT AC POWER CORD(s)	39
STEP 13 ORDER OPTIONAL CABLE MANAGEMENT ARM	42
STEP 14 ORDER SECURITY DEVICES (OPTIONAL)	43
STEP 15 SELECT MANAGEMENT CONFIGURATION (OPTIONAL)	44
STEP 16 SELECT SERVER BOOT MODE (OPTIONAL)	45
STEP 17 CHOOSE OPERATING SYSTEM AND VALUE-ADDED SOFTWARE	46
STEP 18 SELECT SERVICE and SUPPORT LEVEL	49
SUPPLEMENTAL MATERIAL	55
CHASSIS	55
Serviceable Component Locations Inside the Main Chassis	56
Serviceable Components Inside a CPU Module	58
Serviceable Components Inside an I/O Module	59
CPUs and DIMMs	60
Physical Layout	60
Memory Population Rules	61
Memory Mirroring	62
Memory Support for CPU Classes and CPU Modes	63
For 2nd Generation Intel® Xeon® Scalable Processors:	63
For Intel® Xeon® Scalable Processors:	64
DIMM Population Order	64
KVM CABLE	65
DISCONTINUED EOL PRODUCTS	66
TECHNICAL SPECIFICATIONS	69
Dimensions and Weight	69
Power Specifications	70
Environmental Specifications	71
Compliance Requirements	72

OVERVIEW

The Cisco UCS C480 ML M5, a purpose-built Server for Deep Learning, is a four-rack-unit (4RU) server supporting 2nd Generation Intel® Xeon® Scalable Processors with 8 NVIDIA Tesla V100-32GB Tensor Core GPUs with NVLink Interconnect. It supports 2933-MHz DDR4 memory, and the new Intel® Optane™ Persistent Memory (PMEMs). With this combination of features, up to 7.5 TB of memory is possible (using 12 x 128 GB DDR4 DIMMs and 12 x 512 GB PMEMs), up to 24 small form factor (SFF) hot-swappable² SAS/SATA SSD/HDD, up to 6 PCIe NVMe disk drives and upto two internal M.2 drives.

4 PCI Express (PCIe) expansion slots support Cisco UCS C-Series and partner network adapters, with additional I/O provided by two 10Gbase-T LOM ports and one 1GbE dedicated out-of-band (OOB) management port. A separate PCIe slot is reserved inside the chassis for a RAID controller card

Figure 1 Cisco UCS C480 ML M5 Purpose Built Deep Learning Server
Front View



Rear View



NOTES:

1. A maximum of 3 TB memory is available using 128 GB DIMMs.

2. Hot-swap replacement means that you do not have to precondition or shut down the component in software before you remove it.

DETAILED VIEWS

Chassis Front View

Figure 2 is a detailed front view of the Cisco UCS C480 ML M5 Deep Learning Rack Server.

Figure 2 Chassis Front View

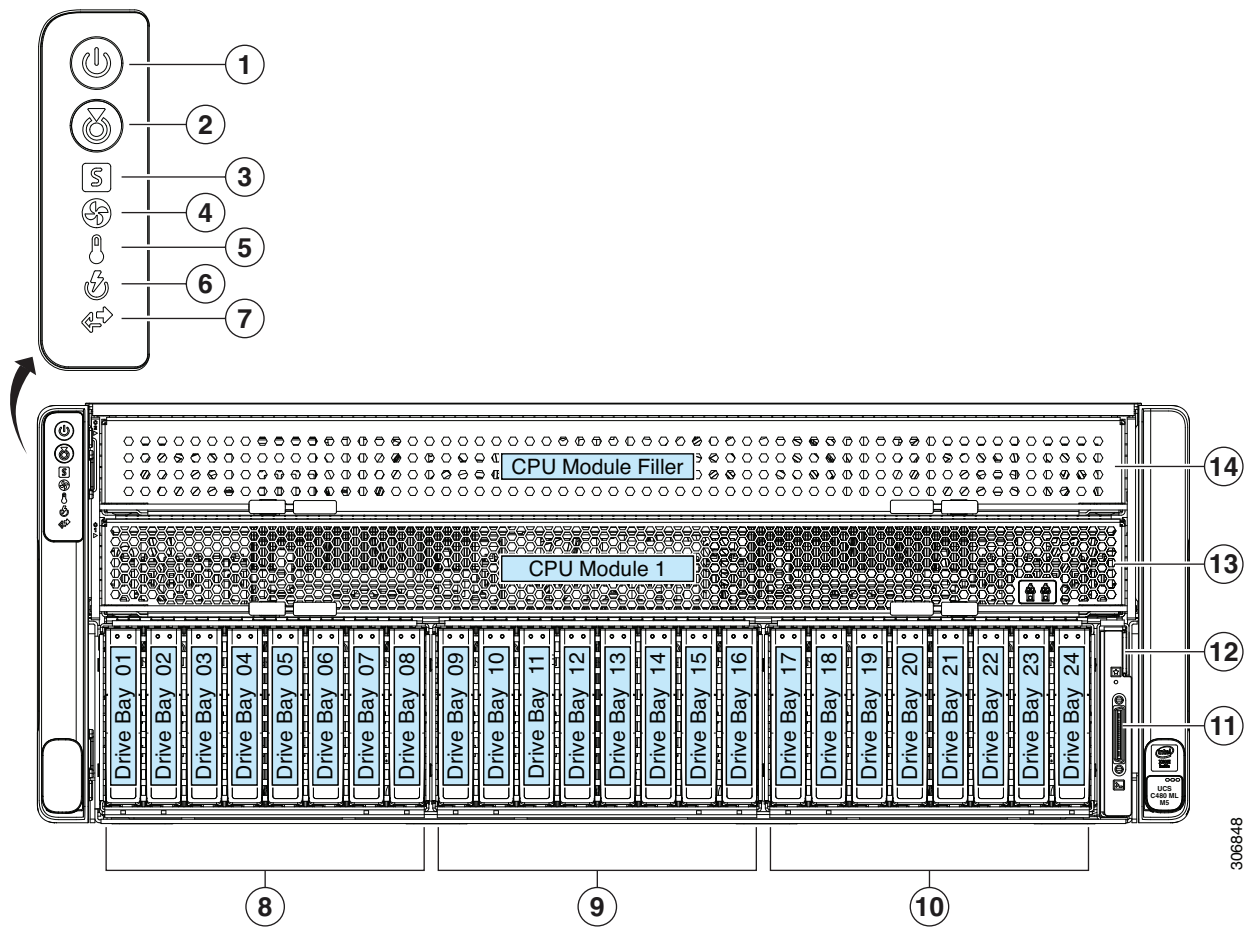

1	Power button/LED	8	Left bay module (drive bays 1 - 8) <ul style="list-style-type: none"> ■ All 8 bays supports SAS/SATA drives. ■ Bays 1, 2, 7, 8 also support NVMe drives.
---	------------------	---	--

2	Identification button/LED	9	Center bay module (drive bays 9 - 16) <ul style="list-style-type: none"> ■ All 8 bays supports SAS/SATA drives. ■ Bay 9 also supports NVMe drives.
3	System status LED	10	Right bay module, supports either: <ul style="list-style-type: none"> ■ Optional DVD drive module ■ Drive bays 17 - 24 (shown) <ul style="list-style-type: none"> • All 8 bays supports SAS/SATA drives. • Bay 17 also supports NVMe drives.
4	Fan status LED	11	KVM console connector (used with a KVM cable that provides two USBs, one VGA, and one serial connector) ¹
5	Temperature status LED	12	Pull-out asset tag
6	Power supply status LED	13	CPU module bay 1 The system must have one CPU module in lower bay 1 to boot.
7	Network link activity LED	14	CPU module bay 2 (blank with filler module) There must be a blank filler module in upper bay 2 or the system will not boot.

Notes:

1. For more details on the KVM connector, see [KVM CABLE on page 65](#).

UCS C480 ML M5 Server Rear Panel Features

Figure 3 shows the features of the rear panel.

Figure 3 UCS C480 ML M5 Server Rear Panel

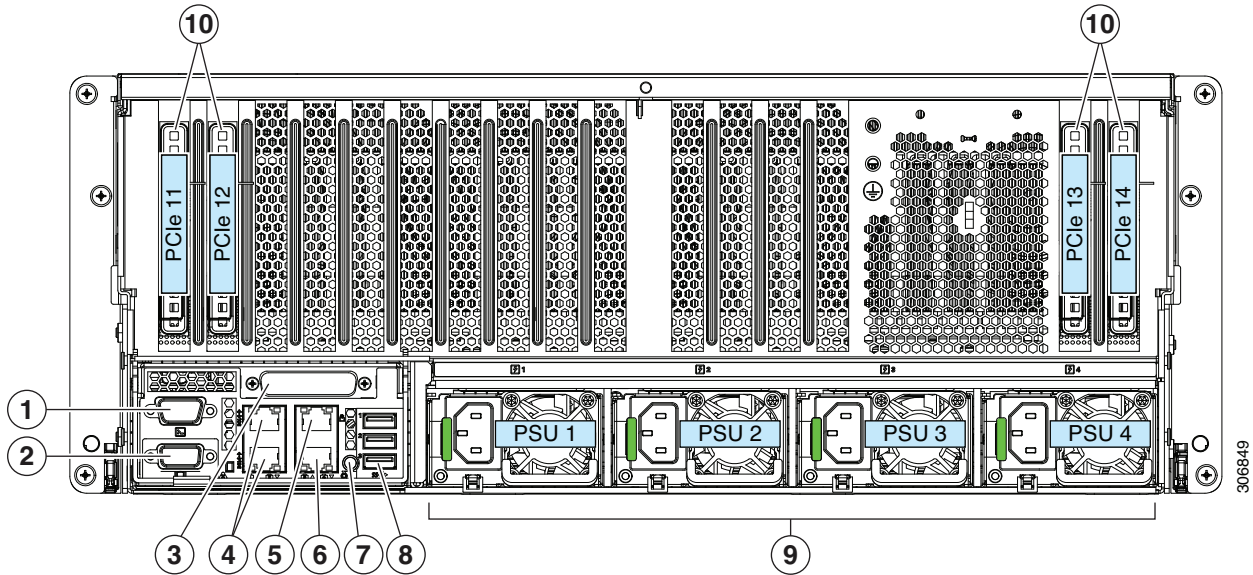

1	Serial port COM 1 (DB-9 connector)	7	Rear identification button/LED
2	VGA video port (DB-15 connector)	8	USB 3.0 ports (three)
3	<i>Not used at this time</i>	9	Power supplies 1-4 (hot-swappable, redundant as 3+1)
4	1-Gb/10-Gb Ethernet ports (LAN1 upper, LAN2 lower) The dual LAN ports can support 1 Gbps and 10 Gbps, depending on the link-partner capability.	10	PCIe slots 11-14 for Network Adapter
5	10/100/1000 Ethernet dedicated management port (Base-T)	–	–
6	<i>Not used at this time</i>	–	–

BASE SERVER STANDARD CAPABILITIES and FEATURES

Table 1 lists the capabilities and features of the base server. Details about how to configure the server for a particular feature or capability (for example, number of processors, disk drives, or amount of memory) are provided in *CONFIGURING the SERVER on page 12*.

Table 1 Capabilities and Features

Capability/Feature	Description
Chassis	Four rack unit (4RU) chassis
GPUs	8 NVIDIA Tesla V100-32GB Tensor Core GPUs with NVLink Interconnect
CPU	2nd Generation Intel® Xeon® scalable processor family CPUs.
Chipset	Intel® C621 series chipset
Memory	24 DIMM slots and support for Intel® Optane™ Persistent Memory (PMEMs)
Mullti-bit error protection	This server supports multi-bit error protection
Expansion slots	<p>There are 4 full-height full-length PCIe expansion slots:</p> <ul style="list-style-type: none"> ■ Slot Marked 11: CPU1 controlled, Gen-3 x16, FL, FH, NCSI, VIC ■ Slot Marked 12: CPU1 controlled, Gen-3 x16, FL, FH, NCSI, VIC ■ Slot Marked 13: CPU2 controlled, Gen-3 x16, FL, FH, NCSI, VIC ■ Slot Marked 14: CPU2 controlled, Gen-3 x16, FL, FH, NCSI, VIC
<div style="display: flex; align-items: center;">  <p>NOTE: UCS C480 ML M5 ships with dual CPUs</p> </div>	
Storage controller	<p>For front-loading drives:</p> <ul style="list-style-type: none"> ■ UCSC-RAID-M5HD is an internally mounted Cisco 12G Modular RAID controller with a 4GB cache with a supercap cache backup (UCSC-SCAP-M5). It is used for controlling the SAS/SATA drives in the front drive bays. It cannot control NVMe drives in the front drive bays. ■ NVMe drives in the front drive bays are controlled directly from the PCIe interfaces on the CPUs.
RAID backup	<p>The system supports supercap power modules (SCPMs):</p> <ul style="list-style-type: none"> ■ Front-loading drive bay controller (UCSC-RAID-M5H)—the SCPM mounting bracket is on the chassis wall near the front RAID controller socket.
DVD drive option	Front-loading drive bay 3 can optionally be replaced with a DVD drive module.

Table 1 Capabilities and Features (continued)

Capability/Feature	Description
Internal storage devices	<p>The server can hold up to 24 2.5-inch drives:</p> <ul style="list-style-type: none"> ■ Front drive bays are divided across three removable drive bay modules. Each drive bay module has 8 drive bays for a total of 24 front-loading drive bays. <ul style="list-style-type: none"> • All 24 front drive bays support SAS/SATA drives. • Each of the three drive bay modules has slots that support NVMe SSDs as well as SAS/SATA drives, for a total of 6 bays that support NVMe SSDs. • Drive Bay 1 can have upto 4 NVMe drives while Drive Bay 2 and Drive Bay3 can have 1 NVMe drive each at designated slots. <p>SAS and SATA drives are hot-swappable¹; NVMe drives are hot-pluggable²</p>
Internal removable media	<ul style="list-style-type: none"> ■ A mini-storage module connector on the motherboard supports either: <ul style="list-style-type: none"> • An M.2 module with two SATA M.2 SSD slots. Mixing different capacity modules is not supported. • An SD card module with two SD card slots. Mixing different capacity SD cards is not Supported ■ One USB 2.0 port on the chassis motherboard.
ACPI	This server supports the advanced configuration and power interface (ACPI) 6.2
Video	<ul style="list-style-type: none"> ■ Resolution up to 1600 x1200, 16 bpp at 60 Hz. Up to 256 MB of video memory.
Interfaces	<ul style="list-style-type: none"> ■ Rear panel <ul style="list-style-type: none"> • One 10/100/1000 dedicated management Ethernet port • Two 10 Base-T Gbps Ethernet ports • One RS-232 serial port (DB-9 connector) • One VGA video port (DB-15 connector) • Three USB 3.0 connectors ■ Front panel <ul style="list-style-type: none"> • One KVM connector (used with the included KVM cable, which provides two USB, one VGA, and one serial connector)
Power subsystem	<ul style="list-style-type: none"> ■ Power supplies are hot-swappable and rear-accessible. Default to redundant 3+1 ■ 1600 W AC power supply



For more information about your server’s power consumption, use the power calculator accessible at

<http://ucspowercalc.cisco.com>

Table 1 Capabilities and Features (*continued*)

Capability/Feature	Description
Fans	<p>Chassis:</p> <ul style="list-style-type: none"> ■ 4 fans modules with 2 fans each, hot-swappable <p>Power supply:</p> <ul style="list-style-type: none"> ■ Each power supply is equipped with a fan.
Baseboard management	<p>Cisco Integrated Management Controller (Cisco IMC) firmware.</p> <p>Depending on your settings, the Cisco IMC can be accessed through the 10/100/1000 dedicated management ports, the 10 GBase-T LOM ports, or a Cisco virtual interface card.</p>
Integrated management processor	<p>The built-in Cisco Integrated Management Controller (CIMC) GUI or CLI interface enables you to monitor the server inventory, health, and system event logs.</p>

Notes:

1. Hot-swappable = No preconditioning of the component is required before removal while the server is powered on.
2. Hot-pluggable = The component must be shut down in the operating system before removal while the server is powered on.

CONFIGURING the SERVER

Follow these steps to configure the Cisco UCS C480 ML M5 Purpose Built Deep Learning Server

- [STEP 1 VERIFY BASE SKU, page 13](#)
- [STEP 2 CHOOSE CPU\(S\), page 14](#)
- [STEP 3 CHOOSE MEMORY, page 16](#)
- [STEP 4 CHOOSE DRIVE MODULES and DRIVES \(OPTIONAL\), page 25](#)
- [STEP 5 CHOOSE RAID CONFIGURATION, page 29](#)
- [STEP 6 CHOOSE PCIe OPTION CARD\(S\), page 31](#)
- [STEP 7 ORDER OPTIONAL PCIe OPTION CARD ACCESSORIES, page 32](#)
- [STEP 9 ORDER SECURE DIGITAL CARDS or M.2 DEVICES \(OPTIONAL\), page 34](#)
- [STEP 10 ORDER INTERNAL MICRO-SD CARD MODULE \(OPTIONAL\), page 37](#)
- [STEP 11 ORDER POWER SUPPLIES, page 38](#)
- [STEP 12 SELECT AC POWER CORD\(s\), page 39](#)
- [STEP 13 ORDER OPTIONAL CABLE MANAGEMENT ARM, page 42](#)
- [STEP 14 ORDER SECURITY DEVICES \(OPTIONAL\), page 43](#)
- [STEP 15 SELECT MANAGEMENT CONFIGURATION \(OPTIONAL\), page 44](#)
- [STEP 16 SELECT SERVER BOOT MODE \(OPTIONAL\), page 45](#)
- [STEP 17 CHOOSE OPERATING SYSTEM AND VALUE-ADDED SOFTWARE, page 46](#)

STEP 1 VERIFY BASE SKU

Verify the product ID (PID) of the base server as shown in [Table 2](#).

Table 2 PID of the Base C480 ML M5 Rack Server

Product ID (PID)	Description
UCSC-C480-M5ML8	Chassis w/8GPU, NoPSU, NoRAID/cable, NoHDDmod, NoCPUmod

The base server:

■ Includes:

- 8 NVIDIA Tesla V100-32GB Tensor Core GPUs with NVLink Interconnect
- Blanking panels for empty drive locations (to maintain cooling air flow)
- Rail kit

■ Does not include:

- CPUs
- DIMMs
- Intel® Optane™ Persistent Memory (PMEMs)
- Power supplies
- Hard disk drives (HDDs)
- Solid-state Drives (SSDs)
- Plug-in PCIe cards



NOTE: Use the steps on the following pages to configure the server with the components that you want to include.

STEP 2 CHOOSE CPU(S)

The standard CPU features are:

- 2nd Generation Intel® Xeon® scalable processor family CPUs.
- Intel C621 series chipset
- Up to 28 cores per processor, for a total of up to 56 cores per server

Select One CPU Module and Two CPUs

Product ID (PID)	Description
UCSC-C480-CM	UCS C480 ML M5 CPU Module w/o CPU, mem

The available CPUs are listed in [Table 3](#).

Table 3 Available Intel CPUs

Product ID (PID)	Clock Freq (GHz)	Power (W)	Cache Size (MB)	Cores	UPI ¹ Links (GT/s)	Highest DDR4 DIMM Clock Support (MHz) ²	Processor Type
Cisco Recommended Processors³ (2nd Generation Intel® Xeon® Processors)							
UCS-CPU-I6248	2.5	150	27.50	20	3 x 10.4	2993	VDI, Oracle, SQL, Virtualization, Microsoft Azure Stack, Splunk, Data Protection
UCS-CPU-I5218	2.3	125	22.00	16	3 x 10.4	2666	
UCS-CPU-I6230	2.1	125	27.50	20	3 x 10.4	2933	
UCS-CPU-I5220	2.2	125	24.75	18	3 x 10.4	2666	Big Data, Virtualization
8000 Series Processor							
UCS-CPU-I8280	2.7	205	38.50	28	3 x 10.4	2933	2 nd Gen Intel® Xeon®
6000 Series Processor							
UCS-CPU-I6254	3.1	200	24.75	18	3 x 10.4	2933	2 nd Gen Intel® Xeon®
UCS-CPU-I6248	2.5	150	27.50	20	3 x 10.4	2993	2 nd Gen Intel® Xeon® ⁴
UCS-CPU-I6244	3.6	150	24.75	8	3 x 10.4	2933	2 nd Gen Intel® Xeon®
UCS-CPU-I6242	2.8	150	22.00	16	3 x 10.4	2933	2 nd Gen Intel® Xeon®
UCS-CPU-I6230	2.1	125	27.50	20	3 x 10.4	2933	2 nd Gen Intel® Xeon®
5000 Series Processor							
UCS-CPU-I5220	2.2	125	24.75	18	3 x 10.4	2666	2 nd Gen Intel® Xeon®
UCS-CPU-I5218	2.3	125	22.00	16	3 x 10.4	2666	2 nd Gen Intel® Xeon®

Notes:

1. UPI = Ultra Path Interconnect

2. If higher or lower speed DIMMs are selected than what is shown in the table for a given CPU, the DIMMs will be clocked at the lowest common denominator of CPU clock and DIMM clock.
3. For details on memory support for processor classes and CPU modes, see [Memory Support for CPU Classes and CPU Modes on page 63](#).
4. For 2nd Generation Intel® Xeon® Scalable Processor, UCSM 4.0(4b) software release is required.

Approved Configurations

(1) Two-CPU Configuration Only

- Must choose two identical CPUs from any one of the rows of [Table 3 on page 14](#)
- CPUs 1 and 2 should always will be populated.



NOTE: See [CHOOSE MEMORY on page 16](#) for details on the compatibility of CPUs and DIMM speeds.

STEP 3 CHOOSE MEMORY

The standard memory features are:

- Clock speed: 2933 MHz depending on CPU type



NOTE: The compatibility of Intel® Xeon® scalable processor family CPUs and 2nd Generation Intel® Xeon® Scalable CPUs with different DIMM memory speeds and production servers is as shown below:

CPU Family	DIMM Speed (MHz)	Configuration
Intel Scalable CPUs	2666	2666 MHz DIMMs are supported for all production servers
	2933	2933 MHz DIMMs are not supported for new production servers
2 nd Gen Intel Scalable CPUs	2666	2666 MHz DIMMs are only supported when upgrading from Intel Scalable CPUs to 2 nd Gen Intel Scalable CPUs
	2933	2933 MHz is the only DIMM speed supported for new production servers

- Ranks per DIMM: 1, 2, 4, or 8
- Operational voltage: 1.2 V
- Registered ECC DDR4 DIMMS (RDIMMs), Load-reduced DIMMs (LRDIMMs) or Intel® Optane™ Persistent Memory (PMEMs).
- New purchases with 2nd Generation Intel Scalable CPUs need to be configured with 2933-MHz DIMMs.

Memory is organized with six memory channels per CPU, with up to two DIMMs per channel, as shown in [Figure 4](#).

Figure 4 C480 M5 Memory Organization

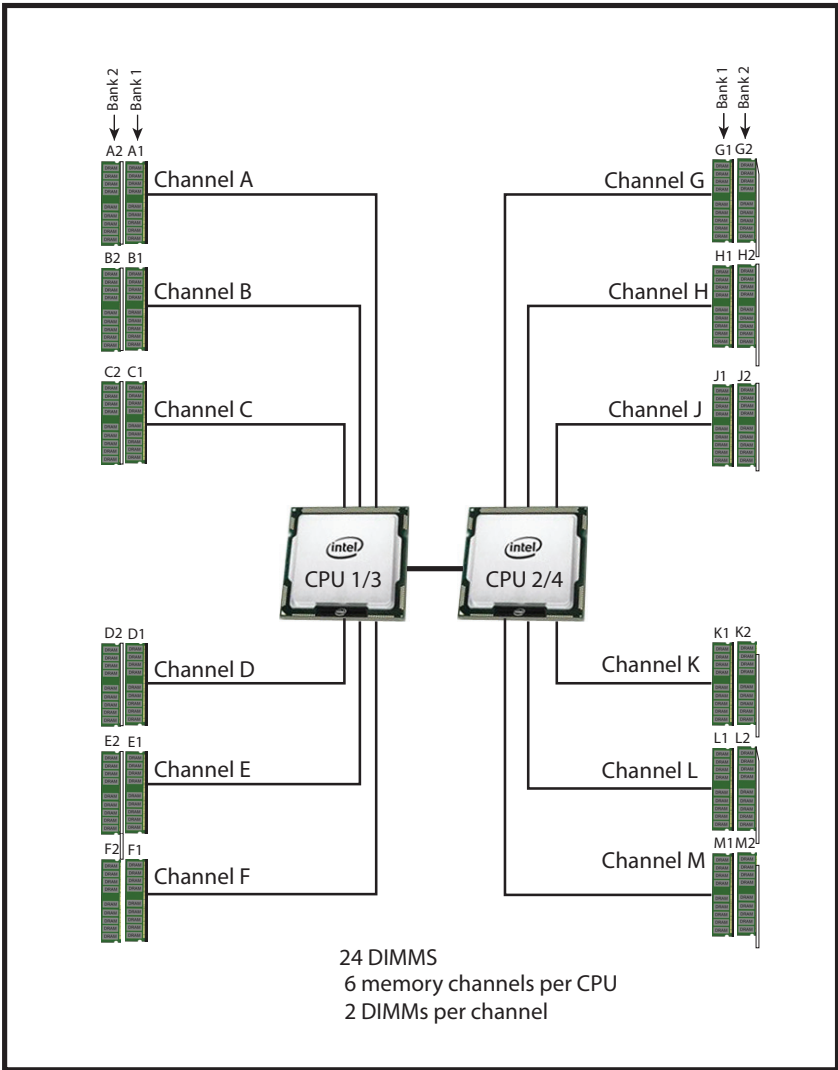

Select DIMMs, PMEM and Memory Mirroring

Select the memory configuration and whether or not you want the memory mirroring option. The supported memory DIMMs and the mirroring option are listed in [Table 4](#).

Table 4 Available DDR4 DIMMs

Product ID (PID)	PID Description	Voltage	Ranks /DIMM
2933-MHz			
UCS-ML-128G4RT-H	128 GB DDR4-2933-MHz LRDIMM/4Rx4 (16Gb) 1.2v	1.2 V	4
UCS-ML-X64G4RT-H	64 GB DDR4-2933-MHz LRDIMM/4Rx4 (8Gb) 1.2v	1.2 V	4
UCS-MR-X64G2RT-H	64 GB DDR4-2933-MHz RDIMM/2Rx4 (16Gb) 1.2v	1.2 V	2
UCS-MR-X32G2RT-H	32GB DDR4-2933-MHz RDIMM/2Rx4 (8Gb) 1.2v	1.2 V	2
UCS-MR-X16G1RT-H	16GB DDR4-2933-MHz RDIMM/1Rx4/1.2v	1.2 V	1
Intel® Optane™ Persistent Memory Product			
UCS-MP-128GS-A0	Intel® Optane™ Persistent Memory, 128GB, 2666MHz		
UCS-MP-256GS-A0	Intel® Optane™ Persistent Memory, 256GB, 2666MHz		
Intel® Optane™ Persistent Memory Product Operational Modes			
UCS-DCPMM-AD	App Direct Mode		
UCS-DCPMM-MM	Memory Mode		
Memory Mirroring Option			
N01-MMIRROR	Memory mirroring option		



NOTE:

- Based on the Intel tech spec, the below DIMMs be used with the 1st Generation Intel® Xeon® scalable processor family CPUs and the 2nd Generation Intel® Xeon® scalable processor family CPUs
 - UCS-MR-X16G1RT-H
 - UCS-MR-X32G2RT-H
 - UCS-ML-X64G4RT-H
- Based on the Intel tech spec, the below DIMMs can be used only with 2nd Generation Intel® Xeon® scalable processor family CPUs, not with Intel® Xeon® scalable processor family CPUs.
 - UCS-ML-128G4RT-H
 - UCS-MR-X64G2RT-H

DIMM Memory Mirroring

When memory mirroring is enabled, the memory subsystem simultaneously writes identical data to two adjacent channels. If a memory read from one of the channels returns incorrect data due to an uncorrectable memory error, the system automatically retrieves the data from the other channel. A transient or soft error in one channel does not affect the mirrored data, and operation continues unless there is a simultaneous error in exactly the same location on a DIMM and its mirrored DIMM. Memory mirroring reduces the amount of memory available to the operating system by 50% because only one of the two populated channels provides data.

CPU Configuration Without Memory Mirroring

Select from 4, 6, 8, or 12 DIMMs per CPU (DIMMs for all four CPUs must be configured identically). The DIMMs will be placed in each CPU module by the factory as shown in the following tables.

#DIMMs	CPU 1/3 DIMM Placement in Channels (for identically ranked DIMMs)
4	(A1, B1); (D1, E1)
6	(A1, B1, C1); (D1, E1, F1)
8	(A1, A2, B1, B2); (D1, D2, E1, E2)
12	(A1, A2, B1, B2, C1, C2); (D1, D2, E1, E2, F1, F2)

#DIMMs	CPU 2/4 DIMM Placement in Channels (for identically ranked DIMMs)
4	(G1, H1); (K1, L1)
6	(G1, H1, J1); (K1, L1, M1)
8	(G1, G2, H1, H2); (K1, K2, L1, L2)
12	(G1, G2, H1, H2, J1, J2); (K1, K2, L1, L2, M1, M2)

CPU Configuration With Memory Mirroring

Select from 4, 6, 8, or 12 DIMMs per CPU (DIMMs for all four CPUs must be configured identically). In addition, the memory mirroring option (N01-MMIRROR) as shown in [Table 4 on page 18](#) must be selected.

The DIMMs will be placed by the factory as shown in the following tables.

#DIMMs	CPU 1/3 DIMM Placement in Channels (for identical ranked DIMMs)	CPU 2/4 DIMM Placement in Channels (for identical ranked DIMMs)
	CPU 1	CPU 2
8	(A1,B1); (D1,E1)	(G1, H1); (K1, L1)
12	(A1, B1, C1); (D1, E1, F1)	(G1, H1, J1); (K1, L1, M1)
16	(A1, A2, B1, B2); (D1, D2, E1, E2)	(G1, G2, H1, H2); (K1, K2, L1, L2)
24	(A1, A2, B1, B2, C1, C2); (D1, D2, E1, E2, F1, F2)	(G1, G2, H1, H2, J1, J2); (K1, K2, L1, L2, M1, M2)



NOTE: System performance is optimized when the DIMM type and quantity are equal for both CPUs, and when all channels are filled equally across the CPUs in the server.

System Speeds

System speed is dependent on how many DIMMs are populated per channel and the CPU DIMM speed support. See [Table 5](#) for details.

Table 5 2666-MHz DIMM Memory Speeds with Different Intel® Xeon® Scalable Processors

DIMM and CPU Frequencies (MHz)	DPC	TSV-RDIMM (8Rx4) - 128 GB (MHz)	TSV-RDIMM (4Rx4) - 64 GB (MHz)	LRDIMM (4Rx4) - 64 GB (MHz)	RDIMM (2Rx4) - 32 GB (MHz)	LRDIMM (2Rx4) - 32 GB (MHz)
		1.2 V	1.2 V	1.2 V	1.2 V	1.2 V
DIMM = 2666 CPU = 2666	1DPC	2666	2666	2666	2666	2666
	2DPC	2666	2666	2666	2666	2666
DIMM = 2666 CPU = 2400	1DPC	2400	2400	2400	2400	2400
	2DPC	2400	2400	2400	2400	2400
DIMM = 2666 CPU = 2133	1DPC	2133	2133	2133	2133	2133
	2DPC	2133	2133	2133	2133	2133

Table 6 2933-MHz DIMM Memory Speeds with Different 2nd Generation Intel®Xeon® Scalable Processors

DIMM and CPU Frequencies (MHz)	DPC	LRDIMM (4Rx4)- 128 GB (MHz)	LRDIMM (4Rx4) - 64 GB (MHz)	RDIMM (2Rx4) - 64 GB (MHz)	RDIMM (2Rx4) - 32 GB (MHz)
		1.2 V	1.2 V	1.2 V	1.2 V
DIMM = 2933 CPU = 2933	1DPC	2933	2933	2933	2933
	2DPC	2933	2933	2933	2933
DIMM = 2933 CPU = 2666	1DPC	2666	2666	2666	2666
	2DPC	2666	2666	2666	2666
DIMM = 2933 CPU = 2400	1DPC	2400	2400	2400	2400
	2DPC	2400	2400	2400	2400
DIMM = 2933 CPU = 2133	1DPC	2133	2133	2133	2133
	2DPC	2133	2133	2133	2133

Memory Configurations and Modes

DIMM Guidelines

- System speed is dependent on the CPU DIMM speed support. Refer to [Table 4 on page 18](#) for DIMM Speeds
- The C480 M5 server supports four different memory reliability, availability, and serviceability (RAS) modes:
 - Independent Channel Mode
 - Mirrored Channel Mode
 - Lockstep Channel Mode
 - Rank Sparing Mode



NOTE: Mixing of Non-Mirrored and Mirrored mode is not allowed.

- Do not mix RDIMMs, LRDIMMs, and TSV-RDIMMs.
- Single-rank DIMMs can be mixed with dual-rank DIMMs in the same channel
- For best performance, observe the following:
 - DIMMs with different timing parameters can be installed on different slots within the same channel, but only timings that support the slowest DIMM will be applied to all. As a consequence, faster DIMMs will be operated at timings supported by the slowest DIMM populated.

- When one DIMM is used, it must be populated in DIMM slot 1 (farthest away from the CPU) of a given channel.
 - When single or dual rank DIMMs are populated for 2DPC, always populate the higher number rank DIMM first (starting from the farthest slot). For a 2DPC example, first populate with dual rank DIMMs in the DIMM slot 1. Then single-rank DIMMs in the DIMM 2 slot.
- DIMMs for all four CPUs must always be configured identically.
 - Cisco memory from previous generation servers (DDR3 and DDR4) is not compatible with UCS C480 M5 server.



NOTE: System performance is optimized when the DIMM type and quantity are equal for both CPUs, and when all channels are filled equally across the CPUs in the server.

- Memory can be configured in any number of DIMMs as pairs, though for optimal performance, refer to the C480 Memory Guide at Cisco.com.

PMEM Guidelines

- PMEMs require second generation Intel Xeon Scalable Family processors. First generation Xeon Scalable processors do not support PMEMs.
- All installed PMEMs must be the same size. Mixing PMEMs of different capacities is not supported.
- The use of 1Rx8 DIMMs with PMEMs is not supported.
- PMEMs and DIMMs must be populated as shown in [Table 7](#) (6 DIMMs per CPU with 2, 4, or 6 PMEMs per CPU, as shown).

Table 7 2nd Generation Intel® Xeon® Scalable Processor DIMM and PMEM¹ Physical Configurations (quad socket)

DIMM to PMEM Count	CPU 1/3											
	iMC1						iMC0					
	Channel 2		Channel 1		Channel 0		Channel 2		Channel 1		Channel 0	
	F2	F1	E2	E1	D2	D1	C2	C1	B2	B1	A2	A1
6 to 2		DIMM		DIMM	PMEM	DIMM		DIMM		DIMM	PMEM	DIMM
6 to 4		DIMM	PMEM	DIMM	PMEM	DIMM		DIMM	PMEM	DIMM	PMEM	DIMM
6 to 6	PMEM	DIMM	PMEM	DIMM	PMEM	DIMM	PMEM	DIMM	PMEM	DIMM	PMEM	DIMM
DIMM to PMEM Count	CPU 2/4											
	iMC1						iMC0					
	Channel 2		Channel 1		Channel 0		Channel 2		Channel 1		Channel 0	
	M2	M1	L2	L1	K2	K1	J2	J1	H2	H1	G2	G1
6 to 2		DIMM		DIMM	PMEM	DIMM		DIMM		DIMM	PMEM	DIMM
6 to 4		DIMM	PMEM	DIMM	PMEM	DIMM		DIMM	PMEM	DIMM	PMEM	DIMM
6 to 6	PMEM	DIMM	PMEM	DIMM	PMEM	DIMM	PMEM	DIMM	PMEM	DIMM	PMEM	DIMM

Notes:

1. All systems must be fully populated with four CPUs when using PMEMs at this time.

- Two CPUs must be installed in each CPU module when using PMEMs.
- For Memory Mode, install a minimum 2 PMEMs and 6 DIMMs per CPU
- For App Direct Mode, install a minimum of 2 PMEMs and 6 DIMMs per CPU
- When either Memory Mode or Mixed Mode is used, the ratio of DIMM capacity to PMEM capacity per CPU must be between 1:16 and 1:2, and the recommended ratio is 1:4 for the best performance. For example, 6x 16GB DIMMs + 2x 256GB PMEMs is a ratio of 1:5.33 (96GB:512GB). In Mixed Mode, the ratio is between memory and only the volatile portion of the PMEMs. This ratio requirement does not apply to App Direct mode. See [Table 8](#) for DCCPM memory modes.

Table 8 Intel® Optane™ Persistent Memory Modes

Intel® Optane™ Persistent Memory Modes	
App Direct Mode:	PMEM operates as a solid-state disk storage device. Data is saved and is non-volatile. Both PMEM and DIMM capacity counts towards CPU tiering (both PMEM and DIMM capacities count towards the CPU capacity limit)
Memory Mode: ¹	PMEM operates as a 100% memory module. Data is volatile and DRAM acts as a cache for PMEMs. Only PMEM capacity counts towards CPU tiering (only the PMEM capacity counts towards the CPU capacity limit). This is the factory default mode.
Mix Mode:	DRAM as cache. Only PMEM capacity counts towards CPU tiering (only the PMEM capacity counts towards the CPU capacity limit).

Notes:

1. For Memory Mode, the Intel-recommended DIMM to PMEM capacity ratio in the same CPU socket is from 1:2 to 1:16.

- For each memory channel with both a PMEM and a DIMM installed, the PMEM is installed in channel slot 2 (closest) and the DIMM is installed in channel slot 1.
- To maximize performance, balance all memory channels
- In configurations with PMEMs installed, memory mirroring is supported, with two restrictions:
 - Mirroring is only enabled on the DIMMs installed in the server; The PMEMs themselves do not support mirroring.
 - Only App Direct mode is supported. Memory mirroring cannot be enabled when PMEMs are in Memory Mode or Mixed Mode.
- Memory sparing is not supported with PMEMs installed

For detailed Intel PMEM configurations, refer to the following link:

[Cisco UCS C480 M5 ML Server Installation and Service Guide](#)

STEP 4 CHOOSE DRIVE MODULES and DRIVES (OPTIONAL)

Table 9 Intel® Optane™ Persistent Memory Modes

Intel® Optane™ Persistent Memory Modes	
App Direct Mode:	PMEM operates as a solid-state disk storage device. Data is saved and is non-volatile. Both PMEM and DIMM capacity counts towards CPU tiering (both PMEM and DIMM capacities count towards the CPU capacity limit)
Memory Mode: ¹	PMEM operates as a 100% memory module. Data is volatile and DRAM acts as a cache for PMEMs. Only PMEM capacity counts towards CPU tiering (only the PMEM capacity counts towards the CPU capacity limit). This is the factory default mode.
Mix Mode:	DRAM as cache. Only PMEM capacity counts towards CPU tiering (only the PMEM capacity counts towards the CPU capacity limit).

Notes:

1. For Memory Mode, the Intel-recommended DIMM to PMEM capacity ratio in the same CPU socket is from 1:2 to 1:16. So if you use a 128 GB DIMM in a channel, you could use a 512 GB PMEM for a 1:4 capacity ratio. if you use a 32 GB DIMM in a channel, you could use a 512 GB PMEM for a 1:16 capacity ration. There are several other combinations possible.

Choose Drive Modules

You can choose the following drive modules:

- Up to three Drive Modules. This is a front-mounting drive cage that accommodates 8 drives as follows:
 - Up to 8 SAS/SATA HDDs or SSDs per module
 - Up to four NVMe drives for left module and one NVMe drive each for rest of the other two modules.
- Up to three drive modules for 6 x NVMe. This is a front-mounting drive cage accommodating up to 6 NVMe

The available drive cages are listed in [Table 10](#).

Table 10 Available Drive Modules

Product ID (PID)	PID Description
Drive Modules	
UCSC-C480-8HDD	UCS C480 M5 Drive Module for 8x HDD (standard cage front facing)

Approved Configurations

- The NVMe drives in the left most Module are restricted to the first two and last two slots only
- The NVMe drives in the middle and right most Modules are restricted to the first slot only.

Choose HDDs and SSDs

The standard hard disk drive (HDD) and solid-state drive (SSD) features are:

- 2.5-inch small form factor
- Hot-swappable
- Sled-mounted

The available drives are listed in [Table 11](#).

Table 11 Supported HDDs and NVMe SSDs

Product ID (PID)	PID Description	Drive Type	Capacity
HDDs			
HDDs(15K RPM)			
UCS-HD900G15K12N	900 GB 12G SAS 15K RPM SFF HDD	SAS	900 GB
HDDs(10K RPM)			
UCS-HD12TB10K12N	1.2 TB 12G SAS 10K RPM SFF HDD	SAS	1.2 TB
UCS-HD18TB10K4KN	1.8 TB 12G SAS 10K RPM SFF HDD (4K)	SAS	1.8 TB
HDDs(7K RPM)			
UCS-HD2T7K12N	2.0 TB 12G SAS 7.2K RPM SFF HDD	SAS	2.0 TB
SAS/SATA SSDs			
Enterprise Performance SSDs (High endurance, supports up to 10X or 3X DDPD (drive writes per day))			
SAS SSDs			
UCS-SD800GK3X-EP	800 GB 2.5in Enterprise Performance 12G SAS SSD(3X endurance)	SAS	800 GB
UCS-SD16TK3X-EP	1.6 TB 2.5in Enterprise Performance 12G SAS SSD(3X endurance)	SAS	1.6 TB
UCS-SD32TK3X-EP	3.2 TB 2.5in Enterprise Performance 12G SAS SSD(3X endurance)	SAS	3.2 TB
Enterprise Value SSDs (Supports up to 1X DDPD (drive writes per day))			
SATA SSDs			
UCS-SD120GM1X-EV	120 GB 2.5 inch Enterprise Value 6G SATA SSD	SATA	120 GB
UCS-SD240GM1X-EV	240 GB 2.5 inch Enterprise Value 6G SATA SSD	SATA	240 GB
UCS-SD480GM1X-EV	480 GB 2.5 inch Enterprise Value 6G SATA SSD	SATA	480 GB
UCS-SD960GM1X-EV	960 GB 2.5 inch Enterprise Value 6G SATA SSD	SATA	960 GB
UCS-SD16TM1X-EV	1.6 TB 2.5 inch Enterprise Value 6G SATA SSD	SATA	1.6 TB
UCS-SD19TM1X-EV	1.9 TB 2.5 inch Enterprise Value 6G SATA SSD	SATA	1.9 TB
UCS-SD38TM1X-EV	3.8 TB 2.5 inch Enterprise Value 6G SATA SSD	SATA	3.8 TB
UCS-SD76TM1X-EV	7.6 TB 2.5 inch Enterprise Value 6G SATA SSD	SATA	7.6 TB

Table 11 Supported HDDs and NVMe SSDs (continued)

Product ID (PID)	PID Description	Drive Type	Capacity
UCS-SD960GK1X-EV	960GB 2.5 inch Enterprise Value 12G SAS SSD	SAS	960 GB
UCS-SD19TK1X-EV	1.9TB 2.5 inch Enterprise Value 12G SAS SSD	SAS	1.9 TB
UCS-SD38TK1X-EV	3.8TB 2.5 inch Enterprise Value 12G SAS SSD	SAS	3.8 TB
UCS-SD76TK1X-EV	7.6TB 2.5 inch Enterprise Value 12G SAS SSD	SAS	7.6 TB
UCS-SD15TK1X-EV	15.3TB 2.5 inch Enterprise Value 12G SAS SSD	SAS	15.3 TB
PCIe/NVMe			
UCSC-NVMEHW-H6400	6.4 TB 2.5in U.2 HGST SN200 NVMe High Perf. High Endurance	NVMe	6.4 TB
UCSC-NVMEHW-H7680	7.7 TB 2.5in U.2 HGST SN200 NVMe High Perf. Value Endurance	NVMe	7.7 TB
UCSC-NVMEHW-H800	800 GB 2.5in U.2 HGST SN200 NVMe High Perf. High Endurance	NVMe	800 GB
UCSC-NVME2H-I2TBV	Cisco 2.5" U.2 2.0TB Intel P4510 NVMe High Perf. Value Endurance	NVMe	2.0 TB
UCSC-NVME2H-I3200	Cisco 2.5" U.2 3.2TB Intel P4610 NVMe High Perf. High Endurance	NVMe	3.2 TB
UCSC-NVME2H-I1600	Cisco 2.5" U.2 1.6TB Intel P4610 NVMe High Perf. High Endurance	NVMe	1.6 TB
UCSC-NVMEHW-I8000	Cisco 2.5" U.2 8TB Intel P4510 NVMe High Perf. Value Endurance	NVMe	8.0 TB
UCSC-NVMEXPB-I375*	375GB 2.5in Intel Optane NVMe Extreme Performance SSD	NVMe	375 GB
UCSC-NVMEXP-I750*	750GB 2.5in Intel Optane NVMe Extreme Performance	NVMe	750 GB
NOTE:			
<ul style="list-style-type: none"> ■ Intel and HGST NVMe drives may NOT be mixed anywhere in a C480 ML M5. (*UCSC-NVMEXP-I750 and UCSC-NVMEXPB-I375 can be mixed for HGST) ■ Cisco uses solid state drives (SSDs) from a number of vendors. All solid state drives are subject to physical write limits and have varying maximum usage limitation specifications set by the manufacturer. Cisco will not replace any solid state drives that have exceeded any maximum usage specifications set by Cisco or the manufacturer, as determined solely by Cisco. 			

Approved Configurations

Many configurations are possible. Some will be shown here.

(1) Three Drive Modules for 8x HDD

- **Option 1:** Fill all three drive modules with all SAS/SATA HDDs or SSDs for a total of 24 drives
- **Option 2:** Fill first drive module (left most) with 4 NVMe and 2 SAS/SATA HDDs or SSDs and the other two with 8 SAS/SATA HDDs/SSDs. You will then have 20 SAS/SATA drives and 4 NVMe drives.
- **Option 3:** Fill first drive module (left most) with 4 NVMe and 2 SAS/SATA HDDs or SSDs and the other two with 7 SAS/SATA HDDs/SSDs and 1 NVMe drive. You will then have 18 SAS/SATA drives and 6 NVMe drives.

Caveats

- You can mix SAS/SATA drives. You can also mix HDD and SSD drives, as long as all the HDDs are in the same RAID volume and all the SSDs are in the same RAID volume.
- SSDs and HDDs should not be mixed in the same RAID volume.
- You can mix SAS/SATA and NVMe drives in the front facing HDD drive module.

STEP 5 CHOOSE RAID CONFIGURATION

The C480 ML M5 server accommodates any one of the following RAID controllers for internal drives:

- Cisco 12G Modular RAID controller with 4GB cache

The C480 ML M5 chassis contains three front drive modules, each housing up to 8 HDD/SSD drives

Cisco can provide factory-configured RAID 0, 1, 5, 6, and 10 systems depending on the RAID implementation chosen, the RAID controller chosen, and the number of drives ordered. Factory-configured RAID options are listed at the end of [Table 12](#). Note that RAID levels 50 and 60 are supported on the Cisco 12G SAS Modular 12-port RAID controller, but are not factory configurable

SSD and HDD requires a RAID controller.

Choose Internal Drive RAID Controller

Choose one internal RAID controller with a desired RAID configuration option from [Table 12](#).

Table 12 Available Internal Drive RAID Options

Product ID (PID)	PID Description
RAID Controllers	
UCSC-RAID-M5HD	<p>Cisco 12G Modular RAID controller with 4GB cache (RAID 0, 1, 5, 6, 10, 50, 60 supported)</p> <ul style="list-style-type: none"> ■ Plugs into a dedicated PCIe slot on the server motherboard ■ Supports from 1 to 24 internal SAS or SATA drives. ■ Must be ordered with a UCSC-SCAP-M5 supercap cache backup. ■ Factory-configured RAID options: RAID 0, 1, 5, 6, 10 (see the RAID PIDs section in this table). ■ This RAID controller supports only SAS/SATA drives in the front-facing HDD card cages.
RAID Configuration	
R2XX-RAID0	<p>Factory pre-configured RAID striping option Enable RAID 0 Setting. Requires a minimum of 1 hard drive.</p>
R2XX-RAID1	<p>Factory pre-configured RAID mirroring option Enable RAID 1 Setting. Requires exactly 2 drives, with same size, speed, capacity.</p>
R2XX-RAID5	<p>Factory pre-configured RAID option Enable RAID 5 Setting. Requires minimum 3 drives of same size, speed, capacity.</p>
R2XX-RAID6	<p>Factory pre-configured RAID option Enable RAID 6 Setting. Requires minimum 4 drives of same size, speed, capacity.</p>

Table 12 Available Internal Drive RAID Options (*continued*)

Product ID (PID)	PID Description
R2XX-RAID10	Factory pre-configured RAID option Enable RAID 10 Setting. Requires an even number of drives (minimum 4 drives) of same size, speed, capacity.



NOTE:

- No RAID option can be chosen if you have one of the following configurations:
 - A mix of SAS and SATA drives
 - No drives

Approved Configurations

(1) One RAID controller card for drive module for 8x HDD SAS/SATA drives

- Choose the UCSC-RAID-M5HD Cisco 12G Modular RAID controller with 4GB cache if you have SAS/SATA drives mounted in any drive module for 8x HDD.



NOTE: NVMe drives in either of the front facing cage options are controlled directly from the PCIe interfaces on the CPUs.

Caveats

- You can choose an optional RAID configuration for the internal drive SAS/SATA RAID controller (RAID 0, 1, 5, 6, or 10), which is pre-configured at the factory. If you do not choose a RAID configuration, the disks will be configured as a JBOD.

STEP 6 CHOOSE PCIe OPTION CARD(S)

The standard PCIe card offerings are:

- Virtual Interface Cards (VIC)
- Network Interface Cards (NICs)

Choose PCIe Option Cards

The available PCIe option cards are listed in [Table 13](#).

Table 13 Available PCIe Option Cards

Product ID (PID)	PID Description	Form Factor	Electrical Slot
Virtual Interface Cards (VIC)			
25 Gb			
UCSC-PCIE-C25Q-04	Cisco UCS VIC 1455 Quad Port 10/25G SFP28 CNA PCIE	HHHL	x8
100 Gb			
UCSC-PCIE-C100-04	Cisco UCS VIC 1495 Dual Port 40/100G QSFP28 CNA PCIe	HHHL	x16
Network Interface Cards (NICs)			
100 Gb NICs			
UCSC-PCIE-QS100GF	Qlogic QLE45611HLCU single port 100G NIC	HHHL	x16
UCSC-P-M5D100GF	Mellanox CX-5 MCX516A-CDAT 2x100GbE QSFP PCIe NIC	HHHL	x16

Caveats

- Cisco VIC card is installed in PCIe slot marked 11, 12, 13, 14
 - Only one Cisco VIC can be used for both UCSM management and data traffic in the C480 ML M5 server
 - The Cisco VIC in slot 11 handles management and data traffic.
 - Only two VICs total are supported in UCSM mode
- All PCIe slots are standard-height and require a standard-height mounting bracket on the PCIe card.
- To help ensure that your operating system is compatible with the cards you have selected, please check the Hardware Compatibility List at this URL:

http://www.cisco.com/en/US/products/ps10477/prod_technical_reference_list.html



NOTE: Mixing 1300 and 1400 series VIC and MLOMs configurations is not supported.

STEP 7 ORDER OPTIONAL PCIe OPTION CARD ACCESSORIES

- For list of supported optics and cables for VIC 1455 and VIC 1497 refer to VIC 1400 series data sheet at the following links:
 - <https://www.cisco.com/c/en/us/products/collateral/interfaces-modules/unified-computing-system-adapters/datasheet-c78-741130.html>
 - <https://www.cisco.com/c/en/us/products/collateral/interfaces-modules/unified-computing-system-adapters/datasheet-c78-734727.html>

Select

- NIC Interoperability with Cisco Cables/Optics. (Table 13.0)

Table 13 100G NIC Interoperability with Cables/Optics

Cisco Product ID (PID)	UCSC-PCIE-QS100GF	UCSC-P-M5D100GF
Cisco Direct Attach Cables (DAC)		
QSFP-100G-AOC5M		✓
QSFP-100G-AOC7M		✓
QSFP-100G-AOC10M		✓
QSFP-100G-CU3M		✓
QSFP-100G-CU5M		✓
Cisco Optical Transceivers		
QSFP-100G-LR4-S		✓
QSFP-100G-SR4-S		✓
QSFP-40/100-SRBD		✓

- a. *: Compiled from testing conducted by Cisco TMG and Vendors.
- b. Refer to the these links for additional Connectivity Options.

Intel:	Marvell/Qlogic:	Mellanox:
Product Guide	41000 series Interoperability Matrix	Firmware Release Notes
Speed White Paper	45000 series Interoperability Matrix	

STEP 8 ORDER OPTICAL DRIVE (OPTIONAL)

You can order an optional front facing optical drive (DVDRW). If you do, it displaces drive bay module 3 in the front facing drive cage.

Select Optical Drive

The available optical drive is listed in [Table 14](#).

Table 14 Available Optical Drive

Product ID (PID)	PID Description
UCSC-C480-DVD	UCS C480 M5 Optional DVD drive

STEP 9 ORDER SECURE DIGITAL CARDS or M.2 DEVICES (OPTIONAL)

A mini-storage connector is provided on the motherboard. There are two choices of mini-storage modular adapters that fit in the connector on the motherboard.

1. Adapter with two SD HC sockets that accommodate up to two SDHC cards
2. Adapter with two M.2 sockets that accommodate up to two M.2 devices

SD Cards and Modular Adapter

The SDHC card ordering information is listed in [Table 15](#).

Table 15 PIDs for Secure Digital High-Capacity Card(s) and Modular Adapter

Product ID (PID)	PID Description
UCS-SD-32G-S	32 GB SD Card for UCS servers
UCS-SD-64G-S	64 GB SD Card for UCS servers
UCS-SD-128G	128GB SD Card for UCS servers
UCS-MSTOR-SD ¹	Modular adapter for SD card

Notes:

1. The SD modular adapter (PID UCS-MSTOR-SD) is auto-included in CCW and is not selectable.

Supported Configurations

- (1) Select one or two Cisco secure digital cards
 - Select up to two 32, 64, or 128 GB SD cards
- (2) Do not mix SD cards
- (3) If you select SDHC cards, you cannot select any M.2 SATA SSD drive.

M.2 SATA Cards and Modular Adapter

Order one or two matching M.2 SATA SSDs (see [Table 16](#)) along with a mini storage carrier or a boot-optimized RAID controller (see [Table 17](#)).



NOTE: It is recommended that M.2 SATA SSDs be used as boot-only devices.

Each mini storage carrier or boot-optimized RAID controller can accommodate up to two SATA M.2 SSDs shown in [Table 16](#).

Table 16 M.2 SATA SSDs

Product ID (PID)	PID Description
UCS-M2-240GB	240 GB M.2 SATA SSD
UCS-M2-960GB	960 GB M.2 SATA SSD

Table 17 Mini Storage Carrier/Boot-Optimized RAID Controller

Product ID (PID)	PID Description
UCS-MSTOR-M2	Mini Storage Carrier for M.2 SATA (holds up to 2 M.2 SATA SSDs)
UCS-M2-HWRAID	Cisco Boot optimized M.2 RAID controller (holds up to 2 M.2 SATA SSDs)



NOTE:

- The UCS-M2-HWRAID boot-optimized RAID controller supports RAID 1 and JBOD mode
- The UCS-M2-HWRAID controller is available only with 240 GB and 960 GB M.2 SSDs.
- (CIMC/UCSM) is supported for configuring of volumes and monitoring of the controller and installed SATA M.2 drives
- The minimum version of Cisco IMC and Cisco UCS Manager that support this controller is 4.0(4b) and later. The name of the controller in the software is MSTOR-RAID
- The SATA M.2 drives can boot in UEFI mode only. Legacy boot mode is not supported
- Hot-plug replacement is not supported. The server must be powered off.
- The boot-optimized RAID controller is not supported when the server is used as a compute node in HyperFlex configurations

- Order either the Mini Storage carrier or the Boot-Optimized RAID controller from [Table 17](#).
 - Choose the UCS-MSTOR-M2 mini storage carrier for controlling the M.2 SATA drives with no RAID control.
 - Choose the UCS-M2-HWRAID Boot-Optimized RAID controller for hardware RAID across the two internal SATA M.2 drives. The Boot-Optimized RAID controller holds up to 2 matching M.2 SATA drives.
- Order up to two matching M.2 SATA SSDs from [Table 16](#).



NOTE: The Boot-Optimized RAID controller supports VMWare, Windows and Linux Operating Systems

Caveats

- You cannot mix M.2 SATA SSDs with SD cards.
 - Order either one or two identical M.2 SATA SSDs for the mini-storage carrier or boot-optimized RAID controller. You cannot mix M.2 SATA SSD capacities.
- (4) When ordering two M.2 SATA drives with embedded software RAID, the maximum number of internal SATA drives supported is six. To support greater than six internal drives, a Cisco 12G Raid Controller or a Cisco 12G SAS HBA must be ordered

STEP 10 ORDER INTERNAL MICRO-SD CARD MODULE (OPTIONAL)

Order a 32 GB micro-SD card.

The micro-SD card serves as a dedicated local resource for utilities such as HUU. Images can be pulled from a files hare (NFS/CIFS) and uploaded to the cards for future use.

Table 18 Secure Digital (SD) Card

Product ID (PID)	PID Description
UCS-MSD-32G	32GB Micro-SD Card for UCS servers

STEP 11 ORDER POWER SUPPLIES

The available power supplies are listed in [Table 19](#).

Table 19 Power Supplies

Product ID (PID)	PID Description
UCSC-PSU1-1600W	Cisco UCS 1600W AC Power Supply for Rack Server

Caveats

- All four power supplies are required

STEP 12 SELECT AC POWER CORD(S)

Select the appropriate AC power cords listed in [Table 20](#). You may select a minimum of no power cords and a maximum of two power cords. If you select the option R2XX-DMYMPWRCORD, no power cord is shipped with the server.

Table 20 Available Power Cords

Product ID (PID)	PID Description	Images
R2XX-DMYMPWRCORD	No power cord (dummy PID to allow for a no power cord option)	Not applicable
CAB-C13-C14-2M	CABASY,WIRE,JUMPER CORD, PWR, 2 Meter, C13/C14,10A/250V	
CAB-250V-10A-AR	Power Cord, SFS, 250V, 10A, Argentina	
CAB-9K10A-AU	Power Cord, 250VAC 10A 3112 Plug, Australia	
CAB-250V-10A-CN	AC Power Cord - 250V, 10A - PRC	
CAB-9K10A-EU	Power Cord, 250VAC 10A CEE 7/7 Plug, EU	
CAB-250V-10A-ID	Power Cord, SFS, 250V, 10A, India	

Table 20 Available Power Cords

Product ID (PID)	PID Description	Images
CAB-250V-10A-IS	Power Cord, SFS, 250V, 10A, Israel	
CAB-9K10A-IT	Power Cord, 250VAC 10A CEI 23-16/VII Plug, Italy	
CAB-9K10A-SW	Power Cord, 250VAC 10A MP232 Plug, Switzerland	
CAB-9K10A-UK	Power Cord, 250VAC 10A BS1363 Plug (13 A fuse), UK	
CAB-AC-L620-C13	AC Power Cord, NEMA L6-20 - C13, 2M/6.5ft	
CAB-250V-10A-BR	Power Cord - 250V, 10A - Brazil	
CAB-C13-C14-2M-JP	Power Cord C13-C14, 2M/6.5ft Japan PSE mark	images not available
CAB-C19-C20-3M-JP	Power Cord C19-C20,3M/10ft Japan PSE mark	images not available
CAB-N5K6A-NA	Power Cord 200/240V 6A North America	images not available
CAB-C13-C14-IN	Power Cord Jumper,C13-C14 Connectors,1.4 Meter Length, India	images not available

Table 20 Available Power Cords

Product ID (PID)	PID Description	Images
CAB-C13-C14-3M-IN	Power Cord Jumper, C13-C14 Connectors, 3 Meter Length, India	images not available

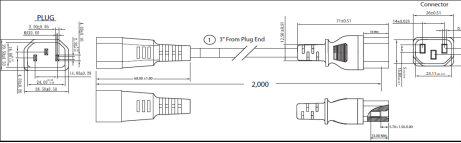
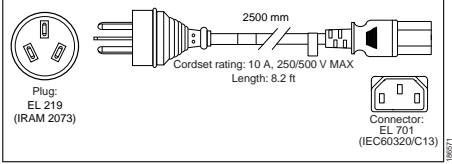
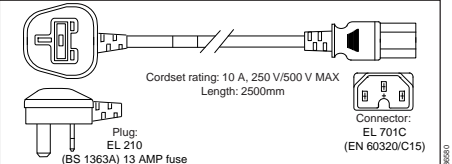
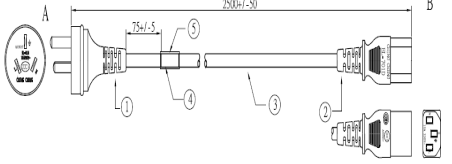
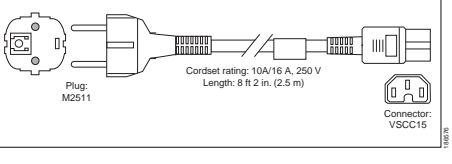
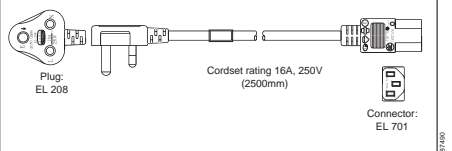
STEP 13 ORDER OPTIONAL CABLE MANAGEMENT ARM

A cable management arm is available for the tool-less slide rail kit (PID UCSC-RAIL-4U-M5). The cable management arm attaches to the left and right slide rails at the rear of the server and is used for cable management. You can order the cable management arm listed in [Table 21](#).

Table 21 Cable Management Arm

Product ID (PID)	PID Description
UCSC-CMA-4U-M5	Cable Management Arm for UCS C480 ML

STEP 14 ORDER SECURITY DEVICES (OPTIONAL)

Trusted Platform Module (TPM) is a computer chip (microcontroller) that can securely store artifacts used to authenticate the platform (server). These artifacts can include passwords, certificates, or encryption keys. A TPM can also be used to store platform measurements that help ensure that the platform remains trustworthy. Authentication (ensuring that the platform can prove that it is what it claims to be) and attestation (a process helping to prove that a platform is trustworthy and has not been breached) are necessary steps to ensure safer computing in all environments.

A safety intrusion switch gives a notification of any unauthorized mechanical access into the server

The security device ordering information listed in [Table 22](#).

Table 22 Security Devices

Product ID (PID)	PID Description
UCSX-TPM2-002	Trusted Platform Module 2.0 for UCS servers
UCSX-TPM2-002B	Trusted Platform Module 2.0 M5 UCS Servers (FIPS 140-2 Compliant)
UCS-C480-INT-SW	UCS C480 Safety Intrusion Switch



NOTE: The module used in this server conforms to TPM v2.0, as defined by the Trusted Computing Group (TCG).

STEP 15 SELECT MANAGEMENT CONFIGURATION (OPTIONAL)

By default, the C480 ML M5 server NIC mode is configured to be Shared LOM Extended. This NIC mode allows any LOM port or adapter card port to be used to access the Cisco Integrated Management Controller (CIMC). The Cisco VIC card must be installed in a slot with NCSI support.

To change the default NIC mode to Dedicated, select the UCSC-DLOM-01 PID shown in [Table 23](#). In Dedicated NIC mode, the CIMC can be accessed only through the dedicated management port. See [UCS C480 ML M5 Server Rear Panel on page 8](#) for the location of the management port.

To change the default NIC mode to Cisco Card Mode, select the UCSC-CCARD-01 PID shown in [Table 23](#). In this mode, you can assign an IP address to the CIMC using DHCP and from there you can fully automate your deployment.

For more details on all the NIC mode settings, see

http://www.cisco.com/c/en/us/td/docs/unified_computing/ucs/c/sw/gui/config/guide/2-0/b_Cisco_UCS_C-series_GUI_Configuration_Guide_201.pdf

Table 23 Management Configuration Ordering Information

Product ID (PID)	PID Description
UCSC-DLOM-01	Dedicated Mode BIOS setting for C-Series Servers
UCSC-CCARD-01	Cisco Card Mode BIOS setting for C-Series Servers

STEP 16 SELECT SERVER BOOT MODE (OPTIONAL)

By default, the C480 ML M5 server will ship with UEFI as the default boot mode. To have a server shipped with the Legacy BIOS mode (which was standard on M4 and previous generation servers), select the Legacy BIOS PID

Table 24 Server Boot Mode Ordering Information

Product ID (PID)	PID Description
UCSC-LBIOS-01	Legacy Boot Mode BIOS setting for C-Series Servers

STEP 17 CHOOSE OPERATING SYSTEM AND VALUE-ADDED SOFTWARE

Several software programs are available. Select as desired from [Table 25](#)

Table 25 OSs and vale added software

Product ID (PID)	PID Description
Microsoft	
MSWS-19-ST16C	Windows Server 2019 Standard (16 Cores/2 VMs)
MSWS-19-ST16C-NS	Windows Server 2019 Standard (16 Cores/2 VMs) - No Cisco SVC
MSWS-19-DC16C	Windows Server 2019 Data Center (16 Cores/Unlimited VMs)
MSWS-19-DC16C-NS	Windows Server 2019 DC (16 Cores/Unlim VMs) - No Cisco SVC
Red Hat	
RHEL-2S2V-3A	Red Hat Enterprise Linux (1-2 CPU,1-2 VN); 3-Yr Support Req
RHEL-2S2V-5A	Red Hat Enterprise Linux (1-2 CPU,1-2 VN); 5-Yr Support Req
RHEL-VDC-2SUV-1A	RHEL for Virt Datacenters (1-2 CPU, Unlim VN) 1 Yr Supp Req
RHEL-VDC-2SUV-3A	RHEL for Virt Datacenters (1-2 CPU, Unlim VN) 3 Yr Supp Req
RHEL-VDC-2SUV-5A	RHEL for Virt Datacenters (1-2 CPU, Unlim VN) 5 Yr Supp Req
RHEL-2S2V-1A	Red Hat Enterprise Linux (1-2 CPU,1-2 VN); 1-Yr Support Req
RHEL-2S2V-1S	Red Hat Enterprise Linux (1-2 CPU,1-2 VN); Prem 1Yr SnS Reqd
RHEL-2S2V-3S	Red Hat Enterprise Linux (1-2 CPU,1-2 VN); Prem 3Yr SnS Reqd
RHEL-2S-HA-1S	RHEL High Availability (1-2 CPU); Premium 1-yr SnS Reqd
RHEL-2S-HA-3S	RHEL High Availability (1-2 CPU); Premium 3-yr SnS Reqd
RHEL-2S-RS-1S	RHEL Resilent Storage (1-2 CPU); Premium 1-yr SnS Reqd
RHEL-2S-RS-3S	RHEL Resilent Storage (1-2 CPU); Premium 3-yr SnS Reqd
RHEL-2S-SFS-1S	RHEL Scalable File System (1-2 CPU); Premium 1-yr SnS Reqd
RHEL-2S-SFS-3S	RHEL Scalable File System (1-2 CPU); Premium 3-yr SnS Reqd
RHEL-VDC-2SUV-1S	RHEL for Virt Datacenters (1-2 CPU, Unlim VN) 1 Yr SnS Reqd
RHEL-VDC-2SUV-3S	RHEL for Virt Datacenters (1-2 CPU, Unlim VN) 3 Yr SnS Reqd
VMware	
VMW-VSP-STD-1A	VMware vSphere 7 Std (1 CPU, 32 Core) 1-yr, Support Required
VMW-VSP-STD-3A	VMware vSphere 7 Std (1 CPU, 32 Core) 3-yr, Support Required
VMW-VSP-STD-5A	VMware vSphere 7 Std (1 CPU, 32 Core) 5-yr, Support Required

Table 25 OSs and value added software

Product ID (PID)	PID Description
VMW-VSP-EPL-3A	VMware vSphere 7 Ent Plus (1 CPU, 32 Core) 1Yr, Support Reqd
VMW-VSP-EPL-1A	VMware vSphere 7 Ent Plus (1 CPU, 32 Core) 3Yr, Support Reqd
VMW-VSP-EPL-5A	VMware vSphere 7 Ent Plus (1 CPU, 32 Core) 5Yr, Support Reqd
SUSE	
SLES-2S2V-1A	SUSE Linux Enterprise Svr (1-2 CPU,1-2 VM); 1-Yr Support Req
SLES-2SUV-1A	SUSE Linux Enterprise Svr (1-2 CPU,Unl VM); 1-Yr Support Req
SLES-2S2V-3A	SUSE Linux Enterprise Svr (1-2 CPU,1-2 VM); 3-Yr Support Req
SLES-2SUV-3A	SUSE Linux Enterprise Svr (1-2 CPU,Unl VM); 3-Yr Support Req
SLES-2S2V-5A	SUSE Linux Enterprise Svr (1-2 CPU,1-2 VM); 5-Yr Support Req
SLES-2SUV-5A	SUSE Linux Enterprise Svr (1-2 CPU,Unl VM); 5-Yr Support Req
SLES-2S2V-1S	SUSE Linux Enterprise Svr (1-2 CPU,1-2 VM); Prio 1-Yr SnS
SLES-2SUV-1S	SUSE Linux Enterprise Svr (1-2 CPU,Unl VM); Prio 1-Yr SnS
SLES-2S2V-3S	SUSE Linux Enterprise Svr (1-2 CPU,1-2 VM); Prio 3-Yr SnS
SLES-2SUV-3S	SUSE Linux Enterprise Svr (1-2 CPU,Unl VM); Prio 3-Yr SnS
SLES-2S2V-5S	SUSE Linux Enterprise Svr (1-2 CPU,1-2 VM); Prio 5-Yr SnS
SLES-2SUV-5S	SUSE Linux Enterprise Svr (1-2 CPU,Unl VM); Prio 5-Yr SnS
SLES-2S-HA-1S	SUSE Linux High Availability Ext (1-2 CPU); 1yr SnS
SLES-2S-HA-3S	SUSE Linux High Availability Ext (1-2 CPU); 3yr SnS
SLES-2S-HA-5S	SUSE Linux High Availability Ext (1-2 CPU); 5yr SnS
SLES-2S-GC-1S	SUSE Linux GEO Clustering for HA (1-2 CPU); 1yr Sns
SLES-2S-GC-3S	SUSE Linux GEO Clustering for HA (1-2 CPU); 3yr SnS
SLES-2S-GC-5S	SUSE Linux GEO Clustering for HA (1-2 CPU); 5yr SnS
SLES-2S-LP-1S	SUSE Linux Live Patching Add-on (1-2 CPU); 1yr SnS Required
SLES-2S-LP-3S	SUSE Linux Live Patching Add-on (1-2 CPU); 3yr SnS Required
SLES-2S-LP-1A	SUSE Linux Live Patching Add-on (1-2 CPU); 1yr Support Req
SLES-2S-LP-3A	SUSE Linux Live Patching Add-on (1-2 CPU); 3yr Support Req
Nvidia NGC Support	

Table 25 OSs and vale added software

Product ID (PID)	PID Description
NV-NGC-S-1YR	Nvidia NGC Support Services For C480 ML; 1 Year
NV-NGC-S-3YR	Nvidia NGC Support Services For C480 ML; 3 Year
NV-NGC-S-R-1YR	Nvidia NGC Support Services For C480 ML; 1 Year, RENEW

STEP 18 SELECT SERVICE and SUPPORT LEVEL

A variety of service options are available, as described in this section.

Smart Net Total Care

For support of the C480 ML Server, Cisco offers the Cisco Smart Net Total Care Service. This service provides expert software and hardware support to help sustain performance and high availability of the unified computing environment. Access to Cisco Technical Assistance Center (TAC) is provided around the clock, from anywhere in the world.

For systems that include Unified Computing System Manager, the support service includes downloads of UCSM upgrades. The Cisco Smart Net Total Care for UCS Service includes flexible hardware replacement options, including replacement in as little as two hours. There is also access to Cisco's extensive online technical resources to help maintain optimal efficiency and uptime of the unified computing environment. For more information please refer to the following url: <http://www.cisco.com/c/en/us/services/technical/smart-net-total-care.html?stickynav=1>

You can choose a desired service listed in [Table 26](#).

Table 26 Cisco SNTC Service (PID UCSC-C480-M5ML8)

Service SKU	Service Level GSP	On Site?	Description
CON-3OSP-480M5ML8	3C4P	Yes	3YR SNTC 24X7X40S
CON-3SNT-480M5ML8	3SNT	No	3YR SNTC 8X5XNBD
CON-3SNTP-480M5ML8	3SNTP	No	3YR SNTC 24X7X4
CON-PREM-480M5ML8	C2P	Yes	SNTC 24X7X20S
CON-UCSD8-480M5ML8	UCSD8	Yes	UC SUPP DR 24X7X20S*
CON-C2PL-480M5ML8	C2PL	Yes	LL 24X7X20S**
CON-OSP-480M5ML8	C4P	Yes	SNTC 24X7X40S
CON-UCSD7-480M5ML8	UCSD7	Yes	UCS DR 24X7X40S*
CON-C4PL-480M5ML8	C4PL	Yes	LL 24X7X40S**
CON-USD7L-480M5ML8	USD7L	Yes	LLUCS HW DR 24X7X40S***
CON-OSE-480M5ML8	C4S	Yes	SNTC 8X5X40S
CON-UCSD6-480M5ML8	UCSD6	Yes	UC SUPP DR 8X5X40S*
CON-SNCO-480M5ML8	SNCO	Yes	SNTC 8x7xNCDOS****
CON-OS-480M5ML8	CS	Yes	SNTC 8X5XNBDOS
CON-UCSD5-480M5ML8	UCSD5	Yes	UCS DR 8X5XNBDOS*
CON-S2P-480M5ML8	S2P	No	SNTC 24X7X2
CON-S2PL-480M5ML8	S2PL	No	LL 24X7X2**
CON-SNTP-480M5ML8	SNTP	No	SNTC 24X7X4

Table 26 Cisco SNTC Service (PID UCSC-C480-M5ML8)

Service SKU	Service Level GSP	On Site?	Description
CON-SNTPL-480M5ML8	SNTPL	No	LL 24X7X4**
CON-SNTE-480M5ML8	SNTE	No	SNTC 8X5X4
CON-SNC-480M5ML8	SNC	No	SNTC 8x7xNCD****
CON-SNT-480M5ML8	SNT	No	SNTC 8X5XNBD
CON-SW-480M5ML8	SW	No	SNTC NO RMA

*Includes Drive Retention (see below for full description)

**Includes Local Language Support (see below for full description) – Only available in China and Japan

***Includes Local Language Support and Drive Retention – Only available in China and Japan

****Available in China Only

Smart Net Total Care with Onsite Troubleshooting Service

An enhanced offer over traditional Smart Net Total Care which provides onsite-troubleshooting expertise to aid in the diagnostics and isolation of hardware issue within our customers’ Cisco Unified Computing System (UCS) environment. It is delivered by a Cisco Certified field engineer (FE) in collaboration with remote TAC engineer and Virtual Internet working Support Engineer (VISE). You can choose a desired service listed in [Table 27](#)

Table 27 SNTC With UCS Onsite Troubleshooting Service (PID UCSC-C480-M5ML8)

Service SKU	Service Level GSP	On Site?	Description
CON-OSPT-480M5ML8	OSPT	Yes	24X7X4OS Trblshtg
CON-OSPTD-480M5ML8	OSPTD	Yes	24X7X4OS TrblshtgDR*
CON-OSPTL-480M5ML8	OSPTL	Yes	24X7X4OS TrblshtgLL**
CON-OPTLD-480M5ML8	OPTLD	Yes	24X7X4OS TrblshtgLLD***

*Includes Drive Retention (see below for full description)

**Includes Local Language Support (see below for full description) – Only available in China and Japan

***Includes Local Language Support and Drive Retention – Only available in China and Japan

Solution Support

Solution Support includes both Cisco product support and solution-level support, resolving complex issues in multivendor environments, on average, 43% more quickly than product support alone. Solution Support is a critical element in data center administration, to help rapidly resolve any issue encountered, while maintaining performance, reliability, and return on investment.

This service centralizes support across your multivendor Cisco environment for both our products and solution partner products you've deployed in your ecosystem. Whether there is an issue with a Cisco or solution partner product, just call us. Our experts are the primary point of contact and own the case from first call to resolution. For more information please refer to the following url:

<http://www.cisco.com/c/en/us/services/technical/solution-support.html?stickynav=1>

You can choose a desired service listed in [Table 28](#)

Table 28 Solution Support Service (PID UCSC-C480-M5ML8)

Service SKU	Service Level GSP	On Site?	Description
CON-SSC2P-480M5ML8	SSC2P	Yes	SOLN SUPP 24X7X2OS
CON-SSC4P-480M5ML8	SSC4P	Yes	SOLN SUPP 24X7X4OS
CON-SSC4S-480M5ML8	SSC4S	Yes	SOLN SUPP 8X5X4OS
CON-SSCS-480M5ML8	SSCS	Yes	SOLN SUPP 8X5XNBDOS
CON-SSDR7-480M5ML8	SSDR7	Yes	SSPT DR 24X7X4OS*
CON-SSDR5-480M5ML8	SSDR5	Yes	SSPT DR 8X5XNBDOS*
CON-SSS2P-480M5ML8	SSS2P	No	SOLN SUPP 24X7X2
CON-SSSNP-480M5ML8	SSSNP	No	SOLN SUPP 24X7X4
CON-SSSNE-480M5ML8	SSSNE	No	SOLN SUPP 8X5X4
CON-SSSNC-480M5ML8	SSSNC	No	SOLN SUPP NCD**
CON-SSSNT-480M5ML8	SSSNT	No	SOLN SUPP 8X5XNBD

Includes Drive Retention (see below for description)

**Available in China only

Table 29 Solution Support Service provider Service(PID UCSC-C480-M5ML8)

Service SKU	Service Level GSP	On Site?	Description
SP-SSC2P-480M5ML8	SSC2P	Yes	SOLN SUPP 24X7X2OS
SP-SSC4P-480M5ML8	SSC4P	Yes	SOLN SUPP 24X7X4OS
SP-SSC4S-480M5ML8	SSC4S	Yes	SOLN SUPP 8X5X4OS
SP-SSCS-480M5ML8	SSCS	Yes	SOLN SUPP 8X5XNBDOS
SP-SSS2P-480M5ML8	SSS2P	No	SOLN SUPP 24X7X2
SP-SSS4P-480M5ML8	SSS4P	No	SOLN SUPP 24X7X4
SP-SSSNE-480M5ML8	SSSNE	No	SOLN SUPP 8X5X4
SP-SSSNT-480M5ML8	SSSNT	No	SOLN SUPP 8X5XNBD
CON-SSSNT-480M5ML8	SSSNT	No	SOLN SUPP 8X5XNBD

Partner Support Service for UCS

Cisco Partner Support Service (PSS) is a Cisco Collaborative Services service offering that is designed for partners to deliver their own branded support and managed services to enterprise customers. Cisco PSS provides partners with access to Cisco's support infrastructure and assets to help them:

- Expand their service portfolios to support the most complex network environments
- Lower delivery costs
- Deliver services that increase customer loyalty

PSS options enable eligible Cisco partners to develop and consistently deliver high-value technical support that capitalizes on Cisco intellectual assets. This helps partners to realize higher margins and expand their practice.

PSS is available to all Cisco PSS partners.

PSS provides hardware and software support, including triage support for third party software, backed by Cisco technical resources and level three support. You can choose a desired service listed in [Table 30](#).

Table 30 PSS (PID UCSC-C480-M5ML8)

Service SKU	Service Level GSP	On Site?	Description
CON-PSJ8- 480M5ML8	PSJ8	Yes	UCS PSS 24X7X2 OS
CON-PSJ7- 480M5ML8	PSJ7	Yes	UCS PSS 24X7X4 OS
CON-PSJD7- 480M5ML8	PSJD7	Yes	UCS PSS 24X7X4 DR*
CON-PSJ6- 480M5ML8	PSJ6	Yes	UCS PSS 8X5X4 OS
CON-PSJD6- 480M5ML8	PSJD6	Yes	UCS PSS 8X5X4 DR*
CON-PSJ4- 480M5ML8	PSJ4	No	UCS SUPP PSS 24X7X2
CON-PSJ3- 480M5ML8	PSJ3	No	UCS SUPP PSS 24X7X4
CON-PSJ2- 480M5ML8	PSJ2	No	UCS SUPP PSS 8X5X4
CON-PSJ1- 480M5ML8	PSJ1	No	UCS SUPP PSS 8X5XNBD

*Includes Drive Retention (see below for description)

Combined Support Service

Combined Services makes it easier to purchase and manage required services under one contract. The more benefits you realize from the Cisco UCS environment, the more important the technology becomes to your business. These services allow you to:

- Optimize the uptime, performance, and efficiency of your UCS
- Protect your vital business applications by rapidly identifying and addressing issues
- Strengthen in-house expertise through knowledge transfer and mentoring

- Improve operational efficiency by allowing UCS experts to augment your internal staff resources
- Enhance business agility by diagnosing potential issues before they affect your operations,

You can choose a desired service listed in [Table 31](#)

Table 31 Combined Support Service for UCS (PID UCSC-C480-M5ML8)

Service SKU	Service Level GSP	On Site?	Description
CON-NCF2P-480M5ML8	NCF2P	Yes	CMB SVC 24X7X2OS
CON-NCF4P-480M5ML8	NCF4P	Yes	CMB SVC 24X7X4OS
CON-NCF4S-480M5ML8	NCF4S	Yes	CMB SVC 8X5X4OS
CON-NCFCS-480M5ML8	NCFCS	Yes	CMB SVC 8X5XNBDOS
CON-NCF2-480M5ML8	NCF2	No	CMB SVC 24X7X2
CON-NCFP-480M5ML8	NCFP	No	CMB SVC 24X7X4
CON-NCFE-480M5ML8	NCFE	No	CMB SVC 8X5X4
CON-NCFT-480M5ML8	NCFT	No	CMB SVC 8X5XNBD
CON-NCFW-480M5ML8	NCFW	No	CMB SVC SW

SP Base Service

Cisco SP Base is Cisco's core foundational product support offer for service provider customers. This device-level service helps reduce downtime with fast, expert technical support and flexible hardware coverage provided by the Cisco Technical Assistance Center (TAC). It also offers integrated smart capabilities, providing current information about installed base, contracts, and security alerts to enhance the efficiency of support workflows. You can choose a service listed in [Table 31](#).

Table 32 SP Base Service (PID UCSC-C480-M5ML8)

Service SKU	Service Level GSP	On Site?	Description
SP-OS4-480M5ML8	SPC2P	Yes	SP Base 24X7X2OS
SP-OS3-480M5ML8	SPC4P	Yes	SP Base 24X7X4OS
SP-OS2-480M5ML8	SPC4S	Yes	SP Base 8X5X4OS
SP-OS1-480M5ML8	SPCS	Yes	SP Base 8X5XNBDOS
SP-AR4-480M5ML8	SPAR4	No	SP Base 24X7X2
SP-AR3-480M5ML8	SPAR3	No	SP Base 24X7X4
SP-AR2-480M5ML8	SPAR2	No	SP Base 8X5X4
SP-AR1-480M5ML8	SPAR1	No	SP Base 8X5XNBD

UCS Drive Retention Service

With the Cisco Drive Retention Service, you can obtain a new disk drive in exchange for a faulty drive without returning the faulty drive.

Sophisticated data recovery techniques have made classified, proprietary, and confidential information vulnerable, even on malfunctioning disk drives. The Drive Retention service enables you to retain your drives and ensures that the sensitive data on those drives is not compromised, which reduces the risk of any potential liabilities. This service also enables you to comply with regulatory, local, and federal requirements.

If your company has a need to control confidential, classified, sensitive, or proprietary data, you might want to consider one of the Drive Retention Services listed in the above tables (where available)



NOTE: Cisco does not offer a certified drive destruction service as part of this service.

Local Language Technical Support for UCS

Where available, and subject to an additional fee, local language support for calls on all assigned severity levels may be available for specific product(s) - see tables above.

For a complete listing of available services for Cisco Unified Computing System, see the following URL:

http://www.cisco.com/en/US/products/ps10312/serv_group_home.html

SUPPLEMENTAL MATERIAL

CHASSIS

An internal view of the C480 ML M5 chassis with the top cover removed is shown in [Figure 5](#).

Figure 5 C480 ML M5 With Top Cover Removed

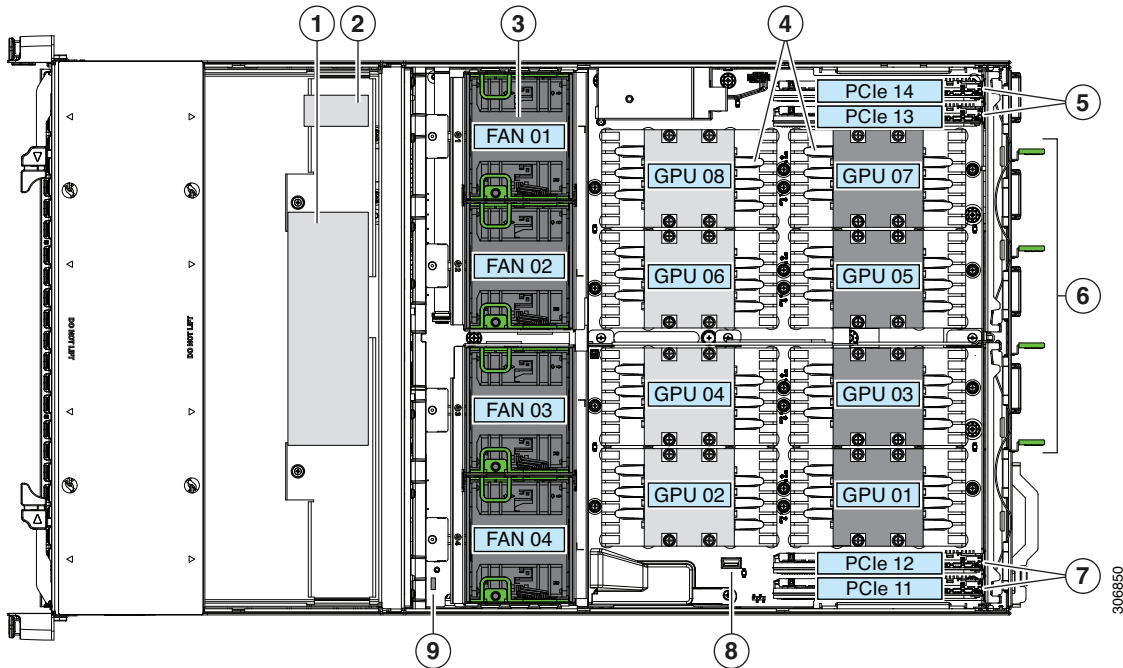

1	RAID controller card for front-loading SAS/SATA drives. (not visible in this view; position is near chassis floor under the CPU module)	6	Power supplies 1-4 (hot-swappable, redundant as 2+2 (default) or 3+1)
2	Supercap (RAID backup) for front RAID controller (not visible in this view; mounting bracket position is on chassis wall under the CPU module)	7	PCIe slots 11 and 12 (Gen-3 x16) <ul style="list-style-type: none"> ■ Slots 11 and 12 support standby power. ■ Slot 11 is the primary slot for a Cisco UCS VIC card, slot 12 is the secondary slot
3	Fan modules (four modules with two fans each; hot-swappable)	8	Internal, vertical USB 2.0 socket on motherboard
4	NVIDIA V100 SXM2 GPUs and heatsinks (eight), Each GPU socket provides a x16 PCIe lane Note: The GPUs are not customer serviceable. Contact Cisco Support if you need service for the GPUs or their heatsinks.	9	Trusted platform module socket (TPM) on motherboard
5	PCIe slots 13 and 14 (Gen-3 x16)	–	–

Serviceable Component Locations Inside the Main Chassis

Figure 6 Serviceable Component Locations Inside the Main Chassis (Front and Rear Views)

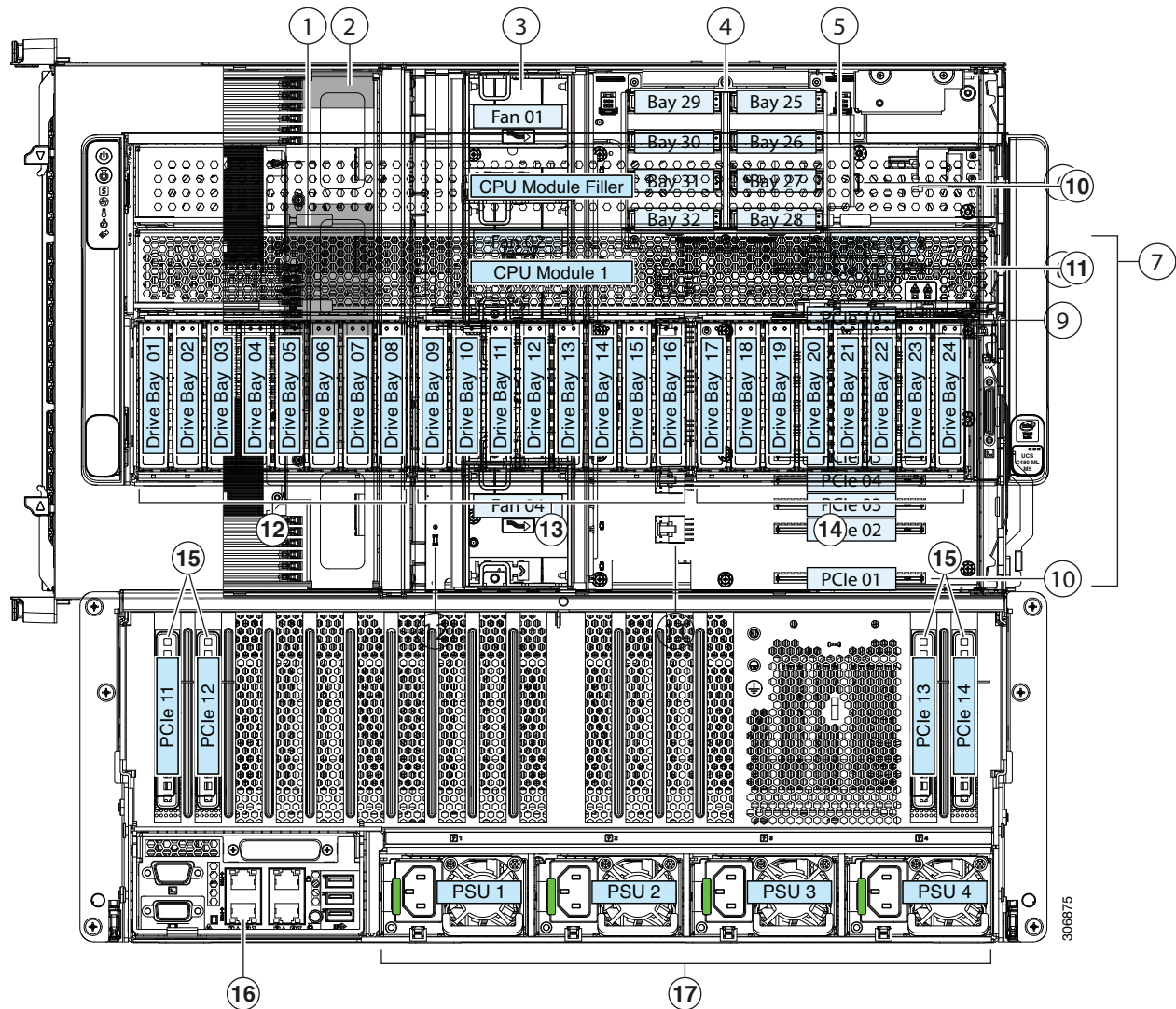

<p>10</p>	<p>CPU module bay 2 (blank with filler module) There must be a blank filler module in upper bay 2 or the system will not boot</p>	<p>14</p>	<p>Right bay module, supports either:</p> <ul style="list-style-type: none"> ■ Optional DVD drive module ■ Drive bays 17 - 24 (shown) <ul style="list-style-type: none"> • All 8 bays supports SAS/SATA drives. • Bay 17 also supports NVMe drives.
<p>11</p>	<p>CPU module bay 1 The system must have one CPU module in lower bay 1 to boot</p>	<p>15</p>	<p>PCIe slots 11 through 14, rear panel openings</p>

12	Left bay module (drive bays 1 - 8) <ul style="list-style-type: none">■ All 8 bays supports SAS/SATA drives.■ Bays 1, 2, 7, 8 also support NVMe drives	16	I/O module Note: The I/O module is not field replaceable, nor can you move an I/O module from one chassis to another. This module contains a security chip that requires it to stay with the PCIe module in the same chassis, as shipped from the factory.
13	Center bay module (drive bays 9 - 16) <ul style="list-style-type: none">■ All 8 bays supports SAS/SATA drives.■ Bay 9 also supports NVMe drives.	17	Power supplies 1-4 (hot-swappable, redundant as 2+2 (default) or 3+1) All power supplies in the system must be identical (no mixing).

Serviceable Components Inside a CPU Module

Figure 7 Serviceable Component Locations Inside a CPU Module

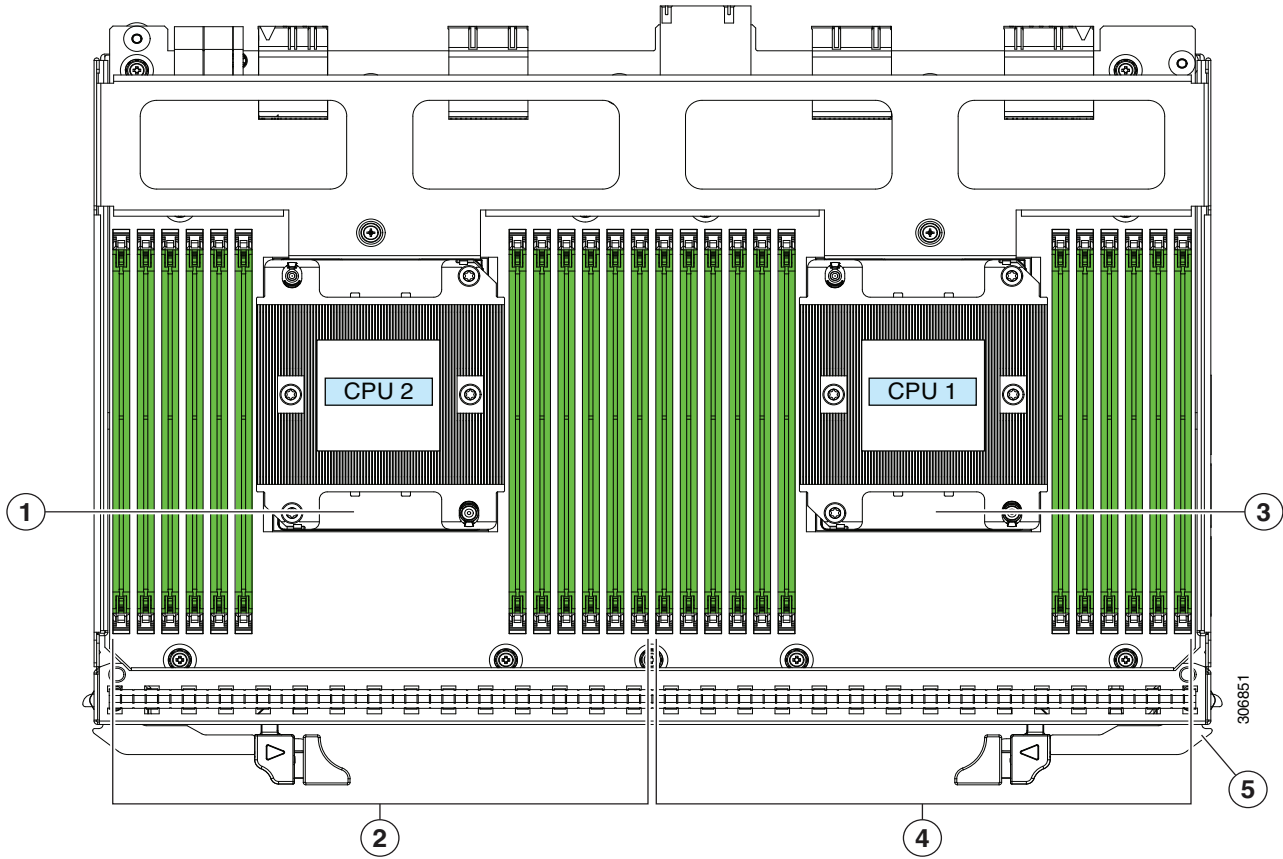

1	CPU 2	4	DIMM sockets controlled by CPU 1 (channels A, B, C, D, E, F.)
2	DIMM sockets controlled by CPU 2 (channels G, H, J, K, L, M.) See Memory Population Rules on page 61 for DIMM slot numbering	5	Release levers for module (two each module)
3	CPU 1	–	–

Serviceable Components Inside an I/O Module

Figure 8 Serviceable Component Locations Inside a I/O Module

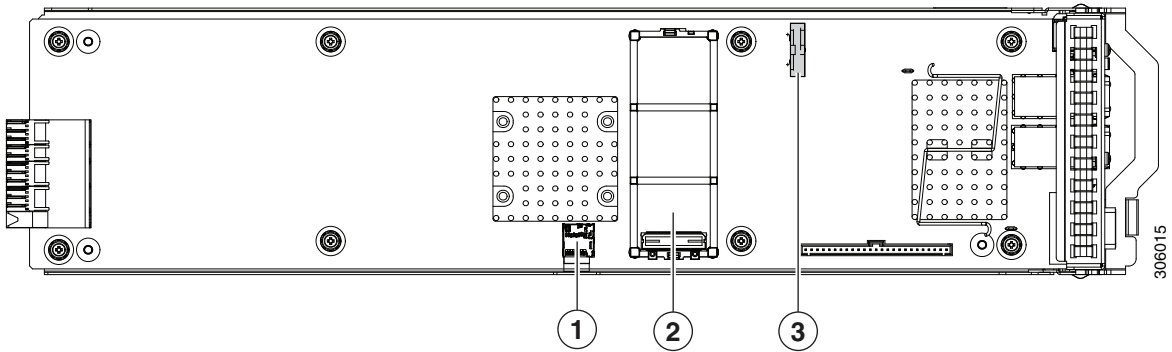

1	Micro SD card socket	3	RTC battery vertical socket
2	Mini storage module connector Supports either an SD card carrier with two SD card slots or an M.2 SSD carrier with two SATA M.2 SSD slots	—	—

CPUs and DIMMs

Physical Layout

Each CPU has six DIMM channels:

- CPU1 has channels A, B, C, D, E, and F
- CPU2 has channels G, H, J, K, L, and M

Each DIMM channel has two slots: slot 1 and slot 2. The blue-colored DIMM slots are for slot 1 and the black slots for slot 2.

As an example, DIMM slots A1, B1, C1, D1, E1, and F1 belong to slot 1, while A2, B2, C2, D2, E2, and F2 belong to slot 2.

Figure 9 shows how slots and channels are physically laid out on the motherboard. The DIMM slots on the right half of the motherboard (channels A, B, C, D, E, and F) are associated with CPU 1, while the DIMM slots on the left half of the motherboard (channels G, H, J, K, L, and M) are associated with CPU 2. The slot 1 (blue) DIMM slots are always located farther away from a CPU than the corresponding slot 2 (black) slots.

Figure 9 Physical Layout of CPU DIMM Channels and Slots

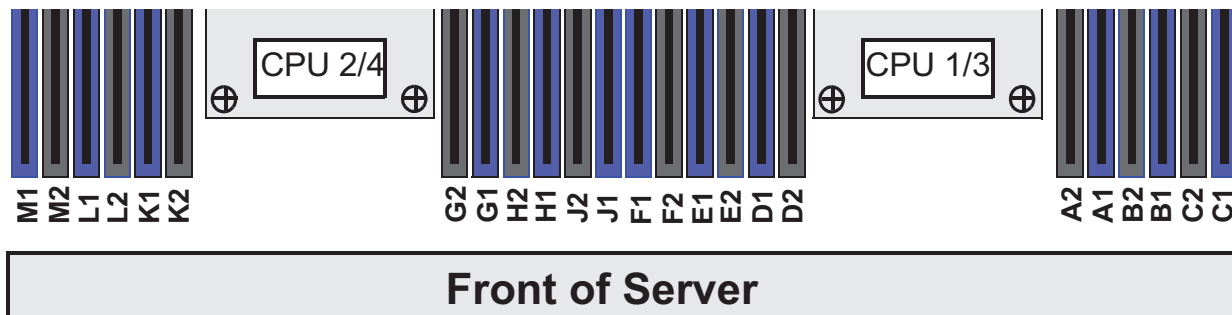

Memory Configuration Best Practices available at <https://www.cisco.com/c/dam/en/us/products/collateral/servers-unified-computing/ucs-c-series-rack-servers/memory-guide-c220-c240-b200-m5.pdf>

Memory Population Rules

When considering the memory configuration of your server, consider the following items:

- Each channel has two DIMM slots (for example, channel A = slots A1 and A2).
 - A channel can operate with one or two DIMMs installed.
- Populate the DIMM slots of each CPU identically.
 - Fill black slots in the channels second: C2, F2, B2, E2, A2, D2

Table 33 DIMM Rules for C480 ML M5 Servers

DIMM Parameter	DIMMs in the Same Channel	DIMM in the Same Slot ¹
<u>DIMM Capacity</u> RDIMM = 8, 16, 32, 64, or 128 GB LRDIMM = 64 GB TSV-RDIMM = 64 GB	DIMMs in the same channel (for example, A1 and A2) can have different capacities. Do not mix TSV-RDIMMS with LRDIMMS nor RDIMMS	For best performance, DIMMs in the same slot (for example, A1, B1, C1, D1, E1, F1) should have the same capacity. Do not mix TSV-RDIMMS with LRDIMMS nor RDIMMS
<u>DIMM Speed</u> 2666-MHz	DIMMs will run at the lowest speed of the CPU installed	DIMMs will run at the lowest speed of the CPU installed
<u>DIMM Type</u> TSV-RDIMMS, RDIMMS, or LRDIMMS	Do not mix DIMM types in a channel	Do not mix DIMM types in a slot
DIMMs per Channel (DPC)	1 DPC or 2 DPC	
	Ensure valid LRDIMM and RDIMM 1 DPC and 2 DPC memory configurations	

Notes:

1. Although different DIMM capacities can exist in the same slot, this will result in less than optimal performance. For optimal performance, all DIMMs in the same slot should be identical.

Memory Mirroring

When Memory Mirroring PID (N01-MMIRROR) is selected in **STEP 3 CHOOSE MEMORY**, the DIMMS will be placed as shown in the below table by the factory

- Select 4, 6,8,12 identical DIMMS per CPU.

(1) 1 CPU config for memory mirroring:

	CPU 1 DIMM Placement in Channels (for identical ranked DIMMs)	CPU 2 DIMM Placement in Channels (for identical ranked DIMMs)
	CPU 1	CPU 2
8	(A1,B1); (D1,E1)	(G1, H1); (K1, L1)
12	(A1, B1, C1); (D1, E1, F1)	(G1, H1, J1); (K1, L1, M1)
16	(A1, A2, B1, B2); (D1, D2, E1, E2)	(G1, G2, H1, H2); (K1, K2, L1, L2)
24	(A1, A2, B1, B2, C1, C2); (D1, D2, E1, E2, F1, F2)	(G1, G2, H1, H2, J1, J2); (K1, K2, L1, L2, M1, M2)

(2) 4 CPU Config for Memory Mirroring - duplicate table above for 2 CPU Config in second Compute Module

Memory Support for CPU Classes and CPU Modes

For 2nd Generation Intel® Xeon® Scalable Processors:

- DIMMs and PMEMs are supported
- CPU PIDs ending in “M” support up to a limit of 2048 GB per CPU
- CPU PIDs ending in “L” support up to a limit of 4608 GB per CPU
- All other CPU PIDs support up to a limit of 1024 GB per CPU
- For the App Direct Mode, both PMEM and DIMM capacities count towards the CPU capacity limit
- For the Memory Mode and Mixed Mode only the PMEM capacity counts towards the CPU capacity limit

For Configurations Using Only DIMMs

- CPU PIDs ending in “M” support DIMM capacities up to 1536 GB per CPU (using 12 x 128 GB DIMMs) and DIMM capacities up to 2048 GB per CPU (using 8 x 256 GB DIMMs).
- CPU PIDs ending in “L” support DIMM capacities up to 1536 GB per CPU (using 12 x 128 GB DIMMs) and DIMM capacities up to 3072 GB per CPU (using 12 x 256 GB DIMMs). The 4608 GB limit cannot be reached with these capacity DIMMs.
- CPU PIDs not ending in “L” or “M” support DIMM capacities up to 1024 GB per CPU (using 8 x 128 GB DIMMs or 4 x 256 GB DIMMs).

For Configurations Using DIMMs and PMEMs in [App Direct Mode](#)

- CPU PIDs ending in “M” support capacities up to 1792 GB per CPU (using 6 x 128 GB DIMMs and 2 x 512 GB PMEMs or 4 x 256 GB PMEMs) or up to 2048 GB per CPU (using 6 x 256 GB DIMMs and 2 x 256 GB PMEMs or 6 x 256 GB DIMMs and 4 x 128 GB PMEMs)
- CPU PIDs ending in “L” support capacities up to 3840 GB per CPU (using 6 x 128 GB DIMMs and 6 x 512 GB PMEMs) or up to 4608 GB per CPU (using 6 x 256 GB DIMMs and 6 x 512 GB PMEMs)
- CPU PIDs not ending in “L” or “M” support capacities up to 1024 GB per CPU (using 6 x 128 GB DIMMs and 2 x 128 GB PMEMs).

For Configurations Using DIMMs and PMEMs in [Memory or Mixed Mode](#)

- CPU PIDs ending in “M” support capacities up to 2816 GB per CPU (using 6 x 128 GB DIMMs and 4 x 512 GB PMEMs) or up to 3584 GB per CPU (using 6 x 256 GB DIMMs and 4 x 512 GB PMEMs)
- CPU PIDs ending in “L” support capacities up to 3840 GB (using 6 x 128 GB DIMMs and 6 x 512 GB PMEMs) or up to 4608 GB per CPU (using 6 x 256 GB DIMMs and 6 x 512 GB PMEMs). The allowable 4608 limit for PMEM capacity is not reached in this case.
- CPU PIDs not ending in “L” or “M” support capacities up to 1024 GB per CPU (using 6 x 128 GB DIMMs and 2 x 128 GB PMEMs).

For Intel® Xeon® Scalable Processors:

- DIMMs are supported; PMEMs are not supported
- CPU PIDs ending in “M” support DIMM capacities up to 1536 GB per CPU (using 12 x 128 GB DIMMs).
- All other CPU PIDs support DIMM capacities up to 768 GB per CPU (using 6 x 128 GB DIMMs or 12 x 64 GB DIMMs)

DIMM Population Order

Populate the DIMMs for a CPU according to [Table 34](#).

Table 34 DIMM Population Order

	Populate CPU 1 or CPU 3 Slot		Populate CPU 2 or CPU 4 Slots	
	Blue #1 Slots	Black #2 Slots	Blue #1 Slots	Black #2 Slots
1	(A1)	-	(G1)	-
2	(A1, B1)	-	(G1, H1)	-
3	(A1, B1, C1)	-	(G1, H1, J1)	-
4	(A1, B1); (D1, E1)	-	(G1, H1); (K1, L1)	-
8	(A1, B1); (D1, E1)	(A2, B2); (D2, E2)	(G1, H1); (K1, L1)	(G2, H2); (K2, L2)
12	(A1, B1); (C1, D1); (E1, F1)	(A2, B2); (C2, D2); (E2, F2)	(G1, H1); (J1, K1); (L1, M1)	(G2, H2); (J2, K2); (L2, M2)

KVM CABLE

The KVM cable provides a connection into the server, providing a DB9 serial connector, a VGA connector for a monitor, and dual USB 2.0 ports for a keyboard and mouse. With this cable, you can create a direct connection to the operating system and the BIOS running on the server.

The KVM cable ordering information is listed in [Table 35](#).

Table 35 KVM Cable

Product ID (PID)	PID Description
N20-BKVM	KVM cable for server console port

Figure 10 KVM Cable

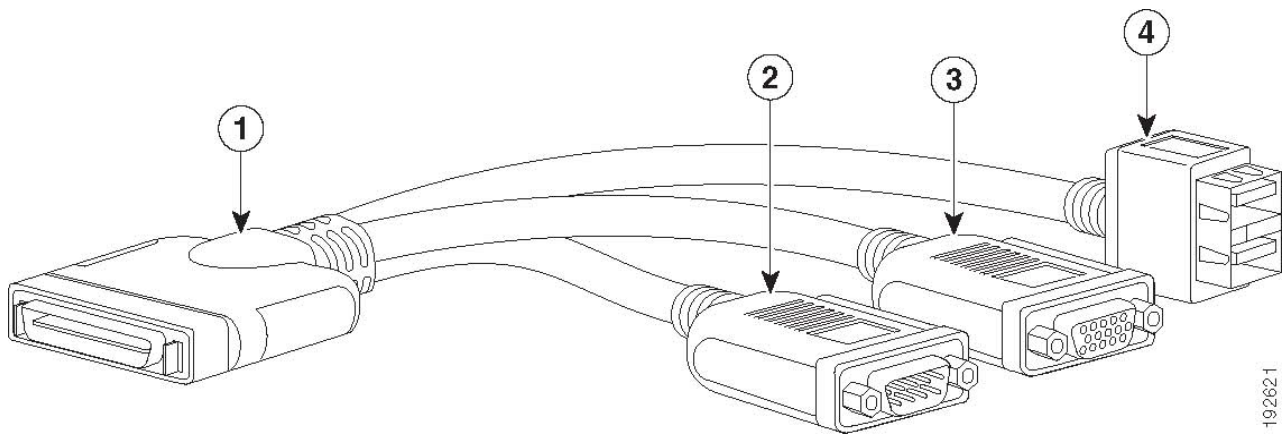

1	Connector (to server front panel)	3	VGA connector (for a monitor)
2	DB-9 serial connector	4	Two-port USB 2.0 connector (for a mouse and keyboard)

DISCONTINUED EOL PRODUCTS

Below is the list of parts were previously available for this product and are no longer sold. Please refer to the EOL Bulletin Links via the [Table 36](#) below to determine if still supported.

Table 36 EOL Products

EOS option PID	Description	EOL bulletin link
MEMORY		
UCS-MR-X16G2RS-H	16GB DDR4-2666-MHz RDIMM/PC4-21300/dual rank/x4/1.2v	https://www.cisco.com/c/en/us/products/collateral/servers-unified-computing/ucs-c-series-rack-servers/eos-eol-notice-c51-740780.html
CPU		
UCS-CPU-I8280M	Intel 8280M 2.7GHz/205W 28C/38.50MB 3DX DDR4 2TB 2933 MHz	https://www.cisco.com/c/en/us/products/collateral/servers-unified-computing/ucs-c-series-rack-servers/eos-eol-notice-c51-743832.html
UCS-CPU-I8260M	Intel 8260M 2.4GHz/165W 24C/35.75MB 3DX DDR4 2TB 2933 MHz	https://www.cisco.com/c/en/us/products/collateral/servers-unified-computing/ucs-c-series-rack-servers/eos-eol-notice-c51-743832.html
UCS-CPU-8180M	2.5 GHz 8180M/205W 28C/38.50MB Cache/DDR4 2666MHz	https://www.cisco.com/c/en/us/products/collateral/servers-unified-computing/ucs-c-series-rack-servers/eos-eol-notice-c51-744580.html
UCS-CPU-8180	2.5 GHz 8180/205W 28C/38.50MB Cache/DDR4 2666MHz	https://www.cisco.com/c/en/us/products/collateral/servers-unified-computing/ucs-c-series-rack-servers/eos-eol-notice-c51-744580.html
UCS-CPU-8160	2.1 GHz 8160/150W 24C/33MB Cache/DDR4 2666MHz	https://www.cisco.com/c/en/us/products/collateral/servers-unified-computing/ucs-c-series-rack-servers/eos-eol-notice-c51-744580.html
UCS-CPU-6154	3.0 GHz 6154/200W 18C/24.75MB Cache/DDR4 2666MHz	https://www.cisco.com/c/en/us/products/collateral/servers-unified-computing/ucs-c-series-rack-servers/eos-eol-notice-c51-744580.html
UCS-CPU-6152	2.1 GHz 6152/140W 22C/30.25MB Cache/DDR4 2666MHz	https://www.cisco.com/c/en/us/products/collateral/servers-unified-computing/ucs-c-series-rack-servers/eos-eol-notice-c51-744580.html
UCS-CPU-6150	2.7 GHz 6150/165W 18C/24.75MB Cache/DDR4 2666MHz	https://www.cisco.com/c/en/us/products/collateral/servers-unified-computing/ucs-c-series-rack-servers/eos-eol-notice-c51-744580.html
UCS-CPU-6148	2.4 GHz 6148/150W 20C/27.50MB Cache/DDR4 2666MHz	https://www.cisco.com/c/en/us/products/collateral/servers-unified-computing/ucs-c-series-rack-servers/eos-eol-notice-c51-744580.html
UCS-CPU-6144	3.5 GHz 6144/150W 8C/24.75MB Cache/DDR4 2666MHz	https://www.cisco.com/c/en/us/products/collateral/servers-unified-computing/ucs-c-series-rack-servers/eos-eol-notice-c51-744580.html
UCS-CPU-6142	2.6 GHz 6142/150W 16C/22MB Cache/DDR4 2666MHz	https://www.cisco.com/c/en/us/products/collateral/servers-unified-computing/ucs-c-series-rack-servers/eos-eol-notice-c51-744580.html
UCS-CPU-6140	2.3 GHz 6140/140W 18C/24.75MB Cache/DDR4 2666MHz	https://www.cisco.com/c/en/us/products/collateral/servers-unified-computing/ucs-c-series-rack-servers/eos-eol-notice-c51-744580.html

Table 36 EOL Products

EOS option PID	Description	EOL bulletin link
UCS-CPU-6142M	2.6 GHz 6142M/150W 16C/22MB Cache/DDR4 2666MHz	https://www.cisco.com/c/en/us/products/collateral/servers-unified-computing/ucs-c-series-rack-servers/eos-eol-notice-c51-744580.html
UCS-CPU-6138	2.0 GHz 6138/125W 20C/27.50MB Cache/DDR4 2666MHz	https://www.cisco.com/c/en/us/products/collateral/servers-unified-computing/ucs-c-series-rack-servers/eos-eol-notice-c51-744580.html
UCS-CPU-6136	3.0 GHz 6136/150W 12C/24.75MB Cache/DDR4 2666MHz	https://www.cisco.com/c/en/us/products/collateral/servers-unified-computing/ucs-c-series-rack-servers/eos-eol-notice-c51-744580.html
UCS-CPU-5122	3.6 GHz 5122/105W 4C/16.50MB Cache/DDR4 2666MHz	https://www.cisco.com/c/en/us/products/collateral/servers-unified-computing/ucs-c-series-rack-servers/eos-eol-notice-c51-744580.html
UCS-CPU-4116	2.1 GHz 4116/85W 12C/16.50MB Cache/DDR4 2400MHz	https://www.cisco.com/c/en/us/products/collateral/servers-unified-computing/ucs-c-series-rack-servers/eos-eol-notice-c51-744580.html
Enterprise Performance		
UCS-SD16T123X-EP	1.6 TB 2.5 inch Enterprise performance 12G SAS SSD (3X endurance)	https://www.cisco.com/c/en/us/products/collateral/hyperconverged-infrastructure/hyperflex-hx-series/eos-eol-notice-c51-2451489.html
UCS-SD32T123X-EP	3.2TB 2.5in Enterprise Performance 12G SAS SSD(3X endurance)	https://www.cisco.com/c/en/us/products/collateral/hyperconverged-infrastructure/hyperflex-hx-series/eos-eol-notice-c51-2451489.html
NVMe		
UCSC-NVMELW-I1000	Cisco 2.5" U.2 1TB Intel P4501 NVMe Med. Perf. Value Endur (Intel)	https://www.cisco.com/c/en/us/products/collateral/servers-unified-computing/ucs-c-series-rack-servers/eos-eol-notice-c51-742509.html
UCSC-NVMEHW-I1000	1 TB 2.5in U.2 Intel P4500 NVMe High Perf. Value Endurance	https://www.cisco.com/c/en/us/products/collateral/servers-unified-computing/ucs-c-series-rack-servers/eos-eol-notice-c51-742509.html
UCSC-NVMELW-I500	500GB 2.5in U.2 Intel P4501 NVMe Med. Perf. Value Endurance	https://www.cisco.com/c/en/us/products/collateral/servers-unified-computing/ucs-c-series-rack-servers/eos-eol-notice-c51-742509.html
UCSC-NVMEHW-I4000	4 TB 2.5in U.2 Intel P4500 NVMe High Perf. Value Endurance	https://www.cisco.com/c/en/us/products/collateral/servers-unified-computing/ucs-c-series-rack-servers/eos-eol-notice-c51-742509.html
UCSC-NVMEHW-I1600	Cisco 2.5" U.2 1.6TB Intel P4600 NVMe High Perf. High Endurance	https://www.cisco.com/c/en/us/products/collateral/servers-unified-computing/ucs-c-series-rack-servers/eos-eol-notice-c51-742823.html
UCSC-NVMEHW-I2000	2 TB 2.5in U.2 Intel P4600 NVMe High Perf. High Endurance	https://www.cisco.com/c/en/us/products/collateral/servers-unified-computing/ucs-c-series-rack-servers/eos-eol-notice-c51-742509.html
UCSC-NVMEHW-I2TBV	2TB 2.5in U.2 Intel P4500 NVMe High Perf. Value Endurance	https://www.cisco.com/c/en/us/products/collateral/servers-unified-computing/ucs-c-series-rack-servers/eos-eol-notice-c51-742823.html

Table 36 EOL Products

EOS option PID	Description	EOL bulletin link
UCSC-NVMEHW-H3200	3.2 TB 2.5in U.2 HGST SN200 NVMe High Perf. High Endurance	https://www.cisco.com/c/en/us/products/collateral/hyperconverged-infrastructure/hyperflex-hx-series/eos-eol-notice-c51-2451489.html
UCSC-NVMEHW-I3200	3.2TB 2.5in U.2 Intel P4600 NVMe High Perf. High Endurance	https://www.cisco.com/c/en/us/products/collateral/servers-unified-computing/ucs-c-series-rack-servers/eos-eol-notice-c51-742823.html
UCSC-NVMEHW-H1600	1.6 TB 2.5in U.2 HGST SN200 NVMe High Perf. High Endurance	https://www.cisco.com/c/en/us/products/collateral/hyperconverged-infrastructure/hyperflex-hx-series/eos-eol-notice-c51-2451489.html
Microsoft Windows server		
MSWS-16-ST16C	Windows Server 2016 Standard (16 Cores/2 VMs)	https://www.cisco.com/c/en/us/products/servers-unified-computing/ucs-c-series-rack-servers/eos-eol-notice-c51-743145.html
MSWS-16-ST24C	Windows Server 2016 Standard (24 Cores/2 VMs)	https://www.cisco.com/c/en/us/products/servers-unified-computing/ucs-c-series-rack-servers/eos-eol-notice-c51-743145.html
MSWS-16-ST16C-NS	Windows Server 2016 Standard (16 Cores/2 VMs) - No Cisco SVC	https://www.cisco.com/c/en/us/products/servers-unified-computing/ucs-c-series-rack-servers/eos-eol-notice-c51-743145.html
MSWS-16-ST24C-NS	Windows Server 2016 Standard (24 Cores/2 VMs) - No Cisco SVC	https://www.cisco.com/c/en/us/products/servers-unified-computing/ucs-c-series-rack-servers/eos-eol-notice-c51-743145.html
MSWS-16-DC16C	Windows Server 2016 Data Center (16 Cores/Unlimited VMs)	https://www.cisco.com/c/en/us/products/servers-unified-computing/ucs-c-series-rack-servers/eos-eol-notice-c51-743145.html
MSWS-16-DC24C	Windows Server 2016 Data Center (24 Cores/Unlimited VMs)	https://www.cisco.com/c/en/us/products/servers-unified-computing/ucs-c-series-rack-servers/eos-eol-notice-c51-743145.html
MSWS-16-DC16C-NS	Windows Server 2016 DC (16 Cores/Unlim VMs) - No Cisco SVC	https://www.cisco.com/c/en/us/products/servers-unified-computing/ucs-c-series-rack-servers/eos-eol-notice-c51-743145.html
MSWS-16-DC24C-NS	Windows Server 2016 DC (24 Cores/Unlim VMs) - No Cisco SVC	https://www.cisco.com/c/en/us/products/servers-unified-computing/ucs-c-series-rack-servers/eos-eol-notice-c51-743145.html

TECHNICAL SPECIFICATIONS

Dimensions and Weight

Table 37 UCS C480 ML M5 Dimensions and Weight¹

Parameter	Value
Height	6.9 in. (176 mm)
Width	19.0 in. (483 mm)
Length (including front handles and power supplies)	32.7 in. (830 mm)
Front Clearance	3 in. (7.62 cm)
Side Clearance	1 in. (25.4 mm)
Rear Clearance	6 in. (152.4 mm)
Weight (maximum configuration, including slide rail brackets and cable management arm)	146 lbs (66.3kg)

Notes:

1. The system weight given here is an estimate for a fully configured system and will vary depending on the number of peripheral devices and power supplies.

Power Specifications

Table 38 Power Supplies

Product ID (PID)	PID Description
UCSC-PSU1-1600W	Cisco UCS 1600W AC Power Supply for Rack Server

The general power specifications for the C480 ML M5 server are listed in [Table 39](#).

Table 39 UCS C480 ML M5 1600 W (AC) Power Supply Specifications

Description	Specification
AC input voltage	Voltage Range 180 - 264 VAC
AC input frequency	50 to 60 Hz nominal (range: 47 to 63 Hz)
Max AC Input current	< 9.5 A maximum at 200 VAC
Maximum Input VA	1600 VA @200 VAC
Maximum output power per power supply	In the 180-265 VAC range the maximum rated output power is 1600 W, not including the standby 12V power.
Maximum inrush current	< 30A Peak at +35 degrees C (charging current for EMI-X capacitors is not considered to be inrush current)
Maximum hold up time	Greater than 12 ms with 2,200 uF of load capacitance
Power supply output voltage	12 VDC
Power supply standby voltage	12 VDC
Efficiency rating	Climate Savers Platinum Efficiency (80Plus Platinum Certified)
Form Factor	RSP2
Input connector	IEC60320 C14 type connector

For configuration-specific power specifications, use the Cisco UCS Power Calculator at:

<http://ucspowercalc.cisco.com>

Environmental Specifications

The power specifications for the C480 ML M5 server are listed in [Table 40](#).

Table 40 UCS C480 ML M5 Environmental Specifications

Parameter	Minimum
Temperature operating	10° C to 35° C (50° F to 95° F)
Temperature non-operating	-40° C to 70° C (-40° F to 158° F)
Altitude	-30 m to 1500 m (-100 ft to 5000 ft)
Humidity non-operating	95%, noncondensing at temperatures of 25° C (77° F) to 30° C (86° F)

Compliance Requirements

The regulatory compliance requirements for C-Series servers are listed in [Table 41](#).

Table 41 UCS C-Series Regulatory Compliance Requirements

Parameter	Description
Regulatory Compliance	Products should comply with CE Markings per directives 2004/108/EC and 2006/95/EC
Safety	UL 60950-1 Second Edition CAN/CSA-C22.2 No. 60950-1 Second Edition EN 60950-1 Second Edition IEC 60950-1 Second Edition AS/NZS 60950-1 GB4943 2001
EMC - Emissions	47CFR Part 15 (CFR 47) Class A AS/NZS CISPR22 Class A CISPR22 Class A EN55022 Class A ICES003 Class A VCCI Class A EN61000-3-2 EN61000-3-3 KN22 Class A CNS13438 Class A
EMC - Immunity	EN55024 CISPR24 EN300386 KN24



Americas Headquarters
Cisco Systems, Inc.
San Jose, CA

Asia Pacific Headquarters
Cisco Systems (USA) Pte. Ltd.
Singapore

Europe Headquarters
Cisco Systems International BV Amsterdam,
The Netherlands

Cisco has more than 200 offices worldwide. Addresses, phone numbers, and fax numbers are listed on the Cisco Website at www.cisco.com/go/offices.

Cisco and the Cisco Logo are trademarks of Cisco Systems, Inc. and/or its affiliates in the U.S. and other countries. A listing of Cisco's trademarks can be found at www.cisco.com/go/trademarks. Third party trademarks mentioned are the property of their respective owners. The use of the word partner does not imply a partnership relationship between Cisco and any other company. (1005R)