



This product has been discontinued

Cisco UCS C3160 Rack Server

CONTENTS

OVERVIEW	3
DETAILED VIEWS	4
Chassis Front View	4
Chassis Rear View	5
BASE SERVER STANDARD CAPABILITIES and FEATURES	6
CONFIGURING the SERVER	8
STEP 1 VERIFY SERVER SKU	9
STEP 2 SELECT SYSTEM I/O CONTROLLER (OPTIONAL)	10
STEP 3 SELECT SERVER NODE	11
STEP 4 SELECT HARD DISK DRIVE (HDD) or SOLID STATE DRIVE (SSD) MULTIPACKS	15
STEP 5 SELECT BOOT DRIVES (OPTIONAL)	20
STEP 6 SELECT DISK EXPANSION TRAY AND DRIVES (OPTIONAL)	21
STEP 7 SELECT AC POWER CORD(s)	22
STEP 8 ORDER REVERSIBLE CABLE MANAGEMENT ARM (OPTIONAL)	25
STEP 9 ORDER OPTIONAL USB DRIVE	26
STEP 10 ORDER A TRUSTED PLATFORM MODULE (OPTIONAL)	27
STEP 11 ORDER A KVM CABLE (OPTIONAL)	28
STEP 12 SELECT OPERATING SYSTEM AND VALUE-ADDED SOFTWARE	29
STEP 13 SELECT OPERATING SYSTEM MEDIA KIT	31
STEP 14 SELECT SERVICE and SUPPORT LEVEL	32
OPTIONAL STEP - ORDER RACK(s)	37
OPTIONAL STEP - ORDER PDU	38
SUPPLEMENTAL MATERIAL	39
CHASSIS	39
CPUs and DIMMs	40
Physical Layout	40
Memory Population Rules	41
Internal Drive Population Guidelines	42
Upgrade and Servicing-Related Parts	43
System I/O Controller Blanking Panel	43
RACKS	44
PDUs	46
TECHNICAL SPECIFICATIONS	47
Dimensions and Weight	47
Power Specifications	48
Environmental Specifications	49
Compliance Requirements	50

OVERVIEW

The Cisco UCS C3160 is a modular, dense storage rack server, optimized for large datasets used in environments such as cloud, object storage and content delivery.

The UCS C3160 chassis is a modular architecture consisting of the following modules:

1. Base Chassis: contains four power supplies and a rail kit.
2. Server Node: two CPUs, 128/256/512 GB of DIMM memory, and choice of a pass-through RAID card or a RAID card with a 1 GB or 4 GB cache.
3. System I/O Controller (SIOC): one or two System I/O Controllers each with an adapter card slot.
4. Optional Drive Expansion Node: comes with four 4 TB, 6 TB, 8 TB, or 10 TB drives for a total capacity of 16, 24, 32, or 40 TB.
5. Solid-state Boot Drive: 1 or 2 SATA SSD boot drives

The enterprise-class UCS C3160 server extends the capabilities of Cisco's Unified Computing System portfolio in a 4U form factor that delivers the best combination of performance, flexibility, and efficiency gains.

Figure 1 Cisco UCS C3160 Dense Rack Server

Front View



Rear View



DETAILED VIEWS

Chassis Front View

Figure 2 shows the Cisco UCS C3160 Rack Server.

Figure 2 Chassis Front View

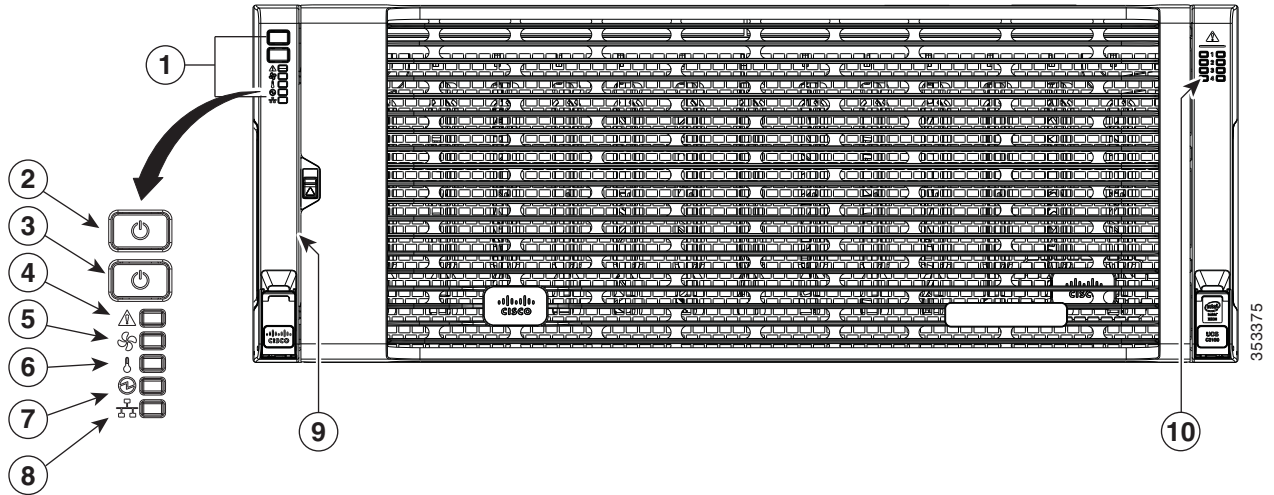

1	Operations panel	6	Temperature status LED
2	System power button/LED	7	Power supply status LED
3	System unit identification button/LED	8	Network link activity LED
4	System status LED	9	Pull-out asset tag (not visible under front bezel)
5	Fan status LED	10	Internal-drive status LEDs

Chassis Rear View

Figure 3 shows the external features of the rear panel.

Figure 3 Chassis Rear View

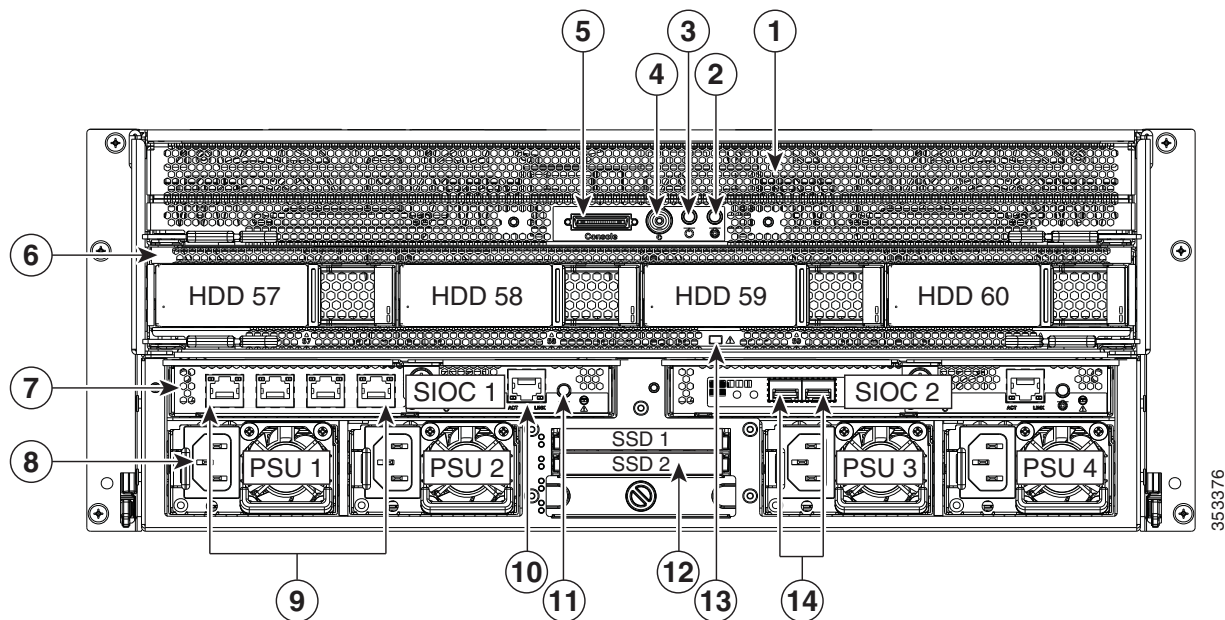

1	Server node	8	Power supplies (four, redundant as 2+2)
2	Server node unit identification button/LED	9	Optional: 1-Gb BASE-T Ethernet ports (RJ-45) (four on each SIOC that contains a quad-port adapter card)
3	Server node Power button/LED (used to shut down node to standby power state)	10	1-Gb Ethernet dedicated management port (one on each SIOC)
4	Server node reset button (resets processor chipset in server node)	11	SIOC Attention LED (one on each SIOC)
5	KVM console connector ¹ on server node Used with a KVM cable that provides two USB, one VGA, and one serial connector	12	Solid state drive 2.5-inch drive bays (only the top two bays are supported)
6	(Optional) Drive expander module with four 3.5-inch drive bays	13	Drive expander module fault LED
7	System I/O controller (SIOC), (one or two modules) Port types vary, depending on the type of adapter card installed.	14	Optional: 10-Gb SFP+ ports (two on each SIOC that contains a dual-port SFP+ adapter card)

Notes

1. For more information on the KVM port, see [ORDER A KVM CABLE \(OPTIONAL\)](#), page 28.

BASE SERVER STANDARD CAPABILITIES and FEATURES

Table 1 lists the capabilities and features of the base server. Details about how to configure the server for a particular feature or capability (for example, number of processors, disk drives, or amount of memory) are provided in *CONFIGURING the SERVER, page 8*.

Table 1 Capabilities and Features

Capability/Feature	Description
Chassis	Four rack unit (4RU) chassis
Server Node	One server node plugs into the back of the server. The node contains two CPUs, up to 512 GB of DIMM memory, and a RAID card in either pass-through mode or with up to up to 4 GB of RAID cache.
CPU	Two Intel Xeon E5-2600 v2 series processor family CPUs in a server node
System I/O Controller	Includes a single adapter card slot for flexible I/O capability and provides a dedicated 1-Gbps RJ45 Management port.
Chipset	Intel® C600 series chipset
Memory	16 slots for registered ECC registered DIMMs (RDIMMs) per server node
Multi-bit Error Protection	This server supports multi-bit error protection.
Expansion slots	None
Video	Integrated 2D graphics controller supporting up to 1600 x 1200 resolution
Internal storage devices	<p>Top loading drives</p> <ul style="list-style-type: none"> ■ Up to 56 4 TB 512n, 6 TB 4Kn, 8 TB 4Kn, or 10 TB 4Kn 3.5” hard disk drives can be installed into top-accessible drive bays, which provide hot-pluggable access. ■ Up to 14 400 GB 2.5” solid-state drives¹ can be installed into top-accessible drive bays, which provide hot-pluggable access. <p>Rear loading drives</p> <ul style="list-style-type: none"> ■ Up to four 4 TB 512n, 6 TB 4Kn, 8 TB 4Kn, or 10 TB 4Kn 3.5” drives can be installed into an optional disk expander module at the back of the chassis. ■ Slots for up to two boot drives located at the rear of the chassis for OS boot mirror <p>USB Storage</p> <ul style="list-style-type: none"> ■ The system includes one internal USB 2.0 slot inside the server node. ■ A front panel controller provides status indications and control buttons
Front Panel Fans	<p>Chassis:</p> <ul style="list-style-type: none"> ■ Four hot-swappable dual fan modules (8 fans total)
Power subsystem	<p>Four of the following hot-swappable power supplies:</p> <ul style="list-style-type: none"> ■ 1050 W <p>Four power supplies are mandatory (redundant as 2+2).</p>

Capability/Feature	Description									
Interfaces	<p>Rear panel</p> <ul style="list-style-type: none"> ■ One or two plug-in System I/O controllers with a dedicated 1 Gbps RJ45 Management port used for remote setup. Each controller has a Cisco adapter card socket, which accommodate three different cards, offering the following capabilities: <ul style="list-style-type: none"> • Four 1 GbE ports (RJ45 connector), with Intel i350 MLOM, or • Two 10 GbE ports (SFP+) with the Cisco VIC 1227 MLOM, or • Two 10 GBASE-T Ethernet ports (with Cisco 1227T VIC) • Two 40 Gbps QSFP ports (with Cisco 1387 VIC) ■ One KVM console connector on the server node (supplies two USB 2.0 connectors, one VGA DB15 video connector, one serial port (RS232) RJ45 connector, and two USB 2.0 ports). ■ Front panel <ul style="list-style-type: none"> • There are no interface ports on the front panel. 									
Storage controller	<p>Each Server Node module has a mezzanine connector that supports the Cisco UCS C3X60 12G SAS RAID Controller card in pass-through mode with write cache and SuperCap backup.</p> <p>Access to the connector and card requires removing the server module and removing its top cover.</p> <p>The Cisco UCS C3X60 12G SAS RAID Controller card is available with an onboard Flash-Backed Write Cache (FBWC), as shown in the table below</p> <table border="1" data-bbox="428 1138 1437 1308"> <thead> <tr> <th>RAID Card Version</th> <th>Supported RAID Levels</th> <th>Onboard FBWC</th> </tr> </thead> <tbody> <tr> <td>UCSC-C3X60-R1GB</td> <td>JBOD, RAID 0, 1, 5, 6, 10, 50, 60</td> <td>1 GB</td> </tr> <tr> <td>UCSC-C3X60-R4GB</td> <td>JBOD, RAID 0, 1, 5, 6, 10, 50, 60</td> <td>4 GB</td> </tr> </tbody> </table> <p>All versions of the RAID controller support up to 60 drives. Boot SSDs are connected to the Intel PCH on the Server Node and managed by OS-level or SW RAID support.</p> <hr/> <p> NOTE: Two of the server node options include a RAID controller that allows pass-through drive control.</p>	RAID Card Version	Supported RAID Levels	Onboard FBWC	UCSC-C3X60-R1GB	JBOD, RAID 0, 1, 5, 6, 10, 50, 60	1 GB	UCSC-C3X60-R4GB	JBOD, RAID 0, 1, 5, 6, 10, 50, 60	4 GB
RAID Card Version	Supported RAID Levels	Onboard FBWC								
UCSC-C3X60-R1GB	JBOD, RAID 0, 1, 5, 6, 10, 50, 60	1 GB								
UCSC-C3X60-R4GB	JBOD, RAID 0, 1, 5, 6, 10, 50, 60	4 GB								
Integrated management processor	<p>Baseboard Management Controller (BMC) running Cisco Integrated Management Controller (CIMC) firmware.</p> <p>Depending on your CIMC settings, the CIMC can be accessed through the 1-GbE dedicated management port.</p>									

Notes

1. Drive carriers adapt the 2.5” drives to the 3.5” drive bays in the top of the chassis.

CONFIGURING the SERVER

Follow these steps to configure the Cisco UCS C3160 Rack Server:

- *STEP 1 VERIFY SERVER SKU, page 9*
- *STEP 2 SELECT SYSTEM I/O CONTROLLER (OPTIONAL), page 10*
- *STEP 3 SELECT SERVER NODE, page 11*
- *STEP 4 SELECT HARD DISK DRIVE (HDD) or SOLID STATE DRIVE (SSD) MULTIPACKS, page 15*
- *STEP 5 SELECT BOOT DRIVES (OPTIONAL), page 20*
- *STEP 6 SELECT DISK EXPANSION TRAY AND DRIVES (OPTIONAL), page 21*
- *STEP 7 SELECT AC POWER CORD(s), page 22*
- *STEP 8 ORDER REVERSIBLE CABLE MANAGEMENT ARM (OPTIONAL), page 25*
- *STEP 9 ORDER OPTIONAL USB DRIVE, page 26*
- *STEP 10 ORDER A TRUSTED PLATFORM MODULE (OPTIONAL), page 27*
- *STEP 11 ORDER A KVM CABLE (OPTIONAL), page 28*
- *STEP 12 SELECT OPERATING SYSTEM AND VALUE-ADDED SOFTWARE, page 29*
- *STEP 13 SELECT OPERATING SYSTEM MEDIA KIT, page 31*
- *STEP 14 SELECT SERVICE and SUPPORT LEVEL, page 32*
- *OPTIONAL STEP - ORDER RACK(s), page 37*
- *OPTIONAL STEP - ORDER PDU, page 38*

STEP 1 VERIFY SERVER SKU

Select the base server product ID (PID) from [Table 2](#).

Table 2 PID of the C3160 Base Server

Product ID (PID)	Description
UCSC-C3160	UCS C3160 Dense Storage Server four 1050 W power supplies, one rail kit.

The Cisco UCS C3160 Dense Storage Server:

- Does not include internal storage drives, system I/O controller, server node (no CPU, memory, or RAID controller).



NOTE: Use the steps on the following pages to configure the server with the components that you want to include.

STEP 2 SELECT SYSTEM I/O CONTROLLER (OPTIONAL)

Select two system I/O controllers from [Table 3](#). Each system I/O controller contains a single adapter card slot.

Table 3 PID of the System I/O Module

Product ID (PID)	Description
UCSC-C3160-SIOC	UCS C3160 System IO Controller with single adapter card slot

Select one adapter card for each system I/O module from [Table 4](#). The adapter card plugs into the adapter card socket on the system I/O controller.

Table 4 Available Adapter Cards

Product ID (PID)	Description
UCSC-MLOM-CSC-02	Cisco UCS VIC1227 VIC adapter card- Dual Port 10Gb SFP+
UCSC-MLOM-IRJ45	Intel i350 MLOM NIC
UCSC-MLOM-C10T-02	Cisco UCS VIC1227T VIC MLOM - Dual Port 10GBaseT
UCSC-MLOM-C40Q-03	Cisco VIC 1387 Dual Port 40Gb QSFP CNA MLOM

Approved Configurations

- Select two system I/O controllers.
- Select one adapter card for each system I/O controller.
- You can have different adapter cards for each system I/O controller.

STEP 3 SELECT SERVER NODE

The server node has the following features:

- CPUs
 - Two E5-2600 v2 series family processor CPUs per server node
 - Quick Path Interconnect (QPI) between the CPUs for high-performance transfers between processors and I/O nodes
- Memory DIMMs
 - 8 DIMMs per CPU
 - 4 DIMM channels
 - 2 DIMMs per channel (DPC)
 - ECC DDR3L registered DIMMs (RDIMMs) or load-reduced DIMMs (LRDIMMs), operating at 1866 MHz
- RAID Controller
 - One Cisco 12G SAS RAID controller in pass-through mode, supporting JBOD and RAID levels 0, 1, 5, 6, 10, 50, 60), with 1 GB or 4 GB flash-backed write cache.



NOTE: Two of the server node options (server node 6 and 7) include a RAID controller that allows for pass-through drive control.

Select one server node product ID (PID) from [Table 5](#).

Table 5 PID of the Server Node

Product ID (PID)	Description
UCSC-C3X60-SVRN1	UCS C3X60 Complete Server Config 1 with CPU, memory, JBOD, RAID Comes with the following:
UCS-CPU-E52620B	2 CPUs: 2.10 GHz E5-2620 v2/80W 6C/15MB Cache/DDR3 1600MHz
UCS-MR-1X162RZ-A	128 GB memory: 8 x 16 GB DDR3-1866-MHz RDIMM/PC3-14900/dual rank/x4/1.5v
UCSC-C3X60-R1GB	1 RAID controller: UCS C3X60 12G SAS RAID Controller with 1GB cache

Table 5 PID of the Server Node *(continued)*

Product ID (PID)	Description
UCSC-C3X60-SVRN2	UCS C3X60 Complete Server Config 2 with CPU, Memory, JBOD, RAID Comes with the following:
UCS-CPU-E52620B	2 CPUs: 2.10 GHz E5-2620 v2/80W 6C/15MB Cache/DDR3 1600MHz
UCS-MR-1X162RZ-A	256 GB memory: 16 x 16GB DDR3-1866-MHz RDIMM/PC3-14900/dual rank/x4/1.5v
UCSC-C3X60-R4GB	1 RAID controller: UCS C3X60 12G SAS RAID Controller with 4GB cache
UCSC-C3X60-SVRN3	UCS C3X60 Complete Server Config 3 with CPU, Memory, JBOD, RAID Comes with the following:
UCS-CPU-E52660B	2 CPUs: 2.20 GHz E5-2660 v2/95W 10C/25MB Cache/DDR3 1866MHz
UCS-MR-1X162RZ-A	256 GB memory: 16 x 16GB DDR3-1866-MHz RDIMM/PC3-14900/dual rank/x4/1.5v
UCSC-C3X60-R4GB	1 RAID controller: UCS C3X60 12G SAS RAID Controller with 4GB cache
UCSC-C3X60-SVRN4	UCS C3X60 Complete Server Config 4 with CPU, Memory, JBOD, RAID Comes with the following:
UCS-CPU-E52695B	2 CPUs: 2.40 GHz E5-2695 v2/115W 12C/30MB Cache/DDR3 1866MHz
UCS-MR-1X162RZ-A	256 GB memory: 16 x 16GB DDR3-1866-MHz RDIMM/PC3-14900/dual rank/x4/1.5v
UCSC-C3X60-R4GB	1 RAID controller: UCS C3X60 12G SAS RAID Controller with 4GB cache
UCSC-C3X60-SVRN5	UCS C3X60 Complete Server Config 5 with CPU, Memory, JBOD, RAID Comes with the following:
UCS-CPU-E52695B	2 CPUs: 2.40 GHz E5-2695 v2/115W 12C/30MB Cache/DDR3 1866MHz
UCS-ML-1X324RZ-A	512 GB memory: 16 x 32GB DDR3-1866-MHz LRDIMM/PC3-14900/quad rank/x4/1.5v
UCSC-C3X60-R4GB	1 RAID controller: UCS C3X60 12G SAS RAID Controller with 4GB cache
UCSC-C3X60-SVRN6	UCS C3X60 Complete Server Config 6 with CPU, Memory Comes with the following:
UCS-CPU-E52660B	2 CPUs: 2.20 GHz E5-2660 v2/95W 10C/25MB Cache/DDR3 1866MHz
UCS-MR-1X162RZ-A	128 GB memory: 8 x 16 GB DDR3-1866-MHz RDIMM/PC3-14900/dual rank/x4/1.5v
UCSC-C3X60-HBA	12G SAS pass-through controller

Table 5 PID of the Server Node (*continued*)

Product ID (PID)	Description
UCSC-C3X60-SVRN7	UCS C3X60 Complete Server Config 7 with CPU, Memory Comes with the following:
UCS-CPU-E52695B	2 CPUs: 2.40 GHz E5-2695 v2/115W 12C/30MB Cache/DDR3 1866MHz
UCS-MR-1X162RZ-A	256 GB memory: 16 x 16 GB DDR3-1866-MHz RDIMM/PC3-14900/dual rank/x4/1.5v
UCSC-C3X60-HBA	12G SAS pass-through controller
UCSC-C3X60-SVRN8	UCS C3X60 Complete Server Config 8 with CPU, Memory, HBA Comes with the following:
UCS-CPU-E52620B	2 CPUs: 2.10 GHz E5-2620 v2/80W 6C/15MB Cache/DDR3 1600MHz
UCS-MR-1X162RZ-A	256 GB memory: 16 x 16 GB DDR3-1866-MHz RDIMM/PC3-14900/dual rank/x4/1.5v
UCSC-C3X60-HBA	12G SAS pass-through controller

Approved Configurations

- Select only one server node PID.

Caveats

- No DIMM configurations other than the factory default are supported.
- RAID levels supported by the 12 Gbps RAID controller (UCSC-C3X60-R4GB and UCSC-C3X60-R1GB) are as follows:
 - RAID 0 uses striping to provide high data throughput, especially for large files in an environment that does not require fault tolerance.
 - RAID 1 uses mirroring so that data written to one drive is simultaneously written to another drive which is good for small databases or other applications that require small capacity, but complete data redundancy.
 - RAID 5 uses disk striping and parity data across all drives (distributed parity) to provide high data throughput, especially for small random access.
 - RAID 6 uses distributed parity, with two independent parity blocks per stripe, and disk striping. A RAID 6 virtual drive can survive the loss of two drives without losing data. A RAID 6 drive group, which requires a minimum of three drives, is similar to a RAID 5 drive group. Blocks of data and parity information are written across all drives. The parity information is used to recover the data if one or two drives fail in the drive group.
 - A RAID 00 drive group is a spanned drive group that creates a striped set from a series of RAID 0 drive groups.

- RAID 10, a combination of RAID 0 and RAID 1, consists of striped data across mirrored spans. A RAID 10 drive group is a spanned drive group that creates a striped set from a series of mirrored drives. RAID 10 allows a maximum of eight spans. You must use an even number of drives in each RAID virtual drive in the span. The RAID 1 virtual drives must have the same stripe size. RAID 10 provides high data throughput and complete data redundancy but uses a larger number of spans.
- RAID 50, a combination of RAID 0 and RAID 5, uses distributed parity and disk striping. A RAID 50 drive group is a spanned drive group in which data is striped across multiple RAID 5 drive groups. RAID 50 works best with data that requires high reliability, high request rates, high data transfers, and medium-to-large capacity.
- RAID 60, a combination of RAID 0 and RAID 6, uses distributed parity, with two independent parity blocks per stripe in each RAID set, and disk striping. A RAID 60 virtual drive can survive the loss of two drives in each of the RAID 6 sets without losing data. It works best with data that requires high reliability, high request rates, high data transfers, and medium-to-large capacity.

STEP 4 SELECT HARD DISK DRIVE (HDD) or SOLID STATE DRIVE (SSD) MULTIPACKS

Select drive multipacks from [Table 6](#). The drives in each multipack mount into drive trays at the top of the server.

Table 6 Available Disk Multipacks

Product ID (PID)	PID Description	Drive Type	Capacity (each)
UCSC-C3X60-14HD4	UCS C3160 1 row of 4 TB NL-SAS drives (14 total) 56 TB raw Includes 14 of the following: UCSC-C3X60-HD4TB UCS C3X60 4TB NL-SAS 7200RPM HDD with C3X60 carrier	SAS-2	4 TB 512n
UCSC-C3X60-28HD4	UCS C3160 2 rows of 4 TB NL-SAS drives (28 total) 112 TB raw Includes 28 of the following: UCSC-C3X60-HD4TB UCS C3X60 4TB NL-SAS 7200RPM HDD with C3X60 carrier	SAS-2	4 TB 512n
UCSC-C3X60-42HD4	UCS C3160 3 rows of 4 TB NL-SAS drives (42 total) 184 TB raw includes 42 of the following: UCSC-C3X60-HD4TB UCS C3X60 4TB NL-SAS 7200RPM HDD with C3X60 carrier	SAS-2	4 TB 512n
UCSC-C3X60-56HD4	UCS C3160 4 rows of 4 TB NL-SAS drives (56 total) 240 TB raw includes 56 of the following: UCSC-C3X60-HD4TB UCS C3X60 4TB NL-SAS 7200RPM HDD with C3X60 carrier	SAS-2	4 TB 512n
UCSC-C3X60-SSD4	UCS C3160 1 row of a combo of 400 GB SSDs and 4 TB NL-SAS drives (up to 14 total) includes from 2 to 14 of the following: UCSC-C3160-400SSD UCS C3160 400GB Enterprise Performance 6G SAS SSD Includes from 0 to 10 of the following: UCSC-C3X60-HD4TB UCS C3X60 4TB NL-SAS 7200RPM HDD with C3X60 carrier A maximum of 14 drives (1 row) can be selected using a combination of 400 GB SSDs and 4 TB HDDs. Select the desired number of SSDs and HDDs.	SAS-2	400 GB/ 4 TB 512n

Table 6 Available Disk Multipacks (*continued*)

Product ID (PID)	PID Description	Drive Type	Capacity (each)
UCSC-C3X60-14HD6	UCS C3160 1 row of 6 TB NL-SAS drives (14 total) 84 TB raw Includes 14 of the following: UCSC-C3X60-HD6TB UCS C3X60 6TB 12Gbps NL-SAS 7200RPM HARD DISK DRIVE including C3X60 HDD carrier (Top-load)	SAS-3	6 TB 4Kn
UCSC-C3X60-28HD6	UCS C3160 2 rows of 6 TB NL-SAS drives (28 total) 168 TB raw Includes 28 of the following: UCSC-C3X60-HD6TB UCS C3X60 6TB 12Gbps NL-SAS 7200RPM HARD DISK DRIVE including C3X60 HDD carrier (Top-load)	SAS-3	6 TB 4Kn
UCSC-C3X60-42HD6	UCS C3160 3 rows of 6 TB NL-SAS drives (42 total) 252 TB raw includes 42 of the following: UCSC-C3X60-HD6TB UCS C3X60 6TB 12Gbps NL-SAS 7200RPM HARD DISK DRIVE including C3X60 HDD carrier (Top-load)	SAS-3	6 TB 4Kn
UCSC-C3X60-56HD6	UCS C3160 4 rows of 6 TB NL-SAS drives (56 total) 336 TB raw includes 56 of the following: UCSC-C3X60-HD6TB UCS C3X60 6TB 12Gbps NL-SAS 7200RPM HARD DISK DRIVE including C3X60 HDD carrier (Top-load)	SAS-3	6 TB 4Kn
UCSC-C3X60-SSD6	UCS C3160 1 row of a combo of 400 GB SSDs and 6 TB NL-SAS drives (up to 14 total) includes from 2 to 14 of the following: UCS-C3X60-12G240 UCS C3X60 400GB Enterprise Performance 12G SAS SSD (10X endurance) Includes from 0 to 10 of the following: UCSC-C3X60-HD6TB UCS C3X60 6TB 12Gbps NL-SAS 7200RPM HARD DISK DRIVE including C3X60 HDD carrier (Top-load) A maximum of 14 drives (1 row) can be selected using a combination of 400 GB SSDs and 4 TB HDDs. Select the desired number of SSDs and HDDs.	SAS-3	400 GB SSD/ 6 TB 4Kn
UCSC-C3X60-14HD8	UCS C3160 1 row of 8 TB NL-SAS drives (14 total) 112 TB raw Includes 14 of the following: UCSC-C3X60-HD8TB UCS C3X60 8TB NL-SAS 7.2K Helium HDD with HDD Carrier (Top load)	SAS-3	8 TB 4Kn

Table 6 Available Disk Multipacks (*continued*)

Product ID (PID)	PID Description	Drive Type	Capacity (each)
UCSC-C3X60-28HD8	UCS C3160 1 row of 8 TB NL-SAS drives (28 total) 224 TB raw Includes 28 of the following: UCSC-C3X60-HD8TB UCS C3X60 8TB NL-SAS 7.2K Helium HDD with HDD Carrier (Top load)	SAS-3	8 TB 4Kn
UCSC-C3X60-42HD8	UCS C3160 1 row of 8 TB NL-SAS drives (42 total) 336 TB raw Includes 42 of the following: UCSC-C3X60-HD8TB UCS C3X60 8TB NL-SAS 7.2K Helium HDD with HDD Carrier (Top load)	SAS-3	8 TB 4Kn
UCSC-C3X60-56HD8	UCS C3160 1 row of 8 TB NL-SAS drives (56 total) 448 TB raw Includes 56 of the following: UCSC-C3X60-HD8TB UCS C3X60 8TB NL-SAS 7.2K Helium HDD with HDD Carrier (Top load)	SAS-3	8 TB 4Kn
UCSC-C3X60-SSD8	UCS C3X60 a combo of SSDs and 8 TB NL-SAS drives UCS-C3X60-12G240 UCS C3X60 400GB Enterprise Performance 12G SAS SSD (10X endurance) UCS-C3X60-12G280 UCS C3X60 800GB Enterprise Performance 12G SAS SSD (10X endurance) UCS-C3X60-12G2160 UCS C3X60 1.6 TB Enterprise Performance 12G SAS SSD (10X endurance) UCSC-C3X60-HD8TB UCS C3X60 8TB NL-SAS 7.2K Helium HDD with HDD Carrier (Top load) A minimum of 14 drives is required.	SAS-3	400 GB/ 800 GB/ 1.6 TB SSD/ 8 TB 4Kn
UCSC-C3X60-14HD10	UCS C3160 1 row of 10 TB NL-SAS drives (14 total) 140 TB raw Includes 14 of the following: UCSC-C3X60-HD10TB UCS C3X60 8TB NL-SAS 7.2K Helium HDD with HDD Carrier (Top load)	SAS-3	10 TB 4Kn
UCSC-C3X60-28HD10	UCS C3160 1 row of 10 TB NL-SAS drives (28 total) 280 TB raw Includes 28 of the following: UCSC-C3X60-HD10TB UCS C3X60 8TB NL-SAS 7.2K Helium HDD with HDD Carrier (Top load)	SAS-3	10 TB 4Kn
UCSC-C3X60-42HD10	UCS C3160 1 row of 10 TB NL-SAS drives (42 total) 420 TB raw Includes 42 of the following: UCSC-C3X60-HD10TB UCS C3X60 8TB NL-SAS 7.2K Helium HDD with HDD Carrier (Top load)	SAS-3	10 TB 4Kn

Table 6 Available Disk Multipacks (*continued*)

Product ID (PID)	PID Description	Drive Type	Capacity (each)
UCSC-C3X60-56HD10	UCS C3160 1 row of 10 TB NL-SAS drives (56 total) 560 TB raw Includes 56 of the following: UCSC-C3X60-HD10TB UCS C3X60 8TB NL-SAS 7.2K Helium HDD with HDD Carrier (Top load)	SAS-3	10 TB 4Kn
UCSC-C3K-SSD10	UCS C3X60 a combo of SSDs and 10 TB NL-SAS drives	SAS-3	400 GB/ 800 GB/ 1.6 TB SSD/ 10 TB 4Kn
	UCS-C3X60-12G240 UCS C3X60 400GB Enterprise Performance 12G SAS SSD (10X endurance)		
	UCS-C3X60-12G280 UCS C3X60 800GB Enterprise Performance 12G SAS SSD (10X endurance)		
	UCS-C3X60-12G2160 UCS C3X60 1.6 TB Enterprise Performance 12G SAS SSD (10X endurance)		
	UCSC-C3X60-10TB UCS C3X60 10TB NL-SAS 7.2K Helium HDD with HDD Carrier (Top load)		
A minimum of 14 drives is required.			

Approved Configurations

- The UCSC-C3X60-14HD4, UCSC-C3X60-28HD4, and UCSC-C3X60-42HD4 multipacks can be selected along with the UCSC-C3X60-SSD4 multipack.
- The UCSC-C3X60-56HD4 multipack cannot be selected with any other multipack.
- The UCSC-C3X60-14HD6, UCSC-C3X60-28HD6, and UCSC-C3X60-42HD6 multipacks can be selected along with the UCSC-C3X60-SSD6 multipack.
- The UCSC-C3X60-56HD6 multipack cannot be selected with any other multipack.
- You cannot mix 4 TB SAS-2 multipacks with 6 TB SAS-3 multipacks.
- Populate drive bays according to [Internal Drive Population Guidelines, page 42](#).

Caveats

- Because the 6 TB, 8 TB, and 10 TB drives have 4096-byte sectors, VMware ESXi does not support this capability and therefore will not work with 6 TB, 8 TB, or 10 TB drives.

STEP 5 SELECT BOOT DRIVES (OPTIONAL)

Select one or two optional boot drives from [Table 8](#).

Table 7 Boot Drives

Product ID (PID)	PID Description	Drive Type	Capacity (each)
UCS-C3X60-G2SD12	UCSC C3X60 120 GB Boot SSD (Gen 2)	SATA	120 GB
UCS-C3X60-G2SD48	UCSC C3X60 480 GB Boot SSD (Gen 2)	SATA	480 GB
UCS-C3X60-G2SD160	UCSC C3X60 1.6 TB Boot SSD (Gen 2)	SATA	1.6 TB

Approved Configurations

- Select one or two boot drives.
- Do not mix boot drive capacities



NOTE: Boot drives are connected to the Intel PCH on the server node and not to the RAID Controller. RAID on the boot drive is handled by means of OS RAID or SW RAID.

STEP 6 SELECT DISK EXPANSION TRAY AND DRIVES (OPTIONAL)

Select the optional disk expansion tray from [Table 8](#). This selection adds an extra four 4, 6, 8, or 10 TB drives that mount at the rear of the chassis.

Table 8 Disk Expansion Tray and Drives

Product ID (PID)	PID Description	Drive Type	Capacity (each)
UCSC-C3X60-EX16T	UCS UCS C3X60 Expander with 4 x 4TB 7200RPM NL-SAS Drives Includes the following: UCS-HD4T7KS3-E	4 TB SAS 7.2K RPM 3.5 inch HDD/hot plug/drive sled mounted	SAS-2 4 TB 512n
UCSC-C3X60-EX24T	UCS UCS C3X60 Expander with 4 x 6TB 12 Gbps 7200RPM NL-SAS Drives Includes the following: UCSC-C3X60-6TBRR	6 TB 12 Gbps NL-SAS 7200 RPM 3.5 inch HDD including CX360 HDD carrier (rear load)	SAS-3 6 TB 4Kn
UCSC-C3X60-EX32T	UCS UCS C3X60 Expander with 4 x 8TB 12 Gbps 7200RPM NL-SAS Drives Includes the following: UCSC-C3X60-8TBRR	8 TB 12 Gbps NL-SAS 7200 RPM 3.5 inch Helium HDD including CX360 HDD carrier (rear load)	SAS-3 8 TB 4Kn
UCSC-C3X60-EX40T	UCS UCS C3X60 Expander with 4 x 10TB 12 Gbps 7200RPM NL-SAS Drives Includes the following: UCSC-C3X60-10TBRR	10 TB 12 Gbps NL-SAS 7200 RPM 3.5 inch Helium HDD including CX360 HDD carrier (rear load)	SAS-3 10 TB 4Kn

Approved Configurations

- Select only a disk expansion tray with the four drives included.
- 6 TB, 8 TB, and 10 TB SAS-3 drives cannot be mixed with 4 TB SAS-2 drives

STEP 7 SELECT AC POWER CORD(s)

Using [Table 9](#), select the appropriate AC power cords. You can select a minimum of no power cords and a maximum of two. If you select the option R2XX-DMYMPWRCORD, no power cord is shipped with the server.

Table 9 Available Power Cords

Product ID (PID)	PID Description	Images
R2XX-DMYMPWRCORD	No power cord (dummy PID to allow for a no power cord option)	Not applicable
CAB-N5K6A-NA	N5000 AC Power Cable, 6A, 250V, North America, 2.5m	
CAB-AC-L620-C13	AC Power Cord, NEMA L6-20 - C13, 2M/6.5ft	
CAB-C13-CBN	Cabinet Jumper Power Cord, 250 VAC 10A, C14-C13 Connectors	
CAB-C13-C14-2M	CABASY,WIRE,JUMPER CORD, PWR, 2 Meter, C13/C14,10A/250V	
CAB-C13-C14-AC	Power cord, C13 to C14 (recessed receptacle), 10A	

Table 9 Available Power Cords

Product ID (PID)	PID Description	Images
CAB-250V-10A-AR	N5000 AC Power Cable, 10A, 250V, Argentina, 2.5m	
CAB-9K10A-AU	N5000 AC Power Cable, 10A, 250V, Australia, 2.5m	
CAB-250V-10A-CN	N5000 AC Power Cable, 10A, 250V, China, 2.5m	
CAB-250V-10A-CN	AC Power Cord - 250V, 10A - PRC	
CAB-9K10A-EU	N5000 AC Power Cable, 10A, 250V, Europe, 2.5m	
CAB-250V-10A-ID	N5000 AC Power Cable, 10A, 250V, India, 2.5m	
CAB-250V-10A-IS	N5000 AC Power Cable, 10A, 250V, Israel, 2.5m	

Table 9 Available Power Cords

Product ID (PID)	PID Description	Images
CAB-9K10A-IT	N5000 AC Power Cable, 10A, 250V, Italy, 2.5m	<p>Plug: 1/3G (CEI 23-16)</p> <p>Cordset rating: 10 A, 250 V Length: 8 ft 2 in (2.5 m)</p> <p>Connector: C15M (EN60320/C15)</p>
CAB-9K10A-SW	N5000 AC Power Cable, 10A, 250V, Switzerland, 2.5m	<p>Plug: MP232-R</p> <p>Cordset rating: 10 A, 250 V Length: 8 ft 2 in (2.5 m)</p> <p>Connector: IEC 60320 C15</p>
CAB-9K10A-UK	N5000 AC Power Cable, 10A, 250V, United Kingdom, 2.5m	<p>Cordset rating: 10 A, 250 V/500 V MAX Length: 2500mm</p> <p>Plug: EL 210 (BS 1363A) 13 AMP fuse</p> <p>Connector: EL 701 C (EN 60320/C15)</p>
CAB-250V-10A-BR	Power Cord - 250V, 10A - Brazil	<p>2,133.6 ± 25</p>

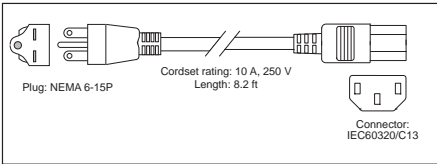
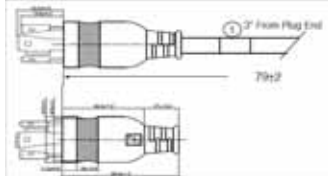
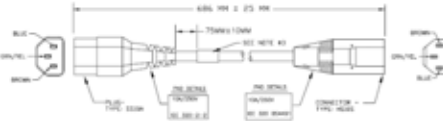
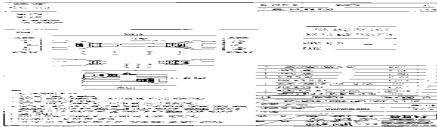
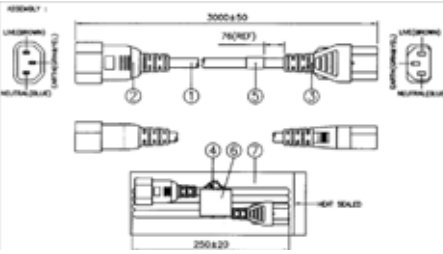
STEP 8 ORDER REVERSIBLE CABLE MANAGEMENT ARM (OPTIONAL)

The reversible cable management arm mounts on either the right or left slide rails at the rear of the server and is used for cable management. Use [Table 10](#) to order a cable management arm.

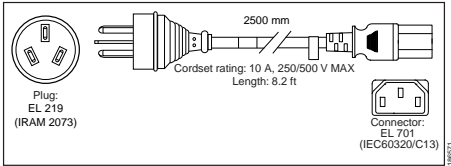
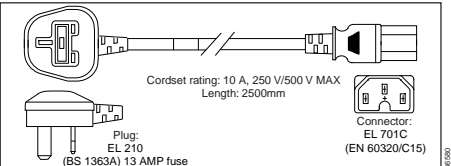
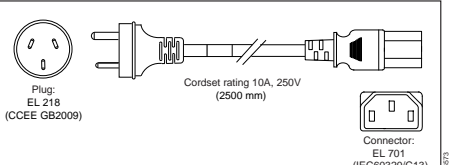
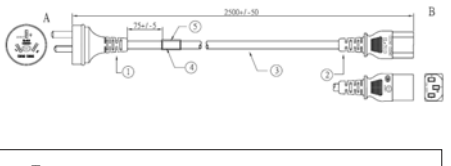
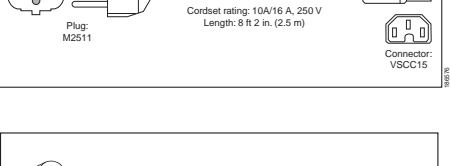
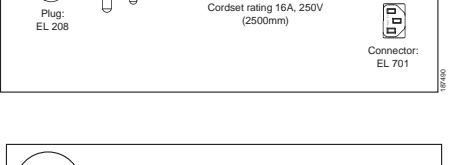
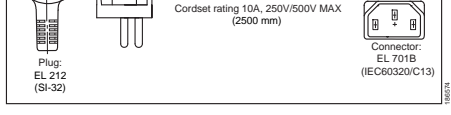
Table 10 Cable Management Arm

Product ID (PID)	PID Description
UCSC-CMA-M4	Reversible CMA for C240 M4 ball bearing rail kit

STEP 9 ORDER OPTIONAL USB DRIVE

You can order one optional USB drive. The USB drive ordering information is listed in [Table 11](#).

Table 11 USB Drive

Product ID (PID)	PID Description
UCS-USBFLSHB-16GB	UCS Servers 16 GB Flash USB Drive

See [Figure 5 on page 39](#) for the location of the USB connector

STEP 10 ORDER A TRUSTED PLATFORM MODULE (OPTIONAL)

Trusted Platform Module (TPM) is a computer chip (microcontroller) that can securely store artifacts used to authenticate the platform (server). These artifacts can include passwords, certificates, or encryption keys. A TPM can also be used to store platform measurements that help ensure that the platform remains trustworthy. Authentication (ensuring that the platform can prove that it is what it claims to be) and attestation (a process helping to prove that a platform is trustworthy and has not been breached) are necessary steps to ensure safer computing in all environments.

The TPM ordering information is listed in [Table 12](#).

Table 12 Trusted Platform Module

Product ID (PID)	PID Description
UCSX-TPM1-001	Trusted Platform Module 1.2 SPI-based for UCS Servers



NOTE: The module used in this system conforms to TPM v1.2 and 2.0, as defined by the Trusted Computing Group (TCG). It is also SPI-based.

STEP 11 ORDER A KVM CABLE (OPTIONAL)

The KVM cable provides a connection into the server, providing a DB9 serial connector, a VGA connector for a monitor, and dual USB 2.0 ports for a keyboard and mouse. With this cable, you can create a direct connection to the operating system and the BIOS running on the server.

The KVM cable ordering information is listed in [Table 13](#).

Table 13 KVM Cable

Product ID (PID)	PID Description
N20-BKVM=	KVM cable for server console port

Figure 4 KVM Cable

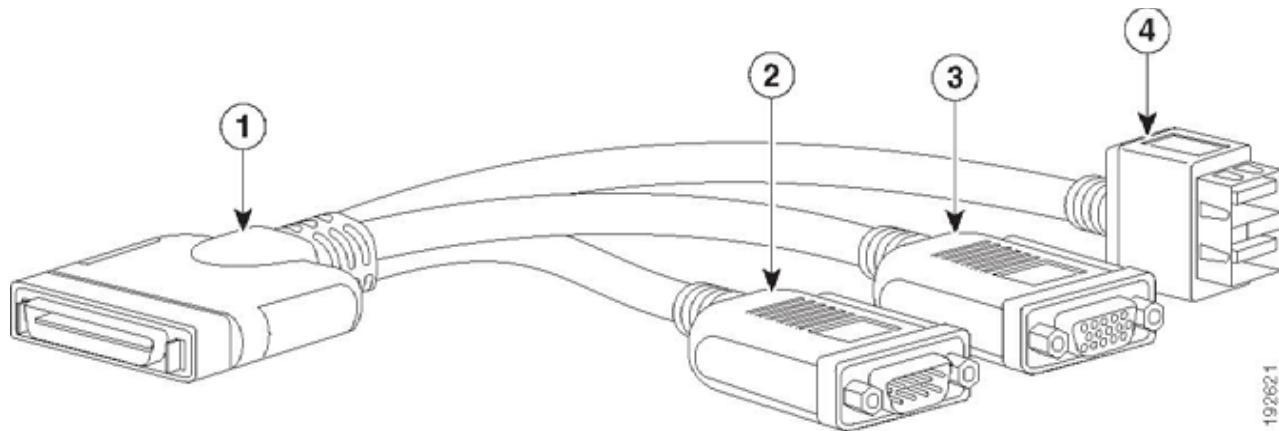

1	Connector (to server front panel)	3	VGA connector (for a monitor)
2	DB-9 serial connector	4	Two-port USB 2.0 connector (for a mouse and keyboard)

STEP 12 SELECT OPERATING SYSTEM AND VALUE-ADDED SOFTWARE

Several operating systems and value-added software programs are available. Select as desired from [Table 14](#).

Table 14 OSs and Value-Added Software (for 2-CPU servers)

PID Description	Product ID (PID)
Microsoft Windows Server	
MSWS-12-ST2S	Windows Server 2012 Standard (2 CPU/2 VMs)
MSWS-12-DC2S	Windows Server 2012 Datacenter (2 CPU/Unlimited VMs)
MSWS-12-ST2S-NS	Windows Server 2012 Standard (2 CPU/2 VMs) No Cisco SVC
MSWS-12-DC2S-NS	Windows Server 2012 Datacenter (2 CPU/Unlim VM) No Cisco SVC
MSWS-12R2-ST2S	Windows Server 2012 R2 Standard (2 CPU/2 VMs)
MSWS-12R2-DC2S	Windows Server 2012 R2 Datacenter (2 CPU/Unlimited VMs)
MSWS-12R2-ST2S-NS	Windows Server 2012 R2 Standard (2 CPU/2 VMs) No Cisco SVC
MSWS-12R2-DC2S-NS	Windows Server 2012 R2 Datacen (2 CPU/Unlim VM) No Cisco Svc
SUSE	
SLES-2S2V-1A	SUSE Linux Enterprise Svr (1-2 CPU,1 Phys);1yr Support Reqd
SLES-2S2V-3A	SUSE Linux Enterprise Svr (1-2 CPU,1 Phys);3yr Support Reqd
SLES-2S2V-5A	SUSE Linux Enterprise Svr (1-2 CPU,1 Phys);5yr Support Reqd
SLES-2S2V-1S	SUSE Linux Enterprise Svr (1-2 CPU,1-2 VM); Prio 1-Yr SnS
SLES-2S2V-3S	SUSE Linux Enterprise Svr (1-2 CPU,1-2 VM); Prio 3-Yr SnS
SLES-2S2V-5S	SUSE Linux Enterprise Svr (1-2 CPU,1-2 VM); Prio 5-Yr SnS
SLES-2SUV-1A	SUSE Linux Enterprise Svr (1-2 CPU,Unl Vrt);1yr Support Reqd
SLES-2SUV-3A	SUSE Linux Enterprise Svr (1-2 CPU,Unl Vrt);3yr Support Reqd
SLES-2SUV-5A	SUSE Linux Enterprise Svr (1-2 CPU,Unl Vrt);5yr Support Reqd
SLES-2SUV-1S	SUSE Linux Enterprise Svr (1-2 CPU,Unl VM); Prio 1-Yr SnS
SLES-2SUV-3S	SUSE Linux Enterprise Svr (1-2 CPU,Unl VM); Prio 3-Yr SnS
SLES-2SUV-5S	SUSE Linux Enterprise Svr (1-2 CPU,Unl VM); Prio 5-Yr SnS
SLES-2S-HA-1S	SUSE Linux High Availability Ext (1-2 CPU); 1yr Support Reqd
SLES-2S-HA-3S	SUSE Linux High Availability Ext (1-2 CPU); 3yr Support Reqd
SLES-2S-HA-5S	SUSE Linux High Availability Ext (1-2 CPU); 5yr Support Reqd
SLES-2S-GC-1S	SUSE Linux GEO Clustering for HA (1-2 CPU); 1yr Sns
SLES-2S-GC-3S	SUSE Linux GEO Clustering for HA (1-2 CPU); 3yr Sns
SLES-2S-GC-5S	SUSE Linux GEO Clustering for HA (1-2 CPU); 5yr Sns
VMware 5	
VMW-VS5-STD-1A	VMware vSphere 5 Standard for 1 Processor, 1 Year, Support Rqd
VMW-VS5-STD-2A	VMware vSphere 5 Standard for 1 Processor, 2 Year, Support Rqd
VMW-VS5-STD-3A	VMware vSphere 5 Standard for 1 Processor, 3 Year, Support Rqd
VMW-VS5-STD-4A	VMware vSphere 5 Standard for 1 Processor, 4 Year, Support Rqd
VMW-VS5-STD-5A	VMware vSphere 5 Standard for 1 Processor, 5 Year, Support Rqd

Table 14 OSs and Value-Added Software (for 2-CPU servers) *(continued)*

PID Description	Product ID (PID)
VMW-VS5-ENT-1A	VMware vSphere 5 Enterprise for 1 Processor, 1 Year Support Rqd
VMW-VS5-ENT-2A	VMware vSphere 5 Enterprise for 1 CPU, 2 Yr Support Rqd
VMW-VS5-ENT-3A	VMware vSphere 5 Enterprise for 1 CPU, 3 Yr Support Rqd
VMW-VS5-ENT-4A	VMware vSphere 5 Enterprise for 1 Processor, 4 Year Support Rqd
VMW-VS5-ENT-5A	VMware vSphere 5 Enterprise for 1 CPU, 5 Yr Support Rqd
VMW-VS5-ENTP-1A	VMware vSphere 5 Enterprise Plus for 1 Processor, 1 Year Support Rqd
VMW-VS5-ENTP-2A	VMware vSphere 5 Enterprise Plus for 1 CPU, 2 Yr Support Rqd
VMW-VS5-ENTP-3A	VMware vSphere 5 Enterprise Plus for 1 Processor, 3 Year Support Rqd
VMW-VS5-ENTP-4A	VMware vSphere 5 Enterprise Plus for 1 Processor, 4 Year Support Rqd
VMW-VS5-ENTP-5A	VMware vSphere 5 Enterprise Plus for 1 Processor, 5 Year Support Rqd
VMW-VC5-STD-1A	VMware vCenter 5 Server Standard, 1 yr support required
VMW-VC5-STD-2A	VMware vCenter 5 Server Standard, 2 yr support required
VMW-VC5-STD-3A	VMware vCenter 5 Server Standard, 3 yr support required
VMW-VC5-STD-4A	VMware vCenter 5 Server Standard, 4 yr support required
VMW-VC5-STD-5A	VMware vCenter 5 Server Standard, 5 yr support required
UCS-VMW-TERMS	Acceptance of Terms, Standalone VMW License for UCS Servers
Red Hat	
RHEL-2S2V-1A	Red Hat Enterprise Linux (1-2 CPU,1-2 VN); 1-Yr Support Req
RHEL-2S2V-3A	Red Hat Enterprise Linux (1-2 CPU,1-2 VN); 3-Yr Support Req

STEP 13 SELECT OPERATING SYSTEM MEDIA KIT

Select the optional operating system media listed in [Table 15](#).

Table 15 OS Media

Product ID (PID)	PID Description
RHEL-6	RHEL 6 Recovery Media Only (Multilingual)
MSWS-12-ST2S-MD	Windows Server 2012 Standard (2 CPU/2 VMs) Recovery Media
MSWS-12-DC2S-MD	Windows Server 2012 Datacenter(2 CPU/Unlimited VM) Rec Media
MSWS-12R2-ST2S-RM	Windows Server 2012 R2 Standard (2 CPU/2 VMs) Recovery Media
MSWS-12R2-DC2S-RM	Windows Server 2012 R2 Datacen(2 CPU/Unlimited VM) Rec Media

STEP 14 SELECT SERVICE and SUPPORT LEVEL

A variety of service options are available, as described in this section.

Unified Computing Warranty, No Contract

If you have noncritical implementations and choose to have no service contract, the following coverage is supplied:

- Three-year parts coverage.
- Next business day (NBD) onsite parts replacement eight hours a day, five days a week.
- 90-day software warranty on media.
- Ongoing downloads of BIOS, drivers, and firmware updates.

SMARTnet for UCS

For support of the entire Unified Computing System, Cisco offers the Cisco SMARTnet for UCS Service. This service provides expert software and hardware support to help sustain performance and high availability of the unified computing environment. Access to Cisco Technical Assistance Center (TAC) is provided around the clock, from anywhere in the world.

Smart Call Home provides proactive, embedded diagnostics and real-time alerts. The Cisco SMARTnet for UCS Service includes flexible hardware replacement options, including replacement in as little as two hours. There is also access to Cisco's extensive online technical resources to help maintain optimal efficiency and uptime of the unified computing environment. You can choose a desired service listed in [Table 16](#).

Table 16 Cisco SMARTnet for UCS Service

Product ID (PID)	On Site?	Description
CON-PREM-C3160BSE	Yes	ONSITE 24X7X2 UCS C3160 Server
CON-OSP-C3160BSE	Yes	ONSITE 24X7X4 UCS C3160 Server
CON-OSE-C3160BSE	Yes	ONSITE 8X5X4 UCS C3160 Server
CON-OS-C3160BSE	Yes	ONSITE 8X5XNBD UCS C3160 Server
CON-S2P-C3160BSE	No	SMARTNET 24X7X2 UCS C3160 Server
CON-SNTP-C3160BSE	No	SMARTNET 24X7X4 UCS C3160 Server
CON-SNTE-C3160BSE	No	SMARTNET 8X5X4 UCS C3160 Server
CON-SNT-C3160BSE	No	SMARTNET 8X5XNBD UCS C3160 Server

SMARTnet for UCS Hardware Only Service

For faster parts replacement than is provided with the standard Cisco Unified Computing System warranty, Cisco offers the Cisco SMARTnet for UCS Hardware Only Service. You can choose from two levels of advanced onsite parts replacement coverage in as little as four hours. SMARTnet for UCS Hardware Only Service provides remote access any time to Cisco support professionals who can determine if a return materials authorization (RMA) is required. You can choose a service listed in [Table 17](#).

Table 17 SMARTnet for UCS Hardware Only Service

Product ID (PID)	Service Level GSP	On Site?	Description
CON-UCW7-C3160BSE	UCW7	Yes	UC PLUS 24X7X40S UCS C3160 Server
CON-UCW5-C3160BSE	UCW5	Yes	UC PLUS 8X5XNBDOS UCS C3160 Server

Unified Computing Partner Support Service

Cisco Partner Support Service (PSS) is a Cisco Collaborative Services service offering that is designed for partners to deliver their own branded support and managed services to enterprise customers. Cisco PSS provides partners with access to Cisco's support infrastructure and assets to help them:

- Expand their service portfolios to support the most complex network environments
- Lower delivery costs
- Deliver services that increase customer loyalty

Partner Unified Computing Support Options enable eligible Cisco partners to develop and consistently deliver high-value technical support that capitalizes on Cisco intellectual assets. This helps partners to realize higher margins and expand their practice.

PSS is available to all Cisco PSS partners, but requires additional specializations and requirements. For additional information, see the following URL:

www.cisco.com/go/partnerucssupport

The two Partner Unified Computing Support Options include:

- Partner Support Service for UCS
- Partner Support Service for UCS Hardware Only

Partner Support Service for UCS provides hardware and software support, including triage support for third party software, backed by Cisco technical resources and level three support.

See [Table 18](#).

Table 18 Partner Support Service for UCS

Product ID (PID)	Service Level GSP	On Site?	Description
CON-PSJ1-C3160BSE	PSJ1	No	UCS SUPP PSS 8X5XNBD UCS C3160 Server
CON-PSJ2-C3160BSE	PSJ2	No	UCS SUPP PSS 8X5X4 UCS C3160 Server
CON-PSJ3-C3160BSE	PSJ3	No	UCS SUPP PSS 24X7X4 UCS C3160 Server
CON-PSJ4-C3160BSE	PSJ4	No	UCS SUPP PSS 24X7X2 UCS C3160 Server
CON-PSJ6-C3160BSE	PSJ6	Yes	UCS SUPP PSS 8X5X4 Onsite UCS C3160 Server
CON-PSJ7-C3160BSE	PSJ7	Yes	UCS SUPP PSS 24X7X4 Onsite UCS C3160 Server
CON-PSJ8-C3160BSE	PSJ8	Yes	UCS SUPP PSS 24X7X2 Onsite UCS C3160 Server

Partner Support Service for UCS Hardware Only provides customers with replacement parts in as little as two hours. See [Table 19](#).

Table 19 Partner Support Service for UCS (Hardware Only)

Product ID (PID)	Service Level GSP	On Site?	Description
CON-PSW2-C3160BSE	PSW2	No	UCS W PL PSS 8X5X4 UCS C3160 Server
CON-PSW3-C3160BSE	PSW3	No	UCS W PL PSS 24X7X4 UCS C3160 Server
CON-PSW4-C3160BSE	PSW4	No	UCS W PL PSS 24X7X2 UCS C3160 Server
CON-PSW6-C3160BSE	PSW6	Yes	UCS W PL PSS 8X5XX4 Onsite UCS C3160 Server
CON-PSW7-C3160BSE	PSW7	Yes	UCS W PL PSS 24X7X4 Onsite UCS C3160 Server

Cisco Combined Services

Combined Services makes it easier to purchase and manage required services under one contract. SMARTnet services for UCS help increase the availability of your vital data center infrastructure and realize the most value from your unified computing investment. The more benefits you realize from the Cisco Unified Computing System (Cisco UCS), the more important the technology becomes to your business. These services allow you to:

- Optimize the uptime, performance, and efficiency of your UCS
- Protect your vital business applications by rapidly identifying and addressing issues
- Strengthen in-house expertise through knowledge transfer and mentoring

- Improve operational efficiency by allowing UCS experts to augment your internal staff resources
- Enhance business agility by diagnosing potential issues before they affect your operations

Unified Computing Drive Retention Service

With the Cisco Unified Computing Drive Retention (UCDR) Service, you can obtain a new disk drive in exchange for a faulty drive without returning the faulty drive. In exchange for a Cisco replacement drive, you provide a signed Certificate of Destruction (CoD) confirming that the drive has been removed from the system listed, is no longer in service, and has been destroyed.

Sophisticated data recovery techniques have made classified, proprietary, and confidential information vulnerable, even on malfunctioning disk drives. The UCDR service enables you to retain your drives and ensures that the sensitive data on those drives is not compromised, which reduces the risk of any potential liabilities. This service also enables you to comply with regulatory, local, and federal requirements.

If your company has a need to control confidential, classified, sensitive, or proprietary data, you might want to consider one of the Drive Retention Services listed in [Table 20](#), [Table 21](#), or [Table 22](#).



NOTE: Cisco does not offer a certified drive destruction service as part of this service.

Table 20 Drive Retention Service Options

Service Description	Service Program Name	Service Level GSP	Service Level	Product ID (PID)
SMARTnet for UCS Service with Drive Retention	UCS DR	UCSD7	24x7x4 Onsite	CON-UCSD7-C3160BSE
		UCSD5	8x5xNBD Onsite	CON-UCSD5-C3160BSE
SMARTnet for UCS HW ONLY+Drive Retention	UCS HW+DR	UCWD7	24x7x4 Onsite	CON-UCWD7-C3160BSE
		UCWD5	8x5xNBD Onsite	CON-UCWD5-C3160BSE

Table 21 Drive Retention Service Options for Partner Support Service

Service Description	Service Level GSP	Service Level	Product ID (PID)
Partner Support Service for UCS Drive Retention	PSJD6	8x5x4 Onsite	CON-PSJD6-C3160BSE
	PSJD7	24x7x4 Onsite	CON-PSJD7-C3160BSE

Table 22 Drive Retention Service Options for Partner Support Service (Hardware Only)

Service Description	Service Level GSP	Service Level	Product ID (PID)
Partner Support Service for UCS Drive Retention Hardware only	PSWD6	8x5x4 Onsite	CON-PSWD6-C3160BSE
	PSWD7	24x7x4 Onsite	CON-PSWD7-C3160BSE

For more service and support information, see the following URL:

http://www.cisco.com/en/US/services/ps2961/ps10312/Unified_Computing_Services_Overview.pdf

For a complete listing of available services for Cisco Unified Computing System, see this URL:

http://www.cisco.com/en/US/products/ps10312/serv_group_home.html

OPTIONAL STEP - ORDER RACK(s)

The optional R42610 rack is available from Cisco for the C-Series servers, including the C3160 server. This rack is a standard 19-inch rack and can be ordered with a variety of options, as listed in [Table 23](#). Racks are shipped separately from the C3160 server.

Table 23 Racks and Rack Options

Product ID (PID)	PID Description
RACK-UCS ¹	Cisco R42610 expansion rack, no side panels
RACK-UCS2 ¹	Cisco R42610 standard rack, w/side panels
RACK-BLANK-001	Filler panels (qty 12), 1U, plastic, toolless
RACK-CBLMGT-001	Cable mgt D rings (qty 10), metal
RACK-CBLMGT-011	Cable mgt straps (qty 10), Velcro
RACK-FASTEN-001	Mounting screws (qty 100), M6
RACK-FASTEN-002	Cage nuts (qty 50), M6
RACK-JOIN-001	Rack joining kit

Notes

1. Use these same base PIDs to order spare racks (available only as next-day replacements).

For more information about the R42610 rack, see [RACKS, page 44](#).

OPTIONAL STEP - ORDER PDU

An optional power distribution unit (PDU) is available from Cisco for the C-Series rack servers, including the C3160 server. This PDU is available in a zero rack unit (RU) style (see [Table 23](#)).

Table 24 PDU Options

Product ID (PID)	PID Description
RP208-30-2P-U-2	Zero RU PDU

For more information about the PDU, see [PDUs, page 46](#).

SUPPLEMENTAL MATERIAL

CHASSIS

An internal view of the C3160 chassis with the top cover removed is shown in *Figure 5*.

Figure 5 C3160 Server With Top Cover Off

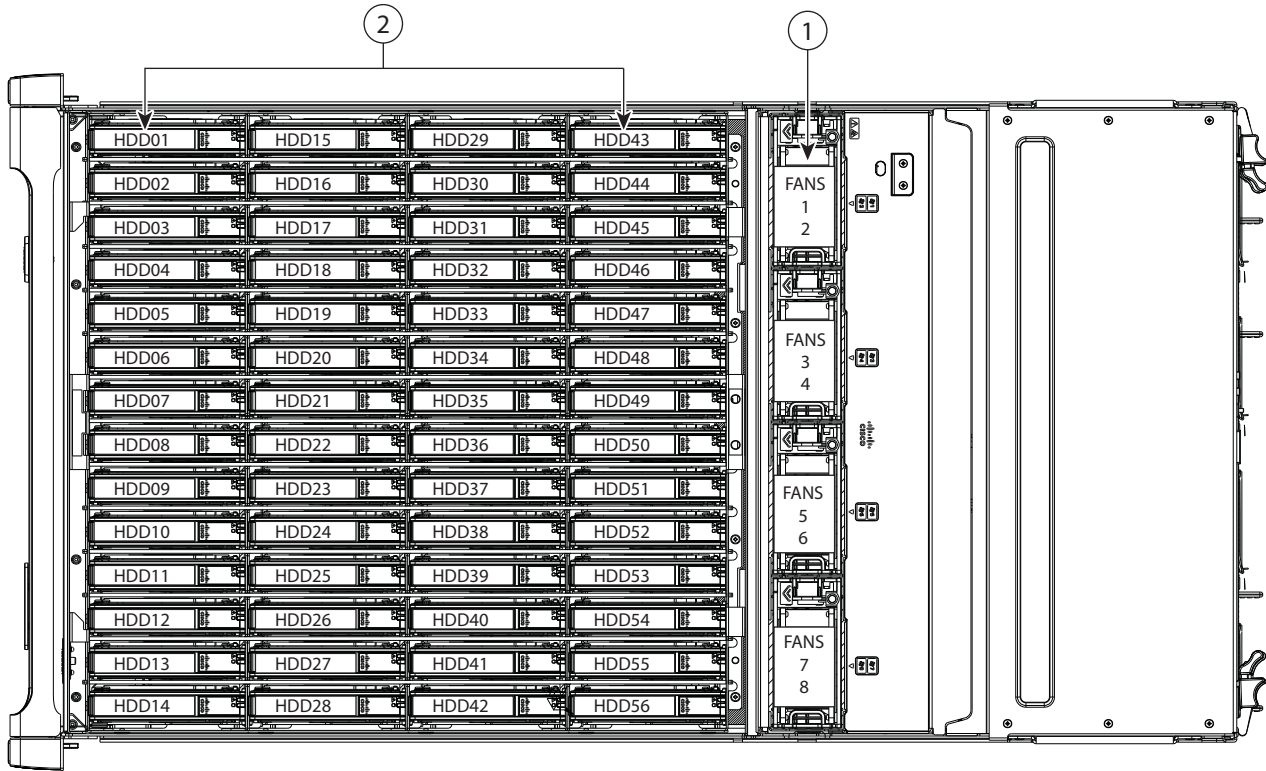

1	<p>Fan modules (four, hot-swappable) Each fan module contains two fans. Even numbers are upper fans, odd numbers are lower fans.</p>	2	<p>Internal drive bays (up to 56 3.5-inch drives, hot-swappable)</p>
---	--	---	--

CPUs and DIMMs

Physical Layout

Each CPU has four DIMM channels:

- CPU1 has channels A, B, C, and D
- CPU2 has channels E, F, G, and H

Each DIMM channel has two slots: slot 1 and slot 2. The blue-colored DIMM slots are for slot 1 and the black-colored slots for slot 2.

As an example, DIMM slots A1, B1, C1, and D1 belong to slot 1, while A2, B2, C2, and D2 belong to slot 2.

Figure 6 shows how slots and channels are physically laid out on the motherboard. The DIMM slots on the right half of the motherboard (channels A, B, C, and D) are associated with CPU 1, while the DIMM slots on the left half of the motherboard (channels E, F, G, and H) are associated with CPU 2. The slot 1 (blue) DIMM slots are always located farther away from a CPU than the corresponding slot 2 (black) slots. Slot 1 slots (blue) are populated before slot 2 slots (black).

Figure 6 Physical Layout of CPU DIMM Channels and Slots

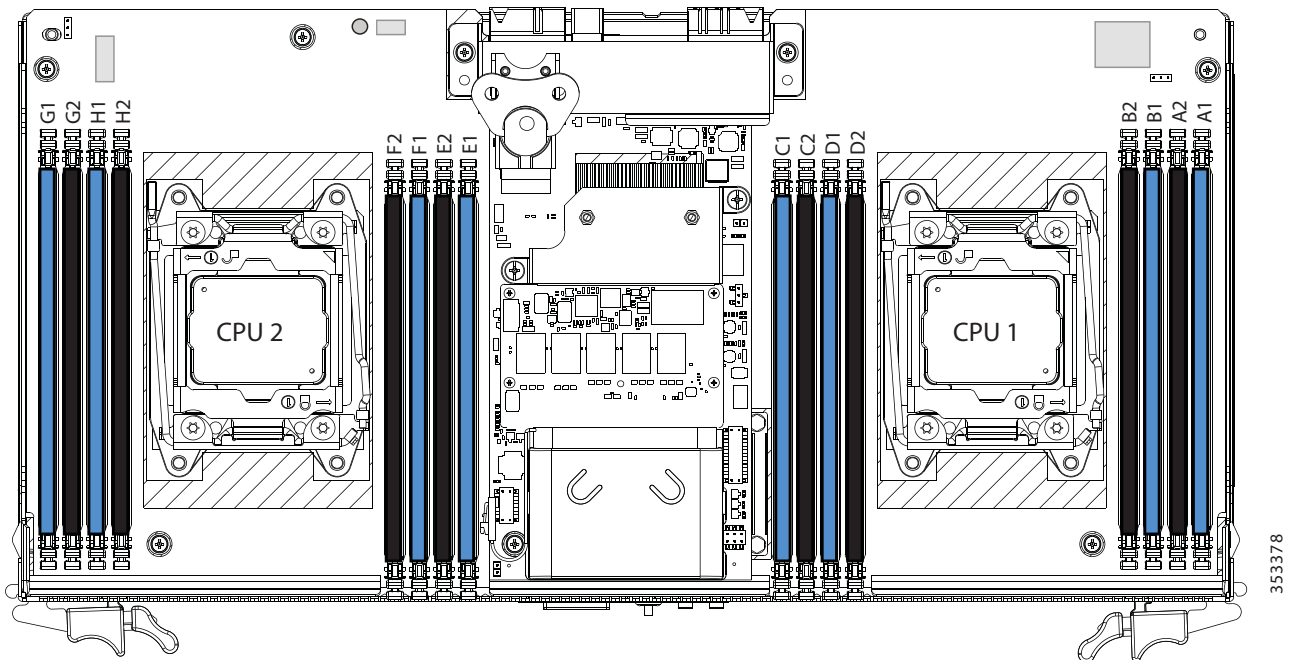

Memory Population Rules

When considering the memory configuration of your server, consider the following items:

- Each channel has two DIMM slots (for example, channel A = slots A1 and A2).
 - A channel can operate with one or two DIMMs installed.
 - If a channel has only one DIMM, populate slot 1 first (the blue slot).
- When both CPUs are installed, populate the DIMM slots of each CPU identically.
 - Fill blue slots in the channels first: A1, E1, B1, F1, C1, G1, D1, H1
 - Fill black slots in the channels second: A2, E2, B2, F2, C2, G2, D2, H2
- Any DIMM installed in a DIMM socket for which the CPU is absent is not recognized.
- Observe the DIMM mixing rules shown in [Table 25](#)

Table 25 DIMM Rules for C3160 Servers

DIMM Parameter	DIMMs in the Same Channel	DIMM in the Same Slot ¹
<u>DIMM Capacity</u>		
8, 16, or 32 GB	DIMMs in the same channel (for example, A1 and A2) can have different capacities.	For best performance, DIMMs in the same slot (for example, A1, B1, C1, D1) should have the same capacity.
	Do not mix LRDIMMs with RDIMMs	Do not mix LRDIMMs RDIMMs
<u>DIMM Speed</u>		
1866-MHz ²	DIMMs will run at the lowest speed of the DIMMs/CPUs installed	DIMMs will run at the lowest speed of the DIMMs/CPUs installed
<u>DIMM Type</u>		
RDIMMs or LRDIMMs	Do not mix DIMM types in a channel	Do not mix DIMM types in a slot

Notes

1. Although different DIMM capacities can exist in the same slot, this will result in less than optimal performance. For optimal performance, all DIMMs in the same slot should be identical.
2. Only 1866-MHz DIMMs are currently available for the C3160 server.

Internal Drive Population Guidelines

The system has 56 internal drive bays in the main chassis. *Figure 7* shows the internal drive bay numbering. When populating internal drives, follow these guidelines:

- Populate drive bays as follows:
 - Populate HDDs starting from the lowest-numbered bays to the highest. Populate row 1 - 14, then row 15 - 28, and so on.
 - Populate SSDs starting from the highest-numbered bays to the lowest. Populate bay 56, then bay 55, and so on.

For example, a system with 36 HDDs and 2 SSDs should have the HDDs in bays 1 - 36 and the SSDs in bays 56 and 55.

- The four colored boxes shown in *Figure 7* represent the four power groups in which the power is distributed for the drive bays. This might be useful for troubleshooting power rail problems.

Figure 7 Internal Drive Bay Numbering

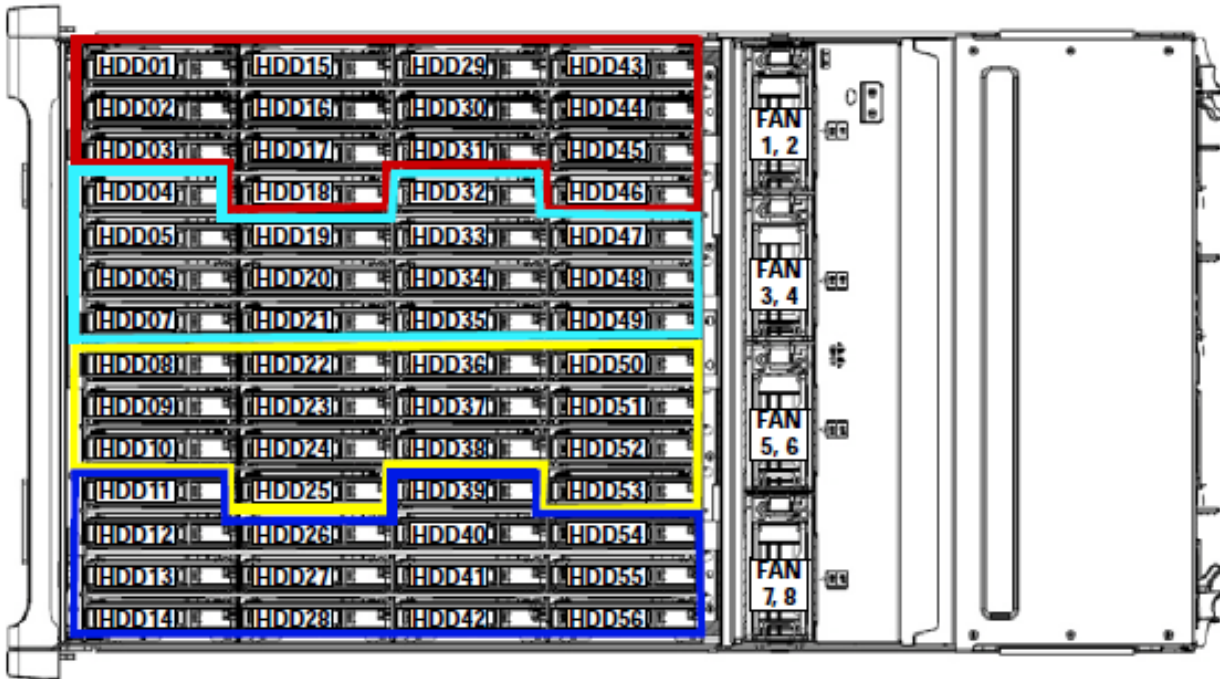

Upgrade and Servicing-Related Parts

This section lists the upgrade and servicing-related parts you may need during the life of your server. Some of these parts are configured with every server, and some may be ordered when needed or may be ordered and kept on hand as spares for future use. See [Table 26](#).

Table 26 Upgrade and Servicing-related Parts for UCS C31360 Server

Spare Product ID (PID)	Description
UCSC-C3160-SIOC=	Cisco UCS C3160 System IO Controller with mezzanine adapter card
UCSC-C3X60-14HD4=	Cisco UCS C3X60 one row of drives containing 14x 4TB (NL-SAS 7200PM). Drives w/ drive brackets. 56 TB combined total storage for add-on row
UCSC-C3X60-14HD6=	Cisco UCS C3X60 one row of drives containing 14 x 6TB Spare (NL-SAS 7200 RPM SAS-3 (total of 84 TB)
UCSC-C3X60-EXPT=	Cisco UCSC C3x60 Disk Expansion Tray
UCSC-C3X60-EX16T=	Cisco UCS C3160 Disk Expansion Tray containing up to 4x 4TB 7200 RPM NL-SAS Drives
UCSC-C3X60-EX24T=	Cisco UCS C3160 Expander with 4 x 6TB 7200RPM NL-SAS Drives
UCSC-C3X60-SSD4=	Cisco UCS C3X60 one row - 14 drives: 400 GB SSD and 4 TB drives
UCSC-C3X60-SSD6=	Cisco UCS C3X60 one row - 14 drives: 400 GB SSD and 6 TB drives
UCSC-C3X60-BLKP=	Cisco UCS C3X60 Server Node blanking plate
UCSC-C3X60-SBLKP=	Cisco UCS C3X60 SIOC blanking plate
UCSC-HS-C3X60=	Cisco UCS C3X60 Server Node CPU Heatsink FRU
UCS-CPU-GREASE3=	M4 Server CPU thermal grease syringe - needed for heatsink seal ¹
UCSC-PSU1-1050W=	Cisco UCS C3X60 1050W Power Supply Unit
UCSC-C3X60-FANM=	Cisco UCS C3X60 Fan module containing 2x80mm fans FRU
UCSX-HSCK=	UCS Processor Heat Sink Cleaning Kit (when replacing a CPU) ¹
N20-BKVM=	KVM local IO cable for UCS servers console port
UCSC-C3X60-RAIL=	UCS C3X60 Rack Rails Kit
N20-MBLIBAT16=	CR1632 Lithium Battery for UCS C3X60 System IO Controller (SIOC)

Notes

1. These parts should be ordered with the purchase of each optional or spare Intel CPU processor kit so that new thermal grease can be applied. You need the heat sink cleaning kit if you are replacing the CPU but re-using the existing heatsink. It is also needed if you RMA (return) the server node and have to move existing CPUs to the new node. In both these cases you must also have replacement grease.

System I/O Controller Blanking Panel

A system I/O controller blanking panel (UCSC-C3X60-SBLKP) must be installed if you remove a System I/O controller from the C3160 server. This panel is required to maintain system temperatures at safe operating levels, and to keep dust away from system components.

RACKS

The Cisco R42610 rack (see [Figure 8](#)) is certified for Cisco UCS installation at customer sites and is suitable for the following equipment:

- Cisco UCS B-Series servers and fabric interconnects
- Cisco UCS C-Series and select Nexus switches

The rack is compatible with hardware designed for EIA-standard 19-inch racks. Rack specifications are listed in [Table 27](#).

Table 27 Cisco R42610 Rack Specifications

Parameter	Standard Rack	Expansion Rack
Dimensions (H x W x D)	78.74 x 24 x 43.38 in. (2000 x 610 x 1102 mm)	78.74 x 23.58 x 43.38 in. (2000 x 599 x 1102 mm)
Dimensions (H x W x D) with packaging	89 x 33 x 47 in. (2261 x 838 x 1194 mm)	89 x 33 x 47 in. (2261 x 838 x 1194 mm)
Distance from front mounting rail to rear mounting rail	29.2 in (741 mm)	29.2 in (741 mm)
Weight	299.83 lb (136 kg)	231.49 lb (105 kg)
Weight with packaging	354 lb (161 kg)	284 lb (129 kg)
Side panels included	Yes	No
Equipment mounting capacity	42RU	42RU
Static load capacity	2100 lb (954 kg)	2100 lb (954 kg)
Dynamic load capacity	Not applicable	Not applicable



NOTE: The AC input connector is an IEC 320 C-14 15 A/250 VAC power inlet.

Figure 8 Cisco R42610 Rack



Front view - door closed



Front view - door open



Front view - door removed

PDU

Cisco RP Series Power Distribution Units (PDUs) offer power distribution with branch circuit protection.

Cisco RP Series PDU models distribute power to up to 24 outlets. The architecture organizes power distribution, simplifies cable management, and enables you to move, add, and change rack equipment without an electrician.

With a Cisco RP Series PDU in the rack, you can replace up to two dozen input power cords with just one. The fixed input cord connects to the power source from overhead or under-floor distribution. Your IT equipment is then powered by PDU outlets in the rack using short, easy-to-manage power cords.

The C-series severs accept the zero-rack-unit (ORU) PDU. See [Figure 9](#).

Figure 9 Zero Rack Unit PDU (PID = RP208-30-2P-U-2)

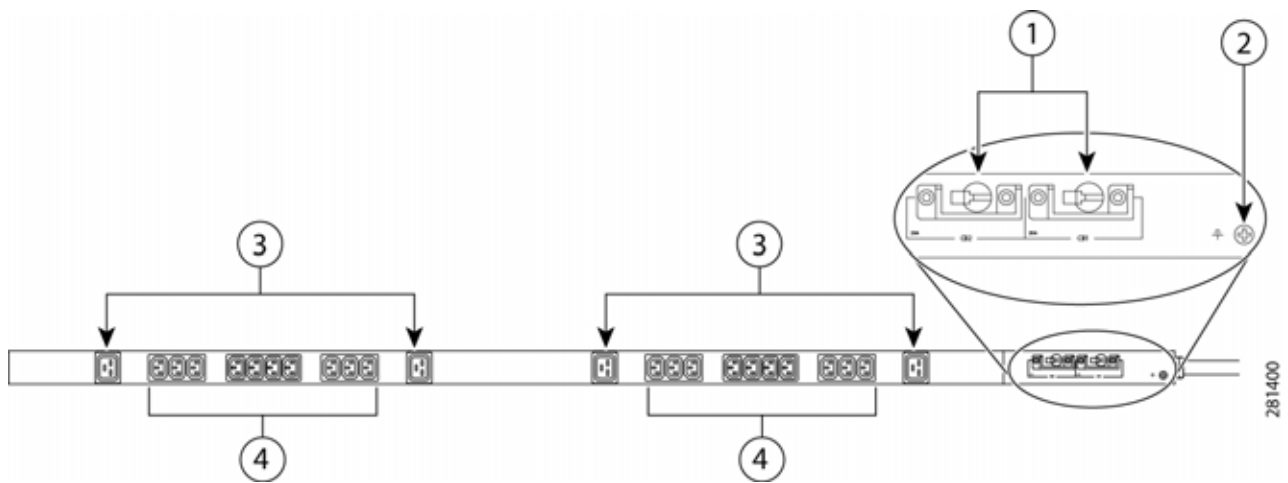

1	Breakers	3	C19 plugs
2	Ground connection	4	C13 plugs

Cisco RP Series PDU models provide two 20-ampere (A) circuit breakers for groups of receptacles. The effects of a tripped circuit are limited to a receptacle group. Simply press a button to reset that circuit.

TECHNICAL SPECIFICATIONS

Dimensions and Weight

Table 28 UCS C3160 Dimensions and Weight

Parameter	Value
Height	6.88 in (174 mm)
Width	17.46 in (444 mm)
Depth	32.00 in (813 mm)
Front Clearance	3 in. (76 mm)
Side Clearance	1 in. (25 mm)
Rear Clearance	6 in. (152 mm)
Weight (maximum configuration without rail kit)	195 lbs (88.45 kg)

Power Specifications

The server is available with a 1050 W (AC) power supply. The power supply specifications are listed in [Table 29](#).

Table 29 UCS C3160 1050 W Power Supply Specifications

Description	Specification
Class	RSP2
AC input voltage	200 to 240 VAC nominal (Range: 180 to 264 VAC)
AC input frequency	50 to 60 Hz nominal (Range: 47 to 63 Hz)
Maximum AC input current	8.5 A at 200 VAC
Maximum output power for each power supply	1050 W on main power 30 W on standby power
Power supply output voltage	Main power: 12 VDC Standby power: 12 VDC
Rated output load	Main power: 116.6 DC Amps Standby power: 2.5 DC Amps

For configuration-specific power specifications, use the Cisco UCS Power Calculator at this URL:

<http://ucspowercalc.cisco.com>

Environmental Specifications

The power specifications for the C3160 server are listed in [Table 30](#).

Table 30 UCS C3160 Environmental Specifications

Parameter	Minimum
Temperature operating	5°C to 35°C (41°F to 95°F)
Temperature nonoperating	-40° C to 65° C (-40° F to 149° F)
Humidity (RH) operating, non-condensing	10% to 90%
Altitude, operating Derated 1° C for each 305 m	0 m to 3048 m (0 ft to 10,000 ft)
Altitude nonoperating	0 m to 12,192 m (0 ft to 40,000 ft)
Acoustic noise, operating	LWAd 5.4 Bel LpAm 38 dBA

Compliance Requirements

The regulatory compliance requirements for C-Series servers are listed in [Table 31](#).

Table 31 UCS C-Series Regulatory Compliance Requirements

Parameter	Description
Regulatory Compliance	Products should comply with CE Markings per directives 2004/108/EC and 2006/95/EC
Safety	UL 60950-1 Second Edition CAN/CSA-C22.2 No. 60950-1 Second Edition EN 60950-1 Second Edition IEC 60950-1 Second Edition AS/NZS 60950-1
EMC - Emissions	47CFR Part 15 (CFR 47) Class A AS/NZS CISPR22 Class A CISPR22 Class A EN55022 Class A ICES003 Class A VCCI Class A EN61000-3-2 EN61000-3-3 KN22 Class A CNS13438 Class A
EMC - Immunity	EN55024 CISPR24 EN300386 KN24



Americas Headquarters
Cisco Systems, Inc.
San Jose, CA

Asia Pacific Headquarters
Cisco Systems (USA) Pte. Ltd.
Singapore

Europe Headquarters
Cisco Systems International BV Amsterdam,
The Netherlands

Cisco has more than 200 offices worldwide. Addresses, phone numbers, and fax numbers are listed on the Cisco Website at www.cisco.com/go/offices.

Cisco and the Cisco Logo are trademarks of Cisco Systems, Inc. and/or its affiliates in the U.S. and other countries. A listing of Cisco's trademarks can be found at www.cisco.com/go/trademarks. Third party trademarks mentioned are the property of their respective owners. The use of the word partner does not imply a partnership relationship between Cisco and any other company. (1005R)