



Cisco HyperFlex HXAF240c M5 Node

CISCO SYSTEMS
170 WEST TASMAN
SAN JOSE, CA, 95134
WWW.CISCO.COM

PUBLICATION HISTORY
REV C.28 JULY 03, 2023

CONTENTS

OVERVIEW	3
DETAILED VIEWS	4
Chassis Front View	4
Chassis Rear View	5
BASE NODE STANDARD CAPABILITIES and FEATURES	7
CONFIGURING the HyperFlex HXAF240c M5 Node	10
STEP 1 VERIFY SERVER SKU	11
STEP 2 SELECT DEPLOYMENT MODE (OPTIONAL)	12
STEP 3 SELECT RISER CARDS	13
STEP 4 SELECT CPU(s)	14
STEP 5 SELECT MEMORY	19
CPU DIMM Configuration Table	22
.....	23
STEP 6 SELECT RAID CONTROLLER	24
SAS HBA (internal HDD/SSD/JBOD support)	24
STEP 7 SELECT DRIVES	25
STEP 8 SELECT PCIe OPTION CARD(s)	28
STEP 9 ORDER GPU CARDS (OPTIONAL)	30
STEP 10 SELECT ACCESSORIES	31
STEP 11 ORDER SECURITY DEVICES (OPTIONAL)	32
STEP 12 ORDER POWER SUPPLY	33
STEP 13 SELECT POWER CORD(s)	34
STEP 14 ORDER TOOL-LESS RAIL KIT AND OPTIONAL REVERSIBLE CABLE MANAGEMENT ARM	37
STEP 15 SELECT HYPERVISOR / HOST OPERATING SYSTEM	38
STEP 16 SELECT HX DATA PLATFORM SOFTWARE	39
STEP 17 SELECT INSTALLATION SERVICE	40
STEP 18 SELECT SERVICE and SUPPORT LEVEL	41
SUPPLEMENTAL MATERIAL	46
Hyperconverged Systems	46
10 or 25 Gigabit Ethernet Dual Switch Topology	48
CHASSIS	49
Riser Card Configuration and Options	51
Serial Port Details	53
.....	SPARE PARTS 54
KVM CABLE	62
DISCONTINUED EOL PRODUCTS	63
TECHNICAL SPECIFICATIONS	70
Dimensions and Weight	70
Power Specifications	71
Environmental Specifications	73
Extended Operating Temperature Hardware Configuration Limits	74
Compliance Requirements	75

OVERVIEW

Cisco HyperFlex™ Systems unlock the full potential of hyperconvergence. The systems are based on an end-to-end software-defined infrastructure, combining software-defined computing in the form of Cisco Unified Computing System (Cisco UCS) servers; software-defined storage with the powerful Cisco HX Data Platform and software-defined networking with the Cisco UCS fabric that will integrate smoothly with Cisco Application Centric Infrastructure (Cisco ACI™). Together with a single point of connectivity and hardware management, these technologies deliver a preintegrated and adaptable cluster that is ready to provide a unified pool of resources to power applications as your business needs dictate.

The Cisco HyperFlex HXAF240c M5 Node is shown in [Figure 1](#).

The HXAF240c M5 servers extend the capabilities of Cisco's HyperFlex portfolio in a 2RU form factor with the addition of the 2nd Generation Intel® Xeon® Scalable Processors, 2933-MHz DDR4 memory, and an all flash footprint of cache and capacity drives for highly available, high performance storage.

Deployment Options

Starting with HyperFlex 4.5(2a) the following 2 deployment options are supported:

- **HX Data Center with Fabric Interconnect** - This deployment option connects the server to Cisco Fabric Interconnect. The installation for this type of deployment can be done using the standalone installer or from the Intersight.
- **HX Data Center without Fabric Interconnect** - This deployment option allows server nodes to be directly connected to existing switches. The installation for this type of deployment can be done from the Intersight only.

Figure 1 Cisco HyperFlex HXAF240c M5 Node

Front View Front View with Bezel attached



Front View Front View with Bezel removed



Rear View



DETAILED VIEWS

Chassis Front View

Figure 2 shows the front view of the Cisco HyperFlex HXAF240c M5 Node

Figure 2 Chassis Front View

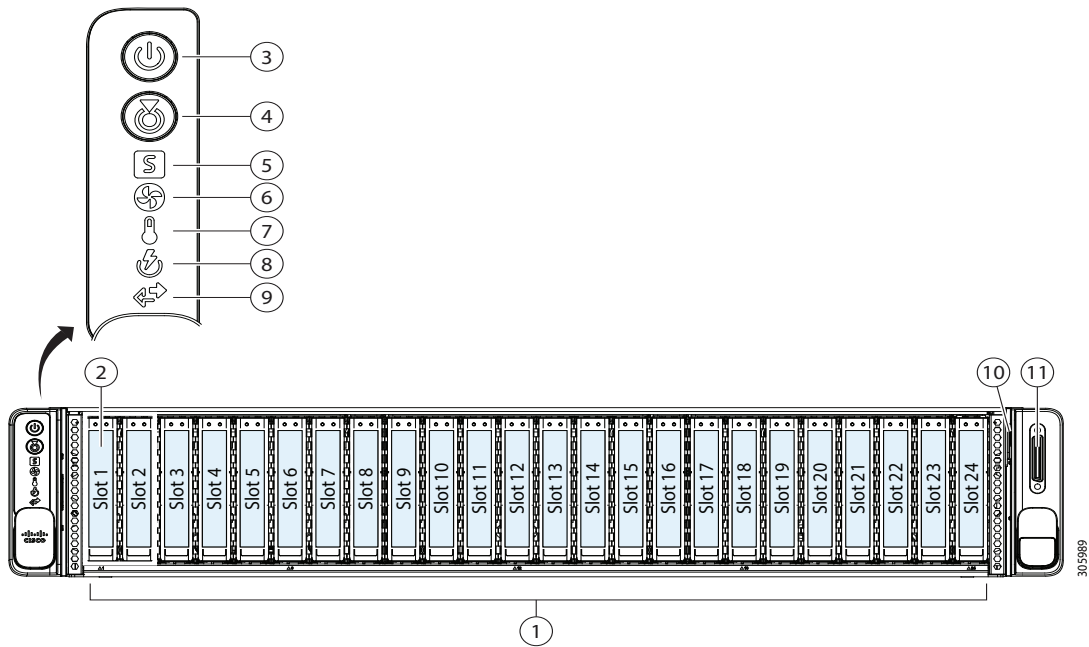

1	<p>Drive Slots:</p> <p>Slot 01 (For HyperFlex System/Log drive)</p> <ul style="list-style-type: none"> • 1 x SATA SSD <p>Slot 02 through 24 (For Capacity drives)</p> <ul style="list-style-type: none"> • Up to 23 x SATA SSD OR • Up to 23 x SED SATA SSD OR • Up to 23 x SED SAS SSD 	7	Temperature status LED
2	N/A	8	Power supply status LED
3	Power button/LED	9	Network link activity LED
4	Unit identification button/LED	10	Pull-out asset tag
5	System status LED	11	KVM connector (used with KVM cable that provides two USB 2.0, one VGA, and one serial connector)
6	Fan status LED	—	—

Chassis Rear View

Figure 3 shows the external features of the rear panel.

Figure 3 Chassis Rear View

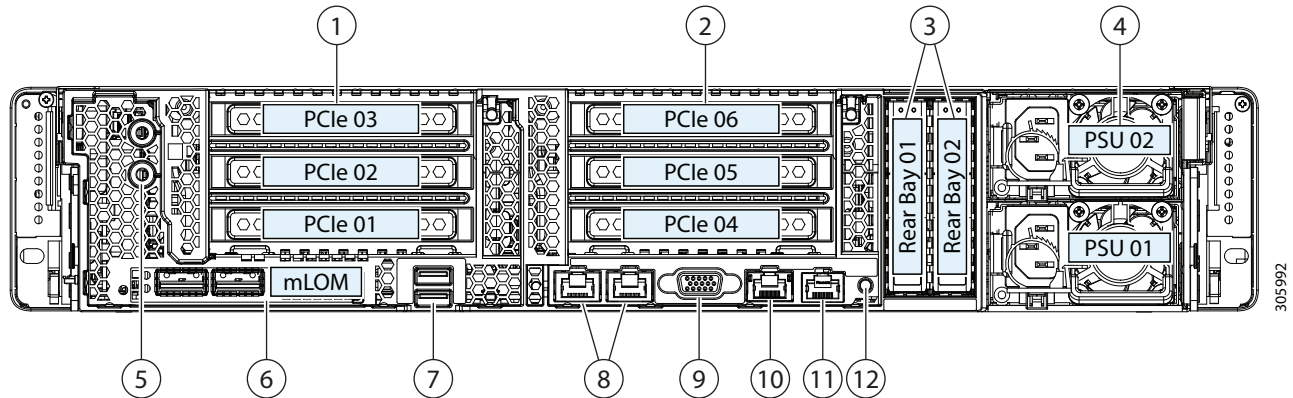

305992

<p>1</p>	<p>PCIe riser 1 (slots 1, 2, 3)</p> <ul style="list-style-type: none"> ■ Option 1A: (three slots available. (Default)) HX-RIS-1-240M5: <ul style="list-style-type: none"> • Slot 1 = full height, 3/4 length, x8, 230 pins, CPU1 controlled, NCSI support. • Slot 2 = full height, full length, x16, 230 pins, CPU1 controlled, NCSI and GPU support. • Slot 3 = full height, half length, x8, 164 pins, CPU2 controlled. ■ Option 1B (Riser 1B 3PCIe slots all from CPU1) HX-RIS-1B-240M5: <ul style="list-style-type: none"> • Slot 1 = full height, 3/4 length, x8, 230 pins, CPU1, NCSI support. • Slot 2 = full height, full length, x8, 230 pins, CPU1, NCSI support. • Slot 3 = full height, full length, x8, 164 pins, CPU1. ■ Riser 1(Riser 1 3PCIe slots all from CPU1) HX-R1-A100-M5: <ul style="list-style-type: none"> • Slot 1 = full height, 3/4 length, x8, 230 pins, CPU1, NCSI support. • Slot 2 = full height, full length, x16, 230 pins, CPU1 controlled, NCSI and GPU support. • Slot 3 = full height, half length, x8, 164 pins, CPU2 controlled. 	<p>7</p> <p>USB 3.0 ports (two)</p>
----------	---	-------------------------------------

2	<p>PCIe riser 2 (slots 4, 5, 6)</p> <ul style="list-style-type: none"> ■ Option 2B (three slots available) <ul style="list-style-type: none"> • Slot 4= full height, 3/4 length, x8, 230 pins, CPU1 controlled, NCSI support. • Slot 5= full height, full length, x16, 230 pins, CPU1 controlled, NCSI and GPU support. • Slot 6= full height, half length, x8, 164 pins, CPU2 controlled. • One x8 NVMe connector (for rear NVMe drive) from slot 4 ■ Option 2A (three slots available) <ul style="list-style-type: none"> • Slot 4 = full height, 3/4 length, x16, 230 pins, NCSI support. • Slot 5 = full height, full length, x16, 230 pins, NCSI and GPU support. • Slot 6 = full height, full length, x8, 164 pins. • Use of PCIe riser 2 requires a dual CPU configuration. ■ Option 2B (three slots available) <ul style="list-style-type: none"> • Slot 4 = full height, full length, x8, 164 pins. • Slot 5 = full height, full length, x16, 230 pins, NCSI and GPU support. • Slot 6 = full height, full length, x8, 164 pins. • Use of PCIe riser 2 requires a dual CPU configuration. 	8	Dual 1/10GE ports (LAN1, LAN2) LAN1 /is left connector, LAN2 is right connector
3	<p>Rear 2.5-inch drive bays:</p> <ul style="list-style-type: none"> ■ For SAS SSD/ NVMe drive for Caching 	9	VGA video port (DB-15 connector)
4	Power supplies (two, redundant as 1+1)	10	1GE dedicated management port
5	Screw holes for dual-hole grounding lug	11	Serial port (RJ-45 connector)
6	Modular LAN-on-motherboard (mLOM) card slot (x16)	12	Rear Unit Identification button/LED

BASE NODE STANDARD CAPABILITIES and FEATURES

Table 1 lists the capabilities and features of the base server. Details about how to configure the server for a particular feature or capability (for example, number of processors, disk drives, or amount of memory) are provided in [CONFIGURING the HyperFlex HXAF240c M5 Node, page 10](#).

Table 1 Capabilities and Features

Capability/Feature	Description
Chassis	Two rack unit (2RU) chassis
CPU	2 nd Generation Intel® Xeon® scalable family CPUs
Chipset	Intel® C621 series chipset
Memory	24 slots for registered ECC DIMMs (RDIMMs), load-reduced DIMMs (LRDIMMs) and Intel® Optane Persistent Memory Module (PMem)
Multi-bit Error Protection	This server supports multi-bit error protection.
Video	The Cisco Integrated Management Controller (CIMC) provides video using the Matrox G200e video/graphics controller: <ul style="list-style-type: none"> ■ Integrated 2D graphics core with hardware acceleration ■ 512MB total DDR4 memory, with 16MB dedicated to Matrox video memory ■ Supports all display resolutions up to 1920 x 1200 x 32bpp resolution at 60Hz ■ High speed Integrated 24-bit RAMDAC ■ Single lane PCI-Express Gen2 host interface
Power subsystem	One or two of the following hot-swappable power supplies: <ul style="list-style-type: none"> ■ 1050 W (AC) ■ 1050 W (DC) ■ 1600 W (AC) ■ 1050 W (AC) ELV One power supply is mandatory; one more can be added for 1 + 1 redundancy.
Front Panel	A front panel controller provides status indications and control buttons.
ACPI	This server supports the advanced configuration and power interface (ACPI) 6.2
Fans	<ul style="list-style-type: none"> ■ Six hot-swappable fans for front-to-rear cooling
Expansion slots	<ul style="list-style-type: none"> ■ Dedicated RAID/JBOD controller slot (see Figure 8 on page 49) <ul style="list-style-type: none"> • An internal slot is reserved for the Cisco 12G SAS HBA. ■ Up to six PCIe slots (on two riser card options) <ul style="list-style-type: none"> • For more details on riser 1 and riser 2 see the Riser Card Configuration and Options, page 51

Table 1 Capabilities and Features (*continued*)

Capability/Feature	Description
Internal storage devices	<ul style="list-style-type: none"> ■ Up to 24 Drives are installed into front-panel drive bays that provide hot-swappable access for SAS/SATA drives. 24 Drives are used as below: <ul style="list-style-type: none"> • Six to twenty-three SATA/SAS SSD or Six to twenty-three SED SATA/SAS SSD (for capacity) • One SATA/SAS SSD (System drive for HXDP Operations) ■ One rear NVMe SSD or One SATA/SAS SSD or One SED SATA/SAS SSD (for caching) ■ A mini-storage module connector on the motherboard for M.2 module for one M.2 SATA SSDs for following usage: <ul style="list-style-type: none"> • ESXi hypervisor boot and HyperFlex storage controller VM ■ One slot for a micro-SD card on PCIe Riser 1 (Option 1 and 1B). <ul style="list-style-type: none"> • The micro-SD card serves as a dedicated local resource for utilities such as host upgrade utility (HUU). Images can be pulled from a file share (NFS/CIFS) and uploaded to the cards for future use. Cisco Intersight leverages this card for advanced server management.
	<ul style="list-style-type: none"> ■ One slot for a micro-SD card on PCIe Riser 1 (Option 1 and 1B). The micro-SD card serves as a dedicated local resource for utilities such as host upgrade utility (HUU). Images can be pulled from a file share (NFS/CIFS) and uploaded to the cards for future use.
I/O Interfaces	<ul style="list-style-type: none"> ■ Rear panel <ul style="list-style-type: none"> • One 1Gbase-T RJ-45 management port (Marvell 88E6176) • Two 10Gbase-T LOM ports (Intel X550 controller embedded on the motherboard) • One RS-232 serial port (RJ45 connector) • One DB15 VGA connector • Two USB 3.0 port connectors • One flexible modular LAN on motherboard (mLOM) slot that can accommodate various interface cards ■ Front panel <ul style="list-style-type: none"> • One KVM console connector (supplies two USB 2.0 connectors, one VGA DB15 video connector, and one serial port (RS232))

Table 1 Capabilities and Features (continued)

Capability/Feature	Description
mLOM Slot	<p>The mLOM slot on the motherboard can flexibly accommodate the follow card:</p> <ul style="list-style-type: none"> ■ Cisco VIC 1387 Dual Port 40Gb QSFP CNA MLOM ■ Cisco UCS VIC 1457 Quad Port 10/25G SFP28 CNA MLOM  <p>Note:</p> <ul style="list-style-type: none"> ■ 1387 VIC natively supports 6300 series FIs. ■ To support 6200 series FIs with 1387, 10G QSAs compatible with 1387 are available for purchase. ■ Breakout cables are not supported with 1387 ■ Use of 10GbE is not allowed when used with 6300 series FI.
PCIe options	<p>PCIe slots on the Riser 1 and 2 can flexibly accommodate the following cards:</p> <p>Network Interface Card (NICs):</p> <ul style="list-style-type: none"> ■ Intel X550-T2 dual port 10Gbase-T ■ Intel XXV710-DA2 dual port 25GE NIC ■ Intel i350 quad port 1Gbase-T ■ Intel X710-DA2 dual port 10GE NIC <p>Virtual Interface Card (VICs):</p> <ul style="list-style-type: none"> ■ Cisco VIC 1385 Dual Port 40Gb QSFP+ CNA w/RDMA ■ Cisco UCS VIC 1455 Quad Port 10/25G SFP28 CNA PCIE
Integrated management processor	<p>Baseboard Management Controller (BMC) running Cisco Integrated Management Controller (CIMC) firmware.</p> <p>Depending on your CIMC settings, the CIMC can be accessed through the 1GE dedicated management port, the 1/10 GE LOM ports, or a Cisco virtual interface card (VIC).</p> <p>CIMC manages certain components within the server, such as the Cisco 12G SAS HBA.</p>
UCSM	<p>Unified Computing System Manager (UCSM) runs in the Fabric Interconnect and automatically discovers and provisions some of the server components.</p>

CONFIGURING the HyperFlex HXAF240c M5 Node

Follow these steps to configure the Cisco HyperFlex HXAF240c M5 Node

- *STEP 1 VERIFY SERVER SKU, page 11*
- *STEP 2 SELECT DEPLOYMENT MODE (OPTIONAL), page 12*
- *STEP 3 SELECT RISER CARDS, page 13*
- *STEP 4 SELECT CPU(s), page 14*
- *STEP 5 SELECT MEMORY, page 19*
- *STEP 6 SELECT RAID CONTROLLER, page 24*
- *STEP 7 SELECT DRIVES, page 25*
- *STEP 8 SELECT PCIe OPTION CARD(s), page 28*
- *STEP 9 ORDER GPU CARDS (OPTIONAL), page 30*
- *STEP 10 SELECT ACCESSORIES, page 31*
- *STEP 11 ORDER SECURITY DEVICES (OPTIONAL), page 32*
- *STEP 13 SELECT POWER CORD(s), page 34*
- *STEP 14 ORDER TOOL-LESS RAIL KIT AND OPTIONAL REVERSIBLE CABLE MANAGEMENT ARM, page 37*
- *STEP 15 SELECT HYPERVISOR / HOST OPERATING SYSTEM, page 38*
- *STEP 16 SELECT HX DATA PLATFORM SOFTWARE, page 39*
- *STEP 17 SELECT INSTALLATION SERVICE, page 40*
- *STEP 18 SELECT SERVICE and SUPPORT LEVEL, page 41*
- *SUPPLEMENTAL MATERIAL, page 46*

STEP 1 VERIFY SERVER SKU

Verify the product ID (PID) of the server as shown in [Table 2](#).

Table 2 PID of the HXAF240c M5 Node

Product ID (PID)	Description
HXAF-M5S-HXDP	This major line bundle (MLB) consists of the Server Nodes (HXAF220c-M5SX, HXAF220c-M5SN and HXAF240C-M5SX) with HXDP software spare PIDs. NOTE: For the HyperFlex data center no fabric interconnect deployment mode, this PID must be used
HXAF240C-M5SX ¹	HXAF240c M5 Node, with two CPUs, memory, up to 23 drives for data storage, one SSD for system/HXDP logs, one SSD for caching, two power supplies, one M.2 SATA SSD, one micro-SD card, one VIC 1387 mLOM card, no PCIe cards, and no rail kit
HXAF2X0C-M5S	This major line bundle (MLB) consists of the Server Nodes (HXAF220C-M5SX and HXAF240C-M5SX), Fabric Interconnects (HX-FI-6248UP, HX-FI-6296UP, HX-FI-6332, HX-FI-6332-16UP) and HXDP software spare PIDs.

Notes:

1. This product may not be purchased outside of the approved bundles (must be ordered under the MLB).

The HXAF240c M5 Node:

- Requires configuration of one or two power supplies, one or two CPUs, recommended memory sizes, 1 SSD for Caching, 1 SSD for system logs, up to 23 data HDDs, 1 VIC mLOM card, 1 M.2 SATA SSD and 1 micro-SD card.
- Provides option to choose 10G QSAs to connect with HX-FI-6248UP and HX-FI-6296UP
- Provides option to choose rail kits.



NOTE: Use the steps on the following pages to configure the node with the components that you want to include.

STEP 2 SELECT DEPLOYMENT MODE (OPTIONAL)

Starting with HyperFlex 4.5(2a), the following 2 deployment options are supported

Select deployment mode

The available deployment modes are listed in [Table 3](#)

Table 3 Deployment Modes

Product ID (PID)	Description
HX-DC-FI	Deployment mode Selection PID to use Hyperflex with FI
HX-DC-NO-FI	Deployment mode Selection PID to use Hyperflex without FI

- **HX Data Center with Fabric Interconnect** - This deployment option connects the server to Cisco Fabric Interconnect. The installation for this type of deployment can be done using the standalone installer or from the Intersight. This deployment mode has been supported since launch of HyperFlex.
- **HX Data Center without Fabric Interconnect** - This deployment option allows server nodes to be directly connected to existing switches. The installation for this type of deployment can be done from the Intersight only.

Note the following apply:

- No support for SED drives
- No hyper-V support
- No support for PMem
- No support for Additional PCIE Cisco VIC
- No support for stretch cluster
- No support for Application acceleration engine

Selecting this option will hence grey out the unsupported options during ordering



NOTE: If no selection is done, the deployment mode is assumed to be DC with FI

STEP 3 SELECT RISER CARDS

There are two riser cards per server, riser card 1 and 2. Order one riser card 1 and one riser 2 card from [Table 4](#). Riser card 1 is the one on the left when viewed from the back of the server and riser card 2 is on the right.

Table 4 Riser 1 Options

Product ID (PID)	Description
PCIe Riser 1 options	
HX-RIS-1B-240M5	Riser 1B 3PCIe slots (x8, x8, x8); all from CPU1, For T4
HX-RIS-1-240M5	Riser 1 3PCIe slots (x8, x16, x8); slot 3 req CPU2, For T4, RTX
HX-R1-A100-M5	Riser1 3PCIe slots(x8, x16, x8)
PCIe Riser 2 options (all slots controlled with CPU2)	
HX-RIS-2B-240M5	Riser 2B 3PCIe slot(x8,x16,x8) supports GPU+rear NVMe, For T4, RTX
HX-R2A-A100-M5	Riser2A 3PCIe slots (x8, x16, x16)
HX-R2B-A100-M5	Riser2B 3PCIe slot(x8,x16,x8) supprts GPU+NVMe

For additional details, see [Riser Card Configuration and Options, page 51](#)

STEP 4 SELECT CPU(s)

The standard CPU features are:

- 2nd Generation Intel®Xeon® scalable family CPUs
- Intel C621 series chipset
- Cache size of up to 38.5 MB

Select CPUs

The available CPUs are listed in [Table 5](#).

Table 5 Available CPUs

Product ID (PID)	Clock Freq (GHz)	Power (W)	Cache Size (MB)	Cores	UPI ¹ Links (GT/s)	Highest DDR4 DIMM Clock Support (MHz)	Workload/Processor type ²
Cisco Recommended CPUs (2nd Generation Intel® Xeon® Processors)							
HX-CPU-I8276	2.2	165	38.50	28	3 x 10.4	2933	Oracle, SAP
HX-CPU-I8260	2.4	165	35.75	24	3 x 10.4	2933	Microsoft Azure Stack
HX-CPU-I6262V	1.9	135	33.00	24	3 x 10.4	2400	Virtual Server infrastructure or VSI
HX-CPU-I6248R	3.0	205	35.75	24	2 x 10.4	2933	
HX-CPU-I6248	2.5	150	27.50	20	3 x 10.4	2933	VDI, Oracle, SQL, Microsoft Azure Stack
HX-CPU-I6238R	2.2	165	38.50	28	2 x 10.4	2933	Oracle, SAP (2-Socket TDI only), Microsoft AzureStack
HX-CPU-I6238	2.1	140	30.25	22	3 x 10.4	2933	SAP
HX-CPU-I6230R	2.1	150	35.75	26	2 x 10.4	2933	Virtual Server Infrastructure, Data Protection, Big Data, Splunk, Microsoft AzureStack
HX-CPU-I6230	2.1	125	27.50	20	3 x 10.4	2933	Big Data, Virtualization
HX-CPU-I5220R	2.2	125	35.75	24	2 x 10.4	2666	Virtual Server Infrastructure, Splunk, Microsoft Azure Stack
HX-CPU-I5220	2.2	125	24.75	18	2 x 10.4	2666	HCI
HX-CPU-I5218R	2.1	125	27.50	20	2 x 10.4	2666	Virtual Server Infrastructure, Data Protection, Big Data, Splunk, Scale-out Object Storage, Microsoft AzureStack

Table 5 Available CPUs

Product ID (PID)	Clock Freq (GHz)	Power (W)	Cache Size (MB)	Cores	UPI ¹ Links (GT/s)	Highest DDR4 DIMM Clock Support (MHz)	Workload/Processor type ²
HX-CPU-I5218	2.3	125	22.00	16	2 x 10.4	2666	Virtualization, Microsoft Azure Stack, Splunk, Data Protection
HX-CPU-I4216	2.1	100	22.00	16	2 x 9.6	2400	Data Protection, Scale Out Storage
HX-CPU-I4214R	2.4	100	16.50	12	2 x 9.6	2400	Data Protection, Splunk, Scale-out Object Storage, Microsoft AzureStack
HX-CPU-I4214	2.2	85	16.50	12	2 x 9.6	2400	Data Protection, Scale Out Storage
HX-CPU-I4210R	2.4	100	13.75	10	2 x 9.6	2400	Virtual Server Infrastructure, Data Protection, Big Data, Splunk
HX-CPU-I4210	2.2	85	13.75	10	2 x 9.6	2400	Virtualization, Big Data, Splunk
8000 Series Processor							
HX-CPU-I8280L	2.7	205	38.50	28	3 x 10.4	2933	2 nd Gen Intel® Xeon®
HX-CPU-I8280	2.7	205	38.50	28	3 x 10.4	2933	2 nd Gen Intel® Xeon®
HX-CPU-I8276L	2.2	165	38.50	28	3 x 10.4	2933	2 nd Gen Intel® Xeon®
HX-CPU-I8276	2.2	165	38.50	28	3 x 10.4	2933	2 nd Gen Intel® Xeon®
HX-CPU-I8270	2.7	205	35.75	26	3 x 10.4	2933	2 nd Gen Intel® Xeon®
HX-CPU-I8268	2.9	205	35.75	24	3 x 10.4	2933	2 nd Gen Intel® Xeon®
HX-CPU-I8260Y	2.4	165	35.75	24/20/ 16	3 x 10.4	2933	2 nd Gen Intel® Xeon®
HX-CPU-I8260L	2.4	165	35.75	24	3 x 10.4	2933	2 nd Gen Intel® Xeon®
HX-CPU-I8260	2.4	165	35.75	24	3 x 10.4	2933	2 nd Gen Intel® Xeon®
6000 Series Processor							
HX-CPU-I6262V	1.9	135	33.00	24	3 x 10.4	2400	2 nd Gen Intel® Xeon®
HX-CPU-I6258R	2.7	205	35.75	28	2 x 10.4	2933	2 nd Gen Intel® Xeon®
HX-CPU-I6256	3.6	205	33.00	12	2 x 10.4	2933	2 nd Gen Intel® Xeon®
HX-CPU-I6254	3.1	200	24.75	18	3 x 10.4	2933	2 nd Gen Intel® Xeon®
HX-CPU-I6252N	2.3	150	35.75	24	3 x 10.4	2933	2 nd Gen Intel® Xeon®
HX-CPU-I6252	2.1	150	35.75	24	3 x 10.4	2933	2 nd Gen Intel® Xeon®
HX-CPU-I6250	3.9	185	35.75	8	2 x 10.4	2933	2 nd Gen Intel® Xeon®
HX-CPU-I6248R	3.0	205	35.75	24	2 x 10.4	2933	2 nd Gen Intel® Xeon®
HX-CPU-I6248	2.5	150	27.50	20	3 x 10.4	2933	2 nd Gen Intel® Xeon®
HX-CPU-I6246R	3.4	205	35.75	16	2 x 10.4	2933	2 nd Gen Intel® Xeon®

Table 5 Available CPUs

Product ID (PID)	Clock Freq (GHz)	Power (W)	Cache Size (MB)	Cores	UPI ¹ Links (GT/s)	Highest DDR4 DIMM Clock Support (MHz)	Workload/Processor type ²
HX-CPU-I6246	3.3	165	24.75	12	3 x 10.4	2933	2 nd Gen Intel® Xeon®
HX-CPU-I6244	3.6	150	24.75	8	3 x 10.4	2933	2 nd Gen Intel® Xeon®
HX-CPU-I6242R	3.1	205	35.75	20	2 x 10.4	2933	2 nd Gen Intel® Xeon®
HX-CPU-I6242	2.8	150	22.00	16	3 x 10.4	2933	2 nd Gen Intel® Xeon®
HX-CPU-I6240R	2.4	165	35.75	24	2 x 10.4	2933	2 nd Gen Intel® Xeon®
HX-CPU-I6240Y	2.6	150	24.75	18/14/8	3 x 10.4	2933	2 nd Gen Intel® Xeon®
HX-CPU-I6240L	2.6	150	24.75	18	3 x 10.4	2933	2 nd Gen Intel® Xeon®
HX-CPU-I6240	2.6	150	24.75	18	3 x 10.4	2933	2 nd Gen Intel® Xeon®
HX-CPU-I6238R	2.2	165	38.50	28	2 x 10.4	2933	2 nd Gen Intel® Xeon®
HX-CPU-I6238L	2.1	140	30.25	22	3 x 10.4	2933	2 nd Gen Intel® Xeon®
HX-CPU-I6238	2.1	140	30.25	22	3 x 10.4	2933	2 nd Gen Intel® Xeon®
HX-CPU-I6234	3.3	130	24.75	8	3 x 10.4	2933	2 nd Gen Intel® Xeon®
HX-CPU-I6230R	2.1	150	35.75	26	2 x 10.4	2933	2 nd Gen Intel® Xeon®
HX-CPU-I6230N	2.3	125	27.50	20	3 x 10.4	2933	2 nd Gen Intel® Xeon®
HX-CPU-I6230	2.1	125	27.50	20	3 x 10.4	2933	2 nd Gen Intel® Xeon®
HX-CPU-I6226R	2.9	150	22.00	16	2 x 10.4	2933	2 nd Gen Intel® Xeon®
HX-CPU-I6226	2.7	125	19.25	12	3 x 10.4	2933	2 nd Gen Intel® Xeon®
HX-CPU-I6222V	1.8	115	27.50	20	3 x 10.4	2400	2 nd Gen Intel® Xeon®
5000 Series Processor							
HX-CPU-I5220S	2.6	125	19.25	18	2 x 10.4	2666	2 nd Gen Intel® Xeon®
HX-CPU-I5220R	2.2	150	35.75	24	2 x 10.4	2666	2 nd Gen Intel® Xeon®
HX-CPU-I5220	2.2	125	24.75	18	2 x 10.4	2666	2 nd Gen Intel® Xeon®
HX-CPU-I5218R	2.1	125	27.50	20	2 x 10.4	2666	2 nd Gen Intel® Xeon®
HX-CPU-I5218B	2.3	125	22.00	16	2 x 10.4	2933	2 nd Gen Intel® Xeon®
HX-CPU-I5218N	2.3	105	22.00	16	2 x 10.4	2666	2 nd Gen Intel® Xeon®
HX-CPU-I5218	2.3	125	22.00	16	2 x 10.4	2666	2 nd Gen Intel® Xeon®
HX-CPU-I5217	3.0	115	11.00	8	2 x 10.4	2666	2 nd Gen Intel® Xeon®
HX-CPU-I5215L	2.5	85	13.75	10	2 x 10.4	2666	2 nd Gen Intel® Xeon®
HX-CPU-I5215	2.5	85	13.75	10	2 x 10.4	2666	2 nd Gen Intel® Xeon®
4000 Series Processor							
HX-CPU-I4216	2.1	100	22.00	16	2 x 9.6	2400	2 nd Gen Intel® Xeon®
HX-CPU-I4215R	3.2	130	11.00	8	2 x 9.6	2400	2 nd Gen Intel® Xeon®
HX-CPU-I4215	2.5	85	11.00	8	2 x 9.6	2400	2 nd Gen Intel® Xeon®

Table 5 Available CPUs

Product ID (PID)	Clock Freq (GHz)	Power (W)	Cache Size (MB)	Cores	UPI ¹ Links (GT/s)	Highest DDR4 DIMM Clock Support (MHz)	Workload/Processor type ²
HX-CPU-I4214R	2.4	100	16.50	12	2 x 9.6	2400	2 nd Gen Intel® Xeon®
HX-CPU-I4214Y	2.2	85	16.50	12/10/8	2 x 9.6	2400	2 nd Gen Intel® Xeon®
HX-CPU-I4214	2.2	85	16.50	12	2 x 9.6	2400	2 nd Gen Intel® Xeon®
HX-CPU-I4210R	2.4	100	13.75	10	2 x 9.6	2400	2 nd Gen Intel® Xeon®
HX-CPU-I4210	2.2	85	13.75	10	2 x 9.6	2400	2 nd Gen Intel® Xeon®
HX-CPU-I4208	2.1	85	11.00	8	2 x 9.6	2400	2 nd Gen Intel® Xeon®
3000 Series Processor							
HX-CPU-I3206R	1.9	85	11.00	8	2 x 9.6	2133	2 nd Gen Intel® Xeon®

Notes:

- UPI = Ultra Path Interconnect. 2-socket servers support only 2 UPI performance, even if the CPU supports 3 UPI.
- HyperFlex Data Platform reserves CPU cycle for each controller VM. Refer to the <[Install Guide](#)> for reservation details.



CAUTION: For systems configured with 2nd Gen Intel® Xeon® 205W R-series processors, operating above 32° C [89.6° F], a fan fault or executing workloads with extensive use of heavy instructions sets like Intel® Advanced Vector Extensions 512 (Intel® AVX-512), may assert thermal and/or performance faults with an associated event recorded in the System Event Log (SEL).

- **HX-CPU-I6258R** - Intel 6258R 2.7GHz/205W 28C/35.75MB DDR4 2933MHz
- **HX-CPU-I6248R** - Intel 6248R 3.0GHz/205W 24C/35.75MB DDR4 2933MHz
- **HX-CPU-I6246R** - Intel 6246R 3.4GHz/205W 16C/35.75MB DDR4 2933MHz
- **HX-CPU-I6242R** - Intel 6242R 3.1GHz/205W 20C/35.75MB DDR4 2933MHz

Approved Configurations**(1) 1-CPU Configuration:**

- Select any one CPU listed in [Table 5 on page 14](#)
- Requires 12 Core and above CPUs

**NOTE:**

- 1-CPU does not support NVMe or Optane Cache drive.

(2) 2-CPU Configuration:

- Select two identical CPUs from any one of the rows of [Table 5 on page 14](#).
- Requires 8 Core and above CPUs

STEP 5 SELECT MEMORY

The standard memory features are:

- Clock speed: Up to 2933 MHz; See available CPUs and their associated DDR4 DIMM maximum clock support in [Table 6](#).
- Rank per DIMM: 1, 2, 4, or 8
- Operational voltage: 1.2 V
- Registered ECC DDR4 DIMMs (RDIMMs), Load-reduced DIMMs (LRDIMMs), or Intel® Optane™ Persistent Memory Modules (PMem)

Memory is organized with six memory channels per CPU, with up to two DIMMs per channel, as shown in [Figure 4](#).

Figure 4 HXAF240c M5 Node Memory Organization

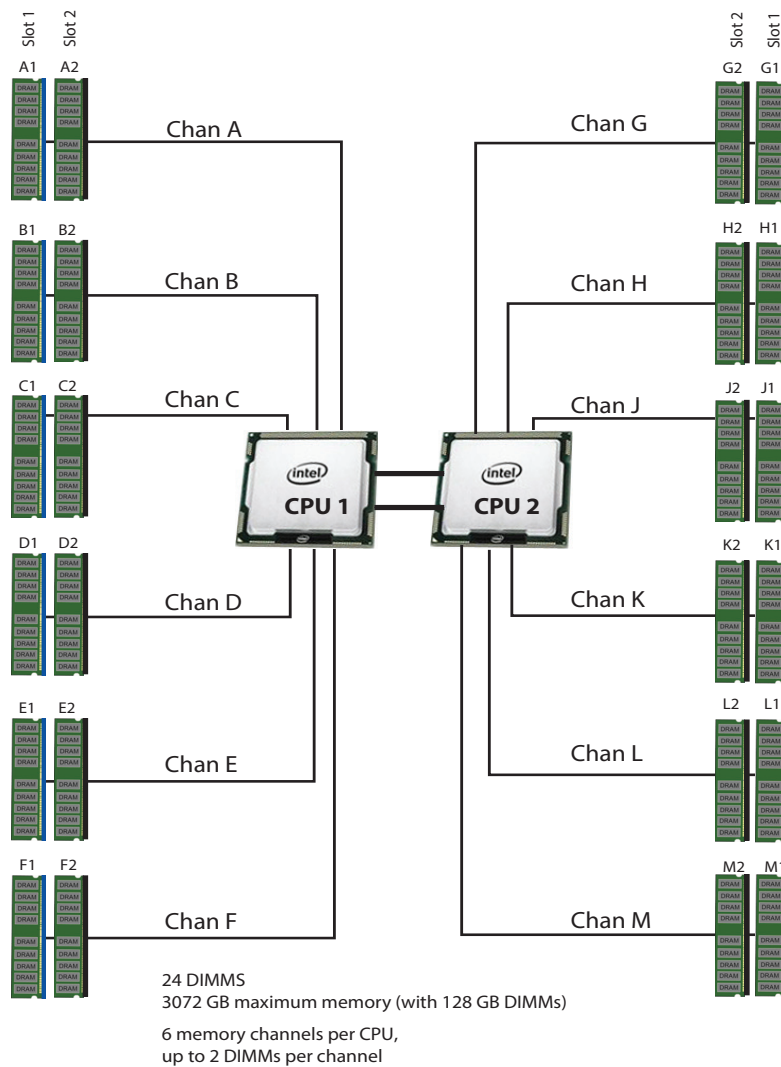

Select DIMMs and PMem

Select the memory configuration. The available memory DIMMs are listed in [Table 6](#)



NOTE: The memory mirroring feature is not supported with HyperFlex nodes.

Table 6 Available DDR4 DIMMs

Product ID (PID)	PID Description	Voltage	Ranks/ DIMM
DIMMs			
HX-ML-128G4RT-H ¹	128 GB DDR4-2933MHz LRDIMM/4Rx4 (16Gb)	1.2 V	4
HX-ML-X64G4RT-H ¹	64 GB DDR4-2933MHz LRDIMM/4Rx4 (8Gb)	1.2 V	4
HX-MR-X64G2RT-H ¹	64 GB DDR4-2933MHz RDIMM/2Rx4 (16Gb)	1.2 V	2
HX-MR-X32G2RT-H ¹	32GB DDR4-2933MHz RDIMM/2Rx4 (8Gb)	1.2 V	2
HX-MR-X16G1RT-H ¹	16 GB DDR4-2933MHz RDIMM/1Rx4 (8Gb)	1.2 V	1
HX-ML-128G4RW ²	128GB DDR4-3200MHz LRDIMM 4Rx4 (16Gb)	1.2 V	1
HX-MR-X64G2RW ²	64GB DDR4-3200MHz RDIMM 2Rx4 (16Gb)	1.2 V	1
HX-MR-X32G2RW ²	32GB DDR4-3200MHz RDIMM 2Rx4 (8Gb)	1.2 V	1
HX-MR-X16G1RW ²	16GB DDR4-3200MHz RDIMM 1Rx4 (8Gb)	1.2 V	1
Intel® Optane Persistent Memory Module (PMem)			
HX-MP-512GS-A0	Intel Optane Persistent Memory, 512GB, 2666MHz		
HX-MP-256GS-A0	Intel Optane Persistent Memory, 256GB, 2666MHz		
HX-MP-128GS-A0	Intel Optane Persistent Memory, 128GB, 2666MHz		
Intel® Optane™ Persistent Memory (PMem) Operational Modes			
UCS-DCPMM-AD	Intel Optane DC Persistent Memory Operational Mode - App Di		

Notes:

1. Cisco announced the End-of-sale of the DDR4-2933MHz Memory DIMM products: [EOL14611](#) lists the product part numbers affected by this announcement. [Table 7](#) describes the replacement Memory DIMM product Part Numbers.
2. DDR4-3200MHz replacement part numbers will operate at the maximum speed of the Intel 2nd generation Xeon Scalable processor memory interface, ranging from 2133 MHz to 2933 MHz.



Data Center Deployment Mode

NOTE: Data center deployment mode without fabric interconnect (HX-DC-no-FI) does not support HX-MP-512GS-A0, HX-MP-256GS-A0, HX-MP-128GS-A0, and UCS-DCPMM-AD. Refer to [STEP 2](#) for the details

[Table 7](#) lists the EOL Memory DIMM product part numbers and their replacement PIDs.

Table 7 EOL14611 Memory DIMM Product Part Numbers and their replacement PIDs

EOS Product Part Number (PID)	PID Description	Replacement Product PID	Replacement Product Description
HX-MR-X16G1RT-H	16GB DDR4-2933MHz RDIMM 1Rx4 (8Gb)/1.2v	HX-MR-X16G1RW	16GB DDR4-3200MHz RDIMM 1Rx4 (8Gb)/1.2v
HX-MR-X32G2RT-H	32GB DDR4-2933MHz RDIMM 2Rx4 (8Gb)/1.2v	HX-MR-X32G2RW	32GB DDR4-3200MHz RDIMM 2Rx4 (8Gb)/1.2v
HX-MR-X64G2RT-H	64GB DDR4-2933MHz RDIMM 2Rx4 (16Gb)/1.2v	HX-MR-X64G2RW	64GB DDR4-3200MHz RDIMM 2Rx4 (16Gb)/1.2v
HX-ML-X64G4RT-H	64GB DDR4-2933MHz LRDIMM 4Rx4 (8Gb)/1.2v	HX-MR-X64G2RW ¹	64GB DDR4-3200MHz RDIMM 2Rx4 (16Gb)/1.2v
HX-ML-128G4RT-H	128GB DDR4-2933MHz LRDIMM 4Rx4 (16Gb)/1.2v	HX-ML-128G4RW	128GB DDR4-3200MHz LRDIMM 4Rx4 (16Gb)/1.2v



NOTE: (1) Cisco doesn't support a Load Reduce DIMM (LRDIMM) 64GB Memory PID as a replacement PID of existing UCS-ML-x64G4RT-H and recommends migrating to the Registered DIMM (RDIMM) instead, delivering the best balance in performance and price.

CPU DIMM Configuration Table

Approved Configurations

(1) 1-CPU configuration

- Select from 1 to 12 DIMMs.

CPU 1 DIMM Placement in Channels (for identically ranked DIMMs)	
1	(A1)
2	(A1, B1)
3	(A1, B1, C1)
4	(A1, B1); (D1, E1)
6	(A1, B1); (C1, D1); (E1, F1)
8	(A1, B1); (D1, E1); (A2, B2); (D2, E2)
12	(A1, B1); (C1, D1); (E1, F1); (A2, B2); (C2, D2); (E2, F2)

(2) 2-CPU configuration

- Select from 1 to 12 DIMMs per CPU.

	CPU 1 DIMM Placement in Channels (for identical ranked DIMMs)	CPU 2 DIMM Placement in Channels (for identical ranked DIMMs)
	CPU 1	CPU 2
1	(A1)	(G1)
2	(A1, B1)	(G1, H1)
3	(A1, B1, C1)	(G1, H1, J1)
4	(A1, B1); (D1, E1)	(G1, H1); (K1, L1)
6	(A1, B1); (C1, D1); (E1, F1)	(G1, H1); (J1, K1); (L1, M1)
8	(A1, B1); (D1, E1); (A2, B2); (D2, E2)	(G1, H1); (K1, L1); (G2, H2); (K2, L2)
12	(A1, B1); (C1, D1); (E1, F1); (A2, B2); (C2, D2); (E2, F2)	(G1, H1); (J1, K1); (L1, M1); (G2, H2); (J2, K2); (L2, M2)



NOTE:

- The selected DIMMs must be all of same type and number of DIMMs must be equal for both CPUs
 - Even though 128GB of DRAM is supported, It is recommended to have a minimum of 192GB of DRAM configured for maximum performance
 - HyperFlex Data Platform reserves memory for each controller VM. Refer to the <[Install Guide](#)> for reservation details.
 - Recommended 6 or 12 DIMMs per CPU.
 - Refer to the “[CPU DIMM Configuration Table](#)” for the configuration details
-

System Speed

Memory will operate at the maximum speed of the Intel Xeon Scalable processor memory controller, ranging from 2133 MHz to 2933 MHz for M5 servers. Check CPU specifications for supported speeds



NOTE: Detailed mixing DIMM configurations are described in Cisco UCS [M5 Memory Guide](#)

STEP 6 SELECT RAID CONTROLLER

SAS HBA (internal HDD/SSD/JBOD support)

Choose the following SAS HBA for internal drive connectivity (non-RAID):

- The Cisco 12G SAS HBA, which plugs into a dedicated RAID controller slot.

Select Controller Options

Select the following:

- Cisco 12 Gbps Modular SAS HBA (see [Table 8](#))

Table 8 Hardware Controller Options

Product ID (PID)	PID Description
Controllers for Internal Drives	
Note that the following Cisco 12G SAS HBA controller is factory-installed in the dedicated internal slot.	
HX-SAS-M5HD	Cisco 12G SAS HBA <ul style="list-style-type: none">■ Supports up to 26 internal SAS HDDs and SAS/SATA SSDs■ Supports JBOD mode only (no RAID functionality. Ideal for SDS (Software Defined Storage) applications. It is also ideal for environments demanding the highest IOPs (for external SSD attach), where a RAID controller can be an I/O bottleneck.

Approved Configurations

The Cisco 12 Gbps Modular SAS HBA supports up to 26 internal drives with non-RAID support.

STEP 7 SELECT DRIVES

The standard disk drive features are:

- 2.5-inch small form factor
- Hot-pluggable
- Drives come mounted in sleds

Select Drives

The available drives are listed in [Table 9](#)



Data Center Deployment Mode

- Data center deployment mode without fabric interconnect (HX-DC-no-FI) does not support SED drives.
- HX-NVMEXPB-I375, HX-NVMEM6-W1600 requires HXDP 4.5(2c) or higher Refer to [STEP 4](#) for the details.

Table 9 Available Hot-Pluggable Sled-Mounted Drives

Product ID (PID)	PID Description	Drive Type	Capacity
Front Capacity Drive			
HX-SD960G61X-EV	960GB 2.5 Inch Enterprise Value 6G SATA SSD (1X endurance)	SATA	960 GB
HX-SD38T61X-EV	3.8TB 2.5 inch Enterprise Value 6G SATA SSD (1X endurance)	SATA	3.8 TB
HX-SD76T61X-EV	7.6TB 2.5 inch Enterprise Value 6G SATA SSD (1X endurance) (HyperFlex Release 4.0(2a) and later)	SATA	7.6 TB
HX-SD960G6S1X-EV	960GB 2.5 inch Enterprise Value 6G SATA SSD (1X endurance) (HyperFlex Release 4.5(2c), 5.0(1c) and later)	SATA	960 GB
HX-SD19T6S1X-EV	1.9TB 2.5 inch Enterprise Value 6G SATA SSD (1X endurance) (HyperFlex Release 4.5(2c), 5.0(1c) and later)	SATA	1.9 TB
HX-SD38T6S1X-EV	3.8TB 2.5 inch Enterprise Value 6G SATA SSD (1X endurance) (HyperFlex Release 4.5(2c), 5.0(1c) and later)	SATA	3.8 TB
HX-SD76T6S1X-EV	7.6TB 2.5 inch Enterprise Value 6G SATA SSD (1X endurance) (HyperFlex Release 4.5(2c), 5.0(1c) and later)	SATA	7.6 TB
Front SED Capacity Drive			
HX-SD76TBKNK9	7.6TB Enterprise value SAS SSD (1 DWPD, SED-FIPS)	SAS	7.6 TB
HX-SD960GBKNK9	960GB Enterprise Value SAS SSD (1X FWPD, SED)	SAS	960 GB
HX-SD38TBKNK9	3.8TB Enterprise Value SAS SSD (1X FWPD, SED)	SAS	1.2 TB
HX-SD960GBM2NK9	960GB Enterprise value SATA SSD (1X, SED) (HyperFlex Release 4.0(2c) and later)	SATA	960 GB
HX-SD19TBEM2NK9	1.9TB Enterprise value SATA SSD (1X, SED)	SATA	1.9 TB
HX-SD38TBEM2NK9	3.8TB 2.5 inch Ent. Value 6G SATA SED SSD (1X endurance) (HyperFlex Release 4.0(2c) and later)	SATA	3.8 TB

Table 9 Available Hot-Pluggable Sled-Mounted Drives

Product ID (PID)	PID Description	Drive Type	Capacity
HX-SD76TBEM2NK9	7.6TB Enterprise value SATA SSD (1X endurance, SED) (HyperFlex Release 4.0(2c) and later)	SATA	7.6 TB
Rear Cache Drive			
HX-NVMEXPB-I375*	375GB 2.5in Intel Optane NVMe Extreme Performance SSD (HyperFlex Release 3.5 (2h) or later) (Mixed drive support with HyperFlex Release 5.0(2b))*	NVMe	375 GB
HX-NVMEM6-W1600*	1.6TB 2.5in U.2 WD SN840 NVMe Extreme Perf. High Endurance (HyperFlex Release 4.5(1a) or later) (Mixed drive support with HyperFlex Release 5.0(2b))*	NVMe	1.6 TB
HX-SD800GK3X-EP	800GB 2.5in Enterprise Performance 12G SAS SSD(3X endurance) (HyperFlex Release 4.5(1a) and later)	SAS	800 GB
HX-SD16TK3X-EP	1.6TB 2.5in Enterprise Performance 12G SAS SSD (3X endurance) (HyperFlex Release 4.5(1a) and later)	SAS	1.6 TB
Rear SED Cache Drive			
HX-SD800GBKNK9	800GB Enterprise Performance SAS SSD (3X FWPD, SED)	SAS	800 GB
Front System Drive / Log Drive			
HX-SD240GM1X-EV	240GB 2.5 inch Enterprise Value 6G SATA SSD (HyperFlex Release 3.5(1a) or later)	SATA	240 GB
Boot Drive			
HX-M2-240GB	240GB SATA M.2 SSD	SATA	240 GB
HX-M2-HWRAID	Cisco Boot optimized M.2 Raid controller (HyperFlex Release 4.5(1a) and later)		
NOTE:			
<ul style="list-style-type: none"> ■ Cisco uses solid state drives (SSDs) from a number of vendors. All solid state drives (SSDs) are subject to physical write limits and have varying maximum usage limitation specifications set by the manufacturer. Cisco will not replace any solid state drives (SSDs) that have exceeded any maximum usage specifications set by Cisco or the manufacturer, as determined solely by Cisco. ■ ** SED drive components are not supported with Microsoft Hyper-V ■ Enterprise Performance Drives are Targeted for write centric IO applications. Supports endurance of 10 or 3 DWPD (drive writes per day). Target App are caching, online transaction processing (OLTP), data warehousing, and virtual desktop infrastructure (VDI). ■ FIPS compliant SED SSDs are indicated in the description of the above PIDs. ■ Enterprise Value Drives Targeted for read centric IO applications. Supports endurance of 1 DWPD (drive write per day). Target applications are boot, streaming media, and collaboration. ■ * HX 5.0(2b) supports the ability to handle inter-operability of mixed cache drives on HyperFlex All Flash clusters with certain hardware configurations: <ul style="list-style-type: none"> • Existing cluster with 375G cache can be expanded with 1.6TB cache. • New cluster creation with heterogeneous cache drives needs two-step approach for a minimum of 4 node cluster; (Step 1) cluster creation with minimum three of lesser capacity 375GB cache, (Step 2) cluster expansion with 1.6TB cache. New heterogeneous cluster with less than three 375GB cache is not supported; Upgrade to homogenous cluster with 1.6TB cache is recommended in this scenario. ■ For expansion of existing clusters or general information about interoperability of different drives, see Cisco HyperFlex Drive Compatibility. 			

Approved Configurations

Select the following drives:

- 6 to 23 capacity drives -



NOTE:

- If you select 'SED capacity' drives, you must choose 'SED cache' drives below
- For cluster scale related information please see the product [release notes](#)

-
- One cache drive -



NOTE:

- 'SED cache' drive can only be selected if you have selected 'SED capacity' drives
- NVMe Cache drives & **SED** drives are not supported with Microsoft Hyper-V.

-
- One system drive
 - One boot drive



NOTE:

- **RAID Support for Boot Drives:** Support for Hardware RAID M.2 boot drives in HyperFlex converged and compute-only nodes. Requires optional HX-M2-HWRAID controller with two boot drives. Existing single boot drive option remains supported.
 - This is supported starting from 4.5 (1a) version and later. please check the [release notes](#) for the further information
-

STEP 8 SELECT PCIe OPTION CARD(s)

The standard PCIe card offerings is:

- Modular LAN on Motherboard (mLOM)
- Virtual Interface Card (VIC)
- Network Interface Card (NIC)

Select PCIe Option Card

The available PCIe option card is listed in [Table 10](#)



Data Center Deployment Mode

- Data center deployment mode without fabric interconnect (HX-DC-no-FI) does not support HX-PCIE-C40Q-03 (40G VICs), HX-PCIE-C25Q-04 and HX-PCIE-OFFLOAD-1. Refer to [STEP 2](#) for the details.
- HX-MLOM-C40Q-03, HX-MLOM-C25Q-04 require HXDP 4.5(2c) or higher for data center deployment mode without fabric interconnect (DC-no-FI).

Table 10 Available PCIe Option Cards

Product ID (PID)	PID Description	Card Height
Modular LAN on Motherboard (mLOM)¹		
HX-MLOM-C40Q-03	Cisco VIC 1387 Dual Port 40Gb QSFP CNA MLOM	N/A
HX-MLOM-C25Q-04	Cisco UCS VIC 1457 Quad Port 10/25G SFP28 CNA MLOM (Requires HX 4.0(1a) or higher)	N/A
Virtual Interface Card (VIC)		
HX-PCIE-C40Q-03	Cisco VIC 1385 Dual Port 40Gb QSFP+ CNA w/RDMA	HHHL*
HX-PCIE-C25Q-04	Cisco UCS VIC 1455 Quad Port 10/25G SFP28 CNA PCIE (Requires HX 4.0(1a) or higher)	HHHL*
Network Interface Card (NIC)		
HX-PCIE-IRJ45	Intel i350 Quad Port 1Gb Adapter	HHHL*
HX-PCIE-ID10GF	Intel X710-DA2 dual-port 10G SFP+ NIC	HHHL*
HX-PCIE-ID10GC	Intel X550-T2 dual-port 10GBase-T NIC	HHHL*
HX-PCIE-ID25GF	Intel XXV710-DA2 10-dual-port 25G NIC	HHHL*
HX PCIe Accel Engine^{2,3}		
HX-PCIE-OFFLOAD-1	Application Acceleration Engine	
* HHHL= Half Height Half length		

Notes:

1. The mLOM card does not plug into any of the riser 1 or riser 2 card slots; instead, it plugs into a connector inside the chassis.
2. • Optional card offloads the compression functionality to HW acceleration card.HX-PCIE-OFFLOAD-1 uses a more computationally intensive compression algorithm. This results in lower storage space and frees up CPU cycles
 - HXDP-P Enterprise licenses are required.
 - HX-PCIE-OFFLOAD-1 works with all HXDP features, including Stretched Cluster, SED drives, T4 GPUs and more
 - Native Replication (NR) will be supported in a future release
3. Please note that, HX-PCIE-OFFLOAD-1 is on Compliance Hold Review, for details contact:
hx-order-compliance-hold@cisco.com

Caveats

Other considerations for the Cisco VIC 1387 card:

- VIC 1387 natively supports 6300 series FI.
- VIC 1387 also supports Cisco QSA Modules when working with HX-FI-6248UP or HX-FI-6296UP is desired.
- Breakout cables cannot be used to connect to 6200 series fabric interconnects. Use a QSA instead.
- Cisco QSA Module is available as an option under 'Accessories -> SFP'. PID for QSA is CVR-QSFP-SFP10G
- Please order two of above QSA modules when connectivity with 6200 is desired.
- Use of 10GE is not permitted with 6300 series FI.

STEP 9 ORDER GPU CARDS (OPTIONAL)

Select GPU Options

The available GPU PCIe options are listed in [Table 11](#)

Table 11 Available PCIe Option Cards

Product ID (PID)	PID Description	Card Height	Max per node
GPU PCIe Cards			
HX-GPU-M10	NVIDIA M10 GPU	Double Wide (consumes 2 slots)	2
HX-GPU-T4-16	NVIDIA T4 PCIE 75W 16GB	Low Profile Single-Width	6
HX-GPU-RTX6000	NVIDIA QUADRO RTX 6000, PASSIVE, 250W TGP, 24GB	Double Wide (consumes 2 slots)	2
HX-GPU-RTX8000	NVIDIA QUADRO RTX 8000, PASSIVE, 250W TGP, 48GB	Double Wide (consumes 2 slots)	2



NOTE:

- All GPU cards must be procured from Cisco as there is a unique SBIOS ID required by CIMC and UCSM
- All GPU cards require two CPUs and a minimum of two power supplies in the server. 1600 W power supplies are recommended. Use the power calculator at the following link to determine the needed power based on the options chosen (CPUs, drives, memory, and so on):
- Only T4 supported with 1 CPU, max 3 with HX-RIS-1B-240M5, Riser 1B 3PCIe slots (x8, x8, x8); all from CPU1, For T4
- HX-GPU-T4-16 require special riser cards (HX-RIS-1-240M5 and HX-RIS-2B-240M5) for full configuration of 5 or 6 cards.

<http://ucspowercalc.cisco.com>

Caveats

- NVIDIA M10 GPUs can support only less than 1 TB of total memory in the server. Do not install more than fourteen 64-GB DIMMs when using an NVIDIA GPU card in this server.
- GPUs cannot be mixed.
- **Slot 5 on riser card 2** is the required slot for the first GPU.
- **Slot 2 on riser card 1** is the secondary slot for a second GPU.

STEP 10 SELECT ACCESSORIES

Select

- Internal micro SD Card Module HX-MSD-32G from [Table 12](#)
- Optional SFP adapter CVR-QSFP-SFP10G from [Table 13](#)

Table 12 Internal microSD Card Module

Product ID (PID)	PID Description
HX-MSD-32G	32GB Micro-SD Card for UCS servers



NOTE:

- This is a required component.
 - The micro-SD card mounts internally on riser 1.
 - The micro-SD card serves as a dedicated local resource for utilities such as HUU. Images can be pulled from a file share (NFS/CIFS) and uploaded to the cards for future use.
-

Table 13 Optional SFP adapter

Product ID (PID)	PID Description
CVR-QSFP-SFP10G	QSFP to SFP10G adapter



NOTE:

- This is a optional adapter and only needed when connected to FI series .
 - When choosing this option, please choose two QSAs per server.This is a required component.
-

STEP 11 ORDER SECURITY DEVICES (OPTIONAL)

A Trusted Platform Module (TPM) is a computer chip (microcontroller) that can securely store artifacts used to authenticate the platform (server). These artifacts can include passwords, certificates, or encryption keys. A TPM can also be used to store platform measurements that help ensure that the platform remains trustworthy. Authentication (ensuring that the platform can prove that it is what it claims to be) and attestation (a process helping to prove that a platform is trustworthy and has not been breached) are necessary steps to ensure safer computing in all environments.

A chassis intrusion switch gives a notification of any unauthorized mechanical access into the server.

The security device ordering information is listed in [Table 14](#).

Table 14 Security Devices

Product ID (PID)	PID Description
HX-TPM2-002	Trusted Platform Module 2.0 for UCS servers
HX-TPM2-002B	Trusted Platform Module 2.0 M5 UCS servers (FIPS 140-2 Compliant)
HX-INT-SW01	C220 M5 and C240 M5 Chassis Intrusion Switch



NOTE:

- The TPM module used in this system conforms to TPM v2.0 as defined by the Trusted Computing Group (TCG). It is also SPI-based.
 - TPM installation is supported after-factory. However, a TPM installs with a one-way screw and cannot be replaced, upgraded, or moved to another server. If a server with a TPM is returned, the replacement server must be ordered with a new TPM.
-

STEP 12 ORDER POWER SUPPLY

Power supplies share a common electrical and physical design that allows for hot-plug and tool-less installation into M5 C-series servers. Each power supply is certified for high-efficiency operation and offers multiple power output options. This allows users to “right-size” based on server configuration, which improves power efficiency, lower overall energy costs and avoids stranded capacity in the data center. Use the power calculator at the following link to determine the needed power based on the options chosen (CPUs, drives, memory, and so on):

<http://ucspowercalc.cisco.com>

Table 15 Power Supply

Product ID (PID)	PID Description
HX-PSU1-1050W	1050W AC power supply for C-Series servers Platinum
HX-PSUV2-1050DC	1050W DC power supply for C-Series servers Platinum
HX-PSU1-1600W ¹	1600W AC power supply for C-Series servers Platinum
HX-PSU1-1050ELV	Cisco UCS 1050W AC Power Supply for Rack Server Low Line Platinum

Notes:

1. PSU supported on C220/C240/HX



NOTE: In a server with two power supplies, both power supplies must be identical.

STEP 13 SELECT POWER CORD(s)

Using [Table 16](#), select the appropriate AC power cords. You can select zero to two power cords. If you select the option R2XX-DMYMPWRCORD, no power cord is shipped with the server.

Table 16 Available Power Cords

Product ID (PID)	PID Description	Images
R2XX-DMYMPWRCORD	No power cord (dummy PID to allow for a no power cord option)	Not applicable
CAB-48DC-40A-8AWG	C-Series -48VDC PSU Power Cord, 3.5M, 3 Wire, 8AWG, 40A	
CAB-N5K6A-NA	Power Cord, 200/240V 6A, North America	
CAB-AC-L620-C13	AC Power Cord, NEMA L6-20 - C13, 2M/6.5ft	
CAB-C13-CBN	CABASY,WIRE,JUMPER CORD, 27\" data-bbox="561 551 838 631"/>	
CAB-C13-C14-2M	CABASY,WIRE,JUMPER CORD, PWR, 2 Meter, C13/C14,10A/250V	
CAB-C13-C14-AC	CORD,PWR,JMP,IEC60320/C14,IEC60320/C13, 3.0M	

Table 16 Available Power Cords

Product ID (PID)	PID Description	Images
CAB-250V-10A-AR	Power Cord, 250V, 10A, Argentina	 <p>Plug: EL 219 (IRAM 2073)</p> <p>Cordset rating: 10 A, 250/500 V MAX Length: 8.2 ft</p> <p>Connector: EL 701 (IEC60320/C13)</p>
CAB-9K10A-AU	Power Cord, 250VAC 10A 3112 Plug, Australia	 <p>Plug: EL 210 (BS 1363A) 13 AMP fuse</p> <p>Cordset rating: 10 A, 250 V/500 V MAX Length: 2500mm</p> <p>Connector: EL 701C (EN 60320/C15)</p>
CAB-250V-10A-CN	AC Power Cord - 250V, 10A - PRC	 <p>Plug: EL 210 (BS 1363A) 13 AMP fuse</p> <p>Cordset rating: 10 A, 250 V/500 V MAX Length: 2500mm</p> <p>Connector: EL 701C (EN 60320/C15)</p>
CAB-9K10A-EU	Power Cord, 250VAC 10A CEE 7/7 Plug, EU	 <p>Plug: M2511</p> <p>Cordset rating: 10A/16 A, 250 V Length: 8 ft 2 in. (2.5 m)</p> <p>Connector: VSCC15</p>
CAB-250V-10A-ID	Power Cord, 250V, 10A, India	 <p>Plug: EL 208</p> <p>Cordset rating 16A, 250V (2500mm)</p> <p>Connector: EL 701</p>
CAB-250V-10A-IS	Power Cord, SFS, 250V, 10A, Israel	 <p>Plug: EL 212 (SI-32)</p> <p>Cordset rating 10A, 250V/500V MAX (2500 mm)</p> <p>Connector: EL 701B (IEC60320/C13)</p>
CAB-9K10A-IT	Power Cord, 250VAC 10A CEI 23-16/VII Plug, Italy	 <p>Plug: I/3G (CEI 23-16)</p> <p>Cordset rating: 10 A, 250 V Length: 8 ft 2 in. (2.5 m)</p> <p>Connector: C15M (EN60320/C15)</p>
CAB-9K10A-SW	Power Cord, 250VAC 10A MP232 Plug, Switzerland	 <p>Plug: MP232-R</p> <p>Cordset rating: 10 A, 250 V Length: 8 ft. 2 in (2.5 m)</p> <p>Connector: IEC 60320 C15</p>

Table 16 Available Power Cords

Product ID (PID)	PID Description	Images
CAB-9K10A-UK	Power Cord, 250VAC 10A BS1363 Plug (13 A fuse), UK	
CAB-9K12A-NA ¹	Power Cord, 125VAC 13A NEMA 5-15 Plug, North America	
CAB-250V-10A-BR	Power Cord - 250V, 10A - Brazil	
CAB-C13-C14-2M-JP	Power Cord C13-C14, 2M/6.5ft Japan PSE mark	Image not available
CAB-9K10A-KOR ¹	Power Cord, 125VAC 13A KSC8305 Plug, Korea	Image not available
CAB-ACTW	AC Power Cord (Taiwan), C13, EL 302, 2.3M	Image not available
CAB-JPN-3PIN	Japan, 90-125VAC 12A NEMA 5-15 Plug, 2.4m	Image not available
CAB-48DC-40A-INT	-48VDC PSU PWR Cord, 3.5M, 3 Wire, 8AWG, 40A (INT)	Image Not available
CAB-48DC-40A-AS	-48VDC PSU PWR Cord, 3.5M, 3Wire, 8AWG, 40A (AS/NZ)	Image Not available
CAB-C13-C14-IN ²	Power Cord Jumper, C13-C14 Connectors, 1.4 Meter Length, India	Image Not available
CAB-C13-C14-3M-IN ²	Power Cord Jumper, C13-C14 Connectors, 3 Meter Length, India	Image Not available

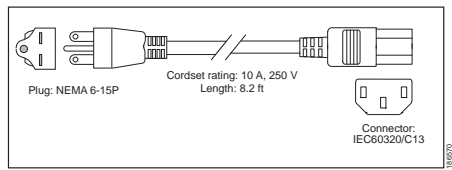
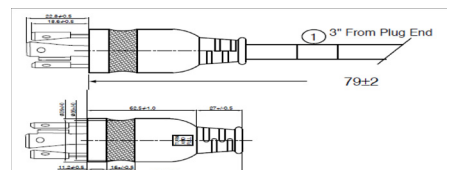
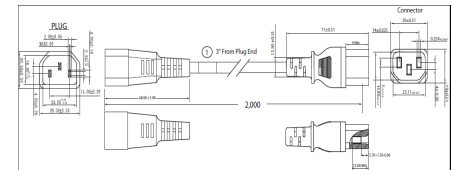
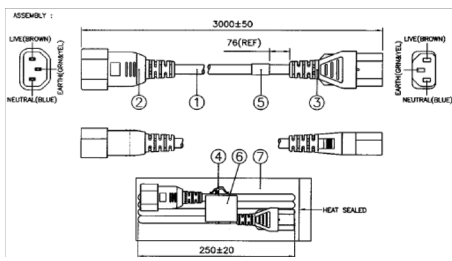
Notes:

1. This power cord is rated to 125V and only supported for PSU rated at 1050W or less
2. These new replacement parts for cards in compliance with the Dec 1st, 2020 Bureau of Indian Standards (BIS) regulatory standard for lower-power consumption products.

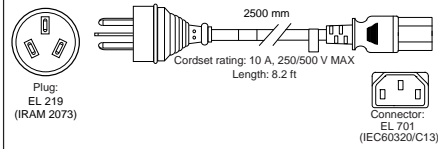
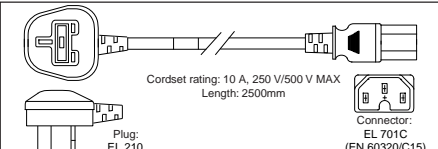
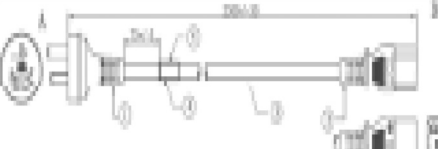
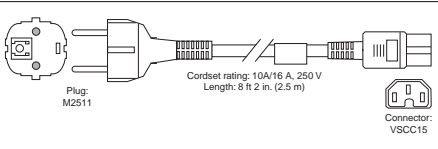
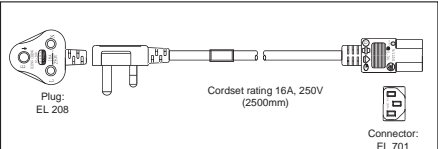
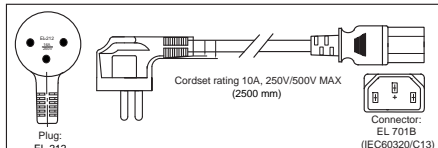
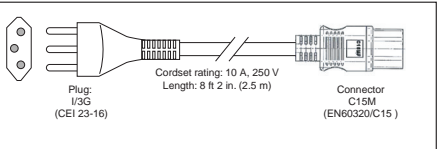
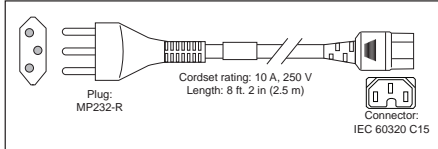
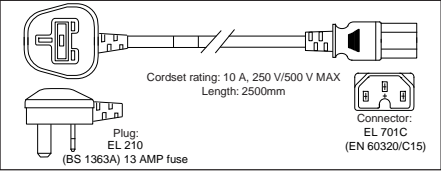
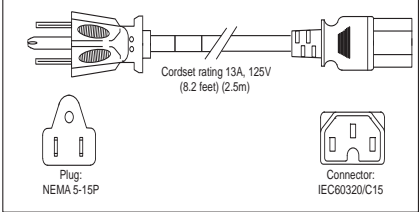
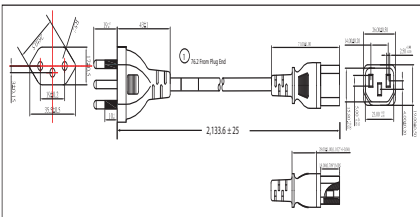
STEP 14 ORDER TOOL-LESS RAIL KIT AND OPTIONAL REVERSIBLE CABLE MANAGEMENT ARM

Select a Tool-Less Rail Kit

Select a tool-less rail kit from [Table 17](#).

Table 17 Tool-less Rail Kit Options

Product ID (PID)	PID Description
HX-RAILB-M4	Ball Bearing Rail Kit for HXAF240c M5 Rack Servers
HX-RAILF-M4	Friction Rail kit for HXAF240c M5 Rack Servers
HX-RAIL-NONE	No rail kit option

Select an Optional Reversible Cable Management Arm

The reversible cable management arm mounts on either the right or left slide rails at the rear of the server and is used for cable management. Use [Table 18](#) to order a cable management arm.

Table 18 Cable Management Arm

Product ID (PID)	PID Description
HX-CMAF-M4	Reversible CMA for tool-less HXAF240c M5 ball bearing rail kit

For more information about the tool-less rail kit and cable management arm, see the Cisco UCS C240 M5 Installation and Service Guide at this URL:

https://www.cisco.com/c/en/us/td/docs/unified_computing/ucs/c/hw/C240M5/install/C240M5.html



NOTE: If you plan to rackmount your HyperFlex HXAF240c Node, you must order a tool-less rail kit. The same rail kits and CMA's are used for M4 and M5 servers.

STEP 15 SELECT HYPERVISOR / HOST OPERATING SYSTEM

Hypervisor/Operating systems are available as follows. Select either VMware ESXi or Microsoft Windows Server with Hyper-V PIDs as desired from [Table 19](#)

Table 19 Hypervisors/Host Operation System

Product ID (PID)	PID Description
ESXi Options	
VMware	
HX-VSP-7-0-FND-D	Factory Installed vSphere SW 7.0 1-CPU Enduser provides License (HyperFlex Release 4.5(1a) and later)
HX-VSP-7-0-FND2-D	Factory Installed vSphere SW 7.0 2-CPU Enduser provides License (HyperFlex Release 4.5(1a) and later)
VMware PAC Licenses¹	
HX-VSP-EPL-1A	VMware vSphere 7.x Ent Plus (1 CPU), 1-yr, Support Required
HX-VSP-EPL-3A	VMware vSphere 7.x Ent Plus (1 CPU), 3-yr, Support Required
HX-VSP-EPL-5A	VMware vSphere 7.x Ent Plus (1 CPU), 5-yr, Support Required
HX-VSP-STD-1A	VMware vSphere 7.x Standard (1 CPU), 1-yr, Support Required
HX-VSP-STD-3A	VMware vSphere 7.x Standard (1 CPU), 3-yr, Support Required
HX-VSP-STD-5A	VMware vSphere 7.x Standard (1 CPU), 5-yr, Support Required
Microsoft Hyper-V^{2,3}	
HX-MSWS-OPT-OUT ⁴	No Factory Install - Windows Server 2016 Data Center
Guest Operating system⁵	
Microsoft Options	
HX-MSWS-19-ST16C	Windows Server 2019 Standard (16 Cores/2 VMs)
HX-MSWS-19-DC16C	Windows Server 2019 Data Center (16 Cores/Unlimited VMs)
HX-MSWS-22-ST16C	Windows Server 2022 Standard (16 Cores/2 VMs)
HX-MSWS-22-DC16C	Windows Server 2022 Data Center (16 Cores/Unlimited VMs)

Notes:

1. Choose quantity of two when choosing PAC licensing for dual CPU systems.
2. Microsoft Windows Server with Hyper-V will NOT be installed in Cisco Factory. Customers need to bring their own Windows Server ISO image that needs to be installed at deployment site.
3. To ensure the best possible Day 0 Installation experience, mandatory Installation Services are required with all Hyper-V orders. Details on PIDs can be found in HyperFlex Ordering Guide.
4. NVIDIA GPUs don't support vGPU (virtual GPU) on VMs running on top of Hyper-V, only pass-through mode (the entire card must be dedicated to a single VM).
5. Optional guest OS licenses that may be purchased to run on top of the hypervisor

STEP 16 SELECT HX DATA PLATFORM SOFTWARE

HyperFlex Data Platform Edition & Subscription Period options are available as follows. Select as desired from [Table 20](#)

Table 20 HX Data Platform Software

Product ID (PID)	PID Description
HXDP-S001-1YR to HXDP-S001-5YR	HyperFlex Data Platform Datacenter Advantage (1 to 5) Yr
HXDP-S-SLR	HyperFlex Data Platform Datacenter Advantage SLR 1 to 10 Years
HXDP-P001-1YR To HXDP-P001-5YR	HyperFlex Data Platform Datacenter Premier (1 to 5) Yr
HXDP-P-SLR	HyperFlex Data Platform Datacenter Premier SLR 1 to 10 Years

STEP 17 SELECT INSTALLATION SERVICE

To ensure the best possible Day 0 Installation experience, mandatory Installation Services are required with all Hyper-V orders. Customers can purchase Cisco Advanced Services (AS) or Cisco Learning partner mentored Services. Select as desired from [Table 21](#)

Table 21 Installation services

Product ID (PID)	PID Description
Cisco Advanced Services	
ASF-ULT2-HPF-QSS	Quick Start Services - 1 Week
ASF-ULT2-HPF-ADS	Accelerated Deployment Services - 2 Weeks
AS-DCN-CNSLT	Advanced Services Consulting

STEP 18 SELECT SERVICE and SUPPORT LEVEL

A variety of service options are available, as described in this section.

Smart Net Total Care (SNTC)

For support of the entire Unified Computing System, Cisco offers the Cisco Smart Net Total Care for UCS Service. This service provides expert software and hardware support to help sustain performance and high availability of the unified computing environment. Access to Cisco Technical Assistance Center (TAC) is provided around the clock, from anywhere in the world.

For systems that include Unified Computing System Manager, the support service includes downloads of UCSM upgrades. The Cisco Smart Net Total Care for UCS Service includes flexible hardware replacement options, including replacement in as little as two hours. There is also access to Cisco's extensive online technical resources to help maintain optimal efficiency and uptime of the unified computing environment. For more information please refer to the following url: <http://www.cisco.com/c/en/us/services/technical/smart-net-total-care.html?stickynav=1>

You can choose a desired service listed in [Table 22](#).

Table 22 Cisco SNTC Service (PID HXAF240C-M5SX)

Service SKU	Service Level GSP	On Site?	Description
CON-PREM-AF240CSX	C2P	Yes	SNTC 24X7X20S
CON-UCSD8-AF240CSX	UCSD8	Yes	UC SUPP DR 24X7X20S*
CON-C2PL-AF240CSX	C2PL	Yes	LL 24X7X20S**
CON-OSP-AF240CSX	C4P	Yes	SNTC 24X7X40S
CON-UCSD7-AF240CSX	UCSD7	Yes	UCS DR 24X7X40S*
CON-C4PL-AF240CSX	C4PL	Yes	LL 24X7X40S**
CON-USD7L-AF240CSX	USD7L	Yes	LLUCS HW DR 24X7X40S***
CON-OSE-AF240CSX	C4S	Yes	SNTC 8X5X40S
CON-UCSD6-AF240CSX	UCSD6	Yes	UC SUPP DR 8X5X40S*
CON-SNCO-AF240CSX	SNCO	Yes	SNTC 8x7xNCDOS****
CON-OS-AF240CSX	CS	Yes	SNTC 8X5XNBDOS
CON-UCSD5-AF240CSX	UCSD5	Yes	UCS DR 8X5XNBDOS*
CON-S2P-AF240CSX	S2P	No	SNTC 24X7X2
CON-S2PL-AF240CSX	S2PL	No	LL 24X7X2**
CON-SNTP-AF240CSX	SNTP	No	SNTC 24X7X4
CON-SNTPL-AF240CSX	SNTPL	No	LL 24X7X4**
CON-SNTE-AF240CSX	SNTE	No	SNTC 8X5X4
CON-SNC-AF240CSX	SNC	No	SNTC 8x7xNCD****
CON-SNT-AF240CSX	SNT	No	SNTC 8X5XNBD
CON-SW-AF240CSX	SW	No	SNTC NO RMA
*Includes Drive Retention (see below for full description)			
**Includes Local Language Support (see below for full description) – Only available in China and Japan			
***Includes Local Language Support and Drive Retention – Only available in China and Japan			
****Available in China Only			

Smart Net Total Care with Onsite Troubleshooting Service

An enhanced offer over traditional Smart Net Total Care which provides onsite troubleshooting expertise to aid in the diagnostics and isolation of hardware issue within our customers' Cisco Hyper-Converged environment. It is delivered by a Cisco Certified field engineer (FE) in collaboration with remote TAC engineer and Virtual Internet working Support Engineer (VISE). You can choose a desired service listed in [Table 23](#)

Table 23 SNTC with UCS Onsite Troubleshooting Service (PID HXAF240C-M5SX)

Service SKU	Service Level GSP	On Site?	Description
CON-OSPT-AF240CSX	OSPT	Yes	24X7X4OS Trblshtg
CON-OSPTD-AF240CSX	OSPTD	Yes	24X7X4OS TrblshtgDR*
CON-OSPTL-AF240CSX	OSPTL	Yes	24X7X4OS TrblshtgLL**
CON-OPTLD-AF240CSX	OPTLD	Yes	24X7X4OS TrblshtgLLD***
*Includes Drive Retention (see below for full description)			
**Includes Local Language Support (see below for full description) - Only available in China and Japan			
***Includes Local Language Support and Drive Retention - Only available in China and Japan			

Solution Support

Solution Support includes both Cisco product support and solution-level support, resolving complex issues in multivendor environments, on average, 43% more quickly than product support alone. Solution Support is a critical element in data center administration, to help rapidly resolve any issue encountered, while maintaining performance, reliability, and return on investment.

This service centralizes support across your multivendor Cisco environment for both our products and solution partner products you've deployed in your ecosystem. Whether there is an issue with a Cisco or solution partner product, just call us. Our experts are the primary point of contact and own the case from first call to resolution. For more information please refer to the following url:

<http://www.cisco.com/c/en/us/services/technical/solution-support.html?stickynav=1>

You can choose a desired service [Table 24](#)

Table 24 Solution Support Service (PID HXAF240C-M5SX)

Service SKU	Service Level GSP	On Site?	Description
CON-SSC2P-AF240CSX	SSC2P	Yes	SOLN SUPP 24X7X2OS
CON-SSC4P-AF240CSX	SSC4P	Yes	SOLN SUPP 24X7X4OS
CON-SSC4S-AF240CSX	SSC4S	Yes	SOLN SUPP 8X5X4OS

Table 24 Solution Support Service (PID HXAF240C-M5SX)

CON-SSCS-AF240CSX	SSCS	Yes	SOLN SUPP 8X5XNBDOS
CON-SSDR7-AF240CSX	SSDR7	Yes	SSPT DR 24X7X4OS*
CON-SSDR5-AF240CSX	SSDR5	Yes	SSPT DR 8X5XNBDOS*
CON-SSS2P-AF240CSX	SSS2P	No	SOLN SUPP 24X7X2
CON-SSSNP-AF240CSX	SSSNP	No	SOLN SUPP 24X7X4
CON-SSSNE-AF240CSX	SSSNE	No	SOLN SUPP 8X5X4
CON-SSSNC-AF240CSX	SSSNC	No	SOLN SUPP NCD**
CON-SSSNT-AF240CSX	SSSNT	No	SOLN SUPP 8X5XNBD
Includes Drive Retention (see below for description)			
**Available in China only			

Partner Support Service for UCS

Cisco Partner Support Service (PSS) is a Cisco Collaborative Services service offering that is designed for partners to deliver their own branded support and managed services to enterprise customers. Cisco PSS provides partners with access to Cisco's support infrastructure and assets to help them:

- Expand their service portfolios to support the most complex network environments
- Lower delivery costs
- Deliver services that increase customer loyalty

PSS options enable eligible Cisco partners to develop and consistently deliver high-value technical support that capitalizes on Cisco intellectual assets. This helps partners to realize higher margins and expand their practice.

PSS is available to all Cisco PSS partners.

PSS provides hardware and software support, including triage support for third party software, backed by Cisco technical resources and level three support. You can choose a desired service listed in [Table 25](#).

Table 25 PSS (PID HXAF240C-M5SX)

Service SKU	Service Level GSP	On Site?	Description
CON-PSJ8-AF240CSX	PSJ8	Yes	UCS PSS 24X7X2 OS
CON-PSJ7-AF240CSX	PSJ7	Yes	UCS PSS 24X7X4 OS
CON-PSJD7-AF240CSX	PSJD7	Yes	UCS PSS 24X7X4 DR*
CON-PSJ6-AF240CSX	PSJ6	Yes	UCS PSS 8X5X4 OS
CON-PSJD6-AF240CSX	PSJD6	Yes	UCS PSS 8X5X4 DR*

Table 25 PSS (PID HXAF240C-M5SX)

CON-PSJ4-AF240CSX	PSJ4	No	UCS SUPP PSS 24X7X2
CON-PSJ3-AF240CSX	PSJ3	No	UCS SUPP PSS 24X7X4
CON-PSJ2-AF240CSX	PSJ2	No	UCS SUPP PSS 8X5X4
CON-PSJ1-AF240CSX	PSJ1	No	UCS SUPP PSS 8X5XNBD
*Includes Drive Retention (see below for description)			

Combined Support Service

Combined Services makes it easier to purchase and manage required services under one contract. The more benefits you realize from the Cisco HyperFlex System, the more important the technology becomes to your business. These services allow you to:

- Optimize the uptime, performance, and efficiency of your HyperFlex System
- Protect your vital business applications by rapidly identifying and addressing issues
- Strengthen in-house expertise through knowledge transfer and mentoring
- Improve operational efficiency by allowing HyperFlex experts to augment your internal staff resources
- Enhance business agility by diagnosing potential issues before they affect your operations

You can choose a desired service listed in [Table 26](#)

Table 26 Combined Support Service (PID HXAF240C-M5SX)

Service SKU	Service Level GSP	On Site?	Description
CON-NCF2P-AF240CSX	NCF2P	Yes	CMB SVC 24X7X2OS
CON-NCF4P-AF240CSX	NCF4P	Yes	CMB SVC 24X7X4OS
CON-NCF4S-AF240CSX	NCF4S	Yes	CMB SVC 8X5X4OS
CON-NCFCS-AF240CSX	NCFCS	Yes	CMB SVC 8X5XNBDOS
CON-NCF2-AF240CSX	NCF2	No	CMB SVC 24X7X2
CON-NCFP-AF240CSX	NCFP	No	CMB SVC 24X7X4
CON-NCFE-AF240CSX	NCFE	No	CMB SVC 8X5X4
CON-NCFT-AF240CSX	NCFT	No	CMB SVC 8X5XNBD
CON-NCFW-AF240CSX	NCFW	No	CMB SVC SW

UCS Drive Retention Service

With the Cisco Drive Retention Service, you can obtain a new disk drive in exchange for a faulty drive without returning the faulty drive.

Sophisticated data recovery techniques have made classified, proprietary, and confidential information vulnerable, even on malfunctioning disk drives. The Drive Retention service enables you to retain your drives and ensures that the sensitive data on those drives is not compromised,

which reduces the risk of any potential liabilities. This service also enables you to comply with regulatory, local, and federal requirements.

If your company has a need to control confidential, classified, sensitive, or proprietary data, you might want to consider one of the Drive Retention Services listed in the above tables (where available)



NOTE: Cisco does not offer a certified drive destruction service as part of this service.

Local Language Technical Support for UCS

Where available, and subject to an additional fee, local language support for calls on all assigned severity levels may be available for specific product(s) - see tables above.

For a complete listing of available services for Cisco HyperFlex System, see the following URL:
<https://www.cisco.com/c/en/us/services/technical.html?stickynav=1>

SUPPLEMENTAL MATERIAL

Hyperconverged Systems

Cisco HyperFlex Systems let you unlock the full potential of hyperconvergence and adapt IT to the needs of your workloads. The systems use an end-to-end software-defined infrastructure approach, combining software-defined computing in the form of Cisco HyperFlex HX-Series nodes; software-defined storage with the powerful Cisco HX Data Platform; and software-defined networking with the Cisco UCS fabric that will integrate smoothly with Cisco Application Centric Infrastructure (Cisco ACI). Together with a single point of connectivity and management, these technologies deliver a preintegrated and adaptable cluster with a unified pool of resources that you can quickly deploy, adapt, scale, and manage to efficiently power your applications and your business.

Figure 5 show a small footprint cluster.

Figure 5 Small Footprint Cluster Using HXAF240c M5 Nodes With Fabric Interconnect Deployment Mode

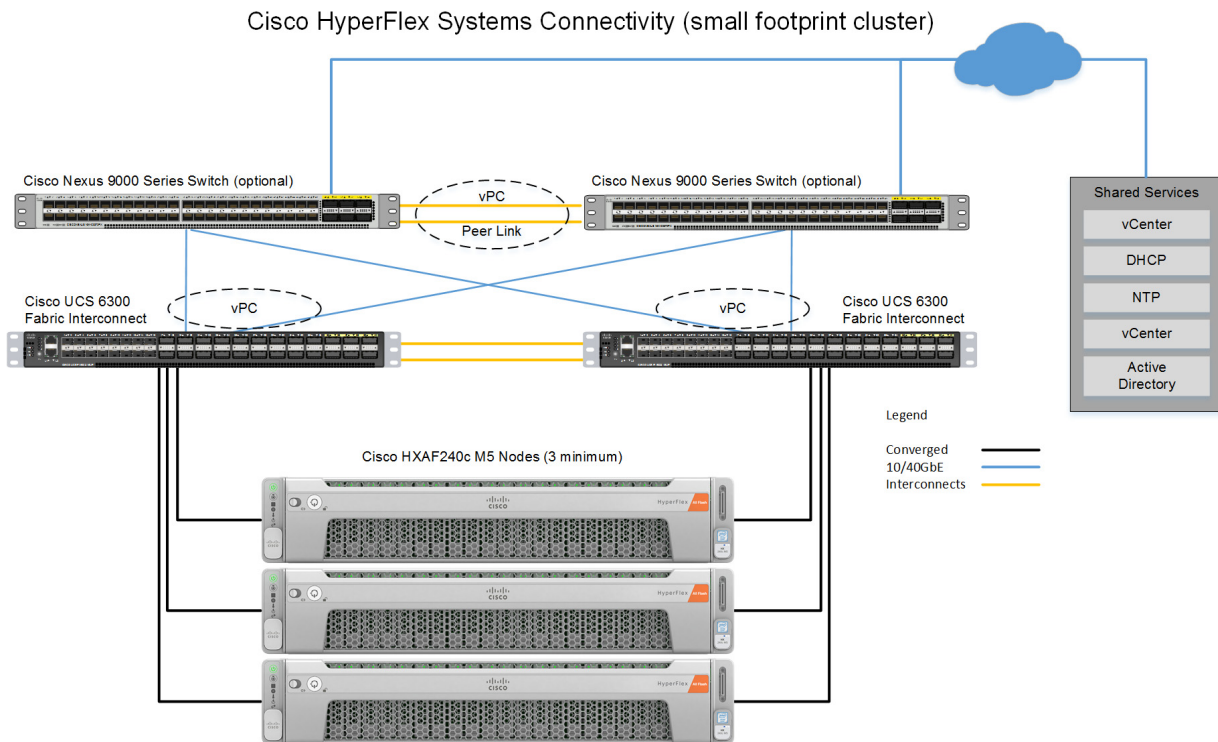
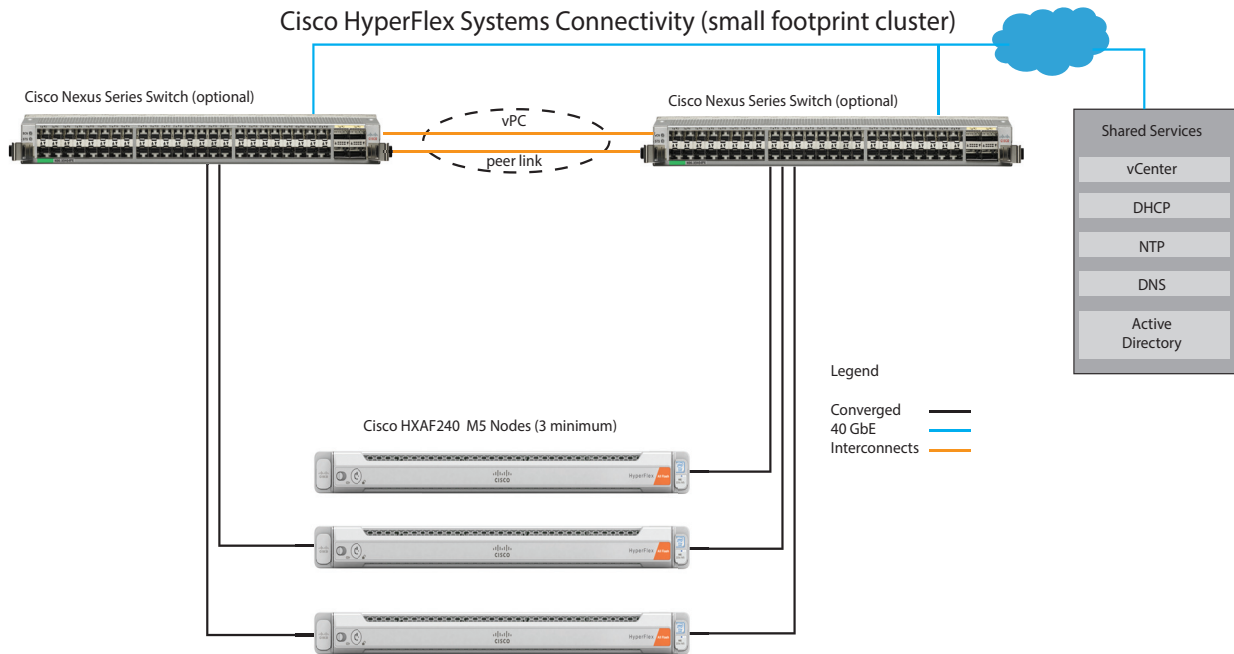

Figure 6 Small Footprint Cluster Using HXAF240c M5 Nodes Data Centre Without Fabric Interconnect Deployment Mode



10 or 25 Gigabit Ethernet Dual Switch Topology

Dual switch configuration provides a slightly more complex topology with full redundancy that protects against: switch failure, link failure, and port failure. It requires two switches that may be standalone or stacked, and two 10/25GE ports, one 1GE port for CIMC management, and one Cisco VIC 1467 per server. Trunk ports are the only supported network port configuration. refer [10/25 Gigabit Ethernet Switch Configuration Guidelines](#) for more information.

To deploy this topology, select from [Table 3](#)

Figure 7 Physical cabling for the 10/25GE Dual Switch Topology. Detailed diagrams for network topologies can be found in the [pre-installation checklist](#).

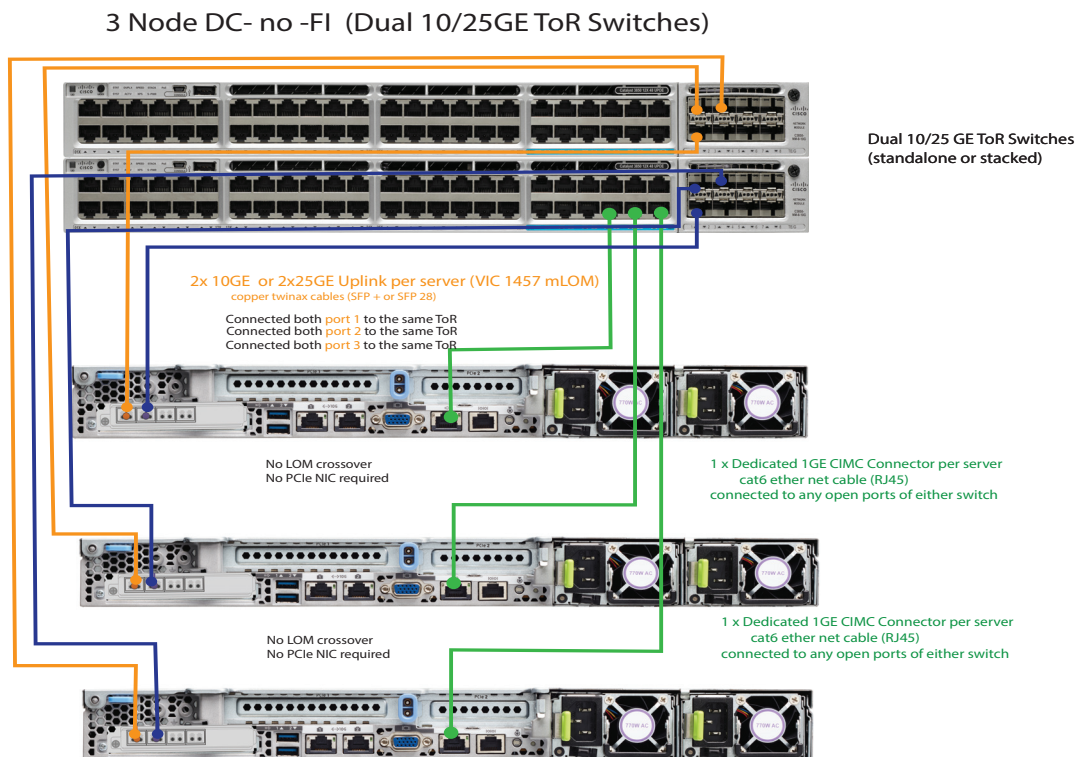

CHASSIS

An internal view of the HXAF240c M5 Node chassis with the top cover removed is shown in [Figure 8](#).

Figure 8 HXAF240c M5 With Top Cover Off

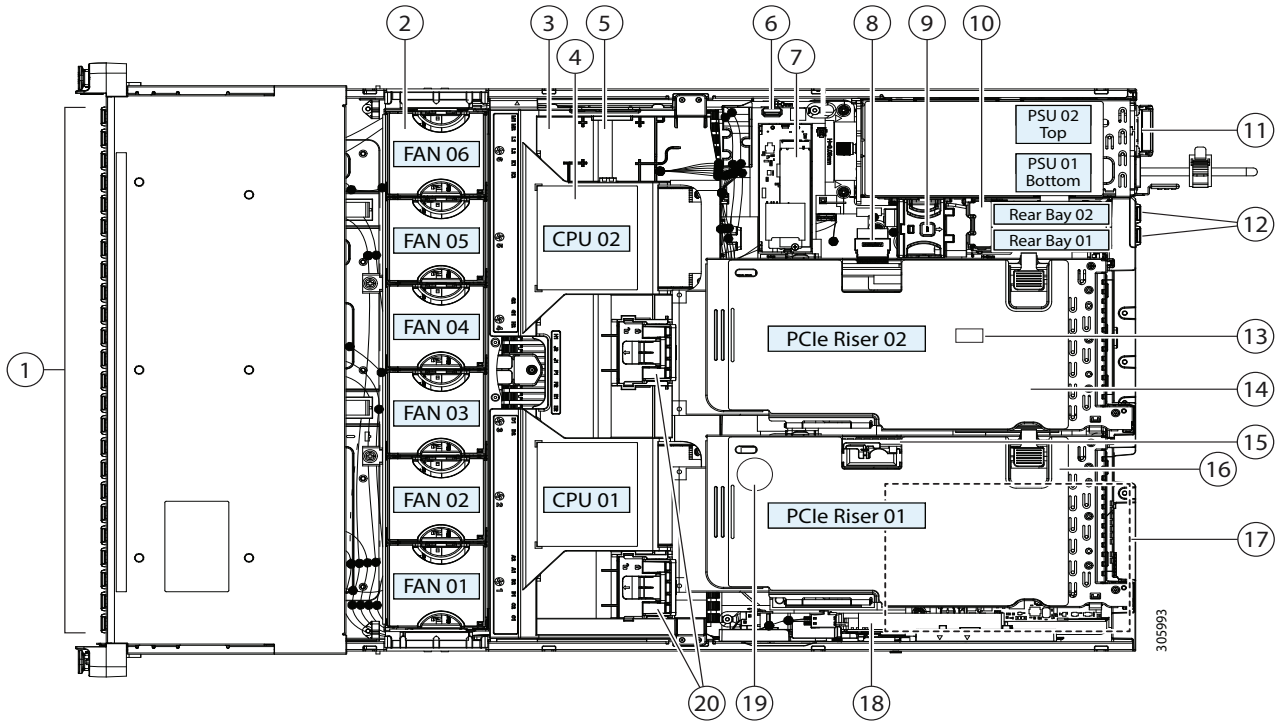

1	Front-Facing drive bays.	11	Power supplies (hot-swappable, redundant as 1+1).
2	Fan modules (six, hot-swappable)	12	Rear 2.5-inch drive bays: <ul style="list-style-type: none"> ■ Choice of SAS/SATA SSD OR ■ NVMe drive
3	DIMM sockets on motherboard (up to 12 per CPU; total 24). Not visible under air baffle in this view.	13	Trusted platform module (TPM) socket on motherboard (not visible in this view)

4	CPUs and heatsinks (one or two). Not visible under air baffle in this view	14	<p>PCIe riser 2 (PCIe slots 4, 5, 6),</p> <ul style="list-style-type: none"> ■ 2B: With slots 4 (x8), 5 (x16), and 6 (x8); includes one PCIe cable connector for rear NVMe SSDs. ■ R2A: With slots 4 (x8), 5 (x16), and 6 (x16); ■ R2B: With slots 4 (x8), 5 (x16), and 6 (x8);
5	N/A	15	Micro-SD card socket on PCIe riser 1
6	USB 3.0 slot on motherboard	16	<p>PCIe riser 1 (PCIe slot 1, 2, 3), with the following options:</p> <ul style="list-style-type: none"> ■ RIS-1: Slots 1 (x8), 2 (x16), 3 (x8); slot 2 requires CPU2. ■ RIS-1B: Slots 1 (x8), 2 (x8), 3 (x8); slot 2 requires CPU2. ■ R1: Slots 1 (x8), 2 (x16), 3 (x8); slot 2 requires CPU2.
7	Mini-storage module connector. Supports M.2 module with SATA M.2 SSD slots	17	mLOM card socket (x16) on motherboard (not visible in this view)
8	Chassis intrusion switch (optional)	18	Cisco modular RAID controller PCIe slot (dedicated slot)
9	<p>PCIe cable connectors for NVMe SSDs, with PCIe riser 2:</p> <p>One connector for rear SFF NVMe SSDs</p>	19	RTC battery on motherboard (not visible in this view)
10	Rear-drive backplane assembly	20	Securing clips for GPU cards on air baffle

Riser Card Configuration and Options

The two riser cards are shown in *Figure 9*.

Figure 9 Riser Card 1 (slots 1, 2, and 3) and Riser Card 2 (slots 4, 5, and 6)

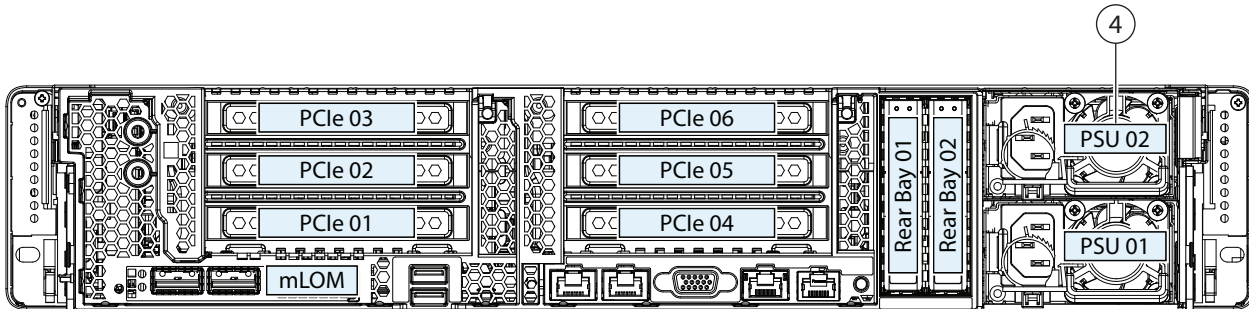

The two riser card 1 options are shown in [Table 27](#). The riser card 2 options are shown in [Table 28](#).

Table 27 Riser Card 1 option

Slot #	Height	Length	Electrical
Riser Card 1 (option 1, PID HX-RIS-1-240M5)			
3	Full	Half	x8
2	Full	Full ¹	x16
1	Full	Half	x8
Riser Card 1 (option 1B, PID HX-RIS-1B-240M5)			
3	Full	Half	x8
2	Full	Full	x8
1	Full	Half	x8
Riser Card 1 (option R1, PID HX-R1-A100-M5)			
3	Full	Full	x8
2	Full	Full ¹	x16
1	Full	Half	x8

Notes:

- 1. GPU capable slot

Table 28 Riser Card 2 Option

Slot #	Height	Length	Electrical
Riser Card 2 (option R2A, PID HX-R2A-A100-M5)			
6	Full	Full	x8
5	Full	Full	x16
4	Full	Half	x16
Riser Card 2 (option 2B, PID HX-RIS-2B-240M5)			
6	Full	Full	x8
5	Full	Full	x16
4	Full	Half	x8
Riser Card 2 (option R2B, PID HX-R2B-A100-M5)			
6	Full	Full	x8
5	Full	Full	x16
4	Full	Half	x8

Serial Port Details

The pinout details of the rear RJ-45 serial port connector are shown in [Figure 10](#).

Figure 10 Serial Port (Female RJ-45 Connector) Pinout

Serial Port (RJ-45 Female Connector)

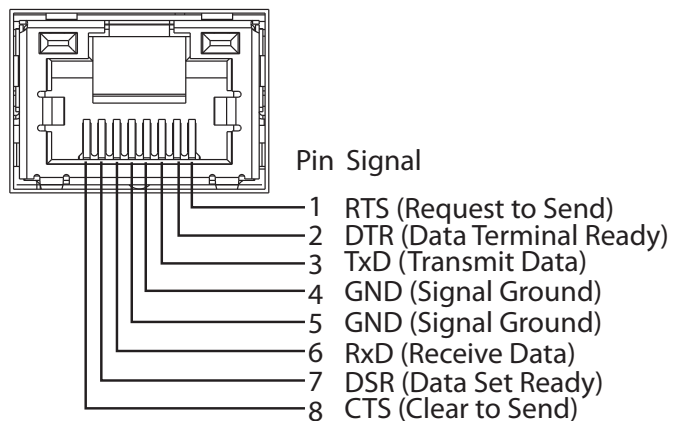

SPARE PARTS

This section lists the upgrade and service-related parts for the M5 Nodes. Some of these parts are configured with every server.



NOTE: Some spare parts you order may also require accessories for full functionality. For example, drives or RAID controllers may need accompanying cables. CPUs may need heatsinks, thermal paste, and installation tools. The spares and their accessory parts are listed in [Table 29](#).

Table 29 Spare Parts

Product ID (PID)	PID Description
UCSC-HS-C240M5=	Heat sink for HX240c M5 rack servers 150W CPUs & below
UCSC-HS2-C240M5=	Heat sink for HX240c M5 rack servers CPUs above 150W
UCS-CPUAT=	CPU Assembly Tool for M5 Servers
UCS-CPU-TIM=	Single CPU thermal interface material syringe for M5 server HS seal
UCSX-HSCK=	UCS Processor Heat Sink Cleaning Kit For Replacement of CPU
UCS-M5-CPU-CAR=	UCS M5 CPU Carrier
UCSC-BBLKD-S2=	C-Series M5 SFF drive blanking panel
UCSC-RSAS-240M5X=	C240 Rear UCS-RAID-M5HD SAS cbl(1)kitinclfan,bkpln
UCSC-PSU-BLKP1U=	Power Supply Blanking Panel for C220 M5 and C240 M5 servers
UCS-MSTOR-M2=	Mini Storage Carrier for M.2 SATA/NVME (holds up to 2)
N20-BKVM=	KVM local IO cable for UCS servers console port
UCS-AMDCBL-C240M5=	C240 M5 AMD 7150X2 Cable
UCS-P40CBL-C240M5=	C240 M5 NVIDIA P40 Cable
UCS-M10CBL-C240M5=	C240 M5 NVIDIA M10 Cable
UCS-P100CBL-240M5=	C240 M5 NVIDIA P100 / V100 Cable
HX240C-BZL-M5S=	HX240C M5 Security Bezel (Request Michael to apply Deviation to use UCS bezel)
UCSC-PCIF-240M5=	C240 M5 PCIe Riser Blanking Panel
Riser	
PCIe Riser 1 options	
HX-RIS-1B-240M5=	Riser 1B 3PCIe slots (x8, x8, x8); all from CPU1, For T4
HX-RIS-1-240M5=	Riser 1 3PCIe slots (x8, x16, x8); slot 3 req CPU2, For T4

Table 29 Spare Parts (continued)

Product ID (PID)	PID Description
HX-R1-A100-M5=	Riser1 3PCIe slots(x8, x16, x8)
PCIe Riser 2 options (all slots controlled with CPU2)	
HX-RIS-2B-240M5=	Riser 2B 3PCIe slot(x8,x16,x8) supports GPU+rear NVMe, For T4
HX-R2A-A100-M5=	Riser2A 3PCIe slots (x8, x16, x16)
HX-R2B-A100-M5=	Riser2B 3PCIe slot(x8,x16,x8) supports GPU+NVMe
CPUs	
8000 Series Processor	
HX-CPU-I8280L=	2.7
HX-CPU-I8280=	2.7
HX-CPU-I8276L=	2.2
HX-CPU-I8276=	2.2
HX-CPU-I8270=	2.7
HX-CPU-I8268=	2.9
HX-CPU-I8260Y=	2.4
HX-CPU-I8260L=	2.4
HX-CPU-I8260=	2.4
6000 Series Processor	
HX-CPU-I6262V=	1.9
HX-CPU-I6258R=	2.7
HX-CPU-I6254=	3.1
HX-CPU-I6252N=	2.3
HX-CPU-I6252=	2.1
HX-CPU-I6248R=	3.0
HX-CPU-I6248=	2.5
HX-CPU-I6246R=	3.4
HX-CPU-I6246=	3.3
HX-CPU-I6244=	3.6
HX-CPU-I6242R=	3.1
HX-CPU-I6242=	2.8

Table 29 Spare Parts (continued)

Product ID (PID)	PID Description
HX-CPU-I6240R=	2.4
HX-CPU-I6240Y=	2.6
HX-CPU-I6240L=	2.6
HX-CPU-I6240=	2.6
HX-CPU-I6238R=	2.2
HX-CPU-I6238L=	2.1
HX-CPU-I6238=	2.1
HX-CPU-I6234=	3.3
HX-CPU-I6230R=	2.1
HX-CPU-I6230N=	2.3
HX-CPU-I6230=	2.1
HX-CPU-I6226R=	2.9
HX-CPU-I6226=	2.7
HX-CPU-I6222V=	1.8
5000 Series Processor	
HX-CPU-I5220S=	2.6
HX-CPU-I5220R=	2.2
HX-CPU-I5220=	2.2
HX-CPU-I5218R=	2.1
HX-CPU-I5218B=	2.3
HX-CPU-I5218N=	2.3
HX-CPU-I5218=	2.3
HX-CPU-I5217=	3.0
HX-CPU-I5215L=	2.5
HX-CPU-I5215=	2.5
4000 Series Processor	
HX-CPU-I4216=	2.1
HX-CPU-I4215R=	3.2
HX-CPU-I4215=	2.5

Table 29 Spare Parts (continued)

Product ID (PID)	PID Description
HX-CPU-I4214R=	2.4
HX-CPU-I4214Y=	2.2
HX-CPU-I4214=	2.2
HX-CPU-I4210R=	2.4
HX-CPU-I4210=	2.2
HX-CPU-I4208=	2.1
3000 Series Processor	
HX-CPU-I3206R=	1.9
Memory	
HX-ML-128G4RW=	128GB DDR4-3200MHz LRDIMM 4Rx4 (16Gb)
HX-MR-X64G2RW=	64GB DDR4-3200MHz RDIMM 2Rx4 (16Gb)
HX-MR-X32G2RW=	32GB DDR4-3200MHz RDIMM 2Rx4 (8Gb)
HX-MR-X16G1RW=	16GB DDR4-3200MHz RDIMM 1Rx4 (8Gb)
Intel® Optane™ Persistent Memory Product	
HX-MP-512GS-A0=	Intel Optane Persistent Memory, 512GB, 2666MHz
HX-MP-256GS-A0=	Intel Optane Persistent Memory, 256GB, 2666MHz
HX-MP-128GS-A0=	Intel Optane Persistent Memory, 128GB, 2666MHz
Intel® Optane™ Persistent Memory Product Operational Modes	
UCS-DCPMM-AD=	Intel Optane DC Persistent Memory Operational Mode - App Di
Drives	
Front Capacity Drive	
HX-SD960G61X-EV=	960GB 2.5 Inch Enterprise Value 6G SATA SSD (1X endurance)
HX-SD38T61X-EV=	3.8TB 2.5 inch Enterprise Value 6G SATA SSD (1X endurance)
HX-SD76T61X-EV=	7.6TB 2.5 inch Enterprise Value 6G SATA SSD (1X endurance)
HX-SD960G6S1X-EV=	960GB 2.5 inch Enterprise Value 6G SATA SSD (1X endurance)
HX-SD19T6S1X-EV=	1.9TB 2.5 inch Enterprise Value 6G SATA SSD (1X endurance)
HX-SD38T6S1X-EV=	3.8TB 2.5 inch Enterprise Value 6G SATA SSD (1X endurance)
HX-SD76T6S1X-EV=	7.6TB 2.5 inch Enterprise Value 6G SATA SSD (1X endurance)
Front SED Capacity Drive	

Table 29 Spare Parts (continued)

Product ID (PID)	PID Description
HX-SD76TBKNK9=	7.6TB Enterprise value SAS SSD (1 DWPD, SED-FIPS)
HX-SD960GBKNK9=	960GB Enterprise Value SAS SSD (1X FWPD, SED)
HX-SD38TBKNK9=	3.8TB Enterprise Value SAS SSD (1X FWPD, SED)
HX-SD960GBM2NK9=	960GB Enterprise value SATA SSD (1X, SED)
HX-SD19TBEM2NK9=	1.9TB Enterprise value SATA SSD (1X, SED)
HX-SD38TBEM2NK9=	3.8TB 2.5 inch Ent. Value 6G SATA SED SSD (1X endurance)
HX-SD76TBEM2NK9=	7.6TB Enterprise value SATA SSD (1X endurance, SED)
Rear Cache Drive	
HX-NVMEXPB-I375=	375GB 2.5 inch Intel Optane Drive, Extreme Perf & Endurance
HX-NVMEM6-W1600=	1.6TB 2.5in U.2 WD SN840 NVMe Extreme Perf. High Endurance
HX-SD800GK3X-EP=	800GB 2.5in Enterprise Performance 12G SAS SSD(3X endurance)
HX-SD16TK3X-EP=	1.6TB 2.5in Enterprise Performance 12G SAS SSD (3X endurance)
Rear SED Cache Drive	
HX-SD800GBKNK9=	800GB Enterprise Performance SAS SSD (3X FWPD, SED)
Front System Drive / Log Drive	
HX-SD240GM1X-EV =	240GB 2.5 inch Enterprise Value 6G SATA SSD
Boot Drive	
HX-M2-240GB=	240GB SATA M.2 SSD
HX-M2-HWRAID=	Cisco Boot optimized M.2 Raid controller
PCIe Cards	
Modular LAN on Motherboard (mLOM)	
HX-MLOM-C40Q-03=	Cisco VIC 1387 Dual Port 40Gb QSFP CNA MLOM
HX-MLOM-C25Q-04=	Cisco UCS VIC 1457 Quad Port 10/25G SFP28 CNA MLOM
Virtual Interface Cards (VICs)	
HX-PCIE-C40Q-03=	Cisco VIC 1385 Dual Port 40Gb QSFP+ CNA w/
HX-PCIE-C25Q-04=	Cisco UCS VIC 1455 Quad Port 10/25G SFP28 CNA PCIe
Network Interface Cards (NICs)	
HX-PCIE-IRJ45 =	Intel i350 Quad Port 1Gb Adapter
HX-PCIE-ID10GF=	Intel X710-DA2 Dual Port 10G SFP+ NIC

Table 29 Spare Parts (continued)

Product ID (PID)	PID Description
HX-PCIE-ID10GC=	Intel X550-T2 Dual Port 10GBase-T NIC
HX-PCIE-ID25GF=	Intel XXV710-DA2 10-Dual Port 25G NIC
HX PCIe Accel Engine	
HX-PCIE-OFFLOAD-1=	Application Acceleration Engine
GPU	
HX-GPU-M10=	NVIDIA M10 GPU
HX-GPU-T4-16=	NVIDIA T4 PCIE 75W 16GB
HX-GPU-RTX6000=	NVIDIA QUADRO RTX 6000, PASSIVE, 250W TGP, 24GB
HX-GPU-RTX8000=	NVIDIA QUADRO RTX 8000, PASSIVE, 250W TGP, 48GB
Raid Controller	
HX-SAS-M5HD=	Cisco 12G SAS HBA
Power Supplies	
HX-PSU1-770W=	770W AC power supply for C-Series Servers Platinum
HX-PSU1-1050W=	1050W AC power supply for C-Series servers Platinum
HX-PSUV2-1050DC=	1050W DC power supply for C-Series servers Platinum
HX-PSU1-1600W=	1600W power supply for C-Series servers Platinum
HX-PSU1-1050ELV=	Cisco UCS 1050W AC Power Supply for Rack Server Low Line Platinum
Security	
HX-TPM2-002=	Trusted Platform Module 2.0 for UCS servers
HX-TPM2-002B=	Trusted Platform Module 2.0 M5 UCS servers (FIPS 140-2 Compliant)
HX-INT-SW01=	C220 M5 and C240 M5 Chassis Intrusion Switch
Power Cables	
R2XX-DMYMPWRCORD=	No power cord (dummy PID to allow for a no power cord option)
CAB-48DC-40A-8AWG=	C-Series -48VDC PSU Power Cord, 3.5M, 3 Wire, 8AWG, 40A
CAB-N5K6A-NA=	Power Cord, 200/240V 6A, North America
CAB-AC-L620-C13=	AC Power Cord, NEMA L6-20 - C13, 2M/6.5ft
CAB-C13-CBN=	CABASY,WIRE,JUMPER CORD, 27" L, C13/C14, 10A/250V
CAB-C13-C14-2M=	CABASY,WIRE,JUMPER CORD, PWR, 2 Meter, C13/C14,10A/250V

Table 29 Spare Parts (continued)

Product ID (PID)	PID Description
CAB-C13-C14-AC=	CORD,PWR,JMP,IEC60320/C14,IEC6 0320/C13, 3.0M
CAB-250V-10A-AR=	Power Cord, 250V, 10A, Argentina
CAB-9K10A-AU=	Power Cord, 250VAC 10A 3112 Plug, Australia
CAB-250V-10A-CN=	AC Power Cord - 250V, 10A - PRC
CAB-9K10A-EU=	Power Cord, 250VAC 10A CEE 7/7 Plug, EU
CAB-250V-10A-ID=	Power Cord, 250V, 10A, India
CAB-250V-10A-IS=	Power Cord, SFS, 250V, 10A, Israel
CAB-9K10A-IT=	Power Cord, 250VAC 10A CEI 23-16/VII Plug, Italy
CAB-9K10A-SW=	Power Cord, 250VAC 10A MP232 Plug, Switzerland
CAB-9K10A-UK=	Power Cord, 250VAC 10A BS1363 Plug (13 A fuse), UK
CAB-9K12A-NA=	Power Cord, 125VAC 13A NEMA 5-15 Plug, North America
CAB-250V-10A-BR=	Power Cord - 250V, 10A - Brazil
CAB-C13-C14-2M-JP=	Power Cord C13-C14, 2M/6.5ft Japan PSE mark
CAB-9K10A-KOR=	Power Cord, 125VAC 13A KSC8305 Plug, Korea
CAB-ACTW=	AC Power Cord (Taiwan), C13, EL 302, 2.3M
CAB-JPN-3PIN=	Japan, 90-125VAC 12A NEMA 5-15 Plug, 2.4m
CAB-48DC-40A-INT=	-48VDC PSU PWR Cord, 3.5M, 3 Wire, 8AWG, 40A (INT)
CAB-48DC-40A-AS =	-48VDC PSU PWR Cord, 3.5M, 3Wire, 8AWG, 40A (AS/NZ)
CAB-C13-C14-IN=	Power Cord Jumper,C13-C14 Connectors,1.4 Meter Length, India
CAB-C13-C14-3M-IN=	Power Cord Jumper, C13-C14 Connectors, 3 Meter Length, India
Select Hypervisor / Host Operating System	
ESXi Options	
VMware	
HX-VSP-7-0-FND-D=	Factory Installed vSphere SW 7.0 1-CPU Enduser provides License (HyperFlex Release 4.5(1a) and later)
HX-VSP-7-0-FND2-D=	Factory Installed vSphere SW 7.0 2-CPU Enduser provides License (HyperFlex Release 4.5(1a) and later)
VMware PAC Licenses	
HX-VSP-EPL-1A=	VMware vSphere 7.x Ent Plus (1 CPU), 1-yr, Support Required
HX-VSP-EPL-3A=	VMware vSphere 7.x Ent Plus (1 CPU), 3-yr, Support Required

Table 29 Spare Parts (continued)

Product ID (PID)	PID Description
HX-VSP-EPL-5A=	VMware vSphere 7.x Ent Plus (1 CPU), 5-yr, Support Required
HX-VSP-STD-1A=	VMware vSphere 7.x Standard (1 CPU), 1-yr, Support Required
HX-VSP-STD-3A=	VMware vSphere 7.x Standard (1 CPU), 3-yr, Support Required
HX-VSP-STD-5A=	VMware vSphere 7.x Standard (1 CPU), 5-yr, Support Required
Guest Operating system	
Microsoft Options	
HX-MSWS-19-ST16C=	Windows Server 2019 Standard (16 Cores/2 VMs)
HX-MSWS-19-DC16C=	Windows Server 2019 Data Center (16 Cores/Unlimited VMs)
HX-MSWS-22-ST16C=	Windows Server 2022 Standard (16 Cores/2 VMs)
HX-MSWS-22-DC16C=	Windows Server 2022 Data Center (16 Cores/Unlimited VMs)

KVM CABLE

The KVM cable provides a connection into the server, providing a DB9 serial connector, a VGA connector for a monitor, and dual USB 2.0 ports for a keyboard and mouse. With this cable, you can create a direct connection to the operating system and the BIOS running on the server.

The KVM cable ordering information is listed in [Table 30](#).

Table 30 KVM Cable

Product ID (PID)	PID Description
N20-BKVM=	KVM cable for UCS Server console port

Figure 11 KVM Cable

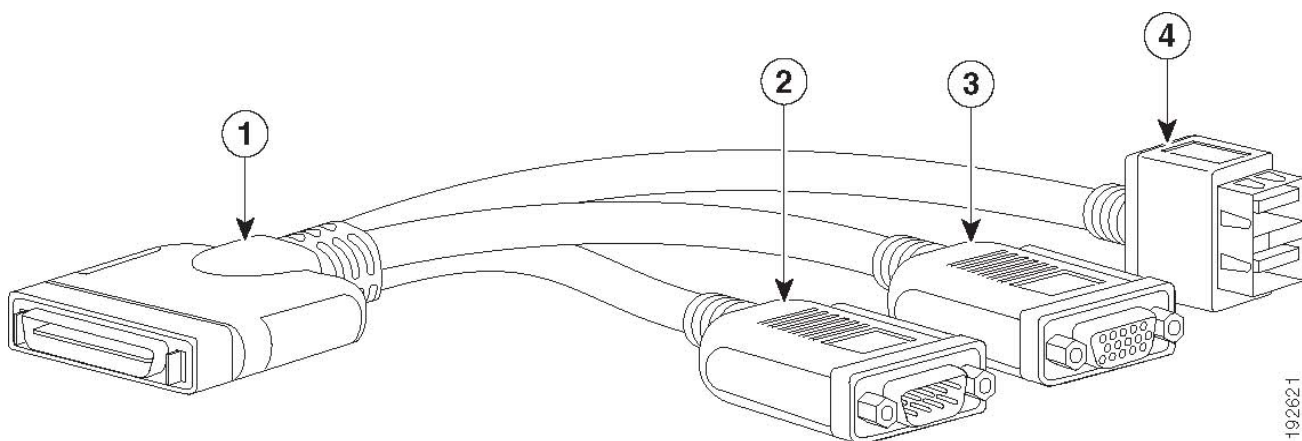

192621

1	Connector (to server front panel)	3	VGA connector (for a monitor)
2	DB-9 serial connector	4	Two-port USB 2.0 connector (for a mouse and keyboard)

DISCONTINUED EOL PRODUCTS

Below is the list of parts were previously available for this product and are no longer sold. Please refer to the EOL Bulletin Links via the [Table 31](#) below to determine if still supported.

Table 31 EOL Products

EOS option PID	Description	EOL bulletin link
DRIVES		
HX-SD240G61X-EV	240GB 2.5 inch Enterprise Value 6G SATA SSD	https://www.cisco.com/c/en/us/products/collateral/servers-unified-computing/ucs-b-series-blade-servers/eos-eol-notice-c51-742066.html
HX-NVMEXP-I375	Cisco 2.5" 375GB Intel Optane NVMe Extreme Performance SSD	https://www.cisco.com/c/en/us/products/collateral/servers-unified-computing/ucs-c-series-rack-servers/eos-eol-notice-c51-742509.html
HX-SD800GBENK9	800GB Enterprise performance SAS SSD (10X FWPD, SED)	https://www.cisco.com/c/en/us/products/collateral/servers-unified-computing/ucs-c-series-rack-servers/eos-eol-notice-c51-742823.html
HX-SD38TBHTNK9**	[FIPS Compliant] 3.8TB Enterprise value 12G SAS SSD (1X FWPD, SED)	https://www.cisco.com/c/en/us/products/collateral/servers-unified-computing/ucs-c-series-rack-servers/eos-eol-notice-c51-742823.html
HX-SD960GBHTNK9**	[FIPS Compliant] 960GB Enterprise value 12G SAS SSD (1X FWPD, SED)	https://www.cisco.com/c/en/us/products/collateral/servers-unified-computing/ucs-c-series-rack-servers/eos-eol-notice-c51-741644.html
HX-SD960G2HTNK9	[FIPS Compliant] 960GB Enterprise value SAS SSD (1X FWPD, SED)	https://www.cisco.com/c/en/us/products/collateral/hyperconverged-infrastructure/hyperflex-hx-series/eos-eol-notice-c51-2451489.html
HX-SD400G12TX-EP	400GB 2.5 inch Ent. Perf. 12G SAS SSD (10X endurance)	https://www.cisco.com/c/en/us/products/collateral/servers-unified-computing/ucs-c-series-rack-servers/eos-eol-notice-c51-741644.html
HX-SD38TBE1NK9	3.8TB Enterprise Value SSD (SATA) (1X FWPD, SED)	https://www.cisco.com/c/en/us/products/collateral/servers-unified-computing/ucs-c-series-rack-servers/eos-eol-notice-c51-744204.html
HX-SD960GBE1NK9	960GB Enterprise value SATA SSD (1X FWPD, SED)	https://www.cisco.com/c/en/us/products/collateral/servers-unified-computing/ucs-c-series-rack-servers/eos-eol-notice-c51-744204.html
HX-SD16T123X-EP	1.6TB 2.5 inch Enterprise performance 12G SAS SSD(3X endurance)	https://www.cisco.com/c/en/us/products/collateral/hyperconverged-infrastructure/hyperflex-hx-series/eos-eol-notice-c51-2451489.html
HX-SD800G123X-EP	800GB 2.5in Enterprise Performance 12G SAS SSD(3X endurance)	https://www.cisco.com/c/en/us/products/collateral/hyperconverged-infrastructure/hyperflex-hx-series/eos-eol-notice-c51-2451489.html
HX-SD800GBHMK9	800GB Enterprise performance SAS SSD (10X FWPD, SED) (HyperFlex Release 3.5(2g)or later)	https://www.cisco.com/c/en/us/products/collateral/servers-unified-computing/ucs-c-series-rack-servers/ucs-hyperflex-accessories-eol.html
HX-NVMEHW-H1600	1.6TB 2.5 inch Ent. Perf. NVMe SSD (3X endurance)	https://www.cisco.com/c/en/us/products/collateral/hyperconverged-infrastructure/hyperflex-hx-series/eos-eol-notice-c51-2451489.html

Table 31 EOL Products

EOS option PID	Description	EOL bulletin link
HX-SD38T2HTNK9	[FIPS Compliant] 3.8TB Enterprise value 12G SAS SSD (1X FWP, SED)	https://www.cisco.com/c/en/us/products/collateral/hyperconverged-infrastructure/hyperflex-hx-series/eos-eol-notice-c51-2451489.html
Host OS		
HX-VSP-ENT-D	Factory Installed - VMware vSphere6 Ent SW and Lic (2 CPU)	https://www.cisco.com/c/en/us/products/collateral/servers-unified-computing/ucs-b-series-blade-servers/eos-eol-notice-c51-740304.html
HX-VSP-ENT-DL	Factory Installed - VMware vSphere6 Enterprise SW Download	https://www.cisco.com/c/en/us/products/collateral/servers-unified-computing/ucs-b-series-blade-servers/eos-eol-notice-c51-740304.html
CPU		
HX-CPU-I8280M	Intel 8280M 2.7GHz/205W 28C/38.50MB 3DX DDR4 2TB 2933 MHz	https://www.cisco.com/c/en/us/products/collateral/servers-unified-computing/ucs-c-series-rack-servers/eos-eol-notice-c51-743832.html
HX-CPU-I8276M	Intel 8276M 2.2GHz/165W 28C/38.50MB 3DX DDR4 2TB 2933 MHz	https://www.cisco.com/c/en/us/products/collateral/servers-unified-computing/ucs-c-series-rack-servers/eos-eol-notice-c51-743832.html
HX-CPU-I8260M	Intel 8260M 2.4GHz/165W 24C/35.75MB 3DX DDR4 2TB 2933 MHz	https://www.cisco.com/c/en/us/products/collateral/servers-unified-computing/ucs-c-series-rack-servers/eos-eol-notice-c51-743832.html
HX-CPU-I6240M	Intel 6240M 2.6GHz/150W 18C/24.75MB 3DX DDR4 2TB 2933 MHz	https://www.cisco.com/c/en/us/products/collateral/servers-unified-computing/ucs-c-series-rack-servers/eos-eol-notice-c51-743832.html
HX-CPU-I6238M	Intel 6238M 2.1GHz/140W 22C/30.25MB 3DX DDR4 2TB 2933 MHz	https://www.cisco.com/c/en/us/products/collateral/servers-unified-computing/ucs-c-series-rack-servers/eos-eol-notice-c51-743832.html
HX-CPU-I5215M	Intel 5215M 2.5GHz/85W 10C/13.75MB 3DX DDR4 2TB 2666MHz	https://www.cisco.com/c/en/us/products/collateral/servers-unified-computing/ucs-c-series-rack-servers/eos-eol-notice-c51-743832.html
HX-CPU-8180M	2.5 GHz 8180M/205W 28C/38.50MB Cache/DDR4 2666MHz	https://www.cisco.com/c/en/us/products/collateral/servers-unified-computing/ucs-c-series-rack-servers/eos-eol-notice-c51-744580.html
HX-CPU-8176M	2.1 GHz 8176M/165W 28C/38.50MB Cache/DDR4 2666MHz	https://www.cisco.com/c/en/us/products/collateral/servers-unified-computing/ucs-c-series-rack-servers/eos-eol-notice-c51-744580.html
HX-CPU-8170M	2.1 GHz 8170M/165W 26C/35.75MB Cache/DDR4 2666MHz	https://www.cisco.com/c/en/us/products/collateral/servers-unified-computing/ucs-c-series-rack-servers/eos-eol-notice-c51-744580.html
HX-CPU-8160M	2.1 GHz 8160M/150W 24C/33MB Cache/DDR4 2666MHz	https://www.cisco.com/c/en/us/products/collateral/servers-unified-computing/ucs-c-series-rack-servers/eos-eol-notice-c51-744580.html
HX-CPU-8180	2.5 GHz 8180/205W 28C/38.50MB Cache/DDR4 2666MHz	https://www.cisco.com/c/en/us/products/collateral/servers-unified-computing/ucs-c-series-rack-servers/eos-eol-notice-c51-744580.html
HX-CPU-8176	2.1 GHz 8176/165W 28C/38.50MB Cache/DDR4 2666MHz	https://www.cisco.com/c/en/us/products/collateral/servers-unified-computing/ucs-c-series-rack-servers/eos-eol-notice-c51-744580.html

Table 31 EOL Products

EOS option PID	Description	EOL bulletin link
HX-CPU-8170	2.1 GHz 8170/165W 26C/35.75MB Cache/DDR4 2666MHz	https://www.cisco.com/c/en/us/products/collateral/servers-unified-computing/ucs-c-series-rack-servers/eos-eol-notice-c51-744580.html
HX-CPU-8168	2.7 GHz 8168/205W 24C/33MB Cache/DDR4 2666MHz	https://www.cisco.com/c/en/us/products/collateral/servers-unified-computing/ucs-c-series-rack-servers/eos-eol-notice-c51-744580.html
HX-CPU-8164	2.0 GHz 8164/150W 26C/35.75MB Cache/DDR4 2666MHz	https://www.cisco.com/c/en/us/products/collateral/servers-unified-computing/ucs-c-series-rack-servers/eos-eol-notice-c51-744580.html
HX-CPU-8160	2.1 GHz 8160/150W 24C/33MB Cache/DDR4 2666MHz	https://www.cisco.com/c/en/us/products/collateral/servers-unified-computing/ucs-c-series-rack-servers/eos-eol-notice-c51-744580.html
HX-CPU-8158	3.0 GHz 8158/150W 12C/24.75MB Cache/DDR4 2666MHz	https://www.cisco.com/c/en/us/products/collateral/servers-unified-computing/ucs-c-series-rack-servers/eos-eol-notice-c51-744580.html
HX-CPU-8153	2.0 GHz 8153/125W 16C/22MB Cache/DDR4 2666MHz	https://www.cisco.com/c/en/us/products/collateral/servers-unified-computing/ucs-c-series-rack-servers/eos-eol-notice-c51-744580.html
HX-CPU-6142M	2.6 GHz 6142M/150W 16C/22MB Cache/DDR4 2666MHz	https://www.cisco.com/c/en/us/products/collateral/servers-unified-computing/ucs-c-series-rack-servers/eos-eol-notice-c51-744580.html
HX-CPU-6140M	2.3 GHz 6140M/140W 18C/24.75MB Cache/DDR4 2666MHz	https://www.cisco.com/c/en/us/products/collateral/servers-unified-computing/ucs-c-series-rack-servers/eos-eol-notice-c51-744580.html
HX-CPU-6134M	3.2 GHz 6134M/130W 8C/24.75MB Cache/DDR4 2666MHz	https://www.cisco.com/c/en/us/products/collateral/servers-unified-computing/ucs-c-series-rack-servers/eos-eol-notice-c51-744580.html
HX-CPU-6154	3.0 GHz 6154/200W 18C/24.75MB Cache/DDR4 2666MHz	https://www.cisco.com/c/en/us/products/collateral/servers-unified-computing/ucs-c-series-rack-servers/eos-eol-notice-c51-744580.html
HX-CPU-6152	2.1 GHz 6152/140W 22C/30.25MB Cache/DDR4 2666MHz	https://www.cisco.com/c/en/us/products/collateral/servers-unified-computing/ucs-c-series-rack-servers/eos-eol-notice-c51-744580.html
HX-CPU-6150	2.7 GHz 6150/165W 18C/24.75MB Cache/DDR4 2666MHz	https://www.cisco.com/c/en/us/products/collateral/servers-unified-computing/ucs-c-series-rack-servers/eos-eol-notice-c51-744580.html
HX-CPU-6148	2.4 GHz 6148/150W 20C/27.50MB Cache/DDR4 2666MHz	https://www.cisco.com/c/en/us/products/collateral/servers-unified-computing/ucs-c-series-rack-servers/eos-eol-notice-c51-744580.html
HX-CPU-6144	3.5 GHz 6144/150W 8C/24.75MB Cache/DDR4 2666MHz	https://www.cisco.com/c/en/us/products/collateral/servers-unified-computing/ucs-c-series-rack-servers/eos-eol-notice-c51-744580.html
HX-CPU-6142	2.6 GHz 6142/150W 16C/22MB Cache/DDR4 2666MHz	https://www.cisco.com/c/en/us/products/collateral/servers-unified-computing/ucs-c-series-rack-servers/eos-eol-notice-c51-744580.html
HX-CPU-6140	2.3 GHz 6140/140W 18C/24.75MB Cache/DDR4 2666MHz	https://www.cisco.com/c/en/us/products/collateral/servers-unified-computing/ucs-c-series-rack-servers/eos-eol-notice-c51-744580.html

Table 31 EOL Products

EOS option PID	Description	EOL bulletin link
HX-CPU-6146	3.2 GHz 6146/165W 12C/24.75MB Cache/DDR4 2666MHz	https://www.cisco.com/c/en/us/products/collateral/servers-unified-computing/ucs-c-series-rack-servers/eos-eol-notice-c51-744580.html
HX-CPU-6138	2.0 GHz 6138/125W 20C/27.50MB Cache/DDR4 2666MHz	https://www.cisco.com/c/en/us/products/collateral/servers-unified-computing/ucs-c-series-rack-servers/eos-eol-notice-c51-744580.html
HX-CPU-6136	3.0 GHz 6136/150W 12C/24.75MB Cache/DDR4 2666MHz	https://www.cisco.com/c/en/us/products/collateral/servers-unified-computing/ucs-c-series-rack-servers/eos-eol-notice-c51-744580.html
HX-CPU-6134	3.2 GHz 6134/130W 8C/24.75MB Cache/DDR4 2666MHz	https://www.cisco.com/c/en/us/products/collateral/servers-unified-computing/ucs-c-series-rack-servers/eos-eol-notice-c51-744580.html
HX-CPU-6132	2.6 GHz 6132/140W 14C/19.25MB Cache/DDR4 2666MHz	https://www.cisco.com/c/en/us/products/collateral/servers-unified-computing/ucs-c-series-rack-servers/eos-eol-notice-c51-744580.html
HX-CPU-6130	2.1 GHz 6130/125W 16C/22MB Cache/DDR4 2666MHz	https://www.cisco.com/c/en/us/products/collateral/servers-unified-computing/ucs-c-series-rack-servers/eos-eol-notice-c51-744580.html
HX-CPU-6126	2.6 GHz 6126/125W 12C/19.25MB Cache/DDR4 2666MHz	https://www.cisco.com/c/en/us/products/collateral/servers-unified-computing/ucs-c-series-rack-servers/eos-eol-notice-c51-744580.html
HX-CPU-5120	2.2 GHz 5120/105W 14C/19.25MB Cache/DDR4 2400MHz	https://www.cisco.com/c/en/us/products/collateral/servers-unified-computing/ucs-c-series-rack-servers/eos-eol-notice-c51-744580.html
HX-CPU-5118	2.3 GHz 5118/105W 12C/16.50MB Cache/DDR4 2400MHz	https://www.cisco.com/c/en/us/products/collateral/servers-unified-computing/ucs-c-series-rack-servers/eos-eol-notice-c51-744580.html
HX-CPU-5117	2.0 GHz 5117/105W 14C/19.25MB Cache/DDR4 2400MHz	https://www.cisco.com/c/en/us/products/collateral/servers-unified-computing/ucs-c-series-rack-servers/eos-eol-notice-c51-744580.html
HX-CPU-5115	2.4 GHz 5115/85W 10C/13.75MB Cache/DDR4 2400MHz	https://www.cisco.com/c/en/us/products/collateral/servers-unified-computing/ucs-c-series-rack-servers/eos-eol-notice-c51-744580.html
HX-CPU-4116	2.1 GHz 4116/85W 12C/16.50MB Cache/DDR4 2400MHz	https://www.cisco.com/c/en/us/products/collateral/servers-unified-computing/ucs-c-series-rack-servers/eos-eol-notice-c51-744580.html
HX-CPU-4114	2.2 GHz 4114/85W 10C/13.75MB Cache/DDR4 2400MHz	https://www.cisco.com/c/en/us/products/collateral/servers-unified-computing/ucs-c-series-rack-servers/eos-eol-notice-c51-744580.html
HX-CPU-4110	2.1 GHz 4110/85W 8C/11MB Cache/DDR4 2400MHz	https://www.cisco.com/c/en/us/products/collateral/servers-unified-computing/ucs-c-series-rack-servers/eos-eol-notice-c51-744580.html
HX-CPU-4108	1.8 GHz 4108/85W 8C/11MB Cache/DDR4 2400MHz	https://www.cisco.com/c/en/us/products/collateral/servers-unified-computing/ucs-c-series-rack-servers/eos-eol-notice-c51-744580.html
HX-CPU-3106	1.7 GHz 3106/85W 8C/11MB Cache/DDR4 2133MHz	https://www.cisco.com/c/en/us/products/collateral/servers-unified-computing/ucs-c-series-rack-servers/eos-eol-notice-c51-744580.html

Table 31 EOL Products

EOS option PID	Description	EOL bulletin link
Memory		
HX-MR-128G8RS-H	128 GB DDR4-2666-MHz TSV-RDIMM/8R/x4	https://www.cisco.com/c/en/us/products/collateral/servers-unified-computing/ucs-c-series-rack-server/eos-eol-notice-c51-740780.html
HX-ML-X64G4RS-H	64 GB DDR4-2666-MHz LRDIMM/4R/x4	https://www.cisco.com/c/en/us/products/collateral/servers-unified-computing/ucs-c-series-rack-server/eos-eol-notice-c51-740780.html
HX-MR-X32G2RS-H	32 GB DDR4-2666-MHz RDIMM/2R/x4	https://www.cisco.com/c/en/us/products/collateral/servers-unified-computing/ucs-c-series-rack-server/eos-eol-notice-c51-740780.html
HX-MR-X16G1RS-H	16 GB DDR4-2666-MHz RDIMM/1R/x4	https://www.cisco.com/c/en/us/products/collateral/servers-unified-computing/ucs-c-series-rack-server/eos-eol-notice-c51-740780.html
HX-MR-X16G1RT-H	16GB DDR4-2933MHz RDIMM 1Rx4 (8Gb)/1.2v	https://www.cisco.com/c/en/us/products/collateral/servers-unified-computing/ucs-c-series-rack-server/ucs-hyperflex-accessories-eol14611.html
HX-MR-X32G2RT-H	32GB DDR4-2933MHz RDIMM 2Rx4 (8Gb)/1.2v	https://www.cisco.com/c/en/us/products/collateral/servers-unified-computing/ucs-c-series-rack-server/ucs-hyperflex-accessories-eol14611.html
HX-MR-X64G2RT-H	64GB DDR4-2933MHz RDIMM 2Rx4 (16Gb)/1.2v	https://www.cisco.com/c/en/us/products/collateral/servers-unified-computing/ucs-c-series-rack-server/ucs-hyperflex-accessories-eol14611.html
HX-ML-X64G4RT-H	64GB DDR4-2933MHz LRDIMM 4Rx4 (8Gb)/1.2v	https://www.cisco.com/c/en/us/products/collateral/servers-unified-computing/ucs-c-series-rack-server/ucs-hyperflex-accessories-eol14611.html
HX-ML-128G4RT-H	128GB DDR4-2933MHz LRDIMM 4Rx4 (16Gb)/1.2v	https://www.cisco.com/c/en/us/products/collateral/servers-unified-computing/ucs-c-series-rack-server/ucs-hyperflex-accessories-eol14611.html
GPU		
HX-GPU-P100-12G	NVIDIA P100 12GB	https://www.cisco.com/c/en/us/products/collateral/servers-unified-computing/ucs-c-series-rack-server/eos-eol-notice-c51-741579.html
HX-GPU-P100-16G	NVIDIA P100 16GB	https://www.cisco.com/c/en/us/products/collateral/servers-unified-computing/ucs-c-series-rack-server/eos-eol-notice-c51-741579.html
HX-GPU-M60	UCS Rack Server M60 GPU HW - GRID 2.0 SW required for VDI	https://www.cisco.com/c/en/us/products/collateral/servers-unified-computing/ucs-c-series-rack-server/eos-eol-notice-c51-743558.html

Table 31 EOL Products

EOS option PID	Description	EOL bulletin link
HX-GPU-7150x2	AMD Firepro 7150x2	https://www.cisco.com/c/en/us/products/collateral/servers-unified-computing/ucs-c-series-rack-servers/eos-eol-notice-c51-741579.html
HX-GPU-V340	AMD Radeon Pro V340, 2X16GB, 300W	https://www.cisco.com/c/en/us/products/collateral/servers-unified-computing/ucs-c-series-rack-servers/eos-eol-notice-c51-741579.html
HX-GPU-P40	NVIDIA P40	https://www.cisco.com/c/en/us/products/collateral/servers-unified-computing/ucs-c-series-rack-servers/eos-eol-notice-c51-744204.html
HX-GPU-P4	NVIDIA P4 (PG414-200), PASSIVE, 75W, 8GB PCIe Card	https://www.cisco.com/c/en/us/products/collateral/servers-unified-computing/ucs-c-series-rack-servers/eos-eol-notice-c51-742510.html
HX-GPU-V100	NVIDIA Volta 100 PCIe	https://www.cisco.com/c/en/us/products/collateral/servers-unified-computing/ucs-c-series-rack-servers/eos-eol-notice-c51-744204.html
HX-GPU-V100-32	NVIDIA TESLA, VOLTA 100 PCIE 32GB, 250W	https://www.cisco.com/c/en/us/products/collateral/servers-unified-computing/ucs-c-series-rack-servers/ucs-hyperflex-accessories-eol.html
Microsoft Windows server		
HX-16-ST16C	Windows Server 2016 Standard (16 Cores/2 VMs)	https://www.cisco.com/c/en/us/products/servers-unified-computing/ucs-c-series-rack-servers/eos-eol-notice-c51-743145.html
HX-16-ST24C	Windows Server 2016 Standard (24 Cores/2 VMs)	https://www.cisco.com/c/en/us/products/servers-unified-computing/ucs-c-series-rack-servers/eos-eol-notice-c51-743145.html
HX-16-ST16C-NS	Windows Server 2016 Standard (16 Cores/2 VMs) - No Cisco SVC	https://www.cisco.com/c/en/us/products/servers-unified-computing/ucs-c-series-rack-servers/eos-eol-notice-c51-743145.html
HX-16-ST24C-NS	Windows Server 2016 Standard (24 Cores/2 VMs) - No Cisco SVC	https://www.cisco.com/c/en/us/products/servers-unified-computing/ucs-c-series-rack-servers/eos-eol-notice-c51-743145.html
HX-16-DC16C	Windows Server 2016 Data Center (16 Cores/Unlimited VMs)	https://www.cisco.com/c/en/us/products/servers-unified-computing/ucs-c-series-rack-servers/eos-eol-notice-c51-743145.html
HX-16-DC24C	Windows Server 2016 Data Center (24 Cores/Unlimited VMs)	https://www.cisco.com/c/en/us/products/servers-unified-computing/ucs-c-series-rack-servers/eos-eol-notice-c51-743145.html
HX-16-DC16C-NS	Windows Server 2016 DC (16 Cores/Unlim VMs) - No Cisco SVC	https://www.cisco.com/c/en/us/products/servers-unified-computing/ucs-c-series-rack-servers/eos-eol-notice-c51-743145.html
HX-16-DC24C-NS	Windows Server 2016 DC (24 Cores/Unlim VMs) - No Cisco SVC	https://www.cisco.com/c/en/us/products/servers-unified-computing/ucs-c-series-rack-servers/eos-eol-notice-c51-743145.html
OS Media		
HX-16-ST16C-RM	Windows Server 2016 Std (16 Cores/2 VMs) - Recovery Media	https://www.cisco.com/c/en/us/products/servers-unified-computing/ucs-c-series-rack-servers/eos-eol-notice-c51-743145.html

Table 31 EOL Products

EOS option PID	Description	EOL bulletin link
HX-16-ST24C-RM	Windows Server 2016 Std (24 Cores/2 VMs) - Recovery Media	https://www.cisco.com/c/en/us/products/servers-unified-computing/ucs-c-series-rack-servers/eos-eol-notice-c51-743145.html
HX-16-DC16C-RM	Windows Server 2016 DC (16 Cores/Unlim VMs) - Recovery Media	https://www.cisco.com/c/en/us/products/servers-unified-computing/ucs-c-series-rack-servers/eos-eol-notice-c51-743145.html
HX-16-DC24C-RM	Windows Server 2016 DC (24 Cores/Unlim VMs) - Recovery Media	https://www.cisco.com/c/en/us/products/servers-unified-computing/ucs-c-series-rack-servers/eos-eol-notice-c51-743145.html

TECHNICAL SPECIFICATIONS

Dimensions and Weight

Table 32 HXAF240 M5 Dimensions and Weight

Parameter	Value
Height	3.43 in. (87.1 mm)
Width (including slam latches)	17.57 in. (446.3 mm) Including handles: 18.96 in. (481.5 mm)
Depth	29.56 in. (750.8 mm) Including handles: 30.44 in. (773.1 mm)
Front Clearance	3 in. (76 mm)
Side Clearance	1 in. (25 mm)
Rear Clearance	6 in. (152 mm)
Weight ¹	
Maximum (24 HDD model with 26 HDDs, 2 CPUs, 24 DIMMs, 2 1600 W power supplies) (8 HDD model with 8 HDDs, 2 CPUs, 24 DIMMs, 2 1600 W power supplies)	59.5 lbs (26.1 kg) 45.5 lbs (20.6 kg)
Minimum (24 HDD model with 1 HDD, 1 CPU, 1 DIMM, 1 770 W power supply) (8 HDD model with 1 HDD, 1 CPU, 1 DIMM, 1 770 W power supply)	41.5 lbs (18.8 kg) 37 lbs (16.8 kg)
Bare (24 HDD model with 0 HDD, 0 CPU, 0 DIMM, 1 770 W power supply) (8 HDD model with 0 HDD, 0 CPU, 0 DIMM, 1 770 W power supply)	40 lbs (18.1 kg) 35.5 lbs (16.1 kg)

Notes:

- Weight includes inner rail, which is attached to the server. Weight does not include outer rail, which is attached to the rack.

Power Specifications

The server is available with the following types of power supplies:

- 1050 W (AC) power supply (see [Table 33](#)).
- 1050 W V2 (DC) power supply (see [Table 34](#))
- 1600 W (AC) power supply (see [Table 35](#))

Table 33 HXAF240c M5 1050 W (AC) Power Supply Specifications

Parameter	Specification			
Input Connector	IEC320 C14			
Input Voltage Range (V rms)	100 to 240			
Maximum Allowable Input Voltage Range (V rms)	90 to 264			
Frequency Range (Hz)	50 to 60			
Maximum Allowable Frequency Range (Hz)	47 to 63			
Maximum Rated Output (W) ¹	800		1050	
Maximum Rated Standby Output (W)	36			
Nominal Input Voltage (V rms)	100	120	208	230
Nominal Input Current (A rms)	9.2	7.6	5.8	5.2
Maximum Input at Nominal Input Voltage (W)	889	889	1167	1154
Maximum Input at Nominal Input Voltage (VA)	916	916	1203	1190
Minimum Rated Efficiency (%) ²	90	90	90	91
Minimum Rated Power Factor ²	0.97	0.97	0.97	0.97
Maximum Inrush Current (A peak)	15			
Maximum Inrush Current (ms)	0.2			
Minimum Ride-Through Time (ms) ³	12			

Notes:

1. Maximum rated output is limited to 800W when operating at low-line input voltage (100-127V)
2. This is the minimum rating required to achieve 80 PLUS Platinum certification, see test reports published at <http://www.80plus.org/> for certified values
3. Time output voltage remains within regulation limits at 100% load, during input voltage dropout

Table 34 HXAF240c M5 1050 W (DC) Power Supply Specifications

Parameter	Specification
Input Connector	Molex 42820
Input Voltage Range (V rms)	-48
Maximum Allowable Input Voltage Range (V rms)	-40 to -72
Frequency Range (Hz)	NA
Maximum Allowable Frequency Range (Hz)	NA
Maximum Rated Output (W)	1050
Maximum Rated Standby Output (W)	36

Table 34 HXAF240c M5 1050 W (DC) Power Supply Specifications

Nominal Input Voltage (V rms)	-48
Nominal Input Current (A rms)	24
Maximum Input at Nominal Input Voltage (W)	1154
Maximum Input at Nominal Input Voltage (VA)	1154
Minimum Rated Efficiency (%) ¹	91
Minimum Rated Power Factor ¹	NA
Maximum Inrush Current (A peak)	15
Maximum Inrush Current (ms)	0.2
Minimum Ride-Through Time (ms) ²	5

Notes:

1. This is the minimum rating required to achieve 80 PLUS Platinum certification, see test reports published at <http://www.80plus.org/> for certified values
2. Time output voltage remains within regulation limits at 100% load, during input voltage dropout

Table 35 HXAF240c M5 1600 W (AC) Power Supply Specifications

Parameter	Specification			
Input Connector	IEC320 C14			
Input Voltage Range (V rms)	200 to 240			
Maximum Allowable Input Voltage Range (V rms)	180 to 264			
Frequency Range (Hz)	50 to 60			
Maximum Allowable Frequency Range (Hz)	47 to 63			
Maximum Rated Output (W) ¹	1600			
Maximum Rated Standby Output (W)	36			
Nominal Input Voltage (V rms)	100	120	208	230
Nominal Input Current (A rms)	NA	NA	8.8	7.9
Maximum Input at Nominal Input Voltage (W)	NA	NA	1778	1758
Maximum Input at Nominal Input Voltage (VA)	NA	NA	1833	1813
Minimum Rated Efficiency (%) ²	NA	NA	90	91
Minimum Rated Power Factor ²	NA	NA	0.97	0.97
Maximum Inrush Current (A peak)	30			
Maximum Inrush Current (ms)	0.2			
Minimum Ride-Through Time (ms) ³	12			

Notes:

1. Maximum rated output is limited to 800W when operating at low-line input voltage (100-127V)
2. This is the minimum rating required to achieve 80 PLUS Platinum certification, see test reports published at <http://www.80plus.org/> for certified values
3. Time output voltage remains within regulation limits at 100% load, during input voltage dropout

For configuration-specific power specifications, use the Cisco [UCS Power Calculator](#)

Environmental Specifications

The environmental specifications for the HXAF240c M5 server are listed in [Table 36](#).

Table 36 Environmental Specifications

Parameter	Minimum
Operating Temperature	<p>Dry bulb temperature of 10°C to 35°C (50°F to 95°F)</p> <p>Maximum temperature change of 20°C (36°F) per hour (a temperature change within a specified period of time and not a rate of change)</p> <p>Humidity condition: Uncontrolled, not to exceed 50% RH starting condition</p> <p>Derate the maximum temperature by 1°C (33.8°F) per every 305 meters of altitude above 900m</p>
Extended Operating Temperature	<p>5°C to 40°C (41°F to 104°F) with no direct sunlight</p> <p>Humidity condition: Uncontrolled, not to exceed 50% RH starting condition</p> <p>Derate the maximum temperature by 1°C (33.8°F) per every 305 meters of altitude above 900m</p>
Non-Operating Temperature	Dry bulb temperature of -40°C to 65°C (-40°F to 149°F)
Operating Relative Humidity	<p>10% to 90% and 28°C (82.4°F) maximum dew-point temperature, non-condensing environment</p> <p>Minimum to be higher (more moisture) of -12°C (10.4°F) dew point or 8% relative humidity</p> <p>Maximum to be 24°C (75.2°F) dew point or 90% relative humidity</p>
Non-Operating Relative Humidity	5% to 93% relative humidity, non-condensing, with a maximum wet bulb temperature of 28°C across the 20°C to 40°C dry bulb range.
Maximum Operating Duration	Unlimited
Operating Altitude	A maximum elevation of 3050 meters (10,006 ft)
Non-Operating Altitude	An elevation of 0 to 12,000 meters (39,370 ft)
Sound Power level, Measure A-weighted per ISO7779 LWAd (Bels) Operation at 23°C (73°F)	5.5
Sound Pressure level, Measure A-weighted per ISO7779 LpAm (dBA) Operation at 23°C (73°F)	40

Extended Operating Temperature Hardware Configuration Limits

Table 37 Cisco HXAF240c M5 Extended Operating Temperature Hardware Configuration Limits

Platform ¹	ASHRAE A3 (5°C to 40°C) ²	ASHRAE A4 (5°C to 45°C) ³
Processors:	155W+	155W+ and 105W+ (4 or 6 Cores)
Memory:	LRDIMMs	LRDIMMs
Storage:	M.2 SATA SSDs NVMe SSDs	M.2 SATA SSDs NVMe SSDs HDDs or SSDs (Rear Bays)
Peripherals:	PCIe NVMe SSDs GPUs	PCIe NVMe SSDs GPUs VICs (Slots 1 and 4) NICs (Slots 1 and 4) HBAs (Slots 1 and 4)

Notes:

1. Two PSUs are required and PSU failure is not supported
2. Non-Cisco UCS qualified peripherals and/or peripherals that consume more than 25W are not supported
3. High power or maximum power fan control policy must be applied

Compliance Requirements

The regulatory compliance requirements for servers are listed in [Table 38](#).

Table 38 HX Regulatory Compliance Requirements

Parameter	Description
Regulatory Compliance	Products should comply with CE Markings per directives 2014/30/EU and 2014/35/EU
Safety	UL 60950-1 Second Edition CAN/CSA-C22.2 No. 60950-1 Second Edition EN 60950-1 Second Edition IEC 60950-1 Second Edition AS/NZS 60950-1 GB4943 2001
EMC - Emissions	47CFR Part 15 (CFR 47) Class A AS/NZS CISPR32 Class A CISPR32 Class A EN55032 Class A ICES003 Class A VCCI Class A EN61000-3-2 EN61000-3-3 KN32 Class A CNS13438 Class A
EMC - Immunity	EN55024 CISPR24 EN300386 KN35



Americas Headquarters
Cisco Systems, Inc.
San Jose, CA

Asia Pacific Headquarters
Cisco Systems (USA) Pte. Ltd.
Singapore

Europe Headquarters
Cisco Systems International BV Amsterdam,
The Netherlands

Cisco has more than 200 offices worldwide. Addresses, phone numbers, and fax numbers are listed on the Cisco Website at www.cisco.com/go/offices.

Cisco and the Cisco Logo are trademarks of Cisco Systems, Inc. and/or its affiliates in the U.S. and other countries. A listing of Cisco's trademarks can be found at www.cisco.com/go/trademarks. Third party trademarks mentioned are the property of their respective owners. The use of the word partner does not imply a partnership relationship between Cisco and any other company. (1005R)