



# Power Management Solutions



CHATSWORTH  
PRODUCTS

Protecting  
your technology  
investment.

# Power Expertise and Innovation

As the interconnected world of the Internet of Everything (IoE) pushes networks to the Edge for better latency and faster processing, power demands in the data center take on more sophisticated roles.

More than ever, enterprise data centers, colocation providers and premise network facilities must rely on power management solutions to support increasing power densities and remote monitoring requirements to stay ahead.

Chatsworth Products (CPI) provides an extensive line of power management products and technology that deliver safe and efficient power distribution to all applications. Ranging from the innovative features of eConnect® Power Distribution Units (PDUs), such as the patented Click Secure Locking Outlets and Secure Array™ IP Consolidation, to basic Power Strips and In-Line Meters, each of CPI's power management products are specifically designed with flexibility and scalability in mind. Additionally, CPI's power products are backed by an industry-leading standard warranty with an optional extended warranty.

## eConnect PDUs

eConnect PDUs are advanced, intelligent PDUs with high ambient temperature ratings, optional Click Secure Locking Outlets to prevent accidental disconnections and Secure Array IP Consolidation to group up to 32 PDUs under one IP address. eConnect PDUs provide detailed monitoring and control down to the outlet level. They are available in vertical and horizontal configurations and are ideal for use in today's high-density data centers. (Pages 4-17)

## PDUs and PowerWedge

Additional PDUs for small-to-medium density power distribution is also available, and provide optional local metering. PowerWedge provides high-outlet density for intelligent power distribution in tight spaces. (Pages 21-22)

## Power Strips

Power Strips offer basic, dependable low-density power distribution with optional surge protection and local metering capabilities. They are available in vertical and horizontal configurations. (Pages 23-25)

## Power Monitoring Software

Monitoring software turns the data collected by eConnect PDUs or other intelligent PDUs into actionable information. Users can build custom dashboards that show power and environmental trends, monitor capacity and alarms, create power charge back reports and group and control devices across racks, rows and sites, among other options. (Pages 18-20)

## Accessories

Several power management accessories are available. Temperature and humidity sensors extend monitoring capabilities, specialized brackets mount PDUs in racks and cabinets and unique input power cords are available for eConnect PDUs. (Pages 26-28)

## Choose the functionality that meets your needs:

Functionality	eConnect PDUs	PDUs and PowerWedge	Power Strips
<b>Basic</b> - Simple, reliable power distribution to equipment in your cabinets when no power monitoring is required.	✓*	✓**	✓
<b>Metered</b> - Includes local current monitoring of attached equipment.	✓*	✓	✓
<b>Monitored</b> - Includes local and remote power and environmental monitoring for monitoring total power used by attached equipment.	✓	✓	
<b>Monitored Pro</b> - Power monitoring for each outlet on the PDU, allowing you to remotely measure individual power used by each piece of equipment attached to the PDU.	✓*		
<b>Switched</b> - Allows remote PDU outlet switching when you need to cycle power to the attached equipment.	✓	✓**	
<b>Switched Pro</b> - Provides power monitoring and control for each outlet on the PDU, allowing remote access to measure and cycle power for each piece of equipment attached to the PDU.	✓*		

\*Vertical configuration only.  
\*\*Horizontal configuration only.

Take advantage of CPI's power expertise and innovation to protect and expand the life of your IT equipment.

# eConnect PDUs Offer Physical Reliability with Superior Monitoring Capability

As consolidation, virtualization and cloud computing continue to grow, networks begin increasing the demand of physical factors, such as kilowattage and temperature ratings, pushing data center facilities to their limits. Improving environmental stability to increase efficiency has become key to optimizing data center performance. CPI's eConnect PDUs connect you to your evolving enterprise data center with intelligent power solutions that have been developed to meet these unique infrastructure needs.

## Why CPI eConnect PDUs?

### Comprehensive Portfolio

- Progressive features: Basic, Metered, Monitored, Monitored Pro, Switched and Switched Pro
- Single- and three-phase voltages
- Up to 100A input
- Vertical and horizontal configurations
- Up to 60 outlet configurations
- C13, C19 and NEMA outlets
- Mixed voltage/plug type configurations
- Cabinet lock and DCIM software integration

### Quick, Low-Cost Deployment

- Secure Array IP Consolidation
- Ability to ship preinstalled in cabinets at no additional cost
- Tool-less mounting buttons
- Top or bottom, left or right input cord orientation
- Load balancing and IP setup through centralized display

### Simple, Ongoing Management

- Embedded web-based GUI
- Consolidated dashboard view for entire Secure Array
- Email alerts and alarms
- Event and data logging
- Grouping capability
- Mass firmware upgrades
- Consolidated power, environmental and access management for cabinets

### High Availability

- 149°F (65°C) ambient temperature rating
- Click Secure Locking Outlets
- 100% rated hydraulic magnetic breakers
- Integrated environmental monitoring
- Thresholds and alarm notifications
- Normally closed relays
- Sequential startup

### High Levels of Security

- HTTP/HTTPS support
- SNMPv1, v2 and v3 support
- RADIUS and LDAP integration
- User and admin permission levels
- SSL support
- Cabinet lock integration

### Customization Capabilities

- PDU faceplate colors
- Power cord lengths
- Hardwired input
- Input plug types
- Receptacle mix and quantity
- Mounting brackets



Functionality	Basic Power Distribution	Inlet Metering	Branch Circuit Metering	Networking	Access Control	Outlet Metering	Switched Outlets
<b>Basic</b> - Simple, reliable power distribution to equipment in your cabinets. Select a Basic PDU when no power monitoring is required.	✓						
<b>Metered</b> - Includes local LED display for easy reading of input current across phases. Selected a Metered PDU when networking of PDUs is not an option.	✓	✓					
<b>Monitored</b> - Includes local and remote power monitoring for the PDU. Select a Monitored PDU when you want to monitor total power usage.	✓	✓	✓	✓	✓		
<b>Monitored Pro</b> - Includes local and remote power monitoring for each outlet on the PDU. Select a Monitored Pro PDU when you need to remotely measure individual power used by each piece of equipment.	✓	✓	✓	✓	✓	✓	
<b>Switched</b> - Includes local and remote power monitoring for the PDU and individual outlet control. Select a Switched PDU if you need to remotely turn power on or off at each outlet.	✓	✓	✓	✓	✓		✓
<b>Switched Pro</b> - Includes local and remote power monitoring for the PDU and each outlet on the PDU, as well as individual outlet control. Select a Switched Pro PDU to remotely measure and control power at each outlet.	✓	✓	✓	✓	✓	✓	✓



# eConnect® PDUs

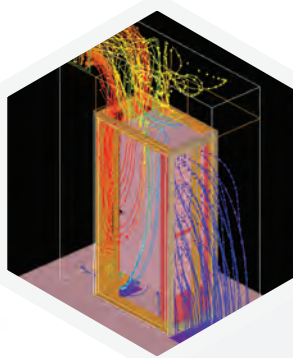

## Thermal Resilience

All eConnect models feature ambient temperature rating up to 149°F (65°C) at the input power rating (kW).



## Locking Outlets

Patented Click Secure Technology prevents accidental disconnections without the need for additional proprietary power cords.



## Universal Tool-less Mounting

Simple, tool-less mounting options are available for on-site installation. All horizontal PDUs include installation hardware.



## Advanced Current Protection

Single and three-phase configurations allow for overcurrent and phase balancing protection. UL486 Breaker withstands high temperatures.



## Over 350 Configurations

Horizontal and vertical configurations with multiple plug types are available to match your unique requirements.



## Complimentary Preinstallation

Simplify ordering, shipping and installation by requesting eConnect PDUs to be installed in CPI's GF-Series GlobalFrame® or F-Series TeraFrame® Cabinets before they arrive.



**Add Power. Make it easy.**

## Choose the functionality that meets your needs:

Included Feature	Basic	Metered	Monitored	Monitored Pro	Switched	Switched Pro
Locking Outlets	✓	✓	✓	✓	✓	✓
Tool-less Mounting	✓	✓	✓	✓	✓	✓
Low-Profile Design	✓	✓	✓	✓	✓	✓
Use in High Temperature Applications up to 149°F (65°C)	✓	✓	✓	✓	✓	✓
Branch/Phase Circuit Breakers	✓	✓	✓	✓	✓	✓
Branch/Phase Monitoring			✓	✓	✓	✓
Local Multi-functional LCD Screen			✓	✓	✓	✓
Temp/Humidity Sensor Port			✓	✓	✓	✓
Local LED Metering		✓				
Network Access for Remote Monitoring (IPv4, IPv6, SNMP)			✓	✓	✓	✓
Network Setup from Local Display			✓	✓	✓	✓
Built-in Web Interface and GUI			✓	✓	✓	✓
Secure Array Linking			✓	✓	✓	✓
Alarm Thresholds			✓	✓	✓	✓
Forward SNMP Traps			✓	✓	✓	✓
Email Notification			✓	✓	✓	✓
Event and Data Logging			✓	✓	✓	✓
Monitored Outlets (Voltage, Current, Power, Energy)				✓		✓
Group Outlets for Remote Current Monitoring				✓		✓
Switched Outlets					✓	✓
Cycle Individual Outlets Remotely					✓	✓
Access Control					✓	✓
Vertical Configurations	✓		✓	✓	✓	✓
Horizontal Configurations			✓		✓	



### eConnect PDU Product Selector

Select the best PDU for your application by narrowing down options based on requirements. You can compare up to four PDUs at once, then email or print the results.

[www.chatsworth.com/econnect-selector](http://www.chatsworth.com/econnect-selector)





# Basic eConnect PDUs

Select Basic eConnect PDUs in high-density applications where no power monitoring is required.

## Features and benefits of the Basic eConnect PDU:

- Click Secure Locking Outlets are available on vertical configurations to securely fasten straight power cords to all IEC outlets
- Withstands hot aisle temperatures of high-density data center environments with an ambient temperature rating of 149°F (65°C)
- Low-profile, UL 489 listed, hydraulic magnetic breakers resist the effects of high temperatures, and limit current to protect equipment
- Vertical PDUs fit in the zero U space behind rear mounting rails, and do not block exhaust airflow from equipment
- Universal tool-less mounting is integrated into all PDUs, which will fit most standard data center cabinets
- Various combinations of IEC C13, IEC C19 and NEMA 5-20R outlets deliver 208 nominal or 120 nominal VAC to equipment
- Outlets are spaced and grouped for convenience
- On multi-breaker PDUs, breaker and outlet groups are color-coded for easy identification
- Various IEC and NEMA style plugs for power inputs for IEC C20 inlets that allow site specific power cords
- Option to preinstall PDUs is available for all cabinet orders

*\*Available in vertical configurations only.*

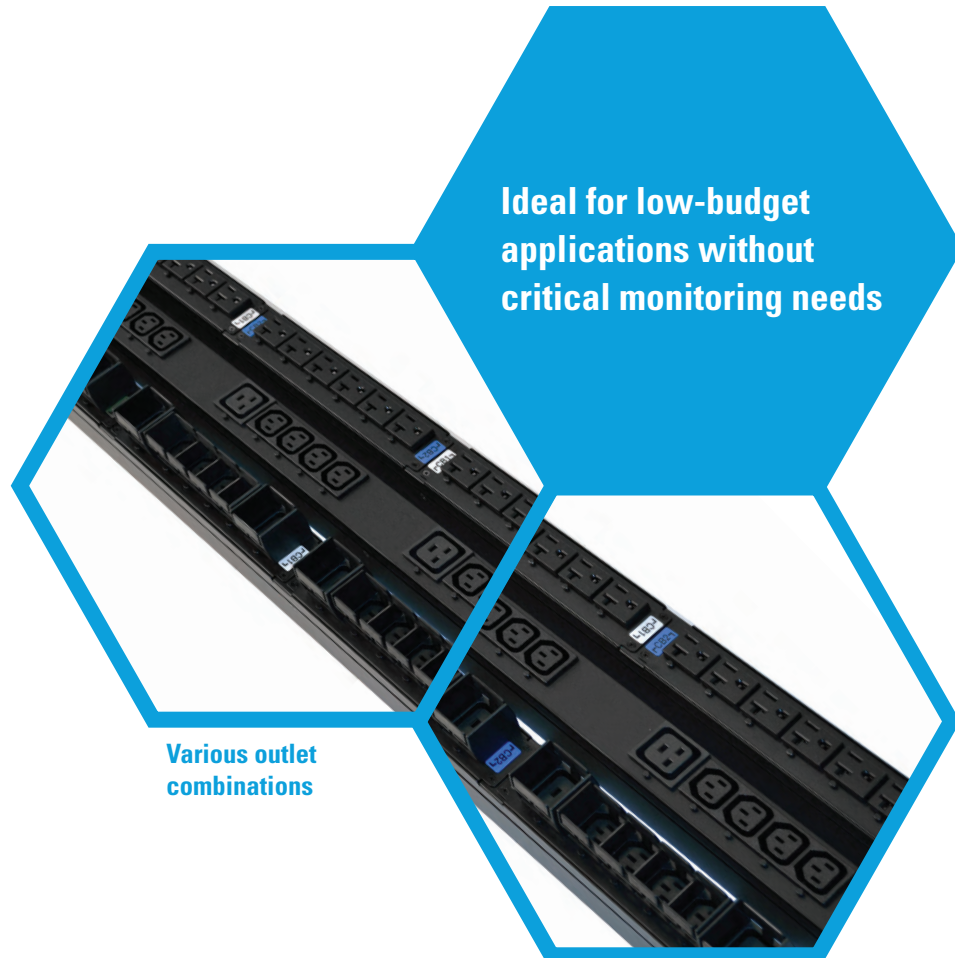

L1-1F0G3

Basic Vertical eConnect PDUs								
Part Number	Input			Output		Dims - in (mm)		
	Amp	kW*	Plug	Breakers (Magnetic)	Outlets	H***	W	D
<b>100-240 Volt, Single-Phase Input - Worldwide</b>								
L1-1A1E3	16/20 <sup>1</sup>	3.6****	C20 Inlet**	1 x 2P 20A	(24) C13, (6) C19	70.5 (1791)	2.2 (56)	2.2 (56)
<b>120 Volt, Single-Phase Input - North America Models</b>								
P1-1C0A5	20	1.9	L5-20P	1 x 2P 20A	(24) 5-20R	70.5 (1791)	2.2 (56)	2.2 (56)
P1-1D0A5	30	2.8	L5-30P	2 x 2P 20A	(24) 5-20R	70.5 (1791)	2.2 (56)	2.2 (56)
P1-1D0B5	30	2.8	L5-30P	2 x 2P 20A	(36) 5-20R	70.5 (1791)	2.2 (56)	2.2 (56)
<b>120-208 Volt, Single-Phase Input - North America Models</b>								
L1-1K0K4	30	4.9	L14-30P	2 x 2P 20A	(24) C13, (6) C19, (6) 5-20R	70.5 (1791)	2.2 (56)	2.2 (56)
<b>208 Volt, Single-Phase Input - North America Models</b>								
L1-1E0E3	20	3.3	L6-20P	1 x 2P 20A	(24) C13, (6) C19	70.5 (1791)	2.2 (56)	2.2 (56)
L1-1F0E3	30	4.9	L6-30P	2 x 2P 20A	(24) C13, (6) C19	70.5 (1791)	2.2 (56)	2.2 (56)
L1-1F0G3	30	4.9	L6-30P	2 x 2P 20A	(30) C13, (6) C19	70.5 (1791)	2.2 (56)	2.2 (56)
L1-1F0B1	30	4.9	L6-30P	2 x 2P 20A	(36) C13	70.5 (1791)	2.2 (56)	2.2 (56)
<b>120-208 Volt, Three-Phase Input - North America Models</b>								
L1-1N0K4	20	5.7	L21-20P	3 x 2P 20A	(24) C13, (6) C19, (6) 5-20R	70.5 (1791)	2.2 (56)	2.2 (56)
L1-1N0G3	20	5.7	L21-20P	3 x 2P 20A	(30) C13, (6) C19	70.5 (1791)	2.2 (56)	2.2 (56)
L1-1N0B1	20	5.7	L21-20P	3 x 2P 20A	(36) C13	70.5 (1791)	2.2 (56)	2.2 (56)
L1-1P0K4	30	8.6	L21-30P	3 x 2P 20A	(24) C13, (6) C19, (6) 5-20R	70.5 (1791)	2.2 (56)	2.2 (56)
L1-1P0G3	30	8.6	L21-30P	3 x 2P 20A	(30) C13, (6) C19	70.5 (1791)	2.2 (56)	2.2 (56)
L1-1P0B1	30	8.6	L21-30P	3 x 2P 20A	(36) C13	70.5 (1791)	2.2 (56)	2.2 (56)
<b>208 Volt, Three-Phase Input - North America Models</b>								
L1-1M0B1	30	8.6	L15-30P	3 x 2P 20A	(36) C13	70.5 (1791)	2.2 (56)	2.2 (56)
L1-1M0G3	30	8.6	L15-30P	3 x 2P 20A	(30) C13, (6) C19	70.5 (1791)	2.2 (56)	2.2 (56)
L1-1T0F3	50	9.9	CS8365C	3 x 2P 20A	(24) C13, (12) C19	70.5 (1791)	2.2 (56)	2.2 (56)
L1-1T0G3	50	9.9	CS8365C	3 x 2P 20A	(30) C13, (6) C19	70.5 (1791)	2.2 (56)	2.2 (56)
L1-1T0B1	50	5.7	CS8365C	3 x 2P 20A	(36) C13	70.5 (1791)	2.2 (56)	2.2 (56)
L1-3U0H3	50	14.3	CS8365C	6 x 2P 20A	(36) C13, (12) C19	75.0 (1905)	2.7 (69)	2.2 (56)
L1-3U0F3	50	14.3	CS8365C	6 x 2P 20A	(24) C13, (12) C19	75.0 (1905)	2.7 (69)	2.2 (56)
L1-3V0F3	60	17.2	IEC 60A 3P+E	6 x 2P 20A	(24) C13, (12) C19	75.0 (1905)	2.7 (69)	2.2 (56)
<b>240/415 Volt, Three-Phase Input - North America Models</b>								
L1-2R0H3	30	17.2	L22-30P	6 x 1P 20A	(36) C13, (6) C19	72.0 (1829)	2.35 (60)	2.2 (56)
L1-2R0F3	30	17.2	L22-30P	6 x 2P 20A	(24) C13, (12) C19	72.0 (1829)	2.35 (60)	2.2 (56)
<b>220-240 Volt, Single-Phase Input - Outside North America</b>								
L1-1G0E3	16	3.6¥	IEC 16A 1P+N+E	1 x 2P 16A	(24) C13, (6) C19	70.5 (1791)	2.2 (56)	2.2 (56)
L1-1H0E3	32	7.3¥	IEC 32A 1P+N+E	2 x 2P 16A	(24) C13, (6) C19	70.5 (1791)	2.2 (56)	2.2 (56)
L1-1H0G3	32	7.3¥	IEC 32A 1P+N+E	2 x 2P 16A	(30) C13, (6) C19	70.5 (1791)	2.2 (56)	2.2 (56)
L1-1H0B1	32	7.3¥	IEC 32A 1P+N+E	2 x 2P 16A	(36) C13	70.5 (1791)	2.2 (56)	2.2 (56)
<b>220-240/380-415 Volt, Three-Phase Input - Outside North America</b>								
L1-1W0G3	16	11=	IEC 16A 3P+N+E	3 x 2P 16A	(30) C13, (6) C19	70.5 (1791)	2.2 (56)	2.2 (56)
L1-1W0B1	16	11=	IEC 16A 3P+N+E	3 x 2P 20A	(36) C13	70.5 (1791)	2.2 (56)	2.2 (56)
L1-2Y0F3	32	22=	IEC 32A 3P+N+E	6 x 1P 16A	(24) C13, (12) C19	72.0 (1829)	2.35 (60)	2.2 (56)
L1-2Y0H3	32	22=	IEC 32A 3P+N+E	6 x 1P 16A	(36) C13, (6) C19	72.0 (1829)	2.35 (60)	2.2 (56)

Notes: Part Number LX= Locking Outlets, PX= Standard Outlets. Order mounting brackets separately. On Single-Phase PDUs, output voltage equals input voltage. On Three-Phase PDUs, 208 VAC nominal output through C13 and C19 outlets; 120 VAC nominal output through NEMA 5-20R outlets.

<sup>1</sup>Amperage: 20A within North America and 16A Outside of North America.

\* For kW column, all values are derated calculations per UL for use in North America. The Input Amp column lists the maximum rated value of the Input Plug/inlet and circuit breaker rating. UL/NEC regulatory code requires current ratings on product labels to be derated to 80% of the maximum rated values (for example: 20 Amp = 16 Amp on UL product label). For the Input kW column, all values are derated calculations per UL for use in North America.

\*\* Order power cord separately for PDU with C20 input.

\*\*\* PDUs that are 72"H (1829 mm) must be placed in 44U or taller CPI cabinets. PDUs that are 75"H (1905 mm) must be placed in 45U or taller CPI cabinets.

\*\*\*\* Capacity when used at 230V with a 16A power cord. Actual capacity will vary if connected to lower voltage or to a lower amperage input plug.

¥ Capacity when used at a Nominal voltage of 230V.

= Capacity when used at a Nominal voltage of 230V/415V 3 Phase.



Configure your CPI cabinet with power installed before it arrives.  
Add power. Make it easy. [www.chatsworth.com/configurators](http://www.chatsworth.com/configurators).

# Metered eConnect PDUs

Select Metered eConnect PDUs for metering capabilities in non-networked applications. The local LED display provides easy reading of input current to help with initial installation and proper balanced operation.

## Features and benefits of the Metered eConnect PDU:

- Provides input current reading for phase load balancing on three-phase PDUs or A/B power load balancing with multiple PDUs
- Click Secure Locking Outlets are available on vertical configurations to securely fasten straight power cords to all IEC outlets
- Withstands hot aisle temperatures of high-density data center environments with an ambient temperature rating of 149°F (65°C)
- Low-profile, UL 489 listed, hydraulic magnetic breakers resist the effects of high temperatures, and limit current to protect equipment
- Vertical PDUs fit in the zero U space behind rear mounting rails, and do not block exhaust airflow from equipment
- Universal tool-less mounting is integrated into all PDUs, which will fit most standard data center cabinets
- Various combinations of IEC C13, IEC C19 and NEMA 5-20R outlets deliver 208 nominal or 120 nominal VAC to equipment
- Outlets are spaced and grouped for convenience
- On multi-breaker PDUs, breaker and outlet groups are color-coded for easy identification
- Various IEC and NEMA style plugs for power inputs for IEC C20 inlets that allow site specific power cords
- Option to preinstall PDUs is available for all cabinet orders

*\*Available in vertical configurations only.*



Provides reliable current reading for phase load balancing in non-networked applications

Four-digit LED display



L2-1F0G3



Metered Vertical eConnect PDUs								
Part Number	Input			Output		Dims - in (mm)		
	Amp	kW*	Plug	Breakers (Magnetic)	Outlets	H***	W	D
<b>100-240 Volt, Single-Phase Input - Worldwide</b>								
L2-1A1E3	20	1.9	C20 Inlet**	1 x 2P 20A	(24) C13, (6) C19	70.5 (1791)	2.2 (56)	2.2 (56)
<b>120 Volt, Single-Phase Input - North America Models</b>								
P2-1C0A5	20	1.9	L5-20P	1 x 2P 20A	(24) 5-20R	70.5 (1791)	2.2 (56)	2.2 (56)
P2-1D0A5	30	2.8	L5-30P	2 x 2P 20A	(24) 5-20R	70.5 (1791)	2.2 (56)	2.2 (56)
P2-1D0B5	30	2.8	L5-30P	2 x 2P 20A	(36) 5-20R	70.5 (1791)	2.2 (56)	2.2 (56)
<b>120-208 Volt, Single-Phase Input - North America Models</b>								
L2-1K0K4	30	4.9	L14-30P	2 x 2P 20A	(24) C13, (6) C19, (6) 5-20R	70.5 (1791)	2.2 (56)	2.2 (56)
<b>208 Volt, Single-Phase Input - North America Models</b>								
L2-1E0E3	20	3.3	L6-20P	1 x 2P 20A	(24) C13, (6) C19	70.5 (1791)	2.2 (56)	2.2 (56)
L2-1F0G3	30	4.9	L6-30P	2 x 2P 20A	(24) C13, (6) C19	70.5 (1791)	2.2 (56)	2.2 (56)
L2-1F0B1	30	4.9	L6-30P	2 x 2P 20A	(36) C13	70.5 (1791)	2.2 (56)	2.2 (56)
<b>120-208 Volt, Three-Phase Input - North America Models</b>								
L2-1N0K4	20	5.7	L21-20P	3 x 2P 20A	(24) C13, (6) C19, (6) 5-20R	70.5 (1791)	2.2 (56)	2.2 (56)
L2-1N0G3	20	5.7	L21-20P	3 x 2P 20A	(30) C13, (6) C19	70.5 (1791)	2.2 (56)	2.2 (56)
L2-1N0B1	20	5.7	L21-20P	3 x 2P 20A	(36) C13	70.5 (1791)	2.2 (56)	2.2 (56)
L2-1P0K4	30	8.6	L21-30P	3 x 2P 20A	(24) C13, (6) C19, (6) 5-20R	70.5 (1791)	2.2 (56)	2.2 (56)
L2-1P0G3	30	8.6	L21-30P	3 x 2P 20A	(30) C13, (6) C19	70.5 (1791)	2.2 (56)	2.2 (56)
L2-1P0B1	30	8.6	L21-30P	3 x 2P 20A	(36) C13	70.5 (1791)	2.2 (56)	2.2 (56)
<b>208 Volt, Three-Phase Input - North America Models</b>								
L2-1M0B1	30	8.6	L15-30P	3 x 2P 20A	(36) C13	70.5 (1791)	2.2 (56)	2.2 (56)
L2-1M0G3	30	8.6	L15-30P	3 x 2P 20A	(30) C13, (6) C19	70.5 (1791)	2.2 (56)	2.2 (56)
L2-1T0F3	50	9.9	CS8365C	3 x 2P 20A	(24) C13, (12) C19	70.5 (1791)	2.2 (56)	2.2 (56)
L2-1T0G3	50	9.9	CS8365C	3 x 2P 20A	(30) C13, (6) C19	70.5 (1791)	2.2 (56)	2.2 (56)
L2-1T0B1	50	9.9	CS8365C	3 x 2P 20A	(36) C13	70.5 (1791)	2.2 (56)	2.2 (56)
L2-3U0H3	50	14.3	CS8365C	6 x 2P 20A	(36) C13, (6) C19	75.0 (1905)	2.7 (69)	2.2 (56)
L2-3U0F3	50	14.3	CS8365C	6 x 2P 20A	(24) C13, (12) C19	75.0 (1905)	2.7 (69)	2.2 (56)
L2-3V0F3	60	17.2	IEC 60A 3P+E	6 x 2P 20A	(24) C13, (12) C19	75.0 (1905)	2.7 (69)	2.2 (56)
<b>240/415 Volt, Three-Phase Input - North America Models</b>								
L2-2R0H3	30	17.2	L22-30P	6 x 1P 20A	(36) C13, (6) C19	72.0 (1829)	2.35 (60)	2.2 (56)
L2-2R0F3	30	17.2	L22-30P	6 x 2P 20A	(24) C13, (12) C19	72.0 (1829)	2.35 (60)	2.2 (56)
<b>220-240 Volt, Single-Phase Input - Outside North America</b>								
L2-1H0E3	32	7.3¥	IEC 32A 1P+N+E	2 x 2P 16A	(24) C13, (6) C19	70.5 (1791)	2.2 (56)	2.2 (56)
L2-1H0G3	32	7.3¥	IEC 32A 1P+N+E	2 x 2P 16A	(30) C13, (6) C19	70.5 (1791)	2.2 (56)	2.2 (56)
L2-1H0B1	32	7.3¥	IEC 32A 1P+N+E	2 x 2P 16A	(36) C13	70.5 (1791)	2.2 (56)	2.2 (56)
<b>220-240/380-415 Volt, Three-Phase Input - Outside North America</b>								
L2-1W0G3	16	11=	IEC 16A 3P+N+E	3 x 2P 16A	(30) C13, (6) C19	70.5 (1791)	2.2 (56)	2.2 (56)
L2-1W0B1	16	11=	IEC 16A 3P+N+E	3 x 2P 20A	(36) C13	70.5 (1791)	2.2 (56)	2.2 (56)
L2-2Y0F3	32	22=	IEC 32A 3P+N+E	6 x 1P 16A	(24) C13, (12) C19	72.0 (1829)	2.35 (60)	2.2 (56)
L2-2Y0H3	32	22=	IEC 32A 3P+N+E	6 x 1P 16A	(36) C13, (6) C19	72.0 (1829)	2.35 (60)	2.2 (56)

Notes: Part Number LX= Locking Outlets, PX= Standard Outlets. Order mounting brackets separately. On Single-Phase PDUs, output voltage equals input voltage. On Three-Phase PDUs, 208 VAC nominal output through C13 and C19 outlets; 120 VAC nominal output through NEMA 5-20R outlets.

\*Amperage: 20A within North America and 16A Outside of North America.

\* For kW column, all values are derated calculations per UL for use in North America. The Input Amp column lists the maximum rated value of the Input Plug/inlet and circuit breaker rating. UL/NEC regulatory code requires current ratings on product labels to be derated to 80% of the maximum rated values (for example: 20 Amp = 16 Amp on UL product label). For the Input kW column, all values are derated calculations per UL for use in North America.

\*\* Order power cord separately for PDU with C20 input.

\*\*\* PDUs that are 72"H (1829 mm) must be placed in 44U or taller CPI cabinets. PDUs that are 75"H (1905 mm) must be placed in 45U or taller CPI cabinets.

\*\*\*\* Capacity when used at 230V with a 16A power cord. Actual capacity will vary if connected to lower voltage or to a lower amperage input plug.

¥ Capacity when used at a Nominal voltage of 230V.

= Capacity when used at a Nominal voltage of 230V/415V 3 Phase.



Configure your CPI cabinet with power installed before it arrives.  
Add power. Make it easy. [www.chatsworth.com/configurators](http://www.chatsworth.com/configurators).

# Monitored eConnect PDUs

Select Monitored eConnect PDUs in high-density applications that require PDU linking capability and continuous, automated monitoring at the rack level. Through Secure Array Technology, Monitored eConnect PDUs allow 32 PDUs to be connected under a single IP address. Additional advantages include full integration with cabinet access control, environmental monitoring and DCIM software.

## Features and benefits of the Monitored eConnect PDU:

Monitored eConnect PDUs include all the features available on Basic eConnect, as well as the following additional benefits:

### Remote Power Monitoring and Control

- Secure Array IP Consolidation allows up to 32 PDUs to be linked under a single IP address using standard Ethernet cables, supports features such as outlet grouping, data logging, threshold alarms and PDU cloning. A second IP address provides failover capability, which allows functioning PDUs to continue communicating when a PDU in the array loses connectivity
- Continuous voltage, current, power (kW), power factor and energy (kWh) monitoring for each branch or phase (breaker) on the unit with  $\pm 1\%$  accuracy power measurement
- Remote PDU access via web browser for detailed measurements and power totals. Web browser supports linked PDU browsing, alarm threshold settings for temperature, humidity, power and access control, and summarizes alarms, forwards alarm notification emails to staff and logs data and events
- Compatibility with eConnect Electronic Access Control (EAC) and many DCIM software packages that accept SNMP v1, v2 and v3 traps

### Local features include:

- A central LCD screen with text rotation. Displays alarm notification and total voltage, current and power usage for each branch/phase on the PDU, as well as line input current on three-phase units
- Support of Initial setup of IP and subnet addresses from LCD screen
- USB ports for firmware updates, serial ports for Secure Array and network ports for web access
- An external connection for two probes with temperature and humidity sensors for monitoring environmental condition
- Vertical configurations feature up to 60 outlets



Secure Array technology links up to 32 PDUs under one IP address



Monitored Horizontal eConnect PDUs								
Part Number	Input			Output		Dimensions - in (mm)		
	Amp	kW*	Plug	Breakers	Outlets	H	W	D
<b>100-240 Volt, Single-Phase - Worldwide</b>								
P3-5A1W1	16	3.6****	C20 Inlet**	1 x 2P 16A	(12) C13	2U	19"EIA (486.2)	10.1 (257)
<b>120 Volt, Single-Phase Input - North America Models</b>								
P3-5C0W5	20	1.9	L5-20P	1 x 2P 20A	(12) 5-20R	2U	19"EIA (486.2)	10.1 (257)
P3-5D0W5	30	2.8	L5-30P	2 x 2P 20A	(12) 5-20R	2U	19"EIA (486.2)	10.1 (257)
<b>208 Volt, Single-Phase - North America Models</b>								
P3-5E1W1	20	3.3	L6-20P	1 x 2P 16A	(12) C13	2U	19"EIA (486.2)	10.1 (257)
P3-5F0Y3	30	4.9	L6-30P	2 x 2P 20A	(8) C13, (4) C19	2U	19"EIA (486.2)	10.1 (257)
P3-5F0W1	30	4.9	L6-30P	2 x 2P 20A	(12) C13	2U	19"EIA (486.2)	10.1 (257)
<b>220-240 Volt, Single-Phase - Outside North America</b>								
P3-5H0W1	32	7.3¥	IEC 32A 1P+N+E	2 x 2P 16A	(12) C13	2U	19"EIA (486.2)	10.1 (257)
P3-5H0Y3	32	7.3¥	IEC 32A 1P+N+E	2 x 2P 16A	(8) C13, (4) C19	2U	19"EIA (486.2)	10.1 (257)

Notes: Part Number LX= Locking Outlets, PX= Standard Outlets. Horizontal PDUs that are 2U, 19"EIA are 3.5"H (89 mm) and 17"W (432 mm). \* For kW column, all values are derated calculations per UL for use in North America. The Input Amp column lists the maximum rated value of the Input Plug/inlet and circuit breaker rating. UL/NEC regulatory code requires current ratings on product labels to be derated to 80% of the maximum rated values (for example: 20 Amp = 16 Amp on UL product label). For the Input kW column, all values are derated calculations per UL for use in North America. For 50A PDUs, the 50A CS8365C plug is rated for 50A, but maximum input is 35A (12.6 kw) on three breaker PDUs.



Horizontal chassis available

L3-1P0K4

Monitored Vertical eConnect PDUs								
Part Number	Input			Output		Dims - in (mm)		
	Amp	kW*	Plug	Breakers (Magnetic)	Outlets	H***	W	D
<b>100-240 Volt, Single-Phase Input - Worldwide</b>								
L3-1A1E3	16/20 <sup>1</sup>	3.6****	C20 Inlet**	1 x 2P 20A	(24) C13, (6) C19	70.5 (1791)	2.2 (56)	2.2 (56)
<b>120 Volt, Single-Phase Input - North America Models</b>								
P3-1A1A5	20	1.9	C20 Inlet**	1 x 2P 20A	(24) 5-20R	70.5 (1791)	2.2 (56)	2.2 (56)
P3-1C0A5	20	1.9	L5-20P	1 x 2P 20A	(24) 5-20R	70.5 (1791)	2.2 (56)	2.2 (56)
P3-1A1B5	20	1.9	C20 Inlet**	1 x 2P 20A	(36) 5-20R	70.5 (1791)	2.2 (56)	2.2 (56)
P3-1C0B5	20	1.9	L5-20P	1 x 2P 20A	(36) 5-20R	70.5 (1791)	2.2 (56)	2.2 (56)
P3-1D0A5	30	2.8	L5-30P	2 x 2P 20A	(24) 5-20R	70.5 (1791)	2.2 (56)	2.2 (56)
P3-1D0B5	30	2.8	L5-30P	2 x 2P 20A	(36) 5-20R	70.5 (1791)	2.2 (56)	2.2 (56)
<b>120-208 Volt, Single-Phase Input - North America Models</b>								
P3-1J0K4	20	3.3	L14-20P	1 x 2P 20A	(24) C13, (6) C19, (6) 5-20R	70.5 (1791)	2.2 (56)	2.2 (56)
L3-1K0K4	30	4.9	L14-30P	2 x 2P 20A	(24) C13, (6) C19, (6) 5-20R	70.5 (1791)	2.2 (56)	2.2 (56)
<b>208 Volt, Single-Phase Input - North America Models</b>								
L3-1E0E3	20	3.3	L6-20P	1 x 2P 20A	(24) C13, (6) C19	70.5 (1791)	2.2 (56)	2.2 (56)
L3-1F0B1	30	4.9	L6-30P	2 x 2P 20A	(36) C13	70.5 (1791)	2.2 (56)	2.2 (56)
L3-1F0E3	30	4.9	L6-30P	2 x 2P 20A	(24) C13, (6) C19	70.5 (1791)	2.2 (56)	2.2 (56)
L3-1F0G3	30	4.9	L6-30P	2 x 2P 20A	(30) C13, (6) C19	70.5 (1791)	2.2 (56)	2.2 (56)
<b>120-208 Volt, Three-Phase Input - North America Models</b>								
L3-1N0B1	20	5.7	L21-20P	3 x 2P 20A	(36) C13	70.5 (1791)	2.2 (56)	2.2 (56)
L3-1N0G3	20	5.7	L21-20P	3 x 2P 20A	(30) C13, (6) C19	70.5 (1791)	2.2 (56)	2.2 (56)
L3-1N0K4	20	5.7	L21-20P	3 x 2P 20A	(24) C13, (6) C19, (6) 5-20R	70.5 (1791)	2.2 (56)	2.2 (56)
L3-1P0B1	30	8.6	L21-30P	3 x 2P 20A	(36) C13	70.5 (1791)	2.2 (56)	2.2 (56)
L3-1P0F3	30	8.6	L21-30P	3 x 2P 20A	(24) C13, (12) C19	70.5 (1791)	2.2 (56)	2.2 (56)
L3-1P0G3	30	8.6	L21-30P	3 x 2P 20A	(30) C13, (6) C19	70.5 (1791)	2.2 (56)	2.2 (56)
L3-1P0K4	30	8.6	L21-30P	3 x 2P 20A	(24) C13, (6) C19, (6) 5-20R	70.5 (1791)	2.2 (56)	2.2 (56)
<b>208 Volt, Three-Phase Input - North America Models</b>								
L3-1M0B1	30	8.6	L15-30P	3 x 2P 20A	(36) C13	70.5 (1791)	2.2 (56)	2.2 (56)
L3-1M0F3	30	8.6	L15-30P	3 x 2P 20A	(24) C13, (12) C19	70.5 (1791)	2.2 (56)	2.2 (56)
L3-1M0G3	30	8.6	L15-30P	3 x 2P 20A	(30) C13, (6) C19	70.5 (1791)	2.2 (56)	2.2 (56)
L3-1T0B1	50	9.9	CS8365C	3 x 2P 20A	(36) C13	70.5 (1791)	2.2 (56)	2.2 (56)
L3-1T0F3	50	9.9	CS8365C	3 x 2P 20A	(24) C13, (12) C19	70.5 (1791)	2.2 (56)	2.2 (56)
L3-1T0G3	50	9.9	CS8365C	3 x 2P 20A	(30) C13, (6) C19	70.5 (1791)	2.2 (56)	2.2 (56)
L3-3U0H3	50	14.3	CS8365C	6 x 2P 20A	(36) C13, (6) C19	75.0 (1905)	2.7 (69)	2.2 (56)
L3-3U0V3	50	14.3	CS8365C	6 x 2P 20A	(12) C13, (18) C19	75.0 (1905)	2.7 (69)	2.2 (56)
L3-3U041	50	14.3	CS8365C	6 x 2P 20A	(60) C13	77.9 (1978)	2.7 (69)	2.2 (56)
L3-3U0F3	60	17.2	CS8365C	6 x 2P 20A	(24) C13, (12) C19	75.0 (1905)	2.7 (69)	2.2 (56)
L3-3V0F3	60	17.2	IEC 60A 3P+E	6 x 2P 20A	(24) C13, (12) C19	75.0 (1905)	2.7 (69)	2.2 (56)
L3-3V0H3	60	17.2	IEC 60A 3P+E	6 x 2P 20A	(36) C13, (6) C19	75.0 (1905)	2.7 (69)	2.2 (56)
L3-3V0V3	60	17.2	IEC 60A 3P+E	6 x 2P 20A	(12) C13, (18) C19	75.0 (1905)	2.7 (69)	2.2 (56)
L3-3V041	60	17.2	IEC 60A 3P+E	6 x 2P 20A	(60) C13	77.9 (1978)	2.7 (69)	2.2 (56)
<b>240/415 Volt, Three-Phase Input - North America Models</b>								
L3-2R0F3	30	17.2	L22-30P	6 x 1P 20A	(24) C13, (12) C19	72.0 (1829)	2.35 (60)	2.2 (56)
L3-2R0H3	30	17.2	L22-30P	6 x 1P 20A	(36) C13, (6) C19	72.0 (1829)	2.35 (60)	2.2 (56)
L3-2R041	30	17.2	L22-30P	6 x 1P 20A	(60) C13	77.9 (1978)	2.7 (68)	2.2 (56)
<b>220-240 Volt, Single-Phase Input - Outside North America</b>								
L3-1G0E3	16	3.6¥	IEC 16A 1P+N+E	1 x 2P 16A	(24) C13, (6) C19	70.5 (1791)	2.2 (56)	2.2 (56)
L3-1H0E3	32	7.3¥	IEC 32A 1P+N+E	2 x 2P 16A	(24) C13, (6) C19	70.5 (1791)	2.2 (56)	2.2 (56)
L3-1H0G3	32	7.3¥	IEC 32A 1P+N+E	2 x 2P 16A	(30) C13, (6) C19	70.5 (1791)	2.2 (56)	2.2 (56)
L3-1H0B1	32	7.3¥	IEC 32A 1P+N+E	2 x 2P 16A	(36) C13	70.5 (1791)	2.2 (56)	2.2 (56)
<b>220-240/380-415 Volt, Three-Phase Input - Outside North America</b>								
L3-1W0B1	16	11±	IEC 16A 3P+N+E	3 x 2P 20A	(36) C13	70.5 (1791)	2.2 (56)	2.2 (56)
L3-1W0F3	16	11±	IEC 16A 3P+N+E	3 x 2P 20A	(24) C13, (12) C19	70.5 (1791)	2.2 (56)	2.2 (56)
L3-1W0G3	16	11±	IEC 16A 3P+N+E	3 x 2P 16A	(30) C13, (6) C19	70.5 (1791)	2.2 (56)	2.2 (56)
L3-2Y0F3	32	22±	IEC 32A 3P+N+E	6 x 1P 16A	(24) C13, (12) C19	72.0 (1829)	2.35 (60)	2.2 (56)
L3-2Y0H3	32	22±	IEC 32A 3P+N+E	6 x 1P 16A	(36) C13, (6) C19	72.0 (1829)	2.35 (60)	2.2 (56)
L3-2Y041	32	22±	IEC 32A 3P+N+E	6 x 1P 16A	(60) C13	77.9 (1978)	2.7 (68)	2.2 (56)

Notes: See previous table for notes.



# Monitored Pro eConnect PDUs

Select Monitored Pro eConnect PDUs in facilities and colocation sites that require power consumption and power charge back reports. Monitored Pro eConnect PDUs provide power monitoring down to the outlet level, making it possible to identify power consumption for each piece of equipment. Monitored Pro eConnect PDUs also provide outlet grouping and naming across one or multiple PDUs, providing insight into some of the most detailed elements of the infrastructure.

## Features and benefits of the Monitored Pro eConnect PDU:

Monitored Pro eConnect PDUs include all the features available on Monitored eConnect, as well as the following additional benefits:

### Remote Power Monitoring and Control down to the Outlet

- Continuous voltage, current, power and energy monitoring for each outlet on the unit that can be remotely monitored using a web browser and continuous voltage, current, kW, power factor and kWh monitoring for each branch or phase (breaker) on the unit with  $\pm 1\%$  accuracy power measurement
- Outlet naming functionality to identify equipment
- Outlet grouping functionality for consolidation of outlets from multiple PDUs into one group
- Group outlets to see total current use for several pieces of connected equipment
- Set alarms for upper and lower current thresholds for each outlet
- Compatibility with eConnect EAC and many DCIM software packages that accept SNMP v1, v2 and v3 traps

*\*Available in vertical configurations only.*



**Features per-outlet monitoring of voltage, current, kW and kWh levels with a  $\pm 1\%$  metering accuracy for each piece of equipment in the data center**



L4-3V0V3

Monitored Pro Vertical eConnect PDUs								
Part Number	Input			Output		Dims - in (mm)		
	Amp	kW*	Plug	Breakers (Magnetic)	Outlets	H***	W	D
<b>100-240 Volt, Single-Phase Input - Worldwide</b>								
L4-1A1A1	16/20 <sup>1</sup>	3.6****	C20 Inlet**	1 x 2P 20A	(24) C13	70.5 (1791)	2.2 (56)	2.2 (56)
L4-1A1C3	16/20 <sup>1</sup>	3.6****	C20 Inlet**	1 x 2P 20A	(18) C13, (6) C19	70.5 (1791)	2.2 (56)	2.2 (56)
<b>120 Volt, Single-Phase Input - North America Models</b>								
P4-1A1A5	20	1.9	C20 Inlet**	1 x 2P 20A	(24) 5-20R	70.5 (1791)	2.2 (56)	2.2 (56)
P4-1C0A5	20	1.9	L5-20P	1 x 2P 20A	(24) 5-20R	70.5 (1791)	2.2 (56)	2.2 (56)
P4-1D0A5	30	2.8	L5-30P	2 x 2P 20A	(24) 5-20R	70.5 (1791)	2.2 (56)	2.2 (56)
<b>208 Volt, Single-Phase Input - North America Models</b>								
L4-1E0A1	20	3.3	L6-20P	1 X 2P 20A	(24) C13	70.5 (1791)	2.2 (56)	2.2 (56)
L4-1E0C3	20	3.3	L6-20P	1 X 2P 20A	(18) C13, (6) C19	70.5 (1791)	2.2 (56)	2.2 (56)
L4-1F0A1	30	4.9	L6-30P	2 x 2P 20A	(24) C13	70.5 (1791)	2.2 (56)	2.2 (56)
L4-1F0B1	30	4.9	L6-30P	2 x 2P 20A	(36) C13	70.5 (1791)	2.2 (56)	2.2 (56)
L4-1F0C3	30	4.9	L6-30P	2 x 2P 20A	(18) C13, (6) C19	70.5 (1791)	2.2 (56)	2.2 (56)
L4-1F0G3	30	4.9	L6-30P	2 x 2P 20A	(30) C13, (6) C19	70.5 (1791)	2.2 (56)	2.2 (56)
<b>120-208 Volt, Three-Phase Input - North America Models</b>								
L4-1N0A5	20	5.7	L21-20P	3 x 2P 20A	(24) 5-20R	70.5 (1791)	2.2 (56)	2.2 (56)
L4-1N0B1	20	5.7	L21-20P	3 x 2P 20A	(36) C13	70.5 (1791)	2.2 (56)	2.2 (56)
L4-1N0G3	20	5.7	L21-20P	3 x 2P 20A	(30) C13, (6) C19	70.5 (1791)	2.2 (56)	2.2 (56)
P4-1P0A5	30	5.7	L21-30P	3 x 2P 20A	(24) 5-20R	70.5 (1791)	2.2 (56)	2.2 (56)
L4-1P0B1	30	8.6	L21-30P	3 x 2P 20A	(36) C13	70.5 (1791)	2.2 (56)	2.2 (56)
L4-1P0F3	30	8.6	L21-30P	3 x 2P 20A	(24) C13, (12) C19	70.5 (1791)	2.2 (56)	2.2 (56)
L4-1P0G3	30	8.6	L21-30P	3 x 2P 20A	(30) C13, (6) C19	70.5 (1791)	2.2 (56)	2.2 (56)
<b>208 Volt, Three-Phase Input - North America Models</b>								
L4-1M0B1	30	8.6	L15-30P	3 x 2P 20A	(36) C13	70.5 (1791)	2.2 (56)	2.2 (56)
L4-1M0F3	30	8.6	L15-30P	3 x 2P 20A	(24) C13, (12) C19	70.5 (1791)	2.2 (56)	2.2 (56)
L4-1M0G3	30	8.6	L15-30P	3 x 2P 20A	(30) C13, (6) C19	70.5 (1791)	2.2 (56)	2.2 (56)
L4-1T0B1	50	9.9	CS8365C	3 x 2P 20A	(36) C13	70.5 (1791)	2.2 (56)	2.2 (56)
L4-1T0F3	50	9.9	CS8365C	3 x 2P 20A	(24) C13, (12) C19	70.5 (1791)	2.2 (56)	2.2 (56)
L4-3U0H3	50	14.3	CS8365C	6 x 2P 20A	(36) C13, (6) C19	75.0 (1905)	2.7 (69)	2.2 (56)
L4-3U0V3	50	14.3	CS8365C	6 x 2P 20A	(12) C13, (18) C19	75.0 (1905)	2.7 (69)	2.2 (56)
L4-3V0F3	60	17.2	IEC 60A 3P+E	6 x 2P 20A	(24) C13, (12) C19	75.0 (1905)	2.7 (69)	2.2 (56)
L4-3V0H3	60	17.2	IEC 60A 3P+E	6 x 2P 20A	(36) C13, (6) C19	75.0 (1905)	2.7 (69)	2.2 (56)
L4-3V0V3	60	17.2	IEC 60A 3P+E	6 x 2P 20A	(12) C13, (18) C19	75.0 (1905)	2.7 (69)	2.2 (56)
<b>240/415 Volt, Three-Phase Input - North America Models</b>								
L4-2R0F3	30	17.2	L22-30P	6 x 1P 20A	(24) C13, (12) C19	72.0 (1829)	2.35 (60)	2.2 (56)
L4-2R0H3	30	17.2	L22-30P	6 x 1P 20A	(36) C13, (6) C19	72.0 (1829)	2.35 (60)	2.2 (56)
<b>220-240 Volt, Single-Phase Input - Outside North America</b>								
L4-1G0A1	16	3.6‡	IEC 16A 1P+N+E	1 x 2P 16A	(24) C13	70.5 (1791)	2.2 (56)	2.2 (56)
L4-1G0C3	16	3.6‡	IEC 16A 1P+N+E	1 x 2P 16A	(18) C13, (6) C19	70.5 (1791)	2.2 (56)	2.2 (56)
L4-1H0A1	32	7.3‡	IEC 32A 1P+N+E	2 x 2P 16A	(24) C13	70.5 (1791)	2.2 (56)	2.2 (56)
L4-1H0B1	32	7.3‡	IEC 32A 1P+N+E	2 x 2P 16A	(36) C13	70.5 (1791)	2.2 (56)	2.2 (56)
L4-1H0C3	32	7.3‡	IEC 32A 1P+N+E	2 x 2P 16A	(18) C13, (6) C19	70.5 (1791)	2.2 (56)	2.2 (56)
L4-1H0G3	32	7.3‡	IEC 32A 1P+N+E	2 x 2P 16A	(30) C13, (6) C19	70.5 (1791)	2.2 (56)	2.2 (56)
<b>220-240/380-415 Volt, Three-Phase Input - Outside North America</b>								
L4-1W0B1	16	11=	IEC 16A 3P+N+E	3 x 2P 20A	(36) C13	70.5 (1791)	2.2 (56)	2.2 (56)
L4-1W0G3	16	11=	IEC 16A 3P+N+E	3 x 2P 16A	(30) C13, (6) C19	70.5 (1791)	2.2 (56)	2.2 (56)
L4-2Y0F3	32	22=	IEC 32A 3P+N+E	6 x 1P 16A	(24) C13, (12) C19	72.0 (1829)	2.35 (60)	2.2 (56)
L4-2Y0H3	32	22=	IEC 32A 3P+N+E	6 x 1P 16A	(36) C13, (6) C19	72.0 (1829)	2.35 (60)	2.2 (56)

Notes: Part Number LX= Locking Outlets, PX= Standard Outlets. Order mounting brackets separately. On Single-Phase PDUs, output voltage equals input voltage. On Three-Phase PDUs, 208 VAC nominal output through C13 and C19 outlets; 120 VAC nominal output through NEMA 5-20R outlets.

<sup>1</sup>Amperage: 20A within North America and 16A Outside of North America.

\* For kW column, all values are derated calculations per UL for use in North America. The Input Amp column lists the maximum rated value of the Input Plug/inlet and circuit breaker rating.

UL/NEC regulatory code requires current ratings on product labels to be derated to 80% of the maximum rated values (for example: 20 Amp = 16 Amp on UL product label). For the Input kW column, all values are derated calculations per UL for use in North America.

\*\* Order power cord separately for PDU with C20 input.

\*\*\* PDUs that are 72"H (1829 mm) must be placed in 44U or taller CPI cabinets. PDUs that are 75"H (1905 mm) must be placed in 45U or taller CPI cabinets.

\*\*\*\* Capacity when used at 230V with a 16A power cord. Actual capacity will vary if connected to lower voltage or to a lower amperage input plug.

‡ Capacity when used at a Nominal voltage of 230V.

= Capacity when used at a Nominal voltage of 230V/415V 3 Phase.



Configure your CPI cabinet with power installed before it arrives.  
Add power. Make it easy. [www.chatsworth.com/configurators](http://www.chatsworth.com/configurators).

# Switched eConnect PDUs

Select Switched eConnect PDUs in high-density applications that require advanced power monitoring and control and outlet switching, as well as full DCIM integration. Switched PDUs take the eConnect DCIM initiative one step further by providing users with the ability to turn power on and off at each outlet, allowing for proper provisioning and sequencing of each piece of equipment and preventing efficiency problems identified during monitoring.

Under the Secure Array, which supports systems with redundancies, power can be toggled on outlets grouped from different PDUs. Switched eConnect PDUs' ability to monitor and control power loads remotely makes them ideal for use in lights-out data centers and remote sites.

## Features and benefits of the Switched eConnect PDU:

Switched PDUs include all the features available on Monitored Pro eConnect, as well as the following additional benefits:

### Remote Power Monitoring, Control and Outlet Switching

- Remote ability to turn individual outlets off, on and to cycle power to attached equipment
- Power cycling to groups of outlets to manage several pieces of equipment at once
- Link outlets from PDUs in the Secure Array for cycling as a group, allowing one-click remote power cycling for redundantly powered equipment
- Ability to set power cycle delays and set-up a sequenced power-on processes and prevent power problems
- Compatibility with eConnect EAC and many DCIM software packages that accept SNMP v1, v2 and v3 traps

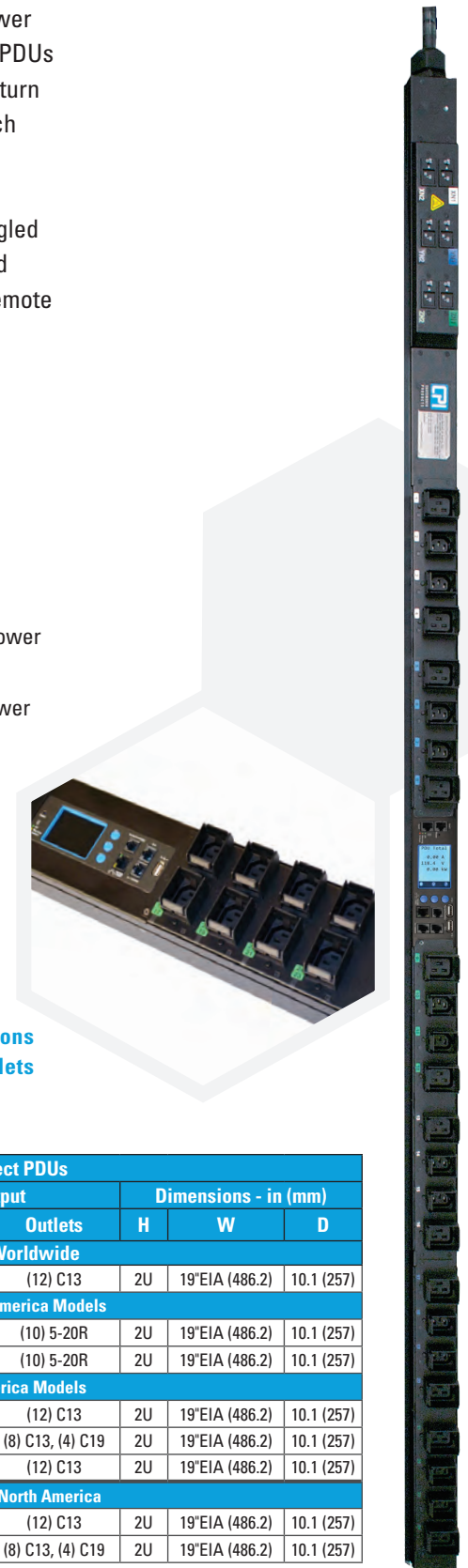

L5-2R0M3



Vertical configurations feature up to 48 outlets



Horizontal chassis available

Switched Horizontal eConnect PDUs								
Part Number	Input			Output		Dimensions - in (mm)		
	Amp	kW*	Plug	Breakers	Outlets	H	W	D
100-240 Volt, Single-Phase - Worldwide								
P5-5A1W1	16	3.6****	C20 Inlet**	1 x 2P 16A	(12) C13	2U	19"EIA (486.2)	10.1 (257)
120 Volt, Single-Phase Input - North America Models								
P5-5C035	20	1.9	L5-20P	1 x 2P 20A	(10) 5-20R	2U	19"EIA (486.2)	10.1 (257)
P5-5D035	30	2.8	L5-30P	2 x 2P 20A	(10) 5-20R	2U	19"EIA (486.2)	10.1 (257)
208 Volt, Single-Phase - North America Models								
P5-5E1W1	20	3.3	L6-20P	1 x 2P 16A	(12) C13	2U	19"EIA (486.2)	10.1 (257)
P5-5F0Y3	30	4.9	L6-30P	2 x 2P 20A	(8) C13, (4) C19	2U	19"EIA (486.2)	10.1 (257)
P5-5F0W1	30	4.9	L6-30P	2 x 2P 20A	(12) C13	2U	19"EIA (486.2)	10.1 (257)
220-240 Volt, Single-Phase - Outside North America								
P5-5H0W1	32	7.3¥	IEC 32A 1P+N+E	2 x 2P 16A	(12) C13	2U	19"EIA (486.2)	10.1 (257)
P5-5H0Y3	32	7.3¥	IEC 32A 1P+N+E	2 x 2P 16A	(8) C13, (4) C19	2U	19"EIA (486.2)	10.1 (257)

Notes: Part Number LX= Locking Outlets, PX= Standard Outlets. Horizontal PDUs that are 2U, 19"EIA are 3.5"H (89 mm) and 17"W (432 mm). \* For kW column, all values are derated calculations per UL for use in North America. The Input Amp column lists the maximum rated value of the Input Plug/inlet and circuit breaker rating. UL/NEC regulatory code requires current ratings on product labels to be derated to 80% of the maximum rated values (for example: 20 Amp = 16 Amp on UL product label). For the Input kW column, all values are derated calculations per UL for use in North America. For 50A PDUs, the 50A CS8365C plug is rated for 50A, but maximum input is 35A (12.6 kw) on three breaker PDUs.



Switched Vertical eConnect PDUs								
Part Number	Input			Output		Dims - in (mm)		
	Amp	kW*	Plug	Breakers (Magnetic)	Outlets	H***	W	D
<b>100-240 Volt, Single-Phase Input - Worldwide</b>								
L5-1A1A1	16/20 <sup>1</sup>	3.6****	C20 Inlet**	1 x 2P 20A	(24) C13	70.5 (1791)	2.2 (56)	2.2 (56)
L5-1A1C3	16/20 <sup>1</sup>	3.6****	C20 Inlet**	1 x 2P 20A	(18) C13, (6) C19	70.5 (1791)	2.2 (56)	2.2 (56)
<b>120 Volt, Single-Phase Input - North America Models</b>								
P5-1A1A5	20	1.9	C20 Inlet**	1 x 2P 20A	(24) 5-20R	70.5 (1791)	2.2 (56)	2.2 (56)
P5-1C0A5	20	1.9	L5-20P	1 x 2P 20A	(24) 5-20R	70.5 (1791)	2.2 (56)	2.2 (56)
P5-1D0A5	30	2.8	L5-30P	2 x 2P 20A	(24) 5-20R	70.5 (1791)	2.2 (56)	2.2 (56)
<b>208 Volt, Single-Phase Input - North America Models</b>								
L5-1E0A1	20	3.3	L6-20P	1 X 2P 20A	(24) C13	70.5 (1791)	2.2 (56)	2.2 (56)
L5-1E0C3	20	3.3	L6-20P	1 X 2P 20A	(18) C13, (6) C19	70.5 (1791)	2.2 (56)	2.2 (56)
L5-1F0A1	30	4.9	L6-30P	2 x 2P 20A	(24) C13	70.5 (1791)	2.2 (56)	2.2 (56)
L5-1F0C3	30	4.9	L6-30P	2 x 2P 20A	(18) C13, (6) C19	70.5 (1791)	2.2 (56)	2.2 (56)
<b>120-208 Volt, Three-Phase Input - North America Models</b>								
L5-1N0A1	20	5.7	L21-20P	3 x 2P 20A	(24) C13	70.5 (1791)	2.2 (56)	2.2 (56)
P5-1N0A5	20	5.7	L21-20P	3 x 2P 20A	(24) 5-20R	70.5 (1791)	2.2 (56)	2.2 (56)
L5-1N0C3	20	5.7	L21-20P	3 x 2P 20A	(18) C13, (6) C19	70.5 (1791)	2.2 (56)	2.2 (56)
L5-1P0A1	30	8.6	L21-30P	3 x 2P 20A	(24) C13	70.5 (1791)	2.2 (56)	2.2 (56)
P5-1P0A5	30	5.7	L21-30P	3 x 2P 20A	(24) 5-20R	70.5 (1791)	2.2 (56)	2.2 (56)
L5-1P0C3	30	8.6	L21-30P	3 x 2P 20A	(18) C13, (6) C19	70.5 (1791)	2.2 (56)	2.2 (56)
L5-6P0Q1	30	8.6	L21-30P	3 x 2P 20A	(48) C13	70.5 (1791)	4.0 (102)	2.2 (56)
<b>208 Volt, Three-Phase Input - North America Models</b>								
L5-1M0A1	30	8.6	L15-30P	3 x 2P 20A	(24) C13	70.5 (1791)	2.2 (56)	2.2 (56)
L5-1M0C3	30	8.6	L15-30P	3 x 2P 20A	(18) C13, (6) C19	70.5 (1791)	2.2 (56)	2.2 (56)
L5-6M0Q1	30	8.6	L15-30P	3 x 2P 20A	(48) C13	70.5 (1791)	4.0 (102)	2.2 (56)
L5-1T0A1	50	9.9	CS8365C	3 x 2P 20A	(24) C13	70.5 (1791)	2.2 (56)	2.2 (56)
L5-1T0C3	50	9.9	CS8365C	3 x 2P 20A	(18) C13, (6) C19	70.5 (1791)	2.2 (56)	2.2 (56)
L5-3U0M3	50	14.3	CS8365C	6 x 2P 20A	(12) C13, (12) C19	75.0 (1905)	2.7 (69)	2.2 (56)
L5-6U0Q1	50	9.9	CS8365C	6 x 2P 20A	(48) C13	70.5 (1791)	4.0 (102)	2.2 (56)
L5-3V0M3	60	17.2	IEC 60A 3P+E	6 x 2P 20A	(12) C13, (12) C19	75.0 (1905)	2.7 (69)	2.2 (56)
L5-6V0Q1	60	17.2	IEC 60A 3P+E	6 x 2P 20A	(48) C13	70.5 (1791)	4.0 (102)	2.2 (56)
<b>240/415 Volt, Three-Phase Input - North America Models</b>								
L5-2R0M3	30	17.2	L22-30P	6 x 1P 20A	(12) C13, (12) C19	72.0 (1829)	2.35 (60)	2.2 (56)
L5-6R0Q1	30	17.2	L22-30P	6 x 1P 20A	(48) C13	70.5 (1791)	4.0 (102)	2.2 (56)
<b>220-240 Volt, Single-Phase Input - Outside North America</b>								
L5-1G0A1	16	3.6¥	IEC 16A 1P+N+E	1 x 2P 16A	(24) C13	70.5 (1791)	2.2 (56)	2.2 (56)
L5-1G0C3	16	3.6¥	IEC 16A 1P+N+E	1 x 2P 16A	(18) C13, (6) C19	70.5 (1791)	2.2 (56)	2.2 (56)
L5-1H0A1	32	7.3¥	IEC 32A 1P+N+E	2 x 2P 16A	(24) C13	70.5 (1791)	2.2 (56)	2.2 (56)
L5-1H0C3	32	7.3¥	IEC 32A 1P+N+E	2 x 2P 16A	(18) C13, (6) C19	70.5 (1791)	2.2 (56)	2.2 (56)
<b>220-240/380-415 Volt, Three-Phase Input - Outside North America</b>								
L5-1W0A1	16	11=	IEC 16A 3P+N+E	3 x 2P 20A	(24) C13	70.5 (1791)	2.2 (56)	2.2 (56)
L5-1W0C3	16	11=	IEC 16A 3P+N+E	3 x 2P 16A	(18) C13, (6) C19	70.5 (1791)	2.2 (56)	2.2 (56)
L5-6W0Q1	16	11=	IEC 16A 3P+N+E	3 x 1P 16A	(48) C13	70.5 (1791)	4.0 (102)	2.2 (56)
L5-2Y0M3	32	22.1=	IEC 32A 3P+N+E	6 x 1P 16A	(12) C13, (12) C19	72.0 (1829)	2.35 (60)	2.2 (56)
L5-6Y0Q1	32	22.1=	IEC 32A 3P+N+E	6 x 1P 16A	(48) C13	70.5 (1791)	4.0 (102)	2.2 (56)

Notes: Part Number LX= Locking Outlets, PX= Standard Outlets. Order mounting brackets separately. On Single-Phase PDUs, output voltage equals input voltage. On Three-Phase PDUs, 208 VAC nominal output through C13 and C19 outlets; 120 VAC nominal output through NEMA 5-20R outlets.

<sup>1</sup>Amperage: 20A within North America and 16A Outside of North America.

\* For kW column, all values are derated calculations per UL for use in North America. The Input Amp column lists the maximum rated value of the Input Plug/inlet and circuit breaker rating. UL/NEC regulatory code requires current ratings on product labels to be derated to 80% of the maximum rated values (for example: 20 Amp = 16 Amp on UL product label). For the Input kW column, all values are derated calculations per UL for use in North America.

\*\* Order power cord separately for PDU with C20 input.

\*\*\* PDUs that are 72"H (1829 mm) must be placed in 44U or taller CPI cabinets. PDUs that are 75"H (1905 mm) must be placed in 45U or taller CPI cabinets.

\*\*\*\* Capacity when used at 230V with a 16A power cord. Actual capacity will vary if connected to lower voltage or to a lower amperage input plug.

¥ Capacity when used at a Nominal voltage of 230V.

= Capacity when used at a Nominal voltage of 230V/415V 3 Phase.



Configure your CPI cabinet with power installed before it arrives.  
Add power. Make it easy. [www.chatsworth.com/configurators](http://www.chatsworth.com/configurators).

# Switched Pro eConnect PDU

Select Switched Pro eConnect PDUs in high-density, lights-out data centers and remote sites where downtime, security and power consumption must be closely managed. Switched Pro eConnect PDUs provide comprehensive remote power control capabilities and monitoring options for each and every outlet and branch phase on the PDU, as well as integration with DCIM software, environmental monitoring and cabinet access control.

Switched Pro eConnect PDUs facilitate the elimination of efficiency problems identified during monitoring, allow users to resolve issues with frozen equipment by cycling the power on individual outlets and, under the Secure Array IP Consolidation Technology, toggle power for groups of outlets from different PDUs.

## Features and benefits of the Switched Pro eConnect PDU:

Switched Pro eConnect PDUs include all the features available on Switched eConnect, as well as the following additional benefits:

### Remote Outlet Monitoring, Control and Switching

- Continuous voltage, current, power and energy monitoring for each outlet on the unit that can be remotely monitored using a web browser and continuous voltage, current, power, power factor and energy monitoring for each branch or phase (breaker) on the unit with  $\pm 1\%$  accuracy power measurement
- Outlet naming functionality to identify equipment
- Outlet grouping functionality for consolidation of outlets from multiple PDUs into one group
- Group outlets to see total current use for several pieces of connected equipment
- Set alarms for upper and lower current thresholds for each outlet
- Remote ability to turn individual outlets off, on and to cycle power to attached equipment
- Power cycling to groups of outlets to manage several pieces of equipment at once
- Link outlets from PDUs in the Secure Array for cycling as a group, allowing one-click remote power cycling for redundantly powered equipment
- Ability to set power cycle delays and set-up a sequenced power-on processes and prevent power problems
- Compatibility with eConnectEAC and many DCIM software packages that accept SNMP v1, v2 and v3 traps

*\*Available in vertical configurations only.*



### eConnect Electronic Access Control



L6-1E0A1

Switched Pro Vertical eConnect PDUs								
Part Number	Input			Output		Dims - in (mm)		
	Amp	kW*	Plug	Breakers (Magnetic)	Outlets	H***	W	D
<b>100-240 Volt, Single-Phase Input - Worldwide</b>								
L6-1A1A1	16/20 <sup>1</sup>	3.6****	C20 Inlet**	1 x 2P 20A	(24) C13	70.5 (1791)	2.2 (56)	2.2 (56)
L6-1A1C3	16/20 <sup>1</sup>	3.6****	C20 Inlet**	1 x 2P 20A	(18) C13, (6) C19	70.5 (1791)	2.2 (56)	2.2 (56)
<b>120 Volt, Single-Phase Input - North America Models</b>								
P6-1A1A5	20	1.9	C20 Inlet**	1 x 2P 20A	(24) 5-20R	70.5 (1791)	2.2 (56)	2.2 (56)
P6-1C0A5	20	1.9	L5-20P	1 x 2P 20A	(24) 5-20R	70.5 (1791)	2.2 (56)	2.2 (56)
P6-1D0A5	30	2.8	L5-30P	2 x 2P 20A	(24) 5-20R	70.5 (1791)	2.2 (56)	2.2 (56)
<b>208 Volt, Single-Phase Input - North America Models</b>								
L6-1E0A1	20	3.3	L6-20P	1 X 2P 20A	(24) C13	70.5 (1791)	2.2 (56)	2.2 (56)
L6-1E0C3	20	3.3	L6-20P	1 X 2P 20A	(18) C13, (6) C19	70.5 (1791)	2.2 (56)	2.2 (56)
L6-1F0A1	30	4.9	L6-30P	2 x 2P 20A	(24) C13	70.5 (1791)	2.2 (56)	2.2 (56)
L6-1F0C3	30	4.9	L6-30P	2 x 2P 20A	(18) C13, (6) C19	70.5 (1791)	2.2 (56)	2.2 (56)
<b>120-208 Volt, Three-Phase Input - North America Models</b>								
L6-1N0A1	20	5.7	L21-20P	3 x 2P 20A	(24) C13	70.5 (1791)	2.2 (56)	2.2 (56)
P6-1N0A5	20	5.7	L21-20P	3 x 2P 20A	(24) 5-20R	70.5 (1791)	2.2 (56)	2.2 (56)
L6-1N0C3	20	5.7	L21-20P	3 x 2P 20A	(18) C13, (6) C19	70.5 (1791)	2.2 (56)	2.2 (56)
L6-1P0A1	30	8.6	L21-30P	3 x 2P 20A	(24) C13	70.5 (1791)	2.2 (56)	2.2 (56)
P6-1P0A5	30	5.7	L21-30P	3 x 2P 20A	(24) 5-20R	70.5 (1791)	2.2 (56)	2.2 (56)
L6-1P0C3	30	8.6	L21-30P	3 x 2P 20A	(18) C13, (6) C19	70.5 (1791)	2.2 (56)	2.2 (56)
<b>208 Volt, Three-Phase Input - North America Models</b>								
L6-1M0A1	30	8.6	L15-30P	3 x 2P 20A	(24) C13	70.5 (1791)	2.2 (56)	2.2 (56)
L6-1M0C3	30	8.6	L15-30P	3 x 2P 20A	(18) C13, (6) C19	70.5 (1791)	2.2 (56)	2.2 (56)
L6-1T0A1	50	9.9	CS8365C	3 x 2P 20A	(24) C13	70.5 (1791)	2.2 (56)	2.2 (56)
L6-1T0C3	50	9.9	CS8365C	3 x 2P 20A	(18) C13, (6) C19	70.5 (1791)	2.2 (56)	2.2 (56)
L6-3U0M3	50	14.3	CS8365C	6 x 2P 20A	(12) C13, (12) C19	75.0 (1905)	2.7 (69)	2.2 (56)
L6-3V0M3	60	17.2	IEC 60A 3P+E	6 x 2P 20A	(12) C13, (12) C19	75.0 (1905)	2.7 (69)	2.2 (56)
<b>240/415 Volt, Three-Phase Input - North America Models</b>								
L6-2R0M3	30	17.2	L22-30P	6 x 1P 20A	(12) C13, (12) C19	72.0 (1829)	2.35 (60)	2.2 (56)
<b>220-240 Volt, Single-Phase Input - Outside North America</b>								
L6-1G0A1	16	3.6¥	IEC 16A 1P+N+E	1 x 2P 16A	(24) C13	70.5 (1791)	2.2 (56)	2.2 (56)
L6-1G0C3	16	3.6¥	IEC 16A 1P+N+E	1 x 2P 16A	(18) C13, (6) C19	70.5 (1791)	2.2 (56)	2.2 (56)
L6-1H0A1	32	7.3¥	IEC 32A 1P+N+E	2 x 2P 16A	(24) C13	70.5 (1791)	2.2 (56)	2.2 (56)
L6-1H0C3	32	7.3¥	IEC 32A 1P+N+E	2 x 2P 16A	(18) C13, (6) C19	70.5 (1791)	2.2 (56)	2.2 (56)
<b>220-240/380-415 Volt, Three-Phase Input - Outside North America</b>								
L6-1W0A1	16	11=	IEC 16A 3P+N+E	3 x 2P 20A	(24) C13	70.5 (1791)	2.2 (56)	2.2 (56)
L6-1W0C3	16	11=	IEC 16A 3P+N+E	3 x 2P 16A	(18) C13, (6) C19	70.5 (1791)	2.2 (56)	2.2 (56)
L6-2Y0M3	32	22.1=	IEC 32A 3P+N+E	6 x 1P 16A	(12) C13, (12) C19	72.0 (1829)	2.35 (60)	2.2 (56)

Notes: Part Number LX= Locking Outlets, PX= Standard Outlets. Order mounting brackets separately. On Single-Phase PDUs, output voltage equals input voltage. On Three-Phase PDUs, 208 VAC nominal output through C13 and C19 outlets; 120 VAC nominal output through NEMA 5-20R outlets.

<sup>1</sup>Amperage: 20A within North America and 16A Outside of North America.

\* For kW column, all values are derated calculations per UL for use in North America. The Input Amp column lists the maximum rated value of the Input Plug/inlet and circuit breaker rating. UL/NEC regulatory code requires current ratings on product labels to be derated to 80% of the maximum rated values (for example: 20 Amp = 16 Amp on UL product label). For the Input kW column, all values are derated calculations per UL for use in North America.

\*\* Order power cord separately for PDU with C20 input.

\*\*\* PDUs that are 72"H (1829 mm) must be placed in 44U or taller CPI cabinets. PDUs that are 75"H (1905 mm) must be placed in 45U or taller CPI cabinets.

\*\*\*\* Capacity when used at 230V with a 16A power cord. Actual capacity will vary if connected to lower voltage or to a lower amperage input plug.

¥ Capacity when used at a Nominal voltage of 230V.

= Capacity when used at a Nominal voltage of 230V/415V 3 Phase.



Configure your CPI cabinet with power installed before it arrives.  
Add power. Make it easy. [www.chatsworth.com/configurators](http://www.chatsworth.com/configurators).



# Power IQ® for eConnect

Power IQ® (PIQ) for eConnect is a data center energy, power, environmental and access control monitoring software that provides out-of-the-box support for eConnect PDUs, as well as devices from many other manufacturers.

## Maintain Uptime

PIQ for eConnect software provides and organizes the information and controls that data center managers need to fully utilize their existing infrastructure resources and alerts them to trouble before it causes downtime.



## Features and benefits:

- Centrally manages and controls CPI eConnect PDUs and Intelligent Assets
- Fully supports Secure Array Technology, allowing for significant savings on PDU networking costs
- Maintains centralized authentication, access and auditing of all equipment and ensuring regulatory compliance with HIPAA, PCI DSS, FIMSA and EU Directive
- Utilizes power and cooling resources efficiently to improve PUE
- Tracks actual power loads of IT devices under computing stress, providing better planning and downtime prevention information
- Monitors overall data center health to prevent costly unplanned downtime
- Monitors cabinet-level access control to ensure regulatory compliance; fully supports eConnect EAC

## Simplified, Dynamic Dashboards and Charts

**Health Monitoring:** A real-time, interactive data center health map warns of issues such as hot spot formation, SLA violations, over charges and loss of redundancy.

**Hot Spot Control:** Ensure uptime, compliance with manufacturer and industry-accepted recommendations, and achieve project costs savings increasing the temperature set point.

**Power Control:** Easily control power on outlets, IT devices, and groups of IT devices with power sources spanning multiple rack PDUs.

**PUE Dashboard:** See real-time PUE and trends and your current power capacity utilization at any level in your data center or lab (PDU, rack, row, busway, room).

**Cabinet Access Management:** Increase productivity with reports that clearly identify door status and allow for the remote control of door access.

**Use Power Charge Back, Stranded Capacity and Power Failure Simulation charts, custom reports and more.**



## Create Custom Reports:

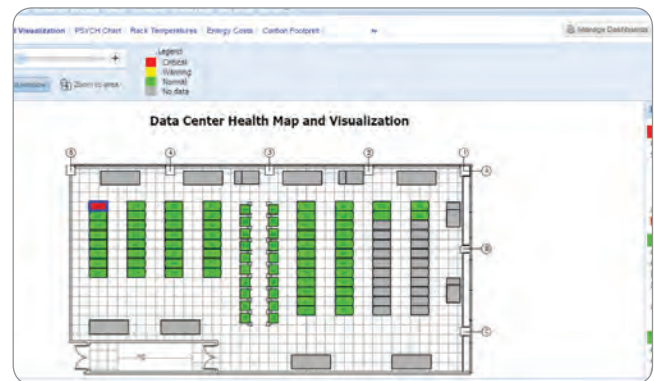

Data Center Health Map



Power and Capacity, PUE Gauge

Power IQ for eConnect Software and License, With 1-Year Maintenance Plan			
Part Number	Number of Licenses	Part Number	Number of Licenses
36603-001	Up to 10 Devices	36603-100	Up to 1000 Devices
36603-002	Up to 20 Devices	36603-150	Up to 1500 Devices
36603-005	Up to 50 Devices	36603-200	Up to 2000 Devices
36603-010	Up to 100 Devices	36603-250	Up to 2500 Devices
36603-020	Up to 200 Devices	36603-300	Up to 3000 Devices
36603-030	Up to 300 Devices	36603-400	Up to 4000 Devices
36603-040	Up to 400 Devices	36603-500	Up to 5000 Devices
36603-050	Up to 500 Devices		
Power IQ for eConnect - Additional 1-Year Maintenance License			
36606-001	Up to 10 Devices	36606-100	Up to 1000 Devices
36606-002	Up to 20 Devices	36606-150	Up to 1500 Devices
36606-005	Up to 50 Devices	36606-200	Up to 2000 Devices
36606-010	Up to 100 Devices	36606-250	Up to 2500 Devices
36606-020	Up to 200 Devices	36606-300	Up to 3000 Devices
36606-030	Up to 300 Devices	36606-400	Up to 4000 Devices
36606-040	Up to 400 Devices	36606-500	Up to 5000 Devices
36606-050	Up to 500 Devices		

Power IQ for eConnect - Support Services	
Part Number	Description
36605-001	1-Hour of Professional Service (Travel & Lodging not included)
36605-002	1-Day Quick-Start Service (Travel & Lodging included)
36605-003	Dynamic Plug-In, Developed, Certified and Tested by Professional Services
Power IQ for eConnect – Additional Device Licenses	
36604-001	Up to 10 Devices
36604-002	Up to 20 Devices
36604-005	Up to 50 Devices
36604-010	Up to 100 Devices
36604-020	Up to 200 Devices
36604-030	Up to 300 Devices
36604-040	Up to 400 Devices
36604-050	Up to 500 Devices
Power IQ for eConnect Server Hardware	
36516-002	Power IQ for eConnect software, Preinstalled on Configured Dual Power Supply Server, 1 Year Support and Maintenance, Includes Rail Kit

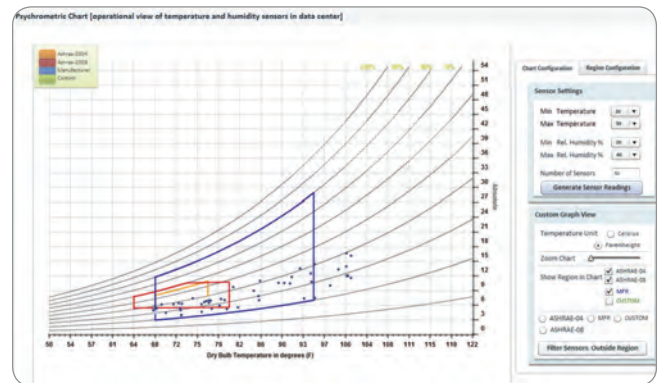
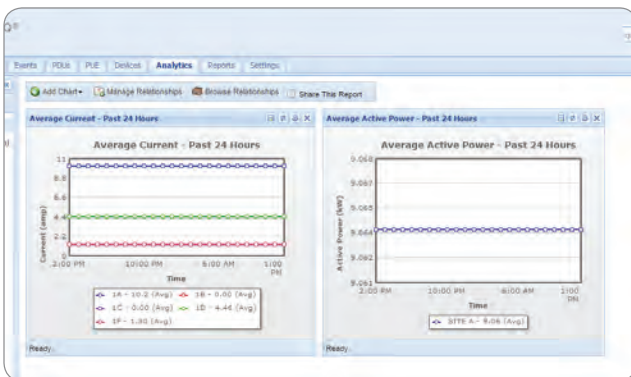

### Cooling Charts

Ensure compliance with manufacturers and industry-accepted recommendations, and project cost savings achieved by increasing temperature set point.

### Power and Energy Analytics

Intuitively create charts to visualize active power by rack, carbon footprint by building, customer bill back, total energy consumption and any other available metric.

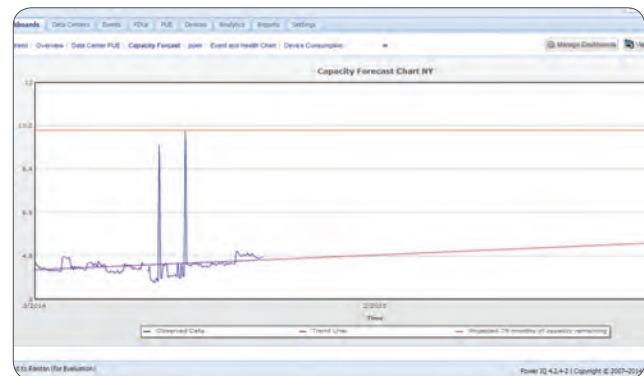

### Power Capacity “Days of Supply” Forecast

Determine your real-time power load, rate of change and forecast at all levels of your infrastructure with capacity forecast charts.



Download fully functional trial software to manage up to five devices with no obligation. See the benefits of power monitoring for yourself.

[pages.chatsworth.com/power-iq-download.html](http://pages.chatsworth.com/power-iq-download.html)

# eConnect Electronic Access Control

eConnect Electronic Access Control (EAC) is a cost-effective, networked solution that works with CPI's Monitored, Monitored Pro, Switched and Switched Pro eConnect PDUs to support the three key elements of remote management at the cabinet level: power monitoring, environmental monitoring and physical access control.

This integrated PDU-based cabinet ecosystem uses a single network connection and one interface to monitor all three elements, greatly simplifying rack management.



### Features and benefits:

- Electronic swinghandle with integrated sensors for lock and latch status, monitoring and alarm functions
- Power for lock operation delivered through eConnect PDU
- Remote unlock capability
- User-configurable unlock time delay
- High-security lock with mechanical key override
- Reader recognizes existing employee 125kHz or 13.56 MHz RFID cards
- Bi-color LED (blue/magenta) to indicate lock and handle status
- Event logging for auditing purposes, regulatory compliance
- Integration with LDAP and Radius for added security
- High temperature rating supports use in hot aisle environments
- Must be used with eConnect PDUs that have auxiliary 1 and auxiliary 2 ports (PDUs manufactured after March 2017)
- Compatible with GF-Series GlobalFrame, F-Series TeraFrame Cabinets and N-Series TeraFrame Cabinets

Part Number	Description	Shipping Weight lb (kg)
36650-001	eConnect EAC Swinghandle Updgrade Kit	3 (1.4)
36652-001	Door Sensor Kit for eConnect EAC	1 (0.5)
36653-001	RF IDeas Frequency Card Enrollment Reader	1 (0.5)
36654-001	eConnect EAC Smart Cards	1 (0.5)

### Have Your Locks and PDUs Preinstalled

Simplify ordering, shipping and installation by requesting to have your locks and eConnect PDUs preinstalled in CPI's GF-Series GlobalFrame and F-Series TeraFrame Cabinets before they leave the factory. Configure a cabinet using CPI Product Configurator. Try it now at [www.chatsworth.com/configurators](http://www.chatsworth.com/configurators).



# PDU

## Metered Vertical PDUs

Vertical PDUs provide locally metered models for low- to medium-density applications. Vertical PDU functionality makes it easier to judge the amount of remaining power available from each PDU and to balance power use across different PDU segments and phases. See the PDU Feature Comparison chart for an exact listing of features available on each model.



### Vertical PDUs offer metered configuration models with features and benefits, including:

- A mix of plugs and outlets to match your facility requirements
- Digital ammeters with display of current usage
- Tool-less installation hardware spaced to match the mounting brackets in CPI cabinets

Metered Vertical PDUs								
Part Number	Input			Output		Dimensions - in (mm)		
	Amp	kW	Plug	Breakers	Outlets	H	W	D
<b>120V, Single Phase PDUs - North America</b>								
35643-2A1	30	2.8*	NEMA L5-30P	2 x 20A	(24) 5-20R	68.5 (1740)	2.0 (51)	3.5 (89)
35643-2A2	30	2.8*	NEMA L5-30P	2 x 20A	(24) C13, (6) C19	68.5 (1740)	2.0 (51)	3.5 (89)
<b>208V, Single Phase PDUs - North America</b>								
35822-2C1	30	4.9*	NEMA L6-30P	2 x 15A	(24) C13	68.5 (1740)	2.0 (51)	3.5 (89)
<b>120/208 Volt, Three-Phase PDUs (208 Volt Output on L6-20R) - North America</b>								
35632-2A7	20	5.7*	NEMA L21-20P	No	(24) 5-20R, (6) L6-20R	68.5 (1740)	2.0 (51)	3.5 (89)
35633-2A1	30	8.6*	NEMA L21-30P	3 x 20A	(24) 5-20R	68.5 (1740)	2.0 (51)	3.5 (89)

## Horizontal PDUs

Horizontal PDUs are available in 1U – 2U rack-mount configurations with different power input plugs and a variety of outlet configurations. Horizontal PDUs are available in three different functionalities: Basic, Metered and Monitored. See the PDU Feature Comparison chart for an exact listing of features available on each model.

### Basic PDUs

- Reliable power distribution into the rack space

### Metered PDUs

- Reliable power distribution into the rack space
- Digital ammeters display in-line current for each circuit/phase of the PDU

### Monitored PDUs

- Reliable power distribution into the rack space
- Digital ammeters display in-line current for each circuit/phase of the PDU
- Remote branch/phase current monitoring
- Alarm threshold settings
- Temp/humidity sensor for port monitoring

Horizontal Rack-Mount PDUs										
Part Number			Input			Output		Dimensions - in (mm)		
Basic	Metered	Monitored	Amp	kW	Plug	Breakers	Outlets	H	W	D
<b>120V, Single Phase PDUs - North America</b>										
-	35692-211	-	20	1.9*	NEMA 5-20P	No	(4) C13, (4) C19	1U	19"EIA	1.9 (48)
35692-121	35692-221	-	20	1.9*	NEMA L5-20P	No	(4) C13, (4) C19	1U	19"EIA	1.9 (48)
35693-112	35693-212	-	30	2.8*	NEMA L5-30P	2 x 20A	(12) 5-20R	1U	19"EIA	6.5 (165)
-	35693-213	-	30	2.8*	NEMA L5-30P	2 x 20A	(20) 5-20R	2U	19"EIA	6.0 (152)
-	35693-211	-	30	2.8*	NEMA L5-30P	2 x 20A	(12) C13	1U	19"EIA	6.5 (165)
<b>100 - 240V, Single Phase PDUs - Worldwide</b>										
35662-112	35662-212	-	16	2.7*	IEC C20*	No	(10) C13	1U	19"EIA	1.6 (41)
-	35662-211	-	16	2.7*	IEC C20*	No	(16) C13	1U	19"EIA	4.5 (114)
<b>208V, Single Phase PDUs - North America</b>										
-	13653-751	-	20	3.3*	NEMA 6-20P	1 x 20A	(12) 6-20R	1U	19"EIA	6.5 (165)
-	35682-211	-	20	3.3*	NEMA 6-20P	No	(4) C13, (4) C19	1U	19"EIA	1.9 (48)
13653-702	13653-752	-	20	3.3*	NEMA L6-20P	1 x 20A	(12) 6-20R	1U	19"EIA	6.5 (165)
35682-121	35682-221	-	20	3.3*	NEMA L6-20P	No	(4) C13, (4) C19	1U	19"EIA	1.9 (48)
35683-111	35683-211	-	30	4.9*	NEMA L6-30P	2 x 20A	(12) C13	1U	19"EIA	6.5 (165)
-	-	35882-3A1	30	4.9*	NEMA L6-30P	2 x 15A	(24) L6-15R	2U	19"EIA	8.0 (203)
-	35882-2A2	35882-3A2	30	4.9*	NEMA L6-30P	2 x 15A	(24) C13	2U	19"EIA	8.0 (203)
<b>208 Volt, Three-Phase PDUs (208 Volt Output) - North America</b>										
35676-111	-	35676-311	60	17.2*	IEC 60A 3P+E	6 x 20A	(12) C19	2U	19"EIA	9.0 (230)
<b>220-240V Single Phase PDUs - Outside North America</b>										
35663-111	35663-211	-	32	7.3‡	IEC 32A 1P+N+E	2 x 16A	(12) C13	1U	19"EIA	6.5 (165)

Note: For Vertical PDUs, order mounting brackets separately.

\* For kW column, all values are derated calculations per UL for use in North America. The Input Amp column lists the maximum rated value of the Input Plug/inlet and circuit breaker rating. UL/NEC regulatory code requires current ratings on product labels to be derated to 80% of the maximum rated values (for example: 20 Amp = 16 Amp on UL product label).

‡ Capacity when used at a Nominal voltage of 230V.



# PowerWedge PDUs

PowerWedge PDUs are low-profile (1U) PDUs with high-density outlets (24) for use in low- and medium-density applications. Controlled units allow remote network monitoring of current, temperature and humidity and control (power on/off/cycle) of each outlet. See the PDU Feature Comparison chart for an exact listing of features available on each model.

- Tapered design provides 24 connections in just 1U of rack space
- Remote branch/phase current monitoring
- Alarm threshold settings
- Temp/humidity sensor for port monitoring
- Remotely switched outlets
- Remote outlet cycling



35882-5A2

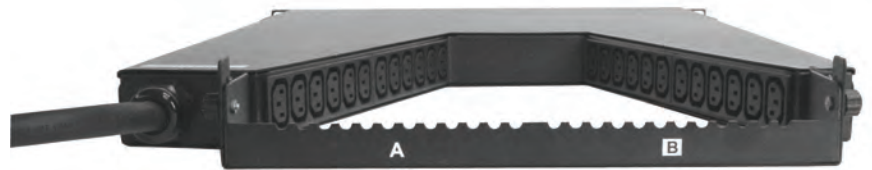

PowerWedge (Controlled) Horizontal Rack-Mount PDUs								
Part Number	Input			Output		Dimensions - in (mm)		
	Amp	kW	Plug	Breakers	Outlets	H	W	D
208V Single Phase - North America								
35882-5A2	30	4.9*	NEMA L6-30P	2 x 15A	(24) C13	1U	19"EIA	28 (711)
220-240V Single Phase - Outside North America								
35883-5B2	32	7.3¥	IEC 32A 1P+N+E	2 x 16A	(24) C13	1U	19"EIA	28 (711)

Note: Includes mounting brackets for 19"EIA rack/cabinet.

\* For kW column, all values are derated calculations per UL for use in North America. The Input Amp column lists the maximum rated value of the Input Plug/inlet and circuit breaker rating. UL/NEC regulatory code requires current ratings on product labels to be derated to 80% of the maximum rated values (for example: 20 Amp = 16 Amp on UL product label).

¥ Capacity when used at a Nominal voltage of 230V.



## Configure Your Power Solutions

Quickly choose between Power Strips, PDUs, PowerWedge or eConnect PDUs with various input/output plug combinations and capabilities.

The [CPI Product Configurator](#) guides you through each step of identifying the monitoring, switching and outlet needs of your PDU.

PDU Feature Comparison	PowerWedge			
	Basic	Metered	Monitored	Controlled
Universal Tool-less Mounting on Vertical PDUs		✓		
Branch/Phase Circuit Breakers	✓	✓	✓	✓
Branch/Phase Monitoring (Current)		Current Only	Current Only	Current Only
Local Digital LED Display		✓	✓	✓
Temp/Humidity Sensor Port/Monitoring			✓	✓
Network Access for Remote Monitoring (IPv4)			IPv4 Only	IPv4 Only
Set Alarm Thresholds			✓	✓
Forward SNMP Traps (v1)			SNMPv1 Only	SNMPv1 Only
Horizontal Orientation	✓	✓	✓	✓
Vertical Orientation		✓		
110-125 VAC, Single-Phase	✓	✓		
110-240 VAC, Single-Phase (includes C20 inlet)	✓	✓		
200-240 VAC, Single-Phase	✓	✓		✓
208 VAC, Three-Phase	✓	✓	✓	

# Power Strips

CPI Power Strips provide basic horizontal and vertical power distribution for low-density applications, such as telecommunications rooms and small offices that do not require remote network monitoring.

- Multiple outlet options
- Optional local digital LED displays current usage
- Optional circuit breakers and surge protection
- Multiple types of input plugs available

**CPI Power Strips are available in two distinct functionalities: Basic and Metered, and offer a mix of the following features:**

- Horizontal rack-mount configurations use only 1U of rack-mount space
- Vertical configurations attach next to rack-mount space with standard 110-125 volt nominal single-phase inputs
- Vertical power strips feature tool-less mounting, and include tool-less installation hardware spaced to match the mounting brackets in CPI cabinets
- On Metered units, the digital ammeter with LED screen displays the amount of current drawn by equipment, making it easier to judge the remaining power available from each power strip
- Select models include surge protection, which limits input voltage during sudden changes in utility power conditions
- Thermal Circuit Breakers limit input current to protect connected equipment



13239-555



12816-705



12848-755



12850-706

Vertical Mount Power Strips									
Part Number		Input			Output		Dimensions - in (mm)		
Basic	Metered	Amp	kW*	Plug	Breakers	Outlets	H	W	D
110-120 Volt, Single-Phase Power Strip									
12850-701	-	15	1.4	NEMA 5-15P	1 x 15A	(14) 5-15R	33.0 (838)	1.7 (43)	1.7 (43)
12848-701	12848-751	15	1.4	NEMA 5-15P	1 x 15A	(24) 5-15R	66.0 (1676)	1.7 (43)	1.7 (43)
12850-703	-	15	1.4	NEMA L5-15P	1 x 15A	(14) 5-15R	33.0 (838)	1.7 (43)	1.7 (43)
12848-703	-	15	1.4	NEMA L5-15P	1 x 15A	(24) 5-15R	66.0 (1676)	1.7 (43)	1.7 (43)
12850-705	-	20	1.9	NEMA 5-20P	1 x 20A	(14) 5-20R	33.0 (838)	1.7 (43)	1.7 (43)
12848-705	12848-755	20	1.9	NEMA 5-20P	1 x 20A	(24) 5-20R	66.0 (1676)	1.7 (43)	1.7 (43)
12850-707	-	20	1.9	NEMA L5-20P	1 x 20A	(14) 5-20R	33.0 (838)	1.7 (43)	1.7 (43)
12848-707	12848-757	20	1.9	NEMA L5-20P	1 x 20A	(24) 5-20R	66.0 (1676)	1.7 (43)	1.7 (43)
110-120 Volt, Single-Phase Power Strip, Surge-Protected									
12850-702	-	15	1.4	NEMA 5-15P	1 x 15A	(14) 5-15R	33.0 (838)	1.7 (43)	1.7 (43)
12848-702	12848-752	15	1.4	NEMA 5-15P	1 x 15A	(24) 5-15R	66.0 (1676)	1.7 (43)	1.7 (43)
12850-704	-	15	1.4	NEMA L5-15P	1 x 15A	(14) 5-15R	33.0 (838)	1.7 (43)	1.7 (43)
12848-704	12848-754	15	1.4	NEMA L5-15P	1 x 15A	(24) 5-15R	66.0 (1676)	1.7 (43)	1.7 (43)
12850-706	-	20	1.9	NEMA 5-20P	1 x 20A	(14) 5-20R	33.0 (838)	1.7 (43)	1.7 (43)
12848-706	12848-756	20	1.9	NEMA 5-20P	1 x 20A	(24) 5-20R	66.0 (1676)	1.7 (43)	1.7 (43)
12850-708	-	20	1.9	NEMA L5-20P	1 x 20A	(14) 5-20R	33.0 (838)	1.7 (43)	1.7 (43)
12848-708	12848-758	20	1.9	NEMA L5-20P	1 x 20A	(24) 5-20R	66.0 (1676)	1.7 (43)	1.7 (43)

Notes: Includes tool-less hardware and mounting brackets for Rack Systems. Order brackets for Cabinet Systems separately. All power strips have IEC C20 inlets and include a power cord. Cords with locking plugs are 10'L (3 m). Cords with straight plugs are 8'2"L (2.4 m).

\* For kW column, all values are derated calculations per UL for use in North America. The Input Amp column lists the maximum rated value of the Input Plug/inlet and circuit breaker rating. UL/NEC regulatory code requires current ratings on product labels to be derated to 80% of the maximum rated values (for example: 20 Amp = 16 Amp on UL product label).

Horizontal Rack-Mount Power Strips									
Part Number		Input			Output		Dimensions - in (mm)		
Basic	Metered	Amp	kW*	Plug	Breakers	Outlets	H	W	D
110-120 Volt, Single-Phase Power Strip									
12816-701	-	15	1.4	NEMA 5-15P	1 x 15A	(8) 5-15R	1U	19"EIA/23"	1.4 (36)
-	13239-751	15	1.4	NEMA 5-15P	1 x 15A	(12) 5-15R	1U	19"EIA	4.6 (117)
12816-702	-	15	1.4	NEMA L5-15P	1 x 15A	(8) 5-15R	1U	19"EIA/23"	1.4 (36)
12816-705	-	20	1.9	NEMA 5-20P	1 x 20A	(8) 5-20R	1U	19"EIA/23"	1.4 (36)
-	13239-755	20	1.9	NEMA 5-20P	1 x 20A	(12) 5-20R	1U	19"EIA	4.6 (117)
12816-706	-	20	1.9	NEMA L5-20P	1 x 20A	(8) 5-20R	1U	19"EIA/23"	1.4 (36)
-	13239-756	20	1.9	NEMA L5-20P	1 x 20A	(12) 5-20R	1U	19"EIA	4.6 (117)
110-120 Volt, Single-Phase Power Strip, Surge-Protected									
12816-703	-	15	1.4	NEMA 5-15P	1 x 20A	(6) 5-20R	1U	19"EIA/23"	1.4 (36)
-	13239-753	15	1.4	NEMA 5-15P	1 x 15A	(12) 5-15R	1U	19"EIA	4.6 (117)
12816-704	-	15	1.4	NEMA L5-15P	1 x 20A	(6) 5-20R	1U	19"EIA/23"	1.4 (36)
12816-707	-	20	1.9	NEMA 5-20P	1 x 20A	(6) 5-20R	1U	19"EIA/23"	1.4 (36)
-	13239-757	20	1.9	NEMA 5-20P	1 x 20A	(12) 5-20R	1U	19"EIA	4.6 (117)
12816-708	-	20	1.9	NEMA L5-20P	1 x 20A	(6) 5-20R	1U	19"EIA/23"	1.4 (36)
-	13239-758	20	1.9	NEMA L5-20P	1 x 20A	(12) 5-20R	1U	19"EIA	4.6 (117)

Notes: Includes 19"EIA and 23"W horizontal rack-mount brackets. All power strips have IEC C20 inlets and include a power cord. Cords with locking plugs are 10'L (3 m). Cords with straight plugs are 8'2"L (2.4 m).

\* For kW column, all values are derated calculations per UL for use in North America. The Input Amp column lists the maximum rated value of the Input Plug/inlet and circuit breaker rating. UL/NEC regulatory code requires current ratings on product labels to be derated to 80% of the maximum rated values (for example: 20 Amp = 16 Amp on UL product label).

# International Power Strips

CPI International Power Strips provide basic power distribution to racks and cabinets, allowing you to share a single power connection with multiple pieces of equipment. Available in two configurations: Basic and Metered, CPI's International Power Strips feature a master lighted switch or thermal circuit breaker and optional surge protection. Circuit breakers limit the amount of current available to equipment, while surge protection blocks excessive voltage from equipment. Both features are critical with unconditioned line power.

Metered configurations include an in-line digital ammeter with display to show the amount of current being used by attached equipment. This feature allows the user to monitor current use, and judge the amount of remaining capacity on the power strip before adding a new device to the circuit.

- Multiple outlet options
- Optional local digital LED displays current usage
- Optional surge protection on vertical units
- Multiple types of input plugs available

Vertical Mount Power Strips									
Part Number		Input			Output		Dimensions - in (mm)		
Basic	Metered	Amp	kW*	Plug	Breakers	Outlets	H	W	D
220-250 Volt, Single-Phase Power Strip									
15642-222	15643-222	32	8.0	IEC 32A 1P+N+E	2 x 16A	(10) C13, (4) C19	48.3 (1227)	2.5 (64)	1.8 (46)
15642-226	15643-226	32	8.0	IEC 32A 1P+N+E	2 x 16A	(12) UK BS1363 13A	53.4 (1357)	2.5 (64)	1.8 (46)
15644-202	15645-202	16	4.0	IEC C20	1 x 16A	(20) C13, (4) C19	61.3 (1557)	2.5 (64)	1.8 (46)
15644-205	15645-205	16	4.0	IEC C20	1 x 16A	(24) Schuko DIN49440 16A	61.0 (1549)	1.8 (46)	2.7 (69)
15644-207	15645-207	16	4.0	IEC C20	1 x 16A	(24) Universal GB2009.3 10A	61.3 (1557)	2.5 (64)	1.8 (46)
15644-208	15645-208	16	4.0	IEC C20	1 x 16A	(20) CH GB1002 10A, (4) 16A	61.3 (1557)	2.5 (64)	1.8 (46)
15644-212	15645-212	16	4.0	IEC 16A 1P+N+E	1 x 16A	(20) C13, (4) C19	61.3 (1557)	2.5 (64)	1.8 (46)
15644-215	15645-215	16	4.0	IEC 16A 1P+N+E	1 x 16A	(24) Schuko DIN49440 16A	61.0 (1549)	1.8 (46)	2.7 (69)
15644-217	15645-217	16	4.0	IEC 16A 1P+N+E	1 x 16A	(24) Universal GB2009.3 10A	61.3 (1557)	2.5 (64)	1.8 (46)
15644-218	15645-218	16	4.0	IEC 16A 1P+N+E	1 x 16A	(20) CH GB1002 10A, (4) 16A	61.3 (1557)	2.5 (64)	1.8 (46)
15644-222	15645-222	32	8.0	IEC 32A 1P+N+E	2 x 16A	(20) C13, (4) C19	66.5 (1689)	2.5 (64)	1.8 (46)
15644-225	15645-225	32	8.0	IEC 32A 1P+N+E	2 x 16A	(24) Schuko DIN49440 16A	64.8 (1646)	1.8 (46)	2.7 (69)
15644-227	15645-227	32	8.0	IEC 32A 1P+N+E	2 x 16A	(24) Universal GB2009.3 10A	66.5 (1689)	2.5 (64)	1.8 (46)
15644-228	15645-228	32	8.0	IEC 32A 1P+N+E	2 x 16A	(20) CH GB1002 10A, (4) 16A	66.5 (1689)	2.5 (64)	1.8 (46)
220-250 Volt, Single-Phase Power Strip, Surge-Protected									
15642-112	15643-112	16	4.0	IEC 16A 1P+N+E	1 x 16A	(10) C13, (4) C19	43.1 (1095)	2.5 (64)	1.8 (46)
15642-116	15643-116	16	4.0	IEC 16A 1P+N+E	1 x 16A	(12) UK BS1363 13A	48.3 (1227)	2.5 (64)	1.8 (46)
15642-122	15643-122	32	8.0	IEC 32A 1P+N+E	2 x 16A	(10) C13, (4) C19	48.3 (1227)	2.5 (64)	1.8 (46)
15642-126	15643-126	32	8.0	IEC 32A 1P+N+E	2 x 16A	(12) UK BS1363 13A	53.4 (1357)	2.5 (64)	1.8 (46)
15644-102	15645-102	16	4.0	IEC C20	1 x 16A	(20) C13, (4) C19	61.3 (1557)	2.5 (64)	1.8 (46)
15644-105	15645-105	16	4.0	IEC C20	1 x 16A	(24) Schuko DIN49440 16A	61.0 (1549)	1.8 (46)	2.7 (69)
15644-107	15645-107	16	4.0	IEC C20	1 x 16A	(24) Universal GB2009.3 10A	61.3 (1557)	2.5 (64)	1.8 (46)
15644-108	15645-108	16	4.0	IEC C20	1 x 16A	(20) CH GB1002 10A, (4) 16A	61.3 (1557)	2.5 (64)	1.8 (46)
15644-112	15645-112	16	4.0	IEC 16A 1P+N+E	1 x 16A	(20) C13, (4) C19	61.3 (1557)	2.5 (64)	1.8 (46)
15644-115	15645-115	16	4.0	IEC 16A 1P+N+E	1 x 16A	(24) Schuko DIN49440 16A	61.0 (1549)	1.8 (46)	2.7 (69)
15644-117	15645-117	16	4.0	IEC 16A 1P+N+E	1 x 16A	(24) Universal GB2009.3 10A	61.3 (1557)	2.5 (64)	1.8 (46)
15644-118	15645-118	16	4.0	IEC 16A 1P+N+E	1 x 16A	(20) CH GB1002 10A, (4) 16A	61.3 (1557)	2.5 (64)	1.8 (46)
15644-122	15645-122	32	8.0	IEC 32A 1P+N+E	2 x 16A	(20) C13, (4) C19	66.5 (1689)	2.5 (64)	1.8 (46)
15644-125	15645-125	32	8.0	IEC 32A 1P+N+E	2 x 16A	(24) Schuko DIN49440 16A	64.8 (1646)	1.8 (46)	2.7 (69)
15644-127	15645-127	32	8.0	IEC 32A 1P+N+E	2 x 16A	(24) Universal GB2009.3 10A	66.5 (1689)	2.5 (64)	1.8 (46)
15644-128	15645-128	32	8.0	IEC 32A 1P+N+E	2 x 16A	(20) CH GB1002 10A, (4) 16A	66.5 (1689)	2.5 (64)	1.8 (46)

Notes: All power strips have attached 10' (3 m) power cord.  
\*kW values are at a Nominal voltage of 250V.



15645-222



## Configure Your Power Solutions

Quickly choose between Power Strips, PDUs, PowerWedge or eConnect PDUs with various input/output plug combinations and capabilities.

The [CPI Product Configurator](#) guides you through each step of identifying the monitoring, switching and outlet needs of your PDU.

**CPI International Power Strips are available in two distinct functionalities: Basic and Metered**

- Horizontal rack-mount configurations use only 1U of rack-mount space
- Metered units have a digital ammeter with LED screen displays amount of current drawn by equipment, making it easier to judge the remaining power available from each power strip
- Select models include surge protection, which limits input voltage during sudden changes in utility power conditions.
- Thermal Circuit Breakers limit input current to protect connected equipment
- Master Lighted Switches are visual power indicators of on/off status



15640-201

Horizontal Rack-Mount Basic Power Strips								
Part Number	Input			Output		Dimensions - in (mm)		
	Amp	kW*	Plug	Control	Outlets	H	W	D
220-250 Volt, Single-Phase Power Strip								
15640-201	16	4.0	IEC C20	Master Lighted Switch	(10) C13	1U	19"EIA/23"	1.8 (46)
15640-202	16	4.0	IEC C20	Master Lighted Switch	(6) C13, (4) C19	1U	19"EIA/23"	4.6 (117)
15640-203	16	4.0	IEC C20	Master Lighted Switch	(4) C19	1U	19"EIA/23"	1.8 (46)
15640-204	16	4.0	IEC C20	Master Lighted Switch	(6) CH GB1002 10A	1U	19"EIA/23"	1.8 (46)
15640-205	16	4.0	IEC C20	Master Lighted Switch	(6) Schuko DIN49440 16A	1U	19"EIA/23"	1.8 (46)
15640-206	16	4.0	IEC C20	Master Lighted Switch	(6) UK BS1363 13A	1U	19"EIA/23"	1.8 (46)
15640-207	16	4.0	IEC C20	Master Lighted Switch	(6) Universal GB2009.3 10A	1U	19"EIA/23"	1.8 (46)
15640-211	16	4.0	IEC 16A 1P+N+E	Master Lighted Switch	(10) C13	1U	19"EIA/23"	1.8 (46)
15640-212	16	4.0	IEC 16A 1P+N+E	Master Lighted Switch	(6) C13, (4) C19	1U	19"EIA/23"	4.6 (117)
15640-213	16	4.0	IEC 16A 1P+N+E	Master Lighted Switch	(4) C19	1U	19"EIA/23"	1.8 (46)
15640-214	16	4.0	IEC 16A 1P+N+E	Master Lighted Switch	(6) CH GB1002 10A	1U	19"EIA/23"	1.8 (46)
15640-215	16	4.0	IEC 16A 1P+N+E	Master Lighted Switch	(6) Schuko DIN49440 16A	1U	19"EIA/23"	1.8 (46)
15640-216	16	4.0	IEC 16A 1P+N+E	Master Lighted Switch	(6) UK BS1363 13A	1U	19"EIA/23"	1.8 (46)
15640-217	16	4.0	IEC 16A 1P+N+E	Master Lighted Switch	(6) Universal GB2009.3 10A	1U	19"EIA/23"	1.8 (46)

Notes: Includes 19"EIA and 23"W horizontal rack-mount brackets. All power strips have a lighted master switch (no breaker) and an attached 10'L (3 m) cord. \*kW values are at a Nominal voltage of 250V.

**Success Story: Oak Ridge Schools Select CPI Cabinet and eConnect PDU for its Data Center Infrastructure.**

Robert Carneim, PhD, Supervisor of Instructional Technology and Doug Cofer, Data Center Director for Oak Ridge Schools chose CPI F-Series TeraFrame Cabinets with Vertical Exhaust Ducts, Monitored eConnect PDUs and custom grommets to keep the room temperature in their data center effectively cool.



**“It’s nice to have a single-vendor solution, so we don’t have to worry about someone else’s PDU fitting and the compatibility with the cabinet. It’s a good package to go along with the cabinet.”**



**Robert Carneim, PhD, Supervisor of Instructional Technology at Oak Ridge Schools**



# Options and Accessories

## Environmental Probes

Environmental Probes combine temperature and humidity sensors that can be attached to Monitored, Monitored Pro, Switched and Switched Pro eConnect PDUs. The probes are attached to a 6'L (1.8 m) cord, allowing them to be positioned near the top or bottom of the rack or cabinet.

Part Number	Description	Shipping Weight lb (kg)
17761-003	(2) Environmental Probes with (1) Temperature and (1) Humidity Sensor Kit with splitter 72"L x 2"H x 2"W (1828 mm x 50 mm x 50 mm)	1 (0.5)
17761-001	Environmental Probe with (1) Temperature and (1) Humidity Sensor 72"L x 1"H x 1"W (1828 mm x 25 mm x 25 mm)	1 (0.5)
17761-002	Environmental Probe Splitter 6"L x 2"H x 2"W (152 mm x 50 mm x 50 mm)	1 (0.5)

Note: eConnect can support two probes with a splitter. All other models support one probe.



## Vertical PDU Mounting Bracket Kit

Mounting Brackets attach vertical PDUs to racks and cabinets. Note that most CPI Cabinets now include mounting brackets. Rack brackets must be ordered separately.

Part Number	Description	Shipping Weight lb (kg)
39110-C01	For F-Series TeraFrame Gen 3 Cabinet System or GF-Series Gen 2 Cabinet System	2 (0.9)
13780-C01	For F-Series TeraFrame Gen 2 Cabinet System	2 (0.9)
25140-701	For GF-Series GlobalFrame Gen 1 Cabinet System	2 (0.9)
13762-701	For M-Series MegaFrame Cabinet System or C-Series SlimFrame Cabinet System	2 (0.9)
35700-701	For Rack Systems	2 (0.9)

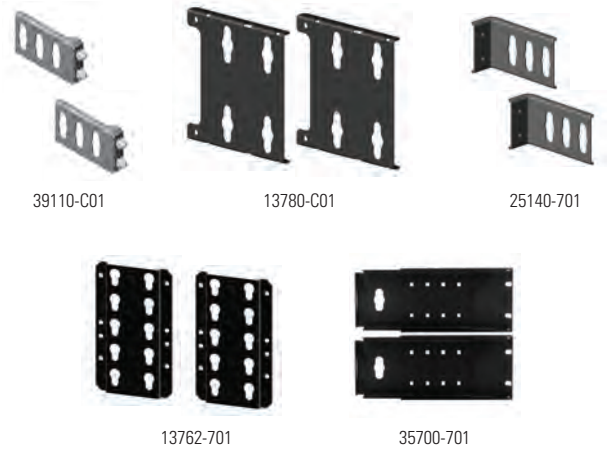

Additional Accessories		
Part Number	Description	Shipping Weight lb (kg)
17762-003	Cord Retention Tethers, Pack of 50	1 (0.5)
17762-002	Ground Wire Kit	1 (0.5)
17762-001	Tool-less Mounting Hardware Kit, Pack of 2	1 (0.5)

Note: Each PDU includes Cord Retention Tethers, Ground Wire Kit and Tool-less Mounting Hardware. They are listed as Service Parts. Mounting Brackets are included with CPI Cabinet Systems.



## IEC C20 PDU Input Power Cords

PDUs and eConnect PDUs that have IEC C20 inlets do not include an attached power cord. The power cord is ordered separately to match site requirements.

Part Number	Description	Shipping Weight lb (kg)
17763-001	PDU Input Power Cord, 110-125 VAC or 200-240 VAC, IEC C19 Connector to IEC C20 Plug, 10'L (3 m)	3 (1.4)
17763-002	PDU Input Power Cord, 110-125 VAC, IEC C19 Connector to NEMA 5-15P Plug, 8'2"L (2.4 m)	3 (1.4)
17763-003	PDU Input Power Cord, 110-125 VAC, IEC C19 Connector to NEMA 5-20P Plug, 8'2"L (2.4 m)	3 (1.4)
17763-004	PDU Input Power Cord, 200-240 VAC, IEC C19 Connector to NEMA 6-15P Plug, 8'2"L (2.4 m)	3 (1.4)
17763-005	PDU Input Power Cord, 200-240 VAC, IEC C19 Connector to NEMA 6-20P Plug, 8'2"L (2.4 m)	3 (1.4)
17763-006	PDU Input Power Cord, 110-125 VAC, IEC C19 Connector to NEMA L5-15P Plug, 10'L (3 m)	3 (1.4)
17763-007	PDU Input Power Cord, 110-125 VAC, IEC C19 Connector to NEMA L5-20P Plug, 10'L (3 m)	3 (1.4)
17763-008	PDU Input Power Cord, 200-240 VAC, IEC C19 Connector to NEMA L6-15P Plug, 10'L (3 m)	3 (1.4)
17763-009	PDU Input Power Cord, 200-240 VAC, IEC C19 Connector to NEMA L6-20P Plug, 10'L (3 m)	3 (1.4)
17763-010	PDU Input Power Cord, 200-240 VAC, IEC C19 Connector to IEC 16A 1P+N+E Plug, 10'L (3 m)	3 (1.4)
International Plugs		
17763-011	PDU Input Power Cord, 200-240 VAC, IEC C19 Connector to 16A CEE7/7 Schuko Plug (Europe), 8'2"L (2.4 m)	3 (1.4)
17763-012	PDU Input Power Cord, 200-240 VAC, IEC C19 Connector to BS1363 Plug (British), 8'2"L (2.4 m)	3 (1.4)
17763-013	PDU Input Power Cord, 200-240 VAC, IEC C19 Connector to CEI23 Plug (Italian), 8'2"L (2.4 m)	3 (1.4)

Note: Order one power cord per PDU. IEC C19 connector attaches to the C20 inlet on the PDU.



## POWER CORD PLUG TABLE:

### NEMA Locking Plugs



NEMA L5-15P  
110-125VAC/15A

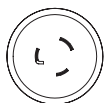

NEMA L5-20P  
110-125VAC/20A



NEMA L6-15P  
200-240VAC/15A



NEMA L6-20P  
200-240VAC/20A

### IEC Plugs

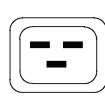

IEC 60320 C-19/C-20  
110-240VAC/20A

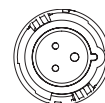

IEC 16A 1P+N+E  
200-240 VAC/16A

### NEMA Straight Plugs



NEMA 5-15P  
110-125VAC/15A



NEMA 5-20P  
110-125VAC/20A

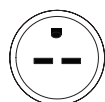

NEMA 6-15P  
200-240VAC/15A



NEMA 6-20P  
200-240VAC/20A

### International Plugs

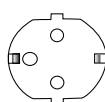

16A CEE7/7  
Schuko Plug

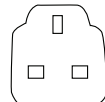

BS1363 Plug

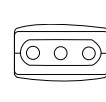

CEI23 Plug

# Outlets and Input Plugs

## Power Receptacle/Outlets

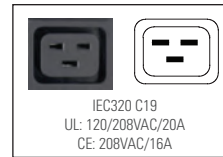
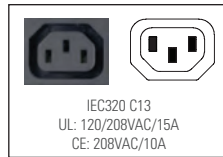
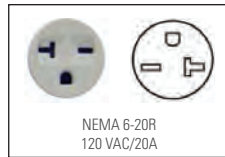
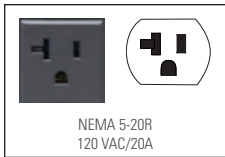

## Power Plugs

### Single-Phase/Locking



### Three-Phase/Locking



### Power Inlet - Universal/Locking

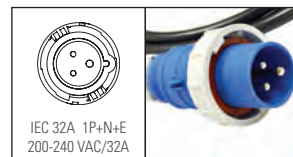
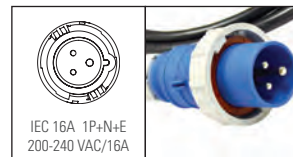
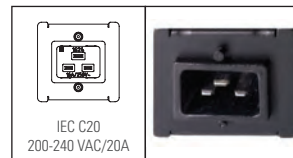
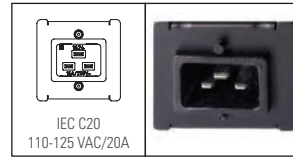

### Split-Phase/Locking

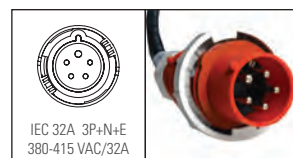
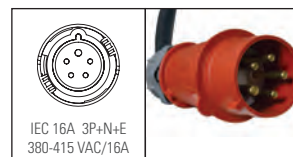

\*Note: 50A CS8365C is rated for 50A, but maximum input in 35A on three breaker PDU's.

## Power Management Feature Comparison

CPI Power Management Solutions include a broad spectrum of functionalities and features. Below is an overall comparison of eConnect PDUs, PDUs and Power Strips. Use this chart to find the unique power management solution that fits your needs.

	eConnect PDUs Advanced local and remote monitoring and switching with Click Secure Locking Outlets and Secure Array IP Consolidation						PDUs Standard local and remote monitoring and switching				Power Strips Basic local monitoring	
	Basic	Metered	Monitored	Monitored Pro	Switched	Switched Pro	Basic	Metered	Monitored	Controlled PowerWedge	Basic	Metered
Universal Tool-less Mounting for Cabinets	✓	✓	✓	✓	✓	✓	✓	✓	✓	✓	✓	✓
Low-Profile Design	✓	✓	✓	✓	✓	✓						
Click Secure Locking Outlets	✓	✓	✓	✓	✓	✓						
Use in High Temperature Applications up to 149°F (65°C)	✓	✓	✓	✓	✓	✓						
Branch/Phase Circuit Breakers	✓	✓	✓	✓	✓	✓	✓	✓	✓	✓	✓	✓
Branch/Phase Monitoring (Voltage, Current, Power, Power Factor, Energy)			✓	✓	✓	✓		Current Only	Current Only	Current Only		Current Only
Local Digital LED Display x								✓	✓	✓		✓
Local Multi-functional LCD Screen			✓	✓	✓	✓						
Temp/Humidity Sensor Port/Monitoring			✓	✓	✓	✓			✓	✓		
Second Temp/Humidity Sensor			✓	✓	✓	✓						
Network Access for Remote Monitoring (IPv4, IPv6)			✓	✓	✓	✓			IPv4 Only	IPv4 Only		
Network Setup from Local Display			✓	✓	✓	✓						
Built-in Web Interface and GUI			✓	✓	✓	✓						
Secure Array IP Consolidation (PDU Linking)			✓	✓	✓	✓						
Set Alarm Thresholds			✓	✓	✓	✓			✓	✓		
Forward SNMP Traps (v1 / v2 / v3)			✓	✓	✓	✓			SNMPv1 Only	SNMPv1 Only		
Email Alarm Notification			✓	✓	✓	✓						
Event and Data Logging (Alarms, Metrics, Logins, Set-up Changes)			✓	✓	✓	✓						
Monitored Outlets (Voltage, Current, Power, Energy)				✓		✓						
Group Outlets for Remote Current Monitoring				✓		✓						
Switched Outlets					✓	✓						
Cycle Individual Outlets Remotely					✓	✓						
Cycle Multiple Outlets Simultaneously					✓	✓						
Horizontal Orientation			✓		✓		✓	✓	✓	✓	✓	✓
Vertical Orientation	✓	✓	✓	✓	✓	✓		✓			✓	✓
100-240 VAC, Single-Phase, Worldwide	✓	✓	✓	✓	✓	✓						
120 VAC, Single-Phase Input, North America	✓	✓	✓	✓	✓	✓						
120-208 VAC, Single-Phase Input, North America	✓	✓	✓									
208 VAC, Single-Phase Input, North America	✓	✓	✓	✓	✓	✓						
120/208 VAC, Three-Phase Input, North America	✓	✓	✓	✓	✓	✓						
208 VAC, Three-Phase Input, North America	✓	✓	✓	✓	✓	✓						
240/415 VAC, Three-Phase Input, North America	✓	✓	✓	✓	✓	✓						
220-240 VAC, Single-Phase Input, Outside North America	✓	✓	✓	✓	✓	✓						
220-240/380-415 Volt, Three-Phase Input, Outside North America	✓	✓	✓	✓	✓	✓						
110-125 VAC, Single-Phase							✓	✓			✓	✓
110-240 VAC, Single-Phase (includes C20 inlet)							✓	✓	✓			
200-240 VAC, Single-Phase							✓	✓		✓	✓	✓
208 VAC, Three-Phase							✓	✓	✓			

For access to additional CPI power products, check out the Product Configurator at [www.chatsworth.com/configurator](http://www.chatsworth.com/configurator).



# Select an eConnect PDU

Use the page below to summarize your eConnect power needs. Contact our Technical Support team, or visit CPI's easy-to-use eConnect PDU Selector at [www.chatsworth.com/econnect-selector](http://www.chatsworth.com/econnect-selector) for recommended part numbers. Please contact our Custom Products Group for unique requirements that do not fall within the model below.

<input type="checkbox"/> Basic No Monitoring or Switching	<input type="checkbox"/> Monitored PDU Monitoring	<input type="checkbox"/> Monitored Pro PDU and Outlet Monitoring	<input type="checkbox"/> Switched Outlet Switching and PDU Monitoring	<input type="checkbox"/> Switched Pro Outlet Switching, PDU Monitoring and Outlet Monitoring
--	--	---	--	---

## 1 Determine your power input requirements. (Input Plug Type Plug type, Voltage, Phase, Amperage, Kilowatts)

**North America**

<input type="checkbox"/> C20 Inlet (100-240V Single Phase Input, 20A North America 1.9/3.3 kW)	<input type="checkbox"/> NEMA L15-30 Plug (208V Three Phase Input, 30A, 8.6 kW)
<input type="checkbox"/> NEMA L5-20 Plug (120V Single Phase Input, 20A, 1.9 kW)	<input type="checkbox"/> NEMA L21-20 Plug (120/208V Three Phase Input, 20A, 5.7 kW)
<input type="checkbox"/> NEMA L5-30 Plug (120V Single Phase Input, 30A, 2.8 kW)	<input type="checkbox"/> NEMA L21-30 Plug (120/208V Three Phase Input, 30A, 8.6 kW)
<input type="checkbox"/> NEMA L6-20 Plug (208V Single Phase Input, 20A, 3.3 kW)	<input type="checkbox"/> CS8365C Plug (208V Three Phase Input, 35A, 9.9 kW)
<input type="checkbox"/> NEMA L6-30 Plug (208V Single Phase Input, 30A, 4.9 kW)	<input type="checkbox"/> CS8365C Plug (208V Three Phase Input, 50A, 14.3 kW)
<input type="checkbox"/> NEMA L14-20 Plug (120/208V Single Phase Input, 20A, 3.3 kW)	<input type="checkbox"/> IEC 60A 3P+E Plug (208V Three Phase Input, 60A, 17.2 kW)
<input type="checkbox"/> NEMA L14-30 Plug (120/208V Single Phase Input, 30A, 4.9 kW)	<input type="checkbox"/> NEMA L22-20 Plug (240/415V Three Phase Input, 20A, 11.4 kW)
<input type="checkbox"/> NEMA L15-20 Plug (208V Three Phase Input, 20A, 5.7 kW)	<input type="checkbox"/> NEMA L22-30 Plug (240/415V Three Phase Input, 30A, 17.2 kW)

**Outside North America**

- C20 Inlet (100-240V Single Phase Input, 16A Outside North America 3.6 kW)
- IEC 16A 1P+N+E Plug (220-240V Single Phase Input, 16A, 3.6 kW)
- IEC 32A 1P+N+E Plug (220-240V Single Phase Input, 32A 7.3 kW)
- IEC 16A 3P+N+E Plug (220-240/380-415V Three Phase Input, 16A 11.0 kW)
- IEC 32A 3P+N+E Plug (220-240/380-415V Three Phase Input, 32A, 22.1 kW)

## 2 Determine your output requirements by identifying type and number of outlets. (Number, Output Plugs, Output Voltage)

<input type="checkbox"/> (24) 5-20R (120 V)	<input type="checkbox"/> (24) C13 (208V)
<input type="checkbox"/> (36) 5-20R (120V)	<input type="checkbox"/> (24) C13 (6) C19 (208V)
<input type="checkbox"/> (24) C13 (6) C19 (6) 5-20R (208/120V)	<input type="checkbox"/> (24) C13 (12) C19 (208V)*
<input type="checkbox"/> (24) C13 (9) C19 (3) 5-20R (208/120V)	<input type="checkbox"/> (30) C13 (6) C19 (208 V)
<input type="checkbox"/> (12) C13 (12) C19 (208V)*	<input type="checkbox"/> (36) C13 (208V)
<input type="checkbox"/> (12) C13 (18) C19 (208V)*	<input type="checkbox"/> (36) C13 (6) C19 Outlets (208V)*
<input type="checkbox"/> (18) C13 (6) C19 (208V)	

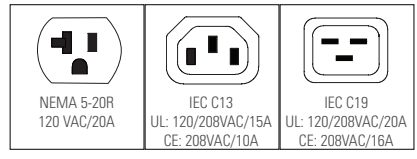

\*These configurations are included in models that are 75"H (1905 mm), which must be placed in 45U or taller cabinets. All other configurations will fit into cabinets 42U or taller.

## 3 Evaluate your accessory needs for a fully deployable power solution.



Input power cords for use with eConnect PDUs with an IEC C20 inlet.

**IEC C20 PDU Input Power Cords**

<input type="checkbox"/> IEC Power Cord IEC C20 Plug	<input type="checkbox"/> IEC Power Cord with NEMA L5-15P Plug
<input type="checkbox"/> IEC Power Cord with NEMA 5-15P Plug	<input type="checkbox"/> IEC Power Cord with NEMA L5-20P Plug
<input type="checkbox"/> IEC Power Cord with NEMA 5-20P Plug	<input type="checkbox"/> IEC Power Cord with NEMA L6-15P Plug
<input type="checkbox"/> IEC Power Cord with NEMA 6-15P Plug	<input type="checkbox"/> IEC Power Cord with NEMA L6-20P Plug
<input type="checkbox"/> IEC Power Cord with NEMA 6-20P Plug	<input type="checkbox"/> IEC Power Cord IEC 16A 1P+N+E Plug



**Environmental Probes**

- 1 Probe per PDU
- 2 Probes per PDU

*Environmental probes and accessories for local temperature and humidity monitoring*



**eConnect PDU Product Selector**  
 Select the best PDU for your application by narrowing down options based on requirements. You can compare up to four PDUs at once, then email or print the results.  
[www.chatsworth.com/econnect-selector](http://www.chatsworth.com/econnect-selector)

# Why Choose CPI?

## Protecting your technology investment.

At CPI, it is our mission to address today's critical IT infrastructure needs with products and services that protect your ever-growing investment in Information and Communication Technology (ICT). We act as your business partner and are uniquely prepared to respond to your specific requirements with global availability and rapid product customization that will give you a competitive advantage.

### Products and Solutions

CPI delivers innovation, configurability, quality and value with a breadth of integrated system components covering virtually all physical layer needs of today's IT infrastructure, structured cabling, enterprise network, data center, physical security, energy management, building automation, environmental monitoring, industrial automation, Edge computing and Internet of Things (IoT). Our product offering includes:

- Cabinet, Enclosure & Containment Systems
- Environmental Enclosure Systems
- Cable Management
- Cable Runway & Tray
- Environmental Monitoring & Security
- Grounding & Bonding
- Industrial Enclosures
- KVM Systems
- Power Management
- Rack Systems
- Seismic Protection Systems
- Wall-Mount Systems
- Zone & Wireless Enclosures

*CPI offers several resources and tools to help you easily and efficiently choose power that's right for you.*

### CPI Online Catalog

Search, filter and compare CPI's full line of intelligent PDUs.



### CPI Mobile App Suite

Includes a cable fill calculator, cabinet selector, eConnect PDU selector, wall-mount cabinet selector and a BOM tool.



## US & Canada

+1-800-834-4969

Toronto, Ontario, Canada

+905-850-7770

[chatsworth.com](http://chatsworth.com)

## Latin America

+52-55-5203-7525

Toll Free within Mexico

01-800-01-7592

[chatsworth.com.com](http://chatsworth.com.com)

## Europe

+44-1628-524-834

[chatsworth.com](http://chatsworth.com)

## Middle East & Africa

### Dubai, UAE

+971-4-2602125

[chatsworth.ae](http://chatsworth.ae)

## Asia Pacific

+86 21 6880-0266

[chatsworth.com.cn](http://chatsworth.com.cn)

Find more information  
about CPI Solutions at:  
[www.chatsworth.com](http://www.chatsworth.com)

+1-800-834-4969 (U.S. & Canada)  
or [techsupport@chatsworth.com](mailto:techsupport@chatsworth.com)

## Manufacturing Capability and Global Availability

Headquartered in the United States, CPI operates from multiple sites worldwide, including offices in Mexico, Canada, China, the United Arab Emirates and the United Kingdom. CPI's manufacturing facilities are located in the United States, Asia and Europe.

Standard products are readily available through a global network of industry-leading distributors. With stock availability, and CPI's consistently short factory lead times, you can be assured that CPI solutions will be accessible to meet your project scheduling needs.

## How to Buy

CPI sales are conducted in partnership with a global network of distributors, contractors and resellers. Whether visiting your local distribution center, or ordering online through the CPI Online Catalog at a distributor near you, CPI has a high level of stock availability. Go to [www.chatsworth.com/how-to-buy/](http://www.chatsworth.com/how-to-buy/) to learn more.

## About CPI

CPI, a 100-percent employee-owned company, was founded in June 1991, when 90 workers joined together and purchased the Dracon Division of Harris Corporation using an Employee Stock Ownership Plan (ESOP). Employee ownership is central to the success of CPI. Employee owners are committed to a philosophy of quality through teamwork, caring and commitment, which are extended to customers through our solutions and services.

## The CPI Total Solution Includes:

- Cabinet, Containment & Enclosure Systems
- Cable Management
- Cable Runway & Tray
- Environmental Monitoring & Security
- Grounding & Bonding
- Industrial Enclosure Systems
- Power Management Products
- Rack Systems
- Wall-Mount Systems
- Zone Cabling & Wiring Enclosures

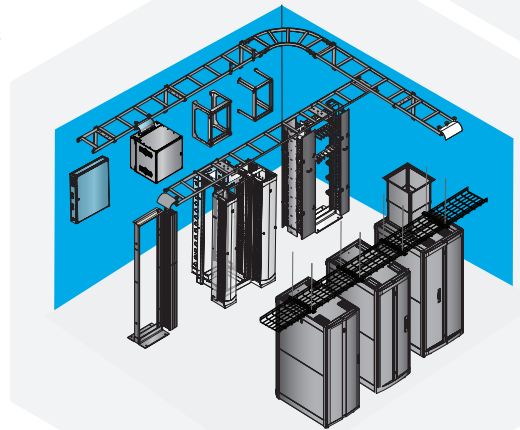

CHATSWORTH  
PRODUCTS



CPI now offers Extended Limited Warranties on CPI-Branded Electronic products, available for two additional years beyond the expiration of the Original Warranty Period (3 years).

Contact CPI Customer Service, or visit [www.chatsworth.com/warranty](http://www.chatsworth.com/warranty) for more information.

While every effort has been made to ensure the accuracy of all information, CPI does not accept liability for any errors or omissions and reserves the right to change information and descriptions of listed services and products.

©2017 Chatsworth Products, Inc. All rights reserved. Chatsworth Products, CPI, CPI Passive Cooling, CUBE-iT PLUS, eConnect, Evolution, GlobalFrame, MegaFrame, OnTrac, QuadraRack, RMR, Saf-T-Grip, Seismic Frame, SlimFrame, TeraFrame and Velocity are federally registered trademarks of Chatsworth Products. Klik-Nut, EuroFrame, Motive, Secure Array and Simply Efficient are trademarks of Chatsworth Products. All other trademarks belong to their respective companies. Rev.5 08/17 MKT-60020-536