

**Tektronix**<sup>®</sup>

# Product Catalog

2021–2022

---

**TEST & MEASUREMENT  
SOLUTIONS**  
For Engineers by Engineers

Information



Get access to the product catalog  
via the web.

[sg.tek.com/e-catalog](https://sg.tek.com/e-catalog)



See each page for details on our new products or visit [www.tek.com](http://www.tek.com)

## NEW 6 Series B MSO

Mixed Signal Oscilloscope

More channels. More bandwidth. Less Noise.

- Bandwidth Ranges: Up to 10 GHz
- Up to 8 Channels
- Sampling rate of up to 50 GS/s
- 12 Bits ADC Resolution. Up to 16-bits in High Res mode
- Excellent ENOB
- Low noise: less than 55  $\mu$ V, 1 mV / div, 1 GHz



→ See page 12 for more details

## NEW Application Bundles

A great alternative to purchasing individual options

- Better value with more functions at a much lower cost
- Cost-effective to purchase capabilities to cover future needs or needs across engineering teams
- Include the most frequently combined options for key applications and industries
- Flexibility to adjust year-to-year with lower cost 1-year subscriptions

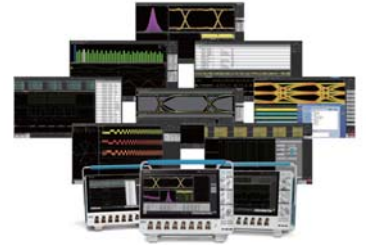

→ See page 21 for more details

## NEW TekScope

PC Analysis Software

Remote analysis anytime, anywhere.

- Oscilloscope analysis without the oscilloscope
- Remotely connect to multiple oscilloscopes to view and analyze real-time data
- Share data with your colleagues and customers
- Enhance your measurements and analysis options



→ See page 23 for more details

## NEW TekDrive

Collaborative T&M Data Workspace

Remotely share test and measurement data

- Secure anywhere-access to team's Data
- Inspect, analyze, and report on any device
- Save and recall directly on an oscilloscope
- Seamless collaboration with unlimited contributors



→ See page 24 for more details

## NEW TIVP Series

IsoVu Isolated Probes

100% Isolation  
New standards for isolated probe technology

- Bandwidth: DC - 1 GHz
- $\pm$ 60 kV Common Mode Voltage range (DC - 1 GHz)
- CMRR: 160 dB (DC - 1 MHz), 100 dB (500 MHz)
- Up to  $\pm$ 2500 V differential input Voltage range



→ See page 31 for more details

## NEW TBS1000C Series

Digital Storage Oscilloscope

Affordable performance in a compact design

- Bandwidth: 50 / 70 / 100 / 200 MHz
- 1 GS/s sample rate on all channels
- 7-inch WVGA color display with 15 horizontal divisions that shows 50% more signal
- Integrated courseware provides lab exercise guidance on the display that make learning and teaching easier



→ See page 4 for more details

## NEW 2601B-PULSE System

SourceMeter® 10  $\mu$ s Pulser / SMU Instrument

High fidelity pulsing and sourcing

- Output 10 A @ 10 V with a 10  $\mu$ s pulse width
- Control loop system eliminates the need to manually tune (for load changes up to 3  $\mu$ H)



→ See page 48 for more details

## NEW 4201-SMU / 4211-SMU / 4215-CVU

Delivers synchronizing current-voltage (I-V), capacitance-voltage (C-V) and ultra-fast pulsed I-V measurements

Low noise and low capacitance measurements

- 4215-CVU is the first C-V meter in its class capable of driving a 1 V AC source voltage and offers low-noise capacitance measurements
- Achieve stable low current measurements for I-V characterization with 4201-SMU/ 4211-SMU with a load capacitance of up to 10  $\mu$ F and 100  $\mu$ F respectively



→ See page 50 for more details

Note: All information on [www.tek.com](http://www.tek.com) supersedes all other information.



# TABLE OF CONTENTS

2021

---

## Oscilloscopes

---

<b>NEW</b> NEW TBS1000C Series .....	4
TBS2000B Series .....	6
TPS2000B Series .....	8
MSO/DPO2000B Series .....	8
Mixed Signal and Mixed Domain Selection Guide .....	9
MDO3000 Series .....	10
MDO4000C Series .....	11
<b>NEW</b> 3 Series MDO, 4/5/6B Series MSO .....	12
<b>NEW</b> Application Bundle .....	21
5 Series MSO Low Profile / 6 Series Low Digitizer .....	22
<b>NEW</b> New TekScope PC Analysis Software .....	23
<b>NEW</b> NEW TekDrive Collaborative T&M Data Workspace .....	24
MSO/DPO70000C/DX Series .....	25
DPO70000SX Series .....	27
P7700 Series TekFlex™ TriMode™ Probes .....	28
Oscilloscope Probes .....	29
<b>NEW</b> TIVP IsoVu® Differential Isolated Measuremen .....	31
TPR Series Power Rail Probes .....	32

---

## Signal Generators / Optical Solutions

---

AFG31000 Series Arbitrary / Function Generator .....	33
AFG1000 Series / AFG2021 Series Arbitrary / Function Generator .....	35
AWG5200 Arbitrary Waveform Generator .....	36
AWG70000B Arbitrary Waveform Generator .....	37
<b>NEW</b> TSO820 8 Series Sampling Oscilloscope .....	
<b>NEW</b> TCR801 Optical Clock Recovery .....	38

---

## Digital Multimeters

---

DMM6500 6½-Digit Bench/System Digital Multimeter .....	39
DAQ6510 Data Acquisition and Logging Multimeter System .....	39
DMM7510 7½-Digit Graphical Sampling Multimeter .....	40
KickStart Instrument Control Software .....	40
DMM Comparison Table .....	41
Data Acquisition Systems .....	43
Ultra Sensitive Measurement .....	44

---

## DC Power Supply

---

2280S Series Precision Measurement DC Power Supply .....	45
2281S Series Precision DC Power Supply with .....	45
Battery Test & Battery Simulation	
2230 Multi-Channel USB and USB/GPIB Programmable .....	46
DC Power Supplies	
2260B Programmable DC Power Supplies .....	46
Series 2290 High Voltage Power Supplies .....	46

---

## Source Measure Units

---

2400 Graphical Touchscreen Series SMU .....	47
2400 Graphical Touchscreen Series SMU / I-V Curve Tracer Software .....	48
<b>NEW</b> 2601B-PULSE 10 µsec Pulser / SMU .....	48
Keithley Source Measure Units .....	49
Keithley Test Script Processor (TSP®) / Test Script Builder .....	49
Semiconductor Test System .....	50

---

## Spectrum Analyzers

---

Real-Time Spectrum Analyzer .....	51
RSA5000B Real-Time Spectrum Analyzer .....	51
RSA306B USB Spectrum Analyzer .....	52
RSA500A / 600A Series USB Real Time Spectrum Analyzer .....	53
SignalVu-PC Vector Signal Analysis Software .....	54
DataVu-PC .....	54
EMCVu All-in-One Pre-compliance and Debug Solution .....	55
RSA7100B Real-Time Spectrum Analyzer .....	55
FCA/MCA3000 Series Frequency Counter/Timers .....	56

---

## Tektronix Service Solutions Organization (SSO) 57

---

---

## Customer Support & Learning Resources 58

---

---

## We're for the Engineer 59

---

# Oscilloscopes

## NEW TBS1000C Series

### Digital Oscilloscope

Affordable performance in a compact design, the TBS1000C digital storage oscilloscope provides the features, versatility and durability



Width: 325mm Height: 155mm Depth: 107mm Weight: 2.0kg

- Bandwidth: 50 / 70 / 100 / 200 MHz
- 1 GS/s sample rate on all channels
- 7-inch WVGA color display with 15 horizontal divisions that shows 50% more signal
- Integrated courseware provides lab exercise guidance on the display that make learning and teaching easier
- 32 automated measurements
- Built-in oscilloscope handbook provides operating instructions and oscilloscope fundamentals
- Fanless design contributes to low noise operation
- Small footprint and light weight

### Affordable Performance in a Compact Design

#### Low Noise Front End Design

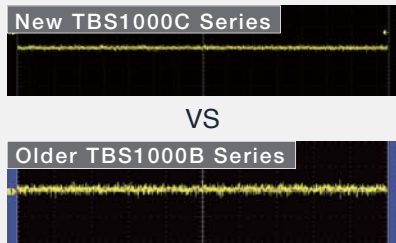

- Input sensitivity range 1 mV/div, Input impedance: 14 pF

#### Dual Window FFT



- Cursors: Time, Amplitude, Screen
- Simultaneous time and frequency domain views

#### Measurement based on Cursor

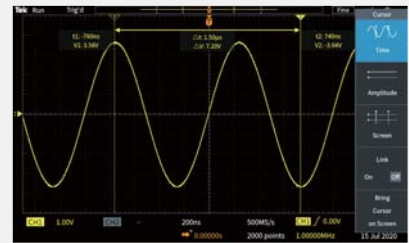

- Time, Amplitude and Screen Type Cursor
- Measured values can be displayed on waveform

#### Innovate Education Solutions

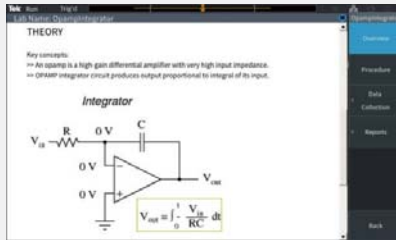

- Built-in oscilloscope handbook provides operating instructions and oscilloscope fundamentals
- HelpEverywhere® system with on-screen tips and hints throughout the user interface
- Built-in Courseware Lab Viewer

#### Enable / Disable Features

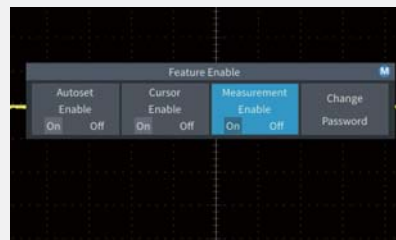

- Password protected to enable/disable autoset, cursors and measurements
- Enable Educators to teach basic concepts of signal capture, analysis and provides operating instructions

#### OpenChoice® Communications Software

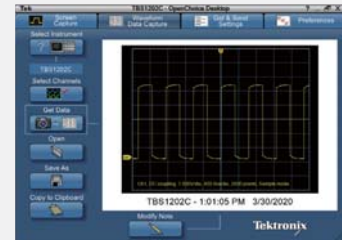

- Remote screen capture
- Capture waveform data
- Get / send instrument settings

### Offers Features that Enable the Educator to Teach Fundamental Concepts

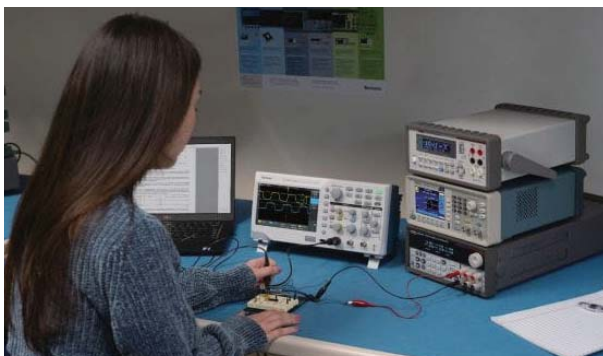

### Easy to use Standard Probe

The Tektronix probe tip is only 3.8mm, providing easy access to your device.

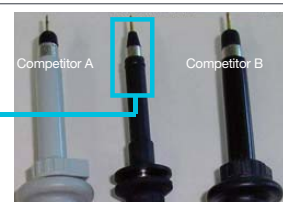

**Note:**  
One probe per analog channel

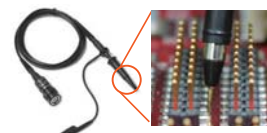



## TekScope PC Analysis Software

Access easily to your remote oscilloscope and analyze waveforms anywhere, anytime

## KickStart [Keithley Control Software]

Automated data collection from multiple instruments

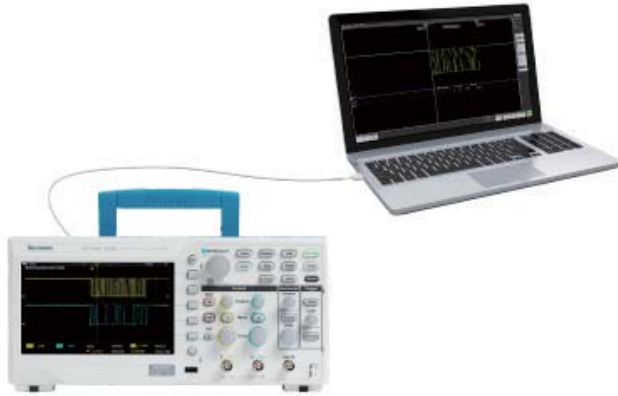

Product Specifications	TBS1052C	TBS1072C	TBS1102C	TBS1202C
Channels	2			
Bandwidth	50MHz	70MHz	100MHz	200MHz
Sample Rate (on all channels)	1GS/s			
Rise Time	8.4ns	5.5ns	4ns	2.5ns
Input Sensitivity Range	1mV/div-10V/div			
Vertical Zoom	Vertically expand or compress a live or stopped waveform			
Offset Range	1mV/div-50mV/div: ±1V, 100mV/div-500mV/div: ±10V, 1V/div-5V/div: ±100V			
DC Gain Accuracy	±3%			
Vertical Resolution	8 bits			
Bandwidth Limit	20MHz (Typ)			
Input Coupling	AC, DC			
Input Impedance	1MΩ ±2% (14pF±2pF)			
Maximum Input Voltage	300 VRMS, Installation Category II; derate above 4 MHz at 20 dB per decade to 200 MHz			
Horizontal Zoom	Horizontally expand or compress a live or stopped waveform			
Timebase Range	2ns/div-100s/div			
Record Length	20 K points			
Timebase Accuracy	20ppm			
External Trigger Input	Included on all models			
Input Output Ports	USB 2.0 Host Port - Supports USB mass storage devices, USB 2.0 device port - Rear-panel connector allows for communication/control of oscilloscope through USBTMC or GPIB with a TEK-USB-488			

Probe: PP0200 200 MHz passive probe (TBS1202C), TPP0100 100 MHz passive probe (TBS1102C, TBS1072C, TBS1052C) per analog channel

### Recommended accessories

- RM2000B..... Rackmount kit
- TEK-USB-488..... GPIB-to-USB converter
- 174-4401-xx..... USB host to device cable, 90cm

### 5-year Warranty

Covering all labor and parts, excluding probes and accessories



### Recommended probes → (See page 29 - 30 for more details).

- P2221.....1X/10X passive probe, 200 MHz bandwidth
- P6101B.....1X passive probe (15 MHz, 300 VRMS CAT II rating)
- P6015A.....1000X high-voltage passive probe (75 MHz)
- P5100A.....100X high-voltage passive probe (500 MHz)
- P5200A.....50 MHz, 50X/500X high-voltage differential probe
- P6021A.....15 A, 60 MHz AC current probe
- P6022.....6 A, 120 MHz AC current probe
- A621.....2000 A, 5 to 50 kHz AC current probe
- A622.....100 A, 100 kHz AC/DC current probe/BNC
- TCP303/TCPA300\*1.....150 A, 15 MHz AC/DC current probe/amplifier
- TCP305A/TCPA300\*1.....50 A, 50 MHz AC/DC current probe/amplifier
- TCP312A/TCPA300\*1.....30 A, 100 MHz AC/DC current probe/amplifier
- TCP404XL/TCPA400\*1.....500 A, 2 MHz AC/DC current probe/amplifier
- TCP2020.....20A, 50MHz AC/DC current probe

\*1 BNC cable (012-0076-00) and 50Ω termination (011-0049-02) are required.

# TBS2000B Series

## Digital Storage Oscilloscope

An affordable, powerful scope that delivers more on your bench



[2ch Model] Width: 372mm Height: 175mm Depth: 103mm Weight: 2.62kg  
 [4ch Model] Width: 413mm Height: 202mm Depth: 128mm Weight: 4.17kg

- Maximum Bandwidth: 200 MHz
- Max Sample Rate: 2 GS/s sampling rate
- TekVPI probe interface supports active, differential, and current probes with automatic scaling and units
- New lower noise front end design offers lower random noise, better signal integrity and more accurate measurements.
- Search and Mark features for easy identification of events that occur in the acquired waveform
- 32 automated measurements, and FFT function for quick waveform analysis
- HelpEverywhere® provides helpful on-screen tips for new users
- Wireless connection with USB wireless LAN adapter\*
- Extensive software for educational institutions

\* USB wireless LAN adapter must be ordered separately

### See More - Designed to display more signal than ever

#### Large 9-inch Display

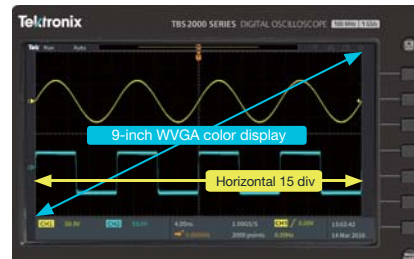

15 horizontal divisions shows 50% more signal

#### Quickly Search for Events of Interest



Search and Mark features for easy identification of events that occur in the acquired waveform

#### Low Noise Front End Design

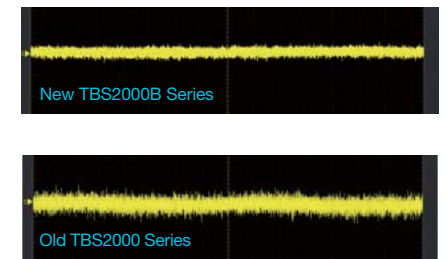

Offers lower noise and higher effective bits enabling more accurate measurements

### Analyze More - Designed to perform wide range of Measurements and Complex Analysis

#### TekVPI® Probe Interface



TekVPI probes communicate scale settings, ranges, and status to the TBS2000B

#### Easy Automated Measurements/ Cursor Measurements

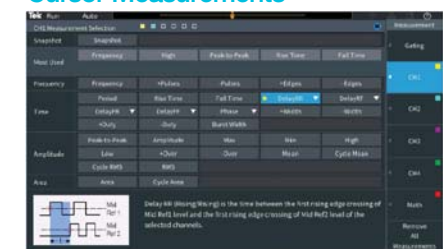

Measurements are all listed and selected on a single screen

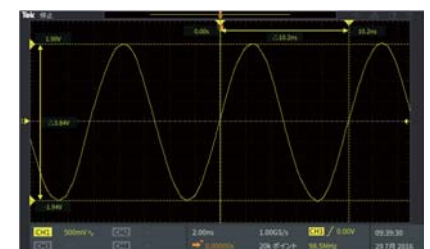

Innovative cursor measurements with on-waveforms readouts

### Access More - Designed with flexible I/O for data transfer and remote access to instrument

#### Supports a Wide Range of Interfaces



Wi-Fi adapters are configured through integrated setup menus and support seamless wireless communications



Easily capture, save, and analyze measurement results using the OpenChoice® PC Communications Software.



Built-in web page enables remote control of horizontal and vertical scale, trigger settings, and measurements.

### Innovative Education Solutions for easy learning and teaching



HelpEverywhere® tips explain important settings.

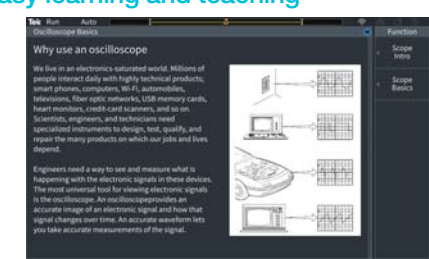

Scope Intro covers basic oscilloscope and TBS2000B usage

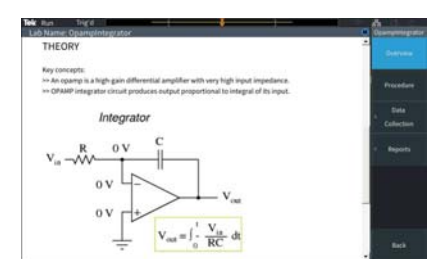

The Courseware function allows students to see lab information on the instrument display.



Models	TBS2072B	TBS2074B	TBS2102B	TBS2104B	TBS2202B	TBS2204B
Analog Channels	2	4	2	4	2	4
Bandwidth	70MHz	70MHz	100MHz	100MHz	200MHz	200MHz
Max Sample Rate	1 GS/s - All Channels, 2 GS/s - Half Channel					
Rise Time	5ns	5ns	3.5ns	3.5ns	1.75ns	1.75ns

Models	TBS2072B	TBS2074B	TBS2102B	TBS2104B	TBS2202B	TBS2204B
Input Sensitivity Range	2mV/div~10V/div					
DC Gain Accuracy	± 2 (10V/div~5mV/div) ±3% (typical 1 mV/div)					
Vertical Resolution	8 bits					
Hardware Bandwidth Limits	20MHz (typical)					
Input Coupling	AC, DC, GND					
Input Impedance	1 MΩ ± 1 %, 13 pF ± 1.5 pF					
Maximum Input Voltage, 1 MΩ	300V rms (Installation Category II; with peaks ≤ ±450V)					
Time Base Range	TBS220x: 1ns/div~100s/div, TBS207x, TBS210x: 2ns/div~100s/div					
Record Length	5M					
Automated Measurements	32					
FFT	Standard					
Probe Interface	TekVPI Probe Interface					
Input Ports	USB2.0 (2 host ports, 1 device port), LAN, Aux Out, WiFi (optional)					
Display Type	9 inch wide format liquid crystal TFT color display.					
Display Resolution	800 (horizontal) × 480 (vertical) displayed pixels (WVGA)					

**Accessories:** 100MHz passive probe TPP0100 (for 100MHz / 70MHz model) / 200MHz passive probe TPP0200 (for 200MHz model) (2: 2 channel model, 4: 4 channel model), manual  
Manual (Web download), installation / safety manual, power cable, calibration certificate

**Option**

Opt. D1.....Calibration Data Report.

**Recommended Accessories**

- TPA-BNC.....TekVPI® to TekProbe® BNC adapter
- TEK-DPG.....TekVPI® Deskew pulse generator signal source
- 067-1686-xx.....Power measurement deskew and calibration fixture
- ACD2000\*.....Soft transit case for TBS2000B 2-channel instrument
- ACD4000B\*.....Soft transit case, for TBS2000B 4-channel instrument
- TEK-USB-488.....GPIB-to-USB adapter

\* The TBS2000B series does not have a front cover. ACD2000 and ACD4000B also have a front cover. Please note that it is not included (the front cover that comes with the ACD2000 is for DPO / MSO2000B).

**5-year warranty**

Covering all labor and parts, excluding probes and accessories



**Recommended Probes**

- P5100A**.....2.5 kV, 500 MHz, 100X high-voltage passive probe
- TDPO500**.....500 MHz TekVPI® differential voltage probe with ±42 V differential input voltage
- TAP1500**.....1.5 GHz TekVPI® active voltage probe
- THDP0200**.....50 MHz TekVPI® 20 Ampere AC/DC current probe
- THDP0100**.....±6 kV 100 MHz high-voltage differential probe
- TCP0030A**.....120 MHz TekVPI® 30 Ampere AC/DC current probe
- TCP0020**.....50 MHz TekVPI® 20 Ampere AC/DC current probe
- TCP0150**.....20MHz AC/DC

**TekSmartLab/TekBench: Lab instrument management solution for quickly setting up and efficiently managing basic electronics in engineering laboratories!**

**TekSmartLab**

- Easy to setup with industrial reliability
- Intuitive instructor - course - exercise organization
- Centralized monitoring and remote assistance
- Online editing and submission of test reports
- Automatic instrument asset information recording
- License transfer between different PCs

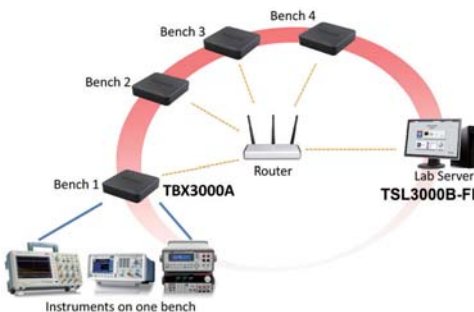

Lab managers can efficiently manage Setup configurations of large fleets of instruments with one click



Automatic measurement function can be turned Off

**TekBench**



- Simple connection to instruments with an intuitive interface to control and monitor instruments
- Automated measurements with data logging and trend plotting
- Automated frequency response analysis

## TPS2000B Series

### Digital Storage Oscilloscope

4-Channel IsolatedChannel™ Technology for floating or differential measurements

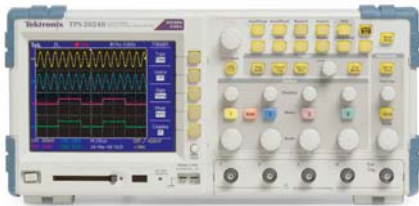

Weight: 336mm Height: 161mm Depth: 130mm Weight: 3.2kg (With 1 battery)

- Highest Bandwidth~200MHz
- Record Length: 2.5k points
- Highest Sample Rate~2GS/s
- Waveform capture rate: 180 waveforms / sec
- Display type: 5.7 inch

- With up to 4-isolated channels to safely make floating or differential measurements
- FFT standard on all models
- Compact design
- Hot-swappable battery pack with up to 8 hours of continuous battery operation
- Optional power application software

#### Key Features

- Safely and easily make 4-Channel floating measurements
- 8 hours of continuous battery operation
- Compact and easy to carry

#### Recommended Accessories

TPSBAT..... Lithium-ion battery  
TPSCHG..... Battery charger

#### Software Option

TPS2PBD2..... Power Measurement Bundle:  
TPS2PWR1 ..... Module and Four P5122 Probes  
TPS2PWR1..... Application Module:  
Power Measurement and  
Analysis Software

#### 3-year Warranty

Covering all labor and parts,  
excluding probes and accessories



\*1 Do not float the TPP0101/TPP0201 probe common lead to >30 V<sub>RMS</sub>

Basis Specifications	TPS2012B	TPS2014B	TPS2024B
Isolated Channels	2	4	4
Bandwidth	100MHz	100MHz	200MHz
Sample rate per channel	1GS/s	1GS/s	2GS/s
Rise time	3.5ns	3.5ns	2.1ns

Detailed Specifications	TPS2012B	TPS2014B	TPS2024B
Vertical Sensitivity	2mV~5V/div		
DC vertical accuracy	±3% (5V/div~10mV/div), ±4% (5mV/div and 2mV/div)		
Vertical resolution	8 bits		
Bandwidth limit	20MHz		
Maximum input voltage (1 MΩ)	300V <sub>RMS</sub> CAT II 1000V <sub>RMS</sub> CAT I (When using P5122 probe)		
Float voltage (BNC shel to earth ground)	600V <sub>RMS</sub> CAT II		
Horizontal System (Seconds/division range)	5ns~50s/div	5ns~50s/div	2.5ns~50s/div
Record length	2.5k points		

**Accessories:** Passive probe TPP0201\*1 (TPS202x type) or passive probe TPP0101\*1 (TPS201X type) is included for each channel, Lithium-ion battery with fuel gauge for 4-hour battery life. Two required for 8 hours of continuous battery operation, Front panel cover, RS232-USB adapter cable (174-5813-xx), AC adapter with power cable, calibration certificate.

## MSO/DPO2000B

### Mixed Signal / Digital Phosphor Oscilloscope

Delivers advanced debug features at an entry-level price



Width: 377mm Height: 180mm Depth: 134mm Net Weight: 3.6kg

- Highest Bandwidth: 200MHz
- Record Length: 1M points
- Highest Sample Rate: 1 GS/s
- Maximum waveform capture rate:  
Up to 5,000 wfm/s
- Display type: 7 inch

- Small footprint and lightweight
- FilterVu™ variable low-pass filter
- Maximum number of bus display: 2
- TekVPI® probe interface
- 16 digital channels (MSO series)

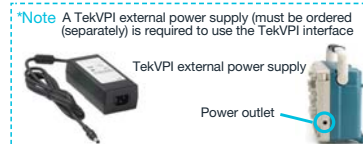

\*Note A TekVPI external power supply (must be ordered separately) is required to use the TekVPI interface



#### Key Features

- FilterVu™ variable low-pass filter allows for removal of unwanted signal noise while still capturing high-frequency events

#### Recommended accessories

TPS2PBD2 ..... Power Measurement Bundle  
TEK-USB-488 ..... GPIB-to-USB adapter  
TEK-DPG\*1 ..... TekVPI® Deskew pulse generator  
signal source  
067-1686-xx ..... Power measurement deskew and  
calibration fixture  
ACD2000 ..... Soft transit case  
(Front protective cover: 200-5045-xx)  
RMD2000 ..... Rackmount kit  
(Part number: 351-1095-xx is  
sold separately)  
DPO2CONN ..... Ethernet (10/100Base-T) and video  
out port  
119-8726-xx ..... TekVPI external power supply  
(Power cable: 161-0342-xx required)

#### Software Option

DPO2EMBD ..... Application Module: Embedded Serial  
Triggering and Analysis (I<sup>2</sup>C, SPI)  
DPO2BND ..... Application Module: Bundle module,  
including DPO2AUTO, DPO2COMP &  
DPO2EMBD, for MSO/DPO2000B Series

#### 5-year Warranty

Covering all labor and parts,  
excluding probes and accessories



Basic Specifications	MSO/DPO 2002B	MSO/DPO 2004B	MSO/DPO 2012B	MSO/DPO 2014B	MSO/DPO 2022B	MSO/DPO 2024B
Analog Channels	2	4	2	4	2	4
Bandwidth (-3dB)	70MHz	70MHz	100MHz	100MHz	200MHz	200MHz
Sample Rate	1GS/s					
Rise time	5.0ns		3.5ns		2.1ns	
Record Length	1M points					

















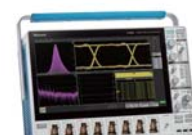

Vertical system digital channels	
Hardware bandwidth limits	20MHz
Input coupling	AC, DC, GND
Input impedance	1MΩ±2%, 11.5pF±2pF
Input sensitivity range, 1MΩ	2mV/div~5V/div
Vertical resolutions	8 bits
Maximum input voltage, 1 MΩ	300 V <sub>RMS</sub> with peaks ≤ ±450 V
DC gain accuracy	±3% (10mV/div~5V/div), ±4% (2mV/div, 5mV/div)
Vertical System (MSO Series only)	
Input channels	16 digital (D15 to D0)
Maximum input voltage	±40V
Input dynamic range	80 Vpk-pk (threshold setting dependent)

**Accessories:** One TPP0100 100MHz, 10X Passive Probe Per Analog Channel (70 MHz model), One TPP0200 200 MHz, 10X Passive Probe Per Analog Channel (100 MHz & 200 MHz models), One P6316 16 Channel Logic Probe (MSO only), OpenChoice® Desktop Software Calibration Certificate, Quick Reference Manual & Documentation on CD, Power Cord

\*1 TekVPI external power supply (119-8726-xx) and power cable (161-0342-xx) are required



# MDO/MSO Series Selector Guide

Series	Model	Analog Channels	Display	Bandwidth	Sample Rate	Record Length	Waveform Capture Rate	Serial Trigger and Analysis	Key Features
<b>MDO3000</b> Mixed Domain Oscilloscope Integrated Spectrum Analyzer. The ultimate general purpose oscilloscope.    1. Oscilloscope 2. Spectrum Analyzer 3. Arbitrary Function Generator 4. Protocol Analyzer 5. Protocol Analyzer 6. DVM/Counter  <b>6 in 1</b> Width: 417mm Height: 203mm Depth: 147mm Weight: 4.2kg	MDO3012	2	9-inch display [wide-screen]  	100MHz	2.5GS/s	10 Mpoints	 >235,000 wfms/s with FastAcq®	I²C/SPI,*2 CAN-FD/ CAN/LIN, FlexRay, USB2.0, RS-232/422/ 485/UART, MIL-STD-1553, ARINC-429, I²S*3	<ul style="list-style-type: none"> <li>The Ultimate 6-in-1 Integrated Oscilloscope</li> <li>Spectrum Analyzer</li> <li>Logic Analyzer</li> <li>Arbitrary Function Generator</li> <li>Protocol Analyzer</li> <li>DVM/Counter</li> </ul> <ul style="list-style-type: none"> <li>Completely customizable, providing what you need now – and later</li> <li>Option to add 16 digital channels</li> </ul> <b>Frequency Domain Specifications</b> <ul style="list-style-type: none"> <li>Frequency range: (Standard) 9 kHz - Analog BW, (Optional) 9 kHz - 3 GHz</li> </ul> *1 The maximum sample rate will change depending on the number of channels selected. *2 *3 Signal Inputs - any Ch1-Ch4, any DO-D15
	MDO3014	4							
	MDO3022	2							
	MDO3024	4							
	MDO3032	2							
	MDO3034	4							
	MDO3052	2							
	MDO3054	4							
MDO3102	2	1GHz	5GS/s <sup>1</sup>	>280,000 wfms/s with FastAcq®					
<b>MDO4000C</b> Mixed Domain Oscilloscope Solve the toughest embedded design challenges quickly and efficiently.    1. Oscilloscope 2. Spectrum Analyzer 3. Arbitrary Function Generator 4. Logic Analyzer 5. Protocol Analyzer 6. DVM/Counter  <b>6 in 1+</b> Width: 439mm Height: 229mm Depth: 147mm Weight: 5.5kg	MDO4024C	4	10.4 inch display [color]  	200MHz	2.5GS/s	20 Mpoints	 >270,000 wfms/s with FastAcq®	I²C, SPI, Ethernet, CAN-FD/ CAN/LIN, USB2.0, RS-232/422/ 485/UART, MIL-STD-1553, ARINC 429, I²S/LJ/RJ/ TDM	<ul style="list-style-type: none"> <li>Performance 6-in-1 integrated oscilloscope for design and debug,</li> <li>EMI Troubleshooting, General Purpose RF Design and Integration</li> <li>&gt;340,000 wfms/s maximum waveform capture rate (FastAcq™) high probability of quickly seeing the infrequent problems</li> <li>MSO (optional) Analog (4ch) + Digital (16ch) time correlation display</li> <li>Time-synchronized capture of spectrum analyzer with analog and digital acquisitions</li> <li>Optional digital 16ch can be added frequency domain specifications</li> </ul> <b>Frequency Domain Specifications</b> <ul style="list-style-type: none"> <li>Frequency range of 9 kHz - 3 GHz or 9 KHz - 6 GHz</li> </ul>
	MDO4034C			350MHz					
	MDO4054C			500MHz					
	MDO4104C			1GHz					
<b>3 Series MDO</b> Largest display in class and improved low-level signal measurement accuracy    Width: 370mm Height: 252mm Depth: 148.6mm Weight: 5.31kg	MDO32	2	11.6-inch HD display [color]  	100MHz 200MHz 350MHz 500MHz 1GHz bandwidth model	2.5 GS/s (All channels)	10 Mpoints	 >280,000 wfms/s with FastAcq®	MIL-STD-1553, ARINC429, I²S, LJ, RJ, TDM, CAN, CAN FD, LIN, FlexRay, RS-232/422/ 485/UART, I²C, SPI, USB 2.0	<ul style="list-style-type: none"> <li>11.6-inch HD (1,920 × 1,080) display with capacitive touchscreen</li> <li>Use intuitive pinch, swipe, zoom gestures on the display</li> <li>Unique built-in spectrum analyzer (1 GHz comes standard on all models / 3 GHz is optional)</li> <li>Integrated AFG, MSO, DVM, Serial Bus Decode function (optional)</li> <li>Low noise, class-leading high ENOB (Vibrant bit)</li> </ul>
	MDO34	4		5 GS/s (1 GHz model)					
<b>4 Series MSO</b> Extreme visibility, versatility and usability for any bench    Width: 405mm Height: 249mm Depth: 155mm Weight: <7.6kg	MSO44	4 Flex Channel	13.3-inch HD display [color]  	200MHz 350MHz 500MHz 1GHz 1.5GHz bandwidth model	6.25GS/s	31.25 Mpoints  62.5 Mpoints (Optional)	 >500,000 waveforms/s with FastAcq®	MIL-STD-1553, ARINC429, I²S, LJ, RJ, TDM, CAN, CAN FD, LIN, FlexRay, SENT, RS-232/422/ 485/UART, I²C, SPI, 10BASE-T, 100BASE-TX, I3C, SPMI, USB 2.0, SPACEWIRE	<ul style="list-style-type: none"> <li>13.3-inch HD (1,920 × 1,080) display with capacitive touchscreen</li> <li>Use intuitive pinch, swipe, zoom gestures on the display</li> <li>Vertical resolution: 12-bit ADC</li> <li>FlexChannel® input to each channel, can be configured as 1 analog or 8 digital channels</li> <li>Built-in optional AFG, MSO, DVM, serial protocol decoding</li> <li>Various analysis options (power, serial bus trigger, decode and analysis, RF vs Time analysis, etc)</li> </ul>
	MSO46	6 Flex Channel							
<b>5 Series MSO</b> The largest display. The Most Channels. The Greatest Experience.    Width: 454mm Height: 309mm Depth: 205mm Weight: <11.4kg	MSO54	4 Flex Channel	15.6-inch HD display [color]  	350MHz 500MHz 1GHz 2GHz bandwidth model	6.25GS/s	62.5 Mpoints  125/ 250/ 500 Mpoints (optional)	 >500,000 waveforms/s with FastAcq®	MIL-STD-1553, ARINC429, I²S, LJ, RJ, TDM, CAN, CAN FD, LIN, FlexRay, SENT, RS-232/ 422/485/UART, I²C, SPI, 10BASE-T, 100BASE-TX, I3C, SPMI, USB 2.0, SPACEWIRE, 100BASE-T1	<ul style="list-style-type: none"> <li>Vertical resolution: 12-bit ADC, up to 16-bits in High Res mode</li> <li>4, 6, or 8 FlexChannel® inputs</li> <li>With 4 or 6 FlexChannel inputs (each flex channel provides one analog signal or can be configured to 16 digital channels)</li> <li>15.6-inch HD (1,920 × 1,080) display with capacitive touchscreen</li> <li>Configurable OS: Optional Windows 10 operating system</li> <li>Powerful analysis options (Power analysis, Ethernet for Automotive Compliance test, etc.)</li> </ul>
	MSO56	6 Flex Channel							
	MSO58	8 Flex Channel							
<b>6 Series B MSO</b> More Bandwidth. More Channels. Less Noise.    Width: 454mm Height: 309mm Depth: 205mm Weight: <13.52kg	MSO64B	4 Flex Channel	15.6-inch HD display [color]  	1GHz 2.5GHz 4GHz 6GHz 8GHz 10GHz bandwidth model	2ch: 50GS/s 4ch: 25GS/s 6 or 8ch: 12.5GS/s	62.5 Mpoints  125/ 250/ 500 Mpoints or 1 Gpoints (optional)	 >500,000 wfms/s (Peak Detect, Envelope acquisition mode), >30,000 wfms/s (all other acquisition modes) FastAcq®	MIL-STD-1553, ARINC429, I²S, LJ, RJ, TDM, CAN, CAN FD, LIN, FlexRay, SENT, RS-232/ 422/485/ UART, I²C, SPI, 10BASE-T, 100BASE-TX, I3C, SPMI, USB 2.0, SPACEWIRE, 100BASE-T1	<ul style="list-style-type: none"> <li>Best signal fidelity with 12-bit ADCs and ultra-low noise</li> <li>4, 6 or 8 FlexChannel™ inputs, with 8 digital inputs available for each channel</li> <li>15.6-inch HD display with capacitive multi-touch touchscreen</li> <li>TekVPI probes communicate with the scope to simplify setup, reduce errors and many probes feature status indicators and controls</li> <li>Powerful statistics and trends provide deep insight.</li> <li>Provides application specific advanced measurements and automated solutions</li> <li>Upgrade at any time to meet future needs</li> </ul>
	MSO66B	6 Flex Channel							
	MSO68B	8 Flex Channel							

# MDO3000

## Mixed Domain Oscilloscope



Width: 417mm Height: 203mm Depth: 147mm Weight: 4.2kg

Integrated Spectrum Analyzer.  
The ultimate general purpose oscilloscope.

- Bandwidth is upgradable (up to 1 GHz), up to 5 GS/s sample rate
- With >280,000 wfms/s with FastAcq, it becomes a powerful design and debug tool
- Integrated spectrum analyzer with frequency range: (Standard) 9 kHz - Analog BW, (Optional) 9 kHz - 3 GHz

1. Oscilloscope
2. Spectrum Analyzer
3. Arbitrary Function Generator
4. Logic Analyzer
5. Protocol Analyzer
6. DVM/Counter

# 6 in 1

	MDO3014 MDO3012	MDO3024 MDO3022	MDO3034 MDO3032	MDO3054 MDO3052	MDO3104 MDO3102
<b>Oscilloscope Specifications</b>					
Analog channel bandwidth	100MHz	200MHz	350MHz	500MHz	1GHz
Analog channels	2 or 4				
Sample Rate	2.5GS/s (all channels)				2.5GS/s (3 or 4ch) 5GS/s (1 or 2ch)
Record length (all channels)	10 Mpoints				
Maximum waveform capture rate	>235,000 wfms/s (FastAcq™)				>280,000 wfms/s (FastAcq™)
Input coupling	AC, DC				
Input impedance	1M1MΩ±1%, 75Ω±1%, 50Ω±1%				1MΩ±1%, 50Ω±1%
Input sensitivity range, 1MΩ, 75Ω/50Ω	1mV/div~10V/div (1MΩ), 1mV/div~1V/div (75Ω*/50Ω)				
Vertical resolution	8 bits (11 bits with Hi Res)				
Maximum input voltage, 1MΩ, 75Ω/50Ω	300 VRMS CAT II with peaks ≤ ±425 V (1MΩ), 5 VRMS with peaks ≤ ±20 V (75Ω*/50Ω)				
DC gain accuracy	±1.5% (5mV/div and above), ±2.0% (2mV/div), ±2.5% (1mV/div)				
<b>Spectrum Analyzer Specifications</b>					
Standard spectrum analyzer frequency range	9kHz~100MHz	9kHz~200MHz	9kHz~350MHz	9kHz~500MHz	9kHz~1GHz
Optional spectrum analyzer frequency range	9kHz~3GHz (with MDO3SA option)				
Maximum capture bandwidth	Ultra-wide capture bandwidth up to 3 GHz				
Span	All models: 9 kHz – 3 GHz with option MDO3SA, in a 1-2-5 sequence				
Resolution bandwidth	20 Hz - 150 MHz in a 1-2-3-5 sequence				
Displayed average noise level (DANL)	9 kHz - 50 kHz < -109 dBm/Hz (< -117 dBm/Hz with TPA-N-PRE preamp attached) 50 kHz - 5 MHz < -126 dBm/Hz (< -136 dBm/Hz with TPA-N-PRE preamp attached) 5 MHz - 2 GHz < -136 dBm/Hz (< -146 dBm/Hz with TPA-N-PRE preamp attached) 2 GHz - 3 GHz < -126 dBm/Hz (< -136 dBm/Hz with TPA-N-PRE preamp attached)				
Phase noise at 1 GHz CW	10 kHz: < -81 dBc/Hz, < -85 dBc/Hz (typical) 100 kHz: < -97 dBc/Hz, < -101 dBc/Hz (typical) 1 MHz: < -118 dBc/Hz, < -122 dBc/Hz (typical)				

\*75 Ω not available on 1 GHz models (MDO3104 and MDO3102).

<b>Logic Analyzer (Requires Opt. MDO3MSO)</b>	
Digital channel	16 ch (One P6316 16-channel logic probe)
Maximum sample rate (Main)	500 MS/s (2 ns resolution)
Maximum sample rate (MagniVu)	8.25 GS/s (121.2 ps resolution)
Input channels	16 digital (D15 to D0)
Thresholds	Threshold per set of 8 channels

<b>Arbitrary Function Generator (Requires Opt. MDO3AFG)</b>	
AFG	Outputs: 1 (13 predefined waveforms and arbitrary waveform generation)
AFG Waveforms	Sine, Square, Pulse, Ramp/Triangle, DC, Noise, Sin(x)/x (Sinc), Gaussian, Lorentz, Exponential Rise, Exponential Decay, Haversine, Cardiac, and Arbitrary.
AFG Frequency Range	50MHz (Sine), 25MHz (Square / Pulse), 5MHz (Gaussian, Lorentz, Exponential Rise/Decay, Haversine, and Arbitrary), 2MHz (Sin(x)/x), 500kHz (Ramp / Triangle, Cardiac)
Amplitude Range	10mV~2.5Vmax (50Ω) 20mV~5Vmax (Hi-Z)
Arbitrary Memory Depth	1 to 128 k
Arbitrary Sample Rate	250MS/s

<b>Digital Voltmeter and Frequency Counter (Available free of charge when the product is registered on the web)</b>	
Voltage Measurement	Digital Voltmeter Resolution: 4 digits, AC RMS, DC, AC+DC RMS
Frequency Measurement	Frequency: 5 digits, Maximum input frequency: 150MHz, 100MHz (100MHz Models)
Frequency Accuracy	±(10 μHz/Hz + 1 count)

**3-year warranty**  
Covering all labor and parts, excluding probes and accessories



**Standard Accessories:** One passive voltage probe per analog channel (100 / 200MHz model: TPP0250 type, 350 / 500MHz model: TPP0500B type, 1GHz model: TPP1000 type), N-to-BNC adapter (103-0473-00), Documentation CD (063-4526-xx), installation and safety instruction manual (071-3249-xx), accessory bag (016-2008-xx), power cable, OpenChoice® desktop software, calibration certificate

### Application Modules

- MDO3AUTO** ..... Automotive Serial Triggering and Analysis Module (CAN, CAN FD, LIN)
  - MDO3COMP** ..... RS-232/422/485/UART Computer Serial Triggering and Analysis Module
  - MDO3EMBD** ..... Embedded Serial Triggering and Analysis Module (I2C, SPI)
  - MDO3PWR** ..... Power Analysis Application Module
  - MDO3BND\*** ..... MDO3000 Application module
- \* Includes all the above modules.

### Recommended Accessories

- 119-4146-00** ..... Near field probe set, 100 kHz - 1 GHz
- 119-6609-00** ..... Flexible monopole antenna
- TPA-N-PRE** ..... Preamplifier, 12 dB nominal Gain, 9 kHz - 6 GHz
- TPA-N-VPI** ..... N-to-TekVPI adapter
- TPA-BNC** ..... TekVPI® to TekProbe™ BNC adapter
- TEK-USB-488** ..... GPIB-to-USB adapter
- ACD3000** ..... Soft transit case (includes front protective cover)
- HCTEK4321** ..... Hard transit case (requires ACD3000)
- RMD3000** ..... Rackmount kit (351-1095-00 - sold separately)
- TEK-DPG** ..... TekVPI Deskew pulse generator signal source
- 067-1686-02** ..... Power measurement deskew and calibration fixture
- SignalVu-PC** ..... Vector Signal Analysis Software
- 200-5052-00** ..... MDO3000 Front protective cover

### Instrument Options

- Opt.MDO3AFG** ..... Arbitrary function generator with 13 predefined waveforms and arbitrary waveform generation (1 ch)
- Opt.MDO3MSO** ..... 16 digital channels; includes P6316 digital probe and accessories
- Opt.MDO3SA** ..... Increase spectrum analyzer input frequency range to 9 kHz – 3 GHz and capture bandwidth to 3 GHz.



# MD04000C Series

## Mixed Domain Oscilloscope



Width: 439mm Height: 229mm Depth: 147mm Weight: 5.1kg

Speeding up each stage of debug even more!  
Synchronize RF, analog and digital channels –  
giving unprecedented insight into your design.

- Bandwidth of up to 1 GHz, up to 5 GS/s sample rate
- >340,000 wfms maximum waveform capture rate and powerful trigger function
- Spectrum Analyzer (optional)  
Time-synchronized capture of spectrum analyzer with analog, digital and RF signals

# 6 in 1<sup>+</sup>

1. Oscilloscope
2. Spectrum Analyzer
3. Arbitrary Function Generator
4. Logic Analyzer
5. Protocol Analyzer
6. DVM/Counter

	MDO4024C	MDO4034C	MDO4054C	MDO4104C
<b>Oscilloscope Specifications</b>				
Analog Channel Bandwidth	200MHz	350MHz	500MHz	1GHz
Analog Channels	4			
Sample Rate	2.5 GS/s (all channels)			2.5GS/s (4ch with SA) 5GS/s (4ch w/o SA, 2ch with SA)
Maximum Record Length (all channels)	20 Mpoints			
Waveform Capture Rate	>270,000 wfms/s (FastAcq™)			>340,000 wfms/s (FastAcq™)
Input Coupling	AC, DC			
Input Impedance	1MΩ±1%, 50Ω±1%			
Input Sensitivity Range, 1MΩ/50Ω	1mV/div-10V/div (1MΩ), 1mV/div-1V/div (50Ω)			
Vertical Resolution	8 bits (11 bits with Hi Res)			
Maximum Input Voltage, 1MΩ/50Ω	300 V <sub>RMS</sub> CAT II with peaks ≤ ±425 V (1MΩ), 5 VRMS with peaks ≤ ±20 V (50Ω)			
DC Gain Accuracy	±1.5%, offset set to 0V			
<b>Spectrum Analyzer (requires Option SA3 or SA6)</b>				
Spectrum Analyzer Frequency Range (Optional)	1Hz-3GHz (Opt. SA3), 1kHz-6GHz (Opt. SA6)			
Ultra-wide Capture Bandwidth	≥1 GHz			
Span	1kHz-3/6GHz (1-2-5 sequence)			
Resolution Bandwidth Range	10Hz-200MHz (Adjusted in a 1-2-3-5 sequence)			
Displayed Average Noise Level (DANL)	400 MHz - 3 GHz: < -157 dBm/Hz (< -160 dBm/Hz, with TPA-N-PRE preamp attached)			
Phase Noise at 1 GHz CW	1 MHz: < -120 dBc/Hz, < -123 dBc/Hz (typical)			

Note: Standard model is discontinued, only S3 / S6 model is on sale

**Accessories:** One passive voltage probe per analog channel (200 / 350 / 500MHz model: TPP0500B (500MHz, 10: 1, 3.9pF), 1GHz model: TPP1000 (1GHz, 10: 1, 3.9pF), front Cover (part number: 200-5130-xx), installation and safety manual (part number: 071-3448-xx), calibration certificate (English), power cable, accessory bag (part number: 016-2030-xx)  
**[MDO4MSO option Accessories]:** P6616 16-channel digital probe x 1, logic probe accessory kit (part number: 020-2662-xx) [SA3 or SA6 optional accessories] N-BNC adapter (part number: 103-0045-xx)

<b>Logic Analyzer (requires Option MDO4MSO)</b>	
Digital channel	16ch (One P6616 16-channel logic probe)
Maximum sample rate (Main)	500 MS/s (2 ns resolution)
Maximum sample rate (MagniVu)	16.5 GS/s (60.6 ps resolution)
Input channels	16 digital (D15 to D0)
Thresholds	Threshold per channel

<b>Arbitrary Function Generator (requires Option MDO4AFG)</b>	
AFG	(13 predefined waveforms and arbitrary waveform generation)
AFG Waveforms	Sine, Square, Pulse, Ramp / Triangle, DC, Noise, Sin(x)/x (Sinc), Gaussian, Lorentz, Exponential Rise, Exponential Decay, Haversine, Cardiac, and Arbitrary.
AFG Frequency Range	50MHz (Sine), 25MHz (Square / Pulse), 5MHz (Gaussian, Lorentz, Exponential Rise / Decay, Haversine, and Arbitrary), 2MHz (Sin(x)/x), 500kHz (Ramp / Triangle, Cardiac)
Amplitude range	10mV-2.5Vmax (50Ω), 20mV-5Vmax (Hi-Z)
Arbitrary Memory depth	2-128k
Arbitrary Sample rate	250MS/s

<b>Digital Voltmeter and Frequency Counter (Available free of charge when the product is registered on the web)</b>	
Voltage Measurement	Digital Voltmeter Resolution: 4 digits, AC RMS, DC, AC+DC RMS
Frequency Measurement	50MHz Frequency: 5 digits, Maximum input frequency: 150MHz
Frequency accuracy	±(10 μHz/Hz + 1 count)

### Options

- Opt. MDO4AFG** .....Arbitrary function generator with 13 predefined waveforms and arbitrary waveform generation (1ch)
- Opt. MDO4MSO** .....16 digital channels, includes P6616 digital probe and accessories
- Opt. SA3** .....Integrated spectrum analyzer with frequency range of 9 kHz to 3 GHz
- Opt. SA6** .....Integrated spectrum analyzer with frequency range of 9 kHz to 6 GHz
- Opt. MDO4SEC** .....Enhanced instrument security

### Application Modules

- DPO4BND** ..... Application bundle module (Excludes DPO4AUTOMAX)
- MDO4TRIG** ..... Advanced RF Power Level Triggering Module (For SA option)

### Recommended Accessories

- 119-4146-00** .....Near field probe set, 100 kHz - 1 GHz
- 119-6609-00** .....Flexible monopole antenna
- TPA-N-PRE** .....Preamplifier, 12 dB nominal Gain, 9 kHz - 6 GHz
- TPA-N-VPI** ..... N-to-TekVPI adapter
- TPA-BNC** ..... TekVPI® to TekProbe™ BNC adapter
- TEK-USB-488** ..... GPIB-to-USB adapter
- ACD4000B** ..... Soft transit case
- HCTEK54** ..... Hard transit case (requires ACD4000B)
- RMD5000** ..... Rackmount kit (351-1-95-xx - sold separately)
- TEK-DPG** ..... TekVPI Deskew pulse generator signal source
- 067-1686-02** ..... Power measurement deskew and calibration fixture

### 3-year warranty

Covering all labor and parts, excluding probes and accessories



### SignalVu-PC-SVE Vector Signal Analysis Software

**CONNL-SVPC** ....SignalVu-PC Live Link (Node Locked License)  
(See page 54 for other options)

### 3 Series MDO

Mixed Domain Oscilloscope

### 4 Series MSO / 5 Series MSO / NEW 6 Series B MSO

Mixed Signal Oscilloscope

Next Generation Oscilloscopes

**User interface** designed for both touch and mouse

**Integrated spectrum analysis**

**Powerful analysis**

- Automated measurements with trend, histogram, and spectrum plots
- Optional jitter analysis
- Power measurement options

**Bandwidth**

- Models from 100 MHz to 10 GHz
- All models offer upgradeable bandwidth

**Large touchscreen HD displays (1,920 x 1,080)**

**Record length**

- 10 to 250 Mpoints depending on model
- Up to 12-bit vertical resolution (Up to 16 bits in HiRes mode)

**Input channels**

- 2 to 8 inputs depending on model

**Protocol options**

Serial bus trigger and analysis

- I<sup>2</sup>C/SPI
- RS-232/ UART
- CAN/ CAN FD/ LIN/ FlexRay
- USB 2.0
- Ethernet
- Audio
- Aerospace
- SENT
- SPMI
- 13C

**Integrated DVM and trigger frequency counter free with product registration**

**Built-in Arbitrary/ Function Generator option**

Not all features shown are available on all oscilloscope models.

### Usability and display



#### Touch Interaction Done Right

These next-generation oscilloscopes feature the industry's first oscilloscope user interface truly designed for touch. The same intuitive gestures you use with your phone or tablet, work on the big HD displays and the gestures are common among the 3, 4, 5 and 6 Series.

- Control inputs, triggers and acquisitions by tapping badges in the settings bar at the bottom of the display
- Drag waveforms to adjust position or to pan
- Pinch to change horizontal or vertical scale



#### Stunning HD Displays

The 15.6" displays on 5 and 6 Series MSOs have 1920 x 1080 HD resolution. You can see many signals at once, along with critical readouts and plots for an extensive view of your system.

Even with their bench-friendly footprints, the 3 and 4 Series offer the largest displays in their classes, with full 1920 x 1080 HD resolution.



Display resolution on some competitors' products is as low as 800 x 480 pixels. That's less than 20% of the 1920 x 1080 pixel display resolution of the 3, 4, 5, and 6 Series products. Even larger 1280 x 800 pixels do not provide the same level of detail.



### More Inputs and Mixed Signal Analysis

The 4, 5 and 6 Series MSOs let you see more signals by going beyond the traditional 4-channel limit, offering up to 8 analog input channels.

FlexChannel® inputs on the 4, 5, and 6 Series MSOs expand your visibility even further. Whenever you need to see more signals, just plug a TLP058 logic probe into any input. The single analog channel converts to 8 digital channels. FlexChannel inputs are backward-compatible with TekVPI probes.

The 3 Series MDO offers 16 digital channels through a dedicated logic probe, included with the MSO option.



### Industry-leading Vertical Resolution

See more signal detail. The 4, 5, and 6 Series MSOs feature 12-bit analog-to-digital converters (ADCs) that provide 16 times more vertical resolution than common 8-bit ADCs.

A new High Res mode further boosts vertical resolution and uses smart filtering to limit noise. High Res mode always provides at least 12 bits and extends all the way to 16 bits of vertical resolution.

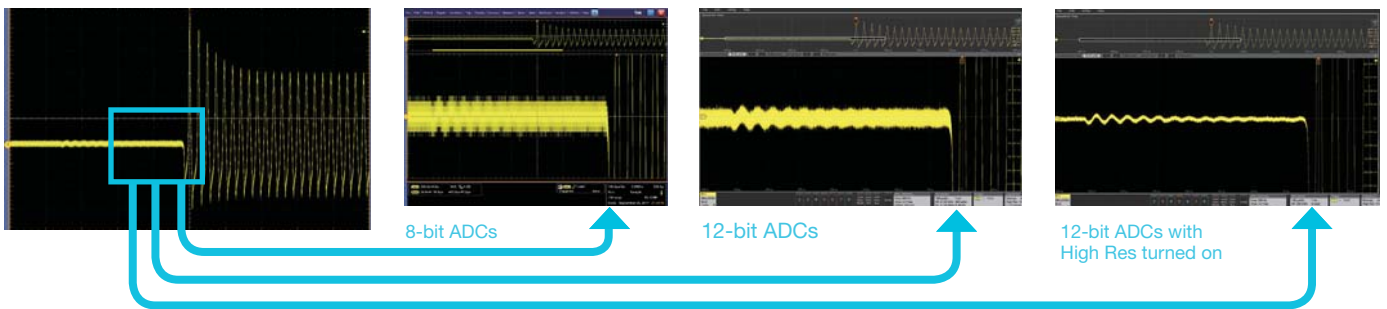

### Stacked Display Mode

Most scopes display all waveforms in the same graticule and rely on vertical scale controls to fit signals on the display. Each waveform uses a fraction of the available ADC range, leading to less accurate measurements.

New stacked display mode lets you view each waveform in its own “slice” of the display. Each slice represents the full ADC range for the waveform for more accurate measurements.

The more traditional overlay display mode is also available, for easy direct comparison of waveforms.

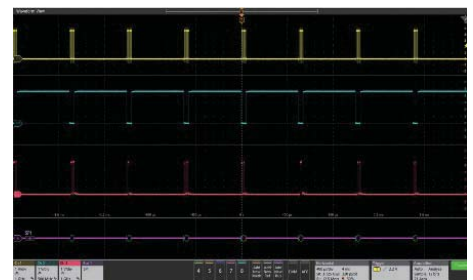

New stacked display mode

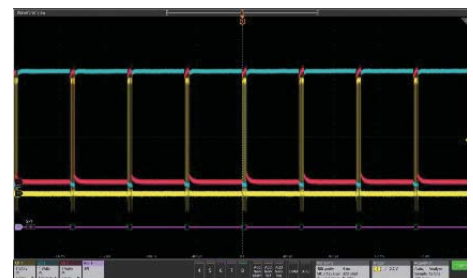

Traditional overlay display mode

## Powerful Measurements

The Results Bar on the right side of the display includes immediate, one tap access to the most common analytical tools such as:

- Cursors
- Automated measurements
- Measurement statistics
- Searches
- Bus decode tables

These scopes deliver rich insights by providing easy access to measurement statistics. Turn on statistics in the Results Bar to get a quick overview.

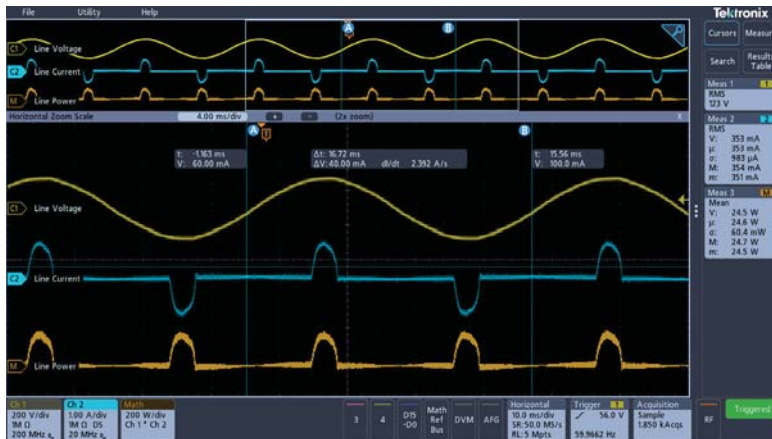

## Advanced Measurements and Analysis

Dive into measurements with Results Tables. Results Tables show statistics for the current acquisition and for all acquisitions. Get insight into one measurement, a hundred measurements, or millions of measurements at a glance.

Plots, such as measurement trends and histograms, deliver quick insight.

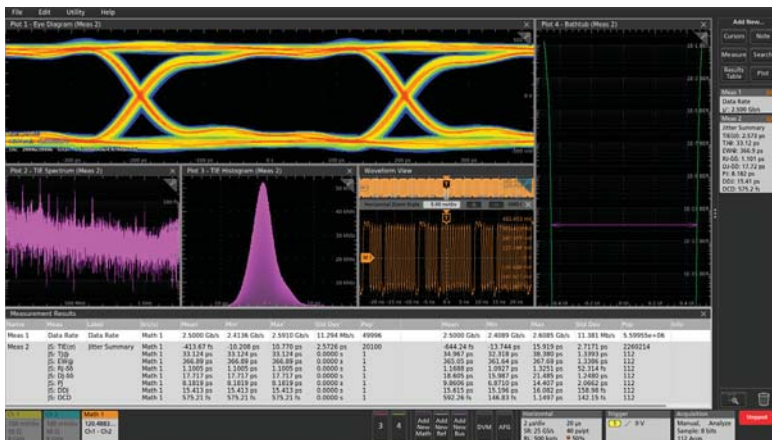

## FastAcq™ High Speed Waveform Capture

FastAcq captures at high speed to increase the probability of seeing infrequent problems such as runt pulses, glitches, timing issues, and more.

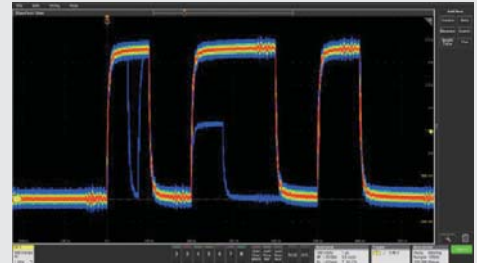

## FastFrame™ Segmented Memory

Make the most efficient use of acquisition memory by not storing deadtime between serial packets or bursts. Capture many triggered frames in a single record.



## Triggering and Search

A complete set of basic and advanced triggers and search criteria.

- Runt
- Logic
- Pulse width
- Timeout
- Rise / Fall time
- Setup and hold violations
- Serial and parallel bus activity
- Sequence
- Video
- Visual triggers\*
- RF vs Time\*
- Window\*



\*4, 5, 6 Series only

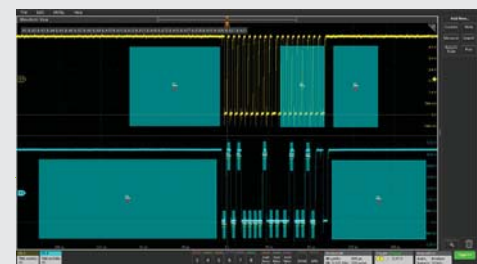

# Integrated Spectrum Analysis

## Spectrum View

Because traditional scope FFTs are driven by the same acquisition system that delivers the analog time-domain view, it is virtually impossible to get optimized views in both domains at once.

Spectrum View is different. It lets you independently adjust time - and frequency-domain views, by using patented technology behind each FlexChannel input. You can turn on a spectrum view for any analog channel, enabling multi-channel mixed domain analysis.

Intuitive spectrum analyzer controls like center frequency, span and resolution bandwidth (RBW) make setups easy, and RF vs time triggers make capturing anomalies straightforward.

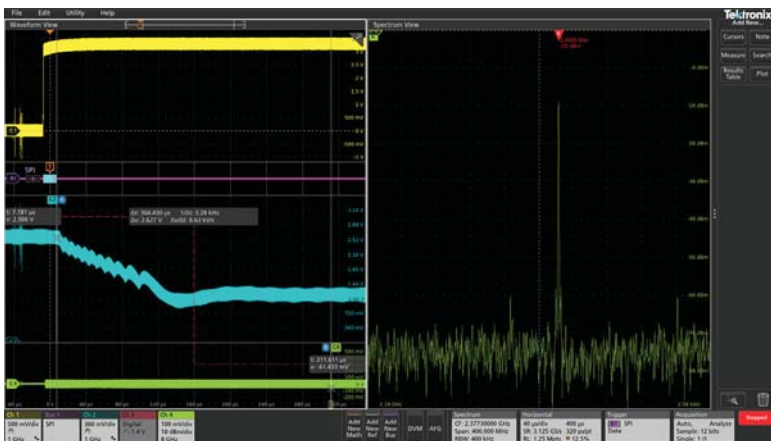

## Built-in Spectrum Analyzer

The Tektronix 3 Series MDO offers an integrated, hardware-based spectrum analyzer ranging from 9 kHz to 1 GHz (standard) or 3 GHz enabling spectral analysis on IoT and most consumer wireless standards.

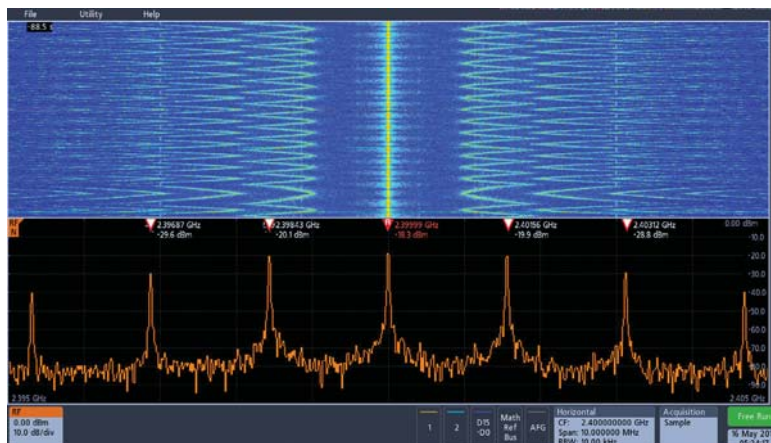

The Spectrogram display illustrates slowly moving RF phenomena. As the peaks change in both frequency and amplitude the changes are easy to see.

## Built-in Arbitrary / Function Generator (AFG)

An integrated function generator is perfect for testing frequency response, simulating sensor signals, and adding noise to signals for stress testing.

- 13 standard waveform functions
- 50 MHz Sine / 25 MHz Square and Pulse
- 128k, 250 MS/s arbitrary waveforms

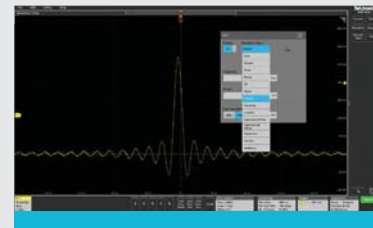

## Connectivity

Every instrument includes a USB port and LXI-compliant Ethernet port for remote control. A thoroughly documented programming interface supports custom programming.

With e\*Scope built-in, you can control the oscilloscope over a network through a standard web browser.



## Optional Windows OS

The 5 and 6 Series MSOs offer the option of including a Microsoft Windows™ operating system. The option provides a Windows desktop where you can install and run additional applications on the oscilloscope.

Upgrading to Windows is as simple as plugging in a pre-configured SSD.





# An Oscilloscope for Every Engineer



## 3 SERIES MDO



## 4 SERIES MSO

<b>Bandwidth</b>	100 MHz, 200 MHz, 350 MHz, 500 MHz, 1 GHz	200 MHz, 350 MHz, 500 MHz, 1 GHz, 1.5 GHz
<b>Max channels, analog</b>	4	6
<b>Max channels, digital</b>	16	48
<b>Inputs</b> (see page 13)	TekVPI inputs	FlexChannel inputs
<b>Max sample rate</b>	2.5 GS/s or 5 GS/s, all channels	6.25 GS/s, all channels
<b>Record length</b>	10 Mpoints	Up to 62.5 Mpoints
<b>Vertical resolution</b> (see page 13)	8 bits	12 bits
<b>Advanced analysis</b> (optional) (see page 18)	Serial bus Power	Serial bus Power 3-Phase Power
<b>Spectrum analysis</b> (see page 15)	Hardware Spectrum Analyzer	Spectrum View
<b>Operating system</b> (see page 15)	Embedded	Embedded
<b>Display</b> (see page 12)	11.6" HD, capacitive touch 1920 × 1080	13.3" HD, capacitive touch 1920 × 1080

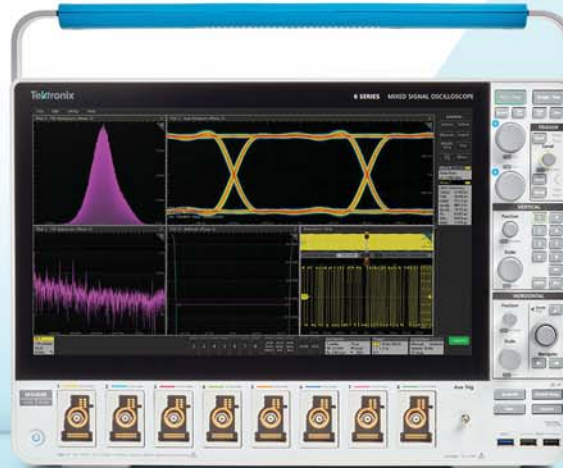
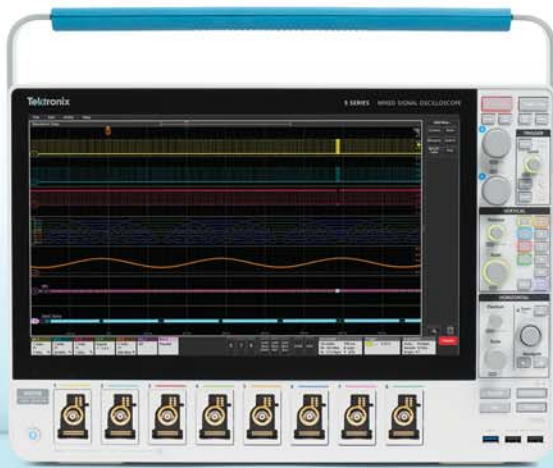

## 5 SERIES MSO

## NEW 6 SERIES B MSO

350 MHz, 500 MHz, 1 GHz, 2 GHz	1 GHz, 2.5 GHz, 4 GHz, 6 GHz, 8 GHz, 10 GHz	<b>Bandwidth</b>
8	8	<b>Max channels, analog</b>
64	64	<b>Max channels, digital</b>
FlexChannel inputs	FlexChannel inputs	<b>Inputs</b> (see page 13)
6.25 GS/s, all channels	50 GS/s, 2 channels	<b>Max sample rate</b>
Up to 500 Mpoints	Up to 1 Gpoints	<b>Record length</b>
12 bits	12 bits	<b>Vertical resolution</b> (see page 13)
Serial bus Power Compliance Jitter Inverters, Motors and Drives	Serial bus Power Compliance Jitter Inverters, Motors and Drives DDR3 LVDS	<b>Advanced analysis</b> (optional) (see page 18)
Spectrum View	Spectrum View	<b>Spectrum analysis</b> (see page 15)
Embedded Windows (optional)	Embedded Windows (optional)	<b>Operating system</b> (see page 15)
15.6" HD, capacitive touch 1920 × 1080	15.6" HD, capacitive touch 1920 × 1080	<b>Display</b> (see page 12)

# Applications and Advanced Analysis.

Emphasis on Analysis.

Oscilloscope built-in features, variety of probes, and optional analysis software support a wide range of applications.

## Advanced Power Measurement and Analysis

4 5 6



Make reliable and repeatable power measurements such as power quality, harmonics, safe operating area and switching loss.

4 5 6

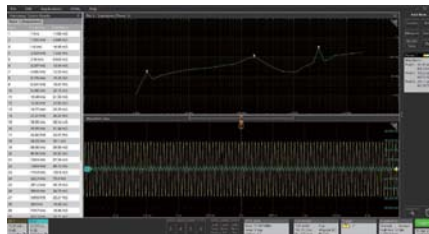

Frequency Response Analysis (FRA) to evaluate the stability of your power converters

5 6

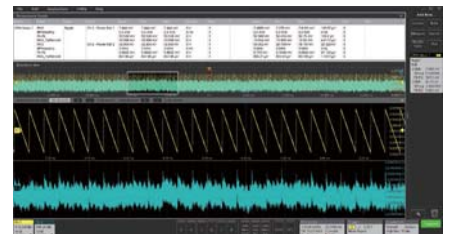

Perform ripple analysis and power sequencing measurements on multiple power rails simultaneously

### 3-Phase Inverter Motor Drive Analysis

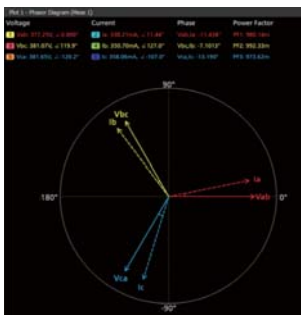

5  
6

Measurements and analysis on three-phase power system and industrial motors drive systems for AC induction motors, permanent magnet synchronous motors (PMSM), and brushless DC (BLDC) motors.

### Advanced Jitter and Eye Diagram Analysis

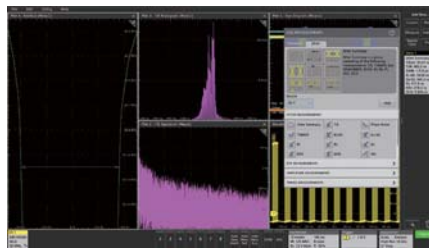

5 6

Comprehensive jitter and eye-diagram analysis and jitter decomposition algorithms enable the discovery of signal integrity issues

### DDR3 / LPDDR3 Analysis

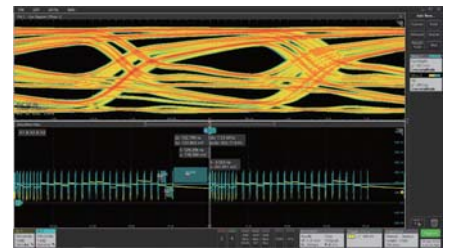

6

Automated compliance test solution and debugging analysis tool for DDR3 and LPDDR3

## Automated Serial Bus Compliance Testing

5 6

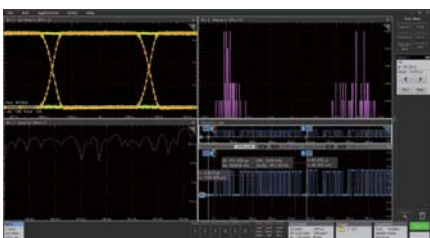

USB 2.0 compliance test and debugging solution with Advanced Jitter and Eye Diagram Analysis

5 6



Supports Ethernet automated compliance test solution (10BASE-T / 100BASE-T / 1000BASE-T)

5 6



Supports Automotive Ethernet automated compliance test solution (100Base-T1, 1000Base-T1) as well as Signal Separation and PAM3 analysis

6



MIPI D-PHY 2.1 Tx automated conformance test solution and DSI-1, CSI-2 serial bus decoding

5  
6

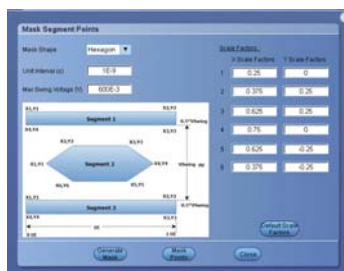

Automated debug and analysis on LVDS

6

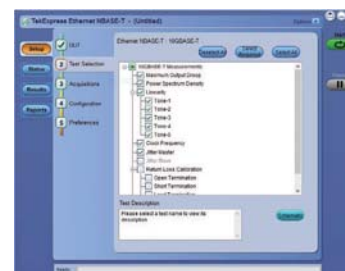

Automated compliance test solution for 10GBASE-T, NBASE-T (2.5GBASE-T and 5GBASE-T)



## Models and Instrument Options

For complete ordering details see the product datasheet or contact your local sales representative.

Base Models	3 Series MDO	4 Series MSO	5 Series MSO	6 Series MSO
2 TekVPI Channels	MDO32			
4 TekVPI Channels	MDO34			
4 FlexChannel Inputs		MSO44	MSO54	MSO64B
6 FlexChannel Inputs		MSO46	MSO56	MSO66B
8 FlexChannel Inputs			MSO58	MSO68B
Bandwidth	100 MHz, 200 MHz, 350 MHz, 500MHz, 1 GHz	200 MHz, 350 MHz, 500 MHz, 1 GHz, 1.5 GHz	350 MHz, 500 MHz, 1 GHz, 2 GHz	1 GHz, 2.5 GHz, 4 GHz, 6 GHz, 8GHz, 10GHz
Digital Channels	•	<i>simply order TLP058 probes to enable 8 digital signals per probe</i>		
Arbitrary Function Generator	•	•	•	•
Spectrum Analyzer	1 GHz (std.), 3 GHz	<i>see Spectrum View analysis below</i>		
Extend Record Length	(10 M standard)	62.5 M/ch max (31.25 M standard)	125 M/ch max 250 M/ch max 500 M/ch max (62.5 M standard)	125 M/ch max 250 M/ch max 500 M/ch max 1 G/ch max (up to 4 ch) (62.5 M standard)
Service Options	3 Series MDO	4 Series MSO	5 Series MSO	6 Series MSO
Calibration service	3 years 5 years	3 years 5 years	3 years 5 years	3 years 5 years
Standard warranty extension	5 years	5 years	5 years	3 years 5 years
Total product protection	3 years 5 years	3 years 5 years	3 years 5 years	3 years 5 years

To learn more about our service options visit: <https://www.tek.com/choose-service-plan>

### Application Software Bundles

Application Software Bundles combine multiple measurement and analysis options for much less than the cost of individual options. They can be a great value, especially if you have a diverse workload.

**4 5 6**

Find out more in [Solution Bundles for 4, 5 and 6 Series MSOs](#)

Individual software options are listed on the next page.

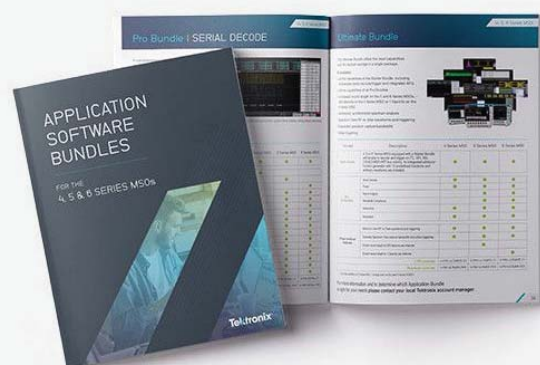

# Serial Bus Decoding, Compliance / Conformance Testing and Advanced Analysis

## Listing of individual software options

	Options	3 Series MDO	4 Series MSO	5 Series MSO	6 Series B MSO
Serial Decode Options	1-Wire serial decoding and analysis		•	•	•
	8b10b serial decoding and analysis			•	•
	Aerospace serial trig. and analysis (MIL-STD-1553, ARINC429)	•	•	•	•
	Audio serial trig. and analysis (I2S, LJ, RJ, TDM)	•	•	•	•
	Automotive serial trig. and analysis (CAN, CAN FD, LIN, FlexRay)	•	•	•	•
	Automotive sensor serial triggering and analysis (SENT)		•	•	•
	Computer serial triggering and analysis (RS-232/422/485/UART)	•	•	•	•
	CXPI decoding and analysis		•	•	•
	Embedded serial triggering and analysis (I <sup>2</sup> C, SPI)	•	•	•	•
	SpaceWire serial decoding and analysis		•	•	•
	eSPI decoding and analysis		•	•	•
	eUSB2 serial decoding and analysis		•	•	•
	Manchester decoding and analysis		•	•	•
	MIPI D-PHY (CSI/DSI) decoding and analysis			•	•
	NRZ decoding and analysis		•	•	•
	PSI5 serial decoding and analysis		•	•	•
	SLDC serial decoding and analysis		•	•	•
	SVID serial decoding and analysis		•	•	•
	MDIO serial decoding and analysis		•	•	•
	Ethernet serial triggering and analysis (10BASE-T, 100BASE-TX)		•	•	•
I3C serial decoding and analysis		•	•	•	
Power management serial triggering and analysis (SPMI)		•	•	•	
USB serial triggering and analysis (USB 2.0 LS, FS, HS)	•	•	•	•	
Compliance Options	Automotive Ethernet (10BASE-T1S) compliance solution				•
	Automotive Ethernet (100BASE-T1, 1000BASE-T1, 10BASE-T1S) automated compliance test application			•	•
	DDR3 and LPDDR3 automated compliance solution				•
	Ethernet (2.5G and 5G BASE-T) automated compliance solution				•
	Ethernet (10G BASE-T) automated compliance solution				•
	Ethernet (1000BASE-T, 100BASE-T, 10BASE-T, 10Base-T1L) automated compliance solution			•	•
	MIPI D-PHY 1.2 automated compliance solution				•
	MIPI C-PHY 2.0 automated compliance solution				•
	MIPI D-PHY 2.1 automated compliance solution				•
	Multi-Gigabit Automotive Ethernet (2.5G/5GBASE-T1) automated compliance solution				•
USB2.0 automated compliance test solution			•	•	
Analysis Options	3-phase, inverter, motor, drive analysis			•	•
	3-phase power measurements and analysis		•		
	Advanced jitter and eye analysis			•	•
	Advanced power measurement and analysis		•	•	•
	Basic power measurements and analysis	•	•		
	DDR3 and LPDDR3 analysis and debug				•
	DQ0 measurements for inverter motor drives			•	•
	Enhanced security for instrument declassification	•	•	•	•
	Removable SSD with Windows license			•	•
	User-defined filter creation tool			•	•
Vector signal analysis (SignalVu-PC)			•	•	

## NEW Application Bundles

### Money Saving Bundles for the 4, 5 and 6 Series MSOs

- Offer better value with more functions at a much lower cost than equivalent individual options
- Make it cost-effective to purchase capabilities to cover future needs or needs across engineering teams
- Include the most frequently combined options for key applications and industries
- Provide flexibility to adjust year-to-year with lower cost 1-year subscriptions

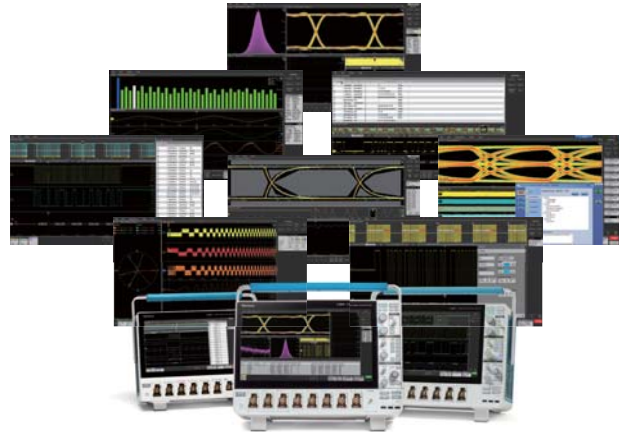

### Starter Bundle

These bundles add capabilities that almost all engineers need for embedded systems design.

4, 5 or 6 Series MSOs equipped with a Starter Bundle (for example, 4-STARTER-PER) will be able to decode and trigger on I<sup>2</sup>C, SPI, RS-232 / 422 / 485 / UART bus activity. Includes an integrated arbitrary/function generator with 13 predefined functions and arbitrary waveforms. This is equivalent to adding -AFG, -SRCOMP and -SREMBD options.

### Pro Bundles

Specially designed to empower engineers in particular applications and industries.

Any Pro Bundle includes the capabilities enabled with the **Starter Bundle** + **Extended record length** to help you take better advantage of advanced analysis capabilities.

Serial Decode (4, 5, 6 Series)	Power (4, 5, 6 Series)	Signal Integrity (5, 6 Series)	Standards Compliance (5, 6 Series)	Automotive (4, 5, 6 Series)	Aerospace (4, 5, 6 Series)
A comprehensive kit of serial protocol support for embedded systems. Eliminates the need to decode by hand.	Automates a wide range of power measurements – from the AC line to point of load.	Essential tools for engineers analyzing jitter and signal integrity of high-speed clocks and data lines.	Comprehensive test automation with full instrument control and reporting for testing to the leading serial standards.	For ECU designers – decoding for automotive protocols, and automated compliance testing for key communications standards.	Serial bus decoding for key aerospace protocols and mask testing for testing unique signals.

### Ultimate Bundle

Everything listed above for the most capabilities and highest savings.

All of the capabilities of the **Starter Bundle** + All capabilities of **ALL Pro Bundles**.

Spectrum View RF vs. time waveforms + Extended Spectrum View capture bandwidth.

Video triggering.

Maximum available record length for the 5 and 6 Series MSOs.

Software Bundle Options	4 Series MSO	5 Series MSO	6 Series B MSO
<b>Starter Bundle: 1 YR Licenses</b>	4-STARTER-1Y	5-STARTER-1Y	6-STARTER-1Y
<b>Starter Bundle: Perpetual Licenses</b>	4-STARTER-PER	5-STARTER-PER	6-STARTER-PER
<b>Pro Bundle: Serial Decode - 1 YR Licenses</b>	4-PRO-SERIAL-1Y	5-PRO-SERIAL-1Y	6-PRO-SERIAL-1Y
<b>Pro Bundle: Serial Decode - Perpetual Licenses</b>	4-PRO-SERIAL-PER	5-PRO-SERIAL-PER	6-PRO-SERIAL-PER
<b>Pro Bundle: Power - 1 YR Licenses</b>	4-PRO-POWER-1Y	5-PRO-POWER-1Y	6-PRO-POWER-1Y
<b>Pro Bundle: Power - Perpetual Licenses</b>	4-PRO-POWER-PER	5-PRO-POWER-PER	6-PRO-POWER-PER
<b>Pro Bundle: Signal Integrity - 1 YR Licenses</b>	-	5-PRO-SIGNAL-1Y	6-PRO-SIGNAL-1Y
<b>Pro Bundle: Signal Integrity - Perpetual Licenses</b>	-	5-PRO-SIGNAL-PER	6-PRO-SIGNAL-PER
<b>Pro Bundle: Standards Compliance - 1 YR Licenses</b>	-	5-PRO-COMPL-1Y	6-PRO-COMPL-1Y
<b>Pro Bundle: Standards Compliance - Perpetual Licenses</b>	-	5-PRO-COMPL-PER	6-PRO-COMPL-PER
<b>Pro Bundle: Automotive - 1 YR Licenses</b>	4-PRO-AUTO-1Y	5-PRO-AUTO-1Y	6-PRO-AUTO-1Y
<b>Pro Bundle: Automotive - Perpetual Licenses</b>	4-PRO-AUTO-PER	5-PRO-AUTO-PER	6-PRO-AUTO-PER
<b>Pro Bundle: Aerospace - 1 YR Licenses</b>	4-PRO-MILGOV-1Y	5-PRO-MILGOV-1Y	6-PRO-MILGOV-1Y
<b>Pro Bundle: Aerospace - Perpetual Licenses</b>	4-PRO-MILGOV-PER	5-PRO-MILGOV-PER	6-PRO-MILGOV-PER
<b>Ultimate Bundle: 1 YR Licenses</b>	4-ULTIMATE-1Y	5-ULTIMATE-1Y	6-ULTIMATE-1Y
<b>Ultimate Bundle: Perpetual Licenses</b>	4-ULTIMATE-PER	5-ULTIMATE-PER	6-ULTIMATE-PER



## LPD64

6 Series Low Profile Digitizer

High Speed Digitizers



LPD64

## MSO58LP

5 Series MSO Low Profile



MSO58LP

- Channels: 8ch / 4ch in a compact 2U "rack ready" form factor
- Bandwidth: 8 GHz, 25 GS/s sample rate
- Vertical Resolution: 12-bit ADC
- Multi-Channel Synchronize & Remote Control
- Up to 2 GHz RF DDC bandwidth on all channels



### High Performance Specifications on ALL channels

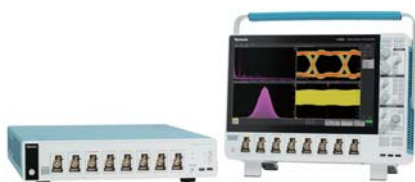

Use the benchtop 5/6 Series MSO with its 15.6-inch HD display and pinch-swipe-zoom touchscreen for design validation. Eliminate work by using exactly the same software and test routines in production that you developed during design.

### Easy Programmatic Integration with Fast Data Transfers



Synchronize multiple high-speed digitizers into a single virtual instrument. Discover, search and analyze across more channels than ever before.

### Multi-Channel Synchronize & Remote Control



8 input channels in a space-saving 2U high package. Fit 6x more channels into your existing rack space.

	MSO58LP	LPD64
<b>Bandwidth</b>	1GHz	1 GHz, 2.5 GHz, 4 GHz, 6 GHz, 8 GHz
<b>Analog Channels</b>	8	4
<b>Digital Channels (MSO)</b>	Up to 64 (TLP058x8)	-
<b>ADC Resolution</b>	12 bits	12 bits
<b>Analog Sample Rate</b>	6.25 GS/s (on all channels)	25 GS/s (on all channels)
<b>Standard Record Length</b>	125 Mpts, up to 500 Mpts optional record length	125 Mpts, up to 1 Gpts optional record length
<b>Input impedance</b>	50Ω/1MΩ	50Ω
<b>Input range</b>	50Ω : 500 μV/div~1V/div 1MΩ : 500 μV/div~10 V/div	50Ω : 1mV/div~1V/div
<b>Effective bits (1 GHz)</b>	7.6	8.2
<b>Input Connectors</b>	FlexChannel	SMA
<b>Dimensions and Weight</b>	87.3 (H) × 432 (W) × 605.7 (D) mm, 12.7kg	87.3 (H) × 432 (W) × 605.7 (D) mm, 13.34kg

# NEW TekScope

## PC Waveform Analysis Software

Get the analysis capability of our award-winning oscilloscopes right on your PC. Analyze waveforms anywhere, anytime. The starter license lets you view and analyze waveforms, perform measurements, and decode I2C, SPI, and RS-232. It also supports remote communication with a range of Tektronix oscilloscopes. Pro and Ultimate licenses add advanced capabilities such as additional serial bus decoding, jitter analysis, power analysis, and multi-scope analysis.

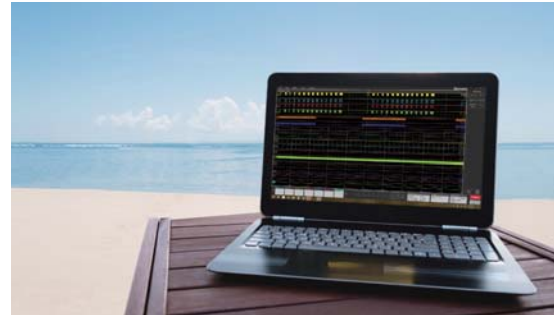

### Greater Productivity and Convenience



- Analyze data at your desk, at home, or on the road
- Nothing to learn. It operates just like your oscilloscope
- Analyze waveform data from most oscilloscopes on your PC
- Remotely access your oscilloscope to view, acquire and analyze waveforms. TekScope is compatible with all of the latest Tektronix oscilloscope models

### Add Analysis Capabilities

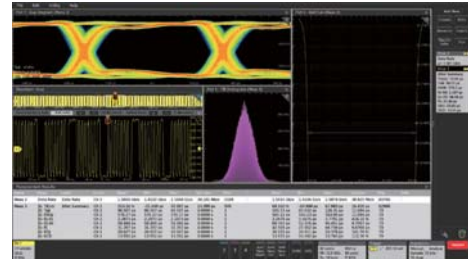

- Utilizes the award-winning 4/5/6 Series MSO user interface
- Augment on-scope capabilities with additional capabilities like bus decoding, jitter analysis, and power measurements
- Flexible licensing makes it easier to add the analysis functions you need, when you need them

### Synch Waveforms from Multiple Scopes

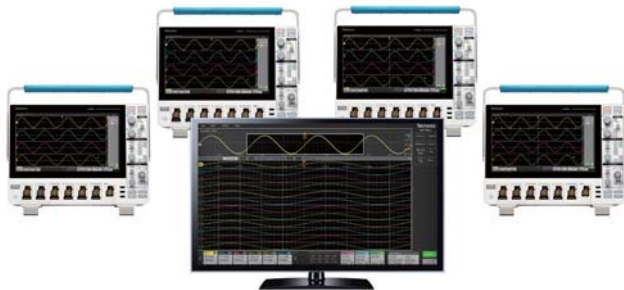

Pan, zoom, rearrange and make measurements on signals acquired on up to four different oscilloscopes

### Analyze Collaboratively



Easily share waveform datasets. Colleagues can rescale waveforms and take measurements as if they were sitting in front of the oscilloscope. In addition, TekDrive natively enables cloud saving, sharing, and analysis

Product	Description	Opt.
<b>TekScope PC Waveform Analysis Software - Base License</b>	Waveforms viewing and analysis, standard measurements, basic and advanced math options, basic and advanced plot options, wide range of file formats, FastFrame of segmented memory, multi-language support	-
<b>Multi-Scope Analysis</b>	License; Multi-Scope Analysis License, Viewing and Analysis of Real-time Channels from Multiple Remote Scopes Simultaneously; 2 Individual Seats, Node Locked.	TEKSCOPE-MULTI
<b>Jitter Measurements and Analysis</b>	License; Advanced Jitter and Eye Analysis	TEKSCOPE-DJA
<b>Remote Analysis for Bench Oscilloscopes</b>	Remote Analysis for Bench Oscilloscopes	TEKSCOPE-ENTRY
<b>Low Speed Protocol Decode</b>	License; Low Speed Protocol Decode - I2C, I3C, SPI, RS-232, SPMI, I2S, LJ, RJ, TDM, CAN, CAN-FD, LIN, FlexRay, SENT, 100BASE-T1 Automotive Ethernet, MIL-STD-1553, ARINC-429, SpaceWire, USB 2.0, eUSB2, PS/5, SVID, 10BASE-T / 100BASE-TX Ethernet, MDIO, NRZ, 8b/10b, MIPI D-PHY, Manchester, SDLC, 1-Wire, MIPI C-PHY CSI/DSI;	TEKSCOPE-DECODE
<b>Power Electronics Analysis</b>	License; Power Electronics: Advanced Power Analysis, Magnetics Analysis, Inverter Motor Drive Analysis	TEKSCOPE-PWR-ELC
<b>Power Integrity Analysis</b>	License; Power Integrity: Digital Power Management and Analysis, Power Management Serial Decode and Analysis (SPMI)	TEKSCOPE-PWR-INT
<b>SpectrumView Analysis</b>	License; SpectrumView Application	TEKSCOPE-SV

OS: 64-bit Windows 10

# NEW TekDrive

## Collaborative Data Workspace

Remotely share test and measurement data

- Secure anywhere-access to team's Data
- Inspect, analyze, and report on any device
- Save and recall directly on an oscilloscope:
- Easy and secure TekDrive mount system
- Seamless collaboration with unlimited contributors
- Splice into any workflow



### Securely Access Data from Anywhere

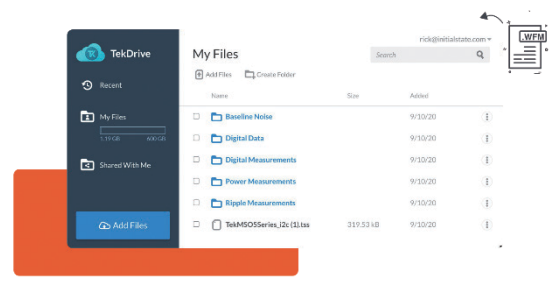

TekDrive features a secure and sophisticated infrastructure to ensure the confidentiality, integrity, and availability of your data

### Save and Recall Directly on Instruments



Once TekDrive is mounted on an oscilloscope or other supported instrument, engineers can interact with files, folders, data in the same manner as any other drive – except backed by the power of instant sharing and seamless accessibility.

### Inspect, Analyze, and Report on any Device



Standard file types generated by Tektronix Oscilloscopes (\*.tss, \*.wfm, \*.isf, \*.csv) can be opened and inspected directly in the TekDrive interface with no loss of data integrity.

### Splice into any Workflow

```

<>
#-----Create File Record-----
def createFileRecord():
    data = { "name": fileName + ".csv", "parentFolderId"
    url = requests.post(apiUrl + "/file", json=data,
    return(url)

#-----Upload File Using uploadURL from File Record-----
def uploadFile(upload):
    file = open(fileName + ".csv", 'rb')
    requests.put(upload, data = file, headers = headers)
    return
    
```

TekDrive is designed to be accessible and developer-friendly for integration, scripting, and automation. Provide approachable starting points with pre-built examples and SDKs for popular languages, like Python, LabVIEW, MATLAB and more.

### Seamless Collaboration with Unlimited Contributors

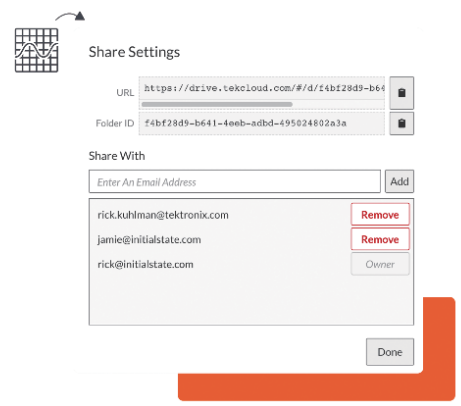

Using a tier that allows sharing, you may have unlimited contributors collaborating with shared data.

TekDrive Service Tier		Contents
TEKDRIVE-IND	TekDrive Individual	200 GB Hosted storage
		Contribute - may not initiate or manage sharing
		In-Browser analysis
		2 Access keys
TEKDRIVE-BUS	TekDrive Business	600 GB Hosted storage
		Unlimited sharing
		In-Browser analysis
		10 Access keys
TEKDRIVE-ENT	TekDrive Enterprise	2TB GB Hosted storage
		Unlimited sharing
		In-Browser analysis
		100 Access keys



# MSO / DP070000 / DX Series

Digital and Mixed Signal Oscilloscopes

See a World that Others Don't



## Features

- 4 to 33 GHz true analog bandwidth for measurements on the latest high-speed serial standards
- Sample Rate: 100 GS/s on 2 Channels / 50 GS/s on 4 Channels
- 4-channel Simultaneous Performance - Up to 23 GHz Bandwidth
- Industry's lowest vertical noise
- FastAcq® captures signals at more than 300,000 waveforms per second
- Industry's only 6.25 Gb/sec Hardware Serial Trigger with Built-in Bit Error Detection
- TriMode™ probing system, highest bandwidth of up to 33GHz
- Leader in performance MSO: 33 GHz bandwidth, 16 digital channels with 80 ps Tme resolution

## Technology that Paces the Industry

Utilizes the reliable, fast SiGe 8HP BiCMOS Process from IBM

- 33GHz and 100GS/s performance packed in a single multi-chip module
- Reduced part count and higher reliability through integration
- 8 way interleaved track and hold achieves significantly lower spurs, low noise to 100GS/s
- Dedicated, newly designed heat dissipation technology provides high cooling capacity for long-term reliability

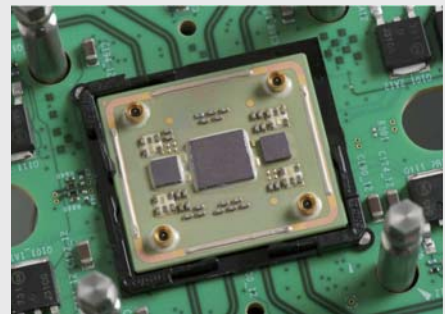

## Capture and Isolate Complex Signal with Pinpoint® Trigger

More than 1400 trigger combinations

- Allow selection of virtually all trigger types on both A and B trigger events delivering the full suite of advanced trigger types for finding sequential trigger events
- Provide trigger reset capabilities that begin the trigger sequence again after a specified time, state, or transition so that even events in the most complex signals can be captured

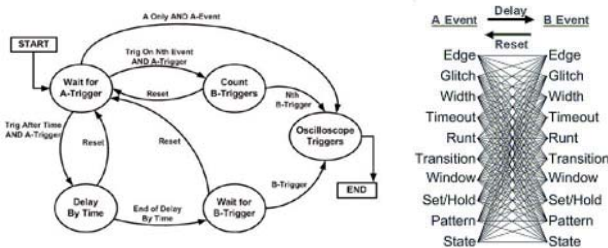

## Mixed Signal Oscilloscope (MSO70000 Series)

The MSO70000 Series is equipped with a 12.5 GS/s, 16-channel digital input in addition to analog with a maximum frequency band of 33 GHz. The MSO has unique capabilities combined with exceptional signal acquisition performance and analysis accelerate your measurement tasks.

## iCapture® - One Connection for Analog and Digital

Using the iCapture digital-to-analog multiplexer feature, you can easily verify the analog characteristics of any of the 16 signals connected to the MSO70000 Series digital channels without changing probes or connections.

16 logic channels: Up to 2.5 GHz

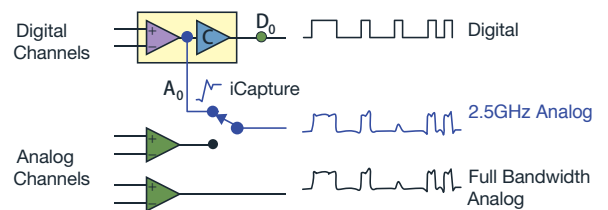

## Visual Trigger – Find the Signal of Interest Quickly

- Precisely qualify triggers and find unique events in complex waveforms



Example: Triggering for DDR signal

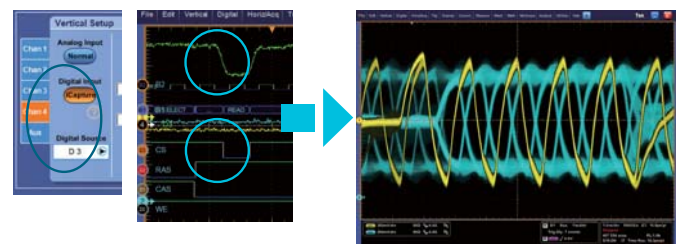

Example: Using iCapture function to observe the analog terminals connected to digital channels

## 4GHz - 33GHz Trimode Differential Probes

With TriMode probing, one probe setup makes differential, single ended, and common mode measurements accurately.

**1 Differential 2 Single Ended 3 Common Mode**



P7500 Series

## P7600 Series

Probe Model	P7633		P7625	
Adapter	P76CA-xxx	P76TA	P76CA-xxx	P76TA
Characteristic	(Typical)	(Typical)	(Typical)	(Typical)
Bandwidth (typical)	33GHz	30GHz	25GHz	
Rise time (10-90%) (typical)	14ps	16ps	18ps	
Rise time (20-80%) (typical)	11ps	12ps	14ps	
Offset voltage range	±4V			

## P7500 Series

TriMode Probe Architecture	P7504	P7506	P7508	P7513A	P7516	P7520A
Bandwidth (Probe only)	4GHz	6GHz	8GHz	13GHz	16GHz	20GHz <sup>1</sup> / 25GHz <sup>2</sup>
Rise time (10-90%) (Probe only)	105ps	75ps	55ps	40ps	32ps	27ps <sup>1</sup>
Rise time (20-80%) (probe only)	70ps	50ps	35ps	28ps	24ps	18ps <sup>1</sup>
Differential input range	±0.75V (5X) ±1.75V (12.5X)				±0.625V (5X) ±1.60V (12.5X)	

<sup>1</sup>A-B mode <sup>2</sup> Using a P7520A probe for up to 25 GHz with DSP and a P75PST solder tip

Basic Specification	MSO70804C DPO70804C	MSO71254C DPO71254C	MSO71604C DPO71604C	MSO72004C DPO72004C	MSO72304DX DPO72304DX	MSO72504DX DPO72504DX	MSO73304DX DPO73304DX
<b>Vertical system - Analog channels</b>							
Analog bandwidth (user-selectable DSP enhance) (-3 dB)	8GHz	12.5GHz	16GHz	20GHz	23GHz (2ch) 23GHz (4ch)	25GHz (2ch) 23GHz (4ch)	33GHz (2ch) 23GHz (4ch)
Hardware Analog Bandwidth (-3 dB)	8GHz	12.5GHz	16GHz (Typical)	16GHz (Typical)	23GHz	25GHz	33GHz
Analog channels	6						
Digital channels (MSO70000 Series only)	16						
Rise time (10% to 90%, typical)	49ps	32ps	24.5ps	18ps	17ps	16ps	13ps
<b>Input sensitivity range</b>							
Below 18 GHz	10 mV/div to 500 mV/div (100 mV to 5 V full scale)				-		
20 GHz, 19 GHz	20 to 500 mV/div (200 mV to 5 V full scale)				-		
23 GHz, 25 GHz, 33 GHz	-				6.25 mV/div to 600 mV/div (62.5 mV to 6 V full scale)		
Maximum input voltage, 50 Ω	<5.0 VRMS for ≥100 mV/div; 1.0 VRMS for <100 mV/div				≤1.2 VFS: ±1.5 V relative to the termination bias (30 mA maximum), ±5 V absolute maximum input, >1.2 VFS: 8.0 V		
Offset range	10mV/div: ±450mV, 20mV/div: ±400mV, 50mV/div: ±250mV, 100mV/div: ±2.0V, 200mV/div: ±1.5V, 500mV/div: ±0.0V				±3.4V		
Termination voltage range	-				≤1.2 VFS: -3.5 V to +3.5 V, >1.2 VFS: 0 V		
Position range	±5div						
Vertical resolution	8 bit (11 bit with averaging)						
<b>Horizontal System</b>							
Time base range	20ps/div~1000s/div			10ps/div~1000s/div			
Timing resolution (ET / IT mode)	200fs			100fs			
Channel-to-Channel deskew range	±75 ns						
Delta time measurement accuracy (RMS over <100 ns Duration; Single Shot; Signal Rise Time = 1.2 × Scope Rise Time; 100 mV/div, bandwidth filter on, max sample rate)	1.24ps	1.23ps	1.15ps	1.43ps	639fs	639fs	555fs
Jitter noise floor (with BWE enabled) (typical)	300fs	270fs	270fs	290fs	< 380 fs	< 365 fs	< 325 fs
Time base accuracy	±1.5 ppm initial accuracy, aging <1 ppm per year						
Time base delay time range	-5.0ks~1.0ks						
Trigger jitter	<100 fsRMS (1 psRMS [typical] with enhanced triggering off)						
<b>Acquisition System</b>							
<b>Sample rate</b>							
Sample rate (1, 2 ch)	25GS/s			100GS/s			
Sample rate (3, 4 ch)	25GS/s			50GS/s			
Sample rate (ET/IT mode)	5TS/s			10TS/s			
<b>Record length</b>							
Record length, points (each channel, standard)	DPO70000 Series : 31.25M MSO70000 Series : 62.5M						
Opt. 5XL	DPO70000 Series: 62.5M/Standard for MSO70000 Series						
Opt. 10XL (each channel)	125 M						
Opt. 20XL (each channel)	-	250M / Models above 12.5 GHz					
Opt. 50XL (each channel)	-	-					500M 1G on 2 channels / DX Models only
<b>Logic Channels (MSO70000 Series only)</b>							
Logic Channels	16						
Thresholds	One per channel, independently set						
Threshold accuracy	±75 mV + 3% of threshold setting						
Threshold resolution	5mV						
Maximum sample rate (all channels)	12.5GS/s						
Timing resolution	80ps						
<b>Physical Characteristics</b>							
Dimensions, Weight, Power	298 (H) × 451 (W) × 489.97 (D) mm, 24kg (Net Weight), <1100 VA typical						

Note: Frequency Band in real time sample: (1, 2ch) 4GHz 6GHz 8GHz 12.5GHz 16GHz 20GHz 23GHz 25GHz 33GHz (4ch) 4GHz 6GHz 8GHz 12.5GHz 16GHz 20GHz 23GHz 23GHz  
Frequency band in equivalent time sample: (4ch) 4GHz 6GHz 8GHz 12.5GHz 16GHz 20GHz 23GHz 25GHz 33GHz

**Ships with product:** User Manual (071-2980-xx), 4 x TCA-292MM TekConnect® to 2.92 mm Adapter (C models), 4 x TCA-292D TekConnect® to 2.92 mm Adapter (DX models), TCA-BNC TekConnect® to BNC Adapter, Accessory Pouch, Front Cover, Mouse, Keyboard, Power Cord, Static Protection Wrist Strap, GPIB Programmer's Reference (on product SSD), Performance Verification Procedure PDF File, Cabellibration Certificate Documenting NIST Traceability, Z 540-1 Compaliance and ISO9001, P6717A General Purpose Logic Probe (MSO models), Logic Probe Deskew Fixture (MSO models), 067-2298-xx Deskew Fixture, logic probes, One-year warranty covering all parts and labor.

# DPO7000SX Series

ATI Performance Oscilloscope / Digital Phosphor Oscilloscope

Lowest Noise. Highest Fidelity. Maximum Performance.  
Flexible. Versatile. Scalable Performance



DPO77002SX 70 GHz ATI Performance Oscilloscope



DPO73304SX 33 GHz Digital Phosphor Oscilloscope

## Features

- Low noise, 70 GHz real time signal capture using patented ATI architecture
- 70GHz Analog Bandwidth (1 ch), 33GHz Analog Bandwidth (2 ch)
- 200GS/s Sample Rate
- Highest trigger performance with >25 GHz Edge trigger bandwidth
- Precise, scalable performance using UltraSync multi-unit time synchronization bus
- Compact instrument package with flexibility for future expansion and simple reconfiguration

## Compact Ultra-performance Oscilloscope

DPO7000SX Series models establish a unique compact oscilloscope package that enables unprecedented workspace efficiency and mounting versatility.

## UltraSync Multi-unit Synchronization

DPO7000SX Series instruments include the Tektronix UltraSync multi-unit time synchronization bus. UltraSync is used to synchronize sample clock, trigger and run-stop control across multiple units. UltraSync provides outstanding integration and time alignment between units in a multi-unit stack.



UltraSync connection on instrument with Master and Extension role



The DPO7AFP Auxiliary Front Panel is a valuable usability accessory that compliments the compact instrument package by enabling users to operate with familiar controls without requiring access to the front of an instrument.



## ATI (Asynchronous Time Interleaving) Technology

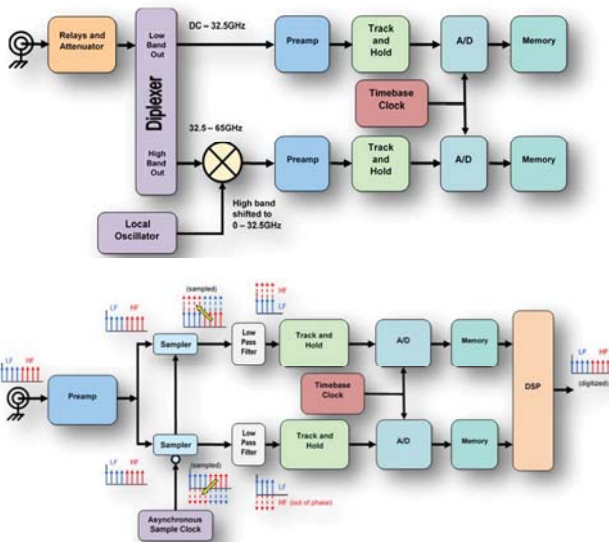

**Legacy Frequency Interleaving Technique**  
"Stitching" via DSP is complicated. Due to path differences, compensation must occur adding to complexity.

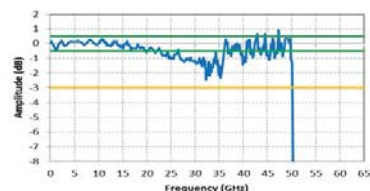

Each digitizing path operates at 100 GS/s and the folded spectrum is band limited to <40 GHz to meet Nyquist criteria. The alternating phase of the sampler has the effect of inverting signal phase 180° in one digitizing path, which provides significant benefit in reconstructing the final digitized signal.

Unlike the frequency interleaving method, Tektronix's unique ATI architecture provides a symmetric technique that delivers all signal energy to both digitizing paths resulting in an inherent noise advantage. The signal spectra are "unfolded" using a DSP equivalent of the sampling process and combined to reproduce the input signal. Phase-inversion introduced by the sampling process causes intermediate frequency components to directly cancel one another. This simplifies the signal reconstruction and provides the lowest noise acquisition.

When designing and debugging high-speed communication/interface systems, not only wideband, but noise, effective bits (ENOB), waveform quality, such as frequency response, are also critical. ATI technology is a breakthrough technology that combines both broadband and waveform quality.



Basic Specifications	DPO77002SX		DPO75002SX	
Input Connector	ATI	TCA	ATI	TCA
Analog channels	1	2	1	2
Bandwidth	70GHz <sup>*1</sup>	33GHz	50GHz	33GHz
Sample rate per channel	200GS/s	100GS/s	200GS/s	100GS/s
Rise Time (20% - 80% <sup>*1</sup> )	4.3ps	9ps	6ps	9ps
Rise Time (10% - 90% <sup>*1</sup> )	5.6ps	13ps	7.8ps	13ps
Sensitivity Range	100mV FS~300mV FS	62.5mV FS~6V FS	100mV FS~300mV FS	62.5mV FS~6V FS
Vertical Noise (% of full scale), BWE on, max sample rate (typical) <sup>*1</sup>	0.83% of full scale	0.71% of full scale	0.83% of full scale	0.71% of full scale
	0.75% of full scale @ 0 V offset (300 mVFS)	0.56% of full scale @ 0 V offset (500 mVFS)	0.75% of full scale @ 0 V offset (300 mVFS)	0.56% of full scale @ 0 V offset (500 mVFS)
Record length, points (each channel, standard)	62.5M			
Record length (each channel, Opt. 50XL)	1G			
Timing Resolution	5ps (200GS/s)	10ps (100GS/s)	5ps (200GS/s)	10ps (100GS/s)
Time base accuracy	Typical: ±0.1 x 10 <sup>-6</sup> initial accuracy after adjustment. <sup>*1</sup>			
Dimensions, mass, power consumption	1577 (height) x 452 (width) x 553 (depth) mm, 19kg (oscilloscope only, <980 W, single instrument, maximum, ≤780 W, single unit (typical)			

Basic Specifications	DPO73304SX	DPO72304SX	DPO71604SX	DPO71304SX
Input Connector	2			
Analog channels	4			
Bandwidth	33GHz	23GHz	16GHz	13GHz
Sample rate per channel	2 ch 100 GS/s, 4 ch 50 GS/s			
Rise Time (20% - 80% <sup>*1</sup> )	9ps	13ps	19ps	23ps
Rise Time (10% - 90% <sup>*1</sup> )	13ps	17ps	26ps	32ps
Sensitivity Range	62.5 mVFS to 6 VFS			
Vertical Noise (% of full scale), BWE on, max sample rate (typical) <sup>*1</sup>	0.71% of full scale @ 0 V offset (500 mVFS)	0.53% of full scale @ 0 V offset (500 mVFS)	0.43% of full scale @ 0 V offset (500 mVFS)	0.44% of full scale @ 0 V offset (500 mVFS)
Record length, points (each channel, standard)	62.5M			
Record length (each channel, Opt. 50XL)	1 G on 2 ch, 500 M on 4 ch			
Timing Resolution	10ps (100GS/s)			
Time base accuracy	Typical: ±0.1 x 10 <sup>-6</sup> initial accuracy after adjustment. <sup>*1</sup>			
Dimensions, mass, power consumption	157 (height) x 452 (width) x 553 (depth) mm, 19kg (oscilloscope only, <980 W, single instrument, maximum, ≤780 W, single unit (typical)			

<sup>\*1</sup>Representative Value

## P7700 Series TekFlex™ TriMode™ Probe Family

High bandwidth for signal fidelity

Easy to connect TekFlex™ Connector technology

- Minimal device impact
  - Active buffer tip design for low probe loading
- Easy to connect TekFlex™ Connector technology
  - Probe cable and solder down tips operate over an extended temperature range
  - Lightweight and flexible probe cable
- Industry-leading low-load performance for LPDDR and MIPI standards
- World's first probe and tip specific S-parameters
- Reduction of total cost of ownership



	P7720		P7716	P7713	P7708
	P77C292MM P77STFLXA P77STCABL	P77BRWSR			
Bandwidth (typical)	20GHz <sup>*2</sup>	16GHz	16GHz	13GHz	8GHz
Rise time (10-90%)	27ps <sup>*3</sup>	32ps	32ps	40ps	55ps
Rise time (20-80%)	18ps	24ps	24ps	28ps	35ps

<sup>\*2</sup> Differential and single ended modes only. Bandwidth is 19 GHz in the common mode setting.

<sup>\*3</sup> Rise times in common mode setting: 29 ps (10 - 90%), 19 ps (20 - 80%).



P77STFLXA and P77STCABL TekFlex connector and two types of soldering tips



P77BRWSR Handheld Browser Accessory



P77C292MM SMA/2.92mm adapter

	Attenuation Ratio	Input Range		Operating Voltage Window	Offset Voltage Range	DC Gain Accuracy	DC Input Resistance (Differential)
		Single-Ended	Differential				
Solder-in Tips	4x	2.5V p-p	5.0V p-p	±5.25V	-4V~+ 4V	±2.0%	100kΩ
Browser	10 : 1	6.0V p-p	12.0V p-p	±10V	-10V~+ 10V		150kΩ
SMA Adaptor	0.7x/1.3x/2.7x/5x/10x	1.2V p-p	2.0V p-p	±4V	-4V~+ 4V		100Ω

## Precision Measurements Start at the Probe Tip

Probes are vital to oscilloscope measurements. In addition to being vital to oscilloscope measurements, probes are also critical to measurement quality.

To maximize signal fidelity and measurement accuracy, it is important to select a probe that is compatible with your oscilloscope. As a leading provider of probe technology, Tektronix offers a broad line of proven products that have earned a reputation for robustness, reliability, and long service life.

### Passive Probes



Model	Frequency Range (-3db)	Attenuation	Maximum Input Voltage	Maximum Voltage	Input Impedance	Cable Length
TPP0051	50MHz	10:1	300V <sub>rms</sub>	15~25pF	10MΩ/12pF	1.3m
TPP0100 TPP0101	100MHz	10:1	300V <sub>rms</sub>	8~18pF 15~25pF	10MΩ/12pF	1.3m
TPP0200 TPP0201	200MHz	10:1	300V <sub>rms</sub>	8~18pF 15~25pF	10MΩ/12pF	1.3m
TPP0250 <sup>*1</sup>	250MHz	10:1	300V <sub>rms</sub>	-	10MΩ/3.9pF	1.3m
TPP0500B <sup>*1</sup>	500MHz	10:1	300V <sub>rms</sub>	-	10MΩ/3.9pF	1.3m
TPP0502 <sup>*1</sup>	500MHz	2:1	300V <sub>rms</sub>	-	2MΩ/12.7pF	1.3m
TPP1000 <sup>*1</sup>	1GHz	10:1	300V <sub>rms</sub>	-	10MΩ/3.9pF	1.3m
P2220 P2221	6/200MHz	1:1/10:1	150V <sub>rms</sub> / 300V <sub>rms</sub>	15~25pF 10~25pF	1MΩ/110pF or 10MΩ/17pF	1.5m
P3010	100MHz	10:1	300V <sub>rms</sub>	10~15pF	10MΩ/13.3pF	2.0m
P5050B	500MHz	10:1	300V <sub>rms</sub>	15~22pF	10MΩ/11.1pF	1.3m
P6101B	15MHz	1:1	300V <sub>rms</sub>	-	1MΩ/100pF	2.0m
P6139B	500MHz	10:1	300V <sub>rms</sub>	8~18pF	10MΩ/8pF	1.3m

### Low Voltage Single-Ended Probe



Model	Frequency Range	Rise Time (10%~90%)	Attenuation	Dynamic Range	Offset Range	Input Impedance
P6243 <sup>2</sup>	1GHz	≤350ps	10X	±8V	-	1 MΩ    ≤ 1 pF
P6245 <sup>2</sup>	1.5GHz	≤267ps	10X	±8V	±10V	1 MΩ    ≤ 1 pF
TAP1500 <sup>1</sup>	1.5GHz	≤267ps	10X	±8V	±10V	1 MΩ    ≤ 1 pF
TAP2500 <sup>1</sup>	2.5GHz	<140 ps	10X	±4V	±10V	40 kΩ    ≤ 0.8 pF
TAP3500 <sup>1</sup>	3.5GHz	<130 ps				
TAP4000 <sup>1</sup>	4.0GHz	≤115 ps	10X	±4V	±10V	40 kΩ    ≤ 0.8 pF

### Low Voltage Differential Probe



Model	Frequency Range	Rise Time (10%~90%)	Attenuation	Maximum Input Voltage	Offset Voltage	Input Impedance
P6247 <sup>2</sup>	1GHz	≤350ps	1X, 10X	1X : ±0.85 V 10X : ±8.5 V	±7.0 V, 1X ±7.0 V, 10X	200 kΩ    <1 pF
P6248 <sup>2</sup>	1.5GHz	<265 ps	1X, 10X	1X : ±0.85 V 10X : ±8.5 V	±7.0 V, 1X ±7.0 V, 10X	200 kΩ    <1 pF
TDP0500 <sup>1</sup>	500MHz	<700 ps	5X / 50X	50X : ±42 V 5X : ±4.25 V	±35V	1 MΩ    ≤ 1 pF
TDP1000 <sup>1</sup>	1GHz	≤350 ps				
TDP1500 <sup>1</sup>	1.5GHz	<265 ps	1X, 10X	1X : ±0.85 V 10X : ±8.5 V	±7.0V	200 kΩ    <1 pF
TDP3500 <sup>1</sup>	3.5GHz	≤140 ps	5X	±2V	+5 V to -4 V	100 kΩ    ≤ 0.3 pF
TDP4000 <sup>1</sup>	4.0GHz	≤125 ps	5X	±2V	+5 V to -4 V	100 kΩ    ≤ 0.3 pF
TDP7704 <sup>1</sup>	4.0GHz	<100 ps	4X*	±5.25V	+4 V to -4 V*	100 kΩ    0.4 pF*
TDP7706 <sup>1</sup>	6.0GHz	<65 ps	4X*	±5.25V	+4 V to -4 V*	100 kΩ    0.4 pF*
TDP7708 <sup>1</sup>	8.0GHz	<55 ps	4X*	±5.25V	+4 V to -4 V*	100 kΩ    0.4 pF*
TDP7710 <sup>1</sup>	8.0GHz	<45 ps	4X*	±5.25V	+4 V to -4 V*	100 kΩ    0.4 pF*

\* Characteristic value for soldering tips. The operating voltage to ground is the offset voltage. Please refer to the data sheet for the specifications of the browser and SMA adapter.

### High Voltage Probe - Single Ended



Model	Frequency Range (-3db)	Rise Time (10%~90%)	Attenuation	Maximum Input Voltage	Compensation Range	Input Resistance / Input Capacitance
TPP0850 <sup>*1</sup>	800MHz	<525ps	50X	2.5kV (DC+PeakAC)	-	40 MΩ/ 1.8 pF
P5100A	500MHz	<700ps	100X	2.5kV (DC+PeakAC)	7~30pF	40 MΩ/ 2.5 pF
P6015A*	75MHz	≤4.67ns	1000X	20kV <sub>rms</sub>	7~49pF	100 MΩ/ 3.0 pF

\* For the lead-out function, specify P6015A Option 1R

<sup>1</sup> Equipped with TekVPI interface. This is a dedicated probe for TekVPI hard key oscilloscopes (MDO3000/4000, MSO/DPO4000B, MSO/DPO5000/B series, and 3/4/5/6 Series)

<sup>2</sup> Equipped with TekProbe LEVEL 2 interface

## High Voltage Differential Probe



P5202A/P5205A

Model	Frequency Range (-3db)	Rise Time (10%-90%)	Attenuation	Maximum Input Voltage (DC+PeakAC)	Offset Voltage	Input Impedance
P5200A <sup>*3</sup>	50MHz	≤7.8ns	50X / 500X	1.3kV / 130V	1kV <sub>rms</sub>	10 MΩ    2 pF
P5202A <sup>*2</sup>	100MHz	≤3.8ns	20X / 200X	640V/64V (DC+PeakAC)	300V <sub>rms</sub>	5 MΩ    2 pF
P5205A <sup>*2</sup>	100MHz	≤3.8ns	50X / 500X	1.3kV/130V (DC+PeakAC)	1kV <sub>rms</sub>	10 MΩ    2 pF
P5210A <sup>*2</sup>	50MHz	≤7.8ns	100X / 1000X	5.6kV/560V (DC+PeakAC)	1kV <sub>rms</sub>	40 MΩ    2.5 pF
TMDP0200 <sup>*1</sup>	200MHz	<1.8 ns	25X / 250X	750V/75V (DC+PeakAC)	300V <sub>rms</sub>	5 MΩ    2 pF
THDP0200 <sup>*1</sup>	200MHz	<1.8 ns	50X / 500X	1.5kV/150V (DC+PeakAC)	1kV <sub>rms</sub>	10 MΩ    2 pF
THDP0100 <sup>*1</sup>	100MHz	<3.5 ns	100X / 1000X	6.0kV/600V (DC+PeakAC)	1kV <sub>rms</sub>	40 MΩ    2.5 pF

## Current Probe



A621



TCP0030A



CT6



1103 Probe Power Supply

Model	Frequency Range	Rise Time (10/90%)	Current / div, or Conversion Ratio	Maximum Current	Maximum Peak Pulse Current <sup>*7</sup>	Current Time Product <sup>*8</sup>
A621	5Hz-50kHz	≤ 7 μs	1A (1mV/A) 100mA (10mV/A) 10mA (100mV/A) <sup>*4</sup>	1,000A <sub>rms</sub> (1mV/A) 200A peak (10mV/A) 20A peak (100mV/A) <sup>*5</sup>	2000A <sub>peak</sub> (1mV/A)	-
A622	DC~100kHz	≤ 3.5 μs	100mA (10mV/A) 10mA (100mV/A) <sup>*4</sup>	100A (DC) 10A (DC) <sup>*6</sup>	-	-
P6021A	150Hz~60MHz	5.8 ns	2mA (0.5V/A) 10mA (0.1V/A) <sup>*4</sup>	15A <sub>p-p</sub>	250A	500A • μs
P6022	935Hz~120MHz	2.9 ns	1mA or 10mA <sup>*4</sup>	6A	100A	9A • ms
TCP202A <sup>*2</sup>	DC~50MHz	≤ 7 ns	10mA (10A/V) <sup>*4</sup>	15A (DC)	50A	500A • μs
TCP2020 <sup>*3</sup>	DC~50MHz	≤ 7 ns	10mA (10A/V) <sup>*4</sup>	20A (DC)	100A	1000A • μs
TCP0020 <sup>*1</sup>	DC~50MHz	≤ 7 ns	10mA (10A/V) <sup>*4</sup>	20A (DC)	100A (1MΩ) 50A (50Ω)	1000A • μs
TCP0030A <sup>*1</sup>	DC~120MHz	≤ 2.92 ns	1mA (1A/V) <sup>*4</sup>	30A (DC)	50A	50A • μs (1A/V) 3000A • μs (5A/V)
TCP0150 <sup>*1</sup>	DC~20MHz	≤ 17.5 ns	5mA (5A/V) <sup>*4</sup>	150A (DC)	500A	3000A • μs (5A/V)
CT1	25kHz~1GHz	0.35 ns	200μA (5V/A) <sup>*4</sup>	500mA <sub>rms</sub>	12A	1A • μs
CT2	1.2kHz~200MHz	0.5 ns	1mA (1V/A) <sup>*4</sup>	2.5A <sub>rms</sub>	36A	50A • μs
CT6	250kHz~2GHz	200 ps	200μA (5V/A) <sup>*4</sup>	120mA <sub>rms</sub>	6A	0.25A • μs

## Rogowski Current Probes



TRCP0300

TRCP0600

TRCP3000

Model	周波数帯域	Sensitivity	Peak Current	Minimum Current	Coil Diameter
TRCP0300	9Hz~30MHz	20mV/A	300A	250mA	1.7mm
TRCP0600	12Hz~30MHz	10mV/A	600A	500mA	4.5mm
TRCP3000	1Hz~16MHz	2.0mV/A	3,000A	500mA	8.5mm

## Current Probe Set



TCPA Series

Model	Frequency Range (-3db)	Rise Time (10%-90%)	Current / div, or Conversion Ratio	Maximum DC Current	Maximum Peak Pulse Current <sup>*7</sup>	Current Time Product <sup>*8</sup>
TCPA300 +TCP312A	DC~100MHz	3.5ns	1mA (1A/V), 10mA(10A/V) <sup>*4</sup>	30A	50A	50A • μs (1A/V)
TCPA300 +TCP305A	DC~50MHz	7ns	5mA (5A/V), 10mA (10A/V) <sup>*4</sup>	50A	50A	500A • μs (5A/V)
TCPA300 +TCP303	DC~15MHz	23ns	5mA (5A/V), 50mA (50A/V) <sup>*4</sup>	150A	500A	3,000A • μs (5A/V)
TCPA400 +TCP404XL	DC~2MHz	175ns	1A (1A/mV) <sup>*4</sup>	750A	750A	NA (1A/mV)

<sup>\*1</sup> Equipped with TekVPI interface

<sup>\*2</sup> Equipped with TekProbe Level 2 interface

<sup>\*3</sup> AC Adapter included

<sup>\*4</sup> Value when the oscilloscope is set to 1mV/div

<sup>\*5</sup> At ≤ 2kHz

<sup>\*6</sup> At ≤ 10kHz

<sup>\*7</sup> Depends on core saturation.

<sup>\*8</sup> Decreases depending on the duty cycle and frequency.

### Note:

For more information on probe, visit:

[www.tek.com/accessories](http://www.tek.com/accessories)



## NEW TIVP Series

### IsoVu™ Isolated Differential Probes

See the signals that were hidden!

100% IsoVu Probe Technology

1/5 smaller, greater performance and easier to use

- Bandwidths: DC~1GHz
- Common mode voltage range: 60 kV peak (DC~1GHz)
- High CMRR: 160dB (DC~1MHz), 100dB @ 500MHz
- Maximum differential input voltage:  $\pm 2500V$
- Maximum offset range:  $\pm 2500V$
- 2m or 10m fiber optic
- Sensor head that does not require battery replacement or charging
- With a wide range of connectors and accessories  
Secure and flexible connection

Uncover the fast, floating signals that your non-isolated probes are hiding. IsoVu™ Probe Technology virtually eliminates common mode interference using optical isolation. This delivers accurate differential measurements on reference voltages slewing  $\pm 60kV$  at 100V/ns or faster. And with our IsoVu Generation 2 design, you get all the benefits of IsoVu technology at 1/5 of the size.



### IsoVu Applications

- Half / Full bridge designs using SiC or GaN, FETs, or IGBTs
- Floating measurements in power supplies
- Power converter design
- Power device evaluation
- Switched Mode Power Supply design
- Inverter design
- Motor Drive design
- Electronic ballast design
- EMI and ESD troubleshooting
- Current shunt measurements

### Wide Bandgap Semiconductor High-side Vgs Measurement example

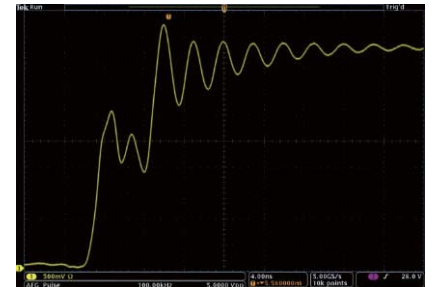

Observation example with IsoVu

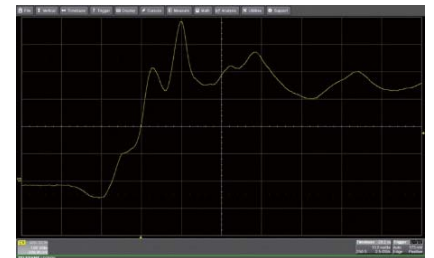

Observation example with a differential probe made by another company

### ESD Test



### Main Performance

Model	Bandwidth	Rise Time	Cable Length	Maximum differential Input voltage	Maximum input Offset range	Maximum common mode voltage
TIVP1	1GHz	450 ps	2m	$\pm 2500V^*$	$\pm 2500V^*$	60kV
TIVP1L	1GHz	450 ps	10m	$\pm 2500V^*$	$\pm 2500V^*$	60kV
TIVP05	500MHz	850 ps	2m	$\pm 2500V^*$	$\pm 2500V^*$	60kV
TIVP05L	500MHz	850 ps	10m	$\pm 2500V^*$	$\pm 2500V^*$	60kV
TIVP02	200MHz	2ns	2m	$\pm 2500V^*$	$\pm 2500V^*$	60kV
TIVP02L	200MHz	2ns	10m	$\pm 2500V^*$	$\pm 2500V^*$	60kV

\* When using TIVPWS500X

Sensor Tip Cable	Differential input voltage range	Offset range	Input impedance	Maximum Non-Destructive Differential Voltage (DC + peak AC)	CMRR		
					DC~1MHz	500MHz	1GHz
SMA Input (50 $\Omega$ mode)	$\pm 5V$	$\pm 25V$	50 $\Omega$	5V <sub>rms</sub>	160dB	100dB	90dB
SMA Input (1 M $\Omega$ mode)	$\pm 5V$	$\pm 25V$	1M $\Omega$    11pF	100Vpk	160dB	100dB	90dB
<b>MMCX Connector Sensor Tip Cable</b>							
TIVPMX10X	$\pm 50V$	$\pm 200V$	10M $\Omega$    2.8pF	250Vpk	160dB	85dB	80dB
TIVPMX50X	$\pm 250V$	$\pm 250V$	10M $\Omega$    <5pF*	300Vpk*	160dB*	73dB*	70dB*
TIVPMX1X	$\pm 5V$	$\pm 25V$	50 $\Omega$ or 1M $\Omega$    28 pF	5V <sub>rms</sub> (50 $\Omega$ ), 100Vpk (1M $\Omega$ )	160dB*	100dB*	90dB*
<b>2.54mm Square Pin Sensor Tip Cable</b>							
TIVPSQ100X	$\pm 500V$	$\pm 500V$	10M $\Omega$    <5pF*	600Vpk*	160dB*	39dB*	30dB*
<b>5.08mm Square Pin Sensor Tip Cable</b>							
TIVPWS500X	$\pm 2500V$	$\pm 2500V$	40M $\Omega$    <4pF*	3300Vpk*	160dB*	33dB*	25dB*

\* Provisional Value

## TPR Series

### Power Rail Probes

#### World's Best-In-Class Power Integrity Solutions

- Top-class low system noise enables minute level ripple measurement
- 1GHz and 4GHz frequency bands that can handle high-speed transients
- Large offset voltage of  $\pm 60V$  and dynamic range of  $\pm 1V$
- Flexible and abundant probing for soldering, browser, high temperature support, etc.
- Rich automatic measurement capabilities to improve test reliability

Power rail probes offer low noise, low loading, high bandwidth, and high DC offset specifically for power integrity measurements.

For engineers that are working on the power integrity of fast devices like microprocessors, memory components, FPGAs, storage devices and image sensors, and need the highest accuracy in ripple measurements with transitions – Tektronix has the solution to meet your every need.”



Model	Bandwidth	Offset Voltage Range	Dynamic range	Input Resistance	Input Coupling	System Noise	Attenuation	Connectivity and accessories
TPR1000	1GHz	$\pm 60V$	$\pm 1V$	50k $\Omega$ DC 50 $\Omega$ AC	DC, LF Reject	<300 $\mu V$ p-p (20MHz BW Limit) <1.3mV p-p (Full Bandwidth)	1.25x	New browser, solder-in and snap-on
TPR4000	4GHz							

### Comparison with other Probes

TPR Series Probe 1GHz Band Limitation



TPP1000 Passive Probe 1GHz Band Limitation

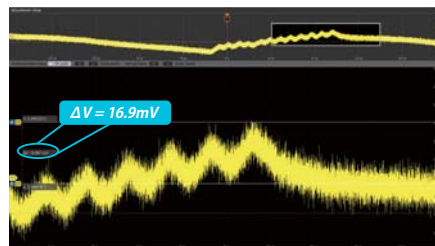

TPR Series Probe 20MHz Band Limitation



TPP1000 Passive Probe 20MHz Band Limitation

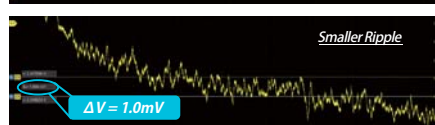
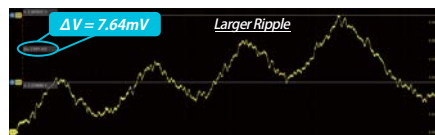

### Digital Power Management And Analysis Software 5-DPM And 6-DPM

The solution enables simultaneous analysis of multiple power rails using power rail probes, sequencing of measurements using passive probes and it also generates an automated report.

#### Measurements

- Ripple
- Overshoot / Turn-on Undershoot
- Settling Time
- Turn-on / Turn-off times
- Ringing
- Voltage Management
- Slew Rate
- Jitter Analysis

#### Recommended Accessories

- TPR4KIT ..... Standard Accessory Kit (standard attachment)
- TPR4KITHT ..... High Temperature Accessory Kit
- TPR4SIAFLEX ..... Soldering Flex Adapter Kit
- TPR4SIACOAX ..... Soldering Coaxial Adapter Kit
- TPRBRWSR1G ..... 1GHz Browser

### Recommended Accessories

Accessory	TPR4KIT	TPR4KITHT	TPRBRWSR1G	TPR4SIAFLEX	TPR4SIACOAX
	Standard	Option	Option	Option	Option
SMA-MMCX cable (1.3m)	✓				
SMA-SMA cable (1.3m)	✓				
SMA-MMCX temperature resistant cable (2m)*		✓			
Browser Probe			✓		
Y lead adapter	✓		✓		
Clamp	✓		✓		
U.FL Connector	✓				
MMCX-Square Pin Adapter	✓				
Soldering Tip	✓	✓			✓
Soldering Flex Tip	✓	✓		✓	

\*Temperature range at the tip: -40 to +155°C

# Signal Generators

Tektronix signal generators cover a wide range of applications from replicating sensor signals to creating high-speed serial data or RF signals with digital modulation applied.

## AFG31000

### Arbitrary Function Generator

Real-time waveform monitoring, built-in ARB waveform creation, low noise

The AFG31000 Series with InstaView™ technology is the first high-performance AFG with built-in waveform generation applications, patented real-time wave monitoring, and a modern user interface.

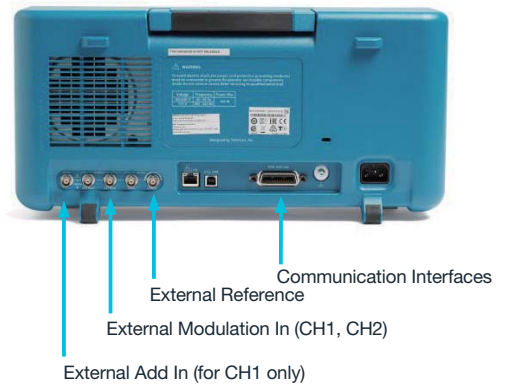
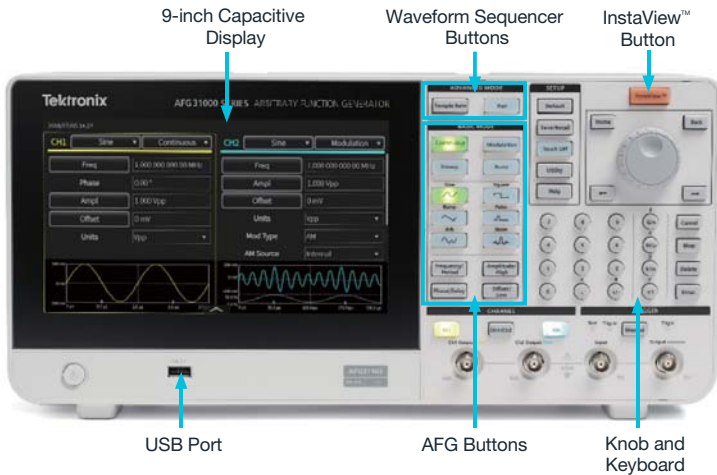

- 9-inch capacitive display touchscreen
- Monitor waveform added at device under test (DUT) in real time (InstaView™)
- Programmable waveform sequencing
- Built-in waveform creation capabilities
- Excellent performance – 10x less noise, 40x less jitter, 1,000x memory
- Upgrade with new options to keep evolving with your needs

### Save Time and Effort with the 9-inch Touchscreen



The AFG31000 Series features the industry's largest AFG touchscreen; pinch, zoom, and scroll just like a smart device to easily locate settings and parameters on the simple menu or shortcuts to frequently-used settings.

### Verify Waveform at the Device Under Test: InstaView™

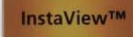

The traditional AFG products display only the setting parameters or ideal waveforms. In order to see the actual waveform on the load of the generator or the input of the DUT, an oscilloscope is needed to probe the related test points.

Patented InstaView™ technology, the AFG31000 Series, lets you see the actual waveform at the device under test (DUT) in real time – without an oscilloscope or probe – eliminating any uncertainty typically caused by mismatched impedance.

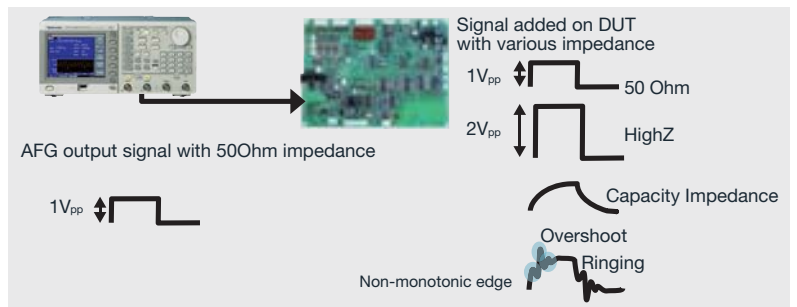

Waveform on Oscilloscope. DUT impedance impacts the waveform.



With InstaView on AFG31000 turned off. Due to an impedance mismatch, the AFG display shows a different waveform from the one observed at the DUT.

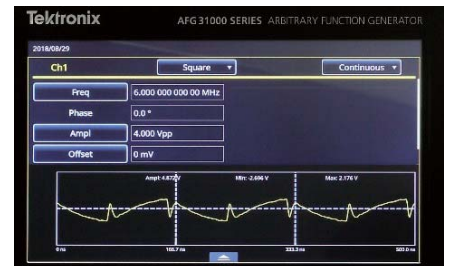

With InstaView on AFG31000 turned on. The AFG31000 shows the waveform as observed at the DUT.





## Generate Multiple Waveforms with Complex Timing



### Key Settings

Visible at a glance, and are easy to adjust using touch, numeric keypad, or rotary controls

Advanced waveform generation and programming capabilities make it easy to compose a list or a sequence of 1 to 256 waveforms with total waveform length up to 16 Mpts/ch (128 Mpts/ch optional) and define the output sequence of these waveforms.

## Built-in ArbBuilder Tool Create and edit Arbitrary Waveforms easier than ever



### Waveform editing screen

Creating an arbitrary waveform using the easy touch screen interface

The built-in ArbBuilder editing tool includes everything you need to create, edit, and transfer an ARB waveform without the need to connect to a PC.

## Simplified Multi-unit Synchronization



Example of how to sync two AFG31000 units

Most applications need one or two channels of output, but some applications require more channels (e.g. 3-phase power signals). The AFG31000 simplifies this process with an onscreen wizard that leads you through the process of making cable connections and configuring settings to synchronize multiple generators.

### Instrument Options

- Opt. MEM**..... Extends arb memory to 128 Mpt
- Opt. SEQ**..... Enables sequence mode

### Recommended Accessories

- 012-1732-xx**... BNC cable shielded, 3 ft.
- 012-0991-xx**... GPIB cable, double shielded
- 011-0049-02**... 50 Ω BNC terminator
- ACD4000B**..... Soft transit case
- HCTEK54**..... Hard transit case (requires ACD4000B)

### Service options

- C3**..... Calibration Service 3 Years
- C5**..... Calibration Service 5 Years
- D1**..... Calibration Data Report
- D3**..... Calibration Data Report 3 Years (with Opt. C3)
- D5**..... Calibration Data Report 5 Years (with Opt. C5)
- R5**..... Repair Service 5 Years
- T3**..... Three Year Total Protection Plan
- T5**..... Five Year Total Protection Plan

## Double Pulse Test in Under a Minute



AFG31000 Double Pulse user interface

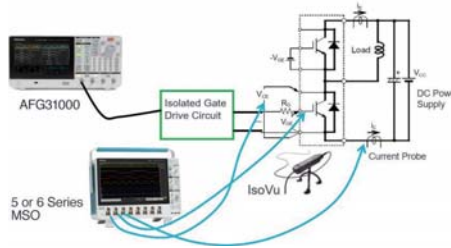

Double Pulse Testing measure switching parameters and evaluate the dynamic behaviors of MOSFET and IGBT power devices. The AFG31000 is the first function generator on the market that includes built-in double pulse test software. You can generate two waveforms with varying pulse widths (from 20 ns to 150 μs) in under a minute directly on the touchscreen display. No need for an external PC application or manual programming.

Basic Specifications	AFG31021	AFG31022	AFG31051	AFG31052	AFG31101	AFG31102	AFG31151	AFG31152	AFG31251	AFG31252
Analog Channels	1	2	1	2	1	2	1	2	1	2
Range (into 50 Ω)	≤60MHz: 1mV p-p~10V <sub>p-p</sub>						≤200MHz: 1mV p-p~5V <sub>p-p</sub>			
	>60MHz~≤80MHz: 1mV p-p~8V p-p						>200MHz~≤250MHz: 1mV p-p~4V p-p			
	>80MHz~≤100MHz: 1mV p-p~6V p-p									
Vertical resolution	14 bits									
Physical characteristics and Power Consumption	192 (Height) × 413 (Width) × 143 (Depth) mm, 4.9 Kg (Weight), Consumption: 120W									
Basic (AFG) Mode										
Standard waveforms	Sine, Square, Pulse, Ramp, More (Noise, DC, Sin(x)/x, Gaussian, Lorentz, Exponential Rise, Exponential Decay, Haversine)									
Sine	1μHz~25MHz*		1μHz~50MHz*		1μHz~100MHz*		1μHz~150MHz*		1μHz~250MHz*	
Square	1μHz~20MHz*		1μHz~40MHz*		1μHz~80MHz*		1μHz~120MHz*		1μHz~160MHz*	
Pulse	1μHz~20MHz		1μHz~40MHz		1μHz~80MHz		1μHz~120MHz		1μHz~160MHz	
Pulse width	16ns~999.99s		10ns~999.99s		6ns~999.99s		5ns~999.99s		4ns~999.99s	
Pulse width resolution	10 ps or 5 digits									
Pulse Duty	0.001%~99.999% (limitations of pulse width apply)									
DC (50Ω)	-5V~5V						-2.5V~2.5V			
Noise type (White Gaussian)	150MHz						360MHz			
Other waveforms	1μHz~500kHz		1μHz~800kHz		1μHz~1MHz		1μHz~1.5MHz		1μHz~2.5MHz	
Arbitrary waveforms										
Frequency range	1mHz~12.5MHz*		1mHz~25MHz*		1mHz~50MHz*		1mHz~75MHz*		1mHz~125MHz*	
Waveform length	2~131 kpoints									
Sample rate	250MS/s		1GS/s (Waveform length >16k points: 250MS/s)				2GS/s (Waveform length >16k points: 250MS/s)			
Jitter, RMS, typical	3.0 ps RMS		2.5 ps RMS		2.0 ps RMS		1.6 ps RMS			
Modulation	AM/FM/PM/FSK/PWM									
Other Run modes	Continuous, Modulation, Sweep and Burst									
Advanced (Waveform Sequence) Mode										
Waveform memory size	16 Mpts (128 Mpts optional) each channel									
Number of waveform entries	1Continuous, Triggered, Gated: 1, Sequence: 1 to 256									
Jump/trigger events	External trigger (rising or falling edge), manual trigger, timer, SCPI commands									
Variable sample rate	1μS/s~250MSa/s		1μS/s~500MS/s		1μS/s~1GS/s		1μS/s~2GS/s			

\*In burst mode, the maximum frequency is halved.

**Accessories:** BNC cable shielded, 3 ft., USB cable, A to B, 3 ft., Power cord, NIST-traceable calibration certificate, 3-year warranty

## AFG1022 / AFG1062

### Arbitrary / Function Generator

New standard for arbitrary waveforms / function generators  
2ch, Best-in-class performance and functionality at affordable price

- Dual-channel output
- 25 MHz or 60 MHz sine waveforms, 12.5 MHz or 30 MHz square waveforms
- 14 bits, Sample rate of up to 300 MS/s arbitrary waveforms
- Modulation, sweeping, and burst modes (only available for CH1 on AFG1022)
- Built-in 6-digit frequency counter



Width: 230mm Height: 112mm  
Depth: 307mm Weight: 3.4kg

AFG1062

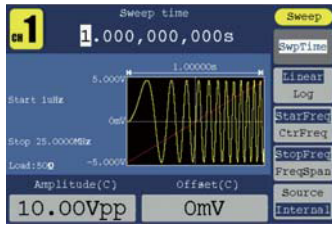

Sweep setting interface

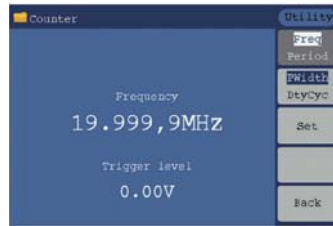

Frequency counter function interface



- 1 Ref CLK out
- 2 Ref CLK / Counter in
- 3 Ext Trigger / Burst / FSK in
- 4 Ext Modulation Input
- 5 USB Device
- 6 Chassis ground
- 7 Line selector (110 / 220VAC)

## AFG2021

### Arbitrary / Function Generator

Compact and easy-to-use multifunctional function generator

- 20 MHz sine, 10 MHz square and pulse waveforms
- 250 MS/s sampling rate and 14-bit vertical resolution
- 12 built-in standard waveforms
- Built-in Modulation, Noise Generator, Burst, and Sweep modes
- Innovative UI for quick and easy access
- USB remote control port and USB flash drive port are included
- GPIB and LAN interfaces are available as an option



Width: 242mm Height: 104mm Depth: 419mm  
Weight: 2.9kg

## Arbitrary Function Generator Models below 100MHz

Basic Specifications	AFG1022	AFG1062	AFG2021	AFG3011C (High Output Model)
Analog Channels	2		1	1
Amplitude (50Ω)	1mV <sub>pp</sub> ~10V <sub>pp</sub>	1mV <sub>pp</sub> ~10V <sub>pp</sub> (≤25 MHz) 1mV <sub>pp</sub> ~5V <sub>pp</sub> (≤25 MHz)	10mV <sub>pp</sub> ~10V <sub>pp</sub>	20mV <sub>pp</sub> ~20V <sub>pp</sub>
Output range	±5V			±10V
Waveforms	Sine, Square, Pulse, Ramp, Noise, and 45 Frequently Used Arbitrary Waveforms		Sine, Square, Pulse, Ramp, Triangle, Sin(x)/x, Exponential Rise and Decay, Gaussian, Lorentz, Haversine, DC, Noise	
Sine wave	1μHz~25MHz* <sup>1</sup>	1μHz~60MHz* <sup>1</sup>	1μHz~20MHz* <sup>2</sup>	1μHz~10MHz* <sup>2</sup>
Square wave	1μHz~12.5MHz* <sup>1</sup>	1μHz~30MHz* <sup>1</sup>	1μHz~10MHz	1μHz~5MHz
Ramp wave	1μHz~1MHz* <sup>1</sup>	1μHz~2MHz* <sup>1</sup>	1μHz~200kHz	1μHz~100kHz
Other waveforms	-		1μHz~200kHz	1μHz~100kHz
Noise Type	White Gaussian			
Noise bandwidth (-3 dB)	25MHz	50MHz	20MHz	10MHz
DC (50Ω)	-5~+5V			-10~+10V
Pulse wave	1μHz~12.5MHz	1μHz~30MHz	1mHz~10MHz	1mHz~5MHz
Pulse width range	40.00ns~999s	17.00ns~999s	30.00ns~999.99s	80.00ns~999.99s
Pulse width resolution	1 ns or 4 digits		10 ps or 5 digits	
Arbitrary Waveforms	1μHz~10MHz* <sup>3</sup>	1μHz~30MHz* <sup>3</sup>	1mHz~10MHz* <sup>2</sup>	1mHz~5MHz* <sup>2</sup>
Effective Analog Bandwidth (-3 dB)	30MHz	60MHz	34MHz	8MHz
Memory: Sample Rate	2~8,192: 125MS/s	2~1M: 300MS/s	2~128K: 250MS/s	2~128K: 250MS/s
Vertical Resolution	14 bits			
Rise/Fall Time	< 10 ns	< 8 ns	≤20 ns	≤80 ns
Jitter (RMS)	< 6 ns (typical)		4ns	4ns
Modulation	AM/FM/PM/FSK	AM/FM/PM/ASK FSK/PSK/PWM	AM/FM/PM/FSK/PWM	
Other output modes	Sweep (Linear, logarithmic), and burst (Triggered, gated) modes are only available for channel 1 on the AFG1022.		Sweep (Linear, logarithmic), and burst modes (Triggered, gated) modes	

\*<sup>1</sup> In burst mode, the minimum frequency is 2 mHz and the maximum frequency is halved.

\*<sup>2</sup> In burst mode, the maximum frequency is halved.

\*<sup>3</sup> Burst mode 2mHz~2.5MHz

# AWG5200

## Arbitrary Waveform Generator

Windows10

Signal Generators



Less noise. Cleaner Signals.  
A scalable, flexible, affordable arbitrary waveform generator.

- Sample rates up to 10 GS/s (with 2x interpolation)
- 2, 4, and 8 channel configurations
- 16 bits vertical resolution
- Digital outputs: 4 markers/channel, 32 max
- Output RF signals directly up to 4 GHz
- Synchronize multiple units to achieve a multi-channel high speed AWG system

### Low Noise, High Quality Signal

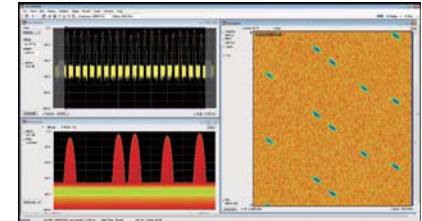

### Scalable, Flexible, Low-cost



Basic Specifications	AWG5202	AWG5204	AWG5208
Number of analog outputs	2	4	8
Sample rate (nominal)	300 S/s to 5 GS/s (10 GS/s Interpolated - Double Data Rate)		
Resolution (nominal)	16 bits (12 - 16 bits depending on the number of active markers)		
Sin(x)/x (-3dB)	2.22 GHz @ 5 GS/s, 4.44 GHz Interpolated @ 10 GS/s		
<b>Analog output characteristics</b>			
Effective frequency output	Fmaximum (specified) is determined as "sample rate / oversampling rate" or "SR / 2.5". 2 GHz, 4 GHz (Double Data Rate - DDR mode)		
DC High Bandwidth output	Amplitude levels are measured as singled-ended outputs. Output doubles when using differential (both) outputs.		
Amplitude range	25 mV <sub>p-p</sub> to 0.75 V <sub>p-p</sub> (single ended, 50 Ω terminated)		
Amplitude accuracy (guaranteed)	±2% of setting ≥ 100 mV <sub>p-p</sub> , ±5% of setting < 100 mV <sub>p-p</sub>		
Offset	±2 V (50 Ω into gnd), ±4 V into DC voltage terminated		
Analog bandwidth	At 750 mV <sub>p-p</sub> : DC to 2 GHz (3 dB), DC to 4 GHz (6 dB)		
DC High Bandwidth Amplified output (option)	Amplitude levels are measured as singled-ended outputs. Output doubles when using differential (both) outputs.		
Amplitude range	25 mV <sub>p-p</sub> to 1.5 V <sub>p-p</sub> (single ended, 50 Ω terminated)		
Amplitude accuracy (guaranteed)	±2% of setting ≥ 100 mV <sub>p-p</sub> , ±5% of setting < 100 mV <sub>p-p</sub>		
Offset	±2 V (50 Ω into GND), ±4 V into DC voltage terminated		
Analog bandwidth	At 750 mV <sub>p-p</sub> : DC to 2 GHz (3 dB), DC to 4 GHz (6 dB) At 1.5 V <sub>p-p</sub> : DC to 1.3 GHz (3 dB)		
DC High Voltage output	Amplitude levels are measured as singled-ended outputs. Output doubles when using differential (both) outputs.		
Amplitude range	10 mV <sub>p-p</sub> to 5.0 V <sub>p-p</sub> (single ended, 50 Ω terminated)		
Amplitude accuracy (guaranteed)	±2% of amplitude ≥ 160 mV <sub>p-p</sub> , ±5% of amplitude < 160 mV <sub>p-p</sub>		
Offset	±2 V (50 Ω into GND), ±4 V into high resistance or matching voltage terminated		
Analog bandwidth	DC - 370 MHz (3 dB) (at 2 V <sub>p-p</sub> ) DC - 200 MHz (3 dB) (at 4 V <sub>p-p</sub> )		
AC Direct output	Amplitude levels are measured as singled-ended outputs		
Amplitude range	-17 dBm to -5 dBm		
Amplitude accuracy	±0.5 dBm at 100 MHz		
DC bias	±5 V at 150 mA		
Analog bandwidth	10 MHz - 2 GHz (-3 dB), 10 MHz - 4 GHz (-6 dB)		
AC Amplified output (option)	Amplitude levels are measured as singled-ended outputs		
Amplitude range	-85 dBm to +10 dBm (10 MHz to 3.5 GHz), -50 dBm to +10 dBm (>3.5 GHz to 5 GHz)		
Amplitude accuracy	±0.5 dBm at 100 MHz		
DC bias	±5 V at 150 mA		
Analog bandwidth	10 MHz - 2 GHz (-3 dB), 10 MHz - 4 GHz (-6 dB)		
<b>Channel timing characteristics</b>			
Bit rate	Bit rate determined as "sample rate / 4 points per cycle", allowing full impairment generation 1.25Gbps		
Rise/fall time	Rise/fall time measured at 20% to 80% levels. < 110 ps at 1.5 V <sub>p-p</sub> single-ended termination, < 180 ps at 1.5 V <sub>p-p</sub> single-ended Opt. DC		
SFDR Performance	-80dBc (100MHz frequency output, DC to 1GHz, 10GS/s, DC direct)		
<b>Markers</b>			
Number of outputs	8	16	32
Marker sample rate	Up to 5 GS/s		
Minimum pulse width	400 ps		
Max data rate	2.5 GS/s		

### AWG5202

Option	AWG5202
Opt. 225	2.5GS/s
Opt. 250	5 GS/s (10 GS/s interpolated)
Opt. 2DC	High Bandwidth Amplified outputs
Opt. 2HV	High Voltage outputs
Opt. 2AC	AC Amplified outputs
Opt. 2DIGUP	Digital up conversion (requires AWG5200-250)

### AWG5204

Option	AWG5204
Opt. 425	2.5GS/s
Opt. 450	5 GS/s (10 GS/s interpolated)
Opt. 4DC	High Bandwidth Amplified outputs
Opt. 4HV	High Voltage outputs
Opt. 4AC	AC Amplified outputs
Opt. 4DIGUP	Digital up conversion (requires AWG5200-450)

### AWG5208

Option	AWG5208
Opt. 825	2.5GS/s
Opt. 850	5 GS/s (10 GS/s interpolated)
Opt. 8DC	High Bandwidth Amplified outputs
Opt. 8HV	High Voltage outputs
Opt. 8AC	AC Amplified outputs
Opt. 8DIGUP	Digital up conversion (requires AWG5200-850)

### Recommended Accessories

Opt. SEQ	Sequencing
Opt. ACCY01	USB mouse, compact USB keyboard, touch screen stylus
GF-RACK3U	Rack mount kit



# AWG7000B Series

## Arbitrary Waveform Generator



For cutting edge applications

- Sample rates up to 50 GS/s
- Waveform memory of up to 32 GSamples
- 1 channel or 2-channels waveform output
- -80 dBc spurious free dynamic range (SPDR)
- 10 bits vertical resolution
- Sequencer with Streaming ID

Signal Generators

Basic Specifications	AWG70001B	AWG70002B
Number of channels	1	2
Waveform memory length	Standard: up to 2 GSamples, with extended memory: up to 32 GSamples*	Standard: up to 2 GSamples per channel, With extended memory: up to 16 GSamples per channel
Sample rate	1.5 kS/s - 50 GS/s	1.5 kS/s - 25 GS/s
Resolution	Amplitude is measured at a single-ended output. >3dB at differential output	
Sin(x)/x Roll Off	11.1GHz	
Frequency related performance		
Effective frequency output	20GHz	10GHz
Output amplitude	Amplitude is measured at a single-ended output. >3dB at differential output	
Output flatness	Sin(x)/x response is mathematically removed from the measured response before recording the -3 dB crossing.	
Flatness	±1.8 dB up to 10 GHz, +1.8 dB to -3 dB from 10 GHz to 15 GHz	+0.8 dB to -1.5 dB up to 10 GHz
Analog Bandwidth	15 GHz @ 50GS/s	13.5 GHz @ 25GS/s
Output Matching	1.32 : 1 (DC-5GHz, 1.52 : 1 (5-10GHz), 1.73 : 1 (10-20GHz)	
SWR	1.61 : 1 (DC-10GHz)	
Time-related characteristics		
Serial Data Bit Rate	Bit rate determined as "sample rate / 4 points per cycle", allowing full impairment generation.	
Bit Rate	12.5Gbps	6.25Gbps
Rise/fall time	Rise / fall time measured at 20% to 80% levels, related by a factor of 0.75 to the industry standard of 10% to 90% levels	
Tr/Tf	Sampling rate ≤ 25 GS/s: < 23 ps Sampling rate at 50 GS/s: < 27 ps	< 22 ps
Output amplitude related characteristics		
Output amplitude	Amplitude levels are measured between differential outputs (+) to (-). For single-ended output, the amplitude level will be one-half the specified voltage levels.	
Range	500mV <sub>p-p</sub> ~1V <sub>p-p</sub>	
Resolution	1.0mV	
DC Accuracy	±(2% of amplitude + 1 mV)	
SFDR Performance	-80dBc (100MHz output frequency, DC-1GHz (typical)	

\*Non-interleaved when ≤ 25GS/s

Options	Description
Opt. 150	50 Gs/s Sample Rate for AWG70001B
Opt. 208	8 Gs/s sample rate for the AWG 70002B
Opt. 216	16 Gs/s sample rate for the AWG 70002B
Opt. 225	25 Gs/s sample rate for the AWG 70002B
Opt. MEM	Increase memory to 32GS (on AWG70001B) or 16GS per channel (on AWG70002B)
Opt. STRID	Streaming ID to the AWG70002B
Opt. AC	Amplifier and attenuator option for AWG 70000 series
Opt. SEQ	Sequencing to the AWG70002B

### AWG7000B Recommended Accessories

AWGRACK	Rack mount kit for AWG70000 Series
AWG701BUP Opt. SSD	Replacement / additional Solid State Disc Drive (AWG700001B)
AWG702BUP Opt. SSD	Replacement / additional Solid State Disc Drive (AWG700002B)
AWGSYNC01	Synchronization Hub

## SourceXpress™ Arbitrary Waveform Generator Software

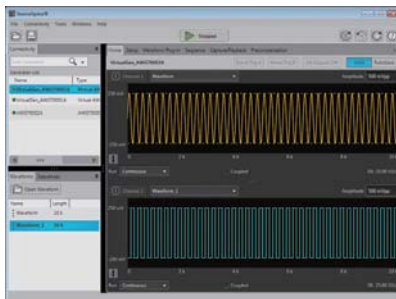

- Software control one or several AWG instruments from one application
- Create waveform using tools specifically targeted for your needs from your PC
- Supports various applications with an ever growing library of plug-ins
- Work seamlessly and remotely to develop offline waveforms with the same UI on the AWGs
- Create waveforms, sequences and sub-sequences with ease

### Plug-ins

Plug-in	Description	Nomenclature
Multitone & Chirp plug-in	Create generate chirps, notches and tones	MTONENL-SS01 MTONEFL-SS01
PreCompensation plug-in	Create correction coefficients that can be applied on waveforms to get flat frequency and linear phase response	PRECOMNL-SS01 PRECOMFL-SS01
High Speed Serial plug-in	Create pre-distorted waveforms to test a device's conformance to standards	HSSNL-SS01 HSSFL-SS01 HSSPACKNL-SS01 HSSPACKFL-SS01
RF Generic plug-in	Create digitally modulated signals with multiple carrier groups	RFGENNL-SS01 RFGENFL-SS01
Optical plug-in	Create waveforms with complex modulation schemes for optical testing	OPTICALNL-SS01 OPTICALFL-SS01
OFDM plug-in	Create Single or Multiple OFDM based Frames with one or more bursts	OFDMNL-SS01 OFDMFL-SS01
RADAR plug-in	Create RADAR pulsed waveforms with various modulations and impairments	RADARNL-SS01 RADARFL-SS01
Environment	Create real world scenarios for commercial, electronic warfare, and simulations for monitoring and receiver testing	ENVNL-SS01 ENVFL-SS01
Spread Spectrum Clocking plug-in	Adds SSC capability to the High Speed Serial and Optical plug-ins	SSCFNL-SS01 SSCFFL-SS01
S-Parameters plug-in	Adds S-Parameter capability to the RF Generic, High Speed Serial, Optical, OFDM, and RADAR plug-ins	SPARNL-SS01 SPARAF-SS01

## NEW TSO820

### 8 Series Sampling Oscilloscope

400G / 100G Ethernet, an ideal test solution for R&D and manufacturing applications

- Simultaneous capture at a high sample acquisition rate (8 times higher)
- Lowest optical noise / Highest Sensitivity
- Optical clock recovery for various NRZ / PAM4

#### Increased Throughput by Disaggregation

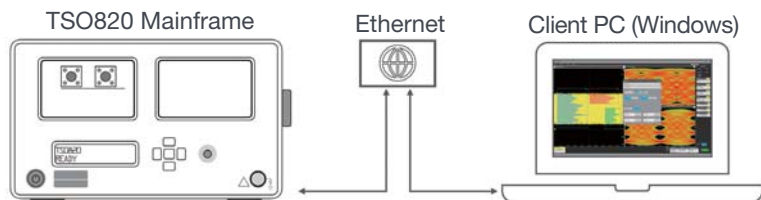

The 8 Series enables inexpensive, adaptable, and scalable solutions by leveraging the separation of acquisition hardware from analysis software. Stream waveform data from the instrument through high-speed Ethernet to the analysis platform, limiting oscilloscope downtime and maximizing investment.

Basic Specifications	TSO820
Rise time / bandwidth	Determined by the sampling modules used
Vertical resolution (nominal)	15.6 bits over the sampling modules' dynamic range
Main time base / horizontal scale	1ps/div-1ms/div
Record length	>80 M samples (PRBS23/PRBS23Q x 10 samples)
Number of sampling modules accommodated	2 Modules
Number of simultaneously acquired inputs	4 inputs
Maximum acquisition rate	300kS/s
Dimension and weight	132 (Height) x 217 (Width) x 590 (Depth) mm, 5.4kg (Weight)

#### Analysis with TSOVu®

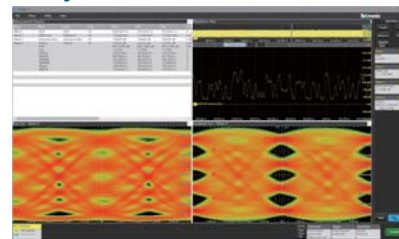

26/53GBd compatible with PAM4 analysis and TDECQ Measurement

#### Save time, space, and money with modular design



3U High, half-rack wide user-swappable modules with up to 4 optical channels per system

8 Series Optical Module	TSO8C17	TSO8C18
Optical channel count	1 optical channel	2 optical channels
Wavelength range	750-1,650nm	
Calibrated wavelength (±20 nm)	850 nm, 1310 nm, and 1550 nm	
Unfiltered optical bandwidth	Multi-mode: 30 GHz, Single mode: >30 GHz	
Fiber Diameter	50µm FC/PC	
Supported Optical Reference Receivers	PAM2 NRZ: 25.78125GBd (TDECQ-MM), 25.78125GBd, 27.95 GBd, 28.05 GBd	
	PAM4: IEEE 802.3™ - 26.5625 GBd SM/MM (BWel 13.28125 GHz, etc), IEEE 802.3™ - 53.125 GBd SM (BWel 26.5625 GHz, etc)	

## NEW TCR801

### Optical Clock Recovery

Dual band clock recovery instrument centered around 26 and 53 GBd

- Designed to lock in two ranges:
  - 25.6 to 29 GBd (PAM2 / NRZ / PAM4)
  - 51.2 to 58 GBd (PAM2 / NRZ / PAM4)
- 1250 nm to 1650 nm wavelength
- Adjustable PLL bandwidths to configure the “Golden PLL” response
- Various locking modes: intelligent auto relock, quick relock, and lock initiation from the front panel of the instrument
- Two separate RF clock outputs





From 5½-digit resolution to 8½-digit resolution DMMs, choose the best Tektronix and Keithley Digital Multimeter (DMM) to meet any measurement requirement for your application

## DMM6500

### 6½-Digit Graphical Digital Multimeter

Better Accuracy, Higher Speed, and Superior Usability

- Large 5-inch (12.7 cm) multi-touch capacitive touchscreen with graphical display
- Get instant measurement insight
- Stream and log data to secure cloud-based data visualizations
- User cursors and computer statistics to characterize waveforms
- Pinch and zoom features allow studying transients and signal waveshapes.
- Rear inputs including 10A current input
- Configured for SCPI emulation for the Keithley 2000 or the Keysight 34401A



DMM6500 (Replacement model for Keithley 2000)

### 1 MS/sec Digitizer; Up to 7M in Memory

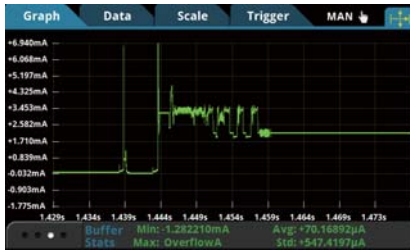

### Customizable Display with options for Special Functions

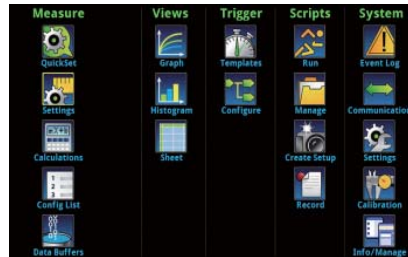

### 15 built-in Measurements with min. Resolution of 100nV / 1µΩ / 10pA



Digital Multimeters

**Accessories:** Standard Test Lead Kit, USB Cable, Calibration Certificate, User documentation: Quick Start Guide, User Manual, Reference Manual (available on the Web)  
**Recommended Accessories:** KTTI-GPIB: GPIB interface with 6 digital I/O ports; KTTI-RS232: RS-232 interface with 6 digital I/O ports; KTTI-TSP: TSP-Link® Expansion interface with 6 digital I/O ports, 2000-SCAN: 10 channel, 2-pole or 5-channel, 4-pole multiplexer; 2001-TCSCAN: 9 channel, 2-pole or 4-channel, 4-pole multiplexer with CJC sensor

## Keithley Switching and Data Acquisition Systems are required for multiple channel systems testing.

## DAQ6510

### Data Acquisition and Logging, Multimeter System

Simplified Setup, Real-time Status and Analysis in a precision system

- Using Keithley's 6½-digit multimeter technology for greater accuracy, functionality, and speed
- Compatible with 2700/2701 mode
- Measure or control up to 80 devices-under-test (DUTs) in a multiplexing configuration
- Select from 12 optional 7700 Series Plug-in Switch Modules for a wide range of tests



DAQ6510 (Replacement model for Keithley 2700/2701)

### Export Measurement Data quickly via the USB



### Display up to 20 Channels Simultaneously

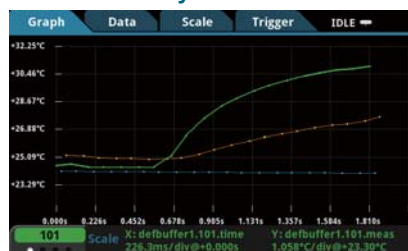

### No PC required for test setup



**Accessories:** Standard Test Lead Kit, USB Cable, Calibration Certificate, User documentation: Quick Start Guide, User Manual, Reference Manual (available on the Web)  
**Recommended Accessories:** KTTI-GPIB: GPIB interface with 6 digital I/O ports; KTTI-RS232: RS-232 interface with 6 digital I/O ports; KTTI-TSP: TSP-Link® Expansion interface with 6 digital I/O ports, 2000-SCAN: 10 channel, 2-pole or 5-channel, 4-pole multiplexer; 77xx Series Plug-in Cards (12 optional Plug-in Switch Modules)



# DMM7510

## 7½-Digit Graphical Sampling Multimeter

### No Compromise: High Speed and High Accuracy

- Precision multimeter with up to 7½-digit resolution
- Capture Waveforms with the Built-in 1 MS/sec, 18-bit Digitizer
- 100 mV, 10 Ω, and 10 μA ranges for ranges deliver the sensitivity needed to measure low signals
- Compact mode storage: 27.5 Million readings
- Visualize and study every waveform using the graphical touchscreen display



DMM7510

#### One Power Line Cycle Noise Performance

The DMM7510 provides noise performance equivalent to or better than many 8½-digit DMMs.

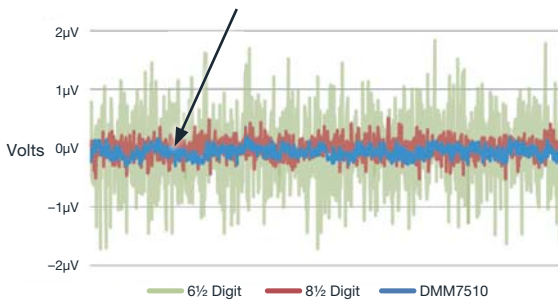

Comparison of the DMM7510's 1 VDC noise performance with that of typical 6½- and 8½-digit multimeters.

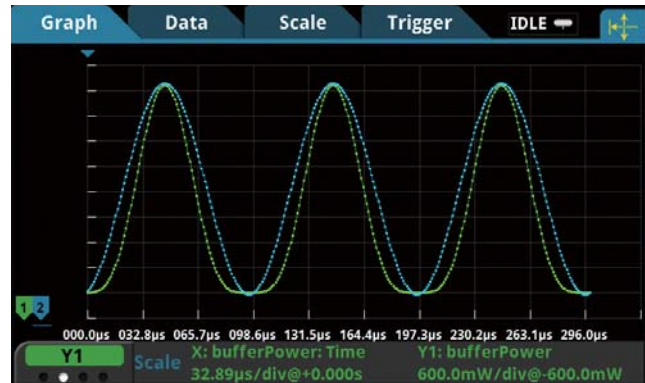

Operate the instrument and make device measurements easily with its intuitive design.

**Accessories:** Quick start guide, test lead, USB cable, TSP-Link cable, power cable

# Keithley KickStart Software

KickStart Software for the PC enables quick test setup and data visualization when using multiple instruments.

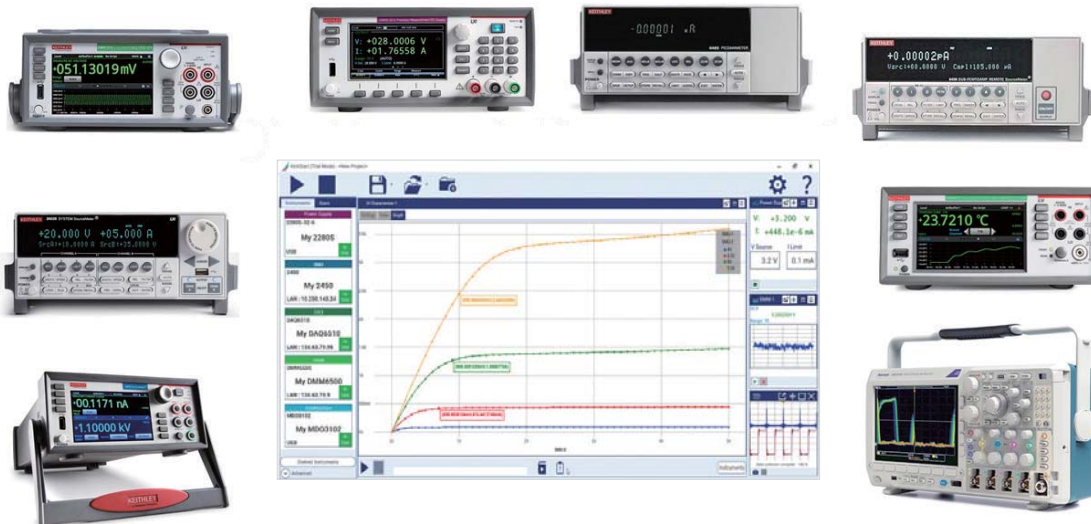

- Data Logger
- 1.946 DMM
- IV Characterizer
- Power Supply
- Scope
- High Resistivity
- Curve Tracer

- Independently control up to eight instruments: power supplies, source measure unit (SMU) instruments, DMMs, dataloggers and oscilloscopes.
- Save time by automating data collection of millions of readings and replicate tests quickly using saved test configurations
- Use built-in plotting and comparison tools to quickly discover measurement anomalies and trends.
- High Resistivity Application (optional)
- Support I-V Tracer Software (see pg 48)

Note: Please check the product page for supported instruments

KickStart Software Suite Licenses	Description
KICKSTARTFL-SUITE	Perpetual Floating License
KICKSTARTFL-SUITE-UP	Annual Maintenance License for extending support of the Perpetual Floating License
KICKSTARTFL-SUITE-AN	1 year Subscription Floating License Option

# DMM Comparison Table

MODEL	BASIC PERFORMANCE			HIGH SPEED, HIGH ACCURACY		HIGH ACCURACY		
	2110	2100	DMM6500	DMM7510	DMM7512	2010	2001	2002
Display	LCD 2 line	VFD 2 line	Touchscreen, 5 in. (12.7 cm)	Touchscreen, 5 in. (12.7 cm)	None	VFD	VFD	VFD
Digits	5½	6½	6½	7½	7½	7½	7½	8½
No. Measurement Channels	1	1	10	1	2	10	10	10
DC VOLTS								
Measurement Range	1 µV–1000 V	0.1 µV–1000 V	100 nV–1000 V	10 nV–1010 V	10 nV–1010 V	10 nV–1000 V	10 nV–1100 V	1 nV–1100 V
Basic Accuracy	0.012%	0.0038%	0.0025%	0.0014%	0.0014%	0.0024%	0.0024%	0.001%
Ratio		✓	✓	✓	✓	✓	Option	Option
DC Peak Spikes							✓	✓
AC VOLTS (TRMS)								
Measurement Range	1 µV–750 V	0.1 µV–750 V	100 nV–750 V	100 nV–707 V		100 nV–750 V	100 nV–775 V	100 nV–775 V
Basic Accuracy	0.12%	0.08%	0.05%	0.06%		0.05%	0.03%	0.02%
Bandwidth	10 Hz–300 kHz	3 Hz–300 kHz	3 Hz–300 kHz	3 Hz to 300 kHz		3 Hz–300 kHz	1 Hz–2 MHz	1 Hz–2 MHz
dB, dBm		✓	✓	✓		✓	✓	✓
Frequency, Period	✓	✓	✓	✓		✓	✓	✓
OHMS (2/4 WIRE)								
Measurement Range	1 mΩ–100 MΩ	100 µΩ–100 MΩ	1 µΩ–120 MΩ	0.1 µΩ–1.2 GΩ	0.1 µΩ–1.2 GΩ	1 µΩ–120 MΩ	1 µΩ–1 GΩ	100 nΩ–1 GΩ
Basic Accuracy	0.02%	0.015%	0.0075%	0.0024%	0.0024%	0.0032%	0.0032%	0.0007%
Continuity Test	✓	✓	✓	✓	✓	✓		
Diode Test	✓	✓	✓	✓	✓	✓		
Offset Compensation			✓	✓	✓	✓	✓	✓
Dry Circuit				✓	✓	✓		
DC AMPS								
Measurement Range	0.1 µA–10 A	10 nA–3 A	10 pA–10 A	1pA–10.1 A	1 pA–3 A	1 nA–3 A	10 pA–2 A	10 pA–2 A
Basic Accuracy	0.15%	0.055%	0.02%	0.006%	0.006%	0.03%	0.03%	0.027%
In Circuit Current							✓	✓
AC AMPS (TRMS)								
Measurement Range	10 µA–10 A	1 µA–3 A	100 pA–10 A	1 nA–10.1 A		1 µA–3 A	100 pA–2 A	100 pA–2 A
Basic Accuracy	0.3%	0.15%	0.1%	0.08%		0.1%	0.1%	0.1%
Bandwidth	10 Hz–5 kHz	3 Hz–5 kHz	3 Hz–10 kHz	3 Hz to 10 kHz		3 Hz–5 kHz	20 Hz–100 kHz	20 Hz–100 kHz
Capacitance								
Measurement Range			0.1 pF–100 µF	0.1 pF–100 µF				
Temperature Measurement	TC, RTD, Thermistor	RTD	TC, RTD, Thermistor	TC, RTD, Thermistor	TC, RTD, Thermistor	TC, RTD	TC, RTD	TC, RTD
GENERAL FEATURES								
Interface	USB, GPIB (opt.)	USB	LAN/LXI, USB, GPIB (opt.), RS-232 (opt.)	GPIB, USB, LAN/LXI	USB, LAN/LXI	GPIB, RS-232	GPIB	GPIB
Reading Hold	✓	✓				✓		
Digital I/O	Trigger In Meter Complete	Trigger In Meter Complete	Trigger In Meter Complete	Trigger In Meter Complete 6 General I/O	Trigger In Meter Complete 6 General I/O	Trigger In Meter Complete	Trigger In Meter Complete 1 In, 4 Out	Trigger In Meter Complete 1 In, 4 Out
Reading Memory	2000 rdg.	2000 rdg.	7 M rdg.	27.5 M rdg.	27.5 M rdg./channel	1024 rdg.	Opt to 30,000	Opt to 30,000
Maximum Speed	50K rdg/s	2000 rdg/s	1 M rdg/s (16-bit digitizing)	1 M rdg/s (18-bit digitizing)	1 M rdg/s (18-bit digitizing)	2000 rdg/s	2000 rdg/s	2000 rdg/s

To learn more about our basic performance, high speed, and high accuracy digital multimeters, visit [www.tek.com/digital-multimeter](http://www.tek.com/digital-multimeter)

To learn more about our multi-channel measurement digital multimeters, visit [www.tek.com/keithley-switching-and-data-acquisition-systems](http://www.tek.com/keithley-switching-and-data-acquisition-systems)

# DMM Comparison Table

MODEL	MULTI-CHANNEL MEASUREMENT		
	DAQ6510	2750	3706A
Display	Touchscreen, 5 in. (12.7 cm)	VFD	VFD 2 line
Digits	6½	6½	7½
No. Measurement Channels	80	200	576
DC VOLTS			
Measurement Range	100 nV–1000 V	100 nV–1000 V	10 nV–300 V
Basic Accuracy	0.0025%	0.003%	0.0025%
Ratio	w/MUX card	w/MUX card	
DC Peak Spikes			
AC VOLTS (TRMS)			
Measurement Range	100 nV–750 V	100 nV–750 V	100 nV–300 V
Basic Accuracy	0.05%	0.06%	0.05%
Bandwidth	3 Hz–300 kHz	3 Hz–300 kHz	3 Hz–300 kHz
dB, dBm			
Frequency, Period	✓	✓	✓
OHMS (2/4 WIRE)			
Measurement Range	1 μΩ–120 MΩ	1 μΩ–120 MΩ	100 nΩ–100 MΩ
Basic Accuracy	0.0075%	0.008%	0.004%
Continuity Test	✓	✓	✓
Diode Test	✓		
Offset Compensation	✓	✓	✓
Dry Circuit		✓	✓
DC AMPS			
Measurement Range	10 pA–3 A	10 nA–3 A	1 pA–3 A
Basic Accuracy	0.02%	0.03%	0.03%
In Circuit Current			
AC AMPS (TRMS)			
Measurement Range	100 pA–3 A	1 μA–3 A	1 nA–3 A
Basic Accuracy	0.10%	0.15%	0.08%
Bandwidth	3 Hz–10 kHz	3 Hz–5 kHz	3 Hz–10 kHz
OTHER MEASUREMENTS			
Capacitance	0.1 pF–100 μF		
Temperature Measurement	TC, RTD, Thermistor	TC, RTD, Thermistor	TC, RTD, Thermistor
GENERAL FEATURES			
Interface	LAN/LXI, USB, GPIB (opt.), RS-232	GPIB, RS-232	GPIB, LAN/LXI, USB
Reading Hold			
Digital I/O	Trigger In	2 Trigger In, 5 Limit Out	14 General I/O
Reading Memory	7 M rdg.	110,000 rdg.	650,000 rdg.
Maximum Speed	1 M rdg/s	2500 rdg/s	>14,000 rdg/s
Other	Embedded Test Script Processor and optional TSP-Link, 6 Digital I/O with Interface Options		Embedded Test Script Processor and TSP-LINK



For multi-channel measurement: DAQ6510 (left) and 3706A (right). TSP-Link Technology provides easy and seamless connection to 3706A and Series 2600 SMU instruments.



# Plug-in Switch Modules for the DAQ6510 Data Acquisition System

Module	7700	7701	7702	7703	7705	7706	7707	7708	7709	7710	7711	7712
Description	20 Channel, Differential Multiplexer Module	32 Ch. Differential Multiplexer Module	40 Ch. Differential Multiplexer Module	32 Ch. High Speed, Differential Multiplexer Module.	40 Ch. Single-pole Control Module	40 Ch. Single-pole Control Module	332 Ch. Digital I/O Module	40 Ch. Differential Multiplexer Module	6x8 Matrix Module.	20 Ch. Solid-state Differential Multiplexer Module	2 GHz 50 Ω RF Module	3.5 GHz 50 Ω RF Module
# Analog Inputs	20	32	40	32	40	20	10	40	48	20	8	8
Configuration	Multiplexer w/CJC	Multiplexer	Multiplexer	Multiplexer	Independent SPST N/A	Multiplexer w/CJC	Digital I/O/ Multiplexer	Multiplexer w/CJC	Matrix	Multiplexer w/CJC	Multiplexer	Multiplexer
	1x20 or two 1x10	1x32 or two 1x16	1x40 or two 1x20	1x32 or two 1x16	N/A	1x20 or two 1x10	1x10 or two 1x5	1x40 or two 1x20	6x8	1x20 or two 1x10	Dual 1x4	Dual 1x4
Type of Connector	Screw terminals	D-sub	Screw terminals	D-sub	D-sub	Screw terminals	D-sub	Screw terminals	D-sub	Removable Screw terminals	SMA	SMA
Max. Voltage	300 V	150 V	300 V	300 V	300 V	300 V	300 V	300 V	300 V	60 V	60 V	42 V
Max. Switched Current	1	1 A	1 A	500 mA	2 A	1 A	1 A	1 A	1 A	0.1 A	0.5 A	0.5 A
Bandwidth	50 MHz	2 MHz	2 MHz	2 MHz	10 MHz	2 MHz	2 MHz	2 MHz	2 MHz	2 MHz	2 GHz	3.5 GHz
Contact Life*1	10 <sup>8</sup>	10 <sup>8</sup>	10 <sup>8</sup>	10 <sup>8</sup>	10 <sup>8</sup>	10 <sup>8</sup>	10 <sup>8</sup>	10 <sup>8</sup>	10 <sup>8</sup>	10 <sup>10</sup>	10 <sup>8</sup>	10 <sup>8</sup>
Switch Speed	3 ms	3 ms	3 ms	1 ms	3 ms	3 ms	3 ms	3 ms	3 ms	0.5 ms	10 ms	10 ms
Other	Maximum power = 125 VA. 2 current measure channels.	Maximum power = 125 VA.	Maximum power = 125 VA. 2 current measure channels.	Reed relays	Maximum power = 125 VA.	2 analog outputs. 16 digital outputs. Maximum power = 125 VA. Event Counter/ Totalizer	32 digital I/O. Maximum power = 125 VA.	Maximum power = 125 VA.	Connects to internal DMM. Daisy chain multiple cards for up to a 6x40 matrix. Maximum power = 125 VA.	Solid state relays, 60 V max. 500 channels/ second scan rate.	Insertion loss <1.0 dB @ 1 GHz. VSWR <1.2 @ 1 GHz.	Insertion loss <1.1 dB @ 2.4 GHz.

\*1 No load contact life. See card data sheet for additional specifications.

# Plug-in Switch Modules for the 3706A System Switch / Multimeter

	3720	3721	3722	3723	3724	3730	3731	3732	3740	3750
No. of Channels	60 (Dual 1x30)	40 (dual 1x20)	96 (dual 1x48)	60 (dual 1x30) or 120 single pole (dual 1x60)	60 (dual 1x30)	6x16	6x16	448 crosspoints (Quad 4x28)	32	40 digital I/O, 4 counter/totalizers, and 2 isolated analog outputs
Card Configuration	Multiplexer	Multiplexer	Multiplexer	Multiplexer	Multiplexer	Matrix	Matrix	Matrix	Independent	Independent
Type of Relay	Latching electro-mechanical	Latching electro-mechanical	Latching electro-mechanical	Dry reed	FET solid-state	Latching electro-mechanical	Dry reed	Dry reed	Latching electro-mechanical	N/A
Contact Configuration	2 Form A	2 Form A	2 Form A	1 Form A	2 Form A	2 Form A	2 Form A	1 Form A	28 Form C, 4 Form A	N/A
Max. Voltage	300 V	300 V (ch 1-40), 60 V (ch 41-42)	300 V	200 V	200 V	300 V	200 V	200 V	300 VDC /250 VAC (Form A)	N/A
Max. Switched Current	1 A	2 A (ch 1-40), 3 A (ch 41-42)	1 A	1 A	0.1 A	1 A	1 A	0.75 A	2 A (Form C), 7 A (Form A)	N/A
Comments	2 independent 1x30 multiplexers. Automatic temperature reference when used with screw terminal accessory (3720-ST)	2 independent 1x20 multiplexers. Automatic temperature reference when used with screw terminal accessory (3721-ST)	2 independent 1x48 multiplexers	2 independent 1x30 multiplexers	2 independent 1x30 multiplexers. Automatic temperature reference when used with screw terminal accessory (3724-ST)	Columns can be expanded through the backplane or isolated by relays	Relay actuation time of 0.5ms. Columns can be expanded through the backplane or isolated by relays	Banks can be connected together via bank configuration relays to create a single 4x112 or dual 4x56 matrix. Analog backplane relays also included for card to card expansion. Row expansion with 3732-ST-R accessory to create a dual 8x28 or single 16x28 matrix.	32 general purpose independent channels.	All-in-one card design. 40 bidirectional I/O. Four 32-bit counter/totalizers. 2 programmable analog (V or I) outputs.

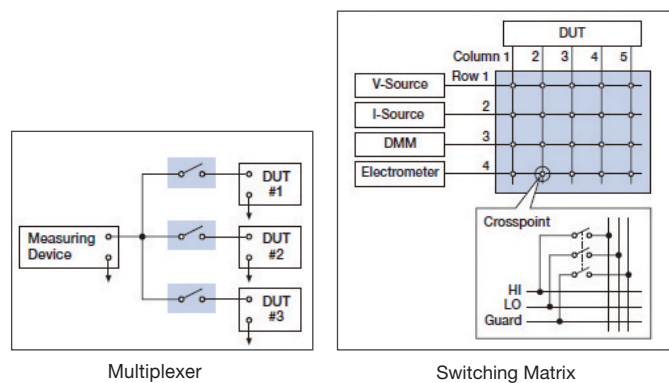

# Keithley Low-Level, Sensitive and Specialty Instruments

Scientists and researchers worldwide rely on Keithley Electrometers, Picoammeters, and Nanovoltmeters for making low-level measurements beyond the capabilities of a typical digital multimeter for applications ranging from nanotechnology and superconductivity research to temperature measurement and HALT-HASS characterization. Keithley Electrometers and Picoammeters provide low current and high resistance measurements and Keithley Nanovoltmeters measure low voltages.



## Keithley 2182A Ultra-low Voltage Measurements Nanovoltmeters



2182A

- 1nV sensitivity, measurement of up to 100V
- Low noise measurements, typically 15nV<sub>p-p</sub> noise at (1s response time)
- 7.5 digit resolution
- Dual Channels
- Delta mode
- Analog output
- Built-in thermocouple linearization and cold junction compensation

Nanovoltmeter	
Model	2182A
Voltage Min	1nV
Voltage Max	100V
Other functions	Delta mode
Interface	GPIB /RS232

**2182A Accessories:** 2107-4 (Low thermal input cables, 1.2m)

## Keithley 6220 / 6221 Ultra-sensitive Precision DC and AC and DC Low Noise Current Sources



AC current source and current source waveform generator

- Source and sink (programmable load) 100fA to 100mA
- 10<sup>14</sup>Ω output impedance
- Delta mode
- 65000-point source memory
- Source AC currents, built-in standard and arbitrary waveform generators with 1mHz to 100kHz frequency range (6221 only)
- Supports pulsed I-V measurements down to 50μs (6221+2182A)
- Differential conductance measurements

AC and DC Current Source		
Model	6220	6221
Min Output Current	100fA	100fA
Max Output Current	100mA	100mA
AC/DC	DC	AC/DC
Frequency range	-	1mHz-100kHz
Interface	GPIB/RS232	GPIB/RS232/LAN

**622x Accessories:** 237-AL G-2 (2m Low noise, input cable with Triax-to-Alligator clips, CA-351 (Communication cable between 2182A and 622x), CS-1195-2 (Safety interlock connector), 174694600 (LAN Cable for 6221 only)

## Keithley Picoammeters 6482 / 6485 / 6487 for Fast, Cost-effective Low Current Measurement Solutions



1fA resolution 6482 Dual-Channel Picoammeter/Voltage Source

- Current sensitivity: 1fA (6482), 10fA (6485/7)
- Resolution: 5.5 digit (6485/7), 6.5 digit (6482)
- Analog output
- Automated voltage sweeps (6482/6487)
- Built-in Model 486 and 487 emulation mode (6487)

**6482 Accessories:** 7078-TRX-BNC Triax-to-BNC Connector (2x)

**6485 Accessories:** 4801 (Low Noise BNC Input Cable, 1.2m)

**6487 Accessories:** CA-186-1D (Ground Connection Cable, Banana to Screw-Lug), CS-459 (Safety Interlock Plug), 7078-TRX-3 (Low Noise Triax Input Cable, 1m), 8607 and 8607-300B (High Voltage Banana Cable Set for Voltage Source Output)

## Keithley 6514 / 6517B Electrometers Ultra-High Resistance / Ultra-Low Current Measurements



Built-in ±1kV voltage source (6517B)

- Extremely low noise: <1fA
- >200TΩ input impedance on voltage measurements
- Charge measurements of up to 20μC (6514)
- Resistance measurements up to 1016Ω (6517B)
- Analog output
- Unique alternating polarity voltage sourcing and measurement method for high resistance measurements (6517B)
- Temperature and Humidity Stamping (6517B)
- 10-Channel Scanner (6517B)

**6514 Accessories:** 237-ALG-2 (Low Noise Triax Cable, 3-Slot Triax to Alligator Clips, 2m)

**6517B Accessories:** 237-ALG-2 (Low Noise Triax Cable, 3-slot Triax to Alligator Clips, 2 m), 8607 (Safety High Voltage Dual Test Leads), 6517-TP (Thermocouple Bead Probe), CS-1305 (Interlock Connector), 8607-300B (Banana Cables)

Model	Picoammeters			Electrometers	
	6485	6487	6482	6514	6517B
Channels	1	1	2	1	1
Current	10fA	10fA	1fA	0.1fA	0.1fA
Voltage source	-	500V	30V	-	1000V
Other Measurements	-	Resistance	-	High impedance voltage / Resistance / Charge measurements	High impedance voltage / Resistance / Charge measurements
Interface	GPIB/RS232	GPIB/RS232	GPIB/RS232	GPIB/RS232	GPIB/RS232

## Series 2280S Precision Measurement, Low Noise, Programmable DC Power Supplies

### 6.5 digit Precision Measurement DC Power Supplies



2280S-32-6



2280S-32-6 rear panel

2280S-32-6: 32V, 6A  
2280S-60-3: 60V, 3.2A

- Monitor load currents from 100 nA to 6 A with high accuracy
- Measure voltage and current with 6½-digit resolution
- Capture dynamic load currents as short as 140 μs
- Output up to 192 W of low noise, linear regulated power
- Remote sensing
- Programmable rise and fall times eliminate voltage
- Built-in graphing simplifies analyzing trends or displaying voltage or current waveforms
- Sink up to 0.45 A to discharge voltage quickly
- 3-year warranty

### Measure Rapidly Changing Loads

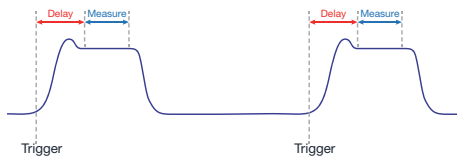

Capture dynamic load currents as short as 140 μs

### DMM - Quality Low Current Measurements with High Resolution

Range*1	Resolution*1
10mA	10nA
100mA	100nA
1A	1μA
10A	10μA

\*1 Resolution is optimized with four ranges, up to 10nA

Model	2280S-32-6	2280S-60-3
No of channel	1	1
Voltage	32V	60V
Full-scale Amps	6.1A	3.2A
Maximum Power	192W	192W
Output Ripple and Noise (20Hz - 200MHz)	<1mV <sub>rms</sub> or <5mV <sub>pp</sub>	<2mV <sub>rms</sub> or <7mV <sub>pp</sub>
Interface	GPIB, USB, LAN	GPIB, USB, LAN

### Simple Setup and Operation



Adjust voltage, current, the current range, the measurement mode, protection levels, and other functions from the home screen.



Access the full functionality from the icon-based main menu.

### Accessories

- 2280-001: Rear Panel Mating Connector and Cover
- 174-6946-00: LAN Crossover Cable, 3 m,
- KUSB-488B: USB-GPIB Interface Adapter

## Series 2281S-20-6

Ideal for development and verification testing of battery powered such as IoT and mobile devices

### Battery Simulator



2281S-20-6



2281S-20-6 Rear Panel

- Output range: 20V, -1A to 6A
- Create, edit, import, and export battery models
- Build a library of battery models using a Source Measure instrument as a model generator
- Display the real-time change of the SOC, Voc, and Vt for the simulated battery
- Compute battery capacity in Amp-Hour and Equivalent Series Resistance (ESR)
- 3-year warranty

Model	2281S-20-6
Output rating	0-20V, -1-6A, 120W
Voltage accuracy, resolution	±(0.02%+3mV), 1mV
Voltage measurement accuracy, resolution	±(0.02%+2mV), 0.1mV
Current measurement accuracy, resolution	±(0.04%+10μA, 10nA (10mA range))
Load regulation	±(0.01%+2mV)
Line regulation	±(0.01%+1mV)
Output ripple and noise	<1mV <sub>rms</sub> or <6mV <sub>pp</sub> (20Hz-20MHz)
Current limit setting, accuracy, resolution	6.1A, ±(0.05%+5mA), 0.1mA
Maximum continuous average sink current	1.02A±0.1A (typical)
Load Transient Recovery Time	<50μs to within 15mV of V-set
Battery status, internal resistance	SOC: 0 to 100%, 0 to 10Ω
Battery Model	101-point or 11-point, 9 models (for user storage, editable) 9 models (for user storage, editable)
Communication interface	GPIB, USB, LAN

### Battery Testing

- State of charge (SOC) and voltage open circuit (Voc) can be set to any state to test a device-under-test's (DUT's) performance

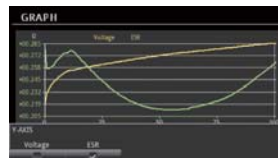

Plot of Voc and ESR as a function of State of Charge (SOC).

SOC (%)	Open Voltage(V)	ESR(Ω)
0	10.000	0.015
1	10.050	0.015
2	10.072	0.016
3	10.083	0.016

Generate battery model table.

### Generate test script to discharge batteries and create battery models with Keithley 2460 SMU



2281S-20-6 Battery Simulator



2460 Keithley 2460 SMU



Data Acquisition

### PMU / IC Test

- Test with battery model
- Full / low battery, new / deteriorated
- Setup battery with arbitrary states (SOC, Voc, ESR)



Build up battery model, compare different battery type performance



Precision DC power supply, with DMM-quality high resolution, low current measurements capability

### Available Accessories

- 2280-001: Rear Panel Mating Connector and Cover
- 174-6946-00: LAN Crossover Cable, 3 m
- KUSB-488B: USB-GPIB Interface Adapter



# Keithley 2220 / 2230 / 2231 Series

Multi-Channel USB and USB / GPIB Programmable DC Power Supplies



- All channels have isolated outputs
- All channels are independently controlled
- Voltage and current outputs for all channels are displayed simultaneously
- Tracking Mode can be activated on the two 30V output channels
- Two 30V channels can be combined either in series or in parallel (max voltage / current: 30V/6A)
- All channels have remote sensing
- 3-year warranty



2230G-30-1

## Independent and Isolated Outputs

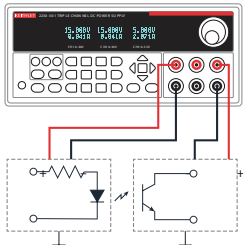

Power two isolated circuits with isolated output channels.

## Create Bipolar Power Supplies

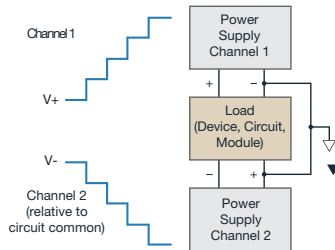

Use the two 30V channels to test a bipolar integrated circuit or a bipolar module over its specified voltage operating range.

## Double Output Voltage or Current

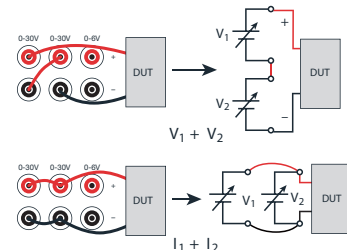

Combine two channels in series to output up to 60V or combine two channels in parallel to output up to 3A. The Model 2220/2230display will show the combined value.

Model	2230-30-1/2230G-30-1*
Number of Channels	3
Max. output voltage	Ch1: 30V, Ch2: 30V, Ch3: 6V
Max. output current	Ch1: 1.5A, Ch2: 1.5A, Ch3: 5A
Output ripple and noise	<1mV <sub>rms</sub>
Voltage setting accuracy, resolution	0.03% + 10mV, 1mV
Interface	GPIB*, USB

\*G versions has flexibility of either GPIB or USB control

## Accessories

- CS-1655-15: Rear Panel Mating Connector (standard)
- 4299-7: Universal Fixed Rack Mount Kit
- KUSB-488B: USB-GPIB Interface Adapter

DC Power Supply

# Series 2260B Programmable DC Power Supplies

Designed for Automated Test and Benchtop Applications



- 360W, 720W, and 1080W versions with voltages up to 800V and currents up to 108A
- Programmable internal resistance simulates battery output
- Internal test sequence mode
- 3-year warranty



Wide range of output voltages and current, combined with multiple interface choices

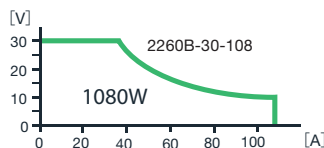

Programmable voltage or current rise and fall times

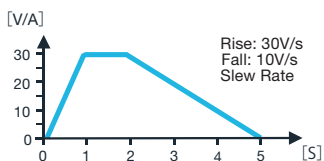

## Burn-In Testing

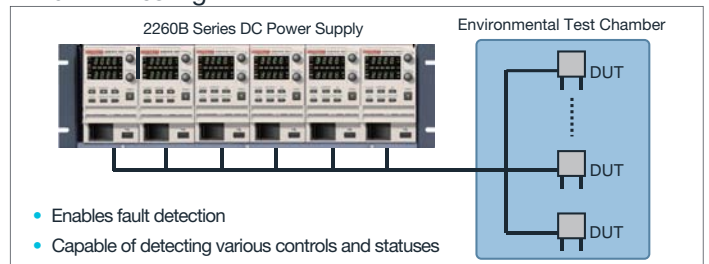

- Enables fault detection
- Capable of detecting various controls and statuses

Model	2260B-30-36	2260B-30-72	2260B-30-108	2260B-80-13	2260B-80-27	2260B-80-40	2260B-250-4	2260B-250-9	2260B-250-13	2260B-800-1	2260B-800-2	2260B-800-4
Number of channel	1	1	1	1	1	1	1	1	1	1	1	1
Output Voltage	30V	30V	30V	80V	80V	80V	250V	250V	250V	800V	800V	800V
Output Current	36A	72A	108A	13.5A	27A	40.5A	4.5A	9A	13.5A	1.44A	2.88A	4.32A
Power	360W	720W	1080W	360W	720W	1080W	360W	720W	1080W	360W	720W	1080W
Ripple and Noise (20MHz Noise bandwidth)	7mV	11mV	14mV	7mV	11mV	14mV	15mV	15mV	15mV	30mV	30mV	30mV
Interface	USB/LAN/GPIB Choose from analog control, USB, LAN, or optional GPIB interface for automated control)											

# 2290-10 High Voltage DC Power Supplies

Designed for high voltage leakage current testing



10kV/1mA

- Source voltages up to 10kV
- Safety interlock controls high voltage output
- Protection module prevents damage to low voltage instrumentation
- 1-year warranty



2290-10

Model	2290-10
Number of channel	1
Output Voltage	100V-10kV
Output Current	1mA
Voltage	1V
Current	1µA
Protection	Arc and short circuit protected; programmable voltage and current limits and current trip.
Interface	GPIB, RS-232C



## Graphical Touchscreen Series SMU Overview

The Source Measure Unit (SMU) is an instrument that can precisely source voltage or current and simultaneously measure voltage and/or current. It combines the useful features of a digital multimeter (DMM), power supply, true current source, electronic load and pulse generator, all into a single, tightly synchronized instrument in a compact form factor. SMUs are considered more useful than the combination of any of the five instruments, due to the measuring instrument's versatility and high accuracy performance.

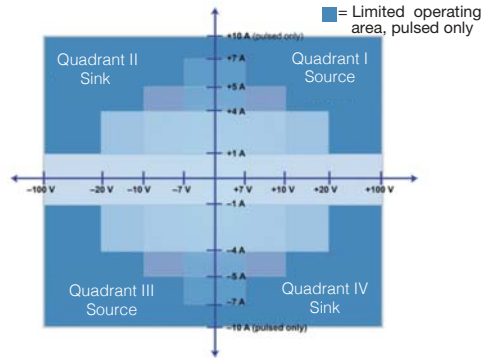
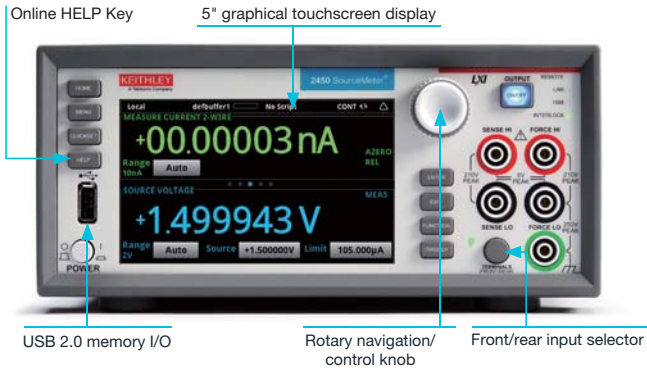

2461 gives the capabilities of a precision power supply and electronic load

### All-in-One Instrument

Simultaneously source/measure voltage, current, resistance in one tightly-coupled instrument

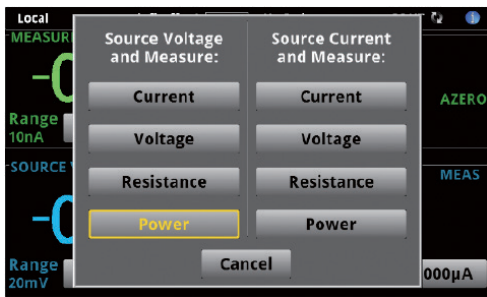

### Icon-based menu

The graphical SMU's icon-based menu structure helps even novice users configure tests quickly and confidently.



### Ease of Use Beyond the Touchscreen

One-touch Quickset modes speed measurement setups and minimize the time to measurements.

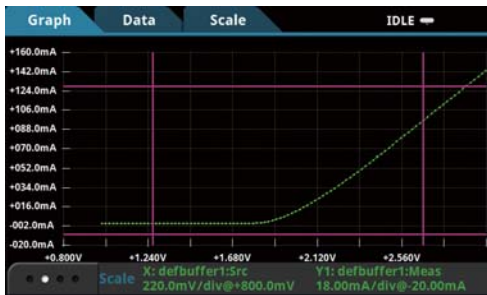

### Built-in Dual 1 MS/sec Digitizers

Capturing and displaying real device operation, waveforms, and transient events

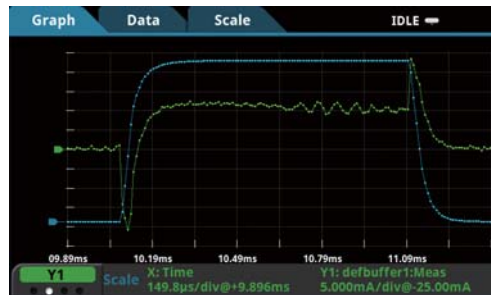

#### Example 1: Nanomaterials and Devices



Provides a DC Power supply and 6.5 digit ammeter in a single form factor for integrated testing. Ultra low current measurements down to 0.01pA are also possible using the Model 2450 SourceMeter

#### Example 2: DC-DC converter steady-state characteristics evaluation

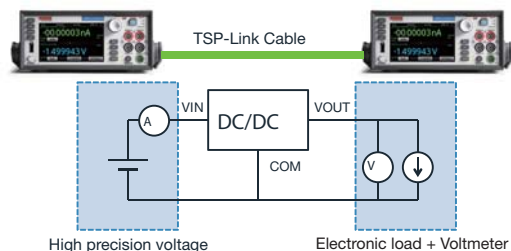

The integration of a precision DC power supply, electronic load, 6.5 digit voltage and current meter, as well as multi-channel TSP-Link capability, enables easy connections to make automated power efficiency measurements

# Graphical Touchscreen Series SMU



## TOUCH, TEST, INVENT

Graphical SourceMeter® SMU Instrument (SMU)

### 2450 / 2460 / 2461 / 2470

- Five-inch, high resolution capacitive touch screen GUI
- 0.012% basic measure accuracy with 6½-digit resolution
- Wide coverage up to 1100 V / 1 A DC 20 W max.
- Source and sink (4-quadrant) operation
- Dual 1 MS/s digitizers for fast sampling measurements (2461)
- Enhanced sensitivity with new 20mV and 10nA source/measure ranges (2450)
- Built-in, context-sensitive front panel help
- SCPI and TSP® scripting programming modes
- Front-panel USB 2.0 memory I/O port for transferring data, test scripts, and test configurations

Model	2450	2460	2461	2470
Max Current Source/Measure Range	1A	7A	10A	1A
Max Voltage Source/Measure Range	200V	100V	100V	1000V
Measurement Resolution (Current / Voltage)	10fA / 10nV	1pA / 100nV	1pA / 100nV	10fA / 100nV
Max Output Power	20W	100W	1000W	20W



## Keithley I-V Tracer Software



The Keithley I-V Tracer is a software package that allows a Keithley graphical Source Measure Unit to behave similar to a traditional Tektronix curve tracer. It is appropriate for low power, two terminal devices.

- Compatible with Keithley 2450, 2460, 2461, and 2470
- Real time control on the front panel knob to see your data more clearly
- +DC, -DC, AC polarity modes (AC mode only compatible with the 2461 SMU)
- Compare mode to display a reference device next to a measured curve
- Save curve data to disk with KickStart for analysis in Excel
- Screen capture curves
- Pinch and zoom on the touchscreen to analyze data immediately
- Small form factor allows user to own a portable curve tracer



Model	
KICKSTARTNL-ACT1	Single license I-V Tracer App pack for one Source Measure Unit
KICKSTARTNL-ACT3	Three license I-V Tracer App pack for three Source Measure Unit
KICKSTARTNL-ACT5	Five license I-V Tracer App pack for five Source Measure Units

Compare mode to display a reference device next to a measured curve



Compliance current can be set to limit the output power to protect the DUT's safety



Current sourcing capabilities allowing the user to sweep current across the device and plot current versus voltage



## NEW 2601B-PULSE 10 μsec Pulser / SMU



Achieve high pulse fidelity without manual pulse tuning. Incorporates the functionality of a fast pulser and SMU in one instrument.

- Industry leading 10 A @ 10 V, 10 microsecond pulse output
- No tuning required; works with inductive loads up to 3 μH
- Dual 1 Megasample/second digitizers for high speed I/V pulse measurements (pulser function only)
- DC capability up to ±40 V @ ±1.0 A, 40 Watt
- TSP technology embeds complete test programs inside the instrument for best-in-class system-level throughput
- TSP-Link expansion technology for multi-channel parallel test without a mainframe
- USB 2.0, LXI Core, GPIB, RS-232, and digital I/O interfaces
- Supported in the Keithley KickStart non-programming software tool



Model	2601B-PULSE
Programming Resolution	10μs
Max Current Limit	10A
Max DC Current	3A
Max DC voltage (using SMU)	40V
Max Output Power (using SMU)	40W
Min DC Current Range	100nA
Manual Pulse Adjustment	NA





# SourceMeter (SMU) Series

## Typical Applications

Ideal for current / voltage characterization and functional test of a wide range of today's modern electronics and devices, including: Nanomaterials and Devices, Semiconductor Structures, Organic Materials and Devices, Energy Efficiency and Lighting (LEDs / AMOLEDs, Photovoltaics / Solar cells, Batteries), Discrete and Passive Components, Material Characterization (Resistivity, Hall Effect).

## Standard Performance SMUs

Model	2401	2614B	2611/2B	2634B	2635/6B	2450	6430
Channels	1	2	1 / 2	2	1 / 2	1	1
Max Output Power (per ch)	20W	30W	30W	30W	30W	20W	2W
Max Output Voltage	20V	200V	200V	200V	200V	200V	200V
Max Output DC Current	1A	1.5A	1.5A	1.5A	1.5A	1A	100mA
Pulse	-	10A	10A	10A	10A	-	-
Min Voltage Measurement Resolution	1µV	100nV	100nV	100nV	100nV	10nV	1µV
Min Current measurement	10pA	100fA	100fA	1fA	0.1fA	10fA	0.01fA
Digits	5.5	6.5	6.5	6.5	6.5	6.5	5.5
Micro Current Measurement	-	-	-	○	○	○	○
TSP-Link	-	-	○	-	○	○	-
Interface	GPIB/RS232	GPIB/RS232/ LAN/USB	GPIB / RS232 / LAN / USB	GPIB / RS232 / LAN/USB	GPIB / RS232 / LAN/USB	GPIB / LAN / USB	GPIB / RS232

## High Voltage / High Power SMUs with Unprecedented Power, Precision, and Speed

Model	2470	2657A	2604B	2601/2B	2601B-PULSE	2606B	2460/2461 <sup>1</sup>	2651A
Channels	1	1	2	1 / 2	1	4	1	1
Max Output Power (per ch)	20W	180W	40W	40W	40W	20W	100W / 1000W Pulse	200W / 2000W Pulse
Max Output Voltage	1000V	3000V	40V	40V	40V	20V	100V	40V
Max Output DC Current	1A	120mA	3A	3A	3A	3A	7A	20A
Pulse	-	-	10A	10A	10A	3A	-/10A	50A
Min Voltage Measurement Resolution	100 nV	100µV	100nV	100nV	100nV	100nV	100nV	1µV
Min Current Measurement	10 fA	1fA	100fA	100fA	100fA	100fA	1pA	1pA
Digits	6.5	6.5	6.5	6.5	6.5	6.5	6.5	6.5
Micro Current Measurement	○	○	-	-	-	-	-	-
TSP-Link	○	○	-	○	○	○	○	○
Interface	GPIB / USB / LAN	GPIB / RS232 / LAN	GPIB / RS232 / LAN / USB	GPIB / RS232 / LAN / USB	GPIB / RS232 / LAN / USB	LAN / USB	GPIB / LAN / USB	GPIB / RS232 / LAN

<sup>1</sup>Pulse only for 2461 (DC is the same for 2460)

## TSP-Link® System Integration / TSP® Programming <Recommended Software>

### Unmatched System Integration and Programming Flexibility

- The TSP-Link® expansion interface allows TSP enabled instruments to trigger and communicate with each other. TSP-Link® jacks make it simple to configure multiple instrument test solutions and eliminate the need to invest in additional adapter accessories.
- The TSP technology supports testing multiple devices in parallel and allows each instrument in the system to run its own complete test sequence, creating a fully multi-threaded test environment.

**Note:** Please check product page for details on compatible model for software.

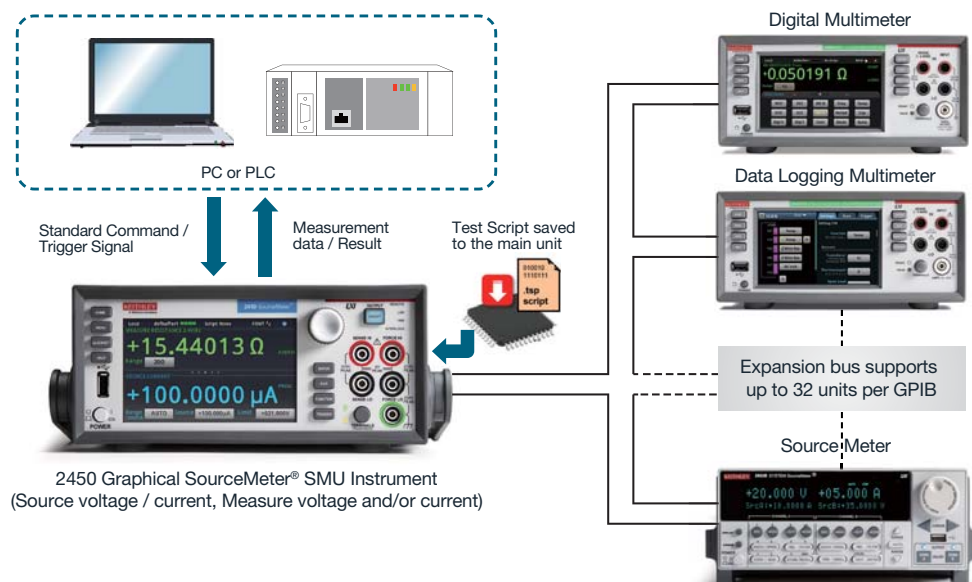

Source Measure Units

# Semiconductor Test Systems

## Keithley 4200A-SCS Parameter Analyzer

The Ultimate Parameter Analyzer for Materials, Semiconductor Devices and Process Development

Perform I-V, C-V and pulsed I-V characterization with speed, clarity and confidence

- Reduce Characterization Complexity
  - Easy setup and analysis in three steps with the latest Clarius user interface
  - More than 450 furnished application tests in the Clarius library
- Simple switching without Re-cabling
  - Switch automatically between I-V, C-V and Pulsed I-V measurements with the CVIC multi-switch
- Ultra-fast Pulsed I-V characterization
  - KEITHLEY established preamplifier with high current resolution of 0.01fA
  - Ultra-fast I-V and transient measurement of  $\pm 40V/800mA$  that covers even the most advanced evaluation



4225-RPM Remote Preamplifier/ Switch Module.

The four-channel switch automatically switches between I-V and C-V measurements without re-cabling.

Mainframes	
4200A-SCS	With 15.6-inch LCD display
4200A-SCS/NFP	Without 15.6-inch LCD display
Upgrading the Parameter Analyzer	
4200A-MF-UP	Convert any 4200-SCS mainframe to the 4200A-SCS widescreen mainframe with Clarius+ software. Any instrument modules will be moved to the 4200A-SCS mainframe, with a one year warranty on the mainframe.

Mainframe + Configured Packages	
4200A-SCS-PKA	High Resolution I-V Package (4200A-SCS, 4201-SMU x 2, 4200-PA, 8101-PIV test fixture)
4200A-SCS-PKB	High Resolution I-V and C-V (4200A-SCS, 4201-SMU x 2, 4200-PA, 4215-CVU, 8101-PIV test fixture)
4200A-SCS-PKC	High Power I-V and C-V (4200A-SCS, 4201-SMU x 2, 4211-SMU x 2, 4200-PA x 2, 4215-CVU, 8101-PIV test fixture)

Instruments/Modules			
4200-SMU	Medium Power SMU	4225-RPM	Remote Preamplifier / Switch Module
4210-SMU	High Power SMU	4220-PGU	High Voltage Pulse Generator
4200-PA	Remote Preamplifier	4201-SMU <b>NEW</b>	Medium Power SMU for High-capacitance Setups
4210-CV IV	C-V / I-V Multi-Switch	4211-SMU <b>NEW</b>	High Power SMU for High-capacitance Setups
4225-PMU	2ch Ultra-fast Pulsed I-V Unit	4215-CVU <b>NEW</b>	High Resolution Multi-frequency C-V Unit

### NEW! SMU modules for unstable low current measurement applications with large load capacitance and units for low capacitance C-V measurement are now available.

4201-SMU and 4211-SMU are capable of applying and measuring load capacitance more than 1,000 times greater than the current value.

4215-CVU has high frequency resolution and best-in-class AC drive voltage low noise and low capacitance measurements.

Ideal for applications such as Bio FETs where small changes in device capacitance need to be detected.

### Parametric Curve Tracer (PCT)

Keithley's line of high power Parametric Curve Tracer configurations supports the full spectrum of device types and test parameters. Keithley's Parametric Curve Trace configurations include everything necessary for the characterization engineer to develop a complete test system quickly. Measurements up to 3kV and 100A are supported.



### Configuration Selection Guide

	Model *1	Collector / Drain Supply *2		Step Generator Base / Gate Supply	Auxiliary Supply
		High Voltage Mode	High Current Mode		
Low Power	2600-PCT-1B	200V/10A	200V/10A	200V/10A	-
High Current	2600-PCT-2B	200V/10A	40V/50A	200V/10A	200V/10A
High Voltage	2600-PCT-3B	3kV/120mA	200V/10A	200V/10A	200V/10A
High Current and High Voltage	2600-PCT-4B	3kV/120mA	40V/50A	200V/10A	200V/10A

\*1 Contact your Keithley field applications engineer for custom configurations.

\*2 Add a Model 2651A to increase high current mode to 50A or 100A.

## Keithley Accessories

### (Test Leads and Probes, Cables, Connectors, Adapters, and Tools)



**KUSB-488B:**  
USB to GPIB Adapter



**2600-BAN:**  
Banana Test Leads/ Adapter Cable for 2601B, 2602B, 2611B, 2612B



**2600-TRIAX:**  
3-Lug Triax Adapter for 2601B, 2602B, 2604B, 2611B, 2612B, 2614B



**5804:**  
General-Purpose, 4-Terminal Test Lead Set for Series 2400, 2750, DMMs



**5805:**  
Kelvin Probes, 0.9m for Series 2400, 2750 and DMMs



**5806:**  
Kelvin Clip Lead Set 0.9m for Series 2400, 2750 and DMMs

- 8606 ..... High Performance Modular Probe Kit
- 2107- x ..... 2182A Input Cable, 2107-4 (1.2m), 2107-30 (9.1m)
- 7078-TRX- x ..... Low noise triax cable 7078-TRX-1 (0.3m), 7078-TRX-3 (0.9m), 7078-TRX-5 (1.5m), 7078-TRX-10 (3m), 7078-TRX-12 (4m), 7078-TRX-20 (6.1m)
- 237-BAN-3A ..... Triax to Banana Plug
- 237-TRX-BAR ..... 3-Lug Triax Female to Female Barrel Adapter

- 237-TRX-T ..... 3-slot Male to Dual 3-Lug Female Triax Tee Adapter
- 7078-TRX-BNC ..... 3-slot Male Triax to BNC Adapter (Triaxial external shield is open)
- 7078-TRX-GND ..... 3-slot Male Triax to BNC Adapter (guard removed)
- 237-BNC-TRX ..... 3-Lug Female Triax to Male BNC (Connector with guard disconnected)

## Real-Time Spectrum Analyzer



### DPX® Acquisition Technology for Spectrum Analyzers Fundamentals

Tektronix's patented Digital Phosphor technology or DPX® is used in our Real-Time Spectrum Analyzers (RTSAs), to reveal signal details that are completely missed by conventional spectrum analyzers and vector signal analyzers. The full-motion DPX spectrum's Live RF display shows signals never seen before, giving users instant insight and greatly accelerating discovery and diagnosis. DPX is a standard feature in all Tektronix Real-Time Spectrum Analyzers (RTSAs).



RSA306B, RSA500A/600A Series USB Spectrum Analyzer

#### Discover

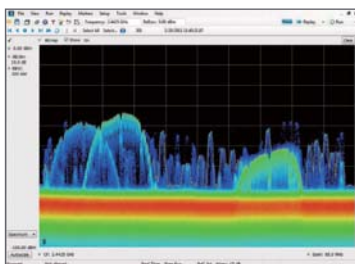

The revolutionary DPX® spectrum display offers an intuitive live color view of signal transients (minimum event duration of 0.434  $\mu$ s) changing over time in the frequency domain, giving you immediate confidence in the stability of your design, or instantly displaying a fault when it occurs.

#### Trigger

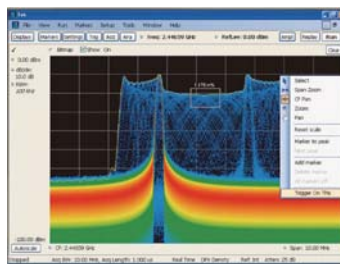

DPX Density™ Trigger works on the measured frequency of occurrence or density of the DPX display. You can capture low-level signals in the presence of high-level signals at the click of a button. The Frequency Mask Trigger (FMT) is easily configured to monitor all changes in frequency occupancy within the acquisition bandwidth.

#### Capture

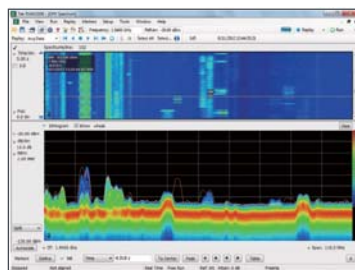

Tektronix Real Time Signal Analyzers use a wideband image-free architecture guaranteeing that signals at frequencies outside of the band to which the instrument is tuned don't create spurious or image responses.

This image-free response is achieved with a series of input filters designed such that all image responses are suppressed.

#### Analyze



In addition to spectrum analysis, spectrograms display both frequency and amplitude changes over time.

Time-correlated measurements can be made across the frequency, phase, amplitude, and modulation domains. This is ideal for signal analysis that includes frequency hopping, pulse characteristics, modulation switching, settling time, bandwidth changes, and intermittent signals.

## RSA5000B Series

### Real Time Spectrum Analyzer

Measures and analyzes signals of up to 165 MHz acquisition bandwidths for WLAN analysis 802.11ac Gigabit Wi-Fi standards

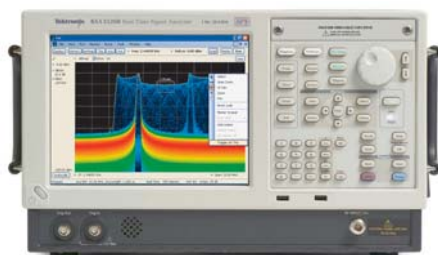

#### Key Features

- Innovative DPX Technology enables 100% probability of intercept for signals of 0.434  $\mu$ s<sup>1</sup>
- Up to 3,125,000 spectrums per second<sup>1</sup>, reliably observe intermittent phenomenon with DPX® live spectrum display
- DPX zero span with real-time amplitude, frequency, or phase
- 165 MHz real time bandwidth with 80 dBc SFDR<sup>2</sup>
- Unprecedented signal discovery over full frequency: 1 Hz - 26.5 GHz (RSA5126B)

<sup>1</sup>Opt. 09 with 300 required <sup>2</sup>Opt. 16XHD required

Basic Performance	RSA5103B	RSA5106B	RSA5115B	RSA5126B
Frequency range	1Hz-3GHz	1Hz-6.2GHz	1Hz-15GHz	1Hz-26.5GHz
Real-time acquisition bandwidth	25MHz (Opt. B25), 40MHz (Opt. B40), 85MHz (Opt. B85), 125MHz (Opt. B125), 165MHz (Opt. B16x)			
Average continuous	+30 dBm (RF ATT: Auto)			
Displayed average noise level	-167dBm/Hz (>10 MHz, preamp on)			
3rd order intermodulation distortion	-82dBc (300MHz-6.2GHz, typical), -72dBc (6.2GHz-26.5GHz, typical)			
Acquisition memory size	1GBB (standard), 4GB (Opt. 53)			



# RSA306B

USB Real-Time Spectrum Analyzer

Compact and Portable Spectrum Analyzer

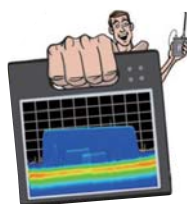

It's loaded with features you'd expect from spectrum analyzers twice the size.



Low-cost, packaged in a portable and rugged form factor



- Frequency range / Real-time capture bandwidth: 9kHz to 6.2GHz / 40MHz
- DPX Spectrum Display: ≤10,000 spectrums per second
- RSA306B Weight: 750g
- Full-featured Spectrum Analysis capability with included Tektronix SignalVu-PC™ software, using USB3.0

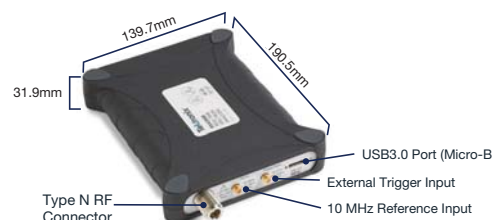

Basic Specifications	RSA306B
RF input frequency range	9kHz–6.2GHz
Measurement bandwidth	Up to 40 MHz
DPX Spectrum Display	DPX spectrum display, DPX spectrogram, DPX sweep
DPX Live Spectrum Display	Spectrum processing rate: ≤10,000 spectrums per second, 100% POI: 27μs
Maximum RF input level without damage	+23dBm (Reference level ≥ -10 dBm) +15dBm (Reference level < -10 dBm)
Maximum RF input level without damage DC voltage	±40V
Amplitude accuracy (all center frequencies)	<±1.0dB (-10C - +55C)
Displayed Average Noise Level (DANL)	5MHz–<1.0G: -163dBm/Hz
Phase noise @ 1 GHz (typical)	≤-87dBc/Hz (10kHz)
SFDR	-60dBc
Trigger	IF power trigger
Max RF acquisition time	Up to 2 seconds (for streaming recording, up to SSD capacity)
Audio Output	AM/FM, IF Bandwidth range: 8kHz–200kHz
<b>Measurement Functions</b>	
Spectrum Analysis	Spectrum, DPX spectrum display, spectrogram, spurious
Analog Modulation Analysis	AM, FM, PM
Digital Modulation Analysis	Modulation formats: APSK, BPSK, C4FM, DBPSK, DPSK, FSK, GFSK, MSK, PSK, QAM, QPSK, etc (For details, refer to SVMxx-SVPC datasheet)
WLAN Analysis	Standards: IEEE802.11a/b/g/p (SV23xx-SVPC required option), IEEE802.11n (SV23xx-SVPC/SV24xx-SVPC required option), IEEE802.11ac (SV23xx-SVPC/SV24xx-SVPC/SV25xx-SVPC required option)
Others	Bluetooth measurement applications, LTE Downlink RF measurements, AM/FM/PM and direct audio measurement, APCO P25 Measurements Application, Spurious measurement (CISPR Quasi-Peak), EMC pre-compliance and troubleshooting
GPS Function	Get location information from GPS receiver connected to a PC
Mapping (MAPNL-SVPC)	Pitney Bowes MapInfo (*.mif), Bitmap (*.bmp), Open Street Maps (.osm), Map file used for the measurements: Google Earth KMZ file, Recallable results files: MapInfo-compatible MIF/MID files
PC	PC with USB 3.0 port is required
Weight	750g

**Standard Accessories:** USB 3.0 locking cable (1M), SignalVu-Pc software, documentation, USB key, Printed safety/installation manual

## Recommended Accessories

- 103-0045-xx ..... Adapter, Coaxial, 50Ω Type-N(m) to Type BNC(f)
- 013-0406-XX ..... Adapter, Coaxial, 50Ω Type-N(m) to Type-SMA(f)
- 119-6609-xx ..... Flexible whip antenna, BNC-Male connector
- 119-4146-xx ..... EMCO E/H-field probes kit (100kHz~1GHz)
- RSA300CASE ..... Soft carrying case

## SignalVu-PC Analysis Option

- SVANL-SVPC ..... AM/FM/PM/Direct Audio analysis
  - SVTNL-SVPC ..... Settling Time (frequency and phase) measurements
  - SVMNL-SVPC ..... General Purpose Modulation analysis
  - SVPNL-SVPC ..... Pulse Analysis
  - SVONL-SVPC ..... Flexible OFDM analysis
  - SV23NL-SVPC ..... WLAN 802.11a / b / g / j / p measurement to work with analyzer
  - SV24NL-SVPC ..... WLAN 802.11n measurement (requires SV23)
  - SV25NL-SVPC ..... WLAN 802.11ac measurements (requires SV23 and SV24)
  - SV26NL-SVPC ..... APCO P25 measurement
  - SV27NL-SVPC ..... Bluetooth®/EDR/LE measurement
  - SV28NL-SVPC ..... LTE Downlink RF measurement
  - SV54NL-SVPC ..... Signal survey and classification
  - SV56NL-SVPC ..... Playback of recorded files
  - MAPNL-SVPC\* ..... Mapping
  - SVQPNL-SVPC ..... EMI CISPR detectors
  - SV31NL-SVPC ..... Bluetooth® 5 measurements (requires SV27)
  - EMCVUNL-SVPC ..... EMC pre-compliance and troubleshooting (includes EMI CISPR detectors)
- \*GPS receiver is required.
- xxxFL-SVPC ..... Floating license
  - xxxNL-SVPC ..... Node-locked

## 3-year warranty

Covering all labor and parts, excluding probes and accessories



## Applications

Maintenance, Installation and Repair in Factory or Field



Interference Hunting



Value-conscious Design and Manufacturing

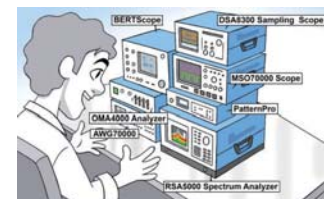

Academics / Education

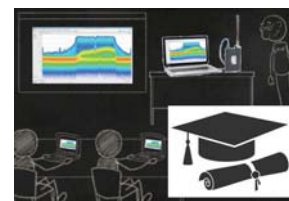

## Key specifications of the instrument controller

- OS: Windows 7/8/8.1/10 Pro 64-bit operating system
- CPU: Intel® Core i5-6300U vPro TM 2.4-3.0 GHz Processor
- Memory: 4GB or more (8GB or more is recommended)

## RSA500A Series

USB Real-Time Spectrum Analyzer

Ultimate in Rugged Portability

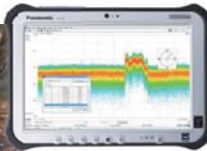

Quickly create a spectral region of interest, enabling users to identify and sort signals efficiently.

- Frequency Range: 9kHz~3GHz/7.5GHz/13.6GHz/18GHz
- Battery operated-solution (RSA500A Series)

## RSA600A Series

USB Real-Time Spectrum Analyzer

High Fidelity, Compact Size



Option SV27 supports Bluetooth Basic Rate / EDR / Low Energy Transmitter Measurements

- Tracking Generator (Optional)
- Real-time acquisition bandwidth: 40MHz (standard)

Basic Specification	RSA503A	RSA507A	RSA513A	RSA518A	RSA603A	RSA607A
Frequency Range	9kHz~3.0GHz	9kHz~7.5GHz	9kHz~13.6GHz	9kHz~18GHz	9kHz~3.0GHz	9kHz~7.5GHz
Max Acquisition Bandwidth (Real Time)	Up to 40MHz					
DPX Spectrum Display	DPX Spectrum Display, DPX spectrogram, DPX sweep					
DPX Live Spectrum Display	Spectrum processing rate 10,000 times/second, 100% POI: 15µs					
Maximum Input	+33dBm (RF input, 10 MHz to 18.0 GHz, RF Attn: ≥ 20 dB)					
Maximum DC voltage	+/- 40V					
Amplitude Accuracy	±0.8dB (9kHz~3GHz), ±1.5dB (3GHz~7.5GHz, RSA507A), ±1.55dB (7.5GHz~13.6GHz, RSA513A/RSA518A), ±1.55dB (13.6GHz~18GHz, RSA518A)					
Displayed average noise level (DANL)	25MHz~1.0GHz : -164dBm/Hz (typical)		25MHz~1.0GHz : -161dBm/Hz (typical)		25MHz~1.0GHz : -164dBm/Hz (typical)	
Phase noise @ 1GHz (typical)	-97dBc/Hz (10kHz)					
SFDR	-70dB					
Trigger Type	IF-level trigger, external trigger					
Max RF Acquisition Time	2 seconds (up to SSD capacity for streaming recording)					
Audio Demodulation	AM/FM, Bandwidth: 8kHz~200kHz					
Tracking Generation (Opt.04)*1	9kHz~3GHz (Transmission) 10MHz~3GHz (Reflection)		9kHz~7.5GHz (Transmission) 10MHz~7.5GHz (Reflection)		9kHz~3GHz (Transmission) 10MHz~3GHz (Reflection)	
Measurement functions	Spectrum Analysis, DPX Spectrum Display, Spectrogram, Spurious					
Spectrum Analysis	Spectrum, DPX Spectrum Display, Spectrogram, Spurious					
Analog Modulation Analysis	AM, FM, PM					
Digital Modulation Analysis	Modulation formats : APSK, BPSK, C4FM, DBPSK, DPSK,FSK, GFSK, MSK, PSK, QAM, QPSK, etc (For details, refer to SVMxx-SVPC datasheet)					
WLAN Analysis	Standards : IEEE802.11a / b / g / j / p (SV23xx-SVPC required option), IEEE802.11n (SV23xx-SVPC/SV24xx-SVPC required option), IEEE802.11ac (SV23xx-SVPC/SV24xx-SVPC/SV25xx-SVPC required option)					
Others	Bluetooth measurement applications, LTE Downlink RF measurements, AM/FM/PM and direct audio measurement, APCO P25 Measurements Application, Spurious measurement (CISPR Quasi-Peak), EMC pre-compliance and troubleshooting					
GPS Format	GPS/GLONASS/BeiDou					
Mapping	Pitney Bowes MapInfo (*.mif), Bitmap (*.bmp), Open Street Maps (.osm), Google Earth KML file, MapInfo-compatible MIF/MID files					
Power Source	Battery (4 hours continuous) or AC100V (15W)				AC100V (45W)	
PC	Requirement: (USB3.0 connection, Windows 7 / 8 / 8.1 / 10, 64-bit operating system)					
Weight	2.99kg (with battery)		3.85kg (with battery)		2.79kg	
Warranty	3 years					

**RSA500A Accessories:** USB 3.0 cable (2 M), A-A connection, screw lock, shoulder strap, carrying case, quick-start manual, connector covers, WFM200BA Li-Ion rechargeable battery pack, WFM200BA Li-Ion battery pack instructions, AC power adapter, power cord, USB memory device with SignalVu-PC, API and documentation files.

**RSA600A Accessories:** USB 3.0 cable (2 M), A-A connection, screw lock, quick-start manual, connector covers, power cord, USB memory device with SignalVu-PC, API and documentation files.

### Recommended Hardware Option

Opt. 04<sup>1</sup>... Tracking generator  
(10 MHz - to maximum range of instrument or 7.5GHz)

### Recommended Accessories

**RSA500TRANSIT**...RSA500 Series Transit Case

### General purpose RF cables

**012-1738-00** ..... Cable,50 Ω, 40 inch,type-N(m) to type-N(f)

**012-0482-00** ..... Cable, 50 Ω, BNC (m) 91 cm

### Adapters

**103-0045-00** .....Adapter, coaxial, 50 Ω type-N(m) to type-BNC(f)

**013-0406-00** ..... Adapter, coaxial, 50 Ω type-N(m) to type-SMA(f)

### Attenuators and 50/75 Ω pads

**013-0422-00** ..... Pad, 50/75 Ω, minimum loss, type-N(m) 50 Ω to type-BNC(f) 75 Ω

**011-0223-00** ..... Attenuator, fixed, 10 dB, 2 W, DC-8 GHz, type-N(m) to type-N(f)

**011-0228-00** ..... Attenuator, fixed, 3 dB, 2 W, DC-18 GHz, type-N(m) to type-N(f)

**011-0226-00** ..... Attenuator, fixed, 40 dB, 50 W, DC-8.5 GHz, type-N(m) to type-N(f)  
DC-18GHz, Type N (Ma) - Type N (Fe)

### Probe

**119-4146-00<sup>2</sup>** ..... EMCO E/H-field probes

### SignalVu-PC Analysis Option

**SVAFI-SVPC** ..... AM/FM/PM/Direct Audio Analysis

**SVTFL-SVPC** ..... Settling Time (frequency and phase) measurements

**SVMFL-SVPC** ..... General Purpose Modulation Analysis

**SVPFLL-SVPC** ..... Pulse Analysis

**SVOFL-SVPC** ..... Flexible OFDM Analysis

**SV23FL-SVPC** ..... WLAN 802.11a/b/g/j/p measurement

**SV24FL-SVPC** ..... WLAN 802.11n measurement (requires SV23)

**SV25FL-SVPC** ..... WLAN 802.11ac measurement (requires SV23 and SV24)

**SV26FL-SVPC** ..... APCO P25 measurement

**SV27FL-SVPC** ..... Bluetooth 4.1/EDR/LE Measurement

**SV28FL-SVPC** ..... LTE Downlink RF measurement

**SV56FL-SVPC** ..... Playback of recorded files

**SV54FL-SVPC** ..... Signal survey and classification

**SV60FL-SVPC** ..... Return loss, distance to fault, VSWR, cable loss

**MAPFL-SVPC** ..... Mapping

**SVQPFL-SVPC** ..... EMI CISPR detectors

**SV31FL-SVPC** ..... Bluetooth 5 measurements (requires SV27)

**EMCVUFL-SVPC**... EMC pre-compliance and troubleshooting (includes EMI CISPR detectors)

**xxxFL-SVPC** ..... Floating license

**xxxNL-SVPC** ..... Node-locked

<sup>1</sup> Opt SV60 required to measure return loss, VSWR, cable loss, and distance to fault.

<sup>2</sup> BNC cable and N-BNC conversion connector (103-0045-00) are required.



# SignalVu®-PC

SignalVu RF and Vector Signal Analysis Software

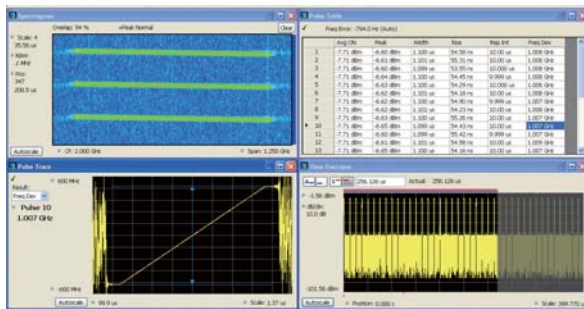

- ### Features
- Supports WLAN spectrum and modulation transmitter measurements based on IEEE 802.11 a/b/g/j/p/n/ac standards (optional)
  - Supports Bluetooth 5/4.1/4.1/EDR/LE (Low Energy) analysis (optional)
  - General Purpose Digital Modulation Analysis provides vector signal analyzer functionality (optional)
  - Automatic mapping of measurement results and labels (optional)
  - Get the functionality of a vector signal analyzer, a spectrum analyzer, and the powerful trigger capabilities of a digital oscilloscope - all in a single package
  - CISPR QP (quasi-peak) detection and CISPR Average detection (optional)
  - EMI/EMC pre-compliance troubleshooting (optional)

### With MSO5/6B Series and MDO4000C Series

- Provides IEEE802.11ac (160MHz bandwidth) wireless LAN analysis at less than half the price of other solutions
- Operates as an ultra-wideband vector signal analyzer with analysis bandwidth of 1 GHz or more (MDO4000C) / 2 GHz (MSO5/6B)
- LiveLink option (MDO4000C) for seamless analysis on PC via USB and Ethernet connections

### With RSA306B type and RSA500A/RSA600A Series

- Standard functions including DPX real-time display are included as standard
- Supports wireless LAN analysis up to 40 MHz bandwidth (optional)
- Operate as a portable vector signal analyzer (optional)

### With other Tektronix oscilloscopes

- Time axis waveforms (\*.wfm, \*.isf format) can be saved and read in Spectrum analysis and modulation analysis
- Options available for integration into Windows-based oscilloscopes (SignalVu software)

### With RSA5100B/7100B Series

- Offline analysis by loading files (\*.TIQ, \*.IQT format) saved in the RSA Series.
- The same user interface enables analysis in an offline environment.

### Licenses for Educational Institutions

Education licenses are available for educational institutions.  
Education-only version of all modules for SignalVu-PC

Option	Description
SVAFLL-SVPC	AM/FM/PM/Direct Audio Analysis
SVTFL-SVPC	Settling Time (frequency and phase) measurements
SVMFL-SVPC	General Purpose Modulation Analysis
SVPFLL-SVPC	Pulse Analysis
SVOFL-SVPC	Flexible OFDM Analysis
SV23FL-SVPC	WLAN 802.11a/b/g/j/p measurement -
SV24FL-SVPC	WLAN 802.11n measurement (requires SV23)
SV25FL-SVPC	WLAN 802.11ac measurement (requires SV23 and SV24)
SV26FL-SVPC	APCO APCO P25 measurement
SV27FL-SVPC	Bluetooth 4.1/EDR/LE Measurement
SV28FL-SVPC	LTE Downlink RF measurement
SV30FL-SVPC	WiGig 802.11ad measurements
SV54FL-SVPC	Signal survey and classification
SV56FL-SVPC	Playback of recorded files
SV60FL-SVPC	Return loss, distance to fault, VSWR, cable loss
MAPFL-SVPC	MAPFL-SVPC Mapping
CONFL-SVPC	SignalVu-PC connection to the 5 or 6 Series MSO, or MDO4000B series mixed-domain oscilloscopes
SV2CFL-SVPC	WLAN 802.11a/b/g/j/p/n/ac and live link to 5 or 6 Series MSO, or MDO4000C (Bundle of SV23, SV24, SV25, CON)
SVQPFL-SVPC	EMI CISPR detectors
SV31FL-SVPC	Bluetooth 5 measurements (requires SV27)
EMCVUFL-SVPC	EMC pre-compliance and troubleshooting (includes EMI CISPR detectors)

xxxFL-SVPC.....Floating license  
xxxNL-SVPC.....Node-locked



- ### Multi-Domain Analysis
- Extensive time-correlated, multidomain displays connect events in time, frequency, phase, and amplitude for quicker understanding of cause and effect when troubleshooting

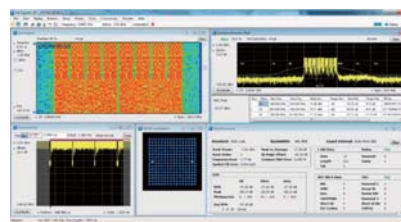

- ### Wireless LAN Analysis
- Supports IEEE801.11ac (160MHz, 256QAM)
  - Supports detailed analysis of wireless LANs such as SEM, constellation, EVM, etc.



- ### Bluetooth Analysis
- Supports analysis of Bluetooth 5 / 4.1 / 4.1 / EDR / LE
  - Pass/Fail results are provided with customizable limits

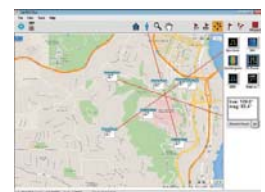

- ### Mapping
- Automatic mapping of measurement results and labels (optional)
  - Obtains location information from a GPS receiver (sold separately) connected to a PC

# DataVu-PC

Record Analysis Software for Real-Time Spectrum Analyzers

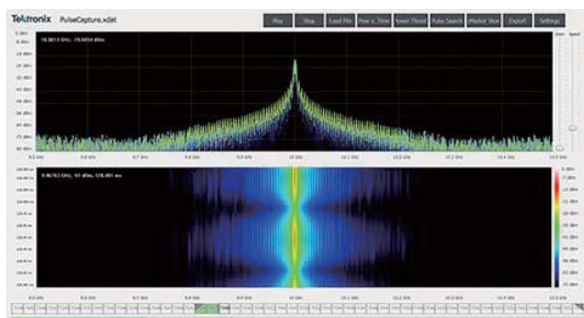

- ### Features
- Licenses available according to the bandwidth of the captured signal.
  - Color-graded Spectrogram
  - FFT overlap and speed control, optimizes between highest probability of intercept vs. analysis time
  - Export areas of interest to .XDAT, SIQ, and .TIQ formats
  - User settable sliders for start/stop point
  - File progress bar, Time Overview display, eMarkers, Pulse Analysis



# EMCVu (SignalVu-PC option) EMI/EMC Pre-Compliance Testing Software

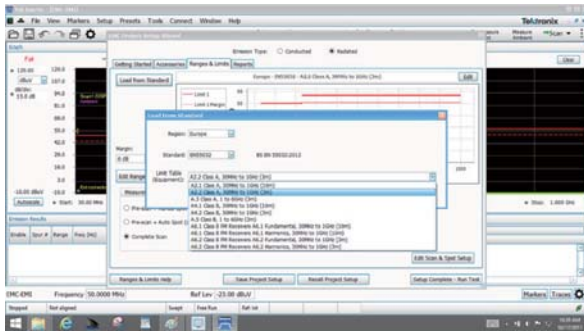

**Supported Standards:** CISPR11, CISPR12, CISPR13, CISPR14, CISPR15, CISPR25, CISPR32 IEC60601-1-2, VCCI, FCC Part 15, FCC Part 18, MIL-STD 461G

## Features

- Built-in standards and accessory setup with push-button selection
- An easy-to-use setup wizard
- Harmonic markers and faster scans using peak detector and spot measurements with quasi-peak and average detector failures
- Automated multiple measurement/multiple format reporting
- Real-time spectrum display for efficient EMI debugging

## Example of Radiated Pre-compliance Test (CISPR11)

EMI-RE-HWPARTS  
(Accessories for Radiated-Pre-compliance Test)

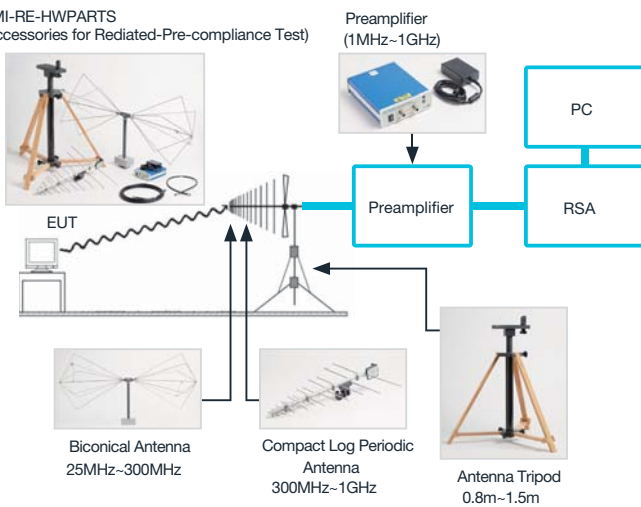

## Debugging and Troubleshooting

EMI-DEBUG-HWPARTS  
(EMI Accessories for Debug)

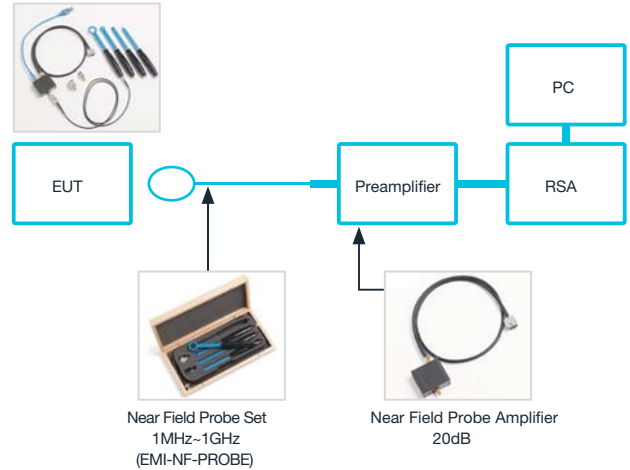

## RSA7100B Series Wideband Spectrum Analyzer



Streaming capture to internal RAID of over 2 hours at full 800 MHz bandwidth

## Features

- Frequency range: 16 kHz to 26.5 GHz
- Real-time acquisition bandwidth of up to 800 MHz for state-of-the-art radar and communications analysis
- Streaming capture to internal RAID of over 2 hours
- High performance spectrum analysis for advanced design verification with -134 dBc/Hz phase noise at 1 GHz, typical amplitude accuracy of +/-0.5 dB
- DataVu-PC software for analysis of recorded events of any length

Basic Specifications	RSA7100B
Frequency Range	16kHz-14GHz (Opt. 14) /26.5GHz (Opt. 26)
Real-time acquisition frequency band	320MHz (standard), 800MHz (Opt. B800)
Phase Noise	-134 dBc/Hz at 10 kHz offset at 1GHz
Displayed Average Noise Level	-168 dBm/Hz (10 MHz to 100 MHz), Preamp ON, typical
RAID Recoding to RAID	165 points 320MHz-800MHz, 1000MS/s, RAID Opt. C) 128 hr (<10MHz, 15.625MS/s, RAID Opt. C)
Max Input DC Voltage	±40V
Max Input Level	+30dBm

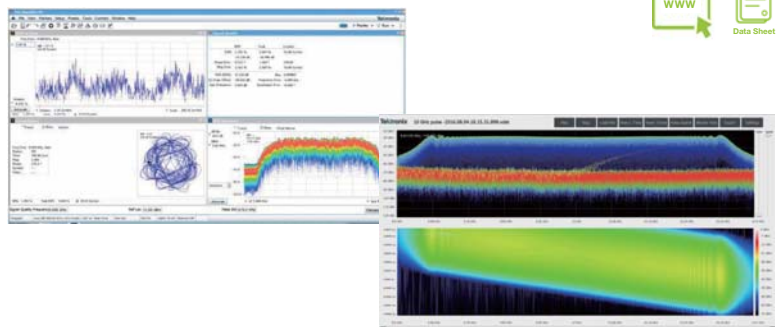

# FCA/MCA3000 Series

Frequency Counter / Timer Analyzer / Microwave Analyzer

Industry-leading resolution, built-in measurement and analysis modes



Width: 210mm Height: 90mm Depth: 395mm Weight: 2.7kg

- 8 models for general purpose to high performance to microwave compatible analysis modes
- Max data transfer rate to internal memory: 250k Sample/s
- Easily connect to a PC with the USB and GPIB ports
- Multi-parameter display
- Up to 3 Input Channels
- Up to 14 types of automated measurements
- Integrated power meter (MCA Series)

Basic Specifications	General Purpose Model			High Performance Model			Microwave Compatible Model	
	FCA3000	FCA3003	FCA3020	FCA3100	FCA3103	FCA3120	MCA3027	MCA3040
Frequency Range	300MHz	300MHz to 3 GHz	3300MHz to 20 GHz	300MHz	300MHz to 3 GHz	300MHz to 20 GHz	300 MHz to 27 GHz	300 MHz to 40 GHz
Time resolution (single)	100ps			50ps			100ps	
Vmax,Vmin Resolution	3mV			1mV			3mV	
Requency Resolution	12 digits per second			12 digits per second			12 digits per second	
Automated Measurements	Frequency, period, ratio, time Interval, time interval error, pulse width, rise/fall time, phase angle, duty cycle, maximum voltage, minimum voltage, peak-to-peak voltage							
Other Measurements	-			Totalize Measurement			Integrated power meter Power Range: -35 dBm to +10 dBm	
Analysis Function	Measurement Statistics Mode, Histogram Mode, Trend Plot Mode							
Display	Multi-parameter Display: Read critical auxiliary measurement values displayed with your main frequency, time, or phase measurement							
External Interface	GPIB/USB							
	250kS/s			250kS/s			250kS/s	
Internal Memory Size	750kpoints			3.75Mpoints			750kpoints	
GPIB/USB	5kS/s (Block mode)			15kS/s (Block mode)			5kS/s (Block mode)	
Warranty	3 years							
Software	TimeView™ Software for Modulation Domain Analysis							

**Accessories:** Power cable, calibration certificate, quick start user manual, user manual CD-ROM, programmer's guide, technical specifications, modulation analysis TimeView software (30-day limited trial version)

## Feature-rich Tools for Precision Measurements

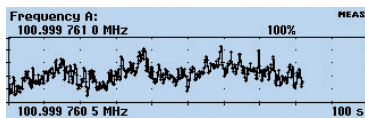

Trend Plots

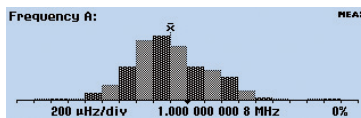

Histograms

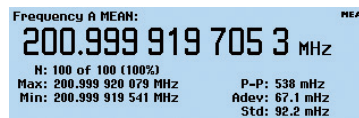

Measurement statistics mode including Allan Deviation

## TimeView™ Modulation Domain Analysis Software (TVA3000)

FCA/MCA Series transform your timer / counter into a modulation domain analyzer and see frequency changes over time to truly characterize your device's performance.

With Windows 10 support.



## Recommended Accessories and Software

- HCTEK4321.....Hard carrying case
- 174-4401-xx.....USB host to device cable (90cm)
- 012-0991-00.....GPIB cable (double shielded, 1m)
- 012-0482-xx.....BNC male to BNC male, cable shielded, 90cm, 50Ω
- TVA3000.....TimeView™ Modulation Domain Analysis Software
- RMU2U.....Rackmount shelf kit for 2 units

## Recommended Options

		FCA Series	MCA Series
MS	Medium-stability over time base	<input type="radio"/>	Standard Feature
HS	High-stability over time base	<input type="radio"/>	<input type="radio"/>
US	Ultra high-stability over time base	<input checked="" type="checkbox"/>	<input type="radio"/>
RP	Rear-panel connectors	<input type="radio"/>	<input checked="" type="checkbox"/>

Opt. D1..... Calibration Data Report    Opt. R5 ..... Repair Service 5 Years



# Tektronix Service Solutions Organisation (SSO)

## Solid quality and reliability based on technological capabilities

Contact Tektronix for calibration and repair of test and measurement instruments.

Tektronix, Inc. was established in 1946 by C. Howard Vullum and Melvin J. Murdock with the creation of the world's first time-base triggered oscilloscope. Headquartered in Beaverton, Oregon, delivers innovative, precise and easy-to-operate test, measurement and monitoring solutions that solve problems, unlock insights and drive discovery globally.



Tektronix has been at the forefront of the digital age for the past 75 years. Renowned globally for its contributions to major technology breakthroughs, from the invention of color television to space exploration, Tektronix is credited as one of the most influential test and measurement companies in history.

In 2010, Tektronix, Inc. merged with Fluke Calibration, Inc. and Keithley Instruments. We have been working to break down the complexities and barriers of customers having to request calibration of their various measuring instruments from different manufacturers.

## Maintenance contract for repair of Tektronix instruments

We recommend that you sign a maintenance contract for peace of mind in case of failure.

Test and Measurement instruments are used in a wide range of fields, including electrical, automotive, and aviation, and are required to meet strict requirements for product development and inspection. They are required to meet stringent requirements for product development and inspection. Sophisticated components / parts are used in the manufacture of our products. When parts used in test and measurement instruments fail, the replacement and/or repair can be expensive.

To minimize the cost burden on the customer, Tektronix maintenance contract and repair services can be added at the time of product purchase. This reduce the cost and time of unexpected repairs.

Plan	Opt	Type of Service	Description
<b>Extended Repair Warranty Service Options</b>	R3	Options available at Point of Sale	Standard warranty extended to 3 years
	R5		Standard warranty extended to 5 years
<b>Repair Contract Services</b>	AREPAIR	Options available After Sale	Standard one-year repair contract service Lock in pricing with multi-year agreements
<b>GOLD CARE</b>	G3	Options available at Point of Sale	3 year Gold Care Plan Access to a loaner product during repair or advance exchange to reduce downtime
	G5		5 year Gold Care Plan Access to a loaner product during repair or advance exchange to reduce downtime
	GOLDCARE	At any point in time	GOLDCARE plan available for later subscription
<b>Total Protection Plan</b>	T3	Options available at Point of Sale	The 3 year Total Product Protection Plan
	T5		The 5 year Total Product Protection Plan

## CalWeb® | Cloud-Based Asset Management

CalWeb enables you to easily manage asset pools and calibration programs.

### [CALWEB Features]

- One-Stop Solution for managing your calibration program
- 3,000 companies and about 15,000 users around the world
- More than 12 years of experience in use, mainly in North America
- Quality, price, and delivery management for calibration, repair, and maintenance
- Approval management\* for calibration failures
- No application required: Web-based (IE/Chrome)
- Intuitive User Interface

(\* Optional, additional charges applies)



## Tektronix Calibration Services

### ISO/IEC 17025 Accredited Calibration / Traceable Calibration Service

Tektronix has the world's most comprehensive network of repair and calibration services management by Tektronix Global QMS (Quality Management System) for test and measurement equipment.

All Tektronix quality systems meet or exceed the requirements of ISO/IEC 17025, and most Tektronix labs are ISO/IEC accredited.

For more information on repair and calibration services, please email: [service.asean@tektronix.com](mailto:service.asean@tektronix.com).

Plan	Opt	Period of Purchase	Description
<b>3-year standard calibration option</b>	C3	At the time of product purchase	3-year standard calibration option. Includes factory calibration plus 2 standard calibrations and a calibration certificate. (1 calibration per year)
<b>5-year standard calibration option</b>	C5	At the time of product purchase	5-year standard calibration option. Includes factory calibration plus 4 standard calibrations and a calibration certificate. (1 calibration per year)
<b>Standard Calibration Contract</b>	ACALVER	Options available After Sale	Purchased once or multiple times at the same time. Guarantees that the product will meet the specifications at the time of manufacture, maintaining performance and accuracy.
<b>Accredited Calibration Contract</b>	AACCDAL	Options available After Sale	Purchased once or multiple times at the same time. Guarantees that products meet IEC/ISO17025 requirements to maintain performance and accuracy.



## Tektronix Test & Measurement Learning Center

Knowledge Center with a Wealth of Technical Resources

[www.tek.com/learning](http://www.tek.com/learning)

The Learning Center offers a variety of popular technical resources, including solution briefs, videos, application notes, and more. Get fundamentals like:

- XYZs of Oscilloscopes Primer
- Understanding and Characterizing Timing Jitter Primer
- ABCs of Probes
- EMI Pre-Compliance Testing and Troubleshooting with Tektronix EMCVu
- 25 Common Things You Can Do with an Arbitrary Function Generators

Hope you find it useful.



## TekShare

The Power of Sharing of Minds

[sg.tek.com/tekshare](http://sg.tek.com/tekshare)

Engineers are great problem solvers. However, sometimes we feel overwhelmed or even left alone at our wit's end. The Tektronix TekShare Series aims at sharing the insights, tips and tricks we had learned from working with many other engineers like you around the world, such that you can see your problems in a new perspective and approach them in a new different way, getting it solved faster and easier.

To facilitate engineering learning of latest test and measurement of various applications, we are consolidating many on-demand webinars for your self-paced learning. We will continue to add new webinar videos throughout the year.



A solution that offers great savings, plus meeting your tight deadlines.

[www.tek.com/encore](http://www.tek.com/encore)

## Tektronix Encore

Factory Certified. Performance Ready.

Reconditioning process to make Tektronix Encore products "good as new". You never sacrifice performance when purchasing a Tektronix Encore product.



## Tek Events

[www.tek.com/events](http://www.tek.com/events)

Learn about Tek's upcoming events, including seminars, tradeshows, webinars and more.



## Get the latest information on Tektronix

Tektronix Official Website

[www.tek.com](http://www.tek.com)

Get the latest information on Tektronix products and services, technical contents, manuals, firmware and more. You can also request for quote and technical support! We're also available on LiveChat. Reach out to us anytime with your needs!

Tektronix YouTube 

<https://www.youtube.com/user/tektronix/videos>

Various easy-to-understand how to videos are available.

Tektronix Facebook 

<https://www.facebook.com/TekAsean/>

Tektronix Twitter 

[twitter.com/tektronix](https://twitter.com/tektronix)

Tektronix LinkedIn 

<https://www.linkedin.com/showcase/tektronixasean>



relentlessly curious  
**problem solvers**  
people who find a way  
**We're for the engineer**  
askers of why  
mentors  
bench masters

## We're Tektronix, and we're for the engineer.

We bring you inspiring stories from our fellow engineers who push the boundaries in science and technology to start making tomorrow better, today.

[www.tek.com/stories](http://www.tek.com/stories)

### Do you have a story to share?

- When did you first know you wanted to be an engineer?
- Who influenced or inspired you on your journey?
- What are the hardest things you've ever done in your work as an engineer?
- What motivates you in your role today?

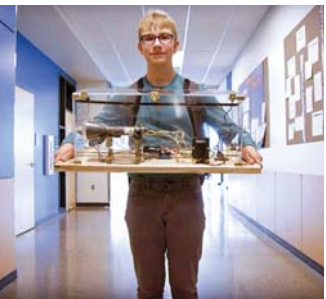

### Share your story with us today!

We're seeking inspiring stories from across the globe.

Your story has a chance to be brought to life and featured in a form of a video, article, blog, social post, etc.

For more inspiring stories from engineers, visit [sg.tek.com/stories](http://sg.tek.com/stories). If you have any questions, feel free to email us at [Stories@tektronix.com](mailto:Stories@tektronix.com).

## Tektronix / Keithley Instruments

For inquiries on our products and services, you can reach us at our toll-free numbers or email us at [asean.mktg@tektronix.com](mailto:asean.mktg@tektronix.com).

### Toll-Free Numbers:

**Australia** 1 800 709 465

**Indonesia** 007 803 601 5249

**Malaysia** 1 800 22 55835

**New Zealand** 0800 800 238

**Philippines** 1 800 1601 0077

**Singapore** 800 6011 473

**Thailand** 1 800 011 931

**Vietnam** 12060128

\*Toll-free numbers. If not accessible, call: +65 6356 3900

*\* IDD charges may apply*



Contact  
Information

[www.tek.com](http://www.tek.com)

### Singapore Office

**Tektronix Southeast Asia Pte Ltd**  
1 Clementi Loop #06-02  
Singapore 129808

### Malaysia Office

**Tektronix Instruments Malaysia Sdn Bhd**  
Unit1-15-12, Suntech @ Penang Cybercity  
Lintang Mayang Pasir 3, 11950 Bayan Baru  
Penang, Malaysia

