



MONTBLANC WRITING INSTRUMENTS COLLECTION 2013/2014

**MONT
BLANC** 



MONTBLANC WRITING INSTRUMENTS
COLLECTION 2013/2014



WRITING INSTRUMENTS





WRITING INSTRUMENTS

Only a wide-ranging commitment to art and culture makes it possible to experience the unique spirit and creativity of humanity.

As a brand firmly rooted in the culture of writing, Montblanc has always seen a commitment to the patronage of art and culture as a matter of principle – for more than 100 years.

True perfection never ages

With the tradition and spirit of master craftsmen, and commitment to the highest quality and its cultural patronage, Montblanc manufactures products that go beyond their functional purpose: products with a soul.





WRITING INSTRUMENTS

CONTENTS

MEISTERSTÜCK

PRECIOUS RESIN - GOLD-PLATED

149	12
LeGrand	13
Classique	18
Hommage à W.A. Mozart	20

PRECIOUS RESIN - PLATINUM-PLATED

LeGrand	22
Classique	26
Hommage à W.A. Mozart	28
Leonardo Sketch Pen	30

MONTBLANC DIAMOND

LeGrand	31
Classique	34
Hommage à W.A. Mozart	36

SIGNATURE FOR GOOD

LeGrand	38
Classique	40



WRITING INSTRUMENTS

CONTENTS

MEISTERSTÜCK SOLITAIRE

METAL

Royal	47
Doué Royal Hommage à W.A. Mozart	49
Platinum	50
Rose Gold Barley	52
Jewellery Edition	53
Jewellery Collection	54
Royal Steel	56
Silver Barley	58
Geometric Dimension	59
Ceramics Black Prisma	60
Platinum-Plated Facet	62
Tribute to the Mont Blanc	64
Sterling Silver	68
Jewellery Collection	70
Carbon & Steel	72

DOUÉ

Black and White	74
Silver Barley	76
Geometric Dimension	78
Signum	80
Stainless Steel	82

MASTERS FOR MEISTERSTÜCK

L'Aubrac	86
----------------	----



WRITING INSTRUMENTS

CONTENTS

BOHÈME

METAL

Royal	92
Je t'aime White Gold	93
Pirouette Lilas	94
Arabesque Azur	96
Paso Doble Bleu	98
Paso Doble Rouge	100

DOUÉ

Doué Ligne	102
Doué Platinum-Plated	104

PRECIOUS RESIN

Bleu	106
Rouge	108
Noir	110
Marron	112

STARWALKER

METAL

Red Gold	118
Midnight Black	120
Black Mystery	122
Metal/Rubber	124

DOUÉ

Doué	126
------------	-----

PRECIOUS RESIN

Red Gold	128
Platinum	130
Midnight Black	132



WRITING INSTRUMENTS

CONTENTS

ETOILE DE MONTBLANC

METAL

Etoile Mystérieuse	138
Etoile Eternelle	140
Etoile Méditerranée	142

PRECIOUS RESIN

Etoile Précieuse	144
Etoile de Montblanc	146

DIVA LINE

Princesse Grace de Monaco	150
---------------------------------	-----

DONATION PEN

Johannes Brahms Special Edition	156
John Lennon Special Edition	158

WRITING ACCESSORIES

Fountain Pen	162
Ballpoint Pen	164
Rollerball	165
Fineliner	166
Document Marker	167
Mechanical Pencil	167
Blister Assortment	168

DESK ACCESSORIES

Meisterstück Desk Accessories gold-plated	172
Meisterstück Desk Accessories platinum-plated	173
Refills	174
Engraving	175
Nib Widths	176

WRITING INSTRUMENTS





Meisterstück – a design that writes history.

The most famous and recognised writing instrument of our time.

Meisterstück

The deep black precious resin surmounted by the white star emblem, handcrafted solid gold nib with rhodium-plated inlay, the three gold-plated rings and gold-plated clip make it a distinctive design icon.





WRITING INSTRUMENTS

MEISTERSTÜCK

> Precious Resin - Gold-Plated



149

p. 12



LeGrand

p. 13



Classique

p. 18



Hommage à W.A. Mozart

p. 20

> Precious Resin - Platinum-Plated



LeGrand

p. 22



Classique

p. 26



Hommage à W.A. Mozart

p. 28





WRITING INSTRUMENTS

MEISTERSTÜCK

> Precious Resin - Platinum-Plated



Leonardo Sketch Pen

p. 30

> Montblanc Diamond



Montblanc Diamond - LeGrand

p. 31



Montblanc Diamond - Classique

p. 34



Montblanc Diamond - Hommage à W.A. Mozart

p. 36

> Signature for Good



Signature for Good - LeGrand

p. 38



Signature for Good - Classique

p. 40

WRITING INSTRUMENTS

MEISTERSTÜCK

> Precious Resin - Gold-Plated 149



MODEL		149 Fountain Pen			
IDENT NO.		10573	10574	10575	10576
NIB WIDTHS		EF	F	M	B
		10577	10578	10579	10580
		BB	OM	OB	OBB
WRITING SYSTEM					
WRITING SYSTEM		Piston Fountain Pen			
NIB		Hand-crafted Au750 / 18 K gold nib with rhodium-plated inlay			
FEATURES					
BARREL		Black precious resin			
CAP		Black precious resin inlaid with Montblanc emblem			
TRIM		Three gold-plated rings embossed with Montblanc brand name			
CLIP		Gold-plated clip with individual serial number			
SPECIAL CHARACTERISTICS		Signature nib (03B) available as a replacement			
PACKAGING		Special 149 packaging including black Montblanc ink as additional gift			
REFILLS					
REFILLS		Montblanc ink: Mystery Black, Royal Blue, Midnight Blue, Burgundy Red, Lavender Purple, Oyster Grey, Toffee Brown, Irish Green			

WRITING INSTRUMENTS

MEISTERSTÜCK

> Precious Resin - Gold-Plated LeGrand



MODEL		LeGrand Fountain Pen			
IDENT NO.		13659	13660	13661	13662
NIB WIDTHS		EF	F	M	B
		13663	13664	13665	13666
		BB	OM	OB	OBB
WRITING SYSTEM					
WRITING SYSTEM		Piston Fountain Pen			
NIB		Hand-crafted Au585 / 14 K gold nib with rhodium-plated inlay			
FEATURES					
BARREL		Black precious resin			
CAP		Black precious resin inlaid with Montblanc emblem			
TRIM		Three gold-plated rings embossed with Montblanc brand name			
CLIP		Gold-plated clip with individual serial number			
SPECIAL CHARACTERISTICS		-			
PACKAGING		-			
REFILLS					
REFILLS		Montblanc ink: Mystery Black, Royal Blue, Midnight Blue, Burgundy Red, Lavender Purple, Oyster Grey, Toffee Brown, Irish Green			

WRITING INSTRUMENTS

MEISTERSTÜCK

> Precious Resin - Gold-Plated LeGrand



MODEL	LeGrand Traveller Fountain Pen
IDENT NO.	12090 M Other nib widths available on request
WRITING SYSTEM	
WRITING SYSTEM	Cartridge Fountain Pen with gold-plated cartridge filling system
NIB	Hand-crafted Au585 / 14 K gold nib with rhodium-plated inlay
FEATURES	
BARREL	Black precious resin
CAP	Black precious resin inlaid with Montblanc emblem
TRIM	Three gold-plated rings embossed with Montblanc brand name
CLIP	Gold-plated clip with individual serial number
SPECIAL CHARACTERISTICS	Travel case made of smooth black cowhide with 6 spare black ink cartridges
PACKAGING	-
REFILLS	
REFILLS	Montblanc ink cartridges: Mystery Black, Royal Blue, Midnight Blue, Burgundy Red, Lavender Purple, Oyster Grey, Toffee Brown, Irish Green

WRITING INSTRUMENTS

MEISTERSTÜCK

> Precious Resin - Gold-Plated LeGrand



MODEL	LeGrand Document Marker
IDENT NO.	13436
WRITING SYSTEM	
WRITING SYSTEM	Document Marker
NIB	-
FEATURES	
BARREL	Black precious resin
CAP	Black precious resin inlaid with Montblanc emblem
TRIM	Three gold-plated rings embossed with Montblanc brand name
CLIP	Gold-plated clip with individual serial number
SPECIAL CHARACTERISTICS	-
PACKAGING	-
REFILLS	
REFILLS	Montblanc document marker refills: Luminous Yellow, Luminous Green

WRITING INSTRUMENTS

MEISTERSTÜCK

> *Precious Resin - Gold-Plated LeGrand*



MODEL	LeGrand Rollerball
IDENT NO.	11402
WRITING SYSTEM	
WRITING SYSTEM	Rollerball
NIB	-
FEATURES	
BARREL	Black precious resin
CAP	Black precious resin inlaid with Montblanc emblem
TRIM	Three gold-plated rings embossed with Montblanc brand name
CLIP	Gold-plated clip with individual serial number
SPECIAL CHARACTERISTICS	-
PACKAGING	-
REFILLS	
REFILLS	Montblanc LeGrand rollerball refills: Mystery Black, Pacific Blue

WRITING INSTRUMENTS

MEISTERSTÜCK

> Precious Resin - Gold-Plated LeGrand



MODEL	LeGrand Ballpoint Pen	LeGrand Mechanical Pencil 0.9 mm
IDENT No.	10456	108952
WRITING SYSTEM		
WRITING SYSTEM	Ballpoint Pen with twist mechanism	Mechanical Pencil with twist mechanism
NIB	-	-
FEATURES		
BARREL	Black precious resin	Black precious resin
CAP	Black precious resin inlaid with Montblanc emblem	Black precious resin inlaid with Montblanc emblem
TRIM	Three gold-plated rings embossed with Montblanc brand name	Three gold-plated rings embossed with Montblanc brand name
CLIP	Gold-plated clip with individual serial number	Gold-plated clip with individual serial number
SPECIAL CHARACTERISTICS	-	-
PACKAGING	-	-
REFILLS		
REFILLS	Montblanc ballpoint pen refills: Mystery Black, Pacific Blue, Nightfire Red, Fortune Green	Montblanc hi-polymer 0.9 mm lead, eraser

WRITING INSTRUMENTS

MEISTERSTÜCK

> Precious Resin - Gold-Plated Classique



MODEL		Classique Fountain Pen			
IDENT NO.		106511	106513	106514	106515
NIB WIDTHS		EF	F	M	B
		106516	106517	106518	106519
		BB	OM	OB	OBB
WRITING SYSTEM					
WRITING SYSTEM		Fountain Pen with piston converter (allows optional use of ink cartridges)			
NIB		Hand-crafted Au585 / 14 K gold nib with rhodium-plated inlay			
FEATURES					
BARREL		Black precious resin			
CAP		Black precious resin inlaid with Montblanc emblem			
TRIM		Three gold-plated rings embossed with Montblanc brand name			
CLIP		Gold-plated clip with individual serial number			
SPECIAL CHARACTERISTICS		-			
PACKAGING		-			
REFILLS					
REFILLS		Montblanc ink: Mystery Black, Royal Blue, Midnight Blue, Burgundy Red, Lavender Purple, Oyster Grey, Toffee Brown, Irish Green			

WRITING INSTRUMENTS

MEISTERSTÜCK

> Precious Resin - Gold-Plated Classique



MODEL	Classique Rollerball	Classique Ballpoint Pen	Classique Mechanical Pencil
IDENT NO.	12890	10883	12737 12746
LEAD SIZE			0.7 mm 0.5 mm
WRITING SYSTEM			
WRITING SYSTEM	Rollerball	Ballpoint Pen with twist mechanism	Mechanical Pencil with twist mechanism
NIB	-	-	-
FEATURES			
BARREL	Black precious resin	Black precious resin	Black precious resin
CAP	Black precious resin inlaid with Montblanc emblem	Black precious resin inlaid with Montblanc emblem	Black precious resin inlaid with Montblanc emblem
TRIM	Three gold-plated rings embossed with Montblanc brand name	Three gold-plated rings embossed with Montblanc brand name	Three gold-plated rings embossed with Montblanc brand name
CLIP	Gold-plated clip with individual serial number	Gold-plated clip with individual serial number	Gold-plated clip with individual serial number
SPECIAL CHARACTERISTICS	-	-	-
PACKAGING	-	-	-
REFILLS			
REFILLS	Montblanc rollerball refills: Mystery Black, Pacific Blue, Nightfire Red, Fortune Green, Chestnut Brown, Amethyst Purple, Barbados Blue; Montblanc fineliner refills: Mystery Black, Pacific Blue	Montblanc ballpoint pen refills: Mystery Black, Pacific Blue, Nightfire Red, Fortune Green	Montblanc hi-polymer 0.7 mm or 0.5 mm lead, eraser

WRITING INSTRUMENTS

MEISTERSTÜCK

> *Precious Resin - Gold-Plated
Hommage à W.A. Mozart*



MODEL	
Hommage à W.A. Mozart Fountain Pen	
IDENT NO.	108728 107701 107702 107703
NIB WIDTHS	EF F M B
	107704 OB
	Other nib widths available on request
WRITING SYSTEM	
WRITING SYSTEM	Cartridge Fountain Pen (no converter)
NIB	Hand-crafted Au585 / 14 K gold nib
FEATURES	
BARREL	Black precious resin
CAP	Black precious resin inlaid with Montblanc emblem
TRIM	Three gold-plated rings embossed with Montblanc brand name
CLIP	Gold-plated clip with individual serial number
SPECIAL CHARACTERISTICS	-
PACKAGING	-
REFILLS	
REFILLS	Montblanc ink cartridges: Mystery Black, Royal Blue, Midnight Blue, Burgundy Red, Lavender Purple, Oyster Grey, Toffee Brown, Irish Green

WRITING INSTRUMENTS

MEISTERSTÜCK

› Precious Resin - Gold-Plated
Hommage à W.A. Mozart



MODEL	Hommage à W.A. Mozart Ballpoint Pen	Hommage à W.A. Mozart Mechanical Pencil 0.7 mm
IDENT No.	108730	108731
WRITING SYSTEM		
WRITING SYSTEM	Ballpoint Pen with twist mechanism	Mechanical Pencil with twist mechanism
NIB	-	-
FEATURES		
BARREL	Black precious resin	Black precious resin
CAP	Black precious resin inlaid with Montblanc emblem	Black precious resin inlaid with Montblanc emblem
TRIM	Three gold-plated rings embossed with Montblanc brand name	Three gold-plated rings embossed with Montblanc brand name
CLIP	Gold-plated clip with individual serial number	Gold-plated clip with individual serial number
SPECIAL CHARACTERISTICS	-	-
PACKAGING	-	-
REFILLS		
REFILLS	Montblanc Meisterstück "Hommage à W.A. Mozart" small ballpoint pen refills: Mystery Black, Pacific Blue	Montblanc hi-polymer 0.7 mm lead, eraser

WRITING INSTRUMENTS

MEISTERSTÜCK

> *Precious Resin - Platinum-Plated
LeGrand*



MODEL		Platinum Line LeGrand Fountain Pen			
IDENT NO.		02849	02850	02851	02852
NIB WIDTHS		EF	F	M	B
		02853	02854	02855	02856
		BB	OM	OB	OBB
WRITING SYSTEM					
WRITING SYSTEM		Piston Fountain Pen			
NIB		Hand-crafted Au585 / 14 K gold nib with rhodium-plated inlay			
FEATURES					
BARREL		Black precious resin			
CAP		Black precious resin inlaid with Montblanc emblem			
TRIM		Three platinum-plated rings embossed with Montblanc brand name			
CLIP		Platinum-plated clip with individual serial number			
SPECIAL CHARACTERISTICS		-			
PACKAGING		-			
REFILLS					
REFILLS		Montblanc ink: Mystery Black, Royal Blue, Midnight Blue, Burgundy Red, Lavender Purple, Oyster Grey, Toffee Brown, Irish Green			

WRITING INSTRUMENTS

MEISTERSTÜCK

> *Precious Resin - Platinum-Plated
LeGrand*



MODEL	Platinum Line LeGrand Rollerball
IDENT No.	07571
WRITING SYSTEM	
WRITING SYSTEM	Rollerball
NIB	-
FEATURES	
BARREL	Black precious resin
CAP	Black precious resin inlaid with Montblanc emblem
TRIM	Three platinum-plated rings embossed with Montblanc brand name
CLIP	Platinum-plated clip with individual serial number
SPECIAL CHARACTERISTICS	-
PACKAGING	-
REFILLS	
REFILLS	Montblanc LeGrand rollerball refills: Mystery Black, Pacific Blue

WRITING INSTRUMENTS

MEISTERSTÜCK

> *Precious Resin - Platinum-Plated
LeGrand*

MODEL	Platinum Line LeGrand Ballpoint Pen	Platinum Line LeGrand Mechanical Pencil 0.9 mm
IDENT No.	07569	108962
WRITING SYSTEM		
WRITING SYSTEM	Ballpoint Pen with twist mechanism	Mechanical Pencil with twist mechanism
NIB	-	-
FEATURES		
BARREL	Black precious resin	Black precious resin
CAP	Black precious resin inlaid with Montblanc emblem	Black precious resin inlaid with Montblanc emblem
TRIM	Three platinum-plated rings embossed with Montblanc brand name	Three platinum-plated rings embossed with Montblanc brand name
CLIP	Platinum-plated clip with individual serial number	Platinum-plated clip with individual serial number
SPECIAL CHARACTERISTICS	-	-
PACKAGING	-	-
REFILLS		
REFILLS	Montblanc ballpoint pen refills: Mystery Black, Pacific Blue, Nightfire Red, Fortune Green	Montblanc hi-polymer 0.9 mm lead, eraser

WRITING INSTRUMENTS

*MEISTERSTÜCK**> Precious Resin - Platinum-Plated
LeGrand*

MODEL	Platinum Line LeGrand Document Marker
IDENT No.	107100
WRITING SYSTEM	
WRITING SYSTEM	Document Marker
NIB	-
FEATURES	
BARREL	Black precious resin
CAP	Black precious resin inlaid with Montblanc emblem
TRIM	Three platinum-plated rings embossed with Montblanc brand name
CLIP	Platinum-plated clip with individual serial number
SPECIAL CHARACTERISTICS	-
PACKAGING	-
REFILLS	
REFILLS	Montblanc document marker refills: Luminous Yellow, Luminous Green

WRITING INSTRUMENTS

MEISTERSTÜCK

> *Precious Resin - Platinum-Plated Classique*



MODEL		Platinum Line Classique Fountain Pen			
IDENT NO.		106520	106521	106522	106523
NIB WIDTHS		EF	F	M	B
		106524	106525	106526	106527
		BB	OM	OB	OBB
WRITING SYSTEM					
WRITING SYSTEM		Fountain Pen with piston converter (allows optional use of ink cartridges)			
NIB		Hand-crafted Au585 / 14 K gold nib with rhodium-plated inlay			
FEATURES					
BARREL		Black precious resin			
CAP		Black precious resin inlaid with Montblanc emblem			
TRIM		Three platinum-plated rings embossed with Montblanc brand name			
CLIP		Platinum-plated clip with individual serial number			
SPECIAL CHARACTERISTICS		-			
PACKAGING		-			
REFILLS					
REFILLS		Montblanc ink: Mystery Black, Royal Blue, Midnight Blue, Burgundy Red, Lavender Purple, Oyster Grey, Toffee Brown, Irish Green			

WRITING INSTRUMENTS

MEISTERSTÜCK

> *Precious Resin - Platinum-Plated
Classique*



MODEL	Platinum Line Classique Rollerball	Platinum Line Classique Ballpoint Pen	Platinum Line Classique Mechanical Pencil
IDENT No.	02865	02866	02868 02867
LEAD SIZE			0.7 mm 0.5 mm
WRITING SYSTEM			
WRITING SYSTEM	Rollerball	Ballpoint Pen with twist mechanism	Mechanical Pencil with twist mechanism
NIB	-	-	-
FEATURES			
BARREL	Black precious resin	Black precious resin	Black precious resin
CAP	Black precious resin inlaid with Montblanc emblem	Black precious resin inlaid with Montblanc emblem	Black precious resin inlaid with Montblanc emblem
TRIM	Three platinum-plated rings embossed with Montblanc brand name	Three platinum-plated rings embossed with Montblanc brand name	Three platinum-plated rings embossed with Montblanc brand name
CLIP	Platinum-plated clip with individual serial number	Platinum-plated clip with individual serial number	Platinum-plated clip with individual serial number
SPECIAL CHARACTERISTICS	-	-	-
PACKAGING	-	-	-
REFILLS			
REFILLS	Montblanc rollerball refills: Mystery Black, Pacific Blue, Nightfire Red, Fortune Green, Chestnut Brown, Amethyst Purple, Barbados Blue; Montblanc fineliner refills: Mystery Black, Pacific Blue	Montblanc ballpoint pen refills: Mystery Black, Pacific Blue, Nightfire Red, Fortune Green	Montblanc hi-polymer 0.7 mm or 0.5 mm lead, eraser

WRITING INSTRUMENTS

MEISTERSTÜCK

> *Precious Resin - Platinum-Plated
Hommage à W.A. Mozart*



MODEL	Platinum Line Hommage à W.A. Mozart Fountain Pen			
IDENT NO.	108742	107705	107706	107707
NIB WIDTHS	EF	F	M	B
	107708			
	OB			
	Other nib widths available on request			
WRITING SYSTEM				
WRITING SYSTEM	Cartridge Fountain Pen (no converter)			
NIB	Hand-crafted Au585 / 14 K gold nib rhodium-plated			
FEATURES				
BARREL	Black precious resin			
CAP	Black precious resin inlaid with Montblanc emblem			
TRIM	Three platinum-plated rings embossed with Montblanc brand name			
CLIP	Platinum-plated clip with individual serial number			
SPECIAL CHARACTERISTICS	-			
PACKAGING	-			
REFILLS				
REFILLS	Montblanc ink cartridges: Mystery Black, Royal Blue, Midnight Blue, Burgundy Red, Lavender Purple, Oyster Grey, Toffee Brown, Irish Green			

WRITING INSTRUMENTS

MEISTERSTÜCK

> *Precious Resin - Platinum-Plated
Hommage à W.A. Mozart*



MODEL	Platinum Line Hommage à W.A. Mozart Ballpoint Pen	Platinum Line Hommage à W.A. Mozart Mechanical Pencil 0.7 mm
IDENT No.	108749	108750
WRITING SYSTEM		
WRITING SYSTEM	Ballpoint Pen with twist mechanism	Mechanical Pencil with twist mechanism
NIB	-	-
FEATURES		
BARREL	Black precious resin	Black precious resin
CAP	Black precious resin inlaid with Montblanc emblem	Black precious resin inlaid with Montblanc emblem
TRIM	Three platinum-plated rings embossed with Montblanc brand name	Three platinum-plated rings embossed with Montblanc brand name
CLIP	Platinum-plated clip with individual serial number	Platinum-plated clip with individual serial number
SPECIAL CHARACTERISTICS	-	-
PACKAGING	-	-
REFILLS		
REFILLS	Montblanc Meisterstück "Hommage à W.A. Mozart" small ballpoint pen refills: Mystery Black, Pacific Blue	Montblanc hi-polymer 0.7 mm lead, eraser

WRITING INSTRUMENTS

MEISTERSTÜCK

> *Precious Resin - Platinum-Plated
Leonardo Sketch Pen*



MODEL	Platinum Line Leonardo Sketch Pen Mechanical Pencil
IDENT No.	108963
WRITING SYSTEM	
WRITING SYSTEM	Sketch Pen
NIB	-
FEATURES	
BARREL	Black precious resin inlaid with Montblanc emblem
CAP	-
TRIM	Three platinum-plated rings embossed with Montblanc brand name
CLIP	-
SPECIAL CHARACTERISTICS	Integrated pencil sharpener
PACKAGING	Includes special leather pouch and soft 4B lead as additional refill
REFILLS	
REFILLS	Montblanc hi-polymer 5,5 mm leads: soft 4B lead and hard HB lead; Artists' leads 5,5 mm - 5,7 mm possible

WRITING INSTRUMENTS

MEISTERSTÜCK

> Montblanc Diamond LeGrand



MODEL	Montblanc Diamond LeGrand Fountain Pen
IDENT NO.	105973 105974
NIB WIDTHS	F M
	Other nib widths available on request
WRITING SYSTEM	
WRITING SYSTEM	Piston Fountain Pen
NIB	Hand-crafted Au585 / 14 K gold nib with rhodium-plated inlay
FEATURES	
BARREL	Black precious resin
CAP	Black precious resin
TRIM	Three platinum-plated rings embossed with Montblanc brand name
CLIP	Platinum-plated clip with individual serial number
SPECIAL CHARACTERISTICS	Montblanc Diamond in cap-top (~0.05 ct)
PACKAGING	Squarish black gift box with imprint
REFILLS	
REFILLS	Montblanc ink: Mystery Black, Royal Blue, Midnight Blue, Burgundy Red, Lavender Purple, Oyster Grey, Toffee Brown, Irish Green

WRITING INSTRUMENTS

MEISTERSTÜCK
 > *Montblanc Diamond*
LeGrand



MODEL	Montblanc Diamond LeGrand Rollerball
IDENT NO.	106126
WRITING SYSTEM	
WRITING SYSTEM	Rollerball
NIB	-
FEATURES	
BARREL	Black precious resin
CAP	Black precious resin
TRIM	Three platinum-plated rings embossed with Montblanc brand name
CLIP	Platinum-plated clip with individual serial number
SPECIAL CHARACTERISTICS	Montblanc Diamond in cap-top (~0.05 ct)
PACKAGING	Squarish black gift box with imprint
REFILLS	
REFILLS	Montblanc LeGrand rollerball refills: Mystery Black, Pacific Blue

WRITING INSTRUMENTS

MEISTERSTÜCK
 > *Montblanc Diamond*
LeGrand



MODEL	Montblanc Diamond LeGrand Ballpoint Pen
IDENT NO.	106125
WRITING SYSTEM	
WRITING SYSTEM	Ballpoint Pen with twist mechanism
NIB	-
FEATURES	
BARREL	Black precious resin
CAP	Black precious resin
TRIM	Three platinum-plated rings embossed with Montblanc brand name
CLIP	Platinum-plated clip with individual serial number
SPECIAL CHARACTERISTICS	Montblanc Diamond in cap-top (~0.05 ct)
PACKAGING	Squarish black gift box with imprint
REFILLS	
REFILLS	Montblanc ballpoint pen refills: Mystery Black, Pacific Blue, Nightfire Red, Fortune Green

WRITING INSTRUMENTS

MEISTERSTÜCK

> Montblanc Diamond Classique



MODEL	Montblanc Diamond Classique Fountain Pen
IDENT NO.	105977 105978
NIB WIDTHS	F M
	Other nib widths available on request
WRITING SYSTEM	
WRITING SYSTEM	Fountain Pen with piston converter (allows optional use of ink cartridges)
NIB	Hand-crafted Au585 / 14 K gold nib with rhodium-plated inlay
FEATURES	
BARREL	Black precious resin
CAP	Black precious resin
TRIM	Three platinum-plated rings embossed with Montblanc brand name
CLIP	Platinum-plated clip with individual serial number
SPECIAL CHARACTERISTICS	Montblanc Diamond in cap-top (~0.05 ct)
PACKAGING	Squarish black gift box with imprint
REFILLS	
REFILLS	Montblanc ink: Mystery Black, Royal Blue, Midnight Blue, Burgundy Red, Lavender Purple, Oyster Grey, Toffee Brown, Irish Green

WRITING INSTRUMENTS

MEISTERSTÜCK

> Montblanc Diamond Classique



MODEL	Montblanc Diamond Classique Rollerball	Montblanc Diamond Classique Ballpoint Pen
IDENT No.	105982	105980
WRITING SYSTEM		
WRITING SYSTEM	Rollerball	Ballpoint Pen with twist mechanism
NIB	-	-
FEATURES		
BARREL	Black precious resin	Black precious resin
CAP	Black precious resin	Black precious resin
TRIM	Three platinum-plated rings embossed with Montblanc brand name	Three platinum-plated rings embossed with Montblanc brand name
CLIP	Platinum-plated clip with individual serial number	Platinum-plated clip with individual serial number
SPECIAL CHARACTERISTICS	Montblanc Diamond in cap-top (~0.03 ct)	Montblanc Diamond in cap-top (~0.03 ct)
PACKAGING	Squarish black gift box with imprint	Squarish black gift box with imprint
REFILLS		
REFILLS	Montblanc rollerball refills: Mystery Black, Pacific Blue, Nightfire Red, Fortune Green, Chestnut Brown, Amethyst Purple, Barbados Blue; Montblanc fineliner refills: Mystery Black, Pacific Blue	Montblanc ballpoint pen refills: Mystery Black, Pacific Blue, Nightfire Red, Fortune Green

WRITING INSTRUMENTS

MEISTERSTÜCK

> Montblanc Diamond Hommage à W.A. Mozart



MODEL	Montblanc Diamond Hommage à W.A. Mozart Fountain Pen		
IDENT No.	108726	107575	107545
NIB WIDTHS	EF	F	M
	Other nib widths available on request		
WRITING SYSTEM	Cartridge Fountain Pen (no converter)		
WRITING SYSTEM	Cartridge Fountain Pen (no converter)		
NIB	Hand-crafted Au585 / 14 K gold nib rhodium-plated		
FEATURES	Black precious resin		
BARREL	Black precious resin		
CAP	Black precious resin		
TRIM	Three platinum-plated rings embossed with Montblanc brand name		
CLIP	Platinum-plated clip with individual serial number		
SPECIAL CHARACTERISTICS	Montblanc Diamond in cap-top (~0.03 ct)		
PACKAGING	Squarish black gift box with imprint		
REFILLS	Montblanc ink cartridges: Mystery Black, Royal Blue, Midnight Blue, Burgundy Red, Lavender Purple, Oyster Grey, Toffee Brown, Irish Green		
REFILLS	Montblanc ink cartridges: Mystery Black, Royal Blue, Midnight Blue, Burgundy Red, Lavender Purple, Oyster Grey, Toffee Brown, Irish Green		

WRITING INSTRUMENTS

MEISTERSTÜCK

> Montblanc Diamond Hommage à W.A. Mozart



MODEL	Montblanc Diamond Hommage à W.A. Mozart Rollerball	Montblanc Diamond Hommage à W.A. Mozart Ballpoint Pen
IDENT No.	107547	107546
WRITING SYSTEM		
WRITING SYSTEM	Rollerball	Ballpoint Pen with twist mechanism
NIB	-	-
FEATURES		
BARREL	Black precious resin	Black precious resin
CAP	Black precious resin	Black precious resin
TRIM	Three platinum-plated rings embossed with Montblanc brand name	Three platinum-plated rings embossed with Montblanc brand name
CLIP	Platinum-plated clip with individual serial number	Platinum-plated clip with individual serial number
SPECIAL CHARACTERISTICS	Montblanc Diamond in cap-top (~0.03 ct)	Montblanc Diamond in cap-top (~0.03 ct)
PACKAGING	Squarish black gift box with imprint	Squarish black gift box with imprint
REFILLS		
REFILLS	Montblanc Meisterstück "Hommage à W.A. Mozart" small rollerball refills: Mystery Black, Pacific Blue	Montblanc Meisterstück "Hommage à W.A. Mozart" small ballpoint pen refills: Mystery Black, Pacific Blue

WRITING INSTRUMENTS

MEISTERSTÜCK

> Signature for Good LeGrand



MODEL	Signature for Good LeGrand Fountain Pen	
IDENT NO.	109347	109348
NIB WIDTHS	F	M
	Other nib widths available on request	
WRITING SYSTEM		
WRITING SYSTEM	Piston Fountain Pen	
NIB	Hand-crafted Au585 / 14 K gold nib with rhodium-plated inlay	
FEATURES		
BARREL	Black precious resin	
CAP	Black precious resin inlaid with Montblanc emblem	
TRIM	Three platinum-plated rings embossed with Montblanc brand name	
CLIP	Platinum-plated clip with individual serial number	
SPECIAL CHARACTERISTICS	Platinum-plated cap-top ring featuring a symbolic brick motif, an individual number and a blue sapphire (~0.02 ct)	
PACKAGING	Black squarish gift box with embossed "Signature for Good" writing	
REFILLS		
REFILLS	Montblanc ink: Mystery Black, Royal Blue, Midnight Blue, Burgundy Red, Lavender Purple, Oyster Grey, Toffee Brown, Irish Green	

WRITING INSTRUMENTS

MEISTERSTÜCK

> Signature for Good LeGrand



MODEL	Signature for Good LeGrand Rollerball	Signature for Good LeGrand Ballpoint Pen
IDENT No.	109350	109351
WRITING SYSTEM		
WRITING SYSTEM	Rollerball	Ballpoint Pen with twist mechanism
NIB	-	-
FEATURES		
BARREL	Black precious resin	Black precious resin
CAP	Black precious resin inlaid with Montblanc emblem	Black precious resin inlaid with Montblanc emblem
TRIM	Three platinum-plated rings embossed with Montblanc brand name	Three platinum-plated rings embossed with Montblanc brand name
CLIP	Platinum-plated clip with individual serial number	Platinum-plated clip with individual serial number
SPECIAL CHARACTERISTICS	Platinum-plated cap-top ring featuring a symbolic brick motif, an individual number and a blue sapphire (~0.02 ct)	Platinum-plated cap-top ring featuring a symbolic brick motif, an individual number and a blue sapphire (~0.02 ct)
PACKAGING	Black squarish gift box with embossed "Signature for Good" writing	Black squarish gift box with embossed "Signature for Good" writing
REFILLS		
REFILLS	Montblanc LeGrand rollerball refills: Mystery Black, Pacific Blue	Montblanc ballpoint pen refills: Mystery Black, Pacific Blue, Nightfire Red, Fortune Green

WRITING INSTRUMENTS

MEISTERSTÜCK

> Signature for Good Classique



MODEL	Signature for Good Classique Fountain Pen	
IDENT NO.	109352	109353
NIB WIDTHS	F	M
	Other nib widths available on request	
WRITING SYSTEM		
WRITING SYSTEM	Fountain Pen with piston converter (allows optional use of ink cartridges)	
NIB	Hand-crafted Au585 / 14 K gold nib with rhodium-plated inlay	
FEATURES		
BARREL	Black precious resin	
CAP	Black precious resin inlaid with Montblanc emblem	
TRIM	Three platinum-plated rings embossed with Montblanc brand name	
CLIP	Platinum-plated clip with individual serial number	
SPECIAL CHARACTERISTICS	Platinum-plated cap-top ring featuring a symbolic brick motif, an individual number and a blue sapphire (~0.01 ct)	
PACKAGING	Black squarish gift box with embossed "Signature for Good" writing	
REFILLS		
REFILLS	Montblanc ink: Mystery Black, Royal Blue, Midnight Blue, Burgundy Red, Lavender Purple, Oyster Grey, Toffee Brown, Irish Green	

WRITING INSTRUMENTS

MEISTERSTÜCK

> Signature for Good Classique



MODEL	Signature for Good Classique Rollerball	Signature for Good Classique Ballpoint Pen
IDENT No.	109354	109355
WRITING SYSTEM		
WRITING SYSTEM	Rollerball	Ballpoint Pen with twist mechanism
NIB	-	-
FEATURES		
BARREL	Black precious resin	Black precious resin
CAP	Black precious resin inlaid with Montblanc emblem	Black precious resin inlaid with Montblanc emblem
TRIM	Three platinum-plated rings embossed with Montblanc brand name	Three platinum-plated rings embossed with Montblanc brand name
CLIP	Platinum-plated clip with individual serial number	Platinum-plated clip with individual serial number
SPECIAL CHARACTERISTICS	Platinum-plated cap-top ring featuring a symbolic brick motif, an individual number and a blue sapphire (~0.01 ct)	Platinum-plated cap-top ring featuring a symbolic brick motif, an individual number and a blue sapphire (~0.01 ct)
PACKAGING	Black squarish gift box with embossed "Signature for Good" writing	Black squarish gift box with embossed "Signature for Good" writing
REFILLS		
REFILLS	Montblanc rollerball refills: Mystery Black, Pacific Blue, Nightfire Red, Fortune Green, Chestnut Brown, Amethyst Purple, Barbados Blue; Montblanc fineliner refills: Mystery Black, Pacific Blue	Montblanc ballpoint pen refills: Mystery Black, Pacific Blue, Nightfire Red, Fortune Green



WRITING INSTRUMENTS





Meisterstück Solitaire

Meisterstück Solitaire – a writing instrument that appeals to customers who appreciate craftsmanship, sophistication and enduring values as well as a touch of surprising innovation, differentiation and uniqueness.



WRITING INSTRUMENTS

MEISTERSTÜCK SOLITAIRE

> Metal



Royal

p. 47



Doué Royal Hommage à W.A. Mozart

p. 49



Platinum

p. 50



Rose Gold Barley

p. 52



Jewellery Edition

p. 53



Jewellery Collection

p. 54



Royal Steel

p. 56



Silver Barley

p. 58



Geometric Dimension

p. 59





MEISTERSTÜCK SOLITAIRE

> Metal



Ceramics Black Prisma

p. 60



Platinum-Plated Facet

p. 62



Tribute to the Mont Blanc

p. 64



Tribute to the Mont Blanc

p. 66



Sterling Silver

p. 68



Jewellery Collection

p. 70



Carbon & Steel

p. 72





WRITING INSTRUMENTS

MEISTERSTÜCK

> *Doué*



Black and White

p. 74



Silver Barley

p. 76



Geometric Dimension

p. 78



Signum

p. 80



Stainless Steel

p. 82



WRITING INSTRUMENTS

MEISTERSTÜCK SOLITAIRE

> Metal
Royal

MODEL	Royal LeGrand Fountain Pen
IDENT NO.	18058 M Other nib widths available on request
WRITING SYSTEM	
WRITING SYSTEM	Piston Fountain Pen
NIB	Hand-crafted Au750 / 18 K gold nib with rhodium-plated inlay
FEATURES	
BARREL	Au750 yellow gold
CAP	Au750 yellow gold
TRIM	Three rings in Au750 yellow gold embossed with Montblanc brand name
CLIP	Au750 yellow gold with individual serial number
SPECIAL CHARACTERISTICS	Montblanc emblem made of 7 diamonds. Barrel and cap set with over 4.600 brilliant-cut diamonds, on request.
PACKAGING	Montblanc lacquered wooden box
REFILLS	
REFILLS	Montblanc ink: Mystery Black, Royal Blue, Midnight Blue, Burgundy Red, Lavender Purple, Oyster Grey, Toffee Brown, Irish Green

WRITING INSTRUMENTS

*MEISTERSTÜCK SOLITAIRE**> Metal
Royal*

MODEL	Royal Classique Ballpoint Pen
IDENT No.	03991
WRITING SYSTEM	
WRITING SYSTEM	Ballpoint Pen with twist mechanism
NIB	-
FEATURES	
BARREL	Au750 yellow gold
CAP	Au750 yellow gold
TRIM	Three rings in Au750 yellow gold embossed with Montblanc brand name
CLIP	Au750 yellow gold with individual serial number
SPECIAL CHARACTERISTICS	Montblanc emblem made of 7 diamonds. Barrel and cap set with over 3,000 brilliant-cut diamonds, on request.
PACKAGING	Montblanc lacquered wooden box
REFILLS	
REFILLS	Montblanc ballpoint pen refills: Mystery Black, Pacific Blue, Nightfire Red, Fortune Green

WRITING INSTRUMENTS

MEISTERSTÜCK SOLITAIRE

> Metal

Doué Royal Hommage à W.A. Mozart

MODEL	Doué Royal Hommage à W. A. Mozart Fountain Pen	Doué Royal Hommage à W. A. Mozart Ballpoint Pen
IDENT No.	03992 M Other nib widths available on request	03993
WRITING SYSTEM		
WRITING SYSTEM	Cartridge Fountain Pen (no converter)	Ballpoint Pen with twist mechanism
NIB	Hand-crafted Au750 / 18 K gold nib	-
FEATURES		
BARREL	Au750 yellow gold	Au750 yellow gold
CAP	Au750 yellow gold set with over 1,200 diamonds	Au750 yellow gold set with over 1,000 diamonds
TRIM	Three rings in Au750 yellow gold embossed with Montblanc brand name	Three rings in Au750 yellow gold embossed with Montblanc brand name
CLIP	Au750 yellow gold with individual serial number	Au750 yellow gold with individual serial number
SPECIAL CHARACTERISTICS	Montblanc emblem made of 7 diamonds, on request	Montblanc emblem made of 7 diamonds, on request
PACKAGING	Montblanc lacquered wooden box	Montblanc lacquered wooden box
REFILLS		
REFILLS	Montblanc ink cartridges: Mystery Black, Royal Blue, Midnight Blue, Burgundy Red, Lavender Purple, Oyster Grey, Toffee Brown, Irish Green	Montblanc Meisterstück "Hommage à W.A. Mozart" small ballpoint pen refills: Mystery Black, Pacific Blue

WRITING INSTRUMENTS

MEISTERSTÜCK SOLITAIRE

> Metal
Platinum

MODEL	Platinum LeGrand Fountain Pen	Platinum Classique Fountain Pen
IDENT No.	18010	18018
	M	M
	Other nib widths available on request	Other nib widths available on request
WRITING SYSTEM		
WRITING SYSTEM	Piston Fountain Pen	Fountain Pen with piston converter (allows optional use of ink cartridges)
NIB	Hand-crafted Au750 / 18 K gold nib with rhodium-plated inlay	Hand-crafted Au750 / 18 K gold nib with rhodium-plated inlay
FEATURES		
BARREL	Pt950 platinum	Pt950 platinum
CAP	Pt950 platinum inlaid with mother-of-pearl Montblanc emblem	Pt950 platinum inlaid with mother-of-pearl Montblanc emblem
TRIM	Three rings in Au750 yellow gold embossed with Montblanc brand name	Three rings in Au750 yellow gold embossed with Montblanc brand name
CLIP	Au750 yellow gold with individual serial number	Au750 yellow gold with individual serial number
SPECIAL CHARACTERISTICS	-	-
PACKAGING	Montblanc lacquered wooden box	Montblanc lacquered wooden box
REFILLS		
REFILLS	Montblanc ink: Mystery Black, Royal Blue, Midnight Blue, Burgundy Red, Lavender Purple, Oyster Grey, Toffee Brown, Irish Green	Montblanc ink: Mystery Black, Royal Blue, Midnight Blue, Burgundy Red, Lavender Purple, Oyster Grey, Toffee Brown, Irish Green

WRITING INSTRUMENTS

MEISTERSTÜCK SOLITAIRE

> Metal
Platinum

MODEL	Platinum Classique Rollerball	Platinum Classique Ballpoint Pen	Platinum Classique Mechanical Pencil
IDENT NO.	18024	18025	18027
WRITING SYSTEM			
WRITING SYSTEM	Rollerball	Ballpoint Pen with twist mechanism	Mechanical Pencil with twist mechanism
NIB	-	-	-
FEATURES			
BARREL	Pt950 platinum	Pt950 platinum	Pt950 platinum
CAP	Pt950 platinum inlaid with mother-of-pearl Montblanc emblem	Pt950 platinum inlaid with mother-of-pearl Montblanc emblem	Pt950 platinum inlaid with mother-of-pearl Montblanc emblem
TRIM	Three rings in Au750 yellow gold embossed with Montblanc brand name	Three rings in Au750 yellow gold embossed with Montblanc brand name	Three rings in Au750 yellow gold embossed with Montblanc brand name
CLIP	Au750 yellow gold with individual serial number	Au750 yellow gold with individual serial number	Au750 yellow gold with individual serial number
SPECIAL CHARACTERISTICS	-	-	-
PACKAGING	Montblanc lacquered wooden box	Montblanc lacquered wooden box	Montblanc lacquered wooden box
REFILLS			
REFILLS	Montblanc rollerball refills: Mystery Black, Pacific Blue, Nightfire Red, Fortune Green, Chestnut Brown, Amethyst Purple, Barbados Blue; Montblanc fineliner refills: Mystery Black, Pacific Blue	Montblanc ballpoint pen refills: Mystery Black, Pacific Blue, Nightfire Red, Fortune Green	Montblanc hi-polymer 0.7 mm lead, eraser

WRITING INSTRUMENTS

MEISTERSTÜCK SOLITAIRE

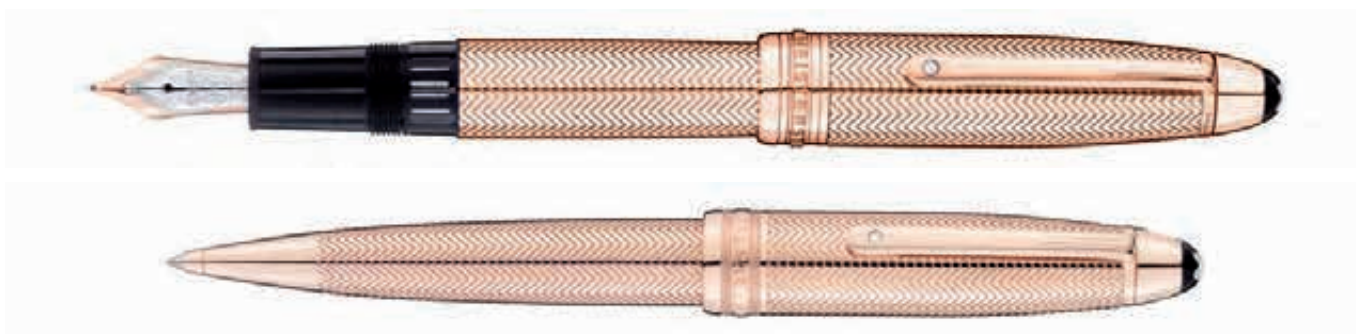
> Metal
Rose Gold Barley

MODEL	Rose Gold Barley LeGrand Fountain Pen	Rose Gold Barley LeGrand Ballpoint Pen
IDENT No.	108724	108725
	M	M
	Other nib widths available on request	Other nib widths available on request
WRITING SYSTEM		
WRITING SYSTEM	Piston Fountain Pen	Ballpoint Pen with twist mechanism
NIB	Hand-crafted Au750 / 18 K gold nib with rhodium-plated inlay	-
FEATURES		
BARREL	Au750 rose gold with barley guilloché pattern	Au750 rose gold with barley guilloché pattern
CAP	Au750 rose gold with barley guilloché pattern inlaid with mother-of-pearl Montblanc emblem	Au750 rose gold with barley guilloché pattern inlaid with mother-of-pearl Montblanc emblem
TRIM	Three rings in Au750 rose gold embossed with Montblanc brand name	Three rings in Au750 rose gold embossed with Montblanc brand name
CLIP	Au750 rose gold clip with individual serial number and set with a diamond	Au750 rose gold clip with individual serial number and set with a diamond
SPECIAL CHARACTERISTICS	-	-
PACKAGING	Montblanc lacquered wooden box	Montblanc lacquered wooden box
REFILLS		
REFILLS	Montblanc ink: Mystery Black, Royal Blue, Midnight Blue, Burgundy Red, Lavender Purple, Oyster Grey, Toffee Brown, Irish Green	Montblanc ballpoint pen refills: Mystery Black, Pacific Blue, Nightfire Red, Fortune Green

WRITING INSTRUMENTS

MEISTERSTÜCK SOLITAIRE

> Metal
Jewellery Edition

MODEL	Jewellery Edition LeGrand Fountain Pen
IDENT No.	106940 M Other nib widths available on request
WRITING SYSTEM	
WRITING SYSTEM	Piston Fountain Pen
NIB	Hand-crafted Au750 / 18 K gold nib rhodium-plated
FEATURES	
BARREL	Elegant guilloché engraving coated with black lacquer
CAP	Elegant guilloché engraving coated with black lacquer
TRIM	Three rings in Au750 white gold embossed with Montblanc brand name
CLIP	Platinum-plated
SPECIAL CHARACTERISTICS	Montblanc Diamond in cap-top (~0.5 ct)
PACKAGING	Montblanc lacquered wooden box
REFILLS	
REFILLS	Montblanc ink: Mystery Black, Royal Blue, Midnight Blue, Burgundy Red, Lavender Purple, Oyster Grey, Toffee Brown, Irish Green

WRITING INSTRUMENTS

MEISTERSTÜCK SOLITAIRE

> Metal
Jewellery Collection

MODEL	Jewellery Collection Gold Hommage à W.A. Mozart Fountain Pen
IDENT No.	107556 M Other nib widths available on request
WRITING SYSTEM	
WRITING SYSTEM	Cartridge Fountain Pen (no converter)
NIB	Hand-crafted Au750 / 18 K gold nib
FEATURES	
BARREL	Au750 champagne-tone gold with an elegant matelassé pattern, set with diamonds
CAP	Au750 champagne-tone gold with an elegant matelassé pattern, set with diamonds
TRIM	Three rings in Au750 champagne-tone gold embossed with Montblanc brand name
CLIP	Au750 champagne-tone gold set with a diamond (~0.25 ct)
SPECIAL CHARACTERISTICS	Montblanc Diamond in cap-top (~0.3 ct)
PACKAGING	Special Packaging
REFILLS	
REFILLS	Montblanc ink cartridges: Mystery Black, Royal Blue, Midnight Blue, Burgundy Red, Lavender Purple, Oyster Grey, Toffee Brown, Irish Green

WRITING INSTRUMENTS

MEISTERSTÜCK SOLITAIRE

> Metal
Jewellery Collection

MODEL	Jewellery Collection Rosé Hommage à W.A. Mozart Fountain Pen
IDENT No.	107555 M Other nib widths available on request
WRITING SYSTEM	
WRITING SYSTEM	Cartridge Fountain Pen (no converter)
NIB	Hand-crafted Au750 / 18 K gold nib
FEATURES	
BARREL	Finely engraved with an elegant Montblanc star pattern and varnished with a mother-of-pearl coloured lacquer
CAP	Finely engraved with an elegant Montblanc star pattern and varnished with a mother-of-pearl coloured lacquer
TRIM	Three rings in Au750 red gold embossed with Montblanc brand name
CLIP	Au750 red gold set with a drop-cut pink sapphire (~0.13 ct)
SPECIAL CHARACTERISTICS	Fittings, forepart and cone made of Au750 red gold. Montblanc emblem made of mother-of-pearl
PACKAGING	Special Packaging
REFILLS	
REFILLS	Montblanc ink cartridges: Mystery Black, Royal Blue, Midnight Blue, Burgundy Red, Lavender Purple, Oyster Grey, Toffee Brown, Irish Green

WRITING INSTRUMENTS

MEISTERSTÜCK SOLITAIRE

> Metal
Royal Steel

MODEL	Royal Steel LeGrand Fountain Pen
IDENT NO.	o6116 M Other nib widths available on request
WRITING SYSTEM	
WRITING SYSTEM	Piston Fountain Pen
NIB	Hand-crafted Au750 / 18 K gold nib with rhodium-plated inlay
FEATURES	
BARREL	High-grade stainless steel
CAP	High-grade stainless steel inlaid with mother-of-pearl Montblanc emblem
TRIM	Three rings in high-grade stainless steel and Au750 white gold embossed with Montblanc brand name
CLIP	Platinum-plated clip with individual serial number
SPECIAL CHARACTERISTICS	Cap rings set with 36 diamonds each, clip ring rhodium-plated and set with 22 diamonds (~0.9 ct)
PACKAGING	Montblanc lacquered wooden box
REFILLS	
REFILLS	Montblanc ink: Mystery Black, Royal Blue, Midnight Blue, Burgundy Red, Lavender Purple, Oyster Grey, Toffee Brown, Irish Green

WRITING INSTRUMENTS

MEISTERSTÜCK SOLITAIRE

> Metal

Royal Steel



MODEL	Royal Steel Classique Ballpoint Pen
IDENT NO.	o6118
WRITING SYSTEM	
WRITING SYSTEM	Ballpoint Pen with twist mechanism
NIB	-
FEATURES	
BARREL	High-grade stainless steel
CAP	High-grade stainless steel inlaid with mother-of-pearl Montblanc emblem
TRIM	Three rings in high-grade stainless steel and Au750 white gold embossed with Montblanc brand name
CLIP	Platinum-plated clip with individual serial number
SPECIAL CHARACTERISTICS	Cap rings set with 36 diamonds each, clip ring rhodium-plated and set with 22 diamonds (~0.9 ct)
PACKAGING	Montblanc lacquered wooden box
REFILLS	
REFILLS	Montblanc ballpoint pen refills: Mystery Black, Pacific Blue, Nightfire Red, Fortune Green

WRITING INSTRUMENTS

MEISTERSTÜCK SOLITAIRE

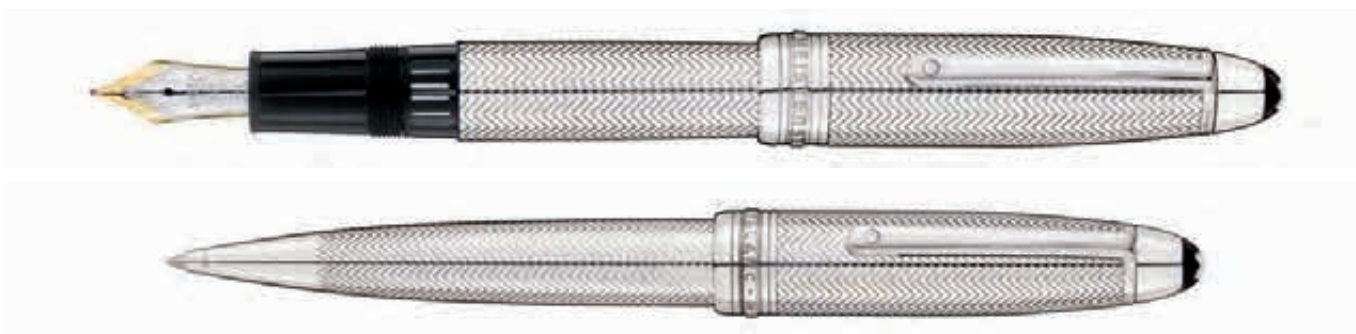
> Metal
Silver Barley

MODEL	Silver Barley LeGrand Fountain Pen	Silver Barley LeGrand Ballpoint Pen
IDENT NO.	104556	104554
NIB WIDTHS	F M	104555
	Other nib widths available on request	
WRITING SYSTEM		
WRITING SYSTEM	Piston Fountain Pen	Ballpoint Pen with twist mechanism
NIB	Hand-crafted Au750 / 18 K gold nib with rhodium-plated inlay	-
FEATURES		
BARREL	Ag925 sterling silver with barley guilloché pattern	Ag925 sterling silver with barley guilloché pattern
CAP	Ag925 sterling silver with barley guilloché pattern inlaid with mother-of-pearl Montblanc emblem	Ag925 sterling silver with barley guilloché pattern inlaid with mother-of-pearl Montblanc emblem
TRIM	Three rings in Ag925 sterling silver embossed with Montblanc brand name	Three rings in Ag925 sterling silver embossed with Montblanc brand name
CLIP	Platinum-plated clip with individual serial number and set with a diamond	Platinum-plated clip with individual serial number and set with a diamond
SPECIAL CHARACTERISTICS	-	-
PACKAGING	-	-
REFILLS		
REFILLS	Montblanc ink: Mystery Black, Royal Blue, Midnight Blue, Burgundy Red, Lavender Purple, Oyster Grey, Toffee Brown, Irish Green	Montblanc ballpoint pen refills: Mystery Black, Pacific Blue, Nightfire Red, Fortune Green

WRITING INSTRUMENTS

MEISTERSTÜCK SOLITAIRE

> Metal

Geometric Dimension



MODEL	Geometric Dimension LeGrand Fountain Pen	Geometric Dimension LeGrand Ballpoint Pen
IDENT No.	105989	105990
NIB WIDTHS	F M	106442
	Other nib widths available on request	
WRITING SYSTEM		
WRITING SYSTEM	Piston Fountain Pen	Ballpoint Pen with twist mechanism
NIB	Hand-crafted Au750 / 18 K gold nib	-
FEATURES		
BARREL	Champagne-tone gold-plated with three dimensional geometric pattern	Champagne-tone gold-plated with three dimensional geometric pattern
CAP	Champagne-tone gold-plated with three-dimensional geometric pattern, inlaid with mother-of-pearl Montblanc emblem	Champagne-tone gold-plated with three-dimensional geometric pattern, inlaid with mother-of-pearl Montblanc emblem
TRIM	Three champagne-tone gold-plated rings embossed with Montblanc brand name	Three champagne-tone gold-plated rings embossed with Montblanc brand name
CLIP	Champagne-tone gold-plated clip with individual serial number	Champagne-tone gold-plated clip with individual serial number
SPECIAL CHARACTERISTICS	-	New mode size
PACKAGING	-	-
REFILLS		
REFILLS	Montblanc ink: Mystery Black, Royal Blue, Midnight Blue, Burgundy Red, Lavender Purple, Oyster Grey, Toffee Brown, Irish Green	Montblanc ballpoint pen refills: Mystery Black, Pacific Blue, Nightfire Red, Fortune Green

WRITING INSTRUMENTS

MEISTERSTÜCK SOLITAIRE

> Metal

Ceramics Black Prisma



MODEL	Ceramics Black Prisma LeGrand Fountain Pen	Ceramics Black Prisma Classique Fountain Pen
IDENT No.	103098 103099 103100 103101	103103 103106 103105
NIB WIDTHS	EF F M B	F M B
	Other nib widths available on request	Other nib widths available on request
WRITING SYSTEM		
WRITING SYSTEM	Piston Fountain Pen	Fountain Pen with piston converter (allows optional use of ink cartridges)
NIB	Hand-crafted Au750 / 18 K gold nib with rhodium-plated inlay	Hand-crafted Au750 / 18 K gold nib with rhodium-plated inlay
FEATURES		
BARREL	Brass, platinum-plated	Brass, platinum-plated
CAP	Ceramic with tactile square pattern inlaid with Montblanc emblem	Ceramic with tactile square pattern inlaid with Montblanc emblem
TRIM	Three platinum-plated rings embossed with Montblanc brand name	Three platinum-plated rings embossed with Montblanc brand name
CLIP	Platinum-plated clip with individual serial number	Platinum-plated clip with individual serial number
SPECIAL CHARACTERISTICS	-	-
PACKAGING	-	-
REFILLS		
REFILLS	Montblanc ink: Mystery Black, Royal Blue, Midnight Blue, Burgundy Red, Lavender Purple, Oyster Grey, Toffee Brown, Irish Green	Montblanc ink: Mystery Black, Royal Blue, Midnight Blue, Burgundy Red, Lavender Purple, Oyster Grey, Toffee Brown, Irish Green

WRITING INSTRUMENTS

MEISTERSTÜCK SOLITAIRE

> Metal

Ceramics Black Prisma

MODEL	Ceramics Black Prisma Classique Rollerball	Ceramics Black Prisma Classique Ballpoint Pen	Ceramics Black Prisma Classique Mechanical Pencil 0.7 mm
IDENT No.	103107	103109	103110
WRITING SYSTEM			
WRITING SYSTEM	Rollerball	Ballpoint Pen with twist mechanism	Mechanical Pencil with twist mechanism
NIB	-	-	-
FEATURES			
BARREL	Brass, platinum-plated	Brass, platinum-plated	Brass, platinum-plated
CAP	Ceramic with tactile square pattern inlaid with Montblanc emblem	Ceramic with tactile square pattern inlaid with Montblanc emblem	Ceramic with tactile square pattern inlaid with Montblanc emblem
TRIM	Three platinum-plated rings embossed with Montblanc brand name	Three platinum-plated rings embossed with Montblanc brand name	Three platinum-plated rings embossed with Montblanc brand name
CLIP	Platinum-plated clip with individual serial number	Platinum-plated clip with individual serial number	Platinum-plated clip with individual serial number
SPECIAL CHARACTERISTICS	-	-	-
PACKAGING	-	-	-
REFILLS			
REFILLS	Montblanc rollerball refills: Mystery Black, Pacific Blue, Nightfire Red, Fortune Green, Chestnut Brown, Amethyst Purple, Barbados Blue; Montblanc fineliner refills: Mystery Black, Pacific Blue	Montblanc ballpoint pen refills: Mystery Black, Pacific Blue, Nightfire Red, Fortune Green	Montblanc hi-polymer 0.7 mm lead, eraser

WRITING INSTRUMENTS

MEISTERSTÜCK SOLITAIRE

> Metal

Platinum-Plated Facet

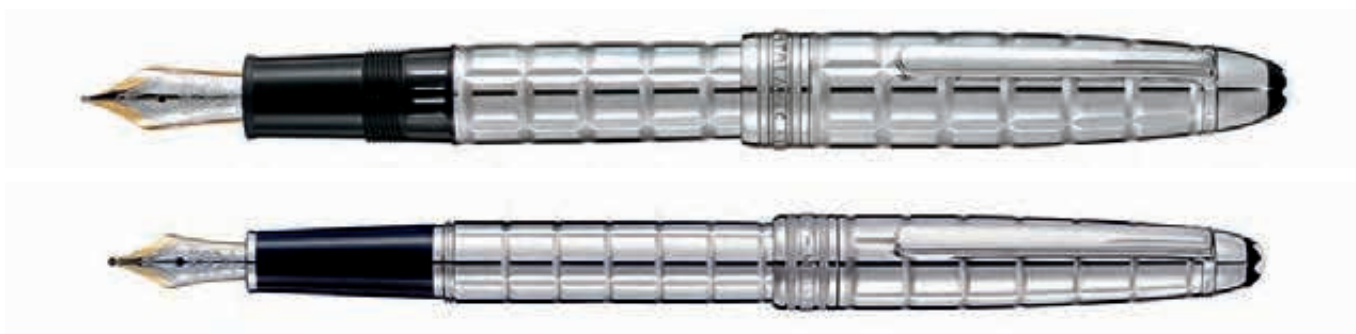

MODEL	Platinum-Plated Facet LeGrand Fountain Pen				Platinum-Plated Facet Classique Fountain Pen			
IDENT No.	38234	38235	38237	38238	38243	38244	38245	38246
NIB WIDTHS	EF	F	M	B	EF	F	M	B
	Other nib widths available on request				Other nib widths available on request			
WRITING SYSTEM								
WRITING SYSTEM	Piston Fountain Pen				Fountain Pen with piston converter (allows optional use of ink cartridges)			
NIB	Hand-crafted Au750 / 18 K gold nib with rhodium-plated inlay				Hand-crafted Au750 / 18 K gold nib with rhodium-plated inlay			
FEATURES								
BARREL	Platinum-plated, with surface of rectangular facets				Platinum-plated, with surface of rectangular facets			
CAP	Platinum-plated with surface of rectangular facets, inlaid with Montblanc emblem				Platinum-plated with surface of rectangular facets, inlaid with Montblanc emblem			
TRIM	Three platinum-plated rings embossed with Montblanc brand name				Three platinum-plated rings embossed with Montblanc brand name			
CLIP	Platinum-plated clip with individual serial number				Platinum-plated clip with individual serial number			
SPECIAL CHARACTERISTICS	-				-			
PACKAGING	-				-			
REFILLS								
REFILLS	Montblanc ink: Mystery Black, Royal Blue, Midnight Blue, Burgundy Red, Lavender Purple, Oyster Grey, Toffee Brown, Irish Green				Montblanc ink: Mystery Black, Royal Blue, Midnight Blue, Burgundy Red, Lavender Purple, Oyster Grey, Toffee Brown, Irish Green			

WRITING INSTRUMENTS

MEISTERSTÜCK SOLITAIRE

> Metal

Platinum-Plated Facet

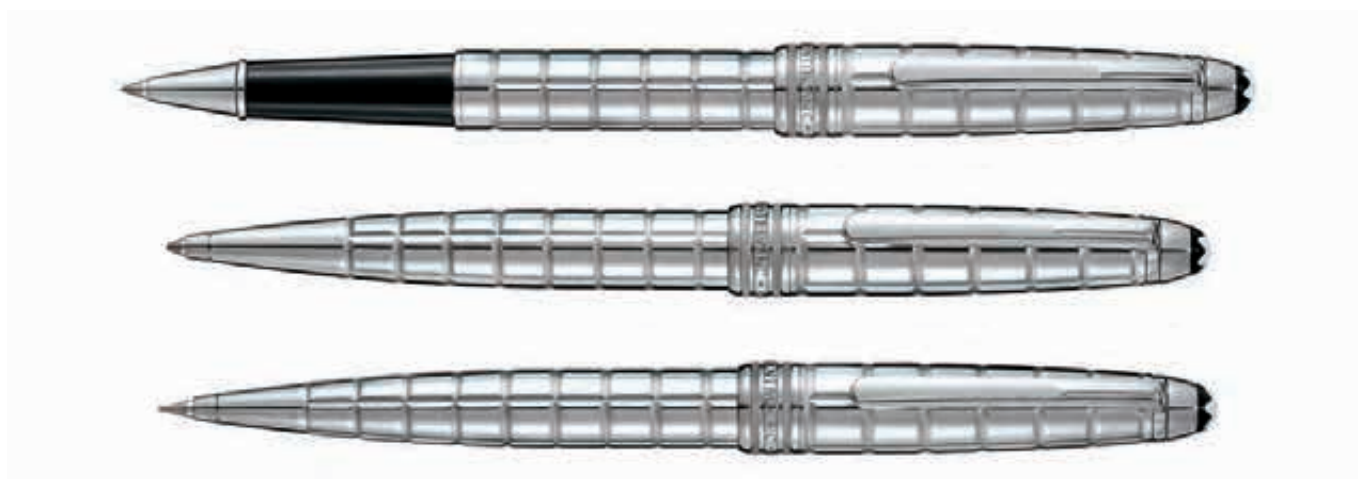

MODEL	Platinum-Plated Facet Classique Rollerball	Platinum-Plated Facet Classique Ballpoint Pen	Platinum-Plated Facet Classique Mechanical Pencil 0.7 mm
IDENT No.	38247	38248	38249
WRITING SYSTEM			
WRITING SYSTEM	Rollerball	Ballpoint Pen with twist mechanism	Mechanical Pencil with twist mechanism
NIB	-	-	-
FEATURES			
BARREL	Platinum-plated, with surface of rectangular facets	Platinum-plated, with surface of rectangular facets	Platinum-plated, with surface of rectangular facets
CAP	Platinum-plated with surface of rectangular facets, inlaid with Montblanc emblem	Platinum-plated with surface of rectangular facets, inlaid with Montblanc emblem	Platinum-plated with surface of rectangular facets, inlaid with Montblanc emblem
TRIM	Three platinum-plated rings embossed with Montblanc brand name	Three platinum-plated rings embossed with Montblanc brand name	Three platinum-plated rings embossed with Montblanc brand name
CLIP	Platinum-plated clip with individual serial number	Platinum-plated clip with individual serial number	Platinum-plated clip with individual serial number
SPECIAL CHARACTERISTICS	-	-	-
PACKAGING	-	-	-
REFILLS			
REFILLS	Montblanc rollerball refills: Mystery Black, Pacific Blue, Nightfire Red, Fortune Green, Chestnut Brown, Amethyst Purple, Barbados Blue; Montblanc fineliner refills: Mystery Black, Pacific Blue	Montblanc ballpoint pen refills: Mystery Black, Pacific Blue, Nightfire Red, Fortune Green	Montblanc hi-polymer 0.7 mm lead, eraser

WRITING INSTRUMENTS

MEISTERSTÜCK SOLITAIRE

> Metal

Tribute to the Mont Blanc



MODEL	Tribute to the Mont Blanc Classique Fountain Pen	
IDENT NO.	106843	106844
NIB WIDTHS	F	M
	Other nib widths available on request	
WRITING SYSTEM		
WRITING SYSTEM	Cartridge Fountain Pen (no converter)	
NIB	Hand-crafted Au750 / 18 K gold nib rhodium-plated	
FEATURES		
BARREL	Precious white lacquer	
CAP	Precious white lacquer with Montblanc emblem made of snow quartz	
TRIM	Platinum-plated metal forepart with laser-engraved Mont Blanc massif, three platinum-plated rings embossed with Montblanc brand name	
CLIP	Platinum-plated clip with individual serial number	
SPECIAL CHARACTERISTICS	-	
PACKAGING	Squarish white gift box with silver-coloured imprint	
REFILLS		
REFILLS	Montblanc ink cartridges: Mystery Black, Royal Blue, Midnight Blue, Burgundy Red, Lavender Purple, Oyster Grey, Toffee Brown, Irish Green	

WRITING INSTRUMENTS

MEISTERSTÜCK SOLITAIRE

> Metal

Tribute to the Mont Blanc



MODEL	Tribute to the Mont Blanc Classique Rollerball	Tribute to the Mont Blanc Classique Ballpoint Pen
IDENT No.	106845	106846
WRITING SYSTEM		
WRITING SYSTEM	Rollerball	Ballpoint Pen with twist mechanism
NIB	-	-
FEATURES		
BARREL	Precious white lacquer	Precious white lacquer
CAP	Precious white lacquer with Montblanc emblem made of snow quartz	Precious white lacquer with Montblanc emblem made of snow quartz
TRIM	Platinum-plated metal forepart with laser-engraved Mont Blanc massif, three platinum-plated rings embossed with Montblanc brand name	Platinum-plated metal tip with laser-engraved Mont Blanc massif, three platinum-plated rings embossed with Montblanc brand name
CLIP	Platinum-plated clip with individual serial number	Platinum-plated clip with individual serial number
SPECIAL CHARACTERISTICS	-	-
PACKAGING	Squarish white gift box with silver-coloured imprint	Squarish white gift box with silver-coloured imprint
REFILLS		
REFILLS	Montblanc rollerball refills: Mystery Black, Pacific Blue, Nightfire Red, Fortune Green, Chestnut Brown, Amethyst Purple, Barbados Blue; Montblanc fineliner refills: Mystery Black, Pacific Blue	Montblanc ballpoint pen refills: Mystery Black, Pacific Blue, Nightfire Red, Fortune Green

WRITING INSTRUMENTS

MEISTERSTÜCK SOLITAIRE

> Metal

Tribute to the Mont Blanc



MODEL	Tribute to the Mont Blanc Hommage à W. A. Mozart Fountain Pen	
IDENT No.	107034	106847
NIB WIDTHS	F	M
	Other nib widths available on request	
WRITING SYSTEM		
WRITING SYSTEM	Cartridge Fountain Pen (no converter)	
NIB	Hand-crafted Au750 / 18 K gold nib	
FEATURES		
BARREL	Precious white lacquer	
CAP	Precious white lacquer with Montblanc emblem made of snow quartz	
TRIM	Red gold-plated metal forepart with laser-engraved Mont Blanc massif, three red gold-plated rings embossed with Montblanc brand name	
CLIP	Red gold-plated clip with individual serial number	
SPECIAL CHARACTERISTICS	-	
PACKAGING	Squarish white gift box with red gold-coloured imprint	
REFILLS		
REFILLS	Montblanc ink cartridges: Mystery Black, Royal Blue, Midnight Blue, Burgundy Red, Lavender Purple, Oyster Grey, Toffee Brown, Irish Green	

WRITING INSTRUMENTS

MEISTERSTÜCK SOLITAIRE

> Metal

Tribute to the Mont Blanc



MODEL	Tribute to the Mont Blanc Hommage à W. A. Mozart Rollerball	Tribute to the Mont Blanc Hommage à W. A. Mozart Ballpoint Pen
IDENT No.	107102	106848
WRITING SYSTEM		
WRITING SYSTEM	Rollerball	Ballpoint Pen with twist mechanism
NIB	-	-
FEATURES		
BARREL	Precious white lacquer	Precious white lacquer
CAP	Precious white lacquer with Montblanc emblem made of snow quartz	Precious white lacquer with Montblanc emblem made of snow quartz
TRIM	Red gold-plated metal forepart with laser-engraved Mont Blanc massif, three red gold-plated rings embossed with Montblanc brand name	Red gold-plated metal tip with laser-engraved Mont Blanc massif, three red gold-plated rings embossed with Montblanc brand name
CLIP	Red gold-plated clip with individual serial number	Red gold-plated clip with individual serial number
SPECIAL CHARACTERISTICS	-	-
PACKAGING	Squarish white gift box with red gold-coloured imprint	Squarish white gift box with red gold-coloured imprint
REFILLS		
REFILLS	Montblanc Meisterstück "Hommage à W.A. Mozart" small rollerball refills: Mystery Black, Pacific Blue	Montblanc Meisterstück "Hommage à W.A. Mozart" small ballpoint pen refills: Mystery Black, Pacific Blue

WRITING INSTRUMENTS

MEISTERSTÜCK SOLITAIRE

> Metal
Sterling Silver

MODEL	Sterling Silver LeGrand Fountain Pen				Sterling Silver Classique Fountain Pen			
IDENT NO.	13836	13837	13838	13839	13844	13845	13846	13847
NIB WIDTHS	EF	F	M	B	EF	F	M	B
	Other nib widths available on request				Other nib widths available on request			
WRITING SYSTEM								
WRITING SYSTEM	Piston Fountain Pen				Fountain Pen with piston converter (allows optional use of ink cartridges)			
NIB	Hand-crafted Au750 / 18 K gold nib with rhodium-plated inlay				Hand-crafted Au750 / 18 K gold nib with rhodium-plated inlay			
FEATURES								
BARREL	Ag925 sterling silver with pinstripe finish				Ag925 sterling silver with pinstripe finish			
CAP	Ag925 sterling silver with pinstripe finish inlaid with Montblanc emblem				Ag925 sterling silver with pinstripe finish inlaid with Montblanc emblem			
TRIM	Three gold-plated rings in Ag925 sterling silver embossed with Montblanc brand name				Three gold-plated rings in Ag925 sterling silver embossed with Montblanc brand name			
CLIP	Gold-plated clip with individual serial number				Gold-plated clip with individual serial number			
SPECIAL CHARACTERISTICS	-				-			
PACKAGING	-				-			
REFILLS								
REFILLS	Montblanc ink: Mystery Black, Royal Blue, Midnight Blue, Burgundy Red, Lavender Purple, Oyster Grey, Toffee Brown, Irish Green				Montblanc ink: Mystery Black, Royal Blue, Midnight Blue, Burgundy Red, Lavender Purple, Oyster Grey, Toffee Brown, Irish Green			

WRITING INSTRUMENTS

MEISTERSTÜCK SOLITAIRE

> Metal
Sterling Silver

MODEL	Sterling Silver Classique Rollerball	Sterling Silver Classique Ballpoint Pen	Sterling Silver Classique Mechanical Pencil 0.7 mm
IDENT No.	17279	13852	13853
WRITING SYSTEM			
WRITING SYSTEM	Rollerball	Ballpoint Pen with twist mechanism	Mechanical Pencil with twist mechanism
NIB	-	-	-
FEATURES			
BARREL	Ag925 sterling silver with pinstripe finish	Ag925 sterling silver with pinstripe finish	Ag925 sterling silver with pinstripe finish
CAP	Ag925 sterling silver with pinstripe finish inlaid with Montblanc emblem	Ag925 sterling silver with pinstripe finish inlaid with Montblanc emblem	Ag925 sterling silver with pinstripe finish inlaid with Montblanc emblem
TRIM	Three gold-plated rings in Ag925 sterling silver embossed with Montblanc brand name	Three gold-plated rings in Ag925 sterling silver embossed with Montblanc brand name	Three gold-plated rings in Ag925 sterling silver embossed with Montblanc brand name
CLIP	Gold-plated clip with individual serial number	Gold-plated clip with individual serial number	Gold-plated clip with individual serial number
SPECIAL CHARACTERISTICS	-	-	-
PACKAGING	-	-	-
REFILLS			
REFILLS	Montblanc rollerball refills: Mystery Black, Pacific Blue, Nightfire Red, Fortune Green, Chestnut Brown, Amethyst Purple, Barbados Blue; Montblanc fineliner refills: Mystery Black, Pacific Blue	Montblanc ballpoint pen refills: Mystery Black, Pacific Blue, Nightfire Red, Fortune Green	Montblanc hi-polymer 0.7 mm lead, eraser

WRITING INSTRUMENTS

MEISTERSTÜCK SOLITAIRE

> Metal Jewellery Collection



MODEL	Jewellery Collection Platinum-plated Hommage à W.A. Mozart Fountain Pen		
IDENT No.	108727	107574	107552
NIB WIDTHS	EF	F	M
	Other nib widths available on request		
WRITING SYSTEM	Cartridge Fountain Pen (no converter)		
WRITING SYSTEM	Cartridge Fountain Pen (no converter)		
NIB	Hand-crafted Au750 / 18 K gold nib rhodium-plated		
FEATURES			
BARREL	Platinum-plated with an elegant matelassé pattern		
CAP	Platinum-plated with an elegant matelassé pattern		
TRIM	Three platinum-plated rings embossed with Montblanc brand name		
CLIP	Platinum-plated clip with individual serial number		
SPECIAL CHARACTERISTICS	Montblanc emblem made of mother-of-pearl		
PACKAGING	-		
REFILLS			
REFILLS	Montblanc ink cartridges: Mystery Black, Royal Blue, Midnight Blue, Burgundy Red, Lavender Purple, Oyster Grey, Toffee Brown, Irish Green		

WRITING INSTRUMENTS

MEISTERSTÜCK SOLITAIRE

> Metal Jewellery Collection



MODEL	Jewellery Collection Platinum-plated Hommage à W.A. Mozart Rollerball	Jewellery Collection Platinum-plated Hommage à W.A. Mozart Ballpoint Pen
IDENT No.	107553	107554
WRITING SYSTEM		
WRITING SYSTEM	Rollerball	Ballpoint Pen with twist mechanism
NIB	-	-
FEATURES		
BARREL	Platinum-plated with an elegant matelassé pattern	Platinum-plated with an elegant matelassé pattern
CAP	Platinum-plated with an elegant matelassé pattern	Platinum-plated with an elegant matelassé pattern
TRIM	Three platinum-plated rings embossed with Montblanc brand name	Three platinum-plated rings embossed with Montblanc brand name
CLIP	Platinum-plated clip with individual serial number	Platinum-plated clip with individual serial number
SPECIAL CHARACTERISTICS	Montblanc emblem made of mother-of-pearl	Montblanc emblem made of mother-of-pearl
PACKAGING	-	-
REFILLS		
REFILLS	Montblanc Meisterstück "Hommage à W.A. Mozart" small rollerball refills: Mystery Black, Pacific Blue	Montblanc Meisterstück "Hommage à W.A. Mozart" small ballpoint pen refills: Mystery Black, Pacific Blue

WRITING INSTRUMENTS

MEISTERSTÜCK SOLITAIRE

> Metal
Carbon & Steel

MODEL	Carbon & Steel LeGrand Fountain Pen	Carbon & Steel Classique Fountain Pen
IDENT NO.	05818 05819	05826 05827
NIB WIDTHS	F M	F M
	Other nib widths available on request	Other nib widths available on request
WRITING SYSTEM		
WRITING SYSTEM	Piston Fountain Pen	Fountain Pen with piston converter (allows optional use of ink cartridges)
NIB	Hand-crafted Au750 / 18 K gold nib with rhodium-plated inlay	Hand-crafted Au750 / 18 K gold nib with rhodium-plated inlay
FEATURES		
BARREL	High-grade stainless steel	High-grade stainless steel
CAP	Carbon casing inlaid with Montblanc emblem	Carbon casing inlaid with Montblanc emblem
TRIM	Three rings in high-grade stainless steel embossed with Montblanc brand name	Three rings in high-grade stainless steel embossed with Montblanc brand name
CLIP	Platinum-plated clip with individual serial number	Platinum-plated clip with individual serial number
SPECIAL CHARACTERISTICS	-	-
PACKAGING	-	-
REFILLS		
REFILLS	Montblanc ink: Mystery Black, Royal Blue, Midnight Blue, Burgundy Red, Lavender Purple, Oyster Grey, Toffee Brown, Irish Green	Montblanc ink: Mystery Black, Royal Blue, Midnight Blue, Burgundy Red, Lavender Purple, Oyster Grey, Toffee Brown, Irish Green

WRITING INSTRUMENTS

MEISTERSTÜCK SOLITAIRE

> Metal Carbon & Steel



MODEL	Carbon & Steel Classique Rollerball	Carbon & Steel Classique Ballpoint Pen	Carbon & Steel Classique Mechanical Pencil 0.7 mm
IDENT No.	05833	05834	05835
WRITING SYSTEM			
WRITING SYSTEM	Rollerball	Ballpoint Pen with twist mechanism	Mechanical Pencil with twist mechanism
NIB	-	-	-
FEATURES			
BARREL	High-grade stainless steel	High-grade stainless steel	High-grade stainless steel
CAP	Carbon casing inlaid with Montblanc emblem	Carbon casing inlaid with Montblanc emblem	Carbon casing inlaid with Montblanc emblem
TRIM	Three rings in high-grade stainless steel embossed with Montblanc brand name	Three rings in high-grade stainless steel embossed with Montblanc brand name	Three rings in high-grade stainless steel embossed with Montblanc brand name
CLIP	Platinum-plated clip with individual serial number	Platinum-plated clip with individual serial number	Platinum-plated clip with individual serial number
SPECIAL CHARACTERISTICS	-	-	-
PACKAGING	-	-	-
REFILLS			
REFILLS	Montblanc rollerball refills: Mystery Black, Pacific Blue, Nightfire Red, Fortune Green, Chestnut Brown, Amethyst Purple, Barbados Blue; Montblanc fineliner refills: Mystery Black, Pacific Blue	Montblanc ballpoint pen refills: Mystery Black, Pacific Blue, Nightfire Red, Fortune Green	Montblanc hi-polymer 0.7 mm lead, eraser

WRITING INSTRUMENTS

MEISTERSTÜCK SOLITAIRE

> Doué
Black and White

MODEL	Doué Black & White LeGrand Fountain Pen		Doué Black & White Classique Fountain Pen			
IDENT NO.	101583	101403	101585	101586	101404	101587
NIB WIDTHS	F	M	EF	F	M	B
	Other nib widths available on request		Other nib widths available on request			
WRITING SYSTEM						
WRITING SYSTEM	Piston Fountain Pen		Fountain Pen with piston converter (allows optional use of ink cartridges)			
NIB	Hand-crafted Au750 / 18 K gold nib with rhodium-plated inlay		Hand-crafted Au750 / 18 K gold nib with rhodium-plated inlay			
FEATURES						
BARREL	Black precious resin		Black precious resin			
CAP	PVD-coated with laser-engraved pattern, inlaid with Montblanc emblem		PVD-coated with laser-engraved pattern, inlaid with Montblanc emblem			
TRIM	Three rings in high-grade stainless steel embossed with Montblanc brand name		Three rings in high-grade stainless steel embossed with Montblanc brand name			
CLIP	Platinum-plated clip with individual serial number		Platinum-plated clip with individual serial number			
SPECIAL CHARACTERISTICS	-		-			
PACKAGING	-		-			
REFILLS						
REFILLS	Montblanc ink: Mystery Black, Royal Blue, Midnight Blue, Burgundy Red, Lavender Purple, Oyster Grey, Toffee Brown, Irish Green		Montblanc ink: Mystery Black, Royal Blue, Midnight Blue, Burgundy Red, Lavender Purple, Oyster Grey, Toffee Brown, Irish Green			

WRITING INSTRUMENTS

MEISTERSTÜCK SOLITAIRE

> Doué
Black and White

MODEL	Doué Black & White Classique Rollerball	Doué Black & White Classique Ballpoint Pen
IDENT No.	101405	101406
WRITING SYSTEM		
WRITING SYSTEM	Rollerball	Ballpoint Pen with twist mechanism
NIB	-	-
FEATURES		
BARREL	Black precious resin	Black precious resin
CAP	PVD-coated with laser-engraved pattern, inlaid with Montblanc emblem	PVD-coated with laser-engraved pattern, inlaid with Montblanc emblem
TRIM	Three rings in high-grade stainless steel embossed with Montblanc brand name	Three rings in high-grade stainless steel embossed with Montblanc brand name
CLIP	Platinum-plated clip with individual serial number	Platinum-plated clip with individual serial number
SPECIAL CHARACTERISTICS	-	-
PACKAGING	-	-
REFILLS		
REFILLS	Montblanc rollerball refills: Mystery Black, Pacific Blue, Nightfire Red, Fortune Green, Chestnut Brown, Amethyst Purple, Barbados Blue; Montblanc fineliner refills: Mystery Black, Pacific Blue	Montblanc ballpoint pen refills: Mystery Black, Pacific Blue, Nightfire Red, Fortune Green

WRITING INSTRUMENTS

MEISTERSTÜCK SOLITAIRE

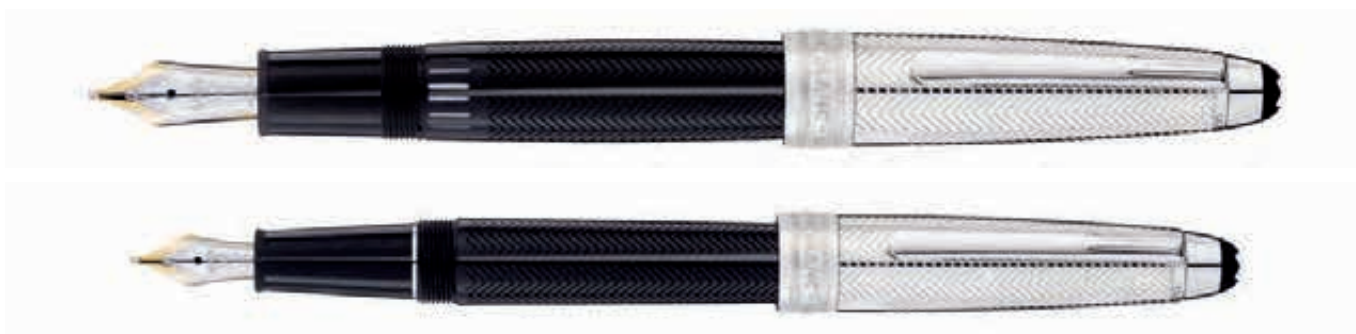
> Doué
Silver Barley

MODEL	Doué Silver Barley LeGrand Fountain Pen	Doué Silver Barley Classique Fountain Pen
IDENT NO.	105215 105216	105219 105220
NIB WIDTHS	F M	F M
	Other nib widths available on request	Other nib widths available on request
WRITING SYSTEM		
WRITING SYSTEM	Piston Fountain Pen	Fountain Pen with piston converter (allows optional use of ink cartridges)
NIB	Hand-crafted Au750 / 18 K gold nib with rhodium-plated inlay	Hand-crafted Au750 / 18 K gold nib with rhodium-plated inlay
FEATURES		
BARREL	Black precious resin with barley guilloché pattern	Black precious resin with barley guilloché pattern
CAP	Ag925 sterling silver with barley guilloché pattern	Ag925 sterling silver with barley guilloché pattern
TRIM	Three rings in Ag925 sterling silver embossed with Montblanc brand name	Three rings in Ag925 sterling silver embossed with Montblanc brand name
CLIP	Platinum-plated clip with individual serial number	Platinum-plated clip with individual serial number
SPECIAL CHARACTERISTICS	-	-
PACKAGING	-	-
REFILLS		
REFILLS	Montblanc ink: Mystery Black, Royal Blue, Midnight Blue, Burgundy Red, Lavender Purple, Oyster Grey, Toffee Brown, Irish Green	Montblanc ink: Mystery Black, Royal Blue, Midnight Blue, Burgundy Red, Lavender Purple, Oyster Grey, Toffee Brown, Irish Green

WRITING INSTRUMENTS

MEISTERSTÜCK SOLITAIRE

> Doué
Silver Barley

MODEL	Doué Silver Barley Classique Rollerball	Doué Silver Barley Classique Ballpoint Pen
IDENT No.	105222	105223
WRITING SYSTEM		
WRITING SYSTEM	Rollerball	Ballpoint Pen with twist mechanism
NIB	-	-
FEATURES		
BARREL	Black precious resin with barley guilloché pattern	Black precious resin with barley guilloché pattern
CAP	Ag925 sterling silver with barley guilloché pattern	Ag925 sterling silver with barley guilloché pattern
TRIM	Three rings in Ag925 sterling silver embossed with Montblanc brand name	Three rings in Ag925 sterling silver embossed with Montblanc brand name
CLIP	Platinum-plated clip with individual serial number	Platinum-plated clip with individual serial number
SPECIAL CHARACTERISTICS	-	-
PACKAGING	-	-
REFILLS		
REFILLS	Montblanc rollerball refills: Mystery Black, Pacific Blue, Nightfire Red, Fortune Green, Chestnut Brown, Amethyst Purple, Barbados Blue; Montblanc fineliner refills: Mystery Black, Pacific Blue	Montblanc ballpoint pen refills: Mystery Black, Pacific Blue, Nightfire Red, Fortune Green

WRITING INSTRUMENTS

MEISTERSTÜCK SOLITAIRE

> Doué

Geometric Dimension



MODEL	Doué Geometric Dimension LeGrand Fountain Pen	Doué Geometric Dimension Classique Fountain Pen
IDENT No.	105983 105984	105985 105986
NIB WIDTHS	F M	F M
	Other nib widths available on request	Other nib widths available on request
WRITING SYSTEM		
WRITING SYSTEM	Piston Fountain Pen	Fountain Pen with piston converter (allows optional use of ink cartridges)
NIB	Hand-crafted Au750 / 18 K gold nib	Hand-crafted Au750 / 18 K gold nib
FEATURES		
BARREL	Black precious resin	Black precious resin
CAP	Champagne-tone gold-plated with three-dimensional geometric pattern, inlaid with Montblanc emblem	Champagne-tone gold-plated with three-dimensional geometric pattern, inlaid with Montblanc emblem
TRIM	Three champagne-tone gold-plated rings embossed with Montblanc brand name	Three champagne-tone gold-plated rings embossed with Montblanc brand name
CLIP	Champagne-tone gold-plated clip with individual serial number	Champagne-tone gold-plated clip with individual serial number
SPECIAL CHARACTERISTICS	-	-
PACKAGING	-	-
REFILLS		
REFILLS	Montblanc ink: Mystery Black, Royal Blue, Midnight Blue, Burgundy Red, Lavender Purple, Oyster Grey, Toffee Brown, Irish Green	Montblanc ink: Mystery Black, Royal Blue, Midnight Blue, Burgundy Red, Lavender Purple, Oyster Grey, Toffee Brown, Irish Green

WRITING INSTRUMENTS

MEISTERSTÜCK SOLITAIRE

> Doué

Geometric Dimension



MODEL	Doué Geometric Dimension Classique Rollerball	Doué Geometric Dimension Classique Ballpoint Pen
IDENT No.	105988	105987
WRITING SYSTEM		
WRITING SYSTEM	Rollerball	Ballpoint Pen with twist mechanism
NIB	-	-
FEATURES		
BARREL	Black precious resin	Black precious resin
CAP	Champagne-tone gold-plated with three-dimensional geometric pattern, inlaid with Montblanc emblem	Champagne-tone gold-plated with three-dimensional geometric pattern, inlaid with Montblanc emblem
TRIM	Three champagne-tone gold-plated rings embossed with Montblanc brand name	Three champagne-tone gold-plated rings embossed with Montblanc brand name
CLIP	Champagne-tone gold-plated clip with individual serial number	Champagne-tone gold-plated clip with individual serial number
SPECIAL CHARACTERISTICS	-	-
PACKAGING	-	-
REFILLS		
REFILLS	Montblanc rollerball refills: Mystery Black, Pacific Blue, Nightfire Red, Fortune Green, Chestnut Brown, Amethyst Purple, Barbados Blue; Montblanc fineliner refills: Mystery Black, Pacific Blue	Montblanc ballpoint pen refills: Mystery Black, Pacific Blue, Nightfire Red, Fortune Green

WRITING INSTRUMENTS

MEISTERSTÜCK SOLITAIRE

> Doué
Signum

MODEL	Doué Signum Classique Fountain Pen
IDENT NO.	o8573 o8574
NIB WIDTHS	F M
	Other nib widths available on request
WRITING SYSTEM	
WRITING SYSTEM	Fountain Pen with piston converter (allows optional use of ink cartridges)
NIB	Hand-crafted Au750 / 18 K gold nib with rhodium-plated inlay
FEATURES	
BARREL	Special design featuring the Montblanc emblem engraved on black precious resin
CAP	Platinum-plated inlaid with Montblanc emblem
TRIM	Three platinum-plated rings embossed with Montblanc brand name
CLIP	Platinum-plated clip with individual serial number
SPECIAL CHARACTERISTICS	Platinum-plated cone engraved with Montblanc brand name
PACKAGING	-
REFILLS	
REFILLS	Montblanc ink: Mystery Black, Royal Blue, Midnight Blue, Burgundy Red, Lavender Purple, Oyster Grey, Toffee Brown, Irish Green

WRITING INSTRUMENTS

MEISTERSTÜCK SOLITAIRE

> Doué
Signum

MODEL	Doué Signum Classique Rollerball	Doué Signum Classique Ballpoint Pen
IDENT No.	o8576	o8579
WRITING SYSTEM		
WRITING SYSTEM	Rollerball	Ballpoint Pen with twist mechanism
NIB	-	-
FEATURES		
BARREL	Special design featuring the Montblanc emblem engraved on black precious resin	Special design featuring the Montblanc emblem engraved on black precious resin
CAP	Platinum-plated inlaid with Montblanc emblem	Platinum-plated inlaid with Montblanc emblem
TRIM	Three platinum-plated rings embossed with Montblanc brand name	Three platinum-plated rings embossed with Montblanc brand name
CLIP	Platinum-plated clip with individual serial number	Platinum-plated clip with individual serial number
SPECIAL CHARACTERISTICS	Platinum-plated cone engraved with Montblanc brand name	Platinum-plated forepart decorated with Montblanc brand name
PACKAGING	-	-
REFILLS		
REFILLS	Montblanc rollerball refills: Mystery Black, Pacific Blue, Nightfire Red, Fortune Green, Chestnut Brown, Amethyst Purple, Barbados Blue; Montblanc fineliner refills: Mystery Black, Pacific Blue	Montblanc ballpoint pen refills: Mystery Black, Pacific Blue, Nightfire Red, Fortune Green

WRITING INSTRUMENTS

MEISTERSTÜCK SOLITAIRE

> Doué
Stainless Steel

MODEL	Doué Stainless Steel LeGrand Fountain Pen	Doué Stainless Steel Classique Fountain Pen
IDENT No.	03996 03997	05012 05013
NIB WIDTHS	F M	F M
	Other nib widths available on request	Other nib widths available on request
WRITING SYSTEM		
WRITING SYSTEM	Piston Fountain Pen	Fountain Pen with piston converter (allows optional use of ink cartridges)
NIB	Hand-crafted Au750 / 18 K gold nib with rhodium-plated inlay	Hand-crafted Au750 / 18 K gold nib with rhodium-plated inlay
FEATURES		
BARREL	Black precious resin	Black precious resin
CAP	High-grade stainless steel inlaid with Montblanc emblem	High-grade stainless steel inlaid with Montblanc emblem
TRIM	Three rings in high-grade stainless steel embossed with Montblanc brand name	Three rings in high-grade stainless steel embossed with Montblanc brand name
CLIP	Platinum-plated clip with individual serial number	Platinum-plated clip with individual serial number
SPECIAL CHARACTERISTICS	-	-
PACKAGING	-	-
REFILLS		
REFILLS	Montblanc ink: Mystery Black, Royal Blue, Midnight Blue, Burgundy Red, Lavender Purple, Oyster Grey, Toffee Brown, Irish Green	Montblanc ink: Mystery Black, Royal Blue, Midnight Blue, Burgundy Red, Lavender Purple, Oyster Grey, Toffee Brown, Irish Green

WRITING INSTRUMENTS

MEISTERSTÜCK SOLITAIRE

> Doué
Stainless Steel

MODEL	Doué Stainless Steel Classique Rollerball	Doué Stainless Steel Classique Ballpoint Pen	Doué Stainless Steel Classique Mechanical Pencil 0.7 mm
IDENT No.	05019	05020	05021
WRITING SYSTEM			
WRITING SYSTEM	Rollerball	Ballpoint Pen with twist mechanism	Mechanical Pencil with twist mechanism
NIB	-	-	-
FEATURES			
BARREL	Black precious resin	Black precious resin	Black precious resin
CAP	High-grade stainless steel inlaid with Montblanc emblem	High-grade stainless steel inlaid with Montblanc emblem	High-grade stainless steel inlaid with Montblanc emblem
TRIM	Three rings in high-grade stainless steel embossed with Montblanc brand name	Three rings in high-grade stainless steel embossed with Montblanc brand name	Three rings in high-grade stainless steel embossed with Montblanc brand name
CLIP	Platinum-plated clip with individual serial number	Platinum-plated clip with individual serial number	Platinum-plated clip with individual serial number
SPECIAL CHARACTERISTICS	-	-	-
PACKAGING	-	-	-
REFILLS			
REFILLS	Montblanc rollerball refills: Mystery Black, Pacific Blue, Nightfire Red, Fortune Green, Chestnut Brown, Amethyst Purple, Barbados Blue; Montblanc fineliner refills: Mystery Black, Pacific Blue	Montblanc ballpoint pen refills: Mystery Black, Pacific Blue, Nightfire Red, Fortune Green	Montblanc hi-polymer 0.7 mm lead, eraser



WRITING INSTRUMENTS





The *Masters for Meisterstück* Collections are a series of Editions that pay tribute to both the excellence of the Meisterstück as well as to the visionary traditions of master craftsmen of different métiers and to their long-standing dedication to product excellence.

Masters for Meisterstück

The *Masters for Meisterstück L'Aubrac* brings together the quintessential expertise of *Montblanc*, as the Maison of exquisite Writing Instruments and *Forge the Laguiole*, as the epitome of traditional French quality knives.



WRITING INSTRUMENTS

MASTERS FOR MEISTERSTÜCK

> L'Aubrac
Special Edition

MODEL	L'Aubrac LeGrand Fountain Pen
IDENT NO.	107548 M Other nib widths available on request
WRITING SYSTEM	
WRITING SYSTEM	Piston Fountain Pen
NIB	Hand-crafted Au750 / 18 K gold nib rhodium-plated
FEATURES	
BARREL	Precious grenadilla wood
CAP	Precious grenadilla wood
TRIM	Three rings in Ag925 sterling silver embossed with Montblanc brand name
CLIP	Platinum-plated clip with individual serial number
SPECIAL CHARACTERISTICS	Montblanc emblem made of mother-of-pearl. Small rivets (on cap and barrel) and engravings (on rings) - as a reference to the traditional knife handles - crafted in cooperation with artisans of "Forge de Laguiole" in L'Aubrac, France.
PACKAGING	Special Packaging
REFILLS	
REFILLS	Montblanc ink: Mystery Black, Royal Blue, Midnight Blue, Burgundy Red, Lavender Purple, Oyster Grey, Toffee Brown, Irish Green

WRITING INSTRUMENTS

MASTERS FOR MEISTERSTÜCK

> L'Aubrac Special Edition



MODEL	L'Aubrac LeGrand Rollerball
IDENT No.	107549
WRITING SYSTEM	
WRITING SYSTEM	Rollerball
NIB	-
FEATURES	
BARREL	Precious grenadilla wood
CAP	Precious grenadilla wood
TRIM	Three rings in Ag925 sterling silver embossed with Montblanc brand name
CLIP	Platinum-plated clip with individual serial number
SPECIAL CHARACTERISTICS	Montblanc emblem made of mother-of-pearl. Small rivets (on cap and barrel) and engravings (on rings) - as a reference to the traditional knife handles - crafted in cooperation with artisans of "Forge de Laguiole" in L'Aubrac, France.
PACKAGING	Special Packaging
REFILLS	
REFILLS	Montblanc LeGrand rollerball refills: Mystery Black, Pacific Blue



WRITING INSTRUMENTS





WRITING INSTRUMENTS

The Bohème collection perfectly combines the traditional values of Montblanc with modern design elements. The retractable nib

Bohème

and the paramount-cut stone on the clip are playful characteristics that turn the Bohème line into a design icon – as much a jewel as a writing instrument.





WRITING INSTRUMENTS

BOHÈME

> Metal



Royal

p. 92



Je t'aime White Gold

p. 93



Pirouette Lilas

p. 94



Arabesque Azur

p. 96



Paso Doble Bleu

p. 98



Paso Doble Rouge

p. 100





WRITING INSTRUMENTS

BOHÈME

> Doué



Doué Ligne

p. 102



Doué Platinum-Plated

p. 104

> Precious Resin



Bleu

p. 106



Rouge

p. 108



Noir

p. 110



Marron

p. 112

WRITING INSTRUMENTS

BOHÈME

> Metal Royal



MODEL	Royal Fountain Pen
IDENT NO.	o8881 M Other nib widths available on request
WRITING SYSTEM	
WRITING SYSTEM	Cartridge Fountain Pen (no converter)
NIB	Hand-crafted Au750 / 18 K gold nib rhodium-plated
FEATURES	
BARREL	Au750 white gold
CAP	Au750 white gold
TRIM	Three rings in Au750 white gold embossed with Montblanc brand name
CLIP	Au750 white gold set with a paramount-cut diamond (~0.4 ct), with individual serial number
SPECIAL CHARACTERISTICS	Barrel, cap and cone set with 1,351 brilliant-cut diamonds (~14 ct.), Montblanc emblem made of 19 diamonds, on request
PACKAGING	Montblanc lacquered wooden box
REFILLS	
REFILLS	Montblanc ink cartridges: Mystery Black, Royal Blue, Midnight Blue, Burgundy Red, Lavender Purple, Oyster Grey, Toffee Brown, Irish Green

WRITING INSTRUMENTS

BOHÈME

> Metal

Je t'aime White Gold



MODEL	Je t'aime White Gold Fountain Pen	Je t'aime White Gold Ballpoint Pen
IDENT No.	07300 M Other nib widths available on request	07302
WRITING SYSTEM		
WRITING SYSTEM	Cartridge Fountain Pen (no converter)	Ballpoint Pen with twist mechanism
NIB	Hand-crafted Au750 / 18 K gold nib rhodium-plated	
FEATURES		
BARREL	Au750 white gold, forepart in black precious resin	Au750 white gold inlaid with Montblanc emblem
CAP	Au750 white gold inlaid with Montblanc emblem	-
TRIM	Three rings in Au750 white gold embossed with Montblanc brand name	Three rings in Au750 white gold embossed with Montblanc brand name
CLIP	Platinum-plated clip set with a heart-shaped natural red ruby, with individual serial number	Platinum-plated clip set with a heart-shaped natural red ruby, with individual serial number
SPECIAL CHARACTERISTICS	-	-
PACKAGING	-	-
REFILLS		
REFILLS	Montblanc ink cartridges: Mystery Black, Royal Blue, Midnight Blue, Burgundy Red, Lavender Purple, Oyster Grey, Toffee Brown, Irish Green	Montblanc ballpoint pen refills: Mystery Black, Pacific Blue, Nightfire Red, Fortune Green

WRITING INSTRUMENTS

BOHÈME

> Metal

Pirouette Lilas



MODEL	Pirouette Lilas Fountain Pen	
IDENT NO.	103794	103795
NIB WIDTHS	F	M
	Other nib widths available on request	
WRITING SYSTEM		
WRITING SYSTEM	Cartridge Fountain Pen (no converter)	
NIB	Hand-crafted Au750 / 18 K gold nib with rhodium-plated inlay	
FEATURES		
BARREL	Translucent anthracite-coloured lacquer underlaid with floating circle guilloché pattern, forepart in black precious resin	
CAP	Red gold-plated with floating circle guilloché pattern, inlaid with Montblanc emblem	
TRIM	Three red gold-plated rings embossed with Montblanc brand name	
CLIP	Red gold-plated clip set with a synthetic amethyst, with individual serial number	
SPECIAL CHARACTERISTICS	-	
PACKAGING	-	
REFILLS		
REFILLS	Montblanc ink cartridges: Mystery Black, Royal Blue, Midnight Blue, Burgundy Red, Lavender Purple, Oyster Grey, Toffee Brown, Irish Green	

WRITING INSTRUMENTS

BOHÈME

> Metal

Pirouette Lilas



MODEL	Pirouette Lilas Rollerball	Pirouette Lilas Ballpoint Pen
IDENT No.	103798	103797
WRITING SYSTEM		
WRITING SYSTEM	Rollerball	Ballpoint Pen with twist mechanism
NIB	-	-
FEATURES		
BARREL	Translucent anthracite-coloured lacquer underlaid with floating circle guilloché pattern, forepart in black precious resin	Translucent anthracite-coloured lacquer underlaid with floating circle guilloché pattern, red gold-plated forepart and cone, inlaid with Montblanc emblem
CAP	Red gold-plated with floating circle guilloché pattern, inlaid with Montblanc emblem	-
TRIM	Three red gold-plated rings embossed with Montblanc brand name	Three red gold-plated rings embossed with Montblanc brand name
CLIP	Red gold-plated clip set with a synthetic amethyst, with individual serial number	Red gold-plated clip set with a synthetic amethyst, with individual serial number
SPECIAL CHARACTERISTICS	-	-
PACKAGING	-	-
REFILLS		
REFILLS	Montblanc rollerball refills: Mystery Black, Pacific Blue, Nightfire Red, Fortune Green, Chestnut Brown, Amethyst Purple, Barbados Blue; Montblanc fineliner refills: Mystery Black, Pacific Blue	Montblanc ballpoint pen refills: Mystery Black, Pacific Blue, Nightfire Red, Fortune Green

WRITING INSTRUMENTS

BOHÈME

> Metal

Arabesque Azur



MODEL	Arabesque Azur Fountain Pen			
IDENT NO.	103045	103046	103047	103048
NIB WIDTHS	EF	F	M	B
	Other nib widths available on request			
WRITING SYSTEM				
WRITING SYSTEM	Cartridge Fountain Pen (no converter)			
NIB	Hand-crafted Au750 / 18 K gold nib rhodium-plated			
FEATURES				
BARREL	Ag925 sterling silver with wave pattern, forepart in black precious resin			
CAP	Ag925 sterling silver with wave pattern inlaid with Montblanc emblem			
TRIM	Three rings in Ag925 sterling silver embossed with Montblanc brand name			
CLIP	Platinum-plated clip set with a synthetic azure-coloured gemstone, with individual serial number			
SPECIAL CHARACTERISTICS	-			
PACKAGING	-			
REFILLS				
REFILLS	Montblanc ink cartridges: Mystery Black, Royal Blue, Midnight Blue, Burgundy Red, Lavender Purple, Oyster Grey, Toffee Brown, Irish Green			

WRITING INSTRUMENTS

BOHÈME

> Metal

Arabesque Azur



MODEL	Arabesque Azur Rollerball	Arabesque Azur Ballpoint Pen
IDENT No.	103050	103049
WRITING SYSTEM		
WRITING SYSTEM	Rollerball	Ballpoint Pen with twist mechanism
NIB	-	-
FEATURES		
BARREL	Ag925 sterling silver with wave pattern, forepart in black precious resin	Ag925 sterling silver with wave pattern, forepart and cone in black precious resin, inlaid with Montblanc emblem
CAP	Ag925 sterling silver with wave pattern inlaid with Montblanc emblem	-
TRIM	Three rings in Ag925 sterling silver embossed with Montblanc brand name	Three rings in Ag925 sterling silver embossed with Montblanc brand name
CLIP	Platinum-plated clip set with a synthetic azure-coloured gemstone, with individual serial number	Platinum-plated clip set with a synthetic azure-coloured gemstone, with individual serial number
SPECIAL CHARACTERISTICS	-	-
PACKAGING	-	-
REFILLS		
REFILLS	Montblanc rollerball refills: Mystery Black, Pacific Blue, Nightfire Red, Fortune Green, Chestnut Brown, Amethyst Purple, Barbados Blue; Montblanc fineliner refills: Mystery Black, Pacific Blue	Montblanc ballpoint pen refills: Mystery Black, Pacific Blue, Nightfire Red, Fortune Green

WRITING INSTRUMENTS

BOHÈME

> Metal

Paso Doble Bleu



MODEL	Paso Doble Bleu Fountain Pen
IDENT No.	104917 M Other nib widths available on request
WRITING SYSTEM	
WRITING SYSTEM	Cartridge Fountain Pen (no converter)
NIB	Hand-crafted Au750 / 18 K gold nib rhodium-plated
FEATURES	
BARREL	Metal engraved with a pattern inspired by the Paso Doble dance and coated with a blue lacquer, forepart in stainless steel, platinum-plated cone and fittings
CAP	Metal engraved with a pattern inspired by the Paso Doble dance and coated with a blue lacquer, inlaid with Montblanc emblem
TRIM	Three platinum-plated rings embossed with Montblanc brand name
CLIP	Platinum-plated clip set with a synthetic sapphire-coloured gemstone, with individual serial number
SPECIAL CHARACTERISTICS	-
PACKAGING	-
REFILLS	
REFILLS	Montblanc ink cartridges: Mystery Black, Royal Blue, Midnight Blue, Burgundy Red, Lavender Purple, Oyster Grey, Toffee Brown, Irish Green

WRITING INSTRUMENTS

BOHÈME

> Metal

Paso Doble Bleu



MODEL	Paso Doble Bleu Rollerball	Paso Doble Bleu Ballpoint Pen
IDENT No.	104920	104919
WRITING SYSTEM		
WRITING SYSTEM	Rollerball	Ballpoint Pen with twist mechanism
NIB	-	-
FEATURES		
BARREL	Metal engraved with a pattern inspired by the Paso Doble dance and coated with a blue lacquer, platinum-plated forepart, cone and fittings	Metal engraved with a pattern inspired by the Paso Doble dance and coated with a blue lacquer, platinum-plated forepart, cone and fittings, inlaid with Montblanc emblem
CAP	Metal engraved with a pattern inspired by the Paso Doble dance and coated with a blue lacquer, inlaid with Montblanc emblem	-
TRIM	Three platinum-plated rings embossed with Montblanc brand name	Three platinum-plated rings embossed with Montblanc brand name
CLIP	Platinum-plated clip set with a synthetic sapphire-coloured gemstone, with individual serial number	Platinum-plated clip set with a synthetic sapphire-coloured gemstone, with individual serial number
SPECIAL CHARACTERISTICS	-	-
PACKAGING	-	-
REFILLS		
REFILLS	Montblanc rollerball refills: Mystery Black, Pacific Blue, Nightfire Red, Fortune Green, Chestnut Brown, Amethyst Purple, Barbados Blue; Montblanc fineliner refills: Mystery Black, Pacific Blue	Montblanc ballpoint pen refills: Mystery Black, Pacific Blue, Nightfire Red, Fortune Green

WRITING INSTRUMENTS

BOHÈME

> Metal

Paso Doble Rouge



MODEL	Paso Doble Rouge Fountain Pen
IDENT NO.	104923 M Other nib widths available on request
WRITING SYSTEM	
WRITING SYSTEM	Cartridge Fountain Pen (no converter)
NIB	Hand-crafted Au750 / 18 K gold nib rhodium-plated
FEATURES	
BARREL	Metal engraved with a pattern inspired by the Paso Doble dance and coated with a red lacquer, forepart in stainless steel, platinum-plated cone and fittings
CAP	Metal engraved with a pattern inspired by the Paso Doble dance and coated with a red lacquer, inlaid with Montblanc emblem
TRIM	Three platinum-plated rings embossed with Montblanc brand name
CLIP	Platinum-plated clip set with a synthetic ruby-coloured gemstone, with individual serial number
SPECIAL CHARACTERISTICS	-
PACKAGING	-
REFILLS	
REFILLS	Montblanc ink cartridges: Mystery Black, Royal Blue, Midnight Blue, Burgundy Red, Lavender Purple, Oyster Grey, Toffee Brown, Irish Green

WRITING INSTRUMENTS

BOHÈME

> Metal

Paso Doble Rouge



MODEL	Paso Doble Rouge Rollerball	Paso Doble Rouge Ballpoint Pen
IDENT No.	104926	104925
WRITING SYSTEM		
WRITING SYSTEM	Rollerball	Ballpoint Pen with twist mechanism
NIB	-	-
FEATURES		
BARREL	Metal engraved with a pattern inspired by the Paso Doble dance and coated with a red lacquer, platinum-plated forepart, cone and fittings	Metal engraved with a pattern inspired by the Paso Doble dance and coated with a red lacquer, platinum-plated forepart, cone and fittings, inlaid with Montblanc emblem
CAP	Metal engraved with a pattern inspired by the Paso Doble dance and coated with a red lacquer, inlaid with Montblanc emblem	-
TRIM	Three platinum-plated rings embossed with Montblanc brand name	Three platinum-plated rings embossed with Montblanc brand name
CLIP	Platinum-plated clip set with a synthetic ruby-coloured gemstone, with individual serial number	Platinum-plated clip set with a synthetic ruby-coloured gemstone, with individual serial number
SPECIAL CHARACTERISTICS	-	-
PACKAGING	-	-
REFILLS		
REFILLS	Montblanc rollerball refills: Mystery Black, Pacific Blue, Nightfire Red, Fortune Green, Chestnut Brown, Amethyst Purple, Barbados Blue; Montblanc fineliner refills: Mystery Black, Pacific Blue	Montblanc ballpoint pen refills: Mystery Black, Pacific Blue, Nightfire Red, Fortune Green

WRITING INSTRUMENTS

BOHÈME

> Doué
Doué Ligne



MODEL	Doué Ligne Fountain Pen			
IDENT NO.	101992	101993	101994	101995
NIB WIDTHS	EF	F	M	B
	Other nib widths available on request			
WRITING SYSTEM				
WRITING SYSTEM	Cartridge Fountain Pen (no converter)			
NIB	Hand-crafted Au750 / 18 K gold nib with rhodium-plated inlay			
FEATURES				
BARREL	Brown-black precious resin, champagne-tone gold-plated cone and fittings			
CAP	Mat champagne-tone gold-plated cap with glossy lines, inlaid with Montblanc emblem			
TRIM	Three champagne-tone gold-plated rings embossed with Montblanc brand name			
CLIP	Champagne-tone gold-plated clip set with a synthetic citrine-coloured gemstone, with individual serial number			
SPECIAL CHARACTERISTICS	-			
PACKAGING	-			
REFILLS				
REFILLS	Montblanc ink cartridges: Mystery Black, Royal Blue, Midnight Blue, Burgundy Red, Lavender Purple, Oyster Grey, Toffee Brown, Irish Green			

WRITING INSTRUMENTS

BOHÈME

> Doué
Doué Ligne



MODEL	Doué Ligne Rollerball	Doué Ligne Ballpoint Pen
IDENT No.	101997	101996
WRITING SYSTEM		
WRITING SYSTEM	Rollerball	Ballpoint Pen with twist mechanism
NIB	-	-
FEATURES		
BARREL	Brown-black precious resin, champagne-tone gold-plated cone and fittings	Brown-black precious resin, champagne-tone gold-plated forepart, cone and fittings, inlaid with Montblanc emblem
CAP	Mat champagne-tone gold-plated cap with glossy lines, inlaid with Montblanc emblem	-
TRIM	Three champagne-tone gold-plated rings embossed with Montblanc brand name	Three champagne-tone gold-plated rings embossed with Montblanc brand name
CLIP	Champagne-tone gold-plated clip set with a synthetic citrine-coloured gemstone, with individual serial number	Champagne-tone gold-plated clip set with a synthetic citrine-coloured gemstone, with individual serial number
SPECIAL CHARACTERISTICS	-	-
PACKAGING	-	-
REFILLS		
REFILLS	Montblanc rollerball refills: Mystery Black, Pacific Blue, Nightfire Red, Fortune Green, Chestnut Brown, Amethyst Purple, Barbados Blue; Montblanc fineliner refills: Mystery Black, Pacific Blue	Montblanc ballpoint pen refills: Mystery Black, Pacific Blue, Nightfire Red, Fortune Green

WRITING INSTRUMENTS

BOHÈME

> Doué

Doué Platinum-Plated



MODEL	Doué Platinum-Plated Fountain Pen			
IDENT NO.	o8582	o8583	o8584	o8585
NIB WIDTHS	EF	F	M	B
	Other nib widths available on request			
WRITING SYSTEM				
WRITING SYSTEM	Cartridge Fountain Pen (no converter)			
NIB	Hand-crafted Au750 / 18 K gold nib rhodium-plated			
FEATURES				
BARREL	Black precious resin with grid guilloché pattern, platinum-plated cone and fittings			
CAP	Platinum-plated inlaid with Montblanc emblem			
TRIM	Three platinum-plated rings embossed with Montblanc brand name			
CLIP	Platinum-plated clip set with a synthetic onyx-coloured gemstone, with individual serial number			
SPECIAL CHARACTERISTICS	-			
PACKAGING	-			
REFILLS				
REFILLS	Montblanc ink cartridges: Mystery Black, Royal Blue, Midnight Blue, Burgundy Red, Lavender Purple, Oyster Grey, Toffee Brown, Irish Green			

WRITING INSTRUMENTS

BOHÈME
 > *Doué*
Doué Platinum-Plated



MODEL	Doué Platinum-Plated Rollerball	Doué Platinum-Plated Ballpoint Pen
IDENT No.	o8587	o8586
WRITING SYSTEM		
WRITING SYSTEM	Rollerball	Ballpoint Pen with twist mechanism
NIB	-	-
FEATURES		
BARREL	Black precious resin with grid guilloché pattern, platinum-plated cone and fittings	Black precious resin with grid guilloché pattern, platinum-plated forepart, cone and fittings, inlaid with Montblanc emblem
CAP	Platinum-plated inlaid with Montblanc emblem	-
TRIM	Three platinum-plated rings embossed with Montblanc brand name	Three platinum-plated rings embossed with Montblanc brand name
CLIP	Platinum-plated clip set with a synthetic onyx-coloured gemstone, with individual serial number	Platinum-plated clip set with a synthetic onyx-coloured gemstone, with individual serial number
SPECIAL CHARACTERISTICS	-	-
PACKAGING	-	-
REFILLS		
REFILLS	Montblanc rollerball refills: Mystery Black, Pacific Blue, Nightfire Red, Fortune Green, Chestnut Brown, Amethyst Purple, Barbados Blue; Montblanc fineliner refills: Mystery Black, Pacific Blue	Montblanc ballpoint pen refills: Mystery Black, Pacific Blue, Nightfire Red, Fortune Green

WRITING INSTRUMENTS

BOHÈME

> Precious Resin Bleu



MODEL		Bleu Fountain Pen			
IDENT NO.		05776	05777	05778	05779
NIB WIDTHS		EF	F	M	B
		05780	05781	05782	05783
		BB	OM	OB	OBB
WRITING SYSTEM					
WRITING SYSTEM		Cartridge Fountain Pen (no converter)			
NIB		Hand-crafted Au585 / 14 K gold nib rhodium-plated			
FEATURES					
BARREL		Black precious resin, platinum-plated fittings			
CAP		Black precious resin inlaid with Montblanc emblem			
TRIM		Three platinum-plated rings embossed with Montblanc brand name			
CLIP		Platinum-plated clip set with a synthetic sapphire-coloured gemstone, with individual serial number			
SPECIAL CHARACTERISTICS		-			
PACKAGING		-			
REFILLS					
REFILLS		Montblanc ink cartridges: Mystery Black, Royal Blue, Midnight Blue, Burgundy Red, Lavender Purple, Oyster Grey, Toffee Brown, Irish Green			

WRITING INSTRUMENTS

BOHÈME

> Precious Resin Bleu



MODEL	Bleu Rollerball	Bleu Ballpoint Pen	Bleu Mechanical Pencil 0.9 mm
IDENT NO.	05796	05795	05797
WRITING SYSTEM			
WRITING SYSTEM	Rollerball	Ballpoint Pen with twist mechanism	Mechanical Pencil with twist mechanism
NIB	-	-	-
FEATURES			
BARREL	Black precious resin, platinum-plated fittings	Black precious resin, platinum-plated fittings, inlaid with Montblanc emblem	Black precious resin, platinum-plated fittings, inlaid with Montblanc emblem
CAP	Black precious resin inlaid with Montblanc emblem	-	-
TRIM	Three platinum-plated rings embossed with Montblanc brand name	Three platinum-plated rings embossed with Montblanc brand name	Three platinum-plated rings embossed with Montblanc brand name
CLIP	Platinum-plated clip set with a synthetic sapphire-coloured gemstone, with individual serial number	Platinum-plated clip set with a synthetic sapphire-coloured gemstone, with individual serial number	Platinum-plated clip set with a synthetic sapphire-coloured gemstone, with individual serial number
SPECIAL CHARACTERISTICS	-	-	-
PACKAGING	-	-	-
REFILLS			
REFILLS	Montblanc rollerball refills: Mystery Black, Pacific Blue, Nightfire Red, Fortune Green, Chestnut Brown, Amethyst Purple, Barbados Blue; Montblanc fineliner refills: Mystery Black, Pacific Blue	Montblanc ballpoint pen refills: Mystery Black, Pacific Blue, Nightfire Red, Fortune Green	Montblanc hi-polymer 0.9 mm lead, eraser

WRITING INSTRUMENTS

BOHÈME

> *Precious Resin Rouge*



MODEL		Rouge Fountain Pen			
IDENT NO.		02758	03664	03665	03666
NIB WIDTHS		EF	F	M	B
		03667	03668	03669	03670
		BB	OM	OB	OBB
WRITING SYSTEM					
WRITING SYSTEM		Cartridge Fountain Pen (no converter)			
NIB		Hand-crafted Au585 / 14 K gold nib with rhodium-plated inlay			
FEATURES					
BARREL		Black precious resin, gold-plated fittings			
CAP		Black precious resin inlaid with Montblanc emblem			
TRIM		Three gold-plated rings embossed with Montblanc brand name			
CLIP		Gold-plated clip set with a synthetic ruby-coloured gemstone, with individual serial number			
SPECIAL CHARACTERISTICS		-			
PACKAGING		-			
REFILLS					
REFILLS		Montblanc ink cartridges: Mystery Black, Royal Blue, Midnight Blue, Burgundy Red, Lavender Purple, Oyster Grey, Toffee Brown, Irish Green			

WRITING INSTRUMENTS

BOHÈME

> *Precious Resin Rouge*



MODEL	Rouge Rollerball	Rouge Ballpoint Pen	Rouge Mechanical Pencil 0.9 mm
IDENT NO.	05096	02760	05097
WRITING SYSTEM			
WRITING SYSTEM	Rollerball	Ballpoint Pen with twist mechanism	Mechanical Pencil with twist mechanism
NIB	-	-	-
FEATURES			
BARREL	Black precious resin, gold-plated fittings	Black precious resin, gold-plated fittings, inlaid with Montblanc emblem	Black precious resin, gold-plated fittings, inlaid with Montblanc emblem
CAP	Black precious resin inlaid with Montblanc emblem	-	-
TRIM	Three gold-plated rings embossed with Montblanc brand name	Three gold-plated rings embossed with Montblanc brand name	Three gold-plated rings embossed with Montblanc brand name
CLIP	Gold-plated clip set with a synthetic ruby-coloured gemstone, with individual serial number	Gold-plated clip set with a synthetic ruby-coloured gemstone, with individual serial number	Gold-plated clip set with a synthetic ruby-coloured gemstone, with individual serial number
SPECIAL CHARACTERISTICS	-	-	-
PACKAGING	-	-	-
REFILLS			
REFILLS	Montblanc rollerball refills: Mystery Black, Pacific Blue, Nightfire Red, Fortune Green, Chestnut Brown, Amethyst Purple, Barbados Blue; Montblanc fineliner refills: Mystery Black, Pacific Blue	Montblanc ballpoint pen refills: Mystery Black, Pacific Blue, Nightfire Red, Fortune Green	Montblanc hi-polymer 0.9 mm lead, eraser

WRITING INSTRUMENTS

BOHÈME

> *Precious Resin*

Noir



MODEL		Noir Fountain Pen			
IDENT NO.		05047	05048	05049	05050
NIB WIDTHS		EF	F	M	B
		05051	05052	05053	05054
		BB	OM	OB	OBB
WRITING SYSTEM					
WRITING SYSTEM		Cartridge Fountain Pen (no converter)			
NIB		Hand-crafted Au585 / 14 K gold nib rhodium-plated			
FEATURES					
BARREL		Black precious resin, platinum-plated fittings			
CAP		Black precious resin inlaid with Montblanc emblem			
TRIM		Three platinum-plated rings embossed with Montblanc brand name			
CLIP		Platinum-plated clip set with a synthetic onyx-coloured gemstone, with individual serial number			
SPECIAL CHARACTERISTICS		-			
PACKAGING		-			
REFILLS					
REFILLS		Montblanc ink cartridges: Mystery Black, Royal Blue, Midnight Blue, Burgundy Red, Lavender Purple, Oyster Grey, Toffee Brown, Irish Green			

WRITING INSTRUMENTS

BOHÈME

> Precious Resin Noir



MODEL	Noir Rollerball	Noir Ballpoint Pen	Noir Mechanical Pencil 0.9 mm
IDENT NO.	05098	05055	05099
WRITING SYSTEM			
WRITING SYSTEM	Rollerball	Ballpoint Pen with twist mechanism	Mechanical Pencil with twist mechanism
NIB	-	-	-
FEATURES			
BARREL	Black precious resin, platinum-plated fittings	Black precious resin, platinum-plated fittings, inlaid with Montblanc emblem	Black precious resin, platinum-plated fittings, inlaid with Montblanc emblem
CAP	Black precious resin inlaid with Montblanc emblem	-	-
TRIM	Three platinum-plated rings embossed with Montblanc brand name	Three platinum-plated rings embossed with Montblanc brand name	Three platinum-plated rings embossed with Montblanc brand name
CLIP	Platinum-plated clip set with a synthetic onyx-coloured gemstone, with individual serial number	Platinum-plated clip set with a synthetic onyx-coloured gemstone, with individual serial number	Platinum-plated clip set with a synthetic onyx-coloured gemstone, with individual serial number
SPECIAL CHARACTERISTICS	-	-	-
PACKAGING	-	-	-
REFILLS			
REFILLS	Montblanc rollerball refills: Mystery Black, Pacific Blue, Nightfire Red, Fortune Green, Chestnut Brown, Amethyst Purple, Barbados Blue; Montblanc fineliner refills: Mystery Black, Pacific Blue	Montblanc ballpoint pen refills: Mystery Black, Pacific Blue, Nightfire Red, Fortune Green	Montblanc hi-polymer 0.9 mm lead, eraser

WRITING INSTRUMENTS

BOHÈME

> Precious Resin Marron



MODEL		Marron Fountain Pen			
IDENT NO.		38266	38267	38268	38269
NIB WIDTHS		EF	F	M	B
Other nib widths available on request					
WRITING SYSTEM					
WRITING SYSTEM		Cartridge Fountain Pen (no converter)			
NIB		Hand-crafted Au585 / 14 K gold nib with rhodium-plated inlay			
FEATURES					
BARREL		Black precious resin, red gold-plated fittings			
CAP		Black precious resin inlaid with Montblanc emblem			
TRIM		Three red gold-plated rings embossed with Montblanc brand name			
CLIP		Red gold-plated clip set with a synthetic smoky brown topaz gemstone, with individual serial number			
SPECIAL CHARACTERISTICS		-			
PACKAGING		-			
REFILLS					
REFILLS		Montblanc ink cartridges: Mystery Black, Royal Blue, Midnight Blue, Burgundy Red, Lavender Purple, Oyster Grey, Toffee Brown, Irish Green			

WRITING INSTRUMENTS

BOHÈME

> Precious Resin Marron



MODEL	Marron Rollerball	Marron Ballpoint Pen	Marron Mechanical Pencil 0.9 mm
IDENT NO.	38265	38270	38271
WRITING SYSTEM			
WRITING SYSTEM	Rollerball	Ballpoint Pen with twist mechanism	Mechanical Pencil with twist mechanism
NIB	-	-	-
FEATURES			
BARREL	Black precious resin, red gold-plated fittings	Black precious resin, red gold-plated fittings, inlaid with Montblanc emblem	Black precious resin, red gold-plated fittings, inlaid with Montblanc emblem
CAP	Black precious resin inlaid with Montblanc emblem	-	-
TRIM	Three red gold-plated rings embossed with Montblanc brand name	Three red gold-plated rings embossed with Montblanc brand name	Three red gold-plated rings embossed with Montblanc brand name
CLIP	Red gold-plated clip set with a synthetic smoky brown topaz gemstone, with individual serial number	Red gold-plated clip set with a synthetic smoky brown topaz gemstone, with individual serial number	Red gold-plated clip set with a synthetic smoky brown topaz gemstone, with individual serial number
SPECIAL CHARACTERISTICS	-	-	-
PACKAGING	-	-	-
REFILLS			
REFILLS	Montblanc rollerball refills: Mystery Black, Pacific Blue, Nightfire Red, Fortune Green, Chestnut Brown, Amethyst Purple, Barbados Blue; Montblanc fineliner refills: Mystery Black, Pacific Blue	Montblanc ballpoint pen refills: Mystery Black, Pacific Blue, Nightfire Red, Fortune Green	Montblanc hi-polymer 0.9 mm lead, eraser



WRITING INSTRUMENTS



StarWalker – a new generation of Writing Instruments for a young, successful generation – the Elite of tomorrow.

StarWalker

Created with new technologies and finest traditional craftsmanship, the StarWalker collection is reflecting a unique and dynamic style.

The modern design of the architectural clip, the characteristic nib shape and the Montblanc emblem in the transparent cap top symbolizes attitudes and values of this target group.



WRITING INSTRUMENTS

STARWALKER

> *Metal*



Red Gold

p. 118



Midnight Black

p. 120



Black Mystery

p. 122



Metal/Rubber

p. 124





WRITING INSTRUMENTS

STARWALKER

> Doué



Doué

p. 126

> Precious Resin



Red Gold

p. 128



Platinum

p.130



Midnight Black

p. 132

WRITING INSTRUMENTS

STARWALKER

> *Metal*
Red Gold



MODEL	Red Gold-Plated Metal Fountain Pen
IDENT NO.	106866 106867
NIB WIDTHS	F M
	Other nib widths available on request
WRITING SYSTEM	
WRITING SYSTEM	Cartridge Fountain Pen (no converter)
NIB	Hand-crafted Au585 / 14 K gold nib
FEATURES	
BARREL	Red gold-plated mat black lacquered surface with diamond-cut lines
CAP	Red gold-plated mat black lacquered surface with diamond-cut lines
TRIM	Red gold-plated fittings
CLIP	Red gold-plated clip with embossed Montblanc brand name and individual serial number
SPECIAL CHARACTERISTICS	Floating Montblanc emblem in transparent cap-top
PACKAGING	-
REFILLS	
REFILLS	Montblanc ink cartridges: Mystery Black, Royal Blue, Midnight Blue, Burgundy Red, Lavender Purple, Oyster Grey, Toffee Brown, Irish Green

WRITING INSTRUMENTS

STARWALKER

> Metal
Red Gold



MODEL	Red Gold-Plated Metal Fineliner	Red Gold-Plated Metal Ballpoint Pen
IDENT No.	106868	106869
WRITING SYSTEM		
WRITING SYSTEM	Fineliner	Ballpoint Pen with twist mechanism
NIB	-	-
FEATURES		
BARREL	Red gold-plated mat black lacquered surface with diamond-cut lines	Red gold-plated mat black lacquered surface with diamond-cut lines
CAP	Red gold-plated mat black lacquered surface with diamond-cut lines	Red gold-plated mat black lacquered surface with diamond-cut lines
TRIM	Red gold-plated fittings	Red gold-plated fittings
CLIP	Red gold-plated clip with embossed Montblanc brand name and individual serial number	Red gold-plated clip with embossed Montblanc brand name and individual serial number
SPECIAL CHARACTERISTICS	Floating Montblanc emblem in transparent cap-top	Floating Montblanc emblem in transparent cap-top
PACKAGING	-	-
REFILLS		
REFILLS	Montblanc fineliner refills: Mystery Black, Pacific Blue; Montblanc rollerball refills: Mystery Black, Pacific Blue, Nightfire Red, Fortune Green, Chestnut Brown, Amethyst Purple, Barbados Blue	Montblanc ballpoint pen refills: Mystery Black, Pacific Blue, Nightfire Red, Fortune Green

WRITING INSTRUMENTS

STARWALKER
 > *Metal*
Midnight Black



MODEL	Midnight Black Metal Fountain Pen
IDENT NO.	105646 105647
NIB WIDTHS	F M
	Other nib widths available on request
WRITING SYSTEM	
WRITING SYSTEM	Cartridge Fountain Pen (no converter)
NIB	Hand-crafted Au585 / 14 K gold nib ruthenium-plated
FEATURES	
BARREL	Mat ruthenium-plated surface with shiny diamond-cut lines
CAP	Mat ruthenium-plated surface with shiny diamond-cut lines
TRIM	Ruthenium-plated fittings
CLIP	Ruthenium-plated clip with embossed Montblanc brand name and individual serial number
SPECIAL CHARACTERISTICS	Floating Montblanc emblem in transparent cap-top
PACKAGING	-
REFILLS	
REFILLS	Montblanc ink cartridges: Mystery Black, Royal Blue, Midnight Blue, Lavender Purple, Oyster Grey, Toffee Brown, Irish Green

WRITING INSTRUMENTS

STARWALKER

> Metal
Midnight Black

MODEL	Midnight Black Metal Fineliner	Midnight Black Metal Ballpoint
IDENT No.	105648	105649
WRITING SYSTEM		
WRITING SYSTEM	Fineliner	Ballpoint Pen with twist mechanism
NIB	-	-
FEATURES		
BARREL	Mat ruthenium-plated surface with shiny diamond-cut lines	Mat ruthenium-plated surface with shiny diamond-cut lines
CAP	Mat ruthenium-plated surface with shiny diamond-cut lines	-
TRIM	Ruthenium-plated fittings	Ruthenium-plated fittings
CLIP	Ruthenium-plated clip with embossed Montblanc brand name and individual serial number	Ruthenium-plated clip with embossed Montblanc brand name and individual serial number
SPECIAL CHARACTERISTICS	Floating Montblanc emblem in transparent cap-top	Floating Montblanc emblem in transparent cap-top
PACKAGING	-	-
REFILLS		
REFILLS	Montblanc fineliner refills: Mystery Black, Pacific Blue; Montblanc rollerball refills: Mystery Black, Pacific Blue, Nightfire Red, Fortune Green, Chestnut Brown, Amethyst Purple, Barbados Blue	Montblanc ballpoint pen refills: Mystery Black, Pacific Blue, Nightfire Red, Fortune Green

WRITING INSTRUMENTS

STARWALKER

> *Metal*
Black Mystery



MODEL	Black Mystery Fountain Pen			
IDENT NO.	104222	104223	104224	104225
NIB WIDTHS	EF	F	M	B
	Other nib widths available on request			
WRITING SYSTEM				
WRITING SYSTEM	Cartridge Fountain Pen (no converter)			
NIB	Hand-crafted Au585 / 14 K gold nib rhodium-plated			
FEATURES				
BARREL	Black lacquer with laser-engraved pattern			
CAP	Black lacquer with laser-engraved pattern			
TRIM	Platinum-plated fittings			
CLIP	Platinum-plated clip with embossed Montblanc brand name and individual serial number			
SPECIAL CHARACTERISTICS	Floating Montblanc emblem in transparent cap-top			
PACKAGING	-			
REFILLS				
REFILLS	Montblanc ink cartridges: Mystery Black, Royal Blue, Midnight Blue, Burgundy Red, Lavender Purple, Oyster Grey, Toffee Brown, Irish Green			

WRITING INSTRUMENTS

STARWALKER

> Metal
Black Mystery

MODEL	Black Mystery Fineliner	Black Mystery Ballpoint Pen
IDENT No.	104226	104227
WRITING SYSTEM		
WRITING SYSTEM	Fineliner	Ballpoint Pen with twist mechanism
NIB	-	-
FEATURES		
BARREL	Black lacquer with laser-engraved pattern	Black lacquer with laser-engraved pattern
CAP	Black lacquer with laser-engraved pattern	-
TRIM	Platinum-plated fittings	Platinum-plated fittings
CLIP	Platinum-plated clip with embossed Montblanc brand name and individual serial number	Platinum-plated clip with embossed Montblanc brand name and individual serial number
SPECIAL CHARACTERISTICS	Floating Montblanc emblem in transparent cap-top	Floating Montblanc emblem in transparent cap-top
PACKAGING	-	-
REFILLS		
REFILLS	Montblanc fineliner refills: Mystery Black, Pacific Blue; Montblanc rollerball refills: Mystery Black, Pacific Blue, Nightfire Red, Fortune Green, Chestnut Brown, Amethyst Purple, Barbados Blue	Montblanc ballpoint pen refills: Mystery Black, Pacific Blue, Nightfire Red, Fortune Green

WRITING INSTRUMENTS

STARWALKER

> *Metal*
Metal/Rubber



MODEL	Metal/Rubber Fountain Pen			
IDENT NO.	o8852	o8853	o8854	o8855
NIB WIDTHS	EF	F	M	B
	Other nib widths available on request			
WRITING SYSTEM				
WRITING SYSTEM	Cartridge Fountain Pen (no converter)			
NIB	Hand-crafted Au585 / 14 K gold nib rhodium-plated			
FEATURES				
BARREL	Black rubber-like surface with diamond-cut lines			
CAP	Black rubber-like surface with diamond-cut lines			
TRIM	Platinum-plated fittings			
CLIP	Platinum-plated clip with embossed Montblanc brand name and individual serial number			
SPECIAL CHARACTERISTICS	Floating Montblanc emblem in transparent cap-top			
PACKAGING	-			
REFILLS				
REFILLS	Montblanc ink cartridges: Mystery Black, Royal Blue, Midnight Blue, Burgundy Red, Lavender Purple, Oyster Grey, Toffee Brown, Irish Green			

WRITING INSTRUMENTS

STARWALKER

> Metal
Metal/Rubber

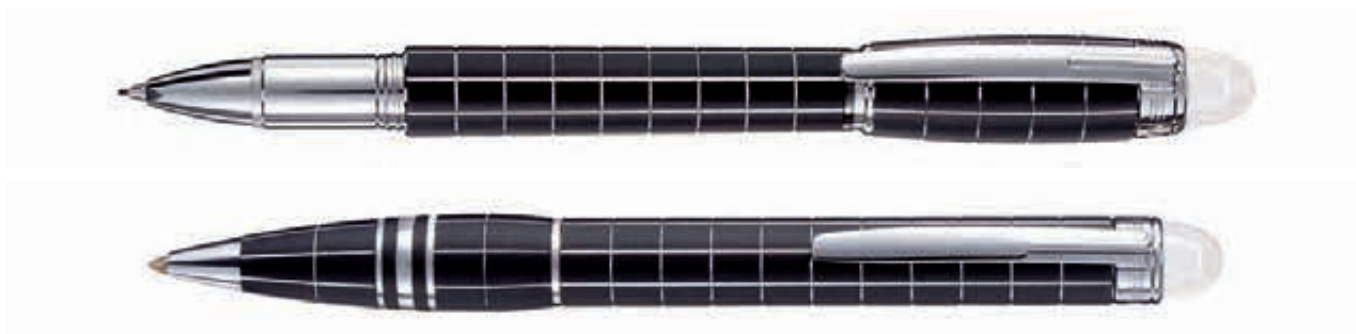

MODEL	Metal/Rubber Fineliner	Metal/Rubber Ballpoint Pen
IDENT No.	o8856 B	o8857
	Other nib widths available on request	
WRITING SYSTEM		
WRITING SYSTEM	Fineliner	Ballpoint Pen with twist mechanism
NIB	-	-
FEATURES		
BARREL	Black rubber-like surface with diamond-cut lines	Black rubber-like surface with diamond-cut lines
CAP	Black rubber-like surface with diamond-cut lines	-
TRIM	Platinum-plated fittings	Platinum-plated fittings
CLIP	Platinum-plated clip with embossed Montblanc brand name and individual serial number	Platinum-plated clip with embossed Montblanc brand name and individual serial number
SPECIAL CHARACTERISTICS	Floating Montblanc emblem in transparent cap-top	Floating Montblanc emblem in transparent cap-top
PACKAGING	-	-
REFILLS		
REFILLS	Montblanc fineliner refills: Mystery Black, Pacific Blue; Montblanc rollerball refills: Mystery Black, Pacific Blue, Nightfire Red, Fortune Green, Chestnut Brown, Amethyst Purple, Barbados Blue	Montblanc ballpoint pen refills: Mystery Black, Pacific Blue, Nightfire Red, Fortune Green

WRITING INSTRUMENTS

STARWALKER

> Doué



MODEL	Doué Fountain Pen			
IDENT NO.	38007	38008	38009	38010
NIB WIDTHS	EF	F	M	B
	Other nib widths available on request			
WRITING SYSTEM				
WRITING SYSTEM	Cartridge Fountain Pen (no converter)			
NIB	Hand-crafted Au585 / 14 K gold nib rhodium-plated			
FEATURES				
BARREL	Black precious resin with horizontal guilloché pattern			
CAP	Platinum-plated with horizontal guilloché pattern			
TRIM	Platinum-plated fittings			
CLIP	Platinum-plated clip with embossed Montblanc brand name and individual serial number			
SPECIAL CHARACTERISTICS	Floating Montblanc emblem in transparent cap-top			
PACKAGING	-			
REFILLS				
REFILLS	Montblanc ink cartridges: Mystery Black, Royal Blue, Midnight Blue, Burgundy Red, Lavender Purple, Oyster Grey, Toffee Brown, Irish Green			

WRITING INSTRUMENTS

STARWALKER

> Doué



MODEL	Doué Fineliner	Doué Ballpoint Pen
IDENT No.	38011	38012
WRITING SYSTEM		
WRITING SYSTEM	Fineliner	Ballpoint Pen with twist mechanism
NIB	-	-
FEATURES		
BARREL	Black precious resin with horizontal guilloché pattern	Black precious resin with horizontal guilloché pattern
CAP	Platinum-plated with horizontal guilloché pattern	-
TRIM	Platinum-plated fittings	Platinum-plated fittings
CLIP	Platinum-plated clip with embossed Montblanc brand name and individual serial number	Platinum-plated clip with embossed Montblanc brand name and individual serial number
SPECIAL CHARACTERISTICS	Floating Montblanc emblem in transparent cap-top	Floating Montblanc emblem in transparent cap-top
PACKAGING	-	-
REFILLS		
REFILLS	Montblanc fineliner refills: Mystery Black, Pacific Blue; Montblanc rollerball refills: Mystery Black, Pacific Blue, Nightfire Red, Fortune Green, Chestnut Brown, Amethyst Purple, Barbados Blue	Montblanc ballpoint pen refills: Mystery Black, Pacific Blue, Nightfire Red, Fortune Green

WRITING INSTRUMENTS

STARWALKER

> *Precious Resin*
Red Gold



MODEL	Red Gold-Plated Resin Fountain Pen	
IDENT NO.	105650	105651
NIB WIDTHS	F	M
	Other nib widths available on request	
WRITING SYSTEM		
WRITING SYSTEM	Cartridge Fountain Pen (no converter)	
NIB	Hand-crafted Au585 / 14 K gold nib	
FEATURES		
BARREL	Black precious resin	
CAP	Black precious resin	
TRIM	Red gold-plated fittings	
CLIP	Red gold-plated clip with embossed Montblanc brand name and individual serial number	
SPECIAL CHARACTERISTICS	Floating Montblanc emblem in transparent cap-top	
PACKAGING	-	
REFILLS		
REFILLS	Montblanc ink cartridges: Mystery Black, Royal Blue, Midnight Blue, Burgundy Red, Lavender Purple, Oyster Grey, Toffee Brown, Irish Green	

WRITING INSTRUMENTS

STARWALKER

> *Precious Resin*
Red Gold



MODEL	Red Gold-Plated Resin Fineliner	Red Gold-Plated Resin Ballpoint Pen
IDENT No.	105652	105653
WRITING SYSTEM		
WRITING SYSTEM	Fineliner	Ballpoint Pen with twist mechanism
NIB	-	-
FEATURES		
BARREL	Black precious resin	Black precious resin
CAP	Black precious resin	Black precious resin
TRIM	Red gold-plated fittings	Red gold-plated fittings
CLIP	Red gold-plated clip with embossed Montblanc brand name and individual serial number	Red gold-plated clip with embossed Montblanc brand name and individual serial number
SPECIAL CHARACTERISTICS	Floating Montblanc emblem in transparent cap-top	Floating Montblanc emblem in transparent cap-top
PACKAGING	-	-
REFILLS		
REFILLS	Montblanc fineliner refills: Mystery Black, Pacific Blue; Montblanc rollerball refills: Mystery Black, Pacific Blue, Nightfire Red, Fortune Green, Chestnut Brown, Amethyst Purple, Barbados Blue	Montblanc ballpoint pen refills: Mystery Black, Pacific Blue, Nightfire Red, Fortune Green

WRITING INSTRUMENTS

STARWALKER

> *Precious Resin Platinum*



MODEL	Platinum-Plated Resin Fountain Pen			
IDENT NO.	08480	08481	08482	08483
NIB WIDTHS	EF	F	M	B
	Other nib widths available on request			
WRITING SYSTEM	Cartridge Fountain Pen (no converter)			
WRITING SYSTEM	Cartridge Fountain Pen (no converter)			
NIB	Hand-crafted Au585 / 14 K gold nib rhodium-plated			
FEATURES				
BARREL	Black precious resin			
CAP	Black precious resin			
TRIM	Platinum-plated fittings			
CLIP	Platinum-plated clip with embossed Montblanc brand name and individual serial number			
SPECIAL CHARACTERISTICS	Floating Montblanc emblem in transparent cap-top			
PACKAGING	-			
REFILLS				
REFILLS	Montblanc ink cartridges: Mystery Black, Royal Blue, Midnight Blue, Burgundy Red, Lavender Purple, Oyster Grey, Toffee Brown, Irish Green			

WRITING INSTRUMENTS

STARWALKER

> *Precious Resin
Platinum*



MODEL	Platinum-Plated Resin Fineliner	Platinum-Plated Resin Ballpoint Pen	Platinum-Plated Resin Mechanical Pencil
IDENT No.	o8485	o8486	o8484
WRITING SYSTEM			
WRITING SYSTEM	Fineliner	Ballpoint Pen with twist mechanism	Mechanical Pencil with twist mechanism
NIB	-	-	-
FEATURES			
BARREL	Black precious resin	Black precious resin	Black precious resin
CAP	Black precious resin	-	-
TRIM	Platinum-plated fittings	Platinum-plated fittings	Platinum-plated fittings
CLIP	Platinum-plated clip with embossed Montblanc brand name and individual serial number	Platinum-plated clip with embossed Montblanc brand name and individual serial number	Platinum-plated clip with embossed Montblanc brand name and individual serial number
SPECIAL CHARACTERISTICS	Floating Montblanc emblem in transparent cap-top	Floating Montblanc emblem in transparent cap-top	Floating Montblanc emblem in transparent cap-top
PACKAGING	-	-	-
REFILLS			
REFILLS	Montblanc fineliner refills: Mystery Black, Pacific Blue; Montblanc rollerball refills: Mystery Black, Pacific Blue, Nightfire Red, Fortune Green, Chestnut Brown, Amethyst Purple, Barbados Blue	Montblanc ballpoint pen refills: Mystery Black, Pacific Blue, Nightfire Red, Fortune Green	Montblanc hi-polymer 0.7 mm lead, eraser

WRITING INSTRUMENTS

*STARWALKER**> Precious Resin**Midnight Black*

MODEL	Midnight Black Resin Fountain Pen	
IDENT NO.	105654	105655
NIB WIDTHS	F	M
	Other nib widths available on request	
WRITING SYSTEM		
WRITING SYSTEM	Cartridge Fountain Pen (no converter)	
NIB	Hand-crafted Au585 / 14 K gold nib ruthenium-plated	
FEATURES		
BARREL	Black precious resin	
CAP	Black precious resin	
TRIM	Ruthenium-plated fittings	
CLIP	Ruthenium-plated clip with embossed Montblanc brand name and individual serial number	
SPECIAL CHARACTERISTICS	Floating Montblanc emblem in transparent cap-top	
PACKAGING	-	
REFILLS		
REFILLS	Montblanc ink cartridges: Mystery Black, Royal Blue, Midnight Blue, Lavender Purple, Oyster Grey, Toffee Brown, Irish Green	

WRITING INSTRUMENTS

STARWALKER

> *Precious Resin*
Midnight Black



MODEL	Midnight Black Resin Fineliner	Midnight Black Resin Ballpoint
IDENT No.	105656	105657
WRITING SYSTEM		
WRITING SYSTEM	Fineliner	Ballpoint Pen with twist mechanism
NIB	-	-
FEATURES		
BARREL	Black precious resin	Black precious resin
CAP	Black precious resin	-
TRIM	Ruthenium-plated fittings	Ruthenium-plated fittings
CLIP	Ruthenium-plated clip with embossed Montblanc brand name and individual serial number	Ruthenium-plated clip with embossed Montblanc brand name and individual serial number
SPECIAL CHARACTERISTICS	Floating Montblanc emblem in transparent cap-top	Floating Montblanc emblem in transparent cap-top
PACKAGING	-	-
REFILLS		
REFILLS	Montblanc fineliner refills: Mystery Black, Pacific Blue; Montblanc rollerball refills: Mystery Black, Pacific Blue, Nightfire Red, Fortune Green, Chestnut Brown, Amethyst Purple, Barbados Blue	Montblanc ballpoint pen refills: Mystery Black, Pacific Blue, Nightfire Red, Fortune Green



WRITING INSTRUMENTS





As a symbol of purity and persistence, a unique diamond cut in the shape of the renowned emblem is the crowning attribute of the line.

Etoile de Montblanc

Floating in a transparent dome, it transforms the writing instrument into an exceptional piece of adornment to fall in love with.





WRITING INSTRUMENTS





WRITING INSTRUMENTS

ÉTOILE DE MONTBLANC

> Metal



Etoile Mystérieuse

p. 138



Etoile Eternelle

p. 140



Etoile Méditerranée

p. 142

> Precious Resin



Etoile Précieuse

p. 144



Etoile de Montblanc

p. 146

WRITING INSTRUMENTS

ÉTOILE DE MONTBLANC> *Metal**Etoile Mystérieuse*

MODEL	Etoile Mystérieuse Fountain Pen
IDENT NO.	105022 M Other nib widths available on request
WRITING SYSTEM	
WRITING SYSTEM	Cartridge Fountain Pen (no converter)
NIB	Hand-crafted Au750 / 18 K gold nib rhodium-plated with Montblanc emblem as hearthole
FEATURES	
BARREL	Ag925 sterling silver, coated with black lacquer, set with 60 diamonds (~0.67 ct, including those on barrel-ring)
CAP	Ag925 sterling silver, coated with black lacquer, set with 42 diamonds (~0.39 ct)
TRIM	Ag925 sterling silver
CLIP	Silver-plated clip set with 43 diamonds (~0.27 ct)
SPECIAL CHARACTERISTICS	Montblanc Diamond in cap-top (~0.10 ct)
PACKAGING	-
REFILLS	
REFILLS	Montblanc ink cartridges: Mystery Black, Royal Blue, Midnight Blue, Burgundy Red, Lavender Purple, Oyster Grey, Toffee Brown, Irish Green

WRITING INSTRUMENTS

ÉTOILE DE MONTBLANC> *Metal**Etoile Mystérieuse*

MODEL	Etoile Mystérieuse Rollerball
IDENT No.	105023
WRITING SYSTEM	
WRITING SYSTEM	Rollerball
NIB	-
FEATURES	
BARREL	Ag925 sterling silver, coated with black lacquer, set with 60 diamonds (~0.67 ct, including those on barrel-ring)
CAP	Ag925 sterling silver, coated with black lacquer, set with 42 diamonds (~0.39 ct)
TRIM	Ag925 sterling silver
CLIP	Silver-plated clip set with 43 diamonds (~0.27 ct)
SPECIAL CHARACTERISTICS	Montblanc Diamond in cap-top (~0.10 ct)
PACKAGING	-
REFILLS	
REFILLS	Montblanc rollerball refills: Mystery Black, Pacific Blue, Nightfire Red, Fortune Green, Chestnut Brown, Amethyst Purple, Barbados Blue; Montblanc fineliner refills: Mystery Black, Pacific Blue

WRITING INSTRUMENTS

*ÉTOILE DE MONTBLANC**> Metal
Étoile Eternelle*

MODEL	Etoile Eternelle Fountain Pen
IDENT NO.	105953 M Other nib widths available on request
WRITING SYSTEM	
WRITING SYSTEM	Cartridge Fountain Pen (no converter)
NIB	Hand-crafted Au750 / 18 K gold nib with Montblanc emblem as hearthole
FEATURES	
BARREL	Ag925 sterling silver coated with a transparent lacquer
CAP	Ag925 sterling silver coated with a transparent lacquer
TRIM	Champagne-tone gold-plated
CLIP	Champagne-tone gold-plated clip with individual serial number
SPECIAL CHARACTERISTICS	Montblanc Diamond in cap-top (~0.05 ct)
PACKAGING	-
REFILLS	
REFILLS	Montblanc ink cartridges: Mystery Black, Royal Blue, Midnight Blue, Burgundy Red, Lavender Purple, Oyster Grey, Toffee Brown, Irish Green

WRITING INSTRUMENTS

ETOILE DE MONTBLANC

> Metal
Etoile Eternelle

MODEL	Etoile Eternelle Rollerball	Etoile Eternelle Ballpoint Pen
IDENT No.	105954	105955
WRITING SYSTEM		
WRITING SYSTEM	Rollerball	Ballpoint Pen with twist mechanism
NIB	-	-
FEATURES		
BARREL	Ag925 sterling silver coated with a transparent lacquer	Ag925 sterling silver coated with a transparent lacquer
CAP	Ag925 sterling silver coated with a transparent lacquer	Ag925 sterling silver coated with a transparent lacquer
TRIM	Champagne-tone gold-plated	Champagne-tone gold-plated
CLIP	Champagne-tone gold-plated clip with individual serial number	Champagne-tone gold-plated clip with individual serial number
SPECIAL CHARACTERISTICS	Montblanc Diamond in cap-top (~0.05 ct)	Montblanc Diamond in cap-top (~0.05 ct)
PACKAGING	-	-
REFILLS		
REFILLS	Montblanc rollerball refills: Mystery Black, Pacific Blue, Nightfire Red, Fortune Green, Chestnut Brown, Amethyst Purple, Barbados Blue; Montblanc fineliner refills: Mystery Black, Pacific Blue	Montblanc ballpoint pen refills: Mystery Black, Pacific Blue, Nightfire Red, Fortune Green

WRITING INSTRUMENTS

ÉTOILE DE MONTBLANC> *Metal**Etoile Méditerranée*

MODEL	Etoile Méditerranée Fountain Pen
IDENT NO.	105957 M Other nib widths available on request
WRITING SYSTEM	
WRITING SYSTEM	Cartridge Fountain Pen (no converter)
NIB	Hand-crafted Au750 / 18 K gold nib with Montblanc emblem as hearthole
FEATURES	
BARREL	Ag925 sterling silver coated with blue-grey translucent lacquer
CAP	Ag925 sterling silver coated with blue-grey translucent lacquer
TRIM	Champagne-tone gold-plated
CLIP	Champagne-tone gold-plated clip with individual serial number
SPECIAL CHARACTERISTICS	Montblanc Diamond in cap-top (~0.05 ct)
PACKAGING	-
REFILLS	
REFILLS	Montblanc ink cartridges: Mystery Black, Royal Blue, Midnight Blue, Burgundy Red, Lavender Purple, Oyster Grey, Toffee Brown, Irish Green

WRITING INSTRUMENTS

ETOILE DE MONTBLANC

> Metal

Etoile Méditerranée



MODEL	Etoile Méditerranée Rollerball	Etoile Méditerranée Ballpoint Pen
IDENT No.	105958	105959
WRITING SYSTEM		
WRITING SYSTEM	Rollerball	Ballpoint Pen with twist mechanism
NIB	-	-
FEATURES		
BARREL	Ag925 sterling silver coated with blue-grey translucent lacquer	Ag925 sterling silver coated with blue-grey translucent lacquer
CAP	Ag925 sterling silver coated with blue-grey translucent lacquer	Ag925 sterling silver coated with blue-grey translucent lacquer
TRIM	Champagne-tone gold-plated	Champagne-tone gold-plated
CLIP	Champagne-tone gold-plated clip with individual serial number	Champagne-tone gold-plated clip with individual serial number
SPECIAL CHARACTERISTICS	Montblanc Diamond in cap-top (~0.05 ct)	Montblanc Diamond in cap-top (~0.05 ct)
PACKAGING	-	-
REFILLS		
REFILLS	Montblanc rollerball refills: Mystery Black, Pacific Blue, Nightfire Red, Fortune Green, Chestnut Brown, Amethyst Purple, Barbados Blue; Montblanc fineliner refills: Mystery Black, Pacific Blue	Montblanc ballpoint pen refills: Mystery Black, Pacific Blue, Nightfire Red, Fortune Green

WRITING INSTRUMENTS

ÉTOILE DE MONTBLANC

> *Precious Resin*
Etoile Précieuse



MODEL	Etoile Précieuse Fountain Pen	
IDENT NO.	106292	106293
NIB WIDTHS	F	M
	Other nib widths available on request	
WRITING SYSTEM		
WRITING SYSTEM	Cartridge Fountain Pen (no converter)	
NIB	Hand-crafted Au750 / 18 K gold nib rhodium-plated with Montblanc emblem as heart-hole	
FEATURES		
BARREL	Black precious resin	
CAP	Black precious resin	
TRIM	Platinum-plated fittings	
CLIP	Platinum-plated clip with individual serial number	
SPECIAL CHARACTERISTICS	Montblanc Diamond in cap-top (~0.10 ct), hand-set diamond paving on cap-top and clip (~0.28 ct)	
PACKAGING	-	
REFILLS		
REFILLS	Montblanc ink cartridges: Mystery Black, Royal Blue, Midnight Blue, Burgundy Red, Lavender Purple, Oyster Grey, Toffee Brown, Irish Green	

WRITING INSTRUMENTS

ETOILE DE MONTBLANC

> *Precious Resin*
Etoile Précieuse



MODEL	Etoile Précieuse Rollerball	Etoile Précieuse Ballpoint Pen
IDENT No.	106294	104303
WRITING SYSTEM		
WRITING SYSTEM	Rollerball	Ballpoint Pen with twist mechanism
NIB	-	-
FEATURES		
BARREL	Black precious resin	Black precious resin
CAP	Black precious resin	-
TRIM	Platinum-plated fittings	Platinum-plated fittings
CLIP	Platinum-plated clip with individual serial number	Platinum-plated clip with individual serial number
SPECIAL CHARACTERISTICS	Montblanc Diamond in cap-top (~0.10 ct), hand-set diamond paving on cap-top and clip (~0.28 ct)	Montblanc Diamond in cap-top (~0.10 ct), hand-set diamond paving on cap-top and clip (~0.28 ct)
PACKAGING	-	-
REFILLS		
REFILLS	Montblanc rollerball refills: Mystery Black, Pacific Blue, Nightfire Red, Fortune Green, Chestnut Brown, Amethyst Purple, Barbados Blue; Montblanc fineliner refills: Mystery Black, Pacific Blue	Montblanc ballpoint pen refills: Mystery Black, Pacific Blue, Nightfire Red, Fortune Green

WRITING INSTRUMENTS

ETOILE DE MONTBLANC

> *Precious Resin*
Etoile de Montblanc



MODEL	Etoile de Montblanc Fountain Pen		
IDENT NO.	106288	106289	106290
NIB WIDTHS	EF	F	M
	Other nib widths available on request		
WRITING SYSTEM			
WRITING SYSTEM	Cartridge Fountain Pen (no converter)		
NIB	Hand-crafted Au750 / 18 K gold nib rhodium-plated with Montblanc emblem as hearthole		
FEATURES			
BARREL	Black precious resin		
CAP	Black precious resin		
TRIM	Platinum-plated fittings		
CLIP	Platinum-plated clip with individual serial number		
SPECIAL CHARACTERISTICS	Montblanc Diamond in cap-top (~0.05 ct)		
PACKAGING	-		
REFILLS			
REFILLS	Montblanc ink cartridges: Mystery Black, Royal Blue, Midnight Blue, Burgundy Red, Lavender Purple, Oyster Grey, Toffee Brown, Irish Green		

WRITING INSTRUMENTS

ETOILE DE MONTBLANC

> *Precious Resin*
Etoile de Montblanc



MODEL	Etoile de Montblanc Rollerball	Etoile de Montblanc Ballpoint Pen	Etoile de Montblanc Mechanical Pencil
IDENT NO.	106291	103379	103380
WRITING SYSTEM			
WRITING SYSTEM	Rollerball	Ballpoint Pen with twist mechanism	Mechanical Pencil with twist mechanism
NIB	-	-	-
FEATURES			
BARREL	Black precious resin	Black precious resin	Black precious resin
CAP	Black precious resin	-	-
TRIM	Platinum-plated fittings	Platinum-plated fittings	Platinum-plated fittings
CLIP	Platinum-plated clip with individual serial number	Platinum-plated clip with individual serial number	Platinum-plated clip with individual serial number
SPECIAL CHARACTERISTICS	Montblanc Diamond in cap-top (~0.05 ct)	Montblanc Diamond in cap-top (~0.05 ct)	Montblanc Diamond in cap-top (~0.05 ct)
PACKAGING	-	-	-
REFILLS			
REFILLS	Montblanc rollerball refills: Mystery Black, Pacific Blue, Nightfire Red, Fortune Green, Chestnut Brown, Amethyst Purple, Barbados Blue; Montblanc fineliner refills: Mystery Black, Pacific Blue	Montblanc ballpoint pen refills: Mystery Black, Pacific Blue, Nightfire Red, Fortune Green	Montblanc hi-polymer 0.7 mm lead, eraser



WRITING INSTRUMENTS





Paying tribute to extraordinary women this Edition perfectly reflects the personality of the honoured Diva in the design of the writing instruments.

Diva Line

Underlining our commitment to manufacture sophisticated products that go beyond their functional beauty the Diva Line embodies something special: a soul.



WRITING INSTRUMENTS

DIVALINE

> *Princesse Grace de Monaco*



MODEL	Princesse Grace de Monaco Fountain Pen	
IDENT NO.	106630	106631
NIB WIDTHS	F	M
	Other nib widths available on request	
WRITING SYSTEM		
WRITING SYSTEM	Cartridge Fountain Pen (no converter)	
NIB	Hand-crafted Au750 / 18 K gold nib with heart-shaped hearthole	
FEATURES		
BARREL	Royal purple precious resin	
CAP	Royal purple precious resin	
TRIM	Champagne-tone gold-plated	
CLIP	Champagne-tone gold-plated, set with a petal-cut pink topaz (heat-treated) of approx. 0.39 ct.	
SPECIAL CHARACTERISTICS	Cone adorned with a mother-of-pearl cabochon	
PACKAGING	Special Packaging	
REFILLS		
REFILLS	Montblanc ink cartridges: Mystery Black, Royal Blue, Midnight Blue, Burgundy Red, Lavender Purple, Oyster Grey, Toffee Brown, Irish Green	

WRITING INSTRUMENTS

DIVALINE

> *Princesse Grace de Monaco*



MODEL	Princesse Grace de Monaco Rollerball	Princesse Grace de Monaco Ballpoint Pen
IDENT No.	106632	106633
WRITING SYSTEM		
WRITING SYSTEM	Rollerball	Ballpoint Pen with twist mechanism
NIB	-	-
FEATURES		
BARREL	Royal purple precious resin	Royal purple precious resin
CAP	Royal purple precious resin	Royal purple precious resin
TRIM	Champagne-tone gold-plated	Champagne-tone gold-plated
CLIP	Champagne-tone gold-plated, set with a petal-cut pink topaz (heat-treated) of approx. 0.39 ct.	Champagne-tone gold-plated, set with a petal-cut pink topaz (heat-treated) of approx. 0.39 ct.
SPECIAL CHARACTERISTICS	Cone adorned with a mother-of-pearl cabochon	-
PACKAGING	Special Packaging	Special Packaging
REFILLS		
REFILLS	Montblanc rollerball refills: Mystery Black, Pacific Blue, Nightfire Red, Fortune Green, Chestnut Brown, Amethyst Purple, Barbados Blue; Montblanc fineliner refills: Mystery Black, Pacific Blue	Montblanc ballpoint pen refills: Mystery Black, Pacific Blue, Nightfire Red, Fortune Green



WRITING INSTRUMENTS





Montblanc's commitment to the arts and culture embraces the
fascinating world of classical music and the beautiful moments of the

Donation Pen

greatest artists of modern time. Each remarkable design refers closely to
the eponym concerned and invites you to dream their most important
moments.





WRITING INSTRUMENTS





WRITING INSTRUMENTS

DONATION PEN



Johannes Brahms Special Edition

p. 156



John Lennon Special Edition

p. 158

WRITING INSTRUMENTS

DONATION PEN

> *Classical Conductors*
Johannes Brahms Special Edition



MODEL	Johannes Brahms Special Edition Fountain Pen			
IDENT No.	107447	107448	107449	107450
NIB WIDTHS	EF	F	M	B
	Other nib widths available on request			
WRITING SYSTEM				
WRITING SYSTEM	Piston Fountain Pen			
NIB	Hand-crafted Au585 / 14 K gold nib rhodium-plated with the peace dove			
FEATURES				
BARREL	Black precious resin, platinum-plated fittings			
CAP	Black precious resin, platinum-plated fittings			
TRIM	Platinum-plated fittings			
CLIP	Clip inspired by a tuning fork, clip ring refers to the five lines of a piano staff			
SPECIAL CHARACTERISTICS	Reproduction of Brahm's signature engraved on the cap ring			
PACKAGING	Special gift box additionally contains a tuning fork			
REFILLS				
REFILLS	Montblanc ink: Mystery Black, Royal Blue, Midnight Blue, Burgundy Red, Lavender Purple, Oyster Grey, Toffee Brown, Irish Green			

WRITING INSTRUMENTS

DONATION PEN

> *Classical Conductors*
Johannes Brahms Special Edition



MODEL	Johannes Brahms Special Edition Rollerball	Johannes Brahms Special Edition Ballpoint Pen
IDENT No.	107451	107452
WRITING SYSTEM		
WRITING SYSTEM	Rollerball	Ballpoint Pen with twist mechanism
NIB	-	-
FEATURES		
BARREL	Black precious resin, platinum-plated fittings	Black precious resin, platinum-plated fittings
CAP	Black precious resin, platinum-plated fittings	Black precious resin, platinum-plated fittings
TRIM	Platinum-plated fittings	Platinum-plated fittings
CLIP	Clip inspired by a tuning fork, clip ring refers to the five lines of a piano staff	Clip inspired by a tuning fork, clip ring refers to the five lines of a piano staff
SPECIAL CHARACTERISTICS	Reproduction of Brahm's signature engraved on the cap ring	Reproduction of Brahm's signature engraved on the cap ring
PACKAGING	Special gift box additionally contains a tuning fork	Special gift box additionally contains a tuning fork
REFILLS		
REFILLS	Montblanc rollerball refills: Mystery Black, Pacific Blue, Nightfire Red, Fortune Green, Chestnut Brown, Amethyst Purple, Barbados Blue; Montblanc fineliner refills: Mystery Black, Pacific Blue	Montblanc ballpoint pen refills: Mystery Black, Pacific Blue, Nightfire Red, Fortune Green

WRITING INSTRUMENTS

DONATION PEN

> *Contemporary Legends*
John Lennon Special Edition



MODEL	John Lennon Special Edition Fountain Pen	
IDENT NO.	105806	105807
NIB WIDTHS	F	M
	Other nib widths available on request	
WRITING SYSTEM		
WRITING SYSTEM	Piston Fountain Pen	
NIB	Hand-crafted Au750 / 18 K gold nib, rhodium-plated with peace sign	
FEATURES		
BARREL	Black precious resin with its surface evoking a vinyl record, platinum-plated cone and fittings	
CAP	Black precious resin with its surface evoking a vinyl record, inlaid with Montblanc emblem	
TRIM	Platinum-plated	
CLIP	Stainless steel	
SPECIAL CHARACTERISTICS	Clip inspired by his guitar, sketched portrait in the guitar hole	
PACKAGING	Specially designed packaging containing his most famous song "Imagine"	
REFILLS		
REFILLS	Montblanc ink: Mystery Black, Royal Blue, Midnight Blue, Burgundy Red, Lavender Purple, Oyster Grey, Toffee Brown, Irish Green	

WRITING INSTRUMENTS

DONATION PEN

> *Contemporary Legends*
John Lennon Special Edition



MODEL	John Lennon Special Edition Rollerball	John Lennon Special Edition Ballpoint Pen
IDENT No.	105809	105808
WRITING SYSTEM		
WRITING SYSTEM	Rollerball	Ballpoint Pen with twist mechanism
NIB	-	-
FEATURES		
BARREL	Black precious resin with its surface evoking a vinyl record, platinum-plated cone and fittings	Black precious resin with its surface evoking a vinyl record, inlaid with Montblanc emblem
CAP	Black precious resin with its surface evoking a vinyl record, inlaid with Montblanc emblem	-
TRIM	Platinum-plated	Platinum-plated
CLIP	Stainless steel	Stainless steel
SPECIAL CHARACTERISTICS	Clip inspired by his guitar, sketched portrait in the guitar hole	Clip inspired by his guitar, sketched portrait in the guitar hole
PACKAGING	Specially designed packaging containing his most famous song "Imagine"	Specially designed packaging containing his most famous song "Imagine"
REFILLS		
REFILLS	Montblanc rollerball refills: Mystery Black, Pacific Blue, Nightfire Red, Fortune Green, Chestnut Brown, Amethyst Purple, Barbados Blue; Montblanc fineliner refills: Mystery Black, Pacific Blue	Montblanc ballpoint pen refills: Mystery Black, Pacific Blue, Nightfire Red, Fortune Green

WRITING INSTRUMENTS



For complementing our writing instruments, Montblanc offers various accessories to suit every individual taste and occasion.

Writing Accessories



There is a selection of a wide variety of colours, writing modes, widths and sizes. Aligned with the luxury appeal of the brand our refills exceed the value of mere utility but rather create an emotional experience.



WRITING ACCESSORIES

> Fountain Pen



Ink Bottle

- Ink bottle with front compartment for emptying residue into
- 60 ml



Ink Cartridges

- 8 cartridges per package
- For all Montblanc Fountain Pens with Cartridge Systems

Colour	Refills' Type	Ident. No.
<i>Mystery Black</i>	Ink Bottle (60 ml)	105190
	Ink Cartridges (8 cartridges per package)	105191
<i>Royal Blue</i>	Ink Bottle (60 ml)	105192
	Ink Cartridges (8 cartridges per package)	105193
<i>Midnight Blue</i>	Ink Bottle (60 ml), permanent	105194
	Ink Cartridges (8 cartridges per package)	105195
<i>Lavender Purple</i>	Ink Bottle (60 ml)	105196
	Ink Cartridges (8 cartridges per package)	105197
<i>Burgundy Red</i>	Ink Bottle (60 ml)	105198
	Ink Cartridges (8 cartridges per package)	105199
<i>Oyster Grey</i>	Ink Bottle (60 ml)	105186
	Ink Cartridges (8 cartridges per package)	105187
<i>Toffee Brown</i>	Ink Bottle (60 ml)	105188
	Ink Cartridges (8 cartridges per package)	105189
<i>Irish Green</i>	Ink Bottle (60 ml)	106273
	Ink Cartridges (8 cartridges per package)	106274



WRITING INSTRUMENTS

WRITING ACCESSORIES

> Fountain Pen



Ink Cartridges

- Decorative round cardboard box
- 20 cartridges per box
- For all Montblanc Fountain Pens with Cartridge Systems

Colour	Refills' Type	Ident. No.
<i>Mystery Black</i>	Ink Cartridges (20 cartridges per box)	105142
<i>Royal Blue</i>	Ink Cartridges (20 cartridges per box)	105143

Model	Ident. No.	
 Piston Converter	105181	Piston filling system, suitable for Montblanc Meisterstück and Meisterstück Solitaire Cartridge Fountain Pens







WRITING INSTRUMENTS

WRITING ACCESSORIES

> Ballpoint Pen

Model		Ident. No.	
	1 Ballpoint Pen Refill (B) Mystery Black	105148	For all Montblanc Ballpoint Pens except Meisterstück Hommage à W.A. Mozart. Packaging unit = 1 Refill. B = Broad.
	1 Ballpoint Pen Refill (B) Pacific Blue	105149	For all Montblanc Ballpoint Pens except Meisterstück Hommage à W.A. Mozart. Packaging unit = 1 Refill. B = Broad.
	1 Ballpoint Pen Refill (M) Mystery Black	105150	For all Montblanc Ballpoint Pens except Meisterstück Hommage à W.A. Mozart. Packaging unit = 1 Refill. M = Medium.
	1 Ballpoint Pen Refill (M) Pacific Blue	105151	For all Montblanc Ballpoint Pens except Meisterstück Hommage à W.A. Mozart. Packaging unit = 1 Refill. M = Medium.
	1 Ballpoint Pen Refill (M) Nightfire Red	105152	For all Montblanc Ballpoint Pens except Meisterstück Hommage à W.A. Mozart. Packaging unit = 1 Refill. M = Medium.
	1 Ballpoint Pen Refill (M) Fortune Green	105153	For all Montblanc Ballpoint Pens except Meisterstück Hommage à W.A. Mozart. Packaging unit = 1 Refill. M = Medium.
	1 Ballpoint Pen Refill (F) Mystery Black	105154	For all Montblanc Ballpoint Pens except Meisterstück Hommage à W.A. Mozart. Packaging unit = 1 Refill. F = Fine.
	1 Ballpoint Pen Refill (F) Pacific Blue	105155	For all Montblanc Ballpoint Pens except Meisterstück Hommage à W.A. Mozart. Packaging unit = 1 Refill. F = Fine.

> Ballpoint Pen Small

	3 Ballpoint Pen Hommage à W.A. Mozart Refills Mystery Black	105156	For Meisterstück Hommage à W.A. Mozart Ballpoint Pens. Packaging unit = 3 Refills.
	3 Ballpoint Pen Hommage à W.A. Mozart Refills Pacific Blue	105157	For Meisterstück Hommage à W.A. Mozart Ballpoint Pens. Packaging unit = 3 Refills.





WRITING INSTRUMENTS

WRITING ACCESSORIES

> Rollerball

Model		Ident. No.	
	2 Rollerball Refills (M) Mystery Black	105158	For all Montblanc Rollerball / Fineliner Pens except Meisterstück LeGrand Rollerball. Packaging unit = 2 Refills. M = Medium.
	2 Rollerball Refills (M) Pacific Blue	105159	For all Montblanc Rollerball / Fineliner Pens except Meisterstück LeGrand Rollerball. Packaging unit = 2 Refills. M = Medium.
	2 Rollerball Refills (M) Nightfire Red	105160	For all Montblanc Rollerball / Fineliner Pens except Meisterstück LeGrand Rollerball. Packaging unit = 2 Refills. M = Medium.
	2 Rollerball Refills (M) Fortune Green	105161	For all Montblanc Rollerball / Fineliner Pens except Meisterstück LeGrand Rollerball. Packaging unit = 2 Refills. M = Medium.
	2 Rollerball Refills (M) Chestnut Brown	106930	For all Montblanc Rollerball / Fineliner Pens except Meisterstück LeGrand Rollerball. Packaging unit = 2 Refills. M = Medium.
	2 Rollerball Refills (M) Amethyst Purple	106931	For all Montblanc Rollerball / Fineliner Pens except Meisterstück LeGrand Rollerball. Packaging unit = 2 Refills. M = Medium.
	2 Rollerball Refills (M) Barbados Blue	106932	For all Montblanc Rollerball / Fineliner Pens except Meisterstück LeGrand Rollerball. Packaging unit = 2 Refills. M = Medium.
	2 Rollerball Refills (F) Mystery Black	105162	For all Montblanc Rollerball / Fineliner Pens except Meisterstück LeGrand Rollerball. Packaging unit = 2 Refills. F = Fine.
	2 Rollerball Refills (F) Pacific Blue	105163	For all Montblanc Rollerball / Fineliner Pens except Meisterstück LeGrand Rollerball. Packaging unit = 2 Refills. F = Fine.





WRITING INSTRUMENTS

WRITING ACCESSORIES



> Rollerball LeGrand

Model		Ident. No.	
	2 Rollerball LeGrand Refills (M) Mystery Black	105164	For Meisterstück LeGrand Rollerball Pens. Packaging unit = 2 Refills. M = Medium.
	2 Rollerball LeGrand Refills (M) Pacific Blue	105165	For Meisterstück LeGrand Rollerball Pens. Packaging unit = 2 Refills. M = Medium.
	2 Rollerball LeGrand Refills (F) Mystery Black	105166	For Meisterstück LeGrand Rollerball Pens. Packaging unit = 2 Refills. F = Fine.
	2 Rollerball LeGrand Refills (F) Pacific Blue	105167	For Meisterstück LeGrand Rollerball Pens. Packaging unit = 2 Refills. F = Fine.

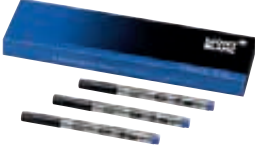
> Rollerball Small

Model		Ident. No.	
	3 Rollerball Small Refills (M) Mystery Black	107323	For all Montblanc Meisterstück "Hommage à W.A. Mozart" small Rollerball Pens. Packaging unit = 3 Refills. M = Medium
	3 Rollerball Small Refills (M) Pacific Blue	107324	For all Montblanc Meisterstück "Hommage à W.A. Mozart" small Rollerball Pens. Packaging unit = 3 Refills. M = Medium

> Fineliner



Model		Ident. No.	
	2 Fineliner Refills Mystery Black	105170	For all Montblanc Fineliner / Rollerball Pens except Meisterstück LeGrand Rollerball. Packaging unit = 2 Refills.
	2 Fineliner Refills Pacific Blue	105171	For all Montblanc Fineliner / Rollerball Pens except Meisterstück LeGrand Rollerball. Packaging unit = 2 Refills.







WRITING ACCESSORIES

> Document Marker

Model		Ident. No.	
	2 Document Marker Refills Luminous Yellow	105168	For all Montblanc Document Markers. Packaging unit = 2 Refills.
	2 Document Marker Refills Luminous Green	105169	For all Montblanc Document Markers. Packaging unit = 2 Refills.

> Mechanical Pencil

Model		Ident. No.	
	Pencil Leads Hi-polymer, HB, 0.5 mm 10 per pack	12928	Only for Meisterstück Classique and Meisterstück Solitaire Mechanical Pencils.
	Pencil Leads Hi-polymer, HB, 0.7 mm 10 per pack	12929	For Meisterstück Classique, Meisterstück Hommage à W.A. Mozart, Meisterstück Solitaire, StarWalker, Etoile de Montblanc Mechanical Pencils.
	Pencil Leads Hi-polymer, HB, 0.9 mm 10 per pack	11088	Only for Meisterstück Le Grand and Bohème Mechanical Pencils.
	2 Leonardo Sketch Pen Leads Hi-polymer, HB, 5.5 mm 2 per pack	07232	Only for Meisterstück Leonardo Sketch Pen.
	Leonardo Sketch Pen Leads Hi-polymer, 4B, 5.5 mm 2 per pack	09001	Only for Meisterstück Leonardo Sketch Pen. 4B is a softer lead than HB.
	Erasers	06520	Only for Bohème Mechanical Pencils. 10 per pack
		12931	For Meisterstück Classique, Meisterstück Solitaire, StarWalker, Etoile de Montblanc Mechanical Pencils. 10 per pack
		11096	Only for Meisterstück Le Grand Mechanical Pencils. 10 per pack
		15673	Only for Meisterstück Hommage à W.A. Mozart Mechanical Pencils. 20 per pack





WRITING INSTRUMENTS

WRITING ACCESSORIES

> Blister Assortment



Model	Colour	Size	Blister (1 refill)	Blister (3 Refills)
Ballpoint Pen Refill	Mystery Black	B (broad)	107862	107864
		M (medium)	107865	107867
		F (fine)	107869	-
	Pacific Blue	B (broad)	107863	-
		M (medium)	107866	107868
		F (fine)	107870	-
For Meisterstück Hommage à W.A. Mozart Ballpoint Pens. Packaging unit = 3 Refills.	Mystery Black	-	-	107871
	Pacific Blue	-	-	107872

Model	Colour	Ident. No.
Ink Cartridges 2 packs = 16 cartridges	Mystery Black	106943
	Royal Blue	106944
	Midnight Blue	106945





WRITING INSTRUMENTS

WRITING ACCESSORIES

> Blister Assortment

107877



107880



107886



107874



107875



Model	Colour	Size	Blister (2 Refills)	Blister (5 Refills)
Rollerball Refill	Mystery Black	M (medium)	107877	107879
		F (fine)	107881	107883
	Pacific Blue	M (medium)	107878	107880
		F (fine)	107882	-
Rollerball Refill LeGrand	Mystery Black	M (medium)	107884	-
		F (fine)	107886	-
	Pacific Blue	M (medium)	107885	-
		F (fine)	107887	-
Fineliner Refill	Mystery Black	-	107873	107875
		Pacific Blue	-	107874



WRITING ACCESSORIES

> Blister Assortment

108965



107888



15176



35104



Model	Size	Ident. No.	
Pencil Leads	Hi-polymer, HB, 0.5 mm	108964	For Meisterstück Classique / Solitaire Mechanical Pencils. HB 0.5mm. Packaging unit = 10 Leads.
	Hi-polymer, HB, 0.7 mm	108965	For Meisterstück Classique / Hommage à W.A. Mozart / Solitaire, StarWalker, Etoile de Montblanc Mechanical Pencils. HB 0.7mm. Packaging unit = 10 Leads.
Document Marker Luminous Yellow		107888	For all Montblanc Document Markers.
Eraser Pack of 10		15176	For Meisterstück Classique, Meisterstück Solitaire, StarWalker, Etoile de Montblanc Mechanical Pencils.
Notepad for Notebook 2 per pack		35105	Refill Block 74 mm x 105 mm
Notepad for Notebook Meisterstück Hommage à W. A. Mozart 2 per pack		35104	Refill Block 52 mm x 105 mm



Desk Accessories





WRITING INSTRUMENTS

DESK ACCESSORIES

> Meisterstück Desk Accessories gold-plated

Trim
• Gold-plated



14073



13923



13921

Model	Ident. No.		Refills
Ink Bottle	13921	Pure lead crystal	Ink Bottle Insert Ident. No. 13913
149 Fountain Pen Stand	13924	Pure lead crystal, pivoted holder, for Meisterstück Fountain Pen No. 149	
LeGrand Fountain Pen Stand	13923	Pure lead crystal, pivoted holder, for Meisterstück Fountain Pen No. 146	
Blotter	14073		Blotting Paper Ident. No. 13912





WRITING INSTRUMENTS

DESK ACCESSORIES

> *Meisterstück Desk Accessories platinum-plated*

Trim

• Platinum-plated



05275

Model	Ident. No.	
LeGrand platinum-plated Fountain Pen Stand	05275	Pure lead crystal, pivoted holder, for Meisterstück Fountain Pen No. 146







WRITING INSTRUMENTS

DESK ACCESSORIES

> Refills

Model	Ident. No.	
Blotting Paper	13912	For Montblanc Meisterstück and Meisterstück Solitaire Blotters Size approximately 65 x 189 mm 10 sheets
		
Ink Bottle Insert	13913	For Meisterstück Ink bottle 13921
		
Filling Aid	13914	For refillable Ink bottle
		





MONTBLANC SERVICE

> Engraving



Typefaces

J.F. Winter — 1. Grotisque, mixed case

J.F. WINTER — 2. Grotisque, upper case

J.F. Winter — 3. Grotisque, mixed case, italic

J.F. WINTER — 4. Grotisque, upper case, italic

J.F. Winter — 5. Script

J.F. Winter — 6. Script, rounded

J.F. Winter — 7. Victoria*

J.F. Winter — 8. Gravo double contour*

J.F. WINTER — 9. Gravo double contour, upper case*

J.F. Winter — 10. Signature engraving

Engraved date — All typefaces (7*, 8*, 9*)

Two line engraving (name and/or date) — All typefaces (7*, 8*, 9*)

*Only on metal surfaces.





WRITING INSTRUMENTS

MONTBLANC SERVICE

> Nib Widths

EF	<i>The art of writing.</i>
F	<i>The art of writing.</i>
M	<i>The art of writing.</i>
B	<i>The art of writing.</i>
BB	<i>The art of writing.</i>
OM	<i>The art of writing.</i>
OB	<i>The art of writing.</i>
OBB	<i>The art of writing.</i>

© Montblanc Meisterstück® Solitaire® Bohème® 4810® · Mat.No. 4053019 · Printed in Germany

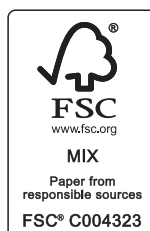



MONTBLANC LEATHER COLLECTION 2013/2014

LEATHER



Imagine a collection inspired by the desire to create pure luxury.
Imagine a provider of almost imperceptible details inspired by the
passion and dedication of a master craftsman seeking to exceed
all known standards.

Presenting the immaculate

Montblanc Leather Collection

Using only top-quality hides, Montblanc craftsmen breathe life
into these exquisite pieces, with secrets guarded by their creators
and handed down from one generation to the next.

The Montblanc leather collection combines traditional Florentine
craftsmanship with modern design and contemporary functions.

These iconic pieces have an unforgettable character, offering that
special luxurious touch.

*CONTENTS***MEISTERSTÜCK**

Overview.....	12
Large Leather Goods	
Business Bags	14
Small Leather Goods	
Pocket Accessories	18
Horizontal Wallets without Coin Case	28
Horizontal Wallets with Coin Case	33
Vertical Wallets without Coin Case.....	35
Long Wallets	40
Organisers & Agendas.....	42
Writing Instrument Pouches	45
Desk Accessories.....	48
Country Specifics · Special Order	51

MEISTERSTÜCK CANVAS

Overview.....	58
Large Leather Goods	
Business Bags	60
City Bags	63
Travel Bags.....	67
Small Leather Goods	
Pocket Accessories	69
Horizontal Wallets without Coin Case	72
Horizontal Wallets with Coin Case	76
Vertical Wallets without Coin Case.....	77
Long Wallets	78

CONTENTS

MEISTERSTÜCK SOFT

Overview.....	82
Large Leather Goods	
Business Bags	84
City Bags	85
Travel Bags.....	86
Small Leather Goods	
Pocket Accessories	87
Horizontal Wallets without Coin Case	88
Vertical Wallets without Coin Case.....	89

MEISTERSTÜCK SELECTION UNICEF

Overview.....	92
Small Leather Goods	
Pocket Accessories	93
Horizontal Wallets without Coin Case	94
Long Wallets	95
Organisers & Agendas.....	96
Writing Instrument Pouches	97

*CONTENTS***MEISTERSTÜCK SELECTION**

Overview.....	98
Large Leather Goods	
Business Bags	100
Small Leather Goods	
Pocket Accessories	109
Horizontal Wallets without Coin Case	118
Horizontal Wallets with Coin Case	122
Vertical Wallets without Coin Case.....	124
Long Wallets	125
Organisers & Agendas.....	126
Writing Instrument Pouches	136

4810 WESTSIDE

Overview.....	138
Large Leather Goods	
Business Bags	140
City Bags	142
Travel Bags.....	144
Small Leather Goods	
Pocket Accessories	145
Horizontal Wallets without Coin Case	149
Horizontal Wallets with Coin Case	153
Long Wallets	154
Organisers	156
Writing Instrument Pouches	157

CONTENTS

4810 WESTSIDE BLACK MYSTERY

Overview.....	160
Large Leather Goods	
Business Bags	162
City Bags	163
Small Leather Goods	
Pocket Accessories	164
Horizontal Wallets without Coin Case	166
Long Wallets	168
Organisers & Agendas.....	169

4810 WESTSIDE BLACK MYSTERY CANVAS

Overview.....	172
Large Leather Goods	
Business Bags	173
City Bags	174

SOFT LEATHER RANGE

Overview.....	180
Large Leather Goods	
Business Bags	182
City Bags	183
Travel Bags.....	185
Small Leather Goods	
Pocket Accessories	186
Horizontal Wallets without Coin Case	188
Horizontal Wallets with Coin Case	190
Long Wallets	191

*CONTENTS***MONTBLANC NIGHTFLIGHT**

Overview.....	194
Large Leather Goods	
Business Bags	196
City Bags	197
Bag on Wheels.....	200
Small Leather Goods	
Pocket Accessories	202
Horizontal Wallets without Coin Case	203
Horizontal Wallets with Coin Case	204

MONTBLANC SIGNATURE

Overview.....	206
Large Leather Goods	
Business Bags	208
City Bags	210
Travel Bags.....	214
Small Leather Goods	
Pocket Accessories	216
Horizontal Wallets without Coin Case	218
Horizontal Wallets with Coin Case	221
Long Wallets	222
Writing Instrument Pouches	223

CONTENTS

DIARIES & NOTES

Overview.....	226
Small Leather Goods	
Pocket Accessories	228
Organisers & Agendas.....	229
Notes	231

BELTS

Overview.....	232
Montblanc Classic Line 30 mm	234
Montblanc Classic Line 35 mm	242
Montblanc Contemporary Line 30 mm	246
Montblanc Casual Line 35 mm	257
Montblanc Casual Line 40 mm	266
Annual Edition	
Montblanc Classic Line 30 mm	270
Montblanc Contemporary Line 30 mm	271

MONTBLANC SIGNATURE LADIES

Overview.....	274
Large Leather Goods	
City Bags	276
Small Leather Goods	
Pocket Accessories	282
Vertical Wallets without Coin Case.....	284
Vertical Wallets with Coin Case	285
Long Wallets	286
Organisers & Agendas.....	289

*CONTENTS***LA VIE DE BOHÈME**

Overview.....	290
Small Leather Goods	
Pocket Accessories	292
Horizontal Wallets with Coin Case	295
Long Wallets	296
Organisers & Agendas.....	298
Writing Instrument Pouches	301
Seasonal Colour Collection 2013/14	
Pocket Accessories	302
Horizontal Wallet with Coin Case	302
Long Wallets	303

DEDICATED PEN POUCHES

Overview.....	310
Small Leather Goods	
Writing Instruments Pouches	311

CONTENTS

REFILLS

Overview.....	316
Punched for Ring Binders.....	318
Bound for Covers.....	321
Not Bound.....	323

SERVICE

Leather Care Set.....	326
Embossing Service.....	327

FUNCTIONS

Functions Overview · Men's Collections

Large Leather Goods.....	330
Small Leather Goods.....	340

Functions Overview · Ladies' Collections







Large Leather Goods.....	368
Small Leather Goods.....	369



MEISTERSTÜCK

> Large Leather Goods

> Business Bags

						
Portfolio with Zip Id. 104604 p. 14	Single Gusset Briefcase Id. 104606 p. 14	Double Gusset Briefcase Id. 104607 p. 15	Double Gusset Briefcase with 2 Front Pockets Id. 104608 p. 15	Triple Gusset Briefcase with Laptop Holder Id. 104610 p. 16	Single Gusset Framed Briefcase Id. 105923 p. 17	Triple Gusset Framed Briefcase with Laptop Holder Id. 105925 p. 17

> Small Leather Goods

> Pocket Accessories

												
Key fob Id. 14085 p. 18	Key Fob Id. 107685 p. 18	Key Case 6 Keys Id. 07161 p. 19	Key Case Valet Ring Id. 107347 p. 19	SmartPhone Holder 4/4s Id. 109051 p. 20	Memo Writing Pad Id. 14109 p. 21	Notepad Id. 14244 p. 21	Notepad Hommage à W.A. Mozart Id. 14879 p. 22	Coin Case Small Id. 14877 p. 22	Pocket Holder 2cc with Money Clip Id. 107346 p. 23	Pocket Holder 6cc Id. 35803 p. 23	Pocket 6cc Id. 106653 p. 24	Pocket 4cc with ID Card Holder Id. 02665 p. 24

> Pocket Accessories

					
Multi Credit Card Case Id. 05527 p. 25	Business Card Holder Id. 14108 p. 25	Business Card Holder with Gusset Id. 07167 p. 26	Business Card Holder with Gusset Id. 107443 p. 26	Business Card Holder with Gusset & View Pocket Id. 108946 p. 27	Passport Holder International Id. 35285 p. 27

> Horizontal Wallets with Coin Case

			
Wallet 4cc Id. 07164 p. 33	Wallet 4cc with ID Card Holder Id. 06179 p. 33	Wallet 5cc Large Id. 14103 p. 34	Wallet 10cc Id. 05524 p. 34

> Horizontal Wallets without Coin Case

									
Wallet 4cc with Money Clip & View Pocket Id. 108945 p. 28	Wallet 6cc Id. 14548 p. 28	Wallet 6cc with Money Clip Id. 05525 p. 29	Wallet 6cc with 2 View Pockets Id. 16354 p. 29	Wallet 8cc Id. 07163 p. 30	Wallet 8cc Id. 106652 p. 30	Wallet 11cc with View Pocket Id. 07162 p. 31	Wallet 12cc Id. 103384 p. 31	Wallet 14cc Id. 14095 p. 32	Wallet 24cc Large Id. 104820 p. 32

MEISTERSTÜCK

> Small Leather Goods

> Vertical Wallets without Coin Case

Wallet 4cc	Wallet 4cc with View Pocket	Wallet 5cc with View Pocket	Wallet 5cc	Wallet 7cc with ID Card Holder	Wallet 7cc	Wallet 8cc with ID Card Holder	Wallet 11cc with ID Card Holder	Wallet 14cc
Id. 11987 p. 35	Id. 02664 p. 35	Id. 102273 p. 36	Id. 15499 p. 36	Id. 35798 p. 37	Id. 14094 p. 37	Id. 35802 p. 38	Id. 35799 p. 38	Id. 35801 p. 39

> Long Wallets

Wallet 6cc	Wallet 14cc with Gusset	Wallet 14cc with zipped Pocket	Travel Wallet 13cc with Zip
Id. 35790 p. 40	Id. 108948 p. 40	Id. 07165 p. 41	Id. 16352 p. 41

> Organisers & Agendas

Organiser Small	Organiser Medium	Organiser Large	Organiser Large with Zip	Notebook Medium	Notepad Large
Id. 06178 p. 42	Id. 14257 p. 42	Id. 14875 p. 43	Id. 104833 p. 43	Id. 103386 p. 44	Id. 05523 p. 44

> Writing Instrument Pouches

1 Pen Sleeve	1 Pen Pouch	2 Pen Pouch	3 Pen Pouch	1 Pen Pouch with Zip
Id. 101871 p. 45	Id. 14309 p. 45	Id. 14311 p. 46	Id. 14313 p. 46	Id. 101872 p. 47

> Desk Accessories

Pen Tray	Desk Pad	Envelope Sorter
Id. 06182 p. 48	Id. 06181 p. 49	Id. 06183 p. 50

> Small Leather Goods · Country Specifics · Special Order

> Pocket Accessories

ID Card Holder with Strap	Document / Passport Holder 6cc
Id. 107345 p. 51	Id. 103891 p. 51

> Horizontal Wallet without Coin Case

Wallet 4cc with View Pocket & Clasp	Wallet 6cc with Chequebook Holder
Id. 102274 p. 52	Id. 36757 p. 53

> Horizontal Wallet with Coin Case

Wallet 1cc Mini
Id. 35804 p. 54

> Long Wallets

Wallet 6cc with Chequebook Holder
Id. 05529 p. 55

MEISTERSTÜCK

> Business Bags

LEATHER | LINING



Black | Black

CLOSURE | EMBLEM



Some things are better left untouched. The Meisterstück collection has always embodied subtle elegance. Each piece symbolises the quintessential combination of a timeless, classic concept with an art that has been refined by tradition.

The Classic

Meisterstück

The durable brilliance of the black cowhide is acquired through a process specially created for Montblanc, and is enhanced by the Montblanc emblem. The owner of a Meisterstück piece will always be able to bask in the quiet truth of this noble classic.

MODEL	Single Gusset Briefcase	Portfolio with Zip
IDENT No.	104606	104604
MATERIAL		
LEATHER	European full-grain cowhide with unique Montblanc deep shine, chrome-tanned, dyed through	European full-grain cowhide with unique Montblanc deep shine, chrome-tanned, dyed through
LINING	Jacquard lining with Montblanc brand name	Jacquard lining with Montblanc brand name
FITTINGS/EMBLEM	Stainless steel with shiny finish, Montblanc emblem	Stainless steel with shiny finish, Montblanc emblem
FEATURES		
CLOSURE/LOCK	Flap, secure combination lock with Montblanc 3 rings motif, engraved Montblanc brand name and emblem	Metal zip
POCKETS	1 main compartment, large zipped inner pocket, large back pocket	1 main compartment suitable for DIN A4 documents or a slim laptop (max. size 32 x 23 x 2.5 cm)
INTERIOR ORGANISATION	Pockets for mobile phone (PDA size), 2 writing instruments, and 1 medium-sized and 6 small document pockets, ring for keys	Pockets for 2 writing instruments, 1 medium and 6 small document pockets
STRAP	Detachable and adjustable branded shoulder strap in black	-
ADDITIONAL CHARACTERISTICS	Sliding mechanism to attach shoulder strap, comfortable leather handle	Suitable for integration with any Meisterstück briefcase
DIMENSIONS		
DIMENSIONS	38 x 30 x 7,5 cm	35 x 26 x 4 cm

MEISTERSTÜCK

> Business Bags

LEATHER | LINING



Black | Black

CLOSURE



MODEL	Double Gusset Briefcase	Double Gusset Briefcase with 2 Front Pockets
IDENT No.	104607	104608
MATERIAL		
LEATHER	European full-grain cowhide with unique Montblanc deep shine, chrome-tanned, dyed through	European full-grain cowhide with unique Montblanc deep shine, chrome-tanned, dyed through
LINING	Jacquard lining with Montblanc brand name	Jacquard lining with Montblanc brand name
FITTINGS/EMBLEM	Stainless steel with shiny finish, Montblanc emblem	Stainless steel with shiny finish, Montblanc emblem
FEATURES		
CLOSURE/LOCK	Flap, secure combination lock with Montblanc 3 rings motif, engraved Montblanc brand name and emblem	Flap, 2 snap locks with Montblanc 3 rings motif, engraved Montblanc brand name and emblem
POCKETS	2 main compartments, large zipped inner pocket, large back pocket	2 main compartments, 2 front pockets, large zipped inner pocket, large back pocket
INTERIOR ORGANISATION	Pockets for mobile phone (PDA size), 2 writing instruments, and 1 medium-sized and 6 small document pockets, ring for keys	Pockets for mobile phone (PDA size), 2 writing instruments, and 1 medium-sized and 6 small document pockets, ring for keys
STRAP	Detachable and adjustable branded shoulder strap in black	Detachable and adjustable branded shoulder strap in black
ADDITIONAL CHARACTERISTICS	Sliding mechanism to attach shoulder strap, comfortable leather handle	Sliding mechanism to attach shoulder strap, comfortable leather handle
DIMENSIONS		
DIMENSIONS	42 x 32 x 12 cm	42 x 32 x 12 cm

MEISTERSTÜCK

> Business Bags

LEATHER | LINING



Black | Black

CLOSURE



MODEL	Triple Gusset Briefcase with Laptop Holder
IDENT No.	104610
MATERIAL	
LEATHER	European full-grain cowhide with unique Montblanc deep shine, chrome-tanned, dyed through
LINING	Jacquard lining with Montblanc brand name
FITTINGS/EMBLEM	Stainless steel with shiny finish, Montblanc emblem
FEATURES	
CLOSURE/LOCK	Flap, secure combination lock with Montblanc 3 rings motif, engraved Montblanc brand name and emblem
POCKETS	3 main compartments, large front pocket, large zipped inner pocket, large back pocket
INTERIOR ORGANISATION	Pockets for mobile phone (PDA size), 2 writing instruments, and 1 medium-sized and 6 small document pockets, ring for keys
STRAP	Detachable and adjustable branded shoulder strap in black
ADDITIONAL CHARACTERISTICS	Removable hanging pocket for laptop (max. size 36 x 23 x 3.5 cm), sliding mechanism to attach shoulder strap, comfortable leather handle
DIMENSIONS	
DIMENSIONS	42 x 32 x 13.5 cm

MEISTERSTÜCK

> Business Bags

LEATHER | LINING



Black | Black

CLOSURE



MODEL	Single Gusset Framed Briefcase	Triple Gusset Framed Briefcase with Laptop Holder
IDENT No.	105923	105925
MATERIAL		
LEATHER	European full-grain cowhide with unique Montblanc deep shine, chrome-tanned, dyed through	European full-grain cowhide with unique Montblanc deep shine, chrome-tanned, dyed through
LINING	Suede calfskin	Suede calfskin
FITTINGS/EMBLEM	Stainless steel with shiny finish, Montblanc emblem	Stainless steel with shiny finish, Montblanc emblem
FEATURES		
CLOSURE/LOCK	Clasp, secure combination lock with Montblanc 3 rings motif, engraved Montblanc brand name and emblem	Clasp, secure combination lock with Montblanc 3 rings motif, engraved Montblanc brand name and emblem
POCKETS	1 main compartment, large zipped inner pocket, large back pocket	2 main compartments, laptop pocket, large zipped inner pocket, large back pocket
INTERIOR ORGANISATION	Pockets for mobile phone (PDA size), 2 writing instruments, 1 small document and 4 credit cards	Pockets for mobile phone (PDA size), 2 writing instruments, 1 small document and 4 credit cards
STRAP	-	-
ADDITIONAL CHARACTERISTICS	Framed opening, comfortable doctor's handle	Framed opening, comfortable doctor's handle
DIMENSIONS		
DIMENSIONS	41 x 33 x 12 cm	45 x 33 x 17 cm

MEISTERSTÜCK

> Pocket Accessories

LEATHER



Black

EMBLEM



MODEL	Key fob	Key Fob
IDENT No.	14085	107685
MATERIAL		
LEATHER	European full-grain cowhide with unique Montblanc deep shine, chrome-tanned, dyed through	European full-grain cowhide with unique Montblanc deep shine, chrome-tanned, dyed through
LINING	-	-
FITTINGS/EMBLEM	Stainless steel with shiny finish, Montblanc emblem with palladium-coated ring	Montblanc emblem with palladium-coated ring
FEATURES		
CLOSURE/LOCK	Clip	-
POCKETS	-	-
INTERIOR ORGANISATION	Ring for several keys	Ring for several keys
ADDITIONAL CHARACTERISTICS	-	-
REFILLS	-	-
DIMENSIONS		
DIMENSIONS	4 x 8 cm	4 x 8 cm

MEISTERSTÜCK

> Pocket Accessories

LEATHER | LINING



Black | Black

EMBLEM



MODEL	Key Case 6 Keys	Key Case Valet Ring
IDENT No.	07161	107347
MATERIAL		
LEATHER	European full-grain cowhide with unique Montblanc deep shine, chrome-tanned, dyed through	European full-grain cowhide with unique Montblanc deep shine, chrome-tanned, dyed through
LINING	Jacquard lining with Montblanc brand name	Jacquard lining with Montblanc brand name
FITTINGS/EMBLEM	Stainless steel with shiny finish, Montblanc emblem with palladium-coated ring	Stainless steel with shiny finish, Montblanc emblem with palladium-coated ring
FEATURES		
CLOSURE/LOCK	Flap with press-stud	Flap with press-studs
POCKETS	-	-
INTERIOR ORGANISATION	Rings for 5 keys and 1 car key	Rings for 6 keys, valet ring for car key
ADDITIONAL CHARACTERISTICS	-	-
REFILLS	-	-
DIMENSIONS		
DIMENSIONS	10 x 7 cm	7 x 11 cm

MEISTERSTÜCK

> Pocket Accessories

LEATHER



Black

EMBLEM



MODEL	SmartPhone Holder 4/4s
IDENT No.	109051
MATERIAL	
LEATHER	European full-grain cowhide with unique Montblanc deep shine, chrome-tanned, dyed through
LINING	-
FITTINGS/EMBLEM	Montblanc emblem with palladium-coated ring
FEATURES	
CLOSURE/LOCK	-
POCKETS	-
INTERIOR ORGANISATION	Suitable for iPhone 4 or 4s
ADDITIONAL CHARACTERISTICS	SmartPhone Holder also available for iPhone 5 (Id. 110000)
REFILLS	-
DIMENSIONS	
DIMENSIONS	7.5 x 12.5 cm

MEISTERSTÜCK

> Pocket Accessories

LEATHER | LINING



Black | Black

EMBLEM



MODEL	Memo Writing Pad	Notepad
IDENT No.	14109	14244
MATERIAL		
LEATHER	European full-grain cowhide with unique Montblanc deep shine, chrome-tanned, dyed through	European full-grain cowhide with unique Montblanc deep shine, chrome-tanned, dyed through
LINING	Jacquard lining with Montblanc brand name	Jacquard lining with Montblanc brand name
FITTINGS/EMBLEM	Montblanc emblem with palladium-coated ring	Montblanc emblem with palladium-coated ring
FEATURES		
CLOSURE/LOCK	-	-
POCKETS	-	-
INTERIOR ORGANISATION	3 pockets for credit cards, additional pocket	Banknote compartment, additional pocket
ADDITIONAL CHARACTERISTICS	Complete with memo sheets	Complete with notepad
REFILLS	Memo Pad (Id. 12467)	Notepad (Id. 13915)
DIMENSIONS		
DIMENSIONS	7,5 x 10,5 cm	8,5 x 12 cm

MEISTERSTÜCK

> Pocket Accessories

LEATHER | LINING



Black | Black

EMBLEM



MODEL	Notepad Hommage à W.A. Mozart	Coin Case Small
IDENT No.	14879	14877
MATERIAL		
LEATHER	European full-grain cowhide with unique Montblanc deep shine, chrome-tanned, dyed through	European full-grain cowhide with unique Montblanc deep shine, chrome-tanned, dyed through
LINING	Jacquard lining with Montblanc brand name	Jacquard lining with Montblanc brand name
FITTINGS/EMBLEM	Montblanc emblem with palladium-coated ring	Stainless steel with shiny finish, Montblanc emblem with palladium-coated ring
FEATURES		
CLOSURE/LOCK	-	Flap with press-stud
POCKETS	-	-
INTERIOR ORGANISATION	2 pockets for credit cards, 2 additional pockets	Large pocket for coins
ADDITIONAL CHARACTERISTICS	Loop for "Hommage à W.A. Mozart" writing instrument, - complete with notepad	-
REFILLS	Notepad HaWAM (Id. 15705)	-
DIMENSIONS		
DIMENSIONS	8 x 11.5 cm	8.5 x 7 cm

MEISTERSTÜCK

> Pocket Accessories

LEATHER | LINING



Black | Black

EMBLEM



MODEL	Pocket Holder 2cc with Money Clip	Pocket Holder 6cc
IDENT No.	107346	35803
MATERIAL		
LEATHER	European full-grain cowhide with unique Montblanc deep shine, chrome-tanned, dyed through	European full-grain cowhide with unique Montblanc deep shine, chrome-tanned, dyed through
LINING	Jacquard lining with Montblanc brand name	Jacquard lining with Montblanc brand name
FITTINGS/EMBLEM	Stainless steel with shiny finish, Montblanc emblem with palladium-coated ring	Montblanc emblem with palladium-coated ring
FEATURES		
CLOSURE/LOCK	-	-
POCKETS	-	-
INTERIOR ORGANISATION	2 pockets for credit cards, money clip for banknotes	6 pockets for credit cards
ADDITIONAL CHARACTERISTICS	-	-
REFILLS	-	-
DIMENSIONS		
DIMENSIONS	7 x 10 cm	10 x 8 cm

MEISTERSTÜCK

> Pocket Accessories

LEATHER | LINING



Black | Black

EMBLEM



MODEL	Pocket 6cc	Pocket 4cc with ID Card Holder
IDENT No.	106653	02665
MATERIAL		
LEATHER	European full-grain cowhide with unique Montblanc deep shine, chrome-tanned, dyed through	European full-grain cowhide with unique Montblanc deep shine, chrome-tanned, dyed through
LINING	Jacquard lining with Montblanc brand name	Jacquard lining with Montblanc brand name
FITTINGS/EMBLEM	Montblanc emblem with palladium-coated ring	Montblanc emblem with palladium-coated ring
FEATURES		
CLOSURE/LOCK	-	-
POCKETS	-	-
INTERIOR ORGANISATION	6 pockets for credit cards	4 pockets for credit cards, 3 additional pockets
ADDITIONAL CHARACTERISTICS	-	Removable view pocket for ID card
REFILLS	-	-
DIMENSIONS		
DIMENSIONS	10 x 8 cm	9 x 12 cm

MEISTERSTÜCK

> Pocket Accessories

LEATHER | LINING



Black | Black

EMBLEM



MODEL	Multi Credit Card Case	Business Card Holder
IDENT No.	05527	14108
MATERIAL		
LEATHER	European full-grain cowhide with unique Montblanc deep shine, chrome-tanned, dyed through	European full-grain cowhide with unique Montblanc deep shine, chrome-tanned, dyed through
LINING	Jacquard lining with Montblanc brand name	Jacquard lining with Montblanc brand name
FITTINGS/EMBLEM	Montblanc emblem with palladium-coated ring	Montblanc emblem with palladium-coated ring
FEATURES		
CLOSURE/LOCK	-	-
POCKETS	-	-
INTERIOR ORGANISATION	12 removable clear pockets for credit cards	Compartment for business cards, 2 pockets for credit cards, additional pocket
ADDITIONAL CHARACTERISTICS	-	-
REFILLS	Clear credit card pockets (ld. 102063)	-
DIMENSIONS		
DIMENSIONS	8 x 10 cm	7.5 x 11 cm

MEISTERSTÜCK

> Pocket Accessories

LEATHER | LINING



Black | Black

EMBLEM



MODEL	Business Card Holder with Gusset	Business Card Holder with Gusset
IDENT No.	07167	107443
MATERIAL		
LEATHER	European full-grain cowhide with unique Montblanc deep shine, chrome-tanned, dyed through	European full-grain cowhide with unique Montblanc deep shine, chrome-tanned, dyed through
LINING	Jacquard lining with Montblanc brand name	Jacquard lining with Montblanc brand name
FITTINGS/EMBLEM	Montblanc emblem with palladium-coated ring	Montblanc emblem with palladium-coated ring
FEATURES		
CLOSURE/LOCK	-	-
POCKETS	-	-
INTERIOR ORGANISATION	Spacious gusset for business cards, 2 pockets for credit cards, 2 additional pockets, back pocket	Spacious gusset for business cards, 2 pockets for credit cards, 2 additional pockets, back pocket
ADDITIONAL CHARACTERISTICS	-	-
REFILLS	-	-
DIMENSIONS		
DIMENSIONS	7 x 10.5 cm	8 x 10.5 cm

MEISTERSTÜCK

> Pocket Accessories

LEATHER | LINING



Black | Black

EMBLEM



MODEL	Business Card Holder with Gusset & View Pocket	Passport Holder International
IDENT No.	108946	35285
MATERIAL		
LEATHER	European full-grain cowhide with unique Montblanc deep shine, chrome-tanned, dyed through	European full-grain cowhide with unique Montblanc deep shine, chrome-tanned, dyed through
LINING	Jacquard lining with Montblanc brand name	Jacquard lining with Montblanc brand name
FITTINGS/EMBLEM	Montblanc emblem with palladium-coated ring	Montblanc emblem with palladium-coated ring
FEATURES		
CLOSURE/LOCK	-	-
POCKETS	Compartment for business cards, view pocket for ID card	-
INTERIOR ORGANISATION	-	Pocket suitable for all international passports, additional pocket
ADDITIONAL CHARACTERISTICS	-	-
REFILLS	-	-
DIMENSIONS		
DIMENSIONS	7,5 x 11 cm	10 x 14 cm

MEISTERSTÜCK

> Horizontal Wallets without Coin Case

LEATHER | LINING



Black | Black

EMBLEM



MODEL	Wallet 4cc with Money Clip & View Pocket	Wallet 6cc
IDENT No.	108945	14548
MATERIAL		
LEATHER	European full-grain cowhide with unique Montblanc deep shine, chrome-tanned, dyed through	European full-grain cowhide with unique Montblanc deep shine, chrome-tanned, dyed through
LINING	Jacquard lining with Montblanc brand name	Jacquard lining with Montblanc brand name
FITTINGS/EMBLEM	Montblanc emblem with palladium-coated ring	Montblanc emblem with palladium-coated ring
FEATURES		
CLOSURE/LOCK	-	-
POCKETS	4 pockets for credit cards, 2 additional pockets, view pocket, and Money Clip	-
INTERIOR ORGANISATION	-	6 pockets for credit cards, 2 compartments for banknotes, 2 additional pockets
ADDITIONAL CHARACTERISTICS	-	-
REFILLS	-	-
DIMENSIONS		
DIMENSIONS	11 x 8 cm	11.5 x 8.5 cm

MEISTERSTÜCK

> Horizontal Wallets without Coin Case

LEATHER | LINING



Black | Black

EMBLEM



MODEL	Wallet 6cc with Money Clip	Wallet 6cc with 2 View Pockets
IDENT No.	05525	16354
MATERIAL		
LEATHER	European full-grain cowhide with unique Montblanc deep shine, chrome-tanned, dyed through	European full-grain cowhide with unique Montblanc deep shine, chrome-tanned, dyed through
LINING	Jacquard lining with Montblanc brand name	Jacquard lining with Montblanc brand name
FITTINGS/EMBLEM	Stainless steel with shiny finish, Montblanc emblem with palladium-coated ring	Montblanc emblem with palladium-coated ring
FEATURES		
CLOSURE/LOCK	-	-
POCKETS	-	-
INTERIOR ORGANISATION	6 pockets for credit cards, money clip	6 pockets for credit cards, 2 view pockets, 2 compartments for banknotes
ADDITIONAL CHARACTERISTICS	-	-
REFILLS	-	-
DIMENSIONS		
DIMENSIONS	11 x 8 cm	11 x 9 cm

MEISTERSTÜCK

> Horizontal Wallets without Coin Case

LEATHER | LINING



Black | Black

EMBLEM



MODEL	Wallet 8cc	Wallet 8cc
IDENT No.	07163	106652
MATERIAL		
LEATHER	European full-grain cowhide with unique Montblanc deep shine, chrome-tanned, dyed through	European full-grain cowhide with unique Montblanc deep shine, chrome-tanned, dyed through
LINING	Jacquard lining with Montblanc brand name	Jacquard lining with Montblanc brand name
FITTINGS/EMBLEM	Montblanc emblem with palladium-coated ring	Montblanc emblem with palladium-coated ring
FEATURES		
CLOSURE/LOCK	-	-
POCKETS	-	-
INTERIOR ORGANISATION	8 pockets for credit cards, 2 compartments for banknotes, 2 additional pockets	8 pockets for credit cards, 2 compartments for banknotes, 2 additional pockets
ADDITIONAL CHARACTERISTICS	-	-
REFILLS	-	-
DIMENSIONS		
DIMENSIONS	10.5 x 9.5 cm	13.5 x 10 cm

MEISTERSTÜCK

> Horizontal Wallets without Coin Case

LEATHER | LINING



Black | Black

EMBLEM



MODEL	Wallet 11cc with View Pocket	Wallet 12cc
IDENT No.	07162	103384
MATERIAL		
LEATHER	European full-grain cowhide with unique Montblanc deep shine, chrome-tanned, dyed through	European full-grain cowhide with unique Montblanc deep shine, chrome-tanned, dyed through
LINING	Jacquard lining with Montblanc brand name	Jacquard lining with Montblanc brand name
FITTINGS/EMBLEM	Montblanc emblem with palladium-coated ring	Montblanc emblem with palladium-coated ring
FEATURES		
CLOSURE/LOCK	-	-
POCKETS	-	-
INTERIOR ORGANISATION	11 pockets for credit cards, small view pocket, compartment for banknotes, additional pocket	12 pockets for credit cards, 2 compartments for banknotes, 5 additional pockets
ADDITIONAL CHARACTERISTICS	-	-
REFILLS	-	-
DIMENSIONS		
DIMENSIONS	10.5 x 9.5 cm	11 x 9 cm

MEISTERSTÜCK

> Horizontal Wallets without Coin Case

LEATHER | LINING



Black | Black

EMBLEM



MODEL	Wallet 14cc	Wallet 24cc Large
IDENT No.	14095	104820
MATERIAL		
LEATHER	European full-grain cowhide with unique Montblanc deep shine, chrome-tanned, dyed through	European full-grain cowhide with unique Montblanc deep shine, chrome-tanned, dyed through
LINING	Jacquard lining with Montblanc brand name	Jacquard lining with Montblanc brand name
FITTINGS/EMBLEM	Montblanc emblem with palladium-coated ring	Montblanc emblem with palladium-coated ring
FEATURES		
CLOSURE/LOCK	-	-
POCKETS	-	-
INTERIOR ORGANISATION	14 pockets for credit cards, compartment for banknotes, additional pocket	24 pockets for credit cards, 2 compartments for banknotes, 2 additional pockets
ADDITIONAL CHARACTERISTICS	-	-
REFILLS	-	-
DIMENSIONS		
DIMENSIONS	10.5 x 9.5 cm	13 x 10 cm

MEISTERSTÜCK

> Horizontal Wallets with Coin Case

LEATHER | LINING



Black | Black

EMBLEM



MODEL	Wallet 4cc	Wallet 4cc with ID Card Holder
IDENT No.	07164	06179
MATERIAL		
LEATHER	European full-grain cowhide with unique Montblanc deep shine, chrome-tanned, dyed through	European full-grain cowhide with unique Montblanc deep shine, chrome-tanned, dyed through
LINING	Jacquard lining with Montblanc brand name	Jacquard lining with Montblanc brand name
FITTINGS/EMBLEM	Montblanc emblem with palladium-coated ring	Montblanc emblem with palladium-coated ring
FEATURES		
CLOSURE/LOCK	-	-
POCKETS	-	-
INTERIOR ORGANISATION	4 pockets for credit cards, compartment for banknotes, flap coin case	4 pockets for credit cards, 2 compartments for banknotes, 2 additional pockets, flap coin case
ADDITIONAL CHARACTERISTICS	-	Removable pocket for ID card
REFILLS	-	-
DIMENSIONS		
DIMENSIONS	10.5 x 9.5 cm	13.5 x 9.5 cm

MEISTERSTÜCK

> Horizontal Wallets with Coin Case

LEATHER | LINING



Black | Black

EMBLEM



MODEL	Wallet 5cc Large	Wallet 10cc
IDENT No.	14103	05524
MATERIAL		
LEATHER	European full-grain cowhide with unique Montblanc deep shine, chrome-tanned, dyed through	European full-grain cowhide with unique Montblanc deep shine, chrome-tanned, dyed through
LINING	Jacquard lining with Montblanc brand name	Jacquard lining with Montblanc brand name
FITTINGS/EMBLEM	Montblanc emblem with palladium-coated ring	Montblanc emblem with palladium-coated ring
FEATURES		
CLOSURE/LOCK	-	-
POCKETS	-	-
INTERIOR ORGANISATION	5 pockets for credit cards, 2 compartments for banknotes, 4 additional pockets, and coin case with flap	10 pockets for credit cards, 2 compartments for banknotes, flap coin case
ADDITIONAL CHARACTERISTICS	-	-
REFILLS	-	-
DIMENSIONS		
DIMENSIONS	12 x 10 cm	11.5 x 9.5 cm

MEISTERSTÜCK

› Vertical Wallets without Coin Case

LEATHER | LINING



Black | Black

EMBLEM



MODEL	Wallet 4cc	Wallet 4cc with View Pocket
IDENT No.	11987	02664
MATERIAL		
LEATHER	European full-grain cowhide with unique Montblanc deep shine, chrome-tanned, dyed through	European full-grain cowhide with unique Montblanc deep shine, chrome-tanned, dyed through
LINING	Jacquard lining with Montblanc brand name	Jacquard lining with Montblanc brand name
FITTINGS/EMBLEM	Montblanc emblem with palladium-coated ring	Montblanc emblem with palladium-coated ring
FEATURES		
CLOSURE/LOCK	-	-
POCKETS	-	-
INTERIOR ORGANISATION	4 pockets for credit cards, compartment for banknotes, 4 additional pockets	4 pockets for credit cards, view pocket for driving licence or ID card, compartment for banknotes, 2 additional pockets
ADDITIONAL CHARACTERISTICS	-	-
REFILLS	-	-
DIMENSIONS		
DIMENSIONS	9 x 12.5 cm	9 x 12.5 cm

MEISTERSTÜCK

> Vertical Wallets without Coin Case

LEATHER | LINING



Black | Black

EMBLEM



MODEL	Wallet 5cc with View Pocket	Wallet 5cc
IDENT No.	102273	15499
MATERIAL		
LEATHER	European full-grain cowhide with unique Montblanc deep shine, chrome-tanned, dyed through	European full-grain cowhide with unique Montblanc deep shine, chrome-tanned, dyed through
LINING	Jacquard lining with Montblanc brand name	Jacquard lining with Montblanc brand name
FITTINGS/EMBLEM	Montblanc emblem with palladium-coated ring	Montblanc emblem with palladium-coated ring
FEATURES		
CLOSURE/LOCK	-	-
POCKETS	-	-
INTERIOR ORGANISATION	5 pockets for credit cards, small view pocket, compartment for banknotes, 4 additional pockets	5 pockets for credit cards, compartment for banknotes, additional small and additional large pocket
ADDITIONAL CHARACTERISTICS	-	-
REFILLS	-	-
DIMENSIONS		
DIMENSIONS	8 x 11 cm	10,5 x 12,5 cm

MEISTERSTÜCK

› Vertical Wallets without Coin Case

LEATHER | LINING



Black | Black

EMBLEM



MODEL	Wallet 7cc	Wallet 7cc with ID Card Holder
IDENT No.	14094	35798
MATERIAL		
LEATHER	European full-grain cowhide with unique Montblanc deep shine, chrome-tanned, dyed through	European full-grain cowhide with unique Montblanc deep shine, chrome-tanned, dyed through
LINING	Jacquard lining with Montblanc brand name	Jacquard lining with Montblanc brand name
FITTINGS/EMBLEM	Montblanc emblem with palladium-coated ring	Montblanc emblem with palladium-coated ring
FEATURES		
CLOSURE/LOCK	-	-
POCKETS	-	-
INTERIOR ORGANISATION	7 pockets for credit cards, compartment for banknotes, 4 additional pockets	7 pockets for credit cards (incl. 1 view pocket), compartment for banknotes, 4 additional pockets
ADDITIONAL CHARACTERISTICS	-	Removable view pocket for ID card
REFILLS	-	-
DIMENSIONS		
DIMENSIONS	11 x 14.5 cm	9 x 12.5 cm

MEISTERSTÜCK

> Vertical Wallets without Coin Case

LEATHER | LINING



Black | Black

EMBLEM



MODEL	Wallet 8cc with ID Card Holder	Wallet 11cc with ID Card Holder
IDENT No.	35802	35799
MATERIAL		
LEATHER	European full-grain cowhide with unique Montblanc deep shine, chrome-tanned, dyed through	European full-grain cowhide with unique Montblanc deep shine, chrome-tanned, dyed through
LINING	Jacquard lining with Montblanc brand name	Jacquard lining with Montblanc brand name
FITTINGS/EMBLEM	Montblanc emblem with palladium-coated ring	Montblanc emblem with palladium-coated ring
FEATURES		
CLOSURE/LOCK	-	-
POCKETS	-	-
INTERIOR ORGANISATION	8 pockets for credit cards, 2 compartments for banknotes, 2 large pockets, additional small pocket	11 pockets for credit cards (incl. 1 view pocket), large view pocket, compartment for banknotes, 3 additional pockets
ADDITIONAL CHARACTERISTICS	Removable holder with 3 large pockets (incl. 2 view pockets) for driving licence or ID card	Removable view pocket for ID card
REFILLS	-	-
DIMENSIONS		
DIMENSIONS	10.5 x 15.5 cm	9 x 12.5 cm

MEISTERSTÜCK

> Vertical Wallets without Coin Case

LEATHER | LINING



Black | Black

EMBLEM



MODEL	Wallet 14cc
IDENT No.	35801
MATERIAL	
LEATHER	European full-grain cowhide with unique Montblanc deep shine, chrome-tanned, dyed through
LINING	Jacquard lining with Montblanc brand name
FITTINGS/EMBLEM	Montblanc emblem with palladium-coated ring
FEATURES	
CLOSURE/LOCK	-
POCKETS	-
INTERIOR ORGANISATION	14 pockets for credit cards, compartment for banknotes, 2 additional pockets
ADDITIONAL CHARACTERISTICS	-
REFILLS	-
DIMENSIONS	
DIMENSIONS	10,5 x 13 cm

MEISTERSTÜCK

> Long Wallets

LEATHER | LINING



Black | Black

EMBLEM



MODEL	Wallet 6cc	Wallet 14cc with Gusset
IDENT No.	35790	108948
MATERIAL		
LEATHER	European full-grain cowhide with unique Montblanc deep shine, chrome-tanned, dyed through	European full-grain cowhide with unique Montblanc deep shine, chrome-tanned, dyed through
LINING	Jacquard lining with Montblanc brand name	Jacquard lining with Montblanc brand name
FITTINGS/EMBLEM	Montblanc emblem with palladium-coated ring	Montblanc emblem with palladium-coated ring
FEATURES		
CLOSURE/LOCK	-	-
POCKETS	-	-
INTERIOR ORGANISATION	6 pockets for credit cards, 2 compartments for banknotes, 2 additional pockets	14 pockets for credit cards, large gusset for banknotes, 2 additional pockets
ADDITIONAL CHARACTERISTICS	-	-
REFILLS	-	-
DIMENSIONS		
DIMENSIONS	9,5 x 19 cm	9,5 x 19 cm

MEISTERSTÜCK

> Long Wallets

LEATHER | LINING



Black | Black

EMBLEM



MODEL	Wallet 14cc with zipped Pocket	Travel Wallet 13cc with Zip
IDENT No.	07165	16352
MATERIAL		
LEATHER	European full-grain cowhide with unique Montblanc deep shine, chrome-tanned, dyed through	European full-grain cowhide with unique Montblanc deep shine, chrome-tanned, dyed through
LINING	Jacquard lining with Montblanc brand name	Jacquard lining with Montblanc brand name
FITTINGS/EMBLEM	Stainless steel with shiny finish, Montblanc emblem with palladium-coated ring	Stainless steel with shiny finish, Montblanc emblem with palladium-coated ring
FEATURES		
CLOSURE/LOCK	-	Metal zip
POCKETS	-	-
INTERIOR ORGANISATION	14 pockets for credit cards, large zipped pocket, 2 compartments for banknotes, 2 additional pockets	13 pockets for credit cards, large pocket for flight ticket, zipped large pocket, 3 additional pockets, and flap coin case
ADDITIONAL CHARACTERISTICS	-	Loop for 1 writing instrument the size of a Meisterstück Classique or LeGrand
REFILLS	-	-
DIMENSIONS		
DIMENSIONS	9,5 x 19 cm	12 x 22 cm

MEISTERSTÜCK

> Organisers & Agendas

LEATHER | LINING



Black | Black

EMBLEM



MODEL	Organiser Small	Organiser Medium
IDENT No.	06178	14257
MATERIAL		
LEATHER	European full-grain cowhide with unique Montblanc deep shine, chrome-tanned, dyed through	European full-grain cowhide with unique Montblanc deep shine, chrome-tanned, dyed through
LINING	Jacquard lining with Montblanc brand name	Jacquard lining with Montblanc brand name
FITTINGS/EMBLEM	Stainless steel with shiny finish, Montblanc emblem with palladium-coated ring	Stainless steel with shiny finish, Montblanc emblem with palladium-coated ring
FEATURES		
CLOSURE/LOCK	Clasp	Clasp
POCKETS	-	-
INTERIOR ORGANISATION	Rings for organisation sheets, 4 credit card pockets, additional pocket	Rings for organisation sheets, 4 credit card pockets, 3 additional pockets
ADDITIONAL CHARACTERISTICS	Loop for writing instrument the size of Meisterstück Classique or Le Grand, complete with organisation sheets	Loop for writing instrument the size of Meisterstück Classique or Le Grand, complete with organisation sheets
REFILLS	Starter Kit Small (Id. 08402), Telephone-Address Sheets Small (Id. 06640), Organisation Kit Small (Id. 06686), Note Sheets Small (Id. 06639), Blank Sheets Small (Id. 06688), Squared Sheets Small (Id. 06687), Calendar 2014 Small (Id. 110138)	Starter Kit Medium (Id. 08403), Telephone-Address Sheets Medium (Id. 03027), Organisation Kit Medium (Id. 03028), Daily Plan Pages Medium (Id. 03025), Blank Sheets Medium (Id. 03021), Squared Sheets Medium (Id. 03026), Calendar 2014 Medium (Id. 110139-1 day on 1 page, 110140-1 week on 2 pages)
DIMENSIONS		
DIMENSIONS	12 x 14 cm (for A7 oblong sheets)	15 x 19 cm (for A6 sheets)

MEISTERSTÜCK

> Organisers & Agendas

LEATHER | LINING



Black | Black

EMBLEM



MODEL	Organiser Large	Organiser Large with Zip
IDENT No.	14875	104833
MATERIAL		
LEATHER	European full-grain cowhide with unique Montblanc deep shine, chrome-tanned, dyed through	European full-grain cowhide with unique Montblanc deep shine, chrome-tanned, dyed through
LINING	Jacquard lining with Montblanc brand name	Jacquard lining with Montblanc brand name
FITTINGS/EMBLEM	Stainless steel with shiny finish, Montblanc emblem with palladium-coated ring	Stainless steel with shiny finish, Montblanc emblem with palladium-coated ring
FEATURES		
CLOSURE/LOCK	Clasp	Metal zip
POCKETS	-	-
INTERIOR ORGANISATION	Rings for organisation sheets, 6 pockets for credit cards, 3 additional pockets	Rings for organisation sheets, 16 pockets for credit cards, 3 pockets for large documents, additional pocket
ADDITIONAL CHARACTERISTICS	Loop for writing instrument the size of Meisterstück Classique or Le Grand, complete with organisation sheets	Loop for writing instrument the size of a Meisterstück Classique or Le Grand, complete with organisation sheets
REFILLS	Starter Kit Large (Id. 08404), Telephone-Address Sheets Large (Id. 03032), Organisation Kit Large (Id. 03033), Daily Plan Pages Large (Id. 03030), Blank Sheets Large (Id. 03051), Squared Sheets Large (Id. 03031), Calendar 2014 Large (Id. 110141)	Starter Kit Large (Id. 08404), Telephone-Address Sheets Large (Id. 03032), Organisation Kit Large (Id. 03033), Daily Plan Pages Large (Id. 03030), Blank Sheets Large (Id. 03051), Squared Sheets Large (Id. 03031), Calendar 2014 Large (Id. 110141)
DIMENSIONS		
DIMENSIONS	24,5 x 20 cm (for A5 sheets)	25 x 21,5 cm

MEISTERSTÜCK

> Organisers & Agendas

LEATHER | LINING



Black | Black

EMBLEM



MODEL	Notebook Medium	Notepad Large
IDENT No.	103386	05523
MATERIAL		
LEATHER	European full-grain cowhide with unique Montblanc deep shine, chrome-tanned, dyed through	European full-grain cowhide with unique Montblanc deep shine, chrome-tanned, dyed through
LINING	Jacquard lining with Montblanc brand name	Jacquard lining with Montblanc brand name
FITTINGS/EMBLEM	Montblanc emblem with palladium-coated ring	Montblanc emblem with palladium-coated ring
FEATURES		
CLOSURE/LOCK	-	-
POCKETS	-	-
INTERIOR ORGANISATION	7 pockets for credit cards, large pocket, additional pocket, pocket for notebook	2 pockets for credit cards, pocket for notepad
ADDITIONAL CHARACTERISTICS	Loop for writing instrument the size of a Meisterstück Classique or LeGrand, complete with notebook	Loop for writing instrument the size of Meisterstück Classique or Le Grand, complete with notepad
REFILLS	Notebook Medium (Id. 09596)	Notepad A4 (Id. 17834; Id. 06711)
DIMENSIONS		
DIMENSIONS	20 x 23.5 cm (for A5 sheets)	24.5 x 32 cm (for A4 sheets)

MEISTERSTÜCK

> Writing Instrument Pouches

LEATHER | LINING



Black | Black

EMBLEM



MODEL	1 Pen Sleeve	1 Pen Pouch
IDENT No.	101871	14309
MATERIAL		
LEATHER	European full-grain cowhide with unique Montblanc deep shine, chrome-tanned, dyed through	European full-grain cowhide with unique Montblanc deep shine, chrome-tanned, dyed through
LINING	Jacquard lining with Montblanc brand name	Jacquard lining with Montblanc brand name
FITTINGS/EMBLEM	Montblanc emblem with palladium-coated ring	Montblanc emblem with palladium-coated ring
FEATURES		
CLOSURE/LOCK	-	Clasp
POCKETS	-	-
INTERIOR ORGANISATION	Slim compartment for 1 writing instrument the size of Meisterstück Classique or Le Grand	Compartment for 1 writing instrument the size of Meisterstück Classique or Le Grand
ADDITIONAL CHARACTERISTICS	-	-
REFILLS	-	-
DIMENSIONS		
DIMENSIONS	3,5 x 15 cm	3 x 16 cm

MEISTERSTÜCK

> Writing Instrument Pouches

LEATHER | LINING



Black | Black

EMBLEM



MODEL	2 Pen Pouch	3 Pen Pouch
IDENT No.	14311	14313
MATERIAL		
LEATHER	European full-grain cowhide with unique Montblanc deep shine, chrome-tanned, dyed through	European full-grain cowhide with unique Montblanc deep shine, chrome-tanned, dyed through
LINING	Jacquard lining with Montblanc brand name	Jacquard lining with Montblanc brand name
FITTINGS/EMBLEM	Montblanc emblem with palladium-coated ring	Montblanc emblem with palladium-coated ring
FEATURES		
CLOSURE/LOCK	Clasp	Clasp
POCKETS	-	-
INTERIOR ORGANISATION	Compartment for 2 writing instruments the size of Meisterstück Classique or Le Grand	Compartment for 3 writing instruments the size of Meisterstück Classique or LeGrand
ADDITIONAL CHARACTERISTICS	-	-
REFILLS	-	-
DIMENSIONS		
DIMENSIONS	4,5 x 16 cm	6,5 x 16 cm

MEISTERSTÜCK

> Writing Instrument Pouches

LEATHER | LINING



Black | Black

EMBLEM



MODEL	1 Pen Pouch with Zip
IDENT No.	101872
MATERIAL	
LEATHER	European full-grain cowhide with unique Montblanc deep shine, chrome-tanned, dyed through
LINING	Jacquard lining with Montblanc brand name
FITTINGS/EMBLEM	Stainless steel with shiny finish, Montblanc emblem with palladium-coated ring
FEATURES	
CLOSURE/LOCK	Metal zip
POCKETS	-
INTERIOR ORGANISATION	Compartment for 1 writing instrument the size of Meisterstück Classique or Le Grand
ADDITIONAL CHARACTERISTICS	-
REFILLS	-
DIMENSIONS	
DIMENSIONS	4.5 x 16 cm

MEISTERSTÜCK

> Desk Accessories

LEATHER



Black

EMBLEM



MODEL	Pen Tray
IDENT No.	o6182
MATERIAL	
LEATHER	European full-grain cowhide with unique Montblanc deep shine, chrome-tanned, dyed through
LINING	-
FITTINGS/EMBLEM	Montblanc emblem with palladium-coated ring
FEATURES	
CLOSURE/LOCK	-
POCKETS	-
INTERIOR ORGANISATION	Framed indentation for several writing instruments
ADDITIONAL CHARACTERISTICS	Soft fabric lining and bottom
REFILLS	-
DIMENSIONS	
DIMENSIONS	25,5 x 7,5 cm

MEISTERSTÜCK

> Desk Accessories

LEATHER



Black

EMBLEM



MODEL	Desk Pad
IDENT No.	06181
MATERIAL	
LEATHER	European full-grain cowhide with unique Montblanc deep shine, chrome-tanned, dyed through
LINING	-
FITTINGS/EMBLEM	Montblanc emblem with palladium-coated ring
FEATURES	
CLOSURE/LOCK	-
POCKETS	-
INTERIOR ORGANISATION	-
ADDITIONAL CHARACTERISTICS	Soft fabric bottom
REFILLS	-
DIMENSIONS	
DIMENSIONS	59 x 39 cm

MEISTERSTÜCK

> Desk Accessories

LEATHER



Black

EMBLEM



MODEL	Envelope Sorter
IDENT No.	06183
MATERIAL	
LEATHER	European full-grain cowhide with unique Montblanc deep shine, chrome-tanned, dyed through
LINING	-
FITTINGS/EMBLEM	Montblanc emblem with palladium-coated ring
FEATURES	
CLOSURE/LOCK	-
POCKETS	-
INTERIOR ORGANISATION	2 compartments for writing paper and envelopes
ADDITIONAL CHARACTERISTICS	Soft fabric bottom
REFILLS	-
DIMENSIONS	
DIMENSIONS	26 x 14 cm

MEISTERSTÜCK

> Country Specifics · Special Order

LEATHER | LINING



Black | Black

EMBLEM



MODEL	ID Card Holder with Strap	Document / Passport Holder 6cc
IDENT No.	107345	103891
MATERIAL		
LEATHER	European full-grain cowhide with unique Montblanc deep shine, chrome-tanned, dyed through	European full-grain cowhide with unique Montblanc deep shine, chrome-tanned, dyed through
LINING	Jacquard lining with Montblanc brand name	Jacquard lining with Montblanc brand name
FITTINGS/EMBLEM	Montblanc emblem with palladium-coated ring	Montblanc emblem with palladium-coated ring
FEATURES		
CLOSURE/LOCK	-	-
POCKETS	-	-
INTERIOR ORGANISATION	View pocket for ID, 2 additional pockets	Pocket suitable for international passports, 8 clear pockets, 6 pockets for credit cards, 4 additional pockets
ADDITIONAL CHARACTERISTICS	Detachable branded neck strap in black	-
REFILLS	-	-
DIMENSIONS		
DIMENSIONS	7,5 x 10,5 cm	10 x 14 cm

MEISTERSTÜCK

> *Country Specifics · Special Order*

LEATHER | LINING



Black | Black

EMBLEM



MODEL	Wallet 4cc with View Pocket & Clasp
IDENT No.	102274
MATERIAL	
LEATHER	European full-grain cowhide with unique Montblanc deep shine, chrome-tanned, dyed through
LINING	Jacquard lining with Montblanc brand name
FITTINGS/EMBLEM	Montblanc emblem with palladium-coated ring
FEATURES	
CLOSURE/LOCK	Clasp with press-stud
POCKETS	-
INTERIOR ORGANISATION	4 pockets for credit cards, small view pocket, 2 compartments for banknotes, 2 additional pockets
ADDITIONAL CHARACTERISTICS	-
REFILLS	-
DIMENSIONS	
DIMENSIONS	11.5 x 8.5 cm

MEISTERSTÜCK

> Country Specifics · Special Order

LEATHER | LINING



Black | Black

EMBLEM



MODEL	Wallet 6cc with Chequebook Holder
IDENT No.	36757
MATERIAL	
LEATHER	European full-grain cowhide with unique Montblanc deep shine, chrome-tanned, dyed through
LINING	Jacquard lining with Montblanc brand name
FITTINGS/EMBLEM	Montblanc emblem with palladium-coated ring
FEATURES	
CLOSURE/LOCK	Flap, press-stud
POCKETS	-
INTERIOR ORGANISATION	6 pockets for credit cards, flap pocket for Italian chequebook, compartment for banknotes, 6 additional pockets
ADDITIONAL CHARACTERISTICS	-
REFILLS	-
DIMENSIONS	
DIMENSIONS	13 x 9.5 cm

MEISTERSTÜCK

> Country Specifics · Special Order

LEATHER | LINING



Black | Black

EMBLEM



MODEL	Wallet 1cc Mini
IDENT No.	35804
MATERIAL	
LEATHER	European full-grain cowhide with unique Montblanc deep shine, chrome-tanned, dyed through
LINING	Jacquard lining with Montblanc brand name
FITTINGS/EMBLEM	Montblanc emblem with palladium-coated ring
FEATURES	
CLOSURE/LOCK	-
POCKETS	-
INTERIOR ORGANISATION	Pocket for credit card, compartment for folded banknotes, 3 additional pockets, flap coin case
ADDITIONAL CHARACTERISTICS	-
REFILLS	-
DIMENSIONS	
DIMENSIONS	10,5 x 6 cm

MEISTERSTÜCK

> Country Specifics · Special Order

LEATHER | LINING



Black | Black

EMBLEM



MODEL	Wallet 6cc with Chequebook Holder
IDENT No.	05529
MATERIAL	
LEATHER	European full-grain cowhide with unique Montblanc deep shine, chrome-tanned, dyed through
LINING	Jacquard lining with Montblanc brand name
FITTINGS/EMBLEM	Montblanc emblem with palladium-coated ring
FEATURES	
CLOSURE/LOCK	-
POCKETS	-
INTERIOR ORGANISATION	6 pockets for credit cards, large pocket for French chequebook, 2 additional large pockets
ADDITIONAL CHARACTERISTICS	-
REFILLS	-
DIMENSIONS	
DIMENSIONS	19,5 x 11 cm

LEATHER

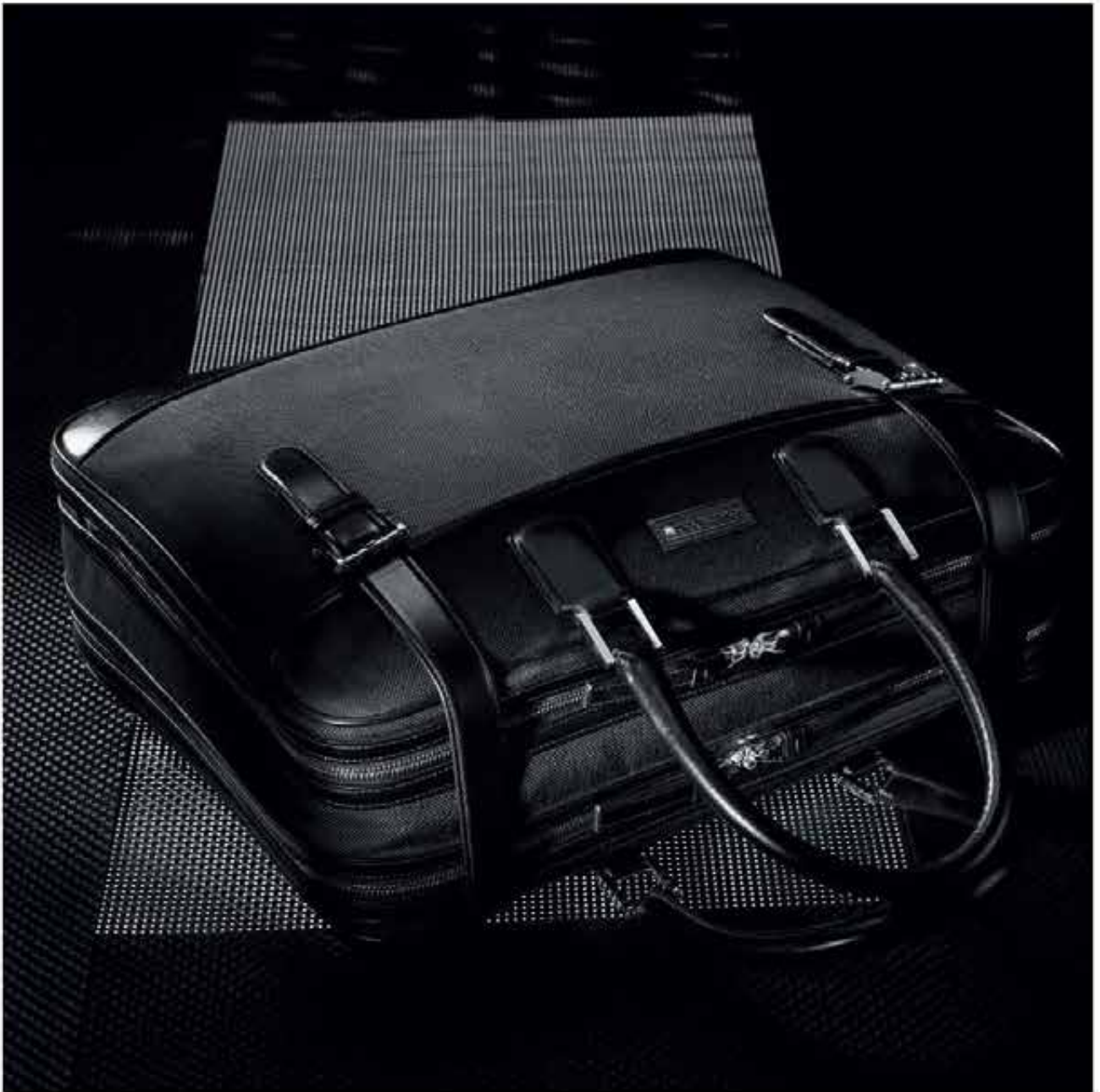

Combining the best of two worlds:
the timeless aesthetics of the Meisterstück range and the practical
advantages of a durable and light fabric.

A Reinvented Classic

Meisterstück Canvas

The collection is made of woven material, in sleek black or elegant
grey, with details in a rich black calfskin. The iconic Meisterstück
details are re-interpreted with a contemporary twist. A modernised
classic is born.

MEISTERSTÜCK CANVAS

> Large Leather Goods

> Business Bags



Single Gusset Briefcase

Id. 106731

p. 60



Document Case

Id. 106723

p. 61

Double Gusset Briefcase
with 2 Front Pockets

Id. 106724

p. 61



Laptop Case

Id. 106725

p. 62

> City Bags



North South Bag Small with Zip

Id. 107948

p. 63



Camera Bag

Id. 107631

p. 63



Messenger Bag with Zip

Id. 107632

p. 64



Messenger Bag

Id. 106726

p. 64



Envelope Bag

Id. 107634

p. 65



Slim Tote Bag

Id. 107635

p. 65



Messenger Bag Large

Id. 107638

p. 66



Executive Tote Bag

Id. 106739

p. 66

> Travel Bags



Travel Companion

Id. 107636

p. 67



48-Hours Bag

Id. 106727

p. 68

MEISTERSTÜCK CANVAS

> Small Leather Goods

> Pocket Accessories



Pocket Holder 2cc

Id. 107349 p. 69



View Pocket Holder

Id. 107637 p. 69



Business Card Holder

Id. 106728 p. 70

Business Card Holder
with Gusset & View Pocket

Id. 109611 p. 70



Passport Holder International

Id. 107638 p. 71

> Horizontal Wallets without Coin Case

Wallet 3cc
with view pocket & money clip

Id. 109612 p. 72



Wallet 6cc

Id. 106729 p. 72



Wallet 6cc

Id. 109613 p. 73



Wallet 6cc with Money Clip

Id. 107350 p. 73



Wallet 8cc

Id. 107351 p. 74

> Horizontal Wallets without Coin Case



Wallet 8cc

Id. 109614 p. 74



Wallet 11cc with View Pocket

Id. 107352 p. 75

> Horizontal Wallets with Coin Case



Wallet 10cc

Id. 107353 p. 76



Wallet 4cc with ID Card Holder

Id. 107639 p. 76

> Vertical Wallets without Coin Case

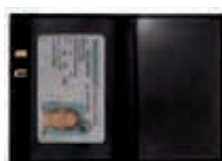

Document / Passport Holder 6cc

Id. 107640 p. 77

> Long Wallets



Wallet 6cc

Id. 106730 p. 78



Wallet 14cc with Gusset

Id. 109615 p. 78



Travel Wallet 14cc

Id. 107641 p. 79

MEISTERSTÜCK CANVAS

> Business Bags

LEATHER | FABRIC | LINING



Black | Grey |
Black

CLOSURE



MODEL	Single Gusset Briefcase
IDENT No.	106731
MATERIAL	
LEATHER	Canvas, 100% polypropylene, highly resistant to abrasion and dirt, combined with Italian calfskin, chrome-tanned, dyed through, coated with PU foil, resistant to stains, water and scratches
LINING	Jacquard lining with Montblanc brand name
FITTINGS/EMBLEM	Stainless steel with shiny finish, Montblanc emblem
FEATURES	
CLOSURE/LOCK	Flap, buckle with Montblanc 3 rings motif, snap lock
POCKETS	1 main compartment, large back pocket
INTERIOR ORGANISATION	Pockets for mobile phone (PDA size), 3 writing instruments and 2 credit cards
STRAP	-
ADDITIONAL CHARACTERISTICS	Comfortable leather handle
DIMENSIONS	
DIMENSIONS	38 x 28 x 7 cm

MEISTERSTÜCK CANVAS

> Business Bags

LEATHER | FABRIC | LINING

Black | Black |
Black

EMBLEM | CLOSURE



MODEL	Document Case	Double Gusset Briefcase with 2 Front Pockets
IDENT No.	106723	106724
MATERIAL		
LEATHER	Canvas, 100% polypropylene, highly resistant to abrasion and dirt, combined with Italian calfskin, chrome-tanned, dyed through, coated with PU foil, resistant to stains, water and scratches	Canvas, 100% polypropylene, highly resistant to abrasion and dirt, combined with Italian calfskin, chrome-tanned, dyed through, coated with PU foil, resistant to stains, water and scratches
LINING	Jacquard lining with Montblanc brand name	Jacquard lining with Montblanc brand name
FITTINGS/EMBLEM	Stainless steel with shiny finish, Montblanc emblem	Stainless steel with shiny finish, Montblanc emblem
FEATURES		
CLOSURE/LOCK	Metal zip with kissing sliders	Flap, 2 buckles with Montblanc 3 rings motif, 2 snap locks
POCKETS	2 main compartments, large front pocket, large inner pocket	2 main compartments, 2 front pockets, large back pocket
INTERIOR ORGANISATION	Pockets for mobile phone (PDA size), 2 writing instruments and 2 credit cards	Pockets for mobile phone (PDA size), 3 writing instruments and 1 small document
STRAP	-	-
ADDITIONAL CHARACTERISTICS	2 comfortable leather handles, luggage tag	Comfortable leather handle
DIMENSIONS		
DIMENSIONS	41 x 32 x 8 cm	41 x 29.5 x 12 cm

MEISTERSTÜCK CANVAS

> Business Bags

LEATHER | FABRIC | LINING



Black | Black |
Black

CLOSURE



MODEL	Laptop Case
IDENT No.	106725
MATERIAL	
LEATHER	Canvas, 100% polypropylene, highly resistant to abrasion and dirt, combined with Italian calfskin, chrome-tanned, dyed through, coated with PU foil, resistant to stains, water and scratches
LINING	Jacquard lining with Montblanc brand name
FITTINGS/EMBLEM	Stainless steel with shiny finish, Montblanc emblem
FEATURES	
CLOSURE/LOCK	Metal zip with kissing sliders, flap, buckle with Montblanc 3 rings motif, engraved Montblanc brand name and emblem, magnet
POCKETS	1 main compartment, 1 padded compartment suitable for a laptop, large front pocket, large inner pocket closed by a press-stud, additional compartment
INTERIOR ORGANISATION	Pockets for mobile phone (PDA size), 3 writing instruments and 6 credit cards
STRAP	Detachable and adjustable branded shoulder strap in black
ADDITIONAL CHARACTERISTICS	2 comfortable leather handles
DIMENSIONS	
DIMENSIONS	41.5 x 33 x 14 cm

MEISTERSTÜCK CANVAS

> City Bags

LEATHER | FABRIC | LINING

Black | Black |
Black

EMBLEM



MODEL	North South Bag Small with Zip	Camera Bag
IDENT No.	107948	107631
MATERIAL		
LEATHER	Canvas, 100% polypropylene, highly resistant to abrasion and dirt, combined with Italian calfskin, chrome-tanned, dyed through, coated with PU foil, resistant to stains, water and scratches	Canvas, 100% polypropylene, highly resistant to abrasion and dirt, combined with Italian calfskin, chrome-tanned, dyed through, coated with PU foil, resistant to stains, water and scratches
LINING	Jacquard lining 40% Nylon 60% Viscose with Montblanc emblem	Jacquard lining 40% Nylon 60% Viscose with Montblanc emblem
FITTINGS/EMBLEM	Stainless steel with shiny finish, Montblanc emblem	Stainless steel with shiny finish, Montblanc emblem
FEATURES		
CLOSURE/LOCK	Metal zip	Metal zip
POCKETS	1 main compartment, zipped front pocket	1 main compartment, zipped front pocket
INTERIOR ORGANISATION	Pockets for mobile phone (PDA size), 2 writing instrument	Pockets for mobile phone (PDA size), 2 writing instruments and 2 credit cards
STRAP	Shoulder strap in black with Montblanc brand name	Shoulder strap in black with Montblanc brand name
ADDITIONAL CHARACTERISTICS	-	-
DIMENSIONS		
DIMENSIONS	23 x 27 x 8,5 cm	29 x 20 x 12 cm

MEISTERSTÜCK CANVAS

> City Bags

LEATHER | FABRIC | LINING

Black | Black |
Black

EMBLEM | CLOSURE



MODEL	Messenger Bag with Zip	Messenger Bag
IDENT No.	107632	106726
MATERIAL		
LEATHER	Canvas, 100% polypropylene, highly resistant to abrasion and dirt, combined with Italian calfskin, chrome-tanned, dyed through, coated with PU foil, resistant to stains, water and scratches	Canvas, 100% polypropylene, highly resistant to abrasion and dirt, combined with Italian calfskin, chrome-tanned, dyed through, coated with PU foil, resistant to stains, water and scratches
LINING	Jacquard lining 40% Nylon 60% Viscose with Montblanc emblem	Jacquard lining with Montblanc brand name
FITTINGS/EMBLEM	Stainless steel with shiny finish, Montblanc emblem	Stainless steel with shiny finish, Montblanc emblem
FEATURES		
CLOSURE/LOCK	Metal zip	Flap, buckle with Montblanc 3 rings motif, snap lock
POCKETS	1 main compartment, large zipped front pocket	1 main compartment, large zipped inner pocket, large back pocket
INTERIOR ORGANISATION	Pockets for mobile phone (PDA size), 2 writing instruments and 2 credit cards	Pockets for mobile phone (PDA size), 3 writing instruments and 2 credit cards
STRAP	Shoulder strap in black with Montblanc brand name	Adjustable branded shoulder strap in black
ADDITIONAL CHARACTERISTICS	-	-
DIMENSIONS		
DIMENSIONS	35 x 26.5 x 9.5 cm	36 x 32 x 10 cm

MEISTERSTÜCK CANVAS

> City Bags

LEATHER | FABRIC | LINING

Black | Grey |
Black

EMBLEM



MODEL	Envelope Bag	Slim Tote Bag
IDENT No.	107634	107635
MATERIAL		
LEATHER	Canvas, 100% polypropylene, highly resistant to abrasion and dirt, combined with Italian calfskin, chrome-tanned, dyed through, coated with PU foil, resistant to stains, water and scratches	Canvas, 100% polypropylene, highly resistant to abrasion and dirt, combined with Italian calfskin, chrome-tanned, dyed through, coated with PU foil, resistant to stains, water and scratches
LINING	Jacquard lining 40% Nylon 60% Viscose with Montblanc emblem	Jacquard lining with Montblanc brand name
FITTINGS/EMBLEM	Stainless steel with shiny finish, Montblanc emblem	Stainless steel with shiny finish, Montblanc emblem
FEATURES		
CLOSURE/LOCK	Metal zip	Metal zip
POCKETS	1 main compartment, zipped front pocket	1 spacious main compartment, large inner pocket
INTERIOR ORGANISATION	Pockets for mobile phone (PDA size), 2 writing instrument, especially fitting for iPad	Pockets for mobile phone (PDA size), 3 writing instruments and 2 credit cards
STRAP	Adjustable black shoulder strap with Montblanc brand name	-
ADDITIONAL CHARACTERISTICS	-	2 comfortable leather handles
DIMENSIONS		
DIMENSIONS	23 x 27 x 2 cm	35 x 37.5 x 8 cm

MEISTERSTÜCK CANVAS

> City Bags

LEATHER | FABRIC | LINING

Black | Grey |
Black

EMBLEM



MODEL	Messenger Bag Large	Executive Tote Bag
IDENT No.	106738	106739
MATERIAL		
LEATHER	Canvas, 100% polypropylene, highly resistant to abrasion and dirt, combined with Italian calfskin, chrome-tanned, dyed through, coated with PU foil, resistant to stains, water and scratches	Canvas, 100% polypropylene, highly resistant to abrasion and dirt, combined with Italian calfskin, chrome-tanned, dyed through, coated with PU foil, resistant to stains, water and scratches
LINING	Jacquard lining with Montblanc brand name	Jacquard lining with Montblanc brand name
FITTINGS/EMBLEM	Stainless steel with shiny finish, Montblanc emblem	Stainless steel with shiny finish, Montblanc emblem
FEATURES		
CLOSURE/LOCK	Flap with 2 hidden magnets	2 metal zips
POCKETS	1 main compartment, zipped front pocket, large back pocket	2 spacious main compartments, large inner pocket
INTERIOR ORGANISATION	Pockets for mobile phone (PDA size), 3 writing instruments and 2 credit cards	Pockets for mobile phone (PDA size), 3 writing instruments and 2 credit cards
STRAP	Adjustable branded shoulder strap in black	-
ADDITIONAL CHARACTERISTICS	-	2 comfortable leather handles
DIMENSIONS		
DIMENSIONS	41 x 49 x 11.5 cm	46 x 38 x 14.5 cm

MEISTERSTÜCK CANVAS

> Travel Bags

LEATHER | FABRIC | LINING



Black | Grey |
Black

EMBLEM



MODEL	Travel Companion
IDENT No.	107636
MATERIAL	
LEATHER	Canvas, 100% polypropylene, highly resistant to abrasion and dirt, combined French fullgrain calfskin with metallic finish, chrome-tanned, dyed through
LINING	Jacquard lining 40% Nylon 60% Viscose with Montblanc emblem
FITTINGS/EMBLEM	Stainless steel with shiny finish, Montblanc emblem
FEATURES	
CLOSURE/LOCK	2 zips
POCKETS	2 main compartments, large zipped inner pocket
INTERIOR ORGANISATION	Pockets for mobile phone (PDA size), 1 writing instrument, 17 credit cards and flight ticket; view pocket, 2 banknote compartments, additional pocket
STRAP	Retractable leather wrist strap
ADDITIONAL CHARACTERISTICS	-
DIMENSIONS	
DIMENSIONS	22 x 13 x 4 cm

MEISTERSTÜCK CANVAS

> Travel Bags

LEATHER | FABRIC | LINING



Black | Black |
Black

CLOSURE



MODEL	48-Hours Bag
IDENT No.	106727
MATERIAL	
LEATHER	Canvas, 100% polypropylene, highly resistant to abrasion and dirt, combined with Italian calfskin, chrome-tanned, dyed through, coated with PU foil, resistant to stains, water and scratches
LINING	Jacquard lining with Montblanc brand name
FITTINGS/EMBLEM	Stainless steel with shiny finish, Montblanc emblem
FEATURES	
CLOSURE/LOCK	2 metal zips with kissing sliders, 2 buckles with Montblanc 3 rings motif, 2 leather straps with magnetic snap lock
POCKETS	1 main compartment with large inner pocket, spacious compartment for clothes with adjustable straps, front pocket, 2 medium and additional large pocket
INTERIOR ORGANISATION	Pockets for mobile phone (PDA size), 3 writing instruments and 6 credit cards
STRAP	-
ADDITIONAL CHARACTERISTICS	2 comfortable leather handles, luggage tag
DIMENSIONS	
DIMENSIONS	45.5 x 36.5 x 13 cm

MEISTERSTÜCK CANVAS

> Pocket Accessories

LEATHER | FABRIC | LINING



Black | Grey |
Black

EMBLEM



MODEL	Pocket Holder 2cc	View Pocket Holder
IDENT No.	107349	107637
MATERIAL		
LEATHER	Canvas, 100% polypropylene, highly resistant to abrasion and dirt, combined French fullgrain calfskin with metallic finish, chrome-tanned, dyed through	Canvas, 100% polypropylene, highly resistant to abrasion and dirt, combined French fullgrain calfskin with metallic finish, chrome-tanned, dyed through
LINING	Jacquard lining with Montblanc brand name	Jacquard lining with Montblanc brand name
FITTINGS/EMBLEM	Montblanc emblem with palladium-coated ring	Montblanc emblem with palladium-coated ring
FEATURES		
CLOSURE/LOCK	-	-
POCKETS	-	-
INTERIOR ORGANISATION	2 pockets for credit cards	2 view pockets for ID card and another similarly sized document
ADDITIONAL CHARACTERISTICS	-	-
REFILLS	-	-
DIMENSIONS		
DIMENSIONS	10 x 8 cm	9 x 11.5 cm

MEISTERSTÜCK CANVAS

> Pocket Accessories

LEATHER | FABRIC | LINING



Black | Grey |
Black

EMBLEM



MODEL	Business Card Holder	Business Card Holder with Gusset & View Pocket
IDENT No.	106728	109611
MATERIAL		
LEATHER	Canvas, 100% polypropylene, highly resistant to abrasion and dirt, combined French fullgrain calfskin with metallic finish, chrome-tanned, dyed through	Canvas, 100% polypropylene, highly resistant to abrasion and dirt, combined French fullgrain calfskin with metallic finish, chrome-tanned, dyed through
LINING	Jacquard lining with Montblanc brand name	Jacquard lining with Montblanc brand name
FITTINGS/EMBLEM	Montblanc emblem with palladium-coated ring	Montblanc emblem with palladium-coated ring
FEATURES		
CLOSURE/LOCK	-	-
POCKETS	-	-
INTERIOR ORGANISATION	Compartment for business cards, 2 pockets for credit cards	Compartment for business cards, 2 pockets for credit cards, with view pocket
ADDITIONAL CHARACTERISTICS	-	-
REFILLS	-	-
DIMENSIONS		
DIMENSIONS	7,5 x 11 cm	8,0 cm x 10,5 cm

MEISTERSTÜCK CANVAS

> Pocket Accessories

LEATHER | FABRIC | LINING



Black | Grey |
Black

EMBLEM



MODEL	Passport Holder International
IDENT No.	107638
MATERIAL	
LEATHER	Canvas, 100% polypropylene, highly resistant to abrasion and dirt, combined French fullgrain calfskin with metallic finish, chrome-tanned, dyed through
LINING	Jacquard lining with Montblanc brand name
FITTINGS/EMBLEM	Montblanc emblem with palladium-coated ring
FEATURES	
CLOSURE/LOCK	-
POCKETS	-
INTERIOR ORGANISATION	Pocket suitable for all international passports, additional pocket
ADDITIONAL CHARACTERISTICS	-
REFILLS	-
DIMENSIONS	
DIMENSIONS	10 x 14 cm

MEISTERSTÜCK CANVAS

> Horizontal Wallets without Coin Case

LEATHER | FABRIC | LINING

Black | Black |
BlackBlack | Grey |
Black

EMBLEM



MODEL	Wallet 3cc with view pocket & money clip	Wallet 6cc
IDENT No.	109612	106729
MATERIAL		
LEATHER	Canvas, 100% polypropylene, highly resistant to abrasion and dirt, combined French fullgrain calfskin with metallic finish, chrome-tanned, dyed through	Canvas, 100% polypropylene, highly resistant to abrasion and dirt, combined French fullgrain calfskin with metallic finish, chrome-tanned, dyed through
LINING	Jacquard lining with Montblanc brand name	Jacquard lining with Montblanc brand name
FITTINGS/EMBLEM	Montblanc emblem with palladium-coated ring	Montblanc emblem with palladium-coated ring
FEATURES		
CLOSURE/LOCK	-	-
POCKETS	-	-
INTERIOR ORGANISATION	3 pockets for credit cards, view pocket, money clip	6 pockets for credit cards, 2 compartments for banknotes, 2 additional pockets
ADDITIONAL CHARACTERISTICS	-	-
REFILLS	-	-
DIMENSIONS		
DIMENSIONS	9.0 x 11.5 cm	8.5 x 11.5 cm

MEISTERSTÜCK CANVAS

> Horizontal Wallets without Coin Case

LEATHER | FABRIC | LINING

Black | Black |
BlackBlack | Grey |
Black

EMBLEM



MODEL	Wallet 6cc	Wallet 6cc with Money Clip
IDENT No.	109613	107350
MATERIAL		
LEATHER	Canvas, 100% polypropylene, highly resistant to abrasion and dirt, combined French fullgrain calfskin with metallic finish, chrome-tanned, dyed through	Canvas, 100% polypropylene, highly resistant to abrasion and dirt, combined French fullgrain calfskin with metallic finish, chrome-tanned, dyed through
LINING	Jacquard lining with Montblanc brand name	Jacquard lining with Montblanc brand name
FITTINGS/EMBLEM	Montblanc emblem with palladium-coated ring	Montblanc emblem with palladium-coated ring
FEATURES		
CLOSURE/LOCK	-	-
POCKETS	-	-
INTERIOR ORGANISATION	6 pockets for credit cards, 2 compartments for banknotes, 2 additional pockets	6 pockets for credit cards, money clip
ADDITIONAL CHARACTERISTICS	-	-
REFILLS	-	-
DIMENSIONS		
DIMENSIONS	11.5 x 9.0 cm	11.5 x 8 cm

MEISTERSTÜCK CANVAS

> Horizontal Wallets without Coin Case

LEATHER | FABRIC | LINING

Black | Grey |
BlackBlack | Black |
Black

EMBLEM



MODEL	Wallet 8cc	Wallet 8cc
IDENT No.	107351	109614
MATERIAL		
LEATHER	Canvas, 100% polypropylene, highly resistant to abrasion and dirt, combined French fullgrain calfskin with metallic finish, chrome-tanned, dyed through	Canvas, 100% polypropylene, highly resistant to abrasion and dirt, combined French fullgrain calfskin with metallic finish, chrome-tanned, dyed through
LINING	Jacquard lining with Montblanc brand name	Jacquard lining with Montblanc brand name
FITTINGS/EMBLEM	Montblanc emblem with palladium-coated ring	Montblanc emblem with palladium-coated ring
FEATURES		
CLOSURE/LOCK	-	-
POCKETS	-	-
INTERIOR ORGANISATION	8 pockets for credit cards, 2 compartments for banknotes, 2 additional pockets	8 pockets for credit cards, 2 compartments for banknotes, 2 additional pockets
ADDITIONAL CHARACTERISTICS	-	-
REFILLS	-	-
DIMENSIONS		
DIMENSIONS	11 x 9,5 cm	11.0 x 9,5 cm

MEISTERSTÜCK CANVAS

> Horizontal Wallets without Coin Case

LEATHER | FABRIC | LINING



Black | Grey |
Black

EMBLEM



MODEL	Wallet 11cc with View Pocket
IDENT No.	107352
MATERIAL	
LEATHER	Canvas, 100% polypropylene, highly resistant to abrasion and dirt, combined French fullgrain calfskin with metallic finish, chrome-tanned, dyed through
LINING	Jacquard lining with Montblanc brand name
FITTINGS/EMBLEM	Montblanc emblem with palladium-coated ring
FEATURES	
CLOSURE/LOCK	-
POCKETS	-
INTERIOR ORGANISATION	11 pockets for credit cards, small view pocket, compartment for banknotes, additional pocket
ADDITIONAL CHARACTERISTICS	-
REFILLS	-
DIMENSIONS	
DIMENSIONS	11.5 x 9.5 cm

MEISTERSTÜCK CANVAS

> Horizontal Wallets with Coin Case

LEATHER | FABRIC | LINING

Black | Grey |
Black

EMBLEM



MODEL	Wallet 4cc with ID Card Holder	Wallet 10cc
IDENT No.	107639	107353
MATERIAL		
LEATHER	Canvas, 100% polypropylene, highly resistant to abrasion and dirt, combined French fullgrain calfskin with metallic finish, chrome-tanned, dyed through	Canvas, 100% polypropylene, highly resistant to abrasion and dirt, combined French fullgrain calfskin with metallic finish, chrome-tanned, dyed through
LINING	Jacquard lining with Montblanc brand name	Jacquard lining with Montblanc brand name
FITTINGS/EMBLEM	Montblanc emblem with palladium-coated ring	Montblanc emblem with palladium-coated ring
FEATURES		
CLOSURE/LOCK	-	-
POCKETS	-	-
INTERIOR ORGANISATION	4 pockets for credit cards, 2 compartments for banknotes, 2 removable additional pockets, flap coin case	10 pockets for credit cards, 2 compartments for banknotes, flap coin case
ADDITIONAL CHARACTERISTICS	-	-
REFILLS	-	-
DIMENSIONS		
DIMENSIONS	14 x 10,5 cm	12 x 9,5 cm

MEISTERSTÜCK CANVAS

> Vertical Wallets without Coin Case

LEATHER | FABRIC | LINING



Black | Grey |
Black

EMBLEM



MODEL	Document / Passport Holder 6cc
IDENT No.	107640
MATERIAL	
LEATHER	Canvas, 100% polypropylene, highly resistant to abrasion and dirt, combined French fullgrain calfskin with metallic finish, chrome-tanned, dyed through
LINING	Jacquard lining with Montblanc brand name
FITTINGS/EMBLEM	Montblanc emblem with palladium-coated ring
FEATURES	
CLOSURE/LOCK	-
POCKETS	-
INTERIOR ORGANISATION	Pocket suitable for all international passports, 6 pockets for credit cards, 2 clear pockets, 2 additional pockets
ADDITIONAL CHARACTERISTICS	-
REFILLS	-
DIMENSIONS	
DIMENSIONS	10,5 x 14 cm

MEISTERSTÜCK CANVAS

> Long Wallets

LEATHER | FABRIC | LINING

Black | Grey |
BlackBlack | Black |
Black

EMBLEM



MODEL	Wallet 6cc	Wallet 14cc with Gusset
IDENT No.	106730	109615
MATERIAL		
LEATHER	Canvas, 100% polypropylene, highly resistant to abrasion and dirt, combined French fullgrain calfskin with metallic finish, chrome-tanned, dyed through	Canvas, 100% polypropylene, highly resistant to abrasion and dirt, combined French fullgrain calfskin with metallic finish, chrome-tanned, dyed through
LINING	Jacquard lining with Montblanc brand name	Jacquard lining with Montblanc brand name
FITTINGS/EMBLEM	Montblanc emblem with palladium-coated ring	Montblanc emblem with palladium-coated ring
FEATURES		
CLOSURE/LOCK	-	-
POCKETS	-	-
INTERIOR ORGANISATION	6 pockets for credit cards, 2 compartments for banknotes, 2 additional pockets	14 pockets for credit cards, 1 compartment for banknotes, 2 additional pockets
ADDITIONAL CHARACTERISTICS	-	-
REFILLS	-	-
DIMENSIONS		
DIMENSIONS	9,5 x 19 cm	19,0 x 10,0 cm

MEISTERSTÜCK CANVAS

> Long Wallets

LEATHER | FABRIC | LINING



Black | Grey |
Black

EMBLEM



MODEL	Travel Wallet 14cc
IDENT No.	107641
MATERIAL	
LEATHER	Canvas, 100% polypropylene, highly resistant to abrasion and dirt, combined French fullgrain calfskin with metallic finish, chrome-tanned, dyed through
LINING	Jacquard lining with Montblanc brand name
FITTINGS/EMBLEM	Montblanc emblem with palladium-coated ring
FEATURES	
CLOSURE/LOCK	Metal zip
POCKETS	-
INTERIOR ORGANISATION	14 pockets for credit cards, large pocket for flight ticket, zipped large pocket, large gusset for banknotes, 2 additional pockets
ADDITIONAL CHARACTERISTICS	Loop for 1 writing instrument the size of a Meisterstück Classique or LeGrand
REFILLS	-
DIMENSIONS	
DIMENSIONS	13 x 22 cm

LEATHER

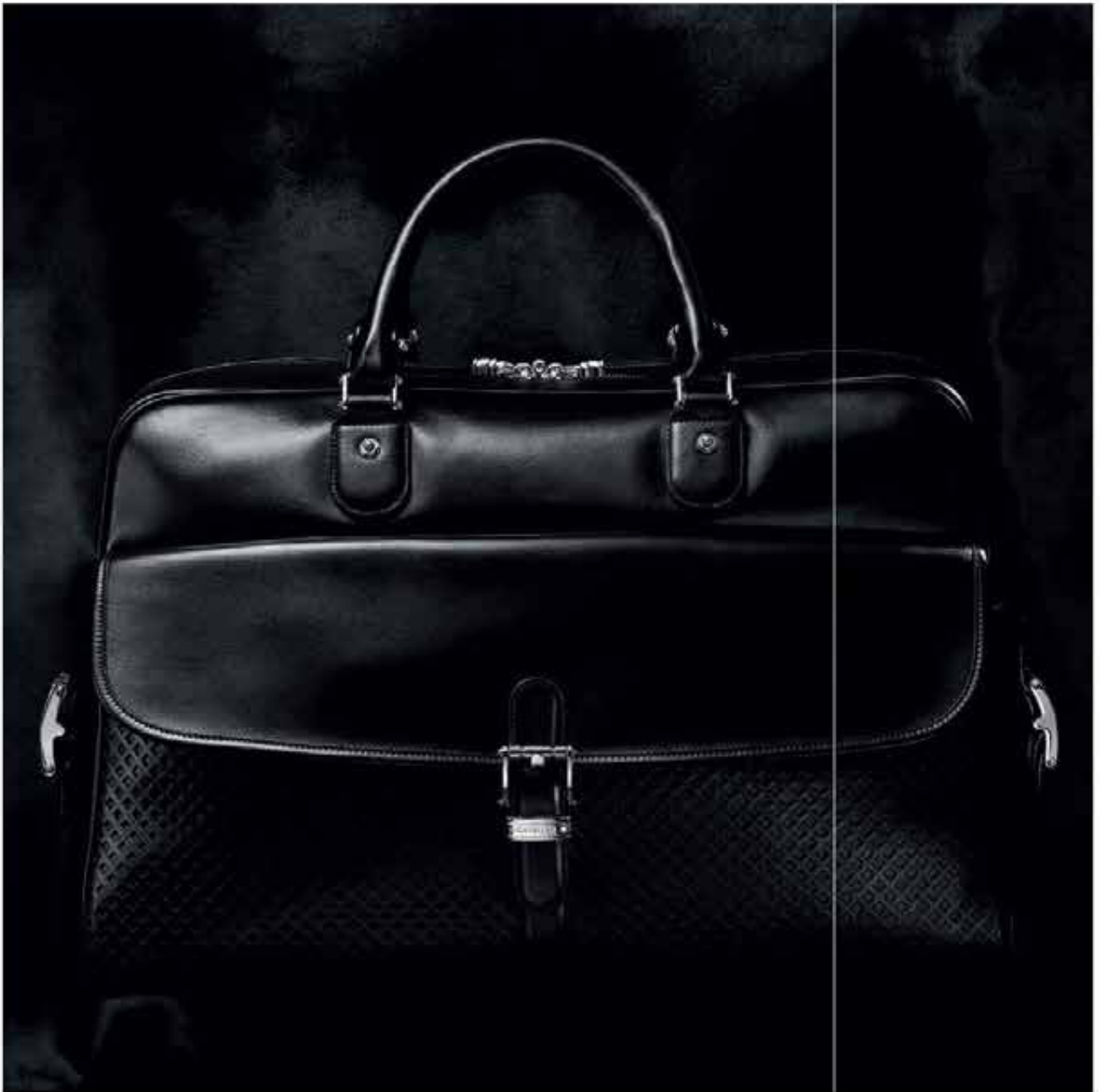

The art of timeless design lies in continuous reinvention. With the Meisterstück Soft collection, Montblanc has given a modern interpretation to the elegant style of the classic Meisterstück family:

The Contemporary Interpretation of a Classic

Meisterstück Soft

The supple calfskin enables the craftsmen to create soft and natural forms, which are then strikingly offset by polished metal parts. Mesh-pattern pockets lend the range a playful touch – a great classic can also be exceptional.

MEISTERSTÜCK SOFT

> Large Leather Goods

> Business Bags



Document Case

Id. 104650

p. 84



Double Gusset Briefcase with 2 Front Pockets

Id. 106019

p. 84

> City Bags



North South Bag Large with Zip

Id. 104651

p. 85



Messenger Bag

Id. 104652

p. 85

> Travel Bags



Weekender Bag

Id. 104654

p. 86

MEISTERSTÜCK SOFT

> Small Leather Goods

> Pocket Accessories



Pocket Holder 2cc

Id. 104642

p. 87



Business Card Holder with Gusset

Id. 104643

p. 87

> Horizontal Wallets without Coin Case



Wallet 11cc with View Pocket

Id. 104646

p. 88

> Vertical Wallets without Coin Case



Wallet 12cc with View Pocket

Id. 104648

p. 89

MEISTERSTÜCK SOFT

> Business Bags

LEATHER | LINING



Black | Brown

CLOSURE



MODEL	Document Case	Double Gusset Briefcase with 2 Front Pockets
IDENT No.	104650	106019
MATERIAL		
LEATHER	French full-grain calfskin, soft to the touch, chrome-tanned, semi-aniline-dyed through	French full-grain calfskin, soft to the touch, chrome-tanned, semi-aniline-dyed through
LINING	Jacquard lining with emblematic "M" pattern	Jacquard lining with emblematic "M" pattern
FITTINGS/EMBLEM	Stainless steel with shiny finish, Montblanc emblem	Stainless steel with shiny finish, Montblanc emblem
FEATURES		
CLOSURE/LOCK	Metal zip with kissing sliders, flap, buckle with Montblanc 3 rings motif, engraved Montblanc brand name and emblem, magnet	Flap, snap-lock with buckle and Montblanc 3 ring motif, engraved Montblanc brand name and emblem
POCKETS	1 main compartment, net front pocket, large zipped inner pocket	2 main compartments, 2 net front pockets, large zipped inner pocket, large back pocket
INTERIOR ORGANISATION	Pockets for mobile phone (PDA size), 1 writing instrument and 1 small document	Pockets for mobile phone (PDA size), 1 writing instrument and 1 small document
STRAP	Detachable and adjustable leather shoulder strap in black	-
ADDITIONAL CHARACTERISTICS	2 comfortable leather handles	Comfortable leather handle
DIMENSIONS		
DIMENSIONS	39 x 27 x 11 cm	42 x 30,5 x 16 cm

MEISTERSTÜCK SOFT

> City Bags

LEATHER | LINING



Black | Brown

CLOSURE



MODEL	North South Bag Large with Zip	Messenger Bag
IDENT No.	104651	104652
MATERIAL		
LEATHER	French full-grain calfskin, soft to the touch, chrome-tanned, semi-aniline-dyed through	French full-grain calfskin, soft to the touch, chrome-tanned, semi-aniline-dyed through
LINING	Jacquard lining with emblematic "M" pattern	Jacquard lining with emblematic "M" pattern
FITTINGS/EMBLEM	Stainless steel with shiny finish, Montblanc emblem	Stainless steel with shiny finish, Montblanc emblem
FEATURES		
CLOSURE/LOCK	Metal zip with kissing sliders, flap, buckle with Montblanc 3 rings motif, engraved Montblanc brand name and emblem, magnet	Flap, buckle with Montblanc 3 rings motif, engraved Montblanc brand name and emblem, magnet
POCKETS	1 main compartment, net front pocket, zipped inner pocket	1 main compartment, net front pocket, large zipped inner pocket
INTERIOR ORGANISATION	Pockets for mobile phone (PDA size), 1 writing instrument and 1 small document	Pockets for mobile phone (PDA size), 1 writing instrument and 1 small document
STRAP	Adjustable leather shoulder strap in black	Adjustable leather shoulder strap in black
ADDITIONAL CHARACTERISTICS	-	Rain protection for main compartment
DIMENSIONS		
DIMENSIONS	25.5 x 30 x 9.5 cm	37 x 29 x 13 cm

MEISTERSTÜCK SOFT

> Travel Bags

LEATHER | LINING



Black | Brown

CLOSURE



MODEL	Weekender Bag
IDENT No.	104654
MATERIAL	
LEATHER	French full-grain calfskin, soft to the touch, chrome-tanned, semi-aniline-dyed through
LINING	Jacquard lining with emblematic "M" pattern
FITTINGS/EMBLEM	Stainless steel with shiny finish, Montblanc emblem
FEATURES	
CLOSURE/LOCK	Metal zip with kissing sliders, flap, buckle with Montblanc 3 rings motif, engraved Montblanc brand name and emblem, magnet
POCKETS	1 spacious main compartment, large net front pocket, large zipped inner pocket
INTERIOR ORGANISATION	Pockets for mobile phone (PDA size), 1 writing instrument and 1 small document
STRAP	Detachable and adjustable leather shoulder strap in black
ADDITIONAL CHARACTERISTICS	2 comfortable leather handles, padlock with leather pouch, luggage tag
DIMENSIONS	
DIMENSIONS	45 x 32 x 26 cm

MEISTERSTÜCK SOFT

> Pocket Accessories

LEATHER | LINING



Black | Brown

EMBLEM



MODEL	Pocket Holder zcc	Business Card Holder with Gusset
IDENT No.	104642	104643
MATERIAL		
LEATHER	French full-grain calfskin, soft to the touch, chrome-tanned, semi-aniline-dyed through	French full-grain calfskin, soft to the touch, chrome-tanned, semi-aniline-dyed through
LINING	Jacquard lining with emblematic "M" pattern	Jacquard lining with emblematic "M" pattern
FITTINGS/EMBLEM	Montblanc emblem with palladium-coated ring	Montblanc emblem with palladium-coated ring
FEATURES		
CLOSURE/LOCK	-	-
POCKETS	-	-
INTERIOR ORGANISATION	2 pockets for credit cards, additional pocket	Spacious gusset for business cards, 2 pockets for credit cards, 2 additional pockets
ADDITIONAL CHARACTERISTICS	-	-
REFILLS	-	-
DIMENSIONS		
DIMENSIONS	10.5 x 7 cm	7 x 10.5 cm

MEISTERSTÜCK SOFT

> Horizontal Wallets without Coin Case

LEATHER | LINING



Black | Brown

EMBLEM



MODEL	Wallet 11cc with View Pocket
IDENT No.	104646
MATERIAL	
LEATHER	French full-grain calfskin, soft to the touch, chrome-tanned, semi-aniline-dyed through
LINING	Jacquard lining with emblematic "M" pattern
FITTINGS/EMBLEM	Montblanc emblem with palladium-coated ring
FEATURES	
CLOSURE/LOCK	-
POCKETS	-
INTERIOR ORGANISATION	11 pockets for credit cards, small view pocket, 2 compartments for banknotes, additional pocket
ADDITIONAL CHARACTERISTICS	-
REFILLS	-
DIMENSIONS	
DIMENSIONS	11.5 x 9.5 cm

MEISTERSTÜCK SOFT

> Vertical Wallets without Coin Case

LEATHER | LINING



Black | Brown

EMBLEM



MODEL	Wallet 12cc with View Pocket
IDENT No.	104648
MATERIAL	
LEATHER	French full-grain calfskin, soft to the touch, chrome-tanned, semi-aniline-dyed through
LINING	Jacquard lining with emblematic "M" pattern
FITTINGS/EMBLEM	Montblanc emblem with palladium-coated ring
FEATURES	
CLOSURE/LOCK	-
POCKETS	-
INTERIOR ORGANISATION	12 pockets for credit cards, view pocket suitable for ID card, 2 compartments for banknotes, 10 additional pockets
ADDITIONAL CHARACTERISTICS	-
REFILLS	-
DIMENSIONS	
DIMENSIONS	9.5 x 13.5 cm

LEATHER



Writing instruments, jewellery and leather combine to create a unique programme, which pays tribute to Montblanc's dedication to support children's education.

Serving the Children

Meisterstück Selection

“Signature for Good”

The fine leather Collection in black Saffiano printed leather is meticulously designed and manufactured by our master atelier in Italy. Famed for its impeccable details, this Collection features the symbolic brick motif and is individually numbered in homage to the charitable programme. The special blue inlays honour the special partnership between Montblanc and UNICEF*.

*UNICEF does not endorse any brand or product. No portion of the purchase price is tax-deductible. For more information visit unicef.org.

MEISTERSTÜCK SELECTION UNICEF

> Small Leather Goods

> Pocket Accessories



Business Card Holder with Gusset

Id. 109370

p. 93

> Horizontal Wallets without Coin Case



Wallet 6cc with removable Card Holder

Id. 109371

p. 94

> Long Wallets



Wallet 12cc with View Pocket

Id. 109372

p. 95

> Organisers & Agendas



Notebook Medium with Zip

Id. 109373

p. 96

> Writing Instrument Pouches



1 Pen Pouch with Zip

Id. 109369

p. 97

MEISTERSTÜCK SELECTION UNICEF

> Pocket Accessories

LEATHER | LINING



Black | Blue

EMBLEM



MODEL	Business Card Holder with Gusset
IDENT No.	109370
MATERIAL	
LEATHER	Italian full-grain calfskin, dyed through, with Saffiano print
LINING	Jacquard lining with blue brick motive
FITTINGS/EMBLEM	Montblanc emblem with palladium-coated ring
FEATURES	
CLOSURE/LOCK	-
POCKETS	-
INTERIOR ORGANISATION	Compartment for business cards, 1 pocket for credit cards, additional flat pocket
ADDITIONAL CHARACTERISTICS	-
REFILLS	-
DIMENSIONS	
DIMENSIONS	7 x 10,5 cm

MEISTERSTÜCK SELECTION UNICEF

> Horizontal Wallets without Coin Case

LEATHER | LINING



Black | Blue

EMBLEM



MODEL	Wallet 6cc with removable Card Holder
IDENT No.	109371
MATERIAL	
LEATHER	Italian full-grain calfskin, dyed through, with Saffiano print
LINING	Jacquard lining with blue brick motive
FITTINGS/EMBLEM	Montblanc emblem with palladium-coated ring
FEATURES	
CLOSURE/LOCK	-
POCKETS	-
INTERIOR ORGANISATION	6 pockets for credit cards, 2 compartments for banknotes, 2 additional pockets, pocket for removable holder
ADDITIONAL CHARACTERISTICS	Removable holder with 2 pockets for credit cards, small view pocket and additional pocket
REFILLS	-
DIMENSIONS	
DIMENSIONS	11.5 x 9 cm

MEISTERSTÜCK SELECTION UNICEF

> Long Wallets

LEATHER | LINING



Black | Blue

EMBLEM



MODEL	Wallet 12cc with View Pocket
IDENT No.	109372
MATERIAL	
LEATHER	Italian full-grain calfskin, dyed through, with Saffiano print
LINING	Jacquard lining with blue brick motive
FITTINGS/EMBLEM	Montblanc emblem with palladium-coated ring
FEATURES	
CLOSURE/LOCK	-
POCKETS	-
INTERIOR ORGANISATION	1 wide compartment for banknotes, 12 pockets for credit cards, small view pocket, additional pocket
ADDITIONAL CHARACTERISTICS	-
REFILLS	-
DIMENSIONS	
DIMENSIONS	9.5 x 19 cm

MEISTERSTÜCK SELECTION UNICEF

> Organisers & Agendas

LEATHER | LINING



Black | Blue

EMBLEM



MODEL	Notebook Medium with Zip
IDENT No.	109373
MATERIAL	
LEATHER	Italian full-grain calfskin, dyed through, with Saffiano print
LINING	Jacquard lining with blue brick motive
FITTINGS/EMBLEM	Montblanc emblem with palladium-coated ring
FEATURES	
CLOSURE/LOCK	Metal zip
POCKETS	-
INTERIOR ORGANISATION	5 pockets for credit cards, 2 additional pockets, pocket for notebook
ADDITIONAL CHARACTERISTICS	Loop for writing instrument the size of a Meisterstück Classique or LeGrand, complete with notebook
REFILLS	Notebook Medium (Id. 9596)
DIMENSIONS	
DIMENSIONS	20 x 23,5 cm (for A5 sheets)

MEISTERSTÜCK SELECTION UNICEF

> Writing Instrument Pouches

LEATHER | LINING



Black | Blue

EMBLEM



MODEL	1 Pen Pouch with Zip
IDENT No.	109369
MATERIAL	
LEATHER	Italian full-grain calfskin, dyed through, with Saffiano print
LINING	Jacquard lining with blue brick motive
FITTINGS/EMBLEM	Montblanc emblem with palladium-coated ring
FEATURES	
CLOSURE/LOCK	Metal zip
POCKETS	-
INTERIOR ORGANISATION	Compartment for 1 writing instrument the size of Meisterstück Classique or Le Grand
ADDITIONAL CHARACTERISTICS	-
REFILLS	-
DIMENSIONS	
DIMENSIONS	4,5 x 16 cm



MEISTERSTÜCK SELECTION

> Large Leather Goods

> Business Bags



Portfolio with Zip

- Id. 109616 p. 100
- Id. 109617 p. 101



Document Case

- Id. 109618 p. 102
- Id. 109621 p. 103
- Id. 109620 p. 103
- Id. 109619 p. 103



Double Gusset Briefcase

- Id. 109625 p. 104
- Id. 109623 p. 105
- Id. 109624 p. 105
- Id. 109622 p. 105

> Shoulder Straps



Shoulder Strap

- Id. 109728 p. 106
- Id. 109914 p. 107
- Id. 109729 p. 107
- Id. 109727 p. 107
- Id. 109730 p. 107
- Id. 109731 p. 107
- Id. 109732 p. 108
- Id. 109733 p. 108

> Small Leather Goods

> Pocket Accessories



Key fob

- Id. 107686 p. 109
- Id. 107688 p. 109
- Id. 107687 p. 109



Key Fob

- Id. 109664 p. 110
- Id. 109665 p. 110
- Id. 109666 p. 110



Pocket Holder 2cc

- Id. 103410 p. 111
- Id. 106657 p. 111
- Id. 106658 p. 111



Business Card Holder

- Id. 103403 p. 112
- Id. 109658 p. 113
- Id. 109659 p. 113
- Id. 109660 p. 113



Notepad Small

- Id. 109645 p. 114



SmartPhone Holder

- Id. 109628 p. 114
- Id. 109632 p. 115
- Id. 109629 p. 115
- Id. 109631 p. 115
- Id. 109630 p. 115



Tablet Computer Pouch with Zip

- Id. 109634 p. 116
- Id. 109638 p. 117
- Id. 109635 p. 117
- Id. 109637 p. 117
- Id. 109636 p. 117



Tablet Computer Cover with Clasp

- Id. 109643 p. 116

> Horizontal Wallets without Coin Case



Wallet 6cc with removable Card Holder

- Id. 103406 p. 118
- Id. 106659 p. 118
- Id. 106660 p. 118



Wallet 6cc

- Id. 109646 p. 119
- Id. 109647 p. 119
- Id. 109648 p. 119



Wallet 6cc with Money Clip

- Id. 106015 p. 120



Wallet 8cc with removable Card Holder

- Id. 106016 p. 120



Wallet 11cc with View Pocket

- Id. 106018 p. 121

> Horizontal Wallets with Coin Case

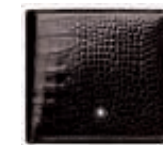

Wallet 4cc

- Id. 103407 p. 122



Wallet 10cc

- Id. 106017 p. 123

> Vertical Wallets without Coin Case



Wallet 12cc with View Pocket

- Id. 103408 p. 124

MEISTERSTÜCK SELECTION

> Small Leather Goods

> Long Wallets



Wallet 14cc with zipped Pocket

■ Id. 109655	p. 125
■ Id. 109656	p. 125
■ Id. 109657	p. 125

> Organisers & Agendas



Agenda Small

■ Id. 106647	p. 126
■ Id. 106663	p. 126
■ Id. 106664	p. 126



Agenda Small with Zip

■ Id. 109674	p. 127
■ Id. 109673	p. 128
■ Id. 109670	p. 128
■ Id. 109671	p. 128
■ Id. 109672	p. 128



Notebook Small

■ Id. 106648	p. 129
--------------	--------



Notebook Medium

■ Id. 106649	p. 130
--------------	--------



Notebook Medium with Zip

■ Id. 109679	p. 131
■ Id. 109678	p. 132
■ Id. 109675	p. 132
■ Id. 109677	p. 132
■ Id. 109676	p. 132



Organiser Medium

■ Id. 106650	p. 133
--------------	--------

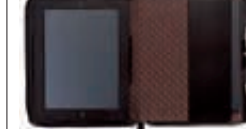

Business Companion

■ Id. 109644	p. 134
--------------	--------



Notepad Large

■ Id. 109680	p. 135
--------------	--------

> Writing Instrument Pouches



1 Pen Pouch

■ Id. 103409	p. 136
--------------	--------



2 Pen Pouch

■ Id. 106651	p. 136
--------------	--------



2 Pen Pouch with Zip

■ Id. 107370	p. 137
■ Id. 107397	p. 137
■ Id. 107398	p. 137



1 Pen Pouch Hard

■ Id. 107371	p. 137
■ Id. 107399	p. 137
■ Id. 107400	p. 137

MEISTERSTÜCK SELECTION

> Business Bags

LEATHER | LINING



Mocha | Dark Brown

EMBLEM



A completely new chapter in the Montblanc leather range, Meisterstück Selection offers a broad variety of the finest leathers and exciting colours. It reinterprets the classic Meisterstück features and artfully turns the familiar into something new and effortlessly modern.

Luxury sparkle in daily business life.

Meisterstück Selection

The meticulously designed range underlines the sophisticated character of Montblanc leather goods through the fine craftsmanship and details. With its array of colours and eye-catching features, the Meisterstück Selection range is sure to be highly prized by the lovers of fine leather goods.

MODEL	Portfolio with Zip
IDENT No.	109616
MATERIAL	
LEATHER	Italian full-grain calfskin, alligator printed, chrome-tanned, semi-aniline dyed through
LINING	Jacquard lining with emblematic "M" pattern
FITTINGS/EMBLEM	Stainless steel with shiny finish, Montblanc emblem with palladium-coated ring
FEATURES	
CLOSURE/LOCK	Metal zip
POCKETS	1 main compartment suitable for DIN A4 documents or slim laptop (max. size 35 x 26 x 3 cm)
INTERIOR ORGANISATION	Inner pocket for small documents
STRAP	-
ADDITIONAL CHARACTERISTICS	-
DIMENSIONS	
DIMENSIONS	35 x 26 x 4 cm

MEISTERSTÜCK SELECTION

> Business Bags

LEATHER | LINING



Black | Black

EMBLEM



MODEL	Portfolio with Zip
IDENT No.	109617
MATERIAL	
LEATHER	Italian full-grain calfskin, saffiano printed, chrome-tanned, semi-aniline dyed through
LINING	Jacquard striped lining with Montblanc brand name
FITTINGS/EMBLEM	Stainless steel with shiny finish, Montblanc emblem with palladium-coated ring
FEATURES	
CLOSURE/LOCK	Metal zip
POCKETS	1 main compartment suitable for DIN A4 documents or slim laptop (max. size 35 x 26 x 3 cm)
INTERIOR ORGANISATION	Inner pocket for small documents
STRAP	-
ADDITIONAL CHARACTERISTICS	-
DIMENSIONS	
DIMENSIONS	35 x 26 x 4 cm

MEISTERSTÜCK SELECTION

> Business Bags

LEATHER | LINING



Mocha | Dark Brown

EMBLEM



MODEL	Document Case
IDENT No.	109618
MATERIAL	
LEATHER	Italian full-grain calfskin, alligator printed, chrome-tanned, semi-aniline dyed through
LINING	Jacquard lining with emblematic "M" pattern
FITTINGS/EMBLEM	Stainless steel with shiny finish, Montblanc emblem with palladium-coated ring
FEATURES	
CLOSURE/LOCK	Metal zip with kissing sliders
POCKETS	2 main compartments
INTERIOR ORGANISATION	Pockets for 3 writing instruments, tablet computer, smartphone, cables, and 1 additional zipped pouch
STRAP	Detachable and adjustable matching leather shoulder strap, to be purchased separately (Id. 109728)
ADDITIONAL CHARACTERISTICS	2 comfortable leather handles
DIMENSIONS	
DIMENSIONS	40 x 32 x 10 cm

MEISTERSTÜCK SELECTION

> Business Bags

LEATHER | LINING



Black | Black



Navy | Black



Burgundy | Black

EMBLEM



MODEL	Document Case
IDENT No.	
Black Black	109621
Navy Black	109620
Burgundy Black	109619
MATERIAL	
LEATHER	Italian full-grain calfskin, saffiano printed, chrome-tanned, semi-aniline dyed through
LINING	Jacquard striped lining with Montblanc brand name
FITTINGS/EMBLEM	Stainless steel with shiny finish, Montblanc emblem with palladium-coated ring
FEATURES	
CLOSURE/LOCK	Metal zip with kissing sliders
POCKETS	2 main compartments
INTERIOR ORGANISATION	Pockets for 3 writing instruments, tablet computer, smartphone, cables, and 1 additional zipped pouch
STRAP	Detachable and adjustable matching leather shoulder strap, to be purchased separately (Id. 109914)
ADDITIONAL CHARACTERISTICS	2 comfortable leather handles
DIMENSIONS	
DIMENSIONS	40 x 32 x 10 cm

MEISTERSTÜCK SELECTION

> Business Bags

LEATHER | LINING



Mocha | Dark Brown

CLOSURE



MODEL	Double Gusset Briefcase
IDENT No.	109625
MATERIAL	
LEATHER	Italian full-grain calfskin, alligator printed, chrome-tanned, semi-aniline dyed through
LINING	Jacquard lining with emblematic "M" pattern
FITTINGS/EMBLEM	Stainless steel with shiny finish, Montblanc emblem with palladium-coated ring
FEATURES	
CLOSURE/LOCK	Flap, secure combination lock with Montblanc 3 rings motif, engraved Montblanc brand name and emblem
POCKETS	2 main compartments, large back pocket
INTERIOR ORGANISATION	Pockets for 3 writing instruments, tablet computer, smartphone, and 1 additional pocket
STRAP	Detachable and adjustable matching leather shoulder strap, to be purchased separately (Id. 109728)
ADDITIONAL CHARACTERISTICS	Comfortable leather handle
DIMENSIONS	
DIMENSIONS	42 x 32 x 12 cm

MEISTERSTÜCK SELECTION

> Business Bags

LEATHER | LINING



Black | Black



Flannel | Black



Cognac | Black

CLOSURE



MODEL	Double Gusset Briefcase
IDENT No.	
Black Black	109623
Flannel Black	109624
Cognac Black	109622
MATERIAL	
LEATHER	Italian full-grain calfskin, saffiano printed, chrome-tanned, semi-aniline dyed through
LINING	Jacquard striped lining with Montblanc brand name
FITTINGS/EMBLEM	Stainless steel with shiny finish, Montblanc emblem with palladium-coated ring
FEATURES	
CLOSURE/LOCK	Flap, secure combination lock with Montblanc 3 rings motif, engraved Montblanc brand name and emblem
POCKETS	2 main compartments, large back pocket
INTERIOR ORGANISATION	Pockets for 3 writing instruments, tablet computer, smartphone, and 1 additional pocket
STRAP	Detachable and adjustable matching leather shoulder strap, to be purchased separately (Id. 109914)
ADDITIONAL CHARACTERISTICS	Comfortable leather handle
DIMENSIONS	
DIMENSIONS	42 x 32 x 12 cm

MEISTERSTÜCK SELECTION

> Shoulder Straps

LEATHER



Mocha | Mocha



MODEL	Shoulder Strap
IDENT No.	109728
MATERIAL	
LEATHER	Italian full-grain calfskin, alligator printed, chrome-tanned, semi-aniline dyed through
LINING	Full-grain calfskin
FITTINGS/EMBLEM	-
FEATURES	
CLOSURE/LOCK	2 hooks and a buckle for length adjustment
POCKETS	-
INTERIOR ORGANISATION	-
ADDITIONAL CHARACTERISTICS	-
REFILLS	-
DIMENSIONS	
DIMENSIONS	129 x 3.5 x 0.5 cm

MEISTERSTÜCK SELECTION

> Shoulder Straps

LEATHER



Black | Black



Navy | Navy

Burgundy |
Burgundy

Cognac | Cognac



Flannel | Flannel



MODEL	
	Shoulder Strap
IDENT No.	
Black Black	109914
Navy Navy	109727
Burgundy Burgundy	109729
Cognac Cognac	109730
Flannel Flannel	109731
MATERIAL	
LEATHER	Italian full-grain calfskin, saffiano printed, chrome-tanned, semi-aniline dyed through
LINING	Full-grain calfskin
FITTINGS/EMBLEM	-
FEATURES	
CLOSURE/LOCK	2 hooks and a buckle for length adjustment
POCKETS	-
INTERIOR ORGANISATION	-
STRAP	-
ADDITIONAL CHARACTERISTICS	-
DIMENSIONS	
DIMENSIONS	129 x 3,5 x 0,5 cm

MEISTERSTÜCK SELECTION

> Shoulder Straps

LEATHER



Forest | Forest



Tobacco | Tobacco



MODEL	Shoulder Strap
IDENT No.	
Forest Forest	109732
Tobacco Tobacco	109733
MATERIAL	
LEATHER	Italian full-grain calfskin, grained, chrome-tanned, semi-aniline dyed through
LINING	Full-grain calfskin
FITTINGS/EMBLEM	-
FEATURES	
CLOSURE/LOCK	2 hooks and a buckle for length adjustment
POCKETS	-
INTERIOR ORGANISATION	-
ADDITIONAL CHARACTERISTICS	-
REFILLS	-
DIMENSIONS	
DIMENSIONS	129 x 3.5 x 0.5 cm

MEISTERSTÜCK SELECTION

> Pocket Accessories

LEATHER | LINING



Mocha | Brown



Forest | Forest

Chocolate |
Chocolate

EMBLEM



MODEL		Key fob
IDENT No.		
Mocha Brown		107686
Forest Forest		107688
Chocolate Chocolate		107687
MATERIAL		
LEATHER		Russian calfskin, printed with glossy finish, chrome-tanned, semi-aniline dyed through
LINING		-
FITTINGS/EMBLEM		Montblanc emblem with palladium-coated ring
FEATURES		
CLOSURE/LOCK		-
POCKETS		-
INTERIOR ORGANISATION		Ring for several keys
ADDITIONAL CHARACTERISTICS		-
REFILLS		-
DIMENSIONS		
DIMENSIONS		3,5 x 8 cm

MEISTERSTÜCK SELECTION

> Pocket Accessories

LEATHER



Black



Flannel



Cognac

EMBLEM



MODEL		Key Fob
IDENT No.		
Black		109664
Flannel		109665
Cognac		109666
MATERIAL		
LEATHER		Italian full-grain calfskin, saffiano printed, chrome-tanned, semi-aniline dyed through
LINING		-
FITTINGS/EMBLEM		Montblanc emblem with palladium-coated ring
FEATURES		
CLOSURE/LOCK		-
POCKETS		-
INTERIOR ORGANISATION		Ring for several keys
ADDITIONAL CHARACTERISTICS		-
REFILLS		-
DIMENSIONS		
DIMENSIONS		4 x 8 cm

MEISTERSTÜCK SELECTION

> Pocket Accessories

LEATHER | LINING



Mocha | Brown



Forest | Forest

Chocolate |
Chocolate

EMBLEM



MODEL	Pocket Holder 2cc
IDENT No.	
Mocha Brown	103410
Forest Forest	106657
Chocolate Chocolate	106658
MATERIAL	
LEATHER	Russian calfskin, printed with glossy finish, chrome-tanned, semi-aniline dyed through
LINING	Exquisite full-grain goatskin, Jacquard lining with emblematic "M" pattern
FITTINGS/EMBLEM	Montblanc emblem with palladium-coated ring
FEATURES	
CLOSURE/LOCK	-
POCKETS	-
INTERIOR ORGANISATION	2 pockets for credit cards, additional pocket
ADDITIONAL CHARACTERISTICS	-
REFILLS	-
DIMENSIONS	
DIMENSIONS	11 x 7 cm

MEISTERSTÜCK SELECTION

> Pocket Accessories

LEATHER | LINING



Mocha | Brown

EMBLEM



MODEL	Business Card Holder
IDENT No.	103403
MATERIAL	
LEATHER	Russian calfskin, printed with glossy finish, chrome-tanned, semi-aniline dyed through
LINING	Exquisite full-grain goatskin, Jacquard lining with emblematic "M" pattern
FITTINGS/EMBLEM	Montblanc emblem with palladium-coated ring
FEATURES	
CLOSURE/LOCK	-
POCKETS	-
INTERIOR ORGANISATION	2 compartments for business cards, 4 pockets for credit cards, back pocket
ADDITIONAL CHARACTERISTICS	Embossed serial number
REFILLS	-
DIMENSIONS	
DIMENSIONS	7.5 x 10.5 cm

MEISTERSTÜCK SELECTION

> Pocket Accessories

LEATHER | LINING



Black | Black



Flannel | Black



Cognac | Black

EMBLEM



MODEL	Business Card Holder
IDENT No.	
Black Black	109658
Flannel Black	109659
Cognac Black	109660
MATERIAL	
LEATHER	Italian full-grain calfskin, saffiano printed, chrome-tanned, semi-aniline dyed through
LINING	Jacquard striped lining with Montblanc brand name
FITTINGS/EMBLEM	Montblanc emblem with palladium-coated ring
FEATURES	
CLOSURE/LOCK	-
POCKETS	-
INTERIOR ORGANISATION	Compartment for business cards, 2 pockets for credit cards, additional pocket
ADDITIONAL CHARACTERISTICS	-
REFILLS	-
DIMENSIONS	
DIMENSIONS	7.5 x 11 cm

MEISTERSTÜCK SELECTION

> Pocket Accessories

LEATHER | LINING | LEATHER



Mocha | Dark Brown



Mocha | Beige

EMBLEM

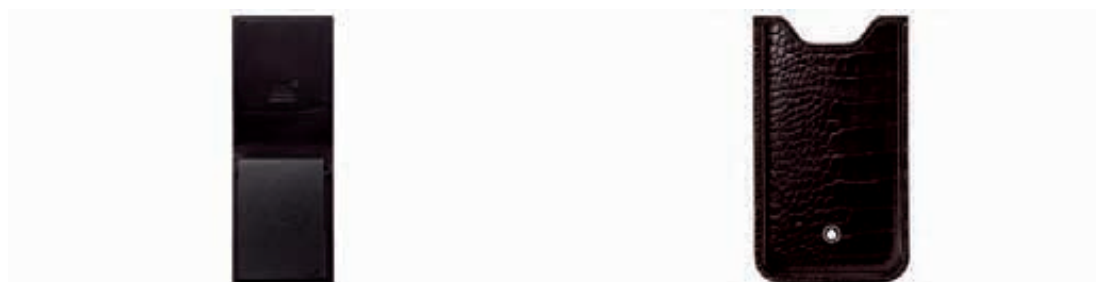

MODEL	Notepad Small	SmartPhone Holder
IDENT No.	109645	109628
MATERIAL		
LEATHER	Italian full-grain calfskin, alligator printed, chrome-tanned, semi-aniline dyed through	Italian full-grain calfskin, alligator printed, chrome-tanned, semi-aniline dyed through
LINING	Jacquard lining with emblematic "M" pattern	Microfibre
FITTINGS/EMBLEM	Montblanc emblem with palladium-coated ring	Montblanc emblem with palladium-coated ring
FEATURES		
CLOSURE/LOCK	-	-
POCKETS	-	-
INTERIOR ORGANISATION	Pocket for banknotes, additional pocket, complete with Notepad	Suitable for iPhone 5
ADDITIONAL CHARACTERISTICS	-	-
REFILLS	A7 Notepad (Id. 13915)	-
DIMENSIONS		
DIMENSIONS	8,5 x 12 cm	7,5 x 12 cm

MEISTERSTÜCK SELECTION

> Pocket Accessories

LEATHER



Navy | Beige



Flannel | Beige



Cognac | Beige



Burgundy | Beige

EMBLEM



MODEL	SmartPhone Holder
IDENT No.	
Navy Beige	109632
Flannel Beige	109629
Cognac Beige	109631
Burgundy Beige	109630
MATERIAL	
LEATHER	Italian full-grain calfskin, saffiano printed, chrome-tanned, semi-aniline dyed through
LINING	Microfibre
FITTINGS/EMBLEM	Montblanc emblem with palladium-coated ring
FEATURES	
CLOSURE/LOCK	-
POCKETS	-
INTERIOR ORGANISATION	Suitable for iPhone 5
ADDITIONAL CHARACTERISTICS	-
REFILLS	-
DIMENSIONS	
DIMENSIONS	7,5 x 12 cm

MEISTERSTÜCK SELECTION

> Pocket Accessories

LEATHER | LINING | LEATHER



Mocha | Dark Brown



Mocha | Beige

EMBLEM



MODEL	Tablet Computer Cover with Clasp	Tablet Computer Pouch with Zip
IDENT No.	109643	109634
MATERIAL		
LEATHER	Italian full-grain calfskin, alligator printed, chrome-tanned, semi-aniline dyed through	Italian full-grain calfskin, saffiano printed, chrome-tanned, semi-aniline dyed through
LINING	Jacquard lining with emblematic "M" pattern	Microfibre
FITTINGS/EMBLEM	Montblanc emblem with palladium-coated ring	Montblanc emblem with palladium-coated ring
FEATURES		
CLOSURE/LOCK	Flap	Metal zip
POCKETS	-	Flat back pocket
INTERIOR ORGANISATION	Tablet computer pocket compatible with iPad 3 or 4 and similarly sized electronic goods	Tablet computer pocket compatible with iPad 3 or 4 and similarly sized electronic goods
ADDITIONAL CHARACTERISTICS	-	-
REFILLS	-	-
DIMENSIONS		
DIMENSIONS	20 x 25 cm	25 x 20 cm

MEISTERSTÜCK SELECTION

> Pocket Accessories

LEATHER | LINING



Navy | Navy



Flannel | Beige



Cognac | Beige



Burgundy | Beige

EMBLEM



MODEL	Tablet Computer Pouch with Zip
IDENT No.	
Navy Navy	109638
Flannel Beige	109635
Cognac Beige	109637
Burgundy Beige	109636
MATERIAL	
LEATHER	Italian full-grain calfskin, saffiano printed, chrome-tanned, semi-aniline dyed through
LINING	Microfibre
FITTINGS/EMBLEM	Montblanc emblem with palladium-coated ring
FEATURES	
CLOSURE/LOCK	Metal zip
POCKETS	Flat back pocket
INTERIOR ORGANISATION	Tablet computer pocket compatible with iPad 3 or 4 and similarly sized electronic goods
ADDITIONAL CHARACTERISTICS	-
REFILLS	-
DIMENSIONS	
DIMENSIONS	20 x 25 cm

MEISTERSTÜCK SELECTION

> Horizontal Wallets without Coin Case

LEATHER | LINING



Mocha | Brown



Forest | Forest

Chocolate |
Chocolate

EMBLEM



MODEL	Wallet 6cc with removable Card Holder
IDENT No.	
Mocha Brown	103406
Forest Forest	106659
Chocolate Chocolate	106660
MATERIAL	
LEATHER	Russian calfskin, printed with glossy finish, chrome-tanned, semi-aniline dyed through
LINING	Exquisite full-grain goatskin, Jacquard lining with emblematic "M" pattern
FITTINGS/EMBLEM	Montblanc emblem with palladium-coated ring
FEATURES	
CLOSURE/LOCK	-
POCKETS	-
INTERIOR ORGANISATION	6 pockets for credit cards, 2 compartments for banknotes, 2 additional pockets, pocket for removable holder
ADDITIONAL CHARACTERISTICS	Removable holder with 2 pockets for credit cards, small view pocket and additional pocket
REFILLS	-
DIMENSIONS	
DIMENSIONS	11.5 x 9 cm

MEISTERSTÜCK SELECTION

> Horizontal Wallets without Coin Case

LEATHER | LINING



Black | Black



Flannel | Black



Cognac | Black

EMBLEM



MODEL	Wallet 6cc
IDENT No.	
Black Black	109646
Flannel Black	109647
Cognac Black	109648
MATERIAL	
LEATHER	Italian full-grain calfskin, saffiano printed, chrome-tanned, semi-aniline dyed through
LINING	Jacquard striped lining with Montblanc brand name
FITTINGS/EMBLEM	Montblanc emblem with palladium-coated ring
FEATURES	
CLOSURE/LOCK	-
POCKETS	-
INTERIOR ORGANISATION	6 pockets for credit cards, 2 compartments for banknotes, 2 additional pockets
ADDITIONAL CHARACTERISTICS	-
REFILLS	-
DIMENSIONS	
DIMENSIONS	11.5 x 8.5 cm

MEISTERSTÜCK SELECTION

> Horizontal Wallets without Coin Case

LEATHER | LINING



Mocha | Brown

EMBLEM



MODEL	Wallet 6cc with Money Clip	Wallet 8cc with removable Card Holder
IDENT No.	106015	106016
MATERIAL		
LEATHER	Russian calfskin, printed with glossy finish, chrome-tanned, semi-aniline dyed through	Russian calfskin, printed with glossy finish, chrome-tanned, semi-aniline dyed through
LINING	Exquisite full-grain goatskin, Jacquard lining with emblematic "M" pattern	Exquisite full-grain goatskin, Jacquard lining with emblematic "M" pattern
FITTINGS/EMBLEM	Stainless steel with shiny finish, Montblanc emblem with palladium-coated ring	Montblanc emblem with palladium-coated ring
FEATURES		
CLOSURE/LOCK	-	-
POCKETS	-	-
INTERIOR ORGANISATION	6 pockets for credit cards	8 pockets for credit cards, 2 compartments for banknotes, 3 additional pockets, pocket for removable holder
ADDITIONAL CHARACTERISTICS	Money clip with resin Montblanc emblem	Removable holder with 2 pockets for credit cards, small view pocket, additional pocket
REFILLS	-	-
DIMENSIONS		
DIMENSIONS	11 x 8 cm	11.5 x 9 cm

MEISTERSTÜCK SELECTION

> Horizontal Wallets without Coin Case

LEATHER | LINING



Mocha | Brown

EMBLEM



MODEL	Wallet 11cc with View Pocket
IDENT No.	106018
MATERIAL	
LEATHER	Russian calfskin, printed with glossy finish, chrome-tanned, semi-aniline dyed through
LINING	Exquisite full-grain goatskin, Jacquard lining with emblematic "M" pattern
FITTINGS/EMBLEM	Montblanc emblem with palladium-coated ring
FEATURES	
CLOSURE/LOCK	-
POCKETS	-
INTERIOR ORGANISATION	11 pockets for credit cards, small view pocket, 2 compartments for banknotes, 2 additional pockets
ADDITIONAL CHARACTERISTICS	-
REFILLS	-
DIMENSIONS	
DIMENSIONS	12 x 9.5 cm

MEISTERSTÜCK SELECTION

> Horizontal Wallets with Coin Case

LEATHER | LINING



Mocha | Brown

EMBLEM



MODEL	Wallet 4cc
IDENT No.	103407
MATERIAL	
LEATHER	Russian calfskin, printed with glossy finish, chrome-tanned, semi-aniline dyed through
LINING	Exquisite full-grain goatskin, Jacquard lining with emblematic "M" pattern
FITTINGS/EMBLEM	Montblanc emblem with palladium-coated ring
FEATURES	
CLOSURE/LOCK	-
POCKETS	-
INTERIOR ORGANISATION	4 pockets for credit cards, 2 compartments for banknotes, additional pocket, coin pocket with flap
ADDITIONAL CHARACTERISTICS	-
REFILLS	-
DIMENSIONS	
DIMENSIONS	11 x 10 cm

MEISTERSTÜCK SELECTION

> Horizontal Wallets with Coin Case

LEATHER | LINING



Mocha | Brown

EMBLEM



MODEL	Wallet 10cc
IDENT No.	106017
MATERIAL	
LEATHER	Russian calfskin, printed with glossy finish, chrome-tanned, semi-aniline dyed through
LINING	Exquisite full-grain goatskin, Jacquard lining with emblematic "M" pattern
FITTINGS/EMBLEM	Montblanc emblem with palladium-coated ring
FEATURES	
CLOSURE/LOCK	-
POCKETS	-
INTERIOR ORGANISATION	10 pockets for credit cards, 2 compartments for banknotes, flap coin case
ADDITIONAL CHARACTERISTICS	-
REFILLS	-
DIMENSIONS	
DIMENSIONS	11.5 x 9 cm

MEISTERSTÜCK SELECTION

> Vertical Wallets without Coin Case

LEATHER | LINING



Mocha | Brown



Forest | Forest

Chocolate |
Chocolate

EMBLEM



MODEL	Wallet 12cc with View Pocket
IDENT No.	
Mocha Brown	103408
Forest Forest	106661
Chocolate Chocolate	106662
MATERIAL	
LEATHER	Russian calfskin, printed with glossy finish, chrome-tanned, semi-aniline dyed through
LINING	Exquisite full-grain goatskin, Jacquard lining with emblematic "M" pattern
FITTINGS/EMBLEM	Montblanc emblem with palladium-coated ring
FEATURES	
CLOSURE/LOCK	-
POCKETS	-
INTERIOR ORGANISATION	12 pockets for credit cards, view pocket suitable for ID card, 2 compartments for banknotes, 10 additional pockets
ADDITIONAL CHARACTERISTICS	-
REFILLS	-
DIMENSIONS	
DIMENSIONS	9.5 x 13.5 cm

MEISTERSTÜCK SELECTION

> Long Wallets

LEATHER | LINING



Black | Black



Flannel | Black



Cognac | Black

EMBLEM



MODEL	Wallet 14cc with zipped Pocket
IDENT No.	
Black Black	109655
Flannel Black	109656
Cognac Black	109657
MATERIAL	
LEATHER	Italian full-grain calfskin, saffiano printed, chrome-tanned, semi-aniline dyed through
LINING	Jacquard striped lining with Montblanc brand name
FITTINGS/EMBLEM	Montblanc emblem with palladium-coated ring
FEATURES	
CLOSURE/LOCK	-
POCKETS	-
INTERIOR ORGANISATION	14 pockets for credit cards, large zipped pocket, 2 compartments for banknotes, 2 additional pockets
ADDITIONAL CHARACTERISTICS	-
REFILLS	-
DIMENSIONS	
DIMENSIONS	-

MEISTERSTÜCK SELECTION

> Organisers & Agendas

LEATHER | LINING



Mocha | Brown



Forest | Forest

Chocolate |
Chocolate

EMBLEM



MODEL	Agenda Small
IDENT No.	
Mocha Brown	106647
Forest Forest	106663
Chocolate Chocolate	106664
MATERIAL	
LEATHER	Russian calfskin, printed with glossy finish, chrome-tanned, semi-aniline dyed through
LINING	Exquisite full-grain goatskin, Jacquard lining with emblematic "M" pattern
FITTINGS/EMBLEM	Montblanc emblem with palladium-coated ring
FEATURES	
CLOSURE/LOCK	-
POCKETS	4 pockets for credit cards, additional pocket
INTERIOR ORGANISATION	-
ADDITIONAL CHARACTERISTICS	Loop for writing instrument the size of Meisterstück Classique or Le Grand, complete with calendar
REFILLS	Calendar 2014 Vertical (Id. 110145)
DIMENSIONS	
DIMENSIONS	11.5 x 16.5 x 2 cm

MEISTERSTÜCK SELECTION

> Organisers & Agendas

LEATHER | LINING



Mocha | Dark Brown

EMBLEM



MODEL	Agenda Small with Zip
IDENT No.	109674
MATERIAL	
LEATHER	Italian full-grain calfskin, alligator printed, chrome-tanned, semi-aniline dyed through
LINING	Jacquard lining with emblematic "M" pattern
FITTINGS/EMBLEM	Montblanc emblem with palladium-coated ring
FEATURES	
CLOSURE/LOCK	Metal zip
POCKETS	-
INTERIOR ORGANISATION	4 pockets for credit cards, additional pocket, complete with calendar
ADDITIONAL CHARACTERISTICS	Loop for writing instrument the size of Meisterstück Classique or LeGrand
REFILLS	Calendar 2014 Vertical (Id. 110145)
DIMENSIONS	
DIMENSIONS	11.5 x 16.5 cm

MEISTERSTÜCK SELECTION

> Organisers & Agendas

LEATHER | LINING



Navy | Black



Flannel | Black



Cognac | Black



Burgundy | Black

EMBLEM



MODEL	Agenda Small with Zip
IDENT No.	
Navy Black	109673
Flannel Black	109670
Cognac Black	109671
Burgundy Black	109672
MATERIAL	
LEATHER	Italian full-grain calfskin, saffiano printed, chrome-tanned, semi-aniline dyed through
LINING	Jacquard striped lining with Montblanc brand name
FITTINGS/EMBLEM	Montblanc emblem with palladium-coated ring
FEATURES	
CLOSURE/LOCK	Metal zip
POCKETS	-
INTERIOR ORGANISATION	4 pockets for credit cards, additional pocket, complete with calendar
ADDITIONAL CHARACTERISTICS	Loop for writing instrument the size of Meisterstück Classique or LeGrand
REFILLS	Calendar 2014 Vertical (Id. 110145)
DIMENSIONS	
DIMENSIONS	11.5 x 16.5 cm

MEISTERSTÜCK SELECTION

> Organisers & Agendas

LEATHER | LINING



Mocha | Brown

EMBLEM



MODEL	Notebook Small
IDENT No.	106648
MATERIAL	
LEATHER	Russian calfskin, printed with glossy finish, chrome-tanned, semi-aniline dyed through
LINING	Exquisite full-grain goatskin, Jacquard lining with emblematic "M" pattern
FITTINGS/EMBLEM	Montblanc emblem with palladium-coated ring
FEATURES	
CLOSURE/LOCK	-
POCKETS	4 pockets for credit cards
INTERIOR ORGANISATION	-
ADDITIONAL CHARACTERISTICS	Loop for writing instrument the size of Meisterstück Classique or Le Grand, complete with notebook, bookmark with metal pendant in "M" design
REFILLS	Notebook Small (Id. 9597)
DIMENSIONS	
DIMENSIONS	11.5 x 15 x 2 cm

MEISTERSTÜCK SELECTION

> Organisers & Agendas

LEATHER | LINING



Mocha | Brown

EMBLEM



MODEL	Notebook Medium
IDENT No.	106649
MATERIAL	
LEATHER	Russian calfskin, printed with glossy finish, chrome-tanned, semi-aniline dyed through
LINING	Exquisite full-grain goatskin, Jacquard lining with emblematic "M" pattern
FITTINGS/EMBLEM	Montblanc emblem with palladium-coated ring
FEATURES	
CLOSURE/LOCK	-
POCKETS	7 pockets for credit cards
INTERIOR ORGANISATION	-
ADDITIONAL CHARACTERISTICS	Loop for writing instrument the size of Meisterstück Classique or Le Grand, complete with notebook, bookmark with metal pendant in "M" design
REFILLS	Notebook Medium (Id. 9596)
DIMENSIONS	
DIMENSIONS	20 x 23 x 2 cm

MEISTERSTÜCK SELECTION

> Organisers & Agendas

LEATHER | LINING



Mocha | Dark Brown

EMBLEM



MODEL	Notebook Medium with Zip
IDENT No.	109679
MATERIAL	
LEATHER	Italian full-grain calfskin, alligator printed, chrome-tanned, semi-aniline dyed through
LINING	Jacquard lining with emblematic "M" pattern
FITTINGS/EMBLEM	Montblanc emblem with palladium-coated ring
FEATURES	
CLOSURE/LOCK	Metal zip
POCKETS	-
INTERIOR ORGANISATION	7 pockets for credit cards, additional pocket, complete with notebook
ADDITIONAL CHARACTERISTICS	Loop for writing instrument the size of Meisterstück Classique or LeGrand
REFILLS	Notebook Medium (Id. 9596)
DIMENSIONS	
DIMENSIONS	20 x 24 cm

MEISTERSTÜCK SELECTION

> Organisers & Agendas

LEATHER | LINING



Navy | Black



Flannel | Black



Cognac | Black



Burgundy | Black

EMBLEM



MODEL	Notebook Medium with Zip
IDENT No.	
Navy Black	109678
Flannel Black	109675
Cognac Black	109677
Burgundy Black	109676
MATERIAL	
LEATHER	Italian full-grain calfskin, saffiano printed, chrome-tanned, semi-aniline dyed through
LINING	Jacquard striped lining with Montblanc brand name
FITTINGS/EMBLEM	Montblanc emblem with palladium-coated ring
FEATURES	
CLOSURE/LOCK	Metal zip
POCKETS	-
INTERIOR ORGANISATION	7 pockets for credit cards, additional pocket, complete with notebook
ADDITIONAL CHARACTERISTICS	Loop for writing instrument the size of Meisterstück Classique or LeGrand
REFILLS	Notebook Medium (Id. 9596)
DIMENSIONS	
DIMENSIONS	20 x 24 cm

MEISTERSTÜCK SELECTION

> Organisers & Agendas

LEATHER | LINING



Mocha | Brown

EMBLEM



MODEL	Organiser Medium
IDENT No.	106650
MATERIAL	
LEATHER	Russian calfskin, printed with glossy finish, chrome-tanned, semi-aniline dyed through
LINING	Exquisite full-grain goatskin, Jacquard lining with emblematic "M" pattern
FITTINGS/EMBLEM	Montblanc emblem with palladium-coated ring
FEATURES	
CLOSURE/LOCK	Flap with 2 press-studs
POCKETS	6 pockets for credit cards, 4 additional pockets
INTERIOR ORGANISATION	-
ADDITIONAL CHARACTERISTICS	Loop for writing instrument the size of Meisterstück Classique or Le Grand, complete with calendar and organisation sheets
REFILLS	Starter Kit Medium (Id. 08403), Telephone-Address Sheets Medium (Id. 03027), Organisation Kit Medium (Id. 03028), Daily Plan Pages Medium (Id. 03025), Blank Sheets Medium (Id. 03021), Squared Sheets Medium (Id. 03026), Calendar 2014 Medium (Id. 110139-1 day on 1 page, 110140-1 week on 2 pages)
DIMENSIONS	
DIMENSIONS	14.5 x 19 x 4 cm

MEISTERSTÜCK SELECTION

> Organisers & Agendas

LEATHER | LINING



Mocha | Dark Brown

EMBLEM



MODEL	Business Companion
IDENT No.	109644
MATERIAL	
LEATHER	Italian full-grain calfskin, alligator printed, chrome-tanned, semi-aniline dyed through
LINING	Jacquard lining with emblematic "M" pattern
FITTINGS/EMBLEM	Montblanc emblem with palladium-coated ring
FEATURES	
CLOSURE/LOCK	Metal zip
POCKETS	-
INTERIOR ORGANISATION	Framed Tablet Computer pocket, compatible with iPad 3 or 4, and similarly sized electronic goods, 5 pockets for credit cards, 3 extra pockets, and a medium-sized notebook
ADDITIONAL CHARACTERISTICS	Loop for 1 writing instrument the size of a Meisterstück Classique or LeGrand
REFILLS	Notebook Medium (Id. 9596)
DIMENSIONS	
DIMENSIONS	22 x 27 cm

MEISTERSTÜCK SELECTION

> Organisers & Agendas

LEATHER | LINING



Mocha | Dark
Brown

EMBLEM



MODEL	Notepad Large
IDENT No.	109680
MATERIAL	
LEATHER	Italian full-grain calfskin, alligator printed, chrome-tanned, semi-aniline dyed through
LINING	Jacquard lining with emblematic "M" pattern
FITTINGS/EMBLEM	Montblanc emblem with palladium-coated ring
FEATURES	
CLOSURE/LOCK	-
POCKETS	-
INTERIOR ORGANISATION	2 pockets for credit cards, complete with notepad
ADDITIONAL CHARACTERISTICS	Loop for writing instrument the size of Meisterstück Classique or LeGrand
REFILLS	Notepad A4 (Id. 6711)
DIMENSIONS	
DIMENSIONS	24.5 x 32 cm (for A4 sheets)

MEISTERSTÜCK SELECTION

> Writing Instrument Pouches

LEATHER | LINING



Mocha | Brown

EMBLEM

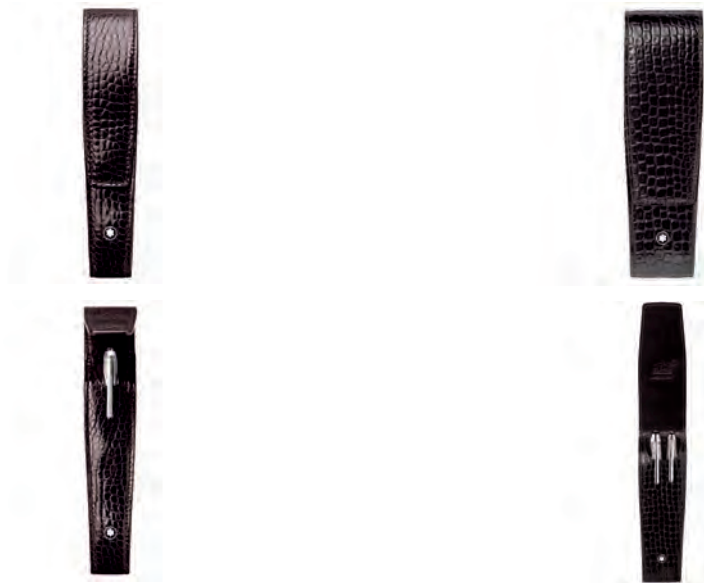

MODEL	1 Pen Pouch	2 Pen Pouch
IDENT No.	103409	106651
MATERIAL		
LEATHER	Russian calfskin, printed with glossy finish, chrome-tanned, semi-aniline dyed through	Russian calfskin, printed with glossy finish, chrome-tanned, semi-aniline dyed through
LINING	Exquisite full-grain goatskin, Jacquard lining with emblematic "M" pattern	Exquisite full-grain goatskin, Jacquard lining with emblematic "M" pattern
FITTINGS/EMBLEM	Montblanc emblem with palladium-coated ring	Embossed brand name and Montblanc emblem with palladium-coated ring
FEATURES		
CLOSURE/LOCK	Clasp with hidden magnet	Clasp with hidden magnet
POCKETS	-	-
INTERIOR ORGANISATION	Compartment for 1 writing instrument the size of a Meisterstück Classique or Le Grand	Compartment for 2 writing instruments the size of Meisterstück Classique or Le Grand
ADDITIONAL CHARACTERISTICS	Embossed serial number	-
REFILLS	-	-
DIMENSIONS		
DIMENSIONS	3,5 x 17 cm	15,5 x 4,5 cm

MEISTERSTÜCK SELECTION

> Writing Instrument Pouches

LEATHER | LINING



Mocha | Brown



Forest | Forest



Chocolate | Chocolate

EMBLEM



MODEL	2 Pen Pouch with Zip	1 Pen Pouch Hard
IDENT NO.		
Mocha Brown	107370	107371
Forest Forest	107397	107399
Chocolate Chocolate	107398	107400
MATERIAL		
LEATHER	Russian calfskin, printed with glossy finish, chrome-tanned, semi-aniline dyed through	Russian calfskin, printed with glossy finish, chrome-tanned, semi-aniline dyed through
LINING	Exquisite full-grain goatskin, Jacquard lining with emblematic "M" pattern	Exquisite full-grain goatskin, Jacquard lining with emblematic "M" pattern
FITTINGS/EMBLEM	Montblanc emblem with palladium-coated ring	Montblanc emblem with palladium-coated ring
FEATURES		
CLOSURE/LOCK	-	-
POCKETS	-	-
INTERIOR ORGANISATION	Compartment for 1 writing instrument the size of a Meisterstück Classique or Le Grand	Compartment for 1 writing instrument the size of a Meisterstück Classique or Le Grand
ADDITIONAL CHARACTERISTICS	Embossed serial number	Embossed serial number
REFILLS	-	-
DIMENSIONS		
DIMENSIONS	6 x 17 cm	3,5 x 17 cm



4810 WESTSIDE

> Large Leather Goods

> Business Bags



Single Gusset Briefcase

Id. 07578 p. 140



Double Gusset Briefcase

Id. 07579 p. 140



Triple Gusset Briefcase with Laptop Holder

Id. 09562 p. 141



Document Case

Id. 09296 p. 141

> City Bags



Clutch Bag with Zip

Id. 104611 p. 142



North South Bag Small

Id. 104612 p. 142



Reporter Bag

Id. 104614 p. 143



Messenger Bag with Zip

Id. 104613 p. 143

> Travel Bags



Travel Companion

Id. 107357 p. 144

4810 WESTSIDE

> Small Leather Goods

> Pocket Accessories



Key fob

Id. 08381

p. 145



Pocket Holder 5cc

Id. 106654

p. 145



Business Card Holder with Gusset

Id. 107354

p. 146



Business Card Holder with Gusset & View Pocket

Id. 108954

p. 146



Multi Credit Card Case

Id. 38061

p. 147



Business Card Holder

Id. 38034

p. 147



Business Card Box

Id. 103400

p. 148



Passport Holder International

Id. 107355

p. 148

> Horizontal Wallets without Coin Case



Wallet 6cc

Id. 38036

p. 149



Wallet 6cc with Money Clip

Id. 101867

p. 149



Wallet 6cc with 2 View Pockets

Id. 103401

p. 150



Wallet 8cc

Id. 08372

p. 151



Wallet 11cc with View Pocket

Id. 101866

p. 151



Wallet 12cc

Id. 09299

p. 152



Wallet 14cc

Id. 38037

p. 152

> Horizontal Wallets with Coin Case



Wallet 4cc

Id. 08373

p. 153



Wallet 4cc with ID Holder

Id. 09680

p. 153

> Long Wallets



Wallet 6cc with zipped Pocket

Id. 08375

p. 154



Wallet 14cc with Gusset

Id. 108949

p. 154



Travel Wallet 12cc with Zip

Id. 107356

p. 155

> Organisers



Notepad Large with Zip

Id. 101865

p. 156

> Writing Instrument Pouches



1 Pen Pouch

Id. 09577

p. 157



2 Pen Pouch with Zip

Id. 103402

p. 157

4810 WESTSIDE

> Business Bags

LEATHER | LINING



Black | Grey

CLOSURE



Innovation and design are the watchwords for this exceptional collection. Traditional fine craftsmanship fuses with the functions, forms and details of a new genre.

The Fascination of a Clean and Modern Silhouette

4810 Westside

Featuring Montblanc exclusive leather with subtle embossing, stainless steel fittings and an uncompromising look, this range makes a stylish everyday companion. Special highlights are the sophisticated locks with two closure systems and a particular sound matching the rhythm of urban lifestyle.

MODEL	Single Gusset Briefcase	Double Gusset Briefcase
IDENT No.	07578	07579
MATERIAL		
LEATHER	Italian split calfskin with subtle print and fine rare finish, chrome-tanned, dyed through	Italian split calfskin with subtle print and fine rare finish, chrome-tanned, dyed through
LINING	Jacquard lining with Montblanc brand name	Jacquard lining with Montblanc brand name
FITTINGS/EMBLEM	Stainless steel with satin-finish, Montblanc emblem	Stainless steel with satin-finish, Montblanc emblem
FEATURES		
CLOSURE/LOCK	Flap, special closure with 2 locking options, engraved Montblanc brand name and emblem	Flap, special closure with 2 locking options, engraved Montblanc brand name and emblem
POCKETS	1 main compartment, large inner pocket, large back pocket	2 main compartments, large zipped inner pocket, large back pocket
INTERIOR ORGANISATION	Pockets for mobile phone (PDA size), 1 writing instrument, 1 medium and 2 small documents	Pockets for mobile phone (PDA size), 2 writing instruments, 1 medium and 6 small documents
STRAP	Detachable branded shoulder strap in black	Detachable branded shoulder strap in black
ADDITIONAL CHARACTERISTICS	Smart sliding system to attach shoulder strap	Smart sliding system to attach shoulder strap
DIMENSIONS		
DIMENSIONS	36 x 26 x 10 cm	41.5 x 30 x 13 cm

4810 WESTSIDE

> Business Bags

LEATHER | LINING



Black | Grey

CLOSURE | EMBLEM



MODEL	Triple Gusset Briefcase with Laptop Holder	Document Case
IDENT No.	09562	09296
MATERIAL		
LEATHER	Italian split calfskin with subtle print and fine rare finish, chrome-tanned, dyed through	Italian split calfskin with subtle print and fine rare finish, chrome-tanned, dyed through
LINING	Jacquard lining with Montblanc brand name	Jacquard lining with Montblanc brand name
FITTINGS/EMBLEM	Stainless steel with satin-finish, Montblanc emblem	Stainless steel with punched-out Montblanc emblem and satin finish
FEATURES		
CLOSURE/LOCK	Flap, special closure with 2 locking options, engraved Montblanc brand name and emblem	Metal zip
POCKETS	2 main compartments, padded zipped centre compartment suitable for a laptop (max. size 33 x 28.5 x 4 cm), large back pocket	1 main compartment, large front pocket, large back pocket
INTERIOR ORGANISATION	Pockets for mobile phone (PDA size), 2 writing instruments, 1 medium and 2 small documents	Pockets for mobile phone (PDA size), 2 writing instruments, 1 medium and 2 small documents
STRAP	Detachable branded shoulder strap in black	-
ADDITIONAL CHARACTERISTICS	Smart sliding system to attach shoulder strap	Extractable handles
DIMENSIONS		
DIMENSIONS	42 x 33 x 12 cm	40 x 30 x 7.5 cm

4810 WESTSIDE

> City Bags

LEATHER | LINING



Black | Grey

EMBLEM | CLOSURE



MODEL	Clutch Bag with Zip	North South Bag Small
IDENT No.	104611	104612
MATERIAL		
LEATHER	Italian split calfskin with subtle print and fine rare finish, chrome-tanned, dyed through	Italian split calfskin with subtle print and fine rare finish, chrome-tanned, dyed through
LINING	Jacquard lining with Montblanc brand name	Jacquard lining with Montblanc brand name
FITTINGS/EMBLEM	Stainless steel with punched-out Montblanc emblem and satin finish	Stainless steel with satin-finish, Montblanc emblem
FEATURES		
CLOSURE/LOCK	Metal zip	Flap, special closure with 2 locking options, engraved Montblanc brand name and emblem
POCKETS	1 main compartment, front pocket, back pocket	1 main compartment, back pocket
INTERIOR ORGANISATION	1 pocket for medium-sized documents	Pockets for mobile phone (PDA size), 1 writing instrument and 1 medium-sized document
STRAP	Detachable leather wrist strap	Shoulder strap in black with Montblanc brand name
ADDITIONAL CHARACTERISTICS	-	-
DIMENSIONS		
DIMENSIONS	26 x 16 x 5 cm	21 x 27 x 7 cm

4810 WESTSIDE

> City Bags

LEATHER | LINING



Black | Grey

EMBLEM



MODEL	Reporter Bag	Messenger Bag with Zip
IDENT No.	104614	104613
MATERIAL		
LEATHER	Italian split calfskin with subtle print and fine rare finish, chrome-tanned, dyed through	Italian split calfskin with subtle print and fine rare finish, chrome-tanned, dyed through
LINING	Jacquard lining with Montblanc brand name	Jacquard lining with Montblanc brand name
FITTINGS/EMBLEM	Stainless steel with punched-out Montblanc emblem and satin finish	Stainless steel with punched-out Montblanc emblem and satin finish
FEATURES		
CLOSURE/LOCK	Metal zip	Metal zip
POCKETS	1 main compartment, zipped front pocket	1 main compartment, large zipped front pocket, large back pocket
INTERIOR ORGANISATION	Pockets for mobile phone (PDA size), 1 writing instrument and 1 medium-sized document	Pockets for mobile phone (PDA size), 1 writing instrument and 1 medium-sized document
STRAP	Shoulder strap in black with Montblanc brand name	Shoulder strap in black with Montblanc brand name
ADDITIONAL CHARACTERISTICS	-	-
DIMENSIONS		
DIMENSIONS	29 x 20 x 12 cm	35 x 26.5 x 9.5 cm

4810 WESTSIDE

> Travel Bags

LEATHER | LINING



Black | Grey

EMBLEM



MODEL	Travel Companion
IDENT No.	107357
MATERIAL	
LEATHER	Italian split calfskin with subtle print and fine rare finish, chrome-tanned, dyed through
LINING	Jacquard lining with Montblanc brand name
FITTINGS/EMBLEM	Stainless steel with punched-out Montblanc emblem and satin finish
FEATURES	
CLOSURE/LOCK	2 metal zips
POCKETS	2 compartments
INTERIOR ORGANISATION	17 pockets for credit cards, view pocket, SmartPhone holder, large pocket for flight ticket, 2 banknote compartments, zipped large pocket, 4 additional pockets
ADDITIONAL CHARACTERISTICS	Loop for 1 writing instrument the size of a Meisterstück Classique or LeGrand, sliding wrist strap
REFILLS	-
DIMENSIONS	
DIMENSIONS	14 x 22 cm

4810 WESTSIDE

> Pocket Accessories

LEATHER | LINING



Black

EMBLEM



MODEL	Key fob	Pocket Holder 5cc
IDENT No.	08381	106654
MATERIAL		
LEATHER	European full-grain cowhide with subtle print and fine rare finish, chrome-tanned, dyed through	Southern German full-grain cowhide with subtle print and fine rare finish, chrome-tanned, dyed through
LINING	-	Jacquard lining with Montblanc brand name
FITTINGS/EMBLEM	Stainless steel with satin finish, Montblanc emblem with branded ruthenium-coated ring	Montblanc emblem with branded ruthenium-coated ring
FEATURES		
CLOSURE/LOCK	-	-
POCKETS	-	-
INTERIOR ORGANISATION	Branded split ring for several keys	5 pockets for business cards and credit cards
ADDITIONAL CHARACTERISTICS	-	-
REFILLS	-	-
DIMENSIONS		
DIMENSIONS	3 x 10 cm	10 x 8 cm

4810 WESTSIDE

> Pocket Accessories

LEATHER | LINING



Black | Grey

EMBLEM



MODEL	Business Card Holder with Gusset	Business Card Holder with Gusset & View Pocket
IDENT No.	107354	108954
MATERIAL		
LEATHER	Southern German full-grain cowhide with subtle print and fine rare finish, chrome-tanned, dyed through	European full-grain cowhide with subtle print and fine rare finish, chrome-tanned, dyed through
LINING	Jacquard lining with Montblanc brand name	Jacquard lining with Montblanc brand name
FITTINGS/EMBLEM	Montblanc emblem with branded ruthenium-coated ring	Stainless steel with satin finish, Montblanc emblem with branded ruthenium-coated ring
FEATURES		
CLOSURE/LOCK	-	-
POCKETS	-	Spacious gusset for business cards, 2 pockets for credit cards, view pocket for ID
INTERIOR ORGANISATION	Spacious gusset for business cards, 1 pocket for credit cards, additional pocket, back pocket	-
ADDITIONAL CHARACTERISTICS	-	-
REFILLS	-	-
DIMENSIONS		
DIMENSIONS	10.5 x 8 cm	8 x 10.5 cm

4810 WESTSIDE

> Pocket Accessories

LEATHER | LINING



Black | Grey

EMBLEM



MODEL	Multi Credit Card Case	Business Card Holder
IDENT No.	38061	38034
MATERIAL		
LEATHER	European full-grain cowhide with subtle print and fine rare finish, chrome-tanned, dyed through	European full-grain cowhide with subtle print and fine rare finish, chrome-tanned, dyed through
LINING	Jacquard lining with Montblanc brand name	Jacquard lining with Montblanc brand name
FITTINGS/EMBLEM	Montblanc emblem with branded ruthenium-coated ring	Montblanc emblem with branded ruthenium-coated ring
FEATURES		
CLOSURE/LOCK	-	-
POCKETS	-	-
INTERIOR ORGANISATION	2 pockets for credit cards, 12 removable clear pockets for credit cards, back pocket	Compartment for business cards, 2 pockets for credit cards, additional pocket, back pocket
ADDITIONAL CHARACTERISTICS	-	-
REFILLS	Clear credit card pockets (Id. 102063)	-
DIMENSIONS		
DIMENSIONS	8 x 10 cm	7.5 x 11 cm

4810 WESTSIDE

> Pocket Accessories

LEATHER | LINING



Black | Black

EMBLEM



MODEL	Business Card Box	Passport Holder International
IDENT No.	103400	107355
MATERIAL		
LEATHER	European full-grain cowhide with subtle print and fine rare finish, chrome-tanned, dyed through	Southern German full-grain cowhide with subtle print and fine rare finish, chrome-tanned, dyed through
LINING	-	Jacquard lining with Montblanc brand name
FITTINGS/EMBLEM	Montblanc emblem with branded ruthenium-coated ring	Montblanc emblem with branded ruthenium-coated ring
FEATURES		
CLOSURE/LOCK	-	-
POCKETS	-	-
INTERIOR ORGANISATION	Framed slip case for several business or credit cards	Pocket suitable for all international passports, 3 pockets for credit cards, additional pocket
ADDITIONAL CHARACTERISTICS	-	-
REFILLS	-	-
DIMENSIONS		
DIMENSIONS	6 x 9,5 x 1,5 cm	10 x 14 cm

4810 WESTSIDE

> Horizontal Wallets without Coin Case

LEATHER | LINING



Black | Grey

EMBLEM



MODEL	Wallet 6cc	Wallet 6cc with Money Clip
IDENT No.	38036	101867
MATERIAL		
LEATHER	European full-grain cowhide with subtle print and fine rare finish, chrome-tanned, dyed through	European full-grain cowhide with subtle print and fine rare finish, chrome-tanned, dyed through
LINING	Jacquard lining with Montblanc brand name	Jacquard lining with Montblanc brand name
FITTINGS/EMBLEM	Montblanc emblem with branded ruthenium-coated ring	Stainless steel with satin finish, Montblanc emblem with branded ruthenium-coated ring
FEATURES		
CLOSURE/LOCK	-	-
POCKETS	-	-
INTERIOR ORGANISATION	6 pockets for credit cards, 2 compartments for banknotes, 4 additional pockets	6 pockets for credit cards, 2 compartments for banknotes, money clip
ADDITIONAL CHARACTERISTICS	-	-
REFILLS	-	-
DIMENSIONS		
DIMENSIONS	11 x 9.5 cm	11 x 8.5 cm

4810 WESTSIDE

> Horizontal Wallets without Coin Case

LEATHER | LINING



Black | Grey

EMBLEM



MODEL	Wallet 6cc with Money Clip	Wallet 6cc with 2 View Pockets
IDENT No.	108944	103401
MATERIAL		
LEATHER	European full-grain cowhide with subtle print and fine rare finish, chrome-tanned, dyed through	European full-grain cowhide with subtle print and fine rare finish, chrome-tanned, dyed through
LINING	Jacquard lining with Montblanc brand name	Jacquard lining with Montblanc brand name
FITTINGS/EMBLEM	Stainless steel with satin finish, Montblanc emblem with branded ruthenium-coated ring	Montblanc emblem with branded ruthenium-coated ring
FEATURES		
CLOSURE/LOCK	-	-
POCKETS	6 pockets for credit cards, money clip	-
INTERIOR ORGANISATION	-	6 pockets for credit cards, 2 compartments for banknotes, 2 view pockets, 3 additional pockets
ADDITIONAL CHARACTERISTICS	-	-
REFILLS	-	-
DIMENSIONS		
DIMENSIONS	11 x 8 cm	11 x 9 cm

4810 WESTSIDE

> Horizontal Wallets without Coin Case

LEATHER | LINING



Black | Grey

EMBLEM



MODEL	Wallet 8cc	Wallet 11cc with View Pocket
IDENT No.	08372	101866
MATERIAL		
LEATHER	European full-grain cowhide with subtle print and fine rare finish, chrome-tanned, dyed through	European full-grain cowhide with subtle print and fine rare finish, chrome-tanned, dyed through
LINING	Jacquard lining with Montblanc brand name	Jacquard lining with Montblanc brand name
FITTINGS/EMBLEM	Montblanc emblem with branded ruthenium-coated ring	Montblanc emblem with branded ruthenium-coated ring
FEATURES		
CLOSURE/LOCK	-	-
POCKETS	-	-
INTERIOR ORGANISATION	8 pockets for credit cards, 2 compartments for banknotes, 4 additional pockets	11 pockets for credit cards, small view pocket, 2 compartments for banknotes, 2 additional pockets
ADDITIONAL CHARACTERISTICS	-	-
REFILLS	-	-
DIMENSIONS		
DIMENSIONS	11 x 9.5 cm	11.5 x 9.5 cm

4810 WESTSIDE

> Horizontal Wallets without Coin Case

LEATHER | LINING



Black | Grey

EMBLEM



MODEL	Wallet 12cc	Wallet 14cc
IDENT No.	09299	38037
MATERIAL		
LEATHER	European full-grain cowhide with subtle print and fine rare finish, chrome-tanned, dyed through	European full-grain cowhide with subtle print and fine rare finish, chrome-tanned, dyed through
LINING	Jacquard lining with Montblanc brand name	Jacquard lining with Montblanc brand name
FITTINGS/EMBLEM	Montblanc emblem with branded ruthenium-coated ring	Montblanc emblem with branded ruthenium-coated ring
FEATURES		
CLOSURE/LOCK	-	-
POCKETS	-	-
INTERIOR ORGANISATION	12 pockets for credit cards, 2 compartments for banknotes, 4 additional pockets	14 pockets for credit cards, 2 compartments for banknotes, 2 additional pockets
ADDITIONAL CHARACTERISTICS	-	-
REFILLS	-	-
DIMENSIONS		
DIMENSIONS	11 x 9 cm	11.5 x 9.5 cm

4810 WESTSIDE

> Horizontal Wallets with Coin Case

LEATHER | LINING



Black | Grey

EMBLEM



MODEL	Wallet 4cc	Wallet 4cc with ID Holder
IDENT No.	08373	09680
MATERIAL		
LEATHER	European full-grain cowhide with subtle print and fine rare finish, chrome-tanned, dyed through	European full-grain cowhide with subtle print and fine rare finish, chrome-tanned, dyed through
LINING	Jacquard lining with Montblanc brand name	Jacquard lining with Montblanc brand name
FITTINGS/EMBLEM	Montblanc emblem with branded ruthenium-coated ring	Montblanc emblem with branded ruthenium-coated ring
FEATURES		
CLOSURE/LOCK	-	-
POCKETS	-	-
INTERIOR ORGANISATION	4 pockets for credit cards, 2 compartments for banknotes, additional pocket, coin pocket with flap	4 pockets for credit cards, 2 compartments for banknotes, 2 additional pockets, flap coin case
ADDITIONAL CHARACTERISTICS	-	Removable holder for ID card with additional pocket
REFILLS	-	-
DIMENSIONS		
DIMENSIONS	10.5 x 9.5 cm	13.5 x 9.5 cm

4810 WESTSIDE

> Long Wallets

LEATHER | LINING



Black | Grey

EMBLEM



MODEL	Wallet 6cc with zipped Pocket	Wallet 14cc with Gusset
IDENT No.	08375	108949
MATERIAL		
LEATHER	European full-grain cowhide with subtle print and fine rare finish, chrome-tanned, dyed through	European full-grain cowhide with subtle print and fine rare finish, chrome-tanned, dyed through
LINING	Jacquard lining with Montblanc brand name	Jacquard lining with Montblanc brand name
FITTINGS/EMBLEM	Stainless steel with satin finish, Montblanc emblem with branded ruthenium-coated ring	Stainless steel with satin finish, Montblanc emblem with branded ruthenium-coated ring
FEATURES		
CLOSURE/LOCK	-	-
POCKETS	-	14 pockets for credit cards, large gusset for banknotes and small documents, 2 additional pockets
INTERIOR ORGANISATION	6 pockets for credit cards, large zipped pocket, 2 compartments for banknotes, 3 additional pockets	-
ADDITIONAL CHARACTERISTICS	-	-
REFILLS	-	-
DIMENSIONS		
DIMENSIONS	9 x 18 cm	-

4810 WESTSIDE

> Long Wallets

LEATHER | LINING



Black | Grey

EMBLEM



MODEL	Travel Wallet 12cc with Zip
IDENT No.	107356
MATERIAL	
LEATHER	Southern German full-grain cowhide with subtle print and fine rare finish, chrome-tanned, dyed through
LINING	Jacquard lining with Montblanc brand name
FITTINGS/EMBLEM	Stainless steel with satin finish, Montblanc emblem with branded ruthenium-coated ring
FEATURES	
CLOSURE/LOCK	Metal zip
POCKETS	-
INTERIOR ORGANISATION	12 pockets for credit cards, large pocket for flight ticket, zipped large pocket, 3 additional pockets
ADDITIONAL CHARACTERISTICS	Loop for 1 writing instrument the size of Meisterstück Classique or LeGrand
REFILLS	-
DIMENSIONS	
DIMENSIONS	12.5 x 22.5 cm

4810 WESTSIDE

> Organisers

LEATHER | LINING



Black | Grey

EMBLEM



MODEL	Notepad Large with Zip
IDENT No.	101865
MATERIAL	
LEATHER	European full-grain cowhide with subtle print and fine rare finish, chrome-tanned, dyed through
LINING	Jacquard lining with Montblanc brand name
FITTINGS/EMBLEM	Stainless steel with satin finish, Montblanc emblem with branded ruthenium-coated ring
FEATURES	
CLOSURE/LOCK	Metal zip
POCKETS	-
INTERIOR ORGANISATION	5 pockets for credit cards, 2 gussets for plenty of business cards, large flexible pocket, 2 additional pockets
ADDITIONAL CHARACTERISTICS	Loop for writing instrument the size of Meisterstück Classique or LeGrand, complete with notepad
REFILLS	Notepad A4 (ld. 17834; ld. 06711)
DIMENSIONS	
DIMENSIONS	25 x 32.5 cm

4810 WESTSIDE

> Writing Instrument Pouches

LEATHER



Black

EMBLEM



MODEL	1 Pen Pouch	2 Pen Pouch with Zip
IDENT No.	09577	103402
MATERIAL		
LEATHER	European full-grain cowhide with subtle print and fine rare finish, chrome-tanned, dyed through	European full-grain cowhide with subtle print and fine rare finish, chrome-tanned, dyed through
LINING	-	-
FITTINGS/EMBLEM	Montblanc emblem with branded ruthenium-coated ring	Stainless steel with satin finish, Montblanc emblem with branded ruthenium-coated ring
FEATURES		
CLOSURE/LOCK	Clasp	Metal zip
POCKETS	-	-
INTERIOR ORGANISATION	Compartment for 1 writing instrument the size of Meisterstück Classique or LeGrand	Compartment for 2 writing instruments the size of Meisterstück Classique or LeGrand
ADDITIONAL CHARACTERISTICS	-	-
REFILLS	-	-
DIMENSIONS		
DIMENSIONS	3 x 14.5 x 2 cm	4.5 x 16 cm

LEATHER



Manhattan by night. Its skyline has fascinated millions, and the oscillating lights inspired the unique Montblanc Mystery pattern on the StarWalker writing instrument, now translated into the eponymous leather collection.

In the Light of a mystical Skyline

4810 Westside Black Mystery

Calfskin with a metallic anthracite shine, a lining reproducing an ancient Manhattan Map, functional business styles: all pay tribute to the birthplace of urban chic.

4810 WESTSIDE BLACK MYSTERY

> Large Leather Goods

> Business Bags



Document Case

Id. 106044

p. 162

> City Bags



Camera Bag with Zip

Id. 106046

p. 163



Messenger Bag

Id. 106047

p. 163

4810 WESTSIDE BLACK MYSTERY

> Small Leather Goods

> Pocket Accessories



Pocket Holder 2cc

Id. 107533

p. 164



Key Case with Valet Ring Large

Id. 107534

p. 164



Business Card Holder with Gusset

Id. 106038

p. 165

> Horizontal Wallets without Coin Case



Wallet 6cc

Id. 107535

p. 166



Wallet 11cc with View Pocket

Id. 107536

p. 167



Wallet 6cc with 2 View Pockets

Id. 106040

p. 166

> Long Wallets



Wallet 14cc with Gusset

Id. 106042

p. 168

> Organisers & Agendas



Notebook Medium with Zip

Id. 107537

p. 169

4810 WESTSIDE BLACK MYSTERY

> Business Bags

LEATHER | LINING



Anthracite-
Metallic | Grey

EMBLEM



MODEL	Document Case
IDENT No.	106044
MATERIAL	
LEATHER	French full-grain calfskin, chrome-tanned, semi-aniline-dyed through, with printed Montblanc Mystery pattern and glossy finish
LINING	Jacquard lining with historical Manhattan map design and Montblanc brand name
FITTINGS/EMBLEM	Ruthenium-plated stainless steel metal fittings and punched-out Montblanc emblem with shiny finish
FEATURES	
CLOSURE/LOCK	Metal zip
POCKETS	2 main compartments, large zipped inner pocket, zipped front pocket, large back pocket, 2 additional pockets
INTERIOR ORGANISATION	Pockets for mobile phone (PDA size), 2 credit cards, 1 writing instrument
STRAP	-
ADDITIONAL CHARACTERISTICS	Detachable metal pendant for address data
DIMENSIONS	
DIMENSIONS	41 x 43.5 x 8 cm

4810 WESTSIDE BLACK MYSTERY

> City Bags

LEATHER | LINING



Anthracite-
Metallic | Grey

EMBLEM



MODEL	Camera Bag with Zip	Messenger Bag
IDENT No.	106046	106047
MATERIAL		
LEATHER	French full-grain calfskin, chrome-tanned, semi-aniline-dyed through, with printed Montblanc Mystery pattern and glossy finish	French full-grain calfskin, chrome-tanned, semi-aniline-dyed through, with printed Montblanc Mystery pattern and glossy finish
LINING	Jacquard lining with historical Manhattan map design and Montblanc brand name	Jacquard lining with historical Manhattan map design and Montblanc brand name
FITTINGS/EMBLEM	Ruthenium-plated stainless steel metal fittings and punched-out Montblanc emblem with shiny finish	Ruthenium-plated stainless steel metal fittings and punched-out Montblanc emblem with shiny finish
FEATURES		
CLOSURE/LOCK	Metal zip	Flap with 2 hidden magnets
POCKETS	1 main compartment, zipped front pocket, large back pocket, additional large pocket	1 main compartment, large zipped front pocket, large inner pocket, large back pocket, additional zipped pocket
INTERIOR ORGANISATION	Pockets for mobile phone (PDA size), 2 credit cards, 1 writing instrument	Pockets for mobile phone (PDA size), 2 credit cards, 1 writing instrument
STRAP	Adjustable branded shoulder strap in black	Adjustable branded shoulder strap in black
ADDITIONAL CHARACTERISTICS	-	-
DIMENSIONS		
DIMENSIONS	28 x 21 x 7.5 cm	36 x 31 x 10 cm

4810 WESTSIDE BLACK MYSTERY

> Pocket Accessories

LEATHER | LINING



Anthracite-
Metallic | Grey

EMBLEM



MODEL	Pocket Holder zcc	Key Case with Valet Ring Large
IDENT No.	107533	107534
MATERIAL		
LEATHER	French full-grain calfskin, chrome-tanned, semi-aniline-dyed through, with printed Montblanc Mystery pattern and glossy finish	French full-grain calfskin, chrome-tanned, semi-aniline-dyed through, with printed Montblanc Mystery pattern and glossy finish
LINING	Jacquard lining with historical Manhattan map design and Montblanc brand name	Jacquard lining with historical Manhattan map design and Montblanc brand name
FITTINGS/EMBLEM	Montblanc emblem with branded ruthenium-coated ring	Montblanc emblem with branded ruthenium-coated ring
FEATURES		
CLOSURE/LOCK	-	-
POCKETS	-	-
INTERIOR ORGANISATION	2 pockets for credit cards, additional pocket	Rings for 6 keys, valet ring for car key
ADDITIONAL CHARACTERISTICS	-	-
REFILLS	-	-
DIMENSIONS		
DIMENSIONS	11 x 7 cm	7 x 10.5 cm

4810 WESTSIDE BLACK MYSTERY

> Pocket Accessories

LEATHER | LINING



Anthracite-
Metallic | Grey

EMBLEM



MODEL	Business Card Holder with Gusset
IDENT No.	106038
MATERIAL	
LEATHER	French full-grain calfskin, chrome-tanned, semi-aniline-dyed through, with printed Montblanc Mystery pattern and glossy finish
LINING	Jacquard lining with historical Manhattan map design and Montblanc brand name
FITTINGS/EMBLEM	Montblanc emblem with branded ruthenium-coated ring
FEATURES	
CLOSURE/LOCK	-
POCKETS	-
INTERIOR ORGANISATION	Spacious gusset for business cards, 2 pockets for credit cards, 3 additional pockets
ADDITIONAL CHARACTERISTICS	Pocket 2cc
REFILLS	-
DIMENSIONS	
DIMENSIONS	7.5 x 10.5 cm

4810 WESTSIDE BLACK MYSTERY

> Horizontal Wallets without Coin Case

LEATHER | LINING



Anthracite-
Metallic | Grey

EMBLEM



MODEL	Wallet 6cc	Wallet 6cc with 2 View Pockets
IDENT No.	107535	106040
MATERIAL		
LEATHER	French full-grain calfskin, chrome-tanned, semi-aniline-dyed through, with printed Montblanc Mystery pattern and glossy finish	French full-grain calfskin, chrome-tanned, semi-aniline-dyed through, with printed Montblanc Mystery pattern and glossy finish
LINING	Jacquard lining with historical Manhattan map design and Montblanc brand name	Jacquard lining with historical Manhattan map design and Montblanc brand name
FITTINGS/EMBLEM	Montblanc emblem with branded ruthenium-coated ring	Montblanc emblem with branded ruthenium-coated ring
FEATURES		
CLOSURE/LOCK	-	-
POCKETS	-	-
INTERIOR ORGANISATION	6 pockets for credit cards, 2 compartments for banknotes, 2 additional pockets	6 pockets for credit cards, 2 view pockets, 2 compartments for banknotes, 3 additional pockets
ADDITIONAL CHARACTERISTICS	Pocket 2cc	Pocket 2cc
REFILLS	-	-
DIMENSIONS		
DIMENSIONS	11,5 x 9 cm	11 x 9 cm

4810 WESTSIDE BLACK MYSTERY

> Horizontal Wallets without Coin Case

LEATHER | LINING



Anthracite-
Metallic | Grey

EMBLEM



MODEL	Wallet 11cc with View Pocket
IDENT No.	107536
MATERIAL	
LEATHER	French full-grain calfskin, chrome-tanned, semi-aniline-dyed through, with printed Montblanc Mystery pattern and glossy finish
LINING	Jacquard lining with historical Manhattan map design and Montblanc brand name
FITTINGS/EMBLEM	Montblanc emblem with branded ruthenium-coated ring
FEATURES	
CLOSURE/LOCK	-
POCKETS	-
INTERIOR ORGANISATION	11 pockets for credit cards, small view pocket, 2 compartments for banknotes, 2 additional pockets
ADDITIONAL CHARACTERISTICS	Pocket 2cc
REFILLS	-
DIMENSIONS	
DIMENSIONS	12.5 x 10 cm

4810 WESTSIDE BLACK MYSTERY

> Long Wallets

LEATHER | LINING



Anthracite-
Metallic | Grey

EMBLEM



MODEL	Wallet 14cc with Gusset
IDENT No.	106042
MATERIAL	
LEATHER	French full-grain calfskin, chrome-tanned, semi-aniline-dyed through, with printed Montblanc Mystery pattern and glossy finish
LINING	Jacquard lining with historical Manhattan map design and Montblanc brand name
FITTINGS/EMBLEM	Montblanc emblem with branded ruthenium-coated ring
FEATURES	
CLOSURE/LOCK	-
POCKETS	-
INTERIOR ORGANISATION	14 pockets for credit cards, 1 compartment for banknotes, 3 additional pockets
ADDITIONAL CHARACTERISTICS	Pocket 2cc
REFILLS	-
DIMENSIONS	
DIMENSIONS	9.5 x 19 cm

4810 WESTSIDE BLACK MYSTERY

> Organisers & Agendas

LEATHER | LINING



Anthracite-
Metallic | Grey

EMBLEM



MODEL	Notebook Medium with Zip
IDENT No.	107537
MATERIAL	
LEATHER	French full-grain calfskin, chrome-tanned, semi-aniline-dyed through, with printed Montblanc Mystery pattern and glossy finish
LINING	Jacquard lining with historical Manhattan map design and Montblanc brand name
FITTINGS/EMBLEM	Montblanc emblem with branded ruthenium-coated ring
FEATURES	
CLOSURE/LOCK	Metal zip
POCKETS	-
INTERIOR ORGANISATION	5 pockets for credit cards, additional pocket, pocket for notebook
ADDITIONAL CHARACTERISTICS	Loop for writing instrument the size of a Meisterstück LeGrand or Classique, complete with notebook
REFILLS	Notebook Medium (Id. 09596)
DIMENSIONS	
DIMENSIONS	21,5 x 24 cm

LEATHER



The 4810 Westside Black Mystery pattern translated onto lightweight fabric. The urban man's collection matching his on the go lifestyle.

Light Luxury dedicated to the Urban Man

4810 Westside Black Mystery Canvas

Refined functionality in black canvas, with the Montblanc Mystery pattern, trimmed with 4810 Westside leather: a tribute to the Manhattan skyline by night.

4810 WESTSIDE BLACK MYSTERY CANVAS

> Large Leather Goods

> Business Bags



Document Case

Id. 107759

p. 173

> City Bags



Clutch Bag with Zip

Id. 109568

p. 174



Envelope Bag

Id. 107760

p. 174



North South Bag Small with Zip

Id. 107761

p. 175



Messenger Bag Medium

Id. 107762

p. 176, 177



North South Bag

Id. 109567

p. 175



Camera Bag with Zip

Id. 109569

p. 176



Tote Bag

Id. 107763

p. 177

4810 WESTSIDE BLACK MYSTERY CANVAS

> Business Bags

LEATHER | FABRIC | LINING



Black | Black |
Black

EMBLEM



MODEL	Document Case
IDENT No.	107759
MATERIAL	
LEATHER	Jacquard with Montblanc Mystery pattern, combined with European full-grain cowhide with subtle imprint and rare finish, chrome tanned, dyed through
LINING	Jacquard 100% cotton
FITTINGS/EMBLEM	Ruthenium-coated stainless steel metal fittings and punched-out Montblanc emblem with shiny finish
FEATURES	
CLOSURE/LOCK	Metal zip
POCKETS	1 main compartment, zipped inner pocket
INTERIOR ORGANISATION	Pockets for mobile phone (PDA size), 3 writing instruments and 2 credit cards
STRAP	Detachable adjustable branded shoulder strap in black
ADDITIONAL CHARACTERISTICS	2 comfortable leather handles
DIMENSIONS	
DIMENSIONS	41.5 x 32 x 8.5 cm

4810 WESTSIDE BLACK MYSTERY CANVAS

> City Bags

LEATHER | FABRIC | LINING

Black | Black |
Black

EMBLEM



MODEL	Clutch Bag with Zip	Envelope Bag
IDENT No.	109568	107760
MATERIAL		
LEATHER	Jacquard with Montblanc Mystery pattern, combined with European full-grain cowhide with subtle imprint and rare finish, chrome tanned, dyed through	Jacquard with Montblanc Mystery pattern, combined with European full-grain cowhide with subtle imprint and rare finish, chrome tanned, dyed through
LINING	Jacquard 100% cotton	Jacquard 100% cotton
FITTINGS/EMBLEM	Ruthenium-coated stainless steel metal fittings and punched-out Montblanc emblem with shiny finish	Ruthenium-coated stainless steel metal fittings and punched-out Montblanc emblem with shiny finish
FEATURES		
CLOSURE/LOCK	Metal zip	Metal zip
POCKETS	1 main compartment, zipped front pocket	1 main compartment
INTERIOR ORGANISATION	Pockets for mobile phone (PDA size), 2 writing instruments and 1 small document	Pockets for mobile phone (PDA size), 2 writing instrument, especially fitting for iPad
STRAP	Leather wrist strap	Adjustable branded shoulder strap in black
ADDITIONAL CHARACTERISTICS	-	-
DIMENSIONS		
DIMENSIONS	26 x 16 x 5 cm	27 x 31 cm

4810 WESTSIDE BLACK MYSTERY CANVAS

> City Bags

LEATHER | FABRIC | LINING

Black | Black |
Black

EMBLEM



MODEL	North South Bag Small with Zip	North South Bag
IDENT No.	107761	109567
MATERIAL		
LEATHER	Jacquard with Montblanc Mystery pattern, combined with European full-grain cowhide with subtle imprint and rare finish, chrome tanned, dyed through	Jacquard with Montblanc Mystery pattern, combined with European full-grain cowhide with subtle imprint and rare finish, chrome tanned, dyed through
LINING	Jacquard 100% cotton	Jacquard 100% cotton
FITTINGS/EMBLEM	Ruthenium-coated stainless steel metal fittings and punched-out Montblanc emblem with shiny finish	Ruthenium-coated stainless steel metal fittings and punched-out Montblanc emblem with shiny finish
FEATURES		
CLOSURE/LOCK	Zip	Flap with magnetic stud
POCKETS	1 main compartment	1 main compartment, zipped back pocket
INTERIOR ORGANISATION	Pockets for mobile phone (PDA size) and 2 writing instruments	Pockets for mobile phone (PDA size) and 2 writing instruments
STRAP	Adjustable branded shoulder strap in black	Adjustable branded shoulder strap in black
ADDITIONAL CHARACTERISTICS	Protective bottom	Protective bottom
DIMENSIONS		
DIMENSIONS	20,5 x 25,5 x 8 cm	21,5 x 27 x 8 cm

4810 WESTSIDE BLACK MYSTERY CANVAS

> City Bags

LEATHER | FABRIC | LINING

Black | Black |
Black

EMBLEM



MODEL	Camera Bag with Zip	Messenger Bag Medium
IDENT No.	109569	107762
MATERIAL		
LEATHER	Jacquard with Montblanc Mystery pattern, combined with European full-grain cowhide with subtle imprint and rare finish, chrome tanned, dyed through	Jacquard with Montblanc Mystery pattern, combined with European full-grain cowhide with subtle imprint and rare finish, chrome tanned, dyed through
LINING	Jacquard 100% cotton	Jacquard 100% cotton
FITTINGS/EMBLEM	Ruthenium-coated stainless steel metal fittings and punched-out Montblanc emblem with shiny finish	Ruthenium-coated stainless steel metal fittings and punched-out Montblanc emblem with shiny finish
FEATURES		
CLOSURE/LOCK	Metal zip	Flap, hidden magnet
POCKETS	1 main compartment, zipped front pocket	1 main compartment, zipped inner pocket
INTERIOR ORGANISATION	Pockets for mobile phone (PDA size), 2 writing instruments and 2 credit cards	Pockets for mobile phone (PDA size), 3 writing instruments
STRAP	Adjustable branded shoulder strap in black	Adjustable branded shoulder strap in black
ADDITIONAL CHARACTERISTICS	-	-
DIMENSIONS		
DIMENSIONS	30 x 20 x 11.5 cm	33 x 29.5 x 7.5 cm

4810 WESTSIDE BLACK MYSTERY CANVAS

> City Bags

LEATHER | FABRIC | LINING



Black | Black |
Black

EMBLEM



MODEL	Messenger Bag Medium	Tote Bag
IDENT No.	107762	107763
MATERIAL		
LEATHER	Jacquard with Montblanc Mystery pattern, combined with European full-grain cowhide with subtle imprint and rare finish, chrome tanned, dyed through	Jacquard with Montblanc Mystery pattern, combined with European full-grain cowhide with subtle imprint and rare finish, chrome tanned, dyed through
LINING	Jacquard 100% cotton	Jacquard 100% cotton
FITTINGS/EMBLEM	Ruthenium-coated stainless steel metal fittings and punched-out Montblanc emblem with shiny finish	Ruthenium-coated stainless steel metal fittings and punched-out Montblanc emblem with shiny finish
FEATURES		
CLOSURE/LOCK	Flap, hidden magnet	Zip
POCKETS	1 main compartment, zipped inner pocket	1 spacious main compartment, 2 large inner pockets, zipped inner pocket
INTERIOR ORGANISATION	Pockets for mobile phone (PDA size), 3 writing instruments	Pockets for mobile phone (PDA size), 3 writing instruments and 2 pockets for credit cards
STRAP	Adjustable branded shoulder strap in black	-
ADDITIONAL CHARACTERISTICS	-	2 comfortable leather handles
DIMENSIONS		
DIMENSIONS	33 x 29.5 x 7.5 cm	46 x 38 x 15 cm

LEATHER



Business style interpreted in a modern effortless way with soft shapes and intricate details hinting at Italian flair.

A Blend of Casualness and Function

Soft Leather Range

The soft shapes are attained by the design, which richly accentuates the softness and natural beauty of the high-quality calfskin. Finally, the famous Florentine touch is visible in every detail of the stitching.

SOFT LEATHER RANGE

> Large Leather Goods

> Business Bags



Single Gusset Briefcase

Id. 105933

p. 182

> City Bags



Camera Bag with Zip

Id. 105934

p. 183



Messenger Bag

Id. 105938

p. 184

> Travel Bags



Hold-all bag

Id. 105935

p. 185

SOFT LEATHER RANGE

> Large Leather Goods

> Pocket Accessories



Pocket Holder 6cc

Id. 105927

p. 186



Pocket Holder 4cc with ID Card Holder

Id. 106655

p. 186



Business Card Holder with Gusset

Id. 105926

p. 187

> Horizontal Wallets without Coin Case



Wallet 6cc

Id. 105928

p. 188



Wallet 8cc

Id. 105929

p. 188



Wallet 11cc with View Pocket

Id. 105931

p. 189

> Horizontal Wallets with Coin Case



Wallet 4cc

Id. 105930

p. 190

> Long Wallets



Wallet 14cc with Gusset

Id. 105932

p. 191

SOFT LEATHER RANGE

> Business Bags

LEATHER | LINING



Black | Grey

EMBLEM



MODEL	Single Gusset Briefcase
IDENT No.	105933
MATERIAL	
LEATHER	Australian full-grain calfskin, chrome-tanned, semi-aniline-dyed through, with imprint
LINING	Jacquard lining with emblematic "M" pattern
FITTINGS/EMBLEM	Ruthenium-coated punched-out Montblanc emblem with shiny finish
FEATURES	
CLOSURE/LOCK	Flap, 2 snap locks with Montblanc 3 rings motif
POCKETS	1 main compartment, large zipped inner pocket, zipped back pocket
INTERIOR ORGANISATION	Pockets for mobile phone (PDA size), 2 credit cards and 1 writing instrument
STRAP	-
ADDITIONAL CHARACTERISTICS	Comfortable leather handle, metal bottom feet
DIMENSIONS	
DIMENSIONS	38 x 28 x 9 cm

SOFT LEATHER RANGE

> City Bags

LEATHER | LINING



Black | Grey

EMBLEM



MODEL	Camera Bag with Zip
IDENT No.	105934
MATERIAL	
LEATHER	Australian full-grain calfskin, chrome-tanned, semi-aniline-dyed through, with imprint
LINING	Jacquard lining with emblematic "M" pattern
FITTINGS/EMBLEM	Ruthenium-coated punched-out Montblanc emblem with shiny finish
FEATURES	
CLOSURE/LOCK	Metal zip
POCKETS	1 main compartment, large zipped front pocket, back pocket
INTERIOR ORGANISATION	Pockets for mobile phone (PDA size), 2 credit cards, 1 writing instrument
STRAP	Adjustable shoulder strap in two-tone black
ADDITIONAL CHARACTERISTICS	-
DIMENSIONS	
DIMENSIONS	33 x 21 x 9 cm

SOFT LEATHER RANGE

> City Bags

LEATHER | LINING



Black | Grey

EMBLEM



MODEL	Messenger Bag
IDENT No.	105938
MATERIAL	
LEATHER	Australian full-grain calfskin, chrome-tanned, semi-aniline-dyed through, with imprint
LINING	Jacquard lining with emblematic "M" pattern
FITTINGS/EMBLEM	Ruthenium-coated punched-out Montblanc emblem with shiny finish
FEATURES	
CLOSURE/LOCK	Flap, hidden magnet
POCKETS	2 main compartments, large zipped inner pocket, zipped front pocket
INTERIOR ORGANISATION	Pockets for mobile phone (PDA size), 2 credit cards, 1 writing instrument
STRAP	Adjustable shoulder strap in two-tone black
ADDITIONAL CHARACTERISTICS	-
DIMENSIONS	
DIMENSIONS	39 x 29 x 15 cm

SOFT LEATHER RANGE

> Travel Bags

LEATHER | LINING



Black | Grey

EMBLEM



MODEL	Hold-all bag
IDENT No.	105935
MATERIAL	
LEATHER	Australian full-grain calfskin, chrome-tanned, semi-aniline-dyed through, with imprint
LINING	Jacquard lining with emblematic "M" pattern
FITTINGS/EMBLEM	Ruthenium-coated punched-out Montblanc emblem with shiny finish
FEATURES	
CLOSURE/LOCK	Metal zip with kissing sliders
POCKETS	1 main compartment, large zipped inner pocket, zipped front pocket
INTERIOR ORGANISATION	Pockets for mobile phone (PDA size), 2 credit cards, 1 writing instrument
STRAP	Detachable and adjustable shoulder strap in two-tone black
ADDITIONAL CHARACTERISTICS	Padlock, metal feet, comfortable leather handle, luggage tag
DIMENSIONS	
DIMENSIONS	53 x 26 x 26.5 cm

SOFT LEATHER RANGE

> Pocket Accessories

LEATHER | LINING



Black | Grey

EMBLEM



MODEL	Pocket Holder 6cc	Pocket Holder 4cc with ID Card Holder
IDENT No.	105927	106655
MATERIAL		
LEATHER	Australian full-grain calfskin, chrome-tanned, semi-aniline-dyed through, with imprint	Australian full-grain calfskin, chrome-tanned, semi-aniline-dyed through, with imprint
LINING	Jacquard lining with emblematic "M" pattern	Jacquard lining with emblematic "M" pattern
FITTINGS/EMBLEM	Montblanc emblem with ruthenium-coated ring bearing Montblanc brand name and shiny finish	Montblanc emblem with branded ruthenium-coated ring
FEATURES		
CLOSURE/LOCK	-	-
POCKETS	-	-
INTERIOR ORGANISATION	6 pockets for credit cards, additional pocket	4 pockets for credit cards, ID Card Holder, 3 additional pocket
ADDITIONAL CHARACTERISTICS	-	-
REFILLS	-	-
DIMENSIONS		
DIMENSIONS	10 x 8 cm	12 x 9 cm

SOFT LEATHER RANGE

> Pocket Accessories

LEATHER | LINING



Black | Grey

EMBLEM



MODEL	Business Card Holder with Gusset
IDENT No.	105926
MATERIAL	
LEATHER	Australian full-grain calfskin, chrome-tanned, semi-aniline-dyed through, with imprint
LINING	Jacquard lining with emblematic "M" pattern
FITTINGS/EMBLEM	Montblanc emblem with ruthenium-coated ring bearing Montblanc brand name and shiny finish
FEATURES	
CLOSURE/LOCK	-
POCKETS	-
INTERIOR ORGANISATION	Spacious gusset for business cards, 2 pockets for credit cards, 2 additional pockets, back pocket
ADDITIONAL CHARACTERISTICS	-
REFILLS	-
DIMENSIONS	
DIMENSIONS	7.5 x 10.5 cm

SOFT LEATHER RANGE

> Horizontal Wallets without Coin Case

LEATHER | LINING



Black | Grey

EMBLEM



MODEL	Wallet 6cc	Wallet 8cc
IDENT No.	105928	105929
MATERIAL		
LEATHER	Australian full-grain calfskin, chrome-tanned, semi-aniline-dyed through, with imprint	Australian full-grain calfskin, chrome-tanned, semi-aniline-dyed through, with imprint
LINING	Jacquard lining with emblematic "M" pattern	Jacquard lining with emblematic "M" pattern
FITTINGS/EMBLEM	Montblanc emblem with ruthenium-coated ring bearing Montblanc brand name and shiny finish	Montblanc emblem with ruthenium-coated ring bearing Montblanc brand name and shiny finish
FEATURES		
CLOSURE/LOCK	-	-
POCKETS	-	-
INTERIOR ORGANISATION	6 pockets for credit cards, 2 compartments for banknotes, 4 additional pockets	8 pockets for credit cards, 2 compartments for banknotes, 4 additional pockets
ADDITIONAL CHARACTERISTICS	-	-
REFILLS	-	-
DIMENSIONS		
DIMENSIONS	12 x 8,5 cm	11,5 x 9,5 cm

SOFT LEATHER RANGE

> Horizontal Wallets without Coin Case

LEATHER | LINING



Black | Grey

EMBLEM



MODEL	Wallet 11cc with View Pocket
IDENT No.	105931
MATERIAL	
LEATHER	Australian full-grain calfskin, chrome-tanned, semi-aniline-dyed through, with imprint
LINING	Jacquard lining with emblematic "M" pattern
FITTINGS/EMBLEM	Montblanc emblem with ruthenium-coated ring bearing Montblanc brand name and shiny finish
FEATURES	
CLOSURE/LOCK	-
POCKETS	-
INTERIOR ORGANISATION	11 pockets for credit cards, small view pocket, 2 compartments for banknotes, 3 additional pockets
ADDITIONAL CHARACTERISTICS	-
REFILLS	-
DIMENSIONS	
DIMENSIONS	12 x 9,5 cm

SOFT LEATHER RANGE

> Horizontal Wallets with Coin Case

LEATHER | LINING



Black | Grey

EMBLEM



MODEL	Wallet 4cc
IDENT No.	105930
MATERIAL	
LEATHER	Australian full-grain calfskin, chrome-tanned, semi-aniline-dyed through, with imprint
LINING	Jacquard lining with emblematic "M" pattern
FITTINGS/EMBLEM	Montblanc emblem with ruthenium-coated ring bearing Montblanc brand name and shiny finish
FEATURES	
CLOSURE/LOCK	-
POCKETS	-
INTERIOR ORGANISATION	4 pockets for credit cards, 2 compartments for banknotes, additional pocket, flap coin pocket
ADDITIONAL CHARACTERISTICS	-
REFILLS	-
DIMENSIONS	
DIMENSIONS	11 x 9,5 cm

SOFT LEATHER RANGE

> Long Wallets

LEATHER | LINING



Black | Grey

EMBLEM



MODEL	Wallet 14cc with Gusset
IDENT No.	105932
MATERIAL	
LEATHER	Australian full-grain calfskin, chrome-tanned, semi-aniline-dyed through, with imprint
LINING	Jacquard lining with emblematic "M" pattern
FITTINGS/EMBLEM	Montblanc emblem with ruthenium-coated ring bearing Montblanc brand name and shiny finish
FEATURES	
CLOSURE/LOCK	-
POCKETS	-
INTERIOR ORGANISATION	14 pockets for credit cards, spacious gusset for banknotes, 2 additional pockets
ADDITIONAL CHARACTERISTICS	-
REFILLS	-
DIMENSIONS	
DIMENSIONS	10 x 19 cm

LEATHER



Delightful to touch, uniquely light and with a subtle sheen, the silk and cotton line provides luxurious companions for trips.

Gliding around the World

Montblanc NightFlight

Fabric, combined with soft leather, creates appealing luggage and city bags. Practical yet unique, with charmingly different details and an eye-catching Montblanc emblem.

MONTBLANC NIGHTFLIGHT

> Large Leather Goods

> Business Bags



Document Case

Id. 35383

p. 196



Double Gusset Briefcase

Id. 08772

p. 196

> City Bags



North South Bag Mini with Zip

Id. 105939

p. 197



North South Bag Small with Zip

Id. 08768

p. 197



North South Bag Large

Id. 38039

p. 198



Camera Bag with Zip

Id. 105940

p. 199



Messenger Bag

Id. 08763

p. 199

> Bag on Wheels



Office Case

Id. 38045

p. 200



Trolley On-board

Id. 38046

p. 201

MONTBLANC NIGHTFLIGHT

> Small Leather Goods

> Pocket Accessories



Passport Holder International

Id. 38041

p. 202

> Horizontal Wallets without Coin Case



Wallet 6cc

Id. 38043

p. 203



Wallet 8cc

Id. 08774

p. 203

> Horizontal Wallets with Coin Case



Wallet 4cc

Id. 08775

p. 204



Wallet 6cc with View Pocket

Id. 101859

p. 205

MONTBLANC NIGHT FLIGHT

> Business Bags

LEATHER | FABRIC | LINING



Black | Black |
Anthracite

CLOSURE



MODEL	Document Case	Double Gusset Briefcase
IDENT NO.	35383	08772
MATERIAL		
LEATHER	Silk / cotton fabric with fine rib structure, resistant to stains, water and scratches, voyage-proofed, combined with soft leather, chrome-tanned, dyed through	Silk / cotton fabric with fine rib structure, resistant to stains, water and scratches, voyage-proofed, combined with soft leather, chrome-tanned, dyed through
LINING	Jacquard lining with Montblanc brand name	Jacquard lining with Montblanc brand name
FITTINGS/EMBLEM	Stainless steel with satin finish, duffle-coat toggle in genuine water buffalo horn with 2 Montblanc emblems	Stainless steel with satin finish, duffle-coat toggle in genuine water buffalo horn with 2 Montblanc emblems
FEATURES		
CLOSURE/LOCK	Zip	Flap with 2 magnetic studs and branded duffle-coat toggle
POCKETS	2 main compartments, large front pocket with branded duffle-coat toggle, large zipped inner pocket, large back pocket	2 main compartments adjustable at sides, large zipped inner pocket, large back pocket
INTERIOR ORGANISATION	Pockets for mobile phone (PDA size), 2 writing instruments and 1 medium document	Pockets for mobile phone (PDA size), 1 writing instrument and 1 medium-sized document
STRAP	-	-
ADDITIONAL CHARACTERISTICS	Satellite System to attach the bag to a trolley	Satellite System to attach the bag to a trolley
DIMENSIONS		
DIMENSIONS	41 x 31 x 9 cm	39 x 28 x 12 cm

MONTBLANC NIGHT FLIGHT

> City Bags

LEATHER | FABRIC | LINING

Black | Black |
Anthracite

EMBLEM

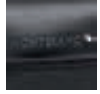

MODEL	North South Bag Mini with Zip	North South Bag Small with Zip
IDENT No.	105939	08768
MATERIAL		
LEATHER	Silk / cotton fabric with fine rib structure, resistant to stains, water and scratches, voyage-proofed, combined with soft leather, chrome-tanned, dyed through	Silk / cotton fabric with fine rib structure, resistant to stains, water and scratches, voyage-proofed, combined with soft leather, chrome-tanned, dyed through
LINING	Jacquard lining with Montblanc brand name	Jacquard lining with Montblanc brand name
FITTINGS/EMBLEM	Stainless steel with satin-finish, Montblanc emblem with palladium-plated ring	Stainless steel with satin finish, Montblanc emblem with palladium-coated ring
FEATURES		
CLOSURE/LOCK	Zip	Zip
POCKETS	1 main compartment, front pocket, back pocket	1 main compartment, zipped front pocket, back pocket
INTERIOR ORGANISATION	Pockets for mobile phone (PDA size), 1 writing instrument and 1 small document	Pockets for mobile phone (PDA size) and 1 writing instrument
STRAP	Adjustable branded shoulder strap in black	Adjustable branded shoulder strap in black
ADDITIONAL CHARACTERISTICS	-	-
DIMENSIONS		
DIMENSIONS	17.5 x 20.5 x 6 cm	20 x 24 x 10 cm

MONTBLANC NIGHT FLIGHT

> City Bags

LEATHER | FABRIC | LINING



Black | Black |
Anthracite

CLOSURE



MODEL	North South Bag Large
IDENT No.	38039
MATERIAL	
LEATHER	Silk / cotton fabric with fine rib structure, resistant to stains, water and scratches, voyage-proofed, combined with soft leather, chrome-tanned, dyed through
LINING	Jacquard lining with Montblanc brand name
FITTINGS/EMBLEM	Stainless steel with satin finish, duffle-coat toggle in genuine water buffalo horn with 2 Montblanc emblems
FEATURES	
CLOSURE/LOCK	Flap with branded duffle-coat toggle
POCKETS	1 main compartment, large zipped inner pocket, large back pocket
INTERIOR ORGANISATION	Pockets for mobile phone (PDA size), 2 writing instruments and 1 small document
STRAP	Adjustable branded shoulder strap in black
ADDITIONAL CHARACTERISTICS	-
DIMENSIONS	
DIMENSIONS	28 x 35 x 8 cm

MONTBLANC NIGHT FLIGHT

> City Bags

LEATHER | FABRIC | LINING



Black | Black |
Anthracite

EMBLEM | CLOSURE



MODEL	Camera Bag with Zip	Messenger Bag
IDENT No.	105940	08763
MATERIAL		
LEATHER	Silk / cotton fabric with fine rib structure, resistant to stains, water and scratches, voyage-proofed, combined with soft leather, chrome-tanned, dyed through	Silk / cotton fabric with fine rib structure, resistant to stains, water and scratches, voyage-proofed, combined with soft leather, chrome-tanned, dyed through
LINING	Jacquard lining with Montblanc brand name	Jacquard lining with Montblanc brand name
FITTINGS/EMBLEM	Stainless steel with satin-finish, Montblanc emblem with palladium-plated ring	Stainless steel with satin finish, duffle-coat toggle in genuine water buffalo horn with 2 Montblanc emblems
FEATURES		
CLOSURE/LOCK	Zip	Flap with branded duffle-coat toggle
POCKETS	1 main compartment, zipped front pocket with additional pocket, back pocket	1 main compartment, large zipped inner pocket, large back pocket
INTERIOR ORGANISATION	Pockets for mobile phone (PDA size), 1 writing instrument and 1 small document	Pockets for mobile phone (PDA size), 4 writing instruments and 1 medium-sized document
STRAP	Adjustable branded shoulder strap in black	Adjustable branded shoulder strap in black
ADDITIONAL CHARACTERISTICS	-	Satellite System to attach the bag to a trolley
DIMENSIONS		
DIMENSIONS	28,5 x 19,5 x 14,5 cm	34 x 31 x 11 cm

MONTBLANC NIGHTFLIGHT

> Bag on Wheels

LEATHER | FABRIC | LINING



Black | Black |
Anthracite

EMBLEM



MODEL	Office Case
IDENT No.	38045
MATERIAL	
LEATHER	Silk / cotton fabric with fine rib structure, resistant to stains, water and scratches, voyage-proofed, combined with soft leather, chrome-tanned, dyed through
LINING	Jacquard lining with Montblanc brand name
FITTINGS/EMBLEM	Stainless steel with satin finish, Montblanc emblem with palladium-coated ring
FEATURES	
CLOSURE/LOCK	Zip with kissing sliders
POCKETS	Main compartment for clothes with all-round zip, adjustable straps, large pocket with zipped divider and 3 additional zipped pockets, spacious padded compartment for a laptop (max. size 30 x 37 x 5 cm) and business files with 2 small pockets and adjustable protection straps, spacious zipped front pocket, zipped inner and back pockets
INTERIOR ORGANISATION	Pockets for mobile phone (PDA size), 2 writing instruments, and 3 small and 2 medium-sized document pockets, ring for keys
STRAP	Branded straps with leather grip
ADDITIONAL CHARACTERISTICS	Quiet-running aluminium wheels, robust wheel case with aluminium trim, stable 4-length handle extensions, comfortable leather handle, extendable zipped centre compartment, rubber zip pullers, luggage tag, combination lock
DIMENSIONS + WEIGHT	
DIMENSIONS	43 x 37 x 23 cm
WEIGHT	5,0 kg

MONTBLANC NIGHTFLIGHT

> Bag on Wheels

LEATHER | FABRIC | LINING



Black | Black |
Anthracite

EMBLEM



MODEL	Trolley On-board
IDENT No.	38046
MATERIAL	
LEATHER	Silk / cotton fabric with fine rib structure, resistant to stains, water and scratches, voyage-proofed, combined with soft leather, chrome-tanned, dyed through
LINING	Jacquard lining with Montblanc brand name
FITTINGS/EMBLEM	Stainless steel with satin finish, Montblanc emblem with palladium-coated ring
FEATURES	
CLOSURE/LOCK	2 zips with kissing sliders
POCKETS	Main compartment for clothes with elastic straps, spacious compartment with zipped cover, 3 zipped pockets and 2 view pockets, small pocket and 2 zipped pockets, zipped front pocket with large inner pocket and zipped pocket, zipped back pocket
INTERIOR ORGANISATION	Pockets for mobile phone (PDA size), 2 writing instruments, and 3 small and 2 medium-sized document pockets, ring for keys
STRAP	-
ADDITIONAL CHARACTERISTICS	Quiet-running aluminium wheels, robust wheel case with aluminium trim, stable 3-length handle extensions, comfortable leather handle, rubber top handle, additional handle at side, strap to attach another bag, rubber zip pullers, luggage tag
DIMENSIONS + WEIGHT	
DIMENSIONS	56 x 38 x 22 cm
WEIGHT	5.4 kg

MONTBLANC NIGHTFLIGHT

> Pocket Accessories

LEATHER | FABRIC | LINING



Black | Black |
Anthracite

EMBLEM



MODEL	Passport Holder International
IDENT No.	38041
MATERIAL	
LEATHER	Silk / cotton fabric with fine rib structure, resistant to stains, water and scratches, voyage-proofed, combined with soft leather, chrome-tanned, dyed through
LINING	Jacquard lining with Montblanc brand name
FITTINGS/EMBLEM	Montblanc emblem with palladium-coated ring
FEATURES	
CLOSURE/LOCK	-
POCKETS	-
INTERIOR ORGANISATION	Pocket suitable for all international passports, additional pocket
ADDITIONAL CHARACTERISTICS	-
REFILLS	-
DIMENSIONS	
DIMENSIONS	10 x 13,5 cm

MONTBLANC NIGHTFLIGHT

> Horizontal Wallets without Coin Case

LEATHER | FABRIC | LINING



Black | Black |
Anthracite

EMBLEM



MODEL	Wallet 6cc	Wallet 8cc
IDENT No.	38043	08774
MATERIAL		
LEATHER	Silk / cotton fabric with fine rib structure, resistant to stains, water and scratches, voyage-proofed, combined with soft leather, chrome-tanned, dyed through	Silk / cotton fabric with fine rib structure, resistant to stains, water and scratches, voyage-proofed, combined with soft leather, chrome-tanned, dyed through
LINING	Jacquard lining with Montblanc brand name	Jacquard lining with Montblanc brand name
FITTINGS/EMBLEM	Montblanc emblem with palladium-coated ring	Montblanc emblem with palladium-coated ring
FEATURES		
CLOSURE/LOCK	-	-
POCKETS	-	-
INTERIOR ORGANISATION	6 pockets for credit cards, 2 compartments for banknotes, 2 additional pockets	8 pockets for credit cards, 2 compartments for banknotes, 2 additional pockets
ADDITIONAL CHARACTERISTICS	-	-
REFILLS	-	-
DIMENSIONS		
DIMENSIONS	12 x 8,5 cm	11 x 9,5 cm

MONTBLANC NIGHTFLIGHT

> Horizontal Wallets with Coin Case

LEATHER | FABRIC | LINING



Black | Black |
Anthracite

EMBLEM



MODEL	Wallet 4cc
IDENT No.	o8775
MATERIAL	
LEATHER	Silk / cotton fabric with fine rib structure, resistant to stains, water and scratches, voyage-proofed, combined with soft leather, chrome-tanned, dyed through
LINING	Jacquard lining with Montblanc brand name
FITTINGS/EMBLEM	Montblanc emblem with palladium-coated ring
FEATURES	
CLOSURE/LOCK	-
POCKETS	-
INTERIOR ORGANISATION	4 pockets for credit cards, 2 compartments for banknotes, additional pocket, coin pocket with flap
ADDITIONAL CHARACTERISTICS	-
REFILLS	-
DIMENSIONS	
DIMENSIONS	11 x 10 cm

MONTBLANC NIGHTFLIGHT

> Horizontal Wallets with Coin Case

LEATHER | FABRIC | LINING



Black | Black |
Anthracite

EMBLEM



MODEL	Wallet 6cc with View Pocket
IDENT No.	101859
MATERIAL	
LEATHER	Silk / cotton fabric with fine rib structure, resistant to stains, water and scratches, voyage-proofed, combined with soft leather, chrome-tanned, dyed through
LINING	Jacquard lining with Montblanc brand name
FITTINGS/EMBLEM	Montblanc emblem with palladium-coated ring
FEATURES	
CLOSURE/LOCK	-
POCKETS	-
INTERIOR ORGANISATION	6 pockets for credit cards, small view pocket, 2 compartments for banknotes, 4 additional pockets, coin case with flap
ADDITIONAL CHARACTERISTICS	-
REFILLS	-
DIMENSIONS	
DIMENSIONS	12.5 x 9 cm



MONTBLANC SIGNATURE

> Large Leather Goods

> Business Bags



Single Gusset Briefcase

Id. 107233 p. 208



Double Gusset Briefcase

Id. 107765 p. 208



Document Case with 2 Compartments

Id. 106752 p. 209

> City Bags



Clutch Bag

Id. 107234 p. 210



Envelope Bag

Id. 106753 p. 210



North South Bag Mini with Zip

Id. 106754 p. 211



North South Bag Small with Zip

Id. 106755 p. 211



Camera Bag

Id. 106756 p. 212



Tote Bag

Id. 106757 p. 213



Messenger Bag

Id. 106758 p. 212

> Travel Bags



Travel Companion

Id. 107235 p. 214



Trolley On-board

Id. 106759 p. 215

MONTBLANC SIGNATURE

> Small Leather Goods

> Pocket Accessories



Key Fob

Id. 107692

p. 216



Pocket Holder 6cc

Id. 106747

p. 216



Business Card Holder

Id. 106748

p. 217



Passport Holder International

Id. 107237

p. 217

> Horizontal Wallets without Coin Case



Wallet 6cc

Id. 106749

p. 218



Wallet 6cc with Money Clip

Id. 107770

p. 218



Wallet 6cc with 2 View Pockets

Id. 107829

p. 219



Wallet 8cc

Id. 107771

p. 219



Wallet 11cc with View Pocket

Id. 107830

p. 220

> Horizontal Wallets with Coin Case



Wallet 4cc

Id. 106750

p. 221



Wallet 10cc

Id. 107831

p. 221

> Long Wallets



Wallet 12cc

Id. 106751

p. 222

> Writing Instrument Pouches



2 Pen Pouch with Zip

Id. 107769

p. 223

MONTBLANC SIGNATURE

> Business Bags

LEATHER | FABRIC | LINING

Black | Black |
Black

CLOSURE | EMBLEM



Passion for detail. Montblanc's iconic M, masterly engraved on each Meisterstück Fountain Pen nib since 1924, has taken centre-stage as the inspiration for this Montblanc leather collection.

An imprinted Icon

Montblanc Signature

The overall pattern printed on the fabric subtly signs each piece of the range, giving it an iconic touch. Crafted with decorative yet robust leather elements, this line is made for the gentleman who drives, as an eye-catching accent to his wardrobe.

MODEL	Single Gusset Briefcase	Double Gusset Briefcase
IDENT No.	107233	107765
MATERIAL		
LEATHER	High-performance PVC-coated fabric, highly resistant to abrasion, water and dirt, combined with Italian full-grain printed calfskin, chrome-tanned, semi-aniline-dyed through	High-performance PVC-coated fabric, highly resistant to abrasion, water and dirt, combined with Italian full-grain printed calfskin, chrome-tanned, semi-aniline-dyed through
LINING	Jacquard 100% cotton	Jacquard 100% cotton
FITTINGS/EMBLEM	Stainless steel with shiny finish, embossed brand name, Montblanc emblem with palladium-coated ring	Stainless steel with shiny finish, embossed brand name, Montblanc emblem with palladium-coated ring
FEATURES		
CLOSURE/LOCK	Flap with snap lock	Flap with snap lock
POCKETS	1 main compartment, large inner pocket, large back pocket	2 main compartments, 2 large front pockets, large zipped inner pocket, large back pocket
INTERIOR ORGANISATION	Pockets for mobile phone (PDA size), 3 writing instruments and 2 credit cards	Pockets for mobile phone (PDA size), 3 writing instruments and 2 credit cards
STRAP	-	Detachable and adjustable branded shoulder strap
ADDITIONAL CHARACTERISTICS	Protective bottom with 3 rings profile, comfortable leather handle, satellite system	Protective bottom with 3 rings profile, comfortable leather handle, satellite system
DIMENSIONS		
DIMENSIONS	36 x 26 x 10 cm	41 x 30 x 13 cm

LEATHER

MONTBLANC SIGNATURE

> Business Bags

LEATHER | FABRIC | LINING



Black | Black |
Black

EMBLEM



MODEL	Document Case with 2 Compartments
IDENT No.	106752
MATERIAL	
LEATHER	High-performance PVC-coated fabric, highly resistant to abrasion, water and dirt, combined with Italian full-grain printed calfskin, chrome-tanned, semi-aniline-dyed through
LINING	Jacquard 100% cotton
FITTINGS/EMBLEM	Stainless steel with shiny finish, embossed brand name, Montblanc emblem with palladium-coated ring
FEATURES	
CLOSURE/LOCK	2 zips with kissing sliders
POCKETS	2 main compartments, 1 pocket for a laptop (max. size 38 x 24 x 6.5 cm) closed by a press-stud
INTERIOR ORGANISATION	Pockets for mobile phone (PDA size), 3 writing instruments and 2 credit cards
STRAP	Adjustable branded shoulder strap in black
ADDITIONAL CHARACTERISTICS	Protective bottom with 3 rings profile, 2 comfortable leather handles, luggage tag, satellite system
DIMENSIONS	
DIMENSIONS	40 x 32 x 11.5 cm

MONTBLANC SIGNATURE

> City Bags

LEATHER | FABRIC | LINING

Black | Black |
Black

EMBLEM



MODEL	Clutch Bag	Envelope Bag
IDENT No.	107234	106753
MATERIAL		
LEATHER	High-performance PVC-coated fabric, highly resistant to abrasion, water and dirt, combined with Italian full-grain printed calfskin, chrome-tanned, semi-aniline-dyed through	High-performance PVC-coated fabric, highly resistant to abrasion, water and dirt, combined with Italian full-grain printed calfskin, chrome-tanned, semi-aniline-dyed through
LINING	Jacquard 100% cotton	Jacquard 100% cotton
FITTINGS/EMBLEM	Stainless steel with shiny finish, embossed brand name, Montblanc emblem with palladium-coated ring	Stainless steel with shiny finish, embossed brand name, Montblanc emblem with palladium-coated ring
FEATURES		
CLOSURE/LOCK	Metal zip	Press-stud
POCKETS	1 main compartment, front pocket	1 main compartment compatible with iPad
INTERIOR ORGANISATION	Pockets for mobile phone (PDA size) and 3 writing instruments	Pockets for mobile phone (PDA size) and 2 writing instruments
STRAP	Leather wrist strap	Adjustable branded shoulder strap in black
ADDITIONAL CHARACTERISTICS	Protective bottom with 3 rings motif	Protective bottom with 3 rings motif
DIMENSIONS		
DIMENSIONS	26 x 16 x 5 cm	24.5 x 30 cm

MONTBLANC SIGNATURE

> City Bags

LEATHER | FABRIC | LINING



Black | Black |
Black

EMBLEM



MODEL	North South Bag Small with Zip	North South Bag Mini with Zip
IDENT No.	106755	106754
MATERIAL		
LEATHER	High-performance PVC-coated fabric, highly resistant to abrasion, water and dirt, combined with Italian full-grain printed calfskin, chrome-tanned, semi-aniline-dyed through	High-performance PVC-coated fabric, highly resistant to abrasion, water and dirt, combined with Italian full-grain printed calfskin, chrome-tanned, semi-aniline-dyed through
LINING	Jacquard 100% cotton	Jacquard 100% cotton
FITTINGS/EMBLEM	Stainless steel with shiny finish, embossed brand name, Montblanc emblem with palladium-coated ring	Stainless steel with shiny finish, embossed brand name, Montblanc emblem with palladium-coated ring
FEATURES		
CLOSURE/LOCK	Zip	Zip
POCKETS	1 main compartment, front pocket, additional pocket	1 main compartment, additional pocket
INTERIOR ORGANISATION	Pockets for mobile phone (PDA size) and 3 writing instruments	Pockets for mobile phone (PDA size) and 2 writing instruments
STRAP	Adjustable branded shoulder strap in black	Adjustable branded shoulder strap in black
ADDITIONAL CHARACTERISTICS	Protective bottom with 3 rings motif	Protective bottom with 3 rings motif
DIMENSIONS		
DIMENSIONS	23 x 27,5 x 8,5 cm	18 x 22,5 x 5,5

MONTBLANC SIGNATURE

> City Bags

LEATHER | FABRIC | LINING

Black | Black |
Black

EMBLEM



MODEL	Camera Bag	Messenger Bag
IDENT No.	106756	106758
MATERIAL		
LEATHER	High-performance PVC-coated fabric, highly resistant to abrasion, water and dirt, combined with Italian full-grain printed calfskin, chrome-tanned, semi-aniline-dyed through	High-performance PVC-coated fabric, highly resistant to abrasion, water and dirt, combined with Italian full-grain printed calfskin, chrome-tanned, semi-aniline-dyed through
LINING	Jacquard 100% cotton	Jacquard 100% cotton
FITTINGS/EMBLEM	Stainless steel with shiny finish, embossed brand name, Montblanc emblem with palladium-coated ring	Stainless steel metal fittings, embossed brand name, Montblanc emblem with palladium-coated ring
FEATURES		
CLOSURE/LOCK	2 zips including 1 with kissing sliders	Flap with 2 hidden magnets
POCKETS	1 main compartment, front pocket	1 main compartment, back pocket, additional pocket
INTERIOR ORGANISATION	Pockets for mobile phone (PDA size) and 3 writing instruments	Pockets for mobile phone (PDA size), 3 writing instruments and 2 credit cards
STRAP	Adjustable branded shoulder strap in black	Adjustable branded shoulder strap in black
ADDITIONAL CHARACTERISTICS	Protective bottom with 3 rings motif	Protective bottom with 3 rings motif
DIMENSIONS		
DIMENSIONS	30 x 20 x 11.5 cm	36.5 x 30 x 8.5 cm

MONTBLANC SIGNATURE

> City Bags

LEATHER | FABRIC | LINING



Black | Black |
Black

EMBLEM



MODEL	Tote Bag
IDENT No.	106757
MATERIAL	
LEATHER	High-performance PVC-coated fabric, highly resistant to abrasion, water and dirt, combined with Italian full-grain printed calfskin, chrome-tanned, semi-aniline-dyed through
LINING	Jacquard 100% cotton
FITTINGS/EMBLEM	Stainless steel with shiny finish, embossed brand name, Montblanc emblem with palladium-coated ring
FEATURES	
CLOSURE/LOCK	Inside tongue with press stud
POCKETS	1 main compartment, additional pocket
INTERIOR ORGANISATION	Pockets for mobile phone (PDA size), 3 writing instruments and 2 credit card pockets
STRAP	-
ADDITIONAL CHARACTERISTICS	Protective bottom with 3 rings motif, 2 comfortable leather handles
DIMENSIONS	
DIMENSIONS	34.5 x 38 x 11 cm

MONTBLANC SIGNATURE

> Travel Bags

LEATHER | FABRIC | LINING



Black | Black |
Black

EMBLEM



MODEL	Travel Companion
IDENT No.	107235
MATERIAL	
LEATHER	High-performance PVC-coated fabric, highly resistant to abrasion, water and dirt, combined with Italian full-grain printed calfskin, chrome-tanned, semi-aniline-dyed through
LINING	Jacquard 100% cotton
FITTINGS/EMBLEM	Stainless steel with shiny finish, embossed brand name, Montblanc emblem with palladium-coated ring
FEATURES	
CLOSURE/LOCK	2 zips
POCKETS	2 main compartments, large zipped inner pocket
INTERIOR ORGANISATION	Pockets for mobile phone (PDA size), 1 writing instrument, 17 credit cards and flight ticket; view pocket, 2 banknote compartments, additional pocket
STRAP	Retractable leather wrist strap
ADDITIONAL CHARACTERISTICS	-
DIMENSIONS	
DIMENSIONS	22 x 13 x 4 cm

MONTBLANC SIGNATURE

> Travel Bags

LEATHER | FABRIC | LINING



Black | Black |
Black

EMBLEM



MODEL	Trolley On-board
IDENT No.	106759
MATERIAL	
LEATHER	High-performance PVC-coated fabric, highly resistant to abrasion, water and dirt, combined with Italian full-grain printed calfskin, chrome-tanned, semi-aniline-dyed through
LINING	Jacquard 100% cotton
FITTINGS/EMBLEM	Stainless steel with satin finish, embossed brand name, Montblanc emblem with palladium-coated ring
FEATURES	
CLOSURE/LOCK	2 zips with kissing sliders
POCKETS	Main compartment for clothes with elastic straps, spacious compartment with zipped cover, 3 zipped pockets and 2 view pockets, small pocket and 2 zipped pockets, zipped front pocket with large inner pocket and zipped pocket, zipped back pocket
INTERIOR ORGANISATION	Pockets for mobile phone (PDA size), 2 writing instruments, 3 small and 2 medium-sized document pockets, ring for keys
STRAP	-
ADDITIONAL CHARACTERISTICS	Quiet-running aluminium wheels, robust wheel case with aluminium trim, stable 3-length handle extensions, comfortable leather handle, rubber top handle, additional handle at side, strap to attach another bag, rubber zip pullers, luggage tag
DIMENSIONS + WEIGHT	
DIMENSIONS	56 x 38 x 22 cm
WEIGHT	5.4 kg

MONTBLANC SIGNATURE

> Pocket Accessories

LEATHER | FABRIC | LINING



Black | Black |
Black

EMBLEM

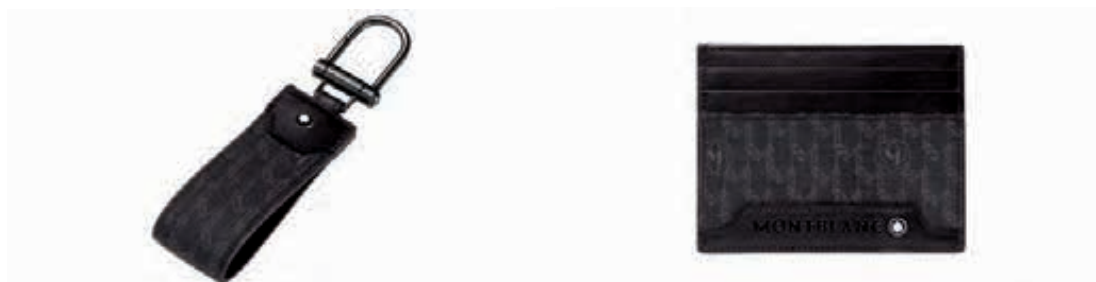

MODEL	Key Fob	Pocket Holder 6cc
IDENT No.	107692	106747
MATERIAL		
LEATHER	High-performance PVC-coated fabric, highly resistant to abrasion, water and dirt, combined with Italian full-grain printed calfskin, chrome-tanned, semi-aniline-dyed through	High-performance PVC-coated fabric, highly resistant to abrasion, water and dirt, combined with Italian full-grain printed calfskin, chrome-tanned, semi-aniline-dyed through
LINING	-	Jacquard lining 60% cotton 40% polyamide
FITTINGS/EMBLEM	Montblanc emblem with palladium-coated ring	Embossed brand name, Montblanc emblem with palladium-coated ring
FEATURES		
CLOSURE/LOCK	-	-
POCKETS	-	-
INTERIOR ORGANISATION	Ring for several keys	6 pockets for credit cards, additional pocket
ADDITIONAL CHARACTERISTICS	-	-
REFILLS	-	-
DIMENSIONS		
DIMENSIONS	3 x 10 cm	8 x 10 cm

MONTBLANC SIGNATURE

> Pocket Accessories

LEATHER | FABRIC | LINING

Black | Black |
Black

EMBLEM



MODEL	Business Card Holder	Passport Holder International
IDENT No.	106748	107237
MATERIAL		
LEATHER	High-performance PVC-coated fabric, highly resistant to abrasion, water and dirt, combined with Italian full-grain printed calfskin, chrome-tanned, semi-aniline-dyed through	High-performance PVC-coated fabric, highly resistant to abrasion, water and dirt, combined with Italian full-grain printed calfskin, chrome-tanned, semi-aniline-dyed through
LINING	Jacquard lining 60% cotton 40% polyamide	Jacquard lining 60% cotton 40% polyamide
FITTINGS/EMBLEM	Embossed brand name, Montblanc emblem with palladium-coated ring	Embossed brand name, Montblanc emblem with palladium-coated ring
FEATURES		
CLOSURE/LOCK	-	-
POCKETS	-	-
INTERIOR ORGANISATION	Compartment for business cards, 2 pockets for credit cards, additional pocket	Pocket suitable for all international passports
ADDITIONAL CHARACTERISTICS	-	-
REFILLS	-	-
DIMENSIONS		
DIMENSIONS	7,5 x 11 cm	10,5 x 14 cm

MONTBLANC SIGNATURE

> Horizontal Wallets without Coin Case

LEATHER | FABRIC | LINING

Black | Black |
Black

EMBLEM



MODEL	Wallet 6cc	Wallet 6cc with Money Clip
IDENT No.	106749	107770
MATERIAL		
LEATHER	High-performance PVC-coated fabric, highly resistant to abrasion, water and dirt, combined with Italian full-grain printed calfskin, chrome-tanned, semi-aniline-dyed through	High-performance PVC-coated fabric, highly resistant to abrasion, water and dirt, combined with Italian full-grain printed calfskin, chrome-tanned, semi-aniline-dyed through
LINING	Jacquard lining 60% cotton 40% polyamide	Jacquard lining 40% Nylon 60% Viscose with Montblanc emblem
FITTINGS/EMBLEM	Embossed brand name, Montblanc emblem with palladium-coated ring	Embossed brand name, Montblanc emblem with palladium-coated ring
FEATURES		
CLOSURE/LOCK	-	-
POCKETS	-	-
INTERIOR ORGANISATION	6 pockets for credit cards, compartment for banknotes, 2 additional pockets	6 pockets for credit cards
ADDITIONAL CHARACTERISTICS	-	Money clip with embossed Montblanc emblem
REFILLS	-	-
DIMENSIONS		
DIMENSIONS	8,5 x 11,5 cm	11 x 8 cm

MONTBLANC SIGNATURE

> Horizontal Wallets without Coin Case

LEATHER | FABRIC | LINING



Black | Black |
Black

EMBLEM



MODEL	Wallet 6cc with 2 View Pockets	Wallet 8cc
IDENT No.	107829	107771
MATERIAL		
LEATHER	High-performance PVC-coated fabric, highly resistant to abrasion, water and dirt, combined with Italian full-grain printed calfskin, chrome-tanned, semi-aniline-dyed through	High-performance PVC-coated fabric, highly resistant to abrasion, water and dirt, combined with Italian full-grain printed calfskin, chrome-tanned, semi-aniline-dyed through
LINING	Jacquard lining 40% Nylon 60% Viscose with Montblanc emblem	Jacquard lining 40% Nylon 60% Viscose with Montblanc emblem
FITTINGS/EMBLEM	Embossed brand name, Montblanc emblem with palladium-coated ring	Embossed brand name, Montblanc emblem with palladium-coated ring
FEATURES		
CLOSURE/LOCK	-	-
POCKETS	-	-
INTERIOR ORGANISATION	6 pockets for credit cards, compartment for banknotes, 2 view pockets, 3 additional pockets	8 pockets for credit cards, compartment for banknotes, 2 additional pockets
ADDITIONAL CHARACTERISTICS	-	-
REFILLS	-	-
DIMENSIONS		
DIMENSIONS	11 x 9 cm	12 x 9,5 cm

MONTBLANC SIGNATURE

> Horizontal Wallets without Coin Case

LEATHER | FABRIC | LINING



Black | Black |
Black

EMBLEM



MODEL	Wallet 11cc with View Pocket
IDENT No.	107830
MATERIAL	
LEATHER	High-performance PVC-coated fabric, highly resistant to abrasion, water and dirt, combined with Italian full-grain printed calfskin, chrome-tanned, semi-aniline-dyed through
LINING	Jacquard lining 40% Nylon 60% Viscose with Montblanc emblem
FITTINGS/EMBLEM	Embossed brand name, Montblanc emblem with palladium-coated ring
FEATURES	
CLOSURE/LOCK	-
POCKETS	-
INTERIOR ORGANISATION	11 pockets for credit cards, small view pocket, compartment for banknotes, 3 additional pockets
ADDITIONAL CHARACTERISTICS	-
REFILLS	-
DIMENSIONS	
DIMENSIONS	11.5 x 9.5 cm

MONTBLANC SIGNATURE

> Horizontal Wallets with Coin Case

LEATHER | FABRIC | LINING

Black | Black |
Black

EMBLEM



MODEL	Wallet 4cc	Wallet 10cc
IDENT No.	106750	107831
MATERIAL		
LEATHER	High-performance PVC-coated fabric, highly resistant to abrasion, water and dirt, combined with Italian full-grain printed calfskin, chrome-tanned, semi-aniline-dyed through	High-performance PVC-coated fabric, highly resistant to abrasion, water and dirt, combined with Italian full-grain printed calfskin, chrome-tanned, semi-aniline-dyed through
LINING	Jacquard lining 60% cotton 40% polyamide	Jacquard lining 40% Nylon 60% Viscose with Montblanc emblem
FITTINGS/EMBLEM	Embossed brand name, Montblanc emblem with palladium-coated ring	Embossed brand name, Montblanc emblem with palladium-coated ring
FEATURES		
CLOSURE/LOCK	-	-
POCKETS	-	-
INTERIOR ORGANISATION	4 pockets for credit cards, compartment for banknotes, additional pocket, flap coin pocket	10 pockets for credit cards, compartment for banknotes, flap coin case
ADDITIONAL CHARACTERISTICS	-	-
REFILLS	-	-
DIMENSIONS		
DIMENSIONS	9,5 x 11 cm	11,5 x 9,5 cm

LEATHER

MONTBLANC SIGNATURE

> Long Wallets

LEATHER | FABRIC | LINING



Black | Black |
Black

EMBLEM



MODEL	Wallet 12cc
IDENT No.	106751
MATERIAL	
LEATHER	High-performance PVC-coated fabric, highly resistant to abrasion, water and dirt, combined with Italian full-grain printed calfskin, chrome-tanned, semi-aniline-dyed through
LINING	Jacquard lining 60% cotton 40% polyamide
FITTINGS/EMBLEM	Embossed brand name, Montblanc emblem with palladium-coated ring
FEATURES	
CLOSURE/LOCK	-
POCKETS	-
INTERIOR ORGANISATION	12 pockets for credit cards, gusset for banknotes, 3 additional pockets
ADDITIONAL CHARACTERISTICS	-
REFILLS	-
DIMENSIONS	
DIMENSIONS	10 x 19 cm

MONTBLANC SIGNATURE

> Writing Instrument Pouches

LEATHER | FABRIC | LINING



Black | Black |
Black

EMBLEM



MODEL	2 Pen Pouch with Zip
IDENT No.	107769
MATERIAL	
LEATHER	High-performance PVC-coated fabric, highly resistant to abrasion, water and dirt, combined with Italian full-grain printed calfskin, chrome-tanned, semi-aniline-dyed through
LINING	Jacquard lining 60% cotton 40% polyamide
FITTINGS/EMBLEM	Embossed brand name, Montblanc emblem with palladium-coated ring
FEATURES	
CLOSURE/LOCK	Metal zip
POCKETS	-
INTERIOR ORGANISATION	Compartment for 2 writing instruments the size of a Meisterstück Classique or LeGrand
ADDITIONAL CHARACTERISTICS	-
REFILLS	-
DIMENSIONS	
DIMENSIONS	4,5 x 16 cm

LEATHER



The Diaries & Notes collection: a tribute to Florentine craftsmanship.
The subtle touch of the high-quality calfskin awakens all the senses.
Enjoy the aroma of the natural leather and the noble look of its warm
colours and masterly crafted cut edges.

Inspired by the Colours of Nature

Diaries & Notes

The distinctive fine leather gains patina with daily use, making each
piece a unique companion for jotting down thoughts and ideas.

DIARIES & NOTES

> Small Leather Goods

> Pocket Accessories



Pocket Holder 2cc

Id. 109200

p. 228



Pocket Holder 2cc

Id. 109201

p. 228



Pocket Holder 2cc

Id. 109212

p. 228



Business Card Holder

Id. 109214

p. 228



Business Card Holder

Id. 109213

p. 228



Business Card Holder

Id. 109215

p. 228

> Organisers & Agendas



Agenda Small

Id. 109206

p. 229



Agenda Small

Id. 109205

p. 229



Agenda Small

Id. 109207

p. 229



Organiser Medium

Id. 109222

p. 230



Organiser Medium

Id. 109211

p. 230



Organiser Medium

Id. 109223

p. 230

DIARIES & NOTES

> *Small Leather Goods*

> *Notes*



Notebook Medium

Id. 109209

p. 231



Notebook Medium

Id. 109208

p. 231



Notebook Medium

Id. 109210

p. 231

DIARIES & NOTES

> Pocket Accessories

LEATHER | LINING



Black | Dark Toffee



Cognac | Dark Grey



Sand | Dark Toffee

EMBLEM



MODEL	Pocket Holder zcc	Business Card Holder
IDENT No.		
Black Dark Toffee	109200	109214
Cognac Dark Grey	109201	109213
Sand Dark Toffee	109212	109215
MATERIAL		
LEATHER	Full-grain calfskin, vegetable tanned, aniline-dyed through	Full-grain calfskin, vegetable tanned, aniline-dyed through
LINING	Jacquard lining with emblematic "M" pattern	Jacquard lining with emblematic "M" pattern
FITTINGS/EMBLEM	Montblanc emblem with palladium-coated ring	Montblanc emblem with palladium-coated ring
FEATURES		
CLOSURE/LOCK	-	-
POCKETS	-	2 pockets for business cards, 2 pockets for credit cards
INTERIOR ORGANISATION	2 pockets for credit cards, additional pocket	-
ADDITIONAL CHARACTERISTICS	Reference ID: 106810	Reference ID: 106813
REFILLS	-	-
DIMENSIONS		
DIMENSIONS	11 x 7 cm	8 x 10.5 cm

DIARIES & NOTES

> Organisers & Agendas

LEATHER | LINING



Black | Dark
Toffee



Cognac | Dark
Grey



Sand | Dark
Toffee

EMBLEM



MODEL	Agenda Small
IDENT No.	
Black Dark Toffee	109206
Cognac Dark Grey	109205
Sand Dark Toffee	109207
MATERIAL	
LEATHER	Full-grain calfskin, vegetable tanned, aniline-dyed through
LINING	Jacquard lining with emblematic "M" pattern
FITTINGS/EMBLEM	Montblanc emblem with palladium-coated ring
FEATURES	
CLOSURE/LOCK	-
POCKETS	5 pockets for credit cards, additional pocket
INTERIOR ORGANISATION	-
ADDITIONAL CHARACTERISTICS	Loop for writing instrument the size of Meisterstück Classique, and calendar. Reference ID: 106816
REFILLS	Calendar 2014 Vertical (Id. 110145)
DIMENSIONS	
DIMENSIONS	11.5 x 16.5 x 1.2 cm

DIARIES & NOTES

> Organisers & Agendas

LEATHER | LINING

Black | Dark
ToffeeCognac | Dark
GreySand | Dark
Toffee

EMBLEM



MODEL	Organiser Medium
IDENT No.	
Black Dark Toffee	109222
Cognac Dark Grey	109211
Sand Dark Toffee	109223
MATERIAL	
LEATHER	Full-grain calfskin, vegetable tanned, aniline-dyed through
LINING	Jacquard lining with emblematic "M" pattern
FITTINGS/EMBLEM	Montblanc emblem with palladium-coated ring
FEATURES	
CLOSURE/LOCK	-
POCKETS	5 pockets for credit cards, additional pocket
INTERIOR ORGANISATION	-
ADDITIONAL CHARACTERISTICS	Loop for writing instrument the size of Meisterstück LeGrand or Classique, and organisation sheets. Reference ID: 106822
REFILLS	Starter Kit Medium (Id. 08403), Telephone-Address Sheets Medium (Id. 03027), Organisation Kit Medium (Id. 03028), Daily Plan Pages Medium (Id. 03025), Blank Sheets Medium (Id. 03021), Squared Sheets Medium (Id. 03026), Calendar 2014 Medium (Id. 110139, 110140)
DIMENSIONS	
DIMENSIONS	15 x 19 x 3.8 cm

DIARIES & NOTES

> Notes

LEATHER | LINING

Black | Dark
ToffeeCognac | Dark
GreySand | Dark
Toffee

EMBLEM





















MODEL	Notebook Medium
IDENT No.	
Black Dark Toffee	109209
Cognac Dark Grey	109208
Sand Dark Toffee	109210
MATERIAL	
LEATHER	Full-grain calfskin, vegetable tanned, aniline-dyed through
LINING	Jacquard lining with emblematic "M" pattern
FITTINGS/EMBLEM	Montblanc emblem with palladium-coated ring
FEATURES	
CLOSURE/LOCK	-
POCKETS	5 pockets for credit cards, additional pocket
INTERIOR ORGANISATION	-
ADDITIONAL CHARACTERISTICS	Loop for writing instrument the size of Meisterstück LeGrand or Classique, and notebook. Reference ID: 106819
REFILLS	Notebook Medium (ld. 9596)
DIMENSIONS	
DIMENSIONS	20 x 23 x 2 cm

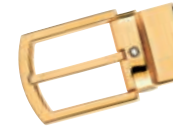

BELTS



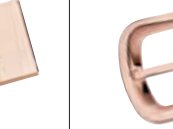

















> Montblanc Classic Line 30 mm

 Reversible Leather Strap Black/Brown 120 x 3 cm										
 3 Rings Motif Shiny Stainless Steel Pin Buckle Id. 106147 p. 234	 3 Rings Motif Oval Shiny Stainless Steel Pin Buckle Id. 106148 p. 234	 3 Rings Motif Trapezium Shiny Stainless Steel Pin Buckle Id. 106149 p. 235	 Rectangular Cut Shiny Palladium-Coated Pin Buckle Id. 109738 p. 235	 Square Shiny Palladium-Coated Pin Buckle Id. 107664 p. 236	 Montblanc Star Rectangular Shiny Palladium-Coated Pin Buckle Id. 09695 p. 236	 Horseshoe Shiny Palladium-Coated Pin Buckle Id. 38157 p. 236	 Revolving Oval Shiny Palladium-Coated Pin Buckle Id. 105123 p. 237	 Star 3 Rings Motif Shiny Palladium-Coated Box Buckle Id. 09693 p. 237	 Horseshoe Shiny Palladium-Coated with Black Inlay Pin Buckle Id. 109740 p. 238	 Oval Shiny Palladium-Coated Box Buckle Id. 106598 p. 238
 Montblanc Star Rectangular Shiny Gold-Coated Pin Buckle Id. 05562 p. 239	 Rectangular Curved Shiny Yellow-Gold-Coated Pin Buckle Id. 109739 p. 239	 Horseshoe Shiny Gold-Coated Pin Buckle Id. 106600 p. 240	 Revolving Oval Shiny Gold-Coated Pin Buckle Id. 38579 p. 240	 3 Rings Bowed Shiny Light Gold-Coated Pin Buckle Id. 107663 p. 240	 Revolving Oblong Shiny Red Gold-Coated Pin Buckle Id. 105122 p. 241	 Revolving Oval Shiny Red-Gold-Coated Pin Buckle Id. 101896 p. 241	 Trapeze Shiny Red-Gold-Coated Pin Buckle Id. 109737 p. 241			

> Montblanc Classic Line 35 mm

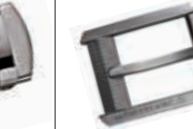











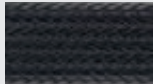

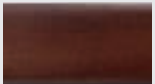
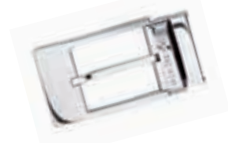

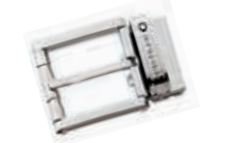

 Black 120 x 3.5 cm	 Cognac 120 x 3.5 cm	 Dark Brown 120 x 3.5 cm	 Black 120 x 3.5 cm	 Burgundy 120 x 3.5 cm	 Navy 120 x 3.5 cm	 Flannel 120 x 3.5 cm	 Cognac 120 x 3.5 cm					
 Horseshoe Shiny Light-Gold-Coated Pin Buckle Id. 109747 p. 242	 Rectangular Roll Shiny Palladium-Coated Pin Buckle Id. 109748 p. 243	 Rectangular Bevel Shiny & Mat Palladium-Coated Pin Buckle Id. 109749 p. 244	 Horseshoe Shiny & Mat Palladium-Coated Pin Buckle Id. 109755 p. 245	 Horseshoe Shiny & Mat Palladium-Coated Pin Buckle Id. 109756 p. 245	 Horseshoe Shiny & Mat Palladium-Coated Pin Buckle Id. 109757 p. 245	 Horseshoe Shiny & Mat Palladium-Coated Pin Buckle Id. 109758 p. 245	 Horseshoe Shiny & Mat Palladium-Coated Pin Buckle Id. 109759 p. 245	 Rectangular Shiny & Mat Palladium-Coated Pin Buckle Id. 109750 p. 245	 Rectangular Shiny & Mat Palladium-Coated Pin Buckle Id. 109751 p. 245	 Rectangular Shiny & Mat Palladium-Coated Pin Buckle Id. 109752 p. 245	 Rectangular Shiny & Mat Palladium-Coated Pin Buckle Id. 109753 p. 245	 Rectangular Shiny & Mat Palladium-Coated Pin Buckle Id. 109754 p. 245

> Montblanc Contemporary Line 30 mm

 Reversible Leather Strap Black/Brown 120 x 3 cm											
 Trapeze Shiny Palladium-Coated Pin Buckle Id. 09781 p. 246	 Trapeze Shiny Palladium-Coated Pin Buckle Id. 106601 p. 246	 Grains Shiny Palladium-Coated Pin Buckle Id. 109760 p. 247	 Square Shiny Palladium-Coated Pin Buckle Id. 107669 p. 247	 Rectangular Shiny Wave Palladium-Coated Pin Buckle Id. 09774 p. 248	 Horseshoe Shiny Palladium-Coated Pin Buckle Id. 106603 p. 248	 Rectangular Shiny Palladium-Coated Pin Buckle Id. 07222 p. 249	 Rectangular Rubber & Shiny Palladium-Coated Pin Buckle Id. 101899 p. 249	 3 Rings Motif Cut-Out Shiny Palladium-Coated Box Buckle Id. 103431 p. 250	 3 Rings Motif Cut-Out Shiny Palladium-Coated Box Buckle Id. 105084 p. 250	 3 Rings Carbon & Shiny Palladium-Coated Box Buckle Id. 101903 p. 250	 Wave Mat Palladium-Coated Pin Buckle Id. 09788 p. 251
 Bowed Mat Palladium-Coated Pin Buckle Id. 09795 p. 251	 Leather & Mat Palladium-Coated Pin Buckle Id. 38158 p. 252	 Meisterstück Mat Palladium-Coated Box Buckle Id. 38156 p. 252	 Rectangular Frame Ruthenium-Coated Pin Buckle Id. 109761 p. 253	 Horseshoe Shiny Ruthenium-Coated Pin Buckle Id. 105078 p. 253	 Elliptic Shiny Ruthenium-Coated Pin Buckle Id. 105080 p. 253	 Starwalker Shiny Ruthenium-Coated Pin Buckle Id. 38163 p. 254	 Starwalker Shiny Ruthenium-Coated Pin Buckle Id. 107668 p. 254	 3 Rings Motif Ruthenium- & Palladium-Coated Box Buckle Id. 103427 p. 255	 3 Rings Motif Ruthenium- & Palladium-Coated Box Buckle Id. 103429 p. 255	 Grooved Palladium- & Ruthenium-Coated Box Buckle Id. 103433 p. 256	

BELTS

> Montblanc Casual Line 35 mm

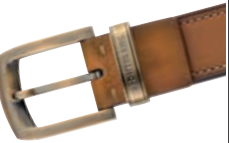
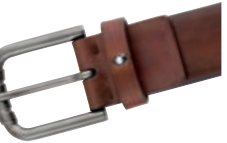
 ① Reversible black/brown leather strap 165 x 3.5 cm	 ② Black Plain French Calfskin Strap 120 x 3.5 cm	 ③ Braid-Printed Black Leather Strap 120 x 3.5 cm	 ④ Plain Stitched Tan Leather Strap 120 x 3.5 cm	 ⑤ Plain Brown Leather Strap 120 x 3.5 cm
 Oblong Shiny Palladium-Coated Pin Buckle ① Id. 09854 p. 257	 Round Shiny Palladium-Coated Pin Buckle ① Id. 101909 p. 257	 Meisterstück Soft Shiny Palladium-Coated Pin Buckle ① Id. 105092 p. 257	 Convex Shiny Ruthenium-Coated Pin Buckle ① Id. 103443 p. 258	 3 Rings Motif Shiny Ruthenium-Coated Pin Buckle ① Id. 103445 p. 258
 Starwalker Shiny Ruthenium-Coated Pin Buckle ① Id. 106604 p. 258	 Cut Mat Ruthenium-Coated Pin Buckle ① Id. 105090 p. 259	 Round Horseshoe Shiny Palladium-Coated Pin Buckle ② Id. 107673 p. 260	 Rectangular Cut Shiny Palladium-Coated Pin Buckle ② Id. 107674 p. 260	 Horseshoe Cut Shiny Palladium-Coated Pin Buckle ② Id. 107675 p. 260
 Rectangular Shiny Palladium-Coated Pin Buckle ② Id. 107676 p. 261	 Bowed Shiny Palladium-Coated Pin Buckle ① Id. 107677 p. 261	 Rectangular Profile Palladium-Coated Pin Buckle ② Id. 107678 p. 261	 Montblanc Signature Shiny Ruthenium-Coated Box Buckle ① Id. 109771 p. 262	 Rectangular Shiny Palladium-Coated Pin Buckle ① Id. 109768 p. 263
 Squarish Horseshoe Mat Bronze-Coated Pin Buckle ① Id. 109769 p. 264	 3 Rings Motif Horseshoe Mat Ruthenium-Coated Pin Buckle ① Id. 109770 p. 265			

> Montblanc Casual Line 40 mm

 ① Black Palmellato Printed Leather Strap 120 x 4 cm	 ② Brown Palmellato Printed Leather Strap 120 x 4 cm	 ③ Grained Black Leather Strap 120 x 4 cm
 Rectangular Tube Palladium-Coated Pin Buckle ① Id. 107679 p. 266	 Rounded Rectangular Palladium-Coated Pin Buckle ① Id. 107680 p. 266	 Rectangular Frame Shiny & Mat Palladium-Coated Pin Buckle ① Id. 109772 p. 267
 Square Mat Bronze-Coated Pin Buckle ① Id. 107681 p. 268	 Squarish Mat Bronze-Coated Pin Buckle ① Id. 109773 p. 269	

> Montblanc Classic Line 30 mm · Annual Edition

 ① Plain Oxblood Leather Strap 120 x 3 cm	 ② Alligator-Printed Mocha Leather Strap 120 x 3 cm
 Horseshoe Shiny Palladium-Coated Pin Buckle ① Id. 109741 p. 270 ② Id. 109742 p. 270	 Montblanc Star Rectangular Shiny Gold-Coated Pin Buckle ① Id. 109743 p. 270 ② Id. 109744 p. 270
 Montblanc Star Oval Shiny Gold-Coated Pin Buckle ① Id. 109745 p. 270 ② Id. 109746 p. 270	

> Montblanc Contemporary Line 30 mm · Annual Edition

 ① Saffiano-Printed Brown Leather Strap 120 x 3 cm	 ② Dark Brown Nubuk Leather Strap 120 x 3 cm
 Rectangular Wave Shiny Palladium-Coated Pin Buckle ① Id. 109762 p. 271 ② Id. 109763 p. 271	 Wave Mat Palladium-Coated Pin Buckle ① Id. 109764 p. 271 ② Id. 109765 p. 271
 Elliptic Shiny Ruthenium-Coated Pin Buckle ① Id. 109766 p. 271 ② Id. 109767 p. 271	

BELTS

> Montblanc Classic Line 30 mm



1 Reversible
Leather Strap
Black/Brown



Colourful yet classic. The extraordinary leather and luxurious metals are fabricated with best Florentine craftsmanship:

A Journey for all the Senses

Belts

The fine leather is complemented by colourful strap variations and innovative buckles, perfectly crafted, stitch by stitch.

An indispensable accessory for men, not only for business but also for casual occasions.

MODEL	3 Rings Motif Shiny Stainless Steel Pin Buckle	3 Rings Motif Oval Shiny Stainless Steel Pin Buckle
IDENT No.		
1 Reversible Leather Strap Black/Brown	106147	106148
BUCKLE		
SHAPE	Rectangular	Oval
MATERIAL	Stainless steel	Stainless steel
COATING	-	-
FINISH	Shiny	Shiny
MECHANISM	Easy-to-open mechanism to adapt strap length	Easy-to-open mechanism to adapt strap length
EMBLEM	Engraved Montblanc brand name	Engraved Montblanc brand name
STRAP		
MATERIAL STRAP	Reversible black/brown leather strap	Reversible black/brown leather strap
STRAP LENGTH AND WIDTH	120 x 3 cm	120 x 3 cm

BELTS

> Montblanc Classic Line 30 mm



1 Reversible
Leather Strap
Black/Brown



MODEL	3 Rings Motif Trapezium Shiny Stainless Steel Pin Buckle	Rectangular Cut Shiny Palladium-Coated Pin Buckle
IDENT No.		
1 Reversible Leather Strap Black/Brown	106149	109738
BUCKLE		
SHAPE	Trapezium	Rectangular
MATERIAL	Stainless steel	Solid brass
COATING	-	Palladium-coated
FINISH	Shiny	Shiny
MECHANISM	Easy-to-open mechanism to adapt strap length	Easy-to-open mechanism to adapt strap length
EMBLEM	Engraved Montblanc brand name	Montblanc emblem
STRAP		
MATERIAL STRAP	Reversible black/brown leather strap	Reversible black/brown leather strap
STRAP LENGTH AND WIDTH	120 x 3 cm	120 x 3 cm

BELTS

> Montblanc Classic Line 30 mm



1 Reversible
Leather Strap
Black/Brown



MODEL	Square Shiny Palladium-Coated Pin Buckle	Montblanc Star Rectangular Shiny Palladium-Coated Pin Buckle	Horseshoe Shiny Palladium-Coated Pin Buckle
IDENT No.			
1 Reversible Leather Strap Black/Brown	107664	09695	38157
BUCKLE			
SHAPE	Square	Rectangular, slightly curved	Horseshoe
MATERIAL	Solid brass	Solid brass	Solid brass
COATING	Palladium-coated	Palladium-coated	Palladium-coated
FINISH	Shiny	Shiny	Shiny
MECHANISM	Easy-to-open mechanism to adapt strap length	Easy-to-open mechanism to adjust strap length	Easy-to-open mechanism to adjust strap length
EMBLEM	Montblanc emblem	Montblanc emblem	Engraved Montblanc emblem
STRAP			
MATERIAL STRAP	Reversible black/brown leather strap	Reversible black/brown leather strap	Reversible black/brown leather strap
STRAP LENGTH AND WIDTH	120 x 3 cm	120 x 3 cm	120 x 3 cm

BELTS

> Montblanc Classic Line 30 mm



1 Reversible
Leather Strap
Black/Brown



MODEL	Revolving Oval Shiny Palladium-Coated Pin Buckle	Star 3 Rings Motif Shiny Palladium-Coated Box Buckle
IDENT NO.		
1 Reversible Leather Strap Black/Brown	105123	09693
BUCKLE		
SHAPE	Oval	Round
MATERIAL	Solid brass	Solid brass
COATING	Palladium-coated	Palladium-coated
FINISH	Shiny	Shiny
MECHANISM	Twisting buckle	Easy-to-open mechanism to adjust strap length
EMBLEM	Engraved Montblanc brand name and emblem	Engraved Montblanc brand name and emblem
STRAP		
MATERIAL STRAP	Reversible black/brown leather strap	Reversible black/brown leather strap
STRAP LENGTH AND WIDTH	120 x 3 cm	120 x 3 cm

BELTS

> Montblanc Classic Line 30 mm



1 Reversible
Leather Strap
Black/Brown



MODEL	Horseshoe Shiny Palladium-Coated with Black Inlay Pin Buckle	Oval Shiny Palladium-Coated Box Buckle
IDENT No.		
1 Reversible Leather Strap Black/Brown	109740	106598
BUCKLE		
SHAPE	Horseshoe	Oval
MATERIAL	Solid brass	Solid brass and precious resin
COATING	Palladium-coated	Palladium-coated
FINISH	Shiny	Shiny
MECHANISM	Easy-to-open mechanism to adapt strap length	Easy-to-open mechanism to adjust strap length
EMBLEM	Montblanc emblem	Engraved Montblanc brand name and emblem
STRAP		
MATERIAL STRAP	Reversible black/brown leather strap	Reversible black/brown leather strap
STRAP LENGTH AND WIDTH	120 x 3 cm	120 x 3 cm

BELTS

> Montblanc Classic Line 30 mm

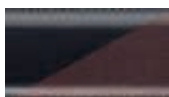

1 Reversible
Leather Strap
Black/Brown



MODEL	Montblanc Star Rectangular Shiny Gold-Coated Pin Buckle	Rectangular Curved Shiny Yellow-Gold-Coated Pin Buckle
IDENT No.		
1 Reversible Leather Strap Black/Brown	05562	109739
BUCKLE		
SHAPE	Rectangular, slightly curved	Rectangular
MATERIAL	Solid brass	Solid brass
COATING	Gold-coated	Yellow-gold-coated
FINISH	Shiny	Shiny
MECHANISM	Easy-to-open mechanism to adjust strap length	Easy-to-open mechanism to adapt strap length
EMBLEM	Montblanc emblem	Montblanc emblem
STRAP		
MATERIAL STRAP	Reversible black/brown leather strap	Reversible black/brown leather strap
STRAP LENGTH AND WIDTH	120 x 3 cm	120 x 3 cm

BELTS

> Montblanc Classic Line 30 mm



1 Reversible
Leather Strap
Black/Brown



MODEL	Horseshoe Shiny Gold-Coated Pin Buckle	Revolving Oval Shiny Gold-Coated Pin Buckle	3 Rings Bowed Shiny Light Gold-Coated Pin Buckle
IDENT No.			
1 Reversible Leather Strap Black/Brown	106600	38579	107663
BUCKLE			
SHAPE	Horseshoe	Oval	Rectangular
MATERIAL	Solid brass	Solid brass	Solid brass
COATING	Gold-coated	Gold-coated	Light gold-coated
FINISH	Shiny	Shiny	Shiny
MECHANISM	Easy-to-open mechanism to adjust strap length	Twisting buckle	Easy-to-open mechanism to adapt strap length
EMBLEM	Engraved Montblanc brand name	Montblanc emblem	Engraved Montblanc brand name
STRAP			
MATERIAL STRAP	Reversible black/brown leather strap	Reversible black/brown leather strap	Reversible black/brown leather strap
STRAP LENGTH AND WIDTH	120 x 3 cm	120 x 3 cm	120 x 3 cm

BELTS

> Montblanc Classic Line 30 mm



1 Reversible
Leather Strap
Black/Brown



MODEL	Revolving Oblong Shiny Red Gold-Coated Pin Buckle	Revolving Oval Shiny Red-Gold-Coated Pin Buckle	Trapeze Shiny Red-Gold-Coated Pin Buckle
IDENT No.			
1 Reversible Leather Strap Black/Brown	105122	101896	109737
BUCKLE			
SHAPE	Rectangular with curved top	Oval	Trapeze
MATERIAL	Solid brass	Solid brass	Solid brass
COATING	Red gold-plated	Red-gold-coated	Red-gold-coated
FINISH	Combination of shiny and satin finishes	Polished	Shiny
MECHANISM	Twisting buckle	Twisting buckle	Easy-to-open mechanism to adapt strap length
EMBLEM	Engraved Montblanc brand name	Montblanc emblem	Engraved Montblanc brand name
STRAP			
MATERIAL STRAP	Reversible black/brown leather strap	Reversible black/brown leather strap	Reversible black/brown leather strap
STRAP LENGTH AND WIDTH	120 x 3 cm	120 x 3 cm	120 x 3 cm

BELTS

> Montblanc Classic Line 35 mm



1 Black



MODEL	Horseshoe Shiny Light-Gold-Coated Pin Buckle
IDENT NO.	
1 Black	109747
BUCKLE	
SHAPE	Horseshoe
MATERIAL	Solid brass
COATING	Light gold-coated
FINISH	Shiny
MECHANISM	Hidden screw mechanism
EMBLEM	Engraved Montblanc brand name, Montblanc emblem on leather loop
STRAP	
MATERIAL STRAP	Plain Black Leather Strap
STRAP LENGTH AND WIDTH	120 x 3,5 cm

BELTS

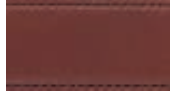
> *Montblanc Classic Line 35 mm*

1 Cognac



MODEL	Rectangular Roll Shiny Palladium-Coated Pin Buckle
IDENT NO.	
1 Cognac	109748
BUCKLE	
SHAPE	Rectangular
MATERIAL	Solid brass
COATING	Palladium-coated
FINISH	Shiny
MECHANISM	Hidden screw mechanism
EMBLEM	Montblanc emblem on leather loop
STRAP	
MATERIAL STRAP	Plain Cognac Leather Strap
STRAP LENGTH AND WIDTH	120 x 3,5 cm

BELTS

> Montblanc Classic Line 35 mm



1 Dark Brown



MODEL	Rectangular Bevel Shiny & Mat Palladium-Coated Pin Buckle
IDENT No. 1 Dark Brown	109749
BUCKLE	
SHAPE	Rectangular
MATERIAL	Solid brass, loop in zamak
COATING	Palladium-coated
FINISH	Shiny and mat
MECHANISM	Hidden screw mechanism
EMBLEM	Montblanc emblem on metal loop
STRAP	
MATERIAL STRAP	Plain Dark Brown Leather Strap
STRAP LENGTH AND WIDTH	120 x 3,5 cm

BELTS

> Montblanc Classic Line 35 mm



MODEL	Rectangular Shiny & Mat Palladium-Coated Pin Buckle	Horseshoe Shiny & Mat Palladium-Coated Pin Buckle
IDENT NO.		
1 Burgundy	109750	109755
2 Navy	109751	109756
3 Flannel	109752	109757
4 Cognac	109753	109758
5 Black	109754	109759
BUCKLE		
SHAPE	Rectangular	Horseshoe
MATERIAL	Solid brass	Solid brass
COATING	Palladium-coated	Palladium-coated
FINISH	Shiny and mat	Shiny and mat
MECHANISM	Hidden screw mechanism	Hidden screw mechanism
EMBLEM	Montblanc emblem on leather loop	Montblanc emblem on leather loop
STRAP		
MATERIAL STRAP	Saffiano-Printed Leather Strap	Saffiano-Printed Leather Strap
STRAP LENGTH AND WIDTH	120 X 3,5 cm	120 X 3,5 cm

BELTS

> Montblanc Contemporary Line 30 mm



1 Reversible
Leather Strap
Black/Brown



MODEL	Trapeze Shiny Palladium-Coated Pin Buckle	Trapeze Shiny Palladium-Coated Pin Buckle
IDENT NO.		
1 Reversible Leather Strap Black/Brown	09781	106601
BUCKLE		
SHAPE	Trapezium	Trapezium
MATERIAL	Solid brass	Solid brass
COATING	Palladium-coated	Palladium-coated
FINISH	Shiny	Shiny
MECHANISM	Easy-to-open mechanism to adjust strap length	Easy-to-open mechanism to adjust strap length
EMBLEM	Engraved Montblanc brand name	Engraved Montblanc brand name
STRAP		
MATERIAL STRAP	Reversible black/brown leather strap	Reversible black/brown leather strap
STRAP LENGTH AND WIDTH	120 x 3 cm	120 x 3 cm

BELTS

> Montblanc Contemporary Line 30 mm

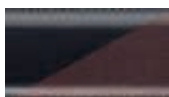

1 Reversible
Leather Strap
Black/Brown



MODEL	Grains Shiny Palladium-Coated Pin Buckle	Square Shiny Palladium-Coated Pin Buckle
IDENT NO.		
1 Reversible Leather Strap Black/Brown	109760	107669
BUCKLE		
SHAPE	Rectangular	Square
MATERIAL	Solid brass	Solid brass
COATING	Palladium-coated	Palladium-coated
FINISH	Shiny	Shiny
MECHANISM	Easy-to-open mechanism to adapt strap length	Easy-to-open mechanism to adapt strap length
EMBLEM	Engraved Montblanc emblem	Engraved Montblanc brand name
STRAP		
MATERIAL STRAP	Reversible black/brown leather strap	Reversible black/brown leather strap
STRAP LENGTH AND WIDTH	120 x 3 cm	120 x 3 cm

BELTS

> Montblanc Contemporary Line 30 mm



1 Reversible
Leather Strap
Black/Brown



MODEL	Rectangular Shiny Wave Palladium-Coated Pin Buckle	Horseshoe Shiny Palladium-Coated Pin Buckle
IDENT NO.		
1 Reversible Leather Strap Black/Brown	09774	106603
BUCKLE		
SHAPE	Rectangular with small wave-motif at sides	Horseshoe
MATERIAL	Solid brass	Stainless steel
COATING	Palladium-coated	Palladium-coated
FINISH	Shiny	Shiny
MECHANISM	Easy-to-open mechanism to adjust strap length	Easy-to-open mechanism to adjust strap length
EMBLEM	Montblanc emblem	Montblanc emblem
STRAP		
MATERIAL STRAP	Reversible black/brown leather strap	Reversible black/brown leather strap
STRAP LENGTH AND WIDTH	120 x 3 cm	120 x 3 cm

BELTS

> Montblanc Contemporary Line 30 mm



1 Reversible
Leather Strap
Black/Brown



MODEL	Rectangular Shiny Palladium-Coated Pin Buckle	Rectangular Rubber & Shiny Palladium-Coated Pin Buckle
IDENT No.		
1 Reversible Leather Strap Black/Brown	07222	101899
BUCKLE		
SHAPE	Convex	Rectangular
MATERIAL	Stainless steel	Solid brass, black rubber-like surface
COATING	Palladium-coated	Palladium-coated
FINISH	Shiny	Shiny
MECHANISM	Easy-to-open mechanism to adjust strap length	Easy-to-open mechanism to adjust strap length
EMBLEM	Engraved Montblanc brand name	Engraved Montblanc brand name
STRAP		
MATERIAL STRAP	Reversible black/brown leather strap	Reversible black/brown leather strap
STRAP LENGTH AND WIDTH	120 x 3 cm	120 x 3 cm

BELTS

> Montblanc Contemporary Line 30 mm



1 Reversible
Leather Strap
Black/Brown



MODEL	3 Rings Motif Cut-Out Shiny Palladium-Coated Box Buckle	3 Rings Motif Cut-Out Shiny Palladium-Coated Box Buckle	3 Rings Carbon & Shiny Palladium-Coated Box Buckle
IDENT No.			
1 Reversible Leather Strap Black/Brown	103431	105084	101903
BUCKLE			
SHAPE	Rectangular with curved top	Rectangular	Rectangular
MATERIAL	Solid brass	Solid brass	Solid brass, carbon inlay
COATING	Palladium-coated	Ruthenium-coated	Palladium-coated
FINISH	Shiny	Shiny	Satin finish
MECHANISM	Easy-to-open mechanism to adjust strap length	Easy-to-open mechanism to adjust strap length	Easy-to-open mechanism to adjust strap length
EMBLEM	Engraved Montblanc brand name	Engraved Montblanc emblem	Engraved Montblanc brand name
STRAP			
MATERIAL STRAP	Reversible black/brown leather strap	Reversible black/brown leather strap	Reversible black/brown leather strap
STRAP LENGTH AND WIDTH	120 x 3 cm	120 x 3 cm	120 x 3 cm

BELTS

> Montblanc Contemporary Line 30 mm



1 Reversible
Leather Strap
Black/Brown



MODEL	Wave Mat Palladium-Coated Pin Buckle	Bowed Mat Palladium-Coated Pin Buckle
IDENT NO.		
1 Reversible Leather Strap Black/Brown	09788	09795
BUCKLE		
SHAPE	Slightly waved	Rectangular, slightly bowed
MATERIAL	Solid brass	Solid brass
COATING	Palladium-coated	Palladium-coated
FINISH	Satin finish	Satin finish
MECHANISM	Easy-to-open mechanism to adjust strap length	Easy-to-open mechanism to adjust strap length
EMBLEM	Engraved Montblanc emblem	Punched-out Montblanc brand name
STRAP		
MATERIAL STRAP	Reversible black/brown leather strap	Reversible black/brown leather strap
STRAP LENGTH AND WIDTH	120 x 3 cm	120 x 3 cm

BELTS

> Montblanc Contemporary Line 30 mm

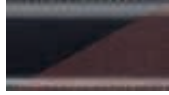

1 Reversible
Leather Strap
Black/Brown



MODEL	Leather & Mat Palladium-Coated Pin Buckle	Meisterstück Mat Palladium-Coated Box Buckle
IDENT NO.		
1 Reversible Leather Strap Black/Brown	38158	38156
BUCKLE		
SHAPE	Rectangular	Rectangular
MATERIAL	Solid brass and leather	Solid brass and leather
COATING	Palladium-coated	Palladium-coated
FINISH	Satin finish	Satin finish
MECHANISM	Easy-to-open mechanism to adjust strap length	Easy-to-open-mechanism to adjust strap length
EMBLEM	Montblanc emblem	Engraved Montblanc brand name and emblem
STRAP		
MATERIAL STRAP	Reversible black/brown leather strap	Reversible black/brown leather strap
STRAP LENGTH AND WIDTH	120 x 3 cm	120 x 3 cm

BELTS

> Montblanc Contemporary Line 30 mm



1 Reversible
Leather Strap
Black/Brown



MODEL	Rectangular Frame Ruthenium-Coated Pin Buckle	Horseshoe Shiny Ruthenium-Coated Pin Buckle	Elliptic Shiny Ruthenium-Coated Pin Buckle
IDENT No.			
1 Reversible Leather Strap Black/Brown	109761	105078	105080
BUCKLE			
SHAPE	Rectangular	Horseshoe	Rectangular with elliptical cut at top
MATERIAL	Stainless steel	Solid brass	Solid brass
COATING	PVD Ruthenium-coated	Ruthenium-coated	Ruthenium-coated
FINISH	Mat	Shiny	Shiny
MECHANISM	Easy-to-open mechanism to adapt strap length	Easy-to-open mechanism to adapt strap length	Easy-to-open mechanism to adapt strap length
EMBLEM	Engraved Montblanc brand name	Engraved Montblanc brand name	Engraved Montblanc brand name
STRAP			
MATERIAL STRAP	Reversible black/brown leather strap	Reversible black/brown leather strap	Reversible black/brown leather strap
STRAP LENGTH AND WIDTH	120 x 3 cm	120 x 3 cm	120 x 3 cm

BELTS

> Montblanc Contemporary Line 30 mm



1 Reversible
Leather Strap
Black/Brown



MODEL	Starwalker Shiny Ruthenium-Coated Pin Buckle	Starwalker Shiny Ruthenium-Coated Pin Buckle
IDENT NO.		
1 Reversible Leather Strap Black/Brown	38163	107668
BUCKLE		
SHAPE	Rectangular	Rectangular
MATERIAL	Solid brass	Solid brass
COATING	Ruthenium-coated	Ruthenium-coated
FINISH	Shiny	Shiny
MECHANISM	Easy-to-open mechanism to adjust strap length	Easy-to-open mechanism to adapt strap length
EMBLEM	Engraved Montblanc brand name and emblem	Engraved Montblanc brand name
STRAP		
MATERIAL STRAP	Reversible black/brown leather strap	Reversible black/brown leather strap
STRAP LENGTH AND WIDTH	120 x 3 cm	120 x 3 cm

BELTS

> Montblanc Contemporary Line 30 mm



1 Reversible
Leather Strap
Black/Brown



MODEL	3 Rings Motif Ruthenium- & Palladium-Coated Box Buckle	3 Rings Motif Ruthenium- & Palladium-Coated Box Buckle
IDENT No.		
1 Reversible Leather Strap Black/Brown	103427	103429
BUCKLE		
SHAPE	Rectangular with vertical geometric pattern	Rectangular with horizontal geometric pattern
MATERIAL	Solid brass	Solid brass
COATING	Ruthenium-coated body, palladium-coated 3 Rings Motif	Ruthenium-coated body, palladium-coated 3 Rings Motif
FINISH	Shiny	Shiny
MECHANISM	Easy-to-open mechanism to adjust strap length	Easy-to-open mechanism to adjust strap length
EMBLEM	Engraved Montblanc emblem	Engraved Montblanc brand name
STRAP		
MATERIAL STRAP	Reversible black/brown leather strap	Reversible black/brown leather strap
STRAP LENGTH AND WIDTH	120 x 3 cm	120 x 3 cm

BELTS

> Montblanc Contemporary Line 30 mm



1 Reversible
Leather Strap
Black/Brown



MODEL	Grooved Palladium- & Ruthenium-Coated Box Buckle
IDENT NO.	
1 Reversible Leather Strap Black/Brown	103433
BUCKLE	
SHAPE	Rectangular shape
MATERIAL	Solid brass
COATING	Ruthenium- and Palladium-coated
FINISH	Shiny
MECHANISM	Easy-to-open-mechanism to adjust strap length
EMBLEM	Engraved Montblanc brand name
STRAP	
MATERIAL STRAP	Reversible black/brown leather strap
STRAP LENGTH AND WIDTH	120 x 3 cm

BELTS

> Montblanc Casual Line 35 mm



1 Reversible
Leather Strap
Black/Brown



MODEL	Oblong Shiny Palladium-Coated Pin Buckle	Round Shiny Palladium-Coated Pin Buckle	Meisterstück Soft Shiny Palladium-Coated Pin Buckle
IDENT No.			
1 Reversible Leather Strap Black/Brown	09854	101909	105092
BUCKLE			
SHAPE	Straight rectangular	Half-moon-shaped top	Rectangular
MATERIAL	Solid brass	Solid brass	Solid brass
COATING	Palladium-coated	Palladium-coated	Palladium-coated
FINISH	Shiny	Shiny	Shiny
MECHANISM	Easy-to-open mechanism to adjust strap length	Easy-to-open mechanism to adjust strap length	Easy-to-open mechanism to adapt strap length
EMBLEM	Engraved Montblanc brand name	Engraved Montblanc brand name	Engraved Montblanc brand name and emblem
STRAP			
MATERIAL STRAP	Reversible black/brown leather strap	Reversible black/brown leather strap	Reversible black/brown leather strap
STRAP LENGTH AND WIDTH	165 x 3.5 cm	165 x 3.5 cm	165 x 3.5 cm

BELTS

> Montblanc Casual Line 35 mm



1 Reversible
Leather Strap
Black/Brown



MODEL	Convex Shiny Ruthenium-Coated Pin Buckle	3 Rings Motif Shiny Ruthenium-Coated Pin Buckle	Starwalker Shiny Ruthenium-Coated Pin Buckle
IDENT No.			
1 Reversible Leather Strap Black/Brown	103443	103445	106604
BUCKLE			
SHAPE	Convex	Rectangular	Rectangular
MATERIAL	Solid brass	Solid brass	Solid brass
COATING	Ruthenium-plated	Ruthenium-coated	Ruthenium-coated
FINISH	Shiny	Shiny	Shiny
MECHANISM	Easy-to-open mechanism to adjust strap length	Easy-to-open mechanism to adjust strap length	Easy-to-open mechanism to adjust strap length
EMBLEM	Engraved Montblanc brand name	Engraved Montblanc brand name	Engraved Montblanc brand name
STRAP			
MATERIAL STRAP	Reversible black/brown leather strap	Reversible black/brown leather strap	Reversible black/brown leather strap
STRAP LENGTH AND WIDTH	165 x 3.5 cm	165 x 3.5 cm	165 x 3.5 cm

BELTS

> Montblanc Casual Line 35 mm

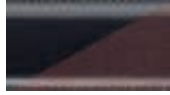

1 Reversible
Leather Strap
Black/Brown



MODEL	Cut Mat Ruthenium-Coated Pin Buckle
IDENT NO.	
1 Reversible Leather Strap Black/Brown	105090
BUCKLE	
SHAPE	Straight rectangular
MATERIAL	Solid brass
COATING	Ruthenium-coated
FINISH	Satin finish
MECHANISM	Easy-to-open mechanism to adapt strap length
EMBLEM	Engraved Montblanc emblem
STRAP	
MATERIAL STRAP	Reversible black/brown leather strap
STRAP LENGTH AND WIDTH	165 x 3.5 cm

BELTS

> Montblanc Casual Line 35 mm



1 Black



MODEL	Round Horseshoe Shiny Palladium-Coated Pin Buckle	Rectangular Cut Shiny Palladium-Coated Pin Buckle	Horseshoe Cut Shiny Palladium-Coated Pin Buckle
IDENT No. 1 Black	107673	107674	107675
BUCKLE			
SHAPE	Horseshoe	Rectangular	Horseshoe
MATERIAL	Zamak	Zamak	Solid brass
COATING	Palladium-coated	Palladium-coated	Palladium-coated
FINISH	Shiny	Shiny	Shiny
MECHANISM	Hidden screw mechanism	Hidden screw mechanism	Hidden screw mechanism
EMBLEM	Engraved Montblanc emblem , Montblanc emblem on leather loop	Montblanc emblem on the leather loop	Montblanc emblem on the leather loop
STRAP			
MATERIAL STRAP	Black Plain French Calfskin Strap	Black Plain French Calfskin Strap	Black Plain French Calfskin Strap
STRAP LENGTH AND WIDTH	120 x 3,5 cm	120 x 3,5 cm	120 x 3,5 cm

BELTS

> Montblanc Casual Line 35 mm



1 Black



MODEL	Rectangular Shiny Palladium-Coated Pin Buckle	Bowed Shiny Palladium-Coated Pin Buckle	Rectangular Profile Palladium-Coated Pin Buckle
IDENT No. 1 Black	107676	107677	107678
BUCKLE			
SHAPE	Rectangular	Rounded rectangular	Rectangular
MATERIAL	Zamak	Zamak	Solid brass
COATING	Palladium-coated	Palladium-coated	Palladium-coated
FINISH	Combination of shiny and satin finishes	Shiny	Shiny
MECHANISM	Hidden screw mechanism	Hidden screw mechanism	Hidden screw mechanism
EMBLEM	Engraved Montblanc emblem , Montblanc emblem on leather loop	Engraved Montblanc brand name	Engraved Montblanc brand name
STRAP			
MATERIAL STRAP	Black Plain French Calfskin Strap	Black Plain French Calfskin Strap	Black Plain French Calfskin Strap
STRAP LENGTH AND WIDTH	120 x 3,5 cm	120 x 3,5 cm	120 x 3,5 cm

BELTS

> *Montblanc Casual Line 35 mm*

1 Black



MODEL	Montblanc Signature Shiny Ruthenium-Coated Box Buckle
IDENT No. 1 Black	109771
BUCKLE	
SHAPE	Rectangular
MATERIAL	Solid brass and leather
COATING	Ruthenium-coated
FINISH	Shiny
MECHANISM	Hidden screw mechanism
EMBLEM	Embossed "M" Pattern
STRAP	
MATERIAL STRAP	Plain Black Leather Strap
STRAP LENGTH AND WIDTH	120 x 3,5 cm

BELTS

> *Montblanc Casual Line 35 mm*

1 Black



MODEL	Rectangular Shiny Palladium-Coated Pin Buckle
IDENT NO.	
1 Black	109768
BUCKLE	
SHAPE	Rectangular
MATERIAL	Solid brass
COATING	Palladium-coated
FINISH	Shiny
MECHANISM	Hidden screw mechanism
EMBLEM	Montblanc emblem on leather loop
STRAP	
MATERIAL STRAP	Braid-Printed Black Leather Strap
STRAP LENGTH AND WIDTH	120 x 3,5 cm

BELTS

> Montblanc Casual Line 35 mm



1 Tan



MODEL	Squarish Horseshoe Mat Bronze-Coated Pin Buckle
IDENT NO.	
1 Tan	109769
BUCKLE	
SHAPE	Square
MATERIAL	Solid brass
COATING	Bronze-coated
FINISH	Mat
MECHANISM	Hidden screw mechanism
EMBLEM	Engraved Montblanc brand name
STRAP	
MATERIAL STRAP	Plain Stitched Tan Leather Strap
STRAP LENGTH AND WIDTH	120 x 3,5 cm

BELTS

> Montblanc Casual Line 35 mm



1 Brown



MODEL	3 Rings Motif Horseshoe Mat Ruthenium-Coated Pin Buckle
IDENT No. 1 Brown	109770
BUCKLE	
SHAPE	Horseshoe
MATERIAL	Solid brass
COATING	Ruthenium-coated
FINISH	Mat
MECHANISM	Hidden screw mechanism
EMBLEM	Montblanc emblem on leather loop
STRAP	
MATERIAL STRAP	Plain Brown Leather Strap
STRAP LENGTH AND WIDTH	120 x 3,5 cm

BELTS

> Montblanc Casual Line 40 mm



1 Black

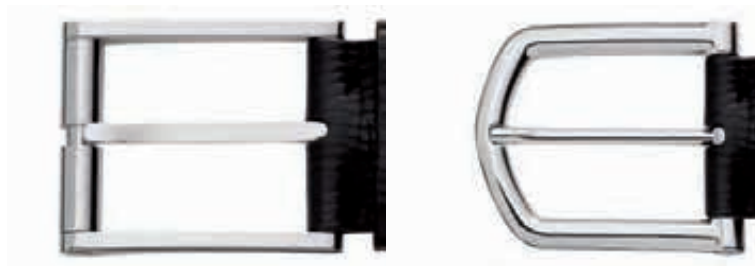

MODEL	Rectangular Tube Palladium-Coated Pin Buckle	Rounded Rectangular Palladium-Coated Pin Buckle
IDENT NO.		
1 Black	107679	107680
BUCKLE		
SHAPE	Rectangular	Horseshoe
MATERIAL	Solid brass	Solid brass
COATING	Palladium-coated	Palladium-coated
FINISH	Shiny	Shiny
MECHANISM	Hidden screw mechanism	Hidden screw mechanism
EMBLEM	Montblanc emblem on the leather loop	Montblanc emblem on the leather loop
STRAP		
MATERIAL STRAP	Black Palmellato Printed Leather Strap	Black Palmellato Printed Leather Strap
STRAP LENGTH AND WIDTH	120 x 4 cm	120 x 4 cm

BELTS

> Montblanc Casual Line 40 mm



1 Black



MODEL	Rectangular Frame Shiny & Mat Palladium-Coated Pin Buckle
IDENT No. 1 Black	109772
BUCKLE	
SHAPE	Rectangular
MATERIAL	Solid brass
COATING	Palladium-coated
FINISH	Shiny and mat
MECHANISM	Hidden screw mechanism
EMBLEM	Engraved Montblanc brand name
STRAP	
MATERIAL STRAP	Grained Black Leather Strap
STRAP LENGTH AND WIDTH	120 x 4 cm

BELTS

> Montblanc Casual Line 40 mm



1 Brown



MODEL	Square Mat Bronze-Coated Pin Buckle
IDENT NO.	
1 Brown	107681
BUCKLE	
SHAPE	Square
MATERIAL	Solid brass
COATING	Bronze-coated
FINISH	Satin finish
MECHANISM	Hidden screw mechanism
EMBLEM	Engraved Montblanc name
STRAP	
MATERIAL STRAP	Brown Palmellato Printed Leather Strap
STRAP LENGTH AND WIDTH	120 x 4 cm

BELTS

> Montblanc Casual Line 40 mm



1 Dark Brown



MODEL	Squarish Mat Bronze-Coated Pin Buckle
IDENT NO.	
1 Dark Brown	109773
BUCKLE	
SHAPE	Square
MATERIAL	Solid brass
COATING	Bronze-coated
FINISH	Mat
MECHANISM	Hidden screw mechanism
EMBLEM	Engraved Montblanc brand name
STRAP	
MATERIAL STRAP	Palmellatto-Printed Dark Brown Leather Strap
STRAP LENGTH AND WIDTH	120 x 4 cm

BELTS

> Montblanc Classic Line 30 mm
Annual Edition



1 Oxblood



2 Mocha



MODEL	Horseshoe Shiny Palladium-Coated Pin Buckle	Montblanc Star Rectangular Shiny Gold-Coated Pin Buckle	Montblanc Star Oval Shiny Gold-Coated Pin Buckle
IDENT No.			
1 Oxblood	109741	109743	109745
2 Mocha	109742	109744	109746
BUCKLE			
SHAPE	Horseshoe	Rectangular	Oval
MATERIAL	Solid brass	Solid brass	Solid brass
COATING	Palladium-coated	Gold-coated	Gold-coated
FINISH	Shiny	Shiny	Shiny
MECHANISM	Easy-to-open mechanism to adapt strap length	Easy-to-open mechanism to adapt strap length	Easy-to-open mechanism to adapt strap length
EMBLEM	Montblanc emblem	Montblanc emblem	Montblanc emblem
STRAP			
MATERIAL STRAP	Plain Oxblood Leather Strap / Alligator-Printed Mocha Leather Strap	Plain Oxblood Leather Strap / Alligator-Printed Mocha Leather Strap	Plain Oxblood Leather Strap / Alligator-Printed Mocha Leather Strap
STRAP LENGTH AND WIDTH	120 x 3 cm	120 x 3 cm	120 x 3 cm

BELTS

> Montblanc Contemporary Line 30 mm
Annual Edition



1 Brown



2 Dark Brown



MODEL	Rectangular Wave Shiny Palladium-Coated Pin Buckle	Wave Mat Palladium-Coated Pin Buckle	Elliptic Shiny Ruthenium-Coated Pin Buckle
IDENT No.			
1 Brown	109762	109764	109766
2 Dark Brown	109763	109765	109767
BUCKLE			
SHAPE	Rectangular with small wave-motif at sides	Rectangular with small wave-motif at sides	Elliptic
MATERIAL	Solid brass	Solid brass	Stainless steel
COATING	Palladium-coated	Palladium-coated	PVD Ruthenium-coated
FINISH	Shiny	Mat	Shiny
MECHANISM	Easy-to-open mechanism to adapt strap length	Easy-to-open mechanism to adapt strap length	Easy-to-open mechanism to adapt strap length
EMBLEM	Montblanc emblem	Engraved Montblanc emblem	Engraved Montblanc brand name
STRAP			
MATERIAL STRAP	Saffiano-Printed Brown Leather Strap / Dark Brown Nubuck Leather Strap	Saffiano-Printed Brown Leather Strap / Dark Brown Nubuck Leather Strap	Saffiano-Printed Brown Leather Strap / Dark Brown Nubuck Leather Strap
STRAP LENGTH AND WIDTH	120 x 3 cm	120 x 3 cm	120 x 3 cm

LEATHER



A feminine counterpart to Montblanc Signature, for the woman in her daily business life. Celebrating Montblanc's iconic M, found on the nib of each Meisterstück Fountain Pen, the pattern has been translated onto iconic styles in leather.

Venturing into subtle femininity

Montblanc Signature Ladies

Stone-coloured fabric combined with elegant mocha leather details; prized by the lover of resilient luxury.

MONTBLANC SIGNATURE LADIES

> Large Leather Goods

> City Bags



The Boston Bag

Id. 107775

p. 276



The Hobo Bag

Id. 107776

p. 276



The Classic Bag

Id. 107777

p. 277



Tote Bag Medium with Zip

Id. 107780

p. 278



Tote Bag Vertical with Zip

Id. 107781

p. 278



Tote Bag with Zip

Id. 107783

p. 279



Envelope Bag

Id. 107778

p. 280



North South Bag Mini with Zip

Id. 107832

p. 280



Messenger Bag

Id. 107833

p. 281

MONTBLANC SIGNATURE LADIES

> Small Leather Goods

> Pocket Accessories



Key Fob

Id. 107693

p. 282



Key Case

Id. 107786

p. 282



Pocket Holder 4cc

Id. 107784

p. 283



Business Card Holder

Id. 107834

p. 283

> Vertical Wallets without Coin Case



Wallet 6cc with Flap

Id. 107835

p. 284

> Vertical Wallets with Coin Case



Wallet 4cc with Flap & Coin Case

Id. 107836

p. 285



Wallet 6cc with Frame & Coin Case

Id. 107837

p. 285

> Long Wallets



Wallet 8cc with Flap & zipped Coin Case

Id. 107838

p. 286



Wallet 14cc with Zip

Id. 107792

p. 287



Travel Wallet 12cc with Zip

Id. 107839

p. 288

> Organisers & Agendas



Pocket Organiser with Zip

Id. 107793

p. 289

MONTBLANC SIGNATURE LADIES

> City Bags

LEATHER | FABRIC | LINING



Brown | Stone | Stone

EMBLEM



MODEL	The Boston Bag	The Hobo Bag
IDENT No.	107775	107776
MATERIAL		
LEATHER	High-performance PVC-coated fabric, highly resistant to abrasion, water and dirt, combined with Australian saffiano printed calfskin, chrome-tanned, semi-aniline, dyed through	High-performance PVC-coated fabric, highly resistant to abrasion, water and dirt, combined with Australian saffiano printed calfskin, chrome-tanned, semi-aniline, dyed through
LINING	Jacquard lining 60% cotton 40% polyamide	Jacquard lining 60% cotton 40% polyamide
FITTINGS/EMBLEM	Ruthenium-coated fittings with shiny finish, Montblanc emblem	Ruthenium-coated fittings with shiny finish, Montblanc emblem
FEATURES		
CLOSURE/LOCK	Metal zip	Metal zip
POCKETS	1 main compartment, additional pocket	1 main compartment, additional pocket
INTERIOR ORGANISATION	Pockets for mobile phone (PDA size), 3 writing instruments and 2 credit cards	Pockets for mobile phone (PDA size), 3 writing instruments and 2 credit cards
STRAP	-	-
ADDITIONAL CHARACTERISTICS	2 comfortable leather handles	Comfortable leather handle
DIMENSIONS		
DIMENSIONS	37 x 22 x 12 cm	34 x 35 x 10 cm

MONTBLANC SIGNATURE LADIES

> City Bags

LEATHER | FABRIC | LINING



Brown | Stone |
Stone

EMBLEM



MODEL	The Classic Bag
IDENT No.	107777
MATERIAL	
LEATHER	High-performance PVC-coated fabric, highly resistant to abrasion, water and dirt, combined with Australian saffiano printed calfskin, chrome-tanned, semi-aniline, dyed through
LINING	Jacquard lining 60% cotton 40% polyamide
FITTINGS/EMBLEM	Ruthenium-coated fittings with shiny finish, Montblanc emblem
FEATURES	
CLOSURE/LOCK	Metal zip
POCKETS	2 main compartments, additional pocket
INTERIOR ORGANISATION	Pockets for mobile phone (PDA size), 3 writing instruments and 2 credit cards
STRAP	-
ADDITIONAL CHARACTERISTICS	2 comfortable leather handles
DIMENSIONS	
DIMENSIONS	41 x 31 x 12.5 cm

MONTBLANC SIGNATURE LADIES

> City Bags

LEATHER | FABRIC | LINING



Brown | Stone | Stone

EMBLEM



MODEL	Tote Bag Medium with Zip	Tote Bag Vertical with Zip
IDENT No.	107780	107781
MATERIAL		
LEATHER	High-performance PVC-coated fabric, highly resistant to abrasion, water and dirt, combined with Australian saffiano printed calfskin, chrome-tanned, semi-aniline, dyed through	High-performance PVC-coated fabric, highly resistant to abrasion, water and dirt, combined with Australian saffiano printed calfskin, chrome-tanned, semi-aniline, dyed through
LINING	Jacquard lining 60% cotton 40% polyamide	Jacquard lining 60% cotton 40% polyamide
FITTINGS/EMBLEM	Ruthenium-coated fittings with shiny finish, Montblanc emblem	Ruthenium-coated fittings with shiny finish, Montblanc emblem
FEATURES		
CLOSURE/LOCK	Metal zip	Metal zip
POCKETS	1 main compartment, additional pocket	1 main compartment, additional pocket
INTERIOR ORGANISATION	Pockets for mobile phone (PDA size), 3 writing instruments and 2 credit cards	Pockets for mobile phone (PDA size), 3 writing instruments and 2 credit cards
STRAP	-	-
ADDITIONAL CHARACTERISTICS	2 comfortable leather handles	2 comfortable leather handles
DIMENSIONS		
DIMENSIONS	38,5 x 28 x 12,5 cm	35 x 37 x 13 cm

MONTBLANC SIGNATURE LADIES

> City Bags

LEATHER | FABRIC | LINING



Brown | Stone | Stone

EMBLEM



MODEL	Tote Bag with Zip
IDENT No.	107783
MATERIAL	
LEATHER	High-performance PVC-coated fabric, highly resistant to abrasion, water and dirt, combined with Australian saffiano printed calfskin, chrome-tanned, semi-aniline, dyed through
LINING	Jacquard lining 60% cotton 40% polyamide
FITTINGS/EMBLEM	Ruthenium-coated fittings with shiny finish, Montblanc emblem
FEATURES	
CLOSURE/LOCK	Metal zip
POCKETS	2 main compartments with gusset, additional pocket
INTERIOR ORGANISATION	Pockets for mobile phone (PDA size), 3 writing instruments and 2 credit cards
STRAP	-
ADDITIONAL CHARACTERISTICS	2 comfortable leather handles
DIMENSIONS	
DIMENSIONS	44 x 31 x 13 cm

MONTBLANC SIGNATURE LADIES

> City Bags

LEATHER | FABRIC | LINING



Brown | Stone | Stone

EMBLEM



MODEL	Envelope Bag	North South Bag Mini with Zip
IDENT No.	107778	107832
MATERIAL		
LEATHER	High-performance PVC-coated fabric, highly resistant to abrasion, water and dirt, combined with Australian saffiano printed calfskin, chrome-tanned, semi-aniline, dyed through	High-performance PVC-coated fabric, highly resistant to abrasion, water and dirt, combined with Australian saffiano printed calfskin, chrome-tanned, semi-aniline, dyed through
LINING	Jacquard lining 60% cotton 40% polyamide	Jacquard lining 60% cotton 40% polyamide
FITTINGS/EMBLEM	Ruthenium-coated fittings with shiny finish, Montblanc emblem	Ruthenium-coated fittings with shiny finish, Montblanc emblem
FEATURES		
CLOSURE/LOCK	Press-stud	Zip
POCKETS	1 main compartment	1 main compartment, additional pocket
INTERIOR ORGANISATION	Pockets for mobile phone (PDA size) and 2 writing instruments	Pockets for mobile phone (PDA size) and 2 writing instruments
STRAP	Adjustable branded shoulder strap in brown	Adjustable branded shoulder strap in brown
ADDITIONAL CHARACTERISTICS	-	-
DIMENSIONS		
DIMENSIONS	27 x 32 x 2 cm	21 x 26 x 8 cm

MONTBLANC SIGNATURE LADIES

> City Bags

LEATHER | FABRIC | LINING



Brown | Stone |
Stone

EMBLEM



MODEL	Messenger Bag
IDENT No.	107833
MATERIAL	
LEATHER	High-performance PVC-coated fabric, highly resistant to abrasion, water and dirt, combined with Australian saffiano printed calfskin, chrome-tanned, semi-aniline, dyed through
LINING	Jacquard lining 60% cotton 40% polyamide
FITTINGS/EMBLEM	Ruthenium-coated fittings with shiny finish, Montblanc emblem
FEATURES	
CLOSURE/LOCK	Flap with 2 hidden magnets
POCKETS	1 main compartment, back pocket, additional pocket
INTERIOR ORGANISATION	Pockets for mobile phone (PDA size), 3 writing instruments and 2 credit cards
STRAP	Adjustable branded shoulder strap in black
ADDITIONAL CHARACTERISTICS	Protective bottom with 3 rings motif
DIMENSIONS	
DIMENSIONS	34 x 30 x 9 cm

MONTBLANC SIGNATURE LADIES

> Pocket Accessories

LEATHER | FABRIC | LINING



Brown | Stone | Stone

EMBLEM



MODEL	Key Fob	Key Case
IDENT No.	107693	107786
MATERIAL		
LEATHER	High-performance PVC-coated fabric, highly resistant to abrasion, water and dirt, combined with Australian saffiano printed calfskin, chrome-tanned, semi-aniline, dyed through	High-performance PVC-coated fabric, highly resistant to abrasion, water and dirt, combined with Australian saffiano printed calfskin, chrome-tanned, semi-aniline, dyed through
LINING	-	Jacquard lining 60% cotton 40% polyamide
FITTINGS/EMBLEM	Ruthenium-coated fittings with shiny finish, Montblanc emblem	Ruthenium-coated with shiny finish, Montblanc emblem
FEATURES		
CLOSURE/LOCK	-	Press-stud
POCKETS	Ring for multiple keys	-
INTERIOR ORGANISATION	-	Rings for 6 keys
ADDITIONAL CHARACTERISTICS	-	-
REFILLS	-	-
DIMENSIONS		
DIMENSIONS	2 x 12 cm	7 x 13 cm

MONTBLANC SIGNATURE LADIES

> Pocket Accessories

LEATHER | FABRIC | LINING



Brown | Stone | Stone

EMBLEM



MODEL	Pocket Holder 4cc	Business Card Holder
IDENT No.	107784	107834
MATERIAL		
LEATHER	High-performance PVC-coated fabric, highly resistant to abrasion, water and dirt, combined with Australian saffiano printed calfskin, chrome-tanned, semi-aniline, dyed through	High-performance PVC-coated fabric, highly resistant to abrasion, water and dirt, combined with Australian saffiano printed calfskin, chrome-tanned, semi-aniline, dyed through
LINING	Jacquard lining 60% cotton 40% polyamide	Jacquard lining 60% cotton 40% polyamide
FITTINGS/EMBLEM	Ruthenium-coated fittings with shiny finish, Montblanc emblem	Ruthenium-coated fittings with shiny finish, Montblanc emblem
FEATURES		
CLOSURE/LOCK	-	Press-stud
POCKETS	4 pockets for credit cards, additional pocket	Large gusset for business cards or credit cards, additional pocket
INTERIOR ORGANISATION	-	-
ADDITIONAL CHARACTERISTICS	-	-
REFILLS	-	-
DIMENSIONS		
DIMENSIONS	10 x 6 cm	7.5 x 11 cm

MONTBLANC SIGNATURE LADIES

> Vertical Wallets without Coin Case

LEATHER | FABRIC | LINING



Brown | Stone | Stone

EMBLEM



MODEL	Wallet 6cc with Flap
IDENT No.	107835
MATERIAL	
LEATHER	High-performance PVC-coated fabric, highly resistant to abrasion, water and dirt, combined with Australian saffiano printed calfskin, chrome-tanned, semi-aniline, dyed through
LINING	Jacquard lining 60% cotton 40% polyamide
FITTINGS/EMBLEM	Ruthenium-coated fittings with shiny finish, Montblanc emblem
FEATURES	
CLOSURE/LOCK	Press-stud
POCKETS	6 pockets for credit cards, additional pocket, compartment for banknotes, back pocket
INTERIOR ORGANISATION	-
ADDITIONAL CHARACTERISTICS	-
REFILLS	-
DIMENSIONS	
DIMENSIONS	9.5 x 12 cm

MONTBLANC SIGNATURE LADIES

> Vertical Wallets with Coin Case

LEATHER | FABRIC | LINING



Brown | Stone | Stone

EMBLEM



MODEL	Wallet 4cc with Flap & Coin Case	Wallet 6cc with Frame & Coin Case
IDENT No.	107836	107837
MATERIAL		
LEATHER	High-performance PVC-coated fabric, highly resistant to abrasion, water and dirt, combined with Australian saffiano printed calfskin, chrome-tanned, semi-aniline, dyed through	High-performance PVC-coated fabric, highly resistant to abrasion, water and dirt, combined with Australian saffiano printed calfskin, chrome-tanned, semi-aniline, dyed through
LINING	Jacquard lining 60% cotton 40% polyamide	Jacquard lining 60% cotton 40% polyamide
FITTINGS/EMBLEM	Ruthenium-coated fittings with shiny finish, Montblanc emblem	Ruthenium-coated fittings with shiny finish, Montblanc emblem
FEATURES		
CLOSURE/LOCK	2 flaps with press-studs	Clasp
POCKETS	4 pockets for credit cards, additional pocket, 2 compartments for banknotes, coin case	6 pockets for credit cards, additional pocket, 2 compartments for banknotes, coin case
INTERIOR ORGANISATION	-	-
ADDITIONAL CHARACTERISTICS	-	-
REFILLS	-	-
DIMENSIONS		
DIMENSIONS	9,5 x 11 cm	9 x 13,5 cm

MONTBLANC SIGNATURE LADIES

> Long Wallets

LEATHER | FABRIC | LINING



Brown | Stone |
Stone

EMBLEM



MODEL	Wallet 8cc with Flap & zipped Coin Case
IDENT No.	107838
MATERIAL	
LEATHER	High-performance PVC-coated fabric, highly resistant to abrasion, water and dirt, combined with Australian saffiano printed calfskin, chrome-tanned, semi-aniline, dyed through
LINING	Jacquard lining 60% cotton 40% polyamide
FITTINGS/EMBLEM	Ruthenium-coated fittings with shiny finish, Montblanc emblem
FEATURES	
CLOSURE/LOCK	Flap with 2 press-studs
POCKETS	8 pockets for credit cards, 2 compartments for banknotes, coin case with zip, additional pockets
INTERIOR ORGANISATION	-
ADDITIONAL CHARACTERISTICS	-
REFILLS	-
DIMENSIONS	
DIMENSIONS	10.5 x 19 cm

MONTBLANC SIGNATURE LADIES

> Long Wallets

LEATHER | FABRIC | LINING



Brown | Stone |
Stone

EMBLEM



MODEL	Wallet 14cc with Zip
IDENT No.	107792
MATERIAL	
LEATHER	High-performance PVC-coated fabric, highly resistant to abrasion, water and dirt, combined with Australian saffiano printed calfskin, chrome-tanned, semi-aniline, dyed through
LINING	Jacquard lining 60% cotton 40% polyamide
FITTINGS/EMBLEM	Ruthenium-coated fittings with shiny finish, Montblanc emblem
FEATURES	
CLOSURE/LOCK	Metal zip
POCKETS	14 pockets for credit cards, large zipped pocket, 3 additional pockets
INTERIOR ORGANISATION	-
ADDITIONAL CHARACTERISTICS	-
REFILLS	-
DIMENSIONS	
DIMENSIONS	10 x 19.5 cm

MONTBLANC SIGNATURE LADIES

> Long Wallets

LEATHER | FABRIC | LINING



Brown | Stone |
Stone

EMBLEM



MODEL	Travel Wallet 12cc with Zip
IDENT No.	107839
MATERIAL	
LEATHER	High-performance PVC-coated fabric, highly resistant to abrasion, water and dirt, combined with Australian saffiano printed calfskin, chrome-tanned, semi-aniline, dyed through
LINING	Jacquard lining 60% cotton 40% polyamide
FITTINGS/EMBLEM	Ruthenium-coated fittings with shiny finish, Montblanc emblem
FEATURES	
CLOSURE/LOCK	Metal zip
POCKETS	12 pockets for credit cards, zipped large pocket, pocket for flight ticket, 3 additional pockets
INTERIOR ORGANISATION	-
ADDITIONAL CHARACTERISTICS	Loop for 1 writing instrument the size of a Meisterstück Classique or LeGrand
REFILLS	-
DIMENSIONS	
DIMENSIONS	12,5 x 22,5 cm

MONTBLANC SIGNATURE LADIES

> Organisers & Agendas

LEATHER | FABRIC | LINING



Brown | Stone | Stone

EMBLEM



MODEL	Pocket Organiser with Zip
IDENT No.	107793
MATERIAL	
LEATHER	High-performance PVC-coated fabric, highly resistant to abrasion, water and dirt, combined with Australian saffiano printed calfskin, chrome-tanned, semi-aniline, dyed through
LINING	Jacquard lining 60% cotton 40% polyamide
FITTINGS/EMBLEM	Ruthenium-coated fittings with shiny finish, Montblanc emblem
FEATURES	
CLOSURE/LOCK	Metal zip
POCKETS	4 pockets for credit cards or busines cards, 2 additional pockets, back pocket
INTERIOR ORGANISATION	Loop for writing instrument the size of Meisterstück Mozart, complete with calendar
ADDITIONAL CHARACTERISTICS	-
REFILLS	Starter Kit Pocket (Id. 08401), Telephone & Address Sheets Pocket (Id. 03022), Organisation Kit Pocket (Id. 03023), Daily Plan Pages Pocket (Id. 03020), Pocket 2014 Calendar (Id. 110137)
DIMENSIONS	
DIMENSIONS	10.5 x 12.5 cm (for A7 sheets)



LA VIE DE BOHÈME

> Small Leather Goods

> Pocket Accessories

											
Key Fob	Key Fob	Key Case 6 Keys	Key Case 6 Keys	Pocket Holder 2cc	Pocket Holder 2cc	Coin Case	Coin Case	Business Card Holder	Business Card Holder	SmartPhone Holder 4/4s	SmartPhone Holder 4/4s
Id. 107694 p. 292	Id. 107695 p. 292	Id. 109282 p. 292	Id. 109283 p. 292	Id. 109320 p. 293	Id. 109321 p. 293	Id. 107603 p. 293	Id. 107604 p. 293	Id. 107605 p. 294	Id. 107606 p. 294	Id. 107607 p. 294	Id. 107608 p. 294

> Horizontal Wallets with Coin Case

			
Wallet 6cc with View Pocket, Flap & Coin Case	Wallet 6cc with View Pocket, Flap & Coin Case	Wallet 6cc with Flap & zipped Coin Case	Wallet 6cc with Flap & zipped Coin Case
Id. 107609 p. 295	Id. 107610 p. 295	Id. 107611 p. 295	Id. 107612 p. 295



> Long Wallets

			
Wallet 8cc with Zip & Coin Case	Wallet 8cc with Zip & Coin Case	Wallet 10cc with Flap & Coin Case	Wallet 10cc with Flap & Coin Case
Id. 107613 p. 296	Id. 107614 p. 296	Id. 109322 p. 297	Id. 109323 p. 297

> Organisers & Agendas

					
Agenda Small	Agenda Small	Notebook Medium	Notebook Medium	Organiser Medium	Organiser Medium
Id. 107615 p. 298	Id. 107616 p. 298	Id. 107617 p. 299	Id. 107618 p. 299	Id. 107619 p. 300	Id. 107620 p. 300

> Writing Instrument Pouches

			
1 Pen Pouch with Zip	1 Pen Pouch with Zip	2 Pen Pouch	2 Pen Pouch
Id. 107601 p. 301	Id. 107602 p. 301	Id. 109318 p. 301	Id. 109319 p. 301

LA VIE DE BOHÈME

> Small Leather Goods · Seasonal Colour Collection 2013/14

> Pocket Accessories



Coin Case with Zip

Id. 109602

p. 302



Coin Case with Zip

Id. 109605

p. 304



Coin Case with Zip

Id. 109608

p. 306

> Horizontal Wallet with Coin Case



Wallet 6cc with Flap & Coin Case

Id. 109603

p. 302



Wallet 6cc with Flap & Coin Case

Id. 109606

p. 304



Wallet 6cc with Flap & Coin Case

Id. 109609

p. 306

> Long Wallets



Wallet 8cc with Zip & Coin Case

Id. 109604

p. 303



Wallet 8cc with Zip & Coin Case

Id. 109607

p. 305



Wallet 8cc with Zip & Coin Case

Id. 109610

p. 307

LA VIE DE BOHÈME

> Pocket Accessories

LEATHER | LINING

Desert Sand |
Desert SandOnyx Black |
Onyx Black

EMBLEM



Starring La Vie de Bohème. Designed for the woman with contemporary taste seeking a surprising flash of colour, while enjoying a touch of extravagance and femininity.

Intricately Detailed Accessories in Luminous Shades

La Vie de Bohème

Stunning with the high-quality alligator-imprinted leather in classic shades accented by seasonal brilliant colours.

La Vie de Bohème: impossible to ignore.

MODEL	Key Fob	Key Case 6 Keys
IDENT No.		
Desert Sand Desert Sand	107695	109283
Onyx Black Onyx Black	107694	109282
MATERIAL		
LEATHER	Russian calfskin, printed with glossy finish, chrome-tanned, semi-aniline dyed through	Russian calfskin, printed with glossy finish, chrome-tanned, semi-aniline dyed through
LINING	-	Jacquard lining with Montblanc emblem
FITTINGS/EMBLEM	Light gold-coated metal fittings with shiny finish, Montblanc emblem	Light gold-coated metal fittings with shiny finish, Montblanc emblem
FEATURES		
CLOSURE/LOCK	-	Flap with press-stud
POCKETS	-	-
INTERIOR ORGANISATION	3 rings for multiple keys	Rings for 5 keys and 1 car key
ADDITIONAL CHARACTERISTICS	-	-
REFILLS	-	-
DIMENSIONS		
DIMENSIONS	3 x 13 cm	7 x 11 cm

LA VIE DE BOHÈME

> Pocket Accessories

LEATHER | LINING

Desert Sand |
Desert SandOnyx Black |
Onyx Black

EMBLEM



MODEL	Pocket Holder zcc	Coin Case
IDENT No.		
Desert Sand Desert Sand	109321	107604
Onyx Black Onyx Black	109320	107603
MATERIAL		
LEATHER	Russian calfskin, printed with glossy finish, chrome-tanned, semi-aniline dyed through	Russian calfskin, printed with glossy finish, chrome-tanned, semi-aniline dyed through
LINING	Jacquard lining with Montblanc emblem	Jacquard lining with Montblanc emblem
FITTINGS/EMBLEM	Light gold-coated metal fittings with shiny finish, Montblanc emblem	Light gold-coated metal fittings with shiny finish, Montblanc emblem
FEATURES		
CLOSURE/LOCK	-	Flap with press-stud
POCKETS	-	-
INTERIOR ORGANISATION	2 pockets for credit cards, additional pocket	Compartment for coins, additional pocket for credit cards
ADDITIONAL CHARACTERISTICS	-	-
REFILLS	-	-
DIMENSIONS		
DIMENSIONS	11 x 7 cm	11 x 7 cm

LA VIE DE BOHÈME

> Pocket Accessories

LEATHER | LINING

Desert Sand |
Desert SandOnyx Black |
Onyx Black

EMBLEM



MODEL	Business Card Holder	SmartPhone Holder 4/4s
IDENT No.		
Desert Sand Desert Sand	107606	107608
Onyx Black Onyx Black	107605	107607
MATERIAL		
LEATHER	Russian calfskin, printed with glossy finish, chrome-tanned, semi-aniline dyed through	Russian calfskin, printed with glossy finish, chrome-tanned, semi-aniline dyed through
LINING	Jacquard lining with Montblanc emblem	Microfibre
FITTINGS/EMBLEM	Light gold-coated metal fittings with shiny finish, Montblanc emblem	Light gold-coated metal fittings with shiny finish, Montblanc emblem
FEATURES		
CLOSURE/LOCK	-	-
POCKETS	-	-
INTERIOR ORGANISATION	2 pockets for business cards, 2 pockets for credit cards	Smartphone holder suitable for iPhone 4 or 4s
ADDITIONAL CHARACTERISTICS	-	SmartPhone Holder also available for iPhone 5 (Id. 110184 / 110183)
REFILLS	-	-
DIMENSIONS		
DIMENSIONS	8 x 11 cm	7.5 x 12 cm

LA VIE DE BOHÈME

> Horizontal Wallets with Coin Case

LEATHER | LINING

Desert Sand |
Desert SandOnyx Black |
Onyx Black

EMBLEM



MODEL	Wallet 6cc with View Pocket, Flap & Coin Case	Wallet 6cc with Flap & zipped Coin Case
IDENT No.		
Desert Sand Desert Sand	107610	107612
Onyx Black Onyx Black	107609	107611
MATERIAL		
LEATHER	Russian calfskin, printed with glossy finish, chrome-tanned, semi-aniline dyed through	Russian calfskin, printed with glossy finish, chrome-tanned, semi-aniline dyed through
LINING	Jacquard lining with Montblanc emblem	Jacquard lining with Montblanc emblem
FITTINGS/EMBLEM	Light gold-coated metal fittings with shiny finish, Montblanc emblem	Light gold-coated metal fittings with shiny finish, Montblanc emblem
FEATURES		
CLOSURE/LOCK	2 flaps with press-studs	Flap with press-stud
POCKETS	-	-
INTERIOR ORGANISATION	6 pockets for credit cards, view pocket, an additional pocket, compartment for banknotes, coin case	6 pockets for credit cards, 4 additional pockets, compartment for banknotes, zipped coin case
ADDITIONAL CHARACTERISTICS	-	-
REFILLS	-	-
DIMENSIONS		
DIMENSIONS	11 x 10 cm	14.5 x 11 cm

LA VIE DE BOHÈME

> Long Wallets

LEATHER | LINING

Desert Sand |
Desert SandOnyx Black |
Onyx Black

EMBLEM



MODEL	Wallet 8cc with Zip & Coin Case
IDENT No.	
Desert Sand Desert Sand	107614
Onyx Black Onyx Black	107613
MATERIAL	
LEATHER	Russian calfskin, printed with glossy finish, chrome-tanned, semi-aniline dyed through
LINING	Jacquard lining with Montblanc emblem
FITTINGS/EMBLEM	Light gold-coated metal fittings with shiny finish, Montblanc emblem
FEATURES	
CLOSURE/LOCK	Metal zip
POCKETS	-
INTERIOR ORGANISATION	8 pockets for credit cards, compartment for banknotes, 2 additional pockets, zipped coin case
ADDITIONAL CHARACTERISTICS	-
REFILLS	-
DIMENSIONS	
DIMENSIONS	19,5 x 10,5 cm

LA VIE DE BOHÈME

> Long Wallets

LEATHER | LINING

Desert Sand |
Desert SandOnyx Black |
Onyx Black

EMBLEM



MODEL	Wallet 10cc with Flap & Coin Case
IDENT No.	
Desert Sand Desert Sand	109323
Onyx Black Onyx Black	109322
MATERIAL	
LEATHER	Russian calfskin, printed with glossy finish, chrome-tanned, semi-aniline dyed through
LINING	Jacquard lining with Montblanc emblem
FITTINGS/EMBLEM	Light gold-coated metal fittings with shiny finish, Montblanc emblem
FEATURES	
CLOSURE/LOCK	Flap with 2 press-studs
POCKETS	-
INTERIOR ORGANISATION	10 pockets for credit cards, 2 compartments for banknotes, coin pocket with zip, 1 additional pocket
ADDITIONAL CHARACTERISTICS	-
REFILLS	-
DIMENSIONS	
DIMENSIONS	10,5 x 19 cm

LA VIE DE BOHÈME

> Organisers & Agendas

LEATHER | LINING

Desert Sand |
Desert SandOnyx Black |
Onyx Black

EMBLEM



MODEL	Agenda Small
IDENT No.	
Desert Sand Desert Sand	107616
Onyx Black Onyx Black	107615
MATERIAL	
LEATHER	Russian calfskin, printed with glossy finish, chrome-tanned, semi-aniline dyed through
LINING	Jacquard lining with Montblanc emblem
FITTINGS/EMBLEM	Light gold-coated metal fittings with shiny finish, Montblanc emblem
FEATURES	
CLOSURE/LOCK	-
POCKETS	-
INTERIOR ORGANISATION	4 pockets for credit cards, additional pocket
ADDITIONAL CHARACTERISTICS	Loop for writing instrument the size of a Bohème or Meisterstück Classique writing instrument, complete with calendar
REFILLS	Calendar 2014 Vertical (Id. 110145)
DIMENSIONS	
DIMENSIONS	11.5 x 16.5 x 2 cm

LA VIE DE BOHÈME

> Organisers & Agendas

LEATHER | LINING

Desert Sand |
Desert SandOnyx Black |
Onyx Black

EMBLEM



MODEL	Notebook Medium
IDENT No.	
Desert Sand Desert Sand	107618
Onyx Black Onyx Black	107617
MATERIAL	
LEATHER	Russian calfskin, printed with glossy finish, chrome-tanned, semi-aniline dyed through
LINING	Jacquard lining with Montblanc emblem
FITTINGS/EMBLEM	Light gold-coated metal fittings with shiny finish, Montblanc emblem
FEATURES	
CLOSURE/LOCK	-
POCKETS	-
INTERIOR ORGANISATION	4 pockets for credit cards, additional pocket
ADDITIONAL CHARACTERISTICS	Loop for writing instrument the size of a Bohème or Meisterstück Classique writing instrument, complete with notebook
REFILLS	Notebook Medium (Id. 09596)
DIMENSIONS	
DIMENSIONS	20 x 23 x 2 cm

LA VIE DE BOHÈME

> Organisers & Agendas

LEATHER | LINING

Desert Sand |
Desert SandOnyx Black |
Onyx Black

EMBLEM



MODEL	Organiser Medium
IDENT No.	
Desert Sand Desert Sand	107620
Onyx Black Onyx Black	107619
MATERIAL	
LEATHER	Russian calfskin, printed with glossy finish, chrome-tanned, semi-aniline dyed through
LINING	Jacquard lining with Montblanc emblem
FITTINGS/EMBLEM	Light gold-coated metal fittings with shiny finish, Montblanc emblem
FEATURES	
CLOSURE/LOCK	Flap with press-stud
POCKETS	-
INTERIOR ORGANISATION	6 pockets for credit cards, additional pocket
ADDITIONAL CHARACTERISTICS	Loop for writing instrument the size of a Bohème or Meisterstück Classique writing instrument, complete with calendar
REFILLS	Starter Kit Medium (Id. 08403), Telephone-Address Sheets Medium (Id. 03027), Organisation Kit Medium (Id. 03028), Daily Plan Pages Medium (Id. 03025), Blank Sheets Medium (Id. 03021), Squared Sheets Medium (Id. 03026), Calendar 2014 Medium (Id. 110139 - 1 day on 1 page, Id. 110140 - 1week on 2 pages)
DIMENSIONS	
DIMENSIONS	14.5 x 19 x 4 cm

LA VIE DE BOHÈME

> Writing Instrument Pouches

LEATHER | LINING

Desert Sand |
Desert SandOnyx Black |
Onyx Black

EMBLEM



MODEL	1 Pen Pouch with Zip	2 Pen Pouch
IDENT No.		
Desert Sand Desert Sand	107602	109319
Onyx Black Onyx Black	107601	109318
MATERIAL		
LEATHER	Russian calfskin, printed with glossy finish, chrome-tanned, semi-aniline dyed through	Russian calfskin, printed with glossy finish, chrome-tanned, semi-aniline dyed through
LINING	Jacquard lining with Montblanc emblem	Jacquard lining with Montblanc emblem
FITTINGS/EMBLEM	Light gold-coated metal fittings with shiny finish, Montblanc emblem	Light gold-coated metal fittings with shiny finish, Montblanc emblem
FEATURES		
CLOSURE/LOCK	Metal zip	Clasp
POCKETS	-	-
INTERIOR ORGANISATION	Compartment for 1 writing instrument the size of Bohème or Meisterstück Classique	Compartment for 2 writing instruments the size of Meisterstück Classique
ADDITIONAL CHARACTERISTICS	-	-
REFILLS	-	-
DIMENSIONS		
DIMENSIONS	4.5 x 16 cm	5 x 15,5 cm

LA VIE DE BOHÈME

> Seasonal Colour Collection 2013/14

LEATHER | LINING



Turquoise |
White

EMBLEM



MODEL	Coin Case with Zip	Wallet 6cc with Flap & Coin Case
IDENT No.	109602	109603
MATERIAL		
LEATHER	Russian calfskin, printed with glossy finish, chrome-tanned, semi-aniline dyed through	Russian calfskin, printed with glossy finish, chrome-tanned, semi-aniline dyed through
LINING	Soft full-grain calfskin, Jacquard lining with Montblanc emblem	Soft full-grain calfskin, Jacquard lining with Montblanc emblem
FITTINGS/EMBLEM	Light gold-coated metal fittings with shiny finish, Montblanc emblem	Light gold-coated metal fittings with shiny finish, Montblanc emblem
FEATURES		
CLOSURE/LOCK	Metal zip	-
POCKETS	-	-
INTERIOR ORGANISATION	2 compartments for coins	6 pockets for credit cards, 1 compartment for banknotes, coin case with flap
ADDITIONAL CHARACTERISTICS	-	-
REFILLS	-	-
DIMENSIONS		
DIMENSIONS	7 x 8 cm	11 x 10 cm

LA VIE DE BOHÈME

> Seasonal Colour Collection 2013/14

LEATHER | LINING



Turquoise |
White

EMBLEM



MODEL	Wallet 8cc with Zip & Coin Case
IDENT No.	109604
MATERIAL	
LEATHER	Russian calfskin, printed with glossy finish, chrome-tanned, semi-aniline dyed through
LINING	Soft full-grain calfskin, Jacquard lining with Montblanc emblem
FITTINGS/EMBLEM	Light gold-coated metal fittings with shiny finish, Montblanc emblem
FEATURES	
CLOSURE/LOCK	Metal zip
POCKETS	-
INTERIOR ORGANISATION	8 pockets for credit cards, 2 compartments for banknotes, coin case with zip, 2 additional pockets
ADDITIONAL CHARACTERISTICS	-
REFILLS	-
DIMENSIONS	
DIMENSIONS	10.5 x 19 cm

LA VIE DE BOHÈME

> Seasonal Colour Collection 2013/14

LEATHER | LINING



Coral | White

EMBLEM



MODEL	Coin Case with Zip	Wallet 6cc with Flap & Coin Case
IDENT No.	109605	109606
MATERIAL		
LEATHER	Russian calfskin, printed with glossy finish, chrome-tanned, semi-aniline dyed through	Russian calfskin, printed with glossy finish, chrome-tanned, semi-aniline dyed through
LINING	Soft full-grain calfskin, Jacquard lining with Montblanc emblem	Soft full-grain calfskin, Jacquard lining with Montblanc emblem
FITTINGS/EMBLEM	Light gold-coated metal fittings with shiny finish, Montblanc emblem	Light gold-coated metal fittings with shiny finish, Montblanc emblem
FEATURES		
CLOSURE/LOCK	Metal zip	-
POCKETS	-	-
INTERIOR ORGANISATION	2 compartments for coins	6 pockets for credit cards, 1 compartment for banknotes, coin case with flap
ADDITIONAL CHARACTERISTICS	-	-
REFILLS	-	-
DIMENSIONS		
DIMENSIONS	7 x 8 cm	11 x 10 cm

LA VIE DE BOHÈME

> Seasonal Colour Collection 2013/14

LEATHER | LINING



Coral | White

EMBLEM



MODEL	Wallet 8cc with Zip & Coin Case
IDENT No.	109607
MATERIAL	
LEATHER	Russian calfskin, printed with glossy finish, chrome-tanned, semi-aniline dyed through
LINING	Soft full-grain calfskin, Jacquard lining with Montblanc emblem
FITTINGS/EMBLEM	Light gold-coated metal fittings with shiny finish, Montblanc emblem
FEATURES	
CLOSURE/LOCK	Metal zip
POCKETS	-
INTERIOR ORGANISATION	8 pockets for credit cards, 2 compartments for banknotes, coin case with zip, 2 additional pockets
ADDITIONAL CHARACTERISTICS	-
REFILLS	-
DIMENSIONS	
DIMENSIONS	10.5 x 19 cm

LA VIE DE BOHÈME

> Seasonal Colour Collection 2013/14

LEATHER | LINING



Shell | White

EMBLEM



MODEL	Coin Case with Zip	Wallet 6cc with Flap & Coin Case
IDENT No.	109608	109609
MATERIAL		
LEATHER	Russian calfskin, printed with glossy finish, chrome-tanned, semi-aniline dyed through	Russian calfskin, printed with glossy finish, chrome-tanned, semi-aniline dyed through
LINING	Soft full-grain calfskin, Jacquard lining with Montblanc emblem	Soft full-grain calfskin, Jacquard lining with Montblanc emblem
FITTINGS/EMBLEM	Light gold-coated metal fittings with shiny finish, Montblanc emblem	Light gold-coated metal fittings with shiny finish, Montblanc emblem
FEATURES		
CLOSURE/LOCK	Metal zip	-
POCKETS	-	-
INTERIOR ORGANISATION	2 compartments for coins	6 pockets for credit cards, 1 compartment for banknotes, coin case with flap
ADDITIONAL CHARACTERISTICS	-	-
REFILLS	-	-
DIMENSIONS		
DIMENSIONS	7 x 8 cm	11 x 10 cm

LA VIE DE BOHÈME

> Seasonal Colour Collection 2013/14

LEATHER | LINING



Shell | White

EMBLEM



MODEL	Wallet 8cc with Zip & Coin Case
IDENT No.	109610
MATERIAL	
LEATHER	Russian calfskin, printed with glossy finish, chrome-tanned, semi-aniline dyed through
LINING	Soft full-grain calfskin, Jacquard lining with Montblanc emblem
FITTINGS/EMBLEM	Light gold-coated metal fittings with shiny finish, Montblanc emblem
FEATURES	
CLOSURE/LOCK	Metal zip
POCKETS	-
INTERIOR ORGANISATION	8 pockets for credit cards, 2 compartments for banknotes, coin case with zip, 2 additional pockets
ADDITIONAL CHARACTERISTICS	-
REFILLS	-
DIMENSIONS	
DIMENSIONS	10.5 x 19 cm

DEDICATED PEN POUCHES

DEDICATED PEN POUCHES

> Small Leather Goods

> Writing Instrument Pouches



1 Pen Pouch with Zip Small

Id. 109269

p. 311



1 Pen Pouch Hard Case

Id. 109144

p. 312



1 Pen Pouch Hard Case

Id. 109145

p. 313

DEDICATED PEN POUCHES

> Writing Instrument Pouches

LEATHER



Black

EMBLEM



MODEL	1 Pen Pouch with Zip Small
IDENT No.	109269
MATERIAL	
LEATHER	European full-grain calfskin, chrome-tanned, dyed through
LINING	-
FITTINGS/EMBLEM	Montblanc emblem and palladium-coated ring
FEATURES	
CLOSURE/LOCK	Metal zip
POCKETS	-
INTERIOR ORGANISATION	Compartment for 1 writing instrument the size of Meisterstück Mozart
ADDITIONAL CHARACTERISTICS	-
REFILLS	-
DIMENSIONS	
DIMENSIONS	4 x 12,5 cm

DEDICATED PEN POUCHES

> Writing Instrument Pouches

LEATHER | LINING

Rose Quartz |
Beige

EMBLEM

MODEL	1 Pen Pouch Hard Case
IDENT No.	109144
MATERIAL	
LEATHER	Russian calfskin, printed with glossy finish, chrome-tanned, semi-aniline dyed through
LINING	Microfibre
FITTINGS/EMBLEM	Light gold-coated metal fittings with shiny finish, Montblanc emblem
FEATURES	
CLOSURE/LOCK	Flap with magnetic closure
POCKETS	-
INTERIOR ORGANISATION	Compartment for 1 writing instrument the size of Limited Edition Princesse Grace de Monaco or Meisterstück Classique
ADDITIONAL CHARACTERISTICS	-
REFILLS	-
DIMENSIONS	
DIMENSIONS	2.5 x 15 cm

DEDICATED PEN POUCHES

> Writing Instrument Pouches

LEATHER | LINING



Amethyst | Beige

EMBLEM



MODEL	1 Pen Pouch Hard Case
IDENT No.	109145
MATERIAL	
LEATHER	Russian calfskin, printed with glossy finish, chrome-tanned, semi-aniline dyed through
LINING	Microfibre
FITTINGS/EMBLEM	Light gold-coated metal fittings with shiny finish, Montblanc emblem
FEATURES	
CLOSURE/LOCK	Flap with magnetic closure
POCKETS	-
INTERIOR ORGANISATION	Compartment for 1 writing instrument the size of Limited Edition Princesse Grace de Monaco or Meisterstück Classique
ADDITIONAL CHARACTERISTICS	-
REFILLS	-
DIMENSIONS	
DIMENSIONS	2.5 x 15 cm

REFILLS

















REFILLS

> Punched for Ring Binders

> Date Related

				
Calendar 2014 Pocket ringbound	Calendar 2014 Small ringbound	Calendar 2014 Medium 1 Day on 1 Page	Calendar 2014 Medium 1 week on 2 pages	Calendar 2014 Large
Id. 110137	Id. 110138	Id. 110139	Id. 110140	Id. 110141

> Non-Date Related

						
Starter Kit Pocket	Organisation Kit Pocket	Telephone-Address Sheets Pocket	Daily Plan Pages Pocket	Blank Sheets Pocket		
Id. 08401	Id. 03023	Id. 03022	Id. 03020	Id. 109082		
						
Starter Kit Small	Organisation Kit Small	Telephone-Address Sheets Small	Daily Plan Pages Small	Blank Sheets Small	Squared Sheets Small	Note Sheets Small
Id. 08402	Id. 06686	Id. 06640	Id. 06641	Id. 06688	Id. 06687	Id. 06639
						
Starter Kit Medium	Organisation Kit Medium	Telephone-Address Sheets Medium	Daily Plan Pages Medium	Blank Sheets Medium	Squared Sheets Medium	
Id. 08403	Id. 03028	Id. 03027	Id. 03025	Id. 03021	Id. 03026	
						
Starter Kit Large	Organisation Kit Large	Telephone-Address Sheets Large	Daily Plan Pages Large	Blank Sheets Large	Squared Sheets Large	
Id. 08404	Id. 03033	Id. 03032	Id. 03030	Id. 03051	Id. 03031	

REFILLS

> Bound for Covers

> Date Related

						
Calendar 2014 Baby	Calendar 2014 Squarish	Calendar 2014 Horizontal	Calendar 2014 Vertical	Calendar 2014 for Wallet	Diarium 2014 bookbound	Agenda 2014 Pocket
Id. 110142	Id. 110143	Id. 110144	Id. 110145	Id. 110146	Id. 110147	Id. 110148

> Non-Date Related

				
Notepad Baby	Notebook Squarish	Notebook Small	Notebook Medium	
Id. 09598	Id. 101323	Id. 09597	Id. 09596	
				
Notepad HaWAM	Notepad Small	Notepad A4	Memo Pad for PDA Holder	Writing Pad
Id. 15705	Id. 13915	Id. 06711	Id. 06713	Id. 06712

> Not Bound

> Non-Date Related

				
Memo Pad	Noteholder Paper	Ink Blotting Paper	Separate Sheets	2x Plastic Inlay 6cc
Id. 12467	Id. 09934	Id. 09935	Id. 06710	Id. 102063

REFILLS

> Punched for Ring Binders



110137



110139

Date Related		Dimensions
Calendar 2014 Pocket ringbound IDENT. No. 110137	<ul style="list-style-type: none"> • 1 week on 2 pages • 2014 and 2015 overview and separate monthly overview consisting of 1 week printed on 2 pages - international public holidays overview - all pages exclusively branded with the Montblanc emblem and made of premium white paper, perfectly adapted to writing with ink, suitable for all Montblanc pocket organisers 	6.7 x 10.5 cm (A7)
Calendar 2014 Small ringbound IDENT. No. 110138	<ul style="list-style-type: none"> • 1 week on 2 pages • 2014 and 2015 overview and separate monthly overviews consisting of 1 month printed on 1 page - international public holidays overview - all pages exclusively branded with the Montblanc emblem and made of premium white paper, perfectly adapted to writing with ink, suitable for all small Montblanc organisers. 	7.5 x 12.6 cm
Calendar 2014 Medium 1 Day on 1 Page IDENT. No. 110139	<ul style="list-style-type: none"> • 1 day on 1 page • 2014 and 2015 overview and separate monthly overviews consisting of 1 month printed on 1 page - international public holidays overview - all pages exclusively branded with the Montblanc emblem and made of premium white paper, perfectly adapted to writing with ink, suitable for all medium-sized Montblanc organisers. 	9.5 x 17.2 cm (A6)
Calendar 2014 Medium 1 week on 2 pages IDENT. No. 110140	<ul style="list-style-type: none"> • 1 week on 2 pages • 2014 and 2015 overview and separate monthly overviews consisting of 1 month printed on 1 page - international public holidays overview - all pages exclusively branded with the Montblanc emblem and made of premium white paper, perfectly adapted to writing with ink, suitable for all medium-sized Montblanc organisers. 	9.5 x 17.2 cm (A6)
Calendar 2014 Large IDENT. No. 110141	<ul style="list-style-type: none"> • 1 day on 1 page • 2014 and 2015 overview and separate monthly overviews consisting of 1 month printed on 1 page - international public holidays overview - all pages exclusively branded with the Montblanc emblem and made of premium white paper, perfectly adapted to writing with ink, suitable for all large Montblanc organisers. 	14.8 x 21.0 cm (A5)

REFILLS

> Punched for Ring Binders



08401



03022

Non-Date Related		Dimensions
Starter Kit Pocket IDENT. No. 08401	Set of divider sheets, blank sheets, address sheets and clear plastic folder for all Montblanc pocket organisers.	6.7 x 10.5 cm (A7)
Organisation Kit Pocket IDENT. No. 03023	Set of divider sheets, ruler and clear plastic folder for Montblanc pocket organiser	6.7 x 10.5 cm (A7)
Telephone-Address Sheets Pocket IDENT. No. 03022	50 address sheets for the Montblanc pocket organiser	6.7 x 10.5 cm (A7)
Daily Plan Pages Pocket IDENT. No. 03020	Suitable for Montblanc pocket organisers	6.7 x 10.5 cm (A7)
Starter Kit Small IDENT. No. 08402	Set of divider sheets, blank sheets, address sheets, world map, international dialling codes and clear plastic folder for all small-sized Montblanc organisers	7.5 x 12.6 cm
Organisation Kit Small IDENT. No. 06686	Set of divider sheets, ruler and clear plastic folder for the small Montblanc organiser	7.5 x 12.6 cm
Telephone-Address Sheets Small IDENT. No. 06640	50 address sheets for small Montblanc organiser	7.5 x 12.6 cm
Daily Plan Pages Small IDENT. No. 06641	50 non-date-related daily plan pages suitable for small Montblanc organisers	7.5 x 12.6 cm
Blank Sheets Small IDENT. No. 06688	Suitable for small-sized Montblanc organisers	7.5 x 12.6 cm
Squared Sheets Small IDENT. No. 06687	Suitable for small-sized Montblanc organisers	7.5 x 12.6 cm
Note Sheets Small IDENT. No. 06639	Suitable for small-sized Montblanc organisers	7.5 x 12.6 cm

REFILLS

> Punched for Ring Binders



03025

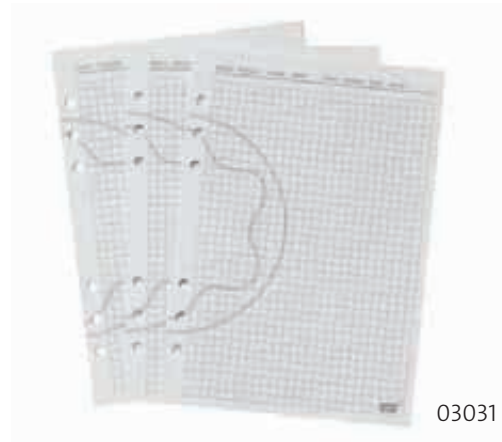

03031

Non-Date Related		Dimensions
Starter Kit Medium Ident. No. 08403	Set of divider sheets, blank sheets and address sheets, world map, international dialling codes, boutique overview, ruler and 2 clear plastic folders for all medium-sized Montblanc organisers.	9.5 x 17.2 cm (A6)
Organisation Kit Medium Ident. No. 03028	Set of divider sheets, ruler and clear plastic folder for the medium-sized Montblanc organiser	9.5 x 17.2 cm (A6)
Telephone-Address Sheets Medium Ident. No. 03027	50 address sheets for the medium-sized Montblanc organiser	9.5 x 17.2 cm (A6)
Daily Plan Pages Medium Ident. No. 03025	50 non-date-related daily plan pages suitable for medium-sized Montblanc organisers	9.5 x 17.2 cm (A6)
Blank Sheets Medium Ident. No. 03021	Suitable for medium-sized Montblanc organisers	9.5 x 17.2 cm (A6)
Squared Sheets Medium Ident. No. 03026	Suitable for medium-sized Montblanc organisers	9.5 x 17.2 cm (A6)
Starter Kit Large Ident. No. 08404	Set of divider sheets, blank sheets, address sheets, world map, international dialling codes, boutique overview, ruler and 2 clear plastic folders for all large-sized Montblanc organisers.	14.8 x 21.0 cm (A5)
Organisation Kit Large Ident. No. 03033	Set of divider sheets, ruler and clear plastic folder for the large Montblanc organiser	14.8 x 21.0 cm (A5)
Telephone-Address Sheets Large Ident. No. 03032	50 address sheets for the large Montblanc organiser	14.8 x 21.0 cm (A5)
Daily Plan Pages Large Ident. No. 03030	50 non-date related daily plan pages suitable for large Montblanc organisers	14.8 x 21.0 cm (A5)
Blank Sheets Large Ident. No. 03051	Suitable for large-sized Montblanc organisers	14.8 x 21.0 cm (A5)
Squared Sheets Large Ident. No. 03031	Suitable for large-sized Montblanc organisers	14.8 x 21.0 cm (A5)

REFILLS

> Bound for Covers

- Exclusively branded with the Montblanc emblem
- Premium white paper, perfectly adapted to writing with ink
- Black cover page with silver-coloured Montblanc emblem



110142



110143

Date Related		Dimensions
Calendar 2014 Baby Ident. No. 110142	<ul style="list-style-type: none"> • 2 days on 1 page • 2014 and 2015 overview and separate monthly overviews with 1 month printed on 1 page - separate address book - international public holidays overview - all pages exclusively branded with the Montblanc emblem and made of premium white paper, perfectly adapted to writing with ink - black cover with silver Montblanc emblem 	7 x 8.5 cm
Calendar 2014 Squarish Ident. No. 110143	<ul style="list-style-type: none"> • 1 week on 2 pages • 2014 and 2015 overview and separate monthly overviews with 1 month printed on 1 page - separate address book - international public holidays overview - all pages exclusively branded with the Montblanc emblem and made of premium white paper, perfectly adapted to writing with ink - black cover with silver Montblanc emblem 	15.5 x 15.5 cm
Calendar 2014 Horizontal Ident. No. 110144	<ul style="list-style-type: none"> • 1 week on 2 pages • 2014 and 2015 overview and separate monthly overviews with 1 month printed on 1 page - separate address book - international public holidays overview - all pages exclusively branded with the Montblanc emblem and made of premium white paper, perfectly adapted to writing with ink - black cover with silver Montblanc emblem 	15.5 x 8 cm
Calendar 2014 Vertical Ident. No. 110145	<ul style="list-style-type: none"> • 1 week on 2 pages • 2014 and 2015 overview and separate monthly overviews with 1 month printed on 1 page - separate address book - international public holidays overview - all pages exclusively branded with the Montblanc emblem and made of premium white paper, perfectly adapted to writing with ink - black cover with silver Montblanc emblem 	8 x 15.5 cm
Calendar 2014 for Wallet Ident. No. 110146	<ul style="list-style-type: none"> • 1 month on 2 pages • 2014 and 2015 overview - all pages exclusively branded with the Montblanc emblem and made of premium white paper, perfectly adapted to writing with ink 	9.3 x 15.2 cm
Diarium 2014 bookbound Ident. No. 110147	<ul style="list-style-type: none"> • 1 day on 1 page • 2014 and 2015 overview and separate monthly overviews with 3 months printed on 1 page - separate address book - international public holidays overview - notes - all pages exclusively branded with the Montblanc emblem and made of premium white paper, perfectly adapted to writing with ink - black hard cover with silver Montblanc emblem 	13.7 x 21.0 cm
Agenda 2014 Pocket Ident. No. 110148	<ul style="list-style-type: none"> • 1 week on 2 pages • 2014 and 2015 overview - separate monthly overviews with 2 months per page - separate address book - international public holidays overview - notes - all pages exclusively branded with the Montblanc emblem and made of premium white paper, perfectly adapted to writing with ink - black cover with silver Montblanc emblem 	8.2 x 17.2 cm

REFILLS

> Bound for Covers



09598



13915



06713

Non-Date Related		Dimensions
Noteepad Baby Ident. No. 09598	88 unlined pages. Black soft cover with silver Montblanc emblem. Inner pages made of premium white paper, perfectly adapted to writing with ink and exclusively branded with the Montblanc emblem.	5.5 x 10 cm
Notebook Squarish Ident. No. 101323	160 lined pages. Black soft cover with silver Montblanc emblem. Inner pages made of premium white paper, perfectly adapted to writing with ink and exclusively branded with the Montblanc emblem.	15.5 x 15.5 cm
Notebook Small Ident. No. 09597	224 lined pages. Black soft cover with silver Montblanc emblem. Inner pages made of premium white paper, perfectly adapted to writing with ink and exclusively branded with the Montblanc emblem.	9.2 x 14.2 cm
Notebook Medium Ident. No. 09596	248 lined pages. Black soft cover with silver Montblanc emblem. Inner pages made of premium white paper, perfectly adapted to writing with ink and exclusively branded with the Montblanc emblem.	17 x 22.4 cm
Notebook Medium Gilt Edge Ident. No. 106447	254 pages. Softcover notebook with gilt edge and Montblanc emblem. Inner pages made of premium white paper, perfectly adapted to writing with ink and exclusively branded with the Montblanc emblem. 190 lined pages for notes and 64 unlined, perforated pages for sketches.	16.8 x 22.0 cm
Noteepad HaWAM Ident. No. 15705	30 unlined pages. Black soft cover with silver Montblanc emblem. Inner pages made of premium white paper, perfectly adapted to writing with ink and exclusively branded with the Montblanc emblem.	5.0 x 10.0 cm (Hommage à W. A. Mozart)
Noteepad Small Ident. No. 13915	30 unlined pages. Black soft cover with silver Montblanc emblem. Inner pages made of premium white paper, perfectly adapted to writing with ink and exclusively branded with the Montblanc emblem.	7.2 x 9.8 cm
Noteepad A4 Ident. No. 06711	50 unlined sheets. Black soft cover with silver Montblanc emblem. Inner pages made of premium white paper, perfectly adapted to writing with ink and exclusively branded with the Montblanc emblem.	29.7 x 21.0 cm (A4)
Noteepad A4 Ident. No. 17834	50 unlined sheets. Black soft cover with silver Montblanc emblem. Inner pages made of premium chamois-coloured paper, perfectly adapted to writing with ink and exclusively branded with the Montblanc emblem.	29.7 x 21.0 cm (A4)
Memo Pad for PDA Holder Ident. No. 06713	Black soft cover with silver Montblanc emblem. Inner pages made of premium white paper, perfectly adapted to writing with ink and exclusively branded with the Montblanc emblem.	7.4 x 13.8 cm
Writing Pad Ident. No. 06712	45 unlined pages. Black soft cover with silver Montblanc emblem. Inner pages made of premium white paper, perfectly adapted to writing with ink and exclusively branded with the Montblanc emblem.	9.5 x 17.2 cm (A6)

REFILLS

> Not Bound



12467



09934



102063

Non-Date Related		Dimensions
Memo Pad Ident. No. 12467	Sheets made of premium white paper, perfectly adapted to writing with ink, each exclusively branded with the Montblanc emblem	7.5 x 10.5 cm
Noteholder Paper Ident. No. 09934	Sheets made of premium white paper, perfectly adapted to writing with ink, each exclusively branded with the Montblanc emblem	9.5 x 9.5 cm
Ink Blotting Paper Ident. No. 09935	Ink blotting paper made of white paperboard 400 g/m ² , acid-free, unsized	6.1 x 17.9 cm
Separate Sheets Ident. No. 06710	250 unlined pages. Sheets made of premium white paper, perfectly adapted to writing with ink, each exclusively branded with the Montblanc emblem	9.5 x 16.0 cm
2x Plastic Inlay 6cc Ident. No. 102063	Set of two credit card pockets with a total of 12 single pockets	7 x 10 cm

SERVICE

SERVICE

> *Leather Care Set*



Model

Leather Care Set
Ident. No. 02756

50 ml bottle of leather-care polish with soft polishing cloth

SERVICE

> *Embossing Service*

J.F. WINTER ——— 2. Grotesque, upper case
optional in silver, gold or blind











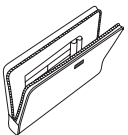







J.F. Winter ——— 6. Script, rounded
optional in silver, gold or blind

Full names can be embossed on small leather goods and, with few exceptions, on belts, up to two lines being allowable for this purpose.

FUNCTIONS

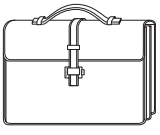



FUNCTIONS OVERVIEW · MEN'S COLLECTIONS

> Large Leather Goods

	Meisterstück	Meisterstück Canvas	Meisterstück Soft	Meisterstück Selection	4810 Westside
> Business Bags					
					
Portfolio with Zip	Id. 104604 p. 14			■ Id. 109616 p. 100 ■ Id. 109617 p. 101	
					
Document Case		Id. 106723 p. 61	Id. 104650 p. 84	■ Id. 109618 p. 102 ■ Id. 109621 p. 103 ■ Id. 109619 p. 103 ■ Id. 109620 p. 103	Id. 09296 p. 141
					
Document Case with 2 Compartments					
					
Single Gusset Briefcase	Id. 104606 p. 14	Id. 106731 p. 60			Id. 07578 p. 140
					
Single Gusset Framed Briefcase	Id. 105923 p. 17				
					
Double Gusset Briefcase	Id. 104607 p. 15			■ Id. 109625 p. 104 ■ Id. 109623 p. 105 ■ Id. 109622 p. 105 ■ Id. 109624 p. 105	Id. 07579 p. 140













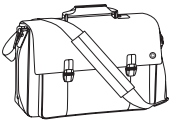

FUNCTIONS OVERVIEW · MEN'S COLLECTIONS

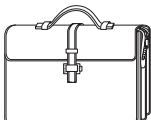
> Large Leather Goods

4810 Westside Black Mystery	4810 Westside Black Mystery Canvas	Soft Leather Range	Montblanc NightFlight	Montblanc Signature
 Id. 106044 p. 162	 Id. 107759 p. 173		 Id. 35383 p. 196	
				 Id. 106752 p. 209
		 Id. 105933 p. 182		 Id. 107233 p. 208
			 Id. 08772 p. 196	

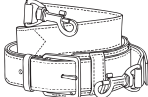

FUNCTIONS OVERVIEW · MEN'S COLLECTIONS

> Large Leather Goods

	Meisterstück	Meisterstück Canvas	Meisterstück Soft	Meisterstück Selection	4810 Westside
> Business Bags					
					
Triple Gusset Framed Briefcase with Laptop Holder	Id. 105925 p. 17				
					
Double Gusset Briefcase with 2 Front Pockets	Id. 104608 p. 15	Id. 106724 p. 61	Id. 106019 p. 84		
					
Triple Gusset Briefcase with Laptop Holder	Id. 104610 p. 16			Id. 09562 p. 141	
					
Laptop Case		Id. 106725 p. 62			
					
Executive Tote Bag		Id. 106739 p. 66			
					
Shoulder Strap				<ul style="list-style-type: none"> ■ Id. 109914 p. 107 ■ Id. 109727 p. 107 ■ Id. 109728 p. 106 ■ Id. 109729 p. 107 ■ Id. 109730 p. 107 ■ Id. 109731 p. 107 ■ Id. 109732 p. 108 ■ Id. 109733 p. 108 	











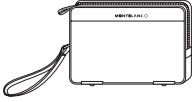

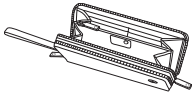

FUNCTIONS OVERVIEW · MEN'S COLLECTIONS

> Large Leather Goods

4810 Westside Black Mystery	4810 Westside Black Mystery Canvas	Soft Leather Range	Montblanc NightFlight	Montblanc Signature
				
				Id. 107765 p. 208
				
	Id. 107763 p. 177			













FUNCTIONS OVERVIEW · MEN'S COLLECTIONS

> Large Leather Goods

	Meisterstück	Meisterstück Canvas	Meisterstück Soft	Meisterstück Selection	4810 Westside
> City Bags					
					 Id. 104611 p. 142
		 Id. 107636 p. 67			 Id. 107357 Travel Bags p. 144
		 Id. 107635 p. 65			
		 Id. 107634 p. 65			
		 Id. 107948 p. 63			
					 Id. 104612 p. 142
			 Id. 104651 p. 85		

FUNCTIONS OVERVIEW · MEN'S COLLECTIONS

> Large Leather Goods

4810 Westside Black Mystery	4810 Westside Black Mystery Canvas	Soft Leather Range	Montblanc NightFlight	Montblanc Signature
				
	Id. 109568 p. 174			Id. 107234 p. 210
				
				Id. 107235 p. 214
				
				Id. 106757 p. 213
				
	Id. 107760 p. 174			Id. 106753 p. 210
				
	Id. 107761 p. 175		Id. 105939 p. 197	Id. 106754 p. 211
				
			Id. 08768 p. 197	Id. 106755 p. 211
				
	Id. 109567 p. 175		Id. 38039 p. 198	

FUNCTIONS OVERVIEW · MEN'S COLLECTIONS

> Large Leather Goods

	Meisterstück	Meisterstück Canvas	Meisterstück Soft	Meisterstück Selection	4810 Westside
> City Bags					
					
Camera Bag		Id. 107631 p. 63			Id. 104614 p. 143
					
Messenger Bag		Id. 106726 p. 64 Id. 107632 p. 64 Id. 106738 p. 66	Id. 104652 p. 85		Id. 104613 p. 143







FUNCTIONS OVERVIEW · MEN'S COLLECTIONS

> Large Leather Goods

4810 Westside	4810 Westside Black Mystery	4810 Westside Black Mystery Canvas	Soft Leather Range	Montblanc NightFlight
 Id. 106046 p. 163	 Id. 109569 p. 176	 Id. 105934 p. 183	 Id. 105940 p. 199	 Id. 106756 p. 212
 Id. 106047 p. 163	 Id. 107762 p. 176, 177	 Id. 105938 p. 184	 Id. 08763 p. 199	 Id. 106758 p. 212





FUNCTIONS OVERVIEW · MEN'S COLLECTIONS

> Large Leather Goods

	Meisterstück	Meisterstück Canvas	Meisterstück Soft	Meisterstück Selection	4810 Westside
> Travel Bags					
					
48-Hours Bag		Id. 106727 p. 68			
					
Hold-all bag / Weekender Bag			Id. 104654 p. 86		
> Bag on Wheels					
					
Office Case					
					
Trolley On-board					

FUNCTIONS OVERVIEW · MEN'S COLLECTIONS

> Large Leather Goods

4810 Westside Black Mystery	4810 Westside Black Mystery Canvas	Soft Leather Range	Montblanc NightFlight	Montblanc Signature
				
		Id. 105935 p. 185		
				
			Id. 38045 p. 200	
				
			Id. 38046 p. 201	Id. 106759 p. 215



FUNCTIONS OVERVIEW · MEN'S COLLECTIONS

> Small Leather Goods

	Meisterstück	Meisterstück Canvas	Meisterstück Soft	Meisterstück Selection	4810 Westside
> Pocket Accessories					
					
Key fob	Id. 14085 p. 18 Id. 107685 p. 18			<ul style="list-style-type: none"> ■ Id. 107686 p. 109 ■ Id. 107687 p. 109 ■ Id. 107688 p. 109 ■ Id. 109664 p. 110 ■ Id. 109666 p. 110 ■ Id. 109665 p. 110 	Id. 08381 p. 145
					
Key Case 6 Keys	Id. 07161 p. 19				
					
Key Case Valet Ring	Id. 107347 p. 19				
					
Memo Writing Pad	Id. 14109 p. 21				
					
Notepad Vertical	Id. 14244 p. 21			Id. 109645 p. 114	
					
Notepad Horizontal	Id. 14879 p. 22				











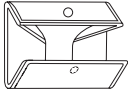



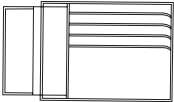

FUNCTIONS OVERVIEW · MEN'S COLLECTIONS

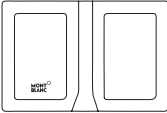
> Small Leather Goods

4810 Westside Black Mystery	4810 Westside Black Mystery Canvas	Soft Leather Range	Montblanc NightFlight	Montblanc Signature	Diaries & Notes
				 Id. 107692 p. 216	
 Id. 107534 p. 164					

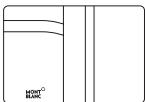





FUNCTIONS OVERVIEW · MEN'S COLLECTIONS

> Small Leather Goods

	Meisterstück	Meisterstück Canvas	Meisterstück Soft	Meisterstück Selection	4810 Westside
> Pocket Accessories					
					
Coin Case Small	Id. 14877 p. 22				
					
Pocket Holder 2cc with Money Clip	Id. 107346 p. 23				
					
Pocket Holder	Id. 35803 p. 23 Id. 106652 p. 30	Id. 107349 p. 69	Id. 104642 p. 87	<ul style="list-style-type: none"> ■ Id. 103410 p. 111 ■ Id. 106657 p. 111 ■ Id. 106658 p. 111 	
					
Pocket ID Card Holder	Id. 02665 p. 24				
					
View Pocket Holder		Id. 107637 p. 69			
					
Multi Credit Card Case	Id. 05527 p. 25				Id. 38061 p. 147
					
Business Card Holder	Id. 14108 p. 25 Id. 107443 p. 26	Id. 106728 p. 70			Id. 38034 p. 147

FUNCTIONS OVERVIEW · MEN'S COLLECTIONS

> Small Leather Goods

4810 Westside Black Mystery	4810 Westside Black Mystery Canvas	Soft Leather Range	Montblanc NightFlight	Montblanc Signature	Diaries & Notes
	 <p>Id. 107533 p. 164</p>	 <p>Id. 105927 p. 186</p>		 <p>Id. 106747 p. 216</p>	 <p> ■ Id. 109200 p. 228 ■ Id. 109201 p. 228 ■ Id. 109212 p. 228 </p>
				 <p>Id. 106748 p. 217</p>	 <p> ■ Id. 109214 p. 228 ■ Id. 109213 p. 228 ■ Id. 109215 p. 228 </p>

FUNCTIONS OVERVIEW · MEN'S COLLECTIONS

> Small Leather Goods

	Meisterstück	Meisterstück Canvas	Meisterstück Soft	Meisterstück Selection	Meisterstück Selection UNICEF
> Pocket Accessories					
					
Business Card Holder with Gusset	Id. 07167 p. 26	Id. 109611 p. 70	Id. 104643 p. 87	<ul style="list-style-type: none"> ■ Id. 103403 p. 112 ■ Id. 109658 p. 113 ■ Id. 109660 p. 113 ■ Id. 109659 p. 113 	Id. 109370 p. 93
					
Business Card Holder with Gusset & View Pocket	Id. 108946 p. 27				
					
Business Card Box					
					
ID Card Holder with Strap	Id. 107345 p. 51				
					
Passport Holder International	Id. 35285 p. 27	Id. 107638 p. 71			
					
Document / Passport Holder	Id. 103891 p. 51	Id. 107640 p. 77			







FUNCTIONS OVERVIEW · MEN'S COLLECTIONS

> Small Leather Goods

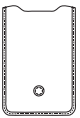
4810 Westside	4810 Westside Black Mystery	Soft Leather Range	Montblanc NightFlight	Montblanc Signature	Diaries & Notes
 Id. 107354 p. 146	 Id. 106038 p. 165	 Id. 105926 p. 187			
 Id. 108954 p. 146					
 Id. 103400 p. 148					
 Id. 107355 p. 148			 Id. 38041 p. 202	 Id. 107237 p. 217	

FUNCTIONS OVERVIEW · MEN'S COLLECTIONS

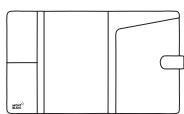
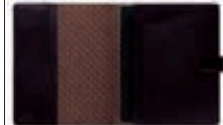
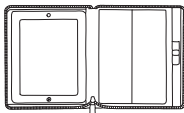
> Small Leather Goods

	Meisterstück	Meisterstück Canvas	Meisterstück Soft	Meisterstück Selection	Meisterstück Selection UNICEF
> Pocket Accessories					
					
SmartPhone Holder	Id. 109051 p. 20			<ul style="list-style-type: none"> ■ Id. 109628 p. 114 ■ Id. 109629 p. 115 ■ Id. 109630 p. 115 ■ Id. 109631 p. 115 ■ Id. 109632 p. 115 	
					
Tablet Computer Pouch with Zip				<ul style="list-style-type: none"> ■ Id. 109634 p. 116 ■ Id. 109635 p. 117 ■ Id. 109636 p. 117 ■ Id. 109637 p. 117 ■ Id. 109638 p. 117 	
					
Tablet Computer Cover with Clasp				Id. 109643 p. 116	
					
Business Companion				Id. 109644 p. 134	









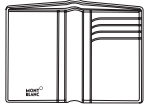

FUNCTIONS OVERVIEW · MEN'S COLLECTIONS

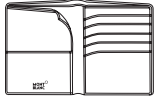
> *Small Leather Goods*

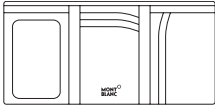
4810 Westside	4810 Westside Black Mystery	Soft Leather Range	Montblanc NightFlight	Montblanc Signature	Diaries & Notes

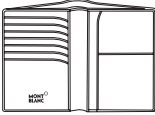
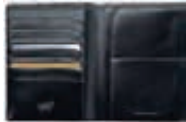
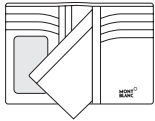
FUNCTIONS OVERVIEW · MEN'S COLLECTIONS

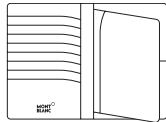
> Small Leather Goods

	Meisterstück	Meisterstück Canvas	Meisterstück Soft	Meisterstück Selection	Meisterstück Selection UNICEF
> Vertical Wallets without Coin Case					
					
Wallet 4cc	Id. 11987 p. 35				
					
Wallet 4cc with View Pocket	Id. 02664 p. 35				
					
Wallet 5cc	Id. 15499 p. 36				
					
Wallet 5cc with View Pocket	Id. 102273 p. 36				
					
Wallet 7cc	Id. 14094 p. 37				
					
Wallet 7cc with ID Card Holder	Id. 35798 p. 37				
					
Wallet 8cc with ID Card Holder	Id. 35802 p. 38				



FUNCTIONS OVERVIEW · MEN'S COLLECTIONS

> Small Leather Goods

4810 Westside	4810 Westside Black Mystery	Soft Leather Range	Montblanc NightFlight	Montblanc Signature	Diaries & Notes

FUNCTIONS OVERVIEW · MEN'S COLLECTIONS

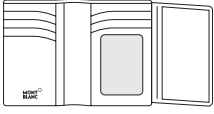
> Small Leather Goods

	Meisterstück	Meisterstück Canvas	Meisterstück Soft	Meisterstück Selection	Meisterstück Selection UNICEF
> Vertical Wallets without Coin Case					
					
Wallet 11cc with ID Card Holder	Id. 35799 p. 38				
					
Wallet 12cc with View Pocket		Id. 104648 p. 89	<ul style="list-style-type: none"> ■ Id. 103408 p. 124 ■ Id. 106661 p. 106 ■ Id. 106662 p. 106 		
					
Wallet 14cc	Id. 35801 p. 39				











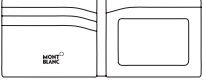

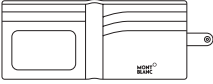

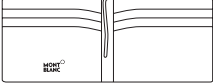

FUNCTIONS OVERVIEW · MEN'S COLLECTIONS

> *Small Leather Goods*

4810 Westside	4810 Westside Black Mystery	Soft Leather Range	Montblanc NightFlight	Montblanc Signature	Diaries & Notes

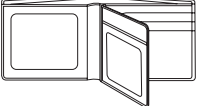
FUNCTIONS OVERVIEW · MEN'S COLLECTIONS

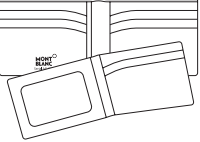
> Small Leather Goods

	Meisterstück	Meisterstück Canvas	Meisterstück Soft	Meisterstück Selection	Meisterstück Selection UNICEF
> Horizontal Wallets without Coin Case					
					
Wallet 3cc with view pocket & money clip		Id. 109612 p. 72			
					
Wallet 4cc with View Pocket	Id. 102274 <i>Country Specifics - Special Order</i> p. 52				
					
Wallet 4cc with Money Clip & View Pocket	Id. 108945 p. 28				
					
Wallet 6cc	Id. 14548 p. 28	Id. 106729 p. 72 Id. 109613 p. 73		<ul style="list-style-type: none"> ■ Id. 109646 p. 119 ■ Id. 109648 p. 119 ■ Id. 109647 p. 119 	
					
Wallet 6cc with Money Clip	Id. 05525 p. 29	Id. 107350 p. 73		Id. 106015 p. 120	
					
Wallet 6cc with 2 View Pockets	Id. 16354 p. 29				
					
Wallet 6cc with removable Card Holder				<ul style="list-style-type: none"> ■ Id. 103406 p. 118 ■ Id. 106659 p. 118 ■ Id. 106660 p. 118 	Id. 109371 p. 94

FUNCTIONS OVERVIEW · MEN'S COLLECTIONS

> Small Leather Goods

4810 Westside	4810 Westside Black Mystery	Soft Leather Range	Montblanc NightFlight	Montblanc Signature	Diaries & Notes
 Id. 38036 p. 149	 Id. 107535 p. 166	 Id. 105928 p. 188	 Id. 38043 p. 203	 Id. 106749 p. 218	
 Id. 101867 p. 149				 Id. 107770 p. 218	
 Id. 103401 p. 150	 Id. 106040 p. 166			 Id. 107829 p. 219	

FUNCTIONS OVERVIEW · MEN'S COLLECTIONS

> Small Leather Goods

	Meisterstück	Meisterstück Canvas	Meisterstück Soft	Meisterstück Selection	Meisterstück Selection UNICEF
> Horizontal Wallets without Coin Case					
					
Wallet 6cc with Chequebook Holder	Id. 36757 <i>Country Specifics · Special Order</i> p. 53				
					
Pocket 6cc	Id. 106653 p. 24				
					
Wallet 8cc	Id. 07163 p. 30	Id. 107351 Id. 109614 p. 74 p. 74			
					
Wallet 8cc with removable Card Holder				Id. 106016 p. 120	
					
Wallet 11cc with View Pocket	Id. 07162 p. 31	Id. 107352 p. 75	Id. 104646 p. 88	Id. 106018 p. 121	
					
Wallet 12cc	Id. 103384 p. 31				
					
Wallet 14cc	Id. 14095 p. 32				

FUNCTIONS OVERVIEW · MEN'S COLLECTIONS

> Small Leather Goods

4810 Westside	4810 Westside Black Mystery Canvas	Soft Leather Range	Montblanc NightFlight	Montblanc Signature	Diaries & Notes
 Id. 08372 p. 151		 Id. 105929 p. 188	 Id. 08774 p. 203	 Id. 107771 p. 219	
 Id. 101866 p. 151	 Id. 107536 p. 167	 Id. 105931 p. 189		 Id. 107830 p. 220	
 Id. 09299 p. 152					
 Id. 38037 p. 152					

FUNCTIONS OVERVIEW · MEN'S COLLECTIONS

> Small Leather Goods

	Meisterstück	Meisterstück Canvas	Meisterstück Soft	Meisterstück Selection	Meisterstück Selection UNICEF
> Horizontal Wallets without Coin Case					
					
Wallet 24cc Large	Id. 104820 p. 32				
> Horizontal Wallets with Coin Case					
					
Wallet 1cc Mini	Id. 35804 <i>Country Specifics - Special Order</i> p. 54				
					
Wallet 4cc	Id. 07164 p. 33			Id. 103407 p. 122	
					
Wallet 4cc with ID Card Holder	Id. 06179 p. 33	Id. 107639 p. 76			
					
Wallet 5cc Large	Id. 14103 p. 34				
					
Wallet 6cc with View Pocket					
					
Wallet 10cc	Id. 05524 p. 34	Id. 107353 p. 76		Id. 106017 p. 123	

FUNCTIONS OVERVIEW · MEN'S COLLECTIONS

> Small Leather Goods

4810 Westside	4810 Westside Black Mystery	Soft Leather Range	Montblanc NightFlight	Montblanc Signature	Diaries & Notes
 Id. 08373 p. 153		 Id. 105930 p. 190	 Id. 08775 p. 204	 Id. 106750 p. 221	
 Id. 09680 p. 153					
			 Id. 101859 p. 205		
				 Id. 107831 p. 221	

FUNCTIONS OVERVIEW · MEN'S COLLECTIONS

> Small Leather Goods

	Meisterstück	Meisterstück Canvas	Meisterstück Soft	Meisterstück Selection	Meisterstück Selection UNICEF
> Long Wallets					
					
Wallet 6cc with Chequebook Holder	Id. 05529 <i>Country Specifics - Special Order</i> p. 55				
					
Wallet 6cc	Id. 35790 p. 40	Id. 106730 p. 78			
					
Wallet 12cc				Id. 109372 p. 95	
					
Travel Wallet 14cc		Id. 107641 p. 79			
					
Wallet 13cc with Zip	Id. 16352 p. 41				
					
Wallet 14cc with Gusset	Id. 07165 p. 41	Id. 109615 p. 78		■ Id. 109655 p. 125 ■ Id. 109656 p. 125 ■ Id. 109657 p. 125	







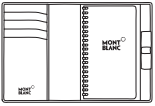
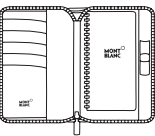
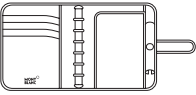

FUNCTIONS OVERVIEW · MEN'S COLLECTIONS

> Small Leather Goods

4810 Westside	4810 Westside Black Mystery	Soft Leather Range	Montblanc NightFlight	Montblanc Signature	Diaries & Notes
 Id. 08375 p. 154					
				 Id. 106751 p. 222	
 Id. 107356 p. 155					
	 Id. 106042 p. 168	 Id. 105932 p. 191			

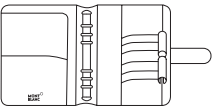

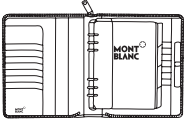
FUNCTIONS OVERVIEW · MEN'S COLLECTIONS

> Small Leather Goods

	Meisterstück	Meisterstück Canvas	Meisterstück Soft	Meisterstück Selection	Meisterstück Selection UNICEF
> Organisers & Agendas					
 <p>Agenda Small</p>				 <p> ■ Id. 106647 p. 126 ■ Id. 106663 p. 126 ■ Id. 106664 p. 126 </p>	
 <p>Agenda Small with Zip</p>				 <p> ■ Id. 109674 p. 127 ■ Id. 109670 p. 128 ■ Id. 109671 p. 128 ■ Id. 109672 p. 128 ■ Id. 109673 p. 128 </p>	
 <p>Organiser Small</p>	 <p>Id. 06178 p. 42</p>				
 <p>Organiser Medium</p>	 <p>Id. 14257 p. 42</p>			 <p>Id. 106650 p. 133</p>	
 <p>Organiser Large</p>	 <p>Id. 14875 p. 43</p>				
 <p>Organiser Large with Zip</p>	 <p>Id. 104833 p. 43</p>				







FUNCTIONS OVERVIEW · MEN'S COLLECTIONS

> Small Leather Goods

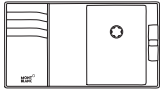
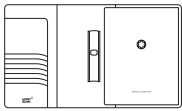
4810 Westside	4810 Westside Black Mystery	Soft Leather Range	Montblanc NightFlight	Montblanc Signature	Diaries & Notes
					 <ul style="list-style-type: none"> Id. 109206 p. 229 Id. 109205 p. 229 Id. 109207 p. 229
					 <ul style="list-style-type: none"> Id. 109222 p. 230 Id. 109211 p. 230 Id. 109223 p. 230

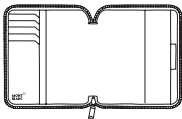

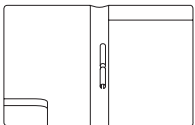
FUNCTIONS OVERVIEW · MEN'S COLLECTIONS

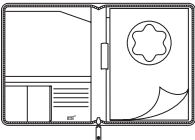
> Small Leather Goods

	Meisterstück	Meisterstück Canvas	Meisterstück Soft	Meisterstück Selection	Meisterstück Selection UNICEF
> Organisers & Agendas					
					
Notebook Small					
					
Notebook Medium	Id. 103386 p. 44			Id. 106649 p. 130	
					
Notebook Medium with Zip				<ul style="list-style-type: none"> ■ Id. 109679 p. 131 ■ Id. 109675 p. 132 ■ Id. 109676 p. 132 ■ Id. 109677 p. 132 ■ Id. 109678 p. 132 	Id. 109373 p. 96
					
Notepad Large	Id. 05523 p. 44			Id. 109680 p. 135	
					
Notepad Large with Zip					

FUNCTIONS OVERVIEW · MEN'S COLLECTIONS

> Small Leather Goods

4810 Westside	4810 Westside Black Mystery	Soft Leather Range	Montblanc NightFlight	Montblanc Signature	Diaries & Notes
					 <ul style="list-style-type: none"> Id. 109209 p. 231 Id. 109208 p. 231 Id. 109210 p. 231
	 <p>Id. 107537 p. 169</p>				
 <p>Id. 101865 p. 156</p>					

FUNCTIONS OVERVIEW · MEN'S COLLECTIONS

> Small Leather Goods

	Meisterstück	Meisterstück Canvas	Meisterstück Soft	Meisterstück Selection	Meisterstück Selection UNICEF
> Writing Instrument Pouches					
					
1 Pen Sleeve	Id. 101871 p. 45				
					
1 Pen Pouch	Id. 14309 p. 45			Id. 103409 p. 136	
					
1 Pen Pouch with Zip	Id. 101872 p. 47				Id. 109369 p. 97
					
1 Pen Pouch Hard				<ul style="list-style-type: none"> ■ Id. 107371 p. 137 ■ Id. 107400 p. 137 ■ Id. 107399 p. 137 	
					
2 Pen Pouch	Id. 14311 p. 46			Id. 106651 p. 136	
					
2 Pen Pouch with Zip				<ul style="list-style-type: none"> ■ Id. 107370 p. 137 ■ Id. 107398 p. 137 ■ Id. 107397 p. 137 	
					
3 Pen Pouch	Id. 14313 p. 46				

FUNCTIONS OVERVIEW · MEN'S COLLECTIONS

> Small Leather Goods

4810 Westside	4810 Westside Black Mystery	Soft Leather Range	Montblanc NightFlight	Montblanc Signature	Diaries & Notes
 Id. 09577 p. 157					
 Id. 103402 p. 157				 Id. 107769 p. 223	

FUNCTIONS OVERVIEW · MEN'S COLLECTIONS

> Small Leather Goods

	Meisterstück	Meisterstück Canvas	Meisterstück Soft	Meisterstück Selection	Meisterstück Selection UNICEF
> Desk Accessories					
					
Pen Tray	Id. 06182 p. 48				
					
Desk Pad	Id. 06181 p. 49				
					
Envelope Sorter	Id. 06183 p. 50				

FUNCTIONS OVERVIEW · MEN'S COLLECTIONS

> *Small Leather Goods*

4810 Westside	4810 Westside Black Mystery	Soft Leather Range	Montblanc NightFlight	Montblanc Signature	Diaries & Notes

FUNCTIONS OVERVIEW · LADIES' COLLECTIONS

> Large Leather Goods

Montblanc Signature Ladies

> City Bags



Envelope Bag



Id. 107778 p. 280



North South Bag Mini with Zip



Id. 107832 p. 280



Messenger Bag



Id. 107833 p. 281



Tote Bag



Id. 107780 p. 278



Id. 107781 p. 278



Id. 107783 p. 279



The Hobo Bag



Id. 107776 p. 276



The Boston Bag



Id. 107775 p. 276



The Classic Bag



Id. 107777 p. 277

FUNCTIONS OVERVIEW · LADIES' COLLECTIONS

> Small Leather Goods

	Montblanc Signature Ladies	La Vie de Bohème
> Pocket Accessories		
		
Key Fob	Id. 107693 p. 282	Id. 107694 p. 292 Id. 107695 p. 292
		
Key Case	Id. 107786 p. 282	Id. 109282 p. 292 Id. 109283 p. 292
		
Coin Case		Id. 107603 p. 293 Id. 107604 p. 293
		
Pocket Holder 4cc	Id. 107784 p. 283	Id. 109320 p. 293 Id. 109321 p. 293
		
Business Card Holder	Id. 107834 p. 283	Id. 107605 p. 294 Id. 107606 p. 294
		
SmartPhone Holder		Id. 107607 p. 294 Id. 107608 p. 294







FUNCTIONS OVERVIEW · LADIES' COLLECTIONS

> Small Leather Goods

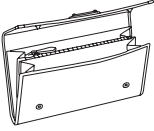
	Montblanc Signature Ladies	La Vie de Bohème
> Vertical Wallets without Coin Case		
		
<p>Wallet 6cc with Flap</p>	<p>Id. 107835</p> <p>p. 284</p>	
> Vertical Wallets with Coin Case		
		
<p>Wallet 4cc with Flap & Coin Case</p>	<p>Id. 107836</p> <p>p. 285</p>	
		
<p>Wallet 6cc with Frame & Coin Case</p>	<p>Id. 107837</p> <p>p. 285</p>	
		 
<p>Wallet 6cc with View Pocket, Flap & Coin Case</p>		<p>Id. 107609</p> <p>Id. 107610</p> <p>p. 295</p> <p>p. 295</p>
		 
<p>Wallet 6cc with Flap & zipped Coin Case</p>		<p>Id. 107611</p> <p>Id. 107612</p> <p>p. 295</p> <p>p. 295</p>

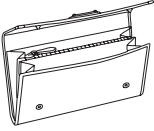
FUNCTIONS OVERVIEW · LADIES' COLLECTIONS

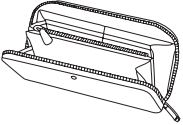
> Small Leather Goods

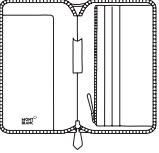
	Montblanc Signature Ladies	La Vie de Bohème
> Long Wallets		
 <p>Wallet 8cc with Flap & zipped Coin Case</p>	 <p>Id. 107838 p. 286</p>	
 <p>Wallet 10cc with Flap & Coin Case</p>		 <p>Id. 109322 p. 297 Id. 109323 p. 297</p>
 <p>Wallet 14cc with Zip</p>	 <p>Id. 107792 p. 287</p>	 <p>Id. 107613 p. 296 Id. 107614 p. 296</p>
 <p>Travel Wallet 12cc with Zip</p>	 <p>Id. 107839 p. 288</p>	





FUNCTIONS OVERVIEW · LADIES' COLLECTIONS

> Small Leather Goods

	Montblanc Signature Ladies	La Vie de Bohème
> Organisers & Agendas		
		
Pocket Organiser	Id. 107793	p. 289
		
Organiser Medium		Id. 107619 Id. 107620
		p. 300 p. 300
		
Notebook Medium		Id. 107617 Id. 107618
		p. 299 p. 299
		
Agenda Small		Id. 107615 Id. 107616
		p. 298 p. 298

FUNCTIONS OVERVIEW · LADIES' COLLECTIONS

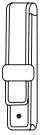
> Small Leather Goods

	Montblanc Signature Ladies	La Vie de Bohème
> Writing Instrument Pouches		
		
1 Pen Pouch with Zip		Id. 107601 Id. 107602 p. 301 p. 301
		
2 Pen Pouch		Id. 109318 Id. 109319 p. 301 p. 301





MONTBLANC WATCH COLLECTION 2013/2014

*CONTENTS***MONTBLANC COLLECTION VILLERET 1858**

Overview.....	8
Timewriter.....	12
High Complications.....	14
Chronographs.....	27
Classics.....	52

MONTBLANC NICOLAS RIEUSSEC COLLECTION

Overview.....	70
Platinum.....	72
Gold.....	75
Steel.....	81

MONTBLANC STAR 4810 COLLECTION

Overview.....	92
Gold.....	93
Steel.....	94

MONTBLANC STAR CLASSIQUE COLLECTION

Overview.....	100
Gold.....	102
Steel Gold.....	106
Steel.....	108

MONTBLANC STAR COLLECTION

Overview.....	112
Gold.....	116
Steel.....	120
Gold.....	117
Steel.....	124

*CONTENTS***MONTBLANC TIMEWALKER COLLECTION**

Overview.....	140
TwinFly Chronographs	143
Gold	146
Steel Gold	148
Steel.....	151

MONTBLANC SPORT COLLECTION

Overview.....	166
Tantalum	167
Steel.....	168

COLLECTION PRINCESSE GRACE DE MONACO

Overview.....	174
Gold	175
Steel.....	177

MONTBLANC PROFILE COLLECTION

Overview.....	182
Gold Jewellery.....	184
Steel Jewellery.....	185
Steel.....	188

MONTBLANC TRAVEL TIMEPIECES

Overview.....	198
Desk Clocks	199
Travel Timepieces.....	202

MONTBLANC CALIBRES

Montblanc Calibres	207
--------------------------	-----

CONTENTS

MONTBLANC COLLECTION VILLERET 1858 SERVICE

Alligator	216
Buckles	219

MONTBLANC NICOLAS RIEUSSEC SERVICE

Alligator	220
Bracelets	222
Clasps	222

MONTBLANC STAR 4810 SERVICE

Alligator	224
Bracelet	224
Buckles and Clasps	224

MONTBLANC STAR CLASSIQUE SERVICE

Alligator	226
Bracelets	228
Buckles	228

MONTBLANC STAR SERVICE

Alligator	230
Calfskin	234
Satin	238
Bracelets	240
Buckles	242
Clasps	244

*CONTENTS***MONTBLANC TIMEWALKER SERVICE**

Alligator	246
Calfskin	248
Bracelets	250
Buckles	252
Clasps	252

MONTBLANC SPORT SERVICE

Alligator	254
Rubber	256
Bracelets	256
Buckles and Clasps	258

PRINCESSE GRACE DE MONACO SERVICE

Alligator	260
Calfskin	262
Buckles	264

MONTBLANC PROFILE SERVICE

Alligator	266
Calfskin	268
Saffiano	270
Satin	272
Bracelets	274
Buckles	276
Clasps	276



MONTBLANC COLLECTION VILLERET 1858

THE FUTURE OF TRADITIONAL WATCHMAKING

The Montblanc watches manufactured in Villeret benefit from over 150 years of uninterrupted traditional Swiss watchmaking expertise. With timeless aesthetics and intricate mechanical movements crafted entirely in-house, the watches produced here still express the same core values upon which the company was founded in 1858.

The prestigious Manufacture Minerva, forerunner of what has today become the Montblanc Manufacture in Villeret, won its spurs

developing groundbreaking movements admired by connoisseurs for their outstanding quality and original design. During the final years of the 19th century, the business transformed itself into a complete watch manufacture, producing their own movement-blanks and cases, finally mastering all the skills necessary to manufacture a watch from start to finish. The calibres already had at that time the typical formal characteristics, making their chronographs distinguishable from all others



to this day. In 1909, the company is one of the first manufactures to produce a movement specifically made for wristwatches and has since developed the chronograph to the peak of perfection.

The manufacture in the small village in the Saint-Imier valley in the Swiss Jura kept its existing infrastructure, which is perfectly geared to the manufacture of small but highly exclusive series. The company is one of the very few manufacturers able to draw on the master watchmakers, the original tools and the expertise needed to develop and produce mechanical timepieces in keeping with authentic Swiss watchmaking tradition. Following the principles of their heritage and constant innovation, the artisans in Villeret present exclusive developments that differ in many respects from anything that modern haute

horlogerie has ever created. Every handmade masterpiece that leaves the workshops of Villeret requires a perfect command of watchmaking technique, a trained eye and an intuitive understanding of a watch's soul. The large, high-inertia balance wheel, the most important part of the watch, is made entirely in-house. Only very few watchmakers possess the level of skill required for such precise work. Even the sensitive balance spring needed to oscillate the balance wheel is likewise manufactured and counted by hand in the company's workshops.

Before the movement finally comes to life, the "régleur" makes minuscule adjustments by hand to the wheel trains to ensure the accuracy of the watch's rate in any position – a process that can take several hours.

MONTBLANC COLLECTION VILLERET 1858

> *Timewriter : 47 mm*



Id. 106168

p. 12

> *Timewriter : 45 mm*



Id. 107343

p. 13

> *High Complications : 47 mm*



Id. 106494

p. 14



Id. 106495

p. 15



Id. 103842

p. 18



Id. 104874

p. 19



Id. 104873

p. 20



Id. 103843

p. 21



Id. 109268

p. 22



Id. 106164

p. 23



Id. 109150

p. 24



Id. 106165

p. 25



Id. 109151

p. 26

> *High Complications : 43.5 mm*



Id. 107582



p. 16

MONTBLANC COLLECTION VILLERET 1858

> Chronographs : 47 mm



Id. 104863 p. 27



Id. 104864 p. 28



Id. 104866 p. 29



Id. 103845 p. 30



Id. 104373 p. 31



Id. 104867 p. 32



Id. 103846 p. 33



Id. 104009 p. 34



Id. 104010 p. 36



Id. 102456 p. 35



Id. 103072 p. 37



Id. 102457 p. 38

MONTBLANC COLLECTION VILLERET 1858

> Chronographs : 43.5 mm



Id. 109433 p. 39



Id. 107341 p. 40



Id. 107342 p. 41



Id. 106166 p. 42



Id. 106167 p. 43

> Chronographs : 41 mm



Id. 104363 p. 44



Id. 104011 p. 45



Id. 104012 p. 46



Id. 102462 p. 47



Id. 103086 p. 48



Id. 102463 p. 49

> Chronographs : 39.5 mm



Id. 106496 p. 50



Id. 106497 p. 51

MONTBLANC COLLECTION VILLERET 1858

> Classics : 47 mm



Id. 104353

p. 52



Id. 103837

p. 53



Id. 102454

p. 54

> Classics : 41 mm



Id. 103839

p. 55



Id. 104343

p. 56



Id. 103840

p. 57



Id. 104231

p. 58



Id. 104230

p. 59



Id. 103079

p. 60



Id. 102460

p. 61

> Classics : 36 mm and 39.5 mm



Id. 109931



p. 62

> Classics : 36 mm



Id. 109184

p. 63



Id. 109182

p. 64

MONTBLANC COLLECTION VILLERET 1858

> Timewriter



MODEL	TimeWriter I: Metamorphosis
Ident No.	106168
MOVEMENT	
Calibre	MB M67.40
Movement type	Manually wound monopusher chronograph with mechanical transformation of function and design of the watch from simple time indication to chronograph
Chronograph	Monopusher chronograph mechanism with column wheel and horizontal coupling
Indications	Hours at 12 o'clock, retrograde minutes, central seconds, date indication at 6 o'clock
Displays (Chronograph)	Central seconds, 30-minute counter via rotating disc at 6 o'clock
Diameter	38.40 mm
Height	12.45 mm
Number of components	744 components
Number of jewels	86 jewels
Power reserve	Approx. 50 hrs
Balance	Screw balance, Ø 14.5 mm; 59 mg.cm ²
Frequency	18,000 vibrations per hour (2.5 Hz)
Balance spring	With Phillips curve
Plate	Rhodium-plated German silver, circular-grained on both sides, hand-chamfered edges
Bridges	Rhodium-plated German silver, "Côtes de Genève", recesses circular-grained on both sides, hand-chamfered edges
Going train	Wheels: gold-plated, circular-grained, chamfered, diamond hubs on both sides Pinions: polished faces and tothing, burnished pivots
CASE	
Material	18 K white gold
Bezel	-
Sapphire crystal	Cambered sapphire crystal
Case back	Sapphire crystal case back
Crown	With Montblanc emblem in mother-of-pearl
Dial	Consisting of various fixed and moving components in German silver and sapphire crystal.
Hands	Date hand in German silver, hour, minute and chronograph hands in steel
Horns	-
Diameter	47 mm
Height	15.80 mm
Water resistant	3 bar (30 m)
STRAP	
Material/Colour	Hand-stitched alligator-skin / Black
Clasp/Buckle	Pin buckle in 18 K white gold
Limitation	28 pieces

MONTBLANC COLLECTION VILLERET 1858

> *Timewriter*

MODEL	Timewriter II: Chronographe Bi-Fréquence 1.000
Ident No.	107343
MOVEMENT	
Calibre	MB M66.26
Movement type	Manually wound monopusher chronograph with a balance wheel for the time indication and a balance wheel for the chronograph
Chronograph	Monopusher chronograph mechanism with column-wheel, pusher at 12 o'clock
Indications	Central hours and minutes, seconds at 9 o'clock
Displays (Chronograph)	60-second counter and 15-minute counter at 6 o'clock, central 1/100th seconds, 1/100th seconds dashboard indicator at 12 o'clock, 45-minute chronograph power reserve indication at 3 o'clock
Diameter	38.40 mm
Height	10.60 mm
Number of components	472 Components
Number of jewels	45 jewels (hemispherical, cambered, olive-cut)
Power reserve	Approx. 100 hrs for the time / Approx. 45 min for the chronograph
Balance	Time indication: Screw balance, Ø 11.4 mm, 26 mgcm ² ; chronograph: non-screw balance
Frequency	Time indication: 18,000 vibrations per hour (2.5 Hz); chronograph: 360.000 vibrations per hour (50 Hz)
Balance spring	With Phillips curve
Plate	Rhodium-plated German silver, circular-grained on both sides, hand-chamfered edges
Bridges	Rhodium-plated German silver, "Côtes de Genève", recesses circular-grained on both sides, hand-chamfered edges
Going train	Wheels: gold-plated, circular-grained, chamfered, diamond hubs on both sides Pinions: polished faces and tothing, burnished pivots
CASE	
Material	18 K white gold
Bezel	-
Sapphire crystal	Cambered sapphire crystal
Case back	Sapphire crystal case back
Crown	With Montblanc emblem in mother-of-pearl
Dial	Open worked dial to reveal the two balance wheels
Hands	18 K gold, central second hand in Pfinodal®
Horns	-
Diameter	45 mm
Height	15.10 mm
Water resistant	3 bar (30 m)
STRAP	
Material/Colour	Hand-stitched alligator-skin / Black with red double stitching
Clasp/Buckle	Pin buckle in 18 K white gold
Limitation	36 pieces

MONTBLANC COLLECTION VILLERET 1858

> High Complications



MODEL	Tourbillon Bi-Cylindrique
Ident No.	106494
MOVEMENT	
Calibre	MB M65.63
Movement type	Manually wound movement with 1-minute tourbillon at 12 o'clock
Chronograph	-
Indications	Hours and minutes at 6 o'clock, seconds on tourbillon cage at 12 o'clock
Displays (Chronograph)	-
Diameter	38.40 mm
Height	10.3 mm
Number of components	284 components
Number of jewels	26 jewels (hemispherical, cambered, olive-cut)
Power reserve	Approx. 45 hrs
Balance	Screw balance, Ø 14.5 mm; 59 mg.cm ²
Frequency	18,000 vibrations per hour (2.5 Hz)
Balance spring	Double cylindrical springs
Plate	Rhodium-plated German silver, circular-grained on both sides, hand-chamfered edges
Bridges	Rhodium-plated German silver, recesses circular-grained on both sides, hand-chamfered edges
Going train	Wheels: gold-plated, circular-grained, chamfered, diamond hubs on both sides Pinions: polished faces and tothing, burnished pivots
CASE	
Material	18 K white gold
Bezel	-
Sapphire crystal	Cambered sapphire crystal
Case back	Screwed case back
Crown	With Montblanc emblem in mother-of-pearl
Dial	Open dial to reveal the details of the "mysterious hours" mechanism
Hands	Hour and minute hands indicated on "mysterious" sapphire crystal discs
Horns	-
Diameter	47 mm
Height	15 mm
Water resistant	3 bar (30 m)
STRAP	
Material/Colour	Hand-stitched alligator-skin / Black
Clasp/Buckle	Pin buckle in 18 K white gold
Limitation	8 pieces

MONTBLANC COLLECTION VILLERET 1858

> High Complications



MODEL	Tourbillon Bi-Cylindrique
Ident No.	106495
MOVEMENT	
Calibre	MB M65.63
Movement type	Manually wound movement with 1-minute tourbillon at 12 o'clock
Chronograph	-
Indications	Hours and minutes at 6 o'clock, seconds on tourbillon cage at 12 o'clock
Displays (Chronograph)	-
Diameter	38.40 mm
Height	10.3 mm
Number of components	284 components
Number of jewels	26 jewels (hemispherical, cambered, olive-cut)
Power reserve	Approx. 45 hrs
Balance	Screw balance, Ø 14.5 mm; 59 mg.cm ²
Frequency	18,000 vibrations per hour (2.5 Hz)
Balance spring	Double cylindrical springs
Plate	Red gold-plated German silver, circular-grained on both sides, hand-chamfered edges
Bridges	Red gold-plated German silver, recesses circular-grained on both sides, hand-chamfered edges
Going train	Wheels: gold-plated, circular-grained, chamfered, diamond hubs on both sides Pinions: polished faces and tothing, burnished pivots
CASE	
Material	18 K red gold
Bezel	-
Sapphire crystal	Cambered sapphire crystal
Case back	Screwed case back
Crown	With Montblanc emblem in mother-of-pearl
Dial	Open dial to reveal the details of the "mysterious hours" mechanism
Hands	Hour and minute hands indicated on "mysterious" sapphire crystal discs
Horns	-
Diameter	47 mm
Height	15 mm
Water resistant	3 bar (30 m)
STRAP	
Material/Colour	Hand-stitched alligator-skin / Brown
Clasp/Buckle	Pin buckle in 18 K red gold
Limitation	8 pieces

MONTBLANC COLLECTION VILLERET 1858

> High Complications



MODEL	Grand Régulateur Nautique
Ident No.	107582
MOVEMENT	
Calibre	MB M16.30
Movement type	Manually wound monopusher régulateur chronograph
Chronograph	Monopusher chronograph mechanism with column wheel and horizontal coupling
Indications	Hours and home time at 12 o'clock, central minutes, seconds at 9 o'clock, day and night display at 2 o'clock, patented emergency power reserve at 6 o'clock
Displays (Chronograph)	Central seconds, 30-minute counter at 3 o'clock
Diameter	38.40 mm
Height	7.90 mm
Number of components	304 components
Number of jewels	33 jewels (hemispherical, cambered, olive-cut)
Power reserve	Approx. 50 h
Balance	Screw balance, Ø 14.5 mm; 59 mg.cm ²
Frequency	18,000 vibrations per hour (2.5 Hz)
Balance spring	With Phillips curve
Plate	Rhodium-plated German silver, circular-grained on both sides, hand-chamfered edges
Bridges	Rhodium-plated German silver, "Côtes de Genève", recesses circular-grained on both sides, hand-chamfered edges
Going train	Wheels: gold-plated, circular-grained, chamfered, diamond hubs on both sides Pinions: polished faces and tothing, burnished pivots
CASE	
Material	18 K white gold
Bezel	-
Sapphire crystal	Cambered sapphire crystal
Case back	Sapphire crystal case back
Crown	Integrated chronograph button with Montblanc emblem in mother-of-pearl
Dial	Open dial to reveal parts of the movement
Hands	18 K gold, chronograph hands in Pfinodal [®]
Horns	-
Diameter	43.5 mm
Height	14.67 mm
Water resistant	3 bar (30 m)
STRAP	
Material/Colour	Hand-stitched alligator-skin / Blue
Clasp/Buckle	Pin buckle in 18 K white gold
Limitation	8 pieces

MONTBLANC COLLECTION VILLERET 1858

> High Complications



MODEL	Chronomètre de Marine
Ident No.	109083
MOVEMENT	
Calibre	Montblanc 4810/1397
Movement type	Marine chronometer with world-time indication
Chronograph	-
Indications	Hours and local time (navigation time) at 12 o'clock, central minutes, continuous seconds at 2 o'clock, 24h home time indication (port of origin) at 9 o'clock, sectorial 24h third time zone (port of destination) at 3 o'clock, world-time indication on drum, patented emergency power reserve
Displays (Chronograph)	-
Diameter	30.1 mm
Height	9.5 mm
Number of components	~ 291 components including 21 ball bearings
Number of jewels	11 jewels (hemispherical, cambered, olive-cut)
Power reserve	15 days
Balance	Screw balance, Ø 18.9 mm
Frequency	18,000 vibrations per hour (2.5 Hz)
Balance spring	Blued balance spring with fusée
Plate	Nickel-plated solid brass, all ground
Bridges	-
Going train	Wheels: brass, circular-grained and gold-plated, pivots in hardened stainless steel
CASE	
Material	Brass chrome-plated, case mounted with 8 ball bearings, case tip serves as heeling indication (polished African granite base, carbon pillars with aluminium inlays)
Bezel	Brass chrome-plated
Sapphire crystal	Domed mineral crystal
Case back	-
Crown	Rewinding with key at 7 o'clock
Dial	Open dial to reveal parts of the movement
Hands	Stainless steel
Horns	-
Diameter	Module 64 cm, base 56 cm, weight ~120 kg
Height	93 cm
Water resistant	N/A
STRAP	
-	-
Clasp/Buckle	-
Limitation	8 pieces

MONTBLANC COLLECTION VILLERET 1858

> High Complications



MODEL	Grand Tourbillon Heures Mystérieuses
Ident No.	103842
MOVEMENT	
Calibre	MB M65.60
Movement type	Manually wound movement with 1-minute tourbillon at 12 o'clock
Chronograph	-
Indications	Hours and minutes at 6 o'clock, seconds on tourbillon cage at 12 o'clock
Displays (Chronograph)	-
Diameter	38.40 mm
Height	9.7 mm
Number of components	281 components
Number of jewels	28 jewels (hemispherical, cambered, olive-cut)
Power reserve	Approx. 45 hrs
Balance	Screw balance, Ø 14.5 mm; 59 mg.cm ²
Frequency	18,000 vibrations per hour (2.5 Hz)
Balance spring	With Phillips curve
Plate	Rhodium-plated German silver, circular-grained on both sides, hand-chamfered edges
Bridges	Rhodium-plated German silver, recesses circular-grained on both sides, hand-chamfered edges
Going train	Wheels: gold-plated, circular-grained, chamfered, diamond hubs on both sides Pinions: polished faces and tothing, burnished pivots
CASE	
Material	18 K white gold
Bezel	-
Sapphire crystal	Cambered sapphire crystal
Case back	Screwed case back
Crown	With Montblanc emblem in mother-of-pearl
Dial	Solid 18 K gold dial with hand-crafted ruthenium guilloché decoration
Hands	Hour and minute hands indicated on "mysterious" sapphire crystal discs
Horns	-
Diameter	47 mm
Height	14.80 mm
Water resistant	3 bar (30 m)
STRAP	
Material/Colour	Hand-stitched alligator-skin / Black
Clasp/Buckle	Pin buckle in 18 K white gold
Limitation	8 pieces

MONTBLANC COLLECTION VILLERET 1858

> High Complications



MODEL	Grand Tourbillon Heures Mystérieuses
Ident No.	104874
MOVEMENT	
Calibre	MB M65.60
Movement type	Manually wound movement with 1-minute tourbillon at 12 o'clock
Chronograph	-
Indications	Hours and minutes at 6 o'clock, seconds on tourbillon cage at 12 o'clock
Displays (Chronograph)	-
Diameter	38.40 mm
Height	9.7 mm
Number of components	281 components
Number of jewels	28 jewels (hemispherical, cambered, olive-cut)
Power reserve	Approx. 45 hrs
Balance	Screw balance, Ø 14.5 mm; 59 mg.cm ²
Frequency	18,000 vibrations per hour (2.5 Hz)
Balance spring	With Phillips curve
Plate	Rhodium-plated German silver, circular-grained on both sides, hand-chamfered edges
Bridges	Rhodium-plated German silver, recesses circular-grained on both sides, hand-chamfered edges
Going train	Wheels: gold-plated, circular-grained, chamfered, diamond hubs on both sides Pinions: polished faces and tothing, burnished pivots
CASE	
Material	18 K white gold
Bezel	-
Sapphire crystal	Cambered sapphire crystal
Case back	Screwed case back
Crown	With Montblanc emblem in mother-of-pearl
Dial	Solid 18 K gold dial with hand-crafted silver-plated circular-grained decoration
Hands	Hour and minute hands indicated on "mysterious" sapphire crystal discs
Horns	-
Diameter	47 mm
Height	14.80 mm
Water resistant	3 bar (30 m)
STRAP	
Material/Colour	Hand-stitched alligator-skin / Black
Clasp/Buckle	Pin buckle in 18 K white gold
Limitation	8 pieces

MONTBLANC COLLECTION VILLERET 1858

> High Complications



MODEL	Grand Tourbillon Heures Mystérieuses
Ident No.	104873
MOVEMENT	
Calibre	MB M65.60
Movement type	Manually wound movement with 1-minute tourbillon at 12 o'clock
Chronograph	-
Indications	Hours and minutes at 6 o'clock, seconds on tourbillon cage at 12 o'clock
Displays (Chronograph)	-
Diameter	38.40 mm
Height	9.7 mm
Number of components	281 components
Number of jewels	28 jewels (hemispherical, cambered, olive-cut)
Power reserve	Approx. 45 hrs
Balance	Screw balance, Ø 14.5 mm; 59 mg.cm ²
Frequency	18,000 vibrations per hour (2.5 Hz)
Balance spring	With Phillips curve
Plate	Red gold-plated German silver, circular-grained on both sides, hand-chamfered edges
Bridges	Red gold-plated German silver, recesses circular-grained on both sides, hand-chamfered edges
Going train	Wheels: gold-plated, circular-grained, chamfered, diamond hubs on both sides Pinions: polished faces and tothing, burnished pivots
CASE	
Material	18 K red gold
Bezel	-
Sapphire crystal	Cambered sapphire crystal
Case back	Screwed case back
Crown	With Montblanc emblem in mother-of-pearl
Dial	Solid 18 K gold dial with hand-crafted ruthenium guilloché decoration
Hands	Hour and minute hands indicated on "mysterious" sapphire crystal discs
Horns	-
Diameter	47 mm
Height	14.80 mm
Water resistant	3 bar (30 m)
STRAP	
Material/Colour	Hand-stitched alligator-skin / Brown
Clasp/Buckle	Pin buckle in 18 K red gold
Limitation	8 pieces

MONTBLANC COLLECTION VILLERET 1858

> High Complications



MODEL	Grand Tourbillon Heures Mystérieuses
Ident No.	103843
MOVEMENT	
Calibre	MB M65.60
Movement type	Manually wound movement with 1-minute tourbillon at 12 o'clock
Chronograph	-
Indications	Hours and minutes at 6 o'clock, seconds on tourbillon cage at 12 o'clock
Displays (Chronograph)	-
Diameter	38.40 mm
Height	9.7 mm
Number of components	281 components
Number of jewels	28 jewels (hemispherical, cambered, olive-cut)
Power reserve	Approx. 45 hrs
Balance	Screw balance, Ø 14.5 mm; 59 mg.cm ²
Frequency	18,000 vibrations per hour (2.5 Hz)
Balance spring	With Phillips curve
Plate	Rhodium-plated German silver, circular-grained on both sides, hand-chamfered edges
Bridges	Rhodium-plated German silver, "Côtes de Genève", recesses circular-grained on both sides, hand-chamfered edges
Going train	Wheels: gold-plated, circular-grained, chamfered, diamond hubs on both sides Pinions: polished faces and tothing, burnished pivots
CASE	
Material	18 K red gold
Bezel	-
Sapphire crystal	Cambered sapphire crystal
Case back	Screwed case back
Crown	With Montblanc emblem in mother-of-pearl
Dial	Solid 18 K gold dial with hand-crafted guilloché decoration
Hands	Hour and minute hands indicated on "mysterious" sapphire crystal discs
Horns	-
Diameter	47 mm
Height	14.40 mm
Water resistant	3 bar (30 m)
STRAP	
Material/Colour	Hand-stitched alligator-skin / Brown
Clasp/Buckle	Pin buckle in 18 K red gold
Limitation	8 pieces

MONTBLANC COLLECTION VILLERET 1858

> High Complications



MODEL	Grand Tourbillon Heures Mystérieuses
Ident No.	109268
MOVEMENT	
Calibre	MB M65.60
Movement type	Manually wound movement with 1-minute tourbillon at 12 o'clock
Chronograph	-
Indications	Hours and minutes at 6 o'clock, seconds on tourbillon cage at 12 o'clock
Displays (Chronograph)	-
Diameter	38.40 mm
Height	9.7 mm
Number of components	281 components
Number of jewels	28 jewels (hemispherical, cambered, olive-cut)
Power reserve	Approx. 45 hrs
Balance	Screw balance, Ø 14.5 mm; 59 mg.cm ²
Frequency	18,000 vibrations per hour (2.5 Hz)
Balance spring	With Phillips curve
Plate	Rhodium-plated German silver, circular-grained on both sides, hand-chamfered edges
Bridges	Rhodium-plated German silver, "Côtes de Genève", recesses circular-grained on both sides, hand-chamfered edges
Going train	Wheels: gold-plated, circular-grained, chamfered, diamond hubs on both sides Pinions: polished faces and tooting, burnished pivots
CASE	
Material	18 K red gold
Bezel	-
Sapphire crystal	Cambered sapphire crystal
Case back	Screwed case back
Crown	With Montblanc emblem in mother-of-pearl
Dial	Solid 18 K gold dial with hand-crafted silver-plated circular-grained decoration
Hands	Hour and minute hands indicated on "mysterious" sapphire crystal discs
Horns	-
Diameter	47 mm
Height	14.80 mm
Water resistant	3 bar (30 m)
STRAP	
Material/Colour	Hand-stitched alligator-skin / Brown
Clasp/Buckle	18 K red gold pin buckle
Limitation	18 pieces

MONTBLANC COLLECTION VILLERET 1858

> High Complications



MODEL	ExoTourbillon Chronographe
Ident No.	106164
MOVEMENT	
Calibre	MB M16.60
Movement type	Manually wound monopusher chronograph with 4-minute ExoTourbillon at 12 o'clock
Chronograph	Monopusher chronograph mechanism with column wheel and horizontal coupling
Indications	Hours and home time at 6 o'clock, central minutes, seconds at 9 o'clock, day and night display at 4 o'clock
Displays (Chronograph)	Central seconds, 30-minute counter at 3 o'clock
Diameter	38.40 mm
Height	10.34 mm
Number of components	341 components
Number of jewels	32 jewels (hemispherical, cambered, olive-cut)
Power reserve	Approx. 50 hrs
Balance	Screw balance, Ø 14.5 mm; 59 mg.cm ²
Frequency	18,000 vibrations per hour (2.5 Hz)
Balance spring	With Phillips curve
Plate	Rhodium-plated German silver, circular-grained on both sides, hand-chamfered edges
Bridges	Rhodium-plated German silver, "Côtes de Genève", recesses circular-grained on both sides, hand-chamfered edges
Going train	Wheels: gold-plated, circular-grained, chamfered, diamond hubs on both sides Pinions: polished faces and tothing, burnished pivots
CASE	
Material	18 K white gold
Bezel	-
Sapphire crystal	Cambered sapphire crystal
Case back	Screwed domed sapphire crystal case back, hinged cuvette with patented release mechanism
Crown	Integrated chronograph button with Montblanc emblem in mother-of-pearl
Dial	Solid 18 K gold dial with hand-crafted ruthenium guilloché decoration
Hands	18 K gold, chronograph hands in Pfinodal [®]
Horns	With patented cuvette release mechanism
Diameter	47 mm
Height	16.67 mm
Water resistant	3 bar (30 m)
STRAP	
Material/Colour	Hand-stitched alligator-skin / Black
Clasp/Buckle	Pin buckle in 18 K white gold
Limitation	8 pieces

MONTBLANC COLLECTION VILLERET 1858

> High Complications



MODEL	ExoTourbillon Chronographe
Ident No.	109150
MOVEMENT	
Calibre	MB M16.60
Movement type	Manually wound monopusher chronograph with 4-minute ExoTourbillon at 12 o'clock
Chronograph	Monopusher chronograph mechanism with column wheel and horizontal coupling
Indications	Hours and home time at 6 o'clock, central minutes, seconds at 9 o'clock, day and night display at 4 o'clock
Displays (Chronograph)	Central seconds, 30-minute counter at 3 o'clock
Diameter	38.40 mm
Height	10.34 mm
Number of components	341 components
Number of jewels	32 jewels (hemispherical, cambered, olive-cut)
Power reserve	Approx. 50 hrs
Balance	Screw balance, Ø 14.5 mm; 59 mg.cm ²
Frequency	18,000 vibrations per hour (2.5 Hz)
Balance spring	With Phillips curve
Plate	Rhodium-plated German silver, circular-grained on both sides, hand-chamfered edges
Bridges	Rhodium-plated German silver, "Côtes de Genève", recesses circular-grained on both sides, hand-chamfered edges
Going train	Wheels: gold-plated, circular-grained, chamfered, diamond hubs on both sides Pinions: polished faces and tothing, burnished pivots
CASE	
Material	18 K white gold
Bezel	-
Sapphire crystal	Cambered sapphire crystal
Case back	Screwed domed sapphire crystal case back, hinged cuvette with patented release mechanism
Crown	Integrated chronograph button with Montblanc emblem in mother-of-pearl
Dial	Solid 18 K gold dial with grained anthracite decoration and polished and satin-finished counters
Hands	18 K gold, chronograph hands in Pfinodal [®]
Horns	With patented cuvette release mechanism
Diameter	47 mm
Height	16.67 mm
Water resistant	3 bar (30 m)
STRAP	
Material/Colour	Hand-stitched alligator-skin / Black
Clasp/Buckle	Pin buckle in 18 K white gold
Limitation	8 pieces

MONTBLANC COLLECTION VILLERET 1858

> High Complications



MODEL	ExoTourbillon Chronographe
Ident No.	106165
MOVEMENT	
Calibre	MB M16.60
Movement type	Manually wound monopusher chronograph with 4-minute ExoTourbillon at 12 o'clock
Chronograph	Monopusher chronograph mechanism with column wheel and horizontal coupling
Indications	Hours and home time at 6 o'clock, central minutes, seconds at 9 o'clock, day and night display at 4 o'clock
Displays (Chronograph)	Central seconds, 30-minute counter at 3 o'clock
Diameter	38.40 mm
Height	10.34 mm
Number of components	341 components
Number of jewels	32 jewels (hemispherical, cambered, olive-cut)
Power reserve	Approx. 50 hrs
Balance	Screw balance, Ø 14.5 mm; 59 mg.cm ²
Frequency	18,000 vibrations per hour (2.5 Hz)
Balance spring	With Phillips curve
Plate	Red gold-plated German silver, circular-grained on both sides, hand-chamfered edges
Bridges	Red gold-plated German silver, "Côtes de Genève", recesses circular-grained on both sides, hand-chamfered edges
Going train	Wheels: gold-plated, circular-grained, chamfered, diamond hubs on both sides Pinions: polished faces and tothing, burnished pivots
CASE	
Material	18 K red gold
Bezel	-
Sapphire crystal	Cambered sapphire crystal
Case back	Screwed domed sapphire crystal case back, hinged cuvette with patented release mechanism
Crown	Integrated chronograph button with Montblanc emblem in mother-of-pearl
Dial	Solid 18 K gold dial with hand-crafted silver-plated circular-grained decoration
Hands	18 K gold, chronograph hands in Pfinodal [®]
Horns	With patented cuvette release mechanism
Diameter	47 mm
Height	16.67 mm
Water resistant	3 bar (30 m)
STRAP	
Material/Colour	Hand-stitched alligator-skin / Brown
Clasp/Buckle	Pin buckle in 18 K red gold
Limitation	8 pieces

MONTBLANC COLLECTION VILLERET 1858

> High Complications



MODEL	ExoTourbillon Chronographe
Ident No.	109151
MOVEMENT	
Calibre	MB M16.60
Movement type	Manually wound monopusher chronograph with 4-minute ExoTourbillon at 12 o'clock
Chronograph	Monopusher chronograph mechanism with column wheel and horizontal coupling
Indications	Hours and home time at 6 o'clock, central minutes, seconds at 9 o'clock, day and night display at 4 o'clock
Displays (Chronograph)	Central seconds, 30-minute counter at 3 o'clock
Diameter	38.40 mm
Height	10.34 mm
Number of components	341 components
Number of jewels	32 jewels (hemispherical, cambered, olive-cut)
Power reserve	Approx. 50 hrs
Balance	Screw balance, Ø 14.5 mm; 59 mg.cm ²
Frequency	18,000 vibrations per hour (2.5 Hz)
Balance spring	With Phillips curve
Plate	Red gold-plated German silver, circular-grained on both sides, hand-chamfered edges
Bridges	Red gold-plated German silver, "Côtes de Genève", recesses circular-grained on both sides, hand-chamfered edges
Going train	Wheels: gold-plated, circular-grained, chamfered, diamond hubs on both sides Pinions: polished faces and tothing, burnished pivots
CASE	
Material	18 K red gold
Bezel	-
Sapphire crystal	Cambered sapphire crystal
Case back	Screwed domed sapphire crystal case back, hinged cuvette with patented release mechanism
Crown	Integrated chronograph button with Montblanc emblem in mother-of-pearl
Dial	Solid 18 K gold dial with grained silver-plated decoration and polished, satin-finished counters
Hands	18 K gold, chronograph hands in Pfinodal [®]
Horns	With patented cuvette release mechanism
Diameter	47 mm
Height	16.67 mm
Water resistant	3 bar (30 m)
STRAP	
Material/Colour	Hand-stitched alligator-skin / Brown
Clasp/Buckle	Pin buckle in 18 K red gold
Limitation	8 pieces

MONTBLANC COLLECTION VILLERET 1858

> Chronographs



MODEL	Grand Chronographe Régulateur
Ident No.	104863
MOVEMENT	
Calibre	MB M16.30
Movement type	Manually wound monopusher régulateur chronograph
Chronograph	Monopusher chronograph mechanism with column wheel and horizontal coupling
Indications	Hours and home time at 12 o'clock, central minutes, seconds at 9 o'clock, day and night display at 2 o'clock, patented emergency power reserve at 6 o'clock
Displays (Chronograph)	Central seconds, 30-minute counter at 3 o'clock
Diameter	38.40 mm
Height	7.90 mm
Number of components	304 components
Number of jewels	33 jewels (hemispherical, cambered, olive-cut)
Power reserve	Approx. 50 h
Balance	Screw balance, Ø 14.5 mm; 59 mg.cm ²
Frequency	18,000 vibrations per hour (2.5 Hz)
Balance spring	With Phillips curve
Plate	Rhodium-plated German silver, circular-grained on both sides, hand-chamfered edges
Bridges	Rhodium-plated German silver, "Côtes de Genève", recesses circular-grained on both sides, hand-chamfered edges
Going train	Wheels: gold-plated, circular-grained, chamfered, diamond hubs on both sides Pinions: polished faces and tothing, burnished pivots
CASE	
Material	18 K white gold
Bezel	-
Sapphire crystal	Cambered sapphire crystal
Case back	Screwed domed sapphire crystal case back, hinged cuvette with patented release mechanism
Crown	Integrated chronograph button with Montblanc emblem in mother-of-pearl
Dial	Solid 18 K gold dial with hand-crafted ruthenium guilloché decoration
Hands	18 K gold, chronograph hands in Pfinodal [®]
Horns	With patented cuvette release mechanism
Diameter	47 mm
Height	16.42 mm
Water resistant	3 bar (30 m)
STRAP	
Material/Colour	Hand-stitched alligator-skin / Black
Clasp/Buckle	Pin buckle in 18 K white gold
Limitation	8 pieces

MONTBLANC COLLECTION VILLERET 1858

> Chronographs



MODEL	Grand Chronographe Régulateur
Ident No.	104864
MOVEMENT	
Calibre	MB M16.30
Movement type	Manually wound monopusher régulateur chronograph
Chronograph	Monopusher chronograph mechanism with column wheel and horizontal coupling
Indications	Hours and home time at 12 o'clock, central minutes, seconds at 9 o'clock, day and night display at 2 o'clock, patented emergency power reserve at 6 o'clock
Displays (Chronograph)	Central seconds, 30-minute counter at 3 o'clock
Diameter	38.40 mm
Height	7.90 mm
Number of components	304 components
Number of jewels	33 jewels (hemispherical, cambered, olive-cut)
Power reserve	Approx. 50 h
Balance	Screw balance, Ø 14.5 mm; 59 mg.cm ²
Frequency	18,000 vibrations per hour (2.5 Hz)
Balance spring	With Phillips curve
Plate	Rhodium-plated German silver, circular-grained on both sides, hand-chamfered edges
Bridges	Rhodium-plated German silver, "Côtes de Genève", recesses circular-grained on both sides, hand-chamfered edges
Going train	Wheels: gold-plated, circular-grained, chamfered, diamond hubs on both sides Pinions: polished faces and tothing, burnished pivots
CASE	
Material	18 K white gold
Bezel	-
Sapphire crystal	Cambered sapphire crystal
Case back	Screwed domed sapphire crystal case back, hinged cuvette with patented release mechanism
Crown	Integrated chronograph button with Montblanc emblem in mother-of-pearl
Dial	Solid 18 K gold dial with hand-crafted silver-plated circular-grained decoration
Hands	18 K gold, chronograph hands in Pfinodal [®]
Horns	With patented cuvette release mechanism
Diameter	47 mm
Height	16.42 mm
Water resistant	3 bar (30 m)
STRAP	
Material/Colour	Hand-stitched alligator-skin / Black
Clasp/Buckle	Pin buckle in 18 K white gold
Limitation	8 pieces

MONTBLANC COLLECTION VILLERET 1858

> Chronographs



MODEL	Grand Chronographe Régulateur
Ident No.	104866
MOVEMENT	
Calibre	MB M16.30
Movement type	Manually wound monopusher régulateur chronograph
Chronograph	Monopusher chronograph mechanism with column wheel and horizontal coupling
Indications	Hours and home time at 12 o'clock, central minutes, seconds at 9 o'clock, day and night display at 2 o'clock, patented emergency power reserve at 6 o'clock
Displays (Chronograph)	Central seconds, 30-minute counter at 3 o'clock
Diameter	38.40 mm
Height	7.90 mm
Number of components	304 components
Number of jewels	33 jewels (hemispherical, cambered, olive-cut)
Power reserve	Approx. 55 hrs
Balance	Screw balance, Ø 14.5 mm; 59 mg.cm ²
Frequency	18,000 vibrations per hour (2.5 Hz)
Balance spring	With Phillips curve
Plate	Rhodium-plated German silver, circular-grained on both sides, hand-chamfered edges
Bridges	Rhodium-plated German silver, "Côtes de Genève", recesses circular-grained on both sides, hand-chamfered edges
Going train	Wheels: gold-plated, circular-grained, chamfered, diamond hubs on both sides Pinions: polished faces and tothing, burnished pivots
CASE	
Material	18 K red gold
Bezel	-
Sapphire crystal	Cambered sapphire crystal
Case back	Screwed domed sapphire crystal case back, hinged cuvette with patented release mechanism
Crown	Integrated chronograph button with Montblanc emblem in mother-of-pearl
Dial	Solid 18 K gold dial with hand-crafted silver-plated circular-grained decoration
Hands	18 K gold, chronograph hands in Pfinodal [®]
Horns	With patented cuvette release mechanism
Diameter	47 mm
Height	15.10 mm
Water resistant	3 bar (30 m)
STRAP	
Material/Colour	Hand-stitched alligator-skin / Brown
Clasp/Buckle	Pin buckle in 18 K red gold
Limitation	8 pieces

MONTBLANC COLLECTION VILLERET 1858

> Chronographs



MODEL	Grand Chronographe Émail Grand Feu
Ident No.	103845
MOVEMENT	
Calibre	MB M16.29
Movement type	Manually wound monopusher chronograph
Chronograph	Monopusher chronograph mechanism with column wheel and horizontal coupling
Indications	Central hours and minutes, seconds at 9 o'clock
Displays (Chronograph)	Central seconds, 30-minute counter at 3 o'clock
Diameter	38.40 mm
Height	6.30 mm
Number of components	252 components
Number of jewels	22 jewels (hemispherical, cambered, olive-cut)
Power reserve	Approx. 50 hrs
Balance	Screw balance, Ø 14.5 mm; 59 mg.cm ²
Frequency	18,000 vibrations per hour (2.5 Hz)
Balance spring	With Phillips curve
Plate	Rhodium-plated German silver, circular-grained on both sides, hand-chamfered edges
Bridges	Rhodium-plated German silver, "Côtes de Genève", recesses circular-grained on both sides, hand-chamfered edges
Going train	Wheels: gold-plated, circular-grained, chamfered, diamond hubs on both sides Pinions: polished faces and tothing, burnished pivots
CASE	
Material	18 K white gold
Bezel	-
Sapphire crystal	Cambered sapphire crystal
Case back	Screwed domed sapphire crystal case back, hinged cuvette with patented release mechanism
Crown	Integrated chronograph button with Montblanc emblem in mother-of-pearl
Dial	Solid 18 K gold dial with black Grand Feu champlevé enamel
Hands	18 K gold, chronograph hands in Pfinodal [®]
Horns	With patented cuvette release mechanism
Diameter	47 mm
Height	14.97 mm
Water resistant	3 bar (30 m)
STRAP	
Material/Colour	Hand-stitched alligator-skin / Black
Clasp/Buckle	Pin buckle in 18 K white gold
Limitation	8 pieces

MONTBLANC COLLECTION VILLERET 1858

> Chronographs



MODEL	Grand Chronographe Émail Grand Feu
Ident No.	104373
MOVEMENT	
Calibre	MB M16.29
Movement type	Manually wound monopusher chronograph
Chronograph	Monopusher chronograph mechanism with column wheel and horizontal coupling
Indications	Central hours and minutes, seconds at 9 o'clock
Displays (Chronograph)	Central seconds, 30-minute counter at 3 o'clock
Diameter	38.40 mm
Height	6.30 mm
Number of components	252 components
Number of jewels	22 jewels (hemispherical, cambered, olive-cut)
Power reserve	Approx. 50 h
Balance	Screw balance, Ø 14.5 mm; 59 mg.cm ²
Frequency	18,000 vibrations per hour (2.5 Hz)
Balance spring	With Phillips curve
Plate	Rhodium-plated German silver, circular-grained on both sides, hand-chamfered edges
Bridges	Rhodium-plated German silver, "Côtes de Genève", recesses circular-grained on both sides, hand-chamfered edges
Going train	Wheels: gold-plated, circular-grained, chamfered, diamond hubs on both sides Pinions: polished faces and tothing, burnished pivots
CASE	
Material	18 K white gold
Bezel	-
Sapphire crystal	Cambered sapphire crystal
Case back	Screwed domed sapphire crystal case back, hinged cuvette with patented release mechanism
Crown	Integrated chronograph button with Montblanc emblem in mother-of-pearl
Dial	Solid 18 K gold dial with white Grand Feu champlevé enamel
Hands	18 K gold, chronograph hands in Pfinodal [®]
Horns	With patented cuvette release mechanism
Diameter	47 mm
Height	14.97 mm
Water resistant	3 bar (30 m)
STRAP	
Material/Colour	Hand-stitched alligator-skin / Black
Clasp/Buckle	Pin buckle in 18 K white gold
Limitation	8 pieces

MONTBLANC COLLECTION VILLERET 1858

> Chronographs



MODEL	Grand Chronographe Émail Grand Feu
Ident No.	104867
MOVEMENT	
Calibre	MB M16.29
Movement type	Manually wound monopusher chronograph
Chronograph	Monopusher chronograph mechanism with column wheel and horizontal coupling
Indications	Central hours and minutes, seconds at 9 o'clock
Displays (Chronograph)	Central seconds, 30-minute counter at 3 o'clock
Diameter	38.40 mm
Height	6.30 mm
Number of components	252 components
Number of jewels	22 jewels (hemispherical, cambered, olive-cut)
Power reserve	Approx. 50 h
Balance	Screw balance, Ø 14.5 mm; 59 mg.cm ²
Frequency	18,000 vibrations per hour (2.5 Hz)
Balance spring	With Phillips curve
Plate	Rhodium-plated German silver, circular-grained on both sides, hand-chamfered edges
Bridges	Rhodium-plated German silver, "Côtes de Genève", recesses circular-grained on both sides, hand-chamfered edges
Going train	Wheels: gold-plated, circular-grained, chamfered, diamond hubs on both sides Pinions: polished faces and tothing, burnished pivots
CASE	
Material	18 K red gold
Bezel	-
Sapphire crystal	Cambered sapphire crystal
Case back	Screwed domed sapphire crystal case back, hinged cuvette with patented release mechanism
Crown	Integrated chronograph button with Montblanc emblem in mother-of-pearl
Dial	Solid 18 K gold dial with black Grand Feu champlevé enamel
Hands	18 K gold, chronograph hands in Pfinodal [®]
Horns	With patented cuvette release mechanism
Diameter	47 mm
Height	14.97 mm
Water resistant	3 bar (30 m)
STRAP	
Material/Colour	Hand-stitched alligator-skin / Black
Clasp/Buckle	Pin buckle in 18 K red gold
Limitation	8 pieces

MONTBLANC COLLECTION VILLERET 1858

> Chronographs



MODEL	Grand Chronographe Émail Grand Feu
Ident No.	103846
MOVEMENT	
Calibre	MB M16.29
Movement type	Manually wound monopusher chronograph
Chronograph	Monopusher chronograph mechanism with column wheel and horizontal coupling
Indications	Central hours and minutes, seconds at 9 o'clock
Displays (Chronograph)	Central seconds, 30-minute counter at 3 o'clock
Diameter	38.40 mm
Height	6.30 mm
Number of components	252 components
Number of jewels	22 jewels (hemispherical, cambered, olive-cut)
Power reserve	Approx. 50 h
Balance	Screw balance, Ø 14.5 mm; 59 mg.cm ²
Frequency	18,000 vibrations per hour (2.5 Hz)
Balance spring	With Phillips curve
Plate	Rhodium-plated German silver, circular-grained on both sides, hand-chamfered edges
Bridges	Rhodium-plated German silver, "Côtes de Genève", recesses circular-grained on both sides, hand-chamfered edges
Going train	Wheels: gold-plated, circular-grained, chamfered, diamond hubs on both sides Pinions: polished faces and tothing, burnished pivots
CASE	
Material	18 K red gold
Bezel	-
Sapphire crystal	Cambered sapphire crystal
Case back	Screwed domed sapphire crystal case back, hinged cuvette with patented release mechanism
Crown	Integrated chronograph button with Montblanc emblem in mother-of-pearl
Dial	Solid 18 K gold dial with white Grand Feu champlevé enamel
Hands	18 K gold, chronograph hands in Pfinodal [®]
Horns	With patented cuvette release mechanism
Diameter	47 mm
Height	14.97 mm
Water resistant	3 bar (30 m)
STRAP	
Material/Colour	Hand-stitched alligator-skin / Brown
Clasp/Buckle	Pin buckle in 18 K red gold
Limitation	58 pieces

MONTBLANC COLLECTION VILLERET 1858

> Chronographs



MODEL	Grand Chronographe Authentique Joaillerie
Ident No.	104009
MOVEMENT	
Calibre	MB M16.29
Movement type	Manually wound monopusher chronograph
Chronograph	Monopusher chronograph mechanism with column wheel and horizontal coupling
Indications	Central hours and minutes, seconds at 9 o'clock
Displays (Chronograph)	Central seconds, 30-minute counter at 3 o'clock
Diameter	38.40 mm
Height	6.30 mm
Number of components	252 components
Number of jewels	22 jewels (hemispherical, cambered, olive-cut)
Power reserve	Approx. 55 hrs
Balance	Screw balance, Ø 9.7 mm; 15 mg.cm ²
Frequency	18,000 vibrations per hour (2.5 Hz)
Balance spring	With Phillips curve
Plate	Rhodium-plated German silver, circular-grained on both sides, hand-chamfered edges
Bridges	Rhodium-plated German silver, "Côtes de Genève", recesses circular-grained on both sides, hand-chamfered edges
Going train	Wheels: gold-plated, circular-grained, chamfered, diamond hubs on both sides Pinions: polished faces and tothing, burnished pivots
CASE	
Material	18 K white gold
Bezel	Diamond pavé setting (~2.25 ct)
Sapphire crystal	Cambered sapphire crystal
Case back	Screwed domed sapphire crystal case back, hinged cuvette with patented release mechanism
Crown	Integrated chronograph button with Montblanc emblem in mother-of-pearl
Dial	Solid 18 K gold dial with white mother-of-pearl inlays
Hands	18 K gold, chronograph hands in Pfinodal [®]
Horns	With patented cuvette release mechanism
Diameter	47 mm
Height	14.97 mm
Water resistant	3 bar (30 m)
STRAP	
Material/Colour	Hand-stitched alligator-skin / Black
Clasp/Buckle	18 K white gold pin buckle
Limitation	8 pieces

MONTBLANC COLLECTION VILLERET 1858

> Chronographs



MODEL	Grand Chronographe Authentique
Ident No.	102456
MOVEMENT	
Calibre	MB M16.29
Movement type	Manually wound monopusher chronograph
Chronograph	Monopusher chronograph mechanism with column wheel and horizontal coupling
Indications	Central hours and minutes, seconds at 9 o'clock
Displays (Chronograph)	Central seconds, 30-minute counter at 3 o'clock
Diameter	38.40 mm
Height	6.30 mm
Number of components	252 components
Number of jewels	22 jewels (hemispherical, cambered, olive-cut)
Power reserve	Approx. 55 hrs
Balance	Screw balance, Ø 14.5 mm; 59 mg.cm ²
Frequency	18,000 vibrations per hour (2.5 Hz)
Balance spring	With Phillips curve
Plate	Rhodium-plated German silver, circular-grained on both sides, hand-chamfered edges
Bridges	Rhodium-plated German silver, "Côtes de Genève", recesses circular-grained on both sides, hand-chamfered edges
Going train	Wheels: gold-plated, circular-grained, chamfered, diamond hubs on both sides Pinions: polished faces and tothing, burnished pivots
CASE	
Material	18 K white gold
Bezel	-
Sapphire crystal	Cambered sapphire crystal
Case back	Screwed domed sapphire crystal case back, hinged cuvette with patented release mechanism
Crown	Integrated chronograph button with Montblanc emblem in mother-of-pearl
Dial	Solid 18 K gold dial with hand-crafted ruthenium guilloché decoration
Hands	18 K gold, chronograph hands in Pfinodal [®]
Horns	With patented cuvette release mechanism
Diameter	47 mm
Height	13.55 mm
Water resistant	3 bar (30 m)
STRAP	
Material/Colour	Hand-stitched alligator-skin / Black
Clasp/Buckle	Pin buckle in 18 K white gold
Limitation	8 pieces

MONTBLANC COLLECTION VILLERET 1858

> Chronographs



MODEL	Grand Chronographe Authentique Joaillerie
Ident No.	104010
MOVEMENT	
Calibre	MB M16.29
Movement type	Manually wound monopusher chronograph
Chronograph	Monopusher chronograph mechanism with column wheel and horizontal coupling
Indications	Central hours and minutes, seconds at 9 o'clock
Displays (Chronograph)	Central seconds, 30-minute counter at 3 o'clock
Diameter	38.40 mm
Height	6.30 mm
Number of components	252 components
Number of jewels	22 jewels (hemispherical, cambered, olive-cut)
Power reserve	Approx. 55 hrs
Balance	Screw balance, Ø 14.5 mm; 59 mg.cm ²
Frequency	18,000 vibrations per hour (2.5 Hz)
Balance spring	With Phillips curve
Plate	Rhodium-plated German silver, circular-grained on both sides, hand-chamfered edges
Bridges	Rhodium-plated German silver, "Côtes de Genève", recesses circular-grained on both sides, hand-chamfered edges
Going train	Wheels: gold-plated, circular-grained, chamfered, diamond hubs on both sides Pinions: polished faces and tothing, burnished pivots
CASE	
Material	18 K red gold
Bezel	Diamond pavé setting (~2.25 ct)
Sapphire crystal	Cambered sapphire crystal
Case back	Screwed domed sapphire crystal case back, hinged cuvette with patented release mechanism
Crown	Integrated chronograph button with Montblanc emblem in mother-of-pearl
Dial	Solid 18 K gold dial with white mother-of-pearl inlays
Hands	18 K gold, chronograph hands in Pfinodal [®]
Horns	With patented cuvette release mechanism
Diameter	47 mm
Height	13.55 mm
Water resistant	3 bar (30 m)
STRAP	
Material/Colour	Hand-stitched alligator-skin / Brown
Clasp/Buckle	18 K red gold pin buckle
Limitation	8 pieces

MONTBLANC COLLECTION VILLERET 1858

> Chronographs



MODEL	Grand Chronographe Authentique
Ident No.	103072
MOVEMENT	
Calibre	MB M16.29
Movement type	Manually wound monopusher chronograph
Chronograph	Monopusher chronograph mechanism with column wheel and horizontal coupling
Indications	Central hours and minutes, seconds at 9 o'clock
Displays (Chronograph)	Central seconds, 30-minute counter at 3 o'clock
Diameter	38.40 mm
Height	6.30 mm
Number of components	252 components
Number of jewels	22 jewels (hemispherical, cambered, olive-cut)
Power reserve	Approx. 55 hrs
Balance	Screw balance, Ø 14.5 mm; 59 mg.cm ²
Frequency	18,000 vibrations per hour (2.5 Hz)
Balance spring	With Phillips curve
Plate	Rhodium-plated German silver, circular-grained on both sides, hand-chamfered edges
Bridges	Rhodium-plated German silver, "Côtes de Genève", recesses circular-grained on both sides, hand-chamfered edges
Going train	Wheels: gold-plated, circular-grained, chamfered, diamond hubs on both sides Pinions: polished faces and tothing, burnished pivots
CASE	
Material	18 K white gold
Bezel	-
Sapphire crystal	Cambered sapphire crystal
Case back	Screwed domed sapphire crystal case back, hinged cuvette with patented release mechanism
Crown	Integrated chronograph button with Montblanc emblem in mother-of-pearl
Dial	Solid 18 K gold dial with hand-crafted silver-plated circular-grained decoration
Hands	18 K gold, chronograph hands in Pfinodal [®]
Horns	With patented cuvette release mechanism
Diameter	47 mm
Height	13.55 mm
Water resistant	3 bar (30 m)
STRAP	
Material/Colour	Hand-stitched alligator-skin / Black
Clasp/Buckle	Pin buckle in 18 K white gold
Limitation	8 pieces

MONTBLANC COLLECTION VILLERET 1858

> Chronographs



MODEL	Grand Chronographe Authentique
Ident No.	102457
MOVEMENT	
Calibre	MB M16.29
Movement type	Manually wound monopusher chronograph
Chronograph	Monopusher chronograph mechanism with column wheel and horizontal coupling
Indications	Central hours and minutes, seconds at 9 o'clock
Displays (Chronograph)	Central seconds, 30-minute counter at 3 o'clock
Diameter	38.40 mm
Height	6.30 mm
Number of components	252 components
Number of jewels	22 jewels (hemispherical, cambered, olive-cut)
Power reserve	Approx. 50 h
Balance	Screw balance, Ø 14.5 mm; 59 mg.cm ²
Frequency	18,000 vibrations per hour (2.5 Hz)
Balance spring	With Phillips curve
Plate	Rhodium-plated German silver, circular-grained on both sides, hand-chamfered edges
Bridges	Rhodium-plated German silver, "Côtes de Genève", recesses circular-grained on both sides, hand-chamfered edges
Going train	Wheels: gold-plated, circular-grained, chamfered, diamond hubs on both sides Pinions: polished faces and tothing, burnished pivots
CASE	
Material	18 K red gold
Bezel	-
Sapphire crystal	Cambered sapphire crystal
Case back	Screwed domed sapphire crystal case back, hinged cuvette with patented release mechanism
Crown	Integrated chronograph button with Montblanc emblem in mother-of-pearl
Dial	Solid 18 K gold dial with hand-crafted silver-plated circular-grained decoration
Hands	18 K gold, chronograph hands in Pfinodal [®]
Horns	With patented cuvette release mechanism
Diameter	47 mm
Height	14.87 mm
Water resistant	3 bar (30 m)
STRAP	
Material/Colour	Hand-stitched alligator-skin / Brown
Clasp/Buckle	Pin buckle in 18 K red gold
Limitation	58 pieces

MONTBLANC COLLECTION VILLERET 1858

> Chronographs



MODEL	Chronographe Régulateur
Ident No.	109433
MOVEMENT	
Calibre	MB M16.30
Movement type	Manually wound monopusher régulateur chronograph
Chronograph	Monopusher chronograph mechanism with column wheel and horizontal coupling
Indications	Hours and home time at 12 o'clock, central minutes, seconds at 9 o'clock, day and night display at 2 o'clock, patented emergency power reserve at 6 o'clock
Displays (Chronograph)	Central seconds, 30-minute counter at 3 o'clock
Diameter	38.40 mm
Height	7.90 mm
Number of components	304 components
Number of jewels	-
Power reserve	Approx. 55 hrs
Balance	Screw balance, Ø 14.5 mm; 59 mg.cm ²
Frequency	18,000 vibrations per hour (2.5 Hz)
Balance spring	With Phillips curve
Plate	Rhodium-plated German silver, circular-grained on both sides, hand-chamfered edges
Bridges	Rhodium-plated German silver, "Côtes de Genève", recesses circular-grained on both sides, hand-chamfered edges
Going train	Wheels: gold-plated, circular-grained, chamfered, diamond hubs on both sides Pinions: polished faces and tothing, burnished pivots
CASE	
Material	18 K red gold
Bezel	-
Sapphire crystal	Cambered sapphire crystal
Case back	Sapphire crystal case back
Crown	Integrated chronograph button with Montblanc emblem in mother-of-pearl
Dial	Open dial with 18 K gold base
Hands	18 K gold, chronograph hands in Pfinodal [®]
Horns	-
Diameter	43.5 mm
Height	14.67 mm
Water resistant	3 bar (30 m)
STRAP	
Material/Colour	Hand-stitched alligator-skin / Black
Clasp/Buckle	18 K red gold pin buckle
Limitation	8 pieces

MONTBLANC COLLECTION VILLERET 1858

> Chronographs



MODEL	Vintage Tachydate
Ident No.	107341
MOVEMENT	
Calibre	MB M16.32
Movement type	Manually wound monopusher chronograph
Chronograph	Monopusher chronograph mechanism with column wheel and horizontal coupling
Indications	Central hours and minutes, seconds at 9 o'clock, date at 6 o'clock
Displays (Chronograph)	Central seconds, 30-minute counter at 3 o'clock, tachymeter scale
Diameter	38.40 mm
Height	7 mm
Number of components	268 components
Number of jewels	22 jewels (hemispherical, cambered, olive-cut)
Power reserve	Approx. 50 h
Balance	Screw balance, Ø 14.5 mm; 59 mg.cm ²
Frequency	18,000 vibrations per hour (2.5 Hz)
Balance spring	With Phillips curve
Plate	Rhodium-plated German silver, circular-grained on both sides, hand-chamfered edges
Bridges	Rhodium-plated German silver, "Côtes de Genève", recesses circular-grained on both sides, hand-chamfered edges
Going train	Wheels: gold-plated, circular-grained, chamfered, diamond hubs on both sides Pinions: polished faces and tothing, burnished pivots
CASE	
Material	18 K white gold
Bezel	-
Sapphire crystal	Cambered sapphire crystal
Case back	Sapphire crystal case back
Crown	Integrated chronograph button with Montblanc emblem in mother-of-pearl
Dial	Solid 18 K gold grained "argenté" dial
Hands	Blued stainless steel, red chronograph hand
Horns	-
Diameter	43.5 mm
Height	13 mm
Water resistant	3 bar (30 m)
STRAP	
Material/Colour	Hand-stitched alligator-skin / Black
Clasp/Buckle	Pin buckle in 18 K white gold
Limitation	58 pieces

MONTBLANC COLLECTION VILLERET 1858

> Chronographs



MODEL	Vintage Tachydate
Ident No.	107342
MOVEMENT	
Calibre	MB M16.32
Movement type	Manually wound monopusher chronograph
Chronograph	Monopusher chronograph mechanism with column wheel and horizontal coupling
Indications	Central hours and minutes, seconds at 9 o'clock, date at 6 o'clock
Displays (Chronograph)	Central seconds, 30-minute counter at 3 o'clock, tachymeter scale
Diameter	38.40 mm
Height	7 mm
Number of components	268 components
Number of jewels	22 jewels (hemispherical, cambered, olive-cut)
Power reserve	Approx. 50 h
Balance	Screw balance, Ø 14.5 mm; 59 mg.cm ²
Frequency	18,000 vibrations per hour (2.5 Hz)
Balance spring	With Phillips curve
Plate	Rhodium-plated German silver, circular-grained on both sides, hand-chamfered edges
Bridges	Rhodium-plated German silver, "Côtes de Genève", recesses circular-grained on both sides, hand-chamfered edges
Going train	Wheels: gold-plated, circular-grained, chamfered, diamond hubs on both sides Pinions: polished faces and tothing, burnished pivots
CASE	
Material	18 K red gold
Bezel	-
Sapphire crystal	Cambered sapphire crystal
Case back	Sapphire crystal case back
Crown	Integrated chronograph button with Montblanc emblem in mother-of-pearl
Dial	Solid 18 K gold grained "argenté" dial
Hands	Blued stainless steel, red chronograph hand
Horns	-
Diameter	43.5 mm
Height	13 mm
Water resistant	3 bar (30 m)
STRAP	
Material/Colour	Hand-stitched alligator-skin / Brown
Clasp/Buckle	Pin buckle in 18 K red gold
Limitation	58 pieces

MONTBLANC COLLECTION VILLERET 1858

> Chronographs



MODEL	Vintage Chronographe
Ident No.	106166
MOVEMENT	
Calibre	MB M16.29
Movement type	Manually wound monopusher chronograph
Chronograph	Monopusher chronograph mechanism with column wheel and horizontal coupling
Indications	Central hours and minutes, seconds at 9 o'clock
Displays (Chronograph)	Central seconds, 30-minute counter at 3 o'clock, telemeter and tachymeter scale
Diameter	38.40 mm
Height	6.30 mm
Number of components	252 components
Number of jewels	22 jewels (hemispherical, cambered, olive-cut)
Power reserve	Approx. 50 hrs
Balance	Screw balance, Ø 14.5 mm; 59 mg.cm ²
Frequency	18,000 vibrations per hour (2.5 Hz)
Balance spring	With Phillips curve
Plate	Rhodium-plated German silver, circular-grained on both sides, hand-chamfered edges
Bridges	Rhodium-plated German silver, "Côtes de Genève", recesses circular-grained on both sides, hand-chamfered edges
Going train	Wheels: gold-plated, circular-grained, chamfered, diamond hubs on both sides Pinions: polished faces and tothing, burnished pivots
CASE	
Material	18 K white gold
Bezel	-
Sapphire crystal	Cambered sapphire crystal
Case back	Sapphire crystal case back
Crown	Integrated chronograph button with Montblanc emblem in mother-of-pearl
Dial	Solid 18 K gold dial with black Grand Feu enamel
Hands	18 K gold, red chronograph hand
Horns	-
Diameter	43.5 mm
Height	13 mm
Water resistant	3 bar (30 m)
STRAP	
Material/Colour	Hand-stitched alligator-skin / Black
Clasp/Buckle	Pin buckle in 18 K white gold
Limitation	58 pieces

MONTBLANC COLLECTION VILLERET 1858

> Chronographs



MODEL	Vintage Chronographe
Ident No.	106167
MOVEMENT	
Calibre	MB M16.29
Movement type	Manually wound monopusher chronograph
Chronograph	Monopusher chronograph mechanism with column wheel and horizontal coupling
Indications	Central hours and minutes, seconds at 9 o'clock
Displays (Chronograph)	Central seconds, 30-minute counter at 3 o'clock, telemeter and tachymeter scale
Diameter	38.40 mm
Height	6.30 mm
Number of components	252 components
Number of jewels	22 jewels (hemispherical, cambered, olive-cut)
Power reserve	Approx. 50 hrs
Balance	Screw balance, Ø 14.5 mm; 59 mg.cm ²
Frequency	18,000 vibrations per hour (2.5 Hz)
Balance spring	With Phillips curve
Plate	Rhodium-plated German silver, circular-grained on both sides, hand-chamfered edges
Bridges	Rhodium-plated German silver, "Côtes de Genève", recesses circular-grained on both sides, hand-chamfered edges
Going train	Wheels: gold-plated, circular-grained, chamfered, diamond hubs on both sides Pinions: polished faces and tothing, burnished pivots
CASE	
Material	18 K red gold
Bezel	-
Sapphire crystal	Cambered sapphire crystal
Case back	Sapphire crystal case back
Crown	Integrated chronograph button with Montblanc emblem in mother-of-pearl
Dial	Solid 18 K gold dial with white Grand Feu enamel
Hands	Blued stainless steel, red chronograph hand
Horns	-
Diameter	43.5 mm
Height	13 mm
Water resistant	3 bar (30 m)
STRAP	
Material/Colour	Hand-stitched alligator-skin / Brown
Clasp/Buckle	Pin buckle in 18 K red gold
Limitation	58 pieces

MONTBLANC COLLECTION VILLERET 1858

> Chronographs



MODEL	Chronographe Émail Grand Feu
Ident No.	104363
MOVEMENT	
Calibre	MB M13.21
Movement type	Manually wound monopusher chronograph
Chronograph	Monopusher chronograph mechanism with column wheel and horizontal coupling
Indications	Central hours and minutes, seconds at 9 o'clock
Displays (Chronograph)	Central seconds, 30-minute counter at 3 o'clock
Diameter	29.50 mm
Height	6.40 mm
Number of components	239 components
Number of jewels	22 jewels (hemispherical, cambered, olive-cut)
Power reserve	Approx. 60 hrs
Balance	Screw balance, Ø 11.40 mm; 26 mg.cm ²
Frequency	18,000 vibrations per hour (2.5 Hz)
Balance spring	With Phillips curve
Plate	Rhodium-plated German silver, circular-grained on both sides, hand-chamfered edges
Bridges	Rhodium-plated German silver, "Côtes de Genève", recesses circular-grained on both sides, hand-chamfered edges
Going train	Wheels: gold-plated, circular-grained, chamfered, diamond hubs on both sides Pinions: polished faces and tothing, burnished pivots
CASE	
Material	18 K white gold
Bezel	-
Sapphire crystal	Cambered sapphire crystal
Case back	Screwed domed sapphire crystal case back, hinged cuvette with patented release mechanism
Crown	With Montblanc emblem in mother-of-pearl
Dial	Solid 18 K gold dial with white Grand Feu champlévé enamel
Hands	18 K gold, chronograph hands in Pfinodal [®]
Horns	With patented cuvette release mechanism
Diameter	41 mm
Height	13.56 mm
Water resistant	3 bar (30 m)
STRAP	
Material/Colour	Hand-stitched alligator-skin / Black
Clasp/Buckle	Pin buckle in 18 K white gold
Limitation	8 pieces

MONTBLANC COLLECTION VILLERET 1858

> Chronographs



MODEL	Chronographe Authentique Joaillerie
Ident No.	104011
MOVEMENT	
Calibre	MB M13.21
Movement type	Manually wound monopusher chronograph
Chronograph	Monopusher split-seconds chronograph mechanism with column wheel and horizontal coupling
Indications	Central hours and minutes, seconds at 9 o'clock
Displays (Chronograph)	Central seconds, 30-minute counter at 3 o'clock
Diameter	29.50 mm
Height	6.40 mm
Number of components	239 components
Number of jewels	22 jewels (hemispherical, cambered, olive-cut)
Power reserve	Approx. 60 hrs
Balance	Screw balance, Ø 11.40 mm; 26 mg.cm ²
Frequency	18,000 vibrations per hour (2.5 Hz)
Balance spring	With Phillips curve
Plate	Rhodium-plated German silver, circular-grained on both sides, hand-chamfered edges
Bridges	Rhodium-plated German silver, "Côtes de Genève", recesses circular-grained on both sides, hand-chamfered edges
Going train	Wheels: gold-plated, circular-grained, chamfered, diamond hubs on both sides Pinions: polished faces and tothing, burnished pivots
CASE	
Material	18 K white gold
Bezel	Diamonds pavé setting (~ 1.55 ct)
Sapphire crystal	Cambered sapphire crystal
Case back	Screwed domed sapphire crystal case back, hinged cuvette with patented release mechanism
Crown	With Montblanc emblem in mother-of-pearl
Dial	Solid 18 K gold dial with white mother-of-pearl inlays
Hands	18 K gold, chronograph hands in Pfinodal [®]
Horns	With patented cuvette release mechanism
Diameter	41 mm
Height	14.29 mm
Water resistant	3 bar (30 m)
STRAP	
Material/Colour	Hand-stitched alligator-skin / Black
Clasp/Buckle	18 K white gold pin buckle
Limitation	8 pieces

MONTBLANC COLLECTION VILLERET 1858

> Chronographs



MODEL	Chronographe Authentique Joaillerie
Ident No.	104012
MOVEMENT	
Calibre	MB M13.21
Movement type	Manually wound monopusher chronograph
Chronograph	Monopusher split-seconds chronograph mechanism with column wheel and horizontal coupling
Indications	Central hours and minutes, seconds at 9 o'clock
Displays (Chronograph)	Central seconds, 30-minute counter at 3 o'clock
Diameter	29.50 mm
Height	6.40 mm
Number of components	239 components
Number of jewels	22 jewels (hemispherical, cambered, olive-cut)
Power reserve	Approx. 60 hrs
Balance	Screw balance, Ø 11.40 mm; 26 mg.cm ²
Frequency	18,000 vibrations per hour (2.5 Hz)
Balance spring	With Phillips curve
Plate	Rhodium-plated German silver, circular-grained on both sides, hand-chamfered edges
Bridges	Rhodium-plated German silver, "Côtes de Genève", recesses circular-grained on both sides, hand-chamfered edges
Going train	Wheels: gold-plated, circular-grained, chamfered, diamond hubs on both sides Pinions: polished faces and tothing, burnished pivots
CASE	
Material	18 K red gold
Bezel	Diamonds pavé setting (~ 1.55 ct)
Sapphire crystal	Cambered sapphire crystal
Case back	Screwed domed sapphire crystal case back, hinged cuvette with patented release mechanism
Crown	With Montblanc emblem in mother-of-pearl
Dial	Solid 18 K gold dial with white mother-of-pearl inlays
Hands	18 K gold, chronograph hands in Pfinodal [®]
Horns	With patented cuvette release mechanism
Diameter	41 mm
Height	14.29 mm
Water resistant	3 bar (30 m)
STRAP	
Material/Colour	Hand-stitched alligator-skin / Brown
Clasp/Buckle	18 K red gold pin buckle
Limitation	8 pieces

MONTBLANC COLLECTION VILLERET 1858

> Chronographs



MODEL	Chronographe Authentique
Ident No.	102462
MOVEMENT	
Calibre	MB M13.21
Movement type	Manually wound monopusher chronograph
Chronograph	Monopusher chronograph mechanism with column wheel and horizontal coupling
Indications	Central hours and minutes, seconds at 9 o'clock
Displays (Chronograph)	Central seconds, 30-minute counter at 3 o'clock
Diameter	29.50 mm
Height	6.40 mm
Number of components	239 components
Number of jewels	22 jewels (hemispherical, cambered, olive-cut)
Power reserve	Approx. 55 hrs
Balance	Screw balance, Ø 11.40 mm; 26 mg.cm ²
Frequency	18,000 vibrations per hour (2.5 Hz)
Balance spring	With Phillips curve
Plate	Rhodium-plated German silver, circular-grained on both sides, hand-chamfered edges
Bridges	Rhodium-plated German silver, "Côtes de Genève", recesses circular-grained on both sides, hand-chamfered edges
Going train	Wheels: gold-plated, circular-grained, chamfered, diamond hubs on both sides Pinions: polished faces and tothing, burnished pivots
CASE	
Material	18 K white gold
Bezel	-
Sapphire crystal	Cambered sapphire crystal
Case back	Screwed domed sapphire crystal case back, hinged cuvette with patented release mechanism
Crown	With Montblanc emblem in mother-of-pearl
Dial	Solid 18 K gold dial with hand-crafted ruthenium guilloché decoration
Hands	18 K gold, chronograph hands in Pfinodal [®]
Horns	With patented cuvette release mechanism
Diameter	41 mm
Height	14.29 mm
Water resistant	3 bar (30 m)
STRAP	
Material/Colour	Hand-stitched alligator-skin / Black
Clasp/Buckle	Pin buckle in 18 K white gold
Limitation	8 pieces

MONTBLANC COLLECTION VILLERET 1858

> Chronographs



MODEL	Chronographe Authentique
Ident No.	103086
MOVEMENT	
Calibre	MB M13.21
Movement type	Manually wound monopusher chronograph
Chronograph	Monopusher chronograph mechanism with column wheel and horizontal coupling
Indications	Central hours and minutes, seconds at 9 o'clock
Displays (Chronograph)	Central seconds, 30-minute counter at 3 o'clock
Diameter	29.50 mm
Height	6.40 mm
Number of components	239 components
Number of jewels	22 jewels (hemispherical, cambered, olive-cut)
Power reserve	Approx. 55 hrs
Balance	Screw balance, Ø 11.40 mm; 26 mg.cm ²
Frequency	18,000 vibrations per hour (2.5 Hz)
Balance spring	With Phillips curve
Plate	Rhodium-plated German silver, circular-grained on both sides, hand-chamfered edges
Bridges	Rhodium-plated German silver, "Côtes de Genève", recesses circular-grained on both sides, hand-chamfered edges
Going train	Wheels: gold-plated, circular-grained, chamfered, diamond hubs on both sides Pinions: polished faces and tothing, burnished pivots
CASE	
Material	18 K white gold
Bezel	-
Sapphire crystal	Cambered sapphire crystal
Case back	Screwed domed sapphire crystal case back, hinged cuvette with patented release mechanism
Crown	With Montblanc emblem in mother-of-pearl
Dial	Solid 18 K gold dial with hand-crafted silver-plated circular-grained decoration
Hands	18 K gold, chronograph hands in Pfinodal [®]
Horns	With patented cuvette release mechanism
Diameter	41 mm
Height	14.29 mm
Water resistant	3 bar (30 m)
STRAP	
Material/Colour	Hand-stitched alligator-skin / Black
Clasp/Buckle	Pin buckle in 18 K white gold
Limitation	8 pieces

MONTBLANC COLLECTION VILLERET 1858

> Chronographs



MODEL	Chronographe Authentique
Ident No.	102463
MOVEMENT	
Calibre	MB M13.21
Movement type	Manually wound monopusher chronograph
Chronograph	Monopusher chronograph mechanism with column wheel and horizontal coupling
Indications	Central hours and minutes, seconds at 9 o'clock
Displays (Chronograph)	Central seconds, 30-minute counter at 3 o'clock
Diameter	29.50 mm
Height	6.40 mm
Number of components	239 components
Number of jewels	22 jewels (hemispherical, cambered, olive-cut)
Power reserve	Approx. 55 hrs
Balance	Screw balance, Ø 11.40 mm; 26 mg.cm ²
Frequency	18,000 vibrations per hour (2.5 Hz)
Balance spring	With Phillips curve
Plate	Rhodium-plated German silver, circular-grained on both sides, hand-chamfered edges
Bridges	Rhodium-plated German silver, "Côtes de Genève", recesses circular-grained on both sides, hand-chamfered edges
Going train	Wheels: gold-plated, circular-grained, chamfered, diamond hubs on both sides Pinions: polished faces and tothing, burnished pivots
CASE	
Material	18 K red gold
Bezel	-
Sapphire crystal	Cambered sapphire crystal
Case back	Screwed domed sapphire crystal case back, hinged cuvette with patented release mechanism
Crown	With Montblanc emblem in mother-of-pearl
Dial	Solid 18 K gold dial with hand-crafted silver-plated circular-grained decoration
Hands	18 K gold, chronograph hands in Pfinodal [®]
Horns	With patented cuvette release mechanism
Diameter	41 mm
Height	14.29 mm
Water resistant	3 bar (30 m)
STRAP	
Material/Colour	Hand-stitched alligator-skin / Brown
Clasp/Buckle	Pin buckle in 18 K red gold
Limitation	58 pieces

MONTBLANC COLLECTION VILLERET 1858

> Chronographs



MODEL	Vintage Pulsographe
Ident No.	106496
MOVEMENT	
Calibre	MB M13.21
Movement type	Manually wound monopusher chronograph
Chronograph	Monopusher chronograph mechanism with column wheel and horizontal coupling
Indications	Central hours and minutes, seconds at 9 o'clock
Displays (Chronograph)	Central seconds, 30-minute counter at 3 o'clock, pulsometer scale
Diameter	29.50 mm
Height	6.40 mm
Number of components	239 components
Number of jewels	22 jewels (hemispherical, cambered, olive-cut)
Power reserve	Approx. 55 hrs
Balance	Screw balance, Ø 11.40 mm; 26 mg.cm ²
Frequency	18,000 vibrations per hour (2.5 Hz)
Balance spring	With Phillips curve
Plate	Rhodium-plated German silver, circular-grained on both sides, hand-chamfered edges
Bridges	Rhodium-plated German silver, "Côtes de Genève", recesses circular-grained on both sides, hand-chamfered edges
Going train	Wheels: gold-plated, circular-grained, chamfered, diamond hubs on both sides Pinions: polished faces and tothing, burnished pivots
CASE	
Material	18 K white gold
Bezel	-
Sapphire crystal	Cambered sapphire crystal
Case back	Sapphire crystal case back
Crown	With Montblanc emblem in mother-of-pearl
Dial	Solid 18 K gold dial with white Grand Feu enamel
Hands	Blued stainless steel, red chronograph hand
Horns	-
Diameter	39.5 mm
Height	12.1 mm
Water resistant	3 bar (30 m)
STRAP	
Material/Colour	Hand-stitched alligator-skin / Black
Clasp/Buckle	Pin buckle in 18 K white gold
Limitation	58 pieces

MONTBLANC COLLECTION VILLERET 1858

> Chronographs



MODEL	Vintage Pulsographe
Ident No.	106497
MOVEMENT	
Calibre	MB M13.21
Movement type	Manually wound monopusher chronograph
Chronograph	Monopusher chronograph mechanism with column wheel and horizontal coupling
Indications	Central hours and minutes, seconds at 9 o'clock
Displays (Chronograph)	Central seconds, 30-minute counter at 3 o'clock, pulsometer scale
Diameter	29.50 mm
Height	6.40 mm
Number of components	239 components
Number of jewels	22 jewels (hemispherical, cambered, olive-cut)
Power reserve	Approx. 55 hrs
Balance	Screw balance, Ø 11.40 mm; 26 mg.cm ²
Frequency	18,000 vibrations per hour (2.5 Hz)
Balance spring	With Phillips curve
Plate	Rhodium-plated German silver, circular-grained on both sides, hand-chamfered edges
Bridges	Rhodium-plated German silver, "Côtes de Genève", recesses circular-grained on both sides, hand-chamfered edges
Going train	Wheels: gold-plated, circular-grained, chamfered, diamond hubs on both sides Pinions: polished faces and tothing, burnished pivots
CASE	
Material	18 K red gold
Bezel	-
Sapphire crystal	Cambered sapphire crystal
Case back	Sapphire crystal case back
Crown	With Montblanc emblem in mother-of-pearl
Dial	Solid 18 K gold dial with black Grand Feu enamel
Hands	18 K gold, red chronograph hand
Horns	-
Diameter	39.5 mm
Height	12.1 mm
Water resistant	3 bar (30 m)
STRAP	
Material/Colour	Hand-stitched alligator-skin / Brown
Clasp/Buckle	Pin buckle in 18 K red gold
Limitation	58 pieces

MONTBLANC COLLECTION VILLERET 1858

> Classics



MODEL	Grande Seconde au Centre Retour à Zéro
Ident No.	104353
MOVEMENT	
Calibre	MB M16.18
Movement type	Manually wound retour à Zéro movement
Chronograph	-
Indications	Central hours, minutes and seconds, second hand with zero-reset function
Displays (Chronograph)	-
Diameter	38.40 mm
Height	6.30 mm
Number of components	209 components
Number of jewels	21 jewels (hemispherical, cambered, olive-cut)
Power reserve	Approx. 52 hrs
Balance	Screw balance, Ø 14.5 mm; 59 mg.cm ²
Frequency	18,000 vibrations per hour (2.5 Hz)
Balance spring	With Phillips curve
Plate	Rhodium-plated German silver, circular-grained on both sides, hand-chamfered edges
Bridges	Rhodium-plated German silver, "Côtes de Genève", recesses circular-grained on both sides, hand-chamfered edges
Going train	Wheels: gold-plated, circular-grained, chamfered, diamond hubs on both sides Pinions: polished faces and tothing, burnished pivots
CASE	
Material	18 K white gold
Bezel	-
Sapphire crystal	Cambered sapphire crystal
Case back	Screwed domed sapphire crystal case back, hinged cuvette with patented release mechanism
Crown	With Montblanc emblem in mother-of-pearl
Dial	Solid 18 K gold dial with hand-crafted silver-plated circular-grained decoration
Hands	18 K gold, central second hand in Pfinodal®
Horns	With patented cuvette release mechanism
Diameter	47 mm
Height	14.97 mm
Water resistant	3 bar (30 m)
STRAP	
Material/Colour	Hand-stitched alligator-skin / Black
Clasp/Buckle	Pin buckle in 18 K white gold
Limitation	8 pieces

MONTBLANC COLLECTION VILLERET 1858

> Classics



MODEL	Grande Seconde au Centre Retour à Zéro
Ident No.	103837
MOVEMENT	
Calibre	MB M16.18
Movement type	Manually wound retour à Zéro movement
Chronograph	-
Indications	Central hours, minutes and seconds, second hand with zero-reset function
Displays (Chronograph)	-
Diameter	38.40 mm
Height	6.30 mm
Number of components	209 components
Number of jewels	21 jewels (hemispherical, cambered, olive-cut)
Power reserve	Approx. 50 hrs
Balance	Screw balance, Ø 14.5 mm; 59 mg.cm ²
Frequency	18,000 vibrations per hour (2.5 Hz)
Balance spring	With Phillips curve
Plate	Rhodium-plated German silver, circular-grained on both sides, hand-chamfered edges
Bridges	Rhodium-plated German silver, "Côtes de Genève", recesses circular-grained on both sides, hand-chamfered edges
Going train	Wheels: gold-plated, circular-grained, chamfered, diamond hubs on both sides Pinions: polished faces and tothing, burnished pivots
CASE	
Material	18 K red gold
Bezel	-
Sapphire crystal	Cambered sapphire crystal
Case back	Screwed domed sapphire crystal case back, hinged cuvette with patented release mechanism
Crown	With Montblanc emblem in mother-of-pearl
Dial	Solid 18 K gold dial with hand-crafted silver-plated circular-grained decoration
Hands	18 K gold, central second hand in Pfinodal®
Horns	With patented cuvette release mechanism
Diameter	47 mm
Height	14.97 mm
Water resistant	3 bar (30 m)
STRAP	
Material/Colour	Hand-stitched alligator-skin / Brown
Clasp/Buckle	Pin buckle in 18 K red gold
Limitation	58 pieces

MONTBLANC COLLECTION VILLERET 1858

> Classics



MODEL	Seconde Grande Authentique
Ident No.	102454
MOVEMENT	
Calibre	MB M16.15
Movement type	Manually wound movement
Chronograph	-
Indications	Central hours and minutes, seconds at 6 o'clock
Displays (Chronograph)	-
Diameter	38.40 mm
Height	5.05 mm
Number of components	158 components
Number of jewels	18 jewels (hemispherical, cambered, olive-cut)
Power reserve	Approx. 55 hrs
Balance	Screw balance, Ø 14.5 mm; 59 mg.cm ²
Frequency	18,000 vibrations per hour (2.5 Hz)
Balance spring	With Phillips curve
Plate	Rhodium-plated German silver, circular-grained on both sides, hand-chamfered edges
Bridges	Rhodium-plated German silver, "Côtes de Genève", recesses circular-grained on both sides, hand-chamfered edges
Going train	Wheels: gold-plated, circular-grained, chamfered, diamond hubs on both sides Pinions: polished faces and tothing, burnished pivots
CASE	
Material	18 K red gold
Bezel	-
Sapphire crystal	Cambered sapphire crystal
Case back	Screwed domed sapphire crystal case back, hinged cuvette with patented release mechanism
Crown	With Montblanc emblem in mother-of-pearl
Dial	Solid 18 K gold dial with hand-crafted silver-plated circular-grained decoration
Hands	18 K gold
Horns	With patented cuvette release mechanism
Diameter	47 mm
Height	14.57 mm
Water resistant	3 bar (30 m)
STRAP	
Material/Colour	Hand-stitched alligator-skin / Brown
Clasp/Buckle	Pin buckle in 18 K red gold
Limitation	58 pieces

MONTBLANC COLLECTION VILLERET 1858

> Classics



MODEL	Seconde au Centre Retour à Zéro
Ident No.	103839
MOVEMENT	
Calibre	MB M13.18
Movement type	Manually wound retour à Zéro movement
Chronograph	-
Indications	Central hours, minutes and seconds, second hand with zero-reset function
Displays (Chronograph)	-
Diameter	29.50 mm
Height	6.40 mm
Number of components	196 components
Number of jewels	21 jewels (hemispherical, cambered, olive-cut)
Power reserve	Approx. 55 hrs
Balance	Screw balance, Ø 11.40 mm; 26 mg.cm ²
Frequency	18,000 vibrations per hour (2.5 Hz)
Balance spring	With Phillips curve
Plate	Rhodium-plated German silver, circular-grained on both sides, hand-chamfered edges
Bridges	Rhodium-plated German silver, "Côtes de Genève", recesses circular-grained on both sides, hand-chamfered edges
Going train	Wheels: gold-plated, circular-grained, chamfered, diamond hubs on both sides Pinions: polished faces and tothing, burnished pivots
CASE	
Material	18 K white gold
Bezel	-
Sapphire crystal	Cambered sapphire crystal
Case back	Screwed domed sapphire crystal case back, hinged cuvette with patented release mechanism
Crown	With Montblanc emblem in mother-of-pearl
Dial	Solid 18 K gold dial with hand-crafted ruthenium guilloché decoration
Hands	18 K gold, central second hand in Pfinodal [®]
Horns	With patented cuvette release mechanism
Diameter	41 mm
Height	14.8 mm
Water resistant	3 bar (30 m)
STRAP	
Material/Colour	Hand-stitched alligator-skin / Black
Clasp/Buckle	Pin buckle in 18 K white gold
Limitation	8 pieces

MONTBLANC COLLECTION VILLERET 1858

> Classics



MODEL	Seconde au Centre Retour à Zéro
Ident No.	104343
MOVEMENT	
Calibre	MB M13.18
Movement type	Manually wound retour à Zéro movement
Chronograph	-
Indications	Central hours, minutes and seconds, second hand with zero-reset function
Displays (Chronograph)	-
Diameter	29.50 mm
Height	6.40 mm
Number of components	196 components
Number of jewels	21 jewels (hemispherical, cambered, olive-cut)
Power reserve	Approx. 55 hrs
Balance	Screw balance, Ø 11.40 mm; 26 mg.cm ²
Frequency	18,000 vibrations per hour (2.5 Hz)
Balance spring	With Phillips curve
Plate	Rhodium-plated German silver, circular-grained on both sides, hand-chamfered edges
Bridges	Rhodium-plated German silver, "Côtes de Genève", recesses circular-grained on both sides, hand-chamfered edges
Going train	Wheels: gold-plated, circular-grained, chamfered, diamond hubs on both sides Pinions: polished faces and tothing, burnished pivots
CASE	
Material	18 K white gold
Bezel	-
Sapphire crystal	Cambered sapphire crystal
Case back	Screwed domed sapphire crystal case back, hinged cuvette with patented release mechanism
Crown	With Montblanc emblem in mother-of-pearl
Dial	Solid 18 K gold dial with hand-crafted silver-plated circular-grained decoration
Hands	18 K gold, central second hand in Pfinodal®
Horns	With patented cuvette release mechanism
Diameter	41 mm
Height	14.8 mm
Water resistant	3 bar (30 m)
STRAP	
Material/Colour	Hand-stitched alligator-skin / Black
Clasp/Buckle	Pin buckle in 18 K white gold
Limitation	8 pieces

MONTBLANC COLLECTION VILLERET 1858

> Classics



MODEL	Seconde au Centre Retour à Zéro
Ident No.	103840
MOVEMENT	
Calibre	MB M13.18
Movement type	Manually wound retour à Zéro movement
Chronograph	-
Indications	Central hours, minutes and seconds, second hand with zero-reset function
Displays (Chronograph)	-
Diameter	29.50 mm
Height	6.40 mm
Number of components	196 components
Number of jewels	21 jewels (hemispherical, cambered, olive-cut)
Power reserve	Approx. 55 hrs
Balance	Screw balance, Ø 11.40 mm; 26 mg.cm ²
Frequency	18,000 vibrations per hour (2.5 Hz)
Balance spring	With Phillips curve
Plate	Rhodium-plated German silver, circular-grained on both sides, hand-chamfered edges
Bridges	Rhodium-plated German silver, "Côtes de Genève", recesses circular-grained on both sides, hand-chamfered edges
Going train	Wheels: gold-plated, circular-grained, chamfered, diamond hubs on both sides Pinions: polished faces and tothing, burnished pivots
CASE	
Material	18 K red gold
Bezel	-
Sapphire crystal	Cambered sapphire crystal
Case back	Screwed domed sapphire crystal case back, hinged cuvette with patented release mechanism
Crown	With Montblanc emblem in mother-of-pearl
Dial	Solid 18 K gold dial with hand-crafted silver-plated circular-grained decoration
Hands	18 K gold, central second hand in Pfinodal®
Horns	With patented cuvette release mechanism
Diameter	41 mm
Height	14.8 mm
Water resistant	3 bar (30 m)
STRAP	
Material/Colour	Hand-stitched alligator-skin / Brown
Clasp/Buckle	Pin buckle in 18 K red gold
Limitation	58 pieces

MONTBLANC COLLECTION VILLERET 1858

> Classics



MODEL	Seconde Authentique Joaillerie
Ident No.	104231
MOVEMENT	
Calibre	MB M62.00
Movement type	Manually wound movement
Chronograph	-
Indications	Central hours and minutes, seconds at 6 o'clock
Displays (Chronograph)	-
Diameter	24 mm
Height	3.90 mm
Number of components	162 components
Number of jewels	19 jewels (hemispherical, cambered and olive-cut)
Power reserve	Approx. 50 hrs
Balance	Screw balance, Ø 9.7 mm; 15 mg.cm ²
Frequency	18,000 vibrations per hour (2.5 Hz)
Balance spring	-
Plate	Rhodium-plated German silver, circular-grained on both sides, hand-chamfered edges
Bridges	Rhodium-plated German silver, "Côtes de Genève", recesses circular-grained on both sides, hand-chamfered edges
Going train	Wheels: gold-plated, circular-grained, chamfered, diamond hubs on both sides Pinions: polished faces and tothing, burnished pivots
CASE	
Material	18 K white gold
Bezel	Diamonds pavé setting (~ 1.55 ct)
Sapphire crystal	Cambered sapphire crystal
Case back	Screwed domed sapphire crystal case back, hinged cuvette with patented release mechanism
Crown	Diamonds pavé (~ 0.165 ct) with unique Montblanc Diamond
Dial	Solid 18 K gold dial with black mother-of-pearl inlays
Hands	18 K gold
Horns	With patented cuvette release mechanism
Diameter	41 mm
Height	13.79 mm
Water resistant	3 bar (30 m)
STRAP	
Material/Colour	Hand-stitched alligator-skin / Black
Clasp/Buckle	Pin buckle in 18 K white gold
Limitation	8 pieces

MONTBLANC COLLECTION VILLERET 1858

> Classics



MODEL	Seconde Authentique Joaillerie
Ident No.	104230
MOVEMENT	
Calibre	MB M62.00
Movement type	Manually wound movement
Chronograph	-
Indications	Central hours and minutes, seconds at 6 o'clock
Displays (Chronograph)	-
Diameter	24 mm
Height	3.90 mm
Number of components	162 components
Number of jewels	19 jewels (hemispherical, cambered and olive-cut)
Power reserve	Approx. 50 hrs
Balance	Screw balance, Ø 9.7 mm; 15 mg.cm ²
Frequency	18,000 vibrations per hour (2.5 Hz)
Balance spring	-
Plate	Rhodium-plated German silver, circular-grained on both sides, hand-chamfered edges
Bridges	Rhodium-plated German silver, "Côtes de Genève", recesses circular-grained on both sides, hand-chamfered edges
Going train	Wheels: gold-plated, circular-grained, chamfered, diamond hubs on both sides Pinions: polished faces and tothing, burnished pivots
CASE	
Material	18 K white gold
Bezel	Diamonds pavé setting (~ 1.55 ct)
Sapphire crystal	Cambered sapphire crystal
Case back	Screwed domed sapphire crystal case back, hinged cuvette with patented release mechanism
Crown	Diamonds pavé (~ 0.165 ct) with unique Montblanc Diamond
Dial	Solid 18 K gold dial with white mother-of-pearl inlays
Hands	18 K gold
Horns	With patented cuvette release mechanism
Diameter	41 mm
Height	13.79 mm
Water resistant	3 bar (30 m)
STRAP	
Material/Colour	Hand-stitched alligator-skin / Black
Clasp/Buckle	Pin buckle in 18 K white gold
Limitation	8 pieces

MONTBLANC COLLECTION VILLERET 1858

> Classics



MODEL	Seconde Authentique
Ident No.	103079
MOVEMENT	
Calibre	MB M62.00
Movement type	Manually wound movement
Chronograph	-
Indications	Central hours and minutes, seconds at 6 o'clock
Displays (Chronograph)	-
Diameter	24 mm
Height	3.90 mm
Number of components	162 components
Number of jewels	19 jewels (hemispherical, cambered and olive-cut)
Power reserve	Approx. 50 hrs
Balance	Screw balance, Ø 9.7 mm; 15 mg.cm ²
Frequency	18,000 vibrations per hour (2.5 Hz)
Balance spring	With Phillips curve
Plate	Rhodium-plated German silver, circular-grained on both sides, hand-chamfered edges
Bridges	Rhodium-plated German silver, "Côtes de Genève", recesses circular-grained on both sides, hand-chamfered edges
Going train	Wheels: gold-plated, circular-grained, chamfered, diamond hubs on both sides Pinions: polished faces and tothing, burnished pivots
CASE	
Material	18 K white gold
Bezel	-
Sapphire crystal	Cambered sapphire crystal
Case back	Screwed domed sapphire crystal case back, hinged cuvette with patented release mechanism
Crown	With Montblanc emblem in mother-of-pearl
Dial	Solid 18 K gold dial with hand-crafted silver-plated circular-grained decoration
Hands	18 K gold
Horns	With patented cuvette release mechanism
Diameter	41 mm
Height	13.79 mm
Water resistant	3 bar (30 m)
STRAP	
Material/Colour	Hand-stitched alligator-skin / Black
Clasp/Buckle	Pin buckle in 18 K white gold
Limitation	8 pieces

MONTBLANC COLLECTION VILLERET 1858

> Classics



MODEL	Seconde Authentique
Ident No.	102460
MOVEMENT	
Calibre	MB M62.00
Movement type	Manually wound movement
Chronograph	-
Indications	Central hours and minutes, seconds at 6 o'clock
Displays (Chronograph)	-
Diameter	24 mm
Height	3.90 mm
Number of components	162 components
Number of jewels	19 jewels (hemispherical, cambered and olive-cut)
Power reserve	Approx. 50 hrs
Balance	Screw balance, Ø 9.7 mm; 15 mg.cm ²
Frequency	18,000 vibrations per hour (2.5 Hz)
Balance spring	-
Plate	Rhodium-plated German silver, circular-grained on both sides, hand-chamfered edges
Bridges	Rhodium-plated German silver, "Côtes de Genève", recesses circular-grained on both sides, hand-chamfered edges
Going train	Wheels: gold-plated, circular-grained, chamfered, diamond hubs on both sides Pinions: polished faces and tothing, burnished pivots
CASE	
Material	18 K red gold
Bezel	-
Sapphire crystal	Cambered sapphire crystal
Case back	Screwed domed sapphire crystal case back, hinged cuvette with patented release mechanism
Crown	With Montblanc emblem in mother-of-pearl
Dial	Solid 18 K gold dial with hand-crafted silver-plated circular-grained decoration
Hands	18 K gold
Horns	With patented cuvette release mechanism
Diameter	41 mm
Height	13.79 mm
Water resistant	3 bar (30 m)
STRAP	
Material/Colour	Hand-stitched alligator-skin / Brown
Clasp/Buckle	Pin buckle in 18 K red gold
Limitation	58 pieces

MONTBLANC COLLECTION VILLERET 1858

> Classics



MODEL	Seconde Authentique - Pour Elle et Lui
Ident No.	109931
MOVEMENT	
Calibre	MB M62.00
Movement type	Manually wound movement
Chronograph	-
Indications	Hour - minute - small second at 6 o'clock
Displays (Chronograph)	-
Diameter	24 mm
Height	3.90 mm
Number of components	162 components
Number of jewels	19 jewels (hemispherical, cambered and olive-cut)
Power reserve	Approx. 50 hrs
Balance	Screw balance, Ø 9.7 mm; 15 mg.cm ²
Frequency	18,000 vibrations per hour (2.5 Hz)
Balance spring	With Phillips curve
Plate	Rhodium-plated German silver, circular-grained on both sides, hand-chamfered edges
Bridges	Rhodium-plated German silver, "Côtes de Genève", recesses circular-grained on both sides, hand-chamfered edges
Going train	Wheels: gold-plated, circular-grained, chamfered, diamond hubs on both sides Pinions: polished faces and tothing, burnished pivots
CASE	
Material	18 K red gold
Bezel	-
Sapphire crystal	Cambered sapphire crystal
Case back	Screwed domed sapphire crystal case back, hinged cuvette with patented release mechanism
Crown	With Montblanc emblem in mother-of-pearl
Dial	Silver mother-of-pearl "marqueterie" and 18 K gold inlays
Hands	18 K gold
Horns	With patented cuvette release mechanism
Diameter	36 mm and 39.5 mm
Height	-
Water resistant	3 bar (30 m)
STRAP	
Material/Colour	Hand-stitched alligator-skin / White (for her) and brown (for him)
Clasp/Buckle	18 K red gold pin buckle
Limitation	58 pieces

MONTBLANC COLLECTION VILLERET 1858

> Classics



MODEL	Seconde Authentique Joaillerie
Ident No.	109184
MOVEMENT	
Calibre	MB M62.00
Movement type	Manually wound movement
Chronograph	-
Indications	Central hours and minutes, seconds at 6 o'clock
Displays (Chronograph)	-
Diameter	24 mm
Height	3.90 mm
Number of components	162 components
Number of jewels	19 jewels (hemispherical, cambered and olive-cut)
Power reserve	Approx. 50 hrs
Balance	Screw balance, Ø 9.7 mm; 15 mg.cm ²
Frequency	18,000 vibrations per hour (2.5 Hz)
Balance spring	-
Plate	Rhodium-plated German silver, circular-grained on both sides, hand-chamfered edges
Bridges	Rhodium-plated German silver, "Côtes de Genève", recesses circular-grained on both sides, hand-chamfered edges
Going train	Wheels: gold-plated, circular-grained, chamfered, diamond hubs on both sides Pinions: polished faces and tothing, burnished pivots
CASE	
Material	18 K red gold
Bezel	Paved with 144 white diamonds (~ 0.93 ct)
Sapphire crystal	Cambered sapphire crystal
Case back	Sapphire crystal case back
Crown	Paved with 38 white diamonds (~ 0.11 ct) and a unique Montblanc Diamond (~ 0.06 ct)
Dial	Silver mother-of-pearl "marqueterie" and 18 K gold inlays
Hands	18 K gold
Horns	-
Diameter	36 mm
Height	9.6 mm
Water resistant	3 bar (30 m)
STRAP	
Material/Colour	Hand-stitched alligator-skin / White
Clasp/Buckle	18 K red gold pin buckle
Limitation	58 pieces

MONTBLANC COLLECTION VILLERET 1858

> Classics



MODEL	Seconde Authentique
Ident No.	109182
MOVEMENT	
Calibre	MB M62.00
Movement type	Manually wound movement
Chronograph	-
Indications	Central hours and minutes, seconds at 6 o'clock
Displays (Chronograph)	-
Diameter	24 mm
Height	3.90 mm
Number of components	162 components
Number of jewels	19 jewels (hemispherical, cambered and olive-cut)
Power reserve	Approx. 50 h
Balance	Screw balance, Ø 9.7 mm; 15 mg.cm ²
Frequency	18,000 vibrations per hour (2.5 Hz)
Balance spring	With Phillips curve
Plate	Rhodium-plated German silver, circular-grained on both sides, hand-chamfered edges
Bridges	Rhodium-plated German silver, "Côtes de Genève", recesses circular-grained on both sides, hand-chamfered edges
Going train	Wheels: gold-plated, circular-grained, chamfered, diamond hubs on both sides Pinions: polished faces and tothing, burnished pivots
CASE	
Material	18 K Red gold
Bezel	-
Sapphire crystal	Cambered sapphire crystal
Case back	Sapphire crystal case back
Crown	18 K red gold with Montblanc emblem diamond
Dial	Silver mother-of-pearl "marqueterie" and 18 K gold inlays
Hands	18 K red gold
Horns	With patented cuvette release mechanism
Diameter	36 mm
Height	-
Water resistant	3 bar (30 m)
STRAP	
Material/Colour	Hand-stitched alligator-skin / White
Clasp/Buckle	18 K red gold pin buckle
Limitation	58 pieces

LE LOCLE: WHERE TIME IS AT HOME

Deep in a valley in the Jura Mountains, inside the airy, spacious premises of the Montblanc manufacture in Le Locle, the master watchmakers are committed to preserving traditional Swiss watchmaking at the very highest level, creating innovative timepieces of the utmost precision, perfection and durability. Their attention to detail is so meticulous, that even those parts forever concealed within a watch's movement must be flawlessly finished.

The timeless contemporary watches express a high degree of technical sovereignty. They beautifully embody the fruitful coexistence of traditional classicism and perpetually modern design.

With the unveiling of its manufacture calibres in the Nicolas Rieussec and TimeWalker collections, Montblanc demonstrates the superior

skill housed within the Montblanc workshops and established the company as one of an elite group of watchmakers, able of producing their own movements from start to finish.

The calibres designed by Montblanc and crafted in the Le Locle workshops embody the company's philosophy of uniting the best of traditional Swiss art of horology with the latest advances in engineering. These highly complex watch movements not only reflect a legacy rich in innovation and excellence, but also herald the future of precision watchmaking. They underscore the status of the Montblanc manufacture in Le Locle with its complete spectrum of capacities, beginning with the initial development of its own watch movements, continuing through their design and engineering, culminating in their final assembly and quality control.





MONTBLANC NICOLAS RIEUSSEC COLLECTION

MONTBLANC NICOLAS RIEUSSEC COLLECTION

> *Platinum : 43 mm*



A Id. 107071



p. 72 **A** Id. 108788



p. 73 **H** Id. 106484 p. 74

> *Gold : 43 mm*



H Id. 106485 p. 75



H Id. 106486 p. 76



H Id. 104705 p. 77



A Id. 107067 p. 78



A Id. 104271 p. 79



A Id. 108789 p. 80

H=Handwinding **A**=Automatic **Q**=Quartz

MONTBLANC NICOLAS RIEUSSEC COLLECTION

> Steel : 43 mm



A Id. 102336 p. 81



A Id. 102337 p. 82



A Id. 106595 p. 83



A Id. 109996 p. 84



A Id. 106488 p. 85



A Id. 106487 p. 86



A Id. 107068 p. 87



A Id. 107070 p. 88



A Id. 108790 p. 90



H Id. 104981 p. 89

MONTBLANC NICOLAS RIEUSSEC COLLECTION

> Platinum



MODEL	Montblanc Nicolas Rieussec Open Home Time Limited Edition - 50 pieces
IDENT NO.	107071
MOVEMENT	
CALIBRE	Montblanc MB R210
FEATURES	Monopusher chronograph with automatic winding, 18 K white gold rotor, column-wheel control and vertical disc clutch, 13 3/4" (31 mm), height 8.46 mm, 323 parts, large balance wheel with screws (moment of inertia: 12 mg.cm ² , diameter: 9.70 mm), flat hairspring, rhodium-plated and circular-grained plates, rhodium-plated bridges with Geneva striping, wheel train with special toothing for more efficient power transmission
INDICATIONS	Off-centre hour - minute hands, date display
COMPLICATIONS	30 min. and 60 sec. counters with rotating discs, second time zone by disc with day and night display
BATTERY	-
POWER RESERVE	Approx. 72 hrs
FREQUENCY/JEWELS	28,800/h, 40 jewels
CASE	
MATERIAL	950 Platinum (~ 123 g)
BEZEL	Fixed
SAPPHIRE CRYSTAL	Domed sapphire crystal with double anti-reflective coating
CASE BACK	Sapphire crystal case back
CROWN	Non-screw crown, 1 O-ring, 18 K white gold with mother-of-pearl Montblanc emblem
DIAL	Solid 950 Platinum dial with blue numerals on applique hour circle
HANDS	Blued steel feuille and baton hands, luminescent hour and minute hands
DISTANCE BETWEEN HORNS/CLASP	22/20 mm
DIAMETER	43 mm
HEIGHT	15 mm
WATER RESISTANT	3 bar (30 m)
BRACELET / STRAP	
MATERIAL/COLOUR	Alligator-skin strap / Blue
CLASP/BUCKLE	18 K white gold double-folding clasp (~ 25 g)

MONTBLANC NICOLAS RIEUSSEC COLLECTION

> Platinum



MODEL	Montblanc Nicolas Rieussec Rising Hours Limited Edition - 28 pieces
IDENT No.	108788
MOVEMENT	
CALIBRE	Montblanc MB R220
FEATURES	Monopusher chronograph with automatic winding, Column-wheel control and vertical disc clutch, 13 3/4" (31 mm), thickness 8.66 mm, 343 parts, large balance wheel with screws (moment of inertia: 12 mg.cm ² , diameter: 9.70 mm), flat hairspring, rhodium-plated and circular-grained plates, rhodium-plated bridges with Geneva striping, wheel train with special toothing for more efficient power transmission
INDICATIONS	Patented rising hours disc with integrated day & night indication, minutes hand, date and day of the week display
COMPLICATIONS	30 min. and 60 sec. counters with rotating discs
BATTERY	-
POWER RESERVE	Approx. 72 hrs
FREQUENCY/JEWELS	28,800/h, 42 jewels
CASE	
MATERIAL	950 Platinum
BEZEL	Fixed
SAPPHIRE CRYSTAL	Domed sapphire crystal with double anti-reflective coating
CASE BACK	950 Platinum case back, with sapphire crystal
CROWN	Non-screw crown, 1 O-ring, 18 K white gold with mother-of-pearl Montblanc emblem
DIAL	Silver-coloured "grain d'orge" guilloché dial
HANDS	Feuille and baton hands
DISTANCE BETWEEN HORNS/CLASP	22/20 mm
DIAMETER	43 mm
HEIGHT	15.30 mm
WATER RESISTANT	3 bar (30 m)
BRACELET / STRAP	
MATERIAL/COLOUR	Alligator-skin strap / Grey
CLASP/BUCKLE	18 K white gold triple-folding clasp

MONTBLANC NICOLAS RIEUSSEC COLLECTION

> Platinum



MODEL	Montblanc Nicolas Rieussec Chronograph Anniversary Edition - 25 pieces
IDENT NO.	106484
MOVEMENT	
CALIBRE	Montblanc MB R110
FEATURES	Monopusher chronograph with manual winding, Column-wheel control and vertical disc clutch, 13 3/4" (31 mm), thickness 7.60 mm, 278 parts, large balance wheel with screws (moment of inertia: 12 mg.cm ² , diameter: 9.70 mm), flat hairspring, rhodium-plated and circular-grained plates, rhodium-plated bridges with Geneva striping, wheel train with special toothing for more efficient power transmission, Power-reserve display on case back
INDICATIONS	Off-centre hour - minute hands
COMPLICATIONS	30 min. and 60 sec. counters with rotating discs
BATTERY	-
POWER RESERVE	Approx. 72 hrs
FREQUENCY/JEWELS	28,800/h, 33 jewels
CASE	
MATERIAL	950 platinum (~ 140 g)
BEZEL	Fixed
SAPPHIRE CRYSTAL	Domed sapphire crystal with double anti-reflective coating
CASE BACK	Sapphire crystal case back
CROWN	Non-screw crown, 1 O-ring, 18 K white gold with mother-of-pearl emblem
DIAL	Silver-coloured "grain d'orge" guilloché dial with black numerals on applique hour circle
HANDS	Blued steel feuille and baton hands
DISTANCE BETWEEN HORNS/CLASP	22/20 mm
DIAMETER	43 mm
HEIGHT	14.8 mm
WATER RESISTANT	3 bar (30 m)
BRACELET / STRAP	
MATERIAL/COLOUR	Alligator-skin strap / Black
CLASP/BUCKLE	18 K white gold double-folding clasp (~ 25 g)

MONTBLANC NICOLAS RIEUSSEC COLLECTION

> Gold



MODEL	Montblanc Nicolas Rieussec Chronograph Anniversary Edition - 90 pieces
IDENT NO.	106485
MOVEMENT	
CALIBRE	Montblanc MB R110
FEATURES	Monopusher chronograph with manual winding, Column wheel control and vertical disc clutch, 13 3/4" (31 mm), thickness 7.60 mm, 263 parts, large balance wheel with screws (moment of inertia: 12 mgcm ² , diameter: 9.70 mm), flat hairspring, rhodium-plated and circular-grained plates, rhodium-plated bridges with Geneva striping, wheel train with special toothing for more efficient power transmission, Power-reserve display on case back
INDICATIONS	Off-centre hour - minute hands
COMPLICATIONS	30 min. and 60 sec. counters with rotating discs
BATTERY	-
POWER RESERVE	Approx. 72 hrs
FREQUENCY/JEWELS	28,800/h, 33 jewels
CASE	
MATERIAL	18 K white gold (~ 105 g)
BEZEL	Fixed
SAPPHIRE CRYSTAL	Domed sapphire crystal with double anti-reflective coating
CASE BACK	Sapphire crystal case back
CROWN	Non-screw crown, 1 O-ring, 18 K white gold with mother-of-pearl Montblanc emblem
DIAL	Black "grain d'orge" guilloché dial with white numerals on applique hour circle
HANDS	Steel feuille and baton hands
DISTANCE BETWEEN HORNS/CLASP	22/20 mm
DIAMETER	43 mm
HEIGHT	14.8 mm
WATER RESISTANT	3 bar (30 m)
BRACELET / STRAP	
MATERIAL/COLOUR	Alligator-skin strap / Black
CLASP/BUCKLE	18 K white gold double-folding clasp (~ 25 g)

MONTBLANC NICOLAS RIEUSSEC COLLECTION

> Gold



MODEL	Montblanc Nicolas Rieussec Chronograph Anniversary Edition - 190 pieces
IDENT NO.	106486
MOVEMENT	
CALIBRE	Montblanc MB R110
FEATURES	Monopusher chronograph with manual winding, Column-wheel control and vertical disc clutch, 13 3/4" (31 mm), thickness 7.60 mm, 278 parts, large balance wheel with screws (moment of inertia: 12 mg.cm ² , diameter: 9.70 mm), flat hairspring, rhodium-plated and circular-grained plates, rhodium-plated bridges with Geneva striping, wheel train with special tothing for more efficient power transmission, Power-reserve display on case back
INDICATIONS	Off-centre hour - minute hands
COMPLICATIONS	30 min. and 60 sec. counters with rotating discs
BATTERY	-
POWER RESERVE	Approx. 72 hrs
FREQUENCY/JEWELS	28,800/h, 33 jewels
CASE	
MATERIAL	18 K red gold (~ 105 g)
BEZEL	Fixed
SAPPHIRE CRYSTAL	Domed sapphire crystal with double anti-reflective coating
CASE BACK	Sapphire crystal case back
CROWN	Non-screw crown, 1 O-ring, 18 K red gold with mother-of-pearl Montblanc emblem
DIAL	Silver-coloured "grain d'orge" guilloché dial with black numerals on applique hour circle
HANDS	Blued steel feuille and baton hands
DISTANCE BETWEEN HORNS/CLASP	22/20 mm
DIAMETER	43 mm
HEIGHT	14.8 mm
WATER RESISTANT	3 bar (30 m)
BRACELET / STRAP	
MATERIAL/COLOUR	Alligator-skin strap / Brown
CLASP/BUCKLE	18 K red gold double-folding clasp (~ 25 g)

MONTBLANC NICOLAS RIEUSSEC COLLECTION

> Gold



MODEL	Montblanc Nicolas Rieussec Chronograph - Open Date
IDENT No.	104705
MOVEMENT	
CALIBRE	Montblanc MB R110
FEATURES	Monopusher chronograph with manual winding, Column-wheel control and vertical disc clutch, 13 3/4" (31 mm), thickness 7.60 mm, 278 parts, large balance wheel with screws (moment of inertia: 12 mg.cm ² , diameter: 9.70 mm), flat hairspring, rhodium-plated and circular-grained plates, rhodium-plated bridges with Geneva striping, wheel train with special toothing for more efficient power transmission, Power-reserve display on case back
INDICATIONS	Off-centre hour - minute hands
COMPLICATIONS	30 min. and 60 sec. counters with rotating discs, date by disc
BATTERY	-
POWER RESERVE	Approx. 72 hrs
FREQUENCY/JEWELS	28,800/h, 33 jewels
CASE	
MATERIAL	18 K red gold (~ 124 g)
BEZEL	Fixed
SAPPHIRE CRYSTAL	Domed sapphire crystal with double anti-reflective coating
CASE BACK	Sapphire crystal case back
CROWN	Non-screw crown, 1 O-ring, 18 K red gold with mother-of-pearl Montblanc emblem
DIAL	Beige dial with black numerals on applique hour circle
HANDS	Red gold-plated feuille and blued steel baton hands
DISTANCE BETWEEN HORNS/CLASP	22/20 mm
DIAMETER	43 mm
HEIGHT	14.8 mm
WATER RESISTANT	3 bar (30 m)
BRACELET / STRAP	
MATERIAL/COLOUR	Alligator-skin strap / Brown
CLASP/BUCKLE	18 K red gold double-folding clasp (~ 21.7 g)

MONTBLANC NICOLAS RIEUSSEC COLLECTION

> Gold



MODEL	Montblanc Nicolas Rieussec Open Home Time
IDENT No.	107067
MOVEMENT	
CALIBRE	Montblanc MB R210
FEATURES	Monopusher chronograph with automatic winding, 18 K red gold rotor, column wheel control and vertical disc clutch, 13,3/4" (31 mm), height 8.46 mm, 323 parts, large balance wheel with screws (moment of inertia: 12 mg.cm ² , diameter: 9.70 mm), flat hairspring, rhodium-plated and circular-grained plates, rhodium-plated bridges with Geneva striping, wheel train with special toothing for more efficient power transmission
INDICATIONS	Off-centre hour - minute hands, date display
COMPLICATIONS	30 min. and 60 sec. counters with rotating discs, second time zone by disc with day and night display
BATTERY	-
POWER RESERVE	Approx. 72 hrs
FREQUENCY/JEWELS	28,800/h, 40 jewels
CASE	
MATERIAL	18 K red gold (~ 95 g)
BEZEL	Fixed
SAPPHIRE CRYSTAL	Domed sapphire crystal with double anti-reflective coating
CASE BACK	Sapphire crystal case back
CROWN	Non-screw crown, 1 O-ring, 18 K red gold with mother-of-pearl Montblanc emblem
DIAL	Anthracite "grain d'orge" guilloché dial with white numerals on applique hour circle
HANDS	Red gold-plated feuille and baton hands, luminescent hour and minute hands
DISTANCE BETWEEN HORNS/CLASP	22/20 mm
DIAMETER	43 mm
HEIGHT	15 mm
WATER RESISTANT	3 bar (30 m)
BRACELET / STRAP	
MATERIAL/COLOUR	Alligator-skin strap / Black
CLASP/BUCKLE	18 K red gold double-folding clasp (~ 25 g)

MONTBLANC NICOLAS RIEUSSEC COLLECTION

> Gold



MODEL	Montblanc Nicolas Rieussec Chronograph Automatic
IDENT No.	104271
MOVEMENT	
CALIBRE	Montblanc MB R200
FEATURES	Monopusher chronograph with automatic winding, 18 K red gold rotor (~ 3.8 g), Column-wheel control and vertical disc clutch, 13 3/4" (31 mm), thickness 8.63 mm, 319 parts, large balance wheel with screws (moment of inertia: 12 mg.cm ² , diameter: 9.70 mm), flat hairspring, rhodium-plated and circular-grained plates, rhodium-plated bridges with Geneva striping, wheel train with special toothing for more efficient power transmission
INDICATIONS	Off-centre hour - minute hands, date display
COMPLICATIONS	30 min. and 60 sec. counters with rotating discs, second time zone with day and night display, date display
BATTERY	-
POWER RESERVE	Approx. 72 hrs
FREQUENCY/JEWELS	28,800/h, 40 jewels
CASE	
MATERIAL	18 K red gold (~ 100 g)
BEZEL	Fixed
SAPPHIRE CRYSTAL	Domed sapphire crystal with double anti-reflective coating
CASE BACK	Sapphire crystal case back
CROWN	Non-screw crown, 1 O-ring, 18 K red gold with mother-of-pearl Montblanc emblem
DIAL	Beige dial with black numerals on applique hour circle
HANDS	Red gold-plated / blued steel feuille and blued steel baton hands, luminescent hour and minute hands
DISTANCE BETWEEN HORNS/CLASP	22/20 mm
DIAMETER	43 mm
HEIGHT	15 mm
WATER RESISTANT	3 bar (30 m)
BRACELET / STRAP	
MATERIAL/COLOUR	Alligator-skin strap / Brown
CLASP/BUCKLE	18 K red gold double-folding clasp (~ 21.7 g)

MONTBLANC NICOLAS RIEUSSEC COLLECTION

> Gold



MODEL	Montblanc Nicolas Rieussec Rising Hours
IDENT No.	108789
MOVEMENT	
CALIBRE	Montblanc MB R220
FEATURES	Monopusher chronograph with automatic winding, Column-wheel control and vertical disc clutch, 13 3/4" (31 mm), thickness 8.66 mm, 343 parts, large balance wheel with screws (moment of inertia: 12 mg.cm ² , diameter: 9.70 mm), flat hairspring, rhodium-plated and circular-grained plates, rhodium-plated bridges with Geneva striping, wheel train with special toothing for more efficient power transmission
INDICATIONS	Patented rising hours disc with integrated day & night indication, minutes hand, date and day of the week display
COMPLICATIONS	30 min. and 60 sec. counters with rotating discs
BATTERY	-
POWER RESERVE	Approx. 72 hrs
FREQUENCY/JEWELS	28,800/h, 42 jewels
CASE	
MATERIAL	18 K red gold
BEZEL	Fixed
SAPPHIRE CRYSTAL	Domed sapphire crystal with double anti-reflective coating
CASE BACK	18 K red gold with sapphire crystal
CROWN	Non-screw crown, 1 O-ring, 18 K red gold with mother-of-pearl Montblanc emblem
DIAL	Silver-coloured "grain d'orge" guilloché dial
HANDS	Feuille and baton hands
DISTANCE BETWEEN HORNS/CLASP	22/20 mm
DIAMETER	43 mm
HEIGHT	15.30 mm
WATER RESISTANT	3 bar (30 m)
BRACELET / STRAP	
MATERIAL/COLOUR	Alligator-skin strap / Brown
CLASP/BUCKLE	18 K red gold triple-folding clasp

MONTBLANC NICOLAS RIEUSSEC COLLECTION

> Steel



MODEL	Montblanc Nicolas Rieussec Chronograph Automatic
IDENT No.	102336
MOVEMENT	
CALIBRE	Montblanc MB R200
FEATURES	Monopusher chronograph with automatic winding, Column-wheel control and vertical disc clutch, 13 3/4" (31 mm), thickness 8.46 mm, 319 parts, large balance wheel with screws (inertia: 12 mg.cm ² , diameter: 9.70 mm), flat hairspring, rhodium-plated and circular-grained plates, rhodium-plated bridges with Geneva striping, wheel train with special toothing for more efficient power transmission
INDICATIONS	Off-centre hour - minute hands, date display
COMPLICATIONS	30 min. and 60 sec. counters with rotating discs, second time zone with day and night display, date display
BATTERY	-
POWER RESERVE	Approx. 72 hrs
FREQUENCY/JEWELS	28,800/h, 40 jewels
CASE	
MATERIAL	Stainless steel
BEZEL	Fixed
SAPPHIRE CRYSTAL	Domed sapphire crystal with double anti-reflective coating
CASE BACK	Sapphire crystal case back
CROWN	Non-screw crown, 1 O-ring
DIAL	Anthracite dial with black numerals on applique hour circle
HANDS	Blued steel feuille and baton hands, luminescent hour and minute hands
DISTANCE BETWEEN HORNS/CLASP	22/20 mm
DIAMETER	43 mm
HEIGHT	14.8 mm
WATER RESISTANT	3 bar (30 m)
BRACELET / STRAP	
MATERIAL	Stainless steel bracelet
CLASP/BUCKLE	Triple-folding clasp

MONTBLANC NICOLAS RIEUSSEC COLLECTION

> Steel



MODEL	Montblanc Nicolas Rieussec Chronograph Automatic
IDENT No.	102337
MOVEMENT	
CALIBRE	Montblanc MB R200
FEATURES	Monopusher chronograph with automatic winding, Column-wheel control and vertical disc clutch, 13 3/4" (31 mm), thickness 8.46 mm, 319 parts, large balance wheel with screws (moment of inertia: 12 mg.cm ² , diameter: 9.70 mm), flat hairspring, rhodium-plated and circular-grained plates, rhodium-plated bridges with Geneva striping, wheel train with special toothing for more efficient power transmission
INDICATIONS	Off-centre hour - minute hands, date display
COMPLICATIONS	30 min. and 60 sec. counters with rotating discs, second time zone with day and night display, date display
BATTERY	-
POWER RESERVE	Approx. 72 hrs
FREQUENCY/JEWELS	28,800/h, 40 jewels
CASE	
MATERIAL	Stainless steel
BEZEL	Fixed
SAPPHIRE CRYSTAL	Domed sapphire crystal with double anti-reflective coating
CASE BACK	Sapphire crystal case back
CROWN	Non-screw crown, 1 O-ring
DIAL	Anthracite dial with black numerals on applique hour circle
HANDS	Blued steel feuille and baton hands, luminescent hour and minute hands
DISTANCE BETWEEN HORNS/CLASP	22/20 mm
DIAMETER	43 mm
HEIGHT	14.8 mm
WATER RESISTANT	3 bar (30 m)
BRACELET / STRAP	
MATERIAL/COLOUR	Alligator-skin strap / Black
CLASP/BUCKLE	Double-folding clasp

MONTBLANC NICOLAS RIEUSSEC COLLECTION

> Steel



MODEL	Montblanc Nicolas Rieussec Chronograph Automatic
IDENT No.	106595
MOVEMENT	
CALIBRE	Montblanc MB R200
FEATURES	Monopusher chronograph with automatic winding, Column-wheel control and vertical disc clutch, 13 3/4" (31 mm), thickness 8.46 mm, 319 parts, large balance wheel with screws (moment of inertia: 12 mg.cm ² , diameter: 9.70 mm), flat hairspring, rhodium-plated and circular-grained plates, rhodium-plated bridges with Geneva striping, wheel train with special toothing for more efficient power transmission
INDICATIONS	Off-centre hour - minute hands, date display
COMPLICATIONS	30 min. and 60 sec. counters with rotating discs, second time zone with day and night display, date display
BATTERY	-
POWER RESERVE	Approx. 72 hrs
FREQUENCY/JEWELS	28,800/h, 40 jewels
CASE	
MATERIAL	Stainless steel
BEZEL	Fixed
SAPPHIRE CRYSTAL	Domed sapphire crystal with double anti-reflective coating
CASE BACK	Sapphire crystal case back
CROWN	Non-screw crown, 1 O-ring
DIAL	Silver-coloured dial with black numerals on applique hour circle
HANDS	Blued steel feuille and baton hands, luminescent hour and minute hands
DISTANCE BETWEEN HORNS/CLASP	22/20 mm
DIAMETER	43 mm
HEIGHT	14.8 mm
WATER RESISTANT	3 bar (30 m)
BRACELET / STRAP	
MATERIAL/COLOUR	Alligator-skin strap / Black
CLASP/BUCKLE	Double-folding clasp

MONTBLANC NICOLAS RIEUSSEC COLLECTION

> Steel



MODEL	Montblanc Nicolas Rieussec Chronograph Automatic
IDENT No.	109996
MOVEMENT	
CALIBRE	Montblanc MB R200
FEATURES	Monopusher chronograph with automatic winding, Column-wheel control and vertical disc clutch, 13 3/4" (31 mm), thickness 8.46 mm, 319 parts, large balance wheel with screws (moment of inertia: 12 mg.cm ² , diameter: 9.70 mm), flat hairspring, rhodium-plated and circular-grained plates, rhodium-plated bridges with Geneva striping, wheel train with special toothing for more efficient power transmission
INDICATIONS	Off-centre hour - minute hands, date display
COMPLICATIONS	30 min. and 60 sec. counters with rotating discs, second time zone with day and night display, date display
BATTERY	-
POWER RESERVE	Approx. 72 hrs
FREQUENCY/JEWELS	28,800/h, 40 jewels
CASE	
MATERIAL	Stainless steel
BEZEL	Fixed
SAPPHIRE CRYSTAL	Domed sapphire crystal with double anti-reflective coating
CASE BACK	Sapphire crystal case back
CROWN	Non-screw crown, 1 O-ring
DIAL	Black "grain d'orge" guilloché dial with white numerals
HANDS	Feuille and baton hands, luminescent hour and minute hands
DISTANCE BETWEEN HORNS/CLASP	22/20 mm
DIAMETER	43 mm
HEIGHT	14.8 mm
WATER RESISTANT	3 bar (30 m)
BRACELET / STRAP	
MATERIAL	Stainless steel bracelet
CLASP/BUCKLE	Triple-folding clasp

MONTBLANC NICOLAS RIEUSSEC COLLECTION

> Steel



MODEL	Montblanc Nicolas Rieussec Chronograph Automatic
IDENT No.	106488
MOVEMENT	
CALIBRE	Montblanc MB R200
FEATURES	Monopusher chronograph with automatic winding, Column-wheel control and vertical disc clutch, 13 3/4" (31 mm), thickness 8.46 mm, 319 parts, large balance wheel with screws (moment of inertia: 12 mg.cm ² , diameter: 9.70 mm), flat hairspring, rhodium-plated and circular-grained plates, rhodium-plated bridges with Geneva striping, wheel train with special toothing for more efficient power transmission
INDICATIONS	Off-centre hour - minute hands, date display
COMPLICATIONS	30 min. and 60 sec. counters with rotating discs, second time zone with day and night display, date display
BATTERY	-
POWER RESERVE	Approx. 72 hrs
FREQUENCY/JEWELS	28,800/h, 40 jewels
CASE	
MATERIAL	Stainless steel
BEZEL	Fixed
SAPPHIRE CRYSTAL	Domed sapphire crystal with double anti-reflective coating
CASE BACK	Sapphire crystal case back
CROWN	Non-screw crown, 1 O-ring
DIAL	Black "grain d'orge" guilloché dial with white numerals
HANDS	Feuille and baton hands, luminescent hour and minute hands
DISTANCE BETWEEN HORNS/CLASP	22/20 mm
DIAMETER	43 mm
HEIGHT	14.8 mm
WATER RESISTANT	3 bar (30 m)
BRACELET / STRAP	
MATERIAL/COLOUR	Alligator-skin strap / Black
CLASP/BUCKLE	Double-folding clasp

MONTBLANC NICOLAS RIEUSSEC COLLECTION

> Steel



MODEL	Montblanc Nicolas Rieussec Chronograph Automatic
IDENT No.	106487
MOVEMENT	
CALIBRE	Montblanc MB R200
FEATURES	Monopusher chronograph with automatic winding, Column-wheel control and vertical disc clutch, 13 3/4" (31 mm), thickness 8.46 mm, 319 parts, large balance wheel with screws (moment of inertia: 12 mg.cm ² , diameter: 9.70 mm), flat hairspring, rhodium-plated and circular-grained plates, rhodium-plated bridges with Geneva striping, wheel train with special toothing for more efficient power transmission
INDICATIONS	Off-centre hour - minute hands, date display
COMPLICATIONS	30 min. and 60 sec. counters with rotating discs, second time zone with day and night display, date display
BATTERY	-
POWER RESERVE	Approx. 72 hrs
FREQUENCY/JEWELS	28,800/h, 40 jewels
CASE	
MATERIAL	Stainless steel
BEZEL	Fixed
SAPPHIRE CRYSTAL	Domed sapphire crystal with double anti-reflective coating
CASE BACK	Sapphire crystal case back
CROWN	Non-screw crown, 1 O-ring
DIAL	Silver-coloured "grain d'orge" guilloché dial with black numerals
HANDS	Blued steel feuille and baton hands, luminescent hour and minute hands
DISTANCE BETWEEN HORNS/CLASP	22/20 mm
DIAMETER	43 mm
HEIGHT	14.8 mm
WATER RESISTANT	3 bar (30 m)
BRACELET / STRAP	
MATERIAL/COLOUR	Alligator-skin strap / Brown
CLASP/BUCKLE	Double-folding clasp

MONTBLANC NICOLAS RIEUSSEC COLLECTION

> Steel



MODEL	Montblanc Nicolas Rieussec Open Home Time
IDENT No.	107068
MOVEMENT	
CALIBRE	Montblanc MB R210
FEATURES	Monopusher chronograph with automatic winding, Column-wheel control and vertical disc clutch, 13 3/4" (31 mm), height 8.46 mm, 323 parts, large balance wheel with screws (moment of inertia: 12 mg.cm ² , diameter: 9.70 mm), flat hairspring, rhodium-plated and circular-grained plates, rhodium-plated bridges with Geneva striping, wheel train with special toothing for more efficient power transmission
INDICATIONS	Off-centre hour - minute hands, date display
COMPLICATIONS	30 min. and 60 sec. counters with rotating discs, second time zone by disc with day and night display
BATTERY	-
POWER RESERVE	Approx. 72 hrs
FREQUENCY/JEWELS	28,800/h, 40 jewels
CASE	
MATERIAL	Stainless steel
BEZEL	Fixed
SAPPHIRE CRYSTAL	Domed sapphire crystal with double anti-reflective coating
CASE BACK	Sapphire crystal case back
CROWN	Non-screw crown, 1 O-ring
DIAL	Silver-coloured "grain d'orge" guilloché dial with black numerals on applique hour circle
HANDS	Blued steel feuille and baton hands, luminescent hour and minute hands
DISTANCE BETWEEN HORNS/CLASP	22/20 mm
DIAMETER	43 mm
HEIGHT	15 mm
WATER RESISTANT	3 bar (30 m)
BRACELET / STRAP	
MATERIAL	Stainless steel bracelet
CLASP/BUCKLE	Triple-folding clasp

MONTBLANC NICOLAS RIEUSSEC COLLECTION

> Steel



MODEL	Montblanc Nicolas Rieussec Open Home Time
IDENT No.	107070
MOVEMENT	
CALIBRE	Montblanc MB R210
FEATURES	Monopusher chronograph with automatic winding, Column-wheel control and vertical disc clutch, 13 3/4" (31 mm), height 8.46 mm, 323 parts, large balance wheel with screws (moment of inertia: 12 mg.cm ² , diameter: 9.70 mm), flat hairspring, rhodium-plated and circular-grained plates, rhodium-plated bridges with Geneva striping, wheel train with special toothing for more efficient power transmission
INDICATIONS	Off-centre hour - minute hands, date display
COMPLICATIONS	30 min. and 60 sec. counters with rotating discs, second time zone by disc with day and night display
BATTERY	-
POWER RESERVE	Approx. 72 hrs
FREQUENCY/JEWELS	28,800/h, 40 jewels
CASE	
MATERIAL	Stainless steel
BEZEL	Fixed
SAPPHIRE CRYSTAL	Domed sapphire crystal with double anti-reflective coating
CASE BACK	Sapphire crystal case back
CROWN	Non-screw crown, 1 O-ring
DIAL	Black "grain d'orge" guilloché dial with white numerals on applique hour circle
HANDS	Feuille and baton hands, luminescent hour and minute hands
DISTANCE BETWEEN HORNS/CLASP	22/20 mm
DIAMETER	43 mm
HEIGHT	15 mm
WATER RESISTANT	3 bar (30 m)
BRACELET / STRAP	
MATERIAL/COLOUR	Alligator-skin strap / Black
CLASP/BUCKLE	Double-folding clasp

MONTBLANC NICOLAS RIEUSSEC COLLECTION

> Steel



MODEL	Montblanc Nicolas Rieussec Chronograph - Open Date
IDENT No.	104981
MOVEMENT	
CALIBRE	Montblanc MB R110
FEATURES	Monopusher chronograph with manual winding, Column-wheel control and vertical disc clutch, 13 3/4" (31 mm), thickness 7.60 mm, 278 parts, large balance wheel with screws (moment of inertia: 12 mg.cm ² , diameter: 9.70 mm), flat hairspring, rhodium-plated and circular-grained plates, rhodium-plated bridges with Geneva striping, wheel train with special toothing for more efficient power transmission, Power-reserve display on case back
INDICATIONS	Off-centre hour - minute hands
COMPLICATIONS	30 min. and 60 sec. counters with rotating discs, date by disc
BATTERY	-
POWER RESERVE	Approx. 72 hrs
FREQUENCY/JEWELS	28,800/h, 33 jewels
CASE	
MATERIAL	Stainless steel
BEZEL	Fixed
SAPPHIRE CRYSTAL	Domed sapphire crystal with double anti-reflective coating
CASE BACK	Sapphire crystal case back
CROWN	Non-screw crown, 1 O-ring
DIAL	Anthracite dial with black numerals on applique hour circle
HANDS	Blued steel feuille and baton hands
DISTANCE BETWEEN HORNS/CLASP	22/20 mm
DIAMETER	43 mm
HEIGHT	14.8 mm
WATER RESISTANT	3 bar (30 m)
BRACELET / STRAP	
MATERIAL/COLOUR	Alligator-skin strap / Black
CLASP/BUCKLE	Double-folding clasp

MONTBLANC NICOLAS RIEUSSEC COLLECTION

> Steel



MODEL	Montblanc Nicolas Rieussec Rising Hours
IDENT No.	108790
MOVEMENT	
CALIBRE	Montblanc MB R220
FEATURES	Monopusher chronograph with automatic winding, Column-wheel control and vertical disc clutch, 13 3/4" (31 mm), thickness 8.46 mm, 343 parts, large balance wheel with screws (moment of inertia: 12 mg.cm ² , diameter: 9.70 mm), flat hairspring, rhodium-plated and circular-grained plates, rhodium-plated bridges with Geneva striping, wheel train with special toothing for more efficient power transmission
INDICATIONS	Patented rising hours disc with integrated day & night indication, minutes hand, date and day of the week display
COMPLICATIONS	30 min. and 60 sec. counters with rotating discs
BATTERY	-
POWER RESERVE	Approx. 72 hrs
FREQUENCY/JEWELS	28,800/h, 42 jewels
CASE	
MATERIAL	Stainless steel
BEZEL	Fixed
SAPPHIRE CRYSTAL	Domed sapphire crystal with double anti-reflective coating
CASE BACK	Stainless steel case back with sapphire crystal
CROWN	Non-screw crown, 1 O-ring
DIAL	Anthracite-coloured "grain d'orge" guilloché dial
HANDS	Feuille and baton hands
DISTANCE BETWEEN HORNS/CLASP	22/20 mm
DIAMETER	43 mm
HEIGHT	15.10 mm
WATER RESISTANT	3 bar (30 m)
BRACELET / STRAP	
MATERIAL/COLOUR	Alligator-skin strap / Black
CLASP/BUCKLE	Triple-folding clasp

MONTBLANC STAR 4810 COLLECTION

MONTBLANC STAR 4810 COLLECTION

> Gold : 44 mm



A Id. 104275

p. 93



A Id. 104274

p. 93

> Steel : 44 mm



A Id. 102376

p. 94



A Id. 102377

p. 94



A Id. 102378

p. 95



A Id. 105856

p. 95

> Steel : 41.5 mm



A Id. 102340

p. 96



A Id. 102341

p. 96



A Id. 102342

p. 97



A Id. 105858

p. 97

H=Handwinding A=Automatic Q=Quartz

MONTBLANC STAR 4810 COLLECTION

> Gold



MODEL	Montblanc Star 4810 Red Gold Chronograph Automatic	Montblanc Star 4810 Red Gold Chronograph Automatic
IDENT No.	104275	104274
MOVEMENT		
CALIBRE	Montblanc 4810/501	Montblanc 4810/501
FEATURES	Automatic chronograph, Officially certified chronometer (COSC)	Automatic chronograph, Officially certified chronometer (COSC)
INDICATIONS	Hour - minute - continuous second hands, date display	Hour - minute - continuous second hands, date display
COMPLICATIONS	12 hrs and 30 min. counters, central chronograph hand	12 hrs and 30 min. counters, central chronograph hand
BATTERY	-	-
POWER RESERVE	Approx. 46 hrs	Approx. 46 hrs
FREQUENCY/JEWELS	28,800/h, 25 jewels	28,800/h, 25 jewels
CASE		
MATERIAL	18 K red gold (~ 120 g)	18 K red gold (~ 120 g)
BEZEL	Fixed	Fixed
SAPPHIRE CRYSTAL	Domed sapphire crystal with double anti-reflective coating	Domed sapphire crystal with double anti-reflective coating
CASE BACK	Sapphire crystal case back	Sapphire crystal case back
CROWN	Non-screw crown, 1 O-ring, 18 K red gold with mother-of-pearl Montblanc emblem	Non-screw crown, 1 O-ring, 18 K red gold with mother-of-pearl Montblanc emblem
DIAL	Anthracite guilloché dial	Silver-coloured guilloché dial
HANDS	Red gold-plated regate and baton hands, luminescent hour and minute hands	Red gold-plated regate and baton hands, luminescent hour and minute hands
DISTANCE BETWEEN HORNS/CLASP	22/20 mm	22/20 mm
DIAMETER	44 mm	44 mm
HEIGHT	14.5 mm	14.5 mm
WATER RESISTANT	3 bar (30 m)	3 bar (30 m)
BRACELET / STRAP		
MATERIAL/COLOUR	Alligator-skin strap / Black	Alligator-skin strap / Brown
CLASP/BUCKLE	18 K red gold pin buckle (~ 5.9 g)	18 K red gold pin buckle (~ 5.9 g)

MONTBLANC STAR 4810 COLLECTION

> Steel



MODEL	Montblanc Star 4810 Chronograph Automatic	Montblanc Star 4810 Chronograph Automatic
IDENT No.	102376	102377
MOVEMENT		
CALIBRE	Montblanc 4810/501	Montblanc 4810/501
FEATURES	Automatic chronograph	Automatic chronograph
INDICATIONS	Hour - minute - continuous second hands, date display	Hour - minute - continuous second hands, date display
COMPLICATIONS	12 hrs and 30 min. counters, central chronograph hand	12 hrs and 30 min. counters, central chronograph hand
BATTERY	-	-
POWER RESERVE	Approx. 46 hrs	Approx. 46 hrs
FREQUENCY/JEWELS	28,800/h, 25 jewels	28,800/h, 25 jewels
CASE		
MATERIAL	Stainless steel	Stainless steel
BEZEL	Fixed	Fixed
SAPPHIRE CRYSTAL	Domed sapphire crystal with double anti-reflective coating	Domed sapphire crystal with double anti-reflective coating
CASE BACK	Sapphire crystal case back	Sapphire crystal case back
CROWN	Non-screw crown, 1 O-ring	Non-screw crown, 1 O-ring
DIAL	Black guilloché dial	Black guilloché dial
HANDS	Rhodium-plated regate and baton hands, luminescent hour and minute hands	Rhodium-plated regate and baton hands, luminescent hour and minute hands
DISTANCE BETWEEN HORNS/CLASP	22/22 mm	22/20 mm
DIAMETER	44 mm	44 mm
HEIGHT	14.5 mm	14.5 mm
WATER RESISTANT	3 bar (30 m)	3 bar (30 m)
BRACELET / STRAP		
MATERIAL	Stainless steel bracelet	Alligator-skin strap / Black
CLASP/BUCKLE	Triple-folding clasp	Triple-folding clasp

MONTBLANC STAR 4810 COLLECTION

> Steel



MODEL	Montblanc Star 4810 Chronograph Automatic	Montblanc Star 4810 Chronograph Automatic
IDENT No.	102378	105856
MOVEMENT		
CALIBRE	Montblanc 4810/501	Montblanc 4810/501
FEATURES	Automatic chronograph	Automatic chronograph
INDICATIONS	Hour - minute - continuous second hands, date display	Hour - minute - continuous second hands, date display
COMPLICATIONS	12 hrs and 30 min. counters, central chronograph hand	12 hrs and 30 min. counters, central chronograph hand
BATTERY	-	-
POWER RESERVE	Approx. 46 hrs	Approx. 46 hrs
FREQUENCY/JEWELS	28,800/h, 25 jewels	28,800/h, 25 jewels
CASE		
MATERIAL	Stainless steel	Stainless steel
BEZEL	Fixed	Fixed
SAPPHIRE CRYSTAL	Domed sapphire crystal with double anti-reflective coating	Domed sapphire crystal with double anti-reflective coating
CASE BACK	Sapphire crystal case back	Sapphire crystal case back
CROWN	Non-screw crown, 1 O-ring	Non-screw crown, 1 O-ring
DIAL	Silver-coloured guilloché dial	Silver-coloured guilloché dial with red gold-plated indexes
HANDS	Rhodium-plated regate and baton hands, luminescent hour and minute hands	Red gold-plated regate and baton hands, luminescent hour and minute hands
DISTANCE BETWEEN HORNS/CLASP	22/20 mm	22/20 mm
DIAMETER	44 mm	44 mm
HEIGHT	14.5 mm	14.5 mm
WATER RESISTANT	3 bar (30 m)	3 bar (30 m)
BRACELET / STRAP		
MATERIAL/COLOUR	Alligator-skin strap / Brown	Alligator-skin strap / Black
CLASP/BUCKLE	Triple-folding clasp	Triple-folding clasp

MONTBLANC STAR 4810 COLLECTION

> Steel



MODEL	Montblanc Star 4810 Automatic	Montblanc Star 4810 Automatic
IDENT No.	102340	102341
MOVEMENT		
CALIBRE	Montblanc 4810/401	Montblanc 4810/401
FEATURES	Automatic	Automatic
INDICATIONS	Hour - minute - second hands, date display	Hour - minute - second hands, date display
COMPLICATIONS	-	-
BATTERY	-	-
POWER RESERVE	Approx. 42 hrs	Approx. 42 hrs
FREQUENCY/JEWELS	28,800 vib./h, 21 jewels	28,800 vib./h, 21 jewels
CASE		
MATERIAL	Stainless steel	Stainless steel
BEZEL	Fixed	Fixed
SAPPHIRE CRYSTAL	Domed sapphire crystal with anti-reflective coating	Domed sapphire crystal with anti-reflective coating
CASE BACK	Sapphire crystal case back	Sapphire crystal case back
CROWN	Non-screw crown, 1 O-ring	Non-screw crown, 1 O-ring
DIAL	Black guilloché dial	Black guilloché dial
HANDS	Rhodium-plated regate and baton hands, luminescent hour and minute hands	Rhodium-plated regate and baton hands, luminescent hour and minute hands
DISTANCE BETWEEN HORNS/CLASP	21/21 mm	21/20 mm
DIAMETER	41.5 mm	41.5 mm
HEIGHT	11.6 mm	11.6 mm
WATER RESISTANT	3 bar (30 m)	3 bar (30 m)
BRACELET / STRAP		
MATERIAL	Stainless steel bracelet	Alligator-skin strap / Black
CLASP/BUCKLE	Triple-folding clasp	Triple-folding clasp

MONTBLANC STAR 4810 COLLECTION

> Steel



MODEL	Montblanc Star 4810 Automatic	Montblanc Star 4810 Automatic
IDENT No.	102342	105858
MOVEMENT		
CALIBRE	Montblanc 4810/401	Montblanc 4810/401
FEATURES	Automatic	Automatic
INDICATIONS	Hour - minute - second hands, date display	Hour - minute - second hands, date display
COMPLICATIONS	-	-
BATTERY	-	-
POWER RESERVE	Approx. 42 hrs	Approx. 42 hrs
FREQUENCY/JEWELS	28,800 vib./h, 21 jewels	28,800 vib./h, 21 jewels
CASE		
MATERIAL	Stainless steel	Stainless steel
BEZEL	Fixed	Fixed
SAPPHIRE CRYSTAL	Domed sapphire crystal with anti-reflective coating	Domed sapphire crystal with anti-reflective coating
CASE BACK	Sapphire crystal case back	Sapphire crystal case back
CROWN	Non-screw crown, 1 O-ring	Non-screw crown, 1 O-ring
DIAL	Silver-coloured guilloché dial	Silver-coloured guilloché dial with red gold-plated indexes
HANDS	Rhodium-plated regate and baton hands, luminescent hour and minute hands	Red gold-plated regate and baton hands, luminescent hour and minute hands
DISTANCE BETWEEN HORNS/CLASP	21/20 mm	21/20 mm
DIAMETER	41.5 mm	41.5 mm
HEIGHT	11.6 mm	11.6 mm
WATER RESISTANT	3 bar (30 m)	3 bar (30 m)
BRACELET / STRAP		
MATERIAL/COLOUR	Alligator-skin strap / Brown	Alligator-skin strap / Black
CLASP/BUCKLE	Triple-folding clasp	Triple-folding clasp

MONTBLANC STAR CLASSIQUE COLLECTION

MONTBLANC STAR CLASSIQUE COLLECTION

> Gold : 34 mm



A Id. 107911

p. 102



A Id. 107958

p. 102

> Gold : 39 mm



A Id. 107340

p. 103



A Id. 107116

p. 103



A Id. 107075

p. 104



A Id. 107076

p. 104

> Steel Gold : 39 mm



A Id. 107914

p. 106



A Id. 107916

p. 106



A Id. 107309

p. 105

> Steel Gold : 34 mm



A Id. 107913

p. 107



A Id. 107915

p. 107

H=Handwinding A=Automatic Q=Quartz

MONTBLANC STAR CLASSIQUE COLLECTION

> Steel : 39 mm



A Id. 107072 p. 108



A Id. 107073 p. 108



Q Id. 108769 p. 109



Q Id. 108770 p. 109



Q Id. 108768 p. 109

> Steel : 34 mm



Q Id. 108764 p. 110



Q Id. 108765 p. 110



Q Id. 108766 p. 110

MONTBLANC STAR CLASSIQUE COLLECTION

> Gold



MODEL	Montblanc Star Classique Lady Automatic	Montblanc Star Classique Lady Automatic
IDENT No.	107911	107958
MOVEMENT		
CALIBRE	Montblanc 4810/408	Montblanc 4810/408
FEATURES	Automatic	Automatic
INDICATIONS	Hour - minute - small second	Hour - minute - small second
COMPLICATIONS	-	-
BATTERY	-	-
POWER RESERVE	Approx. 42 hrs	Approx. 42 hrs
FREQUENCY/JEWELS	28,800/h, 27 jewels	28,800/h, 27 jewels
CASE		
MATERIAL	18 K red gold (24.70 g)	18 K red gold (24.70 g)
BEZEL	Fixed, 18 K red gold	Fixed 18 K red gold, bezel set with 72 Top Wesselton diamonds (~ 0.526 ct)
SAPPHIRE CRYSTAL	Domed sapphire crystal with double anti-reflective coating	Domed sapphire crystal with double anti-reflective coating
CASE BACK	18 K red gold with sapphire crystal	18 K red gold with sapphire crystal
CROWN	Non-screw crown, 1 O-ring, 18 K red gold with mother-of-pearl Montblanc emblem	Non-screwed crown, 1 O-ring, 18 K red gold with mother-of-pearl Montblanc emblem
DIAL	White mother-of-pearl dial with red gold-plated indexes and numerals	White mother-of-pearl dial with red gold-plated indexes and numerals
HANDS	Red gold-plated feuille hands	Red gold-plated feuille hands
DISTANCE BETWEEN HORNS/CLASP	17/16 mm	17/16 mm
DIAMETER	34 mm	34 mm
HEIGHT	8.98 mm	8.98 mm
WATER RESISTANT	3 bar (30 m)	3 bar (30 m)
BRACELET / STRAP		
MATERIAL/COLOUR	Alligator-skin strap / Brown, shiny	Alligator-skin strap / White, shiny
CLASP/BUCKLE	18 K red gold pin buckle (8.3 g)	18 K red gold pin buckle (~ 8.3 g)

MONTBLANC STAR CLASSIQUE COLLECTION

> Gold



MODEL	Montblanc Star Classique Automatic	Montblanc Star Classique Automatic
IDENT No.	107340	107116
MOVEMENT		
CALIBRE	Montblanc 4810/408	Montblanc 4810/408
FEATURES	Automatic	Automatic
INDICATIONS	Hour - minute - small second at 6 o'clock	Hour - minute - small second at 6 o'clock
COMPLICATIONS	-	-
BATTERY	-	-
POWER RESERVE	Approx. 42 hrs	Approx. 42 hrs
FREQUENCY/JEWELS	28,800/h, 27 jewels	28,800/h, 27 jewels
CASE		
MATERIAL	18 K yellow gold (~ 41 g)	18 K yellow gold (~ 41 g)
BEZEL	Fixed, 18 K yellow gold	Fixed, 18 K yellow gold
SAPPHIRE CRYSTAL	Domed sapphire crystal with double anti-reflective coating	Domed sapphire crystal with double anti-reflective coating
CASE BACK	18 K yellow gold, with sapphire crystal	18 K yellow gold, with sapphire crystal
CROWN	Non-screw crown, 1 O-ring, 18 K yellow gold with mother-of-pearl Montblanc emblem	Non-screw crown, 1 O-ring, 18 K yellow gold with mother-of-pearl Montblanc emblem
DIAL	Black dial with yellow gold-plated indexes and numerals	White silver-coloured dial with yellow gold-plated indexes and numerals
HANDS	Yellow gold-plated feuille hands	Yellow gold-plated feuille hands
DISTANCE BETWEEN HORNS/CLASP	19/17 mm	19/17 mm
DIAMETER	39 mm	39 mm
HEIGHT	8.90 mm	8.90 mm
WATER RESISTANT	3 bar (30 m)	3 bar (30 m)
BRACELET / STRAP		
MATERIAL/COLOUR	Alligator-skin strap / Black	Alligator-skin strap / Black
CLASP/BUCKLE	18 K yellow gold pin buckle (~ 8.3 g)	18 K yellow gold pin buckle (~ 8.3 g)

MONTBLANC STAR CLASSIQUE COLLECTION

> Gold



MODEL	Montblanc Star Classique Automatic	Montblanc Star Classique Automatic
IDENT No.	107075	107076
MOVEMENT		
CALIBRE	Montblanc 4810/408	Montblanc 4810/408
FEATURES	Automatic	Automatic
INDICATIONS	Hour - minute - small second at 6 o'clock	Hour - minute - small second at 6 o'clock
COMPLICATIONS	-	-
BATTERY	-	-
POWER RESERVE	Approx. 42 hrs	Approx. 42 hrs
FREQUENCY/JEWELS	28,800/h, 27 jewels	28,800/h, 27 jewels
CASE		
MATERIAL	18 K red gold (~ 40.2 g)	18 K red gold (~ 40.2 g)
BEZEL	Fixed, 18 K red gold	Fixed, 18 K red gold
SAPPHIRE CRYSTAL	Domed sapphire crystal with double anti-reflective coating	Domed sapphire crystal with double anti-reflective coating
CASE BACK	18 K red gold with sapphire crystal	18 K red gold with sapphire crystal
CROWN	Non-screw crown, 1 O-ring, 18 K red gold with mother-of-pearl Montblanc emblem	Non-screw crown, 1 O-ring, 18 K red gold with mother-of-pearl Montblanc emblem
DIAL	Anthracite dial with red gold-plated indexes and numerals	White silver-coloured dial with red gold-plated indexes and numerals
HANDS	Red gold-plated feuille hands	Red gold-plated feuille hands
DISTANCE BETWEEN HORNS/CLASP	19/17 mm	19/17 mm
DIAMETER	39 mm	39 mm
HEIGHT	8.90 mm	8.90 mm
WATER RESISTANT	3 bar (30 m)	3 bar (30 m)
BRACELET / STRAP		
MATERIAL/COLOUR	Alligator-skin strap / Brown	Alligator-skin strap / Brown
CLASP/BUCKLE	18 K red gold pin buckle (~ 8.2 g)	18 K red gold pin buckle (~ 8.2 g)

MONTBLANC STAR CLASSIQUE COLLECTION

> Steel Gold



MODEL	Montblanc Star Classique Automatic
IDENT No.	107309
MOVEMENT	
CALIBRE	Montblanc 4810/408
FEATURES	Automatic
INDICATIONS	Hour - minute - small second at 6 o'clock
COMPLICATIONS	-
BATTERY	-
POWER RESERVE	Approx. 42 hrs
FREQUENCY/JEWELS	28,800/h, 27 jewels
CASE	
MATERIAL	Stainless steel
BEZEL	Fixed, 18 K red gold
SAPPHIRE CRYSTAL	Domed sapphire crystal with double anti-reflective coating
CASE BACK	Stainless steel case back with sapphire crystal
CROWN	Non-screw crown, 1 O-ring, 18 K red gold with mother-of-pearl Montblanc emblem
DIAL	White silver-coloured dial with red gold-plated indexes and numerals
HANDS	Red gold-plated feuille hands
DISTANCE BETWEEN HORNS/CLASP	19/17 mm
DIAMETER	39 mm
HEIGHT	8.90 mm
WATER RESISTANT	3 bar (30 m)
BRACELET / STRAP	
MATERIAL/COLOUR	Alligator-skin strap / Brown
CLASP/BUCKLE	Pin buckle

MONTBLANC STAR CLASSIQUE COLLECTION

> Steel Gold



MODEL	Montblanc Star Classique Automatic	Montblanc Star Classique Automatic
IDENT No.	107914	107916
MOVEMENT		
CALIBRE	Montblanc 4810/408	Montblanc 4810/408
FEATURES	Automatic	Automatic
INDICATIONS	Hour - minute - small second	Hour - minute - small second
COMPLICATIONS	-	-
BATTERY	-	-
POWER RESERVE	Approx. 42 hrs	Approx. 42 hrs
FREQUENCY/JEWELS	28,800/h, 27 jewels	28,800/h, 27 jewels
CASE		
MATERIAL	Stainless steel with 18 K red gold ring	Stainless steel with 18 K red gold ring
BEZEL	Fixed	Fixed
SAPPHIRE CRYSTAL	Domed sapphire crystal with double anti-reflective coating	Domed sapphire crystal with double anti-reflective coating
CASE BACK	Stainless steel case back with sapphire crystal	Stainless steel case back with sapphire crystal
CROWN	Non-screw crown, 1 O-ring, 18 K yellow gold	Non-screw crown, 1 O-ring, 18 K red gold
DIAL	White silver-coloured dial with yellow gold-plated indexes and numerals	White silver-coloured dial with red gold-plated indexes and numerals
HANDS	Yellow gold-plated feuille hands	Red gold-plated feuille hands
DISTANCE BETWEEN HORNS/CLASP	19/19 mm	19/19 mm
DIAMETER	39 mm	39 mm
HEIGHT	8.90 mm	8.90
WATER RESISTANT	3 bar (30 m)	3 bar (30 m)
BRACELET / STRAP		
MATERIAL	Stainless steel with 18 K yellow gold caps	Stainless steel with 18 K red gold caps
CLASP/BUCKLE	Triple-folding clasp	Triple-folding clasp

MONTBLANC STAR CLASSIQUE COLLECTION

> Steel Gold



MODEL	Montblanc Star Classique Lady Automatic	Montblanc Star Classique Lady Automatic
IDENT No.	107913	107915
MOVEMENT		
CALIBRE	Montblanc 4810/408	Montblanc 4810/408
FEATURES	Automatic	Automatic
INDICATIONS	Hour - minute - small second	Hour - minute - small second
COMPLICATIONS	-	-
BATTERY	-	-
POWER RESERVE	Approx. 42 hrs	Approx. 42 hrs
FREQUENCY/JEWELS	28,800/h, 27 jewels	28,800/h, 27 jewels
CASE		
MATERIAL	Stainless steel with 18 K yellow gold ring	Stainless steel with 18 K red gold ring
BEZEL	Fixed	Fixed
SAPPHIRE CRYSTAL	Domed sapphire crystal with double anti-reflective coating	Domed sapphire crystal with double anti-reflective coating
CASE BACK	Stainless steel case back with sapphire crystal	Stainless steel case back with sapphire crystal
CROWN	Non-screw crown, 1 O-ring, 18 K yellow gold	Non-screw crown, 1 O-ring, 18 K red gold
DIAL	White mother-of-pearl dial with yellow gold-plated indexes and numerals	White mother-of-pearl dial with red gold-plated indexes and numerals
HANDS	Yellow gold-plated feuille hands	Red gold-plated feuille hands
DISTANCE BETWEEN HORNS/CLASP	17/17 mm	17/17 mm
DIAMETER	34 mm	34 mm
HEIGHT	8.98 mm	8.98 mm
WATER RESISTANT	3 bar (30 m)	3 bar (30 m)
BRACELET / STRAP		
MATERIAL	Stainless steel with 18 K yellow gold caps	Stainless steel with 18 K red gold caps
CLASP/BUCKLE	Triple-folding clasp	Triple-folding clasp

MONTBLANC STAR CLASSIQUE COLLECTION

> Steel



MODEL	Montblanc Star Classique Automatic	Montblanc Star Classique Automatic
IDENT No.	107072	107073
MOVEMENT		
CALIBRE	Montblanc 4810/408	Montblanc 4810/408
FEATURES	Automatic	Automatic
INDICATIONS	Hour - minute - small second at 6 o'clock	Hour - minute - small second at 6 o'clock
COMPLICATIONS	-	-
BATTERY	-	-
POWER RESERVE	Approx. 42 hrs	Approx. 42 hrs
FREQUENCY/JEWELS	28,800/h, 27 jewels	28,800/h, 27 jewels
CASE		
MATERIAL	Stainless steel	Stainless steel
BEZEL	Fixed	Fixed
SAPPHIRE CRYSTAL	Domed sapphire crystal with double anti-reflective coating	Domed sapphire crystal with double anti-reflective coating
CASE BACK	Sapphire crystal case back	Sapphire crystal case back
CROWN	Non-screw crown, 1 O-ring	Non-screw crown, 1 O-ring
DIAL	Black dial with silver-coloured indexes and numerals	White silver-coloured dial with black indexes and numerals
HANDS	Rhodium plated feuille hands	Blued steel feuille hands
DISTANCE BETWEEN HORNS/CLASP	19/17 mm	19/17 mm
DIAMETER	39 mm	39 mm
HEIGHT	8.90 mm	8.90 mm
WATER RESISTANT	3 bar (30 m)	3 bar (30 m)
BRACELET / STRAP		
MATERIAL/COLOUR	Alligator-skin strap / Black	Alligator-skin strap / Black
CLASP/BUCKLE	Pin buckle	Pin buckle

MONTBLANC STAR CLASSIQUE COLLECTION

> Steel



MODEL	Montblanc Star Classique Date	Montblanc Star Classique Date	Montblanc Star Classique Date
IDENT No.	108769	108770	108768
MOVEMENT			
CALIBRE	Montblanc 4810/101	Montblanc 4810/101	Montblanc 4810/101
FEATURES	Quartz	Quartz	Quartz
INDICATIONS	Hour - minute hands, date display	Hour - minute hands, date display	Hour - minute hands, date display
COMPLICATIONS	-	-	-
BATTERY	395/1.5 V	395/1.5 V	395/1.5 V
POWER RESERVE	-	-	-
FREQUENCY/JEWELS	7 jewels	7 jewels	7 jewels
CASE			
MATERIAL	Stainless steel	Stainless steel	Stainless steel
BEZEL	Fixed	Fixed	Fixed
SAPPHIRE CRYSTAL	Domed sapphire crystal with double anti-reflective coating	Domed sapphire crystal with double anti-reflective coating	Domed sapphire crystal with double anti-reflective coating
CASE BACK	Stainless steel case back	Stainless steel case back	Stainless steel case back
CROWN	Non-screw crown, 1 O-ring	Non-screw crown, 1 O-ring	Non-screw crown, 1 O-ring
DIAL	Black "soleillé" dial with rhodium-plated indexes and numeral	Silvery white "soleillé" dial with rhodium-plated indexes and numeral	Silvery white "soleillé" dial with rhodium-plated indexes and numeral
HANDS	Rhodium-plated feuille hands	Rhodium-plated feuille hands	Rhodium-plated feuille hands
DISTANCE BETWEEN HORNS/CLASP	19/17 mm	19/17 mm	19/19 mm
DIAMETER	39 mm	39 mm	39 mm
HEIGHT	7.47 mm	7.47 mm	7.47 mm
WATER RESISTANT	3 bar (30 m)	3 bar (30 m)	3 bar (30 m)
BRACELET / STRAP			
MATERIAL/COLOUR	Alligator-skin strap with stitching / Black	Alligator-skin strap with stitching / Brown	Stainless steel bracelet
CLASP/BUCKLE	Pin buckle	Pin buckle	Triple-folding clasp

MONTBLANC STAR CLASSIQUE COLLECTION

> Steel



MODEL	Montblanc Star Classique Lady	Montblanc Star Classique Lady	Montblanc Star Classique Lady
IDENT No.	108764	108766	108765
MOVEMENT			
CALIBRE	Montblanc 4810/101	Montblanc 4810/101	Montblanc 4810/101
FEATURES	Quartz	Quartz	Quartz
INDICATIONS	Hour - minute hands, date display	Hour - minute hands, date display	Hour - minute hands, date display
COMPLICATIONS	-	-	-
BATTERY	395/1.5 V	395/1.5 V	395/1.5 V
POWER RESERVE	-	-	-
FREQUENCY/JEWELS	7 jewels	7 jewels	7 jewels
CASE			
MATERIAL	Stainless steel	Stainless steel	Stainless steel
BEZEL	Fixed	Fixed	Fixed
SAPPHIRE CRYSTAL	Domed sapphire crystal with double anti-reflective coating	Domed sapphire crystal with double anti-reflective coating	Domed sapphire crystal with double anti-reflective coating
CASE BACK	Stainless steel case back	Stainless steel case back	Stainless steel case back
CROWN	Non-screw crown, 1 O-ring	Non-screw crown, 1 O-ring	Non-screw crown, 1 O-ring
DIAL	White mother-of-pearl dial with rhodium-plated indexes and numeral	White mother-of-pearl dial with rhodium-plated indexes and numeral	White mother-of-pearl dial with red gold-plated indexes and numerals
HANDS	Rhodium-plated feuille hands	Rhodium-plated feuille hands	Red gold-plated feuille hands
DISTANCE BETWEEN HORNS/CLASP	17/17 mm	17/16 mm	17/16 mm
DIAMETER	34 mm	34 mm	34 mm
HEIGHT	7.50 mm	7.50 mm	7.50 mm
WATER RESISTANT	3 bar (30 m)	3 bar (30 m)	3 bar (30 m)
BRACELET / STRAP			
MATERIAL	Stainless steel bracelet	Alligator-skin strap / Grey	Alligator-skin strap / White
CLASP/BUCKLE	Triple-folding clasp	Pin buckle	Pin buckle

MONTBLANC STAR COLLECTION

MONTBLANC STAR COLLECTION

> Gold : 42 mm



A Id. 101638

p. 116



A Id. 108737

p. 116

> Gold : 40 mm



A Id. 101640

p. 119

> Steel : 42 mm



A Id. 108736

p. 120



A Id. 36967

p. 121



A Id. 107113

p. 121

> Steel : 39 mm



A Id. 107114

p. 122

> Steel : 36 mm



A Id. 107115

p. 123

MONTBLANC STAR COLLECTION

> Gold : 42 mm



A Id. 103092 p. 117



A Id. 102345 p. 117

> Gold : 40 mm



A Id. 103093 p. 118

> Steel : 42 mm



A Id. 102135 p. 124



A Id. 109286 p. 125



A Id. 109285 p. 125



A Id. 106528 p. 126



A Id. 106462 p. 126

> Steel : 40 mm



Q Id. 102136 p. 127

MONTBLANC STAR COLLECTION

> Steel : 39 mm



A Id. 106468 p. 128



A Id. 106466 p. 128



A Id. 106467 p. 128



A Id. 107316 p. 129



A Id. 107315 p. 129



A Id. 107314 p. 129



A Id. 105961 p. 130



A Id. 105896 p. 130



A Id. 105895 p. 130



Q Id. 108761 p. 131



Q Id. 108762 p. 131



Q Id. 108763 p. 131



Q Id. 105913 p. 132



Q Id. 105893 p. 132



Q Id. 105894 p. 132

H=Handwinding **A**=Automatic **Q**=Quartz

MONTBLANC STAR COLLECTION

> Steel : 38 mm



A Id. 05222 p. 133



A Id. 08451 p. 133

> Steel : 36 mm



A Id. 105892 p. 134



A Id. 105891 p. 134



A Id. 103112 p. 135



A Id. 103111 p. 135



A Id. 107117 p. 136



A Id. 107118 p. 136



A Id. 107119 p. 137



Q Id. 07249 p. 137

MONTBLANC STAR COLLECTION

> Gold



MODEL	Montblanc Star Red Gold Chronograph GMT Automatic	Montblanc Star Quantième Complet
IDENT No.	101638	108737
MOVEMENT		
CALIBRE	Montblanc 4810/503	Montblanc 4810/912
FEATURES	Automatic chronograph, Officially certified chronometer (COSC)	Automatic
INDICATIONS	Hour - minute - continuous second hands, date display	Hour - minute - second hands
COMPLICATIONS	12 hrs and 30 min. counters, central chronograph hand, 24-hour display with second time zone	Quantième complet with moonphase, day, date and month display
BATTERY	-	-
POWER RESERVE	Approx. 48 hrs	Approx. 42 hrs
FREQUENCY/JEWELS	28,800/h, 25 jewels	28,000/h, 25 jewels
CASE		
MATERIAL	18 K red gold (~ 76.8 g)	18 K red gold (68.78 g)
BEZEL	Fixed	Fixed
SAPPHIRE CRYSTAL	Domed sapphire crystal with double anti-reflective coating	Domed sapphire crystal with double anti-reflective coating
CASE BACK	Sapphire crystal case back	18 K red gold case back with sapphire crystal fixed by 6 screws
CROWN	Non-screw crown, 1 O-ring, 18 K red gold with mother-of-pearl Montblanc emblem	Non-screw crown, 1 O-ring, 18 K red gold with mother-of-pearl Montblanc emblem
DIAL	Beige guilloché dial	White silver-coloured dial with black indexes and numerals
HANDS	Blued steel feuille and baton hands	Blued steel feuille and baton hands
DISTANCE BETWEEN HORNS/CLASP	22/20 mm	22/20 mm
DIAMETER	42 mm	42 mm
HEIGHT	14.7 mm	12.17 mm
WATER RESISTANT	3 bar (30 m)	3 bar (30 m)
BRACELET / STRAP		
MATERIAL/COLOUR	Alligator-skin strap / Brown	Alligator-skin strap / Brown
CLASP/BUCKLE	Triple-folding steel / 18 K red gold clasp (~ 8 g)	18 K red gold pin buckle (12.70 g)

MONTBLANC STAR COLLECTION

> Gold



MODEL	Montblanc Star Gold Chronograph GMT Automatic	Montblanc Star Gold Chronograph GMT Automatic
IDENT No.	103092	102345
MOVEMENT		
CALIBRE	Montblanc 4810/503	Montblanc 4810/503
FEATURES	Automatic chronograph, Officially certified chronometer (COSC)	Automatic chronograph, Officially certified chronometer (COSC)
INDICATIONS	Hour - minute - continuous second hands, date display	Hour - minute - continuous second hands, date display
COMPLICATIONS	12 hrs and 30 min. counters, central chronograph hand, 24-hour display with second time zone	12 hrs and 30 min. counters, central chronograph hand, 24-hour display with second time zone
BATTERY	-	-
POWER RESERVE	Approx. 48 hrs	Approx. 48 hrs
FREQUENCY/JEWELS	28,800/h, 25 jewels	28,800/h, 25 jewels
CASE		
MATERIAL	18 K yellow gold (~ 67.5 g)	18 K yellow gold (~ 67.5 g)
BEZEL	Fixed	Fixed
SAPPHIRE CRYSTAL	Domed sapphire crystal with double anti-reflective coating	Domed sapphire crystal with double anti-reflective coating
CASE BACK	Sapphire crystal case back	Sapphire crystal case back
CROWN	Non-screw crown, 1 O-ring, 18 K yellow gold with mother-of-pearl Montblanc emblem	Non-screw crown, 1 O-ring, 18 K yellow gold with mother-of-pearl Montblanc emblem
DIAL	Black guilloché dial	Beige guilloché dial
HANDS	Yellow gold-plated feuille and baton hands	Yellow gold-plated feuille and baton hands
DISTANCE BETWEEN HORNS/CLASP	22/20 mm	22/20 mm
DIAMETER	42 mm	42 mm
HEIGHT	14.7 mm	14.7 mm
WATER RESISTANT	3 bar (30 m)	3 bar (30 m)
BRACELET / STRAP		
MATERIAL/COLOUR	Alligator-skin strap / Black	Alligator-skin strap / Brown
CLASP/BUCKLE	18 K yellow gold pin buckle (~ 12.8 g)	18 K yellow gold pin buckle (~ 12.8 g)

MONTBLANC STAR COLLECTION

> Gold



MODEL	Montblanc Star Gold XL Automatic
IDENT No.	103093
MOVEMENT	
CALIBRE	Montblanc 4810/401
FEATURES	Automatic, Officially certified chronometer (COSC)
INDICATIONS	Hour - minute - second hands, date display
COMPLICATIONS	-
BATTERY	-
POWER RESERVE	Approx. 42 hrs
FREQUENCY/JEWELS	28,800 vib./h, 21 jewels
CASE	
MATERIAL	18 K yellow gold (~ 56.2 g)
BEZEL	Fixed
SAPPHIRE CRYSTAL	Domed sapphire crystal with double anti-reflective coating
CASE BACK	18 K yellow gold case back
CROWN	Non-screw crown, 1 O-ring, 18 K yellow gold with mother-of-pearl Montblanc emblem
DIAL	Black guilloché dial
HANDS	Yellow gold-plated feuille and baton hands
DISTANCE BETWEEN HORNS/CLASP	21/18 mm
DIAMETER	40 mm
HEIGHT	12 mm
WATER RESISTANT	3 bar (30 m)
BRACELET / STRAP	
MATERIAL/COLOUR	Alligator-skin strap / Black
CLASP/BUCKLE	18 K yellow gold pin buckle (~ 10.2 g)

MONTBLANC STAR COLLECTION

> Gold



MODEL	Montblanc Star Red Gold XL Automatic
IDENT No.	101640
MOVEMENT	
CALIBRE	Montblanc 4810/401
FEATURES	Automatic, Officially certified chronometer (COSC)
INDICATIONS	Hour - minute - second hands, date display
COMPLICATIONS	-
BATTERY	-
POWER RESERVE	Approx. 42 hrs
FREQUENCY/JEWELS	28,800 vib./h, 21 jewels
CASE	
MATERIAL	18 K red gold (~ 63.7 g)
BEZEL	Fixed
SAPPHIRE CRYSTAL	Domed sapphire crystal with double anti-reflective coating
CASE BACK	18 K red gold case back
CROWN	Non-screw crown, 1 O-ring, 18 K red gold with mother-of-pearl Montblanc emblem
DIAL	Beige guilloché dial
HANDS	Blued steel feuille and baton hands
DISTANCE BETWEEN HORNS/CLASP	21/18 mm
DIAMETER	40 mm
HEIGHT	12 mm
WATER RESISTANT	3 bar (30 m)
BRACELET / STRAP	
MATERIAL/COLOUR	Alligator-skin strap / Brown
CLASP/BUCKLE	Triple-folding steel / 18 K red gold clasp (7.8 g)

MONTBLANC STAR COLLECTION

> Steel



MODEL	Montblanc Star Quantième Complet
IDENT No.	108736
MOVEMENT	
CALIBRE	Montblanc 4810/912
FEATURES	Automatic
INDICATIONS	Hour - minute - second hands
COMPLICATIONS	Quantième complet with moonphase, day, date and month display
BATTERY	-
POWER RESERVE	Approx. 42 hrs
FREQUENCY/JEWELS	28,000/h, 25 jewels
CASE	
MATERIAL	Stainless steel
BEZEL	Fixed
SAPPHIRE CRYSTAL	Domed sapphire crystal with double anti-reflective coating
CASE BACK	Sapphire crystal case back fixed by 6 screws
CROWN	Non-screw crown, 1 O-ring
DIAL	White silver-coloured dial with black indexes and numerals
HANDS	Blued steel feuille and baton hands
DISTANCE BETWEEN HORNS/CLASP	22/20 mm
DIAMETER	42 mm
HEIGHT	12.17 mm
WATER RESISTANT	3 bar (30 m)
BRACELET / STRAP	
MATERIAL/COLOUR	Alligator-skin strap / Black
CLASP/BUCKLE	Triple-folding clasp

MONTBLANC STAR COLLECTION

> Steel



MODEL	Montblanc Star Chronograph GMT Automatic	Montblanc Star Chronograph UTC Automatic
IDENT No.	36967	107113
MOVEMENT		
CALIBRE	Montblanc 4810/503	Montblanc 4810/503
FEATURES	Automatic chronograph	Automatic chronograph with second time zone
INDICATIONS	Hour - minute - continuous second hands, date display	Hour - minute - continuous second hands, date display
COMPLICATIONS	12 hrs and 30 min. counters, central chronograph hand, 24-hour display with second time zone	12 hrs and 30 min. counters, central chronograph hand, 24-hour display with second time zone
BATTERY	-	-
POWER RESERVE	Approx. 46 hrs	Approx. 46 hrs
FREQUENCY/JEWELS	28,800/h, 25 jewels	28,000/h, 25 jewels
CASE		
MATERIAL	Stainless steel	Stainless steel
BEZEL	Fixed	Fixed
SAPPHIRE CRYSTAL	Domed sapphire crystal with anti-reflective coating	Domed sapphire crystal with double anti-reflective coating
CASE BACK	Sapphire crystal case back	Sapphire crystal case back fixed by 6 screws
CROWN	Non-screw crown, 1 O-ring	Non-screw crown, 1 O-ring
DIAL	Silver-coloured dial	White silver-coloured guilloché dial with black numerals
HANDS	Red gold-plated feuille hands and numerals, baton hands and triangle hand	Blued steel feuille and baton hands
DISTANCE BETWEEN HORNS/CLASP	22/20 mm	22/20 mm
DIAMETER	42 mm	42 mm
HEIGHT	14.5 mm	14.72 mm
WATER RESISTANT	3 bar (30 m)	3 bar (30 m)
BRACELET / STRAP		
MATERIAL/COLOUR	Alligator-skin strap / Black	Alligator-skin strap / Black
CLASP/BUCKLE	Triple-folding clasp	Triple-folding clasp

MONTBLANC STAR COLLECTION

> Steel



MODEL	Montblanc Star Date Automatic
IDENT No.	107114
MOVEMENT	
CALIBRE	Montblanc 4810/409
FEATURES	Automatic
INDICATIONS	Hour - minute - second hands, date display
COMPLICATIONS	-
BATTERY	-
POWER RESERVE	Approx. 42 hrs
FREQUENCY/JEWELS	28,000/h, 25 jewels
CASE	
MATERIAL	Stainless steel
BEZEL	Fixed
SAPPHIRE CRYSTAL	Domed sapphire crystal with double anti-reflective coating
CASE BACK	Sapphire crystal case back fixed by 6 screws
CROWN	Non-screw crown, 1 O-ring
DIAL	White silver-coloured guilloché dial with black numerals
HANDS	Blued steel feuille hands
DISTANCE BETWEEN HORNS/CLASP	19/17 mm
DIAMETER	39 mm
HEIGHT	9.95 mm
WATER RESISTANT	3 bar (30 m)
BRACELET / STRAP	
MATERIAL/COLOUR	Alligator-skin strap / Black
CLASP/BUCKLE	Triple-folding clasp

MONTBLANC STAR COLLECTION

> Steel



MODEL	Montblanc Star Date Automatic
IDENT No.	107115
MOVEMENT	
CALIBRE	Montblanc 4810/409
FEATURES	Automatic
INDICATIONS	Hour - minute - second hands, date display
COMPLICATIONS	-
BATTERY	-
POWER RESERVE	Approx. 42 hrs
FREQUENCY/JEWELS	28,000/h, 25 jewels
CASE	
MATERIAL	Stainless steel
BEZEL	Fixed
SAPPHIRE CRYSTAL	Domed sapphire crystal with double anti-reflective coating
CASE BACK	Sapphire crystal case back fixed by 6 screws
CROWN	Non-screw crown, 1 O-ring
DIAL	White silver-coloured guilloché dial with black numerals
HANDS	Blued steel feuille hands
DISTANCE BETWEEN HORNS/CLASP	19/17 mm
DIAMETER	36 mm
HEIGHT	9.97 mm
WATER RESISTANT	3 bar (30 m)
BRACELET / STRAP	
MATERIAL/COLOUR	Alligator-skin strap / Black
CLASP/BUCKLE	Triple-folding clasp

MONTBLANC STAR COLLECTION

> Steel



MODEL	Montblanc Star Chronograph GMT Automatic
IDENT No.	102135
MOVEMENT	
CALIBRE	Montblanc 4810/503
FEATURES	Automatic chronograph
INDICATIONS	Hour - minute - continuous second hands, date display
COMPLICATIONS	12 hrs and 30 min. counters, central chronograph hand, 24-hour display with second time zone
BATTERY	-
POWER RESERVE	Approx. 48 hrs
FREQUENCY/JEWELS	28,800/h, 25 jewels
CASE	
MATERIAL	Stainless steel
BEZEL	Fixed
SAPPHIRE CRYSTAL	Domed sapphire crystal with double anti-reflective coating
CASE BACK	Sapphire crystal case back
CROWN	Non-screw crown, 1 O-ring
DIAL	Black guilloché dial
HANDS	Rhodium-plated feuille and baton hands
DISTANCE BETWEEN HORNS/CLASP	22/20 mm
DIAMETER	42 mm
HEIGHT	14.7 mm
WATER RESISTANT	3 bar (30 m)
BRACELET / STRAP	
MATERIAL/COLOUR	Alligator-skin strap / Black
CLASP/BUCKLE	Triple-folding clasp

MONTBLANC STAR COLLECTION

> Steel



MODEL	Montblanc Star World-Time GMT Automatic	Montblanc Star World-Time GMT Automatic
IDENT No.	109286	109285
MOVEMENT		
CALIBRE	Montblanc 4810/405	Montblanc 4810/405
FEATURES	Automatic	Automatic
INDICATIONS	Hour - minute - second hands, date display	Hour - minute - second hands, date display
COMPLICATIONS	Second time zone, world time indication of 24 time zones	Second time zone, world time indication of 24 time zones
BATTERY	-	-
POWER RESERVE	Approx. 42 hrs	Approx. 42 hrs
FREQUENCY/JEWELS	28,800 vib./h, 21 jewels	28,800 vib./h, 21 jewels
CASE		
MATERIAL	Stainless steel	Stainless steel
BEZEL	Fixed	Fixed
SAPPHIRE CRYSTAL	Domed sapphire crystal with anti-reflective coating	Domed sapphire crystal with double anti-reflective coating
CASE BACK	Sapphire crystal case back fixed by 6 screws	Sapphire crystal case back fixed by 6 screws
CROWN	Screw-down crown, 1 O-ring	Screw-down crown, 1 O-ring
DIAL	White silver-coloured guilloché dial with black numerals	Black guilloché dial with silver-coloured numerals
HANDS	Blued steel feuille and baton hands	Rhodium-plated feuille and baton hands
DISTANCE BETWEEN HORNS/CLASP	22/20 mm	22/20 mm
DIAMETER	42 mm	42 mm
HEIGHT	12.60 mm	-
WATER RESISTANT	3 bar (30 m)	3 bar (30 m)
BRACELET / STRAP		
MATERIAL	stainless steel bracelet	Alligator-skin strap / Black
CLASP/BUCKLE	Triple-folding clasp	Triple-folding clasp

MONTBLANC STAR COLLECTION

> Steel



MODEL	Montblanc Star Retrograde Automatic	Montblanc Star Retrograde Automatic
IDENT No.	106528	106462
MOVEMENT		
CALIBRE	Montblanc 4810/909	Montblanc 4810/909
FEATURES	Automatic	Automatic
INDICATIONS	Hour - minute - second hands	Hour - minute - second hands
COMPLICATIONS	Retrograde day and date by hand, power-reserve indicator	Retrograde day and date by hand, power-reserve indicator
BATTERY	-	-
POWER RESERVE	Approx. 42 hrs	Approx. 42 hrs
FREQUENCY/JEWELS	28,800/h, 30 jewels	28,800/h, 30 jewels
CASE		
MATERIAL	Stainless steel	Stainless steel
BEZEL	Fixed	Fixed
SAPPHIRE CRYSTAL	Domed sapphire crystal with double anti-reflective coating	Domed sapphire crystal with double anti-reflective coating
CASE BACK	Sapphire crystal case back fixed by 6 screws	Sapphire crystal case back fixed by 6 screws
CROWN	Non-screw crown, 1 O-ring	Non-screw crown, 1 O-ring
DIAL	Black guilloché dial with silver-coloured numerals	Beige guilloché dial with black numerals
HANDS	Rhodium-plated feuille and baton hands	Blued steel feuille and baton hands
DISTANCE BETWEEN HORNS/CLASP	22/20 mm	22/20 mm
DIAMETER	42 mm	42 mm
HEIGHT	12.20 mm	12.20 mm
WATER RESISTANT	3 bar (30 m)	3 bar (30 m)
BRACELET / STRAP		
MATERIAL/COLOUR	Alligator-skin strap / Black	Alligator-skin strap / Brown
CLASP/BUCKLE	Triple-folding clasp	Triple-folding clasp

MONTBLANC STAR COLLECTION

> Steel



MODEL	Montblanc Star XL
IDENT No.	102136
MOVEMENT	
CALIBRE	Montblanc 4810/101
FEATURES	Quartz, Battery end-of-life indicator
INDICATIONS	Hour - minute - second hands, date display
COMPLICATIONS	-
BATTERY	395/1.5 V
POWER RESERVE	-
FREQUENCY/JEWELS	7 jewels
CASE	
MATERIAL	Stainless steel
BEZEL	Fixed
SAPPHIRE CRYSTAL	Domed sapphire crystal with anti-reflective coating
CASE BACK	Stainless steel case back
CROWN	Non-screw crown, 1 O-ring
DIAL	Black guilloché dial
HANDS	Rhodium-plated feuille and baton hands
DISTANCE BETWEEN HORNS/CLASP	21/18 mm
DIAMETER	40 mm
HEIGHT	12 mm
WATER RESISTANT	3 bar (30 m)
BRACELET / STRAP	
MATERIAL/COLOUR	Calfskin strap / Black
CLASP/BUCKLE	Pin buckle

MONTBLANC STAR COLLECTION

> Steel



MODEL	Montblanc Star Chronograph Automatic	Montblanc Star Chronograph Automatic	Montblanc Star Chronograph Automatic
IDENT NO.	106468	106466	106467
MOVEMENT			
CALIBRE	Montblanc 4810/501	Montblanc 4810/501	Montblanc 4810/501
FEATURES	Automatic chronograph	Automatic chronograph	Automatic chronograph
INDICATIONS	Hour - minute - continuous second hands, date/day display	Hour - minute - continuous second hands, date/day display	Hour - minute - continuous second hands, date/day display
COMPLICATIONS	12 hrs and 30 min. counters, central chronograph hand	12 hrs and 30 min. counters, central chronograph hand	12 hrs and 30 min. counters, central chronograph hand
BATTERY	-	-	-
POWER RESERVE	Approx. 46 hrs	Approx. 46 hrs	Approx. 46 hrs
FREQUENCY/JEWELS	28,800/h, 25 jewels	28,800/h, 25 jewels	28.800/h, 25 Jewels
CASE			
MATERIAL	Stainless steel	Stainless steel	Stainless steel
BEZEL	Fixed	Fixed	Fixed
SAPPHIRE CRYSTAL	Domed sapphire crystal with double anti-reflective coating	Domed sapphire crystal with double anti-reflective coating	Domed sapphire crystal with double anti-reflective coating
CASE BACK	Sapphire crystal case back fixed by 6 screws	Sapphire crystal case back fixed by 6 screws	Sapphire crystal case back fixed by 6 screws
CROWN	Non-screw crown, 1 O-ring	Non-screw crown, 1 O-ring	Non-screw crown, 1 O-ring
DIAL	White silver-coloured guilloché dial with black numerals	White silver-coloured guilloché dial with black numerals	Black guilloché dial with silver-coloured numerals
HANDS	Luminescent blued steel feuille and baton hands	Luminescent blued steel feuille and baton hands	Luminescent rhodium-plated feuille and baton hands
DISTANCE BETWEEN HORNS/CLASP	19/19 mm	19/17 mm	19/17 mm
DIAMETER	39 mm	39 mm	39 mm
HEIGHT	13.95 mm	13.95 mm	13.95 mm
WATER RESISTANT	3 bar (30 m)	3 bar (30 m)	3 bar (30 m)
BRACELET / STRAP			
MATERIAL	Stainless steel bracelet	Alligator-skin strap / Brown	Alligator-skin strap / Black
CLASP/BUCKLE	Triple-folding clasp	Triple-folding clasp	Triple-folding clasp

MONTBLANC STAR COLLECTION

> Steel



MODEL	Montblanc Star Date Automatic	Montblanc Star Date Automatic	Montblanc Star Date Automatic
IDENT No.	107316	107315	107314
MOVEMENT			
CALIBRE	Montblanc 4810/409	Montblanc 4810/409	Montblanc 4810/409
FEATURES	Automatic	Automatic	Automatic
INDICATIONS	Hour - minute - second hands, date display	Hour - minute - second hands, date display	Hour - minute - second hands, date display
COMPLICATIONS	-	-	-
BATTERY	-	-	-
POWER RESERVE	Approx. 42 hrs	Approx. 42 hrs	Approx. 42 hrs
FREQUENCY/JEWELS	28,800/h, 25 jewels	28,800/h, 25 jewels	28,800/h, 25 jewels
CASE			
MATERIAL	Stainless steel	Stainless steel	Stainless steel
BEZEL	Fixed	Fixed	Fixed
SAPPHIRE CRYSTAL	Domed sapphire crystal with double anti-reflective coating	Domed sapphire crystal with double anti-reflective coating	Domed sapphire crystal with double anti-reflective coating
CASE BACK	Sapphire crystal case back fixed by 6 screws	Sapphire crystal case back fixed by 6 screws	Sapphire crystal case back fixed by 6 screws
CROWN	Non-screw crown, 1 O-ring	Non-screw crown, 1 O-ring	Non-screw crown, 1 O-ring
DIAL	White silver-coloured guilloché dial with black numerals	White silver-coloured guilloché dial with black numerals	Black guilloché dial with rhodium-plated numerals
HANDS	Blued steel feuille hands	Blued steel feuille hands	Rhodium-plated feuille hands
DISTANCE BETWEEN HORNS/CLASP	19/19 mm	19/17 mm	19/17 mm
DIAMETER	39 mm	39 mm	39 mm
HEIGHT	9.95 mm	9.95 mm	9.95 mm
WATER RESISTANT	3 bar (30 m)	3 bar (30 m)	3 bar (30 m)
BRACELET / STRAP			
MATERIAL	Stainless steel bracelet	Alligator-skin strap / Brown	Alligator-skin strap / Black
CLASP/BUCKLE	Triple-folding clasp	Triple-folding clasp	Triple-folding clasp

MONTBLANC STAR COLLECTION

> Steel



MODEL	Montblanc Star Date Automatic	Montblanc Star Date Automatic	Montblanc Star Date Automatic
IDENT No.	105961	105896	105895
MOVEMENT			
CALIBRE	Montblanc 4810/401	Montblanc 4810/401	Montblanc 4810/401
FEATURES	Automatic	Automatic	Automatic
INDICATIONS	Hour - minute - second hands, date display	Hour - minute - second hands, date display	Hour - minute - second hands, date display
COMPLICATIONS	-	-	-
BATTERY	-	-	-
POWER RESERVE	Approx. 42 hrs	Approx. 42 hrs	Approx. 42 hrs
FREQUENCY/JEWELS	28,800 vib./h, 21 jewels	28,800 vib./h, 21 jewels	28,800 vib./h, 21 jewels
CASE			
MATERIAL	Stainless steel	Stainless steel	Stainless steel
BEZEL	Fixed	Fixed	Fixed
SAPPHIRE CRYSTAL	Domed sapphire crystal with double anti-reflective coating	Domed sapphire crystal with double anti-reflective coating	Domed sapphire crystal with double anti-reflective coating
CASE BACK	Sapphire crystal case back fixed by 6 screws	Sapphire crystal case back fixed by 6 screws	Sapphire crystal case back fixed by 6 screws
CROWN	Non-screw crown, 1 O-ring	Non-screw crown, 1 O-ring	Non-screw crown, 1 O-ring
DIAL	Silver-coloured guilloché dial with red gold-plated indexes and numerals	Silver-coloured guilloché dial with red gold-plated indexes and numerals	Black guilloché dial with rhodium-plated indexes and numerals
HANDS	Red gold-plated feuille and baton hands	Red gold-plated feuille and baton hands	Rhodium-plated feuille and baton hands
DISTANCE BETWEEN HORNS/CLASP	19/19 mm	19/17 mm	19/17 mm
DIAMETER	39 mm	39 mm	39 mm
HEIGHT	9.97 mm	9.97 mm	9.97 mm
WATER RESISTANT	3 bar (30 m)	3 bar (30 m)	3 bar (30 m)
BRACELET / STRAP			
MATERIAL	Stainless steel bracelet	Alligator-skin strap / Brown	Alligator-skin strap / Black
CLASP/BUCKLE	Triple-folding clasp	Triple-folding clasp	Triple-folding clasp

MONTBLANC STAR COLLECTION

> Steel



MODEL	Montblanc Star Date	Montblanc Star Date	Montblanc Star Date
IDENT No.	108761	108762	108763
MOVEMENT			
CALIBRE	Montblanc 4810/101	Montblanc 4810/101	Montblanc 4810/101
FEATURES	Quartz, Battery end-of-life indicator	Quartz, Battery end-of-life indicator	Quartz, Battery end-of-life indicator
INDICATIONS	Hour - minute - second hands, date display	Hour - minute - second hands, date display	Hour - minute - second hands, date display
COMPLICATIONS	-	-	-
BATTERY	395/1.5 V	395/1.5 V	395/1.5 V
POWER RESERVE	-	-	-
FREQUENCY/JEWELS	7 jewels	7 jewels	7 jewels
CASE			
MATERIAL	Stainless steel	Stainless steel	Stainless steel
BEZEL	Fixed	Fixed	Fixed
SAPPHIRE CRYSTAL	Domed sapphire crystal with double anti-reflective coating	Domed sapphire crystal with double anti-reflective coating	Domed sapphire crystal with double anti-reflective coating
CASE BACK	Stainless steel case back	Stainless steel case back	Stainless steel case back
CROWN	Non-screw crown, 1 O-ring	Non-screw crown, 1 O-ring	Non-screw crown, 1 O-ring
DIAL	Silvery white guilloché dial with rhodium-plated indexes and numerals	Silvery white guilloché dial with rhodium-plated indexes and numerals	Black guilloché dial with rhodium-plated indexes and numerals
HANDS	Rhodium-plated feuille hands	Rhodium plated feuille hands	Rhodium-plated feuille hands
DISTANCE BETWEEN HORNS/CLASP	19/19 mm	19/17 mm	19/17 mm
DIAMETER	39 mm	39 mm	39 mm
HEIGHT	9.17 mm	9.17 mm	9.17 mm
WATER RESISTANT	3 bar (30 m)	3 bar (30 m)	3 bar (30 m)
BRACELET / STRAP			
MATERIAL	Stainless steel bracelet	Grained calfskin strap / Brown	Grained calfskin strap / Black
CLASP/BUCKLE	Triple-folding clasp	Pin buckle	Pin buckle

MONTBLANC STAR COLLECTION

> Steel



MODEL	Montblanc Star Date	Montblanc Star Date	Montblanc Star Date
IDENT No.	105913	105893	105894
MOVEMENT			
CALIBRE	Montblanc 4810/101	Montblanc 4810/101	Montblanc 4810/101
FEATURES	Quartz, Battery end-of-life indicator	Quartz movement, Battery end-of-life indicator	Quartz, Battery end-of-life indicator
INDICATIONS	Hour - minute - second hands, date display	Hour - minute - second hands, date display	Hour - minute - second hands, date display
COMPLICATIONS	-	-	-
BATTERY	395/1.5 V	395/1.5 V	397/1.5 V
POWER RESERVE	-	-	-
FREQUENCY/JEWELS	7 jewels	7 jewels	7 jewels
CASE			
MATERIAL	Stainless steel	Stainless steel	Stainless steel
BEZEL	Fixed	Fixed	Fixed
SAPPHIRE CRYSTAL	Domed sapphire crystal with double anti-reflective coating	Domed sapphire crystal with double anti-reflective coating	Domed sapphire crystal with double anti-reflective coating
CASE BACK	Stainless steel case back	Stainless steel case back	Stainless steel case back
CROWN	Non-screw crown, 1 O-ring	Non-screw crown, 1 O-ring	Non-screw crown, 1 O-ring
DIAL	Black guilloché dial with rhodium-plated indexes and numerals	Black guilloché dial with rhodium-plated indexes and numerals	Silver-coloured guilloché dial with black indexes and numerals
HANDS	Rhodium-plated feuille and baton hands	Rhodium-plated feuille and baton hands	Black feuille and baton hands
DISTANCE BETWEEN HORNS/CLASP	19/19 mm	19/17 mm	19/17 mm
DIAMETER	39 mm	39 mm	39 mm
HEIGHT	9.17 mm	9.17 mm	9.17 mm
WATER RESISTANT	3 bar (30 m)	3 bar (30 m)	3 bar (30 m)
BRACELET / STRAP			
MATERIAL	Stainless steel bracelet	Buffalo-hide strap / Black	Buffalo-hide strap / Brown
CLASP/BUCKLE	Triple-folding clasp	Pin buckle	Pin buckle

MONTBLANC STAR COLLECTION

> Steel



MODEL	Montblanc Star Chronograph Automatic	Montblanc Star Chronograph Automatic
IDENT No.	05222	08451
MOVEMENT		
CALIBRE	Montblanc 4810/501	Montblanc 4810/501
FEATURES	Automatic chronograph	Automatic chronograph
INDICATIONS	Hour - minute - continuous second hands, date/day display	Hour - minute - continuous second hands, date/day display
COMPLICATIONS	12 hrs and 30 min. counters, central chronograph hand	12 hrs and 30 min. counters, central chronograph hand
BATTERY	-	-
POWER RESERVE	Approx. 46 hrs	Approx. 46 hrs
FREQUENCY/JEWELS	28,800/h, 25 jewels	28,800/h, 25 jewels
CASE		
MATERIAL	Stainless steel	Stainless steel
BEZEL	Fixed	Fixed
SAPPHIRE CRYSTAL	Domed sapphire crystal with anti-reflective coating	Domed sapphire crystal with anti-reflective coating
CASE BACK	Sapphire crystal case back	Sapphire crystal case back
CROWN	Non-screw crown, 1 O-ring	Non-screw crown, 1 O-ring
DIAL	Silver-coloured guilloché dial	Black dial
HANDS	Rhodium-plated feuille and baton hands	Rhodium-plated feuille and baton hands
DISTANCE BETWEEN HORNS/CLASP	19/19 mm	19/17 mm
DIAMETER	38 mm	38 mm
HEIGHT	14.1 mm	14.1 mm
WATER RESISTANT	3 bar (30 m)	3 bar (30 m)
BRACELET / STRAP		
MATERIAL	Stainless steel bracelet	Alligator-skin strap / Black
CLASP/BUCKLE	Triple-folding clasp	Triple-folding clasp

MONTBLANC STAR COLLECTION

> Steel



MODEL	Montblanc Star Lady Chronograph	Montblanc Star Lady Chronograph
IDENT No.	105892	105891
MOVEMENT		
CALIBRE	Montblanc 4810/105 b	Montblanc 4810/105 b
FEATURES	Chronograph, Battery end-of-life indicator	Chronograph, Battery end-of-life indicator
INDICATIONS	Hour - minute - second hands, date display	Hour - minute - second hands, date display
COMPLICATIONS	1/10 sec. and 30 min. counters	1/10 sec. and 30 min. counters
BATTERY	394/1.5 V	394/1.5 V
POWER RESERVE	-	-
FREQUENCY/JEWELS	22 jewels	22 jewels
CASE		
MATERIAL	Stainless steel	Stainless steel
BEZEL	Fixed	Fixed
SAPPHIRE CRYSTAL	Domed sapphire crystal with anti-reflective coating	Domed sapphire crystal with anti-reflective coating
CASE BACK	Stainless steel case back	Stainless steel case back
CROWN	Non-screw crown, 1 O-ring	Non-screw crown, 1 O-ring
DIAL	Black mother-of-pearl dial with 9 Top Wesselton diamonds (~0.027 ct)	White mother-of-pearl dial with 9 Top Wesselton diamonds (~0.027 ct)
HANDS	Rhodium-plated feuille and baton hands, luminescent hour and minute hands	Rhodium-plated feuille and baton hands, luminescent hour and minute hands
DISTANCE BETWEEN HORNS/CLASP	19/17 mm	19/17 mm
DIAMETER	36 mm	36 mm
HEIGHT	12.5 mm	12.5 mm
WATER RESISTANT	3 bar (30 m)	3 bar (30 m)
BRACELET / STRAP		
MATERIAL/COLOUR	Synthetic Satin Strap / Black	Synthetic Satin Strap / White
CLASP/BUCKLE	Pin buckle	Pin buckle

MONTBLANC STAR COLLECTION

> Steel



MODEL	Montblanc Star Lady Moonphase Automatic	Montblanc Star Lady Moonphase Automatic
IDENT No.	103112	103111
MOVEMENT		
CALIBRE	Montblanc 4810/908	Montblanc 4810/908
FEATURES	Automatic	Automatic
INDICATIONS	Hour - minute - second hands	Hour - minute - second hands
COMPLICATIONS	Moonphase display, date by hand	Moonphase display, date by hand
BATTERY	-	-
POWER RESERVE	42 hrs	42 hrs
FREQUENCY/JEWELS	28,800 vib./h, 21 jewels	28,800 vib./h, 21 jewels
CASE		
MATERIAL	Stainless steel	Stainless steel
BEZEL	Fixed	Fixed
SAPPHIRE CRYSTAL	Domed sapphire crystal with double anti-reflective coating	Domed sapphire crystal with double anti-reflective coating
CASE BACK	Steel with sapphire crystal in the shape of the Montblanc emblem	Steel with sapphire crystal in the shape of the Montblanc emblem
CROWN	Non-screw crown, 1 O-ring	Non-screw crown, 1 O-ring
DIAL	Black mother-of-pearl dial with 8 Top Wesselton diamonds (~0.032 ct)	White mother-of-pearl dial with 8 Top Wesselton diamonds (~0.032 ct)
HANDS	Rhodium-plated feuille and baton hands	Rhodium-plated feuille and baton hands
DISTANCE BETWEEN HORNS/CLASP	19/17 mm	19/17 mm
DIAMETER	36 mm	36 mm
HEIGHT	11.8 mm	11.8 mm
WATER RESISTANT	3 bar (30 m)	3 bar (30 m)
BRACELET / STRAP		
MATERIAL/COLOUR	Alligator-skin strap / Anthracite-coloured	Alligator-skin strap / White
CLASP/BUCKLE	Triple-folding clasp	Triple-folding clasp

MONTBLANC STAR COLLECTION

> Steel



MODEL	Montblanc Star Lady Automatic	Montblanc Star Lady Automatic
IDENT No.	107117	107118
MOVEMENT		
CALIBRE	Montblanc 4810/409	Montblanc 4810/409
FEATURES	Automatic	Automatic
INDICATIONS	Hour - minute - second hands, date display	Hour - minute - second hands, date display
COMPLICATIONS	-	-
BATTERY	-	-
POWER RESERVE	Approx. 42 hrs	Approx. 42 hrs
FREQUENCY/JEWELS	28,800/h, 25 jewels	28,800/h, 25 jewels
CASE		
MATERIAL	Stainless steel	Stainless steel
BEZEL	Fixed	Fixed
SAPPHIRE CRYSTAL	Domed sapphire crystal with double anti-reflective coating	Domed sapphire crystal with double anti-reflective coating
CASE BACK	Stainless steel case back	Stainless steel case back
CROWN	Non-screw crown, 1 O-ring	Non-screw crown, 1 O-ring
DIAL	White mother-of-pearl dial with silver-coloured numerals and 6 Top Wesselton diamonds (~ 0.011 ct.)	White mother-of-pearl dial with silver-coloured numerals and 6 Top Wesselton diamonds (~ 0.011 ct.)
HANDS	Rhodium-plated feuille and baton hands	Rhodium-plated feuille and baton hands
DISTANCE BETWEEN HORNS/CLASP	19/17 mm	19/17 mm
DIAMETER	36 mm	36 mm
HEIGHT	11.7 mm	11.7 mm
WATER RESISTANT	3 bar (30 m)	3 bar (30 m)
BRACELET / STRAP		
MATERIAL	Stainless steel bracelet	Calfskin strap / Black
CLASP/BUCKLE	Triple-folding clasp	Pin buckle

MONTBLANC STAR COLLECTION

> Steel



MODEL	Montblanc Star Lady Automatic	Montblanc Star Large
IDENT No.	107119	07249
MOVEMENT		
CALIBRE	Montblanc 4810/409	Montblanc 4810/101
FEATURES	Automatic	Quartz, Battery end-of-life indicator
INDICATIONS	Hour - minute - second hands, date display	Hour - minute - second hands, date display
COMPLICATIONS	-	-
BATTERY	-	395/1.5 V
POWER RESERVE	Approx. 42 hrs	-
FREQUENCY/JEWELS	28,800/h, 25 jewels	7 jewels
CASE		
MATERIAL	Stainless steel	Stainless steel
BEZEL	Fixed	Fixed
SAPPHIRE CRYSTAL	Domed sapphire crystal with double anti-reflective coating	Domed sapphire crystal with anti-reflective coating
CASE BACK	Stainless steel case back	Stainless steel case back
CROWN	Non-screw crown, 1 O-ring	Non-screw crown, 1 O-ring
DIAL	White mother-of-pearl dial with red gold-plated numerals and 6 diamonds	Silver-coloured guilloché dial
HANDS	Red gold-plated feuille and baton hands	Rhodium-plated feuille and baton hands
DISTANCE BETWEEN HORNS/CLASP	19/17 mm	19/17 mm
DIAMETER	36 mm	36 mm
HEIGHT	11.7 mm	11.5 mm
WATER RESISTANT	3 bar (30 m)	3 bar (30 m)
BRACELET / STRAP		
MATERIAL/COLOUR	Calfskin strap / White	Grained calfskin strap / Black
CLASP/BUCKLE	Pin buckle	Pin buckle

MONTBLANC TIMEWALKER COLLECTION

MONTBLANC TIMEWALKER COLLECTION

> TwinFly Chronographs : 43 mm



A Id. 107338 p. 143



A Id. 104286 p. 144



A Id. 109133 p. 144



A Id. 105077 p. 145



A Id. 109134 p. 145

> Gold : 43 mm



A Id. 101565 p. 146



A Id. 106504 p. 146



A Id. 101564 p. 146



A Id. 104668 p. 147



A Id. 104669 p. 147

> Steel Gold : 43 mm



A Id. 107320 p. 148



A Id. 107321 p. 148



A Id. 107322 p. 149



A Id. 105805 p. 149

> Steel Gold : 39 mm



A Id. 106501 p. 150



A Id. 106502 p. 150



A Id. 106500 p. 150

H=Handwinding **A**=Automatic **Q**=Quartz

MONTBLANC TIMEWALKER COLLECTION

> Steel : 43 mm



A Id. 107303 p. 151



A Id. 107336 p. 151



A Id. 107063 p. 151



A Id. 107339 p. 152



A Id. 107065 p. 152



A Id. 103094 p. 153



A Id. 102365 p. 153



A Id. 09668 p. 154



A Id. 09669 p. 154



A Id. 09670 p. 155



A Id. 09671 p. 155



A Id. 106503 p. 156



A Id. 101548 p. 157



A Id. 101549 p. 157

H =Handwinding **A** =Automatic **Q** =Quartz

MONTBLANC TIMEWALKER COLLECTION

> Steel : 42 mm



A Id. 108956 p. 158



A Id. 108955 p. 158



A Id. 109135 p. 159



A Id. 109137 p. 159



A Id. 109136 p. 159



A Id. 36065 p. 160



A Id. 106593 p. 160



A Id. 09672 p. 161



A Id. 101551 p. 161



A Id. 09675 p. 162



A Id. 101550 p. 162

> Steel : 39 mm



A Id. 105962 p. 163



A Id. 105812 p. 163



A Id. 105813 p. 163

H=Handwinding A=Automatic Q=Quartz

MONTBLANC TIME WALKER COLLECTION

> TwinFly Chronographs



MODEL	Montblanc TimeWalker TwinFly Chronograph GreyTech Limited Edition - 888 pieces
IDENT NO.	107338
MOVEMENT	
CALIBRE	Montblanc MB LL100
FEATURES	Automatic flyback chronograph, column-wheel control and vertical disc clutch, 13 3/4" (31 mm), height 7.90 mm, 303 parts, large balance wheel with screws (moment of inertia: 12 mg.cm ² , diameter: 9.70 mm), flat hairspring, twin barrels, grey rhodium-plated plates and bridges, wheel train with special toothing for more efficient power transmission
INDICATIONS	Hour - minute - continuous second hands, relief date disc
COMPLICATIONS	Flyback chronograph with central minute and second hands, 24-hour display with second time zone
BATTERY	-
POWER RESERVE	Approx. 72 hrs
FREQUENCY/JEWELS	28,800/h, 36 jewels
CASE	
MATERIAL	Satin-finished and shot-blasted titanium
BEZEL	Fixed, shot-blasted titanium
SAPPHIRE CRYSTAL	Domed sapphire crystal with double anti-reflective coating
CASE BACK	Shot-blasted titanium case back with sapphire crystal
CROWN	Non-screw crown, 1 O-ring
DIAL	Open worked grey dial with black numerals
HANDS	Black luminescent hands
DISTANCE BETWEEN HORNS/CLASP	22/20 mm
DIAMETER	43 mm
HEIGHT	15.30 mm
WATER RESISTANT	3 bar (30 m)
BRACELET / STRAP	
MATERIAL/COLOUR	Alligator-skin strap / Grey
CLASP/BUCKLE	Pin buckle in shot-blasted titanium

MONTBLANC TIMEWALKER COLLECTION

> TwinFly Chronographs



MODEL	Montblanc TimeWalker TwinFly Chronograph	Montblanc TimeWalker Twinfly Chronograph
IDENT No.	104286	109133
MOVEMENT		
CALIBRE	Montblanc MB LL100	Montblanc MB LL100
FEATURES	Automatic TwinFly chronograph, Column-wheel control and vertical disc clutch, 13 3/4" (31 mm), height 7.90 mm, 303 parts, large balance wheel with screws (moment of inertia: 12 mg.cm ² , diameter: 9.70 mm), flat hairspring, twin barrel, rhodium-plated and circular-grained plates, rhodium-plated bridges with Geneva striping, wheel train with special toothing for more efficient power transmission	Automatic TwinFly chronograph, Column-wheel control and vertical disc clutch, 13 3/4" (31 mm), height 7.90 mm, 303 parts, large balance wheel with screws (moment of inertia: 12 mg.cm ² , diameter: 9.70 mm), flat hairspring, twin barrel, rhodium-plated and circular-grained plates, rhodium-plated bridges with Geneva striping, wheel train with special toothing for more efficient power transmission
INDICATIONS	Hour - minute - continuous second hands, date display	Hour - minute - continuous second hands, date display
COMPLICATIONS	Flyback chronograph with central minute and second hands, 24-hour display with second time zone	Flyback chronograph with central minute and second hands, 24-hour display with second time zone
BATTERY	-	-
POWER RESERVE	Approx. 72 hrs	Approx. 72 hrs
FREQUENCY/JEWELS	28,800/h, 36 jewels	28,800/h, 36 jewels
CASE		
MATERIAL	Stainless steel	Stainless steel
BEZEL	Fixed	Fixed
SAPPHIRE CRYSTAL	Domed sapphire crystal with double anti-reflective coating	Domed sapphire crystal with double anti-reflective coating
CASE BACK	Sapphire crystal case back	Sapphire crystal case back
CROWN	Non-screw crown, 1 O-ring	Non-screw crown, 1 O-ring
DIAL	Black dial with rhodium-plated numerals	Silver-coloured dial with black numerals
HANDS	Rhodium-plated luminescent hands	Rhodium-plated luminescent hands
DISTANCE BETWEEN HORNS/CLASP	22/22 mm	22/20 mm
DIAMETER	43 mm	43 mm
HEIGHT	15.30 mm	15.30 mm
WATER RESISTANT	3 bar (30 m)	3 bar (30 m)
BRACELET / STRAP		
MATERIAL	Stainless steel bracelet	Stainless steel bracelet
CLASP/BUCKLE	Triple-folding clasp	Triple-folding clasp

MONTBLANC TIMEWALKER COLLECTION

> TwinFly Chronographs



MODEL	Montblanc TimeWalker TwinFly Chronograph	Montblanc TimeWalker TwinFly Chronograph
IDENT No.	105077	109134
MOVEMENT		
CALIBRE	Montblanc MB LL100	Montblanc MB LL100
FEATURES	Automatic TwinFly chronograph, Column-wheel control and vertical disc clutch, 13 3/4" (31 mm), height 7.90 mm, 303 parts, large balance wheel with screws (moment of inertia: 12 mg.cm ² , diameter: 9.70 mm), flat hairspring, twin barrel, rhodium-plated and circular-grained plates, rhodium-plated bridges with Geneva striping, wheel train with special toothing for more efficient power transmission	Automatic TwinFly chronograph, Column-wheel control and vertical disc clutch, 13 3/4" (31 mm), height 7.90 mm, 303 parts, large balance wheel with screws (moment of inertia: 12 mg.cm ² , diameter: 9.70 mm), flat hairspring, twin barrel, rhodium-plated and circular-grained plates, rhodium-plated bridges with Geneva striping, wheel train with special toothing for more efficient power transmission
INDICATIONS	Hour - minute - continuous second hands, date display	Hour - minute - continuous second hands, date display
COMPLICATIONS	Flyback chronograph with central minute and second hands, 24-hour display with second time zone	Flyback chronograph with central minute and second hands, 24-hour display with second time zone
BATTERY	-	-
POWER RESERVE	Approx. 72 hrs	Approx. 72 hrs
FREQUENCY/JEWELS	28,800/h, 36 jewels	28,800/h, 36 jewels
CASE		
MATERIAL	Stainless steel	Stainless steel
BEZEL	Fixed	Fixed
SAPPHIRE CRYSTAL	Domed sapphire crystal with double anti-reflective coating	Domed sapphire crystal with double anti-reflective coating
CASE BACK	Sapphire crystal case back	Sapphire crystal case back
CROWN	Non-screw crown, 1 O-ring	Non-screw crown, 1 O-ring
DIAL	Black dial with rhodium-plated numerals	Silver-coloured dial with black numerals
HANDS	Rhodium-plated luminescent hands	Rhodium-plated luminescent hands
DISTANCE BETWEEN HORNS/CLASP	22/20 mm	22/20 mm
DIAMETER	43 mm	43 mm
HEIGHT	15.30 mm	15.30 mm
WATER RESISTANT	3 bar (30 m)	3 bar (30 m)
BRACELET / STRAP		
MATERIAL/COLOUR	Alligator-skin strap / Black	Alligator-skin strap / Brown
CLASP/BUCKLE	Triple-folding clasp	Triple-folding clasp

MONTBLANC TIME WALKER COLLECTION

> Gold



MODEL	Montblanc TimeWalker Chronograph Automatic Red Gold	Montblanc TimeWalker Chronograph Automatic Red Gold	Montblanc TimeWalker Chronograph Automatic Red Gold
IDENT NO.	101565	106504	101564
MOVEMENT			
CALIBRE	Montblanc 4810/502	Montblanc 4810/502	Montblanc 4810/502
FEATURES	Automatic chronograph, Officially certified chronometer (COSC)	Automatic chronograph, Officially certified chronometer (COSC)	Automatic chronograph, Officially certified chronometer (COSC)
INDICATIONS	Hour - minute - continuous second hands, date display	Hour - minute - continuous second hands, date display	Hour - minute - continuous second hands, date display
COMPLICATIONS	12 hrs and 30 min. counters, central chronograph hand	12 hrs and 30 min. counters, central chronograph hand	12 hrs and 30 min. counters, central chronograph hand
BATTERY	-	-	-
POWER RESERVE	Approx. 46 hrs	Approx. 46 hrs	Approx. 46 hrs
FREQUENCY/JEWELS	28,800/h, 27 jewels	28,800/h, 27 jewels	28,800/h, 27 jewels
CASE			
MATERIAL	18 K red gold (~ 68.4 g)	18 K red gold (~ 68.4 g)	18 K red gold (~ 68.4 g)
BEZEL	Fixed	Fixed	Fixed
SAPPHIRE CRYSTAL	Domed sapphire crystal with double anti-reflective coating	Domed sapphire crystal with double anti-reflective coating	Domed sapphire crystal with double anti-reflective coating
CASE BACK	Sapphire crystal case back	Sapphire crystal case back	Sapphire crystal case back
CROWN	Non-screw crown, 1 O-ring, 18 K red gold with mother-of-pearl Montblanc emblem	Non-screw crown, 1 O-ring, 18 K red gold with mother-of-pearl Montblanc emblem	Non-screw crown, 1 O-ring, 18 K red gold with mother-of-pearl Montblanc emblem
DIAL	Black dial with red gold-plated numerals	Black dial with red gold-plated numerals	Mat silver-coloured dial with red gold-plated numerals
HANDS	Red gold-plated luminescent hands	Red gold-plated luminescent hands	Red gold-plated luminescent hands
DISTANCE BETWEEN HORNS/CLASP	22/20 mm	22/20 mm	22/20 mm
DIAMETER	43 mm	43 mm	43 mm
HEIGHT	14.3 mm	14.3 mm	14.3 mm
WATER RESISTANT	3 bar (30 m)	3 bar (30 m)	3 bar (30 m)
BRACELET / STRAP			
MATERIAL/COLOUR	Alligator-skin strap with stitching / Brown	Embossed calfskin strap with red gold-coloured stitching / Black	Alligator-skin strap with stitching / Brown
CLASP/BUCKLE	18 K red gold pin buckle (~ 10.6 g)	18 K red gold pin buckle (~ 10.6 g)	18 K red gold pin buckle (~ 10.6 g)

MONTBLANC TIMEWALKER COLLECTION

> Gold



MODEL	Montblanc TimeWalker Chronograph Automatic Red Gold Ceramic	Montblanc TimeWalker Chronograph Automatic Red Gold Ceramic
IDENT NO.	104668	104669
MOVEMENT		
CALIBRE	Montblanc 4810/502	Montblanc 4810/502
FEATURES	Automatic chronograph, Officially certified chronometer (COSC)	Automatic chronograph, Officially certified chronometer (COSC)
INDICATIONS	Hour - minute - continuous second hands, date display	Hour - minute - continuous second hands, date display
COMPLICATIONS	12 hrs and 30 min. counters, central chronograph hand	12 hrs and 30 min. counters, central chronograph hand
BATTERY	-	-
POWER RESERVE	Approx. 46 hrs	Approx. 46 hrs
FREQUENCY/JEWELS	28.800/h, 27 jewels	28.800/h, 27 Jewels
CASE		
MATERIAL	18 K red gold (~ 60 g)	18 K red gold (~ 60 g)
BEZEL	Fixed, black ceramic	Fixed, white ceramic
SAPPHIRE CRYSTAL	Domed sapphire crystal with double anti-reflective coating	Domed sapphire crystal with double anti-reflective coating
CASE BACK	Sapphire crystal case back	Sapphire crystal case back
CROWN	Non-screw crown, 1 O-ring, black ceramic	Non-screw crown, 1 O-ring, white ceramic
DIAL	Black dial with red gold-plated numerals	White dial with red gold-plated numerals
HANDS	Red gold-plated luminescent hands	Red gold-plated luminescent hands
DISTANCE BETWEEN HORNS/CLASP	22/20 mm	22/20 mm
DIAMETER	43 mm	43 mm
HEIGHT	14.4 mm	14.4 mm
WATER RESISTANT	3 bar (30 m)	3 bar (30 m)
BRACELET / STRAP		
MATERIAL/COLOUR	Alligator-skin strap / Black	Alligator-skin strap / White
CLASP/BUCKLE	18 K red gold pin buckle (~ 10.6 g)	18 K red gold pin buckle (~ 10.6 g)

MONTBLANC TIMEWALKER COLLECTION

> Steel Gold



MODEL	Montblanc TimeWalker Chronograph Automatic Steel Gold	Montblanc TimeWalker Chronograph Automatic Steel Gold
IDENT NO.	107320	107321
MOVEMENT		
CALIBRE	Montblanc 4810/502	Montblanc 4810/502
FEATURES	Automatic chronograph	Automatic chronograph
INDICATIONS	Hour - minute - continuous second hands, date display	Hour - minute - continuous second hands, date display
COMPLICATIONS	12 hrs and 30 min. counters, central chronograph hand	12 hrs and 30 min. counters, central chronograph hand
BATTERY	-	-
POWER RESERVE	Approx. 46 hrs	Approx. 46 hrs
FREQUENCY/JEWELS	28,800/h, 27 jewels	28,800/h, 27 jewels
CASE		
MATERIAL	Stainless steel	Stainless steel
BEZEL	Fixed, 18 K yellow gold	Fixed, 18 K red gold
SAPPHIRE CRYSTAL	Domed sapphire crystal with double anti-reflective coating	Domed sapphire crystal with double anti-reflective coating
CASE BACK	Stainless steel case back with sapphire crystal	Stainless steel case back with sapphire crystal
CROWN	Non-screw crown, 1 O-ring, 18 K yellow gold	Non-screw crown, 1 O-ring, 18 K red gold
DIAL	Silver-coloured dial with yellow gold-plated numerals	Anthracite-coloured dial with red gold-plated numerals
HANDS	Yellow gold-plated luminescent hands	Red gold-plated luminescent hands
DISTANCE BETWEEN HORNS/CLASP	22/20 mm	22/20 mm
DIAMETER	43 mm	43 mm
HEIGHT	14.30 mm	14.30 mm
WATER RESISTANT	3 bar (30 m)	3 bar (30 m)
BRACELET / STRAP		
MATERIAL	Stainless steel	Stainless steel
CLASP/BUCKLE	Triple-folding clasp	Triple-folding clasp

MONTBLANC TIMEWALKER COLLECTION

> Steel Gold



MODEL	Montblanc TimeWalker Chronograph Automatic Steel Gold	Montblanc TimeWalker Chronograph Automatic Dual Carbon
IDENT NO.	107322	105805
MOVEMENT		
CALIBRE	Montblanc 4810/502	Montblanc 4810/501
FEATURES	Automatic chronograph	Automatic chronograph
INDICATIONS	Hour - minute - continuous second hands, date display	Hour - minute - continuous second hands, date display
COMPLICATIONS	12 hrs and 30 min. counters, central chronograph hand	12 hrs and 30 min. counters, central chronograph hand
BATTERY	-	-
POWER RESERVE	Approx. 46 hrs	Approx. 46 hrs
FREQUENCY/JEWELS	28,800/h, 27 jewels	28.800/h, 25 Jewels
CASE		
MATERIAL	Stainless steel	Black DLC-coated stainless steel / 18 K red gold pushers
BEZEL	Fixed, 18 K red gold	Fixed
SAPPHIRE CRYSTAL	Domed sapphire crystal with double anti-reflective coating	Domed sapphire crystal with double anti-reflective coating
CASE BACK	Stainless steel case back with sapphire crystal	Sapphire crystal case back
CROWN	Non-screw crown, 1 O-ring, 18 K red gold	Non-screw crown, 1 O-ring, black ceramic
DIAL	Mat silver-coloured dial with red gold-plated numerals	Black dial
HANDS	Red gold-plated luminescent hands	Red gold-plated luminescent hands
DISTANCE BETWEEN HORNS/CLASP	22/20 mm	22/20 mm
DIAMETER	43 mm	43 mm
HEIGHT	14.30 mm	14.4 mm
WATER RESISTANT	3 bar (30 m)	3 bar (30 m)
BRACELET / STRAP		
MATERIAL/COLOUR	Alligator-skin strap / Brown	Alligator-skin strap with stitching / Black
CLASP/BUCKLE	Pin buckle	Black DLC-coated stainless steel pin buckle

MONTBLANC TIMEWALKER COLLECTION

> Steel Gold



MODEL	Montblanc TimeWalker Automatic Steel Gold	Montblanc TimeWalker Automatic Steel Gold	Montblanc TimeWalker Automatic Steel Gold
IDENT NO.	106501	106502	106500
MOVEMENT			
CALIBRE	Montblanc 4810/409	Montblanc 4810/409	Montblanc 4810/409
FEATURES	Automatic	Automatic	Automatic
INDICATIONS	Hour - minute - second hands, date display	Hour - minute - second hands, date display	Hour - minute - second hands, date display
COMPLICATIONS	-	-	-
BATTERY	-	-	-
POWER RESERVE	Approx. 42 hrs	Approx. 42 hrs	Approx. 42 hrs
FREQUENCY/JEWELS	28,800/h, 25 jewels	28,800/h, 25 jewels	28,800/h, 25 jewels
CASE			
MATERIAL	Stainless steel	Stainless steel	Stainless steel
BEZEL	Fixed, 18 K red gold	Fixed, 18 K yellow gold	Fixed, 18 K red gold
SAPPHIRE CRYSTAL	Domed sapphire crystal with double anti-reflective coating	Domed sapphire crystal with double anti-reflective coating	Domed sapphire crystal with double anti-reflective coating
CASE BACK	Sapphire crystal case back	Sapphire crystal case back	Sapphire crystal case back
CROWN	Non-screw crown, 1 O-ring, 18 K red gold	Non-screw crown, 1 O-ring, 18 K yellow gold	Non-screw crown, 1 O-ring, 18 K red gold
DIAL	Anthracite-coloured dial with red gold-plated numerals	Mat silver-coloured dial with red gold-plated numerals	White dial with red gold-plated numerals
HANDS	Red gold-plated luminescent hands	Luminescent yellow gold-plated hands	Red gold-plated luminescent hands
DISTANCE BETWEEN HORNS/CLASP	20/20 mm	20/20 mm	20/18 mm
DIAMETER	39 mm	39 mm	39 mm
HEIGHT	10.4 mm	10.4 mm	10.4 mm
WATER RESISTANT	3 bar (30 m)	3 bar (30 m)	3 bar (30 m)
BRACELET / STRAP			
MATERIAL	Stainless steel bracelet	Stainless steel bracelet	Alligator-skin strap / Brown
CLASP/BUCKLE	Triple-folding clasp	Triple-folding clasp	Pin buckle

MONTBLANC TIME WALKER COLLECTION

> Steel



MODEL	Montblanc TimeWalker ChronoVoyager UTC	Montblanc TimeWalker ChronoVoyager UTC	Montblanc TimeWalker ChronoVoyager UTC
IDENT NO.	107303	107336	107063
MOVEMENT			
CALIBRE	Montblanc 4810/503	Montblanc 4810/503	Montblanc 4810/503
FEATURES	Automatic chronograph	Automatic chronograph	Automatic chronograph
INDICATIONS	Hour - minute - continuous second hands, date display	Hour - minute - continuous second hands, date display	Hour - minute - continuous second hands, date display
COMPLICATIONS	12 hrs and 30 min. counters, central chronograph hand, Second time zone with 24-hour display and day/night indication	12 hrs and 30 min. counters, central chronograph hand, Second time zone with 24-hour display and day/night indication	12 hrs and 30 min. counters, central chronograph hand, Second time zone with 24-hour display and day/night indication
BATTERY	-	-	-
POWER RESERVE	Approx. 46 hrs	Approx. 46 hrs	Approx. 46 hrs
FREQUENCY/JEWELS	28,800/h, 25 jewels	28,800/h, 25 jewels	28,800/h, 25 jewels
CASE			
MATERIAL	Stainless steel	Stainless steel	Stainless steel
BEZEL	Fixed, satin-finished	Fixed, satin-finished	Fixed, satin-finished
SAPPHIRE CRYSTAL	Domed sapphire crystal with double anti-reflective coating	Domed sapphire crystal with double anti-reflective coating	Domed sapphire crystal with double anti-reflective coating
CASE BACK	Sapphire crystal case back	Sapphire crystal case back	Sapphire crystal case back
CROWN	Non-screw crown, 1 O-ring	Non-screw crown, 1 O-ring	Non-screw crown, 1 O-ring
DIAL	Anthracite-coloured dial with red gold-plated numerals	Black dial with rhodium-plated numerals	Anthracite-coloured dial with red gold-plated numerals
HANDS	Red gold-plated luminescent hands	Rhodium-plated luminescent hands	Red gold-plated luminescent hands
DISTANCE BETWEEN HORNS/CLASP	22/20 mm	22/20 mm	22/20 mm
DIAMETER	43 mm	43 mm	43 mm
HEIGHT	14.80 mm	14.80 mm	14.80 mm
WATER RESISTANT	3 bar (30 m)	3 bar (30 m)	3 bar (30 m)
BRACELET / STRAP			
MATERIAL	Stainless steel with satin-finished central links	Alligator-skin strap with grey stitching / Black	Alligator-skin strap with grey stitching / Black
CLASP/BUCKLE	Triple-folding clasp	Pin buckle	Pin buckle

MONTBLANC TIME WALKER COLLECTION

> Steel



MODEL	Montblanc TimeWalker ChronoVoyager UTC	Montblanc TimeWalker ChronoVoyager UTC
IDENT No.	107339	107065
MOVEMENT		
CALIBRE	Montblanc 4810/503	Montblanc 4810/503
FEATURES	Automatic chronograph	Automatic chronograph
INDICATIONS	Hour - minute hands, continuous second disc, date display	Hour - minute - continuous second hands, date display
COMPLICATIONS	12 hrs and 30 min. counters, central chronograph hand, Second time zone with 24-hour display and day/night indication	12 hrs and 30 min. counters, central chronograph hand, Second time zone with 24-hour display and day/night indication
BATTERY	-	-
POWER RESERVE	Approx. 46 hrs	Approx. 46 hrs
FREQUENCY/JEWELS	28,800/h, 25 jewels	28,800/h, 25 jewels
CASE		
MATERIAL	Stainless steel	Stainless steel
BEZEL	Fixed, shot-blasted titanium	Fixed, satin-finished
SAPPHIRE CRYSTAL	Domed sapphire crystal with double anti-reflective coating	Domed sapphire crystal with double anti-reflective coating
CASE BACK	Sapphire crystal case back	Sapphire crystal case back
CROWN	Non-screw crown, 1 O-ring	Non-screw crown, 1 O-ring
DIAL	Anthracite-coloured dial with black numerals	Silver-coloured dial with rhodium-plated numerals
HANDS	Black luminescent hands	Rhodium-plated luminescent hands
DISTANCE BETWEEN HORNS/CLASP	22/20 mm	22/20 mm
DIAMETER	43 mm	43 mm
HEIGHT	14.80 mm	14.80 mm
WATER RESISTANT	3 bar (30 m)	3 bar (30 m)
BRACELET / STRAP		
MATERIAL/COLOUR	Alligator-skin strap with grey stitching / Black	Alligator-skin strap / Brown
CLASP/BUCKLE	Pin buckle	Pin buckle

MONTBLANC TIMEWALKER COLLECTION

> Steel



MODEL	Montblanc TimeWalker Chronograph Automatic Ceramic	Montblanc TimeWalker Chronograph Automatic Ceramic
IDENT NO.	103094	102365
MOVEMENT		
CALIBRE	Montblanc 4810/502	Montblanc 4810/502
FEATURES	Automatic chronograph	Automatic chronograph
INDICATIONS	Hour - minute - continuous second hands, date display	Hour - minute - continuous second hands, date display
COMPLICATIONS	12 hrs and 30 min. counters, central chronograph hand	12 hrs and 30 min. counters, central chronograph hand
BATTERY	-	-
POWER RESERVE	Approx. 46 hrs	Approx. 46 hrs
FREQUENCY/JEWELS	28,800/h, 27 jewels	28,800/h, 27 jewels
CASE		
MATERIAL	Stainless steel	Stainless steel
BEZEL	Fixed, black ceramic	Fixed, black ceramic
SAPPHIRE CRYSTAL	Domed sapphire crystal with double anti-reflective coating	Domed sapphire crystal with double anti-reflective coating
CASE BACK	Sapphire crystal case back	Sapphire crystal case back
CROWN	Non-screw crown, 1 O-ring, black ceramic	Non-screw crown, 1 O-ring, black ceramic
DIAL	Black dial with rhodium-plated numerals	Black dial with rhodium-plated numerals
HANDS	Rhodium-plated luminescent hands	Rhodium-plated luminescent hands
DISTANCE BETWEEN HORNS/CLASP	22/22 mm	22/20 mm
DIAMETER	43 mm	43 mm
HEIGHT	14.5 mm	14.5 mm
WATER RESISTANT	3 bar (30 m)	3 bar (30 m)
BRACELET / STRAP		
MATERIAL	Stainless steel / black ceramic bracelet	Alligator-skin strap with stitching / Black
CLASP/BUCKLE	Triple-folding clasp	Pin buckle

MONTBLANC TIMEWALKER COLLECTION

> Steel



MODEL	Montblanc TimeWalker Chronograph Automatic	Montblanc TimeWalker Chronograph Automatic
IDENT No.	09668	09669
MOVEMENT		
CALIBRE	Montblanc 4810/502	Montblanc 4810/502
FEATURES	Automatic chronograph	Automatic chronograph
INDICATIONS	Hour - minute - continuous second hands, date display	Hour - minute - continuous second hands, date display
COMPLICATIONS	12 hrs and 30 min. counters, central chronograph hand	12 hrs and 30 min. counters, central chronograph hand
BATTERY	-	-
POWER RESERVE	Approx. 46 hrs	Approx. 46 hrs
FREQUENCY/JEWELS	28,800/h, 27 jewels	28,800/h, 27 jewels
CASE		
MATERIAL	Stainless steel	Stainless steel
BEZEL	Fixed	Fixed
SAPPHIRE CRYSTAL	Domed sapphire crystal with anti-reflective coating	Domed sapphire crystal with anti-reflective coating
CASE BACK	Sapphire crystal case back	Sapphire crystal case back
CROWN	Non-screw crown, 1 O-ring	Non-screw crown, 1 O-ring
DIAL	Black dial with rhodium-plated numerals	Silver-coloured dial with rhodium-plated numerals
HANDS	Rhodium-plated luminescent hands	Rhodium-plated luminescent hands
DISTANCE BETWEEN HORNS/CLASP	22/22 mm	22/22 mm
DIAMETER	43 mm	43 mm
HEIGHT	14.5 mm	14.5 mm
WATER RESISTANT	3 bar (30 m)	3 bar (30 m)
BRACELET / STRAP		
MATERIAL	Stainless steel bracelet	Stainless steel bracelet
CLASP/BUCKLE	Triple-folding clasp	Triple-folding clasp

MONTBLANC TIMEWALKER COLLECTION

> Steel



MODEL	Montblanc TimeWalker Chronograph Automatic	Montblanc TimeWalker Chronograph Automatic
IDENT No.	09670	09671
MOVEMENT		
CALIBRE	Montblanc 4810/502	Montblanc 4810/502
FEATURES	Automatic chronograph	Automatic chronograph
INDICATIONS	Hour - minute - continuous second hands, date display	Hour - minute - continuous second hands, date display
COMPLICATIONS	12 hrs and 30 min. counters, central chronograph hand	12 hrs and 30 min. counters, central chronograph hand
BATTERY	-	-
POWER RESERVE	Approx. 46 hrs	Approx. 46 hrs
FREQUENCY/JEWELS	28,800/h, 27 jewels	28,800/h, 27 jewels
CASE		
MATERIAL	Stainless steel	Stainless steel
BEZEL	Fixed	Fixed
SAPPHIRE CRYSTAL	Domed sapphire crystal with anti-reflective coating	Domed sapphire crystal with anti-reflective coating
CASE BACK	Sapphire crystal case back	Sapphire crystal case back
CROWN	Non-screw crown, 1 O-ring	Non-screw crown, 1 O-ring
DIAL	Black dial with rhodium-plated numerals	Silver-coloured dial with rhodium-plated numerals
HANDS	Rhodium-plated luminescent hands	Rhodium-plated luminescent hands
DISTANCE BETWEEN HORNS/CLASP	22/20 mm	22/20 mm
DIAMETER	43 mm	43 mm
HEIGHT	14.5 mm	14.5 mm
WATER RESISTANT	3 bar (30 m)	3 bar (30 m)
BRACELET / STRAP		
MATERIAL/COLOUR	Alligator-skin strap / Black	Alligator-skin strap / Brown
CLASP/BUCKLE	Pin buckle	Pin buckle

MONTBLANC TIME WALKER COLLECTION

> Steel



MODEL	Montblanc TimeWalker Chronograph Automatic Club Brown
IDENT No.	106503
MOVEMENT	
CALIBRE	Montblanc 4810/501
FEATURES	Automatic chronograph
INDICATIONS	Hour - minute - continuous second hands, date display
COMPLICATIONS	12 hrs and 30 min. counters, central chronograph hand
BATTERY	-
POWER RESERVE	Approx. 46 hrs
FREQUENCY/JEWELS	28,800/h, 25 jewels
CASE	
MATERIAL	Stainless steel
BEZEL	Fixed
SAPPHIRE CRYSTAL	Domed sapphire crystal with double anti-reflective coating
CASE BACK	Sapphire crystal case back
CROWN	Non-screw crown, 1 O-ring
DIAL	Brown dial with rhodium-plated numerals
HANDS	Rhodium-plated luminescent hands
DISTANCE BETWEEN HORNS/CLASP	22/20 mm
DIAMETER	43 mm
HEIGHT	14.5 mm
WATER RESISTANT	3 bar (30 m)
BRACELET / STRAP	
MATERIAL/COLOUR	Alligator-skin strap with stitching / Brown
CLASP/BUCKLE	Pin buckle

MONTBLANC TIMEWALKER COLLECTION

> Steel



MODEL	Montblanc TimeWalker Chronograph Automatic	Montblanc TimeWalker Chronograph Automatic
IDENT No.	101548	101549
MOVEMENT		
CALIBRE	Montblanc 4810/502	Montblanc 4810/502
FEATURES	Automatic chronograph	Automatic chronograph
INDICATIONS	Hour - minute - continuous second hands, date display	Hour - minute - continuous second hands, date display
COMPLICATIONS	12 hrs and 30 min. counters, central chronograph hand	12 hrs and 30 min. counters, central chronograph hand
BATTERY	-	-
POWER RESERVE	Approx. 46 hrs	Approx. 46 hrs
FREQUENCY/JEWELS	28,800/h, 27 jewels	28,800/h, 27 jewels
CASE		
MATERIAL	Stainless steel	Stainless steel
BEZEL	Fixed	Fixed
SAPPHIRE CRYSTAL	Domed sapphire crystal with anti-reflective coating	Domed sapphire crystal with anti-reflective coating
CASE BACK	Sapphire crystal case back	Sapphire crystal case back
CROWN	Non-screw crown, 1 O-ring	Non-screw crown, 1 O-ring
DIAL	Black dial with red gold-plated numerals	Mat silver-coloured dial with red gold-plated numerals
HANDS	Red gold-plated luminescent hands	Red gold-plated luminescent hands
DISTANCE BETWEEN HORNS/CLASP	22/20 mm	22/20 mm
DIAMETER	43 mm	43 mm
HEIGHT	14.3 mm	14.3 mm
WATER RESISTANT	3 bar (30 m)	3 bar (30 m)
BRACELET / STRAP		
MATERIAL/COLOUR	Alligator-skin strap with stitching / Black	Alligator-skin strap with stitching / Black
CLASP/BUCKLE	Pin buckle	Pin buckle

TIMEWALKER COLLECTION

> Steel



MODEL	Montblanc TimeWalker World-Time Hemispheres, Southern Hemisphere	Montblanc TimeWalker World-Time Hemispheres, Northern Hemisphere
IDENT NO.	108956	108955
MOVEMENT		
CALIBRE	4810/412	4810/410
FEATURES	Automatic	Automatic
INDICATIONS	Hour - minute - second hands, date display	Hour - minute - second hands, date display
COMPLICATIONS	World time indication for 24 time zones	World time indication for 24 time zones
BATTERY	-	-
POWER RESERVE	Approx. 42 hrs	Approx. 42 hrs
FREQUENCY/JEWELS	28,000/h, 21 jewels	28,800 vib./h, 21 jewels
CASE		
MATERIAL	Stainless steel	Stainless steel
BEZEL	Fixed, satin-finished titanium	Fixed, satin-finished titanium
SAPPHIRE CRYSTAL	Domed sapphire crystal with double anti-reflective coating	Domed sapphire crystal with double anti-reflective coating
CASE BACK	Stainless steel case back with display of 24 time zones of northern hemisphere	Stainless steel case back with display of 24 time zones of southern hemisphere
CROWN	Non-screw crown, 1 O-ring	Non-screw crown, 1 O-ring
DIAL	Anthracite dial showing the southern hemisphere as seen from the South Pole	Silver-coloured dial showing the northern hemisphere as seen from the North Pole
HANDS	Rhodium-plated luminescent hands	Rhodium-plated luminiscent hands
DISTANCE BETWEEN HORNS/CLASP	22/20 mm	22/20 mm
DIAMETER	42 mm	42 mm
HEIGHT	12.05 mm	12.05 mm
WATER RESISTANT	3 bar (30 m)	3 bar (30 m)
BRACELET / STRAP		
MATERIAL	Stainless steel bracelet with satin-finished titanium central links	Embossed calfskin strap with blue stitching / Black
CLASP/BUCKLE	Triple-folding clasp	Pin buckle

TIMEWALKER COLLECTION

> Steel



MODEL	Montblanc TimeWalker Voyager UTC	Montblanc TimeWalker Voyager UTC	Montblanc TimeWalker Voyager UTC
IDENT NO.	109135	109137	109136
MOVEMENT			
CALIBRE	Montblanc 4810/405	Montblanc 4810/405	Montblanc 4810/405
FEATURES	Automatic	Automatic	Automatic
INDICATIONS	Hour - minute - second hands, date display	Hour - minute - second hands, date display	Hour - minute - second hands, date display
COMPLICATIONS	Second time zone with 24-hour display and day/night indication	Second time zone with 24-hour display and day/night indication	Second time zone with 24-hour display and day/night indication
BATTERY	-	-	-
POWER RESERVE	Approx. 42 hrs	Approx. 42 hrs	Approx. 42 hrs
FREQUENCY/JEWELS	28,800 vib./h, 21 jewels	28,800 vib./h, 21 jewels	28,000/h, 21 jewels
CASE			
MATERIAL	Stainless steel	Stainless steel	Stainless steel
BEZEL	Fixed, satin-finished	Fixed, shot-blasted titanium	Fixed, satin-finished
SAPPHIRE CRYSTAL	Domed sapphire crystal with double anti-reflective coating	Domed sapphire crystal with double anti-reflective coating	Domed sapphire crystal with double anti-reflective coating
CASE BACK	Sapphire crystal case back	Sapphire crystal case back	Sapphire crystal case back
CROWN	Non-screw crown, 1 O-ring	Non-screw crown, 1 O-ring	Non-screw crown, 1 O-ring
DIAL	Black dial with rhodium-plated numerals	Anthracite dial with rhodium-plated numerals	Mat silver-coloured dial with red gold-plated numerals
HANDS	Rhodium-plated luminescent hands	Rhodium-plated luminescent hands	Red gold-plated luminescent hands
DISTANCE BETWEEN HORNS/CLASP	22/20 mm	22/20 mm	22/20 mm
DIAMETER	42 mm	42 mm	42 mm
HEIGHT	11 mm	11 mm	11 mm
WATER RESISTANT	3 bar (30 m)	3 bar (30 m)	3 bar (30 m)
BRACELET / STRAP			
MATERIAL	Stainless steel with satin-finished central links	Embossed calfskin strap with orange stitching / Black	Alligator-skin strap / Black
CLASP/BUCKLE	Triple-folding clasp	Pin buckle	Pin buckle

MONTBLANC TIMEWALKER COLLECTION

> Steel



MODEL	Montblanc TimeWalker GMT Automatic	Montblanc TimeWalker GMT Automatic Club Brown
IDENT No.	36065	106593
MOVEMENT		
CALIBRE	Montblanc 4810/405	Montblanc 4810/405
FEATURES	Automatic	Automatic
INDICATIONS	Hour - minute - second hands, date display	Hour - minute - second hands, date display
COMPLICATIONS	24-hour display with second time zone	24-hour display with second time zone
BATTERY	-	-
POWER RESERVE	Approx. 42 hrs	Approx. 42 hrs
FREQUENCY/JEWELS	28,800 vib./h, 21 jewels	28,800 vib./h, 21 jewels
CASE		
MATERIAL	Stainless steel	Stainless steel
BEZEL	Fixed	Fixed
SAPPHIRE CRYSTAL	Domed sapphire crystal with anti-reflective coating	Domed sapphire crystal with anti-reflective coating
CASE BACK	Sapphire crystal case back	Sapphire crystal case back
CROWN	Non-screw crown, 1 O-ring	Non-screw crown, 1 O-ring
DIAL	Black dial with rhodium-plated numerals	Brown dial with rhodium-plated numerals
HANDS	Rhodium-plated luminescent hands	Rhodium-plated luminescent hands
DISTANCE BETWEEN HORNS/CLASP	22/20 mm	22/20 mm
DIAMETER	42 mm	42 mm
HEIGHT	11 mm	11 mm
WATER RESISTANT	3 bar (30 m)	3 bar (30 m)
BRACELET / STRAP		
MATERIAL/COLOUR	Alligator-skin strap / Black	Alligator-skin strap with stitching / Brown
CLASP/BUCKLE	Pin buckle	Pin buckle

MONTBLANC TIMEWALKER COLLECTION

> Steel



MODEL	Montblanc TimeWalker Automatic	Montblanc TimeWalker Automatic
IDENT No.	09672	101551
MOVEMENT		
CALIBRE	Montblanc 4810/401	Montblanc 4810/401
FEATURES	Automatic	Automatic
INDICATIONS	Hour - minute - second hands, date display	Hour - minute - second hands, date display
COMPLICATIONS	-	-
BATTERY	-	-
POWER RESERVE	Approx. 42 hrs	Approx. 42 hrs
FREQUENCY/JEWELS	28,800 vib./h, 21 jewels	28,800 vib./h, 21 jewels
CASE		
MATERIAL	Stainless steel	Stainless steel
BEZEL	Fixed	Fixed
SAPPHIRE CRYSTAL	Domed sapphire crystal with anti-reflective coating	Domed sapphire crystal with anti-reflective coating
CASE BACK	Screwed stainless steel case back	Screwed stainless steel case back
CROWN	Non-screw crown, 1 O-ring	Non-screw crown, 1 O-ring
DIAL	Black dial with rhodium-plated numerals	Black dial with red gold-plated numerals
HANDS	Rhodium-plated luminescent hands	Red gold-plated luminescent hands
DISTANCE BETWEEN HORNS/CLASP	22/22 mm	22/20 mm
DIAMETER	42 mm	42 mm
HEIGHT	11.5 mm	11.6 mm
WATER RESISTANT	3 bar (30 m)	3 bar (30 m)
BRACELET / STRAP		
MATERIAL	Stainless steel bracelet	Alligator-skin strap with stitching / Black
CLASP/BUCKLE	Triple-folding clasp	Pin buckle

MONTBLANC TIMEWALKER COLLECTION

> Steel



MODEL	Montblanc TimeWalker Automatic	Montblanc TimeWalker Automatic
IDENT No.	09675	101550
MOVEMENT		
CALIBRE	Montblanc 4810/401	Montblanc 4810/401
FEATURES	Automatic	Automatic
INDICATIONS	Hour - minute - second hands, date display	Hour - minute - second hands, date display
COMPLICATIONS	-	-
BATTERY	-	-
POWER RESERVE	Approx. 42 hrs	Approx. 42 hrs
FREQUENCY/JEWELS	28,800 vib./h, 21 jewels	28,800 vib./h, 21 jewels
CASE		
MATERIAL	Stainless steel	Stainless steel
BEZEL	Fixed	Fixed
SAPPHIRE CRYSTAL	Domed sapphire crystal with anti-reflective coating	Domed sapphire crystal with anti-reflective coating
CASE BACK	Screwed stainless steel case back	Screwed stainless steel case back
CROWN	Non-screw crown, 1 O-ring	Non-screw crown, 1 O-ring
DIAL	Silver-coloured dial with rhodium-plated numerals	Mat silver-coloured dial with red gold-plated numerals
HANDS	Rhodium-plated luminescent hands	Red gold-plated luminescent hands
DISTANCE BETWEEN HORNS/CLASP	22/20 mm	22/20 mm
DIAMETER	42 mm	42 mm
HEIGHT	11.5 mm	11.6 mm
WATER RESISTANT	3 bar (30 m)	3 bar (30 m)
BRACELET / STRAP		
MATERIAL/COLOUR	Alligator-skin strap / Brown	Alligator-skin strap with stitching / Brown
CLASP/BUCKLE	Pin buckle	Pin buckle

MONTBLANC TIME WALKER COLLECTION

> Steel



MODEL	Montblanc TimeWalker Automatic	Montblanc TimeWalker Automatic	Montblanc TimeWalker Automatic
IDENT No.	105962	105812	105813
MOVEMENT			
CALIBRE	Montblanc 4810/409	Montblanc 4810/409	Montblanc 4810/409
FEATURES	Automatic	Automatic	Automatic
INDICATIONS	Hour - minute - second hands, date display	Hour - minute - second hands, date display	Hour - minute - second hands, date display
COMPLICATIONS	-	-	-
BATTERY	-	-	-
POWER RESERVE	Approx. 42 hrs	Approx. 42 hrs	Approx. 42 hrs
FREQUENCY/JEWELS	28,800 vib./h, 21 jewels	28,800 vib./h, 21 jewels	28,800 vib./h, 21 jewels
CASE			
MATERIAL	Stainless steel	Stainless steel	Stainless steel
BEZEL	Fixed	Fixed	Fixed
SAPPHIRE CRYSTAL	Domed sapphire crystal with anti-reflective coating	Domed sapphire crystal with anti-reflective coating	Domed sapphire crystal with anti-reflective coating
CASE BACK	Screwed stainless steel case back	Screwed stainless steel case back	Screwed stainless steel case back
CROWN	Non-screw crown, 1 O-ring	Non-screw crown, 1 O-ring	Non-screw crown, 1 O-ring
DIAL	Black dial with rhodium-plated numerals	Black dial with rhodium-plated numerals	Mat silver-coloured dial with red gold-plated numerals
HANDS	Rhodium-plated luminescent hands	Rhodium-plated luminescent hands	Red gold-plated luminescent hands
DISTANCE BETWEEN HORNS/CLASP	20/20 mm	20/18 mm	20/18 mm
DIAMETER	39 mm	39 mm	39 mm
HEIGHT	10.4 mm	10.4 mm	10.4 mm
WATER RESISTANT	3 bar (30 m)	3 bar (30 m)	3 bar (30 m)
BRACELET / STRAP			
MATERIAL	Stainless steel bracelet	Alligator-skin strap with stitching / Black	Alligator-skin strap with stitching / Brown
CLASP/BUCKLE	Triple-folding clasp	Pin buckle	Pin buckle

MONTBLANC SPORT COLLECTION

MONTBLANC SPORT COLLECTION

> Tantalum : 44 mm



A Id. 103113 p. 167

> Steel : 44 mm



A Id. 104659 p. 168



A Id. 104279 p. 168



A Id. 104280 p. 169

> Steel : 41.5 mm



A Id. 03273 p. 170



A Id. 03274 p. 170

> Steel : 34.5 mm



Q Id. 102362 p. 171



Q Id. 103893 p. 171

H=Handwinding **A**=Automatic **Q**=Quartz

MONTBLANC SPORT COLLECTION

> Tantalum



MODEL	Montblanc Sport Tantalum Red Gold Chronograph Automatic
IDENT No.	103113
MOVEMENT	
CALIBRE	Montblanc 4810/501
FEATURES	Automatic chronograph, Automatic helium valve, Officially certified chronometer (COSC)
INDICATIONS	Hour - minute - continuous second hands, date display with magnifying glass
COMPLICATIONS	12 hrs and 30 min. counters, central chronograph hand
BATTERY	-
POWER RESERVE	Approx. 48 hrs
FREQUENCY/JEWELS	28,800/h, 25 jewels
CASE	
MATERIAL	Tantalum / 18 K red gold pushers
BEZEL	18 K red gold unidirectional rotating bezel
SAPPHIRE CRYSTAL	Flat sapphire crystal with anti-reflective coating
CASE BACK	Screwed tantalum case back
CROWN	Screw-down crown, 2 O-rings, 18 K red gold with mother-of-pearl Montblanc emblem
DIAL	Black dial with luminescent indexes and 18 K red gold-plated counter rings
HANDS	18 K red gold-plated luminescent hands
DISTANCE BETWEEN HORNS/CLASP	22/20 mm
DIAMETER	44 mm
HEIGHT	15,6 mm
WATER RESISTANT	30 bar (300 m)
BRACELET / STRAP	
MATERIAL/COLOUR	Rubber strap / Black
CLASP/BUCKLE	18 K red gold pin buckle (~ 13 g)

MONTBLANC SPORT COLLECTION

> Steel



MODEL	Montblanc Sport Chronograph Automatic	Montblanc Sport DLC Chronograph Automatic
IDENT No.	104659	104279
MOVEMENT		
CALIBRE	Montblanc 4810/501	Montblanc 4810/501
FEATURES	Automatic chronograph	Automatic chronograph
INDICATIONS	Hour - minute - continuous second hands, date display with magnifying glass	Hour - minute - continuous second hands, date display with magnifying glass
COMPLICATIONS	12 hrs and 30 min. counters, central chronograph hand	12 hrs and 30 min. counters, central chronograph hand
BATTERY	-	-
POWER RESERVE	Approx. 46 hrs	Approx. 46 hrs
FREQUENCY/JEWELS	28,800/h, 25 jewels	28,800/h, 25 jewels
CASE		
MATERIAL	Stainless steel	Black DLC-coated stainless steel
BEZEL	Unidirectional turning bezel, details in relief	Unidirectional turning bezel, details in relief
SAPPHIRE CRYSTAL	Flat sapphire crystal with double anti-reflective coating	Flat sapphire crystal with double anti-reflective coating
CASE BACK	Screwed stainless steel case back	Screwed black DLC-coated stainless steel case back
CROWN	Screw-down crown, 2 O-rings	Screw-down crown, 2 O-rings
DIAL	Black dial with luminescent indexes	Black dial with luminescent indexes
HANDS	Rhodium-plated luminescent hands	Rhodium-plated luminescent hands
DISTANCE BETWEEN HORNS/CLASP	22/22 mm	22/20 mm
DIAMETER	44 mm	44 mm
HEIGHT	15,8 mm	15,8 mm
WATER RESISTANT	20 bar (200 m)	20 bar (200 m)
BRACELET / STRAP		
MATERIAL	Stainless steel bracelet	Alligator-skin strap / Black
CLASP/BUCKLE	Triple-folding clasp	Triple-folding clasp

MONTBLANC SPORT COLLECTION

> Steel



MODEL	Montblanc Sport Chronograph Automatic
IDENT No.	104280
MOVEMENT	
CALIBRE	Montblanc 4810/501
FEATURES	Automatic chronograph
INDICATIONS	Hour - minute - continuous second hands, date display with magnifying glass
COMPLICATIONS	12 hrs and 30 min. counters, central chronograph hand
BATTERY	-
POWER RESERVE	Approx. 46 hrs
FREQUENCY/JEWELS	28,800/h, 25 jewels
CASE	
MATERIAL	Stainless steel
BEZEL	Unidirectional turning bezel, details in relief
SAPPHIRE CRYSTAL	Flat sapphire crystal with double anti-reflective coating
CASE BACK	Screwed stainless steel case back
CROWN	Screw-down crown, 2 O-rings
DIAL	Silver-coloured dial with luminescent indexes
HANDS	Rhodium-plated luminescent hands
DISTANCE BETWEEN HORNS/CLASP	22/20 mm
DIAMETER	44 mm
HEIGHT	15.8 mm
WATER RESISTANT	20 bar (200 m)
BRACELET / STRAP	
MATERIAL/COLOUR	Alligator-skin strap / Black
CLASP/BUCKLE	Triple-folding clasp

MONTBLANC SPORT COLLECTION

> Steel



MODEL	Montblanc Sport Chronograph Automatic	Montblanc Sport Chronograph Automatic
IDENT NO.	03273	03274
MOVEMENT		
CALIBRE	Montblanc 4810/501	Montblanc 4810/501
FEATURES	Automatic chronograph	Automatic chronograph
INDICATIONS	Hour - minute - continuous second hands, date display with magnifying glass	Hour - minute - continuous second hands, date display with magnifying glass
COMPLICATIONS	12 hrs and 30 min. counters, central chronograph hand	12 hrs and 30 min. counters, central chronograph hand
BATTERY	-	-
POWER RESERVE	Approx. 46 hrs	Approx. 46 hrs
FREQUENCY/JEWELS	28,800/h, 25 jewels	28,800/h, 25 jewels
CASE		
MATERIAL	Stainless steel	Stainless steel
BEZEL	Unidirectional rotating bezel	Unidirectional rotating bezel
SAPPHIRE CRYSTAL	Flat sapphire crystal with anti-reflective coating	Flat sapphire crystal with anti-reflective coating
CASE BACK	Screwed stainless steel case back	Screwed stainless steel case back
CROWN	Screw-down crown, 2 O-rings	Screw-down crown, 2 O-rings
DIAL	Black dial with luminescent indexes	Black dial with luminescent indexes
HANDS	Rhodium-plated luminescent hands	Rhodium-plated luminescent hands
DISTANCE BETWEEN HORNS/CLASP	20/20 mm	20/18 mm
DIAMETER	41.5 mm	41.5 mm
HEIGHT	14.5 mm	14.5 mm
WATER RESISTANT	20 bar (200 m)	20 bar (200 m)
BRACELET / STRAP		
MATERIAL	Stainless steel bracelet	Rubber strap / Black
CLASP/BUCKLE	Triple-folding clasp	Triple-folding clasp

MONTBLANC SPORT COLLECTION

> Steel



MODEL	Montblanc Sport Lady Diamonds	Montblanc Sport Lady
IDENT No.	102362	103893
MOVEMENT		
CALIBRE	Montblanc 4810/101	Montblanc 4810/101
FEATURES	Quartz, Battery end-of-life indicator	Quartz, Battery end-of-life indicator
INDICATIONS	Hour - minute - second hands, date display	Hour - minute - second hands, date display
COMPLICATIONS	-	-
BATTERY	395/1.5 V	395/1.5 V
POWER RESERVE	-	-
FREQUENCY/JEWELS	7 jewels	7 jewels
CASE		
MATERIAL	Stainless steel	Stainless steel
BEZEL	Fixed, set with 11 diamonds and a Montblanc Diamond (patented Montblanc Diamond cut / ~ 0.055 ct)	Unidirectional rotating bezel
SAPPHIRE CRYSTAL	Flat sapphire crystal with anti-reflective coating	Flat sapphire crystal with anti-reflective coating
CASE BACK	Stainless steel case back	Screwed stainless steel case back
CROWN	Screw-down crown, 2 O-rings	Screw-down crown, 2 O-rings
DIAL	White mother-of-pearl dial with 11 diamonds (~ 0.033 ct)	White mother-of-pearl dial with 11 diamonds (~ 0.033 ct)
HANDS	Rhodium-plated luminescent hands	Rhodium-plated luminescent hands
DISTANCE BETWEEN HORNS/CLASP	17/17 mm	17/16 mm
DIAMETER	34.5 mm	34.5 mm
HEIGHT	11.15 mm	11.15 mm
WATER RESISTANT	20 bar (200 m)	20 bar (200 m)
BRACELET / STRAP		
MATERIAL	Polished stainless steel bracelet	Rubber strap / White
CLASP/BUCKLE	Triple-folding clasp	Triple-folding clasp

COLLECTION PRINCESSE GRACE DE MONACO

COLLECTION PRINCESSE GRACE DE MONACO

> Gold : 34 mm



A Id. 109275 p. 175



Q Id. 106886 p. 176

> Steel : 34 mm



A Id. 109273 p. 177



Q Id. 106499 p. 178



Q Id. 106884 p. 178



A Id. 109274 p. 179



Q Id. 107334 p. 180



Q Id. 107335 p. 180

COLLECTION *PRINCESSE GRACE DE MONACO*

> Gold



MODEL	Montblanc Collection Princesse Grace de Monaco Automatic
IDENT No.	109275
MOVEMENT	
CALIBRE	Montblanc 4810/409
FEATURES	Automatic
INDICATIONS	Hour - minute - second hands, date display
COMPLICATIONS	-
BATTERY	-
POWER RESERVE	Approx. 42 hrs
FREQUENCY/JEWELS	28,800/h, 25 jewels
CASE	
MATERIAL	18 K red gold (32 g)
BEZEL	Fixed 18 K red gold bezel set with 126 Top Wesselton diamonds (~ 0.618 ct)
SAPPHIRE CRYSTAL	Domed sapphire crystal with double anti-reflective coating
CASE BACK	18 K red gold case back with sapphire crystal fixed by 4 screws
CROWN	Non-screw crown, 1 O-ring, 18 K red gold with a Montblanc Diamond (patented Montblanc Diamond cut: ~ 0.055 ct)
DIAL	White mother-of-pearl dial with red gold-plated numeral, 9 Top Wesselton diamond indexes (~0.054 ct) and pear-shaped pink sapphire (~0.02 ct)
HANDS	Red gold-plated feuille hands
DISTANCE BETWEEN HORNS/CLASP	15/14 mm
DIAMETER	34 mm
HEIGHT	10.80 mm
WATER RESISTANT	3 bar (30 m)
BRACELET / STRAP	
MATERIAL/COLOUR	Alligator-skin strap / White
CLASP/BUCKLE	18 K red gold pin buckle (4.80 g)

COLLECTION PRINCESSE GRACE DE MONACO

> Gold



MODEL	Montblanc Collection Princesse Grace de Monaco
IDENT No.	106886
MOVEMENT	
CALIBRE	Montblanc 4810/160
FEATURES	Quartz
INDICATIONS	Hour - minute - small second at 6 o'clock
COMPLICATIONS	-
BATTERY	364/1.5 V
POWER RESERVE	-
FREQUENCY/JEWELS	4 jewels
CASE	
MATERIAL	18 K red gold (~ 35.40 g)
BEZEL	Fixed, 18 K red gold
SAPPHIRE CRYSTAL	Domed sapphire crystal with double anti-reflective coating
CASE BACK	18 K red gold case back with engraved Princesse Grace monogram
CROWN	Non-screwed crown, 1 O-ring, 18 K red gold with a Montblanc Diamond (patented Montblanc Diamond cut / ~ 0.055 ct)
DIAL	White mother-of-pearl dial with red gold-plated numerals, 6 diamonds (~ 0.02 ct) and a drop-cut pink sapphire (~ 0.02 ct), flange set with 130 diamonds (~ 0.39 ct)
HANDS	Red gold-plated feuille hands
DISTANCE BETWEEN HORNS/CLASP	15/14 mm
DIAMETER	34 mm
HEIGHT	9.70 mm
WATER RESISTANT	3 bar (30 m)
BRACELET / STRAP	
MATERIAL/COLOUR	Alligator-skin strap / White
CLASP/BUCKLE	18 K red gold pin buckle (~ 4.80 g)

COLLECTION PRINCESSE GRACE DE MONACO

> Steel



MODEL	Montblanc Collection Princesse Grace de Monaco Automatic
IDENT No.	109273
MOVEMENT	
CALIBRE	Montblanc 4810/409
FEATURES	Automatic
INDICATIONS	Hour - minute - second hands, date display
COMPLICATIONS	-
BATTERY	-
POWER RESERVE	Approx. 42 hrs
FREQUENCY/JEWELS	28,000/h, 25 jewels
CASE	
MATERIAL	Stainless steel
BEZEL	Fixed, set with 126 Top Wesselton diamonds (0.618 ct)
SAPPHIRE CRYSTAL	Domed sapphire crystal with double anti-reflective coating
CASE BACK	Sapphire crystal case back fixed by 4 screws
CROWN	Non-screw crown, 1 O-ring, with mother-of-pearl Montblanc emblem
DIAL	White mother-of-pearl dial with rhodium-plated numeral, 9 Top Wesselton diamond indexes (~0.054 ct) and pear-shaped pink sapphire (~0.02 ct)
HANDS	Rhodium-plated feuille hands
DISTANCE BETWEEN HORNS/CLASP	15/14 mm
DIAMETER	34 mm
HEIGHT	10.80 mm
WATER RESISTANT	3 bar (30 m)
BRACELET / STRAP	
MATERIAL/COLOUR	Alligator-skin strap / White
CLASP/BUCKLE	Pin buckle

COLLECTION *PRINCESSE GRACE DE MONACO*> *Steel*

MODEL	Montblanc Collection Princesse Grace de Monaco	Montblanc Collection Princesse Grace de Monaco
IDENT No.	106884	106499
MOVEMENT		
CALIBRE	Montblanc 4810/160	Montblanc 4810/160
FEATURES	Quartz	Quartz
INDICATIONS	Hour - minute - small second at 6 o'clock	Hour - minute - small second at 6 o'clock
COMPLICATIONS	-	-
BATTERY	364/1.5 V	364/1.5 V
POWER RESERVE	-	-
FREQUENCY/JEWELS	4 jewels	4 jewels
CASE		
MATERIAL	Stainless steel	Stainless steel
BEZEL	Fixed	Fixed
SAPPHIRE CRYSTAL	Domed sapphire crystal with double anti-reflective coating	Domed sapphire crystal with double anti-reflective coating
CASE BACK	Stainless steel case back with engraved Princesse Grace monogram	Stainless steel case back with engraved Princesse Grace monogram
CROWN	Non-screwed crown, 1 O-ring with mother-of-pearl Montblanc emblem	Non-screwed crown, 1 O-ring with mother-of-pearl Montblanc emblem
DIAL	White dial with silver-coloured numerals, 6 diamonds (~ 0.0204 ct) and a drop-cut pink sapphire at 6 o'clock (~ 0.02 ct), flange set with 130 diamonds (~ 0.39 ct)	White dial with red gold-plated numerals, 6 diamonds (~ 0.0204 ct) and a drop-cut pink sapphire (~ 0.02 ct), flange set with 130 diamonds (~ 0.39 ct)
HANDS	Rhodium-plated feuille hands	Red gold-plated feuille hands
DISTANCE BETWEEN HORNS/CLASP	15/14 mm	15/14 mm
DIAMETER	34 mm	34 mm
HEIGHT	9.70 mm	9.70 mm
WATER RESISTANT	3 bar (30 m)	3 bar (30 m)
BRACELET / STRAP		
MATERIAL/COLOUR	Alligator-skin strap / Black	Alligator-skin strap / White
CLASP/BUCKLE	Pin buckle	Pin buckle

COLLECTION *PRINCESSE GRACE DE MONACO*> *Steel*

MODEL	Montblanc Collection Princesse Grace de Monaco Automatic
IDENT No.	109274
MOVEMENT	
CALIBRE	Montblanc 4810/409
FEATURES	Automatic
INDICATIONS	Hour - minute - second hands, date display
COMPLICATIONS	-
BATTERY	-
POWER RESERVE	Approx. 42 hrs
FREQUENCY/JEWELS	28,000/h, 25 jewels
CASE	
MATERIAL	Stainless steel
BEZEL	Fixed
SAPPHIRE CRYSTAL	Domed sapphire crystal with double anti-reflective coating
CASE BACK	Sapphire crystal case back fixed by 4 screws
CROWN	Non-screwed crown, 1 O-ring with mother-of-pearl Montblanc emblem
DIAL	White mother-of-pearl dial with red gold-plated numeral, 9 Top Wesselton diamond indexes (~0.054 ct) and pear-shaped pink sapphire (~0.02 ct)
HANDS	Red gold-plated feuille hands
DISTANCE BETWEEN HORNS/CLASP	15/14 mm
DIAMETER	34 mm
HEIGHT	10.80 mm
WATER RESISTANT	3 bar (30 m)
BRACELET / STRAP	
MATERIAL/COLOUR	Alligator-skin strap / White
CLASP/BUCKLE	Pin buckle

COLLECTION *PRINCESSE GRACE DE MONACO*> *Steel*

MODEL	Montblanc Collection Princesse Grace de Monaco	Montblanc Collection Princesse Grace de Monaco
IDENT No.	107334	107335
MOVEMENT		
CALIBRE	Montblanc 4810/160	Montblanc 4810/160
FEATURES	Quartz	Quartz
INDICATIONS	Hour - minute - small second at 6 o'clock	Hour - minute - small second at 6 o'clock
COMPLICATIONS	-	-
BATTERY	364/1.5 V	364/1.5 V
POWER RESERVE	-	-
FREQUENCY/JEWELS	4 jewels	4 jewels
CASE		
MATERIAL	Stainless steel	Stainless steel
BEZEL	Fixed	Fixed
SAPPHIRE CRYSTAL	Domed sapphire crystal with double anti-reflective coating	Domed sapphire crystal with double anti-reflective coating
CASE BACK	Stainless steel case back with engraved Princesse Grace monogram	Stainless steel case back with engraved Princesse Grace monogram
CROWN	Non-screwed crown, 1 O-ring with mother-of-pearl Montblanc emblem	Non-screwed crown, 1 O-ring with mother-of-pearl Montblanc emblem
DIAL	White dial with red gold-plated numerals, 6 diamonds (~0.0204 ct) and a drop-cut pink sapphire at 6 o'clock (~0.02 ct)	White dial with silver-coloured numerals, 6 diamonds (~0.0204 ct) and a drop-cut pink sapphire (~0.02 ct)
HANDS	Red gold-plated feuille hands	Rhodium-plated feuille hands
DISTANCE BETWEEN HORNS/CLASP	15/14 mm	15/14 mm
DIAMETER	34 mm	34 mm
HEIGHT	9.70 mm	9.70 mm
WATER RESISTANT	3 bar (30 m)	3 bar (30 m)
BRACELET / STRAP		
MATERIAL/COLOUR	Calfskin strap / White	Calfskin strap / Grey
CLASP/BUCKLE	Pin buckle	Pin buckle

MONTBLANC PROFILE COLLECTION

MONTBLANC PROFILE COLLECTION

> Gold Jewellery : 23 x 35 mm



Q Id. 104289

p. 184



Q Id. 104288

p. 184

> Steel Jewellery : 23 x 35 mm



Q Id. 101557

p. 185



Q Id. 101559

p. 185



Q Id. 101558

p. 186



Q Id. 101556

p. 186



Q Id. 102370

p. 187



Q Id. 102369

p. 187

MONTBLANC PROFILE COLLECTION

> Steel : 23 x 35 mm



Q Id. 104291 p. 188



Q Id. 104294 p. 188



Q Id. 106490 p. 189



Q Id. 106491 p. 189



Q Id. 104293 p. 190



Q Id. 106169 p. 191



Q Id. 105862 p. 191



Q Id. 101554 p. 192



Q Id. 102623 p. 192



Q Id. 102624 p. 193



Q Id. 102622 p. 193



Q Id. 107311 p. 194



Q Id. 107312 p. 194



Q Id. 107313 p. 194



Q Id. 36056 p. 195



Q Id. 36975 p. 195



Q Id. 36974 p. 195

H=Handwinding A=Automatic Q=Quartz

MONTBLANC PROFILE COLLECTION

> Gold Jewellery



MODEL	Montblanc Profile Lady Elegance	Montblanc Profile Lady Elegance
IDENT No.	104289	104288
MOVEMENT		
CALIBRE	Montblanc 4810/110	Montblanc 4810/110
FEATURES	Quartz	Quartz
INDICATIONS	Hour - minute hands	Hour - minute hands
COMPLICATIONS	-	-
BATTERY	317/1.5 V	317/1.5 V
POWER RESERVE	-	-
FREQUENCY/JEWELS	5 jewels	5 jewels
CASE		
MATERIAL	18 K red gold (~ 38.4 g), set with 29 Top Wesselton diamonds (~ 0.14 ct.)	18 K red gold (~ 38.4 g), set with 29 Top Wesselton diamonds (~ 0.14 ct.)
BEZEL	-	-
SAPPHIRE CRYSTAL	Domed sapphire crystal with anti-reflective coating	Domed sapphire crystal with anti-reflective coating
CASE BACK	18 K red gold case back	18 K red gold case back
CROWN	Non-screw crown, 1 O-ring, 18 K red gold with mother-of-pearl Montblanc emblem	Non-screw crown, 1 O-ring, 18 K red gold with mother-of-pearl Montblanc emblem
DIAL	Black mother-of-pearl dial with crossover numerals, 25 Top Wesselton diamonds (~0.074 ct) at 3, 6 and 9 o'clock and a Montblanc Diamond (~0.1 ct) at 12 o'clock	White mother-of-pearl dial with crossover numerals, 25 Top Wesselton diamonds (~0.074 ct) at 3, 6 and 9 o'clock and a Montblanc Diamond (~0.1 ct) at 12 o'clock
HANDS	Red gold-plated luminescent baton hands	Red gold-plated luminescent baton hands
DISTANCE BETWEEN HORNS/CLASP	18/16 mm	18/16 mm
DIAMETER	23 x 35 mm	23 x 35 mm
HEIGHT	8.4 mm	8.4 mm
WATER RESISTANT	3 bar (30 m)	3 bar (30 m)
BRACELET / STRAP		
MATERIAL/COLOUR	Brushed satin manchette strap / Black	Brushed satin manchette strap / White
CLASP/BUCKLE	18 K red gold pin buckle (~ 6.3 g)	18 K red gold pin buckle (~ 6.3 g)

MONTBLANC PROFILE COLLECTION

> Steel Jewellery



MODEL	Montblanc Profile Lady Elegance	Montblanc Profile Lady Elegance
IDENT No.	101557	101559
MOVEMENT		
CALIBRE	Montblanc 4810/110	Montblanc 4810/110
FEATURES	Quartz	Quartz
INDICATIONS	Hour - minute hands	Hour - minute hands
COMPLICATIONS	-	-
BATTERY	321/1,5 V	321/1.5 V
POWER RESERVE	-	-
FREQUENCY/JEWELS	5 jewels	5 jewels
CASE		
MATERIAL	Stainless steel, set with 29 Top Wesselton diamonds (~0.14 ct)	Stainless steel, set with 29 Top Wesselton diamonds (~0.14 ct)
BEZEL	-	-
SAPPHIRE CRYSTAL	Domed sapphire crystal with anti-reflective coating	Domed sapphire crystal with anti-reflective coating
CASE BACK	Stainless steel case back	Stainless steel case back
CROWN	Non-screw crown, 1 O-ring	Non-screw crown, 1 O-ring
DIAL	White mother-of-pearl dial with crossover numerals, 25 Top Wesselton diamonds (~0.074 ct) at 3, 6 and 9 o'clock and a Montblanc Diamond (~0.1 ct) at 12 o'clock	Black mother-of-pearl dial with crossover numerals, 25 Top Wesselton diamonds (~0.074 ct) at 3, 6 and 9 o'clock and a Montblanc Diamond (~0.1 ct) at 12 o'clock
HANDS	Rhodium-plated luminescent baton hands	Rhodium-plated luminescent baton hands
DISTANCE BETWEEN HORNS/CLASP	18/18 mm	18/18 mm
DIAMETER	23 x 35 mm	23 x 35 mm
HEIGHT	8.3 mm	8.3 mm
WATER RESISTANT	3 bar (30 m)	3 bar (30 m)
BRACELET / STRAP		
MATERIAL	Polished stainless steel bracelet	Polished stainless steel bracelet
CLASP/BUCKLE	Triple-folding clasp	Triple-folding clasp

MONTBLANC PROFILE COLLECTION

> Steel Jewellery



MODEL	Montblanc Profile Lady Elegance	Montblanc Profile Lady Elegance
IDENT No.	101558	101556
MOVEMENT		
CALIBRE	Montblanc 4810/110	Montblanc 4810/110
FEATURES	Quartz	Quartz
INDICATIONS	Hour - minute hands	Hour - minute hands
COMPLICATIONS	-	-
BATTERY	321/1,5 V	321/1,5 V
POWER RESERVE	-	-
FREQUENCY/JEWELS	5 jewels	5 jewels
CASE		
MATERIAL	Stainless steel, set with 29 Top Wesselton diamonds (~0.14 ct)	Stainless steel, set with 29 Top Wesselton diamonds (~0.14 ct)
BEZEL	-	-
SAPPHIRE CRYSTAL	Domed sapphire crystal with anti-reflective coating	Domed sapphire crystal with anti-reflective coating
CASE BACK	Stainless steel case back	Stainless steel case back
CROWN	Non-screw crown, 1 O-ring	Non-screw crown, 1 O-ring
DIAL	Black mother-of-pearl dial with crossover numerals, 25 Top Wesselton diamonds (~0.074 ct) at 3, 6 and 9 o'clock and a Montblanc Diamond (~0.1 ct) at 12 o'clock	White mother-of-pearl dial with crossover numerals, 25 Top Wesselton diamonds (~0.074 ct) at 3, 6 and 9 o'clock and a Montblanc Diamond (~0.1 ct) at 12 o'clock
HANDS	Rhodium-plated luminescent baton hands	Rhodium-plated luminescent baton hands
DISTANCE BETWEEN HORNS/CLASP	18/14 mm	18/14 mm
DIAMETER	23 x 35 mm	23 x 35 mm
HEIGHT	8.3 mm	8.3 mm
WATER RESISTANT	3 bar (30 m)	3 bar (30 m)
BRACELET / STRAP		
MATERIAL/COLOUR	Alligator-skin strap / Black	Alligator-skin strap / White
CLASP/BUCKLE	Triple-folding clasp	Triple-folding clasp

MONTBLANC PROFILE COLLECTION

> Steel Jewellery



MODEL	Montblanc Profile Lady Elegance	Montblanc Profile Lady Elegance
IDENT No.	102370	102369
MOVEMENT		
CALIBRE	Montblanc 4810/110	Montblanc 4810/110
FEATURES	Quartz	Quartz
INDICATIONS	Hour - minute hands	Hour - minute hands
COMPLICATIONS	-	-
BATTERY	317/1.5 V	317/1.5 V
POWER RESERVE	-	-
FREQUENCY/JEWELS	5 jewels	5 jewels
CASE		
MATERIAL	Stainless steel	Stainless steel
BEZEL	-	-
SAPPHIRE CRYSTAL	Domed sapphire crystal with anti-reflective coating	Domed sapphire crystal with anti-reflective coating
CASE BACK	Stainless steel case back	Stainless steel case back
CROWN	Non-screw crown, 1 O-ring	Non-screw crown, 1 O-ring
DIAL	Black mother-of-pearl dial with crossover numerals at 3, 6 and 9 o'clock and a Montblanc Diamond (~0.1 ct) at 12 o'clock	White mother-of-pearl dial with crossover numerals at 3, 6 and 9 o'clock and a Montblanc Diamond (~0.1 ct) at 12 o'clock
HANDS	Rhodium-plated luminescent baton hands	Rhodium-plated luminescent baton hands
DISTANCE BETWEEN HORNS/CLASP	18/14 mm	18/14 mm
DIAMETER	23 x 35 mm	23 x 35 mm
HEIGHT	8.3 mm	8.3 mm
WATER RESISTANT	3 bar (30 m)	3 bar (30 m)
BRACELET / STRAP		
MATERIAL/COLOUR	Alligator-skin strap / Black	Alligator-skin strap / White
CLASP/BUCKLE	Triple-folding clasp	Triple-folding clasp

MONTBLANC PROFILE COLLECTION

> Steel



MODEL	Montblanc Profile Lady Elegance	Montblanc Profile Lady Elegance
IDENT No.	104291	104294
MOVEMENT		
CALIBRE	Montblanc 4810/110	Montblanc 4810/110
FEATURES	Quartz	Quartz
INDICATIONS	Hour - minute hands	Hour - minute hands
COMPLICATIONS	-	-
BATTERY	317/1.5 V	317/1.5 V
POWER RESERVE	-	-
FREQUENCY/JEWELS	5 jewels	5 jewels
CASE		
MATERIAL	Stainless steel	Stainless steel
BEZEL	-	-
SAPPHIRE CRYSTAL	Domed sapphire crystal with anti-reflective coating	Domed sapphire crystal with anti-reflective coating
CASE BACK	Stainless steel case back	Stainless steel case back
CROWN	Non-screw crown, 1 O-ring	Non-screw crown, 1 O-ring
DIAL	White mother-of-pearl dial with crossover numerals at 3, 6, 9 and 12 o'clock	Black mother-of-pearl dial with crossover numerals at 3, 6, 9 and 12 o'clock
HANDS	Rhodium-plated luminescent baton hands	Rhodium-plated luminescent baton hands
DISTANCE BETWEEN HORNS/CLASP	18/18 mm	18/16 mm
DIAMETER	23 x 35 mm	23 x 35 mm
HEIGHT	8.3 mm	8.3 mm
WATER RESISTANT	3 bar (30 m)	3 bar (30 m)
BRACELET / STRAP		
MATERIAL	Polished stainless steel manchette bracelet	Alligator-skin manchette strap / Dark blue
CLASP/BUCKLE	Triple-folding clasp	Pin buckle

MONTBLANC PROFILE COLLECTION

> Steel



MODEL	Montblanc Profile Lady Elegance Cabochon	Montblanc Profile Lady Elegance Cabochon
IDENT No.	106490	106491
MOVEMENT		
CALIBRE	Montblanc 4810/110	Montblanc 4810/110
FEATURES	Quartz	Quartz
INDICATIONS	Hour - minute hands	Hour - minute hands
COMPLICATIONS	-	-
BATTERY	317/1.5 V	317/1.5 V
POWER RESERVE	-	-
FREQUENCY/JEWELS	5 jewels	5 jewels
CASE		
MATERIAL	Stainless steel, set with 20 white cabochon stones	Stainless steel, set with 20 white cabochon stones
BEZEL	-	-
SAPPHIRE CRYSTAL	Domed sapphire crystal with anti-reflective coating	Domed sapphire crystal with anti-reflective coating
CASE BACK	Stainless steel case back	Stainless steel case back
CROWN	Non-screw crown, 1 O-ring	Non-screw crown, 1 O-ring
DIAL	White mother-of-pearl dial with crossover numerals, 25 white cabochon stones at 3, 6, 9 and 12 o'clock	White mother-of-pearl dial with crossover numerals, 25 white cabochon stones at 3, 6, 9 and 12 o'clock
HANDS	Rhodium-plated luminescent baton hands	Rhodium-plated luminescent baton hands
DISTANCE BETWEEN HORNS/CLASP	18/16 mm	18/16 mm
DIAMETER	23 x 35 mm	23 x 35 mm
HEIGHT	8.3 mm	8.3 mm
WATER RESISTANT	3 bar (30 m)	3 bar (30 m)
BRACELET / STRAP		
MATERIAL/COLOUR	Grained calfskin strap / Black	Grained calfskin strap / White
CLASP/BUCKLE	Pin buckle	Pin buckle

MONTBLANC PROFILE COLLECTION

> Steel



MODEL	Montblanc Profile Lady Elegance
IDENT No.	104293
MOVEMENT	
CALIBRE	Montblanc 4810/110
FEATURES	Quartz
INDICATIONS	Hour - minute hands
COMPLICATIONS	-
BATTERY	317/1.5 V
POWER RESERVE	-
FREQUENCY/JEWELS	5 jewels
CASE	
MATERIAL	Stainless steel
BEZEL	-
SAPPHIRE CRYSTAL	Domed sapphire crystal with anti-reflective coating
CASE BACK	Stainless steel case back
CROWN	Non-screw crown, 1 O-ring
DIAL	White mother-of-pearl dial with crossover numerals at 3, 6, 9 and 12 o'clock
HANDS	Rhodium-plated luminescent baton hands
DISTANCE BETWEEN HORNS/CLASP	18/16 mm
DIAMETER	23 x 35 mm
HEIGHT	8.3 mm
WATER RESISTANT	3 bar (30 m)
BRACELET / STRAP	
MATERIAL/COLOUR	Alligator-skin manchette strap / Pink
CLASP/BUCKLE	Pin buckle

MONTBLANC PROFILE COLLECTION

> Steel



MODEL	Montblanc Profile Lady Elegance Nacre Magique	Montblanc Profile Lady Elegance Nacre Magique
IDENT No.	106169	105862
MOVEMENT		
CALIBRE	Montblanc 4810/110	Montblanc 4810/110
FEATURES	Quartz	Quartz
INDICATIONS	Hour - minute hands	Hour - minute hands
COMPLICATIONS	-	-
BATTERY	317/1.5 V	317/1.5 V
POWER RESERVE	-	-
FREQUENCY/JEWELS	5 jewels	5 jewels
CASE		
MATERIAL	Stainless steel	Stainless steel
BEZEL	-	-
SAPPHIRE CRYSTAL	Domed sapphire crystal with anti-reflective coating	Domed sapphire crystal with anti-reflective coating
CASE BACK	Stainless steel case back	Stainless steel case back
CROWN	Non-screw crown, 1 O-ring	Non-screw crown, 1 O-ring
DIAL	White mother-of-pearl dial	White mother-of-pearl dial
HANDS	Rhodium-plated luminescent baton hands	Rhodium-plated luminescent baton hands
DISTANCE BETWEEN HORNS/CLASP	18/16 mm	18/16 mm
DIAMETER	23 x 35 mm	23 x 35 mm
HEIGHT	8.3 mm	8.3 mm
WATER RESISTANT	3 bar (30 m)	3 bar (30 m)
BRACELET / STRAP		
MATERIAL/COLOUR	Brushed synthetic satin strap / Grey	Brushed synthetic satin strap / White
CLASP/BUCKLE	Pin buckle	Pin buckle

MONTBLANC PROFILE COLLECTION

> Steel



MODEL	Montblanc Profile Lady Elegance	Montblanc Profile Lady Elegance
IDENT No.	101554	102623
MOVEMENT		
CALIBRE	Montblanc 4810/107	Montblanc 4810/110
FEATURES	Quartz	Quartz
INDICATIONS	Hour - minute hands	Hour - minute hands
COMPLICATIONS	-	-
BATTERY	321/1.5 V	317/1.5 V
POWER RESERVE	-	-
FREQUENCY/JEWELS	6 jewels	5 jewels
CASE		
MATERIAL	Stainless steel	Stainless steel
BEZEL	-	-
SAPPHIRE CRYSTAL	Domed sapphire crystal with anti-reflective coating	Domed sapphire crystal with anti-reflective coating
CASE BACK	Stainless steel case back	Stainless steel case back
CROWN	Non-screw crown, 1 O-ring	Non-screw crown, 1 O-ring
DIAL	Black dial and silver-coloured numerals	White dial and anthracite-coloured numerals
HANDS	Black lacquered luminescent baton hands	Rhodium-plated luminescent baton hands
DISTANCE BETWEEN HORNS/CLASP	18/14 mm	18/14 mm
DIAMETER	23 x 35 mm	23 x 35 mm
HEIGHT	8.3 mm	8.65 mm
WATER RESISTANT	3 bar (30 m)	3 bar (30 m)
BRACELET / STRAP		
MATERIAL/COLOUR	Detachable Starisma calfskin strap / Black	Detachable satin strap with pattern inspired by Montblanc's Starisma line / Anthracite-coloured
CLASP/BUCKLE	Pin buckle	Pin buckle

MONTBLANC PROFILE COLLECTION

> Steel



MODEL	Montblanc Profile Lady Elegance	Montblanc Profile Lady Elegance
IDENT No.	102624	102622
MOVEMENT		
CALIBRE	Montblanc 4810/110	Montblanc 4810/110
FEATURES	Quartz	Quartz
INDICATIONS	Hour - minute hands	Hour - minute hands
COMPLICATIONS	-	-
BATTERY	317/1.5 V	317/1.5 V
POWER RESERVE	-	-
FREQUENCY/JEWELS	5 jewels	5 jewels
CASE		
MATERIAL	Stainless steel	Stainless steel
BEZEL	-	-
SAPPHIRE CRYSTAL	Domed sapphire crystal with anti-reflective coating	Domed sapphire crystal with anti-reflective coating
CASE BACK	Stainless steel case back	Stainless steel case back
CROWN	Non-screw crown, 1 O-ring	Non-screw crown, 1 O-ring
DIAL	White dial and brown numerals	White dial and silver-coloured numerals
HANDS	Rhodium-plated luminescent baton hands	Rhodium-plated luminescent baton hands
DISTANCE BETWEEN HORNS/CLASP	18/14 mm	18/14 mm
DIAMETER	23 x 35 mm	23 x 35 mm
HEIGHT	8.65 mm	8.65 mm
WATER RESISTANT	3 bar (30 m)	3 bar (30 m)
BRACELET / STRAP		
MATERIAL/COLOUR	Detachable satin strap with pattern inspired by Montblanc's Starisma line / Brown	Detachable satin strap with pattern inspired by Montblanc's Starisma line / Silver
CLASP/BUCKLE	Pin buckle	Pin buckle

MONTBLANC PROFILE COLLECTION

> Steel



MODEL	Montblanc Profile Lady Elegance	Montblanc Profile Lady Elegance	Montblanc Profile Lady Elegance
IDENT No.	107312	107311	107313
MOVEMENT			
CALIBRE	Montblanc 4810/110	Montblanc 4810/110	Montblanc 4810/110
FEATURES	Quartz	Quartz	Quartz
INDICATIONS	Hour - minute hands	Hour - minute hands	Hour - minute hands
COMPLICATIONS	-	-	-
BATTERY	317/1.5 V	317/1.5 V	317/1.5 V
POWER RESERVE	-	-	-
FREQUENCY/JEWELS	5 jewels	5 jewels	5 jewels
CASE			
MATERIAL	Stainless steel	Stainless steel	Stainless steel
BEZEL	-	-	-
SAPPHIRE CRYSTAL	Domed sapphire crystal with anti-reflective coating	Domed sapphire crystal with anti-reflective coating	Domed sapphire crystal with anti-reflective coating
CASE BACK	Stainless steel case back	Stainless steel case back	Stainless steel case back
CROWN	Non-screw crown, 1 O-ring	Non-screw crown, 1 O-ring	Non-screw crown, 1 O-ring
DIAL	White dial and anthracite-coloured numerals	White dial and silver-coloured numerals	White dial and brown numerals
HANDS	Rhodium-plated luminescent baton hands	Rhodium-plated luminescent baton hands	Rhodium-plated luminescent baton hands
DISTANCE BETWEEN HORNS/CLASP	18/14 mm	18/14 mm	18/14 mm
DIAMETER	23 x 35 mm	23 x 35 mm	23 x 35 mm
HEIGHT	8.65 mm	8.65 mm	8.65 mm
WATER RESISTANT	3 bar (30 m)	3 bar (30 m)	3 bar (30 m)
BRACELET / STRAP			
MATERIAL/COLOUR	Brushed calfskin strap / Black	Brushed calfskin strap / Silver	Brushed calfskin strap / White
CLASP/BUCKLE	Pin buckle	Pin buckle	Pin buckle

MONTBLANC PROFILE COLLECTION

> Steel



MODEL	Montblanc Profile Lady Elegance	Montblanc Profile Lady Elegance	Montblanc Profile Lady Elegance
IDENT No.	36056	36975	36974
MOVEMENT			
CALIBRE	Montblanc 4810/107	Montblanc 4810/107	Montblanc 4810/107
FEATURES	Quartz	Quartz	Quartz
INDICATIONS	Hour - minute	Hour - minute	Hour - minute
COMPLICATIONS	-	-	-
BATTERY	321/1,5 V	321/1,5 V	321/1,5 V
POWER RESERVE	-	-	-
FREQUENCY/JEWELS	5 jewels	5 jewels	5 jewels
CASE			
MATERIAL	Stainless steel	Stainless steel	Stainless steel
BEZEL	-	-	-
SAPPHIRE CRYSTAL	Domed sapphire crystal with anti-reflective coating	Domed sapphire crystal with anti-reflective coating	Domed sapphire crystal with anti-reflective coating
CASE BACK	Stainless steel case back	Stainless steel case back	Stainless steel case back
CROWN	Non-screw crown, 1 O-ring	Non-screw crown, 1 O-ring	Non-screw crown, 1 O-ring
DIAL	Beige dial with rhodium-plated numerals	Beige dial with rhodium-plated numerals	Beige dial with rhodium-plated numerals
HANDS	Baton hands	Baton hands	Baton hands
DISTANCE BETWEEN HORNS/CLASP	18/18 mm	18/14 mm	18/14 mm
DIAMETER	23 x 35 mm	23 x 35 mm	23 x 35 mm
HEIGHT	8,4 mm	8,5 mm	8,5 mm
WATER RESISTANT	3 bar (30 m)	3 bar (30 m)	3 bar (30 m)
BRACELET / STRAP			
MATERIAL	Stainless steel bracelet	Detachable safiano strap / Black	Detachable safiano strap / Pink
CLASP/BUCKLE	Triple-folding clasp	Pin buckle	Pin buckle

MONTBLANC TRAVEL TIMEPIECES

MONTBLANC TRAVEL TIMEPIECES

> Desk Clocks



Q Id. 101566 p. 199



Q Id. 102375 p. 200



Q Id. 104295 p. 201

> Travel Timepieces



Q Id. 05708 p. 202



Q Id. 101571 p. 203



Q Id. 101568 p. 203



Q Id. 101569 p. 204



Q Id. 105814 p. 205



Q Id. 102373 p. 206



Q Id. 102374 p. 206

MONTBLANC TRAVEL TIMEPIECES

> Desk Clocks



MODEL	Montblanc Star Desk Clock
IDENT No.	101566
MOVEMENT	
CALIBRE	-
FEATURES	Quartz movement
INDICATIONS	Hour - minute - second hands
COMPLICATIONS	-
BATTERY	-
POWER RESERVE	-
FREQUENCY/JEWELS	-
CASE	
MATERIAL	Palladium-plated
BEZEL	-
SAPPHIRE CRYSTAL	-
CASE BACK	Stainless steel case back
CROWN	Non-screw crown
DIAL	Silver-coloured Montblanc Star platinum dial
HANDS	Blue feuille and baton hands
DISTANCE BETWEEN HORNS/CLASP	-
DIAMETER	7.5 cm
HEIGHT	-
WATER RESISTANT	-
BRACELET / STRAP	
-	-
CLASP/BUCKLE	-

MONTBLANC TRAVEL TIMEPIECES

> Desk Clocks



MODEL	Montblanc TimeWalker Desk Clock
IDENT No.	102375
MOVEMENT	
CALIBRE	-
FEATURES	Quartz movement
INDICATIONS	hour - minute hands / dual time
COMPLICATIONS	-
BATTERY	357/1.5 V and 379/1.5 V
POWER RESERVE	-
FREQUENCY/JEWELS	-
CASE	
MATERIAL	Stainless steel
BEZEL	-
SAPPHIRE CRYSTAL	Flat mineral crystal
CASE BACK	Palladium-plated
CROWN	Non-screw crown
DIAL	Silver-coloured dial with rhodium-plated numerals
HANDS	Luminescent hands
DISTANCE BETWEEN HORNS/CLASP	-
DIAMETER	100 mm
HEIGHT	45 mm
WATER RESISTANT	-
BRACELET / STRAP	
-	-
CLASP/BUCKLE	-

MONTBLANC TRAVEL TIMEPIECES

> Desk Clocks



MODEL	Montblanc TimeWalker Desk Clock
IDENT No.	104295
MOVEMENT	
CALIBRE	-
FEATURES	Quartz movement
INDICATIONS	Hour - minute - continuous second hands, 24-hour display with second time zone
COMPLICATIONS	24-hour display with second time zone
BATTERY	317/1.5 V
POWER RESERVE	-
FREQUENCY/JEWELS	-
CASE	
MATERIAL	Stainless steel
BEZEL	-
SAPPHIRE CRYSTAL	Domed mineral crystal
CASE BACK	Stainless steel case back
CROWN	Non-screw crown, 1 O-ring
DIAL	Black dial with red gold-plated numerals
HANDS	Red gold-plated luminescent baton hands
DISTANCE BETWEEN HORNS/CLASP	-
DIAMETER	75 mm
HEIGHT	30 mm
WATER RESISTANT	-
BRACELET / STRAP	
-	-
CLASP/BUCKLE	-

MONTBLANC TRAVEL TIMEPIECES

> Travel Timepieces



MODEL	Montblanc Star Travel Clock
IDENT No.	05708
MOVEMENT	
CALIBRE	-
FEATURES	Quartz movement, Alarm function
INDICATIONS	Hour - minute hands and alarm disc
COMPLICATIONS	-
BATTERY	377/1.5 V
POWER RESERVE	-
FREQUENCY/JEWELS	-
CASE	
MATERIAL	Palladium-plated brass
BEZEL	-
SAPPHIRE CRYSTAL	Flat mineral crystal
CASE BACK	Stainless steel case back
CROWN	Non-screw crown
DIAL	White dial
HANDS	Luminescent feuille hands
DISTANCE BETWEEN HORNS/CLASP	-
DIAMETER	45 mm
HEIGHT	-
WATER RESISTANT	-
BRACELET / STRAP	
-	-
CLASP/BUCKLE	-

MONTBLANC TRAVEL TIMEPIECES

> Travel Timepieces



MODEL	Montblanc Star Travel Clock	Montblanc Mini Travel Clock
IDENT No.	101571	101568
MOVEMENT		
CALIBRE	-	-
FEATURES	Quartz movement, Alarm function	Quartz movement, Alarm function
INDICATIONS	Hour - minute hands	Hour - minute hands
COMPLICATIONS	-	-
BATTERY	-	-
POWER RESERVE	-	-
FREQUENCY/JEWELS	-	-
CASE		
MATERIAL	Palladium-plated	Palladium-plated
BEZEL	-	-
SAPPHIRE CRYSTAL	-	-
CASE BACK	-	-
CROWN	-	-
DIAL	Silver-coloured Montblanc Star dial	Silver-coloured Summit dial
HANDS	Black feuille hands and red baton hand	Luminescent silver baton hands and red baton hand
DISTANCE BETWEEN HORNS/CLASP	-	-
DIAMETER	46 mm	45 mm
HEIGHT	-	-
WATER RESISTANT	-	-
BRACELET / STRAP		
MATERIAL/COLOUR	Calfskin with alligator-skin motif leather box / Black	Calfskin with alligator-skin motif leather box / Black
CLASP/BUCKLE	-	-

MONTBLANC TRAVEL TIMEPIECES

> Travel Timepieces



MODEL	Montblanc Star Travel Clock
IDENT No.	101569
MOVEMENT	
CALIBRE	-
FEATURES	Quartz movement, Alarm function
INDICATIONS	Hour - minute hands
COMPLICATIONS	-
BATTERY	-
POWER RESERVE	-
FREQUENCY/JEWELS	-
CASE	
MATERIAL	Palladium-plated
BEZEL	-
SAPPHIRE CRYSTAL	-
CASE BACK	-
CROWN	-
DIAL	Silver-coloured Montblanc Star platinum dial
HANDS	Luminescent blue feuille hands and red baton hand
DISTANCE BETWEEN HORNS/CLASP	-
DIAMETER	45 mm
HEIGHT	-
WATER RESISTANT	-
BRACELET / STRAP	
MATERIAL/COLOUR	Calfskin / Black
CLASP/BUCKLE	-

MONTBLANC TRAVEL TIMEPIECES

> Travel Timepieces



MODEL	Montblanc TimeWalker Travel Clock
IDENT No.	105814
MOVEMENT	
CALIBRE	-
FEATURES	Quartz movement, Alarm function
INDICATIONS	Hour - minute hands
COMPLICATIONS	-
BATTERY	377/1.5 V
POWER RESERVE	-
FREQUENCY/JEWELS	-
CASE	
MATERIAL	Palladium-plated
BEZEL	-
SAPPHIRE CRYSTAL	Domed mineral crystal
CASE BACK	Palladium-plated
CROWN	Non-screw crown, 1 O-ring
DIAL	Silver-coloured dial with red gold-plated figures
HANDS	Red gold-plated luminescent baton hands
DISTANCE BETWEEN HORNS/CLASP	-
DIAMETER	45 mm
HEIGHT	-
WATER RESISTANT	-
BRACELET / STRAP	
-	-
CLASP/BUCKLE	-

MONTBLANC TRAVEL TIMEPIECES

> Travel Timepieces



MODEL	Montblanc Profile Sliding Travel Clock	Montblanc Profile Sliding Travel Clock
IDENT No.	102373	102374
MOVEMENT		
CALIBRE	-	-
FEATURES	Quartz movement, Alarm function	Quartz movement, Alarm function
INDICATIONS	Hour - minute hands	Hour - minute hands
COMPLICATIONS	-	-
BATTERY	377/1.5 V	377/1.5 V
POWER RESERVE	-	-
FREQUENCY/JEWELS	-	-
CASE		
MATERIAL	Stainless steel	Stainless steel
BEZEL	-	-
SAPPHIRE CRYSTAL	Flat mineral crystal	Flat mineral crystal
CASE BACK	Stainless steel case back	Stainless steel case back
CROWN	Non-screw crown	Non-screw crown
DIAL	Black dial with rhodium numerals	Silver-coloured dial with blue numerals
HANDS	Luminescent baton hands	Luminescent baton hands
DISTANCE BETWEEN HORNS/CLASP	-	-
DIAMETER	94 x 50 mm	94 x 50 mm
HEIGHT	14 mm	14 mm
WATER RESISTANT	-	-
BRACELET / STRAP		
MATERIAL/COLOUR	Calfskin embossed with alligator-skin motif / Black	Calfskin embossed with alligator-skin motif / Brown
CLASP/BUCKLE	-	-

MONTBLANC CALIBRES

MONTBLANC CALIBRES

> Montblanc Collection Villeret 1858 : High Complications

Montblanc MB *M*65.63

Functions: Manual winding calibre with 1-minute Tourbillon at 12 o'clock, 16 3/4" (38.40 mm), height 10.30 mm, 284 parts, balance wheel with screws (inertia: 59 mgcm², diameter: 14.50 mm), double cylindrical hairspring, rhodium plated and circular-grained plates with hand-chamfered edges in German Silver, rhodium plated German Silver bridges with Geneva striping and hand-chamfered edges, Wheel train with gold-plated circular-grained and chamfered wheels as well as polished and burnished pinions / hour - minute indication on "mysterious" sapphire crystal discs at 6 o'clock

Calendar: -

Power Reserve: Approx. 45 hrs

Frequency/Jewels: 18,000/h, 26 jewels

Montblanc MB *M*65.60

Functions: Manual winding calibre with 1-minute Tourbillon at 12 o'clock, 16 3/4" (38.40 mm), height 9.70 mm, 281 parts, balance wheel with screws (Inertia: 59 mgcm², Diameter: 14.50 mm), hairspring with Phillips curve, rhodium plated and circular-grained plates with hand-chamfered edges in German Silver, rhodium plated German Silver bridges with Geneva striping and hand-chamfered edges, Wheel train with gold-plated circular-grained and chamfered wheels as well as polished and burnished pinions / hour - minute indication on "mysterious" sapphire crystal discs at 6 o'clock

Calendar: -

Power Reserve: Approx. 50 hrs

Frequency/Jewels: 18,000/h, 28 jewels

Montblanc MB *M*16.60

Functions: Monopusher Chronograph with 4-minute ExoTourbillon at 12 o'clock, manual winding calibre with column wheel control and horizontal clutch, 16 3/4" (38.40 mm), height 10.34 mm, 341 parts, balance wheel with screws (Inertia: 59 mgcm², Diameter: 14.50 mm), hairspring with Phillips curve, rhodium plated and circular-grained plates with hand-chamfered edges in German Silver, rhodium plated German Silver bridges with Geneva striping and hand-chamfered edges, Wheel train with gold-plated circular-grained and chamfered wheels as well as polished and burnished pinions / hour hands for local and home time at 6 o'clock with Day-Night display at 4 o'clock / central minute indication and continuous seconds hand at 9 o'clock / Chronograph functions: 30 min. counter at 3 o'clock and central seconds hand

Calendar: -

Power Reserve: Approx. 55 hrs

Frequency/Jewels: 18,000/h, 32 jewels

MONTBLANC CALIBRES

> Montblanc Collection Villeret 1858 : Chronographs

Montblanc MB *16.30*

- Functions:** Monopusher Chronograph, manual winding calibre with column wheel control and horizontal clutch, 16 3/4" (38.40 mm), height 7.90 mm, 304 parts, balance wheel with screws (Inertia: 59 mgcm², Diameter: 14.50 mm), hairspring with Phillips curve, rhodium plated and circular-grained plates with hand-chamfered edges in German Silver, rhodium plated German Silver bridges with Geneva striping and hand-chamfered edges, Wheel train with gold-plated circular-grained and chamfered wheels as well as polished and burnished pinions / hour hands for local and home time at 12 o'clock with Day-Night display at 2 o'clock / central minute indication and continuous seconds hand at 9 o'clock / Chronograph functions: 30 min. counter at 3 o'clock and central seconds hand / Patented emergency power reserve at 6 o'clock
- Calendar:** -
- Power Reserve:** Approx. 55 hrs (indicated on patented emergency power reserve display at 6 o'clock)
- Frequency/Jewels:** 18,000/h, 33 jewels

Montblanc MB *16.32*

- Functions:** Monopusher Chronograph, manual winding calibre with column wheel control and horizontal clutch, 16 3/4" (38.40 mm), height 7 mm, 268 parts, balance wheel with screws (Inertia: 59 mgcm², Diameter: 14.50 mm), hairspring with Phillips curve, rhodium plated and circular-grained plates with hand-chamfered edges in German Silver, rhodium plated German Silver bridges with Geneva striping and hand-chamfered edges, Wheel train with gold-plated circular-grained and chamfered wheels as well as polished and burnished pinions / Centre hour - minute indication and continuous seconds hand at 9 o'clock / Chronograph functions: 30 min. counter at 3 o'clock and central seconds hand / Date display at 6 o'clock
- Calendar:** Date display
- Power Reserve:** Approx. 50 hrs
- Frequency/Jewels:** 18,000/h, 22 jewels

Montblanc MB *16.29*

- Functions:** Monopusher Chronograph, manual winding calibre with column wheel control and horizontal clutch, 16 3/4" (38.40 mm), height 6.30 mm, 252 parts, balance wheel with screws (Inertia: 59 mgcm², Diameter: 14.50 mm), hairspring with Phillips curve, rhodium plated and circular-grained plates with hand-chamfered edges in German Silver, rhodium plated German Silver bridges with Geneva striping and hand-chamfered edges, Wheel train with gold-plated circular-grained and chamfered wheels as well as polished and burnished pinions / Centre hour - minute indication and continuous seconds hand at 9 o'clock / Chronograph functions: 30 min. counter at 3 o'clock and central seconds hand
- Calendar:** -
- Power Reserve:** Approx. 55 hrs
- Frequency/Jewels:** 18,000/h, 22 jewels

MONTBLANC CALIBRES

Montblanc MB *M*13.21

Functions: Monopusher Chronograph, manual winding calibre with column wheel control and horizontal clutch, 12 3/4" (29.50 mm), height 6.40 mm, 239 parts, balance wheel with screws (Inertia: 26 mgcm², Diameter: 11.40 mm), hairspring with Phillips curve, rhodium plated and circular-grained plates with hand-chamfered edges in German Silver, rhodium plated German Silver bridges with Geneva striping and hand-chamfered edges, Wheel train with gold-plated circular-grained and chamfered wheels as well as polished and burnished pinions / Centre hour - minute indication and continuous seconds hand at 9 o'clock / Chronograph functions: 30 min. counter at 3 o'clock and central seconds hand

Calendar: -

Power Reserve: Approx. 60 hrs

Frequency/Jewels: 18,000/h, 22 jewels

> Montblanc Collection Villeret 1858 : Classics

Montblanc MB *M*16.18

Functions: Manual winding calibre, 16 3/4" (38.40 mm), height 6.30 mm, 209 parts, balance wheel with screws (Inertia: 59 mgcm², Diameter: 14.50 mm), hairspring with Phillips curve, rhodium plated and circular-grained plates with hand-chamfered edges in German Silver, rhodium plated German Silver bridges with Geneva striping and hand-chamfered edges, Wheel train with gold-plated circular-grained and chamfered wheels as well as polished and burnished pinions / Central hour - minute - second indication, central seconds hand with Reset to Zero function

Calendar: -

Power Reserve: Approx. 55 hrs

Frequency/Jewels: 18,800/h, 21 jewels

Montblanc MB *M*13.18

Functions: Manual winding calibre, 12 3/4" (29.50 mm), height 6.40 mm, 196 parts, balance wheel with screws (Inertia: 26 mgcm², Diameter: 11.40 mm), hairspring with Phillips curve, rhodium plated and circular-grained plates with hand-chamfered edges in German Silver, rhodium plated German Silver bridges with Geneva striping and hand-chamfered edges, Wheel train with gold-plated circular-grained and chamfered wheels as well as polished and burnished pinions / Central hour - minute - second indication, central seconds hand with Reset to Zero function

Calendar: -

Power Reserve: Approx. 60 hrs

Frequency/Jewels: 18,000/h, 21 jewels

MONTBLANC CALIBRES

Montblanc MB *M*16.15



Functions: Manual winding calibre, 16 3/4" (38.40 mm), height 5.05 mm, 158 parts, balance wheel with screws (Inertia: 59 mgcm², Diameter: 14.50 mm), hairspring with Phillips curve, rhodium plated and circular-grained plates with hand-chamfered edges in German Silver, rhodium plated German Silver bridges with Geneva striping and hand-chamfered edges, Wheel train with gold-plated circular-grained and chamfered wheels as well as polished and burnished pinions / Central hour - minute indication and continuous seconds hand at 6 o'clock

Calendar: -

Power Reserve: Approx. 55 hrs

Frequency/Jewels: 18,000/h, 18 jewels

Montblanc MB *M*62.00



Functions: Manual winding calibre, 10 1/2" (24.00 mm), height 3.90 mm, 162 parts, balance wheel with screws (Inertia: 15 mgcm², Diameter: 9.70 mm), hairspring with Phillips curve, rhodium plated and circular-grained plates with hand-chamfered edges in German Silver, rhodium plated German Silver bridges with Geneva striping and hand-chamfered edges, Wheel train with gold-plated circular-grained and chamfered wheels as well as polished and burnished pinions / Central hour - minute indication and continuous seconds hand at 6 o'clock

Calendar: -

Power Reserve: Approx. 50 hrs

Frequency/Jewels: 18,000/h, 19 jewels

MONTBLANC CALIBRES

> Montblanc Nicolas Rieussec Collection

Montblanc MB R220



Functions: Monopusher chronograph, automatic winding with column wheel control and vertical disc clutch, 13 3/4" (31 mm), thickness 8.66 mm, 343 parts, large balance wheel with screws (moment of inertia: 12 mgcm², diameter: 9.70 mm), flat hairspring, rhodium-plated and circular-grained plates, rhodium-plated bridges with Geneva striping, wheel train with special tothing for more efficient power transmission / Patented rising hours disc with integrated day & night indication, minutes hand, date and day of the week display

Calendar: Date display

Power Reserve: Approx. 72 hrs

Frequency/Jewels: 28,800/h, 42 jewels

Montblanc MB R210



Functions: Monopusher Chronograph, automatic winding calibre with column wheel control and vertical disc clutch, 13 3/4" (31 mm), height 8.46 mm, 295 parts, large balance wheel with screws (Inertia: 12 mgcm², Diameter: 9.70 mm), flat hairspring, rhodium plated and circular-grained plates, rhodium plated bridges with Geneva striping. Wheel train with special tothing for a more efficient power transmission / Off-centre hour - minute - home-time indication / Chronograph functions: 30 min. and 60 seconds counters with rotating discs / second timezone by disc and Day-Night display

Calendar: Date display

Power Reserve: Approx. 72 hrs

Frequency/Jewels: 28,800/h, 40 jewels

Montblanc MB R200



Functions: Monopusher Chronograph, automatic winding calibre with column wheel control and vertical disc clutch, 13 3/4" (31 mm), height 8.46 mm, 293 parts, Large balance wheel with screws (Inertia: 12 mgcm², Diameter: 9.70 mm), flat hairspring, rhodium plated and circular-grained plates, rhodium plated bridges with Geneva striping. Wheel train with special tothing for a more efficient power transmission / Off-centre hour - minute - home-time indication / Chronograph functions: 30 min. and 60 seconds counters with rotating discs / Second timezone with Day-Night display

Calendar: Date display

Power Reserve: Approx. 72 hrs

Frequency/Jewels: 28,800/h, 40 jewels

MONTBLANC CALIBRES

Montblanc MB *R*110

- Functions:** Monopusher Chronograph, manual winding calibre with column wheel control and vertical disc clutch, 13 3/4 (31 mm), height 7.60 mm, 259 parts, Large balance wheel with screws (Inertia: 12 mgcm², Diameter: 9.70 mm), flat hairspring, rhodium plated and circular-grained plates, rhodium plated bridges with Geneva striping, Wheel train with special toothing for a more efficient power transmission / Off-centre hour - minute indication / Chronograph functions: 30 min. and 60 seconds counters with rotating discs
- Calendar:** Date display by disc
- Power Reserve:** Approx. 72 hrs (indication on the back)
- Frequency/Jewels:** 28,800/h, 33 jewels

Montblanc MB *R*100

- Functions:** Monopusher Chronograph, manual winding calibre with column wheel control and vertical disc clutch, 13 3/4" (31 mm), height 7.60 mm, 286 parts, balance wheel with screws (Inertia: 12 mgcm², Diameter: 9.70 mm), flat hairspring, rhodium plated and circular-grained plates, rhodium plated bridges with Geneva striping, Wheel train with special toothing for a more efficient power transmission / Off-centre hour - minute indication / Chronograph functions: 30 min. and 60 seconds counters with rotating discs
- Calendar:** Date display by hand
- Power Reserve:** Approx. 72 hrs (indication on the back)
- Frequency/Jewels:** 28,800/h, 33 jewels

> Montblanc TimeWalker Collection

Montblanc MB *LL*100

- Functions:** Flyback chronograph, automatic winding calibre with column wheel control and vertical disc clutch, 13 3/4" (31 mm), height 7.90 mm, 299 parts, large balance wheel with screws (inertia: 12 mgcm², diameter: 9.70 mm), flat hairspring, rhodium-plated and circular-grained plates, rhodium-plated bridges with Geneva striping, wheel train with special toothing for more efficient power transmission / Central hour - minute indication / Chronograph functions: central minute and second hands with flyback function / 24-hour display with second time zone and Day-Night display
- Calendar:** Date display
- Power Reserve:** Approx. 72 hrs
- Frequency/Jewels:** 28,800/h, 36 jewels

MONTBLANC CALIBRES

Product Family	Montblanc Calibre	Base Calibre
<i>> Montblanc Star Collection</i>		
Quartz movement	Montblanc 4810/101	ETA 955.112
Quartz movement	Montblanc 4810/103	ETA 956.412
Quartz movement	Montblanc 4810/105b	ETA 251.372
Quartz movement	Montblanc 4810/106	ETA 251.471
Mechanical Movement	Montblanc 4810/401	ETA 2892-A2
Mechanical Movement	Montblanc 4810/405	ETA 2893-2
Mechanical Movement	Montblanc 4810/407	ETA 2681
Mechanical Movement	Montblanc 4810/501	ETA 7750
Mechanical Movement	Montblanc 4810/408	ETA 2895-2
Mechanical Movement	Montblanc 4810/409	Sellita SW300
Mechanical Movement	Montblanc 4810/503	ETA 7754
Mechanical Movement	Montblanc 4810/908	Dubois-Dépraz 9231
Mechanical Movement	Montblanc 4810/909	Soprod 9094
Mechanical Movement	Montblanc 4810/912	Dubois-Dépraz 9000
<i>> Montblanc Sport Collection</i>		
Quartz movement	Montblanc 4810/101	ETA 955.112
Quartz movement	Montblanc 4810/102	ETA 956.112
Mechanical Movement	Montblanc 4810/401	ETA 2892-A2
Mechanical Movement	Montblanc 4810/405	ETA 2893-2
Mechanical Movement	Montblanc 4810/501	ETA 7750
<i>> Collection Princesse Grace de Monaco</i>		
Quartz movement	Montblanc 4810/160	ETA 902.501
Mechanical Movement	Montblanc 4810/409	Sellita SW300
<i>> Montblanc Profile Collection</i>		
Quartz movement	Montblanc 4810/102	ETA 956.112
Quartz movement	Montblanc 4810/106	ETA 251.471
Quartz movement	Montblanc 4810/107	ETA 976.001
Quartz movement	Montblanc 4810/110	ETA E01.001
Mechanical Movement	Montblanc 4810/401	ETA 2892-A2
Mechanical Movement	Montblanc 4810/406	ETA 2897
Mechanical Movement	Montblanc 4810/911	Soprod TT651
<i>> Montblanc TimeWalker Collection</i>		
Mechanical Movement	Montblanc 4810/401	ETA 2892-A2
Mechanical Movement	Montblanc 4810/405	ETA 2893-2
Mechanical Movement	Montblanc 4810/409	Sellita SW 300
Mechanical Movement	Montblanc 4810/412	ETA 2893
Mechanical Movement	Montblanc 4810/501	ETA 7750
Mechanical Movement	Montblanc 4810/502	ETA 7753
Mechanical Movement	Montblanc 4810/503	ETA 7754
Mechanical Movement	Montblanc 4810/410	ETA 2893-1
Mechanical Movement	Montblanc 4810/412	ETA 2893-1 (inverse)
Mechanical Movement	Montblanc 4810/911	Soprod TT651

MONTBLANC SERVICE

MONTBLANC COLLECTION VILLERET 1858 SERVICE

> Alligator



Hand-stitched black alligator-skin, semi-mat finish

Ident. No.	Length of strap in mm	Case Size in mm	Width of Horns / Clasp, Buckle	Suitable for:
105358	XS 105 / 65 mm	41 mm	20 mm / 18 mm	102462, 103086, 102459, 103079, 104230, 104231
105551	XS 105 / 65 mm	41 mm	20 mm / 18 mm	103848, 104363, 103839, 104343
103157	Standard 115 / 75 mm	41 mm	20 mm / 18 mm	102462, 103086, 102459, 103079, 104230, 104231
105547	Standard 115 / 75 mm	41 mm	20 mm / 18 mm	103848, 104363, 103839, 104343
105354	XL 125 / 85 mm	41 mm	20 mm / 18 mm	102462, 103086, 102459, 103079, 104230, 104231
105549	XL 125 / 85 mm	41 mm	20 mm / 18 mm	103848, 104363, 103839, 104343



Hand-stitched brown alligator-skin, semi-mat finish

Ident. No.	Length of strap in mm	Case Size in mm	Width of Horns / Clasp, Buckle	Suitable for:
105359	XS 105 / 65 mm	41 mm	20 mm / 18 mm	102463, 102460, 104229
105552	XS 105 / 65 mm	41 mm	20 mm / 18 mm	103849, 103840
103161	Standard 115 / 75 mm	41 mm	20 mm / 18 mm	102463, 102460, 104229
105548	Standard 115 / 75 mm	41 mm	20 mm / 18 mm	103849, 103840
105355	XL 125 / 85 mm	41 mm	20 mm / 18 mm	102463, 102460, 104229
105550	XL 125 / 85 mm	41 mm	20 mm / 18 mm	103849, 103840



Hand-stitched black alligator-skin, semi-mat finish

Ident. No.	Length of strap in mm	Case Size in mm	Width of Horns / Clasp, Buckle	Suitable for:
107319	Standard 115 / 75 mm	39.5 mm	20 mm / 18 mm	106496



Hand-stitched brown alligator-skin, semi-mat finish

Ident. No.	Length of strap in mm	Case Size in mm	Width of Horns / Clasp, Buckle	Suitable for:
107318	Standard 115 / 75 mm	39.5 mm	20 mm / 18 mm	106497



Hand-stitched black alligator-skin, semi-mat finish

Ident. No.	Length of strap in mm	Case Size in mm	Width of Horns / Clasp, Buckle	Suitable for:
107085	Standard 115 / 75 mm	43.5 mm	22 mm / 20 mm	106166

MONTBLANC COLLECTION VILLERET 1858 SERVICE

> Alligator

**Hand-stitched brown alligator-skin, semi-mat finish**

Ident. No.	Length of strap in mm	Case Size in mm	Width of Horns / Clasp, Buckle	Suitable for:
107086	Standard 115 / 75 mm	43.5 mm	22 mm / 20 mm	106167

**Hand-stitched blue alligator-skin, semi-mat finish**

Ident. No.	Length of strap in mm	Case Size in mm	Width of Horns / Clasp, Buckle	Suitable for:
109089	Standard 115 / 75 mm	43.5 mm	22 mm / 20 mm	107582

**Hand-stitched black alligator-skin, semi-mat finish**

Ident. No.	Length of strap in mm	Case Size in mm	Width of Horns / Clasp, Buckle	Suitable for:
105356	XS 105 / 65 mm	47 mm	22 mm / 20 mm	102456, 103072, 102453
105545	XS 105 / 65 mm	47 mm	22 mm / 20 mm	103845, 104373, 103836, 104353
103152	Standard 115 / 75 mm	47 mm	22 mm / 20 mm	102456, 103072, 102453
105541	Standard 115 / 75 mm	47 mm	22 mm / 20 mm	103845, 104373, 103836, 104353
107087	Standard 115 / 75 mm	47 mm	22 mm / 20 mm	104863, 104864, 104865
107083	Standard 115 / 75 mm	47 mm	22 mm / 20 mm	106164
105352	XL 125 / 85 mm	47 mm	22 mm / 20 mm	102456, 103072, 102453
105543	XL 125 / 85 mm	47 mm	22 mm / 20 mm	103845, 104373, 103836, 104353

**Hand-stitched black alligator-skin with double red stitching, semi-mat finish**

Ident. No.	Length of strap in mm	Case Size in mm	Width of Horns / Clasp, Buckle	Suitable for:
109165	Standard 115 / 75 mm	47 mm	22 mm / 20 mm	107343

MONTBLANC COLLECTION VILLERET 1858 SERVICE

> Alligator



Hand-stitched brown alligator-skin, semi-mat finish

Ident. No.	Length of strap in mm	Case Size in mm	Width of Horns / Clasp, Buckle	Suitable for:
105357	XS 105 / 65 mm	47 mm	22 mm / 20 mm	102457, 102454
105546	XS 105 / 65 mm	47 mm	22 mm / 20 mm	103846, 103837
107084	Standard 115 / 75 mm	47 mm	22 mm / 20 mm	106165
103156	Standard 115 / 75 mm	47 mm	22 mm / 20 mm	102457, 102454
105542	Standard 115 / 75 mm	47 mm	22 mm / 20 mm	103846, 103837
107090	Standard 115 / 75 mm	47 mm	22 mm / 20 mm	104866
105353	XL 125 / 85 mm	47 mm	22 mm / 20 mm	102457, 102454
105544	XL 125 / 85 mm	47 mm	22 mm / 20 mm	103846, 103837



Hand-stitched black alligator-skin, semi-mat finish

Ident. No.	Length of strap in mm	Case Size in mm	Width of Horns / Clasp, Buckle	Suitable for:
106469	Standard 115 / 75 mm	47 mm	22 mm / 20 mm	104874, 103842, 106494, 106495
107082	Standard 115 / 75 mm	47 mm	22 mm / 20 mm	106168



Hand-stitched brown alligator-skin, semi-mat finish

Ident. No.	Length of strap in mm	Case Size in mm	Width of Horns / Clasp, Buckle	Suitable for:
106470	Standard 115 / 75 mm	47 mm	22 mm / 20 mm	104873, 103843, 109931



Hand-stitched white alligator skin, glossy finish

Ident. No.	Length of strap in mm	Case Size in mm	Width of Horns / Clasp, Buckle	Suitable for:
110443	Standard 115 / 75 mm	36 mm	18 mm / 20 mm	Suitable for: 109931, 109182, 109184
110444	Standard 105 / 65 mm	36 mm	18 mm / 20 mm	Suitable for: 109931, 109182, 109184

MONTBLANC COLLECTION VILLERET 1858 SERVICE

> Buckles



Platinum buckle

Ident. No.	Width of strap in mm	Case Size in mm	Suitable for:
103165	18 mm	39.5 / 41 mm	Fits all Villeret watches with a 39.5 / 41 mm platinum case
103162	20 mm	43.5 / 47 mm	Fits all Villeret watches with a 43.5 / 47 mm platinum case



18 K white gold buckle

Ident. No.	Width of strap in mm	Case Size in mm	Suitable for:
103166	18 mm	39.5 / 41 mm	Fits all watches with a 39.5 / 41 mm white gold case
103163	20 mm	43.5 / 47 mm	Fits all watches with a 43.5 / 47 mm white gold case



18 K red gold buckle

Ident. No.	Width of strap in mm	Case Size in mm	Suitable for:
110445	16 mm	36 mm	Fits all watches with a 36 mm red gold case
103167	18 mm	39.5 / 41 mm	Fits all watches with a 39.5 / 41 mm red gold case
103164	20 mm	43.5 / 47 mm	Fits all watches with a 43.5 / 47 mm red gold case



18 K white gold clasp

Ident. No.	Width of strap in mm	Case Size in mm	Suitable for:
101288 *	20 mm	43.5 / 47 mm	Fits all watches with a 43.5 / 47 mm white gold case



18 K red gold clasp

Ident. No.	Width of strap in mm	Case Size in mm	Suitable for:
101288 *	20 mm	43.5 / 47 mm	Fits all watches with a 43.5 / 47 mm red gold case

* Case back opening mechanism does not function with engaged deployant buckle

MONTBLANC NICOLAS RIEUSSEC SERVICE

> Alligator



Hand-made, brown alligator skin, semi-mat finish, for gold and platinum models



Hand-made, black alligator skin, semi-mat finish, for gold and platinum models



Hand-made, blue alligator skin, semi-mat finish



Hand-made, grey alligator skin, semi-mat finish

*MONTBLANC NICOLAS RIEUSSEC SERVICE**> Alligator*

Case Size in mm	42 / 43		
Width of Horns / Clasp, Buckle	22/20		
Length of strap in mm	Standard	XL	XS
	110/75	120/85	100/65

Ident. No.	101286	105613	106461
------------	--------	--------	--------

Ident. No.	101285	102284	106460
------------	--------	--------	--------

Ident. No.	107560	107562	107561
------------	--------	--------	--------

Ident. No.	110151	110153	110152
------------	--------	--------	--------

MONTBLANC NICOLAS RIEUSSEC SERVICE

> *Bracelets*

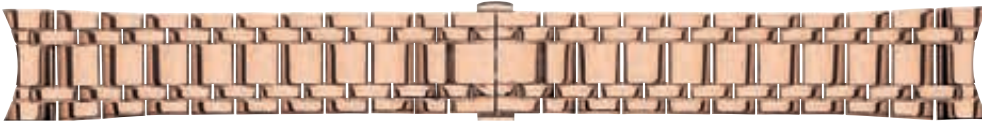

18 K red gold polished



Stainless steel polished

> *Clasps*



18 K red gold clasp

18 K yellow gold clasp

*MONTBLANC NICOLAS RIEUSSEC SERVICE**> Bracelets*

Case Size in mm	42 / 43
Width of strap in mm	20

Ident. No. 109289

Ident. No. 107972

> Clasps

Case Size in mm	42 / 43
Width of strap in mm	20

Ident. No. 101288

Ident. No. 101289

MONTBLANC STAR 4810 SERVICE

> Alligator



Brown alligator skin, semi-mat finish, for clasp



Black alligator skin, semi-mat finish, for clasp

> Bracelet



Stainless steel, satin-finish, partly polished

> Buckles and Clasps



Stainless steel clasp, for Star 4810 models



18 K red-gold buckle, for Star 4810 models

MONTBLANC STAR 4810 SERVICE

> Alligator

Case Size in mm	41.5			44		
Width of Horns / Clasp, Buckle	21/20			22/20		
Length of strap in mm	Standard	XL	XS	Standard	XL	XS
	110/75	120/85	-	110/75	120/85	-

Ident. No.	103972	105659	-	105319	105661	-
------------	--------	--------	---	--------	--------	---

Ident. No.	103974	105597	-	105318	105598	-
------------	--------	--------	---	--------	--------	---

> Bracelet

Case Size in mm	41.5	44
Width of Horns in mm	21	22

Ident. No.	103973	105320
------------	--------	--------

> Buckles and Clasps

Case Size in mm	41.5	44
Width of strap in mm	20	20

Ident. No.	103993	103993
------------	--------	--------

Ident. No.	105021	105021
------------	--------	--------

MONTBLANC STAR CLASSIQUE SERVICE

> Alligator



Black alligator skin, semi-mat, with stitching



Brown alligator skin, semi-mat, with stitching



Black alligator skin, semi-mat finish



Brown alligator skin, semi-mat finish



Black alligator skin, shiny



Brown alligator skin, shiny



Grey alligator skin, shiny



White alligator skin, shiny



Red alligator skin, shiny



Purple alligator skin, shiny

MONTBLANC STAR CLASSIQUE SERVICE

> Alligator

Case Size in mm	34			39		
Width of Horns / Clasp, Buckle	17/16			19/17		
Length of strap in mm	Standard	XL	XS	Standard	XL	XS
	110/70	120/80	100/60	115/75	125/85	105/65

Ident. No.	-	-	-	109196	109198	109197
------------	---	---	---	--------	--------	--------

Ident. No.	-	-	-	109193	109195	109194
------------	---	---	---	--------	--------	--------

Ident. No.	-	-	-	110228	110229	110230
------------	---	---	---	--------	--------	--------

Ident. No.	-	-	-	110231	110232	110233
------------	---	---	---	--------	--------	--------

Ident. No.	110482	-	-	-	-	-
------------	--------	---	---	---	---	---

Ident. No.	109160	-	109162	-	-	-
------------	--------	---	--------	---	---	---

Ident. No.	110227	-	110181	-	-	-
------------	--------	---	--------	---	---	---

Ident. No.	109157	-	109159	-	-	-
------------	--------	---	--------	---	---	---

Ident. No.	110483	-	-	-	-	-
------------	--------	---	---	---	---	---

Ident. No.	110484	-	-	-	-	-
------------	--------	---	---	---	---	---

MONTBLANC STAR CLASSIQUE SERVICE

> *Bracelets*



Stainless steel / 18 K yellow gold, polished



Stainless steel / 18 K red gold, polished



Stainless steel, polished

> *Buckles*



18 K red gold buckle



18 K yellow gold buckle



Stainless steel buckle

MONTBLANC STAR CLASSIQUE SERVICE

> Bracelets

Case Size in mm	34	39
Width of Horns in mm	17	19

Ident. No.	109153	109154
------------	--------	--------

Ident. No.	109155	109156
------------	--------	--------

Ident. No.	109304	109305
------------	--------	--------

> Buckles

Case Size in mm	34	39
Width of strap in mm	17/16	19/17

Ident. No.	102183	103992
------------	--------	--------

Ident. No.	-	107512
------------	---	--------

Ident. No.	35469	35470
------------	-------	-------

MONTBLANC STAR SERVICE

> Alligator



Black alligator skin with shiny finish



Black alligator skin, semi-mat



Black alligator skin, semi-mat



Black alligator skin, semi-mat



Anthracite alligator skin, semi-mat finish



Black alligator skin with shiny finish



Brown alligator skin, semi-mat



Chocolate-brown alligator skin



Brown alligator skin, semi-mat



Brown alligator skin, semi-mat

MONTBLANC STAR SERVICE

> Alligator

Case Size in mm	24	32			36 / 38 / 39			40			42 / 43		
Width of Horns / Clasp, Buckle	12/10	17/16			19/17			21/18			22/20		
Length of strap in mm	Standard 110/70	Standard 110/70	XL 120/80	XS 100/60	Standard 120/80	XL 130/90	XS 110/70	Standard 110/75	XL 120/85	XS 100/65	Standard 110/75	XL 120/85	XS 100/65

Ident. No.	-	01499	09440	09441	01500	-	102208	-	-	-	-	-	-
Ident. No.	-	-	-	-	08092	09442	105290	35430	35431	35432	35427	35428	35429
Ident. No.	-	-	-	-	106769	107282	107281	-	-	-	-	-	-
Ident. No.	-	-	-	-	-	-	-	-	-	-	106767	107286	107285
Ident. No.	-	-	-	-	-	-	103981	-	-	-	-	-	-
Ident. No.	01498	-	-	-	-	-	-	-	-	-	-	-	-
Ident. No.	-	36854	-	-	07027	-	-	-	-	-	101284	103149	106459
Ident. No.	-	-	-	-	106315	-	106853	-	-	-	-	-	-
Ident. No.	-	-	-	-	106768	107280	107279	-	-	-	-	-	-
Ident. No.	-	-	-	-	-	-	-	-	-	-	106766	107284	107283

MONTBLANC STAR SERVICE

> Alligator



Semi-mat light brown alligator skin



Brown alligator skin with shiny finish



Blue alligator skin with shiny finish



Blue alligator skin, semi-mat finish



Purple alligator skin with shiny finish



Pink alligator skin with shiny finish



White alligator skin, semi-mat finish



White alligator skin with shiny finish

MONTBLANC STAR SERVICE

> Alligator

Case Size in mm	24	32			36 / 38 / 39			40			42 / 43		
Width of Horns / Clasp, Buckle	12/10	17/16			19/17			21/18			22/20		
Length of strap in mm	Standard 110/70	Standard 110/70	XL 120/80	XS 100/60	Standard 120/80	XL 130/90	XS 110/70	Standard 110/75	XL 120/85	XS 100/65	Standard 110/75	XL 120/85	XS 100/65

Ident. No.	-	-	-	-	-	-	-	102163	-	-	102162	-	-
Ident. No.	36767	-	-	-	-	-	-	-	-	-	-	-	-
Ident. No.	-	08411	-	-	-	-	-	-	-	-	-	-	-
Ident. No.	-	-	-	-	38807	-	-	-	-	-	-	-	-
Ident. No.	-	38902	-	-	-	-	-	-	-	-	-	-	-
Ident. No.	-	08412	-	-	-	-	-	-	-	-	-	-	-
Ident. No.	-	-	-	-	38806	-	103980	-	-	-	-	-	-
Ident. No.	-	102412	-	-	-	-	-	-	-	-	-	-	-

MONTBLANC STAR SERVICE

> *Calfskin*



Black calfskin



Black carbon



Black carbon fiber, with insert



Black satinated calfskin



White satinated calfskin



White calfskin

MONTBLANC STAR SERVICE

> Calfskin

Case Size in mm	32			36 / 38 / 39			40		
Width of Horns / Clasp, Buckle	17/16			19/17			21/18		
Length of strap in mm	Standard	XL	XS	Standard	XL	XS	Standard	XL	XS
	110/70	120/80	105/65	120/80	125/85	110/70	110/75	120/85	100/65

Ident. No.	01495	-	02240	01496	01502	35444	36510	101622	-
Ident. No.	-	-	-	08138	-	-	-	-	-
Ident. No.	-	-	-	08137*	-	-	-	-	-
Ident. No.	-	-	-	107699	107740	107739	-	-	-
Ident. No.	-	-	-	107700	107742	107741	-	-	-
Ident. No.	105376	-	-	-	-	-	-	-	-

* Integrated strap

MONTBLANC STAR SERVICE

> Calfskin



Black grained calfskin



Black grained calfskin



Brown grained calfskin



Burgundy grained calfskin



Golden-coloured grained calfskin



White grained calfskin

MONTBLANC STAR SERVICE

> Calfskin

Case Size in mm	32			36 / 38 / 39		
Width of Horns / Clasp, Buckle	17/16			19/17		
Length of strap in mm	Standard	XL	XS	Standard	XL	XS
	110/70	120/80	100/60	120/80	130/90	110/70

Ident. No.	36513*	-	-	-	-	-
Ident. No.	07017	09434	09435	07023	09438	09439
Ident. No.	07016	-	-	07022	-	-
Ident. No.	08101	-	-	-	-	-
Ident. No.	07001	-	-	-	-	-
Ident. No.	101332	-	-	-	-	-

* Detachable strap for all Medium Montblanc Star models

MONTBLANC STAR SERVICE

> *Satin*



Black satin



Black tech satin



Anthracite-coloured satin



Brown satin



Brown/grey satin



White satin



White satin

MONTBLANC STAR SERVICE

> *Satin*

Case Size in mm	32			36 / 38 / 39		
Width of Horns / Clasp, Buckle	17/16			19/17		
Length of strap in mm	Standard	XL	XS	Standard	XL	XS
	110/70	120/80	100/60	120/80	130/90	110/70

Ident. No.	102181	-	-	-	-	105981
------------	--------	---	---	---	---	--------

Ident. No.	-	-	-	106296	-	106458
------------	---	---	---	--------	---	--------

Ident. No.	103976	-	-	-	-	-
------------	--------	---	---	---	---	---

Ident. No.	103940	-	-	-	-	-
------------	--------	---	---	---	---	---

Ident. No.	-	-	-	-	-	103979
------------	---	---	---	---	---	--------

Ident. No.	102179	-	-	-	-	103978
------------	--------	---	---	---	---	--------

Ident. No.	-	-	-	106295	-	106457
------------	---	---	---	--------	---	--------

MONTBLANC STAR SERVICE

> Bracelets



Stainless steel polished



Stainless steel, satin-finish, partly polished



Stainless steel, satin-finish

MONTBLANC STAR SERVICE

> Bracelets

Case Size in mm	32	36	38	39	40	42	43
Width of Horns in mm	17	19	19	19	21	22	22

Ident. No.	102177	-	-	-	-	-	-
------------	--------	---	---	---	---	---	---

Ident. No.	03178 ¹⁾ 36507 ²⁾ 09187	03177 ³⁾ 09186 ⁴⁾	03175	105960 ⁵⁾ 107278 ⁶⁾	36504 ⁷⁾ 36506 ⁸⁾	36505	101282
------------	---	--	-------	--	--	-------	--------

Ident. No.	-	08129 107698 ⁹⁾	08128	-	-	-	-
------------	---	-------------------------------	-------	---	---	---	---

- 1) Montblanc Star models 1997 - 2005 / Technical reference 7020
- 2) All Montblanc Star models since 2005 / Technical reference 7079
- 3) Large Automatic Quartz only
- 4) Chrono Quartz only
- 5) Technical References 7189 and 7190
- 6) Technical Reference 7201
- 7) Only Reserve de Marche Automatic 40 mm
- 8) All Montblanc Star Quartz / Automatic 40 mm except Reserve de Marche
- 9) Star Quartz and Automatic

MONTBLANC STAR SERVICE

> Buckles



18 K white gold buckle



18 K red gold buckle



18 K yellow gold buckle



Stainless steel buckle

MONTBLANC STAR SERVICE

> Buckles

Case Size in mm	24	32	36 / 38 / 39	40	42
Width of strap in mm	10	16	17	18	20
Ident. No.	-	-	38808	-	-
Ident. No.	-	102183	103992	-	-
Ident. No.	-	103939	107512	104566	104567
Ident. No.	-	35469	35470	36758	-

MONTBLANC STAR SERVICE

> Clasps



Stainless steel clasp



18 K white gold clasp



18 K red gold clasp



18 K yellow gold clasp



Stainless steel clasp

MONTBLANC STAR SERVICE

> Clasps

Case Size in mm	32	36 / 38 / 39	40	41.5	42 / 43
Width of strap in mm	16	17	18	20	20
Ident. No.	105013	105014	104889	-	105015
Ident. No.	-	-	-	-	101287
Ident. No.	-	-	-	-	101288
Ident. No.	-	-	-	-	101289
Ident. No.	-	-	-	-	101283

MONTBLANC TIMEWALKER SERVICE

> Alligator



Black alligator skin, semi-mat finish, with stitching and beige lining



Black alligator skin, semi-mat with grey stitching and beige lining



Black alligator skin, shiny finish, with stitching and beige lining



Black alligator skin, semi-mat finish, with black lining



Grey alligator skin, semi-mat with grey stitching and grey lining

MONTBLANC TIMEWALKER SERVICE

> Alligator

Case Size in mm	39			42 / 43			
Width of Horns / Clasp, Buckle	20/18			22/20			
Length of strap in mm	Standard	XL	XS	Standard	XL	XS	XXS
	115/75	125/85	105/65	114/74	134/84	114/64	104/54

Ident. No.	106304	106303	106302	102176	104016	104017	105722
------------	--------	--------	--------	--------	--------	--------	--------

Ident. No.	-	-	-	107738	109000	109001	109062
------------	---	---	---	--------	--------	--------	--------

Ident. No.	-	-	-	106297	106300	106299	106298
------------	---	---	---	--------	--------	--------	--------

Ident. No.	-	-	-	107295	107298	107296	107297
------------	---	---	---	--------	--------	--------	--------

Ident. No.	-	-	-	108632	108633	108634	108635
------------	---	---	---	--------	--------	--------	--------

MONTBLANC TIMEWALKER SERVICE

> Alligator



Brown alligator skin, semi-mat with stitching and beige lining



Brown alligator skin, semi-mat finish, with stitching and gold lining



Semi-mat cognac alligator skin with stitching and beige lining



Semi-mat white alligator skin with grey lining

> Calfskin



Black calfskin with gold stitching



Black calfskin with blue stitching



Black calfskin with orange stitching

MONTBLANC TIMEWALKER SERVICE

> Alligator

Case Size in mm	39			42 / 43			
Width of Horns / Clasp, Buckle	20/18			22/20			
Length of strap in mm	Standard	XL	XS	Standard	XL	XS	XXS
	115/75	125/85	105/65	114/74	134/84	114/64	104/54

Ident. No.	-	-	-	107505	107540	107541	107542
------------	---	---	---	--------	--------	--------	--------

Ident. No.	-	-	-	107027	107291	107289	107290
------------	---	---	---	--------	--------	--------	--------

Ident. No.	106307	106306	106305	102175	104018	104019	105723
------------	--------	--------	--------	--------	--------	--------	--------

Ident. No.	-	-	-	105019	105020	105018	105726
------------	---	---	---	--------	--------	--------	--------

> Calfskin

Ident. No.	-	-	-	107012	107294	107292	107293
------------	---	---	---	--------	--------	--------	--------

Ident. No.	-	-	-	110160	110161	110162	110163
------------	---	---	---	--------	--------	--------	--------

Ident. No.	-	-	-	110165	110166	110167	110168
------------	---	---	---	--------	--------	--------	--------

MONTBLANC TIMEWALKER SERVICE

> Bracelets



Stainless steel, polished, and 18 K red gold



Stainless steel, polished, and 18 K yellow gold



Stainless steel with satin-finished titanium central links



Stainless steel, polished, with black ceramic links



Stainless steel polished



Stainless steel with satin-finished central links

MONTBLANC TIMEWALKER SERVICE

> Bracelets

Case Size in mm	39	42 / 43
Width of Horns in mm	20	22

Ident. No.	107036	107544
Ident. No.	107037	107543
Ident. No.	-	110164
Ident. No.	-	103984
Ident. No.	106308	104020
Ident. No.	-	107504

MONTBLANC TIMEWALKER SERVICE

> Buckles



18 K red gold buckle



Titanium buckle



Black DLC stainless steel buckle



Mat black DLC-coated stainless steel buckle



Stainless steel buckle

> Clasps



Stainless steel triple folding clasp

MONTBLANC TIMEWALKER SERVICE

> Buckles

Case Size in mm	39	42 / 43
Width of strap in mm	18	20

Ident. No.	-	102182
------------	---	--------

Ident. No.	-	109026
------------	---	--------

Ident. No.	-	106301
------------	---	--------

Ident. No.	-	107226
------------	---	--------

Ident. No.	106309	35475
------------	--------	-------

> Clasps

Ident. No.	-	104232
------------	---	--------

MONTBLANC SPORT SERVICE

> Alligator



Black alligator skin



Black alligator skin, semi-mat finish



Black nubuck alligator skin, semi-mat finish



Brown alligator skin

MONTBLANC SPORT SERVICE

> Alligator

Case Size in mm	38			41.5			44		
	19/17			20/17			22/20		
Width of Horns / Clasp, Buckle									
Length of strap in mm	Standard	XL	XS	Standard	XL	XS	Standard	XL	XS
	110/80	120/90	100/70	115/85	125/95	105/75	105/75	115/85	95/65
Ident. No.	08133	09451	09452	08131	09449	09450	-	-	-
Ident. No.	-	-	-	-	-	-	105674*	105316*	105675*
Ident. No.	-	-	-	-	-	-	105672*	105323*	105673*
Ident. No.	36516	36581	36580	08112	09447	09448	-	09150	-

* integrated strap

MONTBLANC SPORT SERVICE

> Rubber



Black rubber without clasp



White rubber without clasp



Black rubber, with diving strap extension

> Bracelets



Polished stainless steel



Stainless steel



Stainless steel / rubber

MONTBLANC SPORT SERVICE

> Rubber

Case Size in mm	34.5	38	41.5	44
Width of Horns / Clasp, Buckle	17/16	19/18	20/18	22/20
Length of strap in mm	Standard	Standard	Standard	Standard
	98/98	103/103	105/105	110/70

Ident. No.	35448	06381	101267 ¹⁾ 06380 ²⁾	-
------------	-------	-------	---	---

Ident. No.	35449	103982	-	-
------------	-------	--------	---	---

Ident. No.	-	-	-	101290 ³⁾
------------	---	---	---	----------------------

- 1) all except Flyback
- 2) only for Flyback
- 3) Diving strap extension: 60 mm

> Bracelets

Case Size in mm	34.5	38	41.5	44
Width of Horns in mm	17	19	20	22

Ident. No.	102178	-	-	-
------------	--------	---	---	---

Ident. No.	06376	06375	06374 09146 ⁴⁾	105324
------------	-------	-------	------------------------------	--------

Ident. No.	-	-	103983	-
------------	---	---	--------	---

- 4) Only for Flyback

MONTBLANC SPORT SERVICE

> Buckles and Clasps



18 K red gold buckle



Stainless steel buckle



Stainless steel clasp



Stainless steel clasp

MONTBLANC SPORT SERVICE

> Buckles and Clasps

Case Size in mm	34.5	38 / 41.5	38 / 41.5	44
Width of strap in mm	16	17	18	20
Ident. No.	-	-	-	104015
Ident. No.	-	-	-	101291
Ident. No.	35478	-	35479	-
Ident. No.	-	105014	104889	105326

PRINCESSE GRACE DE MONACO SERVICE

> Alligator



Black alligator skin, semi-mat



White alligator skin, semi-mat



Grey alligator skin, shiny



Black alligator skin, shiny



Grey alligator skin, shiny



Purple alligator skin, shiny



Aubergine alligator skin, shiny

PRINCESSE GRACE DE MONACO SERVICE

> Alligator

Case Size in mm	34		
Width of Horns / Clasp, Buckle	15/14		
Length of strap in mm	Standard	XL	XS
	110/70	120/80	100/60

Ident. No.	107500	107516	107515
------------	--------	--------	--------

Ident. No.	107499	107514	107513
------------	--------	--------	--------

Ident. No.	110224	110225	110226
------------	--------	--------	--------

Ident. No.	110485	-	-
------------	--------	---	---

Ident. No.	110486	-	-
------------	--------	---	---

Ident. No.	110487	-	-
------------	--------	---	---

Ident. No.	110488	-	-
------------	--------	---	---

PRINCESSE GRACE DE MONACO SERVICE
> *Calfskin*



Grey satin-finished calfskin



White satinated calfskin

PRINCESSE GRACE DE MONACO SERVICE

> *Calfskin*

Case Size in mm	34		
Width of Horns / Clasp, Buckle	15/14		
Length of strap in mm	Standard	XL	XS
	110/70	120/80	100/60

Ident. No.	107502	107520	107519
------------	--------	--------	--------

Ident. No.	107501	107518	107517
------------	--------	--------	--------

PRINCESSE GRACE DE MONACO SERVICE

> Buckles



18 K red gold buckle



Stainless steel buckle

*PRINCESSE GRACE DE MONACO SERVICE**> Buckles*

Case Size in mm	34
Width of strap in mm	14

Ident. No. 107498

Ident. No. 107497

MONTBLANC PROFILE SERVICE

> Alligator



Black alligator skin, shiny finish



White alligator skin, semi-mat finish



Pink alligator skin, semi-mat finish



Dark blue alligator skin, semi-mat finish

MONTBLANC PROFILE SERVICE

> Alligator

Case Size in mm	23 x 30/35			23 x 35
Width of Horns / Clasp, Buckle	18/14			18/16
Length of strap in mm	Standard	XL	XS	Standard
	105/75	115/85	95/65	105/75

Ident. No.	09159	09465	09467	-
------------	-------	-------	-------	---

Ident. No.	101301	-	101299	-
------------	--------	---	--------	---

Ident. No.	-	-	-	105072
------------	---	---	---	--------

Ident. No.	-	-	-	105073
------------	---	---	---	--------

MONTBLANC PROFILE SERVICE

> Calfskin



Black grained calfskin



White grained calfskin



White calfskin strap & buckle, detachable



Black satinated calfskin



Grey satin-finish calfskin



White satinated calfskin

MONTBLANC PROFILE SERVICE

> Calfskin

Case Size in mm	23 x 30/35			23 x 35
Width of Horns / Clasp, Buckle	18/14			18/16
Length of strap in mm	Standard	XL	XS	Standard
	105/75	115/85	95/65	105/75

Ident. No.	-	-	-	107268
------------	---	---	---	--------

Ident. No.	-	-	-	107269
------------	---	---	---	--------

Ident. No.	102171	-	-	
------------	--------	---	---	--

Ident. No.	107454	-	-	
------------	--------	---	---	--

Ident. No.	107453	-	-	
------------	--------	---	---	--

Ident. No.	107455	-	-	
------------	--------	---	---	--

MONTBLANC PROFILE SERVICE

> *Saffiano*



Black Saffiano strap & buckle,
detachable



Pink Saffiano strap & buckle,
detachable

*MONTBLANC PROFILE SERVICE**> Saffiano*

Case Size in mm	23 x 30/35		
Width of Horns / Clasp, Buckle	18/14		
Length of strap in mm	Standard	XL	XS
	105/75	115/85	95/65

Ident. No.	38563	-	38562
------------	-------	---	-------

Ident. No.	-	-	38561
------------	---	---	-------

MONTBLANC PROFILE SERVICE

> *Satin*



Black satin



White satin



Grey satin



White satin



Anthracite-coloured satin with Starisma-inspired pattern, strap & buckle, detachable



Silver-coloured satin with Starisma pattern, strap & buckle, detachable



Brown satin with Starisma pattern, strap & buckle, detachable

MONTBLANC PROFILE SERVICE

> *Satin*

Case Size in mm	23 x 30/35			23 x 35
Width of Horns / Clasp, Buckle	18/14			18/16
Length of strap in mm	Standard	XL	XS	Standard
	105/75	115/85	95/65	105/75

Ident. No.	-	-	-	104913
------------	---	---	---	--------

Ident. No.	-	-	-	104912
------------	---	---	---	--------

Ident. No.	08139	-	-	-
------------	-------	---	---	---

Ident. No.	104887	-	-	-
------------	--------	---	---	---

Ident. No.	103986	-	-	-
------------	--------	---	---	---

Ident. No.	103985	-	-	-
------------	--------	---	---	---

Ident. No.	103987	-	-	-
------------	--------	---	---	---

MONTBLANC PROFILE SERVICE

> Bracelets



Stainless steel, satin finish



Stainless steel polished



Stainless steel polished

MONTBLANC PROFILE SERVICE

> Bracelets

Case Size in mm	23 x 30/35	23 x 35
Width of Horns in mm	18	18

Ident. No.

08121

-

Ident. No.

36508

-

Ident. No.

-

105071

MONTBLANC PROFILE SERVICE

> Buckles



18 K white gold buckle



Stainless steel buckle



18 K red gold buckle

> Clasps



Stainless steel clasp

MONTBLANC PROFILE SERVICE

> Buckles

Case Size in mm	23 x 30/35	23 x 35
Width of strap in mm	14	16

Ident. No.

38554

-

Ident. No.

35472

105074

Ident. No.

104896

104914

> Clasps

Ident. No.

105012

-

