

**BUNZL**

Processor Division  
**KOCH** SUPPLIES



# FISH & SEAFOOD PLANT OPERATING SUPPLIES

# BUNZL PROCESSOR DIVISION... OVER 130 YEARS OF THE RIGHT PEOPLE, RIGHT PRODUCTS AND RIGHT PRICES

Bunzl Processor Division is a leading supplier of the food processing industry. The acquisition of Koch Supplies, Packers Engineering & Equipment and Enterprise allowed us to combine and expand our product offerings, warehousing, distribution expertise and buying power - giving our customers a high level of quality and service. We provide an unparalleled ability to service national platforms, as well as multi-plant, single-plant, small shops and game processors.



## A Renowned History

Koch Supplies is one of the oldest businesses in Kansas City, establishing its roots as Koch Butcher Supply Company over 130 years ago. In fact, the grandchildren of people who did

business with Koch Supplies during the World War II era are now running many of their family's businesses and are some of our best customers. Many of the associates at Bunzl Processor Division/Koch Supplies have tenure of over 20 years, with their relatives and children working alongside them.

In 2001, Koch Supplies became a proud part of Bunzl Processor Division - a leader in the food processing and food packaging industries.

Bunzl Processor Division offers more than 35,000 different supply items and 14 distribution centers serving Central and North America, including the Caribbean and Mexico. But even though we have grown in size and scope, we continue the tradition of outstanding customer service that our customers have come to expect of us over the years - while ever expanding our product lines to fit our customers' needs.



## WHY BUY FROM BUNZL PROCESSOR DIVISION?

- Dedicated exclusively to food processors
- 14 distribution centers
- Award-winning service
- Inside and outside sales and support
- Over 130 years in the industry
- Free UPS Ground shipping on orders over \$400
- Small orders - no problem
- Large orders - big savings

This is just a sampling of our plant operating supplies. Call **800-456-5624** or go on-line [www.bunzlpd.com](http://www.bunzlpd.com) to order your copy of our **Buyers Guide** catalog.



**2 - 4**

**CUTLERY**



**5 - 8**

**CUT PROTECTION**

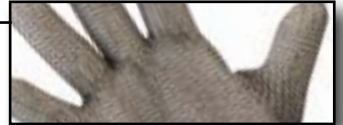

**9 - 10**

**GLOVES**



**11 - 15**

**CLOTHING**



**16 - 18**

**BOOTS**



**19 - 22**

**MATERIAL HANDLING**



**23 - 26**

**JAN/SAN**



**27 - 28**

**PACKAGING**



**29**

**EARPLUGS**



**30**

**SCALES**





# Oyster Knives

- Red SuperGrip handle prevents slipping.
- New Haven knife has a hooked tip to help pry open shells.
- Boston knives have round tip for extra leverage.
- Galveston knife has a broad straight-edged blade.



**VICTORINOX**  
SWISS ARMY



*Providence, 2-3/4"*

**A**



*New Haven, 2-3/4"*

**B**



*Boston, 3"*

**C**



*Boston, 4" Narrow*

**D**



*Galveston, 4"*

**E**

> 6 per box.  
EACH

ITEM NO.	PRODUCT	MFR. NO.	1-5	6+
3367 46921	A. Providence, 2-3/4" Blade . . . . .	44692 . . . . .	\$12.60	\$9.24
3367 46931	B. New Haven, 2-3/4" Blade . . . . .	44693 . . . . .	12.45	9.13
3367 46941	C. Boston, 3" Blade . . . . .	44694 . . . . .	13.13	9.63
3367 46961	D. Boston, 4" Blade, Narrow . . . . .	44696 . . . . .	13.59	9.96
3367 46951	E. Galveston, 4" Blade . . . . .	44695 . . . . .	13.43	9.85

PRICES ARE SUBJECT TO CHANGE

## Oyster Knife



- 3" Boston-style blade.
- Sani-safe handle withstands high and low temperatures.



> 12 per box.  
EACH

ITEM NO.	PRODUCT	MFR. NO.	1-11	12+
5816 0493	Oyster Knife . . . . .	S124 . . . . .	\$13.50	\$9.00

## Scallop Sani-Safe Knife



- Designed to split and pry open shells.



> 12 per box.  
EACH

ITEM NO.	PRODUCT	MFR. NO.	1-11	12+
5816 00261	2" Scallop Knife . . . . .	S124 . . . . .	\$12.19	\$8.13

## Catfish Sani-Safe Boning Knives



- Yellow, sure grip textured handle.
- Protective finger guard.
- Proprietary DEXSTEEL blade.



> 6 per box.  
EACH

ITEM NO.	PRODUCT	MFR. NO.	1-5	6+
5816 03091	5" Narrow, Straight Stiff . . . . .	C135N-5 . . . . .	\$18.94	\$12.63
5816 03131	6" Narrow, Curved Flex . . . . .	C131F-6 . . . . .	18.98	12.65

## Clam Sani-Safe Knife



- Textured, slip-resistant, polypropylene Sani-safe handle.
- Easy to clean, blade-to-handle seal



> 12 per box.  
EACH

ITEM NO.	PRODUCT	MFR. NO.	1-11	12+
5816 04431	3" blade, 6" overall length . . . . .	S127 . . . . .	\$9.45	\$6.30
5816 00281	3-3/8" blade, 7-3/8" overall length . . . . .	S129 . . . . .	10.46	6.98



**VICTORINOX**  
SWISS ARMY

## Curved Boning Knives



> 6 per box.

ITEM NO.	PRODUCT	HANDLE COLOR	MFR. NO.	EACH	
				1-5	6+
3367 05141	A. 5" Curved Semi-Stiff . . . black . . .	40514 . .	\$21.00	\$15.55	
3367 00051	5" Curved Flex . . . . . black . . .	40516 . .	21.00	15.55	
3367 00141	6" Curved Semi-Stiff . . . black . . .	40515 . .	22.05	16.19	
3367 04201	6" Curved Semi-Stiff . . . red . . . .	40420 . .	22.05	16.19	
3367 04701	6" Curved Semi-Stiff . . . yellow . . .	40470 . .	22.05	16.19	
3367 0450	6" Curved Semi-Stiff . . . blue . . . .	40450 . .	22.05	16.19	
3367 94151	6" Curved Flex . . . . . black . . .	40517 . .	21.75	15.96	
3367 01681	6" Curved Flex . . . . . yellow . . .	43517 . .	21.75	15.96	

## 6" Fillet Knife



> 6 per box.

ITEM NO.	PRODUCT	MFR. NO.	EACH	
			1-5	6+
3367 07141	6" Straight . . . . .	40714 . .	\$20.40	\$14.96

## Narrow Boning Knives



> 6 per box.

ITEM NO.	PRODUCT	MFR. NO.	EACH	
			1-5	6+
3367 00271	5" Narrow Semi-Flex . . . . .	40518 . .	\$21.00	\$15.55
3367 05121	5" Narrow Flex . . . . .	40512 . .	20.10	14.74
3367 00451	6" Narrow Semi-Flex . . . . .	40519 . .	21.45	15.73
3367 00031	6" Narrow Flex . . . . .	40513 . .	21.00	15.55
3367 06131	8" Straight Flex . . . . .	40613 . .	27.00	19.85

## Breaking Knives



> 6 per box.

ITEM NO.	PRODUCT	MFR. NO.	EACH	
			1-5	6+
3367 05371	8" Curved . . . . .	40537 . .	\$35.55	\$26.07
3367 05381	10" Curved . . . . .	40538 . .	40.88	29.98

## Paring Knives



> 12 per box.

ITEM NO.	PRODUCT	BLADE	MFR. NO.	EACH	
				1-11	12+
3367 06001	A. 3-1/4" Small Handle . . .	Straight . .	40600 . .	\$5.25	\$3.85
3367 05081	3-1/4" Long Handle . . .	Straight . .	40508 . .	6.38	4.68
3367 06021	B. 3-1/4" Small Handle . . .	Wavy . . . .	40602 . .	5.25	3.85
3367 05091	3-1/4" Long Handle . . .	Wavy . . . .	40509 . .	6.38	4.68

**Frosts**  
MORA

## Curved Boning Knives



#6818 00561 G-grip, Flex



#6818 00661 G1-grip, Flex



#6818 21511 E-Grip, Medium Flex

> 10 per box.

ITEM NO.	SIZE	MFR. NO.	HANDLE STYLE	FLEX	EACH	
					1-9	10+
6818 10651	5"	10902	G1-grip . . . . .	Flex . . . . .	\$14.95	\$13.95
6818 00551	5"	10867	G-grip . . . . .	Flex . . . . .	12.95	11.95
6818 10521	5"	10251	E-grip . . . . .	Stiff . . . . .	12.95	11.95
6818 10551	5"	10885	G-grip . . . . .	Stiff . . . . .	14.95	13.95
6818 21511	5"	10643	E-grip . . . . .	Medium-Flex . .	11.95	10.95
6818 10611	6"	10253	E-grip . . . . .	Flex . . . . .	13.95	12.95
6818 10621	6"	10254	E-grip . . . . .	Stiff . . . . .	13.95	12.95
6818 00661	6"	10903	G1-grip . . . . .	Flex . . . . .	15.95	14.95
6818 00561	6"	10868	G-grip . . . . .	Flex . . . . .	13.95	12.95
6818 10561	6"	10874	G-grip . . . . .	Stiff . . . . .	14.95	13.95
6818 10661	6"	10875	G1-grip . . . . .	Stiff . . . . .	15.95	14.95

## X-traFlex Curved Knives

• Hardness and flexibility have been incorporated into the finest quality Swedish high-carbon, no-stain steel to give the best possible service and life.

• Blade memory allows knife blade to return to its original position when it bends or twists during the cutting process.

• ER-grip: Double-moulded rubber handle with ribs, good for wet conditions. Also comes in a small (ERS) style.

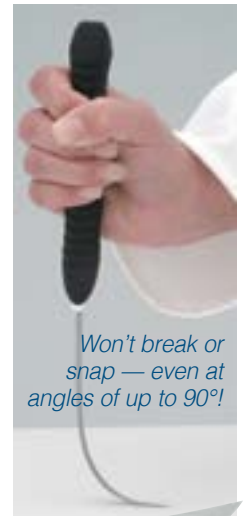

Won't break or snap — even at angles of up to 90°!



ERS (small)-Grip, X-traFlex



ER-Grip, X-traFlex

> 10 per box.

ITEM NO.	SIZE	MFR. NO.	HANDLE STYLE	EACH	
				1-9	10+
6818 12601	6"	10255 . . . . .	ER-grip . . . . .	\$14.95	\$13.95
6818 11601	6", Smaller Handle . . .	10256 . . . . .	ERS-grip . . . . .	14.95	13.95

PRICES ARE SUBJECT TO CHANGE

## Sliming Knife



- 4-1/2" blade.
- Sani-safe handle withstands high and low temperatures.



> 6 per box.  
EACH

ITEM NO.	PRODUCT	MFR. NO.	1-5	6+
5816 13381	Sliming Knife	SL125	\$10.70	\$7.06

## Gut Knife with Spoon



- 4-1/2" or 6" blade.
- Sani-safe handle withstands high and low temperatures.



> 6 per box.  
EACH

ITEM NO.	PRODUCT	MFR. NO.	1-5	6+
5816 01471	4-1/2" Gut Knife w/Spoon	10683	\$10.76	\$7.11
5816 01761	6" Gut Knife w/Spoon	10673	\$11.18	\$7.38

## Net Knife



- 3-1/2" blade.
- Sani-safe handle withstands high and low temperatures.



> 12 per box.  
EACH

ITEM NO.	PRODUCT	MFR. NO.	1-11	12+
5816 53531	Net Knife	S151SCGWE	\$6.40	\$4.22

## Forschner Polished Steel

Compare to the industry's most popular polished butcher steel.

- Tapered shaft is made of magnetized chromium alloy steel.
- Corrosion-resistant.
- Plastic handle with safety slip guard and ring.



> 10 per box.  
EACH

**FORSCHNER**

ITEM NO.	PRODUCT	MFR. NO.	1-9	10+
3367 06961	10" Polished	40696	\$14.95	\$13.95

## IM313 Multi Oilstone Set

Ideal for general sharpening and honing large straight edge knives and tools.

- Non-skid base serves as an oil reservoir in which stones may be immersed when not in use.
- Set includes:
  - oilstone holder base.
  - dust cover.
  - 1 pint of mineral oil.
  - 1 coarse-grit Crystolon®
  - 1 medium-grit Crystolon®
  - 1 fine-grit India stone.



Knives not included

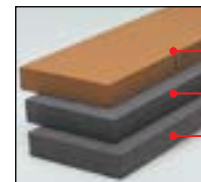

ITEM NO.	PRODUCT	DIMENSIONS	EACH
4808 0313	Multi Oilstone Sharpener Set		\$199.95
4808 10031	Coarse Grit Replacement Stone	11-1/2" x 2-1/2" x 1/2"	29.95
4808 10061	Medium Grit Replacement Stone	11-1/2" x 2-1/2" x 1/2"	29.95
4808 00091	Fine Grit Replacement Stone	11-1/2" x 2-1/2" x 1/2"	29.95
4808 10021	Mineral Oil, 1-Quart		17.95





# WORKHORSE® Cut Resistant Gloves

Constructed of spun threads with fully encapsulated glass fibers and stainless steel.

- FDA approved antimicrobial fibers meet USDA food handling requirements.
- Exceptional comfort that is 100% latex and silicone free. • Resistant to acids, alkali, and organic solvents.
- Extended cuff offers extra cut protection around the wrist. • Machine washable. Antimicrobial fiber. • Ambidextrous.

**WARNING: THESE GLOVES ARE CUT-RESISTANT BUT NOT CUT PROOF OR PUNCTURE PROOF. DO NOT SUBJECT TO MOVING OR HIGHLY SERRATED BLADES.**



Gray

Standard Cuff

White

A4		A5	
Lightweight blend of high-performance synthetic fibers. No steel.			
<b>13 GAUGE</b> CUT RESISTANCE LEVEL <b>ANSI 4</b>		<b>10 GAUGE</b> CUT RESISTANCE LEVEL <b>ANSI 5</b>	
<b>A413 STANDARD CUFF</b>		<b>A510 STANDARD CUFF</b>	
<b>Gray</b>		<b>Gray</b>	
ITEM NO.	SIZE CUFF EDGE COLOR	ITEM NO.	SIZE CUFF EDGE COLOR
E542 85001	X-Small . . . Green	E542 85101	X-Small . . . Green
E542 85011	Small . . . . . White	E542 85111	Small . . . . . White
E542 85021	Medium . . . . Red	E542 85121	Medium . . . . Red
E542 85031	Large . . . . . Blue	E542 85131	Large . . . . . Blue
E542 85041	X-Large . . . . Orange	E542 85141	X-Large . . . . Orange
<b>White</b>		<b>White</b>	
ITEM NO.	SIZE CUFF EDGE COLOR	ITEM NO.	SIZE CUFF EDGE COLOR
E542 85051	X-Small . . . Green	E542 85151	X-Small . . . Green
E542 85061	Small . . . . . White	E542 85161	Small . . . . . White
E542 85071	Medium . . . . Red	E542 85171	Medium . . . . Red
E542 85081	Large . . . . . Blue	E542 85181	Large . . . . . Blue
E542 85091	X-Large . . . . Orange	E542 85191	X-Large . . . . Orange
	1-5      6+		1-5      6+
	\$9.95    \$8.95		\$8.95    \$7.95

**A513 STANDARD CUFF**

**Gray**

ITEM NO.	SIZE	CUFF EDGE COLOR
E542 85201	X-Small . . .	Green
E542 85211	Small . . . . .	White
E542 85221	Medium . . . .	Red
E542 85231	Large . . . . .	Blue
E542 85241	X-Large . . . .	Orange

**White**

ITEM NO.	SIZE	CUFF EDGE COLOR
E542 85251	X-Small . . .	Green
E542 85261	Small . . . . .	White
E542 85271	Medium . . . .	Red
E542 85281	Large . . . . .	Blue
E542 85291	X-Large . . . .	Orange

## What Cut Resistance Level Should I Order?

Gauge indicates thickness of threads used in the glove. The higher the gauge = thinner threads for more flexibility.

**10 GAUGE**  
CUT RESISTANCE LEVEL  
**ANSI 5**

Indicates ANSI Cut Level Rating. SEE CHART. Higher the cut level rating = more cut protection.

## ANSI Cut Level Rating Chart

Higher the cut level rating = more cut protection.

CUT RESISTANCE LEVEL ANSI ?	CUT LEVEL	WEIGHT* IN GRAMS
	0	0 -199
	A1	200 - 499
	A2	500 - 999
	A3	1000 -1499
	A4	1500 -2199
	A5	2200 - 2999
	A6	3000 - 3999
	A7	4000 - 4999
	A8	5000 - 5999
	A9	6000+

\* Weight needed to cut through material with 25mm of blade travel.



Extended Cuff

## A513X EXTENDED CUFF

**Gray**

ITEM NO.	SIZE	CUFF EDGE COLOR
E542 85301	X-Small . . .	Green
E542 85311	Small . . . . .	White
E542 85321	Medium . . . .	Red
E542 85331	Large . . . . .	Blue
E542 85341	X-Large . . . .	Orange

**White**

ITEM NO.	SIZE	CUFF EDGE COLOR
E542 85351	X-Small . . .	Green
E542 85361	Small . . . . .	White
E542 85371	Medium . . . .	Red
E542 85381	Large . . . . .	Blue
E542 85391	X-Large . . . .	Orange

1-5      6+  
**\$11.95      \$10.95**

# SPENDING LESS THAN \$10 CAN SAVE YOU THOUSANDS

## THE COST OF HAND CUT INJURIES:

In the food processing industry **70%** of workers who suffered hand injuries were **NOT** wearing protective gloves.

Average hand injury bill **EXCEEDS \$6,000**, with each workers' compensation claim reaching **\$7,500**.

Indirect costs can include **lost worker productivity** (potentially running into the 10's of thousands of dollars), cost of training replacement employees, damage to workers' morale and **company reputation**.

A6			A9					
<b>10 GAUGE</b> CUT RESISTANCE LEVEL <b>ANSI 6</b>			<b>7 GAUGE</b> CUT RESISTANCE LEVEL <b>ANSI 6</b>			<b>7 GAUGE</b> CUT RESISTANCE LEVEL <b>ANSI 9</b>		
<b>A610 STANDARD CUFF</b>			<b>A607 STANDARD CUFF</b>			<b>A907 STANDARD CUFF</b>		
<b>Gray</b>			<b>Gray</b>			<b>White</b>		
ITEM NO.	SIZE	CUFF EDGE COLOR	ITEM NO.	SIZE	CUFF EDGE COLOR	ITEM NO.	SIZE	CUFF EDGE COLOR
E542 85601	X-Small	Green	E542 85401	X-Small	Green	E542 85751	X-Small	Green
E542 85611	Small	White	E542 85411	Small	White	E542 85761	Small	White
E542 85621	Medium	Red	E542 85421	Medium	Red	E542 85771	Medium	Red
E542 85631	Large	Blue	E542 85431	Large	Blue	E542 85781	Large	Blue
E542 85641	X-Large	Orange	E542 85441	X-Large	Orange	E542 85791	X-Large	Orange
E542 06501	XX-Large	Gray						
<b>White</b>			<b>White</b>					
ITEM NO.	SIZE	CUFF EDGE COLOR	ITEM NO.	SIZE	CUFF EDGE COLOR			
E542 85651	X-Small	Green	E542 85451	X-Small	Green			
E542 85661	Small	White	E542 85461	Small	White			
E542 85671	Medium	Red	E542 85471	Medium	Red			
E542 85681	Large	Blue	E542 85481	Large	Blue			
E542 85691	X-Large	Orange	E542 85491	X-Large	Orange			
1-5	6+		1-5	6+		1-5	6+	
<b>\$8.95</b>	<b>\$7.95</b>		<b>\$10.95</b>	<b>\$9.95</b>		<b>\$14.95</b>	<b>\$13.95</b>	
<b>A610X EXTENDED CUFF</b>			<b>A607X EXTENDED CUFF</b>					
<b>Gray</b>			<b>Gray</b>					
ITEM NO.	SIZE	CUFF EDGE COLOR	ITEM NO.	SIZE	CUFF EDGE COLOR			
E542 33001	X-Small	Green	E542 85501	X-Small	Green			
E542 33011	Small	White	E542 85511	Small	White			
E542 33021	Medium	Red	E542 85521	Medium	Red			
E542 33031	Large	Blue	E542 85531	Large	Blue			
E542 33041	X-Large	Orange	E542 85541	X-Large	Orange			
<b>White</b>			<b>White</b>					
ITEM NO.	SIZE	CUFF EDGE COLOR	ITEM NO.	SIZE	CUFF EDGE COLOR			
E542 33101	X-Small	Green	E542 85551	X-Small	Green			
E542 33111	Small	White	E542 85561	Small	White			
E542 33121	Medium	Red	E542 85571	Medium	Red			
E542 33131	Large	Blue	E542 85581	Large	Blue			
E542 33141	X-Large	Orange	E542 85591	X-Large	Orange			
1-5	6+		1-5	6+				
<b>\$9.95</b>	<b>\$8.95</b>		<b>\$11.95</b>	<b>\$10.95</b>				

NOTE: These gloves are sold individually, NOT as a pair.



Cuff Edge Color indicates size



Cut Resistant Glove can be worn on knife hand, when a metal mesh glove is used.

**PROUDLY MADE IN THE USA**



# THE NEW INDUSTRY STANDARD FOR AFFORDABLE METAL MESH CUT PROTECTION!

## WORKHORSE® Stainless Steel Metal Mesh Glove, with Claw Hook closure

The longest lasting, safest, most comfortable mesh glove — at the **LOWEST COST!**

- The links on glove connect over and under to at least four adjacent rings, making them stronger, safer and more secure than other mesh gloves — even at the seams!
- Heavy gauge stainless steel rings are machine welded to give the longest lasting protection against cuts and lacerations.
- Ergonomically designed to give the best fit and dexterity.
- Easy to clean and sanitize.

Reversible design fits both left and right hand workers.

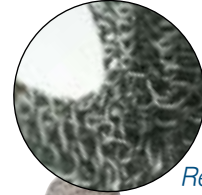

Reinforced links at the crotch of each finger.

Claw hook style closure. No straps to replace.



### WRIST-LENGTH CUFF, CLAW HOOK CLOSURE

ITEM NO.	SIZE	COLOR	PER GLOVE
E542 02631	X-Small . . . . .	Gray . . . . .	<b>\$79.95</b>
E542 02641	Small . . . . .	White . . . . .	<b>79.95</b>
E542 02701	Medium . . . . .	Red . . . . .	<b>79.95</b>
E542 02711	Large . . . . .	Blue . . . . .	<b>79.95</b>
E542 02721	X-Large . . . . .	Green . . . . .	<b>79.95</b>

All gloves include bar code tags with serial numbers so that they can be tracked and recorded.

**NOTE: These gloves are sold individually, NOT as a pair.**

### METAL MESH GLOVE & APRON REPAIR

Most metal mesh can be repaired. All items are sterilized and gloves are returned with a new color-coded strap.

Call 1-800-456-5624 for a quote and a sales order number, then mail your metal mesh product to:

Bunzl Processor Division  
c/o International Services, Inc.  
6129 N. 89th Circle  
Omaha, NE 68134



Individually welded stainless steel links.

Color-coding indicates size.

Metal mesh glove tensioner  
Item No. 6235 01005



We recommend wearing a cotton knit glove underneath your metal mesh  
**SEE PAGE 9**

PRICES ARE SUBJECT TO CHANGE

## WORKHORSE® Replacement Straps

For use with WORKHORSE 2" and 3" extended cuff. See FACING PAGE.

- No need for glove repairs with these easily replaceable straps.



Straps are color-coded to indicate size.

ITEM NO.	SIZE	COLOR	PER STRAP
B140 9015	X-Small . . . . .	Gray . . . . .	<b>\$6.95</b>
B140 9016	Small . . . . .	White . . . . .	<b>6.95</b>
B140 9017	Medium . . . . .	Red . . . . .	<b>6.95</b>
B140 9018	Large . . . . .	Blue . . . . .	<b>6.95</b>
B140 9019	X-Large . . . . .	Green . . . . .	<b>6.95</b>





PRICES ARE SUBJECT TO CHANGE

Reversible design fits both left and right hand workers.



# WORKHORSE® Stainless Steel Metal Mesh Gloves

The longest lasting, safest, most comfortable mesh glove — at the **LOWEST COST!**

- Heavy gauge stainless steel rings are machine welded to give the longest lasting protection against cuts and lacerations.
- Ergonomically designed to give the best fit and dexterity.
- Metal dome snap reduces donning and doffing time.
- Available in full hand style with permanently attached straps, and extended 3 inch cuff designs with field-replaceable straps.
- Color-coded adjustable strap denotes size.
- Easy to clean and sanitize.



Double reinforced rings at stress points to extend glove life and eliminate repairs.

Wrist length cuff.

## **A** WRIST-LENGTH CUFF

ITEM NO.	SIZE	STRAP COLOR	PER GLOVE
E542 10001	X-Small . Size 6 . . .	Gray . .	<b>\$74.95</b>
E542 10011	Small . . . Size 7 . . .	White . .	<b>74.95</b>
E542 10021	Medium . Size 8 . . .	Red . .	<b>74.95</b>
E542 10031	Large . . . Size 9 . . .	Blue . .	<b>74.95</b>
E542 10041	X-Large, Size 10 .	Green . .	<b>74.95</b>



**B**



**NOTE: These gloves are sold individually, NOT as a pair.**

2" and 3" cuff with field replaceable straps.  
See left page for more information.

## **B** 2" EXTENDED-LENGTH CUFF

ITEM NO.	SIZE	STRAP COLOR	PER GLOVE
E542 02531	X-Small. Size 6 . . .	Gray . .	<b>\$84.95</b>
E542 02541	Small. . . Size 7 . . .	White . .	<b>84.95</b>
E542 02601	Medium . Size 8 . . .	Red . .	<b>84.95</b>
E542 02611	Large. . . Size 9 . . .	Blue . .	<b>84.95</b>
E542 02621	X-Large . Size 10 .	Green . .	<b>84.95</b>



**C**

## **C** 3" EXTENDED-LENGTH CUFF

ITEM NO.	SIZE	STRAP COLOR	PER GLOVE
E542 30001	X-Small. Size 6 . . .	Gray . .	<b>\$94.95</b>
E542 30011	Small. . . Size 7 . . .	White . .	<b>94.95</b>
E542 30021	Medium . Size 8 . . .	Red . .	<b>94.95</b>
E542 30031	Large. . . Size 9 . . .	Blue . .	<b>94.95</b>
E542 30041	X-Large . Size 10 .	Green . .	<b>94.95</b>

# String Knit Gloves

- Poly/cotton blend knitted gloves.
- Bleached and unbleached with sewn wrist bands.
- Color-coded cuff edges designates glove weight.
- Ambidextrous and machine washable.
- One Size Fits All

# Light Weight Knit Gloves natural with white cuff edge

► 12 pair per pack— 40 packs per case.

ITEM NO.	PRODUCT	PER DOZEN PAIR	
		1-39	40+
E542 03725	Lightweight Glove . . . . .	\$7.95	\$6.95



# Medium Weight Knit Gloves white with green cuff edge

► 12 pair per pack— 40 packs per case.

ITEM NO.	PRODUCT	PER DOZEN PAIR	
		1-39	40+
E542 03745	Medium weight Glove. . . . .	\$9.95	\$8.95

# Solvex® Unlined Nitrile Gloves

- Made from component materials which comply with FDA regulations for food contact 21CFR 177.2600.
- Offers versatile protection against chemicals and oils.
- Straight cuff. • San patch grip pattern on palm and fingertips. • Latex-free.



# 11-mil. 13" Straight, Unlined

37-145

► 12 dozen pair per case.

ITEM NO.	SIZE	PER DOZEN PAIR	
		1-11	12+
2201 45075	7-7 1/2, Small . . . . .	\$15.95	\$14.95
2201 45085	8-8 1/2, Medium . . . . .	15.95	14.95
2201 45095	9-9 1/2, Large . . . . .	15.95	14.95
2201 45105	10, X-Large . . . . .	15.95	14.95
2201 45115	11, 2X-Large . . . . .	15.95	14.95

# 15-mil. 13" Straight, Unlined

37-155

► 12 dozen pair per case.

ITEM NO.	SIZE	PER DOZEN PAIR	
		1-11	12+
2201 55075	7-7 1/2, Small . . . . .	\$20.95	\$19.95
2201 55085	8-8 1/2, Medium . . . . .	20.95	19.95
2201 55095	9-9 1/2, Large . . . . .	20.95	19.95
2201 55105	10, X-Large . . . . .	20.95	19.95
2201 55115	11, 2X-Large . . . . .	20.95	19.95

# 22-mil. 15" Straight, Unlined

37-165

► 6 dozen pair per case.

ITEM NO.	SIZE	PER DOZEN PAIR	
		1-5	6+
2201 16575	7-7 1/2, Small . . . . .	\$68.95	\$67.95
2201 16585	8-8 1/2, Medium . . . . .	68.95	67.95
2201 16595	9-9 1/2, Large . . . . .	68.95	67.95
2201 65105	10, X-Large . . . . .	68.95	67.95
2201 65115	11, 2X-Large . . . . .	68.95	67.95

# VersaTouch 11-mil. 13" Straight, Unlined Nitrile Gloves

Grip makes it easier to handle foods.

- Form-fitting fingers and tapered wrist.
- Complies with FDA regulations for food contact and complements HACCP food safety guidelines for color-coded gloves.



## Blue Gloves 37-510

► 12 dozen pair per case

ITEM NO.	SIZE	PER DOZEN PAIR	
		1-11	12+
2201 01575	7-7 1/2, Small . . . . .	\$15.95	\$14.95
2201 01585	8-8 1/2, Medium . . . . .	15.95	14.95
2201 01595	9-9 1/2, Large . . . . .	15.95	14.95
2201 01605	10, X-Large . . . . .	15.95	14.95
2201 01615	11, 2X-Large . . . . .	15.95	14.95

## Green Gloves 37-646

► 12 dozen pair per case

ITEM NO.	SIZE	PER DOZEN PAIR	
		1-11	12+
2201 46075	7, Small . . . . .	\$15.95	\$14.95
2201 46085	8, Medium . . . . .	15.95	14.95
2201 46095	9, Large . . . . .	15.95	14.95
2201 46105	10, X-Large . . . . .	15.95	14.95
2201 46115	11, 2X-Large . . . . .	15.95	14.95



# 650 SERIES PREMIUM

## NITRILE DISPOSABLE GLOVES

Flexibility with color coding compliance

Latex **FREE!**

• 5 mil. at the palm.



**Orange**  
Powder-Free

► 100 per box — 10 boxes per case.

ITEM NO.	SIZE	PER BOX	
		1-9	10+
E542 02555	Small . . . . .	\$11.95	\$10.95
E542 02565	Medium . . . . .	11.95	10.95
E542 02575	Large . . . . .	11.95	10.95
E542 02585	X-Large . . . . .	11.95	10.95
E542 02595	2X-Large . . . . .	11.95	10.95



**Grape**  
Powder-Free

► 100 per box — 10 boxes per case.

ITEM NO.	SIZE	PER BOX	
		1-9	10+
E542 02455	Small . . . . .	\$11.95	\$10.95
E542 02465	Medium . . . . .	11.95	10.95
E542 02475	Large . . . . .	11.95	10.95
E542 02485	X-Large . . . . .	11.95	10.95
E542 02495	2X-Large . . . . .	11.95	10.95



**Lime Green**  
Powder-Free

► 100 per box — 10 boxes per case.

ITEM NO.	SIZE	PER BOX	
		1-9	10+
E542 02655	Small . . . . .	\$11.95	\$10.95
E542 02665	Medium . . . . .	11.95	10.95
E542 02675	Large . . . . .	11.95	10.95
E542 02685	X-Large . . . . .	11.95	10.95
E542 02695	2X-Large . . . . .	11.95	10.95



**Black**  
Powder-Free

► 100 per box — 10 boxes per case.

ITEM NO.	SIZE	PER BOX	
		1-9	10+
E542 02755	Small . . . . .	\$11.95	\$10.95
E542 02765	Medium . . . . .	11.95	10.95
E542 02775	Large . . . . .	11.95	10.95
E542 02785	X-Large . . . . .	11.95	10.95
E542 02795	2X-Large . . . . .	11.95	10.95



**Green**  
Powder-Free

► 100 per box — 10 boxes per case.

ITEM NO.	SIZE	PER BOX	
		1-9	10+
E542 04215	Small . . . . .	\$11.95	\$10.95
E542 04225	Medium . . . . .	11.95	10.95
E542 04235	Large . . . . .	11.95	10.95
E542 04245	X-Large . . . . .	11.95	10.95
E542 04255	2X-Large . . . . .	11.95	10.95



**Blue**  
Powder-Free

► 100 per box — 10 boxes per case.

ITEM NO.	SIZE	PER BOX	
		1-9	10+
E542 04115	Small . . . . .	\$11.95	\$10.95
E542 04125	Medium . . . . .	11.95	10.95
E542 04135	Large . . . . .	11.95	10.95
E542 04145	X-Large . . . . .	11.95	10.95
E542 04155	2X-Large . . . . .	11.95	10.95

PRICES ARE SUBJECT TO CHANGE



## .19mm Impertech™ Sanitation Bib

Chemical and mildew resistant.

- .16 mm circular knit polyester backing with stretch polyurethane coating.
- High waist functional bib pant.
- Elastic at ankles for added protection.
- Adjustable elastic suspenders.
- Chest pocket with hook and loop closure on right side.
- Snap adjustment at hem and waist.
- MicroWeld® seam construction.
- Blood borne pathogen tested — blood doesn't penetrate the garment.



> 10 per case.

### BIBS, NAVY BLUE

ITEM NO.	SIZE	EACH	
		1-9	10+
6417 05901	X-Small	\$57.95	\$56.95
6417 05911	Small	57.95	56.95
6417 05921	Medium	57.95	56.95
6417 05931	Large	57.95	56.95
6417 05941	X-Large	57.95	56.95
6417 05951	2X-Large	57.95	56.95
6417 05961	3X-Large	64.95	63.95

## .16mm Impertech™ Sanitation Jacket

Super tough yet comfortable to wear.

- .16 mm circular knit polyester backing with stretch polyurethane coating.
- Attached hood with elastic for added protection.
- Generously cut jacket with raglan sleeves.
- Elastic on wrists for snug fit.
- Over flap front closure with plastic snaps.
- Back cape for ventilation.
- MicroWeld® seam construction.
- Front zip with snap storm flap.
- Blood borne pathogen tested.



> 10 per case.

### JACKET, NAVY BLUE

ITEM NO.	SIZE	EACH	
		1-9	10+
6417 03171	X-Small	\$57.95	\$56.95
6417 03181	Small	57.95	56.95
6417 03191	Medium	57.95	56.95
6417 03201	Large	57.95	56.95
6417 03211	X-Large	57.95	56.95
6417 03221	2X-Large	57.95	56.95
6417 03231	3X-Large	64.95	63.95

## .35mm Mandal Jacket

Chemical and mildew resistant.

- PVC on a durable polyester scrim backing.
- Drawcord hood.
- Storm flap with snap closure.
- Extreme weather protection.



> 10 per case.

### JACKET

YELLOW ITEM NO.	ORANGE ITEM NO.	WHITE ITEM NO.	DARK GREEN ITEM NO.	SIZE	EACH	
					1-9	10+
6417 02111	N/A	6417 02211	6417 14801	X-Small	\$39.95	\$38.95
6417 02121	6417 02321	6417 02221	6417 14811	Small	39.95	38.95
6417 02131	6417 02331	6417 02231	6417 14821	Medium	39.95	38.95
6417 02141	6417 02341	6417 02241	6417 14831	Large	39.95	38.95
6417 02151	6417 02351	6417 02251	6417 14841	X-Large	39.95	38.95
6417 02161	6417 02361	6417 02261	6417 14851	2X-Large	39.95	38.95
6417 02171	6417 02371	6417 02271	6417 14861	3X-Large	46.95	45.95

## .35mm Mandal Bib

Chemical and mildew resistant.

- PVC on a durable polyester scrim backing.
- Symmetrical cut on front and back.
- Heavy-duty attached suspenders and click-type connectors.
- Take-up snap at waist.

### BIBS

YELLOW ITEM NO.	ORANGE ITEM NO.	WHITE ITEM NO.	DARK GREEN ITEM NO.	SIZE	EACH	
					1-9	10+
6417 13101	N/A	N/A	6417 04801	X-Small	\$39.95	\$38.95
6417 13111	6417 13211	6417 13311	6417 04811	Small	39.95	38.95
6417 13121	6417 13221	6417 13321	6417 04821	Medium	39.95	38.95
6417 13131	6417 13231	6417 13331	6417 04831	Large	39.95	38.95
6417 13141	6417 13241	6417 13341	6417 04841	X-Large	39.95	38.95
6417 13151	6417 13251	6417 13351	6417 04851	2X-Large	39.95	37.95
6417 13161	6417 13261	6417 13361	6417 04861	3X-Large	46.95	45.95

PRICES ARE SUBJECT TO CHANGE

# DISPOSABLE SLEEVES



## Polyethylene Sleeves

- Low-cost waterproof protection for light-duty, limited-use applications.



> 2,000 per case.

ITEM NO.	SIZE	COLOR	THICKNESS	CASE
7500 7231	16"	Blue	1-mil.	\$99.95
7500 7221	16"	White	1-mil.	99.95
7500 7224	18"	Blue	1-mil.	129.95
7500 7223	18"	White	1-mil.	129.95



## 18" VR™ Vinyl Replacement Sleeves

- Superior strength and can be recycled.
- Will not become brittle even after multiple uses.
- Material becomes softer after each use.
- Easy to clean and reuse.



> 150 sleeves per case.

ITEM NO.	SIZE	COLOR	THICKNESS	CASE
3386 4352	18"	Clear	4-mil.	\$119.95
3386 3758	18"	Blue	4-mil.	119.95
3386 4350	18"	White	4-mil.	119.95
3386 4351	18"	Yellow	4-mil.	119.95
3386 4355	18"	Clear	6-mil.	129.95
3386 3759	18"	Blue	6-mil.	129.95
3386 4353	18"	White	6-mil.	129.95
3386 4354	18"	Yellow	6-mil.	129.95



## 18" Vinyl Processing Sleeves

- Heat-sealed with enclosed elastic at each end.



> 12 dozen pair per case.

ITEM NO.	SIZE	COLOR	THICKNESS	PER DOZEN PAIR	
				1-11	12+
7500 70645	18"	Clear	4-Mil.	\$13.95	\$12.95
7500 70715	18"	Blue	6-Mil.	14.95	13.95
7500 70815	18"	Blue	8-Mil.	15.95	14.95
7500 70845	18"	Clear	8-Mil.	15.95	14.95
7500 70825	18"	White	8-Mil.	15.95	14.95

# 6 & 8-mil. Blue, Vinyl Aprons

Our best selling vinyl aprons.

- Protection from oil, fat, grease and salt.
- Made of quality vinyl with nylon-serged edges and four heat-sealed grommets.
- Ties in each apron.
- 35" wide, various lengths.



Heat sealed grommet and serged edges are easy to clean and maintain.



Sewn edge  
Raw edge

### A. VINYL APRON WITH TIE

> 6 dozen per case.  
PER DOZEN

ITEM NO.	PRODUCT	SIZE/COLOR	1-5	6+
7500 70015	6-mil., Raw	45" Blue	\$14.95	\$13.95
7500 70025	6-mil., Raw	48" Blue	15.95	14.95
7500 70035	6-mil., Raw	50" Blue	15.95	14.95
7500 70045	6-mil., Raw	55" Blue	16.95	15.95
7500 70065	6-mil., Sewn	45" Blue	15.95	14.95
7500 70075	6-mil., Sewn	48" Blue	16.95	15.95
7500 70355	6-mil., Sewn	48" White	16.95	15.95
7500 70085	6-mil., Sewn	50" Blue	16.95	15.95
7500 70095	6-mil., Sewn	55" Blue	17.95	16.95
7500 70265	8-mil., Sewn	45" Blue	19.95	18.95
7500 70275	8-mil., Sewn	48" Blue	21.95	20.95
7500 70295	8-mil., Sewn	55" Blue	22.95	21.95
7500 70285	8-mil., Raw	45" White	20.95	19.95

### B. DIE CUT VINYL APRON

> 6 dozen per case.  
PER DOZEN

ITEM NO.	PRODUCT	SIZE/COLOR	1-5	6+
2201 00885	6-mil., Die Cut	48" Blue	\$16.95	\$15.95



Over 8,000 plant operating supplies in our 2017-2018 Buyers Guide call **800.456.5624** for your copy.



## Neoprene Kill Floor Apron

*Our most popular apron for kill floor applications.*

- Neoprene coated twice on the front, this apron will not absorb water.
- Every edge is hemmed.
- Weighs 16-oz.
- 35" wide x 48" long.
- 36" sewn ties with metal grommets.



*Sewn neck band does not adjust.*

> 12 per case.

ITEM NO.	COLOR	EACH	
		1-11	12+
3279 35461	Maroon	\$14.95	\$13.95



## 16-Mil. Hycar Apron

*Offering the highest level of abrasion-resistance.*

- 16-oz. heavy-coated hycar aprons.
- Resistance to animal fats and oils.
- Includes cloth neck strap, reinforced nickel plated brass grommets and 36" waist ties.
- 35" wide x 48" long.
- Available in white, black and yellow.



*All edges are sewn.*

> 12 per case.

ITEM NO.	COLOR	EACH	
		1-11	12+
3279 10161	White	\$13.95	\$12.95
3279 10171	Black	13.95	12.95
3279 10181	Yellow	13.95	12.95



## 22-Mil. General Purpose Nitrile Apron

*Economical, heavy-duty nitrile apron coated on both sides.*

- Made of heavy-duty nitrile on a cotton base fabric.
- Snap-on neck band made of polypropylene.
- All edges are hemmed.
- Weighs 22-oz.
- 35" wide x 48" long.



*Double-coated.*

> 24 per case.

ITEM NO.	COLOR	EACH	
		1-23	24+
3419 90001	Yellow	\$19.95	\$18.95



# Disposable Polyethylene Aprons

Economical light-duty alternative.

- Made of polyethylene:  
2-mil. & 1.5-mil. (heavy-duty) or 1-mil. (standard-duty).
- Available in white, red, clear and blue.
- Smooth or embossed surface finish.
- Extra long ties.

**1-MIL. APRON** ▶ 100 aprons per pack — 10 packs per case.

ITEM NO.	PRODUCT	SIZE	PER PACK	
			1-9	10+
7500 72435	Smooth, White . . . . .	28" x 46" . . . . .	\$7.95	\$6.95
7500 72425	Smooth, Blue . . . . .	28" x 46" . . . . .	7.95	6.95
7500 72395	Embossed, Clear . . . . .	28" x 46" . . . . .	7.95	6.95
7500 72495	Smooth, White . . . . .	24" x 42" . . . . .	6.95	5.95

**1.5-MIL. APRON** ▶ 100 aprons per pack — 5 packs per case.

ITEM NO.	PRODUCT	SIZE	PER PACK	
			1-4	5+
7500 72715	Smooth, Red . . . . .	28" x 46" . . . . .	\$11.95	\$10.95
7500 72695	Smooth, White . . . . .	28" x 46" . . . . .	11.95	10.95
7500 72675	Embossed, White . . . . .	28" x 46" . . . . .	11.95	10.95
7500 72485	Smooth, White . . . . .	28" x 55" . . . . .	15.95	14.95
7500 72755	Smooth, Blue . . . . .	28" x 55" . . . . .	15.95	14.95
7500 00895	Embossed, Blue . . . . .	28" x 46" . . . . .	15.95	14.95

**2-MIL. APRON** ▶ 100 aprons per pack — 5 packs per case.

ITEM NO.	PRODUCT	SIZE	PER PACK	
			1-4	5+
7500 72735	Smooth, White . . . . .	28" x 46" . . . . .	\$16.95	\$15.95
7500 72725	Embossed, White . . . . .	28" x 46" . . . . .	16.95	15.95



Choose from blue, clear, red or white.

PRICES ARE SUBJECT TO CHANGE

## Endeavor Apron



Adjustable dielectrically sealed, self-material neck strap.



Self material waist ties are long enough to tie in front or back.

*Tougher, lighter, better quality, lasts longer than vinyl, neoprene, nitrile, hycar for a fraction of the price!*



- Provides ten times the abrasion-resistance of PVC and five times that of vinyl.
- Resistant to fats, oils, and chemicals.
- Remains flexible in cold temperatures down to -65° F; withstands heat up to 180° F.
- Material returns to original shape even after a variety of physical and temperature stresses.
- Slick finish allows for easy clean-up — machine washable.
- One Endeavor apron will outlast dozens of disposable aprons.
- 5.5-mil. thickness.
- 100% recyclable. • 100% non-toxic.

▶ 10 per case.

ITEM NO.	COLOR	SIZE	EACH	
			1-9	10+
5644 35531	White . . . . .	35" x 50" . . . . .	\$10.95	\$9.95
5644 35541	Yellow . . . . .	35" x 50" . . . . .	10.95	9.95
5644 35521	Blue . . . . .	35" x 50" . . . . .	10.95	9.95

## Die-Cut Endeavor Apron



One-piece, self-material neck strap and waist ties for added strength.

▶ 10 dozen per case.

ITEM NO.	COLOR	SIZE	PER DOZEN	
			1-9	10+
5644 35455	White . . . . .	35" x 50" . . . . .	\$97.95	\$95.95
5644 35465	Yellow . . . . .	35" x 50" . . . . .	97.95	95.95
5644 35475	Blue . . . . .	35" x 50" . . . . .	97.95	95.95

# Disposable Polyethylene Gown

- Economical light-duty alternative.
- 1.25-mil. • Extra long ties and hang loop.
- Easy to put on and take off.

Open Back



Thumb loops.



Elastic wrist.

Perforated back for easy removal.



### Thumb Loop Wrist

- Bulk Case pack, individually wrapped.

> 100 per case.

ITEM NO.	PRODUCT	COLOR	CASE
7500 7276	50" Length, Embossed . . .	Blue . . . . .	<b>\$69.95</b>
3386 4250	50" Length, Embossed . . .	Blue . . . . .	<b>69.95</b>

### Elastic Wrist

> 100 per case.

ITEM NO.	PRODUCT	COLOR	CASE
7500 7280	46" Length . . . . .	Blue . . . . .	<b>\$57.95</b>
7500 7281	60" Length . . . . .	White . . . . .	<b>59.95</b>
7500 7279	60" Length, Embossed . . .	Blue . . . . .	<b>59.95</b>

## WORKHORSE® Color-Coded Latex-Free Bouffant Caps

Color-coding your workplace has never been easier!

**Latex FREE**

- Cool and comfortable to wear.
- Choose from: white, green, blue, red, yellow or pink.



> 100 per bag— 10 bags per case.



WHITE

ITEM NO.	SIZE	COLOR	PER BAG	
			1-9	10+
E542 04615	18"	White . . . . .	<b>\$4.95</b>	<b>\$4.45</b>
E542 04625	21"	White . . . . .	<b>5.45</b>	<b>4.95</b>
E542 04635	24"	White . . . . .	<b>5.95</b>	<b>5.45</b>
E542 04645	28"	White . . . . .	<b>6.95</b>	<b>6.45</b>



GREEN

ITEM NO.	SIZE	COLOR	PER BAG	
			1-9	10+
E542 04655	18"	Green . . . . .	<b>\$5.95</b>	<b>\$5.45</b>
E542 04665	21"	Green . . . . .	<b>6.45</b>	<b>5.95</b>
E542 04675	24"	Green . . . . .	<b>6.95</b>	<b>6.45</b>



BLUE

ITEM NO.	SIZE	COLOR	PER BAG	
			1-9	10+
E542 04695	18"	Blue . . . . .	<b>\$5.95</b>	<b>\$5.45</b>
E542 04705	21"	Blue . . . . .	<b>6.45</b>	<b>5.95</b>
E542 04715	24"	Blue . . . . .	<b>6.95</b>	<b>6.45</b>



PINK

ITEM NO.	SIZE	COLOR	PER BAG	
			1-9	10+
E542 04845	21"	Pink . . . . .	<b>\$6.45</b>	<b>\$5.95</b>
E542 04855	24"	Pink . . . . .	<b>6.95</b>	<b>6.45</b>



RED

ITEM NO.	SIZE	COLOR	PER BAG	
			1-9	10+
E542 04885	21"	Red . . . . .	<b>\$6.45</b>	<b>\$5.95</b>
E542 04895	24"	Red . . . . .	<b>6.95</b>	<b>6.45</b>



YELLOW

ITEM NO.	SIZE	COLOR	PER BAG	
			1-9	10+
E542 04865	21"	Yellow . . . . .	<b>\$6.45</b>	<b>\$5.95</b>
E542 04875	24"	Yellow . . . . .	<b>6.95</b>	<b>6.45</b>



PRICES ARE SUBJECT TO CHANGE

# PUROFORT® FoodPro Boots



**35% lighter than traditional rubber and PVC boots! Weighs only 4-lbs!**

- Resistant to mineral, animal & vegetable oil, fats, blood, disinfectants, solvents and various chemicals.
- Thermal insulation keeps feet warm in cold conditions down to -4°F and comfortable in hot conditions.
- Steel mid-plate stays at room temperature when working in cold environments.
- Complies with CSA Z195-09 Omega, ASTM F2413-11 M 1/75 C/75 EH.
- Highest slip resistant sole of any boot. Certified slip resistance (EN ISO 20345:2011 S4 CI SRC).
- Steel toe cap for added safety.
- Remains flexible at low temperatures.
- Shock-absorbing heel.
- Sole designed for specific food processing areas.
- Four colors to reduce cross-contamination.
- Seamed anti-bacterial lining.
- Orthopedic insole design.

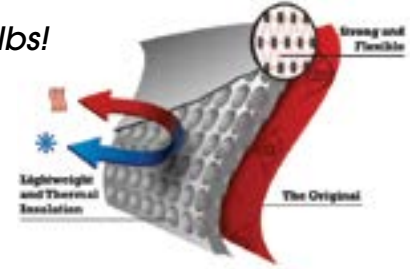

Scan this QR code to watch a video about Purofort Boots

*Purofort® is the unique Dunlop® material with millions of evenly distributed air pockets making it lightweight and thermally insulating plus a cross-linked structure that provides flexibility and strength. The material is created using a special recipe at the time of manufacture, giving your Purofort® boots a "born on" date. This gives Purofort® boots their remarkable properties.*

Unique feature allows boots to be locked together. (separate lock required)



Multigrip Safety Sole: SRC rated for best slip resistance.



PRICES ARE SUBJECT TO CHANGE

## 14" STEEL TOE

SIZE	YELLOW ITEM NO.	GREEN ITEM NO.	BLUE ITEM NO.	WHITE ITEM NO.	6 pair per case. PER PAIR	
					1-5	6+
Men's, Size 4.	E014 07001	E014 18341	E014 16041	E014 00401	\$119.95	\$118.95
Size 5.	E014 07011	E014 18351	E014 16051	E014 00411	119.95	118.95
Size 6.	E014 07021	E014 18361	E014 16061	E014 00421	119.95	118.95
Size 7.	E014 07031	E014 18371	E014 16071	E014 00431	119.95	118.95
Size 8.	E014 07041	E014 18381	E014 16081	E014 00441	119.95	118.95
Size 9.	E014 07051	E014 18391	E014 16091	E014 00451	119.95	118.95
Size 10.	E014 07061	E014 18401	E014 16101	E014 00461	119.95	118.95
Size 11.	E014 07071	E014 18411	E014 16111	E014 00471	119.95	118.95
Size 12.	E014 07081	E014 18421	E014 16121	E014 00481	119.95	118.95
Size 13.	E014 07091	E014 18431	E014 16131	E014 00491	119.95	118.95
Size 14.	E014 07101	E014 18441	E014 16141	E014 00501	119.95	118.95
Size 15.	E014 07111	E014 18451	E014 16151	E014 00511	119.95	118.95





## 16" Steel Toe Sureflex Boot

*Excellent for use in chemicals and food processing.*

- 100% waterproof, PVC/Nitrile sole and soft flexible, high performance PVC compound upper.
- Steel toe complies with ASTM F2413-11.
- Resists animal fats, petroleum, oils, grease and chemicals.
- Orange slip-resistant Safety-Loc™ outsole is designed for superior traction on wet or slippery surfaces.
- Steel shank for firm arch support.

### STEEL TOE

► 6 pair per case.

ITEM NO.	SIZE	PER PAIR	
		1-5	6+
3161 81051	Men's, Size 5	\$41.95	\$40.95
3161 81061	Size 6	41.95	40.95
3161 81071	Size 7	41.95	40.95
3161 81081	Size 8	41.95	40.95
3161 81091	Size 9	41.95	40.95
3161 81101	Size 10	41.95	40.95
3161 81111	Size 11	41.95	40.95
3161 81121	Size 12	41.95	40.95
3161 81131	Size 13	41.95	40.95
3161 81141	Size 14	41.95	40.95
3161 81151	Size 15	41.95	40.95



## Polyblend Boots

*Boot is constructed of a proprietary blend of polyurethane and PVC compound with pull-up and kick-off lugs.*

- Provides general all-purpose chemical-resistance.
- Steel toe meets ASTM F2413-11 standard.
- Non-slip, self-cleaning cleated sole.
- Moderate chemical resistance.
- Easy clean seamless construction.

### STEEL TOE

► 6 pair per case.

ITEM NO.	SIZE	PER PAIR	
		1-5	6+
3161 52041	Men's, Size 4	\$30.95	\$29.95
3161 52051	Size 5	30.95	29.95
3161 52061	Size 6	30.95	29.95
3161 52071	Size 7	30.95	29.95
3161 52081	Size 8	30.95	29.95
3161 52091	Size 9	30.95	29.95
3161 52101	Size 10	30.95	29.95
3161 52111	Size 11	30.95	29.95
3161 52121	Size 12	30.95	29.95
3161 52131	Size 13	30.95	29.95



## Monarch Economy Boots

*An economic alternative for light-duty applications.*

- 16" boot has a polyester lining for easy cleaning.
- Constructed with a reinforced shank and kick-off lugs.
- Cut off band for height adjustment.

### PLAIN TOE

ITEM NO.	SIZE	PER PAIR	
		1-5	6+
3161 42541	Men's, Size 4	\$18.95	\$17.95
3161 42551	Size 5	18.95	17.95
3161 42561	Size 6	18.95	17.95
3161 42571	Size 7	18.95	17.95
3161 42581	Size 8	18.95	17.95
3161 42591	Size 9	18.95	17.95
3161 42601	Size 10	18.95	17.95
3161 42611	Size 11	18.95	17.95
3161 42621	Size 12	18.95	17.95
3161 42631	Size 13	18.95	17.95

PRICES ARE SUBJECT TO CHANGE



## Blue DuraPro® Boots



*DuraPro® insoles provide superior shock absorption, support and comfort with a comfort rim making it feel more like a shoe than a boot.*

- Larger circumference at the top makes it quick and easy to pull the boot on.
- Inner liner allows for increased flexibility and subtle feel at the calf.
- Conformance information molded in sidewall for easy identification.
- Wider metatarsal design and comfort ankle for all day comfort.
- Honeycomb design molded inside the heel to reduce impact when walking.
- Ergonomically designed foot-bed to provide better underfoot support.
- Safety-Loc Surfex outsole.

► 6 pair per case.

ITEM NO.	SIZE	PER PAIR	
		1-5	6+
3161 49541	Men's Size 4 . . . . .	<b>\$36.95</b>	<b>\$35.95</b>
3161 49551	Size 5 . . . . .	<b>36.95</b>	<b>35.95</b>
3161 49561	Size 6 . . . . .	<b>36.95</b>	<b>35.95</b>
3161 49571	Size 7 . . . . .	<b>36.95</b>	<b>35.95</b>
3161 49581	Size 8 . . . . .	<b>36.95</b>	<b>35.95</b>
3161 49591	Size 9 . . . . .	<b>36.95</b>	<b>35.95</b>
3161 49601	Size 10 . . . . .	<b>36.95</b>	<b>35.95</b>
3161 49611	Size 11 . . . . .	<b>36.95</b>	<b>35.95</b>
3161 49621	Size 12 . . . . .	<b>36.95</b>	<b>35.95</b>
3161 49631	Size 13 . . . . .	<b>36.95</b>	<b>35.95</b>
3161 49641	Size 14 . . . . .	<b>36.95</b>	<b>35.95</b>
3161 49651	Size 15 . . . . .	<b>36.95</b>	<b>35.95</b>
3161 49661	Size 16 . . . . .	<b>36.95</b>	<b>35.95</b>



## PolyGoliath Boot



*Highly abrasion-resistant and 100% waterproof.*

- Special urethane/PVC compound is resistant to acids, oils, greases, chemicals and animal fats.
- Two stage, injection-molded, one-piece construction is highly abrasion-resistant and 100% waterproof.
- Outsole provides excellent traction both indoors and outdoors.
- Lower toe spring for a more comfortable fit and better surface contact.
- Cut off bands to shorten boots if desired.
- Kick-off lugs for easy removal.
- One-piece steel shank. • 15" upper.

► 6 pair per case.

ITEM NO.	SIZE	PER PAIR	
		1-5	6+
3161 88061	Men's, Size 6 . . .	<b>\$25.95</b>	<b>\$24.95</b>
3161 88071	Size 7 . . . . .	<b>25.95</b>	<b>24.95</b>
3161 88081	Size 8 . . . . .	<b>25.95</b>	<b>24.95</b>
3161 88091	Size 9 . . . . .	<b>25.95</b>	<b>24.95</b>
3161 88101	Size 10 . . . . .	<b>25.95</b>	<b>24.95</b>
3161 88111	Size 11 . . . . .	<b>25.95</b>	<b>24.95</b>
3161 88121	Size 12 . . . . .	<b>25.95</b>	<b>24.95</b>
3161 88131	Size 13 . . . . .	<b>25.95</b>	<b>24.95</b>
3161 88141	Size 14 . . . . .	<b>25.95</b>	<b>24.95</b>
3161 88151	Size 15 . . . . .	<b>25.95</b>	<b>24.95</b>

# MACX™ Storage System

The durability and versatility of steel for the cost of plastic.  
Lightweight • Strong • Durable • Stackable

- One-piece, injection molded construction.
- Made from high-density, food-grade structural plastic with a service life comparable to steel.
- Will not warp, dent, chip, splinter, rot or rust and are chemical and corrosion-resistant.
- Withstands temperatures from -32° to +165° F.
- Completely sanitary: can be high-pressure washed and steam sterilized.
- Capacity: single bin, unstacked, static weight of 1,500-lbs.
- Drain and cap are available for liquid applications.
- Customizable: add casters, drain plugs, label holders, drop doors, attachable lids, custom colors, and even emboss your company logo on the side.

*Call for more information about customizing this product.*

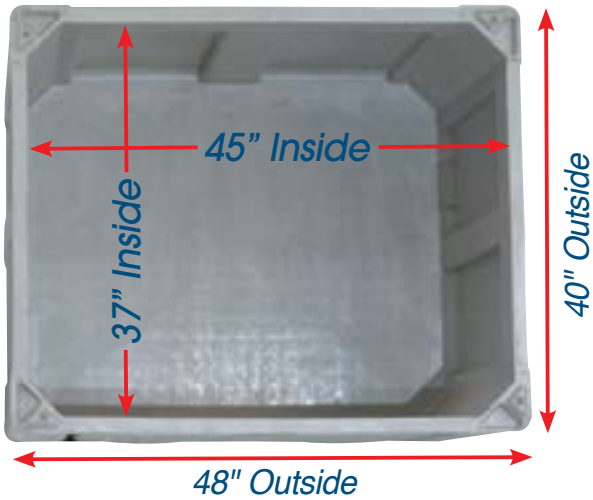

MACX fits your equipment:  
48" x 40" standard pallet footprint.  
25.4 cubic feet; 190 US gallons.  
➤ Shipping weight: 89-lbs.

PRICES ARE SUBJECT TO CHANGE



MACX come standard with runners -- easy for dumping or moving with a forklift.

ITEM NO.	PRODUCT	EACH
3515 0014	Storage Bin, Solid Gray	\$299.95
3515 0013	.....Solid White	299.95
3515 0029	.....Vented Gray	229.95
3515 5862	Stacking Lid, White	99.95
3515 5863	Drain and Cap Kit (for DIY installation)	42.95



# Molded Poly Boxes

# ToteAll 2000<sup>®</sup>

## NEW ADVANCED DESIGN

**All colors are food approved!**

**50-lb. capacity**

**Weighs only 3.8-lbs. empty**

**1.3-cu.ft.**

90° cross stacking via stacking grooves built into bottom of tote.



Smooth interior and wide radius corners for easy cleaning.

Stacking grooves allows cross stacking.

Molded-in handles.

Reinforced nesting-stops prevent jamming.

Wall thickness - .125"

Finely etched exterior resists cuts and scratches.

### Tote Dimensions

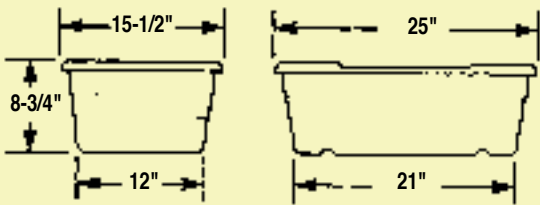

Our ToteAll 2000<sup>®</sup> poly boxes were already a first-class product, but we didn't want to stop there. We've now added 12 additional ribs along the bottom lifting ledge to increase the strength of the ledge when it's used in tote dollies. These reinforcements took our first-class tote to an all new level of excellence!

4:1 nesting ratio saves space.



The green lines below indicate the location of the additional ribs which were added for increased strength.

**All eleven colors are food approved!**

### Molded Poly Boxes

> 100 per pallet. EACH

ITEM NO.	PRODUCT	1-99	100+
3195 06641	Orange	\$11.95	\$10.95
3195 2013	Tan	11.95	10.95
3195 46331	Yellow	11.95	10.95
3195 46351	Green	11.95	10.95
3195 46341	Blue	11.95	10.95
3195 00021	Purple	11.95	10.95
3195 46321	Red	11.95	10.95
3195 73041	Pink	11.95	10.95
3195 07071	White	11.95	10.95
3195 06621	Gray	11.95	10.95
3195 46361	Black	11.95	10.95

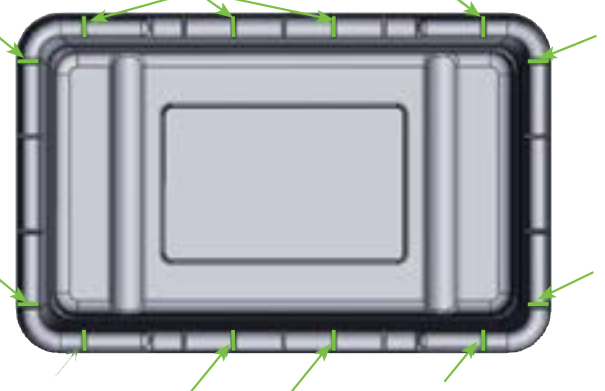

PRICES ARE SUBJECT TO CHANGE

## Distribution Totes

*The only tote accepted by many retail food operations.*

- Complies with sanitation and material handling requirements of many retail food processors.
- Sturdy design with reinforcing ribs and deep molded hand grips for convenient lifting and carrying.
- Made of injection-molded polyethylene.
- Stack with optional covers, nest when empty.
- Cross-stack and interlock on a 40" x 48" pallet.
- FDA approved.
- Color: beige.



## REMCO Molded Poly Kart Tub

- Strong, one piece high-density polyethylene.
- Smooth interior for easy cleaning.
- Full, lidded kart tubs stack securely for storage or shipping.
- Empty tubs nest for space conservation.
- Capacity: 13.7 cu. ft., 1,000-lbs.
- Made from FDA approved materials.
- Dimensions: 30.5" x 54.7" x 20.6" high (36" high with regular undercarriage, 28" with low undercarriage).



ITEM NO.	PRODUCT	DIMENSIONS	CAPACITY	EACH
1814 41681	Tote, Standard Size . . . . .	24" x 16" x 8.7" . . . . .	40-lbs. . . . .	<b>\$14.95</b>
1814 07681	Tote, Large Size . . . . .	24" x 16" x 10-3/4" . . . . .	55-60-lbs. . . . .	<b>15.95</b>
1814 07701	Lid, Standard Size . . . . .	24" x 16" x 1-1/2" . . . . .	2-1/5-lbs. . . . .	<b>8.95</b>
1814 9014	Lid, Large Size . . . . .	24-3/10" x 16-3/10" x 1-4/5" . . . . .	2-1/5-lbs. . . . .	<b>9.95</b>

ITEM NO.	PRODUCT	SHIPPING WEIGHT	EACH
5281 6901	Kart Tub . . . . .	31-lbs. . . . .	<b>\$319.95</b>
5281 6902	Stacking lid . . . . .	15-lbs. . . . .	<b>169.95</b>
5281 6903	Undercarriage . . . . .	69-lbs. . . . .	<b>599.95</b>

PRICES ARE SUBJECT TO CHANGE

## ChillTote™ Trays

**Cuts Conventional Freezing Time in Half!**



- Flow-thru basket design allow maximum air circulation for faster, more efficient freezing.
- ChillTotes fit four-up on standard 42" x 48" pallets.
- Heavy ribs on bottoms of trays prevent the contents of upper and lower trays from freezing together.
- Injection molded from high-density polyethylene to withstand constant freezer temperatures without cracking or warping.
- Lightweight and easy to clean for reuse.
- Heavy-duty, high-density polyethylene won't crack or warp in freezers.
- Holds 1.4 cubic feet, 50-lb. capacity.



*Two 3/8" zinc-plated steel wire bails swing down to allow nesting and swing up for stacking.*

ITEM NO.	PRODUCT	DIMENSIONS	CAPACITY	EACH
1814 28631	Standard Chilltote™ . . . . .	22" l x 19" w x 6" h. . . . .	50-lbs. . . . .	<b>\$19.95</b>
1814 58901	Deep Chilltote™ . . . . .	24" l x 20" w x 13" h. . . . .	75-lbs. . . . .	<b>31.95</b>



## Round BRUTE® Food-Approved Drums



• Proprietary design constructed with the highest quality material plus a UV inhibitor ensures long life in even the most extreme commercial environments.

- Guaranteed to never fade, warp, crack, or crush.
- Optional tight-fitting lids allow drums to be stacked when full.
- Easy-to-clean, seamless molded plastic.
- Anti-jam nesting when drums are not in use saves valuable storage space.
- NSF 2 & 21 Approved.



### 32-Gallon drums

➤ 6 per case.  
EACH

ITEM NO.	PRODUCT	1-5	6+
1770 71041	32-gal. Blue.....	\$31.95	\$30.95
1770 24731	Dark Green.....	31.95	30.95
1770 71011	Gray.....	31.95	30.95
1770 71031	Red.....	31.95	30.95
1770 71021	Yellow.....	31.95	30.95
1770 71001	White.....	31.95	30.95

### 44-Gallon drums

➤ 4 per case.  
EACH

ITEM NO.	PRODUCT	1-3	4+
1770 71091	44-gal. Blue.....	\$47.95	\$46.95
1770 24751	Dark Green.....	47.95	46.95
1770 43881	Gray.....	47.95	46.95
1770 71081	Red.....	47.95	46.95
1770 71071	Yellow.....	47.95	46.95
1770 71051	White.....	47.95	46.95

### 55-Gallon drums

➤ 3 per case.  
EACH

ITEM NO.	PRODUCT	1-2	3+
1770 17401	55-gal. Blue.....	\$72.95	\$71.95
1770 22801	Dark Green.....	72.95	71.95
1770 71101	Gray.....	72.95	71.95
1770 24771	Red.....	72.95	71.95
1770 22791	Yellow.....	72.95	71.95
1770 24781	White.....	72.95	71.95

10 and 20-Gallon drums, lids and dollies also available.

## REMCO Plastic Shovels

- Sturdy injection molded one-piece polypropylene.
- Features a solid shaft and extra thick blade.
- Non-sparking. • Chemical- and corrosion-resistant.
- Made from FDA compliant materials.

### SMALL BLADE

➤ 6 per case.  
EACH

ITEM NO.	PRODUCT	1-5	6+
5281 98101	White.....	\$39.95	\$38.95
5281 00081	Red.....	39.95	38.95
5281 69801	Yellow.....	39.95	38.95
5281 98131	Blue.....	39.95	38.95
5281 98121	Green.....	39.95	38.95

### LARGE BLADE

➤ 6 per case.  
EACH

ITEM NO.	PRODUCT	1-5	6+
5281 98251	White.....	\$40.95	\$39.95
5281 69831	Red.....	40.95	39.95
5281 69891	Yellow.....	40.95	39.95
5281 69881	Blue.....	40.95	39.95
5281 69901	Green.....	40.95	39.95
5281 98271	Orange.....	40.95	39.95
5281 69921	Purple.....	40.95	39.95
5281 98291	Black.....	40.95	39.95



Small Blade: 11" x 14"  
Overall length: 38"  
2.7-lbs.

Large blade: 14" x 17"  
Overall length: 42"  
4-lbs.



PRICES ARE SUBJECT TO CHANGE



## Vikan® Push Brooms

Perfect for HACCP color-coding

- Contains two types of bristles to first help loosen stubborn dirt and move heavy debris, and then gather the finer particles.
- Polypropylene block material with polyester bristles.
- 24" length.



- Handles sold separately see next page.



### Soft/Stiff

> 6 per case.  
EACH

ITEM NO.	COLOR	1-5	6+
5281 19441	Red . . . .	\$44.95	\$43.95
5281 1942	Green . . .	44.95	43.95
5281 1943	Blue . . . .	44.95	43.95
5281 19451	White . . .	44.95	43.95
5281 19461	Yellow . . .	44.95	43.95
5281 00371	Black . . .	44.95	43.95

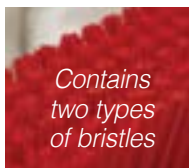

## Vikan® Color-Coded Angle Cut Brooms

Color-coded for environments where hygiene is essential.

- Angled design makes it easy to reach into narrow spaces.
- It is particularly effective for collecting large particles of debris like meat and vegetables in a moist environment.
- Polypropylene block material with polyester bristles.
- 12" length.

- Handles sold separately see next page.



> 12 per case.  
EACH

ITEM NO.	COLOR	1-11	12+
5281 91421	Green . . . .	\$26.95	\$25.95
5281 91431	Blue . . . .	26.95	25.95
5281 91441	Red . . . . .	26.95	25.95
5281 91451	White . . . .	26.95	25.95
5281 91461	Yellow . . . .	26.95	25.95
5281 00351	Black . . . .	26.95	25.95

## Vikan® Color-Coded Dustpans

Color-coded to help organize your workplace.

- Rigid, one-piece, injection-molded polypropylene construction.
- Ergonomic raised-handle design with thumb grip.
- Non-sparking material will not rust or corrode.
- Made from FDA-compliant materials.



> 10 per case.  
EACH

ITEM NO.	COLOR	ITEM NO.	COLOR	1-9	10+
5281 66021	Green . . . .	5281 66061	Yellow . . . .	\$15.95	\$14.95
5281 66031	Blue . . . . .	5281 66071	Orange . . . .	15.95	14.95
5281 66041	Red . . . . .	5281 66091	Purple . . . .	15.95	14.95
5281 66051	White . . . .	5281 66101	Black . . . . .	15.95	14.95

## Vikan® Total Color Deck Brushes

- Hygienic, solid block polypropylene construction with stiff bristles.
- Low water absorption polyester bristles with stainless steel staples.
- Made from FDA-compliant materials.
- Autoclavable at temperatures up to 250° F/121° C.
- Block size: 3" x 12".
- Bristle length: 1-3/4".

> 16 per case.



- Handles sold separately see next page.



ITEM NO.	COLOR	1-15	16+
5281 16051	White . . . . .	\$34.95	\$33.95
5281 0604	Red . . . . .	34.95	33.95
5281 0603	Blue . . . . .	34.95	33.95
5281 06021	Green . . . . .	34.95	33.95
5281 0606	Yellow . . . . .	34.95	33.95
5281 06071	Orange . . . . .	34.95	33.95
5281 06081	Purple . . . . .	34.95	33.95
5281 16091	Black . . . . .	34.95	33.95

# Vikan® One-Piece Ultra Hygiene Squeegees

- One-piece design and co-molded construction eliminates areas that could harbor bacteria.
- Specially blended rubber blade retains its flexibility and durability and is useful on a variety of work surfaces.
- Reinforced polypropylene head.
- Made from FDA-compliant materials.



Seamless one-piece design

- Handles sold separately see below.

- 10" squeegee includes 6-1/2" one-piece sealed-design threaded handle.

## 10" Squeegee > 15 per case.

ITEM NO.	COLOR	EACH	
		1-14	15+
5281 07401	Green ..	\$19.95	\$18.95
5281 12531	Blue....	19.95	18.95
5281 07421	Red ...	19.95	18.95
5281 12551	White...	19.95	18.95
5281 07441	Yellow..	19.95	18.95
5281 07451	Orange..	19.95	18.95

## 16" Squeegee > 15 per case.

ITEM NO.	COLOR	EACH	
		1-14	15+
5281 14011	Pink....	\$27.95	\$26.95
5281 07461	Green ..	27.95	26.95
5281 07471	Blue ...	27.95	26.95
5281 07481	Red....	27.95	26.95
5281 07491	White ..	27.95	26.95
5281 07501	Yellow..	27.95	26.95

## 20" Squeegee > 15 per case.

ITEM NO.	COLOR	EACH	
		1-14	15+
5281 07511	Green ..	\$31.95	\$30.95
5281 07521	Blue....	31.95	30.95
5281 07531	Red ...	31.95	30.95
5281 07541	White...	31.95	30.95
5281 07551	Yellow..	31.95	30.95

## 24" Squeegee > 15 per case.

ITEM NO.	COLOR	EACH	
		1-14	15+
5281 07681	Green..	\$34.95	\$33.95
5281 07571	Blue ...	34.95	33.95
5281 07581	Red ...	34.95	33.95
5281 07591	White ..	34.95	33.95
5281 07601	Yellow..	34.95	33.95
5281 07611	Purple..	34.95	33.95
5281 07621	Black...	34.95	33.95

## 28" Squeegee > 15 per case.

ITEM NO.	COLOR	EACH	
		1-14	15+
5281 07631	Green ..	\$39.95	\$38.95
5281 07641	Blue....	39.95	38.95
5281 07651	Red ...	39.95	38.95
5281 07661	White...	39.95	38.95
5281 07671	Yellow..	39.95	38.95

# Vikan® Ultra Hygiene Poly Handles

- Made of food-grade polypropylene.
- Safe alternative to fiberglass handles.
- Easy to clean rounded grip handles.
- Hygienic smooth surface, sealed to prevent bacterial growth.
- Larger diameter ergonomic handle shape reduces worker fatigue.

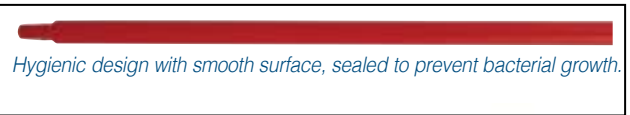

Euro Thread



## 51" Handle

ITEM NO.	COLOR
5281 96011	Pink .....
5281 86021	Green .....
5281 86031	Blue .....
5281 16041	Red .....
5281 86051	White .....
5281 96061	Yellow .....
5281 86071	Orange .....
5281 96081	Purple .....
5281 96091	Black .....

## 59" Handle

ITEM NO.	COLOR
5281 96211	Pink .....
5281 86221	Green .....
5281 16231	Blue .....
5281 16241	Red .....
5281 96301	White .....
5281 96321	Yellow .....
5281 86271	Orange .....
5281 86281	Purple .....
5281 96311	Black .....

## > 10 per case. EACH

	1-9	10+
	\$27.95	\$26.95
	27.95	26.95
	27.95	26.95
	27.95	26.95
	27.95	26.95
	27.95	26.95
	27.95	26.95
	27.95	26.95
	27.95	26.95

## 67" Handle

ITEM NO.	COLOR
5281 01101	Green .....
5281 96431	Blue .....
5281 01111	Red .....
5281 01121	White.....
5281 01171	Yellow .....

## > 10 per case. EACH

	1-9	10+
	\$34.95	\$33.95
	34.95	33.95
	34.95	33.95
	34.95	33.95
	34.95	33.95

# Vikan® Total Color Scrub Brushes

Choose from three styles and multiple colors

- Low water absorption polyester bristles with stainless steel staples.
- Made from FDA-compliant materials.
- Hygienic, solid block polypropylene construction.
- Autoclavable at temperatures up to 250° F/121° C.



Scan this QR code with your mobile device to watch a video about Vikan® color-coded brush usage.



## Short Handle Scrub Brush

- 2.75" x 10". • Choose from stiff or soft bristles.

### Stiff

ITEM NO.	COLOR	ITEM NO.	COLOR	EACH
5281 19251	White	5281 19051	White ..	<b>\$11.95</b>
5281 19241	Red	5281 19041	Red ...	<b>11.95</b>
5281 19261	Yellow	5281 19061	Yellow..	<b>11.95</b>
5281 19221	Green	5281 19021	Green..	<b>11.95</b>
5281 19231	Blue	5281 19031	Blue ...	<b>11.95</b>
5281 19271	Orange			<b>11.95</b>
5281 19281	Purple			<b>11.95</b>
5281 19291	Black			<b>11.95</b>

### Soft



## Long Handle Scrub Brush

- 2.75" x 15.75". • Choose from stiff or soft bristles.

### Stiff

ITEM NO.	COLOR	ITEM NO.	COLOR	EACH
5281 18651	White	5281 28251	White ..	<b>\$12.95</b>
5281 18641	Red	5281 18241	Red ...	<b>12.95</b>
5281 18661	Yellow	5281 18261	Yellow..	<b>12.95</b>
5281 18621	Green	5281 18221	Green..	<b>12.95</b>
5281 18631	Blue	5281 28231	Blue ...	<b>12.95</b>

### Soft

# Vikan® Ultra Safe Technology (UST) Brushes

UST provides a new level of hygienic design and bristle arrangement

The innovative technology utilizes enhanced bristle security units directly molded to the brush block, removing any gaps or seams while offering unprecedented bristle retention strength.

- One piece design, no metal staples or resin.
- FDA compliant.
- Easy to clean and dry.
- Easy color-coded visual inspection.



Easy-to-clean bristle arrangement

## Short Handle UST Scrub Brush

ITEM NO.	COLOR	EACH
5281 00381	Pink .....	<b>\$19.95</b>
5281 00281	Green .....	<b>19.95</b>
5281 00391	Blue .....	<b>19.95</b>
5281 00291	Red .....	<b>19.95</b>
5281 00301	White .....	<b>19.95</b>
5281 00311	Yellow .....	<b>19.95</b>
5281 00401	Orange .....	<b>19.95</b>
5281 00411	Purple .....	<b>19.95</b>

## Long Handle UST Scrub Brush

ITEM NO.	COLOR	EACH
5281 00431	Pink .....	<b>\$24.95</b>
5281 00441	Green .....	<b>24.95</b>
5281 00451	Blue .....	<b>24.95</b>
5281 00461	Red .....	<b>24.95</b>
5281 00471	White .....	<b>24.95</b>
5281 00481	Yellow .....	<b>24.95</b>
5281 19671	Orange .....	<b>24.95</b>
5281 00491	Purple .....	<b>24.95</b>



PRICES ARE SUBJECT TO CHANGE



PRICES ARE SUBJECT TO CHANGE

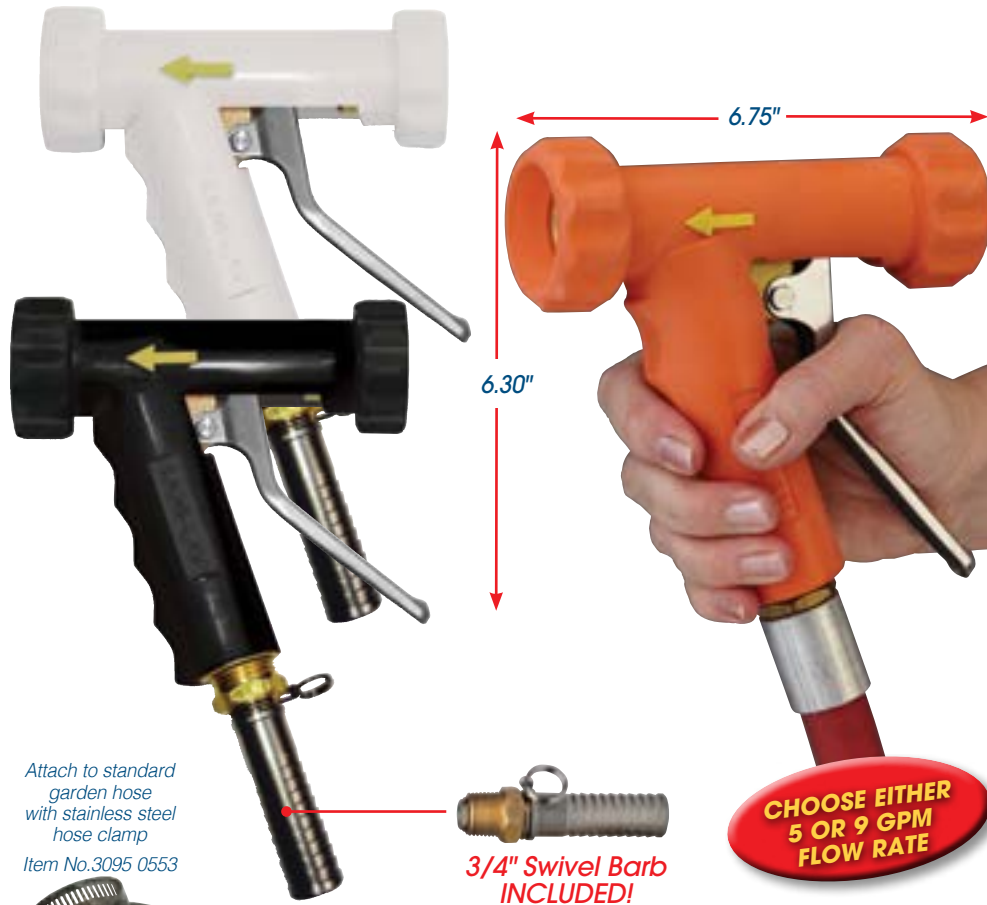

Attach to standard garden hose with stainless steel hose clamp

Item No. 3095 0553

3/4" Swivel Barb INCLUDED!

CHOOSE EITHER 5 OR 9 GPM FLOW RATE

## Heavy-Duty, Insulated Hot Water Spray Nozzles

- Heavy-Duty nozzle withstands the harshest working conditions.
- Quality built with stainless steel and brass parts.
- Insulated rubber cover with yellow direction arrows.
- Rated 200° F (93° C).
- Maximum working pressure 150 psi.
- Variable spray pattern. • Brass main body.

> 3/4" FEMALE GHT INLET. > Weight: 2.7-lb.

### 5 GPM Large Low-Flow Nozzle with Swivel Barb Adapter

ITEM NO.	PRODUCT	EACH
3013 00121	Orange.....	<b>\$139.95</b>
3013 00081	White.....	<b>139.95</b>
3013 00091	Black.....	<b>139.95</b>

### 9 GPM Large Nozzle with Swivel Barb Adapter

ITEM NO.	PRODUCT	EACH
3013 00071	Orange.....	<b>\$139.95</b>
3013 00051	White.....	<b>139.95</b>
3013 00061	Black.....	<b>139.95</b>



Double Braided Nylon Reinforced

FREE rubber insulator keeps hose cool to the touch.

## Hot Water Packinghouse Hose

Multiple textile spirals reinforces hose and extends hose life. **FREE with this hose** — rubber insulators that keep the hose cool to the touch.

- Couplings are securely attached to each end of the hose with no sharp edges and are covered by a heavy-duty reinforcement insulator to prevent failure at the base of the hose and to keep the ends cool to the touch.
- Hose assemblies are pre coupled with garden hose couplings on each end.
- Withstands 500 psi. • Withstands temperatures up to 212° F.
- Highly-resistant to cuts and abrasions.
- Available in 3/4" I.D. & 1/2" I.D.

ITEM NO.	LENGTH	EACH
3538 7108	25' . . . 1/2" I.D. w/ GHT couplings each end . . .	<b>\$119.95</b>
3538 7109	50' . . . 1/2" I.D. w/ GHT couplings each end . . .	<b>199.95</b>
3538 7100	100' . . 1/2" I.D. w/ GHT couplings each end. . . .	<b>349.95</b>
3538 2025	25' . . . 3/4" I.D. w/ GHT couplings each end . . .	<b>139.95</b>
3538 2050	50' . . . 3/4" I.D. w/ GHT couplings each end . . .	<b>229.95</b>
3538 2075	75' . . . 3/4" I.D. w/ GHT couplings each end . . .	<b>349.95</b>
3538 4085	85' . . . 3/4" I.D. w/ GHT couplings each end . . .	<b>349.95</b>
3538 0100	100' . . 3/4" I.D. w/ GHT couplings each end. . . .	<b>459.95</b>



Many more Jan/San supplies available in our 2017-2018 Buyers Guide. Just call **800-456-5624** or go on-line [www.bunzlpd.com](http://www.bunzlpd.com) to order your copy of our 600 page catalog

# CLARITY™

## VACUUM POUCHES

The **FACTS** behind our pouches:



- FDA approved for food contact.
- Contains NO BPA or Melamine.
- Contains NO Starches or Animal By-Products.
- Made from cast co-extruded film providing a true, consistent 3-mil. pouch.
- More flexible & form fitting with an aggressive sealant.
- Easy to open when filling.
- Crystal clear with a glossy finish.



## 3-Mil. Standard Vacuum Pouches

ITEM NO.	IN INCHES	POUCHES PER BOX	PER BOX			
			1 - 4	5 - 9	10-14	15+
7500 1815	6 x 8	1,000	39	34	30	28
7500 1817	6 x 10	1,000	45	42	37	34
7500 1818	6 x 12	1,000	57	51	45	42
7500 1820	6 x 20	1,000	97	85	76	70
7500 1826	7 x 11	1,000	61	54	50	44
7500 1829	8 x 10	1,000	63	57	51	45
7500 1830	8 x 12	1,000	76	66	61	55
7500 1831	8 x 15	1,000	96	84	76	69
7500 1836	10 x 10	1,000	80	70	63	57
7500 1838	10 x 13	1,000	102	91	81	75

ITEM NO.	IN INCHES	POUCHES PER BOX	PER BOX			
			1 - 4	5 - 9	10-14	15+
7500 1839	10 x 15	1,000	119	105	95	86
7500 1840	10 x 18	500	73	62	56	52
7500 1842	10 x 22	500	86	77	69	63
7500 1854	12 x 16	500	76	66	61	55
7500 1856	12 x 22	500	103	92	83	76
7500 1861	14 x 16	500	88	78	70	64
7500 1866	16 x 16	500	103	92	84	76
7500 1867	16 x 20	500	128	112	100	92
7500 1875	18 x 28	250	99	89	79	73
7500 1879	20 x 28	250	111	99	88	80

**THESE VACUUM POUCHES ARE ONLY FOR USE IN VACUUM CHAMBER MACHINES.**



**CLARITY™**  
VACUUM POUCHES

### Gold Metallic Vacuum Pouches

Custom sizes available upon request.

Distinctive packaging to enhance your products visibility!

- Metallic design on back panel with a clear front panel.
- Differentiate yourself from the competition.
- 3-mil. gauge film.



ITEM NO.	SIZE	POUCHES PER BOX	PER BOX			
			1 - 4	5 - 9	10-14	15+
7500 1991	4" x 9"	500	\$47	\$45	\$43	\$40
7500 1992	6" x 8"	500	66	64	61	57
7500 1996	8" x 10"	500	105	100	94	89
7500 1997	8" x 12"	500	114	111	105	100
7500 1999	10" x 15"	500	187	183	174	164

### HP2780 10K OTR Fresh Fish Non-Barrier Bags

- Good for fresh seafood: tuna loins, mahi, sea bass fillets, bulk fillets such as salmon, catfish, cod, flounder and tilapia.
- Standard gauge. • Untaped bags.



#### CASE PACK

ITEM NO.	SIZE	SEAL	QTY PER CASE	PER CASE	MIX & MATCH ANY 3 SIZES PER CASE	
1800 2199	8 x 12	SE	2,000	\$553	\$526	
1800 2203	13 x 19	SE	1,250	583	554	
1800 2204	13 x 40	SE	500	499	475	

#### SMART PACK

ITEM NO.	SIZE	QTY PER BOX	PRICE PER BOX
7584 3488	8 x 12	250	\$61
7584 3490	13 x 19	250	131
7584 3491	13 x 40	250	268



# LOCKER PAPER

- Consistent polyethylene coating helps lock in moisture.
- FDA approved for direct food handling.
- Prevents freezer burn.
- Retains strength when wet.
- 3" core diameter.



## Kold-Lok™ Polyethylene

LOCKS OUT freezer burn up to **6 months**.

ITEM NO.	PRODUCT	PER ROLL	
		1 - 19	20+
1500 2995	15" x 1,100-ft. . . . .	\$41.95	\$39.95
1500 3100	18" x 1,100-ft. . . . .	46.95	44.95
1500 0024	24" x 1,100-ft. . . . .	66.95	64.95



## Freshgard™/Loxol

LOCKS OUT freezer burn up to **9 months**.

ITEM NO.	PRODUCT	PER ROLL	
		1 - 19	20+
1500 0798	15" x 1,100-ft. . . . .	\$51.95	\$49.95
1500 0797	18" x 1,100-ft. . . . .	56.95	54.95
1500 0819	24" x 1,100-ft. . . . .	76.95	74.95

## SuperLoxol™

LOCKS OUT freezer burn up to **12 months**.

ITEM NO.	PRODUCT	PER ROLL	
		1 - 19	20+
1500 1301	15" x 1,000-ft. . . . .	\$56.95	\$54.95
1500 5510	18" x 1,000-ft. . . . .	64.95	62.95

PRICES ARE SUBJECT TO CHANGE

## Industrial Strength Masking Tape 3M

- Core diameter: 3".
- Utility grade masking tape designed for routine packaging, sealing and labeling.
- Non-staining tape can be used in temperatures between 50° to 180° F.

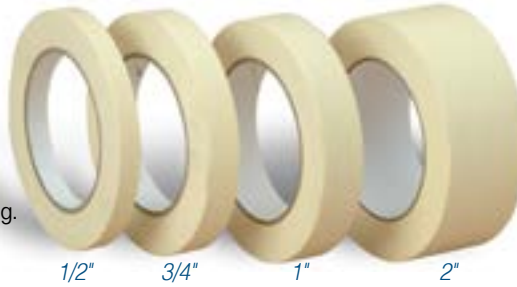

**NOT INTENDED FOR FREEZER USE**

ITEM NO.	SIZE	EACH	
		1-71	72+
6655 19761	1/2" x 180' . . . 72 per case . . .	\$1.95	\$1.45
		EACH	
		1-47	48+
6655 19941	3/4" x 180' . . . 48 per case . . .	\$2.95	\$1.95
		EACH	
		1-35	36+
6655 19681	1" x 180' . . . .36 per case . . .	\$3.95	\$2.95
		EACH	
		1-23	24+
6655 19491	2" x 180' . . . .24 per case . . .	\$4.95	\$3.95

## Multiple Roll Tape Dispensers

Easily dispense multiple rolls of tape from one convenient location.

- Dispenser has screw holes so that it can be securely mounted to tabletop. (Mounting hardware not included).
- Available in two sizes. Smaller dispenser holds any combination of tapes up to 4" wide; larger dispenser holds up to 6" wide.

Spool does not rotate — when one tape is dispensed the other tapes on the spool will not move.



ITEM NO.	PRODUCT	EACH
2330 74041	4" Dispenser. . . . .	\$59.95
2330 74061	6" Dispenser. . . . .	69.95

## Freezer Tape

**SUPER STRONG adhesive for wet and cold temperatures.**

- GUARANTEED to stick in cold, wet applications!
- 3/4" x 180', 18mm x 55m.
- Core diameter: 3".



> 48 per case.

ITEM NO.	PRODUCT	EACH	
		1-47	48+
6655 55931	Freezer Tape . . . . .	\$5.95	\$4.95

## Clear, Low-Temp Flash Freezer Tape

- Can handle storage temperatures down to -20°.
- Core diameter 3".
- 48mm/2" approx. width.
- 100m/110 approx. yards long.



> 36 per case.

ITEM NO.	PRODUCT	EACH	
		1-35	36+
6655 61801	Clear Freezer Tape. . .	\$5.95	\$4.95



## MAX® Foam Disposable Earplugs

NRR-Small Size: 30  
NRR-Regular Size: 33

- Polyurethane foam enhances comfort, especially for long-term wear.
- Smooth, soil-resistant closed-cell foam skin prevents dirt build-up.
- Individually poly-bagged.



> 100 pair per dispenser box — 10 boxes per case.

ITEM NO.	PRODUCT	PER BOX	
		1-9	10+
3140 88025	Reg Foam w/Cord . . . . .	\$29.95	\$28.95
3140 20305	Sm Foam w/Cord . . . . .	29.95	28.95

## MAX Lite® Foam Disposable Earplugs

NRR-30

- Contoured T-shape for easier insertion and removal.
- Low pressure foam expands gently for comfortable long-term wear.
- Individually poly-bagged.



> 200 pair w/o cord per dispenser box — 10 boxes per case.  
> 100 pair w/cord per dispenser box — 10 boxes per case.

ITEM NO.	PRODUCT	PER BOX	
		1-9	10+
3140 99235	MAX Lite® w/o Cord . . . . .	\$24.95	\$23.95
3140 01505	MAX Lite® w/Cord . . . . .	24.95	23.95

## Laser Trak® Detectable Disposable Plugs

NRR-32

- Metal detectable, yet disposable.
- Easily detected by visual and automated inspection.

**Honeywell**  
HOWARD  
LEIGHT



> 100 pair per dispenser box — 10 boxes per case.

ITEM NO.	PRODUCT	PER BOX	
		1-9	10+
3140 38745	Laser-Trak® w/Cord . . . . .	\$39.95	\$38.95

## 3M™ Express™ Pod Plugs™

NRR-25 dB\*

- Reusable or disposable.
- Soft, flexible grips.
- Individually packaged.

**3M**



> 100 pair per dispenser box — 4 boxes per case.

ITEM NO.	PRODUCT	PER BOX	
		1-3	4+
3207 86745	Express™ Pod Plugs™ w/Cord . . . . .	\$104.95	\$103.95

## 3M™ UltraFit™ Metal Detectable Reusable Earplugs

NRR-25 dB\*

- Non-toxic, non-allergenic flexible polymer.
- Soft, pliable, reusable earplugs are washable for extended use.
- Each "reusable" pair is poly-bagged.



Embedded metal ball bearing allows metal detection.

**3M**



> 200 pair per box.

ITEM NO.	PRODUCT	EACH	
		1-199	200+
3207 40171	UltraFit™ Detectable w/Cord . . . . .	\$1.95	\$1.65

PRICES ARE SUBJECT TO CHANGE

# Stainless Steel Washdown Scale



Washdown when powered by batteries.

- Removable 9" x 7-1/2" platform for easy washdown.
- Digital LCD readout displays 1" numerals and also features auto shutoff and push button tare, zero reset and low battery indicator.
- Class III rated.

• Scales weigh in lbs/decimal lbs and g/kg.

➤ Shipping Weight: 8-lbs.

Legal for trade.

ITEM NO.	CAPACITY	RESOLUTION	CAPACITY	RESOLUTION	EACH
3416 1001	2.2-lbs.	.001-lb.	1,000g	.05g	\$399.00
3416 2002	4.4-lbs.	.002-lb.	2,000g	1g	399.00
3416 5002	11-lbs.	.005-lb.	5,000g	2g	399.00
3416 0011	22-lbs.	.01-lb.	10kg	.005kg	399.00
3416 0021	44-lbs.	.02-lb.	20kg	.01kg	399.00
3416 00041	Optional AC Adapter				59.95

NOT Legal for trade.

ITEM NO.	CAPACITY	RESOLUTION	CAPACITY	RES.	EACH
3416 9200	4-lbs. 6-oz.	1/6-oz., 0.1-oz., 0.002-lb.	2,000g	1g	\$399.00
3416 5004	11-lbs.	1/8-oz., 0.1-oz., 0.005-lb.	5,000g	2g	399.00
3416 0024	44-lbs.	1-oz., 0.02-lb.	20kg	0.01kg	399.00
3416 00041	Optional Adapter				59.95



A/C Adaptor Sold Separately.

Batteries Not Included.  
Six "D" batteries required.  
Sold separately: Item #7784 00025

# Titan Stainless Steel Washdown Scale

Stainless steel washdown construction is dust- and water-resistant.

- Resolution can be changed automatically for three capacity levels.
- Set your own high and low weight targets and show them on the easy-to-read display.
- Weighing data can be controlled at 3 set points.
- Change the weighing units and mode with the press of a button.
- Stainless steel display is adjustable and detachable so it can be remotely mounted.
- Largest model has a 500-lbs. capacity.
- 120 volts.
- Standard RS-232C.
- NTEP #00-088A1.

• Legal for Trade.

➤ Shipping Weight: 21-lbs.

(3416 1060 is 35-lbs.;

3416 1200 is 50-lbs.)



F.O.B. FACTORY

ITEM NO.	CAPACITY	RESOLUTION	PLATFORM SIZE	EACH
3416 1015	30-lbs.	.01-lb.	9.8" x 9.8"	\$1,399.00
3416 1060	150-lbs.	.05-lb.	13" x 16.7"	1,399.00
3416 1200	500-lbs.	.02-lb.	15.4" x 20.9"	1,499.00

# Stainless Steel Bench Scale

Splashproof when powered by batteries.

- Large, easy-to-read display is mounted in a tiltable and rotatable indicator.
- Over/Under indicator, push button tare, zero reset and low battery indicator.
- Auto shut-off.
- NEMA 4 water rating when battery operated; optional AC adaptor included.
- 13.8" x 19.7" stainless steel platform and housing.

• Legal for Trade.

Batteries Not Included.  
Six "D" batteries required.  
Sold separately: Item #7784 00025



A/C Adaptor Included.

ITEM NO.	CAPACITY	RESOLUTION	SHIPPING WEIGHT	EACH
4893 9150	150-lbs.	.05-lb.	38-lbs.	\$799.00
4893 6200	300-lbs.	.1-lb.	47-lbs.	799.00

# BUNZL PROCESSOR DIVISION DISTRIBUTION CENTERS

*Our inventory includes over 35,000 ready-to-ship products from 14 distribution centers serving Central and North America, including the Caribbean and Mexico.*



**Springdale, AR**  
**Fresno, CA**  
**Denver, CO**  
**Atlanta, GA**  
**Eldridge, IA**  
**Liberal, KS**  
**Austin, MN**  
**Kansas City, MO**  
**Lumberton, NC**  
**Omaha, NE**  
**Fairfield, OH**  
**York, PA**  
**Dallas, TX**  
**Spokane, WA**

**800-456-5624 • WWW.BUNZLPD.COM**

Stay connected with us:



**FREE\* SHIPPING on orders of \$400 or more**

\*Some restrictions apply & some items may not qualify, see page 5 for more details.



Over 8,000 plant operating supplies available in our 2017-2018 Buyers Guide.

Call **800-456-5624** or go on-line [www.bunzlpd.com](http://www.bunzlpd.com) to order your copy of our 600 page catalog.