

2016 — 2017 | SUPPLIES & EQUIPMENT FOR THE BAKING INDUSTRY

BUNZL | KOCH Supplies

Bakery

2016 — 2017

SUPPLIES & EQUIPMENT
FOR THE BAKING INDUSTRY

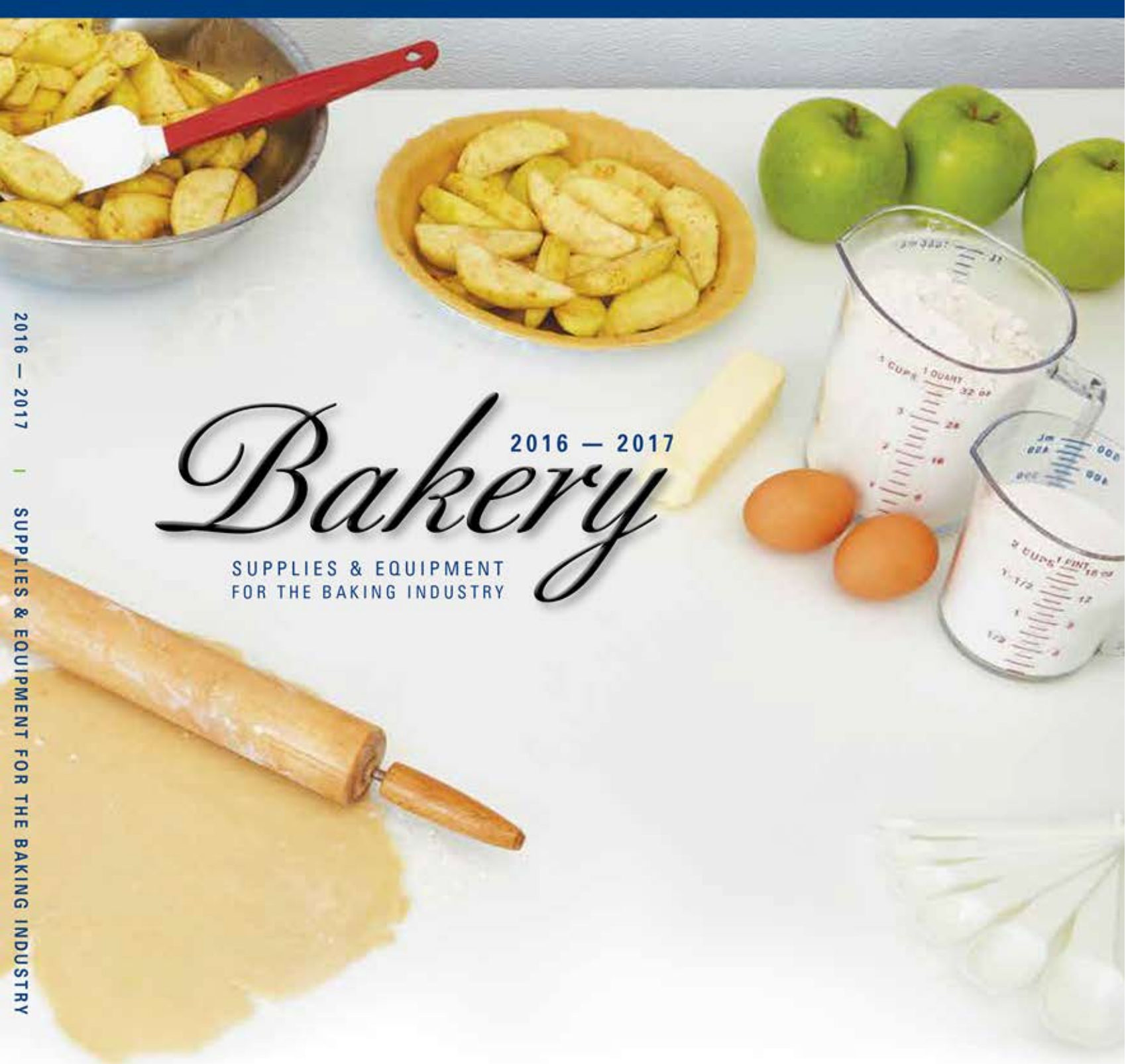

KOCH Supplies — 130 Years of the Right People, Right Products and Right Prices.

Bunzl Processor Division | KOCH Supplies

130 Years of the Right People, Right Products and Right Prices

Bunzl Processor Division/KOCH Supplies is a leader in the food processing and food packaging industries that services national platforms, as well as multi-plant, single-plant, and small shop bakeries. Bunzl Processor Division/KOCH Supplies offers an assortment of high-quality products designed specifically to meet the needs of the food service, food processing, janitorial/sanitation, and industrial industries.

Bunzl Processor Division/KOCH Supplies knows you work hard at what you do best – and that is why we want to partner with you and provide all the supplies you need to keep your baking facility up and running smoothly. And we make it easy to order — one phone call or web order and your supplies will be shipped to you right away. That's because our inventory includes over 35,000 ready-to-ship products so you won't have to wait long to receive the supplies you need. This catalog was made with you in mind, and it is just a sampling of our most popular supplies ordered by bakery businesses just like yours.



For our entire product listing, please visit our website: www.bunzlkochsupplies.com or call **1-800-456-5624** to place an order or to request a **FREE** copy of our Buyers Guide.



Table of Contents

Bakery 2016-2017



Clothing

Boots	4-7
Insoles, Overshoes & Shoe Covers	8-9
Bouffants, Hairnets & Beard Guards	10-11
Frocks	12-13
Aprons & Labcoats	14-16
Rainsuits	17
Insulated Clothing	18
Thermal Hand/Arm Protection	19-21
Gloves	22-29

Jan/San

Hand & Floor Brushes	30-33
Squeegees & Handles	34-37
Brooms, Sweeps & Dustpans	38
Microfiber Dusting/Mopping	39
Mops, Mop Handles & Mop Accessories	40-41
Sinks, Wash Stations	42-43
Nozzles, Hoses & Adapters	44-46
Sanitizers & Cleaners	47-54
Floor Scrubbers, Scour Pads & Wipers	55-57
Hand Soaps & Dispensers	58-59
Paper Towels & Tissue	60-61

Material Handling

Platters & Platter Dollies, Pans, Shelving	62-65
Food Boxes, Totes, Tote Dollies	65-67
Freezer Baskets, Totes & ChillTotes™	68-69
Dough Boxes, Utility Carts, Mixer Bowl Dollies	70-71
Food Storage Containers, Ingredient Bins	72-74
Measuring Cups & Spatulas	75
Dump Buggies, Scoops & Scrapers	76-79
Cutting Boards, Work Tables	80-83
Storage Bins & Pallets	84
Shovels & Spades	85
Pails & Buckets	86
Brute Drums, Dollies & Trash Liners	87-89

Scales

Analog, Digital & Bench	90-91
-------------------------	-------

Thermometers

Dial & Digital	92-93
----------------	-------

Quality Control

Stopwatches	94
-------------	----

Spices & Seasonings

95

Cutlery

Knives	96-99
Sharpeners & Steels	100
Knife Scabbards & Sheaths	101
Shears	101-102
Utility Knives	102
Scrapers, Spatulas & Hand Tools	103-104

Packaging

Shrink Bags, Cook Chill Bags	106-107
Vacuum Pouches	108
Poly Food Bags, Shrink Film	109
Twist ties, Bag Clips, PVC Wrapping	110
Tapes & Dispensers	111
Platter Liners, Deli Paper, Cups, Sacks	112-113

Safety

Eye Protection	114-115
Ear Protection	116
Respirators	117
Head Protection	118
Back Supports & Knee Pads	119
Cut Protection	120-121
Medical, Bandages, First Aid	122-123
Lockout/Tagout	124
Floor Mats	125

ORDERING FROM US IS EASY:



Phone Orders

800-456-5624

- Monday - Friday.
- 7:00 am - 5:30 pm **CST**.
- Knowledgeable sales staff.



Fax Orders

800-329-5624

- Order 24 hours a day, 7 days a week.



Online Orders

www.bunzlkochsupplies.com

- Order 24 hours a day, 7 days a week.
- Real time pricing.
- Secure.



Email Orders

kochsupplies@bunzlusa.com

- Order anytime.



Need Assistance?

Whether you have a rush order or need to arrange regular shipments, you can count on us for the friendliest, most dependable service. Our experienced staff will answer your questions on pricing, product availability and any other technical questions you may have, as well as take your order.



Purchase in case quantities and **SAVE MONEY!**

Our order-packing and expediting teams are working hard to get you the supplies you need when you need them. Ordering by the case allows us to efficiently fill your order. And because we don't have to break a case, we save time fulfilling your order — and then are able to pass that savings on to you.

Here's a quick look at how our pricing is structured:

Product Name & Item Number		Number of units per case.	Unit of measure.
ITEM NO.	PRODUCT	1-19	20+ EACH
1234 56789	Product Name.....	\$12.95	\$10.95

> 20 per case.

DISCOUNTED PRICE
Price per unit of measure when you purchase 20 items or more.

Price per each unit of measure.

It's easy to see how case quantity purchasing SAVES you money! Here's an example:

Buy 18 individually for \$12.95 each
and spend a total of \$233.10

OR

Buy 20 by the case for \$10.95 each
and spend only \$219.00.

You Save \$14.10 & receive 2 additional units!

Watch for these symbols:



Shipped by truck freight. Freight rates are available when ordering.



Products marked with this image are eco-friendly and environmentally safe.



Product complies with HACCP regulations.



Products Made in the USA



These products are considered hazardous materials, and therefore could require special shipping. Call for details.



Certain items in this catalog are not returnable and have a "No Return" symbol next to them.

MSDS SHEETS ONLINE

You can find MSDS sheets on our website www.bunzlkochsupplies.com



Scan QR codes with your mobile device app for direct links to websites, videos, & much more.

Prices

Prices in this catalog are current prices at publication and are subject to change without notice. In the rare event of a printing error, we reserve the right to charge the correct price. Confirm current prices and availability by phone, fax, or e-mail. Prices are in U.S. dollars and do not include applicable taxes. Current up-to-date pricing can be found on our website www.bunzlkochsupplies.com.

Payment Terms



We accept Visa®, MasterCard®, American Express®, Discover® and checks by phone (via TeleCheck®).

We offer credit terms of Net 10 days for customers with a minimum monthly volume of \$500, subject to credit approval.

International Customers

Please contact us directly for a "pro forma quotation" with current pricing, appropriate freight, duty, taxes and clearance costs.

Payments may be made in U.S. dollars, Visa®, MasterCard®, American Express®, Discover®, bank transfer, or irrevocable Letter of Credit confirmed by any U.S. bank.

Please note: some items are not available to be shipped outside of the U.S. Check with your sales representative for details.

Specifications Changes

Due to continuing improvements, product specifications and pricing are subject to change without notice.

Discounts

Discounted prices for certain catalog items purchased in quantity do not apply to orders shipped outside the United States.

Satisfaction Guarantee

When purchasing from our catalog, you can rest assured that any product you order will meet your expectations – guaranteed! That's a promise from our friendly and knowledgeable Customer Service Representatives. However, in the rare case that any stocked supply item fails to meet with your expectations or approval, simply call our toll free number within 30 days and we can arrange for a repair, refund, exchange or credit towards your next purchase, except for those items noted as "No Return" items.

Call for warranty information on non-stock or special order items (i.e. equipment, doors, walls, etc.).

A restocking or repair fee may apply on certain special order items.

Shipping

Unless specified, we will determine the most expedient and efficient means of shipment based on dimensional weight - UPS or LTL (less than truckload).

Alternate delivery may require additional cost. Appropriate charges will be added to your invoice.

Bunzl Processor Division will not be liable for any claim, loss, or damage caused in whole or in part due to delay in or failure to make delivery when such delay or failure is directly or indirectly caused by act of God; strike or other labor difficulty; transportation problems; accident; act of any civil or military authority; act of war; or act of purchaser; or by the occurrence of any other contingency beyond Bunzl Processor Division's reasonable control.

Receiving/Claims

It is the buyers responsibility to thoroughly inspect shipments upon receiving.

Prior to signing for your items, check the number of packages received, as well as the condition of the product. Failure to do so will negate the ability to claim damages. Notification of short shipments or damage must occur within 2 business days of receipt of product for credit to be considered.

Report the details immediately to our Customer Service Department by calling **800-456-5624**. Keep the carton and all packing materials. Notify shipper of shortage or obvious damage at time of delivery.

Returns

Please call our Customer Service Department to obtain a return authorization number before returning items.

When you call, please provide us with:

- Our reference number (on packing slip) or invoice number.
- Your purchase order number.
- Reason for return.
- Date of purchase.

All items returned due to duplication or a change of need must be in unused, resalable condition and in its original packaging -- within 30 days. Returned items may be subject to a restocking fee. Items returned due to damage occurring during shipping or defective products must be packaged so no further damage occurs.

Note: Returns without prior return authorization will be charged a restock fee and may be refused.

Note: Certain items in this catalog are not returnable and have a "NO RETURN" symbol next to them:



Some of these items include:

- Direct food contact items such as: casings, seasonings, packaging products, etc.
- Medicines and medical supplies.
- Certain chemicals, or coatings.
- Stunner loads and solvents.

Confirming Orders

Please do not send a confirming order. If in your system you must send a confirming order, please mark it clearly as confirming to avoid duplication of orders sent.

RECEIVE FREE* SHIPPING
when you place an order for \$400.00 or more

*FREE SHIPPING does not include UPS Next Day Air, UPS 2nd Day or UPS 3rd Day Select. Certain items may not qualify.

This offer is good only on orders shipped UPS Ground in the 48 contiguous states. Based on dimensional weight, we will determine the most efficient means of shipment, either UPS or LTL. Products may ship by truckline.

DuraPro® XCP Boot

- Larger circumference at the top makes it quick and easy to pull the boot on.
- Inner liner allows for increased flexibility and subtle feel at the calf.
- Conformance information molded in sidewall for easy identification.
- Wider metatarsal design and comfort ankle for all day comfort.
- DuraPro® insoles provide superior shock absorption, support and comfort.
- Honeycomb design molded inside the heel to reduce impact when walking.
- Ergonomically designed foot-bed to provide better underfoot support.
- Sloped comfort top rim prevents chafing and reduces discomfort when walking, bending and kneeling.



Brown DuraPro® XCP Superpoly Upper

For use in the red meat industry where high chemical resistance is required.



Blue DuraPro® XCP Polyblend Upper

For use in the poultry industry where moderate chemical resistance is required.



MEN'S BROWN DURAPRO® XCP BOOT

► 6 pair per case.

ITEM NO.	PLAIN TOE	SIZE	PER PAIR	
			1-5	6+
3161 47531	Men's,	Size 3...	\$39.95	\$38.95
3161 47541		Size 4...	39.95	38.95
3161 47551		Size 5...	39.95	38.95
3161 47561		Size 6...	39.95	38.95
3161 47571		Size 7...	39.95	38.95
3161 47581		Size 8...	39.95	38.95
3161 47591		Size 9...	39.95	38.95
3161 47601		Size 10...	39.95	38.95
3161 47611		Size 11...	39.95	38.95
3161 47621		Size 12...	39.95	38.95
3161 47631		Size 13...	39.95	38.95
3161 47641		Size 14...	39.95	38.95
3161 47651		Size 15...	39.95	38.95
3161 47661		Size 16...	39.95	38.95

► 6 pair per case.

ITEM NO.	STEEL TOE	SIZE	PER PAIR	
			1-5	6+
3161 46531	Men's,	Size 3...	\$41.95	\$40.95
3161 46541		Size 4...	41.95	40.95
3161 46551		Size 5...	41.95	40.95
3161 46561		Size 6...	41.95	40.95
3161 46571		Size 7...	41.95	40.95
3161 46581		Size 8...	41.95	40.95
3161 46591		Size 9...	41.95	40.95
3161 46601		Size 10...	41.95	40.95
3161 46611		Size 11...	41.95	40.95
3161 46621		Size 12...	41.95	40.95
3161 46631		Size 13...	41.95	40.95
3161 46641		Size 14...	41.95	40.95
3161 46651		Size 15...	41.95	40.95
3161 46661		Size 16...	41.95	40.95

MEN'S BLUE DURAPRO® BOOT

► 6 pair per case.

ITEM NO.	PLAIN TOE	SIZE	PER PAIR	
			1-5	6+
3161 48531	Men's,	Size 3...	\$29.95	\$28.95
3161 48541		Size 4...	29.95	28.95
3161 48551		Size 5...	29.95	28.95
3161 48561		Size 6...	29.95	28.95
3161 48571		Size 7...	29.95	28.95
3161 48581		Size 8...	29.95	28.95
3161 48591		Size 9...	29.95	28.95
3161 48601		Size 10...	29.95	28.95
3161 48611		Size 11...	29.95	28.95
3161 48621		Size 12...	29.95	28.95
3161 48631		Size 13...	29.95	28.95
3161 48641		Size 14...	29.95	28.95
3161 48651		Size 15...	29.95	28.95
3161 48661		Size 16...	29.95	28.95

► 6 pair per case.

ITEM NO.	STEEL TOE	SIZE	PER PAIR	
			1-5	6+
3161 49531	Men's,	Size 3...	\$31.95	\$30.95
3161 49541		Size 4...	31.95	30.95
3161 49551		Size 5...	31.95	30.95
3161 49561		Size 6...	31.95	30.95
3161 49571		Size 7...	31.95	30.95
3161 49581		Size 8...	31.95	30.95
3161 49591		Size 9...	31.95	30.95
3161 49601		Size 10...	31.95	30.95
3161 49611		Size 11...	31.95	30.95
3161 49621		Size 12...	31.95	30.95
3161 49631		Size 13...	31.95	30.95
3161 49641		Size 14...	31.95	30.95
3161 49651		Size 15...	31.95	30.95
3161 49661		Size 16...	31.95	30.95

Any of our boots can be ordered and worn by ladies. There is a two size difference between men's & womens boots. A woman ordering a man's boot should order two sizes smaller than her regular size. Example: Women's size 9 would order man's size 7.



PURFORT® FoodPro Boots

35% lighter than traditional rubber and PVC boots!

- Resistant to mineral, animal & vegetable oil, fats, blood, disinfectants, solvents and various chemicals.
- Thermal insulation keeps feet warm in cold conditions and comfortable in hot conditions.
- Steel toe cap for added safety. • Remains flexible at low temps. • Shock-absorbing heel.
- Complies with CSA Z195-09 Omega, ASTM F2413-11 M 1/75 C/75 EH

Dunlop® are the only company with the Purofort® Technology. Specialized high pressure manufacturing introduces millions of tiny air bubbles into the synthetic material.

The material is created using a special recipe at the time of manufacture, giving your Purofort® boots a "born on" date. This gives Purofort® boots their remarkable properties.

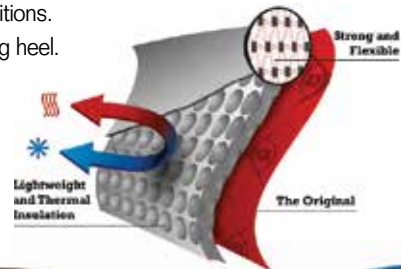

Unique feature allows boots to be locked together. (separate lock required)

Multigrip Safety Sole: SRC rated for best slip resistance.



Scan this QR code to watch a video about Purofort Boots

YELLOW 14", STEEL TOE BOOT

> 6 pair per case.

ITEM NO.	MEN'S SIZE	PER PAIR	
		1-5	6+
E014 07001	Size 4...	\$114.95	\$113.95
E014 07011	Size 5...	114.95	113.95
E014 07021	Size 6...	114.95	113.95
E014 07031	Size 7...	114.95	113.95
E014 07041	Size 8...	114.95	113.95
E014 07051	Size 9...	114.95	113.95
E014 07061	Size 10...	114.95	113.95
E014 07071	Size 11...	114.95	113.95
E014 07081	Size 12...	114.95	113.95
E014 07091	Size 13...	114.95	113.95
E014 07101	Size 14...	114.95	113.95
E014 07111	Size 15...	114.95	113.95

GREEN 14", STEEL TOE BOOT

> 6 pair per case.

ITEM NO.	MEN'S SIZE	PER PAIR	
		1-5	6+
E014 18341	Size 4...	\$114.95	\$108.95
E014 18351	Size 5...	114.95	113.95
E014 18361	Size 6...	114.95	113.95
E014 18371	Size 7...	114.95	113.95
E014 18381	Size 8...	114.95	113.95
E014 18391	Size 9...	114.95	113.95
E014 18401	Size 10...	114.95	113.95
E014 18411	Size 11...	114.95	113.95
E014 18421	Size 12...	114.95	113.95
E014 18431	Size 13...	114.95	113.95
E014 18441	Size 14...	114.95	113.95
E014 18451	Size 15...	114.95	113.95

BLUE 14", STEEL TOE BOOT

> 6 pair per case.

ITEM NO.	MEN'S SIZE	PER PAIR	
		1-5	6+
E014 16041	Size 4...	\$114.95	\$113.95
E014 16051	Size 5...	114.95	113.95
E014 16061	Size 6...	114.95	113.95
E014 16071	Size 7...	114.95	113.95
E014 16081	Size 8...	114.95	113.95
E014 16091	Size 9...	114.95	113.95
E014 16101	Size 10...	114.95	113.95
E014 16111	Size 11...	114.95	113.95
E014 16121	Size 12...	114.95	113.95
E014 16131	Size 13...	114.95	113.95
E014 16141	Size 14...	114.95	113.95
E014 16151	Size 15...	114.95	113.95



PURFORT® NeoBuster Boots

Neobuster boots last up to 3x longer than Neoprene & PVC

- Supplied in polybag to keep product clean and less packaging to dispose of.
- 2 cut down points for easy height adjustment.
- High pressure injection moulded, no seams = no leaking.
- Boots can be cleaned inside to reduce bacteria.
- Cushioned insole for added comfort.
- Steel toe & midsole for extra protection.
- Lined for easy on-off.
- Easy clean sole & upper.
- Soft & flexible even at low temperatures.
- Insulated down to -4F.



> 6 pair per case.

ITEM NO.	SIZE	PER PAIR	
		1-5	6+
E014 31031	Men's, Size 3...	\$79.95	\$78.95
E014 31041	Size 4...	79.95	78.95
E014 31051	Size 5...	79.95	78.95
E014 31061	Size 6...	79.95	78.95
E014 31071	Size 7...	79.95	78.95
E014 31081	Size 8...	79.95	78.95
E014 31091	Size 9...	79.95	78.95
E014 31101	Size 10...	79.95	78.95
E014 31111	Size 11...	79.95	78.95
E014 31121	Size 12...	79.95	78.95
E014 31131	Size 13...	79.95	78.95
E014 31141	Size 14...	79.95	78.95
E014 31151	Size 15...	79.95	78.95

XTP™ Xtra Traction Performance Boot

- XTP™ is engineered with reinforced construction and an organic chemical resistant formulation to provide superior protection in harsh environments.
- The seamless, 3-stage, PVC injection molded construction is 100% waterproof to keep feet comfortable and dry.
- Removable FOOT FORM contour cushion insoles provide support for comfort and wick away moisture to keep workers' feet dry.
- Extended steel shanks are thicker, longer and wider as well as curved and ribbed, to provide the best possible arch support for increased worker comfort.
- TDT – dual compound outsole is optimally designed to provide a durable exterior for tough abrasion resistance, and a softer interior for comfort and excellent traction to help prevent slips and falls.
- Steel toe boot meets ASTM F2413-11 M I/75 C/75.

SERVUS
by Honeywell

Steel toe.



Plain toe.

PLAIN TOE, RED				STEEL TOE, YELLOW			
ITEM NO.	MEN'S SIZE	PER PAIR		ITEM NO.	MEN'S SIZE	PER PAIR	
		1-5	6+			1-5	6+
3330 35131	Size 3 ...	\$29.95	\$28.95	3330 33331	Size 3 ...	\$32.95	\$31.95
3330 35141	Size 4 ...	29.95	28.95	3330 33341	Size 4 ...	32.95	31.95
3330 35151	Size 5 ...	29.95	28.95	3330 33351	Size 5 ...	32.95	31.95
3330 35161	Size 6 ...	29.95	28.95	3330 33361	Size 6 ...	32.95	31.95
3330 35171	Size 7 ...	29.95	28.95	3330 33371	Size 7 ...	32.95	31.95
3330 35181	Size 8 ...	29.95	28.95	3330 33381	Size 8 ...	32.95	31.95
3330 35191	Size 9 ...	29.95	28.95	3330 33391	Size 9 ...	32.95	31.95
3330 35201	Size 10 ...	29.95	28.95	3330 33401	Size 10 ...	32.95	31.95
3330 35211	Size 11 ...	29.95	28.95	3330 33411	Size 11 ...	32.95	31.95
3330 35221	Size 12 ...	29.95	28.95	3330 33421	Size 12 ...	32.95	31.95
3330 35231	Size 13 ...	29.95	28.95	3330 33431	Size 13 ...	32.95	31.95
3330 35241	Size 14 ...	29.95	28.95	3330 33441	Size 14 ...	32.95	31.95
3330 35251	Size 15 ...	29.95	28.95	3330 33451	Size 15 ...	32.95	31.95

Goliath Boot Highly abrasion-resistant and 100% waterproof.

- Special urethane/PVC compound is resistant to acids, oils, greases, chemicals and fats.
- Two stage, injection-molded, one-piece construction is highly abrasion-resistant and 100% waterproof.
- Outsole provides excellent traction both indoors and outdoors.
- Lower toe spring for a more comfortable fit and better surface contact.
- One-piece steel shank.

15" upper with cut-off lines and convenient large kick-off lug.

ONGUARD



PLAIN TOE				STEEL TOE			
ITEM NO.	SIZE	PER PAIR		ITEM NO.	MEN'S SIZE	PER PAIR	
		1-5	6+			1-5	6+
3161 88051	Size 5 ...	\$24.95	\$23.95	3161 72051	Size 5 ...	\$26.95	\$25.95
3161 88061	Size 6 ...	24.95	23.95	3161 72061	Size 6 ...	26.95	25.95
3161 88071	Size 7 ...	24.95	23.95	3161 72071	Size 7 ...	26.95	25.95
3161 88081	Size 8 ...	24.95	23.95	3161 72081	Size 8 ...	26.95	25.95
3161 88091	Size 9 ...	24.95	23.95	3161 72091	Size 9 ...	26.95	25.95
3161 88101	Size 10 ...	24.95	23.95	3161 72101	Size 10 ...	26.95	25.95
3161 88111	Size 11 ...	24.95	23.95	3161 72111	Size 11 ...	26.95	25.95
3161 88121	Size 12 ...	24.95	23.95	3161 72121	Size 12 ...	26.95	25.95
3161 88131	Size 13 ...	24.95	23.95	3161 72131	Size 13 ...	26.95	25.95
3161 88141	Size 14 ...	24.95	23.95	3161 72141	Size 14 ...	26.95	25.95
3161 88151	Size 15 ...	24.95	23.95	3161 72151	Size 15 ...	26.95	25.95



**Additional
BOOTS, SHOES, INSOLES & BOOT WASH ACCESSORIES
available on our website:
www.bunzlkochsupsplies.com**





The Lady Monarch Pink Steel Toe Boots

- Pink PVC upper, black lug sole.
- Steel toe is ASTM F2413-05 compliant.
- Injection molded for seamless construction and complete waterproof protection.
- Reinforced PVC shank for added support.
- Cut off band for height adjustment.
- Replaceable cushion insoles.
- 100% waterproof.



STEEL TOE

ITEM NO.	SIZE	> 6 pair per case.	
		PER PAIR	
		1-5	6+
3161 36051	Women's, Size 5	\$24.95	\$23.95
3161 36061	Size 6	24.95	23.95
3161 36071	Size 7	24.95	23.95
3161 36081	Size 8	24.95	23.95
3161 36091	Size 9	24.95	23.95
3161 36101	Size 10	24.95	23.95
3161 36111	Size 11	24.95	23.95

Muck® Chore Cool Safety Toe Boot

- Spandura® added to the exterior of the neoprene for added protection against wear and abrasion.
- New comfortable XpressCool™ lining material keeps your feet cool and dry in warm weather by quickly dispersing perspiration.
- Vibram® outsole for improved durability and performance.
- etc® sockliner lining to reduce friction and heat buildup.
- 4mm CR flex-foam bootie with 4-way stretch nylon.
- 100% waterproof, lightweight and flexible.
- Steel shank for additional arch support.
- Upper is tripled reinforced in the toe area and quadruple reinforced in the heel.
- Meets ASTM F2413-11 M I/75 C/75 EH.
- Comfort Range:
Sub Freezing to 95° F/35°C.



STEEL TOE

ITEM NO.	SIZE	> 6 pair per case.	
		PER PAIR	
		1-5	6+
3330 18251	Men's, Size 5	\$129.95	\$128.95
3330 18261	Size 6	129.95	128.95
3330 18271	Size 7	129.95	128.95
3330 18281	Size 8	129.95	128.95
3330 18291	Size 9	129.95	128.95
3330 18301	Size 10	129.95	128.95
3330 18311	Size 11	129.95	128.95
3330 18321	Size 12	129.95	128.95
3330 18331	Size 13	129.95	128.95
3330 18341	Size 14	129.95	128.95

Muck® Chore Pro Cool 16" Safety Boot

- New comfortable XpressCool™ lining material keeps feet cool and dry in warm weather by quickly dispersing perspiration.
- 4mm CR flex-foam bootie with 4-way stretch nylon.
- 100% waterproof, lightweight and flexible.
- Steel shank for additional arch support.
- Meets ASTM F2413-11 M I/75 C/75 EH.
- Comfort Range:
Sub Freezing to 95° F/35°C.



STEEL TOE

ITEM NO.	SIZE	> 6 pair per case.	
		PER PAIR	
		1-5	6+
3330 27051	Men's, Size 5	\$134.95	\$133.95
3330 27061	Size 6	134.95	133.95
3330 27071	Size 7	134.95	133.95
3330 27081	Size 8	134.95	133.95
3330 27091	Size 9	134.95	133.95
3330 27101	Size 10	134.95	133.95
3330 27111	Size 11	134.95	133.95
3330 27121	Size 12	134.95	133.95
3330 27131	Size 13	134.95	133.95
3330 27141	Size 14	134.95	133.95

SF™ SuperFit 4" Overshoe

Reinforced bumpers on heel and toe for extra protection.

- Dual compounding construction permits a light, stretchable upper to be molded to a high-abrasion outsole.
- Seamless construction is 100% waterproof.
- Outsole has self-cleaning treads for better traction.
- Tabbed grips can be easily grasped and pulled with one hand – even with gloves.



12" overboot also available.
Visit our website for more information.

> 6 pair per case.
PER PAIR

ITEM NO.	SIZE	PER PAIR	
		1-5	6+
3330 51811	X-Small (4-5)	\$19.95	\$18.95
3330 51821	Small (6-8)	19.95	18.95
3330 51831	Medium (9-10)	19.95	18.95
3330 51841	Large (11-13)	19.95	18.95
3330 51851	X-Large (14-15)	19.95	18.95

One-piece Injection Molded Overshoes

Four-way cleated outsole is specifically designed for self cleaning and maximum slip resistance.

- Excellent cold-weather flexibility .
- Easy entry interior finish.
- Kick-off lug for easy removal.
- Special fold line for snug fit if desired.
- 10" Upper, Color: Black



Also available in yellow and white, as well as 17" upper.

Visit our website:

www.bunzlkochsups.com



> 6 pair per case.

ITEM NO.	SIZE	PER PAIR	
		1-5	6+
3161 98941	Men's, XS (4-5)	\$21.95	\$20.95
3161 98951	S (6-7)	21.95	20.95
3161 98961	M (8-9)	21.95	20.95
3161 98971	L (10-11)	21.95	20.95
3161 98981	XL (12-13)	21.95	20.95
3161 44111	2XL (14-15)	21.95	20.95



Standard Preformed Insoles

- Provides additional comfort and cushion protection.
- Built-in arch support.

> 6 pair per case.

ITEM NO.	SIZE	PER PAIR	
		1-5	6+
3161 10831	Size 3	\$6.95	\$5.95
3161 10841	Size 4	6.95	5.95
3161 10851	Size 5	6.95	5.95
3161 10861	Size 6	6.95	5.95
3161 10871	Size 7	6.95	5.95
3161 10881	Size 8	6.95	5.95
3161 10891	Size 9	6.95	5.95
3161 10901	Size 10	6.95	5.95
3161 10911	Size 11	6.95	5.95
3161 10921	Size 12	6.95	5.95
3161 10931	Size 13	6.95	5.95
3161 10941	Size 14	6.95	5.95
3161 10951	Size 15	6.95	5.95



Sorbothane® Shock-Absorbing Insoles

- Reduces lower back fatigue and pain.
- Resistant to odor-causing bacteria.
- Machine washable.

More insoles available online

www.bunzlkochsups.com

> 6 pair per case.

ITEM NO.	SIZE	PER PAIR	
		1-5	6+
F203 95161	Women's, 4-1/2 to 5-1/2	\$18.95	\$17.95
F203 95171	Women's, 6 to 7	18.95	17.95
F203 95181	Men's, 5 to 6	18.95	17.95
	Women's, 7-1/2 to 8-1/2		
F203 95191	Men's, 6-1/2 to 7-1/2	18.95	17.95
	Women's, 9 to 10		
F203 95201	Men's, 8 to 9	18.95	17.95
	Women's, 10-1/2 to 11-1/2		
F203 95211	Men's, 9-1/2 to 10-1/2	18.95	17.95
	Women's, 12		
F203 95221	Men's, 11 to 12	18.95	17.95
F203 95231	Men's, 12-1/2 to 13-1/2	18.95	17.95



Rack 'Em™ Boot Rack

- Dries boots by elevating and allowing for greater air circulation.
- Increases boot life by holding shape.
- Black PVC coated heavy-duty galvanized steel construction resists rust.
- Screws supplied for easy mounting and are 16" on center.
- Holds four pairs.

ITEM NO.	PRODUCT	DIMENSIONS	EACH
3446 10441	Boot Rack	4.5" x 35.25" x 10.5"	\$39.95



Disposable Poly Shoe Covers

Elastic top securely seals shoe covers to keep footwear clean.

Elastic top.

- Poly covers fit over shoes or boots.
- 3-mil. polyethylene.
- Dispenser roll for easy access.



► 50 covers per roll — 10 rolls per case.

ITEM NO.	SIZE	PER ROLL	
		1-9	10+
6599 00015	One Size Fits All	\$13.95	\$12.95

Disposable, Non-Skid Shoe Covers

- Constructed of lightweight polypropylene fabric.
- Elastic ankle allows for fit over most shoes.
- Resistant to punctures.
- 18" length. • Color: blue.



Elastic ankle.

Non-skid sole.

► 150 pair per case.

ITEM NO.	SIZE	CASE
4724 2118	One Size	\$39.95

CHOOSE YOUR DISPENSER SHOE COVER

SHOE INN™ Fusion Stationary Shoe Cover Dispenser

- Elastic ankle band allows for a one-size-fits-most fit.
- Cleanroom validated/certified.

Waterproof Shoe Cover

Super anti-skid traction, completely waterproof and durable.

- Includes super anti-skid coating that provides unparalleled traction.
- Color: White

A



Durable Shoe Cover

Excellent durability, waterproof bottom layer and moderate traction.

- Constructed of durable spunbond polypropylene material with cast polyethylene (CPE) layer for durability.

B



Traction Pattern Shoe Cover

Good durability, moderate traction and low lint.

- Breathable nonwoven fabric shoe cover with good durability and moderate traction.
- Constructed of heavy-duty spunbond polypropylene material with traction pattern.

C



Stationary, non-electric automatic shoe cover dispenser.

- Because no electricity is needed, it's easily deployed at any suitable locations.
- Intended for medium to high-volume uses.
- Made from stainless steel and ABS plastic.
- Holds up to 110 shoe covers and easily loads in bulk, making it easy to maintain in higher volume applications.
- Dimensions: 27-1/2" l x 12-1/2" w x 8" h.
- Weight: 20-lbs.



Dispense by resting the ball of your foot on the metal plate and move your foot back in one continuous motion.



What is the Shoe Inn Fusion Dispenser? Scan this code with your QR reader for info.



4x Faster! Scan this code with your QR reader to see the comparison.

Single Shoe Cover.

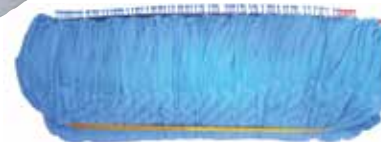

Shoe cover bundle for easy bulk loading.

ITEM NO.	PRODUCT	EACH
G826 71501	Stationary Shoe Cover Dispenser	\$299.00

ITEM NO.	PRODUCT	BUNDLE
G826 17805	A. Coated Spunbound Waterproof (80 per Bundle)	\$29.95
G826 17705	B. Coated Spunbound Durable (70 per Bundle).	24.95
G826 17905	C. Spunbound Traction Pattern (80 per Bundle).	27.95



Color-Coded Latex-Free Bouffant Caps

Color-coding your workplace has never been easier!

- Comfortable and cool to wear. **Latex FREE**
- Choose from: white, green, blue, red, yellow or pink.



ITEM NO.	SIZE	COLOR	PER BAG	
			1-9	10+
7500 92225	18"	White	\$4.95	\$4.45
7500 92245	21"	White	5.45	4.95
7500 92265	24"	White	5.95	5.45
7500 92285	28"	White	6.95	6.45

ITEM NO.	SIZE	COLOR	PER BAG	
			1-9	10+
7500 92325	18"	Green	\$5.95	\$5.45
7500 92345	21"	Green	6.45	5.95
7500 92365	24"	Green	6.95	6.45

ITEM NO.	SIZE	COLOR	PER BAG	
			1-9	10+
7500 92425	18"	Blue	\$5.95	\$5.45
7500 92445	21"	Blue	6.45	5.95
7500 92465	24"	Blue	6.95	6.45

ITEM NO.	SIZE	COLOR	PER BAG	
			1-9	10+
2466 01385	21"	Pink	\$6.45	\$5.95
2466 01525	24"	Pink	6.95	6.45

ITEM NO.	SIZE	COLOR	CASE
3463 0007	21"	.Red (Case of 500)	\$24.95
3463 0009	24"	.Red (Case of 500)	29.95

ITEM NO.	SIZE	COLOR	CASE
3463 9021	21"	.Yellow (Case of 500)	\$24.95
3463 0024	24"	.Yellow (Case of 500)	29.95

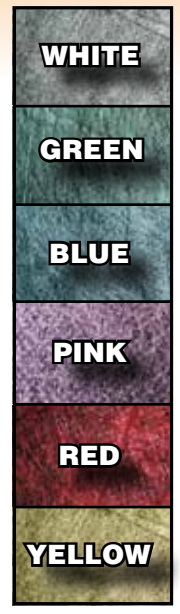

Honeycomb Weave Hairnet

- Nylon.



► 100 per bag — 10 bags per case.

ITEM NO.	SIZE	COLOR	PER BAG	
			1-9	10+
7500 92025	18"	White	\$9.95	\$8.95
7500 92045	21"	White	10.95	9.95
7500 92065	24"	White	11.95	10.95
7195 00665	27"	Brown	16.95	15.95

Pleated Bouffant Caps

- 14-gram polypropylene.
- White.



Latex FREE

► 100 per bag — 10 bags per case.

ITEM NO.	SIZE	COLOR	PER BAG	
			1-9	10+
7500 92525	18"	White	\$5.95	\$5.45
7500 92545	21"	White	6.45	5.95
7500 92565	24"	White	6.95	6.45



Polyester Honeycomb Beard Guard

- Breathable fine mesh of 100% polyester.
- Full size with easy to wear elastic fit.

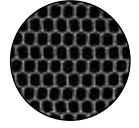

► 100 per bag — 10 bags per case.

ITEM NO.	COLOR	PER BAG	
		1-9	10+
7500 92665	White	\$10.95	\$9.95
7500 92675	Blue	10.95	9.95



Beard Guard

- Lightweight, cloth-like and non-woven.
- Elastic band keeps guard securely in place.
- Lint-free fabric.



► 100 per bag — 10 bags per case.

ITEM NO.	SIZE	COLOR	PER BAG	
			1-9	10+
7500 92625	18"	.White	\$4.45	\$3.95

► 500 per case.

ITEM NO.	SIZE	COLOR	CASE
7500 9264	21"	White	\$21.95

Rack 'Em™ Bouffant Cap & Hair Net Dispenser

- Holds all styles of hair net/bouffants or beard covers— whether bagged or boxed.
- Rack does not collect dust or dirt.



ITEM NO.	PRODUCT	DIMENSIONS	EACH
3446 40201	Cap Dispenser.	12-1-4" x 5" x 6-1/2"	\$49.95

Poly Hood

A bouffant and beard guard all in one!

- Comfortable and cool to wear.



> 1,000 per case.

ITEM NO.	PRODUCT	CASE
7500 9346	Poly Hood	\$119.95

Acrylic Bouffant Dispenser

Put bouffants at your employees' fingertips.

- Clear acrylic construction for easy recognition of contents.

> Dimensions: 10" x 10" x 10" with a round opening.



ITEM NO.	PRODUCT	EACH
3364 28261	Acrylic Bouffant Dispenser	\$89.95

Men's Overseas Style Caps

- Sturdy white kraft paper headband.
- Crown is made of soft, white paper mesh.



CELLUCAP
MANUFACTURING

> 100 per bag— 10 bags per case.

ITEM NO.	PRODUCT	PER BAG	
		1-9	10+
2466 08265	Men's Overseas Cap.	\$10.95	\$9.95

Polyethylene Sleeves

- Low-cost waterproof protection for light-duty, limited-use applications.



> 2,000 per case.

ITEM NO.	SIZE	COLOR	THICKNESS	CASE
7500 7231	16"	Blue	1-mil.	\$99.95
7500 7221	16"	White	1-mil.	99.95
7500 7224	18"	Blue	1-mil.	129.95
7500 7223	18"	White	1-mil.	129.95

18" PE-Coated Sleeves

- Water-resistant polypropylene-coated white fabric.
- Offers protection against dry particulates and light liquid sprays.



> 200 per case.

ITEM NO.	STYLE	CASE
3419 8531	Non-Tapered	\$39.95
4804 5018	Tapered	39.95

18" VR™ Vinyl Replacement Sleeves

- Superior strength and can be recycled.
- Will not become brittle even after multiple uses.
- Material becomes softer after each use.
- Easy to clean and reuse.



> 150 sleeves per case.

ITEM NO.	SIZE	COLOR	THICKNESS	CASE
3386 4352	18"	Clear	4-mil.	\$119.95
3386 3758	18"	Blue	4-mil.	119.95
3386 4350	18"	White	4-mil.	119.95
3386 4351	18"	Yellow	4-mil.	119.95
3386 4355	18"	Clear	6-mil.	129.95
3386 3759	18"	Blue	6-mil.	129.95
3386 4353	18"	White	6-mil.	129.95
3386 4354	18"	Yellow	6-mil.	129.95

Neoprene Sleeves

- Heavy-duty, 16-mil.
- Cut-resistant and waterproof hyprene on nylon.
- Sewn overlock with enclosed elastic at each end.



> 12 per pack.

ITEM NO.	SIZE	COLOR	THICKNESS	PER PACK
4804 20185	18"	Yellow	16-mil.	\$59.95

Snap-Front Poly/Cotton Butcher Frocks

Roomy bell-shape eliminates the need for slit back.

5-oz. White Frocks

Lightweight, easy care permanent press 65/35 poly/cotton blend.



SIZE	A. 4-OUTSIDE POCKETS		B. 2-INSIDE 2-OUTSIDE POCKETS		EACH	
	1-11	12+	1-11	12+	1-11	12+
Small	3092 55401		N/A		\$26.95	\$25.95
Medium	3092 55411	3092 55461			26.95	25.95
Large	3092 55421	3092 55471			26.95	25.95
X-Large	3092 55431	3092 55481			26.95	25.95
2X-Large	3092 30761	3092 30771			29.95	28.95

White, long-sleeved frocks with dome-style snaps.



7-oz. White Frocks

Easy care permanent press 65/35 poly/cotton blend.

- Available in four styles: 4-outside pockets; 2-inside pockets; 2-outside pockets; or no pockets with 2-side slits to allow access to pant pockets.

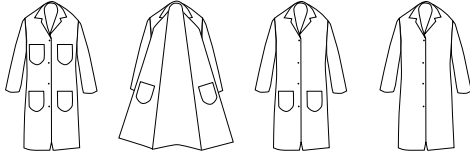

7-OZ. WHITE SNAP FRT FROCK	4-OUTSIDE POCKETS	2-INSIDE POCKETS	2-OUTSIDE POCKETS	NO POCKET	EACH	
					1-11	12+
Small	3092 31341	3092 57251	3092 47051	N/A	\$29.95	\$28.95
Medium	3092 31351	3092 57261	3092 47061	3092 30601	29.95	28.95
Large	3092 31361	3092 57271	3092 47071	3092 30611	29.95	28.95
X-Large	3092 31371	3092 57281	3092 47081	3092 30621	29.95	28.95
2X-Large	3092 57841	3092 57291	3092 47091	3092 30631	30.95	29.95
3X-Large	3092 30661	N/A	3092 47101	3092 30641	31.95	30.95
4X-Large	3092 30671	N/A	3092 47111	3092 30651	32.95	31.95

11-oz. White Frocks

Heavyweight, durable 50/50 poly/cotton blend.

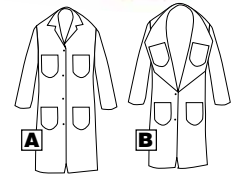

SIZE	A. 4-OUTSIDE POCKETS		B. 2-INSIDE 2-OUTSIDE POCKETS		EACH	
	1-11	12+	1-11	12+	1-11	12+
Medium	3092 45461	3092 09111			\$32.95	\$31.95
Large	3092 45471	3092 09121			32.95	31.95
X-Large	3092 45481	3092 09131			32.95	31.95
2X-Large	3092 56091	N/A			34.95	33.95

7-oz. Color Frocks, Long Sleeved

- Style available: 4-outside pockets plus 2-side slits to allow access to pant pockets.
- Gripper style front snaps.



SIZE	DARK BLUE	LT. BLUE	BROWN	BURGUNDY	MED. GREY	EACH	
	4-PKT/2-SLIT	4-PKT/2-SLIT	4-PKT/2-SLIT	4-PKT/2-SLIT	4-PKT/2-SLIT	1-11	12+
Small	3092 04421	3092 92051	N/A	3092 22351	3092 06551	\$34.95	\$33.95
Medium	3092 04431	3092 92061	3092 23561	3092 22361	3092 06561	34.95	33.95
Large	3092 04441	3092 92071	3092 23571	3092 22371	3092 06571	34.95	33.95
X-Large	3092 04451	3092 91351	3092 23581	3092 22381	3092 06581	34.95	33.95
2X-Large	3092 30731	3092 30721	3092 23591	3092 22391	3092 06591	36.95	35.95



COLORS AVAILABLE:
Light Blue, Dark Blue, Burgundy, Med Gray, Brown



5-oz. Color Wrap-Around Frocks

- Bar-tacks at stress point for added strength.
- Style available: 3 pockets (1-breast and 2-hip pockets)
- 3/4 length sleeve.

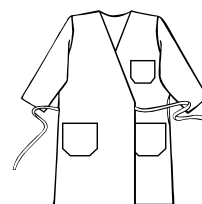

COLORS AVAILABLE:
Tan, Light Blue, Navy



SIZE				▶ 12 per case. EACH	
	LT. BLUE 3-POCKETS	TAN 3-POCKETS	NAVY 3-POCKETS	1-11	12+
Small	3092 84331	3092 82331	3092 79341	\$29.95	\$28.95
Medium	3092 84341	3092 82341	3092 79341	29.95	28.95
Large	3092 84351	3092 82351	3092 79351	29.95	28.95
X-Large	3092 84361	3092 82361	3092 79361	29.95	28.95
2X-Large	3092 84371	3092 82371	3092 79371	30.95	29.95



CUSTOM EMBROIDERY AVAILABLE

Would you like your company logo or employee names custom embroidered on your frocks?

- 1.) Choose **BLOCK** or *Script* lettering.
- 2.) Choose your lettering Color.
- 3.) Choose location of embroidery (left or right).

YOUR NAME *Dave*

	EACH		
	1-5	6-11	12+
1-Line text	\$8.40	\$6.30	\$5.25
Multiple Line text	CALL FOR PRICING		

CALL 800-456-5624 for more information & to place your order

Cotton Bib Aprons

- 65/35 poly/cotton blend.
- Sewn neck band.
- Grommets at stress points.
- Waist tie string.
- Available with or without pencil pocket.
- 30" wide x 35" long.

Cotton Bib Apron with pocket



▶ 1 dozen aprons per pack — 12 packs per case.

ITEM NO.	PRODUCT	PER PACK	
		1-11	12+
3092 08415	3-1/2-oz. w/o Pocket, White	\$64.95	\$63.95
3092 08795	7-oz. w/o Pocket, White . . .	87.95	86.95
3092 08455	7-oz. w/ Pocket, White	87.95	86.95
3092 9007	7-oz. w/ Pocket, Navy.	99.95	98.95



Cotton Work Clothing

- Permanent press finish.
- Shirts are white, short sleeved with snap front and chest pocket.
- Pants are white, unhemmed, with 4 pockets and zipper fly.
- 65/35 cotton/poly blend.



Shirts

▶ 6 per case.

ITEM NO.	SIZE	EACH	
		1-5	6+
4689 0373	Medium	\$8.95	\$7.95
4689 0372	Large	8.95	7.95
4689 5003	X-Large	8.95	7.95

Pants

▶ 6 per case.

ITEM NO.	SIZE	EACH	
		1-5	6+
4689 0323	30" Waist	\$14.95	\$13.95
4689 0431	32" Waist	14.95	13.95
4689 2025	34" Waist	14.95	13.95
4689 2026	36" Waist	14.95	13.95
4689 2024	38" Waist	14.95	13.95
4689 2109	40" Waist	14.95	13.95
4689 2027	42" Waist	14.95	13.95

Clothing

Rack'Em Apron Dispenser Tray

- Space saving tray holds bagged and boxed aprons.
- Does not collect dust or dirt.
- White PVC coated steel.



Aprons sold separately.

ITEM NO.	DIMENSIONS	EACH
3446 40221	20.5" x 15" x 6"	\$59.95

6 & 8-Mil. Vinyl Aprons

Our best selling vinyl aprons.

- Protection from oil, fat, grease and salt.
- Made of vinyl with four heat-sealed grommets.
- Ties in each apron.
- 35" wide, various lengths.

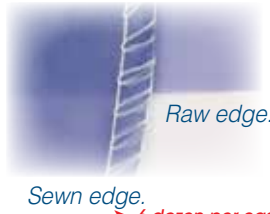

Raw edge.

Sewn edge.

► 6 dozen per case.

Vinyl Apron with Tie

ITEM NO.	PRODUCT	SIZE/COLOR	PER DOZEN	
			1-5	6+
7500 70015	6-mil., Raw	45" Blue	\$14.95	\$13.95
7500 70025		48" Blue	15.95	14.95
7500 70035		50" Blue	15.95	14.95
7500 70045		55" Blue	16.95	15.95
7500 70065	6-mil., Sewn	45" Blue	15.95	14.95
7500 70075		48" Blue	16.95	15.95
7500 70355		48" White	16.95	15.95
7500 70085		50" Blue	16.95	15.95
7500 70095		55" Blue	17.95	16.95
7500 70265	8-mil., Sewn	45" Blue	19.95	18.95
7500 70275		48" Blue	21.95	20.95
7500 70295		55" Blue	22.95	21.95
7500 70285	8-mil., Raw	45" White	20.95	19.95



6-Mil. Vinyl Retail Apron

Available in 6 easy-to-clean colors.

- Vinyl remains pliable in temperatures down to -32° F.
- Excellent moisture-resistance.
- 31" x 39" with pencil pocket on bib.
- Metal grommets at stress points; string ties at waist.



Available in 6 colors.

► 12 per case.
EACH

ITEM NO.	COLOR	1-11	12+
4465 91001	White	\$4.95	\$3.95
4465 91011	Red	4.95	3.95
4465 91021	Green	4.95	3.95
4465 91031	Blue	4.95	3.95
4465 91041	Clear	4.95	3.95
4465 91061	Yellow	4.95	3.95

Chemical-Resistant Neoprene Aprons

- Hemmed on all four sides.
- Aprons are 35" wide x 48" long.
- 36" sewn ties with metal grommets.



Snap-on cloth neckstrap adjusts easily.

► 12 per case.
EACH

ITEM NO.	COLOR	1-11	12+
3279 22181	Maroon	\$14.95	\$13.95
3279 41321	White	14.95	13.95
3279 90201	Yellow	14.95	13.95

Disposable Polyethylene Aprons

Economical light-duty alternative.

- Made of polyethylene: 2-mil. & 1.5-mil. (heavy-duty) or 1-mil. (standard-duty).
- Smooth or embossed surface finish.
- Extra long ties.



1-Mil. Apron > 100 aprons per pack — 10 packs per case.

ITEM NO.	PRODUCT	SIZE	PER PACK	
			1-9	10+
7500 72435	Smooth, White	28" x 46"	\$7.95	\$6.95
7500 72425	Smooth, Blue	28" x 46"	7.95	6.95
7500 72395	Embossed, Clear	28" x 46"	7.95	6.95
7500 72495	Smooth, White	24" x 42"	6.95	5.95

1.5-Mil. Apron > 100 aprons per pack — 5 packs per case.

ITEM NO.	PRODUCT	SIZE	PER PACK	
			1-4	5+
7500 72715	Smooth, Red	28" x 46"	\$11.95	\$10.95
7500 72695	Smooth, White	28" x 46"	11.95	10.95
7500 72675	Embossed, White	28" x 46"	11.95	10.95
7500 72485	Smooth, White	28" x 55"	15.95	14.95
7500 72755	Smooth, Blue	28" x 55"	15.95	14.95
7500 00895	Embossed, Blue	28" x 46"	15.95	14.95

2-Mil. Apron > 100 aprons per pack — 5 packs per case.

ITEM NO.	PRODUCT	SIZE	PER PACK	
			1-4	5+
7500 72735	Smooth, White	28" x 46"	\$16.95	\$15.95
7500 72725	Embossed, White	28" x 46"	16.95	15.95

Choose from blue, clear, red or white.

Polyethylene Coated Disposable Aprons

Ideal for grimy, non-hazardous work environments.

- Color: white.
- Weighs 1.25 oz.
- Breathable, comfortable, spun, non-woven fabric with a moisture resistant polyethylene coating, lightly textured finish.
- Sewn ties.

> Sold in cases of 100.

ITEM NO.	COLOR	SIZE	PER CASE
4724 2510	White	28" x 36"	\$49.95

Endeavor Apron

Tougher, lighter, better quality, lasts longer than vinyl, neoprene, nitrile, hycar for a fraction of the price!



Adjustable dielectrically sealed, self-material neck strap.



Self material waist ties are long enough to tie in front or back.



- Provides ten times the abrasion-resistance of PVC and five times that of vinyl.
- Resistant to fats, oils, and chemicals.
- Remains flexible in cold temperatures down to -65° F; withstands heat up to 180° F.
- Material returns to original shape even after a variety of physical and temperature stresses.
- Slick finish allows for easy clean-up — machine washable.
- One Endeavor apron will outlast dozens of disposable aprons.
- 5.5-mil. thickness.
- 100% recyclable. • 100% non-toxic.

> 10 per case.

ITEM NO.	COLOR	SIZE	EACH	
			1-9	10+
5644 35531	White	35" x 50"	\$9.95	\$8.95
5644 35541	Yellow	35" x 50"	9.95	8.95
5644 35521	Blue	35" x 50"	9.95	8.95

Die-Cut Endeavor Apron



One-piece, self-material neck strap and waist ties for added strength.

> 10 dozen per case.

ITEM NO.	COLOR	SIZE	PER DOZEN	
			1-9	10+
5644 35455	White	35" x 50"	\$94.95	\$92.95
5644 35465	Yellow	35" x 50"	94.95	92.95
5644 35475	Blue	35" x 50"	94.95	92.95

Vinyl Replacement Gown

Extruded triple layer material out performs comparable PVC and vinyl products 3:1.

- VR material is softer, flexible and lighter weight.
- Odorless, non-toxic and 100% recyclable.
- Gown interior is pebbled; no static electricity.
- 4-mil. and 6-mil. available.



Self-Tie



Choose between "Thumb Loop" and "Elastic Cuff".



Thumb Loop wrist

ITEM NO.	PRODUCT	SIZE	COLOR	CASE
3386 6659	4-mil., 38" x 45"	Regular	Blue	\$139.95
3386 0012	38" x 45"	Regular	White	139.95
3386 6660	42" x 50"	Large	Blue	169.95
3386 6661	45" x 55"	X-Large	Blue	249.95
3386 6663	6-mil., 42" x 50"	Large	Blue	229.95
3386 6664	45" x 55"	X-Large	Blue	349.95

Elastic wrist

ITEM NO.	PRODUCT	SIZE	COLOR	CASE
3386 2454	4-mil., 38" x 45"	Regular	Yellow	\$169.95
3386 2588	42" x 55"	X-Large	Red	273.95
3386 5375	6-mil., 42" x 50"	Large	Blue	269.95



4-mil. VR is comparable to 6-mil. PVC.
6-mil. VR is comparable to 8-mil. PVC.

Disposable Labcoats

Disposable labcoats offer light-duty protection against dirt, grime and certain non-hazardous dry particulates.

B



A. Disposable Labcoat

- Manufactured from lightweight spunbound polypropylene fabric.
- Repels water yet breaths to control perspiration.
- Lightweight and cool to wear.
- Long sleeves, no pockets.
- Color: white.

4-snap front.

> 50 per case.

ITEM NO.	SIZE	CASE
1540 0402	Large	\$129.95
1540 0403	X-Large	129.95
1540 0404	2X-Large	129.95
1540 0405	3X-Large	129.95

B. Polypro Disposable Labcoats

- Color: white.
- Constructed of cool, comfortable and lightweight polypropylene.
- 1.25-oz. labcoat has snaps, long sleeves and no pockets.

ITEM NO.	SIZE	CASE
4724 1710	Small	\$29.95
4724 1711	Medium	29.95
4724 1712	Large	29.95
4724 1713	X-Large	29.95
4724 1714	2X-Large	29.95
4724 1716	3X-Large	29.95
4724 1717	4X-Large	31.95
4724 1718	5X-Large	31.95

> 30 per case.

A



Elastic wrists.

Polypro labcoat (B) is also available in blue.
Visit our website for more information.

TINGLEY

Iron Eagle® Polyurethane-Coated Nylon Rainsuit

5.5 oz. material weight, 10-mil. thick.

- 2-mil. exterior polyurethane coating on 200 denier nylon oxford fabric is resistant to abrasions, fats, oils, pine tars, gasoline, grease and a variety of other liquids and chemicals.
- Lightweight/flexible material stays soft and comfortable in cold conditions.
- Slick coating sheds liquids with ease, making this suit easy to clean.
- Heat sealed seams are guaranteed for 100% liquid proof protection.
- Rainsuit is able to withstand extensive laundering.



Heavy-duty snaps are guaranteed not to corrode.

Heavy-duty suspenders with crossover back.



Available in gold, green or blue.

JACKET WITHOUT HOOD (Includes hood snaps)

➤ 12 per case.

GOLD ITEM NO.	GREEN ITEM NO.	BLUE ITEM NO.	SIZE	EACH	
				1-11	12+
4059 02071	4059 22281	4059 22001	Small	\$34.95	\$33.95
4059 02081	4059 22291	4059 22011	Medium	34.95	33.95
4059 02091	4059 22301	4059 22021	Large	34.95	33.95
4059 02101	4059 22311	4059 22031	X-Large	34.95	33.95
4059 02111	4059 22321	4059 22041	2X-Large	37.95	36.95
4059 02121	4059 22331	4059 22051	3X-Large	37.95	36.95
4059 02131	4059 22341	4059 22061	4X-Large	37.95	36.95

HOOD WITH SNAPS

➤ 12 per case.

GOLD ITEM NO.	GREEN ITEM NO.	BLUE ITEM NO.	PRODUCT	EACH	
				1-11	12+
4059 2147	4059 2148	4059 21411	Hood w/ Snaps	\$9.95	\$8.95

OVERALLS

➤ 12 per case.

GOLD ITEM NO.	GREEN ITEM NO.	BLUE ITEM NO.	SIZE	EACH	
				1-11	12+
4059 20071	4059 23081	4059 73001	Small	\$32.95	\$31.95
4059 20081	4059 23091	4059 73011	Medium	32.95	31.95
4059 20091	4059 23101	4059 73021	Large	32.95	31.95
4059 20101	4059 23111	4059 73031	X-Large	32.95	31.95
4059 20111	4059 23121	4059 73041	2X-Large	34.95	33.95
4059 20121	4059 23131	4059 73051	3X-Large	34.95	33.95
4059 20131	4059 23141	4059 73061	4X-Large	34.95	33.95

Overalls also available in 5X and 6X size. Call for more details.

Visit our website to find more RAINSUITS: www.bunzlkochsupplies.com



Heavy-duty ribbed material for use in warm or cool climates.



Underarm Vents



Bib-Style Trousers with Elastic Suspenders



Cuff Take Ups

Webtex – Ribbed, .65 mm PVC on Non-Woven Polyester Rainsuit



- Heat sealed seams for a stronger waterproof seal.
- Flocked lining wicks moisture away from skin.
- Overall has snap-fly front

JACKET

➤ 20 per case.

ITEM NO.	SIZE	EACH	
		1-19	20+
3161 34791	Small	\$17.95	\$16.95
3161 34801	Medium	17.95	16.95
3161 34811	Large	17.95	16.95
3161 34821	X-Large	17.95	16.95
3161 34831	2X-Large	17.95	16.95
3161 39481	3X-Large	17.95	16.95

OVERALLS

➤ 20 per case.

ITEM NO.	SIZE	EACH	
		1-19	20+
3161 34961	Small	\$17.95	\$16.95
3161 34971	Medium	17.95	16.95
3161 34981	Large	17.95	16.95
3161 34991	X-Large	17.95	16.95
3161 35001	2X-Large	17.95	16.95
3161 39491	3X-Large	17.95	16.95

HOOD

➤ 50 per case.

ITEM NO.	SIZE	EACH	
		1-49	50+
3161 34841	One Size Fits All	\$6.95	\$5.95

Clothing

KOOLERWEAR®

Our most popular and economical insulated wear!

7.4-oz. Insulated Cooler Jackets & Vests

- Insulated with a full 7-ounces of DuPont Dacron 808® fiber fill.
- Two insulated hand warmer pockets.
- 100% nylon outer shell. • Machine washable.
- Heavy-duty zipper.



Blue with Red Lining

JACKET

ITEM NO.	SIZE	EACH	
		1 - 5	6+
4648 50221	Small	\$44.95	\$42.95
4648 50231	Medium	44.95	42.95
4648 50241	Large	44.95	42.95
4648 50251	X-Large	44.95	42.95
4648 50261	2X-Large	49.95	47.95
4648 28221	3X-Large	54.95	52.95
4648 28231	4X-Large	59.95	57.95
4648 28241	5X-Large	69.95	67.95

VEST

ITEM NO.	SIZE	EACH	
		1 - 5	6+
4648 50271	Small	\$29.95	\$27.95
4648 50281	Medium	29.95	27.95
4648 50291	Large	29.95	27.95
4648 50301	X-Large	29.95	27.95
4648 50311	2X-Large	34.95	32.95
4648 55801	3X-Large	39.95	37.95
4648 55811	4X-Large	39.95	37.95

Jacket & Vest also available in HI-VIZ ORANGE.

Visit us online at:

www.bunzlkochsupplies.com



KOLDWEAR®

11.5-oz. Insulated KOLDWEAR® Separates

High-Back Bib Overalls

Nylon duck outer covering 11.5-oz. 808 DuPont HolloFil® insulation is rated down to -45°F.

- Synthetic fur lined hood with a draw cord and Velcro® closure.
- Long sleeves with ribbed-knit fabric cuffs and waistband.
- All stress points and pockets are reinforced.



Optional Hood.

Synthetic fur collar.



High back bib with elasticized waist provides extra warmth and protection to the lower back and kidneys.

Storm fly front with snaps, no exposed zippers for moisture protection.

11.5-OZ. SEPARATES

ITEM NO.	PRODUCT	EACH	
		1 - 5	6+
4648 02021	Waist-Length Jacket, Small	\$109.95	\$107.95
4648 02031	Medium	109.95	107.95
4648 02041	Large	109.95	107.95
4648 02051	X-Large	109.95	107.95
4648 02061	2X-Large	109.95	107.95
4648 02071	3X-Large	119.95	117.95
4648 02081	4X-Large	139.95	137.95
4648 02091	5X-Large	149.95	147.95
4648 02101	6X-Large	169.95	167.95
4648 03011	Overalls, Small	\$109.95	\$107.95
4648 03021	Medium	109.95	107.95
4648 03031	Large	109.95	107.95
4648 03041	X-Large	109.95	107.95
4648 03051	2X-Large	119.95	117.95
4648 03061	3X-Large	139.95	137.95
4648 03071	4X-Large	149.95	147.95
4648 03081	5X-Large	169.95	167.95
4648 03091	6X-Large	179.95	177.95
4648 14141	Optional Hood, One Size Fits All	\$19.95	\$18.95

Jacket has red lining.



Storm snap leg flies with ankle to hip heavy-duty 28" brass zipper.



Hooded Thermal Zip-Front Jacket

This is not your average sweatshirt! Cotton/Poly fleece shell with a 5-oz. thermal lining for added warmth.

- Full-length zipper and two-needle stitched main seams for durability.
- Double-layered three-piece hood with drawstring closure.
- Oversized front pockets.
- Elasticized knit waistband.
- Storm knit cuffs.
- Color: navy.



EACH

ITEM NO.	PRODUCT	1 - 5	6+
3385 54811	Small	\$39.95	\$38.95
3385 54821	Medium	39.95	38.95
3385 54831	Large	39.95	38.95
3385 54841	X-Large	39.95	38.95
3385 54851	2X-Large	39.95	38.95
3385 54861	3X-Large	39.95	38.95

NorthFlex Cold Grip™ Gloves

Foamed PVC palm-coated, lined gloves

- Recommended for temperatures down to -15° F (-26° C).
- Seamless brushed synthetic liner provides superior insulation from the cold.
- Form fitting design.
- Provides excellent wet and dry grip.

Honeywell

NORTH



> 12 pairs per case.

ITEM NO.	SIZE	PER PAIR	
		1-11	12+
3476 86351	Size 8/Medium	\$8.95	\$7.95
3476 86361	Size 9/Large	8.95	7.95
3476 86371	Size 10/X-Large	8.95	7.95
3476 86381	Size 11/2X-Large	8.95	7.95

Grip N® Kevlar® Gloves

Kevlar® provides good cut and slash protection, while nitrile coating improves grip and abrasion resistance.

- Ambidextrous design. • Cotton/poly lining.
- Machine washable.

Honeywell
NORTH

> 12 dozen pair per case.



ITEM NO.	SIZE	PER DOZEN PAIR	
		1-11	12+
3476 66465	Small	\$67.95	\$66.95
3476 66475	Medium	67.95	66.95

Pink Work Gloves

- Pink and black mechanics-style work gloves.
- Synthetic leather fingers.
- Nylon back with padded palms.
- Angled and piped seams.
- One size fits all.



ITEM NO.	PRODUCT	PER PAIR
3425 88601	Pink Work Gloves	\$13.95

Kevlar®/Nomex® Seamless Gloves

Good for applications where heat protection and dexterity is required.

- Provides excellent thermal properties, allowing wearer to handle hot objects.
- Knit, continuous cuff. • Ambidextrous.
- One size fits all.



PROTECTS UP TO 500° F

ITEM NO.	SIZE	EACH	
		1-1	12+
4164 26081	Small	\$11.95	\$10.95
4164 26091	Medium	11.95	10.95
4164 26101	Large	11.95	10.95

More work gloves available online
www.bunzlkochsupplies.com

Clothing

Heavyweight Wrist-Length Gloves

- 28-oz. terry protects up to 250° F.
- Black-striped knit wrist.
- Gunn cut with inset thumb.
- Reversible.



**PROTECTS
UP TO
250° F**



► 6 dozen pair per case.

PER DOZEN PAIR

ITEM NO.	SIZE	1-5	6+
3314 16885	Large Size Fits All	\$26.95	\$25.95

Extra-Heavyweight 11" Gauntlet Gloves

- 32-oz. terry protects up to 320° F.
- Looped out gauntlet finished with brown piping.
- Clute cut with straight thumb.



**PROTECTS
UP TO
320° F**



► 3 dozen pair per case.

PER DOZEN PAIR

ITEM NO.	SIZE	1-2	3+
3314 16925	Large Size Fits All	\$74.95	\$73.95

Extra-Heavyweight 5" High Heat Gauntlet Gloves

- 32-oz. terry protects up to 450° F.
- 10-oz. jersey lining.
- Loop out gauntlet finished with brown piping.
- Gunn cut with inset thumb.
- Reversible.



**PROTECTS
UP TO
450° F**



► 3 dozen pair per case.

PER DOZEN PAIR

ITEM NO.	SIZE	1-2	3+
3314 16905	X-Large Size Fits All	\$99.95	\$98.95

Triple-Knit Hot Mill Gloves

Handle hot or cold without worry.

- Triple-thick knitted cotton gloves.
- Open-knit cuff for easy-on and off.
- Machine washable.

**PROTECTS
UP TO
275° F**



► 3 dozen pair per case.

PER DOZEN PAIR

ITEM NO.	SIZE	1-2	3+
2814 92705	One Size Fits All	\$69.95	\$68.95

Terry Cloth Baker's Glove

Perfect for grabbing hot trays, pans & utensils.

- Extra thick terry glove with sewn wrist band.
- Machine washable.



► 10 dozen pair per case.

PER DOZEN PAIR

ITEM NO.	PRODUCT	1-9	10+
6292 27045	Medium Weight (18-oz.)	\$19.95	\$18.95
6292 27005	Heavy Weight (24-oz.)	21.95	20.95



► One size fits all.

**PROTECTS
UP TO
450° F**



Terry Cloth Baker's Pad

- Two layers protect up to 460°F.
- Provides protection against hot trays, pans and other utensils.
- Machine washable.

WELLS LAMONT
Industrial

JOMAC



**PROTECTS
UP TO
460°F**



Hand hole in pad for ease of use.

► 12 per case.

ITEM NO.	SIZE	EACH
4164 00081	9.5" x 11"	\$2.95



Terry Cloth Baker's Sleeve

- Thick 14" terry sleeve with sewn wrist band.
- Machine washable.

WELLS LAMONT
Industrial

JOMAC

**PROTECTS
UP TO
350°F**

► 12 per case.

ITEM NO.	SIZE	EACH	
		1-11	12+
4164 15151	One Size Fits All	\$4.95	\$3.95

Grip N® Hot Mill Gloves

Honeywell
NORTH

Choose from steamproof or non-steamproof.

- Provides protection from intermittent contact with hot surfaces up to 400°F.
- Outer shell is made of a cotton/acrylic blend that is nitrile coated for improved grip and longer life.
- Knitted, seamless construction provides superior comfort and lessens hand fatigue.
- The steamproof glove provides heat-resistance and protection in moist, steamy conditions.
- Machine washable. Steamproof not dryable.
- One size fits all.



**PROTECTS
UP TO
400°F**

► 6 dozen pair per case.

ITEM NO.	SIZE	PER DOZEN PAIR	
		1-5	6+
3476 89705	Non-Steamproof	\$69.95	\$68.95
3476 05115	Steamproof	69.95	68.95

BurnGuard™ High Temperature Gloves

- Aramid fabric makes these gloves up to 20 times more durable than conventional gloves.
- Able to withstand contact with direct flames.
- Double-stitched seams.
- Machine wash and dry without losing heat barrier.



**PROTECTS
UP TO
450°F**



► 12 per case.

ITEM NO.	SIZE	PER GLOVE	
		1-11	12+
4386 51501	15" Glove	\$59.95	\$58.95
4386 52411	24" Glove	79.95	78.95

Knit Gloves

- Poly/cotton blend knitted gloves.
- Bleached and unbleached with sewn wrist bands.
- Color-coded wrist band designates glove weight.
- Ambidextrous and machine washable.
- One Size Fits All



**OUR LOWEST COST
COTTON KNIT GLOVE!**
AVAILABLE BY THE CASE ONLY

Economy Knit Glove with blue wristband



18 GRAMS



➤ 40 dozen pair per case.

ITEM NO.	PRODUCT	CASE
7500 7501	Economy Glove	\$149.00

Lightweight Knit Glove with white wristband

22 GRAMS

➤ 12 pair per pack— 40 packs per case.

ITEM NO.	PRODUCT	PER DOZEN PAIR	
		1-39	40+
7500 75075	Lightweight Glove	\$7.95	\$6.95



Medium weight Knit Glove with green wristband

28 GRAMS

➤ 12 pair per pack— 40 packs per case.

ITEM NO.	PRODUCT	PER DOZEN PAIR	
		1-39	40+
7500 75035	Medium weight Glove	\$9.95	\$8.95



Heavyweight Knit Glove with gold wristband

38 GRAMS

➤ 12 pair per pack—24 packs per case.

ITEM NO.	PRODUCT	PER DOZEN PAIR	
		1-23	24+
7500 75055	Heavyweight Glove	\$10.95	\$9.95



Women's Knit Gloves

Smaller size to fit women's hands better.

- Poly/cotton blend.
- Reversible and machine washable.
- Sewn wristband.
- One size fits all.



➤ 40 dozen pair per case.

ITEM NO.	PRODUCT	WRISTBAND COLOR	PER DOZEN PAIR	
			1-39	40+
E542 51045	Standard-weight	Light Blue	\$7.95	\$6.95
E542 51055	Heavy-weight	Light Blue	9.95	8.95



Shrink-Resistant Poly/Cotton Knit Gloves

Test washed and dried
20 times with less than 10% shrinkage.

- Custom poly/cotton blend.
- Sewn wristband.
- One size fits all.
- Gray wristband edge



40 GRAMS

➤ 30 dozen pair per case.

ITEM NO.	PRODUCT	PER DOZEN PAIR	
		1-29	30+
E542 51015	Shrink-Resistant Glove	\$10.95	\$9.95



Knit Eco-Gloves®

Go 'green' with Eco-Gloves® - made from recycled post-consumer plastics.

- Using EarthSPUN™ green-certified technology, recycled plastic bottles are processed into fibers that are used to create Eco-Gloves®.
- Recycled fibers shrink less than normal gloves, extending life of glove.
- Stain-resistant.
- Machine-knitted wrist.
- Available in 3 colors.



Made from recycled plastic bottles.

► 12 pair per pack — 40 packs per case.

ITEM NO.	COLOR	PER DOZEN	
		1-39	40+
7419 20075	Green	\$9.95	\$8.95
7419 11075	Blue	9.95	8.95
7419 70075	Gray	9.95	8.95

Single/Double-Dot Gloves

PVC dots provide better grip and abrasion-resistance for longer wear.

- Reversible, fits either hand.
- 50/50 cotton/acrylic blend.
- Machine washable.

► One size fits all.

Single-Dot



► 25 dozen pair per case.

ITEM NO.	PRODUCT	PER DOZEN PAIR	
		1-24	25+
6292 05885	Single-Dot	\$12.95	\$11.95
6292 03305	Double-Dot	\$14.95	\$13.95

Double-Dot



Pink Knit Glove

- 100% acrylic.
- Seamless knit.
- Ambidextrous.



► 12 pair per case.

ITEM NO.	SIZE	PER CASE	
		1-19	20+
3425 13325	One Size Fits All	\$21.95	\$20.95

Low-Cost Cotton Lisle Inspector's Gloves

- Reversible gloves absorb body oils and prevent damage to product from contact with skin.
- Ideal glove liners.
- Unhemmed.



Close up of cotton fabric.



► 100 dozen pair per case.

ITEM NO.	SIZE	PER DOZEN PAIR	
		1-99	100+
6292 25005	One Size Fits All	\$6.95	\$5.95

Tight-Knit Gloves

Perfect for use as a glove liner.

- Tight, 13 threads per inch knit increases both dexterity and sensitivity.
- Poly/cotton blend.
- Machine washable.
- Sewn wristband.



► 30 dozen pair per case.

ITEM NO.	SIZE	PER DOZEN PAIR	
		1-29	30+
3140 01315	One Size Fits All	\$10.95	\$9.95

Honeywell

VersaTouch 11-mil. 13" Straight, Unlined Nitrile Gloves

Grip makes it easier to handle foods.

- Form-fitting fingers and tapered wrist.
- Complies with FDA regulations for food contact and complements HACCP food safety guidelines for color-coded gloves.



Ansell

Blue Gloves 37-510

ITEM NO.	SIZE	PER DOZEN PAIR	
		1-11	12+
2201 01575	7-7 1/2, Small	\$14.95	\$13.95
2201 01585	8-8 1/2, Medium	14.95	13.95
2201 01595	9-9 1/2, Large	14.95	13.95
2201 01605	10, X-Large	14.95	13.95
2201 01615	11, 2X-Large	14.95	13.95

> 12 dozen pair per case

Green Gloves 37-646

ITEM NO.	SIZE	PER DOZEN PAIR	
		1-11	12+
2201 46075	7, Small	\$14.95	\$13.95
2201 46085	8, Medium	14.95	13.95
2201 46095	9, Large	14.95	13.95
2201 46105	10, X-Large	14.95	13.95
2201 46115	11, 2X-Large	14.95	13.95

> 12 dozen pair per case

Solvex® Unlined Nitrile Gloves

Made from component materials which comply with FDA regulations for food contact 21CFR 177-2600.



11-mil. 13" Straight, Unlined

37-145

> 12 dozen pair per case.

ITEM NO.	SIZE	PER DOZEN PAIR	
		1-11	12+
2201 45075	7-7 1/2, Small	\$14.95	\$13.95
2201 45085	8-8 1/2, Medium	14.95	13.95
2201 45095	9-9 1/2, Large	14.95	13.95
2201 45105	10, X-Large	14.95	13.95
2201 45115	11, 2X-Large	14.95	13.95

Bulk Pak, 11-mil. 13" Straight Unlined

37-145. Buy in bulk and save!

> 6 dozen pair per box.

ITEM NO.	SIZE	EACH BOX
2201 4807	7-7 1/2, Small	\$79.95
2201 4808	8-8 1/2, Medium	79.95
2201 4809	9-9 1/2, Large	79.95
2201 4810	10-10 1/2, XL	79.95
2201 4811	11-11 1/2, 2XL	79.95

15- and 22-mil styles available. Call for details.

Ansell

AFR-282 Nitrile Over Latex 13" Gloves

The improved chemical, fat and acid resistance of nitrile with the comfort of latex.

- Cotton flock lining adds comfort and absorbs perspiration.
- Blue/green color.



Flocked lining.

MAPA
PROFESSIONAL

> Note: Natural rubber latex may cause allergic reactions in some individuals.



Embossed diamond pattern grip.

> 6 dozen pair per case.

ITEM NO.	SIZE	PER DOZEN PAIR	
		1-5	6+
7975 06375	Small	\$24.95	\$23.95
7975 06385	Medium	24.95	23.95
7975 06395	Large	24.95	23.95
7975 06405	X-Large	24.95	23.95
7975 06415	2X-Large	24.95	23.95

NITRILE GLOVE ADVANTAGES:

- Will not weaken or swell in most solvents, caustics or animal fats.
- Curved finger design and contoured palm minimize hand fatigue.
- Handle the largest combination of physical and chemical hazards.
- Offer longer wear, better protection against snags, punctures, abrasions and cuts.

More NITRILE GLOVES

available online:

www.bunzlkochsupplies.com



Nitri-Knit® Nitrile Coated Gloves

Hand portion of glove is treated with anti-bacterial and anti-mildew agents.



- Dipped nitrile coating is resistant to chemicals, fats, oils, acids and solvents.
- Pebbled grip finish provides a sure grip on oily and wet products.
- Cotton interlock knit liner is dipped and won't peel apart like a glued-in liner.
- Superior resistance to snags, cuts, abrasions and punctures.
- Available in short 12" length or a 24" length with elastic at shoulder to prevent sleeve from sliding down arm.

Insulated (order one size larger)

➤ 6 pair per case.
PER PAIR

ITEM NO.	SIZE		1-5	6+
3476 83371	12" Short Length . . .	Size 7	\$12.95	\$11.95
3476 83381		Size 8	12.95	11.95
3476 83391		Size 9	12.95	11.95
3476 83401		Size 10	12.95	11.95
3476 83411		Size 11	12.95	11.95
3476 80421	26" Shoulder Length,	Size 7	27.95	26.95
3476 80431		Size 8	27.95	26.95
3476 80441		Size 9	27.95	26.95
3476 80451		Size 10	27.95	26.95
3476 80461		Size 11	27.95	26.95

PROTECTS UP TO 300° F



Non-Insulated

➤ 6 pair per case.
PER PAIR

ITEM NO.	SIZE		1-5	6+
3476 81371	12" Short Length . . .	Size 7	\$9.95	\$8.95
3476 81381		Size 8	9.95	8.95
3476 81391		Size 9	9.95	8.95
3476 81401		Size 10	9.95	8.95
3476 81411		Size 11	9.95	8.95
3476 80371	26" Shoulder Length,	Size 7	18.95	17.95
3476 80381		Size 8	18.95	17.95
3476 80391		Size 9	18.95	17.95
3476 80401		Size 10	18.95	17.95
3476 80411		Size 11	18.95	17.95



Available as an insulated glove for working in hot or cold environments.



Pebbled texture grip.

SHOWA 6781R Neoprene Gloves

For protection against acids, caustics, oils, greases and many solvents.

- Multi-dipped in premium grade neoprene for superior quality and durability.
- Rough finish for a superb grip in wet conditions.
- 12" gauntlet.



Soft cotton liner absorbs perspiration and makes it easy to pull on & off.



ITEM NO.	SIZE	PER DOZEN PAIR
3841 67815	Large	\$149.95

18" Neoprene Supported Fryer Glove

Ideal for restaurant deep fryer grease, broiler and oil applications.

- Withstands radiant temperatures up to 450° Fahrenheit.
- NOT recommended for open flame contact.
- One size fits all.



Rough finish on hand area.

Sewn in loop.



Available with built-in liner or 100% heavy cotton double jersey removable liner.

ITEM NO.	PRODUCT	PER PAIR	
		1-11	12+
4663 41851	With Removable Heavy-Duty Liner	\$34.95	\$33.95
4663 31851	With Built-In Liner	24.95	23.95

9-mil. Natural Latex Finger Cots

► *Note: Natural rubber latex may cause allergic reactions in some individuals.*

Ideal for covering up bandages.



Honeywell
NORTH

► 144 per box — 20 boxes per case.

ITEM NO.	SIZE	PER BOX	
		1-19	20+
3476 21155	Size 1, Small	\$11.95	\$10.95
3476 21165	Size 2, Medium	11.95	10.95
3476 21175	Size 3, Large	11.95	10.95
3476 21185	Size 4, X-Large	11.95	10.95

Acrylic Glove Dispenser

Put gloves at your employees' fingertips.

- Holds one box.
- Clear acrylic construction.
- Mounts to walls with two screws (not included).
- Gloves not included.



ITEM NO.	PRODUCT	DIMENSIONS	EACH
3364 28281	Glove Dispenser	6-5/8" x 11-1/8" x 4"	\$39.95

Stainless Steel, Disposable Glove Dispenser

Electropolished finish to enhance corrosion resistance, improve surface finish and ease of cleaning.

- Available in 1-box, 2-box or 3-box sizes.
- Stainless steel construction can be easily washed down without rusting.
- Easily mounts to wall (mounting hardware not included).
- Gloves not included.



ITEM NO.	PRODUCT	DIMENSIONS	EACH
3013 2021	1-Box Dispenser	5.5" x 3.5" x 10.75"	\$49.95
3013 2023	2-Box Dispenser	10" x 3.5" x 11.75"	59.95
3013 2022	3-Box Dispenser	10" x 3.5" x 17"	69.95

Rack 'Em™ Disposable Glove Box Dispenser Rack

- Shelves organize gloves for quick and easy access.
- Holds all gloves on one convenient rack.
- Racks do not collect dust or dirt.
- Holds all manufacturers' glove boxes of any size.
- PVC coated to resist bleaches and solvents.
- Gloves not included.



ITEM NO.	PRODUCT	DIMENSIONS	EACH
3446 57031	1-Box Rack	4.5" x 11.5" x 5.5"	\$29.95
3446 40091	2-Box Rack	9.25" x 14" x 7"	49.95
3446 40101	3-Box Rack	16.5" x 14" x 7"	59.95
3446 40151	4-Box Rack	24.5" x 14" x 7"	69.95

Rack 'Em™ Glove Rack

Organize, dry and store your gloves in one place, ready to wear.

- Rust-resistant black PVC coating over heavy-duty galvanized steel.
- Allows for quicker drying time.
- Screws supplied for 16" on center holes.
- Holds four pairs. • 14" high.



ITEM NO.	PRODUCT	EACH
3446 20441	Glove Rack	\$39.95



5-Mil. Powdered Vinyl Gloves



5-Mil. Powder-Free Gloves



Powdered > 100 per dispenser box — 10 dispenser boxes per case.

ITEM NO.	CLEAR	ITEM NO.	BLUE	PER BOX	
				1-9	10+
7500 61205	Small	7500 66205	Small	\$8.95	\$7.95
7500 61305	Medium	7500 66305	Medium	8.95	7.95
7500 61405	Large	7500 66405	Large	8.95	7.95
7500 61505	X-Large	7500 66505	X-Large	8.95	7.95
7500 61555	2X-Large	7500 66555	2X-Large	8.95	7.95

Powder-Free > 100 per dispenser box — 10 dispenser boxes per case.

ITEM NO.	CLEAR	ITEM NO.	BLUE	PER BOX	
				1-9	10+
7500 62205	Small	7500 67205	Small	\$8.95	\$7.95
7500 62305	Medium	7500 67305	Medium	8.95	7.95
7500 62405	Large	7500 67405	Large	8.95	7.95
7500 62505	X-Large	7500 67505	X-Large	8.95	7.95
7500 62555	2X-Large			8.95	7.95

5-Mil. Metal Detectable Powder-Free Vinyl Gloves

- Detectable in the 50Khz — 1Mhz range to ensure detection should the glove fall into product on the line.



Metal detectable gloves are easy to detect in food.



> 100 per box — 10 boxes per case.

ITEM NO.	SIZE	PER BOX	
		1-9	10+
7195 47005	Small	\$10.95	\$9.95
7195 47015	Medium	10.95	9.95
7195 47025	Large	10.95	9.95
7195 47035	X-Large	10.95	9.95

6.5-mil. Extended-Use Powdered Vinyl Disposable Gloves

- 9-1/2" length with rolled cuff.
- Ambidextrous.
- Color: green.



> 100 per dispenser box — 4 dispenser boxes per case.

ITEM NO.	SIZE	PER BOX	
		1 - 3	4+
3314 50225	Small	\$11.95	\$10.95
3314 50235	Medium	11.95	10.95
3314 50245	Large	11.95	10.95
3314 50255	X-Large	11.95	10.95

Poly Disposable Gloves



Clear, Wrist-Length Gloves

- High-quality.
- Made of polyethylene.
- Embossed.

> 1,000 per box — 10 boxes per case.

ITEM NO.	SIZE	PER BOX	
		1-9	10+
7500 71205	7, Small	\$9.95	\$8.95
7500 71305	8, Medium	9.95	8.95
7500 71405	9, Large	9.95	8.95

White, Shoulder-Length Gloves

- Ambidextrous.
- 34" long.
- Made of 1.5 mil. poly film.

> 100 per box — 10 boxes per case.

ITEM NO.	SIZE	PER BOX	
		1-9	10+
3439 04885	One Size Fits All	\$11.95	\$10.95

Clothing

5-mil. Disposable Latex Gloves

High quality, single-use gloves.

- Available in powdered or powder-free styles.
- 9" length with rolled cuff.
- Color: natural.
- Ambidextrous



► Note: Natural rubber latex may cause allergic reactions in some individuals.



► 100 per dispenser box — 10 dispenser boxes per case.

Powdered

ITEM NO.	SIZE	PER BOX	
		1-9	10+
7500 51205	Small	\$12.95	\$11.95
7500 51305	Medium	12.95	11.95
7500 51405	Large	12.95	11.95
7500 51505	X-Large	12.95	11.95

Powder-Free

ITEM NO.	SIZE	PER BOX	
		1-9	10+
7500 52205	Small	\$12.95	\$11.95
7500 52305	Medium	12.95	11.95
7500 52405	Large	12.95	11.95
7500 52505	X-Large	12.95	11.95



SHOWA N-DEX 6205PF BWC™ (Because We Care) 4-mil. Pink Nitrile Disposable Gloves

Show your support of cancer survivors while enjoying the best N-DEX hand protection.

- Powder-free.
- 9.5" long with slightly textured fingertips.
- Ambidextrous.



► 100 per box — 10 boxes per case.

ITEM NO.	POWDER-FREE	PER BOX	
		1-9	10+
3841 62055	6, X-Small	\$15.95	\$14.95
3841 62065	7, Small	15.95	14.95
3841 62075	8, Medium	15.95	14.95
3841 62085	9, Large	15.95	14.95
3841 62095	10, X-Large	15.95	14.95

SHOWA will donate a portion of the proceeds from N-DEX® BWC™ to organizations promoting breast cancer research and awareness.

350 SERIES ECONOMY Nitrile Disposable Gloves

- Fingertip texture.
- 2.5 mil. at the palm
- Ambidextrous.
- 9" glove length.



Powder-Free

► 100 per box — 10 boxes per case.

ITEM NO.	SIZE	PER BOX	
		1-9	10+
E542 02175	Small	\$7.95	\$6.95
E542 02195	Medium	7.95	6.95
E542 02155	Large	7.95	6.95
E542 02165	X-Large	7.95	6.95
E542 32205	2X-Large	7.95	6.95



450 SERIES INDUSTRIAL Nitrile Disposable Gloves

- Fingertip texture.
- 3.5 mil. at the palm.
- Ambidextrous.
- 9" glove length.



Powder-Free

► 100 per box — 10 boxes per case.

ITEM NO.	SIZE	PER BOX	
		1-9	10+
7500 86295	Small	\$9.95	\$8.95
7500 86395	Medium	9.95	8.95
7500 86495	Large	9.95	8.95
7500 86595	X-Large	9.95	8.95
7500 86695	2X-Large	9.95	8.95



650 SERIES PREMIUM Nitrile Disposable Gloves

Protection against animal fats, oil-based solvents, petroleum and caustics with strength, puncture-resistance and color-coding compliance.

- Fingertip texture improves grip without sacrificing dexterity.
- 9" glove length. • 5-mil. at the palm. • Ambidextrous.

Latex FREE



Orange
Powder-Free

► 100 per box — 10 boxes per case.

ITEM NO.	SIZE	PER BOX	
		1-9	10+
E542 02555	Small	\$10.95	\$9.95
E542 02565	Medium	10.95	9.95
E542 02575	Large	10.95	9.95
E542 02585	X-Large	10.95	9.95
E542 02595	2X-Large	10.95	9.95



Grape
Powder-Free

► 100 per box — 10 boxes per case.

ITEM NO.	SIZE	PER BOX	
		1-9	10+
E542 02455	Small	\$10.95	\$9.95
E542 02465	Medium	10.95	9.95
E542 02475	Large	10.95	9.95
E542 02485	X-Large	10.95	9.95
E542 02495	2X-Large	10.95	9.95



Lime Green
Powder-Free

► 100 per box — 10 boxes per case.

ITEM NO.	SIZE	PER BOX	
		1-9	10+
E542 02655	Small	\$10.95	\$9.95
E542 02665	Medium	10.95	9.95
E542 02675	Large	10.95	9.95
E542 02685	X-Large	10.95	9.95
E542 02695	2X-Large	10.95	9.95



Black
Powder-Free

► 100 per box — 10 boxes per case.

ITEM NO.	SIZE	PER BOX	
		1-9	10+
E542 02755	Small	\$10.95	\$9.95
E542 02765	Medium	10.95	9.95
E542 02775	Large	10.95	9.95
E542 02785	X-Large	10.95	9.95
E542 02795	2X-Large	10.95	9.95



Green
Powder-Free

► 100 per box — 10 boxes per case.

ITEM NO.	SIZE	PER BOX	
		1-9	10+
7500 82395	Small	\$10.95	\$9.95
7500 82495	Medium	10.95	9.95
7500 82595	Large	10.95	9.95
7500 82695	X-Large	10.95	9.95
7500 82795	2X-Large	10.95	9.95



Blue
Powder-Free

► 100 per box — 10 boxes per case.

ITEM NO.	SIZE	PER BOX	
		1-9	10+
7500 84295	Small	\$10.95	\$9.95
7500 84395	Medium	10.95	9.95
7500 84495	Large	10.95	9.95
7500 84595	X-Large	10.95	9.95
7500 84695	2X-Large	10.95	9.95



Powdered

► 100 per box — 10 boxes per case.

ITEM NO.	SIZE	PER BOX	
		1-9	10+
7500 83295	Small	\$10.95	\$9.95
7500 83395	Medium	10.95	9.95
7500 83495	Large	10.95	9.95
7500 83595	X-Large	10.95	9.95
7500 83695	2X-Large	10.95	9.95

Vikan® Ultra Safe Technology (UST) Brushes

UST provides a new level of hygienic design and bristle arrangement

The innovative technology utilizes enhanced bristle security units directly molded to the brush block, removing any gaps or seams while offering unprecedented bristle retention strength.

- One piece design, no metal staples or resin.
- FDA compliant.
- Easy to clean and dry.
- Easy color-coded visual inspection.

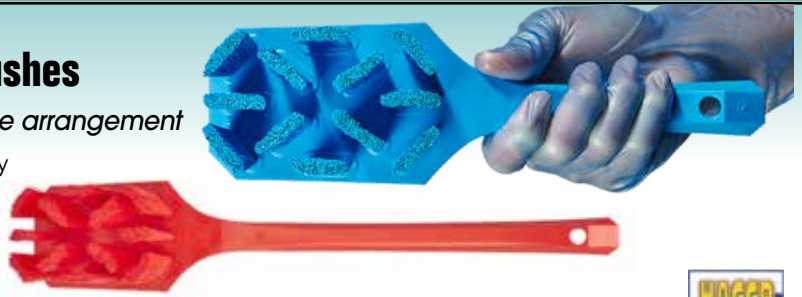

Short Handle UST Scrub Brush

ITEM NO.	COLOR	EACH
5281 00381	Pink	\$19.95
5281 00281	Green	19.95
5281 00391	Blue	19.95
5281 00291	Red	19.95
5281 00301	White	19.95
5281 00311	Yellow	19.95
5281 00401	Orange	19.95
5281 00411	Purple	19.95

Long Handle UST Scrub Brush

ITEM NO.	COLOR	EACH
5281 00431	Pink	\$24.95
5281 00441	Green	24.95
5281 00451	Blue	24.95
5281 00461	Red	24.95
5281 00471	White	24.95
5281 00481	Yellow	24.95
5281 19671	Orange	24.95
5281 00491	Purple	24.95

Easy-to-clean bristle arrangement



Vikan® Total Color Scrub Brushes

Choose from three styles and multiple colors

- Low water absorption polyester bristles with stainless steel staples.
- Made from FDA-compliant materials.
- Hygienic, solid block polypropylene construction.
- Autoclavable at temperatures up to 250° F/121° C.



Choose from these colors.



Scan this QR code with your mobile device to watch a video about Vikan® color-coded brush usage.



Scrub Brush

- 3" x 8" with stiff bristles.

Stiff

ITEM NO.	COLOR	EACH
5281 89051	White	\$13.95
5281 89041	Red	13.95
5281 89061	Yellow	13.95
5281 89021	Green	13.95
5281 89031	Blue	13.95
5281 89071	Orange	13.95
5281 89081	Purple	13.95
5281 89091	Black	13.95

Short Handle Scrub Brush

- 2.75" x 10". • Choose from stiff or soft bristles.

Stiff

ITEM NO.	COLOR	EACH
5281 19251	White	
5281 19241	Red	
5281 19261	Yellow	
5281 19221	Green	
5281 19231	Blue	
5281 19271	Orange	
5281 19281	Purple	
5281 19291	Black	

Soft

ITEM NO.	COLOR	EACH
5281 19051	White	\$11.95
5281 19041	Red	11.95
5281 19061	Yellow	11.95
5281 19021	Green	11.95
5281 19031	Blue	11.95
		11.95
		11.95
		11.95

Long Handle Scrub Brush

- 2.75" x 15.75". • Choose from stiff or soft bristles.

Stiff

ITEM NO.	COLOR	EACH
5281 18651	White	
5281 18641	Red	
5281 18661	Yellow	
5281 18621	Green	
5281 18631	Blue	
5281 18641	Orange	
5281 18651	Purple	

Soft

ITEM NO.	COLOR	EACH
5281 28251	White	\$12.95
5281 18241	Red	12.95
5281 18261	Yellow	12.95
5281 18221	Green	12.95
5281 28231	Blue	12.95
		12.95
		12.95

Vikan® Total Color Round Hand Brush

- 5" diameter brush made with stiff 44mm bristles.
- Block and bristles are made from the same color.
- Made from FDA-compliant materials.

ITEM NO.	COLOR	EACH
5281 8855	White	\$16.95
5281 88541	Red	16.95
5281 8856	Yellow	16.95
5281 8852	Green	16.95
5281 8853	Blue	16.95



Vikan® Total Color UST, Ultra Safe Technology Bench Brush

Colored brushes help eliminate cross-contamination.

- Block and bristles are made from the same color.
- Made from FDA-compliant materials.



Soft

ITEM NO.	COLOR	EACH
5281 00501	Pink	\$21.95
5281 00511	Green	21.95
5281 00521	Blue	21.95
5281 00541	Red	21.95
5281 00551	White	21.95
5281 00561	Yellow	21.95
5281 00571	Orange	21.95
5281 00581	Purple	21.95

Medium Stiffness

ITEM NO.	COLOR	EACH
5281 00591	Pink	\$21.95
5281 00601	Green	21.95
5281 00611	Blue	21.95
5281 00621	Red	21.95
5281 00631	White	21.95
5281 00641	Yellow	21.95
5281 00651	Orange	21.95
5281 00661	Purple	21.95

Vikan® Total Color Hand Brush

Colored brushes help eliminate cross-contamination.

- Block and bristles are made from the same color.
- Made from FDA-compliant materials.

Soft

ITEM NO.	COLOR	EACH
5281 50751	White	\$10.95
5281 50741	Red	10.95
5281 50761	Yellow	10.95
5281 50721	Green	10.95
5281 50731	Blue	10.95
5281 58771	Orange	10.95
5281 58781	Purple	10.95
5281 58791	Black	10.95

Medium Stiffness

ITEM NO.	COLOR	EACH
5281 58951	White	\$10.95
5281 58941	Red	10.95
5281 58961	Yellow	10.95
5281 58921	Green	10.95
5281 58931	Blue	10.95
5281 58971	Orange	10.95
5281 58981	Purple	10.95
5281 58991	Black	10.95



Vikan® Stiff Bristle Tube Brushes

Tough polypropylene blocks and polyester bristles are suitable for food processing environments.

- Made with low water absorption polyester bristles.
- Made from FDA-compliant materials.

► Requires a European-thread handle, sold separately. We recommend our mini handle shown right. Additional Vikan handles available on page 105.

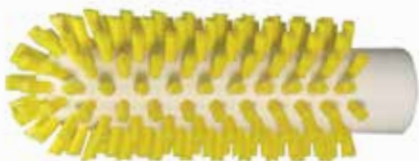

Vikan® 6-1/2" Mini Handle



For use with tube brushes shown to left.

- Made from FDA-compliant materials.
- Ideal for those jobs in small places.
- Rounded grooves on handle improve grip without compromising hygiene.
- Available in five colors.



2" x 5-3/4" Stiff Bristle

ITEM NO.	COLOR	EACH
5281 39051	White	\$17.95
5281 39041	Red	17.95
5281 39061	Yellow	17.95
5281 39021	Green	17.95
5281 39031	Blue	17.95

4" x 6-1/2" Stiff Bristle

ITEM NO.	COLOR	EACH
5281 39471	White	\$19.95
5281 39441	Red	19.95
5281 39461	Yellow	19.95
5281 39421	Green	19.95
5281 3943	Blue	19.95
5281 39481	Black	19.95



ITEM NO.	COLOR	EACH
5281 93451	White	\$7.95
5281 93431	Blue	7.95
5281 93461	Yellow	7.95
5281 93421	Green	7.95
5281 9344	Red	7.95

Sparta® Spectrum® Iron Handle Scrub Brush



- Resins used to produce blocks and bristles are made of FDA approved materials.
- Polyester crimped bristles are staple set into solid 6" iron handle for a comfortable, easy grip.
- Plastic block won't crack or splinter.

ITEM NO.	COLOR	12 per case. EACH	
		1-11	12+
6387 24061	White	\$8.95	\$7.95
6387 24051	Red	8.95	7.95
6387 24041	Yellow.	8.95	7.95
6387 24141	Blue	8.95	7.95
6387 24091	Green.	8.95	7.95

Sparta® Spectrum® Hand Scrub Brush



Handle block size: 2-1/2" x 6"

- Medium stiff bristles are ideal for scrubbing hard-to-clean surfaces such as counter tops and cutting boards.
- Resins used to produce blocks and bristles are made of FDA approved materials.

ITEM NO.	COLOR	12 per case. EACH	
		1-11	12+
6387 01021	White	\$9.95	\$8.95
6387 21051	Red	9.95	8.95
6387 21041	Yellow.	9.95	8.95
6387 21141	Blue	9.95	8.95
6387 21091	Green.	9.95	8.95

Sparta® Spectrum® All-Purpose Utility Scrub Brushes

Tough, durable and economical brushes that are perfect for a multitude of clean-up chores.

- Multiple trim angles on bristles give you better surface contact for cleaning.
- Pistol grip handles are ergonomically shaped, with smooth edges for superior comfort.
- Rugged white plastic handles and crimped staple set polyester bristles will not absorb oils or moisture.



8" Short Handle

Handle block size: 3" x 8" > 12 per case. EACH

ITEM NO.	COLOR	1-11	12+
6387 41011	White	\$10.95	\$9.95
6387 05411	Red	10.95	9.95
6387 05421	Yellow.	10.95	9.95
6387 41141	Blue	10.95	9.95
6387 41091	Green	10.95	9.95
6387 41241	Orange	10.95	9.95
6387 41681	Purple.	10.95	9.95
6387 41031	Black	10.95	9.95

20" Long Handle

Handle block size: 3" x 20" > 12 per case. EACH

ITEM NO.	COLOR	1-11	12+
6387 01031	White	\$14.95	\$13.95
6387 05011	Red	14.95	13.95
6387 01041	Yellow.	14.95	13.95
6387 01141	Blue	14.95	13.95
6387 01091	Green.	14.95	13.95
6387 09361	Orange.	14.95	13.95
6387 22681	Purple.	14.95	13.95
6387 01151	Black	14.95	13.95

Sparta® Spectrum® Flow-Thru Brush

For use with Sparta® Flow-Thru Handle.

- Ideal for cleaning greasy surfaces such as walls and equipment.
- Soft (flagged) bristles are fashioned in a 5" x 12" spread and set in a non-absorbent plastic block that won't crack or chip.
- 10" brush features threaded flow-thru handle hole.
- Resins used to produce blocks and bristles are made of FDA approved materials.

BRUSH

ITEM NO.	PRODUCT	12 per case. EACH	
		1-11	12+
6387 78021	White	\$22.95	\$21.95
6387 78051	Red	22.95	21.95
6387 78041	Yellow.	22.95	21.95
6387 78141	Blue	22.95	21.95
6387 78091	Green.	22.95	21.95

HANDLE

ITEM NO.	PRODUCT	12 per case. EACH	
		1-11	12+
6387 41041	60" Flow-Thru w/ Valve Handle	\$19.95	



> Handles sold separately.

We recommend Sparta® valve controlled Flow-Thru Handle, sold separately.

Sparta® Spectrum® Tank and Kettle Brush

For use with Spectrum® Self-Locking Flex-Tip™ Fiberglass Handles.



- Flare head design cleans thoroughly and can be used with different length threaded handles to reach bottom of kettles and tanks.
- Polyester crimped bristles are staple set into solid 5-1/2" x 9" plastic head.
- Resins used to produce blocks and bristles are made of FDA approved materials.

Brushes

ITEM NO.	COLOR	> 12 per case. EACH	
		1-11	12+
6387 43021	White ..	\$34.95	\$33.95
6387 43051	Red ...	34.95	33.95
6387 43041	Yellow..	34.95	33.95
6387 43141	Blue ...	34.95	33.95
6387 43091	Green...	34.95	33.95

60" Handles

ITEM NO.	COLOR	> 12 per case. EACH	
		1-11	12+
6387 00921	White ...	\$16.95	\$15.95
6387 00891	Red ...	16.95	15.95
6387 00621	Yellow..	16.95	15.95
6387 02001	Blue ...	16.95	15.95
6387 00721	Green...	16.95	15.95

Sparta® Spectrum® Counter Brush

- Polyester bristles are set into a 13" plastic block handle for easy washing and quick drying.
- Resins used to produce blocks and bristles are made of FDA approved materials.
- Available in 7 colors.



ITEM NO.	COLOR	> 12 per case. EACH	
		1-11	12+
6387 80031	White	\$12.95	\$11.95
6387 80061	Red	12.95	11.95
6387 80051	Yellow ...	12.95	11.95
6387 80071	Blue	12.95	11.95
6387 00881	Green.....	12.95	11.95
6387 80241	Orange...	12.95	11.95
6387 80681	Purple....	12.95	11.95

Sparta® Spectrum® Tile and Grout Brush

For use with Spectrum® Self-Locking Flex-Tip™ Fiberglass Handles.



- Triangular block with molded-in scraper, two different handle holes and polyester bristles can be hand held or used with a handle to effectively remove stubborn stains from grouted tile.
- Resins used to produce blocks and bristles are made of FDA approved materials.

Brushes

ITEM NO.	COLOR	> 12 per case. EACH	
		1-11	12+
6387 23021	White ...	\$9.95	\$8.95
6387 23051	Red ...	9.95	8.95
6387 23041	Yellow..	9.95	8.95
6387 23141	Blue ...	9.95	8.95
6387 23091	Green...	9.95	8.95

60" Handles

ITEM NO.	COLOR	> 12 per case. EACH	
		1-11	12+
6387 00921	White ...	\$16.95	\$15.95
6387 00891	Red ...	16.95	15.95
6387 00621	Yellow..	16.95	15.95
6387 02001	Blue ...	16.95	15.95
6387 00721	Green...	16.95	15.95

Sparta® Spectrum® Valve and Fitting Brush

For use with Spectrum® Self-Locking Flex-Tip™ Fiberglass Handles.



- Versatile for cleaning equipment that needs a rounded cleaning utensil, such as kettles, vats and tanks.
- Rounded heads and ends protect against scratching and clean in all directions.
- Available in 16" or 30" sizes.
- 3-1/2" diameter.
- Resins used to produce blocks and bristles are made of FDA approved materials.

16" Length

ITEM NO.	COLOR	> 6 per case. EACH	
		1-5	6+
6387 02021	White ...	\$26.95	\$25.95
6387 02051	Red	26.95	25.95
6387 02041	Yellow...	26.95	25.95
6387 02141	Blue	26.95	25.95
6387 02091	Green....	26.95	25.95

30" Length

ITEM NO.	COLOR	> 6 per case. EACH	
		1-5	6+
6387 03021	White	\$29.95	\$28.95
6387 03051	Red	29.95	28.95
6387 03041	Yellow...	29.95	28.95
6387 03141	Blue	29.95	28.95
6387 03091	Green....	29.95	28.95

Rack 'Em™ Brush Racks

- Color-coded rack reduces the spread of bacteria.
- Holds brushes, brooms, scrapers, scoops, shovels, mops and squeegees on 2-1/2" long hooks.
- One inch spacing allows for cleaning behind rack.
- PVC-coated steel wire construction is not effected by bleaches and most acids and solvents
- Mounts on wall (mounting hardware not included).
- Available in 5-, 12- and 16-hook sizes.
- Rack also available in black, brown, and red. Ask your Customer Service Representative for details.



Brushes sold separately.

5-Hook Rack 17.25" x 3" x 3"

ITEM NO.	COLOR	EACH
3446 40311	Yellow	\$34.95
3446 40301	White	34.95
3446 40331	Green	34.95
3446 40341	Blue	34.95

12-Hook Rack 26" x 4" x 6.5"

ITEM NO.	COLOR	EACH
3446 40411	Yellow	\$54.95
3446 40401	White	54.95
3446 40431	Green	54.95
3446 40441	Blue	54.95

16-Hook Rack 36" x 4" x 6.5"

ITEM NO.	COLOR	EACH
3446 40511	Yellow	\$64.95
3446 40501	White	64.95
3446 40531	Green	64.95
3446 40541	Blue	64.95

Vikan® Total Color Wall Brackets

Available in 8 colors.

- Proper storage of cleaning equipment enhances food safety and extends shelf life of equipment.
- Made from FDA-compliant materials.
- Autoclavable at temperatures up to 250° F/121° C.
- Additional rubber clips and hooks available to modify your bracket to fit your equipment needs.

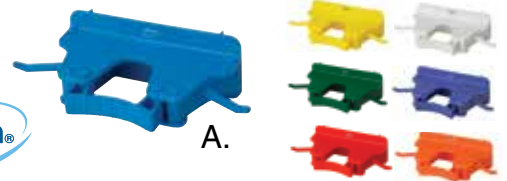

Helps keep supplies off the floor. Brushes and other supplies are sold separately.

A. 6" Bracket Includes: One Rubber Clip and Two Side Hooks

ITEM NO.	COLOR	EACH
5281 01761	Yellow	\$21.95
5281 01751	White	21.95
5281 01721	Green	21.95
5281 01731	Blue	21.95
5281 01741	Red	21.95
5281 01771	Orange	21.95
5281 01781	Purple	21.95
5281 01791	Black	21.95

B. 15-1/2" Bracket Includes: Four Rubber Clips and Two Side Hooks

ITEM NO.	COLOR	EACH
5281 01861	Yellow	\$34.95
5281 01851	White	34.95
5281 01821	Green	34.95
5281 01831	Blue	34.95
5281 01841	Red	34.95
5281 01871	Orange	34.95
5281 01881	Purple	34.95
5281 01891	Black	34.95

10" Fixed Head Bench Squeegees

- Durable, one-piece molded head with double blades.
- Dense white foam blade measures 10" in length.
- Blades held in place with locking cassette.
- Double splash guard for push or pull applications.
- Includes 6-3/4" one-piece sealed design threaded handle.



Easy to replace refill blades with special finger grip.

Foam blades

ITEM NO.	PRODUCT	EACH
5281 75241	Red	\$10.95
5281 75171	Blue	10.95
5281 7672	Green	10.95
5281 76751	White	10.95
5281 7677	Yellow	10.95
5281 77151	Replacement Blade, white	6.95

➤ Longer handles available and sold separately.

Vikan® One-Piece Ultra Hygiene Squeegees

- Specially blended rubber blade retains its flexibility and durability and is useful on a variety of work surfaces.
- One-piece design and co-molded construction eliminates areas that could harbor bacteria.
- Reinforced polypropylene head.
- Made from FDA-compliant materials.

> 16" & 28" also available. Call for details.



10" Squeegee

> 15 per case.

ITEM NO.	COLOR	EACH	
		1-14	15+
5281 07401	Green ..	\$19.95	\$18.95
5281 12531	Blue ...	19.95	18.95
5281 07421	Red ...	19.95	18.95
5281 12551	White ...	19.95	18.95
5281 07441	Yellow ..	19.95	18.95
5281 07451	Orange ..	19.95	18.95

- 10" Includes 6-3/4" one-piece sealed design threaded handle.



20" Squeegee

> 15 per case.

ITEM NO.	COLOR	EACH	
		1-14	15+
5281 07511	Green ..	\$31.95	\$30.95
5281 07521	Blue ...	31.95	30.95
5281 07531	Red ...	31.95	30.95
5281 07541	White ...	31.95	30.95
5281 07551	Yellow ..	31.95	30.95



24" Squeegee

> 15 per case.

ITEM NO.	COLOR	EACH	
		1-14	15+
5281 07681	Green ..	\$34.95	\$33.95
5281 07571	Blue ...	34.95	33.95
5281 07581	Red ...	34.95	33.95
5281 07591	White ...	34.95	33.95
5281 07601	Yellow ..	34.95	33.95
5281 07611	Purple ..	34.95	33.95
5281 07621	Black ...	34.95	33.95

Vikan® Swivel Neck Squeegees

- Easy to remove blade cartridges for increased efficiency and improved hygiene.
- Swivel neck provides the flexibility to clean narrow and hard-to-reach areas.
- Blade retains its durability and is useful on a variety of work surfaces.
- Polypropylene head.

Foam blades



> Must be used with Vikan handles, sold separately. See page 101.

20" Squeegee

> 10 per case.

ITEM NO.	COLOR	EACH	
		1-9	10+
5281 76321	Green ..	\$45.95	\$44.95
5281 76331	Blue ...	45.95	44.95
5281 76341	Red ...	45.95	44.95
5281 76351	White ..	45.95	44.95
5281 76361	Yellow ..	45.95	44.95

Easy to replace refill blades with special finger grip.



Replacement Blades

> 20 per case.

ITEM NO.	PRODUCT	EACH	
		1-19	20+
5281 77351	20" Repl. Blade, White	\$12.95	\$11.95

Vikan® Fixed Head Squeegees



- Superior sweeping action with blades that are easy to clean or replace.
- Choose from 20", 24" or 28" polypropylene head with black foam blade.

20" Squeegee

> 10 per case.

ITEM NO.	COLOR	EACH	
		1-9	10+
5281 08221	Green ...	\$26.95	\$25.95
5281 08231	Blue ...	26.95	25.95
5281 08241	Red ...	26.95	25.95
5281 75351	White ...	26.95	25.95
5281 08361	Yellow ...	26.95	25.95
5281 75371	Orange ...	26.95	25.95
5281 75391	Black ...	26.95	25.95

Foam blades



24" Squeegee

> 10 per case.

ITEM NO.	COLOR	EACH	
		1-9	10+
5281 75421	Green ...	\$28.95	\$27.95
5281 75431	Blue ...	28.95	27.95
5281 75441	Red ...	28.95	27.95
5281 00031	White ...	28.95	27.95
5281 08461	Yellow ...	28.95	27.95
5281 75471	Orange ...	28.95	27.95
5281 75481	Purple ...	28.95	27.95
5281 75491	Black ...	28.95	27.95

Easy to replace refill blades with special finger grips.



28" Squeegee

> 10 per case.

ITEM NO.	COLOR	EACH	
		1-9	10+
5281 07631	Green ...	\$34.95	\$33.95
5281 07641	Blue ...	34.95	33.95
5281 07651	Red ...	34.95	33.95
5281 07661	White ...	34.95	33.95
5281 75561	Yellow ...	34.95	33.95

Easy to replace refill cassette with special finger grip.



> Must be used with Vikan handles, sold separately. See page 37.

Vikan® Double Blade Ultra Hygiene Squeegees

- Durable, one-piece molded head with double blades.
- Autoclavable at temperatures up to 250° F/121° C.

> 28" also available. Call for details.

20" Squeegee

> 10 per case.

ITEM NO.	COLOR	EACH	
		1-9	10+
5281 71321	Green ...	\$29.95	\$28.95
5281 71331	Blue ...	29.95	28.95
5281 71341	Red ...	29.95	28.95
5281 71351	White ...	29.95	28.95
5281 71371	Yellow ...	29.95	28.95
5281 71381	Orange ...	29.95	28.95
5281 71391	Black ...	29.95	28.95

24" Squeegee

> 10 per case.

ITEM NO.	COLOR	EACH	
		1-9	10+
5281 71421	Green ...	\$33.95	\$32.95
5281 71431	Blue ...	33.95	32.95
5281 71501	Red ...	33.95	32.95
5281 71451	White ...	33.95	32.95
5281 71461	Yellow ...	33.95	32.95
5281 71471	Orange ...	33.95	32.95
5281 71491	Black ...	33.95	32.95

Sparta® Spectrum® 24" Color-Coded Squeegees

For use with Spectrum® Self-Locking Flex-Tip™ fiberglass handles.

- All plastic construction will not rust and is safe to use on delicate tile and marble floors.
- Closed cell double foam blades ensures against bacteria growth.
- Available in 7 HACCP compliant colors.



Squeegees

ITEM NO.	COLOR	> 6 per case.	
		EACH	
		1-5	6+
6387 08091	Green	\$27.95	\$26.95
6387 08141	Blue	27.95	26.95
6387 08051	Red	27.95	26.95
6387 08021	White	27.95	26.95
6387 08041	Yellow	27.95	26.95
6387 68261	Orange	27.95	26.95
6387 68721	Purple	27.95	26.95



Foam blades

> We recommend using Sparta Flex-Tip™ color-coded handles, sold separately. SEE BELOW.

Sparta® Spectrum® Threaded Handles 60" Flex-Tip™ Handles

ITEM NO.	COLOR	ITEM NO.	COLOR	> 12 per case.	
				EACH	
				1-11	12+
6387 00721	Green	6387 00621	Yellow	\$16.95	\$15.95
6387 02001	Blue	6387 65891	Orange	16.95	15.95
6387 00891	Red	6387 25681	Purple	16.95	15.95
6387 00921	White	6387 00431	Black	16.95	15.95



One-Piece 24" Color-Coded Squeegee

One-piece design minimizes possible contamination areas that can harbor dirt and bacteria.

- Squeegee will not rust and is safe to use on delicate tile and marble floors.
- Available in 8 colors.



24" Squeegees

ITEM NO.	COLOR	> 6 per case.	
		EACH	
		1 - 5	6+
6387 68091	Green	\$24.95	\$23.95
6387 28141	Blue	24.95	23.95
6387 68051	Red	24.95	23.95
6387 68021	White	24.95	23.95
6387 68041	Yellow	24.95	23.95
6387 68251	Orange	24.95	23.95
6387 68701	Purple	24.95	23.95
6387 28031	Black	24.95	23.95



> We recommend using Sparta Flex-Tip™ color-coded handles, sold separately. SEE ABOVE.

Economy Industrial Plastic Squeegees



- Lightweight, non-marking rustproof squeegees.
- Double-edged, sponge rubber blades are fat and oil resistant.
- The flexible blades conform to irregular and uneven surfaces, making them perfect for smooth, grouted and uneven floors.
- Plastic squeegee with bristles contains fused plastic bristles for greater agitation ability.

> Threaded handle sold separately, see below

Squeegees

ITEM NO.	PRODUCT	> 10 per case.	
		EACH	
		1-9	10+
6387 07151	18" Blade	\$11.95	\$10.95
6387 07371	22" Blade	14.95	13.95
6387 07161	30" Blade	16.95	15.95
6387 18061	18" Blade w/Bristles	21.95	20.95

Handle

		1-11	12+
6387 65001	54" Threaded Plastic Handle	\$19.95	\$18.95

TAPERED HANDLES

> 12 per case.

ITEM NO.	TAPERED HANDLES	EACH	
		1-11	12+
1 6387 02631	54" Wood Handle	\$6.95	\$5.95
6387 08991	60" Wood Handle	6.95	5.95
2 6387 41231	60" Plastic Handle	20.95	19.95

THREADED HANDLES

> 12 per case.

ITEM NO.	THREADED HANDLES	EACH	
		1-11	12+
3 6387 71011	60" Wood Handle	\$3.95	\$2.95
4 6387 40281	60" Nylon/Wood Handle	8.95	7.95
5 6387 65001	54" Plastic Handle	19.95	18.95
6 6387 00921	60" Fiberglass Handle	16.95	15.95
7 1770 02431	57" Aluminum Handle	21.95	20.95
8 6387 99001	60" Stainless Steel Handle	89.95	88.95
9 6387 41041	60" Flow-Thru w/ Valve Handle	19.95	18.95
10 6387 06441	60" Black, Plastic Coated Metal Hdl.	6.95	5.95
11 6387 01481	60" Wood Handle w/ Metal Threads	6.95	5.95
12 6387 21111	60" Fiberglass Hdl. w/15/16" O.D. Thread	13.95	12.95

COMBO TAPERED & THREADED

> 12 per case.

ITEM NO.	COMBO TAPERED AND THREADED	EACH	
		1-11	12+
13 6387 20111	60" Fiberglass Handle	\$18.95	\$17.95

Find the right handle for your needs:

Tapered handles fit most squeegees. Threaded handles fit scrub brushes, push brooms and some squeegees. The handles we list with these products on the following pages, are only our recommendation.

Need help?
Call one of our Customer Service Representatives for additional information, or to find out about other types of handles not shown.

TAPERED	THREADED	COMBO

Hygienic design with smooth surface, sealed to prevent bacterial growth.



Vikan® Ultra Hygiene Poly Handles



- Hygienic smooth surface, sealed to prevent bacterial growth.
- Made of food-grade polypropylene.
- Easy to clean rounded grip handles.
- Larger diameter ergonomic handle shape reduces worker fatigue.
- Euro-thread. > 67" also available. Call for details.

> 10 per case. EACH

ITEM NO.	51" HANDLE	ITEM NO.	59" HANDLE	1-9	10+
5281 96011	Pink	5281 96211	Pink	\$27.95	\$26.95
5281 86021	Green	5281 86221	Green	27.95	26.95
5281 86031	Blue	5281 16231	Blue	27.95	26.95
5281 16041	Red	5281 16241	Red	27.95	26.95
5281 86051	White	5281 96301	White	27.95	26.95
5281 96061	Yellow	5281 96321	Yellow	27.95	26.95
5281 86071	Orange	5281 86271	Orange	27.95	26.95
5281 96081	Purple	5281 86281	Purple	27.95	26.95
5281 96091	Black	5281 96311	Black	27.95	26.95

Sparta® Spectrum® Threaded Handles

For use with Spectrum® push brooms, sweeps, squeegees and floor scrubs.

> 12 per case. EACH



ITEM NO.	PRODUCT/COLOR	1-11	12+
6387 02001	A. Flex-Tip™ Handle, Blue	\$16.95	\$15.95
6387 00891	Red	16.95	15.95
6387 00921	White	16.95	15.95
6387 00621	Yellow	16.95	15.95
6387 00721	Green	16.95	15.95
6387 65891	Orange	16.95	15.95
6387 25681	Purple	16.95	15.95
6387 00431	Black	16.95	15.95
6387 20001	B. Telescoping Handle, White	34.95	33.95
6387 20051	Red	34.95	33.95
6387 20041	Yellow	34.95	33.95
6387 20091	Green	34.95	33.95
6387 30141	Blue	34.95	33.95
6387 20011	Tan	34.95	33.95

A. 60" Self-Locking Flex-Tip™ Handles

- 1" diameter fiberglass, threaded, self-locking Flex-Tip™ handles offer greater flexibility and reduce handle stress.
- Available in 9 colors for HACCP compliance.

B. Telescoping Handle

- 1" diameter fiberglass handle extends from 54" to 8' to get to hard to reach places.



Vikan Color-Coded Dustpans



> 10 per case.
EACH

Color-coded to help organize your workplace.

ITEM NO.	DUST PAN	1-9	10+
5281 66021	Green	\$15.95	\$14.95
5281 66031	Blue	15.95	14.95
5281 66041	Red	15.95	14.95
5281 66051	White	15.95	14.95
5281 66061	Yellow	15.95	14.95
5281 66071	Orange	15.95	14.95
5281 66091	Purple	15.95	14.95
5281 66101	Black	15.95	14.95

- Rigid, one-piece, injection-molded polypropylene construction.
- Ergonomic raised-handle design with thumb grip.
- Non-sparking material will not rust or corrode.
- Made from FDA-approved materials.

Vikan® Color-Coded Angle Cut Brooms

- Angled design makes it easy to reach into narrow spaces.
- It is particularly effective for collecting large particles of debris like meat and vegetables in a moist environment.
- Polypropylene block material with polyester bristles.
- 11" length.

Handles sold separately
SEE PAGE 37



> 12 per case.
EACH

ITEM NO.	COLOR	1-11	12+
5281 91421	Green	\$26.95	\$25.95
5281 91431	Blue	26.95	25.95
5281 91441	Red	26.95	25.95
5281 91451	White	26.95	25.95
5281 91461	Yellow	26.95	25.95
5281 00351	Black	26.95	25.95

Vikan® Soft/Stiff Broom

Perfect for HACCP color-coding

- Contains two types of bristles to first help loosen stubborn dirt and move heavy debris, and then gather the finer particles.
- Polypropylene block material with polyester bristles.
- 23.5" length.



Contains two types of bristles



> 6 per case.
EACH

ITEM NO.	COLOR	1-5	6+
5281 19441	Red	\$44.95	\$43.95
5281 19921	Green	44.95	43.95
5281 19931	Blue	44.95	43.95
5281 19451	White	44.95	43.95
5281 19461	Yellow	44.95	43.95
5281 00371	Black	44.95	43.95



Ultra Hygiene Handles sold separately.
SEE PAGE 37



Dust Pan With Handle

For fast effective spot cleaning without bending.

- Dimensions: 12-3/4" x 11-1/4" x 5".
- Color: black. • 31" handle.

> 12 per case.
EACH

ITEM NO.	DUST PAN	1-11	12+
1770 41491	Dust Pan w/Handle	\$31.95	\$30.95

Dust Pan Broom

- Flagged polypropylene bristles.
- 28" vinyl coated handle with 7-7/8" broom head.

> 6 per case.
EACH

ITEM NO.	PRODUCT	1-5	6+
1770 78631	Dust Pan Broom	\$12.95	\$11.95

Dust Pan

- 12" long x 8" wide x 2-5/8" deep.
- Color: charcoal.

> 12 per case.
EACH

ITEM NO.	PRODUCT	1-11	12+
1770 20051	Dust Pan	\$9.95	\$8.95

Sparta® Spectrum® Duo-Sweep® Angle Broom

- Durable, sanitary Polypropylene bristles with a Self-Locking Flex-Tip™ fiberglass handle.
- Ergonomic shape that prevents uneven wear.
- 54" total length
- 12" width.

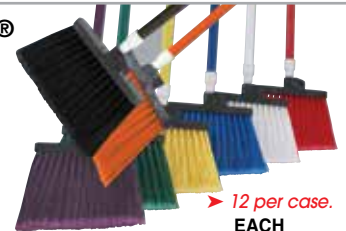

> 12 per case.
EACH

ITEM NO.	COLOR	1-11	12+
6387 82041	Yellow	\$27.95	\$26.95
6387 82091	Green	27.95	26.95
6387 82061	Red	27.95	26.95
6387 82051	White	27.95	26.95
6387 82081	Blue	27.95	26.95
6387 82241	Orange	27.95	26.95
6387 82681	Purple	27.95	26.95
6387 82031	Black	27.95	26.95

Sparta® Spectrum® Color-Coded 24" Omni Sweeps®



- Made of FDA approved materials, these sweeps combine the features of fine, medium and heavy floor sweeps into one package.
- Hygienic plastic block won't absorb liquids or chemicals.
- Synthetic bristles have angled pitch for fast, effective sweeping on all types of floor surfaces.



> 12 per case.
EACH

ITEM NO.	COLOR	1-11	12+
6387 91121	White	\$24.95	\$23.95
6387 91051	Red	24.95	23.95
6387 91041	Yellow	24.95	23.95
6387 91141	Blue	24.95	23.95
6387 91091	Green	24.95	23.95
6387 91241	Orange	24.95	23.95
6387 91681	Purple	24.95	23.95

For use with Sparta® Spectrum® Self-Locking Flex-Tip™ Handles Sold separately, see page 37.



Microfiber™ Cleaning System



Microfiber material dries faster and more thoroughly than common rags and rag mops —reducing the potential for encouraging bacterial, mold and mildew growth.

A Wet Mop Pad

- Greater surface contact eliminates the need to mop the same area over and over.
- Special looped-end fibers glide over floors for easier mopping, no linting.
- Available in two sizes: 18" or 24".

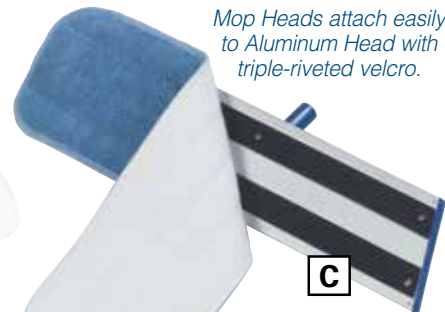

Mop Heads attach easily to Aluminum Head with triple-riveted velcro.

B Dry Mop Pad

- Ribbed center mat attracts and hold dust like a magnet.
- Large looped fringe keeps dust from flying; grabs larger particles and debris.
- Unique design polishes hardwood, marble, terrazzo, and other smooth surfaces as you dust.
- Available in two sizes: 18" or 24".



C Aluminum Heads

- For use with wet or dry microfiber floor pads.
- Heavy-duty aluminum construction.
- Triple riveted velcro for durability.

D Telescoping Aluminum Handle

- Designed for use with aluminum mop head shown above.
- Handle extends from 39-1/2" to 70".



Handle, Aluminum Head and Mop Pads are all sold separately.

6-Gallon Mop Pail with Lid

- Rectangular shape.
- Ideal for carrying soiled pads and cloths.
- Includes lid (not shown).
- Color: gray.



Ideal for use with wet mop pads.

► Dimensions:
18" l x 9" w x 11" h.

► 12 per case.
EACH

ITEM NO.	PRODUCT	1-11	12+
6387 37611	6-Gallon Mop Pail.	\$39.95	\$38.95

► 12 per case.
EACH

ITEM NO.	PRODUCT	1-11	12+
6387 37101	A. Wet Mop Pad, 18"	\$6.95	\$5.95
6387 37151	24"	8.95	7.95
6387 37201	B. Dry Mop Pad, 18"	6.95	5.95
6387 37211	24"	8.95	7.95
6387 35191	C. Aluminum Head, 18"	13.95	12.95
6387 25021	24"	15.95	14.95
6387 37331	D. Telescoping Handle, 70"	12.95	11.95



TRADITIONAL DUST MOPS
available on our website:

www.bunzlkochsupplies.com

Polishing/Cleaning Cloths

- Keeps surfaces gleaming without sprays and chemicals.
- Super-tough terry cleaning cloths work better and last longer than cotton rags.
- Microfiber loops hold dirt and grease — won't redeposit.
- Rinse clean and dry fast.
- Color: blue.



► Dimensions:
16" x 16".

► 12 per case.
EACH

ITEM NO.	PRODUCT	1-11	12+
6387 37261	Terry Polishing Cloth.	\$3.95	\$2.95

Laundryable Dust Mop

- Pre-laundered; synthetic backing and looped-end construction for less lint and effective dust mopping.
- Blue synthetic backing, with key hole and ties, withstands repeated laundering.
- Sewn construction for longer life.



► Fits wire mop dust frame sold separately.
Call for ordering information.

► 12 per case.
EACH

ITEM NO.	PRODUCT	1-11	12+
6387 09191	24"	\$24.95	\$23.95
6387 09201	36"	29.95	28.95

Our **MOST POPULAR** mop head!

4-Ply Cotton Cut-End Mop Head

- Constructed of natural cotton fiber.
- #24 large mop head.



ITEM NO.	PRODUCT	EACH
7500 46531	Narrow Band, #24	\$3.95

Color-Coded mop heads available. Call for details.

4-Ply Cut-End Mop Heads

- Synthetic rayon fiber mop head is mildew resistant, has good tensile strength and is quick drying.
- Natural cotton fiber mop head has higher absorbency for heavier cleaning applications and requires less "break in" time.



A. SYNTHETIC RAYON

ITEM NO.	PRODUCT	PER DOZEN
7500 4671	Narrow Band, #16 . . .	\$39.95
7500 4673	#24	59.95
7500 4675	#32	79.95
7500 4681	Wide Band, #16	49.95
7500 4683	#24	64.95
7500 4685	#32	79.95

B. NATURAL COTTON

ITEM NO.	PRODUCT	PER DOZEN
7500 4651	Narrow Band, #16 . . .	\$33.95
7500 4655	#32	59.95
7500 4661	Wide Band, #16	34.95
7500 4663	#24	49.95
7500 4665	#32	59.95

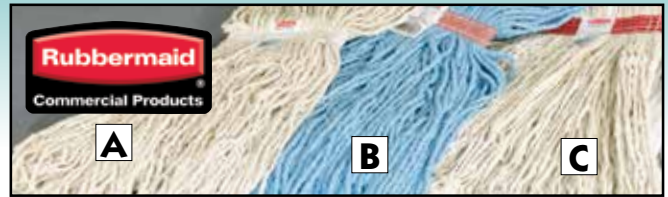

A. Value-Pro™ Cotton Mop

- Economical cotton mop for all-purpose cleaning.
- 20-oz. with 1" white headband.
- White strands with cut ends.

► 12 per case.
EACH

ITEM NO.	PRODUCT	1-11	12+
1770 11171	Value-Pro™ Cotton Mop	\$7.95	\$6.95

B. Dura-Pro® Blend Mop

- 4-ply cotton/rayon/synthetic yarn blend for performance and reliability.
- 24-oz. with 1" orange headband.
- Blue strands with cut ends.

► 12 per case.
EACH

ITEM NO.	PRODUCT	1-11	12+
1770 65181	Dura-Pro™ Blend Mop	\$11.95	\$10.95

C. Super Stitch® Blend Mop

Outperforms and outlasts premium cut-end mops two to one.

- Balanced blend of cotton and synthetic yarns for absorbency and strength.
- 24-oz. with 1" red headband.
- White strands with looped ends.

► 12 per case.
EACH

ITEM NO.	PRODUCT	1-11	12+
1770 21301	Super Stitch® Blend Mop	\$14.95	\$13.95

31-Qt. Tandem™ Mop Bucket and Wringer



Quality and convenience for mops up to 24-ounces.

- Holes in both wringing plates force more water from mop in less time.
- Reverse-wringing mechanism for more comfortable use.
- Built-in lift handles on bottom of bucket make lifting and emptying easier.



► Capacity: 31-qt.

► Dimensions: 22-5/8" l x 13-1/4" d x 32-1/4" h.

ITEM NO.	PRODUCT	EACH
1770 7380	Mop Bucket w/Wringer	\$84.95

26-35 Quart Mop Bucket and Wringer

Our most economically-priced mop buckets.

- Constructed of durable and corrosion-resistant molded polyethylene.
- Available with side-press or down-press wringers.
- Non-marking casters.



Mop Bucket Dimensions
20.75" l x 16.75" w x 16.5" h

ITEM NO.	PRODUCT	COLOR	EACH
6387 69051	A. Down-Press Mop Bucket/Wringer	yellow	\$89.95
6387 6904	B. Side-Press Mop Bucket/Wringer	yellow	79.95
6387 1162	B. Side-Press Mop Bucket/Wringer	green	79.95
6387 1164	B. Side-Press Mop Bucket/Wringer	blue	79.95
6387 1163	B. Side-Press Mop Bucket/Wringer	red	79.95

HOW TO CHOOSE THE RIGHT MOP

Choose your mop handle style



Quick Slide Style Grip/Clamp Style

Choose your matching mop head style



Quick Slide Style Grip/Clamp Style

Jan/Jan
Need a replacement handle for brooms, sweeps, squeegees or other tools?
SEE PAGE 37
for ordering information



Questions? Call us 800-456-5624

Speed Change™ 60" Mop Handle

- High-impact plastic head features a side release gate for fast and easy changes.
- Recommended for narrow band mop heads.



> 12 per case.
EACH

ITEM NO.	PRODUCT	1-11	12+
7500 46991	With Fiberglass Handle #94	\$13.95	\$12.95
7500 46971	With Wood Handle #94	13.95	12.95

Invader® Wet Mop Handle

Hinged side gate allows mop to easily slide on and off handle.

- Large plastic mop heads contain antimicrobial product protection which inhibits the growth of bacteria that cause odors and stains.
- Thumb wheel on handle clamps the mop firmly in place.
- Fiberglass handle is 60" in length.
- Uses only 1" headband mops.



Easy to use hinged side gate.

> Mop heads sold separately.

> 12 per case.
EACH

ITEM NO.	PRODUCT	1-11	12+
1770 14601	Invader® Wet Mop Handle	\$26.95	\$25.95

SuperJaws™ 60" Mop Handle

- Extra durable nylon construction.
- Recommended for wide band mop heads.



> 12 per case.
EACH

ITEM NO.	PRODUCT	1-11	12+
7500 46981	With Fiberglass Handle	\$14.95	\$13.95
7500 46961	With Wood Handle	14.95	13.95

Metal Stirrup Quick Change 60" Mop Handle

- Quick release bar.
- Recommended for narrow band mop heads.
- Wood handle.



> 12 per case.
EACH

ITEM NO.	PRODUCT	1-11	12+
7500 46951	Mop Handle	\$9.95	\$8.95

Sparta® Spectrum® Color-Coded Quik-Release™ Mop Handle

- 60" mop handle. > 12 per case.

ITEM NO.	PRODUCT	EACH	
		1-11	12+
6387 64051	Red	\$18.95	\$17.95
6387 64021	White	18.95	17.95
6387 64141	Blue	18.95	17.95
6387 64041	Yellow	18.95	17.95
6387 64091	Green	18.95	17.95
6387 64241	Orange	18.95	17.95
6387 64681	Purple	18.95	17.95



Gripper® Wet Mop Handle

Holds mop firmly between the jaws of the mop handle.

- Plastic mop heads contain antimicrobial product protection which inhibits the growth of bacteria that cause odors and stains.
- Fiberglass handle is 60" in length.
- Uses only 5" headband mops.



Jaws open to allow easy installation.

> 12 per case.
EACH

ITEM NO.	PRODUCT	1-11	12+
1770 06051	Gripper® Wet Mop Handle	\$26.95	\$25.95



Mop heads sold separately. SEE FACING PAGE

- Constructed of 16 gauge, type 304 stainless steel.
- All seams are TIG welded and ground to a smooth #4 satin finish.
- Sink compartments are square cornered.
- Sanitary rolled rim is 1-1/2" wide and 2" tall.
- Unibody construction provides maximum durability.
- Backsplash is 8" tall with a 2" wide return.
- Faucet holes are 1-1/8" diameter, drilled on 8" centers. (Order faucet separately).
- Leg sockets are welded directly to sink body providing proper load support.
- Drainboard(s) are pitched to drain into adjacent sink bowl.
- Sink legs are 1-5/8" diameter with adjustable feet.
- Drain openings are 3-1/2", recessed.
- Flood level is 14". • Basket drains are 1-1/2" IPS.
- Supply is 1/2" IPS, hot and cold.

Two-Compartment Stainless Steel Sink

- > 18" x 18" x 14"d
2-Compartment Sink
weighs 71-lbs.
- > 24" x 24" x 14"d
2-Compartment Sink
weighs 85-lbs.



> Order faucet # 3013 20051 separately.
Call for details

One-Compartment Stainless Steel Sink



- > 18" x 18" x 14"d
1-Compartment Sink
weighs 38-lbs.
- > 24" x 24" x 14"d
1-Compartment Sink
weighs 57-lbs.

F.O.B. FACTORY

ITEM NO.	PRODUCT	EACH
3048 8181	18" x 18"	\$599.00
3048 4242	24" x 24"	679.00

F.O.B. FACTORY

ITEM NO.	PRODUCT	EACH
3048 8374	18" x 18"	\$859.00
3048 8242	24" x 24"	1,049.00

Three-Compartment Stainless Steel Sink



- > 18" x 18" x 14"d
3-Compartment Sink.
- > Weight: 81-lbs.

F.O.B. FACTORY

ITEM NO.	PRODUCT	EACH
3048 4183	18" x 18"	\$1,129.00

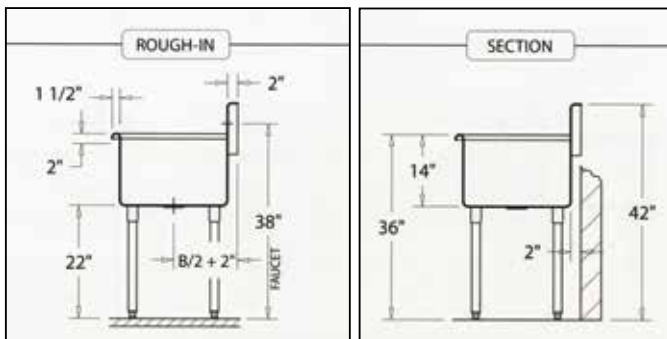

Stainless Steel Wash Stations



- Heavy-duty 16-gauge, 304 stainless steel construction with a 10" high backsplash.
- Lavatories include gooseneck, strainer and double foot pedal valves.
- Valve pedals lift for easy cleaning.
- All wash stations also available with single pedal valves.
- All bowls are 8" deep.
- Available in 2-, 3-, 4-, 5- or 6-station sizes.

SANI-LAV®
COLUMBIA PRODUCTS



6-Station Wash Basin

Additional faucets and valves available. Rough-In dimensionals upon request.



2-Station Wash Basin

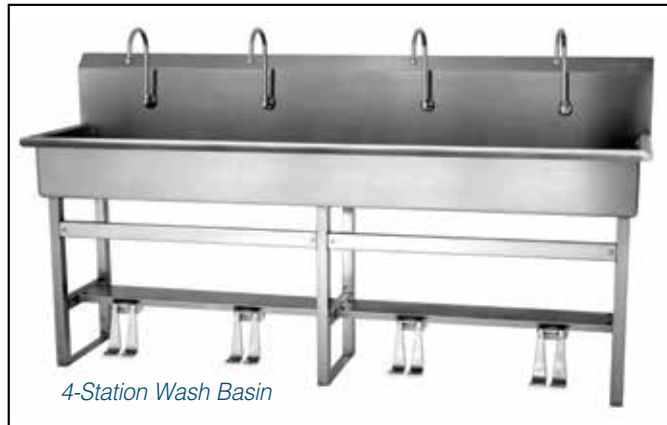

4-Station Wash Basin

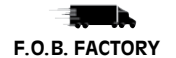

Wall mount units available.
Call for more details.



ITEM NO.	PRODUCT	EACH
3013 5040	2-Station, 40" x 19-3/8" x 10" deep	\$2,269.00
3013 5080	4-Station, 80" x 19-3/8" x 10" deep	3,579.00
3013 5120	6-Station, 120" x 19-3/8" x 10" deep	4,699.00

Front Mount Replacement Gooseneck & Aerator

- Chrome plated, includes aerator.
- 5-3/4" swivel spout.
- Fits all lavatories on pages 162-164
- Certified NSF Standard 2 Food Equipment and NSF/ANSI 372 low lead.



LOW LEAD

ITEM NO.	PRODUCT	EACH
3013 20031	Replacement Gooseneck	\$67.95
3013 1002	Replacement Aerator	4.95

QuikFlo™ Automatic Faucet Control

Avoid cross-contamination, hands don't touch faucet handles.

- Push stainless steel rod for instant water flow, release for instant shut-off.
- Fits all faucets (dual-threaded), installs in minutes.



ITEM NO.	PRODUCT	EACH
E538 30031	3" (fits regular faucets)	\$54.95
E538 30051	5" (fits tall faucets)	54.95

Ergonomic Half-Size, Insulated Hot Water Spray Nozzles

- Designed for use in the food service and processing industry.
- Brass main body.
- Quality built with stainless steel and brass parts.
- Insulated rubber cover with yellow direction arrows.
- Maximum working pressure 150 psi.
- Rated 200° F (93° C).
- Variable spray pattern.

➤ **3/4" FEMALE GHT INLET.**
➤ **Weight: 1.7-lb.**

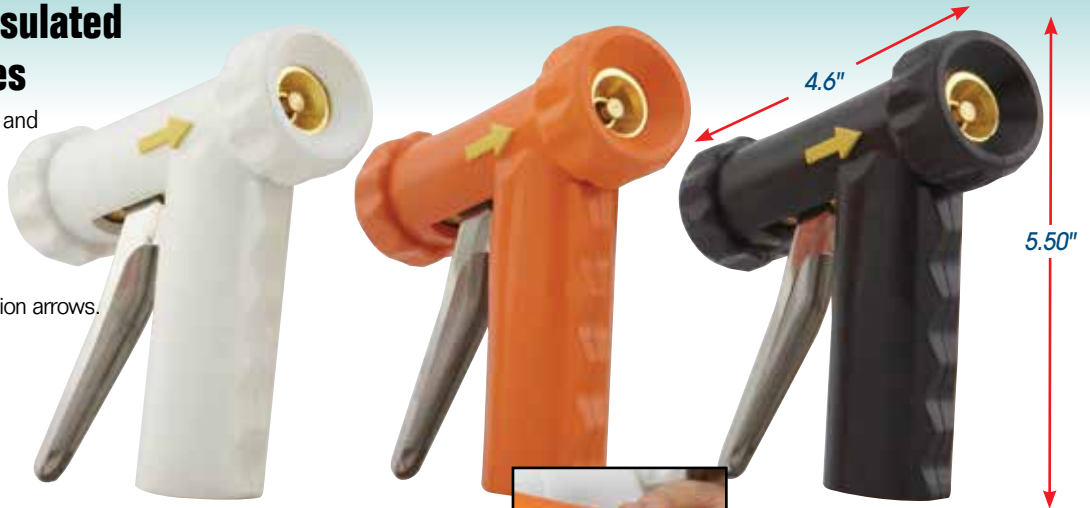

7 GPM FLOW RATE

Outlet cover can be unscrewed for GHT access.



7 GPM Ergonomic Half-Size Nozzle

ITEM NO.	PRODUCT	EACH
3013 30011	Orange	\$59.95
3013 21001	White	59.95
3013 21011	Black	59.95
3013 00171	Opt. Brass Swivel Adapter, male GHT x female GHT	19.95
3013 21031	Opt. Stainless Steel Swivel Adapter, male GHT x female GHT	27.95



These nozzles connect directly to garden hose threads with no adapter needed **OR** add a swivel adapter (sold separately) to extend hose life and prevent kinking.

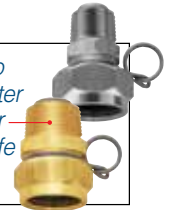

Heavy-Duty, Insulated Hot Water Spray Nozzles

- Heavy-Duty nozzle withstands the harshest working conditions.
- Brass main body.
- Quality built with stainless steel and brass parts.
- Insulated rubber cover with yellow direction arrows.
- Rated 200° F (93° C).
- Maximum working pressure 150 psi.
- Variable spray pattern.

➤ **3/4" FEMALE GHT INLET.** ➤ **Weight: 2.7-lb.**



Heavy Duty vs. Half Size Comparison



3/4" Swivel Barb INCLUDED!

5 GPM Large Low-Flow Nozzle with Swivel Barb Adapter

ITEM NO.	PRODUCT	EACH
3013 00121	Orange	\$139.95
3013 00081	White	139.95
3013 00091	Black	139.95

9 GPM Large Nozzle with Swivel Barb Adapter

ITEM NO.	PRODUCT	EACH
3013 00071	Orange	\$139.95
3013 00051	White	139.95
3013 00061	Black	139.95

Variable Spray Nozzles

Trigger lever controls variable spray pattern.



Standard-Duty Nozzle with Plastic Handle

- NOT for high pressure. Rated at 100 psi, up to 180° F (82 C).
- Insulated, molded santoprene grip for comfort.
- Water-saver flow control.
- Instant shut off at nozzle.
- Rust-resistant stainless steel spring.
- Male hose threaded front for attaching accessories.
- Brass stem.

> 3/4" GHT inlet. > Use with city water pressure only. NOT for high pressure.

We recommend use with a 3/4" male GHT x 3/4" female GHT, swivel adapter, sold separately.

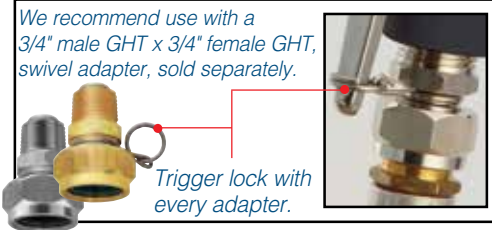

Trigger lock with every adapter.



ITEM NO.	PRODUCT	EACH
3013 30021	Orange, Standard Water Nozzle	\$8.95
3013 40231	Black, Standard Water Nozzle	8.95
3013 40241	White, Standard Water Nozzle	8.95
3013 40251	Red, Standard Water Nozzle	8.95
3013 40261	Blue, Standard Water Nozzle	8.95
3013 40271	Green, Standard Water Nozzle	8.95
3013 40281	Yellow, Standard Water Nozzle	8.95
3013 00171	Optional Brass Swivel Adapter 3/4" GHT, 3/4" GHT	19.95
3013 21031	Optional Stainless Steel Swivel Adapter 3/4" GHT, 3/4" GHT	27.95

Lightweight Aluminum Spray Nozzle

Lightweight, cost-saving industrial spray nozzle.

- Variable spray pattern.
- Insulated replaceable rubber cover.
- Instant shut-off when trigger is released.
- Rated at 150 psi, up to +180° F, flow rate: 7-gpm.

> Weighs only 1.8-lbs.

> 1/2" NPT inlet.

> We recommend use with swivel adapter sold separately.



ITEM NO.	PRODUCT	EACH
3566 01511	Aluminum Nozzle	\$79.95
3566 9122	Replacement Rubber Cover	35.95
3566 09661	Replacement Barrel Assembly	27.95
3013 10111	Swivel Adapter 1/2" NPT, 3/4" GHT	18.95

Watersaver Junior Insulated Nozzle

Less than 2/3 the weight of a standard industrial nozzle.

- Water saving nozzle, low rate: 5-gpm.
- Constructed of bronze and stainless steel.
- Insulated black rubber cover with yellow directional arrows.
- Instant shut off when trigger is released.
- Rated at 150 psi, up to +180° F.
- Variable spray pattern.



Swivel Included!
Ready to connect to standard male GHT.

> 3/8" NPT inlet.

Attach to standard garden hose with stainless steel hose clamp, sold separately.



ITEM NO.	PRODUCT	EACH
3566 11511	Nozzle & Swivel	\$79.95
3013 10121	Replacement Swivel, 3/8" brass	17.95



3/4" Male GHT x 3/4" Female GHT



N16 On/Off Valve Included



Treaded connector end



Sprayer end

Straight Nozzle

- Triggerless design for ease of handling and direct spraying capability.
- Easily attaches to any standard hose. • 6.6mm, 10GPM



ITEM NO.	PRODUCT	EACH
3013 00141	Straight Nozzle, includes on/off valve	\$34.95
3013 10161	Replacement Brass Valve	21.95
3013 21021	Replacement Stainless Steel Valve	59.95

Hot Water Packinghouse Hose

Multiple textile spirals reinforces hose and extends hose life.

FREE with this hose — rubber insulators that keep the hose cool to the touch.

- Couplings are securely attached to each end of the hose with no sharp edges and are covered by a heavy-duty reinforcement insulator to prevent failure at the base of the hose and to keep the ends cool to the touch.
- Withstands 500 psi. • Highly-resistant to cuts and abrasions.
- Withstands temperatures up to 212° F. • Available in 3/4" I.D. & 1/2" I.D.
- Hose assemblies are pre coupled with garden hose couplings on each end.



Double Braided Nylon Reinforced



FREE rubber insulator keeps hose cool to the touch.

ITEM NO.	PRODUCT	EACH
3538 7108	25', 1/2" I.D. w/G.H.T. Couplings Each End.....	\$119.95
3538 7109	50', 1/2" I.D. w/G.H.T. Couplings Each End.....	199.95
3538 7100	100', 1/2" I.D. w/G.H.T. Couplings Each End.....	349.95
3538 2025	25', 3/4" I.D. w/G.H.T. Couplings Each End.....	139.95
3538 2050	50', 3/4" I.D. w/G.H.T. Couplings Each End.....	219.95
3538 2075	75', 3/4" I.D. w/G.H.T. Couplings Each End.....	329.95
3538 4085	85', 3/4" I.D. w/G.H.T. Couplings Each End.....	349.95
3538 0100	100', 3/4" I.D. w/G.H.T. Couplings Each End.....	399.95

3/4" I.D. Single-Ply General Purpose Hose

- Recommended for hot water washdown and light-duty applications.
- Red EPDM cover is resistant to weathering, abrasion and oil.
- Withstands temperatures to 180° F.



Medium-weight single-ply reinforced for hot and cold water mixing.



Coupled with female and male garden hose thread.

ITEM NO.	PRODUCT	EACH
3538 3025	25'.....	\$64.95
3538 3050	50'.....	99.95
3538 3075	75'.....	139.95
3538 0105	100'.....	189.95

Hose Accessories

NOTE: GHT: Garden Hose Thread NPT: National Pipe Thread

ON/OFF FLOW CONTROL VALVE MALE GHT X FEMALE GHT

BRASS
3013 10161
\$21.95



STAINLESS STEEL
3013 21021
\$59.95



QUICK CONNECT SET MALE GHT x FEMALE GHT

BRASS
3538 6361
\$12.95



STAINLESS STEEL
3013 21041
\$36.95



A. FEMALE GHT X FEMALE GHT B. MALE GHT X MALE GHT

\$8.95 **\$6.95**



A. ITEM NO. 3538 1003
B. ITEM NO. 3538 1008

REPAIR COUPLERS MALE GHT x FEMALE GHT

\$15.95



ITEM NO. 3538 3122

ADAPTER 3/4" NPT X GHT

\$4.95

Male GHT to Female NPT
ITEM NO. 3538 0006
Female GHT to Male NPT
ITEM NO. 3538 0002

3/8" MALE NPT x FEMALE GHT

\$7.95



ITEM NO.
3538 0030

RUBBER HOSE BEND RESTRICTORS

• 8" lengths. Fits most 3/4" I.D. hose.

\$3.95

ITEM NO. 3538 3508

D2-rated sanitizers are for all surfaces and do not always require a rinse.

TOTAL SOLUTIONS® D-2 Rated Sanitizers

Meets EPA and USDA guidelines for D2 no-rinse sanitizer.

A. Ready-To-Use Quart Bottles

- Pre-mixed solution — just add a sprayer to the bottle and you are ready to sanitize!

> 12 quarts per case.

ITEM NO.	PRODUCT	EACH
2117 01691	Quart Bottles (Includes 1 Trigger Sprayer with case purchase) . . .	\$4.95
6710 00071	Trigger Sprayer	1.95

B. Premoistened Wipes

- Premoistened, ready to use. • Kills 99.9% of bacteria in seconds.

ITEM NO.	PRODUCT	EACH
2117 50511	Tub of 500 Wipes Size, 6" x 8"	\$27.95
2117 1566	Refill Rolls, 250 Wipes Per Roll (Case of 2) . . .	24.95

C. Vanquish "One Step" Gallon Concentrate

Disinfectant • Sanitizer • Cleaner • Fungicide • Deodorizer

Mixed with water, one bottle makes 64 gallons.

> 4 bottles per case.

ITEM NO.	PRODUCT	PER GALLON BOTTLE	
		1-3	4+
2117 01751	Vanquish Sanitizer, 1-Gallon	\$17.95	\$16.95



> See page 138-140 for multipurpose wipes & towels.



Ideal for multiple uses — hard hats, gloves, scales, aprons, totes, table tops, door knobs, knives, and many more.

Alpet D2 No-Rinse Surface Sanitizer

For food contact surfaces — works where other sanitizers won't! Ideal for water sensitive areas. Use on scales, tables, tools, blades, slicers, mixing bowls, cutting boards, etc.

- Fast drying – 60 second dwell time saves sanitizing turnover time – no rinsing.
- Dual active ingredients – kill 99.999% of both gram positive and gram negative bacteria.
- Fill the empty gallon bottle for easy transportation of solution throughout the plant.
- NOTE: Alpet D2 is an approved boot sanitizer
- Non-corrosive and non-caustic.
- Ready to use – no diluting or mixing.
- NSF approved & Kosher certified.

> Meets D2 guidelines.



ITEM NO.	PRODUCT	EACH	CASE
0031 9009	1-quart Spray Bottles Alpet D2 Sanitizer, case of 4	—	\$61.95
0031 9003	1-quart Spray Bottles Alpet D2 Sanitizer, case of 12	—	149.95
0031 1004	1-quart EMPTY Spray Bottle w/ trigger, case of 12	—	48.95
0031 2010	1-gallon EMPTY Bottle	6.95	5.95
0031 0002	5-gallon Pail of Alpet D2 Solution with Pump	149.95	—

Alpet D2 No-Rinse Surface Sanitizer Wipes

- Reusable canister comes with 90 and/or 160 moist 100% polyester wipes.
- Wet wipes kill 99.999% of both gram positive and gram negative bacteria.

> D2 Sanitizer sold separately, shown to the left.



Scan this QR code with your mobile device to watch a video about Alpet D2 Sanitizer Wipes usage and benefits.

> 6 canisters per case.

ITEM NO.	PRODUCT	EACH	
		1-5	6+
0031 20011	D2 Moist Wipes, 90-ct. Canister	\$19.95	\$18.95
0031 20031	D2 Moist Wipes, 160-ct. Canister	21.95	20.95
0031 0009	Plastic Wall Bracket for 90-Wipe Canister	\$19.95	—



Film Free Glass Cleaner

Ready-to-use formula.

- Heavy-duty, streak-free cleaning.
- Non-ammonia with no harsh odors; may be used on plexiglass surfaces.
- Can be used as an all purpose cleaner, eliminating need for multiple chemicals.



> Aerosol: 12 per case.
> Gallon: 4 per case.

ITEM NO.	PRODUCT	CASE
7500 4049	Aerosol, 19-oz.....	\$36.95
7500 4051	1-Gallon.....	29.95

Handy Man Drain Opener

Ready to use formula.

- Pour 16-oz. or 1/2 bottle to unclog drain.
- Powerful, fast acting alkaline formula saves labor and time.
- Heavier than water. Displaces water over clogs.



> 12 bottles per case.

ITEM NO.	PRODUCT	CASE
6129 6720	1-Quart.....	\$89.95

25-lbs. Laundry Detergent Powder

Economical, biodegradable, low phosphate.

- Optical brighteners and borax stain removers for grease and soiled laundry.
- Water softening ingredients assure excellent performance even in hard water.
- Pleasant lemon scent.
- > Meets B1 guidelines.



ITEM NO.	PRODUCT	EACH
2117 2126	25-lb.	\$69.95

Liquid Bleach

- Cleans and removes stains.
- Safe for nylon.
- Caution: eye and skin irritant.



> 6 per case.

ITEM NO.	PRODUCT	CASE
5000 20015	A. 1-Gallon- 5% Sodium Hypochlorite .	\$15.95
5000 1066	B. 96-oz.- 6% Sodium Hypochlorite .	16.95

64-oz. Clorox® Ultra Germicidal Bleach

- Meets FDA guidelines for sanitizing food-contact surfaces.
- This EPA-registered product is effective against E. coli, HIV-1 (AIDS virus), salmonella, staph, TB and Hepatitis-A.
- Complies with OSHA's Blood Borne Pathogens Standard.



> 8 bottles per case.

ITEM NO.	PRODUCT	CASE
3838 1009	64-oz.	\$34.95

Lysol® Disinfectant Spray

Kills 99.9% of germs in 30 seconds.

- Kills viruses, bacteria, mold and mildew.
- Eliminates odors.
- Original scent.



> 12 cans per case.

ITEM NO.	PRODUCT	CASE
5834 4650	19-oz. Aerosol	\$129.95

Clorox® Clean-Up Bleach

- Disinfects and kills 99.9% of bacteria.
- Kills viruses that cause colds & flu.
- Removes tough stains, grease and grime.



ITEM NO.	PRODUCT	CASE
3838 1266	32-oz. (9 bottles per case)	\$54.95
3838 1250	1-Gallon (4 bottles per case)	51.95

Clorox® Disinfectant Wipes

- Cleaning and disinfecting agent for touch-up and everyday cleaning.
- 75 wet wipes per canister.
- Bleach free.
- Orange scent.
- Removes tough grease, grime and carbonized soil from ovens and grills.



> 6 canisters per case.

ITEM NO.	PRODUCT	CASE
3838 1686	75-Wipe Canister	\$46.95

32-oz. Spray Bottles

- 9-3/4" dip tube.
- Adjustable spray pattern with full off position.
- Chemical resistant.



Bottles have embossed graduations marks with dilution rates.



ITEM NO.	PRODUCT	EACH
2760 15471	32-oz. Graduated Spray Bottle.....	\$2.95
2760 09051	Spray Pump	1.95

24-oz. Spray Bottles

- 9-3/4" dip tube.
- Bottles can easily be marked to identify contents.
- Adjustable spray pattern with full off position.
- Chemical resistant.
- Replacement pump available (sold separately, listed below).



Bottles are labeled with safety information and bilingual check off grid (printed in English/Spanish)



ITEM NO.	PRODUCT	EACH
2760 02565	24-oz. Spray Bottles, each with Spray Pumps (Set of 3).....	\$8.95
2760 09051	Replacement Spray Pump (1 each).....	1.95

Pump Dispensers for Gallon Bottles

- Pumps from 1/8-oz. to 1-oz. increments.
- Pump fits any 1-gallon bottle.



ITEM NO.	PRODUCT	EACH
6710 61001	Pump Dispenser, 1-oz.	\$1.95
6710 11091	Pump Dispenser, 1/4-oz.	2.95

Deluxe Carry Caddy

- Holds up to eight 32-oz. spray bottles.
- Ergonomic handle design.



Ideal for carrying cleaning supplies.

ITEM NO.	PRODUCT	EACH
1770 54001	Deluxe Carry Caddy.....	\$19.95



Total Solutions Multi-Purpose Towels

- Versatile, waterless cleaner cuts through tar, grease, wax, paint, lubricants and adhesives.
- Non-scratching, towels contain emollient and natural oils so they won't crack or dry skin.
- Can use instead of soap and water, and won't leave filmy residue.



► 6 canisters per case.

ITEM NO.	PRODUCT	1-5	6+
2117 15391	70-Wipe Canister	\$19.95	\$18.95

19-Quart Double Pail

- Gray plastic pail separates cleaning solution and rinse water for an easy-to-use cleaning system.
- 19-qt. capacity.



Pail has quart and liter measurement markings inside.



Easy-to-pour spout.



ITEM NO.	PRODUCT	DIMENSIONS	EACH
1770 26281	Double Pail	18" x 14.5" x 10"	\$36.95



Dawn® Manual Pot & Pan Detergent

- Tough on grease.
- Fast-activating formula.



ITEM NO.	PRODUCT	CASE
1690 5112	38-oz. (8 per case)	\$64.95
1690 0339	1-Gallon (4 per case)	99.95

Sunlight® Lemon Liquid Dish Soap

Ideal for the greasiest dishes, glassware, cutlery or pots and pans! Its super-concentrated, high-sudsing formula is pH balanced for mildness on hands.

- Rinses clean for a great shine.
- Powerful grease cutting formula leaves behind a citrus scent.
- Specifically designed for the institutional environment.
- Recommended for food service, lodging, healthcare, education and industrial.



▶ 4 bottles per case.

ITEM NO.	PRODUCT	CASE
1520 0935	1-Gallon	\$59.95

Special Pink Detergent

Light duty equipment, pot and pan detergent.

- Neutral pH formula.
- Mild to the hands.
- Pink color.
- Pleasant lemon scent.
- No corrosion.
- Safe on all surfaces.



▶ 4 bottles per case.

ITEM NO.	PRODUCT	CASE
6129 6746	1-Gallon	\$37.95

Lime-Out— Delimer/Descaler

Concentrated cleaner designed especially for dishwashing machines.

- Safely and effectively dissolves and removes lime scale buildup.
- Also removes lime scale and stain buildups on other kitchen equipment.
- Green color; no fragrance.
- **Multi-use concentration.**
Dilution rate: 2-oz. per gallon of water or straight up.



▶ 4 bottles per case.

ITEM NO.	PRODUCT	CASE
6129 7359	1-Gallon	\$109.95



Knit Dish Cloths

- Use anywhere from kitchen to shop to car.
- Versatile cloth ideal for washing, dusting or cleaning anything.

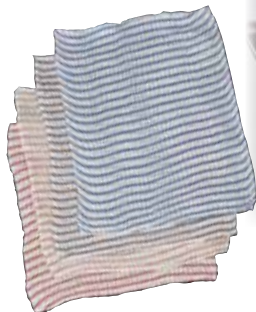

Unique construction for durability and absorbency.



ITEM NO.	PRODUCT	DOZEN
2607 75305	Knit Dish Cloths	\$14.95

Scotch-Brite™ Stainless Steel Scrubber #84



FDA approved stainless steel.

- Heavy-duty wide band construction prevents rusting, corroding and splintering, even when used with chemicals.
- 50-gram. Long-lasting durability and cutting strength.



Heavy-duty, wide band construction.



▶ 12 per case.

ITEM NO.	PRODUCT	CASE
6655 0884	Stainless Steel Sponges	\$29.95

Scotch-Brite™ Non-Stick Cookware Cleaning Pad #9000

All-purpose scouring pads clean surfaces without scratching.

- Thick, hand-size scouring pad cleans most types of surfaces without scratching. Specially designed for cleaning hot griddles with mirror or highly polished finishes. Ideal for porcelain, ceramic, tile, stainless steel, glass & nonstick pans.
- Size: 4" x 5.25"



SOLD BY THE CASE ONLY. ▶ 40 per case.

ITEM NO.	PRODUCT	CASE
6655 5014	Nonstick Cookware Pad	\$44.95



Pine Brite

General Purpose Cleaner/Deodorant

- Pine scented.
- Concentrated.
- Effective performance.
- Excellent rinsability leaves surfaces film free.
- **Concentrated.**
- **Dilution rate varies.**



> 4 gallons per case.

ITEM NO.	PRODUCT	CASE
6129 6737	Pine Brite, 1-Gallon	\$39.95

Mr. Clean All-Purpose Citrus Cleaner

- Disinfects and kills 99% of bacteria.
- Safe to use on appliances, floors and countertops.



> 9 bottles per case.

ITEM NO.	PRODUCT	CASE
1690 0309	24-oz.	\$47.95

Misty Clear Lemon Disinfectant

- One step disinfectant, germicidal detergent and deodorant.
- Biodet ND32 dual quat based.
- Concentrated.
- Lemon fragrance.
- **Dilution rate:**
- **4-oz. per gallon of water.**



> 4 bottles per case.

ITEM NO.	PRODUCT	CASE
7507 4280	Misty Lemon, 1-Gallon	\$59.95

Divosan® Spectrum Sanitizer

Concentrated neutral quaternary sanitizer.

- No-rinse sanitizer suitable for use in dairies, food processing, pharmaceutical, breweries and beverage operations.
- Sanitizes food contact and other hard nonporous surfaces & equipment.
- An effective bactericide, virucide and fungicide.
- Phosphate-free.
- **Concentrate.**
- **Dilution rate: 1 oz. per 4 gallons of water.**

> Meets D2 guidelines for all surfaces not always requiring a rinse.



> 4 bottles per case.

ITEM NO.	PRODUCT	CASE
1520 6561	Spectrum, 1-Gallon	\$69.95

Ready-To-Use Disinfectant Cleaner

No mixing required.

- EPA Registered disinfectant for H1N1.
- Non-acid formula is safe on most hard surfaces.
- Effective as a disinfectant, cleaner, degreaser or deodorizer.



> 12 bottles per case.

ITEM NO.	PRODUCT	CASE
6129 6739	Disinfectant, 1-Quart	\$39.95

USC Lemon Cleaner Disinfectant

Germicidal detergent and deodorizer.

- Recommended for floors, walls and toilet facilities.
- Kills virus type 1 (HIV-1, associated with AIDS).
- Lemon scented.

- **Concentrate.**
- **Dilution rate:1:64.**



> 4 bottles per case.

ITEM NO.	PRODUCT	CASE
1520 7668	Lemon Cleaner, 1-Gallon	\$49.95



Sokoff™ Degreaser

Remove baked-on grease & carbon easily.

- Can be used on stoves, grills, baking pans and more.
- Simple to use: brush on & rinse off.
- Safe to use on any metal.
- Contains no acids, caustic soda or ammonia.
- Non-flammable and non-corrosive.



ITEM NO.	PRODUCT	EACH	
		1-11	12+
3452 46011	1-Pint (12 per case)	\$18.95	\$17.95

ITEM NO.	PRODUCT	EACH	
		1-3	4+
3452 46021	1-Gallon (4 per case)	\$67.95	\$66.95

Smokehouse Cleaner

Removes grease, soot, tar and other accumulations from smokehouse walls, floors and ceilings.

- When cleaning wall or floor areas, wet the surface thoroughly and allow the solution to penetrate.
- Wipe with a cloth or scrub with a brush.
- Rinse with water.

➤ Meets A4 guidelines.

➤ 4 bottles per case.

ITEM NO.	PRODUCT	CASE
2117 0433	1-Gallon	\$44.95



Quickline Showdown

All purpose cleaner and degreaser.

- Controlled foaming for less wiping.
- Aggressive solvent formula — compare to 409.
- Free rinsing — use on any surface not harmed by water.



➤ 6 bottles per case.

ITEM NO.	PRODUCT	CASE
6129 6691	1-Quart Spray Bottle	\$44.95

Powder Fryer Cleaner

For use only in deep fat fryers.

- Non-abrasive. Does not scratch or abrade surfaces.
- No scent. Non-foamer.
- Free flowing powder.
- Applied with a long handled brush.
- **Concentrated.**
Dilution rate: Straight to 2-3 oz. per gallon of water.



➤ 4 boxes per case.

ITEM NO.	PRODUCT	CASE
6129 6717	3.75-Lb Box	\$49.95

TKO Oven & Grill Cleaner

- Ready to use; no mixing required.
- Powerful Alkaline formula removes burnt-on food, grease and animal fats.
- Use on ovens, grills and stove tops.



➤ 6 bottles per case.

ITEM NO.	PRODUCT	CASE
6129 6693	1-Quart Spray Bottle	\$49.95

Heavy Duty Oven & Grill Cleaner

- Ready to use; no mixing required.
- Powerful Alkaline formula removes burnt-on food, grease and animal fats.
- Use on ovens, grills and stove tops.



➤ 4 bottles per case.

ITEM NO.	PRODUCT	CASE
6129 6718	1-Gallon	\$49.95



QuickLine T-A-P Orange

- Heavy-duty degreaser/cleaner in a convenient, ready-to use form.
- Free rinsing — use on any surface not harmed by water.
- Citrus fragrance.



➤ 6 bottles per case.

ITEM NO.	PRODUCT	CASE
6129 6692	1-Quart Spray Bottle	\$44.95

Freezer Cleaner

Safe, effective concentrate for cleaning frozen food processing areas.

- Cleans at temperatures down to -44°F.
- Odorless • Fast acting. • Corrosion inhibitors.
- **Dilution rate: 1:1 or use straight.**



➤ 4 bottles per case.

ITEM NO.	PRODUCT	CASE
6129 6714	1-Gallon	\$89.95





USC All-Purpose Liquid Degreaser

For general cleaning anywhere heavy grease is a problem.

- Cuts through oils and greases.
- Pine-floral scented.
- Institutional strength.
- Solvent based.
- **Concentrated.**

Dilution rate: Versatile with many dilutions and applications.

➤ 4 gallons per case.



Hi-Voltage Degreaser

50-lbs. makes 2,000-gal. of cleaning solution.

- Removes grease and fat accumulations quickly and thoroughly.

➤ Meets A4 guidelines.



ITEM NO.	PRODUCT	CASE
6129 6699	1-Gallon.....	\$39.95

ITEM NO.	PRODUCT	EACH
3032 3700	10-Lb. Box.....	\$29.95
3032 3701	50-Lb. Box.....	119.95

Terrifico Industrial Cleaner/Degreaser

- For general cleaning of floors, walls, kitchen equipment and hoods, and anywhere heavy grease is a problem.
- Lavender-pine scent provides a pleasant work environment.
- Institutional strength.
- Low use cost.
- Solvent based.
- Cuts through oils and greases.

Dilution rate:
1-oz. per 1.5-gal. of water.

➤ 4 gallons per case.



Challenge General Purpose Cleaner

- Safely and effectively removes animal grease and blood soils.
- Low odor and pleasant to use.

➤ Rated USDA A1.



ITEM NO.	PRODUCT	CASE
6129 6752	1-Gallon.....	\$49.95

ITEM NO.	PRODUCT	CASE
6129 6703	1-Gallon.....	\$59.95

Flare Stainless Steel Cleaner & Polish

- Oil-based formulation helps seal out corrosion.
- Restores original brilliance to stainless steel.



➤ 12 per case.



ITEM NO.	PRODUCT	CASE
7500 4061	Aerosol, 15-oz.....	\$64.95

USC Stainless Steel Polish

- Liquid polish
- Non-abrasive won't scratch surfaces.
- Spearmint scented.
- Provides protective coating.
- Non-flammable
- Aids in soil removal.

➤ 6 per case.



ITEM NO.	PRODUCT	CASE
6129 6748	Liquid, 32-oz.....	\$76.95

J-Works™/MC Natrasolve® Citrus Solvent Cleaner/Degreaser

High alkaline, D-limonene-based degreaser for industrial cleaning applications.

- Removes adhesives, rubber marks, inks, oils and greases, metal working fluids, shop dirt and food-based soils.
- Use for spray-and-wipe cleaning, mopping and immersion cleaning applications.
- Heavy-duty degreaser with D-limonene.

• **Concentrated.**
Dilution rate varies.



➤ 4 per case.

ITEM NO.	PRODUCT	CASE
1520 0515	1-Gallon.....	\$129.95

J-Fill® QuattroSelect® Dispensing System

Wall-mounted dispensing system that accurately dispenses four different products into bottles or buckets. This system is safer, more reliable and more accurate than any other chemical dispensing platform in the industry.

- No metering tip installation — bottles come pre-tipped to ensure dilution accuracy & cost control.
- Simple bottle installation. Simply select four cleaning products from the list below.
- One-handed low flow bottle filling, or use the hose to fill a bucket.
- Easy to repair, quick change manifold.
- Powder-coated locking steel doors.
- Product identification windows.
- Meets ASSE 1055-B back-flow prevention requirements.

For chemical Safety Data Sheet information visit www.bunzlmsds.com



- Unit Dimensions: 24.25" h x 18.5" w x 7.5" d
- Low Flow Rate: 1.5 gpm
- High Flow Rate: 3.1 gpm
- Water In-Let Hose: 4'
- Remote Bucket Fill Hose: 8'
- Drip Tray Drainage Hose: 8'
- Water Pressure: 30-85 psi
- Water Temperature: 50°-100°



Simple installation.



Remote high flow bucket/autoscrubber fill gun.



SmartValve™ product selection.



Low flow bottle filling option.

CALL 800-456-5624 FOR PRICING AND TO ORDER.

F.O.B. FACTORY

ITEM NO.	PRODUCT
1520 6426	QuattroSelect® with Safe Gap
1520 4386	QuattroSelect® with Air Gap

Choose four chemicals/cleaners for your J-Fill dispensing system:

ITEM NO.		pH	DILUTION RATE	FINISHED PER BOTTLE	FINISHED PER CASE
1520 1512	A. Alpha-HP® Multi-Surface Cleaner	12	1:64	42.5 gal.	85 gal.
1520 2650	B. Crew® Bathroom Cleaner & Scale Remover	3.9	1:18	11.9 gal.	23.8 gal.
1520 0790	C. Crew® Multi-Purpose Restroom Cleaner	8.6	1:16	10.5 gal.	21 gal.
1520 8763	D. Crew® Restroom Floor/Surface SC Non-Acid Disinfectant	6-8	1:256	169 gal.	338 gal.
1520 0791	E. Crew® Shower, Tub & Tile Cleaner	0.54	1:40	26.4 gal.	52.8 gal.
1520 5783	F. Glance® HC Glass Cleaner	11.5	1:40	26.4 gal.	52.8 gal.
1520 0760	G. Glance® N.A. Glass Cleaner	7	1:40	26.4 gal.	52.8 gal.
1520 0771	H. GP Forward® SC General Purpose Cleaner	12.9	1:128	84.5 gal.	169 gal.
1520 6034	I. J-512 Sanitizer	7.75	1:512	338 gal.	676 gal.
1520 3934	J. Morning Mist Disinfectant	7	1:64	42.5 gal.	85 gal.
1520 0789	K. PERdiem™ General Purpose Cleaner w/Hydrogen Peroxide	2	1:64	42.5 gal.	85 gal.
1520 0209	L. Spitfire® SC Power Cleaner	11.7	1:12	8 gal.	16 gal.
1520 0839	M. STRIDE HC Neutral Cleaner	6.5-7	1:375	247.5 gal.	495 gal.
1520 4329	N. Virex® II 256 Germicidal Cleaner	10.2	1:256	169 gal.	338 gal.



Need cleaning chemicals SDS information?



Scan this code with your smartphone QR code reader app for a listing of Sealed Air/Diversey Safety Data Sheets.
<http://sds.sealedair.com>



All chemicals/cleaners are 2.5-liter bottle concentrates.

Packaged 2 bottles per case.

3M Doodlebug™ Cleaning System

Pads and brushes are designed for most cleaning tasks, from light-duty cleaning of delicate surfaces to heavy-duty cleaning of dirt or finish build-up.

Doodlebug™ Handblock

- Convenient built-in handle puts cleaning versatility in the palm of your hand.
- Grippers hold pad firmly in place yet provide for easy attachment and replacement.



Doodlebug™ Cleaning System Pads

- White pad is for light-duty, blue pad is for medium-duty, brown pad is for heavy-duty use and black pads are for stripping.
- 4-5/8" x 10".



Doodlebug™ Swivel Pad Holder

- Durable holder lets holder twist and turn to reach hard-to-get places.
- Grippers hold pad firmly in place yet provide for easy attachment and replacement.
- Has threaded inlet for use with brush handle.

➤ Order threaded handle separately, ordering information listed below.
 ➤ Each holder comes with one light-duty and one heavy-duty pad. ➤ 4 per case.

ITEM NO.	PRODUCT	EACH	
		1-3	4+
6655 61731	Handblock Holder	\$44.95	\$43.95
6655 64721	Swivel Holder	49.95	48.95
➤ 12 per case.			
ITEM NO.	PRODUCT	EACH	
		1-11	12+
6387 65001	54" Threaded Plastic Handle	\$19.95	\$18.95

➤ 5 pads per box — 4 boxes per case.

ITEM NO.	PRODUCT	PER BOX	
		1-3	4+
6655 84405	White, Light-Duty	\$14.95	\$13.95
6655 82425	Blue, Medium-Duty	14.95	13.95
6655 85415	Brown, Heavy-Duty	14.95	13.95
6655 00545	Black, Heavy-Duty Stripper	39.95	38.95



Super Disposable Rags

- Ideal alternative to cloth rags and shop towels.
- Strong, durable and absorbent rags are virtually lint-free and reusable.
- 13" x 18" rags are 1/4 folded and come in a convenient dispenser box.

250 wipes per box.

ITEM NO.	PRODUCT	BOX
4702 0792	Disposable Multi-Purpose Rags	\$59.95

Cellulose Sponges

- Cellulose sponges are made from wood fiber and are biodegradeable.
- Choose from small or large size.

➤ Dimensions:
 Small: 6" l x 3-1/2" w x 1-1/2" h.
 Large: 7-1/2" l x 4-3/8" w x 2-1/16" h.

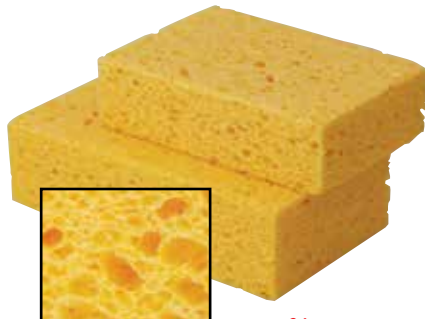

➤ 24 per case.

ITEM NO.	PRODUCT	CASE
6655 1031	Small	\$49.95
6655 1041	Large	59.95

Large Cellulose Sponges

- Perfect for everyday use and maintenance.
- Provides unparalleled absorption.

➤ Dimensions: 8-1/2" l x 4" w x 2-3/4" h.



➤ 100 per case.

ITEM NO.	PRODUCT	1-99	100+
7035 10011	Sponge	\$3.95	\$2.95

Hydra® Aquawash-n-Dri® Sponges

- Easy to handle sponge stays soft and pliable.
- 7" x 4-1/4" x 2" synthetic material will not mildew.
- Excellent abrasive action when washing walls or other surfaces.



➤ 48 per case.

ITEM NO.	PRODUCT	CASE
3898 0001	Pink	\$51.95
3898 0002	Blue	51.95
3898 0003	Green	51.95
3898 0007	Orange	51.95

Niagara™ 6" x 9" Scouring Pads

#98N Light-Duty Scouring Pad

- Ideal for stainless steel, chrome, copper, porcelain and ceramics because it won't scratch or dull surfaces.

#96N Medium-Duty Scouring Pad

- Cleans pots, pans, kitchen equipment, and is ideal for interiors, walls, railings, floors, stairways and counters.
- Ideal for removing scuff marks on floors.

#86N Heavy-Duty Scouring Pad

- Replaces scrapers, steel wool and metal sponges for tough maintenance jobs.

➤ Light-Duty — 20 pads per case.

➤ Medium & Heavy-Duty — 60 pads per case.

ITEM NO.	PRODUCT	SIZE	CASE
6655 98995	#98N Light-Duty	6" x 9"	\$9.95
6655 9696	#96N Medium-Duty	6" x 9"	23.95
6655 0186	#86N Heavy-Duty	6" x 9"	39.95

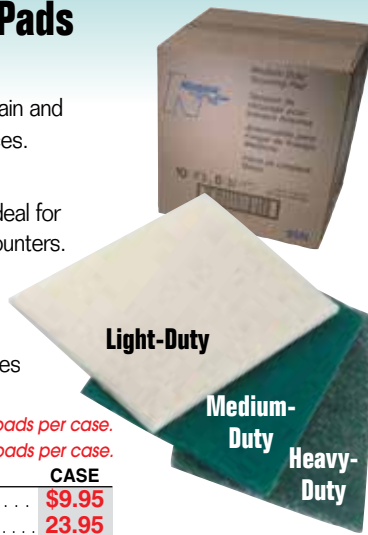

Niagara™ Medium-Duty Scrub Sponge #74N

- Dual action cleaning tool with sponge on one side and scouring pad on the other.
- Cellulose sponge wipes up spills and messes and can carry cleaning solutions to the work surfaces.



SOLD BY THE CASE ONLY.

➤ 20 per case.

ITEM NO.	PRODUCT	SIZE	CASE
6655 1074	Scrub Sponge #74	3.5" x 6"	\$29.95

Scotch-Brite™ Heavy-Duty Scouring Pads #86

Made for tough equipment cleaning jobs.



- Can replace scrapers, steel wool and metal sponges.
- Heavy-duty nylon pads cannot rust.

➤ 12 pads per box — 3 boxes per case.

ITEM NO.	PRODUCT	SIZE	PER BOX	
			1-2	3+
6655 86005	#86 Heavy-Duty Pads	6" x 9"	\$24.95	\$23.95
6655 0686	#86 Heavy-Duty Pads (Bulk Pack of 60 pads)			\$59.95

Scotch-Brite™ General Purpose Scouring Pads #96

Great for all those common cleaning jobs.



- Performs well on equipment, walls, railings, floors, stairways and counter tops.

➤ 20 pads per box — 3 boxes per case.

ITEM NO.	PRODUCT	SIZE	PER BOX	
			1-2	3+
6655 96005	#96 General Purpose Pads	6" x 9"	\$17.95	\$16.95

Scotch-Brite™ Power Sponge #3000

- Designed with antibacterial technology that kills odor-causing bacteria in the sponge itself.
- One side of the sponge has a built-in scouring pad for those hard to clean items.



SOLD BY THE CASE ONLY.
➤ 20 per case.

ITEM NO.	PRODUCT	SIZE	CASE
6655 3001	Anti-Bacterial Sponge	4.5" x 2.8" x .6"	\$49.95

Scotch-Brite™ Non-Stick Cookware Cleaning Pad #9000

All-purpose scouring pads clean surfaces without scratching.

- Thick, hand-size scouring pad cleans most types of surfaces without scratching.



SOLD BY THE CASE ONLY.
➤ 40 per case.

ITEM NO.	PRODUCT	SIZE	CASE
6655 5014	Blue Nonstick Cookware Pad	4" x 5.25"	\$44.95

Scotch-Brite™ Power Pad #2000

- Advanced non-woven synthetic fibers scour 4x faster than conventional scouring products.
- 8x less likely to scratch equipment and surfaces than other medium/heavy-duty commercial scouring pads.



SOLD BY THE CASE ONLY.
➤ 20 per case.

ITEM NO.	PRODUCT	SIZE	CASE
6655 7206	Power Pad #2000	5.5" x 3.9" x .40"	\$18.95

Scotch-Brite™ Purple Scour Pad #2020

- Scratches up to 11 times less than conventional scouring pads.
- Unique open web construction allows debris to rinse out easily.
- Use on pots and pans, kitchen equipment, counter tops, stainless steel and more!
- Use wet or dry.

SOLD BY THE CASE ONLY.

➤ NOT for use on non-stick surfaces, so plastics, clear plastics, fiberglass and highly decorated surfaces.



➤ 24 per case.

ITEM NO.	PRODUCT	SIZE	CASE
6655 2020	Purple Scour Pad	4-1/2" x 2-7/8"	\$24.95

WYPALL® L30 Economizer® Wipers

Lightweight wiper with a cloth-like feel.

- Strong, yet soft enough for personal use.
- Lightweight double re-creped design for high surface softness.
- Reinforced grid provides strength for wet surface wiping and cleaning.
- Available in folded packs or Pop-Up® boxes.



ITEM NO.	PRODUCT	QUANTITY	CASE
1540 5812	1/4 Band Folded Wiper . . .	90 wipes per pack, 12 packs/case	\$57.95
1540 0355	Pop-Up® Box	120 wipes per box, 6 boxes/case	64.95

WYPALL® L40 Wipers

General-purpose wiper is soft enough to use on face and hands.

- Lightweight double re-creped design for high-surface softness.
- Inner layer of sponge-like cells that absorb liquids, lubricants and oils quickly and efficiently.



ITEM NO.	PRODUCT	QUANTITY	CASE
1540 5009	Jumbo Roll, white.	750 wipes per roll, 1 roll/case	\$69.95
1540 0571	1/4 Fold Wipes.	56 wipes per box, 18 boxes/case	109.95
1540 5790	Pop-Up® Box.	100 wipes per box, 9 boxes/case	109.95

WYPALL® X50 Wipers

- Combines versatile performance with economical design for light-duty tasks.
- Reinforced for strength when wet or dry.
- 1/4 fold wipes: 10" x 12-1/2"
Pop-Up box wipes: 9" x 12-1/2".



ITEM NO.	PRODUCT	QUANTITY	CASE
1540 5025	1/4 Fold Wipe.	26 wipes per pack, 32 packs/case	\$37.95
1540 3550	Pop-Up® Box.	176 wipes per box, 10 boxes/case	84.95
1540 5015	Jumbo Roll, white.	1,100 wipes per roll, 1 roll/case	69.95

WYPALL® X60 Teri® Wipers

Replace your rags with WypAll X60s. Rags are made from different fabrics that may or may not hold up to the rigors of daily wear and tear. WypAll X60s have no adhesives or binders, so they won't leave behind anything besides a clean surface — wipe after wipe.

- Designed to replace and out-perform rags, for increased sanitation and less laundering.
- Reinforced for extra scrubbing and cleaning power, but soft enough for use on the face and hands.



ITEM NO.	PRODUCT	QUANTITY	CASE
1540 4015	Brag® Box	180 wipes per box, 1 box/case.	\$21.95
1540 0410	Small Roll, 4 Ply.	130 wipes per roll, 6 rolls/case	174.95
1540 9050	Pop-Up® Box	126 wipes per box, 10 boxes/case	109.95
1540 4955	Jumbo Roll	1,100 wipes per roll, 1 roll/case	94.95
1540 0150	Perforated Roll	130 wipes per roll, 12 rolls/case	169.95

WYPALL® X70 WorkHorse® Rags

Versatile and economical alternative to cloth, rags and towels.

- Long-lasting performance extends usage of wipe and reduces waste.
- Pound-for-pound, absorbs more oil and water than cloth or rags.
- Cleans oil, grime and solvent with just one wipe.
- Available in Brag® Boxes, Pop-Up® Boxes or Jumbo Rolls.



ITEM NO.	PRODUCT	QUANTITY	CASE
1540 0368	Brag® Box	150 wipes/box, 1 box/case	\$34.95
1540 0343	Jumbo Roll	870 wipes/roll, 1 Roll/case)	119.95
1540 4145	Pop-Up® Box.	100 wipes/box, 10 boxes/case.	144.95



Adding a pump makes the 1-gallon bottle a perfect portable dispenser.



Coconut Hand Soap

- Removes grease, dirt, ink and carbon.
- No abrasive, caustic or solvent material.
- Safe as a water soluble lubricant in food areas.

> Meets E4 guidelines.

> 6 bottles per case.

ITEM NO.	PRODUCT	EACH	
		1 - 5	6+
2117 02641	Coconut Soap . . .	\$16.95	\$15.95



E2 Sanitizing Hand Soap

- Odorless hand soap contains bacteria killing agents.
- Mild enough to use with every washing.

> Meets E2 guidelines.

> 6 bottles per case.

ITEM NO.	PRODUCT	EACH	
		1 - 5	6+
1520 67621	Sanitizing Soap	\$13.95	\$12.95



Antibacterial Hand Soap

- Contains Triclosan, an anti-bacterial agent that works continuously to prevent the spread of microbe-borne skin diseases.
- Skin conditioners soothe damaged skin and promote healing.

> USDA rated E4.

> 6 bottles per case.

ITEM NO.	PRODUCT	EACH	
		1 - 5	6+
2117 02681	Antibacterial . . .	\$18.95	\$17.95

Hands-Free Industrial Dispensing System

Eliminate cross-contamination easily.

- Suitable for wet or dry environments.
- Made of stainless steel.
- Holds a standard 1-gallon plastic pump container.

ITEM NO.	PRODUCT	EACH
0031 0006	A. Wrist-Activated Dispenser	\$109.95
0031 00241	B. Foot-Activated Dispenser Stand	\$299.95

Foot-Activated Dispenser and Stand



Single button, pushed by the foot, allows the soap to dispense.



Wrist-Activated Wall-Mount Dispenser



Adjustable fork allows for different sized bottle or pump to be used.



Pump Dispensers for Gallon Bottles

- Pumps from 1/8-oz. to 1-oz. increments.
- Pump fits any 1-gallon bottle.



ITEM NO.	PRODUCT	EACH
6710 61001	Pump Disp, 1-oz.	\$1.95
6710 11091	Pump Disp, 1/4-oz.	2.95

Stainless Wall Mount Gallon Bottle Dispenser Holder

- Holds a standard 1-gallon plastic container.
- 6.5" l x 6.5" w x 12" h
- See page 169 for more product information

ITEM NO.	PRODUCT	EACH
2990 2687	Gal. Disp. Holder . . .	\$54.95



Hand & Nail Brush

- 5" x 2" brush has dual level bristles for more thorough cleaning.
- Includes tether cord, wall mount hook for easy storage and bilingual instruction sheet for proper usage and cleaning technique.



Brush helps clean around and under nails.



ITEM NO.	PRODUCT	EACH
6387 21001	Hand & Nail Brush	\$15.95



Manual Hand Soaps & Dispensers

E2-Handwashing and sanitizing compound can be used by all plant personnel before returning to the processing line. Eliminates the need to use a sanitizing compound after washing.

E2 Foam Sanitizing Soap, 2,000-mL.

A one-step foaming handwash and sanitizing soap.

- E2 formula has a rich, smooth lather that effectively removes animal fats and oils, and rinses very quickly.
- Meets USDA regulated food processing environment requirements.
- Non-irritating, fragrance-free. • Meets E2 guidelines.
- Meets USDA regulated food processing environment requirements.

FMX-20™ Manual Foam Soap Dispenser, 2,000-mL.

- Unlike pump soaps, one push delivers a generous portion of E2 foam; eliminating waste and allowing almost 3,000 hand washes per refill with 2,000-mL system.
- Dispenser is easy to install and 100% moisture tolerant for washdowns.
- Ideal for high-traffic areas.



Choose from these 2 styles



ITEM NO.	PRODUCT	CASE	
7500 4247	E2 Foaming Soap, 2,000-mL (no scent)	\$89.95	
		> 2 per case.	
ITEM NO.	PRODUCT	1-5	6+
7500 03221	2,000-mL., Soap Dispenser, Gray	\$19.95	\$18.95
		> 6 per case.	

ITEM NO.	PRODUCT	CASE
3540 5264	GOJO E2 Foaming Soap, 2,000-mL (no scent)	\$89.95
		> 2 per case.
ITEM NO.	PRODUCT	EACH
3540 70091	GOJO 2,000-mL., Soap Dispenser, Gray	\$19.95
		> 6 per case.

GOJO® E2 Foam Sanitizing Soap, 1,200-mL.

A one-step foaming handwash and sanitizing soap formulated for the food processing industry.

- Removes fats, oils and other food processing soils. • Effective against common spoilage and foodborne pathogens.
- Exceeds the 50 ppm chlorine equivalency standard for sanitizer status.
- Meets guidelines for use in USDA federally regulated food processing facilities and listed with NSF International.
- Dermatologist tested: Mild • Kosher certified. • Use with GOJO® TFX™ Touch-Free Dispenser shown below.

> Meets E2 guidelines.

> 2 per case.

ITEM NO.	PRODUCT	CASE
3540 0165	GOJO E2 Foam Sanitizing Soap, 1,200-mL.	\$89.95

GOJO TFX™ Touch Free Dispenser, 1,200-mL.

Automatically dispenses the perfect amount of foam soap needed.

- Nothing for the user to touch, preventing cross-contamination.
- Dispenser features an extra-large site window making it easy to see when it's time to refill.
- Fully ADA compliant.

> Requires 2 AA batteries sold separately, see page 273.

ITEM NO.	PRODUCT	EACH
3540 30141	GOJO TFX™ Touch Free Soap Dispenser	\$34.95



Visit our website to find more HAND SOAPS & DISPENSERS: www.bunzlkochsupplies.com



Scott® Hard Roll Towels, White

- Highest capacity towel in the market — more towels, same space.
- Hydroflex compression adds 25% more feet without sacrificing roll diameter or performance.

ITEM NO.	PRODUCT	COLOR	SIZE	QUANTITY	CASE
1540 0376	Hard Roll Towels . . .	White . . .	8" x 1,000' . . .	12 rolls per case	\$159.95
1540 2000	Hard Roll Towels . . .	White . . .	8" x 950'	6 rolls per case	84.95

Scott® Hard Roll Towels, Brown

- 100% recycled fiber content.
- Reliable quality and long shelf life.

➤ 12 rolls per case.

ITEM NO.	PRODUCT	COLOR	SIZE	CASE
1540 4150	Hard Roll Towels . . .	Brown . . .	8" x 800'	\$89.95



- White towels are made from 100% recycled paper.
- Meets or exceeds the EPA'S guidelines without sacrificing quality and performance.

Hardwound Roll Towels

- High-quality, value priced towels.
- Soft and absorbent.
- Ideal for all public environments.
- Rolls are more cost-efficient than folded towels.

➤ Dimensions: 8" x 10-3/4".

➤ 12 rolls per case.

ITEM NO.	PRODUCT	COLOR	SIZE	CASE
7500 0257	Towel Roll	Natural	350' roll	\$36.95
7500 0256	Towel Roll	White	350' roll	41.95

➤ 6 rolls per case.

ITEM NO.	PRODUCT	COLOR	SIZE	CASE
7500 0259	Towel Roll	Natural	800' roll	\$42.95
7500 0258	Towel Roll	White	800' roll	48.95

➤ 30 rolls per case.

ITEM NO.	PRODUCT	COLOR	SIZE	CASE
7500 0260	Perforated Towel Roll . . .	White	80' roll	\$38.95

Folded Paper Towels

➤ 250 towels/ pack, 16 packs/case

ITEM NO.	PRODUCT	COLOR	SIZE	CASE
7500 0250	Single-Fold Towels, Natural . . .		9-3/10" x 10-1/2"	\$37.95

➤ 200 towels/ pack, 12 packs/case

ITEM NO.	PRODUCT	COLOR	SIZE	CASE
7500 0252	C-Fold Towels, White		10-1/4" x 13-1/2"	\$35.95

➤ 200 towels/ pack, 20 packs/case

ITEM NO.	PRODUCT	COLOR	SIZE	CASE
7500 0254	Multi-Fold Towels, Natural		9-1/8" x 9-1/2"	\$34.95
7500 0253	Multi-Fold Towels, White		9-1/8" x 9-1/2"	43.95



Plastic Lever Action Paper Roll Dispenser

Use with 8" hardwound roll towels.

- Constructed of sturdy plastic and designed with an attractive translucent styling for a coordinated washroom appearance.
- Unit made to be wall-mounted.

➤ Use with roll paper shown above.

➤ Dimensions: 11-3/5" x 10-3/5"d x 15-2/5"h.

➤ Shipping weight: 9-lbs.



Folded Paper Towel Dispenser

- Stainless steel cabinet with satin finish.
- Large capacity dispenses 400 C-fold or 525 multi-fold paper towels.
- Locking door, piano hinge.

➤ Large Capacity Dimensions:
10-3/4"l x 4"d x 14-3/4"h.

ITEM NO.	PRODUCT	EACH
3003 0160	Paper Roll Dispenser	\$99.95

ITEM NO.	PRODUCT	EACH
2293 0262	Large Capacity Folded Towel Dispenser	\$51.95

VERDEdri™ Hand Dryer

High Speed, surface mounted, ADA compliant hand dryer featuring HEPA filtration system & antimicrobial technology.

- HEPA filter reduces contaminants in the air while hand drying.
- Energy efficient, adjustable two speed controls to customize drying time, sound level and energy usage.
- Incorporates SteriTouch® antimicrobial technology to inhibit growth of bacteria, mold and fungus.
- 12 second dry time.
- Universal voltage - accepts 110-220/208 / 220-240 VAC input



F.O.B. FACTORY

ITEM NO.	PRODUCT	COLOR	DIMENSIONS	EACH
C313 09741	VERDEdri™	white aluminum	13.3" x 11.6" x 3.9"	\$495.95
C313 19731	VERDEdri™	brushed stainless steel	13.3" x 11.6" x 3.9"	545.95

Surpass® Facial Tissue

- Signal® feature alerts you when it's time to change the box.
- Meets EPA guidelines for post consumer waste.



> 100 tissues per box — 30 boxes per case.

ITEM NO.	PRODUCT	CASE
1540 1340	8" x 8-3/10" Tissues	\$49.95

1/2-Fold Toilet Seat Covers

- Biodegradable covers are safe for all septic tanks.
- Covers will fit most seat cover dispensers.



SOLD BY THE CASE ONLY.
> 250 covers per box — 20 boxes per case.

ITEM NO.	PRODUCT	CASE
7500 4370	1/2-Fold Toilet Seat Covers	\$49.95

Standard Roll Toilet Tissue

- Perforated tissue.
- Ideal for all public environments.



> 96 rolls per case.



ITEM NO.	PRODUCT	CASE
7500 4360	2-ply, 4" x 4" — 500'	\$69.95

In-Sight® Series-I JRT® Jr. Escort® Jumbo Roll Tissue Dispenser



- Dispenses a 9.38" diameter x 3-8/10" wide tissue roll with a 3-1/4" diameter core.
- Designed for easier access to tissue.
- Tear-off bars located on side and front of dispenser opening.
- Hinged front cover can be opened with a push-button or it can be locked to prevent product pilferage.
- Cover includes provision for custom deco strip.
- For use with Scott® JRT® Jr. Jumbo Roll Tissue Paper (1540 0373).



> Dimensions: 16" l x 5-3/4" d x 13-9/10" h.

ITEM NO.	PRODUCT	F.O.B. FACTORY	EACH
1540 9507	Jumbo Roll Tissue Dispenser		\$46.95

Scott® JRT® Jr. Jumbo Roll Tissue Paper

- Jumbo roll is equivalent in length to nearly five standard sized rolls.
- Meets EPA guidelines for post consumer waste.
- Two-ply, white.

> 1,000 sheets per roll — 12 rolls per case.

ITEM NO.	PRODUCT	CASE
1540 0373	Jumbo Roll Tissue Paper	\$99.95
1540 7006	Jumbo Roll Tissue Paper, Coreless	79.95



Stainless Steel Toilet Tissue Dispenser

- Surface mounted.
- Holds and dispenses 2 standard rolls of toilet tissue.
- Extra roll automatically drops into place after bottom roll is used.
- Type 304 stainless steel with satin finish.
- Cabinet locks.

> Use with standard roll tissue shown above.



ITEM NO.	PRODUCT	EACH
2293 0007	Toilet Tissue Dispenser	\$67.95

Material Handling

A Aluminum 10-Platter Dolly



- Constructed of 1" square welded aluminum tubing.
- Spacing: 4-3/4" apart.

- Four 5" swivel casters, two with brakes

B Heavy Duty Aluminum 12-Platter Dolly



- Spacing: 5" apart.
- Four 5" swivel casters.

Aluminum 20-Platter Dolly

- Stations are spaced 2-7/8" apart.
- Four 5" swivel casters, two with brakes.
- Holds 20, 18" x 26" platters.

C Side Load

D End Load



PLATTERS SOLD SEPARATELY, SEE FACING PAGE.



ITEM NO.	PRODUCT	DIMENSIONS	CAPACITY	EACH
3775 8394	A. 10-Platter Dolly	20" x 28-1/2" x 58" h	300-lb	\$379.95
3775 3003	B. 12-Platter Dolly	21-1/4" x 26-3/4" x 69-1/4" h	500-lb	379.95
3775 1332	C. 20-Platter, Side Load	28" x 20-1/4" x 69-1/2" h	500-lb	399.95
3775 1331	D. 20-Platter, End Load	28-1/2" x 19-3/4" x 69-1/2" h	500-lb	399.95

Knock-Down Stainless Steel 10-Platter Dolly

- 20-1/4"l x 28"d x 58"h overall.
- Spacing: 4-3/4" apart.
- Four 5" swivel casters, two with brakes.
- 1" square welded stainless steel.

Knock-Down Stainless Steel 20-Platter Dolly

- 20-1/4"l x 28"d x 69-1/4"h overall.
- Spacing: 2-7/8" apart.



PLATTERS SOLD SEPARATELY, SEE FACING PAGE



ITEM NO.	PRODUCT	CAPACITY	EACH
2990 2939	10 Platter	300-lb	\$749.95
2990 2985	20 Platter	500-lb	1,269.95



Knock-down Aluminum Deli Platter Dolly

- Designed to hold 12" wide platters on 1-5/8" angles with built-in easy slide ribs.
- Uprights are reinforced with a channel to help prevent breakage from the stem casters.
- Framework is constructed of 1" x 1" x .070" wall tubing. Angle runners are constructed of 1-1/4" x 1-5/8" x .100" wall angle.
- Includes four, 5" swivel stem casters, 2 with brakes.
- All aluminum — will not rust.

PLATTERS SOLD SEPARATELY.

► **Capacity:**
500-lbs. when weight is evenly distributed.



Built-in easy-slide ribs allow platters to glide smoothly.



F.O.B. FACTORY

ITEM NO.	PRODUCT	DIMENSIONS	RUNNER SPACING	SHIPPING WEIGHT	EACH
3775 1346	6-Platter Capacity	15-1/4" x 30" x 39" h	5"	24-lbs.	\$319.95
3775 1348	10-Platter Capacity	15-1/4" x 30" x 69" h	6"	43-lbs.	349.95
3775 1347	12-Platter Capacity	15-1/4" x 30" x 69" h	5"	45-lbs.	359.95
0844 22191	Replacement Swivel Stem Caster (uses 2)				14.95
0844 22201	Replacement Swivel Stem Caster with Brake (uses 2)				16.95



A High-Impact Polystyrene*

* NOT TO BE USED WITH VEGETABLE OIL.

B White Fiberglass

C Aluminum Alloy

D Stainless Steel

➤ 12 per case.

Mini Platter

- Designed specifically for case display of meats and other packaged foods.
- Heavy-duty plastic is lightweight and easy to clean.



ITEM NO.	PRODUCT	DIMENSIONS	EACH	
			1-11	12+
3195 29961	A. Polystyrene	18" x 26" x 1-1/8"	\$12.95	\$11.95
1695 12241	Polystyrene	12" x 24" x 3/4"	9.95	8.95
2432 18261	B. Fiberglass	18" x 26" x 1-1/8"	29.95	28.95
6387 00271	C. Aluminum	17-13/16" x 25-3/4" x 1-1/8"	16.95	15.95
3013 11641	D. Stainless Steel	18" x 26" x 1"	64.95	63.95
3013 21211	Stainless Steel	18" x 13" x 1"	44.95	43.95
4219 12301	E. Mini Platter	12-1/2" x 30" x 3/4"	10.95	9.95

Aluminum Pan/Platter Dolly

- For use moving and storing 26" x 18" pans.
- Four, 3" swivel casters.
- Aluminum will not rust.

PLATTERS SOLD SEPARATELY, SEE ABOVE.



Corners are open for easy cleaning.

ITEM NO.	PRODUCT	DIMENSIONS	SHIPPING WEIGHT	EACH
3775 8326	Alum. Pan Dolly	26-1/2" l x 18-3/8" w x 6" h	12.5-lbs	\$109.95
3775 9926	Pan Dolly with handle	28-1/4" l x 18-3/8" w x 32-1/2" h	17.5-lbs.	199.95

Platter Liners

- Interleaved for serving and storage.
- Allows complete release from platters.
- Easy cleanup.
- FDA approved.



➤ 1,000 per case.

ITEM NO.	PRODUCT	DIMENSIONS	CASE
7500 3991	Platter Liner Sheets	16-3/8" x 24-3/8"	\$54.95



Aluminum Slant Display 7-Platter Dolly

Provides an attractive display with high product visibility.

- Designed to hold up to seven 18" x 26" platters. Six slanted for display and one on the bottom base.
- Framework is made of 1" x 1" wall tubing with all welded 1-5/8" angle racks.
- 22"l x 28-1/2"w x 70"h overall.
- Four 5" stem type casters with polyolefin wheels, two with locks.

PLATTERS SOLD SEPARATELY

ITEM NO.	PRODUCT	CAPACITY	EACH
3775 1137	Slant Display Dolly	400-lb	\$399.95



Disposable Platter Dolly Cover

- Clear plastic cover protects product from dust and contaminants.
- Fits 10-platter dolly, as pictured, without dragging on ground.



DOLLY & PLATTERS SOLD SEPARATELY

➤ 50 covers per roll.

ITEM NO.	PRODUCT	DIMENSIONS	ROLL
7500 1750	Dolly Cover	52" x 80"	\$29.95

Material Handling

Super Pan II® Stainless Steel Pans

- Pans are constructed of 22-gauge stainless steel to resist rust and corrosion.
- Reinforcer® comers won't bend and will withstand more impact than ordinary pans.
- Coved comers make scooping easier and allow for easy clean-up.
- Anti-jamming design keeps pans from sticking together when stored.
- Flat edges keep pans tight in steam table well to seal in heat.
- Optional covers have reinforced edges and fit securely to prevent spills during transport.



F.O.B. FACTORY > 6 per case. EACH

ITEM NO.	PRODUCT	DIMENSIONS	1-5	6+
7160 00601	Half Pan	10-3/8" x 12-3/4", 2.5" Deep .	\$21.95	\$20.95
7160 20241	Half Pan	10-3/8" x 12-3/4", 4" Deep .	26.95	25.95
7160 00621	Half Pan	10-3/8" x 12-3/4", 6" Deep .	39.95	38.95
7160 13221	1/3 Pan	6-7/8" x 12-3/4", 2.5" Deep .	19.95	18.95
7160 13421	1/3 Pan	6-7/8" x 12-3/4", 4" Deep .	26.95	25.95
7160 13621	1/3 Pan	6-7/8" x 12-3/4", 6" Deep .	36.95	35.95
7160 63301	Full Pan	20-3/4" x 12-3/4", 2.5" Deep .	34.95	33.95
7160 70971	Full Pan	20-3/4" x 12-3/4", 4" Deep .	39.95	38.95
7160 00541	Full Pan	20-3/4" x 12-3/4", 6" Deep .	64.95	63.95
7160 01361	Half Pan Cover		19.95	18.95
7160 01371	1/3 Pan Cover		17.95	16.95
7160 01471	Full Pan Cover		37.95	36.95

Optional pan cover.

Knock-down Aluminum Universal Pan Rack

- Easy clean bar supports 3-1/4" wide pan slides.
- Holds 18" x 26" half and full sized sheet pans by the base of the pan.
- Holds steam pans by the lip of the pan.
- Strong and durable aluminum will not rust.
- Easy assembly, ships "knocked down".

> Dimensions: 21" l x 26" w x 71" h.

> Shipping Weight:
10 Pan Capacity: 41-lbs.
15 Pan Capacity: 43-lbs.
20 Pan Capacity: 45-lbs.



Holds platters and steam pans, sold separately.



F.O.B. FACTORY

ITEM NO.	PRODUCT	EACH
2510 3020	10-Pan Capacity	\$379.95
2510 3021	15-Pan Capacity	439.95
2510 3019	20-Pan Capacity	519.95

Aluminum Universal Rack

Ideal for transporting various sized platters, trays, boxes and totes.

- Strong and durable, all welded aluminum construction will not rust.
- Framework is constructed of 1" x 1" x .070" wall tubing.
- Shelves are constructed of 1/2" x 1-1/4" oval tubing.



Open slat oval tubing shelves provide easy access.

Equipped with four, 5" swivel plate casters, two with brakes.



ITEM NO.	PRODUCT	DIMENSIONS	SHIPPING WEIGHT	F.O.B. FACTORY EACH
3775 1354	5-Shelf	16" x 32-1/2" x 42" h	37-lbs.	\$339.95
3775 1356	6-Shelf	21-3/4" x 29-1/2" x 61-1/2" h	47-lbs.	399.95
3775 1357	7-Shelf	29-1/2" x 32-1/2" x 67" h	78-lbs.	549.95
3775 1358	8-Shelf	21-1/2" x 29-1/2" x 61-1/4" h	53-lbs.	449.95
0844 22161	Replacement Heavy-Duty Caster, Plate Swivel (uses 2)			15.95
0844 22171	Replacement Heavy-Duty Caster, Plate w/Brake (uses 2)			20.95

Food Boxes
sold separately.



Holds up to 2,400-lbs!

Recommended weight distribution:
800-lbs. max per lower shelves & 400-lbs. max per upper shelves.
Load capacity with casters is **500-lbs. total.**

Caster Kit

Move your shelving easily by replacing levelers with casters. Each caster kit contains four, 5" casters (2 with locks and 2 without locks), and four easy-to-install adapter sleeves, that better reinforce the legs of the shelving structure and allow the casters to fit securely over them.

These unique sleeves keep the legs from bending on **loads totaling up to 500-lbs.**



Heavy Duty Wire Shelving

- Rustproof, green epoxy coating is applied over a zinc-chromate finish and will stand up to years of harsh conditions.
- Shelves feature an open heavy-gauge wire design allowing greater air circulation and improving visibility of stored items.

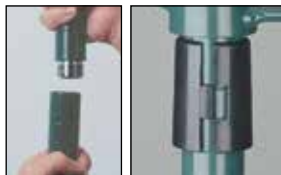

No-Tools Assembly!

- Just screw the post together then snap the sleeve onto the desired indexing groove and drop the shelf's collar over it.

- Shelves can be adjusted at 1" increments along the entire length of the post.

- Tie multiple units together with our "S"-clips for increased rigidity and storage space.



Leveling Is a Breeze!

- Level with just a twist of the wrist.
- Adjust loaded shelves with just an open-end wrench.
- Leveling bolt: 3/8" x 16 tpi.



ITEM NO.	PRODUCT	EACH	
		1-3	4+
3419 49681	18" x 24" Shelves	\$29.95	\$28.95
3419 49691	18" x 36" Shelves	34.95	33.95
3419 49701	18" x 48" Shelves	42.95	41.95
3419 49711	18" x 60" Shelves	56.95	55.95
3419 49721	18" x 72" Shelves	64.95	63.95
3419 49731	24" x 36" Shelves	45.95	44.95
3419 49741	24" x 48" Shelves	57.95	56.95
3419 49751	24" x 60" Shelves	69.95	68.95
3419 49761	24" x 72" Shelves	77.95	76.95
3419 49781	72" Post (comes as two pieces)	18.95	—
3419 49791	36" Post (comes as one piece)	12.95	—
3419 49771	"S" Clip	3.95	—
3419 4100	Replacement Shelf Clips, 4/Bag	3.95	—
4804 0000	Caster Kit, 4 Casters	79.95	78.95

Large Food Boxes

- Shatter and crack-resistant containers with date control panels.
- NSF certified and commercial dishwasher safe.
- Record freshness dates with a grease pencil.
- Tight-fitting lids for longer shelf life.
- Assists in HACCP compliance.



Food boxes
sold separately.



FOOD BOX DOLLY

- Stainless steel construction.
- Holds 18" x 26" food boxes.

ITEM NO.	DIMENSIONS	EACH
2990 2986	28.5" x 15.25" x 33"	\$309.95

WHITE, DUR-X™ FOOD BOXES

> 6 per case.
EACH

ITEM NO.	DIMENSIONS	CAPACITY	EACH	
			1-5	6+
1770 35071	18"l x 12"d x 3-1/2"h.	2-gal.	\$17.95	\$16.95
1770 79721	18"l x 12"d x 6"h.	3.5-gal.	22.95	21.95
1770 79681	18"l x 12"d x 9"h.	5-gal.	27.95	26.95
1770 08561	26"l x 18"d x 6"h.	8.5-gal.	36.95	35.95
1770 00281	26"l x 18"d x 9"h.	12.5-gal.	47.95	46.95
1770 79641	26"l x 18"d x 15"h.	21.5-gal.	69.95	68.95
1770 79661	Lid for 26" x 18" Boxes.		22.95	21.95
1770 79741	Lid for 18" x 12" Boxes.		13.95	12.95

CLEAR, CARB-X® FOOD BOXES

EACH

ITEM NO.	DIMENSIONS	CAPACITY	EACH	
			1-5	6+
1770 33081	26"l x 18"d x 6"h.	8.5-gal.	\$48.95	\$47.95
1770 79141	26"l x 18"d x 9"h.	12.5-gal.	63.95	62.95
1770 33281	26"l x 18"d x 12"h.	16.6-gal.	74.95	73.95
1770 79181	Lid		26.95	25.95



50-lb. capacity
Weighs only 3.8-lbs. empty
1.3-cu.ft.

90° cross stacking
via stacking grooves
built into bottom of tote.



- Molded-in handles.
- Reinforced nesting-stops prevent jamming.
- Finely etched exterior resists cuts & scratches.
- Smooth interior & wide radius corners for easy cleaning.

4:1 nesting ratio
saves space.

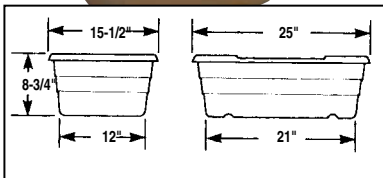

All eleven colors are food approved!

Molded Poly Totes

> 100 per pallet.

ITEM NO.	PRODUCT	EACH	
		1-99	100+
3195 07071	White.....	\$11.95	\$10.95
3195 06621	Gray.....	11.95	10.95
3195 46331	Yellow.....	11.95	10.95
3195 06641	Orange.....	11.95	10.95
3195 46341	Blue.....	11.95	10.95
3195 46321	Red.....	11.95	10.95
3195 46351	Green.....	11.95	10.95
3195 46361	Black.....	11.95	10.95
3195 2013	Tan.....	11.95	10.95
3195 73041	Pink.....	11.95	10.95
3195 00021	Purple.....	11.95	10.95

ToteAll 2000[®] Imprinted Poly Tote Boxes

- Our same famous poly boxes imprinted with "Edible" or "Inedible" verbiage.



> 100 per pallet. EACH

ITEM NO.	PRODUCT	1-99	100+
3195 01271	White, "Edible"	\$14.95	\$13.95
3195 01281	Gray, "Inedible"	14.95	13.95
3195 01291	Red, "Inedible"	14.95	13.95
3195 58761	Yellow, "Inedible" . . .	14.95	13.95

Poly Tote Disposable Liners

Clean-ups have never been easier!
Liners are approved for food contact.

- Blue, 1.5-mil. polyethylene liners fit all ToteAll 2000[®] totes.
- Liners eliminate the need for cleaning totes — just pull off the used liner and throw away!

Call and
request a
**FREE
SAMPLE!**



> 500 per case.

ITEM NO.	PRODUCT	CASE
E179 2215	Blue Tote Liners	\$79.95

ToteAll 2000® Welded Aluminum Tote Dollies

Choose from standard-duty or heavy-duty tote dollies.

- All standard-duty tote dollies are made of heavy-duty 1-1/4" x 1-1/4" square tube frame with 1" square tube cross supports.
- Single, double and triple heavy-duty tote dollies are made of heavy-duty 1-1/4" x 1-1/4" square tube frame with 1" square tube cross supports.
- Six, seven and ten tote heavy-duty dollies are made of heavy-duty 1-1/4" x 1-1/2" D-shaped tube frame with 1" square tube cross supports.
- All welded aluminum dollies accept 16" x 25" x 8-1/2" high totes. • All dolly seams are welded and sealed.
- Each tote shown has the capacity to hold up to 50-lbs. each.



D-shaped tubing.



Square tubing.



Side-By-Side Two Tote



Double Tote



Single Tote



Six+ Tote



Three Tote



Six Tote



Ten Tote



TOTES SOLD SEPARATELY.

REPLACEMENT CASTERS AVAILABLE.

HEAVY-DUTY DOLLIES

ITEM NO.	PRODUCT	DIMENSIONS	EACH
3775 9317	Single Tote	16-1/4" x 26" x 19"	\$169.95
3775 9318	Double Stacked	16-1/4" x 28-1/4" x 33"	189.95
3775 9319	Side-By-Side Double	26" x 33" x 19"	199.95
3775 9304	Three Tote	16" x 29" x 42-1/2"	249.95
3775 3797	Side-By-Side Six Tote	20-3/4" x 29-3/4" x 38"	349.95
3775 2535	Six+ Tote	18-3/4" x 72" x 26-1/2"	329.95
3775 4198	Ten Tote	29-1/2" x 31-1/2" x 61"	389.95

STANDARD-DUTY DOLLIES

ITEM NO.	PRODUCT	DIMENSIONS	EACH
3775 6265	Single Tote	16" x 26" x 19"	\$99.95
3775 0511	Double Stacked	15-3/4" x 28-1/4" x 33"	149.95
3775 9316	Side-by-Side Double	26" x 32-1/2" x 19"	159.95
3775 6262	Four Tote	18-7/8" x 26" x 51"	199.95
3775 6264	Six Tote	18-7/8" x 26" x 71"	269.95



Material Handling

Universal Freezer Basket Dollies

- Welded aluminum construction with no crevices to trap bacteria.
- Two plate swivel and two plate rigid casters with heavy-duty wheels. Replacement casters available.
- Dollies accept freezer baskets. Sold separately.
- Supports are 7-3/4" apart



Freezer baskets sold separately.



Easy slide angles have built-in stop to prevent freezer baskets from sliding all the way out.

ITEM NO.	PRODUCT	CAPACITY	DIMENSIONS	EACH
3775 2130	7-Basket Dolly	500 lbs.	20-1/2" l x 29" w x 60-7/8" h.	\$429.95
3775 1272	8-Basket Dolly	500 lbs.	21-1/4" l x 29-1/2" w x 62-1/2" h.	459.95
3775 1273	9-Basket Dolly	500 lbs.	21-1/4" l x 29-1/2" w x 70-1/2" h.	479.95
3775 4325	12-Basket Dolly	500 lbs.	31-1/2" l x 35-1/2" w x 60" h.	499.95

All-Purpose Freezer Baskets

Heavy, chrome-plated, welded steel wire construction.

- Designed to fit our standard basket dollies.
- Ideal for freezing or cooling product.
- Nest when empty to save space.

> 28" l x 17" w.



Baskets are available in three sizes.

> 7 per case.

ITEM NO.	PRODUCT	EACH	
		1-6	7+
3056 07211	4" Deep	\$21.95	\$20.95
3056 0722	5" Deep	22.95	21.95
3056 4326	7" Deep	26.95	25.95

Our Freezer Tote Spreader is ideal for stacking & palletizing freezer totes.

This product is available on our website:

www.bunzlkochsupplies.com

Freezer Totes

Heavy-duty poly food boxes won't warp, split or crack when frozen.

- Molded bottom ridges.
- Wide radius corners and a smooth finish for easy cleaning.
- Pebble finish exterior.
- Optional standard tote reinforced lid for stacking.
- Color: white.



STANDARD FREEZER TOTE

> Outside Dimensions: 21-1/2" l x 15-1/4" w



LARGE FREEZER TOTE

> Outside Dimensions: 25" l x 16" w x 8-1/2" h



ITEM NO.	PRODUCT	EACH
6604 47761	5" deep	\$9.95
6604 47771	7" deep	10.95
6604 47781	Lid	7.95

ITEM NO.	PRODUCT	EACH
3502 58951	8-1/2" deep	\$24.95

ChillTote™ System Cuts Conventional Freezing Time in Half!

Heavy-duty, high-density polyethylene won't crack or warp in freezers.

Lightweight and easy to clean for reuse.

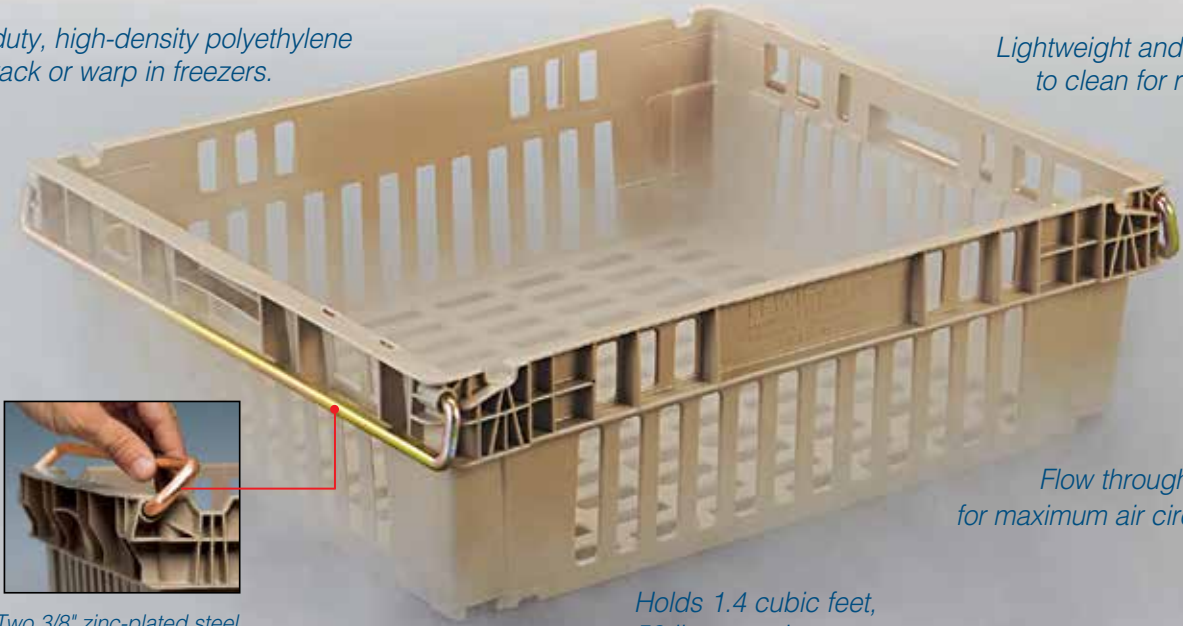

Two 3/8" zinc-plated steel wire bails swing down to allow nesting and swing up for stacking.

Flow through design for maximum air circulation.

Holds 1.4 cubic feet, 50-lb. capacity.

ChillTote™ Trays

- Freezer proof ChillTote™ trays with stacking and nesting options.
- Flow-thru basket design allow maximum air circulation for faster, more efficient freezing.
- ChillTotes fit four-up on standard 42" x 48" pallets.
- Heavy ribs on bottoms of trays prevent the contents of upper and lower trays from freezing together.
- Injection molded from high-density polyethylene to withstand constant freezer temperatures without cracking or warping.
- Maximize your freezer space and eliminate basket shelving by using ChillTote™ aluminum transport dollies (see below).



ITEM NO.	PRODUCT	DIMENSIONS	WT.CAPACITY	VOLUME	EACH
1814 28631	Standard Chilltote™	22-1/2" l x 19"w x 6" h	50-lbs.	1.4 cu. ft.	\$18.95
1814 58901	Deep Chilltote™	22" l x 19"w x 13" h	75-lbs.	2.7 cu. ft.	29.95

ChillTote™ Dollies

- For use in moving and storing Chilltotes™.
- Open corners for easy cleaning
- Strong, durable aluminum construction with four 3" swivel casters.
- Will not rust.

➤ Shipping weight: 10-lbs.



CHILLTOTE™ TRAYS SOLD SEPARATELY.



ITEM NO.	PRODUCT	DIMENSIONS	EACH
3775 9322	Dolly	22" l x 19" w x 6" h	\$99.95

Single, double and triple ChillTote™ dollies available on our website:
www.bunzlkochsupplies.com

Material Handling

Dough Boxes

- Prevents crusting and reduces frequency of dough making.
- Rigid polycarbonate reinforced on all sides; boxes have rounded edges for safety.
- Boxes available in two sizes. • Boxes stack securely.

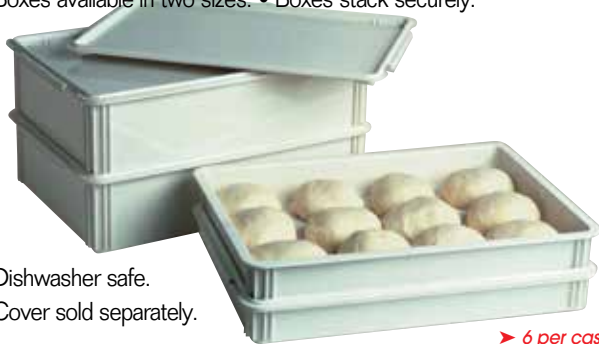

- Dishwasher safe.
- Cover sold separately.

> 6 per case.
EACH

ITEM NO.	PRODUCT	DIMENSIONS	1-5	6+
2432 63551	3" Dough Box.	26"l x 18"w x 3" h	\$39.95	\$38.95
2432 38111	6" Dough Box.	26"l x 18"w x 6" h	49.95	48.95
2432 63561	Dough Box Cover.		29.95	28.95

Aluminum Dough Box/Platter Dolly



- For use moving and storing dough boxes.
- Corners are open for easy cleaning.
- Equipped with four, 3" swivel casters.
- Strong and durable aluminum will not rust.

> Shipping Weight: 10-lbs.



DOUGH BOXES & PLATTERS
SOLD SEPARATELY

ITEM NO.	PRODUCT	DIMENSIONS	SHIPPING WEIGHT	EACH
3775 8326	Alum. Dolly.	26-1/2" l x 18-3/8" w x 6" h	12.5-lbs.	\$109.95
3775 9926	Dolly with handle	28-1/4" l x 18-3/8" w x 32-1/2" h	17.5-lbs.	199.95

Flat Shelf Utility™ Cart

Perfect for transporting materials, supplies, and heavy loads in almost any environment.

- Ergonomically designed push handle provides optimum hand placement and push height, improving control and worker safety.
- Molded-in storage compartments, holsters, hooks, and notches.
- Heavy duty casters.
- Molded-in customizable fittings.
- High density structural resin construction.



> Shelf Capacity: 250-lbs.

Convenient storage bin built into handle.



Easy-access bottom shelf.

ITEM NO.	PRODUCT	DIMENSIONS	COLOR	EACH
1770 4505	Small.	37-7/8"l x 19"d x 33" h.	Beige	\$299.95
1770 0525	Large.	43-7/8"l x 25-7/8"d x 33" h.	Beige	299.95

Heavy-Duty Utility Carts

- Heavy-duty structural foam plastic construction won't rust, dent, chip or peel.
- Molded-in storage compartments, holsters, hooks and notches.
- Ergonomically designed push handle for greater maneuverability.
- High density structural resin construction.
- Easy access bottom shelf.

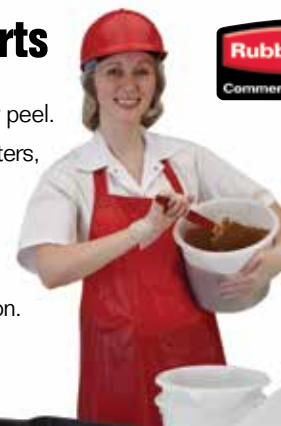

4" non-marking casters.

CONTAINERS WITH LIDS
SOLD SEPARATELY.
SEE PAGE 60.

ITEM NO.	PRODUCT	DIMENSIONS	COLOR	CAPACITY	EACH
1770 0090	Standard Shelf Cart.	17-7/8"l x 39"w x 33-1/4"h"	Black.	500-lb.	\$269.95
1770 4500	Standard Shelf Cart.	17-7/8"l x 39"w x 33-1/4"h"	Beige.	500-lb.	269.95
1770 2093	Large Shelf Cart.	25-7/8"l x 45-1/4"w x 33-1/4"h.	Black.	500-lb.	299.95
1770 2089	Large Shelf Cart.	25-7/8"l x 45-1/4"w x 33-1/4"h.	Beige.	500-lb.	299.95
1770 4550	Extra Large Shelf Cart.	26"l x 55"w x 33-1/4"h	Black.	750-lb.	479.95
0844 01861	Rigid Replacement Caster				12.95
0844 01871	Swivel Replacement Caster				15.95

Multi-Use Tray

These heavy-duty trays are perfect for extreme industrial applications that compromise injected or thermoformed trays.

- Straight sidewalls and no rims.
- Color: Natural
- Approved for food contact.



Three Tier Tray Cart

Designed to hold three Multi-Use Trays. (shown at left)

- Includes 5" casters: two rigid and two swivel with brake.
- 1-1/4" aluminum tubing construction.



ITEM NO.	PRODUCT	DIMENSIONS	SHIPPING WEIGHT	F.O.B. FACTORY EACH
4743 20081	Multi-Use Tray	37.5" l x 25" w x 2-1/2" h	9-lbs.	\$69.95
3775 0472	Aluminum Cart	28-1/8" l x 40-3/8" w x 53-1/4" h	35-lbs.	659.95

Heavy-Duty Mixer Bowl Dollies

Maneuver easily from one station to the next.

- Aluminum construction. Guaranteed rust free.

Mixing bowl not included.



A

3" platform casters



B

Ring size - 20-3/4" ID

5" Casters
2-swivel, 2-swivel with brake



ITEM NO.	PRODUCT	CAPACITY	DIMENSIONS	SHIP WT.	EACH
3775 9936	A. Low-profile Bowl Dolly	80-qt./ 800 lbs.	14" l x 14" w x 7.5" h	15-lb.	\$179.95
3775 5636	B. High-profile Bowl Dolly	80-qt.	26.75" l x 26.75" w x 30" h	34-lb.	399.95

ProSave™ Ingredient System

Increase productivity, improve food safety and decrease supply costs.

- Scoop hook allows the scoop to be stored inside the bin and out of the product for quick access to each ingredient.
- By holding the scoop handle and securing it to the hook, hands do not touch the ingredients and the risk of cross-contamination is decreased.
- Integrated sliding lid for one handed access.
- See-thru lid slides along easy-glide track, to open.
- Assists in complying with FDA Food Code 30304.12.

Integrated Safety Portioning Scoop and hook provide dedicated scoop storage for safe ingredient portioning. Replacement scoop available. See page 76.



FIFO (First In, First Out) barrier aids in proper rotation of ingredients.



A

B

C

Safety Storage Cart



Patent-pending lid design provides one-handed access to ingredients while stacked, on a shelf, or under a prep table. Lid can swivel and rest under or over bin opening.

ITEM NO.	PRODUCT	CAPACITY	DIMENSIONS	FLOUR/SUGAR CAPACITY	SHIP WT.	EACH
1770 5557	A. 100-Cup Shelf Storage Bin & 2-Cup Scoop	6.25 gal	23.5" l x 11.5" w x 16.88" h	25 lb./50 lb.	13.25 lb.	\$169.95
1770 5558	B. 200-Cup Shelf Storage Bin & 2-Cup Scoop	12.63 gal	23.5" l x 19.2" w x 16.88" h	50 lb./100 lb.	18.50 lb.	\$249.95



Safety Storage Cart has 2-shelves with bars to secure bins during transport, holds 200-lbs per shelf and has 5" casters.

C



Safety Storage Cart

- Cart shelves have safety positioning locators to securely store and transport ingredient bins.
- Each shelf holds two 100 cup ingredient bins or one 200 cup bin.
- Includes casters.

INGREDIENT BINS SOLD SEPARATELY. SEE ABOVE



ITEM NO.	PRODUCT	DIMENSIONS	SHIP WT.	EACH
1770 5540	C. Safety Storage Cart	18" l x 26" w x 47.75" h	37.5lbs.	\$349.95



Scoop included and is easily stored inside.

10-gal. lid includes 2-cup scoop.
20-gal. lid includes 3-cup scoop.
32-gal. lid includes 4-cup scoop.



D

3" casters.



Scoop hook allows scoop to be easily accessible.



Scoop handle is held out of ingredient bin preventing cross-contamination.



Snap fit secures to base to make handling easier.



E

Rotating clear lid fits on 10-, 20-, or 32-gallon round Brute® containers (sold separately).

F

Optional Brute® dolly available. See page 89.

More Brute® colors available. See page 89.

ITEM NO.	PRODUCT	CAPACITY	DIMENSIONS	FLOUR/SUGAR CAPACITY	SHIP WT.	EACH
1770 0017	D. 170-lb. Slant-Front Storage Bin & 32-oz Scoop	20.5 gal.	29.25" l x 13.13" w x 28" h	124 lb./158 lb.	27.7 lb.	\$399.95
1770 0018	200-lb. Slant-Front Storage Bin & 32-oz Scoop	26.2 gal.	29.5" l x 15.5" w x 28" h	154 lb./197 lb.	32.7 lb.	419.95
1770 0019	250-lb. Slant-Front Storage Bin & 32-oz Scoop	30.8 gal.	29.75" l x 18" w x 28" h	188 lb./240 lb.	38.7 lb.	429.95
1770 9142	170-lb. Replacement Lid & 32-oz. Scoop					129.95
1770 0800	200-lb. Replacement Lid & 32-oz. Scoop					134.95
1770 0979	250-lb. Replacement Lid & 32-oz. Scoop					139.95

ITEM NO.	PRODUCT	EACH
1770 0343	E. 10-Gallon ProSave™ Lid (White)	\$69.95
1770 0344	20-Gallon ProSave™ Lid (White)	89.95
1770 0522	32-Gallon ProSave™ Lid (White)	109.95

ITEM NO.	PRODUCT	1-5	6+
1770 21091	F. 10-Gallon Round Brute® Drum (White)	\$16.95	\$15.95
1770 21031	20-Gallon Round Brute® Drum (White)	24.95	23.95
1770 71001	32-Gallon Round Brute® Drum (White)	31.95	30.95

Material Handling



Premier Small Capacity Storage Containers with Lids

Space-efficient storage for small ingredients and spices.

- Durable polycarbonate resists stains, odors, and breakage.
- Lids snap to base and to other lids for easy storage.
- Commercial dishwasher safe.



Lids lock and containers stack inside each other.



ITEM NO.	PRODUCT	CAPACITY	EACH
1770 75221	2-Cup	5.06" sq. x 3.38" h.	\$12.95
1770 75211	3-Cup	7.13" sq. x 2.5" h.	16.95
1770 75231	5-Cup	7.13" sq. x 3.56" h.	18.95
1770 24161	9-Cup	9.44" sq. x 3.31" h.	24.95
1770 24171	14-Cup	9.44" sq. x 4.88" h.	31.95

Space Saving Containers

Square containers use 25% less space than round containers.

- Molded handles have drain holes making them safe for commercial dishwashing.
- Measurement markings are hot stamped for long lasting readability.
- Polyethylene construction is NSF Standard #2 certified.
- Temperature range from -20° F to 140° F.



► 2-, 4- and 6-qt. sizes have 12 containers per case.

ITEM NO.	PRODUCT	DIMENSIONS	EACH	
			1-11	12+
1770 63021	2-Quart.	8-3/4" l x 8-5/16" w x 2-11/16" h	\$9.95	\$8.95
1770 99411	4-Quart.	8-3/4" l x 8-5/16" w x 4-3/4" h	11.95	10.95
1770 95001	6-Quart.	8-3/4" l x 8-5/16" w x 6-15/16" h	12.95	11.95

► 8-, 12-, 18- and 22-qt. sizes have 6 containers per case.

ITEM NO.	PRODUCT	DIMENSIONS	EACH	
			1-5	6+
1770 96021	8-Quart.	8-3/4" l x 8-5/16" w x 8-3/4" h	\$14.95	\$13.95
1770 97001	12-Quart.	11-5/16" l x 10-1/2" w x 7-3/4" h	21.95	20.95
1770 98001	18-Quart.	11-5/16" l x 10-1/2" w x 11-15/16" h	27.95	26.95
1770 99001	22-Quart.	11-5/16" l x 10-1/2" w x 14-7/16" h	31.95	30.95



Stackable design.

Lids sold separately.



► 12 lids per case.

ITEM NO.	PRODUCT	EACH
		1-11 12+
1770 65091	Lid for 2-, 4-, 6-, & 8-qt. Containers	\$6.95 \$5.95
1770 00441	Lid for 12-, 18-, & 22-qt. Containers	8.95 7.95

Food Storage Containers

Lids allow for easily recorded food and date information.



► 12 per case.

ITEM NO.	PRODUCT	DIMENSIONS	EACH	
			1-11	12+
1770 20241	2-Quart.	8-1/2" dia. x 4-1/4" h.	\$4.95	\$3.95
1770 76681	4-Quart.	8-1/2" dia. x 7-1/8" h.	5.95	4.95
1770 57231	6-Quart.	10" dia. x 7-7/8" h.	7.95	6.95
1770 57241	8-Quart.	10" dia. x 10-5/8" h.	8.95	7.95
1770 57261	12-Quart.	13-1/8" dia. x 8" h.	13.95	12.95
1770 07661	18-Quart.	13-1/8" dia. x 11-1/8" h.	16.95	15.95
1770 57281	22-Quart.	13-1/8" dia. x 14" h.	21.95	20.95
1770 15181	22-Quart w/Bail	13-1/8" dia. x 14" h.	26.95	25.95
770 04421	Lid for 2 & 4-qt. Containers, Yellow		3.95	2.95
1770 57251	Lid for 6 & 8-qt. Containers, Yellow		4.95	3.95
1770 57301	Lid for 12, 18 & 22-qt. Containers, Yellow		8.95	7.95

- Temperature range from -20° F to 212° F.
- Stain-resistant.
- NSF certified and commercial dishwasher safe.
- Seamless white containers are easy-to-clean and stain-resistant.
- Positive locking lids have gripper ring.



Measuring Cups

Crystal-clear material makes measuring easy.

- Printed on one side in metric and on the other in standard measurements.
- Measurements cannot be scratched, chipped or washed off.
- Molded handle will not break off.
- Dishwasher safe; not affected by food acids.



► 12 per case.
EACH

ITEM NO.	CAPACITY	1-11	12+
2432 02511	1 Cup	\$6.95	\$5.95
2432 02491	1 Pint	9.95	8.95
2432 03101	1 Quart	11.95	10.95
2432 02521	2 Quart	14.95	13.95
2432 60031	4 Quart	15.95	14.95

Measuring Cups and Spoons

- Made of FDA compliant materials.
- Capacities clearly engraved for easy identification.
- Secured with detachable ring.
- Accurate ingredient portioning to manage food costs.
- Commercial dishwasher safe.
- Measuring Cup Set includes: 1/4, 1/3, 1/2, and 1 cups
- Measuring Spoon Set includes:
1/8 tsp., 1/4 tsp., 1/2 tsp., 1 tsp., 1/2 Tbsp., 1 Tbsp.

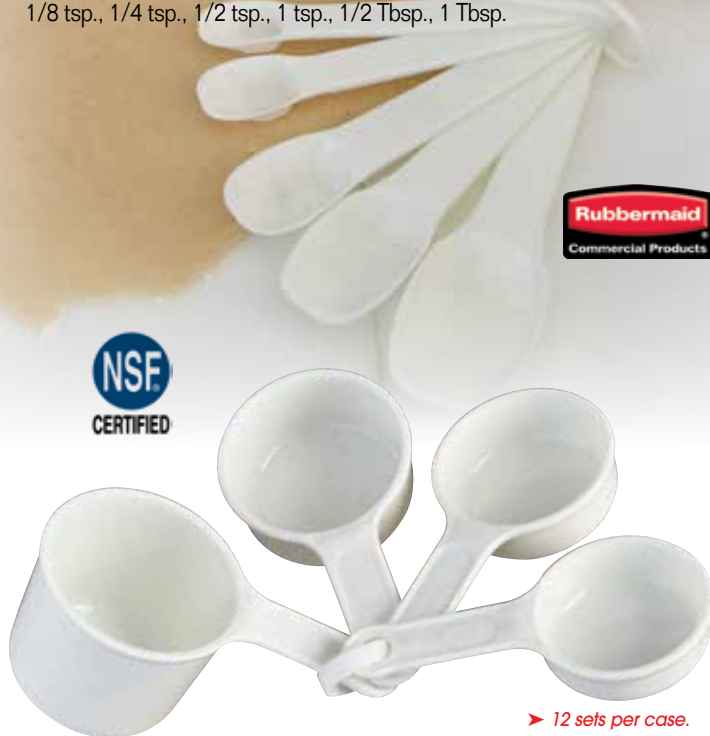

► 12 sets per case.

ITEM NO.	PRODUCT	EACH	
		1-11	12+
1770 83161	Measuring Spoon Set	\$4.95	\$3.95
1770 83151	Measuring Cup Set	4.95	3.95



High-Heat Spatulas and Spoons

Dishwasher safe scrapers resist heat up to 500° F/260° C.

- Stain- and scratch-resistant design protects grill and cookware.
- Handle is always cool to the touch, even when used in the hottest of applications.
- Clean-Rest™ feature keeps blade off countertops, reducing cross-contamination.



Notched scraper blade cleanly scrapes sides of pans.



Molded-in hook allows easy attachment to a pan.

► 24 per case.

ITEM NO.	SIZE	EACH	
		1-23	24+
1770 19681	16-1/2" Spoon	\$25.95	\$24.95
1770 19671	13-1/2" Spoon	20.95	19.95
1770 19661	9-1/2" Spoon	17.95	16.95
1770 19641	16-1/2" Spatula	24.95	23.95
1770 06591	13-1/2" Spatula	19.95	18.95
1770 06601	9-1/2" Spatula	16.95	15.95



Choose from spoon or spatula heads.

Material Handling

2-Cup Safety Portioning Scoop

- Dishwasher safe.
- Anti-roll design prevents handle from coming into contact with food, reducing cross-contamination.
- Clear polycarbonate allows for use in cold or hot environments (-40° F to 212° F / -40° C to 100° C).
- Measurement markings in cups, ounces, and milliliters.
- Unique flat front provides access to corners & bottom of pan.



> 12 per case.

EACH

ITEM NO.	CAPACITY	1-11	12+
1770 55561	2-Cup	\$13.95	\$12.95

THIS SCOOP WORKS GREAT WITH THE PROSAVE™ INGREDIENT SYSTEM SEE PAGE 72-73

Aluminum Scoops

- High-quality, stain-resistant aluminum alloy.
- One-piece, smooth finish casting.

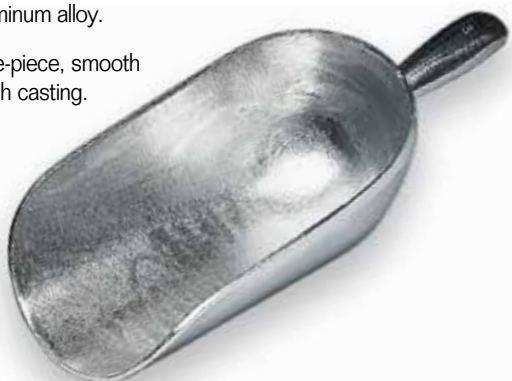

> 6 per case.
EACH

ITEM NO.	CAPACITY	BOWL DIMENSIONS	EACH	
			1-5	6+
3009 07041	22-oz	4" x 7"	\$12.95	\$11.95
3009 07051	36-oz	5" x 8-1/4"	16.95	15.95
3009 07061	56-oz	5-1/2" x 10-1/4"	19.95	18.95

Closed-Back Stainless Steel Scoops

- 4" welded handle-seams ground smooth.
- Heavy-gauge 304 stainless steel.
- Polished finish.



> 6 per case.

ITEM NO.	CAPACITY	BOWL DIMENSIONS	EACH	
			1-5	6+
3013 3997	1/2-pt.	2-3/4" x 4"	\$49.95	\$48.95
3013 4002	1-pt.	3-3/8" x 5-1/8"	56.95	55.95
3013 4003	1-qt.	4-1/4" x 6-5/8"	59.95	58.95
3013 9004	2-qt.	5-1/8" x 8-1/4"	69.95	68.95
3013 4005	3-qt.	5-3/4" x 9-1/2"	77.95	76.95
3013 3998	1-gal.	6-1/2" x 9"	79.95	78.95
3013 3999	5-qt.	8" x 10"	89.95	88.95



Stainless Steel Scoops

- Heavy-gauge 316 stainless steel.
- Polished finish.
- Fully welded construction.
- Round bottom.

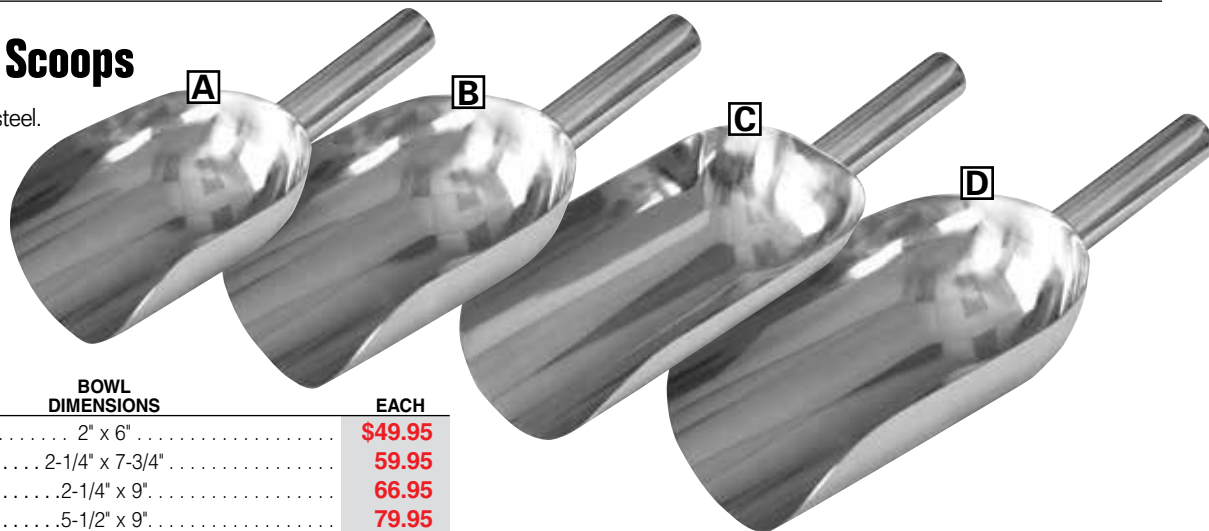

ITEM NO.	CAPACITY	BOWL DIMENSIONS	EACH
3013 00431	A. 8-oz.	2" x 6"	\$49.95
3013 00441	B. 16-oz.	2-1/4" x 7-3/4"	59.95
3013 00401	C. 32-oz.	2-1/4" x 9"	66.95
3013 00411	D. 50-oz.	5-1/2" x 9"	79.95



Vikan® Colored Plastic Bowl Scoops

- One-piece molded polypropylene with no seams or cracks to encourage bacterial growth.
- Raised handle design with thumb grip.
- Measured graduation marks.
- Made from FDA approved materials.



32-oz. Small Bowl
 > Dimensions: 7-1/4" x 3-1/4".

64-oz. Large Bowl
 > Dimensions: 7-1/2" x 4-3/4".

SMALL BOWL, 32-oz.

> 12 per case.
EACH

ITEM NO.	COLOR	1-11	12+
5281 01321	Green	\$12.95	\$11.95
5281 01351	Blue	12.95	11.95
5281 01361	Red	12.95	11.95
5281 01381	Yellow	12.95	11.95
5281 01371	White	12.95	11.95

LARGE BOWL, 64-oz.

> 10 per case.
EACH

ITEM NO.	COLOR	1-9	10+
5281 6802	Green	\$13.95	\$12.95
5281 6803	Blue	13.95	12.95
5281 68041	Red	13.95	12.95
5281 6806	Yellow	13.95	12.95
5281 6805	White	13.95	12.95



REMCO Colored Plastic Scoops

- One-piece molded polypropylene.
- Chemical-resistant.
- Can be sterilized and stacked for storage.
- Made from FDA approved materials.

16-OZ.

> 12 per case.
EACH

ITEM NO.	COLOR	1-11	12+
5281 30021	Green	\$4.95	\$3.95
5281 30031	Blue	4.95	3.95
5281 30041	Red	4.95	3.95
5281 30061	Yellow	4.95	3.95
5281 30051	White	4.95	3.95
5281 30071	Orange	4.95	3.95
5281 30081	Purple	4.95	3.95

32-OZ.

> 12 per case.
EACH

ITEM NO.	COLOR	1-11	12+
5281 64011	Green	\$5.95	\$4.95
5281 64031	Blue	5.95	4.95
5281 64021	Red	5.95	4.95
5281 40061	Yellow	5.95	4.95
5281 64001	White	5.95	4.95
5281 40051	Orange	5.95	4.95
5281 40081	Purple	5.95	4.95

82-OZ.

> 12 per case.
EACH

ITEM NO.	COLOR	1-11	12+
5281 46301	Green	\$6.95	\$5.95
5281 65011	Blue	6.95	5.95
5281 46321	Red	6.95	5.95
5281 46331	Yellow	6.95	5.95
5281 50051	White	6.95	5.95
5281 50071	Orange	6.95	5.95
5281 50081	Purple	6.95	5.95

White Plastic Scoop

- Made of sanitary, seamless injection-molded white poly.
- 5-pint capacity.
- > Dimensions: 6" l x 9" d x 3-1/4" h.



> 36 per case.
EACH

ITEM NO.	SIZE	1-5	6+
3049 25151	5-pint	\$4.95	\$3.95



Bouncer® Scoops

- Made of clean, durable polycarbonate.
- Large grip with hole for hanging.
- Commercial dishwasher safe.
- Assists in HACCP compliance.
- Easy to clean.
- NSF certified.



> 12 per case.
EACH

ITEM NO.	CAPACITY	1-11	12+
1770 78201	32-oz.	\$14.95	\$13.95
1770 78241	64-oz.	15.95	14.95

Transparent Polycarbonate Scoops

- Constructed of rustproof, durable molded plastic.
- Retains look and performance, even after multiple washings.



> 12 per case.
EACH

ITEM NO.	SIZE	1-11	12+
2432 97111	6-oz.	\$5.95	\$4.95
2432 68101	12-oz.	6.95	5.95
2432 08741	24-oz.	7.95	6.95
2432 96571	64-oz.	10.95	9.95

Material Handling

Stainless Steel V-Edge Dump Buggies

- Solid, 1" rolled and welded rim.
- Full width stainless steel drip guard meets USDA standards.
- Solid stainless steel construction with smooth seams.
- Heavy-duty, 14-gauge type 304 stainless steel body with a 10-gauge bottom.
- 2" x 6" white poly wheels, replaceable Delrin® spanner bushings with greaseable zerk axles.



Optional heavy-duty plastic lid (order separately).



12-gauge quick-drain, stainless wheel support.



Rolled and welded rim.

Full width stainless steel drip guard.

V-Edge Buggy Dimensions

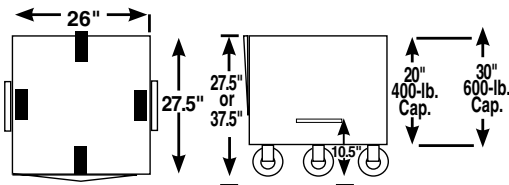

► Interior Dimensions:
400-lb. — 21"l x 24"w x 20"h
600-lb. — 21"l x 24"w x 30"h

ITEM NO.	PRODUCT	SHIPPING WEIGHT	EACH
2990 4528	V-Edge Buggy 400-lb. Capacity	77-lbs.	\$595.00
2990 4529	V-Edge Buggy 600-lb. Capacity	97-lbs.	729.00
2990 4251	V-Edge Buggy 600-lb. Capacity, w/Handle	99-lbs.	749.00
2990 0028	Heavy Duty V-Edge Buggy		799.95
3502 98241	Optional V-Edge Buggy Lid		30.95
0844 2225	Replacement Wheel		7.95
0844 2229	Replacement Bushing (Stainless Steel)		9.95
0844 20311	Replacement Zerk Axle		9.95



Replaceable wheels and bushings.



Greaseable/replaceable zerk axle.

Colored Plastic Scrapers

- One-piece molded polypropylene with no seams or cracks to encourage bacterial growth.
- Chemical, rust and corrosion-resistant.
- Will not scratch metal surfaces.
- Tapered handles and thumb indentation.
- Made from FDA approved materials.



REMCO

SMALL 3" x 8" ► 12 per case.

ITEM NO.	COLOR	EACH	
		1-11	12+
5281 96121	Green . . .	\$5.95	\$4.95
5281 96131	Blue	5.95	4.95
5281 96141	Red	5.95	4.95
5281 9616	Yellow . . .	5.95	4.95
5281 6961	White	5.95	4.95
5281 00161	Black	5.95	4.95

LARGE 4-3/8" x 9-3/4" ► 12 per case.

ITEM NO.	COLOR	EACH	
		1-11	12+
5281 10011	Green	\$6.95	\$5.95
5281 96231	Blue	6.95	5.95
5281 10031	Red	6.95	5.95
5281 10041	Yellow	6.95	5.95
5281 96251	White	6.95	5.95
5281 96271	Orange	6.95	5.95
5281 96281	Purple	6.95	5.95
5281 96291	Black	6.95	5.95

Metal Detectable Hand Scrapers



SMALL ► 12 per case.

ITEM NO.	COLOR	EACH	
		1-11	12+
5281 02251	Green	\$9.95	\$8.95
5281 0226	Blue	9.95	8.95
5281 02271	Red	9.95	8.95
5281 02281	Gray	9.95	8.95

LARGE ► 12 per case.

ITEM NO.	COLOR	EACH	
		1-11	12+
5281 02301	Green	\$11.95	\$10.95
5281 02311	Blue	11.95	10.95
5281 02321	Red	11.95	10.95
5281 02331	Gray	11.95	10.95

REMCO 

Polypropylene Mixing Paddle Scrapers

- One-piece injection molded polypropylene cleans easily.
- Features a lightweight design with a modified T-grip handle.
- Paddle shape and tapered edges allow the scraper to mix product and scrape tubs and vats without damaging the work surface.
- Lightweight but virtually unbreakable.
- Available in 5 colors. • Made from FDA approved materials.

Overall length: 40"
Blade: 6" x 13"
Weight: 2.3-lbs.

PADDLE **WITH** HOLES

ITEM NO.	40" LENGTH	EACH
5281 77421	Green	\$47.95
5281 77431	Blue	47.95
5281 77441	Red	47.95
5281 77451	White	47.95
5281 77461	Yellow	47.95

PADDLE **WITHOUT** HOLES

ITEM NO.	40" LENGTH	EACH
5281 7752	Green	\$47.95
5281 77531	Blue	47.95
5281 77541	Red	47.95
5281 6775	White	47.95
5281 77561	Yellow	47.95

Overall length: 52"
Blade: 6" x 13"
Weight: 3-lbs.

PADDLE **WITH** HOLES

ITEM NO.	52" LENGTH	EACH
5281 77621	Green	\$57.95
5281 77631	Blue	57.95
5281 77641	Red	57.95
5281 7765	White	57.95
5281 77661	Yellow	57.95

PADDLE **WITHOUT** HOLES

ITEM NO.	52" LENGTH	EACH
5281 77721	Green	\$57.95
5281 7773	Blue	57.95
5281 7774	Red	57.95
5281 77751	White	57.95
5281 77761	Yellow	57.95



Choose with holes or without.

Available in
40" & 52" lengths.



40" Long Handled Paddle Spatula

Perfect for stirring, mixing and cleaning kettles, vats and large pots.

- 4-1/2" x 7-1/2" nylon blade sharpens and contours to your specific application with use.
- Smooth finished, waterproof construction won't harbor bacteria and is easily cleaned. It's also BPA free.

► 6 per case.

ITEM NO.	COLOR	EACH	
		1-5	6+
6387 00421	White	\$34.95	\$33.95
6387 52051	Red	34.95	33.95
6387 52041	Yellow	34.95	33.95



Stainless Steel Paddles

Perfect for stirring and mixing bulk products.

- Electropolished finish enhances corrosion resistance; improves surface finish for ease of cleaning.
- Tough and durable stainless steel mixing paddle has a one-piece, highly smooth finish.
- Seamless stainless steel type 304.

COLUMBIA PRODUCTS

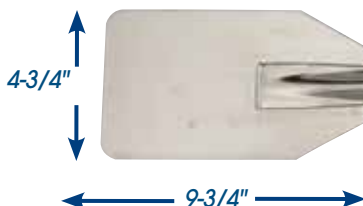

ITEM NO.	PRODUCT	EACH
3013 20911	36" Stainless Steel Paddle	\$54.95
3013 20881	42" Stainless Steel Paddle	64.95
3013 20891	48" Stainless Steel Paddle	74.95
3013 20901	60" Stainless Steel Paddle	81.95

Material Handling

Sanalite Poly Cutting Board Table Tops

An economical alternative to wood surfaces.

- Made of sanitary polyethylene with a reversible slip-resistant pebble finish that won't dull knives.
- Surface will not absorb odors – clean with soap and water.
- USDA requires that all boards can be removed by a single worker and measure no larger than 1-1/2' x 5'.
- Select from three thicknesses, sold per square foot.

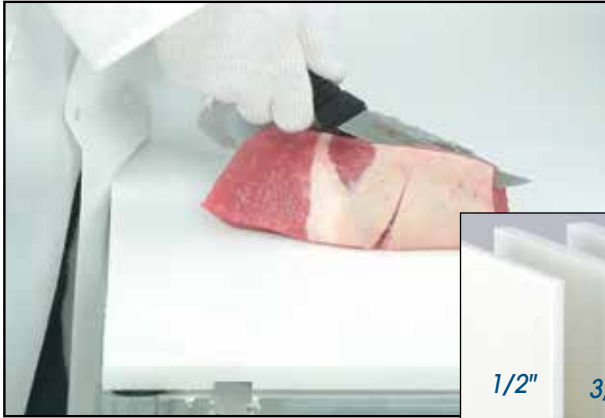

Custom Cut Into Any Size Or Shape to Fit Your Table!

Call for information on calculating dimensions for replacement cutting boards. Boards 3' x 4' or smaller ship UPS. Larger boards are shipped via freight line.

ITEM NO.	PRODUCT	F.O.B. FACTORY	PER SQ. FT.
3201 1424	1/4" Cutting Board		\$7.95
3201 2094	1/2" Cutting Board		15.95
3201 1425	3/4" Cutting Board		16.95
3201 1426	1" Cutting Board		21.95

How to: Calculate Replacement Cutting Boards

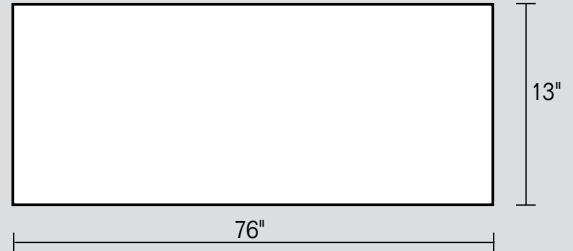

L x W = Total Sq. Inches

1. Measure length and width in inches.
2. Multiply length x width for total square inches.
3. Divide total square inches by 144.
4. Round calculation up to the nearest foot.
5. Take that number x price per square ft.

Example:

1. Board desired is 13" wide x 76" long.
2. 13" x 76" = 988 sq. ft.
3. 988 divided by 144 = 6.86
4. Round 6.86 up to nearest foot = 7
5. Take 7 x price of board per square ft. = Total price

We recommend boards no larger than 18" wide x 5' long, removable for cleaning by a single worker.

Pre-Cut Sanalite for Aluminum Tables

- Specify length of aluminum frame table.
4' table requires 2 pieces;
6' table requires 3 pieces;
8' table requires 4 pieces.
- Removable for easy cleaning.



ITEM NO.	PRODUCT	DIMENSIONS	WEIGHT	EACH
3201 2500	Pre-Cut Sani-Lite®	30"w x 24" x 3/4" Thick	10-lbs	\$76.95

CARLISLE 6" Hand Scrub Brush

- Resins used to produce block and bristles are made of FDA approved materials.
- Block size: 2-1/2" x 6".
Bristle trim: 1-3/8".

More scrub brushes available on pages 30-33.



► 12 per case.

ITEM NO.	PRODUCT	EACH
6387 01021	Hand Scrub Brush	1-11 \$9.95 12+ \$8.95

Cutting Board Scraper/Refinisher

- Removes bacteria-harboring scratches and cuts.
- Dishwasher safe and easy to clean.



► 12 per case.

ITEM NO.	PRODUCT	EACH
6387 17891	Scraper/Refinisher	1-11 \$36.95 12+ \$35.95

Stainless Steel Knockdown Tables

- Available in three lengths with or without a 6" stainless steel backsplash & undershelf.
- 16-gauge, Type 304 stainless steel work surface, legs and rails.
- 12-gauge galvanized steel table channels provide maximum stability.
- Ships knocked-down with easy assembly — *assembly hardware is included.*
- NSF approved.

Table ships knocked-down.

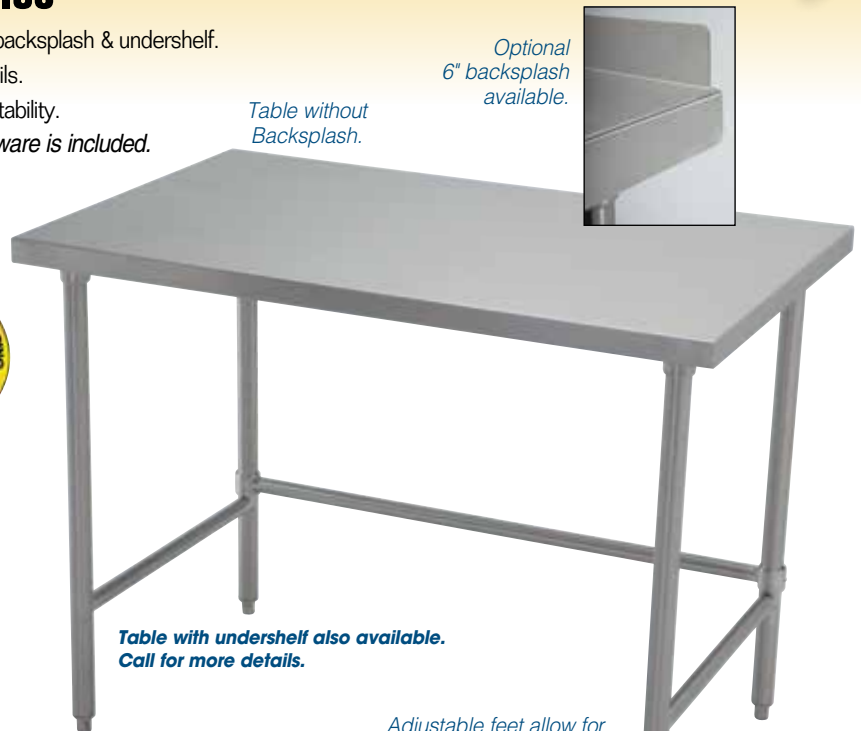

Optional 6" backsplash available.

Table without Backsplash.

Table with undershelf also available. Call for more details.

Adjustable feet allow for height adjustment.

F.O.B. FACTORY

ITEM NO.	PRODUCT	DIMENSIONS	EACH
3048 2324	36" Table <u>without</u> Backsplash.	36"l x 24"w x 36"h.	\$749.00
3048 2325	48" Table <u>without</u> Backsplash.	48"l x 24"w x 36"h.	779.00
3048 2326	60" Table <u>without</u> Backsplash.	60"l x 24"w x 36"h.	849.00
3048 1324	36" Table <u>WITH</u> 6" Backsplash.	36"l x 24"w x 36"h.	749.00
3048 1325	48" Table <u>WITH</u> 6" Backsplash.	48"l x 24"w x 36"h.	789.00
3048 1326	60" Table <u>WITH</u> 6" Backsplash.	60"l x 24"w x 36"h.	859.00



24" x 30" Aluminum Knock Down Table with Poly Top

- Made with heavy-duty aluminum frame.
- Includes 4 non-locking 4" casters.
- Available with or without 6" backsplash.



Tote slides easily on built-in slide rails.

Additional tote colors available. See page 66.

50-lb. CAPACITY TOTE INCLUDED!

Optional Backsplash.



F.O.B. FACTORY



ITEM NO.	PRODUCT	DIMENSIONS	EACH
2510 3501	Poly Top Table w/Tote.	24"l x 30"w x 34"h.	\$299.00
2510 3502	Poly Top Table w/Tote & 6" Backsplash.		349.00

Material Handling

Stainless Steel Work Tables

Rock Solid • No Wobble • Guaranteed

1. Start with a "Rock Solid" stainless frame

- Unique design yields a table which is remarkably rigid front-to-back and side-to-side, yet flexible along its length to twist to accommodate uneven floors. Even with a one inch block under one leg, all legs make solid contact with the floor and the table won't wobble or shake. (see inset). The key is the oversized, welded gussets. Legs are adjustable to level the table.
- Available in 72" or 96" lengths x 30" deep.



2. Choose from a split-poly or full stainless steel work top

No tools needed to install either top. Stainless steel clips hold poly top in place. Or, remove the clips and install the full stainless top in minutes. To comply with USDA regulations, the poly top is only available as a two-piece unit.



ITEM NO.	FULL STAINLESS TOP ON FULL TABLE	SHIPPING WEIGHT	EACH
2990 2990	72"l x 30"w	102-lbs.	\$1,419.00
2990 2991	96"l x 30"w	113-lbs.	1,819.00



ITEM NO.	SPLIT POLY TOP ON FULL TABLE	SHIPPING WEIGHT	EACH
2990 2992	72"l x 30"w	98-lbs.	\$1,299.00
2990 2993	96"l x 30"w	131-lbs.	1,569.00

ITEM NO.	REPLACEMENT CLIPS (FOR POLY TABLES)	EACH
2990 3254	For 72" Tables	\$8.95



Breaks down for easy shipping.



Easily install lower shelf.



Clips simplify removal of poly top.



ASSEMBLES IN MINUTES!

The only tool you'll need is an allen wrench, and it's included.

3. Customize to suit your specific needs

- A** Stainless steel 12" wide shelf runs the length of the table. No drilling or bolting to attach to the table. Allen wrench included. Easy vertical adjustment.

F.O.B. FACTORY



ITEM NO.	OVERHEAD STAINLESS STEEL SHELF KITS	SHIPPING WEIGHT	EACH
2990 4257	For 72" Tables	28-lbs.	\$619.00
2990 4258	For 96" Tables	32-lbs.	759.00

- B** Fully adjustable stainless steel shelf. Shelf removes easily from clips for washdown, no tools needed.

F.O.B. FACTORY



ITEM NO.	LOWER STAINLESS SHELF KITS	SHIPPING WEIGHT	EACH
2990 3250	For 72" Tables	40-lbs.	\$469.00
2990 3251	For 96" Tables	55-lbs.	569.00

- C** Backsplash is available for use with poly top tables.

F.O.B. FACTORY



ITEM NO.	BACKSPASH (FOR POLY TABLES)	SHIPPING WEIGHT	EACH
2990 3248	For 72" Tables	13-lbs.	\$219.00
2990 3249	For 96" Tables	15-lbs.	239.00

- D** Add mobility with 5" diameter casters. Wheels lock at all four corners for stability while working.

ITEM NO.	CASTER KITS	EACH
2990 3255	For 72" Tables (4 locking casters).	\$119.00
2990 3256	For 96" Tables (4 lock, 2 std.).	159.00

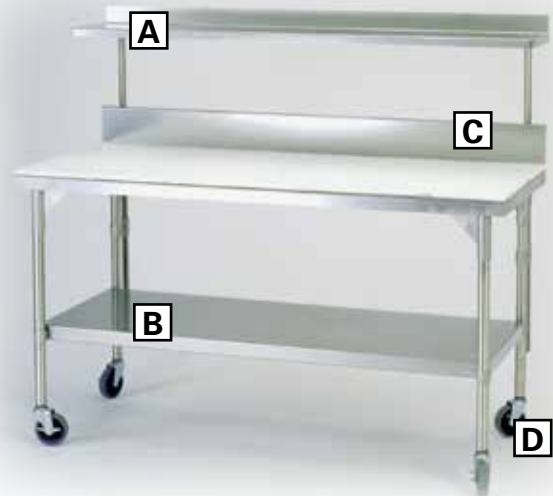

Aluminum Knockdown Tables

Build your own table— choose from three sizes of either a poly or a stainless steel top, and then add your options.

- Knockdown aluminum tables will not rust.
- All tables have an I-under brace for additional support.
- Optional undershelf nests on the frame below the table for convenient storage.
- Optional overshelf allows you to place objects up and out of the way.

1. Choose your TYPE of table:

- Aluminum Knockdown Table with Stainless Steel Top.
- Aluminum Knockdown Table with Stainless Steel Top and Backsplash.
- Aluminum Knockdown Table with Poly Top.
- Aluminum Knockdown Table with Poly Top and Backsplash.

2. Choose the SIZE of table:

- 48" l x 30" d x 34" h.
- 72" l x 30" d x 34" h.
- 96" l x 30" d x 34" h.

3. Choose one or both OPTIONS:

- Stainless Steel Undershelf.
- Stainless Steel Overshelf.

NOW, look below at the ordering information box and determine which Product Numbers match the table you have built.

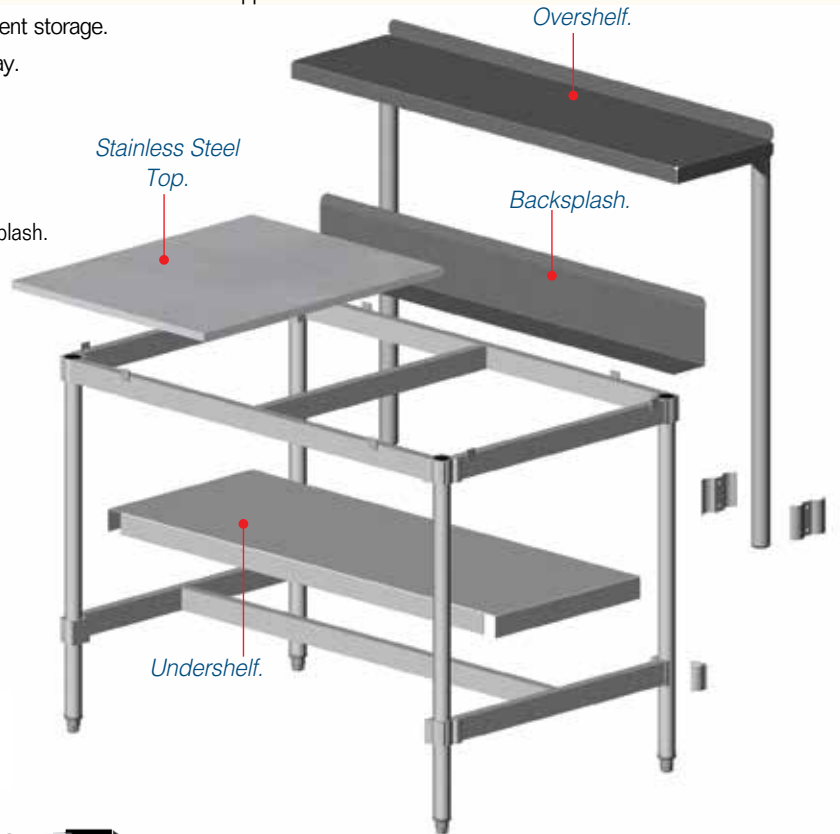

Knockdown Table with Stainless Top

F.O.B. FACTORY

ITEM NO.	PRODUCT	SIZE	COMPLETE TABLE
2510 3449	Table w/ Stainless Top, 48" x 30" x 34" (This item can ship UPS)	48" x 30" x 34"	\$499.95
2510 3473	Table w/ Stainless Top, 72" x 30" x 34"	72" x 30" x 34"	589.95
2510 3497	Table w/ Stainless Top, 96" x 30" x 34"	96" x 30" x 34"	699.95
2510 3448	Table w/ Stainless Top and Backsplash, 48" x 30" x 34" (Can ship UPS)	48" x 30" x 34"	549.95
2510 3472	Table w/ Stainless Top and Backsplash, 72" x 30" x 34"	72" x 30" x 34"	649.95
2510 3496	Table w/ Stainless Top and Backsplash, 96" x 30" x 34"	96" x 30" x 34"	779.95

Knockdown Table with Poly Top

NOTE: Poly tops come in multiple pieces for ease of handling.

- 4' table requires 2 pieces
- 6' table requires 3 pieces
- 8' table requires 4 pieces



F.O.B. FACTORY

ITEM NO.	PRODUCT	SIZE	POLY TOP PIECES	COMPLETE TABLE
2510 3450	Table w/ Poly Top, 48" x 30" x 34" (This item can ship UPS)	48" x 30" x 34"	2	\$369.95
2510 3474	Table w/ Poly Top, 72" x 30" x 34"	72" x 30" x 34"	3	499.95
2510 3498	Table w/ Poly Top, 96" x 30" x 34"	96" x 30" x 34"	4	599.95
2510 3488	Table w/ Poly Top and Backsplash, 48" x 30" x 34" (Can ship UPS)	48" x 30" x 34"	2	469.95
2510 3475	Table w/ Poly Top and Backsplash, 72" x 30" x 34"	72" x 30" x 34"	3	649.95
2510 3499	Table w/ Poly Top and Backsplash, 96" x 30" x 34"	96" x 30" x 34"	4	799.95



Optional Features

F.O.B. FACTORY

ITEM NO.	PRODUCT	SIZE	COMPLETE TABLE
2510 1848	Stainless Steel Undershelf, 48" x 18" x 2" (This item can ship UPS)	48" x 18" x 2"	\$149.95
2510 1872	Stainless Steel Undershelf, 72" x 18" x 2"	72" x 18" x 2"	219.95
2510 1896	Stainless Steel Undershelf, 96" x 18" x 2"	96" x 18" x 2"	289.95
2510 1248	Stainless Steel Overshelf, 48" x 12" x 1-1/2" (This item can ship UPS)	48" x 12" x 1-1/2"	169.95
2510 1272	Stainless Steel Overshelf, 72" x 12" x 1-1/2"	72" x 12" x 1-1/2"	229.95
2510 1296	Stainless Steel Overshelf, 96" x 12" x 1-1/2"	96" x 12" x 1-1/2"	289.95

Material Handling

Standard MACX™ Bins

Lightweight, yet strong enough to hold 1,500-lbs. of product.

- One-piece, injection molded construction.
- Made from high-density, food-grade structural plastic with a service life comparable to steel.
- Will not warp, dent, chip, splinter, rot or rust and are chemical and corrosion-resistant.
- Withstands temperatures from -32° to +165° F.
- Completely sanitary: can be high-pressure washed and steam sterilized.
- Capacity: single bin, unstacked, static weight of 1,500-lbs.
- Drain and cap are available for liquid applications.
- Customizable: add casters, drain plugs, label holders, drop doors, attachable lids, custom colors, and even emboss your company logo on the side.

Call for more information about customizing your product.

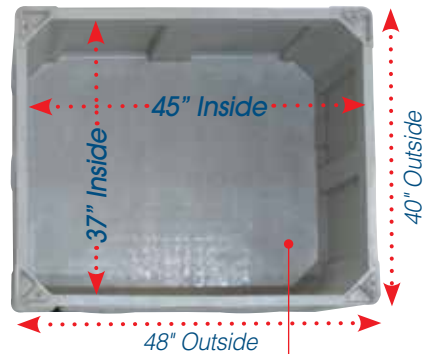

*MACX™ fits your equipment:
48" x 40" standard pallet footprint.
25.4 cubic feet;
190 US gallons.*



F.O.B. FACTORY 

ITEM NO.	PRODUCT	EACH
3515 0014	Storage Bin, Solid Gray	\$299.95
3515 0013	Solid White	299.95
3515 0029	Vented Gray	199.95
3515 5862	Stacking Lid, White	99.95
3515 5863	Drain and Cap (uninstalled)	42.95

Smooth interior can easily be high-pressure washed and sterilized. Meets USDA/HACCP standards for food handling.

*Bins and lids available in gray, white, yellow and blue.
Call for more information.*

Decade KitBin® Color Pallets

Perfect for food processing applications.

- Single-piece, high-density polyethylene construction stands up to heavy loads and continuous use.
- Easy-to-clean smooth surfaces have no splinters or wood chips.
- Up to 4,000-lbs. dynamic load; up to 13,200-lbs. static load.
- Available in gray, yellow, green or blue.

➤ *Dimensions: 48"l x 40"d x 5.9"h.*
➤ *Shipping Weight: 41-lbs.*

F.O.B. FACTORY 

ITEM NO.	COLOR	EACH
3515 9201	Gray	\$149.95
3515 9202	Yellow	149.95
3515 9203	Green	149.95
3515 9901	Blue	149.95



Reinforced Stainless Steel Shovels

- Electropolished finish to enhance corrosion resistance, improve surface finish and ease of cleaning.



Blade Dimensions: 10-3/4" x 15"
Overall Length: 40"

> Weight: 5-lbs.

ITEM NO.	PRODUCT	EACH	
		1-5	6+
3013 02081	Reinforced Stainless Steel Shovel	\$167.95	\$165.95



Blade Dimensions: 9-1/2" x 12-1/2"
Overall Length: 40"

> Weight: 6-lbs.

ITEM NO.	PRODUCT	EACH	
		1-5	6+
3013 12171	Reinforced Stainless Steel Shovel	\$164.95	\$162.95



Reinforced Stainless Steel Spade

Blade Dimensions: 7" x 9"
Overall Length: 39"

> Weight: 6-lbs.

ITEM NO.	PRODUCT	EACH	
		1-5	6+
3013 02691	Reinforced Stainless Steel Spade	\$169.95	\$167.95

Ergonomic Color-Coded Shovels

The shovel designed to get the job done without doing a number on your back!

- Ergonomic design reduces strain when lifting from the floor level.
- Heavy-duty, one-piece, injection molded polypropylene construction.
- Working temperature range: -22° F/-30° C to 176° F/80° C.
- Features a D-grip extended handle.
- Made from FDA-approved materials.
- Chemical and corrosion resistant.
- Available in 5 colors: white, red, green, blue and yellow.

> Dimensions: Blade: 14" x 18" x 48" l.



Ergonomic dual grip handles.

REMCO

Choose from 5 colors.

ITEM NO.	PRODUCT	> 6 per case. EACH	
		1-5	6+
5281 98451	White	\$51.95	\$50.95
5281 98441	Red	51.95	50.95
5281 98421	Green	51.95	50.95
5281 98431	Blue	51.95	50.95
5281 98461	Yellow	51.95	50.95

More Color-Coded & Metal-Detectable Shovels available:
www.bunzlkochsupplies.com

Material Handling

Round Poly Pails

Perfect for any job.

- Durable steel handle.
- Built-in pour spout.
- Made of durable high density polyethylene.
- Molded graduations on inside make it easy to measure fluids.



> 12 per case.

ITEM NO.	PRODUCT	EACH	
		1-11	12+
2760 14891	10-qt., Red	\$9.95	\$8.95
2760 14861	Gray	9.95	8.95
2760 99291	White	9.95	8.95
2760 14951	14-qt., Red	15.95	14.95
2760 14921	Gray	15.95	14.95
2760 14981	White	15.95	14.95

5-Gal. Food Approved Plastic Bucket

- Lid available in white only and has tear-tabs for easier openings.
- 90-mil. heavy duty polyethylene.
- FDA approved for contact with food products.



Buckets have child warning labels.

> 12 per case.

ITEM NO.	PRODUCT	EACH	
		1 - 11	12+
4438 04661	White	\$9.95	\$8.95
4438 21211	Red	9.95	8.95
4438 00691	Blue	9.95	8.95
4438 12341	Green	9.95	8.95
4438 96671	Yellow	9.95	8.95
4438 79651	Black	9.95	8.95
4438 86511	Lid, White	2.45	1.95



Vikan 3-Gallon Flat Sided Pails

- Polypropylene pail is designed with one side flat so the pail can be stored flush against a wall.
- Raised bottom for added stability and a wide spout to prevent spilling and splashing while pouring.
- Handle constructed of non-rusting stainless steel.
- Optional snap-on lid to keep pail contents secure.



Stainless steel handle.



Flat-sided pail is designed to hang upside down against a wall to allow pail to drain and dry.

Optional stainless steel mounting bracket.



> Dimensions: 12" dia. x 12-3/4" h.

> 5 per case EACH

ITEM NO.	PRODUCT	EACH	
		1-4	5+
5281 68651	Flat-Sided Pail, White	\$27.95	\$26.95
5281 68661	Yellow	27.95	26.95
5281 68621	Green	27.95	26.95
5281 68631	Blue	27.95	26.95
5281 68641	Red	27.95	26.95
5281 68671	Orange	27.95	26.95
5281 68701	Purple	27.95	26.95
5281 68681	Black	27.95	26.95
5281 68751	Optional Lid, White	13.95	12.95
5281 68761	Yellow	13.95	12.95
5281 68721	Green	13.95	12.95
5281 68731	Blue	13.95	12.95
5281 68741	Red	13.95	12.95
5281 68771	Orange	13.95	12.95
5281 68801	Purple	13.95	12.95
5281 68791	Black	13.95	12.95
5281 16201	Optional Mounting Bracket	49.95	—

Stainless Steel Pails with Tilt Handle

- Ergonomic handle positioned for easy pouring.
- Welded construction, no crevices to collect dirt or bacteria.



ITEM NO.	SIZE	WEIGHT	EACH
3013 20141	13-qt. with Tilt Handle	4.5 lbs.	\$119.95
3013 20181	16-qt. with Tilt Handle	5.5 lbs.	134.95

Stainless Steel Pail

- One piece chime, sealed around the bottom.
- Welded construction, no crevices to collect dirt or bacteria.
- Smooth top edge.



ITEM NO.	SIZE	WEIGHT	EACH
3013 20131	13-qt.	4.5 lbs.	\$109.95
3013 20161	16-qt. (No handle)	5.5 lbs.	119.95

Brute® Drum Dollies & Trash Liners

Fits Brute Drums shown on pages 88-89.

MegaSteady Drum Dolly

- Five wheel, pentagon shaped dolly for super steady rolling.
- Heavy-duty 3" wheels and swivel caster allow easy mobility.
- Holds various sizes of round Brute® drums.
- 625-lb. capacity.



ITEM NO.	PRODUCT	EACH
2510 0319	Aluminum Drum Dolly	\$49.95
3013 0025	Stainless Steel Drum Dolly	199.95

Universal Dolly

Makes moving drums around the plant easy!

- Universal dolly fits all 10- through 55-gallon brutes.
- Load capacity: 500-lb.
- Dolly height: 7-1/8".
- Color: black.



ITEM NO.	PRODUCT	EACH
1770 77581	Round Universal Dolly	\$129.95
3414 2650	Replacement Casters	16.95

Round Twist-On Dolly

- Round twist-on dolly fits 20, 32, 44 and 55 gallon round brutes.
- May be permanently attached to drum.
- Dolly height: 5".
- Riveted casters.
- Wheels are NOT replaceable.



ITEM NO.	PRODUCT	1	2+
1770 77321	Round Twist-On Dolly	\$39.95	\$38.95

► 2 per case.
EACH

Heavy-Duty Industrial Liners

Coreless rolls packed in an easy-to-use dispenser case.

- Strong, low-density bags are ideal for wet trash and heavy loads.
- Black color bags hide unsightly garbage.
- Six gussets for added strength.



ITEM NO.	CAPACITY	SIZE	GAUGE	TOTAL BAGS	PER CASE
7600 4265	20-30-Gallon	30" x 36"	1.3	200	\$33.95
7600 4270	32-Gallon	33" x 39"	1.3	100	29.95
7600 4275	44-Gallon	40" x 46"	1.3	100	39.95
7600 4281	56-Gallon	42" x 47"	1.3	100	44.95
7600 4293	60-Gallon	38" x 58"	1.3	100	47.95

High-Density Economy Liners

Coreless rolls packed in an easy-to-use dispenser case.

- Perforated coreless rolls are time saving, cost efficient and easy to dispense.
- Clear, puncture resistant bags are perfect for light loads.
- Star-seal bottom.

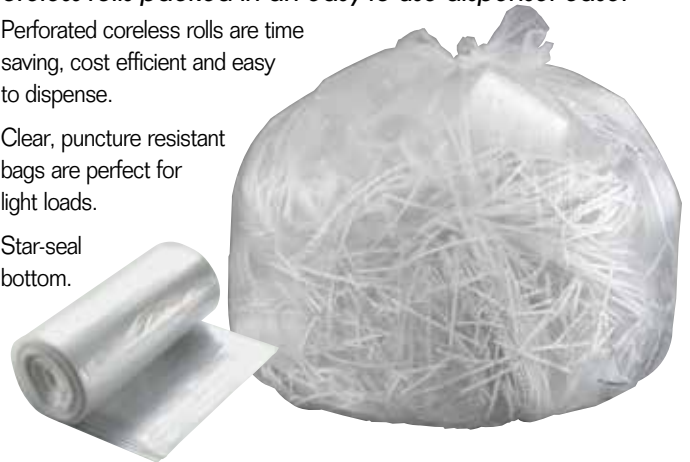

ITEM NO.	CAPACITY	SIZE	GAUGE	TOTAL BAGS	PER CASE
7500 4857	10-Gallon	23" x 33"	.05 Microns	1,000	\$35.95
7500 4862	20-Gallon	30" x 36"	.13 Microns	250	37.95
7500 4860	20-Gallon	30" x 36"	.8 Microns	500	36.95
7500 4869	32-Gallon	33" x 39"	.15 Microns	250	34.95
7500 4867	32-Gallon	33" x 39"	.13 Microns	250	29.95
7500 4884	40-45-Gallon	40" x 46"	.15 Microns	250	46.95
7500 4874	55-Gallon	38" x 57"	.20 Microns	150	45.95
7500 4872	55-Gallon	38" x 57"	.13 Microns	200	38.95
7500 4889	56-Gallon	42" x 47"	.15 Microns	200	39.95

Visit our website to find more TRASH LINERS:

www.bunzlkochsupplies.com

Material Handling



Imprinted Bronco™ Containers

Imprinted for clarity and easy identification.

- Each style is Hot Stamp imprinted with black 2" lettering.
- All drums are imprinted on 2 sides, in Spanish and English.
- BPA free. • NSF Std. 2 approved for food contact & cleanliness.

20-Gallon drums

ITEM NO.	COLOR	PRODUCT	EACH	
			1-5	6+
6387 13281	Gray	INEDIBLE imprint	\$26.95	\$25.95
6387 13441	Yellow	CONDEMNED imprint	26.95	25.95

32-Gallon drums

ITEM NO.	COLOR	PRODUCT	EACH	
			1-5	6+
6387 13121	White	EDIBLE imprint	\$34.95	\$33.95
6387 12671	Gray	INEDIBLE imprint	34.95	33.95
6387 12661	Red	INEDIBLE imprint	34.95	33.95
6387 13081	Yellow	INEDIBLE imprint	34.95	33.95
6387 13091	Blue	TRASH imprint	34.95	33.95
6387 12691	Gray	TRASH imprint	34.95	33.95
6387 13071	Red	CONDEMNED imprint	34.95	33.95
6387 12681	Yellow	CONDEMNED imprint	34.95	33.95

44-Gallon drums

ITEM NO.	COLOR	PRODUCT	EACH	
			1-3	4+
6387 13131	White	EDIBLE imprint	\$34.95	\$33.95
6387 13231	Gray	INEDIBLE imprint	34.95	33.95
6387 13271	Red	INEDIBLE imprint	34.95	33.95
6387 13201	Yellow	INEDIBLE imprint	34.95	33.95
6387 13211	Blue	TRASH imprint	34.95	33.95
6387 13221	Gray	TRASH imprint	34.95	33.95
6387 13241	Yellow	TRASH imprint	34.95	33.95
6387 13261	Yellow	CONDEMNED imprint	34.95	33.95

20-Gallon Lid

ITEM NO.	COLOR	PRODUCT	EACH	
			1-5	6+
6387 34361	Gray	Lid	\$7.95	\$6.95

32-Gallon Lids

ITEM NO.	COLOR	PRODUCT	EACH	
			1-5	6+
6387 32491	Blue	Lid	\$10.95	\$9.95
6387 32501	Gray	Lid	10.95	9.95
6387 32471	Red	Lid	10.95	9.95
6387 32461	Yellow	Lid	10.95	9.95
6387 32451	White	Lid	10.95	9.95

44-Gallon Lids

ITEM NO.	COLOR	PRODUCT	EACH	
			1-5	6+
6387 34361	Blue	Lid	\$18.95	\$17.95
6387 32851	Gray	Lid	18.95	17.95
6387 32821	Red	Lid	18.95	17.95
6387 32811	Yellow	Lid	18.95	17.95
6387 32801	White	Lid	18.95	17.95



Custom Imprinted containers available by special order. Call for details.



Square Brute® Food-Approved Drums

All the features of our round brutes, plus space efficient square brutes provide 14% more capacity.

Square Drums

ITEM NO.	PRODUCT	EACH	
		1-5	6+
1770 89541	28-gal. White	\$54.95	\$53.95
1770 08261	28-gal. Gray	54.95	53.95

ITEM NO.	PRODUCT	EACH	
		1-3	4+
1770 89501	40-gal. White	\$79.95	\$78.95
1770 09161	40-gal. Gray	79.95	78.95

Square Flat Lid

ITEM NO.	PRODUCT	EACH	
		1-5	6+
1770 89561	28-gal. White	\$19.95	\$18.95
1770 89551	28-gal. Gray	19.95	18.95

ITEM NO.	PRODUCT	EACH	
		1-3	4+
1770 35391	40-gal. White	\$24.95	\$23.95
1770 79801	40-gal. Gray	24.95	23.95

Square Twist-On Dolly

- Dolly height: 6-1/4".
- Square twist-on dolly fits both the 28- and 40-gallon square brutes.
- May be permanently attached to drum.



ITEM NO.	PRODUCT	EACH	
		1	2+
1770 01201	Twist-On Dolly	\$89.95	\$88.95

ITEM NO.	PRODUCT	EACH
3414 5234	Replacement Casters	\$9.95



23-1/2" Sq.
28-3/4" H.

21-1/2" Sq.
22-1/2" H.

Round Brute® Food-Approved Drums



Pallet prices available.
Call for details.

- NSF 2 & 21 Approved.

Round Brute® Food-Approved Drums

- Proprietary design constructed with the highest quality material plus a UV inhibitor ensures long life in even the most extreme commercial environments.
- Optional tight-fitting lids allow drums to be stacked when full.
- Easy-to-clean, seamless molded plastic.
- Anti-jam nesting when drums are not in use saves valuable storage space. ➤ 6 per case.

Dome Lid

- For use on 44 & 55 gallon round brute drums.
- Hinged door swings shut automatically to trap odors.
- Color: red or gray.



ITEM NO.	PRODUCT	EACH	
		1-5	6+
1770 7750	44-gal. Red	\$129.95	
1770 4788	Gray	129.95	
1770 0008	55-gal. Red	149.95	
1770 4790	Gray	149.95	



➤ 6 per case.

ITEM NO.	PRODUCT	EACH	
		1-5	6+
1770 79871	32-gal. Gray	\$54.95	\$53.95

Self Draining Lid



➤ 6 per case.

ITEM NO.	PRODUCT	EACH	
		1-5	6+
1770 26171	20-gal. Black	\$7.95	\$6.95
1770 97311	Blue	7.95	6.95
1770 26671	Dark Green	7.95	6.95
1770 26191	Gray	7.95	6.95
1770 26661	Red	7.95	6.95
1770 26251	Yellow	7.95	6.95
1770 26241	White	7.95	6.95

➤ 6 per case.

ITEM NO.	PRODUCT	EACH	
		1-5	6+
1770 75321	32-gal. Black	\$10.95	\$9.95
1770 77111	Blue	10.95	9.95
1770 26541	Dark Green	10.95	9.95
1770 77141	Gray	10.95	9.95
1770 77151	Red	10.95	9.95
1770 77181	Yellow	10.95	9.95
1770 77161	White	10.95	9.95

➤ 4 per case.

ITEM NO.	PRODUCT	EACH	
		1-3	4+
1770 26601	44-gal. Black	\$18.95	\$17.95
1770 96361	Blue	18.95	17.95
1770 26681	Dark Green	18.95	17.95
1770 08611	Gray	18.95	17.95
1770 77471	Red	18.95	17.95
1770 26631	Yellow	18.95	17.95
1770 26621	White	18.95	17.95

Round Flat Lid



➤ 6 per case.

ITEM NO.	PRODUCT	EACH	
		1-5	6+
1770 68261	10-gal. Black	\$6.95	\$5.95
1770 96981	Blue	6.95	5.95
1770 76751	Dark Green	6.95	5.95
1770 76741	Gray	6.95	5.95
1770 76721	Red	6.95	5.95
1770 76731	Yellow	6.95	5.95
1770 76761	White	6.95	5.95

➤ 3 per case.

ITEM NO.	PRODUCT	EACH	
		1-2	3+
1770 97381	55-gal. Black	\$24.95	\$23.95
1770 97331	Blue	24.95	23.95
1770 77631	Dark Green	24.95	23.95
1770 77601	Gray	24.95	23.95
1770 77611	Red	24.95	23.95
1770 77661	Yellow	24.95	23.95
1770 77651	White	24.95	23.95

ITEM NO.	PRODUCT	EACH	
		1-5	6+
1770 21391	10-gal. Black	\$16.95	\$15.95
1770 21561	Blue	16.95	15.95
1770 21551	Dark Green	16.95	15.95
1770 21051	Gray	16.95	15.95
1770 21651	Red	16.95	15.95
1770 24641	Yellow	16.95	15.95
1770 21091	White	16.95	15.95

ITEM NO.	PRODUCT	EACH	
		1-5	6+
1770 24681	20-gal. Black	24.95	23.95
1770 21021	Blue	24.95	23.95
1770 24691	Dark Green	24.95	23.95
1770 21041	Gray	24.95	23.95
1770 21701	Red	24.95	23.95
1770 20901	Yellow	24.95	23.95
1770 21031	White	24.95	23.95

➤ 6 per case.

ITEM NO.	PRODUCT	EACH	
		1-5	6+
1770 24711	32-gal. Black	\$31.95	\$30.95
1770 71041	Blue	31.95	30.95
1770 24731	Dark Green	31.95	30.95
1770 71011	Gray	31.95	30.95
1770 71291	Orange	31.95	30.95
1770 71031	Red	31.95	30.95
1770 71021	Yellow	31.95	30.95
1770 71001	White	31.95	30.95

➤ 4 per case.

ITEM NO.	PRODUCT	EACH	
		1-3	4+
1770 24741	44-gal. Black	\$47.95	\$46.95
1770 71091	Blue	47.95	46.95
1770 24751	Dark Green	41.95	46.95
1770 43881	Gray	47.95	46.95
1770 71081	Red	47.95	46.95
1770 71071	Yellow	47.95	46.95
1770 71051	White	47.95	46.95

➤ 3 per case.

ITEM NO.	PRODUCT	EACH	
		1-2	3+
1770 24761	55-gal. Black	\$72.95	\$71.95
1770 17401	Blue	72.95	71.95
1770 22801	Dark Green	72.95	71.95
1770 71101	Gray	72.95	71.95
1770 24771	Red	72.95	71.95
1770 22791	Yellow	72.95	71.95
1770 24781	White	72.95	71.95

Scales

Checkweigh Scale

Fast Stability Time — accurate reading is completed in less than one second.

- Status indication function — battery, stable, zero and net.
- High resolution, easy-to-read LCD display.
- Auto power off.
- Full digital calibration function. 9" x 7-1/2" stainless steel platform.
- Spirit level and adjustable feet for accurate weighing.
- Overall dimensions: 10-2/5" l x 9-4/5" d x 4-1/10" h.
- Weight in kilograms, decimal lb., oz. or decimal ounces.

⊗ **Batteries not included. Order six "D" batteries, item no. 7784 00025.**

➤ **AC adapter optional.**

➤ **Shipping Weight: 4.6-lbs.**



ITEM NO.	CAPACITY	RESOLUTION	EACH
3416 20121	26-lbs.	1-oz.	\$199.00
	423 oz.02-oz.	
	26-lbs.	0.01-lb.	
	12 kg.	0.005 kg.	
3416 0005	Optional Adapter		\$34.95

Stainless Steel Dial Scales

- These compact, portable dial scales were developed as a result of tests conducted in cooperation with Federal Inspectors and plant managers.
- All interior parts are nickel- and zinc-plated, housing is stainless steel.
- Two capacity ranges available: from 32-oz. x 1/8-oz., and from 5-lbs. x 1/2-oz.
- Removable 7-1/2" x 7-1/2" stainless steel platform cover snaps on and off for easy cleaning.

What's a Dashpot?
A stabilizing dial mechanism that eliminates time consuming indicator needle bounce and provides instant readings.

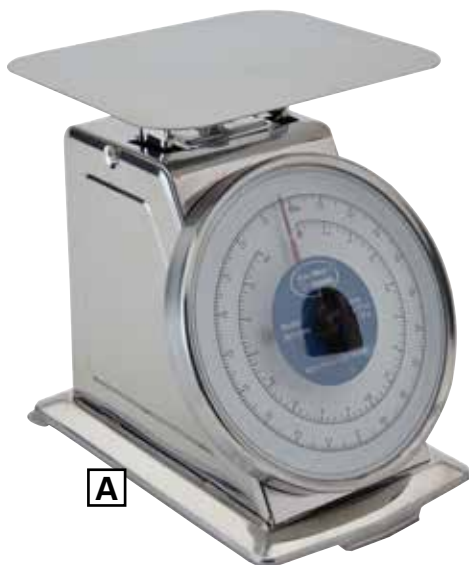

Not legal for trade.

➤ **Dimensions: 10-1/2" l x 7-1/2" w x 10-1/2" h.**

Stainless Steel Kitchen Dial Scale

- Stainless steel housing with corrosion-resistant components.
- Removable stainless steel platform.
- Easy-to-read 30° tilted dial is constructed of shatterproof plastic.
- Zero setting mechanism with fine point indicator for easy taring.

ITEM NO.	CAPACITY	EACH
4893 20031	4-lb. x 1/2-oz.	\$69.00

Universal Dial Scales

- Accuracy is enhanced by temperature compensation and fine-tooth rack and pinion assembly.
- Strong under-platform construction with two supports and two spring mechanisms.
- Replacement plexiglass face plate available separately.

ITEM NO.	CAPACITY	EACH
4893 00281	32-oz. x 1/8-oz. w/o Dashpot . . .	\$159.00
4893 20051	5-lb. x 1/2-oz. w/o Dashpot	159.00
4893 10281	32-oz. x 1/8-oz. with Dashpot . . .	199.00
4893 00431	Replacement Face Plate	16.95

Portion Control Scales

- Patented rotating dial with three over/under tolerance zones.
- Easy-to-read "target" zones of acceptable weight.
- Dashpot included.
- Replacement plexiglass face plate and ring available separately.

ITEM NO.	PRODUCT	EACH
4893 10021	32-oz. x 1/8-oz. w/ Dashpot . . .	\$249.00
4893 10051	5-lb. x 1/2-oz. w/ Dashpot	249.00
4893 00451	Replacement Ring	19.95
4893 00431	Replacement Face Plate	16.95

Stainless Steel Washdown Safe Scale

Washdown when powered by batteries.

- Weighs in grams, pounds or ounces.
- Easy-to-read 1/3000 resolution LCD display.
- 6-4/5" x 5-2/5" stainless steel platform.
- Stability indicator and adjustable legs keep scale level.
- Auto power off. • Tare function.
- Battery operated; AC adapter optional.
- Overall dimensions: 6-4/5"l x 8-7/10"d x 2-1/2"h.



• **Legal for trade.**

➤ **Shipping Weight: 2-lbs.**

⊗ **Batteries not included.**

Order six "AA" batteries, item no. 7784 00035.

ITEM NO.	CAPACITY	RESOLUTION	CAPACITY	RESOLUTION	EACH
3416 3000	6.6-lbs.	.002-lb.	3000g	1g	\$369.00
3416 0005	Optional AC Adapter				34.95

Stainless Steel Washdown Scale

Washdown when powered by batteries.

- Removable 9" x 7-1/2" platform for easy washdown.
- Digital LCD readout displays 1" numerals and also features auto shutoff and push button tare, zero reset and low battery indicator.
- Class III rated.



• **Scales weigh in lb/decimal lb and g/kg.**

⊗ **Batteries not included.**

Order six "D" batteries, item no. 7784 00025;

⊗ **Adapter not included.**

➤ **Shipping Weight: 8-lbs.**

Legal for trade.

ITEM NO.	CAPACITY	RESOLUTION	CAPACITY	RESOLUTION	EACH
3416 1001	2.2-lbs.	.001-lb.	1,000g	.05g	\$399.00
3416 2002	4.4-lbs.	.002-lb.	2,000g	1g	399.00
3416 5002	11-lbs.	.005-lb.	5,000g	2g	399.00
3416 0011	22-lbs.	.01-lb.	10kg	.005kg	399.00
3416 0021	44-lbs.	.02-lb.	20kg	.01kg	399.00
3416 0005	Optional AC Adapter				34.95

NOT Legal for trade.

ITEM NO.	CAPACITY	RESOLUTION	CAPACITY	RES.	EACH
3416 9200	4-lb. 6-oz.	1/6-oz., 0.1-oz., 0.002-lb.	2,000g	1g	\$399.00
3416 5004	11-lbs.	1/8-oz., 0.1-oz., 0.005-lb.	5,000g	2g	399.00
3416 0024	44-lbs.	1-oz., 0.02-lb.	20kg	0.01kg	399.00
3416 0005	Optional Adapter				34.95



• **Weight in lbs, grams, ounces and lb/oz.**

⊗ **Batteries not included and optional. Order two "AA" batteries, item no. 7784 00035.**

➤ **Shipping Weight: 6-lbs.**

Advanced Solar Powered Portion Control Stainless Steel Scale

A cost-effective solution for restaurants, kitchens, delis, and bakeries.

- Solar powered operation (more than 300 Lx) or two optional AA batteries.
- Long battery life (10,000 hours).
- 6.7" w x 6.3" d stainless steel removable platform.
- Operating temperature: 32°F ~ 104°F (0°C ~ 40°C).
- Over/under function. • Adjustable auto shut-off. • Large, easy-to-read LCD display.
- Liquid crystal display: 5 digits plus annunciators.
- Initial, automatic and semi-automatic zero setting mechanisms.

Dual Range Scale	
Low Range	High Range
0 to 2.2-lb x 0.002-lb	2.2 to 4.4-lb x 0.005-lb
0 to 2-lb 3-oz x 0.05-oz	2-lb 3-oz to 4-lb 6-oz x 0.1-oz
0 to 35-oz x 0.05-oz	35 to 70-oz x 0.1-oz
0 to 1000-g x 1-g	1000 to 2000-g x 2-g

ITEM NO.	PRODUCT	EACH
4893 67061	Solar Powered Portion Control Scale	\$219.95

Thermometers

Stainless Steel Bi-Metal Pocket Dial Thermometers

- 1" dial thermometer comes with plastic sheath with clip.
- External easy recalibration.
- All stainless steel external parts.
- Shatter-resistant plastic lens.
- Accuracy $\pm 1^\circ$ F at calibration point.
- NSF approved.



1" dial includes probe sheath and pocket clip. Calibration tool included on sheath.

ITEM NO.	PRODUCT	TEMP RANGE	EACH	
			1 - 5	6+
3542 92221	1" Dial Diameter, 5" Skewer	0° to +220° F	\$7.95	\$6.95
3542 9621	1" Dial Diameter, 5" Skewer	-40° to +160° F	7.95	6.95
3327 0044	1-3/8" Dial Diameter, 5" Skewer	0° to +220° F	16.95	15.95
3327 0225	2" Dial Diameter, 5" Skewer	0° to +220° F	17.95	16.95
3327 1225	2" Dial Diameter, 8" Skewer	0° to +220° F	17.95	16.95



HACCP Approved Dial Pocket Thermometer

3-Point Calibration. Rustproof—dustproof—leakproof.

Hermetically sealed.

- Lexan® lens.
- High-visibility dial graphics.
- Ranges: 0° to 220° F; -40° to 160° F.
- PT-50R to within $\pm 1/2^\circ$.



Plastic sheath with clip included.

ITEM NO.	PRODUCT	EACH
3327 1050	0° to +220° F	\$16.95
3327 0050	-40° to +160° F	16.95

ITEM NO.	PRODUCT	EACH
3327 2401	Pan Clip	\$2.95



Pan Clip

Dual Scale Pocket Thermometer



Plastic sheath with clip included.

- Plastic watertight lens.
- Stainless 5" stem, 1-3/4" dial
- 3-pt. calibratable.
- External calibration nut.

ITEM NO.	PRODUCT	TEMP RANGE	EACH
3327 3606	0°F to +220°F / 18°C to +105°C		\$18.95

2" Cooking Thermometer



- Stainless steel bi-metal thermometer has a heavy-duty 5" stem.
- Easy-to-read dial lists the "wellness" of meat (i.e. rare, medium and well-done).
- Hermetically sealed with heat compensated bezel.
- Designed with glass lens to withstand oven temperatures.

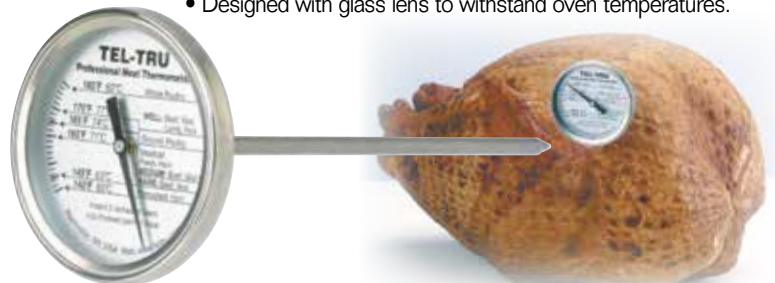

ITEM NO.	PRODUCT	TEMP RANGE	EACH
3327 02751	2" dial	140°F to 180° F	\$27.95

Hot Water Thermometer

- Protective 15" long hardwood frame surrounds glass tube thermometer.
- Accurate to $\pm 2^\circ$.



ITEM NO.	PRODUCT	TEMP RANGE	EACH
3849 03591	Hot Water Thermometer	10° F to 220° F	\$34.95

BIG RED® Pocket Thermometer

Designed with a heavy-duty probe.

- Range: -58° F to +302° F/-50° C to +150° C. Accurate to ±2° F.
- .1° F/C resolution.
- 1/4" large readout LCD display.
- Continuous update.
- 4-3/4" extra sturdy stainless steel probe.
- Flat edge design won't roll-off counters.
- Pocket clip sheath for stem protection.

☛ Battery included. Replacement batteries available. Order 3508 0800.



ITEM NO.	PRODUCT	EACH	
		1-5	6+
E542 70021	Pocket Thermometer	\$14.95	\$12.95

BIG RED® Water-Resistant Digital Thermometers

Choose from two styles: pocket or heavy-duty T-handle.

- Range: -58° F to + 536° F/-50° C to +280° C. Accurate to ±2° F.
- Large 5/16" digital readout in either F° or C°.
- .1° F/C resolution.
- Max./Min. memory button.
- Resistant to water and liquids.
- Five minute auto-off.
- Pocket style thermometer (A) has 4-1/4" stainless steel stem and includes clip sheath for stem protection.
- T-Handle style thermometer (B) has 4-1/2" stainless steel probe for use with firm or semi-firm product. Includes pocket clip sheath.

☛ Battery included. Replacement batteries available.



A



In-line overall dimension: 7.5" x 1"

Both therms include a pocket clip sheath for stem protection.

B

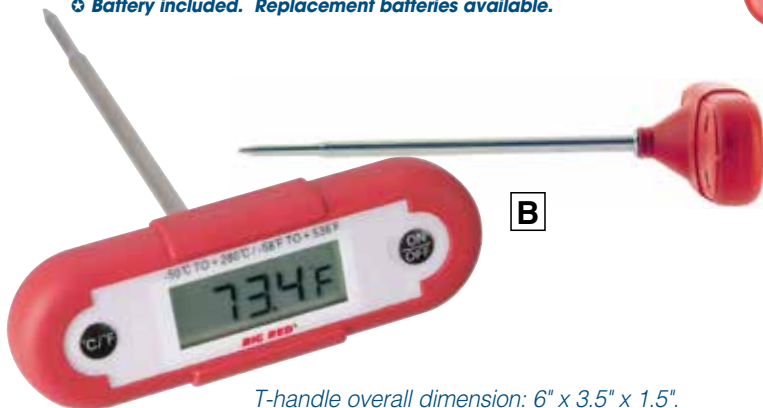

T-handle overall dimension: 6" x 3.5" x 1.5".

ITEM NO.	PRODUCT	EACH	
		1 - 5	6+
E542 70011	A. Pocket Thermometer	\$26.95	\$24.95
E542 59091	B. T-Handle Thermometer	26.95	24.95

Waterproof Digital Lollipop Thermometer

Totally submersible unit can be used as a food or dishwasher holding thermometer.

- IP65 Waterproof housing – completely submersible.
- Automatic calibration feature.
- Range: -58° to 392° F/-50° to 200° C.
- Min/Max memory stores lowest/highest readings.
- °C/°F switchable.
- Resolution: .1° between -20° to 200° C or F.
- Includes probe cover with large pocket clip and hanging loop.

IP65 Waterproof housing.

Includes probe cover with pocket clip and hanging loop.

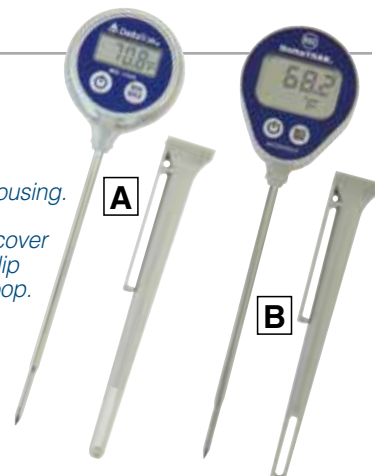

A

B

ITEM NO.	PRODUCT	EACH	
		1 - 11	12+
4599 10401	A. Waterproof Lollipop Therm model 11040	\$14.95	\$13.95
4599 10501	B. Waterproof Lollipop Therm model 11050	21.95	20.95

☛ 1.5v LR44 battery included. Replacement batteries sold separately. Item #3508 0800.



Completely submersible.

Pro-Survivor Water-Resistant Stopwatch



- Stopwatch is designed with no-fail switches and is water-resistant.
- 24-hour range is displayed in 6 digits, so resolution goes from 1/100 second to 1 second after 30 minutes.
- Cumulative split function along with time, month, second and day of the week.
- Neck strap included.
- Water-resistant up to 160 feet.



• Available in 5 colors.
 ☛ Replacement battery sold separately. Item No. 3508 0800.

➤ 6 per case.

ITEM NO.	PRODUCT	EACH	
		1-5	6+
3244 46011	Blue	\$19.95	\$18.95
3244 36011	Red	19.95	18.95
3244 26011	Yellow	19.95	18.95
3244 16011	Green	19.95	18.95
3244 06011	Black	19.95	18.95

Large Digit Countdown Timer

Large LCD display is ideal for reading countdown time from a distance.

- Minutes are displayed by two 3/4" digits and seconds are displayed by two 1/2" digits.
- Magnetic back and clip with stand.
- Set-point is automatically stored in memory.
- Large push-buttons for minutes, seconds and start/stop.
- Counts up or down.

☛ Includes one "AAA" battery. Replacement battery 7784 00045.



➤ 6 per case.
EACH

ITEM NO.	PRODUCT	1-5	6+
A692 02641	Countdown Timer	\$12.95	\$11.95

Aluminum Clipboard

- Storage compartment holds thirty 3-part forms.
- Clip holds paperwork securely.

➤ 12 per case.

ITEM NO.	PRODUCT	EACH	
		1-11	12+
3845 51671	Aluminum Clipboard	\$29.95	\$28.95



Pens available in black, blue, green or red ink. Call for more details.

Handheld Solar Calculator

- Features the four basic arithmetic functions.
- Easy-to-read, eight-digit LCD display.
- Solar powered from any available light source.
- Overall size: 3" wide x 5-1/2" high x 1/4" deep.
- Comes with protective travel case.



ITEM NO.	PRODUCT	EACH	
		1-9	10+
3304 21681	Calculator	\$6.95	\$5.95

Metal Detectable Stick Pens

- Constructed from a polypropylene mix, containing a non-toxic, metal-detectable additive.
- Pen body is shatterproof and will not splinter.

➤ 50 pens per box.

ITEM NO.	PRODUCT	BOX
B639 76855	Blue body/ink WITH pocket clip	\$89.95
B639 39055	Blue body/ink WITHOUT clip	99.95



Spices & Seasonings



Basil, Ground (6-oz.)
A leafy herb from the mint family. ▶ 12 bottles per case.

ITEM NO.	PRODUCT	PER BOTTLE	
		1-11	12+
3030 51501	6-oz. Ground Basil	\$6.95	\$5.95



Oregano, Whole (2-oz.)
Similar to Marjoram, but more pungent and not as sweet. ▶ 12 bottles per case.

ITEM NO.	PRODUCT	PER BOTTLE	
		1-11	12+
3030 55201	2-oz. Oregano	\$3.95	\$2.95



Cinnamon, Ground (9-oz.)
Warm and sweet. ▶ 12 bottles per case.

ITEM NO.	PRODUCT	PER BOTTLE	
		1-11	12+
3030 64701	9-oz. Grd. Cinnamon	\$5.95	\$4.95



Paprika (9-oz.)
Use for garnish and seasoning. ▶ 12 bottles per case.

ITEM NO.	PRODUCT	PER BOTTLE	
		1-11	12+
3030 55301	9-oz. Paprika	\$6.95	\$5.95



Coriander, Ground (6-oz.)
Made from seeds of the cilantro plant. Light, lemony flavor. ▶ 12 bottles per case.

ITEM NO.	PRODUCT	PER BOTTLE	
		1-11	12+
3030 52801	6-oz. Grd. Coriander	\$5.95	\$4.95



Parsley Flakes (1-oz.)
Ideal herb for flavor and garnish. ▶ 12 bottles per case.

ITEM NO.	PRODUCT	PER BOTTLE	
		1-11	12+
3030 55401	1-oz. Parsley Flakes	\$3.95	\$2.95



Cumin, Ground (7-oz.)
Aromatic Mediterranean flavor. ▶ 12 bottles per case.

ITEM NO.	PRODUCT	PER BOTTLE	
		1-11	12+
3030 52901	7-oz. Ground Cumin	\$6.95	\$5.95



Pepper, Black Butcher Grind (7-oz.)
For coarse pepper appeal. ▶ 12 bottles per case.

ITEM NO.	PRODUCT	PER BOTTLE	
		1-11	12+
3030 56701	7-oz. Black Pepper Butcher	\$10.95	\$9.95



Curry Powder (7-oz.)
A savory taste of the East. ▶ 12 bottles per case.

ITEM NO.	PRODUCT	PER BOTTLE	
		1-11	12+
3030 62101	7-oz. Curry Powder	\$7.95	\$6.95



Pepper, Black Table Grind (8-oz.)
Our Best! Ready for the shaker. ▶ 12 bottles per case.

ITEM NO.	PRODUCT	PER BOTTLE	
		1-11	12+
3030 50201	8-oz. Black Pepper Table . . .	\$10.95	\$9.95



Dill Weed, Whole (2-oz.)
Lemony, pine herb. ▶ 12 bottles per case.

ITEM NO.	PRODUCT	PER BOTTLE	
		1-11	12+
3030 53201	2-oz. Dill Weed	\$4.95	\$3.95



Pepper, White Ground (9-oz.)
Tastes similar to black pepper, but less pungent. ▶ 12 bottles per case.

ITEM NO.	PRODUCT	PER BOTTLE	
		1-11	12+
3030 60301	9-oz. White Pepper	\$14.95	\$13.95



Garlic & Pepper (14-oz.)
Use to flavor any types of meat. ▶ 12 bottles per case.

ITEM NO.	PRODUCT	PER BOTTLE	
		1-11	12+
3030 51001	14-oz. Garlic & Pepper . . .	\$9.95	\$8.95



Rosemary, Whole (3-oz.)
Use to flavor meats & sauces. ▶ 12 bottles per case.

ITEM NO.	PRODUCT	PER BOTTLE	
		1-11	12+
3030 60801	3-oz. Rosemary	\$4.95	\$3.95



Garlic, Herb & Dried Tomato w/Cilantro (10-oz.)
Top quality flavor, easy application. ▶ 12 bottles per case.

ITEM NO.	PRODUCT	PER BOTTLE	
		1-11	12+
3030 80021	10-oz. Garlic & Tomato . . .	\$6.95	\$5.95



Sage, Rubbed Dalmation (3-oz.)
Dalmation Sage is simply, "The Best!" ▶ 12 bottles per case.

ITEM NO.	PRODUCT	PER BOTTLE	
		1-11	12+
3030 50101	3-oz. Dalmation Sage . . .	\$4.95	\$3.95



Garlic Powder (9-oz.)
Top quality flavor, easy application. ▶ 12 bottles per case.

ITEM NO.	PRODUCT	PER BOTTLE	
		1-11	12+
3030 53801	9-oz. Garlic Powder . . .	\$7.95	\$6.95



Sea Salt (47-oz.)
Perfect for adding flavor to beef, seafood, poultry and vegetables. ▶ 12 bottles per case.

ITEM NO.	PRODUCT	PER BOTTLE	
		1-10	11+
3030 60011	20-oz. Sea Salt	\$5.95	\$4.95



Italian Seasoning (5-oz.)
Spice blend for Italian dishes. ▶ 12 bottles per case.

ITEM NO.	PRODUCT	PER BOTTLE	
		1-11	12+
3030 62301	5-oz. Italian Seasoning . . .	\$6.95	\$5.95

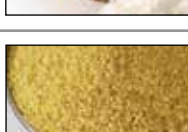

Seasoned Salt (14-oz.)
Better than the "Restaurant" blends. ▶ 12 bottles per case.

ITEM NO.	PRODUCT	PER BOTTLE	
		1-11	12+
3030 50301	14-oz. Seasoned Salt . . .	\$5.95	\$4.95



Onion, Minced (8-oz.)
Conveniently minced for dozens of applications. ▶ 12 bottles per case.

ITEM NO.	PRODUCT	PER BOTTLE	
		1-11	12+
3030 54801	8-oz. Minced Onion . . .	\$5.95	\$4.95



Sundried Tomato Bits (6-oz.)
Classic tomato flavor, great eye appeal. ▶ 12 bottles per case.

ITEM NO.	PRODUCT	PER BOTTLE	
		1-11	12+
3030 61301	6-oz. Tomato Bits	\$8.95	\$7.95



Onion Powder (10-oz.)
Grinded, dehydrated onion. ▶ 12 bottles per case.

ITEM NO.	PRODUCT	PER BOTTLE	
		1-11	12+
3030 54901	10-oz. Onion Powder . . .	\$6.95	\$5.95



Thyme (7-oz.)
Mildly pungent flavors and, highly aromatic. ▶ 12 bottles per case.

ITEM NO.	PRODUCT	PER BOTTLE	
		1-11	12+
3030 79001	7-oz. Thyme	\$8.95	\$7.95

Tapered Paring Knife



> 12 per box.
EACH

ITEM NO.	PRODUCT	MFR. NO.	1-11	12+
5816 01301	3-1/8" Paring	P94843	\$5.33	\$3.55

Vegetable Produce Sani-Safe® Knives



> 12 per box.
EACH

ITEM NO.	PRODUCT	MFR. NO.	1-11	12+
5816 01851	5" Produce	S185	\$14.67	\$9.78

> 6 per box.
EACH

ITEM NO.	PRODUCT	MFR. NO.	1-5	6+
5816 11861	6" Veg/Produce	S186	\$15.60	\$10.40

3-1/4" Sani-Safe® Paring Knife



> 12 per box.
EACH

ITEM NO.	PRODUCT	MFR. NO.	1-11	12+
5816 53031	3-1/4" Paring	S104	\$6.18	\$4.12

3-1/2" Vegetable Knife



> 12 per box.
EACH

ITEM NO.	PRODUCT	MFR. NO.	1-11	12+
5816 0145	3-1/2" Vegetable	S151	\$11.85	\$7.91

Sani-Safe® Bread Slicer



> 6 per box.
EACH

ITEM NO.	PRODUCT	MFR. NO.	1-5	6+
5816 81731	10" Scalloped Edge Slicer	S147-10SC	\$24.52	\$16.35

Trim Ergonomic Knife

- Stain-free, high-carbon steel hollow-ground blade.
- Textured safety orange polypropylene handle with finger guard.



> 12 per box.
EACH

ITEM NO.	PRODUCT	MFR. NO.	1-11	12+
5816 11831	2-1/2" blade	EP151HG	\$10.92	\$6.65

Slicer Knives



> 6 per box.
EACH

ITEM NO.	PRODUCT	MFR. NO.	1-5	6+
5816 01651	10" Scalloped	P94804	\$15.06	\$10.04
5816 16051	12" Scalloped	P94805	16.84	11.22

Cheese Knife



> 6 per box.
EACH

ITEM NO.	PRODUCT	MFR. NO.	1-5	6+
5816 03011	12" Cheese Knife	S11812	\$46.35	\$30.09



14" Sani-Safe® Dual-Handled Knife

- Sani-Safe® handle withstands high and low temperatures.



> 6 per box.
EACH

ITEM NO.	PRODUCT	MFR. NO.	1-5	6+
5816 0051	14" Dual-Handled Knife	09223	\$71.07	\$47.38



VICTORINOX
SWISS ARMY
FACTORY AUTHORIZED DISTRIBUTOR

Fibrox™ Handle Knives

- Premium Stainless Steel Blade
- Non-Slip Plastic Fibrox™ Handle
- Safety Guard

Curved Paring Knife

- Polypropylene handle. • High carbon stainless steel.



> 6 per box.
EACH

ITEM NO.	PRODUCT	MFR. NO.	1-5	6+
3367 06061	2-1/4" Curved Paring	40606. . . .	\$6.38	\$4.68



Wavy edge.

Bread Knives



> 6 per box.
EACH

ITEM NO.	PRODUCT	HANDLE COLOR	MFR. NO.	1-5	6+
3367 05491	8" Wavy	black	40549	\$28.35	\$20.79
3367 0547	10-1/4" Wavy	black	40547	38.25	28.05
3367 04531	10-1/4" Wavy	blue	40453	38.25	28.05
3367 04831	10-1/4" Wavy	green	40483	38.25	28.05

Paring Knives • Polypropylene handle.



> 12 per box.
EACH

ITEM NO.	PRODUCT	BLADE	MFR. NO.	1-11	12+
3367 40601	A. 3-1/4" Small Red Handle. Wavy.	40603. . . .	\$5.25	\$3.85	
3367 61151	3-1/4" Small Pink Handle. Straight.	6.7606.L115.	5.25	3.85	
3367 06001	B. 3-1/4" Small Handle.	40600. . . .	5.25	3.85	
3367 05081	3-1/4" Long Handle	40508. . . .	6.38	4.68	
3367 40501	4" Utility	40501. . . .	6.38	4.68	
3367 06021	C. 3-1/4" Small Handle	40602. . . .	5.25	3.85	
3367 05091	3-1/4" Long Handle	40509. . . .	6.38	4.68	



Chef Knives

> 6 per box.
EACH

ITEM NO.	PRODUCT	HANDLE COLOR	MFR. NO.	1-5	6+
3367 04211	8" Chef, straight slicer	red	40421. . . .	\$37.87	\$27.77
3367 04511	8" Chef, straight slicer	blue	40451. . . .	37.87	27.77
3367 04711	8" Chef, straight slicer	yellow	40471. . . .	37.87	27.77
3367 04241	10" Chef, straight slicer	red	40424. . . .	42.00	30.80
3367 04541	10" Chef, straight slicer	blue	40454. . . .	42.00	30.80
3367 04741	10" Chef, straight slicer	yellow	40474. . . .	42.00	30.80
3367 40511	10" Chef, straight slicer	black	40521. . . .	40.40	30.83
3367 15221	12" Chef, straight slicer	black	40522. . . .	53.70	38.38

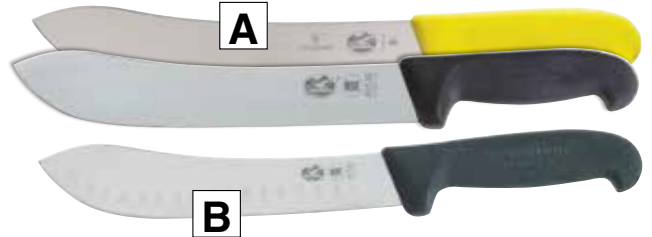

Butcher Knives

> 6 per box.
EACH

ITEM NO.	PRODUCT	MFR. NO.	1-5	6+
3367 06351	A. 7"	40635. . . .	\$34.50	\$25.30
3367 00421	10"	40530	44.10	32.34
3367 04721	10" yellow handle	40472	44.10	32.34
3367 05311	12"	40531	53.70	39.38
3367 05331	B. 8" Granton Edge	40533	58.50	42.90
3367 06381	10" Granton Edge	40638	65.83	50.22
3367 40671	12" Granton Edge	40636	82.88	60.78



Curved Boning Knives

> 6 per box.
EACH

ITEM NO.	PRODUCT	HANDLE COLOR	MFR. NO.	1-5	6+
3367 05141	A. 5" Curved Semi-Stiff	black	40514	\$21.00	\$15.55
3367 00051	5" Curved Flex	black	40516	21.00	15.55
3367 00141	6" Curved Semi-Stiff	black	40515	22.05	16.19
3367 04201	6" Curved Semi-Stiff	red	40420	22.05	16.19
3367 04701	6" Curved Semi-Stiff	yellow	40470	22.05	16.19
3367 0450	6" Curved Semi-Stiff	blue	40450	22.05	16.19
3367 94151	6" Curved Flex	black	40517	21.75	15.96
3367 01681	6" Curved Flex	yellow	43517	21.75	15.96
3367 26101	B. 6" Curved, Granton Edge	black	42610	27.75	20.36

Granton® Edge Knives

Premium Stainless Steel Blade • Non-Slip Plastic Handle • Safety Guard



Granton® Handles are double-tapered and ergonomically angled. For added comfort, the thumb platform is contoured and the blade back is rounded.



Developed by Granton® over 50 years ago, the Granton® Edge is a superb razor sharp cutting edge that can be re-sharpened on a steel in the usual way.

Granton® Edge

Patented ground scallops are the secret to the Granton® advantage.

Granton® Edge knives use an innovative fluted edge that creates air cushions which allow for very smooth, fast cutting. Granton® blades are made from fully hardened and tempered Sheffield stainless steel.

Boning Knives



> 6 per box.
EACH

ITEM NO.	PRODUCT	MFR. NO.	1-5	6+
3288 65151	5"	26515ER	\$18.54	\$17.30
3288 45501	6" Rigid	24550ER	21.10	19.68
3288 45181	6" Broad Curved	24518ER	19.26	17.98

Cooks Knives



> 6 per box.
EACH

ITEM NO.	PRODUCT	MFR. NO.	1-5	6+
3288 76581	8.5" Cooks	27658ER	\$30.29	\$28.27
3288 76501	10" Cooks	27650ER	35.62	33.24

Counter Knives



> 6 per box.
EACH

ITEM NO.	PRODUCT	MFR. NO.	1-5	6+
3288 41101	8" Counter	24110ER	\$18.54	\$17.30
3288 41401	10" Counter	24140ER	24.12	22.51

Butcher Knives



> 6 per box.
EACH

ITEM NO.	PRODUCT	MFR. NO.	1-5	6+
3288 46081	8" Butcher	24608ER	\$31.75	\$29.63
3288 46001	10" Butcher	24600ER	36.95	34.48

Plain Edge Knives



> 6 per box.

ITEM NO.	PRODUCT	MFR. NO.	EACH	
			1-5	6+
3288 75151	Red Handle, 5" Curved	47515ER	\$13.50	\$12.60
3288 75091	5" Straight	47509ER	13.50	12.60
3288 75161	6" Curved	47516ER	13.50	12.60
3288 75101	6" Straight	47510ER	13.50	12.60
3288 75211	6" Narrow	47521ER	13.50	12.60
3288 05151	Blue Handle, 5" Curved	47515EB	13.50	12.60
3288 05091	5" Straight	47509EB	13.50	12.60
3288 05161	6" Curved	47516EB	13.50	12.60
3288 05101	6" Straight	47510EB	13.50	12.60
3288 05211	6" Narrow	47521EB	13.50	12.60
3288 35151	Yellow Handle, 5" Curved	47515EY	13.50	12.60
3288 35091	5" Straight	47509EY	13.50	12.60
3288 35161	6" Curved	47516EY	13.50	12.60
3288 35101	6" Straight	47510EY	13.50	12.60
3288 35211	6" Narrow	47521EY	13.50	12.60
3288 55151	Green Handle, 5" Curved	47515EG	13.50	12.60
3288 55091	5" Straight	47509EG	13.50	12.60
3288 55161	6" Curved	47516EG	13.50	12.60
3288 55101	6" Straight	47510EG	13.50	12.60
3288 00051	6" Narrow	47521EG	13.50	12.60

- Color-Coded Handles
- Premium Stainless Steel Blade
- Hygienic Polypropylene Co-Polymer Handle
- Safety Guard



Handles available in four colors.





Titanium Bonded[®] Knives with antimicrobial[™] Ergonomic Handles

- Titanium Bonded[®] blades make these knives 3 times harder than stainless steel.
- Ergonomic, non-slip grip handles contain an antimicrobial agent to inhibit the growth of bacterial stains and odors.
- Oversized backbone for strength and durability.
- Precision ground blades.
- Corrosion-resistant.

2.5" Curved Paring Knife



> 3 per box.
EACH

ITEM NO.	PRODUCT	MFR. NO.	1-2	3+
2644 84141	2.5" Curved Paring	18414	\$6.95	\$5.95

2.5" Straight Paring Knife



> 3 per box.
EACH

ITEM NO.	PRODUCT	MFR. NO.	1-2	3+
2644 84281	2.5" Straight Paring	18428	\$6.95	\$5.95

6.5" Slicing Knife



> 3 per box.
EACH

ITEM NO.	PRODUCT	MFR. NO.	1-2	3+
2644 84161	6.5" Slicing	18416	\$12.95	\$11.95

6", 8" & 10" Chef Knives



> 3 per box.
EACH

ITEM NO.	PRODUCT	MFR. NO.	1-2	3+
2644 84121	6" Chef	18412	\$14.95	\$13.95
2644 87461	8" Chef	18746	15.95	14.95
2644 84521	10" Chef	18452	18.95	17.95

9" Serrated Utility Knife



> 3 per box.
EACH

ITEM NO.	PRODUCT	MFR. NO.	1-2	3+
2644 87471	9" Serrated Utility	18747	\$13.95	\$12.95

9" Serrated Slicing Knife



> 3 per box.
EACH

ITEM NO.	PRODUCT	MFR. NO.	1-2	3+
2644 84111	9" Serrated Slicer	18411	\$14.95	\$13.95

5" & 7" Santoku Knives



> 3 per box.
EACH

ITEM NO.	PRODUCT	MFR. NO.	1-2	3+
2644 87441	5" Santoku	18744	\$10.95	\$9.95
2644 87451	7" Santoku	18745	12.95	11.95

9" Offset Serrated Knife



> 3 per box.
EACH

ITEM NO.	PRODUCT	MFR. NO.	1-2	3+
2644 87481	9" Offset	18748	\$14.95	\$13.95

Cutlery

10" High Carbon Steel

- Polished/Smooth cut.
- Heavy-duty hang ring.
- Green poly handle with guard.



> 6 per box.
EACH

ITEM NO.	PRODUCT	MFR. NO.	1-5	6+
5816 73131	10" Polished	.07313	\$24.95	\$23.95

Sharpening Steels

- Available in regular, fine or polished cut.
- Molded plastic handle with guard and chain ring.



> 6 per box.
EACH

ITEM NO.	PRODUCT	MFR. NO.	HANDLE COLOR	1-5	6+
3367 06871	9" Regular Cut	40687	Black	\$18.95	\$17.95
3367 05801	10" Regular Cut	40580	Black	26.95	25.95
3367 05811	10" Fine Cut	40581	Black	26.95	25.95
3367 06831	10" Polished Cut	40683	Orange	26.95	25.95
3367 05861	14" Regular Cut	40586	Black	30.95	29.95

10" polished cut steel available with orange handle.



Handheld Sharpener

- Two or three passes on the blade is sufficient to sharpen blade.
- Large handle easily fits either hand and its full length guard protects fingers.
- Carbide blade will not rust; clean with soap and water.



> 6 per box.

ITEM NO.	PRODUCT	1-5	6+
4808 75201	Knife/Scissor Sharpener	\$10.95	\$9.95

ExtremEdge™ V2 Knife and Shear Sharpener

- Safer to use than other sharpeners because it suctions securely to flat, clean surfaces.
- Allows for one-handed sharpening.
- Tungsten carbide knife sharpener plus ceramic shear sharpener.
- Will sharpen non-serrated knives and shears.
- Industrial construction.



ITEM NO.	PRODUCT	MFR. NO.	EACH
2644 86891	ExtremEdge V2 Sharpener	18689	\$14.95

Suctions to flat surfaces for one-handed sharpening

Magnetic Knife Rack

Utilizes space allowing an unspecified number and size of cutlery tools to be stored.

- Black molded plastic surrounds two magnetic strips.
- Easily mounts to wall utilizing two screws.
- Clean by wiping with a damp cloth.



➤ Cutlery tools not included.

ITEM NO.	PRODUCT	DIMENSIONS	EACH
4894 55181	Magnetic Knife Rack18"l x 1"d x 1.5" h	\$14.95

A. Plastic Knife Holder

- Holds 12 knives, 1 cleaver and 1 steel.
- Safe, easy-to-clean housing.
- Will not rust or dull knives.



B. Stainless Tool Holder

- Reversible, replaceable neoprene rubber insert removes for cleaning.
- Heavy-gauge stainless guard has side hooks to hold butcher saw.
- Holds 7 knives & 3 steels.

ITEM NO.	PRODUCT	DIMENSIONS	EACH
3278 0151	A. Plastic Knife Holder16"l x 3"w x 15"h		\$29.95
3060 05611	B. Stainless Tool Holder23"l x 1"w x 12"h		41.95
3060 0562	Replacement Neoprene Insert		14.95



A



B

Cutlery NOT included.



Portable Cutlery Cases

Store and transport your knives safely!

- Choose from 3 or 7 knife capacity.



ITEM NO.	PRODUCT	MFR NO.	EACH
5816 0206	A. 3-pc Knife Case#20206		\$19.95
5816 0153	B. 7-pc Knife Case#20204		34.96

9" Large Bow SoftHandle Shears

Soft, lightweight ergonomic handles. Choose from bent or straight handle.

- Long-lasting polyolefin handle provides resistance to chemicals, fats and oils.
- Extra large, comfortable lower bow. Excellent for applications that require gloves.
- Extra sharp stainless steel blades hold an incredible edge.
- 3-1/4" - 3-3/4" cut length. • Ambidextrous.



Bent Handle

ITEM NO.	BENT TRIMMERS	MFR. NO.	1-5	6+
3318 72201	A. 9", Large Bow Handle, Straight	7220	\$12.95	\$11.95

Straight Handle

ITEM NO.	STRAIGHT TRIMMERS	MFR. NO.	1-5	6+
3318 71611	B. 9" Large Bow Handle, Straight	7159	\$11.95	\$10.95

➤ 6 per box. EACH

➤ 6 per box. EACH

Additional SOFTHANDLE SHEARS available on our website: www.bunzlkochsupplies.com

Visit our website to find more SHARPENERS, STEELS & KNIFE ACCESSORIES: www.bunzlkochsupplies.com

Cutlery

Fiskars Cuts+More™ Scissors

These are not your average scissors!

- Fully hardened, precision-ground steel blades stay sharp, even when cutting a wide range of heavy-duty materials.
- Ergonomically sculpted handles provide comfortable use and cutting control.
- Pointed awl tip is perfect for piercing small holes in cardboard, leather & more.
- Wire cutter makes it easy to cut wire without damaging the blades.
- Bottle opener makes it easy to open your favorite beverage.
- Scissors can be taken apart for a titanium-enhanced knife that is ideal for cutting large or awkward objects.
- Sheath protects blades, sharpens scissors and includes a tape cutter for opening boxes.
- Dishwasher safe for easy cleaning.
- Twine cutter cuts twine cleanly and quickly.
- Power notch cuts light rope.



Cuts through poultry with ease.

Includes sheath with built-in sharpener.



Box/tape cutter built into sheath.



Scan this QR code with your smart phone to watch a short video that shows all these scissors can do!



Breaks apart to use one side as a knife.



Serves as a handy bottle opener.



Use as wire cutter for maintenance.



Ideal twine cutter built into blade.

ITEM NO.	PRODUCT	EACH
2182 57101	Cuts+More™ Shears, 9" length	\$16.95

Quickblade® Autoloading Utility Knife

Easy-to-use slider knob automatically loads new blade.

- Side-loading blade chamber allows for 5 blades to be stored inside the knife at one time.
- Quick and safe blade change without the use of tools.
- All metal construction with a one-piece hinge design contains no loose parts.

> 5 blades included with knife — box of 100 replacement blades available.



Five blade storage inside chamber.



DuraTip® Safety Point Blade for longer lasting precision cutting.

Ergonomic Rubber Handle for secure grip.

> 10 knives per case.

ITEM NO.	PRODUCT	EACH	
		1-9	10+
5415 03751	Autoload Knife	\$9.95	\$8.95
5415 00925	Replacement Blades (box of 100 blades)	12.95	—

TWO WAYS TO LOAD BLADES



Push button to use other side of current blade.



Remove old blade and push slider knob forward to automatically load new blade.

Lizard Safety Knife

Eliminates all loose and broken razor blades — and the injuries associated with them.

- Constructed of high-impact, shatter-resistant plastic and specially formulated surgical stainless steel resists corroding and will bend instead of shatter under normal use.
- Can be used with either hand.



Ergonomically designed handles with non-slip surface.

> SOLD PER BOX OF 6 KNIVES.

Safety blade guard automatically retracts after use.

ITEM NO.	PRODUCT	BOX
1156 00365	Safety Knife	\$18.95

Visit our website to find more SHARPENERS, STEELS & KNIFE ACCESSORIES: www.bunzlkochsupplies.com

10" Bakers Spatula

The ideal spatula for finishing cakes and desserts.

- Sani-Safe® polypropylene handle is slip resistant and withstands high and low temperatures.
- Impervious blade-to-handle seal.



> 6 per box.
EACH

ITEM NO.	PRODUCT	1-5	6+
5816 84101	10" Bakers Spatula	\$20.95	\$19.95

3-1/2" Sandwich Spreader



> 12 per box.
EACH

ITEM NO.	PRODUCT	1-11	12+
4894 56881	Sandwich Spreader	\$4.95	\$3.95

Sani-Safe® Dough Cutter

- Stain-free, high-carbon steel with slip-resistant polypropylene handle.
- Withstands high and low temperatures.
- NSF certified.
- 6" x 3".

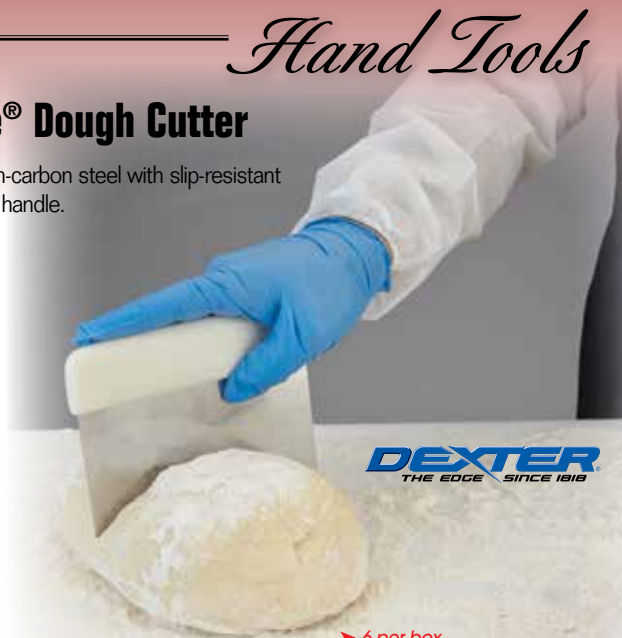

> 6 per box.
EACH

ITEM NO.	PRODUCT	1-5	6+
5816 01961	Dough Cutter	\$9.95	\$8.95

Plastic Block Scraper

- 6" x 4-1/2" stainless steel blade.
- One-piece molded plastic block handle.
- Sanitary, won't rust or pit.



> 12 per box.
EACH

ITEM NO.	PRODUCT	1-11	12+
3145 04911	Block Scraper	\$7.95	\$6.95

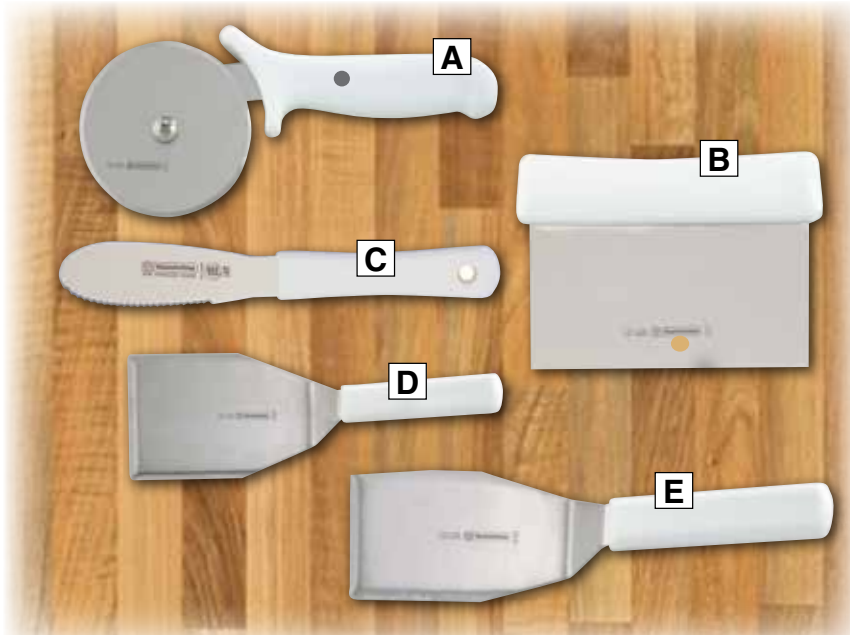

Tramontina Food Service Hand Tools

Textured white polypropylene handles provide slip-resistant grip.

- Dishwasher safe.
- Stain-free, high-carbon chrome molybdenum steel.



ITEM NO.	PRODUCT	EACH
3450 92041	A. 4" Pizza Cutter	\$18.95
3450 92161	B. 6" x 3" Dough Cutter/Scraper	9.95
3450 01041	C. 3" Wavy Edge Spreader (2-pk)	7.95
3450 91041	D. 4" x 3" Hamburger Turner	11.95
3450 91051	E. 5" x 4" Hamburger Turner	13.95

Packaging

11" Stainless Steel Skewers

- Stainless steel construction will not rust or stain.



> 125 per box.
EACH
1-124 125+
\$0.75 \$0.65

ITEM NO.	PRODUCT	EACH
4804 00111	Stainless Skewers.....	\$0.75 \$0.65

16" Utility Tongs

- Stainless steel.
- Heavy-duty.



ITEM NO.	PRODUCT	EACH
7160 71441	16" Utility Tongs	\$4.95

5-1/2" Corn Dog Stick



Ideal for corn dogs, grilling shrimp and scallops.

Great for use with strawberries, other fruit and desserts.

- 5-1/2" flat corn dog stick.
- Machine beveled rounded ends.

> 10,000 per case.

ITEM NO.	PRODUCT	CASE
3419 1005	Corn Dog Stick	\$79.95

Nylon Skewers

- Constructed of heat-stabilized, food-grade nylon, skewers can be used for temperatures up to 500° F.
- Eliminates the use of toothpicks (which can splinter and break) and metal objects in products.



- FDA and USDA approved.
- Microwave safe.



ITEM NO.	PRODUCT	BAG
7154 1004	1" Nylon Skewers (Bag of 2,500)	\$159.95
7154 1003	2" Nylon Skewers (Bag of 2,000)	169.95

Hickory Skewers

- Perfect for standard sized corn dogs and candy apples.
- Size: 4.5" x 11/64" point.
- Sharp pointed end.



ITEM NO.	PRODUCT	BOX
3953 09825	Wooden sharp point skewer	\$27.95

Ziploc® Commercial Resealable Bags

- Both storage and freezer bags can be microwaved to reheat or defrost (should not be microwaved on high heat or used as a boil-in bag).
- Ziploc® features "grip strips" for easy handling with wet or greasy hands.
- Low-density polyethylene: 1.75-mil. storage bags and 2.7-mil. freezer bags.
- Write-on labels for content ID and date coding.
- Convenient self-dispensing bulk cartons.



ITEM NO.	ZIPLOC® STORAGE BAGS	CASE
1520 0059	Quart, 7" x 8", 500 Per Case	\$49.95
1520 0060	Gallon, 10-1/2" x 11", 250 Per Case	44.95
1520 0062	2-Gallon, 15-1/2" x 13", 100 Per Case	46.95

ITEM NO.	ZIPLOC® FREEZER BAGS	CASE
1520 0063	Gallon, 10-1/2" x 11", 250 Per Case	\$49.95
1520 4605	2-Gallon, 15-1/2" x 13", 100 Per Case	59.95



Custom Cloth Bags

Set your product apart from the competition!



- Bags are puncture resistant, recyclable, and last longer than the actual product contained within them, so they can be reused again & again.
- Approved for food contact.



- Full color custom printed Cloth Bags are available in a variety of sizes, types and fabrics.
- We can accommodate virtually any size or type of Custom Cloth Bags to fit your needs.

Choose your Custom

- Bag size
- Fabric/material
- Edge Finish
- String tie options
- Sewn-in tag options
- Full color printing options on front and back of bags.



Call our Packaging Specialists at 800-456-5624 for FREE samples and quotes!

Custom Printed Rollstock Web Film

Choose from custom printing on clear or black

CALL US FOR ORDERING INFORMATION & BUILD-A-ROLL FORM



Custom Printed Shrink Bags

Choose from plain, one-color, multi-color or photographic image printing



Multi-Color
Random Print



One-Color
Random Print



Multi-Color Print
Up to 10 Colors



Photographic
Image
Printing



SEE PAGE 106 FOR SHRINK BAG STYLE OPTIONS • CALL TO ORDER 800-456-5624



CRYOVAC®

CLARITY™

FLEXIBLE PACKAGING

Sealed Air
Food Care

SHRINK BAG Options

BAG TYPE	CUSTOM PRINTING AVAILABLE	SERIES	ABUSE	SHRINK	MIN WIDTH	MAX WIDTH	MIN LENGTH	MAX LENGTH	USE FOR
Value Barrier Bags	Yes	6000	LOW	HIGH	8"	24"	8"	32"	Boneless Fresh Meat, Other Soft Products
All Purpose Barrier Bags	Yes	2000	MED	HIGH	3"	24"	3"	32"	Cheese, Processed Meats, Retail Fresh Meats
High Abuse Barrier Bags	Yes	4000	HIGH	MED	5"	24"	6.5"	32"	Cheese, Processed Meats, Retail Fresh Meats
Extra High Abuse Barrier Bags	Yes	4000	X-HIGH	MED	5"	18"	6.5"	32"	Hard Processed Meats and Cheeses
Patch-less Bone-in Barrier Bags	Yes	XG7670	BONE	LOW	7"	16.75"	8"	32"	Bone-in Fresh Meats, Other Very High Abuse Products
Cheese Block Barrier Bags	Yes	BH280	HIGH	MED	18"	22"	20"	28"	Industrial Size Cheese Blocks
Fresh Poultry Non-Barrier Bags	Yes	E2380	MED	MED	6"	18"	8"	32"	Fresh or Frozen Poultry (Whole Chicken, Cornish Hens, Duck or Turkey)
Fresh Produce Non-Barrier Bags	Yes	PD980	MED	MED	7"	19"	8"	32"	Vacuum Packed Produce
Fresh Fish Non-Barrier Bags	Yes	HP2780	LOW	MED	7"	16"	8"	32"	Fresh Vacuum Packed Fish (Whole Fish and Fillets)

PLEASE CALL FOR MORE INFORMATION ON CUSTOM SHRINK BAGS, PRINTED BAGS AND PRICING.



Finishing Options

Packaging

- Carton
- Box
- Roll-Taped

Taping

- Untaped
- Taped
- 2 Tape (for hand pull)

Shrink Bag Styles and Seal Descriptions

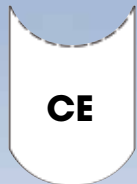

Curved End Seal

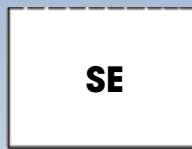

Straight End Seal



Poultry Shape End Seal



Shank End Seal

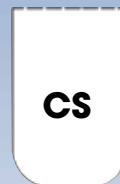

Curved Side Seal



Straight Side Seal



Wedge Side Seal

Bunzl Processor Division—

Your only Authorized Distributor of Genuine Cryovac® Shrink Bags.



CLARITY™ SHRINK BAGS

- Boxes easily fit at your work station.
- Unique dispensing system reduces waste.*



Series 2000 High Shrink Barrier Bags B2870 All Purpose

Good for cheese, boneless meat, processed meats and retail fresh meats.

Series 4000 High Abuse Barrier Bags B4870 Medium Shrink

Good for hard cheese, bone-in meat, processed meat and retail fresh meat.

Standard Gauge • Untaped bags.

> 250 bags per box.

ITEM NO.	SIZE	EACH BOX	ITEM NO.	SIZE	EACH BOX
7584 3306	4 x 8	\$35	7584 3344	6.5 x 8	\$39
7584 3315	4.5 x 12	41	7584 3349	7 x 9	41
7584 3320	5 x 8	37	7584 3350	7 x 12	49
7584 3321	5 x 9	38	7584 3351	7 x 14	53
7584 3322	5 x 10	39	7584 3358	8 x 10	49
7584 3325	5 x 13	45	7584 3359	8 x 12	52
7584 3326	5 x 17	52	7584 3360	8 x 14	58
7584 3328	5.5 x 8	38	7584 3361	8 x 16	63
7584 3329	5.5 x 9	39	7584 3362	8 x 18	69
7584 3332	5.5 x 16	51	7584 3372	10 x 15	72
7584 3335	6 x 8	38	7584 3373	10 x 18	84
7584 3336	6 x 9	39	7584 3374	10 x 20	88
7584 3338	6 x 11	45	7584 3375	10 x 24	104
7584 3339	6 x 14	49	7584 3393	14 x 16	121

Standard Gauge

• Untaped bags. > 250 bags per box.

ITEM NO.	SIZE	EACH BOX
7584 3420	8 x 14	\$58
7584 3441	11 x 16	84
7584 3446	12 x 18	104
7584 3447	12 x 20	110
7584 3448	12 x 24	130
7584 3455	14 x 22	152
7584 3460	16 x 24	200

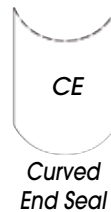

Heavy-Duty Gauge

• Untaped bags. > 250 bags per box.

ITEM NO.	SIZE	EACH BOX
7584 3469	12 x 20	\$137

Bunzl Processor Division
Your only Authorized Distributor of
Genuine Cryovac® Shrink Bags.

400 more SHRINK BAG Styles & Sizes available.
Call for details 800-456-5624

* Shrink bags larger than 12" wide or 24" long are not available in the dispenser box shown above, but are in a flat 250 count Smart Pack box.

Cook Chill Bags — Sealed On One End

- Bag is sealed on one end. After filling, the open end is then closed with a clip or impulse sealer.

ITEM NO.	EST. VOLUME	SIZE	GAUGE MIL	QTY PER CASE	PER CASE	MIX & MATCH ANY 3 SIZES PER CASE
E179 2100	1 Pint	6 x 8	4.5	2,000	\$184	\$173
E179 2101	1 Pint	6 x 8	3	2,000	139	130
E179 2102	1 Quart	6 x 12	4.5	1,500	204	192
E179 2103	1 Quart	6 x 12	3	2,000	201	189
E179 2104	3 Pints	8 x 18	4.5	800	219	206
E179 2105	3 Pints	8 x 18	3	1,000	201	189
E179 2106	1/2 Gallon	10 x 18	4.5	600	159	149
E179 2107	1/2 Gallon	10 x 18	3	1,000	190	179
E179 2108	1 Gallon	10 x 24	4.5	500	174	164
E179 2109	1 Gallon	10 x 24	3	800	203	191
E179 2110	1-1/2 Gallon	10 x 28	4.5	400	164	154
E179 2111	1-1/2 Gallon	10 x 28	3	500	149	140
E179 2112	2 Gallon	10 x 30	4.5	400	174	164
E179 2113	2 Gallon	10 x 30	3	500	159	149
E179 2114	3 Gallon	12 x 30	4.5	300	159	145
E179 2115	3 Gallon	12 x 30	3	500	190	179

CLARITY™ FLEXIBLE PACKAGING



Handle bags available.
Call for details.

On larger bags an angled seal adds extra strength and a surface to hold onto.





CLARITY™ VACUUM POUCHES

The FACTS behind our pouches:

- FDA approved for food contact.
- Contains NO BPA or Melamine.
- Contains NO Starches or Animal By-Products.
- Made from cast co-extruded film providing a true, consistent 3-mil. pouch.
- More flexible and form fitting with an aggressive sealant.
- Easy to open when filling.
- Crystal clear with a glossy finish.



Many more VACUUM POUCH Styles & Sizes available.
Call for details **800-456-5624**

3-mil. Standard Vacuum Pouches

ITEM NO.	SIZE IN INCHES	POUCHES PER BOX	PER BOX			
			1 - 4	5 - 9	10-14	15+
7500 1802	2-1/4 x 13...	2,000	\$89	\$82	\$72	\$65
7500 1803	2-1/2 x 10...	2,000	55	50	45	40
7500 1807	4 x 8...	1,000	35	31	27	24
7500 1808	4 x 10...	1,000	37	33	29	27
7500 1615	4-1/2 x 15...	1,000	65	57	52	48
7500 1812	5 x 7...	1,000	28	24	21	19
7500 1811	5 x 9...	1,000	34	30	26	24
7500 1815	6 x 8...	1,000	35	31	27	25
7500 1816	6 x 8-1/2...	1,000	37	32	30	27
7500 1817	6 x 10...	1,000	41	38	34	31
7500 1818	6 x 12...	1,000	52	46	41	38
7500 1819	6 x 15...	1,000	66	57	52	48
7500 1820	6 x 20...	1,000	88	77	69	64
7500 1824	7 x 8...	1,000	42	37	34	30
7500 1825	7 x 9...	1,000	46	40	37	33
7500 1826	7 x 11...	1,000	55	49	45	40
7500 1828	8 x 8...	1,000	46	41	37	33
7500 1829	8 x 10...	1,000	57	52	46	41
7500 1830	8 x 12...	1,000	69	60	55	50
7500 1831	8 x 15...	1,000	87	76	69	63
7500 1836	10 x 10...	1,000	73	64	57	52
7500 1837	10 x 12...	1,000	87	75	69	66
7500 1838	10 x 13...	1,000	93	83	74	68
7500 1839	10 x 15...	1,000	108	95	86	78
7500 1840	10 x 18...	500	66	56	51	47

ITEM NO.	SIZE IN INCHES	POUCHES PER BOX	PER BOX			
			1 - 4	5 - 9	10-14	15+
7500 1841	10 x 20...	500	\$72	\$63	\$57	\$52
7500 1842	10 x 22...	500	78	70	63	57
7500 1843	10 x 30...	500	105	95	86	78
7500 1848	11 x 30...	500	137	105	95	89
7500 1851	12 x 12...	1,000	105	91	83	75
7500 1852	12 x 14...	1,000	121	107	96	89
7500 1853	12 x 15...	500	63	57	51	47
7500 1854	12 x 16...	500	69	60	55	50
7500 1855	12 x 18...	500	77	69	61	56
7500 1856	12 x 22...	500	94	84	75	69
7500 1861	14 x 16...	500	80	71	64	58
7500 1862	14 x 20...	500	101	89	81	73
7500 1863	14 x 24...	500	120	107	96	88
7500 1866	16 x 16...	500	94	84	76	69
7500 1867	16 x 20...	500	116	102	91	84
7500 1868	16 x 24...	500	143	127	116	104
7500 1869	16 x 26...	250	73	66	59	54
7500 1870	16 x 28...	500	158	142	127	117
7500 1873	18 x 18...	500	116	105	94	86
7500 1874	18 x 22...	500	141	126	113	103
7500 1875	18 x 28...	250	90	81	72	66
7500 1878	20 x 25...	250	89	80	71	65
7500 1879	20 x 28...	250	101	90	80	73
7500 1880	22 x 34...	250	134	120	107	98
7500 1883	24 x 30...	250	130	116	105	94

THESE VACUUM POUCHES ARE ONLY FOR USE IN VACUUM CHAMBER MACHINES.

CUSTOM SIZES ARE AVAILABLE. CALL FOR MORE INFORMATION.



Additional
PACKAGING SUPPLIES
available on our website:
www.bunzlkochsupplies.com

Scan the
QR Code
to link directly
to our catalog.



Request a
FREE Copy of our
Flexible Packaging
Catalog





Shrink Film

This multilayered film is versatile enough to perform on all sealing systems and shrink tunnels. The premium resin formulation provides our strongest seals, and offers a high shrink force, making it an ideal choice for multipacking and unitizing product.

Features and Benefits:

- Wide window of operation — Performs across a complete range of applications and equipment. Ideal for older equipment.
- Crosslinked technology — Provides consistent sealing and shrinking at a broader range of temperatures.
- Superior sealing performance — On all types of equipment and sealing technology. Yields cleaner, stronger seals eliminating blowouts. Save time and money on expensive rewraps.
- Higher shrink force — Ensures greater package integrity for multi-pack applications.
- FDA compliant — for direct food contact.
- Printable — For enhanced marketing opportunities.
- Fully recyclable.



ITEM NO.	PRODUCT	GAUGE	PRICE PER ROLL	
			1 - 2	3+
3957 1600	16" x 5830' Center Fold	45	\$239	\$219
3957 1400	14" x 4375' Center Fold	60	219	199
3957 0140	16" x 4375' Center Fold	60	229	209
3957 1801	18" x 4375' Center Fold	60	249	229
3957 1601	16" x 3500' Center Fold	75	229	209
3957 1802	18" x 3500' Center Fold	75	249	229



Low-Density Poly Food Bags

- Constructed of linear, low-density polyethylene.
- Available in regular or heavy gauge.
- Twist ties sold separately, SEE PAGE 528.
- Provides excellent clarity of product.
- FDA approved.



Regular Gauge

ITEM NO.	PRODUCT	SIZE	BAGS PER CASE	CASE
1380 1025	Bakery (.5 Mil, Non-Perf)	5.5" x 4.75" x 15"	1,000	\$37
1380 0003	Bakery (.5 Mil, Non-Perf)	5.5" x 4.75" x 19"	1,000	45
1380 1085	Produce (.7 Mil, Perforated)	6" x 3.5" x 18"	1,000	44
1380 1078	Bakery (.5 Mil, Non-Perf)	6" x 3" x 15"	1,000	34
1380 1015	Clear (.5 Mil, Non-Perf)	8" x 3" x 15"	1,000	37
1380 0705	Vented Produce (.8 Mil, Perforated)	8" x 3" x 20"	1,000	71

Heavy Gauge

ITEM NO.	PRODUCT	SIZE	BAGS PER CASE	CASE
7600 0151	Clear Poly Bag (1 Mil)	5.5" x 3" x 24"	1,000	\$65
7600 0150	Clear Bakery (.9 Mil)	5.5" x 4.75" x 20"	1,000	61
7600 0149	Clear Bakery (1 Mil)	5.5" x 4" x 29"	1,000	81
7978 6315	Clear Poultry (.75 Mil)	6" x 3" x 15"	1,000	71
7600 0665	Clear Food Bag (1.0 Mil)	8" x 3" x 15"	1,000	77
7600 0208	Clear Food Bag (.9 Mil)	8" x 4" x 18"	1,000	86
7600 0435	Clear Poly Bag (1.2 Mil)	12" x 6" x 24"	500	96



Packaging



White Twist Ties

- Paper and wire construction.
- 4" length.

➤ 2,000 per box.

ITEM NO.	PRODUCT	BOX
3490 03915	White Twist Ties	\$3.95



Ideal for closing Poly Food Bags.



Plastic White Bag Clips

- Heavy-duty closures contain up to 10-lbs. of weight.

➤ 3,500 per pack.

ITEM NO.	PRODUCT	PACK
4235 30025	Plastic White Bag Clips	\$39.95

PVC Wrapping Film & Film Cutter

- All steel welded construction holds 9" diameter rolls with universal mounting.

➤ Overall dimensions:
12"h x 5"w base x 2-1/2"
greater than roll length.

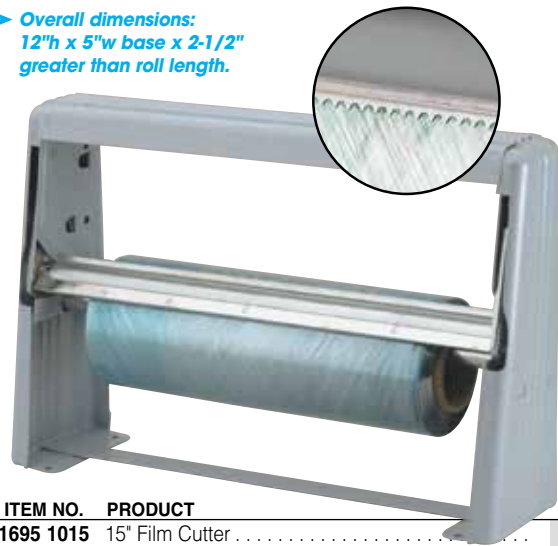

ITEM NO.	PRODUCT	EACH
1695 1015	15" Film Cutter	\$109.95
1695 1018	18" Film Cutter	119.95
1695 2224	24" Film Cutter	124.95
3546 0019	1-mil. Poly Film, 18" x 4,400' Roll.	79.95

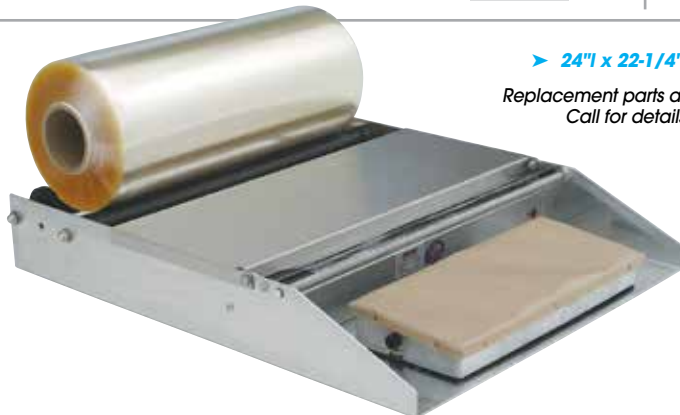

➤ 24"l x 22-1/4"w x 5"h.

Replacement parts available.
Call for details.

Twine Dispenser

Dispense and cut twine without unraveling.

- Dispenses twine, does not cut twine.
- Purchase twine knives separately.



Built-in spring plunger keeps twine secure by preventing spinning.

Twine sold separately.



ITEM NO.	PRODUCT	EACH
2330 10081	Twine Dispenser.	\$24.95

Butcher Twine

- Breaking strengths:
- 12-ply 30-lbs.
- 24-ply 60-lbs.
- 30-ply 75-lbs.



➤ 25 cones per case.



ITEM NO.	PRODUCT	PER CONE
7500 02001	12-ply, 3,600-ft.	\$9.95
7500 02091	24-ply, 1,680-ft.	9.95
7500 02131	30-ply, 1,344-ft.	9.95

PVC Wrapping Film

Superior strength, stretch and clarity.



➤ 1 roll per carton.

ITEM NO.	PRODUCT	EACH	
		1-3	4+
7500 3813	15" x 5,000'	\$129.95	\$119.95
7500 3815	18" x 5,000'	149.95	139.95

PVC Film Wrapper

- Constructed from aluminum and stainless steel.
- Teflon covered 6" x 15" hot plate prevents sticking.
- Sanitary, easily maintained and quality control inspected.
- UL listed. 115 volts.
- 20" maximum width.

ITEM NO.	PRODUCT	EACH
3821 0030	PVC Film Wrapper.	\$439.95

Industrial Strength Masking Tape

- Core diameter: 3".
- Utility grade masking tape designed for routine packaging, sealing and labeling.
- Non-staining tape can be used in temperatures between 50° to 180° F.



NOT INTENDED FOR FREEZER USE



ITEM NO.	PRODUCT	EACH	
		1-71	72+
6655 19761	1/2" x 180', 12mm . . .72 per case . .	\$1.95	\$1.45
		EACH	
ITEM NO.	PRODUCT	1-47	48+
6655 19941	3/4" x 180', 18mm . . .48 per case . .	\$2.95	\$1.95
		EACH	
ITEM NO.	PRODUCT	1-35	36+
6655 19681	1" x 180', 24mm . . .36 per case . .	\$3.95	\$2.95
		EACH	
ITEM NO.	PRODUCT	1-23	24+
6655 19491	2" x 180', 48mm . . .24 per case . .	\$4.95	\$3.95

Clear, Low-Temp Flash Freezer Tape

- Once applied can be exposed immediately to extreme subfreezing temperatures.
- Adhesive will not solidify and stays pliable maintaining a strong and secure seal.
- Can handle storage temperatures down to -20°.
- Core diameter 3".
- 48mm/2" approx. width.
- 100m/110 approx. yards long.



➤ 36 per case.

ITEM NO.	PRODUCT	EACH	
		1-35	36+
3957 11001	2.3-Mil.	\$4.95	\$3.95

Freezer Masking Tape

STRONGER and STICKIER — won't come loose in freezer!

- GUARANTEED to stick in cold, wet applications.
- Core diameter: 3".
- Color: yellow.



➤ 48 rolls per case.



ITEM NO.	PRODUCT	SIZE	EACH	
			1-47	48+
6655 55931	Freezer Masking Tape . . .3/4" x 180'		\$5.95	\$4.95

Clear Carton Sealing Tape

- Versatile tape for a wide variety of storage applications, from freezer/cold storage to dry warehousing environments.
- Applied above 32°F can handle storage temperatures from -10°F to 200°F.
- For use on cartons up to 40-lbs.
- Moisture-resistant polypropylene film.
- Core diameter 3".
- 100m/110 approx. yards long.



ITEM NO.	PRODUCT	WIDTH	CASE	EACH	
				1-23	24+
6655 58021	1.8-Mil.	2"	36 Rolls	\$3.95	\$3.45
6655 30511	1.8-Mil.	3"	24 Rolls	4.95	4.45

Box Tape Dispenser

- For 3" core diameter tape rolls.
- Fits 48mm/2" approx. width tapes.
- Pistol grip with adjustable brake.



ITEM NO.	PRODUCT	EACH
3105 00101	Tape Dispenser.	\$9.95

DYKEM® SAFE-MARK NSF Certified Food Safe Markers

Designed for marking on food contact surfaces used in processing, transporting, or holding food products.

- General purpose, quick-drying permanent ink marker.
- Marks withstand temperatures spanning -20°F to 475°F.
- Valve action mechanism prevents ink in barrel from drying when the cap is left off.
- "Locked nib" prevents tip from falling out and into processing operations.
- Available in 5 HACCP colors.



➤ 12 per box.

ITEM NO.	PRODUCT	EACH	
		1-11	12+
3112 09991	Blue.	\$4.95	\$3.95
3112 09071	Black.	4.95	3.95
3112 09971	Yellow	4.95	3.95
3112 09961	White.	4.95	3.95
3112 09981	Green	4.95	3.95

Packaging

Deli Paper

- Lightweight interfold deli sheet dispenses easily.
- Dry waxed coating strips clean from baked goods, meat, cheese and other deli foods.



> 500 per box — 12 boxes per case.

ITEM NO.	PRODUCT	SIZE	PER BOX	
			1-11	12+
7300 00265	Junior.	7-1/2" x 10-3/4".	\$6.95	\$5.95
7300 00275	Senior.	10" x 10-3/4".	8.95	7.95
7300 00285	Large.	12" x 10-3/4".	9.95	8.95

DIIE Satin-Pac® Deli Paper

- Poly film provides barrier to contain wetness.
- Ideal for bakery handling, as a freezer interleaver, deli pickup sheet or weighing scale sheet.
- Handy dispenser box packaging, interfolded for easy one-at-a-time dispensing.



> 1,000 sheets per box — 10 boxes per case.

ITEM NO.	PRODUCT	SIZE	BOX
1500 49205	Deli Paper.	8" x 10-3/4"	\$9.95

Film Dispenser with Cutter

- Crystal clear PVC wrapping film packaged in convenient and portable film dispenser box.
- Dispenser box contains metal blade/bar for easy and precise cutting of film.



> 4 per case.

ITEM NO.	PRODUCT	EACH	
		1-3	4+
7500 3821	12" wide x 2,000'	\$26.95	\$24.95
7500 3831	18" wide x 2,000'	39.95	37.95



Platter Liners

Handles high heat with great release!

- Interleaved for serving and storage.
- Allows complete release from platters.
- FDA approved.



> 1,000 per case.

ITEM NO.	PRODUCT	CASE
7500 3991	16-3/8" x 24-3/8"	\$54.95

Deli Cups



- Withstands refrigeration and microwave temperatures and are dishwasher safe.
- Highly resistant to fats and oils.
- Available in white or clear in 8-oz. or 16-oz. capacities.
- New gullet lids available in clear only.
- Polypropylene containers are strong and reusable.



> 250 containers and lids per case.

ITEM NO.	PRODUCT	CAPACITY	CASE
7500 2460	Clear Cup w/ Lid.	8-oz.	\$79.95
7500 2456	Clear Cup w/ Lid.	16-oz.	99.95
7500 2457	White Cup w/ Lid.	16-oz.	99.95

Aluminum Foil Food Wrap

Ideal for schools, hospitals, hotels, restaurants, cafeterias and caterers. Perfect for storing freezing & cooking.



- Handy corrugated dispenser box for easy tearing.

ROLL	ITEM NO.	PRODUCT	EACH
	7500 2050	18" x 500'	\$49.95



- Pop-up dispenser box to get one sheet at a time.

> 500 sheets per box
> 6 boxes per case

SHEETS	ITEM NO.	PRODUCT	CASE
	7500 0950	9" x 10-3/4"	\$109.95

Brown Paper Sacks

Back to the basics with biodegradable paper sacks!

- Strong paper sacks are perfect for grocery industry.
- Available in two sizes and weight strengths: 12# (lighter) and 57# (thicker).



CALL FOR PALLET PRICING

> 1,000 per bundle.

ITEM NO.	PRODUCT	DIMENSIONS	BUNDLE
1010 0242	12# Brown Paper Sacks. . . .	7-1/16" x 4-1/2" x 13-3/4"	\$69.95

> 500 per bundle.

ITEM NO.	PRODUCT	DIMENSIONS	BUNDLE
1320 0059	57# Brown Paper Sacks.	12" x 7" x 17"	\$69.95

T-Sacks and T-Racks

Multi-purpose plastic bags are perfect for wet or frozen product.

- Sturdy metal T-rack is designed to house multiple T-sacks and hold individual sacks open for easy filling.
- T-rack constructed of polished metal with white poly base.
- White T-sacks are constructed of strong plastic to carry heavy loads without breaking, splitting or puncturing.



> 1,000 per case.

ITEM NO.	PRODUCT	SIZE	CASE
7771 2419	T-Sacks w/ red print,	11.5" w x 6.5" x 21" h	\$37.95

ITEM NO.	PRODUCT	EACH
1830 28681	T-Rack	\$19.95

Shopping Baskets

Molded plastic will not rust or dent and are easy to clean.

- BASKETS WILL NOT JAM.
- Removable handles fold down to nest.
- No more wire handles that pinch and hurt your hands when basket is full.
- Made from 100% recycled materials.
- Color: red with black handles.



ITEM NO.	PRODUCT	DIMENSIONS	EACH
2978 04151	Basket, red, 30-lb capacity	17"l x 12"w x 9"d.	\$14.95

Paper Cone Cups

• The ideal cup for on-the-go environments.



> 5,000 per case.

ITEM NO.	PRODUCT	CASE
3478 0449	4-oz. Cups	\$99.95
1820 7310	7-oz. Cups	199.95

Foam Cups

• Choose from 6-, 8-, 12- or 16-oz.



ITEM NO.	PRODUCT	CASE
1940 0703	6-oz. Cups (1,000 per case).	\$39.95
1940 4228	8-oz. Cups (20/sleeve / 50 slv/case)	41.95
1940 0139	12-oz. Cups (1,000 per case).	54.95
1940 6183	16-oz. Cups (500 per case).	39.95

Nordic Ice Temperature Control Packs

Packs are reusable and non-toxic, stay frozen longer than ice and are very economical to use.

- When packing product place gel pack on top of product, as cold travels downward. Leave as little dead space as possible.
- Biodegradable.
- Freezes solid.



> SOLD BY CASE ONLY - 36 per case.

ITEM NO.	PRODUCT	CASE
C928 1016	16-oz., 6-1/2" x 5-1/2" x 1" h	\$22.95

> SOLD BY CASE ONLY - 24 per case.

ITEM NO.	PRODUCT	CASE
C928 1024	24-oz., 8" x 5-1/2" x 1-1/4" h	\$17.95

> SOLD BY CASE ONLY - 12 per case.

ITEM NO.	PRODUCT	CASE
C928 1048	48-oz., 10-1/2" x 7-1/2" x 1-1/4" h	\$16.95



Soft PVC, Fog-Free Goggles

Fog-free impact goggles provide protection against many processing and splash hazards.

- .050" polycarbonate lens have Duramass® fog-free coating.
- Fits over most prescription glasses.
- Meets ANSI Z87+ standard.



> 50 per case.
EACH



ITEM NO.	PRODUCT	1-49	50+
3420 32221	Fog-Free PVC Goggle, Clear Lens	\$8.95	\$7.95

Bouton Basic Goggles

Universal goggle design.

- Pliable one-piece frame.
- Direct side ventilation.
- Polycarbonate lens with anti-scratch coating.
- Fits over most prescription eyewear.
- Meets ANSI Z87.1+ High Impact Requirements.



> 144 per case.
EACH

ITEM NO.	PRODUCT	1-143	144+
6292 43001	Basic Goggle, Clear Lens	\$2.95	\$1.95

Small Pink Goggles

- Multi-purpose ultra soft goggle.
- Flexible vinyl frame provides excellent small facial fit.
- Perforated to allow ventilation.
- Clear lens, translucent pink frame & pink elastic strap.



> 144 per case.

ITEM NO.	PRODUCT	1-143	144+
3425 51461	Small Goggle, Pink	\$2.95	\$1.95

Sterile Eyesaline® Eye Wash Station

- Two 16-oz. bottles of sterile solution.
- Station is made of heavy-gauge polystyrene.
- Can be mounted with screws.
- Personal use bottles for flushing of eyes.



Each bottle has a large opening with a smooth flange for safe and easy use.

ITEM NO.	PRODUCT	EACH
3415 65011	Eyewash Station	\$49.95
3140 54001	16-oz. Refill Bottle	9.95



Uvex Clear® Portable Lens Cleaning Station

Cleans both plastic and glass lenses.

Dispenser station includes:

- 1500, 4-1/2" x 5" disposable tissues.
- One, 16-oz. plastic pump bottle of anti-static, anti-fog lens cleaning fluid.



ITEM NO.	PRODUCT	EACH
3415 33491	Lens Cleaning Station	\$14.95
3179 0463	Replacement Spray, 16-oz.	4.95
3179 04625	Replacement Tissues (Box of 500)	3.95

Check out more EYE PROTECTION & SAFETY PRODUCTS available on our website: www.bunzlkochsupsplies.com

DID YOU KNOW?
An estimated 1,000 eye injuries occur in American workplaces every day. The financial costs of these injuries is more than \$300 million per year in lost production time, medical expenses and workers compensation. 90% of eye injuries can be prevented through the use of protective eyewear.

— Source: U.S. Department of Labor

Pink Frame Scratch Resistant Safety Glasses

Show your support for breast cancer awareness.

- Smaller and narrower frame design with pink accents.
- Thin, flexible temples provide secure fit without pinching.
- Narrow saddle nose bridge design.
- Meets ANSI Z87.1+ standard.

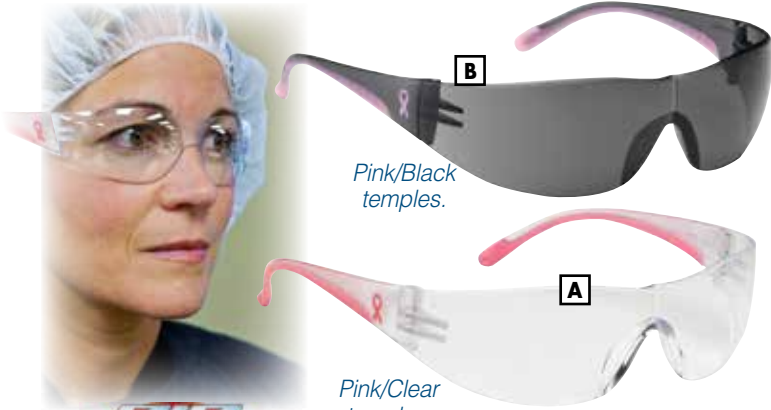

Pink/Black temples.

Pink/Clear temples.



> 12 per case.

ITEM NO.	SIZE	LENS	COLOR	EACH	
				1-11	12+
6292 09001	A. Regular	Clear	Pink/Clear	\$4.95	\$3.95
6292 09101	Petite	Clear	Pink/Clear	4.95	3.95
6292 09061	B. Regular	Gray	Pink/Black	4.95	3.95
6292 09111	Petite	Gray	Pink/Black	4.95	3.95

Economy Scratch-Resistant Safety Glasses

Lightweight rimless design.

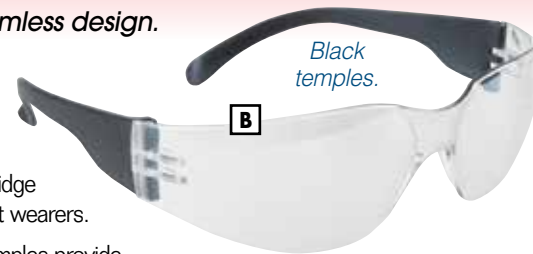

Black temples.

- Saddle nose bridge design fits most wearers.
- Thin, flexible temples provide secure fit without pinching.
- Meets ANSI Z87.1+ standard.

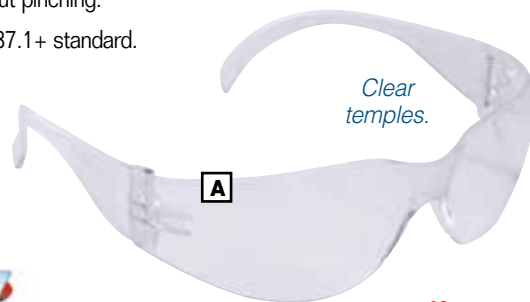

Clear temples.



> 12 per case.

ITEM NO.	SIZE	LENS	TEMPLE	EACH	
				1-11	12+
6292 09131	A. Small	Clear, Scratch-Resistant	Clear	\$1.95	\$1.45
6292 09201	Regular	Clear, Uncoated	Clear	1.95	1.45
6292 05841	B. Small	Clear, Scratch-Resistant	Black	1.95	1.45
6292 09051	Regular	Clear, Uncoated	Black	1.95	1.45

Tomahawk® Safety Glasses

- Wraparound design with adjustable, ratchet action temples and a one-piece polycarbonate lens with side shields.
- Lenses offer 99.9% ultraviolet protection along with Duramass® scratch-resistant coating.
- Meets ANSI Z87+ standards.



Ratchet action temples.



> 12 per case.

ITEM NO.	LENS	COLOR	EACH	
			1-11	12+
3314 64011	Clear	Black Frame	\$3.95	\$2.95
3420 64021	Clear	Blue Frame	3.95	2.95
3420 64031	Clear	Red, White & Blue Frame	3.95	2.95
3420 64071	Clear Anti-Fog	Black Frame	4.95	3.95

3M™ Virtua™ Sport Safety Glasses

Give workers the look they want with the safety you demand.

- 9.0 base curved lens for excellent "wrap" front/side coverage.
- Sporty and sleek, unisex styling for better looks.
- Polycarbonate construction.
- Available with a clear anti-fog lens, a gray anti-fog lens or an indoor/outdoor mirrored lens.
- Meets ANSI Z87.1-2003 high impact and CSA Z94.3 standards.
- Lightweight — less than 1 oz.
- Absorbs 99.9% UV.



Anti-Fog Gray Lens with Gray Temples.



Indoor/Outdoor Mirrored Lens with Clear Temples.



Anti-Fog Clear Lens with Clear Temples.

> 20 per box.

ITEM NO.	LENS	COLOR	EACH	
			1-19	20+
3207 13861	Anti-Fog Lens	Gray	\$3.95	\$2.95
3207 13841	Anti-Fog Lens	Clear	3.95	2.95
3207 13881	Indoor/Outdoor Mirrored Lens	Clear	3.95	2.95

Safety

3M™ Ultra Fit™ Reusable Earplugs

NRR-25 dB*

- Extremely comfortable, non-toxic, non-allergenic polymer.
- Patented three-flange design for easy fitting.
- Softly "hugs" the sides of the ear to form a triple seal.
- Washable, reusable earplugs comfortably.
- Individually poly-bagged.



3M

➤ 200 pair per dispenser box.

ITEM NO.	PRODUCT	EACH	
		1-199	200+
3207 40141	UltraFit™ w/Cord	\$1.95	\$0.95

MAX® Small Pink Earplugs

NRR-30 dB

- A reduced size that offers workers with smaller ear canals a better and more comfortable fit.
- The same bell shape and patented varied-cell polyurethane foam as the standard orange MAX® earplug — but are 20% smaller.



Honeywell
HOWARD LEIGHT

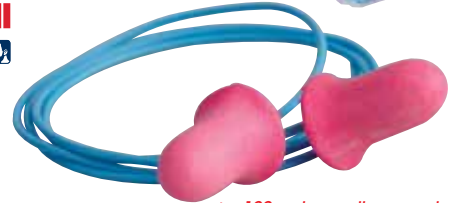

➤ 100 pair per dispenser box — 10 boxes per case.

ITEM NO.	PRODUCT	PER BOX	
		1-9	10+
3140 01885	MAX® Small Pink w/Cord	\$29.95	\$28.95

3M™ E-A-R™ UltraFit™ Metal Detectable Reusable Earplugs

- Embedded magnetic metal ball bearing allows metal detection.
- Non-toxic, non-allergenic flexible polymer.
- Soft, pliable, reusable earplugs are washable for extended use.
- Each "reusable" pair is poly-bagged.

NRR-25

3M



Includes metal detectable cord.

➤ 200 pair per box.

ITEM NO.	PRODUCT	EACH	
		1-199	200+
3207 40171	UltraFit® w/ Cord	\$1.75	\$1.45

Laser Trak® Metal Detectable Disposable Plugs

- Metal detectable, yet disposable.
- Individually packed in poly bags.

Honeywell
HOWARD LEIGHT

NRR-32



➤ 100 pair per dispenser box — 10 boxes per case.

ITEM NO.	PRODUCT	PER BOX	
		1-9	10+
3140 38745	Laser-Trak® w/ Cord	\$39.95	\$38.95

Pink Foldable Earmuffs

- Unique folding design allows for convenient storage.
- Foam-filled ear cushions
- Height adjustable.

NRR-23

ERB
Safety Products for LIFE™



➤ 12 per case.

ITEM NO.	PRODUCT	EACH	
		1-11	12+
3425 42421	Pink Foldable Earmuffs	\$9.95	\$8.95

Check out more EAR PLUGS, EARMUFFS & EARBANDS available on our website:
www.bunzlkochsupsplies.com

NON N95 APPROVED

Disposable Nuisance Dust Mask

- Ideal protection from non-toxic nuisance dust & particles.
- Made of non-irritating woven material.
- Adjustable nosepiece.
- Large filter area for easy breathing.

► *Not NIOSH approved, not N95 approved.*



Head strap is heat sealed to mask —no staples that can fall into food.



► 50 per box — 12 boxes per case.

ITEM NO.	PRODUCT	PER BOX	
		1-11	12+
6292 10025	Disposable Dust Mask	\$5.95	\$4.95

N95 APPROVED RESPIRATORS

3M™ Particulate Respirator, 8210

- Lightweight, for general non-oil particle exposures or short-time use when heat, humidity or sparks are not present.
- Meets 42 CFR84 Certification.
- NIOSH approval TC-84A-0007.
- N95 approved.



► 20 per box — 8 boxes per case.

ITEM NO.	PRODUCT	PER BOX	
		1-7	8+
6655 01755	8210 Dust Mask	\$21.95	\$20.95

#2300N95 Respirator w/Valve

- Particulate respirator (N95) approved.
- For use against particulate aerosols free of oil.



Includes exhalation valve to reduce hot air build-up.



► 10 per box — 10 boxes per case.

ITEM NO.	PRODUCT	PER BOX	
		1-9	10+
2222 00955	Medium/Large	\$27.95	\$26.95

ONE-Fit® N95 Respirators

Our **LOWEST PRICED** respirator!

- Strong and rigid outer shell prevents mask from collapse in high-humidity.
- Dual welded head straps keep the respirator comfortably on user's face.
- Woven suspension straps reduce the possibility of breakage and does not pull or tangle hair.
- Molded nose bridge comfortably fits a variety of face shapes and sizes.

Latex FREE

► 20 per box — 10 boxes per case.

ITEM NO.	PRODUCT	PER BOX	
		1-9	10+
3476 89955	A. ONE-Fit® No Valve	\$12.95	\$11.95

► 10 per box — 10 boxes per case.

ITEM NO.	PRODUCT	PER BOX	
		1-9	10+
3415 60905	B. ONE-Fit® With Valve	\$14.95	\$13.95

Honeywell

Head strap is heat sealed to mask —no staples that can fall into food.



Without Valve.

A



With Valve.

B



Check out more DISPOSABLE & REUSABLE RESPIRATORS & MASKS available on our website:

www.bunzlkochsupplies.com

Safety

JACKSON
SAFETY BRAND



Standard Bump Cap

- Molded from dielectric high density polyethylene (HDPE).
- Four point adjustable plastic suspension system.
- Adjusts to fit sizes 6-1/2 to 8-1/4.
- Lightweight, 8-oz.
- Smooth, dome design.



Plastic suspension system with Coolmax™ terry cloth sweatband.



CAUTION: These bump caps do not meet ANSI Z89.1 or CSA Z 94.1. They are not meant to be worn for protection from impact of falling or glancing objects.

> 12 per case.

ITEM NO.	COLOR	EACH	
		1-11	12+
C241 15461	Red	\$6.95	\$5.95
C241 15471	Gray	6.95	5.95
C241 15411	Yellow	6.95	5.95
C241 15421	White	6.95	5.95
C241 15431	Green	6.95	5.95
C241 15441	Blue	6.95	5.95

Disposable Sweat Band

- Sanitized sponge absorbs perspiration.
- Rinse sweatband with cool water before and after each use to remove perspiration.
- Store in a well-ventilated place and re-wet to reuse.

JACKSON
SAFETY BRAND



> 100 per bag — 10 bags per case.

ITEM NO.	PRODUCT	BAG
C241 53385	Disposable Sweat Band . . .	\$59.95

V-GARD® Safety Hard Hat

Injection molded of non-conductive, high-density polyethylene, the V-Gard safety hard hat is lightweight and comfortable to wear all day.

- Meets requirements for Type 1, ANSI/ISEA Z98.1-2009 (Class E) and CSA Z94.1-2005 (Class E)
- Adjustable suspension.
- Replaceable Staz-On or ratchet style suspension provides a minimum safety crown clearance of 1-1/4" between top of head and shell.

> 20 per case.

ITEM NO.	COLOR	EACH	
		1-19	20+
3085 71271	White	\$9.95	\$8.95
3085 71291	Green	9.95	8.95
3085 71281	Blue	9.95	8.95
3085 71301	Yellow	9.95	8.95
3085 71311	Red	9.95	8.95
3085 71321	Orange	9.95	8.95
3085 71331	Gray	9.95	8.95
3085 48511	Gold	9.95	8.95
3085 11801	Tan	9.95	8.95
3085 31111	Light Blue	9.95	8.95
3085 11241	Burgundy	9.95	8.95
3085 53641	Pink	9.95	8.95
3085 52301	Hot Pink (ratchet style)	14.95	13.95

ERB
Safety Products for LIFE™



Includes Staz-On suspension

Optional Ratchet-style replacement suspension



ITEM NO.	PRODUCT	EACH
3085 79211	Replacement Staz-On Suspension	\$8.95
3085 87081	Replacement Ratchet Suspension	13.95

Accessory Clip for Hard Hats

Handy clip for holding eyewear, pencils or personal items within reach

- Adheres to safety helmet with durable adhesive.
- Easily holds eyewear, pencils, ruler or any item that needs easy access.
- Color: pink.

> 12 per case.

ITEM NO.	PRODUCT	EACH	
		1-11	12+
3425 56441	Hard Hat Clip . . .	\$2.95	\$1.95



Hard hats sold separately

**Additional
BUMP CAPS &
HARD HAT ACCESSORIES
available on our website:
www.bunzlkochsupplies.com**

Cool-Weave Back Support Belt

Cool and comfortable without suspenders.

- Velcro® front closure with ventilated 8" back.
- 5" front, 8" back.
- Patented Sta-Put™ belt loops and four internal gripper strips keep belt in place.

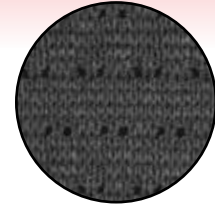

Cool-Weave Material

**MIX & MATCH SIZES
TO MAKE YOUR CASE AND SAVE!**

> 6 per case.

EACH

ITEM NO.	PRODUCT	1-5	6+
3264 07311	Small, 32" - 36"	\$29.95	\$26.95
3264 07321	Medium, 36" - 40"	29.95	26.95
3264 07331	Large, 40" - 48"	29.95	26.95
3264 07341	X-Large, 48" - 52"	29.95	26.95



ProFlex® 300/315 Hard Cap Knee Pads



- Lightweight contoured 12 mm NBR foam protects sensitive knee joints.
- Abrasion-resistant hard caps.
- Woven elastic straps adjust to an exact fit.
- Available with a long, textured hard cap for tough environments, or a smooth round hard cap for applications that require swiveling and pivoting.
- Buckle closures.



ITEM NO.	PRODUCT	PAIR
3321 0315	A. Hard Cap Knee Pads. Long, Textured	\$29.95
3321 0300	B. Hard Cap Knee Pads. Round, Smooth	29.95

ProFlex® 260 Slip-On Soft Knee Pads

Economical protection for knees.

- Lightweight contoured foam covered with durable fabric protects sensitive knee joints.
- Easy on and off.



ITEM NO.	PRODUCT	PAIR
3321 0260	One Size Fits All	\$12.95



**Additional
BACK, WRIST & ELBOW SUPPORTS
available on our website:
www.bunzlkochsupplies.com**



Safety

PolarBear® PawGard® Gloves

- Constructed of multiple strands of Dyneema® and encapsulated stainless steel fibers.
- **Tuff-Cuff™** anti-shrink cuff construction, dramatically reduces cuff blowout from repeated laundering in bleach.
- Outstanding protection, combined with a close, comfortable fit.



Ansell



CUT RESISTANCE LEVEL
ANSI 5

10-Gauge — 74-048

CUFF EDGE

> 12 per case.
EACH

ITEM NO.	COLOR	SIZE	COLOR	1-11	12+
2201 12741	Gray	X-Small	Silver	\$11.95	\$10.95
2201 12751	Gray	Small	Red	11.95	10.95
2201 12761	Gray	Medium	Yellow	11.95	10.95
2201 12771	Gray	Large	Blue	11.95	10.95
2201 12781	Gray	X-Large	Black	11.95	10.95
2201 22751	White	Small	Red	\$11.95	\$10.95
2201 22761	White	Medium	Yellow	11.95	10.95
2201 22771	White	Large	Blue	11.95	10.95
2201 22781	White	X-Large	Black	11.95	10.95

LN Series Cut-Resistant Gloves

- Antimicrobial fibers offer an additional layer of protection by inhibiting bacterial and fungal growth.
- High performance fibers and stainless steel provide a high level of abrasion resistance.
 - Excellent tensile strength and superior cut protection.
 - Color-coded overedge identifies glove size.
- Prewashed and preshrunk for a close, flexible fit.



WELLS LAMONT
Industrial

WHIZARD

7-Gauge Heavy Weight 3" yellow cuff. > 12 per case.

ITEM NO.	SIZE	EDGE COLOR	1-11	12+
4164 56481	X-Small	Green	\$11.95	\$10.95
4164 56491	Small	Yellow	11.95	10.95
4164 56501	Medium	Blue	11.95	10.95
4164 56511	Large	White	11.95	10.95
4164 56521	X-Large	Orange	11.95	10.95

CUT RESISTANCE LEVEL
ANSI 5

10-Gauge Med. Weight 3" blue cuff. > 12 per case.

ITEM NO.	SIZE	EDGE COLOR	1-11	12+
4164 56391	X-Small	Green	\$10.95	\$9.95
4164 56401	Small	Yellow	10.95	9.95
4164 56411	Medium	Blue	10.95	9.95
4164 56421	Large	White	10.95	9.95
4164 56431	X-Large	Orange	10.95	9.95

CUT RESISTANCE LEVEL
ANSI 5

13-Gauge Light Weight 3" gray cuff. > 12 per case.

ITEM NO.	SIZE	EDGE COLOR	1-11	12+
4164 55581	X-Small	Green	\$9.95	\$8.95
4164 55591	Small	Yellow	9.95	8.95
4164 55601	Medium	Blue	9.95	8.95
4164 55611	Large	White	9.95	8.95
4164 55621	X-Large	Orange	9.95	8.95

CUT RESISTANCE LEVEL
ANSI 4

Knit Gloves with Kevlar®

Two-ply knit gloves with Kevlar® protect hands from minor cuts and abrasions.

- For use as a safety glove on the cutting hand only.
- Not designed specifically for knife protection.
- Machine washable.



PIP
PROTECTIVE INDUSTRIAL PRODUCTS™

> 12 dozen pair per case.

ITEM NO.	SIZE	PER DOZEN PAIR
		1-11 12+
6292 03015	Medium	\$69.95 \$68.95
6292 03025	Large	69.95 68.95
6292 03035	X-Large	69.95 68.95

Kevlar® Knit Sleeves

Protects forearm from cuts, abrasions and minor burns.

- Lightweight, non-irritating, two-ply Kevlar® stretch knit sleeves.
- Machine wash or dry clean.
- Available with or without thumb loops.



ITEM NO.	PRODUCT	EACH
2201 95301	14" Sleeve	\$5.95
2201 02901	18" Sleeve	6.95
3226 44951	14" Sleeve w/ thumb loop	6.95
3226 45091	18" Sleeve w/ thumb loop	7.95

Visit our website to find more
CUT-RESISTANT GLOVES, SLEEVES & APRONS
www.bunzlkochsupplies.com





Cuff Edge Color indicates size

WORKHORSE® Cut-Resistant Gloves

Constructed of spun threads with fully encapsulated glass fibers and stainless steel.

- FDA approved antimicrobial fibers meet USDA food handling requirements.
- Exceptional comfort that is 100% latex and silicone free.
- Resistant to acids, alkali, and organic solvents.
- Extended cuff offers extra cut protection around the wrist.
- Machine washable.
- Antimicrobial fiber.



Extended Cuff

10 GAUGE
CUT RESISTANCE LEVEL
ANSI 5

Gray

ITEM NO.	SIZE	CUFF EDGE COLOR	PER GLOVE
E542 33001	X-Small . . .	Gray	\$7.95
E542 33011	Small	White	7.95
E542 33021	Medium . . .	Red	7.95
E542 33031	Large	Blue	7.95
E542 33041	X-Large . . .	Orange	7.95

White

ITEM NO.	SIZE	CUFF EDGE COLOR	PER GLOVE
E542 33101	X-Small . . .	Gray	\$7.95
E542 33111	Small	White	7.95
E542 33121	Medium . . .	Red	7.95
E542 33131	Large	Blue	7.95
E542 33141	X-Large . . .	Orange	7.95



Double reinforced rings at stress points to extend glove life and eliminate repairs.

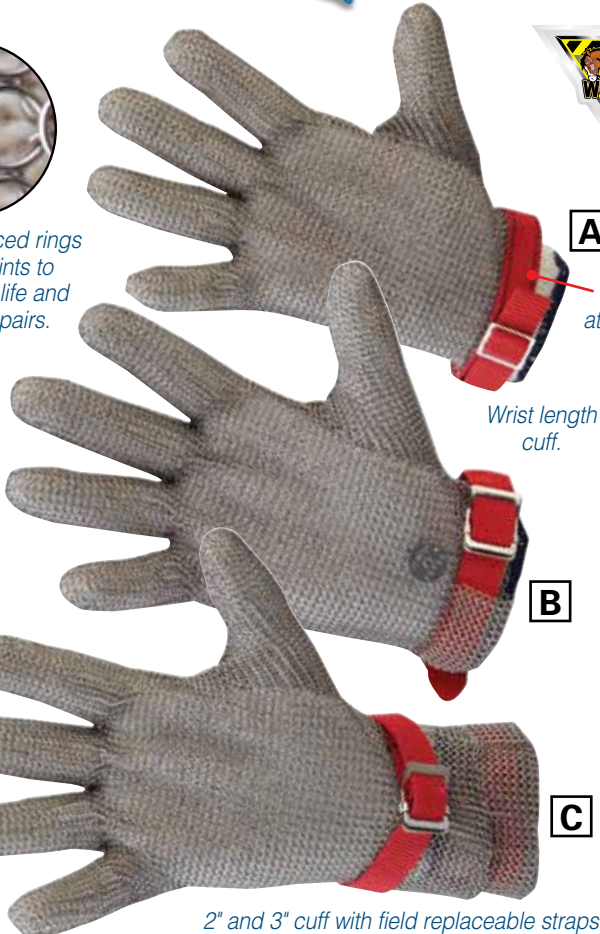

A

Permanently attached straps.

Wrist length cuff.

B

C

2" and 3" cuff with field replaceable straps.
Replacement straps available Call for Details.



WORKHORSE® Stainless Steel Metal Mesh Gloves

The longest lasting, safest, most comfortable mesh glove — at the **LOWEST COST!**

- Heavy gauge stainless steel rings are machine welded to give the longest lasting protection against cuts and lacerations.
- Ergonomically designed to give the best fit and dexterity.
- Metal dome snap reduces donning and doffing time.
- Available in full hand style with permanently attached straps, and extended 3 inch cuff designs with field-replaceable straps.
- Color-coded adjustable strap denotes size.
- Easy to clean.

NOTE: These gloves are sold individually, NOT as a pair.

A WRIST-LENGTH CUFF

ITEM NO.	SIZE	STRAP COLOR	PER GLOVE
E542 10001	X-Small . Size 6 . .	Gray . .	\$69.95
E542 10011	Small . . . Size 7 . .	White . .	69.95
E542 10021	Medium Size 8 . . .	Red . . .	69.95
E542 10031	Large . . . Size 9 . .	Blue . . .	69.95
E542 10041	X-Large, Size 10 .	Green . .	69.95

B 2" EXTENDED-LENGTH CUFF

ITEM NO.	SIZE	STRAP COLOR	PER GLOVE
E542 02531	X-Small. Size 6 . .	Gray . .	\$84.95
E542 02541	Small. . . Size 7 . .	White . .	84.95
E542 02601	Medium Size 8 . . .	Red . . .	84.95
E542 02611	Large. . . Size 9 . .	Blue . . .	84.95
E542 02621	X-Large Size 10 .	Green . .	84.95

C 3" EXTENDED-LENGTH CUFF

ITEM NO.	SIZE	STRAP COLOR	PER GLOVE
E542 30001	X-Small. Size 6 . .	Gray . .	\$87.95
E542 30011	Small. . . Size 7 . .	White . .	87.95
E542 30021	Medium Size 8 . . .	Red . . .	87.95
E542 30031	Large. . . Size 9 . .	Blue . . .	87.95
E542 30041	X-Large Size 10 .	Green . .	87.95



Therapy Ice

- Relief of minor aches and pains of muscles and joints associated with simple backache, arthritis, strains, bruises and sprains.

• 8-oz. jar.



➤ 12 per case.

ITEM NO.	PRODUCT	1-11	12+
3377 09811	Therapeutic Blue Gel . . .	\$7.95	\$6.95

Octogen 2

- Arthritis pain heat rub.
- Contains: Eucalyptus, Camphor, Menthol, and oil of winter green.



➤ 1.25-oz. jar — 12 per case.

ITEM NO.	PRODUCT	1-11	12+
4479 10911	1.25-oz.	\$7.95	\$6.95

➤ 15-oz. jar — 6 per case.

ITEM NO.	PRODUCT	1-5	6+
4479 11151	15-oz.	\$47.95	\$46.95

Burn Spray

- Relieves pain from minor burns.
- Contains antiseptic to help prevent infection from burns, minor cuts and abrasions.
- Water soluble and non-staining.
- 3-oz. aerosol can.



Honeywell
NORTH

➤ 12 per case.

ITEM NO.	PRODUCT	1-11	12+
0047 10051	Burn Spray . . .	\$6.95	\$5.95

Hydrocortisone Cream

- For temporary relief of itching associated with minor skin irritations.
- 1% solution formula.

Honeywell
NORTH



➤ 144 foil packets per box — 12 boxes per case.

ITEM NO.	PRODUCT	1-11	12+
0047 01445	Hydrocortisone Cream . .	\$17.95	\$16.95

Alcohol Wipes

- 70% isopropyl.
- Convenient, individually packaged wipes in dispenser box.

Honeywell
NORTH



➤ 50 per box.

ITEM NO.	PRODUCT	SIZE	BOX
0047 48185	Alcohol Wipes . . .	1" x 2-1/2"	\$3.95

Waterjel® Burn Dressing



- Emergency first aid for burns.
- Sterile gel-soaked burn dressing.
- 4" x 4".

Honeywell
NORTH

➤ 60 per case.

ITEM NO.	PRODUCT	1-59	60+
0047 04041	Burn Dressing . .	\$7.95	\$6.95

Triple Antibiotic

- Antibiotic ointment
- Helps prevent infection in minor cuts, scrapes and burns.

Honeywell
NORTH

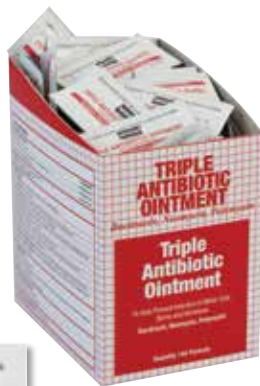

➤ 144 foil packs per box — 12 boxes per case.

ITEM NO.	PRODUCT	1-11	12+
0047 12095	Triple Antibiotic	\$16.95	\$15.95

Hydrogen Peroxide

Honeywell
NORTH

- 3% solution for treatment of minor cuts and abrasions.
- 16-oz. bottle.

Rubbing Alcohol

- 70% isopropyl.
- 16-oz. bottle.



ITEM NO.	PRODUCT	EACH
0047 09691	Hydrogen Peroxide	\$3.95
0047 09351	Rubbing Alcohol	3.95

“Kwik Kold” Instant Ice Pack



Honeywell
NORTH

➤ 16 packs per case.

ITEM NO.	PRODUCT	CASE
0047 0107	6" x 8" Ice Pack.	\$29.95



Safety

Adhesive Fabric Bandages

- Latex-free flexible fabric.
- 100 bandages per dispenser box.



> 100 per box — 12 boxes per case.

ITEM NO.	PRODUCT	PER BOX	
		1-11	12+
0047 64595	1" x 3" Bandages . . .	\$9.95	\$8.95

Metal Detectable Woven Bandage

- 1" x 3" size.
- Blue fabric.



> 100 bandages per box.

ITEM NO.	PRODUCT	BOX
0047 64605	Detectable Bandages	\$9.95

Metal Detectable Knuckle Bandage

- Uniquely designed to fit on injured knuckle.
- Blue fabric.



> 40 per box.

ITEM NO.	PRODUCT	PER BOX
0047 3940	Detectable Knuckle Bandage. .	\$9.95

#25 First Aid Kit

- ANSI Z308.1-2015 compliant.
- White steel water-resistant box with handle and hanging bracket.
- For up to 25 people.



Honeywell
NORTH

Kit includes:
Qty Description

- | | |
|-----------------------------------|------------------------------------|
| 1- Adhesive Bandage, 4" x 2" | 4- Eye Pads w/Adhesive Strips |
| 32- Adhesive Bandage, 1" x 3" | 1- Eye Wash 1 oz |
| 3- Fingertip Bandage | 10- Antiseptic Towelette |
| 2- Knuckle Bandage | 10- Hand Sanitizer .9 g |
| 1- Triangular Bandage, 40"x40x56" | 6- Sting Relief Wipe |
| 2- Roller Bandage, 2" | 1- Cold Pack 5" x 6" |
| 1- Roller Bandage, 3" | 1- Scissors |
| 10- Neomycin Antibiotic | 1- Tweezers |
| 4- Gauze Pad, 3" x 3" | 2- Exam Gloves, Pair |
| 2- Trauma Pad, 5" x 9" | 3- Non-Aspirin Pain Reliever, 2/pk |
| 2- Adhesive Tape 1/2"x5 yds | 1- CPR Filtershield |
| 10- Burn Cream 1.0 g | 1- First Aid Guide |
| 1- Burn Dressing 4"x4" | |



ITEM NO.	PRODUCT	DIMENSIONS	EACH
3140 00091	#25 First Aid Kit, Class A . . .	9-1/2" x 6-5/8" x 2-5/8"	\$49.95
3140 00111	#25 First Aid Kit (plastic case) .	9-1/2" x 6-5/8" x 2-5/8"	29.95

#100 First Aid Kit

- For up to 100 people.
- ANSI Z308.1-2015 compliant.
- White steel weatherproof box with handle and hanging bracket.



Kit includes:
Qty Description



- | | |
|-----------------------------------|------------------------------------|
| 6- Adhesive Bandage, 4" x 2" | 2- Burn Dressing 4"x4" |
| 100- Adhesive Bandage, 1" x 3" | 8- Eye Pads w/ Adhesive Strips |
| 40- Fingertip Bandage | 1- Eyewash 4oz |
| 40- Knuckle Bandage | 1- Pump Antiseptic 2oz |
| 2- Triangular Bandage, 40"x40x56" | 10- Alcohol Prep Pads |
| 4- Roller Bandage, 2" | 10- Hand Sanitizer 9g |
| 4- Roller Bandage, 4" | 2- Cold Pack 5"x6" |
| 1- Elastic Bandage 2" x 4.5 yds | 1- Scissors |
| 30- Neomycin Antibiotic | 1- Tweezers |
| 4- Blood Stopper Trauma Pad | 4- Exam Gloves, Pair |
| 10- Gauze Pad, 2" x 2" | 50- Non-Aspirin Pain Reliever 2/pk |
| 25- Gauze Pad, 3" x 3" | 1- Tourniquet |
| 2- Adhesive Tape 1" x 5 yds | 1- Wire Splint |
| 10- Non Adherent Pads 2"x3" | 1- CPR Filtershield |
| 1- Pump Burn Relief 2oz | 1- First Aid Guide |

ITEM NO.	PRODUCT	DIMENSIONS	EACH
3140 00171	#100 Bulk First Aid Kit, Class B . . .	15" x 10-1/2" x 4-3/4"	\$169.95
3140 00161	#50-person First Aid Kit	(not pictured)	79.95

Bloodborne Pathogen Response Kit

- Rustproof plastic kit, comes with wall mount bracket for easy installation.

- | | |
|-------------------------|------------------------|
| 2- Pair, Medical Gloves | 1- Scraper |
| 2- Red Bio-hazard Bags | 1- Pair of Shoe Covers |
| 1- Germicidal Towelette | 1- Absorbent Towel |
| 1- Antiseptic Wipes | 1- Shovel |
| 1- Gown, X-Large | 1- 2-oz. Solidifier |
| 1- Face Mask | 2- Twist Ties |

Honeywell
NORTH



ITEM NO.	PRODUCT	EACH
3476 1033	Bloodborne Pathogen Kit	\$39.95

Lockout Locks

- Six pin cylinder, retaining key, dedicated safety key way and designation by end user.
- Available in seven different colors, with safety identification on lock and key.
- Xenoy body padlocks.
- Keyed differently.
- Write-on labels included.

Complies with latest OSHA standards.



Includes write-on labels.

Master Lock

Locks also available keyed alike. Call for more details.



1-1/2" LOCK

3" LOCK

ITEM NO.	COLOR	ITEM NO.	COLOR	EACH	
				1 - 5	6+
3198 14101	Yellow	3198 34101	Blue	\$13.95	\$12.95
3198 4100	Orange	3198 24101	Green . . .	13.95	12.95
3198 04101	Red	3198 34121	Black. . . .	13.95	12.95
3198 41031	Purple			13.95	12.95

ITEM NO.	COLOR	ITEM NO.	COLOR	EACH	
				1 - 5	6+
3198 24111	Yellow	3198 66741	Blue	\$14.95	\$13.95
3198 34011	Orange	3198 04221	Green . . .	14.95	13.95
3198 66731	Red	3198 34051	Black. . . .	14.95	13.95
3198 04341	Purple			14.95	13.95

Lockout Hasp

- Accommodates up to six locks.
- Choose from steel jaw with vinyl coated handle or spark-resistant aluminum lockout hasp.

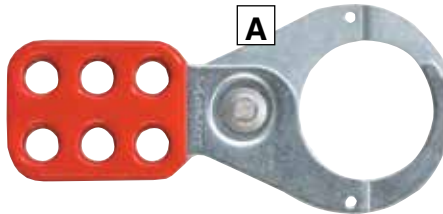

ITEM NO.	PRODUCT	EACH
3198 04201	A. 1" Steel Jaw with Vinyl Coated Handle Lockout Hasp	\$6.95
3198 04211	1-1/2" Steel Jaw with Vinyl Coated Handle Lockout Hasp	6.95
3198 0416	B. 1" Spark Resistant Aluminum Lockout Hasp	6.95

Latch Tight™ Group Lock Box

Latch-Tight™ feature eliminates all gaps to ensure keys can not be accessed until the very last lock is removed.

- Can be used as traditional bulk key storage through the key slot, or each of the 12 key holders can be labeled to determine which key opens which lockout point.
- Powder-coated red finish on heavy-duty steel box and stainless steel handle withstand harsh environments.
- Can be wall-mounted or used as a portable unit.
- Accommodates up to 14 workers.

Master Lock



ITEM NO.	PRODUCT	DIMENSIONS	EACH
3198 0503	Group Lock Box. . .	6-3/8" x 3-1/2" x 12-3/4"h.	\$69.95



Check out more
SECURITY LOCKS & LOCKOUT KITS
 available on our website:
www.bunzlkochsupplies.com



1/2" Thick.

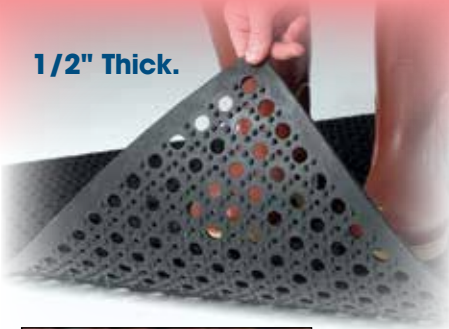

Safe Walk Light™ Anti-Fatigue Floor Mat With Beveled Edge

- 1/2" thick mat contains beveled edges on all sides to prevent tripping, and facilitate movement of wheeled carts.
- Raised blocks on underside of mat allow water to flow easily for quick clean up.



Extra thickness allows for mat to sit above spilled water to prevent slipping.

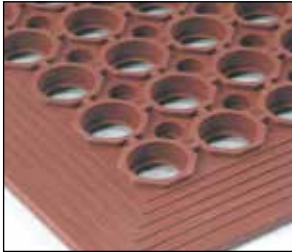

Grease-proof mat prevents grease build-up.

Grease-Resistant Black Floor Mat

ITEM NO.	SIZE	THICKNESS	SHIPPING WT	EACH
4480 0354	36" x 60"	1/2"	26-1/2-lbs	\$49.95

Grease-Proof Terra Cotta Floor Mat

ITEM NO.	SIZE	THICKNESS	SHIPPING WT	EACH
4480 0005	36" x 60"	1/2"	26-1/2-lbs	\$79.95

Foam Anti-Fatigue Mat

- Durable, abrasion-resistant surface is wear-bonded to a highly-ergonomic Zedlan foam.
- Wear-bonding process bonds layers together without the use of adhesives.
- For use in medium-duty, dry areas.



1/2" Thick.



Pebble surface texture.

ITEM NO.	SIZE	THICKNESS	SHIPPING WEIGHT	EACH
4480 0057	24" x 36"	1/2"	5-1/2-lbs	\$49.95

Foam Rubber Anti-Fatigue Mat

- Ideal for use as a workstation mat to reduce leg and back stress on workers who have to stand for prolonged periods of time.
- Constructed of closed cell foam rubber.
- Beveled edges reduce tripping.



Textured surface provides slip-resistant footing.

9/16" Thick.



ITEM NO.	SIZE	THICKNESS	SHIPPING WEIGHT	EACH
4480 0489	2' x 3'	9/16"	7-lbs.	\$39.95

Raised Knob Entrance Mat

- Beveled edges reduce tripping hazard.
- Easy to clean.
- Color: black.

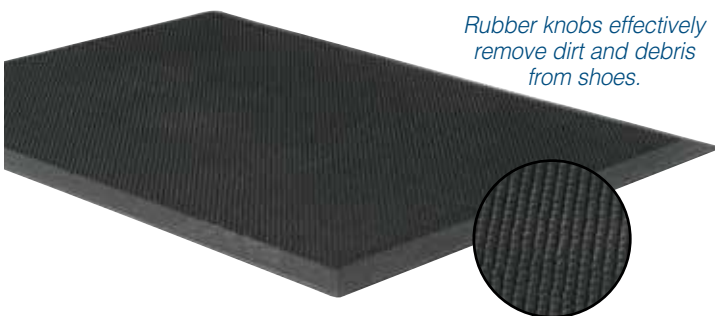

Rubber knobs effectively remove dirt and debris from shoes.

5/8" Thick.



ITEM NO.	SIZE	THICKNESS	EACH
4480 0254	24" x 32"	5/8"	\$49.95

Red Knobby Mat™

Designed specifically for use in food processing.

- Knobby design allows free air flow to prevent bacterial growth.
- Use as anti-fatigue mat or cut to fit utility carts or shelving for no-slip surface.

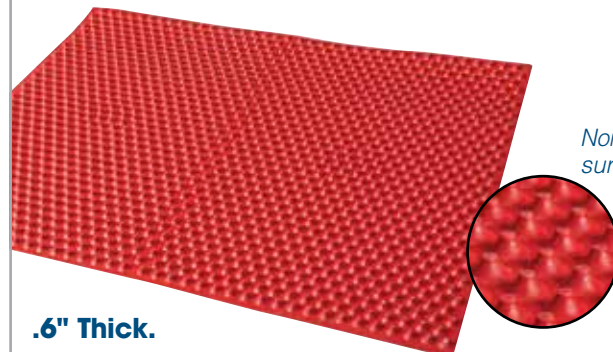

Non-slip surface.

.6" Thick.

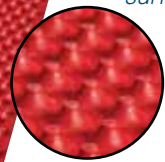

ITEM NO.	SIZE	THICKNESS	SHIPPING WEIGHT	EACH
E531 27291	21" x 27"	.6"	6-lbs.	\$79.95

YOUR PACKAGING HEADQUARTERS

CLARITY™

C5000 COOK CHILL BAGS

Cook, Fill, Seal, Chill, Store, Reheat and Serve



Available with or without handle

CLARITY™

VACUUM POUCHES

Mix & Match Sizes for Discounts



Zippered pouches available

CLARITY™

CRYOVAC®

Sealed Air
Food Care

Cryovac® shrink bags now in smaller quantities — only available from Bunzl Processor Division!



Scan the QR Code to link directly to our packaging website www.bunzlpdpackaging.com



Custom Cloth Bags

Set your product apart from the competition!

- Full color custom printed Cloth Bags are available in a variety of sizes, types and fabrics.
- We can accommodate virtually any size or type of Custom Cloth Bags to fit your needs.
- Bags are puncture resistant, recyclable, and last longer than the actual product contained within them, so they can be reused again & again.
- Approved for food contact.

Choose your Custom

- Bag size
- Fabric/material
- Edge Finish
- String tie options
- Sewn-in tag options
- Full color printing options on front and back of bags.



CUSTOM COLOR PRINT & CUSTOM SIZES



Dry Mix Bags Can Be Used For:

- Sausage • Coffee • Cornbread Mix
- Cocoa • Pancake/Waffle Mix
- Rice/Grain/Flour • Soup Mix
- Cake/Scone Mix • And Much More!

Call our Packaging Specialists at 800-456-5624 for FREE samples and quotes!

Conversion Chart

LIQUIDS

1 gallon = 3.7853 liters
 1 gallon = 4 quarts
 1 gallon = 8 pints
 1 liter = 0.2642 gallons
 1 liter = 1.057 quarts
 1 liter = 2.113 pints
 1 pint = 0.125 gallons
 1 pint = .732 liters
 1 pint = 0.5 quarts
 1 pint = 16 ounces

WEIGHT

1 pound (1-lb.) = 0.4536 kilograms
 1 pound = 16 ounces
 1 pound = 453.592 grams
 1 kilogram = 2.2046 pounds
 1 kilogram = 35.2736 ounces
 1 kilogram = 1,000 grams
 1 ounce = 28.3495 grams
 1 gram = 0.0353 ounces

TEMPERATURE

$^{\circ}\text{F} = (^{\circ}\text{C} \times 9/5) + 32$
 $^{\circ}\text{C} = (^{\circ}\text{F} - 32) \times 5/9$

CONVERSION FACTORS

CONVERT	INTO	MULTIPLY BY
Acres	Square Feet	43,560
Acres	Hectares	.4047
Barrels (US Liquid)	Gallons	31.5
Barrels (Oil)	Gallons (Oil)	42
Centimeters	Feet	.03281
Centimeters	Inches	.3937
Cubic Feet	Cubic Meters	.02832
Cubic Feet	Cubic Yards	.03704
Cubic Feet	Gallons (US Liquid)	7.48052
Cubic Meters	Cubic Feet	35.31
Cubic Meters	Gallons (US Liquid)	264.2
Feet	Meters	.3048
Gallons	Cubic Feet	.1337
Gallons	Cubic Meters	.003785
Gallons of Water	Pounds of Water	8.3453
Horsepower	Kilowatts	.7457
Horsepower	Watts	745.7
Kilograms	Pounds	2.2046
Kilometers	Feet	3,281
Kilometers	Miles	.6214
Kilowatts	Horsepower	1.34
Liters	Quarts	1.057
Meters	Feet	3.281
Meters	Inches	39.37
Miles (statute)	Kilometers	1.609
Ounces	Grams	28.35
Pounds	Kilograms	.4536
Square Feet	Square Meters	.09290
Square Meters	Square Feet	10.76
Tons (metric)	Pounds	2,205

METRIC EQUIVALENTS

APPROXIMATE EQUIVALENTS

1 decimeter = 4 inches
 1 liter = 1.06 qts. fluid, .9 qt dry
 1 meter = 1.1 yards
 1 kilometer = 5/8 mile
 1 hectoliter = 2-5/8 bushels
 1 cubic meter = 1/4 of a cord
 1 metric ton = 1.1 English tons

LINEAR MEASURE

1 centimeter = .3937 inch
 1 inch = 2.54 centimeters
 1 inch = 25.4 millimeters
 1 decimeter = 3.937 inches
 1 foot = 3.048 decimeters
 1 foot = .3 meters
 50 feet = 15 meters
 1 meter = 39.37 inches
 1 yard = .9144 meter
 1 dekameter = 1.9884 rods
 1 rod = .5029 dekameter
 1 kilometer = .62137 mile
 1 mile = 1.6093 kilometers

SQUARE MEASURE

1 sq. cm = .1550 sq. inch
 1 sq. inch = 6.452 sq. cm
 1 sq. dm = .1076 sq. foot
 1 sq. foot = 9.2903 sq. dm
 1 sq. meter = 1.196 sq. yards
 1 sq. yard = .8361 sq. meter
 1 acre = 3,954 sq. rods
 1 sq. rod = .2529 acre
 1 hectare = 2.47 acres
 1 acre = .4047 hectare
 1 sq. km = .386 sq. mile
 1 sq. mile = 2.59 sq. km

LINEAR MEASURE

10 millimeters = 1 centimeter
 10 centimeters = 1 decimeter
 10 decimeters = 1 meter
 10 meters = 1 dekameter
 10 dekameters = 1 hectometer
 10 hectometers = 1 kilometer

SQUARE MEASURE

100 sq. mm = 1 sq. centimeter
 100 sq. cm = 1 sq. decimeter
 100 sq. dm = 1 sq. meter
 100 sq. meters = 1 sq. dekameter
 100 sq. dkm = 1 sq. hectometer
 100 sq. hm = 1 sq. kilometer

CUBIC MEASURE

1,000 cu. mm = 1 cu. centimeter
 1,000 cu. cm = 1 cu. decimeter
 1,000 cu. dm = 1 cu. meter

MEASURE OF VOLUME

1 cu. cm = .061 cu. inch
 1 cu. inch = 16.39 cu. cm
 1 cu. dm = .0353 cu. foot
 1 cu. foot = 28.347 cu. dm
 1 cu. meter = 1.308 cu. yards
 1 cu. yard = .7646 cu. meter
 1 stere = .2759 cord
 1 cord = 3.624 steres
 1 liter = .908 qt. dry, 1.0567 qts. liq.
 1 qt. dry = 1.101 liters
 1 qt. liquid = .9463 liter
 1 dekaliter = 2.6417 gallons
 1 gallon = .3785 deciliter
 1 peck = .881 deciliter
 1 hectoliter = 2.8375 bushels
 1 bushel = .3524 hectoliter

WEIGHTS

1 gram = .03527 ounce
 1 ounce = 28.35 grams
 1 kilogram = 2.2046 pounds
 1 pound = .4536 kilogram
 1 metric ton = 1.1023 English tons
 1 English ton = .9027 metric ton

COMMON METRIC PREFIXES

Mega = 1,000,000
 Kilo = 1,000
 Hecto = 100
 Deka = 10
 Deci = .1 (tenth)
 Centi = .01 (hundredth)
 Milli = .001 (thousandth)
 Micro = .000001 (millionth)

LIQUID MEASURE

10 milliliters = 1 centiliter
 10 centiliters = 1 deciliter
 10 deciliters = 1 liter
 10 liters = 1 dekaliter
 10 dekaliters = 1 hectoliter
 10 hectoliters = 1 kiloliter

WEIGHTS

10 milligrams = 1 centigram
 10 centigrams = 1 decigram
 10 decigrams = 1 gram
 10 grams = 1 dekagram
 10 dekagrams = 1 hectogram
 10 hectograms = 1 kilogram
 100 kilograms = 1 quintal
 1000 kilograms = 1 metric ton
 10 quintal = 1 metric ton



DISTRIBUTION CENTERS

Our inventory includes over 35,000 ready-to-ship products from 14 distribution centers serving Central and North America, including the Caribbean and Mexico, so you won't have to wait long to receive the supplies you need:

Springdale, AR • Fresno, CA
Frederick, CO • Atlanta, GA
Eldridge, IA • Liberal, KS
Austin, MN • North Kansas City, MO
St. Pauls, NC • Omaha, NE
Fairfield, OH • York, PA
Dallas, TX • Spokane, WA



FREE SHIPPING*
on orders of \$400 or more, **PLUS**
Request a **FREE BUYERS GUIDE!**

*Some restrictions apply. See page 2 for more details.



www.bunzlkochsupplies.com

Scan this QR code with your mobile device for a direct link to our website.

BUNZL
Processor Division
KOCH SUPPLIES

528 East 19th Avenue
North Kansas City, MO 64116