

ULTRA[®]-600

BY MAGUIRE[®]

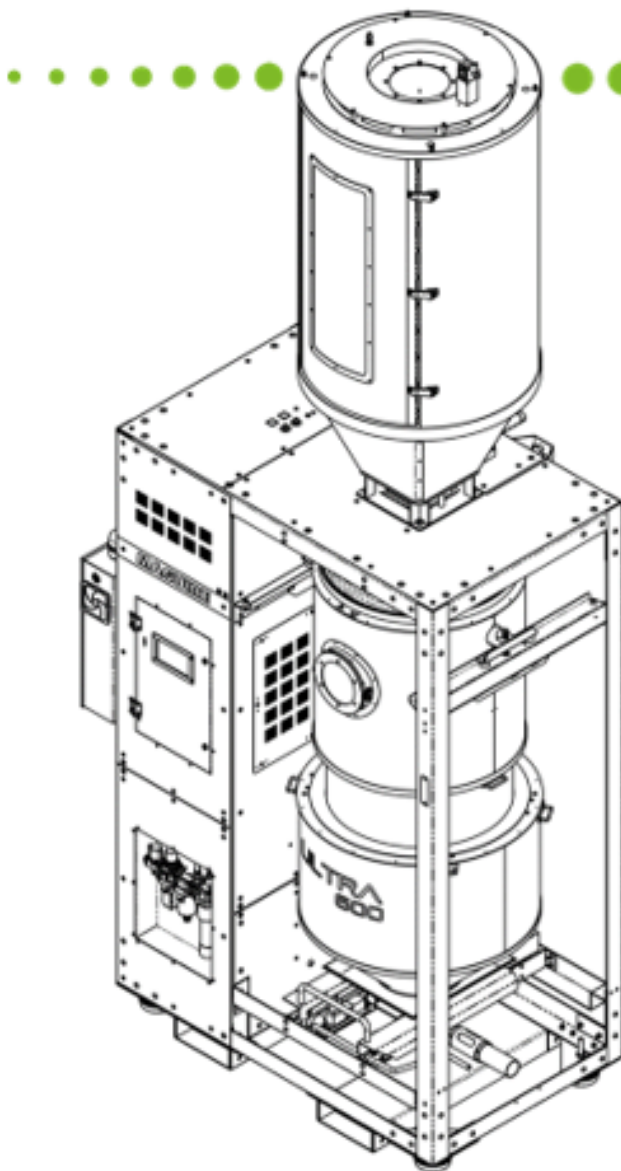

- INSTALLATION
- OPERATION
- MAINTENANCE

ULTRA-600® - Ultra-Low Energy Dryer®

This document is the Original Instructions manual of the Maguire ULTRA-600® Dryer equipped with the Touchscreen Controller.

Copyright © 2019 Maguire Products Inc.

The information contained within this manual including any translations thereof, is the property of Maguire Products Inc. and may not be reproduced, or transmitted in any form or by any means without the express written consent of Maguire Products Inc.

To every person concerned with use and maintenance of the Maguire ULTRA-600® it is recommended to read thoroughly these operating instructions. Maguire Products Inc. accepts no responsibility or liability for damage or malfunction of the equipment arising from non-observance of these operating instructions.

To avoid errors and to ensure trouble-free operation, it is essential that these operating instructions are read and understood by all personnel who are to use the equipment.

Should you have problems or difficulties with the equipment, please contact Maguire Products Inc. or your local Maguire distributor.

These operating instructions only apply to the equipment described within this manual.

Manufacturer's Contact Information

Maguire Products Inc.
11 Crozerville Road
Aston, PA. 19014

Phone: 610.459.4300
Fax: 610.459.2700

Website: <http://www.maguire.com>

Email: info@maguire.com

Accuracy of this Manual

We make every effort to keep this manual as correct and current as possible. However, technology and product changes may occur more rapidly than the reprinting of this manual. Generally, modifications made to the dryer design or to the operation of the software may not be reflected in the manual for several months. The date at the footer of this manual will indicate approximately how current this manual is. Likewise, your ULTRA dryer may have been produced at an earlier time and the information in this manual may not accurately describe your dryer since this manual is written for the current line of ULTRA dryers in production (as of the date in the footer). We always reserve the right to make these changes without notice, and we do not guarantee the manual to be entirely accurate. If you question any information in this manual, or find errors, please let us know so that we may make the required corrections or provide you with accurate information. Additionally, we will gladly provide you with an updated copy of any manuals you need at any time. We welcome comments and suggestions on ways we can improve this manual.

For additional information, or to download the latest copy of this manual or any other Maguire manual, please visit our website or contact us directly.

On the Web at: www.maguire.com

Maguire Products Inc.
Main Headquarters
11 Crozerville Road
Aston, PA 19014
Tel: 610.459.4300
Fax: 610.459.2700
info@maguire.com

Maguire Europe
Tame Park
Tamworth
Staffordshire
B775DY
UK
Tel: + 44 1827 265 850
Fax: + 44 1827 265 855
info@maguire-europe.com

Maguire Products Asia PTE LTD
15 Changi North Street 1
#01-15, I-Lofts
Singapore 498765
Tel: 65 6848-7117
Fax: 65 6542-8577
magasia@maguire-products.com.sg

Maguire Canada
299 Basaltic Road, Unit 1
Vaughan, Ontario L4K 4W8,
CANADA
Toll Free: 866-441-8409
Tel: 905-879-1100
Fax: 905-879-1101
info@maguirecanada.com

Maguire Imea Fzco -
India, Middle East & Africa
Lobby 18, Floor 7, Office 6
JAFZA View 18Jebel Ali
Downtown
PO Box 17493, Dubai, UAE
Tel: +971 4 881 6700
info@maguire-imea.com

Please e-mail comments and suggestions to: support@maguire.com

Table of Contents

INSTALLATION	8
Dryer Assembly	11
Engaging the Load Cells	13
Dryer Connections	14
Compressed Air Connection	15
Electrical Connection	16
Temperature Sensor (RTD) Locations	17
Home Screen Overview	18
Setup Menu Map -Brief Explanation	26
Parameters Explained	29
Changing Parameters	52
Batch Mode	29
Communication Setup	53
Operation	19
Start Up and Operation Instructions	19
What is happening when the Dryer is Running	21
Shutdown-Options	22
Auto-Stop Setup	23
Advanced Information	24
Recommended Drying Temperatures	25
Maintenance	55
Drain and purge Air Filter / Regulator	55
Air Pressure Adjustments	55
Loadcell Calibration	56
Cleanout Procedure	59
Alarms - Cause and Solution	63
Logs and Print Outputs	69
Dryer Firmware Updates	75
General Information	76
Technical Specifications	72
Theory of Operation / Performance	79
Warranty	80
Recommended Spare Parts List	75
Wiring Diagrams	82
Declaration of Conformity	87
Technical Support / Contact Information	88

Warranty – Exclusive 5-Year

MAGUIRE PRODUCTS OFFERS THE MOST COMPREHENSIVE WARRANTY in the plastics auxiliary equipment industry. We warrant each MAGUIRE ULTRA Dryer manufactured by us to be free from defects in material and workmanship under normal use and service; excluding only those items listed below as 'excluded items'; our obligation under this warranty being limited to making good at our factory any Dryer which shall, within FIVE (5) YEARS after delivery to the original purchaser, be RETURNED intact to us, transportation charges PREPAID, and which our examination shall disclose to our satisfaction to have been thus defective; this warranty being expressly in lieu of all other warranties expressed or implied and of all other obligations or liabilities on our part, and MAGUIRE PRODUCTS neither assumes nor authorizes any other persons to assume for it any other liability in connection with the sale of its Dryers.



This warranty shall not apply to equipment repaired or altered outside MAGUIRE PRODUCTS INC. factory, unless such repair or alteration was, in our judgment, not responsible for the failure; nor which has been subject to misuse, negligence or accident, incorrect wiring by others, or installation or use not in accord with instructions furnished by Maguire Products, Inc.

Our liability under this warranty will extend only to equipment that is returned to our factory in Aston, Pennsylvania, PREPAID.

Please note that we always strive to satisfy our customers in whatever manner is deemed most expedient to overcome any problems they may have in connection with our equipment.

**GETTING STARTED:
PROCEED TO: SAFETY WARNINGS NEXT PAGE**

SAFETY WARNINGS



WARNING

HOT SURFACES:

As with all dryers, there are **HOT SURFACES** to avoid. Temperatures can reach 350F, (180C).



Typically, these surfaces are not at dangerous temperatures, however all hot surfaces should be avoided.



Warning Label indicate:
HOT SURFACES

USE CAUTION when removing and installing canisters.

USE GLOVES

DO NOT REACH into the dryer enclosure.

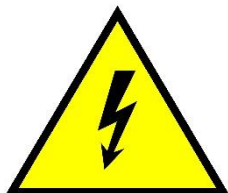

DANGER

RISK OF SHOCK:

Disconnect power supply before servicing the Dryer.



GETTING STARTED: PROCEED TO: INSTALLATION - NEXT PAGE

Installation

Transport and Setup

Shipment

The ULTRA-600 Dryer is shipped as separate components that require re-assembly.

The 2 main sections that are shipped are:

Retention Hopper and Vacuum Chamber Assembly Frame (A & B) – The retention hopper (A) and vacuum chamber (B) assembly is identified by the large metal frame encompassing the recessed pneumatics cabinet, the electrical cabinet, the mounted vacuum chamber (B), and the removable material retention hopper (A). Total assembly weight is 1681 lb. (762 kg).

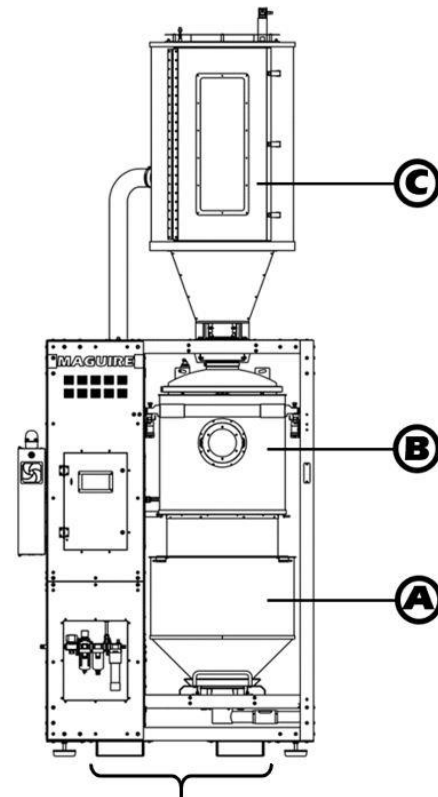

Heating Hopper Assembly (C) – Located on top of the vacuum chamber/retention hopper assembly frame. Weight is 349 lb. (158 kg).

Other smaller components will be included.



Forklift Channels

Lifting and Moving components of the Dryer

 WARNING	<p>Ensure your lifting equipment is rated to lifting the weight of the individual sections of the ULTRA-600.</p>		<p>Follow forklift safety rules and regulations whenever moving portions of the ULTRA-600</p>
---	---	---	--

The ULTRA-600 platform is designed for ease of lifting and moving. The retention hopper and vacuum chamber assembly frame was designed with two steel channels spanning the depth of the machine to allow for a fork truck to safely and easily lift and position the machine into place.

Overall layout and Dimensions

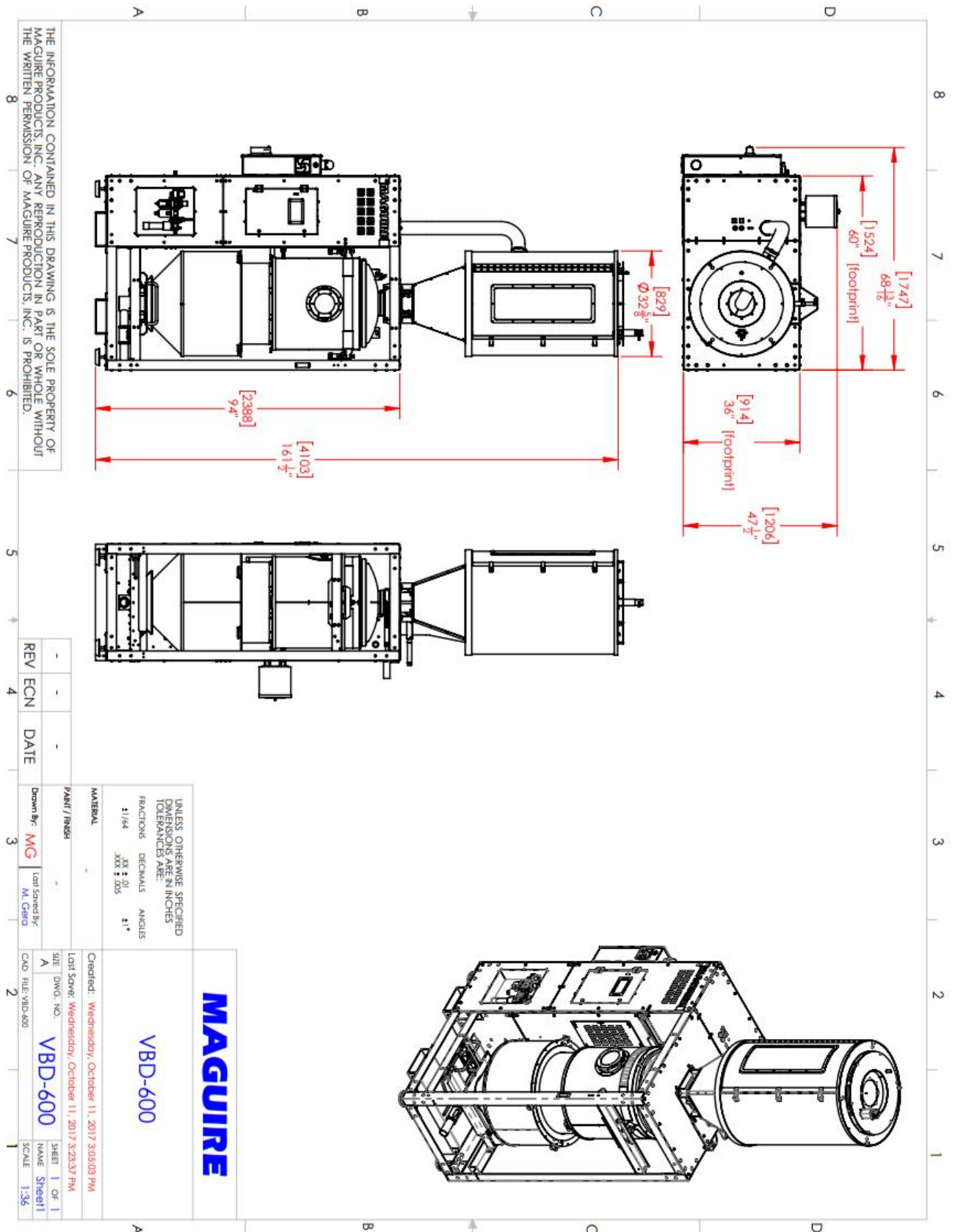

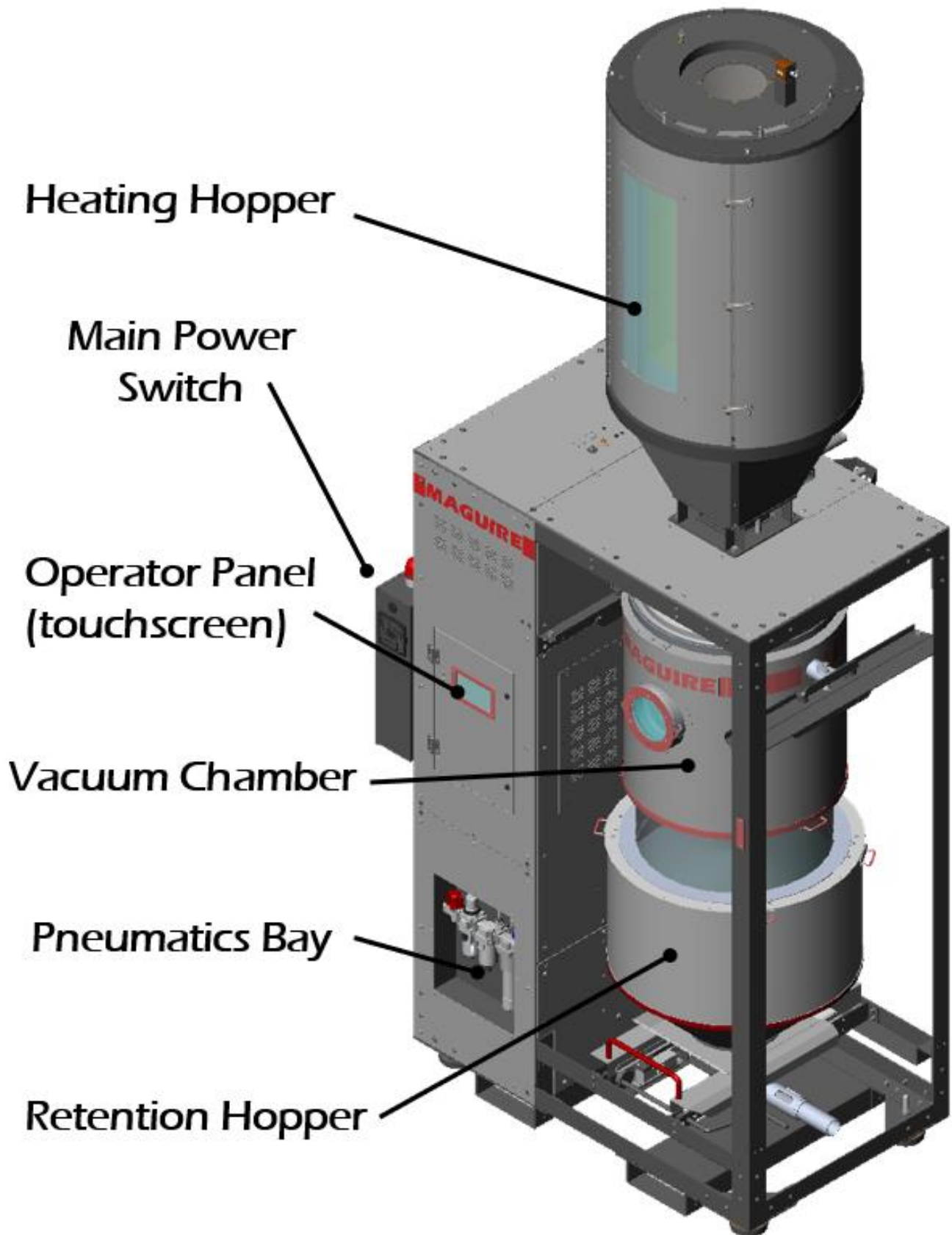

Dryer Assembly

Leveling Feet



If using the leveling feet, make sure the surface that the ULTRA-600 will be placed on can support the weight at all 4 corners.



When adjusting the leveling feet, keep the frame as close to the floor as possible. Over extending the threads below the frame is not recommended for stability reasons.

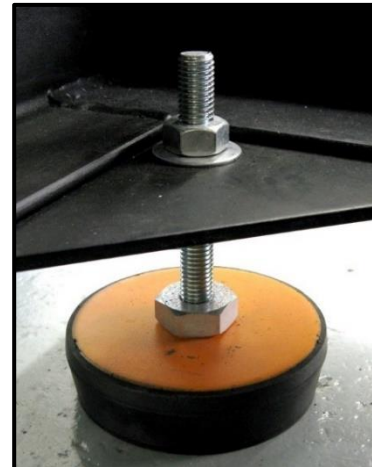

Install the Heating Hopper

Following proper forklift safety regulations, carefully lift up the heating hopper, by positioning the forks underneath the intermediate retaining ring. Place the heating hopper on top of the machine frame. Ensure that the front hatch of the heating hopper faces the same direction as the front of the machine.



Install the four 1/2-13, 1-1/4" long, grade 8, hex head bolts and tighten.

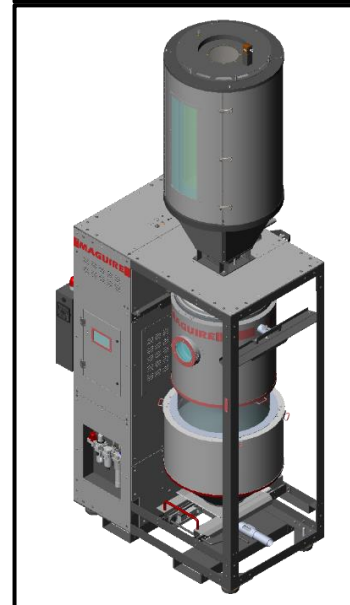

Installing the Upper Vacuum Gate

Note: If your Upper Vacuum Slide Gate is already installed from factory, skip this step.

If the ULTRA-600 Upper Vacuum Gate was shipped detached from the ULTRA-600 it must be installed after the Heating Hopper is mounted and installed on the machine.

Items with this assembly:

- Upper Vacuum Gate
- Retainer Bracket
- two 1/4-20 1/2" button head screws

The Upper Vacuum Gate will install from the rear of the Dryer. Locate the slot on the mount ring at the very top of the Vacuum Tank. See photo at right.

With the Slide Gate facing up, slide the Upper Vacuum Gate assembly into the slot on the mount ring as shown in the photo to the right. Slide the Upper Vacuum Gate onto the mount ring until it fully seats into the slot. It may be helpful to slide the Upper Vacuum Gate left and right as it is installed.

Note: To fully seat the Vacuum Gate onto the mount ring, the tab in the inner arch of the Upper Vacuum Gate must go into the recessed hole of the mount ring on the Vacuum Chamber.

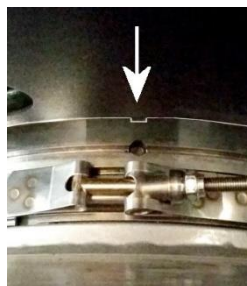

From the front side of the Dryer, install the Retaining Bracket onto the Upper Vacuum Gate and fully into the slot on the mount ring and secure it using the two 1/4-20 1/2" button head screws.

Install the two 5/32 (4mm) airlines onto the Upper Vacuum Gate air cylinder. The shorter line will connect to the air cylinder fitting closest to the slide gate.

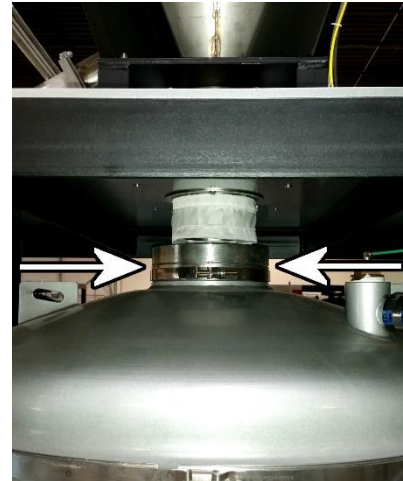
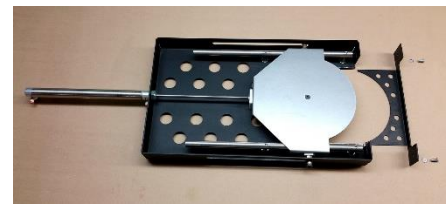

Engaging the Load Cells



The load cells are immobilized prior to shipping and must be engaged for proper operation of the ULTRA-600 Dryer. There is a total of 4 load cells on machine: 2 for the vacuum chamber and 2 for the retention hopper

Vacuum Chamber Load Cells

The first step in engaging the vacuum chamber load cells is to remove the 2 retaining bolts that secure the vacuum chamber to the frame.

Next, the jam nut located on the loadcell transfer bolt needs to be loosened.

To engage the load cell, tighten down the load cell transfer bolt until there is roughly a ¼ inch (6mm) gap between the hanger bumper stops and the frame.

Tighten down the jam nut to secure the position and ensure proper load cell engagement.

Repeat steps for the other side.

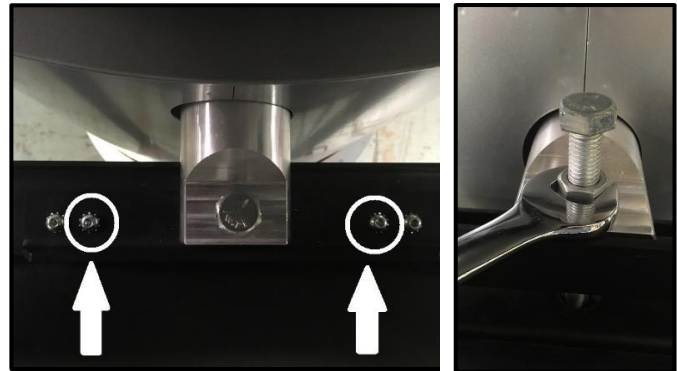

Retention Hopper Load Cells

To engage the Retention Hopper load cell pair, remove the packaging straps from the Retention Hopper Lifting Lever. Lower the Retention hopper onto the load cell by pressing the lever back and down. This will engage the Retention Hopper lower frame onto the load cell pair.

When the Retention Hopper Lifting Lever is in its upright position, the lever's cams lift the weigh off of the load cell pair and allow the Retention Hopper to be pulled out for servicing and cleaning purposes.

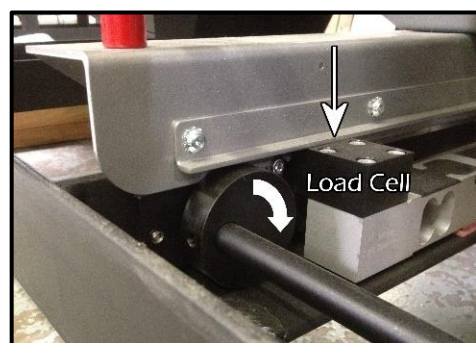
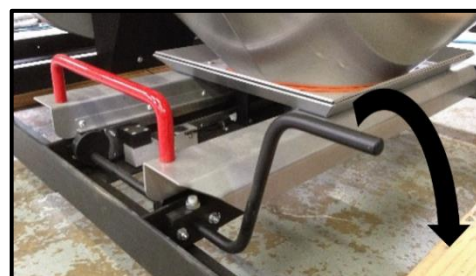

Dryer External Connections

Heating Hopper Air Lines/RTD/Sensor Cables

On top of the machine, next to the heating hopper, there are a series of air lines and cables that need to be connected.

There is a total of 3 air lines; two are which are for the vacuum chamber upper slide gate (red), and one to supply cooling air to the heating hopper level sensor (yellow).

There are 2 RTD cables that need to be connected. The orange connector indicates T1, which is the inlet temperature going into the heater hopper. The black connector signifies T3, which is the temperature at the top of the heating hopper.

Connect the level sensor cable to the corresponding CPC connection on the top of the machine.

If the air lines are not protruding through the top of the machine, through the grommets, the top panel will need to be removed. The air lines will have to be located and fed through the grommets on the top metal panel. Re-install the top panel.

Install Heating Hopper Level Sensor and Bracket

Install the heating hopper bracket and level sensor onto the adaptor plate located on top of the heating hopper (as shown). Locate the sensor cable that exits the top of the ULTRA Heating Hopper and attach the sensor cable to the sensor.

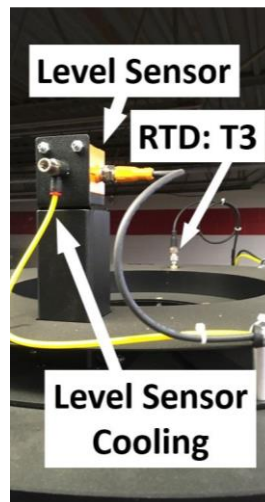
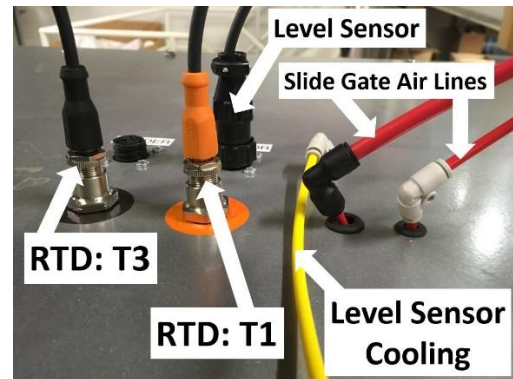

Compressed Air Connection

Connect an air supply to the air regulator's IN port using a male 1/2" NPT fitting.

An operating air pressure of 80 psi (5.5 bar) while the vacuum generator is running is required for proper operation of the Dryer.

If your air supply has oil in it, add an oil separator (coalescing filter).
Oil in the air will combine with dust drawn from the vacuum tank forming a paste inside the vacuum generator. It will stop working and require cleaning.

Observe the air pressure gauge to be sure the pressure maintains 80 psi (5.5 bar) while the vacuum generator is running as you check and adjust the regulator. If pressure drops below 80 psi, adjust the regulator. If the pressure cannot be maintained at 80 psi (5.5 bar) while the vacuum generator is running, then the air supply line is not adequate.



Air Pressure



Air pressure affects the ability to draw a high vacuum. We recommend a pressure setting of **80 PSI while the dryer is running**. Air is used when the **vacuum generator** is running so observe the PSI while the Dryer is drawing a vacuum. The gauge should continue to read this setting even when the vacuum unit is on. If it does not maintain pressure your supply line is not sized properly.



Do not supply Dryer with a lubricated air supply. Damage to Dryer may result. Use only a clean, dry, oil-free air supply.

Electrical Connection



RISK OF INJURY!
Only qualified technicians should make electrical connections.



Connect Main Power

The electrical cable located on the left side of the Dryer on the power box supplies the power to the Dryer. Within the cable is four wires. Three of the wires are black and labeled with a number: 1, 2, and 3. The fourth wire is a green/yellow wire and is the ground wire.

Connect power to a properly fused disconnect.

See page 84 for the High Voltage Wiring Diagram

**THREE PHASE: 60 cycle 480 volts
 or 50 cycle 400 volts**

Temperature Sensor (RTD) Locations

T1 – Heating Hopper Air Inlet

T1s – Heating Hopper Air Inlet Temperature **Setting**
 T1a – Heating Hopper Air Inlet Temperature **Actual**

T2 – Dry Purge Air Temperature

T2s – Dry Purge Air Temperature **Setting**
 T2a – Dry Purge Air Temperature **Actual**

T3 – Heating Hopper Air Outlet Temperature

T3s – Heating Hopper Air Outlet Temperature **Setting**
 T3a – Heating Hopper Air Outlet Temperature **Actual**

T4 – Material Outlet Temperature (optional)

T4s – Material Outlet Temperature **Setting**
 T4a – Material Outlet Temperature **Actual**

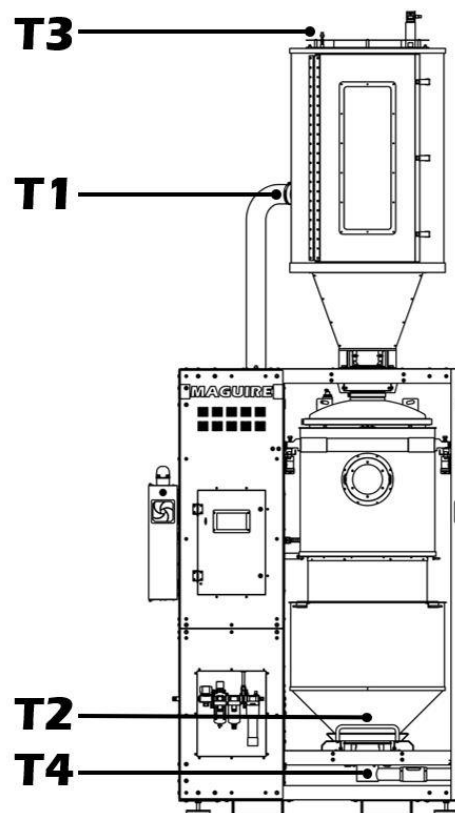

Home Screen Overview



Shown with enabled options: Auto Shutdown, Batch Mode, and Preheat, ULTRA-600 screen

T1 Actual - Actual Heating Hopper inlet air temperature

T1 Setpoint - Heating Hopper inlet air temperature Setpoint. Touch to adjust.

T3 Temp – Actual Heating Hopper temperature

Vacuum Time – Vacuum Time Actual and Vacuum Time Setpoint. Touch to adjust.

Vacuum Chamber Weight
Vacuum Chamber Actual and Maximum Weight

Retention Hopper Weight
Actual and maximum weight

Title Bar - Located across the top of the screen, the title bar displays Model, ID, I/O status, current operating mode, date and time, Ethernet and USB status.

Navigation Menu - Located along the right side of the screen, these buttons allow quick navigation to frequently used and top-level screens. The middle three buttons are soft buttons that can be changed or removed.

Start / Shutdown (Auto Shutdown shown above) Button - Main Start Stop Control Button of the Dryer.

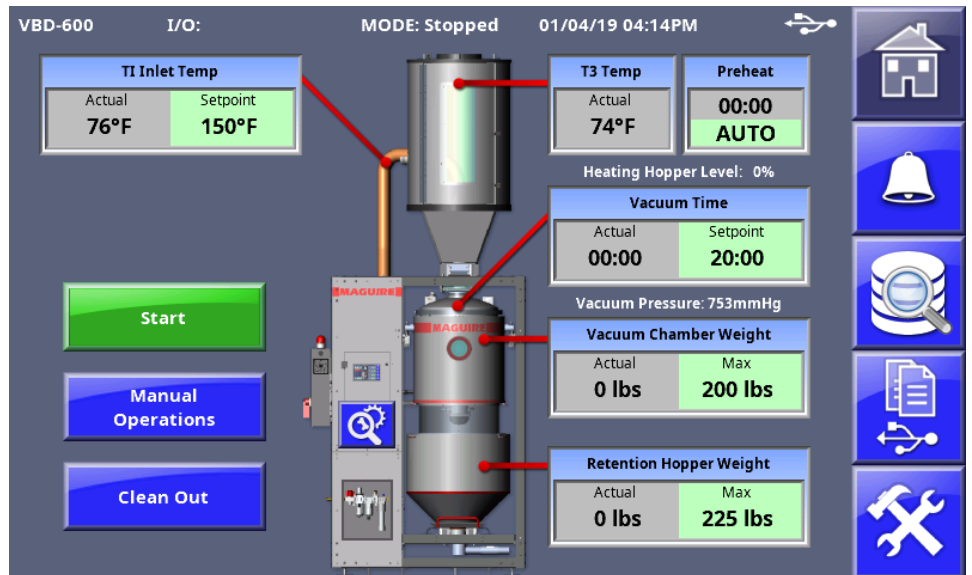

Preheat – Preheat Time Actual and Preheat Time Setpoint. Touch to adjust.

Advanced Information - Access to advance information.

Additional information can be accessed by touching the Heating Hopper, Vacuum Chamber and the Retention Hopper.

Navigation Menu



Home Screen

Pressing the Home Screen button from any other screen will return the operator to the main Home Screen.



Alarm and Event

Alarm and Event Log displays a history of alarms and other events with a date and time stamps and description.



Presets

Interactive screen for material presets (recipes) that enable users to input, edit, and load material parameters to minimize testing setup time.



Print Center

A menu screen of print related options including Totals, Parameters, Alarm History, Events, Cycle History, Diagnostics. See page 69.



Setup Login

Password protected access to advanced Dryer and System configuration information. Also displays firmware/software, IP and MAC address info.

Run Dryer - See page 19

Clean Out – See page 59

Manual Operations - See page 26

Top Level Menu:

Start Up and Operation

This section will help you understand what the dryer is doing during operation from a cold start. There are 3 concurrent operations. Heating, Vacuum and, Retention. Cold startup begins with Preheat. Preheat only occurs before the first cycle of the dryer's initial startup, otherwise each cycle begins with material heating. The vacuum operation pulls and holds a vacuum on the material for at least the Vacuum Time Set-point (or longer if material remains in the Retention Hopper). The Retention operation holds the dried material in the Retention Hopper, blanketing the material with hot, dry air, until the material is conveyed away.

Important: Inspect the ULTRA dryer, verify that machine is clear of all material from all tanks, heating hopper, Vacuum Chamber and Retention Hopper. To facilitate a Clean Out, use the Clean Out function accessible from the home screen.

Startup and Operation Instructions

- 1. ENSURE HATCHES ARE CLOSED.** Ensure that all the latches are properly closed on both the heating hopper door and vacuum chamber access hatch. Also, make sure that the removable retention hopper is in place and that the load cells are properly engaged.
- 2. Load material into the Upper Heating Hopper.** Wait for the Heating Hopper to fill with material before starting the Dryer.
- 3. Turn on Main Power** by rotating the 60 AMP Main Disconnect Handle to the Red ON position. This powers up the ULTRA-600 Dryer.

On initial power up of the ULTRA, the Control Panel powers ON automatically. If the main power is ON but the Control Panel is OFF, press and hold the Red Power Button located on the Control Panel for 2 seconds. (Note: The ULTRA's Control Panel can be powered OFF without powering down the Main Power by pressing and holding the Red Power button for 4 seconds).

Door/Window Latches

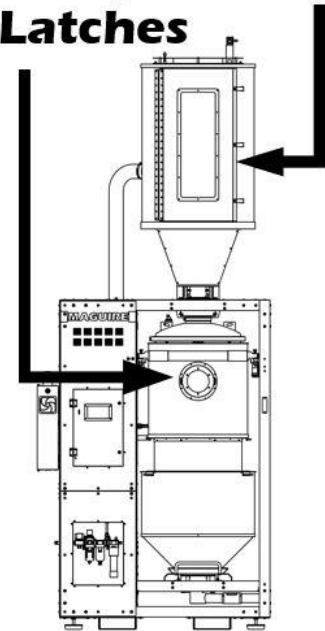

Important Settings

4. On the Home Screen:

Bulk Density – Bulk density is the weight per unit volume of the raw plastic material as it is received from the material manufacturer. This parameter is important to set to ensure proper performance of the ULTRA-600. Bulk density can be edited under ‘Advanced Info’.

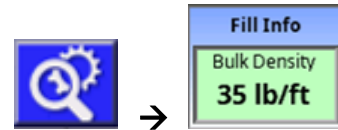

*****WARNING:** *Without setting this parameter the machine may not maximize its material throughput and/or have a chance to overflow.*

T1 Inlet Temp Setpoint – This is heat hopper inlet temperature. By the end of the *preheat* cycle time, all material in the Heating Hopper will be heated to this temperature. By default, the Setpoint temperature is set to 150°F. Contact the material manufacturer for temperature recommendations.

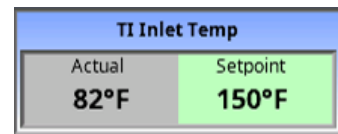

Preheat Time – This is the duration of heating from a cold start.

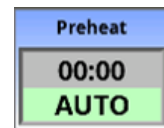

Vacuum Time – This is the duration of a vacuum and is what determines the cycle time. The default vacuum time is 20 minutes. In the vast majority of drying operations, this time is adequate and does not need to be adjusted. Special circumstances may require different vacuum times. Please consult a Maguire Dryer Technical for additional information.

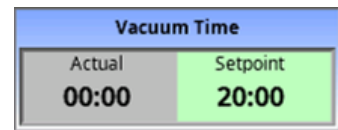

Press the setpoint field to adjust the setting. Use the on-screen keypad to enter the setpoint and press the green check to complete the setting adjustment.



5. Press the **START** button to start the dryer.



6. The display will show that the dryer is running in **PREHEAT mode and display the following:**

T1 Actual - Actual Heating Hopper inlet air temperature

T1 Setpoint - Heating Hopper inlet air temperature Setpoint.

T2 Temp – Actual Heating Hopper temperature

Vacuum Time – Vacuum Time Actual and Vacuum Time Setpoint.

Vacuum Chamber Weight - Vacuum Chamber Actual/Maximum Weight.

What is happening when the dryer is running:

During the Pre-heat operation material in the heating hopper is brought up to temperature (T1s). Preheat time is determined by the specified Preheat Time on the Pre-Start screen (timed preheat, default 60 minutes) or by the Preheat Setup Auto option, which sets an inlet to outlet temperature delta and a minimum preheat time.

After pre-heat, approximately one third of the material in the heating hopper is dispensed into vacuum chamber, and the first vacuum cycle begins. Each vacuum cycle has a minimum vacuum time, set on the Pre-start screen, or the main run screen (VTs). (default is 20 minutes).

The loader loads the Heating Hopper with new material as the Vacuum Chamber receives the heated material and heating cycle begins concurrent to vacuum cycle (the first vacuum cycle is timed). The new batch of material in the upper portion of the heating hopper will take less time to heat. Minimum time in the heating is dictated vacuum time.

After first vacuum cycle, material is then dispensed into retention hopper ready for use. Material in the retention hopper is blanketed with dry air.

The rate of consumption of dried material from the retention hopper ultimately dictates the amount of time that the material will be preheated and under vacuum. **Examples:** If it takes 30 minutes to deplete the retention hopper, the vacuum cycle will run past its 20-minute setpoint (pre-start screen) to 30 minutes. This is normal operation. However, if the retention hopper is depleted in 15 minutes and the vacuum time is set to 20 minutes, there will be a 5-minute window where no material is available. This indicates that the throughput of the dryer has been exceeded. If the Throughput Alarm is enabled (Alarm Setup), a Throughput Alarm (Alarm Code 20) will be triggered.

Shutdown Options

End Preheat - (shown only if in a preheat cycle)

Skips the preheat allowing material to immediately pass down to the Vacuum Chamber (example: material has already been heated and dryer has been taking offline briefly and powered back on).



At any point after the preheat cycle has ended (or forced to end), pressing the red Shutdown button will bring up the Shutdown Options screen with the following shutdown options:

Shutdown – Pressing the red ‘Shutdown’ button (after preheat has ended) will prompt a series of shutdown options



Smart Stop – With the ‘Smart Stop’ feature, the machine will not add more material into the machine and completely dry the remainder of the material in the machine. At the end of the ‘Smart Stop,’ there will be no material in the ULTRA which is essential for quick cleanout.



Immediate Shutdown – This causes an instantaneous, yet controlled, complete shutdown of all systems within the ULTRA (heater, blower, vacuum and purge system).



Cooldown & Shutdown – When this feature is selected, the ULTRA will gradually cool down the material in the heating hopper to a desired temperature over a specific designated time period.

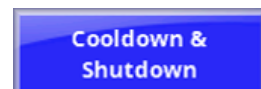

Cancel - Exits the shutdown option screen









Pause – Press the Vacuum Chamber will display the Vacuum Chamber Setup screen. Pause is the red button at the bottom of the screen. Pauses the vacuum timer indefinitely. To restart after a pause, press RESUME.

Auto Stop (must first be enabled) – Initiates a shutdown at specified date and time. For further explanation on how to set the Auto Stop date and time see page 23.

Auto-Stop Setup

Auto-Stop initiates a shutdown at a specified time on specific days if the week. To enable and configure Auto-Stop follow the steps below.

Press		Display will prompt for a password. (default: 22222)	Then press:	
Press	Dryer Configuration	Display will show the Dryer Configuration categories.		
Press	Auto-Stop Setup	Display will show the Auto-Stop screen.		
To Enable Auto-Stop:				
Press		Auto-Stop Enabled	to enable Auto-Stop. Display will show Auto-Stop scheduling.	
Press	Schedule	Set the time of day Auto-Stop should occur.		
Press		to select the days of the week Auto-Stop should occur.		
Press		to save the Auto-Stop settings.		
Press		the Home Button to return to the Home Screen.		



Advanced Information

Pressing  on the Home Screen will display additional information such as readings of all RTD thermometers, vacuum time elapsed, absolute pressure in the Vacuum Chamber, blower drive frequency.

T1 Actual - Actual Heating Hopper inlet air temperature.

T1 Setpoint - Heating Hopper inlet air temperature Setpoint.

Heat Hopper - Heating Percent (%) output.

T2 Temp – Actual Heating Hopper temperature

Fill Info – The desired weight of material to be dispensed into the Vacuum Chamber.

Bulk Density - Bulk density of material in either pounds per cubic foot or kilograms per liter.

Cycle Count - Total number of cycles since start button was pressed.

Cycle Time - Total time to process a completed batch of dry material.

Valve Timing - Fill - Total time to fill the Vacuum Chamber.

Valve Timing - Dump - Total time to dump the Vacuum Chamber.

Totalizer - Calculated total of all cycles since last clear of totals.

Thruput - Calculated throughput, weight per hour.

Vacuum - Vacuum Chamber Actual Weight

Retention - Current material weight in Retention Hopper.

Residence – Actual Vacuum Time.

Recommended Drying Temperatures

MATERIAL	FINAL MOISTURE % *	DRYING TEMPERATURE**	
		°C	°F
ABS	0.10	80 - 85	180 – 190
ABS/PC	0.02	100	210
LCP	0.02	150	300
PA	0.20 - 0.10	80 - 85	180 – 190
PBT	0.02	120	250
PC	0.02	125	250
PC/PBT	0.02	125	250
PEEK	0.20 - 0.10	150	300
PEI	0.02	150	300
PES	0.05 - 0.02	150	300
PET (Molding Grade)	0.010	150-180	300-350
PET (Preform, Extrusion)	0.005	150-180	300-350
PMMA (Acrylic)	0.02 - 0.04	79	175
POM (Acetal)	0.20 - 0.10	80 - 110	180 – 230
PPO	0.02	100 - 120	210 – 250
PPS	0.02	150	300
PUR	0.02	125 - 140	260 – 280
PSU	0.02	150	300
SAN	0.20 - 0.10	80	180
* Final moisture content as recommended by the raw material manufacturer.			
** Drying temperature as recommended by the material manufacturer.			

Drying is accomplished when all material reaches the proper temperature, and is then placed under sufficient vacuum for a sufficient period of time.

Measurement of moisture content of material, both prior to and after drying, is accomplished by using a moisture analyzer.

Setup Menu Map - Brief Explanation

This section outlines the Setup menu. For detailed info, see Setup Menu Full Explanation.

▶		Setup (password protected) – Settings and Options Menus
	▶	Dryer Configuration - Dryer specific settings
		▶ Alarm Setup – Enable or disable various alarms.
		▶ Auto-Stop Setup - Scheduling Auto-Stop of the dryer.
		▶ Dry Purge Setup - Configuration of dry purge.
		▶ Preheat Setup - Configuration of Preheat.
		▶ Auto-Start Setup - Scheduling Auto-Start of the dryer.
		▶ Convey Setup - Configuration of material convey and loaders.
		▶ Load-cell Setup - Loadcell calibration, zero and full calibration.
		▶ Parameters - Operation Parameters
		▶ Blower
		▶ Heater
		▶ System
		▶ Dispensing
		▶ Load-Cell
		▶ Vacuum
	▶	System Configuration System specific settings
		▶ Print Options
		▶ Print Parameters - Prints parameter report to USB Flash Drive
		▶ Print Alarms and Events - Prints alarms and events to USB Flash Drive
		▶ Copy Log File - Copies raw log file to USB drive.
		▶ Print Alarm History - Prints Alarm History to USB Flash Drive
		▶ Print All - Prints all above reports to USB Flash Drive
		▶ Diagnostics
		▶ System Information - Firmware, bootloader, I/O versions
		▶ Load-Cell Diagnostics - Loadcell raw counts
		▶ Alarm and Event Log - Alarms and Events displayed and printable
		▶ Live Diagnostics - Live Cycle diagnostic report, printable history
		▶ Communication Diagnostics - Information for communications
		▶ Resets
		▶ User Settings - Save / Restore User entered Settings
		▶ Restore All - Restores factory default settings
		▶ Firmware Updates - Reads USB drive for updates, selects and updates firmware. Contact Maguire Products Inc. for updates.
		▶ Factory Access - Factory Access Only
		▶ Restore Parameters - Restores factory default parameters
		▶ Preferences
		▶ Change Passwords - Change Admin and Operator passwords
		▶ Display Options – On-screen information display preferences
		▶ Language - Language selection
		▶ Screen Options - Screen saver, brightness, calibration, options
		▶ Date and Time
		▶ Weight Units - pounds, ounces, grams kilograms
		▶ Menu Bar Options - menu button preferences
		▶ Communications
		▶ MLAN I.D. Number - Set Dryer identification number
		▶ Modbus Server - enable/disable Modbus TCP
		▶ TCP/IP Configuration - Sets IP address, Subnet mask, gateway
		▶ MLAN Serial Baud Rate - Set baud rate of MLAN over serial

Modes of Operation

Three modes of operation (on Home Screen): **Run Dryer**, **Manual Operations**, **Clean Out**.

Run Dryer - See Operation on page 19.

Manual Operations – Options that allow direct control over specific outputs.

Operate Outputs

Alarm Audio – OFF/ON – Operates audible alarm.

Alarm Strobe – OFF/ON – Operates strobe.

Dry Purge Supply – CLOSED/OPEN of dry purge supply air valve

Vac Gate Upper – OPEN/CLOSED – Material gate above vacuum chamber.

Vac Gate Lower – OPEN/CLOSED – visible disk-shaped gate below vacuum chamber.

Vac Cham Fill – OPEN/CLOSED - Gate located at the base of the heating hopper.

Vac Cham Dump – OPEN/CLOSED – Internal gate (not visible) located at the base of the vacuum chamber.

Vac Gen Supply – OPEN/CLOSED – Vacuum generator supply. When operating, the vacuum generator supply pulls a vacuum on the vacuum chamber.

Vac Gen Check – OPEN/CLOSED – Vacuum generator check valve located on the vacuum generator. Holds the vacuum on the vacuum chamber.

Vac Cham Purge – OPEN/CLOSED – Located below the vacuum generator. When open the vacuum on the vacuum chamber is released.

Blower Test – Operates the blower.

Blower: OFF/ON toggle using ENTER button.

Aux: OFF/ON toggle using ENTER button.

Fail Safe: OFF/ON toggle using ENTER button.

T1s: Heating Hopper inlet temp setpoint.

T1a: Heating Hopper inlet temp actual.

Vacuum Test - Tests the Vacuum System

Vac: Vacuum pressure readout

Start Test: Starts the vacuum test. Runs the vacuum generator system.

Evac Time: Amount of time in minutes/seconds to attain the vacuum setpoint during the current test.

Cycle: Amount of time in minutes/seconds between vacuum generator runs during a vacuum hold. Used to determine vacuum chamber seal integrity.

Pset: Absolute pressure that the Vacuum Chamber will be evacuated to. See VPL parameter.

Pdel: The pressure difference above VPL at while the vacuum generator turns back on. See VPD parameter.

Purge Cham: OFF/CYC/ON

Vacuum Chamber Timed Dispense – Opens valves for specified milliseconds.

Fill: Fill Time of the Vacuum Chamber in milliseconds.

Dump: Dump time of the Vacuum Chamber in milliseconds.

Input Status – Shows status of various inputs

Blower – OFF/ON

Level – Heating Hooper Level (0-100%)

Pressure – LOW/OK

VAC – Vacuum chamber absolute pressure (mmHg)

Primary OT – Primary Heater temperature switch - OK/OVERTMP

Purge OT - Purge Heater temperature switch - OK/OVERTMP

HH Rem. Dump – Remote heating hopper dump – ON/OFF

VC LC – Raw counts of the vacuum chamber loadcell

RH LC - Raw counts of the retention hopper loadcell

T1 – Heating hopper inlet temperature

T2 – Heating hopper outlet temperature

T4 – Material exit temperature (optional RTD)

Heater Test – Operates heater and blower that supplies heat to the Heating Hopper.

T1s: Heating Hopper inlet temp setpoint.

T1a: Heating Hopper inlet temp actual.

Start: Starts the heater test. Blower will run during test.

Heater Output: Heater duty cycle expressed in percent

Blower: Status of blower

Control: PID or manual. Controller will modulate the heater as it would during auto cycle. In manual mode the operator can select a heater duty cycle.

Edit Settings: Easy access to heater control parameters

Clean Out – Clean Out opens all valves and allows for material evacuation and cleanout.

Dump Heat Hopper – Opens the Vacuum Chamber Fill Valve, drains the Heating Hopper.



Dump Vacuum Chamber – Opens Vacuum Chamber dump valve, draining Vacuum Chamber

Dump All – Opens both the Vacuum Chamber Fill Valve and Vacuum Chamber dump valve

Batch Mode



Batch Mode enables the dryer to dry a predetermined amount of material and then automatically stop and display a message indicating the batch is complete. To turn on Batch Mode see: System Configuration / System Preferences / Display Options / Batch Mode.

To enable and run the dryer in Batch Mode follow these steps from the Home Screen:

Press	Start Batch	Start Batch button is located on the Home Screen after Batch Mode is enabled. Display will show: Batch Start Options.
Press	Set Batch Target	Keypad screen will display. Enter Batch Weight.
Press		To save the batch weight or press the red X to cancel and exit.
Press	Reset Totalizer	to reset the totalized value back to zero (if applicable).
Press		To save the entered batch weight and begin the batch and start the Dryer. Press the red X to cancel.

Setup Menu – Full Explanation

Setup is a password protected area for accessing Dryer or System specific configuration settings. Setup is accessible from the main screen by pressing:

Press		Display will prompt for a password. (default: 22222)	Then press: 
-------	---	--	---



NOTE

Parameters – All Dryers operate according to certain internal PARAMETERS. Because customer requirements vary widely, we have made a wide range of parameters accessible for change through the touchscreen. Parameters are grouped into the following categories: Blower, Heater, System, Dispensing, Load-Cell, and Vacuum. Parameters are covered on page 29.

Setup is divided into two categories: Dryer Configuration and System Configuration.

Dryer Configuration includes device specific settings such as: Alarm Setup, Auto-Stop Setup, Dry Purge Setup, Preheat Setup, Auto-Start Setup, Convey Setup, Load-Cell Setup, and Parameters.

System Configuration includes system wide general settings such as: print options, diagnostics, resets, system preferences, and communications settings.

The following section describes the features within the Setup Menu.

Dryer Configuration

Setup Menu Option

Description / Options

Alarm Setup

Material Shortage Alarm

OFF: Disables the Material Shortage alarm

WARN: In the event of a material shortage, activate the audible alarm and strobe light but continue retrying for material.

SHUTDOWN: In the event of a material shortage, activate the audible alarm and strobe light and automatically initiate a planned shutdown. Audible alarm with sound for 15 seconds and the strobe will flash until the dryer is completely shut down.

When Material Shortage Alarm is in Warn or Shutdown Mode Fill Retries are ENABLED. When set to OFF, Fill Retries are disabled.

Material Ready Alarm - If the Material Ready alarm is enabled, this alarm will trigger after the first and only first batch of material has completed a full vacuum cycle. After 15 seconds, the audible portion of this alarm will automatically silence. The first batch of material will remain under vacuum indefinitely until this alarm is cleared. There are two main purposes of this alarm:

1. To alert the operator that dry material is ready for the process.
2. To act as a hold-back, when necessary, giving the operator additional time to prepare the process.

OFF: Disables the Material Ready Alarm

1st: Material Ready Alarm sounds after the first and only the first batch of material is ready to drop from the Vacuum Chamber.

ON: Material Ready Alarm sounds after every batch of material is ready to drop from the Vacuum Chamber. This mode can be useful in lab environments.

Material Temperature Alarm - When the Material Temp alarm is enabled, during any instance where the Heating Hopper is called upon to dispense material into the vacuum chamber and the T2 (heating hopper exit) temperature is below the ESM parameter level, this alarm will trigger. Its purpose is to alert the operator that insufficient heating has occurred, most likely from a process throughput that exceeds the capacity of the ULTRA.

ON: When the Material Temperature Alarm is enabled, the alarm will sound when this alarm is triggered.

OFF: Disables the Material Temperature Alarm

Residence Alarm (labeled “Material Residence”) - When the Residence Alarm is enabled, an alarm will sound if dried material has sat in the retention hopper too long. The RAL parameter determines when a residence alarm will occur based on elapsed time and weight of remaining material in the retention hopper. See the RAL parameter for more information.

ON: When the Residence Alarm is enabled, the alarm will sound when this alarm is triggered.

OFF: Disables the Residence Alarm

Throughput Alarm - If the Throughput alarm is enabled, the alarm will sound if the material in the Retention Hopper is used faster than the dryer can produce dried material. (Material level reaches RTL parameter before the Vacuum Time Setting expires VTS parameter)

ON: If the Throughput alarm is enabled, the alarm will sound when this alarm is triggered.

OFF: Disables the Throughput alarm

Vacuum Chamber Dump Alarm - If the Vacuum Chamber Dump alarm is enabled, the dispensing of material from the vacuum chamber into the retention hopper is monitored using the CDR (Chamber Dump Retries) parameter. CDR's default settings of 05003 requires that at least 50% of the material that is in the vacuum chamber be detected in the retention hopper after the dispense. If it's under 50% the dispense will retry 3 times before triggering the alarm. Retries will continue indefinitely until 50% is satisfied.

ON: If the Vacuum Chamber Dump alarm is enabled, the alarm will sound when this alarm is triggered.

OFF: Disables both the vacuum chamber dump alarm and vacuum chamber Dump retries.

Print Alarm Log - Prints the Alarm Log. See page 69.

Clear Alarm Log - Clears the Alarm Log. See page 69.

Auto-Start Setup

Auto-Starts the Dryer at a specified Time and Day(s). Can be set to Auto-Start the Dryer at one time only or on a repeated schedule. Must be turned ON in Display Setup (see below).

Auto-Stop Setup

Auto-Stop the Dryer at a specified Time and Day(s). Can be set to Auto-Stop the Dryer at one time only or on a repeated schedule. Must be turned ON in Display Setup (see below).

Convey Setup

Convey Setup - Material Convey Options - Optional - Uses dedicated outputs on the I/O board that may be used to control customer supplied Loader(s).

See the I/O Board Wiring Diagram at the end of this manual.

- **Loader 1** - Off / Auto - Stops loader that supplies the heating hopper for shutdown sequence.
- **Loader 2** - Off / Auto - When material is ready, loader will convey material away from dryer retention hopper. When enabled, select Throughput or Weight.
- **Reset Totalizer** - Resets Weighed totals to zero. Totals are the amount of material that has been conveyed away from the dryer since the Totalizer has been reset.

Dry Purge Setup **Purge Cham** - OFF/CYC/ON – Controls when the vacuum chamber is purged with membrane dried air.

OFF – No vacuum chamber purging occurs.

CYC - Vacuum chamber purging occurs during allotted vacuum cycle time (VTs).

ON – Vacuum chamber purging occurs during allotted vacuum cycle time (VTs) and extended vacuum if applicable.

Purge Interval - Interval in seconds between purges.

Purge Duration - Duration in seconds that the purge will occur.

Preheat Setup **Preheat Mode** - Auto or time - Preheat time for the material in the Material Hopper. Default preheat time is 30 minutes.

Preheat Time - The Preheat Time is the duration of preheat time.

Parameters Parameters access. See page 29.

System Configuration

Print Options **Print Setup** - See page 69

- **Print Parameters** - Prints the parameter list to a USB.
- **Print Alarm History** - Prints the Alarm History to USB.
- **Print Alarms and Event:** Prints Alarm and Events to USB.
- **Print All** - Prints parameters, events, and alarms to USB.
- **Copy Log File** – Copies raw log file to USB.

System Preferences **Change Passwords** - Sets the Setup Menu Password. Default password is 22222. Setting the password to 00000 disables password protection.

Date and Time - Set time, date and date format.

Display Options - Show / Hide Information and options on the controller screens

- **Batch Mode - ON/OFF** – When ON, the option to dry a batch of material is displayed on the home screen.
- **Cycle Info - ON/OFF** – Displays Cycle info on main screen.
- **Dispense Time - ON/OFF** – Displays the fill time on main screen.

- **Residence Time - ON/OFF** – When ON, displays a countdown timer (RAL parameter) indicating when an alarm will sound alerting that material has sat in the retention hopper too long.
- **Show Throughput** – Displays throughput (lbs or kgs per hour)
- **Show T4 Temperature** - Displays actual temperature.

Display Units: Fahrenheit (°F) or Celsius (°C), Pounds (lbs) or Kilograms (kgs), Pressure: Absolute or Differential, Pressure units: mmHg or inHg.

Language – Set current language.

Menu Bar Options – Allows changes to right-side menu buttons.

Screen Options – Screen Saver options, Screen Brightness, Screen Calibration and On-Screen Options. On-Screen Options is information shown across the top of the home screen including: Date/Time, Model Number, MLAN ID, USB Connectivity, Ethernet Connectivity.

Diagnostics

System Information – System Information displays specific system related information about the controller and Dryer.

Load-Cell Diagnostics – Displays Vacuum Chamber and Retention Hopper loadcell diagnostics information.

Alarm and Event Log – Displays the Alarm and Event Log screen.

Communications

Blender I.D. Number – Sets the Blender ID number. Enter an identification number for this particular weigh scale blender. This I.D. number will appear on all printed reports. If you have more than one unit, this helps to identify reports. If you are using the MLAN Protocol to automatically gather data, then each controller must have a unique address. Valid numbers are 000 to 255.

Modbus Server – Enable or disable Modbus TCP.

TCP/IP Configuration – Enable DHCP or set a static IP address, subnet mask and default gateway.

For more information on communications see page 53.

Resets

User Settings – Save/Restore Settings – Used for saving or restoring previously saved parameters. For more information on Saving and Restoring Settings, see “Saving Parameters in the User Backup Settings” on page 74.

Factory Access – For factory access only.

Restore All – Restores Factory Defaults.

WARNING: Only do a Restore All when directed by a Maguire Technician.

Restore Parameters – Resets parameters back to factory defaults.

Firmware Update - Update ULTRA-600 firmware. See page 75.

Parameters

All Maguire ULTRA controllers operate according to certain internal PARAMETERS. Because customer requirements vary widely, we have made parameters accessible for change through the keypad. In most cases, these parameters will never need to be changed. Some parameters that are routinely adjusted values are adjustable from the main display. To access and edit the parameters, see **Changing Parameters** in this section:



Changing parameters can have an impact on the Dryers performance. It is highly recommended that a supervisor change the default Program Mode password to protect the values. Prior to making any changes, make sure you understand what you are doing. If in doubt, contact a Maguire Dryer Technician before making changes to your dryer.

Blower Parameters:

BDT	Blower Delay Time
BLF	VFD Low Limit
BHF	VFD High Limit
BDF	VFD Frequency
BZL	VFD Zero Level
BLA	VFD Level Adjustment
BHT	VFD Heat Throttle
BMW	Blower Max Wattage

Dispensing Parameters:

VCH	Vac. Chamber Hi Level
VCL	Vacuum Chamber Low Level
RHH	Ret. Hopper Hi Level
RHL	Retention Hopper Low Level
BLK	Bulk Density
VFR	Vacuum Chamber Fill Rate
VDR	Vacuum Chamber Dump Rate
VFT	Chamber Fill Time
VDT	Chamber Dump Time
FLA	Fill Lag Time
DLA	Dump Lag Time
VGD	Vacuum Gate Delay
VFA	Chamber Fill Adjust
HDD	Heating Hopper Dump Delay
VCT	Vacuum Chamber Dump Threshold
CDR	Chamber Dump Reties
RAL	Residence Alarm
BCH	Batch Size
LTP	Loader Trip Point
LTC	Loader Throughput Cutoff
HHV	Heating Hopper Volume
HHU	Heating Hopper High Level
HLA	Heating Hopper Level Alarm
L1T	Loader 1 Timings
L1A	Loader 1 Alarm
L2T	Loader 2 Timings
L2A	Loader 2 Alarm

Vacuum Parameters:

VTS	Vacuum Time Setting
VPL	Vacuum Pressure Low
VPD	Vacuum Pressure Delta
VSO	Vacuum Shutdown Offset
LVT	Low Vacuum Timeout
NVT	No Vacuum Timeout
VPT	Chamber Purge Timer
VPI	Chamber Purge Interval
ATM	Atmospheric Pressure

Heater Parameters:

PTS	Preheat Temperature Setting
PHT	Preheat Time
PHD	Preheat Differential
PTD	Preheat Target Delta
RTS	Run Temperature Set-Point
PT1	PD Loop Proportional
DT1	PD Loop Derivative
UT1	PD Loop Update Time
OT1	Heat1 Over-Target Alarm
NH1	Heat1 No Heat Alarm
SO1	Heat1 Set-Point Off. Percent
MP1	Heat1 Max Percent
RO1	Heat1 Restart Offset
MAX	Max Temp Set-Point
ESL	Energy Savings Limit
ESD	E.S. Differential
EST	Energy Savings Time
ESP	ES Proportioning
RMP	Temperature Ramp Settings
CTM	Cool-Down Temperature
CTR	Cool-Down Timer
H1W	Heater 1 Max Wattage
PGS	Heat2 Temp Set-Point
PT2	Heat2 Proportional
DT2	Heat2 Derivative
UT2	Heat2 Update Time
OT2	Heat2 OverTarg Alarm
NH2	Heat2 No Heat Alarm
SO2	Heat2 Set-Point Off.
FO2	Heat2 Fixed Output
DPD	Dry Purge Delay
PST	Purge and Shutdown
H2W	Heater 2 Max Wattage

Load Cell Parameters:

KDF	Loadcell Stable Wt.
LST	Load Cell Stable Time
LCZ	Loadcell Zero
WST	Weight Settle Time
LZ1	Loadcell 1 Zero
LZ2	Loadcell 2 Zero

System Parameters:

ELT	Event Logging Time
EUS	Energy Usage Setting

Parameter Units

TIMES	Are expressed as full seconds or full minutes.
PERCENTAGES	are expressed as percentages.
TEMPERATURES	are expressed in full degrees (Fahrenheit or Celsius).
TERM	used to calculate a value.

3-letter Acronym	Parameter title (units) – default parameter value
	Parameter description

Blower**BDT - Blower Delay Time**

format: xxxxy (seconds / seconds)

function(s): xxx: The amount of time between the blower powering-up and the heater powering-up.

 yy: The amount of time between the blower powering-down and the heater powering-down.

BLF - Blower Low Frequency

format: xxxxx (Hz)

function(s): Minimum allowable user-enterable blower drive frequency. *Note: this parameter is only visible on units equipped with a VFD.*

BHF - Blower High Frequency

format: xxxxx (Hz)

function(s): Maximum allowable user-enterable blower drive frequency. *Note: this parameter is only visible on units equipped with a VFD.*

BDF - Blower Drive Frequency

format: xxxxx (Hz)

function(s): VFD setpoint frequency. VFD frequency is directly proportional to blower RPM, which is directly proportional to airflow. *Note: this parameter is only visible on units equipped with a VFD.*

BZL - Blower Zero Level

format: xxxxx (%)

function(s): When the heating hopper level is at or below this level, the blower will run at a reduced frequency set by the BLA parameter. *Note: this parameter is only visible on units equipped with a VFD.*

BLA - Blower Level Adjustment

format: xxxxx (Hz)

function(s): Blower drive frequency when the heating hopper level is at or below that set by the BZL parameter. *Note: this parameter is only visible on units equipped with a VFD.*

BHT - Blower Heat Throttle

format: xxxxx (%)

function(s): After a vacuum chamber fill, when the heater powers back up, it will run at this percentage of the duty cycle it ran at the end of the previous vacuum cycle if the heating hopper level is below that established by the BZL parameter. This is to mitigate temperature runaways caused by different airflows (caused by different pressure drops across the heating hopper). *Note: this parameter is only visible on units equipped with a VFD and a heating hopper level sensor.*

BMW - Blower Maximum Wattage

format: xxxxx (watts)

function(s): The amount of power the blower consumes when running at full speed. This value is used in energy consumption calculations.

Dispensing**VCH - Vacuum Chamber High Level**

format: xxxxx (lbs. or kgs.)

function(s): Vacuum chamber fill dispense target. Also known as “fill weight”.

VCL - Vacuum Chamber Low Level

format: xxxxx (lbs. or kgs.)

function(s): 1. When the dryer is started, if an amount of material equal or greater to this level is detected in the vacuum chamber, a “Warning: Material in Vacuum Chamber” message will pop up.

2. When in Clean-Out mode, the vacuum chamber fill valve will not open automatically until the vacuum chamber weight reading is at or below this level.

3. The minimum allowable final dispense of a standard Auto Stop.

RHH - Retention Hopper High Level

format: xxxxx (lbs. or kgs.)

function(s): Retention hopper fill dispense target. This value is typically slightly higher than VCH to ensure that 100% of the vacuum chamber contents dispense into the retention hopper.

RHL - Retention Hopper Low Level

format: xxxxx (lbs. or kgs.)

- function(s):
1. When the dryer is started, if an amount of material equal or greater to this level is detected in the retention hopper, a “Warning: Material in Retention Hopper” message will pop up.
 2. When in Clean-Out mode, the vacuum chamber dump valve will not open automatically until the retention hopper weight reading is at or below this level.
 3. When the dryer is running, the retention hopper must be depleted down to this level before a vacuum chamber dump is allowed.

BLK - Bulk Density

format: xxxxx (lbs./ft³ or g/L)

- function(s):
- User-enterable material bulk density. Setting this parameter to match the material being dried ensures that a fill weight that could potentially overflow the vacuum chamber cannot be entered. Note that this parameter has no effect on drying.

VFR - Vacuum Chamber Fill Rate

format: xxxxx (g/sec.)

- function(s):
- Learned flow rate of the vacuum chamber fill valve. This parameter will automatically adjust over time. As it adjusts, vacuum chamber fills will converge on the targeted fill weight.

VDR - Vacuum Chamber Dump Rate

format: xxxxx (g/sec.)

- function(s):
- Learned flow rate of the vacuum chamber dump valve. This parameter will automatically adjust over time. As it adjusts, retention hopper fills will converge on the targeted fill weight.

Note: this parameter is typically set to 00000, which means that rate learning does NOT occur, and vacuum chamber dumps will terminate on low flow or high level (RHH). Manually setting this parameter to any value other than zero will enable rate learning.

VFT - Vacuum Chamber Fill Time

format: xxxxx (seconds)

- function(s):
1. When the most significant digit is set to a 0 (0xxxx), this is the maximum allowable vacuum chamber fill time. Fills are not allowed to go beyond this time.
 2. When the most significant digit is set to a 1 (1xxxx), this is the vacuum chamber fill time. VFR is ignored. Note, however, that a timed fill will terminate prematurely if VCH is reached.

VDT - Vacuum Chamber Dump Time

format: xxxxx (seconds)

function(s): 1. When the most significant digit is set to a 0 (0xxxx), this is the maximum allowable vacuum chamber dump time. Dumps are not allowed to go beyond this time.

 2. When the most significant digit is set to a 1 (1xxxx), this is the vacuum chamber dump time. VDR is ignored. Note, however, that a timed dump will terminate prematurely if RHH is reached.

FLA - Fill Lag Time

format: xxxxx (milliseconds)

function(s): Amount of time added to every vacuum chamber fill valve opening. This is to account for the delay between the controller signaling the opening of the valve and the first pellets beginning to flow. This can also be considered the minimum vacuum chamber fill valve open time.

DLA - Dump Lag Time

format: xxxxx (milliseconds)

function(s): Amount of time added to every vacuum chamber dump valve opening. This is to account for the delay between the controller signaling the opening of the valve and the first pellets beginning to flow. This can also be considered the minimum vacuum chamber dump valve open time.

VGD - Vacuum Gate Delay

format: xxxyy (seconds / seconds)

function(s): xxx: The amount of time between the lower vacuum valve opening and the vacuum chamber dump valve opening.

 yy: The amount of time between upper vacuum gate opening and the vacuum chamber fill valve opening.

VFA - Vacuum Fill Adjust

format: xxxyy (retries, 10ths of pounds or 10ths of kilograms)

function(s): xxx: The number of vacuum chamber fill retries that will be attempted before a material shortage alarm is triggered

 yy: The allowable negative deviation from the vacuum chamber fill target (VCH). If, after a vacuum chamber fill, the vacuum chamber weight reading is not within this tolerance, a fill retry will be initiated.

HDD - Heating Hopper Dump Delay

format: xxxxx (seconds)

function(s): The amount of time between blower shutdown and the initiation of a vacuum chamber fill. This is to allow for blower wind-down time.

VCT - Vacuum Dump Threshold

format: xxxxx (g/sec.)

function(s): During a vacuum chamber dump, if the real-time vacuum chamber dump valve flow rate reaches this low level, the dump will be terminated on the assumption that the vacuum chamber is completely empty.

CDR - Chamber Dump Retries

format: xxxyy (% / retries)

function(s): xxx: If a vacuum chamber dump does not reach at least this percentage of the target (RHH), a vacuum chamber dump retry is initiated.

yy: The number of vacuum chamber dump retries that will occur before a Vacuum Chamber Dump Alarm is triggered.

RAL - Residence Alarm

format: xxyyy (pounds or kilograms / minutes)

function(s): xx: If at least this amount of material is not evacuated from the retention hopper within the amount of time shown in (yyy) below, a Residence Time alarm will trigger.

yyy: Residence Time alarm time.

Note: This parameter is only active when the Residence Time alarm is enabled.

BCH - Batch Mode Target

Format: xxxxx (pounds or kilograms)

function(s): The targeted total amount of material that will be dried during a batch run.

LTP - Loader Trip Point

format: xxyyy (seconds / 10ths of pounds or 10ths of kilograms)

function(s): xx: loader #2 off-delay timer

yyy: If the retention hopper contents drop below this level, initiate the de-powering of the loader #2 output.

LTC - Loader Throughput Cutoff

format: xxxxx (pounds or kilograms per minute)

function(s): When loader #2 is set to Throughput cutoff mode, the loader output will de-energize when the throughput drops below this level.

HHV - Heating Hopper Volume

format: xxxxx (10ths of cubic feet or 10ths of liters)

function(s): Volume of the heating hopper. This value is used to estimate the total amount of material in the dryer, which is used in the Loader #1 triggered Auto Stop calculation.

HHU - Heating Hopper High Level

format: xxxxx (%)

function(s): When Loader #1 is set to "Auto" mode, the Loader #1 output will de-energize when the heating hopper material reaches this level. *Note: this parameter is only visible on units equipped with a heating hopper level sensor.*

HLA - Heating Hopper Level Alarm

format: xxxxx (%)

function(s): If the heating hopper material drops to this level, the heating hopper level alarm will be triggered (if enabled). *Note: this parameter is only visible on units equipped with a heating hopper level sensor.*

L1T - Loader #1 Timings

format: xxyyy (seconds / seconds)

function(s): xx: Loader #1 ON time
yyy: Loader #1 OFF time.

Note: Loader #1 must be set to "Internal" mode for this parameter to have effect.

L1A - Loader #1 Alarm

format: xxxxx (counts)

function(s): Number of failed load attempts after which a Loader #1 alarm is triggered.

Note: Loader #1 must be set to "Internal" mode for this parameter to have effect.

L2T - Loader #2 Timings

format: xxyyy (seconds / seconds)

function(s): xx: Loader #2 ON time

 yyy: Loader #2 OFF time.

Note: Loader #2 must be set to “Internal” mode for this parameter to have effect.

L2A - Loader #2 Alarm

format: xxxxx (counts)

function(s): Number of failed load attempts after which a Loader #2 alarm is triggered.

Note: Loader #2 must be set to “Internal” mode for this parameter to have effect.

Heater**PTS - Preheat Temperature Setpoint**

format: xxxxx (°F or °C)

function(s): Target heating hopper air inlet temperature during preheat (when the Preheat Setpoint is set to “Temperature”).

PHT - Preheat Time

format: xxxxx (minutes)

function(s): 1. When Preheat mode is set to “Auto”, this is the *minimum* preheat duration.
 2. When Preheat mode is set to “Timed”, this is the preheat duration.

PHD - Preheat Differential Temperature

format: xxxxx (°F or °C)

function(s): When Preheat Setpoint mode is set to “Differential”, the preheat temperature is automatically set to this number of degrees below the run temperature (RTS).

PTD - Preheat Target Delta

format: xxxxx (°F or °C)

function(s): When Preheat mode is set to “Auto”, the preheat will automatically terminate when the heating hopper exit air temperature is within this number of degrees of the preheat temperature, assuming PHT has expired.

RTS - Run Temperature Setting

format: xxxxx (°F or °C)

function(s): Target heating hopper air inlet temperature during preheat (when Preheat Setpoint is set to "Same as Run Temp.") and during all subsequent heating cycles.

PT1 - Heating Hopper Heater Proportional Term

format: xxxxx (constant)

function(s): Heating hopper heater PID control loop proportional term. This term makes adjustments to the heater output that are directly proportional to the current error.

DT1 - Heating Hopper Heater Derivative Term

format: xxxxx (constant)

function(s): Heating hopper heater PID control loop derivative term. This term makes adjustments to the heater output that are proportional to the slope of the error over time. The purpose of this term is to make predictive adjustments to help mitigate overshoots (and undershoots).

UT1 - Heating Hopper Heater Update Time

format: xxxyy (seconds / seconds)

function(s): xxx: Amount of time between heating hopper heater PID updates when the actual heating hopper inlet temperature is *above* setpoint.

yy: Amount of time between heating hopper heater PID updates when the actual heating hopper inlet temperature is *below* setpoint.

OT1 - Heating Hopper Heater Over-Temp Alarm

format: xxxyy (seconds / °F or °C)

function(s): xxx: Amount of time that the heating hopper inlet air temperature must be above setpoint before a Heating Hopper Over-Temperature alarm is triggered.

yy: Number of degrees that the heating hopper inlet air temperature must be above setpoint before a Heating Hopper Over-Temperature alarm is triggered.

NH1 - Heating Hopper Heater No Heat Alarm

format: xxxxx (seconds)

function(s): Maximum amount of time after a heat cycle begins during which one of the following two conditions must be detected:

1. the temperature must climb 20 degrees

2. the temperature must move at least 20 percent toward the target

If neither condition is met, a “NO HEAT” alarm will be triggered.

SO1 - Heating Hopper Heater Setpoint Offset

format: xxxxy (seconds / °F or °C)

function(s): xxx: Amount of time at the beginning of a heat cycle to temporarily target a lower temperature. This is to mitigate the inherent overshoot of a PID loop.

yy: Difference, in degrees, from the current temperature target and the temporary temperature target.

MP1 - Heating Hopper Heater Maximum Percentage

format: xxxxx (%)

function(s): Maximum allowable heater duty cycle. This can be used to effectively limit the effective size of the heater.

MAX - Maximum Temperature Setpoint

format: xxxxx (°F or °C)

function(s): Maximum allowable user-enterable preheat and run temperature setpoints. Used to limit how high an operator can set the drying temperatures.

ESL - Energy Saver Limit

format: xxxxx (°F or °C)

function(s): The heating hopper exhaust air temperature at which Energy Saver mode will kick in if set to “Limit” mode.

ESD - Energy Saver Differential

format: xxxxx (°F or °C)

function(s): When Energy Saver is set to Differential mode, this is the difference between the heating hopper exhaust air temperature and the current setpoint (RTS) that will trigger Energy Saver mode. For example, if T1s is 250°F and ESD=00030, when the heating hopper exhaust air temperature reaches 220°F, Energy Saver will kick in.

EST - Energy Saver Time

format: xxxxx (minutes)

function(s): If this amount of time elapses after Energy Saver kicks in during a cycle, the blower and heater will power-up to bring the heating hopper back up to temperature.

ESP - Energy Saver Proportioning

format: xxyyy (minutes / %)

function(s): xx: Minimum beginning-of-cycle heater OFF time when Energy Saver is set to Dynamic mode
yyy: Beginning-of-cycle heater OFF time percentage when Energy Saver is set to Dynamic mode

RMP - Temperature Ramp Settings

format: xyzz (increments / minutes / °F or °C)

function(s): x: Number of temperature steps during a temperature ramp.
yy: Duration of a temperature ramp.
zz: Temperature span of a temperature ramp.

CTM - Cooldown Temperature

format: xxxxx (°F or °C)

function(s): Heating hopper cooldown temperature target.

Note: Cooldown mode must be enabled for this parameter to have effect.

CTR - Cooldown Timer

format: xxxxx (minutes)

function(s): Heating hopper cooldown time.

Note: Cooldown mode must be enabled for this parameter to have effect.

H1W - Heating Hopper Heater Wattage

format: xxxxx (Watts)

function(s): Wattage of the primary heater. This value is used in energy consumption calculations.

PGS - Purge Heater Setpoint [ULTRA-600 and ULTRA-1000 only]

format: xxxxx (°F or °C)

function(s): Purge / blanketing air setpoint temperature.

PT2 - Purge Heater Proportional Term [ULTRA-600 and ULTRA-1000 only]

format: xxxxx (constant)

function(s): Purge heater PID control loop proportional term. This term makes adjustments to the purge heater output that are directly proportional to the current error.

DT2 - Purge Heater Derivative Term [ULTRA-600 and ULTRA-1000 only]

format: xxxxx (constant)

function(s): Purge heater PID control loop derivative term. This term makes adjustments to the purge heater output that are proportional to the slope of the error over time. The purpose of this term is to make predictive adjustments to help mitigate overshoots (and undershoots).

UT2 - Purge Heater Update Time [ULTRA-600 and ULTRA-1000 only]

format: xxxxy (seconds / seconds)

function(s): xx: Amount of time between purge heater PID updates when the actual purge air temperature is *above* setpoint.

yy: Amount of time between purge heater PID updates when the actual purge air temperature is *below* setpoint.

OT2 - Purge Heater Over-Temp Alarm [ULTRA-600 and ULTRA-1000 only]

format: xxxyy (seconds / °F or °C)

function(s): xxx: Amount of time that the heating hopper inlet air temperature must be above setpoint before a Purge Heater Over-Temperature alarm is triggered.

yy: Number of degrees that the heating hopper inlet air temperature must be above setpoint before a Purge Heater Over-Temperature alarm is triggered.

NH2 - Heating Hopper Heater No Heat Alarm [ULTRA-600 and ULTRA-1000 only]

format: xxxxx (seconds)

function(s): Maximum amount of time after the purge heat cycle begins during which one of the following two conditions must be detected:

1. the purge air temperature must climb 20 degrees
2. the purge air temperature must move at least 20 percent toward the target

If neither condition is met, a "NO HEAT" alarm will be triggered.

SO2 - Purge Heater Setpoint Offset [ULTRA-600 and ULTRA-1000 only]

format: xxxyy (seconds / °F or °C)

function(s): xxx: Amount of time at the beginning of a purge heat cycle to temporarily target a lower temperature. This is to mitigate the inherent overshoot of a PID loop.

yy: Difference, in degrees, from the current purge air temperature target and the temporary temperature target.

DPD - Dry Purge Delay [ULTRA-600 and ULTRA-1000 only]

format: xxyyy (seconds / seconds)

function(s): xx: The amount of time between the purge air solenoid valve opening and the purge air heater powering-up

yyy: The amount of time between the purge air heater powering-down and the purge air solenoid valve closing.

PST - Purge and Shutdown Time [ULTRA-600 and ULTRA-1000 only]

format: xxxxx (minutes)

function(s): The amount of time that the purge air system will continue to run after the final vacuum chamber dispense.

H2W - Purge Heater Wattage [ULTRA-600 and ULTRA-1000 only]

format: xxxxx (watts)

function(s): Wattage of the purge heater. This value is used in energy consumption calculations.

Load Cell**KDF -Load Cell Stable Weight**

format: xxxxx (counts)

function(s): Maximum allowable load cell fluctuations during a weight reading during filling operations. A lower number will equate to a more accurate reading but could slow the system down.

LST -Load Cell Stable Time

format: xxxxx (milliseconds)

function(s): The amount of time that the load cell raw counts must remain within the window established by KDF before a weight reading is taken.

LCZ -Load Cell Zero

format: xxxxx (counts)

function(s): Maximum allowable load cell fluctuations during a weight reading during zero and full calibration.

WST -Weight Settle Time

format: xxxyy (seconds / seconds)

function(s): xxx: The amount of time between the closing of the vacuum chamber fill valve and the recording of the vacuum chamber load cell reading. This is to allow for settling of the vacuum chamber load cell reading.

yy: The amount of time between the closing of the retention hopper fill valve and the recording of the retention hopper load cell reading. This is to allow for settling of the retention hopper load cell counts.

LZ1 -Load Cell Zero

format: xxxxx (counts)

function(s): Factory-set retention hopper zero load cell counts. This parameter ensures that all post-factory retention hopper load cell zero calibrations fall within +/- 20% of nominal, ensuring that a gross out-of-calibration condition does not develop.

LZ2 -Load Cell Zero

format: xxxxx (counts)

function(s): Factory-set vacuum chamber zero load cell counts. This parameter ensures that all post-factory vacuum chamber load cell zero calibrations fall within +/- 20% of nominal, ensuring that a gross out-of-calibration condition does not develop.

Vacuum**VTS -Vacuum Time Setting**

format: xxyyy (minutes / minutes)

function(s): xx: Minimum user-enterable vacuum cycle time.

yyy: Vacuum cycle time.

VPL -Vacuum Pressure Low

format: xxxxx (mm Hg absolute)

function(s): Vacuum chamber pressure setpoint.

VPD -Vacuum Pressure Delta

format: xxyyy (seconds / mm Hg)

function(s): xx: Amount of time the vacuum generator will continue to run after VPL is reached.
 yyy: Vacuum pressure deadband / hysteresis.

VSO -Vacuum Shutdown Offset

format: xxxxx (seconds)

function(s): Amount of time before the vacuum time (VTS) expires that vacuum pressure equalization begins. This is to compensate for equalization time.

LVT -Vacuum Shutdown Offset

format: xxxxx (seconds)

function(s): Amount of time the vacuum generator will run before a LOW VACUUM condition check is made. See LOW VACUUM alarm in Alarms section.

NVT - No Vacuum Timeout

format: xxyyy (counts / seconds)

function(s): xx: Number of vacuum gate recycle attempts that will be made in an attempt to clear a vacuum fault before a NO VACUUM alarm is triggered.

 yyy: Amount of time the vacuum generator will run before a NO VACUUM condition check is made. See NO VACUUM alarm in Alarms section.

VPT -Vacuum Purge Timer

format: xxxxx (seconds)

function(s): Additional time the vacuum chamber purge/equalization valve will remain open after the vacuum chamber reaches equalization pressure. This is to ensure that the vacuum chamber is not left under a partial vacuum state at the end of a vacuum cycle.

VPI - Vessel Purge Interval

format: xxyyy (seconds / seconds)

function(s): xx: Duration of a vacuum chamber purge cycle.

 yyy: Interval between vacuum chamber purge cycles.

ATM - Atmospheric Pressure

format: xxxxx (mm Hg absolute)

function(s): The measured atmospheric pressure. This parameter is automatically updated once per cycle.

System**ELT - Event Logging Time**

format: xxxxx (seconds)

function(s): The amount of time between event log data line entries.

EUS - Energy Usage Settings

format: xyyy (10ths of hours / seconds)

function(s): xx: Length of energy consumption averaging array.

 yyy: Amount of time between instantaneous energy consumption readings. These readings populate the energy consumption averaging array.





Changing Parameters



IMPORTANT!

Changing parameters can have an impact on the Dryers performance. It is highly recommended that a supervisor change the default Program Mode password to protect the parameter values. Prior to making any parameter changes, make sure you understand what you are doing.

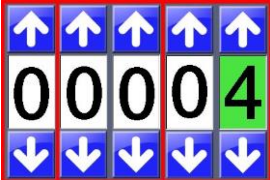
Navigating and Making Changes to Parameters:

Press		Display will prompt for a password. (default: 22222)	Then press:	
Press	Dryer Configuration	Display will show the Dryer Configuration categories.		
Press	Parameters	Display will show the categories of Parameters. Parameters are divided into 6 categories. Blower, Heater, System, Dispensing, Load-Cell, and Vacuum.		
Press	The category that would contain the parameter you want to adjust.	Categories will have several parameters indicated by a 3-letter acronym on the left of the screen. Some categories have multiple pages. Navigate pages using the arrow buttons at the lower-left of the screen.		
Press	The parameter that you want to adjust.	Display will show 5 digits. Press the up or down arrows to adjust.		
Press		To save the parameter adjustment or press the red X to cancel and exit.		





Communications Setup

ULTRA-600 communications enabled software communication over Ethernet using the MLAN Protocol. For more information about the MLAN Protocol and the ULTRA-600 Dryer see the MLAN Protocol manual, available on the Maguire Products Inc website.







MLAN communications over Ethernet use port 9999 to communicate. Modbus communications, when enabled (see below), use port 502.





Setting the MLAN ID Number

Press		Display will prompt for a password. (default: 22222)	Then press:	
Press		Display will show the System Configuration categories.		
Press	Communications	Display will show the System Communications categories.		
Press	MLAN I.D. Number	Display will show the MLAN I.D. Number screen.		
		On this screen, enter the new ID number using the keypad. Valid I.D. numbers are 1 through 254.		
Press		To save the Changes.		

Setting the IP Address, Subnet Mask, Gateway

Press		Display will prompt for a password. (default: 22222)	Then press:	
Press		Display will show the System Configuration categories.		
Press	Communications	Display will show the System Communications categories.		
Press	TCP/IP Configuration	Display will show the TCP/IP Configuration screen. On this screen, enter the IP Address, Subnet Mask and Default Gateway. Use the keypad to enter the number into the field highlighted in green. To advance to the next field, touch the field you want to edit and type the desired value.		
Press		To save the Changes.		

Enabling Modbus

Press		Display will prompt for a password. (default: 22222)	Then press:	
Press				Display will show the System Configuration categories.
Press		Communications		Display will show the System Communications categories.
Press		Modbus Server		Display will show the Modbus Server screen. On this screen, press the checkbox Enable to enable Modbus.
Press				To save the Changes.

Maintenance

Drain and purge Air Filter / Regulator

The purpose of the air filter is to remove moisture and contaminants from the compressed air supply and protect the pneumatic components of the Dryer. The air filter must be periodically purged of moisture.



Do not supply Dryer with a lubricated air supply. Damage to Dryer may result. Use only a clean, dry, oil-free air supply.

Color Dew Point Indicator: Only available on dryers equipped with the optional membrane air dryer. When outlet air is moist, the indicator will be **YELLOW**; when dry, it will be **GREEN**

**Dryers received prior to 2019 will show moist as PINK and dry as BLUE*



Clean Air Filter

The purpose of the air filter located on the back of the dryer enclosure is to remove contaminants from the ambient air supply and protect the heating components of the Dryer. The air filter must be periodically checked and cleaned. Recommended cleaning interval is monthly. More frequent in very dusty environments.

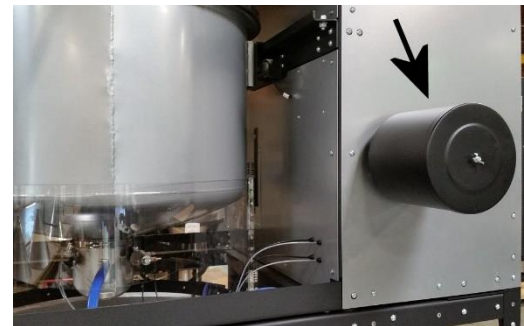

Air Pressure Adjustments

Air Pressure



Air pressure affects the ability to draw a high vacuum. We recommend a pressure setting of **80 PSI while the dryer is running**. Air is used when the **vacuum generator** is running so observe the PSI while the Dryer is drawing a vacuum. The gauge should continue to read this setting even when the vacuum unit is on. If it does not maintain pressure your supply line is not sized properly.



Do not supply Dryer with a lubricated air supply. Damage to Dryer may result. Use only a clean, dry, oil-free air supply.







Loadcell Calibration

Zero Weight Calibration

- BE SURE The Air supply is on.
- BE SURE The Vacuum Chamber and Retention Hopper is EMPTY.
- BE SURE The Vacuum Chamber and Retention Hopper are hanging / resting freely on the load cells.
- BE SURE The air lines are connected.

LOAD CELL ZERO CALIBRATION

The sequence is as follows:

Press		Display will prompt for a password. (default: 22222)	Then press:	
Press	Dryer Configuration		Display will show menu options	
Press	Load-Cell Setup		Display will show Load-Cell Calibration Screen	
Press	Vacuum Chamber Zero/Full Calibration		Display will show the ZERO / FULL Calibration screen.	
Press	ZERO		Display will say: Confirm Vacuum Chamber is empty then press ZERO. Gram weight of 0 follows successful calibration.	
Press			To return to the Load-Cell Setup screen.	
Press	Retention Hopper Zero/Full Calibration		Display will show the ZERO / FULL Calibration screen.	
Press	ZERO		Display will say: Confirm Retention Hopper is empty then press ZERO. Gram weight of 0 follows successful calibration.	
Press			To return to the Load-Cell Setup screen.	
Press			To return to the Main Screen.	

The ZERO point of the load cells is now set properly. FULL weight calibration may also be done at this time; however, it probably is NOT NECESSARY. When load cell readings shift due to rough handling, the entire range of readings from ZERO to FULL shift together. The ZERO weight calibration routine resets the full range of the cells and, therefore, corrects FULL weight readings as well.

Full Weight Calibration

When SETTING FULL WEIGHT, BE SURE you know the exact weight (in grams or pounds) that you are adding to the chamber. Place this weight in the chamber.



Enter the EXACT weight that you have placed in the chamber. Weigh units are in tenths of a pound or tenths of a kilogram depending on the weigh units set in LOAD Cell Setup menu. The weight should be close to 35.0 lbs. or 16.0 kilograms.

After FULL weight calibration, if the display says (BAD CELL), the weight you are using does not match the weight you entered, the chamber is not free to move, OR the load cells are bad.

Full Weight Calibrations - Full weight calibration will be done on both the Vacuum Chamber and Retention Hopper. It is recommended to use a known weight of material for the Full Calibration. Place approximately 35 lb. of material into the Heating Hopper. Using Manual Operations, Operation Outputs, Vac Cham Fill, dispense the material from the Heating Hopper to the Vacuum Chamber prior to entering the Full Calibration Routine.

If material totals are being observed loadcell full weigh calibration is recommended periodically (approximately every six months).

The ZERO point of the load cells is now set properly. FULL weight calibration may also be done at this time, however, it probably is NOT NECESSARY. When load cell readings shift due to rough handling, the entire range of readings from ZERO to FULL shift together. The ZERO weight calibration routine resets the full range of the cells and, therefore, corrects FULL weight readings as well.

Press		Display will prompt for a password. (default: 22222)	Then press:	
Press	Dryer Configuration	Display will show the Dryer Configuration categories.		
Press	Load-Cell Setup	Display will show the Load-Cell Setup screen.		
Press	Vacuum Chamber Zero/Full Calibration		Display will show the ZERO / FULL Calibration screen.	
Press	ZERO	Display will say: Confirm Vacuum Chamber is empty then press ZERO. Gram weight of 0 follows successful calibration.		
Press	FULL	Display will show a keypad and the message: Enter the known weight and then press ENTER. Enter your known weight in GRAMS and then press ENTER.		

Place the known weight in the Vacuum Chamber and then properly re-install the Vacuum Chamber into the Dryer. Press CONTINUE to proceed.

Wait while calibrating load cells. Do not touch weigh bin during calibration. After Full calibration has proceeded successfully, you will be prompted.

Press



**To exit Zero / Full Weight Calibration screen.
Repeat procedure for Retention Hopper.**

Clean Out Procedure

Dumps the Heating Hopper and/or the Vacuum Chamber. The following explains how to perform these procedures.



HEATING HOPPER HOT SURFACES:

As with all dryers, there are **HOT SURFACES** to avoid. Temperatures can reach 350F, (180C). Typically, these surfaces are not at dangerous temperatures, however all hot surfaces should be avoided.



Do Not Perform a Clean Out Unless ULTRA-600 Dryer is First Properly Shut Down.

For proper shutdown procedure, see **Startup and Operation** on page 22.



During the Clean Out, keep hands and tools clear of all valves. **DO NOT** reach into machine during Clean Out.

Using the Heating Hopper Clean Out

The Heating Hopper has a front hatch for access to the full internal height of the Heating Hopper. The Heating Hopper is non-removable. Prior to opening the front hatch, removal of all material is recommended. Material in the Heating Hopper can be evacuated by dropping the material down into the vacuum chamber.

Note: use of the Heating Hopper Manual Dump Valve is optional. Material can be dumped into the vacuum chamber, then into the retention hopper and conveyed away from the VTA at the base of the dryer.



Emptying the Heating Hopper

Press		<p>The Clean Out button is located on the Home Screen. Display will show: Batch Start Clean Out Mode screen.</p>
Press		<p>Confirmation window will appear.</p>
Press		<p>to Dump Heating Hopper and start the Clean Out.</p>

Emptying the Vacuum Chamber





The Vacuum Chamber is non-removable. The Vacuum Chamber has a front facing cleanout hatch. Prior to opening the front access hatch, removal of all material is recommended.

IMPORTANT: During the Clean Out, keep hands and tools clear of all valves. **DO NOT** reach into machine during Clean Out.





<p>Press</p>		<p>The Clean Out button is located on the Home Screen. Display will show: Batch Start Clean Out Mode screen.</p> <p>Both the Dump Heating Hopper button and the Heating Hopper Drain Valve button (located near the upper rear of the Vacuum Chamber area) can be used to empty the Heating Hopper.</p>
<p>Press</p>		<p>status window will appear.</p>
<p>Press</p>		<p>to return to the Home Screen.</p>

Clean Out / Dump All – Dump All opens all valves allowing material to flow freely through the dryer. Material in the Heating Hopper will pass into the Vacuum Chamber and then pass into the Retention Hopper. In this mode, it is possible to empty the entire dryer using a conveying system pulling from the material outlet at the base of the dryer.

IMPORTANT: During the Clean Out, keep hands and tools clear of all valves. **DO NOT** reach into machine during Clean Out.





<p>Press</p>		<p>The Clean Out button is located on the Home Screen. Display will show: Batch Start Clean Out Mode screen.</p> <p>Both the Dump Heating Hopper button and the Heating Hopper Drain Valve button (located near the upper rear of the Vacuum Chamber area) can be used to empty the Heating Hopper.</p>
<p>Press</p>		<p>Confirmation window will appear.</p>
<p>Press</p>		<p>to start the Clean Out.</p>
<p>Press</p>		<p>to return to the Home Screen.</p>

Cleanout of the Vacuum Chamber

<p>Access to the Vacuum Chamber through the cleanout hatch located on the front of the Vacuum Chamber.</p>	
<p>To remove the hatch insert rotate the two butterfly latches and then unhook from the hatch faceplate.</p>	
<p>Using two hands slide the hatch insert out of the Vacuum Chamber. Use caution handling the Vacuum Chamber Hatch. Do not drop.</p>	
<p>Access the interior of the Vacuum Chamber through the hatch opening.</p>	
<p>When cleanout is complete, clean the seal around the hatch insert and then re-secure the hatch to the Vacuum Chamber.</p>	

Cleanout of the Retention Hopper

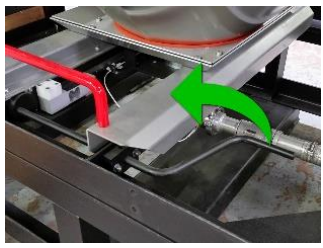
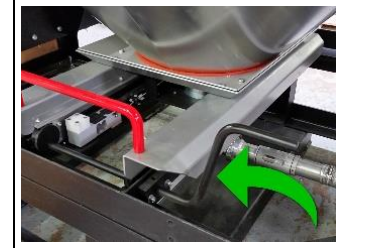
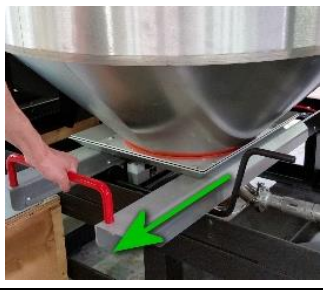
The Retention Hopper will slide out for easy access. Prior to sliding out the Retention Hopper remove all material. Sliding out the Retention Hopper will open the bottom drain of the hopper.

<p>To slide the Retention Hopper out, the sealing collar needs to be dropped. It is held up using a series of magnets. Grab the red handles and pull downward.</p>		
<p>Locate the black lift handle and raise the Retention Hopper by rotating the lift handle up and towards the front of the Dryer.</p>		
<p>With the lift handle raised, use the red handle to slide the Retention Hopper out towards the front of the Dryer.</p>		
<p>When cleanout is complete, slide the Retention Hopper back into the Dryer, then lower the Retention Hopper using the black lift handle. Finally lift up on the retention hopper sealing collar.</p>		

Alarms - Cause and Solution

Typically, problems are indicated by an alarm condition on the Dryer controller’s display with an audible alarm and a flashing strobe light. The following alarm troubleshooting chart will describe the alarm condition and possible causes and solutions.

Alarm Display:

Troubleshooting:

<p>BLOWER FAILURE ALARM:01</p>	<p>Problem: The blower is not running. Motor contactor overload relay has tripped. See wiring diagram on page 82 for Blower Motor Contactor. Item # 3, overload relay on wiring diagram. This alarm will trigger a dryer shutdown.</p> <p>Solution: Reset contactor. Check that blower motor shaft is not locked. Check line voltage to machine; make sure voltage is not too low which can cause an increase in amperage. Check that power source has not lost a phase.</p>
<p>ALARM:02 HH NO HEAT</p>	<p>Problem: No heat or inadequate heat detected by the Heating Hopper inlet RTD. This alarm is triggered by the NH1 parameter. NH1 parameter is the maximum time limit, in seconds, after the heat cycle begins, during which one of the following two conditions must be detected: Either the temperature must climb 20 degrees, or the temperature must move at least 20 percent toward the target temperature. If neither condition is met the “NO HEAT” alarm will sound. Such an occurrence would signal a failure of either the heater or the airflow from the blower. This parameter and consequent alarm protects the heater from burn out in the event the blower fails or airflow is blocked.</p> <p>Solution: Check for airflow from the blower. Check blower inlet obstruction, check that 2” air duct from blower to heater is not detached, obstructed or perforated. Check 2” air duct from top of heater to heating hopper inlet for detachment, obstruction or perforation. Check resistance across heater. Disconnecting heater from circuit is not necessary to measure resistance. Measurement should read 80 ohms. See wiring diagram on page 82. If the dryer’s heater shorted, the result would be a trip of the breaker or fuse supplying power to the ULTRA-600 dryer.</p>
<p>ALARM:03 HH SP EXCEEDED</p>	<p>Problem: The heating hopper air inlet temperature has drifted above set-point. If the Heating hopper air inlet temperature (T1a sensor) is over the degrees specified in parameter OT1 (default 6° F or 6° C) for a time greater than the time in seconds specified in OT1, then the alarm is triggered and the heater output will drop by 20%. The alarm will occur but the machine will keep running. See OT1 parameter for more information.</p> <p>Solution: No solution is necessary under normal circumstances as the dryer is alerting to a temperature adjustment. If this alarm continued to repeat, contact Maguire Technical Support.</p>

<p>ALARM:04 HH OVERHEAT</p>	<p>Problem: The heating air temperature has drifted above set-point.</p> <p>If the heating air temperature (T1a sensor) is over the degrees specified in parameter OT1 (default 6° F or 6° C) for a time greater than the time in seconds specified in OT1, then the alarm is triggered and the heater output will drop by 20%. The alarm will occur but the machine will keep running. See OT1 parameter for more information.</p> <p>Solution: No solution is necessary under normal circumstances as the dryer is alerting to a temperature adjustment. If this alarm continued to repeat, contact Maguire Technical Support.</p>
<p>ALARM:05 PURGE HTR NO HEAT</p>	<p>Problem: No heat or inadequate heat detected by the Purge Heater RTD.</p> <p>This alarm is triggered by the NH2 parameter. NH2 parameter is the maximum time limit, in seconds, after the heat cycle begins, during which one of the following two conditions must be detected: Either the temperature must climb 10 degrees, or the temperature must move at least 10 percent toward the target temperature. If neither condition is met the “NO HEAT” alarm will sound. Such an occurrence would signal a failure of either the heater or the compressed airflow. This parameter and consequent alarm protects the purge heater from burn out in the event the compressed air failure or airflow is blocked.</p> <p>Solution: Check compressed airflow to the purge heater is adequate. Check that the air line that supplies the solenoid valve in the inlet of the purge heater is properly attached.</p>
<p>ALARM:06 PURGE SP EXCEEDED</p>	<p>Problem: The purge air temperature has drifted above set-point.</p> <p>If the purge air inlet temperature (T2a sensor) is over the degrees specified in parameter OT2 (default 6° F or 6° C) for a time greater than the time in seconds specified in OT2, then the alarm is triggered and the heater output will drop by 20%. The alarm will occur but the machine will keep running. See OT2 parameter for more information.</p> <p>Solution: No solution is necessary under normal circumstances as the dryer is alerting to a temperature adjustment. If this alarm continued to repeat, contact Maguire Technical Support.</p>
<p>ALARM:07 PURGE OVERHEAT</p>	<p>Problem: The purge air temperature has drifted above set-point.</p> <p>If the purge air temperature (T2a sensor) is over the degrees specified in parameter OT2 (default 6° F or 6° C) for a time greater than the time in seconds specified in OT2, then the alarm is triggered and the heater output will drop by 20%. The alarm will occur but the machine will keep running. See OT2 parameter for more information.</p> <p>Solution: No solution is necessary under normal circumstances as the dryer is alerting to a temperature adjustment. If this alarm continued to repeat, contact Maguire Technical Support.</p>

<p>NO VACUUM ALARM:08</p>	<p>Problem: The dryer failed to pull a vacuum after three attempts. Dryer attempted to pull a vacuum 200mm below atmosphere within 45 seconds (default). Dryer attempted three times (number of default retries). After each attempt vacuum was equalized and vacuum gates were opened and closed in an attempt to reseal the Vacuum Chamber (possible debris or pellets preventing adequate seal). Defaults are controlled the NVT parameter (retries and seconds). This alarm is non-fatal. Dryer will continue to reseal after alarming.</p> <p>Solution: If Dryer continues to alarm, check: compressed air connection and pressure (dryer’s regulator should be reading 85psi). Check for debris in seals above and below Vacuum Chamber.</p>
<p>RETEN.NOT PRESENT ALARM:09</p>	<p>Problem: The Retention Hopper is missing. If retention hopper loadcell (pair) is reading 23.2 pounds (10000 grams) below tare during AUTO run, this alarm is triggered and Dryer stops (fatal). This alarm is generally caused by a missing Retention Hopper but may also be caused by dryer Retention Hopper load cells having been zero calibrated while material was in the Retention Hopper, or faulty loadcells.</p> <p>Solution: If Retention Hopper is missing replace Retention Hopper. If Retention Hopper is in place, ensure the tank is empty and zero calibrate the load cells. If load cells are damaged, a zero calibration may detect this.</p>
<p>RTD FAILURE ALARM:11</p>	<p>Problem: RTD (temperature sensor) reading is above or below max/min reading RTD Sensor is probably disconnected or damaged. Check temperature display reading in a cool state. Temperature should display room temperature. If reading is below -25C or above 450C RTD sensor has failed.</p> <p>Solution: Contact Maguire Technical Support for a replacement RTD Sensor.</p>
<p>MATERIAL SHORTAGE ALARM:12</p>	<p>Problem: Maximum Fill Time (VFT parameter) has been reached before target material weight (VTH parameter) has been achieved. This alarm is triggered when the VFT parameter has been reached (Vessel Fill Time) before the VTH (Vacuum Chamber High level), indicating shortage of material in heating hopper or possible valve jam. The outcome of this alarm is controlled by the Material Shortage Alarm settings.</p> <p>Solution: Check material supply. Check Vacuum Chamber fill valve located at the base of the heating hopper.</p>
<p>LOW AIR PRESSURE ALARM:15</p>	<p>Problem: Air pressure sensor has detected air pressure below 50 psi.</p> <p>Solution: Check exhausting lockout valve located on the front lower left side of ULTRA-600. Ensure that the valve is open. Check pressure of air supply.</p>

<p>HH FAIL-SAFE ALARM:16</p>	<p>Problem: The heating hopper heater thermal safety switch has opened due to an overheat condition. Located on the top of the Heater Tube is a Temperature Safety Switch. If the temperature of the heater exceeds the safety switch maximum, this switch opens, shutting down the entire dryer (FATAL Alarm).</p> <p>Solution: Allow the dryer to cool. Open the left side panel of the dryer and locate the Heater Tube Safety Switch on the upper side of the stainless-steel heater tube. Press the red safety switch button to reset the Temperature Safety Switch. If problem occurs repeatedly, contact Maguire Technical Support.</p>
<p>PH FAIL-SAFE ALARM:17</p>	<p>Problem: The purge heater thermal safety switch has opened due to an overheat condition. Located on the side of the purge heater tube is a Temperature Safety Switch. If the temperature of the purge heater exceeds the safety switch maximum, this switch opens, shutting down the entire dryer (FATAL Alarm).</p> <p>Solution: Allow the dryer to cool. Open the left side panel of the dryer and locate the purge heater thermal safety switch on the side of the stainless-steel purge heater tube. Press the red reset button to reset the thermal safety switch. If problem occurs repeatedly, contact Maguire Technical Support.</p>
<p>VC MISSING ALARM:18</p>	<p>Problem: The Vacuum Chamber is missing. If Vacuum Chamber load cell is reading 33 pounds (15000 grams) below tare during AUTO run, this alarm is triggered and Dryer stops (fatal). This alarm is generally caused by a missing Vacuum Chamber but may also be caused by the dryer Vacuum Chamber load cells having been zero calibrated while material was in the Vacuum Chamber.</p> <p>Solution: If Vacuum Chamber is missing replace Vacuum Chamber. If Vacuum Chamber is in place, ensure the tank is empty and zero calibrate the load cells. If load cells are damaged, a zero calibration may detect this.</p>
<p>RH MISSING ALARM:19</p>	<p>Problem: The Retention Hopper is missing. If Retention Hopper load cell is reading 23.2 pounds (10000 grams) below tare during AUTO run, this alarm is triggered and Dryer stops (fatal). This alarm is generally caused by a missing Retention Hopper but may also be caused by dryer Retention Hopper load cells having been zero calibrated while material was in the Retention Hopper.</p> <p>Solution: If Retention Hopper is missing replace Retention Hopper. If Retention Hopper is in place, ensure the hopper is empty and zero calibrate the load cells. If load cells are damaged, a zero calibration may detect this.</p>

<p>THROUGHPUT ALARM:20</p>	<p>Problem: The throughput of the dryer has been exceeded. This is an optional alarm (under alarms menu), defaulted to enabled. This alarm is triggered when the Retention Hopper low level has been reached before the vacuum timer has elapsed. This means demand for material has exceeded dried material supplied. This alarm is non-fatal, dryer continues to run.</p> <p>Solution: This is cause by exceeding material demand.</p>
<p>LOW VACUUM ALARM:21</p>	<p>Problem: Dryer failed to pull vacuum down to target vacuum pressure set in VPL parameter. Dryer attempted to pull a vacuum down to target vacuum pressure within 120 seconds (default value in LVT parameter).</p> <p>Possible causes and Solution: If dryer alarms, check: compressed air connection and pressure (dryer's regulator should be reading 85psi). Check for debris in seals above and below Vacuum Chamber. Alarm may also have been caused by a vacuum leak. Contact Maguire technical support if cause is not found.</p>
<p>LOW BATCH ALARM:22</p>	<p>Problem: Material supplied to Vacuum Chamber is below minimum allowable weight. This alarm is triggered by the VFA parameter (Vessel Fill Adjust) and pertains to filling the Vacuum Chamber. The VFA parameter is a two-part parameter. The first three digits are the number of retries to fill the Vacuum Chamber (default 3 retries). Last two digits are the minimum allowable percent under the targeted maximum fill weight of the Vacuum Chamber (VTH parameter). After the third failed retry the "Low Batch" alarm is generated while the retries continue.</p> <p>Solution: Check material supply feeding the heating hopper. Check heating hopper material flow (sticking material, melted material, hard to flow regrind). Check Vacuum Chamber Fill Valve (butterfly valve below heating hopper). Check air pressure (80 psi).</p>
<p>RESIDENCE ALARM ALARM:23</p>	<p>Problem: Material has been in the retention hopper too long. This alarm is triggered by the RAL parameter. When the Residence Alarm has been enabled, this alarm will sound if not enough material has been removed from the retention hopper in the time specified in the RAL parameter. For more information, see the RAL parameter on page 29.</p> <p>Solution: To prevent this alarm: decrease fill weight, or turn on Fill Weight Adjust (Material Setup menu).</p>
<p>BATCH COMPLETE ALARM:24</p>	<p>Batch is complete This alarm triggers at the end of a batch run, the end being defined as the time at which the retention hopper is depleted to the HHL parameter level after the final vacuum chamber dump of said batch run.</p>

<p>MATERIAL SHUTDOWN ALARM:25</p>	<p>Material Shutdown This alarm triggers if the Material Shortage alarm is set to "SHUTDOWN" and is it determined that the heating hopper has been fully depleted of material via the VFA parameter criteria. When this alarm triggers, the ULTRA enters a Shutdown state automatically. This alarm can be useful. For example: at the end of the day, one can intentionally run the heating hopper empty (by turning off its feed loader) and have the ULTRA automatically initiate a shut down at the appropriate time.</p>
<p>MATERIAL READY ALARM:26</p>	<p>Material Ready If the Material Ready alarm is enabled under the "Alarm Setup" menu, this alarm will trigger after the first and only first batch of material has completed a full vacuum cycle. After 15 seconds, the audible portion of this alarm will automatically silence. The first batch of material will remain under vacuum indefinitely until this alarm is cleared. There are two main purposes of this alarm:</p> <ol style="list-style-type: none"> 1. To alert the operator that dry material is ready for the process. 2. To act as a hold-back, when necessary, giving the operator additional time to prepare the process.
<p>AUTO SHUTDOWN ALARM:27</p>	<p>Auto Shutdown This alarm triggers when an Auto Shutdown, that is, a shutdown at a pre-determined time, has commenced. "Commencement" is defined as the time at which the final vacuum chamber fill has occurred.</p>
<p>HH MATERIAL LOW ALARM:28</p>	<p>Heating Hopper Material On ULTRA's with an optional Heating Hopper Level sensor, this alarm triggers when the "HH Mat. Level" alarm is enabled under the "Alarm Setup" menu and the level in the heating hopper has dropped below the HHA parameter value.</p>
<p>MATERIAL TEMP ALARM:29</p>	<p>Material Temp When the Material Temp alarm is enabled under the "Alarm Setup" menu, during any instance where the Heating Hopper is called upon to dispense material into the vacuum chamber and the T2 (heating hopper exit) temperature is below the ESM parameter level, this alarm will trigger. Its purpose is to alert the operator that insufficient heating has occurred, most likely from a process throughput that exceeds the capacity of the ULTRA.</p>

Print Center Logs and Print Outputs



Print Center is available from the Home Screen by pressing by pressing the Pinter Center button. Print Center displays a menu screen of print related options including Parameters, Events and Alarms, raw data log file and Alarm History. To print the Alarm Log, Parameters or Event Log a USB Flash Drive must be plugged into the ULTRA dryer.

Files will be created on the flash drive in the root of the drive.

ULTRA_ALARM.LOG - Alarm Log

ULTRA_EVENT.LOG - Event Log

ULTRA_PARAM.TXT - Parameter Report

Print Parameters	Prints the full parameter and parameter values as well as other information list to the USB flash drive.
Print Event and Alarms	A combination of machine status lines at defined intervals as well as mechanical events as they occur.
Print Alarm History	Prints to USB any alarms recorded since the alarm log was last cleared.
Copy Log File	Copies raw log file to USB stick for analysis by a Maguire technician.
Print All	Prints all of the above logs to USB.

Alarm and Event Log



Alarm and Event Log displays a history of alarms currently active alarms and other events with a date and time stamps and description. Press the upper or lower half of the event display windows to page up or page down. Alarms can be silenced from this screen. Other options in this screen include: Print to USB and Clear the Alarm Log. To print the Alarm and Events Log a USB Flash Drive must be plugged into the ULTRA dryer.

Files will be created on the flash drive in the root of the drive.

ULTRA_ALARM.LOG - Alarm Log

ULTRA_EVENT.LOG - Event Log

Logs and Print Outputs

Alarm Log - Display of the most recent log outputs. Toggle Select button to Alarm Log.

Event Log - The Event log is written to a file on a USB drive. To write the log file, toggle to wrench mode, Print Setup, Print Event Log. Each log entry is a single line of information that was recorded about the Dryer at the moment the line in the log was written.

The following is a description of the columns of information in a log. Note: line wrap in the manual due to page space constraints. Actual log file continues as a single line with a carriage return after "ABS:"

Column	Example	Description
1	08-20-2017	Date of the log (the date is stored in the Dryer).
2	10:10:08	Time of the log.
3	MODE: PHT	Current mode of the dryer when the log entry was written.
4	T1s: 180F	T1s (Heating Hopper Inlet temperature Setpoint)
5	T1a: 90F	T1a (Heating Hopper Inlet Actual Temperature)
6	H1: 0.0	Heating Hopper Heater Duty Cycle
7	T2s: 180F	Dry Purge Air Temperature Setpoint
8	T2a: 77F	Dry Purge Air Actual Temperature
9	H2: 7.5	Dry Purge Heater Duty Cycle
10	T3: 84F	Heating Hopper Outlet Air Temperature
11	T4: 78F	Optional T4 Material Exit Temperature
12	BLW: 0.00ma	Blower Speed Reference (4-20 mA)
13	LS: 98%	Heating Hopper Level Sensor (percent)
14	VTIME: 00:00/20:00	Vacuum Time (actual/setpoint in seconds)
15	ABS: 753mmHg	Vacuum Chamber Pressure
16	VT LC: 7	Vacuum Chamber Loadcell Reading (weight in lbs or kgs)
17	RH LC: 6	Retention Hopper Loadcell Reading (weight in lbs or kgs)
18	THROUGHPUT: 0	Throughput (lbs or kgs / hour)

Example of an ULTRA Event Log:

ULTRA Event Log
 MODEL: 600
 CPU Firmware: N0819B
 I/O Firmware: N0819B
 Serial#: 000000-00

08-20-2014 12:25:17

08-20-2014 10:10:04 | *** OPERATOR START ***
 08-20-2014 10:10:05 | *** DRYER STARTED ***
 08-20-2014 10:10:05 | *** BLOWER STARTED ***
 08-20-2014 10:10:05 | *** DRYPURGE SUPPLY VALVE: ON ***
 08-20-2014 10:10:05 | *** HEATER FAIL-SAFE: HIGH ***
 08-20-2014 10:10:05 | *** BLOWER STATUS: STARTED ***

08-20-2014 10:10:08 | MODE: PHT | T1s: 180F | T1a: 90F | H1: 0.0 | T2s: 180F | T2a: 77F | H2: 7.5 | T3: 84F | T4: 78F | BLW: 0.00ma | LS: 98% | VTIME: 00:00/20:00 | ABS: 753mmHg | VT LC: 7 | RH LC: 6 | THROUGHPUT: 0

08-20-2014 10:10:15 | *** HEATING HOPPER HEATER STARTED ***

08-20-2014 10:10:23 | MODE: PHT | T1s: 180F | T1a: 90F | H1: 10.8 | T2s: 180F | T2a: 78F | H2: 7.5 | T3: 85F | T4: 78F | BLW: 0.00ma | LS: 98% | VTIME: 00:00/20:00 | ABS: 753mmHg | VT LC: 6 | RH LC: 6 | THROUGHPUT: 0

08-20-2014 10:10:39 | MODE: PHT | T1s: 180F | T1a: 112F | H1: 20.3 | T2s: 180F | T2a: 80F | H2: 14.3 | T3: 87F | T4: 78F | BLW: 0.00ma | LS: 98% | VTIME: 00:00/20:00 | ABS: 753mmHg | VT LC: 6 | RH LC: 6 | THROUGHPUT: 0

08-20-2014 10:10:54 | MODE: PHT | T1s: 180F | T1a: 145F | H1: 23.0 | T2s: 180F | T2a: 82F | H2: 14.3 | T3: 88F | T4: 78F | BLW: 0.00ma | LS: 98% | VTIME: 00:00/20:00 | ABS: 753mmHg | VT LC: 6 | RH LC: 6 | THROUGHPUT: 0

08-20-2014 10:11:09 | MODE: PHT | T1s: 180F | T1a: 165F | H1: 22.0 | T2s: 180F | T2a: 85F | H2: 20.3 | T3: 89F | T4: 79F | BLW: 0.00ma | LS: 98% | VTIME: 00:00/20:00 | ABS: 753mmHg | VT LC: 6 | RH LC: 6 | THROUGHPUT: 0

08-20-2014 10:11:24 | MODE: PHT | T1s: 180F | T1a: 172F | H1: 21.2 | T2s: 180F | T2a: 88F | H2: 20.3 | T3: 89F | T4: 79F | BLW: 0.00ma | LS: 98% | VTIME: 00:00/20:00 | ABS: 753mmHg | VT LC: 6 | RH LC: 10 | THROUGHPUT: 0

08-20-2014 10:11:39 | MODE: PHT | T1s: 180F | T1a: 174F | H1: 21.2 | T2s: 180F | T2a: 91F | H2: 25.5 | T3: 89F | T4: 80F | BLW: 0.00ma | LS: 98% | VTIME: 00:00/20:00 | ABS: 755mmHg | VT LC: 6 | RH LC: 10 | THROUGHPUT: 0

Interpreting the Parameter Printout

First column is the parameter's description.

Second column is the parameter's 3-letter acronym.

Third column is the parameter's setting in RAM, which is the currently loaded user settings.

Fourth column is the parameter's default setting in ROM (Read Only Memory). This is the factory default.

Fifth column is the lower limit of the parameter's value.

Sixth column is the upper limit of the parameter's value.

Seventh column is the units of the parameter.

Example of a Parameter Printout:

ULTRA-600 Parameters

Mon 08/15/2016 17:04
 CPU Firmware: P0812A
 I/O Firmware: P0812A
 CPU Bootloader: 1.03
 I/O Bootloader: 1.03
 Serial#: 000000-00
 MAC Address: 00:1C:1A:00:4B:0F

INDEX	NAME	ABBR	RAM	DFT	LO LIMIT	HI LIMIT	UNITS
Blower:							
B1	Blower Delay Time	BDT	01002	01002	00000	99999	Second
B2	VFD Low Limit	BLF	00025	00025	00025	00060	Freq
B3	VFD High Limit	BHF	00060	00060	00050	00070	Freq
B4	VFD Drive	BDF	00040	00040	00000	65535	Freq
B5	VFD Zero Level	BZL	00045	00045	00000	00100	Percent
B6	VFD Level Adjustment	BLA	00025	00025	00025	00060	Freq
B7	VFD Heat Throttle	BHT	00100	00100	00000	65535	Percent
B8	VFD Air Flow Cutback	BAC	00000	00000	00000	65535	Freq/Sec
B9	VFD Temp. Cutback	BTC	00000	00000	00000	65535	Freq/Deg
B10	VFD Throttle Adjust	BTA	00000	00000	00000	65535	Freq/Sec

Dispensing:

D1	Vac. Cham. Hi Level	VCH	00300	00300	00000	00350	Weight
D2	Vac. Cham. Low Level	VCL	00025	00025	00000	00100	Weight
D3	Ret. Hop. Hi Level	RHH	00375	00375	00000	00385	Weight
D4	Ret. Hop. Low Level	RHL	00025	00025	00000	00227	Weight
D5	Bulk Density	BLK	00035	00035	00000	65535	Weight
D6	Vac.Cham. Fill Rate	VFR	12000	12000	02500	15000	Gram/Sec
D7	Vac.Cham. Dump Rate	VDR	00000	00000	00000	15000	Gram/Sec
D8	Chamber Fill Time	VFT	00025	00025	00000	99999	Second
D9	Chamber Dump Time	VDT	00060	00060	00000	99999	Second
D10	Fill Lag Time	FLA	00400	00400	00000	01000	Time
D11	Dump Lag Time	DLA	00300	00300	00000	01000	Time
D12	Vacuum Gate Delay	VGD	00404	00404	00000	65535	Second
D13	Chamber Fill Adjust	VFA	00450	00450	00000	65535	Cnt/Pct
D14	HH Dump Delay	HDD	00015	00015	00000	65535	Second
D15	Vac. Dump Threshold	VCT	00250	00250	00000	65535	Gram/Sec
D16	Chamber Dump Retries	CDR	05003	05003	00000	10099	Perc/Ret
D17	Residence Alarm	RAL	20120	20120	00000	65999	Wt/Min
D18	Batch Size	BCH	00000	00000	00000	65535	Weight
D19	Loader Trip Point	LTP	00050	00050	00000	00250	Weight
D20	Ldr. Thruput Cutoff	LTC	00005	00005	00000	65535	Wt/Min
D21	Heat Hopper Volume	HHV	00205	00205	00000	65535	Volume
D22	Heat Hopper Hi Level	HHU	00095	00095	00000	65535	Percent
D23	HH Level Alarm	HLA	00050	00050	00000	00100	Percent

Heater:

H1-1	Preheat Temperature	PTS	00150	00150	00074	00375	Degree
H1-2	Preheat Time	PHT	00060	00060	00001	00999	Minute
H1-3	Preheat Targ. Delta	PTD	00030	00030	00000	65535	Degree
H1-4	Heat1 Temp Set-Point	RTS	00150	00150	00074	00375	Degree
H1-5	Heat1 Proportional	PT1	00040	00040	00000	00100	Term
H1-6	Heat1 Derivative	DT1	00015	00015	00000	00100	Term
H1-7	Heat1 Update Time	UT1	00415	00415	00000	65535	Sec/Sec
H1-8	Heat1 OverTarg Alarm	OT1	06006	06006	00000	65535	Sec/Deg
H1-9	Heat1 No Heat Alarm	NH1	00090	00090	00000	65535	Second

H1-10	Heat1 Set-Point Off.	SO1	03002	03002	00000	65535	Sec/Deg
H1-11	Heat1 Max. Percent	MP1	00100	00100	00000	00100	Percent
H1-12	Heat1 Restart Offset	RO1	05040	05040	00000	65535	Pct/Sec
H1-13	Max Temp Set-Point	MAX	00350	00350	00074	00375	Degree
H1-14	Energy Savings Mode	ESM	00150	00150	00000	65535	Degree
H1-15	Energy Savings Time	EST	00030	00030	00000	65535	Minute
H1-16	Ramp Settings	RMP	52036	52036	00000	99999	Min/Deg
H1-17	Cool-Down Temp.	CTM	00120	00120	00032	00300	Degree
H1-18	Cool-Down Timer	CTR	00060	00060	00000	65535	Minutes
H2-1	Heat2 Temp Set-Point	PGS	00150	00150	00074	00375	Degree
H2-2	Heat2 Proportional	PT2	00030	00030	00000	65535	Term
H2-3	Heat2 Derivative	DT2	00015	00015	00000	65535	Term
H2-4	Heat2 Update Time	UT2	00830	00830	00000	65535	Second
H2-5	Heat2 OverTarg Alarm	OT2	09006	09006	00000	65535	Sec/Deg
H2-6	Heat2 No Heat Alarm	NH2	00180	00180	00000	65535	Second
H2-7	Heat2 Set-Point Off.	SO2	00006	00006	00000	65535	Pct/Sec
H2-8	Heat2 Fixed Output	FO2	00000	00000	00000	65535	Percent
H2-9	Dry Purge Delay	DPD	00003	00003	00000	65535	Second
H2-10	Purge and Shutdown	PST	00020	00020	00000	65535	Minutes

Load Cell:

L1	Loadcell Stable Wt.	KDF	00200	00006	00000	65535	Number
L2	Loadcell Stable Time	LST	00100	00100	00000	65535	Millisec
L3	Loadcell Zero	LCZ	01000	01000	00000	65535	Number
L4	Weight Settle Time	WST	01005	01005	00003	65535	Second
L5	Loadcell 1 Zero	LZ1	00000	00000	00000	65535	Number
L6	Loadcell 2 Zero	LZ2	00000	00000	00000	65535	Number

Vacuum:

V1	Vacuum Time Setting	VTS	05020	05020	00001	65535	Minute
V2	Vac. Pressure Low	VPL	00125	00125	00000	65535	Number
V3	Vac. Pressure Delta	VPD	00020	00020	00000	65535	Number
V4	Vac. Shutdown Offset	VSO	00060	00060	00000	65535	Second
V5	Low Vacuum Timeout	LVT	00150	00150	00000	65535	Second
V6	No Vacuum Timeout	NVT	00345	00345	00000	65535	Cnt/Sec
V7	Cham. Purge Timer	VPT	00015	00015	00000	65535	Second
V8	Cham. Purge Interval	VPI	35240	35240	00000	65535	Sec/Sec
V9	Atmospheric Pressure	ATM	00760	00760	00000	00999	mmHg

System:

S1	Event Logging Time	ELT	00060	00060	00001	65535	Second
----	--------------------	-----	-------	-------	-------	-------	--------

Alarm Flags:

Material Shortage Alarm	Warn
Material Ready	Off
Material Temp	Off
HH Level Alarm	Off
Residence	Off
Throughput Alarm	On
Dump Retry	On

Display Flags:

Auto Shutdown	Off
Batch Mode	Off
Cycle Info	On
Display	Temp.
Fill Time	On
Dump Time	On
I/O Status	On
Preheat Temp	Off
Preheat Temp.	On
Residence Time	Off
Screen Timeout	Off
Vacuum Time	On

Heat Settings:

Temperature Unit	Fahrenheit
Preheat Mode	Timed
Energy Saver	Off
Ramp	Off
DryPurge Temp.	Auto

Misc. Settings:

Auto-Fill Adjust Off
 HH Level Sensor Off
 Loader 1 Off
 Loader 2 Off
 Loader 2 Mode Thruput
 Purge Chamber On

Admin. Settings:





Blower VFD
 T4 On
 T5 Off

LOADCELL CALIBRATION





NAME	ZERO	DELTA	FULL	LAST ZERO	LAST FULL
RH LC: 3303829	1588575		15422	Fri 06/17/2016 11:01	Thu 01/01/1970 00:00
VT LC: 3364083	1408275		16147	Fri 06/17/2016 11:01	Thu 01/01/1970 00:00

Saving and Restoring User Settings

All parameter information can be saved to the User Backup Settings for future retrieval. To SAVE all parameter information to the User Backup Settings:

Press		Display will prompt for a password. (default: 22222)	Then press:	
Press	System Configuration	Display will show the System Configuration categories.		
Press	Resets	Display will show the categories of System resets: User Settings, Factory Access, Restore All, Restore Parameters, Firmware Update.		
Press	User Settings	Display will show Restore User Settings / Save User Settings.		
Press	Save User Settings	Display will prompt for confirmation to save user settings.		
Press		To save the user settings including parameters or press the red X to cancel and exit.		

Restoring Parameters from Backup





Press		Display will prompt for a password. (default: 22222)	Then press:	
Press	System Configuration	Display will show the System Configuration categories.		
Press	Resets	Display will show the categories of System resets: User Settings, Factory Access, Restore All, Restore Parameters, Firmware Update.		
Press	User Settings	Display will show Restore User Settings / Save User Settings.		
Press	Restore User Settings	Display will prompt for confirmation to Restore user settings.		
Press		To restore the user settings including parameters or press the red X to cancel and exit.		

Updating the ULTRA Firmware

When the ULTRA control panel is turned on, the first screen displayed will show the current firmware version. If necessary, the firmware in the ULTRA can be updated using a firmware update supplied by Maguire Products. Firmware updates use the USB port located below the control screen. The following instructions detail how to do a firmware update.



Do not turn off controller or remove the flash drive while firmware is updating! Doing so may corrupt the controller's firmware.

Copy	the new firmware update into a USB flash drive. (do not put in a directory)	
Insert	the USB Flash drive into the USB port on the ULTRA.	
Press	 Display will prompt for a password. (default: 22222) Then press:	
Press	System Configuration	Display will show the System Configuration categories.
Press	Resets	Display will show System reset options.
Press	Firmware Update	The controller will search the USB drive for a firmware update file with the XUF extension.
Select	the file from the white display area on the left. If more than one firmware version is stored on the flash drive, multiple version will be displayed in the white display area. If the display is blank check USB for the file and that the file is location directly on the drive (not in a sub-folder). Exit out of this screen and enter again to refresh the display window.	
Highlight	the version in the white panel on the left and press PROGRAM .	
Press	 To proceed with the firmware update or press	 the red X to cancel and exit.
The display will show progress in transferring to the internal SD card, then it will show progress in verifying the update file. Then the controller will prompt: " Please toggle power. " At this time, remove the flash drive, power off the controller then on. When the controller restarts the display will show progress updating to the new firmware. When complete, the display will show: UPDATES COMPLETE Toggle power. At this time turn off power, then turn back on.		

Additional Firmware Update Information

Software updates can be supplied electronically, via email or by download. Software updates are named according to their date of release. For instance, **VTQ0620A.XUF** can be interpreted as VT=Vacuum Touchscreen, Q=2017 (R=2018), 06=June, 20=June 20th, A=the first revision for that day. During the update process detailed above, new software found on the USB flash drive is first copied to an internally mounted SD card. From the SD card, the software is then loaded into the ULTRA. If there is ever a problem with the ULTRA and the USB port cannot be used or the ULTRA software is corrupted and cannot load new software through the menu, new software can be acquired from Maguire and renamed VTUPDATE.XUF. This renamed software can be copied onto the Flash Drive and inserted into the USB port of the ULTRA. When the ULTRA is turned on, this VTUPDATE.XUF file will be automatically loaded into the dryer, restoring the software.

General Information

ULTRA-600 Technical Specifications

SCOPE

- Provide up to 600 pounds per hour (272 kg/hr) of dry material to an injection molding or extrusion platform utilizing energy efficient vacuum drying technology. Drying temperature up to 350° F (185° C).

POWDER REQUIREMENTS

- Voltage: 480 Vac, 3 Phase, 60 Hz or 400 Vac, 3 Phase, 50 Hz
- FLA: 49 / 54
- Disconnect: 60 amp
- Air: 85 psi / 6 bar
- Heating Element: Primary: 20 Kw, Secondary: 1.25 kW (purge circuit)
- Blower: 8.5 HP, 350 SCFM @ 40" water

HEATING HOPPER

- Capacity: 420 lbs. (191 kg)
- Insulated construction, 4" of R-15 insulation
- Large Access Door
- Diffuser cone
- 304 Stainless steel internal wall construction, material contact

VACUUM CHAMBER

- Capacity: 195 lb. (88 kg)
- Rail mounted for ease of removal
- Insulated construction, 4" of R-7.5 insulation
- Access Hatch, insulated glass with captive air gap insulation
- 304 Stainless steel internal wall construction, material contact
- Unions on most air connections for ease of maintenance
- Load cell based continuous level control

MATERIAL SHUT-OFF / VACUUM VALVE

- Slide gate style material shut-off valve
- Camming slide gate style vacuum shut-off valve

RETENTION HOPPER

- Capacity: 215 lb. (98 kg)
- Insulated construction, 4" of R-7.5 insulation
- 304 Stainless steel internal wall construction, material contact
- Load cell based continuous level control

CONTROLLER

- Microprocessor based control (Motorola 6812)
- 4 x 20 character Blue back lit display
- 4 Digit 1" high Red LED for display of Actual or Set Temperature
- Icon representation of function
- Flash Memory, SD card with micro capability
- Ethernet & USB ports
- Optional CANbus communications for remote / repeater control

ELECTRICS

- Main Disconnect, 60 Amp, class J fuses
- Altec Euro style disconnects
- Step down transformer with regulated DC power supply
- 70 cfm cooling fan, bottom vented
- 8.5 HP regenerative blower, 350 SCFM w/ VFD
- RTD Inputs, 3: Heating hopper inlet, Heating hopper exit, Dry Purge inlet

DRY AIR PURGE CIRCUIT

- Air filter regulator
- Coalescing Filter, 1/10th micron for removal of oil and fine particulates
- Exhaust Shut-off
- Compressed Air Dryer, 75 L/min.
- 1,250 kW heater dedicated for dry air purge

The majority of the dry air is directed to the retention hopper, the vacuum chamber receives a constant low volume of -40 C dew point dry air. At the end of the vacuum cycle during atmospheric equalization a valve shifts to allow an inrush of dry air.

VACUUM CIRCUIT

- 6 Element, 3 Stage PIAB configuration for maximum effectiveness
- 1" Electro-pneumatic check valve

line no.	parameter	Domestic/Canadian		European	
		value	units	value	units
1	design throughput	600	lbs./hour	454	kgs./hour
2	maximum run temperature	350	°F	176	°C
3	maximum vacuum level, absolute	75	mm Hg.	75	mm Hg.
4	complete unit weight, empty	1824	lbs.	827	kgs.
5	overall unit height	161.5	inches	4.10	meters
6	voltage	480/575	volts	400	volts
7	full load amps (FLA)	49.0	amps	54.1	amps
8	phase	3	∅	3	∅
9	frequency	60	Hz	50	Hz
10	compressed air requirement, sustained pressure	85	psi	5.86	bar
11	compressed air requirement, max flow rate	28	SCFM	727	NI/min
12	compressed air requirement, average flow rate	11.2	SCFM	291	NI/min
13	blower model	RBH8-805-3	All-Star	RBH8-805-3	All-Star
14	blower power	8.5	HP	5.5	kW
15	blower max flow	400	SCFM	5380	L/min
16	blower max pressure	116	inches H ₂ O	270	mbar
17	blower noise level	79	db(A)	74	db(A)
18	primary heater power	20000	watts	20000	watts
19	purge heater power	1250	watts	1250	watts
20	vacuum generator model	JS-350	Vaccon	JS-350	Vaccon
21	heating hopper cylinder I.D.	24	in.	610	mm.
22	heating hopper cylinder height	46	in.	1168	mm.
23	heating hopper material capacity	12	cu. ft.	339.8	L
24	heating hopper absolute capacity	13.875	cu. ft.	392.9	L
25	heating hopper empty weight	349	lbs.	158	kgs.
26	vacuum chamber cylinder I.D.	24	in.	610	mm.
27	vacuum chamber cylinder height	17.875	in.	454	mm.
28	vacuum chamber material capacity	5.5	cu. ft.	155.7	L
29	vacuum chamber absolute air capacity	6.5	cu. ft.	184.1	L
30	vacuum chamber normal evacuation volume	3.75	cu. ft.	106.2	L
31	vacuum chamber weight, empty	217	lbs.	98.4	kgs.
32	retention hopper cylinder I.D.	28	in.	711	mm.
33	retention hopper cylinder height	16.5	in.	419	mm.
34	retention hopper material capacity	6.125	cu. ft.	173.4	L
35	retention hopper absolute capacity	7.625	cu. ft.	215.9	L
36	retention hopper weight, empty	77	lbs.	34.9	kgs.

Theory of Operation / Performance

THEORY OF VACUUM DRYING

Water boils at 212 F (100 C) degrees. However, this is only true at sea level, which is to say at standard atmospheric pressure, which is 14.7 pounds/sq in (1 bar), also expressed as 29.92 inches (760mm) of Mercury (Hg).

At lower pressures the boiling point of water is reduced.

Standard atmospheric pressure can support a column of Mercury 29.92 inches (760mm) high. If we pull a perfect vacuum above a column of Mercury, the mercury will rise in that column 29.92 inches and, for that reason, the number we can expect to read on the vacuum gauge, at full vacuum, is 29.92 inches. Lesser vacuums read lower numbers. No vacuum reads zero.

When water is subjected to a vacuum level of 25 inches (635mm) of mercury, it will boil at 133F (56C) degrees. When plastic pellets are heated to 160F (71C) degrees, or greater, and subjected to a vacuum of 25 inches (635mm), the water vapor within wants very much to boil. This increased molecular activity within the pellet and the greatly reduced pressure surrounding the pellet drives the moisture from the pellet in a remarkably short time. This then is the reason for the remarkable short drying time of an ULTRA vacuum dryer.

PERFORMANCE

The true measure of a dryer's performance is determined by the moisture content of the resin after the dryer has done its job. Resin moisture content, however, is not easily measured, so dryer manufacturers use other criteria to assure performance.

Conventional "desiccant" dryers use DEW POINT as a measure of performance. This is a measure of the dryness of the air passing over the resin, but not the dryness of the resin itself.

For example, for a particular resin, experience may tell us that 180f (82c) degree air dried to minus 40 dew point, and passed over the material for 4 hours, is sufficient to reduce the moisture content of that resin to the required level of dryness.

Since our ULTRA Dryer does NOT use dry air, we have no "dew point" to measure.

In our case, for the same resin, experience tells us that a vacuum of 25 inches (635mm) applied for 20 minutes to material that has been heated to 180f (82c) degrees, is sufficient to reduce the moisture content of that same resin to the correct level of dryness.

Therefore, just as desiccant driers assure dry material by measuring temperature and DEW POINT over time, we assure dry material by measuring temperature and VACUUM over time.

When we assure that a certain temperature has been reached and a certain vacuum level achieved for a correct length of time, we can then be assured the material is dry.

You may visually assess performance by monitoring temperature and vacuum levels yourself. Of course, the final test is in the quality of the product you manufacture. We welcome your comments and observations.

Warranty

MAGUIRE PRODUCTS offers THE MOST COMPREHENSIVE WARRANTY in the plastics auxiliary equipment industry. We warrant each MAGUIRE ULTRA DRYER manufactured by us to be free from defects in material and workmanship under normal use and service; our obligation under this warranty being limited to making good at our factory any Dryer which shall, within FIVE (5) YEARS after delivery to the original purchaser, be RETURNED intact to us, transportation charges PREPAID, and which our examination shall disclose to our satisfaction to have been thus defective; this warranty being expressly in lieu of all other warranties expressed or implied and of all other obligations or liabilities on our part, and MAGUIRE PRODUCTS neither assumes nor authorizes any other persons to assume for it any other liability in connection with the sale of its Dryers.



This warranty shall not apply to equipment repaired or altered outside MAGUIRE PRODUCTS INC. factory, unless such repair or alteration was, in our judgment, not responsible for the failure; nor which has been subject to misuse, negligence or accident, incorrect wiring by others, or installation or use not in accord with instructions furnished by Maguire Products, Inc.

Our liability under this warranty will extend only to equipment that is returned to our factory in Aston, Pennsylvania, PREPAID.

Please note that we always strive to satisfy our customers in whatever manner is deemed most expedient to overcome any problems they may have in connection with our equipment.

DISCLAIMER - PRODUCTION of FAULTY PRODUCT

This dryer is of a new design. We have had excellent results in all tests performed to date, but we HAVE NOT tested every material available to the plastics industry. We have not anticipated all possible materials, processing conditions, and requirements. We are not certain that our equipment will perform properly in all instances. You must observe and verify the performance level of this equipment in your plant as part of your overall manufacturing process. You must verify to your own satisfaction that this level of performance meets your requirements. We CAN NOT be responsible for losses due to product not dried correctly, even when due to equipment malfunction or design incorrect for your requirements; and/or any consequential losses due to our equipment not drying material to your requirements.

We will only be responsible to correct, repair, replace, or accept return for full refund, our equipment if it fails to perform as designed, or we have inadvertently misrepresented our equipment for your application. If for any reason this disclaimer is not acceptable, we will accept return of the equipment for full refund, including freight costs both ways.

ULTRA-600 Recommended Spare Parts List

Note: it is recommended that items #1 - #8 be kept on hand by the maintenance department.

line item	MPI p/n	Description	General Location
1	hf23-E	replacement filter element, blower intake	upper rear panel
2	8324-11	silicone seal, vacuum chamber dump valve	vacuum chamber
3	go-365V	o-ring, size 365, Viton	upper vacuum gate
4	go-359V	o-ring, size 359, Viton	lower vacuum gate
5	8324-03	vac. seal plate assy., vac. cham. dump valve	lower vacuum gate
6	nv88	solenoid valve segment, 4-way, 24 VDC	main cabinet
7	nf-AW40f	filter element, for "AW30" series regulator	pneumatics cabinet
8	nf-AFM40f	filter element, for oil separator	pneumatics cabinet

Other Potential Replacement Parts

9	es4TAT5	fuse, 60 amp class J, AJT60	electrical cabinet
10	ezd-.5t	fuse, 1/2 amp time delay, Midget style	electrical cabinet
11	eg-.3E2	circuit breaker, .3 amp, E-trip, 2-pole	electrical cabinet
12	eg-10C2	circuit breaker, 10 amp, E-trip, 2-pole	electrical cabinet
13	eg-30C3	circuit breaker, 30 amp, C-trip, 3-pole	electrical cabinet
14	eg-40C3	circuit breaker, 40 amp, C-trip, 3-pole	electrical cabinet
15	es3RT2016	motor contactor, 3 pole, 20A, 24 VDC	electrical cabinet
16	esCGC32D	motor contactor, 3 pole, 50A, 24 VDC	electrical cabinet
17	ehr09	relay, SS, 480V 25A, 24-265 VAC signal	electrical cabinet
18	ehr11	relay, SS, 480V 50A, 24-265 VAC signal	electrical cabinet
19	eRTD6-100	RTD sensor, 6mm dia x 100mm long, Pt100	heating hopper
20	eRTD2-32	4-wire 100 ohm RTD, 1/8" dia. x 2" long	mat. outflow valve
21	elc50V	load cell, 50 kg capacity	retention hopper
22	elc150V	load cell, 150 kg capacity	vacuum chamber
23	esp-50	pressure switch, 50 psi set-point, 1/8" NPT	main cabinet
24	eabVBD-01	I/O circuit board	electrical cabinet
25	eabVBD-02	display / HMI circuit board	front control panel
26	eabVBD-03	pendant circuit board (.8" 4-digit numeric)	front control panel
27	ebTS-7V	touch screen board, 7", ULTRA	front control panel
28	nmd-07E	replacement element, for membrane air dryer	pneumatics cabinet
29	eht20-40	tube heater, 20,000 watt 3-phase 400 VAC	main cabinet
30	eht20-48	tube heater, 20,000 watt 3-phase 480 VAC	main cabinet
31	ehsl-02	strobe light, red, magnetic base, 24VDC	electrical cabinet
32	ehb-2	piezo buzzer, 24VDC	electrical cabinet
33	esw-09H	interlock handle, red/yellow pistol	electrical cabinet
34	ecf-120	cooling fan, 120mm, 106 CFM, 115VAC .24A	electrical cabinet

Wiring Diagrams

ULTRA-600 I/O Board Wiring Diagram

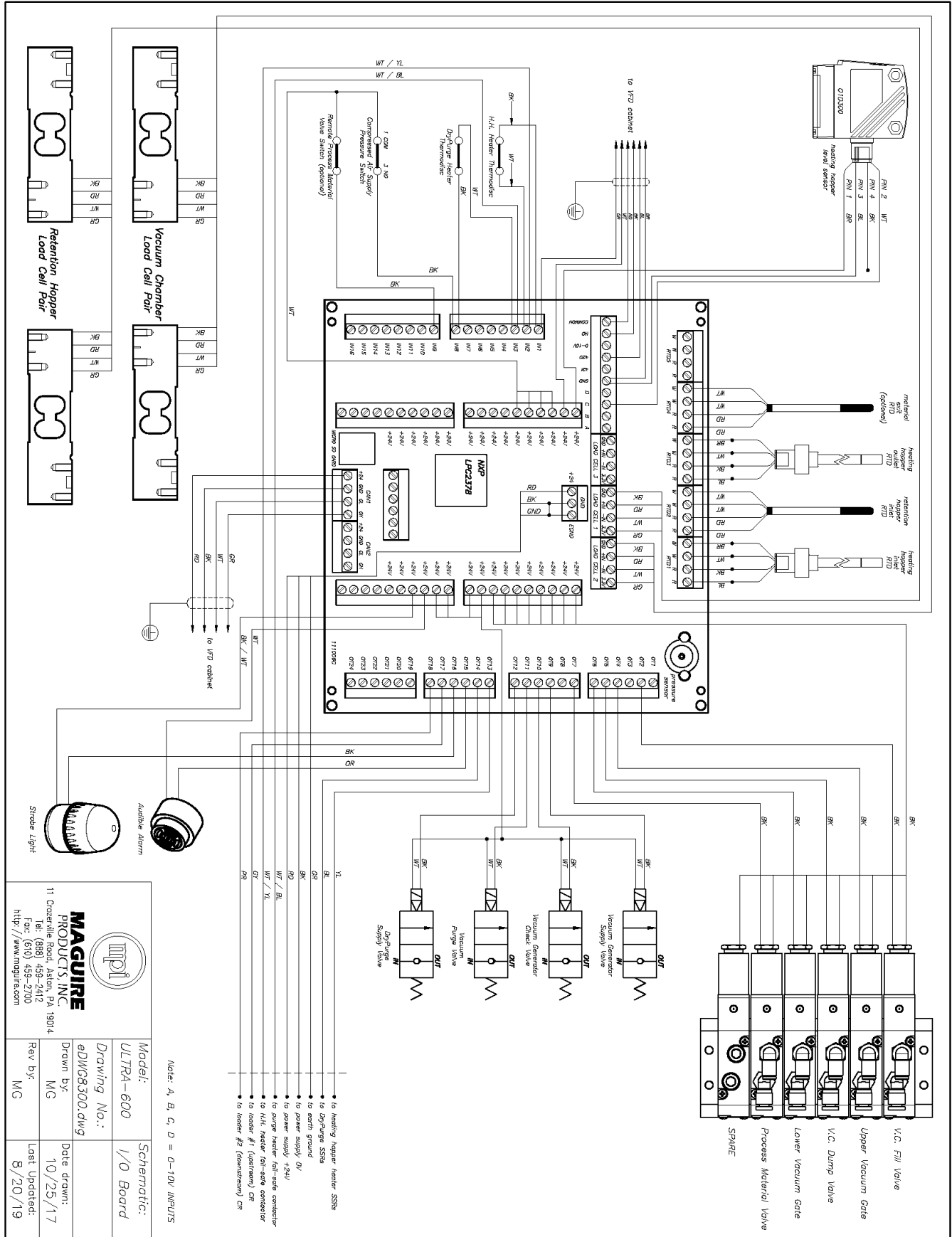

ULTRA-600 Wiring Diagram with VFD

Bill of Materials	
ITEM	description
1	eVFD-10F4 variable frequency drive, 3φ, 16 amp
2	eh21 relay, 24 VDC 1PDT, slim DIN mount
3	ehvcb5 ring compressor blower, 8.5 HP, 3PH
4	ehvbu-02 HMI / display circuit board, VFD
5	ehbr-110 braking resistor, 110 Ohm

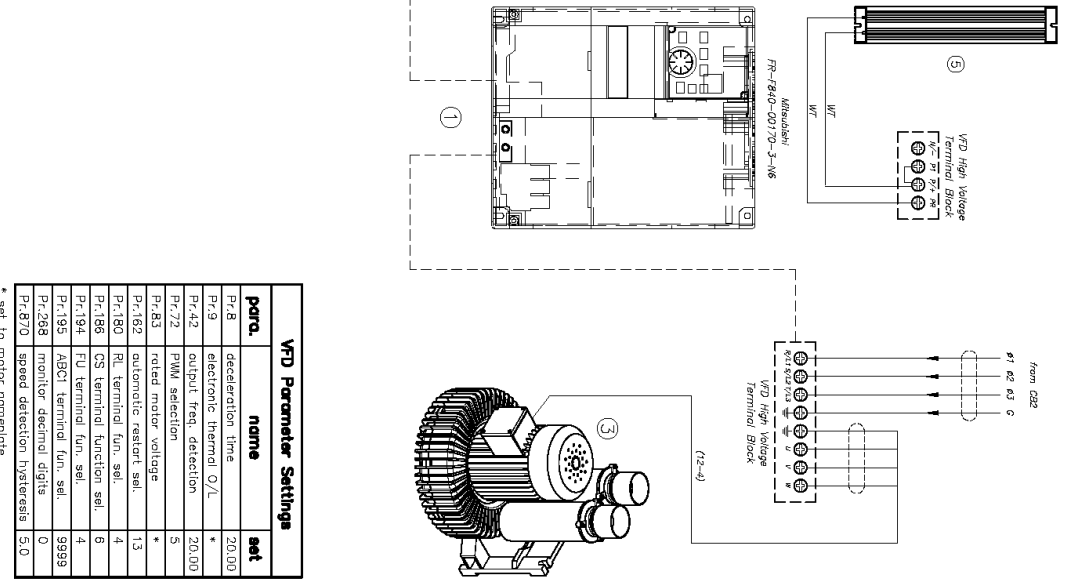
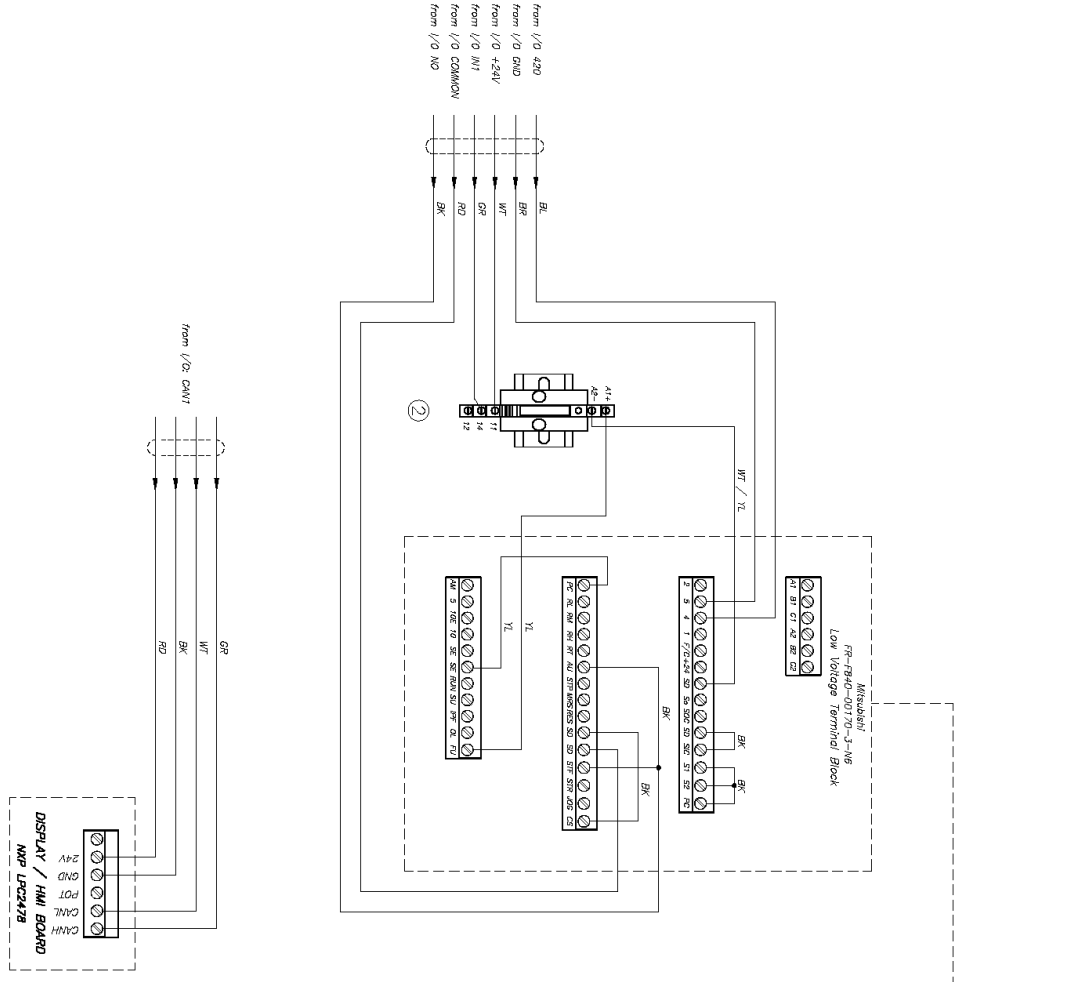

VFD Parameter Settings		
para.	name	set
Pr.8	deceleration time	20.00
Pr.9	electronic thermal O/L	*
Pr.42	output freq. detection	20.00
Pr.72	PMI selection	5
Pr.83	rotated motor voltage	*
Pr.162	automatic restart sel.	13
Pr.180	RL terminal fun. sel.	4
Pr.186	CS terminal function sel.	6
Pr.194	FU terminal fun. sel.	4
Pr.195	ASCT terminal fun. sel.	9999
Pr.268	monitor decimal digits	0
Pr.870	speed detection hysteresis	5.0

* set to motor nameplate

MAGUIRE
PRODUCTS, INC.
11 Crozerville Road, Aston, PA 19014
Tel: (888) 459-2412
Fax: (610) 459-2700
http://www.maguire.com

Model: **ULTRA-600**
Drawing No.: **edW/C8300.dwg**
Date drawn: **10/25/17**
Rev by: **MG**
Last Updated: **8/20/19**

Schematic: **VFD Cabinet**

High Voltage Wiring Diagrams

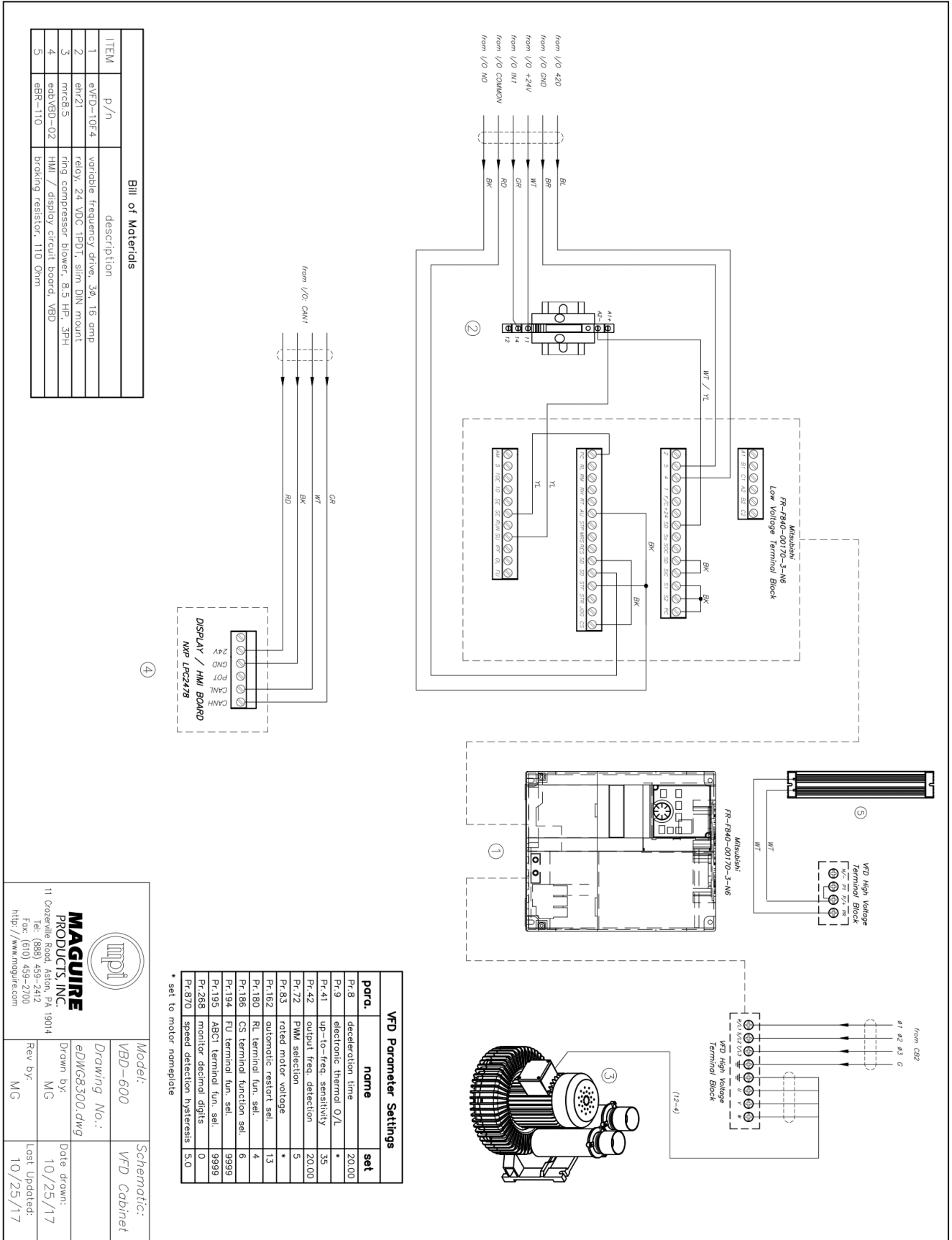

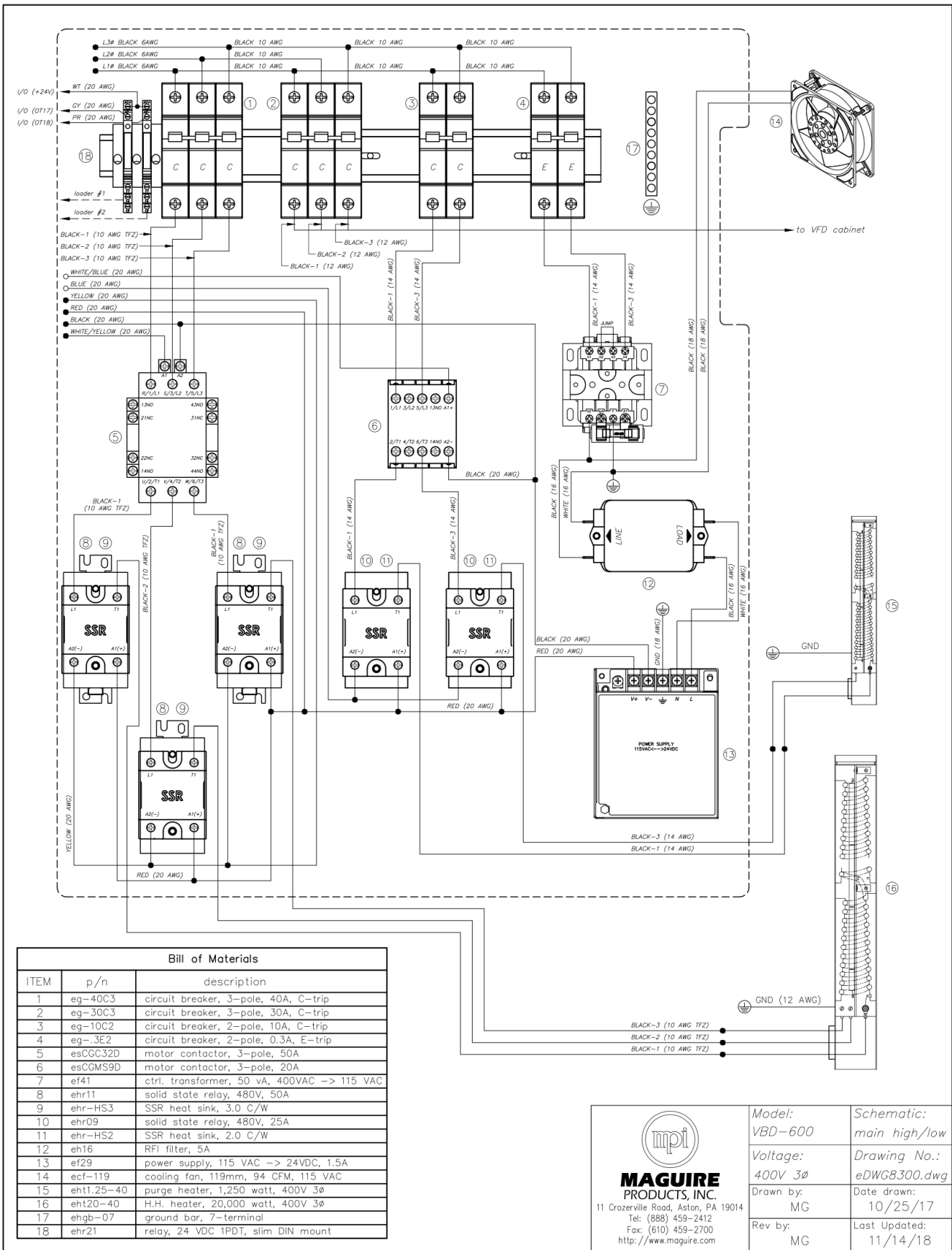

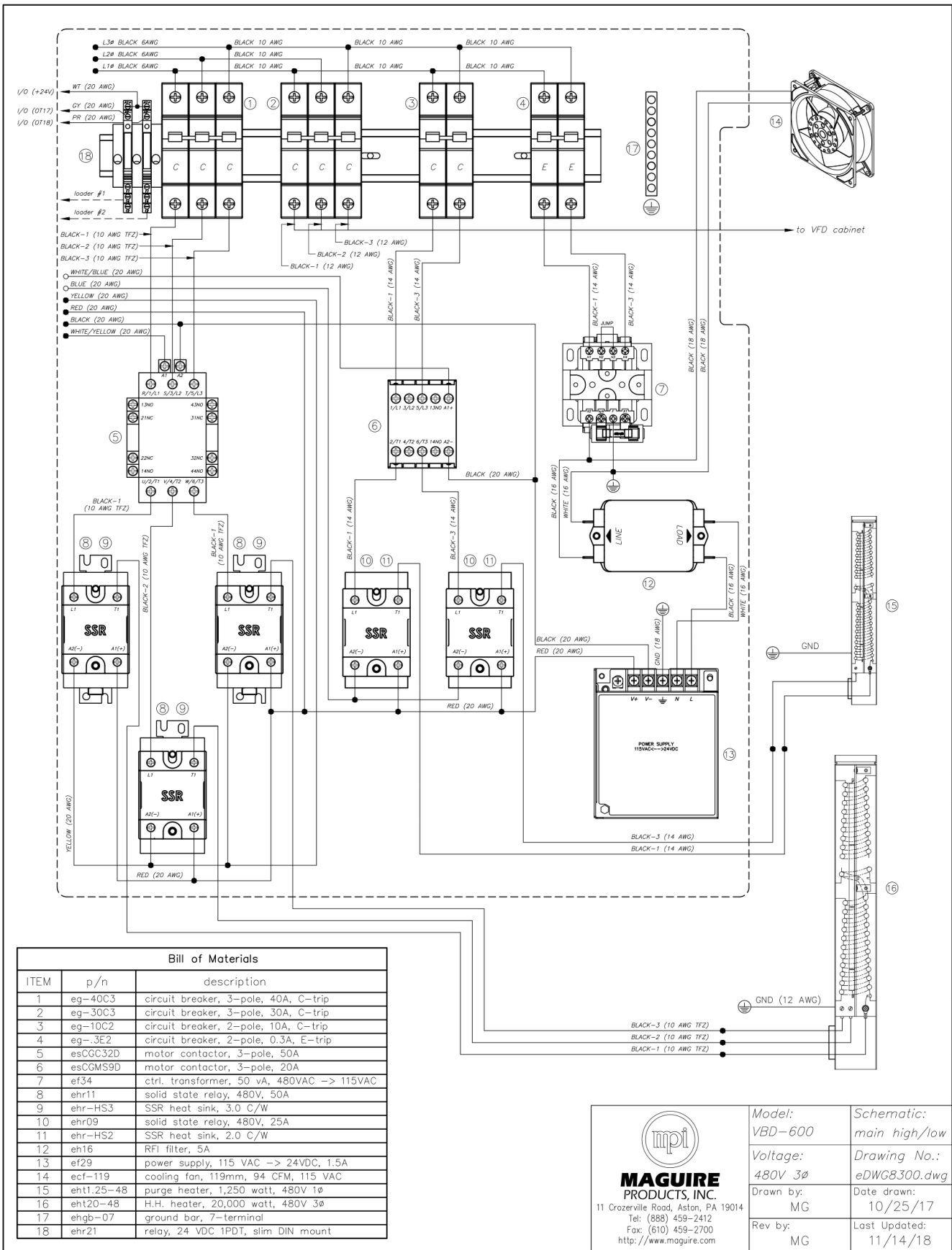

DECLARATION OF CONFORMITY



2006/42/EC Machinery Directive

2014/30/EU EMC Directive

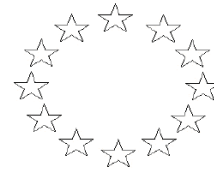

Name of manufacturer or supplier

Maguire Products Inc.

Full postal address including country of origin

11 Crozerville Road, Aston, Pennsylvania 19014, USA

Description of product

Name, type or model, batch or serial number

Model: Serial Number:

Standards used, including number, title, issue date and other relative documents

EN4414 (2010); EN11201 (2010); EN12100 (2010); EN13849-1 (2015); EN13850 (2015); EN13857 (2008)
EN14119 (2013); EN14120 (2015); EN60204-1 (AC:2010) and EN61310 (2008)

Name of Responsible Person within the EU - Mr Paul Edmondson Director

Full postal address if different from manufacturers

Maguire Europe Sales Limited, Unit F, Vanguard, Tame Park, Tamworth, Staffs, B77 5DY, UK

Declaration

I declare that as the manufacturer, the above information in relation to the supply / manufacture of this product, is in conformity with the stated standards and other related documents following the provisions of the above Directives and their amendments.

Responsible Person: Mr Steve Maguire

Signature 

Position *PRESIDENT*



ORIGINAL

Date

www.maguire.com

Technical Support and Contact Information

Maguire Products Inc.

11 Crozerville Road

Aston, PA 19014

Tel: 610.459.4300

Fax: 610.459.2700

Email: info@maguire.com

Web: www.maguire.com

Maguire Europe

Tame Park

Tamworth

Staffordshire

B775DY

UK

Tel: + 44 1827 265 850

Fax: + 44 1827 265 855

Email: info@maguire-europe.com

Maguire Products Asia PTE LTD

Main Office

15 Changi North Street 1

#01-15, I-Lofts

Singapore 498765

Tel: 65 6848-7117

Fax: 65 6542-8577

E-mail: magasia@maguire-products.com.sg