

ULTRA[®]-150/300

BY **MAGUIRE[®]**

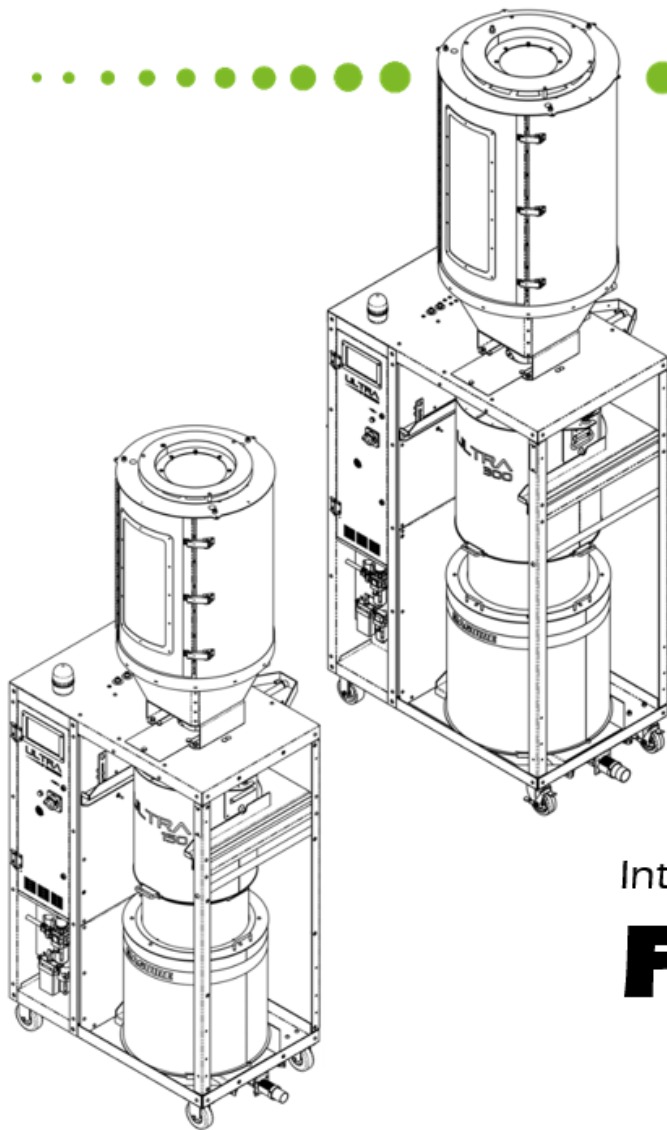

- INSTALLATION
- OPERATION
- MAINTENANCE

Integrated with

FlexBus Lite[®]
Receiver Control System

ULTRA-150[®] / ULTRA-300[®] Ultra-Low Energy Dryer

This document is the original Instruction manual of the Maguire ULTRA-150[®] and ULTRA-300[®] Vacuum Dryer equipped with the Touchscreen Controller.

Copyright © 2021 Maguire Products Inc.

The information contained within this manual including any translations thereof, is the property of Maguire Products Inc. and may not be reproduced, or transmitted in any form or by any means without the express written consent of Maguire Products Inc.

The Maguire ULTRA series of dryers are CE certified in accordance with the relevant EU directives and EN Standards, current at the time of manufacture. Any modification or adjustment to the machines by the End User, without with the express permission of the manufacturer, may invalidate the CE compliance of the dryer.

To every person concerned with use and maintenance of the Maguire ULTRA-150[®] and ULTRA-300[®] it is recommended to read thoroughly these operating instructions. Maguire Products Inc. accepts no responsibility or liability for damage or malfunction of the equipment arising from non-observance of these operating instructions. The intended use of the Maguire ULTRA dryer series is specifically for raw pelletized plastics materials and recycled plastics materials and should not be used for applications outside of the intended use.

To avoid errors and to ensure trouble-free operation, it is essential that these operating instructions are read and understood by all personnel who are to use the equipment.

Should you have problems or difficulties with the equipment, please contact Maguire Products Inc. or your local Maguire distributor.

Manufacturer's Contact Information

Maguire Products Inc.
11 Crozerville Road
Aston, PA. 19014

Phone: (610) 459-4300
Fax: (610) 459-2700

Website: www.maguire.com

Email: info@maguire.com

Table of Contents

<u>Maguire Products, Inc. Exclusive 5-Year Warranty</u>	6
<u>Declaration of Conformity</u>	7
<u>Safety Warnings</u>	8
<u>Transport and Setup</u>	8
Lifting and Handling Specifications.....	9
Component Weights Table.....	9
Overall Layout and Dimensions.....	10
Shipment Inventory and Unpackaging.....	12
<u>Assembly: ULTRA-150/300</u>	12
Component Installation.....	13
Compressed Air Connection.....	20
Electrical Connection / Proper 3-Phase.....	21
<u>Machine Overview: ULTRA-150/300</u>	23
RTD (Temperature Sensor) Locations.....	23
Machine Label Descriptions.....	24
Home Screen Overview.....	26
Modes of Operation (Run Dryer, Manual Operations, Clean-out).....	26
<u>Operating the ULTRA Dryer</u>	27
Startup Instructions.....	27
What is Happening When the ULTRA Dryer is Operating?.....	29
Unknown Material Bulk Density? Try This.....	29
Theory of Operation / Drying Performance.....	30
Energy Saver Modes.....	31
Presets Feature.....	32
Shutdown Options.....	34
Auto-Start Setup.....	35
Auto-Stop Setup.....	36
Advanced Information.....	37
Manual Operations (Home screen).....	38
<u>Setup Menu Explanation</u>	39
<u>Dryer Configuration Overview</u>	40
Convey Setup.....	42
Special Features.....	43
Changing Parameters / Parameters Explained.....	45
<u>System Configuration Overview</u>	61
Data Logging.....	62
Access Control.....	63
Display Options.....	63
Communications Setup.....	64

<u>Print Center Overview</u>	66
Parameter Printout - Example.....	67
<u>Alarms and Events</u>	69
Alarm and Event Log.....	69
Event Log Example.....	70
Alarms – Causes and Solutions.....	71
<u>Maintenance</u>	75
Lockout/Tagout.....	75
Preventative Maintenance Items.....	76
Clean Out - Procedure.....	79
Valve Clean Pause.....	83
Loadcell Calibration.....	84
Temperature and Pressure Verification.....	86
Updating the Firmware.....	87
<u>FlexBus Lite Integrated Loading System</u>	88
Table of Contents.....	88
<u>Technical Documentation: ULTRA-150</u>	106
ULTRA-150 Technical Specifications.....	106
ULTRA-150 I/O Board Schematics.....	107
ULTRA-150 High Voltage STANDARD Schematics.....	109
ULTRA-150 High Voltage PHASE MONITORING Schematics.....	115
ULTRA-150 High Voltage VARIABLE FREQUENCY DRIVE Schematics.....	121
ULTRA-150 PNEUMATIC Diagram.....	127
ULTRA-150 Recommended Spare Parts List.....	128
<u>Technical Documentation: ULTRA-300</u>	129
ULTRA-300 Technical Specifications.....	129
ULTRA-300 I/O Board Schematics.....	130
ULTRA-300 High Voltage STANDARD Schematics.....	132
ULTRA-300 High Voltage PHASE MONITORING Schematics.....	136
ULTRA-300 High Voltage VARIABLE FREQUENCY DRIVE Schematics.....	140
ULTRA-300 PNEUMATIC Diagram.....	144
ULTRA-300 Recommended Spare Parts List.....	145
<u>Disclaimers</u>	148
Intended Use.....	148
Production of Faulty Product.....	148
Decommissioning and Disposal.....	148
Accuracy of this Technical Manual.....	148
<u>Technical Support / Contact Information</u>	149

Warranty – Exclusive 5-Year

MAGUIRE PRODUCTS INC. OFFERS THE MOST COMPREHENSIVE WARRANTY in the plastics auxiliary equipment industry. We warrant each MAGUIRE ULTRA – Dryer manufactured by us to be free from defects in material and workmanship under normal use and service; excluding only those items listed below as 'excluded items'; our obligation under this warranty being limited to making good at our factory any Dryer which shall, within FIVE (5) YEARS after delivery to the original purchaser, be RETURNED intact to us, transportation charges PREPAID, and which our examination shall disclose to our satisfaction to have been thus defective; this warranty being expressly in lieu of all other warranties expressed or implied and of all other obligations or liabilities on our part, and MAGUIRE PRODUCTS neither assumes nor authorizes any other persons to assume for it any other liability in connection with the sale of its Dryers.



This warranty shall not apply to equipment repaired or altered outside MAGUIRE PRODUCTS INC. factory, unless such repair or alteration was, in our judgment, not responsible for the failure; nor which has been subject to misuse, negligence or accident, incorrect wiring by others, or installation or use not in accord with instructions furnished by Maguire Products, Inc.

Our liability under this warranty will extend only to equipment that is returned to our factory in Aston, Pennsylvania, PREPAID.

Please note that we always strive to satisfy our customers in whatever manner is deemed most expedient to overcome any problems they may have in connection with our equipment.

This page intentionally left blank.

Safety Warnings



HOT SURFACES:

As with all dryers, there are **HOT SURFACES** to avoid. Temperatures can reach 350°F (180°C).

Typically, these surfaces are not at dangerous temperatures, however all hot surfaces should be avoided.



**Warning Label indicate:
HOT SURFACES**

USE CAUTION when removing and installing canisters.

USE GLOVES

DO NOT REACH into the dryer enclosure.



RISK OF SHOCK:

Disconnect power supply before servicing the Dryer.



Transport and Setup

Shipment

The ULTRA-150 dryer is shipped on one pallet, whereas the ULTRA-300 is shipped on two pallets. The machines, heating hopper, and three cardboard boxes containing the vacuum chamber, the retention hopper, and loose components are securely fastened to the pallet(s).

The 4 main sections of the ULTRA dryer are:

- (A) Heating Hopper Assembly
- (B) Vacuum Chamber Assembly
- (C) Retention Hopper Assembly
- (D) Control Panel

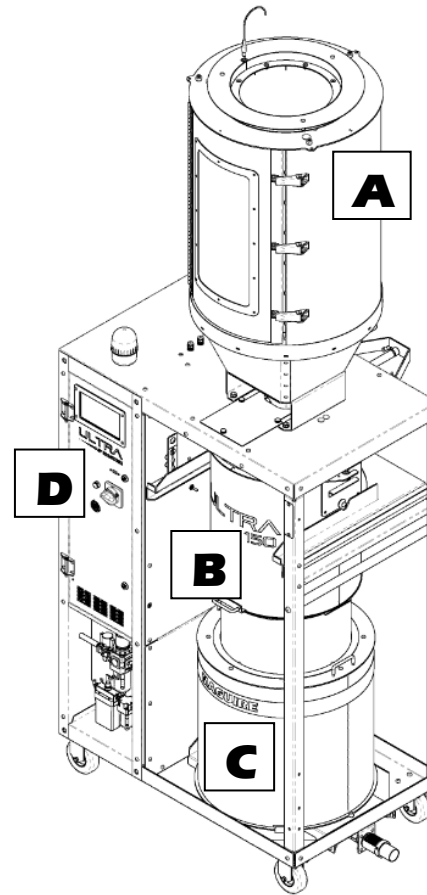

Lifting and handling components of the Dryer



DO NOT LIFT MANUALLY: Ensure the lifting equipment is rated to lift the weight of the individual sections of the ULTRA-150 / 300.

COMPONENT WEIGHTS

	ULTRA-150	ULTRA-300
Complete Unit	501 lbs. (227 kg.)	918 lbs. (416 kg.)
Heating Hopper	115 lbs. (52 kg.)	201 lbs. (91 kg.)
Vacuum Chamber	44 lbs. (20 kg.)	73 lbs. (33 kg.)
Retention Hopper	22 lbs. (10 kg.)	32 lbs. (15 kg.)

Overall Layout and Dimensions - ULTRA-150

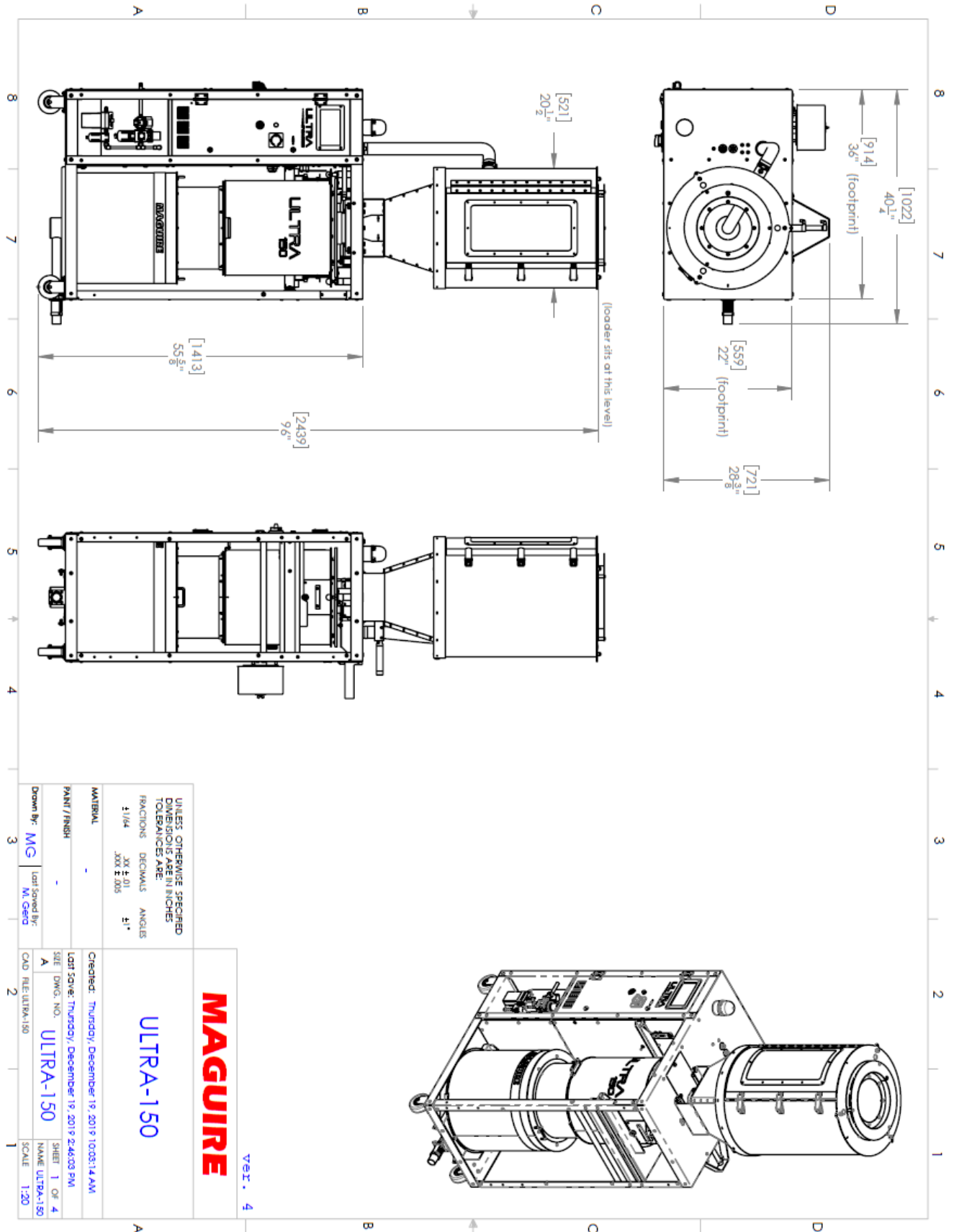

Overall layout and Dimensions - ULTRA-300

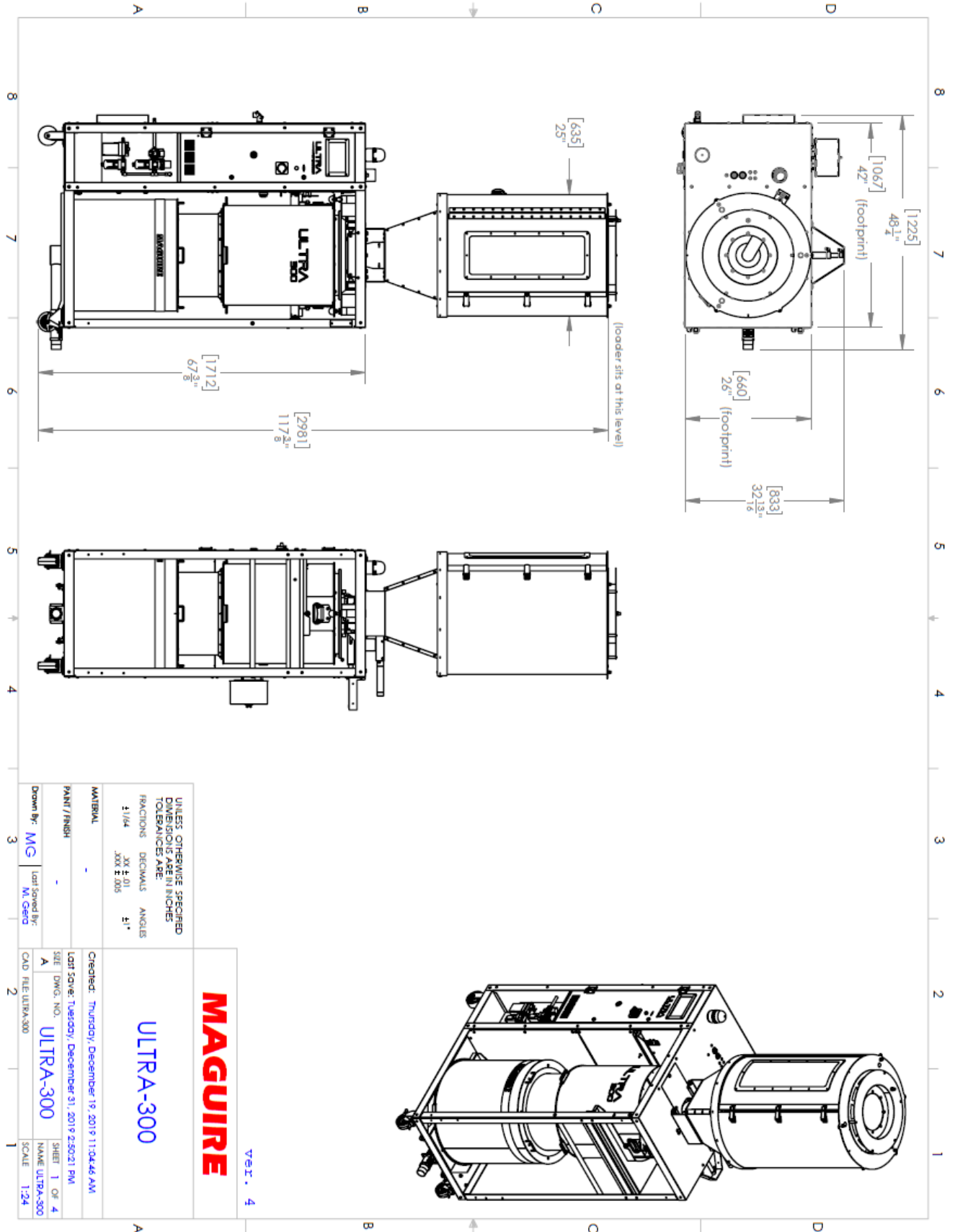

Shipment Inventory





The ULTRA-150 is shipped on one pallet; whereas the ULTRA-300 is shipped on two pallets. The machine, heating hopper, and three cardboard boxes, containing the vacuum chamber, the retention hopper, and loose components are securely fastened to the pallet(s).

<p>ULTRA-150:</p> <ul style="list-style-type: none"> • Upper vacuum gate assembly • Recollector • 2" high heat tubing w/ insulation • 2-9/16" hose clamps (2) 	<p>ULTRA-300:</p> <ul style="list-style-type: none"> • Vacuum Chamber fill valve assembly • 3/8"-16 x 1/2" hex bolts (2) • Recollector • 2-1/2" high heat tubing w/ insulation • 2-3/4" hose clamps (2) • 1/4-20 nyloc/wingnuts (2)
--	--

Unpackaging the ULTRA-150/300

Remove the boxes containing the Vacuum Chamber and Retention Hopper from the pallet. With the ULTRA-150/300 pallet on the floor, secure the wheels so that it will not roll once it is unbolted from the pallet. Two wheels can be locked.

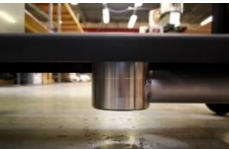
A 9/16" socket and wrench combination is recommended for component removal from pallet.

<p>Locate and remove the load cell support bolt (3/8"-16 x 6") on the bottom of the machine. This MUST be done prior to taking the machine off the plate.</p> <p>locate the two shipping bolts (3/8"-16 x 7") that attach the ULTRA-150/300 to the pallet. Unbolt the upper visible nuts from the frame and allow the bolt to drop out of the ULTRA-150/300 frame. Remove the Wood blocks. The ULTRA-150/300 is now detached from the shipping pallet. Use caution.</p>	
<p>Do NOT wheel the ULTRA-150/300 directly off the pallet. Damage to the VTA can occur. The ULTRA-150/300 can be gently wheeled off the pallet using stacked 2x4 pieces of wood. Use two or more people to guide the Dryer off the pallet. Make sure enough clearance is given to the VTA.</p> <div style="display: flex; align-items: center;"> <div style="margin-right: 20px;">  <p>WARNING</p> </div> <div> <p>Under the Dryer there is a VTA. Use enough ramp clearance to prevent contact with the VTA below Dryer.</p> </div> <div style="margin-left: 20px;">  </div> </div>	

Assembly: ULTRA-150/300

Heating Hopper – Installation

The heating hopper is secured to the pallet using (4) 3/8"-16 x 2.5" bolts. Locate and remove.

<p>Remove the <u>mounting hardware</u> from the heating hopper mounting holes, located on top of the machine.</p>	
<p>Lift the heating hopper onto the ULTRA by positioning the forks beneath the black structural ring, as shown. The front access hatch should face the front of the machine.</p> <p>Using the supplied hardware (3/8"-16 x 1" hex bolts), securely fasten down the Heating Hopper.</p> <p><i>***Ensure that the caster wheels are in the 'Locked' position.</i></p>	
<p>Using a 9/16" open-end wrench and ratchet, secure the heating hopper to the machine using the mounting hardware that was provided. Tighten down firmly.</p> <p><i>Note: flat washers should be on top and the split lock washers should be underneath</i></p>	
<p>Install the vacuum chamber fill valve assembly* to the underside of the heating hopper using the supplied hardware (3/8"-16 x 1" flanged hex bolts). The air cylinder must be on the BACK SIDE of the machine.</p> <p>The vacuum chamber fill valve utilizes key slots to allow for proper line-up and ease of installation.</p> <p><i>*ULTRA-150 machines will likely have this valve installed on the heating hopper prior to shipping and can be ignored.</i></p>	

Attaching the Upper Vacuum Slide Gate*

Remove one of the screws securing the air cylinder guard on the back of the machine to install the upper vacuum slide gate.

Remove the front retaining bracket on the upper vacuum slide gate by removing the two screws with a 5/32" Allen key.

**ULTRA-300 machines will likely have this valve installed on the machine prior to shipping and can be ignored.*

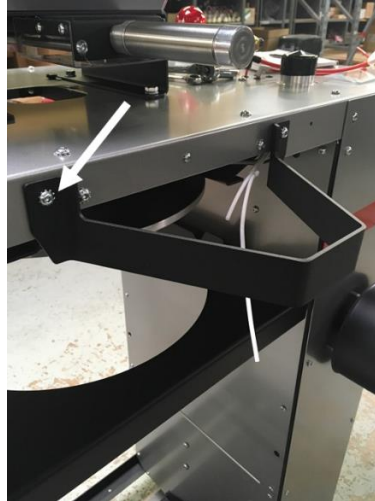

Insert the upper vacuum slide gate assembly into the groove of the mounting collar on the vacuum chamber tank head.

****The air cylinder will protrude out from the back side of the machine*

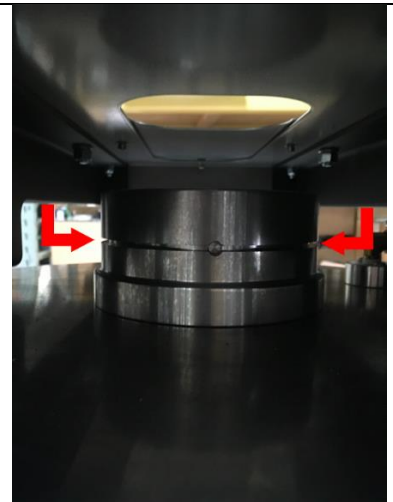
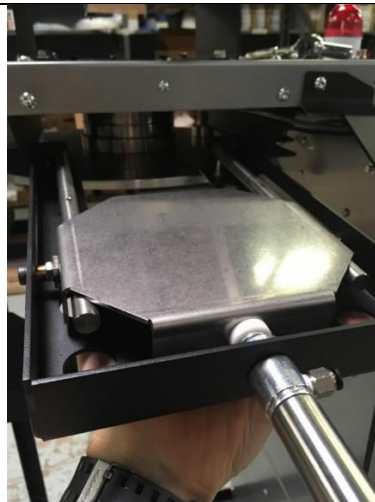

Secure the front retaining bracket back onto the upper vacuum slide gate assembly.

Connect the white air lines to their corresponding fittings on the air cylinder.

Secure the air cylinder guard on the back of the machine

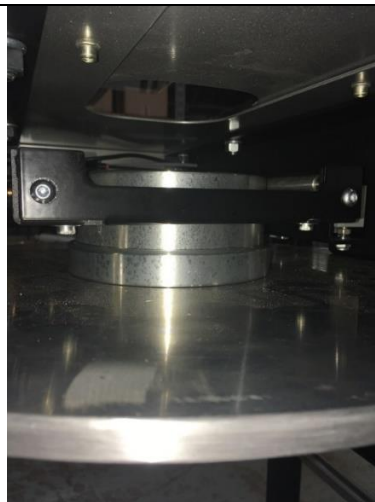

Installing the Recollector

Remove the access plate on the top of the machine by removing the 3 black thumb screws, or 10-24 x 1/2" button head cap screws (EU machines).

Remove the wing nuts (or 1/4-20 Nylok nuts for EU) from the vacuum chamber fill valve assembly.



Slide the cast aluminum recollector onto the threaded rods of the vacuum chamber fill valve assembly.

Secure with the wing nuts and re-attach the access plate.



Install Connections – Heating Hopper

Connect the **red air lines** to the corresponding fittings on the air cylinder on the material fill valve.

Install the **insulated heater tubing** and tighten the hose clamps.

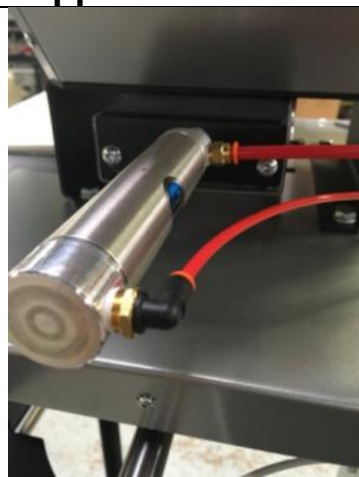

Installing the Retention Hopper

Unbox the retention hopper. The retention hopper is identified by the red handles located on the top of the hopper along with the sealing skirt that is seated inside the hopper.



Install the retention hopper with the manual drain valve slide gate located at the front right-hand corner of the dryer frame.

Ensure the slide gate is CLOSED (pushed IN) so the retention hopper locates properly onto the base tray of the ULTRA.



Use the two locating bolts on the base tray to properly line up the retention hopper.

Lock the retention hopper into place by pulling out the drain valve to the OPEN position. Material is now able to flow out of the machine.

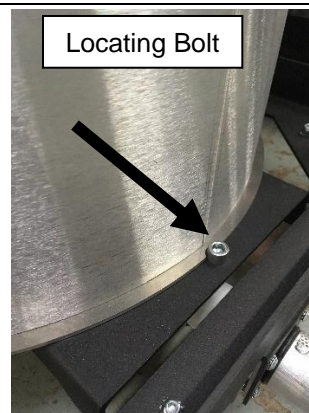

Installing the Vacuum Chamber

Unbox the vacuum chamber.

Lift the slider lock located on the right side of the ULTRA-150/300 cabinet.

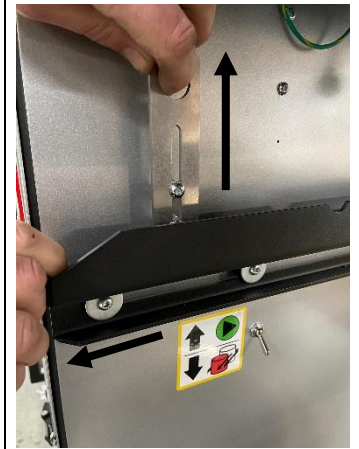

Lock Slider into Open Position

While holding the Slider Lock up, pull the vacuum chamber slider out. When the slider is fully extended, release the Slider Lock, which will lock behind the retaining plate at the very rear of the opened slider locking the slider into the fully extended position.

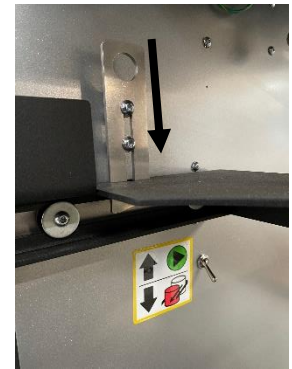

Rest the vacuum chamber onto the fully extended sliders. The vacuum chamber has three resting pins. Orient the side with two resting pins on the left slider rail.



WARNING

Two people are required to lift the ULTRA-300 vacuum chamber.



Unlock Slider to Close

Hold the Slider Lock up and push the Vacuum Chamber Slider in until it clears the retaining plate. Release the Slider Lock and continue pushing the Vacuum Chamber Slider in.

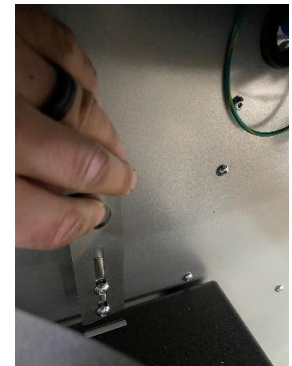

Push the Slider rails and Vacuum Chamber back into the Dryer until the Slider Lock falls into place in front of the Vacuum Chamber Slider, locking the Vacuum Chamber Slider into the operating position.



Connect the air lines. Rotate the locking ring fully clockwise to secure the air connection.



Slide the Retention Hopper sealing collar up so that the magnets engage onto the bottom of the Vacuum Chamber.



PINCH HAZARD – Keep fingers clear from the top of the sealing collar when lifting it.



When operating the ULTRA dryer, the vacuum chamber must be lifted into position by operating the switch (UP position), as shown. The chamber will be lifted off the rails pneumatically using two lifting air cylinders, until it sits flush with the tank head, creating a vacuum seal.



PINCH HAZARD – Keep fingers clear from the top of the vacuum chamber when lifting it.



KEEP FINGERS CLEAR!

Storage of the Optional Heating Hopper Dump Chute

The heating Hopper Drain Chute (optional) should be stored on the right of the dryer hanging on the black frame. See photo.



Installing the RTDs (Temperature Sensors)

The heating hopper must be securely mounted on the machine prior to installing the RTDs.

Attach the RTD harness assembly to the side of the heating hopper using a 5/32" Allen wrench. The RTD harness will have supplied p-clamps around the conduit along with 1/4-20 hardware, which will serve to anchor the harness in place.

The RTD cables are pre-wired into the machine at the I/O board

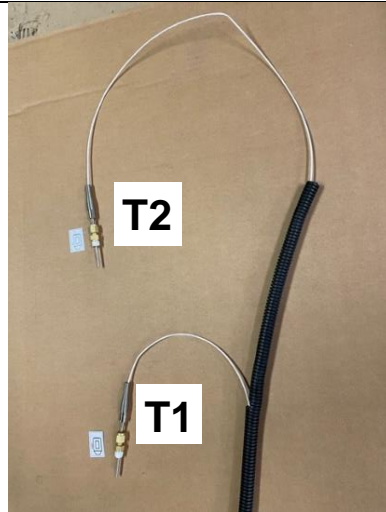

Using a 7/16" open end wrench, secure and tighten the new RTD's into the two locations on the heating hopper. Ensure that there is an adequate length of wire loop to prevent damage. Leave excessive wire length for the T2 RTD in the instance that a heating hopper extension is added in the future.

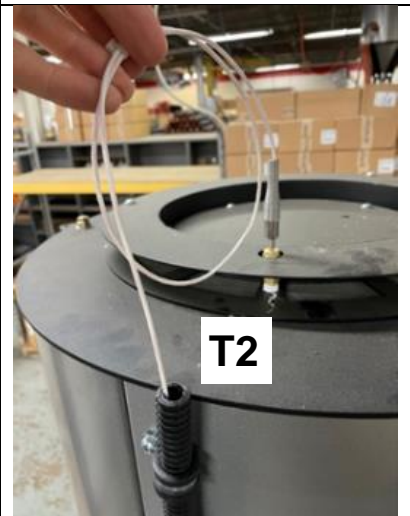

Compressed Air Connection

Connect an air supply to the air regulator's IN port using a female 1/4" NPT pipe fitting.



An operating air pressure of 80 psi (5.5 bar) while the vacuum generator is running is required for proper operation of the Dryer. Setting the air pressure to 85 psi while the machine is idle will usually attain the desired 80 psi while the vacuum generator is running.

If the air supply has oil in it, add an oil separator (coalescing filter). Oil in the air will combine with dust drawn from the Vacuum Chamber forming a paste inside the vacuum generator. It will stop working and require cleaning.

Observe the air pressure gauge to be sure the pressure maintains 80 psi (5.5 bar) while the vacuum generator is running whilst checking and adjusting the regulator. If pressure drops below 80 psi, adjust the regulator. If the pressure cannot be maintained at 80 psi (5.5 bar) while the vacuum generator is running, then the air supply line is not adequate.



Do not supply Dryer with a lubricated air supply. Damage to Dryer may result. Use only a clean, dry, oil-free air supply.

Electrical Connection



RISK OF INJURY! Only qualified technicians should make electrical connections.

Connect Main Power

The electrical cable located on the left side of the Dryer on the power box supplies the power to the Dryer. Within the cable are four wires. Three of the wires are black and labeled with a number: 1, 2, and 3. The fourth wire is a green/yellow wire and is the ground wire.

Connect power to a properly fused disconnect.



ULTRA Branch Circuit Protection

Protect the unit with fuses or circuit breakers at the amp ratings shown below:

AMPS		
Voltage	ULTRA-150	ULTRA-300
208 3Ø	40	-
240 3Ø	40	-
400 3Ø	30	40
480 3Ø	20	30
575 3Ø	15	30

User must take caution and care when connecting electrical supplies to the Maguire ULTRA dryer and ensure that all supply cables and/or interconnecting cables are correctly secured to the machines and/or are in a suitable cable tray, and/or conduit, as per the requirements of EN 60204-1, Clause 13.4.2.

Electrical checks (in accordance with EN 60204-1, Section 18) should be conducted on the equipment during the installation and commissioning phases.



CONFIRM proper 3-Phase power connection prior to loading material. Failure to confirm proper 3-phase connection can result in reversed blower rotation and damage to blower if the blower sucks in material from heating hopper rather than blow heated air into heating hopper.

To confirm proper 3-phase connection following these instructions:

Turn power on using main power switch.

There are two methods to confirm proper 3-phase connection:

Incorrect 3-phase connection will result in reversed blower rotation. Both methods for checking correct 3-phase connection involve testing the blower rotation.



Method one requires disconnecting the orange hot air hose from the heating hopper and manually turning on the blower. The air from the blower should blow out of the hose. Air should not suck into the hose. If air does not blow out and sucks in, the 3-phase connection is NOT correct.



Method two requires the removal of the left side panel to view the blower and confirm blower rotation on power up. Rotation must be clockwise as indicated by the arrow.

See page 38

1. From the Main Screen press Manual Operations.
2. Press Blower Test.
3. Press the Blower button once to turn ON the Blower. Press again to turn OFF.

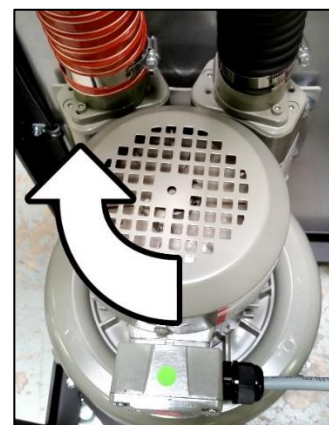

Machine Overview: **ULTRA-150/300**

RTD (Temperature Sensor) Locations

The dryers utilize Resistance Temperature Detectors (RTDs) to precisely monitor the temperature of the air that is delivered to the material before the material before it is subjected to vacuum.

T2 – Heating Hopper Outlet Temperature

T2

T1 – Heating Hopper Inlet Temperature

T1
(T1s, T1a)

T1s – Heating Hopper Air Inlet Temperature **Setting**

T1a – Heating Hopper Air Inlet Temperature **Actual**





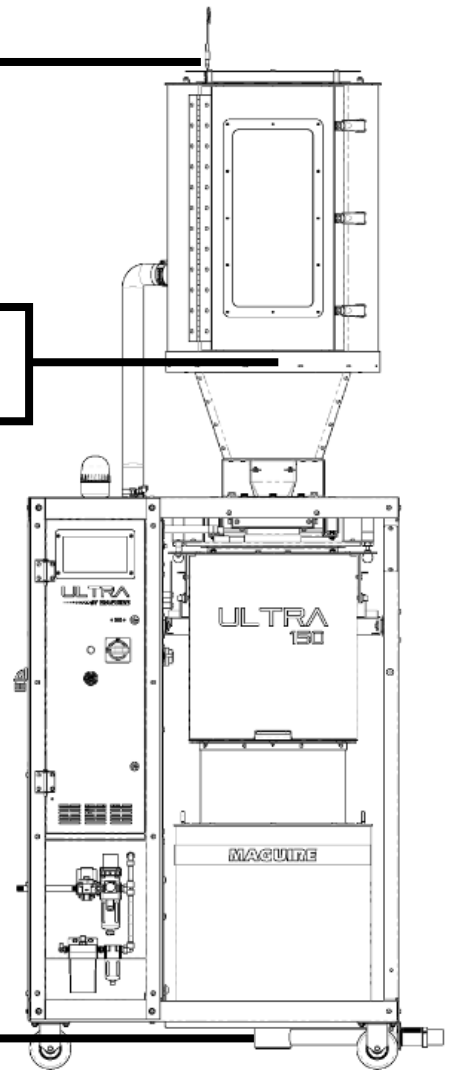



T4 – Material Outlet Temperature (optional)

T4

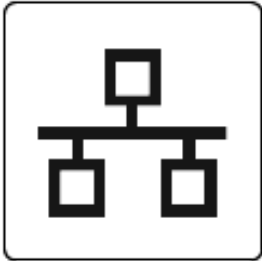

Machine Label Descriptions

Label Icon	Description	Label Icon	Description
	<p><u>Vacuum chamber lift switch</u></p> <p>UP: Pneumatically lifts chamber up, continuing process</p> <p>DOWN: remove chamber; clean-out</p>		<p><u>Heating Hopper Manual Drain Button</u></p> <p>Pressing this button opens the necessary valves to perform a clean-out, emptying the heating hopper</p>
	<p><u>Retention Hopper Drain Valve</u></p> <p>IN: Unlocked, is now removeable, valve closed</p> <p>OUT: Locked, convey material, valve open</p>		<p><u>CAUTION!</u></p> <p>Hot surfaces</p>
<p>L1/U</p> <p>L2/V</p> <p>L3/W</p>	<p><u>Incoming Main Phase Numbers</u></p> <p>L1/U-Main Phase 1 L2/V-Main Phase 2 L3/W-Main Phase 3</p>	<p>SV-1 SV-2 SV-3</p> <p>SV-4 SV-5</p>	<p><u>Solenoid Valve Numbering</u></p> <p>SV-1: Valve #1 SV-2: Valve #2 SV-3: Valve #3 SV-4: Valve #4 SV-5: Valve #5</p>
	<p><u>DISCLAIMER</u></p> <p>Two people are recommended to lift, due to excessive weight</p>		<p><u>DISCLAIMER</u></p> <p>Do not use as a step. Doing so may results in damage to the ULTRA Dryer</p>
<p>85 psi [5.9 Bar]</p>	<p><u>Air Supply</u></p> <p>Do not use a lubricated (oil) air supply.</p> <p>Equipped with a mechanical lock-out device</p>		<p><u>DISCLAIMER</u></p> <p>Read the owner's manual.</p> <p>Automatic start</p>
	<p><u>CAUTION</u></p> <p>Pinch Point. Keep fingers away to prevent injury.</p>		<p><u>Primary Earth (Ground)</u></p>

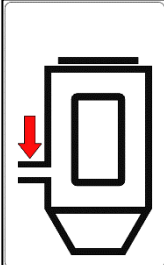
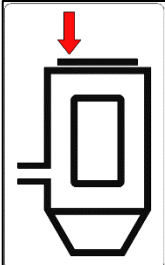
	<p><u>Main Voltage</u></p> <p>208V, 3-phase 240V, 3-phase 400V, 3-phase 480V, 3-phase 575V, 3-phase</p>	<p><u>208V 3Ø</u></p> 	<p><u>Power Cabinet Safety Warnings</u></p> <p>208V, 3 Phase</p> <p>Electrocution hazard Arc flash hazard Electrical LOTO</p>
<p><u>240V 3Ø</u></p> 	<p><u>Power Cabinet Safety Warnings</u></p> <p>240V, 3 Phase</p> <p>Electrocution hazard Arc flash hazard Electrical LOTO</p>	<p><u>400V 3Ø</u></p> 	<p><u>Power Cabinet Safety Warnings</u></p> <p>400V, 3 Phase</p> <p>Electrocution hazard Arc flash hazard Electrical LOTO</p>
<p><u>480V 3Ø</u></p> 	<p><u>Power Cabinet Safety Warnings</u></p> <p>480V, 3 Phase</p> <p>Electrocution hazard Arc flash hazard Electrical LOTO</p>	<p><u>575V 3Ø</u></p> 	<p><u>Power Cabinet Safety Warnings</u></p> <p>575V, 3 Phase</p> <p>Electrocution hazard Arc flash hazard Electrical LOTO</p>
	<p><u>CAUTION</u></p> <p>If equipped if (optional) 3-phase monitoring relay, LED indicator will illuminate if rotation is backwards.</p>		<p><u>Ethernet Port</u></p>
	<p><u>FlexBus Lite Port</u></p>		<p><u>Remote Mounted Controller Port</u></p>
	<p><u>RTD Location T1 - Inlet</u></p>		<p><u>RTD Location T2 - Outlet</u></p>

Home Screen Overview



T1 Actual - Actual Heating Hopper inlet air temperature

T1 Setpoint - Heating Hopper inlet air temperature Setpoint. Touch to adjust.

T2 Temp – Actual Heating Hopper temperature

Vacuum Time – Vacuum Time Actual and Vacuum Time Setpoint. Touch to adjust.

Vacuum Chamber Weight
Vacuum Chamber Actual and Maximum Weight

Retention Hopper Weight
Actual and max. weight

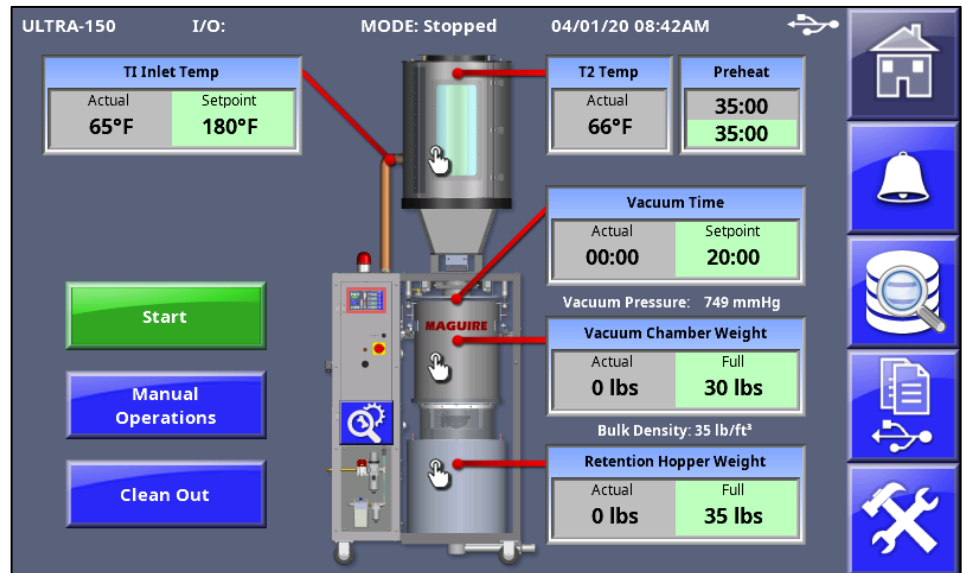

Preheat – Preheat Time Actual and Preheat Time Setpoint. Touch to adjust.

Info - Access to advance information.

Heating Hopper Setup, Vacuum Chamber Setup, and Retention Hopper Setup screens are accessed by pressing the heating hopper, vacuum chamber, or retention hopper icons on the home screen (mouse-over icons).

Title Bar - Located across the top of the screen, the title bar displays Model, ID, I/O status, current operating mode, date and time, and Ethernet / USB status.

Navigation Menu - Located along the right side of the screen, these buttons allow quick navigation to frequently used and top-level screens. The middle buttons can be rearranged if needed.

Start / Shutdown Button - Main Start/Stop Control Button.

Navigation Menu

	Home Screen	Pressing the Home Screen button from any other screen will return the operator to the Home Screen.
	Alarm and Event	Displays a history of alarms and other events with a date and time stamp and description.
	Presets	Material presets (recipes) that enable users to input, edit, and load material parameters to minimize testing setup time.
	Print Center	Print related options including Totals, Parameters, Alarm History, Events, Cycle History, Diagnostics. See page 66.
	Setup Login	Password protected access to advanced Dryer and System configuration information. See Page 39.

Modes of Operation

Run Dryer – Initiates preheat cycle for material processing. See page 27

Run Dryer in Batch Mode – See page 44

Manual Operations - Allows the user to have direct control of specific machine outputs See page 38.

Clean Out – Allows for individual chambers to be easily cleaned. See page 79

Operating the ULTRA Dryer

Startup Instructions

Ambient Operating Conditions

Temperature Range: 41°F – 122°F (5°C – 50°C)

Maximum Allowable Humidity: 80% @ 122°F (50°C)

Maximum Altitude: 8200 ft. (2500m)

This section explains how the dryer operates from a cold start. There are three concurrent operations. Heating, Vacuum and, Retention. Cold startup begins with Preheat. Preheat only occurs before the first cycle of the dryer’s initial startup, otherwise each cycle begins with material heating. The vacuum operation pulls and holds a vacuum on the material for at least the Vacuum Time setpoint (or longer if material is at or above the retention hopper low level parameter RHL before the vacuum time reaches setpoint). The Retention operation holds the dried material in the Retention Hopper. If equipped with the optional membrane air dryer, the material will be blanketed with hot dry air until it is conveyed away.

Important: Inspect the ULTRA, verify that machine is clear of all material from heating hopper, Vacuum Chamber and Retention Hopper. To facilitate a Clean Out, use the Clean Out function accessible from the home screen.

Startup and Operation Instructions

1. **ENSURE HATCH IS CLOSED.** Ensure that all the latches are properly closed on both the heating hopper door and vacuum chamber access hatch. Also, make sure that the removable retention hopper is in place and that the load cells are properly engaged.

2. **Load material into the Upper Heating Hopper.** Wait for the Heating Hopper to fill with material before starting the Dryer.

3. **Turn on Main Power** by rotating the 25-amp Main Disconnect Handle to the Red ON position. This powers up the ULTRA-150/300 Dryer. On initial power up of the ULTRA, the Control Panel powers ON automatically.

Secure Hatch

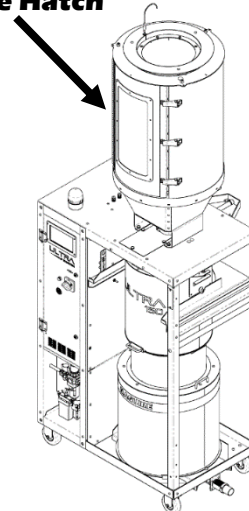

4. On the Home Screen:

Bulk Density – Bulk density is the weight per unit volume of the raw plastic material as it is received from the material manufacturer. Set this parameter accurately to ensure proper performance of the dryer. Bulk density can be edited under ‘Advanced Info’.

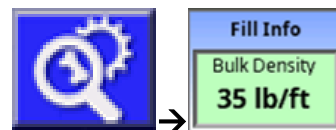

*****WARNING:** Without setting this parameter the machine may not maximize its material throughput and/or overflow.



NOTE: If the **bulk density** of the material is not published and is **unknown**, refer to [page 29](#)

T1 Inlet Temp Setpoint – This is heat hopper inlet temperature. By the end of the *preheat* cycle time, all material in the Heating Hopper will be heated to this temperature. By default, the Setpoint temperature is set to 150°F (65°C). Contact the material manufacturer for temperature recommendations.

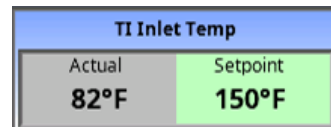

Some materials tend to mechanically lock themselves into the base of the heating hopper after rapidly thermally expanding. In this case, temperature ramping may be necessary.

[HOME](#) > [Heating Hopper Setup](#) > [Temp. Ramping](#)

Off [def.]: No temperature ramping occurs.
Preheat: During preheat cycle only, the T1 inlet temperature is incrementally increased to setpoint temp. via a series of steps defines by the RMP parameter (see [page 57](#)).
On: Ramping occurs on every heat cycle, including preheat.

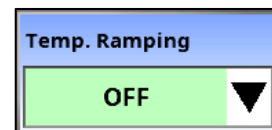

Preheat Time – This is the duration of heating from a cold start.



Vacuum Time – This is the duration of a vacuum and is what determines the cycle time. The default vacuum time is 20 minutes. In most drying operations, this time is adequate and does not need to be adjusted. Special circumstances may require different vacuum times. Please consult a Maguire dryer technician for additional information.

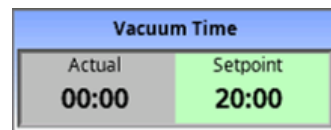

Press the setpoint field to adjust the setting. Use the on-screen keypad to enter the setpoint and press the green check to complete the setting adjustment.



5. Press the **START** button to start the dryer.
6. **The display will show that the dryer is running in PREHEAT mode and display the following:**



- T1 Actual** - Actual Heating Hopper inlet air temperature
- T1 Setpoint** - Heating Hopper inlet air temperature Setpoint.
- T2 Temp** – Actual Heating Hopper temperature
- Vacuum Time** – Vacuum Time Actual and Vacuum Time Setpoint.
- Vacuum Chamber Weight** - Vacuum Chamber Actual/Maximum Weight.

What is Happening When the ULTRA Dryer is Operating?

During the Pre-heat operation material in the heating hopper is brought up to temperature (T1s). Preheat time is determined by the specified Preheat Time on the Pre-Start screen (timed preheat, default 35 minutes) or by the Preheat Setup Auto option, which sets an inlet to outlet temperature delta and a minimum preheat time.

After pre-heat, approximately one third of the material in the heating hopper is dispensed into the vacuum chamber, and the first vacuum cycle begins. Each vacuum cycle has a minimum vacuum time, set on the Pre-start screen, or the main run screen (VTs). (default is 20 minutes).

The loader loads the Heating Hopper with new material as the Vacuum Chamber receives the heated material and heating cycle begins concurrent to vacuum cycle (the first vacuum cycle is timed). The new batch of material in the upper portion of the heating hopper will take less time to heat. Minimum time in the heating is dictated vacuum time.

After first vacuum cycle, material is then dispensed into retention hopper ready for use. Material in the retention hopper is blanketed with dry air (if equipped with optional membrane air dryer).

The rate of consumption of dried material from the retention hopper ultimately dictates the amount of time that the material will be preheated and under vacuum. **Examples:** If it takes 25 minutes to deplete the retention hopper, the vacuum cycle will run past its 20-minute setpoint (pre-start screen) to 25 minutes. This is normal operation. However, if the retention hopper is depleted in 15 minutes and the vacuum time is set to 20 minutes, there will be a 5-minute window where no material is available. This indicates that the throughput of the dryer has been exceeded. If the Throughput Alarm is enabled (Alarm Setup), a Throughput Alarm (Alarm Code 20) will be triggered.

Unknown Material Bulk Density? Try this...

Some materials do not have published specifications, such as bulk density, and it is important that an approximated value be determined. The ULTRA will perform more efficiently, and throughput will be maximized, if this parameter is properly set prior to operation. Follow the steps below.

1. Power on the ULTRA-150 or ULTRA-300; ensure machine is free from any material.
2. On the home screen, verify that the 'Actual' Vacuum Chamber Weight and Retention Hopper Weight read, "0 lbs. (0 kg.)."
3. **ULTRA-150:** Pour 1 cubic foot (~28 Liters) of material into either the vacuum chamber or the retention hopper. Use images in table below as reference.
ULTRA-300: Pour 2 cubic feet (~57 Liters) of material into either the vacuum chamber or the retention hopper. Use images in table below as reference.
4. Home screen will display weight of material in either chamber or hopper.
5. Calculate the bulk density but dividing the material weight by the estimated volume (1 or 2 cu. ft)

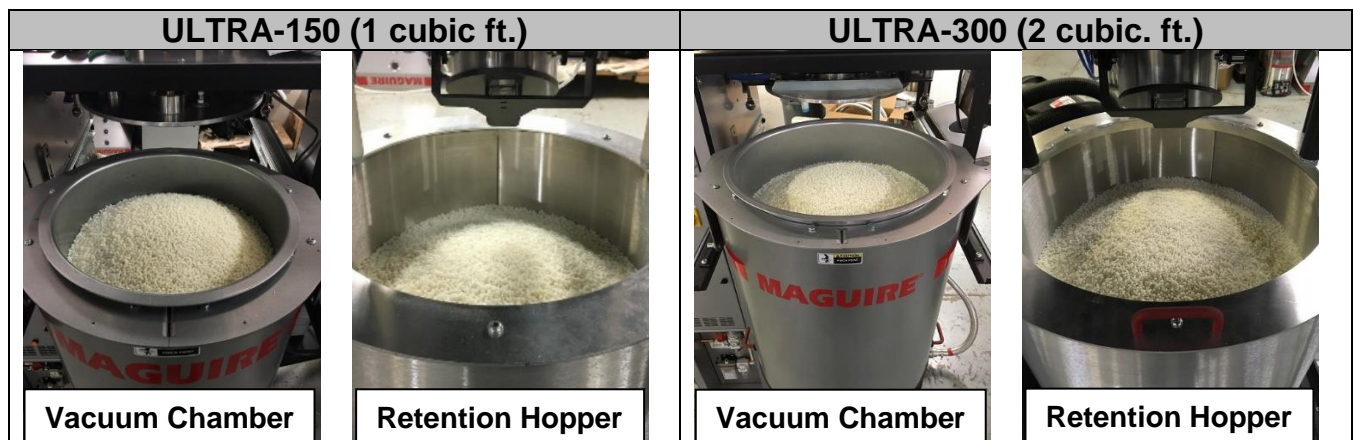

Theory of Operation / Performance

Theory of Vacuum Drying

Vacuum Drying requires two sequential steps: heat and vacuum. The effects of both are explained below:

Heat: Heating the pellets does two things:

1. It breaks the molecular bond between the water molecules and the polymer molecules.
2. It excites the water molecules, causing them to ultimately migrate to the surface of the pellet where they can escape into the surrounding vacuum atmosphere.

Vacuum: Applying a vacuum to the pellets (i.e., lowering the absolute pressure of their surrounding atmosphere) does three things:

1. It lowers the boiling point of water, causing any surface moisture to flash off.
2. It creates a vapor pressure differential which drives water trapped internally to the surface via capillaries.
3. It creates an extremely dry surrounding atmosphere via rarefaction. The relatively high concentration of water molecules inside the pellet then naturally migrates to the area of lower concentration to establish equilibrium.

Measuring Performance

The true measure of a dryer's performance is determined by the moisture content of the resin after the dryer has completed its process. Resin moisture content, however, is not easily measured, so dryer manufacturers use other criteria to measure performance.

Conventional desiccant dryers use dew point as a measure of performance. This is a measure of the dryness of air passing over the resin, but not the dryness of the resin itself.

For example, for a particular resin, 180°F (82°C) degree air dried to a -40°F (-40°C) dew point and passed over the material for 4 hours is sufficient to reduce the moisture content to the required level of dryness based on industry experience.

Since the ULTRA dryer does not use dry air, dew point values do not come into play. Rather, setpoint temperature, heat residence time, vacuum residence time, and vacuum level are used as drying metrics. For example, testing has shown that heating ABS to a temperature of 180°F (82°C) and subjecting it to a vacuum level of 80 mm Hg (absolute) will typically result in an acceptable final moisture content.

It is important to note that in vacuum drying, just as in any other type of drying, many variables come into play. Ambient conditions, starting moisture content, the stringency of the desired final moisture content, material quality, and material condition are all part of the equation.

For this reason, some amount of experimentation and/or consultation with Maguire may be necessary to attain desired results.

Energy Saver Modes

Maguire ULTRA Low Energy Dryers are proven to dry plastic materials 6x faster than conventional dryers and use up to 85% less energy. This is due in part to the utilization of various Energy Saver Modes that the user can enable.

Energy saver modes, limit temperature, and time can be managed from the Heating Hopper Setup Menu.

Home Screen > Heating Hopper Setup > Energy Saver (E.S) > Limit / Dynamic

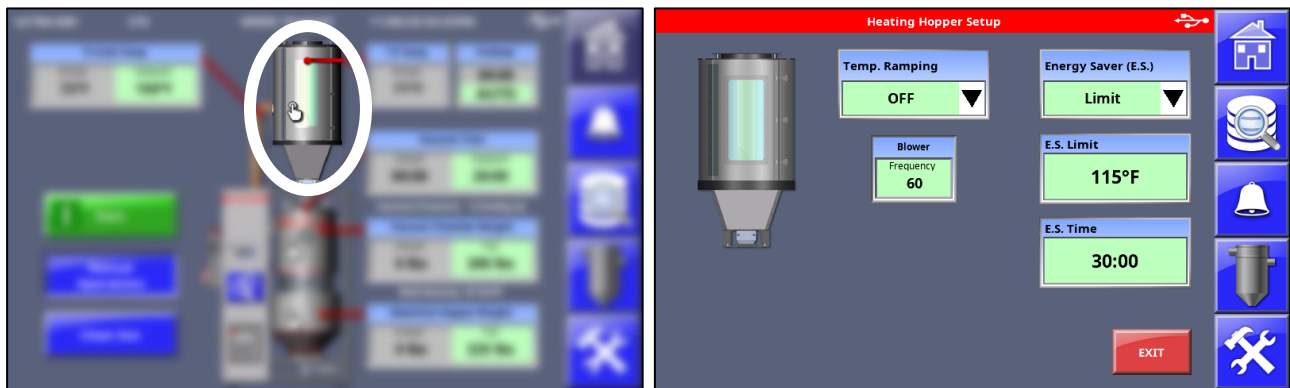

LIM (limit) mode [default]:

Preheat is unaffected. All post-preheat cycles: When the temperature of the air exiting the heating hopper (T2) reaches ESL (default = 125°F / 52°C), the heater and blower shut down. They remain in a dormant state until one of two things happen: the unit cycles, or EST minutes (default = 30) elapse. If EST minutes elapse, the blower and heater resume normal operation, bringing the material in the heating hopper back up to temperature, then shut down again. This could continue indefinitely. This logic is blocked for the first 5 minutes of a cycle to prevent residual heat from a previous cycle from triggering a premature Energy Saver heater/blower shutdown.

DYN (dynamic) mode:

Preheat is unaffected. The first post-preheat cycle is run as a LIM cycle. The amount of heater/blower dormant time at the end of said LIM cycle is then proportioned over the beginning and the end of the subsequent cycle as per the ESP parameter (default = 02060) setting. Example:

During the first post-preheat cycle, which ends up being 35 minutes long, the heater and blower shut off at VTA=15 minutes, equating to 20 minutes of blower/heater dormant time.

At the beginning of the next cycle, the blower and heater will remain OFF for $(.60 * 20) = 12$ minutes.

In theory, the blower and heater will be shut down for the 8 remaining minutes (of the 20 minutes) at the end of the cycle (triggered by the ESL parameter as in LIM mode) if the throughput demand does not change.

The "02" in the ESP parameter (default) is the minimum amount of beginning-of-cycle heater/blower OFF time regardless of the previous cycle, so long as the previous cycle terminated via LIM.

The intention of the DYN mode is to allow a 3rd party loader to fill the heating hopper before heating starts.

Presets: Feature



The ULTRA controller has a built-in 'Presets' feature where users can import/export material presets. This can be found on the default navigation bar. Within the interactive screen, users can input, edit, and load material parameters which minimize material processing setup time. The four main capabilities of the Presets feature are explained below.

1. Selecting and Loading a Preset

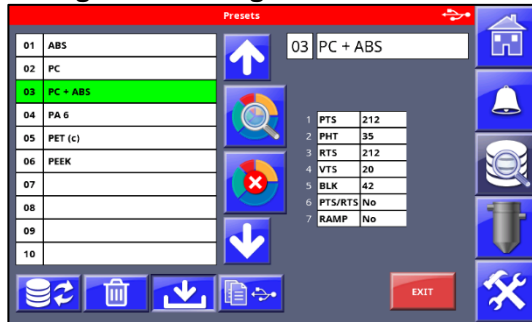

Select the preset by clicking and highlighting it

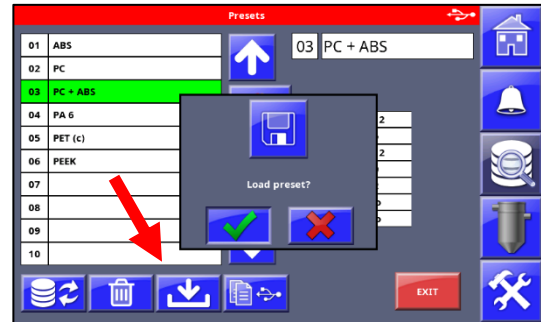

Pressing the 'Load Preset' button will load the material preset and its associated parameters.

2. Viewing and Editing a Preset

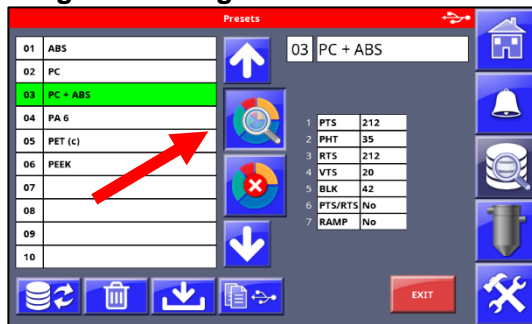

Highlight the material preset from the list and select the 'Preset Details' button to view its parameter settings.

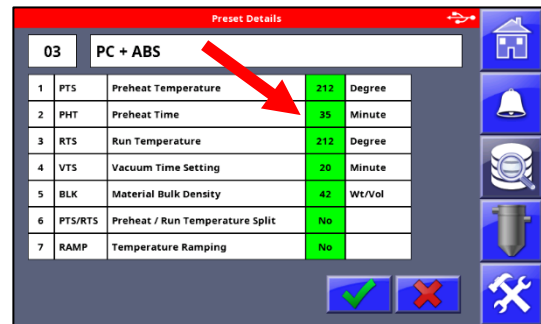

The preset name (i.e., PC + ABS) and setpoint values can be edited here by clicking inside the field and modifying.

3. Online Creation of a New Preset

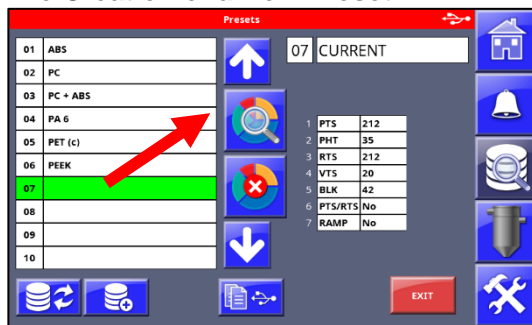

Highlighting a blank row and selecting the 'Preset Details' button allows for a user to input a new material preset.

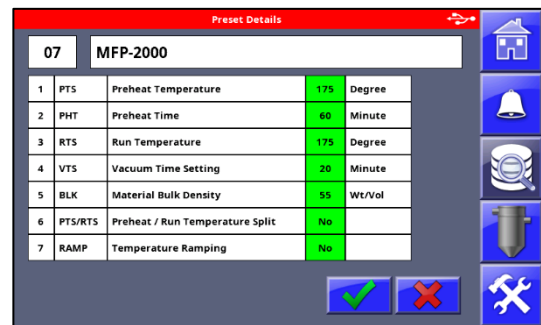

In the 'Preset Details' screen, the user can assign a name and input new setpoint values. Current parameter settings are used to pre-populate the new preset profile.

Presets: Feature – Cont.

4. Offline Editing / Adding New presets

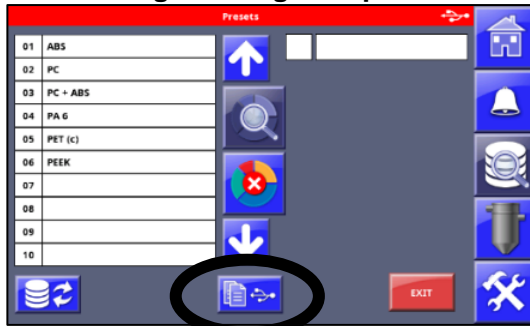

Press the 'Copy to USB' in the 'Presets Menu'



Exports presets to USB in Excel Format (.CSV)

	A	B	C	D
1	Preset_Name	Active	PTS	PHT
2	ABS	0	180	35
3	PC	0	230	35
4	PC + ABS	0	212	35
5	PA 6	0	180	45
6	PET (c)	0	350	45
7	PEEK	0	302	45
8	CUSTOM	0	275	60

Input desired material with parameters in a new row.



Plug in USB with new material preset added to .CSV file and press the 'Import Presets' button.



The new material preset now shows up in the list of available presets



The parameter values in the 'Preset Details' screen will mimic what was inputted into the .CSV file.

Shutdown Options

Shutdown Options are only present after a 'Start' has been initiated.

End Preheat - (shown only if in a preheat cycle)

Skips the preheat allowing material to immediately pass down to the Vacuum Chamber (example: material has already been heated and dryer has been taking offline briefly and powered back on).



At any point after the preheat cycle has ended (or forced to end), pressing the red Shutdown button will bring up the Shutdown Options screen with the following shutdown options:

Shutdown – Pressing the red 'Shutdown' button (after preheat has ended) will prompt a series of shutdown options



Smart Stop – With the 'Smart Stop' feature, the machine will not add more material into the machine and completely dry the remainder of the material in the machine. At the end of the 'Smart Stop,' there will be no material in the ULTRA which is essential for quick cleanout.



Immediate Shutdown – This causes an instantaneous, yet controlled, complete shutdown of all systems within the ULTRA (heater, blower, vacuum and purge system).



Cooldown & Shutdown [special feature] – When this feature is selected, the ULTRA will gradually cool down the material in the heating hopper to a desired temperature over a specific designated time period.

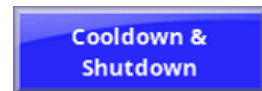







Cancel - Exits the shutdown option screen



Auto Stop (must first be enabled) – Initiates a shutdown at specified date and time. For further explanation on how to set the Auto Stop date and time see page 36.

Auto-Start Setup





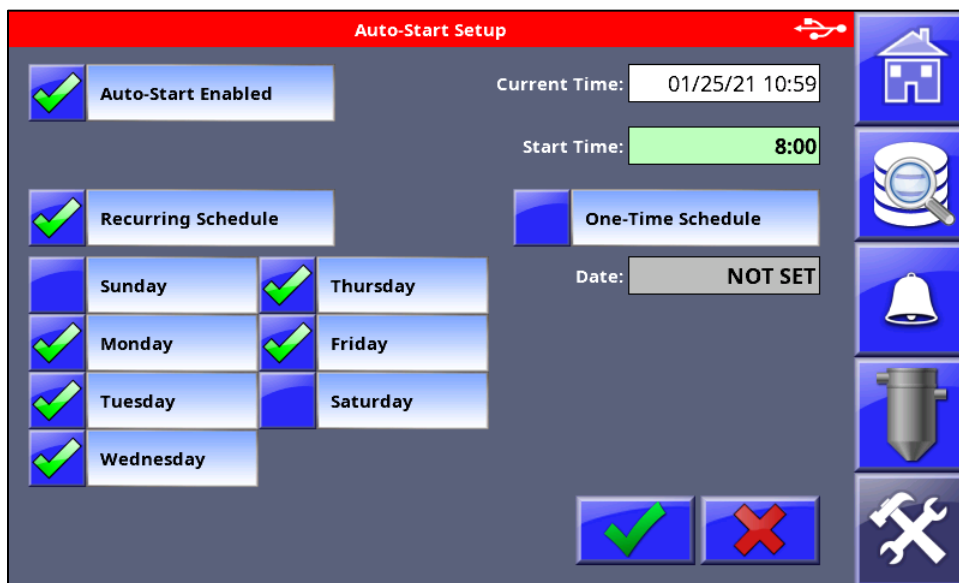

Auto-Start initiates a start-up at a specified time on specific days of the week. To enable and configure Auto-Start follow the steps below.

Press 	Display will prompt for a password. (default: 2222)	Then press: 
Press Dryer Configuration	Display will show the Dryer Configuration categories.	
Press Auto-Start Setup	Display will show the Auto-Start screen.	
To Enable Auto-Start:		
Press 	Auto-Start Enabled	to enable Auto-Start. Display will show Auto-Start scheduling.
Press Recurring Schedule	or One-Time Schedule	Set the time of day Auto-Start should occur.
Press 	to select the days of the week Auto-Start should occur.	
Press 	to save the Auto-Start settings.	
Press 	the Home Button to return to the Home Screen.	



Auto-Stop Setup

Auto-Stop initiates a shutdown at a specified time on specific days of the week. To enable and configure Auto-Stop follow the steps below.

Press		Display will prompt for a password. (default: 2222)	Then press:	
Press	Dryer Configuration	Display will show the Dryer Configuration categories.		
Press	Auto-Stop Setup	Display will show the Auto-Stop screen.		
To Enable Auto-Stop:				
Press		Auto-Stop Enabled	to enable Auto-Stop. Display will show Auto-Stop scheduling.	
Press	Schedule	Set the time of day Auto-Stop should occur.		
Press		to select the days of the week Auto-Stop should occur.		
Press		to save the Auto-Stop settings.		
Press		the Home Button to return to the Home Screen.		

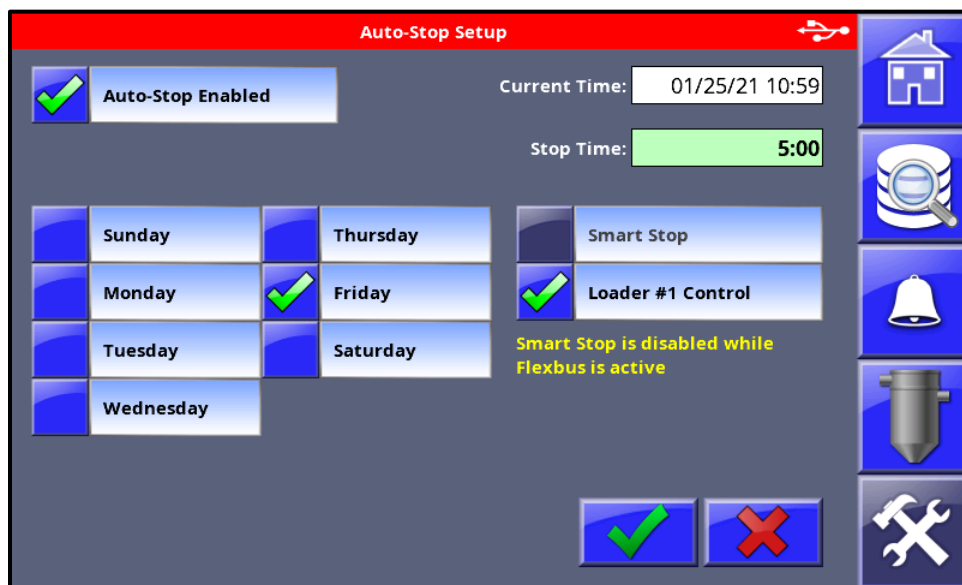

Advanced Information



On the Home Screen, pressing this will display additional information such as readings of all RTD thermometers, vacuum time elapsed, absolute pressure in the vacuum chamber, blower drive frequency, etc.

Note: By default, some of these readings will not be shown in the 'Advanced Information' screens, unless they are enabled in the 'Display Options' menu.

T1 Actual: Actual heating hopper inlet air temperature.

T1 Setpoint: Heating hopper inlet air temperature Setpoint.

Heat Hopper: Heating Percent (%) output.

T2 Temp: Actual heating hopper temperature

Heat Hopper: Heating hopper level sensor reading (%)

T4 Actual: Material outlet temperature

Fill Info Max: The desired weight of material to be dispensed into the Vacuum Chamber.

Material Bulk Density: Bulk density of material in either pounds per cubic foot or kilograms per liter.

Cycle Count: Total number of cycles since start button was pressed.

Cycle Time: Total time to process a completed batch of dry material.

Valve Timings – Fill: Total time to fill the Vacuum Chamber.

Valve Timings – Dump: Total time to dump the Vacuum Chamber.

Batch Mode Totals – Portion: Current batch weight reading

Batch Mode Totals – Target: Set target batch weight.

Next Purge: Time until next purge cycle

Valve Rates – Fill (VFR): Vacuum chamber fill rate (gram/second)

Valve Rates – Dump (VDR): Vacuum chamber dump rate (gram/second)

Load Cell Readings – Vacuum: Weight in vacuum chamber

Load Cell Readings – Retention: Weight in retention hopper

Totalizer Weight: Calculated total of all cycles since last clear of totals.

Thruput Rate: Calculated throughput, weight per hour.

Residence Time: Actual Vacuum Time.

Energy Usage: Displays values in wattage, W/lb (W/kg.) Cur., and W/lb. (W/kg.) Avg.

Data View: Table showing additional information.

Manual Operations

This menu gives the user direct control of specific machine outputs.

Operate Outputs – Manually toggle essential machine capabilities.

Alarm Audio – OFF/ON – Operates audible alarm.

Alarm Strobe – OFF/ON – Operates strobe.

Vac Cham Fill – CLOSED/OPEN - Gate located at the base of the heating hopper.

Vac Gate Upper – CLOSED/OPEN – Material gate above vacuum chamber.

Vac Cham Dump – CLOSED/OPEN – Internal gate (not visible) at the base of vac chamber.

Vac Gate Lower – CLOSED/OPEN – visible disk-shaped gate below vacuum chamber.

Vac Gen Supply – CLOSED/OPEN – Vacuum generator supply. When operating, the vacuum generator supply pulls a vacuum on the vacuum chamber.

Vac Gen Check – CLOSED/OPEN – Vacuum generator check valve located on the vacuum generator.

Holds the vacuum on the vacuum chamber.

Vac Cham Purge – CLOSED/OPEN – Located below the vacuum generator. When open the vacuum on the vacuum chamber is released.

Loader 1 – In 'Relays' Mode, this tests functionality of Loader 1

Loader 2 – In 'Relays' Mode, this tests functionality of Loader 2

Running Contact – testing the functionality of the drying running contact. Refer to [page 43](#)

Blower Test – Operates the blower.

Blower – OFF/ON toggle the blower on and off.

Auxiliary – CLOSED/OPEN: Input status

Heater Contactor – CLOSED/OPEN: Input status

Frequency – Set Blower Frequency

Speed Reference – Input Status of blower speed reference

T1a – Heating Hopper inlet temp actual.

T2a – Heating Hopper exhaust temperature actual

Wattage – Actual Blower wattage

Heater Test – Operates heater and blower that supplies heat to the Heating Hopper.

T1a – Heating Hopper inlet temp actual.

T1s – Heating Hopper inlet temp setpoint. Run temperate can be set here.

Heat Hopper Output – Heater duty cycle displayed as a percentage of max capacity.

T2a – Heating Hopper exhaust temperature actual

Start – Starts the heater test. Blower will run during test.

Blower Status – ON/OFF: Input status of blower

Wattage – With 'Energy Usage' enabled, heater wattage is displayed in watts.

Blower Frequency – Blower Frequency expressed in Hz.

Test Mode – Auto or Manual. In Auto, controller will modulate the heater based on a temperature setpoint. In manual mode, the heating hopper output percentage is the driver.

Vacuum Test - Tests the Vacuum System

Start – Starts the vacuum test. Runs the vacuum generator system.

Mode: Manual Mode – Vacuum test cycles continue until manually halted.

Mode: Cycle Mode – Vacuum test cycles are driven by the Vacuum Time Setpoint (minutes)

Purge Cham: OFF/ON/CYCLE – Behavior of Purge Chamber during Vacuum Test

Test Timers: Evac Time – Amount of time to attain the vacuum setpoint during the current test.

Test Timers: Cycle Time – Amount of time in between vacuum generator runs during a vacuum hold.

Used to determine vacuum chamber seal integrity.

Settings: Pdel – The pressure difference above VPL at which the vac generator turns back on. See VPD

Settings: Pset – Absolute pressure that the Vacuum Chamber will be evacuated to. See VPL parameter.

Next Purge – Countdown timer until vacuum chamber's next purge cycle

Pressure: Actual (Δ) – Displays the amount of vacuum within the vacuum chamber in mmHg[def.]

Vacuum Chamber Fill Test – Test material flow rates and diagnose fill/valve problems with the vacuum chamber.

Timed Dispense – Opens necessary valves for a designated amount of time in milliseconds.

Weighed Dispense – Keeps necessary valves open until designated dispense weight has been achieved.

Start – Initiates the dispense test. Results can be printed to a USB drive.

Retention Hopper Fill Test – Test material flow rates and diagnose fill/valve problems with the retention hopper.

Timed Dispense – Opens necessary valves for a designated amount of time in milliseconds.

Weighed Dispense – Keeps necessary valves open until designated dispense weight has been achieved.

Start – Initiates the dispense test. Results can be printed to a USB drive.

Setup Menu Explanation



The setup menu is a password protected area for accessing Dryer or System specific configuration settings and is accessible from the main screen's navigation panel. This screen is also home to firmware information such as: TSC Version, TSC bootloader, I/O Version, I/O Bootloader, and MAC Address. The Setup menu and its nesting is laid out below.

<ul style="list-style-type: none"> ➤ <u>Dryer Configuration</u> <ul style="list-style-type: none"> ➤ Alarm Setup <ul style="list-style-type: none"> ➤ Material Shortage Alarm ➤ Material Ready Alarm ➤ Misc. alarm options ➤ Auto-Start Setup <ul style="list-style-type: none"> ➤ Enable Auto-Start ➤ Recurring Schedule ➤ One-Time Schedule ➤ Auto-Stop Setup <ul style="list-style-type: none"> ➤ Enable Auto-Stop ➤ Smart Stop ➤ Loader #1 Control ➤ Convey Setup <ul style="list-style-type: none"> ➤ Convey Via... ➤ Loader #1 Mode ➤ Loader #2 Mode ➤ Totalizer ➤ HH High Level ➤ Purge Setup <ul style="list-style-type: none"> ➤ Purge Chamber ➤ Purge Interval ➤ Purge % ➤ Load Cell Setup <ul style="list-style-type: none"> ➤ Zero / Full Weight Calib. ➤ Flow Rate Calibration ➤ Preheat Setup <ul style="list-style-type: none"> ➤ Preheat Mode ➤ Preheat Setpoint ➤ Preheat Delta Temp. ➤ Preheat Time ➤ Preheat and Run Temp. ➤ Parameters <ul style="list-style-type: none"> ➤ Blower ➤ Dispensing ➤ Heater ➤ Load Cell ➤ System ➤ Vacuum ➤ Special Features <ul style="list-style-type: none"> ➤ Batch Mode ➤ Auto Fill Adjust ➤ Cycle Pause ➤ Valve Clean Pause ➤ Cooldown Mode ➤ Running Contact ➤ HH Level Sensor 	<ul style="list-style-type: none"> ➤ <u>System Configuration</u> <ul style="list-style-type: none"> ➤ Data Logging <ul style="list-style-type: none"> ➤ Logging Interval (sec.) ➤ Log Events to: ➤ Preferences <ul style="list-style-type: none"> ➤ Change Passwords ➤ Date and Time ➤ Display Units ➤ Language ➤ Navigation Bar Options ➤ Screen Options ➤ Diagnostics <ul style="list-style-type: none"> ➤ System Information ➤ Load Cell Diagnostics ➤ Alarm and Event Log ➤ Hour Meters ➤ Communications <ul style="list-style-type: none"> ➤ MLAN I.D. Number ➤ TCP/IP Configuration ➤ Modbus Server ➤ Resets <ul style="list-style-type: none"> ➤ Restore Parameters ➤ Firmware Update ➤ Restore All ➤ Factory Access ➤ Access Control <ul style="list-style-type: none"> ➤ Key Features ➤ Access Levels ➤ Display Options <ul style="list-style-type: none"> ➤ Cycle Info ➤ Dispense Data ➤ HH Residence ➤ T4 Temperature ➤ Throughput ➤ Energy Usage ➤ Mouse Over 	<ul style="list-style-type: none"> ➤ <u>Print Center</u> <ul style="list-style-type: none"> ➤ Print Parameters ➤ Print Alarm History ➤ Print Events ➤ Print Events to .CSV ➤ Copy Log File ➤ Print All ➤ Clear All Alarms and Events
--	--	--

Dryer Configuration Overview

The Dryer Configuration menu includes device specific settings such as: Alarm Setup, Auto-Stop setup, Dry Purge Setup, Preheat Setup, Auto-Start Setup, Convey Setup, Load-Cell Setup, and Parameters.

Alarm Setup	<p>Material Shortage Alarm</p> <p>OFF: Disables the Material Shortage alarm</p> <p><u>WARN:</u> In the event of a material shortage, activate the audible alarm and strobe light but continue retrying for material.</p> <p>SHUTDOWN: In the event of a material shortage, activate the audible alarm and strobe light and automatically initiate a planned shutdown. Audible alarm with sound for 15 seconds and the strobe will flash until the dryer is completely shut down.</p> <p>When Material Shortage Alarm is in Warn or Shutdown Mode Fill Retries are ENABLED. When set to OFF, Fill Retries are disabled.</p> <p>Material Ready Alarm - If the Material Ready alarm is enabled, this alarm will trigger after the first and only first batch of material has completed a full vacuum cycle. After 15 seconds, the audible portion of this alarm will automatically silence. The first batch of material will remain under vacuum indefinitely until this alarm is cleared. There are two main purposes of this alarm:</p> <ol style="list-style-type: none"> 1. To alert the operator that dry material is ready for the process. 2. To act as a hold-back, when necessary, giving the operator additional time to prepare the process. <p><u>OFF:</u> Disables the Material Ready Alarm</p> <p>1st: Material Ready Alarm sounds after the first and only the first batch of material is ready to drop from the Vacuum Chamber.</p> <p>ON: Material Ready Alarm sounds after every batch of material is ready to drop from the Vacuum Chamber. This mode can be useful in lab environments.</p> <p>Material Temperature Alarm - When the Material Temp alarm is enabled, during any instance where the Heating Hopper is called upon to dispense material into the vacuum chamber and the T2 (heating hopper exit) temperature is below the ESM parameter level, this alarm will trigger. Its purpose is to alert the operator that insufficient heating has occurred, most likely from a process throughput that exceeds the capacity of the ULTRA.</p> <p>ON: When the Material Temperature Alarm is enabled, the alarm will sound when this alarm is triggered.</p> <p><u>OFF:</u> Disables the Material Temperature Alarm</p>
--------------------	---

	<p>Residence Alarm (labeled “Material Residence”) - When the Residence Alarm is enabled, an alarm will sound if dried material has sat in the retention hopper too long. The RAL parameter determines when a residence alarm will occur based on elapsed time and weight of remaining material in the retention hopper. See the RAL parameter for more information.</p> <p>ON: When the Residence Alarm is enabled, the alarm will sound when this alarm is triggered.</p> <p>OFF: Disables the Residence Alarm</p> <p>Throughput Alarm - If the Throughput alarm is enabled, the alarm will sound if the material in the Retention Hopper is used faster than the dryer can produce dried material. (Material level reaches RTL parameter before the Vacuum Time Setting expires VTS parameter)</p> <p>ON: If the Throughput alarm is enabled, the alarm will sound when this alarm is triggered.</p> <p>OFF: Disables the Throughput alarm</p> <p>Vacuum Chamber Dump Alarm - If the Vacuum Chamber Dump alarm is enabled, the dispensing of material from the vacuum chamber into the retention hopper is monitored using the CDR (Chamber Dump Retries) parameter. CDR’s default settings of 05003 requires that at least 50% of the material that is in the vacuum chamber be detected in the retention hopper after the dispense. If it is under 50% the dispense will retry 3 times before triggering the alarm. Retries will continue indefinitely until 50% is satisfied.</p> <p>ON: If the Vacuum Chamber Dump alarm is enabled, the alarm will sound when this alarm is triggered.</p> <p>OFF: Disables both the vacuum chamber dump alarm and vacuum chamber Dump retries.</p>
<p>Auto-Start Setup</p>	<p>Auto-Starts the Dryer at a specified Time and Day(s). Can be set to Auto-Start the Dryer at one time only or on a repeated schedule. Must be ENABLED in Display Setup.</p>
<p>Auto-Stop Setup</p>	<p>Auto-Stop the Dryer at a specified Time and Day(s). Can be set to Auto-Stop the Dryer at one time only or on a repeated schedule. Must be ENABLED in Display Setup.</p>
<p>Purge Setup</p>	<p>Purge Chamber - OFF/<u>CYC</u>/ON – Controls when the vacuum chamber is purged with membrane dried air.</p> <p>OFF – No vacuum chamber purging occurs.</p> <p>CYC - Vacuum chamber purging occurs during allotted vacuum cycle time (VTs).</p> <p>ON – Vacuum chamber purging occurs during allotted vacuum cycle time (VTs) and extended vacuum if applicable.</p> <p>Purge Interval - Interval in seconds between purges.</p> <p>Purge Duration - Duration in seconds that the purge will occur.</p>



<p>Convey Setup</p>	<p>Convey Setup - Material Convey Options - <u>Optional</u> - Uses dedicated outputs on the I/O board that may be used to control customer supplied Loader(s). Can be Conveyed Via Relays [R] where loaders are enabled and disabled via demand signal interrupt relays inside the ULTRA electrical cabinet or by FlexBus [FB] where connected FlexBus-capable receivers are controlled via the ULTRA dryer. For more information on conveying via FlexBus, refer to page 88.</p> <p>Loader #1 (Feed) Mode - refer to diagram on page 146</p> <p><u>Off [R]:</u> The Loader #1 demand signal interrupt relay is disabled.</p> <p><u>Manual [FB]:</u> Receiver #1 is manually enabled/disabled from the FlexBus Lite receiver setup screen.</p> <p><u>Auto [R]:</u> The Loader #1 demand signal interrupt relay will be energized if a Loader#1-driven AutoStop sequence has not commenced.</p> <p><u>Auto [FB]:</u> Receiver #1 is enabled if a Receiver #1-driven Auto Stop sequence has not commenced.</p> <p><u>Convey In Loop [R]:</u> The Loader #1's demand signal interrupt relay is controlled by Loader #2's logic. The Loader #1 material feed line is connected to the ULTRA's vacuum take-off. Material is moved in a loop. This is mode is usually for testing purposes.</p> <p><u>Convey In Loop [FB]:</u> Receiver #1 is controlled by Receiver #2's logic. The Receiver #1 material feed line is connected to the ULTRA's vacuum take-off. Material is moved in a loop. This is mode is typically limited to testing purposes.</p> <p>Loader #2 (Take-Away) Mode [Relays]</p> <p><u>Off [Relays]:</u> The Loader #2 demand signal interrupt relay is disabled.</p> <p><u>Manual [Flexbus]:</u> Receiver #2 is manually enabled/disabled from the FlexBus Lite receiver screen.</p> <p><u>Throughput [R]:</u> The Loader #2 demand signal interrupt relay will be energized if the amount of material in the retention hopper is at or above the amount specified by the LTP parameter. It will de-energize if the throughput drops below the amount specified by the LTC parameter.</p> <p><u>Throughput [FB]:</u> Receiver #2 will be enabled if the amount of material in the retention hopper is at or above the amount specified by the LTP parameter. It will de-energize if the throughput drops below the amount specified by the LTC parameter.</p> <p><u>Weight [R]:</u> The Loader #2 demand signal interrupt relay will be energized if the amount of material in the retention hopper is at or above the amount specified by the LTP parameter. It will de-energize if the amount of material in the retention hopper drops below the amount specified by the LTP parameter for the time specified by the LTP parameter.</p>
----------------------------	--

	<p>Weight [FB]: Receiver #2 will be enabled if the amount of material in the retention hopper is at or above the amount specified by the LTP parameter. It will be disabled if the amount of material in the retention hopper drops below the amount specified by the LTP parameter for the time specified by the LTP parameter.</p> <p>Reset Totalizer - Resets Weighed totals to zero. Totals are the amount of material that has been conveyed away from the dryer since the Totalizer has been reset.</p>
Load cell Setup	<p>Load cell Info – For instructions on how to calibrate the load cells on the ULTRA Dryer, see page 84.</p>
Preheat Setup	<p>Preheat Mode – Material preheats prior to a vacuum cycle</p> <p>Timed – Preheat based on a set time</p> <p>Auto (default) – Preheat dependent on a min. time and delta temp.</p> <p>Manual – Preheat until heater is turned off</p>
Parameters	<p>Dryer Parameters access. Parameters for the blower, heater, load cells, vacuum, system, and dispensing are found here. For information on how to change parameter settings, refer to page 45.</p>
Special Features	<p>Special Features that are exclusive to the ULTRA series of dryers can be enabled here.</p> <p>Batch Mode - refer to page 44</p> <p>Auto Fill Adjust – dynamically adjust the vacuum chamber fill weight based on learned throughput to minimize the amount of retention hopper residence time. See page 44 for the software logic.</p> <p>Cycle Pause – freezes/pauses the vacuum timer while all other operations remain.</p> <p>Valve Clean Pause - refer to page 83</p> <p>Cooldown Mode – refer to page 34</p> <p>Running Contact – When the dryer is running, an output on the I/O board is energized. This can be, for example, tied into a customer’s PLC. See I/O board wiring schematics on page 107 for ULTRA-150 and page 130 for ULTRA-300.</p>

Batch Mode

Batch Mode enables the dryer to dry a predetermined amount of material and then automatically stop and display a message indicating the batch is complete. To turn on Batch Mode see: Setup Menu > Dryer Configuration > Special Features > Batch Mode.

To enable and run the dryer in Batch Mode follow these steps from the Home Screen:

Press	Start Batch	Start Batch button is located on the Home Screen after Batch Mode is enabled. Display will show: Batch Start Options.
Press	Set Batch Target	Keypad screen will display. Enter Batch Weight.
Press		To save the batch weight or press the red X to cancel and exit.
Press	Reset Totalizer	to reset the totalized value back to zero (if applicable).
Press		To save the entered batch weight and begin the batch and start the Dryer. Press the red X to cancel.

Auto Fill Adjust

To enable this adjustment, Setup Menu / Dryer Configuration / Special Features / Auto Fill Adjust.

After the first cycle is complete, and before the next vacuum chamber fill, it begins calculating the throughput (since there is weight in the retention hopper). The throughput is calculated as follows:

- liw = accumulated loss in weight, since last cycle (grams)
- time = time since end of last cycle (seconds)

$$throughput \left(\frac{grams}{hour} \right) = \frac{liw (grams)}{time (seconds)} * \left(\frac{3600 seconds}{1 hour} \right)$$

The software takes the Vacuum Time in seconds (VTS parameter) and converts to minutes.

$$Fill Weight Adjusted(grams) = throughput \left(\frac{grams}{hour} \right) * \left(\frac{1 hour}{60 minutes} \right)$$

The value is again adjusted by 10% of its value.

$$New Fill Weight Adjusted (grams) = Fill Weight Adjusted (grams) * 1.1$$

The minimum value that the adjusted fill weight can be set to is 10lb.(4.5kg.) and 50lb.(22.7kg.) for an ULTRA-150 and ULTRA-300, respectively. The value defaults to the minimum if the calculated value is lower.

The software logic uses this new value as the target fill weight for the fill logic to use. This adjustment is applied to every fill after the first fill.





NOTE: Setting a new VCH value while ‘Auto Fill Adjust’ is enabled will force a fill with the new value of VCH as the target for one cycle before making future adjustments.

Changing Parameters



Changing parameters can have an impact on the Dryers performance. It is highly recommended that a supervisor change the default Program Mode password to protect the values. Prior to making any changes, make sure it is understood what is being changed. If in doubt, contact a Maguire Dryer Technician before making changes to the dryer.

Navigating and Making Changes to Parameters:

Press		Display will prompt for a password. (default: 22222)	Then press:	
Press	Dryer Configuration	Display will show the Dryer Configuration categories.		
Press	Parameters	Display will show the categories of Parameters. Parameters are divided into 6 categories. Blower, Heater, System, Dispensing, Load-Cell, and Vacuum.		
Press	The category that would contain the parameter.	Categories will have several parameters indicated by a 3-letter acronym on the left of the screen. Some categories have multiple pages. Navigate pages using the arrow buttons at the lower-left of the screen.		
Press	The parameter	Display will show 5 digits. Press the up or down arrows to adjust.		
Press		To save the parameter adjustment or press the red X to cancel and exit.		

Parameters – Explained

All Maguire ULTRA controllers operate according to certain internal PARAMETERS. Because customer requirements vary widely, we have made parameters accessible for change through the keypad. In most cases, these parameters will never need to be changed. Some parameters that are routinely adjusted values are adjustable from the main display.

Blower Parameters:		Heater Parameters:	
BLF	VFD Low Limit	PTS	Preheat Temperature Setting
BHF	VFD High Limit	PHT	Preheat Time
BDF	VFD Frequency	PHD	Preheat Differential
BZL	VFD Zero Level	PTD	Preheat Target Delta
BLA	VFD Level Adjustment	RTS	Run Temperature Set-Point
BHT	VFD Heat Throttle	AS1	Anticipator Gain (Heater)
BMW	Blower Max Wattage	CF1	Cycle Frequency (Heater)
ADT	Airflow Delay Time	RU1	Rate of Correction Upward (Heater)
BDT	Blower Detect Time	RD1	Rate of Correction Downward (Heater)
Dispensing Parameters:		CH1	No Change High (Heater)
VCH	Vac. Chamber Hi Level	CL1	No Change Low (Heater)
VCL	Vacuum Chamber Low Level	PR1	Percent Reduction (Heater)
RHH	Ret. Hopper Hi Level	UT1	Update Time (Heater)
RHL	Retention Hopper Low Level	OT1	Over-Temp Alarm (Heater)
BLK	Bulk Density	NH1	No Heat Alarm (Heater)
VFR	Vacuum Chamber Fill Rate	MP1	Maximum Percentage
VDR	Vacuum Chamber Dump Rate	MAX	Maximum Temperature Setpoint
VFT	Vacuum Chamber Fill Time	ESL	Energy Saver Limit
VDT	Vacuum Chamber Dump Time	EST	Energy Saver Time
FLA	Fill Lag Time	ESP	Energy Saver Proportioning
DLA	Dump Lag Time	RMP	Temperature Ramp Settings
VGD	Vacuum Gate Delay	CTM	Cooldown Temperature
VFA	Chamber Fill Adjust	CTR	Cooldown Timer
HDD	Heating Hopper Dump Delay	H1W	Heater Wattage
VCT	Vacuum Chamber Dump Threshold	HCT	Heater Cooldown Time
CDR	Chamber Dump Reties	Load Cell Parameters:	
RAL	Residence Alarm	KDF	Loadcell Stable Wt.
BCH	Batch Size	LST	Load Cell Stable Time
LTP	Loader Trip Point	LCZ	Loadcell Zero
LTC	Loader Throughput Cutoff	WST	Weight Settle Time
HHV	Heating Hopper Volume	LZ1	Loadcell 1 Zero
HHU	Heating Hopper High Level	LZ2	Loadcell 2 Zero
HLA	Heating Hopper Level Alarm	System Parameters:	
L2D	Loader 2 Delay Time	ELT	Event Logging Time
PMC	Progressively Metered Cycles	EUS	Energy Usage Setting
RLT	Rate Learning Threshold		
Vacuum Parameters:			
VTS	Vacuum Time Setting		
VPL	Vacuum Pressure Low		
VPD	Vacuum Pressure Delta		
VSO	Vacuum Shutdown Offset		
LVT	Low Vacuum Timeout		
NVT	No Vacuum Timeout		
VPT	Chamber Purge Timer		
VPI	Chamber Purge Interval		
ATM	Atmospheric Pressure		

Parameter Units	
Time	is expressed as full seconds or full minutes.
Percentages	are expressed as a percentage.
Temperatures	are expressed in full degrees (Fahrenheit or Celsius).
Term	used to calculate a value.
3-letter Acronym	Parameter title (units) – default parameter value Parameter description

Blower

BLF - Blower Low Frequency

format: xxxxx (Hz)

function(s): Minimum allowable user-enterable blower drive frequency. *Note: this parameter is only visible on units equipped with a VFD.*

BHF - Blower High Frequency

format: xxxxx (Hz)

function(s): Maximum allowable user-enterable blower drive frequency. *Note: this parameter is only visible on units equipped with a VFD.*

BDF - Blower Drive Frequency

format: xxxxx (Hz)

function(s): VFD setpoint frequency. VFD frequency is directly proportional to blower RPM, which is directly proportional to airflow. *Note: this only applies to units equipped with a VFD.*

BZL - Blower Zero Level

format: xxxxx (%)

function(s): When the heating hopper level is at or below this level, the blower will run at a reduced frequency set by the BLA parameter. *Note: this parameter is only visible on units equipped with a VFD.*

BLA - Blower Level Adjustment

format: xxxxx (Hz)

function(s): Blower drive frequency when the heating hopper level is at or below that set by the BZL parameter. *Note: this parameter is only visible on units equipped with a VFD.*

BHT - Blower Heat Throttle

format: xxxxx (%)

function(s): After a vacuum chamber fill, when the heater powers back up, it will run at this percentage of the duty cycle it ran at the end of the previous vacuum cycle if the heating hopper level is below that established by the BZL parameter. This is to mitigate temperature runaways caused by different airflows (caused by different pressure drops across the heating hopper).
Note: this parameter only applies to units equipped with a VFD and heating hopper level sensor.

BMW - Blower Maximum Wattage

format: xxxxx (watts)

function(s): The amount of power the blower consumes when running at full speed. This value is used in energy consumption calculations.

ADT - Airflow Delay Time

format: xxxxx (seconds)

function(s): The amount of time between the completion of vacuum chamber re-filling and the blower powering-up

BDT - Blower Detect Time

format: xxxxx (seconds)

function(s): The amount of time between the completion of vacuum chamber re-filling and the blower powering-up.

Dispensing

VCH - Vacuum Chamber High Level

format: xxxxx (lbs. or kgs.)

function(s): Vacuum chamber fill dispense target. Also known as “fill weight”.

VCL - Vacuum Chamber Low Level

format: xxxxx (lbs. or kgs.)

function(s):

1. When starting, if an amount of material equal or greater to this level is detected in the vacuum chamber, a “Warning: Material in Vacuum Chamber” message will pop up.
2. When in Clean-Out mode, the vacuum chamber fill valve will not open automatically until the vacuum chamber weight reading is at or below this level.
3. The minimum allowable final dispense of a standard Auto Stop.

RHH - Retention Hopper High Level

format: xxxxx (lbs. or kgs.)

function(s): Retention hopper fill dispense target. This value is typically slightly higher than VCH to ensure that 100% of the vacuum chamber contents dispense into the retention hopper.

RHL - Retention Hopper Low Level

format: xxxxx (lbs. or kgs.)

function(s):

1. When starting, if an amount of material equal or greater to this level is detected in the retention hopper, a “Warning: Material in Retention Hopper” message will pop up.
2. When in Clean-Out mode, the vacuum chamber dump valve will not open automatically until the retention hopper weight reading is at or below this level.
3. When the dryer is running, the retention hopper must be depleted down to this level before a vacuum chamber dump is allowed.

BLK - Bulk Density

format: xxxxx (lbs./ft³ or g/L)

function(s): User-enterable. Setting this correctly ensures that a fill weight that could potentially overflow the vacuum chamber cannot be entered. Note: has no effect on drying.

VFR - Vacuum Chamber Fill Rate

format: xxxxx (g/sec.)

function(s): Learned flow rate of the vacuum chamber fill valve. This parameter will automatically adjust over time. As it adjusts, vacuum chamber fills will converge on the targeted fill weight.

VDR - Vacuum Chamber Dump Rate

format: xxxxx (g/sec.)

function(s): Learned flow rate of the vacuum chamber dump valve. This parameter will automatically adjust over time. As it adjusts, retention hopper fills will converge on the targeted fill weight.

Note: this parameter is typically set to 00000, which means that rate learning does NOT occur, and vacuum chamber dumps will terminate on low flow or high level (RHH). Manually setting this parameter to any value other than zero will enable rate learning.

VFT - Vacuum Chamber Fill Time

format: xxxxx (seconds)

function(s): 1. When the most significant digit is set to a 0 (0xxxx), this is the maximum allowable vacuum chamber fill time. Fills are not allowed to go beyond this time.
2. When the most significant digit is set to a 1 (1xxxx), this is the vacuum chamber fill time. VFR is ignored. Note, however, that a timed fill will terminate prematurely if VCH is reached.
3. When the most significant digit is set to a 2 (2xxxx), this is the vacuum chamber fill time. VFR is ignored. This is also known as, "Volumetric Fill Mode."

VDT - Vacuum Chamber Dump Time

format: xxxxx (seconds)

function(s): 1. When the most significant digit is set to a 0 (0xxxx), this is the maximum allowable vacuum chamber dump time. Dumps are not allowed to go beyond this time.
2. When the most significant digit is set to a 1 (1xxxx), this is the vacuum chamber dump time. VDR is ignored. Note, however, that a timed dump will terminate prematurely if RHH is reached.
3. When the most significant digit is set to a 2 (2xxxx), this is the vacuum chamber dump time. VDR is ignored. This is also known as, "Volumetric Dump Mode."

FLA - Fill Lag Time

format: xxxxx (milliseconds)

function(s): Amount of time added to every vacuum chamber fill valve opening. This is to account for the delay between the controller signaling the opening of the valve and the first pellets beginning to flow. This can also be considered the minimum vacuum chamber fill valve open time.

DLA - Dump Lag Time

format: xxxxx (milliseconds)

function(s): Amount of time added to every vacuum chamber dump valve opening. This is to account for the delay between the controller signaling the opening of the valve and the first pellets beginning to flow. This also is considered the min. vacuum chamber dump valve open time.

VGD - Vacuum Gate Delay

format: xxxyy (seconds / seconds)

function(s): xxx: The amount of time between the lower vacuum valve opening and the vacuum chamber dump valve opening.

yy: The amount of time between upper vacuum gate opening and the vacuum chamber fill valve opening.

VFA - Vacuum Fill Adjust

format: xxxyy (retries, 10ths of pounds or 10ths of kilograms)

function(s): xxx: The number of vacuum chamber fill retries that will be attempted before a material shortage alarm is triggered

yy: The allowable negative deviation from the vacuum chamber fill target (VCH). If, after a vacuum chamber fill, the vacuum chamber weight reading is not within this tolerance, a fill retry will be initiated.

HDD - Heating Hopper Dump Delay

format: xxxxx (seconds)

function(s): The amount of time between blower shutdown and the initiation of a vacuum chamber fill. This is to allow for blower wind-down time.

VCT - Vacuum Dump Threshold

format: xxxxx (g/sec.)

function(s): During a vacuum chamber dump, if the real-time vacuum chamber dump valve flow rate reaches this low level, the dump will be terminated on the assumption that the vacuum chamber is completely empty.

CDR - Chamber Dump Retries

format: xxxyy (% / retries)

function(s): xxx: If a vacuum chamber dump does not reach at least this percentage of the target (RHH), a vacuum chamber dump retry is initiated.

yy: The number of vacuum chamber dump retries that will occur before a Vacuum Chamber Dump Alarm is triggered.

RAL - Residence Alarm

format: xyyy (pounds or kilograms / minutes)

function(s): xx: If at least this amount of material is not evacuated from the retention hopper within the amount of time shown in (yyy) below, a Residence Time alarm will trigger.

yyy: Residence Time alarm time.

Note: This parameter is only active when the Residence Time alarm is enabled.

BCH - Batch Mode Target

Format: xxxxx (pounds or kilograms)

function(s): The targeted total amount of material that will be dried during a batch run.

LTP - Loader Trip Point

format: xyyy (seconds / 10ths of pounds or 10ths of kilograms)

function(s): xx: loader #2 off-delay timer

yyy: If the retention hopper contents drop below this level, initiate the de-powering of the loader #2 output.

LTC - Loader Throughput Cutoff

format: xxxxx (pounds or kilograms per minute)

function(s): When loader #2 is set to Throughput cutoff mode, the loader output will de-energize when the throughput drops below this level.

HHV - Heating Hopper Volume

format: xxxxx (10ths of cubic feet or 10ths of liters)

function(s): Volume of the heating hopper. This value is used to estimate the total amount of material in the dryer, which is used in the Loader #1 triggered Auto Stop calculation.

HHU - Heating Hopper High Level

format: xxxxx (%)

function(s): When Loader #1 is set to "Auto" mode, the Loader #1 output will de-energize when the heating hopper material reaches this level. *Note: Must have level sensor equipped*

HLA - Heating Hopper Level Alarm

format: xxxxx (%)

function(s): If the heating hopper material drops to this level, the heating hopper level alarm will be triggered (if enabled). *Note: only applies to units with a heating hopper level sensor.*

L2D - Loader #2 Delay Time

format: xxxxx (seconds)

function(s): The amount of time, after a vacuum chamber dump, between weight being sensed in the retention hopper and loader #2 turning on. A delay here ensures that material is not being conveyed away during the dump, which could cause throughput and totalizer reading inaccuracies.

PMC - Progressively Metered Cycles

format: xxyyy (counts / percentage)

function(s): xx: Number of cycles to meter for initial rate adjustments.

 yyy: Percentage of threshold weight to target during initial metered cycles.

RLT – Rated Learning Threshold

format: xxxxx (%)

function(s): Percentage of dispense target that must be achieved via a given fill attempt in order for a rate adjustment to occur.

Heater

PTS - Preheat Temperature Setpoint

format: xxxxx (°F or °C)

function(s): Target heating hopper air inlet temp during preheat, when the Preheat Setpt. is set to “Temp”

PHT - Preheat Time

format: xxxxx (minutes)

function(s): 1. When Preheat mode is set to “Auto”, this is the *minimum* preheat duration.
 2. When Preheat mode is set to “Timed”, this is the preheat duration.

PHD - Preheat Differential Temperature

format: xxxxx (°F or °C)

function(s): When Preheat Setpoint mode is set to “Differential”, the preheat temperature is automatically set to this number of degrees below the run temperature (RTS).

PTD - Preheat Target Delta

format: xxxxx (°F or °C)

function(s): When Preheat mode is set to “Auto”, the preheat will automatically terminate when the heating hopper exit air temperature is within this number of degrees of the preheat temperature, assuming PHT has expired.

RTS - Run Temperature Setting

format: xxxxx (°F or °C)

function(s): Target heating hopper air inlet temperature during preheat (when Preheat Setpoint is set to “Same as Run Temp.”) and during all subsequent heating cycles.

AS1 - Anticipator Gain (Heater)

format: xxxxx (number)

function(s): Anticipator influence gain. This determines how much of an effect the anticipated future temperature has on heater power level adjustments. Higher values will result in a more conservative heat control loop.

CF1 - Cycle Frequency (Heater)

format: xxxxx (°F or °C)

function(s): Loop update time exception. If a rise in temperature above this value occurs within a given loop update period, a loop update will happen sooner.

RU1 - Rate of Correction Upward (Heater)

format: xxxxx (%)

function(s): Damping factor applied to periods of control that have an anticipated temperature below setpoint. Higher values will result in a more conservative temperature rise.

RD1 - Rate of Correction Downward (Heater)

format: xxxxx (%)

function(s): Damping factor applied to periods of control that have an anticipated temperature above setpoint. Higher values will result in a less conservative temperature drop.

CH1 - No Change High (Heater)

format: xxxxx (1/10th °F or °C)

function(s): Above-setpoint deadband. Expressed in tenths of a degree.

CL1 - No Change Low (Heater)

format: xxxxx (1/10th °F or °C)

function(s): Below-setpoint deadband. Expressed in tenths of a degree.

PR1 - Percent Reduction (Heater)

format: xxxxx (%)

function(s): Special-case heat reduction percent. If the actual temperature is more than OT1 above setpoint, the heater duty cycle will be reduced by this amount.

UT1 - Update Timer (Heater)

format: xxxxx (seconds)

function(s): Normal heat control loop update time.

OT1 - Over-Temp Alarm (Heater)

format: xxxyy (seconds / °F or °C)

function(s): xxx: Amount of time that the heating hopper inlet air temperature must be above setpoint before a Heating Hopper Over-Temperature alarm is triggered.

yy: Number of degrees that the heating hopper inlet air temperature must be above setpoint before a Heating Hopper Over-Temperature alarm is triggered.

NH1 - No Heat Alarm (Heater)

format: xxxxx (seconds)

function(s): Maximum amount of time after a heat cycle begins during which one of the following two conditions must be detected:

1. the temperature must climb 20 degrees
 2. the temperature must move at least 20 percent toward the target
- If neither condition is met, a "NO HEAT" alarm will be triggered.

MP1 - Maximum Percentage (Heater)

format: xxxxx (%)

function(s): Maximum allowable heater duty cycle. This can be used to effectively limit the effective size of the heater.

MAX - Maximum Temperature Setpoint

format: xxxxx (°F or °C)

function(s): Maximum allowable user-enterable preheat and run temperature setpoints. Used to limit how high an operator can set the drying temperatures.

ESL - Energy Saver Limit

format: xxxxx (°F or °C)

function(s): The heating hopper exhaust air temperature at which Energy Saver mode will kick in if set to "Limit" mode.

EST - Energy Saver Time

format: xxyyy (minutes / minutes)

function(s): xx: Beginning-of-cycle Energy Saver black-out time. Energy Saver is inhibited for this amount of time at the beginning of a heat cycle.

yyy: If this amount of time elapses after Energy Saver kicks in during a heat cycle, the blower and heater will power-up to bring the heating hopper back up to temperature.

ESP - Energy Saver Proportioning

format: xxyyy (minutes / %)

function(s): xx: Minimum beginning-of-cycle heater OFF time when Energy Saver is set to Dynamic mode

yyy: Beginning-of-cycle heater OFF time percentage when Energy Saver is set to Dynamic mode

RMP - Temperature Ramp Settings

format: xyyzz (increments / minutes / °F or °C)

function(s): x: Number of temperature steps during a temperature ramp.

yy: Duration of a temperature ramp.

zz: Temperature span of a temperature ramp.

CTM - Cooldown Temperature

format: xxxxx (°F or °C)

function(s): Heating hopper cooldown temperature target.

Note: Cooldown mode must be enabled for this parameter to have effect.

CTR - Cooldown Timer

format: xxxxx (minutes)

function(s): Heating hopper cooldown time.

Note: Cooldown mode must be enabled for this parameter to have effect.

H1W - Heater Wattage (Heater)

format: xxxxx (Watts)

function(s): Wattage of the primary heater. This value is used in energy consumption calculations.

HCT - Heater Cooldown Time (Heater)

format: xxxxx (seconds)

function(s): xx: The amount of time between the blower powering down and the heater powering down.

Load Cell

KDF -Load Cell Stable Weight

format: xxxxx (counts)

function(s): Maximum allowable load cell fluctuations during a weight reading during filling operations. A lower number will equate to a more accurate reading but could slow the system down.

LST -Load Cell Stable Time

format: xxxxx (milliseconds)

function(s): The amount of time that the load cell raw counts must remain within the window established by KDF before a weight reading is taken.

LCZ -Load Cell Zero

format: xxxxx (counts)

function(s): Maximum allowable load cell fluctuations during a weight reading during zero and full calibration.

WST -Weight Settle Time

format: xxxxyy (seconds / seconds)

function(s): xxx: The amount of time between the closing of the vacuum chamber fill valve and the recording of the vacuum chamber load cell reading. This is to allow for settling of the vacuum chamber load cell reading.

yy: The amount of time between the closing of the retention hopper fill valve and the recording of the retention hopper load cell reading. This is to allow for settling of the retention hopper load cell counts.

LZ1 -Load Cell Zero

format: xxxxx (counts)

function(s): Factory-set retention hopper zero load cell counts. This parameter ensures that all post-factory retention hopper load cell zero calibrations fall within +/- 20% of nominal, ensuring that a gross out-of-calibration condition does not develop.

LZ2 -Load Cell Zero

format: xxxxx (counts)

function(s): Factory-set vacuum chamber zero load cell counts. This parameter ensures that all post-factory vacuum chamber load cell zero calibrations fall within +/- 20% of nominal, ensuring that a gross out-of-calibration condition does not develop.

Vacuum

VTS -Vacuum Time Setting

format: xxyyy (minutes / minutes)

function(s): xx: Minimum user-enterable vacuum cycle time.

yyy: Vacuum cycle time.

VPL -Vacuum Pressure Low

format: xxxxx (mm Hg absolute)

function(s): Vacuum chamber pressure setpoint.

VPD -Vacuum Pressure Delta

format: xxyyy (seconds / mm Hg)

function(s): xx: Amount of time the vacuum generator will continue to run after VPL is reached.

yyy: Vacuum pressure deadband / hysteresis.

VSO -Vacuum Shutdown Offset

format: xxxxx (seconds)

function(s): Amount of time before the vacuum time (VTS) expires that vacuum pressure equalization begins. This is to compensate for equalization time.

LVT -Vacuum Shutdown Offset

format: xxxxx (seconds)

function(s): Amount of time the vacuum generator will run before a LOW VACUUM condition check is made. See LOW VACUUM alarm in Alarms section.

NVT - No Vacuum Timeout

format: xxyyy (counts / seconds)

function(s): xx: Number of vacuum gate recycle attempts that will be made in an attempt to clear a vacuum fault before a NO VACUUM alarm is triggered.

yyy: Amount of time the vacuum generator will run before a NO VACUUM condition check is made. See NO VACUUM alarm in Alarms section.

VPT - Vacuum Purge Timer

format: xxxxx (seconds)

function(s): Additional time the vacuum chamber purge/equalization valve will remain open after the vacuum chamber reaches equalization pressure. This is to ensure that the vacuum chamber is not left under a partial vacuum state at the end of a vacuum cycle.

VPI - Vessel Purge Interval

format: xxyyy (seconds / seconds)

function(s): xx: Percentage of evacuated atmosphere that will be replaced during a purge.

yyy: Interval between vacuum chamber purge cycles.

ATM - Atmospheric Pressure

format: xxxxx (mm Hg absolute)

function(s): The measured atmospheric pressure. This parameter is automatically updated once per cycle.

System**ELT - Event Logging Time**

format: xxxxx (seconds)

function(s): The amount of time between event log data line entries.

EUS - Energy Usage Settings

format: xxyyy (10ths of hours / seconds)

function(s): xx: Length of energy consumption averaging array.

yyy: Amount of time between instantaneous energy consumption readings. These readings populate the energy consumption averaging array.

System Configuration Overview

The System Configuration menu is accessible from the setup menu screen and includes system wide general settings such as: Data logging, preferences, diagnostics, rests, and communications. Below is a general overview of the options that are located within the system configuration menu.

System Preferences

Change Passwords - Sets the Setup Menu Password. Default password is 22222. Setting the password to 00000 disables password protection.

Date and Time - Set time, date, and date format.

Display Units: Fahrenheit (°F) or Celsius (°C), Pounds (lbs) or Kilograms (kgs), Pressure: Absolute or Differential, Pressure units: mmHg or inHg.

Language – Set current language.

Navigation Bar Options – Configure right-side soft keys.

Screen Options – Screen Saver options, Screen Brightness, Screen Calibration and On-Screen Options. On-Screen Options is information shown across the top of the home screen including: Date/Time, Model Number, MLAN ID, USB Connectivity, Ethernet Connectivity.

Diagnostics

System Information – System Information displays specific system related information about the controller and Dryer.

Load-Cell Diagnostics – Displays Vacuum Chamber and Retention Hopper loadcell diagnostics information.

Alarm and Event Log – Displays the Alarm and Event Log screen. See page 69 for more details

Hour Meters – Logs processing/running time of the machine. Maintenance Hour Meter is resettable.

Communications

Dryer I.D. Number – Sets the dryer ID number. Enter an identification number for this particular ULTRA dryer. This I.D. number will appear on all printed reports. If more than one unit is present, this helps to identify reports. If using the MLAN Protocol to automatically gather data, then each controller must have a unique address. Valid numbers are 000 to 255.

Modbus Server – Enable or disable Modbus TCP.

TCP/IP Configuration – Enable DHCP or set a static IP address, subnet mask and default gateway.

For more information on communications see page 64.

Resets

User Settings – Save/Restore Settings – Used for saving or restoring previously saved parameters. For more information on Saving and Restoring Settings, see page 65.

Factory Access – For factory access only.

Restore All – Restores Factory Defaults.

WARNING: Only do a ‘Restore All’ when directed by a Maguire Technician.

Restore Parameters – Resets parameters back to factory defaults.

Firmware Update - Update ULTRA-150/300 firmware. See page 87.

Data Logging

The Maguire ULTRA touchscreen controller gives the user a few options on how to log events from the machine and where to save such events. Once accessing the ‘System Configuration’ menu, the user can access the Data Logging Menu.

The user will be taken to the following screen (shown below), to toggle between ‘Internal Flash Only’ and ‘Internal Flash and USB’.

With the ‘**Internal Flash and USB**’ checked, events will print to a USB flash drive, if one is present. A file named, “ULT_DIAG.TXT” and “ULT_DIAG.CSV” will be saved in the /MAGUIRE directory.

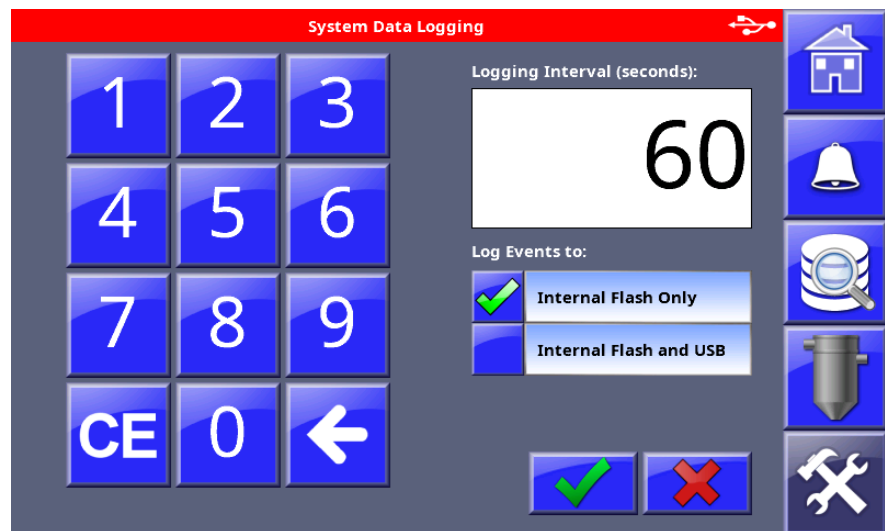

Access Control

The Access Control menu allows for password protection to be added to key features of the ULTRA drying process. Within each 'Access Level' if the features has a green checkmark, then it applies to that current access level. For example, if every feature is checked within the 'Everyone' category, then there is no password protection for any of the features. If password protection was desired for 'T1 Inlet Temperature' then it needs to be un-checked from the 'Everyone' level and enabled within either the 'Operator' or 'Admin' level.

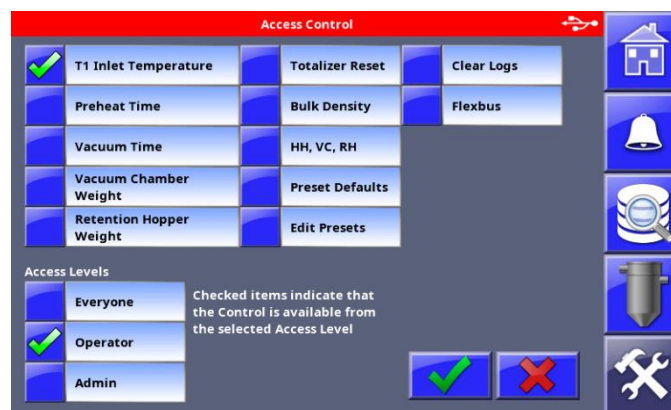
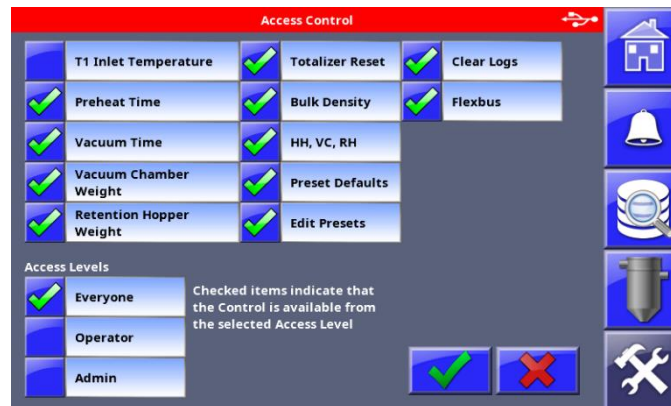

Display Options

Display Options – Show/Hide info and options on the controller screens.

- **Cycle Info - ON/OFF** – Displays Cycle info on main screen.
- **Dispense Time - ON/OFF** – Displays the fill time on main screen.
- **HH Residence - ON/OFF** – When ON, displays a countdown timer (RAL parameter) indicating when an alarm will sound alerting that material has sat in the retention hopper too long.
- **Show Throughput** – Displays throughput (lbs or kgs per hour)
- **Show T4 Temperature** - Displays actual temp., if equipped.
- **Energy Usage – ON/OFF** – Toggles the energy usage and is viewable in the Advanced Information menu on the home screen.
- **Mouse Over – ON/OFF** - Mouse icon on home screen chambers toggles on and off. This is purely for visual aesthetics.

Communications Setup





ULTRA-150/300 communications enabled software communication over Ethernet using the MLAN Protocol. For more information about the MLAN Protocol and the ULTRA-150/300 Dryer see the MLAN Protocol manual, available on the Maguire Products, Inc. website.







MLAN communications over Ethernet use port 9999 to communicate. Modbus communications, when enabled (see below), use port 502.

NOTE





Setting the MLAN ID Number

Press		Display will prompt for a password. (default: 22222)	Then press:	
Press		Display will show the System Configuration categories.		
Press	Communications	Display will show the System Communications categories.		
Press	MLAN I.D. Number	Display will show the MLAN I.D. Number screen.		
		On this screen, enter the new ID number using the keypad. Valid I.D. numbers are 1 through 254.		
Press		To save the Changes.		

Setting the IP Address, Subnet Mask, Gateway

Press		Display will prompt for a password. (default: 22222)	Then press:	
Press		Display will show the System Configuration categories.		
Press	Communications	Display will show the System Communications categories.		
Press	TCP/IP Configuration	Display will show the TCP/IP Configuration screen. On this screen, enter the IP Address, Subnet Mask and Default Gateway. Use the keypad to enter the number into the field highlighted in green. To advance to the next field, touch the field to edit and type the desired value.		
Press		To save the Changes.		

Enabling Modbus

Press		Display will prompt for a password. (default: 22222)	Then press:	
Press		Display will show the System Configuration categories.		
Press	Communications	Display will show the System Communications categories.		
Press	Modbus Server	Display will show the Modbus Server screen. On this screen, press the checkbox Enable to enable Modbus.		
Press		To save the Changes.		

Print Center Overview



Print Center is available from the Home Screen by pressing the Print Center button. Print Center displays a menu screen of print related options including Parameters, Events and Alarms, raw data log file and Alarm History. To print the Alarm Log, Parameters or Event Log a USB Flash Drive must be plugged into the ULTRA.

The Print Center can also be accessed from the 'Setup' Menu as shown below

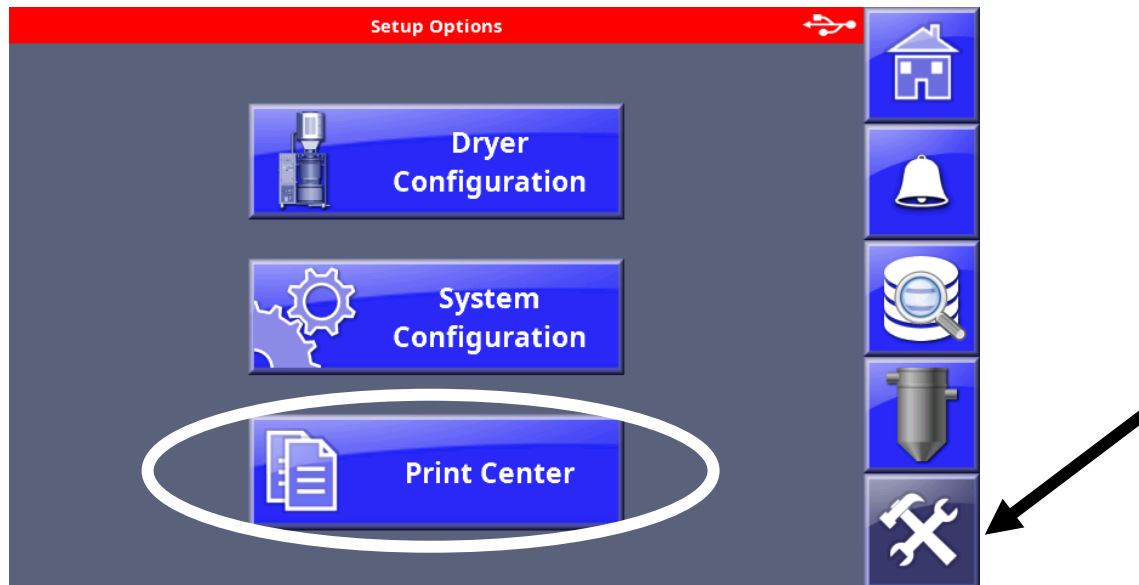

Files will be created on the flash drive in the root of the drive.

- ULT_ALARM.TXT - Alarm Log
- ULT_EVNT.CSV – Event Log (.CSV)
- ULT_EVNT.TXT – Event Log
- ULT_PARM.TXT – Parameter Log

Print Parameters	Prints the full parameter and values as well as other info to the USB flash drive.
Print Events	A combination of status lines at defined intervals as well as mechanical events.
Print Alarm History	Prints to USB any alarms recorded since the alarm log was last cleared.
Print Events to .CSV	Exports data to .CSV file.
Copy Log File	Copies raw log file to USB stick for analysis by a Maguire technician.
Print All	Prints all the above logs to USB.
Clear All Alarms and Events	Clears all alarms and events that are stored locally and erases the log.

Parameter Printout – Example

*An asterisk next to a value in the ‘setting’ column indicates that the parameter has been changed from its default value.

Parameter Report
 Printed 01/14/21 04:29PM

Model: ULTRA-150
 HMI Core: 4357 (Touchscreen)
 HMI Firmware: T1222A
 I/O Firmware: T1222A
 HMI Bootloader: 2.26
 I/O Bootloader: 1.03
 Serial#: 000000-00
 MAC Address: 00:1C:1A:00:86:CE

INDEX	NAME	ABBR	SETTING	DEFAULT	MIN	MAX	UNITS
Blower:							
B1	VFD Low Limit	BLF	00025	00025	00025	00060	Freq
B2	VFD High Limit	BHF	00060	00060	00050	00070	Freq
B3	VFD Drive	BDF	00060	00060	00000	99999	Freq
B4	VFD Zero Level	BZL	00045	00045	00000	00100	Percent
B5	VFD Level Adjustment	BLA	00025	00025	00025	00060	Freq
B6	VFD Heat Throttle	BHT	00100	00100	00000	99999	Percent
B10	Blower Max Wattage	BMW	00640	00640	00000	99999	Watts
B11	Airflow Delay Time	ADT	00000	00000	00000	99999	Second
B12	Blower Detect Time	BDT	00005	00005	00000	99999	Second
Dispensing:							
D1	Vacuum Chamber High Level	VCH	00030	00030	00000	00035	Weight
D2	Vacuum Chamber Low Level	VCL	00005	00005	00000	00010	Weight
D3	Retention Hopper High Level	RHH	00035	00035	00000	00045	Weight
D4	Retention Hopper Low Level	RHL	00005	00005	00000	00020	Weight
D5	Material Bulk Density	BLK	00035	00035	00000	00150	Wt/Vol
D6	Vacuum Chamber Fill Rate	VFR	02500	02500	00250	05000	Gram/Sec
D7	Vacuum Chamber Dump Rate	VDR	00000	00000	00000	02000	Gram/Sec
D8	Chamber Fill Time	VFT	00035	00035	00000	99999	Second
D9	Chamber Dump Time	VDT	00060	00060	00000	99999	Second
D10	Fill Lag Time	FLA	00250	00250	00000	00500	Time
D11	Dump Lag Time	DLA	00100	00100	00000	00500	Time
D12	Vacuum Gate Delay	VGD	00303	00303	00000	99999	Second
D13	Chamber Fill Adjust	VFA	04010	04010	00000	99999	Cnt/Wt
D14	Heat Hopper Dump Delay	HDD	00004	00004	00000	99999	Second
D15	Vacuum Dump Threshold	VCT	00050	00050	00000	99999	Gram/Sec
D16	Chamber Dump Retries	CDR	05003	05003	00000	10099	Pct/Ret
D17	Residence Alarm	RAL	05120	05120	00000	65999	Wt/Min
D18	Batch Size	BCH	00000	00000	00000	99999	Weight
D19	Loader Trip Point	LTP	15015	15015	00000	99250	Time/Wt
D20	Loader Throuput Cutoff	LTC	00005	00005	00000	99999	Wt/Min
D21	Heat Hopper Volume	HHV	00020	00020	00000	99999	Volume
D24	Loader 1 Timings	L1T	20012	20012	00000	99999	Term
D25	Loader 1 Alarm	L1A	00004	00004	00000	00999	Term
D26	Loader 2 Timings	L2T	20012	20012	00000	99999	Term
D27	Loader 2 Alarm	L2A	00004	00004	00000	00999	Term
D28	Loader 2 Delay Time	L2D	00030	00030	00000	99999	Second
D29	Progressively Metered Cycles	PMC	01060	01060	00000	99999	Cnt/Pct
D30	Rate Learning Threshold	RLT	00025	00025	00000	99999	Percent
Heater:							
H1-1	Preheat Temperature	PTS	00150	00150	00074	00437	Degree
H1-2	Preheat Time	PHT	00035	00035	00001	00999	Minute
H1-3	Preheat Differential	PHD	00020	00020	00001	00999	Degree
H1-4	Preheat Target Delta	PTD	00030	00030	00000	99999	Degree
H1-5	Run Temperature	RTS	00180*	00150	00074	00437	Degree
H1-6	Anticipator Gain (Heater)	AS1	00150	00150	00000	99999	Number
H1-7	Cycle Frequency (Heater)	CF1	00010	00010	00000	99999	Degree
H1-8	Rate of Correction Upward (Heater)	RU1	00008	00008	00000	99999	Percent
H1-9	Rate of Correction Downward (Heater)	RD1	00006	00006	00000	99999	Percent
H1-10	No Change High (Heater)	CH1	00005	00005	00000	99999	1/10Degree
H1-11	No Change Low (Heater)	CL1	00010	00010	00000	99999	1/10Degree
H1-12	Percent Reduction (Heater)	PR1	00005	00005	00000	99999	Percent
H1-13	Update Timer (Heater)	UT1	00010	00010	00000	99999	Second
H1-14	Over-Temp Alarm (Heater)	OT1	06006	06006	00000	99999	Sec/Deg
H1-15	No Heat Alarm (Heater)	NH1	00120	00120	00000	99999	Second
H1-16	Maximum Percentage (Heater)	MP1	00100	00100	00000	99999	Percent
H1-17	Max Temperature Set-Point	MAX	00356	00356	00074	00374	Degree
H1-18	Energy Saver Limit	ESL	00115	00115	00095	00115	Degree
H1-19	Energy Saver Time	EST	05030	05030	00000	99999	Min/Min
H1-20	Energy Saver Proportioning	ESP	02060	02060	00000	60999	Min/Pct
H1-21	Temperature Ramp Settings	RMP	52036	52036	00000	99999	Inc/Min/Deg

H1-22	Cooldown Temperature	CTM	00120	00120	00032	00300	Degree
H1-23	Cooldown Timer	CTR	00030	00030	00000	99999	Minutes
H1-24	Heater Wattage (Heater)	HLW	10000	10000	00000	99999	Watts
H1-25	Heater Cooldown Time (Heater)	HCT	00002	00002	00000	99999	Second

Load Cell:

L1	Load Cell Stable Weight	KDF	00500	00500	00000	99999	Number
L2	Load Cell Stable Time	LST	00100	00100	00000	99999	Millisec
L3	Load Cell Zero	LCZ	01000	01000	00000	99999	Number
L4	Weight Settle Time	WST	00805	00805	00002	99999	Second
L5	Load Cell 1 Zero Limit	LZ1	00000	00000	00000	99999	Number
L6	Load Cell 2 Zero Limit	LZ2	00000	00000	00000	99999	Number

Vacuum:

V1	Vacuum Time Setting	VTS	05025*	05020	00001	99999	Minute
V2	Vacuum Pressure Low	VPL	00080	00080	00000	99999	Number
V3	Vacuum Pressure Delta	VPD	05020	05020	00000	99999	Sec/mmHg
V4	Vacuum Shutdown Offset	VSO	00060	00060	00000	99999	Second
V5	Low Vacuum Timeout	LVT	00120	00120	00000	99999	Second
V6	No Vacuum Timeout	NVT	03045	03045	00000	99999	Cnt/Sec
V7	Chamber Purge Timer	VPT	00010	00010	00000	99999	Second
V8	Chamber Purge Interval	VPI	85300	85300	00000	99999	Sec/Sec
V9	Atmospheric Pressure	ATM	00760	00760	00000	00999	mmHg

System:

S1	Event Logging Time	ELT	00030*	00060	00001	99999	Second
S2	Energy Usage Setting	EUS	20030	20030	00001	99999	Minute

Alarm Flags:

Material Shortage Alarm	Warn
Material Ready	Off
Material Temp	Off
HH Level Alarm	Off
Residence	Off
Throughput Alarm	On
Dump Retry	On

Display Flags:

Auto Shutdown	Off
Batch Mode	Off
Cycle Info	On
Display	Throughput
Dispense Time	Off
I/O Status	Off
Residence Time	Off
Vacuum Time	Off
Pressure Reference	Absolute

Heat Settings:

Temperature Unit	Fahrenheit
Preheat Mode	Auto
Preheat Setpoint	Same As Run Temp.
Energy Saver	Lim
Ramp	Off

Misc. Settings:

Weight Unit	Pounds
Vacuum Pressure Unit	mm Hg
Auto-Fill Adjust	Off
HH Level Sensor	Off
Loader 1	Off
Loader 2	Off
Purge Chamber	On

Admin. Settings:

Blower	VFD
--------	-----

LOAD CELL CALIBRATION

NAME	ZERO	DELTA	CTS/GM	FULL	LAST CALIBRATED
RH LC: 3318976	1977000		14.7	297.0	01/01/70 12:00AM
VC LC: 3336931	1642710		12.2	296.0	01/01/70 12:00AM
Hour Meter			0.0		
Maintenance Hour Meter:			0.0		(last reset: 12/02/20 01:09PM)

Alarms and Events

Alarm and Event Log



Alarm and Event Log displays a history of alarms currently active alarms and other events with a date and time stamps and description. Press the upper or lower half of the event display windows to page up or page down. Alarms can be silenced from this screen. Other options in this screen include: Print to USB and Clear the Alarm Log. To print the Alarm and Events Log a USB Flash Drive must be plugged into the ULTRA dryer.

Files will be created on the flash drive in the root of the drive.

ULTRA_ALARM.LOG - Alarm Log

ULTRA_EVENT.LOG - Event Log

Interpreting the Event Log

The following is a description of the columns of information in a log.

Column	Description
1	date and time
2	mode of the dryer operation
3	heating hopper inlet air temperature setpoint
4	actual heating Hopper temperature
5	heater duty cycle (%)
6	heating hopper air outlet temperature
7	material exit temperature (optional RTD)
8	vacuum cycle elapsed time and set time
9	vacuum chamber pressure
10	vacuum chamber material weight
11	retention hopper material weight
12	dryer throughput
13	totalizer reading

Event Log - Example

ULTRA Event Log
Printed 02/15/21 07:49AM

Model: ULTRA-150
HMI Core: 4357 (Touchscreen)
HMI Firmware: U0204A
I/O Firmware: U0204A
HMI Bootloader: 2.26
I/O Bootloader: 1.03
Serial#: 000000-00

02/15/21 07:35:54AM : *** Dryer Started ***
02/15/21 07:35:54AM : *** Blower Started ***
02/15/21 07:35:56AM : *** Heating Hopper Heater Started ***
02/15/21 07:35:57AM : *** Heater Contactor: HIGH ***

02/15/21 07:36:07AM : MODE: PHT	T1s: 180F	T1a: 77.5F	T1(ATS): 84.0F	H1: 19.2	T2: 67.6F	VT: 00:00/20:00	ABS: 758mmHg	VC: 0	RH: 0	TPT: 0	TOT: 600
02/15/21 07:36:17AM : MODE: PHT	T1s: 180F	T1a: 108.5F	T1(ATS): 147.2F	H1: 19.2	T2: 67.6F	VT: 00:00/20:00	ABS: 758mmHg	VC: 0	RH: 0	TPT: 0	TOT: 600
02/15/21 07:36:28AM : MODE: PHT	T1s: 180F	T1a: 139.5F	T1(ATS): 180.1F	H1: 19.2	T2: 67.6F	VT: 00:00/20:00	ABS: 758mmHg	VC: 0	RH: 0	TPT: 0	TOT: 600
02/15/21 07:36:38AM : MODE: PHT	T1s: 180F	T1a: 151.7F	T1(ATS): 169.9F	H1: 19.2	T2: 67.6F	VT: 00:00/20:00	ABS: 758mmHg	VC: 0	RH: 0	TPT: 0	TOT: 600
02/15/21 07:36:48AM : MODE: PHT	T1s: 180F	T1a: 155.3F	T1(ATS): 162.9F	H1: 20.8	T2: 67.6F	VT: 00:00/20:00	ABS: 758mmHg	VC: 0	RH: 0	TPT: 0	TOT: 600
02/15/21 07:36:58AM : MODE: PHT	T1s: 180F	T1a: 161.6F	T1(ATS): 165.0F	H1: 22.1	T2: 67.6F	VT: 00:00/20:00	ABS: 758mmHg	VC: 0	RH: 0	TPT: 0	TOT: 600
02/15/21 07:37:08AM : MODE: PHT	T1s: 180F	T1a: 168.3F	T1(ATS): 173.3F	H1: 22.8	T2: 67.6F	VT: 00:00/20:00	ABS: 758mmHg	VC: 0	RH: 0	TPT: 0	TOT: 600
02/15/21 07:37:18AM : MODE: PHT	T1s: 180F	T1a: 172.8F	T1(ATS): 179.4F	H1: 22.8	T2: 67.6F	VT: 00:00/20:00	ABS: 758mmHg	VC: 0	RH: 0	TPT: 0	TOT: 600
02/15/21 07:37:29AM : MODE: PHT	T1s: 180F	T1a: 175.6F	T1(ATS): 180.0F	H1: 22.8	T2: 67.6F	VT: 00:00/20:00	ABS: 758mmHg	VC: 0	RH: 0	TPT: 0	TOT: 600
02/15/21 07:37:39AM : MODE: PHT	T1s: 180F	T1a: 177.4F	T1(ATS): 180.1F	H1: 22.8	T2: 67.6F	VT: 00:00/20:00	ABS: 758mmHg	VC: 0	RH: 0	TPT: 0	TOT: 600
02/15/21 07:37:49AM : MODE: PHT	T1s: 180F	T1a: 178.9F	T1(ATS): 180.0F	H1: 22.8	T2: 67.6F	VT: 00:00/20:00	ABS: 758mmHg	VC: 0	RH: 0	TPT: 0	TOT: 600
02/15/21 07:37:59AM : MODE: PHT	T1s: 180F	T1a: 180.1F	T1(ATS): 181.8F	H1: 22.6	T2: 67.6F	VT: 00:00/20:00	ABS: 758mmHg	VC: 0	RH: 0	TPT: 0	TOT: 600
02/15/21 07:38:09AM : MODE: PHT	T1s: 180F	T1a: 180.3F	T1(ATS): 181.8F	H1: 22.5	T2: 67.6F	VT: 00:00/20:00	ABS: 757mmHg	VC: 0	RH: 0	TPT: 0	TOT: 600
02/15/21 07:38:19AM : MODE: PHT	T1s: 180F	T1a: 180.3F	T1(ATS): 179.6F	H1: 22.5	T2: 67.6F	VT: 00:00/20:00	ABS: 758mmHg	VC: 0	RH: 0	TPT: 0	TOT: 600
02/15/21 07:38:30AM : MODE: PHT	T1s: 180F	T1a: 181.8F	T1(ATS): 181.9F	H1: 22.3	T2: 67.6F	VT: 00:00/20:00	ABS: 758mmHg	VC: 0	RH: 0	TPT: 0	TOT: 600
02/15/21 07:38:40AM : MODE: PHT	T1s: 180F	T1a: 181.6F	T1(ATS): 183.4F	H1: 22.1	T2: 67.6F	VT: 00:00/20:00	ABS: 758mmHg	VC: 0	RH: 0	TPT: 0	TOT: 600
02/15/21 07:38:50AM : MODE: PHT	T1s: 180F	T1a: 181.6F	T1(ATS): 180.7F	H1: 22.0	T2: 67.6F	VT: 00:00/20:00	ABS: 758mmHg	VC: 0	RH: 0	TPT: 0	TOT: 600
02/15/21 07:39:00AM : MODE: PHT	T1s: 180F	T1a: 181.9F	T1(ATS): 182.1F	H1: 21.8	T2: 67.6F	VT: 00:00/20:00	ABS: 758mmHg	VC: 0	RH: 0	TPT: 0	TOT: 600
02/15/21 07:39:10AM : MODE: PHT	T1s: 180F	T1a: 182.3F	T1(ATS): 182.7F	H1: 21.6	T2: 67.6F	VT: 00:00/20:00	ABS: 758mmHg	VC: 0	RH: 0	TPT: 0	TOT: 600
02/15/21 07:39:20AM : MODE: PHT	T1s: 180F	T1a: 181.9F	T1(ATS): 182.7F	H1: 21.4	T2: 67.6F	VT: 00:00/20:00	ABS: 758mmHg	VC: 0	RH: 0	TPT: 0	TOT: 600
02/15/21 07:39:30AM : MODE: PHT	T1s: 180F	T1a: 180.9F	T1(ATS): 180.9F	H1: 21.3	T2: 67.6F	VT: 00:00/20:00	ABS: 758mmHg	VC: 0	RH: 0	TPT: 0	TOT: 600
02/15/21 07:39:41AM : MODE: PHT	T1s: 180F	T1a: 180.7F	T1(ATS): 179.2F	H1: 21.4	T2: 67.6F	VT: 00:00/20:00	ABS: 758mmHg	VC: 0	RH: 0	TPT: 0	TOT: 600
02/15/21 07:39:51AM : MODE: PHT	T1s: 180F	T1a: 181.2F	T1(ATS): 181.2F	H1: 21.3	T2: 67.6F	VT: 00:00/20:00	ABS: 758mmHg	VC: 0	RH: 0	TPT: 0	TOT: 600
02/15/21 07:40:01AM : MODE: PHT	T1s: 180F	T1a: 181.0F	T1(ATS): 181.4F	H1: 21.1	T2: 67.6F	VT: 00:00/20:00	ABS: 758mmHg	VC: 0	RH: 0	TPT: 0	TOT: 600
02/15/21 07:40:11AM : MODE: PHT	T1s: 180F	T1a: 181.2F	T1(ATS): 181.0F	H1: 21.0	T2: 67.6F	VT: 00:00/20:00	ABS: 758mmHg	VC: 0	RH: 0	TPT: 0	TOT: 600
02/15/21 07:40:21AM : MODE: PHT	T1s: 180F	T1a: 181.2F	T1(ATS): 181.6F	H1: 20.9	T2: 67.6F	VT: 00:00/20:00	ABS: 758mmHg	VC: 0	RH: 0	TPT: 0	TOT: 600
02/15/21 07:40:31AM : MODE: PHT	T1s: 180F	T1a: 181.0F	T1(ATS): 181.0F	H1: 20.8	T2: 67.6F	VT: 00:00/20:00	ABS: 758mmHg	VC: 0	RH: 0	TPT: 0	TOT: 600
02/15/21 07:40:42AM : MODE: PHT	T1s: 180F	T1a: 181.0F	T1(ATS): 180.9F	H1: 20.8	T2: 67.6F	VT: 00:00/20:00	ABS: 758mmHg	VC: 0	RH: 0	TPT: 0	TOT: 600
02/15/21 07:40:52AM : MODE: PHT	T1s: 180F	T1a: 181.2F	T1(ATS): 181.4F	H1: 20.6	T2: 67.6F	VT: 00:00/20:00	ABS: 758mmHg	VC: 0	RH: 0	TPT: 0	TOT: 600
02/15/21 07:41:02AM : MODE: PHT	T1s: 180F	T1a: 181.4F	T1(ATS): 181.4F	H1: 20.5	T2: 67.6F	VT: 00:00/20:00	ABS: 758mmHg	VC: 0	RH: 0	TPT: 0	TOT: 600
02/15/21 07:41:12AM : MODE: PHT	T1s: 180F	T1a: 181.2F	T1(ATS): 181.2F	H1: 20.4	T2: 67.6F	VT: 00:00/20:00	ABS: 758mmHg	VC: 0	RH: 0	TPT: 0	TOT: 600
02/15/21 07:41:22AM : MODE: PHT	T1s: 180F	T1a: 181.4F	T1(ATS): 181.0F	H1: 20.3	T2: 67.6F	VT: 00:00/20:00	ABS: 758mmHg	VC: 0	RH: 0	TPT: 0	TOT: 600
02/15/21 07:41:32AM : MODE: PHT	T1s: 180F	T1a: 180.5F	T1(ATS): 181.9F	H1: 20.2	T2: 67.6F	VT: 00:00/20:00	ABS: 758mmHg	VC: 0	RH: 0	TPT: 0	TOT: 600
02/15/21 07:41:43AM : MODE: PHT	T1s: 180F	T1a: 179.6F	T1(ATS): 178.3F	H1: 20.4	T2: 67.6F	VT: 00:00/20:00	ABS: 758mmHg	VC: 0	RH: 0	TPT: 0	TOT: 600
02/15/21 07:41:53AM : MODE: PHT	T1s: 180F	T1a: 180.0F	T1(ATS): 180.3F	H1: 20.4	T2: 67.6F	VT: 00:00/20:00	ABS: 758mmHg	VC: 0	RH: 0	TPT: 0	TOT: 600
02/15/21 07:42:03AM : MODE: PHT	T1s: 180F	T1a: 180.3F	T1(ATS): 180.9F	H1: 20.3	T2: 67.6F	VT: 00:00/20:00	ABS: 758mmHg	VC: 0	RH: 0	TPT: 0	TOT: 600
02/15/21 07:42:13AM : MODE: PHT	T1s: 180F	T1a: 180.3F	T1(ATS): 180.5F	H1: 20.3	T2: 67.6F	VT: 00:00/20:00	ABS: 758mmHg	VC: 0	RH: 0	TPT: 0	TOT: 600
02/15/21 07:42:23AM : MODE: PHT	T1s: 180F	T1a: 180.5F	T1(ATS): 180.7F	H1: 20.2	T2: 67.6F	VT: 00:00/20:00	ABS: 758mmHg	VC: 0	RH: 0	TPT: 0	TOT: 600
02/15/21 07:42:33AM : MODE: PHT	T1s: 180F	T1a: 180.9F	T1(ATS): 181.4F	H1: 20.1	T2: 67.6F	VT: 00:00/20:00	ABS: 758mmHg	VC: 0	RH: 0	TPT: 0	TOT: 600
02/15/21 07:42:44AM : MODE: PHT	T1s: 180F	T1a: 180.1F	T1(ATS): 179.2F	H1: 20.1	T2: 67.6F	VT: 00:00/20:00	ABS: 758mmHg	VC: 0	RH: 0	TPT: 0	TOT: 600
02/15/21 07:42:54AM : MODE: PHT	T1s: 180F	T1a: 180.3F	T1(ATS): 180.5F	H1: 20.1	T2: 67.6F	VT: 00:00/20:00	ABS: 758mmHg	VC: 0	RH: 0	TPT: 0	TOT: 600
02/15/21 07:43:04AM : MODE: PHT	T1s: 180F	T1a: 180.7F	T1(ATS): 181.2F	H1: 20.0	T2: 67.6F	VT: 00:00/20:00	ABS: 758mmHg	VC: 0	RH: 0	TPT: 0	TOT: 600
02/15/21 07:43:14AM : MODE: PHT	T1s: 180F	T1a: 180.3F	T1(ATS): 180.1F	H1: 19.9	T2: 67.6F	VT: 00:00/20:00	ABS: 758mmHg	VC: 0	RH: 0	TPT: 0	TOT: 600
02/15/21 07:43:24AM : MODE: PHT	T1s: 180F	T1a: 178.9F	T1(ATS): 176.7F	H1: 20.2	T2: 67.6F	VT: 00:00/20:00	ABS: 758mmHg	VC: 0	RH: 0	TPT: 0	TOT: 600
02/15/21 07:43:34AM : MODE: PHT	T1s: 180F	T1a: 178.9F	T1(ATS): 178.2F	H1: 20.4	T2: 67.6F	VT: 00:00/20:00	ABS: 758mmHg	VC: 0	RH: 0	TPT: 0	TOT: 600
02/15/21 07:43:45AM : MODE: PHT	T1s: 180F	T1a: 180.3F	T1(ATS): 182.5F	H1: 20.2	T2: 67.6F	VT: 00:00/20:00	ABS: 758mmHg	VC: 0	RH: 0	TPT: 0	TOT: 600
02/15/21 07:43:55AM : MODE: PHT	T1s: 180F	T1a: 181.0F	T1(ATS): 181.9F	H1: 20.0	T2: 67.6F	VT: 00:00/20:00	ABS: 758mmHg	VC: 0	RH: 0	TPT: 0	TOT: 600
02/15/21 07:44:05AM : MODE: PHT	T1s: 180F	T1a: 180.3F	T1(ATS): 180.0F	H1: 20.0	T2: 67.6F	VT: 00:00/20:00	ABS: 758mmHg	VC: 0	RH: 0	TPT: 0	TOT: 600
02/15/21 07:44:15AM : MODE: PHT	T1s: 180F	T1a: 178.9F	T1(ATS): 177.3F	H1: 20.2	T2: 67.6F	VT: 00:00/20:00	ABS: 758mmHg	VC: 0	RH: 0	TPT: 0	TOT: 600
02/15/21 07:44:25AM : MODE: PHT	T1s: 180F	T1a: 179.4F	T1(ATS): 179.2F	H1: 20.2	T2: 67.6F	VT: 00:00/20:00	ABS: 758mmHg	VC: 0	RH: 0	TPT: 0	TOT: 600

02/15/21 07:44:31AM : *** Heating Hopper Heater Stopped ***
02/15/21 07:44:31AM : *** Blower Stopped ***

02/15/21 07:44:37AM : *** Heater Contactor: LOW ***
02/15/21 07:44:37AM : *** Upper Vacuum Gate: OPENED ***
02/15/21 07:44:40AM : *** Vacuum Chamber Fill Valve: OPENED ***
02/15/21 07:44:43AM : *** Vacuum Chamber Fill Valve: CLOSED ***
02/15/21 07:44:51AM : Fill Time: 3.517 | Fill Rate: 1294 g/s | VC: 9.9
02/15/21 07:44:51AM : *** Fill Retry ***
02/15/21 07:44:51AM : *** Vacuum Chamber Fill Valve: OPENED ***
02/15/21 07:44:58AM : *** Vacuum Chamber Fill Valve: CLOSED ***
02/15/21 07:45:06AM : *** Upper Vacuum Gate: CLOSED ***
02/15/21 07:45:06AM : *** Blower Started ***

02/15/21 07:45:09AM : *** Heating Hopper Heater Started ***
02/15/21 07:45:10AM : *** Heater Contactor: HIGH ***
02/15/21 07:45:11AM : Fill Time: 7.074 | Fill Rate: 1294 g/s | VC: 31.8
02/15/21 07:45:11AM : Final Fill Weight: 31.9 / 30.0

02/15/21 07:45:14AM : *** Vacuum Generator Supply Valve: OPENED ***
02/15/21 07:45:15AM : *** Vacuum Generator Check Valve: OPENED ***

02/15/21 07:45:19AM : MODE: HT/VAC | T1s: 180F | T1a: 138.0F | T1(ATS): 107.4F | H1: 8.6 | T2: 68.4F | VT: 00:00/20:00 | ABS: 426mmHg | VC: 33 | RH: 0 | TPT: 0 | TOT: 60
02/15/21 07:45:29AM : MODE: HT/VAC | T1s: 180F | T1a: 122.0F | T1(ATS): 98.1F | H1: 16.2 | T2: 68.2F | VT: 00:00/20:00 | ABS: 159mmHg | VC: 33 | RH: 0 | TPT: 0 | TOT: 60
02/15/21 07:45:39AM : MODE: HT/VAC | T1s: 180F | T1a: 133.3F | T1(ATS): 150.4F | H1: 18.9 | T2: 68.2F | VT: 00:07/20:00 | ABS: 93mmHg | VC: 33 | RH: 0 | TPT: 0 | TOT: 60

...

Alarms – Causes and Solutions



Typically, problems are indicated by an alarm condition on the Dryer controller's display with an audible alarm and a flashing strobe light. The following alarm troubleshooting chart will describe the alarm condition and possible causes and solutions.

Alarm Display:	Troubleshooting:
<p>ALARM:01</p> <p><u>Screen: Blower Failure</u></p> <p>Log: BLOWER FAILURE</p>	<p>Problem: The blower is not running. Motor contactor overload relay has tripped. See wiring diagrams in the back of this manual. Item # 3, overload relay on wiring diagram. This alarm will trigger a dryer shutdown.</p> <p>Solution: Reset contactor. Check that blower motor shaft is not locked. Check line voltage to machine; make sure voltage is not too low which can cause an increase in amperage. Check that power source has not lost a phase.</p>
<p>ALARM:02</p> <p><u>Screen: Heat Hopper No Heat</u></p> <p>Log: NO HEAT</p>	<p>Problem: No heat or inadequate heat detected by the Heating Hopper inlet RTD. This alarm is triggered by the NH1 parameter. NH1 parameter is the maximum time limit, in seconds, after the heat cycle begins, during which one of the following two conditions must be detected: Either the temperature must climb 20 degrees, or the temperature must move at least 20 percent toward the target temperature. If neither condition is met the "NO HEAT" alarm will sound. Such an occurrence would signal a failure of either the heater or the airflow from the blower. This parameter and consequent alarm protects the heater from burn out in the event the blower fails or airflow is blocked.</p> <p>Solution: Check for airflow from the blower. Check for a blower inlet obstruction, check that 2" air duct from blower to heater is not detached, obstructed or perforated. Check 2" air duct from top of heater to heating hopper inlet for detachment, obstruction or perforation. Check continuity across heater leads. See wiring diagram in the back of this manual. If the dryer's heater shorted, the result would be a trip of the breaker or fuse supplying power to the ULTRA-150 dryer.</p>
<p>ALARM:03</p> <p><u>Screen: Heater Setpoint Exceeded</u></p> <p>Log: SETPOINT EXCEEDED</p>	<p>Problem: The heating hopper air inlet temperature has drifted above set-point.</p> <p>If the Heating hopper air inlet temperature (T1a sensor) is over the degrees specified in parameter OT1 (default: 6°F or 6°C) for a time greater than the time in seconds specified in OT1, then the alarm is triggered. The alarm will occur but the machine will keep running. See OT1 parameter for more information.</p> <p>Solution: No solution is necessary under normal circumstances as the dryer is alerting to a temperature adjustment. If this alarm continued to repeat, contact Maguire Technical Support.</p>
<p>ALARM:04</p> <p><u>Screen: Heater Runaway</u></p> <p>Log: RUNAWAY</p>	<p>Problem: The heating hopper air inlet temperature has exceeded set-point by an excessive amount.</p> <p>If the Heating hopper air inlet temperature (T1a sensor) goes 20°F (11°C) over set-point, and alarm is triggered and a system shutdown occurs.</p> <p>Solution: Contact Maguire Technical Support</p>

<p>ALARM:08</p> <p><u>Screen: No Vacuum</u></p> <p>Log: NO VACUUM</p>	<p>Problem: The dryer failed to pull a vacuum after three attempts.</p> <p>The dryer was unable to achieve a vacuum 200mm below atmosphere within 45 seconds (default). Dryer attempted three times (number of default retries). After each attempt vacuum was equalized and vacuum gates were opened and closed in an attempt to reseal the Vacuum Chamber (possible debris or pellets preventing adequate seal). Defaults are controlled the NVT parameter (retries and seconds). This alarm is non-fatal. Dryer will continue to reseal after alarming.</p> <p>Solution: If Dryer continues to alarm, check: compressed air connection and pressure (dryer's regulator should be reading 85psi). Check for debris in seals above and below Vacuum Chamber.</p>
<p>ALARM:11</p> <p><u>Screen: RTD Failure</u></p> <p>Log: RTD FAILURE</p>	<p>Problem: RTD (temperature sensor) reading is above or below max/min reading</p> <p>RTD Sensor is probably disconnected or damaged. Check temperature display reading in a cool state. Temperature should display room temperature. If reading is below -25°C or above 450°C RTD sensor has failed.</p> <p>Solution: Contact Maguire Technical Support for a replacement RTD Sensor.</p>
<p>ALARM:12</p> <p><u>Screen: Material Shortage</u></p> <p>Log: MATERIAL SHORTAGE</p>	<p>Problem: Maximum Fill Time (VFT parameter) has been reached before target material weight (VTH parameter) has been achieved.</p> <p>This alarm is triggered when the VFT parameter has been reached (Vessel Fill Time) before the VCH (Vacuum Chamber High level), indicating shortage of material in heating hopper or possible valve jam. The outcome of this alarm is controlled by the Material Shortage Alarm settings. See page 40.</p> <p>Solution: Check material supply. Check Vacuum Chamber fill valve located at the base of the heating hopper.</p>
<p>ALARM:15</p> <p><u>Screen: Low Air Pressure</u></p> <p>Log: LOW AIR PRESSURE</p>	<p>Problem: Air pressure sensor has detected air pressure below 50 psi.</p> <p>Solution: Check exhausting lockout valve located on the front lower left side of ULTRA-150. Ensure that the valve is open. Check pressure of air supply.</p>
<p>ALARM:16</p> <p><u>Screen: Heat Hopper Fail-Safe</u></p> <p>Log: HEATER FAIL-SAFE</p>	<p>Problem: The temperature safety switch has opened due to an overheat condition.</p> <p>Located on the top of the Heater Tube is a Temperature Safety Switch. If the temperature of the heater exceeds the safety switch maximum, this switch opens, shutting down the entire dryer (FATAL Alarm).</p> <p>Solution: Allow the dryer to cool. Open the left side panel of the dryer and locate the Heater Tube Safety Switch on the upper side of the stainless steel heater tube. Press the red safety switch button to reset the Temperature Safety Switch. If problem occurs repeatedly, contact Maguire Technical Support.</p>

<p>ALARM:18</p> <p><u>Screen: Vacuum Chamber Missing</u></p> <p>Log: VC MISSING</p>	<p>Problem: The Vacuum Chamber is missing. If Vacuum Chamber load cell is reading 4.5 pounds (2000 grams) below tare during AUTO run, this alarm is triggered and Dryer stops (fatal). This alarm is generally caused by a missing Vacuum Chamber but may also be caused by the dryer Vacuum Chamber load cells having been zero calibrated while material was in the Vacuum Chamber.</p> <p>Solution: If Vacuum Chamber is missing replace Vacuum Chamber. If Vacuum Chamber is in place, ensure the chamber is empty and zero calibrate the load cells. If load cells are damaged, a zero calibration may detect this.</p>
<p>ALARM:19</p> <p><u>Screen: Retention Hopper Missing</u></p> <p>Log: RH MISSING</p>	<p>Problem: The Retention Hopper is missing. If Retention Hopper load cell is reading 6.6 pounds (3000 grams) for the ULTRA-150 or 11 pounds (5000 grams) below tare during AUTO run, this alarm is triggered and Dryer stops (fatal). This alarm is generally caused by a missing Retention Hopper but may also be caused by dryer Retention Hopper load cells having been zero calibrated while material was in the Retention Hopper.</p> <p>Solution: If Retention Hopper is missing replace Retention Hopper. If Retention Hopper is in place, ensure the hopper is empty and zero calibrate the load cells. If load cells are damaged, a zero calibration may detect this.</p>
<p>ALARM:20</p> <p><u>Screen: Throughput Exceeded</u></p> <p>Log: THRUPUT EXCEEDED</p>	<p>Problem: The throughput of the dryer has been exceeded. This is an optional alarm (under alarms menu), defaulted to enabled. This alarm is triggered when the Retention Hopper low level has been reached before the vacuum timer has elapsed. This means demand for material has exceeded dried material supplied. This alarm is non-fatal, dryer continues to run.</p> <p>Solution: This is cause by exceeding material demand.</p>
<p>ALARM:21</p> <p><u>Screen: Low Vacuum</u></p> <p>Log: LOW VACUUM</p>	<p>Problem: Dryer failed to pull vacuum down to target vacuum pressure set in VPL parameter. Dryer attempted to pull a vacuum down to target vacuum pressure within 120 seconds (default value in LVT parameter).</p> <p>Possible causes and Solution: If dryer alarms, check: compressed air connection and pressure (dryer's regulator should be reading 85psi). Check for debris in seals above and below Vacuum Chamber. Alarm may also have been caused by a vacuum leak. Contact Maguire technical support if cause is not found.</p>
<p>ALARM:23</p> <p><u>Screen: Residence Time</u></p> <p>Log: RESIDENCE TIME</p>	<p>Problem: Material has been in the retention hopper too long. This alarm is triggered by the RAL parameter. When the Residence Alarm has been enabled, this alarm will sound if not enough material has been removed from the retention hopper in the time specified in the RAL parameter. For more information, see the RAL parameter on page 52.</p> <p>Solution: To prevent this alarm: decrease fill weight, or turn on Fill Weight Adjust (Material Setup menu).</p>
<p>ALARM:24</p> <p><u>Screen: Batch Complete</u></p> <p>Log: BATCH COMPLETE</p>	<p>Batch is complete This alarm triggers at the end of a batch run, the end being defined as the time at which the retention hopper is depleted to the HHL parameter level after the final vacuum chamber dump of said batch run.</p>

<p>ALARM:25</p> <p><u>Screen: Material Shutdown</u></p> <p>Log: MATERIAL SHUTDOWN</p>	<p>Material Shutdown</p> <p>This alarm triggers if the Material Shortage alarm is set to "SHUTDOWN" and is it determined that the heating hopper has been fully depleted of material via the VFA parameter criteria. When this alarm triggers, the ULTRA enters a Shutdown state automatically. This alarm can be useful. For example: at the end of the day, one can intentionally run the heating hopper empty (by turning off its feed loader) and have the ULTRA automatically initiate a shut down at the appropriate time.</p>
<p>ALARM:26</p> <p><u>Screen: Material Ready</u></p> <p>Log: MATERIAL READY</p>	<p>Material Ready</p> <p>If the Material Ready alarm is enabled under the "Alarm Setup" menu, this alarm will trigger after the first and only first batch of material has completed a full vacuum cycle. After 15 seconds, the audible portion of this alarm will automatically silence. The first batch of material will remain under vacuum indefinitely until this alarm is cleared. There are two main purposes of this alarm:</p> <ol style="list-style-type: none"> 1. To alert the operator that dry material is ready for the process. 2. To act as a hold-back, when necessary, giving the operator additional time to prepare the process.
<p>ALARM:27</p> <p><u>Screen: Auto Shutdown</u></p> <p>Log: AUTO SHUTDOWN</p>	<p>Auto Shutdown</p> <p>This alarm triggers when an Auto Shutdown, that is, a shut down at a pre-determined time, has commenced. "Commencement" is defines as the time at which the final vacuum chamber fill has occurred.</p>
<p>ALARM:28</p> <p><u>Screen: Heat Hopper Material Low</u></p> <p>Log: HH MATERIAL LOW</p>	<p>Heating Hopper Material Low</p> <p>On ULTRA dryers with an optional Heating Hopper Level sensor, this alarm triggers when the "HH Mat. Level" alarm is enabled under the "Alarm Setup" menu and the level in the heating hopper has dropped below the HHA parameter value.</p>
<p>ALARM:29</p> <p><u>Screen: Material Temp</u></p> <p>Log: MATERIAL TEMP</p>	<p>Material Temperature Alarm</p> <p>When the Material Temp alarm is enabled under the "Alarm Setup" menu, during any instance where the Heating Hopper is called upon to dispense material into the vacuum chamber and the T2 (heating hopper exit) temperature is below the ESM parameter level, this alarm will trigger. Its purpose is to alert the operator that insufficient heating has occurred, most likely from a process throughput that exceeds the capacity of the ULTRA.</p>
<p>ALARM:30</p> <p><u>Screen: Vacuum Chamber Dump Failure</u></p> <p>Log: VC DUMP FAILURE</p>	<p>VC Dump Failure</p> <p>When the VC Dump alarm is enabled under the Alarm Setup menu, vacuum chamber dumping is monitored. When is has been determined that the vacuum chamber has failed to dump sufficient material into the retention hopper after a certain amount of retries as defined by the VDR parameter, this alarm will trigger. The vacuum chamber will continue dump attempts indefinitely, until the "successful dump" criteria is satisfied, at which point this alarm will auto-silence.</p>
<p>ALARM:31</p> <p><u>Screen: Preheat Complete</u></p> <p>Log: PREHEAT COMPLETE</p>	<p>Preheat Complete</p> <p>Optional advisory alarm, that when enabled, is triggered at the completion of the preheat cycle</p>

Maintenance



Prior to performing any maintenance procedures and/or cleanout procedures, the ULTRA dryer must be pneumatically and electrically locked out to prevent the risk of serious injury and/or damage to the machine.

Lockout/Tagout



Prior to performing any maintenance procedures and/or cleanout procedures, the ULTRA dryer must be pneumatically and electrically locked out to prevent the risk of serious injury and/or damage to the machine.

Pneumatic Lockout/Tagout

The lockout/tagout safety device is in the pneumatics bay beneath the electrical cabinet and is attached directly to the air regulator. Turning the red knob will properly cut off the supply air as well as completely dump the residual internal pressure to atmosphere.

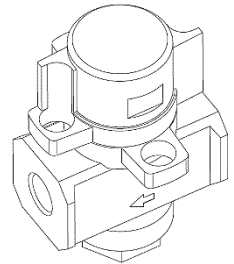

Electrical Lockout/Tagout

The electrical lockout device is located on the electrical cabinet. This switch will cut off all power to the machine and is designed to safeguard from electrocution in the event of unexpected energization of the machine during maintenance. When shifted into the 'OFF' position, power to the machine is cut off and the controller will not power on. Refer to the ladder diagram below.

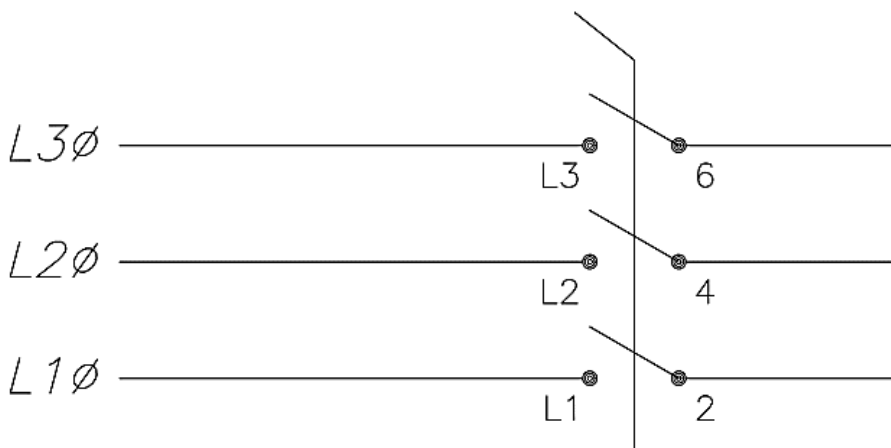
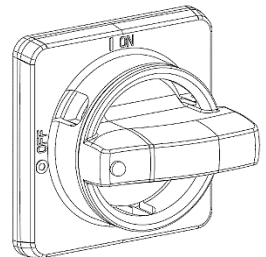

Preventative Maintenance

Weekly: It is advised that the following be performed once per week.

Particle Build-Up: Check for build-up of pellet/dust particulate. Depending on the material being processed, particles may accumulate on the upper vacuum gate or the vacuum chamber tank head. It is crucial to keep the upper vacuum gate O-ring free from any debris to ensure a proper vacuum.

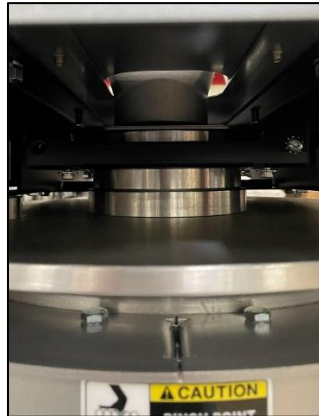

Moisture Traps: Depending on the quality of the supply air, moisture and/or oil may build up in the moisture traps of the air regulator. Press button to drain. If equipped with the optional membrane air dryer, there will be an additional moisture trap attached to the mist eliminator.

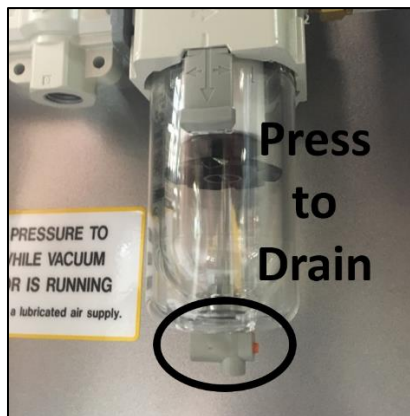

Do not supply Dryer with a lubricated air supply. Damage to Dryer may occur. Use only a clean, dry, oil-free air supply.

Preventative Maintenance – Cont.

Monthly: It is advised that the following be performed once per month.

Air Supply Filter(s):

Unscrew the drainage trap from the air regulator unit and remove and inspect the filter element. Replace if necessary. If equipped with an optional membrane air dryer, there is an additional filter that should be inspected.



Membrane Air Dryer:

This is an option for Maguire ULTRA dryers. If equipped, monitor the **Color Dew Point Indicator**. When outlet air is moist, the indicator will be YELLOW; when dry, it will be GREEN. If it is YELLOW, a replacement may be needed.



**Dryers received prior to 2019 will show moist as PINK and dry as BLUE*

Inlet Air Filter:

Located on the back side of the machine, the inlet air filter needs to be periodically inspected and cleaned. Remove the air filter housing and inspect the 5 micron filter. Replace if necessary. The purpose of this filter is to remove contaminants from the ambient air.

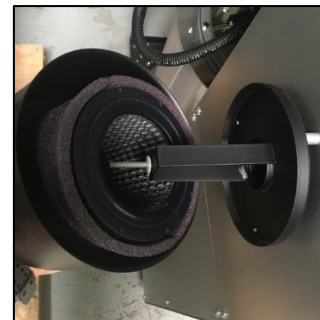

Preventative Maintenance – Cont.

Bi-Annually: It is advised that the following be performed every 6 months.

Manual Operations:

Using the touchscreen controller, check the machine functionality within the 'Operate Outputs' menu. Valves and other devices can be manually activated with this feature. This also serves as a built-in troubleshooting tool.

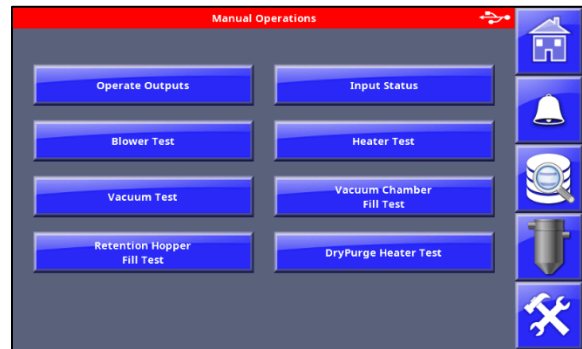

Lower Vacuum Gate:

Ensure that the flapper arm is not bent and that the seal can provide a proper seal for a vacuum. If the machine cannot efficiently pull a vacuum, it will alarm and not allow for the material to dry as intended.

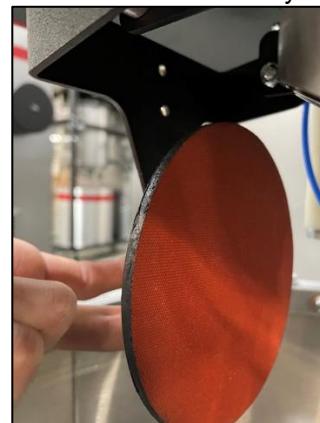

Seals/O-rings:

Check the integrity of all seals and O-rings and clear any debris that may prevent proper seal. Failure to do so could result in material leakage and low vacuum.



Clean Out – Procedure

'Clean Out' dumps the heating hopper or the vacuum chamber or both at the same time. The following explains how to perform these procedures.



HEATING HOPPER HOT SURFACES:

As with all dryers, there are **HOT SURFACES** to avoid. Temperatures can reach 350°F, (180°C). Typically, these surfaces are not at dangerous temperatures, however all hot surfaces should be avoided.



Do Not Perform a Clean Out Unless ULTRA-150 Dryer is First Properly Shut Down.

For proper shutdown procedure, see Startup and Operation on page 34.

During the Clean Out, keep hands and tools clear of all valves. DO NOT reach into machine during Clean Out.

Using the Optional Heating Hopper Dump Chute (Does not come standard)

For easy cleanout, material in the Heating Hopper can be evacuated using the Heating Hopper Dump Chute, if equipped. The Heating Hopper has a front side door for access to the full internal height of the Heating Hopper. The Heating Hopper is non-removable. Prior to opening the front access door, removal of all material is recommended. To evacuate material from the Heating Hopper using the optional Heating Hopper Dump Chute, use the following procedure.

Note: Use of the chute is optional. Material can be dumped into the vacuum chamber, then into the retention hopper and conveyed away from the VTA at the base of the dryer.

<p>Lower the Retention Hopper Sealing Collar located at the bottom of the Vacuum Chamber. The Sealing Collar is attached to the base of the Vacuum Chamber with magnets. Detach the Sealing Collar by pulling down.</p>	
<p>Lower the Vacuum Chamber by switching down the Vacuum Chamber Lift Switch.</p>	
<p>Lift the Slider Lock located to the left of the Vacuum Chamber. While holding the Slider Lock up, pull the Vacuum Chamber slider out. Release the Slider Lock, which will rest on top of the opened slider.</p>	

Slide out the Vacuum Chamber.



Install the Heating Hopper Dump Chute onto the Vacuum Chamber lift cylinders. Orient the Heating Hopper Dump Chute so that material will exit out the back of the dryer. Dump Chute to direct material to a holding vessel.

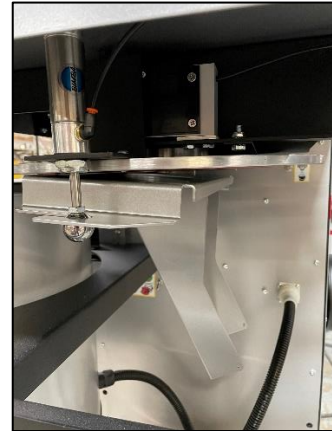
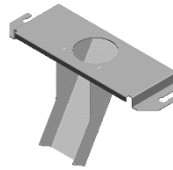

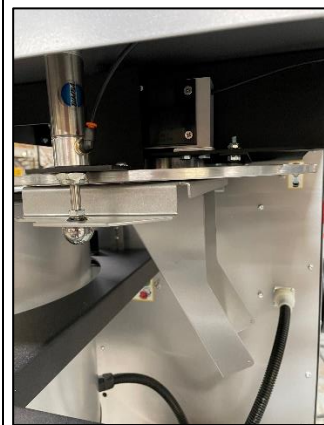
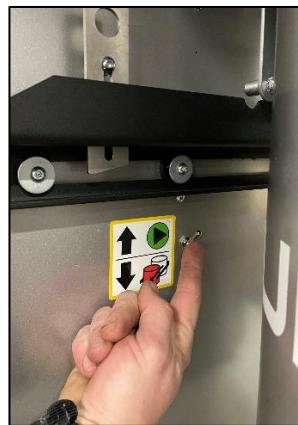

Pinch Hazard - Keep fingers clear of Heating Hopper Dump Chute when the Vacuum Chamber Lift Switch is flipped up.

Raise the heating hopper dump chute by switching up the vacuum chamber lift switch.



Emptying the Heating Hopper

Press	Clean Out	The Clean Out button is located on the Home Screen. Display will show dumping options. Both the Dump Heating Hopper screen button and the Heating Hopper Drain Valve button (located near the upper rear of the Vacuum Chamber area) can be used to empty the Heating Hopper.
Press	Dump Heating Hopper	Confirmation window will appear.
Press		to Dump Heating Hopper and start the Clean Out.
To use the Heating Hopper Drain Valve button continue to next step.		
Press		The Heating Hopper Drain Valve button. While in the Clean Out screen, press the Heating Hopper Drain Valve button once to open the valve. Press the button again to close the valve.

Emptying the Vacuum Chamber



While the Vacuum Chamber is extended out, the Vacuum Chamber dump valve can be opened to dispense the material into a container using the following procedure.

IMPORTANT: During the Clean Out, keep hands and tools clear of all valves. DO NOT reach into machine during Clean Out.

Press	Clean Out	The Clean Out button is located on the Home Screen. Display will show dumping options. Both the Dump Heating Hopper screen button and the Heating Hopper Drain Valve button (located near the upper rear of the Vacuum Chamber area) can be used to empty the Heating Hopper.
Press	Dump Vacuum Chamber	status window will appear.
Press		to return to the Home Screen.

Clean Out / Dump All – Dump All opens all valves allowing material to flow freely through the dryer. Material in the Heating Hopper will pass into the Vacuum Chamber and then pass into the Retention Hopper. In this mode, it is possible to empty the entire dryer using a conveying system pulling from the material outlet at the base of the dryer.

IMPORTANT: During the Clean Out, keep hands and tools clear of all valves. DO NOT reach into machine during Clean Out.

Press	Clean Out	The Clean Out button is located on the Home Screen. Display will show: Batch Start Clean Out Mode screen. Both the Dump Heating Hopper screen button and the Heating Hopper Drain Valve button (located near the upper rear of the Vacuum Chamber area) can be used to empty the Heating Hopper.
Press	Dump All	Confirmation window will appear.
Press		to start the Clean Out.
Press		to return to the Home Screen.

Valve Clean Pause

This feature is utilized to clean the upper and/or lower vacuum gates on the fly by keeping them open for any desired time, while pausing operation. By default, this feature is NOT enabled and must be done so in the system configuration screen.

Setup Menu > [PASSWORD] > Dryer Configuration > Special Features > Valve Clean Pause

Enable “Valve Clean Pause” by checking the option as shown below:



In order to clean the vacuum gate valves on the fly, press the **vacuum chamber** on the Home screen. The Valve Clean Pause button is now displayed and can be used. Once pressed, the button will turn red once a Pause is queued up.



After the next vacuum chamber dump/fill cycle, both the upper and lower vacuum gates will stay open. Yellow “Pause” icons will now appear on the Home screen. To resume operation, press the vacuum chamber on the home screen and deselect (press) the Valve Clean Pause button.

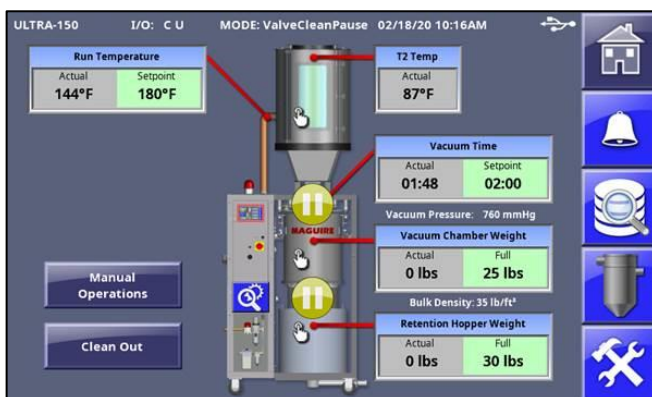

Load Cell Calibration

Load Cell Gapping

Prior to calibrating, check that the load cell gaps are properly set to 0.024" (0.61mm). The load cells are quality inspected, and the gap is set in-house; however, unforeseeable adjustments could occur during shipping. If the gap happens to be incorrect, set the load cell over-travel limit gap between the overtravel bolt and the load cell adjustment screw. It should be set such that the 0.024" feeler gauge passes through while having minimal friction between the two heads of the screws.



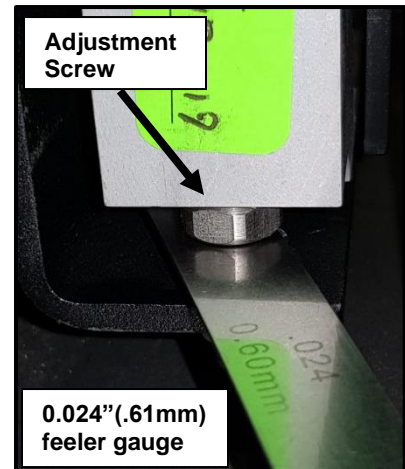



Load cells should be unloaded prior to gap-checking; meaning the vacuum chamber will be in the 'down' position and resting on the rails, rather than the load cells



Zero Weight Calibration

- BE SURE The air lines are connected, and the air supply is ON
- BE SURE The vacuum chamber and retention hopper are EMPTY.
- BE SURE The vacuum chamber is in the UP position and is hanging/resting freely on the load cells.
- BE SURE The clear sealing skirt is attached to the bottom of vacuum chamber.

LOAD CELL ZERO CALIBRATION - The sequence is as follows:

Press		Display will prompt for a password. (default: 22222)	Then press:	
Press	Dryer Configuration		Display will show menu options	
Press	Load-Cell Setup		Display will show Load-Cell Calibration Screen	
Press	Vacuum Chamber Zero/Full Calibration		Display will show the ZERO / FULL Calibration screen.	
Press	ZERO		Display will say: Confirm Vacuum Chamber is empty then press ZERO. Weight of 0.0 follows successful calibration.	
Press			To return to the Load-Cell Setup screen.	
Press	Retention Hopper Zero/Full Calibration		Display will show the ZERO / FULL Calibration screen.	
Press	ZERO		Display will say: Confirm Retention Hopper is empty then press ZERO. Weight of 0.0 follows successful calibration.	
Press			To return to the Load-Cell Setup screen.	
Press			To return to the Main Screen.	

The ZERO point of the load cells is now set properly. FULL weight calibration may also be done at this time; however, it is not necessary. When load cell readings shift due to rough handling, the entire range of readings from ZERO to FULL shift together. The ZERO weight calibration routine resets the full range of the cells and, therefore, corrects FULL weight readings as well.

Full Weight Calibration





For a full weight calibration to be performed, a zero weight calibration must be completed, whether it be for the vacuum chamber or retention hopper.

Once zero weight calibration is complete, a calibration weight or material of known weight can be placed into the corresponding chamber. The weight should be close to 35.0 pounds (16.0 kg.) for the ULTRA-150 or 70.0 pounds (32.0 kg.) for the ULTRA-300. Input the exact known weight (in kilograms or pounds).

After full weight calibration, if the display reads “BAD CELL,” the weight being used either does not match the weight that was entered, the chamber is not free to move, OR the load cells are faulty.

It is also recommended that a “Return to Zero” test be performed where the weight or material is removed from the chamber being calibrated and it is observed returning to zero.

If material totals are being observed, full weigh calibration is recommended periodically (approximately every six months).

Press		Display will prompt for a password. (default: 22222)	Then press:	
Press	Dryer Configuration	Display will show the Dryer Configuration categories.		
Press	Load-Cell Setup	Display will show the Load-Cell Setup screen.		
Press	Vacuum Chamber Zero/Full Calibration		Display will show the ZERO / FULL Calibration screen.	
Press	ZERO	Display will say: Confirm Vacuum Chamber is empty then press ZERO. Gram weight of 0 follows successful calibration.		
Press	FULL	Display will show a keypad and the message: Enter the known weight and then press ENTER. Enter the known weight in GRAMS and then press ENTER.		
Place the known weight in the Vacuum Chamber and then properly re-install the Vacuum Chamber into the Dryer. Press CONTINUE to proceed.				
Wait while calibrating load cells. Do not touch vacuum chamber during calibration. After Full calibration has proceeded successfully, a prompt will emerge.				
Press		To exit Zero / Full Weight Calibration screen. Repeat procedure for Retention Hopper.		

Temperature and Pressure Verification

Should it be deemed necessary to verify the ULTRA’s T1a RTD (heating hopper air inlet temperature measurement) and/or pressure sensor (vacuum level reading), this page outlines how to accomplish this. We would first like to state that “perfect” accuracy of both devices is not necessary for the machine to run properly. The manufacturer’s advertised accuracy of the RTD sensor used in the ULTRA is to within 1/10th of a degree Celsius and, by the nature of the design, will either work or not work. The RTD should never vary in its accuracy nor can it be calibrated. With that being said, if the temperature were to vary +/- 3 degrees Celsius, most materials will complete the drying process within acceptable tolerance levels. This is not to say that the RTD will vary in the temperature reading, rather most materials dry fine within this tolerance. The pressure sensor, used for vacuum level readings, is accurate to within ±2 mm Hg. The pressure sensor cannot be calibrated.

T1a RTD Sensor Verification:

The T1a RTD sensor is located about 1/3rd the way up the heating hopper on the hot air inlet tube. Insert a handheld reference thermocouple or RTD through the red silicone hose (make a *very* small slit with a razor blade to allow for this) as close to the ULTRA’s T1A RTD as possible.

Observe the temperature on the top red ULTRA display screen and compare this to a handheld reference temperature sensor.

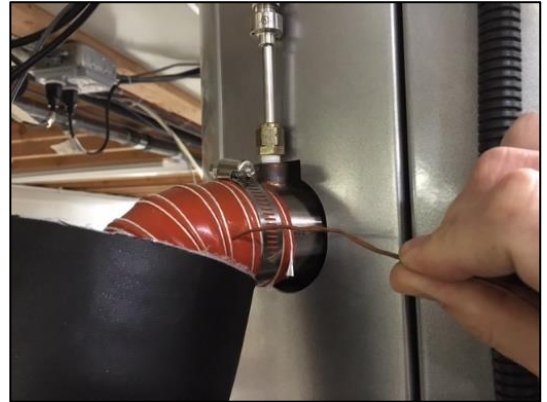

Pressure Sensor Verification:

The absolute pressure sensor (vacuum level reading) is in the ULTRA electronics cabinet. Sensor accuracy can be verified using two methods. Method one: set the ULTRA to display in millimeters of mercury (default) and compare the reading on the display to a hand-held barometer device located next to the machine. Method two: tap into the 1/4” diameter green pressure sensor air line (see arrow in picture at right) with a barometer device. Measure the barometric pressure within the line. Compare that measurement to what is displayed on the ULTRA display.

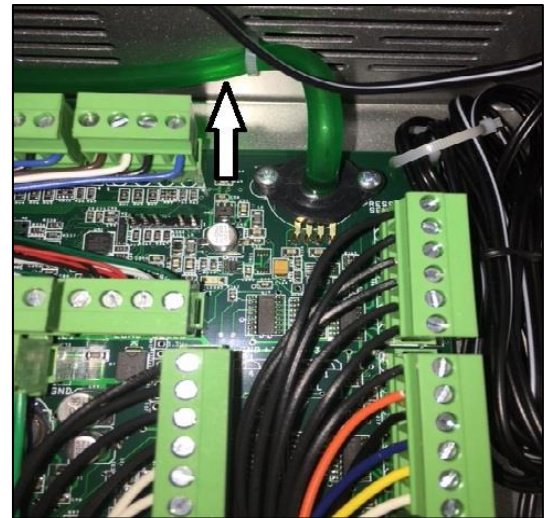





Updating the Firmware

When the ULTRA dryer control panel is turned on, the first screen displayed will show the current firmware version. If necessary, the firmware in the ULTRA can be updated using a firmware update supplied by Maguire Products. Firmware updates use the USB port located below the control screen. The following instructions detail how to do a firmware update.



Do not turn off controller or remove the flash drive while firmware is updating! Doing so may corrupt the controller's firmware.

Copy	the new firmware update into a USB flash drive. (do not put in a directory)	
Insert	the USB Flash drive into the USB port on the ULTRA.	
Press	 Display will prompt for a password. (default: 22222)	Then press: 
Press	System Configuration	Display will show the System Configuration categories.
Press	Resets	Display will show System reset options.
Press	Firmware Update	The controller will search the USB drive for a firmware update file with the XUF extension.
Select	the file from the white display area on the left. If more than one firmware version is stored on the flash drive, multiple version will be displayed in the white display area. If the display is blank check USB for the file and that the file is location directly on the drive (not in a sub-folder). Exit out of this screen and enter again to refresh the display window.	
Highlight	the version in the white panel on the left and press PROGRAM .	
Press		To proceed with the firmware update or press the red X to cancel and exit. 
<p>The display will show progress in transferring to the internal SD card, then it will show progress in verifying the update file. Then the controller will prompt: <i>Please toggle power.</i> At this time, remove the flash drive, power off the controller then on. When the controller restarts the display will show progress updating to the new firmware. When complete, the display will show: UPDATES COMPLETE Toggle power. At this time, turn off power, then turn back on.</p>		

Additional Firmware Update Information

Software updates can be supplied electronically, via email or by download. Software updates are named according to their date of release. For instance, **VTU0204A.XUF** can be interpreted as VT=Vacuum Touchscreen, U=2021 (T=2020), 06=February, 04= 4th day, A=the first revision for that day. During the update process detailed above, new software found on the USB flash drive is first copied to an internally mounted SD card. From the SD card, the software is then loaded into the ULTRA. If there is ever a problem with the ULTRA and the USB port cannot be used or the ULTRA software is corrupted and cannot load new software through the menu, new software can be acquired from Maguire and renamed **VTUPDATE.XUF**. This renamed software can be copied onto the Root Flash Drive and inserted into the USB port of the ULTRA. When the ULTRA is turned on, this **VTUPDATE.XUF** file will be automatically loaded into the ULTRA, restoring the software.







FlexBus Lite Integrated Loading System

The Flexbus Lite Loading System is integrated into the Maguire ULTRA Touchscreen Controller, enabling local control of a single pump and up to 9 receivers. This section, outlines and explains the Flexbus Lite Loading System.

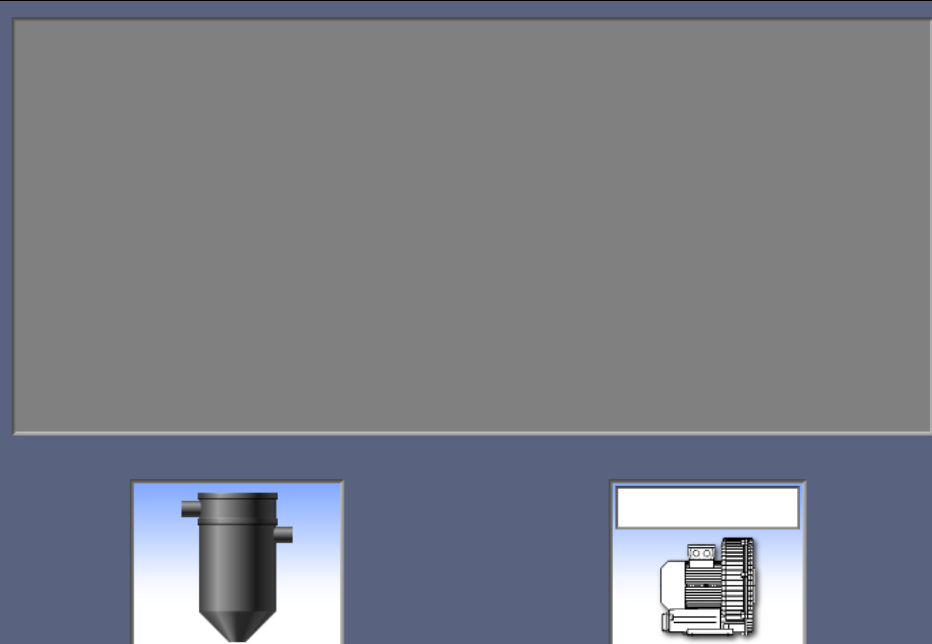
Table of Contents

Flexbus Lite Overview _____	88
Flexbus Home Screen _____	89
Flexbus Setup and Configuration _____	89
Flexbus Pump Assignment _____	92
Receiver Assignment _____	94
Receiver Configuration _____	95
Pump Configuration _____	97
Removing Receivers or Pumps _____	99
Flexbus System Setup Options _____	100
Receiver: Configuration Save, Restore, Defaults _____	100
Flexbus Main Screen Details _____	101
Flexbus Wiring Diagram _____	103
Flexbus Lite Component Map _____	105

Flexbus Lite Home Screen Overview

Live View Panel (gray area) - Displays the live view of Receivers		Navigation Menu	
			Home Screen
			Display Pump
			Event Log and Alarm History
			Switch to ULTRA Home Screen
			Setup (password protected)
<p style="text-align: center;">Receivers Navigation / Setup of all Receivers</p>		<p style="text-align: center;">Pump Setup of Pump</p>	







Flexbus Lite Setup and Configuration

Flexbus Lite uses a MAC address to individually identify each Flexbus pump and receiver. Identification and numeric assignment of each Flexbus pump and receiver is setup within the Flexbus Lite through the order that the receiver is turned on and discovered during the Pump Assignment routine and the Receiver Assignment routine setup processes.

Once the initial setup has been completed, Flexbus Lite will retain the setup and identification of the pump and each receiver indefinitely. After the initial identification order and numeric assignment has been saved, the operator can later make adjustments to the receiver numeric assignment order and assign a 4-character alphanumeric identification name to each receiver.

Enabling Flexbus Lite in the ULTRA Touchscreen Controller



Flexbus Lite is an option that can be enabled within the ULTRA Touchscreen controller allowing local control of a single pump and up to 9 receivers. Additional components are required for dryer loading including receivers equipped with Flexbus, a T-drop, a position hub, pump module, and necessary cabling. Please see the Flexbus Lite component map on page 105 for setup details.

Press		Display will prompt for a password. (default: 22222)	Then press:	
Press	Dryer Configuration	Display will show the Dryer Configuration categories.		
Press	Convey Setup	Display will show Convey categories.		
Press	Flexbus	Flexbus is now enabled and will display on navigation bar		
Press		To save and exit or press the red X to cancel and exit.		
Press		To access Flexbus Lite.		
Press		To toggle the display back to the ULTRA Dryer controller screen. When the ULTRA controller is displaying the ULTRA dryer icon, Flexbus continues to operate. Press the Flexbus button at any time to return to Flexbus.		

Flexbus Lite System Setup Screen

Pump assignment is set through the SETUP screen. The setup screen is accessed by pressing the Setup button on the right side of the screen.



<p>On the HOME screen, PRESS:</p>		<p>Pressing the SETUP button prompts for a password.</p>
<p>PRESS:</p>	<p>22222</p>	<p>Enter the password (default password is 22222) Press  to confirm password.</p>
<p>This enters the Setup screen. This screen contains several setup specific options.</p>		

Pump and Receivers Setup Buttons

Pressing PUMP or RECEIVERS enters Setup for those devices

Navigation Menu

Pump: 0 **Receivers: 0**

Flexbus Lite System Setup Options







- Returns to Home screen
- Display Pump
- Event Log and Alarm History
- Switch to ULTRA Home Screen
- Setup (password protected)



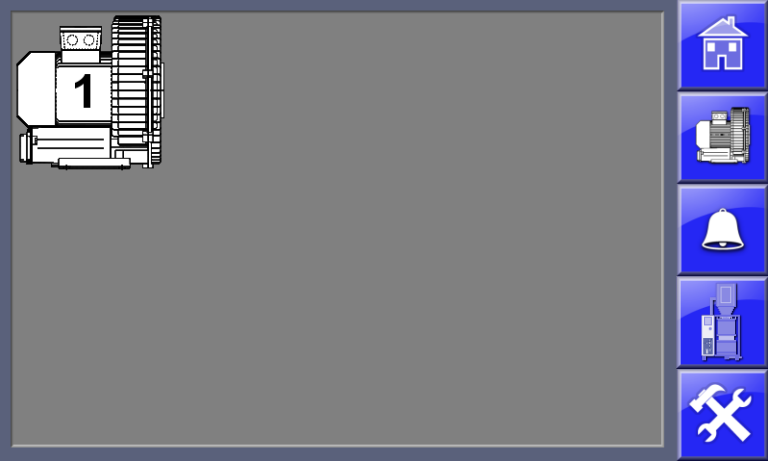

Note: Pump must be assigned before Receivers.

Note: Flexbus Lite uses a single pump and up to 9 receivers.

Pump Assignment - Pumps must be assigned before Receivers.

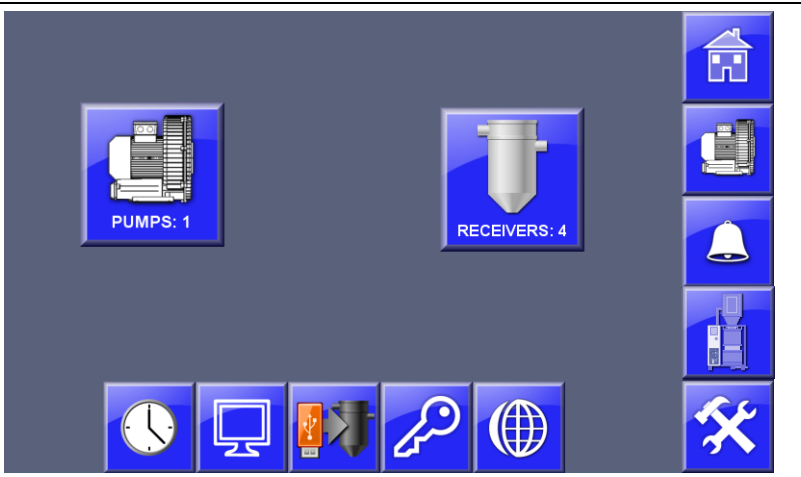







Flexbus Lite controls a single pump. The Flexbus System can control of to 5 pumps. If there are two or more pumps (Flexbus only), turn OFF all pumps prior to running Setup in the Flexbus controller, otherwise: To assign Pumps, follow these instructions:

<p>On the HOME screen, PRESS:</p>		<p>Pressing the SETUP button prompts for a password.</p>
<p>PRESS:</p>	<p>22222</p>	<p>Enter the password (default password is 22222) Press  to confirm password.</p>
<p>This enters the Setup screen. This screen contains several setup specific options.</p>		
<p>To setup Pumps: PRESS:</p>		<p>Press the large Pumps button on the far left of the screen.</p>
<p>This enters the PUMP assignment screen. This gray screen contains any previously assigned pumps. For first time setup, this screen is probably blank and no pumps have been assigned. At this time, turn on the intended Flexbus Lite Pump to assign.</p>		
<p>With a single pump, that pump will appear on the screen and be labeled with the number 1.</p>		
<p>PRESS:</p>		<p>To return to the Setup screen. When you return to the Setup screen, the Pump button will show the Setup symbol  on the Pump button indicating that you are still in the Pump Assignment mode.</p>
<p>PRESS:</p>		<p>To Exit the Pump Assignment Mode. Setup icon  overlaying the button will disappear indicating you are out of Pump assignment mode.</p>



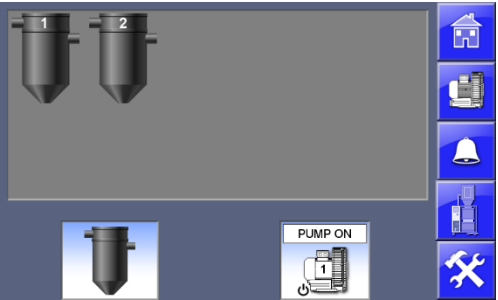













<p>While in the Setup screen you can go straight to setting up Receivers without re-entering the password.</p>		
<p>PRESS:</p>		<p>To enter the Receivers assignment screen.</p> <p>See  Next Page for Receivers Assignment instructions.</p> <p>Otherwise, to exit SETUP...</p>
<p>PRESS:</p>		<p>To exit the Setup screen.</p>

Receiver Assignment

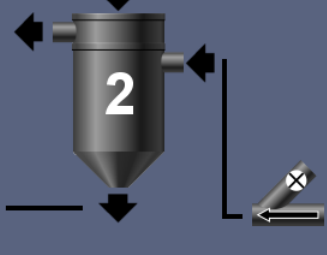
NOTE: If you are already entered into SETUP, skip the password step and go to the  below.

<p>On the HOME screen PRESS:</p>		<p>Pressing the SETUP button prompts for a password.</p>
<p>PRESS:</p>	<p>22222</p>	<p>Enter the password (default password is 22222) Press  to confirm password.</p>
<p> This enters the Setup screen. This screen contains several setup specific options.</p>		
<p>PRESS:</p>		<p>Press the large Receivers button to enter the Receiver assignment screen.</p>
<p>The gray screen contains any previously assigned Receivers. For first time setup, this screen is probably blank and no Receivers have been assigned. Turn on your Flexbus Receivers in the order that you want then to be assigned.</p>		
<p>Your receivers will appear on the screen and be numbered in the order that they were turned on.</p> <p>If necessary, pressing each receiver icon will allow you to re-assign the ID number to a different unassigned number.</p> <p>Pump  symbol in the pump panel to toggle the Pump online or offline.</p>		
<p>PRESS:</p>		<p>To return to the Setup screen. When you return to the Setup screen, the Receivers button will show the Setup symbol on the pumps button indicating that you are still in the Receiver Assignment mode.</p>
<p>PRESS:</p>		<p>To Exit the Receiver Assignment Mode. Setup icon  will disappear indicating you are out of Receiver assignment mode.</p>
<p>PRESS:</p>		<p>To exit the Setup screen.</p>

Receiver Configuration

<p>The Receiver configuration screen is accessible from the Home screen. Pressing a receiver on the Home Screen, takes you to the Receiver's Configuration screen. The receiver that you are configuring is identified by the Receiver's ID number on the receiver images on this screen. You can select another Receiver by using the Receiver navigation arrows at the bottom center of this screen.</p>	RECEIVER SETUP	    
<div style="border: 1px solid black; padding: 5px; margin-bottom: 5px;"> LOAD TIME 15  </div> <div style="border: 1px solid black; padding: 5px; margin-bottom: 5px;"> LOAD RETRY 2  </div> <div style="border: 1px solid black; padding: 5px; margin-bottom: 5px;"> DUMP TIME 5  </div> <div style="border: 1px solid black; padding: 5px;"> PUMP 1  </div>	<div style="border: 1px solid black; padding: 5px; margin-bottom: 5px;"> BLOWBACK  35 </div>  <div style="border: 1px solid black; padding: 5px; margin-top: 5px;"> LOADER ON    </div>	<div style="border: 1px solid black; padding: 5px; margin-bottom: 5px;"> PULSE TIME  0.0 </div> <div style="border: 1px solid black; padding: 5px; margin-bottom: 5px;"> PURGE TIME  5 </div> <div style="border: 1px solid black; padding: 5px;"> PRIORITY  5 </div>







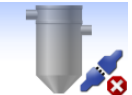



Receiver Navigation

<div style="border: 1px solid black; padding: 5px; margin-bottom: 5px;"> RECEIVER ON </div> 	<p>Receiver Navigation and Status Panel - This multi-function panel displays messages and receiver status, allows for navigation to each Receiver's configuration screen using the arrow buttons, and allows the receiver to be turned OFF or ON.</p>
---	--

The receiver symbol can display the following states:

	<p>Pressing the Receiver symbol toggles receiver OFF or ON. This symbol indicates that the receiver is turned off and will not run.</p>
	<p>This symbol indicates that the controller has lost communication with the receiver. The receiver will not run in this state.</p>

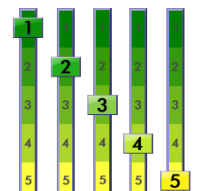
Receiver Configuration Fields

	<p>Blowback - Blowback is a pulse of air to clear the filter. Blowback has two configuration fields. Skip cycle defines the number of cycles the receiver will skip between blowback pulses. Default for Skip Cycle is 3. Setting Skip Cycle to 0 (zero) will pulse every time. Time Interval is a multiplication factor of 400ms to pressurize the charge canister. Default Time Interval is 1 (1=400ms).</p>
	<p>Load Time - The time in seconds that the receiver will load.</p>
	<p>Load Retry - The number of times the receiver will try to successfully load material and satisfy the sensor. Exceeding this retry count will cause the receiver to alarm.</p>
	<p>Dump Time - The time in seconds that the receiver will remain open during the dump cycle.</p>
	<p>Pump Assignment - The ID number of the pump that this receiver is assigned to.</p>
	<p>Pulse Time - Pulsed on-time in tenths of a second that the Bridge Breaker output (output 6) will pulse during Dump Time. (see Flexbus Receiver Card Wiring Diagram, Output 6).</p>
	<p>Purge Time - The time in seconds that the purge valve will open to purge the convey line. (Purge time follows Load time).</p>
	<p>Priority - Sets the order of importance of the receivers. Setting a receiver to level 1 sets to the highest priority, while setting to level 5 sets to the lowest priority. Higher priority receivers receive material first while lower priority receivers receive material later.</p> 
	<p>Purge - This symbol represents the purge valve. When purging, the symbol will show a blue arrow.</p>
	<p>The Receiver's label and defaults can be reset by touching the large receiver image in the center of the screen.</p>

Pump Configuration

Pressing the pump button in the right navigation takes you to the Pump overview screen and then pressing a pump in this overview screen will open the Pump's Configuration screen. The pump that you are configuring is identified by the pump's ID label on the pump's image on this screen. You can select another pump by using the pump navigation arrows at the bottom center of this screen.



Pump Overview Screen

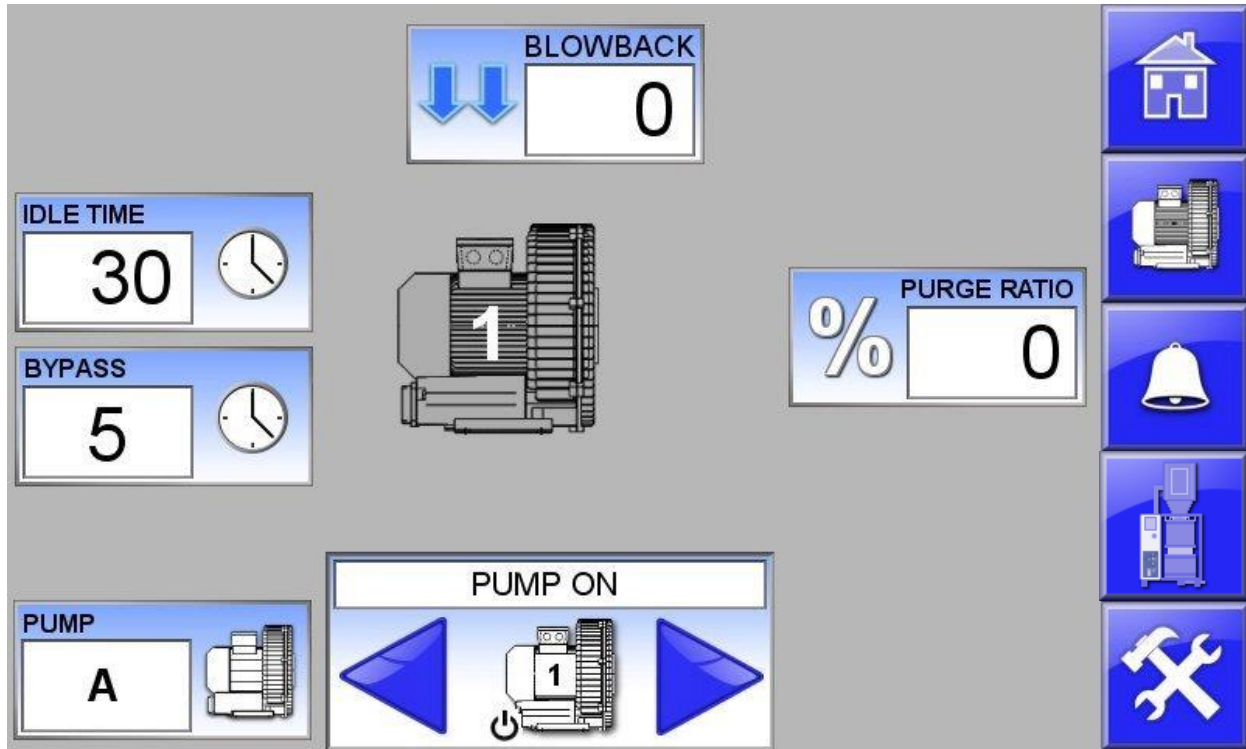

Pump Configuration Screen





Pump Control

	<p>Pump Status Panel - This panel displays messages and pump status and allows the pump to be turned OFF or ON.</p>
--	--

The pump symbol can display the following states:

	<p>Pressing the pump symbol toggles the pump OFF or ON. Message will display PUMP OFF.</p>
	<p>This symbol indicates that the pump has lost communication. The pump will not run in this state. Message will display PUMP LOST COM.</p>

Pump Configuration Fields

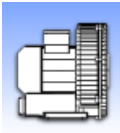



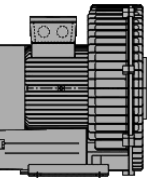

	<p>Blowback - Blowback is a pulse of air to clear the filter. Blowback has two configuration fields. Skip cycle defines the number of Bypass cycles skipped between each blowback pulse. Default for Skip Cycle is 10. Setting Skip Cycle to 0 (zero) will pulse every time. Time Interval is a multiplication factor of 400ms to pressurize the charge canister. Default Time Interval is 5 (1=400ms).</p>
	<p>IDLE TIME - The time in minutes that the pump runs after the last convey request before shutting off.</p>
	<p>BYPASS - The time delay in 10ths of seconds (0-50, zero seconds to 5 seconds) before the Bypass valve opens after all receivers are satisfied.</p>
	<p>PURGE RATIO - The % of time split between two purge valves. Used to clear material that overshoots the receiver.</p>
	<p>PUMP - Selects between pump A or pump B outputs.</p>

Pump Labeling

	<p>Pressing the Pump's image in the center of the screen displays information about the pump and allows the Pump's label and defaults can be reset.</p>
---	---

Removing Receivers from the configuration









If a receiver needs to be removed from the configuration, it can be removed using this procedure.

<p>On the HOME screen PRESS:</p>		<p>Pressing the SETUP button prompts for a password.</p>
<p>PRESS:</p>	<p>22222</p>	<p>Enter the password (default password is 22222) Press  to confirm password.</p>
<p>This enters the Setup screen. This screen contains several setup specific options.</p>		
<p>PRESS:</p>		<p>Press the large Receiver button.</p>
<p>The screen will contain any previously assigned devices (Pumps or Receivers). A device must be turned off or communication must be disconnected to remove the device. When a device is turned off or communication to the device is disconnected, the loader or pump icon will show a red X over it. The red X enables the option for the device to be removed by pressing the device.</p>		
<p>PRESS:</p>		<p>To remove the receiver.</p>
<p>A prompt to remove the receiver will be shown.</p>		
<p>PRESS:</p>		<p>To return to the Setup screen. When you return to the Setup screen, the Receivers button will show the Setup symbol indicating that you are still in the Receiver Assignment mode.</p>
<p>PRESS:</p>		<p>To Exit the Assignment Mode. Setup icon will disappear indicating you are out of the assignment mode.</p>
<p>PRESS:</p>		<p>To exit the Setup screen.</p>

Flexbus Lite System Setup Options



The Setup screen also allows for setting: Date and time, screensaver timeout, screen brightness, screen calibration, updating Flexbus controller and receiver/pump firmware, changing the password, language selection and date format. To enter Setup press the Setup button on the home screen. Default password is 22222.

	<p>Set Date and Time</p>
	<p>Set Screen Brightness</p>
	<p>Update Receiver and Pump Firmware Requires a firmware update provided by Maguire Products Inc. Copy firmware (.XUF file) to USB and insert USB into the controllers USB port. Press this Update button. Press the green check  to start the update. The firmware update will be copied from the flash drive to the Pumps and Receivers that require the update (up-to-date firmware will not be changed). When the copy has completed, you will be prompted to toggle power (off/on). Updates to devices are logged in the Alarm/Event log.</p>
	<p>Change Passwords Set the Operator password and the Administrator password.</p> <p> Operator Password - When enabled, all Pump and Receiver parameter fields are password protected.</p> <p> Administrator Password - Changes the Administrator password.</p> <p>Type the new password, then type the password again in the 2nd field to confirm. Valid passwords are numbers 0-9, 1 to 6 characters long. Press the green check  when complete.</p>
	<p>Set Language</p>

Flexbus Lite Main Screen

Live Status Panel

Displays the live status of all receivers.
See below for receiver symbol representation.

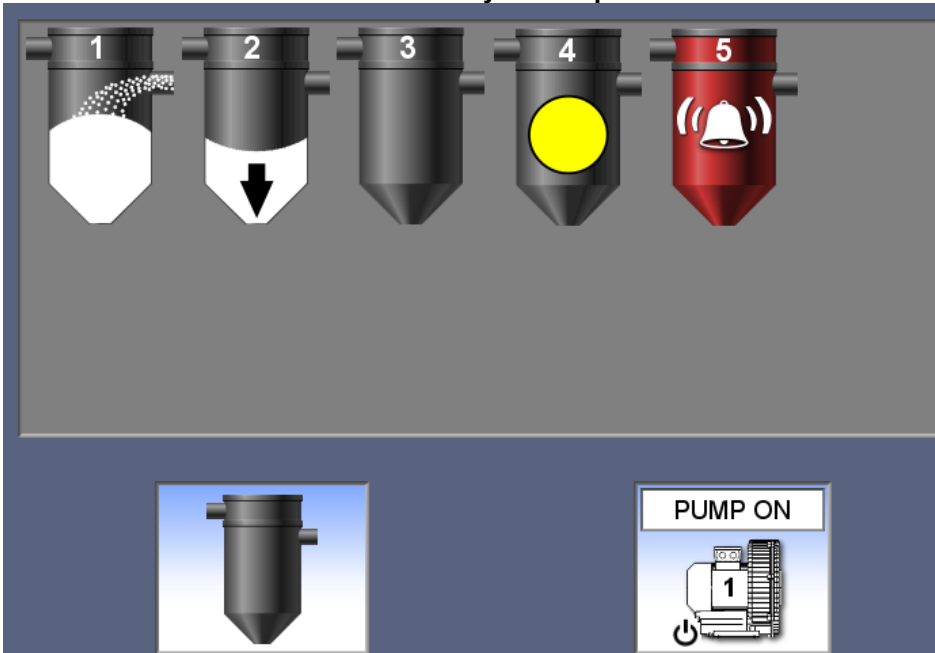

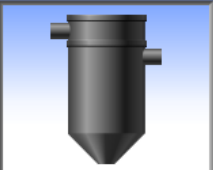

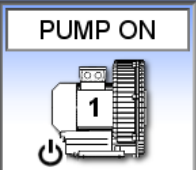

Receivers
Setup of all Receivers





Pump
Setup of Pump

Navigation Menu

- 

Returns to Home screen from any screen.
- 

Display Pump
Changes the Live view panel to the Pump
- 

Alarm History
Displays red when there is an alarm notification.
- 

Switch the ULTRA Home Screen
- 





Setup
Enters password protected setup screens.

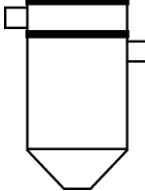
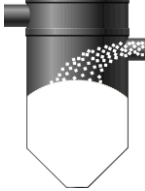

Live Status Panel

In the Live Status Panel, the receivers will display their current status. See the next page for a description of each live receiver status symbol.

Pressing any of the receiver symbols in the Live Status Panel will display the Receiver Configuration screen for that specific receiver. See Receiver Configuration for more information on configuring receivers.

What the Receiver Symbols Represent:

	<p>Receiver is online and idle.</p>
	<p>Receiver is inactive.</p>
	<p>Virgin material filling receiver.</p>
	<p>Demand for material.</p>
	<p>Virgin material only purging.</p>
	<p>Proportioned material purging.</p>

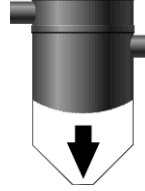
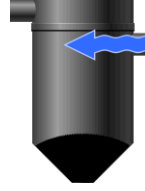
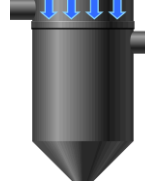
	<p>Lost communication with receiver. Cause may be receiver's power is off or a disconnected communication wire.</p>
	<p>Receiver is alarming.</p>
	<p>Regrind material filling receiver.</p>
	<p>Material discharging</p>
	<p>Regrind material only purging.</p>
	<p>Blowback active. Cleaning receiver's air filter.</p>

Flexbus Lite Wiring Diagrams

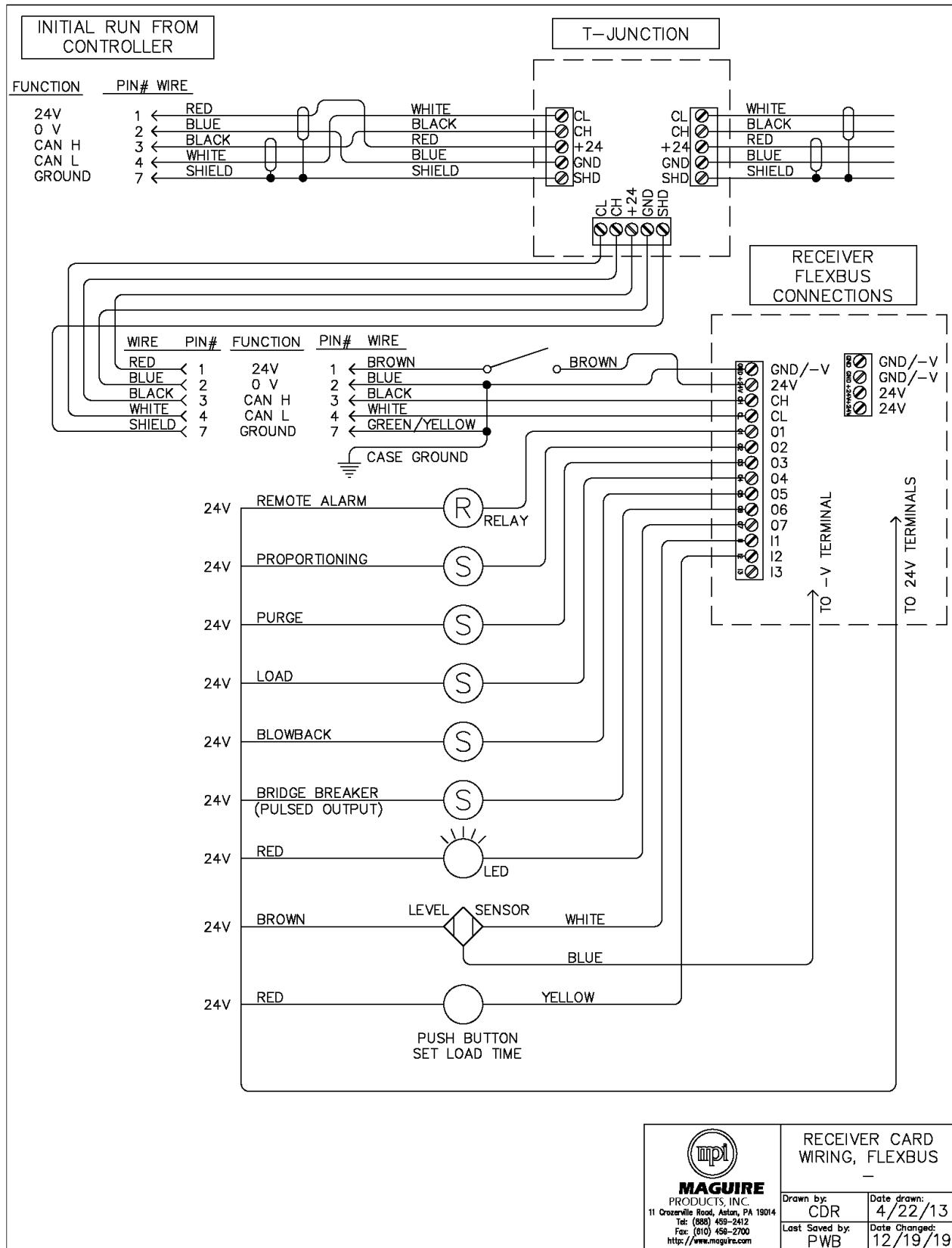

<p>MAGUIRE PRODUCTS, INC. 11 Crozerville Road, Aston, PA 19014 Tel: (888) 459-2412 Fax: (810) 459-2700 http://www.maguire.com</p>	RECEIVER CARD WIRING, FLEXBUS	
	Drawn by: CDR	Date drawn: 4/22/13
	Last Saved by: PWB	Date Changed: 12/19/19
	-	

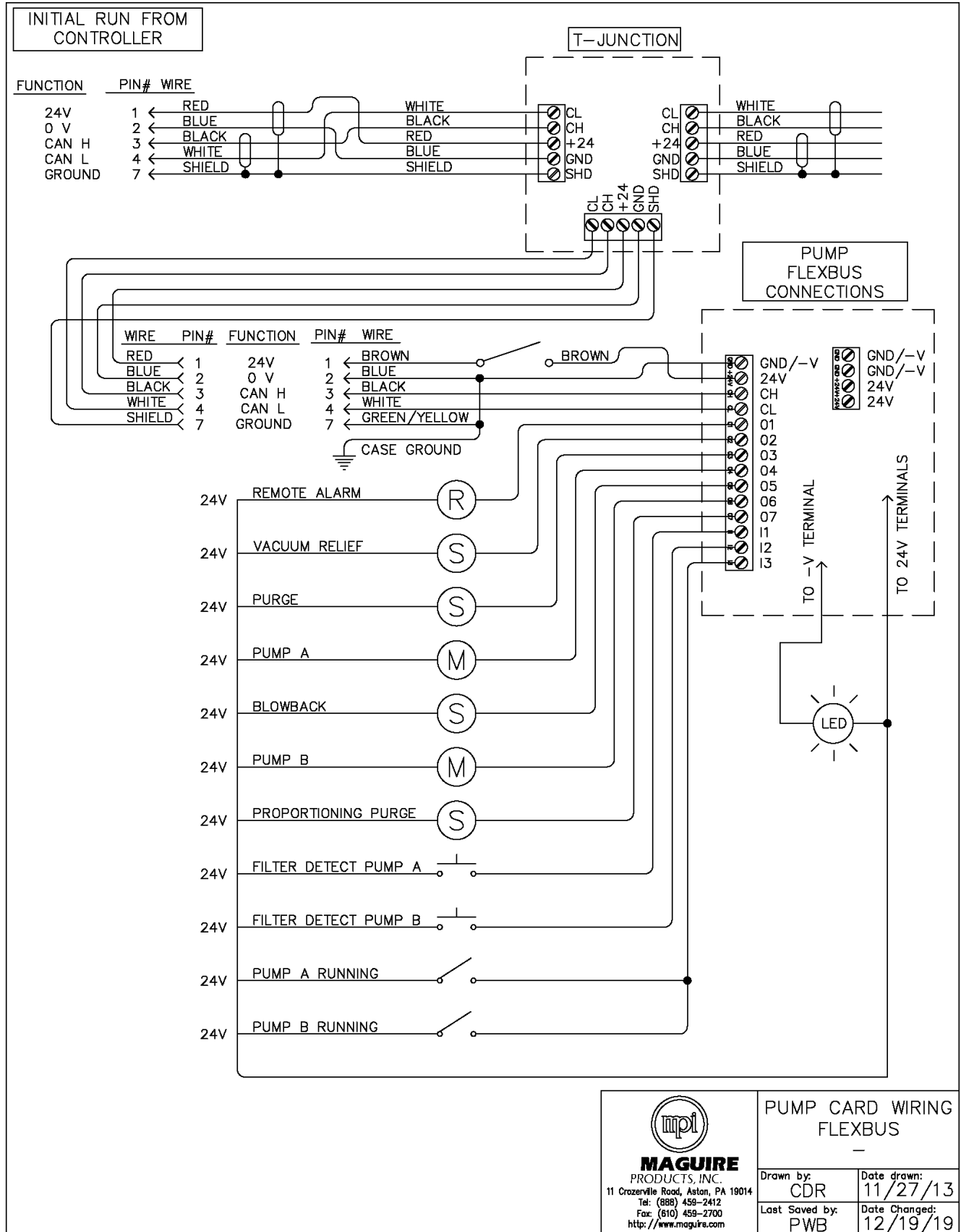

MAGUIRE
PRODUCTS, INC.
11 Crozerville Road, Aston, PA 19014
Tel: (888) 459-2412
Fax: (610) 459-2700
http://www.maguire.com

PUMP CARD WIRING FLEXBUS	
Drawn by: CDR	Date drawn: 11/27/13
Last Saved by: PWB	Date Changed: 12/19/19

Flexbus Lite Component Map

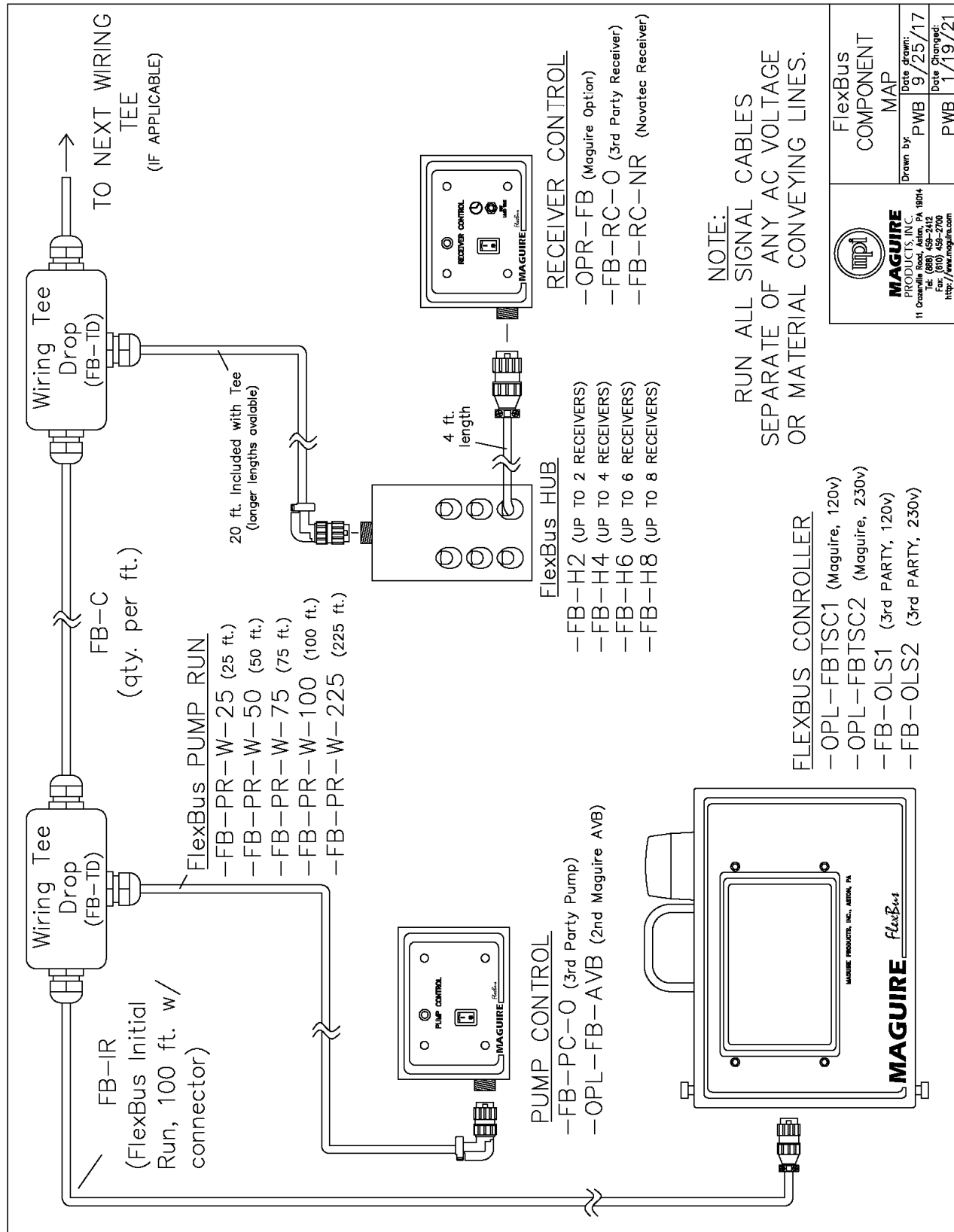

FlexBus COMPONENT MAP	
Drawn by:	PWB
Date drawn:	9/25/17
Drawn by:	PWB
Date Changed:	1/19/21

MAGUIRE
 11000 Rock Hill, PA 18044
 Tel: (888) 458-2412
 Fax: (610) 458-2700
 http://www.maguire.com

Technical Documentation: ULTRA-150

ULTRA-150 Technical Specifications

line no.	parameter	value	units	value	units
1	design throughput	150	lbs./hour	68	kgs./hour
2	maximum run temperature	350	°F	180	°C
3	maximum vacuum level, absolute	75	mm Hg.	75	mm Hg.
4	complete unit weight, empty	501	lbs.	227	kgs.
5	overall unit height	96	inches	2.44	meters
6	overall unit height w/ extension	108	inches	2.74	meters
7	voltage	240 / 480 / 575	volts	400	volts
8	full load amps (FLA)	16.4 / 8.2 / 6.8	amps	9.7	amps
9	phase	3	∅	3	∅
10	frequency	60	Hz	50	Hz
11	compressed air requirement, sustained pressure	85	psi	5.86	bar
12	compressed air requirement, max flow rate	12.5	SCFM	19.5	N m ³ /hr
13	compressed air requirement, average flow rate	1.56	SCFM	2.4	N m ³ /hr
14	blower model	RBH3	All-Star	RBH3	All-Star
15	blower power	1.1	HP	0.75	kW
16	blower maximum rated airflow	105	SCFM	148	m ³ /hour
17	blower maximum rated pressure	58	inches H ₂ O	139	mbar
18	blower noise level	64	db(A)	63	db(A)
19	heater power	10,000	watts	10,000	watts
20	vacuum generator model	JS-250	Vaccon	JS-250	Vaccon
21	heating hopper cylinder I.D.	13.5	in.	343	mm
22	heating hopper cylinder height	27	in.	686	mm
23	heating hopper material capacity	2	cu. ft.	56.6	L
24	heating hopper absolute capacity	2.5	cu. ft.	70.8	L
25	heating hopper material capacity w/ extension	3	cu. ft.	85.0	L
26	heating hopper absolute capacity w/ extension	3.5	cu. ft.	99.1	L
27	heating hopper empty weight	115	lbs.	52.2	kgs.
28	vacuum chamber cylinder I.D.	12.5	in.	318	mm
29	vacuum chamber cylinder height	14	in.	356	mm
30	vacuum chamber material capacity	1	cu. ft.	28.3	L
31	vacuum chamber absolute air capacity	1.15	cu. ft.	32.5	L
32	vacuum chamber normal evacuation volume	0.59	cu. ft.	16.6	L
33	vacuum chamber empty weight	44	lbs.	20.0	kgs.
34	retention hopper cylinder I.D.	15	in.	381.0	mm
35	retention hopper cylinder height	11.5	in.	292.1	mm
36	retention hopper material capacity	1.3	cu. ft.	36.8	L
37	retention hopper absolute capacity	1.6	cu. ft.	45.3	L
38	retention hopper empty weight	21.5	lbs.	9.8	kgs.

ULTRA-150 I/O Board Wiring Diagram

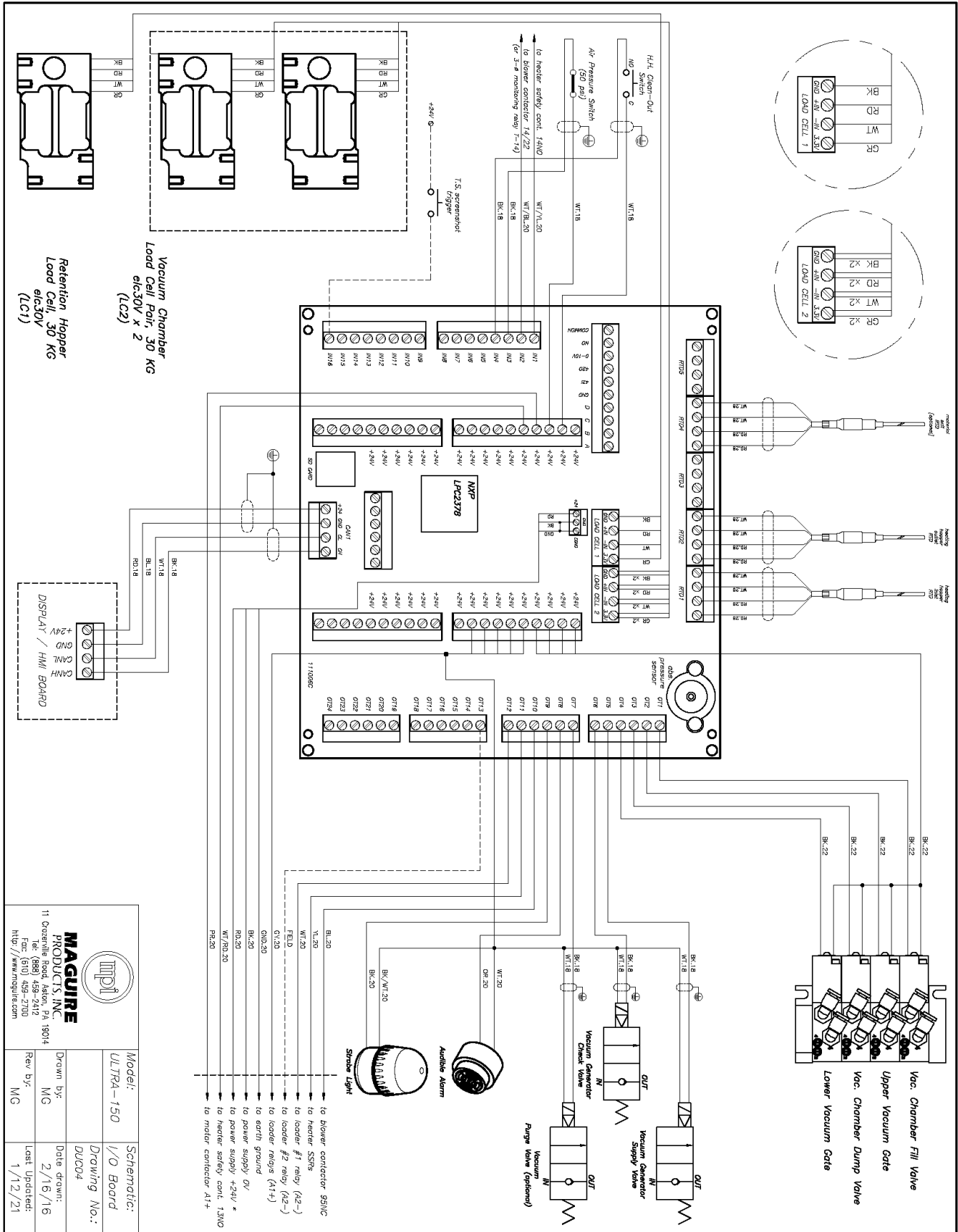

11 Oerterville Road, Astoria, PA 19014 Tel: (800) 438-2412 Fax: (610) 438-2700 http://www.maguire.com	
MAGUIRE PRODUCTS, INC. Model: ULTRA-150 Drawing No.: DUC04	Drawn by: MG Date drawn: 2/16/16 Rev by: MG Last Updated: 1/12/21

High Voltage Schematics

ULTRA-150 – STANDARD – 240V

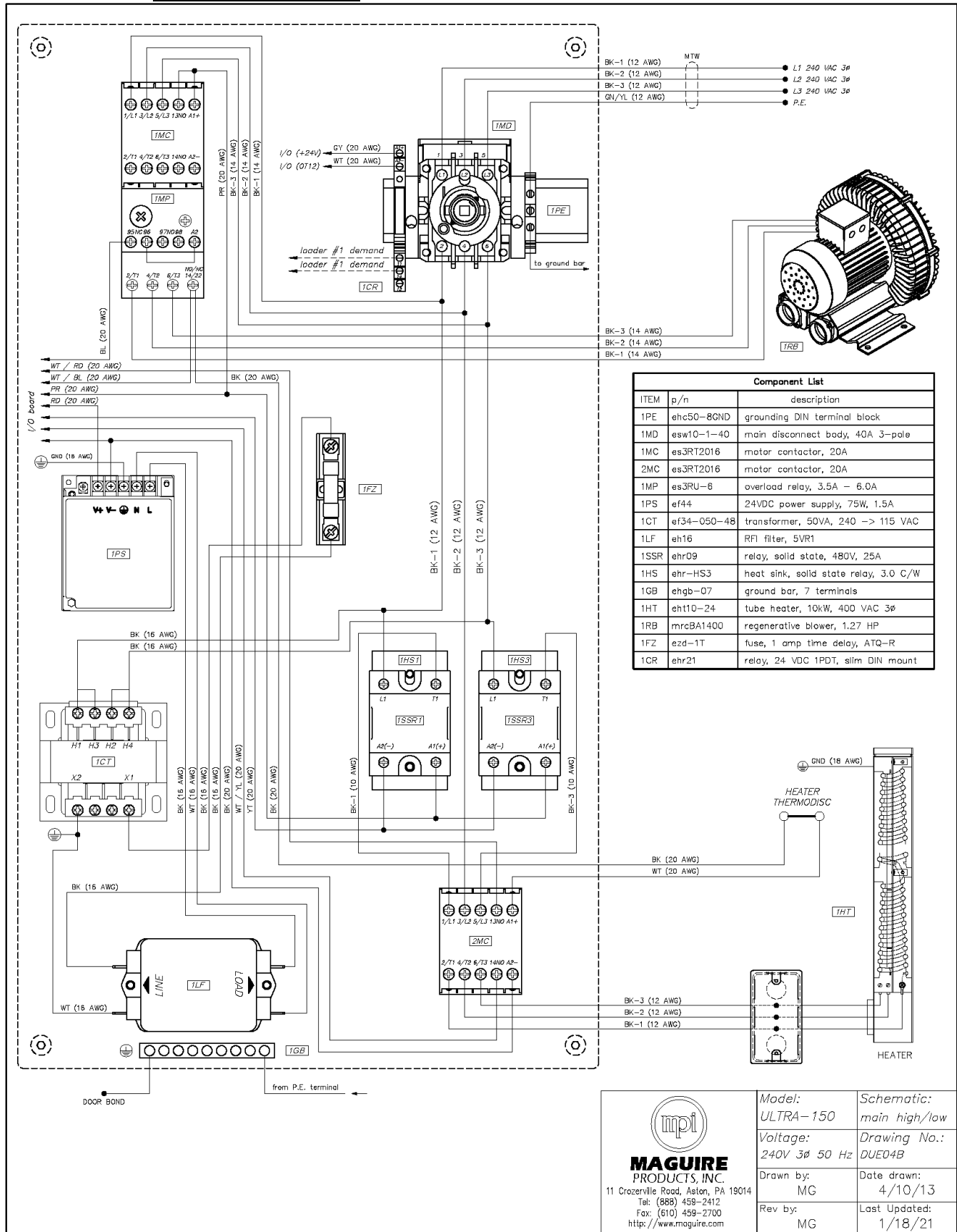

ULTRA-150 – STANDARD – 240V – CSA

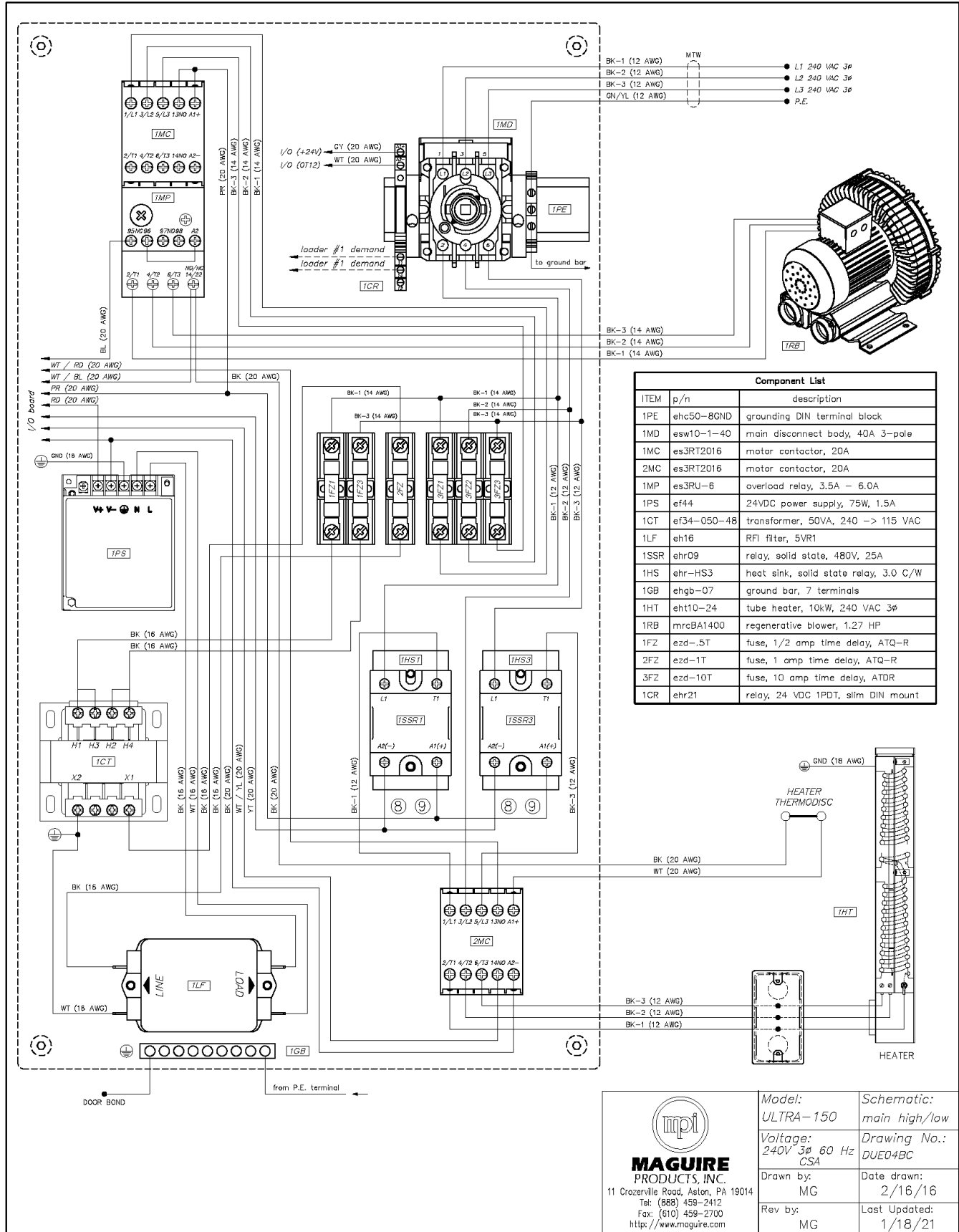

ULTRA-150 – STANDARD – 400V

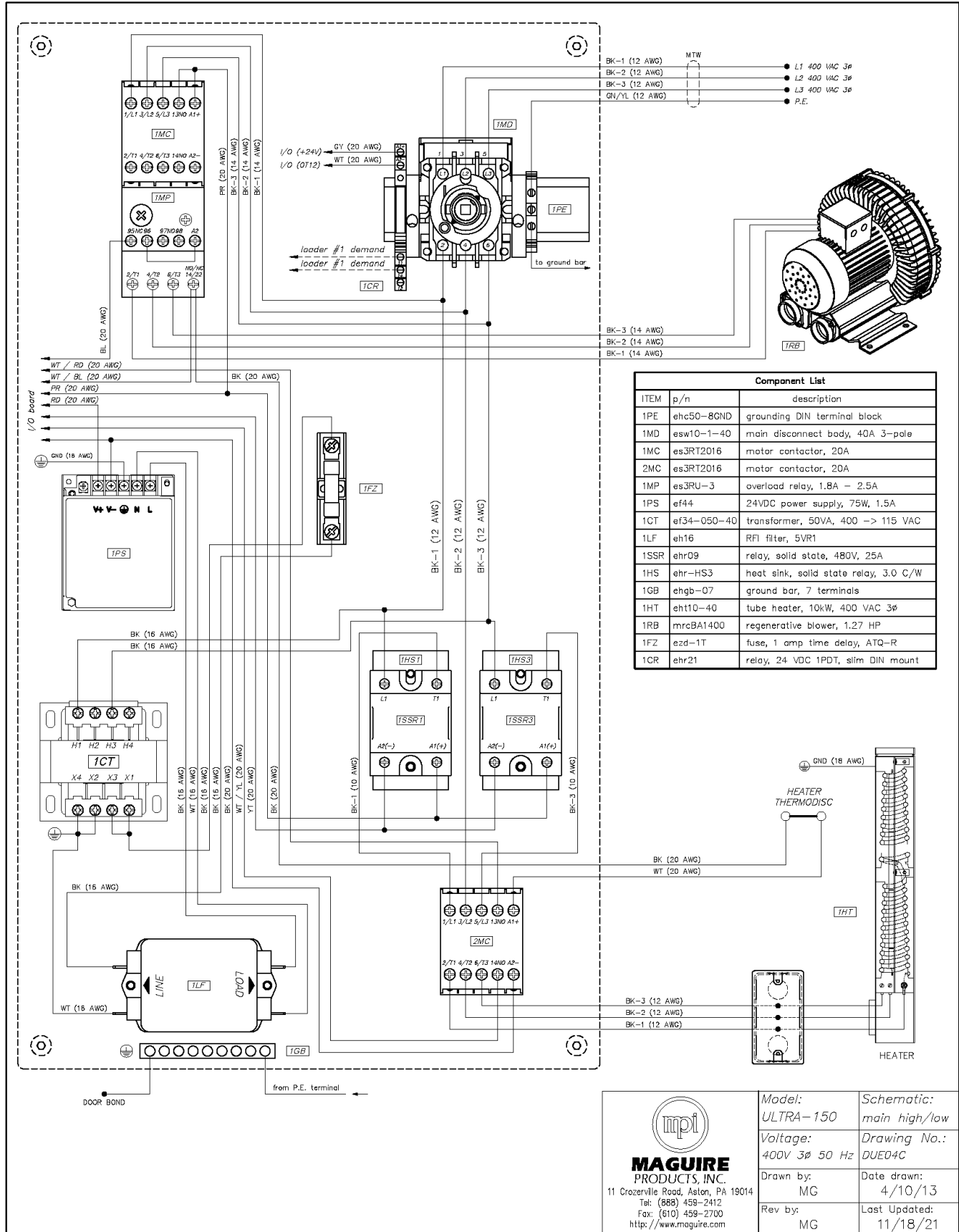

ULTRA-150 – STANDARD – 480V

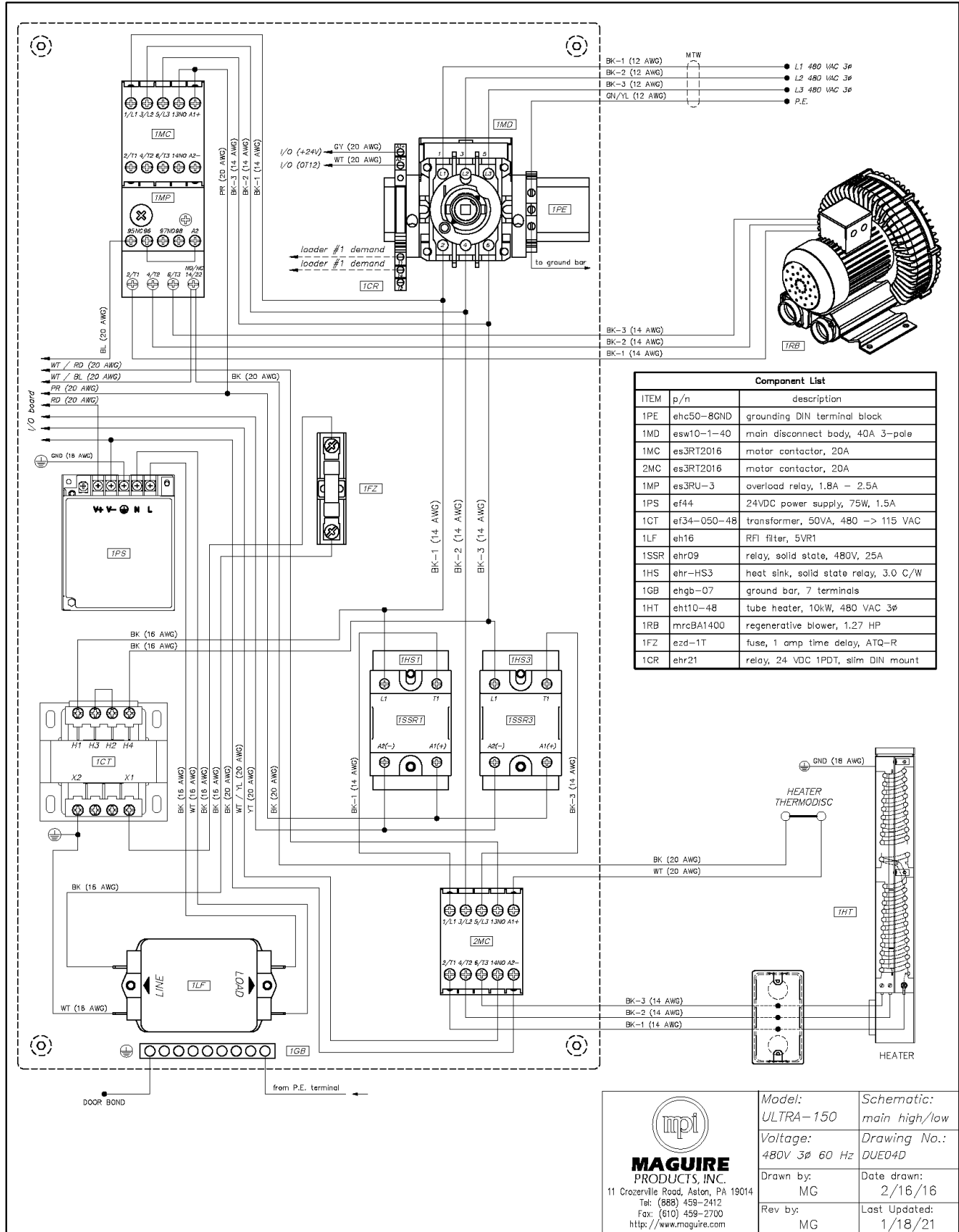

ULTRA-150 – STANDARD – 480V – CSA

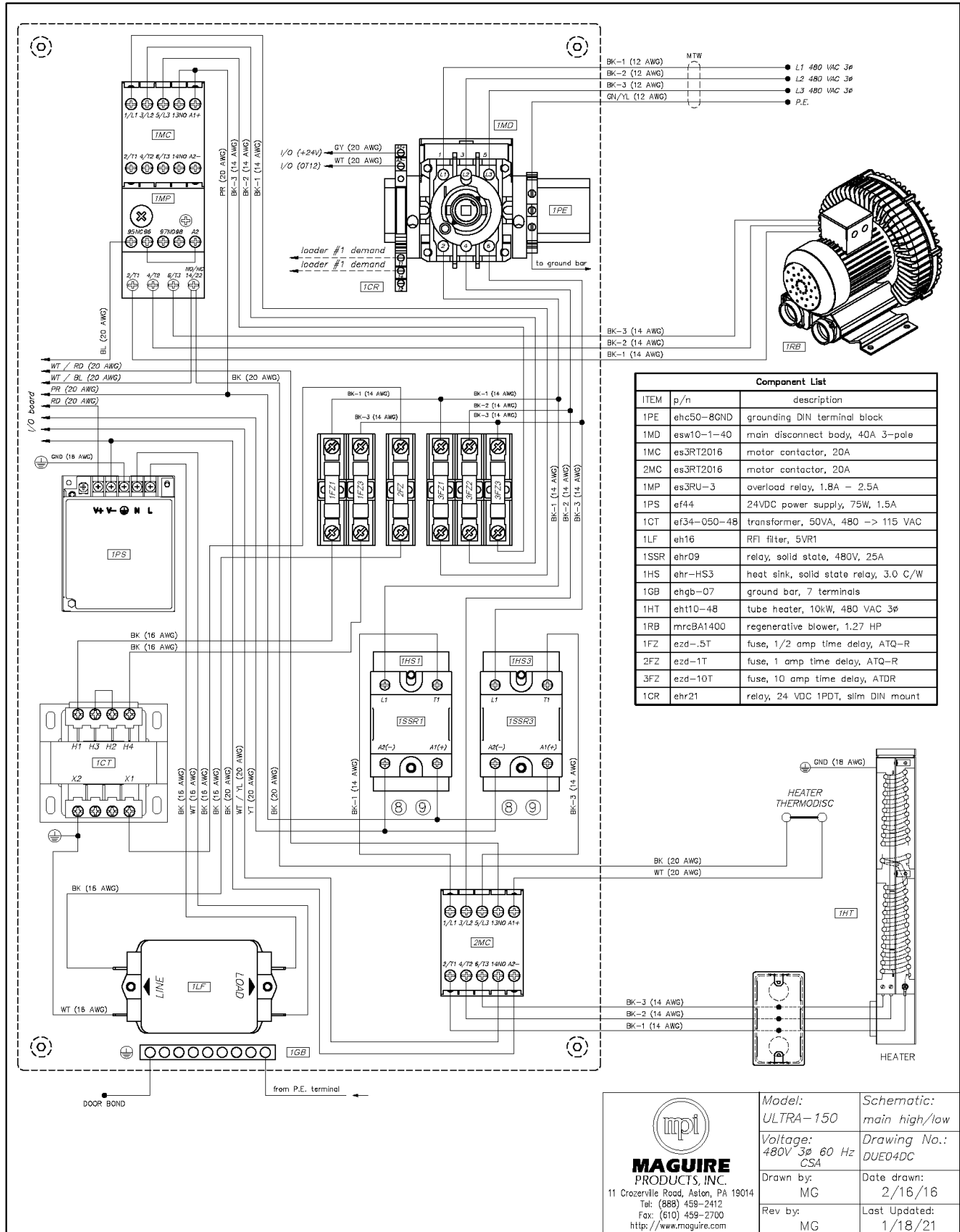

ULTRA-150 – STANDARD – 575V – CSA

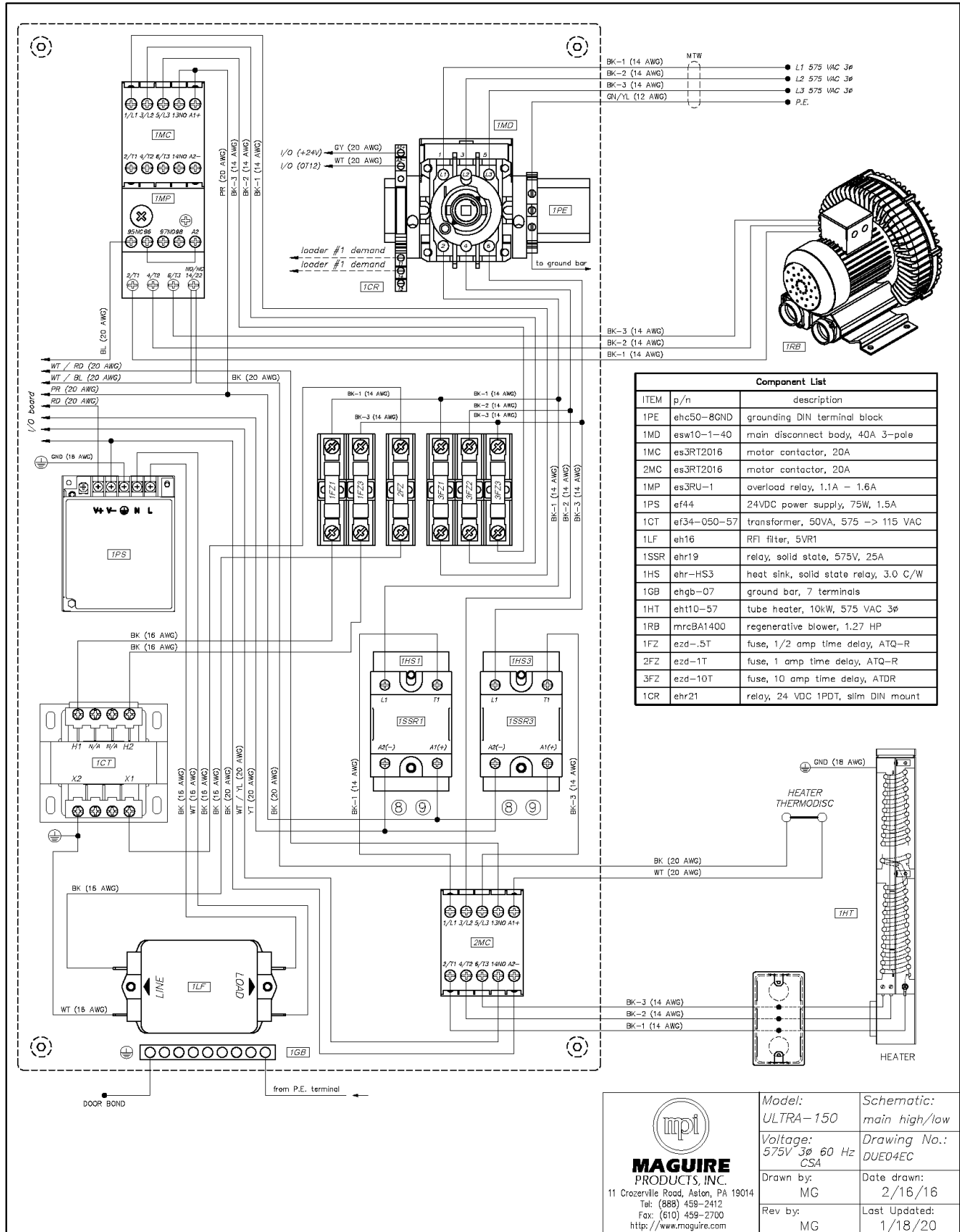

ULTRA-150 – PHASE MONITORING – 240V

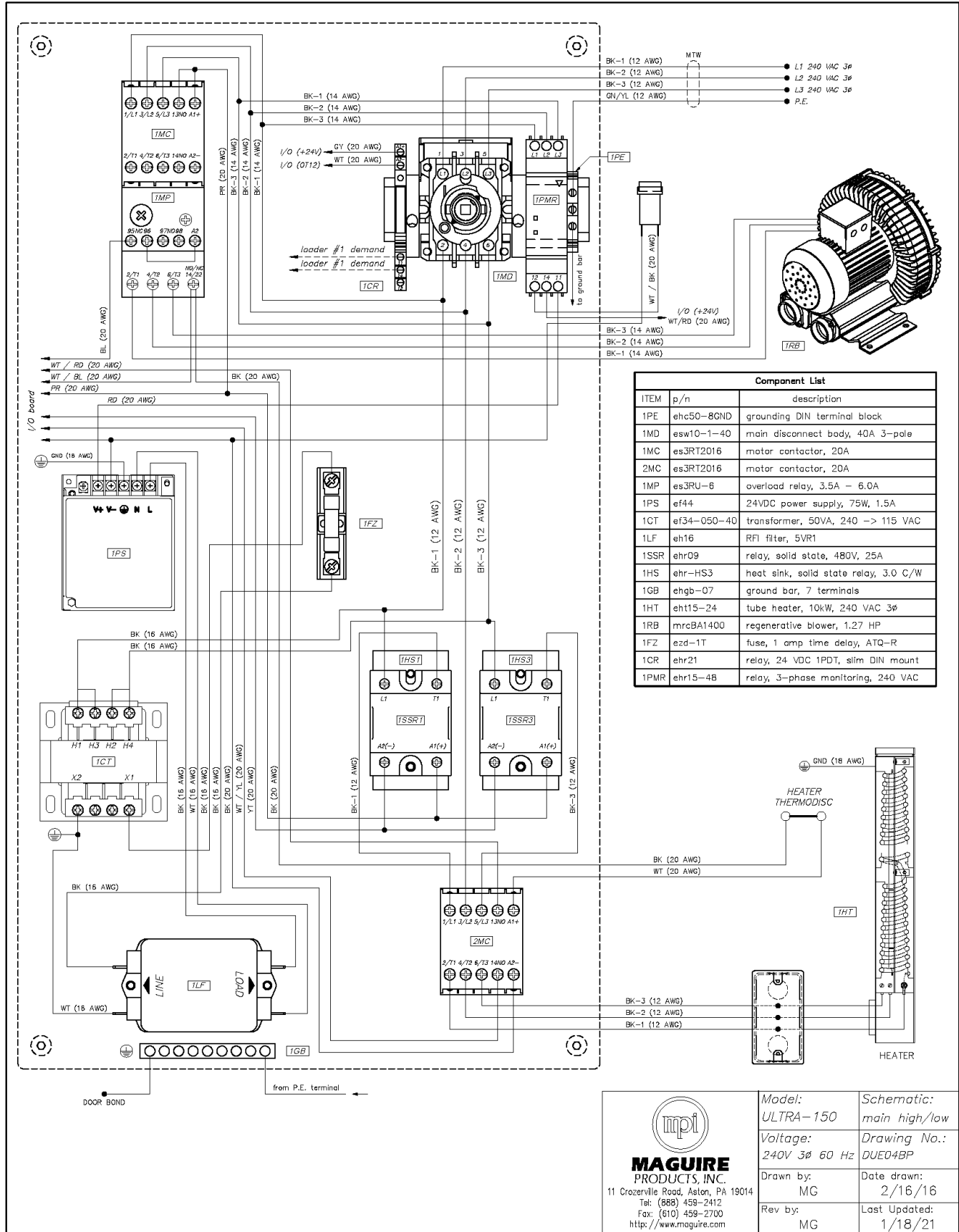

ULTRA-150 – PHASE MONITORING – 240V – CSA

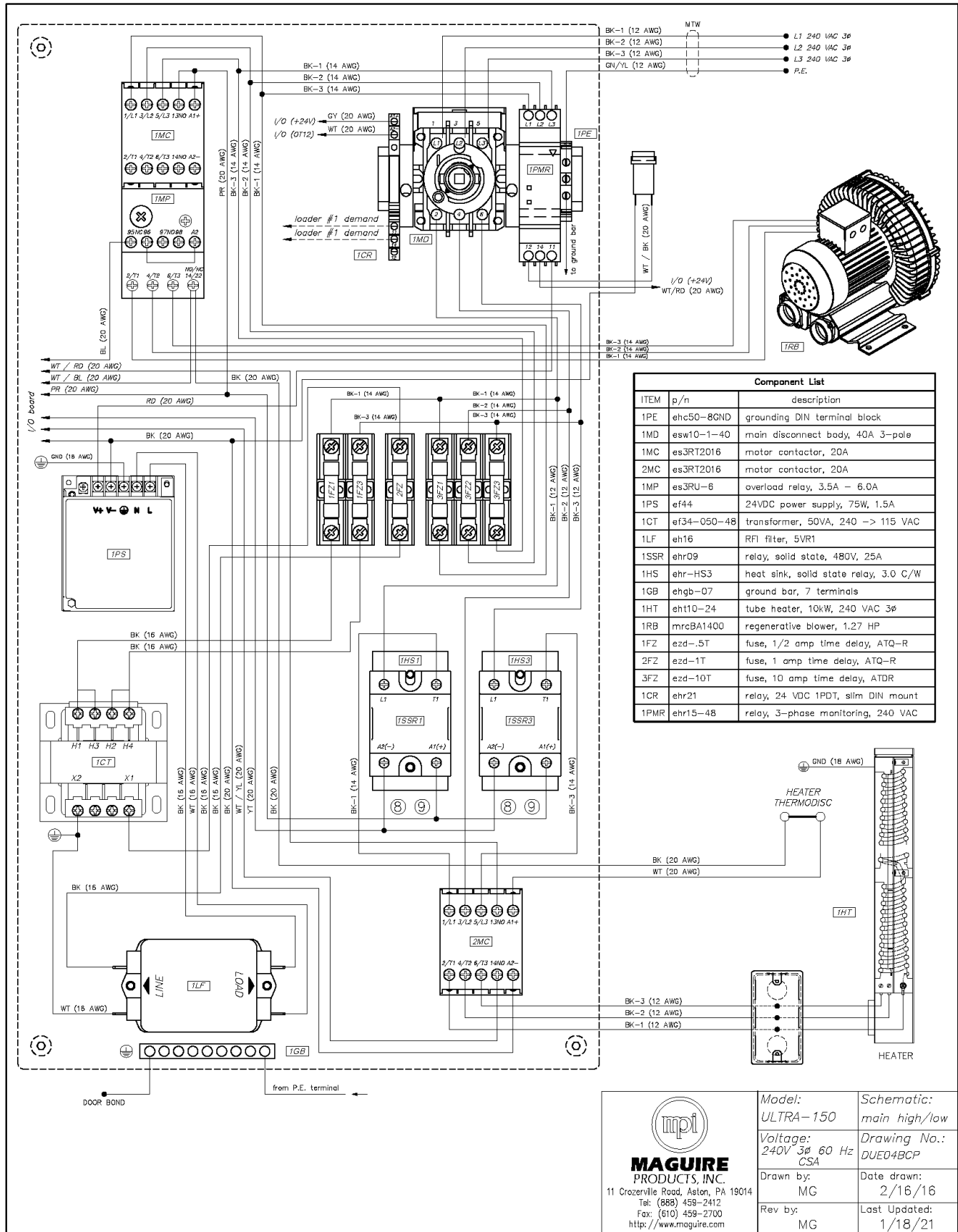

ULTRA-150 – PHASE MONITORING – 400V

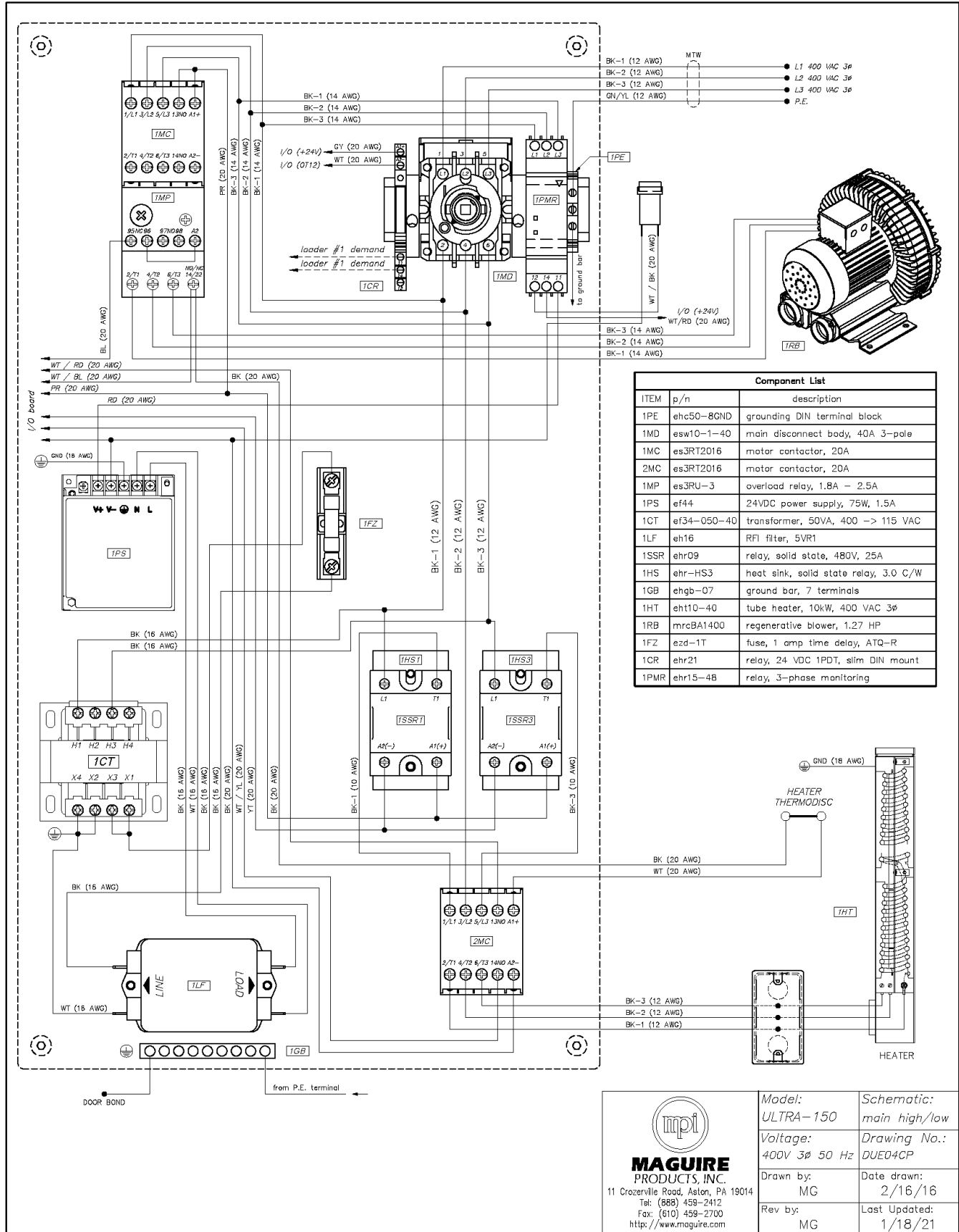

ULTRA-150 – PHASE MONITORING – 480V

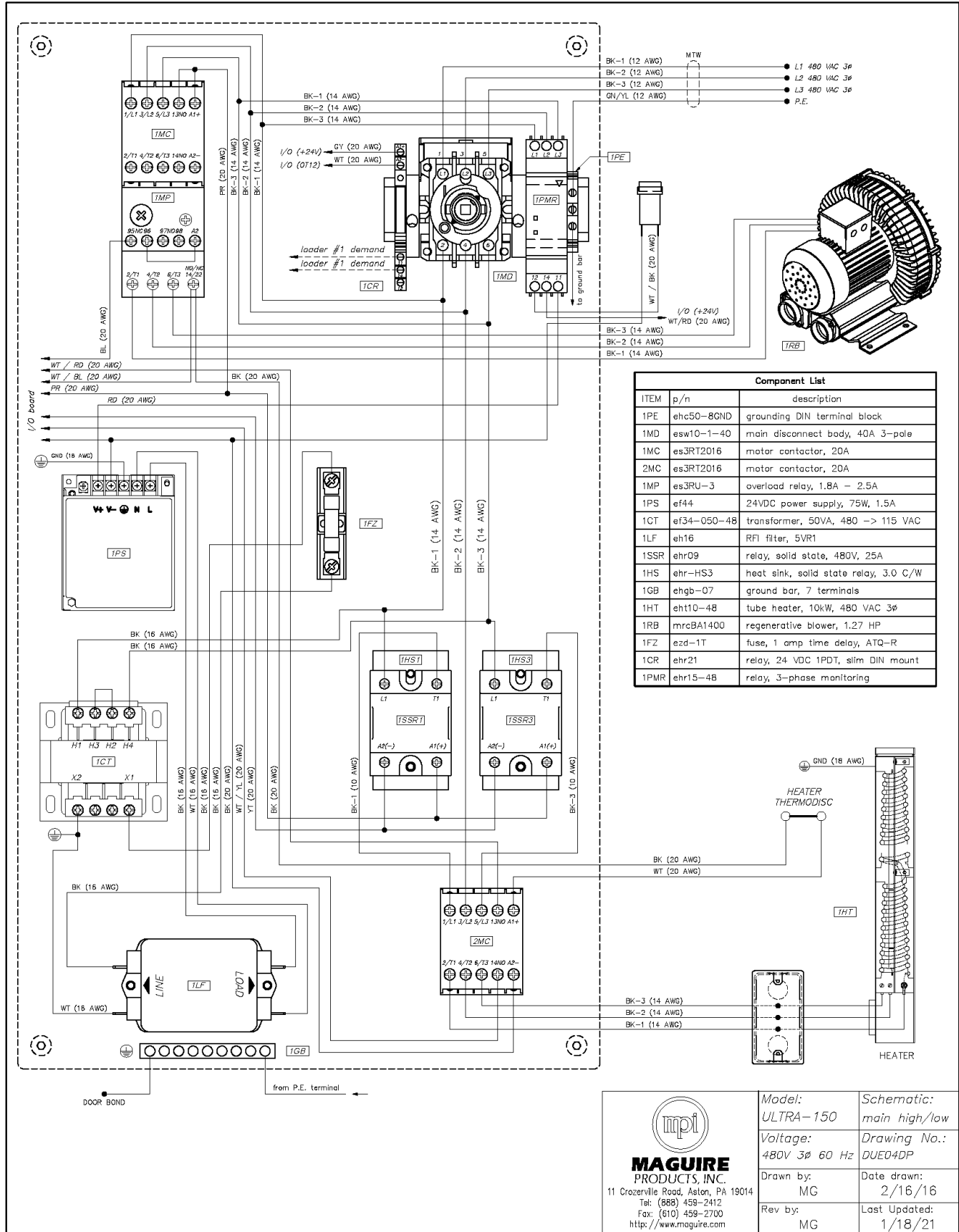

ULTRA-150 – PHASE MONITORING – 480V – CSA

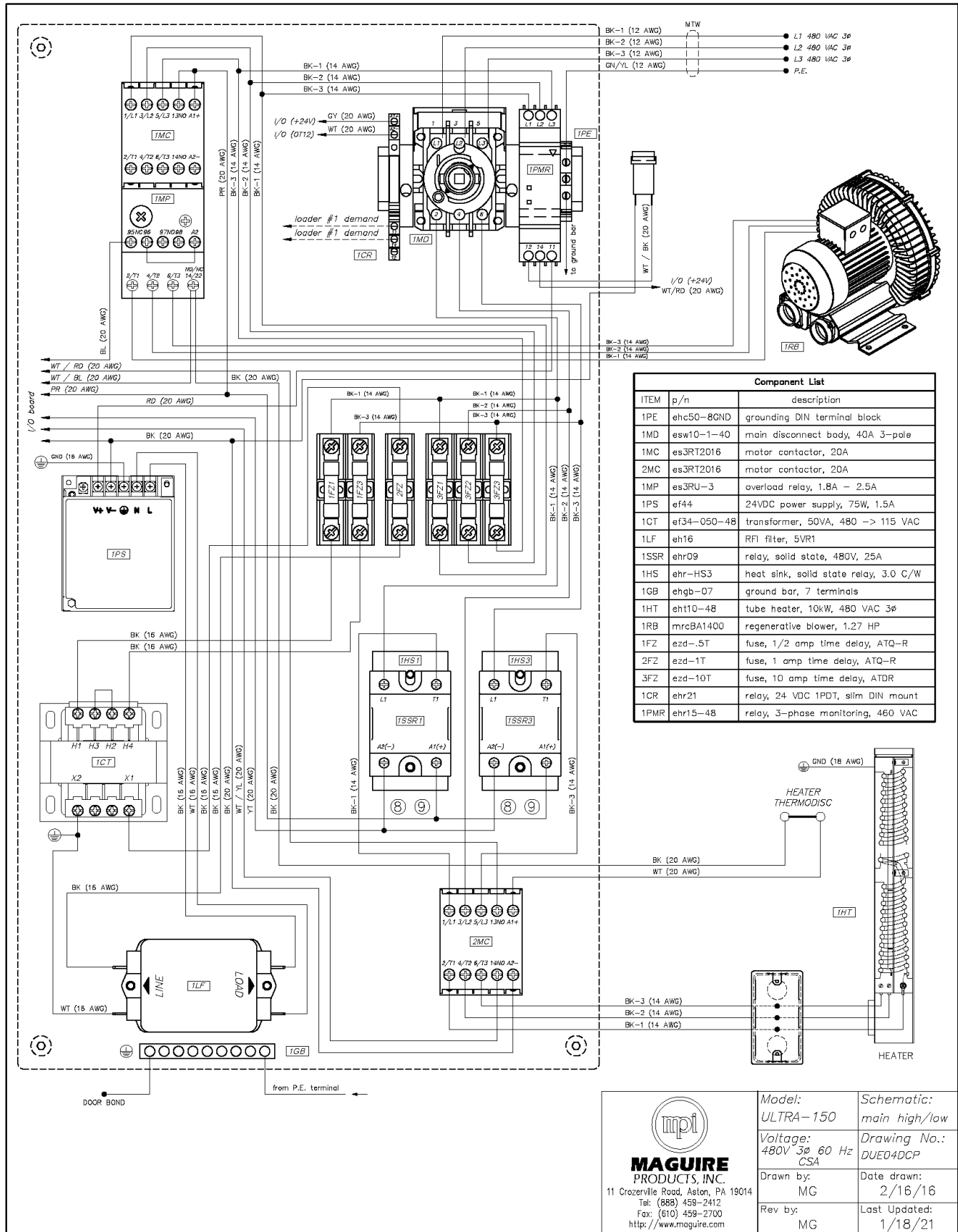

ULTRA-150 – PHASE MONITORING – 575V – CSA

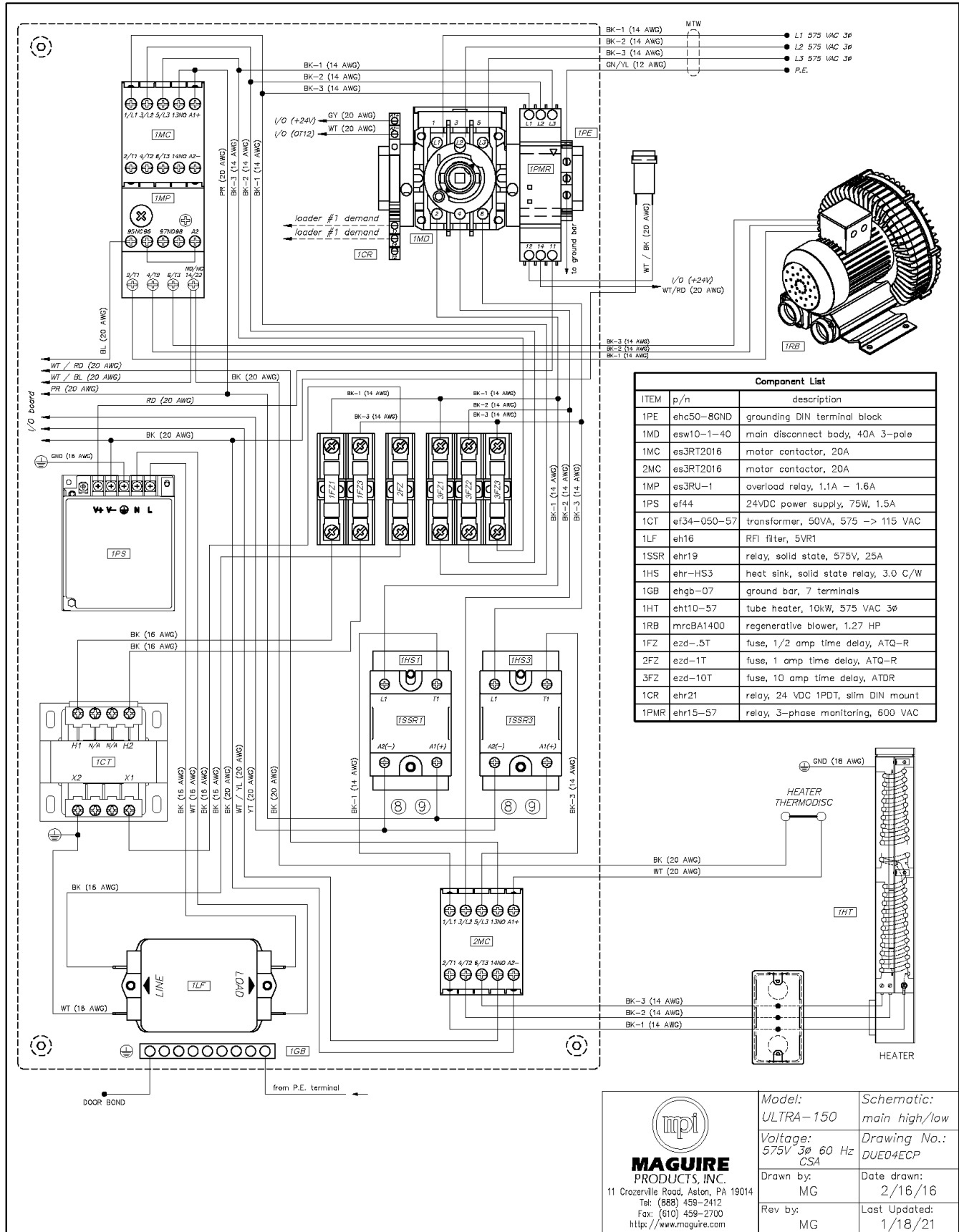

ULTRA-150 – VARIABLE FREQUENCY DRIVE (VFD) – 240V

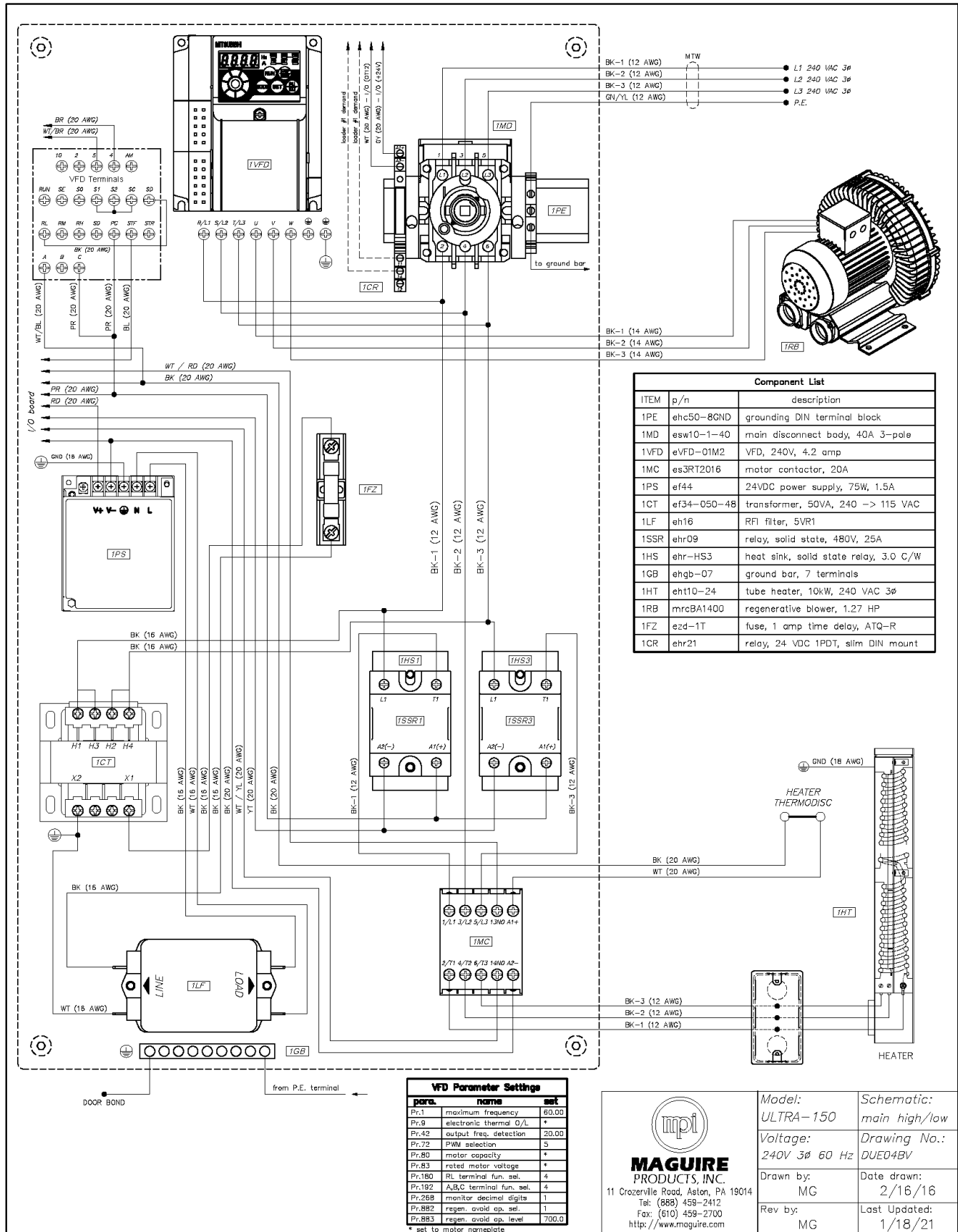

Component List		
ITEM	p/n	description
1PE	ehc50-8GND	grounding DIN terminal block
1MD	esw10-1-40	main disconnect body, 40A 3-pole
1VFD	eVFD-01M2	VFD, 240V, 4.2 amp
1MC	es3RT2016	motor contactor, 20A
1PS	ef44	24VDC power supply, 75W, 1.5A
1CT	ef34-050-48	transformer, 50VA, 240 -> 115 VAC
1LF	eh16	RFI filter, 5VRI
1SSR	ehr09	relay, solid state, 480V, 25A
1HS	ehr-HS3	heat sink, solid state relay, 3.0 C/W
1GB	ehgb-07	ground bar, 7 terminals
1HT	eht10-24	tube heater, 10kW, 240 VAC 3ø
1RB	mrcBA1400	regenerative blower, 1.27 HP
1FZ	ezd-1T	fuse, 1 amp time delay, ATQ-R
1CR	ehr21	relay, 24 VDC 1PDT, slim DIN mount

VFD Parameter Settings		
para.	name	set
Pr.1	maximum frequency	60.00
Pr.9	electronic thermal O/L	*
Pr.42	output freq. detection	20.00
Pr.72	PWM selection	5
Pr.80	motor capacity	*
Pr.83	rated motor voltage	*
Pr.180	RL terminal fun. sel.	4
Pr.192	A,B,C terminal fun. sel.	4
Pr.208	monitor decimal digits	1
Pr.882	regen. avoid op. sel.	1
Pr.883	regen. avoid op. level	700.0
* set to motor nameplate		



MAGUIRE
 PRODUCTS, INC.
 11 Crozerville Road, Aston, PA 19014
 Tel: (888) 459-2412
 Fax: (610) 459-2700
<http://www.maguire.com>

Model: ULTRA-150	Schematic: <i>main high/low</i>
Voltage: 240V 3ø 60 Hz	Drawing No.: DUE04BV
Drawn by: MG	Date drawn: 2/16/16
Rev by: MG	Last Updated: 1/18/21

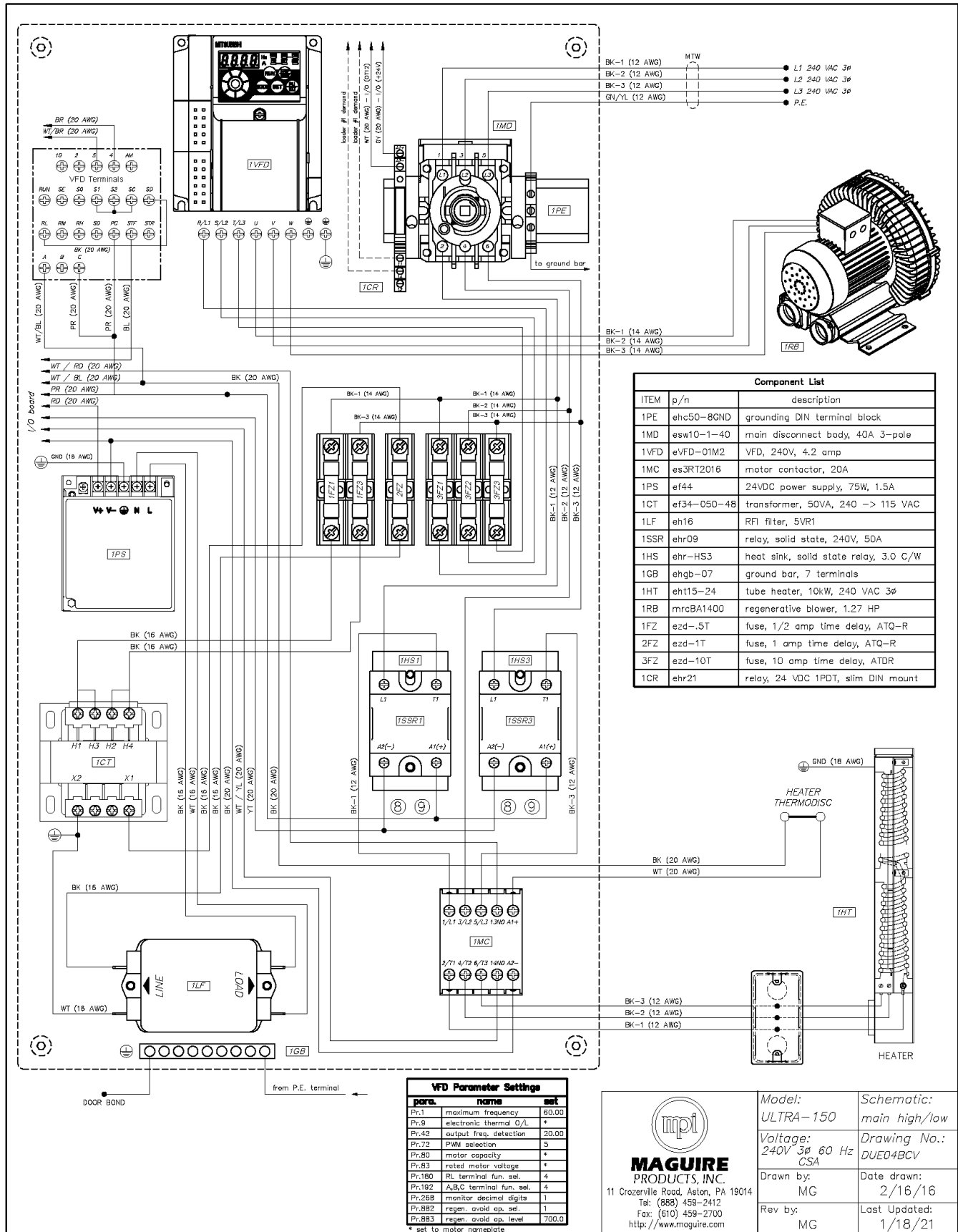
ULTRA-150 – VARIABLE FREQUENCY DRIVE (VFD) – 240V – CSA

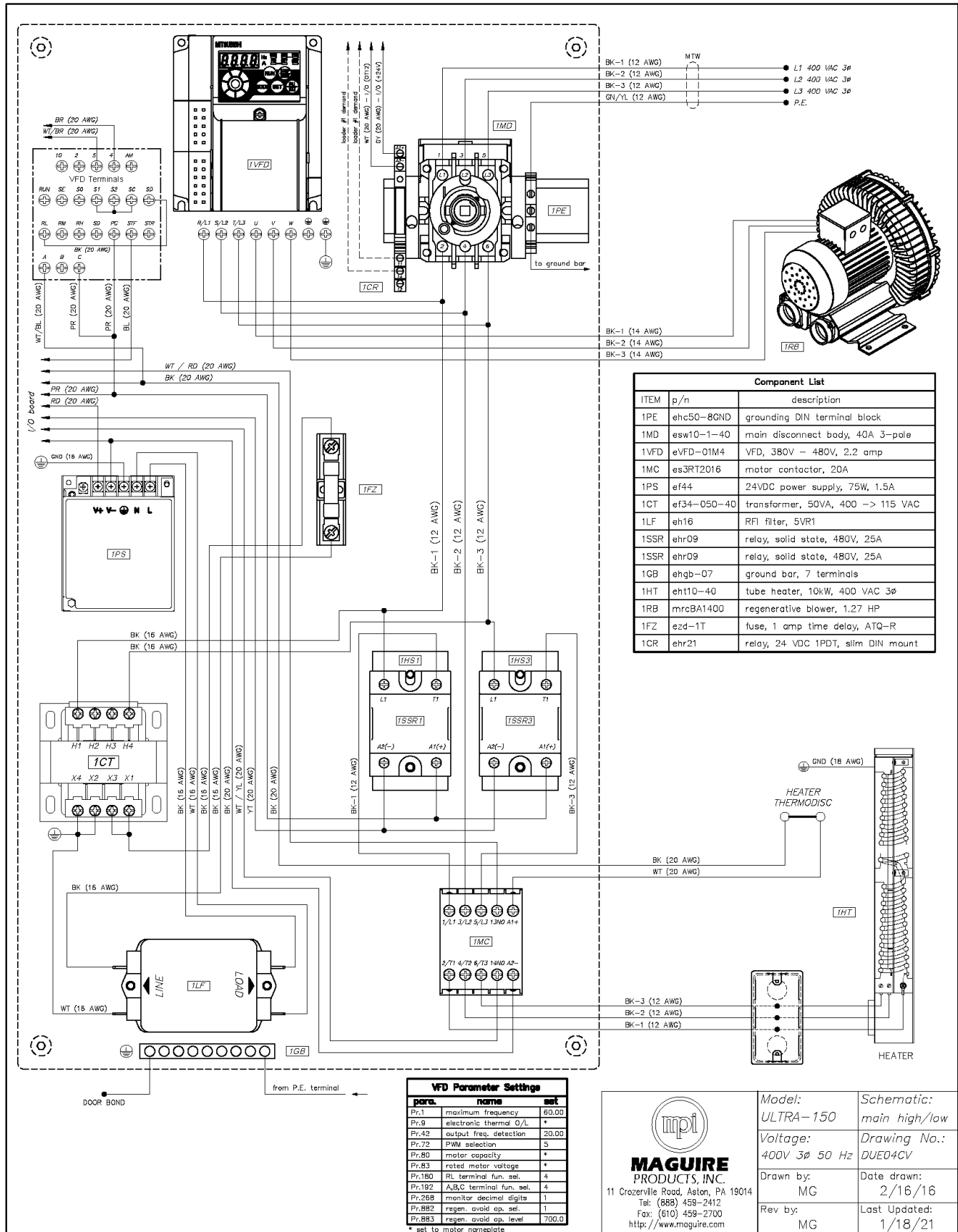

ULTRA-150 – VARIABLE FREQUENCY DRIVE (VFD) – 400V



ULTRA-150 – VARIABLE FREQUENCY DRIVE (VFD) – 480V

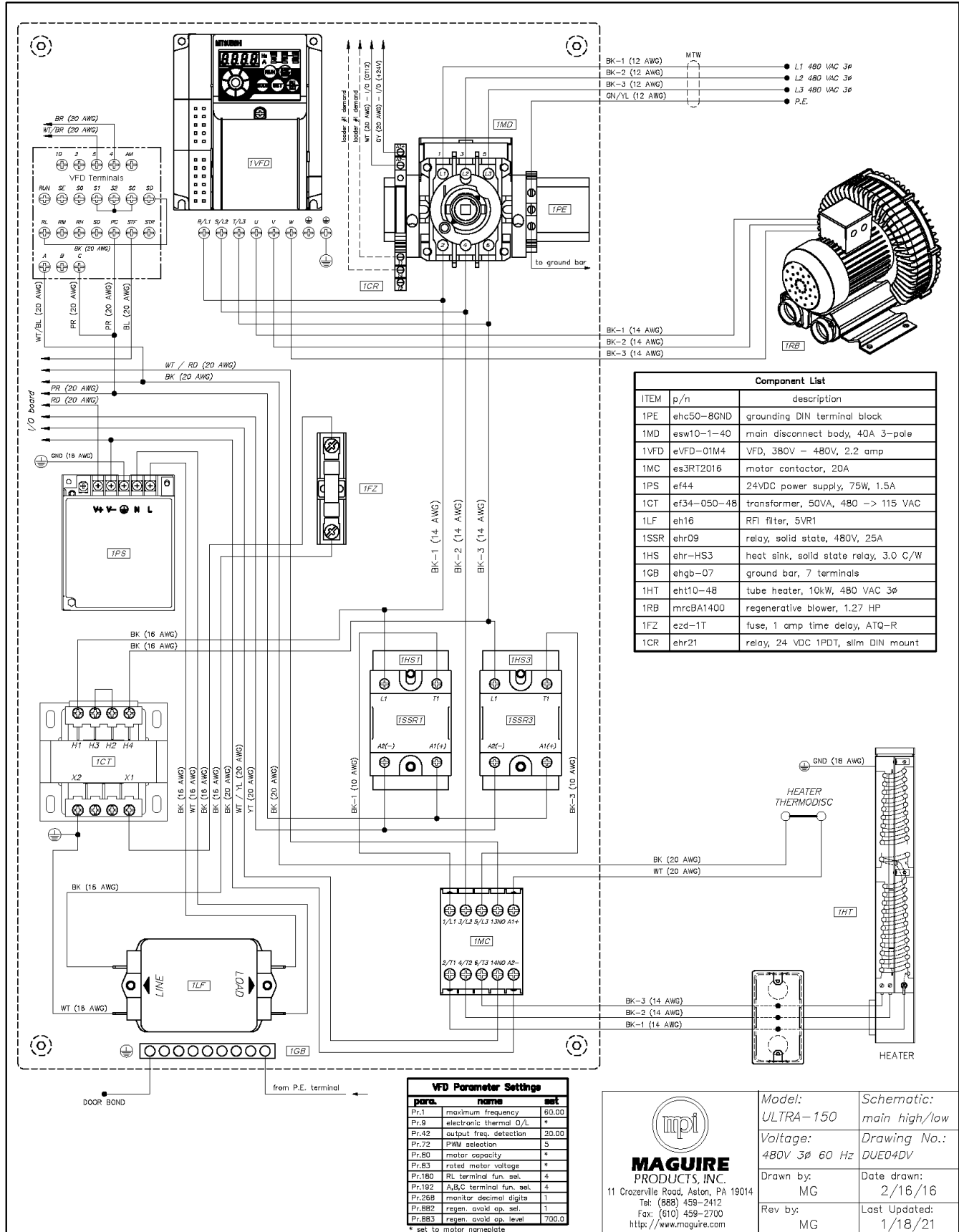

ULTRA-150 – VARIABLE FREQUENCY DRIVE (VFD) – 480V – CSA

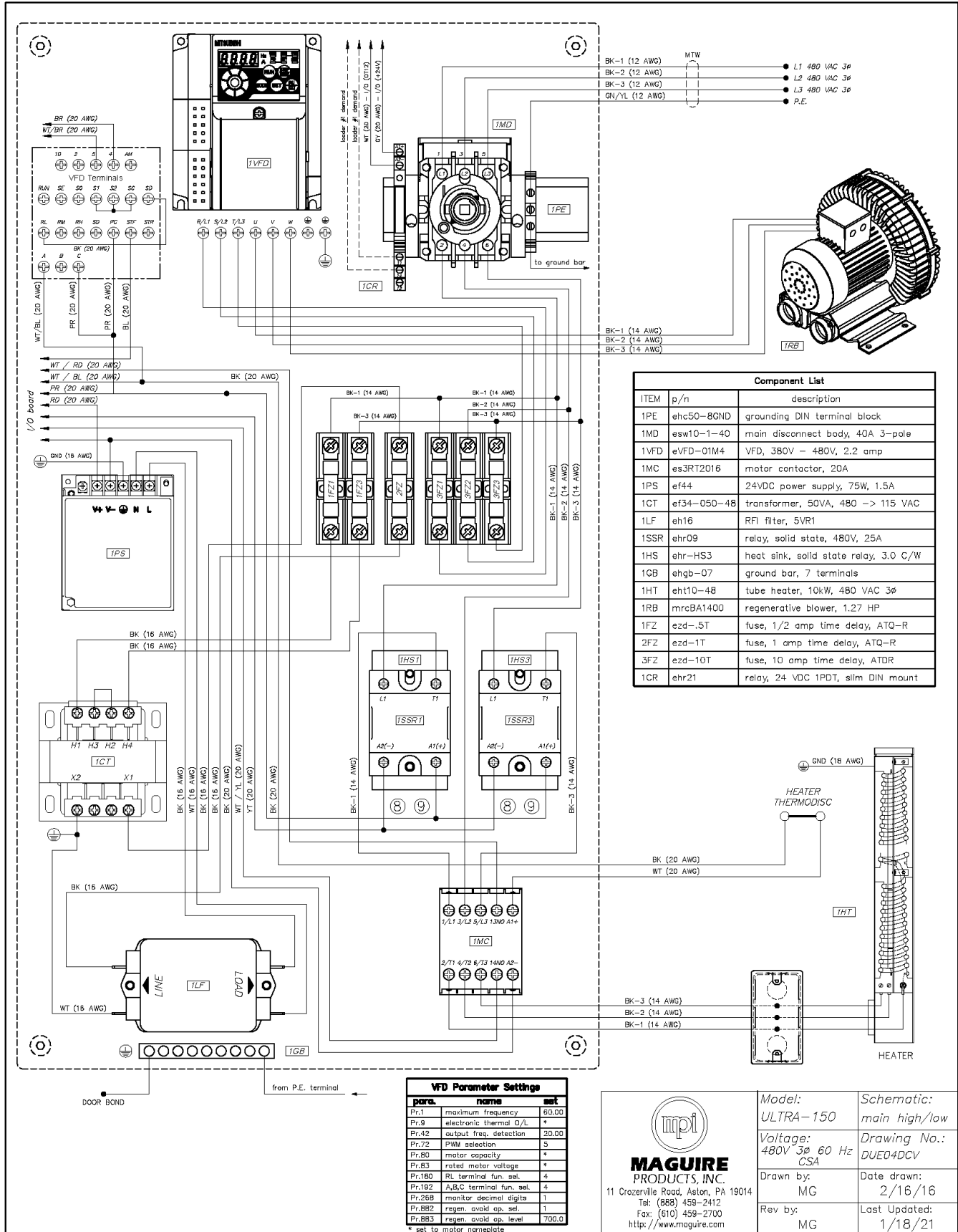

ULTRA-150 Recommended Spare Parts List

Note: it is recommended that items #1 - #8 be kept on hand by the maintenance department.

Item	MPI P/N	Description	General Location
1	hf19-E	replacement filter element, blower intake	rear panel
2	8124-11	silicone seal, vacuum chamber dump valve	vacuum chamber
3	go-349V	o-ring, size 349, Viton	upper vacuum gate
4	go-341V	o-ring, size 341, Viton	lower vacuum gate
5	as8124-03	vac. seal plate assy., vac. cham. dump valve	lower vacuum gate
6	nv88-sol	solenoid valve segment, 4-way, 24 VDC	main cabinet
7	nf-30E	filter element, for "AW30" series regulator	pneumatics cabinet
8	nfos2E	filter element, for oil separator	pneumatics cabinet

Other Potential Replacement Parts

9	es3RU-1	overload relay, 1.1 A - 1.6 A	electrical cabinet
10	es3RU-3	overload relay, 1.8 A - 2.5 A	electrical cabinet
11	es3RU-6	overload relay, 3.5 A - 5.0 A	electrical cabinet
12	es3RT2016	motor contactor, 3 pole, 20A, 24 VDC	electrical cabinet
13	ehr09	relay, SS, 480V 25A, 24-265 VAC signal	electrical cabinet
14	ezd-1T	fuse, 1-amp time delay, ATQ-R	electrical cabinet
15	eRTD2-40-128	RTD temp. sensor, 1/8" dia. x 2-1/2" long, Pt100	heating hopper
16	elc30V	load cell, 30 kg capacity	ret., vac. chamber
17	esp-05	pressure switch, 60 psi set-point, 1/8" NPT	main cabinet
18	eabVBD-01	I/O circuit board	electrical cabinet
19	eabVBD-02	standard display / HMI circuit board	front control panel
20	eabVBD-03	pendant circuit board (.8" 4-digit numeric)	front control panel
21	ebTS-7V	touch screen	front control panel
22	nmd-01E	replacement element, for membrane air dryer	pneumatics cabinet
23	eht10-24	tube heater, 10,000 watt 3 phase 240 VAC	main cabinet
24	eht10-40	tube heater, 10,000 watt 3 phase 400 VAC	main cabinet
25	eht10-48	tube heater, 10,000 watt 3 phase 480 VAC	main cabinet
26	eht10-56	tube heater, 10,000 watt 3 phase 575 VAC	main cabinet
27	ehsl-02	strobe light, red, magnetic base, 24VDC	top deck
28	ehb-2	piezo buzzer, 24VDC	front control panel
29	esh-01	interlock handle, red/yellow pistol	front control panel

Technical Documentation: ULTRA-300

ULTRA-300 Technical Specifications

line no.	parameter	value	units	value	units
1	design throughput	300	lbs./hour	136	kgs./hour
2	maximum run temperature	350	°F	180	°C
3	maximum vacuum level, absolute	75	mm Hg.	75	mm Hg.
4	complete unit weight, empty	918	lbs.	416	kgs.
5	overall unit height	119	inches	3.02	meters
6	overall unit height w/ extension	134	inches	3.40	meters
7	voltage	480 / 575	volts	380	volts
8	full load amps (FLA)	27 / 22	amps	33	amps
9	phase	3	∅	3	∅
10	frequency	60	Hz	50	Hz
11	compressed air requirement, sustained pressure	85	psi	5.86	bar
12	compressed air requirement, max flow rate	12.5	SCFM	19.5	N m3/hr
13	compressed air requirement, average flow rate	3.6	SCFM	5.6	N m3/hr
14	blower model	RBH6-305-3	All-Star	RBH4-2-3	All-Star
15	blower power	3.5	HP	2.2	kW
16	blower maximum rated airflow	228	SCFM	323	m3/hour
17	blower maximum rated pressure	89	inches H2O	228	mbar
18	blower noise level	77	db(A)	72	db(A)
19	heater power	15,000	watts	15,000	watts
20	vacuum generator model	JS-250	Vaccon	JS-250	Vaccon
21	heating hopper cylinder I.D.	17	in.	432	mm
22	heating hopper cylinder height	27	in.	686	mm
23	heating hopper material capacity	4.25	cu. ft.	120.3	L
24	heating hopper absolute capacity	5.125	cu. ft.	145.1	L
25	heating hopper material capacity w/ extension	6.25	cu. ft.	177.0	L
26	heating hopper absolute capacity w/ extension	7.125	cu. ft.	201.8	L
27	heating hopper empty weight	201	lbs.	91.2	kgs.
28	vacuum chamber cylinder I.D.	16.35	in.	415	mm
29	vacuum chamber cylinder height	17.5	in.	445	mm
30	vacuum chamber material capacity	2	cu. ft.	56.6	L
31	vacuum chamber absolute air capacity	2.5	cu. ft.	70.8	L
32	vacuum chamber normal evacuation volume	1.6	cu. ft.	45.3	L
33	vacuum chamber empty weight	72.5	lbs.	32.9	kgs.
34	retention hopper cylinder I.D.	19	in.	483	mm
35	retention hopper cylinder height	14	in.	356	mm
36	retention hopper material capacity	2.25	cu. ft.	63.7	L
37	retention hopper absolute capacity	2.8	cu. ft.	79.3	L
38	retention hopper empty weight	31.5	lbs.	14.3	kgs.

ULTRA-300 I/O Board Wiring Diagram

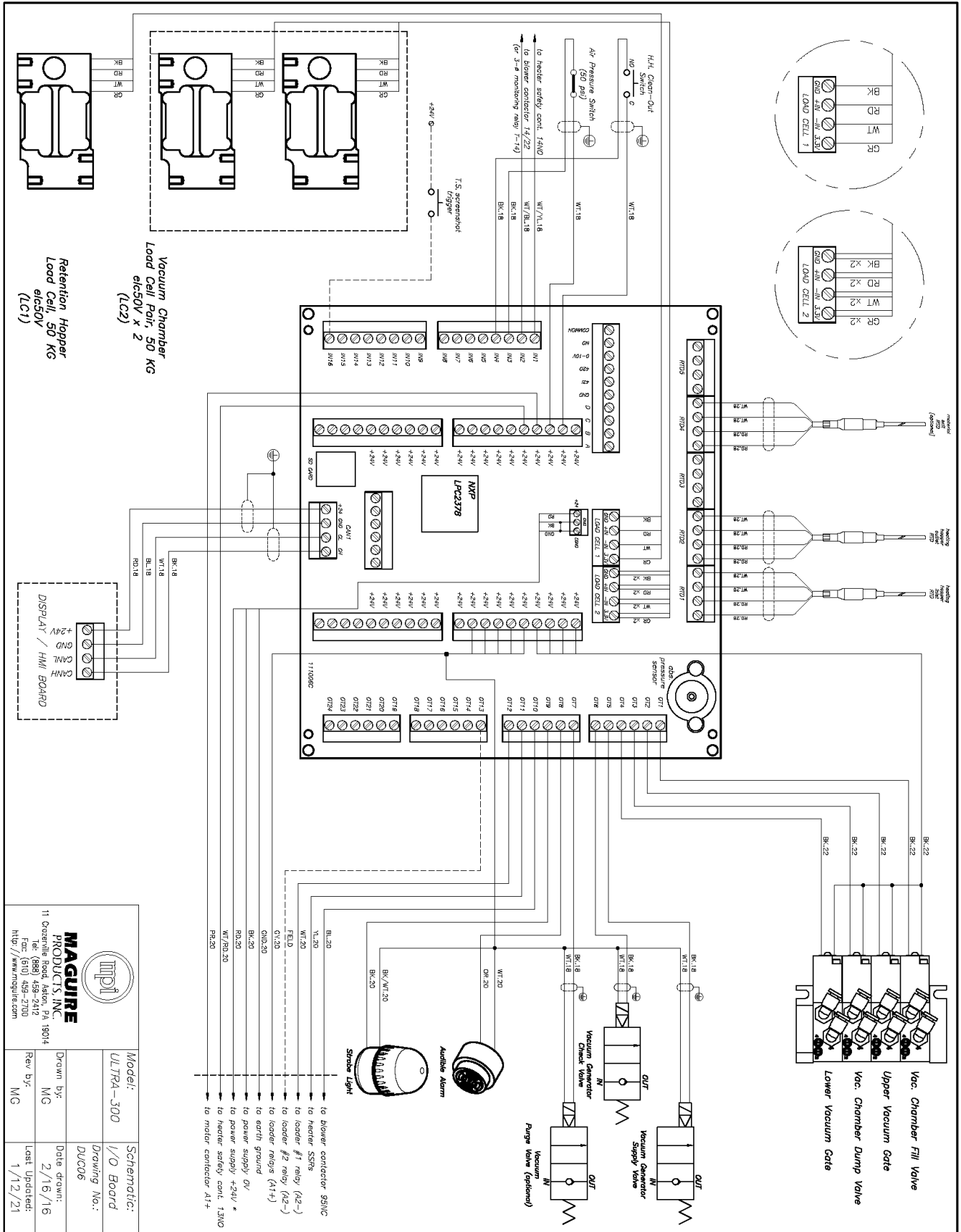

<p>MAGUIRE PRODUCTS, INC. 11 Ockenville Road, Astoria, PA 19014 Tel: (800) 438-2412 Fax: (301) 431-2700 http://www.maguire.com</p>	
Model:	ULTRA-300
Schematic:	I/O Board
Drawn by:	MG
Drawing No.:	DUC06
Date drawn:	2/16/16
Rev by:	MG
Lost Updated:	1/12/21

ULTRA-300 I/O Board Wiring Diagram – With Variable Frequency Drive (VFD)

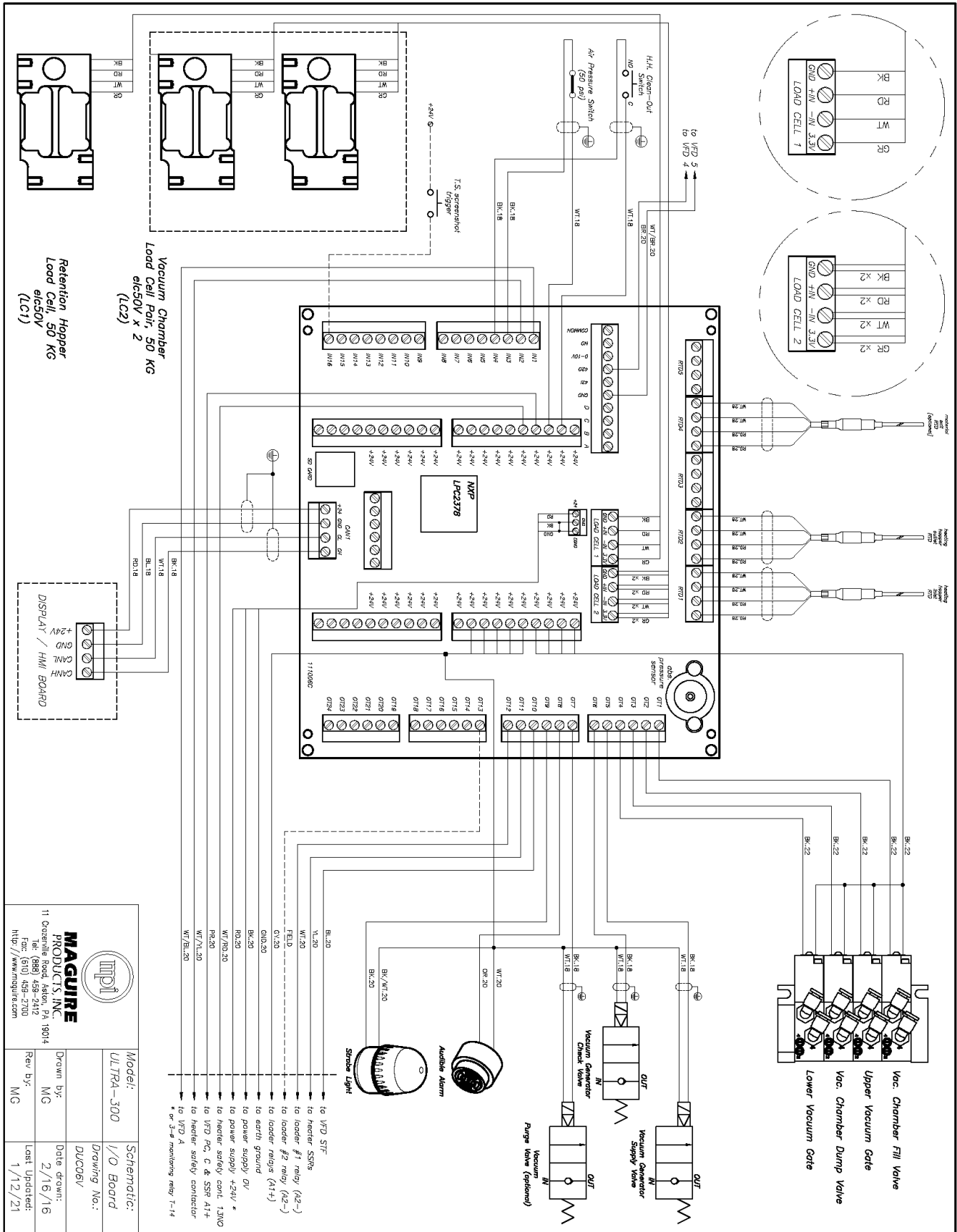

MAGUIRE PRODUCTS, INC.
 11 Greenville Road, Aston, PA 19014
 Tel: (486) 439-2412
 Fax: (486) 439-2100
 Http://www.maguire.com

Model:	ULTRA-300	Schematic:
Drawn by:	M/G	Drawing No.:
Rev by:	M/G	Date drawn:
		2/16/16
		1/12/21

High Voltage Schematics

ULTRA-300 – STANDARD – 400V

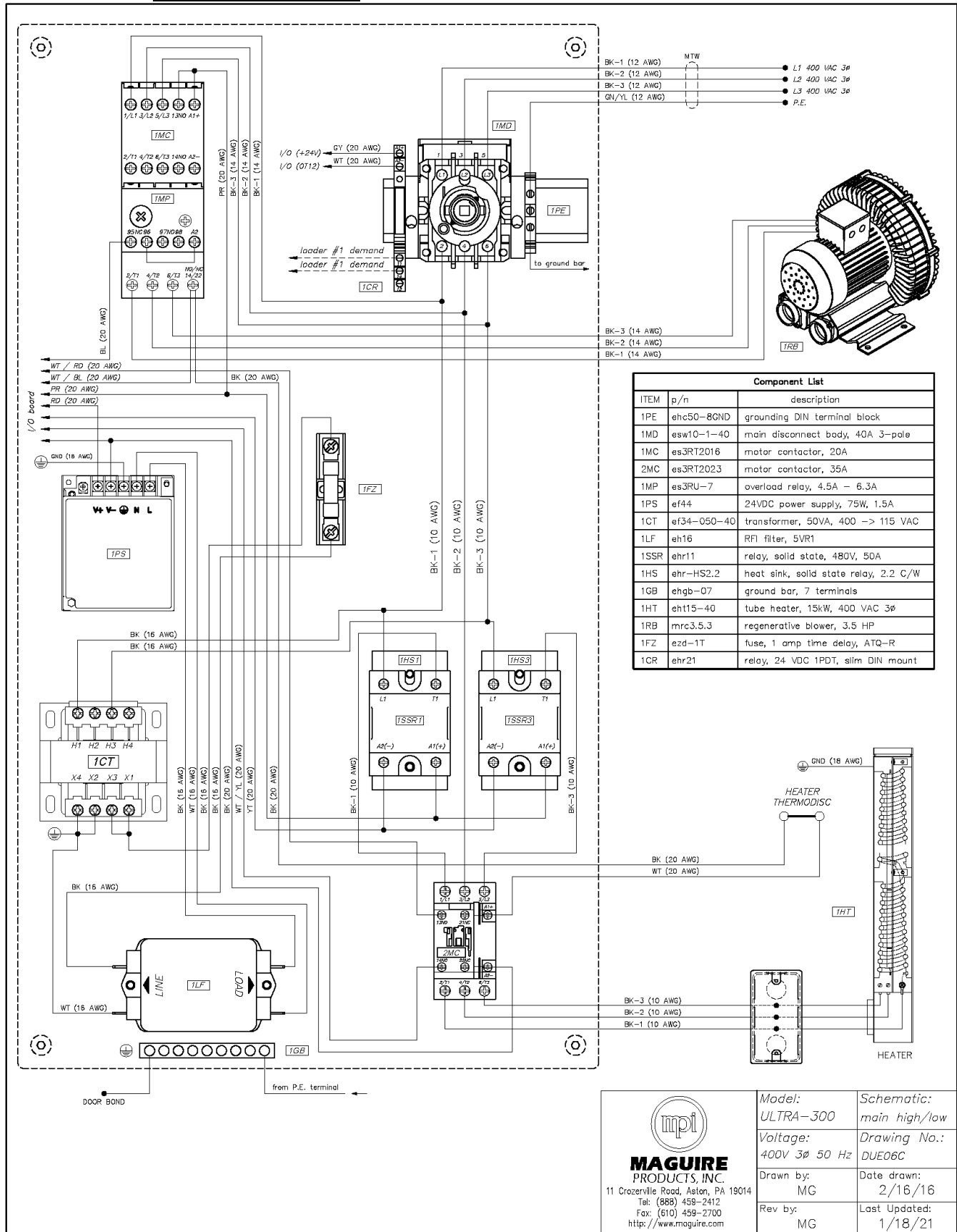

ULTRA-300 – STANDARD – 480V

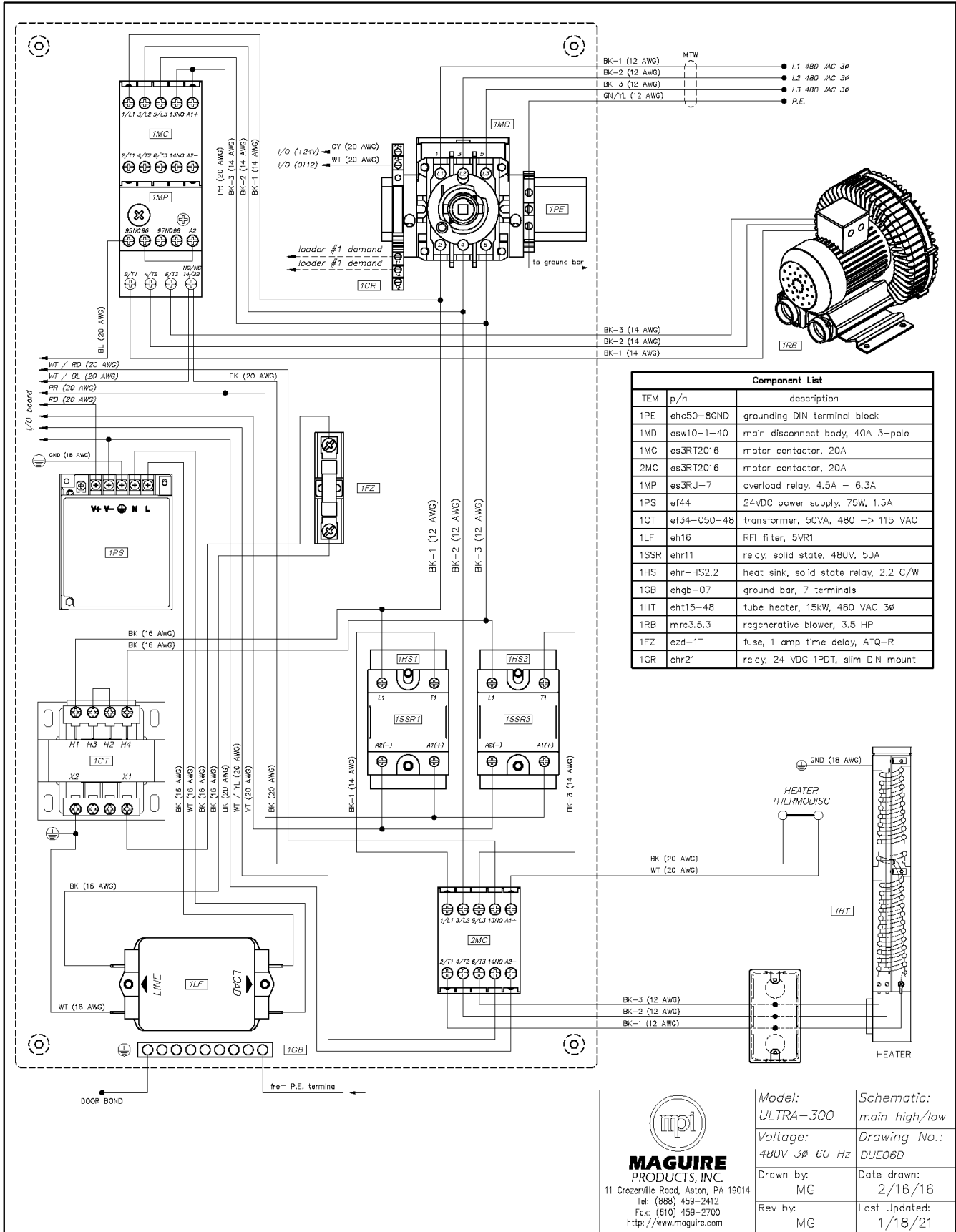

ULTRA-300 – STANDARD – 480V – CSA

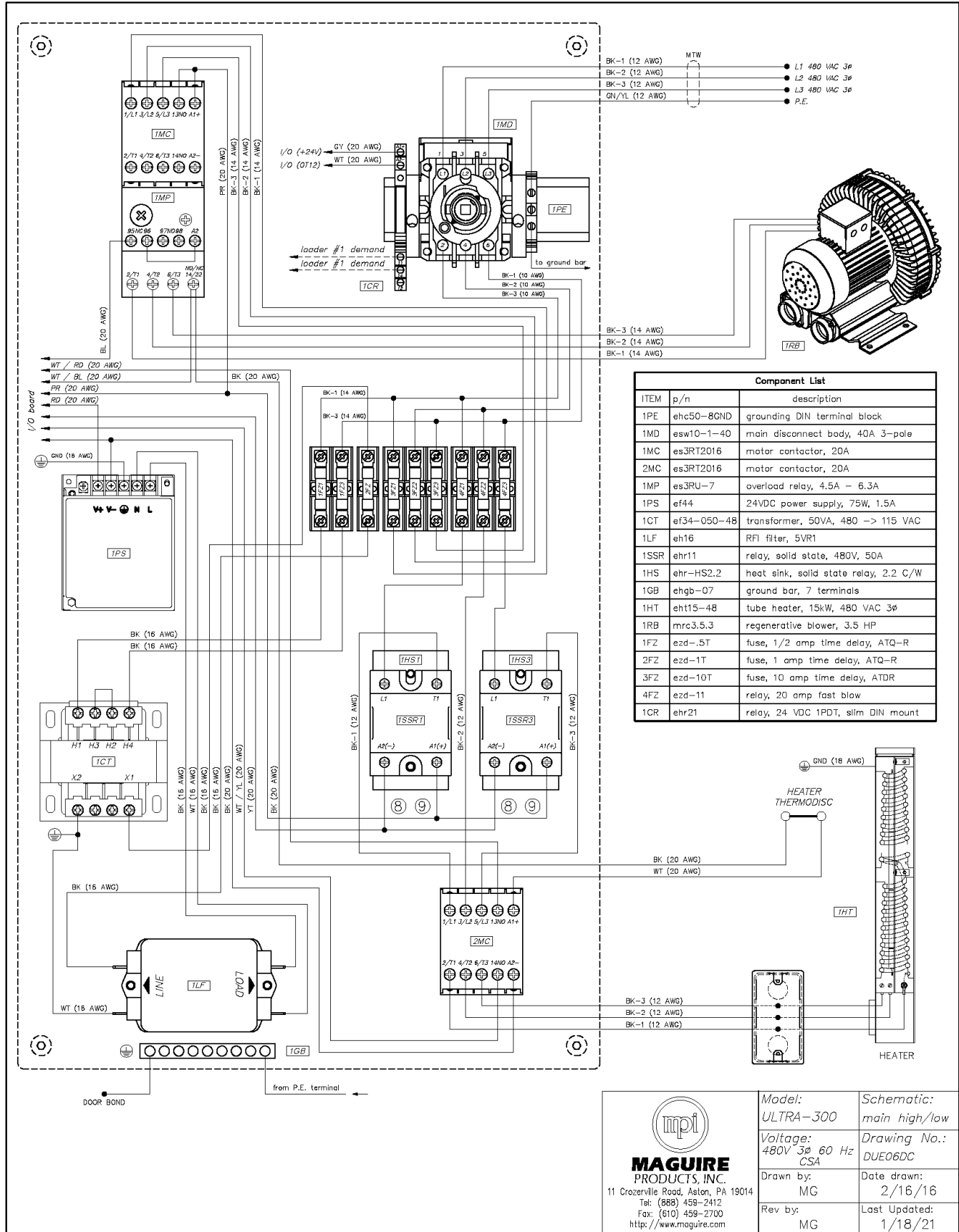

ULTRA-300 – STANDARD – 575V – CSA

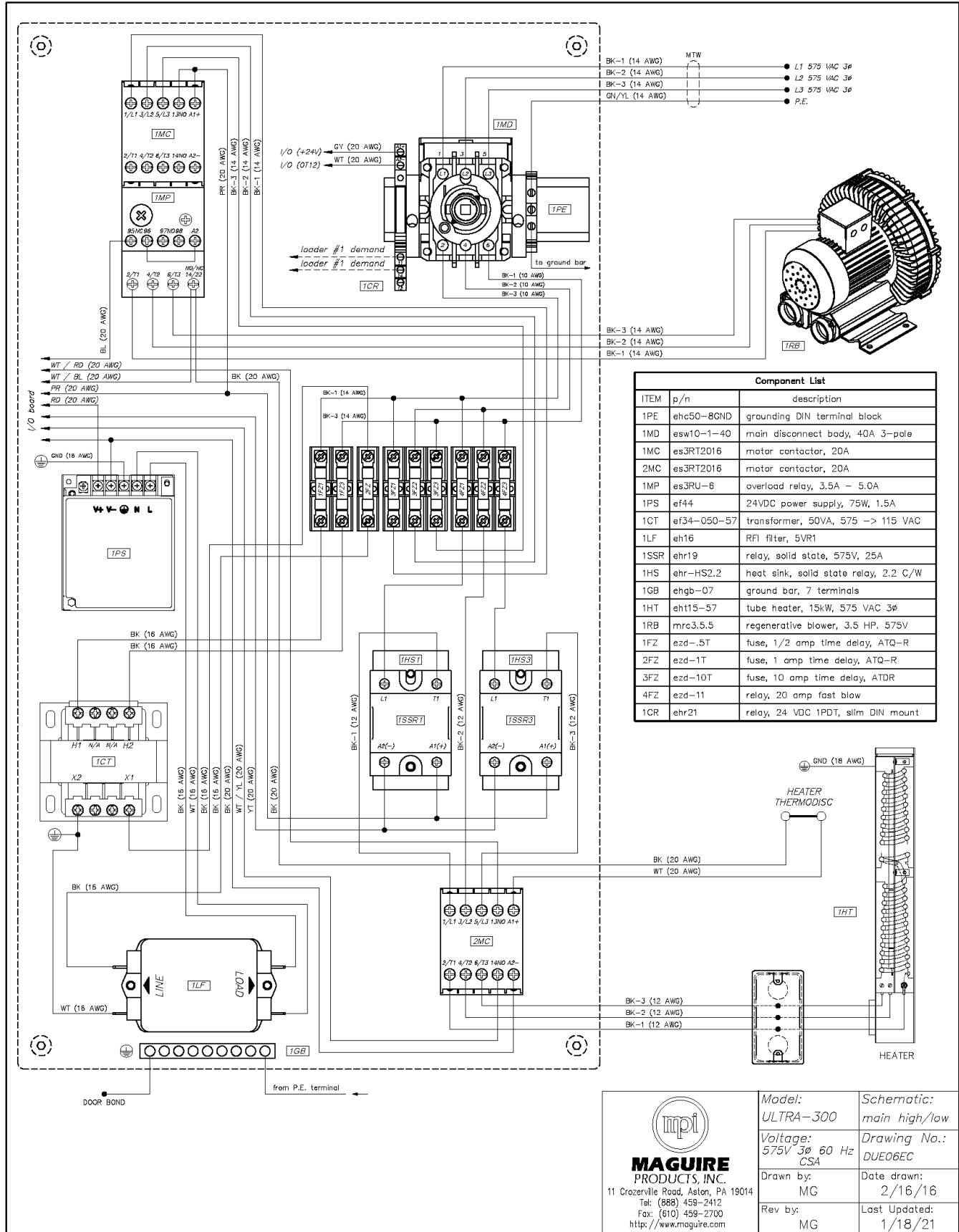



MAGUIRE
PRODUCTS, INC.
11 Crozerville Road, Aston, PA 19014
Tel: (888) 458-2412
Fax: (610) 458-2700
<http://www.maguire.com>

Model: ULTRA-300	Schematic: main high/low
Voltage: 575V 3ø 60 Hz CSA	Drawing No.: DUE06EC
Drawn by: MG	Date drawn: 2/16/16
Rev by: MG	Last Updated: 1/18/21

ULTRA-300 – PHASE MONITORING – 400V

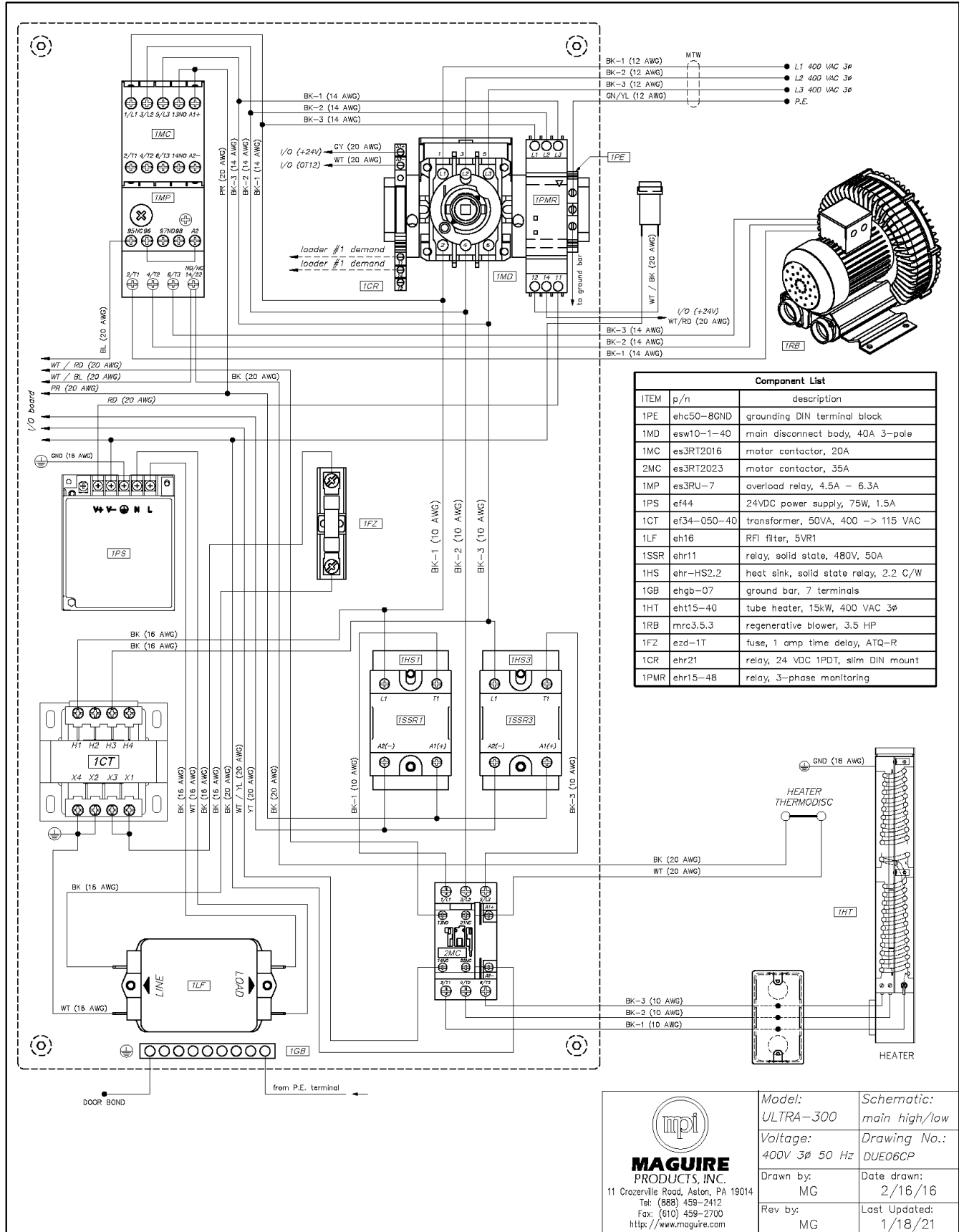

<p>MAGUIRE PRODUCTS, INC. 11 Crozerville Road, Aston, PA 19014 Tel: (888) 458-2412 Fax: (610) 458-2700 http://www.maguire.com</p>	Model: ULTRA-300	Schematic: main high/low
	Voltage: 400V 3ø 50 Hz	Drawing No.: DUE06CP
	Drawn by: MG	Date drawn: 2/16/16
	Rev by: MG	Last Updated: 1/18/21

ULTRA-300 – PHASE MONITORING – 480V

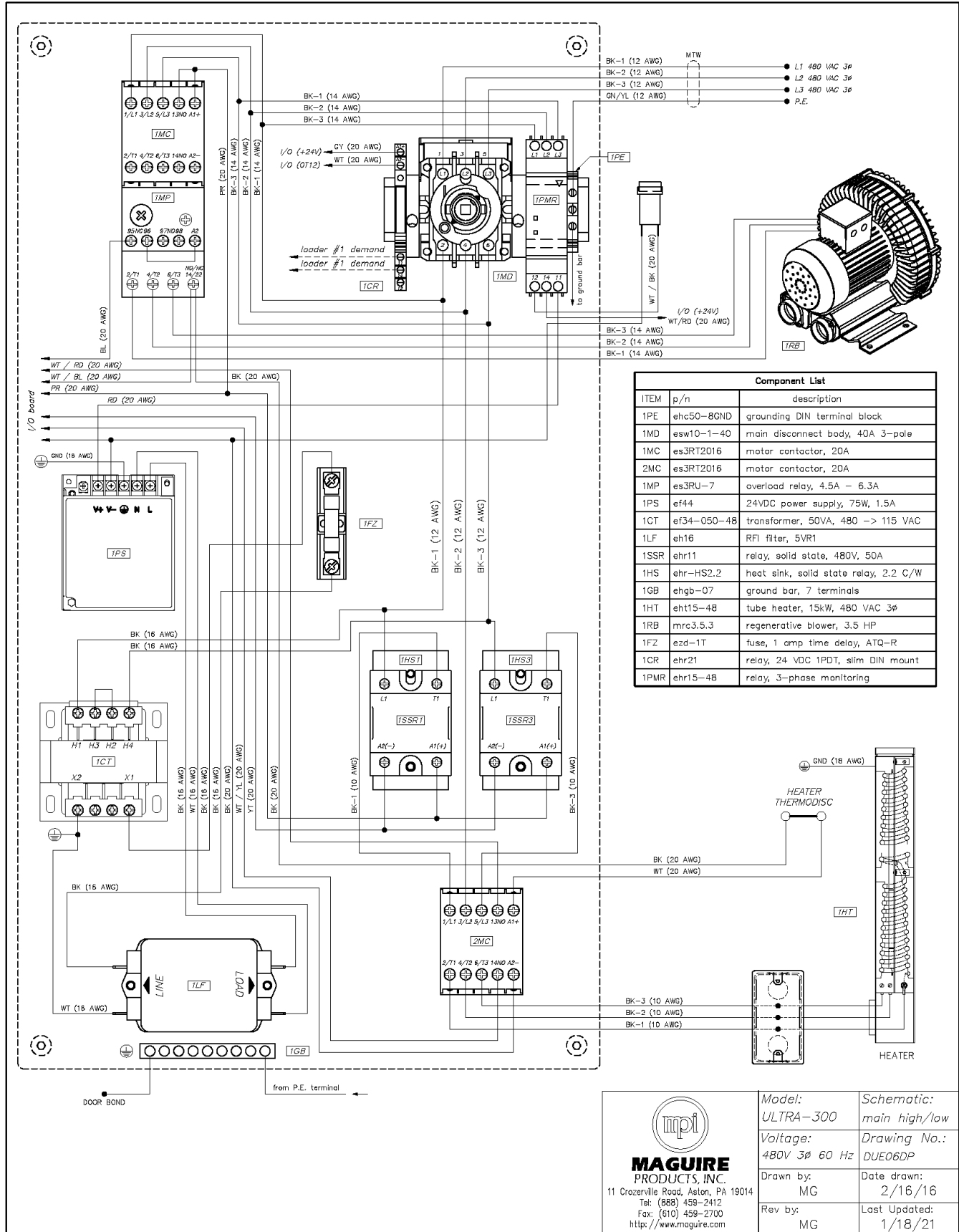

ULTRA-300 – PHASE MONITORING – 480V – CSA

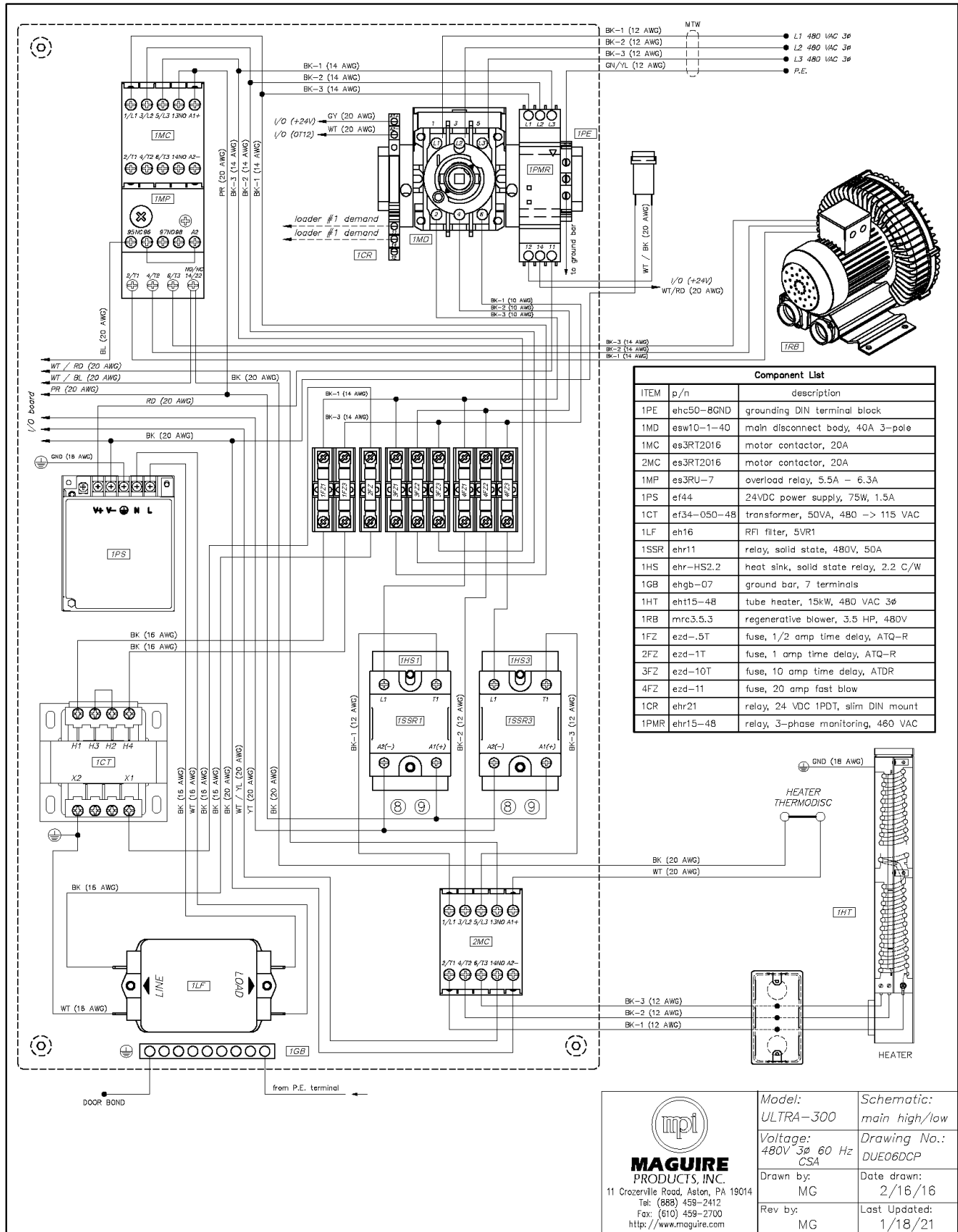

ULTRA-300 – PHASE MONITORING – 575V – CSA

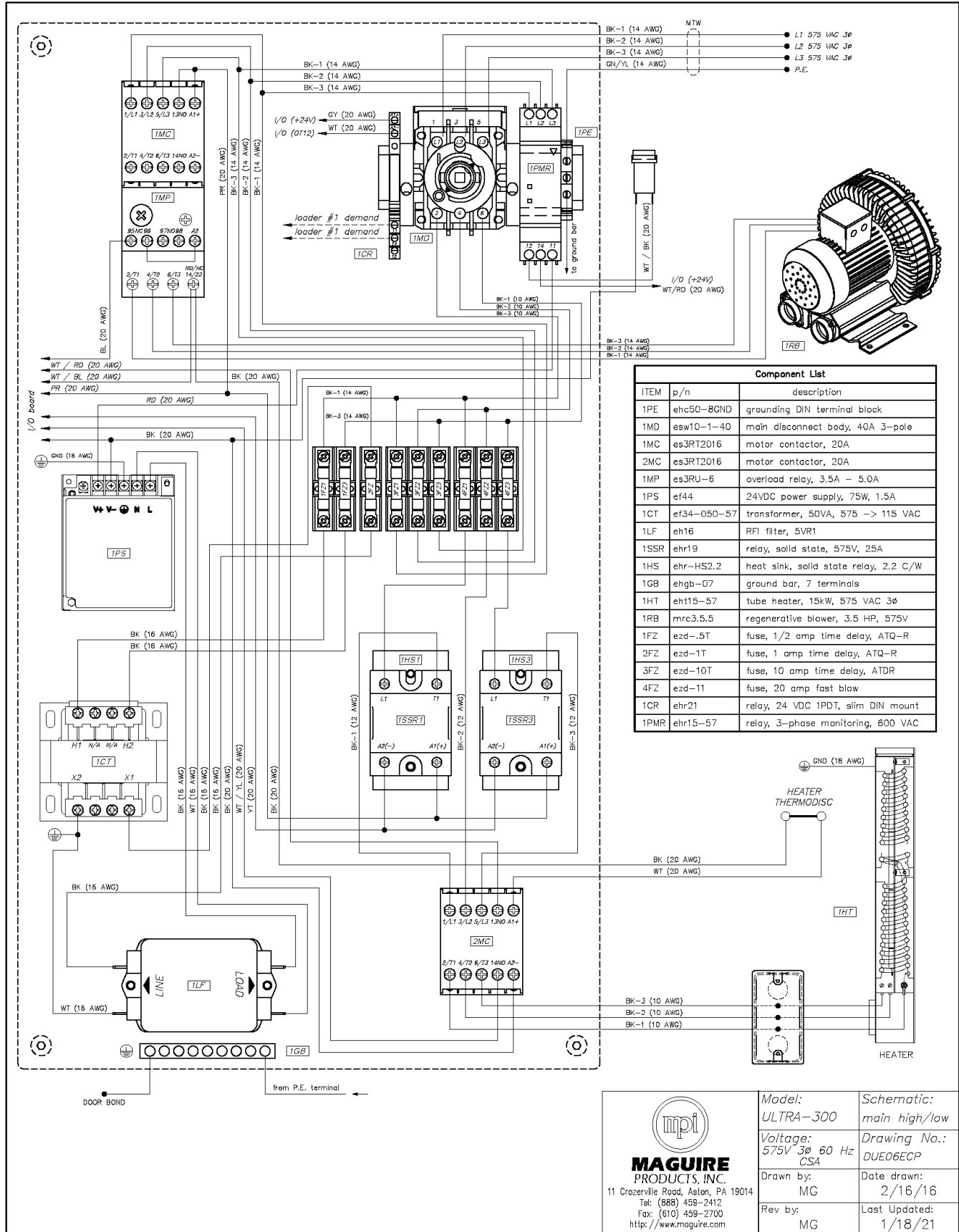

ULTRA-300 – VARIABLE FREQUENCY DRIVE (VFD) – 400V

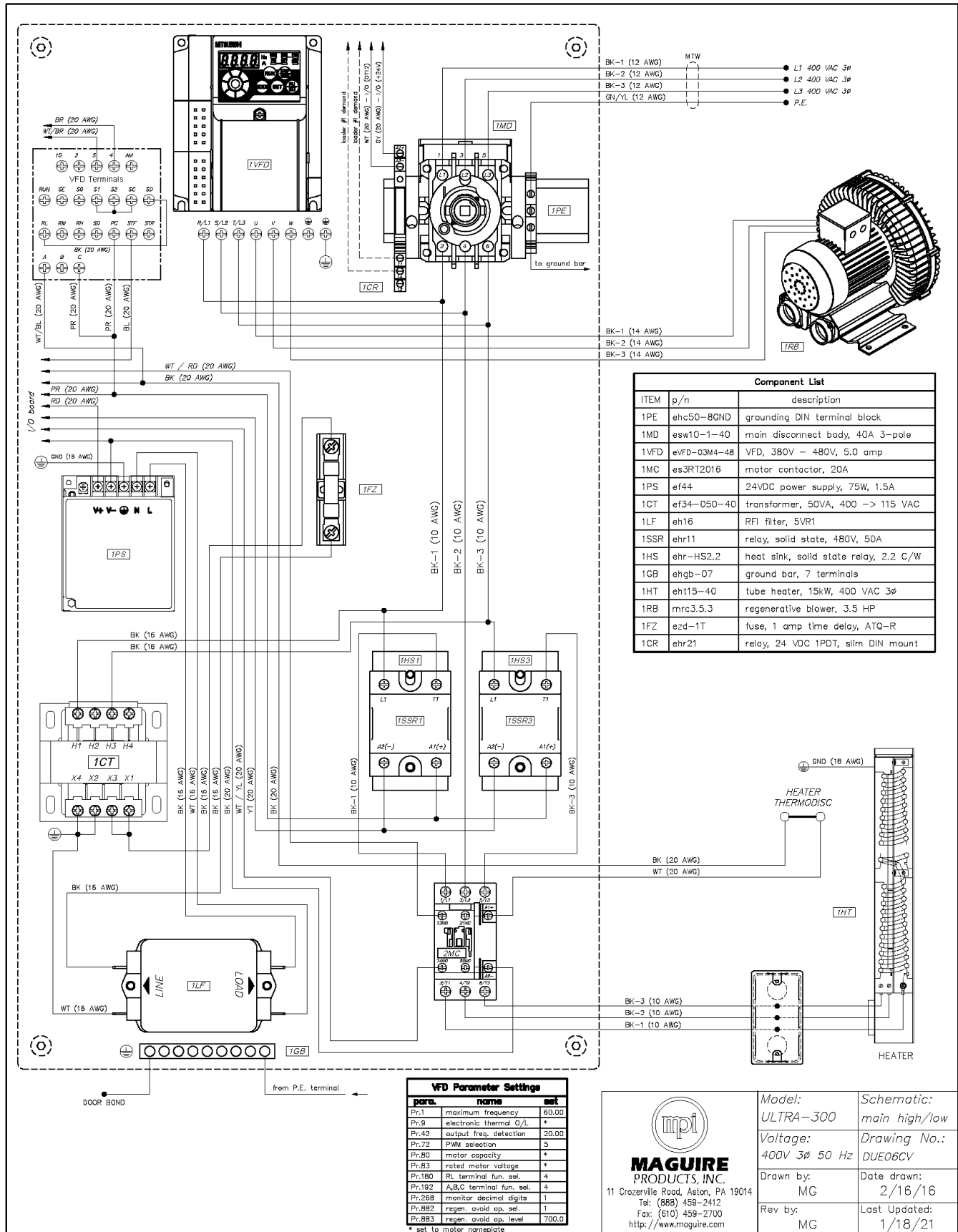

ULTRA-300 – VARIABLE FREQUENCY DRIVE (VFD) – 480V

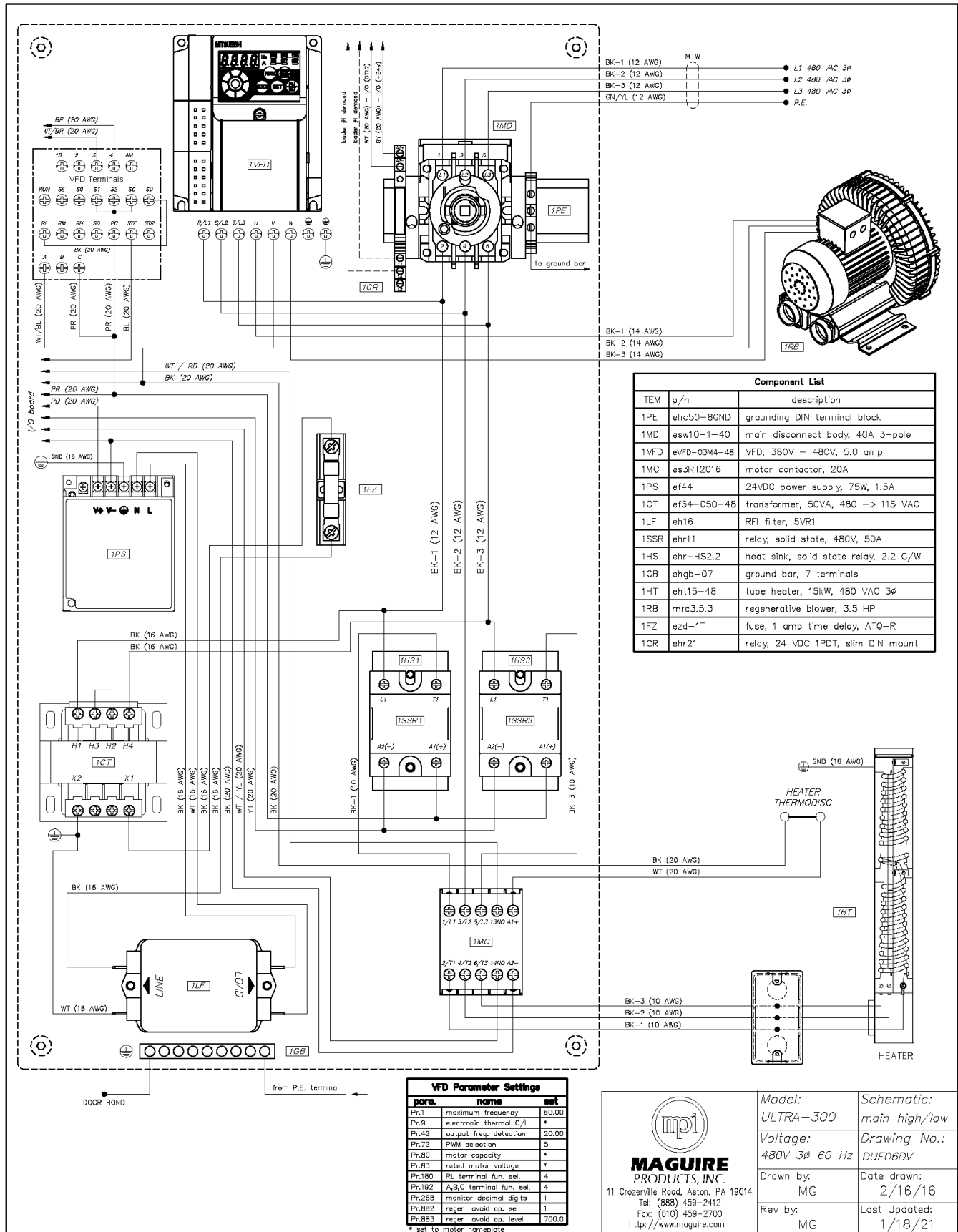

ULTRA-300 – VARIABLE FREQUENCY DRIVE (VFD) – 480V – CSA

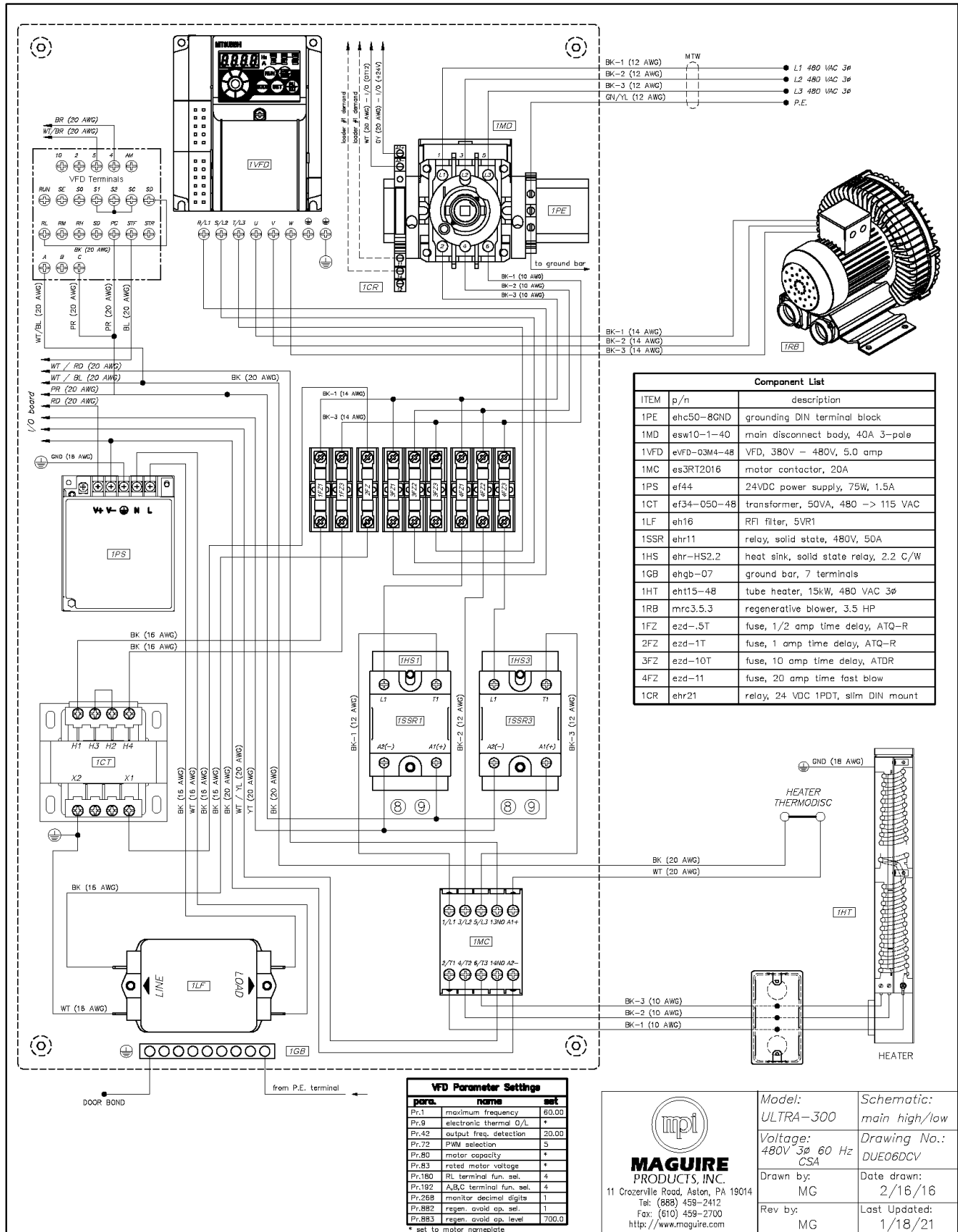

ULTRA-300 – VARIABLE FREQUENCY DRIVE (VFD) – 575V – CSA

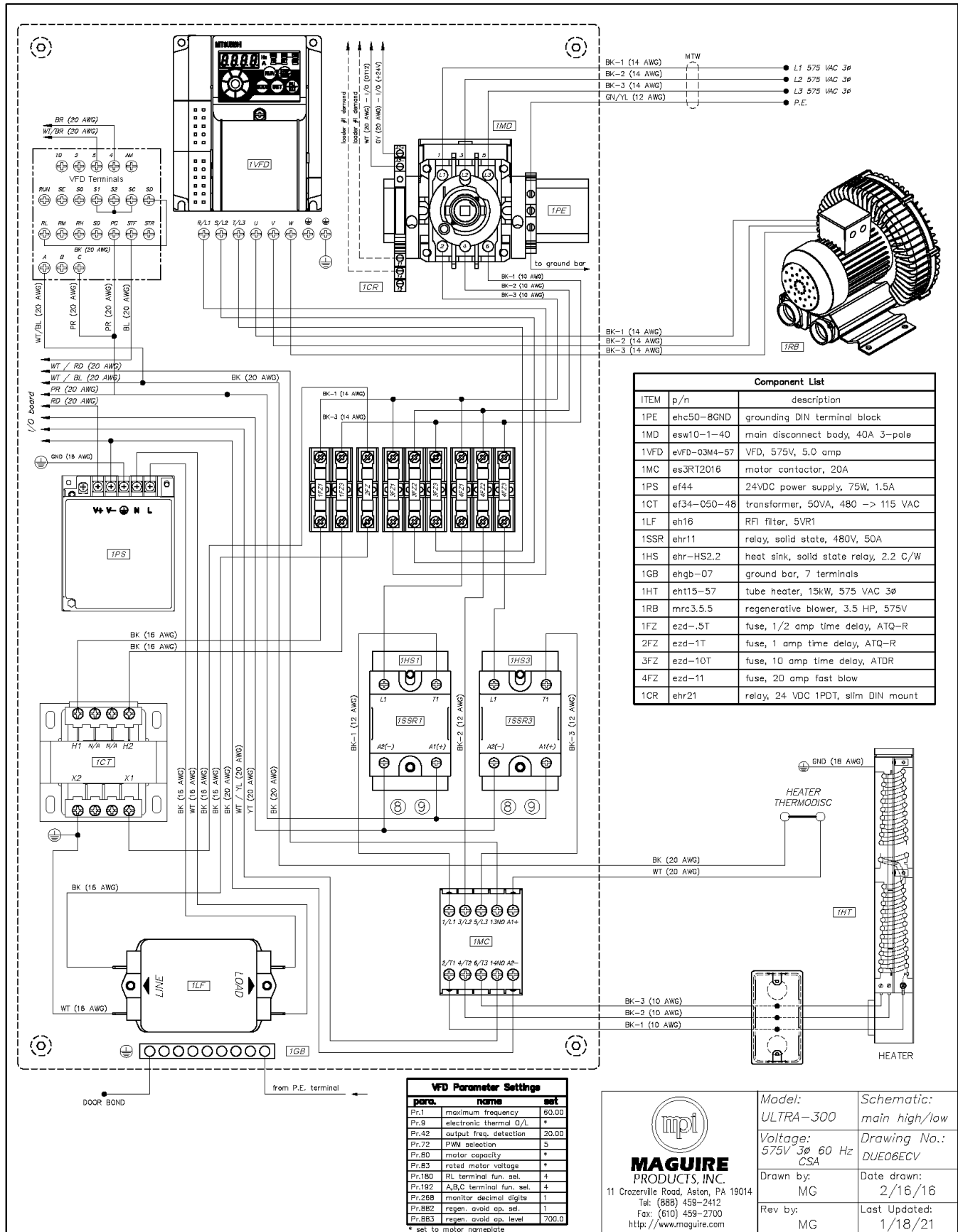

ULTRA-300 – PNEUMATIC DIAGRAM

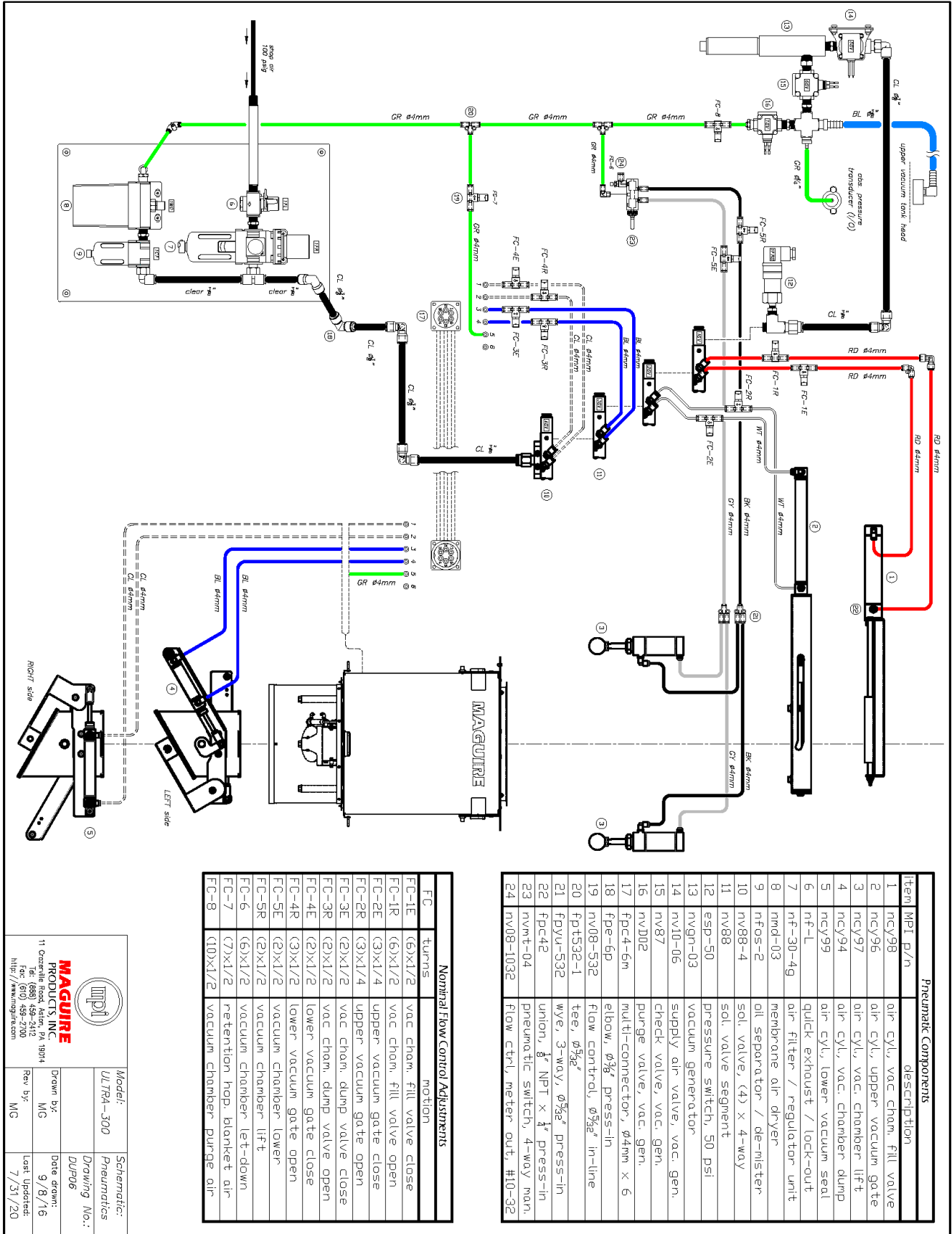

FC	turns	nominal	Flow Control Adjustments
FC-1E	(6)x1/2	vac cham. fill valve close	
FC-1R	(6)x1/2	vac cham. fill valve open	
FC-2E	(3)x1/4	upper vacuum gate close	
FC-2R	(3)x1/4	upper vacuum gate open	
FC-3E	(2)x1/2	vac cham. dump valve close	
FC-3R	(2)x1/2	vac cham. dump valve open	
FC-4E	(2)x1/2	lower vacuum gate close	
FC-4R	(3)x1/2	lower vacuum gate open	
FC-5E	(2)x1/2	vacuum chamber lower	
FC-5R	(2)x1/2	vacuum chamber lift	
FC-6	(6)x1/2	vacuum chamber let-down	
FC-7	(7)x1/2	retention hop. blanket air	
FC-8	(10)x1/2	vacuum chamber purge air	

Item	MPI p/n	description
1	ncy98	air cyl, vac cham. fill valve
2	ncy96	air cyl, upper vacuum gate
3	ncy97	air cyl, vac. chamber lift
4	ncy94	air cyl, vac. chamber dump
5	ncy99	air cyl, lower vacuum seal
6	nf-L	quick exhaust / lock-out unit
7	nf-30-4g	air filter / regulator unit
8	nmd-03	membrane air dryer
9	nfos-2	oil separator / de-mister
10	nv88-4	sol. valve (4) x 4-way
11	nv88	sol. valve segment
12	esp-50	pressure switch, 50 psi
13	nvgn-03	vacuum generator
14	nv10-06	supply air valve, vac. gen.
15	nv87	check valve, vac. gen.
16	nv1002	purge valve, vac. gen.
17	fpc4-6m	multi-connector, 64mm x 6
18	fpe-6p	elbow, 63/8" press-in
19	nv08-532	flow control, 5/8" in-line
20	fpt532-1	tee, 5/8" 3/4"
21	fyu-532	wye, 3-way, 5/8" press-in
22	fpc42	union, 3/4" NPT x 1/2" press-in
23	nvmt-04	pneumatic switch, 4-way man.
24	nv08-1032	flow ctrl. meter out, #10-3/2

MAGUIRE PRODUCTS, INC.
 11 Granite Road, Aston, PA 19014
 Tel: (610) 488-2700
 Fax: (610) 488-2700
 Http: //www.maguire.com

Model: ULTRA-300
Schematic: Pneumatics

Drawn by: MJS
DUP#06
Date drawn: 9/8/16

Rev by: MG
Last Updated: 7/31/20

ULTRA-300 Recommended Spare Parts List

Note: it is recommended that items #1 - #8 be kept on hand by the maintenance department.

Item	MPI P/N	Description	General Location
1	hf19-E	replacement filter element, blower intake	rear panel
2	8224-11	silicone seal, vacuum chamber dump valve	vacuum chamber
3	go-357V	o-ring, size 357, Viton	upper vacuum gate
4	go-350V	o-ring, size 350, Viton	lower vacuum gate
5	as8224-03	vac. seal plate assy., vac. cham. dump valve	lower vacuum gate
6	nv88-sol	solenoid valve segment, 4-way, 24 VDC	main cabinet
7	nf-30E	filter element, for "AW30" series regulator	pneumatics cabinet
8	nfos3E	filter element, for oil separator	pneumatics cabinet

Other Potential Replacement Parts

9	es3RU-6	overload relay, 3.5 A - 5.0 A	electrical cabinet
10	es3RU-7	overload relay, 4.5 A - 6.3 A	electrical cabinet
11	es3RT2016	motor contactor, 3 pole, 20A, 24 VDC	electrical cabinet
12	ehr11	relay, SS, 480V 50A, 24-265 VAC signal	electrical cabinet
13	ezd-1T	fuse, 1-amp time delay, ATQ-R	electrical cabinet
14	eRTD2-40-160	RTD temp. sensor, 1/8" dia. x 2-1/2" long, Pt100	heating hopper
15	elc50V	load cell, 50 kg capacity	ret., vac. chamber
16	esp-05	pressure switch, 60 psi set-point, 1/8" NPT	main cabinet
17	eabVBD-01	I/O circuit board	electrical cabinet
18	eabVBD-02	display / HMI circuit board	front control panel
19	eabVBD-03	pendant circuit board (.8" 4-digit numeric)	front control panel
20	ebTS-7V	touch screen	front control panel
21	nmd-03E	replacement element, for membrane air dryer	pneumatics cabinet
22	eht15-24	tube heater, 15,000-watt 3 phase 240 VAC	main cabinet
23	eht15-40	tube heater, 15,000-watt 3 phase 400 VAC	main cabinet
24	eht15-48	tube heater, 15,000-watt 3 phase 480 VAC	main cabinet
25	eht15-56	tube heater, 15,000-watt 3 phase 575 VAC	main cabinet
26	ehs1-02	strobe light, red, magnetic base, 24VDC	top deck
27	ehb-2	piezo buzzer, 24VDC	front control panel
28	esh-01	interlock handle, red/yellow pistol	front control panel

ULTRA-150 / 300 Loader #1 (Upstream) Demand Signal Interrupt

ULTRA-150 / 300 Loader #1 (upstream) demand signal interrupt

Used to tie the loader #1 (heating hopper feed loader) into the ULTRA controller. This gives the dryer's Auto Stop logic control of the loader, allowing for planned material depletion.

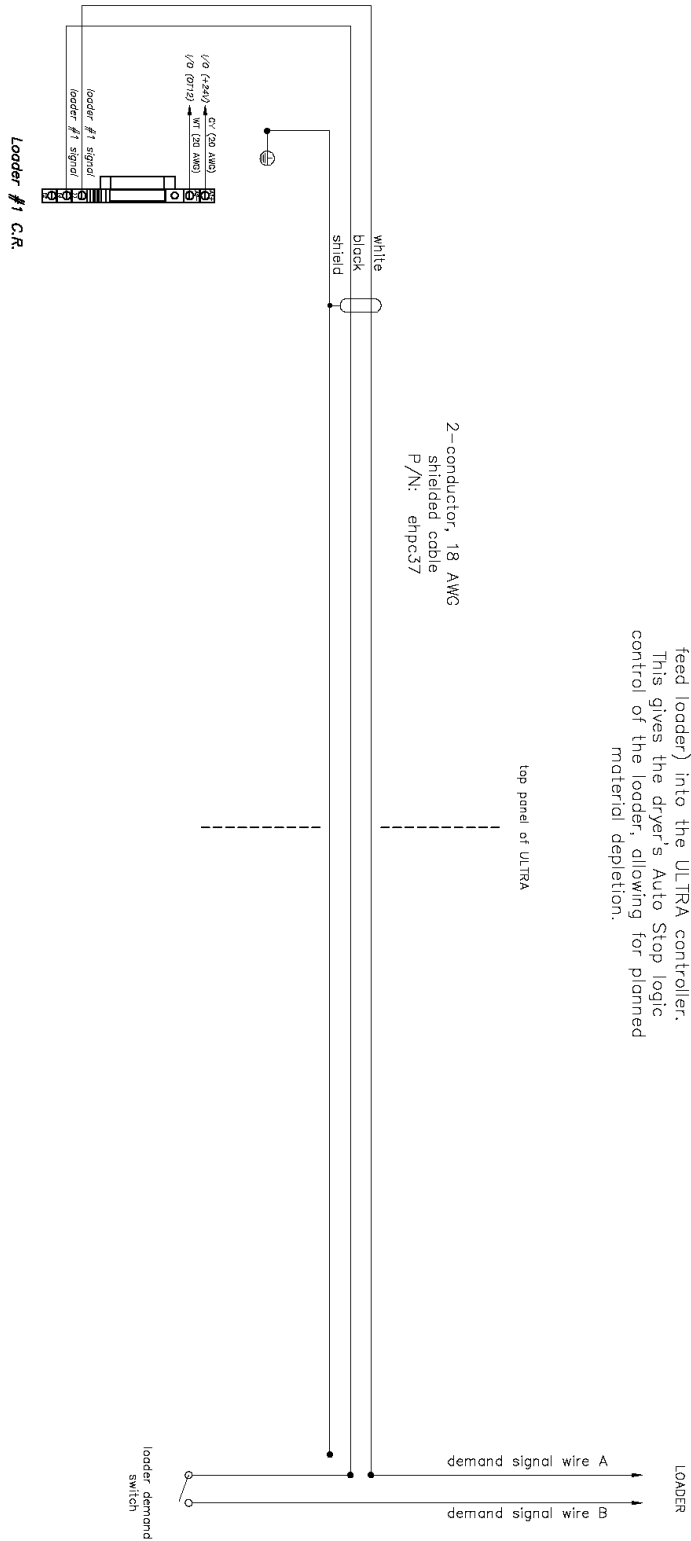

 MAGUIRE PRODUCTS, INC. 11 Oysterella Pond, Ash, PA, 19014 Tel: (888) 458-2412 Fax: (610) 458-2700 http://www.maguire.com		Model: various	Schematic:
Drawing No.: eDMGR100-L1C	Date drawn: 6/23/20	Drawn by: MG	Last Updated: 6/23/20
Rev by: MG			

ULTRA-150 / 300 Communications Ports Internal Wiring

ULTRA Comms. Ports Internal Wiring

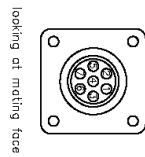
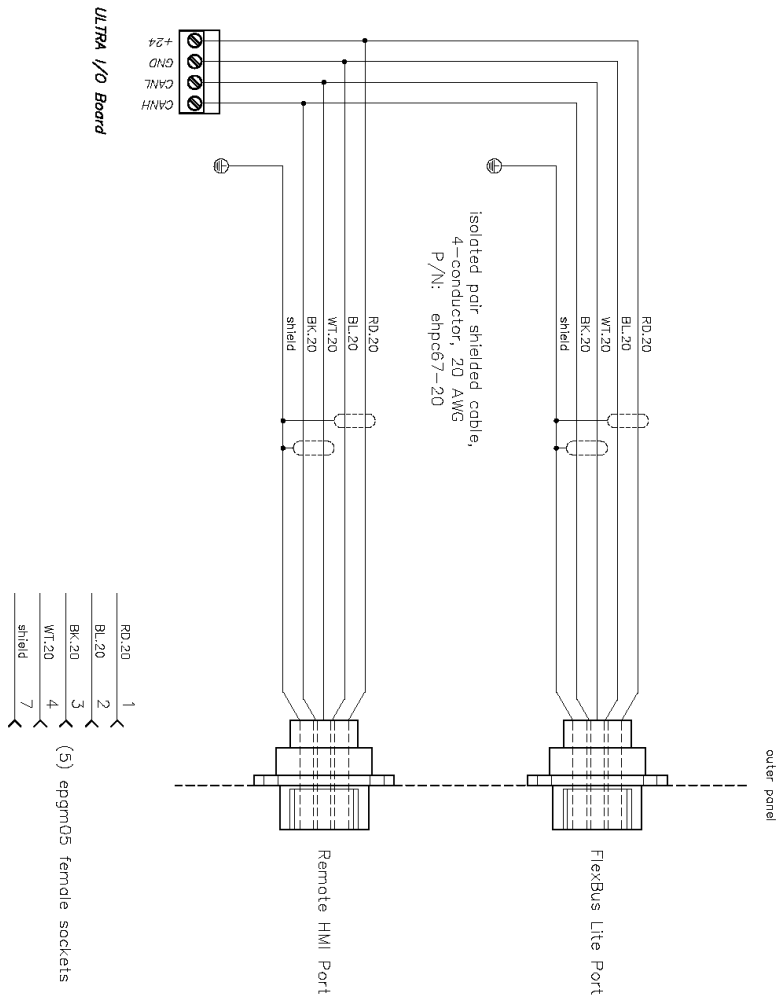
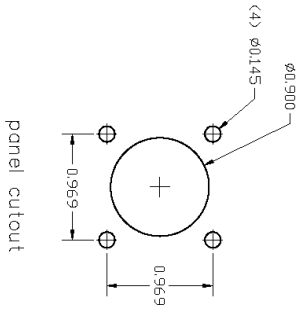

7-pin reverse flange receptacle
FEMALE pins
P/N: epgm16

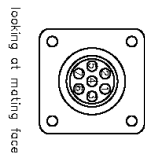

looking at making face

 MAGUIRE PRODUCTS, INC. 11 Coatesville Road, Ash, PA 19014 Tel: (888) 458-2412 Fax: (610) 458-2700 http://www.maguire.com		Model: various	Schematic:
Drawing No.: ULTRA_comms	Drawn by: MG	Date drawn: 11/2/20	Last Updated: 11/2/20
Rev by: MG	Date drawn: 11/2/20	Last Updated: 11/2/20	Last Updated: 11/2/20

Disclaimers

Intended Use - The intended use of the Maguire ULTRA series of Dryers is specifically for processing and drying raw and recycled plastics materials. The Maguire blenders should not be used for applications outside of the intended use.

Production of Faulty Product - Processing conditions and materials vary widely from customer to customer and from product to product. It is impossible for Maguire to anticipate all processing conditions and requirements, or to be certain that our equipment is guaranteed in all circumstances. The customer must observe and verify the performance level of the equipment as part of the overall manufacturing process.

The end user must verify to his/her own satisfaction that this level of performance meets the proper requirements. Maguire cannot be responsible for losses due to product that is dried incorrectly, even if equipment malfunctions. Maguire Products, Inc. is only responsible to correct, repair, replace, or accept return for full refund, if our equipment fails to perform per design, or is inadvertently misrepresented for the customer's application.

Decommissioning and Disposal - Decommissioning the unit: Disconnect the unit from the power supply. Disconnect the compressed air supply. Cut all Electrical cables and Pneumatic Hoses.

Disposal: Remove air hoses and inspection glasses and dispose of with plastic refuse. Remove electric motor dispose of with metal. Remainder of unit dispose of with metal. Controller: Remove battery and dispose of battery with hazardous waste. Remainder of controller dispose of with electronic waste. Re-cycle any hazardous materials/substances in accordance with the Local & National regulations of the End User e.g., Lithium batteries etc., specific attention should be paid to the European RoHS & WEEE Directives; remove any 'sharps' and dispose of in accordance with Local & National regulations.

Accuracy of this Technical Manual - Maguire Products, Inc. makes every effort to keep this manual as correct and current as possible. However, technology and product changes may occur more rapidly than the reprinting of this manual. Generally, modifications made to the dryer design or to the operation of the software may not be reflected in the manual for several months. The date at the footer of this manual will indicate approximately how current this manual is. Likewise, a customer's dryer may have been produced at an earlier time and the information in this manual may not accurately describe said dryer, since this manual is written for the current line of dryers in production (as of the date in the footer). Maguire Products Inc. always reserves the right to make these changes without notice and does guarantee the manual to be entirely up to date. This manual assumes software version U0204A or later.

If there are any questions regarding information in this manual, or errors exist, please reach out to Maguire Products, Inc. so that necessary corrections can be made, and proper information can be provided. Additionally, Maguire will gladly provide the customer with an updated copy of any manuals at any time. Comments and suggestions are always welcome as Maguire strives to constantly improve/update this technical manual.

For additional information, or to download the latest copy of this manual or any other Maguire manual, please visit our website at <http://www.maguire.com> or contact us directly.

Maguire Products Inc.

11 Crozerville Road
Aston, PA. 19014

Phone: (610) 459-4300
Fax: (610)459-2700

Technical Support / Contact Information

Visit Maguire Products, Inc. on the web at: www.maguire.com

Maguire Products Inc.

Main Headquarters

11 Crozerville Road
Aston, PA 19014
Tel: (610) 459-4300
Fax: (610) 459-2700
Email: info@maguire.com

Maguire Europe

Tame Park
Tamworth
Staffordshire
B775DY, UK
Tel: + 44 1827 265 850
Fax: + 44 1827 265 855
Email: info@maguire-europe.com

Maguire Products Asia PTE LTD

15 Changi North Street 1
#01-15, I-Lofts
Singapore 498765
Tel: 65 6848-7117
Fax: 65 6542-8577
magasia@maguire-products.com.sg

Maguire Canada

299 Basaltic Road, Unit 1
Vaughan, Ontario, L4K 4W8
Canada
Tel: +1 905 879 1100
Fax: +1 905 879 1101
Email: info@maguirecanada.com

Maguire IMEA FZCO

India, Middle East, & Africa
Lobby 18, Floor 7, Office 6
JAFZA View 18 Jebel Ali Downtown
PO Box 17493, Dubai, UAE
Tel: +971 4 881 6700
Email: info@maguire-imea.com

Maguire Italy

Via Zancanaro 40
35020 Vigorovea (PD)
Tel: +39 049 970 54 29
Fax: +39 049 971 18 38
Email: info@maguire-italia.it

Please e-mail comments and suggestions to: support@maguire.com