



BOSCH
Invented for life

Batteries



de

Effizienz ist unser Antrieb

Technologien von Bosch kommen weltweit in fast allen Fahrzeugen zum Einsatz. Dabei stehen für uns die Menschen und die Sicherstellung ihrer Mobilität im Vordergrund.

Ihnen widmen wir über 125 Jahre Pioniergeist, Forschung, Fertigung und Expertise.

Und für sie arbeiten wir unentwegt an einer Kombination aus Ersatzteilen, Diagnose, Werkstattausrüstung und Serviceleistungen.

en

Driven by efficiency

Bosch technologies are used worldwide in almost all vehicles. People, and assuring their mobility, is what we are focused on.

Therefore, we have dedicated the last 125 years of pioneering spirit and expertise in research and manufacturing to achieving this.

We continue to work on our unique combination of solutions for spare parts, diagnostic devices, workshop equipment and services.

fr

Guidés par l'efficacité

Les technologies de Bosch sont utilisées partout dans le monde, dans la quasi-totalité des véhicules. Nous nous concentrons sur les populations et cherchons avant tout à assurer leur mobilité.

Depuis 125 ans, nous mettons notre esprit pionnier et notre expertise en matière de recherche et de fabrication au service de cet objectif.

Chaque jour, nous travaillons sur notre offre unique de pièces détachées, d'appareils de diagnostic, de matériel et sur les services proposés dans les ateliers.

it

Guidati dall'efficienza

Le tecnologie Bosch sono utilizzate a livello mondiale in quasi tutti i veicoli. Siamo concentrati sulle persone e sulla loro mobilità.

Per raggiungere questo risultato, abbiamo dedicato gli ultimi 125 anni alla ricerca e produzione, con spirito pionieristico e competenza.

Continuiamo a lavorare sulla nostra combinazione unica di soluzioni per ricambi, dispositivi di diagnosi, attrezzature e servizi per l'officina.

es

La eficiencia es nuestra motivación

La tecnología de Bosch se utiliza en todo el mundo en casi todos los vehículos. Garantizar la movilidad de las personas es nuestra prioridad.

Llevamos más de 125 años siendo pioneros en el mundo del automóvil, investigando, fabricando y aportando nuestra experiencia.

Trabajamos para ofrecer una combinación exclusiva de piezas de recambio, diagnosis, equipamiento de taller y servicios.

ru

Обеспечивая эффективность

Технологии Bosch используются по всему миру практически во всех автомобилях. Центром внимания для нас являются забота о людях и обеспечение их мобильности.

Достижению этого мы посвятили последние 125 лет своего новаторского духа и знаний в сфере исследований и производства.

Мы продолжаем работать над тем, чтобы обеспечить уникальный комплекс решений по запчастям, оборудованию для СТО и сервисным концепциям.



BOSCH

2020 | 2021



BOSCH

1 987 720 213/201910

AA/MBC2 – 10.2019 – Int

© 2019 Robert Bosch GmbH
Automotive Aftermarket
Postfach 41 09 60
76225 Karlsruhe

Token fee: € 5,00

Editorial closing: 15.08.2019

Subject to change without notice. Please direct questions and comments to our Authorized Representative in your country. This edition supersedes all previous editions.



Bosch parts fast and easy on:
bosch-automotive-catalog.com



4 047023 037992



de en fr it es pt fi pl cs ru

bosch-automotive-aftermarket.com

de Bosch-Batterien Gesamtprogramm	en Overall Bosch batteries range	fr Batteries Bosch gamme générale	it Gamma completa batterie Bosch	es Programa completo de baterías Bosch
pt Baterias Bosch Programa completo	fi Bosch-akut Tuotevalikoima	pl Akumulatory Bosch Pełny asortyment	cs Akumulátory Bosch Celkový program	ru Программа аккумуляторов Bosch



de Effiziente Bosch-Qualität für unterschiedliche Ansprüche und Fahrzeugtypen. Bosch-Batterien liefern dank moderner Technik und korrosionsbeständiger Konstruktion über lange Zeiträume die passende Energie für unterschiedliche Fahrzeugtypen.	en Efficient Bosch quality for a wide range of requirements and vehicle types. Equipped with modern technology and featuring a corrosion-proof design, Bosch batteries provide different types of vehicles with the energy they need – over long periods.	fr La qualité Bosch : une même efficacité en divers niveaux d'exigences et pour divers types de véhicules. Grâce à leur technologie moderne et à leur construction qui résiste durablement à la corrosion, les batteries Bosch fournissent l'énergie requise pour divers types de véhicules.	it Efficiente qualità Bosch per le più svariate esigenze e diversi tipi di veicoli. Grazie alla tecnologia moderna e al design resistente alla corrosione, le batterie Bosch forniscono l'energia giusta per diversi tipi di veicoli per lunghi periodi di tempo.	es Eficiente calidad Bosch para distintas exigencias y diferentes tipos de vehículos. Gracias a su moderna tecnología y a la construcción resistente a la corrosión por periodos prolongados, las baterías Bosch suministran la energía adecuada para diferentes tipos de vehículos.
-----------------------------------------------------------------------------------------------------------------------------------------------------------------------------------------------------------------------------------------------------------------------	-------------------------------------------------------------------------------------------------------------------------------------------------------------------------------------------------------------------------------------------------------------------------------	------------------------------------------------------------------------------------------------------------------------------------------------------------------------------------------------------------------------------------------------------------------------------------------------------------------	---------------------------------------------------------------------------------------------------------------------------------------------------------------------------------------------------------------------------------------------------------------------------------------	----------------------------------------------------------------------------------------------------------------------------------------------------------------------------------------------------------------------------------------------------------------------------------------------------------







pt Qualidade Bosch eficiente para diferentes exigências e tipos de veículos. Graças a tecnologia moderna e a uma construção resistente à corrosão, as baterias Bosch fornecem, durante longos períodos de tempo, a energia adequada para diversos tipos de veículos.	fi Tehokasta Bosch-laatus eri ajoneuvotyyppien erilaisia laatuvaatimuksia. Boschin akut toimittavat modernin tekniikan ja korroosionkestävän rakenteen ansiosta pitkään aikaa sopivaa energiaa eri ajoneuvotyyppille.	pl Doświadczona jakość Bosch, dopasowana do różnych wymagań i typów pojazdów. Akumulatory Bosch, dzięki nowoczesnej technice i konstrukcji odpornej na korozję, przez długi czas dostarczają energię dostosowaną do różnych typów pojazdów.	cs Výkonná kvalita Bosch pro různé požadavky a typy vozidel. Akumulátory Bosch dodávají díky moderní technice a konstrukci odolné proti korozi dlouhou dobu vhodnou energii různým typům vozidel.	ru Эффективное качество Bosch для различных требований и типов автомобилей. Благодаря современным технологиям и коррозионностойкой конструкции аккумуляторы Bosch обеспечивают в течение длительных периодов времени соответствующее энергоснабжение для различных типов автомобилей.
------------------------------------------------------------------------------------------------------------------------------------------------------------------------------------------------------------------------------------------------------------------------------------------	-------------------------------------------------------------------------------------------------------------------------------------------------------------------------------------------------------------------------------------------	-----------------------------------------------------------------------------------------------------------------------------------------------------------------------------------------------------------------------------------------------------------------	-----------------------------------------------------------------------------------------------------------------------------------------------------------------------------------------------------------------------	-----------------------------------------------------------------------------------------------------------------------------------------------------------------------------------------------------------------------------------------------------------------------------------------------------------

de Online-Katalog	en Online catalog	fr Catalogue online	it Catalogo online	es Catálogo online
pt Catálogo online	fi Verkkokuvasto	pl Katalog online	cs Online-katalog	ru Онлайн каталог

www.bosch-automotive-catalog.com

Einfacher und schneller Zugriff auf Kfz-Ausrüstungsdaten von Bosch.	Easy and quick access to vehicle application data from Bosch.	Accès facile et rapide aux données de rechange automobile Bosch.	Ricerca semplice e veloce dei dati Bosch di equipaggiamento veicoli.	Fácil y rápido acceso a la información de equipamiento Bosch para vehículos.
Fácil e rápido acceso a dados de equipamentos automotivos da Bosch.	Helppo ja nopea pääsy autotekniikka tietojä Boschilta.	Łatwy i szybki dostęp do danych naprawczych pojazdów od Bosch.	Snadný a rychlý přístup k datům o automobilových náhradních dílech firmy Bosch.	Легкий и быстрый доступ к автомобильным данным оборудования из Bosch.

de Inhalt	en Content	fr Contenu	it Contenuto	es Contenido
pt Conteúdo	fi Sisältö	pl Spis treści	cs Obsah	ru Содержание

Produkt- informationen	Product informations	Informations produit	Informazioni sul prodotto	Informaciones productos	A 2	
Informações de produtos	Tuotetiedot	Informacje o produkcie	Informace o produktu	Информация о продукте		
Technische Legende	Tecnical legend	Légende technique	Legenda tecnica	Leyenda técnica	A 46	
Legenda técnica	Tekninen erittely	Opis techniczny	Technická legenda	Технические условные		
				S5 A - S4 E	A 50	
				S5 - S4 - S3	A 54	
				TE - T5 - T4 - T3	A 68	
				L5 - L4	A 82	
				Optima	A 88	
Verwendung	Applications	Affectations	Impiego	Aplicación	B 1	
Utilização	Käyttö	Przeznaczenie	Použití	Применение		
					B 002	
					B 286	
					B 325	
					B 359	
					B 370	



de

Besondere Batterie-typen für Fahrzeuge mit Start/Stop-System

en

Special battery types for vehicles with start/stop

fr

Types de batteries spéciales pour véhicules équipés d'un start/stop

it

Speciali tipi di batterie per veicoli con start/stop

es

Tipos de baterías especiales para vehículos con start/stop



Mehr Energiebedarf im Fahrzeug

Heute ist der Energiebedarf in Kraftfahrzeugen enorm gestiegen. Sicherheitssysteme und Komfortfunktionen werden in immer mehr Fahrzeugen eingesetzt – und das in beinahe allen Fahrzeugsegmenten. Speziell die kraftvollen Bosch-Batterien S5 A mit AGM-Technologie und S4 E mit EFB-Technologie sind für moderne Fahrzeuge besonders geeignet.

Increased energy demand of vehicles

The energy demand of today's motor vehicles is much higher. More and more vehicles – of almost all vehicle segments – are equipped with safety systems, convenience and comfort functions. The powerful Bosch batteries S5 A with AGM technology and S4 E with EFB technology are particularly well-suited for modern vehicles.

Besoin accru d'énergie dans le véhicule

Aujourd'hui les besoins en énergie se sont énormément accrus à bord des véhicules à moteur. Les systèmes de sécurité et les fonctions de confort sont utilisées dans un nombre toujours croissant de véhicules - dans pratiquement tous les segments de véhicules. Les puissantes batteries Bosch S5 A en technologie AGM et S4 E en technologie EFB sont particulièrement adaptées aux besoins des véhicules modernes.

Maggiore richiesta energetica da parte dei veicoli

La richiesta di energia dei veicoli a motore di oggi è molto più elevata. Sempre più veicoli, di quasi tutti i segmenti, sono dotati di sistemi di sicurezza, praticità e funzioni comfort. Le potenti batterie S5 A di Bosch con tecnologia AGM e le S4 E con tecnologia EFB sono particolarmente indicate per i veicoli moderni.

Increased energy demand of vehicles

The energy demand of today's motor vehicles is much higher. More and more vehicles – of almost all vehicle segments – are equipped with safety systems, convenience and comfort functions. The powerful Bosch batteries S5 A with AGM technology and S4 E with EFB technology are particularly well-suited for modern vehicles.

pt

Tipos de bateria especiais para veículos com Start/Stop

fi

Erityiset akkutyypit autoille, joissa on start/stop

pl

Specjalne typy akumulatorów do pojazdów z systemem Start/Stop

cs

Speciální typy akumulátorů pro vozidla se systémem start/stop

ru

Аккумуляторы особого типа для транспортных средств с пуском/остановкой

Battery straining in case of frequent starts and stops

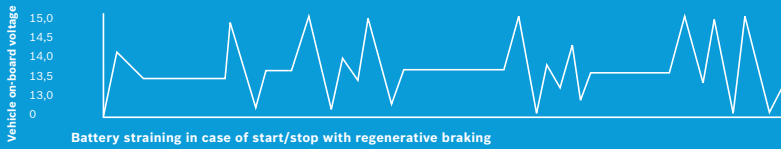

Battery straining in case of frequent starts and stops



Battery straining in case of conventional vehicles

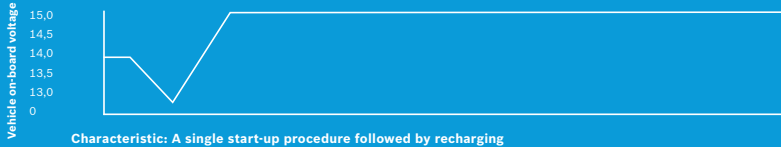

Maior exigência de energia dos veículos

A exigência de energia dos veículos a motor atuais é muito mais elevada. Cada vez mais veículos – de quase todos os segmentos de veículos – estão equipados com sistemas de segurança e funções de conforto e conveniência. As potentes baterias Bosch S5 A com tecnologia AGM e S4 E com tecnologia EFB são particularmente adequadas para os veículos modernos.

Ajoneuvojen suurempi energiantarve

Moottoriajoneuvojen energiantarve on tänä päivänä huomattavasti suurempi kuin aikaisemmin. Ajoneuvoissa käytetään yhä enemmän turvajärjestelmiä ja mukavuustoimintoja – miltei kaikissa ajoneuvon elementeissä. Boschin AGM-tekniikalla varustetut akut S5 A ja EFB-tekniikalla varustetut akut S4 E sopivat erityisen hyvin moderneihin ajoneuvoihin.

Większe zapotrzebowanie pojazdów na energię

Zapotrzebowanie współczesnych pojazdów silnikowych na energię jest znacznie większe. Coraz więcej pojazdów w prawie wszystkich segmentach jest wyposażonych w systemy bezpieczeństwa, funkcje poprawiające wygodę i zwiększające komfort. Potężne akumulatory Bosch S5 A z technologią AGM i S4 z technologią EFB są wyjątkowo dobrze dostosowane do potrzeb nowoczesnych pojazdów.

Vyšší spotřeba energie ve vozidle

Dnešní spotřeba energie motorových vozidel je mnohem vyšší než dříve. Vozidla jsou vybavena větším množstvím bezpečnostních systémů a komfortních funkcí, a sice bezmála ve všech segmentech vozidla. Pro moderní vozidla jsou vhodné především speciální výkonné baterie Bosch S5 A s technologií AGM a baterie S4 E s technologií EFB.

Растущие потребности автомобилей в энергии

Потребность в энергии современных двигателей намного выше. Все больше и больше автомобилей почти из всех сегментов оснащены системами безопасности, функциями удобства и комфорта. Мощные аккумуляторы Bosch S5 A с технологией AGM и S4 E с технологией EFB особенно хорошо подходят для современных автомобилей.

de

Besondere Batterie-typen für Fahrzeuge mit Start/Stopp-System
(Fortsetzung)

en

Special battery types for vehicles with start/stop
(continued)

fr

Types de batteries spéciales pour véhicules équipés d'un start/stop
(suite)

it

Speciali tipi di batterie per veicoli con start/stop
(seguito)

es

Tipos de baterías especiales para vehículos con start/stop
(continuación)



Die Batterie S5 A ist für Fahrzeuge mit Start/Stopp-System und Bremsenergieerückgewinnung ausgelegt und zeichnet sich durch eine hohe Zyklenfestigkeit aus.

In Fahrzeugen mit Rekuperation wird beim Bremsvorgang Energie zurückgewonnen. In Start/Stopp-Anwendungen ist der Ladezustand normalerweise auf ungefähr 80 % eingestellt, um die Wiedergewinnung der Bremsenergie zu ermöglichen.

Vorteile:
Exzellente Zyklenfestigkeit Hohe Startkraft

Die Batterie S4 E ist für Fahrzeuge mit Start/Stopp-System und Bremsenergieerückgewinnung ausgelegt und zeichnet sich durch eine hohe Zyklenfestigkeit aus.

Vorteile:
Haltbarkeit und Startssicherheit Energie für viele Verbraucher

The S5 A battery is designed for vehicles with start/stop system and brake energy recuperation and is characterized by a high deep-cycle resistance.

In vehicles with brake energy recuperation energy is recovered during the braking process. In start/stop applications the state of charge is typically set to approx. 80% in order to enable brake energy recuperation.

Benefits:
Excellent deep-cycle resistance High starting power

The S4 E battery is designed for vehicles with start/stop system and is characterized by a high deep-cycle resistance.

Benefits:
Durability and reliable starts Energy for a high number of consumers

La batterie S5 A est prévue pour les véhicules équipés d'un système start/stop et à récupération d'énergie de freinage et se caractérise par une résistance élevée à la décharge profonde.

Sur les véhicules à récupération de l'énergie de freinage, l'énergie se reconstitue durant le processus de freinage. Dans les applications start/stop, le niveau de charge est maintenu généralement à 80% environ de manière à permettre la récupération d'énergie lors du freinage.

Avantages :
Excellente résistance au processus de décharge profonde et forte puissance de démarrage

La batterie S4 E est prévue pour les véhicules équipés d'un système start/stop et à récupération d'énergie de freinage et se caractérise par une résistance élevée à la décharge profonde.

Avantages :
Longue durée de vie et grande fiabilité de démarrage Energie pour un grand nombre d'équipements consommateurs de courant

La batteria S5 A è progettata per veicoli con sistema start/stop e recupero dell'energia in frenata ed è caratterizzata da un'alta resistenza a scariche profonde.

Nei veicoli con recupero dell'energia in frenata, l'energia viene recuperata durante la fase di frenata. Nelle applicazioni con start/stop, lo stato di carica è generalmente impostato sull'80% circa in modo da consentire il recupero dell'energia in frenata.

Vantaggi:
Eccellente resistenza a scariche profonde Elevata potenza di avviamento

La batteria S4 E è progettata per veicoli con sistema start/stop ed è caratterizzata da un'elevata resistenza a scariche profonde.

Vantaggi:
Lunga durata e avviamenti affidabili Energia per un elevato numero di dispositivi elettrici

La batería S5 A ha sido diseñada para vehículos con sistema start/stop y recuperación de energía de frenado y se caracteriza por su alta resistencia de ciclo profundo.

En los vehículos con recuperación de energía de frenado se recupera la energía generada durante el proceso de frenado. En las aplicaciones de start/stop, el estado de carga de la batería suele ser del 80 % para que sea posible recuperar la energía de frenado.

Ventajas:
Buena resistencia de ciclo profundo Gran potencia de arranque

La batería S4 E ha sido diseñada para vehículos con sistema start/stop y se caracteriza por su alta resistencia de ciclo profundo.

Ventajas:
Durabilidad y arranques fiables Energía para gran cantidad de consumidores

pt

Tipos de bateria especiais para veículos com Start/Stop
(continuação)

fi

Eriyiset akkutyypit autoille, joissa on start/stop
(jatkoa)

pl

Specjalne typy akumulatorów do pojazdów z systemem Start/Stop
(ciąg dalszy)

cs

Speciální typy akumulátorů pro vozidla se systémem start/stop
(pokračování)

ru

Аккумуляторы особого типа для транспортных средств с пуском/остановкой
(продолжение)

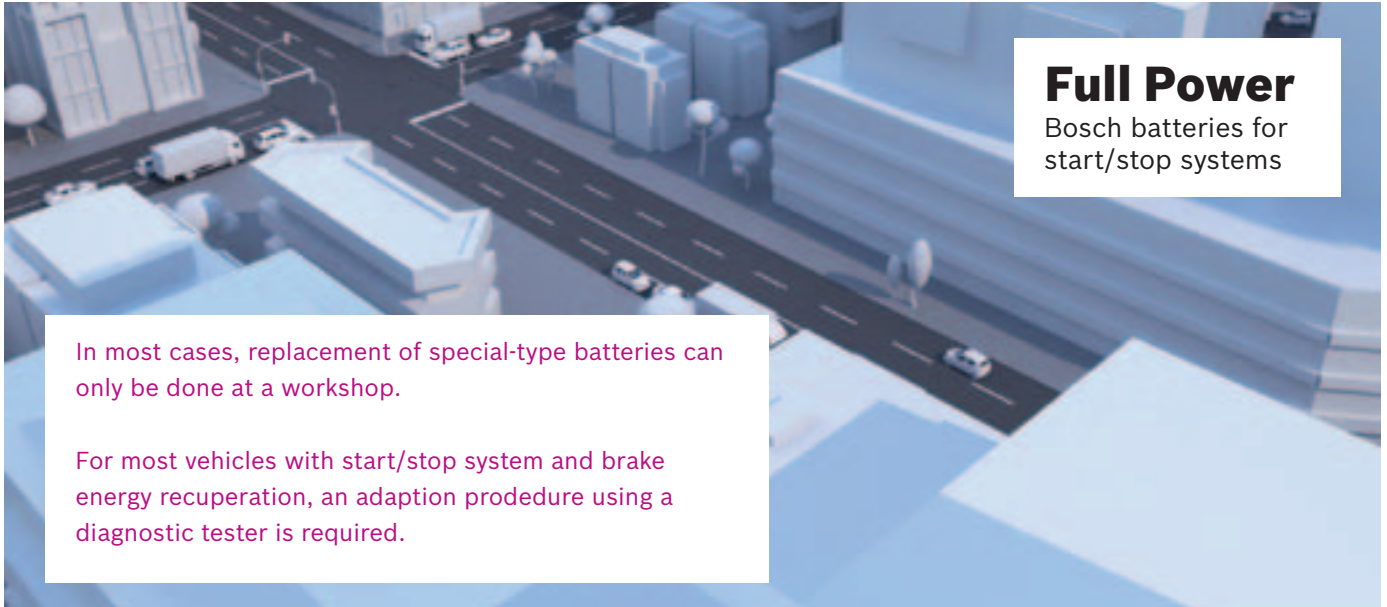

Full Power

Bosch batteries for start/stop systems

In most cases, replacement of special-type batteries can only be done at a workshop.

For most vehicles with start/stop system and brake energy recuperation, an adaption procedure using a diagnostic tester is required.

A bateria S5 A foi concebida para veículos com sistema Start/Stop e recuperação da energia de travagem e é caracterizada por uma elevada resistência a ciclos profundos.

Em veículos com recuperação da energia de travagem, é recuperada energia durante o processo de travagem. Em aplicações Start/Stop, o estado da carga é normalmente definido para aprox. 80%, de modo a permitir a recuperação da energia de travagem.

Vantagens:

Excelente resistência a ciclos profundos
Elevada potência de arranque

A bateria S4 E foi concebida para veículos com sistema Start/Stop e é caracterizada por uma elevada resistência a ciclos profundos.

Vantagens:

Durabilidade e arranques fiáveis
Energia para um elevado número de consumidores

S5 A -akku on suunniteltu autoille, joissa on start/stop-järjestelmä ja jarrutusenergian rekuperaatio, ja sille on tunnusomaista sen korkea syvään syklin resistanssi.

Jarrutusenergian rekuperaatiolla varustetuissa autoissa energia talteenotetaan jarrutusprosessin aikana. Start/stop-sovelluksissa lataustila on tyypillisesti asetettu n. 80 %:iin jarrutusenergian rekuperaation mahdollistamiseksi.

Edut:

Erinomainen syvään syklin resistanssi
Suuri käynnistysteho

S4 E -akku on suunniteltu autoille, joissa on start/stop-järjestelmä, ja sille on tunnusomaista sen korkea syvään syklin resistanssi.

Edut:

Kestävyys ja luotettavat käynnistykset
Energiaa suurille määrittäjäkuluttajia

Akumulator S5 A jest przeznaczony do pojazdów z systemem Start/Stop oraz rekuperacją energii hamowania i charakteryzuje się wysoką odpornością na głębokie rozładowanie.

W pojazdach z rekuperacją energii hamowania energia jest odzyskiwana w trakcie procesu hamowania. W zastosowaniach start/stop stan naładowania jest standardowo ustawiony na około 80%, aby umożliwić rekuperację energii hamowania.

Korzyści:

Doskonała odporność na cykle głębokiego wyładowania
Wysoka moc rozruchowa

Akumulator S4 E jest przeznaczony do pojazdów z systemem start/stop i charakteryzuje się wysoką odpornością na cykle głębokiego wyładowania.

Korzyści:

Trwałość i niezawodność rozruchu
Energia dla dużej liczby odbiorników

Akumulátor S5 A je určen pro vozidla se systémem start/stop a rekuperací brzděné energie. Je charakterizován vysokou odolností proti hlubokému cyklu vybíjení.

Vozidla vybavená rekuperací brzděné energie jsou schopna při procesu brzdění rekuperovat energii. Při použití vozidla v režimu start/stop se stav nabití obvykle nastavuje přibližně na 80 %, aby bylo možné zajistit rekuperaci brzděné energie.

Výhody:

Vynikající odolnost vůči hlubokému cyklu vybíjení
Vysoký startovací výkon

Akumulátor S4 E je určen pro vozidla se systémem start/stop. Je charakterizován vysokou odolností proti hlubokému cyklu vybíjení.

Výhody:

Trvanlivost, spolehlivost při startování
Energie pro velký počet spotřebitelů

Аккумулятор S5 A предназначен для автомобилей с системой пуска/остановки и рекуперации энергии торможения и характеризуется высоким сопротивлением многократному циклу глубокого заряда-разряда.

В автомобилях с рекуперацией энергии торможения энергия восстанавливается в процессе торможения. В приложениях пуска/остановки состояние заряда обычно устанавливается на уровне около 80 %, что позволяет обеспечить рекуперацию энергии торможения.

Преимущества:

отличное сопротивление многократному циклу глубокого заряда-разряда, высокая пусковая мощность

Аккумулятор S4 E предназначен для автомобилей с системой пуска/остановки и характеризуется высоким сопротивлением многократному циклу глубокого заряда-разряда.

Преимущества:

долговечность и надежность запусков, энергия для большого количества потребителей

de

Bosch-Batterien S5 A mit AGM-Technologie

en

Bosch batteries S5 A with AGM technology

fr

Batteries Bosch S5 A en technologie AGM

it

Batterie Bosch S5 A con tecnologia AGM

es

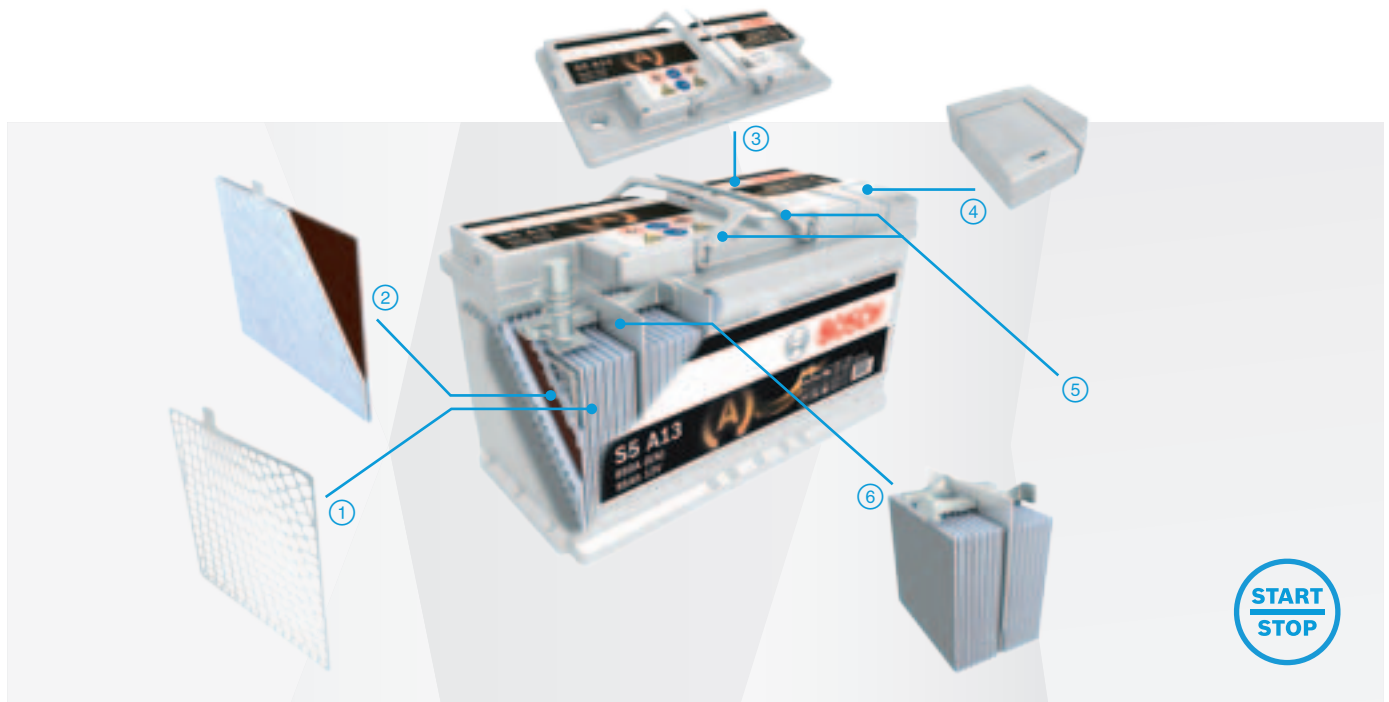
Baterías Bosch S5 A con tecnología AGM

Die erstklassige Bosch-Batterie mit AGM-Technologie liefert genügend Energie für häufige Starts und Stopps, unterstützt die Bremsenergieerückgewinnung (Rekuperation) und versorgt die elektrischen Verbraucher während der Stopp-Phase zuverlässig.

Die Vorteile:

- ▶ Konstante Leistung auch bei Kurzstreckenfahrten, stockendem Verkehr oder hohem Verbrauch im Standbetrieb: in Mikroglasfasermatten gebundene Säure lässt höhere Energiemassen passieren.
- ▶ Höhere Lebensdauer und bis zu 4-mal höhere Zyklenfestigkeit im Vergleich zu herkömmlichen Starterbatterien: bei der AGM-Technologie binden spezielle Mikroglasfasermatten die Batteriesäure und halten somit die Selbstentladung gering.

The premium Bosch battery with AGM technology provides enough power for frequent starts and stops, supports regenerative braking (recuperation) and is a reliable source of power for electrical consumers during the stop phase.

The advantages:

- ▶ Constant power even for short trips, stop-and-go traffic or high consumption in stationary mode: acid absorbed by micro-fiberglass mats allow higher amounts of energy to be provided.
- ▶ Longer service life and up to 4 times higher deep-cycle resistance than conventional starter batteries: in case of AGM technology, the acid is absorbed by micro-fiberglass mats thus keeping the self-discharge rates low.

La batterie Bosch haut de gamme en technologie AGM fournit une énergie suffisante aux nombreux arrêts et redémarrages, soutient la récupération énergétique lors du freinage (récupération) et assure l'alimentation fiable des divers consommateurs électriques du véhicule durant la phase d'arrêt.

Les avantages :

- ▶ Une puissance constante, même lors de courts trajets, dans les embouteillages ou lors de la forte consommation du véhicule à l'arrêt : l'acide retenu dans des nappes de microfibras de verre laisse passer des masses d'énergie plus élevées.
- ▶ Plus grande durabilité et résistance cyclique jusqu'à 4 fois supérieure aux batteries de démarrage conventionnelles : dans la technologie AGM, des nappes spéciales en micro-fibras de verre retiennent l'acide de la batterie et maintiennent ainsi le phénomène d'auto-décharge à un niveau aussi bas que possible.

La batteria premium Bosch con tecnologia AGM fornisce abbastanza energia per avvii e arresti frequenti, supporta il recupero di energia in frenata e alimenta le utenze elettriche in modo affidabile durante la fase di arresto.

I vantaggi:

- ▶ Potenza costante anche in caso di tragitti brevi, rallentamenti nel traffico o consumo elevato da fermi: l'acido legato in feltri in microfibra di vetro permette un passaggio più elevato di energia.
- ▶ Maggiore durata e una resistenza ai cicli di carica e scarica fino a 4 volte superiore rispetto alle batterie d'avviamento tradizionali: nella tecnologia AGM lo speciale tessuto in microfibra di vetro assorbe l'acido della batteria contenendo così l'autoscarica.

La batería Bosch de alta calidad con tecnología AGM suministra suficiente energía para arranques y paradas frecuentes, soporta la obtención de energía de frenado (recuperación) y abastece a los consumidores eléctricos durante la fase de parada de manera fiable.

Las ventajas:

- ▶ Potencia constante también en recorridos cortos, tráfico lento o alto consumo en modo parado: el ácido que se encuentra en las esterillas de microfibra deja pasar altas masas de energía.
- ▶ Prolongada duración y una resistencia a los ciclos hasta 4 veces mayor en comparación a las baterías de arranque convencionales: En la tecnología AGM, las esterillas de microfibra especiales ligan el ácido de la batería manteniendo así la autodescarga reducida.

pt

Baterias Bosch S5 A com tecnologia AGM

fi

Bosch-akut S5 A AGM-teknologialla

pl

Akumulatory Bosch S5 A z technologią AGM

cs

Akumulátory Bosch S5 A s technologií AGM

ru

Аккумуляторы Bosch S5 A с технологией AGM

① Patented PowerFrame® (grid) for optimized current flow and reduced corrosion:

The flow-optimized grid design of the PowerFrame® guarantees consistently high starting power and a long service life. In addition, a special alloy ensures a high corrosion resistance and significantly lower self-discharge.

② AGM (Absorbent Glass Mat) – acid absorbed by micro-fiberglass mats

In AGM technology, special micro-fiberglass mats are installed close to the lead plates and absorb the battery acid completely. High contact pressure minimizes the loss of active material at very low internal resistance. Due to the fast reaction of acid and plate material, higher amounts of energy can be provided.

③ Special lid design for high operational safety

The safety valve and the central degassing make the S5 A absolutely maintenance-free and leak-proof.

④ Terminal-post covers

Provide protection against short circuits.

⑤ Ergonomic handles

For easy transport and installation.

⑥ Set of plates with particularly robust connection

The central arrangement of the connectors between positive and negative plates ensures additional stability.

A bateria Bosch de excelência com tecnologia AGM fornece energia suficiente para arranques e paragens frequentes, apoia a recuperação da energia de travagem e alimenta os consumidores elétricos de forma fiável durante a fase de paragem.

As vantagens:

- Potência constante mesmo em trajetos de curta distância e situações de tráfego congestionado ou elevado consumo com o veículo parado: o ácido ligado em mantas de microfibra de vidro deixa passar maiores massas de energia.
- Maior vida útil e uma estabilidade do ciclo até 4 vezes superior em comparação com baterias do sistema de arranque convencionais: na tecnologia AGM, mantas especiais de microfibra de vidro ligam o ácido da bateria e minimizam, assim, a autodescarga.

Ensiluokkaiset Bosch-akku AGM-teknologialla toimittavat tarpeeksi energiaa toistuvia käynnistyksiä ja pysäytyksiä varten, tukevat jarruenergian takaisinottoa (rekuperaatio) ja syöttävät sähkökuluttajia pysähdysvaiheen aikana luotettavasti.

Edut:

- Tasainen teho myös lyhyillä matkoilla, liikenteen jumituessa tai kulutuksen ollessa suurta seisonkäytöllä: mikro-kuitumattoihin sidottu happo sallii suurempien energiama-sojen ohituksen.
- Korkeampi elinikä ja jopa 4 kertaa korkeampi syklinkestävyys verrattuna perinteisiin käynnistysakkuihin: AGM-teknologiassa erityiset mikrolasikuitumatot sitovat akkuhappoa ja pitävät näin its-epurkautumista vähäisenä.

Wysokiej klasy akumulator Bosch z technologią AGM zapewnia wystarczającą ilość energii do realizacji częstych cykli uruchamiania i wyłączenia, wspomaga odzyskiwanie energii z hamowania (rekuperację) i skutecznie zaopatruje odbiorniki elektryczne w fazie zatrzymania.

Zalety:

- Stała moc nawet podczas jazdy na krótkich odcinkach, w krokach lub przy dużym zużyciu energii w trybie postoju: kwas związany w matach z mikrowłókna umożliwia przepływ większych mas energii.
- Dłuższa żywotność i nawet 4-krotnie większa odporność na cykle ładowania i wyładowania w porównaniu z tradycyjnymi akumulatorami rozruchowymi: w technologii AGM specjalne maty z mikrowłókna wiążą kwas akumulatorowy i w ten sposób utrzymują samoczynnie wyładowanie na niskim poziomie.

Prvotřídní akumulátor Bosch s technologií AGM dodává dostatečné množství energie pro časté startování a zastavování, podporuje zpětné získávání brzdě energie (rekuperace) a spolehlivě napájí elektrické spotřebiče během fáze zastavení.

Přednosti:

- Konstantní výkon také při jízdách na krátkou vzdálenost, váznoucím provozu nebo vysoké spotřebě v podpůrném provozu: kyselina vázaná v rohožích z mikrovlákn umožňuje proudění většího množství energie.
- Delší životnost a až 4-krát vyšší cyklická pevnost v porovnání s obvyklými startovacími akumulátory: v technologii AGM vážou speciální rohože z mikrovlákn kyselinu akumulátoru a udržují tak samovybíjení na nízké úrovni.

Первоклассный аккумулятор Bosch с технологией AGM обеспечивает достаточное количество энергии для частых запусков и остановок, поддерживает рекуперацию энергии торможения и надежное энергоснабжение потребителей во время фазы останова.

Преимущества :

- Постоянная производительность даже в коротких поездках, при медленном движении или высоком потреблении энергии в стояночном режиме: кислота, связанная в mataх из микростекловолокна, обеспечивает прохождение более высоких энергетических масс.
- Более длительный срок службы и до 4 раз более высокий ресурс АКБ по сравнению с традиционными стартерными аккумуляторами: с технологией AGM специальные маты из микростекловолокна связывают кислоту аккумулятора и таким образом сводят к минимуму саморазрядку.

de

Bosch-Batterien S5 A mit AGM-Technologie
(Fortsetzung)

en

Bosch batteries S5 A with AGM technology
(continued)

fr

Batteries Bosch S5 A en technologie AGM
(suite)

it

Batterie Bosch S5 A con tecnologia AGM
(seguito)

es

Baterías Bosch S5 A con tecnología AGM
(continuación)



Did you know?

Battery expert since 1922

The first Bosch battery was produced in 1922 in Stuttgart-Feuerbach.

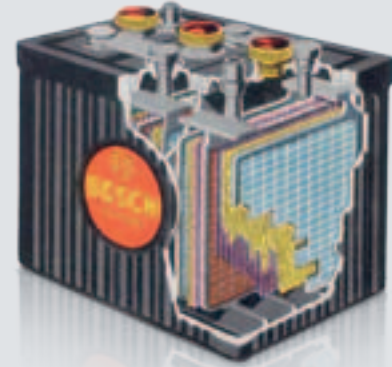

Die Vorteile (Fortsetzung):

- ▶ Sicherer Start auch bei extremen Temperaturen und hoher Anzahl elektrischer Verbraucher: gleichmäßige Säureverteilung verhindert Säureschichtung.
- ▶ Besonders gute Ladungsaufnahme: patentiertes PowerFrame® (Gitter) für optimierten Stromfluss und geringere Korrosion erhöht die Kaltstartkraft.
- ▶ Besonders korrosionsbeständig: durch optimierte Fertigungsprozesse.
- ▶ Absolut wartungsfrei: der Doppeldeckel mit Labyrinth-Konstruktion führt kondensiertes Wasser in die Batterie zurück und senkt damit den Wasserverbrauch; bei Schräglage wird das spontane Auslaufen der Säure verhindert.

The advantages (continued):

- ▶ Reliable starting even under extreme temperatures and with several electrical consumers: ensured by even acid distribution preventing stratification.
- ▶ Particularly good charge acceptance: the patented PowerFrame® (grid) for optimized current flow and less corrosion increases the cold start performance.
- ▶ Particularly high corrosion resistance: ensured by optimized production processes.
- ▶ Absolutely maintenance-free: the double lid with labyrinth design returns condensed water to the battery thus reducing the water consumption; and preventing sudden leaks of acid if tilted.

Les avantages (suite) :

- ▶ Démarrage fiable, même lors de températures extrêmes et d'un nombre élevé de consommateurs électriques : la répartition uniforme de l'acide empêche sa stratification.
- ▶ Transmission particulièrement bonne de la charge : le PowerFrame® breveté (grille) assurant un flux optimisé du courant et le faible niveau de corrosion accroissent la puissance lors des démarrages à froid.
- ▶ Résistance particulière à la corrosion grâce à l'optimisation des processus de production.
- ▶ Absolut est totalement exempt de maintenance. Le double couvercle à construction en labyrinthe ramène l'eau de condensation dans la batterie et abaisse la consommation d'eau ; en position inclinée, on évite ainsi l'écoulement spontané de l'acide.

I vantaggi (seguito):

- ▶ Avviamento sicuro anche a temperature estreme e con numerose utenze elettriche collegate: la distribuzione uniforme dell'acido impedisce ne impedisce la stratificazione.
- ▶ Assorbimento della carica ottimo: PowerFrame® (griglia) brevettata per un flusso di corrente ottimale e una corrosione ridotta, in grado di aumentare la potenza di avviamento a freddo.
- ▶ Elevata resistenza alla corrosione: grazie a processi produttivi ottimizzati.
- ▶ Assolutamente esente da manutenzione: il doppio coperchio con struttura a labirinto riporta l'acqua di condensa nella batteria diminuendo così il consumo di acqua. In posizione inclinata evita la fuoriuscita spontanea dell'acido.

Las ventajas (continuación):

- ▶ Arranque seguro también a temperaturas extremas y un número elevado de consumidores eléctricos: la distribución uniforme de ácido evita la estratificación del ácido.
- ▶ Aceptación de carga especialmente buena: La rejilla PowerFrame® patentada para un flujo de corriente óptimo y una menor corrosión incrementa la fuerza de arranque en frío.
- ▶ Especialmente resistente a la corrosión: mediante procesos de fabricación optimizados.
- ▶ Absolutamente libre de mantenimiento: la tapa doble con construcción de laberinto dirige agua condensada de regreso a la batería, lo que disminuye el consumo de agua; en posición inclinada se evita el derrame espontáneo del ácido.

pt

Baterias Bosch S5 A com tecnologia AGM
(continuação)

fi

Bosch-akut S5 A AGM-teknologialla
(jatkoa)

pl

Akumulatory Bosch S5 A z technologią AGM
(ciąg dalszy)

cs

Akumulátory Bosch S5 A s technologií AGM
(pokračování)

ru

Аккумуляторы Bosch S5 A с технологией AGM
(продолжение)



ESI[tronic] 2.0 software for diagnoses and servicing



By means of ESI[tronic] 2.0 software, Bosch offers workshops an excellent solution for effective and efficient vehicle diagnoses for repair or servicing.

Advantages:

- ▶ Easy operation
- ▶ Standardized system
- ▶ Comprehensive vehicle coverage
- ▶ Modular design



As vantagens (continuação):

- ▶ Arranque seguro mesmo perante temperaturas extremas e um elevado número de consumidores elétricos: a distribuição uniforme do ácido impede a estratificação do mesmo.
- ▶ Aceitação da carga particularmente boa: a tecnologia PowerFrame® (grelha) patenteada para um fluxo de corrente otimizado e uma menor corrosão aumenta a potência de arranque a frio.
- ▶ Altamente resistente à corrosão: graças a processos de fabrico otimizados.
- ▶ Absolutamente isenta de manutenção: a tampa dupla com sistema de labirinto conduz a água condensada de volta para a bateria e reduz, assim, o consumo de água; em caso de inclinação, é impedido o vazamento espontâneo do ácido.

Edut (jatkoa):

- ▶ Varma käynnistyminen myös äärimmäisissä lämpötiloissa ja paljon sähkökuluttajia: hapon tasainen jakautuminen estää hapon kerrostumisen.
- ▶ Erittäin hyvät varausominaisuudet: PowerFrame® (ritilä) optimoi virrankulkua, vähentää korroosiota ja parantaa kylmäkäynnistysvoimaa.
- ▶ Erittäin korroosionkestävä: optimoidun valmistusprosessin ansiosta.
- ▶ Absolut huoltovapaa: labirintti-rakenteella varustettu kaksoiskansi ohjaa kondensoituneen veden takaisin akkuun ja vähentää näin vedenkulutusta; vino asento estää hapon spontaanin ulosvirtauksen.

Zalety (ciąg dalszy):

- ▶ Pewnie i bezpiecznie uruchamianie nawet przy ekstremalnych temperaturach i dużej liczbie odbiorników elektrycznych: równomierny rozdział kwasu zapobiega jego nawarstwianiu.
- ▶ Wyjątkowo dobre pobieranie ładunku: opatentowana siatka PowerFrame® zapewnia zoptymalizowany przepływ prądu, a mniejsza korozja zwiększa moc przy zimnym rozruchu.
- ▶ Doskonała odporność na korozję dzięki zoptymalizowanemu procesom produkcyjnym.
- ▶ Absolutna bezobsługowość: podwójna pokrywa o konstrukcji labirynutowej prowadzi kondensat z powrotem do akumulatora i w ten sposób zmniejsza zużycie wody; przy ukośnym położeniu nie jest możliwe spontaniczne wypływanie kwasu.

Přednosti (pokračování):

- ▶ Bezpečný start také při extrémních teplotách a vysokém počtu elektrických spotřebičů: rovnoměrné rozložení kyseliny zabraňuje vrstvení kyseliny.
- ▶ Obzvláště dobrý příjem nabíjení: patentovaný PowerFrame® (mříž) pro optimální tok proudu a nízká koróze zvyšují sílu studeného startu.
- ▶ Obzvláště odolný proti korozi: díky optimalizovaným výrobním procesům.
- ▶ Absolutně bez údržby: Dvojitě víko s konstrukcí labirintu vede kondenzovanou vodu zpět do akumulátoru a snižuje tak spotřebu vody; v případě šikmé polohy je zabráněno spontánnímu úniku kyseliny.

Преимущества (продолжение):

- ▶ Безопасный пуск даже при экстремальных температурах и большом количестве электрических нагрузок: равномерное распределение кислоты предотвращает ее расслоение.
- ▶ Улучшенное потребление зарядного тока: запатентованная PowerFrame® (решетка) для оптимизированного протекания тока и снижения коррозии увеличивает усилие пуска холодного двигателя.
- ▶ Повышенная устойчивость к коррозии: благодаря оптимизированным производственным процессам.
- ▶ Совершенно не нуждается в техническом обслуживании: двойная крышка лабиринтной конструкции возвращает конденсатную воду в аккумулятор, тем самым снижая потребление воды; при наклонном положении предотвращается спонтанная утечка кислоты.

de

Bosch-Batterien S4 E mit EFB-Technologie

en

Bosch batteries S4 E with EFB technology

fr

Batteries Bosch S4 E en technologie EFB

it

Batteria Bosch S4 E con tecnologia EFB

es

Baterías Bosch S4 E con tecnología EFB

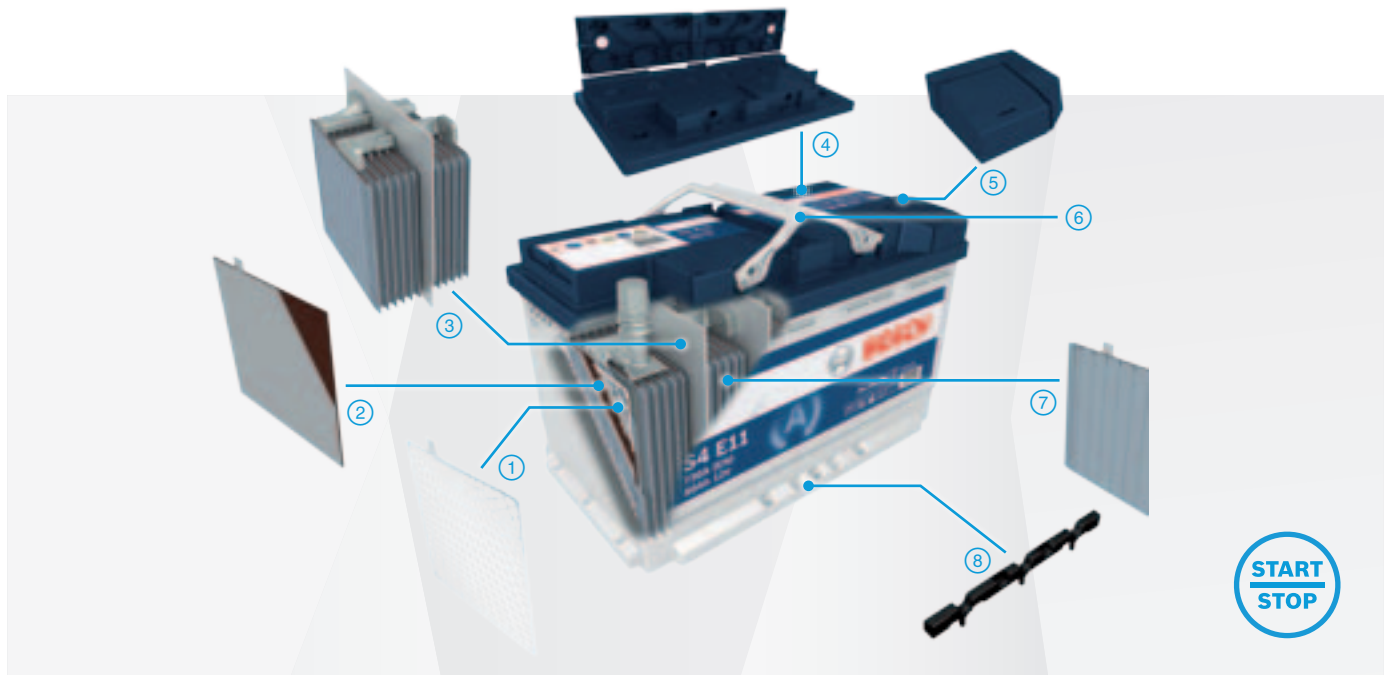

Die kraftvolle Bosch-Batterie mit EFB-Technologie ist zugeschnitten auf die Erfordernisse von Pkw mit Start/Stop-Systemen. Sie gewährleistet einen sicheren Start – selbst wenn viele elektrische Verbraucher im Fahrzeug in Betrieb sind.

Die Vorteile:

- Höhere Lebensdauer und doppelte Zyklenfestigkeit im Vergleich zu herkömmlichen Starterbatterien: bei der EFB-Technologie ist die positive Platte mit einem so genannten Polyester-Scrim beschichtet, der dem aktiven Material zusätzlichen Halt verleiht und so die Selbstentladung gering hält.

The powerful Bosch battery with EFB technology is customized to meet the requirements of cars with start/stop systems. It ensures safe starting – even if the vehicle operates several electrical consumers.

The advantages:

- Longer service life and twice the deep-cycle resistance of conventional starter batteries: in case of EFB technology, the positive plate is coated with a polyester scrim, providing additional hold for the active material thus keeping the self-discharge rates low.

La puissante batterie Bosch en technologie EFB est spécialement conçue pour supporter les sollicitations de véhicules légers équipés de systèmes Start/Stop. Elle garantit un démarrage fiable – même lorsque de nombreux consommateurs électriques fonctionnent simultanément à bord du véhicule.

Les avantages:

- Une plus grande durée de vie et une résistance cyclique deux fois plus élevée par comparaison aux batteries de démarrage classiques. En technologie EFB, la plaque positive est revêtue d'un Scrim Polyester qui confère au matériau une robustesse supplémentaire et maintient ainsi l'auto-décharge aussi basse que possible.

La potente batteria Bosch con tecnologia EFB è stata progettata su misura per le esigenze delle autovetture con sistemi start/stop. Garantisce un avviamento sicuro - anche quando nel veicolo sono in funzione diverse utenze elettriche.

I vantaggi:

- Maggiore durata e resistenza ai cicli di scarica raddoppiata rispetto alle batterie di avviamento tradizionali: nella tecnologia EFB la piastra positiva è rivestita da una garza in poliestere che conferisce al materiale attivo una presa ancora maggiore e contiene così l'autoscarica.

La poderosa batería Bosch con tecnología EFB está hecha a la medida de las necesidades de los automóviles de pasajeros con sistemas de arranque/parada. Garantiza un arranque seguro, incluso si varios consumidores eléctricos están en funcionamiento en el vehículo.

Las ventajas:

- Prolongada duración y una resistencia a los ciclos doble en comparación con las baterías de arranque convencionales: en la tecnología EFB, la placa positiva está recubierta con una llamada malla de poliéster que proporciona al material activo un agarre adicional, el cual mantiene reducida la autodescarga.

pt

Baterias Bosch S4 E com tecnologia EFB

fi

Bosch-akut S4 E EFB-tekniologia

pl

Akumulatory Bosch S4 E z technologią EFB

cs

Akumulátory Bosch S4 E s technologií EFB

ru

Аккумуляторы Bosch S4 E с технологией EFB

- ① **Patented PowerFrame® (grid) for optimized current flow and reduced corrosion:**
The flow-optimized grid design of the PowerFrame® guarantees consistently high starting power and a long service life. In addition, a special alloy ensures a high corrosion resistance and significantly lower self-discharge.
- ② **EFB (Enhanced Flooded Battery) – positive plate coated with polyester scrim**
In EFB technology, the positive plate is coated with a so-called polyester scrim providing additional retention of the active material on the plate. The S4 E battery therefore features an improved deepcycle resistance compared to conventional batteries and remains operational even if there are strong vibrations.
- ③ **Set of plates with particularly robust connection**
The central arrangement of the connectors between positive and negative plates ensures additional stability.
- ④ **Labyrinth lid for high operational safety**
The double lid with labyrinth design ensures that evaporated liquid remains inside the battery. This makes the S4 E battery absolutely maintenance-free and leak-proof.
- ⑤ **Terminal-post covers**
Provide protection against short circuits.
- ⑥ **Ergonomic handles**
For easy transport and installation.
- ⑦ **Ion-permeable pocket separator**
Prevents contact between positive and negative plate – for longer service life and higher starting power.
- ⑧ **Universal adapter bottom rail with high degree of vehicle compatibility**
For safe, precisely fitting installation.

A potente bateria Bosch com tecnologia EFB foi concebida especificamente para as exigências de veículos ligeiros de passageiros com sistemas Start/Stop. Garante um arranque seguro – mesmo quando estão a ser utilizados vários consumidores elétricos no veículo.

As vantagens:

- Maior vida útil e o dobro da estabilidade do ciclo em comparação com baterias do sistema de arranque convencionais: na tecnologia EFB, a placa positiva é revestida com um chamado "scrim" de poliéster, que confere uma aderência adicional ao material ativo e minimiza, assim, a autodescarga.

Bosch-voima-akku EFB-tekniologia on räätälöity start/stop-järjestelmällä varustettujen henkilöautojen vaatimusten mukaisesti. Se takaa turvallisen käynnistyksen – myös silloin, kun ajoneuvon sähkökuluttajat ovat toiminnassa.

Edut:

- Korkeampi elinikä ja kaksinkertainen syklinkestävyys verrattuna perinteisiin käynnistinakuihin: EFB-tekniologiassa positiivinen levy on päällystetty polyesteristä valmistetulla ns. scrim-verkkokankaalla, joka antaa aktiiviselle materiaalille lisäksi pitoa ja pitää näin itsepurkautumista vähäisenä.

Potężny akumulator Bosch z technologią EFB jest dostosowany do wymogów samochodów osobowych z systemami Start/Stop. Zapewnia on bezpieczny rozruch – nawet, gdy w pojeździe pracuje wiele odbiorników elektrycznych.

Zalety:

- Dłuższa żywotność i dwukrotnie większa odporność na cykle ładowania i wyładowania w porównaniu z tradycyjnymi akumulatorami rozruchowymi: w przypadku technologii EFB płytką dodatnią jest powleczona specjalną warstwą poliestrowego materiału "polyester scrim", który zapewnia dodatkową wytrzymałość aktywnego materiału i utrzymuje samoczynne wyładowanie na niskim poziomie.

Výkonný akumulátor Bosch s technologií EFB je vyrobena podle požadavků osobních vozidel vybavených systémem Start/Stop. Zaručuje bezpečné nastartování i v případě, že je ve vozidle v provozu velké množství elektrických spotřebičů.

Přednosti:

- Vyšší životnost a dvojnásobná cyklická pevnost v porovnání s obvyklými startovacími akumulátory: u technologie EFB je pozitivní deska povrstvena tzv. Polyester-Scrim, který aktivnímu materiálu dodává další podporu a udržuje tak samovybění na nízké úrovni.

Мощный аккумулятор Bosch с технологией EFB разработан с учетом требований легковых автомобилей с системами start/stop. Он обеспечивает безопасный пуск, даже при задействовании большого количества электрических нагрузок в автомобиле.

Преимущества:

- Более длительный срок службы и двойной ресурс АКБ по сравнению с обычными стартерными аккумуляторами: с технологией EFB положительная пластина покрыта так называемой полиэфирной сеткой, которая придает активному материалу дополнительную прочность и сводит к минимуму саморазряд.

de

Bosch-Batterien S4 E mit EFB-Technologie
(Fortsetzung)

en

Bosch batteries S4 E with EFB technology
(continued)

fr

Batteries Bosch S4 E en technologie EFB
(suite)

it

Batterie Bosch S4 E con tecnologia EFB
(seguito)

es

Baterías Bosch S4 E con tecnología EFB
(continuación)



Die Vorteile (Fortsetzung):

- ▶ Sicherer Start auch bei extremen Temperaturen und hoher Anzahl elektrischer Verbraucher: durch optimiertes aktives Material.
- ▶ Besonders gute Ladungsaufnahme: patentiertes PowerFrame® (Gitter) für optimierten Stromfluss und geringere Korrosion erhöht die Kaltstartkraft.
- ▶ Besonders korrosionsbeständig: durch optimierte Fertigungsprozesse.
- ▶ Absolut wartungsfrei: der Doppeldeckel mit Labyrinth-Konstruktion führt kondensiertes Wasser in die Batterie zurück und senkt damit den Wasserverbrauch; bei Schräglage wird das spontane Auslaufen der Säure verhindert.

The advantages (continued):

- ▶ Reliable starting even under extreme temperatures and with several electrical consumers: thanks to optimized active material.
- ▶ Particularly good charge acceptance: the patented PowerFrame® (grid) for optimized current flow and less corrosion increases the cold start performance.
- ▶ Particularly high corrosion resistance: ensured by optimized production processes.
- ▶ Absolutely maintenance-free: the double lid with labyrinth design returns condensed water to the battery thus reducing the water consumption; and preventing sudden leaks of acid if tilted.

Les avantages (suite) :

- ▶ Démarrage fiable, même lors de températures extrêmes et d'un nombre élevé de consommateurs électriques par l'optimisation du matériau actif.
- ▶ Transmission particulièrement bonne de la charge : le PowerFrame® breveté (grille) assurant un flux optimisé du courant et un plus faible niveau de corrosion accroît la puissance lors des démarrages à froid.
- ▶ Résistance particulière à la corrosion grâce à l'optimisation des processus de production.
- ▶ Absolut est totalement exempté de maintenance. Le double couvercle à construction en labyrinthe ramène l'eau de condensation dans la batterie et abaisse la consommation d'eau ; en position inclinée, on évite ainsi l'écoulement spontané de l'acide.

I vantaggi (seguito):

- ▶ Avviamento sicuro anche a temperature estreme e con numerose utenze elettriche collegate: grazie al materiale attivo ottimizzato.
- ▶ Assorbimento della carica ottimo: PowerFrame® (griglia) brevettata per un flusso di corrente ottimale e una corrosione ridotta, in grado di aumentare la potenza di avviamento a freddo.
- ▶ Elevata resistenza alla corrosione: grazie a processi produttivi ottimizzati.
- ▶ Assolutamente esente da manutenzione: il doppio coperchio con struttura a labirinto riporta l'acqua di condensa nella batteria diminuendo così il consumo di acqua. In posizione inclinata evita la fuoriuscita spontanea dell'acido.

Las ventajas (continuación):

- ▶ Arranque seguro también a temperaturas extremas y un número elevado de consumidores eléctricos: mediante el material activo optimizado.
- ▶ Aceptación de carga especialmente buena: PowerFrame® patentada (rejilla) para un flujo de corriente óptimo y una menor corrosión incrementa la fuerza de arranque en frío.
- ▶ Especialmente resistente a la corrosión: mediante procesos de fabricación optimizados.
- ▶ Absolutamente libre de mantenimiento: la tapa doble con construcción de laberinto dirige agua condensada de regreso a la batería, lo que disminuye el consumo de agua; en posición inclinada se evita el derrame espontáneo del ácido.

pt

Baterias Bosch S4 E com tecnologia EFB
(continuação)

fi

**Bosch-akut S4 E EFB-
teknologialla**
(jatkoa)

pl

Akumulatory Bosch S4 E z technologią EFB
(ciąg dalszy)

cs

Akumulátory Bosch S4 E s technologií EFB
(pokračování)

ru

Аккумуляторы Bosch S4 E с технологией EFB
(продолжение)



Bosch Automotive eCat-online catalog

The quick way to find the matching product

- ▶ Free-of-charge online spare-parts catalog
- ▶ With a wealth of additional information and 360° product images
- ▶ Available in 28 languages

www.bosch-automotive-catalog.com



As vantagens (continuação):

- ▶ Arranque seguro mesmo perante temperaturas extremas e um elevado número de consumidores elétricos: graças ao material ativo otimizado.
- ▶ Aceitação da carga particularmente boa: a tecnologia PowerFrame® (grelha) patenteada para um fluxo de corrente otimizado e uma menor corrosão aumenta a potência de arranque a frio.
- ▶ Altamente resistente à corrosão: graças a processos de fabrico otimizados.
- ▶ Absolut isenta de manutenção: a tampa dupla com sistema de labirinto conduz a água condensada de volta para a bateria e reduz, assim, o consumo de água; em caso de inclinação, é impedido o vazamento espontâneo do ácido.

Edut (jatkoa):

- ▶ Varma käynnistyminen myös äärimmäisissä lämpötiloissa ja lukuisten sähkökuluttajien yhteydessä: optimoidun aktiivisen materiaalin ansiosta.
- ▶ Erittäin hyvät varausominaisuudet: PowerFrame® (ritilä) optimoi virrankulkua, vähentää korroosiota ja parantaa kylmäkäynnistysvoimaa.
- ▶ Erittäin korroosionkestävä: optimoidun valmistusprosessin ansiosta.
- ▶ Absolut huoltovapaa: labyrintti-rakenteella varustettu kaksoiskansi ohjaa kondensoituneen veden takaisin akkuun ja vähentää näin vedenkulutusta; vino asento estää hapon spontaanin ulosvirtauksen.

Zalety (ciąg dalszy):

- ▶ Pewne i bezpieczne uruchamianie nawet przy ekstremalnych temperaturach i dużej liczbie odbiorników elektrycznych: dzięki zoptymalizowanemu materiałowi aktywnemu.
- ▶ Wyjątkowo dobre pobieranie ładunku: opatentowana siatka PowerFrame® zapewnia zoptymalizowany przepływ prądu, a mniejsza korozja zwiększa moc przy zimnym rozruchu.
- ▶ Doskonała odporność na korozję dzięki zoptymalizowanemu procesowi produkcyjnym.
- ▶ Absolutna bezobsługowość: podwójna pokrywa o konstrukcji labiryntowej prowadzi kondensat z powrotem do akumulatora i w ten sposób zmniejsza zużycie wody; przy ukośnym położeniu nie jest możliwe spontaniczne wypływanie kwasu.

Přednosti (pokračování):

- ▶ Bezpečný start také při extrémních teplotách a vysokém počtu elektrických spotřebičů: díky optimalizovanému aktivnímu materiálu.
- ▶ Obzvláště dobrý příjem nabíjení: patentovaný PowerFrame® (mříž) pro optimální tok proudu a nízká koroze zvyšují sílu studeného startu.
- ▶ Obzvláště odolný proti korozi: díky optimalizovaným výrobním procesům.
- ▶ Absolutně bez údržby: Dvojitě víko s konstrukcí labiryntu vede kondenzovanou vodu zpět do akumulátoru a snižuje tak spotřebu vody; v případě šikmé polohy je zabráněno spontánnímu úniku kyseliny.

Преимущества (продолжение):

- ▶ Безопасный пуск даже при экстремальных температурах и больших электрических нагрузках: посредством оптимизированного активного материала.
- ▶ Улучшенное потребление зарядного тока: запатентованная PowerFrame® (решетка) для оптимизированного протекания тока и снижения коррозии увеличивает усилие пуска холодного двигателя.
- ▶ Повышенная устойчивость к коррозии: благодаря оптимизированным производственным процессам.
- ▶ Совершенно не нуждается в техническом обслуживании: двойная крышка лабиринтной конструкции возвращает конденсатную воду в аккумулятор, тем самым снижая потребление воды; при наклонном положении предотвращается спонтанная утечка кислоты.

de

Service und Diagnose für Start/ Stopp-Systeme

en

Service and diagnosis for start/ stop systems

fr

Entretien et diagnostic pour systèmes start/stop

it

Service e diagnosi per sistemi start/stop

es

Servicio y diagnóstico de los sistemas start/ stop



1



2



3



Effizienz in der Werkstatt: Service und Diagnose für Start/ Stopp-Systeme

Als Systemhersteller mit umfassender Kompetenz bietet Bosch

- ▶ Optimale technische Lösungen in Erstausrüstungsqualität
- ▶ Ersatzteile
- ▶ Diagnosetechnik der ersten Wahl
- ▶ Schulungen

Efficiency in the workshop: Service and diagnosis for start/ stop systems

As a system manufacturer with comprehensive expertise, Bosch offers

- ▶ Optimal technical solutions in original equipment quality
- ▶ Replacement parts
- ▶ First-choice diagnosis technology
- ▶ Training courses

Efficacité dans l'atelier : entretien et diagnostic pour systèmes start/stop

En tant que fournisseur d'équipements aux compétences étendues, Bosch offre les avantages suivants :

- ▶ solutions techniques optimales de qualité première monte
- ▶ pièces de rechange
- ▶ technique de diagnostic de premier choix
- ▶ formations

In qualità di costruttore di sistemi con competenze approfondite Bosch offre

In qualità di costruttore di sistemi con una competenza a tutto campo Bosch offre

- ▶ Soluzioni tecniche ottimizzate con qualità identica al primo equipaggiamento
- ▶ Ricambi
- ▶ Tecnica di diagnosi di prima scelta
- ▶ Corsi di formazione

Eficacia en el taller: servicio y diagnóstico de los sistemas start/stop

Como fabricante de sistemas con una amplia competencia Bosch ofrece

- ▶ Soluciones técnicas óptimas en calidad de primeros equipamientos
- ▶ Piezas de recambio
- ▶ Tecnología de diagnóstico: la primera elección
- ▶ Cursos de formación

1

KTS 350: Diagnosetests mit zugehöriger Diagnosesoftware ESI[tronic]

KTS 350: Diagnosis tests with accompanying diagnosis software ESI[tronic]

KTS 350 : contrôles de diagnostic à l'aide du logiciel de diagnostic approprié ESI[tronic]

KTS 350: test di diagnosi con il relativo software di diagnosi ESI[tronic]

KTS 350: Pruebas para diagnóstico con el software de diagnóstico ESI[tronic] correspondiente

2

BAT 131: Überprüfung des Zustands von Batterien für Fahrzeuge mit Start/Stop-Systemen

BAT 131: Testing the condition of batteries for vehicles with start/stop systems

BAT 131 : Vérification de l'état de batteries de véhicules équipés de systèmes Start/Stop

BAT 131: Verifica dello stato delle batterie per veicoli con sistema start/stop

BAT 131: Comprobación del estado de las baterías para vehículos con sistema de arranque/paro

3

BAT 645/BAT 690: Zuverlässig Batterien mit Start/Stop-Systemen laden

BAT 645/BAT 690: Reliably charging batteries with start/stop systems

BAT 645/BAT 690 : Charge fiable de batteries avec systèmes Start/Stop

BAT 645/BAT 690: Ricarica affidabile delle batterie per sistemi start/stop

BAT 645/BAT 690: Carga segura de baterías con sistemas de arranque/paro

4

FSA 740: Funktionsfähigkeit relevanter Sensoren des Start/ Stopp-Systems testen

FSA 740: Tests functionality of relevant sensors in the start/stop system

FSA 740 : contrôle du fonctionnement des capteurs correspondants du système start/stop

FSA 740: test dei sensori fondamentali per il funzionamento del sistema start/stop

FSA 740: comprobar la capacidad de funcionamiento de los sensores relevantes del sistema start/stop

Schulungen im Bosch Service Training Center:

- ▶ Funktionsprinzip des Start/ Stopp-Systems
- ▶ Vernetzung mit anderen Fahrzeugsystemen
- ▶ Diagnose und Reparatur der Komponenten
- ▶ Batteriewechsel mit Diagnose-tester

Training courses in the Bosch Service Training Center:

- ▶ Operating principle of the start/stop system
- ▶ Networking with other vehicle systems
- ▶ Component diagnosis and repair
- ▶ Battery change with diagnostic tester

Formations dans le centre de formation Bosch Service :

- ▶ principe de fonctionnement du système start/stop
- ▶ interconnexion avec d'autres systèmes automobiles
- ▶ diagnostic et réparation des composants
- ▶ remplacement de la batterie à l'aide du testeur de diagnostic

Corsi di formazione presso i centri di formazione Bosch:

- ▶ Principio di funzionamento del sistema start/stop
- ▶ Interconnessione con altri sistemi automobilistici
- ▶ Diagnosi e riparazione di componenti
- ▶ Sostituzione batterie con tester di diagnosi

Cursos de formación en Bosch Service Centros de formación:

- ▶ Principio de funcionamiento del sistema start/stop
- ▶ Conexión con otros sistemas de vehículo
- ▶ Diagnóstico y reparación de componentes
- ▶ Cambio de batería con tester para diagnóstico

pt

Serviço de assistência e diagnóstico para sistemas start/stop

fi

Huolto ja diagnoosi start/stop-järjestelmissä

pl

Serwis i diagnostyka do systemów start/stop

cs

Servis a diagnostika pro systémy start/stop

ru

Техобслуживание и диагностика систем старт/стоп



Eficácia na oficina: serviço de assistência e diagnóstico para sistemas start/stop

Como fabricante de sistemas com abrangente competência, a Bosch oferece

- ▶ ótimas soluções técnicas com qualidade de equipamento original
- ▶ peças de reposição
- ▶ técnica de diagnóstico de primeira água
- ▶ treinamentos

KTS 350: testes de diagnose com o respectivo software de diagnose ESI[tronic]

BAT 131: Verificação do estado de baterias para veículos com sistema Start/Stop

BAT 645/BAT 690: Carregamento fiável de baterias com sistemas Start/Stop

FSA 740: testar a operacionalidade de sensores relevantes do sistema start/stop

Treinamentos na assistência técnica da Bosch Centro de treinamento:

- ▶ princípio de funcionamento do sistema start/stop
- ▶ ligação em rede com outros sistemas de veículo
- ▶ diagnósticos e reparo dos componentes
- ▶ troca da bateria com aparelho de teste de diagnose

Tehokkuutta korjaamoon: Huolto ja diagnoosi start/stop-järjestelmissä

Järjestelmätoimittajana Bosch tarjoaa kattavaa osaamista

- ▶ Optimaaliset tekniset ratkaisut alkuperäistoimittajan laatusa
- ▶ Varaosat
- ▶ Ykkösluokan diagnositeknoologiaa
- ▶ Koulutusta

KTS 350: Diagnositestit ESI[tronic]-diagnosiohjelmistolla

BAT 131: Paristojen tilan tarkastus, kun kyseessä on start/stop-järjestelmällä varustettujen ajoneuvojen yhteydessä

BAT 645/BAT 690: Lataa luotettavat paristot start/stop-järjestelmiin

FSA 740: Start/stop-järjestelmien oleellisten tunnistimien toimintakyvyn testaus

Koulutusta Bosch-huoltoon Trainings Center:

- ▶ Start/stop-järjestelmän toimintaperiaate
- ▶ Verkotus auton muihin järjestelmiin
- ▶ Komponenttien diagnoosi ja korjaus
- ▶ Akun vaihto diagnosio-testerillä

Wydajność w stacji obsługi: serwis i diagnostyka do systemów start/stop

Jako producent systemów posiadający szerokie kompetencje, firma Bosch zapewnia

- ▶ optymalne rozwiązania techniczne w jakości wyposażenia fabrycznego
- ▶ czeski zamiennik
- ▶ technologie diagnostyczna pierwszego wyboru
- ▶ szkolenia

KTS 350: testy diagnostyczne z odpowiednim oprogramowaniem diagnostycznym ESI[tronic]

BAT 131: sprawdzanie stanu akumulatorów do pojazdów z systemem start/stop

BAT 645/BAT 690: niezawodne ładowanie akumulatorów z systemami start/stop

FSA 740: testowanie sprawności odpowiednich czujników systemu start/stop

Szkolenia Bosch Service Centrum szkoleniowe:

- ▶ zasada działania systemu start/stop
- ▶ połączenie w sieć z innymi systemami pojazdu
- ▶ diagnostyka i naprawa elementów
- ▶ wymiana akumulatora z testerem diagnostycznym

Efektivnost v servisní dílně: Servis a diagnostika pro systémy start/stop

Jako výrobce systému s rozsáhlou kompetencí nabízí společnost Bosch

- ▶ Optimální technická řešení v kvalitě originálního vybavení
- ▶ Náhradní díly
- ▶ Diagnostickou techniku první volby
- ▶ Školení

KTS 350: Diagnostické testy s příslušným diagnostickým softwarem ESI[tronic]

BAT 131: Kontrola stavu akumulátorů pro vozidla se systémy start/stop

BAT 645/BAT 690: Spolehlivé nabíjení akumulátorů se systémy Start/Stop

FSA 740: Testování funkční způsobilosti relevantních snímacího systému start/stop

Školení v servisní službě Bosch Školící středisko:

- ▶ Princip funkce systému start/stop
- ▶ Síťové propojení s jinými systémy vozidla
- ▶ Diagnostika a opravy komponent
- ▶ Výměna akumulátorů s diagnostickým testerem

Эффективность на СТО: Техобслуживание и диагностика систем старт/стоп

Являясь системным производителем с комплексной компетенцией, Bosch предлагает

- ▶ Оптимальные технические решения с качеством конвейерной комплектации
- ▶ Запчасти
- ▶ Диагностическое оборудование
- ▶ Обучения и тренинги

KTS 350: диагностическое тестирование с помощью соответствующего программного обеспечения ESI[tronic]

BAT 131: Проверка состояния аккумуляторов для автомобилей с системами "старт/стоп"

BAT 645/BAT 690: Надежная зарядка аккумуляторов при наличии систем "старт/стоп"

FSA 740: тестирование работоспособности соответствующих датчиков системы старт/стоп

Обучение в сервисной службе Bosch Учебный центр:

- ▶ Принцип работы системы старт/стоп
- ▶ Взаимодействие с другими автомобильными системами
- ▶ Диагностика и ремонт компонентов
- ▶ Замена аккумулятора с использованием диагностического тестера

de

**PowerFrame®-
Technologie:
Mehr Leistung
vom Start weg**

en

**PowerFrame®
technology:
More power, right
from the start**

fr

**Technologie
PowerFrame® :
Plus de puissance
dès le démarrage**

it

**Tecnologia
PowerFrame®:
più potenza fin
dall'accensione**

es

**Tecnología
PowerFrame®:
Más potencia
desde el arranque**

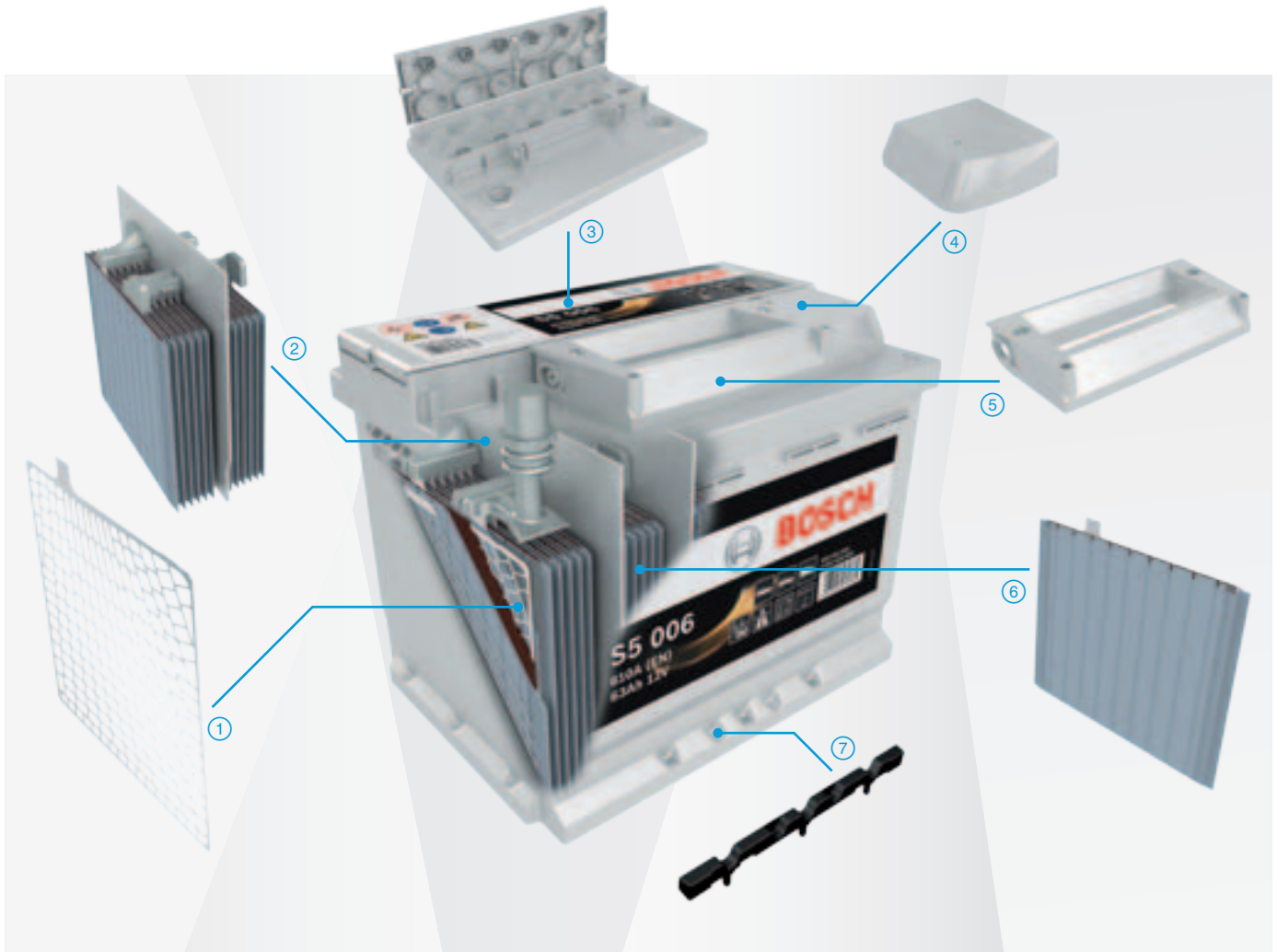

**Patentiertes
PowerFrame®(Gitter)**

Die spezielle Legierung des PowerFrame® sorgt, im Vergleich zu herkömmlichen Gittern, für hohe Korrosionsfestigkeit bei gleichzeitig besonders ausgeprägter Leitfähigkeit. Das belegene Haltbarkeitstests nach der Norm SAE J240 bei 75 °C. Zusätzlich generiert das stromflussoptimierte Gitterdesign des PowerFrame® kontinuierlich hohe Startkraft und unterstützt eine lange Lebensdauer.

Patented PowerFrame® (grid)

Compared to conventional grids, the special alloy of the PowerFrame® ensures a higher corrosion resistance and at the same time a particularly high conductivity – as has been proven by durability tests in line with the SAE J240 standard performed at 75 °C. Furthermore, the flow-optimized PowerFrame® grid design also generates continuously high starting power thus contributing to a long service life.

PowerFrame® (grille) breveté

L'alliage spécial du PowerFrame® garantit comparativement aux grilles classiques une haute résistance à la corrosion qui s'accompagne simultanément d'une excellente conductivité de très haut niveau. Les tests de durabilité effectués selon la norme SAE J240 à 75 °C le prouvent de manière éloquent. En outre le design de la grille optimisée pour les flux de courant du PowerFrame® génère une forte puissance continue de démarrage et soutient une longue durée de vie.

**PowerFrame® brevettata
(griglia)**

La speciale lega della griglia PowerFrame® offre un'elevata resistenza alla corrosione rispetto alle griglie tradizionali, garantendo al tempo stesso un'ottima conducibilità. Ciò è comprovato da test di durata ai sensi della norma SAE J240 ad una temperatura di 75°C. Inoltre, il design ottimizzato della griglia PowerFrame® genera continuamente un'elevata potenza di avviamento e garantisce una lunga durata.

**PowerFrame® patentado
(rejilla)**

La aleación especial de PowerFrame® proporciona, en comparación con las rejillas convencionales, una mayor resistencia a la corrosión y al mismo tiempo una conductividad especialmente notable. Esto se demuestra en las pruebas de durabilidad según la norma SAE J240 a 75 °C. Además, el diseño de rejilla de flujo de corriente optimizado de PowerFrame® genera continuamente una potencia de arranque alta y contribuye a una duración prolongada.

pt

Tecnologia PowerFrame®:
Mais potência desde a partida

fi

PowerFrame®-teknologia:
Lisää tehoa heti käynnistyksellä

pl

Tecnologia PowerFrame®:
Większa moc rozruchu już od pierwszego startu

cs

Technologie PowerFrame®:
Více výkonu již od startu

ru

Технология PowerFrame®:
больше мощности уже на старте

① **Patented PowerFrame® (grid) for optimized current flow and reduced corrosion:**

The flow-optimized grid design of the PowerFrame® guarantees consistently high starting power and a long service life. In addition, a special alloy ensures a high corrosion resistance and significantly lower self-discharge.

② **Set of plates with particularly robust connection**

The central arrangement of the connectors between positive and negative plates ensures additional stability.

③ **Labyrinth lid for high operational safety**

The double lid with labyrinth design ensures that evaporated liquid remains inside the battery. This makes the SLI batteries absolutely maintenance-free and leak-proof.

④ **Terminal-post covers**

Provide protection against short circuits.

⑤ **Ergonomic handles**

For easy transport and installation.

⑥ **Ion-permeable pocket separator**

Prevents contact between positive and negative plate – for longer service life and higher starting power.

⑦ **Universal adapter bottom rail with high degree of vehicle compatibility**

For safe, precisely fitting installation.

SAE J240 durability test (75°C) after 8 weeks:

Standard grid:



Severe corrosion. The grid becomes brittle.

PowerFrame®:



Minimal corrosion. The grid is completely intact.

PowerFrame®(grelha) patenteada

A liga especial da PowerFrame® proporciona, em comparação com as grelhas convencionais, uma elevada resistência à corrosão em simultâneo com uma condutividade particularmente acentuada. Tal é comprovado por testes de resistência em conformidade com a norma SAE J240 a 75 °C. Além disso, o design da grelha da PowerFrame® otimizado em função do fluxo gera continuamente uma elevada potência de arranque e promove uma longa vida útil.

Patentoitu PowerFrame® (ritilä)

PowerFrame® -ritilän erityinen metalliseos varmistaa, perinteisiin ritilöihin verrattuna, korkean korroosionkestävyyden ja samalla erinomaisen johtokyvyn. Tätän todistavat normin SAE J240:n mukaiset kestävyystestit, jotka on tehty lämpötilassa 75 °C. Lisäksi virrankulkuun optimoitu PowerFrame®-ritilä kehittää jatkuvasti korkeaa käynnistysvoimaa ja tukee pitkää elinikää.

Opatentowana siatka PowerFrame®

Specjalny stop siatki PowerFrame® zapewnia większą odporność na korozję przy jednoczesnym zachowaniu odpowiedniej przewodności w porównaniu z tradycyjnymi siatkami. Potwierdzają to testy wytrzymałości według normy SAE J240 przy 75°C. Dodatkowo budowa siatki PowerFrame®, zoptymalizowana pod kątem przepływu prądu, generuje stale wysoką moc rozruchową i przyczynia się do wydłużenia żywotności.

Patentovaný PowerFrame®(mříž)







Speciální slitina PowerFrame® nabízí v porovnání s obvyklými mřížkami vysokou odolnost proti korozi a současně obzvláště dobrou vodivost. To dokazují testy stálosti podle normy SAE J240 při teplotě 75 °C. Design mřížky PowerFrame®, který je optimalizovaný pro tok proudu, dodatečně neustále generuje vysokou startovací sílu a podporuje dlouhou životnost.

Запатентованная PowerFrame®(решетка)

Специальный сплав PowerFrame® обеспечивает, по сравнению с обычными решетками, высокую коррозионную стойкость и в то же время особенно ярко выраженную электропроводность. Это подтверждается испытаниями на прочность по стандарту SAE J240 при температуре 75 °C. Кроме того, оптимизированная по протеканию тока конструкция сети PowerFrame® обеспечивает постоянное высокое пусковое усилие и длительный срок службы.

de	en	fr	it	es
Bosch-Batterien S5 A – S4 E – S5 – S4 – S3 für PKW	Bosch batteries S5 A – S4 E – S5 – S4 – S3 for passenger cars	Batteries Bosch S5 A – S4 E – S5 – S4 – S3 pour voiture particulière	Batteria Bosch S5 A – S4 E – S5 – S4 – S3 per autovettura	Baterías Bosch S5 A – S4 E – S5 – S4 – S3 para turismo



	S5 A	S4 E
		
Technology	 AGM: Absorbent Glass Mat⁽¹⁾, PowerFrame^{®(2)}	 EFB: Enhanced Flooded Battery⁽³⁾, PowerFrame^{®(2)}
Scope of application	 Recent vehicle models and upmarket models with start/stop systems and regenerative braking (recuperation)	 Recent vehicle models and upmarket models with start/stop systems and several electrical consumers
Service life	● ● ●	● ● ●
Cold starting performance	● ● ●	● ●
Deep-cycle resistance	● ● ●	● ● ●
Number of electronic consumers	● ● ●	● ●
Suitability for short distances	● ● ●	● ● ●
Maintenance and water consumption	Absolutely maintenance-free	Absolutely maintenance-free
Installation inside the vehicle	Yes	Yes
Installation angle	Up to 90°	0°
Shelf life	18 month	18 month

Die Fahrzeuge von heute stellen an Batterien besondere Anforderungen. Daher ist bei einem Batteriewechsel die Auswahl der richtigen Batterie entscheidend.

Beim Batteriewechsel muss geprüft werden, ob eine Standardbatterie oder eine besondere Batterie gebraucht wird.

Das Bosch-Batterieprogramm deckt die unterschiedlichen Anforderungen der verschiedensten Pkw ab.

Modern vehicles place special demands on batteries. Therefore, the selection of the right battery is essential for the battery replacement.

When replacing a battery, it is essential to check whether a standard battery or a special battery is required.

The Bosch battery product portfolio covers the diverse requirements of cars.

Les véhicules modernes sont sources de demandes spéciales en matière de batteries. La sélection de la batterie spécialement adaptée au véhicule est essentielle lors de son remplacement.

Lors du remplacement d'une batterie, il est essentiel si le véhicule nécessite une batterie standard ou une batterie spécifique.

La gamme de produits des batteries Bosch couvre toutes les exigences spécifiques des véhicules.

I veicoli moderni chiedono molta energia alle batterie. Pertanto, è essenziale scegliere la giusta batteria quando è il momento di cambiarla.

Quando si sostituisce una batteria, è essenziale controllare se è necessaria una batteria standard o una batteria speciale.

La gamma di batterie Bosch copre le diverse esigenze delle auto.

Los vehículos modernos plantean exigencias especiales para las baterías. Por tanto, elegir la batería correcta es vital para reemplazarla.

Al sustituir una batería, es esencial comprobar si se necesita una batería estándar o una especial.

La gama de baterías de Bosch cubre la amplia variedad de requisitos de los coches.

(1) AGM (Absorbent Glass Mat): acid absorbed by micro-fiberglass mat allows more energy to pass through

(2) PowerFrame®: patented stamping process for optimized current flow, reduced corrosion and long service life

(3) EFB (Enhanced Flooded Battery): positive plate coated with polyester scrim ensures additional retention of the active material and a high deep-cycle resistance

pt

Baterias Bosch
S5 A – S4 E –
S5 – S4 – S3
para veículo ligeiro

fi

Bosch-akut
S5 A – S4 E –
S5 – S4 – S3
ja HA

pl

Akumulatory Bosch
S5 A – S4 E –
S5 – S4 – S3 dla
samochody osobowe

cs

Akumulátory Bosch
S5 A – S4 E –
S5 – S4 – S3
pro osobní vozidlo

ru

Аккумуляторы Bosch
S5 A – S4 E –
S5 – S4 – S3 для
Легковой автомобиль

S5



S4



S3



Lead-acid SLI: Starting-lighting-ignition/starter battery with PowerFrame⁽¹⁾ and labyrinth lid⁽²⁾

 Recent vehicle models and upmarket models

 All vehicles, also for Asian models

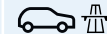
 Older vehicles with fewer electrical consumers

● ● ●

● ● ●

● ●

● ● ●

● ●

●

● ●

● ●

●

● ●

●

●

● ●

●

●

Absolutely maintenance-free

Absolutely maintenance-free

Absolutely maintenance-free

Yes

Yes

No

0°

0°

0°

18 month

15 month

12 month

Os veículos modernos impõem exigências especiais no que se refere às baterias. Por conseguinte, a seleção da bateria certa é essencial para a substituição da bateria.

Ao substituir uma bateria, é fundamental verificar se é necessária uma bateria padrão ou uma bateria especial.

A gama de baterias da Bosch abrange os diversos requisitos dos automóveis.

Modernit autot asettavat erityisiä vaatimuksia akuille. Oikean akun valinta on tästä syystä olennaisen tärkeää akun vaihtamisen osalta.

Akkua vaihdettaessa on olennaisen tärkeää tarkastaa, vaaditaanko vakiomallinen akku vai erikoisakku.

Bosch akkutuotevalikolima kattaa autojen vaatimusten laajan kirjon.

Nowoczesne pojazdy stawiają specjalne wymagania wobec akumulatorów. Dlatego dobór odpowiedniego akumulatora ma istotne znaczenie przy jego wymianie.

Przy wymianie akumulatora należy koniecznie sprawdzić, czy wymagany jest akumulator standardowy, czy też akumulator specjalny.

Oferta akumulatorów firmy Bosch obejmuje różne wymagania związane z samochodami.

Moderní vozidla kladou na akumulátory speciální požadavky. Proto je při výměně akumulatoru zásadně důležité správně zvolit nový akumulátor.

Při výměně akumulatoru je nutné zkontrolovat, zda je třeba standardní, nebo speciální akumulátor.

Portfolio akumulátorů společnosti Bosch pokrývá rozmanité požadavky různých typů automobilů.

Современные автомобили характеризуются особыми требованиями к аккумуляторам. Поэтому, когда речь идет о замене аккумулятора, выбор правильного аккумулятора критически важен.

При замене аккумулятора необходимо проверить, требуется ли стандартный или специальный аккумулятор.

Ассортимент аккумуляторов Bosch соответствует различным требованиям автомобилей.

(1) PowerFrame®: patented stamping process for optimized current flow, reduced corrosion and long service life

(2) Labyrinth lid: returns condensed water to the battery; integrated central degassing, backfire protection and an additional sealing ring ensure high operational safety

de

Bosch-Batterien TE für Nutzfahrzeuge mit EFB-Technologie

en

Bosch commercial vehicle batteries TE with EFB technology

fr

Batteries Bosch TE pour véhicules utilitaires en technologie EFB

it

Batterie Bosch TE per veicoli commerciali con tecnologia EFB

es

Baterías Bosch TE para vehículos comerciales con tecnología EFB

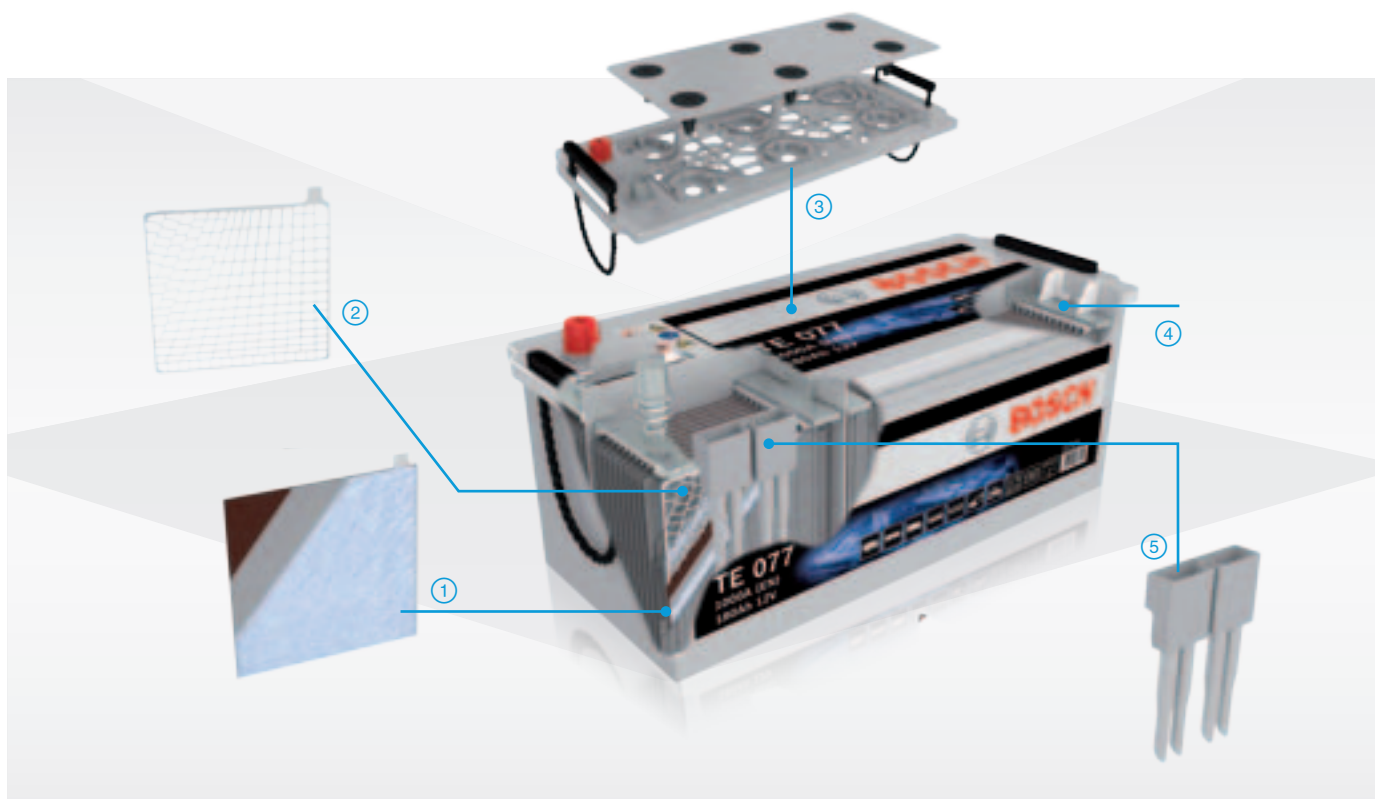

Die leistungsstarke Nfz-Batterie unterstützt enorme elektrische Anforderungen sowie zahlreiche Hotel- und Komfortfunktionen im Standbetrieb: die EFB-Technologie (Enhanced Flooded Battery) sorgt für doppelte Zyklenfestigkeit im Vergleich zu herkömmlichen Batterien – häufiges Entladen und Laden macht der Batterie weniger aus.

Besonders rüttelfest und sicher für Hinterachs-Einbau, Off-Highway-Fahrzeuge und Heavy-Duty-Baumaschinen gemäß V4-Norm: das spezialverklebte Polyester-Vlies hält die Batterie-Platten zuverlässig in Position, zusätzliche Verstärkungen und Fixierungen machen die Batterie sehr rüttelfest.

The powerful commercial vehicle battery supports tremendous electrical demands as well as several convenience and comfort functions in stationary operation: EFB (Enhanced Flooded Battery) technology ensures twice the deep-cycle resistance of conventional batteries – the battery copes much better with frequent discharging and charging.

Particularly vibration-resistant and for safe installation at the rear axle, off-highway vehicles and heavy-duty construction machinery, meeting V4 standard: a specially glued polyester fleece reliably keeps the battery plates in position, additional reinforcements and stabilized connectors make the battery highly vibration-resistant.

Cette puissante batterie destinée aux véhicules utilitaires soutient d'énormes besoins d'énergie électrique et permet de bénéficier à l'arrêt de nombreuses fonctions hôtel et confort : la technologie EFB (Enhanced Flooded Battery) assure une résistance cyclique deux fois plus élevée que les batteries classiques – la batterie est ainsi moins sensible aux charges et décharges fréquentes.

Particulièrement résistante aux secousses et fiable pour une installation sur l'essieu arrière, véhicules Off-Highway et machines de travaux publics Heavy Duty selon Norme V4 : la nappe polyester non tissée à encollage spécial maintient avec une grande fiabilité les plaques de batterie en position, des renforts et fixations supplémentaires permettent à la batterie de supporter sans broncher les pires secousses et ébranlements.

La potente batteria per veicoli commerciali supporta notevoli requisiti elettrici nonché numerose funzioni hotel e comfort nel funzionamento standard: la tecnologia EFB (Enhanced Flooded Battery) garantisce una resistenza ai cicli di carica/scarica doppia rispetto alle batterie tradizionali - la scarica e la ricarica frequente rendono la batteria meno efficiente.

Particolarmente resistente alle vibrazioni e adatta ad un'installazione sicura nell'asse posteriore, per macchine movimento terra e un utilizzo fuoristrada rispettando gli standard V4: le garze di poliestere mantengono le piastre della batteria in posizione in modo affidabile, rinforzi e fissaggi aggiuntivi rendono la batteria molto resistente alle vibrazioni.

La potente batería del vehículo industrial es compatible con enormes requisitos eléctricos, así como numerosas funciones de hotel y confort en el funcionamiento estacionario: la tecnología EFB (Enhanced Flooded Battery) proporciona una doble resistencia a los ciclos en comparación con las baterías convencionales: las frecuentes cargas y descargas apenas afectan la batería.

Especialmente resistente a vibraciones y segura para montaje en el eje trasero, vehículos fuera de carretera y maquinaria de construcción para trabajo pesado según la norma V4: la malla de poliéster con pegado especial mantiene las placas de la batería en su lugar de manera fiable, los refuerzos y fijaciones adicionales hacen que la batería sea muy resistente a las vibraciones.

pt

Baterias Bosch TE para veículos comerciais com tecnologia EFB

fi

Bosch-akut TE hyötyajoneuvoihin EFB-tekniologialla

pl

Akumulatory Bosch TE z technologią EFB do pojazdów użytkowych

cs

Akumulátory Bosch TE pro užitková vozidla s technologií EFB

ru

Аккумуляторы Bosch TE для коммерческих автомобилей с технологией EFB

① EFB (Enhanced Flooded Battery) technology

At EFB (Enhanced Flooded Battery) technology, the positive plate is coated with a polyester scrim (fleece). It ensures additional retention of the active material on the battery plates doubling the deep-cycle resistance in comparison with conventional batteries. The specially glued polyester fleece reliably keeps the battery plates in position. As a consequence, the battery remains operational even if subject to strong and lasting vibrations.

② Patented PowerFrame® (grid) for optimized current flow and reduced corrosion

The special grid-stamping technique makes this battery particularly corrosion-resistant and durable. The flow-optimized PowerFrame® grid design ensures consistently high starting power. This results in a very low self-discharge rate.

③ Labyrinth lid

The double lid with labyrinth design returns condensed water to the battery. As a result, TE batteries are absolutely maintenance-free and leakproof. They consume very little water. The integrated central degassing, backfire protection and an additional sealing ring ensure high operational safety.

④ Additional stabilization for vibration resistance in line with V4 standard

⑤ Mixing elements

improve electrolyte mixing and prevent acid layering – thus expanding the service life and improving the deep-cycle resistance.

A bateria potente para veículo comercial suporta requisitos elétricos enormes, assim como inúmeras funções de hotel e conforto no modo de estacionamento: a tecnologia EFB (Enhanced Flooded Battery) proporciona o dobro da estabilidade do ciclo em comparação com as baterias convencionais – os ciclos frequentes de carga e descarga afetam menos a bateria.

Particularmente resistente a vibrações e segura para instalação no eixo traseiro, veículos fora de estrada e máquinas de construção pesadas em conformidade com a norma V4: o velo de poliéster colado de forma especial mantém as placas da bateria no lugar de forma fiável, eventuais reforços e fixações adicionais tornam a bateria bastante resistente a vibrações.

Tehokas NFZ-akku tukee korkeita sähköille asetettuja vaatimuksia sekä useita hotelli- ja mukavuustoimintoja kiinteässä käytössä: EFB-tekniologia (Enhanced Flooded Battery) huolehtii kaksinkertaisesti syklikestävyvyydestä perinteisiin akkuihin verrattuna – usein tapahtuvat purkautuminen ja varaus eivät vaikuta akkuun. **Erittäin ravistelunkestävä ja varma ratkaisu asennettavaksi taka-akseliin; muut kuin teillä käytettävät ajoneuvot ja suurta rasiustusta kestävä rakennuskoneet V4-normin mukaisesti:** Erityinen liimattu polyesterikuitukangas pitää akkulevyn luotettavasti paikoillaan, lisävahvisteet ja kiinnitys tekevät akusta puolestaan ravistusta kestävä.

Wydatny akumulator do pojazdów użytkowych spełnia wyjątkowe wymagania elektryczne i pozwala realizować liczne funkcje hotelowe i komfortowe w trybie postojowym: technologia EFB (Enhanced Flooded Battery) zapewnia dwukrotnie większą odporność na cykle ładowania i wyładowania w porównaniu z tradycyjnymi akumulatorami – częste wyładowanie i ładowanie mniej szkodzi akumulatorowi. **Wyjątkowa odporność na wstrząsy i przystosowanie do montaż przy tylniej osi, do pojazdów terenowych i ciężkich maszyn budowlanych zgodnie z normą V4:** specjalnie klejone włókno poliestrowe utrzymuje płytki akumulatora na pozycji, a dodatkowo wzmocnienia i mocowania zapewniają wyjątkową odporność akumulatora na wstrząsy.

Výkonný akumulátor pro užitková vozidla splňuje enormní elektrické nároky a velké množství hotelových a komfortních funkcí v podpůrném provozu: technologie EFB (Enhanced Flooded Battery) nabízí dvojnásobnou cyklickou pevnost v porovnání s obvyklými akumulátory – časté vybíjení a nabíjení akumulátoru neškodí. **Obzvláště odolný proti otřesům a bezpečný pro vestavbu u zadní nápravy, vozidla Off-Highway a stavební stroje Heavy-Duty podle normy V4:** speciálně lepený polyesterový flís udržuje desky akumulátoru spolehlivě v jejich poloze, díky dalšímu zesílení a upevnění je akumulátor velmi odolný proti otřesům.

Мощный аккумулятор для коммерческих транспортных средств способен удовлетворить самые высокие потребности в электропитании, а также обеспечивает многочисленные функции для комфорта во время работы и в режиме гостиничной блокировки в стояночном режиме: технология EFB (Enhanced Flooded Battery) обеспечивает вдвое больший ресурс АКБ, чем обычные аккумуляторы, таким образом, при отсутствии частой разрядки и зарядки аккумулятор меньше изнашивается. **Особенно виброустойчив и безопасен для установки задней оси, внедорожников и строительных машин для тяжелых условий работы в соответствии со стандартом V4:** специально склеенный полиэфирный холст надежно удерживает пластины аккумулятора, дополнительные элементы усиления и крепления делают аккумулятор очень виброустойчивым.

de

Bosch-Batterien TE für Nutzfahrzeuge mit EFB-Technologie
(Fortsetzung)

en

Bosch commercial vehicle batteries TE with EFB technology
(continued)

fr

Batteries Bosch TE pour véhicules utilitaires en technologie EFB
(suite)

it

Batterie Bosch TE per veicoli commerciali con tecnologia EFB
(seguito)

es

Baterías Bosch TE para vehículos comerciales con tecnología EFB
(continuación)



Hohe Qualität und überdurchschnittliche Startkraft: qualitativ gleichwertige Materialien und Standards wie in der Erstausrüstung.

Besonders hohe Lebensdauer: durch Einsatz passiver Mischelemente zur Reduktion der Säureschichtung.

Absolut wartungsfrei und auslaufsicher – das spart Flottenbetriebskosten: der Labyrinthdeckel sorgt dafür, dass verdampfte Flüssigkeit in der Batterie verbleibt; der Wasserverbrauch ist folglich sehr gering.

High quality and above-average starting power: material quality and standards equivalent to original-equipment ones.

Particularly long service life: ensured by passive mixing elements for reduced stratification.

Absolutely maintenance-free and leakproof – reducing fleet operating costs: the labyrinth lid ensures evaporated liquid to remain inside the battery; this results in very low water consumption.

Durée de vie particulièrement élevée et puissance de démarrage nettement supérieure à la moyenne : des matériaux et standards identiques à ceux des premiers équipements.

Durée de vie particulièrement : élevée par l'emploi d'éléments mélangeurs passifs destinés à réduire la stratification de l'acide.

Entièrement exempté d'entretien et absence totale d'écoulements – voilà comment abaisser les frais d'exploitation pour les flottes de véhicules : le couvercle à structure en labyrinthe garantit que le liquide de condensation reste dans la batterie ; la consommation en eau reste ainsi très faible.

Elevata qualità e potenza di avviamento superiore alla media: materiali e standard della stessa qualità dell'equipaggiamento originale.

Durata particolarmente lunga: grazie all'impiego di miscelatori passivi per ridurre la stratificazione dell'acido.

Non richiede alcuna manutenzione ed è a prova di perdite - questo consente di risparmiare sui costi operativi della flotta: il coperchio a labirinto assicura che il liquido evaporato rimanga nella batteria; il consumo d'acqua è quindi molto basso.

Alta calidad y potencia de arranque superior al promedio: estándares y materiales del mismo valor cualitativo como en el equipo original.

Duración especialmente prolongada: mediante el empleo de elementos mezcladores para la reducción de la estratificación del ácido.

Totalmente libre de mantenimiento y a prueba de derrames, lo que ahorra costes operativos de la flota: la tapa con laberinto asegura que el líquido evaporado permanezca en la batería, por lo que el consumo de agua es muy reducido.

pt

Baterias Bosch TE para veículos comerciais com tecnologia EFB
(continuação)

fi

Bosch-akut TE hyötyajoneuvoihin EFB-teknologialla
(jatkoa)

pl

Akumulatory Bosch TE z technologią EFB do pojazdów użytkowych
(ciąg dalszy)

cs

Akumulátory Bosch TE pro užitková vozidla s technologií EFB
(pokračování)

ru

Аккумуляторы Bosch TE для коммерческих автомобилей с технологией EFB
(продолжение)



KTS Truck: ECU diagnoses for modern commercial-vehicle electronics

- ▶ KTS Truck module for trucks, vans, LCVs, trailers and buses
- ▶ Can be connected to DCU 220 and all common laptops/PCs thanks to USB interface
- ▶ Integrated long-distance Bluetooth connection (up to 100 m)
- ▶ Bluetooth-USB adapter included within scope of delivery
- ▶ Robust housing



Elevada qualidade e potência de arranque acima da média: materiais e padrões de qualidade equivalente à do equipamento original.

Vida útil especialmente longa: graças à utilização de elementos de mistura passivos para a redução da estratificação do ácido.

Absolutamente isenta de manutenção e à prova de fugas – o que reduz os custos relacionados com gestão de frotas: a tampa de labirinto permite que o líquido evaporado permaneça na bateria; o consumo de água é, consequentemente, muito reduzido.

Korkea laatu ja keskivertoa parempi käynnistysvoima: laadullisesti samanarvoiset materiaalit ja standardit kuten ensivarustuksessa.

Erityisen pitkä elinikä: happokerroksia vähentävien passiivisten sekoitettujen elementtien käytön ansiosta.

Ehdottoman huoltovapaa ja vuotamaton – vähentää ajoneuvokannan käyttökustannuksia: labyrinttikansi huolehtii, että höyryntynyt neste jää akkuun; vedenkulutus on sen seurauksena erittäin vähäistä.

Wysoka jakość i ponadprzeciętna moc rozruchowa: wysokiej klasy materiały i standardy na poziomie pierwszego wyposażenia.

Wyjątkowo długa żywotność: dzięki zastosowaniu pasywnych elementów mieszających, zapewniających redukcję nawarstwiania kwasu.

Absolutna bezobsługowość i ochrona przed wylaniem – zapewnia oszczędność kosztów eksploatacji floty: pokrywa labyrintowa zatrzymuje odparowany plyn w akumulatorze, dzięki czemu zużycie wody jest bardzo małe.

Vysoká kvalita a nadprůměrná startovací síla: kvalitativně rovnocenné materiály a standardy jako u originální výbavy.

Obzvláště dlouhá životnost: Díky použití pasivních směsových prvků ke snížení vrstvení kyseliny.

Absolutně bezúdržbové a neprosakující – to znamená úsporu provozních nákladů na vozový park: labyrintové víko zajišťuje, že vypařená tekutina zůstává v akumulátoru; díky tomu je velmi nízká spotřeba vody.

Высокое качество и пусковое усилие выше среднего:

качественно эквивалентные материалы и стандарты как в заводской комплектации.

Особенно долгий срок службы: благодаря использованию пассивных смесительных элементов для уменьшения кислотного расслоения.

Абсолютно не требующий техобслуживания и герметичный, это экономит производственные затраты автопарка: лабиринтная крышка обеспечивает сохранение испарившейся жидкости в аккумуляторе; поэтому расход воды очень низкий.

de

**Bosch-Batterien
TE – T5 – T4 – T3
für Nutzfahrzeuge**

en

**Bosch commercial-
vehicle batteries
TE – T5 – T4 – T3**

fr

**Batteries Bosch
TE – T5 – T4 – T3 pour
véhicules utilitaires**

it

**Batterie Bosch
TE – T5 – T4 – T3 per
veicoli commerciali**

es

**Baterías Bosch
TE – T5 – T4 – T3 para
vehículos industriales**

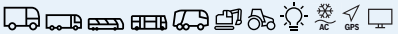

	TE EFB	
		
Technology	 <p>EFB (Enhanced Flooded Battery): positive plate coated with polyester scrim ensures additional retention of the active material and a high deep-cycle resistance</p>	
Scope of application	 <p>Long-haul trucks, distribution traffic / trucks with tail lift, construction machinery and off-road trucks, coaches and buses, municipal vehicles with a high rate of city traffic and fire-fighting vehicles, agricultural vehicles, applications with numerous electrical consumers</p>	
Service life	● ● ● ● ●	
Cold starting performance	● ● ●	
Deep-cycle resistance	● ● ●	
Number of electronic consumers	● ● ●	
Vibration resistance	● ● ● V4/EN-50342-1	
Maintenance and water consumption	Absolutely maintenance-free – reduces fleet operating costs very low water consumption thanks to labyrinth lid	
Installation inside the vehicle	Yes	
Installation angle	0°	
Shelf life	18 month	

Gut, dass auf Bosch-Nfz-Batterien Verlass ist: Sie sind leistungsstark, rüttelfest und dazu noch wartungsfrei. Das senkt die Flottenbetriebskosten.

Good to know, you can fully rely on Bosch commercial-vehicle batteries. They are powerful, vibration-resistant and even maintenance-free. This will cut the fleet operating costs.

On apprécie alors tout particulièrement de pouvoir faire entière confiance aux batteries Bosch pour véhicules utilitaires car elles sont puissantes, résistantes aux secousses et ébranlements et qui plus est exemptes d'entretien. On abaisse ainsi notablement les frais d'exploitation de flottes de véhicules.

È un bene poter contare sulle batterie Bosch: sono efficienti, resistenti alle vibrazioni e inoltre non necessitano di manutenzione. Ciò consente di ridurre i costi della flotta.

Que bueno es poder confiar en las baterías Bosch para vehículos comerciales: son potentes, resistentes a las vibraciones y además no requieren mantenimiento. Eso reduce los costes operativos de la flota.

pt

**Baterias Bosch
TE – T5 – T4 – T3 para
veículos comerciais
e camiões**

fi

**Bosch-akut
TE – T5 – T4 – T3
hyötyajoneuvoihin**

pl







**Akumulatory Bosch
TE – T5 – T4 – T3 do
samochodów
dostawczych**

cs

**Akumulátory Bosch
TE – T5 – T4 – T3 pro
užitková vozidla**

ru

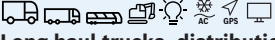
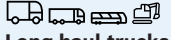
**Аккумуляторы
Bosch TE – T5 – T4 – T3
для коммерческого
транспорта**

T5 SLI	T4 SLI	T3 SLI
		
 Lead-acid SLI: Starting-Lighting-Ignition / starter battery	 Lead-acid SLI: Starting-Lighting-Ignition / starter battery	
 Long-haul trucks, distribution traffic/trucks with tail lift, construction machinery and off-road trucks, coaches, applications with numerous electrical consumers	 Long-haul trucks, distribution traffic/trucks with tail lift, construction machinery and off-road trucks, coaches	 Distribution traffic/trucks with tail lift, vans and LCVs
● ● ●	● ● ●	● ●
● ● ●	● ● ●	● ●
● ●	● ●	●
● ●	● ●	●
● ● V3/EN-50342-1	● ● V3/EN-50342-1	● V1, V2 or V3* / EN-50342-1 * depending on type
Absolutely maintenance-free – reduces the fleet operating costs very low water consumption thanks to labyrinth lid	Absolutely maintenance-free – reduces the fleet operating costs very low water consumption thanks to labyrinth lid	Maintenance-free – depending on type, hybrid lid allows topping-up with water, in case of excessive use
Yes	Yes	Yes
0°	0°	0°
18 month	15 month	12 month

Ainda bem que pode contar com as baterias Bosch para veículos comerciais: são potentes, resistentes a vibrações e também isentas de manutenção. Tal reduz os custos relacionados com a gestão de frotas.

Voit kuitenkin luottaa Bosch hyötyajoneuvoakkuihin: ne ovat tehokkaita, ravistuksen kestäviä ja vieläpä huoltovapaita. Tämä laskee ajoneuvokannan käyttökustannuksia.

Na akumulatorach Bosch do pojazdów użytkowych można polegać: są mocne, odporne na wstrząsy i w dodatku bezobsługowe. Zmniejsza to koszty eksploatacji floty.

Je dobré, že se můžete spolehnout na akumulátory pro užitková vozidla Bosch: Jsou výkonné, odolné proti nárazu a také bezúdržbové. To snižuje provozní náklady na vozový park.

Хорошо, что можно положиться на аккумуляторы Bosch для коммерческих автомобилей: они мощные, вибростойкие и не требуют технического обслуживания. Это снижает производственные затраты автопарка.

de

Bosch-Batterien TE – T5 – T4 – T3 für Nutzfahrzeuge (Fortsetzung)

en

Bosch commercial- vehicle batteries TE – T5 – T4 – T3 (continued)

fr

Batteries Bosch TE – T5 – T4 – T3 pour véhicules utilitaires (suite)

it

Batterie Bosch TE – T5 – T4 – T3 per veicoli commerciali (seguito)

es

Baterías Bosch TE – T5 – T4 – T3 para vehículos industriales (continuación)



Was Nfz-Batterien heute leisten

Zuverlässigkeit

Moderne Trucks legen durchschnittlich 145 000 km jährlich zurück. Häufig fallen bis zu 5 Übernachtungen pro Woche an. Dennoch muss die Batterie am nächsten Morgen zuverlässig starten.

Leistungsstärke

Die Batterie versorgt zahlreiche Sicherheitssysteme und Komfortfunktionen, auch im Standbetrieb. Häufiges Entladen und Laden sollte der Batterie dennoch nichts ausmachen.

Wirtschaftlichkeit

Ein geringer Wartungsaufwand hilft, die Flottenbetriebskosten zu reduzieren.

Rüttelfestigkeit

Durch den zunehmenden Einbau im Hinterachsen-Bereich sind Nfz-Batterien stärkeren Erschütterungen ausgesetzt. Hohe Stabilität und Rüttelfestigkeit sind gefragt.

A tough job for today's commercial-vehicle batteries

Reliability

On an average, modern trucks cover some 145 000 km every year. Often, the drivers sleep inside the cab up to 5 nights per week. And yet the batteries need to provide enough starting power to start the engine the next day.

Performance

Even in case of stationary operation, the batteries power a wealth of safety and convenience features. And yet they are to cope with frequent charge and discharge cycles.

Economy

Low maintenance efforts help reducing the fleet operating costs.

Vibration resistance

As commercial-vehicle batteries are installed close to the rear axle more and more often, they are subject to increased vibrations. High robustness and vibration resistance are thus required.

Caractéristiques des batteries actuelles pour véhicules utilitaires

Fiabilité

Les semi-remorques modernes parcourent en moyenne 145 000 km chaque année. On enregistre souvent jusqu'à 5 nuits par semaine au dehors. La batterie doit toutefois assurer un démarrage fiable le jour suivant.

Puissance

La batterie alimente de nombreux systèmes de sécurité et de nombreuses fonctions de confort, même à l'arrêt. Les charges et décharges fréquentes ne doivent nullement affecter les performances de la batterie.

Rentabilité

Des faibles coûts d'entretien permettent de réduire les frais d'exploitation de flottes de véhicules.

Résistance aux secousses et ébranlements

Comme elles sont de plus en plus installées sur les essieux arrière, les batteries NFZ sont soumises à des secousses et ébranlements plus violents. Une grande robustesse et une résistance aux ébranlements sont particulièrement demandées.

Cosa possono fare oggi le batterie dei veicoli commerciali

Affidabilità

I camion moderni percorrono in media 145.000 km all'anno. Spesso, fino a 5 notti a settimana. Tuttavia, la batteria deve avviarsi in modo affidabile la mattina successiva.

Efficienza

La batteria offre numerosi sistemi di sicurezza e funzioni di comfort, anche da fermi. I frequenti cicli di scarica e carica non devono compromettere la batteria.

Redditività

La ridotta manutenzione aiuta a ridurre i costi operativi della flotta.

Resistenza alle vibrazioni

A seguito della crescente installazione nell'area dell'asse posteriore, le batterie dei veicoli commerciali sono esposte a forti vibrazioni. Sono necessarie elevata stabilità e resistenza alle vibrazioni.

Lo que las baterías para vehículos comerciales ofrecen actualmente

Fiabilidad

Los camiones modernos conducen en promedio 145 000 km anualmente. Con frecuencia tienen 5 pernoctas por semana. Sin embargo, se debe garantizar que la batería arranque a la mañana siguiente.

Rendimiento

La batería suministra muchos sistemas de seguridad y funciones de confort, también en modo parado. Además, la descarga y carga frecuentes no debe afectar la batería.

Rentabilidad

Un coste de mantenimiento reducido ayuda a disminuir los costos operativos de la flota.

Resistencia a las vibraciones

Las baterías para vehículos comerciales están expuestas a sacudidas fuertes debido al montaje en la zona del eje trasero cada vez más frecuente. Se requiere una resistencia a las vibraciones y una alta estabilidad.

pt

Baterias Bosch TE – T5 – T4 – T3 para veículos comerciais e camiões
(continuação)

fi

Bosch-akut TE – T5 – T4 – T3 hyötyajoneuvoihin
(jatkoa)

pl

Akumulatory Bosch TE – T5 – T4 – T3 do samochodów dostawczych
(ciąg dalszy)

cs

Akumulátory Bosch TE – T5 – T4 – T3 pro užitková vozidla
(pokračování)

ru

Аккумуляторы Bosch TE – T5 – T4 – T3 для коммерческого транспорта
(продолжение)



ESI[tronic] Truck

In Europe,

2,600

workshops subscribed to
ESI[tronic] Truck software.



O que oferecem atualmente as baterias para veículos comerciais

Fiabilidade

Os camiões modernos percorrem, em média, 145 000 km por ano. Frequentemente, ocorrem até 5 pernoitas por semana. Por conseguinte, a bateria tem de ser capaz de arrançar de forma fiável na manhã seguinte.

Capacidade

A bateria alimenta vários sistemas de segurança e funções de conforto, mesmo com o veículo parado. Contudo, os ciclos frequentes de carga e descarga não deverão afetar a bateria.

Rentabilidade

Uma reduzida necessidade de manutenção ajuda a diminuir os custos relacionados com a gestão de frotas.

Resistência a vibrações

Graças à instalação crescente na zona do eixo traseiro, as baterias para veículos comerciais estão expostas a vibrações mais fortes. São necessárias uma maior estabilidade e resistência a vibrações.

Hyötyajoneuvojen akkujen edut tänä päivänä

Luotettavuus

Moderneilla kuorma-autoilla ajetaan keskimäärin 145 000 km vuodessa. Yöpyisiä on usein jopa 5 kertaa viikossa. Kuitenkin akun pitää käynnistyä luotettavasti seuraavana aamuna.

Tehokkuus

Akku syöttää energiaa lukuisiin turvajärjestelmiin ja mukavuustoimintoihin, myös seison-takäytössä. Usein tapahtuvan purkauksen ja varauksen ei kuitenkaan pitäisi vaikuttaa akkuun.

Taloudellisuus

Vähäinen huollontarve auttaa pitämään ajoneuvokannan kustannukset matalina.

Ravistuksen kestävä

Koska akkuja asennetaan yhä enemmän taka-akselin alueelle, hyötyajoneuvojen akut on altistettu vahvemmillä tärinöille. Akulta vaaditaan vakautta ja ravistuksen kestävyttä.

Obecne możliwości akumulatorów do pojazdów użytkowych

Niezawodność

Nowoczesne ciężarówki przemierzają średnio 145 000 km rocznie. Na jeden tydzień często przypada nawet pięć noclegów. Mimo tego akumulator musi zapewnić niezawodny rozruch kolejnego ranka.

Wydajność

Akumulator zasila liczne systemy bezpieczeństwa i funkcje komfortowe, również w trakcie postoju. Częste wyładowanie i ładowanie nie powinno jednak szkodzić akumulatorowi.

Ekonomiczność

Niewielki nakład prac konserwacyjnych pomaga w zmniejszeniu kosztów eksploatacji floty.

Odporność na wstrząsy

Coraz częstszy montaż w obszarze tylnej osi sprawia, że akumulatory w pojazdach użytkowych są narażone na silniejsze wstrząsy. Pożądane są wysoka stabilność i odporność na wstrząsy.

Co akumulátory užitkových vozidel dnes nabíží

Spolehlivost

Moderní nákladní vozidla ujedou průměrně 145 000 km ročně. Často dochází k přenocování až 5 krát za týden. Akumulátor však musí přistít ráno spolehlivě nastartovat.

Výkonnost

Akumulátor napájí velké množství bezpečnostních systémů a komfortních funkcí, také v podpůrném provozu. Časté vybití a nabíjení však akumulátoru v ničem neuškodí.

Hospodárnost

Nízké náklady na údržbu pomáhají snižovat provozní náklady na vozový park.

Odolnost proti nárazu

Z důvodu častější vestavby v oblasti zadní nápravy jsou akumulátory užitkových vozidel vystaveny silnějším otřesům. Důležitá je dobrá stabilita a odolnost proti nárazu.

Современные возможности аккумуляторов для коммерческих автомобилей

Надежность

Современные грузовики проходят в среднем 145 000 км в год. Часто получается до 5 ночевок в неделю. Тем не менее, аккумулятор должен надежно работать на следующее утро.

Производительность

Аккумулятор обеспечивает многочисленные системы безопасности и функции обеспечения комфорта, даже в стояночном режиме. Тем не менее, частая разрядка и зарядка не должны отрицательно сказываться на аккумуляторе.

Экономичность

Низкие затраты на техническое обслуживание помогают снизить производственные затраты автопарка.

Вибростойкость

Вследствие все более частого монтажа в области задней оси, аккумуляторы коммерческих автомобилей подвержены более сильным вибрациям. Существует спрос на высокую стабильность и вибростойкость.

de

Bosch-Batterie
L5 – L5 G –
L4 – Optima
für Freizeit-
anwendungen

en

Bosch battery
L5 – L5 G –
L4 – Optima
for leisure
applications

fr

Batterie Bosch
L5 – L5 G –
L4 – Optima
pour les applications
de loisirs

it

Batteria Bosch
L5 – L5 G –
L4 – Optima
per applicazioni
del tempo libero

es

Baterías Bosch
L5 – L5 G –
L4 – Optima
para aplicaciones
de ocio



L4 und L5
 mit PowerFrame-Technologie¹⁾,
 Labyrinthdeckel²⁾
 und Deep-Cycle-Technologie³⁾

L4 and L5
 with PowerFrame® technology¹⁾,
 Labyrinth Lid²⁾
 and Deep Cycle technology³⁾

L4 et L5
 avec technologie PowerFrame® ¹⁾,
 couvercle labyrinthe ²⁾
 et technologie Deep Cycle ³⁾

L4 e L5
 con tecnologia PowerFrame® ¹⁾,
 coperchio a labirinto ²⁾
 e tecnologia ciclo profondo ³⁾

L4 y L5
 con tecnología PowerFrame® ¹⁾,
 tapa del laberinto ²⁾
 y tecnología ciclo profundo ³⁾

L5 G
 mit Deep Cycle-Technologie³⁾

L5 G
 with Deep Cycle technology³⁾

L5 G
 avec technologie Deep Cycle ³⁾

L5 G
 con tecnologia ciclo profundo ³⁾

L5 G
 con tecnología ciclo profundo ³⁾

OPTIMA®
 mit AGM ⁴⁾- und SpiralCell®-
 Technologie ⁵⁾
 Für konstante Energieversorgung
 auch über längere Zeiträume –
 besonders marinegeeignet.

OPTIMA®
 With AGM ⁴⁾ and SpiralCell®
 technology⁵⁾
 For a constant energy supply
 over long periods – particularly
 suited for marine applications.

OPTIMA®
 avec technologie AGM ⁴⁾
 et SpiralCell® ⁵⁾
 Pour une alimentation constante
 en énergie également sur des
 périodes prolongées, convient
 particulièrement pour la marine.

OPTIMA®
 con tecnologia AGM ⁴⁾
 e SpiralCell® ⁵⁾
 Per una costante fornitura di
 energia, anche per lunghi periodi,
 particolarmente adatta per
 applicazioni marine.

OPTIMA®
 con tecnología AGM ⁴⁾
 y SpiralCell® ⁵⁾
 Para un suministro constante
 de energía también sobre un
 periodo mayor, especialmente
 adecuado para marino.

¹⁾ PowerFrame® (Gitter) für optimierten Stromfluss und geringere Korrosion. Das stromungsoptimierte Gitterdesign des PowerFrame® generiert kontinuierlich hohe Startkraft und unterstützt eine lange Lebensdauer. Zusätzlich sorgt die spezielle Legierung für hohe Korrosionsfestigkeit und deutlich geringere Selbstentladung
²⁾ Labyrinthdeckel für hohe Betriebssicherheit. Der Doppeldeckel mit Labyrinth-Konstruktion stellt sicher, dass verdampfte Flüssigkeit in der Batterie bleibt
³⁾ Deep Cycle: Hohe Zyklenfestigkeit und Leistungsdichte
⁴⁾ AGM (Absorbent Glass Mat): in Mikroglasfasermatte gebundene Säure lässt höhere Energiemassen passieren
⁵⁾ SpiralCell®: Durch stabile Konstruktion mit Spiraltechnologie extrem rüttelfest und marinegeeignet

¹⁾ PowerFrame®: (grid) for optimized current flow and reduced corrosion. The flow-optimized grid design of the PowerFrame® guarantees consistently high starting power and a long service life. In addition, a special alloy ensures a high corrosion resistance and significantly lower self-discharge
²⁾ Labyrinth lid for high operational safety. The double lid with labyrinth design ensures that evaporated liquid remains inside the battery
³⁾ Deep Cycle: High cycle-life and power output
⁴⁾ AGM (absorbent glass mat): the acid is contained in a micro-glass fibre mat which allows an increased flow of energy
⁵⁾ SpiralCell®: the stable construction offered by spiral technology makes the battery extremely vibration resistant and suitable for marine purposes

¹⁾ PowerFrame®(Grille) assurant un flux optimisé du courant et un plus faible niveau de corrosion. Le design de la grille optimisée pour les flux de courant du PowerFrame® génère une forte puissance continue de démarrage et soutient une longue durée de vie. L'alliage spécial garantit en outre une résistance élevée à la corrosion et une auto-décharge nettement plus faible
²⁾ Le couvercle à structure labyrinthe assure une grande fiabilité de fonctionnement. Le couvercle double à construction en labyrinthe garantit que le liquide de condensation reste dans la batterie
³⁾ Deep Cycle : grande résistance au cyclage et densité de puissance élevée
⁴⁾ AGM (Absorbent Glass Mat) : L'acide est emprisonné dans les enveloppes en microfibres de verre facilite la circulation d'énergie en quantité plus importante
⁵⁾ SpiralCell® : grâce à un structure stable avec une technologie à spirale, extrêmement résistantes aux vibrations et adaptées pour la marine

¹⁾ PowerFrame® (griglia) per un flusso ottimale della corrente e una corrosione ridotta. Il design ottimizzato della griglia PowerFrame® genera continuamente un'elevata potenza di avviamento e garantisce una lunga durata. Inoltre la speciale lega garantisce un'elevata resistenza alla corrosione e un'autoscarica significativamente ridotta
²⁾ Coperchio a labirinto per elevata sicurezza operativa. Il doppio coperchio dalla struttura a labirinto garantisce che il liquido evaporato rimanga all'interno della batteria
³⁾ Deep Cycle: lunga durata potenza specifica
⁴⁾ AGM (Absorbent Glass Mat): l'acido trattenuto nel cuscinetto in microfibra di vetro permette il passaggio di maggiore
⁵⁾ SpiralCell®: la struttura stabile dotata di tecnologia a spirale garantisce resistenza alle scosse e un buon utilizzo in marina

¹⁾ PowerFrame® (rejilla) para un flujo de corriente óptimo y una menor corrosión. El diseño de rejilla de flujo de corriente optimizado de PowerFrame® genera continuamente una potencia de arranque alta y contribuye a una duración prolongada. Adicionalmente, la aleación especial proporciona una elevada resistencia a la corrosión y una descarga espontánea claramente inferior
²⁾ Tapa con laberinto para una elevada seguridad de funcionamiento. La tapa doble con construcción de laberinto garantiza que el líquido evaporado permanece dentro de la batería
³⁾ Ciclo profundo: alta resistencia a los ciclos y densidad de potencia
⁴⁾ AGM (fibra de vidrio absorbente): en Estructura de microfibras de vidrio ligado Acidez deja pasar masa de energía
⁵⁾ SpiralCell®: Mediante una construcción estable con tecnología de espiral extrema a prueba de vibraciones y adecuado para marina

pt

**Baterias Bosch
L5 – L5 G –
L4 – Optima
para aplicações
de lazer**

fi

**Bosch-akut
L5 – L5 G –
L4 – Optima
vapaa-ajan
viettoon**

pl

**Akumulatory Bosch
L5 – L5 G –
L4 – Optima
do zastosowań
trakcyjnych**

cs

**Akumulátor Bosch
L5 – L5 G –
L4 – Optima
pro volnočasové
aplikace**

ru

**Аккумуляторы
Bosch L5 – L5 G –
L4 – Optima
для привода
и освещения**

**L4 e L5**

com tecnologia PowerFrame® ¹⁾,
estrutura labirintica da tampa ²⁾
e tecnologia ciclo Deep Cycle ³⁾

L5 G

com tecnologia ciclo Deep
Cycle ³⁾

OPTIMA®

com tecnologia AGM ⁴⁾
e SpiralCell® ⁵⁾
Para fornecimento constante
de energia mesmo em períodos
de tempo alargados – especial-
mente indicado para contexto
marinho.

L4 ja L5

PowerFrame®-teknologialla ¹⁾,
labyrinttikannella ²⁾
ja Deep Cycle -akulla-teknolo-
gialla ³⁾

L5 G

kanssa Deep Cycle -akulla-
teknologialla ³⁾

OPTIMA®

AGM ⁴⁾- ja SpiralCell®-
teknologialla ⁵⁾
Jatkuvaan energiahuoltoon myös
pidemille ajanjaksoille –
soveltuu erityisen hyvin
merikäyttöön.

L4 i L5

z technologią PowerFrame® ¹⁾,
pokrywą labiryntową ²⁾
i technologią zwiększoną
odpornością na pracę cykliczną ³⁾

L5 G

z technologią zwiększoną
odpornością na pracę cykliczną ³⁾

OPTIMA®

z technologią AGM ⁴⁾ i
SpiralCell® ⁵⁾
Jako źródło zasilania, wszędzie
tam, gdzie wymagane jest do-
starczanie energii elektrycznej
z akumulatora przez dłuższy
czas – również do stosowania
w łodziach.

L4 a L5

s technologií PowerFrame® ¹⁾,
víkem s labyrintem ²⁾
a technologií Deep Cycle ³⁾

L5 G

s technologií Deep Cycle ³⁾

OPTIMA®

s technologií AGM ⁴⁾
SpiralCell® ⁵⁾
Pro konstantní přívod energie i
po delší časové úseky – vhodná
především pro námořnictvo.

L4 i L5

s технологией PowerFrame® ¹⁾,
лабиринтной крышкой ²⁾
и технологией deep-cycle ³⁾

L5 G

s технологией deep-cycle ³⁾

OPTIMA®

s технологией AGM ⁴⁾
и SpiralCell® ⁵⁾
Для непрерывного
энергоснабжения, в том
числе и в течение длительных
периодов времени, благодаря
чему такие батареи наилучшим
образом подойдут для водной
техники.

¹⁾ PowerFrame® (grelha) para um fluxo de corrente otimizado e uma menor corrosão. O design da grelha da PowerFrame® otimizado em função do fluxo gera continuamente uma elevada potência de arranque e promove uma longa vida útil. Além disso, a liga especial proporciona uma elevada resistência à corrosão e uma autodescarga significativamente inferior.

²⁾ Tampa de labirinto para uma elevada segurança operacional. A tampa dupla com sistema de labirinto assegura que o líquido evaporado permanece na bateria.

³⁾ Ciclo Deep Cycle: maior capacidade dos ciclos e densidade de potência

⁴⁾ AGM (Absorbent Glass Mat): os ácidos ligados em feltro de microfibras de vidro permitem uma melhor condução da massa energética

⁵⁾ SpiralCell®: em estrutura com tecnologia em espiral extremamente resistente a vibrações e indicada para ambiente marinho

¹⁾ PowerFrame® (ritilä) optimoi virrankulkua ja vähentää korroosiota. Lisäksi virrankulkuun optimoitu PowerFrame®-ritilä kehittää jatkuvasti korkeaa käynnistysvoimaa ja tukee pitkää elinikää. Lisäksi erityinen metalliseos takaa korkean korroosionkestävyyden ja huomattavasti vähemmän itsepurkautumisen

²⁾ Labyrinttikansi takaa korkean käyttöturvallisuuden. Labyrinttikanteinen kaksoiskansi varmistaa, että höyrystynyt neste jää akkuun

³⁾ Deep Cycle: Korkea syklin vakaus ja tehontiheys

⁴⁾ AGM (Absorbent Glass Mat): mikro-lasikuitumattoihin sitoutunut happo mahdollistaa suurempien energiama-
sojen läpi kulkeutumisen

⁵⁾ SpiralCell®: Vakaaan spiraalitekno-
logialla varustetun rakenteen ansiosta äärimmäisen
tärinänkestävä ja merikäyttöön soveltuva

¹⁾ Siatka PowerFrame® zapewnia zoptymalizowany przepływ prądu i mniejszą korozję. Budowa siatki PowerFrame® zoptymalizowana pod kątem przepływu prądu generuje stale wysoką moc rozruchową i przyczynia się do wydłużenia żywotności. Dodatkowo specjalny stop zapewnia dużą odporność na korozję i znacznie zmniejsza poziom samoczynnego wyładowania

²⁾ Pokrywa labiryntowa zwiększa bezpieczeństwo eksploatacji. Podwójna pokrywa o konstrukcji labiryntowej zatrzymuje odparowaną ciecz w akumulatorze.

³⁾ Deep Cycle: Wysoka odporność cykliczna i wyjątkowa wydajność ⁴⁾

⁴⁾ AGM (Absorbent Glass Mat): Elektrolit wstrzymano w matach z włókna szklanego umożliwia transfer większej ilości energii.

⁵⁾ SpiralCell®: Stabilna konstrukcja z technologią spiralną zapewnia wyjątkową wytrzymałość na wstrząsy i możliwość stosowania w sprzeczce wodnym (łodziach, jachtach).

¹⁾ PowerFrame® (Gitter) pro optimalizovaný tok proudu a nízkou korózi. Design mřížky PowerFrame®, který je optimalizovaný pro tok proudu, neustále generuje vysokou startovací sílu a podporuje dlouhou životnost. Speciální slitina dále nabízí vysokou odolnost proti korózi a výrazně nižší samovybíjení

²⁾ Labyrintové víko pro vysokou provozní bezpečnost. Dvojitě víko s labyrintovou konstrukcí zajistí uchování vypařené tekutiny v akumulatoru

³⁾ Deep Cycle: vysoká odolnost proti cyklům a hustota výkonu

⁴⁾ AGM (absorbent skl. mat.): kyselina navázána v rohoži z mikrovlákna umožňuje vznik větších množství energie

⁵⁾ SpiralCell®: Diky stabilní konstrukci se spirálovou technologií mimořádně odolná proti otřesům a vhodná pro námořnictvo

¹⁾ PowerFrame® (решетка) для оптимизированного протекания тока и снижения коррозии. Оптимизированная по протеканию тока конструкция сети PowerFrame® обеспечивает постоянное высокое пусковое усилие и длительный срок службы. Кроме того, специальный слав обеспечивает высокую коррозионную стойкость и значительное снижение саморазряда

²⁾ Лабиринтная крышка для высокой эксплуатационной безопасности. Двойная крышка лабиринтной конструкции гарантирует, что испарившаяся жидкость останется в аккумуляторе

³⁾ Deep Cycle: большой ресурс и высокая энергетическая плотность

⁴⁾ AGM (Absorbent Glass Mat): удерживаемая сепараторами из микростекловолокна кислота пропускает большие объемы энергии

⁵⁾ SpiralCell®: благодаря прочной конструкции, созданной с использованием спиральной технологии, такие аккумуляторы отличаются очень высоким уровнем виброустойчивости и пригодны для использования на водной технике

de

**Bosch-Batterien
für Off-Highway
Anwendungen**

en

**Bosch batteries
for off-highway
uses**

fr

**Batteries Bosch
pour des applications
hors routes**

it

**Le batterie Bosch
per utilizzi
fuoristrada**

es

**Baterías Bosch
para aplicación
en todoterrenos**



Batterien für Offroad-Fahrzeuge müssen unter schwierigsten Einsatzbedingungen ganz unterschiedliche Anforderungen erfüllen. So benötigen etwa Baumaschinen und -fahrzeuge Batterien mit maximaler Startleistung - kombiniert mit extremer Vibrationsfestigkeit und Kippsicherheit. Hingegen müssen Batterien für landwirtschaftliche Fahrzeuge lange, saisonbedingte Standzeiten verkraften.

Batteries for off-road vehicles must satisfy a wide range of requirements under extreme conditions. For example, construction machinery and vehicles require batteries with strong starting power combined with extreme vibration resistance and resistance to overturning. In contrast, batteries for agricultural vehicles must endure long downtimes depending on the season.

Les batteries pour les véhicules tout-terrain doivent être adaptées à différentes exigences dans des conditions d'utilisation extrêmes. Les machines de construction et les véhicules ont donc besoin de batteries avec une puissance de démarrage maximum, combinée à une résistance extrême aux vibrations et à une grande stabilité. À l'inverse, les batteries pour les véhicules agricoles doivent alimenter les véhicules pendant des périodes prolongées en fonction des saisons.

Le batterie per veicoli fuoristrada devono soddisfare requisiti diversi, alle condizioni più avverse. Alcune macchine edili e veicoli necessitano di batterie con la massima potenza di avvio, combinata con estrema resistenza alle vibrazioni e stabilità. Al contrario le batterie per i veicoli agricoli devono poter affrontare lunghi periodi di inattività stagionale.

Baterías para vehículos todoterrenos deben llenarse bajo delicadas condiciones de uso en aplicaciones completamente diferentes. Así pues se requieren algunas baterías de máquinas y vehículos de construcción con capacidad de arranque máxima combinada con la resistencia extrema de vibración y seguridad antivuelco. Por el contrario, las baterías de los vehículos agrarios deben durar toda la temporada.

pt

Baterias Bosch para aplicações fora da estrada

fi

Bosch-akut maasto käyttöön

pl

Akumulatory Bosch do zastosowań off-roadowych

cs

Akumulátory Bosch pro aplikace Off-Highway

ru

Аккумуляторы Bosch для спецтехники



As baterias para veículos todo-o-terreno devem preencher condições de utilização extremas face a solicitações totalmente diferentes. Ou seja, algumas máquinas e veículos pesados requerem máxima potência de arranque - em combinação com resistência extrema a vibrações e estabilidade anti-capotamento. Ao contrário, as baterias para veículos agrícolas têm de enfrentar tempos de paragem sazonal prolongados.

Maastoajoneuvojen akkujen täytyy hankalimmissakin käyttöolosuhteissa täyttää täysin erilaisia vaatimuksia. Tästä syystä esimerkiksi rakennuskoneisiin ja ajoneuvoihin vaaditaan akut, joilla on maksimaalinen käynnistysteho yhdessä äärimmäisen tärinänkestävyyden ja kaatumisvarmuuden kanssa. Maatalousajoneuvojen akkujen taas täytyy kestää pitkiä, kausikohtaisia seisokkeja.

Akumulatory do pojazdów terenowych muszą sprostać szczególnie trudnym wymaganiom, często w najcięższych warunkach eksploatacji. Maszyny i pojazdy budowlane potrzebują akumulatorów o maksymalnej mocy rozruchowej — połączonej z ekstremalną wytrzymałością na wibracje i zabezpieczeniem przy przechyleniach. Z kolei akumulatory do pojazdów rolniczych muszą sprostać długim czasom przestoju.

Akumulátory pro vozidla offroad musí v těch nejnáročnějších podmínkách splňovat rozdílné požadavky v těch nenáročnějších podmínkách použití. Stavební stroje a vozidla proto potřebují akumulátory s maximálním startovacím výkonem - ve spojení s odolností proti vibracím a příčnou stabilitou. Naproti tomu musí akumulátory pro zemědělské stroje zvládnout dlouhé prostoje podle sezóny.

Батареи для внедорожных автомобилей (спецтехники) должны отвечать совершенно разным требованиям при использовании в самых суровых условиях. Например, для строительных машин и автомобилей нужны батареи с максимальной пусковой мощностью, а также с очень высокой виброустойчивостью и устойчивостью против опрокидывания. А батареи для автомобилей, используемых в сельском хозяйстве, должны выдерживать длительные периоды простоя в определенные сезоны.

de

**Betriebskosten
reduzieren:
Zuverlässigkeit
zahlt sich aus**

en

**Reducing operating
costs:
reliability pays off**

fr

**Réduire les coûts
d'exploitation :
la fiabilité paie**

it

**Ridurre i costi
operativi:
l'affidabilità paga**

es

**Reducir costes de
funcionamiento:
la fiabilidad merece
la pena**



Calculation example



Type of cost	Non-maintenance-free battery	Commercial-vehicle battery from Bosch
Purchase price (for 2 batteries)	300.00 EUR	425.00 EUR
Maintenance costs per vehicle	350.00 EUR	
Total Cost of Ownership (TCO)*	650.00 EUR	425.00 EUR
Downtime costs due to maintenance		
Maintenance time for the batteries of one vehicle	3.50 hours	
Operating hours of a vehicle per day	8.00 hours	
Costs caused by unavailability of one vehicle per day	300.00 EUR	
Downtime costs due to maintenance per vehicle	131.25 EUR	
Total Cost of Ownership (TCO)*	781.25 EUR	425.00 EUR

* TCO: Total Cost of Ownership represents an overview of all costs including purchase price, costs for running operation and hidden costs for maintenance and repair.

Mit der Wahl der richtigen Batterie lassen sich die Kosten für den allgemeinen Unterhalt, Kraftstoffverbrauch, die Pflege und Instandhaltung senken. Auch Verschleiß und Reparaturaufwand verringern sich. Mit einem optimalen Batterie-Management ist das Risiko für Verdienstaussfälle durch unerwartete Stand- und Reparaturzeiten niedriger. Der Rechner zeigt Ihnen Ihr Einsparpotenzial.

Selecting the right battery reduces the costs for general maintenance, fuel consumption, care and service. There is less wear and repairs as well. With the right battery management, the risk of lost earnings from unanticipated downtime and repairs is reduced. The computer shows your potential savings.

En choisissant la bonne batterie, il est possible de réduire les coûts d'entretien général, la consommation de carburant, l'entretien et la maintenance. L'usure et les intervalles de remplacement sont également réduits. Avec une gestion optimale de la batterie, le risque de pertes de revenus dues à des temps d'arrêt et de réparation imprévus est réduit. Le compteur vous indique votre potentiel d'économie.

Scegliendo la batteria corretta, il costo del mantenimento generale, il consumo di carburante, la cura e la manutenzione possono essere ridotti. Anche usura e costi di riparazione vengono ridotti. Con una gestione ottimale della batteria il rischio di perdita di guadagno a causa di tempi inaspettati di manutenzione e downtime è inferiore. Il calcolo mostra la possibilità di risparmio.

Con la selección de la batería correcta, los costes de subsistencia general, consumo de combustible, el cuidado y conservación bajan. También reduce el desgaste y reparaciones. Con una gestión excelente de la batería, el riesgo para el lucro cesante mediante los periodos bajos de reparación y fuera de servicio inesperados. El ordenador le muestra su potencial de ahorro.

pt

Reduzir os custos de produção:
A eficácia compensa

fi

Käyttökustannusten alentaminen:
luotettavuus kannattaa

pl

Redukcja kosztów eksploatacji:
niezawodność się opłaca

cs

Snížení provozních nákladů:
spolehlivost se vyplatí

ru

Снижение производственных расходов:
надежность окупается



A escolha da bateria certa permite reduzir os custos totais, o consumo de combustível, as necessidades de conservação e manutenção. É também reduzido o desgaste e as despesas de reparação. Com uma gestão ótima da bateria o risco de perda de receitas provocada por tempos de conservação e reparação inesperados é diminuído. A calculadora mostra-lhe o seu potencial de poupança.

Oikean akun valinnan avulla voidaan alentaa yleisen ylläpidon, polttoaineen kulutuksen, huollon ja kunnossapidon kustannuksia. Myös kulumis- ja korjauskustannukset alenevat. Optimaalisen akunhallinnan ansiosta odottamattomista seisokki- ja korjausajoista aiheutuvien palkan menetysten riski on alhaisempi. Laskin näyttää sinulle säästöpotentiaalisi.

Wybór właściwego akumulatora pozwala na obniżenie kosztów ogólnego utrzymania pojazdu. Także zużycie i nakłady na prace naprawcze są niższe. Dzięki właściwemu postępowaniu z akumulatorem ryzyko nieoczekiwanych przestołów w pracy i kosztownych napraw jest znacznie niższe. Kalkulator pokaże potencjalne oszczędności.

Výběrem správného akumulátoru je možné snížit náklady na údržbu obecně, spotřebu paliva, péči a opravy. Snižuje se také opotřebení a potřebné opravy. S optimálním managementem akumulátoru je nižší riziko ušlého zisku způsobené neočekávanými odstávkami a opravami. Kalkulátor vám ukazuje možné úspory.

При правильном выборе батареи снижаются расходы на общее содержание, топливо, уход и техническое обслуживание. Кроме того, замедляется процесс износа и уменьшаются затраты на ремонт. При оптимальном управлении аккумулятором снижается риск уменьшения заработка из-за неожиданных простоев или ремонтных работ. Расчет покажет потенциал снижения затрат.

de

Die schwarze Klassik-Batterie von Bosch: historische Optik, moderne Technik

en

The black classic battery from Bosch: historical looks, modern technology

fr

La batterie noire classique de Bosch est à nouveau disponible : look historique, technique de pointe

it

La classica batteria nera di Bosch: estetica storica e tecnologia moderna

es

La batería clásica de Bosch negra: aspecto histórico, tecnología moderna



Damit Ihr Klassiker nicht nur gut aussieht, sondern auch gut fährt. Die schwarze Klassik-Batterie von Bosch ist nicht nur ein optisches Highlight, sie punktet auch mit moderner Technik.

Batterien mit moderner Technik zeigen geringeres Gasen und verfügen über eine höhere Startleistung sowie eine deutlich verbesserte Recyclingfähigkeit. Zudem zeichnen sie sich durch eine längere Lebensdauer aus.

Die Bosch Klassik-Batterie wird trocken und vorgeladen ausgeliefert. Nach dem Befüllen mit Batteriesäure (nicht im Lieferumfang enthalten) und kurzer Wartezeit ist sie somit einsatzbereit. Lieferbar in 6 und 12 Volt.

Ersatzteile für klassische Fahrzeuge finden Sie auf:

www.bosch-classic.com

So your classic car not only looks great but also runs well. The black classic battery from Bosch is not only a highlight visually, it also boasts modern technology.

Batteries equipped with modern technology are less subject to gassing and have better starting performance as well as a significantly improved recycling capability. Another benefit is their increased service life.

Bosch classic batteries come in dry and pre-charged condition. After charging the battery with battery acid (not included in the scope of delivery) and a brief waiting period, it will be ready for use. Available in 6 and 12 volts.

You can find replacement parts for classic vehicles at:

www.bosch-classic.com

Pour que votre modèle classique ne soit pas seulement beau à regarder mais fonctionne aussi bien. La batterie noire classique de Bosch ne possède pas seulement un look sensationnel, elle dispose également d'une technique de pointe.

Les batteries modernes produisent beaucoup moins de gaz que précédemment et disposent d'une puissance accrue au démarrage et d'une capacité de recyclage nettement améliorée. Elles se distinguent également par leur plus grande durée de vie.

La batterie classique de Bosch est livrée sèche et préchargée. Après son remplissage avec de l'acide à batterie (non fourni) et après une brève période d'attente, elle est prête à l'emploi. Disponible dès maintenant en 6 et 12 V.

Vous trouverez toutes les pièces de rechange pour véhicules classiques sous :

www.bosch-classic.com

Affinché il vostro classico non solo abbia un bell'aspetto, ma viaggi anche bene. La classica batteria nera di Bosch non è solo un elemento visivo, ma ha anche sistemi tecnologici moderni.

Le batterie con moderna tecnologia dimostrano un minore consumo di gas e dispongono di una potenza all'avvio maggiore e ovviamente una capacità di riciclaggio migliorata. Inoltre esse si distinguono per una durata superiore.

La batteria classica Bosch è fornita a secco e pre-caricata. Dopo il riempimento con acido per batterie (non compreso nella fornitura) e tempi di attesa brevi è pronta per l'uso. Disponibile da 6 e 12 Volt.

Pezzi di ricambio per vetture classiche in vendita sul sito:

www.bosch-classic.com

Para que tu clásico no solo tenga un buen aspecto, sino que también funcione bien. La batería clásica de Bosch negra no solo es una atracción para la vista, también destaca por su moderna tecnología.

Las baterías con una moderna tecnología presentan menos gases y cuentan con una mayor potencia de arranque, así como una capacidad de reciclaje claramente mejor. Además se caracterizan por una duración más prolongada.

La batería clásica de Bosch se suministra seca y cargada. Después de llenar el ácido de la batería (no incluido en el volumen de suministro) y tras un breve tiempo de espera está lista para su funcionamiento. Disponible en 6 y 12 voltios.

Encontrará piezas de repuesto para vehículos clásicos en:

www.bosch-classic.com

pt

A bateria preta clássica da Bosch: ótica histórica, tecnologia moderna

fi

Bosch musta Klassik-akku: historiallinen ulkonäkö, moderni tekniikka

pl

Czarny, klasyczny akumulator Bosch: historyczny wygląd, nowoczesna technika

cs

Černý akumulátor Klassik Bosch: historický vzhled, moderní technika

ru

Черный классический аккумулятор Bosch: исторически сложившийся внешний вид, современная технология



Bosch advertisements for batteries from 1938 – 2017

Para que o seu clássico não tenha apenas um bom aspeto, mas para que também ande bem. A bateria preta clássica da Bosch não é apenas um destaque ótico, mas também pontua com a tecnologia moderna.

As baterias com a mais moderna tecnologia mostram um aceleração menor e dispõem de uma potência de arranque superior, assim como de uma capacidade de reciclagem claramente melhorada. Além disso distinguem-se por uma vida útil mais prolongada.

A bateria clássica da Bosch é fornecida seca e pré-carregada. Após o abastecimento com o ácido da bateria (não incluído no volume de fornecimento) e após um breve período de espera fica pronta a utilizar. Agora novamente disponível em 6 e 12 Volt.

Encontra peças de substituição para veículos clássicos em:

www.bosch-classic.com

Jotta Klassik-akku ei vain näyttäisi hyvältä, vaan myös toimii hyvin. Bosch musta Klassik-akku ei ole vain optisesti näyttävä, vaan se kerää pisteitä myös modernista tekniikastaan.

Modernilla tekniikalla varustetut akut kehittyvät vähemmän kaasa, niiden käynnistysteho on korkeampi ja niiden kierrätysominaisuuksia on paranneltu huomattavasti. Lisäksi niiden elinikä on pidettyntä entisestään.

Bosch Klassik-akku toimitetaan kuivana ja esiladattuna. Akkuhapolla täyttämisen (ei kuulu toimitukseen) ja lyhyen odotusajan jälkeen se on heti käyttövalmis. Saatavilla 6 ja 12 V.

Varaosta klassisiin ajoneuvoihin, katso:

www.bosch-classic.com

Aby Twój klasyk nie tylko stylowo wyglądał, ale również świetnie jeździł. Czarny, klasyczny akumulator Bosch nie jest jedynie efekownym wizualnie akcentem – jego zaletą jest również nowoczesna technika.

Akumulatory wyposażone w nowoczesne rozwiązania techniczne cechują się mniejszym gazowaniem, mają większą moc rozruchową i znacznie lepiej nadają się do recyklingu. Dodatkowo wyróżniają się dłuższą żywotnością.

Klasyczny akumulator Bosch jest dostarczany w stanie suchym i wstępnie naładowanym. Po napełnieniu kwasem akumulatorowym (poza zakresem dostawy) i krótkim czasie oczekiwania jest gotowy do zastosowania. Dostępny w wersji 6 i 12 V.

Części zamienne do klasycznych pojazdów są dostępne na stronie:

www.bosch-classic.com

Aby Váš klasik nejen dobře vypadal, ale také dobře jezdil. Černý akumulátor Klassik firmy Bosch není jenom optickým zážitkem, ale obsahuje také moderní techniku.

Akumulátory s moderní technikou vykazují nižší plynování a mají vyšší počáteční výkon a také výrazně lepší možnost recyklace. Kromě toho mají také delší životnost.

Akumulátor Bosch Klassik se dodává suchý a předběžně nabíjí. Po naplnění akumulátorovou kyselinou (není rozsahem dodávky) a po krátké době čekání je připraven k provozu. K dodání 6 a 12 V.

Náhradní díly pro klasická vozidla viz:

www.bosch-classic.com

Имеет классический внешний вид и характеризуется высокой эффективностью. Преимущества черного классического аккумулятора Bosch заключаются не только в привлекательном дизайне. В нем использованы все современные технологии.

Аккумуляторы, созданные по современной технологии, отличаются низким кипением, обеспечивают повышенную пусковую мощность, наилучшим образом пригодны ко вторичной переработке. Кроме того, они имеют увеличенный срок службы.

Классический аккумулятор Bosch поставляется в сухом виде и предварительно заряженным. Через некоторое время после заправки электролитом (электролит не входит в объем поставки) аккумулятор готов к работе. Доступны аккумуляторы на 6 и 12 V.

Информацию о запасных частях к классическим изделиям можно найти на следующем веб-сайте:

www.bosch-classic.com

A 36

de

Starter-Batterie,
Klassik

en

Starter battery,
classic

fr

Batterie de démarrage,
Classique

it

Batteria per motorino
di avviamento, classica

es

Batería del motor de
arranque, clásico

pt

Bateria do sistema de
arranque, clássico

fi

Käynnistinakku,
Klassik

pl

Akumulator rozruchowy,
klasyczny

cs

Startérový akumulátor,
Klassik

ru

Аккумулятор стартера,
классический

No	DIN	Ah	A (EN)	L	kg		L
6 Volt							
F 026 T02 300	00811	8	40	- +	1,6	85 x 95 x 165	0,6
F 026 T02 302	06611	66	360	- +	7,9	186 x 169 x 192	2,5
F 026 T02 303	07715	77	360	- +	8,7	215 x 169 x 192	3,2
F 026 T02 304	08411	84	390	- +	10	244 x 173 x 216	3,2
F 026 T02 306	09811	98	480	- +	10,6	263 x 172 x 220	4,2
F 026 T02 307	11211	112	540	- +	12	263 x 177 x 255	4,7
12 Volt							
F 026 T02 310	54419	44	200	- +	8,72	210 x 175 x 175	2,95
F 026 T02 311	56011	60	280	- +	15,15	260 x 173 x 225	4,2
F 026 T02 312	56037	60	280	+ -	15,15	260 x 173 x 225	4,2
F 026 T02 313	55613	60	330	+ -	15,15	312 x 172 x 216	4,3
F 026 T02 314	56014	60	330	- +	15,15	312 x 172 x 216	4,3

Weitere Informationen finden Sie auf www.bosch-classic.com in der Rubrik "Produkte".

You can find more information at www.bosch-classic.com under "Products".

Pour plus d'informations, rendez-vous sur www.bosch-classic.com dans la rubrique "Produits".

Ulteriori informazioni sono disponibili sul sito www.bosch-classic.com nella rubrica "Prodotti".

Encontrará más información en www.bosch-classic.com en la sección "Productos".

Encontra mais informações em www.bosch-classic.com na rubrica "Produtos".

Lisätietoja, katso www.bosch-classic.com otsikon "tuote" alta.

Więcej informacji znajduje się na stronie internetowej www.bosch-classic.com w rubryce "Produkty".

Další informace viz www.bosch-classic.com rubrika "Produkty".

Более подробная информация приводится на сайте: www.bosch-classic.com в рубрике "Изделия".



BOSCH

Invented for life

Driven by
originals

Bosch Classic

Quality spare parts by Bosch
for classic cars
Part of your life. Part of you.

BOSCH

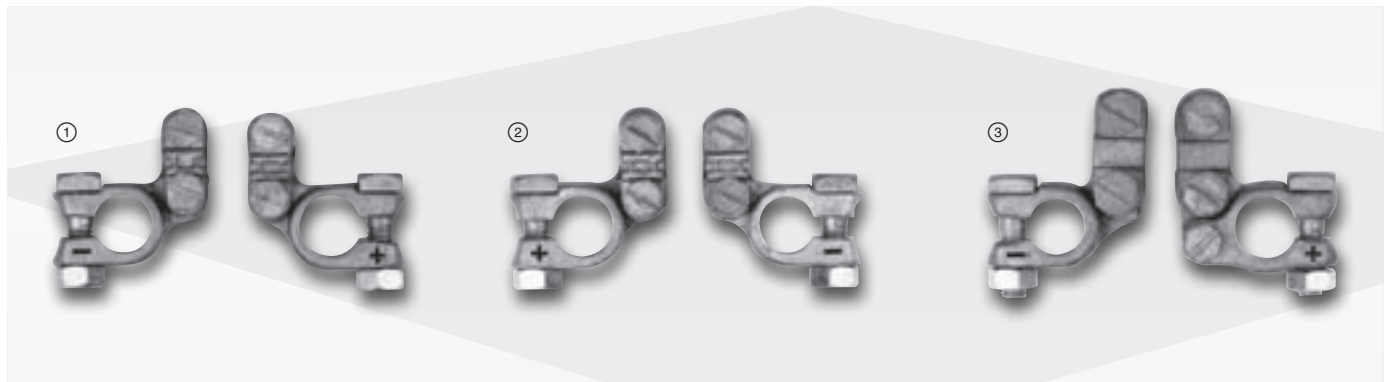

Batteriepolklemmen mit verzinnter Oberfläche Battery pole terminals with tin-plated surface Bornes de batterie étamées Morsetti batteria con superficie stagnata Bornes de los polos de la batería con superficie cincada Terminais dos pólos da bateria com superfície estanhada Akkunapojen pinta on tinattu Zaciski biegunów akumulatora z cynkowaną powierzchnią Svorky pólu akumulátoru s pozinkovaným povrchem Клеммы полюсных выводов с оцинкованной поверхностью	Leiterquerschnitt mm ² Cable cross-section mm ² Section du conducteur mm ² Sezione del conduttore mm ² Sección de cable mm ² Seção transversal do cabo mm ² Johdinpoikkipinta mm ² Przekrój przewodu w mm ² Průřez vodiče mm ² Поперечное сечение, mm ²	Pol Terminal Pôle Polo Pólo Napa Biegun Pól Полюсный вывод	Bestellnummer * Order number * Référence * Numero d'ordinazione * Referencia de pedido * Referència * Tilausnumero* Nr katalogowy * Objednací číslo * Номер для заказа *
①	16,0 – 70,0	+	1 901 315 100
		-	1 901 315 102
		- +	1 901 315 120
②	16,0 – 70,0	+	1 901 315 104
		-	1 901 315 105
		- +	1 901 315 125
③	70,0 – 120,0	+	1 901 315 101
		-	1 901 315 103

* DIN 72 331

pt

Acessórios da bateria

fi

Akun lisävarusteet

pl

Wyposażenie dodat-
kowe akumulatora

cs

Příslušenství
akumulátoru

ru

Принадлежности
для аккумуляторов

④ **Bodenleisten-Adapter**
von B13 auf B14 (Set bestehend
aus 2 Adaptern)
0 189 999 020

④ **Bottom-rail adapter**
from B13 to B14 (Set consisting
of 2 adapters)
0 189 999 020

④ **Adaptateurs pour rebord
de fixation** de B13 à B14
(kit comprenant 2 adaptateurs)
0 189 999 020

④ **Adattatore listello
di fissaggio** da B13 a B14
(kit comprendente 2 adattatori)
0 189 999 020

④ **Listón de sujeción**
de B13 a B14
(juego de 2 adaptadores)
0 189 999 020

⑤ **Ford Pol-Adapter Set**
von Pol 1 auf Pol 19
(Set bestehend aus
1 x Pluspol-Adapter und
1 x Minuspol-Adapter)
0 189 999 021

⑤ **Ford terminal-adapter set**
from terminal 1 to terminal 19
(Set consists of 1 x positive-
terminal adapter and
1 x negative-terminal adapter)
0 189 999 021

⑤ **Kit adaptateur de pôle Ford**
de pôle 1 à pôle 19 (kit com-
prenant 1 adaptateur de pôle
positif et 1 adaptateur de pôle
négatif)
0 189 999 021

⑤ **Kit adattatori poli Ford**
da polo 1 a polo 19 (kit com-
posto da 1 x adattatore polo
positivo e 1 x adattatore polo
negativo)
0 189 999 021

⑤ **Juego adaptador terminal
Ford** de polo 1 a polo 19
(juego de 1 x adaptador polo
positivo y 1 x adaptador polo
negativo)
0 189 999 021

④ **Adaptador das barras de
fixação**
de B13 para B14 (conjunto
composto por 2 adaptadores)
0 189 999 020

④ **Pohjakiinnityksen sovitin**
koosta B13 kokoon B14
(sarjassa 2 sovitinta)
0 189 999 020

④ **Adapter listew
podłożowych**
z B13 na B14 (zestaw
składający się z 2 adapterów)
0 189 999 020

④ **Adaptér pro podlahové
lišty**
z B13 na B14 (sada se skládá
ze 2 adaptérů)
0 189 999 020

④ **Адаптер к нижней части
корпуса**
с B13 на B14 (комплект,
состоящий из 2 адаптеров)
0 189 999 020

⑤ **Conjunto de adaptadores
de pólos Ford**
de pólo 1 ao pólo 19 (conjunto
composto por 1 x adaptador
de pólo positivo e 1 x adaptador
de pólo negativo)
0 189 999 021

⑤ **Ford-napasovitin sarja**
navalta 1 navalle 19 (sarjassa
1 x plusnavan ja 1 x miinus-
navan sovitin)
0 189 999 021

⑤ **Zestaw adaptera biegun
Ford**
z biegun 1 na biegun 19
(zestaw składający się z 1-go
adaptera biegun dodatniego
i 1-go adaptera biegun
ujemnego)
0 189 999 021

⑤ **Pólový adaptér Ford**
z pólu 1 na pól 19 (sada se
skládá z 1 x adaptéru pro pól
plus 1 x adaptéru pro pól
minus)
0 189 999 021

⑤ **Комплект адаптеров для
клемм Ford**
с клеммы 1 на клемму 19
(комплект, состоящий из 1
адаптера положительного
полюса и 1 адаптера
отрицательного полюса)
0 189 999 021

de

Die kompakten Batterielader C1, C3 und C7

en

The compact battery chargers C1, C3 and C7

fr

Les chargeurs de batteries compacts C1, C3 et C7

it

I caricabatterie compatti C1, C3 e C7

es

Los cargadores de baterías compactos C1, C3 y C7



Die kompakten Batterielader C1, C3 und C7: volle Leistung auf Knopfdruck

► C1 Batterielader für 12 V-Batterien

Der leistungsstarke Batterielader für 12-V-Pkw-Batterien ist genau das Richtige für die unkomplizierte Batteriepflege; selbst für tiefentladene Batterien.

► C3 Batterielader für 6 V- und 12 V-Batterien

Der praktische Batterielader für 12-V-PKW-Starterbatterien wie auch 6-V- und 12-V-Zweirad-Batterien - erkennt den Batterietyp und die richtige Lademenge automatisch.

► C7 Batterielader für 12 V- und 24 V-Batterien

Der vielseitig einsetzbare Batterielader für 12-V-Starterbatterien von großen Motorrädern und 24-V-Starterbatterien von Transportern und Campern - auch für mobile elektrische Geräte geeignet.

Compact battery chargers C1, C3 and C7: full power at the push of a button

► C1 battery charger for 12 V batteries

The efficient battery charger for 12 V car batteries is just right for straightforward battery care, even for deeply discharged batteries.

► C3 battery charger for 6 V and 12 V batteries

Practical battery charger for 12 V PC starter batteries and also for 6 V and 12 V two-wheeler batteries - automatically detects the type of battery and the correct charge level.

► C7 battery charger for 12 V and 24 V batteries

Versatile battery charger for 12 V starter batteries of large motorcycles and 24-V-starter batteries of LCVs, motor homes - also perfectly suitable for mobile electric devices.

Chargeurs de batterie compacts C1, C3 et C7 : puissance maximale d'une simple pression sur un bouton

► Chargeur de batterie C1 pour batteries 12 V

Le puissant chargeur de batterie pour véhicules légers 12 V s'impose pour un entretien facile des batteries ; même pour celles se trouvant en décharge profonde.

► Chargeur de batterie C3 pour batteries 6 V- et 12 V

Le chargeur de batterie pratique pour les batteries de démarrage en 12 V de véhicules légers ainsi que pour les batteries en 6 V- et 12 V des deux roues - identifie automatiquement le type de batterie et la charge nécessaire.

► Chargeur de batterie C7 pour batteries 12 V et 24 V

Le chargeur de batteries polyvalent pour les batteries de démarrage 12 V de grosses motos et les batteries de démarrage 24 V de camionnettes et mobile-homes - convient également pour les appareils électriques portatifs.

I caricabatterie compatti C1, C3 e C7: piena potenza con la semplice pressione di un pulsante

► Caricabatterie C1 per batterie da 12 V

L'efficiente caricabatterie per batterie di autovetture da 12 V è certamente la soluzione ideale per una cura delle batterie priva di complicazioni, anche per batterie profondamente scariche.

► Caricabatterie C3 per batterie da 6 V e 12 V

Il pratico caricabatterie per batterie di avviamento per autovetture da 12 V e batterie per veicoli a due ruote da 6 V e 12 V - riconosce automaticamente il tipo di batteria e la carica corretta.

► Caricabatteria C7 per batterie a 12 V e 24 V

Il versatile caricabatterie per batterie di avviamento da 12 V di moto di grandi dimensioni e batterie di avviamento da 24 V per furgoni e camper - ideale anche per dispositivi elettrici mobili.

Los cargadores de baterías compactos C1, C3 y C7: potencia total con solo pulsar un botón

► Cargador de batería C1 para baterías de 12 V

El potente cargador de baterías para baterías de vehículos de pasajeros de 12 V es ideal para el cuidado sencillo de la batería, incluso para baterías descargadas profundamente.

► Cargador de baterías C3 para baterías de 6 V y 12 V

El práctico cargador de baterías para baterías de arranque para vehículos de pasajeros de 12 V, así como para baterías de bicicletas de 6 V y 12 V reconoce automáticamente el tipo de batería y la cantidad de carga correcta.

► Cargador de baterías C7 para baterías de 12 V y 24 V

El cargador de baterías de múltiples usos para baterías de arranque de 12 V de motocicletas grandes y baterías de arranque de 24 V de furgonetas y casas rodantes, también apta para aparatos eléctricos móviles.

pt

Os carregadores de baterias compactos C1, C3 e C7

fi

Kompaktit akkuvaraajat C1, C3 ja C7

pl

Ładowarki do akumulatorów C1, C3 i C7

cs

Kompaktní nabíjecí zařízení akumulátorů, C1, C3 a C7

ru

Компактные зарядные устройства аккумуляторов C1, C3 и C7



Compactos carregadores de bateria C1, C3 e C7: potência total ao alcance de um botão

► **Carregador de bateria C1 para baterias de 12 V**

O potente carregador para baterias de 12 V de veículos ligeiros de passageiros é perfeito para a fácil manutenção das baterias, mesmo no caso de baterias totalmente descarregadas.

► **Carregador de bateria C3 para baterias de 6 V e 12 V**

O prático carregador para baterias do sistema de arranque de 12 V de veículos ligeiros de passageiros e baterias de 6 V e 12 V de motociclos - deteta automaticamente o tipo de bateria e a quantidade de carga correta.

► **Carregador de bateria C7 para baterias de 12 V e 24 V**

O versátil carregador para baterias do sistema de arranque de 12 V de motociclos grandes e baterias do sistema de arranque de 24 V de furgões e caravanas - também adequado para dispositivos elétricos móveis.

Kompaktit akkuvaraajat C1, C3 ja C7: täysi teho yhdellä nupin painalluksella

► **C1 Akkulaturi 12 V-akkuihin**

Tehokas akkuvaraaja henkilöautojen 12-V-akkuihin on juuri oikea ratkaisu helppoon akun hoitoon; myös syväpurkautuneihin akkuihin.

► **C3 Akkuvaraaja 6 V- ja 12 V-akkuihin**

Käytännöllinen akkuvaraaja, 12-V- henkilöautojen käynnistysakut kuten 6-V- ja 12-V-kaksipyöräakut, - tunnistaa akkutyypin ja oikean varausmäärän automaattisesti.

► **C7 Akkuvaraaja 12 V- ja 24 V-akkuihin**

Monipuolisesti käytettävä akkuvaraaja suurien moottoripyörien 12-V-käynnistysakkuihin ja ikkunapaketiautojen ja asuntoautojen 24-V-käynnistysakkuihin - sopii käytettäväksi myös liikuttavissa sähkölaitteissa.

Kompaktowe prostowniki do akumulatorów C1, C3 i C7: pełna moc za jednym naciśnięciem przycisku

► **Ładowarka C1 do akumulatorów 12 V**

Wydajna ładowarka do akumulatorów 12 V do samochodów osobowych jest doskonałym rozwiązaniem do nieskomplikowanego utrzymania akumulatorów. Nadaje się również do głęboko wyładowanych akumulatorów.

► **Prostownik C3 do akumulatorów 6 V i 12 V**

Praktyczny prostownik do akumulatorów rozruchowych 12 V do samochodów osobowych oraz do akumulatorów 6 V i 12 V do pojazdów dwukołowych – automatycznie wykrywa rodzaj akumulatora i odpowiedni poziom ładowania.

► **Prostownik C7 do akumulatorów 12 V i 24 V**

Wszechstronny prostownik do akumulatorów rozruchowych 12 V dużych motocykli i akumulatorów rozruchowych 24 V pojazdów transportowych i samochodów kempingowych – nadaje się również do mobilnych urządzeń elektrycznych.

Kompaktní zařízení pro nabíjení akumulátorů C1, C3 a C7: Plný výkon stisknutím tlačítka.

► **C1 Nabíječka akumulátoru pro akumulátory 12 V**

Výkonná nabíječka akumulátorů pro akumulátory osobních vozidel 12 V je přesně to právě pro nekomplikovanou údržbu akumulátoru; i pro hluboce vybité akumulátory.

► **C3 Nabíječka akumulátoru pro akumulátory 6 V a 12 V**

Praktická nabíječka akumulátoru pro startovací akumulátory osobních vozidel 12 V a také akumulátorů dvoukolových vozidel 6 V a 12 V - automaticky rozpozná typ akumulátoru a správné nabíjecí množství.

► **C7 Nabíječka akumulátoru pro akumulátory 12 V a 24 V**

Mnohostranně použitelná nabíječka akumulátoru pro startovací akumulátory 12 V velkých motocyklů a startovací akumulátory 24 V transportérů a caravanů - vhodná také pro mobilní elektrická zařízení.

Компактные зарядные устройства C1, C3 и C7: запуск одним нажатием кнопки

► **Аккумуляторное зарядное устройство C1 для аккумуляторов 12 В**

Мощное аккумуляторное зарядное устройство для аккумуляторов 12 В легковых автомобилей — это именно то, что нужно для несложного ухода за аккумуляторами; даже для глубоко разряженных аккумуляторов.

► **Аккумуляторное зарядное устройство C3 для аккумуляторов 6 В и 12 В**

Практичное зарядное устройство 12 В для стартерных аккумуляторов легковых автомобилей, а также аккумуляторов 6 В и 12 В двухколесных транспортных средств — автоматически распознает тип аккумулятора и правильное количество заряда.

► **Аккумуляторное зарядное устройство C7 для аккумуляторов 12 В и 24 В**

Универсальное зарядное устройство для стартерных аккумуляторов 12 В больших мотоциклов и стартерных аккумуляторов 24 В грузовых автомобилей и кемперов также подходит для мобильных электрических устройств.

de

Batterietester von Bosch – BAT 131 für alle 6 V und 12 V Starter-Batterien

en

Battery tester from Bosch – BAT 131 for all 6 V and 12 V starter batteries

fr

Testeur de batterie Bosch – BAT 131 pour toutes les batteries de démarrage de 6 V et de 12 V

it

Tester per batterie Bosch – BAT 131 per tutte le batterie di avviamento da 6 V e 12 V

es

Comprobador de baterías de Bosch – BAT 131 para todas las baterías de arranque de 6 V y 12 V



Schnell, präzise und verlässlich

Der tragbare Batterietester BAT 131 eignet sich optimal zum Testen von Starter-Batterien (Blei-Säure-, Gel- und Vlies-Batterien/AGM).

Der Kaltstartstrom ist wahlweise nach den Normen EN, EN2, DIN, SAE, IEC und JIS von 100-2000 A einstellbar.

Fast, precise and reliable

The portable battery tester BAT 131 is perfectly convenient for testing starter batteries (lead acid, gel and fleece batteries / AGM).

The cold start current can be set as required between 100 and 2,000 A according to the standards EN, EN2, DIN, SAE, IEC and JIS.

Rapide, précis, fiable

Le testeur de batterie portable BAT 131 de Bosch est idéal pour tester les batteries de démarrage (batteries au plomb-acide, au gel et AGM).

Le courant démarrage à froid est réglable au choix selon les normes EN, EN2, DIN, SAE, IEC et JIS de 100 à 2 000 A.

Rapido, preciso ed affidabile

Il tester portatile per batterie BAT 131 si presta in modo ottimale per il controllo di batterie di avviamento (al piombo-acido, gel e AGM).

La corrente di avviamento a bassa temperatura è impostabile a scelta, secondo le norme EN, EN2, DIN, SAE, IEC e JIS, da 100 a 2000 A.

Rápido, preciso y fiable

El comprobador de baterías portátil BAT 131 es óptimo para la comprobación de baterías de arranque (baterías de plomo-ácido, gel y AGM).

La corriente de arranque en frío se puede ajustar opcionalmente según las normas EN, EN2, DIN, SAE, IEC y JIS entre 100 y 2000 A.

Vorteile auf einen Blick

- ▶ Menügeführte intuitive Bedienung
- ▶ Test des Batteriezustands und Erkennung von Batterie-defekten
- ▶ Optimierter Testalgorithmus für die Überprüfung neuer Batterien
- ▶ Erweiterter Test des Start- / Ladesystems für 12 V und 24 V Batterien
- ▶ Integrierter Drucker stellt Messergebnisse übersichtlich und grafisch dar
- ▶ USB-Anschluss zur Speicherung der Testergebnisse
- ▶ Austauschbares, 3 m langes Kabel

Advantages at a glance

- ▶ Menu-guided intuitive operation
- ▶ Test of battery condition and identification of defective batteries
- ▶ Optimized test algorithm for testing new batteries
- ▶ Extended test of the 12 V and 24 V starting/ charging system for batteries
- ▶ Integrated printer provides graphical printouts
- ▶ USB port for transferring the test results
- ▶ 3 m replaceable cable

Les avantages

- ▶ Utilisation intuitive à l'aide de menus
- ▶ Test de l'état de la batterie et détection de défauts ses
- ▶ Algorithme de test optimisé pour le contrôle des batteries neuves
- ▶ Test étendu du système de démarrage/charge pour les batteries de 12 V et 24 V
- ▶ Graphique des résultats clair grâce à l'imprimante intégrée
- ▶ Port USB pour l'enregistrement des résultats des tests
- ▶ Câble de 3 m amovible

Ecco un riepilogo dei vantaggi decisivi

- ▶ Comando intuitivo guidato da menu
- ▶ Test dello stato della batteria e riconoscimento di difetti della batteria
- ▶ Algoritmo di controllo ottimizzato per il controllo di batterie nuove
- ▶ Test ampliato del sistema di avviamento/carica per batterie da 12 V e 24 V
- ▶ La stampante integrata consente una chiara rappresentazione grafica dei risultati di misura
- ▶ Presa USB per il salvataggio dei risultati dei test
- ▶ Cavo lungo 3 m, sostituibile

Las ventajas de un vistazo

- ▶ Manejo intuitivo guiado por menú
- ▶ Prueba del estado de la batería y detección de defectos en la misma
- ▶ Algoritmo optimizado para comprobación de baterías nuevas
- ▶ Comprobación extendida del sistema de arranque/carga para baterías de 12 V y 24 V
- ▶ Impresora integrada presenta los resultados de las mediciones de forma gráfica e intuitiva
- ▶ Puerto USB para almacenar los resultados de las pruebas
- ▶ Cable de 3 m de longitud, sustituible

Technische Daten BAT 131

Menüsprachen: 21
Maße mit Drucker: (BxHxT): ca. 270x113x50 mm
Gewicht mit Drucker: ca. 700 g
Betriebstemperatur: 0° – 40° C

Technical data BAT 131

Menu languages: 21
Dims. inclusive printer: (B x W x T) approx. 270x113x50 mm
Weight inclusive printer: approx. 700 g
Operating temperature: 0° – 40° C

Caractéristiques techniques BAT 131

Langues des menus : 21
Dimensions avec imprimante : (LxHxP) : env. 270x113x50 mm
Poids avec imprimante : env. 700 g
Température de service : 0° – 40° C

Dati tecnici BAT 131

Lingue del menu: 21
Dimensioni con stampante (Lxaxp): ca. 270x113x50 mm
Peso con stampante: ca. 700 g
Temperatura di esercizio: 0° – 40° C

Datos técnicos de BAT 131

Idiomas: 21
Medidas con impresora: (ancho x alto x profundo): aprox. 270x113x50 mm
Peso con impresora: aprox. 700 g
Temperatura de servicio: 0° – 40° C

pt

Aparelho de teste para baterias da Bosch – BAT 131 para todas as baterias de partida de 6 V e 12 V

fi

Bosch-akutesteri BAT 131 kaikkiin 6 V ja 12 V käynnistysakuihin

pl

Tester akumulatorów – Bosch BAT 131 do wszystkich akumulatorów rozruchowych 6 V i 12 V

cs

Tester akumulátorů Bosch – BAT 131 pro všechny startovací akumulátory 6 V a 12 V

ru

Тестер БАТ 131 от Bosch – для всех стартерных аккумуляторов 6 В и 12 В



Rápido, preciso e fiável

O aparelho de teste para baterias portátil BAT 131 é ideal para testar baterias de partida (baterias de chumbo-ácido, de gel e AGM).

A corrente de partida a frio é ajustável opcionalmente de 100 – 2 000 A segundo as normas EN, EN2, DIN, SAE, IEC e JIS.

Resumo das vantagens

- ▶ Utilização intuitiva guiada por menu
- ▶ Teste do estado da bateria e deteção de defeitos na mesma
- ▶ Algoritmo de teste otimizado para a verificação de baterias novas
- ▶ Teste ampliado do sistema de partida / carga para baterias de 12 V e 24 V
- ▶ Impressora integrada apresenta resultados de medição de forma clara e gráfica
- ▶ Conexão USB para a memorização dos resultados de teste
- ▶ Substituível, cabo com 3 m de comprimento

Dados técnicos BAT 131

Idiomas: 21
Dimensões com impressora: (LxAxP): aprox. 270x113x50 mm
Peso com impressora: aprox. 700 g
Temperatura de serviço: 0° – 40° C

Nopea, tarkka ja luotettava

Kannettava akutesteri BAT 131 soveltuu ihanteellisesti käynnistysakkujen testaukseen (lyijy-, happo-, geeli ja kuituakut / AGM). Kylmäkäynnistysvirta voidaan säätää valinnaisesti eri standardien mukaan: EN, EN2, DIN, SAE, IEC ja JIS alueelle 100 – 2 000 A.

Valikaiseppa etuja

- ▶ Valikko-ohjatut, intuitiiviset toiminnot
- ▶ Akun kunnon tarkastus ja vikojen tunnistus
- ▶ Optimoitu testialgoritmi uusien akkujen tarkastukseen
- ▶ Laajennettu testi käynnistys-/varausjärjestelmiin 12 V ja 24 V
- ▶ Yhdysrakenteinen printteli tulostaa mittaustulokset selkeään, graafiseen muotoon
- ▶ USB-portti testitulosten tallentamista varten
- ▶ Vaihdettava 3 m:n pituinen kaapeli

Tekniset tiedot – BAT 131

Valikkokielet: 21
Printerin mitat (LxKxS): n. 270x113x50 mm
Printerin paino: n. 700 g
Käyttölämpötila: 0° – 40° C

Szybko, precyzyjnie i niezawodnie

Przenośny tester akumulatorów BAT 131 jest przeznaczony do testowania ołowioowo-kwasowych akumulatorów rozruchowych (z elektrolitem płynnym, żelowych i AGM).

Testowy prąd zimnego rozruchu można ustawić od 100 do 2000 A według norm EN, EN2, DIN, SAE, IEC i JIS.

Najważniejsze zalety

- ▶ Intuicyjne menu
- ▶ Test stanu akumulatora i rozpoznawanie uszkodzeń akumulatora
- ▶ Optymalny algorytm testu do sprawdzania nowych akumulatorów
- ▶ Rozszerzony test startowy/ładowania dla akumulatorów 12 V i 24 V
- ▶ Zintegrowana drukarka przedstawia wyniki pomiarów w sposób przejrzysty i graficznie
- ▶ Port USB do zapisywania wyników testów
- ▶ Wymienny kabel 3 m

Dane techniczne BAT 131

Języki menu: 21
Wymiary z drukarką (SxWxG): ok. 270x113x50 mm
Masa z drukarką: ok. 700 g
Temperatura robocza: 0° – 40° C

Rychlý, přesný a spolehlivý

Přenosný tester akumulátorů BAT 131 je optimálně vhodný k testování startovacích akumulátorů (akumulátory olovo-kyselina, gel a AGM).

Vybíjecí proud za studena je volitelně nastavitelný podle norem EN, EN2, DIN, SAE, IEC a JIS v rozsahu 100 – 2 000 A.

Stručný přehled výhod

- ▶ Intuitivní ovládání pomocí menu
- ▶ Test stavu akumulátoru a rozpoznání vad akumulátoru
- ▶ Optimalizovaný testovací algoritmus pro kontrolu nových akumulátorů
- ▶ Rozšířený test startovacího/nabíjecího systému pro akumulátory 12 V a 24 V
- ▶ Integrovaná tiskárna znázorňuje výsledky měření v přehledném grafickém provedení
- ▶ Přípojka USB pro uložení výsledků testu
- ▶ Výměnný kabel délka 3 m

Technické údaje BAT 131

Jazyky menu: 21
Rozměry s tiskárnou (ŠxVxH): cca 270x113x50 mm
Hmotnost s tiskárnou: cca 700 g
Provozní teplota: 0° – 40° C

Быстро, точно и надежно

Переносной тестер БАТ 131 оптимально подходит для проверки стартерных аккумуляторов (свинцово-кислотных, гелевых и со стекловолоконными сепараторами/AGM).

Ток холодного пуска согласно нормам EN, EN2, DIN, SAE, IEC и JIS выбирается в диапазоне 100 – 2000 А.

Основные преимущества

- ▶ Интуитивно-понятное меню с подсказками
- ▶ Проверка состояния аккумулятора и распознавание поврежденного аккумулятора
- ▶ Оптимизированный алгоритм проверки новых аккумуляторов
- ▶ Расширенная проверка стартеров/генераторов 12 В и 24 В
- ▶ Наглядное графическое представление результатов измерения с помощью встроенного принтера
- ▶ Разъем USB для сохранения результатов проверки
- ▶ Сменный кабель длиной 3 м

Технические данные БАТ 131

Языки меню: 21 (включая русский)
Размеры с принтером: (ШxВxГ): 270x113x50 мм
Вес с принтером: 700 г
Рабочая температура: 0° – 40° C

de

Das Multitalent Elektroniklader BAT 645/690

en

The multitalent Electronic charger BAT 645/690

fr

BAT 645/690, le char- geur électronique aux multiples talents

it

L'autentico tuttofare Caricabatterie elett- ronico BAT 645/690

es

El multitalento: cargador electrónico BAT 645/690



BAT 645

Mit den Batterieladern BAT 645 und BAT 690 stehen ab sofort zwei universell einsetzbare Geräte mit 45 und 90 Ampere Dauerausgangsstrom zur Verfügung. Beide Lader können sowohl für 12-V-Pkw- als auch für 24-V-Nfz-Bordnetze verwendet werden. Ein Stütz- und Pufferbetrieb steht zur Verfügung. Mit dem USB-Anschluss für Software-Updates können Kennlinien für neuartige Batterietypen aufgespielt und die Geräte immer auf dem neuesten Stand der Technik gehalten werden.

BAT 690

Produkteigenschaften

- ▶ 45 oder 90 Ampere – für alle Bleibatteriearten (Standard, wartungsfrei, Gel, Vlies, AGM, EFB) und neue Li-Ion – Lithiumeisenphosphat (LFP)
- ▶ Vollautomatische Ladeigenschaften – universal: für alle Batteriearten (UNI), spezifische Eigenschaften für WET, AGM, GEL, EFB und LFP sowie sanfte Ladephase für tiefentladene Batterien (automatisch)
- ▶ Stützbetrieb – hält die Stromversorgung zum Puffern von Daten (z. B. Autoradios, Versorgungs- und Steuerungseinheiten usw.) während des Batterietauschs aufrecht
- ▶ Pufferbetrieb – erhält den Batterieladezustand und stabilisiert elektrische Anlagen des Fahrzeugs (Motor ist aus)
- ▶ Anzeige- und Bedieneinheit mit einer Punktmatrix-Anzeige – 18 Sprachen
- ▶ Elektronisches Schutz-Management-System

BAT 645

The battery chargers BAT 645 and BAT 690 are two universal devices with a continuous output current of 45 and 90 ampere. Both chargers can be used for both 12 V passenger car and 24 V commercial vehicle electrical systems. Back-up and buffer operation is available. The USB port for software updates allows the installation of characteristics for new battery types and guarantees that the devices are always state-of-the-art.

BAT 690

Product characteristics

- ▶ 45 A or 90 A – for all lead acid battery types (standard, maintenance-free, gel, fleece, AGM, EFB) and new Li-Ion – Lithium Iron Phosphate (LFP)
- ▶ Fully automatic charging characteristics – universal for all battery types (UNI) and specific characteristics for WET, AGM, GEL, EFB and LFP and soft charging phase for deeply discharged batteries (automatic)
- ▶ Backup mode – maintains voltage supply to buffer data (e.g. car stereos, supply and control units etc.) during battery replacement
- ▶ Buffer mode – keeps SOC of the battery and stabilizes vehicle electrical systems (engine is off)
- ▶ HMI with a dot matrix display – 18 languages
- ▶ Electronic protection management system

BAT 645

Les chargeurs de batteries BAT 645 et BAT 690 permettent de disposer de deux appareils universels en sortie courant continu en 45 et 90 Ampères. Ces deux chargeurs peuvent être utilisés pour les réseaux de bord de véhicules légers en 12 V et ceux en 24 V de véhicules utilitaires. Ils disposent d'un mode d'entretien et d'un mode tampon. Grâce au branchement USB pour les mises à niveau logicielles, il est possible de visualiser les courbes caractéristiques de nouveaux types de batteries et d'adapter les appareils aux dernières évolutions techniques.

BAT 690

Caractéristiques du produit

- ▶ 45 ou 90 Ampères – pour tous les types de batteries au plomb (Standard, sans entretien, Gel, Nappe, AGM, EFB) et les nouvelles Li-ion – Lithium-Fer-Phosphate (LFP)
- ▶ Caractéristiques de charge entièrement automatiques – universel : pour tous types de batteries (UNI), Caractéristiques spécifiques pour WET, AGM, GEL, EFB et LFP ainsi que phase de charge douce pour les batteries en décharge profonde (automatique)
- ▶ Fonction de soutien – maintient l'alimentation en courant pour les tampons de données (p. ex. autoradios, unités d'alimentation et de commande etc.) durant le remplacement de la batterie
- ▶ Fonction tampon – maintient le niveau de la batterie et stabilise les équipements électriques du véhicule (Moteur à l'arrêt)
- ▶ Unité d'affichage et de commande avec écran à matrice de points – 18 langues
- ▶ Système de gestion de protection électronique

BAT 645

Con i nuovi caricabatterie BAT 645 e 690 Bosch offre alle autofficine due attrezzature professionali universali con uscita di corrente continua di 45 e 90 ampere. Rilevando automaticamente la tensione nominale necessaria, entrambi i caricabatterie possono essere utilizzati sia per le batterie da 12V sia per quelle da 24V. È disponibile la modalità di sostegno e tampone. Grazie alla connessione USB per gli aggiornamenti software, è possibile caricare le caratteristiche dei nuovi tipi di batterie e mantenerle sempre aggiornati i dispositivi con le più recenti tecnologie.

BAT 690

Proprietà del prodotto

- ▶ 45 o 90 ampere - per tutti i tipi di batterie al piombo (standard, prive di manutenzione, gel, TNT, AGM, EFB) e le nuove batterie agli ioni di litio - litio-ferro-fosfato (LFP)
- ▶ Proprietà di carica completamente automatica - universale: per tutti i tipi di batterie (UNI), proprietà specifiche per WET, AGM, GEL, EFB e LFP nonché fase di carica delicata per batterie profondamente scariche (automatica)
- ▶ Modalità di sostegno - mantiene attiva l'alimentazione di corrente ai buffer di dati (ad es. autoradio, unità di alimentazione e comando ecc.) durante durante la sostituzione della batteria
- ▶ Modalità tampone - mantiene lo stato di carica della batteria e stabilizza i sistemi elettrici del veicolo (a motore spento)
- ▶ Unità di visualizzazione e controllo con un display a matrice di punti - 18 lingue
- ▶ Sistema di gestione della protezione elettronica

BAT 645

Con los cargadores de batería BAT 645 y BAT 690 ya se dispone de dos aparatos de uso universal con corriente de salida continua de 45 y 90 amperios. Ambos cargadores se pueden utilizar tanto para redes a bordo de vehículos comerciales de 24 V como para vehículos de pasajeros de 12 V. Se dispone de un modo de reserva y soporte. Con la conexión USB para actualizaciones de software se pueden instalar curvas características para nuevos tipos de baterías y así mantener los aparatos siempre a la vanguardia tecnológica.

BAT 690

Características del producto

- ▶ 45 o 90 amperios para todos los tipos de batería de plomo (estándar, sin mantenimiento, gel, malla, AGM, EFB) y la nueva ion de litio: litio ferfosfato (LFP)
- ▶ Características de carga totalmente automática universal: para todos los tipos de batería (UNI), características específicas para WET, AGM, GEL, EFB y LFP, así como una fase de carga suave para baterías de descarga profunda (automática)
- ▶ Modo de soporte: mantiene el suministro de corriente para almacenamiento intermedio de datos (p. ej., radios de vehículos, unidades de suministro y control, etc.) durante el cambio de batería
- ▶ Modo de reserva: mantiene el estado de carga de batería y estabiliza los sistemas eléctricos del vehículo (el motor está apagado)
- ▶ Unidad de visualización y manejo con una pantalla de matriz de puntos: 18 idiomas
- ▶ Sistema de gestión de protección electrónica

pt

O carregador eletrônico multi-funções BAT 645/690

fi

Monilahjakas elektroninen varaaja BAT 645/690

pl

Elektroniczny prostownik Multi-talent BAT 645/690

cs

Univerzální elektronické nabíjecí zařízení BAT 645/690

ru

Многофункциональное электронное зарядное устройство BAT 645/690



BAT 645

Com os carregadores de bateria BAT 645 e BAT 690, estão disponíveis de imediato dois dispositivos de utilização universal com uma corrente de saída contínua de 45 e 90 amperes. Ambos os carregadores podem ser utilizados tanto para as redes de bordo de 12 V dos veículos ligeiros de passageiros como para as redes de bordo de 24 V dos veículos comerciais. Estão disponíveis um modo de apoio e um modo de reserva. Com a ligação USB para atualizações de software, é possível transferir curvas características para novos tipos de bateria e manter os dispositivos sempre atualizados.

BAT 690

Características do produto

- ▶ 45 ou 90 amperes – para todos os tipos de baterias (pa-drão, isentas de manutenção, gel, velo, AGM, EFB) e as novas Li-ion – fosfato de ferro-lítio (LFP)
- ▶ Propriedades de carga totalmente automáticas – universal: para todos os tipos de baterias (UNI), propriedades específicas para WET, AGM, GEL, EFB e LFP, assim como uma fase de carregamento suave para baterias totalmente descarregadas (automático)
- ▶ Modo de apoio – mantém a alimentação elétrica para guardar os dados na memória (por exemplo, autorrádios, unidades de alimentação e comando, etc.) durante a substituição da bateria.
- ▶ Modo de reserva – mantém o estado de carga da bateria e estabiliza os sistemas elétricos do veículo (com o motor desligado).
- ▶ Unidade de visualização e comando com um ecrã Punktmatrix – 18 idiomas
- ▶ Sistema de gestão de proteção eletrônico

BAT 645

Akkuvaraajien BAT 645 ja BAT 690 kanssa on heti käytettävissä kaksi yleiskäyttöistä laitetta, joiden jatkuva lähtövirta on 45 ja 90 A. Molempia varaajia voidaan käyttää sekä 12-V-henkilöautojen sekä 24-V-hyötyajoneuvojen sähköjärjestelmissä. Tuki- ja puskurikäyttö ovat käytettävissä. Ohjelmistopäivitysten USB-liitännän avulla voidaan uudentyyppisten akkujen ominaiskäyriä ladata ja laitteita voidaan pitää aina tekniikan uusimmalla tasolla.

BAT 690

Tuoteominaisuudet

- ▶ 45 tai 90 ampeeria – kaikkiin liijakkumalleihin (vakio, huoltovapaa, geeli, kuitukangas, AGM, EFB) ja uusi li-ioni – litiumrautafosfaatti (LFP)
- ▶ Täysautomaattiset varausominaisuudet – yleiskäyttöinen: kaikkiin akkumalleihin (UNI), erityisominaisuuksilla malleihin WET, AGM, GEL, EFB ja LFP sekä pehmeä varausvaihe syväpurkautuneita akkuja varten (automaattinen)
- ▶ Tukikäyttö – pitää yllä virransyöttöä yllä tietojen puskuroimista varten (esim. autoradiot, syöttö- ja ohjauslaitteistot, jne.) akun vaihdon aikana
- ▶ Puskurikäyttö – pitää yllä akun varausilaa ja vakauttaa ajoneuvon sähkölaitteita (moottori pois päältä)
- ▶ Näyttö- ja käyttöyksikkö piste-matriisinäytöllä – 18 kieltä
- ▶ Elektroninen suojamagneettijärjestelmä

BAT 645

Prostowniki akumulatorów BAT 645 i BAT 690 to dwa uniwersalne urządzenia o stałym prądzie wyjściowym o natężeniu 45 i 90 amperów. Obu prostowników można używać zarówno do sieci pokładowych 12 V w samochodach osobowych i do sieci 24 V w pojazdach użytkowych. Dostępny jest tryb podtrzymania i tryb buforowy. Złącze USB do aktualizacji oprogramowania pozwala na zapisywanie charakterystyk do nowoczesnych typów akumulatorów, dzięki czemu urządzenia będą zawsze w najnowszym stanie techniki.

BAT 690

Właściwości produktu

- ▶ 45 lub 90 amperów – do wszystkich rodzajów akumulatorów ołowianych (standardowych, bezobsługowych, żelowych, włóknowych, AGM, EFB) i nowych litowo-jonowych – litowo-żelazowo-fosforanowy (LFP)
- ▶ Całkowicie automatyczne właściwości ładowania – uniwersalne: do wszystkich typów akumulatorów (UNI), specyficzne właściwości dla WET, AGM, GEL, EFB i LFP oraz łagodna faza ładowania dla głęboko wyładowanych akumulatorów (automatycznie)
- ▶ Tryb podtrzymania – utrzymuje zasilenie elektryczne w celu buforowania danych (np. radia samochodowego, jednostek zasilających i sterujących itp.) podczas wymiany akumulatora
- ▶ Tryb buforowy – utrzymuje stan naładowania akumulatora i stabilizuje instalacje elektryczne pojazdu (silnik jest wyłączony)
- ▶ Jednostka wskazująca i obsługowa z wyświetlaczem punktowo-matrycowym – 18 języków
- ▶ Elektroniczny system zarządzania zabezpieczeniami

BAT 645

Díky nabíječkám akumulátorů BAT 645 a BAT 690 jsou od tohoto okamžiku k dispozici dva univerzálně použitelné přístroje s trvalým výstupním proudem 45 a 90 Ampérů. Obě nabíječky je možné používat jak pro palubní sítě osobních vozidel 12 V, tak také pro palubní sítě užitkových vozidel 24 V. K dispozici je podpůrný a akumuláční provoz. Pomocí přípojky USB pro aktualizace softwaru mohou být nahrané charakteristiky pro nové typy akumulátorů a přístroje jsou tak vždy udržovány na nejnovějším stavu techniky.

BAT 690

Vlastnosti produktu

- ▶ 45 nebo 90 Ampérů – pro všechny druhy akumulátorů (standard, bez údržby, gelové, flisové, AGM, EFB) a nové Li-ion – Lithiumeisenfosfát (LFP)
- ▶ Zcela automatické vlastnosti nabíjení – univerzální: pro všechny druhy akumulátorů (UNI), specifické vlastnosti pro WET, AGM, GEL, EFB a LFP a také jemná nabíjecí fáze pro hluboce vybité akumulátory (automaticky)
- ▶ Podpůrný provoz – udržuje napájení proudem k udržení dat (např. autorádia, napájecí a řídicí jednotky atd.) během výměny akumulatoru
- ▶ Akumuláční provoz – udržuje stav nabití akumulátoru a stabilizuje elektrická zařízení vozidla (motor je vyp.)
- ▶ Indikační a obslužná jednotka s bodovou indikací – 18 jazyků
- ▶ Elektronický systém managementu ochrany

BAT 645

Теперь с аккумуляторными зарядными устройствами BAT 645 и BAT 690 доступны два универсальных устройства с постоянным выходным током 45 А и 90 А. Оба зарядных устройства могут использоваться как для бортовых электросетей 12 В легковых автомобилей, так и для бортовых электросетей 24 В коммерческих автомобилей. Доступны режим поддержания питания и параллельная работа генератора и аккумулятора. С помощью USB-порта для обновления программного обеспечения можно загружать характеристики для новых типов аккумуляторов и обеспечивать соответствие устройств современному уровню развития техники.

BAT 690

Характеристики продуктов

- ▶ 45 или 90 ампер – для всех типов свинцовых аккумуляторов (стандартные, не требующие техобслуживания, гелевые, волокно, AGM, EFB) и новые литий-ионные – фосфат лития железа (LFP)
- ▶ Полностью автоматические характеристики зарядки – универсальные: для всех типов аккумуляторов (UNI), специфические характеристики для WET, AGM, гелевые, EFB и LFP и бережная фаза зарядки для глубоко разряженных аккумуляторов (автоматическая)
- ▶ Режим поддержания питания – обеспечивает подачу питания для буферизации данных (например, автомобильные радиоприемники, блоки электропитания и управления и т.д.) во время замены аккумулятора
- ▶ Режим буферизации – поддерживает уровень заряда аккумулятора и стабилизирует работу электрических систем автомобиля (двигатель выключен)
- ▶ Блок индикации и управления с точечной матричной индикацией – 18 языков
- ▶ Система управления электронной защитой

A 36

de Starter-Batterie, Klassik	en Starter battery, classic	fr Batterie de démarrage, Classique	it Batteria per motorino di avviamento, classica	es Batería del motor de arranque, clásico
pt Bateria do sistema de arranque, clássico	fi Käynnistinakku, Klassik	pl Akumulator rozruchowy, klasyczny	cs Startérový akumulátor, Klassik	ru Аккумулятор стартера, классический



No	DIN	Ah	A (EN)	L	kg		L
6 Volt							
F 026 T02 300	00811	8	40	- +	1,6	85 x 95 x 165	0,6
F 026 T02 302	06611	66	360	- +	7,9	186 x 169 x 192	2,5
F 026 T02 303	07715	77	360	- +	8,7	215 x 169 x 192	3,2
F 026 T02 304	08411	84	390	- +	10	244 x 173 x 216	3,2
F 026 T02 306	09811	98	480	- +	10,6	263 x 172 x 220	4,2
F 026 T02 307	11211	112	540	- +	12	263 x 177 x 255	4,7
12 Volt							
F 026 T02 310	54419	44	200	- +	8,72	210 x 175 x 175	2,95
F 026 T02 311	56011	60	280	- +	15,15	260 x 173 x 225	4,2
F 026 T02 312	56037	60	280	+ -	15,15	260 x 173 x 225	4,2
F 026 T02 313	55613	60	330	+ -	15,15	312 x 172 x 216	4,3
F 026 T02 314	56014	60	330	- +	15,15	312 x 172 x 216	4,3

Weitere Informationen finden Sie auf www.bosch-classic.com in der Rubrik "Produkte".

You can find more information at www.bosch-classic.com under "Products".

Pour plus d'informations, rendez-vous sur www.bosch-classic.com dans la rubrique "Produits".

Ulteriori informazioni sono disponibili sul sito www.bosch-classic.com nella rubrica "Prodotti".

Encontrará más información en www.bosch-classic.com en la sección "Productos".

Encontra mais informações em www.bosch-classic.com na rubrica "Produtos".

Lisätietoja, katso www.bosch-classic.com otsikon "tuote" alta.

Więcej informacji znajduje się na stronie internetowej www.bosch-classic.com w rubryce "Produkty".

Další informace viz www.bosch-classic.com rubrika "Produkty".

Более подробная информация приводится на сайте: www.bosch-classic.com в рубрике "Изделия".

de

Technische
Legende

en

Technical
legend

fr

Légende
technique

it

Legenda
tecnica

es

Leyenda
técnica

pt

Legenda
técnica

fi

Tekninen
erittely

pl

Opis
techniczny

cs

Technická
legenda

ru

Технические
условные
обозначения



L

Schaltung, Layout, Schéma, Circuito, Circuito,
Circuito, Kytkentä, Przełączanie, Zapojení, Схема

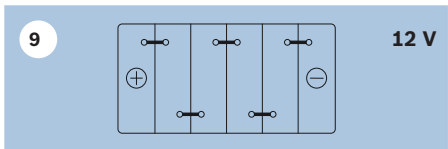
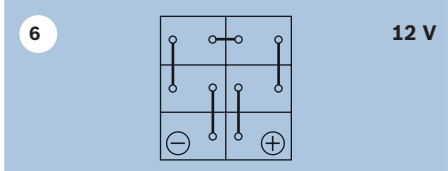
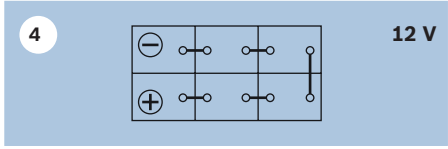
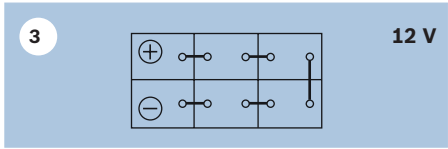
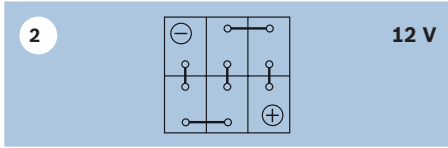
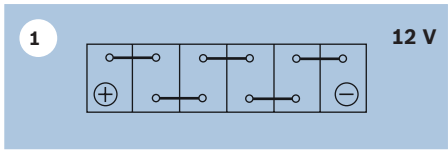
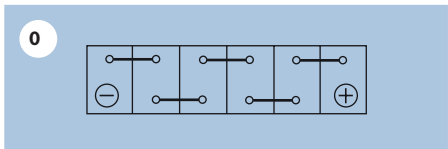
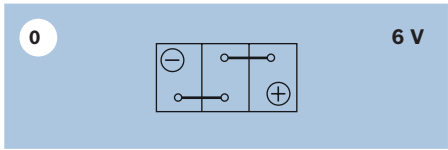

T

Endpole, Terminal posts, Bornes, Polo terminale,
Terminales, Pólos finais, Navat, Bieguny krańcowe,
Koncové póly, Конечные полюса

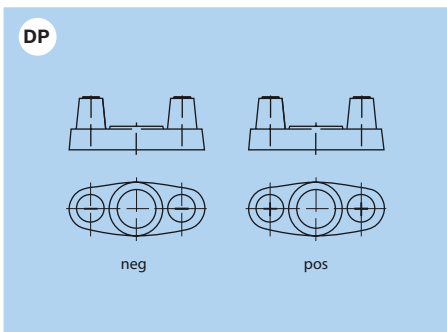
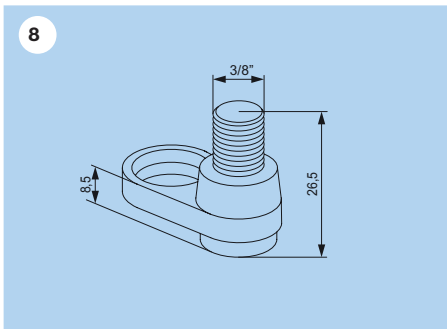
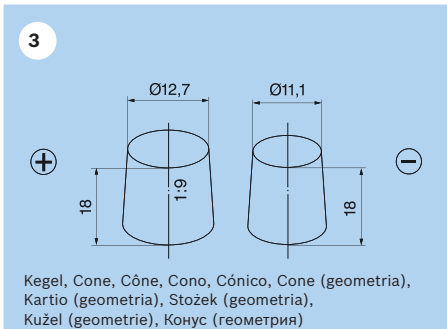
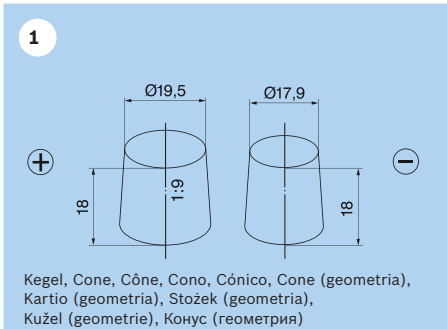

B

Bodenbefestigung, Bottom rail, Fixations par la batterie,
Fissaggio alla base, Fijación en el suelo, Fixação ao piso,
Pohjakiinnitys, Mocowanie do podłoża, Upevnění k pod-
laze, Напольное крепление

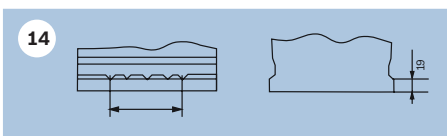
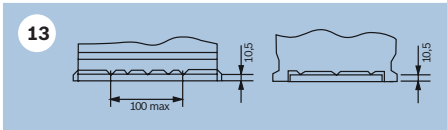
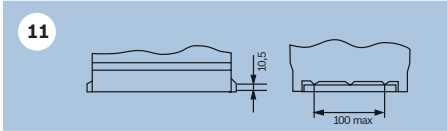
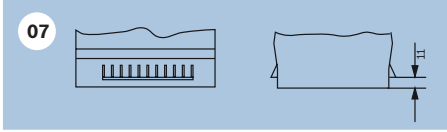
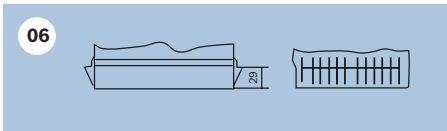
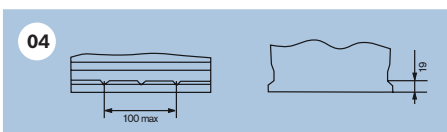
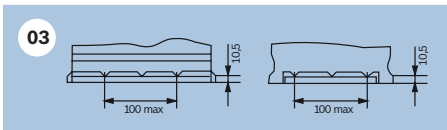
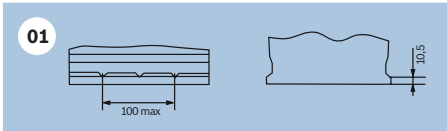
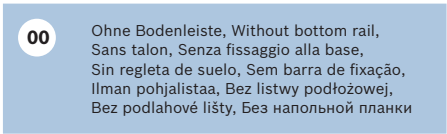





BOSCH

Invented for life

Bosch S5 A – S4 E – S5 – S4 – S3

Automotive Aftermarket



ETN	№	№	AGM Technology	EFB Technology	Asia Type	Vibration Proof	Ah 20 h	A (EN)		L	T	B	EAN	kg	 max. pcs.	Group Size
Start/stop system S5 A / 12 V																
560 901 068	0 092 S5A 050	S5 A05	•			•	60	680	242 x 175 x 190	0	1	B13	4047 025 244 336	17,35	57	LN2
570 901 076	0 092 S5A 080	S5 A08	•			•	70	760	278 x 175 x 190	0	1	B13	4047 025 244 343	20,09	48	LN3
580 901 080	0 092 S5A 110	S5 A11	•			•	80	800	315 x 175 x 190	0	1	B13	4047 025 244 350	22,76	36	LN4
595 901 085	0 092 S5A 130	S5 A13	•			•	95	850	353 x 175 x 190	0	1	B13	4047 025 244 367	25,92	36	LN5
605 901 095	0 092 S5A 150	S5 A15	•			•	105	950	394 x 175 x 190	0	1	B13	4047 025 244 374	29,40	36	LN6
Start/stop system S4 E / 12 V																
560 500 064	0 092 S4E 051	S4E05		•			60	640	242 x 175 x 190	0	1	B13	4047 026 293 173	16,67	63	LN2
565 500 065	0 092 S4E 070	S4 E07		•			65	760	278 x 175 x 175	0	1	B13	4047 025 244 398	18,63	48	LBN3
570 500 076	0 092 S4E 081	S4E08		•			70	760	278 x 175 x 190	0	1	B13	4047 026 293 180	19,14	48	LN3
575 500 073	0 092 S4E 100	S4 E10		•			75	800	315 x 175 x 175	0	1	B13	4047 025 244 411	21,19	42	LBN4
580 500 080	0 092 S4E 111	S4E11		•			80	800	315 x 175 x 190	0	1	B13	4047 026 293 197	21,78	42	LN4
595 500 085	0 092 S4E 130	S4E13		•			95	850	353 x 175 x 190	0	1	B13	4047 026 329 056	24,98	36	LN5
565 501 065	0 092 S4E 400	S4E40		•	•		65	650	231 x 173 x 218,5	0	1	B0	4047 026 328 998	16,93	54	D23
572 501 076	0 092 S4E 410	S4E41		•	•		72	760	260,7 x 175 x 218,5	0	1	B01	4047 026 329 018	19,55	48	D26
585 501 080	0 092 S4E 420	S4E42		•	•		85	800	303,9 x 173 x 218,5	0	1	B01	4047 026 329 025	21,69	42	D31
S5 / 12 V																
552 401 052	0 092 S50 010	S5 001					52	520	207 x 175 x 175	0	1	B13	4047 023 479 426	11,97	72	LBN1
554 400 053	0 092 S50 020	S5 002					54	530	207 x 175 x 190	0	1	B13	4047 023 479 419	12,70	72	LN1
561 400 060	0 092 S50 040	S5 004					61	600	242 x 175 x 175	0	1	B13	4047 023 479 334	13,99	63	LBN2
563 400 061	0 092 S50 050	S5 005					63	610	242 x 175 x 190	0	1	B13	4047 023 479 358	14,85	63	LN2
563 401 061	0 092 S50 060	S5 006					63	610	242 x 175 x 190	1	1	B13	4047 023 479 365	14,85	63	LN2
574 402 075	0 092 S50 070	S5 007					74	750	278 x 175 x 175	0	1	B13	4047 023 479 563	16,98	48	LBN3
577 400 078	0 092 S50 080	S5 008					77	780	278 x 175 x 190	0	1	B13	4047 023 479 617	17,54	48	LN3
585 200 080	0 092 S50 100	S5 010					85	800	315 x 175 x 175	0	1	B13	4047 023 573 230	18,79	42	LBN4
585 400 080	0 092 S50 110	S5 011					85	800	315 x 175 x 190	0	1	B13	4047 024 937 598	19,36	42	LN4
600 402 083	0 092 S50 130	S5 013					100	830	353 x 175 x 190	0	1	B13	4047 023 479 495	21,71	36	LN5
610 402 092	0 092 S50 150	S5 015					110	920	393 x 175 x 190	0	1	B13	4047 024 016 989	25,00	36	LN6
S4 / 12 V																
544 401 042	0 092 S40 001	S4 000					44	420	175 x 175 x 190	0	1	B13	4047 024 937 567	10,64	72	LN0
544 402 044	0 092 S40 010	S4 001					44	440	207 x 175 x 175	0	1	B13	4047 023 479 372	11,50	72	LBN1
552 400 047	0 092 S40 020	S4 002					52	470	207 x 175 x 190	0	1	B13	4047 023 479 389	12,16	72	LN1
560 409 054	0 092 S40 040	S4 004					60	540	242 x 175 x 175	0	1	B13	4047 023 479 297	13,59	63	LBN2
560 408 054	0 092 S40 050	S4 005					60	540	242 x 175 x 190	0	1	B13	4047 023 479 310	14,69	63	LN2
560 127 054	0 092 S40 060	S4 006					60	540	242 x 175 x 190	1	1	B03	4047 023 479 327	14,28	63	LN2
572 409 068	0 092 S40 070	S4 007					72	680	278 x 175 x 175	0	1	B13	4047 023 479 549	16,70	48	LBN3
574 012 068	0 092 S40 080	S4 008					74	680	278 x 175 x 190	0	1	B13	4047 023 479 594	17,54	48	LN3
574 013 068	0 092 S40 090	S4 009					74	680	278 x 175 x 190	1	1	B13	4047 023 479 600	17,02	48	LN3
580 406 074	0 092 S40 100	S4 010					80	740	315 x 175 x 175	0	1	B13	4047 023 479 648	18,79	42	LBN4
580 400 074	0 092 S40 110	S4 011					80	740	315 x 175 x 190	0	1	B13	4047 024 937 581	18,69	42	LN4
595 402 080	0 092 S40 130	S4 013					95	800	353 x 175 x 190	0	1	B13	4047 023 479 471	21,12	36	LN5
540 126 033	0 092 S40 180	S4 018			•		40	330	187 x 140 x 227	0	3	B00	4047 023 479 990	9,74	84	B19H
540 127 033	0 092 S40 190	S4 019			•		40	330	187 x 127 x 227	1	3	B00	4047 023 479 808	9,74	84	B19R
545 155 033	0 092 S40 200	S4 020			•		45	330	238 x 129 x 227	0	3	B00	4047 023 479 822	11,43	72	B24
545 156 033	0 092 S40 210	S4 021			•		45	330	238 x 129 x 227	0	1	B00	4047 023 479 839	11,43	72	B24R
545 157 033	0 092 S40 220	S4 022			•		45	330	238 x 129 x 227	1	3	B00	4047 023 479 846	11,43	72	B24RS
545 158 033	0 092 S40 230	S4 023			•		45	330	238 x 129 x 227	1	1	B00	4047 023 479 853	11,43	72	B24RS
560 410 054	0 092 S40 240	S4 024			•		60	540	232 x 173 x 225	0	1	B00	4047 023 479 877	14,11	54	D23R
560 411 054	0 092 S40 250	S4 025			•		60	540	232 x 173 x 225	1	1	B00	4047 023 479 884	14,11	54	D23R
570 412 063	0 092 S40 260	S4 026			•		70	630	260 x 175 x 225	0	1	B01	4047 023 479 730	16,24	48	D31R
570 413 063	0 092 S40 270	S4 027			•		70	630	260 x 175 x 225	1	1	B01	4047 023 479 747	16,24	48	D26R
595 404 083	0 092 S40 280	S4 028			•		95	830	306 x 173 x 225	0	1	B01	4047 023 479 891	20,23	39	D31
595 405 083	0 092 S40 290	S4 029			•		95	830	306 x 173 x 225	1	1	B01	4047 023 479 907	20,23	39	D31R
540 125 033	0 092 S40 300	S4 030			•		40	330	187 x 140 x 227	0	3	B01	4047 024 891 012	9,74	84	B19H

pt

Vista geral do programa veículos de passeio

fi

Tuotevalikoima henkilöautoihin

pl

Przegląd asortymentu – samochody osobowe

cs

Přehled výrobního programu pro osobní automobily

ru

Обзор программ для легковых автомобилей

ETN	No	No	AGM Technology	EFB-Technology	Asia Type	Vibration Proof	Ah 20 h	A (EN)	 ¹⁾	L	T	B	EAN	kg	max. pos.	Group Size
S3 / 12 V																
540 406 034	0 092 S30 000	S3 000					40	340	175 x 175 x 190	0	1	B13	4047 024 659 407	9,78	72	LNO
541 400 036	0 092 S30 010	S3 001					41	360	207 x 175 x 175	0	1	B13	4047 023 479 204	10,76	72	LBN1
545 412 040	0 092 S30 020	S3 002					45	400	207 x 175 x 190	0	1	B13	4047 023 479 228	11,57	72	LN1
545 413 040	0 092 S30 030	S3 003					45	400	207 x 175 x 190	1	1	B13	4047 023 479 242	11,57	72	LN1
553 401 050	0 092 S30 041	S3 004					53	500	242 x 175 x 175	0	1	B13	4047 024 937 574	13,41	63	LBN2
556 400 048	0 092 S30 050	S3 005					56	480	242 x 175 x 190	0	1	B13	4047 023 479 266	13,47	63	LN2
556 401 048	0 092 S30 060	S3 006					56	480	242 x 175 x 190	1	1	B13	4047 023 479 280	13,47	63	LN2
570 144 064	0 092 S30 070	S3 007					70	640	278 x 175 x 175	0	1	B13	4047 023 479 525	15,73	48	LBN3
570 409 064	0 092 S30 080	S3 008					70	640	278 x 175 x 190	0	1	B13	4047 023 479 570	16,45	48	LN3
588 403 074	0 092 S30 120	S3 012					88	740	353 x 175 x 175	0	1	B13	4047 023 479 457	19,78	36	LBN5
590 122 072	0 092 S30 130	S3 013					90	720	353 x 175 x 190	0	1	B13	4047 023 479 464	20,43	36	LN5
545 077 030	0 092 S30 160	S3 016					45	300	220 x 135 x 225	0	1	B01	4047 023 573 278	10,78	78	E2
545 079 030	0 092 S30 170	S3 017					45	300	220 x 135 x 225	1	1	B01	4047 023 573 261	10,78	78	E2
S3 / 6 V																
066 017 036	0 092 S30 600	S3 060					66	360	178 x 175 x 188	0	1	B04	4047 024 437 708	9,50	96	6V
077 015 036	0 092 S30 610	S3 061					77	360	216 x 170 x 191	0	1	B06	4047 024 437 692	11,50	96	6V

¹⁾ Maßabweichung +/- 2mm / Permissible dimensional deviation of +/- 2mm / Écart de mesure de +/- 2 mm / Tolleranza dimensionale +/- 2 mm / desviación de la medida +/- 2mm / Divergência de medida +/- 2mm / Mittapoiikkeama +/- 2mm / Odchylenie wymiarów +/- 2 mm / Rozměrové odchylky +/- 2mm / Отклонение от размера +/- 2 мм





A50

de	en	fr	it	es
Bosch-Batterie S5A – S4 E für Pkw 12 V	Bosch battery S5A – S4 E for cars 12 V	Batterie Bosch S5A – S4 E pour véhicules particuliers 12 V	Batteria Bosch S5A – S4 E per autovetture 12 V	Batería Bosch S5A – S4 E para turismos 12 V

i	ETN	Ah	A	1)	L T B	EAN	kg	max. pcs.	Group Size	
	Bosch Reference Short code	20 h	(EN)							
car	S5 A (12 V)									
	560 901 068 0 092 S5A 050 S5 A05	60	680			4 047 025 244 336	17,35	57	LN2	
	570 901 076 0 092 S5A 080 S5 A08	70	760			4 047 025 244 343	20,09	48	LN3	
	580 901 080 0 092 S5A 110 S5 A11	80	800			4 047 025 244 350	22,76	36	LN4	
	595 901 085 0 092 S5A 130 S5 A13	95	850			4 047 025 244 367	25,92	36	LN5	
	605 901 095 0 092 S5A 150 S5 A15	105	950			4 047 025 244 374	29,40	36	LN6	

1) Maßabweichung +/- 2mm / Permissible dimensional deviation of +/- 2mm / Écart de mesure de +/- 2 mm / Tolleranza dimensionale +/- 2 mm / desviación de la medida +/- 2mm / Divergència de medida +/- 2mm / Mittapoikkeama +/- 2mm / Odchylenie wymiarów +/- 2 mm / Rozměrové odchytky +/- 2mm / Отклонение от размера +/- 2 мм

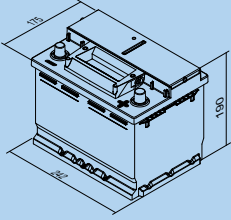
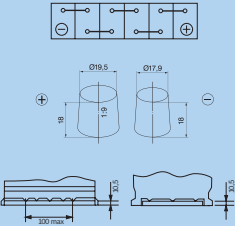
pt	fi	pl	cs	ru
Bateria Bosch S5A – S4 E para veículos de passeio 12 V	Bosch-akut S5A – S4 E, 12 V: henkiöautot	Akumulator Bosch S5A – S4 E do samochodów osobowych 12 V	Akumulátory Bosch S5A – S4 E pro osobní vozy 12 V	Аккумуляторы Bosch S5A – S4 E для легковых автомобилей 12 В

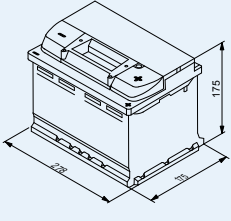
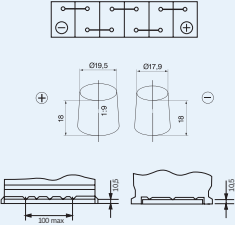
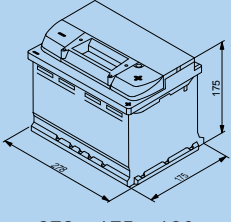
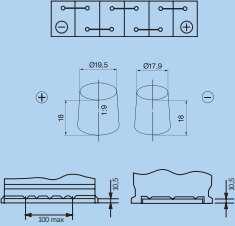
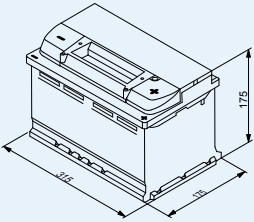
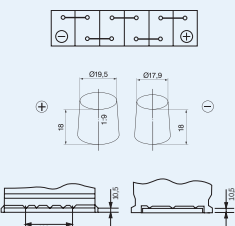
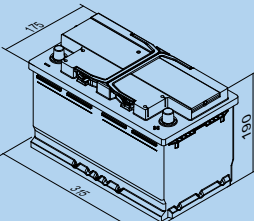
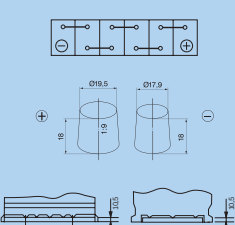
ETN Bosch Reference Short code	Ah 20 h	A (EN)	 1)	L T B	E A N	kg	 max. pcs.	Group Size	
S4 E (12 V)									
560 500 064 0 092 S4E 051 S4E05	60	640	 242 x 175 x 190		4 047 026 293 173	16,67	63	LN2	
565 500 065 0 092 S4E 070 S4 E07	65	760	 278 x 175 x 175		4 047 025 244 398	18,63	48	LBN3	
570 500 076 0 092 S4E 081 S4 E08	70	760	 278 x 175 x 190		4 047 026 293 180	19,14	48	LN3	
575 500 073 0 092 S4E 100 S4 E10	75	800	 315 x 175 x 175		4 047 025 244 411	21,19	42	LBN4	
580 500 080 0 092 S4E 111 S4 E11	80	800	 315 x 175 x 190		4 047 026 293 197	21,78	42	LN4	

de	en	fr	it	es
Bosch-Batterie S5A – S4 E für Pkw 12 V (Fortsetzung)	Bosch battery S5A – S4 E for cars 12 V (continued)	Batterie Bosch S5A – S4 E pour véhicules particuliers 12 V (suite)	Batteria Bosch S5A – S4 E per autovetture 12 V (seguito)	Batería Bosch S5A – S4 E para turismos 12 V (continuación)

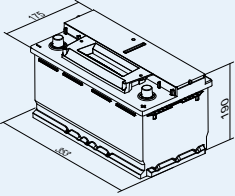
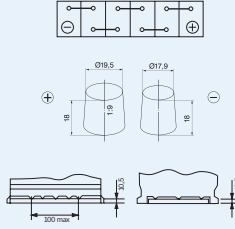
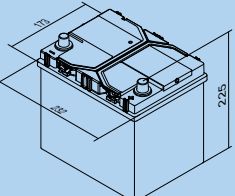
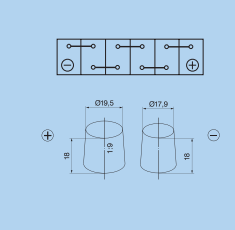
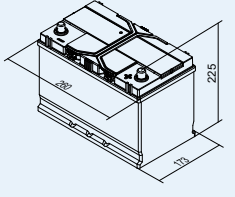
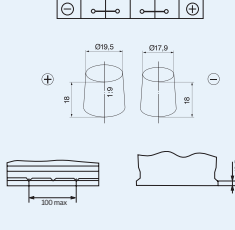
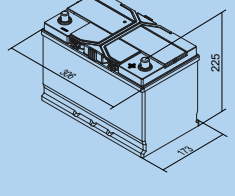
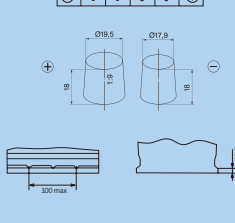
i	ETN	Ah	A	1)	L T B	EAN	kg	max. pcs.	Group Size
	Bosch Reference Short code	20 h	(EN)						
car	595 500 085 0 092 S4E 130 S4 E13	95	850			4 047 026 329 056	24,98	36	LN5
	565 501 065 0 092 S4E 400 S4 E40	65	650			4 047 026 328 998	16,93	54	D23
	572 501 076 0 092 S4E 410 S4 E41	72	760			4 047 026 329 018	19,55	48	D26
	585 501 080 0 092 S4E 420 S4 E42	80	800			4 047 026 329 025	21,69	42	D31



1) Maßabweichung +/- 2mm / Permissible dimensional deviation of +/- 2mm / Écart de mesure de +/- 2 mm / Tolleranza dimensionale +/- 2 mm / desviación de la medida +/- 2mm /
Divergència de medida +/- 2mm / Mittapoikkeama +/- 2mm / Odchylenie wymiarów +/- 2 mm / Rozměrové odchytky +/- 2mm / Отклонение от размера +/- 2 мм

A 54

de Bosch-Batterie S5-S4-S3 für Pkw 12 V	en Bosch battery S5-S4-S3 for cars 12 V	fr Batterie Bosch S5-S4-S3 pour véhicules particuliers 12 V	it Batteria Bosch S5-S4-S3 per autovetture 12 V	es Batería Bosch S5-S4-S3 para turismos 12 V
----------------------------------------------------------------------------------------	----------------------------------------------------------------------------------------	----------------------------------------------------------------------------------------------------------------------	------------------------------------------------------------------------------------------------	---------------------------------------------------------------------------------------------

i	ETN	Ah	A	1)	L T B	EAN	kg	max. pcs.	Group Size	
	Bosch Reference Short code	20 h	(EN)							
car	S5 (12 V)									
	552 401 052 0 092 S50 010 S5 001	52	520			4 047 023 479 426	11,97	72	LBN1	
	554 400 053 0 092 S50 020 S5 002	54	530			4 047 023 479 419	12,70	72	LN1	
	561 400 060 0 092 S50 040 S5 004	61	600			4 047 023 479 334	13,99	63	LBN2	
	563 400 061 0 092 S50 050 S5 005	63	610			4 047 023 479 358	14,85	63	LN2	
563 401 061 0 092 S50 060 S5 006	63	610			4 047 023 479 365	14,85	63	LN2		

pt Bateria Bosch S5-S4-S3 para veículos de passeio 12 V	fi Bosch-akut S5-S4-S3, 12 V: henkiöautot	pl Akumulator Bosch S5-S4-S3 do samochodów osobowych 12 V	cs Akumulátory Bosch S5-S4-S3 pro osobní vozy 12 V	ru Аккумуляторы Bosch S5-S4-S3 для легковых автомобилей 12 В
--------------------------------------------------------------------------	------------------------------------------------------------	----------------------------------------------------------------------------	---------------------------------------------------------------------	-------------------------------------------------------------------------------

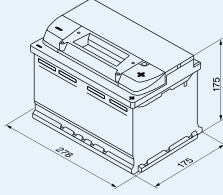
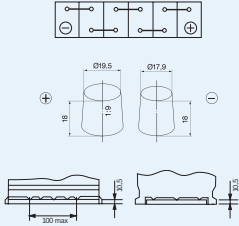
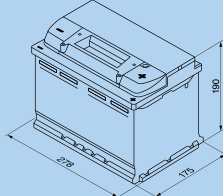
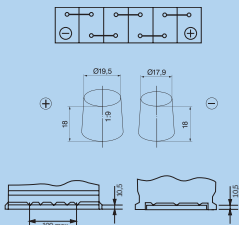
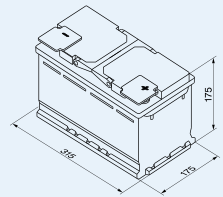
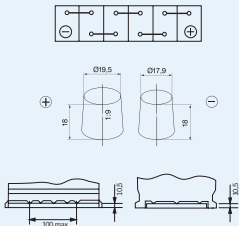
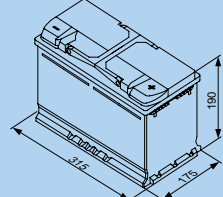
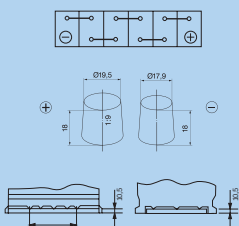
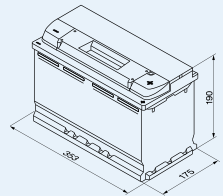
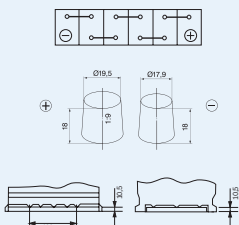
ETN Bosch Reference Short code	Ah 20 h	A (EN)	 1)	L T B	E A N	kg	 max. pcs.	Group Size
S5 (12 V)								
574 402 075 0 092 S50 070 S5 007	74	750	 278 x 175 x 175		4 047 023 479 563	16,98	48	LBN3
577 400 078 0 092 S50 080 S5 008	77	780	 278 x 175 x 190		4 047 023 479 617	17,54	48	LN3
585 200 080 0 092 S50 100 S5 010	85	800	 315 x 175 x 175		4 047 023 573 230	18,79	42	LBN4
585 400 080 0 092 S50 110 S5 011	85	800	 315 x 175 x 190		4047 024 937 598	19,36	42	LN4
600 402 083 0 092 S50 130 S5 013	100	830	 353 x 175 x 190		4 047 023 479 495	21,71	36	LN5

1) Maßabweichung +/- 2mm / Permissible dimensional deviation of +/- 2mm / Écart de mesure de +/- 2 mm / Tolleranza dimensionale +/- 2 mm / desviación de la medida +/- 2mm / Divergència de medida +/- 2mm / Mittapoikkeama +/- 2mm / Odchylenie wymiarów +/- 2 mm / Rozměrové odchylky +/- 2mm / Отклонение от размера +/- 2 мм

A 56

de	en	fr	it	es
Bosch-Batterie S5-S4-S3 für Pkw 12 V (Fortsetzung)	Bosch battery S5-S4-S3 for cars 12 V (continued)	Batterie Bosch S5-S4-S3 pour véhicules particuliers 12 V (suite)	Batteria Bosch S5-S4-S3 per autovetture 12 V (seguito)	Batería Bosch S5-S4-S3 para turismos 12 V (continuación)

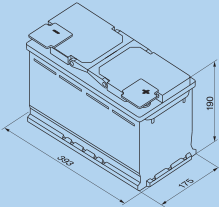
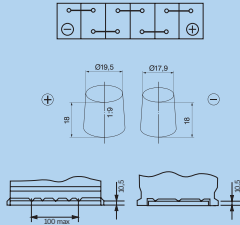
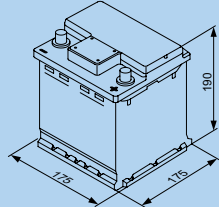
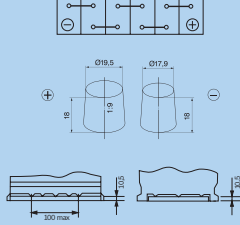
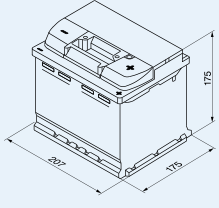
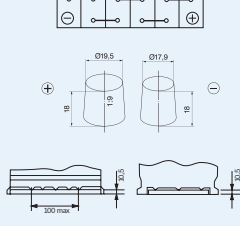
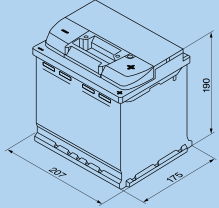
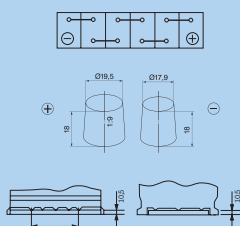
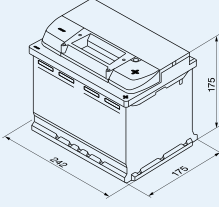
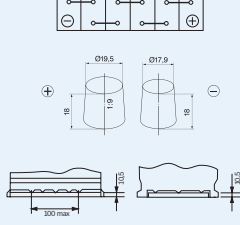
i	ETN	Ah	A	1)	L T B	EAN	kg	max. pcs.	Group Size
	Bosch Reference Short code	20 h	(EN)						
S5 (12 V)									
i	610 402 092	110	920			4 047 024 016 989	23,91	36	LN6
	0 092 S50 150								
	S5 015								
S4 (12 V)									
i	544 401 042	44	420			4047 024 937 567	10,64	72	LNO
	0 092 S40 001								
	S4 000								
i	544 402 044	44	440			4 047 023 479 372	11,50	72	LBN1
	0 092 S40 010								
	S4 001								
i	552 400 047	52	470			4 047 023 479 389	12,16	72	LN1
	0 092 S40 020								
	S4 002								
i	560 409 054	60	540			4 047 023 479 297	13,59	63	LBN2
	0 092 S40 040								
	S4 004								

pt

Bateria Bosch S5-S4-S3 para veículos de passeio 12 V
(continuação)

fi

Bosch-akut S5-S4-S3, 12 V: henkiöautot
(jatkoa)

pl



Akumulator Bosch S5-S4-S3 do samochodów osobowych 12 V
(ciąg dalszy)

cs

Akumulátory Bosch S5-S4-S3 pro osobní vozy 12 V
(pokračování)

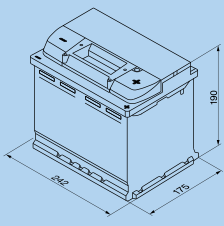
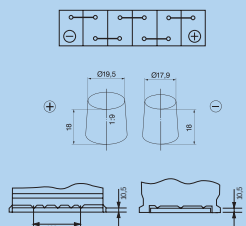
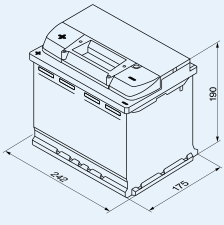
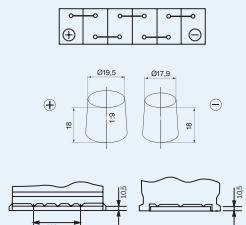
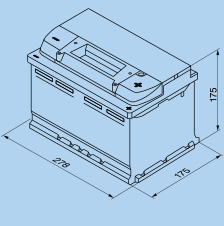
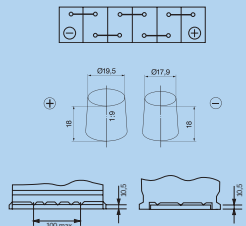
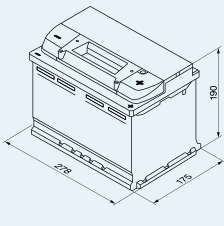
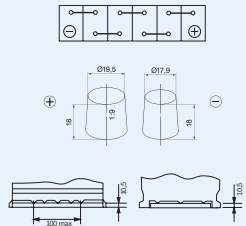
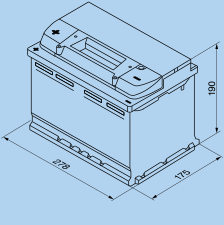
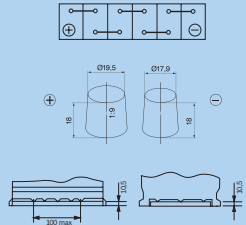

ru

Аккумуляторы Bosch S5-S4-S3 для легковых автомобилей 12 В
(продолжение)



ETN Bosch Reference Short code	Ah 20 h	A (EN)	 1)	L T B	E A N	 kg	 max. pcs.	Group Size
S4 (12 V)								
560 408 054 0 092 S40 050 S4 005	60	540	 242 x 175 x 190		4 047 023 479 310	14,69	63	LN2
560 127 054 0 092 S40 060 S4 006	60	540	 242 x 175 x 190		4 047 023 479 327	14,28	63	LN2
572 409 068 0 092 S40 070 S4 007	72	680	 278 x 175 x 175		4 047 023 479 549	16,70	48	LBN3
574 012 068 0 092 S40 080 S4 008	74	680	 278 x 175 x 190		4 047 023 479 594	17,54	48	LN3
574 013 068 0 092 S40 090 S4 009	74	680	 278 x 175 x 190		4 047 023 479 600	17,02	48	LN3

¹⁾ Maßabweichung +/- 2mm / Permissible dimensional deviation of +/- 2mm / Écart de mesure de +/- 2 mm / Tolleranza dimensionale +/- 2 mm / desviación de la medida +/- 2mm / Divergència de medida +/- 2mm / Mittapoikkeama +/- 2mm / Odchylenie wymiarów +/- 2 mm / Rozměrové odchylky +/- 2mm / Отклонение от размера +/- 2 мм

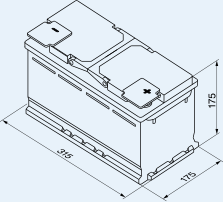
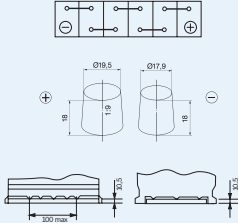
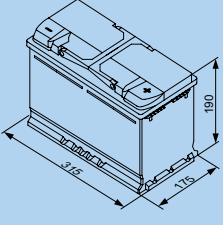
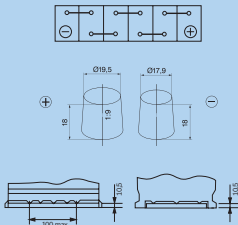
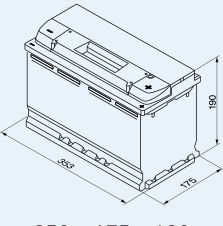
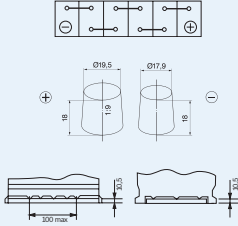
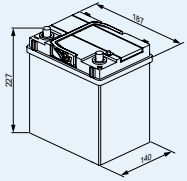
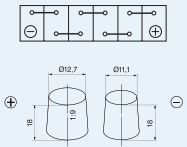
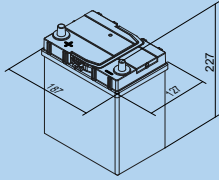
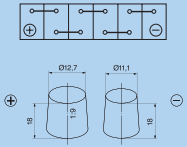
de Bosch-Batterie S5-S4-S3 für Pkw 12 V (Fortsetzung)	en Bosch battery S5-S4-S3 for cars 12 V (continued)	fr Batterie Bosch S5-S4-S3 pour véhicules particuliers 12 V (suite)	it Batteria Bosch S5-S4-S3 per autovetture 12 V (seguito)	es Batería Bosch S5-S4-S3 para turismos 12 V (continuación)
---------------------------------------------------------------------------------------------------------	-------------------------------------------------------------------------------------------------------	---------------------------------------------------------------------------------------------------------------------------------	-------------------------------------------------------------------------------------------------------------	---------------------------------------------------------------------------------------------------------------

i	ETN Bosch Reference Short code	Ah 20 h	A (EN)	1) 	L T B	EAN	kg	 max. pcs.	Group Size	
										S4 (12 V)
	580 406 074 0 092 S40 100 S4 010	80	740	 315 x 175 x 175		4 047 023 479 648	18,79	42	LBN4	
	580 400 074 0 092 S40 110 S4 011	80	740	 315 x 175 x 190		4 047 024 937 581	18,69	42	LN4	
	595 402 080 0 092 S40 130 S4 013	95	800	 353 x 175 x 190		4 047 023 479 471	21,12	36	LN5	
S4 (12 V) Asiatische Typen / Asiatic models / Types asiatiques / Tipi asiatici / Tipos asiáticos / Para vehículos asiáticos / Ajoneuvot Aasian maista / Do pojazdów azjatyckich / Pro asijská vozidla / Для азиатских автомобилей										
	540 126 033 0 092 S40 180 S4 018	40	330	 187 x 140 x 227 JIS		4 047 023 479 990	9,74	84	B19H	
	540 127 033 0 092 S40 190 S4 019	40	330	 187 x 127 x 227 JIS		4 047 023 479 808	9,74	84	B19R	

pt	fi	pl	cs	ru
Bateria Bosch S5-S4-S3 para veículos de passeio 12 V (continuação)	Bosch-akut S5-S4-S3, 12 V: henkiöautot (jatkoa)	Akumulator Bosch S5-S4-S3 do samochodów osobowych 12 V (ciąg dalszy)	Akumulátory Bosch S5-S4-S3 pro osobní vozy 12 V (pokračování)	Аккумуляторы Bosch S5-S4-S3 для легковых автомобилей 12 В (продолжение)

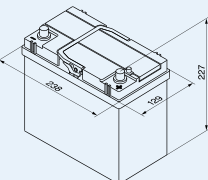
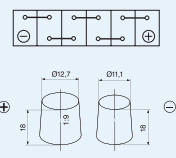
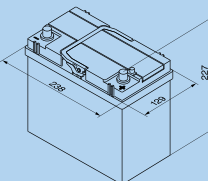
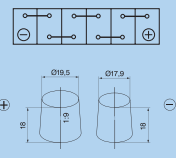
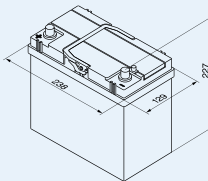
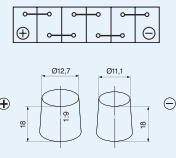
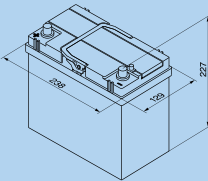
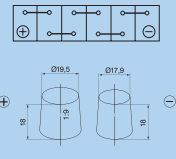
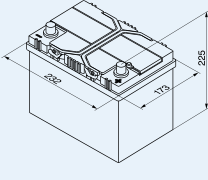
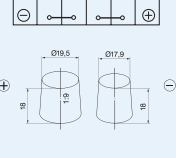
ETN Bosch Reference Short code	Ah 20 h	A (EN)	 ¹⁾	L T B	E A N	 kg	 max. pcs.	Group Size
S4 (12 V) Asiatische Typen / Asiatic models / Types asiatiques / Tipi asiatici / Tipos asiáticos / Para vehículos asiáticos / Ajoneuvot Aasian maista / Do pojazdów azjatyckich / Pro asijská vozidla / Для азиатских автомобилей								
545 155 033 0 092 S40 200 S4 020	45	330	 238 x 129 x 227 JIS		4 047 023 479 822	11,43	72	B24
545 156 033 0 092 S40 210 S4 021	45	330	 238 x 129 x 227 JIS		4 047 023 479 839	11,43	72	B24R
545 157 033 0 092 S40 220 S4 022	45	330	 238 x 129 x 227 JIS		4 047 023 479 846	11,43	72	B24RS
545 158 033 0 092 S40 230 S4 023	45	330	 238 x 129 x 227 JIS		4 047 023 479 853	11,43	72	B24RS
560 410 054 0 092 S40 240 S4 024	60	540	 232 x 173 x 225 JIS		4 047 023 479 877	14,11	54	D23R

JIS (= Japanese Industrial Standard) = für asiatische Fahrzeuge / for Asiatic vehicles / pour véhicules asiatiques / per veicoli asiatici / para vehículos asiáticos

Para vehículos asiáticos / Ajoneuvot Aasian maista / Do pojazdów azjatyckich / Pro asijská vozidla / Для азиатских автомобилей







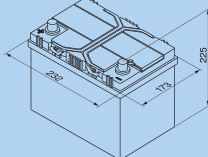
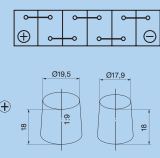
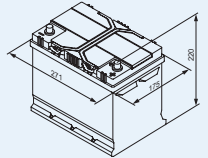
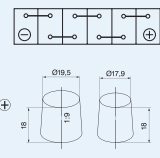
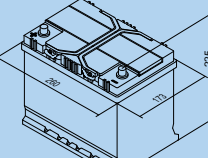
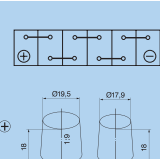
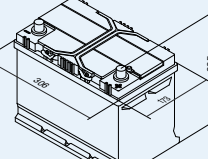
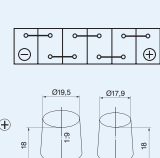
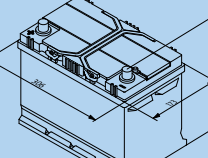
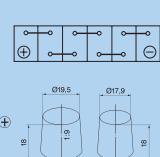





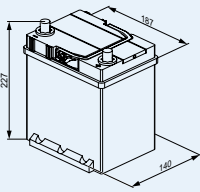
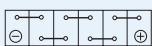
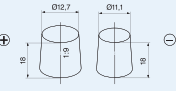

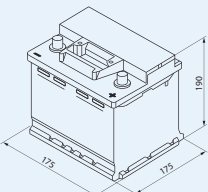
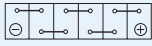
¹⁾ Maßabweichung +/- 2mm / Permissible dimensional deviation of +/- 2mm / Écart de mesure de +/- 2 mm / Tolleranza dimensionale +/- 2 mm / desviación de la medida +/- 2mm / Divergência de medida +/- 2mm / Mittapoikkeama +/- 2mm / Odchylenie wymiarów +/- 2 mm / Rozměrové odchyly +/- 2mm / Отклонение от размера +/- 2 мм

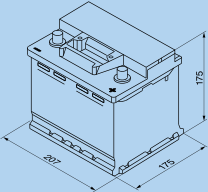
A 60

de Bosch-Batterie S5-S4-S3 für Pkw 12 V (Fortsetzung)	en Bosch battery S5-S4-S3 for cars 12 V (continued)	fr Batterie Bosch S5-S4-S3 pour véhicules particuliers 12 V (suite)	it Batteria Bosch S5-S4-S3 per autovetture 12 V (seguito)	es Batería Bosch S5-S4-S3 para turismos 12 V (continuación)
---------------------------------------------------------------------------------------------------------	-------------------------------------------------------------------------------------------------------	---------------------------------------------------------------------------------------------------------------------------------	-------------------------------------------------------------------------------------------------------------	---------------------------------------------------------------------------------------------------------------

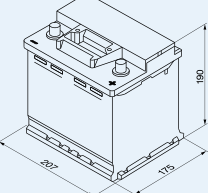
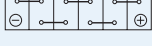
i	ETN	Ah	A	1)	L T B	EAN	kg	max. pcs.	Group Size	
	Bosch Reference Short code	20 h	(EN)							
i	S4 (12 V) Asiatische Typen / Asiatic models / Types asiatiques / Tipi asiatici / Tipos asiáticos / Para vehículos asiáticos / Ajoneuvot Aasian maista / Do pojazdów azjatyckich / Pro asijská vozidla / Для азиатских автомобилей									
	560 411 054 0 092 S40 250 S4 025	60	540	 232 x 173 x 225 JIS		4 047 023 479 884	14,11	54	D23R	
	570 412 063 0 092 S40 260 S4 026	70	630	 260 x 175 x 225 JIS		4 047 023 479 730	16,24	48	D31R	
	570 413 063 0 092 S40 270 S4 027	70	630	 260 x 175 x 225 JIS		4 047 023 479 747	16,24	48	D26R	
	595 404 083 0 092 S40 280 S4 028	95	830	 306 x 173 x 225 JIS		4 047 023 479 891	20,23	39	D31	
595 405 083 0 092 S40 290 S4 029	95	830	 306 x 173 x 225 JIS		4 047 023 479 907	20,23	39	D31R		

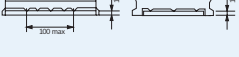
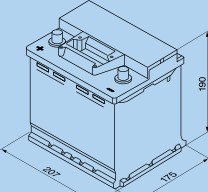
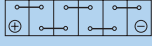
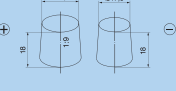
pt Bateria Bosch S5-S4-S3 para veículos de passeio 12 V (continuação)	fi Bosch-akut S5-S4-S3, 12 V: henkiöautot (jatkoa)	pl Akumulator Bosch S5-S4-S3 do samochodów osobowych 12 V (ciąg dalszy)	cs Akumulátory Bosch S5-S4-S3 pro osobní vozy 12 V (pokračování)	ru Аккумуляторы Bosch S5-S4-S3 для легковых автомобилей 12 В (продолжение)
-------------------------------------------------------------------------------------------	------------------------------------------------------------------------	---------------------------------------------------------------------------------------------	--------------------------------------------------------------------------------------	------------------------------------------------------------------------------------------------

ETN Bosch Reference Short code	Ah 20 h	A (EN)	 L x W x H	L T B	E A N	kg	 max. pcs.	Group Size
S4 (12 V) Asiatische Typen / Asiatic models / Types asiatiques / Tipi asiatici / Tipos asiáticos / Para vehículos asiáticos / Ajoneuvot Aasian maista / Do pojazdów azjatyckich / Pro asijská vozidla / Для азиатских автомобилей								
540 125 033 0 092 S40 300 S4 030	40	330	 187 x 140 x 227 JIS	  	4 047 024 891 012	9,74	84	B19H
S3 (12 V)								
540 406 034 0 092 S30 000 S3 000	40	340	 175 x 175 x 190	  	4 047 024 659 407	9,78	72	LN0
541 400 036 0 092 S30 010 S3 001	41	360	 207 x 175 x 175	  	4 047 023 479 204	10,76	72	LBN1
545 412 040 0 092 S30 020 S3 002	45	400	 207 x 175 x 190	  	4 047 023 479 228	11,57	72	LN1
545 413 040 0 092 S30 030 S3 003	45	400	 207 x 175 x 190	  	4 047 023 479 242	11,57	72	LN1

JIS (= Japanese Industrial Standard) = für asiatische Fahrzeuge / for Asiatic vehicles / pour véhicules asiatiques / per veicoli asiatici / para vehículos asiáticos

Para vehículos asiáticos / Ajoneuvot Aasian maista / Do pojazdów azjatyckich / Pro asijská vozidla / Для азиатских автомобилей

¹⁾ Maßabweichung +/- 2mm / Permissible dimensional deviation of +/- 2mm / Écart de mesure de +/- 2 mm / Tolleranza dimensionale +/- 2 mm / desviación de la medida +/- 2 mm /





Divergência de medida +/- 2mm / Mittapoikkeama +/- 2mm / Odchylenie wymiarów +/- 2 mm / Rozměrové odchylky +/- 2mm / Отклонение от размера +/- 2 мм

de Bosch-Batterie S5-S4-S3 für Pkw 12 V (Fortsetzung)	en Bosch battery S5-S4-S3 for cars 12 V (continued)	fr Batterie Bosch S5-S4-S3 pour véhicules particuliers 12 V (suite)	it Batteria Bosch S5-S4-S3 per autovetture 12 V (seguito)	es Batería Bosch S5-S4-S3 para turismos 12 V (continuación)
---------------------------------------------------------------------------------------------------------	-------------------------------------------------------------------------------------------------------	---------------------------------------------------------------------------------------------------------------------------------	-------------------------------------------------------------------------------------------------------------	---------------------------------------------------------------------------------------------------------------

i	ETN	Ah	A	1)	L T B	EAN	kg	max. pcs.	Group Size
	Bosch Reference Short code	20 h	(EN)						
S3 (12 V)									
i	553 401 050 0 092 S30 041 S3 004	53	500			4 047 024 937 574	13,41	63	LBN2
	242 x 175 x 175								
i	556 400 048 0 092 S30 050 S3 005	56	480			4 047 023 479 266	13,47	63	LN2
	242 x 175 x 190								
i	556 401 048 0 092 S30 060 S3 006	56	480			4 047 023 479 280	13,47	63	LN2
	242 x 175 x 190								
i	570 144 064 0 092 S30 070 S3 007	70	640			4 047 023 479 525	15,73	48	LBN3
	278 x 175 x 175								
i	570 409 064 0 092 S30 080 S3 008	70	640			4 047 023 479 570	16,45	48	LN3
	278 x 175 x 190								

1) Maßabweichung +/- 2mm / Permissible dimensional deviation of +/- 2mm / Écart de mesure de +/- 2 mm / Tolleranza dimensionale +/- 2 mm / desviación de la medida +/- 2mm / Divergència de medida +/- 2mm / Mittapoikkeama +/- 2mm / Odchylenie wymiarów +/- 2 mm / Rozměrové odchytky +/- 2mm / Отклонение от размера +/- 2 мм

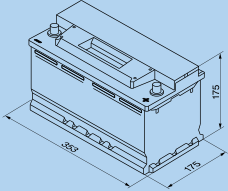
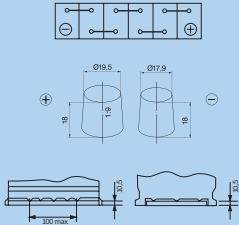
pt	fi	pl	cs	ru
Bateria Bosch S5-S4-S3 para veículos de passeio 12 V (continuação)	Bosch-akut S5-S4-S3, 12 V: henkiöautot (jatkoa)	Akumulator Bosch S5-S4-S3 do samochodów osobowych 12 V (ciąg dalszy)	Akumulátory Bosch S5-S4-S3 pro osobní vozy 12 V (pokračování)	Аккумуляторы Bosch S5-S4-S3 для легковых автомобилей 12 В (продолжение)

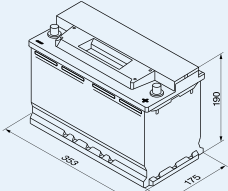
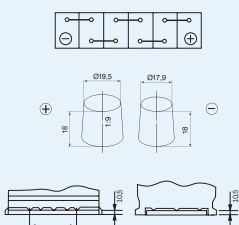
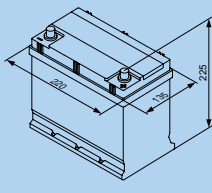
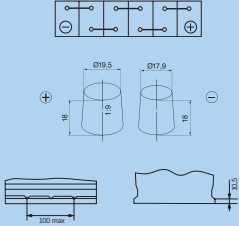
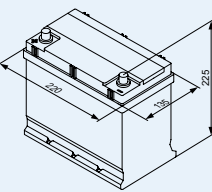
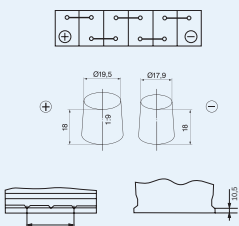
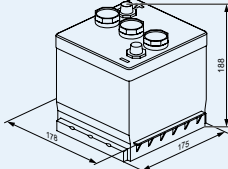
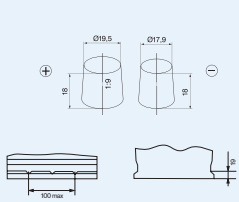
ETN Bosch Reference Short code	Ah 20 h	A (EN)	 1)	L T B	E A N	kg	 max. pcs.	Group Size	
S3 (12 V)									
588 403 074 0 092 S30 120 S3 012	88	740	 353 x 175 x 175		4 047 023 479 457	19,78	36	LBN5	
590 122 072 0 092 S30 130 S3 013	90	720	 353 x 175 x 190		4 047 023 479 464	20,43	36	LN5	
545 077 030 0 092 S30 160 S3 016	45	300	 220 x 135 x 225		4 047 023 573 278	10,78	78	E2	
545 079 030 0 092 S30 170 S3 017	45	300	 220 x 135 x 225		4 047 023 573 261	10,78	78	E2	
S3 (6 V)									
066 017 036 0 092 S30 600 S3 060	66	360	 178 x 175 x 188		4 047 024 437 708	9,50	96	6V	

A 64

de

Bosch-Batterie
S5-S4-S3
für Pkw
12 V
 (Fortsetzung)

en

Bosch battery
S5-S4-S3
for cars
12 V
 (continued)

fr

Batterie Bosch
S5-S4-S3
pour véhicules
particuliers
12 V
 (suite)

it

Batteria Bosch
S5-S4-S3
per autovetture
12 V
 (seguito)

es

Batería Bosch
S5-S4-S3
para turismos
12 V
 (continuación)

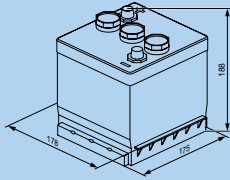
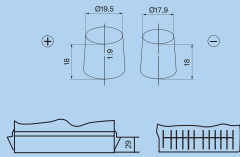
i	ETN	Ah	A	1)	L T B	EAN	kg	max. pcs.	Group Size
	Bosch Reference Short code	20 h	(EN)						
S3 (6 V)									
car	077 015 036	77	360	 <p>216 x 170 x 191</p>		4 047 024 437 692	11,50	96	6V
	0 092 S30 610								



BOSCH

Invented for life

Bosch TA – TE – T5 – T4 – T3

Automotive Aftermarket



de
Programmübersicht
Nfz

en
Product range
commercial vehicles

fr
Aperçu de la gamme
véhicules utilitaires

it
Panoramica della
gamma per veicoli
commerciali

es
Relación programa
vehículos
industriales

ETN	No	No	AGM Technology	EFB-Technology	Vibration Proof	Heavy Duty	Heavy Duty Extra	Ah 20 h	A (EN)		L	T	B	EAN	kg	Group Size
TA / 12 V ²⁾																
710 901 120	0 092 TA0 800	TA 080	•	•	•	•	•	210	1200	518 x 276 x 242	3	1	B00	4047 026 442 052	61,00	C
TE / 12 V																
690 500 105	0 092 TE0 777	TE 077	•	•	•	•	•	190	1050	513 x 223 x 223	3	1	B00	4047 026 011 050	46,99	B
740 500 120	0 092 TE0 888	TE 088	•	•	•	•	•	240	1200	518 x 276 x 242	3	1	B00	4047 026 011 067	59,47	C
T5 / 12 V																
645 400 080	0 092 T50 750	T5 075	•	•	•	•	•	145	800	513 x 189 x 223	3	1	B00	4047 024 345 058	37,12	A
680 108 100	0 092 T50 770	T5 077	•	•	•	•	•	180	1000	513 x 223 x 223	3	1	B00	4047 024 344 754	44,14	B
725 103 115	0 092 T50 800	T5 080	•	•	•	•	•	225	1150	518 x 276 x 242	3	1	B00	4047 024 345 041	57,50	C
T4 / 12 V																
640 103 080	0 092 T40 750	T4 075	•	•	•	•	•	140	800	513 x 189 x 223	3	1	B00	4047 024 345 126	35,76	A
640 400 080	0 092 T40 760	T4 076	•	•	•	•	•	140	800	513 x 189 x 223	3	1	B03	4047 024 344 716	35,76	A
670 103 100	0 092 T40 770	T4 077	•	•	•	•	•	170	1000	513 x 223 x 223	3	1	B00	4047 024 345 133	45,10	B
670 104 100	0 092 T40 780	T4 078	•	•	•	•	•	170	1000	513 x 223 x 223	3	1	B03	4047 024 345 140	44,20	B
715 400 115	0 092 T40 800	T4 080	•	•	•	•	•	215	1150	518 x 276 x 242	3	1	B00	4047 024 345 157	56,75	C
T3 / 6 V																
700 110 030	0 092 T30 600	T3 060						70	300	175 x 167 x 220	0	1	B00	4047 024 345 126	9,35	M1
112 025 051	0 092 T30 610	T3 061						112	510	260 x 175 x 238	0	1	B01	4047 024 344 716	16,50	M4
140 023 072	0 092 T30 620	T3 062						140	720	260 x 175 x 236	0	1	B01	4047 024 345 133	19,50	M4
150 030 076	0 092 T30 630	T3 063						150	760	333 x 175 x 235	0	1	B11	4047 024 345 140	23,80	M5
200 023 095	0 092 T30 640	T3 064						200	950	403 x 175 x 235	0	DP	B11	4047 024 345 157	31,00	M6
T3 / 12 V																
545 200 030	0 092 T30 010	T3 001						45	300	207 x 175 x 175	0	1	B13	4047 024 344 761	10,76	LBN1
555 064 042	0 092 T30 050	T3 005						55	420	242 x 175 x 190	0	1	B13	4047 024344778	13,44	LN2
566 047 051	0 092 T30 080	T3 008						66	510	278 x 175 x 190	0	1	B03	4047 024 344 785	15,83	LN3
588 038 068	0 092 T30 130	T3 013						88	680	353 x 174 x 190	0	1	B13	4047 024 344 792	20,34	LN5
590 040 054	0 092 T30 300	T3 030		•				90	540	346 x 173 x 236	0	1	B00	4047 024 344 808	25,20	D2
590 041 054	0 092 T30 310	T3 031		•				90	540	346 x 173 x 236	1	1	B00	4047 024 344 815	27,43	D2
600 123 072	0 092 T30 320	T3 032		•				100	720	315 x 175 x 210	0	1	B03	4047 024 344 822	22,34	GB28
610 047 068	0 092 T30 350	T3 035		•	•			110	680	346 x 173 x 236	0	1	B00	4047 024 344 839	28,58	D2
610 048 068	0 092 T30 360	T3 036		•	•			110	680	346 x 173 x 236	1	1	B00	4047 024 344 846	28,58	D2
610 048 068	0 092 T30 370	T3 037		•	•			110	680	346 x 173 x 236	0	1	B01	4047 024 344 853	28,58	D2
610 013 076	0 092 T30 380	T3 038		•	•			110	760	514 x 175 x 210	3	1	B03	4047 024 344 860	32,31	MAC 110
620 109 076	0 092 T30 390	T3 039		•	•			120	760	510 x 175 x 227	4	1	B03	4047 024 345 089	35,12	MAC 120
625 012 072	0 092 T30 400	T3 040		•				125	720	344 x 172 x 285	0	1	B00	4047 024 344 877	31,22	D3
625 014 072	0 092 T30 410	T3 041		•				125	720	344 x 172 x 285	1	1	B00	4047 024 344 884	31,22	D3
625 023 000	0 092 T30 420	T3 042		•				125	1000	284 x 269 x 230	2	1	B00	4047 024 345 096	36,80	D7
630 014 068	0 092 T30 430	T3 043		•	•			130	680	514 x 218 x 205	3	1	B00	4047 024 344 891	37,83	MAC 130
635 042 068	0 092 T30 440	T3 044		•				135	680	360 x 253 x 240	6	1	B11	4047 024 345 102	42,30	12C135
635 052 100	0 092 T30 450	T3 045		•	•			135	1000	514 x 175 x 210	3	1	B03	4047 024 344 907	35,46	MAC 110
643 107 090	0 092 T30 460	T3 046		•				143	900	508 x 174 x 205	0	1	B01	4047 024 345 119	36,50	MAC 132
643 033 095	0 092 T30 470	T3 047		•	•			143	950	514 x 218 x 210	3	1	B03	4047 024 344 747	39,85	MAC 140
655 104 090	0 092 T30 480	T3 048		•	•			155	900	516 x 218 x 223	4	1	B03	4047 024 344 914	42,88	MAC 154
605 102 080	0 092 T30 500	T3 050		•	•			105	800	329 x 172 x 237	9	1	B01	4047 025 290 616	23,70	GR31
605 103 080	0 092 T30 520	T3 052		•	•			105	800	329 x 172 x 237	9	8	B01	4047 025 290 593	23,70	GR31
654 011 115	0 092 T30 540	T3 054		•	•			154	1150	513 x 189 x 223	3	1	B00	4047 025 290 562	39,84	A
680 011 140	0 092 T30 550	T3 055		•	•			180	1400	513 x 223 x 223	3	1	B00	4047 025 290 609	46,42	B
690 033 120	0 092 T30 560	T3 056		•	•			190	1200	513 x 223 x 223	4	1	B03	4047 025 290 555	44,99	B
600 035 060	0 092 T30 710	T3 071		•	•			100	600	412 x 175 x 219	1	1	B00	4047 024 344 921	27,43	D
600 047 060	0 092 T30 720	T3 072		•	•			100	600	412 x 175 x 219	0	1	B00	4047 024 344 938	26,70	D
610 050 085	0 092 T30 730	T3 073		•	•			110	850	412 x 175 x 219	0	1	B03	4047 024 344 945	29,60	D
620 045 068	0 092 T30 750	T3 075		•	•			120	680	513 x 189 x 223	3	1	B00	4047 024 344 952	33,64	A
655 013 090	0 092 T30 770	T3 077		•	•			155	900	513 x 223 x 223	3	1	B00	4047 024 344 969	40,98	B
680 033 110	0 092 T30 790	T3 079		•	•			180	1100	513 x 223 x 223	4	1	B03	4047 024 344 976	44,99	B

pt

Vista geral do programa veículos utilitários

fi

Tuotevalikoimat – hyötyajoneuvot

pl

Przegląd asortymentu – samochody dostawcze

cs

Přehled výrobního programu pro užitková vozidla

ru

Обзор программ для коммерческих автомобилей

ETN	No	No	AGM Technology	EFB-Technology	Vibration Proof	Heavy Duty	Heavy Duty Extra	Ah 20 h	A (EN)		L	T	B	EAN	kg	Group Size
700 038 105	0 092 T30 800	T3 080				•	•	200	1050	518 x 276 x 242	3	1	B00	4047 024 344 983	53,61	C
720 018 115	0 092 T30 810	T3 081				•	•	220	1150	518 x 291 x 242	3	1	B00	4047 024 344 990	56,79	D6

¹⁾ Maßabweichung +/- 2mm / Permissible dimensional deviation of +/- 2mm / Écart de mesure de +/- 2 mm / Tolleranza dimensionale +/- 2 mm / desviación de la medida +/- 2mm /

Divergència de medida +/- 2mm / Mittapoikkeama +/- 2mm / Odchylenie wymiarów +/- 2 mm / Rozměrové odchylky +/- 2mm / Отклонение от размера +/- 2 мм

²⁾ Verfügbar ab Q4/2019 / Will be available in Q4/2019 / Sera disponible au 4e trimestre 2019 / Disponibile nel T4/2019 / Estará disponible en el cuarto trimestre de 2019 /

Estará disponível no 4.º trimestre de 2019 / Tulee saataville Q4/2019 / Będzie dostępny w 4 kwartale 2019 r. / Bude k dispozici ve 4. čtvrtletí 2019 / Будет доступно в 4 квартале 2019 года

de

Bosch-Batterien
TE – T5 – T4 – T3 für
Nutzfahrzeuge
6 V/12 V

en

Bosch batteries
TE – T5 – T4 – T3 for
commercial vehicles
6 V/12 V

fr

Batteries Bosch
TE – T5 – T4 – T3 pour
véhicules utilitaires
6 V/12 V



it

Batterie Bosch
TE – T5 – T4 – T3 per
veicoli commerciali
6 V/12 V

es

Bosch Baterías
TE – T5 – T4 – T3 para
vehículos industriales
6 V/12 V



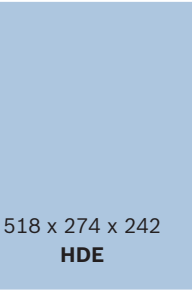
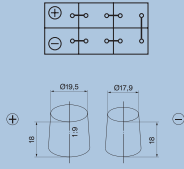
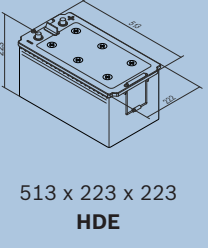
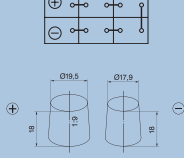
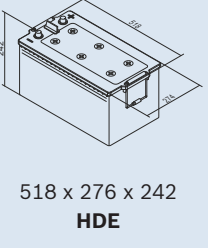
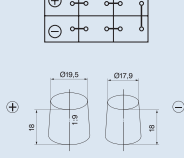
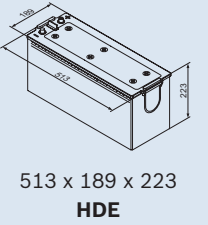
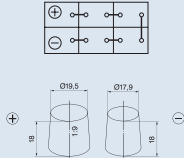

ETN Bosch Reference Short code	Ah 20 h	A (EN)	 ¹⁾	L T B	EAN		Group Size
TA (12 V)							
710 901 120 0 092 TA0 800 ²⁾ TA 080	210	1200	 518 x 274 x 242 HDE		4047 026 442 052	61,00	C
TE (12 V)							
690 500 105 0 092 TE0 777 TE 077	190	1050	 513 x 223 x 223 HDE		4 047 026 011 050	46,99	B
740 500 120 0 092 TE0 888 TE 088	240	1200	 518 x 276 x 242 HDE		4 047 026 011 067	59,47	C
T5 (12 V)							
645 400 080 0 092 T50 750 T5 075	145	800	 513 x 189 x 223 HDE		4 047 024 345 058	37,12	A

¹⁾ Maßabweichung +/- 2mm / Permissible dimensional deviation of +/- 2mm / Écart de mesure de +/- 2 mm / Tolleranza dimensionale +/- 2 mm / desviación de la medida +/- 2mm / Divergência de medida +/- 2mm / Mittapoikkeama +/- 2mm / Odchylenie wymiarów +/- 2 mm / Rozměrové odchylky +/- 2mm / Отклонение от размера +/- 2 мм

²⁾ Verfügbar ab Q4/2019 / Will be available in Q4/2019 / Sera disponible au 4e trimestre 2019 / Disponibile nel T4/2019 / Estará disponible en el cuarto trimestre de 2019 / Estará disponible no 4.º trimestre de 2019 / Tulee saataville Q4/2019 / Będzie dostępny w 4 kwartale 2019 r. / Bude k dispozici ve 4. čtvrtletí 2019 / Будет доступно в 4 квартале 2019 года

pt Baterias Bosch TE - T5 - T4 - T3 para veículos utilitários 6 V/12 V	fi Bosch-akut TE - T5 - T4 - T3, 6 V/12 V: hyötyajoneuvot	pl Akumulatory Bosch TE - T5 - T4 - T3 do samochodów dostaw- czych 6 V/12 V	cs Akumulátory Bosch TE - T5 - T4 - T3 pro užitková vozidla 6 V/12 V	ru Аккумуляторы Bosch TE - T5 - T4 - T3 для коммерческих автомобилей 6 В/12 В
-----------------------------------------------------------------------------------------------------------------------	----------------------------------------------------------------------------------------------------------	----------------------------------------------------------------------------------------------------------------------------	---------------------------------------------------------------------------------------------------------------------	----------------------------------------------------------------------------------------------------------------------------------------

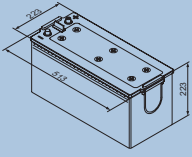
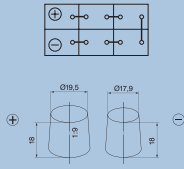
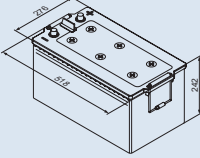
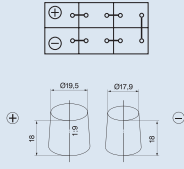
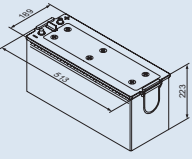
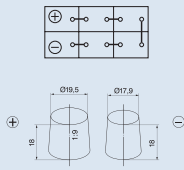
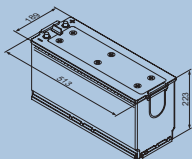
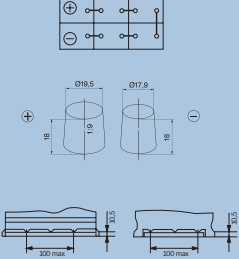
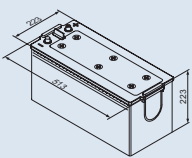
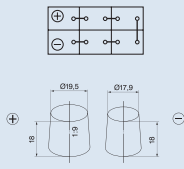
ETN Bosch Reference Short code	Ah 20 h	A (EN)		L T B	E A N		Group Size
T5 (12 V)							
680 108 100 0 092 T50 770 T5 077	180	1000	 513 x 223 x 223 HDE		4 047 024 344 754	44,14	B
725 103 115 0 092 T50 800 T5 080	225	1150	 518 x 276 x 242 HDE		4 047 024 345 041	57,50	C
T4 (12 V)							
640 103 080 0 092 T40 750 T4 075	140	800	 513 x 189 x 223 HD		4 047 024 345 126	35,76	A
640 400 080 0 092 T40 760 T4 076	140	800	 513 x 189 x 223 HD		4 047 024 344 716	35,76	A
670 103 100 0 092 T40 770 T4 077	170	1000	 513 x 223 x 223 HD		4 047 024 345 133	45,10	B

HD = Heavy Duty, HDE = Heavy Duty Extra

A70

de

Bosch-Batterien
TE – T5 – T4 – T3 für
Nutzfahrzeuge
6 V/12 V
 (Fortsetzung)

en

Bosch batteries
TE – T5 – T4 – T3 for
commercial vehicles
6 V/12 V
 (continued)

fr





Batteries Bosch
TE – T5 – T4 – T3 pour
véhicules utilitaires
6 V/12 V
 (suite)

it

Batterie Bosch
TE – T5 – T4 – T3 per
veicoli commerciali
6 V/12 V
 (seguito)

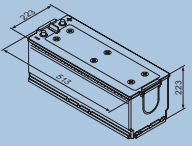
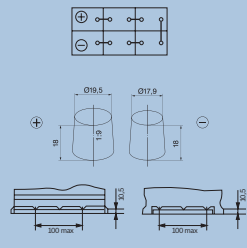
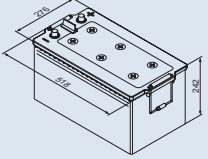
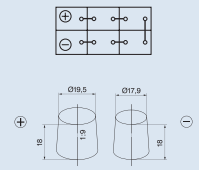
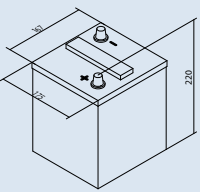
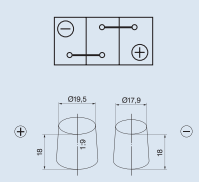
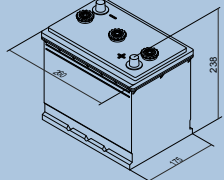
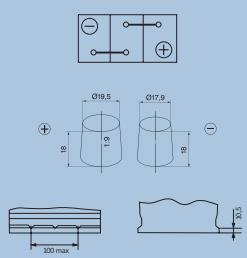

es

Bosch Baterías
TE – T5 – T4 – T3 para
vehículos industriales
6 V/12 V
 (continuación)

 ETN Bosch Reference Short code		Ah 20 h	A (EN)	 ¹⁾ 	L T B	EAN	 kg	Group Size
T4 (12 V)								
670 104 100 0 092 T40 780 T4 078	170	1000	 513 x 223 x 223 HD		4 047 024 345 140	44,20	B	
715 400 115 0 092 T40 800 T4 080	215	1150	 518 x 276 x 242 HD		4 047 024 345 157	56,75	C	
T3 (6 V)								
070 011 030 0 092 T30 600 T3 060	70	300	 175 x 167 x 220		4 047 024 345 126	9,35	M1	
112 025 051 0 092 T30 610 T3 061	112	510	 260 x 175 x 238 Rf		4 047 024 344 716	16,50	M4	

Rf = Rüttelfest / Vibration resistant / Résistant aux fortes vibrations / Resistente alle vibrazioni / Resistente a sacudidas / resistente à vibração / tārinānkestāvā / odporny na wstrząsy / Odolné otřesům / вибростойкость
HD = Heavy Duty

pt Baterias Bosch TE – T5 – T4 – T3 para veículos utilitários 6 V/12 V (continuação)	fi Bosch-akut TE – T5 – T4 – T3, 6 V/12 V: hyötyajoneuvot (jatkoa)	pl Akumulatory Bosch TE – T5 – T4 – T3 do samochodów dostaw- czych 6 V/12 V (ciąg dalszy)	cs Akumulátory Bosch TE – T5 – T4 – T3 pro užitková vozidla 6 V/12 V (pokračování)	ru Аккумуляторы Босх TE – T5 – T4 – T3 для коммерческих автомобилей 6 В/12 В (продолжение)
----------------------------------------------------------------------------------------------------------------------------------------	----------------------------------------------------------------------------------------------------------------------	---------------------------------------------------------------------------------------------------------------------------------------------	--------------------------------------------------------------------------------------------------------------------------------------	--------------------------------------------------------------------------------------------------------------------------------------------------------

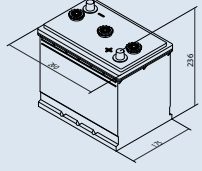
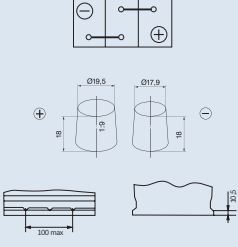
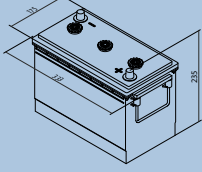
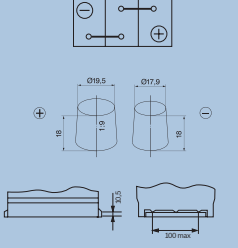
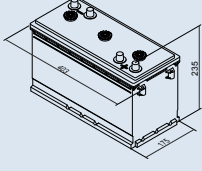
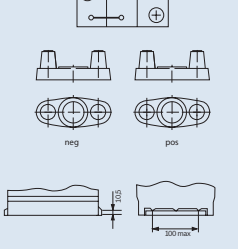
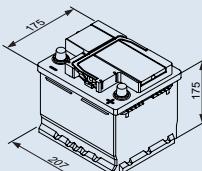
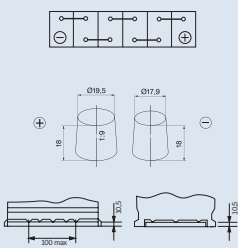
ETN Bosch Reference Short code	Ah 20 h	A (EN)		L T B	E A N		Group Size
T3 (6 V)							
140 023 072 0 092 T30 620 T3 062	140	720	 260 x 175 x 236 Rf		4 047 024 345 133	19,50	M4
150 030 076 0 092 T30 630 T3 063	150	760	 333 x 175 x 235 Rf		4 047 024 345 140	23,80	M5
200 023 095 0 092 T30 640 T3 064	200	950	 403 x 175 x 235 Rf		4 047 024 345 157	31,00	M6
T3 (12 V)							
545 200 030 0 092 T30 010 T3 001	45	300	 207 x 175 x 175 Rf		4 047 024 344 761	10,76	LBN1

¹⁾ Maßabweichung +/- 2mm / Permissible dimensional deviation of +/- 2mm / Écart de mesure de +/- 2 mm / Tolleranza dimensionale +/- 2 mm / desviación de la medida +/- 2mm / Divergencia de medida +/- 2mm / Mittapoikkeama +/- 2mm / Odchylenie wymiarów +/- 2 mm / Rozměrové odchylky +/- 2mm / Отклонение от размера +/- 2 мм

de

Bosch-Batterien
TE-T5-T4-T3 für
Nutzfahrzeuge
6 V/12 V
 (Fortsetzung)

en

Bosch batteries
TE-T5-T4-T3 for
commercial vehicles
6 V/12 V
 (continued)

fr



Batteries Bosch
TE-T5-T4-T3 pour
véhicules utilitaires
6 V/12 V
 (suite)

it

Batterie Bosch
TE-T5-T4-T3 per
veicoli commerciali
6 V/12 V
 (seguito)

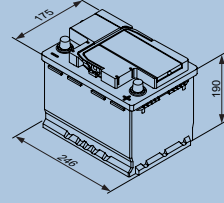
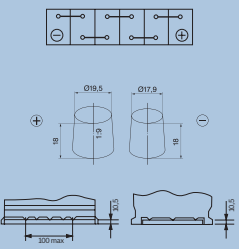
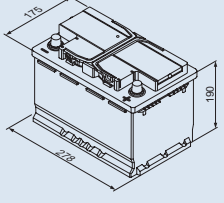
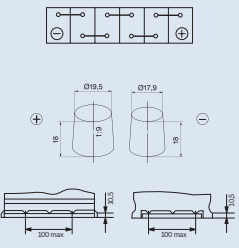
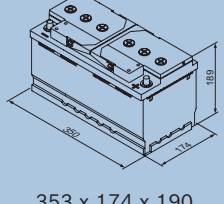
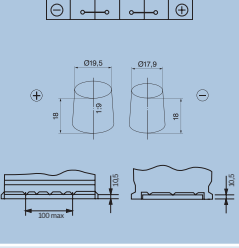
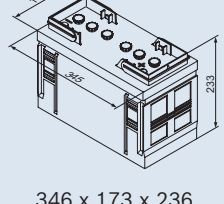
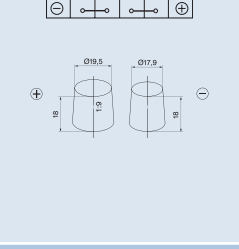
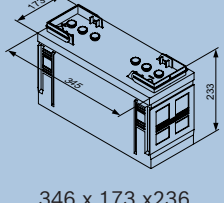
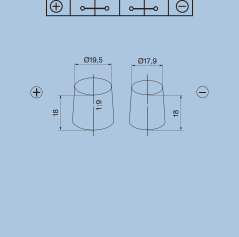

es

Bosch Baterías
TE-T5-T4-T3 para
vehículos industriales
6 V/12 V
 (continuación)

 ETN Bosch Reference Short code		Ah 20 h	A (EN)	 ¹⁾ L x W x H	L T B	EAN	 kg	Group Size
T3 (12 V)								
555 064 042 0 092 T30 050 T3 005	55	420	 242 x 175 x 190 Rf		4 047 024 344 778	13,44	LN2	
566 047 051 0 092 T30 080 T3 008	66	510	 278 x 175 x 190 HD		4 047 024 344 785	15,83	LN3	
588 038 068 0 092 T30 130 T3 013	88	680	 353 x 174 x 190 HD		4 047 024 344 792	20,34	LN5	
590 040 054 0 092 T30 300 T3 030	90	540	 346 x 173 x 236 Rf		4 047 024 344 808	25,20	D2	
590 041 054 0 092 T30 310 T3 031	90	540	 346 x 173 x 236 Rf		4 047 024 344 815	27,43	D2	

Rf = Rüttelfest / Vibration resistant / Résistant aux fortes vibrations / Resistente alle vibrazioni / Resistente a sacudidas / resistente à vibração / tārinānkestävä / odporny na wstrząsy / Odolné otřesům / вибростойкость
HD = Heavy Duty

pt Baterias Bosch TE-T5-T4-T3 para veículos utilitários 6 V/12 V (continuação)	fi Bosch-akut TE-T5-T4-T3, 6 V/12 V: hyötyajoneuvot (jatkoa)	pl Akumulatory Bosch TE-T5-T4-T3 do samochodów dostaw- czych 6 V/12 V (ciąg dalszy)	cs Akumulátory Bosch TE-T5-T4-T3 pro užitková vozidla 6 V/12 V (pokračování)	ru Аккумуляторы Босх TE-T5-T4-T3 для коммерческих автомобилей 6 В/12 В (продолжение)
----------------------------------------------------------------------------------------------------------------------------------	----------------------------------------------------------------------------------------------------------------	---------------------------------------------------------------------------------------------------------------------------------------	--------------------------------------------------------------------------------------------------------------------------------	--------------------------------------------------------------------------------------------------------------------------------------------------

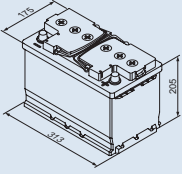
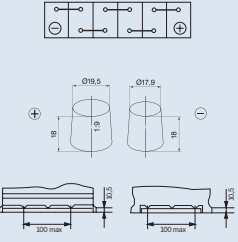
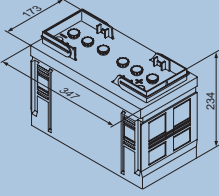
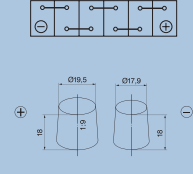
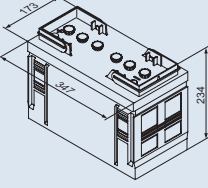
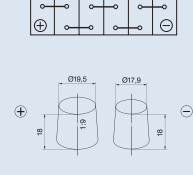
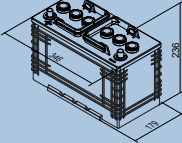
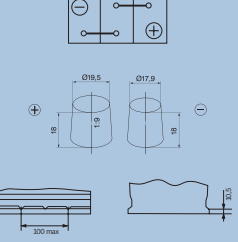
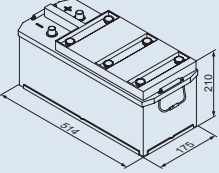
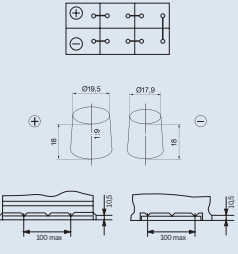
ETN Bosch Reference Short code	Ah 20 h	A (EN)		L T B	E A N		Group Size
T3 (12 V)							
600 123 072 0 092 T30 320 T3 032	100	720	 315 x 175 x 210		4 047 024 344 822	22,34	GB28
610 047 068 0 092 T30 350 T3 035	110	680	 346 x 173 x 236 HD		4 047 024 344 839	28,58	D2
610 048 068 0 092 T30 360 T3 036	110	680	 346 x 173 x 236 HD		4 047 024 344 846	28,58	D2
610 048 068 0 092 T30 370 T3 037	110	680	 346 x 173 x 236 HD		4 047 024 344 853	28,58	D2
610 013 076 0 092 T30 380 T3 038	110	760	 514 x 175 x 210 HD		4 047 024 344 860	32,31	MAC 110

¹⁾ Maßabweichung +/- 2mm / Permissible dimensional deviation of +/- 2mm / Écart de mesure de +/- 2 mm / Tolleranza dimensionale +/- 2 mm / desviación de la medida +/- 2mm / Divergència de medida +/- 2mm / Mittapoikkeama +/- 2mm / Odchylenie wymiarów +/- 2 mm / Rozměrové odchylky +/- 2mm / Отклонение от размера +/- 2 мм

A74

de

Bosch-Batterien
TE-T5-T4-T3 für
Nutzfahrzeuge
6 V/12 V
 (Fortsetzung)

en

Bosch batteries
TE-T5-T4-T3 for
commercial vehicles
6 V/12 V
 (continued)

fr



Batteries Bosch
TE-T5-T4-T3 pour
véhicules utilitaires
6 V/12 V
 (suite)

it

Batterie Bosch
TE-T5-T4-T3 per
veicoli commerciali
6 V/12 V
 (seguito)

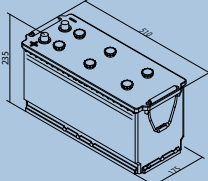
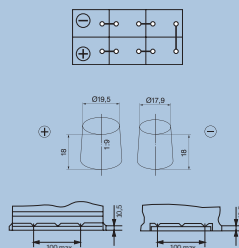
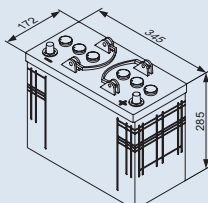
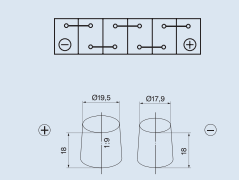
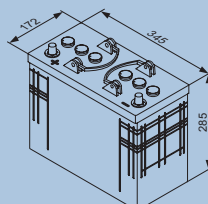
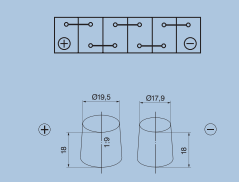
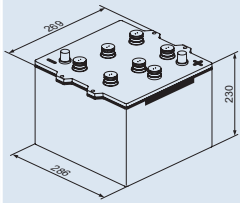
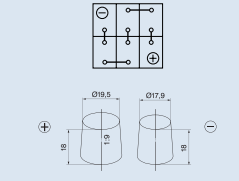
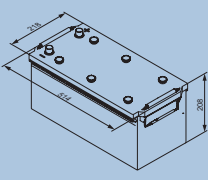
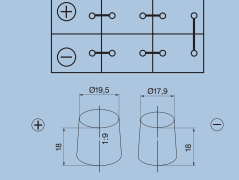

es

Bosch Baterías
TE-T5-T4-T3 para
vehículos industriales
6 V/12 V
 (continuación)

 ETN Bosch Reference Short code		Ah 20 h	A (EN)	 ¹⁾ L x W x H	L T B	EAN	 kg	Group Size
T3 (12 V)								
620 109 076 0 092 T30 390 T3 039	120	760	 510 x 175 x 227 HD		4 047 024 345 089	35,12	MAC 120	
625 012 072 0 092 T30 400 T3 040	125	720	 344 x 172 x 285 Rf		4 047 024 344 877	31,22	D3	
625 014 072 0 092 T30 410 T3 041	125	720	 344 x 172 x 285 Rf		4 047 024 344 884	31,22	D3	
625 023 000 0 092 T30 420 T3 042	125	1000	 286 x 269 x 230 Rf		4 047 024 345 096	36,80	D7	
630 014 068 0 092 T30 430 T3 043	130	680	 514 x 218 x 205 HD		4 047 024 344 891	37,83	MAC 130	

Rf = Rüttelfest / Vibration resistant / Résistant aux fortes vibrations / Resistente alle vibrazioni / Resistente a sacudidas / resistente à vibração / tärinänkestävä / odporny na wstrząsy / Odolné otřesům / вибростойкость
HD = Heavy Duty

pt Baterias Bosch TE-T5-T4-T3 para veículos utilitários 6 V/12 V (continuação)	fi Bosch-akut TE-T5-T4-T3, 6 V/12 V: hyötyajoneuvot (jatkoa)	pl Akumulatory Bosch TE-T5-T4-T3 do samochodów dostaw- czych 6 V/12 V (ciąg dalszy)	cs Akumulátory Bosch TE-T5-T4-T3 pro užitková vozidla 6 V/12 V (pokračování)	ru Аккумуляторы Бosch TE-T5-T4-T3 для коммерческих автомобилей 6 В/12 В (продолжение)
----------------------------------------------------------------------------------------------------------------------------------	----------------------------------------------------------------------------------------------------------------	---------------------------------------------------------------------------------------------------------------------------------------	--------------------------------------------------------------------------------------------------------------------------------	---------------------------------------------------------------------------------------------------------------------------------------------------

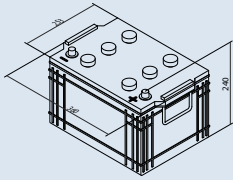
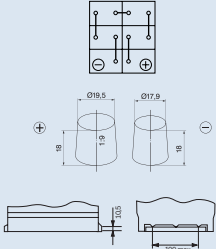
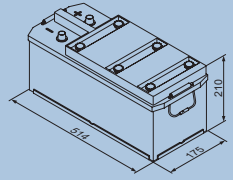
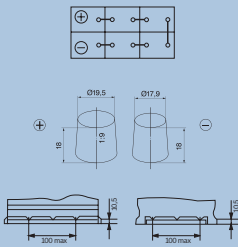
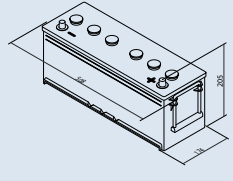
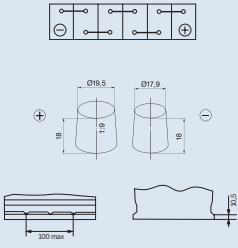
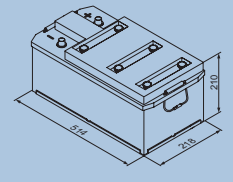
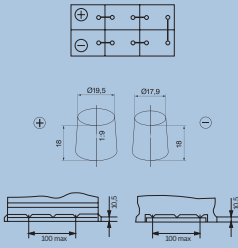
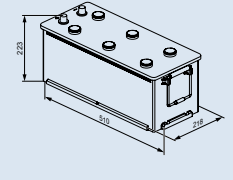
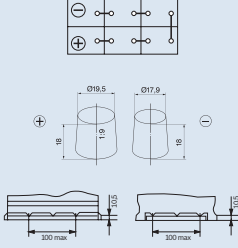
ETN Bosch Reference Short code	Ah 20 h	A (EN)		L T B	E A N		Group Size
T3 (12 V)							
635 042 068 0 092 T30 440 T3 044	135	680	 360 x 253 x 240 Rf		4 047 024 345 102	42,30	12C135
635 052 100 0 092 T30 450 T3 045	135	1000	 514 x 175 x 210 HD		4 047 024 344 907	35,46	MAC 110
643 107 090 0 092 T30 460 T3 046	143	900	 508 x 174 x 205 HD		4 047 024 345 119	36,50	MAC 132
643 033 095 0 092 T30 470 T3 047	143	950	 514 x 218 x 210 HD		4 047 024 344 747	39,85	MAC 140
655 104 090 0 092 T30 480 T3 048	155	900	 510 x 218 x 223 HD		4 047 024 344 914	42,88	MAC 154

¹⁾ Maßabweichung +/- 2mm / Permissible dimensional deviation of +/- 2mm / Écart de mesure de +/- 2 mm / Tolleranza dimensionale +/- 2 mm / desviación de la medida +/- 2mm / Divergència de medida +/- 2mm / Mittapoikkeama +/- 2mm / Odchylenie wymiarów +/- 2 mm / Rozměrové odchylky +/- 2mm / Отклонение от размера +/- 2 мм



de
Bosch-Batterien
TE-T5-T4-T3 für
Nutzfahrzeuge
6 V/12 V
 (Fortsetzung)

en
Bosch batteries
TE-T5-T4-T3 for
commercial vehicles
6 V/12 V
 (continued)

fr
Batteries Bosch
TE-T5-T4-T3 pour
véhicules utilitaires
6 V/12 V
 (suite)

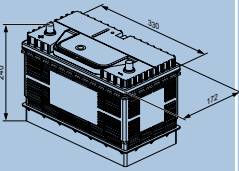
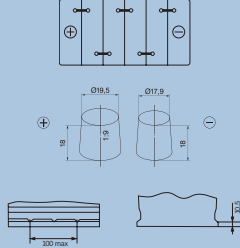
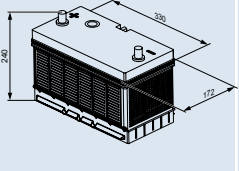
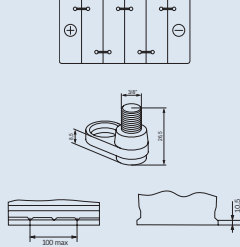
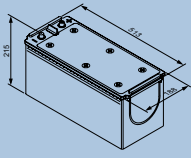
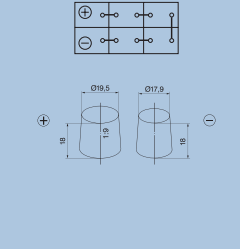
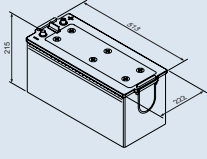
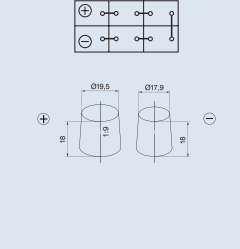
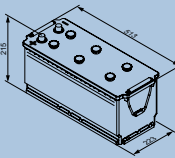
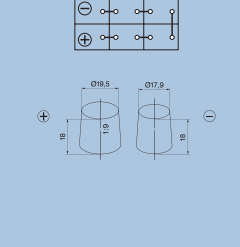

it
Batterie Bosch
TE-T5-T4-T3 per
veicoli commerciali
6 V/12 V
 (seguito)

es
Bosch Baterías
TE-T5-T4-T3 para
vehículos industriales
6 V/12 V
 (continuación)

i	ETN	Ah	A	 1)	L T B	EAN	 kg	Group Size	
	Bosch Reference Short code	20 h	(EN)	L x W x H					
	T3 (12 V)								
	605 102 080 0 092 T30 500 T3 050	105	800	 329 x 172 x 237 HD		4 047 025 290 616	23,70	GR31	
	605 103 080 0 092 T30 520 T3 052	105	800	 329 x 172 x 237 HD		4 047 025 290 593	23,70	GR31	
	654 011 115 0 092 T30 540 T3 054	154	1150	 513 x 189 x 223 HDE		4 047 025 290 562	39,84	A	
	680 011 140 0 092 T30 550 T3 055	180	1400	 513 x 223 x 223 HD		4 047 025 290 609	46,42	B	
	690 033 120 0 092 T30 560 T3 056	190	1200	 513 x 223 x 223 HD		4 047 025 290 555	44,99	B	

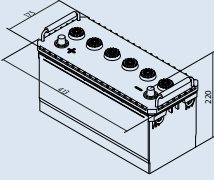
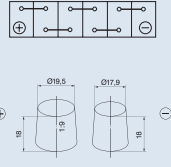
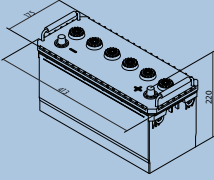
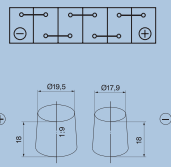
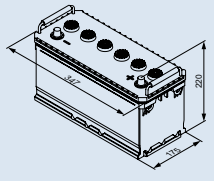
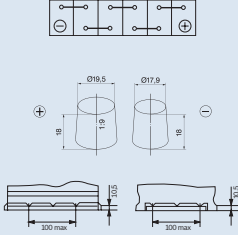
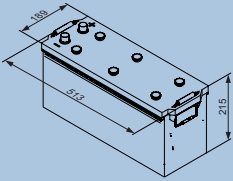
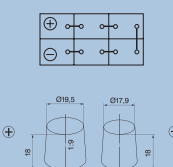
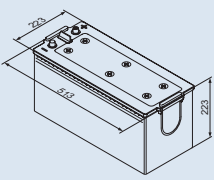
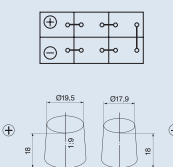

HD = Heavy Duty, HDE = Heavy Duty Extra

pt Baterias Bosch TE – T5 – T4 – T3 para veículos utilitários 6 V/12 V (continuação)	fi Bosch-akut TE – T5 – T4 – T3, 6 V/12 V: hyötyajoneuvot (jatkoa)	pl Akumulatory Bosch TE – T5 – T4 – T3 do samochodów dostaw- czych 6 V/12 V (ciąg dalszy)	cs Akumulátory Bosch TE – T5 – T4 – T3 pro užitková vozidla 6 V/12 V (pokračování)	ru Аккумуляторы Босх TE – T5 – T4 – T3 для коммерческих автомобилей 6 В/12 В (продолжение)
----------------------------------------------------------------------------------------------------------------------------------------	----------------------------------------------------------------------------------------------------------------------	---------------------------------------------------------------------------------------------------------------------------------------------	--------------------------------------------------------------------------------------------------------------------------------------	--------------------------------------------------------------------------------------------------------------------------------------------------------

ETN Bosch Reference Short code	Ah 20 h	A (EN)		L T B	E A N		Group Size
T3 (12 V)							
600 035 060 0 092 T30 710 T3 071	100	600	 412 x 175 x 219 HD		4 047 024 344 921	27,43	D
600 047 060 0 092 T30 720 T3 072	100	600	 412 x 175 x 219 HD		4 047 024 344 938	26,70	D
610 050 085 0 092 T30 730 T3 073	110	850	 412 x 175 x 219 HD		4 047 024 344 945	29,60	D
620 045 068 0 092 T30 750 T3 075	120	680	 513 x 189 x 223 HD		4 047 024 344 952	33,64	A
655 013 090 0 092 T30 770 T3 077	155	900	 513 x 223 x 223 HD		4 047 024 344 969	40,98	B

¹⁾ Maßabweichung +/- 2mm / Permissible dimensional deviation of +/- 2mm / Écart de mesure de +/- 2 mm / Tolleranza dimensionale +/- 2 mm / desviación de la medida +/- 2mm / Divergência de medida +/- 2mm / Mittapoikkeama +/- 2mm / Odchylenie wymiarów +/- 2 mm / Rozměrové odchylky +/- 2mm / Отклонение от размера +/- 2 мм

de	en	fr	it	es
Bosch-Batterien TE – T5 – T4 – T3 für Nutzfahrzeuge 6 V/12 V (Fortsetzung)	Bosch batteries TE – T5 – T4 – T3 for commercial vehicles 6 V/12 V (continued)	Batteries Bosch TE – T5 – T4 – T3 pour véhicules utilitaires 6 V/12 V (suite)	Batterie Bosch TE – T5 – T4 – T3 per veicoli commerciali 6 V/12 V (seguito)	Bosch Baterías TE – T5 – T4 – T3 para vehículos industriales 6 V/12 V (continuación)

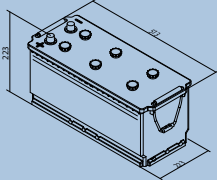
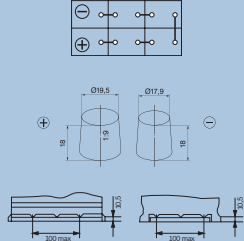
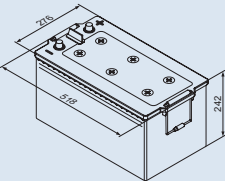
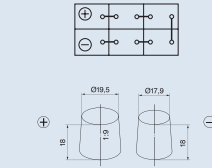
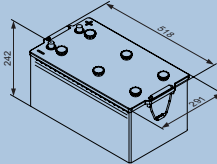
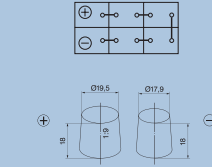
i	ETN	Ah	A		L	T	B	EAN		Group Size	
	Bosch Reference Short code	20 h	(EN)								
	T3 (12 V)										
	680 033 110 0 092 T30 790 T3 079	180	1100	 513 x 223 x 223 HD				4 047 024 344 976	44,99	B	
	700 038 105 0 092 T30 800 T3 080	200	1050	 518 x 276 x 242 HD				4 047 024 344 983	53,61	C	
720 018 115 0 092 T30 810 T3 081	220	1150	 518 x 291 x 242 HD				4 047 024 344 990	56,79	D6		

HD = Heavy Duty

1) Maßabweichung +/- 2mm / Permissible dimensional deviation of +/- 2mm / Écart de mesure de +/- 2 mm / Tolleranza dimensionale +/- 2 mm / desviación de la medida +/- 2mm / Divergència de medida +/- 2mm / Mittapoikkeama +/- 2mm / Odchylenie wymiarów +/- 2 mm / Rozměrové odchyly +/- 2mm / Отклонение от размера +/- 2 мм



BOSCH

Invented for life



Bosch L5 – L4

Automotive Aftermarket



de

Programmübersicht
L5 – L4
für Freizeit-
anwendungen

en

Product range
L5 – L4
for leisure
applicatiions

fr









Aperçu de la gamme
L5 – L4
pour les applications
de loisirs

it

Panoramica della
gamma L5 – L4 per
applicazioni da
tempo libero









es

Relación programa
L5 – L4
para aplicaciones
de ocio

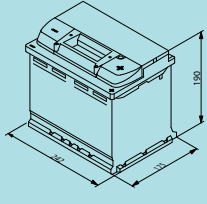
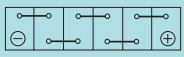
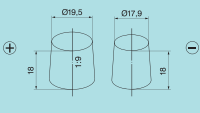
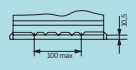
	ETN	 No	 No	Ah 20 h	Ah 5 h	RC @25A min	A (EN)	 ¹⁾ L x W x H	L	T	B	EAN	 kg	 max. pos.	Group Size
L5 / 12 V															
	930 060 056	0 092 L50 050	L5 005	60	51	109	560	242 x 175 x 190	0	1	B13	4047 024 776 852	16,93	63	LN2
	930 075 065	0 092 L50 080	L5 008	75	64	141	650	278 x 175 x 190	0	1	B13	4047 024 776 869	18,91	48	LN3
	930 090 080	0 092 L50 130	L5 013	90	76,5	174	800	353 x 175 x 190	0	1	B13	4047 024 776 876	23,73	36	LN5
	930 140 080	0 092 L50 750	L5 075	140	119	284	800	513 x 189 x 223	3	1	B00	4047 024 776 883	35,76	24	A
	930 180 100	0 092 L50 770	L5 077	180	153	377	1000	513 x 223 x 223	3	1	B00	4047 024 776 890	45,10	21	B
	930 230 115	0 092 L50 800	L5 080	230	196	499	1150	518 x 276 x 242	3	1	B00	4047 024 776 906	56,75	12	C
L5 / 8 V															
	400 170 000	0 092 L50 G40	L5 0G4	170	138	337		261 x 181 x 288	1	UTL	B00	4047 024 996 458	31,00	24	GC8
L5 / 6 V															
	300 208 000	0 092 L50 G10	L5 0G1	208	163	415		261 x 181 x 283	0	UTL	B00	4047 024 996 427	28,80	24	GC2
	300 216 000	0 092 L50 G20	L5 0G2	216	174	445		261 x 181 x 283	0	UTL	B00	4047 024 996 434	29,20	24	GC2
	300 232 000	0 092 L50 G30	L5 0G3	232	183	475		261 x 181 x 283	0	UTL	B00	4047 024 996 441	30,20	24	GC2
	L4 / 12 V														
	812 071 000	0 092 L40 270	L4 027	75	60	124		272 x 175 x 225	1	1	B01	4047 024 776 838	18,10	48	EG4
	820 054 080	0 092 L40 340	L4 034	105	85	193	800	330 x 172 x 238	9	1	B01	4047 025 515 702	23,70	36	Gr31

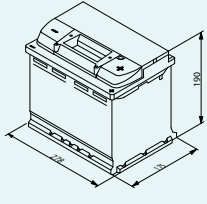
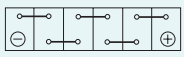
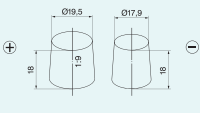
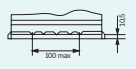

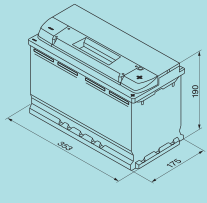
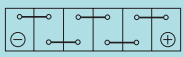
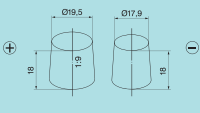
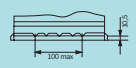
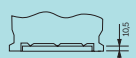
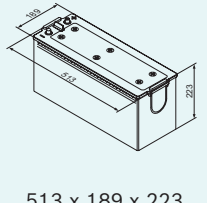

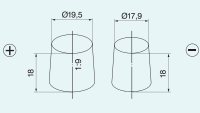
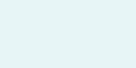
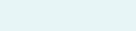







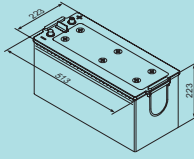

¹⁾ Maßabweichung +/- 2mm / Permissible dimensional deviation of +/- 2mm / Écart de mesure de +/- 2 mm / Tolleranza dimensionale +/- 2 mm / desviación de la medida +/- 2mm /
Divergència de medida +/- 2mm / Mittapoikkeama +/- 2mm / Odchylenie wymiarów +/- 2 mm / Rozměrové odchyly +/- 2mm / Отклонение от размера +/- 2 мм

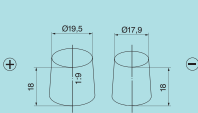
de	en	fr	it	es
Bosch-Batterien L5 – L4 für Freizeit- anwendungen 6 V/8 V/12 V	Bosch batteries L5 – L4 for leisure applicatiions 6 V/8 V/12 V	Batterie Bosch L5 – L4 pour les applications de loisirs 6 V/8 V/12 V	Batterie Bosch L5 – L4 per applicazioni da tempo libero 6 V/8 V/12 V	Batería Bosch L5 – L4 para aplicaciones de ocio 6 V/8 V/12 V

i	ETN	Ah	Ah	RC	A	1)	L	T	B	EAN	kg	max. pcs.	Group Size
	Bosch Reference Short code	20 h	5 h	@25A min	(EN)								
L5 (12 V)													
  	930 060 056 0 092 L50 050 L5 005	60	51	109	560	 242 x 175 x 190	   	4 047 024 776 852	16,93	63	LN2		
	930 075 065 0 092 L50 080 L5 008	75	64	141	650	 278 x 175 x 190	   	4 047 024 776 869	18,91	48	LN3		
	930 090 080 0 092 L50 130 L5 013	90	76,5	174	800	 353 x 175 x 190	   	4 047 024 776 876	23,73	36	LN5		
930 140 080 0 092 L50 750 L5 075	140	119	284	800	 513 x 189 x 223	   	4 047 024 776 883	35,76	24	A			

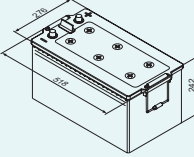
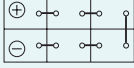
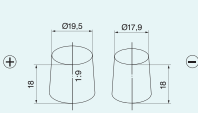
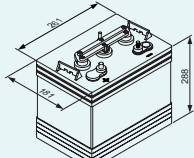

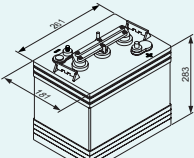
1) Maßabweichung +/- 2mm / Permissible dimensional deviation of +/- 2mm / Écart de mesure de +/- 2 mm / Tolleranza dimensionale +/- 2 mm / desviación de la medida +/- 2mm / Divergència de medida +/- 2mm / Mittapoikkeama +/- 2mm / Odchylenie wymiarów +/- 2 mm / Rozměrové odchytky +/- 2mm / Отклонение от размера +/- 2 мм

pt	fi	pl	cs	ru
Bateria Bosch L5-L4 para aplicações de lazer 6 V/8 V/12 V	Bosch-akku L5-L4 6 V/8 V/12 V vara-a-ajan viettoon	Akumulator Bosch L5-L4 do zastosowań w wolnym czasie 6 V/8 V/12 V	Akumulátory Bosch L5-L4 pro volnočasové aplikace 6 V/8 V/12 V	Аккумулятор Bosch L5-L4 для бытового использования 6 В/8 В/12 В

ETN Bosch Reference Short code	Ah 20 h	Ah 5 h	RC @25A min	A (EN)		L	T	B	EAN	 kg	 max. pcs.	Group Size	
L5 (12 V)													
930 180 100 0 092 L50 770 L5 077	180	153	377	1000	 513 x 223 x 223	 			4 047 024 776 890	45,10	21	B	  
930 230 115 0 092 L50 800 L5 080	230	196	499	1150	 518 x 276 x 242	 			4 047 024 776 906	56,75	12	C	
L5 (8 V)													
400 170 000 0 092 L50 G40 L5 0G4	170	138	337		 261 x 181 x 288				4 047 024 996 458	31,00	24	GC8	
L5 (6 V)													
300 208 000 0 092 L50 G10 L5 0G1	208	163	415		 261 x 181 x 283				4 047 024 996 427	28,80	24	GC2	

A84

de	en	fr	it	es
Bosch-Batterien L5 – L4 für Freizeit- anwendungen 6 V/8 V/12 V (Fortsetzung)	Bosch batteries L5 – L4 for leisure applicatiions 6 V/8 V/12 V (continued)	Batterie Bosch L5 – L4 pour les applications de loisirs 6 V/8 V/12 V (suite)	Batterie Bosch L5 – L4 per applicazioni da tempo libero 6 V/8 V/12 V (seguito)	Batería Bosch L5 – L4 para aplicaciones de ocio 6 V/8 V/12 V (continuación)

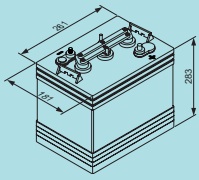
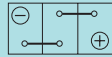
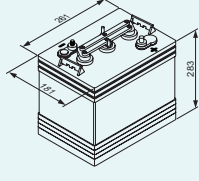
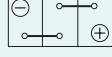
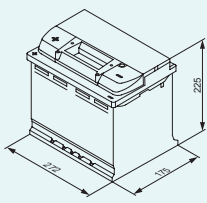
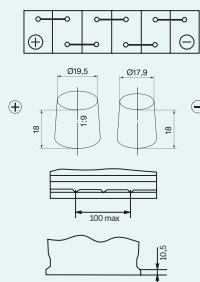
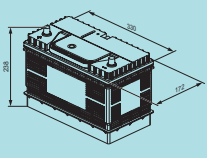
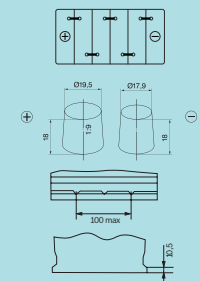
ETN Bosch Reference Short code	Ah	Ah	RC	A		L	T	B	EAN			Group Size
	20 h	5 h	@25A min	(EN)								
L5 (6 V)												
300 216 000 0 092 L50 G20 L5 0G2	216	174	445						4 047 024 996 434	29,20	24	GC2
261 x 181 x 283												
300 232 000 0 092 L50 G30 L5 0G3	232	183	475						4 047 024 996 441	30,20	24	GC2
261 x 181 x 283												
L4 (12 V)												
812 071 000 0 092 L40 270 L4 027	75	60	124						4 047 024 776 838	18,10	48	EG4
272 x 175 x 225												
820 054 080 0092L40340 L4034	105	85	193	800					4 047 025 515 702	23,70	36	Gr31
330 x 172 x 238												

¹⁾ Maßabweichung +/- 2mm / Permissible dimensional deviation of +/- 2mm / Écart de mesure de +/- 2 mm / Variazione dimensionale +/- 2 mm / desviación de la medida +/- 2mm / Divergència de medida +/- 2mm / Mittapoikkeama +/- 2mm / Odchylenie wymiarów +/- 2 mm / Rozměrové odchytky +/- 2mm / Отклонение от размера +/- 2 мм



BOSCH

Invented for life

Bosch Optima

Automotive Aftermarket





de
Programmübersicht
OPTIMA

en
Product range
OPTIMA

fr
Aperçu de la gamme
OPTIMA

it
Panoramica della
gamma OPTIMA

es
Relación programa
OPTIMA

Optima Reference	Nº	ETN	Nº	V	Ah	A (EN)	T	EAN	 ¹⁾ L x W x H	kg	 max. pcs.	Group Size
Red Top												
RT C 4,2	0 098 001 287	801 287 000	8001-287	12	50	815	1	4016 987 113 455	254 x 175 x 200	18,50	48	34C
RT S 4,2	0 098 002 250	802 250 000	8002-250	12	50	815	1	4016 987 113 462	254 x 175 x 200	18,00	48	34
RTR 4,2	0 098 003 251	803 251 000	8003-251	12	50	815	1	4016 987 113 479	254 x 175 x 200	18,00	48	34R
RT U 4,2	0 098 004 250	804 250 000	8004-250	12	50	815	1 & 21	4016 987 113 486	254 x 175 x 200	18,40	48	34/78
RT F 4,2	0 098 078 209	878 209 000	8078-209	12	50	815	21	4016 987 128 237	254 x 185 x 184	18,30	48	78
RT S 3,7	0 098 020 255	820 255 000	8020-255	12	44	730	1	4016 987 113 554	237 x 171 x 197	15,60	48	25
RT R 3,7	0 098 035 255	835 255 000	8035-255	12	44	730	1	4016 987 113 578	237 x 171 x 197	15,60	48	35
RT U 3,7	0 098 022 255	822 255 000	8022-255	12	44	730	1 & 21	4016 987 113 561	237 x 171 x 197	15,70	48	75/25
RT S 2,1	0 098 010 355	810 355 000	8010-355	6	50	815	1	4016 987 113 516	252 x 90 x 206	8,90	48	6 Volt
Yellow Top												
YTS 5,5	0 098 051 187	851 187 000	8051-187	12	75	975	1	4016 987 113 585	325 x 165 x 238	27,90	36	D31A
YTR 5,0	0 098 037 327	837 327 000	8037-327	12	66	845	1	4016 987 141 038	309 x 172 x 219	24,10	36	D27F
YTS 4,2	0 098 012 254	812 254 000	8012-254	12	55	765	1	4016 987 113 523	254 x 175 x 200	20,30	48	D34
YT U 4,2	0 098 014 254	814 254 000	8014-254	12	55	765	1 & 21	4016 987 113 530	254 x 175 x 200	20,60	48	D34/78
YTR 3,7	0 098 040 222	840 222 000	8040-222	12	48	660	1	4016 987 114 667	237 x 171 x 197	17,00	48	D35
YTS 2,7	0 098 071 176	871 176 000	8071-176	12	38	460	1	4016 987 113 615	237 x 129 x 227	12,50	64	D51
YTR 2,7	0 098 073 176	873 176 000	8073-176	12	38	460	1	4016 987 113 639	237 x 129 x 227	12,50	64	D51R
Blue Top												
BT DCM 5,5	0 098 052 188	852 188 000	8052-188	12	75	975	1 & S	4016 987 113 592	325 x 165 x 238	27,90	36	D31M
BT DCM 5,0	0 098 027 227	827 227 000	8027-227	12	66	845	1 & S	4016 987 130 346	309 x 172 x 221	22,70	36	D27M
BT DCM 4,2	0 098 016 253	816 253 000	8016-253	12	55	765	1 & S	4016 987 113 547	254 x 175 x 200	20,60	48	D34M
BT SLIM 4,2	0 098 006 252	806 252 000	8006-252	12	50	815	1 & S	4016 987 113 493	254 x 175 x 200	18,40	48	34M

¹⁾ Maßabweichung +/- 2mm / Permissible dimensional deviation of +/- 2mm / Écart de mesure de +/- 2 mm / Tolleranza dimensionale +/- 2 mm / desviación de la medida +/- 2mm /
Divergência de medida +/- 2mm / Mittapoikkeama +/- 2mm / Odchylenie wymiarów +/- 2 mm / Rozměrové odchyly +/- 2mm / Отклонение от размера +/- 2 мм

de

OPTIMA
Red Top
6 V/12 V

en

OPTIMA
Red Top
6 V/12 V

fr

OPTIMA
Red Top
6 V/12 V

it

OPTIMA
Red Top
6 V/12 V

es

OPTIMA
Red Top
6 V/12 V

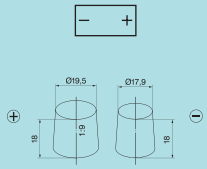
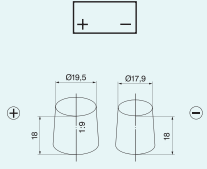
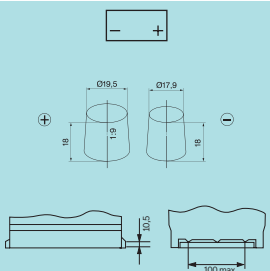
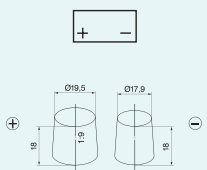
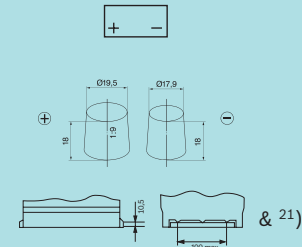
i	Optima Reference	Ah	A	1)	L T B	EAN	kg	max. pcs.	Group Size
	Bosch Reference	20 h	(EN)						
12 V									
i	RT C 4,2	50	815	254 x 175 x 200		4 016 987 113 455	18,50	48	34C
	0 098 001 287								
	8001-287								
RT S 4,2	50	815	254 x 175 x 200		4 016 987 113 462	18,00	48	34	
0 098 002 250									
8002-250									
RT R 4,2	50	815	254 x 175 x 200		4 016 987 113 479	18,00	48	34R	
0 098 003 251									
8003-251									
RT U 4,2	50	815	254 x 175 x 200		4 016 987 113 486	18,40	48	34/78	
0 098 004 250									
8004-250									
RT F 4,2	50	815	254 x 185 x 184		4 016 987 128 237	18,30	48	78	
0 098 078 209									
8078-209									

pt

OPTIMA
Red Top
6 V/12 V

fi

OPTIMA
Red Top
6 V/12 V

pl



OPTIMA
Red Top
6 V/12 V

cs

OPTIMA
Red Top
6 V/12 V

ru

OPTIMA
Red Top
6 V/12 V

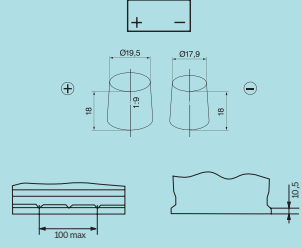
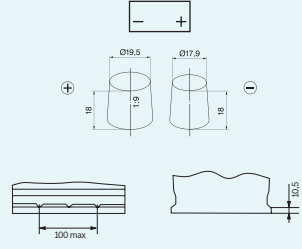
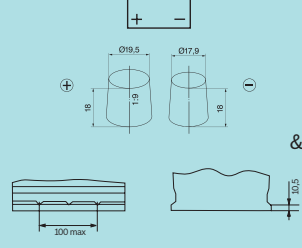
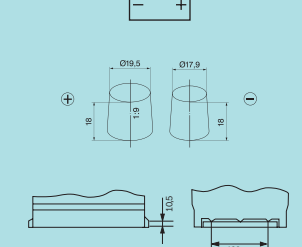
Optima Reference Bosch Reference Short code	Ah 20 h	A (EN)		L T B	EAN	 kg	 max. pcs.	Group Size
12 V								
RT S 3,7 0 098 020 255 8020-255	44	730	237 x 171 x 197		4 016 987 113 554	15,60	48	25
RT R 3,7 0 098 035 255 8035-255	44	730	237 x 171 x 197		4 016 987 113 578	15,60	48	35
RT U 3,7 0 098 022 255 8022-255	44	730	237 x 171 x 197		4 016 987 113 561	15,70	48	75/25
6 V								
RT S 2,1 0 098 010 355 8010-355	50	815	252 x 90 x 206		4 016 987 113 516	8,90	48	6 Volt

¹⁾ Maßabweichung +/- 2mm / Permissible dimensional deviation of +/- 2mm / Écart de mesure de +/- 2 mm / Tolleranza dimensionale +/- 2 mm / desviación de la medida +/- 2mm / Divergência de medida +/- 2mm / Mittapoikkeama +/- 2mm / Odchylenie wymiarów +/- 2 mm / Rozměrové odchylky +/- 2mm / Отклонение от размера +/- 2 мм

²⁾ 3/16"-16 UNC-2B korrosionsfestes Innengewinde / 3/16"-16 UNC-2B non-corroding female thread / Filet femelle anticorrosion 3/16"-16 UNC-2B / Filettatura interna anticorrosione 3/16"-16 UNC-2B / Rosca interior resistente a la corrosión de 3/16"-16 UNC-2B / 3/16"-16 UNC-2B Rosca interior resistente à corrosão / 3/16"-16 UNC-2B korroosionkestävä sisäkierte / 3/16"-16 UNC-2B antykorozyjny gwint wewnętrzny / 3/16"-16 UNC-2B korozivzdorný vnitřní závit / 3/16"-16 UNC-2B Коррозионностойкая внутренняя резьба

A90

de

**OPTIMA
Yellow Top<
6 V/12 V**

en

**OPTIMA
Yellow Top
6 V/12 V**

fr





**OPTIMA
Yellow Top
6 V/12 V**

it

**OPTIMA
Yellow Top
6 V/12 V**

es

**OPTIMA
Yellow Top
6 V/12 V**

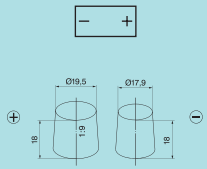
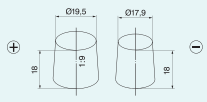
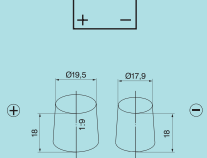
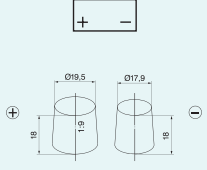
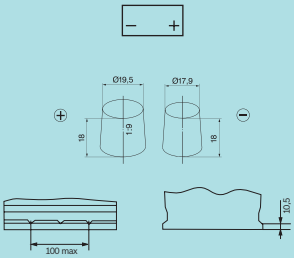
i	Optima Reference Bosch Reference Short code	Ah 20 h	A (EN)		L T B	E A N	 kg	 max. pcs.	Group Size
	12 V								
 	YT S 5,5 0 098 051 187 8051-187	75	975	325 x 165 x 238		4 016 987 113 585	27,90	36	D31A
	YT R 5,0 0 098 037 327 8037-327	66	845	309 x 172 x 219		4 016 987 141 038	24,10	36	D27F
	YT S 4,2 0 098 012 254 8012-254	55	765	254 x 175 x 200		4 016 987 113 523	20,30	48	D34
	YT U 4,2 0 098 014 254 8014-254	55	765	254 x 175 x 200	 & 21)	4 016 987 113 530	20,60	48	D34/ 78
	YT R 3,7 0 098 040 222 8040-222	48	660	237 x 171 x 197		4 016 9s87 114 667	17,00	48	D35

pt

OPTIMA
Yellow Top
6 V/12 V

fi

OPTIMA
Yellow Top
6 V/12 V

pl



OPTIMA
Yellow Top
6 V/12 V

cs

OPTIMA
Yellow Top
6 V/12 V

ru

OPTIMA
Yellow Top
6 V/12 V

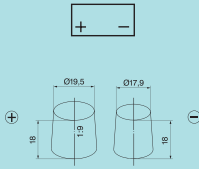
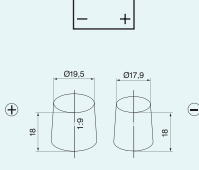
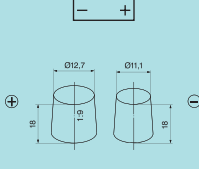
Optima Reference Bosch Reference Short code	Ah 20 h	A (EN)		L T B	E A N	 kg	 max. pcs.	Group Size
12 V								
YT S 2,7 0 098 071 176 8071-176	38	460	237 x 129 x 227		4 016 987 113 615	12,50	64	D51
YT R 2,7 0 098 073 176 8073-176	38	460	237 x 129 x 227		4 016 987 113 639	12,50	64	D51R
YT R 2,7 J 0 098 072 176 8072-176	38	460	237 x 129 x 227		4 016 987 113 622	12,50	64	

¹⁾ Maßabweichung +/- 2mm / Permissible dimensional deviation of +/- 2mm / Écart de mesure de +/- 2 mm / Tolleranza dimensionale +/- 2 mm / desviación de la medida +/- 2mm / Divergência de medida +/- 2mm / Mittapoikkeama +/- 2mm / Odchylenie wymiarów +/- 2 mm / Rozměrové odchylky +/- 2mm / Отклонение от размера +/- 2 mm

²⁾ 3/8"-16 UNC-2B korrosionsfestes Innengewinde / 3/8"-16 UNC-2B non-corroding female thread / Filet femelle anticorrosion 3/8"-16 UNC-2B / Filettatura interna anticorrosione 3/8"-16 UNC-2B / Rosca interior resistente a la corrosión de 3/8"-16 UNC-2B / 3/8"-16 UNC-2B Rosca interior resistente à corrosão / 3/8"-16 UNC-2B korroosionkestävä sisäkierre / 3/8"-16 UNC-2B antykorozyjny gwint wewnętrzny / 3/8"-16 UNC-2B korozivzdorný vnitřní závit / 3/8"-16 UNC-2B Коррозионностойкая внутренняя резьба

Benutzerhinweise

In diesem Katalog sind die Daten von Fahrzeugen, Motoren und Geräten für den europäischen Markt von Baujahr 1998 bis einschließlich 2018 erfasst. Diese wurden aus Hersteller- und Importeurangaben, aus Fahrzeuguntersuchungen sowie aus Unterlagen von Bosch nach bestem Wissen sorgfältig zusammengestellt und geben den Stand zum Zeitpunkt der Drucklegung wieder.

Zwangsläufige Abweichungen durch länderspezifische technische Änderungen können nie ganz ausgeschlossen werden. Bosch kann daher insoweit nicht für die Vollständigkeit und Fehlerfreiheit der Daten haften. Für Irrtümer und Druckfehler, die zu Schäden am Eigentum oder Vermögen führen, haftet Bosch nur bei grob fahrlässiger Pflichtverletzung und bei Vorsatz für unmittelbare Schäden. Bei Personenschäden haftet Bosch auch bei leichter Fahrlässigkeit.

Notes for users

This catalog contains the data from the vehicles, engines, and equipment for the European market from year of manufacture 1998 up to and including the year 2018. This data has been assembled from information provided by manufacturers and importers, and taken from Bosch documentation, as well as from investigations made on vehicles. It has been compiled to the best of our knowledge and belief, and reflects the status at the date of going to print.

It is impossible to avoid deviations caused by technical changes resulting from the conditions and regulations applying in a particular country. Bosch can therefore accept no liability for the completeness and faultlessness of the data. In case of mistakes and misprints which result in damage to property or assets, Bosch is only liable for immediate damages insofar as a gross breach of duty or wrongful intent apply. If personal injury is involved, Bosch is liable also in case of ordinary negligence.

A l'attention de l'utilisateur

Le présent catalogue mentionne les données spécifiques de véhicules, moteurs et appareils pour le marché européen depuis l'année de fabrication 1998 jusqu'au millésime 2018 inclus. Ces informations ont été rassemblées soigneusement et en toute impartialité à partir des indications des constructeurs et importateurs, des contrôles techniques des véhicules et de la documentation Bosch, et matérialisent le stade des connaissances au moment de la mise sous presse.

Il n'est jamais possible d'exclure totalement les divergences éventuelles dues aux modifications techniques, spécifiques des différents pays considérés. En aucun cas, Bosch n'engage sa responsabilité en ce qui concerne l'intégralité et l'exactitude des données. En ce qui concerne les erreurs et les fautes d'impression, qui peuvent entraîner des dommages à la propriété ou à la fortune, Bosch n'engage sa responsabilité pour les dommages directs qu'en cas d'atteinte et de négligence graves et intentionnelles envers ses obligations. En cas de dommages causés aux personnes, Bosch engage sa responsabilité aussi en cas de légère négligence.

Avvertenze per la consultazione

Nella seguente parte di catalogo sono contemplati veicoli, motori ed apparecchi a partire dall'anno di costruzione 1998 fino all'anno 2018. Tali informazioni sono state rilevate dalle documentazioni di Case Auto, Importatori, da verifiche eseguite sui veicoli, così come da documentazione Bosch.

Eventuali discordanze dovute a specifiche esigenze del Paese e variazioni tecniche non possono essere previste. Per questo Bosch non si assume alcuna responsabilità per mancanze ed eventuali errori riferite ai dati. Per danni a cose o danni patrimoniali, dovuti ad errori o refusi di stampa, Bosch è responsabile solo in caso di dolo o colpa grave. Per danni alla persona, Bosch è responsabile anche in caso di colpa meno grave.

Avertencia al usuario

Los datos recogidos en este catálogo para vehículos, motores y maquinaria del mercado europeo abarcan los años de fabricación entre 1998 y 2018, inclusive. Estos datos han sido recogidos del fondo documental de Bosch, así como de las inspecciones de vehículos, datos de fabricantes e importadores.

No obstante, y debido al cuantioso material de información, no se puede excluir la posibilidad de modificaciones, diferencias propias de aplicaciones específicas de los países, fallos, equivocaciones o errores. En caso de inexactitudes y errores de imprenta, la responsabilidad de Bosch se limita al daño inmediato, con posibles perjuicios patrimoniales, a no ser que el daño previsible y típico del contrato sea de mayor cuantía o se deba a dolo o culpa intencionada o a negligencia grave.

pt

Aplicação

fi

Sovelluskohteet

pl

Aplikacja

cs

Používaný díl

ru

Применение

Instruções de utilização

Este catálogo contém os dados de veículos, motores e aparelhos para o mercado europeu desde o ano de fabricação de 1998 até 2018 inclusive. Estes foram reunidos com base nas indicações de fabricantes e importadores, inspeções de veículos e na documentação da Bosch de modo criterioso e da melhor forma possível, refletindo o estado da altura da impressão.

Não é possível excluir inteiramente as divergências inevitáveis em virtude das alterações técnicas específicas de países. Por conseguinte, a Bosch não pode garantir que os dados estejam completos e isentos de erros. No que respeita a equívocos e erros de impressão, que resultem em danos na propriedade ou no património, a Bosch apenas se responsabiliza por danos diretos no caso de violação gravemente negligente de obrigações e dolo. Se houver danos pessoais, a Bosch será responsabilizada mesmo em casos de negligência ligeira.

Ohjeita käyttäjälle

Oheiseen esitteeseen on koostettu ajoneuvo-, moottori- ja laitekohtaisia tietoja, jotka kattavat Euroopan maissa markkinoidut mallit vm. 1998 lähtien – vm. 2018 mukaan lukien. Tiedot on kerätty valikoiden valmistajien ja maahantuojaen laatimista tiedoista, katsastusdokumenteista sekä Bosch-dokumenteista ja ne vastaavat painatusajankohdan tietämystasoa.

Maakohtaisten teknisten muutosten aiheuttamia poikkeuksia ei voida koskaan täysin sulkea pois. Bosch ei siten voi taata tietojen täydellisyyttä ja virheettömyyttä. Bosch vastaa omaisuus- tai varallisuusvahinkoihin johtavista erehdyksistä ja painovirheistä vain, jos ne on aiheutettu tahallisesti ja törkeästi huolimattomuudesta ja johtavat välittömiin vahinkoihin. Henkilövahinkojen yhteydessä Bosch vastaa vain, jos kyse on lievistä huolimattomuudesta.

Wskazówki dla użytkownika

W tym katalogu zawarte są dane pojazdów, silników i urządzeń na rynek europejski, wyprodukowanych od roku 1998 do 2018 włącznie. Zostały one zebrane przy zachowaniu najwyższej staranności i w najlepszej wierze na podstawie danych producentów i importerów, na podstawie badań pojazdów oraz dokumentacji Bosch.

Przedstawione dane odzwierciedlają stan wiedzy w momencie druku. Ewentualne odstępstwa warunkowane przez zmiany techniczne w poszczególnych krajach nigdy nie mogą zostać całkowicie wykluczone. Dlatego Bosch nie odpowiada za kompletność i bezbłądność danych. Za pomyłki i błędy w druku, które prowadzą do szkód własnościowych lub majątkowych, Bosch odpowiada tylko w przypadku rażącego nieumyślnego naruszenia zobowiązań, a za szkody pośrednie w przypadku działania umyślnego. W przypadku szkód osobowych Bosch odpowiada także w przypadku zaniedbania.

Pokyny pro uživatele

V tomto katalogu jsou zahrnuty údaje vozidel, motorů a přístrojů pro evropský trh počínajíc rokem výroby 1998 do roku 2018 včetně. Tyto údaje byly pečlivě sestaveny na základě údajů výrobce a importérů, z prohlídek vozidel a také z podkladů firmy Bosch podle nejlepšího svědomí a daném stavu v okamžiku tisku.

Nevyhnutelné odchylky v důsledku technických změn dané země nelze nikdy zcela vyloučit. Společnosti Bosch proto nemůže ručit za úplnost a bezchybnost údajů. Za omyly a tiskové chyby, které vedou ke škodám na majetku nebo jmění, přebírá společnost Bosch odpovědnost jen v případě hrubého nedbalého porušení povinnosti a za přímé škody v případě úmyslného jednání. Při škodách na zdraví osob ručí společnost Bosch také v případech lehké nedbalosti.

Указания для пользователей

Этот каталог содержит данные транспортных средств, двигателей и устройств для европейского рынка, выпущенных с 1998 по 2018 г. включительно. Эти данные были тщательно и по лучшему разумению собраны на основе сведений, полученных от производителей и импортеров, результатов исследований автомобильной промышленности и документации Bosch, и являются актуальными на момент сдачи в печать.

Нельзя полностью исключить наличие расхождений, вызванных внесением технических изменений, обусловленных национальными требованиями определенной страны. Поэтомu Bosch не несет ответственности за полноту и достоверность всех данных. Bosch не несет ответственности за ошибки и опечатки, ставшие причиной нанесения ущерба имуществу, за исключением случаев грубого и халатного нарушения обязанностей или предумышленного нанесения ущерба. В случае причинения вреда людям Bosch несет ответственность даже в случае незначительной халатности.

B2 | ABARTH

Navigation icons: Car, Calendar, Question mark, and filter icons (A, A (EN), B, B (EN), C, C (EN), D, D (EN)).

0092 ...0 0092 ...0 0092 ...0 0092 ...0

ABARTH									
Grande Punto									
1.4 [199]	10.07-12.10		63	610	S5 005				
SS [199]	10.07-12.10		54	530	S5 002	52	470	S4 002	
			54	530	S5 002	60	640	S4 E05	
Punto									
1.4 [199]	01.12-12.13		60	680	S5 A05				
		SSJ				60	640	S4 E05	
SS [199]	01.12-12.13	SSJ	60	680	S5 A05			S4 E05	
Punto Evo									
1.4 [199]	06.10-12.12	SSJ				70	650	S4 E07	
500									
1.4 [312]	05.08-02.16					52	470	S4 002	
						60	640	S4 E05	
	05.08→					42	390	S4 000	40 340 S3 000
						60	640	S4 E05	40 340 S3 000
	05.10→		54	530	S5 002	52	470	S4 002	45 400 S3 002
			54	530	S5 002	60	640	S4 E05	45 400 S3 002
	01.15→		54	530	S5 002	52	470	S4 002	
	03.16→	SSJ	60	680	S5 A05	60	640	S4 E05	
500C									
1.4 [312]	09.09→		54	530	S5 002	52	470	S4 002	
	07.10→		60	680	S5 A05	60	640	S4 E05	
	05.11-02.16					60	640	S4 E05	
	03.12-02.16		54	530	S5 002	52	470	S4 002	45 400 S3 002
	03.16→	SSJ				60	640	S4 E05	
AIXAM									
A721									
Diesel									
	09.04-03.10					44	420	S4 000	
A741									
Diesel									
	09.04-03.10					44	420	S4 000	
A751									
Diesel									
	07.05-03.10					44	420	S4 000	
	09.04-03.10					44	420	S4 000	
City									
eCity/ eCoupé									
	01.12→					44	420	S4 000	
Diesel									
	01.12→					44	420	S4 000	
Club									
1.1/ 1.4 , 4x4	01.94-12.02		54	530	S5 002	52	470	S4 002	45 400 S3 002
Diesel									
1.5 D, D 4x4	01.94-12.02		54	530	S5 002	52	470	S4 002	45 400 S3 002
Crossline									
	01.07-12.15					44	420	S4 000	
Scouty Cabriolet									
0.5	08.07-07.12					44	420	S4 000	
500									
Diesel									
0.5 D	12.97-03.04		40	330	S4 030				

- ① **Fahrzeugmarke**
Hervorhebung der Hersteller im Graubalken
- ② **Fahrzeugmodell**
Alphanumerisch aufsteigend
- ③ **Modelldetail**
Besondere Fahrzeugmerkmale
- ④ **Volt/Amperestunde**
- ⑤ **Sonderfall**
Erläuterung siehe Katalogende
- ⑥ **Produktionszeitraum**
Einbauzeitraum des jeweiligen Produktes
- ⑦ **Bildzeichen**
Erläuterung siehe Katalogende
- ⑧ **Konstanter Teil**
der 10-stelligen Bestellnummer
- ⑨ **Variabler Teil/ Kurzsuchnummer**
der 10-stelligen Bestellnummer

en

How to use this catalog

fr

Consignes d'utilisation

it

Istruzioni d'uso

es

Indicaciones de uso**① Vehicle brand**

Manufacturer indicated in bold print within gray bar

① Marque du véhicule

Mise en avant des constructeurs sur fond gris

① Marca del veicolo

Evidenziata con fondo grigio

① Marca de vehículo

Fabricante destacado en la franja gris

② Vehicle model

in alphabetical order

② Modèle du véhicule

par ordre alphanumérique croissant

② Modello del veicolo

In ordine alfabetico

② Modelo de vehículo

Orden alfanumérico creciente

③ Model specifics

special vehicle information

③ Détails du modèle

Caractéristiques du véhicule

③ Dettagli modello

Particolari caratteristiche

③ Detalle de modelo

Características especiales de vehículo

④ Voltage/Ampere hours**④ Volt/Ampère-heure****④ Volt/Ampere-ore****④ Voltios/amperios-horas****⑤ Special version**

See end of catalog for explanation

⑤ Cas particulier

Explication, voir la fin du catalogue

⑤ Caso specifico

Indicazioni a fine catalogo

⑤ Caso especial

Explicación, véase la parte final del catálogo

⑥ Production period

Mounting period for each product

⑥ Période de fabrication

Première et dernière date de montage du produit considéré.

⑥ Periodo di produzione

Prima e ultima data di montaggio del rispettivo prodotto

⑥ Intervalo de producción

Periodo de montaje de dicho producto

⑦ Explanation of symbols

See end of catalog for explanation

⑦ Légende des symboles

Explication, voir la fin du catalogue

⑦ Legenda dei simboli

Indicazioni a fine catalogo

⑦ Explicación de símbolo gráfico

Explicación, véase la parte final del catálogo

⑧ Constant component of 10-digit order number**⑧ Partie constante de la référence à 10 chiffres****⑧ Parte fissa del numero di ordinazione a 10 cifre****⑧ Parte constante de la referencia de pedido de 10 caracteres****⑨ Variable component/ Short code of 10-digit order number****⑨ Partie variable/ Référence simplifiée de la référence à 10 chiffres****⑨ Parte variabile/ Codice breve del numero di ordinazione a 10 cifre****⑨ Parte variable/ Código breve de la referencia de pedido de 10 caracteres**

B2 | ABARTH

7

0092...0 0092...0 0092...0 0092...0 8

ABARTH									
Grande Punto									
1.4 [199]	10.07-12.10		63	610	S5 005				
SS [199]	10.07-12.10		54	530	S5 002	52	470	S4 002	
			54	530	S5 002	60	640	S4 E05	
Punto									
1.4 [199]	01.12-12.13		60	680	S5 A05				
		SSJ				60	640	S4 E05	
SS [199]	01.12-12.13	SSJ	60	680	S5 A05				
						60	640	S4 E05	
Punto Evo									
1.4 [199]	06.10-12.12	SSJ				70	650	S4 E07	
500									
1.4 [312]	05.08-02.16					52	470	S4 002	
						60	640	S4 E05	
	05.08→					42	390	S4 000	40 340 S3 000
						60	640	S4 E05	40 340 S3 000
	05.10→		54	530	S5 002	52	470	S4 002	45 400 S3 002
			54	530	S5 002	60	640	S4 E05	45 400 S3 002
	01.15→		54	530	S5 002	52	470	S4 002	
	03.16→	SSJ	60	680	S5 A05	60	640	S4 E05	
500C									
1.4 [312]	09.09→		54	530	S5 002	52	470	S4 002	
	07.10→		60	680	S5 A05	60	640	S4 E05	
	05.11-02.16					60	640	S4 E05	
	03.12-02.16		54	530	S5 002	52	470	S4 002	45 400 S3 002
	03.16→	SSJ				60	640	S4 E05	
AIXAM									
A721									
Diesel									
	09.04-03.10					44	420	S4 000	
A741									
Diesel									
	09.04-03.10					44	420	S4 000	
A751									
Diesel									
	07.05-03.10					44	420	S4 000	
	09.04-03.10					44	420	S4 000	
City									
eCity/ eCoupé									
	01.12→					44	420	S4 000	
Diesel									
	01.12→					44	420	S4 000	
Club									
1.1/ 1.4 , 4x4	01.94-12.02		54	530	S5 002	52	470	S4 002	45 400 S3 002
Diesel									
1.5 D, D 4x4	01.94-12.02		54	530	S5 002	52	470	S4 002	45 400 S3 002
Crossline									
	01.07-12.15					44	420	S4 000	
Scouty Cabriolet									
0.5	08.07-07.12					44	420	S4 000	
500									
Diesel									
0.5 D	12.97-03.04		40	330	S4 030				

① **Marca do veículo**
Destaque dos fabricantes na barra cinzenta

② **Modelo de veículo**
Por ordem alfanumérica ascendente

③ **Pormenor do modelo**
Características especiais do veículo

④ **Volt/ampere-hora**

⑤ **Situação especial**
Explicação ver final do catálogo

⑥ **Período de produção**
Período de montagem do respetivo produto

⑦ **Pictogramas**
Explicação ver final do catálogo

⑧ **Parte constante**
do n.º de referência de 10 algarismos

⑨ **Parte variável/número de busca abreviado**
do n.º de referência de 10 algarismos

fi

Käyttöön liittyvät ohjeet

pl

Wskazówki dotyczące korzystania

cs

Upozornění při použití

ru

Указания по использованию

① **Automerkki,**
almistajan korostus harmaassa palkissa

② **Ajoneuvomalli**
Aakkosnumeerisesti nouseva

③ **Mallin yksityiskohta**
Ajoneuvon erikoisominaisuudet

④ **Voltti/ampeeritunti**

⑤ **Erikoistapaus,**
katso selitys luettelon lopusta

⑥ **Tuotantokausi,**
kunkin tuotteen asennusaika

⑦ **Kuvamerkki,**
katso selitys luettelon lopusta

⑧ **vakio-osa**
10-numeroisen tilausnumeron

⑨ **vaihtuva osa /
lyhythaun numero**
10-numeroisen tilausnumeron

① **Marka pojazdu**
Nazwa producenta na szarym pasku

② **Model pojazdu**
Alfanumerycznie, rosnąco

③ **Szczegół modelu**
Szczegółowe właściwości pojazdu

④ **Wolt/amperogodzina**

⑤ **Przypadek specjalny,**
patrz objaśnienie – koniec katalogu

⑥ **Okres produkcji**
Okres montażu danego produktu

⑦ **Rysunek**
Objaśnienie, patrz objaśnienie – koniec katalogu

⑧ **Część stała**
10-znakowy numer katalogowy

⑨ **Część zmienna / Skrót**
10-znakowego numeru katalogowego

① **Značka vozidla**
zvýraznění výrobce v šedém sloupci

② **Model vozidla**
alfanumericky vzestupně

③ **Detail modelu**
Zvláštní vlastnosti vozidla

④ **Volt/ampérhodina**

⑤ **Zvláštní případ**
vysvětlení viz konec katalogu

⑥ **Období produkce**
období instalace příslušného výrobku

⑦ **Piktogram**
vysvětlení viz konec katalogu

⑧ **Konstantní část**
10-místného objednáčíslo

⑨ **Variabilní část/krátké
vyhledávací číslo**
10-místného objednáčíslo

① **Марка автомобиля**
Имя производителя на серой полосе

② **Модель автомобиля**
Буквенно-цифровые обозначения с сортировкой по возрастанию

③ **Информация о модели**
Особые характеристики автомобиля

④ **Вольт/ампер-часы**

⑤ **Особый случай**
Пояснение см. в конце каталога

⑥ **Период производства**
Период выпуска продукта

⑦ **Графический знак**
Пояснение см. в конце каталога

⑧ **Постоянная часть**
10-значного номера для заказа

⑨ **Переменная часть/
короткий код для поиска**
10-значного номера для заказа

			Ah A (EN)	Ah A (EN)	Ah A (EN)	Ah A (EN)
			0 092 ...0	0 092 ...0	0 092 ...0	0 092 ...0

ABARTH

Grande Punto										
1.4 [199]	10.07-12.10				63	610	S5 005			
SS [199]	10.07-12.10				54	530	S5 002	52	470	S4 002
					54	530	S5 002	60	640	S4 E05
Punto										
1.4 [199]	01.12-12.13				60	680	S5 A05			
		SSJ						60	640	S4 E05
SS [199]	01.12-12.13	SSJ			60	680	S5 A05	60	640	S4 E05
Punto Evo										
1.4 [199]	06.10-12.12	SSJ						70	650	S4 E07
500										
1.4 [312]	05.08-02.16							52	470	S4 002
								60	640	S4 E05
	05.08→							42	390	S4 000
								60	640	S4 E05
								40	340	S3 000
	05.10→				54	530	S5 002	52	470	S4 002
					54	530	S5 002	60	640	S4 E05
								45	400	S3 002
	01.15→				54	530	S5 002	52	470	S4 002
	03.16→	SSJ			60	680	S5 A05	60	640	S4 E05
500C										
1.4 [312]	09.09→				54	530	S5 002	52	470	S4 002
	07.10→				60	680	S5 A05	60	640	S4 E05
	05.11-02.16							60	640	S4 E05
	03.12-02.16				54	530	S5 002	52	470	S4 002
	03.16→	SSJ						60	640	S4 E05

AIXAM

A721										
Diesel										
	09.04-03.10							44	420	S4 000
A741										
Diesel										
	09.04-03.10							44	420	S4 000
A751										
Diesel										
	07.05-03.10							44	420	S4 000
	09.04-03.10							44	420	S4 000
City										
eCity/ eCoupé										
	01.12→							44	420	S4 000
Diesel										
	01.12→							44	420	S4 000
Club										
1.1/ 1.4, 4x4	01.94-12.02				54	530	S5 002	52	470	S4 002
Diesel										
1.5 D, D 4x4	01.94-12.02				54	530	S5 002	52	470	S4 002
Crossline										
	01.07-12.15							44	420	S4 000
Scouty Cabriolet										
0.5	08.07-07.12							44	420	S4 000
500										
Diesel										
0.5 D	12.97-03.04							40	330	S4 030



			Ah	A (EN)		Ah	A (EN)		Ah	A (EN)		Ah	A (EN)	
					0 092 ...0			0 092 ...0			0 092 ...0			0 092 ...0

ALFA ROMEO

Brera														
1.8 TBi [939]	05.09-12.10					54	530	S5 002	52	470	S4 002			
2.2 JTS [939]	01.06-12.10					63	610	S5 005	60	540	S4 005			
						63	610	S5 005	60	640	S4 E05			
3.2 JTS 24V, JTS 24V Q4 [939]	01.06-12.10	70	760	S5 A08		77	780	S5 008	74	680	S4 008			
Diesel														
2.0/2.4 JTDM, JTDM 20V [939]	04.06-12.10	70	760	S5 A08		77	780	S5 008	74	680	S4 008			
Giuletta														
Diesel														
1.6 JTDM [940]	09.18→	70	760	S5 A08					70	760	S4 E08			
Giulia														
2.0 Turbo [952]	02.16→	SSJ							80	800	S4 E11			
									95	850	S4 E13			
Turbo Q4 [952]	08.16→	SSJ							95	850	S4 E13			
2.9 Twin Turbo [952]	02.16→	SSJ							80	800	S4 E11			
									95	850	S4 E13			
Diesel														
2.2 Multijet [952]	02.16→	SSJ							80	800	S4 E11			
									95	850	S4 E13			
	08.18→								80	800	S4 E11			
									95	850	S4 E13			
Multijet Q4 [952]	02.16→	SSJ							80	800	S4 E11			
									95	850	S4 E13			
	08.18→								80	800	S4 E11			
									95	850	S4 E13			
Giulietta														
1.4 BiFuel [940]	05.10→	SSJ							60	640	S4 E05			
TB [940]	04.10→	SSJ							60	640	S4 E05			
	09.14→	SSJ	60	680	S5 A05				60	640	S4 E05			
T-Jet [940]	04.10-12.16	SSJ							60	640	S4 E05			
	08.13→	SSJ	60	680	S5 A05				60	640	S4 E05			
1.8 TBi [940]	05.10→		60	680	S5 A05	63	610	S5 005	60	540	S4 005			
	07.13→		60	680	S5 A05	63	610	S5 005	60	640	S4 E05			
Diesel														
1.6 JTDM [940]	05.10-12.15	SSJ							60	640	S4 E05			
									70	760	S4 E08			
	04.15→	SSJ	70	760	S5 A08				70	760	S4 E08			
2.0 JTDM [940]	04.10-12.15	SSJ							60	640	S4 E05			
	04.10→	SSJ							70	760	S4 E08			
	08.13-12.15		70	760	S5 A08	77	780	S5 008	74	680	S4 008			
	12.13→					74	750	S5 007	70	650	S4 E07			
						74	750	S5 007	72	680	S4 007			
	02.14→		70	760	S5 A08									
GT														
1.8 TS [937]	10.03-12.10		60	680	S5 A05	63	610	S5 005	60	540	S4 005			
2.0/3.2 JTS, V6 [937]	10.03-12.10					63	610	S5 005	60	540	S4 005			
Diesel														
1.9 JTD 16V [937]	10.03-12.10		60	680	S5 A05	63	610	S5 005	60	540	S4 005			
GTV														
1.8 T.S. 16V [916]	05.98-12.00		70	760	S5 A08	77	780	S5 008	60	540	S4 005	56	480	S3 005
2.0 JTS [916]	04.03-12.05		70	760	S5 A08	77	780	S5 008	60	540	S4 005			
T.S. 16V [916]	04.95-08.00		70	760	S5 A08	77	780	S5 008	60	540	S4 005	56	480	S3 005
	08.00-12.05		70	760	S5 A08	77	780	S5 008	60	540	S4 005			
V6 Turbo [916]	04.95-04.98					63	610	S5 005	60	540	S4 005	56	480	S3 005
	05.98-07.00		70	760	S5 A08	77	780	S5 008	60	540	S4 005	56	480	S3 005
3.0 V6 24V [916]	10.96-04.98		70	760	S5 A08	77	780	S5 008	74	680	S4 008			
	05.98-07.00		70	760	S5 A08	77	780	S5 008	60	540	S4 005	56	480	S3 005
	08.00-12.05		70	760	S5 A08	77	780	S5 008	60	540	S4 005			



				Ah	A (EN)		Ah	A (EN)		Ah	A (EN)		Ah	A (EN)	
				0 092 ...0			0 092 ...0			0 092 ...0			0 092 ...0		
◀ ALFA ROMEO															
3.2 V6 24V [916]	04.03-12.05			70	760	S5 A08	77	780	S5 008	60	540	S4 005			
MiTo															
0.9 i.e. [955]	07.11-12.13	SSJ								60	640	S4 E05			
	03.13-12.18	SSJ	60	680	S5 A05					60	640	S4 E05			
	12.13-12.18					61	600	S5 004	60	540	S4 004				
						61	600	S5 004	70	650	S4 E07				
1.4 [955]	10.09-12.18	SSJ								60	640	S4 E05			
	05.11-12.18					54	530	S5 002	52	470	S4 002				
						54	530	S5 002	60	640	S4 E05				
BiFuel [955]	07.11-12.18					54	530	S5 002	52	470	S4 002				
		SSJ								60	640	S4 E05			
i.e. [955]	05.08-12.11					54	530	S5 002	52	470	S4 002				
	08.08-12.11					77	780	S5 008	60	540	S4 005	53	500	S3 004	
		SSJ								60	640	S4 E05			
Turbo [955]	08.08-12.18					54	530	S5 002	52	470	S4 002				
	10.09-12.18	SSJ								60	640	S4 E05			
			60	680	S5 A05					60	640	S4 E05			
	12.13-12.18		60	680	S5 A05										
16V Turbo [955]	07.09-12.14	SSJ								60	640	S4 E05			
Diesel															
1.3 JTD [955]	10.08-12.15	SSJ								60	640	S4 E05			
	10.08-12.18		70	760	S5 A08	77	780	S5 008	74	680	S4 008	53	500	S3 004	
JTDM [955]	12.13-12.15					61	600	S5 004	60	540	S4 004				
						61	600	S5 004	70	650	S4 E07				
SDE [955]	05.16-12.18					61	600	S5 004	60	540	S4 004				
						61	600	S5 004	70	650	S4 E07				
1.6 JTD [955]	08.08-12.15	BWD,SSJ								60	640	S4 E05			
										70	760	S4 E08			
	09.08-12.15					77	780	S5 008	60	540	S4 005	53	500	S3 004	
		SSJ								60	640	S4 E05			
Spider															
1.8 TBi [939]	05.09-03.11						54	530	S5 002	52	470	S4 002			
T.S. 16V [916]	05.98-07.00		60	680	S5 A05	63	610	S5 005	60	540	S4 005				
2.0 JTS [916]	04.03-02.06		70	760	S5 A08	77	780	S5 008	60	540	S4 005				
T.S. 16V [916]	04.95-08.00		70	760	S5 A08	77	780	S5 008	60	540	S4 005	56	480	S3 005	
	08.00-02.06		70	760	S5 A08	77	780	S5 008	60	540	S4 005				
2.0/ 3.0 V6 Turbo, V6 12V [916]	04.95-12.00		70	760	S5 A08	77	780	S5 008	60	540	S4 005	56	480	S3 005	
2.2/ 3.2 JTS, JTS 24V, JTS 24V Q4 [939]	03.06-12.10		70	760	S5 A08	77	780	S5 008	60	540	S4 005				
3.0/ 3.2 V6 24V [916]	08.00-02.06		70	760	S5 A08	77	780	S5 008	60	540	S4 005				
Diesel															
2.0 JTDM [939]	04.09-12.10		70	760	S5 A08	77	780	S5 008	74	680	S4 008				
	05.09-12.10					85	800	S5 010	80	740	S4 010				
2.4 JTDM 20V [939]	03.07-12.10		70	760	S5 A08	77	780	S5 008	74	680	S4 008				
Stelvio															
2.0 Turbo Q4	11.16→	SSJ								80	800	S4 E11			
										95	850	S4 E13			
Diesel															
2.2 Multijet Q4	11.16→	SSJ								80	800	S4 E11			
										95	850	S4 E13			
	08.18→									80	800	S4 E11			
										95	850	S4 E13			
4C															
1.8 [960]	08.13→						54	530	S5 002	52	470	S4 002	45	400	S3 002
4C Spider															
1.7 [960]	10.14→						63	610	S5 005	60	540	S4 005			
8C Competizione															
4.7	02.07-12.09						85	800	S5 011	80	740	S4 011			
		SSJ	80	800	S5 A11										
8C Spider															
4.7	02.07-12.09						85	800	S5 011	80	740	S4 011			
		SSJ	80	800	S5 A11										



		Ah A (EN) S5A			Ah A (EN) S5			Ah A (EN) S4			Ah A (EN) S3		
		0 092 ...0			0 092 ...0			0 092 ...0			0 092 ...0		
145													
1.4/ 1.6 i.e. 16V T.S. [930 MY97]	12.96-02.99				63	610	S5 005	52	470	S4 002	45	400	S3 002
1.4/ 1.6/ 1.8 i.e. 16V T.S. [930 MY99]	02.99-12.00				63	610	S5 005	52	470	S4 002	45	400	S3 002
1.8 i.e. 16V T.S. [930 MY97]	11.96-04.98				63	610	S5 005	60	540	S4 005	45	400	S3 002
	11.96-02.99				63	610	S5 005	52	470	S4 002	45	400	S3 002
2.0 i.e. 16V T.S. [930 MY97;930 MY99]	11.96-12.00				63	610	S5 005						
Diesel													
1.9 JTD, TD [930 MY97;930 MY99]	11.96-12.00	70	760	S5 A08	77	780	S5 008	74	680	S4 008	70	640	S3 008
146													
1.4/ 1.6/ 1.8 i.e. 16V T.S. [930 MY97; 930 MY99]	11.96-12.00				63	610	S5 005	52	470	S4 002	45	400	S3 002
2.0 ti 16V T.S. [930 MY97; 930 MY99]	11.96-12.00				63	610	S5 005						
Diesel													
1.9 JTD, TD [930 MY97;930 MY99]	11.96-12.00	70	760	S5 A08	77	780	S5 008	74	680	S4 008	70	640	S3 008
147													
1.6/ 2.0/ 3.2 GTA, TS 16V, TS 16V ECO [937]	11.00-12.10				63	610	S5 005	60	540	S4 005			
Diesel													
1.9 JTD, JTDM [937] JTDM 16V [937]	11.00-12.10	70	760	S5 A08	77	780	S5 008	74	680	S4 008			
	10.02-12.10	70	760	S5 A08	77	780	S5 008	74	680	S4 008			
	10.07-12.10				77	780	S5 008	74	680	S4 008			
156 Berlina													
1.6 TS 16V [932]	10.97-09.00				63	610	S5 005	52	470	S4 002	45	400	S3 002
	09.00-10.05				63	610	S5 005	52	470	S4 002			
1.8 TS 16V [932]	09.97-10.00				63	610	S5 005	52	470	S4 002	45	400	S3 002
	09.00-10.05				63	610	S5 005	52	470	S4 002			
2.0 JTS 16V [932] TS 16V [932]	01.02-12.05				63	610	S5 005	60	540	S4 005			
	09.97-09.00				63	610	S5 005						
	10.97-10.05				63	610	S5 005	60	540	S4 005			
2.5 24V [932]	10.97-12.01				63	610	S5 005						
	09.00-10.05	70	760	S5 A08	63	610	S5 005	60	540	S4 005			
3.2 GTA [932]	03.02-10.05	70	760	S5 A08	77	780	S5 008	74	680	S4 008			
Diesel													
1.9 JTD [932] JTD 16V [932]	09.97-09.00	70	760	S5 A08	77	780	S5 008	74	680	S4 008	70	640	S3 008
	09.00-10.05	70	760	S5 A08	77	780	S5 008	74	680	S4 008			
	10.02-10.05	70	760	S5 A08	77	780	S5 008	74	680	S4 008			
	07.04-12.05	70	760	S5 A08	77	780	S5 008	74	680	S4 008	70	640	S3 008
2.4 JTD [932] JTD 20V [932]	09.97-09.00	70	760	S5 A08	77	780	S5 008	74	680	S4 008	70	640	S3 008
	09.00-10.05	70	760	S5 A08	77	780	S5 008	74	680	S4 008			
	10.04-10.05	70	760	S5 A08	77	780	S5 008	74	680	S4 008			
156 Sportwagon													
1.6/ 1.8 TS [932]	05.00-12.05				63	610	S5 005	52	470	S4 002			
2.0 TS [932]	05.00-10.05				63	610	S5 005	60	540	S4 005			
2.0/ 2.5 JTS, V6 [932]	05.00-12.05	70	760	S5 A08	63	610	S5 005	60	540	S4 005			
3.2 GTA [932]	03.02-10.05	70	760	S5 A08	77	780	S5 008	74	680	S4 008			
Diesel													
1.9/ 2.4 JTD, JTD Q4 [932]	05.00-12.05	70	760	S5 A08	77	780	S5 008	74	680	S4 008			
159 Berlina													
1.8 i [939] Tbi [939]	03.06-11.11				63	610	S5 005	60	540	S4 005			
	05.09-12.12				63	610	S5 005	60	540	S4 005			
1.9/ 2.2 JTS [939]	06.05-12.08				63	610	S5 005	60	540	S4 005			
3.2 JTS [939] JTS Q4 [939]	08.07-12.11	70	760	S5 A08	77	780	S5 008	74	680	S4 008			
	12.05-12.11	70	760	S5 A08	77	780	S5 008	74	680	S4 008			
Diesel													
1.9 JTDM 8V, JTDM 16V [939]	06.05-12.08				63	610	S5 005	60	540	S4 005			
2.0 JTDM [939]	05.09-12.11				77	780	S5 008	74	680	S4 008			



			Ah A (EN) S5A			Ah A (EN) S5			Ah A (EN) S4			Ah A (EN) S3		
			0 092 ...0			0 092 ...0			0 092 ...0			0 092 ...0		
ALFA ROMEO														
2.4 JTD, JTD Q4 [939]	09.06-12.08		70	760	S5 A08	77	780	S5 008	74	680	S4 008			
JTDM [939]	06.05-12.08		70	760	S5 A08	77	780	S5 008	74	680	S4 008			
159 Sportwagon														
1.8 i [939]	03.06-12.08					63	610	S5 005	60	540	S4 005			
TBi [939]	05.09-11.11					63	610	S5 005	60	540	S4 005			
1.9/2.2 JTS [939]	03.06-12.08					63	610	S5 005	60	540	S4 005			
3.2 JTS [939]	08.07-12.11		70	760	S5 A08	77	780	S5 008	74	680	S4 008			
JTS Q4 [939]	03.06-12.11		70	760	S5 A08	77	780	S5 008	74	680	S4 008			
Diesel														
1.9 JTDM [939]	03.06-12.08					63	610	S5 005	60	540	S4 005			
2.0 JTDM [939]	05.09-12.11					77	780	S5 008	74	680	S4 008			
2.4 JTD, JTD Q4 [939]	09.06-12.08		70	760	S5 A08	77	780	S5 008	74	680	S4 008			
JTDM [939]	03.06-12.08		70	760	S5 A08	77	780	S5 008	74	680	S4 008			
164														
2.0/2.5 I.E. V6, T.S., V6 Turbo [164]	09.92-12.98		60	680	S5 A05	63	610	S5 005	60	540	S4 005			
3.0 Q4, V6 12V, V6 24V [164]	09.92-10.98		70	760	S5 A08	63	610	S5 005	60	540	S4 005			
Diesel														
2.5 D Turbo [164]	09.92-10.98		95	850	S5 A13	100	830	S5 013	95	800	S4 013	90	720	S3 013
166														
2.0/2.5/3.0/3.2 T.S. 16V, Turbo V6, V6 24V [936]	07.98-10.07		70	760	S5 A08	77	780	S5 008	74	680	S4 008			
Diesel														
2.4 JTD [936]	09.98-09.00		95	850	S5 A13	100	830	S5 013	95	800	S4 013	90	720	S3 013
	09.00-10.07		95	850	S5 A13	100	830	S5 013	95	800	S4 013			
JTD 20V, JTDM 20V [936]	06.03-10.07		95	850	S5 A13	100	830	S5 013	95	800	S4 013			

ALPINA (B. BOVENSIEPEN KG)

B3														
3.0 BiTurbo [F30]	03.13-02.17	SSJ	95	850	S5 A13									
BiTurbo, S BiTurbo [E90]	07.07-05.13		80	800	S5 A11									
3.2 [E36]	04.96-03.99		70	760	S5 A08	77	780	S5 008	74	680	S4 008	70	640	S3 008
3.3 [E46]	03.99-01.05		80	800	S5 A11	85	800	S5 010	80	740	S4 010			
B3 Cabrio														
3.0 BiTurbo [E93]	01.08-03.10	SSJ	80	800	S5 A11									
			95	850	S5 A13									
S BiTurbo [E93]	03.10-05.13		80	800	S5 A11									
3.2 [E36]	04.96-03.99		70	760	S5 A08	77	780	S5 008	74	680	S4 008	70	640	S3 008
3.3 , S [E46]	09.00-01.06		70	760	S5 A08	77	780	S5 008	74	680	S4 008			
B3 Coupé														
3.0 BiTurbo, S BiTurbo [E92]	01.08-05.13		80	800	S5 A11									
GT3 [E92]	03.12-12.13		95	850	S5 A13									
3.2 [E36]	04.96-03.99		70	760	S5 A08	77	780	S5 008	74	680	S4 008	70	640	S3 008
3.3 , S [E46]	03.99-01.06		70	760	S5 A08	77	780	S5 008	74	680	S4 008			
B3 Touring														
3.0 BiTurbo [F31]	03.13-02.17	SSJ	95	850	S5 A13									
BiTurbo, S BiTurbo [E91]	10.08-05.13		80	800	S5 A11									
3.2 [E36]	04.96-03.99		70	760	S5 A08	77	780	S5 008	74	680	S4 008	70	640	S3 008
3.3 , S [E46]	02.00-01.06		70	760	S5 A08	77	780	S5 008	74	680	S4 008			
B4 Cabrio														
3.0 BiTurbo [F33]	03.14-02.17	SSJ	95	850	S5 A13									
B4 Coupé														
3.0 BiTurbo [F32]	03.14-02.17	SSJ	95	850	S5 A13									
B5														
4.4 [E60]	03.05-10.07		95	850	S5 A13	110	920	S5 015	95	800	S4 013			
BiTurbo [F10]	09.10-12.14		95	850	S5 A13									
	01.15-12.16		105	950	S5 A15									
S [E60]	10.07-05.10		95	850	S5 A13									
B5 Touring														
4.4 [E61]	03.05-10.07		95	850	S5 A13	110	920	S5 015	95	800	S4 013			

			0 092 ...0			0 092 ...0			0 092 ...0			0 092 ...0		
			Ah	A (EN)	S5A	Ah	A (EN)	S5	Ah	A (EN)	S4	Ah	A (EN)	S3
4.4	BiTurbo [F11]	03.11-12.14	95	850	S5 A13									
		01.15-12.16	105	950	S5 A15									
B6 Cabrio														
4.4	, S [E64]	04.06-08.10	95	850	S5 A13									
	BiTurbo [F12]	09.11-09.14	95	850	S5 A13									
B6 Cabrio Edition 50														
4.4	BiTurbo [F12]	01.15-03.16	105	950	S5 A15									
B6 Coupé														
4.4	, S [E63]	04.06-08.10	95	850	S5 A13									
	BiTurbo [F13]	09.11-09.14	95	850	S5 A13									
B6 Coupé Edition 50														
4.4	BiTurbo [F13]	01.15-03.16	105	950	S5 A15									
B6 GC														
4.4	BiTurbo [F06]	03.15→	105	950	S5 A15									
	BiTurbo Allrad [F06]	04.14-12.14	SSJ	95	850	S5 A13								
			105	950	S5 A15									
B7														
4.4	[E65/66]	12.03-06.08	95	850	S5 A13									
	BiTurbo [F01/F02]	07.12-07.15	105	950	S5 A15									
	BiTurbo [F01/02]	03.09-06.12	95	850	S5 A13									
	BiTurbo Allrad [G12]	02.16→	SSJ	105	950	S5 A15								
B8														
4.6	[E36]	01.95-11.98	95	850	S5 A13	100	830	S5 013	95	800	S4 013	90	720	S3 013
B8 Cabrio														
4.6	[E36]	01.95-11.98	95	850	S5 A13	100	830	S5 013	95	800	S4 013	90	720	S3 013
B8 Coupé														
4.6	[E36]	01.95-11.98	95	850	S5 A13	100	830	S5 013	95	800	S4 013	90	720	S3 013
B8 Touring														
4.6	[E36]	01.95-11.98	95	850	S5 A13	100	830	S5 013	95	800	S4 013	90	720	S3 013
B10														
3.2	[E39]	08.97-12.98	95	850	S5 A13	100	830	S5 013	95	800	S4 013	90	720	S3 013
3.3	[E39]	02.99-10.03	95	850	S5 A13	100	830	S5 013	95	800	S4 013	90	720	S3 013
4.6/ 4.8	S V8, V8 [E39]	01.97-05.04	95	850	S5 A13	110	920	S5 015						
B10 Touring														
3.2	[E39]	08.97-12.98	95	850	S5 A13	100	830	S5 013	95	800	S4 013	90	720	S3 013
3.3	[E39]	02.99-10.03	95	850	S5 A13	100	830	S5 013	95	800	S4 013	90	720	S3 013
4.6/ 4.8	S V8, V8 [E39]	01.97-05.04	95	850	S5 A13	110	920	S5 015						
B12														
5.7	[E38]	12.95-08.98	95	850	S5 A13									
6.0	[E38]	07.99-07.01	95	850	S5 A13									
D3														
Diesel														
2.0	[E90]	12.05-04.08	95	850	S5 A13									
	BiTurbo [E90]	07.08-05.13	95	850	S5 A13									
3.0	BiTurbo [F30]	03.14→	SSJ	95	850	S5 A13								
D3 Coupé														
Diesel														
2.0	BiTurbo [E92]	07.08-05.13	95	850	S5 A13									
D3 Touring														
Diesel														
2.0	[E91]	05.06-04.08	95	850	S5 A13									
	BiTurbo [E91]	07.08-05.13	95	850	S5 A13									
3.0	BiTurbo [F31]	03.14→	SSJ	95	850	S5 A13								
D4 Cabrio														
Diesel														
3.0	BiTurbo [F33]	09.14→	SSJ	105	950	S5 A15								
D4 Coupé														
Diesel														
3.0	BiTurbo [F32]	09.14→	SSJ	95	850	S5 A13								
D5														
Diesel														
3.0	BiTurbo [F10]	09.11-12.16	95	850	S5 A13									



			Ah A (EN)	Ah A (EN)	Ah A (EN)	Ah A (EN)
			0 092 ...0	0 092 ...0	0 092 ...0	0 092 ...0

◀ ALPINA

D5 Touring											
Diesel											
3.0	BiTurbo [F11]	09.11-12.16	95	850	S5 A13						
D10											
Diesel											
3.0	BiTurbo [E39]	04.00-10.03	95	850	S5 A13	100	830	S5 013	95	800	S4 013
D10 Touring											
Diesel											
3.0	BiTurbo [E39]	04.00-10.03	95	850	S5 A13	100	830	S5 013	95	800	S4 013
Roadster											
S	[Z4]	07.03-12.05	70	760	S5 A08	77	780	S5 008	74	680	S4 008
V8	[Z8]	06.02-10.03	95	850	S5 A13	110	920	S5 015	95	800	S4 013
XD3											
Diesel											
3.0	BiTurbo [F25]	04.13-03.14	SSJ	95	850	S5 A13					
3											
3.3	S [E46]	08.02-01.06	80	800	S5 A11	85	800	S5 010	80	740	S4 010

ARO

ARO 10											
1.2/ 1.6	i 16V, Spartana	01.90-12.06							45	400	S3 003
Diesel											
1.9	D	09.90-12.06				63	610	S5 005	60	540	S4 005
	TD	06.97-12.06				63	610	S5 005	60	540	S4 005
ARO 240-244											
3.0	, V6	01.89-12.06							74	680	S4 008
Diesel											
2.5	D	01.84-12.06				77	780	S5 008	74	680	S4 008
	D Turbo	01.92-12.06	70	760	S5 A08	77	780	S5 008	74	680	S4 008

ARTEGA

GT											
3.6		07.09→	70	760	S5 A08	77	780	S5 008	74	680	S4 008

ASIA (ASIA MOTORS)

Rocsta											
1.8	i AWD [CA]	09.91-12.98							60	540	S4 024
Diesel											
2.2	D [CA]	08.94-12.98							60	540	S4 024

ASTON MARTIN

Cygnnet											
1.3		04.11-10.13							60	540	S4 025
DBS Cabrio											
5.9	Volante	03.09-12.12	95	850	S5 A13	100	830	S5 013	95	800	S4 013
DBS Coupé											
5.9	Vantage	09.07-12.12	95	850	S5 A13	100	830	S5 013	95	800	S4 013
DB7 Cabrio											
3.2	Volante	03.94-02.99	70	760	S5 A08	77	780	S5 008	74	680	S4 008
		11.95-06.99	70	760	S5 A08	77	780	S5 008	74	680	S4 008
5.9	AR1 Volante	03.02-12.04	95	850	S5 A13	100	830	S5 013	95	800	S4 013
	V12 Volante	03.99-08.02	70	760	S5 A08	77	780	S5 008	74	680	S4 008
DB7 Coupé											
3.2	Vantage	03.94-02.99	70	760	S5 A08	77	780	S5 008	74	680	S4 008
		05.94-06.99	70	760	S5 A08	77	780	S5 008	74	680	S4 008



			Ah A (EN) S5A			Ah A (EN) S5			Ah A (EN) S4			Ah A (EN) S3		
			0 092 ...0			0 092 ...0			0 092 ...0			0 092 ...0		
5.9 V12 Vantage	03.99-08.02		70	760	S5 A08	77	780	S5 008	74	680	S4 008	70	640	S3 008
		AGM	95	850	S5 A13									
V12 Zagato	09.02-12.03		95	850	S5 A13	100	830	S5 013	95	800	S4 013			
6.0 V12 Vantage	10.02-08.04		70	760	S5 A08	77	780	S5 008	74	680	S4 008			
DB9 Cabrio														
5.9 Volante	01.08→		95	850	S5 A13	100	830	S5 013	95	800	S4 013			
DB9 Coupe														
5.9	03.13→		95	850	S5 A13									
DB9 Coupé														
4.2/ 5.9 Vantage	06.05→		95	850	S5 A13	100	830	S5 013	95	800	S4 013			
DB9 GT														
5.9	08.15→		95	850	S5 A13									
DB9 GT Volante														
5.9	08.15→		95	850	S5 A13									
DB9 Vantage														
5.9 Vantage	01.04-12.07	AGM	95	850	S5 A13									
DB9 Volante														
5.9	04.04-12.07	AGM	95	850	S5 A13									
	03.13→		95	850	S5 A13									
DB11														
5.2	03.16→		95	850	S5 A13									
Lagonda														
5.3/ 6.3	10.93-12.99								70	630	S4 027			
One-77														
7.3	07.10-12.12		95	850	S5 A13	100	830	S5 013						
Rapide														
5.9	03.10→		95	850	S5 A13	100	830	S5 013						
S	03.13→		95	850	S5 A13									
Vanquish Coupé														
5.9	09.00-08.04		95	850	S5 A13	100	830	S5 013	95	800	S4 013			
	09.04-08.07	AGM	95	850	S5 A13									
	03.13→		95	850	S5 A13									
Vanquish Volante														
5.9	06.13→		95	850	S5 A13									
Vantage Coupe														
4.3 V8	03.05-09.08					100	830	S5 013	95	800	S4 013			
		AGM	95	850	S5 A13									
4.7 V8	10.08→		95	850	S5 A13	100	830	S5 013	95	800	S4 013			
4.7/ 6.0 V8 S, V12	03.09→		95	850	S5 A13	100	830	S5 013	95	800	S4 013			
Vantage Coupé GT8														
4,7	11.16→		95	850	S5 A13									
Vantage Roadster														
4.3 V8	04.07-09.08	AGM	95	850	S5 A13									
4.7 V8	09.12→		95	850	S5 A13	100	830	S5 013	95	800	S4 013			
V8 S	06.11→		95	850	S5 A13	100	830	S5 013	95	800	S4 013			
6.0 V12	03.13→		95	850	S5 A13									
Vantage S Coupé														
5.9	06.13→		95	850	S5 A13									
Virage Cabrio														
5.3 Volante	01.97-12.00		70	760	S5 A08	77	780	S5 008	74	680	S4 008			
6.0 Volante	05.11-12.12		95	850	S5 A13	100	830	S5 013	95	800	S4 013			
Virage Coupé														
5.3 Kompressor	10.92-12.99								70	630	S4 027			
6.0	05.11-12.12		95	850	S5 A13	100	830	S5 013	95	800	S4 013			
V8 Coupe														
5.3 32V Kompressor	10.92-12.99								70	630	S4 027			
Zagato Coupe														
6.0 V12	09.11→		95	850	S5 A13									



			Ah A (EN)	Ah A (EN)	Ah A (EN)	Ah A (EN)
			0 092 ...0	0 092 ...0	0 092 ...0	0 092 ...0

AUDI

A1						
1.0 TFSI [8X]	03.15-10.18		60	680	S5 A05	60 540 S4 005
		BWD,SSJ				60 640 S4 E05
	01.16-10.18	BWD,SSJ	60	680	S5 A05	60 640 S4 E05
1.2 TFSI [8X]	05.10-04.15	BWD,SSJ	60	680	S5 A05	
		SSJ	60	680	S5 A05	
1.4 TDI [8X]	11.14-10.18		70	760	S5 A08	
		BWD,SSJ				60 640 S4 E05
TFSI [8X]	05.10-04.15	BWD,SSJ	70	760	S5 A08	
			80	800	S5 A11	
		KZO,SSJ	70	760	S5 A08	
		KZO,SSJ	80	800	S5 A11	
	11.11-04.15	SSJ	80	800	S5 A11	
	02.13-10.18		70	760	S5 A08	
	11.14-10.18	BWD,SSJ				60 640 S4 E05
	05.15-10.18	BWD	60	680	S5 A05	60 640 S4 E05
			70	760	S5 A08	60 640 S4 E05
1.8 TFSI [8X]	02.15-10.18		70	760	S5 A08	
			80	800	S5 A11	
		BWD,SSJ				80 800 S4 E11
		SSJ				60 640 S4 E05
2.0 TFSI quattro [8X]	03.12-12.12		80	800	S5 A11	
Diesel						
1.4 TDI [8X]	11.14-10.18		70	760	S5 A08	
		BWD,SSJ				60 640 S4 E05
1.6 TDI [8X]	05.10-04.15	BWD,SSJ	70	760	S5 A08	
			80	800	S5 A11	
		KZO,SSJ	70	760	S5 A08	
		KZO,SSJ	80	800	S5 A11	
	03.11-04.15	BWD,SSJ	60	680	S5 A05	
	11.14-10.18		70	760	S5 A08	
		BWD,SSJ				60 640 S4 E05
2.0 TDI [8X]	09.11-04.15	BWD	70	760	S5 A08	
		BWD,KZO,SSJ	70	760	S5 A08	
		BWD,KZO,SSJ	80	800	S5 A11	
A1 Sportback						
1.0 TFSI [8X]	03.15-10.18		60	680	S5 A05	
		BWD,SSJ				60 640 S4 E05
	01.16-10.18	BWD,SSJ	60	680	S5 A05	60 640 S4 E05
1.2 TFSI [8X]	01.12-04.15	BWD,SSJ	60	680	S5 A05	
		SSJ	60	680	S5 A05	
1.4 TFSI [8X]	11.11-04.15	BWD,SSJ	70	760	S5 A08	
			80	800	S5 A11	
		KZO,SSJ	70	760	S5 A08	
		KZO,SSJ	80	800	S5 A11	
	05.12-04.15	SSJ	80	800	S5 A11	
	05.12-10.18		70	760	S5 A08	
	11.14-10.18	BWD,SSJ				60 640 S4 E05
			70	760	S5 A08	60 640 S4 E05
	05.15-10.18	BWD	60	680	S5 A05	60 640 S4 E05
1.8 TFSI [8X]	02.15-10.18		80	800	S5 A11	
		BWD,SSJ	70	760	S5 A08	60 640 S4 E05
			70	760	S5 A08	80 800 S4 E11
Diesel						
1.4 TDI [8X]	11.14-10.18				63 610 S5 005	60 540 S4 005
		BWD,SSJ	70	760	S5 A08	60 640 S4 E05



			Ah A (EN) S5A			Ah A (EN) S5			Ah A (EN) S4			Ah A (EN) S3			
			0 092 ...0			0 092 ...0			0 092 ...0			0 092 ...0			
1.6 TDI [8X]	11.11-04.15	BWD,KZO,SSJ	70	760	S5 A08										
		BWD,KZO,SSJ	80	800	S5 A11										
		BWD,SSJ	70	760	S5 A08										
			80	800	S5 A11										
		KZO,SSJ	70	760	S5 A08										
		KZO,SSJ	80	800	S5 A11										
	11.14-10.18		70	760	S5 A08										
BWD,SSJ						60	640	S4 E05							
2.0 TDI [8X]	09.11-04.15	BWD	70	760	S5 A08										
	05.12-04.15		70	760	S5 A08										
A2															
1.4 [8Z0]	09.99-04.02		70	760	S5 A08	77	780	S5 008	74	680	S4 008	70	640	S3 008	
	11.01-08.05		70	760	S5 A08	77	780	S5 008	74	680	S4 008				
1.6 FSI [8Z0]	01.02-08.05		70	760	S5 A08	85	800	S5 011	74	680	S4 008	70	640	S3 008	
Diesel															
1.2 TDI 3L [8Z0]	03.01-08.05		70	760	S5 A08	85	800	S5 011	74	680	S4 008	70	640	S3 008	
1.4 TDI [8Z0]	09.99-08.05		70	760	S5 A08	85	800	S5 010	74	680	S4 008	70	640	S3 008	
A3															
1.0/ 2.0 TFSI [8V1; 8VK]	05.16→	BWD,SSJ	70	760	S5 A08				70	760	S4 E08				
1.2 TFSI [8P1]	04.10-03.13	BWD				77	780	S5 008	60	540	S4 005	45	400	S3 002	
		BWD,SSJ	70	760	S5 A08										
TFSI [8V1; 8VK]	12.12-05.15		70	760	S5 A08										
	05.14→	BWD,SSJ	70	760	S5 A08										
1.4 TFSI [8P1]	09.07-03.13					63	610	S5 005	52	470	S4 002				
		BWD,SSJ	70	760	S5 A08										
		SSJ	70	760	S5 A08										
		04.10-03.13	BWD				63	610	S5 005	52	470	S4 002			
TFSI [8V1; 8VK]	04.12-08.13		70	760	S5 A08										
	01.13→	BWD	70	760	S5 A08										
	05.14→		70	760	S5 A08	77	780	S5 008	74	680	S4 008				
		BWD,SSJ								70	760	S4 E08			
1.6 [8L1]	09.96-06.01					63	610	S5 005	52	470	S4 002	45	400	S3 002	
	05.00-06.03					63	610	S5 005	52	470	S4 002				
	09.00-09.06					74	750	S5 007	72	680	S4 007				
	[8P1]	05.03-08.12					63	610	S5 005	52	470	S4 002	45	400	S3 002
		07.08-03.13		60	680	S5 A05	63	610	S5 005	60	540	S4 005			
	05.10-03.13					63	610	S5 005							
		BWD	60	680	S5 A05				60	540	S4 005				
FSI [8P1]	08.03-09.07					63	610	S5 005	60	540	S4 005				
1.8 [8L1]	09.96-06.03					63	610	S5 005	60	540	S4 005	56	480	S3 005	
	quattro [8L1]	08.98-06.99				63	610	S5 005	60	540	S4 005	56	480	S3 005	
	T [8L1]	12.96-06.03				63	610	S5 005	60	540	S4 005	56	480	S3 005	
		05.99-09.06					74	750	S5 007	72	680	S4 007			
	T quattro [8L1]	08.97-06.03				63	610	S5 005	60	540	S4 005	56	480	S3 005	
	TFSI [8P1]	11.06-05.08		70	760	S5 A08	77	780	S5 008	74	680	S4 008			
		07.08-08.12		70	760	S5 A08	77	780	S5 008	74	680	S4 008			
	TFSI [8V1; 8VK]	04.12-08.16		70	760	S5 A08									
	TFSI quattro [8P1]	07.08-03.13								60	540	S4 005			
			BWD	60	680	S5 A05	63	610	S5 005						
TFSI quattro [8V1; 8VK]	08.12-08.16		70	760	S5 A08										
2.0 FSI [8P1]	05.03-06.08		70	760	S5 A08	77	780	S5 008	60	540	S4 005	56	480	S3 005	
	TFSI [8P1]	09.04-06.08		70	760	S5 A08	77	780	S5 008	60	540	S4 005	56	480	S3 005
		07.08-03.13	BWD	70	760	S5 A08	77	780	S5 008	60	540	S4 005	56	480	S3 005
	TFSI quattro [8P1]	09.04-06.08		70	760	S5 A08	77	780	S5 008	60	540	S4 005	56	480	S3 005
		07.08-03.13	BWD	70	760	S5 A08	77	780	S5 008	60	540	S4 005	56	480	S3 005
TFSI quattro [8V1; 8VK]	05.16→	BWD,SSJ	70	760	S5 A08				70	760	S4 E08				
3.2 quattro [8P1]	07.03-05.09		70	760	S5 A08	85	800	S5 011	74	680	S4 008				
	11.05-05.09		70	760	S5 A08	85	800	S5 010	74	680	S4 008				
			70	760	S5 A08	85	800	S5 011	80	740	S4 011				
Diesel															
1.6 TDI [8P1]	05.09-03.13	BWD				77	780	S5 008	60	540	S4 005				
		BWD,SSJ	70	760	S5 A08										



A

				Ah	A (EN)		Ah	A (EN)		Ah	A (EN)		Ah	A (EN)	
				0 092 ...0			0 092 ...0			0 092 ...0			0 092 ...0		
◀ AUDI															
1.6 TDI [8P1]	11.09-08.12	BWD,KZO,SSJ	70	760	S5 A08										
		BWD,KZO,SSJ	80	800	S5 A11										
TDI [8V1; 8VK]	09.12-05.15		70	760	S5 A08										
	05.15-03.17		70	760	S5 A08	77	780	S5 008	60	540	S4 005				
		BWD	70	760	S5 A08										
	03.17→	BWD,SSJ	70	760	S5 A08				70	760	S4 E08				
1.9 TDI [8P1]	06.03-05.10		70	760	S5 A08	85	800	S5 011	74	680	S4 008	70	640	S3 008	
TDI, TDI quattro [8L1]	09.96-06.03		70	760	S5 A08	77	780	S5 008	74	680	S4 008				
2.0 TDI [8P1]	05.03-06.08		70	760	S5 A08	85	800	S5 010	74	680	S4 008	70	640	S3 008	
			70	760	S5 A08	85	800	S5 011	74	680	S4 008	70	640	S3 008	
	03.06-06.08					85	800	S5 011	74	680	S4 008	70	640	S3 008	
		BWD,SSJ	70	760	S5 A08										
		SSJ	70	760	S5 A08										
	06.06-06.08		70	760	S5 A08	77	780	S5 008	74	680	S4 008				
	07.08-03.13	BWD	70	760	S5 A08	85	800	S5 011	74	680	S4 008	70	640	S3 008	
	09.08-05.10	BWD				85	800	S5 011	74	680	S4 008	70	640	S3 008	
	09.08-03.13	BWD,SSJ	70	760	S5 A08										
TDI [8V1; 8VK]	04.12→		70	760	S5 A08										
	05.13-08.16	BWD,SSJ	70	760	S5 A08										
	05.15→	BWD	70	760	S5 A08										
TDI quattro [8P1]	05.03-06.08		70	760	S5 A08	85	800	S5 010	74	680	S4 008	70	640	S3 008	
			70	760	S5 A08	85	800	S5 011	74	680	S4 008	70	640	S3 008	
	11.04-06.08		70	760	S5 A08	85	800	S5 010	74	680	S4 008				
	03.06-06.08					85	800	S5 011	74	680	S4 008	70	640	S3 008	
		SSJ	70	760	S5 A08										
	03.06-03.13	BWD,SSJ	70	760	S5 A08										
	07.08-05.10	BWD				85	800	S5 011	74	680	S4 008	70	640	S3 008	
	09.08-03.13	BWD	70	760	S5 A08	85	800	S5 011	74	680	S4 008	70	640	S3 008	
TDI quattro [8V1; 8VK]	10.12-05.17		70	760	S5 A08										
A3 Cabriolet															
1.2 TFSI [8P7]	03.10-05.13	BWD				63	610	S5 005				70	640	S3 008	
		BWD,SSJ	70	760	S5 A08										
1.4 TFSI [8P7]	02.11-05.13	BWD	70	760	S5 A08										
TFSI [8V7; 8VE]	10.13-05.14		70	760	S5 A08	63	610	S5 005	60	540	S4 005				
	02.14→		70	760	S5 A08	77	780	S5 008	74	680	S4 008				
		BWD,SSJ							70	760	S4 E08				
	02.16-07.16	BWD,SSJ	70	760	S5 A08				70	760	S4 E08				
1.6 [8P7]	09.08-05.10					63	610	S5 005							
		BWD	60	680	S5 A05				60	540	S4 005				
1.8 TFSI [8V7; 8VE]	10.13-07.16		70	760	S5 A08	63	610	S5 005	60	540	S4 005				
	05.14-07.16		70	760	S5 A08										
		BWD,SSJ							70	760	S4 E08				
TFSI quattro [8V7; 8VE]	03.14-07.16		70	760	S5 A08	77	780	S5 008	74	680	S4 008	70	640	S3 008	
		BWD,SSJ							70	760	S4 E08				
1.8/2.0 TFSI [8P7]	04.08-05.13		60	680	S5 A05	63	610	S5 005	60	540	S4 005				
2.0 TFSI [8V7; 8VE]	05.16→	BWD,SSJ	70	760	S5 A08				70	760	S4 E08				
TFSI quattro [8V7; 8VE]	05.14→	BWD,SSJ	70	760	S5 A08				70	760	S4 E08				
Diesel															
1.6 TDI [8P7]	05.09-05.13	BWD				63	610	S5 005				70	640	S3 008	
		BWD,KZO,SSJ	70	760	S5 A08										
		BWD,KZO,SSJ	80	800	S5 A11										
TDI [8V7; 8VE]	02.14-05.15					77	780	S5 008	74	680	S4 008	70	640	S3 008	
		BWD,SSJ	70	760	S5 A08				70	760	S4 E08				
	05.15→		70	760	S5 A08	63	610	S5 005	60	540	S4 005				
1.9 TDI [8P7]	04.08-05.09	BWD	70	760	S5 A08	85	800	S5 011	74	680	S4 008	70	640	S3 008	
2.0 TDI [8P7]	04.08-05.10		70	760	S5 A08	85	800	S5 010	74	680	S4 008				
	04.08-05.13	BWD				85	800	S5 011	74	680	S4 008	70	640	S3 008	
		BWD,SSJ	70	760	S5 A08										
	11.09-05.13	BWD				77	780	S5 008	74	680	S4 008				
TDI [8V7; 8VE]	10.13-05.17					63	610	S5 005	60	540	S4 005				
						77	780	S5 008	74	680	S4 008	70	640	S3 008	
		BWD,SSJ	70	760	S5 A08				70	760	S4 E08				
			70	760	S5 A08										



						Ah A (EN) S5A		Ah A (EN) S5		Ah A (EN) S4		Ah A (EN) S3	
				0 092 ...0		0 092 ...0		0 092 ...0		0 092 ...0		0 092 ...0	
2.0	TDI quattro [8V7; 8VE]	03.14-05.17				77	780	S5 008	74	680	S4 008		
			BWD,SSJ	70	760			S5 A08	70	760	S4 E08		
A3 Limousine													
1.0	TFSI [8VS; 8VM]	07.16→	BWD,SSJ	70	760			S5 A08	70	760	S4 E08		
1.2	TFSI [8VS; 8VM]	10.13-05.15		60	680			S5 A05					
			BWD,SSJ	70	760			S5 A08					
			SSJ						60	640	S4 E05		
		05.14→		70	760			S5 A08					
			BWD,SSJ						70	760	S4 E08		
1.4	TFSI [8VS; 8VM]	09.13-05.15	BWD,SSJ	70	760			S5 A08	70	760	S4 E08		
		09.13→		70	760			S5 A08					
			BWD,SSJ						70	760	S4 E08		
				70	760			S5 A08					
		05.14-08.16	BWD	70	760			S5 A08					
		05.14→		70	760		77	780	S5 008	74	680	S4 008	
1.8	TFSI [8VS; 8VM]	05.13-08.16	BWD	70	760			S5 A08					
		10.13-08.16	BWD,SSJ	70	760			S5 A08					
		11.13-08.16		70	760			S5 A08					
			BWD,SSJ						70	760	S4 E08		
	TFSI quattro [8VS; 8VM]	11.13-08.16				63	610	S5 005	60	540	S4 005		
			BWD,SSJ	70	760			S5 A08					
2.0	TFSI [8VS; 8VM]	05.16→	BWD,SSJ	70	760			S5 A08	70	760	S4 E08		
	TFSI quattro [8VS; 8VM]	05.16→	BWD,SSJ	70	760			S5 A08	70	760	S4 E08		
Diesel													
1.6	TDI [8VS; 8VM]	09.13-05.15		70	760			S5 A08					
		05.14-05.15				77	780	S5 008	74	680	S4 008		
			BWD,SSJ	70	760			S5 A08	70	760	S4 E08		
		05.15-03.17		70	760		77	780	S5 008	74	680	S4 008	
			BWD						70	760	S4 E08		
				70	760			S5 A08					
		03.17→	BWD,SSJ	70	760			S5 A08	70	760	S4 E08		
	TDI quattro [8VS; 8VM]	05.15-03.17				54	530	S5 002	60	540	S4 005		
			BWD,SSJ	70	760			S5 A08	60	640	S4 E05		
				70	760			S5 A08	70	760	S4 E08		
2.0	TDI [8VS; 8VM]	05.13-08.16	BWD,SSJ	70	760			S5 A08					
		05.13→		70	760			S5 A08					
		05.14-05.17	BWD,SSJ	70	760			S5 A08	70	760	S4 E08		
		05.15→	BWD	70	760			S5 A08					
	TDI quattro [8VS; 8VM]	10.13-05.15		70	760			S5 A08					
		10.13-08.16		70	760			S5 A08	60	540	S4 005		
		05.14-05.17				77	780	S5 008	74	680	S4 008	70	640
			BWD,SSJ	70	760			S5 A08	70	760	S4 E08		
A3 Sportback													
1.0	TFSI [8V1; 8VF]	07.16→	BWD,SSJ	70	760			S5 A08	70	760	S4 E08		
1.2	TFSI [8PA]	11.09-08.12	BWD			63	610	S5 005	60	540	S4 005		
			BWD,SSJ	70	760			S5 A08					
	TFSI [8VA; 8VF]	05.13→	BWD,SSJ	70	760			S5 A08					
1.4	TFSI [8PA]	06.07-08.12	BWD			63	610	S5 005	52	470	S4 002		
		06.07-03.13	BWD,SSJ	70	760			S5 A08					
		04.10-03.13	SSJ	70	760			S5 A08					
	TFSI [8VA; 8VF]	09.12→		70	760			S5 A08					
		02.13→	BWD,SSJ	70	760			S5 A08					
	TFSI e-tron [8VA; 8VF]	05.14→				77	780	S5 008	74	680	S4 008		
			BWD,SSJ	70	760			S5 A08	70	760	S4 E08		
		09.15→	BWD,SSJ	70	760			S5 A08					
	TFSI g-tron [8VA; 8VF]	05.13→	BWD,SSJ	70	760			S5 A08					
1.6	[8PA]	09.04-03.13				63	610	S5 005	52	470	S4 002	45	400
		05.10-03.13	BWD			63	610	S5 005	52	470	S4 002		
	FSI [8PA]	09.04-09.07				63	610	S5 005	60	540	S4 005		
1.8	TFSI [8PA]	11.06-08.12				63	610	S5 005	60	540	S4 005		
	TFSI [8VA; 8VF]	09.12-08.16		70	760			S5 A08					
	TFSI quattro [8PA]	07.08-03.13	BWD			77	780	S5 008	60	540	S4 005		
	TFSI quattro [8VA; 8VF]	05.13-08.16	BWD,SSJ	70	760			S5 A08					



A

			Ah A (EN) S5A			Ah A (EN) S5			Ah A (EN) S4			Ah A (EN) S3			
			0 092 ...0			0 092 ...0			0 092 ...0			0 092 ...0			
◀ AUDI															
2.0 FSI [8PA]	09.04-01.05		70	760	S5 A08	77	780	S5 008	60	540	S4 005				
	09.04-06.08		70	760	S5 A08	77	780	S5 008	60	540	S4 005	56	480	S3 005	
	11.05-11.06	BWD				63	610	S5 005	60	540	S4 005				
						63	610	S5 005	74	680	S4 008				
	TFSI [8PA]	09.04-08.13		70	760	S5 A08	77	780	S5 008	60	540	S4 005	56	480	S3 005
		07.08-03.13	BWD	70	760	S5 A08	77	780	S5 008	60	540	S4 005	56	480	S3 005
	TFSI [8VA; 8VF]	05.16→	BWD,SSJ	70	760	S5 A08				70	760	S4 E08			
	TFSI quattro [8PA]	09.04-05.09		70	760	S5 A08	77	780	S5 008	60	540	S4 005	56	480	S3 005
		07.08-03.13	BWD	70	760	S5 A08	77	780	S5 008	60	540	S4 005	56	480	S3 005
	TFSI quattro [8VA; 8VF]	05.16→	BWD,SSJ	70	760	S5 A08				70	760	S4 E08			
3.2 quattro [8PA]	09.04-05.09		70	760	S5 A08	85	800	S5 011	74	680	S4 008				
Diesel															
1.6 TDI [8PA]	05.09-03.13	BWD				77	780	S5 008	60	540	S4 005				
		BWD,SSJ	70	760	S5 A08										
	TDI [8VA; 8VF]	01.13-03.17		70	760	S5 A08									
		05.15-03.17	BWD	70	760	S5 A08									
	03.17→	BWD,SSJ	70	760	S5 A08				70	760	S4 E08				
TDI quattro [8VA; 8VF]	05.15-03.17	BWD,SSJ	70	760	S5 A08				60	640	S4 E05				
			70	760	S5 A08				70	760	S4 E08				
1.9 TDI [8PA]	09.04-05.10		70	760	S5 A08	85	800	S5 011	74	680	S4 008	70	640	S3 008	
2.0 TDI [8PA]	09.04-06.08		70	760	S5 A08	85	800	S5 010	74	680	S4 008	70	640	S3 008	
			70	760	S5 A08	85	800	S5 011	74	680	S4 008	70	640	S3 008	
	03.06-06.08					85	800	S5 011	74	680	S4 008	70	640	S3 008	
		SSJ	70	760	S5 A08										
		03.06-03.13	BWD,SSJ	70	760	S5 A08									
		06.06-06.08		70	760	S5 A08	77	780	S5 008	74	680	S4 008			
		07.08-05.10	BWD				85	800	S5 011	74	680	S4 008	70	640	S3 008
		07.08-03.13	BWD	70	760	S5 A08	85	800	S5 011	74	680	S4 008	70	640	S3 008
		09.09-08.13					85	800	S5 011	80	740	S4 011			
	TDI [8VA; 8VF]	09.12→	BWD,SSJ	70	760	S5 A08									
		10.12→		70	760	S5 A08									
		05.15→	BWD	70	760	S5 A08									
	TDI quattro [8PA]	09.04-06.08		70	760	S5 A08	85	800	S5 010	74	680	S4 008	70	640	S3 008
			70	760	S5 A08	85	800	S5 011	74	680	S4 008	70	640	S3 008	
03.06-06.08						85	800	S5 011	74	680	S4 008	70	640	S3 008	
		SSJ	70	760	S5 A08										
		03.06-03.13	BWD,SSJ	70	760	S5 A08									
		07.08-05.10	BWD				85	800	S5 011	74	680	S4 008	70	640	S3 008
		07.08-03.13	BWD	70	760	S5 A08	85	800	S5 011	74	680	S4 008	70	640	S3 008
TDI quattro [8VA; 8VF]	02.13-05.15	BWD,SSJ	70	760	S5 A08										
	05.13-05.17		70	760	S5 A08										
A4															
1.4 TFSI [8W2; B9]	08.15→	BWD,SSJ	70	760	S5 A08										
1.6 [8D2; B5]	10.96-10.00	VAD	70	760	S5 A08	77	780	S5 008	60	540	S4 005	45	400	S3 002	
1.6/ 1.8/ 2.0, T [8EC; B7]	11.04-06.08		70	760	S5 A08	77	780	S5 008	60	540	S4 005	56	480	S3 005	
1.6/ 2.0/ 2.4, FSI [8E2; B6]	10.00-12.04		70	760	S5 A08	77	780	S5 008	60	540	S4 005				
1.8 [8D2; B5]	11.94-04.99								44	440	S4 001				
	11.94-10.00	VAD	70	760	S5 A08	77	780	S5 008	60	540	S4 005	45	400	S3 002	
	quattro [8D2; B5]	11.94-04.99							44	440	S4 001				
		11.94-10.01	VAD	70	760	S5 A08	77	780	S5 008	60	540	S4 005	45	400	S3 002
	T [8D2; B5]	11.94-12.98							44	440	S4 001				
		11.94-10.00	VAD	70	760	S5 A08	77	780	S5 008	60	540	S4 005	45	400	S3 002
		05.00-08.01		70	760	S5 A08	77	780	S5 008	74	680	S4 008			
	T [8E2; B6]	11.00-08.05		70	760	S5 A08	77	780	S5 008	60	540	S4 005			
		07.02-12.04		70	760	S5 A08	77	780	S5 008	44	440	S4 001			
	T quattro [8D2; B5]	11.94-10.00								44	440	S4 001			
		VAD	70	760	S5 A08	77	780	S5 008	60	540	S4 005	45	400	S3 002	
T quattro [8EC; B7]	11.04-06.08		70	760	S5 A08	77	780	S5 008	60	540	S4 005				
T quattro [8E2; B6]	11.00-06.02		70	760	S5 A08	77	780	S5 008	60	540	S4 005	56	480	S3 005	
	09.01-08.05		70	760	S5 A08	77	780	S5 008	60	540	S4 005				
TFSI [8K2; B8]	11.07-12.15	BWD	70	760	S5 A08	77	780	S5 008	60	540	S4 005	56	480	S3 005	
	11.11-12.15	BWD	80	800	S5 A11										
TFSI quattro [8K2; B8]	09.08-03.12	BWD	70	760	S5 A08	77	780	S5 008	74	680	S4 008				



			Ah A (EN) S5A			Ah A (EN) S5			Ah A (EN) S4			Ah A (EN) S3			
			0 092 ...0			0 092 ...0			0 092 ...0			0 092 ...0			
1.8 TFSI quattro [8K2; B8]	11.11-12.15	BWD	80	800	S5 A11										
2.0 TFSI [8EC; B7]	11.04-06.08		70	760	S5 A08	77	780	S5 008	60	540	S4 005	56	480	S3 005	
	10.06-06.08					63	610	S5 006	60	540	S4 005				
							77	780	S5 008	60	540	S4 005			
TFSI [8K2; B4]	05.13-12.15	BWD,SSJ	80	800	S5 A11										
TFSI [8K2; B8]	06.08-05.13	BWD				77	780	S5 008	74	680	S4 008	70	640	S3 008	
		BWD,KZO,SSJ	70	760	S5 A08										
		BWD,KZO,SSJ	105	950	S5 A15										
	06.08-12.15	BWD	70	760	S5 A08	77	780	S5 008	74	680	S4 008	70	640	S3 008	
	08.08-08.13	KZO,SSJ	70	760	S5 A08										
		KZO,SSJ	105	950	S5 A15										
	09.08-03.12		70	760	S5 A08	77	780	S5 008	74	680	S4 008	70	640	S3 008	
	05.13-12.15	BWD,SSJ	80	800	S5 A11										
TFSI [8W2; B9]	05.15→	BWD,SSJ	80	800	S5 A11										
			95	850	S5 A13										
	10.15→	SSJ	95	850	S5 A13										
TFSI flexible fuel [8K2; B8]	11.09-12.15	BWD				77	780	S5 008	74	680	S4 008				
		BWD,KZO,SSJ	70	760	S5 A08										
		BWD,KZO,SSJ	105	950	S5 A15										
TFSI Mild Hybrid quattro [8W2; B9]	05.17→	BWD	80	800	S5 A11										
			95	850	S5 A13										
TFSI quattro [8EC; B7]	11.04-06.08		70	760	S5 A08	77	780	S5 008	60	540	S4 005				
	01.05-05.06		70	760	S5 A08	77	780	S5 008	60	540	S4 005	56	480	S3 005	
TFSI quattro [8K2; B8]	06.08-05.13	BWD				77	780	S5 008	74	680	S4 008	70	640	S3 008	
		BWD,KZO,SSJ	70	760	S5 A08										
		BWD,KZO,SSJ	105	950	S5 A15										
	08.08-05.13	BWD,SSJ	70	760	S5 A08										
		KZO,SSJ	70	760	S5 A08										
			KZO,SSJ	105	950	S5 A15									
	05.13-12.15	BWD,SSJ	80	800	S5 A11										
			95	850	S5 A13										
	TFSI quattro [8W2; B9]	10.15→	BWD,SSJ	80	800	S5 A11									
			SSJ	95	850	S5 A13									
11.15→		BWD,SSJ	95	850	S5 A13										
TFSI quattro flexible fuel [8K2; B8]	11.09-12.15	BWD				77	780	S5 008	74	680	S4 008				
		BWD,SSJ	70	760	S5 A08										
		95	850	S5 A13											
	03.12-05.13	BWD	70	760	S5 A08										
			105	950	S5 A15										
KZO,SSJ		70	760	S5 A08											
		KZO,SSJ	105	950	S5 A15										
2.4 [8D2; B5]	08.97-10.00				85	800	S5 011	80	740	S4 011					
quattro [8D2; B5]	08.97-12.98	VAD	70	760	S5 A08	77	780	S5 008	60	540	S4 005	45	400	S3 002	
					85	800	S5 011	80	740	S4 011					
	02.99-10.00	VAD	70	760	S5 A08	77	780	S5 008	60	540	S4 005	45	400	S3 002	
					85	800	S5 011	80	740	S4 011					
2.6 [8D2; B5]	11.94-07.98	VAD	70	760	S5 A08	77	780	S5 008	60	540	S4 005	45	400	S3 002	
					85	800	S5 011	80	740	S4 011					
	quattro [8D2; B5]	11.94-07.98				85	800	S5 011	80	740	S4 011				
2.8 [8D2; B5]	03.96-06.00	VAD	70	760	S5 A08	77	780	S5 008	60	540	S4 005	45	400	S3 002	
					85	800	S5 011	80	740	S4 011					
	03.96-10.00	VAD	70	760	S5 A08	77	780	S5 008	60	540	S4 005	45	400	S3 002	
					85	800	S5 011	80	740	S4 011					
					70	760	S5 A08	77	780	S5 008	60	540	S4 005	45	400
quattro [8D2; B5]	03.96-07.98	VAD	70	760	S5 A08	77	780	S5 008	60	540	S4 005	45	400	S3 002	
					85	800	S5 011	80	740	S4 011					
	02.99-10.00	VAD	70	760	S5 A08	77	780	S5 008	60	540	S4 005	45	400	S3 002	
					85	800	S5 011	80	740	S4 011					
3.0 TFSI quattro [8K2; B8]	02.12-12.15	VAD	70	760	S5 A08	77	780	S5 008	60	540	S4 005	45	400	S3 002	
					85	800	S5 011	80	740	S4 011					
					70	760	S5 A08	77	780	S5 008	60	540	S4 005	45	400
3.0/3.2, FSI, FSI quattro, quattro [8EC; B7; 8E2; B6]	12.00-06.08		95	850	S5 A13	100	830	S5 013	95	800	S4 013				



			Ah A (EN) S5A			Ah A (EN) S5			Ah A (EN) S4			Ah A (EN) S3		
			0 092 ...0			0 092 ...0			0 092 ...0			0 092 ...0		
◀ AUDI														
3.2 FSI, FSI quattro [8K2; B8]	01.08-03.12	BWD	70	760	S5 A08	77	780	S5 008	74	680	S4 008			
Diesel														
1.9 TDI [8D2; B5]	02.96-11.00					85	800	S5 011	80	740	S4 011			
		VAD	70	760	S5 A08	77	780	S5 008	74	680	S4 008	70	640	S3 008
TDI [8E2; B6]	12.00-12.04		70	760	S5 A08	77	780	S5 008	74	680	S4 008			
			70	760	S5 A08	77	780	S5 008	80	740	S4 011			
			70	760	S5 A08	85	800	S5 011	74	680	S4 008			
TDI quattro [8D2; B5]	07.96-12.98					85	800	S5 011	80	740	S4 011			
		VAD	70	760	S5 A08	77	780	S5 008	74	680	S4 008	70	640	S3 008
	08.99-10.00					85	800	S5 011	80	740	S4 011			
		VAD	70	760	S5 A08	77	780	S5 008	74	680	S4 008	70	640	S3 008
TDI quattro [8E2; B6]	04.01-12.04		70	760	S5 A08	77	780	S5 008	74	680	S4 008			
			70	760	S5 A08	77	780	S5 008	80	740	S4 011			
			70	760	S5 A08	85	800	S5 011	74	680	S4 008			
1.9/ 2.0 TDI [8EC; B7]	11.04-06.08		70	760	S5 A08	85	800	S5 011	74	680	S4 008	70	640	S3 008
2.0 TDI [8K2; B8]	11.07-12.15	BWD				77	780	S5 008	74	680	S4 008	70	640	S3 008
		BWD, KZO, SSJ	70	760	S5 A08									
		BWD, KZO, SSJ	105	950	S5 A15									
	01.08-03.12	BWD				77	780	S5 008	60	540	S4 005			
		BWD, SSJ	95	850	S5 A13									
	01.08-12.15	BWD	70	760	S5 A08	77	780	S5 008	74	680	S4 008			
	11.11-07.13	BWD	70	760	S5 A08	77	780	S5 008	74	680	S4 008	70	640	S3 008
			105	950	S5 A15	77	780	S5 008	74	680	S4 008	70	640	S3 008
	11.11-12.15	BWD	80	800	S5 A11									
	01.12-12.15					77	780	S5 008	60	540	S4 005			
		BWD, SSJ	70	760	S5 A08									
		KZO, SSJ	70	760	S5 A08									
		KZO, SSJ	105	950	S5 A15									
	05.13-12.15		80	800	S5 A11									
		BWD, SSJ	80	800	S5 A11									
			95	850	S5 A13									
	04.14-12.15	BWD	95	850	S5 A13	77	780	S5 008	74	680	S4 008			
TDI [8W2; B9]	05.15-06.18	SSJ	95	850	S5 A13									
	05.15→	BWD, SSJ	80	800	S5 A11									
			95	850	S5 A13									
TDI quattro [8EC; B7]	01.06-06.08		70	760	S5 A08	77	780	S5 008	74	680	S4 008			
			70	760	S5 A08	77	780	S5 008	80	740	S4 011			
			70	760	S5 A08	85	800	S5 011	74	680	S4 008			
TDI quattro [8K2; B8]	06.08-03.12	BWD				77	780	S5 008	74	680	S4 008	70	640	S3 008
	06.08-07.13	BWD, KZO, SSJ	70	760	S5 A08									
		BWD, KZO, SSJ	105	950	S5 A15									
	05.09-07.13	BWD				77	780	S5 008	74	680	S4 008			
	11.11-12.15		80	800	S5 A11									
	05.13-12.15	BWD, SSJ	80	800	S5 A11									
			95	850	S5 A13									
TDI quattro [8W2; B9]	05.15-06.18	SSJ	95	850	S5 A13									
	05.15→	BWD, SSJ	80	800	S5 A11									
			95	850	S5 A13									
2.5 TDI [8D2; B5]	08.97-10.00	VAD	95	850	S5 A13	77	780	S5 008	74	680	S4 008	70	640	S3 008
TDI [8E2; B6]	04.01-12.04		95	850	S5 A13	100	830	S5 013	74	680	S4 008			
TDI quattro [8D2; B5]	11.97-10.00	VAD	95	850	S5 A13	77	780	S5 008	74	680	S4 008	70	640	S3 008
TDI quattro [8E2; B6]	12.00-12.04		95	850	S5 A13	100	830	S5 013	74	680	S4 008			
2.5/ 2.7 TDI [8EC; B7]	11.04-06.08		95	850	S5 A13	100	830	S5 013	74	680	S4 008	70	640	S3 008
2.7 TDI [8K2; B8]	11.07-03.12	BWD	70	760	S5 A08	77	780	S5 008	74	680	S4 008	70	640	S3 008
			95	850	S5 A13	100	830	S5 013	74	680	S4 008	70	640	S3 008
3.0 TDI [8K2; B8]	11.11-12.15	BWD	80	800	S5 A11									
TDI [8W2; B9]	09.15→	BWD, SSJ	80	800	S5 A11									
			95	850	S5 A13									
TDI quattro [8EC; B7]	01.05-06.08		95	850	S5 A13	100	830	S5 013						
TDI quattro [8K2; B8]	11.07-03.12	BWD	95	850	S5 A13	100	830	S5 013						
	11.11-12.15	BWD	80	800	S5 A11									
TDI quattro [8W2; B9]	05.15-08.18	BWD, SSJ	80	800	S5 A11									
			95	850	S5 A13									



			Ah	A (EN)		Ah	A (EN)		Ah	A (EN)		Ah	A (EN)	
					0 092 ...0			0 092 ...0			0 092 ...0			0 092 ...0

A4 Allroad															
2.0 TFSI [8KH]	04.09-05.13	BWD				77	780	S5 008	60	540	S4 005				
		BWD, KZO ,SSJ	70	760	S5 A08										
		BWD,KZO,SSJ	105	950	S5 A15										
	05.13-04.16	BWD,SSJ	80	800	S5 A11										
			95	850	S5 A13										
TFSI [8WH]	01.16→	BWD,SSJ	80	800	S5 A11										
			95	850	S5 A13										
		SSJ	95	850	S5 A13										
TFSI flexible fuel [8KH]	03.12-05.13	BWD				77	780	S5 008	60	540	S4 005				
		BWD, KZO ,SSJ	70	760	S5 A08										
		BWD,KZO,SSJ	105	950	S5 A15										
TFSI Mild Hybrid [8WH]	05.17→	BWD	80	800	S5 A11										
			95	850	S5 A13										
Diesel															
2.0 TDI [8KH]	04.09-01.12	BWD				77	780	S5 008	60	540	S4 005				
			70	760	S5 A08	77	780	S5 008	74	680	S4 008				
		BWD, KZO ,SSJ	70	760	S5 A08										
		BWD,KZO,SSJ	105	950	S5 A15										
		09.09-05.15	BWD,SSJ	105	950	S5 A15									
		09.09-04.16	BWD	95	850	S5 A13	100	830	S5 013	95	800	S4 013			
		11.11-04.16	BWD	80	800	S5 A11									
		03.12-03.13	BWD				77	780	S5 008	60	540	S4 005			
			BWD, KZO ,SSJ	70	760	S5 A08									
			BWD,KZO,SSJ	105	950	S5 A15									
		03.12-04.16	BWD	70	760	S5 A08	77	780	S5 008	74	680	S4 008			
		05.13-04.16	BWD,SSJ	80	800	S5 A11									
		09.13-05.16		70	760	S5 A08	63	610	S5 005	60	540	S4 005			
TDI [8WH]	01.16→	BWD	80	800	S5 A11										
			95	850	S5 A13										
		BWD,SSJ	80	800	S5 A11										
			95	850	S5 A13										
		SSJ	95	850	S5 A13										
3.0 TDI [8KH]	04.09-05.16	BWD	80	800	S5 A11										
	TDI [8WH]	01.16-08.18	BWD,SSJ	80	800	S5 A11									
			95	850	S5 A13										
A4 Avant															
1.4 TFSI [8W5; B9]	08.15→	BWD,SSJ	70	760	S5 A08										
1.6/ 1.8 [8D5; B5]	11.94-09.01	VAD	70	760	S5 A08	77	780	S5 008	60	540	S4 005	45	400	S3 002	
1.6/ 1.8/ 2.0 , T, T quattro [8ED; B7]	11.04-06.08		70	760	S5 A08	77	780	S5 008	60	540	S4 005				
1.6/ 2.0/ 2.4 , FSI [8E5; B6]	09.01-12.04		70	760	S5 A08	77	780	S5 008	60	540	S4 005				
	1.8 quattro [8D5; B5]	11.94-04.99							44	440	S4 001				
T [8D5; B5]	11.94-09.01	VAD	70	760	S5 A08	77	780	S5 008	60	540	S4 005	45	400	S3 002	
	10.95-09.01								44	440	S4 001				
T [8E5; B6]	10.95-09.01	VAD	70	760	S5 A08	77	780	S5 008	60	540	S4 005	45	400	S3 002	
	09.01-12.04		70	760	S5 A08	77	780	S5 008	60	540	S4 005				
T quattro [8D5; B5]	07.02-12.04		70	760	S5 A08	77	780	S5 008	44	440	S4 001				
	02.96-09.01	VAD	70	760	S5 A08	77	780	S5 008	60	540	S4 005	45	400	S3 002	
T quattro [8E5; B6]	08.97-09.01								44	440	S4 001				
	09.01-06.02		70	760	S5 A08	77	780	S5 008	44	440	S4 001				
TFSI [8K5; B8]	09.01-01.05		70	760	S5 A08	77	780	S5 008	60	540	S4 005				
	11.07-03.12	BWD	70	760	S5 A08	63	610	S5 005	60	540	S4 005	56	480	S3 005	
	06.08-12.15	BWD	70	760	S5 A08	77	780	S5 008	60	540	S4 005	56	480	S3 005	
TFSI quattro [8K5; B8]	11.11-12.15	BWD	80	800	S5 A11										
	09.08-03.12	BWD				63	610	S5 005	52	470	S4 002				
	11.11-12.15	BWD	80	800	S5 A11										
2.0 TFSI [8ED; B7]	11.04-06.08		70	760	S5 A08	77	780	S5 008	60	540	S4 005				
	03.07-06.08		70	760	S5 A08	77	780	S5 008	95	800	S4 013				
			70	760	S5 A08	100	830	S5 013	60	540	S4 005				
TFSI [8K5; B8]	06.08-05.13	BWD				77	780	S5 008	74	680	S4 008	70	640	S3 008	
		BWD, KZO ,SSJ	70	760	S5 A08										
		BWD,KZO,SSJ	105	950	S5 A15										



			Ah A (EN) S5A			Ah A (EN) S5			Ah A (EN) S4			Ah A (EN) S3		
			0 092 ...0			0 092 ...0			0 092 ...0			0 092 ...0		
◀ AUDI														
2.0 TFSI [8K5; B8]	06.08-12.15	BWD	70	760	S5 A08	77	780	S5 008	74	680	S4 008			
	05.13-12.15	BWD,SSJ	80	800	S5 A11									
			95	850	S5 A13									
TFSI [8W5; B9]	05.15→	BWD,SSJ	80	800	S5 A11									
			95	850	S5 A13									
TFSI flexible fuel [8K5; B8]	11.09-12.15	BWD				77	780	S5 008	74	680	S4 008			
		BWD,KZO,SSJ	70	760	S5 A08									
		BWD,KZO,SSJ	105	950	S5 A15									
TFSI g-tron [8W5; B9]	11.16→	BWD,SSJ	80	800	S5 A11									
			95	850	S5 A13									
TFSI Mild Hybrid quattro [8W5; B9]	05.17→	BWD,SSJ	80	800	S5 A11									
		SSJ	95	850	S5 A13									
TFSI quattro [8ED; B7]	11.04-06.08		70	760	S5 A08	77	780	S5 008	60	540	S4 005			
TFSI quattro [8K5; B8]	06.08-05.13	BWD				77	780	S5 008	74	680	S4 008			
		BWD,KZO,SSJ	70	760	S5 A08									
		BWD,KZO,SSJ	105	950	S5 A15									
	05.13-12.15	BWD,SSJ	80	800	S5 A11									
TFSI quattro [8W5; B9]	11.15→	BWD,SSJ	80	800	S5 A11									
			95	850	S5 A13									
TFSI quattro flexible fuel [8K5; B8]	11.09-12.15	BWD	70	760	S5 A08	77	780	S5 008	74	680	S4 008			
2.4 [8D5; B5]	08.97-09.01					85	800	S5 011	80	740	S4 011			
		VAD	70	760	S5 A08	77	780	S5 008	60	540	S4 005	45	400	S3 002
quattro [8D5; B5]	08.97-09.01									80	740	S4 011		
		VAD	70	760	S5 A08	77	780	S5 008	60	540	S4 005	45	400	S3 002
2.6 [8D5; B5]	11.94-07.98					85	800	S5 011	80	740	S4 011			
		VAD	70	760	S5 A08	77	780	S5 008	60	540	S4 005	45	400	S3 002
quattro [8D5; B5]	11.94-07.98									80	740	S4 011		
		VAD	70	760	S5 A08	77	780	S5 008	60	540	S4 005	45	400	S3 002
2.8 [8D5; B5]	03.96-09.01					85	800	S5 011	80	740	S4 011			
		VAD	70	760	S5 A08	77	780	S5 008	60	540	S4 005	56	480	S3 005
quattro [8D5; B5]	03.96-09.01									80	740	S4 011		
		VAD	70	760	S5 A08	77	780	S5 008	60	540	S4 005	56	480	S3 005
3.0 TFSI quattro [8K5; B8]	02.12-12.15		80	800	S5 A11									
3.0/3.2 , FSI, FSI quattro, quattro [8ED; B7; 8E5; B6]	09.01-06.08		95	850	S5 A13	100	830	S5 013	95	800	S4 013			
3.2 FSI, FSI quattro [8K5; B8]	04.08-03.12	BWD	70	760	S5 A08	77	780	S5 008	74	680	S4 008			
Diesel														
1.9 TDI [8D5; B5]	02.96-09.01					85	800	S5 011	80	740	S4 011			
		VAD	70	760	S5 A08	77	780	S5 008	74	680	S4 008	70	640	S3 008
TDI [8ED; B7]	11.04-12.05		70	760	S5 A08	85	800	S5 011	80	740	S4 011			
	11.04-06.08		70	760	S5 A08	77	780	S5 008	74	680	S4 008			
			70	760	S5 A08	85	800	S5 011	74	680	S4 008			
	01.06-06.08		70	760	S5 A08	77	780	S5 008	80	740	S4 011			
TDI [8E5; B6]	09.01-12.04		70	760	S5 A08	77	780	S5 008	74	680	S4 008			
			70	760	S5 A08	77	780	S5 008	80	740	S4 011			
			70	760	S5 A08	85	800	S5 011	74	680	S4 008			
TDI quattro [8D5; B5]	07.96-01.00					85	800	S5 011	80	740	S4 011			
		VAD	70	760	S5 A08	77	780	S5 008	74	680	S4 008	70	640	S3 008
			70	760	S5 A08	77	780	S5 008	74	680	S4 008			
			70	760	S5 A08	77	780	S5 008	80	740	S4 011			
	01.00-09.01		70	760	S5 A08	85	800	S5 011	74	680	S4 008			
			70	760	S5 A08	77	780	S5 008	80	740	S4 011			
			70	760	S5 A08	85	800	S5 011	74	680	S4 008			
TDI quattro [8E5; B6]	09.01-12.04		70	760	S5 A08	77	780	S5 008	74	680	S4 008			
			70	760	S5 A08	77	780	S5 008	80	740	S4 011			
			70	760	S5 A08	85	800	S5 011	74	680	S4 008			
2.0 TDI [8ED; B7]	11.04-06.08		70	760	S5 A08	77	780	S5 008	74	680	S4 008			
			70	760	S5 A08	77	780	S5 008	80	740	S4 011			
			70	760	S5 A08	85	800	S5 011	74	680	S4 008			
TDI [8K5; B8]	04.08-03.12	BWD				77	780	S5 008	74	680	S4 008	70	640	S3 008
		BWD,SSJ	95	850	S5 A13									



				Ah	A (EN)		Ah	A (EN)		Ah	A (EN)		Ah	A (EN)			
				0 092 ...0			0 092 ...0			0 092 ...0			0 092 ...0				
2.0 TDI [8K5; B8]	04.08-12.15	BWD		77	780	S5 008	74	680	S4 008								
				70	760	S5 A08	77	780	S5 008	74	680	S4 008					
			BWD,KZO,SSJ	70	760	S5 A08											
			BWD,KZO,SSJ	105	950	S5 A15											
	11.11-07.13	BWD		77	780	S5 008	74	680	S4 008	70	640	S3 008					
				105	950	S5 A15	77	780	S5 008	74	680	S4 008	70	640	S3 008		
	11.11-12.15	BWD		80	800	S5 A11											
	01.12-12.15				77	780	S5 008	74	680	S4 008							
			BWD,SSJ	70	760	S5 A08											
			KZO,SSJ	70	760	S5 A08											
		KZO,SSJ	105	950	S5 A15												
05.13-12.15			80	800	S5 A11												
		BWD,SSJ	80	800	S5 A11												
			95	850	S5 A13												
	04.14-12.15	BWD	95	850	S5 A13	77	780	S5 008	74	680	S4 008						
TDI [8W5; B9]	05.15-06.18	SSJ	95	850	S5 A13												
	05.15→	BWD,SSJ	80	800	S5 A11												
			95	850	S5 A13												
TDI quattro [8ED; B7]	01.06-06.08		70	760	S5 A08	77	780	S5 008	74	680	S4 008						
			70	760	S5 A08	77	780	S5 008	80	740	S4 011						
			70	760	S5 A08	85	800	S5 011	74	680	S4 008						
TDI quattro [8K5; B8]	06.08-03.12	BWD				77	780	S5 008	74	680	S4 008						
	06.08-07.13	BWD,KZO,SSJ	70	760	S5 A08												
		BWD,KZO,SSJ	105	950	S5 A15												
	05.09-07.13	BWD				77	780	S5 008	60	540	S4 005						
	11.11-12.15	BWD	80	800	S5 A11												
	05.13-12.15	BWD,SSJ		80	800	S5 A11											
				95	850	S5 A13											
	04.14-12.15		80	800	S5 A11												
TDI quattro [8W5; B9]	05.15-06.18	SSJ	95	850	S5 A13												
	05.15→	BWD,SSJ	80	800	S5 A11												
			95	850	S5 A13												
2.5 TDI [8D5; B5]	11.97-09.01	VAD	95	850	S5 A13	77	780	S5 008	74	680	S4 008	70	640	S3 008			
	TDI [8ED; B7]	11.04-05.06		95	850	S5 A13	85	800	S5 011	74	680	S4 008					
			95	850	S5 A13	85	800	S5 011	80	740	S4 011						
			95	850	S5 A13	100	830	S5 013	74	680	S4 008						
TDI [8E5; B6]	09.01-12.04		95	850	S5 A13	100	830	S5 013	74	680	S4 008						
TDI quattro [8D5; B5]	11.97-06.00	VAD	95	850	S5 A13	77	780	S5 008	74	680	S4 008	70	640	S3 008			
TDI quattro [8E5; B6]	09.01-12.04		95	850	S5 A13	100	830	S5 013	74	680	S4 008						
2.7 TDI [8ED; B7]	11.05-06.08		95	850	S5 A13	100	830	S5 013	74	680	S4 008						
	TDI [8K5; B8]	04.08-05.08				85	800	S5 011									
			95	850	S5 A13	100	830	S5 013	74	680	S4 008						
			BWD	80	800	S5 A11											
				95	850	S5 A13											
			KZO,SSJ	95	850	S5 A13											
			KZO,SSJ	80	800	S5 A11											
06.08-03.12			BWD		80	800	S5 A11	85	800	S5 011							
					95	850	S5 A13	85	800	S5 011							
					95	850	S5 A13	100	830	S5 013	74	680	S4 008				
				BWD,KZO,SSJ	95	850	S5 A13										
		BWD,KZO,SSJ	80	800	S5 A11												
3.0 TDI [8K5; B8]	11.11-12.15	BWD	80	800	S5 A11												
	TDI [8W5; B9]	09.15-08.18	BWD,SSJ	80	800	S5 A11											
			95	850	S5 A13												
TDI quattro [8ED; B7]	01.05-06.08		95	850	S5 A13	100	830	S5 013									
TDI quattro [8K5; B8]	04.08-05.08	BWD		80	800	S5 A11											
				70	760	S5 A08	77	780	S5 008								
	11.11-12.15	BWD		80	800	S5 A11											
				80	800	S5 A11											
01.12-09.13		80	800	S5 A11													
TDI quattro [8W5; B9]	05.15-08.18	BWD,SSJ		80	800	S5 A11											
				95	850	S5 A13											

A4 Cabriolet

1.8 T [8HE; B7] 01.06-03.09 70 760 S5 A08 77 780 S5 008 60 540 S4 005



						Ah A (EN) S5A		Ah A (EN) S5		Ah A (EN) S4		Ah A (EN) S3			
				0 092 ...0		0 092 ...0		0 092 ...0		0 092 ...0		0 092 ...0			
◀ AUDI															
1.8 T, T quattro [8H7; B6]	04.02-06.06			70	760	S5 A08	77	780	S5 008	60	540	S4 005	56	480	S3 005
2.0 TFSI [8HE; B7]	01.06-03.09			70	760	S5 A08	77	780	S5 008	60	540	S4 005			
	08.06-03.09			70	760	S5 A08	77	780	S5 008	60	540	S4 005	56	480	S3 005
2.0/ 2.4 [8H7; B6]	04.02-12.05			70	760	S5 A08	77	780	S5 008	60	540	S4 005			
3.0/ 3.2/ 4.2, FSI, FSI quattro, quattro [8HE; B7; 8H7; B6]	04.02-03.09			95	850	S5 A13	100	830	S5 013	95	800	S4 013			
Diesel															
2.0 TDI [8HE; B7]	01.06-03.09			70	760	S5 A08	77	780	S5 008	74	680	S4 008			
				70	760	S5 A08	77	780	S5 008	80	740	S4 011			
				70	760	S5 A08	85	800	S5 011	74	680	S4 008			
2.5 TDI [8H7; B6]	08.02-12.05			95	850	S5 A13	100	830	S5 013	74	680	S4 008			
2.7 TDI [8HE; B7]	11.05-03.09			95	850	S5 A13	100	830	S5 013	74	680	S4 008			
3.0 TDI quattro [8HE; B7]	01.06-03.09			95	850	S5 A13	100	830	S5 013						
A4 Sportback															
Diesel															
2.0 TDI quattro [8TA]	01.12-01.17	BWD		80	800	S5 A11									
A5 Cabriolet															
1.8 TFSI [8F7]	09.09-03.12	BWD		70	760	S5 A08	77	780	S5 008	74	680	S4 008			
	09.11-03.16	BWD		80	800	S5 A11									
	05.15-01.17			70	760	S5 A08									
				105	950	S5 A15									
		BWD,SSJ		80	800	S5 A11				80	800	S4 E11			
				95	850	S5 A13				80	800	S4 E11			
2.0 quattro [8F7]	09.13-08.17	SSJ		80	800	S5 A11									
				95	850	S5 A13									
TFSI [F57]	03.17→	BWD,SSJ		80	800	S5 A11									
				95	850	S5 A13									
	05.17→	SSJ		95	850	S5 A13									
TFSI [8F7]	03.09-03.12	BWD		70	760	S5 A08	77	780	S5 008	74	680	S4 008			
	03.09-05.13	BWD					77	780	S5 008	74	680	S4 008			
		BWD,KZO,SSJ		70	760	S5 A08									
		BWD,KZO,SSJ		105	950	S5 A15									
	05.09-03.12			70	760	S5 A08	77	780	S5 008	74	680	S4 008			
	05.13-01.17	BWD,SSJ		80	800	S5 A11									
				95	850	S5 A13									
TFSI quattro [F57]	11.16→	BWD,SSJ		80	800	S5 A11									
		SSJ		95	850	S5 A13									
	01.17→	BWD,SSJ		95	850	S5 A13									
	05.17→	BWD		80	800	S5 A11									
				95	850	S5 A13									
TFSI quattro [8F7]	03.09-05.13	BWD					77	780	S5 008	74	680	S4 008			
		BWD,KZO,SSJ		70	760	S5 A08									
		BWD,KZO,SSJ		105	950	S5 A15									
	05.13-01.17	BWD,SSJ		80	800	S5 A11									
				95	850	S5 A13									
TFSI quattro flexible fuel [8F7]	03.12-05.13						110	920	S5 015	95	800	S4 013			
		BWD		95	850	S5 A13									
				105	950	S5 A15									
3.0 FSI quattro [8F7]	11.11-06.14	BWD		80	800	S5 A11									
TFSI quattro [8F7]	05.14-01.17	BWD,SSJ		80	800	S5 A11									
		SSJ		95	850	S5 A13									
3.2 FSI [8F7]	03.09-03.12	BWD		80	800	S5 A11	77	780	S5 008	74	680	S4 008			
FSI quattro [8F7]	03.09-03.12	BWD		80	800	S5 A11	77	780	S5 008	74	680	S4 008			
Diesel															
2.0 TDI [F57]	03.17-06.18	BWD,SSJ		80	800	S5 A11									
				95	850	S5 A13									
TDI [8F7]	05.09-03.12	BWD					77	780	S5 008	74	680	S4 008			
		BWD,KZO,SSJ		70	760	S5 A08									
		BWD,KZO,SSJ		105	950	S5 A15									
	05.09-06.14	BWD		70	760	S5 A08	77	780	S5 008	74	680	S4 008			
	10.11-06.14	BWD		80	800	S5 A11	77	780	S5 008	74	680	S4 008			
	10.11-01.17	BWD		80	800	S5 A11									



			Ah A (EN) S5A			Ah A (EN) S5			Ah A (EN) S4			Ah A (EN) S3		
			0 092 ...0			0 092 ...0			0 092 ...0			0 092 ...0		
2.0 TDI [8F7]	05.13-05.15	BWD,SSJ	95	850	S5 A13									
	05.13-01.17	BWD,SSJ	80	800	S5 A11									
	09.13-01.17		70	760	S5 A08	63	610	S5 005	60	540	S4 005			
	05.14-01.17	SSJ	95	850	S5 A13									
TDI quattro [8F7]	01.12-01.17		80	800	S5 A11									
	09.13-01.17		70	760	S5 A08	63	610	S5 005	60	540	S4 005			
2.7 TDI [8F7]	03.09-03.12	BWD	80	800	S5 A11	77	780	S5 008	74	680	S4 008			
3.0 TDI [F57]	03.17→	BWD,SSJ	95	850	S5 A13									
TDI [8F7]	09.11-01.17	BWD	80	800	S5 A11									
TDI quattro [F57]	11.16→	BWD,SSJ	95	850	S5 A13									
TDI quattro [8F7]	03.09-03.12	BWD	95	850	S5 A13	110	920	S5 015						
	10.11-01.17	BWD	80	800	S5 A11									
	06.13-01.17	BWD,SSJ	80	800	S5 A11									
		SSJ	95	850	S5 A13									
	05.15-01.17		70	760	S5 A08									
			80	800	S5 A11									
		105	950	S5 A15										
		BWD,SSJ							80	800	S4 E11			
A5 Coupé														
1.4 TFSI [F53]	11.16→	BWD,SSJ	70	760	S5 A08									
			95	850	S5 A13									
1.8 TFSI [8T3]	10.07-11.08	BWD	95	850	S5 A13	100	830	S5 013	95	800	S4 013			
	05.09-09.11	BWD	70	760	S5 A08	77	780	S5 008	74	680	S4 008			
	08.11-01.17					100	830	S5 013	95	800	S4 013			
			BWD,SSJ	80	800	S5 A11								
			95	850	S5 A13									
	05.15-01.17		105	950	S5 A15									
		70	760	S5 A08										
		105	950	S5 A15										
		BWD,SSJ	80	800	S5 A11				80	800	S4 E11			
			95	850	S5 A13				80	800	S4 E11			
2.0 TFDI quattro [F53]	06.16→	BWD,SSJ	80	800	S5 A11									
			95	850	S5 A13									
TFSI [F53]	06.16→	BWD,SSJ	80	800	S5 A11									
			95	850	S5 A13									
	05.17→	SSJ	95	850	S5 A13									
	07.17→	BWD	80	800	S5 A11									
			95	850	S5 A13									
TFSI [8T3]	06.08-06.14	BWD				77	780	S5 008	74	680	S4 008			
		BWD,KZO,SSJ	70	760	S5 A08									
		BWD,KZO,SSJ	105	950	S5 A15									
	05.13-01.17	BWD,SSJ	80	800	S5 A11									
	08.15-01.17	BWD,SSJ	95	850	S5 A13									
	06.16→	BWD,SSJ	80	800	S5 A11									
TFSI quattro [F53]	06.16→	BWD,SSJ	80	800	S5 A11									
			95	850	S5 A13									
	11.16→	BWD,SSJ	95	850	S5 A13									
	05.17→	BWD	80	800	S5 A11									
			95	850	S5 A13									
TFSI quattro [8T3]	06.08-05.13	BWD				77	780	S5 008	74	680	S4 008			
		BWD,KZO,SSJ	70	760	S5 A08									
		BWD,KZO,SSJ	105	950	S5 A15									
	05.13-01.17	BWD,SSJ	80	800	S5 A11									
	09.13-08.17	SSJ	70	760	S5 A08									
			95	850	S5 A13									
08.15-01.17	BWD,SSJ	95	850	S5 A13										
TFSI quattro flexible fuel [8T3]	05.13-01.17	BWD,SSJ	70	760	S5 A08									
			80	800	S5 A11									
			95	850	S5 A13									
3.0 TFSI quattro [8T3]	12.11-01.17	BWD	80	800	S5 A11									
	05.14-01.17	BWD,SSJ	80	800	S5 A11									
		SSJ	95	850	S5 A13									
3.2 FSI [8T3]	06.07-03.12	BWD	95	850	S5 A13									



				Ah	A (EN)		Ah	A (EN)		Ah	A (EN)		Ah	A (EN)	
				0 092 ...0			0 092 ...0			0 092 ...0			0 092 ...0		
◀ AUDI															
3.2	FSI quattro [8T3]	11.07-03.12	BWD				110	920	S5 015	95	800	S4 013			
			BWD,SSJ	95	850	S5 A13									
				105	950	S5 A15									
Diesel															
2.0	TDI [F53]	06.16→	BWD,SSJ	80	800	S5 A11									
				95	850	S5 A13									
		09.16-06.18	SSJ	95	850	S5 A13									
	TDI [8T3]	01.08-03.12	BWD				77	780	S5 008	74	680	S4 008			
				70	760	S5 A08	77	780	S5 008	74	680	S4 008			
			BWD,KZO,SSJ	70	760	S5 A08									
			BWD,KZO,SSJ	105	950	S5 A15									
		08.11-06.14	BWD,SSJ	70	760	S5 A08									
			SSJ	95	850	S5 A13									
		08.11-01.17					110	920	S5 015	95	800	S4 013			
			BWD	80	800	S5 A11									
		09.13-01.17					63	610	S5 005	60	540	S4 005			
			BWD	70	760	S5 A08									
				95	850	S5 A13									
	TDI quattro [F53]	06.16→	BWD,SSJ	80	800	S5 A11									
				95	850	S5 A13									
		09.16-06.18	SSJ	95	850	S5 A13									
		11.16→	BWD	80	800	S5 A11									
				95	850	S5 A13									
	TDI quattro [8T3]	08.08-03.12	BWD				77	780	S5 008	74	680	S4 008			
			BWD,KZO,SSJ	70	760	S5 A08									
			BWD,KZO,SSJ	105	950	S5 A15									
		08.11-01.17	BWD	80	800	S5 A11									
		09.13-01.17					63	610	S5 005	60	540	S4 005			
				70	760	S5 A08									
2.7	TDI [8T3]	07.07-03.12	BWD				110	920	S5 015	95	800	S4 013			
			BWD,SSJ	95	850	S5 A13									
				105	950	S5 A15									
		09.07-03.12	BWD	80	800	S5 A11	85	800	S5 010	80	740	S4 010			
		06.08-03.12					110	920	S5 015						
3.0	TDI [F53]	06.16→	BWD,SSJ	95	850	S5 A13									
	TDI [8T3]	10.11-01.17	BWD	80	800	S5 A11									
	TDI quattro [F53]	06.16→	BWD,SSJ	95	850	S5 A13									
	TDI quattro [8T3]	06.07-03.12	BWD				110	920	S5 015	95	800	S4 013			
			BWD,SSJ	95	850	S5 A13									
				105	950	S5 A15									
		03.08-05.10	BWD	95	850	S5 A13									
		03.08-03.12					110	920	S5 015						
		08.11-01.17	BWD	80	800	S5 A11									
		05.15-01.17					70	760	S5 A08	85	800	S5 011	60	540	S4 005
							70	760	S5 A08	110	920	S5 015	60	540	S4 005
							80	800	S5 A11	85	800	S5 011	60	540	S4 005
							105	950	S5 A15	85	800	S5 011	60	540	S4 005
			BWD,SSJ							80	800	S4 E11			
A5 Sportback															
1.4	TFSI [F5A]	01.17→	BWD,SSJ	70	760	S5 A08									
				95	850	S5 A13									
1.8	TFSI [8TA]	11.09-09.11	BWD	70	760	S5 A08	77	780	S5 008	74	680	S4 008			
		08.11-01.17	BWD	80	800	S5 A11									
		09.14-01.17	BWD,SSJ	80	800	S5 A11				80	800	S4 E11			
				105	950	S5 A15				80	800	S4 E11			
		05.15-01.17					70	760	S5 A08						
2.0	TFSI [F5A]	01.17→	BWD,SSJ	80	800	S5 A11									
				95	850	S5 A13									
		05.17→	SSJ	95	850	S5 A13									
	TFSI [8TA]	09.09-01.17	BWD				77	780	S5 008	74	680	S4 008			
			BWD,KZO,SSJ	70	760	S5 A08									
			BWD,KZO,SSJ	105	950	S5 A15									
		05.13-01.17	BWD,SSJ	80	800	S5 A11									
				95	850	S5 A13									



			Ah A (EN) S5A			Ah A (EN) S5			Ah A (EN) S4			Ah A (EN) S3		
			0 092 ...0			0 092 ...0			0 092 ...0			0 092 ...0		
2.0 TFSI g-tron [F5A]	02.17→	BWD,SSJ	80	800	S5 A11									
			95	850	S5 A13									
TFSI quattro [F5A]	06.16→	BWD,SSJ	80	800	S5 A11									
			95	850	S5 A13									
	05.17→	SSJ	95	850	S5 A13									
TFSI quattro [8TA]	09.09-01.17	BWD				77	780	S5 008	74	680	S4 008			
		BWD,KZO,SSJ	70	760	S5 A08									
		BWD,KZO,SSJ	105	950	S5 A15									
	05.13-01.17	BWD,SSJ	80	800	S5 A11									
	08.15-01.17	BWD,SSJ	95	850	S5 A13									
3.0 TFSI quattro [8TA]	12.11-01.17	BWD	80	800	S5 A11									
	05.14-01.17	BWD,SSJ	80	800	S5 A11									
		SSJ	95	850	S5 A13									
3.2 FSI quattro [8TA]	09.09-03.12	BWD	80	800	S5 A11	85	800	S5 010	80	740	S4 010			
Diesel														
2.0 TDI [F5A]	06.16→	BWD,SSJ	80	800	S5 A11									
			95	850	S5 A13									
	09.16-06.18	SSJ	95	850	S5 A13									
TDI [8TA]	09.09-03.12	BWD				77	780	S5 008	74	680	S4 008			
						110	920	S5 015	80	740	S4 010			
			70	760	S5 A08	77	780	S5 008	74	680	S4 008			
		BWD,KZO,SSJ	70	760	S5 A08									
		BWD,KZO,SSJ	105	950	S5 A15									
	09.09-01.17	BWD,SSJ	70	760	S5 A08									
	08.11-01.17								74	680	S4 008			
									95	800	S4 013			
		BWD	80	800	S5 A11									
		SSJ	80	800	S5 A11									
	11.11-05.13	BWD	70	760	S5 A08									
	11.11-01.17					77	780	S5 008	74	680	S4 008			
	05.13-01.17	BWD,SSJ	80	800	S5 A11									
			95	850	S5 A13									
	09.13-01.17		70	760	S5 A08	63	610	S5 005	60	540	S4 005			
	BWD	70	760	S5 A08										
	SSJ	95	850	S5 A13										
04.14-01.17	BWD	95	850	S5 A13										
TDI quattro [F5A]	06.16→	BWD,SSJ	80	800	S5 A11									
			95	850	S5 A13									
	09.16-06.18	SSJ	95	850	S5 A13									
	11.16→	BWD	80	800	S5 A11									
			95	850	S5 A13									
TDI quattro [8TA]	09.09-03.12	BWD				77	780	S5 008	74	680	S4 008			
		BWD,KZO,SSJ	70	760	S5 A08									
		BWD,KZO,SSJ	105	950	S5 A15									
	09.13-01.17		70	760	S5 A08	63	610	S5 005	60	540	S4 005			
2.7 TDI [8TA]	09.09-03.12	BWD							80	740	S4 011			
									95	800	S4 013			
			80	800	S5 A11	77	780	S5 008	74	680	S4 008			
			80	800	S5 A11	85	800	S5 010	80	740	S4 010			
		BWD,SSJ	80	800	S5 A11									
		95	850	S5 A13										
TDI [8T3]	09.09-03.12	BWD	80	800	S5 A11	85	800	S5 010	80	740	S4 010			
3.0 TDI [F5A]	02.17→	BWD,SSJ	95	850	S5 A13									
TDI [8TA]	10.11-01.17	BWD	80	800	S5 A11									
TDI quattro [F5A]	10.16→	BWD,SSJ	95	850	S5 A13									
TDI quattro [8F7]	05.15-01.17		70	760	S5 A08									
			80	800	S5 A11									
			105	950	S5 A15									
		BWD,SSJ							80	800	S4 E11			
TDI quattro [8TA]	05.09-05.10	BWD	95	850	S5 A13	100	830	S5 013	95	800	S4 013			
	05.09-03.12	BWD				110	920	S5 015	95	800	S4 013			
		BWD,SSJ	95	850	S5 A13									
			105	950	S5 A15									



			Ah A (EN) S5A			Ah A (EN) S5			Ah A (EN) S4			Ah A (EN) S3			
			0 092 ...0			0 092 ...0			0 092 ...0			0 092 ...0			
◀ AUDI															
3.0	TDI quattro [8TA]	09.09-03.12	BWD	95	850	S5 A13									
		08.11-01.17	BWD	80	800	S5 A11									
		06.13-01.17	BWD	95	850	S5 A13									
A6															
1.8	[4B2; C5]	05.97-04.01	VAD	70	760	S5 A08	77	780	S5 008	60	540	S4 005	45	400	S3 002
	T [4B2; C5]	04.97-05.99		70	760	S5 A08	100	830	S5 013	74	680	S4 008	70	640	S3 008
		11.97-05.04	VAD	70	760	S5 A08	100	830	S5 013	74	680	S4 008	70	640	S3 008
	T quattro [4B2; C5]	04.97-01.99		70	760	S5 A08	100	830	S5 013	74	680	S4 008	70	640	S3 008
		06.97-05.01	VAD	70	760	S5 A08	100	830	S5 013	74	680	S4 008	70	640	S3 008
		05.00-05.04		70	760	S5 A08	100	830	S5 013	74	680	S4 008			
	TFSI [4G; C7]	09.14-09.18					85	800	S5 011	80	740	S4 011			
			BWD,SSJ	80	800	S5 A11				80	800	S4 E11			
				95	850	S5 A13				80	800	S4 E11			
2.0	[4B2; C5]	06.01-05.04	VAD	70	760	S5 A08	77	780	S5 008	60	540	S4 005			
	TFSI [4F2; C6]	06.05-08.11		95	850	S5 A13	100	830	S5 013	80	740	S4 010			
		01.07-03.11		95	850	S5 A13	100	830	S5 013	74	680	S4 008	70	640	S3 008
	TFSI [4G; C7]	03.11-05.13		80	800	S5 A11									
		05.11-04.15	BWD	80	800	S5 A11									
		05.13-04.15	BWD,SSJ	80	800	S5 A11									
				95	850	S5 A13									
		09.14-09.18								80	740	S4 011			
				80	800	S5 A11				80	740	S4 011			
			BWD							80	800	S4 E11			
			BWD,SSJ	80	800	S5 A11				80	800	S4 E11			
				95	850	S5 A13				80	800	S4 E11			
		05.15-09.18		70	760	S5 A08				80	800	S4 E11			
				80	800	S5 A11				80	800	S4 E11			
				105	950	S5 A15				80	800	S4 E11			
	TFSI Hybrid [4G; C7]	11.11-04.15	BWD	80	800	S5 A11									
	TFSI quattro [4G; C7]	05.12-09.18	BWD,SSJ	80	800	S5 A11									
				95	850	S5 A13									
		09.14-09.18	SSJ	95	850	S5 A13									
		05.15-09.18		70	760	S5 A08									
				105	950	S5 A15									
			BWD,SSJ	80	800	S5 A11				80	800	S4 E11			
				95	850	S5 A13				80	800	S4 E11			
2.4	[4B2; C5]	04.97-04.01		70	760	S5 A08	100	830	S5 013	74	680	S4 008	70	640	S3 008
		11.98-04.01		70	760	S5 A08	74	750	S5 007	72	680	S4 007	70	640	S3 008
				70	760	S5 A08	74	750	S5 007	74	680	S4 008	70	640	S3 008
				70	760	S5 A08	100	830	S5 013	72	680	S4 007	70	640	S3 008
		06.01-05.04		70	760	S5 A08	100	830	S5 013	74	680	S4 008			
	[4F2; C6]	04.04-10.08		95	850	S5 A13	100	830	S5 013	80	740	S4 010			
	quattro [4B2; C5]	04.97-09.01	VAD	70	760	S5 A08	100	830	S5 013	74	680	S4 008	70	640	S3 008
		06.00-05.04		70	760	S5 A08	100	830	S5 013	74	680	S4 008			
2.4/ 3.0/ 4.2	quattro [4F2; C6]	04.04-10.08	BWD	95	850	S5 A13	100	830	S5 013	80	740	S4 010			
2.7	Biturbo [4B2; C5]	02.99-05.01	VAD	70	760	S5 A08	100	830	S5 013	74	680	S4 008	70	640	S3 008
	Biturbo quattro [4B2; C5]	10.97-08.00	VAD	70	760	S5 A08	100	830	S5 013	74	680	S4 008	70	640	S3 008
		09.00-05.01		70	760	S5 A08	100	830	S5 013	74	680	S4 008			
		06.01-05.04		70	760	S5 A08	74	750	S5 007	72	680	S4 007			
				70	760	S5 A08	74	750	S5 007	74	680	S4 008			
				70	760	S5 A08	100	830	S5 013	72	680	S4 007			
2.8	[4B2; C5]	04.97-07.98								74	680	S4 008			
			VAD	70	760	S5 A08	77	780	S5 008						
		06.97-04.01	VAD	70	760	S5 A08	100	830	S5 013	74	680	S4 008	70	640	S3 008
	FSI [4F2; C6]	11.06-10.08	BWD	95	850	S5 A13	100	830	S5 013	80	740	S4 010			
		10.08-08.11	BWD	70	760	S5 A08	77	780	S5 008						
	FSI [4G; C7]	11.10-04.15	BWD	80	800	S5 A11									
	FSI quattro [4F2; C6]	11.06-10.08	BWD	95	850	S5 A13	100	830	S5 013	80	740	S4 010			
		10.08-08.11	BWD				100	830	S5 013	95	800	S4 013			
	FSI quattro [4G; C7]	11.10-04.15	BWD	70	760	S5 A08									
			BWD,KZO,SSJ	80	800	S5 A11									
			BWD,KZO,SSJ	105	950	S5 A15									



			Ah A (EN) S5A			Ah A (EN) S5			Ah A (EN) S4			Ah A (EN) S3		
			0 092 ...0			0 092 ...0			0 092 ...0			0 092 ...0		
2.8	FSI quattro [4G; C7]	09.14-09.18	BWD,SSJ	95	850	S5 A13								
	quattro [4B2; C5]	04.97-05.01		70	760	S5 A08	100	830	S5 013	74	680	S4 008	70	640
		01.99-05.01					74	750	S5 007	72	680	S4 007		
			VAD	70	760	S5 A08	100	830	S5 013	74	680	S4 008	70	640
		07.99-05.01		95	850	S5 A13	100	830	S5 013	95	800	S4 013		
3.0	[4B2; C5]	06.01-05.04		70	760	S5 A08	74	750	S5 007	72	680	S4 007		
				70	760	S5 A08	74	750	S5 007	74	680	S4 008		
				70	760	S5 A08	100	830	S5 013	72	680	S4 007		
				70	760	S5 A08	100	830	S5 013	74	680	S4 008		
	[4F2; C6]	04.04-05.06					74	750	S5 007	72	680	S4 007		
			BWD	95	850	S5 A13	100	830	S5 013	80	740	S4 010		
	quattro [4B2; C5]	06.01-05.04		70	760	S5 A08	100	830	S5 013	74	680	S4 008		
	TFSI quattro [4F2; C6]	10.08-08.11	BWD	95	850	S5 A13	100	830	S5 013	74	680	S4 008		
		10.08-09.11	BWD	80	800	S5 A11	85	800	S5 010	80	740	S4 010		
	TFSI quattro [4G; C7]	11.10-05.12	BWD,KZO,SSJ	70	760	S5 A08								
			BWD,KZO,SSJ	105	950	S5 A15								
		03.11-05.12	BWD,SSJ	80	800	S5 A11								
				95	850	S5 A13								
		11.11-04.15	BWD	80	800	S5 A11								
		09.14→					85	800	S5 011					
			BWD,SSJ	80	800	S5 A11				80	800	S4 E11		
				95	850	S5 A13				80	800	S4 E11		
3.2	FSI [4F2; C6]	04.04-10.08					74	750	S5 007	72	680	S4 007		
			BWD	95	850	S5 A13	100	830	S5 013	80	740	S4 010		
		06.06-05.09		95	850	S5 A13	100	830	S5 013	80	740	S4 010		
		03.09-08.11	BWD	95	850	S5 A13	100	830	S5 013	74	680	S4 008		
	FSI quattro [4F2; C6]	04.04-10.08	BWD	95	850	S5 A13	100	830	S5 013	80	740	S4 010		
4.2	FSI quattro [4F2; C6]	06.06-08.11	BWD	95	850	S5 A13				80	740	S4 010		
	quattro [4B4; C5]	04.99-05.04		70	760	S5 A08	74	750	S5 007	72	680	S4 007		
				70	760	S5 A08	74	750	S5 007	74	680	S4 008		
				70	760	S5 A08	100	830	S5 013	72	680	S4 007		
		06.01-07.04					74	750	S5 007	72	680	S4 007		
Diesel														
1.9	TDI [4B2; C5]	04.97-04.01		70	760	S5 A08	85	800	S5 011	74	680	S4 008	70	640
				70	760	S5 A08	100	830	S5 013	74	680	S4 008	70	640
		08.99-10.00		70	760	S5 A08	85	800	S5 011	80	740	S4 011	70	640
		06.01-05.04		95	850	S5 A13	100	830	S5 013	74	680	S4 008		
2.0	TDI [4F2; C6]	07.04-06.08	BWD	95	850	S5 A13	100	830	S5 013	80	740	S4 010		
		10.08-08.11	BWD	70	760	S5 A08	77	780	S5 008					
				70	760	S5 A08	85	800	S5 010					
	TDI [4G; C7]	02.11-04.15	BWD	80	800	S5 A11								
		01.12-09.16		80	800	S5 A11								
		11.13-09.18		95	850	S5 A13	100	830	S5 013	95	800	S4 013		
		09.14-09.16					85	800	S5 011					
			BWD,SSJ	80	800	S5 A11				80	800	S4 E11		
				95	850	S5 A13				80	800	S4 E11		
		05.15-09.18	BWD,SSJ	80	800	S5 A11								
			SSJ	95	850	S5 A13								
		05.16-09.18	BWD	80	800	S5 A11								
				95	850	S5 A13								
	TDI e [4F2; C6]	10.08-03.11	BWD	95	850	S5 A13	100	830	S5 013	80	740	S4 010		
	TDI quattro [4G; C7]	04.15-09.18		70	760	S5 A08								
				105	950	S5 A15								
			BWD,SSJ	80	800	S5 A11				80	800	S4 E11		
				95	850	S5 A13				80	800	S4 E11		
		05.16-09.18	BWD,SSJ	80	800	S5 A11								
			SSJ	95	850	S5 A13								
2.5	TDI [4B2; C5]	04.97-08.03	VAD	95	850	S5 A13	100	830	S5 013	74	680	S4 008	70	640
		06.01-05.04	VAD	95	850	S5 A13	100	830	S5 013	74	680	S4 008		
	TDI quattro [4B2; C5]	07.97-08.03	VAD	95	850	S5 A13	100	830	S5 013	74	680	S4 008	70	640
		02.03-05.04		95	850	S5 A13	100	830	S5 013	74	680	S4 008		
2.7	TDI [4F2; C6]	11.04-05.09	BWD	95	850	S5 A13	100	830	S5 013	80	740	S4 010		
		10.08-08.11	BWD	95	850	S5 A13	100	830	S5 013	95	800	S4 013		



				Ah	A (EN)		Ah	A (EN)		Ah	A (EN)		Ah	A (EN)		
				0 092 ...0			0 092 ...0			0 092 ...0			0 092 ...0			
◀ AUDI																
2.7 TDI quattro [4F2; C6]	11.04-08.11	BWD	95	850	S5 A13	100	830	S5 013	80	740	S4 010					
	10.08-08.11					100	830	S5 013								
		BWD	95	850	S5 A13	110	920	S5 015								
3.0 TDI [4G; C7]	11.10-04.15	BWD	80	800	S5 A11											
	09.14-07.15					85	800	S5 011	80	740	S4 011					
		BWD,SSJ	80	800	S5 A11				80	800	S4 E11					
			95	850	S5 A13				80	800	S4 E11					
	08.15-09.18	BWD,SSJ	80	800	S5 A11											
	SSJ	95	850	S5 A13												
TDI quattro [4F2; C6]	04.04-08.11	BWD	95	850	S5 A13	100	830	S5 013								
	10.08-08.11					100	830	S5 013								
		BWD	95	850	S5 A13	100	830	S5 013	95	800	S4 013					
			95	850	S5 A13	110	920	S5 015								
TDI quattro [4G; C7]	11.10-05.12	BWD,KZO,SSJ	70	760	S5 A08											
		BWD,KZO,SSJ	105	950	S5 A15											
	02.11-04.15	BWD	80	800	S5 A11											
	04.12-04.15	BWD	70	760	S5 A08											
			105	950	S5 A15											
			KZO,SSJ	70	760	S5 A08										
		KZO,SSJ	105	950	S5 A15											
	04.12-06.16	BWD,KZO	95	850	S5 A13											
	09.14-11.15						85	800	S5 011	80	740	S4 011				
			BWD,SSJ	80	800	S5 A11				80	800	S4 E11				
				95	850	S5 A13				80	800	S4 E11				
09.14→			80	800	S5 A11	85	800	S5 011	80	740	S4 011					
		BWD,SSJ							80	800	S4 E11					
11.15-09.18	BWD,SSJ	80	800	S5 A11												
	SSJ	95	850	S5 A13												
A6 Allroad																
2.7/4.2, T [4BH; C5]	05.00-08.05		105	950	S5 A15	110	920	S5 015	74	680	S4 008	70	640	S3 008		
3.0 TFSI [4FH; C6]	10.08-08.11	BWD	95	850	S5 A13	100	830	S5 013	74	680	S4 008					
	TFSI [4G; C7]	01.12-12.14	80	800	S5 A11											
	09.14-09.18		80	800	S5 A11	85	800	S5 011	80	740	S4 011					
		SSJ							80	800	S4 E11					
3.2 FSI [4FH; C6]	05.06-10.08	BWD	95	850	S5 A13				95	800	S4 013					
4.2 FSI [4FH; C6]	05.06-08.11	BWD	95	850	S5 A13				80	740	S4 010					
Diesel																
2.5 TDI [4BH; C5]	05.00-05.03		95	850	S5 A13	100	830	S5 013	74	680	S4 008					
	06.03-08.05		105	950	S5 A15	110	920	S5 015	74	680	S4 008					
			105	950	S5 A15	110	920	S5 015	74	680	S4 008	70	640	S3 008		
2.7 TDI [4FH; C6]	05.06-10.08	BWD	95	850	S5 A13				95	800	S4 013					
	10.08-08.11	BWD	95	850	S5 A13	100	830	S5 013	74	680	S4 008					
				95	850	S5 A13	100	830	S5 013	95	800	S4 013	90	720	S3 013	
3.0 TDI [4FH; C6]	05.06-05.07	BWD	95	850	S5 A13	100	830	S5 013	95	800	S4 013					
	05.06-10.08	BWD	95	850	S5 A13				95	800	S4 013					
	10.08-08.11	BWD	80	800	S5 A11											
				95	850	S5 A13	100	830	S5 013	95	800	S4 013				
				95	850	S5 A13										
TDI [4G; C7]	01.12-12.14		95	850	S5 A13											
	01.12-06.16		80	800	S5 A11											
	09.14-09.18						85	800	S5 011	80	740	S4 011				
				80	800	S5 A11	85	800	S5 011	80	740	S4 011				
			BWD,SSJ	80	800	S5 A11				80	800	S4 E11				
			95	850	S5 A13				80	800	S4 E11					
	11.15-09.18	BWD	80	800	S5 A11											
			95	850	S5 A13											
		BWD,SSJ	95	850	S5 A13											
A6 Avant																
1.8 [4B5; C5]	02.98-04.01		105	950	S5 A15	110	920	S5 015	60	540	S4 005	45	400	S3 002		
	01.99-04.01	VAD	105	950	S5 A15	110	920	S5 015	60	540	S4 005	45	400	S3 002		
T [4B5; C5]	02.98-04.01	VAD	105	950	S5 A15	110	920	S5 015	74	680	S4 008	70	640	S3 008		
	05.00-01.05		105	950	S5 A15	110	920	S5 015	74	680	S4 008					



			Ah A (EN) S5A			Ah A (EN) S5			Ah A (EN) S4			Ah A (EN) S3			
			0 092 ...0			0 092 ...0			0 092 ...0			0 092 ...0			
1.8 T quattro [4B5; C5]	02.98-05.01	VAD	105	950	S5 A15	110	920	S5 015	74	680	S4 008	70	640	S3 008	
	11.98-05.01					74	750	S5 007	72	680	S4 007				
	05.00-01.05		105	950	S5 A15	110	920	S5 015	74	680	S4 008				
TFSI [4G; C7]	09.14-09.18					85	800	S5 011	80	740	S4 011				
		BWD,SSJ	80	800	S5 A11				80	800	S4 E11				
			95	850	S5 A13				80	800	S4 E11				
2.0 [4B5; C5]	06.01-01.05		105	950	S5 A15	110	920	S5 015	60	540	S4 005				
TFSI [4F5; C6]	06.05-08.11	BWD	95	850	S5 A13	100	830	S5 013	74	680	S4 008	70	640	S3 008	
TFSI [4G; C7]	09.14-09.18					85	800	S5 011	80	740	S4 011				
			80	800	S5 A11	85	800	S5 011	80	740	S4 011				
		BWD							80	800	S4 E11				
		BWD,SSJ	80	800	S5 A11				80	800	S4 E11				
			95	850	S5 A13				80	800	S4 E11				
TFSI quattro [4G; C7]	09.14-09.18		70	760	S5 A08	85	800	S5 011	60	540	S4 005				
			70	760	S5 A08	110	920	S5 015	60	540	S4 005				
			105	950	S5 A15	85	800	S5 011	60	540	S4 005				
		BWD,SSJ	80	800	S5 A11				80	800	S4 E11				
			95	850	S5 A13				80	800	S4 E11				
2.0/2.8 FSI, FSI quattro [4G; C7]	05.11-04.15	BWD	80	800	S5 A11										
2.4 [4B5; C5]	04.97-01.99		105	950	S5 A15	74	750	S5 007	72	680	S4 007	70	640	S3 008	
			105	950	S5 A15	74	750	S5 007	74	680	S4 008	70	640	S3 008	
			105	950	S5 A15	110	920	S5 015	72	680	S4 007	70	640	S3 008	
	02.98-04.01		105	950	S5 A15	110	920	S5 015	74	680	S4 008	70	640	S3 008	
		VAD	105	950	S5 A15	110	920	S5 015	74	680	S4 008	70	640	S3 008	
						74	750	S5 007	72	680	S4 007				
	11.98-06.00		105	950	S5 A15	110	920	S5 015	74	680	S4 008				
	06.00-04.01		105	950	S5 A15	74	750	S5 007	72	680	S4 007				
			105	950	S5 A15	74	750	S5 007	74	680	S4 008				
			105	950	S5 A15	110	920	S5 015	72	680	S4 007				
			105	950	S5 A15	110	920	S5 015	74	680	S4 008				
	[4F5; C6]	03.05-10.08	BWD	95	850	S5 A13	100	830	S5 013	80	740	S4 010			
			quattro [4B5; C5]	04.97-06.99	105	950	S5 A15	110	920	S5 015	74	680	S4 008	70	640
08.98-05.01				VAD	105	950	S5 A15	110	920	S5 015	74	680	S4 008	70	640
	06.00-01.05		105	950	S5 A15	110	920	S5 015	74	680	S4 008				
2.4/3.0 quattro [4F5; C6]	03.05-10.08	BWD	95	850	S5 A13	100	830	S5 013	80	740	S4 010				
2.7 Biturbo [4B5; C5]	02.99-05.01		105	950	S5 A15	74	750	S5 007	72	680	S4 007				
			105	950	S5 A15	74	750	S5 007	74	680	S4 008				
			105	950	S5 A15	110	920	S5 015	72	680	S4 007				
Biturbo quattro [4B5; C5]	02.99-08.00		105	950	S5 A15	74	750	S5 007	72	680	S4 007	70	640	S3 008	
			105	950	S5 A15	74	750	S5 007	74	680	S4 008	70	640	S3 008	
			105	950	S5 A15	110	920	S5 015	72	680	S4 007	70	640	S3 008	
	09.00-05.01		105	950	S5 A15	110	920	S5 015	74	680	S4 008				
		06.01-01.05		105	950	S5 A15	74	750	S5 007	72	680	S4 007			
				105	950	S5 A15	74	750	S5 007	74	680	S4 008			
			105	950	S5 A15	110	920	S5 015	72	680	S4 007				
2.8 [4B5; C5]	02.98-04.01		105	950	S5 A15	74	750	S5 007	72	680	S4 007	70	640	S3 008	
			105	950	S5 A15	74	750	S5 007	74	680	S4 008	70	640	S3 008	
			105	950	S5 A15	110	920	S5 015	72	680	S4 007	70	640	S3 008	
			105	950	S5 A15	110	920	S5 015	74	680	S4 008	70	640	S3 008	
FSI [4F5; C6]	11.06-10.08	BWD	95	850	S5 A13	100	830	S5 013	80	740	S4 010				
	10.08-08.11								80	740	S4 011				
		BWD	95	850	S5 A13				80	740	S4 010				
FSI quattro [4F5; C6]	11.06-10.08	BWD	95	850	S5 A13	100	830	S5 013	80	740	S4 010				
	10.08-08.11								80	740	S4 011				
		BWD	95	850	S5 A13				80	740	S4 010				
quattro [4A5; C4]	09.94-08.98					85	800	S5 011	80	740	S4 011				
		VAD	70	760	S5 A08	100	830	S5 013	74	680	S4 008	70	640	S3 008	
quattro [4B5; C5]	02.98-05.01		105	950	S5 A15	74	750	S5 007	72	680	S4 007	70	640	S3 008	
			105	950	S5 A15	74	750	S5 007	74	680	S4 008	70	640	S3 008	
			105	950	S5 A15	110	920	S5 015	72	680	S4 007	70	640	S3 008	
			105	950	S5 A15	110	920	S5 015	74	680	S4 008	70	640	S3 008	
TFSI quattro [4G; C7]	09.14-09.18	BWD,SSJ	95	850	S5 A13										



					Ah	A (EN)		Ah	A (EN)		Ah	A (EN)		Ah	A (EN)	
					0 092 ...0			0 092 ...0			0 092 ...0			0 092 ...0		
◀ AUDI																
3.0	[4B5; C5]	06.01-01.05			105	950	S5 A15	110	920	S5 015	74	680	S4 008			
	[4F5; C6]	03.05-05.06									80	740	S4 011			
			BWD		95	850	S5 A13				80	740	S4 010			
	quattro [4B5; C5]	06.01-01.05			105	950	S5 A15	110	920	S5 015	74	680	S4 008			
	TFSI quattro [4F5; C6]	10.08-08.11			95	850	S5 A13	100	830	S5 013	95	800	S4 013			
			BWD		80	800	S5 A11	85	800	S5 010	80	740	S4 010			
	TFSI quattro [4G; C7]	05.11-04.15	BWD		80	800	S5 A11									
		09.14-09.18						85	800	S5 011	80	740	S4 011			
			BWD,SSJ		80	800	S5 A11				80	800	S4 E11			
					95	850	S5 A13				80	800	S4 E11			
3.2	FSI [4F5; C6]	03.05-10.08	BWD		95	850	S5 A13	100	830	S5 013	80	740	S4 010			
	FSI quattro [4F5; C6]	03.05-10.08	BWD		95	850	S5 A13	100	830	S5 013	80	740	S4 010			
4.2	FSI quattro [4F5; C6]	06.06-08.11						74	750	S5 007	72	680	S4 007			
			BWD		95	850	S5 A13				80	740	S4 010			
	quattro [4B6; C5]	04.99-05.01			95	850	S5 A13	74	750	S5 007	72	680	S4 007			
					95	850	S5 A13	100	830	S5 013	72	680	S4 007			
		06.01-01.05			70	760	S5 A08	100	830	S5 013	74	680	S4 008			
	quattro [4F5; C6]	03.05-05.06						74	750	S5 007	72	680	S4 007			
			BWD		95	850	S5 A13	100	830	S5 013	80	740	S4 010			
Diesel																
1.9	TDI [4B5; C5]	02.98-04.01						85	800	S5 011	80	740	S4 011			
			VAD		105	950	S5 A15	110	920	S5 015	74	680	S4 008	70	640	S3 008
		06.01-01.05			105	950	S5 A15	110	920	S5 015	74	680	S4 008			
2.0	TDI [4F5; C6]	06.05-11.05			95	850	S5 A13	100	830	S5 013	80	740	S4 010			
		06.05-10.08	BWD		95	850	S5 A13	100	830	S5 013	80	740	S4 010			
					105	950	S5 A15	110	920	S5 015						
			BWD,SSJ		105	950	S5 A15									
		11.08-08.11	BWD		95	850	S5 A13				80	740	S4 010			
	TDI [4G; C7]	05.11-04.15	BWD		80	800	S5 A11									
		05.11-09.16			80	800	S5 A11									
		11.13-09.18			95	850	S5 A13	100	830	S5 013	95	800	S4 013			
		09.14-09.16						85	800	S5 011	80	740	S4 011			
			BWD,SSJ		80	800	S5 A11				80	800	S4 E11			
					95	850	S5 A13				80	800	S4 E11			
		05.15-09.18	BWD,SSJ		80	800	S5 A11									
			SSJ		95	850	S5 A13									
		05.16-09.18	BWD		80	800	S5 A11									
					95	850	S5 A13									
	TDI e [4F5; C6]	10.08-03.11	BWD		95	850	S5 A13	100	830	S5 013	80	740	S4 010			
	TDI quattro [4G; C7]	04.15-09.18			70	760	S5 A08	85	800	S5 011	60	540	S4 005			
					70	760	S5 A08	110	920	S5 015	60	540	S4 005			
					105	950	S5 A15	85	800	S5 011	60	540	S4 005			
			BWD,SSJ		80	800	S5 A11				80	800	S4 E11			
					95	850	S5 A13				80	800	S4 E11			
		05.16-09.18	BWD,SSJ		80	800	S5 A11									
			SSJ		95	850	S5 A13									
2.5	TDI [4B5; C5]	02.98-01.05	VAD		105	950	S5 A15	110	920	S5 015	74	680	S4 008			
		10.99-01.05	VAD		105	950	S5 A15	85	800	S5 011	74	680	S4 008			
	TDI quattro [4B5; C5]	02.98-08.03	VAD		105	950	S5 A15	110	920	S5 015	74	680	S4 008	70	640	S3 008
		02.03-01.05	VAD		105	950	S5 A15	110	920	S5 015	74	680	S4 008			
2.7	TDI [4F5; C6]	11.04-05.09	BWD		95	850	S5 A13	100	830	S5 013	80	740	S4 010			
		10.08-08.11	BWD		95	850	S5 A13				80	740	S4 010			
	TDI quattro [4F5; C6]	11.04-10.08			95	850	S5 A13	77	780	S5 008	74	680	S4 008			
		06.05-08.11	BWD		95	850	S5 A13	100	830	S5 013	80	740	S4 010			
		10.08-08.11	BWD		95	850	S5 A13				80	740	S4 010			
3.0	TDI [4G; C7]	05.11-04.15	BWD		95	850	S5 A13									
		09.14-07.15						85	800	S5 011	80	740	S4 011			
			BWD,SSJ		80	800	S5 A11				80	800	S4 E11			
					95	850	S5 A13				80	800	S4 E11			
		08.15-09.18	BWD,SSJ		80	800	S5 A11									
			SSJ		95	850	S5 A13									
	TDI quattro [4F5; C6]	03.05-08.11	BWD		95	850	S5 A13	100	830	S5 013	80	740	S4 010			
		06.06-10.08	BWD,SSJ		95	850	S5 A13									



			Ah A (EN) S5A			Ah A (EN) S5			Ah A (EN) S4			Ah A (EN) S3		
			0 092 ...0			0 092 ...0			0 092 ...0			0 092 ...0		
3.0	TDI quattro [4F5; C6]	06.06-08.11	BWD	95	850	S5 A13	100	830	S5 013					
	TDI quattro [4G; C7]	05.11-04.15	BWD	95	850	S5 A13								
		12.11-04.15	BWD	80	800	S5 A11								
		04.12-04.15	BWD	95	850	S5 A13	110	920	S5 015	95	800	S4 013		
			BWD,SSJ	95	850	S5 A13								
		04.12-06.16		95	850	S5 A13								
		09.14-11.15					85	800	S5 011	80	740	S4 011		
			BWD,SSJ	80	800	S5 A11				80	800	S4 E11		
				95	850	S5 A13				80	800	S4 E11		
		09.14-09.18		80	800	S5 A11	85	800	S5 011	80	740	S4 011		
			BWD,SSJ							80	800	S4 E11		
		11.15-09.18	BWD,SSJ	80	800	S5 A11								
			SSJ	95	850	S5 A13								
A7 Sportback														
1.8	TFSI [4G; C7]	05.15-05.18		70	760	S5 A08	85	800	S5 011					
				70	760	S5 A08	110	920	S5 015					
			BWD,SSJ	80	800	S5 A11				80	800	S4 E11		
				95	850	S5 A13				80	800	S4 E11		
2.0	TFSI [4G; C7]	09.14-05.18	BWD,SSJ	80	800	S5 A11				80	800	S4 E11		
				95	850	S5 A13				80	800	S4 E11		
		05.15-05.18	BWD,SSJ	80	800	S5 A11								
				95	850	S5 A13								
	TFSI quattro [4G; C7]	05.15-05.18		70	760	S5 A08								
				70	760	S5 A08	85	800	S5 011					
				70	760	S5 A08	110	920	S5 015					
				80	800	S5 A11								
				95	850	S5 A13								
			BWD							80	800	S4 E11		
			BWD,SSJ	80	800	S5 A11				80	800	S4 E11		
				95	850	S5 A13				80	800	S4 E11		
2.8	FSI [4G; C7]	02.11-03.15	BWD	80	800	S5 A11								
			BWD,KZO,SSJ	70	760	S5 A08								
			BWD,KZO,SSJ	105	950	S5 A15								
	FSI quattro [4G; C7]	10.10-03.15	BWD,KZO,SSJ	70	760	S5 A08								
			BWD,KZO,SSJ	105	950	S5 A15								
		09.14-05.18	BWD,SSJ	80	800	S5 A11								
				95	850	S5 A13								
3.0	TFSI quattro [4G; C7]	07.10-05.12	BWD,KZO,SSJ	70	760	S5 A08								
			BWD,KZO,SSJ	105	950	S5 A15								
		01.11-05.12	BWD	70	760	S5 A08	110	920	S5 015	80	740	S4 010		
			BWD,SSJ	70	760	S5 A08								
		11.11-03.15	BWD	80	800	S5 A11								
		05.12-03.15	BWD,SSJ	80	800	S5 A11								
		05.14-05.18	BWD,SSJ	80	800	S5 A11				80	800	S4 E11		
				95	850	S5 A13				80	800	S4 E11		
Diesel														
3.0	TDI [4G; C7]	11.10-03.15	BWD	95	850	S5 A13								
			BWD,KZO,SSJ	70	760	S5 A08								
			BWD,KZO,SSJ	105	950	S5 A15								
		07.14-11.15		105	950	S5 A15								
		11.15-05.18	BWD,SSJ	95	850	S5 A13								
				105	950	S5 A15								
			SSJ	105	950	S5 A15								
	TDI quattro [4G; C7]	07.10-06.17	BWD,KZO,SSJ	70	760	S5 A08								
			BWD,KZO,SSJ	105	950	S5 A15								
		12.10-03.15	BWD	95	850	S5 A13								
		11.11-05.12					85	800	S5 011					
		11.11-03.15	BWD,SSJ	95	850	S5 A13								
		05.12-03.15	BWD	95	850	S5 A13	85	800	S5 011					
		05.12-05.16	BWD	70	760	S5 A08								
		05.12-05.18	BWD	105	950	S5 A15								
		05.14-05.18		105	950	S5 A15								



				Ah	A (EN)		Ah	A (EN)		Ah	A (EN)		Ah	A (EN)	
				0 092 ...0			0 092 ...0			0 092 ...0			0 092 ...0		
◀ AUDI															
3.0	TDI quattro [4G, C7]	11.15-05.18	BWD	95	850	S5 A13									
			BWD,SSJ	95	850	S5 A13									
				105	950	S5 A15									
			SSJ	105	950	S5 A15									
A8															
2.0	TFSI Hybrid [4H, D4]	02.12-11.15		95	850	S5 A13									
	TFSI quattro [4H, D4]	09.16-01.18	BWD,SSJ	95	850	S5 A13									
2.5	TFSI [4H, D4]	07.12-04.14	SSJ	105	950	S5 A15									
		07.12-06.16	BWD,SSJ	95	850	S5 A13									
		03.14-06.16	BWD,SSJ	80	800	S5 A11									
				105	950	S5 A15									
2.8	[4D2, D2]	03.96-12.98		70	760	S5 A08	100	830	S5 013	74	680	S4 008	70	640	S3 008
		10.97-09.02		95	850	S5 A13	100	830	S5 013	74	680	S4 008	70	640	S3 008
	FSI [4E, D3]	09.07-07.10		95	850	S5 A13									
		01.09-07.10		95	850	S5 A13	110	920	S5 015						
	quattro [4D2, D2]	03.96-04.99		95	850	S5 A13	100	830	S5 013	74	680	S4 008	70	640	S3 008
		05.00-09.02		95	850	S5 A13	100	830	S5 013	74	680	S4 008	70	640	S3 008
3.0	[4E, D3]	07.03-05.06		95	850	S5 A13									
	quattro [4E, D3]	11.03-05.06	BWD	95	850	S5 A13									
	TFSI quattro [4H, D4]	06.10-01.18	BWD	95	850	S5 A13									
		03.12-01.18		95	850	S5 A13									
3.2	FSI [4E, D3]	06.05-07.10		95	850	S5 A13									
3.2/ 4.2	FSI quattro [4E, D3]	06.05-07.10		95	850	S5 A13									
3.7	[4D2, D2]	07.95-09.02		95	850	S5 A13	110	920	S5 015	95	800	S4 013	90	720	S3 013
3.7/ 4.2	quattro [4D2, D2]	06.94-08.03		95	850	S5 A13	110	920	S5 015	95	800	S4 013	90	720	S3 013
3.7/ 4.2/ 6.0	quattro [4E, D3]	11.02-07.10		95	850	S5 A13									
4.0	FSI quattro [4H, D4]	05.12-04.14		95	850	S5 A13									
		10.13-01.18	BWD,SSJ	80	800	S5 A11									
				95	850	S5 A13									
				105	950	S5 A15									
	TFSI quattro [4H, D4]	09.12-08.16		95	850	S5 A13									
		09.15-→	BWD,SSJ	95	850	S5 A13									
			SSJ	105	950	S5 A15									
4.2	FSI quattro [4H, D4]	11.09-04.14	BWD	95	850	S5 A13									
6.0	quattro [4D2, D2]	03.01-08.02		95	850	S5 A13									
6.3	FSI quattro [4H, D4]	01.11-04.14	BWD	95	850	S5 A13									
		09.13-01.18	BWD,SSJ	80	800	S5 A11									
				95	850	S5 A13									
			SSJ	105	950	S5 A15									
Diesel															
2.5/ 3.3	TDI, TDI quattro [4D2, D2]	06.97-09.02		95	850	S5 A13	110	920	S5 015	95	800	S4 013	90	720	S3 013
3.0	TDI quattro [4H, D4]	07.10-04.14	BWD				100	830	S5 013	95	800	S4 013			
			BWD,KZO,SSJ	95	850	S5 A13									
			BWD,KZO,SSJ	105	950	S5 A15									
		08.10-01.18	BWD	95	850	S5 A13									
		03.12-04.14					100	830	S5 013	95	800	S4 013			
			KZO,SSJ	95	850	S5 A13									
			KZO,SSJ	105	950	S5 A15									
		03.12-01.18	BWD,SSJ	80	800	S5 A11									
				95	850	S5 A13									
		09.13-01.18	BWD	105	950	S5 A15									
			SSJ	105	950	S5 A15									
		10.13-01.18	BWD,SSJ	105	950	S5 A15									
		05.15-01.18		80	800	S5 A11	85	800	S5 011						
				80	800	S5 A11	110	920	S5 015						
			BWD,SSJ	95	850	S5 A13				80	800	S4 E11			
				105	950	S5 A15				80	800	S4 E11			
3.0/ 4.0/ 4.2	TDI quattro [4E, D3]	05.03-07.10		95	850	S5 A13									
4.2	TDI quattro [4H, D4]	11.09-04.14	BWD	95	850	S5 A13									



			Ah A (EN) S5A			Ah A (EN) S5			Ah A (EN) S4			Ah A (EN) S3		
			0 092 ...0			0 092 ...0			0 092 ...0			0 092 ...0		
4.2 TDI quattro [4H, D4]	10.13-01.18					100	830	S5 013	95	800	S4 013			
		BWD,SSJ	95	850	S5 A13									
			105	950	S5 A15									
Cabriolet														
1.8/ 2.0/ 2.6/ 2.8 [8G7; B4]	11.92-08.00	VAD				74	750	S5 007	72	680	S4 007	70	640	S3 007
Diesel														
1.9 TDI [8G7; B4]	07.96-08.00	VAD				74	750	S5 007	72	680	S4 007	70	640	S3 007
Q2														
1.0 TFSI [GAB]	10.16→	BWD,SSJ	60	680	S5 A05				60	640	S4 E05			
1.4 TFSI [GAB]	06.16→	BWD,SSJ	70	760	S5 A08				70	760	S4 E08			
Diesel														
1.6 TDI [GAB]	06.16-07.18	BWD,SSJ	70	760	S5 A08				70	760	S4 E08			
2.0 TDI quattro [GAB]	07.16→	BWD,SSJ	70	760	S5 A08				70	760	S4 E08			
	09.16→	BWD	70	760	S5 A08									
		BWD,SSJ							70	760	S4 E08			
Q3														
1.4 TFSI [8U]	10.13-04.15	BWD,SSJ	70	760	S5 A08									
	11.14-10.18		70	760	S5 A08									
2.0 TFSI [8U]	05.15-10.18	BWD,SSJ	70	760	S5 A08				70	760	S4 E08			
			80	800	S5 A11				70	760	S4 E08			
TFSI quattro [8U]	06.11-04.15					74	750	S5 007	72	680	S4 007			
		SSJ	70	760	S5 A08									
	06.11-10.18	BWD,SSJ	70	760	S5 A08									
	11.14-10.18					54	530	S5 002	60	540	S4 005			
		BWD,SSJ	80	800	S5 A11									
Diesel														
2.0 TDI [8U]	09.11-04.15	SSJ	70	760	S5 A08									
	09.11-11.15		70	760	S5 A08									
	09.11-10.18	BWD,SSJ	70	760	S5 A08									
	11.14-11.15					54	530	S5 002	60	540	S4 005	45	400	S3 002
		BWD,SSJ	80	800	S5 A11									
	05.15-11.15	BWD,SSJ	70	760	S5 A08				70	760	S4 E08			
			80	800	S5 A11				70	760	S4 E08			
	11.15-10.18	BWD	70	760	S5 A08									
			80	800	S5 A11									
			SSJ	80	800	S5 A11								
TDI quattro [8U]	06.11-04.15		70	760	S5 A08									
		SSJ	70	760	S5 A08									
	06.11-10.18	BWD,SSJ	70	760	S5 A08									
	01.12-04.15		80	800	S5 A11									
	11.14-11.15					54	530	S5 002	60	540	S4 005			
		BWD,SSJ	80	800	S5 A11									
	02.15-11.15	BWD,SSJ	70	760	S5 A08				70	760	S4 E08			
			80	800	S5 A11				70	760	S4 E08			
05.15-10.18		70	760	S5 A08	54	530	S5 002	60	540	S4 005				
11.15-10.18	BWD	70	760	S5 A08										
		80	800	S5 A11										
		SSJ	80	800	S5 A11									
Q3 RS														
2.5 TFSI quattro [8U]	10.13→	BWD,SSJ	80	800	S5 A11									
Q3 RS plus														
2.5 TFSI quattro [8U]	03.16→	BWD,SSJ	80	800	S5 A11									
Q5														
2.0 TFSI Hybrid quattro [8RB]	06.11-06.16	BWD,KZO,SSJ	70	760	S5 A08									
		BWD,KZO,SSJ	105	950	S5 A15									
TFSI quattro [FYB]	05.16→	BWD,SSJ	95	850	S5 A13									
TFSI quattro [8RB]	11.08-09.12	BWD				77	780	S5 008	74	680	S4 008			
		BWD,KZO,SSJ	70	760	S5 A08									
		BWD,KZO,SSJ	105	950	S5 A15									
	06.12-05.16		70	760	S5 A08									
	05.13-05.17		80	800	S5 A11									
09.14-05.17	BWD	95	850	S5 A13	77	780	S5 008	74	680	S4 008				



				Ah	A (EN)		Ah	A (EN)		Ah	A (EN)		Ah	A (EN)	
				0 092 ...0			0 092 ...0			0 092 ...0			0 092 ...0		
◀ AUDI															
2.0 TFSI quattro [8RB]	08.15-05.17	BWD,SSJ	70	760	S5 A08										
			80	800	S5 A11										
TFSI quattro flexible fuel [8RB]	07.11-05.13		70	760	S5 A08										
3.0 TFSI quattro [8RB]	06.12-05.17		80	800	S5 A11										
3.2 FSI quattro [8RB]	11.08-09.12	BWD	80	800	S5 A11	85	800	S5 010	80	740	S4 010				
Diesel															
2.0 TDI [FYB]	01.17→	BWD,SSJ	95	850	S5 A13										
TDI [8RB]	11.10-05.13	BWD,KZO,SSJ	70	760	S5 A08										
		BWD,KZO,SSJ	105	950	S5 A15										
	11.10-05.17	BWD	70	760	S5 A08										
	05.13-05.17	BWD,SSJ	70	760	S5 A08										
			80	800	S5 A11										
TDI quattro [FYB]	05.16→	BWD,SSJ	95	850	S5 A13										
TDI quattro [8RB]	11.08-09.12	BWD				110	920	S5 015	80	740	S4 010				
		BWD,SSJ	70	760	S5 A08										
	11.08-05.13	BWD				77	780	S5 008	74	680	S4 008				
		BWD,KZO,SSJ	70	760	S5 A08										
		BWD,KZO,SSJ	105	950	S5 A15										
	08.09-06.14	BWD	80	800	S5 A11	85	800	S5 010	80	740	S4 010				
	10.10-09.12	BWD	70	760	S5 A08										
			105	950	S5 A15										
		KZO,SSJ	70	760	S5 A08										
		KZO,SSJ	105	950	S5 A15										
	10.10-06.14					77	780	S5 008	74	680	S4 008				
	06.12-06.14					77	780	S5 008	95	800	S4 013				
		BWD	80	800	S5 A11										
			95	850	S5 A13										
	06.12-05.17		80	800	S5 A11										
	05.13-05.17	BWD,SSJ	80	800	S5 A11										
	04.14-05.17	BWD	70	760	S5 A08	100	830	S5 013	95	800	S4 013				
		BWD,SSJ	80	800	S5 A11				80	800	S4 E11				
			95	850	S5 A13				80	800	S4 E11				
	05.14-05.17	BWD	80	800	S5 A11	77	780	S5 008	74	680	S4 008				
3.0 TDI quattro [8RB]	11.08-09.12	BWD				100	830	S5 013	95	800	S4 013				
						110	920	S5 015							
		BWD,SSJ	80	800	S5 A11										
			95	850	S5 A13										
			105	950	S5 A15										
	06.12-05.17		95	850	S5 A13										
	09.13-05.17					110	920	S5 015							
		BWD,SSJ	80	800	S5 A11										
			95	850	S5 A13										
		SSJ	105	950	S5 A15										
	11.13-05.17	BWD,SSJ	105	950	S5 A15										
35/40 TDI quattro [FYB]	09.18→		95	850	S5 A13										
Q7															
2.0 TFSI [4MB]	08.15→	BWD,SSJ	95	850	S5 A13										
3.0 TFSI [4LB]	05.10-08.15		95	850	S5 A13										
	05.11-05.12	BWD,SSJ	80	800	S5 A11										
			95	850	S5 A13										
			105	950	S5 A15										
TFSI [4MB]	01.15→		70	760	S5 A08										
			80	800	S5 A11										
			105	950	S5 A15										
		BWD,SSJ	95	850	S5 A13										
3.6 FSI [4LB]	03.07-05.10	BWD	95	850	S5 A13										
4.2 FSI [4LB]	03.06-05.10		95	850	S5 A13										
Diesel															
3.0 TDI [4LB]	03.06-08.15		95	850	S5 A13										
	08.06-08.15	BWD	95	850	S5 A13										



						Ah A (EN) S5A		Ah A (EN) S5		Ah A (EN) S4		Ah A (EN) S3	
				0 092 ...0		0 092 ...0		0 092 ...0		0 092 ...0		0 092 ...0	
3.0 TDI [4LB]	11.08-05.12			110	920	S5 015							
		BWD,SSJ	80	800	S5 A11								
			95	850	S5 A13								
	11.08-08.15	BWD,SSJ	105	950	S5 A15								
	05.10-11.10	KZO,SSJ	95	850	S5 A13								
	05.10-08.15	KZO,SSJ	105	950	S5 A15								
	05.11-08.15	BWD	105	950	S5 A15								
		KZO,SSJ	95	850	S5 A13								
TDI [4MB]	01.15→		70	760	S5 A08								
			80	800	S5 A11								
			105	950	S5 A15								
		BWD,SSJ	95	850	S5 A13								
	08.15→		95	850	S5 A13								
		BWD,SSJ	105	950	S5 A15								
TDI e-tron [4MB]	08.15→	BWD,SSJ	105	950	S5 A15								
4.2 TDI [4LB]	03.07-06.09	BWD	95	850	S5 A13								
	06.09-08.15		95	850	S5 A13								
6.0 TDI [4LB]	09.08-04.12		95	850	S5 A13		110	920	S5 015				
RS3 Sportback													
2.5 quattro [8VA; 8VF]	02.15-08.16	BWD,SSJ	80	800	S5 A11								
TFSI quattro [8PA]	01.11-12.12	BWD	80	800	S5 A11								
RS4													
4.2 quattro [8EC; B7]	11.05-06.08		95	850	S5 A13		110	920	S5 015				
RS4 Avant													
2.7 quattro [8D5; B5]	05.00-09.01					85	800	S5 011		74	680	S4 008	
4.2 quattro [8ED; B7]	05.06-06.08		95	850	S5 A13		110	920	S5 015				
quattro [8K5; B8]	05.12-08.15		95	850	S5 A13								
RS4 Cabriolet													
4.2 quattro [8HE; B7]	05.06-01.08		95	850	S5 A13		110	920	S5 015				
RS5 Cabriolet													
4.2 FSI quattro [8F7]	11.12-08.15	BWD,SSJ	70	760	S5 A08								
			80	800	S5 A11								
			95	850	S5 A13								
RS5 Coupé													
4.2 FSI quattro [8T3]	03.10-08.15	BWD	95	850	S5 A13		110	920	S5 015				
RS6													
4.2 quattro [4B4]	07.02-04.04					110	920	S5 015					
5.0 TFSI quattro [4F2; C6]	09.08-08.10	BWD	105	950	S5 A15		110	920	S5 015				
RS6 Avant													
4.0 TFSI quattro [4G; C7]	01.13-12.14	BWD,SSJ	80	800	S5 A11								
	01.13→	BWD,SSJ	95	850	S5 A13								
4.2 quattro [4B6]	05.02-09.04		95	850	S5 A13		110	920	S5 015				
5.0 TFSI quattro [4F5; C6]	04.08-08.10	BWD	105	950	S5 A15		110	920	S5 015				
RS6 plus Avant													
4.0 TFSI quattro [4G; C7]	11.15-09.18	BWD,SSJ	95	850	S5 A13								
RS7 plus Sportback													
4.0 TFSI quattro [4G]	11.15-04.18	BWD,SSJ	95	850	S5 A13								
RS7 Sportback													
4.0 TFSI quattro [4G]	05.13-04.18	BWD,SSJ	80	800	S5 A11								
			95	850	S5 A13								
R8													
4.2 FSI quattro [423]	04.07-07.15					110	920	S5 015					
5.2 FSI GT quattro [422]	11.10-10.12		95	850	S5 A13								
FSI quattro [4S3; 4SP]	07.15-11.17	BWD,SSJ	80	800	S5 A11								
			95	850	S5 A13								
FSI quattro [423]	04.09-07.12					110	920	S5 015					
	09.12-07.15					110	920	S5 015					
			95	850	S5 A13		110	920	S5 015				
	07.14-07.15		70	760	S5 A08								
R8 Spyder													
4.2/ 5.2 FSI quattro [429]	02.10-07.15					110	920	S5 015					
5.2 FSI quattro [4S9; 4SR]	05.16-11.17	BWD,SSJ	80	800	S5 A11								
			95	850	S5 A13								



A

			Ah A (EN) S5A			Ah A (EN) S5			Ah A (EN) S4			Ah A (EN) S3			
			0 092 ...0			0 092 ...0			0 092 ...0			0 092 ...0			
◀ AUDI															
R8 Spyder GT															
5.2	FSI quattro [427]	11.11-10.12	95	850	S5 A13	110	920	S5 015							
SQ5															
3.0	TFSI quattro [FYB]	11.16→	BWD,SSJ	95	850	S5 A13									
	TFSI quattro [8RB]	06.13-05.17		95	850	S5 A13									
Diesel															
3.0	TDI quattro [8RB]	12.12-05.15		95	850	S5 A13									
		05.15-11.15	SSJ	105	950	S5 A15									
		05.15-05.17		70	760	S5 A08									
				80	800	S5 A11									
				105	950	S5 A15									
			BWD,SSJ				80	800	S4 E11						
				95	850	S5 A13									
		11.15-05.17	BWD,SSJ	105	950	S5 A15									
SQ7															
Diesel															
4.0	TDI quattro [4MB]	04.16→	BWD,SSJ	105	950	S5 A15									
S1															
2.0	TFSI quattro [8X]	01.14→		70	760	S5 A08	77	780	S5 008	74	680	S4 008			
			BWD,SSJ							70	760	S4 E08			
S1 Sportback															
2.0	TFSI quattro [8X]	01.14→		70	760	S5 A08	77	780	S5 008	74	680	S4 008			
			BWD,SSJ							70	760	S4 E08			
S3															
1.8	quattro [8L1]	08.98-04.02		70	760	S5 A08				60	540	S4 005	56	480	S3 005
				70	760	S5 A08				74	680	S4 008	56	480	S3 005
		08.01-06.03		70	760	S5 A08	77	780	S5 008	74	680	S4 008	70	640	S3 008
2.0	TFSI quattro [8P1]	11.06-06.08		70	760	S5 A08	85	800	S5 011	74	680	S4 008	70	640	S3 008
		07.08-03.13	BWD	70	760	S5 A08	85	800	S5 011	74	680	S4 008	70	640	S3 008
	TFSI quattro [8V1; 8VK]	11.12-08.16		70	760	S5 A08									
		02.13-05.14	BWD,SSJ	70	760	S5 A08									
		05.14-08.16	BWD,SSJ	70	760	S5 A08				70	760	S4 E08			
		06.16→	BWD,SSJ	70	760	S5 A08									
S3 Cabriolet															
2.0	TFSI quattro [8V7; 8VE]	05.14-07.16					77	780	S5 008	74	680	S4 008	70	640	S3 008
			BWD,SSJ	70	760	S5 A08				70	760	S4 E08			
		06.16→	BWD,SSJ	70	760	S5 A08									
S3 Limousine															
2.0	TFSI quattro [8VS; 8VM]	10.13-08.16		70	760	S5 A08									
		05.14-08.16	BWD,SSJ							70	760	S4 E08			
		06.16→	BWD,SSJ	70	760	S5 A08									
S3 Sportback															
2.0	TFSI quattro [8PA]	07.08-03.13		70	760	S5 A08	74	750	S5 007	72	680	S4 007			
				70	760	S5 A08	74	750	S5 007	74	680	S4 008			
				70	760	S5 A08	77	780	S5 008	72	680	S4 007			
				70	760	S5 A08	77	780	S5 008	74	680	S4 008			
	TFSI quattro [8VA; 8VF]	05.13-08.16		70	760	S5 A08									
		05.14-08.16	BWD,SSJ							70	760	S4 E08			
		06.16→	BWD,SSJ	70	760	S5 A08									
S4															
2.7	Biturbo quattro [8D2; B5]	10.97-10.00	VAD	70	760	S5 A08	85	800	S5 010	72	680	S4 007	70	640	S3 007
		10.97-09.01					85	800	S5 011	80	740	S4 011			
		11.00-09.01	VAD	70	760	S5 A08	85	800	S5 010	72	680	S4 007			
3.0	TFSI quattro [8K2; B8]	03.09-12.15	BWD	80	800	S5 A11	85	800	S5 010	80	740	S4 010			
		05.09-03.12		80	800	S5 A11	85	800	S5 010	80	740	S4 010			
		01.12-12.15					85	800	S5 011						
							110	920	S5 015						
			BWD	80	800	S5 A11									
				95	850	S5 A13									
	TFSI quattro [8W2; B9]	05.16→	BWD,SSJ	95	850	S5 A13									
4.2	quattro [8EC; B7]	11.04-06.08		95	850	S5 A13	100	830	S5 013	95	800	S4 013			



			Ah A (EN) S5A			Ah A (EN) S5			Ah A (EN) S4			Ah A (EN) S3		
			0 092 ...0			0 092 ...0			0 092 ...0			0 092 ...0		
4.2 quattro [8E2; B6]	03.03-12.04		95	850	S5 A13	74	750	S5 007	72	680	S4 007			
			95	850	S5 A13	74	750	S5 007	95	800	S4 013			
			95	850	S5 A13	100	830	S5 013	72	680	S4 007			
S4 Avant														
2.7 Biturbo quattro [8D5; B5]	10.97-09.01					85	800	S5 011	80	740	S4 011			
		VAD	70	760	S5 A08	85	800	S5 010	72	680	S4 007	70	640	S3 007
quattro [8D5; B5]	06.00-08.02					74	750	S5 007	72	680	S4 007			
		VAD	70	760	S5 A08	85	800	S5 010	72	680	S4 007			
3.0 TFSI quattro [8K5; B8]	03.09-12.15	BWD	80	800	S5 A11	85	800	S5 010	80	740	S4 010			
	05.14-12.15	BWD	80	800	S5 A11	77	780	S5 008	74	680	S4 008			
TFSI quattro [8W5; B9]	05.16→	BWD,SSJ	95	850	S5 A13									
4.2 quattro [8ED; B7]	11.04-06.08		95	850	S5 A13	100	830	S5 013	95	800	S4 013			
	01.05-06.08					74	750	S5 007	72	680	S4 007			
quattro [8E5; B6]	03.03-12.04		95	850	S5 A13	74	750	S5 007	72	680	S4 007			
			95	850	S5 A13	74	750	S5 007	95	800	S4 013			
			95	850	S5 A13	100	830	S5 013	72	680	S4 007			
S4 Cabriolet														
4.2 quattro [8HE; B7]	01.06-03.09		95	850	S5 A13	100	830	S5 013	95	800	S4 013			
quattro [8H7; B7]	02.04-12.05		95	850	S5 A13	100	830	S5 013	95	800	S4 013	90	720	S3 013
S5 Cabriolet														
3.0 TFSI quattro [F57]	11.16→	BWD,SSJ	95	850	S5 A13									
TFSI quattro [8F7]	05.09-06.14	BWD	80	800	S5 A11	77	780	S5 008	74	680	S4 008			
	03.12-05.13	BWD	70	760	S5 A08	77	780	S5 008	74	680	S4 008			
	05.14-01.17	BWD	70	760	S5 A08	77	780	S5 008	74	680	S4 008			
S5 Coupé														
3.0 TFSI quattro [F53]	07.16→	BWD,SSJ	95	850	S5 A13									
TFSI quattro [8T3]	09.11-01.17	BWD	80	800	S5 A11									
	03.12-05.13	BWD,SSJ	80	800	S5 A11									
	05.13-01.17	BWD	95	850	S5 A13									
4.2 FSI quattro [8T3]	06.07-03.12	BWD	95	850	S5 A13	110	920	S5 015						
S5 Sportback														
3.0 TFSI quattro [F5A]	07.16→	BWD,SSJ	95	850	S5 A13									
TFSI quattro [8TA]	01.10-06.14	BWD	80	800	S5 A11	77	780	S5 008	74	680	S4 008			
	05.13-01.17	BWD	70	760	S5 A08	77	780	S5 008	74	680	S4 008			
S6														
4.0 TFSI quattro [4G; C7]	04.12-04.15		95	850	S5 A13									
	10.14→		80	800	S5 A11	85	800	S5 011	80	740	S4 011			
		BWD,SSJ							80	800	S4 E11			
4.2 quattro [4B4; C5]	09.99-05.04		95	850	S5 A13	100	830	S5 013	95	800	S4 013			
5.2 FSI quattro [4F2; C6]	06.06-08.11	BWD	95	850	S5 A13	100	830	S5 013						
S6 Avant														
4.0 TFSI quattro [4G; C7]	04.12-04.15		95	850	S5 A13									
	10.14→		80	800	S5 A11	85	800	S5 011	80	740	S4 011			
		BWD,SSJ							80	800	S4 E11			
4.2 quattro [4B6; C5]	09.99-01.05		95	850	S5 A13	100	830	S5 013	95	800	S4 013			
5.2 FSI quattro [4F5; C6]	06.06-08.11	BWD	95	850	S5 A13	100	830	S5 013						
S7 Sportback														
4.0 TFSI quattro [4G]	04.12-03.15		95	850	S5 A13									
	07.14-05.18	BWD,SSJ	95	850	S5 A13									
			105	950	S5 A15									
S8														
4.0 FSI quattro, TFSI quattro [4H; D4]	04.12-01.18		95	850	S5 A13									
4.2 quattro [4D2]	09.96-12.98		70	760	S5 A08	100	830	S5 013	74	680	S4 008	70	640	S3 008
			95	850	S5 A13	100	830	S5 013	74	680	S4 008	70	640	S3 008
		05.99-09.02	95	850	S5 A13	110	920	S5 015	95	800	S4 013	90	720	S3 013
	09.00-01.03		95	850	S5 A13									
5.2 FSI quattro [4E2]	06.06-07.10	BWD	105	950	S5 A15	110	920	S5 015						
S8 plus														
4.0 TFSI quattro [4H; D4]	11.15-01.18	BWD,SSJ	105	950	S5 A15									
TT Coupé														
1.8 T [8N3]	07.98-09.00		60	680	S5 A05	63	610	S5 005	60	540	S4 005			



				Ah	A (EN)		Ah	A (EN)		Ah	A (EN)		Ah	A (EN)		
				0 092 ...0			0 092 ...0			0 092 ...0			0 092 ...0			
◀ AUDI																
1.8 T [8N3]	09.00-06.06		60	680	S5 A05	63	610	S5 005	72	680	S4 007					
			60	680	S5 A05	74	750	S5 007	60	540	S4 005					
			60	680	S5 A05	74	750	S5 007	72	680	S4 007					
		09.05-06.06		60	680	S5 A05	63	610	S5 005	60	540	S4 005				
	T quattro [8N3]	07.98-06.06		60	680	S5 A05	63	610	S5 005	60	540	S4 005				
	TFSI [FV3]	08.15-08.18		95	850	S5 A13	85	800	S5 011							
			BWD,SSJ	70	760	S5 A08				80	800	S4 E11				
				80	800	S5 A11				80	800	S4 E11				
			05.16-08.18		70	760	S5 A08	85	800	S5 011						
					80	800	S5 A11	85	800	S5 011						
		BWD								80	800	S4 E11				
TFSI [8J3]	06.08-06.14					85	800	S5 010	80	740	S4 011					
		BWD,SSJ	80	800	S5 A11											
2.0 TFSI [FV3]	11.14→	BWD,SSJ	70	760	S5 A08				70	760	S4 E08					
			80	800	S5 A11				70	760	S4 E08					
TFSI [8J3]	07.06-06.10		105	950	S5 A15	85	800	S5 010	80	740	S4 011					
	07.06-06.14	BWD,SSJ	80	800	S5 A11											
	06.09-06.10	BWD	80	800	S5 A11				80	740	S4 011					
	06.09-06.14					85	800	S5 010								
	05.10-06.14	BWD							80	740	S4 011					
TFSI quattro [FV3]	07.14→	BWD,SSJ	70	760	S5 A08				70	760	S4 E08					
			80	800	S5 A11				70	760	S4 E08					
TFSI quattro [8J3]	06.08-06.10		105	950	S5 A15	85	800	S5 010	80	740	S4 011					
	06.08-06.14	BWD,SSJ	80	800	S5 A11											
	05.10-06.14					85	800	S5 010								
		BWD							80	740	S4 011					
	09.14-08.15	BWD				85	800	S5 010	80	740	S4 010					
3.2 quattro [8J3]	07.06-06.10		105	950	S5 A15	85	800	S5 010	80	740	S4 011					
			80	800	S5 A11											
quattro [8N3]	07.03-06.06		70	760	S5 A08	77	780	S5 008	74	680	S4 008					
Diesel																
2.0 TDI [FV3]	07.14-08.18	BWD,SSJ	70	760	S5 A08				70	760	S4 E08					
			80	800	S5 A11				70	760	S4 E08					
TDI quattro [FV3]	01.17-08.18								70	760	S4 E08					
			BWD,SSJ	70	760	S5 A08										
TDI quattro [8J3]	06.08-06.10					85	800	S5 010	80	740	S4 011					
	06.08-06.14	BWD,SSJ	80	800	S5 A11											
	05.10-06.14					85	800	S5 010								
		BWD							80	740	S4 011					
TT Roadster																
1.8 T [8N9]	04.99-10.01		60	680	S5 A05	63	610	S5 005	60	540	S4 005					
			08.00-06.06		60	680	S5 A05	63	610	S5 005	72	680	S4 007			
					60	680	S5 A05	74	750	S5 007	60	540	S4 005			
					60	680	S5 A05	74	750	S5 007	72	680	S4 007			
		01.01-06.06		70	760	S5 A08	74	750	S5 007	72	680	S4 007				
		09.05-06.06		60	680	S5 A05	63	610	S5 005	60	540	S4 005				
				80	800	S5 A11	63	610	S5 005	70	760	S4 E08				
	T quattro [8N9]	03.99-08.02		70	760	S5 A08	63	610	S5 005	60	540	S4 005				
		07.99-06.06		60	680	S5 A05	63	610	S5 005	60	540	S4 005				
		09.00-06.06		70	760	S5 A08	63	610	S5 005	72	680	S4 007				
			70	760	S5 A08	74	750	S5 007	60	540	S4 005					
			70	760	S5 A08	74	750	S5 007	72	680	S4 007					
TFSI [FV9]	08.15-08.18		80	800	S5 A11	85	800	S5 011								
			95	850	S5 A13	85	800	S5 011								
		BWD,SSJ	70	760	S5 A08				80	800	S4 E11					
		05.16-08.18		70	760	S5 A08	85	800	S5 011							
		BWD							80	800	S4 E11					
TFSI [8J9]	06.08-06.14					85	800	S5 010	80	740	S4 011					
		BWD,SSJ	80	800	S5 A11											
2.0 TFSI [FV9]	11.14→	BWD,SSJ	80	800	S5 A11	85	800	S5 011	80	740	S4 011					
									80	800	S4 E11					
TFSI [8J9]	02.07-06.10		70	760	S5 A08	85	800	S5 011	80	740	S4 010					



				Ah	A (EN)		Ah	A (EN)		Ah	A (EN)		Ah	A (EN)	
				0 092 ...0			0 092 ...0			0 092 ...0			0 092 ...0		
2.0 TFSI [8J9]	05.10-06.14						85	800	S5 010						
		BWD								80	740	S4 011			
		BWD,SSJ	80	800	S5 A11										
TFSI quattro [FV9]	11.14→		80	800	S5 A11	85	800	S5 011	80	740	S4 011				
		BWD,SSJ							80	800	S4 E11				
TFSI quattro [8J9]	06.08-06.10		105	950	S5 A15				80	740	S4 011				
			105	950	S5 A15	85	800	S5 010	80	740	S4 011				
		SSJ				85	800	S5 010							
		SSJ	80	800	S5 A11										
	06.08-06.14	BWD,SSJ	80	800	S5 A11										
	05.10-06.14					85	800	S5 010							
		BWD							80	740	S4 011				
3.2 quattro [8J9]	02.07-06.10		70	760	S5 A08	85	800	S5 011	80	740	S4 010				
	09.07-08.09					85	800	S5 011	80	740	S4 011				
quattro [8N9]	07.03-06.06		70	760	S5 A08										
Diesel															
2.0 TDI [FV9]	11.14-08.18		80	800	S5 A11	85	800	S5 011	80	740	S4 011				
		BWD,SSJ							80	800	S4 E11				
TDI quattro [FV9]	01.17-08.18		80	800	S5 A11	85	800	S5 011	80	740	S4 011				
			80	800	S5 A11	85	800	S5 011	80	800	S4 E11				
TDI quattro [8J9]	06.08-06.10					85	800	S5 010	80	740	S4 011				
	06.08-06.14	BWD,SSJ	80	800	S5 A11										
	05.10-06.14					85	800	S5 010							
		BWD							80	740	S4 011				
TT RS Coupé															
2.5 TFSI quattro [FV3]	05.16→	BWD,SSJ	80	800	S5 A11										
TFSI quattro [8J3]	07.09-06.14					85	800	S5 010							
		BWD							80	740	S4 011				
		BWD,SSJ	70	760	S5 A08										
	05.11-06.14	BWD	80	800	S5 A11										
TT RS Roadster															
2.5 TFSI quattro [FV9]	05.16→	BWD,SSJ	80	800	S5 A11										
TFSI quattro [8J9]	07.09-06.14					85	800	S5 010							
		BWD							80	740	S4 011				
		BWD,SSJ	70	760	S5 A08										
	03.12-06.14	BWD	80	800	S5 A11										
TTS Coupé															
2.0 TFSI quattro [FV3]	11.14→		80	800	S5 A11	85	800	S5 011	80	740	S4 011				
		BWD,SSJ							80	800	S4 E11				
	02.15→		95	850	S5 A13	85	800	S5 011							
		BWD,SSJ	70	760	S5 A08				80	800	S4 E11				
			80	800	S5 A11				80	800	S4 E11				
TFSI quattro [8J3]	05.08-06.14					85	800	S5 010	80	740	S4 011				
			105	950	S5 A15	85	800	S5 010	80	740	S4 011				
		BWD,SSJ	80	800	S5 A11										
	09.14-08.15					85	800	S5 010	80	740	S4 010				
TTS Roadster															
2.0 TFSI quattro [FV9]	02.15→		80	800	S5 A11										
			80	800	S5 A11				80	740	S4 011				
			95	850	S5 A13										
		BWD,SSJ							80	800	S4 E11				
			70	760	S5 A08				80	800	S4 E11				
TFSI quattro [8J9]	05.08-06.14					85	800	S5 010	80	740	S4 011				
			70	760	S5 A08	85	800	S5 011	80	740	S4 010				
		BWD,SSJ	80	800	S5 A11										
100															
2.6 E [4A2; C4]	01.92-12.98	VAD				85	800	S5 010	72	680	S4 007	70	640	S3 007	



			Ah A (EN)	Ah A (EN)	Ah A (EN)	Ah A (EN)
			0 092 ...0	0 092 ...0	0 092 ...0	0 092 ...0

BENTLEY

Arnage										
4.4/ 6.8 , T	04.98-08.09						70	630	S4 027	
Azure										
6.8 , T, V8 Mulliner	09.95-12.11						70	630	S4 027	
Bentayga										
6.0	11.15→	SSJ	105	950	S5 A15					
Diesel										
4.0 TDI	11.16→	SSJ	105	950	S5 A15					
Brooklands										
6.8 R	06.96-12.98						70	630	S4 027	
Brooklands Coupé										
6.8	03.07-12.11					74	750	S5 007	72	680 S4 007
Continental Cabrio										
6.8 V8 R	03.91-08.99						70	630	S4 027	
Continental Coupé										
6.8 , R, T Mulliner	10.89-08.03						70	630	S4 027	
Continental Flying Spur										
6.0	03.05-05.13		70	760	S5 A08	63	610	S5 005		
			95	850	S5 A13	63	610	S5 005		
			95	850	S5 A13	63	610	S5 005	60	540 S4 005
TW12 4x4	10.13→					100	830	S5 013	95	800 S4 013 90 720 S3 013
Continental Flying Spur Speed										
6.0	07.08-05.13		70	760	S5 A08	63	610	S5 005		
			95	850	S5 A13	63	610	S5 005		
Continental GT										
4.0 V8	01.12-12.14		95	850	S5 A13	100	830	S5 013	95	800 S4 013 90 720 S3 013
	01.14-11.17		95	850	S5 A13	77	780	S5 008	60	540 S4 005
V8 S	07.13-11.17		70	760	S5 A08	63	610	S5 005		
			95	850	S5 A13	63	610	S5 005		
6.0	06.03-12.12		70	760	S5 A08	63	610	S5 005		
			95	850	S5 A13	63	610	S5 005		
	05.15-12.17		95	850	S5 A13				52	470 S4 002
Continental GT Speed										
6.0	05.06-07.10		70	760	S5 A08	63	610	S5 005		
			95	850	S5 A13	63	610	S5 005		
	09.12-05.14		95	850	S5 A13	100	830	S5 013	95	800 S4 013 90 720 S3 013
	03.14-05.15		95	850	S5 A13					
	07.15-05.16		70	760	S5 A08	63	610	S5 005		
			95	850	S5 A13	63	610	S5 005		
FFV	05.06-07.10		70	760	S5 A08	63	610	S5 005		
			95	850	S5 A13	63	610	S5 005		
Continental GTC										
4.0 V8	01.12-12.14		70	760	S5 A08	63	610	S5 005		
			95	850	S5 A13	63	610	S5 005		
	01.14-08.18		95	850	S5 A13	77	780	S5 008	60	540 S4 005
V8 S	07.13-08.18		70	760	S5 A08	63	610	S5 005		
			95	850	S5 A13	63	610	S5 005		
6.0	12.04-04.11		70	760	S5 A08	63	610	S5 005		
			95	850	S5 A13	63	610	S5 005		
	10.11-12.12		70	760	S5 A08	63	610	S5 005		
			95	850	S5 A13	63	610	S5 005		
	09.12-05.15		95	850	S5 A13	77	780	S5 008	60	540 S4 005
	05.15-08.18		95	850	S5 A13				52	470 S4 002
FFV	12.04-04.11		70	760	S5 A08	63	610	S5 005		
			95	850	S5 A13	63	610	S5 005		
Continental GTC Speed										
6.0	05.09-04.11		70	760	S5 A08	63	610	S5 005		
			95	850	S5 A13	63	610	S5 005		
	09.12-05.14		105	950	S5 A15	77	780	S5 008	60	540 S4 005



		Ah A (EN) S5A			Ah A (EN) S5			Ah A (EN) S4			Ah A (EN) S3		
		0 092 ...0			0 092 ...0			0 092 ...0			0 092 ...0		
6.0	03.14-05.15	70	760	S5 A08	63	610	S5 005						
		95	850	S5 A13	63	610	S5 005						
	07.15-05.16	70	760	S5 A08	63	610	S5 005						
		95	850	S5 A13	63	610	S5 005						
FFV	05.09-04.11	70	760	S5 A08	63	610	S5 005						
		95	850	S5 A13	63	610	S5 005						
Continental GT3 R													
4.0	06.14-12.16	95	850	S5 A13				52	470	S4 002			
Continental Supersport													
6.0	03.10-12.11	70	760	S5 A08	77	780	S5 008	74	680	S4 008			
Continental Supersports													
6.0	03.10-12.11	70	760	S5 A08									
Continental Supersports Cabrio													
6.0	03.10-12.11	70	760	S5 A08	77	780	S5 008	74	680	S4 008			
Continental Supersports ISR Cabrio													
6.0	03.11-12.11	95	850	S5 A13	100	830	S5 013	95	800	S4 013			
Flying Spur													
4.0 V8	02.14-08.15				100	830	S5 013	95	800	S4 013	90	720	S3 013
	06.14→	95	850	S5 A13									
		105	950	S5 A15									
6.0	07.15→	70	760	S5 A08	63	610	S5 005						
		95	850	S5 A13	63	610	S5 005						
W12	03.13-05.15	70	760	S5 A08	63	610	S5 005						
		95	850	S5 A13	63	610	S5 005						
Mulsanne													
6.8	09.09-05.15	95	850	S5 A13	100	830	S5 013	95	800	S4 013			
	02.15→	95	850	S5 A13	63	610	S5 005	60	540	S4 005			
Mulsanne Speed													
6.8	10.14→	95	850	S5 A13				52	470	S4 002			
Turbo RT													
6.8	10.94-10.99							70	630	S4 027			
Turbo S													
6.8	07.95-07.99							70	630	S4 027			

BERTONE

Freeclimber													
1.6/ 2.0i, i4x4	01.91→				77	780	S5 008	74	680	S4 008	70	640	S3 008

BMW

Serie i 3														
60Ah Rex [I 01]	11.13→							44	420	S4 000				
Serie M														
M 3 [E 90]	11.07-10.11	AHB,BWD			85	800	S5 010	74	680	S4 008				
		AHB,BWD,SSJ	70	760	S5 A08									
		BWD	70	760	S5 A08									
[F 80]	06.14→		95	850	S5 A13									
CRT [E 90]	03.11-12.11	BWD,SSJ	95	850	S5 A13									
3.2 [E 36]	09.96-06.98		70	760	S5 A08	74	750	S5 007	72	680	S4 007	70	640	S3 007
M 5 5.0 [E 39]	10.98-07.03		95	850	S5 A13	110	920	S5 015	95	800	S4 013			
5.0 [E 60]	11.04-12.09	BWD	95	850	S5 A13	110	920	S5 015	95	800	S4 013			
M 5/X 5 M/X 6 M xDrive, 4.4, 50 [E 70; E 71; F 10]	09.09-10.16	AHB,BWD	95	850	S5 A13									
M 6 [E 63]	03.05-07.10	BWD	95	850	S5 A13	110	920	S5 015						
M 135i [F 20]	07.12-02.15		80	800	S5 A11									
	03.15-06.16	BWD,SSJ	80	800	S5 A11									
			95	850	S5 A13									
i [F 21]	09.12-06.16	BWD,SSJ	80	800	S5 A11									
			95	850	S5 A13									
i xDrive [F 20]	11.12-02.15		80	800	S5 A11									



				Ah	A (EN)		Ah	A (EN)		Ah	A (EN)		Ah	A (EN)	
				0 092 ...0			0 092 ...0			0 092 ...0			0 092 ...0		
BMW															
M 135 i xDrive [F 20]	03.15-06.16	BWD,SSJ	80	800	S5 A11										
			95	850	S5 A13										
ixDrive [F 21]	11.12-02.15	BWD,SSJ	80	800	S5 A11										
			95	850	S5 A13										
M 140 i [F 20]	07.16→	BWD,SSJ	80	800	S5 A11										
			95	850	S5 A13										
i [F 21]	07.16→	BWD,SSJ	80	800	S5 A11										
			95	850	S5 A13										
ixDrive [F 20]	07.16→	BWD,SSJ	80	800	S5 A11										
			95	850	S5 A13										
ixDrive [F 21]	07.16→	BWD,SSJ	80	800	S5 A11										
			95	850	S5 A13										
X 4 M 40 i xDrive [F 26]	11.15→	BWD,SSJ	95	850	S5 A13										
X 5 M 50 [F 85]	03.15-06.18	BWD,SSJ	95	850	S5 A13										
			105	950	S5 A15										
X 6 M xDrive [F 86]	03.15→	BWD,SSJ	95	850	S5 A13										
			105	950	S5 A15										
Z 3 M [E 36/7]	11.96-12.00		70	760	S5 A08	77	780	S5 008	60	540	S4 005				
	02.01-09.02		70	760	S5 A08	77	780	S5 008	60	540	S4 005				
Diesel															
M 550/ M 550 Touring/ X 5 M/ X 6 M d xDrive, 50 d, 50 d xDrive [E 70; E 71; F 10; F 11]	03.12-02.17	AHB,BWD	95	850	S5 A13										
X 5 M 50 d [F 15]	11.13-06.18	BWD,SSJ	105	950	S5 A15										
X 6 M 50 d [F 16]	11.14→		105	950	S5 A15										
Serie M Cabrio															
M 3 [E 46]	04.01-08.06		70	760	S5 A08	77	780	S5 008	74	680	S4 008				
[E 93]	03.08-10.13	AHB,BWD				85	800	S5 010	74	680	S4 008				
		AHB,BWD,SSJ	70	760	S5 A08										
3.2 [E 36]	01.96-12.99		70	760	S5 A08	77	780	S5 008	74	680	S4 008	70	640	S3 008	
M 4 [F 83]	09.14→	BWD,SSJ	95	850	S5 A13										
M 6 [E 64]	11.06-07.10	BWD	105	950	S5 A15	110	920	S5 015							
[F 12]	03.12-05.18	AHB,BWD	95	850	S5 A13										
Serie M Coupé															
M 2 [F 87]	04.16→	BWD,SSJ	80	800	S5 A11										
			95	850	S5 A13										
M 3 [E 92]	05.07-06.13	BWD	70	760	S5 A08	77	780	S5 008	74	680	S4 008				
, CSL [E 46]	09.00-05.06		70	760	S5 A08	85	800	S5 010	74	680	S4 008	70	640	S3 008	
3.2 [E 36]	10.95-12.98		70	760	S5 A08	74	750	S5 007	72	680	S4 007	70	640	S3 007	
M 4 [F 82]	06.14→	BWD,SSJ	95	850	S5 A13										
M 4 GTS [F 82]	04.16→	BWD	95	850	S5 A13										
M 6 [F 13]	09.12→		95	850	S5 A13										
Z 3 M [E 36/8]	09.97-12.00		70	760	S5 A08	77	780	S5 008	60	540	S4 005				
	03.01-06.02		70	760	S5 A08	77	780	S5 008	60	540	S4 005				
Z 4 M [E 86]	03.06-08.09		70	760	S5 A08	77	780	S5 008							
Serie M GC															
M 6 [F 06]	06.13→		105	950	S5 A15										
Serie M Roadster															
Z 4 M [E 85]	02.06-08.08	AHB,BWD	70	760	S5 A08	77	780	S5 008	60	540	S4 005				
Serie M Touring															
M 5 5.0 [E 61]	03.07-08.10	AHB,BWD	95	850	S5 A13	110	920	S5 015							
Serie M5															
550 i xDrive [G 30]	02.17→	BWD,SSJ	95	850	S5 A13										
Serie X1															
16 i sDrive [E 84]	05.13-06.15					77	780	S5 008							
		BWD,SSJ	70	760	S5 A08				70	760	S4 E08				
			80	800	S5 A11				70	760	S4 E08				
18 i sDrive [E 84]	03.10-06.15	AHB,BWD	70	760	S5 A08										
18/ 20/ 25 i sDrive, i xDrive [F 48]	10.15-03.18	BWD,SSJ	80	800	S5 A11										
20 i sDrive [E 84]	09.11-06.15	AHB,BWD	80	800	S5 A11										
20/ 25 i xDrive [E 84]	03.10-06.15	AHB,BWD	80	800	S5 A11										



B

			Ah A (EN) S5A			Ah A (EN) S5			Ah A (EN) S4			Ah A (EN) S3			
			0 092 ...0			0 092 ...0			0 092 ...0			0 092 ...0			
28	ixDrive [E 84]	10.09-08.11	AHB,BWD			85	800	S5 010	74	680	S4 008				
			AHB,BWD,SSJ	70	760	S5 A08									
		03.11-06.15	AHB,BWD	80	800	S5 A11									
Diesel															
16	d sDrive [E 84]	07.12-06.15		80	800	S5 A11									
16/ 18/ 20/ 25	d sDrive, d xDrive [F 48]	10.15→	BWD,SSJ	80	800	S5 A11									
18	d sDrive [E 84]	11.09-06.12	AHB,BWD,SSJ	70	760	S5 A08									
				80	800	S5 A11									
		07.12-06.15		70	760	S5 A08									
				80	800	S5 A11									
18/ 20	d xDrive [E 84]	10.09-06.12	AHB,BWD,SSJ	80	800	S5 A11									
20	d sDrive [E 84]	10.09-06.12	AHB,BWD,SSJ	80	800	S5 A11									
		07.12-06.15	BWD,SSJ	80	800	S5 A11									
	s xDrive [E 84]	07.12-06.15		80	800	S5 A11									
23	d xDrive [E 84]	10.09-06.12	AHB,BWD,SSJ	80	800	S5 A11									
			BWD			85	800	S5 010	74	680	S4 008				
25	d xDrive [E 84]	07.12-06.15		80	800	S5 A11									
Serie X3															
2.0	i [E 83]	09.05-08.08	AHB,BWD	70	760	S5 A08	77	780	S5 008	60	540	S4 005	56	480	S3 005
2.5	i [E 83]	03.04-08.06		70	760	S5 A08	77	780	S5 008	74	680	S4 008			
2.5/ 3.0	si [E 83]	09.06-08.08	AHB,BWD	95	850	S5 A13	100	830	S5 013	80	740	S4 010	70	640	S3 008
3.0	i [E 83]	01.04-08.06	AHB,BWD	95	850	S5 A13	100	830	S5 013	80	740	S4 010	70	640	S3 008
		09.06-08.08		95	850	S5 A13	100	830	S5 013	80	740	S4 010			
20	i sDrive [F 25]	03.14-08.17		95	850	S5 A13									
		04.14-08.17	BWD,SSJ	95	850	S5 A13									
				105	950	S5 A15									
	ixDrive [E 83]	09.08-08.10	AHB,BWD			77	780	S5 008	60	540	S4 005				
			AHB,BWD,SSJ	70	760	S5 A08									
			BWD	70	760	S5 A08				60	640	S4 E05			
	ixDrive [F 25]	09.11-08.17	AHB,BWD	95	850	S5 A13									
25	ixDrive [E 83]	09.08-08.10	AHB,BWD			100	830	S5 013	95	800	S4 013				
			AHB,BWD,SSJ	70	760	S5 A08									
			BWD	70	760	S5 A08									
28	ixDrive [F 25]	11.10-03.12	AHB,BWD	80	800	S5 A11									
		04.12-08.17		80	800	S5 A11									
30	ixDrive [E 83]	09.08-08.10	AHB,BWD			100	830	S5 013	80	740	S4 010				
			AHB,BWD,SSJ	70	760	S5 A08									
			BWD	70	760	S5 A08									
35	ixDrive [F 25]	10.10-08.17	AHB,BWD,SSJ	95	850	S5 A13									
Diesel															
2.0	d [E 83]	10.04-09.07	AHB,BWD	95	850	S5 A13	100	830	S5 013	80	740	S4 010			
		09.07-08.08	AHB,BWD	95	850	S5 A13	100	830	S5 013	95	800	S4 013			
3.0	d [E 83]	01.04-08.08		95	850	S5 A13	100	830	S5 013	95	800	S4 013			
	sd [E 83]	09.06-08.08		95	850	S5 A13	100	830	S5 013	95	800	S4 013			
18	d sDrive [F 25]	10.12-03.14		80	800	S5 A11									
		04.14-11.14	BWD,SSJ	105	950	S5 A15									
		04.14-08.17	BWD,SSJ	95	850	S5 A13									
		11.14-08.17		105	950	S5 A15									
	d xDrive [E 83]	05.09-08.10	AHB,BWD,SSJ	80	800	S5 A11									
			BWD	80	800	S5 A11									
20	d xDrive [E 83]	09.08-08.10	AHB,BWD	80	800	S5 A11									
	d xDrive [F 25]	10.10-08.17	AHB,BWD,SSJ	95	850	S5 A13									
		04.14-08.17	BWD,SSJ	95	850	S5 A13									
				105	950	S5 A15									
30	d xDrive [E 83]	09.08-08.10	AHB,BWD			100	830	S5 013	95	800	S4 013				
			AHB,BWD,SSJ	95	850	S5 A13									
			BWD	95	850	S5 A13									
	d xDrive [F 25]	04.11-08.17	AHB,BWD	80	800	S5 A11									
35	d xDrive [E 83]	09.08-08.10	AHB,BWD			100	830	S5 013	95	800	S4 013				
			AHB,BWD,SSJ	95	850	S5 A13									
			BWD	95	850	S5 A13									
	d xDrive [F 25]	09.11-08.17	AHB,BWD	95	850	S5 A13									



			Ah A (EN) S5A			Ah A (EN) S5			Ah A (EN) S4			Ah A (EN) S3		
			0 092 ...0			0 092 ...0			0 092 ...0			0 092 ...0		
◀ BMW														
Serie X4														
20 i xDrive [F 26]	06.14→	BWD,SSJ	95	850	S5 A13									
			105	950	S5 A15									
28 i xDrive [F 26]	06.14→	BWD,SSJ	95	850	S5 A13									
			105	950	S5 A15									
35 i xDrive [F 26]	06.14→	BWD,SSJ	95	850	S5 A13									
			105	950	S5 A15									
Diesel														
20 d xDrive [F 26]	06.14→	BWD,SSJ	95	850	S5 A13									
			105	950	S5 A15									
30 d xDrive [F 26]	06.14→	BWD,SSJ	95	850	S5 A13									
			105	950	S5 A15									
35 d xDrive [F 26]	06.14→	BWD,SSJ	95	850	S5 A13									
			105	950	S5 A15									
Serie X5														
3.0 i [E 53]	10.99-09.06		95	850	S5 A13	100	830	S5 013	95	800	S4 013			
si xDrive [E 70]	11.06-09.08		95	850	S5 A13	100	830	S5 013	95	800	S4 013			
		AHB,BWD	95	850	S5 A13	100	830	S5 013	80	740	S4 010	70	640	S3 008
4.4 i [E 53]	03.99-09.03	AHB,BWD	95	850	S5 A13	100	830	S5 013	95	800	S4 013	90	720	S3 013
	10.03-10.06		95	850	S5 A13	100	830	S5 013	95	800	S4 013			
4.6 is [E 53]	02.02-09.03		95	850	S5 A13	100	830	S5 013	95	800	S4 013			
4.8 i xDrive [E 70]	11.06-09.08	AHB,BWD	95	850	S5 A13	100	830	S5 013	80	740	S4 010	70	640	S3 008
is [E 53]	03.04-10.06		95	850	S5 A13	100	830	S5 013	95	800	S4 013			
30/ 35/ 50 i xDrive [E 70]	10.08-06.13	AHB,BWD	95	850	S5 A13									
35 i xDrive [F 15]	11.13-06.18		105	950	S5 A15	110	920	S5 015						
40 e xDrive [F 15]	10.15-06.18	BWD,SSJ	95	850	S5 A13									
48 i xDrive [E 70]	10.08-03.10	AHB,BWD, JEA	95	850	S5 A13	100	830	S5 013	95	800	S4 013			
50 i xDrive [F 15]	11.13-06.18	BWD,SSJ	105	950	S5 A15									
Diesel														
3.0 d [E 53]	03.01-09.03	AHB,BWD	95	850	S5 A13	100	830	S5 013	95	800	S4 013	90	720	S3 013
	10.03-10.06		95	850	S5 A13	100	830	S5 013	95	800	S4 013			
d xDrive [E 70]	03.07-09.08	AHB,BWD	95	850	S5 A13	100	830	S5 013	80	740	S4 010	70	640	S3 008
sd xDrive [E 70]	10.07-09.08	AHB,BWD	95	850	S5 A13	100	830	S5 013	95	800	S4 013	90	720	S3 013
25 d sDrive [F 15]	12.13-07.15					110	920	S5 015						
	12.13-06.18	BWD,SSJ	105	950	S5 A15									
	07.15-06.18		95	850	S5 A13									
d xDrive [F 15]	12.13-07.15					110	920	S5 015						
	12.13-06.18	BWD,SSJ	105	950	S5 A15									
	07.15-06.18		95	850	S5 A13									
30 d xDrive [E 70]	10.08-03.10	AHB,BWD	95	850	S5 A13									
	04.10-06.13	AHB,BWD,SSJ	95	850	S5 A13									
		BWD	95	850	S5 A13									
d xDrive [F 15]	11.13-06.18	BWD,SSJ	95	850	S5 A13									
			105	950	S5 A15									
35/ 40 d xDrive [E 70]	10.08-06.13	AHB,BWD	95	850	S5 A13									
40 d xDrive [F 15]	03.14-06.18		105	950	S5 A15	110	920	S5 015						
Serie X6														
Active Hybrid [E 72]	12.09-10.11	AHB,BWD	95	850	S5 A13									
35 i xDrive [E 71]	03.08-03.10	AHB,BWD	95	850	S5 A13	100	830	S5 013	95	800	S4 013			
	04.10-06.14	AHB,BWD	95	850	S5 A13									
		BWD	105	950	S5 A15									
		BWD,SSJ	70	760	S5 A08									
			95	850	S5 A13									
35/ 50 i xDrive [F 16]	11.14→	BWD,SSJ	105	950	S5 A15									
50 i xDrive [E 71]	05.08-06.14		70	760	S5 A08									
			105	950	S5 A15									
		AHB,BWD	95	850	S5 A13									
		BWD,SSJ	95	850	S5 A13									
Diesel														
30 d xDrive [E 71]	05.08-06.14	AHB,BWD	95	850	S5 A13									



			Ah A (EN) S5A			Ah A (EN) S5			Ah A (EN) S4			Ah A (EN) S3		
			0 092 ...0	0 092 ...0	0 092 ...0	0 092 ...0	0 092 ...0	0 092 ...0	0 092 ...0					
30 d xDrive [E 71]	04.10-06.14	BWD	105	950	S5 A15									
		BWD,SSJ	70	760	S5 A08									
			95	850	S5 A13									
d xDrive [F 16]	11.14→	BWD,SSJ	95	850	S5 A13									
35 d xDrive [E 71]	05.08-03.10	AHB,BWD	95	850	S5 A13	100	830	S5 013	95	800	S4 013			
40 d xDrive [E 71]	04.10-06.14	AHB,BWD	95	850	S5 A13									
		BWD	105	950	S5 A15									
		BWD,SSJ	70	760	S5 A08									
			95	850	S5 A13									
d xDrive [F 16]	12.14→		105	950	S5 A15									
Serie Z3														
1.8/ 1.9/ 2.0/ 2.2/ 2.5/ , i	03.95-09.02		70	760	S5 A08	77	780	S5 008	60	540	S4 005			
2.8/ 3.0 [E 36/7; E 36/8]														
Serie Z3 Coupé														
3.0 i [E 36/8]	05.00-06.02		70	760	S5 A08	77	780	S5 008	60	540	S4 005			
Serie Z4														
2.0/ 2.2/ 2.5/ 3.0 i, si [E 85]	10.02-08.08	AHB,BWD	70	760	S5 A08	77	780	S5 008	60	540	S4 005	56	480	
18 i sDrive [E 89]	03.13-08.16	BWD,SSJ	70	760	S5 A08									
20/ 28 i sDrive [E 89]	09.11-08.16	AHB,BWD	80	800	S5 A11									
23/ 30/ 35 i sDrive [E 89]	04.09-08.16	AHB,BWD	70	760	S5 A08									
35 i sDrive [E 89]	03.10-08.16		70	760	S5 A08									
Serie Z4 Coupé														
3.0 si [E 86]	03.06-08.08		70	760	S5 A08	77	780	S5 008	60	540	S4 005			
Serie Z8														
5.0 [E 52]	03.00-07.03		95	850	S5 A13	100	830	S5 013	95	800	S4 013	90	720	
Serie 1														
114 i [F 20]	07.12-02.15		80	800	S5 A11									
i [F 21]	09.12-02.15	BWD,SSJ	80	800	S5 A11									
116 i [E 81]	09.07-11.11		70	760	S5 A08	54	530	S5 002	52	470	S4 002			
			80	800	S5 A11	54	530	S5 002	52	470	S4 002			
	09.07-12.11	AHB,BWD				54	530	S5 002	52	470	S4 002			
		AHB,BWD,SSJ	70	760	S5 A08									
			80	800	S5 A11									
	03.09-12.11	AHB,BWD,SSJ	95	850	S5 A13									
i [E 87]	09.04-06.11					54	530	S5 002	52	470	S4 002			
	09.07-06.11	BWD	80	800	S5 A11									
	03.09-06.11		80	800	S5 A11									
		BWD,SSJ	70	760	S5 A08									
			95	850	S5 A13									
		KZO,SSJ	70	760	S5 A08									
		KZO,SSJ	95	850	S5 A13									
i [F 20]	09.11-02.15	AHB,BWD,SSJ	80	800	S5 A11									
	03.15→	BWD,SSJ	80	800	S5 A11									
			95	850	S5 A13									
i [F 21]	09.12→	BWD,SSJ	80	800	S5 A11									
	03.15→	BWD,SSJ	95	850	S5 A13									
118 i [E 81]	05.07-12.11		70	760	S5 A08									
		AHB,BWD,SSJ	95	850	S5 A13									
i [E 87]	11.04-03.07		60	680	S5 A05	63	610	S5 005	60	540	S4 005			
	03.07-06.11		70	760	S5 A08									
		BWD	70	760	S5 A08									
			95	850	S5 A13									
		KZO,SSJ	70	760	S5 A08									
		KZO,SSJ	95	850	S5 A13									
i [F 20]	09.11-02.15	AHB,BWD,SSJ	80	800	S5 A11									
	03.15→	BWD,SSJ	80	800	S5 A11									
			95	850	S5 A13									
i [F 21]	11.12→	BWD,SSJ	80	800	S5 A11									
	03.15→	BWD,SSJ	95	850	S5 A13									



											Ah A (EN)			Ah A (EN)			Ah A (EN)			Ah A (EN)		
					0 092 ...0			0 092 ...0			0 092 ...0			0 092 ...0								
◀ BMW																						
120 i [E 81]	05.07-12.11		70	760	S5 A08																	
		BWD	70	760	S5 A08																	
			95	850	S5 A13																	
		KZO,SSJ	70	760	S5 A08																	
		KZO,SSJ	95	850	S5 A13																	
i [E 87]	09.04-03.07		60	680	S5 A05	63	610	S5 005	60	540	S4 005											
	03.07-06.11		70	760	S5 A08																	
		BWD	70	760	S5 A08																	
			95	850	S5 A13																	
		KZO,SSJ	70	760	S5 A08																	
		KZO,SSJ	95	850	S5 A13																	
i [F 20]	03.15→	BWD,SSJ	80	800	S5 A11																	
			95	850	S5 A13																	
i [F 21]	03.15→	BWD,SSJ	80	800	S5 A11																	
			95	850	S5 A13																	
125 i [F 20]	03.12-06.16	AHB,BWD	80	800	S5 A11																	
	07.16→	BWD,SSJ	80	800	S5 A11																	
			95	850	S5 A13																	
i [F 21]	09.12→	BWD,SSJ	80	800	S5 A11																	
			95	850	S5 A13																	
130 i [E 81]	05.07-08.09					63	610	S5 005														
		AHB,BWD	60	680	S5 A05				60	540	S4 005											
	09.09-12.11	AHB,BWD	70	760	S5 A08	77	780	S5 008	60	540	S4 005											
i [E 87]	09.05-06.11		70	760	S5 A08	63	610	S5 005	60	540	S4 005											
Diesel																						
114 d [F 20]	11.12-05.15		80	800	S5 A11																	
	07.15→	BWD,SSJ	80	800	S5 A11																	
			95	850	S5 A13																	
d [F 21]	11.12-05.15	BWD,SSJ	80	800	S5 A11																	
			95	850	S5 A13																	
	07.15→	BWD,SSJ	80	800	S5 A11																	
			95	850	S5 A13																	
116 d [E 81]	03.09-12.11	AHB,BWD,SSJ	80	800	S5 A11																	
			95	850	S5 A13																	
d [E 87]	03.09-06.11	BWD,KZO,SSJ	70	760	S5 A08																	
		BWD,KZO,SSJ	95	850	S5 A13																	
d [F 20]	09.11-02.15	AHB,BWD,SSJ	80	800	S5 A11																	
	03.15→	BWD,SSJ	80	800	S5 A11																	
			95	850	S5 A13																	
d [F 21]	09.12-02.15		80	800	S5 A11																	
	03.15→	BWD,SSJ	80	800	S5 A11																	
			95	850	S5 A13																	
d ed [F 20]	03.12-02.15	AHB,BWD	80	800	S5 A11																	
d ed [F 21]	09.12-02.15	BWD,SSJ	80	800	S5 A11																	
			95	850	S5 A13																	
118 d [E 81]	05.07-12.11	AHB,BWD				85	800	S5 010	80	740	S4 010											
		AHB,BWD,SSJ	95	850	S5 A13																	
d [E 87]	09.04-03.07					85	800	S5 010	80	740	S4 010											
	03.07-06.11	BWD				85	800	S5 010	80	740	S4 010											
		BWD,SSJ	80	800	S5 A11																	
d [F 20]	09.11-02.15	AHB,BWD,SSJ	80	800	S5 A11																	
	03.15→	BWD,SSJ	80	800	S5 A11																	
			95	850	S5 A13																	
d [F 21]	09.12→	BWD,SSJ	80	800	S5 A11																	
			95	850	S5 A13																	
d xDrive [F 20]	07.13-02.15		95	850	S5 A13																	
	03.15→	BWD,SSJ	80	800	S5 A11																	
			95	850	S5 A13																	
d xDrive [F 21]	07.13-02.15		95	850	S5 A13	100	830	S5 013	95	800	S4 013											
120 d [E 81]	05.07-12.11	AHB,BWD,SSJ	80	800	S5 A11																	
			95	850	S5 A13																	
d [E 87]	09.04-03.07					85	800	S5 010	80	740	S4 010											
		BWD,SSJ	95	850	S5 A13																	



			Ah A (EN) S5A			Ah A (EN) S5			Ah A (EN) S4			Ah A (EN) S3		
			0 092 ...0	0 092 ...0	0 092 ...0	0 092 ...0	0 092 ...0	0 092 ...0	0 092 ...0					
120 d [E 87]	09.04-06.11	BWD,SSJ	80	800	S5 A11									
	03.07-06.11	BWD				85	800	S5 010	80	740	S4 010			
		SSJ	95	850	S5 A13									
d [F 20]	09.11-02.15	AHB,BWD	80	800	S5 A11									
	03.15→	BWD,SSJ	80	800	S5 A11									
			95	850	S5 A13									
d [F 21]	11.12→	BWD,SSJ	80	800	S5 A11									
			95	850	S5 A13									
d xDrive [F 20]	11.12-02.15		80	800	S5 A11									
	03.15→	BWD,SSJ	80	800	S5 A11									
			95	850	S5 A13									
d xDrive [F 21]	11.12→	BWD,SSJ	80	800	S5 A11									
			95	850	S5 A13									
123 d [E 81]	09.07-12.11	AHB,BWD,SSJ	95	850	S5 A13									
d [E 87]	09.07-06.11	BWD	70	760	S5 A08									
			95	850	S5 A13									
		KZO,SSJ	70	760	S5 A08									
		KZO,SSJ	95	850	S5 A13									
125 d [F 20]	03.12-02.15	AHB,BWD	80	800	S5 A11									
	03.15→	BWD,SSJ	80	800	S5 A11									
			95	850	S5 A13									
d [F 21]	09.12→	BWD,SSJ	80	800	S5 A11									
			95	850	S5 A13									
Serie 1 Cabrio														
118 i [E 88]	03.08-10.13	AHB,BWD				63	610	S5 005	60	540	S4 005			
		AHB,BWD,SSJ	95	850	S5 A13									
	09.08-09.13	BWD,SSJ	70	760	S5 A08				70	760	S4 E08			
			80	800	S5 A11				70	760	S4 E08			
120 i [E 88]	03.08-10.13	AHB,BWD				63	610	S5 005	60	540	S4 005			
			70	760	S5 A08									
		AHB,BWD,SSJ	95	850	S5 A13									
125 i [E 88]	03.08-10.13	AHB,BWD,SSJ	70	760	S5 A08									
			80	800	S5 A11									
			95	850	S5 A13									
135 i [E 88]	03.08-10.13	AHB,BWD,SSJ	80	800	S5 A11									
			95	850	S5 A13									
is [E 88]	09.12-08.13	AHB,BWD				85	800	S5 010	80	740	S4 010			
Diesel														
118/ 123 d [E 88]	09.08-10.13	AHB,BWD,SSJ	95	850	S5 A13									
120 d [E 88]	03.08-10.13	AHB,BWD,SSJ	80	800	S5 A11									
Serie 1 Coupé														
M [E 82]	04.11-06.12	AHB,BWD	80	800	S5 A11									
120 i [E 82]	09.09-09.13	AHB,BWD				85	800	S5 010	74	680	S4 008			
		AHB,BWD,SSJ	70	760	S5 A08									
	09.09-10.13	BWD,SSJ	70	760	S5 A08				70	760	S4 E08			
			80	800	S5 A11				70	760	S4 E08			
125 i [E 82]	03.08-09.13	AHB,BWD,SSJ	95	850	S5 A13									
135 i [E 82]	10.07-10.13	AHB,BWD	70	760	S5 A08									
			70	760	S5 A08									
is [E 82]	09.12-08.13	AHB,BWD	70	760	S5 A08									
Diesel														
118 d [E 82]	09.09-10.13	AHB,BWD				100	830	S5 013	80	740	S4 010			
		AHB,BWD,SSJ	70	760	S5 A08									
			95	850	S5 A13									
120/ 123 d [E 82]	10.07-10.13	AHB,BWD,	95	850	S5 A13									
Serie 2 Active Tourer														
215 i [F 45]	11.15→	BWD,SSJ	70	760	S5 A08									
			80	800	S5 A11									
218 i [F 45]	07.14→	BWD,SSJ	70	760	S5 A08									
			80	800	S5 A11									
220 i [F 45]	11.14→	BWD,SSJ	70	760	S5 A08									
			80	800	S5 A11									
225 i [F 45]	07.14→	BWD,SSJ	70	760	S5 A08									
			80	800	S5 A11									



				Ah	A (EN)		Ah	A (EN)		Ah	A (EN)		Ah	A (EN)	
				0 092 ...0			0 092 ...0			0 092 ...0			0 092 ...0		
BMW															
225 i xDrive [F 45]	11.14→	BWD,SSJ	70	760	S5 A08										
			80	800	S5 A11										
xe [F 45]	11.15→	BWD,SSJ	70	760	S5 A08										
			80	800	S5 A11										
Diesel															
214 d [F 45]	03.15-02.18	BWD,SSJ	70	760	S5 A08										
			80	800	S5 A11										
216 d [F 45]	11.14→	BWD,SSJ	70	760	S5 A08										
			80	800	S5 A11										
218 d [F 45]	09.14→		80	800	S5 A11										
		BWD,SSJ				80	800	S4 E11							
	11.15→	BWD,SSJ	70	760	S5 A08										
			80	800	S5 A11										
220 d [F 45]	11.14→	BWD,SSJ	70	760	S5 A08										
			80	800	S5 A11										
d xDrive [F 45]	11.14→	BWD,SSJ	70	760	S5 A08										
			80	800	S5 A11										
Serie 2 Cabrio															
M 235 i [F 23]	11.14-06.16	BWD,SSJ	80	800	S5 A11										
			95	850	S5 A13										
i xDrive [F 23]	07.15-06.16	BWD,SSJ	80	800	S5 A11										
			95	850	S5 A13										
M 240 i [F 23]	07.16→	BWD,SSJ	80	800	S5 A11										
			95	850	S5 A13										
i xDrive [F 23]	07.16→	BWD,SSJ	80	800	S5 A11										
			95	850	S5 A13										
218 i [F 23]	03.15→	BWD,SSJ	80	800	S5 A11										
			95	850	S5 A13										
220 i [F 23]	11.14→	BWD,SSJ	80	800	S5 A11										
			95	850	S5 A13										
228 i [F 23]	11.14-06.16	BWD,SSJ	80	800	S5 A11										
			95	850	S5 A13										
230 i [F 23]	07.16→	BWD,SSJ	80	800	S5 A11										
			95	850	S5 A13										
Diesel															
218 d [F 23]	07.15→	BWD,SSJ	80	800	S5 A11										
			95	850	S5 A13										
220 d [F 23]	11.14→	BWD,SSJ	80	800	S5 A11										
			95	850	S5 A13										
225 d [F 23]	07.15→	BWD,SSJ	80	800	S5 A11										
			95	850	S5 A13										
Serie 2 Coupé															
M 235 i [F 22]	03.14-06.16	BWD,SSJ	80	800	S5 A11										
			95	850	S5 A13										
i xDrive [F 22]	06.14-06.16														
M 240 i [F 22]	07.16→	BWD,SSJ	80	800	S5 A11										
			95	850	S5 A13										
i xDrive [F 22]	07.16→	BWD,SSJ	80	800	S5 A11										
			95	850	S5 A13										
218 i [F 22]	03.15→	BWD,SSJ	80	800	S5 A11										
			95	850	S5 A13										
220 i [F 22]	03.14-06.16	BWD,SSJ	80	800	S5 A11					80	800	S4 E11			
			95	850	S5 A13					80	800	S4 E11			
	07.16→	BWD,SSJ	80	800	S5 A11										
			95	850	S5 A13										
228 i [F 22]	06.14-06.16	BWD,SSJ	80	800	S5 A11										
			95	850	S5 A13										
230 i [F 22]	07.16→	BWD,SSJ	80	800	S5 A11										
			95	850	S5 A13										
Diesel															
218 d [F 22]	03.14-06.15		95	850	S5 A13										
	07.15→	BWD,SSJ	80	800	S5 A11										
			95	850	S5 A13										



			Ah A (EN) S5A			Ah A (EN) S5			Ah A (EN) S4			Ah A (EN) S3		
			0 092 ...0			0 092 ...0			0 092 ...0			0 092 ...0		
220 d [F 22]	03.14→	BWD,SSJ	80	800	S5 A11									
	11.14→	BWD,SSJ	95	850	S5 A13									
d xDrive [F 22]	03.15→	BWD,SSJ	80	800	S5 A11									
			95	850	S5 A13									
225 d [F 22]	03.14-06.15		95	850	S5 A13									
	07.15→	BWD,SSJ	80	800	S5 A11									
			95	850	S5 A13									
Serie 2 Grand Tourer														
216 i [F 46]	07.15→	BWD,SSJ	80	800	S5 A11									
			95	850	S5 A13									
218 i [F 46]	06.15→	BWD,SSJ	80	800	S5 A11									
			95	850	S5 A13									
220 i [F 46]	06.15→	BWD,SSJ	80	800	S5 A11									
			95	850	S5 A13									
Diesel														
214 d [F 46]	07.15→	BWD,SSJ	80	800	S5 A11									
			95	850	S5 A13									
215 d [F 46]	06.15→	BWD,SSJ	80	800	S5 A11									
			95	850	S5 A13									
218 d [F 46]	06.15→	BWD,SSJ	80	800	S5 A11									
			95	850	S5 A13									
d xDrive [F 46]	03.16→	BWD,SSJ	80	800	S5 A11									
220 d [F 46]	07.15→	BWD,SSJ	80	800	S5 A11									
			95	850	S5 A13									
d xDrive [F 46]	06.15→	BWD,SSJ	80	800	S5 A11									
			95	850	S5 A13									
Serie 3														
ActiveHybrid [F 30]	09.12-05.15		95	850	S5 A13									
316 i [E 36]	09.93-12.98		60	680	S5 A05	63	610	S5 005	60	540	S4 005			
	04.98-09.02	SSJ	70	760	S5 A08									
i [E 46]	04.98-03.05		70	760	S5 A08	77	780	S5 008	60	540	S4 005	56	480	
	09.05-10.11		95	850	S5 A13									
i [E 90]	09.07-10.11	AHB,BWD,SSJ	95	850	S5 A13									
	07.12-07.15		95	850	S5 A13									
318 i [E 36]	09.93-12.98		80	800	S5 A11	85	800	S5 010	80	740	S4 010	53	500	
	09.95-08.98					61	600	S5 004	60	540	S4 004	53	500	
i [E 46]	04.98-09.01		70	760	S5 A08	77	780	S5 008	60	540	S4 005	56	480	
	09.01-03.05		70	760	S5 A08	77	780	S5 008	60	540	S4 005			
i [E 90]	09.05-10.11	AHB,BWD	60	680	S5 A05	63	610	S5 005	60	540	S4 005			
	09.07-10.11	AHB,BWD,SSJ	95	850	S5 A13									
i [F 30]	07.15-10.18	BWD,SSJ	80	800	S5 A11									
			95	850	S5 A13									
is [E 36]	03.95-12.98					61	600	S5 004	60	540	S4 004	53	500	
320 i [E 36]	09.94-12.98					74	750	S5 007	72	680	S4 007	70	640	
	04.98-03.05		70	760	S5 A08	85	800	S5 010	74	680	S4 008	70	640	
i [E 90]	03.05-12.11					63	610	S5 005	60	540	S4 005			
	09.07-12.11	AHB,BWD,SSJ	95	850	S5 A13									
i [F 30]	03.12-10.18	AHB,BWD	95	850	S5 A13									
	07.15-10.18	BWD,SSJ	80	800	S5 A11									
			95	850	S5 A13									
i EfficientDynamics [F 30]	11.12-06.16	BWD,SSJ	95	850	S5 A13									
si [E 90]	03.06-09.06		70	760	S5 A08	63	610	S5 005	52	470	S4 002			
320/ 335 i xDrive [F 30]	07.12-08.15		95	850	S5 A13									
323 i [E 36]	10.94-12.98	AHB,BWD				74	750	S5 007	72	680	S4 007	70	640	
						63	610	S5 005	52	470	S4 002			
i [E 46]	04.98-10.00		70	760	S5 A08	85	800	S5 010	74	680	S4 008	70	640	
	03.99-12.03		70	760	S5 A08	77	780	S5 008	74	680	S4 008	70	640	
	09.00-08.01		70	760	S5 A08				74	680	S4 008			
323/ 328 i [E 90]	09.05-12.11		95	850	S5 A13	85	800	S5 010	74	680	S4 008			
325 i [E 46]	09.00-03.05		70	760	S5 A08	85	800	S5 010	74	680	S4 008	70	640	
	09.02-12.04					85	800	S5 010	80	740	S4 010			
i [E 90]	03.05-12.11	AHB,BWD	95	850	S5 A13	85	800	S5 010	74	680	S4 008	70	640	
	09.07-12.11	BWD	95	850	S5 A13	85	800	S5 010	74	680	S4 008			



				Ah	A (EN)		Ah	A (EN)		Ah	A (EN)		Ah	A (EN)	
				0 092 ...0			0 092 ...0			0 092 ...0			0 092 ...0		
BMW															
325 i xDrive [E 90]	09.08-10.11	AHB,BWD	80	800	S5 A11										
			95	850	S5 A13	85	800	S5 010	74	680	S4 008	70	640	S3 008	
xi [E 90]	09.05-08.08	AHB,BWD	95	850	S5 A13	85	800	S5 010	74	680	S4 008	70	640	S3 008	
	09.07-08.08	AHB,BWD	70	760	S5 A08	77	780	S5 008	74	680	S4 008				
325/ 330 xi [E 46]	07.00-03.05		70	760	S5 A08	85	800	S5 010	74	680	S4 008	70	640	S3 008	
328 i [E 36]	10.94-12.98					74	750	S5 007	72	680	S4 007	70	640	S3 007	
ixDrive [F 30]	07.12-06.15	BWD,SSJ	80	800	S5 A11										
			95	850	S5 A13										
328/ 330 i [E 46]	04.98-04.05		70	760	S5 A08	85	800	S5 010	74	680	S4 008	70	640	S3 008	
328/ 335 i [F 30]	02.12-08.15	AHB,BWD,SSJ	95	850	S5 A13										
330 e [F 30]	12.15-10.18	BWD,SSJ	80	800	S5 A11										
			95	850	S5 A13										
i [E 90]	03.05-12.11	AHB,BWD	95	850	S5 A13	85	800	S5 010	74	680	S4 008	70	640	S3 008	
	09.07-10.11	AHB,BWD	80	800	S5 A11	77	780	S5 008	74	680	S4 008				
i [F 30]	07.15-10.18	BWD,SSJ	80	800	S5 A11										
			95	850	S5 A13										
ixDrive [F 30]	07.15-10.18	BWD,SSJ	80	800	S5 A11										
			95	850	S5 A13										
xi [E 90]	09.05-09.07	AHB,BWD	95	850	S5 A13	85	800	S5 010	74	680	S4 008	70	640	S3 008	
	09.07-08.08	AHB,BWD	70	760	S5 A08	77	780	S5 008	74	680	S4 008				
330/ 335 i xDrive [E 90]	09.08-10.11	AHB,BWD	80	800	S5 A11										
335 i [E 90]	09.06-12.11	AHB,BWD	95	850	S5 A13	85	800	S5 010	74	680	S4 008	70	640	S3 008	
xi [E 90]	03.07-08.08	AHB,BWD	70	760	S5 A08	77	780	S5 008	74	680	S4 008				
340 i [F 30]	07.15-10.18	BWD,SSJ	80	800	S5 A11										
			95	850	S5 A13										
ixDrive [F 30]	07.15-10.18	BWD,SSJ	80	800	S5 A11										
			95	850	S5 A13										
Diesel															
316 d [E 90]	09.09-10.11	AHB,BWD				85	800	S5 010	74	680	S4 008				
		AHB,BWD,SSJ	95	850	S5 A13										
d [F 30]	03.12-02.15		95	850	S5 A13										
	03.15-10.18	BWD,SSJ	95	850	S5 A13										
318 d [E 46]	09.01-03.03		70	760	S5 A08	85	800	S5 010	80	740	S4 010				
	03.03-03.05					85	800	S5 010	80	740	S4 010				
d [E 90]	09.05-09.07	AHB,BWD	95	850	S5 A13	100	830	S5 013	80	740	S4 010				
	09.07-10.11	BWD,KZO,SSJ	70	760	S5 A08										
		BWD,KZO,SSJ	95	850	S5 A13										
d [F 30]	03.12-06.15	AHB,BWD	95	850	S5 A13										
	07.15-10.18	BWD,SSJ	80	800	S5 A11										
			95	850	S5 A13										
d xDrive [F 30]	07.13-05.15		95	850	S5 A13										
	07.15-02.18	BWD,SSJ	80	800	S5 A11										
			95	850	S5 A13										
318/ 325 td, tds [E 36]	09.91-12.98		95	850	S5 A13	100	830	S5 013	80	740	S4 010				
320 d [E 46]	04.98-03.05		95	850	S5 A13	85	800	S5 010	80	740	S4 010				
d [E 90]	03.05-09.07	AHB,BWD				100	830	S5 013	80	740	S4 010				
		AHB,BWD,SSJ	95	850	S5 A13										
	09.05-09.07	AHB,BWD	95	850	S5 A13	100	830	S5 013	80	740	S4 010				
	09.07-03.10	BWD,SSJ	95	850	S5 A13										
	03.10-12.11	AHB,BWD,SSJ	95	850	S5 A13										
d [F 30]	02.12-03.16	AHB,BWD,SSJ	95	850	S5 A13										
	07.15-10.18	BWD,SSJ	80	800	S5 A11										
			95	850	S5 A13										
d ed [E 90]	03.10-11.11	BWD	95	850	S5 A13										
		BWD,SSJ	95	850	S5 A13										
d ed [F 30]	02.12-06.15	AHB,BWD,SSJ	95	850	S5 A13										
	07.15-10.18	BWD,SSJ	95	850	S5 A13										
d xDrive [E 90]	09.08-10.11	AHB,BWD	95	850	S5 A13										
d xDrive [F 30]	07.12-06.15		95	850	S5 A13										
	07.15-10.18	BWD,SSJ	80	800	S5 A11										
			95	850	S5 A13										
323/ 330 d [F 30]	07.12-10.18		95	850	S5 A13										
325 d [E 90]	09.06-02.10		95	850	S5 A13	100	830	S5 013	80	740	S4 010				



			Ah A (EN) S5A			Ah A (EN) S5			Ah A (EN) S4			Ah A (EN) S3		
			0 092 ...0			0 092 ...0			0 092 ...0			0 092 ...0		
325 d [E 90]	03.10-10.11	AHB,BWD	95	850	S5 A13									
D [F 30]	03.16-02.18	BWD,SSJ	80	800	S5 A11									
			95	850	S5 A13									
330 d [E 46]	10.99-03.05		95	850	S5 A13	100	830	S5 013	95	800	S4 013	90	720	S3 013
d [E 90]	09.05-08.08		95	850	S5 A13	100	830	S5 013	80	740	S4 010			
	09.08-12.11	AHB,BWD,SSJ	95	850	S5 A13									
		BWD	95	850	S5 A13									
d xDrive [E 90]	09.08-10.11	AHB,BWD,	95	850	S5 A13									
		BWD	95	850	S5 A13									
xd [E 46]	07.00-03.05		95	850	S5 A13	100	830	S5 013	80	740	S4 010			
xd [E 90]	09.05-08.08		95	850	S5 A13	100	830	S5 013	80	740	S4 010			
335 d [E 90]	09.06-10.11		95	850	S5 A13	100	830	S5 013	80	740	S4 010			
d xDrive [F 30]	07.13-10.18		95	850	S5 A13	100	830	S5 013	95	800	S4 013			
Serie 3 Cabrio														
318 i [E 36]	01.94-12.99		80	800	S5 A11	85	800	S5 010	80	740	S4 010	53	500	S3 004
i [E 93]	03.10-09.13	AHB,BWD	95	850	S5 A13									
318/ 325/ 330 i [E 46]	05.00-08.06		80	800	S5 A11	85	800	S5 010	80	740	S4 010			
320 i [E 46]	09.00-08.06		70	760	S5 A08	77	780	S5 008	74	680	S4 008			
i [E 93]	03.07-08.13					77	780	S5 008	74	680	S4 008			
		BWD,SSJ	80	800	S5 A11									
			95	850	S5 A13									
	03.07-10.13					63	610	S5 005	52	470	S4 002	45	400	S3 002
		BWD	70	760	S5 A08									
			95	850	S5 A13									
		KZO,SSJ	70	760	S5 A08									
		KZO,SSJ	95	850	S5 A13									
320/ 323/ 328 i [E 36]	09.94-12.99		80	800	S5 A11	85	800	S5 010	80	740	S4 010			
323 i [E 46]	03.00-09.00		70	760	S5 A08	85	800	S5 010	74	680	S4 008	70	640	S3 008
i [E 93]	09.07-04.12					77	780	S5 008						
		AHB,BWD	70	760	S5 A08				74	680	S4 008			
325/ 330 i [E 93]	03.07-09.13		70	760	S5 A08	77	780	S5 008	74	680	S4 008			
335 i [E 93]	03.07-02.10		70	760	S5 A08	77	780	S5 008	74	680	S4 008			
	03.10-10.13	AHB,BWD	70	760	S5 A08	77	780	S5 008	74	680	S4 008	70	640	S3 008
Diesel														
320 d [E 93]	03.08-02.10	BWD,SSJ	95	850	S5 A13									
	03.10-10.13	AHB,BWD,SSJ	95	850	S5 A13									
320/ 330 d [E 46]	01.05-08.06		95	850	S5 A13	85	800	S5 010	80	740	S4 010			
325 d [E 93]	09.07-02.10	AHB,BWD	95	850	S5 A13	85	800	S5 010	80	740	S4 010			
	03.10-09.13	AHB,BWD	95	850	S5 A13									
330 d [E 93]	03.07-02.09		95	850	S5 A13	85	800	S5 010	80	740	S4 010			
	03.09-09.13	BWD	95	850	S5 A13									
		BWD,SSJ	95	850	S5 A13									
Serie 3 Compact														
316 g [E 36]	09.95-09.00		60	680	S5 A05	63	610	S5 005	60	540	S4 005			
i [E 36]	03.94-09.00		60	680	S5 A05	63	610	S5 005	60	540	S4 005	53	500	S3 004
	12.98-09.00		60	680	S5 A05	63	610	S5 005	60	540	S4 005			
ti [E 46]	06.01-12.04		70	760	S5 A08	77	780	S5 008	60	540	S4 005	56	480	S3 005
	03.02-12.04		60	680	S5 A05	63	610	S5 005	60	540	S4 005			
318 ti [E 36]	12.95-09.00		60	680	S5 A05	63	610	S5 005	60	540	S4 005	53	500	S3 004
ti [E 46]	09.01-12.04		70	760	S5 A08	77	780	S5 008	60	540	S4 005	56	480	S3 005
323 ti [E 36]	06.97-09.00					77	780	S5 008	74	680	S4 008			
325 ti [E 46]	06.01-12.04		70	760	S5 A08	85	800	S5 010	74	680	S4 008	70	640	S3 008
Diesel														
318 td [E 46]	03.03-12.04		80	800	S5 A11	85	800	S5 010	80	740	S4 010			
tds [E 36]	01.95-09.00		95	850	S5 A13	100	830	S5 013	80	740	S4 010			
320 td [E 46]	09.01-12.04		70	760	S5 A08	77	780	S5 008	74	680	S4 008			
Serie 3 Coupé														
316 i [E 36]	09.93-12.99					63	610	S5 005	60	540	S4 004	56	480	S3 005
i [E 46]	10.99-09.02		70	760	S5 A08	77	780	S5 008	60	540	S4 005	56	480	S3 005
	03.02-05.06		70	760	S5 A08	77	780	S5 008	60	540	S4 005			
i [E 92]	09.07-06.13	AHB,BWD				63	610	S5 005	52	470	S4 002			
		BWD,SSJ	70	760	S5 A08									
318 i [E 46]	04.99-05.06		70	760	S5 A08	77	780	S5 008	60	540	S4 005	56	480	S3 005



			Ah A (EN) S5A			Ah A (EN) S5			Ah A (EN) S4			Ah A (EN) S3		
			0 092 ...0			0 092 ...0			0 092 ...0			0 092 ...0		
◀ BMW														
318 i [E 92]	03.10-06.13	AHB,BWD	95	850	S5 A13									
is [E 36]	12.95-08.99					63	610	S5 005	60	540	S4 005	56	480	S3 005
320 i [E 46]	04.98-09.01		70	760	S5 A08	85	800	S5 010	74	680	S4 008	70	640	S3 008
	09.00-05.06		70	760	S5 A08	77	780	S5 008	74	680	S4 008			
i [E 92]	03.07-06.13		70	760	S5 A08	77	780	S5 008	74	680	S4 008			
		AHB,BWD				77	780	S5 008	74	680	S4 008	70	640	S3 008
		AHB,BWD,SSJ	95	850	S5 A13									
320/ 323/ 328 i [E 36]	09.94-06.99		70	760	S5 A08	77	780	S5 008	74	680	S4 008	70	640	S3 008
323 i [E 46]	04.98-09.00		70	760	S5 A08	85	800	S5 010	74	680	S4 008	70	640	S3 008
i [E 92]	09.06-02.12		95	850	S5 A13	85	800	S5 010	74	680	S4 008			
325 i [E 46]	09.00-05.06		70	760	S5 A08	85	800	S5 010	74	680	S4 008	70	640	S3 008
	09.02-05.06					85	800	S5 010	80	740	S4 010			
i [E 92]	09.06-06.13	AHB,BWD	95	850	S5 A13	85	800	S5 010	74	680	S4 008	70	640	S3 008
	09.07-06.13	AHB,BWD	80	800	S5 A11	77	780	S5 008	74	680	S4 008			
ixDrive [E 92]	09.08-04.13		95	850	S5 A13	85	800	S5 010	74	680	S4 008			
	09.08-06.13	AHB,BWD	80	800	S5 A11									
xi [E 92]	09.06-08.08	AHB,BWD	95	850	S5 A13	85	800	S5 010	74	680	S4 008	70	640	S3 008
	09.07-08.08	AHB,BWD	70	760	S5 A08	77	780	S5 008	74	680	S4 008			
328 i [E 46]	04.98-09.00		70	760	S5 A08	85	800	S5 010	74	680	S4 008	70	640	S3 008
330 i [E 46]	05.00-05.06		70	760	S5 A08	77	780	S5 008	74	680	S4 008			
		AHB,BWD				77	780	S5 008	60	540	S4 005			
i [E 92]	09.06-06.13	AHB,BWD	95	850	S5 A13	85	800	S5 010	74	680	S4 008	70	640	S3 008
xi [E 92]	09.06-08.08	AHB,BWD	95	850	S5 A13	85	800	S5 010	74	680	S4 008	70	640	S3 008
330/ 335 ixDrive [E 92]	09.08-06.13	AHB,BWD	80	800	S5 A11									
335 i [E 92]	09.06-02.10		95	850	S5 A13	85	800	S5 010	74	680	S4 008			
	03.10-06.13	AHB,BWD	70	760	S5 A08	77	780	S5 008	74	680	S4 008	70	640	S3 008
xi [E 92]	09.07-08.08	AHB,BWD	70	760	S5 A08	77	780	S5 008	74	680	S4 008			
Diesel														
320 d [E 46]	09.03-05.06		70	760	S5 A08	85	800	S5 010	74	680	S4 008	70	640	S3 008
d [E 92]	03.07-02.10	BWD	95	850	S5 A13	100	830	S5 013	95	800	S4 013			
		BWD,SSJ	95	850	S5 A13									
	03.10-06.13	AHB,BWD,SSJ	95	850	S5 A13									
dxDrive [E 92]	09.08-02.10	BWD,SSJ	95	850	S5 A13									
	03.10-06.13	AHB,BWD,SSJ	95	850	S5 A13									
325 d [E 92]	03.07-02.10	BWD	95	850	S5 A13	100	830	S5 013	95	800	S4 013			
	03.10-06.13	AHB,BWD	95	850	S5 A13									
330 d [E 46]	03.03-05.06		95	850	S5 A13	100	830	S5 013	95	800	S4 013			
d [E 92]	09.06-08.08	BWD	95	850	S5 A13	100	830	S5 013	95	800	S4 013			
	09.08-06.13	BWD	95	850	S5 A13									
		BWD,SSJ	95	850	S5 A13									
dxDrive [E 92]	09.08-06.13	BWD	95	850	S5 A13									
		BWD,SSJ	95	850	S5 A13									
xd [E 92]	09.06-08.08	BWD	95	850	S5 A13	100	830	S5 013	95	800	S4 013			
335 d [E 92]	09.06-03.13	BWD	95	850	S5 A13	100	830	S5 013	95	800	S4 013			
Serie 3 GT														
320/ 325/ 328/ 330/ 340 i, ixDrive [F 34]	06.13→	BWD,SSJ	95	850	S5 A13									
Diesel														
318/ 320/ 325/ 330/ 335 d, dxDrive [F 34]	06.13→	BWD,SSJ	95	850	S5 A13									
Serie 3 Touring														
316 i [E 36]	01.96-12.99		60	680	S5 A05	63	610	S5 005	60	540	S4 005			
i [E 91]	09.08-05.12	AHB,BWD,SSJ	95	850	S5 A13									
i [F 31]	03.13-05.15	BWD,SSJ	95	850	S5 A13									
316/ 318 i [E 46]	10.99-09.05		70	760	S5 A08	77	780	S5 008	60	540	S4 005	56	480	S3 005
318 i [E 36]	07.95-12.99					61	600	S5 004	60	540	S4 004	53	500	S3 004
i [E 91]	03.06-03.10	AHB,BWD,SSJ	70	760	S5 A08									
			80	800	S5 A11									
	09.07-05.12	AHB,BWD	80	800	S5 A11									
i [F 31]	07.15→	BWD,SSJ	80	800	S5 A11									
			95	850	S5 A13									
320 i [E 46]	10.99-09.05		70	760	S5 A08	85	800	S5 010	74	680	S4 008	70	640	S3 008
i [E 91]	09.05-05.12		70	760	S5 A08	77	780	S5 008	74	680	S4 008			



			Ah A (EN) S5A			Ah A (EN) S5			Ah A (EN) S4			Ah A (EN) S3		
			0 092 ...0			0 092 ...0			0 092 ...0			0 092 ...0		
320 i [E 91]	09.07-06.12	AHB,BWD,SSJ	95	850	S5 A13									
i [F 31]	11.12-06.15		95	850	S5 A13									
	07.15→	BWD,SSJ	80	800	S5 A11									
i xDrive [F 31]	03.13→	BWD,SSJ	95	850	S5 A13									
	07.15→	BWD,SSJ	80	800	S5 A11									
320/ 323/ 328 i [E 36]	03.95-12.99					74	750	S5 007	72	680	S4 007	70	640	S3 007
323 i [E 46]	10.98-09.00		70	760	S5 A08	77	780	S5 008	74	680	S4 008	70	640	S3 008
i [E 91]	09.05-05.12		70	760	S5 A08	77	780	S5 008	74	680	S4 008			
325 i [E 46]	09.00-09.05		70	760	S5 A08	85	800	S5 010	74	680	S4 008	70	640	S3 008
i [E 91]	09.02-01.05					85	800	S5 010	80	740	S4 010			
	09.05-12.10		95	850	S5 A13	77	780	S5 008	74	680	S4 008			
i xDrive [E 91]	09.07-05.12					77	780	S5 008	74	680	S4 008	70	640	S3 008
		BWD,SSJ	80	800	S5 A11									
xi [E 91]	09.08-08.11		95	850	S5 A13	77	780	S5 008	74	680	S4 008			
	09.08-05.12	AHB,BWD	80	800	S5 A11									
325/ 330 xi [E 46]	07.00-09.05		70	760	S5 A08	85	800	S5 010	74	680	S4 008	70	640	S3 008
328 i xDrive [F 31]	03.13-06.16	BWD,SSJ	95	850	S5 A13									
328/ 330 i [E 46]	10.99-09.05		70	760	S5 A08	85	800	S5 010	74	680	S4 008	70	640	S3 008
328/ 335 i [F 31]	06.12-06.15		95	850	S5 A13									
330 i [E 91]	09.05-02.12		95	850	S5 A13	77	780	S5 008	74	680	S4 008			
	09.07-05.13	AHB,BWD	80	800	S5 A11	77	780	S5 008	74	680	S4 008			
i [F 31]	07.15→	BWD,SSJ	80	800	S5 A11									
			95	850	S5 A13									
i xDrive [F 31]	07.15→	BWD,SSJ	80	800	S5 A11									
			95	850	S5 A13									
xi [E 91]	09.05-09.07		95	850	S5 A13	77	780	S5 008	74	680	S4 008			
	09.07-08.08	AHB,BWD	70	760	S5 A08	77	780	S5 008	74	680	S4 008			
330/ 335 i xDrive [E 91]	09.08-05.12	AHB,BWD	80	800	S5 A11									
335 i [E 91]	09.06-02.10		95	850	S5 A13	85	800	S5 010	74	680	S4 008			
	03.10-05.12	AHB,BWD	95	850	S5 A13	77	780	S5 008	74	680	S4 008	70	640	S3 008
i xDrive [F 31]	03.13-06.15		95	850	S5 A13									
	03.07-08.08	AHB,BWD	70	760	S5 A08	77	780	S5 008	74	680	S4 008			
340 i [F 31]	07.15→	BWD,SSJ	80	800	S5 A11									
			95	850	S5 A13									
i xDrive [F 31]	07.15→	BWD,SSJ	80	800	S5 A11									
			95	850	S5 A13									
Diesel														
316 d [E 91]	03.10-05.12	AHB,BWD,SSJ	95	850	S5 A13									
	11.12-02.15		95	850	S5 A13									
d [F 31]	03.15→	BWD,SSJ	95	850	S5 A13									
318 d [E 46]	03.02-09.05		70	760	S5 A08	85	800	S5 010	80	740	S4 010			
d [E 91]	03.06-09.07	AHB,BWD	95	850	S5 A13	100	830	S5 013	80	740	S4 010			
	09.07-05.12	BWD,KZO,SSJ	70	760	S5 A08									
d [F 31]		BWD,KZO,SSJ	95	850	S5 A13									
	11.12-06.15		95	850	S5 A13									
d xDrive [F 31]	07.15→	BWD,SSJ	80	800	S5 A11									
			95	850	S5 A13									
d [F 31]	07.13-05.15		95	850	S5 A13									
	07.15→	BWD,SSJ	80	800	S5 A11									
			95	850	S5 A13									
318/ 325 tds [E 36]	03.95-12.99		95	850	S5 A13	100	830	S5 013	80	740	S4 010			
320 d [E 46]	10.99-09.01		80	800	S5 A11	85	800	S5 010	80	740	S4 010			
	09.01-09.05		95	850	S5 A13	85	800	S5 010	80	740	S4 010			
d [E 91]	09.05-08.07	AHB,BWD	95	850	S5 A13	100	830	S5 013	80	740	S4 010			
	09.07-02.10	BWD				77	780	S5 008	74	680	S4 008			
d [F 31]		BWD,SSJ	70	760	S5 A08									
	03.10-05.12	AHB,BWD,SSJ	95	850	S5 A13									
d [F 31]	09.12-02.16		95	850	S5 A13									
	07.15→	BWD,SSJ	80	800	S5 A11									
			95	850	S5 A13									



				Ah A (EN) S5A			Ah A (EN) S5			Ah A (EN) S4			Ah A (EN) S3		
				0 092 ...0			0 092 ...0			0 092 ...0			0 092 ...0		
◀ BMW															
320 d ed [E 91]	03.11-05.12			100	830	S5 013	95	800	S4 013						
		AHB,BWD	95	850	S5 A13										
d ed [F 31]	03.13-06.15		95	850	S5 A13										
	07.15→	BWD,SSJ	80	800	S5 A11										
		SSJ	95	850	S5 A13										
d xDrive [E 91]	09.08-05.12	AHB,BWD	95	850	S5 A13										
d xDrive [F 31]	03.13-06.15		95	850	S5 A13										
	07.15→	BWD,SSJ	80	800	S5 A11										
			95	850	S5 A13										
325 d [E 91]	09.06-02.10		95	850	S5 A13	100	830	S5 013	80	740	S4 010				
	03.10-05.12	AHB,BWD	95	850	S5 A13										
d [F 31]	03.13-02.16		95	850	S5 A13										
	03.16→	BWD,SSJ	80	800	S5 A11										
			95	850	S5 A13										
330 d [E 46]	10.99-03.03		95	850	S5 A13	100	830	S5 013	95	800	S4 013	90	720	S3 013	
		AHB,BWD	95	850	S5 A13	100	830	S5 013	95	800	S4 013	90	720	S3 013	
	03.03-09.05		95	850	S5 A13	100	830	S5 013	95	800	S4 013				
d [E 91]	09.05-08.08		95	850	S5 A13	100	830	S5 013	95	800	S4 013				
	09.08-05.12	AHB,BWD,SSJ	95	850	S5 A13										
		BWD	95	850	S5 A13										
d [F 31]	09.12→		95	850	S5 A13										
d xDrive [E 91]	09.08-05.12	AHB,BWD,SSJ	95	850	S5 A13										
		BWD	95	850	S5 A13										
xd [E 46]	07.00-09.05		95	850	S5 A13	100	830	S5 013	95	800	S4 013				
xd [E 91]	09.05-08.08	AHB,BWD	95	850	S5 A13	100	830	S5 013	95	800	S4 013	90	720	S3 013	
330/ 335 d xDrive [F 31]	03.13→		95	850	S5 A13										
335 d [E 91]	09.06-05.12		95	850	S5 A13	100	830	S5 013	95	800	S4 013				
Serie 4 Cabrio															
420/ 428/ 430/ 435/ 440 i, i xDrive [F 33]	03.14→	BWD,SSJ	95	850	S5 A13										
Diesel															
420/ 425/ 430/ 435 d [F 33]	03.14→	BWD,SSJ	95	850	S5 A13										
Serie 4 Coupé															
418/ 420/ 428/ 430/ 435/ i, 440 i xDrive [F 32]	09.13→	BWD,SSJ	95	850	S5 A13										
Diesel															
418/ 420/ 425/ 430/ 435 d, d xDrive [F 32]	09.13→	BWD,SSJ	95	850	S5 A13										
Serie 4 GC															
418/ 420/ 428/ 430/ 435/ i, 440 i xDrive [F 36]	05.14→	BWD,SSJ	95	850	S5 A13										
Diesel															
418/ 420/ 425/ 430/ 435 d, d xDrive [E 36; F 36]	05.14→	BWD,SSJ	95	850	S5 A13										
Serie 5															
Active Hybrid [F 10]	11.11-08.16	AHB,BWD	95	850	S5 A13										
520 i [E 60]	07.03-03.05	AHB,BWD	95	850	S5 A13	110	920	S5 015	80	740	S4 010				
	09.07-02.10		80	800	S5 A11	85	800	S5 011							
			95	850	S5 A13	100	830	S5 013	95	800	S4 013				
i [F 10]	09.11-10.16	AHB,BWD	95	850	S5 A13										
520/ 525/ 530 i [E 39]	09.95-07.03		95	850	S5 A13	100	830	S5 013	95	800	S4 013				
523 i [E 39]	09.95-09.00		95	850	S5 A13	100	830	S5 013	95	800	S4 013	70	640	S3 008	
i [F 10]	03.10-08.11	AHB,BWD	95	850	S5 A13										
		BWD,SSJ	95	850	S5 A13										
			105	950	S5 A15										
523/ 525/ 530 i [E 60]	07.03-02.10	AHB,BWD	95	850	S5 A13	110	920	S5 015	80	740	S4 010				
525 i xDrive [E 60]	09.08-02.10	AHB,BWD	80	800	S5 A11										
525/ 530 xi [E 60]	03.05-08.08	AHB,BWD	95	850	S5 A13	110	920	S5 015	80	740	S4 010				
528 i [F 10]	03.10-08.11	AHB,BWD	95	850	S5 A13										
	09.11-10.16	AHB,BWD	80	800	S5 A11										
i xDrive [F 10]	09.11-10.16	AHB,BWD	80	800	S5 A11										
528/ 535 i [E 39]	09.95-07.03		95	850	S5 A13	100	830	S5 013	74	680	S4 008	70	640	S3 008	
530 i [F 10]	09.11-06.13	AHB,BWD	95	850	S5 A13										



			Ah A (EN) S5A			Ah A (EN) S5			Ah A (EN) S4			Ah A (EN) S3		
			0 092 ...0			0 092 ...0			0 092 ...0			0 092 ...0		
530 i [F 10]	05.12-06.13		80	800	S5 A11									
			95	850	S5 A13									
ixDrive [E 60]	09.08-02.10		95	850	S5 A13	110	920	S5 015	80	740	S4 010			
		AHB,BWD	80	800	S5 A11									
530/ 540/ 550	02.17→	BWD,SSJ	95	850	S5 A13									
e iPerformance, i, ixDrive [G 30]														
535 i [F 10]	03.10-10.16	AHB,BWD	95	850	S5 A13									
ixDrive [F 10]	09.10-10.16	AHB,BWD	95	850	S5 A13									
540 i [E 39]	01.96-07.03		95	850	S5 A13	100	830	S5 013	95	800	S4 013	90	720	S3 013
540/ 545/ 550 i [E 60]	09.03-02.10	AHB,BWD	95	850	S5 A13	110	920	S5 015	95	800	S4 013			
550 i [F 10]	03.10-06.13	AHB,BWD	95	850	S5 A13									
	07.13-10.16	BWD,SSJ	95	850	S5 A13									
ixDrive [F 10]	09.10-06.13	AHB,BWD	95	850	S5 A13									
	07.13-10.16	BWD,SSJ	95	850	S5 A13									
Diesel														
518 d [F 10]	07.13-10.16	BWD,SSJ	95	850	S5 A13									
			105	950	S5 A15									
520 d [E 60]	09.05-09.07	AHB,BWD	95	850	S5 A13	110	920	S5 015	95	800	S4 013			
	09.05-02.08	AHB,BWD	80	800	S5 A11	100	830	S5 013	95	800	S4 013			
	09.07-02.10	AHB,BWD	80	800	S5 A11				80	740	S4 011			
d [F 10]	05.10-10.16	AHB,BWD,	105	950	S5 A15									
	06.14-10.16	BWD,SSJ	95	850	S5 A13									
			105	950	S5 A15									
d ed [F 10]	09.11-06.13	AHB,BWD,SSJ	95	850	S5 A13									
d xDrive [F 10]	07.13-10.16	BWD,SSJ	95	850	S5 A13									
			105	950	S5 A15									
520/ 525 d [E 39]	04.00-07.03		95	850	S5 A13	100	830	S5 013	95	800	S4 013			
520/ 530 d , d xDrive [G 30]	02.17→	BWD,SSJ	95	850	S5 A13									
525 d [E 60]	05.04-02.10	AHB,BWD	95	850	S5 A13	110	920	S5 015	95	800	S4 013			
d [F 10]	03.10-08.11		70	760	S5 A08									
		BWD,SSJ	95	850	S5 A13									
			105	950	S5 A15									
	03.10-10.16	AHB,BWD	95	850	S5 A13									
d xDrive [E 60]	09.08-02.10	AHB,BWD	95	850	S5 A13									
td, tds [E 39]	01.96-09.00		95	850	S5 A13	100	830	S5 013	95	800	S4 013	90	720	S3 013
xd [E 60]	09.07-08.08	AHB,BWD	95	850	S5 A13	100	830	S5 013	95	800	S4 013			
525/ 530/ 535 d xDrive [F 10]	03.11-10.16	AHB,BWD	95	850	S5 A13									
530 d [E 39]	08.98-07.03		95	850	S5 A13	100	830	S5 013	95	800	S4 013	90	720	S3 013
d [E 60]	07.03-09.05	BWD	95	850	S5 A13	110	920	S5 015	95	800	S4 013			
	09.05-12.09	AHB,BWD	95	850	S5 A13	110	920	S5 015	95	800	S4 013			
d [F 10]	03.10-08.11	BWD,SSJ	95	850	S5 A13									
			105	950	S5 A15									
	09.11-10.16	AHB,BWD	95	850	S5 A13									
d xDrive [E 60]	09.08-12.09	AHB,BWD	95	850	S5 A13	110	920	S5 015						
xd [E 60]	09.05-08.08	AHB,BWD	95	850	S5 A13	110	920	S5 015	95	800	S4 013			
535 d [E 60]	09.04-02.10	AHB,BWD	95	850	S5 A13	110	920	S5 015	95	800	S4 013			
d [F 10]	09.10-10.16	AHB,BWD	95	850	S5 A13									
Serie 5 GT														
528 i [F 07]	07.13-02.17	BWD,SSJ	95	850	S5 A13									
			105	950	S5 A15									
535 i [F 07]	10.09-08.17	AHB,BWD	95	850	S5 A13									
ixDrive [F 07]	09.10-08.17	AHB,BWD	95	850	S5 A13									
550 i [F 07]	10.09-06.12	AHB,BWD	95	850	S5 A13									
	07.12-02.17	BWD,SSJ	95	850	S5 A13									
ixDrive [F 07]	06.10-06.12	AHB,BWD	95	850	S5 A13									
	07.12-02.17	BWD,SSJ	95	850	S5 A13									
Diesel														
520 d [F 07]	07.12-02.17	BWD,SSJ	95	850	S5 A13									
530 d [F 07]	10.09-06.12	AHB,BWD	95	850	S5 A13									
	07.12-02.17	BWD,SSJ	95	850	S5 A13									
			105	950	S5 A15									



				Ah	A (EN)		Ah	A (EN)		Ah	A (EN)		Ah	A (EN)	
				0 092 ...0			0 092 ...0			0 092 ...0			0 092 ...0		
◀ BMW															
530 d xDrive [F 07]	06.10-06.12	AHB,BWD	95	850	S5 A13										
	07.12-02.17	BWD,SSJ	95	850	S5 A13										
			105	950	S5 A15										
535 d [F 07]	03.10-06.12	AHB,BWD	95	850	S5 A13										
	07.12-02.17	BWD,SSJ	95	850	S5 A13										
			105	950	S5 A15										
d xDrive [F 07]	09.10-06.12	AHB,BWD	95	850	S5 A13										
	07.12-02.17		95	850	S5 A13										
Serie 5 Touring															
520 i [E 61]	09.07-08.10	AHB,BWD	95	850	S5 A13		85	800	S5 010		80	740	S4 010		
i [F 11]	09.11-02.17	AHB,BWD	80	800	S5 A11										
520/ 523/ 525/ 528/ 530/ 540i [E 39]	12.96-05.04		95	850	S5 A13		100	830	S5 013		95	800	S4 013		
523 i [E 61]	03.05-08.10	AHB,BWD	95	850	S5 A13		110	920	S5 015		80	740	S4 010		
	03.07-08.10	BWD	95	850	S5 A13		100	830	S5 013		95	800	S4 013		
i [F 11]	09.10-08.11	AHB,BWD	95	850	S5 A13										
		BWD,SSJ	95	850	S5 A13										
			105	950	S5 A15										
	09.11→	AHB,BWD	80	800	S5 A11										
525 i [E 61]	05.04-08.10	AHB,BWD	95	850	S5 A13		110	920	S5 015		80	740	S4 010		
	03.07-08.10	AHB,BWD	95	850	S5 A13		110	920	S5 015		95	800	S4 013		90 720 S3 013
ixDrive [E 61]	09.08-08.10	AHB,BWD	95	850	S5 A13										
xi [E 61]	03.05-03.07	AHB,BWD	95	850	S5 A13		110	920	S5 015		80	740	S4 010		
	03.07-08.08	AHB,BWD	95	850	S5 A13		110	920	S5 015		95	800	S4 013		90 720 S3 013
528 i [F 11]	09.10-08.11	AHB,BWD	95	850	S5 A13										
	09.11-02.17	AHB,BWD	80	800	S5 A11										
ixDrive [F 11]	09.11-02.17	AHB,BWD	80	800	S5 A11										
530 i [E 61]	03.05-03.10	AHB,BWD	95	850	S5 A13		110	920	S5 015		80	740	S4 010		
	03.07-08.10	AHB,BWD	95	850	S5 A13		110	920	S5 015		95	800	S4 013		90 720 S3 013
i [F 11]	09.11-06.13	AHB,BWD	95	850	S5 A13										
	05.12-05.13	BWD,SSJ	95	850	S5 A13										
			105	950	S5 A15										
ixDrive [E 61]	09.08-03.10		95	850	S5 A13		110	920	S5 015		95	800	S4 013		
	09.08-08.10	AHB,BWD	95	850	S5 A13										
xi [E 61]	03.05-08.08	AHB,BWD	95	850	S5 A13		110	920	S5 015		80	740	S4 010		
	03.07-08.08	AHB,BWD	95	850	S5 A13		110	920	S5 015		95	800	S4 013		90 720 S3 013
530/ 540i, ixDrive [G 31]	06.17→	BWD,SSJ	95	850	S5 A13										
535 i [F 11]	09.10-02.17	AHB,BWD	95	850	S5 A13										
	09.11-02.17	AHB,BWD	95	850	S5 A13										
ixDrive [F 11]	09.11-02.17	AHB,BWD	95	850	S5 A13										
545/ 550i [E 61]	05.04-08.10	AHB,BWD	95	850	S5 A13		110	920	S5 015		95	800	S4 013		
550i [F 11]	03.11-06.13	AHB,BWD	95	850	S5 A13										
	07.13-02.17	BWD,SSJ	95	850	S5 A13										
			105	950	S5 A15										
Diesel															
518 d [F 11]	07.13-02.17	BWD,SSJ	95	850	S5 A13										
			105	950	S5 A15										
520 d [E 61]	09.05-09.07	AHB,BWD	95	850	S5 A13		110	920	S5 015		95	800	S4 013		
	09.05-02.08	AHB,BWD	80	800	S5 A11		100	830	S5 013		95	800	S4 013		
	09.07-08.10	AHB,BWD	80	800	S5 A11										
d [F 11]	09.10-10.16	AHB,BWD,SSJ	105	950	S5 A15										
	06.14-02.17	BWD,SSJ	95	850	S5 A13										
			105	950	S5 A15										
d xDrive [F 11]	07.13-02.17	BWD,SSJ	95	850	S5 A13										
			105	950	S5 A15										
520/ 525 d [E 39]	04.00-05.04		95	850	S5 A13		110	920	S5 015		95	800	S4 013		
520/ 530 d, d xDrive [G 31]	06.17→	BWD,SSJ	95	850	S5 A13										
525 d [E 61]	05.04-03.07	BWD	95	850	S5 A13		110	920	S5 015		95	800	S4 013		
	12.04-03.07	AHB,BWD	95	850	S5 A13		110	920	S5 015		95	800	S4 013		
	03.07-08.10	AHB,BWD	95	850	S5 A13		100	830	S5 013		95	800	S4 013		90 720 S3 013
	d [F 11]	09.10-08.11		70	760	S5 A08									
		AHB,BWD	95	850	S5 A13										
		BWD,SSJ	95	850	S5 A13										
			105	950	S5 A15										



			Ah A (EN) S5A			Ah A (EN) S5			Ah A (EN) S4			Ah A (EN) S3		
			0 092 ...0			0 092 ...0			0 092 ...0			0 092 ...0		
525 d [F 11]	09.11-02.17	AHB,BWD,SSJ	105	950	S5 A15									
d xDrive [E 61]	09.08-08.10	AHB,BWD	95	850	S5 A13									
d xDrive [F 11]	09.11-02.17	AHB,BWD,SSJ	105	950	S5 A15									
tds [E 39]	03.97-09.00		95	850	S5 A13	100	830	S5 013	95	800	S4 013	90	720	S3 013
xd [E 61]	09.07-08.08	AHB,BWD	95	850	S5 A13	100	830	S5 013	95	800	S4 013			
530 d [E 39]	08.98-05.04		95	850	S5 A13	100	830	S5 013	95	800	S4 013			
d [E 61]	05.04-02.07	AHB,BWD	95	850	S5 A13	110	920	S5 015	95	800	S4 013			
	03.07-05.10	AHB,BWD	95	850	S5 A13	100	830	S5 013	95	800	S4 013	90	720	S3 013
d xDrive [E 61]	09.08-05.10	AHB,BWD	95	850	S5 A13	110	920	S5 015						
xd [E 61]	09.05-02.07	AHB,BWD	95	850	S5 A13	110	920	S5 015	95	800	S4 013			
	03.07-08.08	AHB,BWD	95	850	S5 A13	100	830	S5 013	95	800	S4 013	90	720	S3 013
530/535 d [F 11]	09.10-02.17	AHB,BWD	95	850	S5 A13									
d xDrive [F 11]	03.11-02.17	AHB,BWD	95	850	S5 A13									
535 d [E 61]	09.04-03.07	AHB,BWD	80	800	S5 A11	110	920	S5 015	95	800	S4 013			
			95	850	S5 A13	110	920	S5 015	95	800	S4 013			
	03.07-08.10	AHB,BWD	95	850	S5 A13	100	830	S5 013	95	800	S4 013	90	720	S3 013
Serie 6														
630 i [E 63]	09.04-07.10	AHB,BWD	95	850	S5 A13	110	920	S5 015	80	740	S4 010			
	09.07-07.10	AHB,BWD	95	850	S5 A13	85	800	S5 010	80	740	S4 010			
645 Ci [E 63]	01.04-09.05	AHB,BWD	95	850	S5 A13	110	920	S5 015	95	800	S4 013			
650 i [E 63]	09.05-07.10	BWD	95	850	S5 A13	110	920	S5 015	95	800	S4 013			
Diesel														
635 d [E 63]	09.07-07.10	AHB,BWD	95	850	S5 A13	110	920	S5 015	95	800	S4 013			
Serie 6 Cabrio														
630 i [E 64]	09.04-07.10	AHB,BWD	95	850	S5 A13	110	920	S5 015	95	800	S4 013			
	09.07-07.10	AHB,BWD	95	850	S5 A13									
640 i [F 12]	03.11-05.18	AHB,BWD,SSJ	105	950	S5 A15									
xDrive [F 12]	03.13-05.18	BWD,SSJ	95	850	S5 A13									
			105	950	S5 A15									
645 Ci [E 64]	04.04-09.05	BWD	95	850	S5 A13	110	920	S5 015	95	800	S4 013			
650 i [E 64]	09.05-07.10	AHB,BWD	95	850	S5 A13	110	920	S5 015	95	800	S4 013			
i [F 12]	03.11-06.12	AHB,BWD	95	850	S5 A13									
	07.12-05.18	BWD,SSJ	95	850	S5 A13									
			105	950	S5 A15									
i xDrive [F 12]	09.11-06.12	AHB,BWD	95	850	S5 A13									
	07.12-05.18	BWD,SSJ	95	850	S5 A13									
			105	950	S5 A15									
Diesel														
635 d [E 64]	09.07-07.10	AHB,BWD	95	850	S5 A13	85	800	S5 010	80	740	S4 010			
640 d [F 12]	09.11-05.18	AHB,BWD	95	850	S5 A13									
d xDrive [F 12]	03.12-05.18		95	850	S5 A13									
Serie 6 Coupé														
640 i [F 13]	10.11→	AHB,BWD,SSJ	105	950	S5 A15									
xDrive [F 13]	03.13→	BWD,SSJ	95	850	S5 A13									
650 i [F 13]	10.11-06.12	AHB,BWD	95	850	S5 A13									
	07.12→		95	850	S5 A13									
i xDrive [F 13]	10.11-06.12	AHB,BWD	95	850	S5 A13									
	07.12→		95	850	S5 A13									
Diesel														
640 d [F 13]	10.11→	AHB,BWD,SSJ	105	950	S5 A15									
d xDrive [F 13]	03.12→	AHB,BWD	95	850	S5 A13									
Serie 6 GC														
640 i xDrive [F 06]	04.13→	BWD,SSJ	95	850	S5 A13									
640/650 i [F 06]	05.12→	BWD,SSJ	95	850	S5 A13									
650 i xDrive [F 06]	07.12→	BWD,SSJ	95	850	S5 A13									
			105	950	S5 A15									
Diesel														
640 d [F 06]	05.12→	BWD,SSJ	95	850	S5 A13									
			105	950	S5 A15									
d xDrive [F 06]	04.13→	BWD,SSJ	95	850	S5 A13									
			105	950	S5 A15									
Serie 7														
ActiveHybrid [F 04]	04.10-06.12	AHB,BWD	95	850	S5 A13									



				Ah	A (EN)		Ah	A (EN)		Ah	A (EN)		Ah	A (EN)	
				0 092 ...0			0 092 ...0			0 092 ...0			0 092 ...0		
◀ BMW															
ActiveHybrid [F 04]	07.12-05.15			95	850	S5 A13									
L [F 02]	07.12-05.15			95	850	S5 A13									
728/735/740/750 i, iL	06.94-10.01			95	850	S5 A13	100	830	S5 013	95	800	S4 013	90	720	S3 013
[E 38]															
730 i [E 65; E 66]	03.03-10.08			95	850	S5 A13	85	800	S5 010	80	740	S4 010			
i [F 01]	09.09-05.15	AHB,BWD		95	850	S5 A13									
i [G 11]	11.15-12.18	BWD,SSJ		95	850	S5 A13									
				105	950	S5 A15									
Li [E 65; E 66]	03.03-10.08			95	850	S5 A13	85	800	S5 010	80	740	S4 010			
Li [F 02]	05.09-05.15	AHB,BWD		95	850	S5 A13									
Li [G 12]	11.15→	BWD,SSJ		95	850	S5 A13									
		SSJ		105	950	S5 A15									
735 i [E 65; E 66]	11.01-03.05			95	850	S5 A13	100	830	S5 013	95	800	S4 013			
Li [E 65; E 66]	03.02-03.05			95	850	S5 A13	100	830	S5 013	95	800	S4 013			
740 e iPerformance [G 11]	07.16→	BWD,SSJ		95	850	S5 A13									
				105	950	S5 A15									
i [F 01]	11.08-06.12	AHB,BWD		95	850	S5 A13									
	07.12-05.15			95	850	S5 A13									
i [G 11]	09.15-11.18			105	950	S5 A15									
		BWD,SSJ		95	850	S5 A13									
Le xDrive iPerformance	07.16→	BWD,SSJ		95	850	S5 A13									
[G 12]				105	950	S5 A15									
Li [F 02]	11.08-06.12	AHB,BWD		95	850	S5 A13									
	07.12-05.15			95	850	S5 A13									
Li [G 12]	09.15→			105	950	S5 A15									
		BWD,SSJ		95	850	S5 A13									
Li xDrive [F 02]	07.12-03.15			95	850	S5 A13									
				105	950	S5 A15									
740/750 i [E 65; E 66]	04.05-10.08			95	850	S5 A13									
Li [E 65; E 66]	04.05-10.08			95	850	S5 A13									
740/760 Li xDrive [G 12]	03.16→	BWD,SSJ		105	950	S5 A15									
745/760 i [E 65; E 66]	11.01-10.08			95	850	S5 A13	100	830	S5 013						
Li [E 65; E 66]	03.02-10.08			95	850	S5 A13	100	830	S5 013						
750 i [F 01]	11.08-06.12	AHB,BWD		95	850	S5 A13									
	07.12-05.15			95	850	S5 A13									
i [G 11]	11.15-11.18			105	950	S5 A15									
		BWD,SSJ		95	850	S5 A13									
i xDrive [F 01]	09.09-06.12	AHB,BWD		95	850	S5 A13									
	07.12-05.15			95	850	S5 A13									
i xDrive [G 11]	09.15-01.19			105	950	S5 A15									
		BWD,SSJ		95	850	S5 A13									
Li [F 02]	11.08-06.12	AHB,BWD		95	850	S5 A13									
	07.12-05.15			95	850	S5 A13									
Li [G 12]	11.15-12.18			105	950	S5 A15									
		BWD,SSJ		95	850	S5 A13									
Li xDrive [F 02]	09.09-06.12	AHB,BWD		95	850	S5 A13									
	07.12-05.15			95	850	S5 A13									
Li xDrive [G 12]	09.15→			105	950	S5 A15									
		BWD,SSJ		95	850	S5 A13									
760 i [F 01]	09.09-11.14	AHB,BWD		95	850	S5 A13									
Li [F 02]	09.09-04.15	AHB,BWD		95	850	S5 A13									
Diesel															
725 tds [E 38]	01.96-12.00			95	850	S5 A13	100	830	S5 013	95	800	S4 013	90	720	S3 013
730 d [F 01]	11.08-06.12	BWD,SSJ		95	850	S5 A13									
	07.12-05.15			95	850	S5 A13									
d [G 11]	09.15→			105	950	S5 A15									
		BWD,SSJ		95	850	S5 A13									
d, Ld [E 65; E 66]	10.02-10.08	AGM		95	850	S5 A13									
d xDrive [F 01]	07.12-05.15			95	850	S5 A13									
d xDrive [G 11]	09.15→			105	950	S5 A15									
		BWD,SSJ		95	850	S5 A13									
Ld [F 02]	03.09-06.12	AHB,BWD,SSJ		95	850	S5 A13									
	07.12-05.15			95	850	S5 A13									



B

			Ah	A (EN)		Ah	A (EN)		Ah	A (EN)		Ah	A (EN)	
			0 092 ...0			0 092 ...0			0 092 ...0			0 092 ...0		

730 Ld [G 12]	09.15→		105	950	S5 A15									
		BWD,SSJ	95	850	S5 A13									
Ld xDrive [G 12]	09.15→		105	950	S5 A15									
		BWD,SSJ	95	850	S5 A13									
730/ 740 d [E 38]	08.98-12.01		95	850	S5 A13	100	830	S5 013	95	800	S4 013			
740 d [E 65]	10.02-03.05		95	850	S5 A13	100	830	S5 013	95	800	S4 013			
d [F 01]	09.09-06.12	AHB,BWD	95	850	S5 A13									
	07.12-05.15		95	850	S5 A13									
d xDrive [F 01]	09.10-06.12	AHB,BWD	95	850	S5 A13									
	07.12-05.15		95	850	S5 A13									
d xDrive [G 11]	11.15→		105	950	S5 A15									
		BWD,SSJ	95	850	S5 A13									
Ld xDrive [G 12]	11.15→		105	950	S5 A15									
		BWD,SSJ	95	850	S5 A13									
745 d [E 65]	03.05-10.08		95	850	S5 A13									
750 d xDrive [F 01]	07.12-05.15		95	850	S5 A13									
d xDrive, Ld xDrive [G 11; G 12]	07.16→	BWD,SSJ	105	950	S5 A15									
Ld xDrive [F 02]	07.12-05.15		95	850	S5 A13									

Serie 8														
840/ 850 Ci [E 31]	03.94-12.99	ZE				74	750	S5 007	72	680	S4 007	70	640	S3 007

BOGDAN

2110														
211010	12.09→					63	610	S5 006	60	540	S4 006	56	480	S3 006
2111														
211120	12.09→					63	610	S5 006	60	540	S4 006	56	480	S3 006
2310														
231010	12.09→					63	610	S5 006	60	540	S4 006	56	480	S3 006

BRISTOL

Blenheim														
5.9	03.94-10.99								70	630	S4 027			
Blenheim 3S														
5.9	03.02→								70	630	S4 027			

BUGATTI

Veyron Coupé														
8.0 Super Sport	09.13-08.15								100	830	S5 013			
16.4 AWD	09.05-12.12		95	850	S5 A13	100	830	S5 013	95	800	S4 013			
Super Sport	09.10-12.12		95	850	S5 A13	100	830	S5 013	95	800	S4 013			
Veyron Roadster														
16.4 Super Sport Vitesse	03.12→		95	850	S5 A13	100	830	S5 013	95	800	S4 013			
Veyron Roadster Grand Sport														
16.4	03.09→		95	850	S5 A13	100	830	S5 013	95	800	S4 013			

BUICK

LeSabre														
3.8	09.99-08.05								70	630	S4 027			
Park Avenue Ultra														
3.8 i	09.96-08.05								70	630	S4 027			



			Ah A (EN)	Ah A (EN)	Ah A (EN)	Ah A (EN)
			0 092 ...0	0 092 ...0	0 092 ...0	0 092 ...0

CADILLAC

ATS												
2.0 T, TAWD	09.15→		70	760	S5 A08	77	780	S5 008				
ATS Coupé												
2.0 T, TAWD	09.15→		80	800	S5 A11	85	800	S5 011				
ATS-V												
3.6 TT	09.15→		80	800	S5 A11							
ATS-V Coupé												
3.6 TT	09.15→		80	800	S5 A11							
BLS												
2.0	10.05-08.09		70	760	S5 A08	77	780	S5 008	74	680	S4 008	70 640 S3 008
2.0/ 2.8 Flexpower, 4x4	04.06-08.10		70	760	S5 A08	77	780	S5 008	74	680	S4 008	
2.8	10.05-08.09		70	760	S5 A08	77	780	S5 008	74	680	S4 008	70 640 S3 008
	06.08-08.10		70	760	S5 A08	77	780	S5 008	74	680	S4 008	
Diesel												
1.9	10.05-08.09		70	760	S5 A08	77	780	S5 008	74	680	S4 008	70 640 S3 008
	10.07-08.09		70	760	S5 A08	77	780	S5 008	74	680	S4 008	
BLS Wagon												
2.0/ 2.8 , Flexpower, 4x4	10.07-08.10		70	760	S5 A08	77	780	S5 008	74	680	S4 008	
Diesel												
1.9	10.07-08.09		70	760	S5 A08	77	780	S5 008	74	680	S4 008	
CTS												
2.0 T, TAWD	09.15→		70	760	S5 A08	77	780	S5 008				
2.6/ 2.8	09.02-08.07								70	630	S4 027	
2.8/ 3.0/ 3.6 AWD, i	07.04-06.12		70	760	S5 A08	77	780	S5 008	74	680	S4 008	
3.0/ 3.6	09.07-08.11		70	760	S5 A08	77	780	S5 008	74	680	S4 008	
CTS Coupé												
3.0/ 3.6 , AWD	09.09-08.11		70	760	S5 A08	77	780	S5 008	74	680	S4 008	
3.6 FFV	09.12-08.14		80	800	S5 A11							
CTS Wagon												
3.0/ 3.6 , AWD	09.09-08.11		70	760	S5 A08	77	780	S5 008	74	680	S4 008	
CTS-V												
5.7	09.03-08.05					63	610	S5 006				
6.2	09.08-08.14		70	760	S5 A08	77	780	S5 008	74	680	S4 008	
	09.15→		80	800	S5 A11							
CTS-V Coupé												
6.2	09.10-08.14		70	760	S5 A08	77	780	S5 008	74	680	S4 008	
CTS-V Wagon												
6.2	09.10-08.14		70	760	S5 A08	77	780	S5 008	74	680	S4 008	
CT6												
3.0 V6 TT AWD	09.15→	SSJ	95	850	S5 A13							
DeVille												
4.6	09.98-08.05					74	750	S5 007	72	680	S4 007	70 640 S3 007
Escalade												
6.0 Hybrid	09.09-08.13		70	760	S5 A08	77	780	S5 008				
6.2 AWD	09.06-08.13								74	680	S4 009	
	09.14→		70	760	S5 A08	77	780	S5 008				
EXT AWD	09.06-08.13								74	680	S4 009	
FFV	09.09-08.14		70	760	S5 A08	77	780	S5 008	74	680	S4 008	
FFV AWD	09.08-08.13								74	680	S4 009	
	09.09-08.13		70	760	S5 A08	77	780	S5 008	74	680	S4 008	
			70	760	S5 A08	77	780	S5 008	74	680	S4 009	
FFV ESV AWD, FFV EXT AWD	09.06-08.14								74	680	S4 009	
Seville												
4.6	09.97-08.04								70	630	S4 027	
SRX												
2.8/ 3.0/ 3.6/ 4.6 , FFV 4x4, 4x4	09.03-08.16		70	760	S5 A08	77	780	S5 008	74	680	S4 008	
STS												
3.6/ 4.6 , 4x4	09.04-08.11		70	760	S5 A08	77	780	S5 008	74	680	S4 008	



			Ah	A (EN)		Ah	A (EN)		Ah	A (EN)		Ah	A (EN)	
			0 092 ...0			0 092 ...0			0 092 ...0			0 092 ...0		

STS-V														
4.4	09.05-08.09		70	760	S5 A08	77	780	S5 008	74	680	S4 008			
XLR														
4.6	09.03-08.09					61	600	S5 004	60	540	S4 004	53	500	S3 004

CHEVROLET

Alero Coupé														
2.2/ 2.4/ 3.4	09.98-12.04					63	610	S5 006						
Aveo														
1.2 [T300]	06.11→								60	540	S4 025			
		SSJ	60	680	S5 A05				60	640	S4 E05			
1.2/ 1.4/ 1.5 , i	08.03→								60	540	S4 025			
		[; T200;T250; T255]												
1.4 [T300]	06.11→								60	540	S4 025			
		SSJ	60	680	S5 A05				60	640	S4 E05			
1.6 [T300]	06.11→								60	540	S4 025			
		SSJ	60	680	S5 A05				60	640	S4 E05			
Diesel														
1.3 D [T300]	09.11-12.17	SSJ	60	680	S5 A05				60	640	S4 E05			
Aveo Hatchback														
1.2 [T300]	06.11→								60	540	S4 025			
		SSJ	60	680	S5 A05				60	640	S4 E05			
1.2/ 1.4/ 1.5 , i	09.02→								60	540	S4 025			
		[; T200;T255]												
1.4 [T300]	06.11→								60	540	S4 025			
		SSJ	60	680	S5 A05				60	640	S4 E05			
i [T200]	09.02-08.08								60	540	S4 025	45	400	S3 003
Turbo [T300]	06.13-12.17	SSJ	60	680	S5 A05				60	640	S4 E05			
1.6 [T300]	06.11→								60	540	S4 025			
		SSJ	60	680	S5 A05				60	640	S4 E05			
Diesel														
1.3 D [T300]	09.11-12.17	SSJ	60	680	S5 A05				60	640	S4 E05			
Camaro Convertible														
2.0	06.16→		70	760	S5 A08									
3.6	09.10-08.11		80	800	S5 A11	85	800	S5 011	80	740	S4 011			
6.2	09.10→					80	730	S4 E11	80	740	S4 010			
						85	800	S5 010	80	740	S4 010			
	02.13-08.15					85	800	S5 010	80	800	S4 E11			
	06.16→		70	760	S5 A08									
Camaro Coupé														
2.0	06.16→		70	760	S5 A08									
3.6	09.11-08.16		80	800	S5 A11	85	800	S5 011	80	740	S4 011			
3.8	09.94-08.02					63	610	S5 006	60	540	S4 006			
5.7 i	09.97-08.02								70	630	S4 027			
6.2	09.09-08.15					85	800	S5 010	80	740	S4 010			
						85	800	S5 010	80	800	S4 E11			
	06.16→		70	760	S5 A08									
SS	09.09→		80	800	S5 A11	85	800	S5 011	80	740	S4 011			
Caprice Station Wagon														
5.7 i	09.91-12.00					63	610	S5 006	60	540	S4 006	56	480	S3 006
Captiva														
2.4 [C100]	10.06-02.11					63	610	S5 006	60	540	S4 006	56	480	S3 006
	04.11→								60	540	S4 025			
4x4 [C100]	10.06-02.11					63	610	S5 006	60	540	S4 006			
4x4 [C140]	04.11→								60	540	S4 025			
3.0 4x4 [C140]	04.11→								60	540	S4 006			
3.2 4x4 [C100]	10.06-02.11								74	680	S4 009			
Diesel														
2.0 CDRI [C100]	10.06-02.11					85	800	S5 010	70	650	S4 E10			
						85	800	S5 010	95	830	S4 029			
CDRI [C140]	01.12→								95	830	S4 029	90	720	S3 013



			Ah	A (EN)	S5A	Ah	A (EN)	S5	Ah	A (EN)	S4	Ah	A (EN)	S3
			0 092 ...0			0 092 ...0			0 092 ...0			0 092 ...0		
CHEVROLET														
2.0	CDRi 4x4 [C100]	10.06-02.11	85	800	S5 010	70	650	S4 E10						
			85	800	S5 010	95	830	S4 029						
2.2	CDRi [C140]	04.11→										90	720	S3 013
						60	540	S4 025						
		SSJ	95	850	S5 A13									
	CDRi 4x4 [C140]	04.11→				60	540	S4 025						
						95	830	S4 029						
Cobalt														
1.5		01.13→				60	540	S4 004						
						60	540	S4 005						
Corsa														
1.4	i	09.01-08.03	61	600	S5 004	44	440	S4 001						
Corvette Cabrio														
5.7		09.91-08.04				70	630	S4 027	56	480	S3 006			
		03.02→	63	610	S5 006									
Corvette Convertible														
6.0		09.04-08.07				74	680	S4 009						
6.2		12.11→	63	610	S5 006									
	Grand Sport	01.11→	63	610	S5 006									
7.0		09.12→	61	600	S5 004									
Corvette Coupé														
5.7		09.96-08.04	63	610	S5 006	60	540	S4 006						
		01.97-08.04	63	610	S5 006	70	630	S4 027						
6.0		09.04-08.07				74	680	S4 009						
6.2		12.11→	63	610	S5 006									
Corvette Grand Sport Coupé														
6.2		01.11→	63	610	S5 006									
Corvette Stingray Convertible														
6.2		09.13→				74	680	S4 009						
Corvette Stingray Coupé														
6.2		09.13→				74	680	S4 009						
Corvette ZR1 Coupé														
6.2		12.11→	61	600	S5 004									
Corvette Z06 Convertible														
6.2		09.15→	77	780	S5 008	74	680	S4 008						
Corvette Z06 Coupé														
6.2		09.15→	77	780	S5 008	74	680	S4 008						
7.0		09.11→				74	680	S4 009						
Cruze														
1.4	[J300]	08.13-08.15	85	800	S5 010	70	650	S4 E10						
			85	800	S5 010	80	740	S4 010						
	Turbo [J300]	08.13-12.17	61	600	S5 004	60	540	S4 004						
			61	600	S5 004	60	540	S4 006						
1.6	[J300]	05.09-12.13	63	610	S5 006	60	540	S4 006						
		05.09-12.17	61	600	S5 004	60	540	S4 004						
			61	600	S5 004	60	540	S4 006						
		SSJ	80	800	S5 A11									
		10.13-12.17	61	600	S5 004	70	650	S4 E10						
		SSJ	70	760	S5 A08									
1.8	[J300]	05.09-12.17	63	610	S5 006	60	540	S4 006						
		06.12-01.17	63	610	S5 006	60	540	S4 006	56	480	S3 006			
Diesel														
1.7	CDI [J300]	01.12-08.15	85	800	S5 010	80	740	S4 010						
		SSJ	70	760	S5 A08	70	650	S4 E10						
			80	800	S5 A11	70	650	S4 E10						
		08.13-08.15	85	800	S5 010	70	650	S4 E10						
2.0	CDI [J300]	05.09-12.17	85	800	S5 010	80	740	S4 010						
		SSJ	70	760	S5 A08	70	650	S4 E10						
			80	800	S5 A11	70	650	S4 E10						
Cruze Hatchback														
	[J305]	08.13-08.15	85	800	S5 010	70	650	S4 E10						
			85	800	S5 010	80	740	S4 010						



			0 092 ...0			0 092 ...0			0 092 ...0			0 092 ...0			
			Ah	A (EN)	S5A	Ah	A (EN)	S5	Ah	A (EN)	S4	Ah	A (EN)	S3	
1.4 Turbo [J305]	07.12-12.17					61	600	S5 004	60	540	S4 004				
						61	600	S5 004	60	540	S4 006				
		SSJ	70	760	S5 A08				70	650	S4 E10				
			80	800	S5 A11				70	650	S4 E10				
1.6 [J305]	07.11-12.13	SSJ	70	760	S5 A08				70	650	S4 E10				
			80	800	S5 A11				70	650	S4 E10				
	07.11-12.14					63	610	S5 006	60	540	S4 006				
	07.11→					61	600	S5 004	60	540	S4 004				
							61	600	S5 004	60	540	S4 006			
			BWD							70	650	S4 E10			
		SSJ	70	760	S5 A08										
			80	800	S5 A11										
	10.13-12.17					63	610	S5 006	60	540	S4 006	56	480	S3 006	
1.8 [J305]	07.11-12.17					61	600	S5 004	60	540	S4 004				
						61	600	S5 004	60	540	S4 006				
			SSJ	70	760	S5 A08				70	650	S4 E10			
				80	800	S5 A11				70	650	S4 E10			
Diesel															
1.7 CDI [J305]	01.12-08.15					85	800	S5 010	80	740	S4 010				
			SSJ	70	760	S5 A08				70	650	S4 E10			
				80	800	S5 A11				70	650	S4 E10			
	08.13-08.15	SSJ	70	760	S5 A08				70	760	S4 E08				
			80	800	S5 A11				70	760	S4 E08				
2.0 CDI [J305]	07.11-12.17					85	800	S5 010	80	740	S4 010				
		SSJ	70	760	S5 A08				70	650	S4 E10				
			80	800	S5 A11				70	650	S4 E10				
Cruze Station Wagon															
1.4 [J308]	08.13-08.15					85	800	S5 010	70	650	S4 E10				
						85	800	S5 010	80	740	S4 010				
Turbo [J308]	07.12-12.16					61	600	S5 004	60	540	S4 004				
						61	600	S5 004	60	540	S4 006				
			SSJ	70	760	S5 A08				70	650	S4 E10			
				80	800	S5 A11				70	650	S4 E10			
1.6 [J308]	07.12-12.13					63	610	S5 006	60	540	S4 006				
	10.13-12.16					63	610	S5 006	60	540	S4 006	56	480	S3 006	
1.8 [J308]	07.12-12.16					63	610	S5 006	60	540	S4 006				
Diesel															
1.7 CDI [J308]	07.12-08.15					85	800	S5 010	80	740	S4 010				
			SSJ	70	760	S5 A08				70	650	S4 E10			
				80	800	S5 A11				70	650	S4 E10			
	08.13-08.15	SSJ							70	650	S4 E10				
2.0 CDI [J308]	07.12-12.16					85	800	S5 010	80	740	S4 010				
		SSJ	70	760	S5 A08				70	650	S4 E10				
			80	800	S5 A11				70	650	S4 E10				
Epica															
2.0 [V250]	06.06-12.11								60	540	S4 006				
	07.06-08.11								70	630	S4 027				
2.5 [V250]	06.06-12.11								70	630	S4 027				
Diesel															
2.0 CDRI [V250]	09.06-12.11								70	630	S4 027				
Evanda															
2.0 i [V200]	02.03-09.06								60	540	S4 025				
HHR															
2.4	09.05-08.08					61	600	S5 004	60	540	S4 004				
	02.08-05.09					61	600	S5 004	60	540	S4 004	53	500	S3 004	
Impala															
3.4	09.99-08.05								70	630	S4 027				
Kalos															
1.2 [T200]	02.05-08.06								52	470	S4 002	45	400	S3 003	
1.4 [T200]	02.05-08.06								60	540	S4 025				
Kalos Hatchback															
1.2/ 1.4 [T200]	02.05-04.08								60	540	S4 025				



		Ah A (EN) S5A			Ah A (EN) S5			Ah A (EN) S4			Ah A (EN) S3		
		0 092 ...0			0 092 ...0			0 092 ...0			0 092 ...0		
← CHEVROLET													
Lacetti													
1.4 [J200]	02.05-04.13				63	610	S5 006	60	540	S4 006	56	480	S3 006
1.6 [J200]	02.05-04.13				63	610	S5 006	60	540	S4 006			
1.8 [J200]	02.05-08.05				63	610	S5 006	60	540	S4 006			
	08.05-04.13				63	610	S5 006	60	540	S4 006	56	480	S3 006
Diesel													
2.0 D [J200]	09.06-04.13				63	610	S5 006	60	540	S4 006	56	480	S3 006
Lanos													
1.4	01.05→				63	610	S5 006	60	540	S4 006			
1.5/ 1.6 i	01.04→				63	610	S5 006	60	540	S4 006	56	480	S3 006
Malibu													
2.2	09.03-08.08				63	610	S5 006	60	540	S4 006			
2.4 [V300]	03.12-12.15	95	850	S5 A13	100	830	S5 013	95	800	S4 013			
2.4/ 3.1	09.96-08.01				63	610	S5 006	60	540	S4 006	56	480	S3 006
Diesel													
2.0 CDRI [V300]	06.12-12.15	95	850	S5 A13	100	830	S5 013	95	800	S4 013			
Matiz													
0.8/ 1.0 i [M200]	02.05-12.10							40	330	S4 018			
Niva													
1.7 i	09.02→				63	610	S5 006	60	540	S4 006	56	480	S3 006
1.8 MT [212360]	09.04→				74	750	S5 007	60	540	S4 004			
Nubira													
1.4 i [J200]	02.05-04.13				100	830	S5 013	60	540	S4 025			
					100	830	S5 013	80	740	S4 011			
1.6 i [J200]	02.05-04.13							60	540	S4 025			
1.8 i [J200]	02.05-08.05							60	540	S4 004			
	08.05-04.13							60	540	S4 025			
Diesel													
2.0 D [J200]	09.06-04.13							60	540	S4 006			
								74	680	S4 009			
Nubira Wagon													
1.6/ 1.8 i [J200]	02.05-04.13							60	540	S4 025			
Diesel													
2.0 D [J200]	09.06-04.13							60	540	S4 006			
Orlando													
1.4 Turbo [J309]	09.12-12.17				63	610	S5 006	60	540	S4 006			
		SSJ	70	760	S5 A08			70	650	S4 E10			
			80	800	S5 A11			70	650	S4 E10			
1.8 [J309]	10.10-12.17				63	610	S5 006	60	540	S4 006			
Diesel													
2.0 CRDi [J309]	10.10-12.17				85	800	S5 010	80	740	S4 010			
		SSJ	70	760	S5 A08			70	650	S4 E10			
			80	800	S5 A11			70	650	S4 E10			
	10.10→							80	740	S4 010			
Rezzo													
1.6 i [U100]	02.05-05.09							60	540	S4 006			
2.0 i [U100]	02.05-05.09				63	610	S5 006	60	540	S4 006			
Sens													
1.3 Si [TF698]	01.02→				63	610	S5 006	60	540	S4 006	56	480	S3 006
Spark													
0.8/ 1.0 , i [; M200]	09.01-12.10							40	330	S4 018			
1.0 i [M300]	12.09-12.15							40	330	S4 018			
1.2 i [M300]	12.09-12.15				54	530	S5 002	40	330	S4 018			
					54	530	S5 002	52	470	S4 002			
Tahoe													
5.3 4x4	09.99-08.06				74	750	S5 007	72	680	S4 007			
6.0 i	09.99-08.14				74	750	S5 007						
Trax													
1.4 Turbo, Turbo 4x4	11.12→		70	760	S5 A08								
1.6	11.12-12.15		70	760	S5 A08								
1.8	09.12→	SSJ	70	760	S5 A08								
	09.12→							60	540	S4 005			
		SSJ	70	760	S5 A08								



			Ah	A (EN)		Ah	A (EN)		Ah	A (EN)		Ah	A (EN)	
			0 092 ...0			0 092 ...0			0 092 ...0			0 092 ...0		

Diesel														
1.7 CDI, CDI 4x4	11.12-12.15		70	760	S5 A08									
Volt														
1.4 EV Hybrid	11.11-12.14	BWD	60	680	S5 A05									

CHRYSLER

Cherokee														
Diesel														
3.1 D	01.00-12.01					85	800	S5 010	80	740	S4 010			
Crossfire Coupé														
3.2 , SRT-6 [ZH]	09.03-08.08		70	760	S5 A08	77	780	S5 008	74	680	S4 008			
Crossfire Roadster														
3.2 , SRT-6 [ZH]	09.04-08.08		70	760	S5 A08	77	780	S5 008	74	680	S4 008			
Delta														
1.4	06.11→					63	610	S5 005	60	540	S4 005			
						63	610	S5 005	60	640	S4 E05			
		SSJ	60	680	S5 A05				60	640	S4 E05			
Diesel														
1.6	06.11→					63	610	S5 005	60	540	S4 005			
		SSJ	60	680	S5 A05				60	640	S4 E05			
2.0	06.11→					77	780	S5 008	74	680	S4 008			
		SSJ	70	760	S5 A08				70	760	S4 E08			
Grand Voyager														
3.6 [RS]	01.11→		95	850	S5 A13	100	830	S5 013	95	800	S4 013			
3.8 [RS]	09.07→								74	680	S4 009			
Diesel														
2.8 [RS]	09.07→					74	750	S5 007	72	680	S4 007			
Neon														
1.6/ 1.8/ 2.0/ 2.4 , i, i 4x4, i 16V [PL]	06.94-12.05					63	610	S5 006	60	540	S4 006			
Neon Coupé														
2.0 i 16V [PL]	09.95-08.99					63	610	S5 006	60	540	S4 006			
New Yorker														
3.5 i 24V [94]	04.93-09.99					77	780	S5 008	70	630	S4 027	70	640	S3 008
PT Cruiser														
1.6/ 2.0 [PT]	06.00-12.07					61	600	S5 004	60	540	S4 004	53	500	S3 004
2.4 [PT]	06.00-12.10					61	600	S5 004	60	540	S4 004	53	500	S3 004
	09.00-08.10											53	500	S3 004
Turbo [PT]	09.02-12.09					61	600	S5 004	60	540	S4 004	53	500	S3 004
Diesel														
2.2 CRD [PT]	09.02-12.09		70	760	S5 A08	74	750	S5 007	72	680	S4 007			
PT Cruiser Cabrio														
2.0/ 2.4 , Turbo [PT]	09.00-12.10					61	600	S5 004	60	540	S4 004	53	500	S3 004
Sebring														
2.0 [JR]	09.00-08.06					63	610	S5 006	60	540	S4 006			
2.0/ 2.4 [JS]	09.06→					63	610	S5 006						
2.7 [JS]	09.06→					74	750	S5 007	72	680	S4 007			
Sebring Convertible														
2.0/ 2.4 [JR]	09.00-08.06					63	610	S5 006	60	540	S4 006			
2.0/ 2.4/ 2.7 [JS]	09.06→					63	610	S5 006						
Stratus														
2.0/ 2.4/ 2.5 i 16V, i 24V [JA; JX]	08.95-04.01								74	680	S4 009			
2.5 i 24V [JA]	08.95-04.01					63	610	S5 006	60	540	S4 006			
Stratus Cabrio														
2.0/ 2.4/ 2.5 i 16V, i 24V [JA; JX]	08.95-04.01								74	680	S4 009			
2.5 i 24V [JA]	08.95-04.01					63	610	S5 006	60	540	S4 006			
	08.97-04.01					63	610	S5 006						
Viper Convertible														
8.0 GTS	06.97→								74	680	S4 009			



			Ah A (EN)	Ah A (EN)	Ah A (EN)	Ah A (EN)
			0 092 ...0	0 092 ...0	0 092 ...0	0 092 ...0

◀ CHRYSLER

Viper Coupé										
8.0 GTS, GTS Lemans	06.96→						74	680	S4 009	
Voyager										
2.0/ 2.4/ 3.3/ 3.8, i, i AWD, i V6, i V6 AWD, i 4x4 [GS; RG; RS; RT]	01.95→						74	680	S4 009	
Diesel										
2.5 CRD [RG]	09.00-08.01			85	800	S5 010	80	740	S4 010	
	09.01-08.07						74	680	S4 009	
TD [GS]	01.95-12.00						74	680	S4 009	
2.5/ 2.8 CRD 4x4 [RG]	09.00-12.07			85	800	S5 010	80	740	S4 010	
2.8 CRD [RG]	08.04-12.07						74	680	S4 009	
CRD [RT]	01.08→			95	850	S5 A13	74	750	S5 007	72 680 S4 007
				95	850	S5 A13	74	750	S5 007	95 800 S4 013
				95	850	S5 A13	100	830	S5 013	95 800 S4 013
Ypsilon										
0.9/ 1.2	06.11→						60	640	S4 E05	
Diesel										
1.3	06.11→						60	640	S4 E05	
300										
2.7/ 5.7/ 6.1, SRT-8 [LX]	09.04-08.10			85	800	S5 010	80	740	S4 010	
Diesel										
3.0 CRD [LE]	01.11→			95	850	S5 A13	100	830	S5 013	95 800 S4 013
300 Touring										
5.7 [LX]	09.09→			85	800	S5 010	80	740	S4 010	
300C										
2.7 [LE]	10.04-08.10									88 740 S3 012
				85	800	S5 010	80	740	S4 010	88 740 S3 012
3.5 [LX]	09.04-08.08			85	800	S5 010	80	740	S4 010	
3.5/ 5.7 [LE]	09.04-08.10			85	800	S5 010	80	740	S4 010	
6.1 SRT-8 [LE]	01.05-08.10			85	800	S5 010	80	740	S4 010	
Diesel										
3.0 CRD [LE]	09.05-08.10			95	850	S5 A13	100	830	S5 013	95 800 S4 013
300C Touring										
2.7/ 3.5/ 5.7/ 6.1, 4x4 [LE]	09.04-08.10			85	800	S5 010	80	740	S4 010	
Diesel										
3.0 CRD [LE]	09.05-08.10			95	850	S5 A13	100	830	S5 013	95 800 S4 013
300M										
2.7/ 3.5 [LH]	06.98-12.04			63	610	S5 006	60	540	S4 006	



CITROEN

AX										
Electrique	09.94-12.98			54	530	S5 002	42	390	S4 000	45 400 S3 002
1.0/ 1.1/ 1.4 i	06.88-12.98			54	530	S5 002	52	470	S4 002	45 400 S3 002
C-Crosser										
2.0 [I4]	11.10-01.13			63	610	S5 005	60	540	S4 005	
4x4 [I4]	11.10-01.13			63	610	S5 005	60	540	S4 005	
2.4 4x4 [I4]	11.07-01.13			70	760	S5 A08	77	780	S5 008	74 680 S4 008 70 640 S3 008
Diesel										
2.2 HDi 4x4 [I4]	09.07-01.13						95	830	S4 028	
C-Elysee										
1.2 E-VTi	12.14→			70	760	S5 A08	54	530	S5 002	52 470 S4 002
1.2/ 1.6 VTi	09.12→			54	530	S5 002	52	470	S4 002	
Diesel										
1.6 BlueHDi	04.15-12.18	SSJ		70	760	S5 A08				
HDi	09.12→			60	680	S5 A05	63	610	S5 005	
C1										
1.0 [B0]	06.05-12.14						44	420	S4 000	40 340 S3 000
[B4]	02.14→			60	680	S5 A05				
		SSJ					60	640	S4 E05	
1.2 VTi [B4]	02.14→			54	530	S5 002	52	470	S4 002	

						Ah A (EN) S5A		Ah A (EN) S5		Ah A (EN) S4		Ah A (EN) S3	
						0 092 ...0		0 092 ...0		0 092 ...0		0 092 ...0	
Diesel													
1.4 HDi [B0]	06.05-12.10					54	530	S5 002	52	470	S4 002		
C2													
1.1 [A6]	09.03-12.09					54	530	S5 002	42	390	S4 000		
						54	530	S5 002	52	470	S4 002		
		SSJ	60	680	S5 A05				60	640	S4 E05		
1.4 [A6]	09.03-12.09					54	530	S5 002	42	390	S4 000		
						54	530	S5 002	52	470	S4 002		
		SSJ	60	680	S5 A05				60	640	S4 E05		
16V [A6]	12.05-12.08					54	530	S5 002	42	390	S4 000	40	340
		SSJ							60	640	S4 E05		
1.6 [A6]	09.03-12.09					54	530	S5 002	42	390	S4 000		
						54	530	S5 002	52	470	S4 002		
		SSJ	60	680	S5 A05				60	640	S4 E05		
VTS [A6]	10.04-05.09					54	530	S5 002	42	390	S4 000		
						54	530	S5 002	52	470	S4 002		
		SSJ	60	680	S5 A05				60	640	S4 E05		
Diesel													
1.4 HDi [A6]	09.03-12.09					63	610	S5 005	60	540	S4 005		
		SSJ	60	680	S5 A05				60	640	S4 E05		
1.6 HDi [A6]	07.07-05.09					63	610	S5 005	42	390	S4 000		
						63	610	S5 005	60	540	S4 005		
		SSJ	60	680	S5 A05				60	640	S4 E05		
C3													
1.0 VTi [A51]	09.12-12.16					54	530	S5 002	42	390	S4 000	45	400
	09.14-12.16					54	530	S5 002	52	470	S4 002		
1.1 [A51]	09.09-12.16	BWD				54	530	S5 002	52	470	S4 002		
		BWD,SSJ	70	760	S5 A08								
i [A8]	01.02-08.05					54	530	S5 002	42	390	S4 000		
						54	530	S5 002	52	470	S4 002		
		SSJ	60	680	S5 A05				60	640	S4 E05		
i [A31]	09.05-09.09					60	680	S5 A05	54	530	S5 002	42	390
						60	680	S5 A05	54	530	S5 002	52	470
		SSJ							60	640	S4 E05		
1.2 THP [A51]	09.14-12.16	SSJ	70	760	S5 A08								
THP [B618]	07.16→								60	540	S4 005		
		BWD	70	760	S5 A08								
		SSJ							70	760	S4 E08		
			70	760	S5 A08				70	760	S4 E08		
VTi [A51]	03.12-12.16								42	390	S4 000		
									52	470	S4 002		
									60	540	S4 005		
		SSJ	70	760	S5 A08								
VTi [B618]	07.16→								60	540	S4 005		
									70	760	S4 E08		
1.4 [A51]	09.09-12.16	BWD				54	530	S5 002	52	470	S4 002		
i [A8]	01.02-08.05					54	530	S5 002	42	390	S4 000		
						54	530	S5 002	52	470	S4 002		
		SSJ	60	680	S5 A05				60	640	S4 E05		
i [A31]	09.05-09.09					54	530	S5 002	42	390	S4 000	40	340
i 16V [A8]	10.03-08.05					54	530	S5 002	42	390	S4 000	40	340
		SSJ							60	640	S4 E05		
i 16V [A31]	09.05-09.09					54	530	S5 002	42	390	S4 000	40	340
		SSJ							60	640	S4 E05		
VTi [A51]	09.09-12.16					52	520	S5 001	44	440	S4 001		
VTi LPG [A51]	06.13-12.16		60	680	S5 A05	63	610	S5 005	60	540	S4 005	40	340
			60	680	S5 A05	63	610	S5 005	60	540	S4 E05	40	340
1.6 i [A8]	01.02-08.05					54	530	S5 002	52	470	S4 002		
		SSJ	60	680	S5 A05				60	640	S4 E05		
i [A31]	09.05-05.09					54	530	S5 002	52	470	S4 002		
		SSJ	60	680	S5 A05				60	640	S4 E05		
VTi [A51]	09.09-12.16	BWD				54	530	S5 002	52	470	S4 002		



				Ah	A (EN)		Ah	A (EN)		Ah	A (EN)		Ah	A (EN)	
				0 092 ...0			0 092 ...0			0 092 ...0			0 092 ...0		
◀ CITROEN															
1.6 16V	05.03-07.12	SSJ		54	530	S5 002	52	470	S4 002						
		SSJ	60 680	S5 A05			60	640	S4 E05						
Diesel															
1.4 HDi [A51]	09.09-12.15	BWD		63	610	S5 005	60	540	S4 005						
		BWD,SSJ	70 760	S5 A08											
1.4/ 1.6 HDi, HDi 16V [A8; A31]	01.02-12.09			63	610	S5 005	60	540	S4 005						
1.6 BlueHDi [A51]	04.14-12.16	SSJ	70 760	S5 A08											
BlueHDi [B618]	07.16→						60	540	S4 005						
		SSJ	70 760	S5 A08			70	760	S4 E08						
HDi [A51]	09.09-12.14	BWD		63	610	S5 005	60	540	S4 005						
		BWD,SSJ	70 760	S5 A08											
	09.09-12.15	BWD	70 760	S5 A08	63	610	S5 005	60	540	S4 005					
	01.12-12.15				63	610	S5 005	60	540	S4 005					
		SSJ	70 760	S5 A08											
C3 Picasso															
1.2 THP [A58]	01.15→						52	470	S4 002						
							60	540	S4 005						
1.4 [A58]	02.09→			61	600	S5 004	60	540	S4 004						
VTi [A58]	01.10→	BWD					60	540	S4 005						
VTi LPG [A58]	06.11→	BWD		63	610	S5 005	60	540	S4 005						
1.6 [A58]	02.09→	BWD		63	610	S5 005	60	540	S4 005						
VTi [A58]	01.10→	BWD		63	610	S5 005	60	540	S4 005						
Diesel															
1.6 BlueHDi [A58]	01.15→						60	540	S4 005						
		SSJ	70 760	S5 A08			70	760	S4 E08						
HDi [A58]	02.09-12.11			61	600	S5 004	60	540	S4 004						
	02.09→	BWD		63	610	S5 005	60	540	S4 005						
	03.10→						60	540	S4 005						
		BWD		77	780	S5 008									
		BWD,SSJ	70 760	S5 A08											
	07.12→	BWD	70 760	S5 A08											
C3-Pluriel															
1.4 [A42]	05.03-10.12			54	530	S5 002	42	390	S4 000	40	340	S3 000			
1.6 16V [A42]	05.03-10.12			54	530	S5 002	52	470	S4 002						
Diesel															
1.4 HDi [A42]	10.03-01.10			63	610	S5 005	60	540	S4 005						
C4															
1.2 THP [B71]	01.14→			63	610	S5 005	60	540	S4 005						
		SSJ	70 760	S5 A08			60	640	S4 E05						
	01.15→						52	470	S4 002						
							60	540	S4 005						
		SSJ	70 760	S5 A08											
1.4 [B5]	11.04-09.10			54	530	S5 002	42	390	S4 000	40	340	S3 000			
VTi [B71]	09.10-12.16	BWD		54	530	S5 002	52	470	S4 002						
1.6 [B5]	11.04-07.08			54	530	S5 002	42	390	S4 000	40	340	S3 000			
	07.06-12.10						44	420	S4 000	40	340	S3 000			
	07.08-09.10		60 680	S5 A05	63	610	S5 005	42	390	S4 000					
			60 680	S5 A05	63	610	S5 005	60	540	S4 005					
i BioFlex [B5]	09.07-07.08			54	530	S5 002	42	390	S4 000	40	340	S3 000			
LPG [B71]	05.11-12.16	BWD	60 680	S5 A05	63	610	S5 005	60	540	S4 005					
THP [B5]	07.08-09.10		60 680	S5 A05	63	610	S5 005	60	540	S4 005					
THP [B71]	09.10-12.16	BWD	60 680	S5 A05	63	610	S5 005	60	540	S4 005					
VTi [B71]	09.10-12.16	BWD	60 680	S5 A05	63	610	S5 005	60	540	S4 005					
16V [B71]	11.10-12.16			54	530	S5 002	52	470	S4 002						
2.0 [B5]	11.04-12.10		60 680	S5 A05	63	610	S5 005	60	540	S4 005					
Diesel															
1.6 BlueHDi [B71]	04.14→						52	470	S4 002						
							60	540	S4 005						
		SSJ	70 760	S5 A08											
			70 760	S5 A08			70	760	S4 E08						
HDi [B5]	11.04-09.10		60 680	S5 A05	63	610	S5 005	60	540	S4 005					
	07.06-12.10				63	610	S5 005	60	540	S4 005					



			Ah A (EN) S5A			Ah A (EN) S5			Ah A (EN) S4			Ah A (EN) S3		
			0 092 ...0			0 092 ...0			0 092 ...0			0 092 ...0		
1.6 HDi [B71]	09.10-12.16	BWD,SSJ	70	760	S5 A08									
	09.10→	BWD	70	760	S5 A08	63	610	S5 005	60	540	S4 005			
	07.12-12.16		70	760	S5 A08	63	610	S5 005	60	540	S4 005	56	480	S3 005
		SSJ							70	760	S4 E08			
2.0 HDi [B5]	11.04-01.10					63	610	S5 005	60	540	S4 005			
	07.08-09.10					77	780	S5 008	74	680	S4 008			
HDi [B71]	09.10-12.16	BWD,SSJ	70	760	S5 A08				70	760	S4 E08			
	09.10→	BWD				77	780	S5 008	74	680	S4 008			
C4 Aircross														
1.6	03.12-12.14		70	760	S5 A08									
Diesel														
1.6 HDi	03.12-12.17		70	760	S5 A08									
	HDi 4x4	03.12-12.17	70	760	S5 A08									
1.8 HDi	03.12-12.14		70	760	S5 A08									
		SSJ							70	760	S4 E08			
HDi 4x4	03.12-12.14		70	760	S5 A08									
		SSJ							70	760	S4 E08			
C4 Cactus														
1.2 [E3]	02.14→					63	610	S5 005	60	540	S4 005			
	03.14→	SSJ	70	760	S5 A08									
THP [E3]	06.14-12.18					63	610	S5 005	60	540	S4 005			
		SSJ	70	760	S5 A08									
VTi [E3]	02.14-12.18		60	680	S5 A05	63	610	S5 005	60	540	S4 005			
		SSJ							60	640	S4 E05			
Diesel														
1.6 Blue HDi [E3]	02.14-12.18	SSJ	70	760	S5 A08									
	HDi [E3]	02.14-12.18	60	680	S5 A05	63	610	S5 005	60	540	S4 005			
		SSJ							60	640	S4 E05			
C4 Coupé														
1.4/ 1.6 [B5]	11.04-07.10					54	530	S5 002	42	390	S4 000	40	340	S3 000
1.6 THP [B5]	07.08-07.10					63	610	S5 005	60	540	S4 005			
2.0 [B5]	11.04-03.08					63	610	S5 005	60	540	S4 005	56	480	S3 005
	11.04-07.08					63	610	S5 005	60	540	S4 005			
Diesel														
1.6 HDi [B5]	11.04-07.10					63	610	S5 005	60	540	S4 005			
2.0 HDi [B5]	11.04-07.09					63	610	S5 005	60	540	S4 005			
	07.08-07.10					77	780	S5 008	74	680	S4 008			
C4 Grand Picasso														
1.2 VTi [B78]	01.15→	SSJ	70	760	S5 A08									
1.6 [B58]	07.08-12.13	BWD				63	610	S5 005	60	540	S4 005	56	480	S3 005
	[B78]	07.13→				63	610	S5 005	60	540	S4 005			
			BWD	70	760	S5 A08								
		SSJ							70	760	S4 E08			
THP [B58]	07.08-11.09	BWD				63	610	S5 005	60	540	S4 005	56	480	S3 005
	07.08-12.13	BWD				63	610	S5 005	60	540	S4 005			
THP [B78]	07.13→					63	610	S5 005	60	540	S4 005			
			BWD	70	760	S5 A08								
			SSJ						70	760	S4 E08			
	02.14→	SSJ	70	760	S5 A08				60	640	S4 E05			
1.8/ 2.0 [B58]	10.06-10.08	BWD	70	760	S5 A08	77	780	S5 008	74	680	S4 008			
Diesel														
1.6 BlueHDi [B78]	04.14→					63	610	S5 005	60	540	S4 005			
			SSJ	70	760	S5 A08				60	640	S4 E05		
	01.15→								60	540	S4 005			
		SSJ	70	760	S5 A08									
HDi [B58]	10.06-12.11	BWD	70	760	S5 A08	77	780	S5 008	74	680	S4 008			
	05.10-12.13	BWD				63	610	S5 005	60	540	S4 005			
						77	780	S5 008	60	540	S4 005			
		BWD,SSJ	70	760	S5 A08									
HDi [B78]	07.13-12.18					77	780	S5 008	74	680	S4 008			
			SSJ	70	760	S5 A08				70	760	S4 E08		
2.0 BlueHDi [B78]	07.13→	SSJ	70	760	S5 A08									
HDi [B58]	10.06-12.11	BWD	60	680	S5 A05	63	610	S5 005	60	540	S4 005			



				Ah	A (EN)		Ah	A (EN)		Ah	A (EN)		Ah	A (EN)	
				0 092 ...0			0 092 ...0			0 092 ...0			0 092 ...0		
◀ CITROEN															
2.0 HDi [B58]	10.06-12.13	BWD	70	760	S5 A08	77	780	S5 008	74	680	S4 008				
	09.10-12.13		60	680	S5 A05	63	610	S5 005	60	540	S4 005				
C4 Picasso															
1.2 VTi [B78]	01.15→					63	610	S5 005	60	540	S4 005				
		SSJ	70	760	S5 A08				70	760	S4 E08				
1.6 [B58]	07.08-12.13					63	610	S5 005	60	540	S4 005				
		BWD,SSJ	70	760	S5 A08										
THP [B58]	07.08-11.09	BWD				63	610	S5 005	60	540	S4 005	56	480	S3 005	
	07.08-12.13	BWD				63	610	S5 005	60	540	S4 005				
THP [B78]	02.13→					63	610	S5 005	60	540	S4 005				
		SSJ	70	760	S5 A08				70	760	S4 E08				
	02.14→	SSJ	70	760	S5 A08				60	640	S4 E05				
VTi [B78]	02.13→					63	610	S5 005	42	390	S4 000				
						63	610	S5 005	60	540	S4 005				
		SSJ	70	760	S5 A08				70	760	S4 E08				
1.8 [B58]	02.07-12.11	BWD				63	610	S5 005	60	540	S4 005				
2.0 [B58]	02.07-10.08	BWD				63	610	S5 005	60	540	S4 005	56	480	S3 005	
Diesel															
1.6 BlueHDi [B78]	04.14→					63	610	S5 005	60	540	S4 005				
		BWD							70	760	S4 E08				
		SSJ	70	760	S5 A08				60	640	S4 E05				
	01.15→								60	540	S4 005				
HDi [B58]	02.07-12.11	BWD,SSJ	70	760	S5 A08										
	02.07-12.13					77	780	S5 008	74	680	S4 008				
	05.10-12.13	SSJ	70	760	S5 A08										
HDi [B78]	02.13-12.18					63	610	S5 005	60	540	S4 005				
						77	780	S5 008	70	650	S4 E07	56	480	S3 005	
						77	780	S5 008	74	680	S4 008	56	480	S3 005	
		SSJ	70	760	S5 A08										
			70	760	S5 A08				70	760	S4 E08				
2.0 BlueHDi [B78]	02.13→					63	610	S5 005	60	540	S4 005				
		SSJ	70	760	S5 A08										
			70	760	S5 A08				70	760	S4 E08				
HDi [B58]	02.07-12.11	BWD	70	760	S5 A08										
	02.07-12.13					77	780	S5 008	74	680	S4 008				
	07.09-12.13	BWD	70	760	S5 A08	77	780	S5 008	74	680	S4 008				
C5															
1.6 THP [X7]	09.09-12.15					63	610	S5 005	60	540	S4 005				
		BWD	60	680	S5 A05										
VTi [X7]	09.10-12.15	BWD	60	680	S5 A05	63	610	S5 005	60	540	S4 005				
1.8 [X7]	04.08-01.11								60	540	S4 005				
		BWD	60	680	S5 A05	63	610	S5 005							
i [X3]	10.04-09.05		60	680	S5 A05	63	610	S5 005	60	540	S4 005				
	09.05-03.08		70	760	S5 A08	63	610	S5 005	60	540	S4 005				
i 16V [X4]	03.01-09.04		60	680	S5 A05	63	610	S5 005	60	540	S4 005				
2.0 [X7]	04.08-01.10					63	610	S5 005	60	540	S4 005				
		BWD	60	680	S5 A05										
HPi [X4]	03.01-09.04		70	760	S5 A08	77	780	S5 008	74	680	S4 008				
i [X3]	10.04-03.08		70	760	S5 A08	63	610	S5 005	60	540	S4 005	56	480	S3 005	
i 16V [X4]	03.01-09.04		70	760	S5 A08	63	610	S5 005	60	540	S4 005				
3.0 [X7]	04.08-04.09					77	780	S5 008							
		BWD	70	760	S5 A08				74	680	S4 008				
i [X3]	10.04-04.07		70	760	S5 A08	77	780	S5 008	74	680	S4 008				
i [X4]	03.01-09.04		70	760	S5 A08	77	780	S5 008	74	680	S4 008	70	640	S3 008	
24V [X7]	04.08-04.09					77	780	S5 008							
		BWD	70	760	S5 A08				74	680	S4 008				
Diesel															
1.6 HDi [X7]	04.08-07.10	BWD	70	760	S5 A08	77	780	S5 008	60	540	S4 005	70	640	S3 008	
	03.10-08.12	BWD,SSJ							60	640	S4 E05				
	03.12-11.14		70	760	S5 A08	63	610	S5 005	60	540	S4 005				
1.6/ 2.0/ 2.2 HDi [X3]	10.04-03.08		70	760	S5 A08	77	780	S5 008	74	680	S4 008				



						Ah A (EN) S5A		Ah A (EN) S5		Ah A (EN) S4		Ah A (EN) S3			
				0 092 ...0		0 092 ...0		0 092 ...0		0 092 ...0		0 092 ...0			
2.0	BlueHDi [X7]	03.15-11.17								60	540	S4 005			
			SSJ	70	760	S5 A08									
		05.15-11.17	BWD							70	760	S4 E08			
	HDi [X4]	03.01-09.04		70	760	S5 A08		77	780	S5 008		74	680	S4 008	
	HDi [X7]	04.08-05.15	BWD	70	760	S5 A08		77	780	S5 008		74	680	S4 008	
		09.09-05.15								60	540	S4 005			
				70	760	S5 A08		77	780	S5 008		74	680	S4 008	
			SSJ	70	760	S5 A08						70	640	S3 008	
2.2	HDi [X4]	03.01-09.04		70	760	S5 A08		77	780	S5 008		74	680	S4 008	
	HDi [X7]	04.08-09.09	BWD	70	760	S5 A08		77	780	S5 008		74	680	S4 008	
		07.10-05.15	BWD	70	760	S5 A08		77	780	S5 008		74	680	S4 008	
2.7	HDi [X7]	04.08-07.09	BWD	70	760	S5 A08		77	780	S5 008		74	680	S4 008	
3.0	HDi 24V [X7]	07.09-04.14	BWD	70	760	S5 A08		77	780	S5 008		74	680	S4 008	
C5 Break															
1.8	i [X3]	10.04-08.05		70	760	S5 A08		63	610	S5 005		60	540	S4 005	
		09.05-03.08		70	760	S5 A08		63	610	S5 005		60	540	S4 005	
	i 16V [X4]	06.01-09.04		70	760	S5 A08		63	610	S5 005		60	540	S4 005	
2.0	i [X3]	10.04-09.07		70	760	S5 A08		63	610	S5 005		60	540	S4 005	
	i 16V [X4]	06.01-09.04		60	680	S5 A05		63	610	S5 005		60	540	S4 005	
2.0/3.0	HPI, i [X4]	06.01-09.04		70	760	S5 A08		77	780	S5 008		74	680	S4 008	
3.0	i [X3]	10.04-04.07		70	760	S5 A08		77	780	S5 008		74	680	S4 008	
Diesel															
1.6/2.0/2.2	HDi [X3; X4]	06.01-03.08		70	760	S5 A08		77	780	S5 008		74	680	S4 008	
C5 Tourer															
1.6	[X7]	09.10-12.15	BWD	60	680	S5 A05		63	610	S5 005		60	540	S4 005	
	THP [X7]	09.09-05.15		60	680	S5 A05		63	610	S5 005		60	540	S4 005	
		09.09-12.15						63	610	S5 005		60	540	S4 005	
			BWD	60	680	S5 A05									
1.8	[X7]	04.08-01.11						63	610	S5 005		60	540	S4 005	
			BWD	60	680	S5 A05									
2.0	[X7]	04.08-01.10	BWD	60	680	S5 A05		63	610	S5 005		60	540	S4 005	
Diesel															
1.6	HDi [X7]	04.08-07.10	BWD	70	760	S5 A08		77	780	S5 008		74	680	S4 008	
		03.10-08.12	BWD,SSJ							60	640	S4 E05			
		03.12-12.15		70	760	S5 A08		63	610	S5 005		60	540	S4 005	
2.0	BlueHDi [X7]	03.15-11.17								60	540	S4 005			
			SSJ	70	760	S5 A08									
		05.15-11.17		70	760	S5 A08									
			BWD							70	760	S4 E08			
	HDi [X7]	04.08-05.15	BWD	70	760	S5 A08		77	780	S5 008		74	680	S4 008	
		09.09-05.15		70	760	S5 A08		77	780	S5 008		74	680	S4 008	
			SSJ	70	760	S5 A08									
2.2	HDi [X7]	04.08-09.09	BWD	70	760	S5 A08		77	780	S5 008		74	680	S4 008	
		07.10-05.15	BWD	70	760	S5 A08		77	780	S5 008		74	680	S4 008	
2.7	HDi [X7]	04.08-07.09	BWD	70	760	S5 A08		77	780	S5 008		74	680	S4 008	
3.0	HDi 24V [X7]	07.09-04.14		70	760	S5 A08		77	780	S5 008		74	680	S4 008	
C6															
3.0	[X6]	11.05-02.09		70	760	S5 A08		77	780	S5 008		74	680	S4 008	
Diesel															
2.2/2.7	HDi [X6]	11.05-07.10		70	760	S5 A08		77	780	S5 008		74	680	S4 008	
3.0	HDi 24V [X6]	07.09-12.12	BWD	70	760	S5 A08		77	780	S5 008		74	680	S4 008	
C8															
2.0	16V [V3]	06.02-05.10		70	760	S5 A08		77	780	S5 008		74	680	S4 008	
2.2	16V [V3]	06.02-05.06		70	760	S5 A08		77	780	S5 008		74	680	S4 008	
3.0	[V3]	10.02-05.06		70	760	S5 A08		77	780	S5 008		74	680	S4 008	
Diesel															
2.0	HDi [V3]	06.02-12.06		70	760	S5 A08		77	780	S5 008		74	680	S4 008	
		06.02-07.14		70	760	S5 A08		77	780	S5 008		74	680	S4 008	
		06.10-07.14		70	760	S5 A08		77	780	S5 008		70	760	S4 E08	
2.2	HDi [V3]	06.02-07.06		70	760	S5 A08		77	780	S5 008		74	680	S4 008	
		09.07-05.10		70	760	S5 A08		77	780	S5 008		74	680	S4 008	
DS3															
1.2	THP [A55]	04.14-04.15	SSJ	70	760	S5 A08									



						Ah A (EN) S5A		Ah A (EN) S5		Ah A (EN) S4		Ah A (EN) S3	
				0 092 ...0		0 092 ...0		0 092 ...0		0 092 ...0			
◀ CITROEN													
1.2	VTi [A55]	06.12-04.15				63	610	S5 005	42	390	S4 000		
						63	610	S5 005	60	540	S4 005		
		SSJ	70	760	S5 A08								
1.4	VTi [A55]	01.10-04.15	BWD			54	530	S5 002	52	470	S4 002		
	VTi LPG [A55]	06.11-04.15				54	530	S5 002	42	390	S4 000	45	400
1.6	THP [A55]	01.10-04.15	BWD			54	530	S5 002	52	470	S4 002		
						60	680	S5 A05	63	610	S5 005	60	540
		10.11-04.15				54	530	S5 002	52	470	S4 002		
		01.12-04.15	SSJ	70	760	S5 A08							
		04.14-04.15		70	760	S5 A08	63	610	S5 005	60	540	S4 005	
	THP Racing [A55]	10.10-04.15	BWD			54	530	S5 002	52	470	S4 002		
						63	610	S5 005	60	540	S4 005		
	VTi [A55]	01.10-04.15	BWD						60	540	S4 005		
Diesel													
1.4	HDi 8V [A55]	03.10-04.15	BWD,SSJ	70	760	S5 A08							
1.6	BlueHDi [A55]	10.13-04.15		60	680	S5 A05	63	610	S5 005	60	540	S4 005	56
			SSJ						60	640	S4 E05	480	S3 005
		02.14-04.15	SSJ	70	760	S5 A08			70	760	S4 E08		
		09.14-04.15	SSJ	70	760	S5 A08							
	HDi [A55]	11.09-04.15				63	610	S5 005	60	540	S4 005		
			SSJ	70	760	S5 A08							
		01.10-04.15	BWD,SSJ						60	640	S4 E05		
DS3 Cabrio													
1.2	THP [A56]	04.14-04.15	SSJ	70	760	S5 A08							
	VTi [A56]	03.14-04.15				54	530	S5 002	52	470	S4 002		
	VTi [A56]	07.12-04.15				54	530	S5 002	52	470	S4 002	40	340
1.6	THP [A56]	07.12-04.15		60	680	S5 A05	63	610	S5 005	60	540	S4 005	56
				60	680	S5 A05	63	610	S5 005	60	640	S4 E05	480
		04.14-04.15	SSJ	70	760	S5 A08							
	VTi [A56]	07.12-04.15				54	530	S5 002	52	470	S4 002	45	400
Diesel													
1.6	BlueHDi [A56]	10.13-04.15	SSJ	70	760	S5 A08							
		01.14-04.15	SSJ	70	760	S5 A08			70	760	S4 E08		
	HDi [A56]	07.12-04.15	SSJ	70	760	S5 A08			70	760	S4 E08		
DS3 Cabrio Racing													
1.6	THP [A56]	03.14-07.15				63	610	S5 005	60	540	S4 005		
			BWD	70	760	S5 A08							
DS4													
1.2	THP [B75]	01.14-09.15				77	780	S5 008	74	680	S4 008		
			SSJ	70	760	S5 A08			60	640	S4 E05		
1.6	THP [B75]	03.11-09.15	BWD			63	610	S5 005	60	540	S4 005		
			BWD,SSJ	70	760	S5 A08							
		01.15-09.15		60	680	S5 A05	63	610	S5 005	60	540	S4 005	
			BWD						60	640	S4 E05		
		07.15-09.15	SSJ	70	760	S5 A08							
	VTi [B75]	03.11-09.15	BWD			63	610	S5 005	60	540	S4 005		
Diesel													
1.6	BlueHDi [B75]	04.14-09.15				77	780	S5 008	74	680	S4 008		
			SSJ	70	760	S5 A08			60	640	S4 E05		
	HDi [B75]	03.11-09.15	BWD,SSJ	70	760	S5 A08							
		07.12-09.15	SSJ	70	760	S5 A08							
		04.14-09.15	BWD	70	760	S5 A08							
			SSJ						70	760	S4 E08		
	HDi 16V [B75]	03.11-09.15		70	760	S5 A08	63	610	S5 005	60	540	S4 005	
			SSJ						70	760	S4 E08		
2.0	BlueHDi [B75]	09.14-09.15				77	780	S5 008	74	680	S4 008		
			SSJ	70	760	S5 A08			60	640	S4 E05		
		07.15-09.15	BWD						70	760	S4 E08		
			SSJ	70	760	S5 A08							
	HDi [B75]	09.11-09.15				77	780	S5 008	74	680	S4 008	70	640
	HDi 16V [B75]	03.11-02.15	BWD			77	780	S5 008	74	680	S4 008		



						Ah A (EN) S5A		Ah A (EN) S5		Ah A (EN) S4		Ah A (EN) S3				
				0 092 ...0		0 092 ...0		0 092 ...0		0 092 ...0		0 092 ...0				
DS5																
1.6 THP [B81]	09.11-04.15			63	610	S5 005										
		70	760	S5 A08				70	760	S4 E08						
		70	760	S5 A08				74	680	S4 008						
	BWD			63	610	S5 005		60	540	S4 005						
		60	680	S5 A05												
	01.15-04.15			77	780	S5 008		74	680	S4 008						
		70	760	S5 A08				70	760	S4 E08						
Diesel																
1.6 BlueHDi [B81]	09.13-04.15			63	610	S5 005		60	540	S4 005		56	480	S3 005		
				77	780	S5 008		74	680	S4 008						
		70	760	S5 A08				60	640	S4 E05						
		70	760	S5 A08				70	760	S4 E08						
HDi [B81]	09.11-11.14	BWD,SSJ	70	760	S5 A08											
2.0 BlueHDi [B81]	08.13-04.15	SSJ	70	760	S5 A08				70	760	S4 E08					
	04.14-04.15			77	780	S5 008		74	680	S4 008						
		SSJ	70	760	S5 A08				60	640	S4 E05					
HDi [B81]	09.11-11.14	BWD	70	760	S5 A08		77	780	S5 008		74	680	S4 008			
	09.11-04.15		70	760	S5 A08		77	780	S5 008							
HDi Hybrid4 4x4 [B81]	09.11-01.15	BWD	70	760	S5 A08		77	780	S5 008		74	680	S4 008			
Evasion																
1.8/ 2.0 i, i Turbo, i 16V [U60]	06.94-07.02			63	610	S5 005		60	540	S4 005		56	480	S3 005		
Diesel																
1.9/ 2.1 D Turbo [U60]	10.94-07.02		70	760	S5 A08		63	610	S5 005		60	540	S4 005			
2.0 HDi [U60]	01.99-07.02		70	760	S5 A08		77	780	S5 008		74	680	S4 008	70	640	S3 008
Picasso																
1.6 i	06.02-02.07			63	610	S5 005		52	470	S4 002		45	400	S3 002		
Saxo																
Electricque [S8]	01.97-09.03			54	530	S5 002		52	470	S4 002		45	400	S3 002		
1.0/ 1.1 i [S8]	02.96-09.03							42	390	S4 000		40	340	S3 000		
								44	420	S4 000		40	340	S3 000		
1.4/ 1.6 i [S8]	02.96-09.03			54	530	S5 002		52	470	S4 002		45	400	S3 002		
1.6 i 16V [S8]	07.96-09.03			54	530	S5 002		52	470	S4 002		45	400	S3 002		
Diesel																
1.5 D [S8]	07.96-09.03			63	610	S5 005		60	540	S4 005						
Xantia																
1.6 i [X1]	03.93-01.98			63	610	S5 005		52	470	S4 002		45	400	S3 002		
1.6/ 1.8 i [X2]	10.97-12.01			63	610	S5 005		52	470	S4 002		45	400	S3 002		
1.8 i [X1]	03.93-01.98			63	610	S5 005		52	470	S4 002		45	400	S3 002		
	04.97-01.98							60	540	S4 005		56	480	S3 005		
								60	640	S4 E05		56	480	S3 005		
i 16V [X2]	12.97-12.01			63	610	S5 005		52	470	S4 002		45	400	S3 002		
1.8/ 2.0 i Turbo, i 16V [X1]	03.93-12.98			63	610	S5 005		60	540	S4 005		56	480	S3 005		
2.0 i [X1]	03.93-01.98			63	610	S5 005		60	540	S4 005		56	480	S3 005		
i [X2]	12.97-12.01			63	610	S5 005		60	540	S4 005		56	480	S3 005		
i Turbo [X2]	12.97-12.01			63	610	S5 005		60	540	S4 005		56	480	S3 005		
i 16V [X2]	12.97-12.01			63	610	S5 005		60	540	S4 005		56	480	S3 005		
3.0 i [X1; X2]	10.96-12.01	70	760	S5 A08		77	780	S5 008		74	680	S4 008	70	640	S3 008	
Diesel																
1.9 D [X1; X2]	07.93-01.98			63	610	S5 005		60	540	S4 005						
D Turbo [X1; X2]	02.94-12.01			63	610	S5 005		60	540	S4 005						
2.0 HDi [X1; X2]	10.98-12.01	70	760	S5 A08		77	780	S5 008		74	680	S4 008	70	640	S3 008	
2.1 D Turbo [X1; X2]	05.95-12.01	70	760	S5 A08		77	780	S5 008		74	680	S4 008	70	640	S3 008	
Xantia Break																
1.8 i [X1]	09.95-01.98			63	610	S5 005		52	470	S4 002		45	400	S3 002		
i [X2]	12.97-12.01			63	610	S5 005		52	470	S4 002		45	400	S3 002		
i 16V [X2]	12.97-12.01			63	610	S5 005		52	470	S4 002		45	400	S3 002		
1.8/ 2.0 i Turbo, i 16V [X1]	09.95-01.98			63	610	S5 005		60	540	S4 005		56	480	S3 005		
2.0 i Turbo [X2]	12.97-12.01			63	610	S5 005		60	540	S4 005		56	480	S3 005		
i [X1]	09.95-01.98			63	610	S5 005		60	540	S4 005		56	480	S3 005		
i 16V [X2]	12.97-12.01			63	610	S5 005		60	540	S4 005		56	480	S3 005		
3.0 i [X2]	01.98-12.01	70	760	S5 A08		77	780	S5 008		74	680	S4 008	70	640	S3 008	



			Ah A (EN) S5A			Ah A (EN) S5			Ah A (EN) S4			Ah A (EN) S3		
			0 092 ...0			0 092 ...0			0 092 ...0			0 092 ...0		
◀ CITROEN														
Diesel														
1.9 D Turbo [X1; X2]	09.95-12.01					63	610	S5 005	60	540	S4 005			
2.0 HDi [X1; X2]	10.98-12.01	70	760	S5 A08	77	780	S5 008	74	680	S4 008	70	640	S3 008	
2.1 D Turbo [X1; X2]	06.96-12.01	70	760	S5 A08	77	780	S5 008	74	680	S4 008	70	640	S3 008	
XM														
2.0 i [Y4]	07.94-10.00	70	760	S5 A08	77	780	S5 008	60	540	S4 005	56	480	S3 005	
i Turbo [Y4]	04.95-10.00	70	760	S5 A08	77	780	S5 008	74	680	S4 008	70	640	S3 008	
i 16V [Y4]	07.94-10.00	70	760	S5 A08	77	780	S5 008	60	540	S4 005	56	480	S3 005	
3.0 i [Y4]	07.94-10.00	70	760	S5 A08	77	780	S5 008	74	680	S4 008	70	640	S3 008	
Diesel														
2.1/ 2.5 D Turbo [Y4]	07.94-10.00	70	760	S5 A08	77	780	S5 008	74	680	S4 008	70	640	S3 008	
Xsara														
1.4 i [N6]	07.97-08.00				63	610	S5 006	60	540	S4 006				
i [N7]	09.00-12.05				63	610	S5 005	52	470	S4 002	45	400	S3 002	
1.6 i 16V [N7]	09.00-12.05				63	610	S5 005	52	470	S4 002	45	400	S3 002	
1.6/ 1.8 i [N6]	07.97-08.00				63	610	S5 005	52	470	S4 002	45	400	S3 002	
1.8 i 16V [N6]	07.97-08.00				63	610	S5 005	60	540	S4 005				
2.0 i 16V [N6]	07.97-08.00				63	610	S5 005	60	540	S4 005	56	480	S3 005	
					63	610	S5 006	60	540	S4 006				
i 16V [N7]	09.00-12.05				63	610	S5 005	60	540	S4 005				
Diesel														
1.4 HDi [N6; N7]	01.03-12.05				63	610	S5 005	60	540	S4 005				
1.5/ 1.8/ 1.9 D, D Turbo [N6; N7]	07.97-12.05				63	610	S5 005	60	540	S4 005				
2.0 HDi [N6; N7]	02.99-12.05	70	760	S5 A08	77	780	S5 008	74	680	S4 008				
Xsara Break														
1.4 i [N7]	09.00-12.05				63	610	S5 005	52	470	S4 002	45	400	S3 002	
1.4/ 1.6/ 1.8 i [N6]	10.97-08.00				63	610	S5 005	52	470	S4 002	45	400	S3 002	
1.6 i 16V [N7]	09.00-03.10				63	610	S5 005	52	470	S4 002	45	400	S3 002	
1.8/ 2.0 i 16V [N6]	04.98-08.00				63	610	S5 005	60	540	S4 005	56	480	S3 005	
2.0 i 16V [N7]	09.00-01.07				63	610	S5 005	60	540	S4 005				
Diesel														
1.4/ 1.5/ 1.8/ 1.9 D, D Turbo, HDi [N6; N7]	10.97-12.05				63	610	S5 005	60	540	S4 005				
2.0 HDi [N6]	02.99-08.00	70	760	S5 A08	77	780	S5 008	74	680	S4 008				
HDi [N7]	09.00-03.10	70	760	S5 A08	77	780	S5 008	74	680	S4 008				
		70	760	S5 A08	77	780	S5 008	74	680	S4 008	70	640	S3 008	
Xsara Coupé														
1.4 i [N7]	09.00-12.05				63	610	S5 005	52	470	S4 002	45	400	S3 002	
1.4/ 1.6/ 1.8 i [N6]	07.97-08.00				63	610	S5 005	52	470	S4 002	45	400	S3 002	
1.6 i 16V [N7]	09.00-12.05				63	610	S5 005	52	470	S4 002	45	400	S3 002	
1.8/ 2.0 i 16V [N6]	07.97-08.00				63	610	S5 005	60	540	S4 005	56	480	S3 005	
2.0 i 16V [N7]	09.00-12.05				63	610	S5 005	60	540	S4 005				
Diesel														
1.4 HDi [N7]	01.03-12.05				63	610	S5 005	60	540	S4 005				
1.8/ 1.9 D, D Turbo [N6]	07.97-08.00				63	610	S5 005	60	540	S4 005				
1.9 D [N7]	09.00-12.05				63	610	S5 005	60	540	S4 005				
2.0 HDi [N6]	02.99-08.00	70	760	S5 A08	77	780	S5 008	74	680	S4 008	70	640	S3 008	
HDi [N7]	09.00-12.05	70	760	S5 A08	77	780	S5 008	74	680	S4 008				
		70	760	S5 A08	77	780	S5 008	74	680	S4 008	70	640	S3 008	
Xsara Picasso														
1.6 i 16V [N68]	03.05-04.10				63	610	S5 005	52	470	S4 002	45	400	S3 002	
1.6/ 1.8 i [N68]	01.00-04.10				63	610	S5 005	52	470	S4 002	45	400	S3 002	
2.0 i 16V [N68]	03.01-04.10				63	610	S5 005	60	540	S4 005	56	480	S3 005	
Diesel														
1.6 HDi [N68]	05.04-04.10	70	760	S5 A08	77	780	S5 008	74	680	S4 008	70	640	S3 008	
2.0 HDi [N68]	12.99-12.07				77	780	S5 008	74	680	S4 008				
	01.00-04.10	70	760	S5 A08	77	780	S5 008	74	680	S4 008				
ZX														
1.6/ 1.8 i 8V, i 16V [; N20/N21]	01.96->				54	530	S5 002	52	470	S4 002	45	400	S3 002	



			Ah A (EN)	Ah A (EN)	Ah A (EN)	Ah A (EN)
			0 092 ...0	0 092 ...0	0 092 ...0	0 092 ...0

DACIA

Duster												
1.2 [HS]	09.13-05.18					63	610	S5 005	60	540	S4 005	
		SSJ	70	760	S5 A08							
4x4 [HS]	05.15-05.18	SSJ	70	760	S5 A08							
1.6 [HS]	10.09-05.18					54	530	S5 002	52	470	S4 002	
						54	530	S5 002	60	540	S4 005	
						63	610	S5 005	52	470	S4 002	
	01.13-05.18	SSJ	70	760	S5 A08							
	09.13-05.18					63	610	S5 005	60	540	S4 005	
4x4 [HS]	10.09-05.18					63	610	S5 005	60	540	S4 005	
	05.15-05.18	SSJ	70	760	S5 A08							
Diesel												
1.5 dCi [HS]	10.09-05.18					63	610	S5 005	60	540	S4 005	
	09.13-05.18	SSJ	70	760	S5 A08							
dCi 4x4 [HS]	10.09-05.18					63	610	S5 005	60	540	S4 005	
	09.13-05.18	SSJ	70	760	S5 A08							
Lodgy												
1.2 [JS]	03.12-12.18					54	530	S5 002	52	470	S4 002	
		SSJ	70	760	S5 A08							
1.6 [JS]	03.12-12.18					54	530	S5 002	52	470	S4 002	
			70	760	S5 A08	63	610	S5 005	60	540	S4 005	
			70	760	S5 A08	63	610	S5 005	70	760	S4 E08	
16V [JS]	11.15→								52	470	S4 002	
									74	680	S4 008	
		SSJ	70	760	S5 A08							
Diesel												
1.5 dCi [JS]	03.12→					63	610	S5 005	60	540	S4 005	
		SSJ	70	760	S5 A08							
	11.16-12.18		70	760	S5 A08				60	540	S4 005	
			70	760	S5 A08				74	680	S4 008	
Logan												
0.9 [L8]	08.12→					54	530	S5 002	52	470	S4 002	
		SSJ	70	760	S5 A08				70	760	S4 E08	
1.2 [L8]	08.12-12.18					54	530	S5 002	52	470	S4 002	
1.2/ 1.4 [LS]	07.04-12.15					54	530	S5 002	52	470	S4 002	
1.6 [LS]	07.04-12.15					63	610	S5 005	60	540	S4 005	
	11.10-12.15					54	530	S5 002	52	470	S4 002	
16V [LS]	12.05-12.15					63	610	S5 005	60	540	S4 005	
Diesel												
1.5 dCi [LS]	06.05-12.15					61	600	S5 004	60	540	S4 004	
	10.05-12.15					61	600	S5 004		53	500	S3 004
dCi [L8]	08.12-12.18					54	530	S5 002	52	470	S4 002	
		SSJ	70	760	S5 A08				70	760	S4 E08	
Logan MCV												
0.9 [K8]	03.13-12.18					54	530	S5 002	52	470	S4 002	
		SSJ	70	760	S5 A08							
	05.15→								52	470	S4 002	
									74	680	S4 008	
		SSJ	70	760	S5 A08				70	760	S4 E08	
1.0 [K8]	12.16→								44	420	S4 000	
									52	470	S4 002	
1.2 [K8]	03.13-12.18					54	530	S5 002	52	470	S4 002	
1.4 [KS/FS]	01.07-12.15					54	530	S5 002	52	470	S4 002	
1.6 [KS/FS]	01.07-12.15					63	610	S5 005	60	540	S4 005	
	11.10-12.15					54	530	S5 002	52	470	S4 002	
16V [KS/FS]	01.07-12.15					63	610	S5 005	60	540	S4 005	
Diesel												
1.5 dCi [KS/FS]	01.07-12.15		70	760	S5 A08	77	780	S5 008	74	680	S4 008	
	11.10-12.15					61	600	S5 004		53	500	S3 004



				Ah	A (EN)		Ah	A (EN)		Ah	A (EN)		Ah	A (EN)	
				0 092 ...0			0 092 ...0			0 092 ...0			0 092 ...0		
◀ DACIA															
1.5 dCi [K8]	03.13-12.18			54	530	S5 002	52	470	S4 002						
				70	760	S5 A08	77	780	S5 008	74	680	S4 008			
		SSJ								70	760	S4 E08			
	06.13→									52	470	S4 002			
										74	680	S4 008			
Nova															
1.4/ 1.6 , i	05.96-09.00			54	530	S5 002	52	470	S4 002	45	400	S3 002			
Sandero															
0.9 [B8]	08.12-12.18			54	530	S5 002	52	470	S4 002						
	08.12→	SSJ		70	760	S5 A08				70	760	S4 E08			
	05.15→									52	470	S4 002			
										74	680	S4 008			
1.0 SCe [B8]	12.16→									52	470	S4 002			
										60	540	S4 005			
1.2 [BS]	06.08-12.15			54	530	S5 002	52	470	S4 002						
1.2/ 1.6 [B8]	08.12→			54	530	S5 002	52	470	S4 002	45	400	S3 002			
1.4 [BS]	06.08-12.15									52	470	S4 002	45	400	S3 002
1.6 [BS]	06.08-12.15			54	530	S5 002	52	470	S4 002	45	400	S3 002			
	11.10-12.15			54	530	S5 002	52	470	S4 002						
16V [BS]	11.10-12.15			54	530	S5 002	52	470	S4 002						
Diesel															
1.5 dCi [BS]	06.08-12.15			63	610	S5 005	60	540	S4 005						
dCi [B8]	08.12-12.18			54	530	S5 002	52	470	S4 002						
				60	680	S5 A05	63	610	S5 005	60	540	S4 005			
		SSJ								60	640	S4 E05			
				70	760	S5 A08				70	760	S4 E08			
	08.12→			63	610	S5 005	60	540	S4 005						
Serie 1300															
1310 1.3	01.79-12.98			54	530	S5 002	60	540	S4 006	45	400	S3 002			
				63	610	S5 006	52	470	S4 002	45	400	S3 002			
				63	610	S5 006	60	540	S4 006	45	400	S3 002			
1.6	01.94-06.04			54	530	S5 002	52	470	S4 002	45	400	S3 002			
Solenza															
1.4 i	04.03-04.05			54	530	S5 002	52	470	S4 002						
Diesel															
1.9 D	04.03-04.05			61	600	S5 004	60	540	S4 004						
Super Nova															
1.4 i	10.00-09.03			54	530	S5 002	52	470	S4 002	45	400	S3 002			



DAEWOO															
Cielo															
1.5 i	03.96-12.99			63	610	S5 005	60	540	S4 024	56	480	S3 005			
i [T-Car]	07.95-03.01			60	680	S5 A05				60	640	S4 E05			
Espero															
1.5/ 1.8/ 2.0 i [KLEJ]	01.95-10.99			63	610	S5 005	60	540	S4 005	56	480	S3 005			
Evanda															
2.0 i	03.03-01.05									60	540	S4 025			
Kalos															
1.4 [T200]	09.02-01.05									60	540	S4 025			
	04.03-01.05									52	470	S4 002	45	400	S3 003
Kalos Hatchback															
1.2 [T200]	04.03-01.05									60	540	S4 025			
1.4 [T200]	09.02-01.05									52	470	S4 002			
	04.03-01.05									60	540	S4 025			
Korando															
2.0 i 16V [KJ]	07.96-12.00									95	830	S4 029			
2.3 i 16V [KJ]	07.96-12.00									40	330	S4 018			
3.2 i 24V [KJ]	07.96-12.00									95	830	S4 029			

			Ah A (EN)	Ah A (EN)	Ah A (EN)	Ah A (EN)
			0 092 ...0	0 092 ...0	0 092 ...0	0 092 ...0

Diesel										
2.3/ 2.9 D, TD Intercooler [KJ]	07.96-12.00				95	830	S4 029			
Lacetti										
1.4/ 1.6/ 1.8 i [J200]	03.04-01.05	63	610	S5 005	60	540	S4 006			
Lanos										
1.4 i [T100]	04.97-09.03	63	610	S5 005	60	540	S4 006	56	480	S3 006
1.5 i [T100]	11.96-12.02	63	610	S5 006	60	540	S4 006	56	480	S3 006
	11.96-09.03	63	610	S5 005	60	540	S4 006	56	480	S3 006
1.6 i [T100]	04.97-09.03	63	610	S5 005	60	540	S4 006	56	480	S3 006
Lanos Hatchback										
1.4 i [T100]	04.97-09.03	63	610	S5 005	60	540	S4 006	56	480	S3 006
1.5 i [T100]	09.96-12.02				60	540	S4 006			
					60	540	S4 025			
	11.96-09.03	63	610	S5 005	60	540	S4 006	56	480	S3 006
1.6 i [T100]	04.97-09.03	63	610	S5 005	60	540	S4 006	56	480	S3 006
Leganza										
1.8 i [V100]	03.97-12.99				40	330	S4 018			
	03.97-12.02	63	610	S5 006	60	540	S4 006	56	480	S3 006
2.0 i [V100]	03.97-12.02	63	610	S5 006	60	540	S4 006	56	480	S3 006
2.2 i [V100]	09.98-08.02	63	610	S5 006	60	540	S4 006			
Matiz										
0.8 ,i	01.01→				40	330	S4 019			
0.8/ 1.0 ,i [; M100]	04.98→				40	330	S4 018			
Musso										
2.0 i 16V [FJ]	05.96-12.00				95	830	S4 029			
2.3 i 16V [FJ]	05.96-12.00				70	630	S4 027			
					95	830	S4 029			
3.2 i 24V [FJ]	01.96-12.00				95	830	S4 029			
Diesel										
2.3/ 2.9 D, TD, TD Intercooler [FJ]	07.93-12.04				95	830	S4 029			
Nexia										
1.5/ 1.6 ,i	01.95→	63	610	S5 005	60	540	S4 005	56	480	S3 005
Nubira										
1.4/ 1.5/ 1.6/ 1.8/ 2.0 i [; J100; J150; J200]	02.97-01.05				60	540	S4 025			
1.6 i [J100]	09.97-09.99	63	610	S5 006	60	540	S4 025			
i [J150]	10.99-06.03	63	610	S5 006						
Nubira Hatchback										
1.6/ 2.0 i [J100]	09.97-09.99				60	540	S4 025			
Nubira II										
1.5 i [J150]	03.99-11.02				60	540	S4 025			
Nubira Station Wagon										
1.6 i [J100]	09.97-09.99				60	540	S4 025			
1.6/ 1.8 i [J200]	03.04-01.05				60	540	S4 025			
1.6/ 2.0 i [J150]	08.99-06.03				60	540	S4 025			
2.0 i [J100]	09.97-09.99				40	330	S4 018			
Prince										
2.0 LPG	01.96-12.99				70	630	S4 027			
Rezzo										
1.6 i [U100]	09.00-01.05				70	630	S4 027			
	08.01-12.04	63	610	S5 006	60	540	S4 006			
1.8/ 2.0 i [U100]	09.00-01.05				70	630	S4 027			
Sens										
1.3 Si [TF698]	01.02→	63	610	S5 005	60	540	S4 006	56	480	S3 006
Tico										
0.8 [KLY3]	06.91-01.05				40	330	S4 018			
	01.96-01.05				45	330	S4 021			



			Ah A (EN)	Ah A (EN)	Ah A (EN)	Ah A (EN)
			0 092 ...0	0 092 ...0	0 092 ...0	0 092 ...0

DAIHATSU

Applause						
1.6 i	09.97-04.00		45	330	S4 020	
Charade						
1.0/ 1.3 , VVT	05.06→		45	330	S4 020	
1.3/ 1.5 i [G2]	05.93-05.03		45	330	S4 020	
Charade Hatchback						
1.3/ 1.5/ 1.6 i [G2]	01.93-09.00		45	330	S4 020	
Copen						
0.7/ 1.3 [80; 81]	05.02→		40	330	S4 018	
Cuore						
1.0/ 850 , i , i 12V [; L2; L5; L7]	08.94→		40	330	S4 018	
Feroza						
1.6 i 16V 4WD, 4WD	10.88-10.99		40	330	S4 019	
Gran Move						
1.5/ 1.6 , i 16V [G3]	11.96-07.02		45	330	S4 020	
Materia						
1.3/ 1.5 , 4WD	09.06→		40	330	S4 018	
Move						
1.0/ 850 , i 12V	01.97-09.02		40	330	S4 018	
Rocky						
2.2 4WD	03.93-06.01		95	830	S4 029	
Diesel						
2.8 D Turbo 4WD, D 4WD	05.93-03.02		95	830	S4 029	
Sirion I						
1.0 12V [M1]	04.98-05.00		45	330	S4 020	
	05.00-07.04	JEA	40	330	S4 018	
			45	330	S4 020	
1.0/ 1.3 12V 4WD, 16V, 16V 4WD [M1]	04.98-07.04		45	330	S4 020	
Sirion II						
1.0/ 1.3/ 1.5 , 4WD [M3]	10.04→		40	330	S4 018	
Terios						
1.3 i [J1]	05.00-12.05		45	330	S4 020	
i Turbo 4WD	08.00-12.05		45	330	S4 022	
i 4WD [J1]	03.97-12.05		45	330	S4 022	
1.3/ 1.5 i 4WD [J2]	01.06→		40	330	S4 018	
1.5 i [J2]	01.06→		45	330	S4 020	
Trevis						
1.0 [L6]	08.06→		40	330	S4 018	
YRV						
1.0 [M2]	08.00-07.05		40	330	S4 018	
4WD [M2]	08.00-07.05		40	330	S4 018	
1.3 [M2]	08.00-07.05		45	330	S4 020	
Turbo [M2]	02.01-07.05		45	330	S4 020	
4WD [M2]	08.00-07.05		45	330	S4 020	

DAIMLER LTD.

Double-Six											
6.0	02.93-12.99		95	850	S5 A13	100	830	S5 013	95	800	S4 013
4.0											
32V/ 32V Kompressor	09.89-12.02		95	850	S5 A13	100	830	S5 013	95	800	S4 013



			Ah A (EN)	Ah A (EN)	Ah A (EN)	Ah A (EN)
			0 092 ...0	0 092 ...0	0 092 ...0	0 092 ...0

DALLAS

FUN														
1.4 i	01.94-12.98				54	530	S5 002		52	470	S4 002	45	400	S3 002
Diesel														
1.8 D	01.94-12.98				63	610	S5 005		60	540	S4 005	56	480	S3 005

DODGE

Avenger														
2.0 [JS]	09.07-08.11				54	530	S5 002		52	470	S4 002			
2.4 [JS]	09.07-08.11				63	610	S5 006							
2.7 FlexFuel [JS]	09.07-08.10				63	610	S5 006							
Diesel														
2.0 CRD [JS]	09.07-08.10				54	530	S5 002		52	470	S4 002			
Caliber														
1.8 [P3]	09.06-08.07								60	540	S4 006			
1.8/2.4 [PM]	09.06-08.11								60	540	S4 006			
2.0 [PM]	09.06-12.10								74	680	S4 008			
[P3]	09.06-08.09								74	680	S4 008			
	09.08-08.09								60	540	S4 025			
2.4 SRT-4, 4x4 [PM]	09.06-08.10								74	680	S4 008			
Diesel														
2.0 CRD [PM]	09.06-08.09								74	680	S4 009			
CRD [P3]	01.06-08.09								74	680	S4 009			
2.2 CRD [PM]	09.09-12.10								60	540	S4 006			
Caravan														
2.0/2.4/3.0/3.3/3.8, 4x4 [NS; RS]	01.95-08.07								70	630	S4 027			
Diesel														
2.5 TD [NS]	01.95-08.03								70	630	S4 027			
Challenger														
3.5/3.6/5.7/6.4 [LC]	09.08→		80	800	S5 A11		85	800	S5 010		80	740	S4 010	
6.1 [LC]	09.07-08.10						85	800	S5 010		80	800	S4 E11	
Charger														
3.6/5.7/6.4, FFV, SRT-8, 4x4 [; LD; T-Car]	09.08→		80	800	S5 A11		85	800	S5 010		80	740	S4 010	
Dart														
1.4	09.12-08.16		60	680	S5 A05					60	640	S4 E05		
2.4	09.12-08.16		60	680	S5 A05		63	610	S5 005		60	540	S4 005	
Grand Caravan														
3.8 [RT]	09.07-08.10									70	630	S4 027		
Journey														
2.4/2.7/3.5, FlexFuel, 4x4 [JC]	09.08-12.10									74	680	S4 008		
Diesel														
2.0 CRD [JC]	09.08-08.10						77	780	S5 008		74	680	S4 008	
	01.11-08.11						77	780	S5 008		74	680	S4 008	
Neon														
2.0 [PL]	09.99-08.05									70	630	S4 027		
Nitro														
4.0 4x4 [KA]	09.06-08.11						74	750	S5 007		70	650	S4 E07	
							74	750	S5 007		72	680	S4 007	
Diesel														
2.8 CRD, CRD 4x4 [KA]	09.06-08.09									95	830	S4 029		
Stratus														
2.0/2.4/2.5 i [JA]	09.94-12.00									70	630	S4 027		
Viper Convertible														
8.3 SRT-10 [ZB]	09.02-08.06		95	850	S5 A13		100	830	S5 013		95	800	S4 013	
8.4 SRT-10 [ZB]	09.07-08.10		95	850	S5 A13		100	830	S5 013		95	800	S4 013	



			Ah A (EN)	Ah A (EN)	Ah A (EN)	Ah A (EN)
			0 092 ...0	0 092 ...0	0 092 ...0	0 092 ...0

◀ DODGE

Viper Coupé											
8.0 GTS [SR]	09.90-08.01		95	850	S5 A13	100	830	S5 013	95	800	S4 013
8.3 SRT-10 [ZB]	09.02-08.06		95	850	S5 A13	100	830	S5 013	95	800	S4 013
8.4 SRT-10 [ZB]	09.07-08.10		95	850	S5 A13	100	830	S5 013	95	800	S4 013

DS (CITROEN)

DS3											
1.2 THP [A55]	05.15→	SSJ	70	760	S5 A08						
	06.15→					63	610	S5 005	60	540	S4 005
VTi [A55]	05.15→	SSJ	70	760	S5 A08						
1.4 VTi [A55]	05.15-12.15	BWD				54	530	S5 002	52	470	S4 002
1.6 THP [A55]	05.15→	SSJ	70	760	S5 A08						
	02.16→					63	610	S5 005	60	540	S4 005

Diesel											
1.6 BlueHDi [A55]	05.15→					63	610	S5 005	60	540	S4 005
		SSJ	70	760	S5 A08						
HDi [A55]	05.15-12.15		70	760	S5 A08						
		BWD							70	760	S4 E08

DS3 Cabrio											
1.2 THP [A55]	06.15→					63	610	S5 005	60	540	S4 005
		SSJ	70	760	S5 A08						
THP [A56]	05.15→	SSJ	70	760	S5 A08						
	02.16→					63	610	S5 005	60	540	S4 005
VTi [A56]	05.15→								60	540	S4 005
									60	640	S4 E05
			70	760	S5 A08				60	540	S4 005
			70	760	S5 A08				60	640	S4 E05
		SSJ							70	760	S4 E08
			70	760	S5 A08				70	760	S4 E08

1.6 THP [A56]	05.15-12.18	SSJ	70	760	S5 A08						
Diesel											
1.6 BlueHDi [A56]	05.15-12.18	SSJ	70	760	S5 A08						

DS4											
1.2 THP [B75]	10.15→	SSJ	70	760	S5 A08						
1.6 THP [B75]	10.15→	BWD				63	610	S5 005	60	540	S4 005
THP [B78]	10.15→	SSJ	70	760	S5 A08						
Diesel											
1.6 BlueHDi [B75]	10.15→					63	610	S5 005	60	540	S4 005
		SSJ	70	760	S5 A08						
			70	760	S5 A08				70	760	S4 E08
HDi [B75]	10.15→		70	760	S5 A08	63	610	S5 005	60	540	S4 005
			70	760	S5 A08	63	610	S5 005	70	760	S4 E08
2.0 BlueHDi [B75]	10.15→	SSJ	70	760	S5 A08						
HDi [B75]	10.15→	BWD				77	780	S5 008	74	680	S4 008

DS5											
1.6 THP [B81]	05.15→								74	680	S4 008
		BWD				63	610	S5 005	60	540	S4 005
		SSJ	70	760	S5 A08						
			70	760	S5 A08				70	760	S4 E08
Diesel											
1.6 BlueHDi [B81]	05.15→								74	680	S4 008
		SSJ	70	760	S5 A08				70	760	S4 E08
2.0 BlueHDi [B81]	05.15→					77	780	S5 008	74	680	S4 008
		SSJ	70	760	S5 A08						
HDi Hybrid4 4x4 [B81]	02.15→	SSJ	70	760	S5 A08						



			Ah	A (EN)		Ah	A (EN)		Ah	A (EN)		Ah	A (EN)	
					0 092 ...0			0 092 ...0			0 092 ...0			0 092 ...0

FERRARI

California														
	01.09→		70	760	S5 A08	77	780	S5 008	74	680	S4 008	70	640	S3 008
	03.11-12.14		95	850	S5 A13									
California T														
	06.14-12.17		95	850	S5 A13									
Enzo														
	09.02-12.05		70	760	S5 A08	77	780	S5 008	74	680	S4 008			
FF														
	09.10-12.17		95	850	S5 A13	100	830	S5 013	95	800	S4 013			
F12 Berlinetta														
	09.12-08.17	SSJ	95	850	S5 A13									
	tdf		95	850	S5 A13									
GTC4 Lusso														
3.9/ 6.3 , T														
	02.16→		70	760	S5 A08	77	780	S5 008						
355														
	05.94-10.99		70	760	S5 A08	77	780	S5 008	74	680	S4 008			
355 Spider														
	10.95-10.10		70	760	S5 A08	77	780	S5 008	74	680	S4 008			
360														
CS														
	05.03-12.05					74	750	S5 007	70	650	S4 E07			
						74	750	S5 007	72	680	S4 007			
360 Modena														
	03.99-12.04					74	750	S5 007	70	650	S4 E07			
						74	750	S5 007	72	680	S4 007			
360 Spider														
	06.00-12.05					74	750	S5 007	70	650	S4 E07			
						74	750	S5 007	72	680	S4 007			
430														
Scuderia														
	01.05-12.09		70	760	S5 A08	77	780	S5 008	74	680	S4 008			
430 Spider														
	05.05-12.09		70	760	S5 A08	77	780	S5 008	74	680	S4 008			
456														
GT/GTA/ M , 48V														
	03.96-12.04		70	760	S5 A08	77	780	S5 008	74	680	S4 008			
458 Italia														
	[F 142]		70	760	S5 A08	77	780	S5 008	74	680	S4 008	70	640	S3 008
458 Italia Speciale														
	[F 142]		70	760	S5 A08	77	780	S5 008	70	760	S4 E08			
458 Spider														
	[F 142]		70	760	S5 A08	77	780	S5 008	74	680	S4 008			
	12.14-12.15		70	760	S5 A08	77	780	S5 008						
488														
GTB														
	04.15→		70	760	S5 A08									
550 Barchetta														
	10.00-01.05								74	680	S4 009			
	10.00-12.05		70	760	S5 A08	77	780	S5 008	74	680	S4 008			
550 Maranello														
	10.96-12.03		70	760	S5 A08	77	780	S5 008	74	680	S4 008			
575 Maranello														
Superamerica														
	02.02-12.06		70	760	S5 A08	77	780	S5 008	74	680	S4 008			
599														
GTB Fiorano/ GTO														
	01.06-12.12		95	850	S5 A13	100	830	S5 013	95	800	S4 013			
SA Aperta														
	04.10-12.12		95	850	S5 A13	100	830	S5 013						
612														
Scaglietti														
	03.04-06.11		70	760	S5 A08	77	780	S5 008	74	680	S4 008			



			Ah A (EN)	Ah A (EN)	Ah A (EN)	Ah A (EN)
			0 092 ...0	0 092 ...0	0 092 ...0	0 092 ...0

FIAT

Albea											
1.2 i.e. 8V [172]	01.02-12.12			54	530	S5 002	52	470	S4 002		
1.2/ 1.6 i.e. 16V, i.e. 16V LPG [172]	01.02-12.12			54	530	S5 002	52	470	S4 002		
1.4 i.e. 8V [172]	07.06-12.12			63	610	S5 005	52	470	S4 002	45 400 S3 002	
Diesel											
1.3 JTD 16V [172]	07.03-12.12			63	610	S5 005					
Barchetta											
1.8 i.e. 16V [183]	01.95-02.05			63	610	S5 005	52	470	S4 002	45 400 S3 002	
Brava											
1.2/ 1.6 16V [182]	10.95-12.01			54	530	S5 002	52	470	S4 002	45 400 S3 002	
1.4 12V [182]	10.95-10.98			54	530	S5 002	52	470	S4 002	45 400 S3 002	
1.8 16V [182]	10.95-09.01			63	610	S5 005	60	540	S4 005	56 480 S3 005	
Diesel											
1.9 D [182]	10.95-10.98			63	610	S5 005	44	420	S4 000		
				63	610	S5 005	60	640	S4 E05		
JTD	01.01-12.02			63	610	S5 005	44	420	S4 000		
				63	610	S5 005	60	640	S4 E05		
JTD [182]	11.98-09.01			63	610	S5 005	60	540	S4 005		
				63	610	S5 005	60	640	S4 E05		
TD [182]	03.96-09.01			63	610	S5 005	60	540	S4 005		
				63	610	S5 005	60	640	S4 E05		
Bravo											
1.2/ 1.6 16V [182]	10.95-09.01			54	530	S5 002	52	470	S4 002	45 400 S3 002	
1.4 [198]	03.10-12.14			54	530	S5 002	52	470	S4 002	45 400 S3 002	
LPG [198]	03.10-12.14			54	530	S5 002	52	470	S4 002		
Turbo [198]	03.10-12.14			54	530	S5 002	52	470	S4 002	45 400 S3 002	
		SSJ					60	640	S4 E05		
Turbo 16V, 16V LPG [198]	07.07-12.09			54	530	S5 002	52	470	S4 002		
12V [182]	10.95-10.98			54	530	S5 002	52	470	S4 002	45 400 S3 002	
16V [198]	03.07-12.09			63	610	S5 005	52	470	S4 002		
1.8 16V [182]	10.95-09.01			63	610	S5 005	60	540	S4 005	56 480 S3 005	
2.0 20V [182]	10.95-09.01			63	610	S5 005	60	540	S4 005		
				63	610	S5 005	60	640	S4 E05		
Diesel											
1.6 Multijet [198]	10.07-12.14			63	610	S5 005					
	11.08-12.09			63	610	S5 005	44	420	S4 000		
				63	610	S5 005	60	640	S4 E05		
	02.09-12.09			63	610	S5 005	60	540	S4 005	56 480 S3 005	
	03.10-12.14			63	610	S5 005	60	540	S4 005		
	10.13-12.14			63	610	S5 005	60	540	S4 005	56 480 S3 005	
1.9 D [182]	10.95-10.98			63	610	S5 005	60	540	S4 005		
				63	610	S5 005	60	640	S4 E05		
JTD [182]	11.98-09.01			63	610	S5 005	60	540	S4 005		
				63	610	S5 005	60	640	S4 E05		
Multijet [198]	03.07-12.09			63	610	S5 005					
TD [182]	03.96-10.01			63	610	S5 005	60	540	S4 005		
				63	610	S5 005	60	640	S4 E05		
2.0 Multijet [198]	10.08-12.09			63	610	S5 005					
	03.10-12.14			63	610	S5 005	60	540	S4 005		
				77	780	S5 008	74	680	S4 008		
Cinquecento											
1.1/ 700/ 900 , i.e [170]	07.91-07.98						42	390	S4 000	40 340 S3 000	
							44	420	S4 000	40 340 S3 000	
Coupé											
1.8 16V [175]	10.96-09.00	70	760	S5 A08	63	610	S5 005	52	470	S4 002	45 400 S3 002
2.0 20V [175]	10.96-04.98	70	760	S5 A08	63	610	S5 005	52	470	S4 002	45 400 S3 002
	04.98-09.00				63	610	S5 005	44	420	S4 000	
					63	610	S5 005	60	640	S4 E05	



		Ah A (EN) S5A			Ah A (EN) S5			Ah A (EN) S4			Ah A (EN) S3		
		0 092 ...0			0 092 ...0			0 092 ...0			0 092 ...0		
2.0 20V Turbo [175]	10.96-09.00	70	760	S5 A08	63	610	S5 005	52	470	S4 002	45	400	S3 002
Croma													
1.8/ 2.2 i.e. [194]	06.05-12.10				63	610	S5 005						
Diesel													
1.9/ 2.4 JTD, JTD 8V, JTD 16V [194]	06.05-12.10				63	610	S5 005						
Doblo													
1.2/ 1.4/ 1.6 i.e., i.e. 8V, i.e. 16V Bipower [223]	07.00-08.16				54	530	S5 002	52	470	S4 002			
1.4 [263]	02.10→				77	780	S5 008	74	680	S4 008	56	480	S3 005
		SSJ						70	650	S4 E07			
	10.11→				77	780	S5 008	74	680	S4 008			
		SSJ	70	760	S5 A08			70	760	S4 E08			
Natural Power [263]	06.10→							60	640	S4 E05			
1.6 i.e. 16V [223]	10.01-09.05				54	530	S5 002	52	470	S4 002	45	400	S3 002
Diesel													
1.3 Multijet [223]	10.05-12.10	60	680	S5 A05	63	610	S5 005						
	10.05-08.16	60	680	S5 A05	63	610	S5 005	60	540	S4 005			
Multijet [263]	02.10→							60	640	S4 E05			
MultiJet [263]	04.16→				63	610	S5 005	52	470	S4 002			
		SSJ	60	680	S5 A05			60	640	S4 E05			
1.3/ 1.9 D, JTD, JTD 16V [223]	07.00-09.05	60	680	S5 A05	63	610	S5 005	44	420	S4 000			
1.6 Multijet [263]	02.10→				54	530	S5 002	42	390	S4 000	40	340	S3 000
		SSJ			54	530	S5 002	44	420	S4 000	40	340	S3 000
	04.15→				63	610	S5 005	60	640	S4 E05			
					77	780	S5 008						
		60	680	S5 A05									
		60	680	S5 A05	63	610	S5 005	44	420	S4 000			
		SSJ	70	760	S5 A08			70	760	S4 E08			
MultiJet [263]	06.17→				70	760	S5 A08	63	610	S5 005			
					70	760	S5 A08	77	780	S5 008			
		SSJ						70	760	S4 E08			
1.9 Multijet [223]	10.05-12.10	60	680	S5 A05	63	610	S5 005	44	420	S4 000			
2.0 Multijet [263]	02.10→	SSJ						70	760	S4 E08			
Freemont													
2.4 VVT [345]	02.13-12.15				77	780	S5 008	74	680	S4 008	70	640	S3 008
3.6 [345]	08.11→							74	680	S4 009			
4x4 [345]	08.11-12.15	70	760	S5 A08	77	780	S5 008	74	680	S4 008			
Diesel													
2.0 Multijet [345]	06.11-12.15							74	680	S4 009			
					77	780	S5 008	70	760	S4 E08			
					77	780	S5 008	74	680	S4 008			
Multijet 4x4 [345]	06.11-12.15				77	780	S5 008	74	680	S4 008			
Grande Punto													
1.2 [199]	10.05-12.11				54	530	S5 002	42	390	S4 000	40	340	S3 000
					54	530	S5 002	44	420	S4 000	40	340	S3 000
	09.10-12.11							44	420	S4 000	40	340	S3 000
		SSJ						60	640	S4 E05			
1.4 [199]	10.05-12.11				54	530	S5 002	42	390	S4 000	40	340	S3 000
					54	530	S5 002	44	420	S4 000	40	340	S3 000
	06.06-12.11				54	530	S5 002	52	470	S4 002			
	06.07-12.09				63	610	S5 005						
CNG, LPG [199]	09.08-12.11							44	420	S4 000	40	340	S3 000
Diesel													
1.3 MultiJet [199]	10.05-12.09				63	610	S5 005	44	420	S4 000			
					63	610	S5 005	60	640	S4 E05			
	10.05-12.11				63	610	S5 005						
	09.08-12.11	60	680	S5 A05	54	530	S5 002	52	470	S4 002			
		60	680	S5 A05	54	530	S5 002	60	540	S4 005			
		60	680	S5 A05	63	610	S5 005	60	540	S4 005			
		SSJ						60	640	S4 E05			



			Ah	A (EN)	S5A	Ah	A (EN)	S5	Ah	A (EN)	S4	Ah	A (EN)	S3
		0 092 ...0			0 092 ...0			0 092 ...0			0 092 ...0			
◀ FIAT														
1.3 MultiJet [199]	04.10-12.11		54	530	S5 002	52	470	S4 002	45	400	S3 002			
1.6/ 1.9 MultiJet [199]	10.05-12.09		63	610	S5 005									
Idea														
1.2 16V [350]	01.04-12.12		54	530	S5 002	52	470	S4 002	45	400	S3 002			
			54	530	S5 002	60	640	S4 E05	45	400	S3 002			
1.4 8V, 8V LPG [350]	11.04-12.12		54	530	S5 002	52	470	S4 002						
16V [350]	01.04-12.12		54	530	S5 002	52	470	S4 002						
Diesel														
1.3 MultiJet [350]	01.04-11.10		63	610	S5 005	60	540	S4 005						
	11.04-11.10		63	610	S5 005									
	05.08-12.12	SSJ				60	640	S4 E05						
1.6 MultiJet [350]	04.08-12.12	SSJ				70	760	S4 E08						
1.9 MultiJet [350]	01.04-12.12		63	610	S5 005	60	540	S4 005						
Linea														
1.4 [323]	03.07-12.17		63	610	S5 005									
Turbo [323]	03.07-12.17		63	610	S5 005									
1.6 [323]	07.08-12.17		54	530	S5 002	52	470	S4 002						
Diesel														
1.3 MultiJet [323]	03.07-12.17		63	610	S5 005									
	09.09-12.17		54	530	S5 002	52	470	S4 002						
1.6 MultiJet [323]	10.08-12.17		63	610	S5 005	60	540	S4 005	56	480	S3 005			
Marea														
1.2 i 16V [185]	03.99-09.02		54	530	S5 002	52	470	S4 002	45	400	S3 002			
1.4 i 12V [185]	09.96-02.99		54	530	S5 002	52	470	S4 002	45	400	S3 002			
1.6 i 16V [185]	10.96-12.02		54	530	S5 002	52	470	S4 002	45	400	S3 002			
	05.01-12.02		54	530	S5 002	52	470	S4 002						
i 16V BI-Power [185]	10.97-09.02		54	530	S5 002	52	470	S4 002	45	400	S3 002			
1.8 i 16V [185]	10.96-09.02		54	530	S5 002	52	470	S4 002	45	400	S3 002			
2.0 i 20V [185]	09.96-09.02		54	530	S5 002	52	470	S4 002	45	400	S3 002			
	10.00-12.02		54	530	S5 002	52	470	S4 002						
Diesel														
1.9 JTD	01.01-12.07		63	610	S5 005									
JTD [185]	03.99-09.02		63	610	S5 005									
JTD S.W. [185]	10.01-09.02		63	610	S5 005									
TD [185]	09.96-09.02		63	610	S5 005									
2.4 JTD [185]	03.99-09.02		63	610	S5 005	60	540	S4 005						
TD [185]	09.96-02.99		63	610	S5 005	60	540	S4 005						
Marea Weekend														
Diesel														
1.9 JTD	01.01-12.07		63	610	S5 005									
Marengo														
Diesel														
1.9 JTD, TD [285]	01.97-09.02		63	610	S5 005									
Multipla														
1.6 Blupower, 16V, 16V Bipower CNG, 16V LPG [186]	01.99-12.10		63	610	S5 005	52	470	S4 002	45	400	S3 002			
Diesel														
1.9 JTD [186]	01.99-03.02		63	610	S5 005									
	04.02-06.10		63	610	S5 005	60	540	S4 005						
	10.03-12.10		63	610	S5 005									
Palio														
1.1 [178]	03.98-07.01		54	530	S5 002	52	470	S4 002	45	400	S3 002			
1.2 i.e. 8V [178]	11.99-12.11		54	530	S5 002	52	470	S4 002	45	400	S3 002			
	01.01-09.01		54	530	S5 002	52	470	S4 002						
i.e. 16V [178]	10.01-12.11		54	530	S5 002	52	470	S4 002	45	400	S3 002			
1.4 i.e. [178]	03.98-09.01		54	530	S5 002	52	470	S4 002	45	400	S3 002			
	07.03-12.11		54	530	S5 002	52	470	S4 002	45	400	S3 002			
1.6 i.e. 16V [178]	03.98-12.11		54	530	S5 002	52	470	S4 002	45	400	S3 002			
	07.01-02.04		54	530	S5 002	52	470	S4 002						
i.e. 16V Sport [178]	10.01-12.11		54	530	S5 002	52	470	S4 002	45	400	S3 002			
Diesel														
1.3/ 1.9 D, JTD 16V [178]	01.03-12.11		63	610	S5 005									



			Ah A (EN) S5A	Ah A (EN) S5	Ah A (EN) S4	Ah A (EN) S3
			0 092 ...0	0 092 ...0	0 092 ...0	0 092 ...0

Palio Weekend						
1.2 i.e. 8V [178]	03.99-09.01		54	530	S5 002	52 470 S4 002 45 400 S3 002
	10.01-12.08		54	530	S5 002	52 470 S4 002
i.e. 16V [178]	10.01-12.08		54	530	S5 002	52 470 S4 002
1.2/ 1.4 i.e. [178]	11.97-02.02		54	530	S5 002	52 470 S4 002 45 400 S3 002
1.2/ 85 MPI 16V, 1.2 i.e. 16V [178]	10.01-09.04		54	530	S5 002	52 470 S4 002
1.6 i.e. 8V [178]	06.01-09.02		54	530	S5 002	52 470 S4 002 45 400 S3 002
	i.e. 16V [178]	11.97-12.08	54	530	S5 002	52 470 S4 002 45 400 S3 002
		03.02-02.04	54	530	S5 002	52 470 S4 002
75/ 100 1.2 i.e., 1.6 i.e. 16V [178]	09.97-09.04		54	530	S5 002	52 470 S4 002 45 400 S3 002
Diesel						
1.7 TD [178]	09.97-10.00		63	610	S5 005	60 540 S4 005
	08.00-02.02		77	780	S5 008	74 680 S4 008
1.9 D [178]	11.00-09.01		63	610	S5 005	
	01.03-02.04		77	780	S5 008	74 680 S4 008
	04.03-09.04		63	610	S5 005	
JTD [178]	10.01-09.04		63	610	S5 005	
	06.02-12.08		63	610	S5 005	60 540 S4 005
Panda						
0.9 [312]	02.12→	SSJ				60 560 S4 E05
						60 640 S4 E05
				60 680 S5 A05	60 640 S4 E05	
	12.13→			60 680 S5 A05		
Natural Power [312]	09.12→	SSJ	60	680	S5 A05	60 640 S4 E05
4x4 [312]	06.12→	SSJ	60	680	S5 A05	60 640 S4 E05
	09.14→		60	680	S5 A05	
		SSJ				60 640 S4 E05
1.1 [169]	01.09-12.11					44 420 S4 000 40 340 S3 000
1.1/ 1.2 i.e., i.e. LPG, i.e. 4x4 [169]	10.03-12.09					42 390 S4 000 40 340 S3 000
						44 420 S4 000 40 340 S3 000
1.2 [169]	01.09-12.11					44 420 S4 000 40 340 S3 000
	09.10-12.12		54	530	S5 002	52 470 S4 002
			54	530	S5 002	60 640 S4 E05
[312]	02.12→		54	530	S5 002	
		SSJ	60	680	S5 A05	60 640 S4 E05
i.e. Natural Power, LPG [169]	12.06-12.12					44 420 S4 000
LPG [312]	05.12→		54	530	S5 002	
		SSJ	60	680	S5 A05	60 640 S4 E05
Natural Power [169]	01.09-12.10					42 390 S4 000 40 340 S3 000
4x4 [169]	01.09-12.10					44 420 S4 000
	09.10-12.12		54	530	S5 002	52 470 S4 002
1.4 [169]	01.09-09.10		54	530	S5 002	52 470 S4 002 45 400 S3 002
i.e. 16V [169]	10.06-12.09		54	530	S5 002	52 470 S4 002
Natural Power [169]	09.10-12.12		54	530	S5 002	52 470 S4 002
750/ 900/ 1000/ 1100 fire, i.e., i.e. Selecta, i.e. 4x4 [141]	07.90-09.03		54	530	S5 002	42 390 S4 000 40 340 S3 000
			54	530	S5 002	44 420 S4 000 40 340 S3 000
Diesel						
1.3 JTD [169]	01.04-12.09		54	530	S5 002	42 390 S4 000
			54	530	S5 002	52 470 S4 002
	01.09-09.10		54	530	S5 002	52 470 S4 002 45 400 S3 002
JTD 4x4 [169]	09.05-12.09		54	530	S5 002	42 390 S4 000
			54	530	S5 002	52 470 S4 002
	01.09-09.10		54	530	S5 002	52 470 S4 002 45 400 S3 002
Multijet [169]	03.10-12.12		54	530	S5 002	52 470 S4 002 45 400 S3 002
MultiJet [312]	02.12-08.16	SSJ				70 650 S4 E07
		05.15→	60	680	S5 A05	
			SSJ			
			60	680	S5 A05	60 640 S4 E05
Multijet 4x4 [169]	03.10-12.12					44 420 S4 000



				Ah	A (EN)		Ah	A (EN)		Ah	A (EN)		Ah	A (EN)			
				0 092 ...0			0 092 ...0			0 092 ...0			0 092 ...0				
◀ FIAT																	
1.3 MultiJet 4x4 [312]	06.12→	SSJ	60	680	S5 A05			60	640	S4 E05							
	09.14→		60	680	S5 A05												
		SSJ							60	640	S4 E05						
Punto																	
0.9 TwinAir [199]	03.12-08.13	SSJ	60	680	S5 A05			60	640	S4 E05							
	11.13→	SSJ	60	680	S5 A05			60	640	S4 E05							
	01.15→		60	680	S5 A05												
		SSJ							60	640	S4 E05						
1.2 [199]	01.12→					54	530	S5 002		52	470	S4 002					
						54	530	S5 002		60	640	S4 E05					
		SSJ	60	680	S5 A05			60	640	S4 E05							
	01.15→		60	680	S5 A05			60	640	S4 E05							
Bipower, i 8V [188]	07.99-12.10								44	420	S4 000						
i 8V Bipower [188]	11.02-06.03					54	530	S5 002		42	390	S4 000		40	340	S3 000	
						54	530	S5 002		44	420	S4 000		40	340	S3 000	
i 16V [188]	07.99-06.03								44	420	S4 000						
i.e. 8V [188]	07.03-12.10								44	420	S4 000						
i.e. 16V [188]	07.03-12.10								44	420	S4 000						
LPG [188]	08.07-12.10					54	530	S5 002		52	470	S4 002					
1.4 LPG [199]	01.12→					54	530	S5 002		52	470	S4 002					
MultiAir [199]	01.12→					54	530	S5 002		52	470	S4 002					
						54	530	S5 002		60	640	S4 E05					
		SSJ	60	680	S5 A05			60	640	S4 E05							
MultiAir Turbo [199]	01.12-12.17	SSJ	60	680	S5 A05			60	640	S4 E05							
Natural Power [199]	01.12→					54	530	S5 002		52	470	S4 002					
						54	530	S5 002		60	640	S4 E05					
1.4/ 1.8 i.e. 16V [188]	07.03-12.10					54	530	S5 002		42	390	S4 000		40	340	S3 000	
1.8 i 16V [188]	07.99-06.03					54	530	S5 002		42	390	S4 000		40	340	S3 000	
						54	530	S5 002		44	420	S4 000		40	340	S3 000	
55/ 60/ 75/ 85 1.1 i.e., 1.2 i.e., 1.2 i.e. 16V [176]	04.97-08.99					54	530	S5 002		42	390	S4 000		40	340	S3 000	
Diesel																	
1.3 JTD 16V [188]	06.03-12.10					54	530	S5 002		52	470	S4 002					
MultiJet [199]	01.12-12.16								60	640	S4 E05						
	01.12→	SSJ							60	640	S4 E05						
	12.13→		60	680	S5 A05												
	05.16→		60	680	S5 A05			60	640	S4 E05							
1.7 TD [176]	05.97-08.99					63	610	S5 005									
1.9 D [188]	07.99-06.03					63	610	S5 005		60	540	S4 005					
JTD [188]	07.99-06.03					63	610	S5 005									
JTD 8V [188]	06.03-12.10					63	610	S5 005		52	470	S4 002					
	07.03-12.10					54	530	S5 002		52	470	S4 002					
Punto Cabrio																	
60/ 85 1.2 i.e., 1.2 i.e. 16V [176]	04.97-08.99					54	530	S5 002		42	390	S4 000		40	340	S3 000	
Punto Evo																	
1.2 8V [199]	10.09-12.11					54	530	S5 002		52	470	S4 002					
		SSJ	60	680	S5 A05			60	640	S4 E05							
	09.10-12.11	SSJ							60	640	S4 E05						
1.4 LPG [199]	10.09-12.11					54	530	S5 002		52	470	S4 002					
8V [199]	10.09-12.11					54	530	S5 002		42	390	S4 000		40	340	S3 000	
						54	530	S5 002		44	420	S4 000		40	340	S3 000	
						54	530	S5 002		52	470	S4 002					
		BWD,SSJ							60	640	S4 E05						
		SSJ	60	680	S5 A05			60	640	S4 E05							
8V Natural [199]	10.09-12.11								44	420	S4 000		40	340	S3 000		
16V [199]	10.09-12.11					54	530	S5 002		42	390	S4 000		40	340	S3 000	
		SSJ							70	650	S4 E07						



			Ah A (EN)	Ah A (EN)	Ah A (EN)	Ah A (EN)
			0 092 ...0	0 092 ...0	0 092 ...0	0 092 ...0

Diesel						
1.3 MultiJet [199]	10.09-12.11		54	530	S5 002	52 470 S4 002
			54	530	S5 002	60 640 S4 E05
			63	610	S5 005	44 420 S4 000
		BWD,SSJ				60 640 S4 E05
		SSJ	60	680	S5 A05	60 640 S4 E05
			70	760	S5 A08	60 640 S4 E05
	05.10-12.11	SSJ				70 650 S4 E07
1.6 MultiJet [199]	10.09-12.11		54	530	S5 002	42 390 S4 000 40 340 S3 000
		SSJ				70 760 S4 E08
Punto GT						
1.4 i.e. Turbo [176]	05.97-08.99		54	530	S5 002	42 390 S4 000 40 340 S3 000
Punto Soft Van						
Diesel						
1.7 TD [276]	05.97-08.99		63	610	S5 005	
Punto Van						
1.1 i.e. [276]	05.97-08.99		54	530	S5 002	42 390 S4 000 40 340 S3 000
1.2 Bipower, i 8V [288]	07.99-12.10					44 420 S4 000
LPG [288]	08.07-12.10		54	530	S5 002	44 420 S4 000
			54	530	S5 002	52 470 S4 002
Diesel						
1.3/ 1.9 D, JTD 16V [288]	05.99-12.10		54	530	S5 002	42 390 S4 000
1.7 D, TD [276]	05.97-08.99		63	610	S5 005	
1.9 JTD [288]	05.99-06.03		63	610	S5 005	
JTD 8V [288]	07.03-12.10		54	530	S5 002	52 470 S4 002
Sedici						
1.6 [189]	09.06-08.09		54	530	S5 002	44 440 S4 001
	08.09-12.14		54	530	S5 002	52 470 S4 002
4x4 [189]	05.06-08.09		63	610	S5 005	52 470 S4 002
	08.09-12.14		54	530	S5 002	52 470 S4 002
Diesel						
1.9 JTD [189]	05.06-09.09		63	610	S5 005	
1.9/ 2.0 JTD 4x4 [189]	05.06-12.14		63	610	S5 005	
2.0 JTD [189]	08.09-12.14		77	780	S5 008	74 680 S4 008
Seicento						
Elettra [187]	10.98-12.03					44 440 S4 001 40 340 S3 000
900/ 1100 [187]	03.98-01.10					44 420 S4 000
Siena						
1.2/ 1.4 i.e., i.e. 8V [178]	04.97-12.01		54	530	S5 002	52 470 S4 002 45 400 S3 002
1.6 i.e. 16V [178]	04.97-12.01		54	530	S5 002	52 470 S4 002 45 400 S3 002
	01.01-12.01		54	530	S5 002	52 470 S4 002
Stilo						
1.2/ 1.4/ 1.6 16V [192]	10.01-12.07		63	610	S5 005	52 470 S4 002 45 400 S3 002
1.8 16V [192]	10.01-12.03		63	610	S5 005	52 470 S4 002 45 400 S3 002
	01.04-12.07		63	610	S5 005	52 470 S4 002
2.4 20V [192]	10.01-12.07		63	610	S5 005	
Diesel						
1.9 JTD 8V, JTD 16V [192]	10.01-12.07		63	610	S5 005	60 540 S4 005
Stilo Multi Wagon						
1.4 16V [192]	01.04-12.07		63	610	S5 005	52 470 S4 002 45 400 S3 002
1.6 16V [192]	10.02-12.07		63	610	S5 005	52 470 S4 002 45 400 S3 002
	07.05-12.07		63	610	S5 005	52 470 S4 002
16V Natural Power [192]	04.06-12.07		63	610	S5 005	52 470 S4 002
1.8 16V [192]	10.02-12.07		63	610	S5 005	52 470 S4 002 45 400 S3 002
2.4 20V [192]	01.04-12.07		63	610	S5 005	
Diesel						
1.9 JTD 8V, JTD 16V [192]	10.02-12.07		63	610	S5 005	60 540 S4 005
Tipo						
1.4 [356]	11.15→		63	610	S5 005	52 470 S4 002
		SSJ	60	680	S5 A05	60 640 S4 E05
T-jet LPG [356]	09.16→		63	610	S5 005	52 470 S4 002
		SSJ	60	680	S5 A05	60 640 S4 E05



			Ah A (EN)	Ah A (EN)	Ah A (EN)	Ah A (EN)
			0 092 ...0	0 092 ...0	0 092 ...0	0 092 ...0

126
BIS/ Maluch 09.87-09.00 45 400 **S3 003**

500

0.9 TwinAir [312]	09.10→	SSJ				60	640	S4 E05			
	09.12→					60	640	S4 E05			
	10.13→		60	680	S5 A05						
	12.13→	SSJ	60	680	S5 A05		60	640	S4 E05		
1.2 [312]	07.07→						44	420	S4 000		
		SSJ	60	680	S5 A05		60	640	S4 E05		
LPG [312]	09.10→					54	530	S5 002	52	470	S4 002
		SSJ	60	680	S5 A05		60	640	S4 E05		
1.4 [312]	07.07→						42	390	S4 000	40	340
		SSJ					60	640	S4 E05		

Diesel

1.3 MultiJet [312]	07.07-12.15					54	530	S5 002	52	470	S4 002
	01.10-12.15	SSJ	60	680	S5 A05				60	640	S4 E05
	01.16→		60	680	S5 A05	54	530	S5 002	52	470	S4 002
		SSJ							60	640	S4 E05
	10.16→								44	420	S4 000
									52	470	S4 002
		SSJ	60	680	S5 A05				60	640	S4 E05

500C

0.9 TwinAir [312]	09.10→	SSJ							60	640	S4 E05
	09.12→								60	640	S4 E05
	10.13→		60	680	S5 A05						
	12.13→								44	420	S4 000
									52	470	S4 002
		SSJ	60	680	S5 A05				60	640	S4 E05
1.2 [312]	07.09→								44	420	S4 000
		SSJ	60	680	S5 A05				60	640	S4 E05
1.4 [312]	07.09→								42	390	S4 000
		SSJ							60	640	S4 E05

Diesel

1.3 MultiJet [312]	07.09-12.15					54	530	S5 002	52	470	S4 002
	01.10-12.15	SSJ	60	680	S5 A05				60	640	S4 E05
	01.16→		60	680	S5 A05	54	530	S5 002	52	470	S4 002
		SSJ							60	640	S4 E05

500L

0.9 [199]	09.12→	SSJ	60	680	S5 A05				60	640	S4 E05
Natural Power [199]	02.13→	SSJ							60	640	S4 E05
1.4 [199]	09.12→								60	640	S4 E05
	01.14→		60	680	S5 A05						
		SSJ							60	640	S4 E05
LPG [199]	02.14→		60	680	S5 A05						
		SSJ							60	640	S4 E05

Diesel

1.3 MultiJet [199]	09.12→	SSJ	60	680	S5 A05				60	640	S4 E05
	04.15→		60	680	S5 A05						
		SSJ							60	640	S4 E05
1.6 MultiJet [199]	03.13→	SSJ							70	760	S4 E08
	09.13-05.17	SSJ	70	760	S5 A08				70	760	S4 E08
	04.15→		70	760	S5 A08						

500X

1.4 MultiAir, MultiAir 4x4 [334]	11.14→	SSJ	60	680	S5 A05				60	640	S4 E05
1.6 E-torQ [334]	11.14→		60	680	S5 A05						
		SSJ							60	640	S4 E05

Diesel

1.3 MultiJet [334]	07.15→		60	680	S5 A05						
		SSJ							60	640	S4 E05
1.6 MultiJet [334]	11.14→		60	680	S5 A05						
		SSJ							60	640	S4 E05
2.0 MultiJet 4x4 [334]	11.14→	SSJ	70	760	S5 A08				70	760	S4 E08



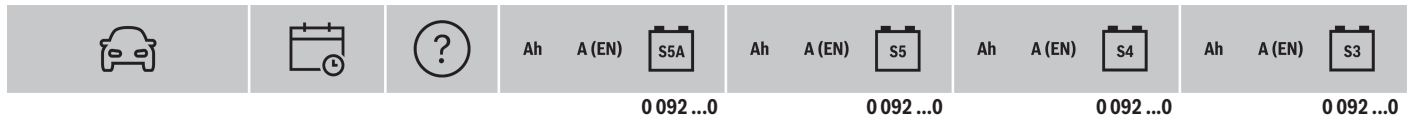

FORD

B-MAX													
1.0 EcoBoost [12]	08.12→	BWD,SSJ							70	650	S4 E07		
1.4/ 1.6, Ti-VCT [12]	08.12→		61	600	S5 004					53	500	S3 004	
Diesel													
1.5 TDCi [12]	08.12→		85	800	S5 010			80	740	S4 010			
		BWD,SSJ						70	650	S4 E10			
	05.15→	BWD,SSJ						70	650	S4 E07			
1.6 TDCi [12]	08.12-06.15		85	800	S5 010			80	740	S4 010			
		BWD,SSJ						70	650	S4 E10			
C-MAX													
1.0 EcoBoost [11]	10.12-03.15							52	470	S4 002	45	400	S3 002
								52	470	S4 002	53	500	S3 004
								60	540	S4 004	45	400	S3 002
			60	680	S5 A05	63	610	S5 005	60	540	S4 005		
		BWD,SSJ						70	650	S4 E07			
		SSJ						60	640	S4 E05			
EcoBoost [15]	04.15→		60	680	S5 A05								
		BWD,SSJ						70	650	S4 E07			
		SSJ						60	640	S4 E05			
	02.18→							70	650	S4 E07			
								70	650	S4 E10			
1.5 EcoBoost [15]	04.15→							70	650	S4 E10			
		BWD,SSJ						70	650	S4 E07			
1.6 EcoBoost [11]	08.10-03.15							70	650	S4 E10			
		SSJ						70	650	S4 E10			
Ti-VCT [11]	08.10-03.15		61	600	S5 004			60	540	S4 004	53	500	S3 004
		BWD,SSJ						70	650	S4 E07			
		SSJ						70	650	S4 E10			
Ti-VCT [15]	04.15→		61	600	S5 004			60	540	S4 004			
		BWD,SSJ						70	650	S4 E07			
		SSJ						70	650	S4 E10			
Ti-VCT FlexiFuel [11]	08.10-03.15		61	600	S5 004			60	540	S4 004	53	500	S3 004
		BWD,SSJ						70	650	S4 E07			
		SSJ						70	650	S4 E10			
Ti-VCT FlexiFuel [15]	04.15→		61	600	S5 004			60	540	S4 004			
		BWD,SSJ						70	650	S4 E07			
		SSJ						70	650	S4 E10			
1.6/ 1.8/ 2.0 , CNG, FFV, LPG [07]	03.07-07.10		61	600	S5 004			60	540	S4 004	53	500	S3 004
2.0 ENERGI [15]	12.15-12.17							44	440	S4 001			
		BWD,SSJ						70	650	S4 E07			
Diesel													
1.5 TDCi [15]	04.15→							70	650	S4 E10			
								80	740	S4 010			
TDCi ECOnetic [15]	04.15→							70	650	S4 E10			
								80	740	S4 010			
		BWD,SSJ						70	650	S4 E07			
1.6 TDCi [07]	03.07-07.10		74	750	S5 007			72	680	S4 007			
		BWD,SSJ						70	650	S4 E07			
		SSJ						70	650	S4 E10			
TDCi [11]	08.10-03.15	SSJ						70	650	S4 E10			
TDCi [15]	04.15-12.18		74	750	S5 007			72	680	S4 007			
		BWD,SSJ						70	650	S4 E07			
1.8/ 2.0 TDCi [07]	03.07-07.10		74	750	S5 007			72	680	S4 007			
2.0 TDCi [11]	08.10-03.15		74	750	S5 007								
			74	750	S5 007			72	680	S4 007			
		BWD,SSJ						70	650	S4 E07			
								70	650	S4 E10			
		SSJ						70	650	S4 E10			
TDCi [15]	04.15→	BWD,SSJ						70	650	S4 E10			



			Ah	A (EN)		Ah	A (EN)		Ah	A (EN)		Ah	A (EN)	
			0 092 ...0			0 092 ...0			0 092 ...0			0 092 ...0		

Cougar														
2.0/ 2.5 i, i ST200 [EC]	08.98-12.00					61	600	S5 004	60	540	S4 004	53	500	S3 004
EcoSport														
1.0 EcoBoost [14]	10.13-12.17	BWD,SSJ							70	650	S4 E07			
	02.16-12.17								60	540	S4 004			
EcoBoost [18]	11.17→								70	650	S4 E07			
1.5 Ti-VCT [14]	10.13-10.17					61	600	S5 004	60	540	S4 004			
		BWD,SSJ							70	650	S4 E07			
Diesel														
1.5 TDCi [14]	10.13-10.17					61	600	S5 004	60	540	S4 004			
		BWD,SSJ							70	650	S4 E07			
Edge														
Diesel														
2.0 TDCi, TDCi Bi-Turbo	01.16→	BWD,SSJ	80	800	S5 A11									
Escort														
1.6 i16V	12.97-01.00					61	600	S5 004	44	440	S4 001	41	360	S3 001
Escort VII														
1.4 i [95]	01.95-09.01											53	500	S3 004
	10.96-09.01					61	600	S5 004	60	540	S4 004	53	500	S3 004
1.6 i16V [95]	01.95-09.01											53	500	S3 004
		FAD				61	600	S5 004	60	540	S4 004	53	500	S3 004
	08.96-01.00					61	600	S5 004	44	440	S4 001	41	360	S3 001
i16V 4x4 [95]	01.95-09.01											53	500	S3 004
		FAD				61	600	S5 004	60	540	S4 004	53	500	S3 004
1.8 i16V [95]	09.95-09.01											53	500	S3 004
	09.96-01.00					61	600	S5 004	44	440	S4 001	41	360	S3 001
Escort VII Cabrio														
1.4 i [95]	01.95-09.01											53	500	S3 004
Escort VII Express 55														
1.4 i [95]	01.95-09.01											53	500	S3 004
Escort VII Express 75														
1.4 i [95]	01.95-09.01											53	500	S3 004
Escort VII Turnier														
1.4/ 1.6/ 1.8 i, i 16V [95]	01.95-09.01											53	500	S3 004
Escort VII XR3i Cabrio														
1.6 i [95]	01.95-09.01											53	500	S3 004
1.8 i [95]	01.95-09.01											53	500	S3 004
		FAD				74	750	S5 007	60	540	S4 004	53	500	S3 004
Explorer														
4.0/ 5.0 , i, 4x4	09.95-08.10					74	750	S5 007	72	680	S4 007	70	640	S3 007
Fiesta IV														
1.3 i [96]	11.95-12.02					61	600	S5 004	44	440	S4 001	41	360	S3 001
1.4/ 1.6 i 16V [96]	01.96-12.02					61	600	S5 004	60	540	S4 004	53	500	S3 004
1.25 i 16V [96]	11.95-12.02					61	600	S5 004	44	440	S4 001	41	360	S3 001
Diesel														
1.8 D, TD [96]	10.95-12.02					74	750	S5 007	60	540	S4 004	53	500	S3 004
Fiesta IV Courier														
1.3 i [96]	11.95-12.02					61	600	S5 004	44	440	S4 001	41	360	S3 001
1.4 i [96]	01.96-12.00					61	600	S5 004	60	540	S4 004	53	500	S3 004
Diesel														
1.8 D [96]	10.95-06.01					74	750	S5 007	60	540	S4 004	53	500	S3 004
TD [96]	02.00-12.02					74	750	S5 007	60	540	S4 004			
Fiesta V														
1.4 i [02]	11.01-09.08					52	520	S5 001	44	440	S4 001			
1.6 i [02]	11.01-09.08					52	520	S5 001	44	440	S4 001	53	500	S3 004
1.25/ 1.3 i [02]	11.01-09.08					52	520	S5 001	44	440	S4 001	41	360	S3 001
2.0 i ST150 [02]	11.04-09.08					61	600	S5 004	60	540	S4 004	53	500	S3 004
Diesel														
1.4/ 1.6 TDCi [02]	11.01-09.08					74	750	S5 007	60	540	S4 004			
Fiesta VI														
1.4 i [08]	07.08-11.12					52	520	S5 001	44	440	S4 001			
LPG [08]	05.09-11.12					52	520	S5 001	44	440	S4 001			
1.6 Ti-VCT [08]	07.08-11.12					61	600	S5 004	60	540	S4 004			



				Ah	A (EN)		Ah	A (EN)		Ah	A (EN)		Ah	A (EN)	
				0 092 ...0			0 092 ...0			0 092 ...0			0 092 ...0		
◀ FORD															
1.6 Ti-VCT Sport S [08]	01.11-11.12			61	600	S5 004							53	500	S3 004
1.25 i [08]	07.08-11.12			52	520	S5 001	44	440	S4 001						
		BWD,SSJ					70	650	S4 E07						
Diesel															
1.4 TDCi [08]	07.08-11.12			74	750	S5 007	70	650	S4 E07						
				74	750	S5 007	72	680	S4 007						
	09.10-11.12						72	680	S4 007						
1.6 TDCi [08]	07.08-11.12			74	750	S5 007	72	680	S4 007						
	03.10-11.12			61	600	S5 004	60	540	S4 004	53	500	S3 004			
		BWD,SSJ					70	650	S4 E07						
Fiesta VII															
1.0 EcoBoost [13]	11.12-12.17	BWD,SSJ					70	650	S4 E07						
GDI [13]	11.12-12.17			61	600	S5 004	60	540	S4 004						
				61	600	S5 004	70	650	S4 E07						
		BWD,SSJ					70	650	S4 E07						
1.4 [13]	11.12-12.17			61	600	S5 004	60	540	S4 004						
		FAD		61	600	S5 004	44	440	S4 001	41	360	S3 001			
1.6 EcoBoost [13]	01.13-12.17			61	600	S5 004	60	540	S4 004						
		BWD,SSJ					70	650	S4 E07						
	06.16-12.17						60	540	S4 004						
Ti-VCT [13]	11.12→			61	600	S5 004	60	540	S4 004						
1.25 [13]	11.12-12.17						44	440	S4 001						
				52	520	S5 001	44	440	S4 001						
		BWD,FAD,SSJ					70	650	S4 E07						
		BWD,SSJ					70	650	S4 E07						
		FAD		52	520	S5 001									
Diesel															
1.5 TDCi [13]	11.12-12.17			74	750	S5 007	72	680	S4 007						
		BWD,SSJ					70	650	S4 E07						
1.6 TDCi [13]	11.12-12.17			74	750	S5 007	70	650	S4 E07						
				74	750	S5 007	72	680	S4 007						
TDCi ECONetic [13]	11.12-12.17			74	750	S5 007	70	650	S4 E07						
				74	750	S5 007	72	680	S4 007						
Fiesta VIII															
1.0 EcoBoost [17]	05.17→	BWD,SSJ					70	650	S4 E07						
1.1 Ti-VCT [17]	05.17→						60	540	S4 004						
		BWD,SSJ					70	650	S4 E07						
Diesel															
1.5 TDCi [17]	05.17→	BWD,SSJ					70	650	S4 E07						
Focus															
1.6 i	06.00-06.04			61	600	S5 004	44	440	S4 001						
i8V [Fase I]	09.03→			52	520	S5 001	44	440	S4 001						
Focus C-MAX															
1.6 [04]	09.03-03.07			61	600	S5 004	60	540	S4 004	53	500	S3 004			
Ti-VCT [04]	07.04-03.07			61	600	S5 004	60	540	S4 004	53	500	S3 004			
1.8/ 2.0 [04]	06.03-03.07			74	750	S5 007	60	540	S4 004	53	500	S3 004			
CNG, FFV [04]	05.05-03.07			74	750	S5 007	60	540	S4 004	53	500	S3 004			
Diesel															
1.6/ 1.8/ 2.0 TDCi [04]	06.03-03.07			74	750	S5 007	72	680	S4 007						
Focus I															
1.4 i [99]	08.98-05.05			61	600	S5 004	44	440	S4 001	41	360	S3 001			
	12.00-05.05			52	520	S5 001	44	440	S4 001						
1.6 i [99]	08.98-08.04			61	600	S5 004	60	540	S4 004	41	360	S3 001			
	08.98-05.05			61	600	S5 004	44	440	S4 001	41	360	S3 001			
	09.02-05.05			52	520	S5 001	44	440	S4 001						
i FFV [99]	10.01-05.05			52	520	S5 001	44	440	S4 001						
1.8/ 2.0 i [99]	08.98-05.05			61	600	S5 004	60	540	S4 004	53	500	S3 004			
2.0 i RS, i ST170 [99]	02.02-05.05			74	750	S5 007	60	540	S4 004	53	500	S3 004			
Diesel															
1.8 TDCi [99]	05.01-05.05			74	750	S5 007	72	680	S4 007						
TDDi [99]	01.99-05.05			74	750	S5 007	72	680	S4 007	70	640	S3 007			
Focus I Turnier															
1.4 i [99]	11.98-05.05			61	600	S5 004	44	440	S4 001	41	360	S3 001			



		Ah A (EN) S5A			Ah A (EN) S5			Ah A (EN) S4			Ah A (EN) S3			
		0 092 ...0			0 092 ...0			0 092 ...0			0 092 ...0			
1.4 i [99]	12.00-05.05				52	520	S5 001	44	440	S4 001				
1.6 i [99]	11.98-05.05				61	600	S5 004	44	440	S4 001	41	360	S3 001	
	09.02-05.05				74	750	S5 007	72	680	S4 007				
i FFV [99]	10.01-05.05				52	520	S5 001	44	440	S4 001				
1.8/ 2.0 i [99]	11.98-05.05				61	600	S5 004	60	540	S4 004	53	500	S3 004	
2.0 i ST170 [99]	02.02-05.05				74	750	S5 007	60	540	S4 004	53	500	S3 004	
Diesel														
1.8 TDCi [99]	05.01-05.05				74	750	S5 007	72	680	S4 007				
TDDi [99]	01.99-05.05				74	750	S5 007	72	680	S4 007	70	640	S3 007	
Focus II														
1.4/ 1.6 i [04]	07.04-01.08				61	600	S5 004	60	540	S4 004	53	500	S3 004	
1.4/ 1.6/ 1.8 i [08]	12.07-12.11				61	600	S5 004	60	540	S4 004	53	500	S3 004	
1.6 Ti-VCT [04]	07.04-01.08				61	600	S5 004	60	540	S4 004	53	500	S3 004	
Ti-VCT [08]	12.07-12.11				61	600	S5 004	60	540	S4 004	53	500	S3 004	
1.8 FFV [04]	07.04-01.08				61	600	S5 004	60	540	S4 004	53	500	S3 004	
	05.05-01.08				74	750	S5 007	60	540	S4 004	53	500	S3 004	
Flexifuel [08]	12.07-12.11				74	750	S5 007	60	540	S4 004	53	500	S3 004	
i [04]	05.05-01.08				61	600	S5 004	60	540	S4 004	53	500	S3 004	
					74	750	S5 007	60	540	S4 004	53	500	S3 004	
2.0 CNG, LPG [08]	01.08-12.11				61	600	S5 004				53	500	S3 004	
i [04]	07.04-01.08				74	750	S5 007	60	540	S4 004	53	500	S3 004	
i [08]	12.07-12.11				74	750	S5 007	60	540	S4 004	53	500	S3 004	
2.5 iRS [08]	01.09-12.11				74	750	S5 007	72	680	S4 007	70	640	S3 007	
i RS 500 [08]	04.10-12.11				74	750	S5 007	72	680	S4 007				
i ST [04]	10.05-01.08				74	750	S5 007	60	540	S4 004	53	500	S3 004	
i ST [08]	12.07-12.11				74	750	S5 007	60	540	S4 004	53	500	S3 004	
Diesel														
1.6 TDCi [04]	07.04-01.08				74	750	S5 007	72	680	S4 007				
					74	750	S5 007	80	740	S4 010				
		BWD,SSJ						70	650	S4 E07				
		SSJ						70	650	S4 E10				
TDCi [08]	12.07-12.11				74	750	S5 007	70	650	S4 E07				
					74	750	S5 007	70	650	S4 E10				
					74	750	S5 007	72	680	S4 007				
					74	750	S5 007	72	680	S4 007	70	640	S3 007	
					74	750	S5 007	80	740	S4 010				
		BWD,SSJ						70	650	S4 E07				
		SSJ						70	650	S4 E10				
1.8/ 2.0 TDCi [04]	07.04-01.08				74	750	S5 007	72	680	S4 007				
TDCi [08]	12.07-12.11				74	750	S5 007	72	680	S4 007	70	640	S3 007	
Focus II Cabriolet														
1.6 i [06]	07.06-07.10				61	600	S5 004	60	540	S4 004	53	500	S3 004	
2.0 i [06]	07.06-07.10				74	750	S5 007	60	540	S4 004	53	500	S3 004	
Diesel														
2.0 TDCi [06]	07.06-07.10				85	800	S5 010	72	680	S4 007				
Focus II Turnier														
1.4/ 1.6/ 1.8 FFV, Flexifuel, i, Ti-VCT [04; 08]	07.04-12.11				61	600	S5 004	60	540	S4 004	53	500	S3 004	
2.0 i [04]	07.04-01.08				74	750	S5 007	60	540	S4 004	53	500	S3 004	
i [08]	12.07-12.11				74	750	S5 007	60	540	S4 004	53	500	S3 004	
LPG [08]	01.08-12.11				61	600	S5 004				53	500	S3 004	
Diesel														
1.6 TDCi [04]	07.04-01.08				74	750	S5 007	72	680	S4 007				
					74	750	S5 007	80	740	S4 010				
		BWD,SSJ	70	760	S5 A08				70	650	S4 E10			
TDCi [08]	12.07-12.11				74	750	S5 007	72	680	S4 007	70	640	S3 007	
			70	760	S5 A08	74	750	S5 007	70	650	S4 E10			
			70	760	S5 A08	74	750	S5 007	72	680	S4 007			
			70	760	S5 A08	74	750	S5 007	80	740	S4 010			
		BWD,SSJ						70	650	S4 E10				
1.8 TDCi [04]	04.05-01.08				74	750	S5 007	72	680	S4 007				
1.8/ 2.0 TDCi [08]	12.07-12.11				74	750	S5 007	72	680	S4 007	70	640	S3 007	



											Ah A (EN)			Ah A (EN)			Ah A (EN)			Ah A (EN)		
		0 092 ...0			0 092 ...0			0 092 ...0			0 092 ...0											
◀ FORD																						
2.0 TDCi [04]	07.04-01.08				74	750	S5 007	72	680	S4 007												
Focus III																						
Electric [11]	06.13-11.14				52	520	S5 001	44	440	S4 001												
1.0 EcoBoost [11]	02.12-12.14		60	680	S5 A05	61	600	S5 004	60	540	S4 004											
		SSJ							60	640	S4 E05											
1.6 EcoBoost [11]	01.11-12.14		60	680	S5 A05				70	650	S4 E10											
		SSJ							70	650	S4 E10											
EcoBoost FlexiFuel [11]	02.14-12.14				61	600	S5 004	60	540	S4 004												
					74	750	S5 007	70	650	S4 E07												
					74	750	S5 007	72	680	S4 007												
Ti-VCT, Ti-VCT FlexiFuel [11]	01.11-12.14				61	600	S5 004							53	500	S3 004						
2.0 EcoBoost ST [11]	06.12-12.14				74	750	S5 007	72	680	S4 007												
		BWD,SSJ							70	650	S4 E07											
GDI Ti-VCT [11]	03.11-12.14				61	600	S5 004	60	540	S4 004												
		BWD	70	760	S5 A08																	
		BWD,SSJ							70	650	S4 E07											
Diesel																						
1.6 TDCi [11]	01.11-12.14								70	650	S4 E10											
		SSJ							70	650	S4 E10											
TDCi ECOnetic [11]	06.12-12.14								70	650	S4 E07											
		SSJ							70	650	S4 E10											
2.0 TDCi [11]	01.11-12.14				74	750	S5 007	72	680	S4 007												
Focus III Turnier																						
1.0 EcoBoost [11]	02.12-12.14		60	680	S5 A05	61	600	S5 004	60	540	S4 004											
		SSJ							60	640	S4 E05											
1.6 EcoBoost [11]	01.11-12.14		60	680	S5 A05				70	650	S4 E10											
		SSJ							70	650	S4 E10											
EcoBoost FlexiFuel [11]	02.14-12.14				61	600	S5 004	60	540	S4 004												
		BWD,SSJ							70	650	S4 E07											
		SSJ							70	650	S4 E10											
Ti-VCT, Ti-VCT FlexiFuel [11]	01.11-12.14				61	600	S5 004							53	500	S3 004						
2.0 EcoBoost ST [11]	06.12-12.14				74	750	S5 007	72	680	S4 007												
		BWD,SSJ							70	650	S4 E07											
		SSJ							70	650	S4 E10											
GDI Ti-VCT [11]	09.11-12.14				61	600	S5 004	60	540	S4 004												
		BWD,SSJ							70	650	S4 E07											
		SSJ							70	650	S4 E10											
Diesel																						
1.6 TDCi [11]	01.11-12.14	SSJ							70	650	S4 E10											
TDCi ECOnetic [11]	06.12-12.14				61	600	S5 004	60	540	S4 004												
					61	600	S5 004	70	650	S4 E10												
2.0 TDCi [11]	01.11-12.14				74	750	S5 007	72	680	S4 007												
Focus IV																						
Electric [15]	12.14→				52	520	S5 001	44	440	S4 001												
1.0 EcoBoost [15]	10.14→	BWD							70	650	S4 E07											
			70	760	S5 A08																	
		BWD,SSJ							70	650	S4 E07											
1.5 EcoBoost [15]	10.14→				85	800	S5 011	80	740	S4 010												
		BWD,SSJ							70	650	S4 E07											
									70	650	S4 E10											
1.6 Ti-VCT [15]	10.14→				61	600	S5 004	60	540	S4 004												
					74	750	S5 007	70	650	S4 E07												
					74	750	S5 007	72	680	S4 007												
Diesel																						
1.5 TDCi [15]	10.14→	BWD	70	760	S5 A08																	
		BWD,SSJ							70	650	S4 E07											
									70	650	S4 E10											
		SSJ							70	650	S4 E10											



						Ah A (EN) S5A		Ah A (EN) S5		Ah A (EN) S4		Ah A (EN) S3							
				0 092 ...0		0 092 ...0		0 092 ...0		0 092 ...0		0 092 ...0							
1.5 TDCi ECOnetic [15]	10.14→	BWD	70	760	S5 A08														
		BWD,SSJ					70	650	S4 E07										
		SSJ					70	650	S4 E10										
1.6 TDCi [15]	10.14→			85	800	S5 010		80	740	S4 010									
		BWD,SSJ					70	650	S4 E07										
								70	650	S4 E10									
2.0 TDCi [15]	10.14→	BWD	70	760	S5 A08														
		BWD,SSJ					70	650	S4 E10										
Focus IV RS																			
2.3 EcoBoost AWD [15]	01.16→	BWD,SSJ					70	650	S4 E10										
Focus IV ST																			
2.0 EcoBoost [15]	10.14→			74	750	S5 007		70	650	S4 E07									
				74	750	S5 007		72	680	S4 007									
Diesel																			
2.0 TDCi [15]	10.14→	BWD	70	760	S5 A08														
		BWD,SSJ					70	650	S4 E10										
Focus IV ST Turnier																			
2.0 EcoBoost [15]	10.14→			74	750	S5 007		70	650	S4 E07									
				74	750	S5 007		72	680	S4 007									
Diesel																			
2.0 EcoBoost [15]	10.14→	BWD	70	760	S5 A08														
		BWD,SSJ					70	650	S4 E10										
Focus IV Turnier																			
1.0 EcoBoost [15]	10.14→	BWD,SSJ					70	650	S4 E07										
1.5 EcoBoost [15]	10.14→							70	650	S4 E10									
		BWD,SSJ							70	650	S4 E10								
1.6 Ti-VCT [15]	10.14→			61	600	S5 004		60	540	S4 004									
				74	750	S5 007		70	650	S4 E07									
				74	750	S5 007		72	680	S4 007									
Diesel																			
1.5 TDCi [15]	10.14→	BWD,SSJ					70	650	S4 E10										
				70	760	S5 A08		70	650	S4 E10									
TDCi ECOnetic [15]	10.14→	BWD,SSJ					70	650	S4 E10										
1.6 TDCi [15]	10.14→							70	650	S4 E10									
2.0 TDCi [15]	10.14→	BWD	70	760	S5 A08														
		BWD,SSJ					70	650	S4 E10										
Fusion																			
1.6 i [02]	10.02-06.12			61	600	S5 004		60	540	S4 004		53	500	S3 004					
1.25/ 1.4 i [02]	10.02-06.12			52	520	S5 001		44	440	S4 001									
Diesel																			
1.4/ 1.6 TDCi [02]	10.02-06.12			74	750	S5 007		60	540	S4 004									
Galaxy																			
1.5 EcoBoost [15]	05.15→							80	740	S4 010									
		BWD,SSJ							70	650	S4 E10								
1.6 EcoBoost [06]	11.10-12.14	BWD,SSJ					70	650	S4 E10										
2.0 EcoBoost [15]	05.15→							70	650	S4 E07									
								72	680	S4 007									
EcoBoost SCTi [06]	03.10-12.14			74	750	S5 007		72	680	S4 007									
		BWD,SSJ							70	650	S4 E10								
FlexiFuel [06]	03.08-12.14			61	600	S5 004		60	540	S4 004		53	500	S3 004					
i [95]	02.95-03.00	VAD	70	760	S5 A08		77	780	S5 008		60	540	S4 005		56	480	S3 005		
2.0/ 2.3 [06]	03.06-12.14			74	750	S5 007		60	540	S4 004		53	500	S3 004					
		i [00]	04.00-08.06	70	760	S5 A08		77	780	S5 008		60	540	S4 005					
2.3 i16V [95]	01.97-03.00	VAD	70	760	S5 A08		77	780	S5 008		60	540	S4 005		56	480	S3 005		
2.8 i [00]	04.00-08.06			95	850	S5 A13		100	830	S5 013		95	800	S4 013		90	720	S3 013	
		i [95]	02.95-03.00	VAD	100	830	S5 013		95	800	S4 013		90	720	S3 013				
i 4x4 [95]	07.96-03.00	VAD	100	830	S5 013		95	800	S4 013		90	720	S3 013						
Diesel																			
1.6 TDCi [06]	02.11-12.14	BWD,SSJ					70	650	S4 E10										
1.8 TDCi [06]	03.06-03.10			74	750	S5 007		80	740	S4 010									
1.9 TDI [00]	04.00-08.06	70	760	S5 A08		100	830	S5 013		95	800	S4 013							



				Ah	A (EN)		Ah	A (EN)		Ah	A (EN)		Ah	A (EN)	
				0 092 ...0			0 092 ...0			0 092 ...0			0 092 ...0		
◀ FORD															
1.9 TDI [95]	09.96-03.00	VAD		100	830	S5 013	95	800	S4 013	90	720	S3 013			
2.0 TDCi [06]	03.06-12.14			74	750	S5 007	80	740	S4 010						
	03.10-12.14						44	440	S4 001						
TDCi [15]	05.15→	BWD	70	760	S5 A08										
		BWD,SSJ					70	650	S4 E10						
TDCi AWD, TDCi Bi-Turbo [15]	05.15→	BWD,SSJ					70	650	S4 E10						
2.2 TDCi [06]	03.08-10.10			85	800	S5 010	72	680	S4 007	70	640	S3 007			
	11.10-12.14			74	750	S5 007	72	680	S4 007						
GT															
5.4	09.04-08.06			85	800	S5 010	70	650	S4 E10						
				85	800	S5 010	80	740	S4 010						
Ka															
1.2 [08]	09.08-05.16			52	520	S5 001	44	440	S4 001						
		BWD,SSJ					60	640	S4 E05						
1.3 i [97]	09.96-10.02			52	520	S5 001	44	440	S4 001	41	360	S3 001			
	10.02-09.08			52	520	S5 001	44	440	S4 001						
1.6 i [97]	07.03-09.08			52	520	S5 001	44	440	S4 001						
Diesel															
1.3 TDCi [08]	09.08-12.14						60	540	S4 005	56	480	S3 005			
		SSJ					70	650	S4 E07						
KA+															
1.2 Ti-VCT	07.16→			52	520	S5 001	60	540	S4 004						
Kuga															
1.5 EcoBoost [13]	10.14→	BWD,SSJ					70	650	S4 E07						
	03.16→	BWD,SSJ					70	650	S4 E10						
EcoBoost 4x4 [13]	10.14→	BWD,SSJ					70	650	S4 E07						
1.6 EcoBoost [13]	11.12-12.16	BWD,SSJ					70	650	S4 E10						
EcoBoost 4x4 [13]	11.12-12.16	BWD,SSJ					70	650	S4 E10						
	10.14-12.16						70	650	S4 E10						
2.0 EcoBoost 4x4 [13]	10.14-08.16			74	750	S5 007	72	680	S4 007						
2.5 [08]	12.08-11.12			85	800	S5 010	80	740	S4 010						
[13]	01.14→			74	750	S5 007	72	680	S4 007						
		BWD,SSJ					70	650	S4 E10						
i 4x4 [08]	12.08-11.12			74	750	S5 007	72	680	S4 007	70	640	S3 007			
Diesel															
1.5 TDCi [13]	09.16→	BWD,SSJ					70	650	S4 E10						
2.0 TDCi [08]	02.08-11.12			74	750	S5 007	72	680	S4 007						
	05.10-11.12			74	750	S5 007	72	680	S4 007	70	640	S3 007			
TDCi [13]	11.12-09.14			74	750	S5 007	72	680	S4 007	70	640	S3 007			
				85	800	S5 010	70	650	S4 E10						
				85	800	S5 010	80	740	S4 010						
	10.14→	BWD,SSJ					70	650	S4 E10						
TDCi 4x4 [08]	02.08-11.12			74	750	S5 007	72	680	S4 007						
	05.10-11.12			74	750	S5 007	72	680	S4 007	70	640	S3 007			
TDCi 4x4 [13]	11.12-09.14			74	750	S5 007	70	650	S4 E07						
				74	750	S5 007	72	680	S4 007						
				74	750	S5 007	72	680	S4 007	70	640	S3 007			
				85	800	S5 010	70	650	S4 E10						
				85	800	S5 010	80	740	S4 010						
	10.14→	BWD,SSJ					70	650	S4 E10						
Maverick															
2.0/ 2.3 i [1EZ, 1N2]	10.00-01.07			63	610	S5 005	60	540	S4 005						
i 4x4 [1EZ, 1N2]	10.00-01.07			63	610	S5 005	60	540	S4 005						
2.4 i [UDS, UNS]	05.96-12.98						95	830	S4 029						
3.0 i [1EZ, 1N2]	07.01-01.07			74	750	S5 007	72	680	S4 007						
i 4x4 [1EZ, 1N2]	07.01-01.07			74	750	S5 007	72	680	S4 007						
Diesel															
2.7 TD [UDS, UNS]	05.96-12.98						95	830	S4 029						
Mondeo I															
1.6 i [97]	08.98-09.00			61	600	S5 004	60	540	S4 004	53	500	S3 004			
Mondeo II															
1.6/ 1.8/ 2.0 i [97]	08.96-09.00			61	600	S5 004	60	540	S4 004	53	500	S3 004			



						Ah A (EN) S5A		Ah A (EN) S5		Ah A (EN) S4		Ah A (EN) S3		
				0 092 ...0		0 092 ...0		0 092 ...0		0 092 ...0		0 092 ...0		
2.5 i [97]	08.96-09.00			74	750	S5 007		60	540	S4 004		53	500	S3 004
i ST200 [97]	09.99-09.00			74	750	S5 007		60	540	S4 004		53	500	S3 004
Diesel														
1.8 TD [97]	08.96-09.00			74	750	S5 007		60	540	S4 004		53	500	S3 004
Mondeo II Turnier														
1.6/ 1.8/ 2.0 i [97]	08.96-09.00			61	600	S5 004		60	540	S4 004		53	500	S3 004
2.5 i [97]	08.96-09.00			74	750	S5 007		60	540	S4 004		53	500	S3 004
i ST200 [97]	09.99-09.00			74	750	S5 007		60	540	S4 004		53	500	S3 004
Diesel														
1.8 TD [97]	08.96-09.00			74	750	S5 007		60	540	S4 004		53	500	S3 004
Mondeo III														
1.8/ 2.0 i [01]	10.00-03.07			61	600	S5 004		44	440	S4 001		41	360	S3 001
2.5 i [01]	10.00-03.07			61	600	S5 004		60	540	S4 004		53	500	S3 004
3.0 i [01]	08.04-03.07			74	750	S5 007		60	540	S4 004		53	500	S3 004
i ST220 [01]	02.02-03.07			74	750	S5 007		60	540	S4 004		53	500	S3 004
Diesel														
2.0 TDDi [01]	10.00-08.02			74	750	S5 007		72	680	S4 007		70	640	S3 007
	10.00-03.07			74	750	S5 007		72	680	S4 007				
2.0/ 2.2 TDCi [01]	10.01-03.07			74	750	S5 007		72	680	S4 007				
Mondeo III Turnier														
1.8/ 2.0 i [01]	10.00-03.07			61	600	S5 004		44	440	S4 001		41	360	S3 001
2.5 i [01]	10.00-03.07			61	600	S5 004		60	540	S4 004		53	500	S3 004
3.0 i [01]	08.04-03.07			74	750	S5 007		60	540	S4 004		53	500	S3 004
i ST220 [01]	02.02-03.07			74	750	S5 007		60	540	S4 004		53	500	S3 004
Diesel														
2.0 TDDi [01]	10.00-08.02			74	750	S5 007		72	680	S4 007				
	10.00-03.07			74	750	S5 007		72	680	S4 007		70	640	S3 007
2.0/ 2.2 TDCi [01]	10.01-03.07			74	750	S5 007		72	680	S4 007				
Mondeo IV														
1.6 EcoBoost [07]	11.10-12.14	BWD,SSJ							70	650	S4 E10			
Ti-VCT [07]	02.07-08.10			61	600	S5 004		44	440	S4 001		41	360	S3 001
				61	600	S5 004		60	540	S4 004				
				74	750	S5 007		60	540	S4 004		53	500	S3 004
	09.10-12.14			61	600	S5 004						53	500	S3 004
2.0 [07]	02.07-12.14			74	750	S5 007		60	540	S4 004		53	500	S3 004
EcoBoost SCTi [07]	03.10-12.14		70	760	S5 A08			72	680	S4 007				
		BWD,SSJ						70	650	S4 E07				
	09.10-12.14		70	760	S5 A08									
			70	760	S5 A08	74	750	S5 007	72	680	S4 007			
		BWD,SSJ						70	650	S4 E10				
Flexifuel [07]	02.08-12.14			74	750	S5 007		60	540	S4 004		53	500	S3 004
LPG [07]	04.09-12.14			61	600	S5 004		60	540	S4 004		53	500	S3 004
2.3 [07]	09.07-12.14			74	750	S5 007		72	680	S4 007		53	500	S3 004
				74	750	S5 007		72	680	S4 007		70	640	S3 007
2.5 [07]	02.07-03.10			74	750	S5 007		60	540	S4 004				
Diesel														
1.6 TDCi [07]	02.11-12.14		70	760	S5 A08	61	600	S5 004	60	540	S4 004			
		BWD,SSJ							70	650	S4 E10			
1.8 TDCi [07]	02.07-11.10					74	750	S5 007	72	680	S4 007			
						85	800	S5 010	72	680	S4 007			
			70	760	S5 A08	74	750	S5 007	72	680	S4 007			
		BWD,SSJ							70	650	S4 E10			
			70	760	S5 A08				70	650	S4 E10			
TDCi eco [07]	02.07-11.10			85	800	S5 010		72	680	S4 007				
2.0 TDCi [07]	02.07-12.14			85	800	S5 010		72	680	S4 007				
			70	760	S5 A08	74	750	S5 007	72	680	S4 007			
			70	760	S5 A08	74	750	S5 007	80	740	S4 010			
		BWD,SSJ							70	650	S4 E10			
	11.07-12.14			74	750	S5 007		72	680	S4 007				
				74	750	S5 007		80	740	S4 010				
		BWD,SSJ	70	760	S5 A08				70	650	S4 E10			
	03.10-12.14			74	750	S5 007		70	650	S4 E07				
			70	760	S5 A08	74	750	S5 007	70	650	S4 E10			



											Ah A (EN)			Ah A (EN)			Ah A (EN)			Ah A (EN)		
		0 092 ...0			0 092 ...0			0 092 ...0			0 092 ...0											
◀ FORD																						
2.0 TDCi eco [07]	09.08-12.14	70	760	S5 A08	74	750	S5 007	72	680	S4 007												
		70	760	S5 A08	74	750	S5 007	80	740	S4 010												
	BWD,SSJ											70	650	S4 E10								
2.2 TDCi [07]	03.08-11.10						85	800	S5 010	72	680	S4 007	70	640	S3 007							
	11.10-12.14						74	750	S5 007	72	680	S4 007										
Mondeo IV Turnier																						
1.6 EcoBoost [07]	11.10-12.14	BWD,SSJ										70	650	S4 E10								
Ti-VCT [07]	02.07-08.10						61	600	S5 004	44	440	S4 001	41	360	S3 001							
	09.10-12.14						61	600	S5 004				53	500	S3 004							
2.0 [07]	02.07-12.14						74	750	S5 007	60	540	S4 004	53	500	S3 004							
EcoBoost SCTi [07]	03.10-12.14	70	760	S5 A08	74	750	S5 007	72	680	S4 007												
	BWD,SSJ											70	650	S4 E10								
Flexifuel [07]	02.08-12.14						74	750	S5 007	60	540	S4 004	53	500	S3 004							
LPG [07]	04.09-12.14						61	600	S5 004	60	540	S4 004	53	500	S3 004							
2.3 [07]	09.07-12.14						74	750	S5 007	72	680	S4 007	53	500	S3 004							
							74	750	S5 007	72	680	S4 007	70	640	S3 007							
2.5 [07]	02.07-03.10						74	750	S5 007	60	540	S4 004										
Diesel																						
1.6 TDCi [07]	02.11-12.14	BWD,SSJ										70	650	S4 E10								
1.8 TDCi [07]	02.07-11.10						74	750	S5 007	72	680	S4 007										
							85	800	S5 010	72	680	S4 007										
	BWD,SSJ	70	760	S5 A08								70	650	S4 E10								
TDCi eco [07]	02.07-11.10						85	800	S5 010	72	680	S4 007										
2.0 TDCi [07]	02.07-12.14						74	750	S5 007	72	680	S4 007										
							74	750	S5 007	80	740	S4 010										
							85	800	S5 010	72	680	S4 007										
	BWD,SSJ	70	760	S5 A08								70	650	S4 E10								
	03.10-12.14	70	760	S5 A08	74	750	S5 007	70	650	S4 E10												
		70	760	S5 A08	74	750	S5 007	72	680	S4 007												
		70	760	S5 A08	74	750	S5 007	80	740	S4 010												
	BWD,SSJ											70	650	S4 E10								
TDCi eco [07]	09.08-12.14	70	760	S5 A08	74	750	S5 007	72	680	S4 007												
		70	760	S5 A08	74	750	S5 007	80	740	S4 010												
	BWD,SSJ											70	650	S4 E10								
2.2 TDCi [07]	03.08-11.10						85	800	S5 010	72	680	S4 007	70	640	S3 007							
	11.10-12.14						74	750	S5 007	72	680	S4 007										
Mondeo V																						
1.0 EcoBoost [15]	09.14→	BWD										70	760	S5 A08								
		BWD,SSJ												70	650	S4 E07						
												70	650	S4 E10								
1.5 EcoBoost [15]	09.14→	BWD										70	760	S5 A08								
		BWD,SSJ												70	650	S4 E10						
2.0 EcoBoost [15]	09.14→	BWD										70	760	S5 A08								
		BWD,SSJ												70	650	S4 E10						
iVCT Hybrid [15]	09.14→	BWD,SSJ												70	650	S4 E10						
2.5 [15]	09.14→	BWD										70	760	S5 A08								
Diesel																						
1.5 TDCi [15]	05.15→	BWD										70	760	S5 A08								
		BWD,SSJ												70	650	S4 E10						
TDCi ECOnetic [15]	05.15→	BWD										70	760	S5 A08								
		BWD,SSJ												70	650	S4 E10						
1.6 TDCi [15]	09.14→	BWD,SSJ												70	650	S4 E10						
TDCi ECOnetic [15]	09.14→	BWD										70	760	S5 A08								
2.0 TDCi [15]	09.14→	BWD										70	760	S5 A08								
		BWD,SSJ												70	650	S4 E10						
TDCi AWD [15]	03.15→	BWD										70	760	S5 A08								
		BWD,SSJ												70	650	S4 E10						
TDCi Bi-Turbo [15]	06.15→	BWD										70	760	S5 A08								
Mondeo V Turnier																						
1.0 EcoBoost [15]	09.14→	BWD,SSJ										70	650	S4 E07								
1.5/2.0 EcoBoost [15]	09.14→	BWD,SSJ										70	650	S4 E10								
Diesel																						
1.5 TDCi [15]	05.15→	BWD										70	760	S5 A08								



			Ah	A (EN)		Ah	A (EN)		Ah	A (EN)		Ah	A (EN)	
			0 092 ...0			0 092 ...0			0 092 ...0			0 092 ...0		

1.5/ 1.6/ 2.0 TDCi AWD, TDCi Bi-Turbo, TDCi ECOnetic [15]	09.14→	BWD	70	760	S5 A08									
1.6/ 2.0 TDCi [15]	09.14→	BWD,SSJ				70	650	S4 E10						
Mustang														
2.3/ 5.0 EcoBoost, Ti-VCT [15]	04.15-09.17					60	540	S4 004						
Mustang Convertible														
2.3/ 5.0 EcoBoost, Ti-VCT [15]	04.15-09.17					60	540	S4 004						
Puma														
1.4 i [ECT]	01.98-11.00					61	600	S5 004	44	440	S4 001	41	360	S3 001
1.6/ 1.7 i [ECT]	06.97-12.01					61	600	S5 004	60	540	S4 004	53	500	S3 004
1.7 i ST160 [ECT]	06.99-12.01					61	600	S5 004	60	540	S4 004	53	500	S3 004
Scorpio II														
2.0/ 2.3 i, i 16V [95]	10.94-12.98	FAD	74	750	S5 007	60	540	S4 004	53	500	S3 004			
2.9 i 24V [95]	10.94-07.98	FAD	74	750	S5 007	72	680	S4 007	70	640	S3 007			
Diesel														
2.5 TD [95]	10.94-12.98	FAD	74	750	S5 007	72	680	S4 007	70	640	S3 007			
Scorpio II Turnier														
2.0/ 2.3 i, i 16V [95]	10.94-12.98	FAD	74	750	S5 007	60	540	S4 004	53	500	S3 004			
2.9 i 24V [95]	10.94-07.98	FAD	74	750	S5 007	72	680	S4 007	70	640	S3 007			
Diesel														
2.5 TD [95]	10.94-12.98	FAD	74	750	S5 007	72	680	S4 007	70	640	S3 007			
S-MAX														
1.5 EcoBoost [15]	05.15→								80	740	S4 010			
		BWD,SSJ							70	650	S4 E10			
1.6 EcoBoost [06]	11.10-12.14	BWD,SSJ							70	650	S4 E10			
2.0 EcoBoost [15]	05.15→								70	650	S4 E07			
									72	680	S4 007			
EcoBoost SCTi [06]	03.10-12.14		61	600	S5 004	60	540	S4 004						
		BWD,SSJ							70	650	S4 E10			
	09.10-12.14		74	750	S5 007	72	680	S4 007						
2.0/ 2.3/ 2.5 , FlexiFuel [06]	03.06-12.14		74	750	S5 007	60	540	S4 004	53	500	S3 004			
Diesel														
1.6 TDCi [06]	02.11-12.14	BWD,SSJ							70	650	S4 E10			
1.8/ 2.0/ 2.2 TDCi [06]	03.06-12.14		74	750	S5 007	80	740	S4 010						
2.0 TDCi [15]	05.15→		70	760	S5 A08				74	680	S4 008			
			70	760	S5 A08				80	740	S4 010			
		BWD	70	760	S5 A08									
		BWD,SSJ							70	650	S4 E10			
		SSJ							70	760	S4 E08			
TDCi AWD [15]	05.15→		70	760	S5 A08				74	680	S4 008			
			70	760	S5 A08				80	740	S4 010			
		BWD,SSJ							70	650	S4 E10			
		SSJ							70	760	S4 E08			
TDCi Bi-Turbo [15]	05.15→		70	760	S5 A08				74	680	S4 008			
			70	760	S5 A08				80	740	S4 010			
		BWD,SSJ							70	650	S4 E10			
		SSJ							70	760	S4 E08			
Streetka														
1.6 i	12.02-12.05		52	520	S5 001	44	440	S4 001						
Taurus														
1.6/ 2.0	10.88-12.99	FAD	61	600	S5 004	44	440	S4 001	41	360	S3 001			
Taurus														
3.0	09.95-08.07		74	750	S5 007	72	680	S4 007	70	640	S3 007			
Taurus Wagon														
3.0	09.99-08.05		74	750	S5 007	72	680	S4 007						
Tourneo Connect														
1.0 EcoBoost [13]	09.13→	BWD	80	800	S5 A11									
		BWD,SSJ							70	650	S4 E07			
1.6 EcoBoost [13]	09.13-12.17	BWD,SSJ							70	650	S4 E10			
1.8 i, LPG [02]	05.02-06.10		61	600	S5 004	60	540	S4 004	53	500	S3 004			



			Ah A (EN)	Ah A (EN)	Ah A (EN)	Ah A (EN)
			0 092 ...0	0 092 ...0	0 092 ...0	0 092 ...0

◀ FORD

Diesel										
1.5 TDCi [13]	06.15→				74	750	S5 007	72	680	S4 007
		BWD	80	800	S5 A11					
		BWD,SSJ						70	650	S4 E10
1.6 TDCi [13]	09.13-12.17				74	750	S5 007	70	650	S4 E07
					74	750	S5 007	72	680	S4 007
1.8 TDCi, TDDi [02]	05.02-12.13				74	750	S5 007	80	740	S4 010
Tourneo Courier										
1.0 EcoBoost [14]	04.14→				74	750	S5 007	72	680	S4 007
		BWD,SSJ						70	650	S4 E07
Diesel										
1.5 TDCi [14]	04.14→				74	750	S5 007	72	680	S4 007
		BWD,SSJ						70	650	S4 E07
	06.15→							72	680	S4 007
		SSJ						70	650	S4 E10
1.6 TDCi [14]	04.14-12.17				74	750	S5 007	72	680	S4 007
		BWD,SSJ						70	650	S4 E07
Windstar										
3.0 i	10.94-08.03							95	830	S4 029

FS LUBLIN

Zuk														
2.1	01.94-04.98							60	540	S4 024				
Diesel														
2.4 D	01.94-04.98		70	760	S5 A08	77	780	S5 008	74	680	S4 008	70	640	S3 008

FSM

126												
P el.	12.94-12.00									45	400	S3 003

FSO

Lanos												
1.4/ 1.5/ 1.6, 16V	05.04-10.08				63	610	S5 006	60	540	S4 006		
Lanos Hatchback												
1.4/ 1.5/ 1.6, 16V	05.04-10.08				63	610	S5 006	60	540	S4 006		
Polonez Atu												
1.4/ 1.6, 16V	01.96-12.02									45	400	S3 003
Polonez Caro												
1.4/ 1.6, 16V	05.87-12.02									45	400	S3 003
Diesel												
1.9 D	01.93-12.02				63	610	S5 006	60	540	S4 006		
126 P												
0.6	07.81-08.00									45	400	S3 003

GAZ

Volga													
2.3 [311]	09.96-12.08				63	610	S5 006	60	540	S4 006	56	480	S3 006
i [311]	01.96-12.08				63	610	S5 006	60	540	S4 006	56	480	S3 006
2.4 [311]	09.96-01.08				63	610	S5 006	60	540	S4 006	56	480	S3 006
	09.96-12.08				63	610	S5 006	60	540	S4 006			
[3102]	01.82-12.08				63	610	S5 006	60	540	S4 006	56	480	S3 006
	01.93-12.08				63	610	S5 006	60	540	S4 006			
i [311]	07.05-12.08				61	600	S5 004	60	540	S4 004			
2.5 [3102]	01.92-12.08				63	610	S5 006	60	540	S4 006	56	480	S3 006

			Ah A (EN)	Ah A (EN)	Ah A (EN)	Ah A (EN)
			0 092 ...0	0 092 ...0	0 092 ...0	0 092 ...0

Diesel												
2.1/ 2.3/ 2.4 d, D, TD	01.81-12.08		63	610	S5 006	60	540	S4 006	56	480	S3 006	
[311; 3102]												
Volga Kombi												
2.3/ 2.4, i, 16V	[311; 3102]	01.82-12.08		63	610	S5 006	60	540	S4 006	56	480	S3 006
Diesel												
2.1/ 2.3/ 2.4 D, TD		09.81-12.08		63	610	S5 006	60	540	S4 006	56	480	S3 006
[311; 3102]												

HOLDEN

Astra											
1.8 i [G]		09.00-08.09		74	750	S5 007	72	680	S4 007		

HONDA

Accord Aerodeck												
2.0/ 2.3 i 16V	[CE2; CF6]	09.93-12.02					60	540	S4 025			
Accord Coupé												
2.0/ 2.2/ 2.3/ 3.0 iLS, i 16V,		09.93-12.02					60	540	S4 025			
i 24V, 16V [; CD7; CG2; CG3; CG4]												
Accord Crosstour												
3.5 i-VTEC 4x4		09.09-12.12					70	630	S4 026			
72 760 S4E41												
Accord Hatchback												
1.6 i [CH5]		10.98-02.03	JEA				45	330	S4 021			
60 540 S4 024												
1.8/ 2.0/ 2.3 i		10.98-02.03	JEA				60	540	S4 024			
[CH6; CH7; CL4]												
Diesel												
2.0 TDi [CH8]		01.99-10.00		74	750	S5 007	72	680	S4 007	70	640	S3 007
Accord Sedan												
1.6 i [CG7]		10.98-02.03	JEA				60	540	S4 024			
iLS [CG7]		10.98-02.03		63	610	S5 005	60	540	S4 005	56	480	S3 005
1.8/ 2.0/ 2.2/ 2.3 i, i Typ R		10.98-02.03	JEA				60	540	S4 024			
[CG8; CG9; CH1; CL3]												
i 4WS, i 16V, 16V		01.91-12.99					60	540	S4 025			
[; CE7; CE8; CE9]												
2.0 [CL7]		02.03-06.08					45	330	S4 021			
01.06-06.08												
61 600 S5 004												
61 600 S5 004												
[CU1]		07.08-12.15					45	330	S4 021			
2.0/ 2.4, i 4WD [CL8; CL9]		10.02-11.08					45	330	S4 021			
2.4 [CU/CW]		07.08-12.15		61	600	S5 004	45	330	S4 021			
61 600 S5 004												
i V-Tec [CM5]		01.01-11.09					45	330	S4 021			
VTI-E [CM5]		09.02-08.05					60	540	S4 025			
3.0 i [CG2]		01.98-12.02					45	330	S4 021			
i [CM6]		09.02-11.06					45	330	S4 021			
3.5 [CP3]		09.07-08.11					60	540	S4 025			
Diesel												
2.0 D Turbo [CF1]		09.95-10.98		74	750	S5 007	72	680	S4 007	70	640	S3 007
TDi [CH2]		01.99-02.03		74	750	S5 007	72	680	S4 007	70	640	S3 007
2.2 CTDi [CN1]		01.04-06.08		70	760	S5 A08	77	780	S5 008	74	680	S4 008
i-DTEC, i-DTEC Type S		07.08-12.15					45	330	S4 021			
[CU3]												
Accord Tourer												
2.0 [CM1]		02.03-08.08					45	330	S4 021			
01.06-08.08												
61 600 S5 004												
61 600 S5 004												



			Ah A (EN) S5A			Ah A (EN) S5			Ah A (EN) S4			Ah A (EN) S3		
			0 092 ...0			0 092 ...0			0 092 ...0			0 092 ...0		
◀ HONDA														
2.0/ 2.4 [CM2; CW1]	02.03-12.15							45	330	S4 021				
2.4 [CW2]	09.08-12.15							45	330	S4 020				
Diesel														
2.2 CTDI [CN2]	01.04-08.08		70	760	S5 A08	77	780	S5 008	74	680	S4 008	70	640	S3 008
i-DTEC, i-DTEC Type S [CW3]	09.08-12.15							45	330	S4 021				
Accord Wagon														
2.4 i [CM2]	11.02-11.08							45	330	S4 021				
Capa														
1.5 i 16V	04.98-12.02							45	330	S4 023				
City														
1.4 [GM]	01.09-12.10							45	330	S4 020				
Civic														
1.7 i [EU]	09.04-08.05							45	330	S4 020				
1.8 i	09.11-08.15	SSJ						60	540	S4 024				
		SSJ	60	680	S5 A05			60	640	S4 E05				
2.0 i [ET]	05.03-12.04							45	330	S4 023				
Civic Aerodeck														
1.4 i 16V [MB/MC]	03.98-02.01							45	330	S4 023				
	03.99-12.00							45	330	S4 020				
1.5 i 16V [MB/MC]	03.98-02.01							45	330	S4 020				
1.6 i 16V [MB/MC]	03.98-12.98							45	330	S4 020				
	03.99-12.00							45	330	S4 022				
	03.99-02.01							45	330	S4 020				
1.8 i 16V [MB/MC]	03.98-02.01							45	330	S4 020				
Diesel														
2.0 D Turbo [MB/MC]	04.98-02.01							45	330	S4 020				
Civic Coupé														
1.6 [EJ6]	09.95-08.00							45	330	S4 021				
[EJ8]	09.95-08.00							45	330	S4 021				
i 16V [EJ7]	01.96-04.00							45	330	S4 023				
i 16V [EJ8]	01.96-04.00							45	330	S4 023				
i 16V [EM1]	09.98-08.00							45	330	S4 023				
1.6/ 1.7 i, i VTEC, i 16V [EM2; EP2]	02.01-12.05							45	330	S4 023				
Civic CRX														
1.6 i 16V [EG; EH]	03.92-12.98							45	330	S4 020				
Civic Fastback														
1.4 i 16V [MB]	03.97-02.01							45	330	S4 021				
								45	330	S4 023				
1.5/ 1.6/ 1.8 i 16V [MB]	03.97-02.01							45	330	S4 023				
Diesel														
2.0 D [MB]	03.97-02.01							45	330	S4 023				
						77	780	S5 008	74	680	S4 008			
Civic Hatchback														
1.0/ 1.5 VTEC Turbo [FC/FK]	03.17→		60	680	S5 A05			60	640	S4 E05				
1.4 [FK/FN]	01.06-12.11							45	330	S4 020				
	10.08-12.11							60	640	S4 E05				
i 16V [EJ]	10.95-02.01							45	330	S4 021				
								45	330	S4 023				
i-VTEC [FK/FN]	09.11-02.17							45	330	S4 020				
								45	330	S4 021				
		SSJ	60	680	S5 A05			60	640	S4 E05				
1.4/ 1.5/ 1.6/ 2.0, i, i 16V, Type R, VSA [EJ/EK; EK; EU/EP]	10.95-12.05							45	330	S4 023				
1.8 [FK/FN]	09.05-12.11							45	330	S4 021				
i-VTEC [FK/FN]	09.11-02.17	SSJ						70	760	S4 E08				
2.0 Type R [FK/FN]	01.07-12.11							70	760	S4 E08				
Diesel														
1.6 i-DTEC [FK/FN]	12.12-02.17							60	540	S4 024				
		SSJ	70	760	S5 A08			70	760	S4 E08				
1.7 CTDI [EU/EP]	01.02-12.05					63	610	S5 005	60	540	S4 005			



			Ah A (EN) S5A			Ah A (EN) S5			Ah A (EN) S4			Ah A (EN) S3		
			0 092 ...0			0 092 ...0			0 092 ...0			0 092 ...0		
2.2	CTDi [FK/FN]	09.05-12.11	70	760	S5 A08	77	780	S5 008	74	680	S4 008			
	i-DTEC [FK/FN]	09.11-12.13	SSJ						70	760	S4 E08			
Civic Hybrid														
1.3	[ES]	01.02-12.05							45	330	S4 023			
	[FD]	01.06-12.10							40	330	S4 018			
Civic Sedan														
1.4/ 1.5/ 1.6/ 1.7	, i, i 16V	10.95-12.06							45	330	S4 023			
	[EJ; EJ/EK; EK; ES]													
1.6	[FB]	09.11-08.13							45	330	S4 022			
	i VTEC [FD6]	06.06-08.10							45	330	S4 021			
1.8	[FD]	10.08-12.11							45	330	S4 020			
	i [FD]	09.05-08.10							45	330	S4 021			
	i-VTEC [FB]	09.11-12.15							45	330	S4 021			
Civic Tourer														
1.8	i-VTEC [FK]	12.13-12.17							60	540	S4 024			
			SSJ	60	680	S5 A05			60	640	S4 E05			
Diesel														
1.6	i-DTEC [FK]	12.13-12.17							60	540	S4 024			
			SSJ	70	760	S5 A08			70	760	S4 E08			
Civic Type R Hatchback														
2.0	Ti-VTEC [FK/FN]	08.15-02.17	60	680	S5 A05				60	640	S4 E05			
Civic Sedan														
1.4	i 16V [EJ]	10.95-10.98							45	330	S4 023			
Crosstour														
3.5	i-VTEC 4WD	09.12→							70	630	S4 026			
									72	760	S4 E41			
CR-V														
2.0	[RE]	01.07-04.13	SSJ				77	780	S5 008	74	680	S4 008		
			SSJ	60	680	S5 A05			60	640	S4 E05			
	i [RM]	11.11-08.16	SSJ				77	780	S5 008	74	680	S4 008		
		11.11-08.17	SSJ	60	680	S5 A05			60	640	S4 E05			
		01.12-08.17					77	780	S5 008	74	680	S4 008		
	i 4WD [KL]	07.03-10.04							45	330	S4 021			
	i 4WD [RD]	07.02-09.06							45	330	S4 021			
	i 4WD [RE]	09.06-12.12					54	530	S5 002	52	470	S4 002	45	400
	i 4x4 [RD]	09.98-08.01							45	330	S4 023			
	i 16V	08.04→	JEA						45	330	S4 021			
	i 16V 4WD	10.95-01.99							45	330	S4 021			
		02.99-12.01	JEA						45	330	S4 021			
	i 16V 4WD [RD]	10.95-07.02							45	330	S4 021			
	i-VTEC [RE]	10.12-12.18		60	680	S5 A05	77	780	S5 008	60	640	S4 E05		
				60	680	S5 A05	77	780	S5 008	74	680	S4 008		
	i-VTEC 4WD [RE]	10.12-12.18					77	780	S5 008	74	680	S4 008		
			SSJ	60	680	S5 A05			60	640	S4 E05			
2.4	[RE]	09.06-08.10					63	610	S5 005	60	540	S4 005		
	i 4WD [RD]	05.04-12.05					63	610	S5 005	60	540	S4 005		
	i 4WD [RM]	01.12-12.14							45	330	S4 021			
	i 4x4 [RD]	08.02-08.06							45	330	S4 021			
	i-VTEC 4x4 [RM]	09.14-12.16							60	540	S4 024			
									60	640	S4 E05			
	4WD [RM]	01.12-12.14							60	540	S4 025			
	4x4 [RE]	09.06-08.11					54	530	S5 002	52	470	S4 002		
		09.07-12.12					63	610	S5 005	60	540	S4 005		
Diesel														
1.6	i-DTEC [RE]	09.13-12.18					77	780	S5 008	74	680	S4 008		
			SSJ						70	760	S4 E08			
	i-DTEC 4WD [RE]	03.15-12.18	SSJ	70	760	S5 A08			70	760	S4 E08			
2.2	CTDi 4x4 [RD]	02.05-09.06		70	760	S5 A08	77	780	S5 008	74	680	S4 008	70	640
	CTDi 4x4 [RE]	01.07-12.09					77	780	S5 008	74	680	S4 008		
	i-DTEC [RE]	10.12-12.14					77	780	S5 008	74	680	S4 008		
			SSJ	70	760	S5 A08			70	760	S4 E08			
	i-DTEC 4x4 [RE]	01.10-12.12					77	780	S5 008	74	680	S4 008		



			Ah A (EN) S5A			Ah A (EN) S5			Ah A (EN) S4			Ah A (EN) S3		
			0 092 ...0			0 092 ...0			0 092 ...0			0 092 ...0		
◀ HONDA														
CR-Z														
1.5 Hybrid [ZF]	03.10-12.12								40	330				S4 030
	09.12-02.14								40	330				S4 018
FR-V														
1.7/ 2.0 i [BE]	01.05-12.06								45	330				S4 021
1.8 [BE]	01.07-06.09								45	330				S4 023
Diesel														
2.2 CTDi [BE]	07.05-06.09		70	760	S5 A08	77	780	S5 008	74	680				S4 008
HR-V														
1.5 i-VTEC [RU]	08.15→	SSJ	60	680	S5 A05				60	640				S4 E05
1.6 i 16V, i 16V VTEC 4WD, i 16V 4WD [GH]	12.98-12.05								45	330				S4 021
Diesel														
1.6 i-DTEC [RU]	08.15-12.18	SSJ	60	680	S5 A05				60	640				S4 E05
Insight Coupé														
1.0 i [ZE]	01.00-12.06								40	330				S4 019
Insight Hatchback														
1.3 Hybrid [ZE]	03.09-02.14								40	330				S4 018
Integra														
1.8 i, i 16V	07.93-09.00								45	330				S4 021
Integra Type R														
1.8 i 16V [DC]	01.98-10.01								45	330				S4 021
2.0 i	02.02→								45	330				S4 021
Jazz														
1.2 [GE/GG]	10.08-12.15	ASB							40	330				S4 018
1.2/ 1.4 [GD]	03.02-12.08								40	330				S4 018
1.3 Hybrid [GP]	09.10-12.15		60	680	S5 A05				40	330				S4 030
			60	680	S5 A05				60	640				S4 E05
1.3/ 1.5 i-VTEC [GK]	09.15→								45	330				S4 020
1.4 [GE/GG]	10.08-12.15								40	330				S4 018
									40	330				S4 030
1.5 i	10.08→								40	330				S4 030
i 16V [GD]	01.04-09.08								45	330				S4 020
Legend														
3.5 i 4WD, i 24V [KA/HS; KB]	01.96-09.08								70	630				S4 027
3.7 i 4WD, 4WD [KB]	09.08-06.12								70	630				S4 026
Logo														
1.3 i	10.96→								45	330				S4 023
NSX														
3.5 V6 [NC]	09.16→	SSJ	70	760	S5 A08									
NSX Coupé														
3.0 i 24V [NA]	06.90-06.00								60	540				S4 024
3.2 i 24V [NA]	01.97-09.05								70	760				S4 E08
NSX-T Cabrio														
3.0 i 24V [NA]	01.95-01.05								60	540				S4 024
3.2 i 24V [NA]	01.97-09.05								70	760				S4 E08
Odyssey														
2.3 16V [RA]	03.00→								70	760				S4 E08
3.5	09.04-08.10								60	540				S4 024
Prelude														
2.0 i 16V [BB]	10.96-12.99								70	760				S4 E08
2.2 i 16V [BB]	10.92→								70	630				S4 026
i 16V 4WS [BB]	10.96-12.01								70	630				S4 026
Shuttle														
2.3 i 16V [RA]	01.98-05.01								60	540				S4 024
Stream														
1.7/ 2.0 i 16V [RN]	05.01-08.05								45	330				S4 021
2.0 i [RN]	10.00-07.06								45	330				S4 023
	12.03-07.06								45	330				S4 021
S2000														
2.0/ 2.2 i, 16V	04.99-09.09								45	330				S4 023



			Ah A (EN)	Ah A (EN)	Ah A (EN)	Ah A (EN)
			0 092 ...0	0 092 ...0	0 092 ...0	0 092 ...0

HUMMER

H3						
3.7 4WD	09.06→		60	540	S4 025	

HYUNDAI

Accent						
1.3 [LC]	05.99-09.02		54	530	S5 002	52 470 S4 002 45 400 S3 002
i	08.99→		54	530	S5 002	52 470 S4 002
i [X3]	04.94-12.99					45 300 S3 016
	07.94-07.99					45 300 S3 017
				60	540 S4 025	45 300 S3 017
1.3/ 1.5/ 1.6 i [LC]	08.99-03.06		54	530	S5 002	52 470 S4 002
1.4/ 1.6 [MC, MCT]	04.06-02.12		54	530	S5 002	52 470 S4 002 45 400 S3 002
1.5 i [X3]	04.94-04.00					45 300 S3 016
	07.94-07.99					45 300 S3 017
	09.97-12.00			60	540 S4 004	
i 16V [X3]	11.95-07.99					45 300 S3 017
1.6 [RB]	11.10→		54	530	S5 002	52 470 S4 002
Diesel						
1.5 CRDi [LC; MC, MCT]	01.02-02.12					70 630 S4 026
Accent blue						
1.4 [RB]	01.11→	60	680	S5 A05		52 470 S4 002
	03.13→					52 470 S4 002
		SSJ	60	680	S5 A05	
Diesel						
1.6 CRDi [RB]	01.11→					60 540 S4 005
		SSJ	60	680	S5 A05	
Accent Hatchback						
1.3 i [LC]	08.99-03.06		54	530	S5 002	52 470 S4 002
			54	530	S5 002	52 470 S4 002 45 400 S3 002
1.3/ 1.5 i [X3]	07.94-07.99					45 300 S3 016
1.4/ 1.6 [MC]	04.06-02.12		54	530	S5 002	52 470 S4 002 45 400 S3 002
1.5/ 1.6 i [LC]	08.99-03.06		54	530	S5 002	52 470 S4 002
Diesel						
1.5 CRDi [LC; MC, MCT]	01.02-02.12					70 630 S4 026
Atos						
0.8 i [MX]	09.97-06.01					40 330 S4 018
						95 830 S4 029
1.0 i [MX]	12.97-12.03					40 330 S4 018
Atos Prime						
1.0 i [MX]	09.99-12.03					40 330 S4 018
						95 830 S4 029
	09.06-12.11					95 830 S4 029
1.1 i [MX]	06.03-03.08					40 330 S4 018
						95 830 S4 029
Avante						
1.5 i [J2]	03.95→					60 540 S4 025 45 300 S3 017
Azera						
3.3	09.05-04.10		77	780	S5 008	74 680 S4 008
Coupé						
1.6/ 1.8/ 2.0 i [RD]	05.96-04.02					70 630 S4 026
1.6/ 2.0/ 2.7 i, i V6 [FX; GK]	07.96→					70 630 S4 026
2.0 i [GK]	10.01-08.09					60 540 S4 024
i F2 Evolution [RD]	01.99-05.99					60 540 S4 024
Creta						
1.6/ 2.0 [GS]	01.16→		54	530	S5 002	60 540 S4 024
Elantra						
1.5 i [J2]	07.96-09.00		54	530	S5 002	52 470 S4 002 45 400 S3 002
1.6 , i [HD]	01.06-09.13		54	530	S5 002	52 470 S4 002



			Ah A (EN) S5A			Ah A (EN) S5			Ah A (EN) S4			Ah A (EN) S3		
			0 092 ...0			0 092 ...0			0 092 ...0			0 092 ...0		
◀ HYUNDAI														
1.6 i 16V [J2]	05.95-05.98										45	300	S3 016	
	06.98-09.00		54	530	S5 002	52	470	S4 002	45	400	S3 002			
16V [XD]	06.00-08.06		63	610	S5 005	52	470	S4 002	45	400	S3 002			
1.6/ 1.8 [MD, UD]	02.11→					44	440	S4 001						
1.8 i 16V [J2]	05.95-09.00		63	610	S5 005	60	540	S4 005	56	480	S3 005			
1.8/ 2.0, 16V [HD; XD]	06.00-06.11		63	610	S5 005	60	540	S4 005						
Diesel														
1.6 CRDi [MD, UD]	01.14-11.15					40	330	S4 018						
						44	440	S4 001						
1.6/ 2.0 CRDi [HD; XD]	06.01-06.11					70	630	S4 027						
1.9 D [J2]	05.95-09.00					70	630	S4 026						
Elantra Hatchback														
1.6 16V [XD]	06.00-08.06		54	530	S5 002	52	470	S4 002						
1.8/ 2.0 16V [XD]	06.00-09.06		63	610	S5 005	60	540	S4 005						
Diesel														
2.0 CRDi [XD]	06.01-08.06					70	630	S4 027						
Elantra VI														
1.6 i	11.03-04.09		63	610	S5 005	60	540	S4 005	56	480	S3 005			
Galopper II														
3.0 i V6	02.97-08.01					70	630	S4 027						
Diesel														
2.5 D Turbo	02.97-09.02					95	830	S4 029						
Genesis														
3.0/ 3.8 GDI, GDI 4WD [DH]	01.14→		100	830	S5 013	95	800	S4 013						
3.8 [BH]	05.08-03.14		100	830	S5 013	95	800	S4 013						
GDI [BH]	02.11-03.14					70	630	S4 026						
Genesis Coupé														
2.0/ 3.8, GDI 24V, T, 24V [BK]	12.08-08.16					70	630	S4 026						
Getz														
1.1/ 1.3/ 1.4 [TB]	09.02-02.10		54	530	S5 002	52	470	S4 002	45	400	S3 002			
1.6 [TB]	09.02-06.09		54	530	S5 002	52	470	S4 002						
Diesel														
1.5 CRDi [TB]	05.03-06.09					70	630	S4 026						
Grand i10														
1.2 [IA]	09.13→					95	830	S4 029						
Grand Santa Fe														
3.3 4WD [NC]	08.13→		80	800	S5 A11				95	830	S4 028			
Diesel														
2.2 CRDi 4WD [NC]	08.13→								95	830	S4 028			
		SSJ	80	800	S5 A11									
Grandeur														
2.4 [HG]	03.11→		60	680	S5 A05	63	610	S5 005						
2.7/ 3.3, 24V [TG]	07.05-12.10		70	760	S5 A08	77	780	S5 008	74	680	S4 008	70	640	
3.0 i [XG]	09.98→		60	680	S5 A05	63	610	S5 005	74	680	S4 008			
Diesel														
2.2 CRDi [TG]	07.06-11.10		70	760	S5 A08	77	780	S5 008	74	680	S4 008			
Ioniq														
1.6 GDI Plug-in-Hybrid [AE]	07.17→					40	330	S4 030						
ix20														
1.4/ 1.6 [JC]	10.10→		60	680	S5 A05				52	470	S4 002			
Diesel														
1.4 CRDi [JC]	10.10→		60	680	S5 A05									
1.6 CRDi [JC]	05.11→								60	540	S4 024			
		SSJ	70	760	S5 A08				70	760	S4 E08			
ix35														
FCEV [LM, EL]	03.13-07.15					63	610	S5 005	60	540	S4 005			
1.6 GDI [LM, EL]	09.10-07.15								70	760	S4 E08			
2.0 [LM, EL]	01.10-08.13								60	540	S4 024			
GDI [LM, EL]	09.13-07.15								60	540	S4 024			
GDI 4x4 [LM, EL]	09.13-07.15								60	540	S4 024			
4x4 [LM, EL]	01.10-08.13								60	540	S4 024			
	09.13-07.15								72	760	S4 E41			



						Ah A (EN) S5A		Ah A (EN) S5		Ah A (EN) S4		Ah A (EN) S3	
						0 092 ...0		0 092 ...0		0 092 ...0		0 092 ...0	
2.4 4x4 [LM, EL]	11.10-07.15			63	610	S5 005		72	760	S4 E41			
	11.10→			63	610	S5 005		60	540	S4 005			
Diesel													
1.7 CRDi [LM, EL]	09.10-07.15							70	630	S4 026			
		SSJ		70	760	S5 A08		85	800	S4 E42			
2.0 CRDi [LM, EL]	01.10-07.15							70	630	S4 026			
								85	800	S4 E42			
								95	830	S4 029			
		SSJ		70	760	S5 A08		85	800	S4 E42			
				80	800	S5 A11		85	800	S4 E42			
CRDi 4x4 [LM, EL]	01.10-07.15							95	830	S4 029			
		SSJ		70	760	S5 A08		85	800	S4 E42			
				80	800	S5 A11		85	800	S4 E42			
ix35 Tucson													
2.0 4x4 [LM, EL]	04.10→							60	540	S4 024			
								72	760	S4 E41			
								95	830	S4 029			
ix55													
3.8 4x4 [EN]	09.08-12.12							70	630	S4 026			
Diesel													
3.0 V6 CRDi 4x4 [EN]	04.09-12.12							70	630	S4 026			
i10													
1.0 [IA]	09.13→	SSJ		60	680	S5 A05							
[PA]	10.10-09.13			60	680	S5 A05		95	830	S4 029			
		SSJ						60	640	S4 E05			
LPGi [IA]	09.13→	SSJ		60	680	S5 A05		65	650	S4 E40			
1.1 [PA]	03.08-09.10							40	330	S4 030			
	10.10-09.13							95	830	S4 029			
1.2 [IA]	09.13→			54	530	S5 002		52	470	S4 002	45	400	S3 002
[PA]	08.08-09.10							40	330	S4 030			
	10.10-09.13							95	830	S4 029			
Diesel													
1.1 CRDi [PA]	03.08-12.10							60	540	S4 024			
i20													
1.0 T-GDi [GB]	10.15→	SSJ		70	760	S5 A08							
1.0/1.4 [GB]	11.14→						54	530	S5 002	52	470	S4 002	
1.2 [GB]	11.14→			70	760	S5 A08		54	530	S5 002			
1.2/1.4/1.6 [iB; PB/PBT]	01.09→						54	530	S5 002	52	470	S4 002	
1.4 [PB, PBT]	01.11→									40	330	S4 030	
i [PB, PBT]	07.09-08.14						54	530	S5 002	52	470	S4 002	45 400 S3 002
1.25 [PB, PBT]	01.09-03.12						54	530	S5 002	52	470	S4 002	45 400 S3 002
	03.12-12.14									52	470	S4 002	
		SSJ		60	680	S5 A05							
Diesel													
1.1 CRDi [PB/PBT]	03.12-12.14						54	530	S5 002	52	470	S4 002	
		SSJ		70	760	S5 A08							
CRDi [GB]	11.14→						54	530	S5 002	52	470	S4 002	
1.4 [GB]	11.14→						63	610	S5 005	60	540	S4 005	
							63	610	S5 005	60	540	S4 024	
[PB, PBT]	03.12→						63	610	S5 005	60	540	S4 005	
							63	610	S5 005	60	540	S4 024	
		SSJ		70	760	S5 A08							
CRDi [PB/PBT]	10.08-12.14						63	610	S5 005	60	540	S4 005	
							63	610	S5 005	60	540	S4 024	
		SSJ		70	760	S5 A08							
1.6 CRDi [PB/PBT]	01.09-03.12						63	610	S5 005	60	540	S4 005	
							63	610	S5 005	60	540	S4 024	
		SSJ		70	760	S5 A08							
i20 Active													
1.0 T-GDi [GB]	01.16→			70	760	S5 A08	54	530	S5 002				
		SSJ		70	760	S5 A08							
1.4 [GB]	03.16→			70	760	S5 A08	54	530	S5 002				



		Ah A (EN) S5A			Ah A (EN) S5			Ah A (EN) S4			Ah A (EN) S3		
		0 092 ...0			0 092 ...0			0 092 ...0			0 092 ...0		
◀ HYUNDAI													
Diesel													
1.4 CRDi [GB]	01.16→	70	760	S5 A08				74	680	S4 008			
i20 Coupé													
1.0/ 1.2/ 1.4 , T-GDI [GB]	04.15→	70	760	S5 A08	54	530	S5 002						
Diesel													
1.1 CRDi [GB]	04.15→	70	760	S5 A08	54	530	S5 002						
1.4 [GB]	04.15→	70	760	S5 A08				74	680	S4 008			
i30													
1.0 GDI [PD]	12.16→	SSJ	60	680	S5 A05								
			70	760	S5 A08								
1.4 [FD/FDH]	09.07-12.11					54	530	S5 002	52	470	S4 002	45 400 S3 002	
		SSJ	60	680	S5 A05								
[GD]	12.11-01.15					54	530	S5 002	52	470	S4 002		
		SSJ	60	680	S5 A05								
			70	760	S5 A08								
	04.15-04.17		60	680	S5 A05				52	470	S4 002		
			60	680	S5 A05				60	540	S4 005		
			60	680	S5 A05				74	680	S4 008		
			70	760	S5 A08				52	470	S4 002		
		SSJ							70	760	S4 E08		
[PD]	12.16→	SSJ	60	680	S5 A05								
			70	760	S5 A08								
GDI [PD]	12.16→	SSJ	60	680	S5 A05								
			70	760	S5 A08								
LPG [FD/FDH]	03.09-12.10		60	680	S5 A05								
		SSJ	60	680	S5 A05								
1.6 [FD/FDH]	09.07-04.12					54	530	S5 002	52	470	S4 002	45 400 S3 002	
		SSJ	60	680	S5 A05								
[GD]	12.11-04.17					54	530	S5 002	52	470	S4 002		
		SSJ	60	680	S5 A05								
			70	760	S5 A08								
GDi [GD]	12.11-04.17					54	530	S5 002	52	470	S4 002		
		SSJ	60	680	S5 A05								
			70	760	S5 A08								
LPG [FD/FDH]	03.09-12.10	SSJ	60	680	S5 A05								
2.0 [FD/FDH]	09.07-04.12					54	530	S5 002	52	470	S4 002	45 400 S3 002	
Diesel													
1.4 CRDi [GD]	12.11-04.17		70	760	S5 A08								
1.6 CRDi [FD/FDH]	09.07-04.12		70	760	S5 A08	63	610	S5 005	60	540	S4 005		
	10.07-12.11		70	760	S5 A08				70	630	S4 026		
		SSJ	70	760	S5 A08								
	11.08-12.11		70	760	S5 A08				60	540	S4 024		
CRDi [GD]	12.11-04.17								60	540	S4 024		
			70	760	S5 A08								
		SSJ	60	680	S5 A05				70	760	S4 E08		
			70	760	S5 A08				70	760	S4 E08		
CRDi [PD]	12.16→	SSJ	60	680	S5 A05								
			70	760	S5 A08								
CRDi [GD]	02.16-04.17								60	540	S4 024		
		SSJ	60	680	S5 A05								
			70	760	S5 A08								
2.0 CRDi [FD/FDH]	09.07-03.11								70	630	S4 026		
i30 Coupé													
1.4 [GD]	02.13-01.15					54	530	S5 002	52	470	S4 002		
		SSJ	60	680	S5 A05								
			70	760	S5 A08								
	11.15-04.17					54	530	S5 002					
		SSJ	70	760	S5 A08								
1.6 [GD]	02.13-04.17					54	530	S5 002					
		SSJ	60	680	S5 A05								
			70	760	S5 A08								



			Ah A (EN) S5A			Ah A (EN) S5			Ah A (EN) S4			Ah A (EN) S3		
			0 092 ...0			0 092 ...0			0 092 ...0			0 092 ...0		
1.6 GDI [GD]	02.13-04.17					54	530	S5 002	52	470	S4 002			
		SSJ	60	680	S5 A05									
			70	760	S5 A08									
Diesel														
1.4 CRDi [GD]	02.13-04.17								60	540	S4 024			
		SSJ	60	680	S5 A05									
			70	760	S5 A08									
1.6 CRDi [GD]	02.13-04.17								60	540	S4 024			
									74	680	S4 008			
		SSJ	60	680	S5 A05									
			70	760	S5 A08									
CRDi [GD]	11.15-04.17								74	680	S4 008			
		SSJ	70	760	S5 A08									
i30 CW														
1.4 [FD/FDH]	08.09-09.12					54	530	S5 002	52	470	S4 002			
		SSJ	60	680	S5 A05									
[GD]	03.12-01.15					54	530	S5 002	52	470	S4 002	45	400	S3 002
	11.15-04.17					54	530	S5 002	52	470	S4 002			
		SSJ	60	680	S5 A05									
			70	760	S5 A08									
LPG [FD/FDH]	03.09-12.10													
		SSJ	60	680	S5 A05									
1.6 [FD/FDH]	03.08-09.12					54	530	S5 002	52	470	S4 002	45	400	S3 002
		SSJ	60	680	S5 A05									
[GD]	03.12-04.17					54	530	S5 002	52	470	S4 002			
		SSJ	60	680	S5 A05									
			70	760	S5 A08									
GDI [GD]	03.12-04.17					54	530	S5 002	52	470	S4 002			
		SSJ	70	760	S5 A08									
LPG [FD/FDH]	03.09-12.10					54	530	S5 002	52	470	S4 002			
		SSJ	60	680	S5 A05									
2.0 [FD/FDH]	03.08-03.11					54	530	S5 002	52	470	S4 002	45	400	S3 002
Diesel														
1.4 CRDi [GD]	03.12-04.17								60	540	S4 024			
1.6 CRDi [FD/FDH]	02.08-09.12								70	630	S4 026			
		SSJ	70	760	S5 A08									
CRDi [GD]	03.12-04.17								60	540	S4 024			
		SSJ	70	760	S5 A08				70	760	S4 E08			
CRDi [GD]	02.16-04.17								74	680	S4 008			
		SSJ	60	680	S5 A05									
			70	760	S5 A08									
2.0 CRDi [FD/FDH]	03.08-03.11								70	630	S4 026			
i40														
1.6 GDI [VF]	04.11→					70	760	S5 A08						
2.0 [VF]	11.11→								70	630	S4 026			
GDI [VF]	04.11→								70	630	S4 026			
									74	680	S4 008			
		SSJ	70	760	S5 A08									
			80	800	S5 A11									
	04.15→					80	800	S5 A11	70	630	S4 026			
Diesel														
1.7 CRDi [VF]	04.11→	SSJ	80	800	S5 A11									
i40 CW														
1.6 GDI [VF]	04.11→								70	630	S4 026			
									74	680	S4 008			
		SSJ	70	760	S5 A08									
			80	800	S5 A11									
2.0 [VF]	06.12→								70	630	S4 026			
GDI [VF]	04.11→								70	630	S4 026			
									74	680	S4 008			
		SSJ	80	800	S5 A11									
	04.15→					80	800	S5 A11	70	630	S4 026			
Diesel														
1.7 CRDi [VF]	04.11→					70	760	S5 A08						



		Ah A (EN) S5A			Ah A (EN) S5			Ah A (EN) S4			Ah A (EN) S3		
		0 092 ...0			0 092 ...0			0 092 ...0			0 092 ...0		
◀ HYUNDAI													
Lantra													
1.5 i [J2]	07.96-09.00		54	530	S5 002		52	470	S4 002		45	400	S3 002
1.6 i 16V [J2]	05.95-05.98										45	300	S3 016
	06.98-09.00		54	530	S5 002		52	470	S4 002		45	400	S3 002
1.8/ 2.0 i 16V [J2]	05.95-09.00		63	610	S5 005		60	540	S4 005		56	480	S3 005
Lantra Kombi													
1.5 i [J2]	07.96-09.00										45	300	S3 016
1.6 i [J2]	05.95-05.98										45	300	S3 016
	06.98-09.00		54	530	S5 002		52	470	S4 002		45	400	S3 002
1.8/ 2.0 i [J2]	05.95-09.00		63	610	S5 005		60	540	S4 005		56	480	S3 005
Matrix													
1.6 i [FC]	08.01-04.10		63	610	S5 005		60	540	S4 005				
	01.02-12.05		63	610	S5 005		60	540	S4 005		56	480	S3 005
1.8 i [FC]	08.01-04.10		63	610	S5 005		60	540	S4 005				
Diesel													
1.5 CRDi [FC]	07.01-04.10						70	630	S4 026				
Santa Fe													
2.0 i [SM]	04.01-12.05	60	680	S5 A05	63	610	S5 005						
2.4 [DM]	09.12→						70	630	S4 026				
							95	830	S4 028				
GDI, GDI 4WD [DM]	09.12→	60	680	S5 A05	63	610	S5 005						
i [CM]	11.09-12.12	60	680	S5 A05	63	610	S5 005						
i [SM]	02.00-12.05	60	680	S5 A05	63	610	S5 005						
	12.00→				63	610	S5 005	60	540	S4 005			
i 4x4 [CM]	11.09-12.12	60	680	S5 A05	63	610	S5 005						
i 4x4 [SM]	12.00-12.05	60	680	S5 A05	63	610	S5 005						
4WD [DM]	09.12→						70	630	S4 026				
							95	830	S4 028				
2.7 i [CM]	03.06-11.09	60	680	S5 A05	63	610	S5 005	60	540	S4 005			
i 4x4 [CM]	03.06-11.09						70	630	S4 026				
i 4x4 [SM]	09.99-12.05	60	680	S5 A05	63	610	S5 005	60	540	S4 005			
3.5 i 24V 4x4 [CM]	10.10-12.12						95	830	S4 028				
4x4 [SM]	09.02-12.05	60	680	S5 A05	63	610	S5 005	60	540	S4 005	56	480	S3 005
		60	680	S5 A05	63	610	S5 005	60	640	S4 E05	56	480	S3 005
Diesel													
2.0 CRDi [DM]	04.01-12.05	70	760	S5 A08	77	780	S5 008						
	09.12→						70	630	S4 026				
CRDi 4WD [DM]	09.12→						70	630	S4 026				
CRDi 4x4, CRDi-VGT 4x4 [SM]	01.01-12.05	70	760	S5 A08	77	780	S5 008						
2.0/ 2.2 CRDi, CRDi 4x4 [CM]	03.06-12.12						70	630	S4 026				
2.2 CRDi [DM]	09.12→						95	830	S4 028				
		SSJ	70	760	S5 A08								
CRDi 4WD [DM]	09.12→						95	830	S4 028				
		SSJ	70	760	S5 A08								
Santamo													
2.0 i	05.99-12.02						60	540	S4 025				
Sante Fe													
Diesel													
2.0 CRDi [DM]	07.13→						70	630	S4 026				
							95	830	S4 028				
		SSJ	95	850	S5 A13								
Solaris													
1.4/ 1.6 [RB]	01.11→		54	530	S5 002		52	470	S4 002				
Solaris Hatchback													
1.4/ 1.6 [RB]	01.11→		54	530	S5 002		52	470	S4 002				
Sonata													
1.8 i [Y3]	07.93-06.98		63	610	S5 006		60	540	S4 006		56	480	S3 006
i GLS [Y3]	07.96-05.98		63	610	S5 006		60	540	S4 006		56	480	S3 006
2.0 [NF]	12.05-12.07						70	630	S4 026				
	01.08-12.10						60	540	S4 024				
[YF]	09.10-08.13						70	630	S4 026				
i [EF]	03.98-03.01		63	610	S5 005		60	540	S4 005		56	480	S3 005



			Ah A (EN) S5A			Ah A (EN) S5			Ah A (EN) S4			Ah A (EN) S3		
			0 092 ...0			0 092 ...0			0 092 ...0			0 092 ...0		
2.0 i [EF]	04.01-11.04					63	610	S5 005	60	540	S4 005			
i [NF]	11.07→								60	540	S4 024			
i [Y3]	07.92-06.98					63	610	S5 006	60	540	S4 006	56	480	S3 006
	09.97→					63	610	S5 005	60	540	S4 005			
2.4 [YF]	09.10-03.14								72	760	S4 E41			
	09.10-07.15								70	630	S4 026			
GDI [YF]	09.10-05.14								70	630	S4 026			
									72	760	S4 E41			
2.4/ 2.5 i [EF]	03.98-03.01					77	780	S5 008	74	680	S4 008	70	640	S3 008
2.4/ 3.3 [NF]	08.04-12.10								70	630	S4 026			
2.7 i [EF]	04.01-01.06					63	610	S5 005	60	540	S4 005			
	10.02-07.05								70	630	S4 026			
3.0 i [Y3]	07.93-06.98								70	630	S4 027			
Diesel														
2.0 CRDi [NF]	01.06-12.10								70	630	S4 026			
Sonata V														
2.7 i [EF]	12.03-05.06					63	610	S5 005	60	540	S4 005			
Terracan														
3.5 i V6 [HP]	07.01-10.06								70	630	S4 026			
Diesel														
2.5/ 2.9 CRDi, D Turbo [HP]	02.01-10.06								70	630	S4 026			
Trajat														
2.0 i [FO]	01.00-06.07					63	610	S5 005	60	540	S4 005			
	01.04-06.07					63	610	S5 005	60	540	S4 005	56	480	S3 005
2.7 i [FO]	01.00-06.07					63	610	S5 005	60	540	S4 005	56	480	S3 005
Diesel														
2.0 CRDi [FO]	01.01-06.07								70	630	S4 026			
Tucson														
2.0 , 4WD [TL]	06.15→	SSJ	80	800	S5 A11									
i [JM]	09.04-03.10								60	540	S4 024			
i 4x4 [JM]	08.04-03.10								70	630	S4 026			
2.7 4x4 [JM]	09.04-03.10								95	830	S4 028			
Diesel														
1.7 CRDi [TL]	03.16→	SSJ	80	800	S5 A11									
2.0 CRDi [JM]	04.04→								95	830	S4 028			
	09.05-03.10								70	630	S4 026			
CRDi 4x4 [JM]	08.04-12.06								70	630	S4 026			
	09.05-03.10								95	830	S4 028			
	01.09-03.10								70	630	S4 026			
VGT CRDi [JM]	12.05→								95	830	S4 028			
Tucson														
1.6 GDI, T-GDI [TL]	06.15→	SSJ	70	760	S5 A08									
T-GDI 4WD [TL]	06.15→								60	540	S4 005			
									70	760	S4 E08			
									74	680	S4 008			
		SSJ	70	760	S5 A08									
Diesel														
1.7/ 2.0 CRDi [TL]	06.15→	SSJ	80	800	S5 A11									
2.0 CRDi 4WD [TL]	06.15→								70	630	S4 026			
									95	830	S4 028			
		SSJ	80	800	S5 A11									
Veloster														
1.6 [FS]	06.11→								54	530	S5 002			
		SSJ	60	680	S5 A05				60	640	S4 E05			
GDI, T-GDI Turbo [FS]	06.11→								54	530	S5 002	60	640	S4 E05
Veracruz D														
Diesel														
3.0 TCI-S2 AWD [EN]	09.06→								95	830	S4 028			
Verna														
1.5 i Lean Burn [LC]	07.99-03.06					54	530	S5 002	52	470	S4 002	45	400	S3 002
XG 25														
2.5 i [F]	12.98-12.05					60	680	S5 A05	63	610	S5 005	74	680	S4 008



			Ah A (EN)	Ah A (EN)	Ah A (EN)	Ah A (EN)
			0 092 ...0	0 092 ...0	0 092 ...0	0 092 ...0

◀ HYUNDAI

XG 30						
3.0 i [F]	12.98-12.05		60	680	S5 A05	63 610 S5 005 74 680 S4 008
XG 35						
3.5 i [F]	08.02-12.05					77 780 S5 008 74 680 S4 008

INFINITI

EX 30						
Diesel						
3.0 d 4x4 [J50]	04.10-06.14					85 800 S5 010 80 740 S4 010
EX 37						
3.7 4x4 [J50]	06.08-06.14					60 540 S4 024
FX 30						
Diesel						
3.0 d 4x4 [S51]	03.10-12.13					85 800 S5 010 80 740 S4 010
FX 35						
3.5 , 4x4 [S50]	12.04-12.08					60 540 S4 024
i [S50]	11.02-08.08		70	760	S5 A08	70 650 S4 E08
			70	760	S5 A08	77 780 S5 008
FX 37						
3.7 4x4 [S51]	07.08-12.13					60 540 S4 024
						72 760 S4 E41
FX 45						
4.5 4x4 [S50]	07.06-08.08	BWD				70 630 S4 027
FX 50						
5.0 4x4 [S51]	07.08-12.14					70 630 S4 026
G 25						
25 [V36]	01.10-06.14					70 630 S4 026
G 37						
3.7 , 4x4 [V36]	07.08-06.14					60 540 S4 024
G 37 Cabrio						
3.7 [HV36]	06.09-12.15					60 540 S4 024
						72 760 S4 E41
G 37 Coupé						
3.7 [CV36]	10.07-12.15					60 540 S4 024
M 25						
2.5 [Y51]	07.10-12.13					70 630 S4 026
						72 760 S4 E41
M 30						
Diesel						
3.0 d [Y51]	07.10-12.13					85 800 S5 010 80 740 S4 010
M 35						
3.5 [Y50]	09.05-08.08					60 540 S4 024
h [Y51]	01.11-12.13					70 630 S4 026
M 37						
3.7 [Y51]	05.10-12.13					70 630 S4 026
4x4 [Y51]	05.10-12.13					70 630 S4 026
						72 760 S4 E41
M 56						
5.6 [Y51]	07.10-06.14					70 630 S4 026
						72 760 S4 E41
Q 30						
1.6/ 2.0 , AWD [H15E]	11.15→	SSJ	70	760	S5 A08	
Diesel						
1.5/ 2.2 , CDi, CDi AWD [H15E]	11.15→	SSJ	80	800	S5 A11	
Q 50						
2.0 [V37]	05.14→					60 540 S4 024
3.0 s [V37]	12.16→					70 630 S4 026
						72 760 S4 E41
3.5 Hybrid [HV37]	07.13→					70 630 S4 026
						72 760 S4 E41



				Ah A (EN) S5A		Ah A (EN) S5		Ah A (EN) S4		Ah A (EN) S3	
				0 092 ...0		0 092 ...0		0 092 ...0		0 092 ...0	
3.5 Hybrid AWD [HV37]	07.13→					70	630	S4 026			
						72	760	S4 E41			
Diesel											
2.2 CDi [V37]	07.13-12.18					70	630	S4 026			
		SSJ				72	760	S4 E41			
Q 60 Cabrio											
3.7	09.13-08.16					60	540	S4 024			
Q 60 Coupé											
2.0 T	08.16→					60	540	S4 024			
						65	650	S4 E40			
3.0	08.16→					60	540	S4 024			
						65	650	S4 E40			
3.7	09.13-08.16					60	540	S4 024			
						65	650	S4 E40			
Q 70											
3.5 Hybrid [Y51]	10.13→					70	630	S4 026			
		SSJ				72	760	S4 E41			
3.7 [Y51]	10.13→					70	630	S4 026			
		SSJ				72	760	S4 E41			
Diesel											
2.1 CDi [Y51]	10.14→					70	630	S4 026			
		SSJ				72	760	S4 E41			
3.0 CDi [Y51]	10.13-12.15					70	630	S4 026			
QX 30											
2.0 4x4	12.16→	SSJ	70	760	S5 A08						
Diesel											
2.2 4x4	12.16→	SSJ	80	800	S5 A11						
QX 50											
3.7 4x4 [J50]	10.13→					70	630	S4 026			
						72	760	S4 E41			
Diesel											
3.0 4x4 [J50]	10.13→					70	630	S4 026			
QX 70											
3.7 AWD [S51]	11.13→					60	540	S4 024			
						72	760	S4 E41			
5.0 AWD [S51]	11.13→					70	630	S4 026			
Diesel											
3.0 CDi AWD [S51]	11.13-12.16					70	630	S4 026			

INNOCENTI (NUOVA INNOCENTI)

Koral

1.3/ 45/ 55 , Cabrio	10.90-12.01					45	400	S3 003			
----------------------	-------------	--	--	--	--	----	-----	--------	--	--	--

IRAN KHODRO (IKCO)

Samand

1.8 i	07.01→					74	680	S4 008	70	640	S3 008
-------	--------	--	--	--	--	----	-----	--------	----	-----	--------

ISUZU

Trooper

3.2/ 3.5 i 4WD, i 24V 4WD [UB]	04.92-09.04					95	830	S4 029			
--------------------------------	-------------	--	--	--	--	----	-----	--------	--	--	--

Diesel

3.0 D Turbo 4WD [UB]	04.00-08.03					95	830	S4 029			
----------------------	-------------	--	--	--	--	----	-----	--------	--	--	--

			Ah A (EN)	Ah A (EN)	Ah A (EN)	Ah A (EN)
			0 092 ...0	0 092 ...0	0 092 ...0	0 092 ...0

IVECO

Massif										
Diesel										
3.0 D	06.08-12.12				100	830	S5 013	95	800	S4 013

JAGUAR

Daimler											
4.0	09.89-10.99				100	830	S5 013	95	800	S4 013	
	09.94-10.98		95	850	S5 A13	100	830	S5 013	95	800	S4 013
	Kompressor, 32V	09.97-08.03	95	850	S5 A13	100	830	S5 013			
5.3 HE	07.91-10.99							70	630	S4 027	
F-Pace											
2.0/ 3.0/ 25t/ 35t AWD, S AWD [X761]	04.16→	SSJ	95	850	S5 A13						
Diesel											
E-Performance/ 2.0/ 3.0, D AWD, TDV6 AWD [X761]	04.16→	SSJ	95	850	S5 A13						
F-Type Cabriolet											
3.0 V6 [X152]	10.12→		95	850	S5 A13						
F-Type Coupé											
3.0 V6	10.13→		95	850	S5 A13						
F-Type R Cabriolet											
5.0 V8, V8 AWD [X152]	10.13→		95	850	S5 A13						
F-Type R Coupé											
5.0 V8, V8 AWD	10.13→		95	850	S5 A13						
F-Type S Cabriolet											
3.0/ 5.0 V6, V6 AWD, V8 [C152; X152]	10.12→		95	850	S5 A13						
F-Type S Coupé											
3.0 V6, V6 AWD	10.13→		95	850	S5 A13						
F-Type SVR / Project 7											
5.0 AWD [X152]	12.14→		95	850	S5 A13						
F-Type SVR Project 7 Coupé											
5.0 V8 AWD	12.15→		95	850	S5 A13						
F-Type 400 Sport Cabriolet											
3.0 V6 [X152]	02.17→		95	850	S5 A13						
F-Type 400 Sport Coupé											
3.0 V6, V6 AWD	02.17→		95	850	S5 A13						
Sovereign											
3.2 24V	09.90-08.99		70	760	S5 A08	77	780	S5 008	74	680	S4 008
4.0, 32V	09.89-08.02		70	760	S5 A08	77	780	S5 008	74	680	S4 008
									70	640	S3 008
S-Type											
2.5/ 3.0/ 4.0/ 4.2 V8 32V, 24V, 32V	10.98-03.08		95	850	S5 A13	100	830	S5 013	95	800	S4 013
									90	720	S3 013
Diesel											
2.7 D	06.04-03.08		95	850	S5 A13	100	830	S5 013	95	800	S4 013
									90	720	S3 013
XE											
3.0/ 20t/ 25t, S	06.15→	SSJ	95	850	S5 A13						
Diesel											
2.0 E-performance	06.15→	SSJ	80	800	S5 A11						
			95	850	S5 A13						
20d	06.15→	SSJ	80	800	S5 A11						
			95	850	S5 A13						
	AWD	10.15→	SSJ	80	800	S5 A11					
			95	850	S5 A13						
XF											
2.0 EcoBoost [X351]	08.12→		95	850	S5 A13						
2.0/ 3.0 EcoBoost, V6 AWD, V6 Supercharged [X250]	03.12-10.15	SSJ	95	850	S5 A13						



			Ah A (EN) S5A			Ah A (EN) S5			Ah A (EN) S4			Ah A (EN) S3		
			0 092 ...0			0 092 ...0			0 092 ...0			0 092 ...0		
3.0 S [X260]	10.15→	SSJ	80	800	S5 A11									
			95	850	S5 A13									
S AWD [X260]	10.15→		80	800	S5 A11									
			95	850	S5 A13									
3.0/ 4.2/ 5.0 Supercharged, V6, V8 [X250]	03.08-10.15		95	850	S5 A13	100	830	S5 013	95	800	S4 013			
35t [X260]	10.15→	SSJ	80	800	S5 A11									
			95	850	S5 A13									
AWD [X260]	10.15→		80	800	S5 A11									
			95	850	S5 A13									
Diesel														
2.0 E-Performance [X260]	10.15→	SSJ	80	800	S5 A11									
			95	850	S5 A13									
2.2 D [X250]	09.11-10.15		80	800	S5 A11									
		SSJ				85	800	S5 010						
2.7 D [X250]	03.08-02.09		95	850	S5 A13	100	830	S5 013	95	800	S4 013			
3.0 D [X250]	03.09-08.11		95	850	S5 A13	100	830	S5 013						
D V6, D V6S [X250]	03.09-10.15		95	850	S5 A13	100	830	S5 013	95	800	S4 013			
20d [X260]	10.15→	SSJ	80	800	S5 A11									
			95	850	S5 A13									
AWD [X260]	03.16→		80	800	S5 A11									
			95	850	S5 A13									
30d [X260]	10.15→		80	800	S5 A11									
			95	850	S5 A13									
XF Sportbrake														
Diesel														
2.2 D	09.12-04.14		80	800	S5 A11									
3.0 D	09.12-04.14					85	800	S5 010						
		SSJ	95	850	S5 A13									
			95	850	S5 A13				70	650	S4 E10			
20d [X260]	07.17→		80	800	S5 A11									
			95	850	S5 A13									
XFR-S Sportbrake														
5.0 V8	02.14-06.17					100	830	S5 013						
		BWD	95	850	S5 A13									
XJ														
2.5 [X350]	03.03-03.05		70	760	S5 A08	77	780	S5 008	74	680	S4 008			
3.0 V6 [X351]	08.11→		95	850	S5 A13	100	830	S5 013						
V6 Supercharged, V6 Supercharged AWD [X351]	08.12→	SSJ	95	850	S5 A13									
3.0/ 3.5/ 4.2 V6 24V, V8 32V, V8 32V Supercharged [X350]	03.03-07.10		70	760	S5 A08	77	780	S5 008	74	680	S4 008	70	640	S3 008
3.2 V8 32V [X308]	09.97-08.02		70	760	S5 A08	77	780	S5 008	74	680	S4 008	70	640	S3 008
4.0 V8 32V [X308]	09.97-08.02		95	850	S5 A13	100	830	S5 013						
5.0 V8, V8 Supercharged [X351]	11.09→		95	850	S5 A13									
Diesel														
2.7 D V6 [X350]	10.05-07.10		70	760	S5 A08	77	780	S5 008	74	680	S4 008	70	640	S3 008
3.0 D V6 [X351]	08.10-07.15		95	850	S5 A13									
D V6 S [X351]	04.15→								95	800	S4 013			
		SSJ	95	850	S5 A13									
XJ 6														
3.2/ 4.0 V6, V6 Supercharged, V6 24V, V6 24V Supercharged [X300]	09.94-12.98		70	760	S5 A08	77	780	S5 008	74	680	S4 008	70	640	S3 008
XJ 12														
6.0	10.93-12.99		70	760	S5 A08	77	780	S5 008	74	680	S4 008	70	640	S3 008
XJR Convertible														
4.2 32V S/C [X300]	03.03-03.09		70	760	S5 A08	77	780	S5 008	74	680	S4 008	70	640	S3 008
XJR Coupé														
4.2 32V S/C [X300]	03.03-03.09		70	760	S5 A08	77	780	S5 008	74	680	S4 008	70	640	S3 008



			Ah A (EN) S5A			Ah A (EN) S5			Ah A (EN) S4			Ah A (EN) S3		
			0 092 ...0			0 092 ...0			0 092 ...0			0 092 ...0		
JAGUAR														
XJR 8														
4.0 V8 32V Supercharged [X308]	09.97-09.03	95	850	S5 A13	100	830	S5 013							
XK Convertible														
3.5/ 4.2 AWD, 32V [X150]	03.06-02.09	95	850	S5 A13	100	830	S5 013	95	800	S4 013	90	720	S3 013	
4.2 R 32V [X150]	03.06-02.09	95	850	S5 A13										
5.0 [X150]	02.09-07.14	95	850	S5 A13	100	830	S5 013	95	800	S4 013				
		95	850	S5 A13	100	830	S5 013	95	800	S4 013	90	720	S3 013	
XK Coupé														
3.5 [X150]	07.07-02.09	95	850	S5 A13	100	830	S5 013	95	800	S4 013	90	720	S3 013	
4.2 32V [X150]	03.06-02.09	95	850	S5 A13	100	830	S5 013							
5.0 [X150]	02.09-→	95	850	S5 A13	100	830	S5 013	95	800	S4 013				
XK 8 Convertible														
4.0 32V [X100]	03.96-09.02	95	850	S5 A13	100	830	S5 013	95	800	S4 013				
4.2 32V [X100]	03.03-02.06	95	850	S5 A13	100	830	S5 013	95	800	S4 013	90	720	S3 013	
XK 8 Coupé														
4.0 32V [X100]	03.96-09.02	95	850	S5 A13	100	830	S5 013	95	800	S4 013				
4.2 32V [X100]	03.03-02.06	95	850	S5 A13	100	830	S5 013	95	800	S4 013	90	720	S3 013	
XKR Convertible														
4.0 32V [X100]	03.98-09.02	95	850	S5 A13	100	830	S5 013	95	800	S4 013	90	720	S3 013	
4.2 32V [X100]	03.03-02.06	95	850	S5 A13	100	830	S5 013	95	800	S4 013	90	720	S3 013	
5.0 [X150]	02.09-07.15	95	850	S5 A13	100	830	S5 013	95	800	S4 013	90	720	S3 013	
S [X150]	01.11-07.14	95	850	S5 A13	100	830	S5 013	95	800	S4 013				
XKR Coupé														
4.0 32V [X100]	03.98-09.02	95	850	S5 A13	100	830	S5 013	95	800	S4 013	90	720	S3 013	
4.2 32V [X100]	03.03-02.07	95	850	S5 A13	100	830	S5 013	95	800	S4 013	90	720	S3 013	
32V [X150]	03.06-02.09	95	850	S5 A13	100	830	S5 013	95	800	S4 013	90	720	S3 013	
		95	850	S5 A13	100	830	S5 013	95	800	S4 013	90	720	S3 013	
5.0 [X150]	01.09-→	95	850	S5 A13	100	830	S5 013	95	800	S4 013	90	720	S3 013	
	09.10-→	95	850	S5 A13										
S [X150]	01.11-→	95	850	S5 A13										
X-Type														
2.0/ 2.5/ 3.0	03.01-06.10	70	760	S5 A08	77	780	S5 008	74	680	S4 008	70	640	S3 008	
Diesel														
2.0 D	09.03-10.05	70	760	S5 A08	77	780	S5 008	74	680	S4 008	70	640	S3 008	
2.2 D	09.05-11.09	70	760	S5 A08	77	780	S5 008	80	740	S4 010				
X-Type Estate														
2.0/ 2.5/ 3.0 ,AWD	03.03-12.09	70	760	S5 A08	77	780	S5 008	74	680	S4 008	70	640	S3 008	
Diesel														
2.0/ 2.2 D	09.03-12.09	70	760	S5 A08	77	780	S5 008	80	740	S4 010				



JEEP													
Cherokee													
2.4 4x4 [KJ]	03.01-12.07							74	680	S4 008	70	640	S3 008
3.2 4x4 [KL]	01.14-→	105	950	S5 A15	110	920	S5 015						
3.7 [KK]	01.08-12.13							95	830	S4 029			
4x4 [KJ]	03.01-12.07							70	630	S4 026			
4x4 [KK]	01.08-12.13				85	800	S5 010	80	740	S4 010			
Diesel													
2.0 JTD, JTD 4x4 [KL]	01.14-08.18	105	950	S5 A15	110	920	S5 015						
2.2 CRD 4x4 [KL]	08.15-→	80	800	S5 A11				80	740	S4 011			
2.5/ 2.8 CRD 4x4 [KJ]	03.01-12.07							74	680	S4 009			
2.8 CRD 4x4 [KK]	01.08-12.13							95	830	S4 029			
					77	780	S5 008	95	830	S4 029			
Commander													
4.7/ 5.7 4x4 [XH]	01.06-08.11	70	760	S5 A08	77	780	S5 008	74	680	S4 008			
Diesel													
3.0 CRD 4x4 [XH]	01.06-08.11				100	830	S5 013						
Compass													
2.0 [PK]	05.11-12.17				77	780	S5 008	74	680	S4 008			
2.4 [MK]	10.06-12.17				61	600	S5 004	60	540	S4 004			

						Ah A (EN)		Ah A (EN)		Ah A (EN)		Ah A (EN)	
				0 092 ...0		0 092 ...0		0 092 ...0		0 092 ...0			
2.4 4x4 [MK]	10.06-12.17			63	610	S5 006		60	540	S4 006			
Diesel													
2.0 CRD, CRD 4x4 [MK]	10.06-12.17			61	600	S5 004		60	540	S4 004			
2.2 CRD 4x4 [PK]	01.11-12.17			100	830	S5 013							
Grand Cherokee													
3.6 VVT [WK2]	10.10→			85	800	S5 010		80	740	S4 010			
3.7 [WK]	09.04-09.10		70 760	S5 A08		77 780	S5 008	74	680	S4 008			
3.7/ 4.7/ 5.7 4x4 [WK]	09.03→			85	800	S5 010		80	740	S4 010			
4.0/ 4.7 , 4x4 [WJ]	09.98-09.04		70 760	S5 A08		77 780	S5 008	74	680	S4 008			
i, i 4x4 [; WG]	09.00-03.07		70 760	S5 A08		77 780	S5 008	74	680	S4 008			
4.0/ 5.2/ 5.9 , i [ZG; ZJ]	09.92-04.99							70	630	S4 027			
4.7 [WK]	08.04-09.10			85	800	S5 010		80	740	S4 010			
i [WG]	09.00-12.04			85	800	S5 010		70	650	S4 E10			
				85	800	S5 010		80	740	S4 010			
i Overland [WG]	10.01-12.04			85	800	S5 010		70	650	S4 E10			
				85	800	S5 010		80	740	S4 010			
4.7/ 5.7 V8, V8 4x4 [WH]	03.05-09.10		70 760	S5 A08		77 780	S5 008	74	680	S4 008			
4.7/ 6.1 FFV, SRT-8 4x4 [WK]	01.06→		70 760	S5 A08		77 780	S5 008	74	680	S4 008			
5.7 [WK]	09.04-09.10			85	800	S5 010		80	740	S4 010			
	09.08-08.09		70 760	S5 A08		77 780	S5 008	74	680	S4 008			
Hemi [WK2]	10.10→			85	800	S5 011		80	740	S4 010			
				85	800	S5 011		80	740	S4 011			
6.1 SRT-8 4x4 [WH]	01.06-09.10		70 760	S5 A08		77 780	S5 008	74	680	S4 008			
			70 760	S5 A08		77 780	S5 008	80	740	S4 010			
			70 760	S5 A08		85 800	S5 010	74	680	S4 008			
6.4 SRT8 4x4 [WK2]	07.11→			100	830	S5 013		95	800	S4 013			
Diesel													
2.5 TD [ZG]	01.96-04.99	VAD				74 750	S5 007	72	680	S4 007	70	640	S3 007
2.7 CRD [WG]	10.01-12.04	VAD	95	850	S5 A13	100	830	S5 013	95	800	S4 013		
3.0 CRD [WH]	03.05-10.11		95	850	S5 A13	100	830	S5 013					
CRDi 4x4 [WK2]	04.11→					100	830	S5 013	95	800	S4 013		
			95	850	S5 A13	100	830	S5 013	95	800	S4 013		
3.1 TD [WG]	09.00-12.02							74	680	S4 009			
TD [WJ]	01.99-12.00							60	540	S4 005			
Liberty													
3.7 [KK]	09.07-08.13							80	740	S4 010			
Patriot													
2.0 [MK]	01.11-08.18			63	610	S5 005		60	540	S4 005			
2.4 [MK]	09.06-08.08							74	680	S4 009			
4x4 [MK]	10.06-08.18							74	680	S4 009			
Diesel													
2.0 CRD [MK]	10.06-12.09			63	610	S5 006							
CRD 4x4 [MK]	10.06-12.09			63	610	S5 006							
2.2 CRD 4x4 [MK]	09.10-12.14							60	540	S4 006			
	11.10-12.14			74	750	S5 007		70	650	S4 E07			
				74	750	S5 007		72	680	S4 007			
Renegade													
1.4/ 1.6 E-torQ, MultiAir, MultiAir 4x4	07.14→	SSJ	60	680	S5 A05			60	640	S4 E05			
Diesel													
1.6 MultiJet	07.14→	SSJ	60	680	S5 A05			70	760	S4 E08			
	08.18→		60	680	S5 A05			70	760	S4 E08			
2.0 MultiJet 4x4	07.14→	SSJ	70	760	S5 A08			80	800	S4 E11			
			80	800	S5 A11			80	800	S4 E11			
	08.18→		80	800	S5 A11			80	800	S4 E11			
Wrangler													
2.4/ 2.5/ 4.0 [TJ]	09.96-12.07			63	610	S5 006		60	540	S4 006			
3.6 4x4 [JK]	10.11-08.19							74	680	S4 009			
3.8 4x4 [JK]	01.07-12.11							70	630	S4 027			
Diesel													
2.8 CRD [JK]	01.07-08.18		95	850	S5 A13								



			Ah A (EN)	Ah A (EN)	Ah A (EN)	Ah A (EN)
			0 092 ...0	0 092 ...0	0 092 ...0	0 092 ...0

JENSEN

S Cabrio						
4.6 V8	10.98→				70 630	S4 027
S Coupé						
4.6 V8	10.00→				70 630	S4 027

KIA

Avella						
1.3 [FV]	03.94-10.99				45 330	S4 021
Carens						
1.6 GDI [RP]	01.13→				63 610	S5 005
		SSJ	70 760	S5 A08	60 540	S4 005
1.6/ 1.8/ 2.0 i [FJ]	09.02-08.06				63 610	S5 005
1.6/ 2.0 , CVT [UN]	09.06-12.12				63 610	S5 005
1.8 i [FC]	04.99-05.02				63 610	S5 005
2.0 GDI [RP]	01.13→				63 610	S5 005
					60 540	S4 005
					56 480	S3 005
Diesel						
1.6 CRDi [UN]	09.10-12.12				63 610	S5 005
			60 680	S5 A05	63 610	S5 005
			60 680	S5 A05	63 610	S5 005
					60 640	S4 E05
					56 480	S3 005
1.7 CRDi [RP]	01.13→				70 630	S4 026
		SSJ	70 760	S5 A08		
2.0 CRDi [UN]	09.06-08.10				70 630	S4 026
CRDi, CRDi VGT [FJ]	04.02-08.06				70 630	S4 026
CRDi VGT [UN]	09.06-12.12				70 630	S4 026
Carnival						
2.5 i V6 [II]	10.01-12.05				45 330	S4 021
					60 540	S4 005
V6 [UP]	06.98-06.06				70 630	S4 026
2.7 V6 [MB]	04.06-12.12				60 540	S4 005
Diesel						
2.2/ 2.9 CRDi, D Turbo [MB; UP]	06.98-12.12				95 830	S4 028
Cee'd						
1.4 [ED/FF2]	11.06-08.09	BWD,SSJ	60 680	S5 A05		
	11.06-12.12				60 540	S4 005
	09.09-12.12	SSJ	60 680	S5 A05		
	01.11-12.12				60 540	S4 024
		SSJ			45 330	S4 021
		SSJ	60 680	S5 A05	60 640	S4 E05
[JD]	05.12→				60 640	S4 E05
	07.15→	SSJ	60 680	S5 A05	60 640	S4 E05
1.6 [ED/FF2]	11.06-01.08	SSJ	60 680	S5 A05		
	11.06-12.12				60 540	S4 005
	02.08-12.12	BWD,SSJ	60 680	S5 A05		
GDi [JD]	05.12→				60 540	S4 005
					60 540	S4 024
		SSJ	60 680	S5 A05		
			70 760	S5 A08		
2.0 [ED/FF2]	11.06-12.12				60 540	S4 005
Diesel						
1.4 CRDi [JD]	05.12→				60 540	S4 005
		SSJ			70 760	S4 E08
1.6 CRDi [ED/FF2]	11.06-12.12				60 540	S4 005
		SSJ	70 760	S5 A08		
	09.10-12.12				60 540	S4 024
		SSJ	70 760	S5 A08	70 760	S4 E08



						Ah A (EN) S5A		Ah A (EN) S5		Ah A (EN) S4		Ah A (EN) S3	
				0 092 ...0		0 092 ...0		0 092 ...0		0 092 ...0			
1.6 CRDi [JD]	05.12→			60	540	S4 005							
		70	760	S5 A08	60	540	S4 005						
		SSJ		70	760	S4 E08							
	07.15→			74	680	S4 008							
		SSJ	70	760	S5 A08								
2.0 CRDi [ED/FF2]	09.07-12.12			60	540	S4 005							
Cee'd GT													
1.0 GDI [JD]	07.15→	SSJ	60	680	S5 A05								
1.6 GDI [JD]	10.13→			77	780	S5 008	60	540	S4 005	45	400	S3 002	
		SSJ	70	760	S5 A08		70	760	S4 E08				
Cee'd Sporty Wagon													
1.4 [ED/FF2]	09.07-12.12			60	540	S4 005							
		SSJ	60	680	S5 A05								
	01.11-12.12			60	540	S4 024							
		SSJ		45	330	S4 021							
		SSJ	60	680	S5 A05		60	640	S4 E05				
[JD]	08.12→			60	540	S4 005							
		SSJ		70	760	S4 E08							
	07.15→			54	530	S5 002							
		SSJ	60	680	S5 A05								
			70	760	S5 A08								
1.6 [ED/FF2]	09.07-12.12			60	540	S4 005							
		BWD,SSJ	60	680	S5 A05								
[JD]	08.12→			60	540	S4 005							
			70	760	S5 A08								
2.0 [ED/FF2]	09.07-12.12			60	540	S4 005							
Diesel													
1.4 CRDi [JD]	08.12→		70	760	S5 A08		70	630	S4 026				
1.6 CRDi [ED/FF2]	09.07-12.12			60	540	S4 005							
			70	760	S5 A08		60	540	S4 005				
		SSJ	70	760	S5 A08								
	09.10-12.12			60	540	S4 024							
		SSJ	70	760	S5 A08		70	760	S4 E08				
CRDi [JD]	08.12→			70	630	S4 026							
			70	760	S5 A08		70	630	S4 026				
		SSJ	60	680	S5 A05								
			70	760	S5 A08								
	07.15→			74	680	S4 008							
2.0 CRDi [ED/FF2]	09.07-12.12			60	540	S4 005							
Cee'd Sporty Wagon GT													
1.0 GDI [JD]	07.15→	SSJ	60	680	S5 A05								
			70	760	S5 A08								
Cerato													
1.6 [TD]	08.10-12.16			63	610	S5 005	60	540	S4 005				
i [FE]	04.04-11.09			54	530	S5 002	52	470	S4 002				
	05.06-11.09			63	610	S5 005	60	540	S4 005	56	480	S3 005	
2.0 [TD]	12.08-12.16			63	610	S5 005	45	330	S4 021				
				63	610	S5 005	60	540	S4 005				
i [FE]	04.04-11.09			63	610	S5 005	60	540	S4 005	56	480	S3 005	
Diesel													
1.5/ 1.6/ 2.0 CRDi [FE]	04.04-11.09			70	630	S4 026							
Cerato Hatchback													
1.6/ 2.0, i [FE]	04.04-11.09			63	610	S5 005	60	540	S4 005	56	480	S3 005	
Diesel													
1.5/ 1.6/ 2.0 CRDi [FE]	04.04-11.09			70	630	S4 026							
Cerato Koup													
1.6 [TD]	08.10-12.16			63	610	S5 005	60	540	S4 005	56	480	S3 005	
	08.10→			63	610	S5 005	60	540	S4 005				
2.0 [TD]	08.10-12.16			63	610	S5 005	60	540	S4 005				
Clarus													
1.8/ 2.0i 16V [GC]	05.96-11.01			45	330	S4 021							
Clarus Kombi													
1.8/ 2.0i [GC]	06.98-11.01			45	330	S4 021							



K

			Ah A (EN) S5A			Ah A (EN) S5			Ah A (EN) S4			Ah A (EN) S3			
			0 092 ...0			0 092 ...0			0 092 ...0			0 092 ...0			
◀ KIA															
Joice															
2.0 i [MT]	08.99-03.03														
						70	630						S4 027		
Magentis															
2.0 [GE]	07.08-04.10												S4 027		
i [GD]	09.00-12.05				63	610		S5 005		60	540		S4 005		
i [GE]	02.06-08.08				63	610		S5 005		60	540		S4 005		
2.5 i [GD]	09.00-12.05		60	680	S5 A05	63	610	S5 005		60	540	S4 005	56	480	S3 005
			60	680	S5 A05	63	610	S5 005		60	640	S4 E05	56	480	S3 005
2.7 [GE]	09.06-08.08					63	610	S5 005		60	540		S4 005		
	07.08-04.10									70	630		S4 027		
Diesel															
2.0 CRDi [GE]	02.06-08.08									70	630		S4 026		
	07.08-04.10									95	830		S4 028		
Mohave															
3.8	01.09-12.16									95	830		S4 028		
Diesel															
3.0 CRDi	01.09-12.16									95	830		S4 028		
Niro															
1.6 GDi Hybrid, GDI Plug In Hybrid [DE]	10.16→									52	470	S4 002	45	400	S3 003
Opirus															
3.5 i [LD]	09.03→									95	830		S4 029		
i V6 [LD]	09.03→									70	630		S4 026		
3.8 i [LD]	03.07-07.09									70	630		S4 026		
Optima															
2.0 [JF]	07.16→		80	800	S5 A11										
	11.16→									60	540		S4 024		
										72	760		S4 E41		
[TF]	03.12→									45	330		S4 021		
										60	540		S4 005		
GDI [JF]	07.16→		80	800	S5 A11										
Hybrid [TFE]	10.12→									60	540		S4 005		
2.4 [TF]	03.12→									60	540		S4 005		
										60	540		S4 024		
Diesel															
1.7 CRDi [JF]	07.16→		80	800	S5 A11										
CRDi [TF]	09.11→		70	760	S5 A08										
Picanto															
1.0 [TA]	05.11→		60	680	S5 A05					40	330		S4 030		
										60	640		S4 E05		
Bi-Fuel [TA]	05.11→									40	330		S4 018		
										60	640		S4 E05		
i [SA]	05.04-01.11									40	330		S4 018		
										40	330		S4 030		
1.1 i [SA]	05.04-01.11									40	330		S4 030		
1.2 [TA]	05.11→									70	650		S4 E07		
						SSJ	70	760	S5 A08						
Diesel															
1.1 CRDi [SA]	11.05-01.11									60	540		S4 005		
Pride															
1.1/1.3 i [DA]	05.90-02.00									60	540		S4 005		
Pro Cee'd															
1.4 [ED]	10.07-12.12		60	680	S5 A05					60	540		S4 024		
										60	640		S4 E05		
	09.09-12.12		60	680	S5 A05					60	540		S4 005		
			60	680	S5 A05					60	540		S4 005		
[JD]	01.13→									60	540		S4 005		
										70	760		S4 E08		
	07.15→		60	680	S5 A05										
			70	760	S5 A08										
1.6 [ED]	03.08-12.12									60	540		S4 005		
						SSJ	60	680	S5 A05						



											Ah A (EN)			Ah A (EN)			Ah A (EN)			Ah A (EN)		
					0 092 ...0			0 092 ...0			0 092 ...0			0 092 ...0								
1.6 GDI [JD]	01.13→							60	540	S4 005												
		SSJ						70	760	S4 E08												
	04.13→							60	540	S4 024												
2.0 [ED]	03.08-12.12		60	680	S5 A05																	
			70	760	S5 A08				60	540	S4 024											
		SSJ							70	760	S4 E08											
Diesel																						
1.4 CRDi [JD]	01.13→							70	630	S4 026												
1.6 CRDi [ED]	03.08-12.12		70	760	S5 A08				70	630	S4 026											
			SSJ						70	760	S4 E08											
		09.10-12.12		70	760	S5 A08				60	540	S4 024										
CRDi [JD]	01.13→							60	540	S4 024												
			SSJ	60	680	S5 A05				70	630	S4 026										
				70	760	S5 A08																
2.0 CRDi [ED]	03.08-12.12		70	760	S5 A08				70	630	S4 026											
			SSJ						70	760	S4 E08											
Pro Cee'd GT																						
1.0 GDI [JD]	07.15→	SSJ	70	760	S5 A08																	
Retona																						
2.0 i [CE]	04.98-12.00								95	830	S4 028											
Diesel																						
2.0 TD [CE]	04.98-12.00								95	830	S4 028											
Rio																						
1.2 [UB]	11.11→								60	540	S4 024											
									60	640	S4 E05											
1.3/ 1.5 i [DC]	07.00-02.05							60	540	S4 024												
1.4 [UB]	11.11→								60	540	S4 005											
	01.12→								65	650	S4 E40											
1.4/ 1.6 i [JB, DE]	03.05-08.15							60	540	S4 005												
1.6 [UB]	01.12→							60	540	S4 005												
Diesel																						
1.5 CRDi [JB, DE]	03.05-09.11							70	630	S4 026												
Rio Hatchback																						
1.0/ 1.2/ 1.4, T-GDI [YB]	02.17→		60	680	S5 A05																	
1.2 [UB]	06.11→								60	640	S4 E05											
	09.11→								60	540	S4 024											
		SSJ	60	680	S5 A05				60	640	S4 E05											
1.4 [UB]	06.11→								60	540	S4 024											
			SSJ	60	680	S5 A05																
i [JB, DE]	03.05-09.11								45	330	S4 021											
									60	540	S4 005											
									45	330	S4 021											
1.5 i	09.00→							45	330	S4 021												
1.6 [UB]	01.12→								60	540	S4 005											
	i [JB, DE]	03.05-09.11							60	540	S4 005											
Diesel																						
1.1 CRDi [UB]	06.11→		60	680	S5 A05				60	540	S4 024											
			SSJ						60	640	S4 E05											
1.4 CRDi [UB]	06.11→								60	540	S4 024											
			SSJ	60	680	S5 A05																
				70	760	S5 A08																
CRDi [YB]	02.17→		60	680	S5 A05																	
1.5 CRDi [JB, DE]	03.05-09.11								70	630	S4 026											
	06.09-09.11								60	540	S4 005											
Rio Kombi																						
1.3/ 1.5 i [DC]	09.02-02.05								60	540	S4 024											
Sedona																						
2.5 i V6	06.98-09.05								70	630	S4 026											
Diesel																						
2.9 D Turbo [UP]	06.98-09.01								60	540	S4 005											
Sephia I																						
1.5 i [FA]	10.97-12.00								60	540	S4 024											



						Ah A (EN) S5A		Ah A (EN) S5		Ah A (EN) S4		Ah A (EN) S3			
						0 092 ...0		0 092 ...0		0 092 ...0		0 092 ...0			
◀ KIA															
1.5/ 1.6 i 16V [FA]	10.97-12.00									60	540	S4 024			
1.8 i 16V [FA]	03.95-08.98									60	540	S4 005			
	01.98-12.00									60	540	S4 024			
Sephia I Hatchback															
1.5/ 1.6 i 16V [FA]	01.98-12.00									60	540	S4 024			
1.8 i 16V [FA]	09.96-12.00									60	540	S4 005			
Sephia II															
1.8 i 16V	08.97-05.00									60	540	S4 024			
Shuma															
1.5 i	12.97-05.00			63	610	S5 006				60	540	S4 006	56	480	S3 006
Shuma I															
1.5/ 1.6 i 16V [FB]	01.98-12.00			63	610	S5 005				60	540	S4 005	56	480	S3 005
1.8 i 16V [FB]	01.98-12.00			63	610	S5 006				60	540	S4 006	56	480	S3 006
Shuma I Hatchback															
1.5/ 1.6 i 16V [FB]	01.98-12.00			63	610	S5 005				60	540	S4 005	56	480	S3 005
1.8 i 16V [FB]	01.98-12.00									60	540	S4 024			
Shuma II															
1.6/ 1.8 i 16V [FB]	01.01-08.04			63	610	S5 005				60	540	S4 005			
Shuma II Hatchback															
1.6/ 1.8 i 16V [FB]	01.01-08.04			63	610	S5 005				60	540	S4 005			
Sorento															
2.4 [XM]	09.09→									70	630	S4 027			
GDI, GDI 4x4 [UM]	02.15→	95	850	S5 A13						95	830	S4 028			
GDI, GDI 4x4 [XM]	08.12→									70	630	S4 026			
4x4 [XM]	09.09→									45	330	S4 021			
										70	630	S4 027			
2.4/ 3.3/ 3.5/ 3.8 i [JC,BL]	03.03-08.09									70	630	S4 027			
3.5 [XM]	09.09→									70	630	S4 026			
										72	760	S4 E41			
4x4 [XM]	09.09→									70	630	S4 026			
										72	760	S4 E41			
Diesel															
2.0 CRDi [XM]	10.10→									95	830	S4 028			
CRDi 4x4 [XM]	10.10→									95	830	S4 028			
2.2 CRDi [UM]	02.15→									95	830	S4 028			
		SSJ	95	850	S5 A13										
CRDi [XM]	09.09→									95	830	S4 028			
										95	830	S4 029			
CRDi 4x4 [UM]	02.15→	95	850	S5 A13						95	830	S4 028			
CRDi 4x4 [XM]	09.09→									95	830	S4 028			
										95	830	S4 029			
2.5 CRDi [JC,BL]	07.02-08.09									95	830	S4 029			
Soul															
1.6 GDI [AM]	08.11-12.14			54	530	S5 002				52	470	S4 002			
GDI [PS]	03.14→			54	530	S5 002				52	470	S4 002	45	400	S3 002
i CVT [AM]	02.09-07.11			61	600	S5 004				60	540	S4 004	53	500	S3 004
	08.11-12.14			54	530	S5 002				52	470	S4 002	45	400	S3 002
T-GDI [PS]	02.17→	SSJ	60	680	S5 A05										
			70	760	S5 A08										
1.6/ 2.0 [PS]	03.14→		70	760	S5 A08					52	470	S4 002			
Diesel															
1.6 CRDi [AM]	02.09-12.14			63	610	S5 005				60	540	S4 005			
				63	610	S5 005				70	630	S4 026			
CRDi [PS]	03.14→	60	680	S5 A05	63	610	S5 005	60	540	S4 005	56	480	S3 005		
		60	680	S5 A05	63	610	S5 005	60	640	S4 E05	56	480	S3 005		
Spectra															
1.8 i 16V [FB]	01.01-12.09			63	610	S5 005				60	540	S4 005			
Sportage															
1.6 GDI [QL]	01.16→	SSJ	70	760	S5 A08										
GDI [SL]	07.10→									60	540	S4 024			
		SSJ	70	760	S5 A08					70	760	S4 E08			
2.0 [SL]	07.10→									60	540	S4 005			
										60	540	S4 024			



						Ah A (EN) S5A		Ah A (EN) S5		Ah A (EN) S4		Ah A (EN) S3		
						0 092 ...0		0 092 ...0		0 092 ...0		0 092 ...0		
2.0	,i [KM]	09.04-05.10								60	540	S4 005		
	,4x4 [QL]	01.16→	SSJ	60	680	S5 A05								
	GDI [SL]	03.14→								60	540	S4 024		
	GDI 4x4 [SL]	03.14→								60	540	S4 024		
	i [AL]	11.98-08.04								60	540	S4 024		
		10.00-08.04						63	610	S5 006	60	540	S4 006	56 480 S3 006
	i 4x4 [AL]	07.93-08.04								60	540	S4 024		
		11.98-08.04						63	610	S5 006	60	540	S4 006	56 480 S3 006
	i 4x4 [KM]	09.04-04.07								45	330	S4 021		
										60	540	S4 005		
	4x4 [KM]	05.07-05.10								60	540	S4 005		
	4x4 [SL]	07.10→								45	330	S4 021		
										60	540	S4 005		
										60	540	S4 024		
2.7	i 4x4 [KM]	09.04-04.07								70	630	S4 026		
	4x4 [KM]	05.07-05.10								70	630	S4 026		
Diesel														
1.7	CRDi [QL]	01.16→	SSJ	80	800	S5 A11								
	CRDi [SL]	09.10→		80	800	S5 A11								
2.0	CRDi [QL]	01.16→								95	830	S4 028		
			SSJ	80	800	S5 A11								
	CRDi [SL]	07.10→		60	680	S5 A05				95	830	S4 028		
				60	680	S5 A05				95	830	S4 029		
	CRDi [SL]	01.11→		80	800	S5 A11								
	CRDi, CRDi 4x4 [KM]	09.04-05.10								95	830	S4 028		
	CRDi 4x4 [QL]	01.16→								95	830	S4 028		
			SSJ	60	680	S5 A05								
				80	800	S5 A11								
	CRDi 4x4 [SL]	07.10→		60	680	S5 A05				95	830	S4 028		
				60	680	S5 A05				95	830	S4 029		
		01.11→		70	760	S5 A08								
2.0/ 2.2	TD 4x4, 4x4 [AL]	05.93-08.04								95	830	S4 029		
Sportage GT														
1.6	GDI [OL]	01.16→	SSJ	60	680	S5 A05								
				70	760	S5 A08								
	GDI [QL]	01.16→	SSJ	70	760	S5 A08								
Sportage R														
2.0	GDI [SL]	04.10→								60	540	S4 005		
										60	540	S4 024		
Venga														
1.4	[YN]	12.09→	SSJ	60	680	S5 A05								
1.6	[YN]	12.09→								60	540	S4 005		
										60	540	S4 024		
			BWD					63	610	S5 005	60	540	S4 005	
			BWD,SSJ							60	640	S4 E05		
Diesel														
1.4	CRDi [YN]	12.09→								60	640	S4 E05		
										70	760	S5 A08		
1.6	CRDi [YN]	12.09→								77	780	S5 008		
										70	760	S5 A08		
			SSJ							70	760	S4 E08		
KTM														
X-Bow														
2.0		08.08→								60	680	S5 A05		
										60	680	S5 A05		
										63	610	S5 005		
										60	640	S4 E05		
X-Bow GT														
2.0		08.12→								60	680	S5 A05		
										60	680	S5 A05		
										63	610	S5 005		
										60	640	S4 E05		



			Ah A (EN)	Ah A (EN)	Ah A (EN)	Ah A (EN)
			0 092 ...0	0 092 ...0	0 092 ...0	0 092 ...0

◀ KTM

X-Bow R										
2.0	08.10→	60	680	S5 A05	63	610	S5 005	60	540	S4 005
		60	680	S5 A05	63	610	S5 005	60	640	S4 E05

LADA

Forma													
1.3/ 1.5	09.91-12.00				63	610	S5 006	60	540	S4 006	56	480	S3 006
Granta													
1.6 Sport	11.14→				63	610	S5 006	60	540	S4 006			
8V, 16V	10.11→				63	610	S5 006	60	540	S4 006	56	480	S3 006
Granta Liftback													
1.6	11.14→				63	610	S5 006	60	540	S4 006			
Kalina													
1.4/ 1.6	11.04-12.12				63	610	S5 006	60	540	S4 006	56	480	S3 006
Kalina Hatchback													
1.4	07.07-12.12				63	610	S5 006	60	540	S4 006	56	480	S3 006
1.6	07.06-12.12				63	610	S5 006	60	540	S4 006	56	480	S3 006
	06.13→				63	610	S5 006	60	540	S4 006	56	480	S3 006
					63	610	S5 006	60	540	S4 006	56	480	S3 006
Kalina Kombi													
1.4	07.07-12.12				63	610	S5 006	60	540	S4 006	56	480	S3 006
1.6	07.07-12.12				63	610	S5 006	60	540	S4 006	56	480	S3 006
	06.13→				63	610	S5 006	60	540	S4 006	56	480	S3 006
	11.14→				63	610	S5 006	60	540	S4 006			
Largus													
1.6 8V, 16V [R90]	04.12→				63	610	S5 006	60	540	S4 006	56	480	S3 006
Niva													
1.7/ 1.8/ 2.0 , i	01.93-12.04				63	610	S5 006	60	540	S4 006	56	480	S3 006
Diesel													
1.5/ 1.8/ 1.9 D, TD	01.93-12.04				63	610	S5 006	60	540	S4 006	56	480	S3 006
Niva Estate													
1.6 4x4	09.87-12.99				63	610	S5 006	60	540	S4 006	56	480	S3 006
Oka													
0.8/ 750	01.95-12.08							40	330	S4 018			
Priora													
1.6	01.10→				63	610	S5 006	60	540	S4 006			
8V	09.08→				63	610	S5 006	60	540	S4 006			
16V	11.06→				63	610	S5 006	60	540	S4 006	56	480	S3 006
1.8	03.08→				63	610	S5 006	60	540	S4 006	56	480	S3 006
Priora Hatchback													
1.6	01.08-12.15				63	610	S5 006	60	540	S4 006	56	480	S3 006
	09.08-12.15				63	610	S5 006	60	540	S4 006			
1.8	03.08-12.15				63	610	S5 006	60	540	S4 006	56	480	S3 006
Priora Kombi													
1.6	01.08-12.15				63	610	S5 006	60	540	S4 006	56	480	S3 006
	01.10-12.15				63	610	S5 006	60	540	S4 006			
Sagona													
Diesel													
1.5 D	07.95→							70	630	S4 027			
Samara													
1.1/ 1.3/ 1.5/ 1.6/ 2.6 , i	01.84-12.13				63	610	S5 006	60	540	S4 006	56	480	S3 006
Diesel													
1.5 D	01.95-12.13							70	630	S4 027			
Samara Fun													
1.1/ 1.3/ 1.5	09.88-12.13				63	610	S5 006	60	540	S4 006	56	480	S3 006
Samara Hatchback													
1.1/ 1.3	01.84-12.13				63	610	S5 006	60	540	S4 006	56	480	S3 006
1.5	01.84-12.13				63	610	S5 006	60	540	S4 006			
	01.86-12.13				63	610	S5 006	60	540	S4 006	56	480	S3 006
Serie 110													
1.5 i	01.96-12.04				63	610	S5 006	60	540	S4 006	56	480	S3 006



		Ah A (EN) S5A			Ah A (EN) S5			Ah A (EN) S4			Ah A (EN) S3		
		0 092 ...0			0 092 ...0			0 092 ...0			0 092 ...0		
1.5 i 16V	01.96-12.04	63	610	S5 006	60	540	S4 006	56	480	S3 006			
1.5/ 1.6 i 8V	01.96-12.10	63	610	S5 006	60	540	S4 006	56	480	S3 006			
1.5/ 2.0 , GTI	01.96-12.04	63	610	S5 006	60	540	S4 006	56	480	S3 006			
1.5/ 2.0/ 2.6 Wankel, 16V, 16V Premier	01.96-12.00	63	610	S5 006	60	540	S4 006	56	480	S3 006			
1.6 i	01.05-12.10				60	540	S4 006	56	480	S3 006			
i 16V	01.05-12.10				60	540	S4 006	56	480	S3 006			
Serie 111													
1.5	01.96-12.04	63	610	S5 006	60	540	S4 006	56	480	S3 006			
i	01.96-12.04	63	610	S5 006	60	540	S4 006	56	480	S3 006			
i 8V, i 16V	01.96-12.04	63	610	S5 006	60	540	S4 006	56	480	S3 006			
1.6 i	01.05-12.09				60	540	S4 006	56	480	S3 006			
		63	610	S5 006	60	540	S4 006	56	480	S3 006			
Serie 112													
1.5 i	01.96-12.08	63	610	S5 006	60	540	S4 006	56	480	S3 006			
i 8V, i 16V	01.96-12.04	63	610	S5 006	60	540	S4 006	56	480	S3 006			
1.6 i	01.05-12.08				60	540	S4 006	56	480	S3 006			
		63	610	S5 006	60	540	S4 006	56	480	S3 006			
Serie 114													
1.6	12.08-12.13	63	610	S5 006	60	540	S4 006	56	480	S3 006			
Serie 115													
1.3/ 1.5	01.98-12.13	63	610	S5 006	60	540	S4 006	56	480	S3 006			
Serie 2100													
2106/ 21074 1.6	09.75-12.12	63	610	S5 006	60	540	S4 006	56	480	S3 006			
2107-02/ 21053-20/ 21072/ 21077/ 21099	01.86-12.12	63	610	S5 006	60	540	S4 006	56	480	S3 006			
1.3, 1.5, 1.5 i													
2115/ 2120/ 21073-40/ 21220 1.6i, 1.7, 1.8	01.86-12.13	63	610	S5 006	60	540	S4 006	56	480	S3 006			
21041-30/ 210540/ 210740 1.6	12.05-12.12				60	540	S4 006	56	480	S3 006			
Diesel													
2104 1.5 TD	01.97-12.00	63	610	S5 006	60	540	S4 006	56	480	S3 006			
Serie 2100 Coupé													
21043-20 1.5i	06.02-12.10	63	610	S5 006	60	540	S4 006	56	480	S3 006			
Serie 2100 Hatchback													
2113/ 2114 1.5i, 1.6i	10.01-12.13	63	610	S5 006	60	540	S4 006	56	480	S3 006			
Serie 2100 Kombi													
2104 1.5, 1.7	08.94-12.00	63	610	S5 006	60	540	S4 006	56	480	S3 006			
Toscana													
1.4/ 1.5	01.86-12.00	63	610	S5 006	60	540	S4 006	56	480	S3 006			
Vesta													
1.6 16V	11.15→	63	610	S5 006	60	540	S4 006						
Xray													
1.6/ 1.8	12.15→	63	610	S5 006	60	540	S4 006						
4x4													
1.7 , i	06.07→	63	610	S5 006	60	540	S4 006						

LAMBORGHINI

Aventador												
LP 700-4/ LP 720-4/ LP 750-4 , Superveloce, 50th Anniversario	03.11→	70	760	S5 A08								
Aventador Cabriolet												
LP 700-4 AWD	03.11→	70	760	S5 A08								
Aventador Roadster												
LP 700-4	03.13→	70	760	S5 A08								
Diablo												
5.7 SE	01.98→	70	760	S5 A08	77	780	S5 008	74	680	S4 008		
Diablo GT												
6.0	10.99-12.01	70	760	S5 A08	77	780	S5 008	74	680	S4 008		



		0 092 ...0			0 092 ...0			0 092 ...0			0 092 ...0		
		Ah	A (EN)	S5A	Ah	A (EN)	S5	Ah	A (EN)	S4	Ah	A (EN)	S3
LAMBORGHINI													
Diablo GT 2													
5.7	01.98→	70	760	S5 A08	77	780	S5 008	74	680	S4 008			
Diablo Roadster													
5.7	01.98-12.01	70	760	S5 A08	77	780	S5 008	74	680	S4 008			
Diablo VT													
5.7/ 6.0	01.98-06.02	70	760	S5 A08	77	780	S5 008	74	680	S4 008			
Diablo VT Roadster													
5.7	12.95-12.98	70	760	S5 A08	77	780	S5 008	74	680	S4 008			
Gallardo													
5.0	06.03→	95	850	S5 A13	100	830	S5 013	95	800	S4 013			
Gallardo Spyder													
LP 550-2/ LP 560-4/ LP, 4x4	08.05→	95	850	S5 A13	100	830	S5 013	95	800	S4 013			
570-4/													
5.0													
Gallardo Superleggera													
5.0	06.03→	95	850	S5 A13	100	830	S5 013	95	800	S4 013			
Huracan													
5.2 LP 580-2	12.15→	SSJ	80	800	S5 A11								
Huracan Coupé													
5.2 LP 610-4	05.14→	SSJ	80	800	S5 A11								
Murcielago													
LP 640/ LP 670-4/ 6.2, SV	09.00-10.10	70	760	S5 A08	77	780	S5 008	74	680	S4 008			
Murcielago Roadster													
LP 640	03.07-10.10	70	760	S5 A08	77	780	S5 008	74	680	S4 008			
6.2	03.04-10.06	70	760	S5 A08	77	780	S5 008	74	680	S4 008	70	640	S3 008

LANCIA													
Dedra Berlina													
1.6 i [835]	10.94-04.98							60	540	S4 005			
1.6/ 1.8/ 2.0 i 16V [835]	10.94-10.99				63	610	S5 005	60	540	S4 005	56	480	S3 005
1.8 i [835]	08.93-07.99							60	540	S4 005	56	480	S3 005
2.0 i [835]	10.94-10.99				63	610	S5 005	60	540	S4 005	56	480	S3 005
Diesel													
1.9 TD [835]	10.94-10.99	70	760	S5 A08	77	780	S5 008	74	680	S4 008	70	640	S3 008
Dedra Station Wagon													
1.6/ 1.8/ 2.0 i, i 16V, i 16V 4x4 [835]	10.94-10.99				63	610	S5 005	60	540	S4 005	56	480	S3 005
Diesel													
1.9 TD [835]	10.94-10.99	70	760	S5 A08	77	780	S5 008	74	680	S4 008	70	640	S3 008
Delta													
1.4 BiFuel [844]	12.09-08.14				63	610	S5 006	60	540	S4 006	56	480	S3 006
	02.14-08.14				63	610	S5 005	60	540	S4 005			
i 16V [844]	07.08-08.14				63	610	S5 005	52	470	S4 002	45	400	S3 002
	08.10-08.14	SSJ						60	640	S4 E05			
1.4/ 1.6 i [836]	06.93-12.99				54	530	S5 002	42	390	S4 000	40	340	S3 000
					54	530	S5 002	44	420	S4 000	40	340	S3 000
1.6 i 16V HPE [836]	01.96-12.99				54	530	S5 002	42	390	S4 000	40	340	S3 000
					54	530	S5 002	44	420	S4 000	40	340	S3 000
1.8 i [836]	06.93-12.99				63	610	S5 005	52	470	S4 002	45	400	S3 002
TBi [844]	05.09-08.14							60	540	S4 005			
1.8/ 2.0 i GT 16V, i 16V, i 16V Turbo HPE [836]	01.96-12.99				63	610	S5 005	52	470	S4 002	45	400	S3 002
Diesel													
1.6 MultiJet [844]	07.08-12.14				63	610	S5 005	60	540	S4 005	56	480	S3 005
					63	610	S5 005	60	540	S4 005	56	480	S3 006
					63	610	S5 005	60	540	S4 006	56	480	S3 006
					63	610	S5 006	60	540	S4 005	56	480	S3 006
	01.14-08.14				63	610	S5 005	60	540	S4 005			
1.9 MultiJet [844]	08.08-08.14	70	760	S5 A08	77	780	S5 008	74	680	S4 008	70	640	S3 008
TD [836]	10.95-12.99	70	760	S5 A08	77	780	S5 008	74	680	S4 008	70	640	S3 008



			Ah A (EN) S5A			Ah A (EN) S5			Ah A (EN) S4			Ah A (EN) S3		
			0 092 ...0			0 092 ...0			0 092 ...0			0 092 ...0		
2.0 MultiJet [844]	08.08-08.14					77	780	S5 008	60	540	S4 005			
						77	780	S5 008	74	680	S4 008	70	640	S3 008
Flavia														
2.4	03.12-12.13					63	610	S5 006	60	540	S4 006	56	480	S3 006
Kappa Berlina														
2.0/ 2.4/ 3.0 i Turbo 16V, i Turbo 20V, i 20V, i 24V [838]	11.94-12.00					63	610	S5 005	60	540	S4 005	56	480	S3 005
Diesel														
2.4 JTD, TD [838]	06.96-12.00	70	760	S5 A08	77	780	S5 008	74	680	S4 008	70	640	S3 008	
Kappa Coupé														
2.0/ 2.4/ 3.0 i Turbo 16V, i Turbo 20V, i 20V, i 24V V6 [838]	04.97-06.00	70	760	S5 A08	77	780	S5 008	60	540	S4 005	56	480	S3 005	
Kappa Station Wagon														
2.0/ 2.4/ 3.0 i Turbo 16V, i Turbo 20V, i 20V, i 24V [838]	11.94-12.00					63	610	S5 005	60	540	S4 005	56	480	S3 005
Diesel														
2.4 D Turbo, JTD [838]	06.96-12.00	70	760	S5 A08	77	780	S5 008	74	680	S4 008	70	640	S3 008	
Lybra Berlina														
1.6 i 16V [839]	10.99-09.05					63	610	S5 005	52	470	S4 002	45	400	S3 002
1.8 i 16V [839]	10.99-02.02					63	610	S5 005	52	470	S4 002	45	400	S3 002
	03.02-09.05					63	610	S5 005	52	470	S4 002			
2.0 i 20V [839]	10.99-09.00					63	610	S5 005	52	470	S4 002	45	400	S3 002
	10.00-09.05					63	610	S5 005	52	470	S4 002			
2.4 i 20V [839]	10.99-05.02	60	680	S5 A05				60	540	S4 005				
Diesel														
1.9/ 2.4 JTD [839]	10.99-11.06	70	760	S5 A08	77	780	S5 008	60	540	S4 005	70	640	S3 008	
Lybra Station Wagon														
1.6 i 16V [839]	10.99-09.05					63	610	S5 005	52	470	S4 002	45	400	S3 002
1.8 i 16V [839]	10.99-09.00					63	610	S5 005	52	470	S4 002	45	400	S3 002
	09.00-09.05					63	610	S5 005	52	470	S4 002			
2.0 i 20V [839]	10.99-09.05					63	610	S5 005	52	470	S4 002	45	400	S3 002
Diesel														
1.9/ 2.4 JTD [839]	10.99-11.06	70	760	S5 A08	77	780	S5 008	60	540	S4 005	56	480	S3 005	
Musa														
1.4 [350]	03.05-12.12					63	610	S5 005	52	470	S4 002	45	400	S3 002
LPG [350]	03.09-12.12								60	640	S4 E05			
16V [350]	10.04-12.12					63	610	S5 005	52	470	S4 002			
		SSJ							60	640	S4 E05			
	03.05-12.12					54	530	S5 002	52	470	S4 002			
						54	530	S5 002	60	640	S4 E05			
Diesel														
1.3 MultiJet [350]	10.04-11.10					63	610	S5 005	60	540	S4 005	56	480	S3 005
	09.05-11.10					54	530	S5 002						
		SSJ	60	680	S5 A05				60	640	S4 E05			
	03.09-12.12					54	530	S5 002	52	470	S4 002	45	400	S3 002
		BWD,SSJ							60	640	S4 E05			
1.6 MultiJet [350]	10.07-12.12					63	610	S5 005	60	540	S4 005	56	480	S3 005
	09.08-12.12								70	760	S4 E08			
									60	540	S4 005			
									60	640	S4 E05			
1.9 MultiJet [350]	10.04-12.12								60	540	S4 005			
Phedra														
2.0/ 3.0 16V, 24V [179]	09.02-09.05	70	760	S5 A08	77	780	S5 008	74	680	S4 008				
Diesel														
2.0 JTD 16V [179]	09.02-12.10	70	760	S5 A08	77	780	S5 008	74	680	S4 008				
2.2 JTD 16V [179]	09.02-09.07	70	760	S5 A08	77	780	S5 008	74	680	S4 008				
	10.07-12.10					77	780	S5 008	74	680	S4 008	70	640	S3 008
	03.08-12.10					77	780	S5 008	60	540	S4 005			
Thema														
3.6 VT	11.11-12.14	95	850	S5 A13	100	830	S5 013							



			Ah A (EN) S5A			Ah A (EN) S5			Ah A (EN) S4			Ah A (EN) S3		
			0 092 ...0			0 092 ...0			0 092 ...0			0 092 ...0		
◀ LANCIA														
Diesel														
3.0 CRD	07.11-12.14		95	850	S5 A13	100	830	S5 013						
Thesis														
2.0/ 2.4 Turbo 20V, 20V [841]	04.02-12.09		95	850	S5 A13	100	830	S5 013	95	800	S4 013			
3.0/ 3.2 V6 24V [841]	04.02-12.09		95	850	S5 A13	100	830	S5 013	95	800	S4 013	90	720	S3 013
Diesel														
2.4 JTD 10V [841]	04.02-02.05		95	850	S5 A13	100	830	S5 013	95	800	S4 013			
JTD 20V [841]	06.03-02.06		95	850	S5 A13	100	830	S5 013	95	800	S4 013			
	06.03-12.09		95	850	S5 A13	100	830	S5 013	95	800	S4 013	90	720	S3 013
Voyager														
3.6 [RT]	09.11-12.16		80	800	S5 A11	85	800	S5 010	80	740	S4 010			
Diesel														
2.8 CRD [RT]	09.11-12.16								74	680	S4 009			
Y														
1.1/ 1.2/ 1.4 i 8V, i 16V, i.e., i.e. 8V, i.e. 12V, i.e. 16V [840]	01.96-06.03					54	530	S5 002	42	390	S4 000	40	340	S3 000
						54	530	S5 002	44	420	S4 000	40	340	S3 000
Ypsilon														
0.9 [312]	06.11→	SSJ							60	640	S4 E05			
	11.13→		60	680	S5 A05									
Natural Power [312]	01.13→		60	680	S5 A05									
		SSJ							60	640	S4 E05			
1.2 [312]	06.11→	SSJ							60	640	S4 E05			
Bi-Fuel [312]	02.12→	SSJ							60	640	S4 E05			
8V [843]	06.03-11.11					54	530	S5 002	42	390	S4 000	40	340	S3 000
	08.10-11.11								60	640	S4 E05			
1.2/ 1.4 16V [843]	06.03-11.11					54	530	S5 002	42	390	S4 000	40	340	S3 000
1.4 LPG [843]	03.09-11.11		60	680	S5 A05				60	640	S4 E05			
8V [843]	10.06-11.11					54	530	S5 002	42	390	S4 000	40	340	S3 000
Diesel														
1.3 JTD, MultiJet [843]	06.03-11.11								60	540	S4 005			
MultiJet [312]	06.11→	SSJ							60	640	S4 E05			
	05.15→		60	680	S5 A05									
	06.16→	SSJ	60	680	S5 A05				60	640	S4 E05			
Zeta														
2.0 i.e. Turbo [122]	09.94-06.99		60	680	S5 A05				60	540	S4 005			
16V [122]	06.99-10.00					63	610	S5 005	60	540	S4 005	56	480	S3 005
	10.00-06.02								60	540	S4 005			
Diesel														
2.0 JTD [122]	06.99-06.02		60	680	S5 A05				60	540	S4 005			
2.1 TD [122]	05.96-06.99		60	680	S5 A05	63	610	S5 005	60	540	S4 005			



LAND ROVER GROUP

Defender 90														
2.5/ 2.8/ 3.5	08.90-09.04								70	630	S4 027			
Diesel														
2.2 Td4	08.11-02.16		95	850	S5 A13				70	630	S4 027			
			95	850	S5 A13				95	800	S4 013			
2.4 Td4	05.07-08.11		95	850	S5 A13				95	800	S4 013			
2.5 D	08.90-09.01								70	630	S4 027			
D Turbo	08.90-12.01					63	610	S5 005	60	540	S4 005			
Defender 110														
2.5/ 3.5/ 4.0, i AWD	08.90-12.01								70	630	S4 027			
Diesel														
2.2 Td4	08.11-02.16		95	850	S5 A13				70	630	S4 027			
			95	850	S5 A13				95	800	S4 013			
2.4 Td4	08.07-08.11		95	850	S5 A13				95	800	S4 013			
2.5 D	08.90-09.01								70	630	S4 027			
D Turbo	08.90-12.01					63	610	S5 005	60	540	S4 005			

			Ah	A (EN)		Ah	A (EN)		Ah	A (EN)		Ah	A (EN)	
			0 092 ...0			0 092 ...0			0 092 ...0			0 092 ...0		

Defender 130														
Diesel														
2.2 Td4	09.11-02.16		95	850	S5 A13				70	630	S4 027			
			95	850	S5 A13				95	800	S4 013			
2.4 Td4	08.07-08.11		95	850	S5 A13				95	800	S4 013			
2.5 D, D Turbo	08.90-12.01								70	630	S4 027			
Discovery I														
2.0/ 3.5/ 3.9/ 4.0 , i, i 4x4, i 16V	09.89-12.99								70	630	S4 027			
Diesel														
2.5 TDi	10.93-12.98								70	630	S4 027			
Discovery II														
4.0/ 4.6 i [LT,LJ]	09.97-12.04								70	630	S4 027			
Discovery III														
4.0/ 4.4 [TAA]	09.04-08.09		95	850	S5 A13	100	830	S5 013	95	800	S4 013			
Diesel														
2.7 TDV6 [TAA]	09.04-08.09		95	850	S5 A13	100	830	S5 013	95	800	S4 013			
Discovery IV														
3.0 Supercharged [LA]	09.13-12.17	SSJ	95	850	S5 A13									
4.0/ 5.0 [LA]	09.09-08.14		95	850	S5 A13	100	830	S5 013	95	800	S4 013			
Diesel														
2.7 TDV6 [LA]	09.09-08.10		95	850	S5 A13				95	800	S4 013			
3.0 TDV6 [LA]	09.09-12.17		95	850	S5 A13	100	830	S5 013	95	800	S4 013			
	09.10-12.17					100	830	S5 013	95	800	S4 013			
		SSJ	95	850	S5 A13									
Discovery Sport														
2.0 Si4 [B5,L550]	09.14→	SSJ	80	800	S5 A11				80	800	S4 E11			
Diesel														
2.0 TD4 [B5,L550]	09.15→								80	740	S4 011			
		SSJ	80	800	S5 A11									
			80	800	S5 A11				80	800	S4 E11			
2.2 SD4 AWD [B5,L550]	09.14-08.17	SSJ	80	800	S5 A11				80	800	S4 E11			
TD4 [B5,L550]	09.14→	SSJ	80	800	S5 A11				80	800	S4 E11			
Discovery V														
3.0 Si6 AWD [LR, B6; LR,B6]	09.16→	SSJ	95	850	S5 A13									
Diesel														
2.0 Sd4 AWD, Td4 AWD [LR,B6]	04.17→	SSJ	95	850	S5 A13									
Freelander I														
1.8 i 16V [LN]	09.97-10.06		60	680	S5 A05	63	610	S5 005						
2.5 [LN]	09.01-10.06					63	610	S5 005	60	540	S4 005	56	480	S3 005
Diesel														
2.0 D [LN]	09.97-09.03		70	760	S5 A08	77	780	S5 008	74	680	S4 008	70	640	S3 008
TD4 [LN]	09.01-10.06		70	760	S5 A08	77	780	S5 008	74	680	S4 008			
Freelander II														
2.0 Si4 [LF]	10.12-11.14		80	800	S5 A11	85	800	S5 011						
3.2 i6 [LF]	10.06-11.12	BWD	70	760	S5 A08	77	780	S5 008	74	680	S4 008			
Diesel														
2.2 eD4 [LF]	09.10-11.14	BWD,SSJ	70	760	S5 A08									
SD4 [LF]	09.10-11.14					85	800	S5 011	80	740	S4 011			
		BWD	70	760	S5 A08									
Td4 [LF]	10.06-11.14					77	780	S5 008	74	680	S4 008			
		SSJ	80	800	S5 A11									
Range Rover Evoque														
2.0 Si4 AWD [L538]	09.11-10.18	SSJ	70	760	S5 A08									
	09.14-10.18		80	800	S5 A11									
						74	750	S5 007	72	680	S4 007			
Diesel														
2.0 eD4 [L538]	09.15-10.18	SSJ	70	760	S5 A08									
			80	800	S5 A11									
TD4 AWD [L538]	09.15-10.18	SSJ	70	760	S5 A08									
			80	800	S5 A11									



			Ah A (EN) S5A			Ah A (EN) S5			Ah A (EN) S4			Ah A (EN) S3		
			0 092 ...0			0 092 ...0			0 092 ...0			0 092 ...0		
LAND ROVER GROUP														
2.2	eD4 [L538]	09.12-08.16	SSJ	70	760	S5 A08								
				80	800	S5 A11								
	SD4 AWD [L538]	09.11-08.15	SSJ	80	800	S5 A11								
	TD4 AWD [L538]	09.11-08.15	SSJ	80	800	S5 A11								
Range Rover Evoque Cabrio														
2.0	Si4 AWD	03.16→					74	750	S5 007	72	680	S4 007		
Diesel														
2.0	TD4 AWD	03.16→								80	800	S4 E11		
			SSJ	70	760	S5 A08								
				80	800	S5 A11								
Range Rover II														
4.0/ 4.6	i, i V8 AWD [LP]	09.94-08.02								70	630	S4 027		
Range Rover III														
4.2	i [LM,L322]	03.05-08.09		95	850	S5 A13	110	920	S5 015	95	800	S4 013		
4.4	V8 [LM,L322]	03.02-08.09		95	850	S5 A13	110	920	S5 015	95	800	S4 013		
		05.05-08.09		95	850	S5 A13	100	830	S5 013	95	800	S4 013		
5.0	V8 AWD [LM,L322]	09.09-01.13		95	850	S5 A13	100	830	S5 013	95	800	S4 013		
	V8 Supercharged AWD [LM,L322]	09.09-01.13		95	850	S5 A13	110	920	S5 015	95	800	S4 013		
Diesel														
3.0	Td6 [LM,L322]	03.02-09.06		95	850	S5 A13	110	920	S5 015	95	800	S4 013		
3.6	TDV8 [LM,L322]	09.06-08.09		95	850	S5 A13	110	920	S5 015					
	TDV8 AWD [LM,L322]	09.09-01.13		95	850	S5 A13	110	920	S5 015					
4.4	TDV8 [LM,L322]	09.10-01.13		95	850	S5 A13	100	830	S5 013	95	800	S4 013		
Range Rover IV														
3.0/ 5.0	i AWD, Supercharged AWD [LG,L405]	02.13→		95	850	S5 A13								
	SDVA AWD, V6 Supercharged AWD [LG,L405]	02.13→	SSJ	95	850	S5 A13								
5.0	AWD [LG,L405]	02.13→		95	850	S5 A13	100	830	S5 013	95	800	S4 013		
Diesel														
3.0/ 4.4	SD AWD, SDV6 HYBRID AWD, TD AWD [LG,L405]	02.13→		95	850	S5 A13								
Range Rover Sport														
3.0	V6 Supercharged [LW,L494]	06.15→	SSJ	70	760	S5 A08								
				80	800	S5 A11								
				95	850	S5 A13								
3.0/ 5.0	, Supercharged [LW,L494]	09.13→	SSJ	95	850	S5 A13								
4.2/ 5.0	Supercharged [LS,L320]	03.05-08.13		95	850	S5 A13	110	920	S5 015	95	800	S4 013		
4.4	[LS,L320]	03.05-08.09		95	850	S5 A13	110	920	S5 015	95	800	S4 013		
5.0	[LS,L320]	09.09-08.13		95	850	S5 A13	100	830	S5 013	95	800	S4 013		
	V8 S/C SVR 4x4 [LX,L494]	09.09-08.13		95	850	S5 A13	100	830	S5 013	95	800	S4 013		
Diesel														
2.0	SD4 [LW,L494]	09.16→	SSJ	70	760	S5 A08								
				80	800	S5 A11								
				95	850	S5 A13								
2.7	TD [LS,L320]	03.05-08.09		95	850	S5 A13	110	920	S5 015	95	800	S4 013		
3.0	SDV6, SDV6 Hybrid [LW,L494]	09.13→	SSJ	95	850	S5 A13								
	SDV6, TDV6 [LS,L320]	09.09-08.13		95	850	S5 A13	100	830	S5 013	95	800	S4 013		
	TDV6 [LW,L494]	09.13→	SSJ	95	850	S5 A13								
3.6	TD [LS,L320]	01.07-08.13		95	850	S5 A13	110	920	S5 015					
4.4	SDV8 [LW,L494]	01.14→		95	850	S5 A13	100	830	S5 013	95	800	S4 013		
Range Rover Velar														
P250/ P380	AWD [LS560]	08.17→	SSJ	95	850	S5 A13								
Diesel														
D180/ D240/ D300	AWD [LS560]	08.17→	SSJ	95	850	S5 A13								



			Ah A (EN)	Ah A (EN)	Ah A (EN)	Ah A (EN)
			0 092 ...0	0 092 ...0	0 092 ...0	0 092 ...0

LEXUS

ES 250						
2.5 i [V]	06.12→				95	830 S4 028
ES 300						
3.0 i [V]	08.96-09.03				60	540 S4 024
ES 300h						
2.5 i [V6]	06.12→				95	830 S4 028
ES 330						
3.3 i [V3]	07.01-03.06				60	540 S4 024
ES 350						
3.5 i [V]	06.12→				72	760 S4 E41
					95	830 S4 028
i [V4]	03.06-09.12				95	830 S4 028
GS F						
5.0 [L1]	10.15→				70	630 S4 026
					70	630 S4 027
GS 200t						
2.0 Turbo [L1]	10.15→				70	630 S4 026
					70	630 S4 027
GS 250						
2.5 [L1]	03.12→				70	630 S4 026
GS 300						
3.0 [S1]	08.97-12.11				70	630 S4 027
	01.05-12.11				70	630 S4 026
GS 300h						
2.5 [L1]	09.13→				70	630 S4 027
GS 350						
3.5 , 4x4 [L1; S1]	08.05→				70	630 S4 026
GS 430						
4.3 [S1]	07.00-09.08				70	630 S4 027
GS 450h						
3.5 [L1; S1]	02.06→				70	630 S4 026
GS 460						
4.6 [S1]	09.07-12.11				70	630 S4 026
					95	830 S4 029
GX 460						
4.6 i4x4 [J1]	11.09→	105	950	S5 A15	110	920 S5 015
IS F						
5.0 [E2]	12.07-05.14				60	540 S4 025
					70	630 S4 026
IS 200						
2.0 i [E1]	01.99-07.05				60	540 S4 025
IS 200 Wagon						
2.0 i [E1]	08.02-07.05				70	630 S4 027
IS 200t						
2.0 Turbo [E3]	08.15→				70	630 S4 026
					70	630 S4 027
	SSJ				72	760 S4 E41
IS 220 Diesel						
2.2 d [E2]	11.05-08.12				95	830 S4 029
	08.10-08.12				95	830 S4 028
IS 250						
2.5 i [E3]	04.13-08.15	70	760	S5 A08	70	630 S4 026
		70	760	S5 A08	70	630 S4 027
i, i 4x4 [E2]	08.05-05.13				70	630 S4 027
IS 250 Cabriolet						
2.5 i [E2]	04.09-04.13				70	630 S4 027
IS 300						
3.0 i [E1]	07.01-07.05				95	830 S4 028



			Ah	A (EN)	S5A	Ah	A (EN)	S5	Ah	A (EN)	S4	Ah	A (EN)	S3
		0 092 ...0			0 092 ...0			0 092 ...0			0 092 ...0			
◀ LEXUS														
IS 300 Wagon														
3.0 i [E1]	07.01-07.05								70	630	S4 027			
IS 300h														
2.5 i [E3]	04.13→		70	760	S5 A08				45	330	S4 022			
IS 350														
3.5 i [E2]	08.10-04.13								60	540	S4 025			
LC 500														
5.0 [Z1]	05.17→		80	800	S5 A11	85	800	S5 011						
LC 500h														
3.5 [Z1]	05.17→		70	760	S5 A08	77	780	S5 008						
LFA														
4.8 i	12.10-12.12								74	680	S4 008			
									95	830	S4 028			
LS 400														
4.0 i [F2]	10.94-08.00								95	830	S4 028			
LS 430														
4.3 i [F3]	08.00-08.06								70	630	S4 026			
LS 460														
4.6 i [F4]	08.06→								95	830	S4 029			
			70	760	S5 A08	77	780	S5 008	70	760	S4 E08			
			70	760	S5 A08	77	780	S5 008	95	830	S4 029			
i 4x4 [F4]	09.08→								95	830	S4 029			
LS 460 L														
4.6 i [F4]	09.08-10.17								95	830	S4 029			
LS 600h														
5.0 i 4x4 [F4]	04.07→								95	830	S4 029			
LS 600h L														
5.0 i 4x4 [F4]	05.07-10.17								95	830	S4 029			
LX 450d														
Diesel														
4.5 4x4 [J2]	09.15→								70	630	S4 026			
									70	630	S4 027			
LX 470														
4.7 4x4 [J1]	01.98-08.07								70	630	S4 027			
LX 570														
5.7 4x4 [J2]	11.07→		70	760	S5 A08	77	780	S5 008	74	680	S4 008			
NX 200														
2.0 i [Z1]	10.14→	SSJ							72	760	S4 E41			
NX 200t														
2.0 Turbo [Z1]	12.14→								70	630	S4 026			
		SSJ							72	760	S4 E41			
Turbo 4x4 [Z1]	12.14→								70	630	S4 026			
		SSJ							72	760	S4 E41			
NX 300h														
2.5 i, i 4x4 [Z1]	07.14→	SSJ							72	760	S4 E41			
RC F														
5.0 [C1]	09.14→								70	630	S4 027			
RC 200t														
2.0 Turbo [C1]	10.15→								70	630	S4 026			
									70	630	S4 027			
		SSJ							72	760	S4 E41			
RC 300h														
2.5 [C1]	10.15→								70	630	S4 026			
									70	630	S4 027			
		SSJ							72	760	S4 E41			
RX 200t														
2.0 i, i 4x4 [L2]	09.15-02.18								95	830	S4 028			
RX 300														
3.0 i 4x4 [U1; U3]	01.98-01.06								70	630	S4 026			
RX 350														
3.5 i, i 4x4 [L1]	12.08-10.15								70	630	S4 026			
i 4x4 [L2]	09.15→								70	630	S4 026			
									70	630	S4 027			



		Ah		A (EN)		S5A		Ah		A (EN)		S5		Ah		A (EN)		S4		Ah		A (EN)		S3	
						0 092 ...0						0 092 ...0						0 092 ...0						0 092 ...0	
3.5 4x4 [U3]	01.06-12.08														70	630	S4 026								
RX 400h																									
3.3 i [U3]	09.05-08.08														70	630	S4 026								
i 4x4 [U3]	03.05-12.08														45	330	S4 021								
															70	630	S4 026								
RX 450h																									
3.5 i, i 4x4 [L1]	12.08-12.15														70	630	S4 026								
i 4x4 [L2]	10.15→														60	540	S4 005								
SC 430																									
4.3 i	05.01-08.10														70	630	S4 026								
															74	680	S4 009								
i [Z4]	08.05-07.10														70	630	S4 026								

LONDON TAXI COMPANY LTC

TX4																							
Diesel																							
2.5 D	01.13-08.17														70	760	S5 A08						

LONDON TAXI INTERNATIONAL LTI

TX																							
Diesel																							
2.4/ 2.5 D, TDi [TX2; TX4]	10.02-12.12														70	760	S5 A08						

LOTUS

Elan																																	
1.6 i DOHC 16V	09.89-09.99														70	760	S5 A08				77	780	S5 008		60	540	S4 005		56	480	S3 005		
Elise																																	
1.6	03.10→																																
1.8	11.98-01.01																																
R	01.04-12.11																																
SC, 16V, 340 R	01.96-12.11																																
Esprit GT3																																	
2.0 Turbo	01.97-12.02																																
Esprit S4																																	
2.2 Turbo	01.93-12.01																																
Esprit V8																																	
3.5 Twin Turbo	03.96-09.03																																
Esprit 300 Sport																																	
2.2 Turbo	01.94-12.02																																
Europa S																																	
2.0 Turbo	07.06-10.10																																
Europa SE																																	
2.0 Turbo	10.08-10.10																																
Evora																																	
3.5	05.09-04.14																																
400	11.15→																																
Evora S																																	
3.5	12.10-04.14																																
Exige																																	
1.8	10.01→																																
Exige GT3																																	
1.8	08.06-06.12																																
Exige S																																	
3.5	06.12→																																
Exige 240R																																	
1.8	04.05-04.07																																



			Ah A (EN)	Ah A (EN)	Ah A (EN)	Ah A (EN)
			0 092 ...0	0 092 ...0	0 092 ...0	0 092 ...0

◀ LOTUS

2 Eleven						
1.8	01.07→		61	600	S5 004	60 540 S4 004

MASERATI

Biturbo						
Spider/ 2.0/ 4.24V/ 222 , SE, 24V, 2800	01.89-12.01		63	610	S5 006	60 540 S4 006 56 480 S3 006
Coupé						
4.2 , 32V V8	12.01-11.07	70	760	S5 A08	77 780 S5 008	74 680 S4 008
Ghibli						
2.0 i Biturbo	02.92-12.01					88 740 S3 012
2.8 BiTurbo	02.92-06.99		74	750	S5 007	72 680 S4 007
3.0 [M157]	01.13→	95	850	S5 A13	100 830 S5 013	
	06.16→	95	850	S5 A13		
Diesel						
3.0 D [M157]	01.13→	95	850	S5 A13		
	06.13→	95	850	S5 A13	100 830 S5 013	
Ghibli S						
3.0 , Q4 [M157]	01.13-12.17	95	850	S5 A13	100 830 S5 013	
GranCabrio						
4.7 V8	03.10→		77	780	S5 008	74 680 S4 008 70 640 S3 008
GranCabrio MC						
4.7 V8	05.12→		77	780	S5 008	74 680 S4 008 70 640 S3 008
GranCabrio Sport						
4.7 V8	03.11-12.17	70	760	S5 A08	77 780 S5 008	
GranTurismo						
4.2	08.07-12.17		100	830	S5 013	88 740 S3 012
4.7	09.10→	70	760	S5 A08	77 780 S5 008	
GranTurismo Convertible						
4.7	09.11→		77	780	S5 008	74 680 S4 008 70 640 S3 008
GranTurismo S						
4.7 V8 32V	08.08→		100	830	S5 013	
GranTurismo Sport						
4.7	05.12→		77	780	S5 008	74 680 S4 008 70 640 S3 008
Karif						
2.8	04.88-12.01	70	760	S5 A08	77 780 S5 008	74 680 S4 008 70 640 S3 008
Levante						
3.0 AWD	05.16→	95	850	S5 A13		
Diesel						
3.0 D AWD	05.16→	95	850	S5 A13		
		SSJ	95	850	S5 A13	
Levante S						
3.0 AWD	05.16→	95	850	S5 A13		
MC 12						
6.0	05.04-12.06	70	760	S5 A08	77 780 S5 008	74 680 S4 008
Quattroporte						
2.0/ 2.8/ 3.2 BiTurbo [AM330; AM337]	03.94-12.00					70 630 S4 027
3.0 BiTurbo [M156]	09.13→	95	850	S5 A13		
4.2 [M139]	03.04-12.12	95	850	S5 A13	100 830 S5 013	95 800 S4 013
Diesel						
3.0 Diesel [M156]	09.13→	95	850	S5 A13		
Quattroporte GT S						
3.8 [M156]	11.12→	95	850	S5 A13		
4.7 [M139]	01.09-12.12	95	850	S5 A13	100 830 S5 013	95 800 S4 013
Quattroporte S						
3.0/ 4.7 , BiTurbo, Q4 BiTurbo [M139; M156]	01.09-12.17	95	850	S5 A13	100 830 S5 013	
Shamal						
3.2	09.89-12.01	70	760	S5 A08	77 780 S5 008	74 680 S4 008 70 640 S3 008



			Ah	A (EN)		Ah	A (EN)		Ah	A (EN)		Ah	A (EN)	
			0 092 ...0			0 092 ...0			0 092 ...0			0 092 ...0		

Spyder														
4.2 GT	12.01-12.05		70	760	S5 A08	77	780	S5 008	74	680	S4 008			
420														
2.0 i	01.87-12.01					63	610	S5 006	60	540	S4 006	56	480	S3 006
430														
2.8	02.88-12.01					63	610	S5 006	60	540	S4 006	56	480	S3 006
3200 GT														
	10.98-12.03		70	760	S5 A08	77	780	S5 008	74	680	S4 008			

MAYBACH

Serie 240														
57/62, S	09.02→		95	850	S5 A13	100	830	S5 013	95	800	S4 013			

MAZDA

CX-3														
2.0 [DK]	02.15→								70	630	S4 027			
		BWD,SSJ							65	650	S4 E40			
4x4 [DK]	02.15→								70	630	S4 027			
		BWD,SSJ							65	650	S4 E40			
Diesel														
1.5 D, D 4x4 [DK]	02.15→	BWD,SSJ							65	650	S4 E40			
CX-5														
2.0 [KE]	11.11-12.17	BWD,SSJ							65	650	S4 E40			
4x4 [KE]	11.11-12.17	BWD,SSJ							65	650	S4 E40			
2.5 4x4 [KE]	01.13-12.17		60	680	S5 A05									
		SSJ							60	640	S4 E05			
Diesel														
2.2 D [KE]	01.12-12.17								95	830	S4 028			
		BWD,SSJ							85	800	S4 E42			
D 4x4 [KE]	01.12-12.17								95	830	S4 028			
		BWD,SSJ							85	800	S4 E42			
CX-7														
2.3 MZR DISI Turbo 4x4 [ER]	05.07→		70	760	S5 A08	77	780	S5 008	65	650	S4 E40	70	640	S3 008
			70	760	S5 A08	77	780	S5 008	74	680	S4 008	70	640	S3 008
Diesel														
2.2 MZR CD 4x4 [ER]	06.09→								72	760	S4 E41			
									95	830	S4 028			
		BWD,SSJ							72	760	S4 E41			
CX-9														
3.7 4x4 [TB]	06.08-12.15								70	630	S4 026			
									72	760	S4 E41			
Demio														
1.3/ 1.5 i, i 16V [DW]	07.96-02.03								45	330	S4 021			
MPV														
2.0/ 2.3/ 2.5/ 3.0 i, i 16V, i 24V [LW]	05.99→								60	540	S4 024			
3.0 i [LV]	11.95→								60	540	S4 024			
	03.96-05.99								95	830	S4 029			
Diesel														
2.0 D Turbo [LW]	03.02-06.04								95	830	S4 028			
2.5 12V D Turbo [LV]	03.96-05.99								95	830	S4 028			
MX-3														
1.6/ 1.8 i [EC]	11.93-02.98								60	540	S4 024			
MX-5														
1.5/ 2.0 [ND]	05.15→								45	330	S4 020			
1.6 i [NB]	01.98-07.05	BAW				52	520	S5 001	44	440	S4 001	41	360	S3 001
1.8 i [NB]	01.98-07.05	BAW				52	520	S5 001	44	440	S4 001	41	360	S3 001
	09.00-07.05					52	520	S5 001	44	440	S4 001	41	360	S3 001
1.8/ 2.0 [NC]	07.05-03.15								45	330	S4 021			



			Ah A (EN) S5A			Ah A (EN) S5			Ah A (EN) S4			Ah A (EN) S3		
			0 092 ...0			0 092 ...0			0 092 ...0			0 092 ...0		
◀ MAZDA														
Premacy														
1.8/ 2.0 i [CP]	03.99-05.05					60	540							
Diesel														
2.0 D Turbo [CP]	06.99-05.05					60	540							
RX-7 Coupé														
1.3 Biturbo [FD]	01.96→					70	630							
RX-8														
1.3 i [FE; SE]	04.03-04.12					70	630							
Serie B														
2200 [UF]	03.96-05.99					60	540							
Diesel														
2500 12V D [UF]	03.96-05.99					95	830							
Tribute														
2.0 i 4x4 [EP]	02.01-12.03		63	610	S5 005	60	540							
2.0/ 2.3 i [EP]	02.01-05.04		63	610	S5 005	60	540							
2.0/ 3.0 i, i 4WD	12.00→		63	610	S5 005	60	540			56	480		S3 005	
2.3/ 3.0 i 4x4 [EP]	04.01-09.09		63	610	S5 005	60	540			56	480		S3 005	
Xedos-6														
1.6/ 2.0 i [CA]	04.96-02.99					60	540							
Xedos-9														
2.0/ 2.3/ 2.5 i, i Kompressor, i 4WS [TA]	06.96-11.02		61	600	S5 004	60	540			S4 004	53	500		S3 004
2														
1.3 [DE]	06.07-10.14									45	330			S4 021
										60	540			S4 024
										65	650			S4 E40
			63	610	S5 005	60	540			S4 005	56	480		S3 005
1.4 [DY]	02.03-06.07									44	440			S4 001
1.5 [DE]	06.07-10.14		63	610	S5 005	60	540							S4 005
	10.09→		60	680	S5 A05	63	610	S5 005	60	540	S4 005	56	480	S3 005
			60	680	S5 A05	63	610	S5 005	60	640	S4 E05	56	480	S3 005
[DJ]	10.14→	BWD,SSJ								65	650			S4 E40
1.6 [DY]	02.03-06.07									45	330			S4 021
1.25 [DY]	02.03-06.07		52	520	S5 001	44	440			S4 001	41	360		S3 001
Diesel														
1.4 CD [DE]	08.07-09.10		63	610	S5 005	60	540			S4 005	56	480		S3 005
D Turbo [DY]	02.03-06.07		52	520	S5 001	44	440			S4 001	41	360		S3 001
1.5 D [DJ]	10.14→	BWD,SSJ								65	650			S4 E40
1.6 CD [DE]	11.08-10.14		63	610	S5 005	60	540			S4 005				
3														
1.5 [BM]	08.13-12.16									65	650			S4 E40
		BWD,SSJ								65	650			S4 E40
[BN]	06.16→	BWD,SSJ								65	650			S4 E40
	09.16→									65	650			S4 E40
1.6 [BK]	07.03-12.08									60	540			S4 024
[BM]	08.13-05.16	BWD,SSJ								65	650			S4 E40
[BN]	06.16→	BWD,SSJ								65	650			S4 E40
MZR [BL]	12.08-12.13									60	540			S4 024
										70	630			S4 026
2.0 [BK]	07.03-12.08		61	600	S5 004	60	540			S4 004	53	500		S3 004
[BM]	08.13-12.16									65	650			S4 E40
		BWD,SSJ								65	650			S4 E40
[BN]	09.16→									65	650			S4 E40
MZR [BL]	12.08-12.13		80	800	S5 A11	45	330			S4 020				
			80	800	S5 A11	60	540			S4 024				
		SSJ								70	650			S4 E10
MZR DISI [BL]	12.08-10.13		80	800	S5 A11	45	330			S4 020				
			80	800	S5 A11	60	540			S4 024				
		SSJ								70	650			S4 E10
Diesel														
1.5 D [BM; BN]	10.15→	BWD,SSJ								65	650			S4 E40
1.6 MZR-CD [BL]	12.08-07.11									70	630			S4 026
	10.10-10.13		63	610	S5 006									



						Ah A (EN) S5A		Ah A (EN) S5		Ah A (EN) S4		Ah A (EN) S3	
				0 092 ...0		0 092 ...0		0 092 ...0		0 092 ...0		0 092 ...0	
1.6/ 2.0 MZ-CD, MZR-CD [BK]	12.03-12.08							70	630	S4 026			
2.2 D [BM; BN]	08.13→							85	800	S4 E42			
MZR-CD [BL]	01.09-07.11							95	830	S4 028			
3 Hatchback													
1.4 [BK]	08.03-12.08			61	600	S5 004		60	540	S4 004	53	500	S3 004
1.5 [BM]	07.13-12.16							65	650	S4 E40			
	08.13-12.16	BWD,SSJ						65	650	S4 E40			
[BN]	06.16→	BWD,SSJ						65	650	S4 E40			
	09.16→							65	650	S4 E40			
1.6 [BM]	07.13-05.16	BWD,SSJ						65	650	S4 E40			
MZR [BL]	12.08-12.13			63	610	S5 005		60	540	S4 005			
1.6/ 2.0 [BK]	07.03-12.08							60	540	S4 024			
2.0 [BM]	07.13-12.16							65	650	S4 E40			
		BWD,SSJ						65	650	S4 E40			
[BN]	09.16→							65	650	S4 E40			
MZR [BL]	12.08-12.13			63	610	S5 006							
		BWD,SSJ						65	650	S4 E40			
MZR DISI [BL]	12.08-10.13		80	800	S5 A11		63	610	S5 006				
		BWD,SSJ						65	650	S4 E40			
		SSJ	80	800	S5 A11								
2.3 MPS [BK]	07.06-12.08			61	600	S5 004		60	540	S4 004	53	500	S3 004
MPS [BL]	09.09-10.13							60	540	S4 024			
Diesel													
1.5 D [BM; BN]	10.15→	BWD,SSJ						65	650	S4 E40			
1.6 MZ-CD [BK; BL]	12.03-12.08							70	630	S4 026			
MZR-CD [BK; BL]	12.08-10.13							70	630	S4 026			
2.0/ 2.2 MZR-CD [BK; BL]	12.06-10.13							95	830	S4 028			
2.2 D [BM; BN]	07.13→							85	800	S4 E42			
5													
1.8 [CW]	06.10-12.15							60	540	S4 024			
		BWD,SSJ						65	650	S4 E40			
1.8/ 2.0 [CR]	02.05-12.10							60	540	S4 024			
2.0 [CW]	09.10-12.15							60	540	S4 024			
								65	650	S4 E40			
DISI [CW]	06.10-12.15		80	800	S5 A11			45	330	S4 020			
		BWD,SSJ						65	650	S4 E40			
Diesel													
1.6 CD [CW]	06.10-12.15							70	630	S4 026			
2.0 CD [CR]	03.05-12.10							95	830	S4 028			
6													
1.8/ 2.0/ 2.3 , MPS 4x4 [GG/GY]	02.02-08.07							60	540	S4 024			
1.8/ 2.0/ 2.5 MZR [GH]	08.07-12.12			63	610	S5 005		60	540	S4 005			
2.0 [GJ]	10.12-12.16		60	680	S5 A05								
		BWD,SSJ						65	650	S4 E40			
		SSJ						60	640	S4 E05			
[GL]	06.16→		60	680	S5 A05								
		SSJ						60	640	S4 E05			
MZR DISI [GH]	04.10-12.12							60	540	S4 024			
2.5 [GJ]	10.12→		60	680	S5 A05								
		SSJ						60	640	S4 E05			
[GL]	06.16→		60	680	S5 A05								
		SSJ						60	640	S4 E05			
Diesel													
2.0 D Turbo [GG/GY]	06.02-08.07							70	630	S4 026			
MZR-CD [GH]	11.07-01.10							95	830	S4 028			
2.2 D [GJ]	10.12-12.16		60	680	S5 A05			95	830	S4 028			
			105	950	S5 A15		110	920	S5 015				
		BWD,SSJ						85	800	S4 E42			
		SSJ						60	640	S4 E05			
D [GL]	06.16→		60	680	S5 A05								
			60	680	S5 A05			95	830	S4 028			
		SSJ						60	640	S4 E05			



				Ah	A (EN)		Ah	A (EN)		Ah	A (EN)		Ah	A (EN)	
				0 092 ...0			0 092 ...0			0 092 ...0			0 092 ...0		
◀ MAZDA															
2.2 MZR-CD [GH]	01.09-12.12			60	680	S5 A05				70	630	S4 026			
		SSJ								60	640	S4 E05			
	04.10-12.12			60	680	S5 A05				95	830	S4 028			
6 Fastback															
1.8/ 2.0/ 2.3 [GG/GY]	04.02-08.08									60	540	S4 024			
1.8/ 2.0/ 2.5 MZR [GH]	08.07-12.12						63	610	S5 005	60	540	S4 005			
2.0 MZR DISI [GH]	04.10-12.12			60	680	S5 A05				60	540	S4 024			
		SSJ								60	640	S4 E05			
Diesel															
2.0 D Turbo [GG/GY]	06.02-08.07									70	630	S4 026			
MZR-CD [GH]	11.07-01.10						63	610	S5 005	60	540	S4 005			
2.2 MZR-CD [GH]	01.09-12.12			60	680	S5 A05				70	630	S4 026			
		SSJ								60	640	S4 E05			
	04.10-12.12			60	680	S5 A05				95	830	S4 028			
6 Wagon															
1.8/ 2.0 MZR [GH]	12.07-12.12									60	540	S4 005			
1.8/ 2.0/ 2.3 , 4x4 [GG/GY]	06.02-12.07									60	540	S4 024			
2.0 [GJ]	08.12-12.16			60	680	S5 A05									
		SSJ								60	640	S4 E05			
[GL]	06.16→			60	680	S5 A05									
		SSJ								60	640	S4 E05			
MZR DISI [GH]	04.10-12.12			60	680	S5 A05				60	540	S4 024			
		SSJ								60	640	S4 E05			
2.5 [GJ]	08.12-12.16			60	680	S5 A05									
		SSJ								60	640	S4 E05			
[GL]	06.16→			60	680	S5 A05									
		SSJ								60	640	S4 E05			
MZR [GH]	12.07-12.12			60	680	S5 A05				70	630	S4 026			
		SSJ								60	640	S4 E05			
Diesel															
2.0 D Turbo [GG/GY]	06.02-12.07									70	630	S4 026			
MZR-CD [GH]	12.07-01.10									60	540	S4 005			
2.2 D [GJ]	08.12-12.16			60	680	S5 A05				95	830	S4 028			
				105	950	S5 A15	110	920	S5 015						
		BWD,SSJ								85	800	S4 E42			
		SSJ								60	640	S4 E05			
D [GL]	06.16→			60	680	S5 A05									
				60	680	S5 A05				95	830	S4 028			
		SSJ								60	640	S4 E05			
D 4x4 [GJ]	11.14-12.16			60	680	S5 A05									
		SSJ								60	640	S4 E05			
D 4x4 [GL]	06.16→			60	680	S5 A05									
		SSJ								60	640	S4 E05			
MZR-CD [GH]	10.08-12.12			60	680	S5 A05				70	630	S4 026			
		SSJ								60	640	S4 E05			
5.5 D 4x4 [GJ]	11.14-12.16			60	680	S5 A05									
		SSJ								60	640	S4 E05			
121															
1.25/ 1.3 i, i 16V [JA/JB; Soho]	01.96-01.02						63	610	S5 005	60	540	S4 005	56	480	S3 005
Diesel															
1.8 D [JA/JB]	01.96-01.02			70	760	S5 A08	77	780	S5 008	74	680	S4 008	70	640	S3 008
323															
1.3/ 1.5/ 1.6 i [BJ]	05.98-09.03									45	330	S4 021			
1.3/ 1.5/ 1.8 i [BA]	10.96-06.98									45	330	S4 021			
1.8 i [BJ]	05.98-09.03									45	330	S4 021			
	07.98-11.00									60	540	S4 024			
2.0 i [BJ]	09.00-08.03									60	540	S4 024			
Diesel															
2.0 D, D Turbo [BA; BJ]	03.97-09.03									60	540	S4 024			
323 F Hatchback															
1.3/ 1.5/ 1.8/ 2.0 i [BA]	08.95-07.98									60	540	S4 024			



			Ah A (EN) S5A	Ah A (EN) S5	Ah A (EN) S4	Ah A (EN) S3
			0 092 ...0	0 092 ...0	0 092 ...0	0 092 ...0

Diesel						
2.0 D [BA]	10.96-05.98		60	540	S4 024	
323 Hatchback						
P 1.3/ P 1.5 i [BA]	10.96-09.00		45	330	S4 021	
1.3/ 1.5/ 1.6/ 1.8/ 2.0 i [BJ]	06.98→		60	540	S4 024	
1.5/ 1.8 i [BA]	11.96-07.98		60	540	S4 024	
Diesel						
P 2.0 D [BA]	03.97-09.00		60	540	S4 024	
2.0 D [BJ]	06.98-09.99		60	540	S4 024	
D Turbo [BJ]	08.98-01.01		60	540	S4 024	
	11.00-09.03		95	830	S4 028	
323 P Hatchback						
1.3/ 1.5 i [BJ]	09.98-10.00		60	540	S4 024	
626						
1.8/ 2.0 i 16V, 16V [GF]	05.97-04.02		60	540	S4 024	
Diesel						
2.0 16V D Turbo [GF]	04.98-07.02		95	830	S4 028	
626 Fastback						
1.8/ 2.0 i 16V [GF]	08.99-04.02		60	540	S4 024	
Diesel						
2.0 16V D Turbo [GF]	08.99-07.00		95	830	S4 028	
626 Hatchback						
1.8/ 2.0 i 16V, 16V [GF]	04.97-10.99		60	540	S4 024	
Diesel						
2.0 16V D Turbo [GF]	04.98-08.99		95	830	S4 028	
	10.00-07.02		95	830	S4 028	
626 Wagon						
1.8/ 2.0 i 16V [GW]	10.97-04.02		60	540	S4 024	
Diesel						
2.0 D Turbo, 16V D Turbo [GW]	05.98-04.02		95	830	S4 028	

MERCEDES-BENZ

AMG GT C Roadster										
4.0 [190]	01.17→	SSJ	60	680	S5 A05					
			80	800	S5 A11					
AMG GT R										
4.0 [190]	11.16→	SSJ	60	680	S5 A05					
			80	800	S5 A11					
AMG GT Roadster										
4.0 [190]	01.17→	SSJ	60	680	S5 A05					
			80	800	S5 A11					
Serie A										
E-Cell [169]	01.11-04.12		70	760	S5 A08					
45 AMG 4MATIC [176]	06.13→	SSJ	80	800	S5 A11					
140/ 160/ 190/ 210	10.97-08.04		70	760	S5 A08	63	610	S5 005	60	540
, Evolution [168]										
150 [169]	09.04-04.09		70	760	S5 A08	63	610	S5 005	60	540
		SSJ	70	760	S5 A08					
160 [169]	04.09-04.12		70	760	S5 A08	63	610	S5 005	60	540
		SSJ	70	760	S5 A08					
160/ 180/ 200/ 250 , Sport [176]	06.12→	SSJ	70	760	S5 A08					
170 [169]	09.04-04.09		70	760	S5 A08	63	610	S5 005	60	540
		SSJ	70	760	S5 A08					
180 [169]	04.09-04.12		70	760	S5 A08	63	610	S5 005	60	540
		SSJ	70	760	S5 A08					
200 [169]	04.04-04.12		70	760	S5 A08	63	610	S5 005	60	540
Turbo [169]	06.05-10.10		70	760	S5 A08	63	610	S5 005	60	540
220 4MATIC [176]	05.14→	SSJ	70	760	S5 A08					
			80	800	S5 A11					



			Ah A (EN) S5A			Ah A (EN) S5			Ah A (EN) S4			Ah A (EN) S3		
			0 092 ...0			0 092 ...0			0 092 ...0			0 092 ...0		
◀ MERCEDES-BENZ														
250 Sport 4MATIC [176]	05.15→	SSJ	80	800	S5 A11									
4MATIC [176]	02.13→	SSJ	70	760	S5 A08									
			80	800	S5 A11									
Diesel														
160 CDI [176]	06.13-06.15	SSJ	70	760	S5 A08									
d [176]	07.15→	SSJ	70	760	S5 A08									
160/170/180/200 CDI [168; 169]	07.98-04.12		70	760	S5 A08	77	780	S5 008	74	680	S4 008			
180 CDI [176]	06.12-12.14	SSJ	80	800	S5 A11									
	10.12-06.15		70	760	S5 A08									
d [176]	07.15→		70	760	S5 A08									
200 CDI [176]	06.12-12.14		70	760	S5 A08									
	02.14-06.15	SSJ	80	800	S5 A11									
200/220 CDI 4MATIC [176]	12.13-06.15	SSJ	80	800	S5 A11									
d [176]	07.15→	SSJ	80	800	S5 A11									
d 4MATIC [176]	07.15→	SSJ	80	800	S5 A11									
220 CDI [176]	06.12-06.15	SSJ	80	800	S5 A11									
Serie B														
150 [245]	04.05-04.09		70	760	S5 A08	63	610	S5 005	60	540	S4 005			
		SSJ	70	760	S5 A08									
160 [245]	04.09-04.11		70	760	S5 A08	63	610	S5 005	60	540	S4 005			
		SSJ	70	760	S5 A08									
[246]	05.15→	SSJ	70	760	S5 A08									
170 [245]	04.05-04.09		70	760	S5 A08	63	610	S5 005	60	540	S4 005			
		SSJ	70	760	S5 A08									
NGT [245]	05.08-04.09		70	760	S5 A08	77	780	S5 008						
180 [245]	04.09-04.11		70	760	S5 A08	63	610	S5 005	60	540	S4 005			
		SSJ	70	760	S5 A08									
[246]	09.11→	SSJ	70	760	S5 A08									
			80	800	S5 A11									
NGT [245]	05.09-04.11					77	780	S5 008						
		SSJ	70	760	S5 A08									
200 [245]	04.05-04.11		70	760	S5 A08	63	610	S5 005	60	540	S4 005			
[246]	09.11→	SSJ	80	800	S5 A11									
c, NGD [246]	09.12→	SSJ	70	760	S5 A08									
Turbo [245]	04.05-10.10		70	760	S5 A08	63	610	S5 005	60	540	S4 005			
220 [246]	09.17→		70	760	S5 A08									
			80	800	S5 A11									
4MATIC [246]	05.13→	SSJ	70	760	S5 A08									
			80	800	S5 A11									
250 [246]	05.12→	SSJ	70	760	S5 A08									
4MATIC [246]	07.14→	SSJ	70	760	S5 A08									
			80	800	S5 A11									
Diesel														
160 CDI [246]	05.13-06.15	SSJ	70	760	S5 A08									
160/180/200/220 CDI 4MATIC, d [246]	08.14→	SSJ	70	760	S5 A08									
180 CDI [246]	09.11-12.15	SSJ	80	800	S5 A11									
	02.13-06.15	SSJ	70	760	S5 A08									
180/200 CDI [245]	04.05-05.11		70	760	S5 A08	77	780	S5 008	74	680	S4 008			
200 CDI [246]	09.11-05.15	SSJ	80	800	S5 A11									
220 CDI [246]	04.12-06.15	SSJ	70	760	S5 A08									
d 4MATIC [246]	09.14→	SSJ	80	800	S5 A11									
Serie C														
32 AMG KOMPRESSOR [203]	01.01-01.04		95	850	S5 A13	85	800	S5 010						
			95	850	S5 A13	100	830	S5 013						
43 AMG [202]	11.97-04.00		70	760	S5 A08	77	780	S5 008						
4MATIC [205]	05.16→	SSJ	70	760	S5 A08									
			80	800	S5 A11									
45 AMG 4MATIC [205]	04.15-04.16	SSJ	80	800	S5 A11									
55 AMG [203]	02.04-08.07		70	760	S5 A08	77	780	S5 008						
63 AMG [204]	02.08-12.14					100	830	S5 013						
		SSJ	95	850	S5 A13									



			Ah A (EN) S5A			Ah A (EN) S5			Ah A (EN) S4			Ah A (EN) S3		
			0 092 ...0			0 092 ...0			0 092 ...0			0 092 ...0		
63 AMG [204]	10.09-12.14	SSJ	80	800	S5 A11									
	11.12-12.14		95	850	S5 A13	100	830	S5 013	95	800	S4 013			
[205]	09.14→	SSJ	60	680	S5 A05									
			95	850	S5 A13									
S [205]	09.14→	SSJ	60	680	S5 A05									
			95	850	S5 A13									
160 [205]	04.15→	SSJ	70	760	S5 A08									
			80	800	S5 A11									
180 [202]	09.95-04.00		70	760	S5 A08	77	780	S5 008	60	540	S4 005			
[205]	03.14→	SSJ	70	760	S5 A08									
			80	800	S5 A11									
CGI [204]	01.09-04.12					63	610	S5 005						
	01.09-12.14	SSJ	80	800	S5 A11									
	04.12-12.14					77	780	S5 008						
		SSJ							74	680	S4 008			
		SSJ	70	760	S5 A08									
KOMPRESSOR [203]	09.02-07.07		70	760	S5 A08	77	780	S5 008	60	540	S4 005			
KOMPRESSOR [204]	01.07-10.08	SSJ	70	760	S5 A08									
	01.07-04.10		70	760	S5 A08	77	780	S5 008	60	540	S4 005			
180/ 230/ 240 [203]	05.00-07.07		70	760	S5 A08	77	780	S5 008	60	540	S4 005			
200 [205]	12.13→	SSJ	70	760	S5 A08									
			80	800	S5 A11									
CGI [204]	04.09-12.14					63	610	S5 005						
						85	800	S5 011						
		SSJ	80	800	S5 A11									
CGI KOMPRESSOR [203]	04.03-04.05		70	760	S5 A08	77	780	S5 008	60	540	S4 005			
KOMPRESSOR [203]	05.00-08.02		70	760	S5 A08	100	830	S5 013	74	680	S4 008			
	09.02-02.07		70	760	S5 A08	77	780	S5 008	60	540	S4 005			
KOMPRESSOR [204]	03.07-04.10		70	760	S5 A08	77	780	S5 008	60	540	S4 005			
		SSJ	70	760	S5 A08									
4MATIC [205]	04.15→	SSJ	70	760	S5 A08									
			80	800	S5 A11									
200/ 230 KOMPRESSOR [202]	09.95-04.00		70	760	S5 A08	77	780	S5 008	60	540	S4 005	56	480	S3 005
200/ 230/ 240 [202]	01.94-04.00		70	760	S5 A08	77	780	S5 008	60	540	S4 005	56	480	S3 005
230 [204]	08.07-08.09		70	760	S5 A08	77	780	S5 008	60	540	S4 005			
KOMPRESSOR [203]	09.02-05.05		70	760	S5 A08	77	780	S5 008	60	540	S4 005			
4MATIC [204]	08.07-04.09		70	760	S5 A08	77	780	S5 008	60	540	S4 005			
240 4MATIC [203]	09.02-06.05		70	760	S5 A08	77	780	S5 008	60	540	S4 005			
250 [204]	09.09-08.11					77	780	S5 008						
		SSJ	70	760	S5 A08									
			80	800	S5 A11									
[205]	03.14→	SSJ	70	760	S5 A08									
			80	800	S5 A11									
CGI [204]	04.09-12.14	BWD,SSJ	80	800	S5 A11									
280 [202]	06.97-08.00		70	760	S5 A08	100	830	S5 013	74	680	S4 008	70	640	S3 008
[204]	03.07-04.09		70	760	S5 A08	77	780	S5 008	60	540	S4 005			
			70	760	S5 A08	77	780	S5 008	80	740	S4 011			
			70	760	S5 A08	85	800	S5 011	60	540	S4 005			
4MATIC [204]	07.07-04.09		70	760	S5 A08	77	780	S5 008	60	540	S4 005			
			70	760	S5 A08	77	780	S5 008	80	740	S4 011			
			70	760	S5 A08	85	800	S5 011	60	540	S4 005			
280/ 350 [203]	06.05-02.07		70	760	S5 A08	100	830	S5 013	74	680	S4 008			
4MATIC [203]	07.05-08.07		70	760	S5 A08	100	830	S5 013	74	680	S4 008			
300 [204]	09.07-01.11					77	780	S5 008						
		SSJ	70	760	S5 A08									
			80	800	S5 A11									
[205]	10.14→	SSJ	80	800	S5 A11									
			95	850	S5 A13									
CGI [204]	08.12-12.14		80	800	S5 A11									
CGI 4MATIC [204]	08.12-12.14	SSJ	80	800	S5 A11									
4MATIC [204]	05.07-08.13		70	760	S5 A08	77	780	S5 008	60	540	S4 005			
			70	760	S5 A08	85	800	S5 011	60	540	S4 005			



											Ah A (EN)			Ah A (EN)			Ah A (EN)			Ah A (EN)		
					0 092 ...0			0 092 ...0			0 092 ...0			0 092 ...0								
◀ MERCEDES-BENZ																						
320 [203]	05.00-05.05				100	830	S5 013	74	680	S4 008												
4MATIC [203]	09.02-06.05				100	830	S5 013	74	680	S4 008												
350 [204]	03.07-08.11		70	760	S5 A08	77	780	S5 008	60	540	S4 005											
			70	760	S5 A08	77	780	S5 008	80	740	S4 011											
			70	760	S5 A08	85	800	S5 011	60	540	S4 005											
CGI [204]	09.08-01.11				100	830	S5 013	95	800	S4 013												
		SSJ	95	850	S5 A13																	
	02.11-12.14	SSJ	80	800	S5 A11																	
CGI 4MATIC [204]	01.11-12.14	SSJ	80	800	S5 A11																	
			95	850	S5 A13																	
e [205]	02.15→	SSJ	80	800	S5 A11																	
4MATIC [204]	07.07-12.10		70	760	S5 A08	77	780	S5 008	60	540	S4 005											
			70	760	S5 A08	77	780	S5 008	80	740	S4 011											
			70	760	S5 A08	85	800	S5 011	60	540	S4 005											
400 4MATIC [205]	10.14→	SSJ	80	800	S5 A11																	
Diesel																						
30 AMG/ 320 CDI [203]	01.03-05.07		70	760	S5 A08	77	780	S5 008														
180 BlueTec [205]	05.14-09.15	SSJ	70	760	S5 A08																	
			80	800	S5 A11																	
CDI [204]	10.10-12.14	SSJ	80	800	S5 A11																	
			95	850	S5 A13																	
d [205]	10.15→	SSJ	70	760	S5 A08																	
			80	800	S5 A11																	
200 BlueTec [205]	05.14-09.15	SSJ	70	760	S5 A08																	
			80	800	S5 A11																	
CDI [204]	01.07-12.10		95	850	S5 A13	85	800	S5 011	80	740	S4 011											
		SSJ	80	800	S5 A11																	
	01.07-12.14		95	850	S5 A13	85	800	S5 010	80	740	S4 010											
			95	850	S5 A13	85	800	S5 011	80	740	S4 010											
	04.08-12.14		95	850	S5 A13	85	800	S5 010	80	740	S4 011											
d [205]	10.15→	SSJ	60	680	S5 A05																	
			70	760	S5 A08																	
			80	800	S5 A11																	
D [202]	09.96-06.99	BAW				100	830	S5 013	74	680	S4 008											
200/ 220 CDI [202]	12.97-04.00					100	830	S5 013	74	680	S4 008											
200/ 220/ 270 CDI [203]	05.00-03.07					100	830	S5 013	74	680	S4 008											
220 BlueTec [205]	11.13-11.15	SSJ	70	760	S5 A08																	
			80	800	S5 A11																	
CDI [204]	03.07-04.09		95	850	S5 A13	85	800	S5 010	80	740	S4 010											
			95	850	S5 A13	85	800	S5 010	80	740	S4 011											
			95	850	S5 A13	85	800	S5 011	80	740	S4 010											
		SSJ	80	800	S5 A11																	
	12.08-12.14					85	800	S5 011	80	740	S4 011											
		BWD,SSJ	80	800	S5 A11																	
CDI 4MATIC [204]	03.13-12.14	SSJ	95	850	S5 A13																	
d [205]	12.15→	SSJ	70	760	S5 A08																	
			80	800	S5 A11																	
D [202]	08.93-06.99								74	680	S4 008											
		BAW	95	850	S5 A13	77	780	S5 008														
d 4MATIC [205]	04.15→	SSJ	80	800	S5 A11																	
250 BlueTec [205]	02.14-11.15	SSJ	70	760	S5 A08																	
			80	800	S5 A11																	
BlueTec 4MATIC [205]	02.14-12.15	SSJ	70	760	S5 A08																	
			80	800	S5 A11																	
CDI [204]	09.08-12.14	BWD,SSJ	80	800	S5 A11																	
CDI 4MATIC [204]	04.10-12.14	SSJ	80	800	S5 A11																	
			95	850	S5 A13																	
d [205]	12.15→	SSJ	70	760	S5 A08																	
			80	800	S5 A11																	
D Turbo [202]	09.95-04.00	BAW				100	830	S5 013	74	680	S4 008											
300 BlueTec Hybrid [205]	05.14-12.15	SSJ	70	760	S5 A08																	
			80	800	S5 A11																	
CDI 4MATIC [204]	03.11-12.14	SSJ	95	850	S5 A13																	



			Ah A (EN) S5A			Ah A (EN) S5			Ah A (EN) S4			Ah A (EN) S3		
			0 092 ...0			0 092 ...0			0 092 ...0			0 092 ...0		
300 h [205]	12.15→	SSJ	70	760	S5 A08									
			80	800	S5 A11									
320 CDI [204]	06.07-04.09		95	850	S5 A13	85	800	S5 010	80	740	S4 010			
			95	850	S5 A13	85	800	S5 010	80	740	S4 011			
			95	850	S5 A13	85	800	S5 011	80	740	S4 010			
CDI 4MATIC [204]	07.07-04.09		95	850	S5 A13	85	800	S5 010	80	740	S4 010			
			95	850	S5 A13	85	800	S5 010	80	740	S4 011			
			95	850	S5 A13	85	800	S5 011	80	740	S4 010			
350 CDI [204]	05.09-01.11					85	800	S5 010	80	740	S4 010			
						85	800	S5 010	95	800	S4 013			
	05.09-12.14	SSJ	95	850	S5 A13									
CDI 4MATIC [204]	05.09-12.14					85	800	S5 010	80	740	S4 010			
		SSJ	95	850	S5 A13									
Serie C (Cabrio)														
43 AMG/ 400 4MATIC [205]	04.16→	SSJ	70	760	S5 A08									
63 AMG S [205]	10.16→	SSJ	80	800	S5 A11									
63 AMG/ 200/ 250/ 300 [205]	09.16→	SSJ	80	800	S5 A11									
180 [205]	09.16→	SSJ	70	760	S5 A08									
200 4MATIC [205]	09.16→	SSJ	80	800	S5 A11									
Diesel														
220 d [205]	09.16→	SSJ	80	800	S5 A11									
	04.18→		70	760	S5 A08									
			95	850	S5 A13									
d 4MATIC [205]	09.16→	SSJ	80	800	S5 A11									
250 d [205]	09.16→	SSJ	80	800	S5 A11									
Serie C (Coupé)														
43 AMG/ 400 4MATIC [205]	04.16→	SSJ	70	760	S5 A08									
63 AMG [204]	03.11-12.14	SSJ	80	800	S5 A11									
	06.11-12.14	SSJ	95	850	S5 A13									
	11.12-12.14		80	800	S5 A11									
[205]	02.16→	SSJ	80	800	S5 A11									
S [205]	02.16→	SSJ	80	800	S5 A11									
180 [205]	10.15→	SSJ	60	680	S5 A05									
			70	760	S5 A08									
CGI [204]	03.11-12.14	SSJ	80	800	S5 A11									
200 [205]	10.15→	SSJ	70	760	S5 A08									
			80	800	S5 A11									
CGI [204]	04.12-12.14	SSJ	70	760	S5 A08									
			80	800	S5 A11									
4MATIC [205]	04.16→	SSJ	60	680	S5 A05									
			80	800	S5 A11									
250 [205]	10.15→	SSJ	70	760	S5 A08									
			80	800	S5 A11									
250/ 350 CGI [204]	03.11-12.14	SSJ	80	800	S5 A11									
300 [205]	10.15→	SSJ	70	760	S5 A08									
Diesel														
220 CDI [204]	03.11-12.14	SSJ	70	760	S5 A08									
			80	800	S5 A11									
d [205]	10.15→	SSJ	80	800	S5 A11									
	04.18→		70	760	S5 A08									
			95	850	S5 A13									
220/ 250 d 4MATIC [205]	04.16→	SSJ	80	800	S5 A11									
250 CDI [204]	03.11-12.14	SSJ	70	760	S5 A08									
			80	800	S5 A11									
d [205]	10.15→	SSJ	80	800	S5 A11									
Serie C (Sportcoupe)														
160/ 180/ 200/ 230 CGI KOMPRESSOR, KOMPRESSOR [203]	01.01-02.08		70	760	S5 A08	77	780	S5 008	60	540	S4 005			
180 [203]	01.01-08.02		70	760	S5 A08	77	780	S5 008	60	540	S4 005			
230 [203]	06.05-02.08		70	760	S5 A08	77	780	S5 008	60	540	S4 005			
320 [203]	09.02-05.05		70	760	S5 A08	77	780	S5 008	74	680	S4 008			



			Ah A (EN) S5A			Ah A (EN) S5			Ah A (EN) S4			Ah A (EN) S3		
			0 092 ...0			0 092 ...0			0 092 ...0			0 092 ...0		
◀ MERCEDES-BENZ														
350 [203]	06.05-02.08		70	760	S5 A08	77	780	S5 008						
Diesel														
30 AMG CDI [203]	09.02-08.04		70	760	S5 A08	77	780	S5 008						
200 CDI [203]	03.03-02.08					100	830	S5 013	74	680	S4 008			
220 CDI [203]	01.01-04.04					100	830	S5 013	74	680	S4 008			
	05.04-02.08		70	760	S5 A08	77	780	S5 008						
			70	760	S5 A08	100	830	S5 013						
Serie C (T-Modell)														
32 AMG KOMPRESSOR [203]	01.01-01.04		95	850	S5 A13	85	800	S5 010						
			95	850	S5 A13	100	830	S5 013						
43 AMG [202]	10.97-02.01		80	800	S5 A11	85	800	S5 010						
4MATIC [205]	05.16→	SSJ	70	760	S5 A08									
			80	800	S5 A11									
55 AMG [203]	02.04-08.07		70	760	S5 A08	77	780	S5 008						
63 AMG [204]	02.08-12.14					100	830	S5 013	95	800	S4 013			
		SSJ	80	800	S5 A11									
			95	850	S5 A13									
	11.12-12.14		95	850	S5 A13	100	830	S5 013	95	800	S4 013			
[205]	10.14→	SSJ	95	850	S5 A13									
S [205]	10.14→	SSJ	95	850	S5 A13									
160 [205]	04.15→	SSJ	70	760	S5 A08									
			80	800	S5 A11									
180 [205]	05.14→	SSJ	70	760	S5 A08									
			80	800	S5 A11									
CGI [204]	10.09-04.12	SSJ	95	850	S5 A13									
	10.09-12.14	SSJ	80	800	S5 A11									
	04.12-12.14					77	780	S5 008	74	680	S4 008			
		SSJ	70	760	S5 A08									
KOMPRESSOR [204]	09.07-08.08		70	760	S5 A08	85	800	S5 011	60	540	S4 005			
	09.07-04.10		70	760	S5 A08	77	780	S5 008	60	540	S4 005			
180/ 200/ 230/ 240	05.96-08.07		70	760	S5 A08	77	780	S5 008	60	540	S4 005			
, CGI KOMPRESSOR, KOMPRESSOR, 4MATIC [202; 203]														
200 [205]	05.14→	SSJ	70	760	S5 A08									
			80	800	S5 A11									
CGI [204]	04.09-12.14					63	610	S5 005						
		SSJ	60	680	S5 A05									
KOMPRESSOR [204]	09.07-04.10		70	760	S5 A08	77	780	S5 008	60	540	S4 005			
4MATIC [205]	04.15→	SSJ	70	760	S5 A08									
			80	800	S5 A11									
230 [204]	09.07-04.09		70	760	S5 A08	77	780	S5 008	60	540	S4 005			
KOMPRESSOR [202]	06.97-02.01		70	760	S5 A08	77	780	S5 008	60	540	S4 005	56	480	S3 005
250 [205]	05.14→	SSJ	70	760	S5 A08									
			80	800	S5 A11									
CGI [204]	04.09-12.14					63	610	S5 005						
		SSJ	80	800	S5 A11									
280 [202]	06.97-02.01					77	780	S5 008	74	680	S4 008			
[204]	09.07-03.09		70	760	S5 A08	77	780	S5 008	60	540	S4 005			
			70	760	S5 A08	77	780	S5 008	80	740	S4 011			
			70	760	S5 A08	85	800	S5 011	60	540	S4 005			
280/ 350 [203]	06.05-08.07		70	760	S5 A08	100	830	S5 013	74	680	S4 008			
4MATIC [203]	07.05-08.07		70	760	S5 A08	100	830	S5 013	74	680	S4 008			
300 [204]	04.09-12.11		70	760	S5 A08	77	780	S5 008	60	540	S4 005			
[205]	04.15→	SSJ	80	800	S5 A11									
320 [203]	01.01-05.05					100	830	S5 013	74	680	S4 008			
4MATIC [203]	09.02-06.05					100	830	S5 013	74	680	S4 008			
350 [204]	09.07-12.10		70	760	S5 A08	77	780	S5 008	60	540	S4 005			
			70	760	S5 A08	77	780	S5 008	80	740	S4 011			
			70	760	S5 A08	85	800	S5 011	60	540	S4 005			
CGI [204]	02.11-12.14	SSJ	80	800	S5 A11									
350/ 450 AMG 4MATIC, e, Hybrid Plus [205]	07.14→	SSJ	80	800	S5 A11									



		?	Ah A (EN) S5A			Ah A (EN) S5			Ah A (EN) S4			Ah A (EN) S3		
			0 092 ...0			0 092 ...0			0 092 ...0			0 092 ...0		
400 4MATIC [205]	10.14→	SSJ	80	800	S5 A11									
Diesel														
30 AMG/ 320 CDI [203]	01.03-08.07		70	760	S5 A08	77	780	S5 008						
180 BlueTec [205]	05.14-12.15	SSJ	70	760	S5 A08									
			80	800	S5 A11									
CDI [204]	01.11-12.14	SSJ	80	800	S5 A11									
200 BlueTec [205]	05.14-12.15	SSJ	70	760	S5 A08									
			80	800	S5 A11									
CDI [203]	10.01-08.07		95	850	S5 A13	100	830	S5 013	95	800	S4 013			
CDI [204]	09.07-10.09		95	850	S5 A13	85	800	S5 010	80	740	S4 010			
			95	850	S5 A13	85	800	S5 010	80	740	S4 011			
			95	850	S5 A13	85	800	S5 011	80	740	S4 010			
		SSJ	80	800	S5 A11									
	01.11-12.14	SSJ	80	800	S5 A11									
			95	850	S5 A13									
d [205]	10.15→	SSJ	80	800	S5 A11									
200/ 220 CDI, D [202]	05.96-02.01		70	760	S5 A08	77	780	S5 008	74	680	S4 008			
220 CDI [204]	09.07-03.09		95	850	S5 A13	85	800	S5 010	80	740	S4 010			
			95	850	S5 A13	85	800	S5 010	80	740	S4 011			
			95	850	S5 A13	85	800	S5 011	80	740	S4 010			
	09.07-12.14	SSJ	80	800	S5 A11									
	04.09-12.14					85	800	S5 011	80	740	S4 011			
CDI 4MATIC [204]	03.13-12.14	SSJ	95	850	S5 A13									
d [205]	12.15→	SSJ	80	800	S5 A11									
	04.18→		70	760	S5 A08									
			95	850	S5 A13									
d BlueTec, d 4MATIC [205]	05.14→	SSJ	80	800	S5 A11									
220/ 270 CDI [203]	01.01-08.07					100	830	S5 013	74	680	S4 008			
250 BlueTec [205]	05.14-11.15	SSJ	80	800	S5 A11									
BlueTec 4MATIC [205]	10.14→	SSJ	80	800	S5 A11									
CDI [204]	04.09-12.14	SSJ	80	800	S5 A11									
			95	850	S5 A13									
CDI 4MATIC [204]	04.10-12.14		80	800	S5 A11									
d [205]	12.15→	SSJ	80	800	S5 A11									
D Turbo [202]	05.96-02.01		70	760	S5 A08	100	830	S5 013	74	680	S4 008			
300 BlueTec Hybrid [205]	10.14→	SSJ	80	800	S5 A11									
			95	850	S5 A13									
CDI 4MATIC [204]	09.11-12.14					85	800	S5 010	80	740	S4 010			
		SSJ	95	850	S5 A13									
h [205]	12.15→	SSJ	80	800	S5 A11									
			95	850	S5 A13									
320 CDI [204]	09.07-04.09		95	850	S5 A13	85	800	S5 010	80	740	S4 010			
CDI 4MATIC [204]	09.07-04.09		95	850	S5 A13	85	800	S5 010	80	740	S4 010			
350 CDI [204]	05.09-10.09	SSJ	95	850	S5 A13									
	05.09-12.14	SSJ	80	800	S5 A11									
	10.09-01.11					85	800	S5 010	80	740	S4 010			
						85	800	S5 010	95	800	S4 013			
CDI 4MATIC [204]	05.09-10.09		95	850	S5 A13	85	800	S5 010	80	740	S4 010			
	10.09-08.11					85	800	S5 010	80	740	S4 010			
						85	800	S5 010	95	800	S4 013			
		SSJ	95	850	S5 A13									
Serie CL (Coupé)														
55 AMG/ 65 AMG/ 500/ 600 , KOMPRESSOR [215]	09.99-08.06		95	850	S5 A13	100	830	S5 013						
63 AMG [216]	01.07-07.10		95	850	S5 A13	100	830	S5 013						
	08.10-12.14	SSJ	95	850	S5 A13									
65 AMG [216]	09.07-07.10		95	850	S5 A13	100	830	S5 013						
	07.10-12.14		95	850	S5 A13									
420/ 500/ 600 [140]	06.96-08.99		95	850	S5 A13	100	830	S5 013	95	800	S4 013	90	720	
500 CGI, CGI 4MATIC [216]	07.10-12.14	SSJ	95	850	S5 A13									
4MATIC [216]	04.08-07.10		95	850	S5 A13	100	830	S5 013						
500/ 600 [216]	06.06-12.14		95	850	S5 A13	100	830	S5 013						



			Ah A (EN)	Ah A (EN)	Ah A (EN)	Ah A (EN)
			0 092 ...0	0 092 ...0	0 092 ...0	0 092 ...0

◀ MERCEDES-BENZ

Serie CLA														
45 AMG 4MATIC [117]	06.13-06.15	SSJ	70	760	S5 A08									
	06.13→	SSJ	80	800	S5 A11									
180/200 [117]	12.12→	SSJ	70	760	S5 A08									
	220 4MATIC [117]	04.16→	SSJ	70	760	S5 A08								
			80	800	S5 A11									
250 [117]	12.12-06.15	SSJ	70	760	S5 A08									
	07.15→	SSJ	80	800	S5 A11									
4MATIC [117]	07.13→	SSJ	70	760	S5 A08									
			80	800	S5 A11									
Diesel														
180/200/220 CDI [117]	12.12-06.15	SSJ	80	800	S5 A11									
	d, d 4MATIC [117]	07.15→	SSJ	80	800	S5 A11								
200 CDI 4MATIC [117]	07.14-06.15	SSJ	80	800	S5 A11									
220 CDI 4MATIC [117]	05.14-06.15	SSJ	70	760	S5 A08									
			80	800	S5 A11									
Serie CLA (Shooting Brake)														
45 AMG 4MATIC [117]	01.15-06.15	SSJ	70	760	S5 A08									
	01.15→	SSJ	80	800	S5 A11									
180 [117]	03.15→	SSJ	70	760	S5 A08									
			80	800	S5 A11									
200 [117]	03.15→	SSJ	70	760	S5 A08									
			80	800	S5 A11									
220 4MATIC [117]	04.16→	SSJ	70	760	S5 A08									
			80	800	S5 A11									
250 [117]	03.15→	SSJ	70	760	S5 A08									
			80	800	S5 A11									
4MATIC [117]	01.15→	SSJ	70	760	S5 A08									
			80	800	S5 A11									
Diesel														
180/200/220 d, d 4MATIC [117]	03.15→	SSJ	80	800	S5 A11									
Serie CLC														
160 [203]	02.09-10.10		70	760	S5 A08									
		SSJ	70	760	S5 A08									
180/200 KOMPRESSOR [203]	03.08-05.10		70	760	S5 A08	77	780	S5 008	60	540	S4 005			
230 [203]	03.08-05.10		70	760	S5 A08	77	780	S5 008	60	540	S4 005			
350 [203]	03.08-05.10					100	830	S5 013	74	680	S4 008			
Diesel														
200/220 CDI [203]	03.08-05.10					100	830	S5 013	74	680	S4 008			
Serie CLK (Cabrio)														
55 AMG/280/320/350/500 [209]	09.01-12.09		70	760	S5 A08	100	830	S5 013	74	680	S4 008			
55 AMG/430 [208]	09.98-01.03		95	850	S5 A13	100	830	S5 013						
63 AMG [209]	09.06-12.09		95	850	S5 A13	100	830	S5 013	95	800	S4 013	90	720	S3 013
200 [208]	06.98-06.00		70	760	S5 A08	77	780	S5 008	60	540	S4 005			
	KOMPRESSOR [209]	02.03-09.06		70	760	S5 A08	77	780	S5 008					
		10.06-12.09		70	760	S5 A08	77	780	S5 008	60	540	S4 005		
200/230 KOMPRESSOR [208]	09.96-01.03		70	760	S5 A08	77	780	S5 008	60	540	S4 005			
240 [209]	02.03-03.05		70	760	S5 A08	77	780	S5 008						
320 [208]	06.98-01.03		70	760	S5 A08	77	780	S5 008						
Diesel														
320 CDI [209]	04.05-12.09		95	850	S5 A13	100	830	S5 013	95	800	S4 013	90	720	S3 013
Serie CLK (Coupé)														
55 AMG [209]	08.01-08.06		95	850	S5 A13	100	830	S5 013						
55 AMG/430 [208]	09.98-04.02		95	850	S5 A13	100	830	S5 013						
63 AMG [209]	09.06-04.09		95	850	S5 A13	100	830	S5 013	95	800	S4 013	90	720	S3 013
	05.07-04.09		95	850	S5 A13	100	830	S5 013	95	800	S4 013			
200 [208]	06.97-06.00		70	760	S5 A08	77	780	S5 008	60	540	S4 005			
	CGI KOMPRESSOR, KOMPRESSOR [209]	05.02-04.09		70	760	S5 A08	77	780	S5 008	60	540	S4 005		



			Ah A (EN) S5A			Ah A (EN) S5			Ah A (EN) S4			Ah A (EN) S3		
			0 092 ...0			0 092 ...0			0 092 ...0			0 092 ...0		
200/ 230 KOMPRESSOR [208]	06.97-04.02		70	760	S5 A08	77	780	S5 008	60	540	S4 005			
240/ 320 [209]	05.02-03.05		70	760	S5 A08	77	780	S5 008	60	540	S4 005			
280/ 350 [209]	04.05-04.09		70	760	S5 A08	100	830	S5 013	74	680	S4 008			
320 [208]	01.97-09.02		70	760	S5 A08	77	780	S5 008						
500 [209]	05.02-07.06		70	760	S5 A08	77	780	S5 008	60	540	S4 005			
	09.06-04.09		70	760	S5 A08	100	830	S5 013	74	680	S4 008			
Diesel														
220/ 270/ 320 CDI [209]	09.02-04.09		95	850	S5 A13	100	830	S5 013						
Serie CLS (Coupé)														
55 AMG/ 63 AMG/ 350/ 500 [219]	06.04-08.11	AGM,BWD	95	850	S5 A13									
63 AMG [218]	10.10→	SSJ	95	850	S5 A13									
	09.11→	SSJ	80	800	S5 A11									
S 4MATIC [218]	02.13→	SSJ	80	800	S5 A11									
			95	850	S5 A13									
4MATIC [218]	05.13→	SSJ	80	800	S5 A11									
			95	850	S5 A13									
280/ 300 [219]	01.08-09.09		95	850	S5 A13									
350 CGI [218]	10.10-12.14	SSJ	80	800	S5 A11									
CGI [219]	04.06-09.10	AGM,BWD	95	850	S5 A13									
400 [218]	05.14→	SSJ	80	800	S5 A11									
			95	850	S5 A13									
4MATIC [218]	05.14→	SSJ	80	800	S5 A11									
			95	850	S5 A13									
500 [218]	02.11-12.18	SSJ	95	850	S5 A13									
4MATIC [218]	06.11-12.18	SSJ	95	850	S5 A13									
Diesel														
220 BlueTec [218]	05.14-02.16	SSJ	80	800	S5 A11									
			95	850	S5 A13									
d [218]	03.16→	SSJ	80	800	S5 A11									
			95	850	S5 A13									
250 BlueTec [218]	09.14-02.16	SSJ	80	800	S5 A11									
			95	850	S5 A13									
BlueTec 4MATIC [218]	05.14-02.16	SSJ	80	800	S5 A11									
			95	850	S5 A13									
CDI [218]	07.10-12.14	SSJ	80	800	S5 A11									
d [218]	03.16→		80	800	S5 A11									
			95	850	S5 A13									
d 4MATIC [218]	03.16→	SSJ	80	800	S5 A11									
			95	850	S5 A13									
300 d [257]	04.18→	BWD	70	760	S5 A08									
			80	800	S5 A11									
			95	850	S5 A13									
320 CDI [219]	05.05-04.09	AGM,BWD	95	850	S5 A13									
350 BlueTec [218]	11.12-02.16	SSJ	80	800	S5 A11									
			95	850	S5 A13									
CDI [218]	10.10-02.16	SSJ	80	800	S5 A11									
			95	850	S5 A13									
CDI [219]	05.09-12.10	AGM	95	850	S5 A13									
CDI 4MATIC [218]	06.11-12.15	SSJ	95	850	S5 A13									
d [218]	03.16-12.18	SSJ	80	800	S5 A11									
			95	850	S5 A13									
d 4MATIC [218]	04.15-12.18	SSJ	80	800	S5 A11									
			95	850	S5 A13									
Serie CLS (Shooting Brake)														
63 AMG S [218]	06.13→	SSJ	80	800	S5 A11									
			95	850	S5 A13									
S 4MATIC [218]	02.13→	SSJ	80	800	S5 A11									
			95	850	S5 A13									
4MATIC [218]	05.13→	SSJ	95	850	S5 A13									
63 AMG/ 350 [218]	06.12→	SSJ	95	850	S5 A13									



			Ah A (EN) S5A			Ah A (EN) S5			Ah A (EN) S4			Ah A (EN) S3		
			0 092 ...0			0 092 ...0			0 092 ...0			0 092 ...0		
◀ MERCEDES-BENZ														
400 [218]	05.14→	SSJ	80	800	S5 A11									
			95	850	S5 A13									
4MATIC [218]	05.14→	SSJ	80	800	S5 A11									
			95	850	S5 A13									
500 [218]	06.12-12.18	SSJ	95	850	S5 A13									
4MATIC [218]	06.12-12.18	SSJ	95	850	S5 A13									
Diesel														
220 BlueTec [218]	05.14-02.16	SSJ	80	800	S5 A11									
			95	850	S5 A13									
d [218]	03.16→	SSJ	80	800	S5 A11									
			95	850	S5 A13									
250 BlueTec [218]	09.14-02.16	SSJ	80	800	S5 A11									
			95	850	S5 A13									
BlueTec 4MATIC [218]	05.14-02.16	SSJ	80	800	S5 A11									
			95	850	S5 A13									
CDI [218]	06.12-12.14	SSJ	80	800	S5 A11									
			95	850	S5 A13									
d [218]	03.16→		80	800	S5 A11									
			95	850	S5 A13									
d 4MATIC [218]	03.16→	SSJ	80	800	S5 A11									
			95	850	S5 A13									
350 BlueTec [218]	05.14-02.16	SSJ	80	800	S5 A11									
			95	850	S5 A13									
BlueTec 4MATIC [218]	05.14-03.15	SSJ	80	800	S5 A11									
			95	850	S5 A13									
CDI [218]	06.12-02.16	SSJ	80	800	S5 A11									
			95	850	S5 A13									
CDI 4MATIC [218]	10.12-03.15	SSJ	80	800	S5 A11									
			95	850	S5 A13									
d [218]	03.16-12.18	SSJ	80	800	S5 A11									
			95	850	S5 A13									
d 4MATIC [218]	04.15-12.18	SSJ	80	800	S5 A11									
			95	850	S5 A13									
Serie E														
43 AMG 4MATIC [213]	06.16→	SSJ	70	760	S5 A08									
			80	800	S5 A11									
			95	850	S5 A13									
55 AMG/ 63 AMG/ 200/230/ 240/ 280/ 320/ 350/ 500	03.02-03.09	AGM,BWD	95	850	S5 A13									
, CGI, KOMPRESSOR, KOMPRESSOR NGT, 4MATIC [211]														
55 AMG/ 280/ 320/ 430 [210]	06.95-08.03		70	760	S5 A08	100	830	S5 013	74	680	S4 008			
63 AMG [212]	04.09-08.15	SSJ	80	800	S5 A11									
			95	850	S5 A13									
S [212]	11.12-08.15	SSJ	80	800	S5 A11									
			95	850	S5 A13									
S 4MATIC [212]	11.12-08.16	SSJ	80	800	S5 A11									
			95	850	S5 A13									
4MATIC [212]	08.12-08.16	SSJ	80	800	S5 A11									
			95	850	S5 A13									
4MATIC [213]	03.17→	SSJ	70	760	S5 A08									
			80	800	S5 A11									
			95	850	S5 A13									
180 [213]	01.17→	SSJ	70	760	S5 A08									
			80	800	S5 A11									
			95	850	S5 A13									
200 [212]	08.12-08.16	SSJ	80	800	S5 A11									
			95	850	S5 A13									
[213]	01.16→	SSJ	70	760	S5 A08									
			80	800	S5 A11									
			95	850	S5 A13									



			Ah A (EN) S5A			Ah A (EN) S5			Ah A (EN) S4			Ah A (EN) S3		
			0 092 ...0			0 092 ...0			0 092 ...0			0 092 ...0		
200 CGI [212]	04.09-12.13					63	610	S5 005						
		SSJ	80	800	S5 A11									
KOMPRESSOR [210]	09.97-03.02		70	760	S5 A08	77	780	S5 008	60	540	S4 005			
NGT [212]	01.11-04.13	SSJ	80	800	S5 A11									
	07.13-08.16	SSJ	80	800	S5 A11									
			95	850	S5 A13									
4MATIC [213]	06.16→	SSJ	70	760	S5 A08									
			80	800	S5 A11									
			95	850	S5 A13									
200/ 240 [210]	06.95-03.02		70	760	S5 A08	77	780	S5 008	60	540	S4 005			
250 [212]	08.12-08.16	SSJ	80	800	S5 A11									
			95	850	S5 A13									
[213]	05.16→	SSJ	70	760	S5 A08									
			80	800	S5 A11									
			95	850	S5 A13									
CGI [212]	04.09-12.13					63	610	S5 005						
		SSJ	80	800	S5 A11									
280/ 320/ 430 4MATIC [210]	03.97-01.03		70	760	S5 A08	100	830	S5 013	74	680	S4 008			
300 [212]	07.11-12.14	SSJ	80	800	S5 A11									
			95	850	S5 A13									
[213]	06.16→	SSJ	70	760	S5 A08									
			80	800	S5 A11									
			95	850	S5 A13									
4MATIC [212]	07.11-12.14	SSJ	80	800	S5 A11									
			95	850	S5 A13									
350 [212]	04.09-07.11	SSJ	80	800	S5 A11									
			95	850	S5 A13									
	09.11-08.16	SSJ	95	850	S5 A13									
CGI [212]	04.09-12.11		95	850	S5 A13									
e [213]	06.16→	SSJ	80	800	S5 A11									
4MATIC [212]	01.09-08.11	SSJ	80	800	S5 A11									
	01.09-08.15	SSJ	95	850	S5 A13									
400 [212]	01.13-08.16	SSJ	80	800	S5 A11									
			95	850	S5 A13									
4MATIC [212]	01.13-09.16	SSJ	80	800	S5 A11									
			95	850	S5 A13									
4MATIC [213]	06.16→	SSJ	70	760	S5 A08									
			80	800	S5 A11									
			95	850	S5 A13									
500 [212]	04.09-08.16	SSJ	80	800	S5 A11									
			95	850	S5 A13									
4MATIC [212]	01.09-08.16	SSJ	80	800	S5 A11									
			95	850	S5 A13									
Diesel														
200 BlueTec [212]	07.14-08.16	SSJ	80	800	S5 A11									
			95	850	S5 A13									
CDI [211]	07.02-12.06					100	830	S5 013	74	680	S4 008			
	07.02-03.09	AGM,BWD	95	850	S5 A13									
CDI [212]	04.09-08.14					63	610	S5 005						
		SSJ	80	800	S5 A11									
d [213]	06.16→	SSJ	80	800	S5 A11									
			95	850	S5 A13									
D [210]	03.97-07.99		70	760	S5 A08	77	780	S5 008						
200/ 220/ 270/ 320 CDI [210]	07.98-03.02		70	760	S5 A08	100	830	S5 013	74	680	S4 008			
220 BlueTec [212]	06.13-08.16	SSJ	80	800	S5 A11									
			95	850	S5 A13									
BlueTec 4MATIC [212]	11.14-08.16	SSJ	80	800	S5 A11									
			95	850	S5 A13									
CDI [211]	03.02-03.09	AGM,BWD	95	850	S5 A13									
CDI [212]	12.08-12.14	SSJ	80	800	S5 A11									
d [213]	01.16→	SSJ	80	800	S5 A11									
			95	850	S5 A13									



			Ah A (EN) S5A			Ah A (EN) S5			Ah A (EN) S4			Ah A (EN) S3		
			0 092 ...0			0 092 ...0			0 092 ...0			0 092 ...0		
◀ MERCEDES-BENZ														
220 d 4MATIC [213]	05.16→	SSJ	70	760	S5 A08									
			80	800	S5 A11									
			95	850	S5 A13									
220/250 D [210]	06.95-07.99		70	760	S5 A08	100	830	S5 013	74	680	S4 008			
250 BlueTec [212]	07.14-08.16	SSJ	80	800	S5 A11									
			95	850	S5 A13									
BlueTec 4MATIC [212]	07.14-08.16	SSJ	80	800	S5 A11									
			95	850	S5 A13									
CDI [212]	12.08-08.16					63	610	S5 005						
		SSJ	80	800	S5 A11									
CDI 4MATIC [212]	01.11-08.16	SSJ	80	800	S5 A11									
			95	850	S5 A13									
250/290/300 D Turbo [210]	01.96-07.99		70	760	S5 A08	100	830	S5 013	74	680	S4 008			
270 CDI [211]	03.02-03.05		70	760	S5 A08									
		AGM,BWD	95	850	S5 A13									
280/320 CDI 4MATIC [211]	04.05-03.09	AGM,BWD	95	850	S5 A13									
280/320/400/420 CDI [211]	11.02-03.09	AGM,BWD	95	850	S5 A13									
300 BlueTec [211]	12.07-01.09	AGM,BWD	95	850	S5 A13									
BlueTec [212]	08.12-08.16		80	800	S5 A11									
			95	850	S5 A13									
BlueTec Hybrid [212]	04.12-08.16	SSJ	95	850	S5 A13									
CDI [212]	12.09-12.13	SSJ	80	800	S5 A11									
			95	850	S5 A13									
d [213]	02.18→	BWD	70	760	S5 A08									
			80	800	S5 A11									
			95	850	S5 A13									
350 BlueTec [212]	04.09-08.16	SSJ	80	800	S5 A11									
			95	850	S5 A13									
BlueTec 4MATIC [212]	08.12-08.16	SSJ	80	800	S5 A11									
			95	850	S5 A13									
CDI [212]	08.08-12.13	SSJ	80	800	S5 A11									
			95	850	S5 A13									
CDI 4MATIC [212]	04.09-12.13	SSJ	80	800	S5 A11									
			95	850	S5 A13									
d [213]	01.16→	SSJ	80	800	S5 A11									
			95	850	S5 A13									
d 4MATIC [213]	06.17→	BWD	70	760	S5 A08									
			80	800	S5 A11									
			95	850	S5 A13									
Serie E All-Terrain (T-Modell)														
Diesel														
220 d 4MATIC [213]	01.17→	SSJ	70	760	S5 A08									
			80	800	S5 A11									
			95	850	S5 A13									
Serie E (Cabrio)														
36 AMG [124]	03.94-06.98		70	760	S5 A08	100	830	S5 013	74	680	S4 008			
200 [207]	01.13→	SSJ	80	800	S5 A11									
			95	850	S5 A13									
200/220 [124]	07.93-06.98		70	760	S5 A08	77	780	S5 008	60	540	S4 005			
200/250 CGI [207]	01.10-12.13	SSJ	80	800	S5 A11									
250 [207]	01.13→	SSJ	80	800	S5 A11									
			95	850	S5 A13									
300 CGI [207]	01.11-12.14	SSJ	80	800	S5 A11									
			95	850	S5 A13									
320 [124]	05.93-06.98		70	760	S5 A08	100	830	S5 013	74	680	S4 008	70	640	S3 008
[207]	07.14-12.17	SSJ	80	800	S5 A11									
			95	850	S5 A13									
350 CGI [207]	01.10-12.15	SSJ	80	800	S5 A11									
			95	850	S5 A13									
400 [207]	02.13-08.17	SSJ	80	800	S5 A11									
			95	850	S5 A13									



			Ah A (EN) S5A			Ah A (EN) S5			Ah A (EN) S4			Ah A (EN) S3		
			0 092 ...0			0 092 ...0			0 092 ...0			0 092 ...0		
400 4MATIC [238]	06.17→	BWD	70	760	S5 A08									
			80	800	S5 A11									
			95	850	S5 A13									
500 [207]	01.10-01.11	SSJ	80	800	S5 A11									
			95	850	S5 A13									
CGI [207]	02.11-12.17	SSJ	80	800	S5 A11									
			95	850	S5 A13									
Diesel														
220 BlueTec [207]	05.14-08.15	SSJ	80	800	S5 A11									
			95	850	S5 A13									
d [207]	09.15-04.17	SSJ	80	800	S5 A11									
			95	850	S5 A13									
d [238]	06.17→	BWD	70	760	S5 A08									
			80	800	S5 A11									
			95	850	S5 A13									
220/ 250 CDI [207]	01.10-08.15	SSJ	80	800	S5 A11									
250 BlueTec [207]	07.14-07.15	SSJ	70	760	S5 A08									
			80	800	S5 A11									
d [207]	08.15-04.17		70	760	S5 A08									
			80	800	S5 A11									
	09.15-04.17	SSJ	80	800	S5 A11									
300 d [238]	02.18→	BWD	70	760	S5 A08									
			80	800	S5 A11									
			95	850	S5 A13									
350 BlueTec [207]	01.13-08.15	SSJ	80	800	S5 A11									
			95	850	S5 A13									
CGI [207]	01.10-01.11	SSJ	80	800	S5 A11									
			95	850	S5 A13									
	04.11-04.13	SSJ	80	800	S5 A11									
			95	850	S5 A13									
d 4MATIC [238]	09.17→	BWD	70	760	S5 A08									
			80	800	S5 A11									
			95	850	S5 A13									
Serie E (Coupé)														
200 [238]	12.16→	SSJ	70	760	S5 A08									
			80	800	S5 A11									
			95	850	S5 A13									
200/ 250 [207]	01.13→	SSJ	95	850	S5 A13									
200/ 250/ 300 CGI [207]	02.09-12.14	SSJ	80	800	S5 A11									
300 [238]	12.16→	SSJ	70	760	S5 A08									
			80	800	S5 A11									
			95	850	S5 A13									
320 [124]	07.93-06.98		70	760	S5 A08	100	830	S5 013	74	680	S4 008	70	640	
			80	800	S5 A11									
			95	850	S5 A13									
[207]	07.14-12.17	SSJ	80	800	S5 A11									
			95	850	S5 A13									
350 [207]	11.08-12.12	SSJ	80	800	S5 A11									
			95	850	S5 A13									
CGI [207]	02.09-01.11								95	800	S4 013			
	02.09-12.15	SSJ	80	800	S5 A11									
4MATIC [207]	09.11-12.15	SSJ	80	800	S5 A11									
			95	850	S5 A13									
400 [207]	02.13-08.17	SSJ	95	850	S5 A13									
	07.14-05.17	SSJ	80	800	S5 A11									
4MATIC [238]	12.16→	SSJ	70	760	S5 A08									
			80	800	S5 A11									
			95	850	S5 A13									
500 [207]	02.09-01.11	SSJ	80	800	S5 A11									
			95	850	S5 A13									
CGI [207]	02.11-12.17	SSJ	80	800	S5 A11									
Diesel														
220 BlueTec [207]	05.14-08.15	SSJ	80	800	S5 A11									
			95	850	S5 A13									
d [207]	09.15-11.16	SSJ	80	800	S5 A11									



			Ah A (EN) S5A			Ah A (EN) S5			Ah A (EN) S4			Ah A (EN) S3		
			0 092 ...0			0 092 ...0			0 092 ...0			0 092 ...0		
◀ MERCEDES-BENZ														
220 d [238]	12.16→	SSJ	70	760	S5 A08									
			80	800	S5 A11									
			95	850	S5 A13									
d 4MATIC [238]	12.16→	BWD	70	760	S5 A08									
			80	800	S5 A11									
			95	850	S5 A13									
220/ 250 CDI [207]	02.09-08.15	SSJ	80	800	S5 A11									
250 BlueTec [207]	07.14-07.15	SSJ	70	760	S5 A08									
			80	800	S5 A11									
d [207]	08.15-11.16		70	760	S5 A08									
			80	800	S5 A11									
	09.15-11.16	SSJ	80	800	S5 A11									
350 BlueTec [207]	01.13-08.15	SSJ	80	800	S5 A11									
			95	850	S5 A13									
CDI [207]	02.09-03.11					85	800	S5 011	80	740	S4 011			
	02.09-04.13	SSJ	80	800	S5 A11									
	04.11-04.13	SSJ	95	850	S5 A13									
d 4MATIC [238]	06.17→	BWD	70	760	S5 A08									
			80	800	S5 A11									
			95	850	S5 A13									
Serie E (T-Modell)														
43 AMG 4MATIC [213]	06.16→	SSJ	70	760	S5 A08									
			80	800	S5 A11									
			95	850	S5 A13									
55 AMG KOMPRESSOR [211]	09.03-05.06	AGM,BWD	95	850	S5 A13									
55 AMG/ 280/ 320 [210]	07.96-01.03		70	760	S5 A08	100	830	S5 013	74	680	S4 008			
63 AMG [212]	08.09-08.15	SSJ	95	850	S5 A13									
	03.11-08.15	SSJ	80	800	S5 A11									
S [212]	11.12-08.15	SSJ	80	800	S5 A11									
			95	850	S5 A13									
S 4MATIC [212]	11.12-08.16	SSJ	80	800	S5 A11									
			95	850	S5 A13									
4MATIC [212]	08.12-08.16	SSJ	80	800	S5 A11									
			95	850	S5 A13									
63 AMG/ 230/ 240/ 280/ 320/ 350/ 500 , CGI [211]	02.03-08.09	AGM,BWD	95	850	S5 A13									
200 [213]	06.16→	SSJ	70	760	S5 A08									
			80	800	S5 A11									
			95	850	S5 A13									
CGI [212]	08.09-12.13					63	610	S5 005						
		SSJ	80	800	S5 A11									
KOMPRESSOR [210]	09.97-01.03		70	760	S5 A08	77	780	S5 008	60	540	S4 005			
KOMPRESSOR [211]	02.03-03.06	AGM,BWD, KZO	70	760	S5 A08									
		AGM,BWD, KZO	95	850	S5 A13									
	04.06-08.09	AGM,BWD	95	850	S5 A13									
4MATIC [213]	01.17→	SSJ	70	760	S5 A08									
			80	800	S5 A11									
			95	850	S5 A13									
200/ 240 [210]	05.96-01.03		70	760	S5 A08	77	780	S5 008	60	540	S4 005			
200/ 250 [212]	08.12-08.16	SSJ	95	850	S5 A13									
240/ 280/ 320/ 350/ 500 4MATIC [211]	09.03-08.09	AGM,BWD	95	850	S5 A13									
250 [213]	06.16→	SSJ	70	760	S5 A08									
			80	800	S5 A11									
			95	850	S5 A13									
CGI [212]	08.09-12.13					63	610	S5 005						
		SSJ	80	800	S5 A11									
280/ 320/ 430 4MATIC [210]	03.97-02.03		70	760	S5 A08	100	830	S5 013	74	680	S4 008			
300 [212]	02.10-12.11	SSJ	95	850	S5 A13									
	02.10-12.14	SSJ	80	800	S5 A11									



			Ah A (EN) S5A			Ah A (EN) S5			Ah A (EN) S4			Ah A (EN) S3		
			0 092 ...0			0 092 ...0			0 092 ...0			0 092 ...0		
300 4MATIC [212]	07.11-12.14	SSJ	80	800	S5 A11									
			95	850	S5 A13									
350 [212]	08.09-12.14	SSJ	95	850	S5 A13									
	08.11-12.14	SSJ	80	800	S5 A11									
CGI [212]	08.09-07.11	SSJ	80	800	S5 A11									
			95	850	S5 A13									
4MATIC [212]	08.09-07.11	SSJ	80	800	S5 A11									
			95	850	S5 A13									
	09.11-08.16	SSJ	80	800	S5 A11									
			95	850	S5 A13									
400 [212]	01.13-08.16	SSJ	95	850	S5 A13									
	07.14-08.16	SSJ	80	800	S5 A11									
4MATIC [212]	01.13-08.16	SSJ	80	800	S5 A11									
			95	850	S5 A13									
4MATIC [213]	06.16→	SSJ	70	760	S5 A08									
			80	800	S5 A11									
			95	850	S5 A13									
430 [210]	09.97-07.99		95	850	S5 A13	100	830	S5 013						
	08.99-01.03		70	760	S5 A08	100	830	S5 013	74	680	S4 008			
500 [212]	08.09-08.16	SSJ	95	850	S5 A13									
	08.11-08.16	SSJ	80	800	S5 A11									
4MATIC [212]	08.11-08.16	SSJ	80	800	S5 A11									
			95	850	S5 A13									
Diesel														
200 BlueTec [212]	07.14-08.16	SSJ	80	800	S5 A11									
			95	850	S5 A13									
CDI [211]	04.07-08.09	AGM,BWD	95	850	S5 A13									
CDI [212]	08.09-08.14					63	610	S5 005						
		SSJ	80	800	S5 A11									
d [213]	06.16→	SSJ	70	760	S5 A08									
			80	800	S5 A11									
			95	850	S5 A13									
220 BlueTec [212]	07.14-08.16	SSJ	70	760	S5 A08									
			80	800	S5 A11									
			95	850	S5 A13									
BlueTec 4MATIC [212]	12.14-08.16	SSJ	80	800	S5 A11									
			95	850	S5 A13									
CDI [211]	02.03-03.06	AGM,BWD	70	760	S5 A08									
	02.03-08.09	AGM,BWD	95	850	S5 A13									
CDI [212]	08.09-08.14					63	610	S5 005						
		SSJ	80	800	S5 A11									
d [213]	06.16→	SSJ	70	760	S5 A08									
			80	800	S5 A11									
			95	850	S5 A13									
d 4MATIC [213]	10.16→	SSJ	70	760	S5 A08									
			80	800	S5 A11									
			95	850	S5 A13									
220/ 250/ 270/ 290/ 300/ 320 CDI, D, D Turbo [210]	05.96-01.03		70	760	S5 A08	100	830	S5 013	74	680	S4 008			
250 BlueTec [212]	07.14-08.16	SSJ	80	800	S5 A11									
			95	850	S5 A13									
BlueTec 4MATIC [212]	07.14-08.16	SSJ	80	800	S5 A11									
			95	850	S5 A13									
CDI [212]	08.09-08.14	SSJ	80	800	S5 A11									
CDI 4MATIC [212]	01.11-08.14	SSJ	80	800	S5 A11									
			95	850	S5 A13									
270/ 280/ 320 CDI [211]	02.03-08.09	AGM,BWD	95	850	S5 A13									
280/ 320 CDI 4MATIC [211]	04.05-08.09	AGM,BWD	95	850	S5 A13									
300 BlueTec [212]	08.12-08.16		80	800	S5 A11									
			95	850	S5 A13									
BlueTec Hybrid [212]	04.12-08.16	SSJ	95	850	S5 A13									
CDI [212]	12.09-12.10	SSJ	80	800	S5 A11									
	12.09-12.13	SSJ	95	850	S5 A13									



			Ah A (EN) S5A			Ah A (EN) S5			Ah A (EN) S4			Ah A (EN) S3		
			0 092 ...0			0 092 ...0			0 092 ...0			0 092 ...0		
◀ MERCEDES-BENZ														
300 CDI [212]	08.11-12.13	SSJ	80	800	S5 A11									
d [213]	02.18→	BWD	70	760	S5 A08									
			80	800	S5 A11									
			95	850	S5 A13									
350 BlueTec [212]	08.09-08.16	SSJ	80	800	S5 A11									
	08.12-08.16	SSJ	95	850	S5 A13									
BlueTec 4MATIC [212]	08.12-08.16	SSJ	80	800	S5 A11									
			95	850	S5 A13									
CDI [212]	08.09-12.13	SSJ	80	800	S5 A11									
			95	850	S5 A13									
CDI 4MATIC [212]	08.09-12.13	SSJ	80	800	S5 A11									
			95	850	S5 A13									
d [213]	06.16→	SSJ	70	760	S5 A08									
			80	800	S5 A11									
			95	850	S5 A13									
	06.17→	BWD	70	760	S5 A08									
			80	800	S5 A11									
			95	850	S5 A13									
d All-Terrain 4MATIC [213]	06.17→	BWD	70	760	S5 A08									
			80	800	S5 A11									
			95	850	S5 A13									
Serie G														
36 AMG/ 55 AMG/ 320 [463]	01.95-08.06		95	850	S5 A13	100	830	S5 013	95	800	S4 013	90	720	S3 013
55 AMG KOMPRESSOR [463]	04.04-08.11		95	850	S5 A13	100	830	S5 013	95	800	S4 013	90	720	S3 013
63 AMG [463]	04.12→	SSJ	95	850	S5 A13									
65 AMG [463]	04.12-05.15	BWD	95	850	S5 A13									
	06.15→	SSJ	95	850	S5 A13									
500 [463]	04.98-09.05		95	850	S5 A13	100	830	S5 013	95	800	S4 013	90	720	S3 013
	09.01-08.08		95	850	S5 A13	100	830	S5 013						
	06.08-12.17	SSJ	95	850	S5 A13									
	12.09-12.15		95	850	S5 A13									
500 AMG E [463]	03.93-09.01		95	850	S5 A13	100	830	S5 013	95	800	S4 013	90	720	S3 013
Diesel														
270 CDI 4MATIC [461]	01.03-12.07		95	850	S5 A13	100	830	S5 013	95	800	S4 013			
270/ 400 CDI [463]	12.00-08.06		95	850	S5 A13	100	830	S5 013	95	800	S4 013			
280 CDI [461]	04.09→		95	850	S5 A13	100	830	S5 013						
290 DT [461]	04.97-09.01	ZE	95	850	S5 A13	100	830	S5 013	95	800	S4 013	90	720	S3 013
300 CDI [461]	09.09→					100	830	S5 013						
		BWD,SSJ	60	680	S5 A05									
		SSJ	95	850	S5 A13									
D Turbo [463]	09.96-11.00		95	850	S5 A13	100	830	S5 013	95	800	S4 013	90	720	S3 013
320 CDI [463]	09.06-12.09		95	850	S5 A13	100	830	S5 013	95	800	S4 013	90	720	S3 013
350 BlueTec. d [463]	07.10→	SSJ	95	850	S5 A13									
Serie GL														
63 AMG/ 400/ 500 4MATIC [166]	08.12-08.16	SSJ	95	850	S5 A13									
450/ 500 4MATIC [164]	02.06-12.12		95	850	S5 A13	100	830	S5 013	95	800	S4 013			
Diesel														
320/ 420 CDI 4MATIC [164]	02.06-04.09		95	850	S5 A13	100	830	S5 013	95	800	S4 013			
350 CDI BlueTec 4MATIC [164]	04.09-12.12		95	850	S5 A13	100	830	S5 013						
CDI BlueTec 4MATIC [166]	08.12-12.15	SSJ	95	850	S5 A13									
CDI 4MATIC [164]	05.09-08.10		95	850	S5 A13	100	830	S5 013						
	09.10-12.12		95	850	S5 A13									
450 CDI 4MATIC [164]	05.09-12.12		95	850	S5 A13	100	830	S5 013						
Serie GLA														
45 AMG 4MATIC [156]	01.14-06.15	SSJ	70	760	S5 A08									
	01.14→	SSJ	80	800	S5 A11									
180 [156]	02.15→	SSJ	70	760	S5 A08									
200 [156]	12.13→	SSJ	70	760	S5 A08									
			80	800	S5 A11									



			Ah A (EN) S5A			Ah A (EN) S5			Ah A (EN) S4			Ah A (EN) S3		
			0 092 ...0			0 092 ...0			0 092 ...0			0 092 ...0		
220 4MATIC [156]	01.17→	SSJ	70	760	S5 A08									
			80	800	S5 A11									
250 [156]	01.14→	SSJ	70	760	S5 A08									
			80	800	S5 A11									
4MATIC [156]	01.14→	SSJ	70	760	S5 A08									
			80	800	S5 A11									
Diesel														
180 CDI [156]	07.14-06.15	SSJ	70	760	S5 A08									
d [156]	07.15→	SSJ	70	760	S5 A08									
200 CDI 4MATIC [156]	01.14-06.15	SSJ	80	800	S5 A11									
200/ 220 CDI [156]	10.13-06.15	SSJ	80	800	S5 A11									
d [156]	07.15→	SSJ	80	800	S5 A11									
d 4MATIC [156]	07.15→	SSJ	80	800	S5 A11									
220 CDI 4MATIC [156]	10.13-06.15		70	760	S5 A08	77	780	S5 008	74	680	S4 008			
Serie GLC														
43 AMG 4MATIC [253]	04.16→	SSJ	70	760	S5 A08									
250 4MATIC [253]	07.15→	SSJ	70	760	S5 A08									
			80	800	S5 A11									
300 4MATIC [253]	05.16→	SSJ	70	760	S5 A08									
			80	800	S5 A11									
350 e 4MATIC [253]	10.15→	SSJ	80	800	S5 A11									
Diesel														
220/ 250/ 350 d 4MATIC [253]	07.15→	SSJ	80	800	S5 A11									
Serie GLC (Coupé)														
43 AMG 4MATIC [253]	10.16→	SSJ	70	760	S5 A08									
			80	800	S5 A11									
250 4MATIC [253]	10.16→	SSJ	60	680	S5 A05									
			80	800	S5 A11									
300 4MATIC [253]	10.16→	SSJ	70	760	S5 A08									
			80	800	S5 A11									
350 e 4MATIC [253]	06.16→	SSJ	80	800	S5 A11									
Diesel														
220/ 250/ 350 d 4MATIC [253]	10.16→	SSJ	80	800	S5 A11									
Serie GLE														
43 AMG/ 63 AMG/ 320/ 400/ 450 AMG/ 500e 4MATIC, S 4MATIC, 4MATIC [166]	04.15→	SSJ	95	850	S5 A13									
Diesel														
250/ 350 d, d 4MATIC [166]	04.15→	SSJ	95	850	S5 A13									
Serie GLE (Coupé)														
43 AMG/ 63 AMG/ 400/ 450 AMG/ 500S 4MATIC, 4MATIC [292]	04.15→	SSJ	95	850	S5 A13									
Diesel														
350 d 4MATIC [292]	04.15→	SSJ	95	850	S5 A13									
Serie GLK														
200 [204]	03.13-08.16					77	780	S5 008						
		SSJ	70	760	S5 A08									
			80	800	S5 A11									
250 [204]	03.13-08.16					77	780	S5 008						
		SSJ	70	760	S5 A08									
			80	800	S5 A11									
4MATIC [204]	03.13-08.16	SSJ	80	800	S5 A11									
280 4MATIC [204]	09.08-04.09								95	800	S4 013			
		SSJ	80	800	S5 A11									
300 4MATIC [204]	05.09-12.12								95	800	S4 013			
		SSJ	80	800	S5 A11									
350 [204]	09.09-08.16	SSJ	80	800	S5 A11									
CGI 4MATIC [204]	06.11-08.15	SSJ	95	850	S5 A13									
4MATIC [204]	09.08-04.12	SSJ	80	800	S5 A11									



						Ah A (EN) S5A		Ah A (EN) S5		Ah A (EN) S4		Ah A (EN) S3	
						0 092 ...0		0 092 ...0		0 092 ...0		0 092 ...0	
◀ MERCEDES-BENZ													
Diesel													
200 CDI [204]	07.10-08.15			63	610	S5 005							
		SSJ	80	800	S5 A11								
220 BlueTec 4MATIC [204]	03.12-08.16		80	800	S5 A11		100	830	S5 013		95	800	S4 013
CDI [204]	04.09-08.15			63	610	S5 005							
		SSJ	80	800	S5 A11								
CDI 4MATIC [204]	06.08-08.15			63	610	S5 005							
		SSJ	80	800	S5 A11								
250 BlueTec 4MATIC [204]	03.12-08.16	SSJ	80	800	S5 A11								
CDI 4MATIC [204]	04.09-12.13			63	610	S5 005							
		SSJ	80	800	S5 A11								
320 CDI 4MATIC [204]	09.08-04.09	SSJ	80	800	S5 A11								
350 CDI 4MATIC [204]	04.09-08.15	SSJ	95	850	S5 A13								
	05.09-02.10	SSJ	80	800	S5 A11								
Serie GLS													
63 AMG/ 400/ 500, 4MATIC [166]	09.15→	SSJ	95	850	S5 A13								
Diesel													
350 d 4MATIC [166]	09.15→	SSJ	95	850	S5 A13								
Serie ML													
55 AMG/ 320 [163]	03.98-06.05		95	850	S5 A13		100	830	S5 013				
63 AMG/ 300/ 350/ 400/ 500 4MATIC [166]	06.11-08.15	SSJ	95	850	S5 A13								
63 AMG/ 350/ 500, 4MATIC [164]	09.05-08.11	AGM	95	850	S5 A13								
230/ 430 [163]	03.98-07.02		95	850	S5 A13		100	830	S5 013		95	800	S4 013
350 [163]	08.02-06.05		95	850	S5 A13		100	830	S5 013		95	800	S4 013
500 [163]	09.01-06.05		95	850	S5 A13		85	800	S5 010		80	740	S4 010
Diesel													
250/ 350 BlueTec 4MATIC, CDI BlueTec 4MATIC [166]	06.11-08.15	SSJ	95	850	S5 A13								
270 CDI [163]	11.99-06.05		95	850	S5 A13		100	830	S5 013				
280 CDI 4MATIC [164]	07.05-04.09	AGM	95	850	S5 A13								
300 CDI 4MATIC [164]	05.09-12.10	AGM	95	850	S5 A13								
	05.09-07.11		95	850	S5 A13								
320 CDI 4MATIC [164]	03.05-04.09	AGM	95	850	S5 A13								
350 BlueTec 4MATIC [164]	05.09-07.11		95	850	S5 A13								
CDI 4MATIC [164]	05.09-01.10	AGM	95	850	S5 A13								
	02.10-08.11		95	850	S5 A13								
400 CDI [163]	09.01-06.05		95	850	S5 A13		100	830	S5 013		95	800	S4 013
420/ 450 CDI 4MATIC [164]	02.06-01.11	AGM	95	850	S5 A13								
Serie R													
63 AMG 4MATIC [251]	04.06-08.07		95	850	S5 A13								
280 4MATIC [251]	07.09-12.11		95	850	S5 A13								
280/ 350 [251]	05.07-05.10	AGM	95	850	S5 A13								
300 [251]	05.09-09.11		95	850	S5 A13								
350 4MATIC [251]	09.05-10.12	AGM	95	850	S5 A13								
	06.11-10.12		95	850	S5 A13								
500 4MATIC [251]	02.06-10.12	AGM	95	850	S5 A13								
Diesel													
280 CDI [251]	05.07-04.09	AGM	95	850	S5 A13								
CDI 4MATIC [251]	04.06-04.09	AGM	95	850	S5 A13								
300 CDI [251]	05.09-10.12		95	850	S5 A13								
CDI 4MATIC [251]	05.09-05.10		95	850	S5 A13								
320 CDI 4MATIC [251]	09.05-04.09	AGM	95	850	S5 A13								
	06.07-05.09		95	850	S5 A13								
350 BlueTec 4MATIC [251]	05.09-10.12		95	850	S5 A13								
CDI 4MATIC [251]	05.09-10.12		95	850	S5 A13								
Serie S													
55 AMG [220]	09.00-09.02		95	850	S5 A13		100	830	S5 013		95	800	S4 013
55 AMG/ 350/ 430/ 500 KOMPRESSOR, 4MATIC [220]	09.02-08.06	AGM	95	850	S5 A13						90	720	S3 013



			Ah A (EN) S5A			Ah A (EN) S5			Ah A (EN) S4			Ah A (EN) S3		
			0 092 ...0			0 092 ...0			0 092 ...0			0 092 ...0		
63 AMG [221]	12.06-07.10	AGM	95	850	S5 A13									
	08.10-12.13	SSJ	95	850	S5 A13									
	[222]	08.13→	SSJ	80	800	S5 A11								
4MATIC [222]	08.13→	SSJ	95	850	S5 A13									
			70	760	S5 A08									
			95	850	S5 A13									
65 AMG [221]	07.06-02.11	AGM	95	850	S5 A13									
	09.10-12.13		95	850	S5 A13									
	[222]	10.13→	SSJ	70	760	S5 A08								
65 AMG/ 350 [220]	09.02-08.06	AGM	95	850	S5 A13									
			95	850	S5 A13	100	830	S5 013						
			95	850	S5 A13	100	830	S5 013	95	800	S4 013	90	720	S3 013
280 [220]	01.99-08.02		95	850	S5 A13	100	830	S5 013	95	800	S4 013	90	720	S3 013
280/ 320/ 420/ 500/ 600 [140]	03.93-02.99		95	850	S5 A13	100	830	S5 013	95	800	S4 013	90	720	S3 013
			95	850	S5 A13									
280/300 [221]	09.05-12.09		95	850	S5 A13				95	800	S4 013			
320 [222]	08.15→	SSJ	70	760	S5 A08									
			95	850	S5 A13									
			105	950	S5 A15									
320/ 430 [220]	10.98-08.06		95	850	S5 A13	100	830	S5 013	95	800	S4 013	90	720	S3 013
350/ 450/ 500 4MATIC [221]	06.06-08.11	AGM	95	850	S5 A13									
350/ 450/ 500/ 600 [221]	09.05-06.13	AGM	95	850	S5 A13									
350/ 500 CGI, CGI 4MATIC [221]	09.10-12.13	SSJ	95	850	S5 A13									
			95	850	S5 A13									
			70	760	S5 A08									
400 [222]	05.13→	SSJ	95	850	S5 A13									
	06.13→	SSJ	70	760	S5 A08									
			105	950	S5 A15									
Hybrid [221]	04.09-12.13	SSJ	80	800	S5 A11									
4MATIC [222]	06.14→	SSJ	80	800	S5 A11									
			95	850	S5 A13									
			80	800	S5 A11									
500 [220]	10.98-08.06		95	850	S5 A13	100	830	S5 013	95	800	S4 013	90	720	S3 013
	06.00-08.05		95	850	S5 A13	100	830	S5 013	95	800	S4 013			
	[222]	07.13-04.17	SSJ	95	850	S5 A13								
e [222]	07.14→	SSJ	70	760	S5 A08									
			95	850	S5 A13									
			95	850	S5 A13									
4MATIC [222]	08.13-04.17	SSJ	95	850	S5 A13									
			105	950	S5 A15									
			95	850	S5 A13									
600 [220]	08.99-08.05		95	850	S5 A13	100	830	S5 013	95	800	S4 013	90	720	S3 013
	09.02-01.06	AGM	95	850	S5 A13									
	[222]	02.14-06.17	SSJ	95	850	S5 A13								
			105	950	S5 A15									
Diesel														
250 CDI [221]	09.10-12.13	BAW,SSJ	95	850	S5 A13									
300 D Turbo [140]	06.96-09.98		95	850	S5 A13	100	830	S5 013	95	800	S4 013	90	720	S3 013
			h [222]	02.14→	SSJ	70	760	S5 A08						
320 CDI [220]	06.99-08.02		95	850	S5 A13	100	830	S5 013	95	800	S4 013	90	720	S3 013
			95	850	S5 A13									
			95	850	S5 A13									
CDI 4MATIC [221]	12.06-04.09	AGM	95	850	S5 A13									
320/ 420/ 450 CDI [221]	12.05-06.10	AGM	95	850	S5 A13									
350 BlueTec [221]	07.10-12.13	SSJ	60	680	S5 A05									
			95	850	S5 A13									
			95	850	S5 A13									
BlueTec [222]	05.13-08.15	SSJ	95	850	S5 A13									
BlueTec 4MATIC [221]	07.10-12.13	SSJ	60	680	S5 A05									
			95	850	S5 A13									
			95	850	S5 A13									
BlueTec 4MATIC [222]	02.14-08.15	SSJ	70	760	S5 A08									
			95	850	S5 A13									
			105	950	S5 A15									
CDI [221]	05.09-06.10		95	850	S5 A13									
CDI 4MATIC [221]	05.09-06.10		95	850	S5 A13									
d [222]	09.15→	SSJ	95	850	S5 A13									
			105	950	S5 A15									



			0 092 ...0			0 092 ...0			0 092 ...0			0 092 ...0		
			Ah	A (EN)	S5A	Ah	A (EN)	S5	Ah	A (EN)	S4	Ah	A (EN)	S3
◀ MERCEDES-BENZ														
350 d 4MATIC [222]	09.15→	SSJ	95	850	S5 A13									
			105	950	S5 A15									
400 CDI [220]	06.99-08.03		95	850	S5 A13	100	830	S5 013	95	800	S4 013	90	720	S3 013
	09.03-08.05	AGM	95	850	S5 A13									
Serie S (Cabrio)														
63 AMG [217]	02.16→	SSJ	95	850	S5 A13									
	11.17→	BWD	70	760	S5 A08									
			95	850	S5 A13									
4MATIC [217]	10.17→	BWD	70	760	S5 A08									
			95	850	S5 A13									
65 AMG/ 500 [217]	12.15→	SSJ	95	850	S5 A13									
560 [217]	10.17→	BWD	70	760	S5 A08									
			95	850	S5 A13									
Serie S (Coupé)														
63 AMG 4MATIC [217]	04.14→	SSJ	95	850	S5 A13									
	10.17→	BWD	70	760	S5 A08									
			95	850	S5 A13									
63 AMG/ 65 AMG [217]	05.14→	SSJ	95	850	S5 A13									
400 4MATIC [217]	10.15→	SSJ	105	950	S5 A15									
500 [217]	11.14-04.17	SSJ	95	850	S5 A13									
			105	950	S5 A15									
4MATIC [217]	02.14-04.17	SSJ	95	850	S5 A13									
			105	950	S5 A15									
560 [217]	10.17→	BWD	70	760	S5 A08									
			95	850	S5 A13									
4MATIC [217]	10.17→	BWD	70	760	S5 A08									
			95	850	S5 A13									
Serie S (Maybach)														
500 [222]	12.14-08.17	SSJ	95	850	S5 A13									
			105	950	S5 A15									
4MATIC [222]	04.15-08.17	SSJ	70	760	S5 A08									
			95	850	S5 A13									
			105	950	S5 A15									
600 [222]	12.14-06.17	SSJ	95	850	S5 A13									
			105	950	S5 A15									
Serie SL														
55 AMG/ 65 AMG [230]	10.01-12.11	AGM,BWD	70	760	S5 A08									
60 AMG [129]	07.93-06.98		95	850	S5 A13	100	830	S5 013						
63 AMG [230]	01.08-08.12		95	850	S5 A13									
63 AMG/ 65 AMG/ 350/ 400/ 500[231]	01.12→	SSJ	95	850	S5 A13									
280 [230]	01.08-04.09	BWD	70	760	S5 A08									
280/ 320/ 500/ 600 [129]	07.93-08.05	BAW	95	850	S5 A13	100	830	S5 013						
300 [230]	05.09-12.11		70	760	S5 A08									
350 [230]	03.03-12.07	AGM,BWD	70	760	S5 A08									
	01.08-12.11	BWD	70	760	S5 A08									
500/ 600 [230]	10.01-11.12	AGM,BWD	70	760	S5 A08									
Serie SLC														
43 AMG [172]	12.15→	SSJ	70	760	S5 A08									
180/ 200/ 300 [172]	01.16→	SSJ	80	800	S5 A11									
Diesel														
250 d [172]	01.16→	SSJ	80	800	S5 A11									
Serie SLK														
32 AMG/ 200/ 230/ 320 , KOMPRESSOR [170]	09.96-03.04		70	760	S5 A08	77	780	S5 008	60	540	S4 005			
55 AMG [172]	09.11-08.16	SSJ	70	760	S5 A08									
			80	800	S5 A11									
55 AMG/ 200/ 280/ 300/ 350 , KOMPRESSOR [171]	04.04-02.11		70	760	S5 A08	77	780	S5 008	74	680	S4 008			
200/ 250/ 300 [172]	01.11-08.16	SSJ	80	800	S5 A11									
350 [172]	01.11-08.16	SSJ	70	760	S5 A08									
			80	800	S5 A11									



			Ah	A (EN)		Ah	A (EN)		Ah	A (EN)		Ah	A (EN)	
					0 092 ...0			0 092 ...0			0 092 ...0			0 092 ...0

Diesel														
250 CDI [172]	09.11-08.16	SSJ	80	800	S5 A11									
Serie SLR (Coupé)														
AMG GT, GT S [190]	10.14-12.16	SSJ	95	850	S5 A13									
5.4 , 722 Edition [199]	04.04-12.09	AGM,BWD	70	760	S5 A08									
Serie SLR (Roadster)														
5.4 [199]	04.07-12.09	AGM,BWD	70	760	S5 A08									
Serie SLS (Coupé)														
6.2 AMG , GT [197]	03.10-06.14		95	850	S5 A13									
Serie SLS (Roadster)														
6.2 AMG [197]	06.11-06.14		95	850	S5 A13									

METROCAB

Taxi														
Diesel														
2.4/ 2.5 D, TD	01.91-05.06					95	830	S4 028						

MG

MG TF 115														
1.6 i	03.02-05.05					63	610	S5 005	60	540	S4 005	56	480	S3 005
MG TF 120														
1.8 i	03.02-05.05					63	610	S5 005	60	540	S4 005	56	480	S3 005
MG TF 135														
1.8 i	03.02→					63	610	S5 005	60	540	S4 005	56	480	S3 005
MG TF 160														
1.8 i	03.02-05.05					63	610	S5 005	60	540	S4 005	56	480	S3 005
MG 6														
1.8 , T	11.10→					63	610	S5 005	60	540	S4 005			
Diesel														
1.9 DTI	09.12→		70	760	S5 A08									
MGF														
1.6/ 1.8 i 16V, 16V Trophy	10.95-03.02					61	600	S5 004	60	540	S4 004	53	500	S3 004
X Power														
4.6 SV	01.03-05.05					74	750	S5 007	72	680	S4 007			
X Power SV-R														
5.0 Supercharged	01.05-05.05					74	750	S5 007	72	680	S4 007			
ZR														
Diesel														
2.0 D Turbo	10.01-05.05					61	600	S5 004	60	540	S4 004	53	500	S3 004
	12.02-05.05					61	600	S5 004	60	540	S4 004			
ZR 105														
1.4 i16V	10.01-05.05					61	600	S5 004	60	540	S4 004	53	500	S3 004
ZR 120														
1.8 i16V	10.01-05.05					61	600	S5 004	60	540	S4 004	53	500	S3 004
ZR 160														
1.8 i16V	10.01-05.05					61	600	S5 004	60	540	S4 004	53	500	S3 004
ZS														
Diesel														
2.0 TD	10.01-05.05					74	750	S5 007	72	680	S4 007	70	640	S3 007
ZS 110														
1.6 i16V	03.05-05.05					54	530	S5 002	52	470	S4 002	45	400	S3 002
ZS 120														
1.8 i16V	10.01-05.05					54	530	S5 002	52	470	S4 002	45	400	S3 002
ZS 180														
2.5 i24V	10.01-05.05					54	530	S5 002	52	470	S4 002	45	400	S3 002
ZT														
1.8 i16V, T16V	03.02-05.05		60	680	S5 A05	63	610	S5 005						



			Ah A (EN) S5A			Ah A (EN) S5			Ah A (EN) S4			Ah A (EN) S3		
			0 092 ...0			0 092 ...0			0 092 ...0			0 092 ...0		
MG														
ZT 135														
Diesel														
2.0 CDTi	10.02-05.05		70	760	S5 A08	77	780	S5 008	74	680	S4 008	70	640	S3 008
ZT 160														
2.5 i 24V	10.01-05.05					63	610	S5 005	60	540	S4 005	56	480	S3 005
ZT 180														
2.5 i 24V	01.03-05.05					63	610	S5 005	60	540	S4 005	56	480	S3 005
ZT 190														
2.5 i 24V	10.01-05.05					63	610	S5 005	60	540	S4 005	56	480	S3 005
Diesel														
2.0 CDT	10.01-05.05		70	760	S5 A08	77	780	S5 008	74	680	S4 008	70	640	S3 008
ZT 260														
4.6 i Power	03.02-05.05					63	610	S5 005	60	540	S4 005	56	480	S3 005
ZT 385														
4.6 i Power Supercharged	03.02-05.05					52	520	S5 001	72	680	S4 007	70	640	S3 007
ZT 500														
4.6 i Power Supercharged	03.02-05.05					52	520	S5 001	72	680	S4 007	70	640	S3 007
ZT-Tourer 135														
Diesel														
2.0 CDTi	10.02-05.05		70	760	S5 A08	77	780	S5 008	74	680	S4 008	70	640	S3 008
ZT-Tourer 160														
2.5 i 24V	10.01-05.05					63	610	S5 005	60	540	S4 005	56	480	S3 005
ZT-Tourer 180														
2.5 i 24V	01.03-05.05					63	610	S5 005	60	540	S4 005	56	480	S3 005
ZT-Tourer 190														
1.8 i 16V, T 16V	03.02-05.05		60	680	S5 A05	63	610	S5 005	60	540	S4 005			
2.5 i 24V	10.01-05.05					63	610	S5 005	60	540	S4 005	56	480	S3 005
Diesel														
2.0 CDT	10.01-05.05		70	760	S5 A08	77	780	S5 008	74	680	S4 008	70	640	S3 008
ZT-Tourer 260														
4.6 i Power	03.03-05.05					63	610	S5 005	60	540	S4 005	56	480	S3 005

MINI (BMW)

Cooper														
1.5 [F 55]	10.14→	SSJ	70	760	S5 A08					70	760	S4 E08		
			80	800	S5 A11					70	760	S4 E08		
[F 56]	03.14→	SSJ				77	780	S5 008	74	680	S4 008			
			70	760	S5 A08									
1.6 [R 56]	11.06-08.10	BWD	70	760	S5 A08									
	03.10-11.13		70	760	S5 A08									
[S [R 50; R 53]	06.01-11.06		60	680	S5 A05	63	610	S5 005	60	540	S4 005			
S [R 56]	11.06-07.10	BWD	70	760	S5 A08									
	03.10-11.13		70	760	S5 A08									
2.0 S [F 55]	10.14→	SSJ	70	760	S5 A08					70	760	S4 E08		
			80	800	S5 A11					70	760	S4 E08		
S [F 56]	03.14→	SSJ				77	780	S5 008	74	680	S4 008			
			70	760	S5 A08									
			80	800	S5 A11									
Diesel														
1.5 D [F 55]	10.14→	SSJ	70	760	S5 A08					70	760	S4 E08		
			80	800	S5 A11					70	760	S4 E08		
D [F 56]	03.14→	SSJ				77	780	S5 008	74	680	S4 008			
			70	760	S5 A08									
1.6 D [R 56]	03.07-07.10	BWD	70	760	S5 A08									
	08.10-11.13	SSJ	70	760	S5 A08									
2.0 D [R 56]	03.11-11.13	SSJ	70	760	S5 A08									
			70	760	S5 A08									
SD [F 55]	10.14→	SSJ	70	760	S5 A08									
			80	800	S5 A11									

			Ah A (EN) S5A			Ah A (EN) S5			Ah A (EN) S4			Ah A (EN) S3		
			0 092 ...0			0 092 ...0			0 092 ...0			0 092 ...0		
2.0 SD [F 56]	07.14→		80	800	S5 A11									
		SSJ						80	800	S4 E11				
SD [R 56]	03.11-11.13		80	800	S5 A11									
Cooper Cabrio														
1.5 [F 57]	03.16→	SSJ	70	760	S5 A08									
			80	800	S5 A11									
1.6 [R 57]	03.09-06.15	SSJ	70	760	S5 A08									
[R 58]	09.11-04.15	BWD						74	680	S4 008				
		BWD,SSJ	70	760	S5 A08			70	760	S4 E08				
, S [R 52]	07.04-07.08					63	610	S5 005	52	470	S4 002	45	400	
S [R 57]	03.09-07.10	BWD	70	760	S5 A08									
	03.10-06.15	SSJ	70	760	S5 A08									
2.0 S [F 57]	03.16→	SSJ	70	760	S5 A08									
			80	800	S5 A11									
Diesel														
1.5 D [F 57]	03.16-10.17	SSJ	70	760	S5 A08									
			80	800	S5 A11									
1.6 D [R 57]	09.10-05.15	SSJ	70	760	S5 A08									
2.0 D [R 57]	03.11-05.15		70	760	S5 A08									
SD [F 57]	03.16-02.18	SSJ	70	760	S5 A08									
			80	800	S5 A11									
SD [R 57]	03.11-05.15	SSJ	70	760	S5 A08									
Cooper Clubman														
1.5/ 2.0, S [F 54]	10.15→	SSJ	70	760	S5 A08									
1.6 [R 55]	11.07-07.10	BWD	70	760	S5 A08									
	03.10-06.14		70	760	S5 A08									
S [R 55]	11.07-07.10	BWD	70	760	S5 A08									
	03.10-06.14		70	760	S5 A08									
		SSJ	70	760	S5 A08									
2.0 S ALL4 [F 54]	05.16→	SSJ	70	760	S5 A08									
			80	800	S5 A11									
Diesel														
1.6 D [R 55]	11.07-07.10	SSJ	70	760	S5 A08									
	09.10-06.14	SSJ	70	760	S5 A08									
2.0 D [F 54]	10.15→	SSJ	70	760	S5 A08									
D [R 55]	03.11-06.14					85	800	S5 010	80	740	S4 010			
SD [F 54]	11.15→	SSJ	70	760	S5 A08									
			80	800	S5 A11									
SD [R 55]	03.11-06.14	SSJ	80	800	S5 A11									
SD ALL4 [F 54]	05.16→	SSJ	70	760	S5 A08									
			80	800	S5 A11									
Cooper Countryman														
1.5 [F 60]	02.17→	SSJ	70	760	S5 A08									
			80	800	S5 A11									
ALL4 [F 60]	02.17→	SSJ	70	760	S5 A08									
			80	800	S5 A11									
S E ALL4 [F 60]	03.17→	SSJ	60	680	S5 A05									
1.6 [R 60]	09.10-10.16	SSJ	70	760	S5 A08									
ALL4 [R 60]	07.13-10.16								74	680	S4 008			
		SSJ	70	760	S5 A08				70	760	S4 E08			
S [R 60]	09.10-06.14		70	760	S5 A08									
		BWD	70	760	S5 A08									
		SSJ	70	760	S5 A08									
	07.14-10.16					77	780	S5 008	74	680	S4 008			
		SSJ	70	760	S5 A08				70	760	S4 E08			
S ALL4 [R 60]	09.10-06.14	BWD	70	760	S5 A08									
		SSJ	70	760	S5 A08									
	07.14-10.16					77	780	S5 008	74	680	S4 008			
		SSJ	70	760	S5 A08				70	760	S4 E08			
2.0 S [F 60]	02.17→	SSJ	70	760	S5 A08									
			80	800	S5 A11									
S ALL4 [F 60]	02.17→	SSJ	70	760	S5 A08									
			80	800	S5 A11									



M

				Ah	A (EN)		Ah	A (EN)		Ah	A (EN)		Ah	A (EN)				
				0 092 ...0			0 092 ...0			0 092 ...0			0 092 ...0					
MINI																		
Diesel																		
1.6 D [R 60]	09.10-10.16	SSJ	70	760	S5 A08													
D ALL4 [R 60]	09.10-09.16	SSJ	70	760	S5 A08													
2.0 D [F 60]	02.17→	SSJ	70	760	S5 A08													
			80	800	S5 A11													
D [R 60]	03.11-10.16	SSJ	95	850	S5 A13													
D ALL4 [F 60]	02.17→	SSJ	70	760	S5 A08													
			80	800	S5 A11													
D ALL4 [R 60]	03.11-09.16	SSJ	95	850	S5 A13													
SD [F 60]	02.17→	SSJ	70	760	S5 A08													
			80	800	S5 A11													
SD [R 60]	03.11-10.16	SSJ	70	760	S5 A08													
SD ALL4 [F 60]	02.17→	SSJ	70	760	S5 A08													
			80	800	S5 A11													
SD ALL4 [R 60]	03.11-09.16		80	800	S5 A11													
Cooper Coupé																		
1.6 S [R 58]	09.11-04.15		70	760	S5 A08													
		BWD					74	680	S4 008									
		BWD,SSJ	70	760	S5 A08		70	760	S4 E08									
Diesel																		
2.0 SD [R 58]	09.11-05.15		80	800	S5 A11													
Cooper One																		
1.2 [F 55]	11.14-10.17	SSJ	70	760	S5 A08													
			80	800	S5 A11													
	03.15-10.17						74	680	S4 008									
		SSJ	70	760	S5 A08		70	760	S4 E08									
			80	800	S5 A11		70	760	S4 E08									
[F 56]	04.14-11.17	SSJ	70	760	S5 A08													
			80	800	S5 A11													
	07.14-11.17						77	780	S5 008		74	680	S4 008					
		SSJ	70	760	S5 A08		70	760	S4 E08									
			80	800	S5 A11		70	760	S4 E08									
1.4 [R 56]	03.07-02.10	BWD	70	760	S5 A08													
	03.09-02.10	SSJ	70	760	S5 A08													
1.4/ 1.6 i [R 50]	06.01-11.06		60	680	S5 A05		63	610	S5 005		60	540	S4 005					
1.6 [R 56]	03.10-11.13		70	760	S5 A08													
		SSJ	70	760	S5 A08													
Diesel																		
1.4 D [R 50]	03.03-09.05		70	760	S5 A08		77	780	S5 008		74	680	S4 008		70	640	S3 008	
	09.05-11.06		70	760	S5 A08		77	780	S5 008		74	680	S4 008					
1.5 [F 55]	11.14→	SSJ	70	760	S5 A08													
			80	800	S5 A11													
D [F 56]	03.14→						77	780	S5 008		74	680	S4 008					
		SSJ	70	760	S5 A08		70	760	S4 E08									
			80	800	S5 A11		70	760	S4 E08									
1.6 D [R 56]	09.09-11.13	SSJ	70	760	S5 A08													
Cooper One Cabrio																		
1.2 [F 57]	03.16-11.17	SSJ	70	760	S5 A08													
			80	800	S5 A11													
1.6 [R 52]	07.04-07.08						63	610	S5 005		52	470	S4 002		45	400	S3 002	
[R 57]	03.10-05.15	SSJ	70	760	S5 A08													
Cooper One Clubman																		
1.2 [F 54]	11.15→	SSJ	70	760	S5 A08													
1.4 [R 55]	03.09-02.10		70	760	S5 A08													
1.6 [R 55]	03.10-06.14	SSJ	70	760	S5 A08													
Diesel																		
1.5 [F 54]	11.15→	SSJ	70	760	S5 A08													
1.6 D [R 55]	09.10-06.14	SSJ	70	760	S5 A08													
Cooper One Countryman																		
1.6 [R 60]	09.10-09.16	SSJ	70	760	S5 A08													
Diesel																		
1.6 D [R 60]	09.10-10.16	SSJ	70	760	S5 A08													



			Ah A (EN)	Ah A (EN)	Ah A (EN)	Ah A (EN)
			0 092 ...0	0 092 ...0	0 092 ...0	0 092 ...0

Cooper Paceman

1.6 [R 61]	03.13-09.16	SSJ	70	760	S5 A08						
ALL4 [R 61]	07.13-09.16						74	680	S4 008		
		SSJ					70	760	S4 E08		
			60	680	S5 A05						
			70	760	S5 A08						
S [R 61]	03.13-06.14	SSJ	70	760	S5 A08						
	07.14-09.16					77	780	S5 008	74	680	S4 008
		SSJ	70	760	S5 A08				70	760	S4 E08
S ALL4 [R 61]	03.13-06.14	SSJ	70	760	S5 A08						
	07.14-09.16					77	780	S5 008	74	680	S4 008
		SSJ	70	760	S5 A08				70	760	S4 E08

Diesel

1.6/2.0 D, D ALL4 [R 61]	03.13-09.16	SSJ	70	760	S5 A08						
2.0 SD [R 61]	03.13-09.16	SSJ	70	760	S5 A08						
			80	800	S5 A11						
SD ALL4 [R 61]	03.13-09.16	SSJ	70	760	S5 A08						
			80	800	S5 A11						

Cooper Roadster

1.6 [R 59]	02.12-04.15	SSJ	70	760	S5 A08						
S [R 59]	02.12-04.15		70	760	S5 A08						
		SSJ	70	760	S5 A08						

Diesel

2.0 SD [R 59]	02.12-04.15	SSJ	70	760	S5 A08						
---------------	-------------	-----	----	-----	---------------	--	--	--	--	--	--

John Cooper Works

1.6 [R 53]	10.03-11.06		60	680	S5 A05	63	610	S5 005	60	540	S4 005
[R 56]	07.08-06.12	BWD	70	760	S5 A08						
	07.12-11.13		70	760	S5 A08						
2.0 [F 56]	03.15→	SSJ	70	760	S5 A08						
			80	800	S5 A11						

John Cooper Works Cabrio

1.6 [R 52]	08.04-07.08					63	610	S5 005	52	470	S4 002	45	400	S3 002
[R 57]	03.09-07.12	BWD	70	760	S5 A08									
	07.12-05.15		70	760	S5 A08									
2.0 [F 57]	03.16→	SSJ	70	760	S5 A08									
			80	800	S5 A11									

John Cooper Works Clubman

1.6 [R 55]	07.08-06.12	BWD	70	760	S5 A08						
	07.12-06.14		70	760	S5 A08						
2.0 ALL4 [F 54]	11.16→	SSJ	80	800	S5 A11						

John Cooper Works Countryman

1.6 ALL4 [R 60]	11.12-10.16		70	760	S5 A08						
2.0 ALL4 [F 60]	03.17→	SSJ	70	760	S5 A08						
			80	800	S5 A11						

John Cooper Works Coupé

1.6 [R 58]	09.11-07.12	BWD							74	680	S4 008
		BWD,SSJ	70	760	S5 A08				70	760	S4 E08
	07.12-05.15		70	760	S5 A08						

John Cooper Works GP

1.6 [R 56]	11.12-08.13		70	760	S5 A08						
------------	-------------	--	----	-----	---------------	--	--	--	--	--	--

John Cooper Works Paceman

1.6 ALL4 [R 61]	03.13-09.16	SSJ	70	760	S5 A08						
-----------------	-------------	-----	----	-----	---------------	--	--	--	--	--	--

John Cooper Works Roadster

1.6 [R 59]	02.12-04.15		70	760	S5 A08						
------------	-------------	--	----	-----	---------------	--	--	--	--	--	--

MITSUBISHI

ASX

1.6 [GA]	04.10→		60	680	S5 A05						
		SSJ							60	640	S4 E05
1.8 [GA]	05.10-11.15		70	760	S5 A08				85	800	S4 E42
2.0 [GA]	05.10→								60	540	S4 024



											Ah A (EN)			Ah A (EN)			Ah A (EN)			Ah A (EN)			
		0 092 ...0			0 092 ...0			0 092 ...0			0 092 ...0												
◀ MITSUBISHI																							
2.0 4WD [GA]	05.10→							60	540	S4 024													
Diesel																							
1.6 DI-D [GA]	06.15→							70	760	S4 E08													
		BWD	70	760	S5 A08																		
DI-D 4WD [GA]	06.15→							70	760	S4 E08													
		BWD	70	760	S5 A08																		
1.8 DI-D [GA]	04.10-12.16							85	800	S4 E42													
		BWD	70	760	S5 A08																		
		SSJ							70	760	S4 E08												
DI-D 4WD [GA]	04.10-12.16							70	760	S5 A08													
		BWD	70	760	S5 A08																		
		BWD,SSJ							70	760	S4 E08												
		SSJ							60	640	S4 E05												
									70	760	S4 E08												
2.2 DI-D 4WD [GA]	05.13→							70	760	S5 A08													
Attrage																							
1.2 MIVEC [A1]	03.18→	SSJ							65	650	S4 E40												
Carisma																							
1.3/ 1.6 i 16V [DA]	05.96-12.03				63	610	S5 005	60	540	S4 005	56	480	S3 005										
1.8 GDI [DA]	05.97-02.99				77	780	S5 008	74	680	S4 008	70	640	S3 008										
	03.99-12.03				77	780	S5 008	74	680	S4 008													
i 16V [DA]	05.96-02.99				77	780	S5 008	74	680	S4 008	70	640	S3 008										
Diesel																							
1.9 D Turbo [DA]	05.96-06.00				77	780	S5 008	74	680	S4 008	70	640	S3 008										
DI-D [DA]	07.00-12.03				77	780	S5 008	74	680	S4 008													
Carisma Hatchback																							
1.6 i 16V [DA]	05.95-12.03				63	610	S5 005	60	540	S4 005	56	480	S3 005										
1.8 GDI [DA]	05.97-02.99				77	780	S5 008	74	680	S4 008	70	640	S3 008										
	03.99-12.03				77	780	S5 008	74	680	S4 008													
i 16V [DA]	05.95-02.99				77	780	S5 008	74	680	S4 008	70	640	S3 008										
2.0 16V GT EVO VI [DA]	11.99-12.03				77	780	S5 008	74	680	S4 008	70	640	S3 008										
Diesel																							
1.9 D Turbo [DA]	05.96-06.00				77	780	S5 008	74	680	S4 008	70	640	S3 008										
DI-D [DA]	07.00-12.03				77	780	S5 008	74	680	S4 008													
Challenger																							
3.0 i 4WD [PA]	02.98→							70	630	S4 027													
Colt																							
1.1/ 1.3 [CZ]	04.04-04.13				60	680	S5 A05	54	530	S5 002	52	470	S4 002										
1.3 i 16V [CJ]	06.00-06.03										60	540	S4 024										
1.3/ 1.5 , i 12V [CJ]	11.95-05.00										60	540	S4 025										
1.5 [CZ]	04.04-06.10				54	530	S5 002	52	470	S4 002													
Turbo [CZ]	01.05-04.13				77	780	S5 008	74	680	S4 008													
1.6 i 16V [CJ]	11.95-06.03										60	540	S4 025										
Diesel																							
1.5 DI-D [CZ]	08.04-09.08				63	610	S5 005	60	540	S4 005													
Colt Cabrio																							
1.5 , Turbo [CZ]	03.06-07.08				63	610	S5 005	60	540	S4 005													
Eclipse																							
2.0/ 2.4 i 16V [D2/3]	08.95-12.00										70	630	S4 027										
Eclipse Spyder																							
2.0 Turbo [; D2/D3]	09.95-09.00										70	630	S4 027										
Galant																							
1.8/ 2.0/ 2.4/ 2.5 GDI, i, i V6-24, i 16V [EA/EC; E3]	11.91-12.03										60	540	S4 025										
Diesel																							
2.0 D Turbo [EA/EC]	10.96-02.00										60	540	S4 025										
Galant Station Wagon																							
2.0/ 2.4 GDI, i 16V [EA/EC]	10.96-09.02										60	540	S4 025										
2.5 i V6-24 [EA/EC]	10.96-09.02										60	540	S4 024										
Diesel																							
2.0 D Turbo [EA/EC]	10.96-02.00										60	540	S4 025										
Galloper																							
3.0 V6 4WD	09.98-12.01										70	630	S4 027										



			Ah A (EN) S5A	Ah A (EN) S5	Ah A (EN) S4	Ah A (EN) S3
			0 092 ...0	0 092 ...0	0 092 ...0	0 092 ...0

Diesel													
2.5 TD Interc. 4WD, TD 4WD	05.98-12.01				70	630	S4 027						
Grandis													
2.4 , i, i 16V	10.97→				60	540	S4 024						
Diesel													
2.0 DI-D	06.05-11.10				60	540	S4 024						
Lancer													
1.3/ 1.5/ 1.8 , i, i 12V [CK/CP/CN]	11.95-05.01				60	540	S4 025						
1.3/ 1.6 i [CS/CT]	06.03-04.10		63	610	S5 005	60	540	S4 005	56	480	S3 005		
1.5 [CY/CZ]	03.07-09.11		63	610	S5 005	60	540	S4 005					
1.5/ 2.0 i [CS/CT; CY]	06.02→		63	610	S5 005	60	540	S4 005					
1.6 [CY/CZ]	07.10→		63	610	S5 005	60	540	S4 005					
		BWD	60	680	S5 A05								
i 16V [CK/CP/CN]	11.95-09.00					70	630	S4 027					
1.8 [CY/CZ]	02.08→				63	610	S5 005	60	540	S4 005			
		BWD	60	680	S5 A05								
	10.11→	SSJ				60	640	S4 E05					
2.0 i Turbo 4WD [CZ]	10.07-09.15		70	760	S5 A08	77	780	S5 008	74	680	S4 008		
Diesel													
1.8 DI-D [CY/CZ]	07.10→				77	780	S5 008						
		BWD	70	760	S5 A08								
		BWD,SSJ				70	760	S4 E08					
		SSJ				60	640	S4 E05					
2.0 DI-D [CY/CZ]	02.08-08.10		70	760	S5 A08	77	780	S5 008					
Lancer Evo IX													
2.0 i Turbo 4WD [CS/CT]	07.05-06.07					60	540	S4 024					
Lancer Evo VIII													
2.0 i Turbo 4WD [CS/CT]	09.02-07.05					70	630	S4 027					
Lancer Evo V/VI													
2.0 i Turbo [CK/CP/CN]	01.98-09.00					70	630	S4 027					
Lancer Evo X													
2.0 FQ-330 4x4 [CY/CZ]	06.08→		70	760	S5 A08	77	780	S5 008	74	680	S4 008		
FQ-360 4x4 [CY/CZ]	06.08→		70	760	S5 A08	77	780	S5 008					
i Turbo 4x4 [CY/CZ]	08.07-06.14					77	780	S5 008					
		BWD	70	760	S5 A08								
		SSJ				70	760	S4 E08					
Lancer Ralliart													
2.0 4x4 [CY/CZ]	03.07-06.12				77	780	S5 008	74	680	S4 008			
Lancer Sportback													
1.5 [CX]	07.08-06.10				63	610	S5 005	60	540	S4 005			
1.6 [CX]	07.10-08.17				63	610	S5 005	60	540	S4 005			
		BWD	60	680	S5 A05								
1.8 [CX]	07.08-08.17				63	610	S5 005	60	540	S4 005			
Diesel													
1.8 DI-D [CX]	07.10-02.15				77	780	S5 008						
		BWD	70	760	S5 A08								
		BWD,SSJ				70	760	S4 E08					
		SSJ				60	640	S4 E05					
2.0 DI-D [CX]	08.08-08.10				77	780	S5 008						
		BWD	70	760	S5 A08								
Lancer Sportback Ralliart													
2.0 4WD [CX]	07.08-09.11				77	780	S5 008	74	680	S4 008			
Lancer Station Wagon													
1.6 i 16V, i 16V 4WD [CA/CB/CD]	06.92-09.00					70	630	S4 027					
1.6/ 2.0 i [CS/CT]	06.03-06.08				63	610	S5 005	60	540	S4 005	56	480	S3 005
Minica													
660 16V, 16V Toppo, 16V 4WD Toppo	09.93→					45	330	S4 023					
Outlander													
PHEV 4WD [GF]	05.13→					45	330	S4 020					



		Ah A (EN) S5A		Ah A (EN) S5		Ah A (EN) S4		Ah A (EN) S3	
		0 092 ...0		0 092 ...0		0 092 ...0		0 092 ...0	
◀ MITSUBISHI									
2.0 [GF]	04.12→					60	540	S4 024	
		SSJ				85	800	S4 E42	
, 4WD [CW]	09.07-12.12					60	540	S4 024	
i 2WD [CU]	02.03-09.07					70	630	S4 027	
4WD [GF]	04.12→					60	540	S4 024	
		SSJ				85	800	S4 E42	
2.0/ 2.4 i Turbo 4WD, i 4WD [CU]	02.03-09.07					60	540	S4 024	
2.4 4WD [GF]	04.12→					95	830	S4 028	
2.4/ 3.0 , i, i 4WD, 4WD [; CW]	10.03→					95	830	S4 028	
Diesel									
2.0 DI-D 4WD [CW]	02.07-06.10					95	830	S4 028	
2.2 DI-D [CW]	07.10-12.12					95	830	S4 028	
		SSJ				85	800	S4 E42	
DI-D [GF]	04.12→					60	540	S4 024	
DI-D 4WD [CW]	09.07-12.12					95	830	S4 028	
		SSJ				85	800	S4 E42	
DI-D 4WD [GF]	04.12→					70	630	S4 027	
		SSJ				85	800	S4 E42	
Pajero									
1.8/ 3.0/ 3.5/ 3000 GDI, i, i 24V, V6 24V, V6 24V 4WD, 4WD [N; NJ/NK/NL; V;V80; V90]	11.93→					70	630	S4 027	
2.4/ 3.0/ 3.5 i 16V, i 24V	09.97→					70	630	S4 027	
3.0 i 4WD	10.90-09.99					70	630	S4 027	
	10.06→					60	540	S4 025	
3.5 GDI 4WD [V60; V70]	02.00-08.06					95	830	S4 028	
3.8 4WD [V80; V90]	09.06-07.16					60	540	S4 025	
Diesel									
2.5 TD [V]	04.91-05.99					70	630	S4 027	
TD Interc. 4WD [V60; V70]	02.00-08.06					95	830	S4 029	
2.5/ 2.8 D, TD Interc., TD Interc. 4WD [V]	12.90-06.00					95	830	S4 029	
3.2 D Turbo 4WD	10.08-08.10	BWD				60	540	S4 024	
DI-D 4WD [V60; V70]	02.00-08.06	BWD				95	830	S4 028	
DI-D 4WD [V80; V90]	09.06→	BWD				60	540	S4 024	
						95	830	S4 028	
Pajero Cabrio									
3000 V6 24V 4WD [V]	06.94-05.01					70	630	S4 027	
Diesel									
2.5 TD Interc. 4WD [V]	12.90-05.01					95	830	S4 029	
Pajero Pinin									
1.8/ 2.0 GDI 4WD, 4WD [H]	10.99-02.05		63 610	S5 005		60	540	S4 005	56 480 S3 005
Pajero Sport									
3.0 [KH]	07.08-11.15					60	540	S4 025	
3.0/ 3.5 , V6 [K; KH]	07.96-09.09					95	830	S4 029	
Diesel									
2.4 4WD [KS]	07.16→					95	830	S4 028	
2.5	01.07-12.10					95	830	S4 028	
DI-D [KH]	10.09-11.15					95	830	S4 029	
TD, TD+ [K]	08.98-02.09	BWD				95	830	S4 029	
3.2 DI-D 4WD [KH]	07.08-09.09					60	540	S4 025	
Santamo									
2.0 , 4WD	05.99-12.02					70	630	S4 027	
Space Gear									
2.0/ 2.4/ 3.0 i, i 2WD, i 4WD, i 24V	12.94-03.01					70	630	S4 027	
Diesel									
2.5/ 2.8 D Turbo, D Turbo Interc. 2WD, D Turbo Interc. 4WD, D Turbo 2WD short	12.94-03.01					95	830	S4 029	



			Ah A (EN)	Ah A (EN)	Ah A (EN)	Ah A (EN)
			0 092 ...0	0 092 ...0	0 092 ...0	0 092 ...0

Space Runner														
1.8/ 2.0/ 2.4 GDI, i, i 16V, i 16V 4WD	06.91-08.02						70	630	S4 027					
Diesel														
2.0 D Turbo	06.92-05.99						70	630	S4 027					
Space Star														
1.0 [A0]	11.12→		60	680	S5 A05									
		SSJ					60	640	S4 E05					
1.2 [A0]	11.12→		60	680	S5 A05									
		SSJ					60	640	S4 E05					
Space Wagon														
2.0/ 2.4 GDI, GDI 4WD, i 16V, i 16V 4WD [N]	06.92-01.04						70	630	S4 027					
Diesel														
2.0 D Turbo [N]	06.92-11.00						95	830	S4 029					
Spacestar														
1.3/ 1.6 i [DG]	06.98-12.04					63	610	S5 005	60	540	S4 005	56	480	S3 005
1.8 GDI [DG]	08.98-08.02		70	760	S5 A08	77	780	S5 008	74	680	S4 008	70	640	S3 008
i [DG]	09.02-12.04		60	680	S5 A05	63	610	S5 005	60	540	S4 005			
Diesel														
1.9 D i-D [DG]	06.00-12.04		70	760	S5 A08	77	780	S5 008	74	680	S4 008	70	640	S3 008
	09.02-12.04		70	760	S5 A08	77	780	S5 008	74	680	S4 008			
3000 GT														
3.0 i Bi-Turbo 4WD/4WS	06.92-12.00						70	630	S4 027					

MORGAN

Aero 8												
4.4 32V	03.00→									45	300	S3 017
4.8	03.08→					61	600	S5 004	60	540	S4 004	
Plus 4												
1.8/ 2.0 i, 16V	09.92-10.99									45	300	S3 017
Plus 8												
3.9/ 4.6 i, V8	01.90-09.04								40	330	S4 019	
Puls 4												
2.0	01.04→					52	520	S5 001	44	440	S4 001	
Roadster												
3.0	03.05→					52	520	S5 001	44	440	S4 001	
4/4												
1600 i	01.91-09.99									45	300	S3 017
	09.08→					52	520	S5 001	44	440	S4 001	
1800 16V	02.93→									45	300	S3 017

MOSKWITSCH

Aleko														
1.5/ 1.6	01.86-12.00					63	610	S5 006	60	540	S4 006	56	480	S3 006
1.7/ 1.8/ 2.0	01.86-12.00								70	630	S4 027			

NISSAN

Almera														
1.4/ 1.6 i [N15]	07.95-04.00									60	540	S4 024		
1.5 i [N16E]	03.01-07.02					52	520	S5 001	44	440	S4 001			
	08.02-11.06					54	530	S5 002	44	440	S4 001			
1.5/ 1.8 i [N16]	04.00-03.01					54	530	S5 002	44	440	S4 001			
1.6 i [B10]	01.06-11.12									60	540	S4 024		
i [H14/15/17]	01.00→					52	520	S5 001	44	440	S4 001	41	360	S3 001
1.8 i [N16E]	03.01-11.06					54	530	S5 002	44	440	S4 001			



		Ah A (EN) S5A			Ah A (EN) S5			Ah A (EN) S4			Ah A (EN) S3		
		0 092 ...0			0 092 ...0			0 092 ...0			0 092 ...0		
◀ NISSAN													
Diesel													
1.5 D Turbo [N16E]	10.02-11.06	74	750	S5 007	72	680	S4 007						
2.0 D [N15]	07.95-04.00						95	830	S4 028				
2.2 D Turbo [N16]	04.00-03.01	74	750	S5 007	72	680	S4 007						
D Turbo [N16E]	03.01-11.06	74	750	S5 007	72	680	S4 007	70	640	S3 007			
Almera Hatchback													
1.4/ 1.6/ 2.0 i [N15]	07.95-04.00						60	540	S4 024				
1.5 i [N16E]	01.00-07.02	52	520	S5 001	44	440	S4 001						
	08.02-11.06	54	530	S5 002	44	440	S4 001						
1.8 i [N16E]	01.00-07.02	52	520	S5 001	44	440	S4 001						
	08.02-11.06	54	530	S5 002	44	440	S4 001						
Diesel													
1.5 D Turbo [N16E]	10.02-11.06	74	750	S5 007	72	680	S4 007						
2.0 D [N15]	07.95-04.00						95	830	S4 028				
2.2 D Turbo [N16E]	01.00-11.06	74	750	S5 007	72	680	S4 007	70	640	S3 007			
Almera Tino													
1.8/ 2.0 i [V10M]	05.00-12.05	52	520	S5 001	44	440	S4 001						
Diesel													
2.2 D Turbo [V10M]	05.00-01.03	74	750	S5 007	72	680	S4 007	70	640	S3 007			
	02.03-12.05	70	760	S5 A08	74	750	S5 007	72	680	S4 007			
Altima													
2.5/ 3.5 i [L31]	09.01-12.06						70	630	S4 026				
i [L32]	08.07-05.12						60	540	S4 025				
Cube													
1.6 [Z12]	08.09-03.11						45	330	S4 021				
Diesel													
1.5 dCi [Z12]	10.09-03.11						45	300	S3 016				
Evalia													
1.6 [M20M]	01.11→	61	600	S5 004						53	500	S3 004	
Diesel													
1.5 dCi [M20M]	10.10→	63	610	S5 005	60	540	S4 005						
GT-R Coupé													
3.8 Nismo 4x4, Turbo, Turbo 4x4, Turbo 4X4 [R35]	12.08→						45	330	S4 020				
GT-R Nismo Coupé													
3.8 4x4 [R35]	07.14-08.16						45	330	S4 020				
Juke													
1.2 DIG-T [F15]	05.14→	77	780	S5 008	74	680	S4 008						
	SSJ	70	760	S5 A08	70	760	S4 E08						
1.6 [F15]	07.10→						60	540	S4 024				
	SSJ	70	760	S5 A08	70	760	S4 E08						
DIG-T [F15]	07.10→						60	540	S4 025				
	12.12→						60	540	S4 024				
DIG-T NISMO [F15]	08.14→	77	780	S5 008									
	SSJ	70	760	S5 A08	70	760	S4 E08						
DIG-T NISMO 4x4 [F15]	08.14→	70	760	S5 A08	77	780	S5 008	70	760	S4 E08			
DIG-T 4x4 [F15]	07.10→						60	540	S4 025				
Diesel													
1.5 dCi [F15]	07.10→	63	610	S5 005	60	540	S4 024						
	SSJ	70	760	S5 A08	70	760	S4 E08						
	05.13→	70	760	S5 A08	63	610	S5 005	70	630	S4 027			
	SSJ						70	760	S4 E08				
Laurel													
2.0/ 2.5 i, i Turbo [C34]	01.93-12.03						60	540	S4 025				
Diesel													
2.8 D [C34]	01.93-08.02						70	630	S4 027				
Leaf													
[ZEO]	10.10→						45	330	S4 020				
March													
1.2 i [K13]	05.10→						40	330	S4 018				
							52	470	S4 002				
Maxima													
3.0 i [A32]	01.95-12.01						60	540	S4 024				



			Ah	A (EN)		Ah	A (EN)		Ah	A (EN)		Ah	A (EN)	
			0 092 ...0			0 092 ...0			0 092 ...0			0 092 ...0		

Maxima QX														
2.0 i [CA33]	01.00-01.06		70	760	S5 A08	77	780	S5 008	74	680	S4 008	70	640	S3 008
2.0/2.5/3.0 i [A32]	10.94-01.00								60	540	S4 024			
2.5 i [CA33]	01.00-01.06		70	760	S5 A08	77	780	S5 008	74	680	S4 008			
3.0 i [CA33]	01.96→		70	760	S5 A08	77	780	S5 008	74	680	S4 008			
	01.00-01.06		70	760	S5 A08	77	780	S5 008	74	680	S4 008	70	640	S3 008
Micra														
0.9/1.0 iG-T [K14FR]	01.17→	SSJ	60	680	S5 A05				60	640	S4 E05			
1.0 i [K12E]	11.02-05.05					52	520	S5 001	44	440	S4 001	41	360	S3 001
1.0/1.3/1.4 i [K11E]	08.92-10.02								45	330	S4 021			
1.2 DIG-S [K13K]	03.11-10.15	SSJ							60	640	S4 E05			
									65	650	S4 E40			
i [K12E]	11.02-10.10					52	520	S5 001	44	440	S4 001	41	360	S3 001
	06.05-10.10	BWD				54	530	S5 002	44	440	S4 001			
i [K13K]	05.10-10.15								40	330	S4 018			
									52	470	S4 002			
		SSJ							65	650	S4 E40			
1.4/1.6 i [K12E]	11.02-10.10					52	520	S5 001	44	440	S4 001	41	360	S3 001
Diesel														
1.5 D [K11E]	02.98-10.02					61	600	S5 004	60	540	S4 004			
D Turbo [K12E]	02.03-09.07					61	600	S5 004	60	540	S4 004			
	08.03-10.10					61	600	S5 004	60	540	S4 004	53	500	S3 004
DCI [K14FR]	01.17→	SSJ	70	760	S5 A08				70	760	S4 E08			
Micra CC														
1.4/1.6 i [K12E]	09.05-10.10					61	600	S5 004	60	540	S4 004			
Murano														
2.5 4x4 [Z52]	06.16→								60	540	S4 024			
									65	650	S4 E40			
3.5 [Z52]	06.16→								60	540	S4 024			
									65	650	S4 E40			
i 4x4 [Z50]	11.04-12.08								60	540	S4 024			
4x4 [Z51]	06.08-06.15	BWD							60	540	S4 024			
	12.10-06.16								70	630	S4 026			
									72	760	S4 E41			
4x4 [Z52]	06.16→								60	540	S4 024			
									65	650	S4 E40			
Diesel														
2.5 dCi 4x4 [Z51]	05.10-06.15								60	540	S4 025			
Note														
1.2 [E12]	08.13→								40	330	S4 018			
		BWD	60	680	S5 A05									
		SSJ							60	640	S4 E05			
DIG-S [E12]	12.13→	BWD	60	680	S5 A05									
		SSJ							60	640	S4 E05			
i [E12]	09.12→	SSJ							40	330	S4 018			
		SSJ	60	680	S5 A05				60	640	S4 E05			
i Supercharged [E12]	09.12→	SSJ	60	680	S5 A05				60	640	S4 E05			
1.4/1.6 [E11]	01.06-08.13					54	530	S5 002	44	440	S4 001			
Diesel														
1.5 DCi Turbo [E12]	12.13→		60	680	S5 A05	63	610	S5 005	60	540	S4 005			
		SSJ							60	640	S4 E05			
dCi 70, dCi 86, dCi 105 [E11]	01.06-08.13					61	600	S5 004	60	540	S4 004			
dCi 90 [E11]	11.10-08.14					61	600	S5 004				53	500	S3 004
Pathfinder														
3.3/3.5 i, i 4x4 [R50]	09.95-04.06								70	630	S4 027			
3.5 4x4 [R50]	01.00-07.04								70	630	S4 027			
									95	830	S4 029			
4x4 [R52R]	09.14-08.15		70	760	S5 A08	77	780	S5 008						
4.0 4x4 [R51]	09.04-08.12					63	610	S5 005	60	540	S4 005			
	06.05-01.10		60	680	S5 A05	63	610	S5 005						
			60	680	S5 A05	77	780	S5 008						



											Ah A (EN)			Ah A (EN)			Ah A (EN)			Ah A (EN)		
		0 092 ...0			0 092 ...0			0 092 ...0			0 092 ...0											
◀ NISSAN																						
4.0 4x4 [R51]	01.06-09.12				63	610	S5 005															
					77	780	S5 008															
		BWD	60	680	S5 A05																	
Diesel																						
2.5 dCi 4x4 [R51]	01.05-12.09	70	760	S5 A08			77	780	S5 008			74	680	S4 008			70	640	S3 008			
	01.10-11.14	70	760	S5 A08			77	780	S5 008													
3.0 dCi 4x4 [R51]	05.10-11.14	70	760	S5 A08			77	780	S5 008													
3.2 D Turbo 4x4 [R50]	09.97-12.07							95	830	S4 029												
Patrol																						
3.0 [260]	04.89-05.98							70	630	S4 027												
5.6 4x4 [Y62]	03.10→							85	800	S5 010			80	740	S4 010							
Diesel																						
2.7 D Turbo [260]	05.98-12.05							95	830	S4 029												
2.8 D [260]	04.89-05.98							70	630	S4 027												
D Turbo [260]	04.89-05.98							95	830	S4 028												
3.2 D [260]	10.90-12.05							95	830	S4 028												
Patrol GR																						
4.8 , i 4x4 [Y61]	10.02→							95	830	S4 028												
Diesel																						
2.8/ 3.0/ 4.2 D, D Turbo 4x4, dCi 4x4, Di Hardtop 4x4, Di 4x4 [Y61]	10.97-03.10							95	830	S4 028												
Pixo Hatchback																						
1.0 [UA0]	03.09-08.13							40	330	S4 030												
Primera																						
1.6 [P12E]	12.01-06.10	60	680	S5 A05			61	600	S5 004			60	540	S4 004								
		60	680	S5 A05			63	610	S5 005			60	540	S4 004								
1.8 i [P12E]	02.02-12.05							63	610	S5 005			60	540	S4 005			56	480	S3 005		
1.8/ 2.0 [P12E]	12.01-07.10							63	610	S5 005			60	540	S4 005							
Diesel																						
1.9/ 2.2 D Turbo [P12E]	12.01-09.10	70	760	S5 A08			77	780	S5 008			74	680	S4 008								
Primera Hatchback																						
1.6/ 1.8/ 2.0 [P12E]	05.02-07.10							63	610	S5 005			60	540	S4 005							
i, iGT [P11E]	06.96-12.01							63	610	S5 005			60	540	S4 005			56	480	S3 005		
Diesel																						
1.9/ 2.2 D Turbo [P12E]	05.02-09.10	70	760	S5 A08			77	780	S5 008			74	680	S4 008								
2.0 D Turbo [P11E]	06.96-12.01	70	760	S5 A08			77	780	S5 008			74	680	S4 008			70	640	S3 008			
Primera Sedan																						
1.6/ 1.8/ 2.0 i, iGT [P11E]	06.96-12.01							63	610	S5 005			60	540	S4 005			56	480	S3 005		
Diesel																						
2.0 D Turbo [P11E]	06.96-12.01	70	760	S5 A08			77	780	S5 008			74	680	S4 008			70	640	S3 008			
Primera Wagon																						
1.6/ 1.8/ 2.0 i [P11; P12E; WP11E]	09.97-06.10							63	610	S5 005			60	540	S4 005			56	480	S3 005		
1.8/ 2.0 [P12E]	12.01-07.10							63	610	S5 005			60	540	S4 005							
Diesel																						
1.9/ 2.2 D Turbo [P12E]	12.01-09.10	70	760	S5 A08			77	780	S5 008			74	680	S4 008								
2.0 D Turbo [WP11E]	01.98-12.01	70	760	S5 A08			77	780	S5 008			74	680	S4 008			70	640	S3 008			
Pulsar																						
1.2 DIG-T [C13]	07.14→	SSJ	70	760	S5 A08									70	760	S4 E08						
1.6 DIG-T [C13]	02.15→	SSJ													70	760	S4 E08					
Diesel																						
1.5 dCi [C13]	07.14→	SSJ	70	760	S5 A08									70	760	S4 E08						
Qashqai																						
1.2 DIG-Ti [J11E]	12.13→							77	780	S5 008			74	680	S4 008							
		SSJ	70	760	S5 A08									70	760	S4 E08						
1.6 [J10]	12.06-12.13	60	680	S5 A05			54	530	S5 002													
		60	680	S5 A05			63	610	S5 005													
	11.10-12.13							63	610	S5 005			60	540	S4 024							
		SSJ	60	680	S5 A05									60	640	S4 E05						
DiG-Ti 4x2 [J11E]	10.14→							77	780	S5 008												
		SSJ	70	760	S5 A08									70	760	S4 E08						



						Ah A (EN) S5A		Ah A (EN) S5		Ah A (EN) S4		Ah A (EN) S3		
				0 092 ...0		0 092 ...0		0 092 ...0		0 092 ...0		0 092 ...0		
2.0 [J10]	12.06-12.13					63	610	S5 005						
		BWD	60	680	S5 A05				60	540	S4 024			
[J11E]	12.13→	SSJ	70	760	S5 A08				70	760	S4 E08			
4x4 [J10]	12.06-12.13					63	610	S5 005						
		BWD	60	680	S5 A05									
4x4 [J11R]	12.15→	SSJ	70	760	S5 A08				70	760	S4 E08			
			70	760	S5 A08				72	760	S4 E41			
Diesel														
1.5 dCi [J10]	12.06-12.13		70	760	S5 A08	77	780	S5 008	74	680	S4 008	70	640	S3 008
		SSJ	70	760	S5 A08									
	01.10-12.13					77	780	S5 008	74	680	S4 008			
dCi [J11E]	12.13→					77	780	S5 008	74	680	S4 008			
		SSJ	70	760	S5 A08				70	760	S4 E08			
1.6 dCi [J10]	07.11-12.13								70	630	S4 026			
									72	760	S4 E41			
dCi [J11E]	12.13→					77	780	S5 008	74	680	S4 008			
		SSJ	70	760	S5 A08				70	760	S4 E08			
dCi 4x4 [J10]	07.11-12.13	SSJ	70	760	S5 A08				72	760	S4 E41			
dCi 4x4 [J11E]	12.13→					77	780	S5 008	74	680	S4 008			
		SSJ	70	760	S5 A08				70	760	S4 E08			
2.0 dCi [J10]	04.07-12.13	BWD	70	760	S5 A08	77	780	S5 008	74	680	S4 008	70	640	S3 008
dCi 4x4 [J10]	04.07-12.13	BWD	70	760	S5 A08	77	780	S5 008	74	680	S4 008	70	640	S3 008
Qashqai+2														
1.6 [JJ10]	08.08-12.13		60	680	S5 A05	54	530	S5 002						
			60	680	S5 A05	63	610	S5 005						
	11.10-12.13					63	610	S5 005	60	540	S4 024			
		BWD	60	680	S5 A05									
		SSJ							60	640	S4 E05			
2.0 [JJ10]	08.08-12.13					63	610	S5 005						
		BWD	60	680	S5 A05				60	540	S4 024			
4x4 [JJ10]	08.08-12.13					63	610	S5 005						
		BWD	60	680	S5 A05									
Diesel														
1.5 dCi [JJ10]	08.08-12.13	BWD	70	760	S5 A08	77	780	S5 008	74	680	S4 008	70	640	S3 008
	01.10-12.13					77	780	S5 008	74	680	S4 008			
1.6 dCi [JJ10]	07.11-12.13								70	630	S4 026			
									72	760	S4 E41			
dCi 4x4 [JJ10]	07.11-12.13		70	760	S5 A08									
		SSJ	70	760	S5 A08									
2.0 dCi [JJ10]	08.08-12.13	BWD	70	760	S5 A08	77	780	S5 008	74	680	S4 008	70	640	S3 008
dCi 4x4 [JJ10]	08.08-12.13	BWD	70	760	S5 A08	77	780	S5 008	74	680	S4 008	70	640	S3 008
Quest														
3.5 [V42]	05.03-08.11								60	540	S4 024			
Safari														
4.5 [Y61]	08.97-12.05								95	830	S4 028			
Serena														
1.6/ 2.0 i [C23]	07.92-11.01								60	540	S4 025			
Diesel														
2.3 D [C23]	09.94-11.01								95	830	S4 029			
Skyline														
2.0/ 2.5 i [R33]	08.93-01.99								70	630	S4 027			
Skyline Coupé														
2.0/ 2.5 i, i 24V [, R34]	05.98-08.02								70	630	S4 027			
3.5 i [V35]	01.03-09.07								70	630	S4 027			
Skyline GT-R														
2.6 i Turbo 4WD [R33]	08.97-09.99								70	630	S4 027			
Sunny														
1.3 i [B14]	01.94→								45	330	S4 020			
									45	330	S4 021			
									60	540	S4 024			
1.5 i 16V [B14]	01.94→								45	330	S4 020			
									45	330	S4 021			
									60	540	S4 024			



						Ah A (EN) S5A		Ah A (EN) S5		Ah A (EN) S4		Ah A (EN) S3		
						0 092 ...0		0 092 ...0		0 092 ...0		0 092 ...0		
◀ NISSAN														
1.6 [B10RS]	03.06-03.13			61	600			S5 004	60	540		S4 004		
i [B14]	01.94→								45	330		S4 020		
									45	330		S4 021		
									60	540		S4 024		
1.8 i [B14]	01.94→								45	330		S4 020		
									45	330		S4 021		
									60	540		S4 024		
Diesel														
2.0 D	01.94→								95	830		S4 028		
Sunny Coupé														
1.3/ 1.5/ 1.6/ 1.8 i, i 16V [B14]	06.94→								60	540		S4 024		
Sunny Wagon														
1.6 i [Y10]	10.92-03.00								60	540		S4 024		
Diesel														
1.7/ 2.0 D [Y10]	11.90-03.00								95	830		S4 028		
Teana														
2.0/ 2.3/ 3.5, i [J31]	02.03-06.08								60	540		S4 024		
2.5/ 3.5 [J32]	02.08-12.13			85	800			S5 010	80	740		S4 010		
Terrano I														
3.3 i [WD21]	09.95-12.05								95	830		S4 029		
Diesel														
2.7/ 3.2 D, D Turbo [WD21]	09.95-12.06								70	630		S4 026		
Terrano II														
2.4 i 4x4 [R20]	05.96-12.06			63	610			S5 006	60	540		S4 006		
Diesel														
2.7 D Turbo 4x4 [R20]	02.93→								95	830		S4 029		
	11.96-12.06								74	680		S4 009		
3.0 D Turbo 4x4 [R20]	02.02-12.06			77	780			S5 008	74	680		S4 008		
Tiida														
1.6/ 1.8, i [C11]	01.05→	BWD		63	610			S5 005	52	470		S4 002		
Diesel														
1.5 dCi [C11]	02.07-03.10	BWD		63	610			S5 005	60	540		S4 005		
Tiida Hatchback														
1.6 [C11]	03.07→			63	610			S5 005	60	540		S4 005	56	480
1.8 [C11]	06.06-07.13			63	610			S5 005	60	540		S4 005		
	03.07-03.10			63	610			S5 005	60	540		S4 005	56	480
Diesel														
1.5 dCi [C11]	03.07-03.10			63	610			S5 005	60	540		S4 005		
Tiida Latio														
1.8 [SC11]	08.05-08.10			63	610			S5 005	60	540		S4 005		
Tiida Sedan														
1.8 [SC11X]	01.07→			63	610			S5 005	60	540		S4 005		
X-Trail														
1.6/ 2.0/ 2.5, DIG-T, 4WD [T32; T32R]	12.14→	SSJ	70	760				S5 A08	70	760		S4 E08		
2.0 i Turbo, 4x2 [T30]	06.01-08.07		70	760				S5 A08	77	780		S5 008	74	680
4x4 [T30]	06.01-03.07		70	760				S5 A08	77	780		S5 008	74	680
4x4 [T31R]	10.09-12.14								60	540		S4 024		
2.0/ 2.5, 4x4 [T31]	04.07-04.14	BWD							60	540		S4 024		
2.5 4x4 [T30]	09.02-03.07		70	760				S5 A08	77	780		S5 008	74	680
4x4 [T31R]	10.09-12.14								70	630		S4 026		
Diesel														
1.6 cDi [T32]	04.14→	SSJ	70	760				S5 A08	70	760		S4 E08		
dCi [T32]	04.14→	SSJ	70	760				S5 A08	70	760		S4 E08		
2.0 dCi [T32]	11.16→	SSJ							72	760		S4 E41		
dCi, dCi 4x4 [T31]	04.07-04.14	BWD							70	630		S4 026		
dCi 4x4 [T32]	11.16→	SSJ							72	760		S4 E41		
2.2 D Turbo 4x2 [T30]	02.05-03.07								95	830		S4 028		
D Turbo 4x4 [T30]	06.01-03.07								70	630		S4 026		
200 SX														
2.0/ 2.4 i, i Turbo [S14]	10.93-12.99								60	540		S4 025		



			Ah A (EN) S5A	Ah A (EN) S5	Ah A (EN) S4	Ah A (EN) S3
			0 092 ...0	0 092 ...0	0 092 ...0	0 092 ...0

350 Z Cabriolet							
3.5 [Z33]	09.03-01.07				60	540	S4 024
	09.06-04.09	BWD			60	540	S4 024
350 Z Coupé							
3.5 [Z33]	09.02-01.07				60	540	S4 024
	09.06-04.09	BWD			60	540	S4 024
370 Z Coupé							
3.7 [Z34]	10.08→				70	630	S4 027
	04.09→	BWD			60	540	S4 024
Nismo [Z34]	03.13→				60	540	S4 024
370 Z Roadster							
3.7 [Z34]	11.09→				60	540	S4 024

OPEL

Adam												
1.0	07.14→	SSJ	60	680	S5 A05		70	760	S4 E08			
1.2	03.13→					54	530	S5 002	52	470	S4 002	
		SSJ	60	680	S5 A05							
1.4	03.13→					54	530	S5 002	52	470	S4 002	
		SSJ	60	680	S5 A05							
	01.15→		60	680	S5 A05	54	530	S5 002	52	470	S4 002	
LPG	09.13→					54	530	S5 002	52	470	S4 002	
Turbo	01.15→								52	470	S4 002	
									74	680	S4 008	
		SSJ	60	680	S5 A05				70	760	S4 E08	
Agila												
1.0 i Twinport [B]	03.08-08.15					52	520	S5 001	44	440	S4 001	
1.0/1.2 i, i Twinport [A]	06.00-02.08					52	520	S5 001	44	440	S4 001	
1.2 i Twinport [B]	03.08-08.15					52	520	S5 001	44	440	S4 001	
		SSJ	60	680	S5 A05				60	640	S4 E05	
Diesel												
1.3 CDTI [A]	08.03-02.08					61	600	S5 004	60	540	S4 004	
CDTI [B]	03.08-08.15					61	600	S5 004	60	540	S4 004	
Ampera												
1.4 Hybrid	10.11-12.15		60	680	S5 A05	63	610	S5 005	60	540	S4 005	
			60	680	S5 A05	63	610	S5 005	60	640	S4 E05	
56	480	S3 005										
Antara												
2.4 i	05.06-12.11								60	540	S4 006	
	11.10-12.17								70	630	S4 027	
i 4x4	05.06-12.11								60	540	S4 006	
	11.10-12.17								70	630	S4 027	
3.0 i V6	01.12-12.17								70	630	S4 027	
i V6 4x4	01.12-12.17								70	630	S4 027	
3.2 i V6 4x4	05.06-12.11								74	680	S4 009	
Diesel												
2.0 CDTI	05.06-12.11								95	830	S4 029	
	03.16-12.17											
		SSJ	95	850	S5 A13					90	720	S3 013
CDTI 4x4	05.06-12.11								95	830	S4 029	
CDTI 4X4	03.16-12.17											
		SSJ	95	850	S5 A13					90	720	S3 013
2.2 CDTI	11.10-12.17								95	800	S4 013	
									95	830	S4 029	
		SSJ	95	850	S5 A13							
CDTI 4x4	11.10-12.17								95	800	S4 013	
									95	830	S4 029	
		SSJ	95	850	S5 A13							
Astra												
1.0 i [K]	09.15→	SSJ	70	760	S5 A08							
			80	800	S5 A11							



		Ah A (EN) S5A			Ah A (EN) S5			Ah A (EN) S4			Ah A (EN) S3			
		0 092 ...0			0 092 ...0			0 092 ...0			0 092 ...0			
◀ OPEL														
1.2/ 1.4/ 1.6/ 1.8/ 2.0 i	09.91-07.09				61	600	S5 004	44	440	S4 001	41	360	S3 001	
i Twinport, Twinport [F; G]														
1.2/ 1.6 i Twinport [H]	03.07-03.09				61	600	S5 004	44	440	S4 001	41	360	S3 001	
1.4 i [H]	09.04-09.05				61	600	S5 004				53	500	S3 004	
i [J]					61	600	S5 004	60	540	S4 004				
					74	750	S5 007	60	540	S4 004				
		SSJ	70	760	S5 A08									
			80	800	S5 A11									
09.12→					61	600	S5 004				53	500	S3 004	
i [K]								52	470	S4 002				
								60	540	S4 005				
		SSJ	70	760	S5 A08									
i Turbo [J]					61	600	S5 004				53	500	S3 004	
					61	600	S5 004	60	540	S4 004	53	500	S3 004	
		SSJ	70	760	S5 A08									
			80	800	S5 A11									
09.12→			70	760	S5 A08	61	600	S5 004			53	500	S3 004	
03.15→					61	600	S5 004	60	540	S4 004				
			70	760	S5 A08	61	600	S5 004	60	540	S4 004			
Twinport [H]		03.04-03.10			61	600	S5 004				53	500	S3 004	
1.6 CDTI [K]	09.15→	SSJ	70	760	S5 A08									
i [J]					61	600	S5 004	60	540	S4 004				
		SSJ	70	760	S5 A08									
			80	800	S5 A11									
09.12→					61	600	S5 004				53	500	S3 004	
i Turbo [J]					61	600	S5 004	44	440	S4 001	41	360	S3 001	
09.12→					61	600	S5 004				53	500	S3 004	
04.13→					61	600	S5 004	60	540	S4 004				
			60	680	S5 A05	61	600	S5 004	60	540	S4 004			
		SSJ						70	760	S4 E08				
			70	760	S5 A08									
			80	800	S5 A11									
Twinport [H]		03.04-03.07			61	600	S5 004	44	440	S4 001	41	360	S3 001	
1.6/ 1.8 i [H]	03.04-08.13				61	600	S5 004	44	440	S4 001	41	360	S3 001	
1.6/ 2.0 i Turbo [H]	03.04-03.10				74	750	S5 007	60	540	S4 004	53	500	S3 004	
1.8/ 2.0 i [G]	09.97-01.04				74	750	S5 007	60	540	S4 004	53	500	S3 004	
2.0 i Turbo [G]	09.02-02.04				74	750	S5 007	60	540	S4 004	53	500	S3 004	
2.2 i [G]	06.00-01.04				74	750	S5 007	72	680	S4 007				
Diesel														
1.3 CDTI [H]	08.05-03.10				74	750	S5 007	60	540	S4 004				
CDTI [J]					61	600	S5 004	44	440	S4 001	41	360	S3 001	
		BWD	70	760	S5 A08									
		SSJ	70	760	S5 A08									
09.12→		SSJ	60	680	S5 A05			60	640	S4 E05				
1.6 CDTI [J]	12.13→				77	780	S5 008	70	650	S4 E07	70	640	S3 008	
					77	780	S5 008	74	680	S4 008	70	640	S3 008	
			60	680	S5 A05	77	780	S5 008	74	680	S4 008			
		SSJ						70	760	S4 E08				
			70	760	S5 A08									
			80	800	S5 A11									
CDTI [K]		09.15→			85	800	S5 010	74	680	S4 008				
		SSJ	80	800	S5 A11									
10.15→					63	610	S5 005	60	540	S4 005				
i [K]					85	800	S5 010	74	680	S4 008				
		SSJ	80	800	S5 A11									
1.7 CDTI [G]	03.03-01.04				74	750	S5 007	72	680	S4 007				
CDTI [H]		03.04-08.13			74	750	S5 007	60	540	S4 004	70	640	S3 007	
02.07-03.10					74	750	S5 007	60	540	S4 004				
CDTI [J]		09.09→									70	640	S3 007	
					61	600	S5 004	60	540	S4 004				
		SSJ	70	760	S5 A08			70	760	S4 E08				
10.10→		SSJ						70	760	S4 E08				



		?	Ah A (EN) S5A			Ah A (EN) S5			Ah A (EN) S4			Ah A (EN) S3		
			0 092 ...0			0 092 ...0			0 092 ...0			0 092 ...0		
1.7 CDTI [J]	07.11→					61	600	S5 004	70	760	S4 E08	53	500	S3 004
		BWD	70	760	S5 A08				70	760	S4 E08			
			70	760	S5 A08									
	09.12→					74	750	S5 007	72	680	S4 007			
			70	760	S5 A08									
		SSJ	70	760	S5 A08									
			80	800	S5 A11									
TD [F]	12.91-02.98					74	750	S5 007	60	540	S4 004			
1.7/2.0/2.2 DT, DTI, DTL [G]	02.98-01.05											70	640	S3 007
1.9 CDTI [H]	04.04-03.10					74	750	S5 007	60	540	S4 004	70	640	S3 007
2.0 CDTI [J]	09.09→					74	750	S5 007	72	680	S4 007			
		SSJ	70	760	S5 A08									
			80	800	S5 A11									
	08.12→		70	760	S5 A08									
Astra Cabrio														
1.4/ 1.6 i [G]	09.97-08.05					61	600	S5 004	44	440	S4 001	41	360	S3 001
1.4/ 1.6/ 1.8/ 2.0 i [F]	09.91-08.98					61	600	S5 004	44	440	S4 001	41	360	S3 001
1.6 i Twinport [G]	03.03-08.05					61	600	S5 004	44	440	S4 001	41	360	S3 001
1.8 i [G]	09.00-08.05					74	750	S5 007	60	540	S4 004	53	500	S3 004
2.0 i Turbo [G]	03.02-08.05					74	750	S5 007	60	540	S4 004	53	500	S3 004
2.2 i [G]	09.00-08.05											70	640	S3 007
Diesel														
1.7 CDTI [G]	03.03-08.05					74	750	S5 007	60	540	S4 004			
2.2 DTI [G]	03.02-08.05											70	640	S3 007
Astra Caravan														
1.2 i Twinport [H]	03.07-03.09					61	600	S5 004	44	440	S4 001			
1.2/ 1.4/ 1.6/ 1.8/ 2.0 i, i CNG, i Twinport [F; G]	09.91-07.09					61	600	S5 004	44	440	S4 001	41	360	S3 001
1.4 i [H]	09.04-09.05					61	600	S5 004				53	500	S3 004
i Twinport [H]	08.04-03.10					63	610	S5 005	44	440	S4 001	41	360	S3 001
1.6 i [H]	03.07-03.10					61	600	S5 004				53	500	S3 004
	01.11-08.13					61	600	S5 004	44	440	S4 001			
i Twinport [H]	08.04-03.07					63	610	S5 005	44	440	S4 001	41	360	S3 001
	09.07-03.09					61	600	S5 004	44	440	S4 001			
1.6/ 2.0 i Turbo [H]	08.04-03.10					74	750	S5 007	60	540	S4 004	53	500	S3 004
1.8 i [H]	08.04-08.13					63	610	S5 005	44	440	S4 001	41	360	S3 001
1.8/ 2.0 i [G]	09.97-06.04					74	750	S5 007	60	540	S4 004	53	500	S3 004
2.0 i Turbo [G]	09.01-06.04					74	750	S5 007	60	540	S4 004	53	500	S3 004
2.2 i [G]	09.00-06.04											70	640	S3 007
Diesel														
1.3 CDTI [H]	08.05-03.10					61	600	S5 004				53	500	S3 004
1.7 CDTI [H]	08.04-08.13					74	750	S5 007	60	540	S4 004			
	02.07-03.10					61	600	S5 004				53	500	S3 004
TD [F]	12.91-02.98					74	750	S5 007	60	540	S4 004			
1.7/ 2.0 CDTI, DT, DTL [G]	02.98-07.09											70	640	S3 007
1.7/ 2.0/ 2.2 DTI [G]	09.00-06.04					74	750	S5 007	72	680	S4 007			
1.9 CDTI [H]	08.04-07.10					74	750	S5 007	60	540	S4 004			
	09.04-03.10					74	750	S5 007	72	680	S4 007			
Astra Classic														
1.4/ 1.6 i [F]	09.97-08.02					61	600	S5 004	44	440	S4 001	41	360	S3 001
Astra Classic Caravan														
1.4/ 1.6 i [F]	09.97-08.02					61	600	S5 004	44	440	S4 001	41	360	S3 001
Astra Coupé														
1.6 i Twinport [G]	03.03-02.05					61	600	S5 004	44	440	S4 001	41	360	S3 001
1.8 i [G]	09.97-02.05					74	750	S5 007	60	540	S4 004	53	500	S3 004
2.0 i Turbo [G]	09.00-02.05					74	750	S5 007	60	540	S4 004	53	500	S3 004
2.2 i [G]	09.00-02.05											70	640	S3 007
Diesel														
1.7 CDTI [G]	03.03-02.05					74	750	S5 007	60	540	S4 004			
2.2 DTI [G]	03.02-02.05					74	750	S5 007	72	680	S4 007			
Astra Estate														
1.6 i [F]	10.93-12.98					61	600	S5 004	44	440	S4 001	41	360	S3 001



			Ah A (EN)	Ah A (EN)	Ah A (EN)	Ah A (EN)
			0 092 ...0	0 092 ...0	0 092 ...0	0 092 ...0

◀ OPEL

Astra GTC														
1.4 i [J]	09.11-12.15					61	600	S5 004	60	540	S4 004	53	500	S3 004
		SSJ	70	760	S5 A08									
			80	800	S5 A11									
i Turbo [J]	09.11-12.15		70	760	S5 A08									
			70	760	S5 A08	61	600	S5 004				53	500	S3 004
	03.15-12.15					61	600	S5 004	60	540	S4 004			
			60	680	S5 A05	61	600	S5 004	60	540	S4 004			
		BWD							70	760	S4 E08			
		SSJ	70	760	S5 A08									
			80	800	S5 A11									
i Twinport [H]	03.05-03.09					61	600	S5 004	44	440	S4 001	41	360	S3 001
	09.05-09.10					61	600	S5 004				53	500	S3 004
1.6 i Turbo [H]	02.07-09.10					63	610	S5 006	60	540	S4 004	53	500	S3 004
i Turbo [J]	09.11→					61	600	S5 004				53	500	S3 004
	04.13→					61	600	S5 004	60	540	S4 004			
		SSJ	70	760	S5 A08									
			80	800	S5 A11									
	09.13→		60	680	S5 A05	77	780	S5 008	60	540	S4 005			
		SSJ							70	760	S4 E08			
i Twinport [H]	03.05-03.08					61	600	S5 004	44	440	S4 001	41	360	S3 001
1.6/ 1.8 i [H]	03.05-12.10					61	600	S5 004	44	440	S4 001	41	360	S3 001
1.8 i [J]	11.11→					61	600	S5 004				53	500	S3 004
2.0 i Turbo [H]	03.05-09.09					74	750	S5 007	60	540	S4 004	53	500	S3 004
i Turbo [J]	06.12→		70	760	S5 A08									
	03.15→	SSJ	70	760	S5 A08									
			80	800	S5 A11									
Diesel														
1.3 CDTI [H]	06.05-02.09					74	750	S5 007	60	540	S4 004			
1.6 CDTI [J]	06.14→		60	680	S5 A05									
		SSJ							70	760	S4 E08			
1.7 CDTI [H]	03.05-03.07											70	640	S3 007
	09.05-10.10					74	750	S5 007	60	540	S4 004	70	640	S3 007
CDTI [J]	11.11-12.15		70	760	S5 A08									
		SSJ	70	760	S5 A08									
			80	800	S5 A11									
1.9 CDTI [H]	03.05-07.10					74	750	S5 007	60	540	S4 004	70	640	S3 007
2.0 CDTI [J]	09.11→		70	760	S5 A08	61	600	S5 004				53	500	S3 004
	08.12→		70	760	S5 A08									
Astra Sporte Tourer														
1.4 i Turbo [J]	03.15→					61	600	S5 004	60	540	S4 004			
		SSJ	70	760	S5 A08									
			80	800	S5 A11									
Astra Sports Tourer														
1.0 [K]	02.16→	SSJ	70	760	S5 A08									
			80	800	S5 A11									
1.4 [K]	02.16→								52	470	S4 002			
									60	540	S4 005			
		SSJ	70	760	S5 A08									
i [J]	09.10→					61	600	S5 004	60	540	S4 004	53	500	S3 004
		SSJ	70	760	S5 A08									
			80	800	S5 A11									
i Turbo [J]	09.10→					61	600	S5 004	60	540	S4 004			
						61	600	S5 004	60	540	S4 004	53	500	S3 004
		SSJ	60	680	S5 A05									
			70	760	S5 A08									
			80	800	S5 A11									
1.6 [K]	02.16→	SSJ	70	760	S5 A08									
i [J]	09.10→					61	600	S5 004	60	540	S4 004	53	500	S3 004
		SSJ	70	760	S5 A08									
			80	800	S5 A11									
	03.15→					61	600	S5 004	60	540	S4 004			
i Turbo [J]	09.10→					61	600	S5 004				53	500	S3 004



						Ah A (EN) S5A		Ah A (EN) S5		Ah A (EN) S4		Ah A (EN) S3		
				0 092 ...0		0 092 ...0		0 092 ...0		0 092 ...0		0 092 ...0		
1.6 i Turbo [J]	04.13→		60	680			S5 A05	61	600	S5 004	60	540	S4 004	
		SSJ									70	760	S4 E08	
	03.15→							61	600	S5 004	60	540	S4 004	
		SSJ	70	760	S5 A08									
			80	800	S5 A11									
Diesel														
1.3 CDTi [J]	09.10→	BWD	70	760	S5 A08									
		SSJ	70	760	S5 A08									
1.6 [K]	02.16→					63	610	S5 005	60	540	S4 005			
						85	800	S5 010	74	680	S4 008			
			SSJ	80	800	S5 A11								
CDTi [J]	10.13→		60	680	S5 A05	77	780	S5 008	74	680	S4 008			
			SSJ						70	760	S4 E08			
1.7 CDTi [J]	09.10→					61	600	S5 004				53	500	
						61	600	S5 004	60	540	S4 004			
			BWD	80	800	S5 A11								
		SSJ	80	800	S5 A11									
	10.10→					74	750	S5 007	72	680	S4 007	70	640	
	07.11→					61	600	S5 004	70	760	S4 E08	53	500	
		BWD	70	760	S5 A08				70	760	S4 E08			
			70	760	S5 A08				70	760	S4 E08			
			80	800	S5 A11				70	760	S4 E08			
		SSJ							70	760	S4 E08			
2.0 CDTi [J]	09.10→					74	750	S5 007	72	680	S4 007			
			SSJ	70	760	S5 A08								
				80	800	S5 A11								
	09.11→		70	760	S5 A08									
Astra TwinTop														
1.6/ 1.8 i [H]	09.05-10.10					61	600	S5 004	44	440	S4 001	41	360	
1.6/ 2.0 i Turbo [H]	09.05-10.10					74	750	S5 007	60	540	S4 004	53	500	
Diesel														
1.9 CDTi [H]	09.05-10.10					74	750	S5 007	60	540	S4 004	70	640	
Cascada														
1.4 Turbo	03.13→	SSJ	70	760	S5 A08									
		BWD	70	760	S5 A08									
			80	800	S5 A11									
		SSJ	80	800	S5 A11									
1.6 Turbo	03.13→	SSJ	70	760	S5 A08									
			60	680	S5 A05	77	780	S5 008	74	680	S4 008			
			SSJ						70	760	S4 E08			
	09.13→		60	680	S5 A05	77	780	S5 008	74	680	S4 008			
		SSJ							70	760	S4 E08			
	03.15→	SSJ	80	800	S5 A11									
Diesel														
2.0 CDTi	03.13→		60	680	S5 A05									
			SSJ						70	760	S4 E08			
			70	760	S5 A08									
	09.15→	SSJ	80	800	S5 A11									
Corsa														
1.0 [E]	10.14→	SSJ	60	680	S5 A05					70	760	S4 E08		
		Twinport [D]					54	530	S5 002	42	390	S4 000	40	340
								54	530	S5 002	42	390	S4 000	
1.0/ 1.2 i [B]	03.93-09.00					61	600	S5 004	44	440	S4 001	41	360	
1.0/ 1.2/ 1.4/ 1.8 i 12V, i 16V, Twinport [C]	09.00-09.06					61	600	S5 004	44	440	S4 001	41	360	
1.2 [E]	10.14→					52	520	S5 001	44	440	S4 001	41	360	
		Twinport [D]					54	530	S5 002	52	470	S4 002		
							54	530	S5 002					
		SSJ	60	680	S5 A05									
			70	760	S5 A08									
1.2/ 1.4 LPG [D]	09.09-12.11					63	610	S5 005	52	470	S4 002	45	400	
1.4 i	03.00-12.06					61	600	S5 004	44	440	S4 001			
						61	600	S5 004	44	440	S4 001	41	360	
						61	600	S5 004	44	440	S4 001			
i [B]	01.00-12.05					61	600	S5 004	44	440	S4 001			



		Ah A (EN) S5A			Ah A (EN) S5			Ah A (EN) S4			Ah A (EN) S3			
		0 092 ...0			0 092 ...0			0 092 ...0			0 092 ...0			
◀ OPEL														
1.4 i [E]	10.14→							52	470	S4 002				
								60	540	S4 005				
		SSJ	60	680	S5 A05									
									70	760	S4 E08			
			60	680	S5 A05									
			60	680	S5 A05				70	760	S4 E08			
Twinport [D]	07.06-11.10							52	470	S4 002	45	400	S3 002	
	12.09-08.14				54	530	S5 002							
					54	530	S5 002	52	470	S4 002				
		SSJ	60	680	S5 A05									
			70	760	S5 A08									
Twinport Turbo [D]	07.12-08.14		70	760	S5 A08	61	600	S5 004				53	500	S3 004
1.6 GSI [B]	03.93-08.00				61	600	S5 004	44	440	S4 001	41	360	S3 001	
i [B]	06.98-08.00				61	600	S5 004	44	440	S4 001	41	360	S3 001	
i [C]	09.01-08.05				61	600	S5 004	44	440	S4 001				
i [E]	03.15→							52	470	S4 002				
								60	540	S4 005				
		SSJ	60	680	S5 A05									
i GSI [B]	03.93-08.99				61	600	S5 004	44	440	S4 001	41	360	S3 001	
i Turbo [D]	02.07-08.14				63	610	S5 005	44	440	S4 001	41	360	S3 001	
i Turbo OPC [D]	02.07-08.14				63	610	S5 005	44	440	S4 001	41	360	S3 001	
	10.11-08.14				61	600	S5 004				53	500	S3 004	
	02.15-08.15				61	600	S5 004	60	540	S4 004	53	500	S3 004	
Diesel														
1.3 [E]	10.14→	SSJ	60	680	S5 A05									
			60	680	S5 A05				70	760	S4 E08			
CDTI [C]	09.03-09.06				74	750	S5 007	60	540	S4 004	70	640	S3 007	
	09.05-09.06				74	750	S5 007	60	540	S4 004				
CDTI [D]	07.06-06.10										70	640	S3 007	
	07.06-07.10				74	750	S5 007	72	680	S4 007				
	12.09-08.14				54	530	S5 002							
		SSJ	70	760	S5 A08									
	01.11-08.14		70	760	S5 A08	74	750	S5 007	72	680	S4 007			
		SSJ							70	760	S4 E08			
1.5/1.7 D, TD, XD, XTD [B]	03.93-08.00				74	750	S5 007	60	540	S4 004				
1.7 CDTI [C]	09.03-09.06				74	750	S5 007	60	540	S4 004	70	640	S3 007	
CDTI [D]	07.06-06.10										70	640	S3 007	
	12.09-08.14				74	750	S5 007	72	680	S4 007				
DI, DTI [C]	09.00-08.03				74	750	S5 007	60	540	S4 004				
Corsa Hatchback														
1.4 i Sail, i Swing [C]	07.01-12.05				61	600	S5 004	44	440	S4 001				
Crossland X														
1.2	01.17→				63	610	S5 005							
		SSJ	70	760	S5 A08				70	760	S4 E08			
Diesel														
1.6	01.17→				63	610	S5 005							
		SSJ	70	760	S5 A08				70	760	S4 E08			
Frontera														
2.0/2.2 i [A]	02.95-08.98		70	760	S5 A08	77	780	S5 008	74	680	S4 008	70	640	S3 008
2.2 i [B]	09.98-12.00		70	760	S5 A08	77	780	S5 008	70	630	S4 026	70	640	S3 008
	09.00-09.04		70	760	S5 A08	77	780	S5 008	70	630	S4 026			
3.2 i [B]	09.98-09.04		70	760	S5 A08	77	780	S5 008	70	630	S4 026	70	640	S3 008
Diesel														
2.2 DTI [B]	09.98-10.02		70	760	S5 A08	77	780	S5 008	70	630	S4 026	70	640	S3 008
	09.02-09.04		70	760	S5 A08	77	780	S5 008	70	630	S4 026			
2.5/2.8 TDI, TDS Turbo [A]	02.95-08.98		70	760	S5 A08	77	780	S5 008	74	680	S4 008	70	640	S3 008
GT														
2.0 Turbo [B]	06.07-12.09										70	640	S3 007	
Insignia														
1.4 Turbo [A]	09.11-12.17				61	600	S5 004	60	540	S4 004	53	500	S3 004	
		SSJ	70	760	S5 A08									
	02.14-12.17		70	760	S5 A08	61	600	S5 004	60	540	S4 004			



						Ah A (EN) S5A		Ah A (EN) S5		Ah A (EN) S4		Ah A (EN) S3		
				0 092 ...0		0 092 ...0		0 092 ...0		0 092 ...0		0 092 ...0		
1.4 Turbo LPG [A]	02.14-12.17			61	600	S5 004		60	540	S4 004				
		BWD	70	760	S5 A08									
1.6 [A]	09.08-12.17			61	600	S5 004		60	540	S4 004				
	07.13-12.17			100	830	S5 013		95	800	S4 013				
		SSJ	95	850	S5 A13			80	800	S4 E11				
	03.15-12.17	SSJ	70	760	S5 A08									
1.8 [A]	09.08-12.17			61	600	S5 004		60	540	S4 004				
				74	750	S5 007		60	540	S4 004				
2.0 Turbo [A]	09.08-12.17			74	750	S5 007		72	680	S4 007				
		SSJ	70	760	S5 A08			70	650	S4 E07				
			80	800	S5 A11									
	01.11-12.17	SSJ	70	760	S5 A08			70	650	S4 E10				
	04.14-12.17			100	830	S5 013		95	800	S4 013				
		SSJ	95	850	S5 A13									
	03.15-12.17	BWD						70	650	S4 E07				
		SSJ	70	760	S5 A08									
Turbo 4x4 [A]	09.08-12.17											70	640	S3 007
	01.12-12.17			74	750	S5 007		72	680	S4 007				
		SSJ	70	760	S5 A08			70	650	S4 E07				
	03.12-12.17	BWD						70	650	S4 E07				
		SSJ	70	760	S5 A08									
03.15-12.17	BWD	70	760	S5 A08			70	650	S4 E07					
2.8 Turbo 4x4 [A]	09.08-12.17			85	800	S5 010		80	740	S4 010				
Diesel														
1.6 [A]	07.15-12.17			74	750	S5 007		72	680	S4 007				
		SSJ	70	760	S5 A08									
2.0 CDTI [A]	09.08-12.17			77	780	S5 008		74	680	S4 008		70	640	S3 008
	07.09-12.17			85	800	S5 010		80	740	S4 010				
				85	800	S5 010		80	800	S4 E11				
	09.13-12.17			100	830	S5 013		95	800	S4 013				
			80	800	S5 A11		85	800	S5 011	80	740	S4 011		
		SSJ						80	800	S4 E11				
			80	800	S5 A11			80	800	S4 E11				
			95	850	S5 A13			80	800	S4 E11				
CDTI 4x4 [A]	01.15-12.17	SSJ	80	800	S5 A11									
	07.09-12.17			85	800	S5 010		80	740	S4 010				
				85	800	S5 010		80	800	S4 E11				
	06.10-12.17			74	750	S5 007		72	680	S4 007				
		SSJ	80	800	S5 A11									
Insignia Grand Sport														
1.5 Turbo [B]	03.17→	BWD	80	800	S5 A11									
		SSJ						70	760	S4 E08				
2.0 4x4 [B]	03.17→	BWD	80	800	S5 A11									
		SSJ						70	760	S4 E08				
Diesel														
1.6 [B]	03.17→	BWD	80	800	S5 A11									
		SSJ						70	760	S4 E08				
2.0 [B]	03.17→	BWD	80	800	S5 A11									
		SSJ						70	760	S4 E08				
4x4 [B]	10.17→	BWD	80	800	S5 A11									
		SSJ						70	760	S4 E08				
Insignia Sports Tourer														
1.4 [A]	09.11-12.17			70	760	S5 A08		61	600	S5 004		53	500	S3 004
	02.14-12.17			70	760	S5 A08		61	600	S5 004		60	540	S4 004
	LPG [A]	02.14-12.17			61	600	S5 004		60	540	S4 004			
		BWD	70	760	S5 A08									
1.5 Turbo [B]	03.17→	BWD	80	800	S5 A11									
		SSJ						70	760	S4 E08				
1.6 [A]	02.09-12.17			61	600	S5 004		60	540	S4 004				
	07.13-12.17			100	830	S5 013		95	800	S4 013				
		SSJ	95	850	S5 A13			80	800	S4 E11				
	03.15-12.17	SSJ	70	760	S5 A08									
1.8 [A]	02.09-12.17			61	600	S5 004		60	540	S4 004				



				Ah	A (EN)		Ah	A (EN)		Ah	A (EN)		Ah	A (EN)	
				0 092 ...0			0 092 ...0			0 092 ...0			0 092 ...0		
◀ OPEL															
2.0 Turbo [A]	02.09-12.17			74	750	S5 007	72	680	S4 007						
		SSJ	70	760	S5 A08		70	650	S4 E07						
	01.11-12.17	SSJ	70	760	S5 A08		70	650	S4 E10						
	04.14-12.17				100	830	S5 013	95	800	S4 013					
		SSJ	95	850	S5 A13										
	03.15-12.17	BWD						70	650	S4 E07					
		SSJ	70	760	S5 A08										
Turbo 4x4 [A]	02.09-12.17						70	640	S3 007						
	01.12-12.17			74	750	S5 007	72	680	S4 007						
		SSJ	70	760	S5 A08		70	650	S4 E07						
	03.12-12.17	BWD					70	650	S4 E07						
SSJ		70	760	S5 A08											
03.15-12.17	BWD	70	760	S5 A08			70	650	S4 E07						
	SSJ														
4x4 [B]	03.17→	BWD	80	800	S5 A11										
		SSJ					70	760	S4 E08						
2.8 Turbo 4x4 [A]	02.09-12.17			85	800	S5 010	80	740	S4 010						
	10.15-12.17			74	750	S5 007	72	680	S4 007						
Diesel															
1.6 [A]	07.15-12.17			74	750	S5 007	72	680	S4 007						
		SSJ	70	760	S5 A08										
	[B]	03.17→	BWD	80	800	S5 A11									
SSJ						70	760	S4 E08							
2.0 [B]	03.17→	BWD	80	800	S5 A11										
CDTI [A]	02.09-12.17			74	750	S5 007	72	680	S4 007						
			70	760	S5 A08	77	780	S5 008	74	680	S4 008	70	640	S3 008	
		SSJ	80	800	S5 A11										
	07.09-12.17			85	800	S5 010	80	740	S4 010						
				85	800	S5 010	80	800	S4 E11						
	09.13-12.17			100	830	S5 013	95	800	S4 013						
		SSJ	80	800	S5 A11		80	800	S4 E11						
			95	850	S5 A13		80	800	S4 E11						
	CDTI 4x4 [A]	07.09-12.17		70	760	S5 A08	77	780	S5 008	74	680	S4 008	70	640	S3 008
		06.10-12.17			74	750	S5 007	72	680	S4 007					
4x4 [B]	10.17→	SSJ	80	800	S5 A11										
		BWD	80	800	S5 A11										
		SSJ					70	760	S4 E08						
Karl															
1.0	05.15→	SSJ	70	760	S5 A08										
ecoFlex	05.15→			54	530	S5 002	52	470	S4 002						
		SSJ	70	760	S5 A08										
Meriva															
1.4 ecoFLEX [B]	04.10-12.17						44	440	S4 001	41	360	S3 001			
	10.12-12.17			61	600	S5 004	60	540	S4 004	53	500	S3 004			
Ecotec [B]	04.10-12.17			61	600	S5 004	60	540	S4 004						
		SSJ	70	760	S5 A08										
			80	800	S5 A11										
iTwinport [A]	07.04-03.10			61	600	S5 004				53	500	S3 004			
Turbo [B]	10.12-12.17			61	600	S5 004	60	540	S4 004						
		SSJ	70	760	S5 A08										
			80	800	S5 A11										
1.6/ 1.8 i, i OPC Turbo, i 16V, i 16V Twinport [A]	03.03-03.10			74	750	S5 007	60	540	S4 004	53	500	S3 004			
Diesel															
1.3 CDTI [A]	09.03-03.10									70	640	S3 007			
		CDTI [B]	04.10-12.17			61	600	S5 004	60	640	S4 E05	53	500	S3 004	
				74	750	S5 007	60	540	S4 004						
		BWD	70	760	S5 A08										
		SSJ	70	760	S5 A08										
1.6 CDTI [B]	10.13-12.17			85	800	S5 010	70	650	S4 E10						
				85	800	S5 010	80	740	S4 010						
	01.14-12.17		60	680	S5 A05										
		SSJ					70	760	S4 E08						









			Ah A (EN) S5A			Ah A (EN) S5			Ah A (EN) S4			Ah A (EN) S3		
			0 092 ...0			0 092 ...0			0 092 ...0			0 092 ...0		
1.7	CDTI [A]	09.03-09.09				74	750	S5 007	72	680	S4 007			
		09.06-03.10										70	640	S3 007
	CDTI [B]	06.10-12.17										70	640	S3 007
						74	750	S5 007	72	680	S4 007			
			SSJ	70	760	S5 A08								
				80	800	S5 A11								
	DTI [A]	03.03-09.05				74	750	S5 007	72	680	S4 007			
Mokka														
1.4	Tube ecoFLEX	03.15→	BWD	70	760	S5 A08								
			SSJ						70	760	S4 E08			
	Turbo ecoFLEX	01.13→		60	680	S5 A05								
			SSJ						70	760	S4 E08			
	Turbo ecoFLEX 4x4	09.12→		70	760	S5 A08								
		03.15→	BWD	70	760	S5 A08								
			SSJ						70	760	S4 E08			
	Turbo 4x4	09.16→	SSJ	70	760	S5 A08								
1.6	ecoFLEX	09.12→		70	760	S5 A08								
		03.15→	BWD	70	760	S5 A08								
			SSJ						70	760	S4 E08			
1.8		09.12→		60	680	S5 A05	77	780	S5 008	74	680	S4 008		
			SSJ							70	760	S4 E08		
	4x4	09.12→		60	680	S5 A05	77	780	S5 008	70	760	S4 E08		
				60	680	S5 A05	77	780	S5 008	74	680	S4 008		
Diesel														
1.6		02.15→		60	680	S5 A05				74	680	S4 008		
			SSJ							70	760	S4 E08		
		09.15→	SSJ	70	760	S5 A08				70	760	S4 E08		
	4x4	02.15→		60	680	S5 A05				74	680	S4 008		
			SSJ							70	760	S4 E08		
1.7	CDTI ecoFLEX	09.12→		70	760	S5 A08	61	600	S5 004			53	500	S3 004
	CDTI ecoFLEX 4x4	09.12→		70	760	S5 A08								
Monterey														
3.5	1V6 4x4 [B]	02.98-12.99								70	630	S4 026		
Diesel														
3.0	DTI 4x4 [B]	02.98-12.99								70	630	S4 026		
Omega														
2.0	i [B]	09.93-08.99				74	750	S5 007	60	540	S4 004	53	500	S3 004
2.2/ 2.5	i [B]	04.94-09.03										70	640	S3 007
2.6	i [B]	09.00-09.03				74	750	S5 007	72	680	S4 007	53	500	S3 004
3.0/ 3.2	i [B]	04.94-09.03				74	750	S5 007	72	680	S4 007			
Diesel														
2.0	DTI Turbo [B]	09.97-08.00				85	800	S5 010	72	680	S4 007	70	640	S3 007
2.2	DTI [B]	06.00-07.03				85	800	S5 010	72	680	S4 007			
2.5	DTI Turbo [B]	06.01-09.03				85	800	S5 010	80	740	S4 010			
	TD [B]	04.94-02.01				85	800	S5 010	80	740	S4 010			
Signum														
1.8	i	05.03-02.05				74	750	S5 007	60	540	S4 004	53	500	S3 004
		09.05-09.08				74	750	S5 007	60	540	S4 004	53	500	S3 004
2.0/ 2.2/ 2.8	Direct, Turbo, V6 Turbo	05.03-09.08										70	640	S3 007
3.2	V6	05.03-09.05				74	750	S5 007	72	680	S4 007			
Diesel														
1.9	CDTI	04.04-09.08										70	640	S3 007
2.0/ 2.2	DTI	05.03-09.05				74	750	S5 007	72	680	S4 007			
3.0	CDTI	05.03-09.05				74	750	S5 007	72	680	S4 007			
		09.05-09.08										88	740	S3 012
Sintra														
2.2	i 16V	09.96-09.99										53	500	S3 004
			JEA			61	600	S5 004	60	540	S4 004	53	500	S3 004
3.0	i 24V	09.96-09.99										53	500	S3 004
			JEA			61	600	S5 004	60	540	S4 004	53	500	S3 004
Diesel														
2.2	TD	09.97-09.99	JEA			74	750	S5 007	60	540	S4 004			



			Ah A (EN) S5A			Ah A (EN) S5			Ah A (EN) S4			Ah A (EN) S3		
			0 092 ...0			0 092 ...0			0 092 ...0			0 092 ...0		
◀ OPEL														
Speedster														
2.0 Turbo	04.03-09.06		52	520	S5 001	44	440	S4 001	41	360	S3 001			
2.2 i	09.00-09.06		52	520	S5 001	44	440	S4 001						
Tigra														
1.4/ 1.6 i, i 16V [A]	09.94-08.99		61	600	S5 004	44	440	S4 001	41	360	S3 001			
Tigra TwinTop														
1.4/ 1.8 i [B]	06.04-12.09		74	750	S5 007	60	540	S4 004	53	500	S3 004			
Diesel														
1.3 CDTI [B]	06.04-03.09		74	750	S5 007	60	540	S4 004						
Vectra														
1.6 i [B]	09.95-07.03		61	600	S5 004	44	440	S4 001	41	360	S3 001			
i [C]	09.01-10.08	70	760	S5 A08	77	780	S5 008	44	440	S4 001	56	480	S3 005	
i GTS [C]	09.01-09.05	70	760	S5 A08	77	780	S5 008	60	540	S4 005				
	08.05-10.08	70	760	S5 A08	77	780	S5 008	60	540	S4 005	56	480	S3 005	
i 16V [B]	09.95-09.02		61	600	S5 004	44	440	S4 001	41	360	S3 001			
1.8 i [C]	09.01-10.08	70	760	S5 A08	77	780	S5 008	60	540	S4 005	56	480	S3 005	
i GTS [C]	09.01-08.05		63	610	S5 005	60	540	S4 005						
	09.01-10.08	70	760	S5 A08	77	780	S5 008	60	540	S4 005	56	480	S3 005	
i 16V [B]	09.95-09.00		61	600	S5 004	44	440	S4 001	41	360	S3 001			
	09.00-09.03		61	600	S5 004	44	440	S4 001						
2.0 Turbo [C]	03.03-10.08	70	760	S5 A08	77	780	S5 008	74	680	S4 008	70	640	S3 008	
Turbo GTS [C]	03.03-10.08	70	760	S5 A08	77	780	S5 008	72	680	S4 007	70	640	S3 007	
2.0/ 2.2 i [B]	09.95-09.02		74	750	S5 007	60	540	S4 004	53	500	S3 004			
i 16V [B]	09.95-09.03		74	750	S5 007	60	540	S4 004	53	500	S3 004			
2.2 Direct, Direct GTS [C]	09.03-10.08	70	760	S5 A08	77	780	S5 008	72	680	S4 007	70	640	S3 007	
2.2/ 3.2 i [C]	09.01-09.05	70	760	S5 A08	77	780	S5 008	72	680	S4 007	70	640	S3 007	
i GTS [C]	09.01-09.05	70	760	S5 A08	77	780	S5 008	72	680	S4 007	70	640	S3 007	
2.5 i V6 [B]	09.95-09.00		74	750	S5 007	60	540	S4 004	53	500	S3 004			
2.6 V6 [B]	09.00-09.02		74	750	S5 007	60	540	S4 004	53	500	S3 004			
2.8 GTS Turbo [C]	09.05-09.07	70	760	S5 A08	77	780	S5 008	72	680	S4 007	70	640	S3 007	
	09.05-10.08								70	640	S3 007			
Turbo [C]	08.05-10.08	70	760	S5 A08	77	780	S5 008	72	680	S4 007	70	640	S3 007	
Diesel														
1.7 TD [B]	09.95-09.98								70	640	S3 007			
1.9 CDTI [C]	04.04-10.08		85	800	S5 010	80	740	S4 010						
CDTI GTS [C]	04.04-10.08		85	800	S5 010	80	740	S4 010						
2.0 DI [B]	09.96-08.02								70	640	S3 007			
DTI [B]	09.97-09.03								70	640	S3 007			
2.0/ 2.2 DTI, DTI GTS [C]	04.02-09.05		85	800	S5 010	80	740	S4 010						
2.2 DTI [B]	09.00-09.03		74	750	S5 007	72	680	S4 007						
3.0 CDTI [C]	03.03-10.08		85	800	S5 010	80	740	S4 010	88	740	S3 012			
CDTI GTS [C]	03.03-10.08	80	800	S5 A11	85	800	S5 010	80	740	S4 010				
Vectra Caravan														
1.6 i [B]	09.95-09.00		61	600	S5 004	44	440	S4 001	41	360	S3 001			
i [C]	09.03-05.04	70	760	S5 A08	77	780	S5 008	60	540	S4 005				
	06.04-10.08	70	760	S5 A08	77	780	S5 008	60	540	S4 005	56	480	S3 005	
i 16V [B]	09.96-09.02		61	600	S5 004	44	440	S4 001	41	360	S3 001			
1.8 i [C]	09.03-08.05	70	760	S5 A08	77	780	S5 008	60	540	S4 005				
	09.03-10.08	70	760	S5 A08	77	780	S5 008	60	540	S4 005	56	480	S3 005	
i 16V [B]	09.95-09.00		61	600	S5 004	44	440	S4 001	41	360	S3 001			
	09.00-09.03		61	600	S5 004	44	440	S4 001						
2.0 i [B]	09.95-09.02		74	750	S5 007	60	540	S4 004	53	500	S3 004			
Turbo [C]	09.03-10.08	70	760	S5 A08	77	780	S5 008	72	680	S4 007	70	640	S3 007	
2.0/ 2.2 i 16V [B]	09.95-09.03		74	750	S5 007	60	540	S4 004	53	500	S3 004			
2.2 Direct [C]	09.03-10.08	70	760	S5 A08	77	780	S5 008	72	680	S4 007	70	640	S3 007	
i [C]	09.03-09.05	70	760	S5 A08	77	780	S5 008	74	680	S4 008				
2.5 i V6 [B]	09.96-06.00		74	750	S5 007	60	540	S4 004	53	500	S3 004			
2.6 V6 [B]	09.00-09.02		74	750	S5 007	60	540	S4 004	53	500	S3 004			
2.8 Turbo [C]	08.05-09.07	70	760	S5 A08	77	780	S5 008	72	680	S4 007	70	640	S3 007	
	08.05-10.08								70	640	S3 007			
3.2 i [C]	09.03-09.05	70	760	S5 A08	77	780	S5 008	72	680	S4 007	70	640	S3 007	
Diesel														
1.7 TD [B]	09.95-09.98								70	640	S3 007			



				Ah	A (EN)		Ah	A (EN)		Ah	A (EN)		Ah	A (EN)	
				0 092 ...0			0 092 ...0			0 092 ...0			0 092 ...0		
1.9 CDTI [C]		04.04-10.08					85	800	S5 010	80	740	S4 010			
2.0 DI [B]		09.96-08.00											70	640	S3 007
DTI [B]		09.97-09.03											70	640	S3 007
2.0/2.2 DTI [C]		09.03-09.05					85	800	S5 010	80	740	S4 010			
2.2 DTI [B]		09.00-09.03					74	750	S5 007	72	680	S4 007			
3.0 CDTI [C]		09.03-08.05		70	760	S5 A08				80	740	S4 010			
		08.05-10.08					85	800	S5 010	80	740	S4 010	88	740	S3 012
Zafira															
1.4 Turbo [C]		01.12→					61	600	S5 004	60	540	S4 004	53	500	S3 004
			SSJ	70	760	S5 A08									
				80	800	S5 A11									
		08.14→					61	600	S5 004	60	540	S4 004			
1.6 CNG [B]		09.05-03.10					61	600	S5 004	44	440	S4 001	41	360	S3 001
CNG [C]		01.12→					61	600	S5 004				53	500	S3 004
		07.14→					61	600	S5 004	60	540	S4 004	53	500	S3 004
CNG Turbo [B]		03.09-07.10					61	600	S5 004	44	440	S4 001	41	360	S3 001
		07.10-08.15					52	520	S5 001	44	440	S4 001			
i [A]		03.99-07.05					61	600	S5 004	44	440	S4 001	41	360	S3 001
i [B]		07.05-12.12					61	600	S5 004	44	440	S4 001	41	360	S3 001
		03.06-02.09					61	600	S5 004	44	440	S4 001			
		01.11-08.15					61	600	S5 004	44	440	S4 001			
i CNG [A]		09.01-07.05					61	600	S5 004	44	440	S4 001	41	360	S3 001
Turbo [C]		04.13→	SSJ	70	760	S5 A08									
		09.13→		60	680	S5 A05	63	610	S5 005	60	540	S4 005			
			SSJ							60	640	S4 E05			
		03.15→					61	600	S5 004	60	540	S4 004			
			SSJ	80	800	S5 A11									
1.8 i [B]		07.05-08.15					61	600	S5 004				53	500	S3 004
		06.13-08.15		80	800	S5 A11	85	800	S5 011	80	740	S4 011			
				80	800	S5 A11	85	800	S5 011	80	800	S4 E11			
i [C]		01.12→					61	600	S5 004				53	500	S3 004
LPG [B]		03.10-12.10					52	520	S5 001	44	440	S4 001			
1.8/ 2.0/ 2.2 i, i Direct, Turbo [A; B]		03.99-12.10					74	750	S5 007	60	540	S4 004	53	500	S3 004
2.2 i [A]		09.00-07.05											70	640	S3 007
Diesel															
1.6 CDTI [C]		05.13→	SSJ	70	760	S5 A08									
		06.14→		60	680	S5 A05									
			SSJ							70	760	S4 E08			
		03.15→	SSJ	80	800	S5 A11									
1.7 CDTI [B]		03.08-07.12					63	610	S5 005	60	540	S4 005			
		03.08-08.15					74	750	S5 007	60	540	S4 005			
1.9 CDTI [B]		07.05-12.10					74	750	S5 007	60	540	S4 004			
2.0 CDTI [C]		01.12→					74	750	S5 007	70	650	S4 E07			
							74	750	S5 007	72	680	S4 007			
			SSJ	70	760	S5 A08									
				80	800	S5 A11									
		08.12→		70	760	S5 A08									
		02.15→		80	800	S5 A11				70	650	S4 E07			
				80	800	S5 A11				70	650	S4 E10			
				80	800	S5 A11				72	680	S4 007			
				80	800	S5 A11				80	740	S4 010			
		03.15→	BWD	70	760	S5 A08									
				80	800	S5 A11									
2.0/ 2.2 DI, DTI [A]		03.99-07.05											70	640	S3 007

OSCA

2500 GT

09.97→ 63 610 **S5 005** 60 540 **S4 005**

			Ah A (EN)	Ah A (EN)	Ah A (EN)	Ah A (EN)
			0 092 ...0	0 092 ...0	0 092 ...0	0 092 ...0

PEUGEOT

iOn												
	09.10→								40	330	S4 018	
RCZ												
1.6 THP [T75]	01.10-12.15	BWD				77	780	S5 008	60	540	S4 005	
			70	760	S5 A08			70	760	S4 E08		
	01.11-12.15			77	780	S5 008	60	540	S4 005			
Diesel												
2.0 HDi [T75]	01.10-12.15	BWD	70	760	S5 A08				70	760	S4 E08	
RCZ R												
1.6 THP [T75]	09.13-12.15		70	760	S5 A08	63	610	S5 005	60	540	S4 005	56 480 S3 005
			70	760	S5 A08	63	610	S5 005	70	760	S4 E08	56 480 S3 005
106												
Electric/ 1.4 [S2]	07.95-05.05					54	530	S5 002	52	470	S4 002	45 400 S3 002
1.0 i [S2]	05.96-05.05					54	530	S5 002				
					54	530	S5 002	44	420	S4 000	40 340 S3 000	
1.1 i [S2]	05.96-05.05					54	530	S5 002	44	420	S4 000	40 340 S3 000
	03.00-05.05					54	530	S5 002				40 340 S3 000
1.4/ 1.6 i [S2]	05.96-05.05					54	530	S5 002	52	470	S4 002	45 400 S3 002
1.6 i 16S [S2]	05.96-05.05					54	530	S5 002	52	470	S4 002	45 400 S3 002
Diesel												
1.5 D [S2]	05.96-05.05					63	610	S5 005	60	540	S4 005	56 480 S3 005
107												
1.0 [B0]	06.05-12.14					54	530	S5 002	44	420	S4 000	
		BWD							52	470	S4 002	
Diesel												
1.4 HDi [B0]	06.05-12.10					54	530	S5 002				40 340 S3 000
108												
1.0 VTi [B3]	02.14-12.18								44	420	S4 000	
	02.14→	SSJ							60	640	S4 E05	
	05.15→		60	680	S5 A05				44	420	S4 000	
1.2 VTi [B3]	02.14-12.18					54	530	S5 002	52	470	S4 002	
205												
1.0/ 1.1/ 1.4/ 1.6/ 1.9 , i	10.87-09.98					54	530	S5 002	52	470	S4 002	45 400 S3 002
Diesel												
1.8 D	07.87-12.98		60	680	S5 A05	63	610	S5 005	60	540	S4 005	56 480 S3 005
	D Turbo	01.90-09.98	70	760	S5 A08	77	780	S5 008	74	680	S4 008	70 640 S3 008
1.9 D	10.87-09.98		70	760	S5 A08	77	780	S5 008	74	680	S4 008	70 640 S3 008
206												
1.1 i [T1]	06.98-10.05											40 340 S3 000
1.4/ 1.6 i [T1]	06.98-03.09					54	530	S5 002	52	470	S4 002	45 400 S3 002
	i 16V [T1]	03.00-08.07				54	530	S5 002	52	470	S4 002	45 400 S3 002
2.0 i RC, iS16 [T1]	01.99-08.06					63	610	S5 005	60	540	S4 005	56 480 S3 005
Diesel												
1.4 HDi [T1]	09.01-02.09					63	610	S5 005	60	540	S4 005	
Hdi 16V [T1]	09.08-12.10					63	610	S5 005	60	540	S4 005	
1.6/ 2.0 HDi [T1]	04.99-03.07					63	610	S5 005	60	540	S4 005	56 480 S3 005
1.9 D [T1]	06.98-10.01					63	610	S5 005	60	540	S4 005	
	02.99-03.06					63	610	S5 005	60	540	S4 005	56 480 S3 005
206+												
1.1 [T3E]	03.09-05.13					54	530	S5 002	52	470	S4 002	
1.4 [T3E]	03.09-09.10					54	530	S5 002	52	470	S4 002	45 400 S3 002
	04.10-05.13					54	530	S5 002	52	470	S4 002	
1.6 [T3E]	02.11-05.13					54	530	S5 002				
Diesel												
1.4 HDi [T3E]	03.09-05.13					63	610	S5 005	60	540	S4 005	
206 CC												
1.6 i 16V [T1]	09.00-03.07					54	530	S5 002	52	470	S4 002	45 400 S3 002
2.0 iS16 [T1]	09.00-03.07					63	610	S5 005	60	540	S4 005	56 480 S3 005
Diesel												
1.6 HDi [T1]	06.05-03.07					63	610	S5 005	60	540	S4 005	56 480 S3 005



			Ah	A (EN)		Ah	A (EN)		Ah	A (EN)		Ah	A (EN)	
			0 092 ...0			0 092 ...0			0 092 ...0			0 092 ...0		

206 Sedan														
1.6 16V [T1]	03.07-12.10					63	610	S5 005	60	540	S4 005	56	480	S3 005
206 SW														
1.1 i [T1]	03.02-10.05											40	340	S3 000
1.4 i [T1]	03.02-12.06					54	530	S5 002	52	470	S4 002	45	400	S3 002
1.4/ 1.6 i 16V [T1]	03.02-12.06					54	530	S5 002	52	470	S4 002	45	400	S3 002
2.0 i S16 [T1]	03.02-10.05					63	610	S5 005	60	540	S4 005	56	480	S3 005
Diesel														
1.4/ 1.6/ 2.0 HDi [T1]	03.02-12.06					63	610	S5 005	60	540	S4 005	56	480	S3 005
207														
1.4 VTi [A7]	07.09-04.12	BWD				63	610	S5 005	52	470	S4 002	45	400	S3 002
16V [A7]	05.06-06.08	BWD				63	610	S5 005	52	470	S4 002	45	400	S3 002
1.4/ 1.6 i, LPG [A7]	05.06-04.12	BWD				63	610	S5 005	52	470	S4 002	45	400	S3 002
1.6 , RC [A7]	03.07-02.11					61	600	S5 004	60	540	S4 004	53	500	S3 004
THP [A7]	07.06-04.10	BWD				63	610	S5 005	60	540	S4 005	56	480	S3 005
	04.10-12.11	BWD							52	470	S4 002			
VTi [A7]	07.09-12.11					61	600	S5 004	60	540	S4 004	53	500	S3 004
Diesel														
1.4 HDi [A7]	05.06-12.11	BWD				63	610	S5 005	60	540	S4 005	56	480	S3 005
1.6 HDi [A7]	05.06-04.11	BWD				63	610	S5 005	60	540	S4 005	56	480	S3 005
	04.10-12.11	BWD							52	470	S4 002			
	04.10-04.12	BWD				63	610	S5 005	60	540	S4 005			
207+														
1.4 i	11.12-06.15	BWD				63	610	S5 005	52	470	S4 002	45	400	S3 002
Diesel														
1.4 HDi	11.12-06.15	BWD				63	610	S5 005	60	540	S4 005	56	480	S3 005
207 CC														
1.6 [A7]	03.07-06.09	BWD				63	610	S5 005	60	540	S4 005	56	480	S3 005
THP [A7]	03.07-09.13	BWD				63	610	S5 005	60	540	S4 005	56	480	S3 005
	07.10-12.13	BWD				54	530	S5 002	52	470	S4 002			
VTi [A7]	07.09-07.13	BWD				63	610	S5 005	60	540	S4 005	56	480	S3 005
Diesel														
1.6 HDi [A7]	03.07-02.11	BWD	70	760	S5 A08	77	780	S5 008	74	680	S4 008	70	640	S3 008
	02.10-06.15	BWD				63	610	S5 005	60	540	S4 005			
207 SW														
1.4/ 1.6 i, LPG, VTi [A7]	06.07-12.13	BWD				63	610	S5 005	52	470	S4 002	45	400	S3 002
1.6 THP [A7]	02.07-12.14					54	530	S5 002	52	470	S4 002			
THP RC [A7]	11.07-06.09	BWD				54	530	S5 002	52	470	S4 002			
Diesel														
1.6 HDi [A7]	06.07-04.11	BWD				63	610	S5 005	60	540	S4 005	56	480	S3 005
	04.10-07.13					63	610	S5 005						
		BWD				63	610	S5 005	60	540	S4 005			
			60	680	S5 A05									
208														
1.0 VTi	01.12-12.18					54	530	S5 002	52	470	S4 002			
	09.14-12.18					54	530	S5 002						
1.2 THP	01.14→		70	760	S5 A08	77	780	S5 008	60	540	S4 005			
		SSJ							70	760	S4 E08			
VTi	01.12→					54	530	S5 002						
		SSJ	70	760	S5 A08									
1.4 VTi	01.12-02.13					54	530	S5 002	52	470	S4 002			
VTi LPG	04.13→					54	530	S5 002						
1.6 HTP	01.12-01.15					63	610	S5 005	60	540	S4 005			
THP	03.15→	SSJ	70	760	S5 A08									
THP GTi	09.12-04.15					63	610	S5 005	60	540	S4 005	56	480	S3 005
	10.14→					77	780	S5 008	60	540	S4 005			
		SSJ	70	760	S5 A08				70	760	S4 E08			
VTi	01.12-09.15					54	530	S5 002						
		SSJ	70	760	S5 A08									
Diesel														
1.4 HDi	01.12-04.15	SSJ	70	760	S5 A08				70	760	S4 E08			
1.6 BlueHDi	02.15→								60	540	S4 005			
		SSJ	70	760	S5 A08									



								Ah A (EN)		Ah A (EN)		Ah A (EN)		Ah A (EN)	
				0 092 ...0		0 092 ...0		0 092 ...0		0 092 ...0					
◀ PEUGEOT															
1.6 HDi	01.12-12.14									70	760	S4 E08			
		BWD		70	760	S5 A08									
	01.12-03.15			70	760	S5 A08									
	01.12→	SSJ		70	760	S5 A08									
				70	760	S5 A08				70	760	S4 E08			
	03.14→							77	780	S5 008		60	540	S4 005	
301															
1.2 E-VTi [M3]	12.14→			54	530	S5 002		52	470	S4 002					
1.2/1.6 VTi [M3]	09.12→			63	610	S5 005		60	540	S4 005		56	480	S3 005	
Diesel															
1.6 Blue HDi [M3]	04.15→	SSJ		70	760	S5 A08									
HDi [M3]	09.12→			63	610	S5 005		60	540	S4 005		56	480	S3 005	
306															
1.4 [N5]	05.97-10.03			54	530	S5 002		52	470	S4 002		45	400	S3 002	
1.4/1.6 i [N5]	05.97-10.03			54	530	S5 002		52	470	S4 002		45	400	S3 002	
1.4/1.8 i	06.96-03.07			54	530	S5 002		52	470	S4 002		45	400	S3 002	
1.8 i [N5]	05.97-10.03			54	530	S5 002		52	470	S4 002		45	400	S3 002	
				63	610	S5 005		52	470	S4 002		45	400	S3 002	
1.8/2.0 i 16V [N5]	05.97-10.03			63	610	S5 005		52	470	S4 002		45	400	S3 002	
Diesel															
1.8/1.9/2.0 D, D Turbo, HDi [; N5]	05.97→			63	610	S5 005		60	540	S4 005		56	480	S3 005	
306 Break															
1.4/1.6/1.8, i [N5]	05.97-03.02			54	530	S5 002		52	470	S4 002		45	400	S3 002	
1.8/2.0 i 16V [N5]	05.97-03.02			63	610	S5 005		52	470	S4 002		45	400	S3 002	
Diesel															
1.9/2.0 D, D Turbo, HDi [N5]	05.97-03.02			63	610	S5 005		60	540	S4 005		56	480	S3 005	
306 Cabriolet															
1.6/1.8 i [N5]	05.97-10.03			54	530	S5 002		52	470	S4 002		45	400	S3 002	
1.8/2.0 i 16V [N5]	05.97-10.03			63	610	S5 005		52	470	S4 002		45	400	S3 002	
307															
1.4 i [T5]	08.00-05.05			54	530	S5 002						40	340	S3 000	
i [T6]	06.05-08.07			54	530	S5 002						40	340	S3 000	
i 16V [T5]	11.03-05.05			54	530	S5 002						40	340	S3 000	
1.6 i [T5]	08.00-05.05			54	530	S5 002						40	340	S3 000	
		BWD								52	470	S4 002			
i [T6]	06.05-08.07			54	530	S5 002									
		BWD								52	470	S4 002			
i 16V [T5]	06.04-04.06			54	530	S5 002									
i 16V [T6]	08.06-01.12			54	530	S5 002									
2.0 i [T5]	08.00-05.05			63	610	S5 005		60	540	S4 005		56	480	S3 005	
i [T6]	06.05-08.07			63	610	S5 005		60	540	S4 005		56	480	S3 005	
i 16V [T5]	06.04-04.06			63	610	S5 005		60	540	S4 005					
i 16V [T6]	08.06-01.12			63	610	S5 005		60	540	S4 005					
Diesel															
1.4/1.6 HDi [T5]	10.01-05.05			63	610	S5 005		60	540	S4 005					
1.6 HDi [T6]	06.05-08.07			63	610	S5 005		60	540	S4 005					
2.0 HDi [T5]	08.00-05.05			63	610	S5 005		60	540	S4 005					
	03.02-05.05			70	760	S5 A08		77	780	S5 008		60	540	S4 005	
HDi [T6]	06.05-08.07			70	760	S5 A08		77	780	S5 008		60	540	S4 005	
307 Break/SW															
1.4 i [T5]	03.02-05.05			54	530	S5 002		44	420	S4 000		40	340	S3 000	
				54	530	S5 002		44	420	S4 000		45	400	S3 002	
				54	530	S5 002		52	470	S4 002		40	340	S3 000	
i [T6]	06.05-05.08			54	530	S5 002						40	340	S3 000	
i 16V [T5]	11.03-05.05			54	530	S5 002						40	340	S3 000	
1.6 i [T5]	03.02-05.05			54	530	S5 002						40	340	S3 000	
i 16V [T6]	06.05-05.08			54	530	S5 002						40	340	S3 000	
i 16V BioFlex [T6]	09.07-12.09			60	680	S5 A05		54	530	S5 002					
				60	680	S5 A05		63	610	S5 005					
2.0 [T5]	06.05-12.14			63	610	S5 005		60	540	S4 005					
i [T5]	03.02-05.05			63	610	S5 005		60	540	S4 005		56	480	S3 005	
i [T6]	06.05-05.08			63	610	S5 005		60	540	S4 005		56	480	S3 005	



			Ah A (EN) S5A	Ah A (EN) S5	Ah A (EN) S4	Ah A (EN) S3
			0 092 ...0	0 092 ...0	0 092 ...0	0 092 ...0

Diesel														
1.4/ 1.6 HDi [T5]	03.02-05.05				63	610	S5 005	60	540	S4 005				
1.6 HDi [T6]	06.05-05.08				63	610	S5 005	60	540	S4 005				
2.0 HDi [T5]	03.02-05.05				63	610	S5 005	60	540	S4 005				
			70	760	S5 A08	77	780	S5 008	60	540	S4 005			
HDi [T6]	06.05-05.08		70	760	S5 A08	77	780	S5 008	60	540	S4 005			
307 CC														
1.6 i [T6]	06.05-03.09				54	530	S5 002		40	340	S3 000			
2.0 i, i Sport [T5; T6]	10.03-03.09				63	610	S5 005	60	540	S4 005	56	480	S3 005	
Diesel														
2.0 HDi [T6]	06.05-03.09		70	760	S5 A08	77	780	S5 008	60	540	S4 005			
308														
1.2 THP [T9]	01.14→				77	780	S5 008	60	540	S4 005				
		SSJ	70	760	S5 A08			70	760	S4 E08				
VTi [T9]	07.13-12.18		70	760	S5 A08	63	610	S5 005	60	540	S4 005	56	480	S3 005
		SSJ						70	760	S4 E08				
	01.14-12.18				54	530	S5 002	52	470	S4 002				
		BWD						70	760	S4 E08				
		SSJ	70	760	S5 A08									
1.4 i [T7]	09.07-03.10	BWD			63	610	S5 005	60	540	S4 005	56	480	S3 005	
VTi [T7]	04.10-06.13	BWD			54	530	S5 002	52	470	S4 002				
1.6 i [T7]	09.07-06.13	BWD	70	760	S5 A08	77	780	S5 008	60	540	S4 005	56	480	S3 005
	07.08-04.12	BWD			63	610	S5 005	60	540	S4 005				
THP [T7]	09.07-04.10	BWD	70	760	S5 A08	77	780	S5 008	60	540	S4 005	56	480	S3 005
	11.07-06.13	BWD			63	610	S5 005	60	540	S4 005				
	03.08-04.10	BWD			63	610	S5 005	60	540	S4 005	56	480	S3 005	
	01.11-06.13				63	610	S5 005	60	540	S4 005				
THP [T9]	07.13→				63	610	S5 005	60	540	S4 005				
			70	760	S5 A08	77	780	S5 008	74	680	S4 008	56	480	S3 005
		SSJ						70	760	S4 E08				
			70	760	S5 A08			70	760	S4 E08				
THP GTi, THP GTi [T9]	11.14→	SSJ	70	760	S5 A08			70	760	S4 E08				
THP GTi [T7]	05.10-06.13	BWD			63	610	S5 005	60	540	S4 005				
VTi [T7]	12.09-06.13	BWD	70	760	S5 A08	77	780	S5 008	60	540	S4 005	56	480	S3 005
1.8 THP [T9]	06.14→				63	610	S5 005	60	540	S4 005				
		BWD	70	760	S5 A08									
		SSJ						70	760	S4 E08				
2.0 i [T7]	07.08-04.12	BWD			63	610	S5 005	60	540	S4 005				
Diesel														
1.6 Blue HDi [T9]	01.14→	BWD						70	760	S4 E08				
		SSJ	70	760	S5 A08									
			70	760	S5 A08			70	760	S4 E08				
HDi [T7]	09.07-03.10	BWD	70	760	S5 A08	77	780	S5 008	74	680	S4 008	70	640	S3 008
	04.10-03.13	BWD,SSJ						70	760	S4 E08				
	04.10-06.13	BWD			63	610	S5 005	60	540	S4 005				
	01.11-06.13				77	780	S5 008	74	680	S4 008				
	01.13-06.13				63	610	S5 005	60	540	S4 005				
		SSJ	70	760	S5 A08			70	760	S4 E08				
HDi [T9]	07.13-12.17				63	610	S5 005	60	540	S4 005				
	07.13-12.18				63	610	S5 005	60	540	S4 005	56	480	S3 005	
		SSJ	70	760	S5 A08			70	760	S4 E08				
2.0 Blue HDi GT [T9]	11.14→	SSJ	70	760	S5 A08			70	760	S4 E08				
HDi [T7]	09.07-06.13	BWD	70	760	S5 A08	77	780	S5 008	74	680	S4 008	70	640	S3 008
	03.10-06.13				77	780	S5 008	74	680	S4 008	70	640	S3 008	
	10.10-06.13	BWD			63	610	S5 005	60	540	S4 005				
HDi [T9]	01.14→				77	780	S5 008	60	540	S4 005	56	480	S3 005	
		SSJ	70	760	S5 A08			70	760	S4 E08				
308 CC														
1.6 THP [T7]	03.09-12.13	BWD			63	610	S5 005	60	540	S4 005				
	01.11-09.14				63	610	S5 005	60	540	S4 005				
		SSJ	70	760	S5 A08			70	760	S4 E08				
THP GTi, VTi [T7]	03.09-07.14	BWD			63	610	S5 005	60	540	S4 005				



			Ah A (EN) S5A			Ah A (EN) S5			Ah A (EN) S4			Ah A (EN) S3				
			0 092 ...0			0 092 ...0			0 092 ...0			0 092 ...0				
◀ PEUGEOT																
Diesel																
1.6 HDi [T7]	03.09-03.13	BWD				63	610	S5 005	60	540	S4 005					
		BWD,SSJ	70	760	S5 A08				70	760	S4 E08					
	01.13-09.14	SSJ	70	760	S5 A08				70	760	S4 E08					
2.0 HDi [T7]	03.09-09.14	BWD	70	760	S5 A08				70	760	S4 E08					
	10.10-04.15					77	780	S5 008	74	680	S4 008					
308 SW																
1.2 THP [T9]	01.14->					77	780	S5 008	60	540	S4 005	56	480	S3 005		
		SSJ	70	760	S5 A08				70	760	S4 E08					
1.4 i [T7]	05.08-03.10	BWD				54	530	S5 002	52	470	S4 002					
		VTi [T7]	04.10-01.14	BWD			54	530	S5 002	52	470	S4 002				
1.6 BioFlex [T7]	03.09-04.12	BWD				63	610	S5 005	60	540	S4 005					
		i [T7]	05.08-01.14	BWD	60	680	S5 A05	63	610	S5 005	60	540	S4 005			
			60	680	S5 A05	63	610	S5 005	60	640	S4 E05					
i [T9]	01.14->					63	610	S5 005	60	540	S4 005					
		SSJ	70	760	S5 A08				70	760	S4 E08					
THP [T7]	05.08-04.10	BWD				63	610	S5 005	60	540	S4 005	56	480	S3 005		
			05.08-01.14	BWD			63	610	S5 005	60	540	S4 005				
THP [T9]	01.14->					63	610	S5 005	60	540	S4 005					
					70	760	S5 A08	77	780	S5 008	60	540	S4 005	56	480	S3 005
		SSJ								70	760	S4 E08				
			70	760	S5 A08				70	760	S4 E08					
THP GT [T9]	11.14->	SSJ	70	760	S5 A08				70	760	S4 E08					
VTi [T7]	12.09-01.14	BWD	60	680	S5 A05	63	610	S5 005	60	540	S4 005					
			60	680	S5 A05	63	610	S5 005	60	640	S4 E05					
2.0 i [T7]	05.08-04.12					63	610	S5 005								
		BWD	60	680	S5 A05											
Diesel																
1.6 Blue HDi [T9]	01.14->	BWD							70	760	S4 E08					
		SSJ	70	760	S5 A08				70	760	S4 E08					
					70	760	S5 A08				70	760	S4 E08			
HDi [T7]	05.08-03.10	BWD				63	610	S5 005	60	540	S4 005					
			04.10-03.13	BWD,SSJ						70	760	S4 E08				
			06.10-01.14	BWD			63	610	S5 005	60	540	S4 005				
			01.13-01.14				63	610	S5 005	60	540	S4 005				
HDi [T9]	01.14-12.17								70	760	S4 E08					
					70	760	S5 A08	77	780	S5 008	60	540	S4 005	56	480	S3 005
					70	760	S5 A08	77	780	S5 008	70	760	S4 E08	56	480	S3 005
	01.14-12.18					77	780	S5 008	60	540	S4 005	56	480	S3 005		
		SSJ	70	760	S5 A08				70	760	S4 E08					
2.0 Blue HDi GT [T9]	11.14->	SSJ	70	760	S5 A08				70	760	S4 E08					
HDi [T7]	05.08-01.14	BWD	70	760	S5 A08				70	760	S4 E08					
			10.10-01.14	BWD			63	610	S5 005	60	540	S4 005				
HDi [T9]	01.14->					77	780	S5 008	60	540	S4 005					
		SSJ	70	760	S5 A08				70	760	S4 E08					
309																
1.4	08.95-09.99					54	530	S5 002	52	470	S4 002	45	400	S3 002		
Diesel																
1.5	02.97-09.99		70	760	S5 A08	77	780	S5 008	60	540	S4 005					
406																
1.6/ 1.8 i [D8; D9]	10.95-06.04					63	610	S5 005	52	470	S4 002	45	400	S3 002		
1.8/ 2.0/ 2.2 i Turbo, i 16V [D8; D9]	10.95-06.04					63	610	S5 005	52	470	S4 002	45	400	S3 002		
2.0 HPI [D8; D9]	10.00-06.04					63	610	S5 005	52	470	S4 002	45	400	S3 002		
3.0 i [D8; D9]	08.96-06.04		70	760	S5 A08	77	780	S5 008	60	540	S4 005	56	480	S3 005		
Diesel																
1.9/ 2.0/ 2.1/ 2.2 D Turbo, HDi [D8; D9]	12.95-06.04		70	760	S5 A08	77	780	S5 008	60	540	S4 005	56	480	S3 005		
406 Break																
1.8 i [D8; D9]	10.96-06.04					63	610	S5 005	52	470	S4 002	45	400	S3 002		
1.8/ 2.0/ 2.2 i Turbo, i 16V [D8; D9]	10.96-06.04					63	610	S5 005	52	470	S4 002	45	400	S3 002		
2.0 HPI [D8; D9]	10.00-06.04					63	610	S5 005	52	470	S4 002	45	400	S3 002		



			Ah A (EN) S5A			Ah A (EN) S5			Ah A (EN) S4			Ah A (EN) S3		
			0 092 ...0			0 092 ...0			0 092 ...0			0 092 ...0		
3.0 i [D8; D9]	10.96-06.04		70	760	S5 A08	77	780	S5 008	60	540	S4 005	56	480	S3 005
Diesel														
1.9/ 2.0/ 2.1/ 2.2 D Turbo, HDi [D8; D9]	10.96-06.04		70	760	S5 A08	77	780	S5 008	60	540	S4 005	56	480	S3 005
406 Coupé														
1.8/ 2.0 i 16V [D8]	03.97-03.99					63	610	S5 005	52	470	S4 002	45	400	S3 002
2.0 i 16V [D9]	04.99-02.05					63	610	S5 005	52	470	S4 002	45	400	S3 002
2.2 i 16V [D9]	03.02-02.05		60	680	S5 A05	54	530	S5 002	60	540	S4 005			
3.0 i [D8; D9]	03.97-02.05		70	760	S5 A08	77	780	S5 008	60	540	S4 005	56	480	S3 005
Diesel														
2.2 HDi [D9]	03.00-02.05		70	760	S5 A08	77	780	S5 008	60	540	S4 005	56	480	S3 005
			70	760	S5 A08	77	780	S5 008	74	680	S4 008	56	480	S3 005
407														
1.8 [D2]	05.04-02.11	BWD				63	610	S5 005	52	470	S4 002	45	400	S3 002
2.0/ 2.2/ 3.0 [D2]	05.04-02.11	BWD				63	610	S5 005	60	540	S4 005	56	480	S3 005
Diesel														
1.6 HDi [D2]	05.04-02.11	BWD	70	760	S5 A08	77	780	S5 008	74	680	S4 008	70	640	S3 008
2.0 HDi [D2]	05.04-02.11	BWD	70	760	S5 A08	77	780	S5 008	74	680	S4 008	70	640	S3 008
	11.09-02.11	BWD	70	760	S5 A08				70	760	S4 E08			
2.2/ 2.7 HDi [D2]	05.06-07.10	BWD	70	760	S5 A08	77	780	S5 008	74	680	S4 008	70	640	S3 008
407 Coupé														
2.2/ 3.0 [D2]	10.05-06.09	BWD				63	610	S5 005	60	540	S4 005	56	480	S3 005
Diesel														
2.0/ 2.7 HDi [D2]	10.05-06.09	BWD	70	760	S5 A08	77	780	S5 008	74	680	S4 008	70	640	S3 008
2.0/ 3.0 HDi 16V, HDi 24V [D2]	07.09-12.11	BWD	70	760	S5 A08				70	760	S4 E08			
407 SW														
1.8 [D2]	05.04-02.11	BWD				63	610	S5 005	52	470	S4 002	45	400	S3 002
2.0/ 2.2/ 3.0 [D2]	05.04-02.11	BWD				63	610	S5 005	60	540	S4 005	56	480	S3 005
Diesel														
1.6 HDi [D2]	05.04-02.11	BWD	70	760	S5 A08	77	780	S5 008	74	680	S4 008	70	640	S3 008
2.0 HDi [D2]	05.04-02.11	BWD	70	760	S5 A08	77	780	S5 008	74	680	S4 008	70	640	S3 008
	11.09-02.11								70	760	S4 E08			
		BWD	70	760	S5 A08									
			70	760	S5 A08				70	760	S4 E08			
2.2/ 2.7 HDi [D2]	09.06-07.10	BWD	70	760	S5 A08	77	780	S5 008	74	680	S4 008	70	640	S3 008
508														
1.6 THP [W2]	11.10→					63	610	S5 005						
		BWD	60	680	S5 A05									
	05.11→					63	610	S5 005	60	540	S4 005			
VTi [W2]	10.10→					63	610	S5 005						
		BWD	60	680	S5 A05									
Diesel														
1.6 BlueHDi [W2]	10.14→	SSJ	70	760	S5 A08				70	760	S4 E08			
HDi [W2]	10.10-12.15	BWD,SSJ							70	760	S4 E08			
	02.12-12.15		70	760	S5 A08									
2.0 BlueHDi [W2]	01.13→					77	780	S5 008	60	540	S4 005	56	480	S3 005
		SSJ	70	760	S5 A08				70	760	S4 E08			
HDi [W2]	10.10→	BWD							70	760	S4 E08			
			70	760	S5 A08				70	760	S4 E08			
		SSJ	70	760	S5 A08									
	01.13→					77	780	S5 008	60	540	S4 005	56	480	S3 005
		SSJ	70	760	S5 A08				70	760	S4 E08			
HDi HYbrid4 [W2]	09.11→					77	780	S5 008	74	680	S4 008			
		SSJ	70	760	S5 A08				70	760	S4 E08			
2.2 HDi [W2]	10.10→	BWD	70	760	S5 A08				70	760	S4 E08			
508 RXH SW														
Diesel														
2.0 HDi HYbrid4 [W2]	09.11→		70	760	S5 A08									
508 SW														
1.6 THP [W2]	11.10→					63	610	S5 005						
		BWD	60	680	S5 A05									
			60	680	S5 A05	63	610	S5 005						



						Ah A (EN) S5A		Ah A (EN) S5		Ah A (EN) S4		Ah A (EN) S3	
				0 092 ...0		0 092 ...0		0 092 ...0		0 092 ...0		0 092 ...0	
◀ PEUGEOT													
1.6 THP [W2]	05.11→			77	780	S5 008		60	540	S4 005			
		SSJ	70 760	S5 A08				70	760	S4 E08			
VTi [W2]	10.10→			63	610	S5 005							
		BWD	60 680	S5 A05									
Diesel													
1.6 BlueHDi [W2]	10.14→	SSJ	70 760	S5 A08				70	760	S4 E08			
HDi [W2]	10.10-12.15	BWD		63	610	S5 005		60	540	S4 005			
		SSJ						70	760	S4 E08			
	02.12-12.15		70 760	S5 A08									
2.0 Blue HDi [W2]	01.13→			77	780	S5 008		60	540	S4 005	56	480	S3 005
		SSJ	70 760	S5 A08				70	760	S4 E08			
HDi [W2]	10.10→	BWD	70 760	S5 A08				70	760	S4 E08			
	11.10→	BWD,SSJ						70	760	S4 E08			
		SSJ	70 760	S5 A08									
	01.13→			77	780	S5 008		60	540	S4 005	56	480	S3 005
		SSJ	70 760	S5 A08				70	760	S4 E08			
2.2 HDi [W2]	10.10→	BWD	70 760	S5 A08				70	760	S4 E08			
605													
2.0 [Y30]	10.89-05.99			63	610	S5 005		52	470	S4 002	45	400	S3 002
i [Y30]	10.89-05.99			63	610	S5 005		52	470	S4 002	45	400	S3 002
2.0/ 3.0 i Turbo, i 16V, i 24V [Y30]	07.93-05.99			63	610	S5 005		52	470	S4 002	45	400	S3 002
3.0 i [Y30]	07.93-05.99			63	610	S5 005		52	470	S4 002	45	400	S3 002
	03.97-05.99		70 760	S5 A08				77	780	S5 008			
Diesel													
2.1/ 2.5 D Turbo [Y30]	07.94-05.99		70 760	S5 A08				77	780	S5 008	74	680	S4 008
70	640	S3 008											
607													
2.0/ 2.2/ 3.0 i, i 16V [Z8; Z9]	03.00-01.09		70 760	S5 A08				77	780	S5 008	74	680	S4 008
70	640	S3 008											
Diesel													
2.0 HDi [Z9]	12.04-12.07		70 760	S5 A08				77	780	S5 008	74	680	S4 008
	03.06-12.09		70 760	S5 A08				77	780	S5 008	74	680	S4 008
											70	640	S3 008
2.0/ 2.2 HDi [Z8]	03.00-11.04		70 760	S5 A08				77	780	S5 008	74	680	S4 008
											70	640	S3 008
2.2/ 2.7 HDi [Z9]	12.04-12.10		70 760	S5 A08				77	780	S5 008	74	680	S4 008
											70	640	S3 008
806													
1.8/ 2.0 i, i Turbo, i 16V [U60]	06.94-08.02			63	610	S5 005		60	540	S4 005	56	480	S3 005
Diesel													
1.9/ 2.0/ 2.1 D Turbo, HDi [U60]	12.94-08.02		70 760	S5 A08				77	780	S5 008	74	680	S4 008
70	640	S3 008											
807													
2.0/ 2.2/ 3.0 i, i 16V [V2]	06.02-05.10			63	610	S5 005		60	540	S4 005	56	480	S3 005
Diesel													
2.0 HDi [V2]	06.02-05.10		70 760	S5 A08				77	780	S5 008	74	680	S4 008
	06.10-12.13			63	610	S5 005		60	540	S4 005			
2.2 HDi [V2]	06.02-07.06		70 760	S5 A08				77	780	S5 008	74	680	S4 008
	04.04-12.14			77	780	S5 008		74	680	S4 008			
	09.07-05.10		70 760	S5 A08				77	780	S5 008	74	680	S4 008
											70	640	S3 008
1007													
1.4/ 1.6 [A8]	04.05-02.11			63	610	S5 005		52	470	S4 002	45	400	S3 002
Diesel													
1.4/ 1.6 HDi [A8]	04.05-02.11			63	610	S5 005		60	540	S4 005	56	480	S3 005
2008													
1.2 THP [A94]	02.15→							60	540	S4 005			
		SSJ	70 760	S5 A08									
VTi [A94]	03.13-12.18			63	610	S5 005		60	540	S4 005			
		SSJ	70 760	S5 A08									
1.6 VTi [A94]	03.13-12.17			63	610	S5 005		60	540	S4 005			
		SSJ	70 760	S5 A08									
Diesel													
1.4 HDi [A94]	03.13→		70 760	S5 A08				63	610	S5 005	60	540	S4 005
		SSJ									70	760	S4 E08
1.6 BlueHDi [A94]	02.15→							60	540	S4 005			
		SSJ	70 760	S5 A08									
HDi [A94]	03.13→	SSJ	70 760	S5 A08									



			Ah A (EN)	Ah A (EN)	Ah A (EN)	Ah A (EN)
			0 092 ...0	0 092 ...0	0 092 ...0	0 092 ...0

3008

1.2 THP [T8]	02.15-12.16					60	540	S4 005		
		SSJ	70	760	S5 A08					
VTi [P84]	07.16→	SSJ	70	760	S5 A08	70	760	S4 E08		
1.6 i [T8]	05.09-12.16	BWD				63	610	S5 005	60	540
THP [P84]	07.16→	BWD	70	760	S5 A08					
		SSJ							70	760
			70	760	S5 A08				70	760
THP [T8]	05.09-12.16	BWD							60	540
						63	610	S5 005	60	540
	01.11-12.16					63	610	S5 005	60	540
	09.13-12.16	SSJ	70	760	S5 A08				70	760
VTi [T8]	09.09-12.16	BWD				63	610	S5 005	60	540

Diesel

1.6 Blue HDi [T8]	03.14-12.16		70	760	S5 A08					
		SSJ	70	760	S5 A08				70	760
BlueHDi [P84]	07.16→		70	760	S5 A08					
		SSJ							70	760
			70	760	S5 A08				70	760
HDi [T8]	05.09-12.16	BWD				63	610	S5 005	60	540
	11.09-12.16	SSJ							70	760
	09.12-12.16					63	610	S5 005	60	540
		SSJ	60	680	S5 A05				60	640
2.0 Blue HDi [P84]	07.16→	SSJ	70	760	S5 A08				70	760
Blue HDi [T8]	03.14-12.16					77	780	S5 008	74	680
		BWD							70	760
		SSJ	70	760	S5 A08					
HDi [T8]	05.09-12.16	BWD				77	780	S5 008	74	680
			70	760	S5 A08				70	760
		BWD,SSJ	70	760	S5 A08				70	760
	05.11-12.16					63	610	S5 005	74	680
HDi HYbrid4 [T8]	09.10-12.16	BWD	70	760	S5 A08					

4007

2.0 i [I3]	11.10-11.12								70	760
		BWD	70	760	S5 A08					
i 4x4 [I3]	11.10-11.12								70	760
		BWD	70	760	S5 A08					
2.4 i 4x4 [I3]	11.07-11.12								95	830

Diesel

2.2 HDi 4x4 [I3]	09.07-11.12								95	830
------------------	-------------	--	--	--	--	--	--	--	----	-----

4008

1.6 i [J3]	03.12-12.18								60	540
									60	540
		SSJ	60	680	S5 A05					
2.0 i [J3]	03.12-12.18		70	760	S5 A08					
i 4x4 [J3]	03.12-12.18								60	540
									60	540
		SSJ	60	680	S5 A05					

Diesel

1.6/1.8 HDi 4x4 [J3]	03.12-12.18		70	760	S5 A08					
1.8 HDi [J3]	03.12-12.18								74	680
									95	830
		SSJ	70	760	S5 A08					

5008

1.2 e-THP [T8]	02.15-12.17	SSJ	70	760	S5 A08				70	760
THP [P87]	01.17→					63	610	S5 005	60	540
		SSJ	70	760	S5 A08				70	760
1.6 ,VTi [T8]	09.09-12.17	BWD				63	610	S5 005	60	540
THP [P87]	01.17→					63	610	S5 005	60	540
		SSJ	70	760	S5 A08				70	760
THP [T8]	09.09-12.17	BWD							60	540
	09.12-12.17		70	760	S5 A08	77	780	S5 008	60	540
			70	760	S5 A08	77	780	S5 008	70	760



			Ah A (EN) S5A			Ah A (EN) S5			Ah A (EN) S4			Ah A (EN) S3		
			0 092 ...0			0 092 ...0			0 092 ...0			0 092 ...0		
PEUGEOT														
1.6 THP [T8]	09.13-12.17		63	610	S5 005	60	540	S4 005						
		SSJ	70	760	S5 A08	70	760	S4 E08						
Diesel														
1.6 Blue HDi [P87]	01.17→		63	610	S5 005	60	540	S4 005						
		SSJ	70	760	S5 A08	70	760	S4 E08						
HDi [T8]	09.09-12.13	BWD	63	610	S5 005	60	540	S4 005						
	11.09-12.13	SSJ				70	760	S4 E08						
	09.12-12.17	SSJ	70	760	S5 A08									
	03.14-12.17		77	780	S5 008	60	540	S4 005						
		SSJ	70	760	S5 A08	70	760	S4 E08						
2.0 Blue HDi [P87]	01.17→		63	610	S5 005	60	540	S4 005						
		SSJ	70	760	S5 A08	70	760	S4 E08						
Blue HDi [T8]	03.14-12.17		63	610	S5 005	60	540	S4 005						
		SSJ	70	760	S5 A08	70	760	S4 E08						
	11.14-12.17		70	760	S5 A08	77	780	S5 008	70	760	S4 E08			
			70	760	S5 A08	77	780	S5 008	74	680	S4 008			
	04.15-12.17		77	780	S5 008	74	680	S4 008						
		BWD				70	760	S4 E08						
		SSJ	70	760	S5 A08									
HDi [T8]	09.09-12.17	BWD	77	780	S5 008	74	680	S4 008						
			70	760	S5 A08	70	760	S4 E08						
		BWD,SSJ	70	760	S5 A08	70	760	S4 E08						

PLYMOUTH

Voyager

2.0 [NS]	01.95-09.01		77	780	S5 008	74	680	S4 008	70	640	S3 008		
----------	-------------	--	----	-----	---------------	----	-----	---------------	----	-----	---------------	--	--

PONTIAC

Bonneville

3.8	09.94-05.05					70	630	S4 027					
-----	-------------	--	--	--	--	----	-----	---------------	--	--	--	--	--

Firebird Coupe

5.7	10.97-12.02		63	610	S5 006								
-----	-------------	--	----	-----	---------------	--	--	--	--	--	--	--	--

Firebird Coupé

3.8/ 5.7	09.94-08.02					70	630	S4 027					
----------	-------------	--	--	--	--	----	-----	---------------	--	--	--	--	--

Grand Am

2.4/ 3.1/ 3.4 , V6, 16V	09.93-08.05					70	630	S4 027					
-------------------------	-------------	--	--	--	--	----	-----	---------------	--	--	--	--	--

Grand Am Coupé

2.4/ 3.4 , 16V	09.95-08.05					70	630	S4 027					
----------------	-------------	--	--	--	--	----	-----	---------------	--	--	--	--	--

Grand Prix

3.1/ 3.8 , Turbo	09.96-08.03					70	630	S4 027					
------------------	-------------	--	--	--	--	----	-----	---------------	--	--	--	--	--

Trans Sport

3.4	09.95-08.99		63	610	S5 006	60	540	S4 006	56	480	S3 006		
-----	-------------	--	----	-----	---------------	----	-----	---------------	----	-----	---------------	--	--

PORSCHE

Boxster

2.0 [718]	03.16→	SSJ	80	800	S5 A11								
			95	850	S5 A13								
2.5 [986]	10.96-08.99					85	800	S5 010	80	740	S4 010		
						85	800	S5 010	80	740	S4 011		
						85	800	S5 011	80	740	S4 010		
			70	760	S5 A08	77	780	S5 008	74	680	S4 008		
2.7 [981]	04.12-08.16		80	800	S5 A11								
[986; 987]	09.99-12.08		80	800	S5 A11	85	800	S5 010					
2.9 [987]	02.09-09.12		80	800	S5 A11	85	800	S5 010					
Boxster GTS													
3.4 [981]	02.14-08.16		80	800	S5 A11								
		SSJ				80	800	S4 E11					

			Ah	A (EN)		Ah	A (EN)		Ah	A (EN)		Ah	A (EN)	
			0 092 ...0			0 092 ...0			0 092 ...0			0 092 ...0		

Boxster S														
2.5 [718]	03.16→	SSJ	80	800	S5 A11									
			95	850	S5 A13									
3.2/ 3.4 [986; 987]	09.99-09.12		80	800	S5 A11	85	800	S5 010						
3.4 [981]	04.12-08.16		80	800	S5 A11									
Boxster Spyder														
3.4 [987]	09.10-09.12		80	800	S5 A11	85	800	S5 010						
3.8 [981]	07.15-08.16	SSJ	70	760	S5 A08									
			80	800	S5 A11									
Carrera GT														
5.7 [980]	10.04-04.06		70	760	S5 A08	77	780	S5 008						
Carrera GT Convertible														
5.7 [980]	09.03-08.05					85	800	S5 011	80	740	S4 010			
Cayenne														
3.2/ 3.6 [9PA]	09.02-09.10		95	850	S5 A13	110	920	S5 015						
3.6 [92A]	07.10-08.14					77	780	S5 008						
		SSJ	95	850	S5 A13									
	09.14-05.18		95	850	S5 A13									
Diesel														
3.0 Diesel [9PA]	09.08-09.10		95	850	S5 A13	110	920	S5 015						
Diesel [92A]	09.10-08.11					77	780	S5 008						
	09.10-08.17	SSJ	95	850	S5 A13									
	06.11-08.14		95	850	S5 A13	110	920	S5 015						
	09.14-08.17		95	850	S5 A13									
		SSJ	105	950	S5 A15									
Cayenne GTS														
3.6 [92A]	09.14-05.18		80	800	S5 A11									
4.8 [9PA]	08.07-09.10		95	850	S5 A13	110	920	S5 015						
[92A]	04.12-08.14		95	850	S5 A13									
Cayenne S														
3.0 Hybrid [92A]	09.10-05.18	SSJ	105	950	S5 A15									
	09.11-05.18	SSJ	95	850	S5 A13									
3.6 [92A]	09.14-05.18	SSJ	95	850	S5 A13									
4.5/ 4.8 [9PA]	09.02-09.10		95	850	S5 A13	110	920	S5 015						
4.8 [92A]	09.10-08.14	SSJ	105	950	S5 A15									
Diesel														
4.2 [92A]	09.12-05.18		105	950	S5 A15									
Cayenne S4														
Diesel														
3.0 Diesel [92A]	09.11→	SSJ	95	850	S5 A13									
			105	950	S5 A15									
Cayenne Turbo														
4.5/ 4.8 [9PA]	09.02-08.10		95	850	S5 A13	110	920	S5 015						
4.8 [92A]	09.10-05.18	SSJ	95	850	S5 A13									
	09.14-05.18	SSJ	105	950	S5 A15									
Cayenne Turbo S														
4.5/ 4.8 [9PA]	09.05-09.10		95	850	S5 A13	110	920	S5 015						
4.8 [92A]	02.13-08.14		95	850	S5 A13									
	09.14-05.18		80	800	S5 A11									
		SSJ	95	850	S5 A13									
			105	950	S5 A15									
Cayman														
2.7 [981C]	03.13-08.16	SSJ	80	800	S5 A11									
2.7/ 2.9 [987C]	09.06-12.12		70	760	S5 A08	85	800	S5 011	80	740	S4 010			
Cayman GTS														
3.4 [981C]	02.14-08.16		80	800	S5 A11									
		SSJ							80	800	S4 E11			
Cayman GT4														
3.8 [981C]	01.15-08.16	SSJ	70	760	S5 A08									
			80	800	S5 A11									
Cayman R														
3.4 [987C]	02.10-12.12		80	800	S5 A11	85	800	S5 010						



				Ah	A (EN)		Ah	A (EN)		Ah	A (EN)		Ah	A (EN)	
				0 092 ...0			0 092 ...0			0 092 ...0			0 092 ...0		
◀ PORSCHE															
Cayman S															
3.4	[981C]	03.13-08.16	SSJ	80	800	S5 A11									
	[987C]	11.05-12.12		70	760	S5 A08	85	800	S5 011	80	740	S4 010			
Macan															
2.0	[95B]	09.14-08.18	SSJ	70	760	S5 A08				70	760	S4 E08			
		09.15-08.18	SSJ	95	850	S5 A13									
		10.15-08.18	SSJ	70	760	S5 A08									
Macan GTS															
3.0	[95B]	10.15-08.18	SSJ	95	850	S5 A13									
Macan S															
3.0	[95B]	03.14-08.18	SSJ	95	850	S5 A13									
				105	950	S5 A15									
Diesel															
3.0	Diesel [95B]	03.14-08.18	SSJ	95	850	S5 A13									
				105	950	S5 A15									
Macan Turbo															
3.6	[95B]	03.14-08.18	SSJ	95	850	S5 A13									
				105	950	S5 A15									
	Performance [95B]	09.16-08.18	SSJ	95	850	S5 A13									
Panamera															
3.0	[971]	09.16→	SSJ	95	850	S5 A13									
3.6	[970]	05.10-08.16	SSJ	95	850	S5 A13									
		07.13-08.16	SSJ	105	950	S5 A15									
Diesel															
3.0	Diesel [970]	08.11-08.16		95	850	S5 A13									
		07.13-10.16	SSJ	95	850	S5 A13									
				105	950	S5 A15									
Panamera GTS															
4.8	[970]	02.12-08.16	SSJ	95	850	S5 A13									
		07.13-08.16	SSJ	105	950	S5 A15									
Panamera Hybrid S															
3.0	[970]	06.11-10.16		95	850	S5 A13									
Panamera S															
3.0	[970]	07.13-08.16	SSJ	95	850	S5 A13									
				105	950	S5 A15									
4.8	[970]	03.09-09.13	SSJ	95	850	S5 A13									
Panamera Turbo															
4.0	[971]	09.16→	SSJ	95	850	S5 A13									
4.8	[970]	03.09-08.16	SSJ	105	950	S5 A15									
		07.13-08.16	SSJ	95	850	S5 A13									
Panamera Turbo S															
4.8	[970]	03.11-09.13		95	850	S5 A13									
		09.13-10.16	SSJ	95	850	S5 A13									
				105	950	S5 A15									
Panamera 4															
3.0	[971]	09.16→	SSJ	95	850	S5 A13									
3.6	[970]	05.10-08.16	SSJ	105	950	S5 A15									
		07.13-08.16	SSJ	95	850	S5 A13									
Panamera 4E Hybrid															
2.9	[971]	09.16→	SSJ	95	850	S5 A13									
Panamera 4S															
2.9	[971]	09.16→	SSJ	95	850	S5 A13									
3.0	[970]	07.13-10.16	SSJ	95	850	S5 A13									
				105	950	S5 A15									
4.8	[970]	03.09-09.13	SSJ	105	950	S5 A15									
Diesel															
4.0	Diesel [971]	11.16-09.18	SSJ	95	850	S5 A13									
718 Cayman															
2.0	[718C]	09.16→		80	800	S5 A11									
				95	850	S5 A13									
718 Cayman S															
2.5	[718C]	09.16→		80	800	S5 A11									
				95	850	S5 A13									



			Ah	A (EN)		Ah	A (EN)		Ah	A (EN)		Ah	A (EN)	
			0 092 ...0			0 092 ...0			0 092 ...0			0 092 ...0		

911 Carrera

3.0 [991]	11.15→	SSJ	95	850	S5 A13									
3.4 [991]	12.11-08.16		95	850	S5 A13									
3.4/3.6 [996]	09.97-08.05		70	760	S5 A08	77	780	S5 008	74	680	S4 008	70	640	S3 008
3.6 [997]	06.08-09.12		70	760	S5 A08	85	800	S5 011	74	680	S4 008	70	640	S3 008

911 Carrera Cabriolet

3.0 [991]	11.15→	SSJ	95	850	S5 A13									
GTS, GTS 4 [991]	01.17→	SSJ	95	850	S5 A13									
3.4 [991]	03.12-08.16		95	850	S5 A13									
[996]	02.98-08.99		70	760	S5 A08	77	780	S5 008	74	680	S4 008	70	640	S3 008
3.6 [996]	09.01-08.05		70	760	S5 A08	77	780	S5 008	74	680	S4 008			
	06.02-07.04		70	760	S5 A08	77	780	S5 008	74	680	S4 008	70	640	S3 008
[997]	04.05-05.08		70	760	S5 A08	77	780	S5 008	74	680	S4 008	70	640	S3 008
	06.08-09.12		70	760	S5 A08	85	800	S5 011	74	680	S4 008	70	640	S3 008

911 Carrera GTS

3.0 [991]	01.17→	SSJ	95	850	S5 A13									
3.8 [991]	09.14-08.16	SSJ	95	850	S5 A13									
[997]	10.10-09.12		70	760	S5 A08	77	780	S5 008	74	680	S4 008			

911 Carrera GTS Cabriolet

3.8 [991]	09.14-08.16	SSJ	95	850	S5 A13									
[997]	10.10-09.12		70	760	S5 A08	77	780	S5 008	74	680	S4 008			

911 Carrera S

3.0 [991]	11.15→	SSJ	95	850	S5 A13									
3.8 [991]	11.11-08.16		95	850	S5 A13									
[997]	07.04-05.08		70	760	S5 A08	77	780	S5 008	74	680	S4 008	70	640	S3 008
	06.08-09.12		70	760	S5 A08	85	800	S5 011	74	680	S4 008	70	640	S3 008

911 Carrera S Cabriolet

3.0 [991]	11.15→	SSJ	95	850	S5 A13									
3.8 [991]	03.12-08.16		95	850	S5 A13									
[997]	04.05-05.08		70	760	S5 A08	77	780	S5 008	74	680	S4 008			
	06.08-09.12		70	760	S5 A08	85	800	S5 011	74	680	S4 008	70	640	S3 008

911 Carrera Targa

3.6 [996]	12.01-08.05		70	760	S5 A08	77	780	S5 008	74	680	S4 008	70	640	S3 008
			70	760	S5 A08	85	800	S5 011	74	680	S4 008	70	640	S3 008

911 Carrera 4

3.0 [991]	11.15→	SSJ	95	850	S5 A13									
3.4 [996]	09.98-08.99		70	760	S5 A08	77	780	S5 008	74	680	S4 008	70	640	S3 008
3.6 [996]	09.01-08.05		70	760	S5 A08	77	780	S5 008	74	680	S4 008	70	640	S3 008
[997]	08.04-05.08		70	760	S5 A08	77	780	S5 008	74	680	S4 008	70	640	S3 008
	06.08-09.12		70	760	S5 A08	85	800	S5 011	74	680	S4 008	70	640	S3 008

911 Carrera 4 Cabriolet

3.0 [991]	11.15→	SSJ	95	850	S5 A13									
3.4 [991]	11.12-08.16		95	850	S5 A13									
3.4/3.6 [996]	08.98-08.05		70	760	S5 A08	77	780	S5 008	74	680	S4 008	70	640	S3 008
3.6 [997]	08.04-05.08		70	760	S5 A08	77	780	S5 008	74	680	S4 008	70	640	S3 008
	06.08-09.12		70	760	S5 A08	85	800	S5 011	74	680	S4 008	70	640	S3 008

911 Carrera 4 GTS

3.0 [991]	01.17→	SSJ	95	850	S5 A13									
3.8 [991]	09.14-08.16	SSJ	95	850	S5 A13									
[997]	10.10-09.12		70	760	S5 A08	77	780	S5 008	74	680	S4 008			

911 Carrera 4 GTS Cabriolet

3.8 [991]	09.14-08.16	SSJ	95	850	S5 A13									
[997]	10.10-09.12		70	760	S5 A08	77	780	S5 008	74	680	S4 008			

911 Carrera 4S

3.0 [991]	11.15→	SSJ	95	850	S5 A13									
3.4/3.8 [991]	11.12-08.16		95	850	S5 A13									
3.6 [993]	09.95-08.98		70	760	S5 A08	77	780	S5 008	74	680	S4 008	70	640	S3 008
[996]	09.01-08.05		70	760	S5 A08	77	780	S5 008	74	680	S4 008			
	06.02-07.04		70	760	S5 A08	77	780	S5 008	74	680	S4 008	70	640	S3 008
3.8 [997]	10.05-05.08		70	760	S5 A08	77	780	S5 008	74	680	S4 008	70	640	S3 008
	06.08-09.12		70	760	S5 A08	85	800	S5 011	74	680	S4 008	70	640	S3 008

911 Carrera 4S Cabriolet

3.0 [991]	11.15→	SSJ	95	850	S5 A13									
-----------	--------	-----	----	-----	---------------	--	--	--	--	--	--	--	--	--



											Ah A (EN)			Ah A (EN)			Ah A (EN)			Ah A (EN)		
		0 092 ...0			0 092 ...0			0 092 ...0			0 092 ...0											
◀ PORSCHE																						
3.6 [996]	10.03-08.05	70	760	S5 A08	77	780	S5 008	74	680	S4 008	70	640	S3 008									
3.8 [991]	11.12-08.16	95	850	S5 A13																		
[997]	10.05-05.08	70	760	S5 A08	77	780	S5 008	74	680	S4 008	70	640	S3 008									
	06.08-09.12	70	760	S5 A08	85	800	S5 011	74	680	S4 008	70	640	S3 008									
911 GT2																						
3.6 Turbo [996]	06.01-09.05	70	760	S5 A08	85	800	S5 011	74	680	S4 008	70	640	S3 008									
Turbo [997]	09.07-08.09	70	760	S5 A08	85	800	S5 011	74	680	S4 008	70	640	S3 008									
911 GT2 RS																						
3.6 Turbo [997]	09.10-08.11	95	850	S5 A13	100	830	S5 013	95	800	S4 013												
911 GT3																						
3.6 [997]	03.06-12.08	70	760	S5 A08	85	800	S5 011	74	680	S4 008	70	640	S3 008									
Turbo [996]	03.99-08.01	70	760	S5 A08	85	800	S5 010	74	680	S4 008	70	640	S3 008									
		70	760	S5 A08	85	800	S5 011	74	680	S4 008	70	640	S3 008									
	10.03-09.05	70	760	S5 A08	85	800	S5 010	74	680	S4 008												
3.8 [991]	09.13-08.16	SSJ	95	850	S5 A13																	
[997]	08.09-08.11		70	760	S5 A08	85	800	S5 011	74	680	S4 008	70	640	S3 008								
4.0 [991]	01.17→		95	850	S5 A13				95	800	S4 013											
911 GT3 RS																						
3.6 [997]	09.06-08.08	70	760	S5 A08	85	800	S5 011	74	680	S4 008	70	640	S3 008									
3.8 [997]	08.10-08.11	70	760	S5 A08	85	800	S5 010	74	680	S4 008												
4.0 [991]	03.15→								95	800	S4 013											
		SSJ	95	850	S5 A13																	
[997]	07.11-08.12		95	850	S5 A13																	
911 R																						
4.0 [991]	09.16→		95	850	S5 A13				95	800	S4 013											
911 Speedster																						
3.6 [997]	07.04-05.08	70	760	S5 A08	77	780	S5 008	74	680	S4 008	70	640	S3 008									
3.8 [997]	10.10-09.11	70	760	S5 A08	85	800	S5 010	74	680	S4 008	70	640	S3 008									
911 Targa 4																						
3.0/3.4 [991]	03.14→	SSJ	95	850	S5 A13																	
3.6 [997]	07.06-09.12		70	760	S5 A08	85	800	S5 011	74	680	S4 008	70	640	S3 008								
911 Targa 4 GTS																						
3.0 [991]	01.17→	SSJ	95	850	S5 A13																	
3.8 [991]	09.14-08.16	SSJ	95	850	S5 A13																	
911 Targa 4S																						
3.0/3.8 [991]	03.14→	SSJ	95	850	S5 A13																	
3.8 [997]	07.06-09.12		70	760	S5 A08	85	800	S5 011	74	680	S4 008	70	640	S3 008								
911 Turbo																						
3.6 [996]	06.00-09.05	70	760	S5 A08	85	800	S5 011	74	680	S4 008	70	640	S3 008									
[997]	03.06-08.09	70	760	S5 A08	85	800	S5 010	74	680	S4 008												
		70	760	S5 A08	85	800	S5 011	74	680	S4 008												
3.8 [991]	09.13-08.16				100	830	S5 013	95	800	S4 013												
	09.13→		95	850	S5 A13	100	830	S5 013	95	800	S4 013											
		SSJ	95	850	S5 A13																	
[997]	10.09-08.13		70	760	S5 A08	77	780	S5 008	74	680	S4 008											
911 Turbo Cabriolet																						
3.6 [996]	10.03-09.05	70	760	S5 A08	85	800	S5 011	74	680	S4 008	70	640	S3 008									
[997]	08.07-08.09	70	760	S5 A08	85	800	S5 010	74	680	S4 008	70	640	S3 008									
3.8 [991]	09.13-08.16	95	850	S5 A13	100	830	S5 013	95	800	S4 013												
[997]	10.09-08.13	70	760	S5 A08	77	780	S5 008	74	680	S4 008												
911 Turbo S																						
3.6 [996]	02.03-09.05	70	760	S5 A08	85	800	S5 011	74	680	S4 008	70	640	S3 008									
3.8 [991]	03.14-08.16				100	830	S5 013	95	800	S4 013												
	03.14→	SSJ	95	850	S5 A13																	
[997]	05.10-08.13		70	760	S5 A08	77	780	S5 008	74	680	S4 008											
911 Turbo S Cabriolet																						
3.6 [996]	10.03-09.05	70	760	S5 A08	85	800	S5 011	74	680	S4 008	70	640	S3 008									
3.8 [991]	03.14-08.16	95	850	S5 A13	100	830	S5 013	95	800	S4 013												
	12.15→	SSJ	95	850	S5 A13																	
[997]	05.10-08.13		70	760	S5 A08	77	780	S5 008	74	680	S4 008											
911 Turbo 4 Cabriolet																						
3.8 [991]	12.15→	SSJ	95	850	S5 A13																	



			Ah A (EN)	Ah A (EN)	Ah A (EN)	Ah A (EN)
			0 092 ...0	0 092 ...0	0 092 ...0	0 092 ...0

PROTON

GEN2							
1.3/ 1.6 i	02.04→				60	540	S4 025
Persona							
1.3/ 1.5/ 1.6/ 1.8 i, i 16V	12.95→				60	540	S4 025
[C90 CC0; C90 CC1]							
Diesel							
2.0 D, D Turbo [C90 CC1]	12.95→				60	540	S4 025
Persona Hatchback							
1.3/ 1.5/ 1.6/ 1.8 i, i 16V	12.95→				60	540	S4 025
[C90 CC1]							
Diesel							
2.0 D, D Turbo [C90 CC1]	12.95→				60	540	S4 025
Savvy							
1.2 i [BT2]	06.05→				45	330	S4 020
Waja							
1.6 i, i CAMPRO [CF1]	09.00→				60	540	S4 025
Wira Aeroback							
1.5	05.93-06.01				60	540	S4 025

RELIANT

Scimitar							
2.9 GTE	10.88-10.98				45	300	S3 017
Scimitar Cabrio							
1.4/ 1.8/ 2.0 i Turbo, i 16V	10.93-10.00				45	300	S3 017
Scimitar SS Cabrio							
1.4 i 16V	10.93-10.99				45	300	S3 017

RENAULT

Avantime														
2.0 16V Turbo [XEO]	09.01-12.03	70	760	S5 A08	77	780	S5 008	74	680	S4 008				
3.0 V6 24V [XEO]	09.01-12.03	70	760	S5 A08	77	780	S5 008	72	680	S4 007				
Diesel														
2.2 DCI [XEO]	12.01-12.03				74	750	S5 007	72	680	S4 007				
Captur														
0.9 [J5]	01.13→		70	760	S5 A08	77	780	S5 008	74	680	S4 008	70	640	S3 008
		SSJ	70	760	S5 A08				70	760	S4 E08			
		01.16→	BWD	70	760	S5 A08								
		SSJ						70	760	S4 E08				
1.2 [J5]	01.13→		70	760	S5 A08	77	780	S5 008	74	680	S4 008	70	640	S3 008
	01.16→	SSJ	70	760	S5 A08				70	760	S4 E08			
Diesel														
1.5 dCi [J5]	01.13→		70	760	S5 A08	77	780	S5 008	74	680	S4 008	70	640	S3 008
	03.13→	BWD	70	760	S5 A08									
	06.13→		70	760	S5 A08									
Clio I														
1.2 i [X57]	01.94-02.98				54	530	S5 002	52	470	S4 002	45	400	S3 002	
1.2/ 1.4 [X57]	06.90-02.98				54	530	S5 002	52	470	S4 002	45	400	S3 002	
1.4 i [X57]	04.90-02.98				63	610	S5 005	52	470	S4 002	45	400	S3 002	
1.8 i [X57]	06.90-02.98				63	610	S5 005	52	470	S4 002	45	400	S3 002	
					63	610	S5 005	52	470	S4 002	53	500	S3 004	
Diesel														
1.9 D [; X57]	06.90→	70	760	S5 A08	77	780	S5 008	74	680	S4 008	70	640	S3 007	
Clio II														
1.0 i [BB/CB/SB]	03.99-11.04				52	520	S5 001	44	440	S4 001	41	360	S3 001	
	i 16V [BB/CB/SB]	06.01-11.04			54	530	S5 002	52	470	S4 002				
1.2 i [BB/CB/SB]	03.98-10.07				54	530	S5 002	52	470	S4 002	45	400	S3 002	



											Ah A (EN)			Ah A (EN)			Ah A (EN)			Ah A (EN)		
					0 092 ...0			0 092 ...0			0 092 ...0			0 092 ...0								
◀ RENAULT																						
1.2	i [BB/CB/SB]	10.99-12.15				52	520	S5 001	44	440	S4 001	41	360	S3 001								
	i 16V [BB/CB/SB]	03.00-03.04				54	530	S5 002	52	470	S4 002											
		10.03-12.15				52	520	S5 001	44	440	S4 001	41	360	S3 001								
1.4	i [BB/CB/SB]	03.98-10.07				63	610	S5 005	52	470	S4 002	45	400	S3 002								
	i 16V [BB/CB/SB]	10.99-10.07				63	610	S5 005	52	470	S4 002	45	400	S3 002								
		05.00-10.07				63	610	S5 005	44	440	S4 001	41	360	S3 001								
1.6	i [BB/CB/SB]	03.98-10.07				63	610	S5 005	52	470	S4 002	45	400	S3 002								
		11.04-10.07				52	520	S5 001	44	440	S4 001											
						54	530	S5 002	44	440	S4 001											
	i 16V [BB/CB/SB]	06.98-10.07				63	610	S5 005	52	470	S4 002	45	400	S3 002								
2.0	i 16V [BB/CB/SB]	03.99-10.07				54	530	S5 002	52	470	S4 002	45	400	S3 002								
3.0	24V Sport [BB/CB/SB]	09.00-06.05				74	750	S5 007	72	680	S4 007											
Diesel																						
1.5	dCi [BB/CB/SB]	06.01-10.07	70	760	S5 A08	77	780	S5 008	74	680	S4 008											
		06.01-12.15				54	530	S5 002	52	470	S4 002											
1.9	D [BB/CB/SB]	03.98-10.07				63	610	S5 005	60	540	S4 005	56	480	S3 005								
	DTI [BB/CB/SB]	03.99-10.07	70	760	S5 A08	77	780	S5 008	60	540	S4 005	70	640	S3 008								
		08.00-10.07	70	760	S5 A08	77	780	S5 008	60	540	S4 005											
Clio III																						
1.2	[BR/CR]	06.05-12.15				61	600	S5 004	44	440	S4 001	41	360	S3 001								
		08.07-12.15				54	530	S5 002	52	470	S4 002											
	TCe [BR/CR]	08.07-12.15				61	600	S5 004	44	440	S4 001	41	360	S3 001								
1.4	[BR/CR]	06.05-12.15				61	600	S5 004	44	440	S4 001	41	360	S3 001								
1.6/2.0	[BR/CR]	06.05-12.15				61	600	S5 004	60	540	S4 004	53	500	S3 004								
2.0	R.S., Sport [BR/CR]	12.05-12.15				61	600	S5 004	60	540	S4 004	53	500	S3 004								
Diesel																						
1.5	dCi [BR/CR]	06.05-12.15				74	750	S5 007	60	540	S4 004											
						74	750	S5 007	60	540	S4 004	70	640	S3 007								
		11.05-12.15				74	750	S5 007	72	680	S4 007											
		11.07-12.11				61	600	S5 004	72	680	S4 007											
Clio III Grandtour																						
1.2	[KR]	08.07-12.15				52	520	S5 001	44	440	S4 001	41	360	S3 001								
	TCe [KR]	08.07-12.15				61	600	S5 004	60	540	S4 004	53	500	S3 004								
1.4	[KR]	08.07-12.15				63	610	S5 005	60	540	S4 005											
1.6	[KR]	08.07-01.10				63	610	S5 005	60	540	S4 005											
		08.07-12.15				74	750	S5 007	60	540	S4 005	56	480	S3 005								
Diesel																						
1.5	dCi [KR]	08.07-12.15				85	800	S5 011	60	540	S4 005	56	480	S3 005								
		11.10-12.15				74	750	S5 007	72	680	S4 007											
Clio IV																						
0.9	[BH]	05.12-12.17	70	760	S5 A08	77	780	S5 008	74	680	S4 008	70	640	S3 008								
		08.15→	SSJ	70	760	S5 A08			70	760	S4 E08											
1.2	[BH]	05.12→				54	530	S5 002	52	470	S4 002											
			SSJ	70	760	S5 A08																
	TCe [BH]	01.13→				70	760	S5 A08	77	780	S5 008	74	680	S4 008								
		01.16→	SSJ	70	760	S5 A08			70	760	S4 E08											
1.6	R.S. 200 [BH]	12.12→	SSJ	70	760	S5 A08																
		12.15→	BWD						70	760	S4 E08											
	R.S. 220 [BH]	05.15→	SSJ	60	680	S5 A05																
Diesel																						
1.5	dCi [BH]	05.12-12.17	SSJ						70	760	S4 E08											
		05.12→		70	760	S5 A08	77	780	S5 008	70	760	S4 E08	70	640	S3 008							
				70	760	S5 A08	77	780	S5 008	74	680	S4 008	70	640	S3 008							
		01.16→	BWD	70	760	S5 A08			70	760	S4 E08											
		09.16→	SSJ	70	760	S5 A08			70	760	S4 E08											
Clio IV Grandtour																						
0.9	[KH]	11.12-12.17		70	760	S5 A08	77	780	S5 008	74	680	S4 008	70	640	S3 008							
			SSJ						70	760	S4 E08											
		01.16→	SSJ	70	760	S5 A08																
1.2	[KH]	11.12-12.17				54	530	S5 002	52	470	S4 002											
	TCe [KH]	01.13-12.17		70	760	S5 A08	77	780	S5 008	74	680	S4 008	70	640	S3 008							
		01.16→	SSJ	70	760	S5 A08			70	760	S4 E08											



			Ah	A (EN)		Ah	A (EN)		Ah	A (EN)		Ah	A (EN)	
			0 092 ...0			0 092 ...0			0 092 ...0			0 092 ...0		

Diesel														
1.5 dCi [KH]	11.12-12.17		70	760	S5 A08	77	780	S5 008	74	680	S4 008	70	640	S3 008
	01.16→					74	750	S5 007	72	680	S4 007			
		BWD							70	760	S4 E08			
		SSJ	70	760	S5 A08									
	09.16→	SSJ	70	760	S5 A08				70	760	S4 E08			

Duster														
1.2 [HS]	09.13→					63	610	S5 005	60	540	S4 005			
1.6 [HS]	03.12→					54	530	S5 002	52	470	S4 002			
	09.13→					63	610	S5 005	60	540	S4 005			
2.0 [HS]	03.12→					63	610	S5 005	60	540	S4 005			
4x4 [HS]	03.12→								60	540	S4 005			
									74	680	S4 008			

Diesel														
1.5 dCi [HS]	06.11→					63	610	S5 005	60	540	S4 005			
	09.13→	SSJ	70	760	S5 A08									
dCi 4x4 [HS]	03.12→					63	610	S5 005	60	540	S4 005			

Espace III														
2.0 i [JEO]	10.96-10.02		70	760	S5 A08	77	780	S5 008	60	540	S4 005	53	500	S3 004
i GPL, i 16V [JEO]	02.98-10.02		70	760	S5 A08	77	780	S5 008	60	540	S4 004	53	500	S3 004
3.0 i V6, i V6 24V [JEO]	10.96-10.02		70	760	S5 A08	77	780	S5 008	74	680	S4 008	70	640	S3 007

Diesel														
1.9/ 2.2 D Turbo, dCi, dTi [JEO]	10.96-10.02		70	760	S5 A08	77	780	S5 008	74	680	S4 008	70	640	S3 007

Espace IV														
2.0/ 3.5 , TCe, Turbo, 16V [JK]	11.02-12.15					74	750	S5 007	72	680	S4 007			

Diesel														
1.9 dCi [JK]	11.02-12.15		70	760	S5 A08	85	800	S5 011	74	680	S4 008	70	640	S3 007
2.0 dCi [JK]	05.05-12.15					85	800	S5 011	80	740	S4 010			
			70	760	S5 A08	85	800	S5 010	80	740	S4 010			
			70	760	S5 A08	85	800	S5 011	80	740	S4 011			
			70	760	S5 A08	85	800	S5 011	80	740	S4 010			
2.2 dCi [JK]	11.02-12.06		70	760	S5 A08	85	800	S5 010	80	740	S4 010			
			70	760	S5 A08	85	800	S5 010	80	740	S4 011			
			70	760	S5 A08	85	800	S5 011	80	740	S4 010			
	11.02-12.15					85	800	S5 011	80	740	S4 010			
3.0 dCi [JK]	11.02-12.15					85	800	S5 011	80	740	S4 010			

Espace V														
1.6 TCe 200 [JR]	04.15-12.17	SSJ							70	760	S4 E08			

Diesel														
1.6 dCi 130, dCi 160 [JR]	04.15→	SSJ							70	760	S4 E08			

Fluence														
Z.E. [L3]	11.11-12.16					54	530	S5 002	52	470	S4 002	45	400	S3 002
1.6/ 2.0 i, i LPG [L3]	11.09-12.16					52	520	S5 001	44	440	S4 001	41	360	S3 001

Diesel														
1.5 dCi [L3]	11.09-12.16		70	760	S5 A08	77	780	S5 008	74	680	S4 008	70	640	S3 007
	11.09-12.17					74	750	S5 007	72	680	S4 007			
1.6 dCi [L3]	11.12-12.16		70	760	S5 A08							41	360	S3 001

Grand Scenic II														
1.4 16V [JM]	05.03-04.09					74	750	S5 007	60	540	S4 004	53	500	S3 004
1.6 16V [JM]	05.03-04.09					74	750	S5 007	60	540	S4 004	53	500	S3 004
	05.05-04.09					74	750	S5 007	60	540	S4 004			
	07.05-04.09					61	600	S5 004	60	540	S4 004	53	500	S3 004
2.0 16V [JM]	05.03-04.09					74	750	S5 007	60	540	S4 004	53	500	S3 004
16V Turbo [JM]	06.03-04.09					74	750	S5 007	60	540	S4 004	53	500	S3 004

Diesel														
1.5/ 1.9 dCi [JM]	05.03-04.09					74	750	S5 007	60	540	S4 004	70	640	S3 007
2.0 dCi [JM]	09.04-04.09					74	750	S5 007	60	540	S4 004	70	640	S3 007
			70	760	S5 A08	77	780	S5 008	72	680	S4 007	70	640	S3 007

Grand Scenic III														
1.2 [JZ]	05.12-12.16		70	760	S5 A08	77	780	S5 008	74	680	S4 008	70	640	S3 008
		SSJ							70	760	S4 E08			



						Ah A (EN) S5A		Ah A (EN) S5		Ah A (EN) S4		Ah A (EN) S3		
				0 092 ...0		0 092 ...0		0 092 ...0		0 092 ...0		0 092 ...0		
◀ RENAULT														
1.2 [JZ]	01.13-12.16											53	500	S3 004
		SSJ	70	760	S5 A08									
1.4 [JZ]	05.09-12.16					61	600	S5 004	60	540	S4 004	53	500	S3 004
1.6 [JZ]	05.09-12.16					63	610	S5 005	60	540	S4 005			
			60	680	S5 A05	63	610	S5 005				53	500	S3 004
	05.12-12.16					54	530	S5 002	52	470	S4 002	53	500	S3 004
2.0 [JZ]	05.09-12.16					74	750	S5 007	72	680	S4 007			
		SSJ	70	760	S5 A08									
Diesel														
1.5 dCi [JZ]	05.09-12.16					63	610	S5 005	60	540	S4 005			
						74	750	S5 007						
						85	800	S5 011						
		SSJ	70	760	S5 A08									
1.6 dCi [JZ]	03.11-12.16					77	780	S5 008	74	680	S4 008	70	640	S3 008
		SSJ	70	760	S5 A08				70	760	S4 E08			
1.9/ 2.0 dCi [JZ]	05.09-12.16					74	750	S5 007	72	680	S4 007			
Grand Scenic IV														
1.2 TCe [R9]	11.16→	SSJ	70	760	S5 A08				70	760	S4 E08			
Diesel														
1.5/ 1.6 dCi [R9]	11.16→	SSJ	70	760	S5 A08				70	760	S4 E08			
Grans Scenic III														
Diesel														
1.6 dCi [JZ]	02.16-12.16					77	780	S5 008	70	760	S4 E08	70	640	S3 008
						77	780	S5 008	74	680	S4 008	70	640	S3 008
		SSJ	70	760	S5 A08									
Kadjar														
1.2 TCe 130 [HL]	06.15→								74	680	S4 008			
		SSJ	70	760	S5 A08				70	760	S4 E08			
Diesel														
1.5/ 1.6 dCi 110, dCi 130, dCi 130 4x4 [HL]	06.15→	SSJ	70	760	S5 A08				70	760	S4 E08			
Koleos														
2.0 [HY]	09.08-12.16		70	760	S5 A08				65	650	S4 E40			
			70	760	S5 A08				70	630	S4 026			
2.5 [HY]	09.08-12.16		70	760	S5 A08				65	650	S4 E40			
			70	760	S5 A08				70	630	S4 026			
4x4 [HY]	09.08-12.16		70	760	S5 A08				65	650	S4 E40			
			70	760	S5 A08				70	630	S4 026			
Diesel														
2.0 dCi [HY]	09.08-12.16		70	760	S5 A08	77	780	S5 008	65	650	S4 E40	70	640	S3 008
			70	760	S5 A08	77	780	S5 008	74	680	S4 008	70	640	S3 008
		SSJ	70	760	S5 A08									
dCi 4x4 [HY]	09.08-12.16		70	760	S5 A08				70	630	S4 026			
			70	760	S5 A08	77	780	S5 008	65	650	S4 E40	70	640	S3 008
			70	760	S5 A08	77	780	S5 008	74	680	S4 008	70	640	S3 008
		SSJ	70	760	S5 A08									
Laguna I														
1.6 i 16V [B56]	05.98-02.01		70	760	S5 A08	77	780	S5 008	74	680	S4 008	53	500	S3 004
			70	760	S5 A08	77	780	S5 008	74	680	S4 008	70	640	S3 007
1.8 GPL [B56]	09.95-02.01					63	610	S5 005	52	470	S4 002	45	400	S3 002
						63	610	S5 005	52	470	S4 002	53	500	S3 004
i [B56]	01.94-03.01					63	610	S5 005	52	470	S4 002	45	400	S3 002
						63	610	S5 005	52	470	S4 002	53	500	S3 004
i 16V [B56]	04.98-02.01		70	760	S5 A08	77	780	S5 008	72	680	S4 007	53	500	S3 004
			70	760	S5 A08	77	780	S5 008	72	680	S4 007	70	640	S3 007
2.0 i [B56]	01.94-02.01					63	610	S5 005	60	540	S4 005	53	500	S3 004
						63	610	S5 005	60	540	S4 005	56	480	S3 005
i 16V [B56]	09.95-02.01					63	610	S5 005	60	540	S4 005	53	500	S3 004
						63	610	S5 005	60	540	S4 005	56	480	S3 005
i 16V [556]	09.99-02.01					63	610	S5 005	60	540	S4 005	53	500	S3 004
						63	610	S5 005	60	540	S4 005	56	480	S3 005
3.0 i [B56]	01.94-02.01					63	610	S5 005	60	540	S4 005	56	480	S3 005
i 24V [B56]	03.97-02.01					63	610	S5 005	60	540	S4 005	56	480	S3 005



			Ah	A (EN)		Ah	A (EN)		Ah	A (EN)		Ah	A (EN)	
			0 092 ...0			0 092 ...0			0 092 ...0			0 092 ...0		

Diesel														
1.9 DCI, DTI [B56]	10.97-02.01		70	760	S5 A08	77	780	S5 008	72	680	S4 007	70	640	S3 007
2.2 D, D Turbo [B56]	09.95-02.01		70	760	S5 A08	77	780	S5 008	74	680	S4 008	70	640	S3 007
Laguna I Grandtour														
1.6 i 16V [K56]	05.98-02.01		70	760	S5 A08	77	780	S5 008	74	680	S4 008	53	500	S3 004
			70	760	S5 A08	77	780	S5 008	74	680	S4 008	70	640	S3 007
1.8 GPL [K56]	09.95-02.01		70	760	S5 A08	77	780	S5 008	74	680	S4 008	53	500	S3 004
			70	760	S5 A08	77	780	S5 008	74	680	S4 008	70	640	S3 007
i [K56]	09.95-02.01					63	610	S5 005	52	470	S4 002	45	400	S3 002
						63	610	S5 005	52	470	S4 002	53	500	S3 004
i 16V [K56]	04.98-02.01					63	610	S5 005	52	470	S4 002	45	400	S3 002
						63	610	S5 005	52	470	S4 002	53	500	S3 004
2.0 i [K56]	09.95-02.01					63	610	S5 005	60	540	S4 005	53	500	S3 004
						63	610	S5 005	60	540	S4 005	56	480	S3 005
i 16V [A56]	09.99-02.01					63	610	S5 005	60	540	S4 005	53	500	S3 004
						63	610	S5 005	60	540	S4 005	56	480	S3 005
i 16V [K56]	09.95-02.01					63	610	S5 005	60	540	S4 005	53	500	S3 004
						63	610	S5 005	60	540	S4 005	56	480	S3 005
3.0 i [K56]	02.96-02.01					63	610	S5 005	60	540	S4 005	56	480	S3 005
i 24V [K56]	03.97-02.01					63	610	S5 005	60	540	S4 005	56	480	S3 005
Diesel														
1.9 DCI, DTI [K56; S56]	10.97-02.01		70	760	S5 A08	77	780	S5 008	72	680	S4 007	70	640	S3 007
2.2 D, D Turbo [K56; S56]	09.95-02.01		70	760	S5 A08	77	780	S5 008	74	680	S4 008	70	640	S3 007
Laguna II														
1.6 16V [BG.]	03.01-09.07					74	750	S5 007	60	540	S4 004	53	500	S3 004
1.8 16V [BG.]	03.01-09.07					61	600	S5 004	60	540	S4 004	53	500	S3 004
						74	750	S5 007	60	540	S4 004	53	500	S3 004
2.0 T [BG.]	07.02-09.07					74	750	S5 007	60	540	S4 004	53	500	S3 004
16V [BG.]	03.01-09.07					74	750	S5 007	60	540	S4 004	53	500	S3 004
16V IDE [BG.]	03.01-09.07					74	750	S5 007	60	540	S4 004	53	500	S3 004
3.0 V6 24V [BG.]	03.01-09.07					74	750	S5 007	72	680	S4 007			
Diesel														
1.9 DCI [BG.]	03.01-09.07					74	750	S5 007	72	680	S4 007			
						74	750	S5 007	72	680	S4 007	70	640	S3 007
2.0 DCI [BG.]	09.04-09.07					74	750	S5 007	72	680	S4 007			
		SSJ	70	760	S5 A08									
2.2 DCI [BG.]	03.01-09.07					74	750	S5 007	72	680	S4 007			
						74	750	S5 007	72	680	S4 007	70	640	S3 007
	07.02-09.07		70	760	S5 A08	77	780	S5 008	72	680	S4 007	70	640	S3 007
Laguna II Grandtour														
1.6 16V [KG.]	03.01-09.07					74	750	S5 007	60	540	S4 004	53	500	S3 004
1.8 16V [KG.]	03.01-09.07					74	750	S5 007	60	540	S4 004	53	500	S3 004
	12.01-09.07					61	600	S5 004	60	540	S4 004	53	500	S3 004
2.0 T [KG.]	07.02-09.07					74	750	S5 007	60	540	S4 004	53	500	S3 004
16V [KG.]	03.01-09.07					74	750	S5 007	60	540	S4 004	53	500	S3 004
16V IDE [KG.]	03.01-09.07					74	750	S5 007	60	540	S4 004	53	500	S3 004
3.0 V6 24V [KG.]	03.01-09.07					74	750	S5 007	72	680	S4 007			
Diesel														
1.9 DCI [KG.]	03.01-12.05					74	750	S5 007	72	680	S4 007	70	640	S3 007
	03.01-09.07					74	750	S5 007	72	680	S4 007			
2.0 DCI [KG.]	09.04-09.07					74	750	S5 007	72	680	S4 007			
2.2 DCI [KG.]	03.01-09.07					74	750	S5 007	72	680	S4 007			
						74	750	S5 007	72	680	S4 007	70	640	S3 007
Laguna III														
1.6/ 2.0/ 3.5 [BT]	10.07-12.16					63	610	S5 005	60	540	S4 005			
2.0 TCe [BT]	10.07-12.16					63	610	S5 005	60	540	S4 005			
	02.08-12.16		70	760	S5 A08	77	780	S5 008	74	680	S4 008			
Diesel														
1.5 dCi [BT]	07.07-12.16		70	760	S5 A08	85	800	S5 010	80	740	S4 010			
	07.12-12.16					77	780	S5 008	74	680	S4 008			
2.0 dCi [BT]	10.07-12.16		70	760	S5 A08	85	800	S5 010	80	740	S4 010			
			70	760	S5 A08	85	800	S5 011	74	680	S4 008			
	02.08-12.16		70	760	S5 A08	77	780	S5 008	74	680	S4 008			



			Ah A (EN) S5A			Ah A (EN) S5			Ah A (EN) S4			Ah A (EN) S3		
			0 092 ...0			0 092 ...0			0 092 ...0			0 092 ...0		
◀ RENAULT														
2.0 dCi [BT]	12.11-12.16		70	760	S5 A08	77	780	S5 008	74	680	S4 008	70	640	S3 008
		BWD							70	760	S4 E08			
3.0 dCi [BT]	02.08-12.16		70	760	S5 A08	85	800	S5 010	80	740	S4 010			
Laguna III Coupé														
2.0 TCe [DT]	02.08-12.16					63	610	S5 005	60	540	S4 005			
			70	760	S5 A08	77	780	S5 008	74	680	S4 008	70	640	S3 008
3.5 [DT]	02.08-12.16					63	610	S5 005	60	540	S4 005			
Diesel														
1.5 dCi [DT]	01.13-12.16		70	760	S5 A08	85	800	S5 010	80	740	S4 010			
2.0 dCi [DT]	02.08-12.16		70	760	S5 A08	77	780	S5 008	74	680	S4 008	70	640	S3 008
			70	760	S5 A08	85	800	S5 010	80	740	S4 010			
3.0 dCi [DT]	02.08-12.16		70	760	S5 A08	85	800	S5 010	80	740	S4 010			
Laguna III Grandtour														
1.6/2.0 [KT]	10.07-12.16					63	610	S5 005	60	540	S4 005			
2.0 TCe [KT]	10.07-12.16					63	610	S5 005	60	540	S4 005			
	02.08-12.16		70	760	S5 A08	77	780	S5 008	74	680	S4 008			
3.5 [KT]	02.08-12.16					77	780	S5 008	74	680	S4 008			
Diesel														
1.5 dCi [KT]	07.07-12.16		70	760	S5 A08	85	800	S5 010	80	740	S4 010			
	07.12-12.16					77	780	S5 008	74	680	S4 008			
		SSJ	80	800	S5 A11									
2.0 dCi [KT]	10.07-12.16		70	760	S5 A08	85	800	S5 010	80	740	S4 010			
			70	760	S5 A08	85	800	S5 011	74	680	S4 008			
	02.08-12.16		70	760	S5 A08	77	780	S5 008	74	680	S4 008			
	12.11-12.16		80	800	S5 A11	85	800	S5 011						
3.0 dCi [KT]	02.08-12.16		70	760	S5 A08	85	800	S5 010	80	740	S4 010			
Latitude														
2.0 [L7]	09.10-12.16					63	610	S5 005	60	540	S4 005			
2.5 [L7]	09.10-12.16		95	850	S5 A13	100	830	S5 013	95	800	S4 013	90	720	S3 013
Diesel														
1.5 dCi [L7]	09.10-12.16		70	760	S5 A08	77	780	S5 008	74	680	S4 008	70	640	S3 008
		SSJ							70	760	S4 E08			
2.0 dCi [L7]	08.10-12.17					85	800	S5 010	74	680	S4 008			
		SSJ	70	760	S5 A08									
			80	800	S5 A11									
	09.10-12.16					77	780	S5 008	74	680	S4 008			
3.0 dCi [L7]	09.10-12.16					85	800	S5 010	80	740	S4 010			
Logan														
1.4/ 1.6, 16V, 16V Hi-Flex [LS]	07.04-12.16					63	610	S5 005	60	540	S4 005			
1.6 [L8]	12.14→					54	530	S5 002	52	470	S4 002			
16V [L8]	12.14→					54	530	S5 002	52	470	S4 002			
						54	530	S5 002	74	680	S4 008			
Diesel														
1.5 dCi [LS]	06.05-12.16					63	610	S5 005	60	540	S4 005			
	10.05-12.16					61	600	S5 004				53	500	S3 004
Logan MCV														
0.9/ 1.2 [K8]	09.15→					54	530	S5 002	52	470	S4 002	45	400	S3 002
1.4 [KS/FS]	01.07-12.13					54	530	S5 002	52	470	S4 002			
1.6 [KS/FS]	01.07-12.13					63	610	S5 005	60	540	S4 005			
16V [KS/FS]	01.07-12.13					63	610	S5 005	60	540	S4 005			
Diesel														
1.5 dCi [KS/FS]	01.07-12.13					61	600	S5 004				53	500	S3 004
			70	760	S5 A08	77	780	S5 008	74	680	S4 008			
Megane														
1.6 i [BA10]	09.97-09.07					54	530	S5 002	52	470	S4 002	45	400	S3 002
Megane I														
1.4 i [X64]	01.96-10.02					54	530	S5 002	52	470	S4 002	45	400	S3 002
i 16V [X64]	06.98-10.02					61	600	S5 004	52	470	S4 002	45	400	S3 002
1.6 i [X64]	01.96-02.99					54	530	S5 002	52	470	S4 002	45	400	S3 002
	01.01-10.02					54	530	S5 002	52	470	S4 002			
i 16V [X64]	06.98-10.02					54	530	S5 002	52	470	S4 002	45	400	S3 002



			Ah A (EN) S5A			Ah A (EN) S5			Ah A (EN) S4			Ah A (EN) S3		
			0 092 ...0			0 092 ...0			0 092 ...0			0 092 ...0		
1.8 i 16V [X64]	03.99-10.02		54	530	S5 002	52	470	S4 002	45	400	S3 002			
			61	600	S5 004	52	470	S4 002	45	400	S3 002			
2.0 i [X64]	01.97-10.02		63	610	S5 005	60	540	S4 005	56	480	S3 005			
i 16V [X64]	05.97-10.02		63	610	S5 005	60	540	S4 005	56	480	S3 005			
Diesel														
1.9 D, D Turbo [X64]	01.96-10.02	70	760	S5 A08	77	780	S5 008	74	680	S4 008	70	640	S3 007	
DCI [X64]	03.99-10.02		70	760	S5 A08	77	780	S5 008	74	680	S4 008			
			70	760	S5 A08	77	780	S5 008	74	680	S4 008	70	640	S3 007
DTI [X64]	06.97-10.02	70	760	S5 A08	77	780	S5 008	74	680	S4 008	70	640	S3 007	
	03.99-10.02	70	760	S5 A08	77	780	S5 008	74	680	S4 008				
Megane I Cabrio														
1.4 i 16V [X64]	03.99-09.03		61	600	S5 004	52	470	S4 002	45	400	S3 002			
1.6 i [X64]	09.96-09.03		54	530	S5 002	52	470	S4 002	45	400	S3 002			
i 16V [X64]	03.99-09.03	70	760	S5 A08	77	780	S5 008	52	470	S4 002	45	400	S3 002	
	05.00-09.03	70	760	S5 A08	77	780	S5 008	74	680	S4 008	70	640	S3 007	
2.0 i [X64]	09.96-09.03		63	610	S5 005	60	540	S4 005	56	480	S3 005			
i 16V [X64]	05.97-09.03		63	610	S5 005	60	540	S4 005	56	480	S3 005			
	01.01-09.03	70	760	S5 A08	77	780	S5 008	60	540	S4 005	56	480	S3 005	
i 16V IDE [X64]	03.99-09.03	70	760	S5 A08	77	780	S5 008	60	540	S4 005	56	480	S3 005	
Megane I Classic														
1.4 i [X64]	09.96-09.03		54	530	S5 002	52	470	S4 002	45	400	S3 002			
	05.00-09.03		61	600	S5 004	52	470	S4 002	45	400	S3 002			
i 16V [X64]	03.99-09.03		61	600	S5 004	52	470	S4 002	45	400	S3 002			
1.6 i [X64]	09.96-09.03		54	530	S5 002	52	470	S4 002	45	400	S3 002			
	08.98-09.03	70	760	S5 A08	77	780	S5 008	52	470	S4 002	45	400	S3 002	
	09.99-09.03	70	760	S5 A08	77	780	S5 008	72	680	S4 007	70	640	S3 007	
	05.00-09.03	70	760	S5 A08	77	780	S5 008	72	680	S4 007				
1.8 i [X64]	05.00-09.03	70	760	S5 A08	77	780	S5 008	52	470	S4 002	45	400	S3 002	
2.0 i [X64]	09.96-09.03		63	610	S5 005	60	540	S4 005	56	480	S3 005			
Diesel														
1.9 D, D Turbo, DCI [X64]	09.96-09.03	70	760	S5 A08	77	780	S5 008	74	680	S4 008	70	640	S3 007	
DTI [X64]	08.97-09.03	70	760	S5 A08	77	780	S5 008	74	680	S4 008	70	640	S3 007	
	11.00-09.03	70	760	S5 A08	77	780	S5 008	60	540	S4 004	70	640	S3 008	
Megane I Coupé														
1.4 i 16V [X64]	03.99-10.02		61	600	S5 004	52	470	S4 002	45	400	S3 002			
1.6 i [X64]	01.96-10.02		54	530	S5 002	52	470	S4 002	45	400	S3 002			
i 16V [X64]	03.99-10.02	70	760	S5 A08	77	780	S5 008	52	470	S4 002	45	400	S3 002	
	05.00-10.02	70	760	S5 A08	77	780	S5 008	74	680	S4 008	70	640	S3 007	
2.0 i [X64]	04.97-10.02		63	610	S5 005	60	540	S4 005	56	480	S3 005			
i 16V [X64]	05.97-10.02		63	610	S5 005	60	540	S4 005	56	480	S3 005			
	09.01-10.02	70	760	S5 A08	77	780	S5 008	60	540	S4 005	56	480	S3 005	
i 16V IDE [X64]	03.99-10.02	70	760	S5 A08	77	780	S5 008	60	540	S4 005	56	480	S3 005	
Diesel														
1.9 DCI, DTI [X64]	06.97-10.02	70	760	S5 A08	77	780	S5 008	74	680	S4 008	70	640	S3 007	
Megane I Grandtour														
1.4 i 16V [X64]	03.99-09.03		61	600	S5 004	52	470	S4 002	45	400	S3 002			
1.4/ 1.6 i [X64]	07.98-09.03		54	530	S5 002	52	470	S4 002	45	400	S3 002			
1.6 i 16V [X64]	03.99-09.03		70	760	S5 A08	77	780	S5 008	52	470	S4 002	45	400	S3 002
			70	760	S5 A08	77	780	S5 008	74	680	S4 008	70	640	S3 007
1.8 i 16V [X64]	10.00-09.03	70	760	S5 A08	77	780	S5 008	52	470	S4 002	45	400	S3 002	
Diesel														
1.9 D [X64]	03.99-09.03	70	760	S5 A08	77	780	S5 008	74	680	S4 008	70	640	S3 007	
	01.01-09.03	70	760	S5 A08	77	780	S5 008	60	540	S4 004	70	640	S3 008	
DCI, DTI [X64]	07.98-09.03	70	760	S5 A08	77	780	S5 008	74	680	S4 008	70	640	S3 007	
Megane II														
1.4 [LM]	10.03-10.09		74	750	S5 007	44	440	S4 001	53	500	S3 004			
1.6/ 2.0 [LM]	09.02-10.09		74	750	S5 007	60	540	S4 004	53	500	S3 004			
Diesel														
1.5 dCi [LM]	11.02-10.09		74	750	S5 007	60	540	S4 004						
			74	750	S5 007	60	540	S4 004	70	640	S3 007			
1.9 dCi [LM]	10.03-10.09		74	750	S5 007	60	540	S4 004						
2.0 dCi [LM]	09.04-10.09	70	760	S5 A08	77	780	S5 008	72	680	S4 007	70	640	S3 008	



								Ah A (EN)		Ah A (EN)		Ah A (EN)		Ah A (EN)	
				0 092 ...0		0 092 ...0		0 092 ...0		0 092 ...0		0 092 ...0		0 092 ...0	
◀ RENAULT															
Megane II Cabrio															
1.6/ 2.0 , T [EM]	10.03-03.10			74	750	S5 007	60	540	S4 004	53	500	S3 004			
Diesel															
1.5/ 1.9/ 2.0 dCi [EM]	10.03-03.10			74	750	S5 007	60	540	S4 004						
Megane II Grandtour															
1.4 [KM.]	10.03-05.09			74	750	S5 007	44	440	S4 001	53	500	S3 004			
1.6 [KM.]	10.03-05.09			74	750	S5 007	44	440	S4 001	53	500	S3 004			
				74	750	S5 007	60	540	S4 004	53	500	S3 004			
Flex-Fuel [KM.]	02.08-05.09			61	600	S5 004	44	440	S4 001	53	500	S3 004			
2.0 [KM.]	10.03-05.09			74	750	S5 007	60	540	S4 004	53	500	S3 004			
Diesel															
1.5/ 1.9/ 2.0 dCi [KM.]	10.03-05.09			74	750	S5 007	60	540	S4 004						
Megane II Hatchback															
1.4 [BM./CM./GM./SM.]	11.02-10.08			74	750	S5 007	60	540	S4 004	53	500	S3 004			
1.6 [BM./CM./GM./SM.]	11.02-10.08			74	750	S5 007	60	540	S4 004	53	500	S3 004			
	10.05-10.08			61	600	S5 004	60	540	S4 004	53	500	S3 004			
Flex-Fuel [BM./CM./GM./SM.]	01.07-10.08			61	600	S5 004	60	540	S4 004	53	500	S3 004			
2.0 [BM./CM./GM./SM.]	11.02-10.08			74	750	S5 007	60	540	S4 004	53	500	S3 004			
Sport, T [BM./CM./GM./SM.]	03.03-10.08			74	750	S5 007	60	540	S4 004	53	500	S3 004			
Diesel															
1.5/ 1.9/ 2.0 dCi, dCi Sport [BM./CM./GM./SM.]	11.02-10.08			74	750	S5 007	60	540	S4 004	70	640	S3 007			
Megane III CC															
1.2 [EZ]	01.13-12.16	SSJ		70	760	S5 A08									
1.4 [EZ]	10.10-12.16			54	530	S5 002	52	470	S4 002	45	400	S3 002			
1.6/ 2.0 [EZ]	10.10-12.16			63	610	S5 005	60	540	S4 005						
2.0 TCe [EZ]	10.10-12.16			63	610	S5 005	60	540	S4 005						
Diesel															
1.5/ 1.6/ 1.9/ 2.0 dCi [EZ]	10.10-12.16			70	760	S5 A08	77	780	S5 008	74	680	S4 008			
Megane III Coupé															
1.2 [DZ]	01.12-12.16	SSJ		70	760	S5 A08									
1.4 [DZ]	01.09-12.16			63	610	S5 005	60	540	S4 005						
1.6 [DZ]	01.09-12.16			63	610	S5 005	60	540	S4 005						
	03.14-12.16			54	530	S5 002	52	470	S4 002						
2.0 [DZ]	01.09-12.16			54	530	S5 002	52	470	S4 002						
	09.13-12.16						70	760	S4 E08						
		SSJ		70	760	S5 A08									
	07.14→	SSJ		70	760	S5 A08		70	760	S4 E08					
R.S. [DZ]	11.09-12.16			63	610	S5 005	60	540	S4 005						
	11.11-12.16			70	760	S5 A08	77	780	S5 008	74	680	S4 008	70	640	S3 008
TCe [DZ]	01.09-12.16			54	530	S5 002	52	470	S4 002						
	11.12-12.16	SSJ		70	760	S5 A08		70	760	S4 E08					
Diesel															
1.5 dCi [DZ]	01.09-12.16			54	530	S5 002	52	470	S4 002						
				63	610	S5 005	60	540	S4 005						
		SSJ		70	760	S5 A08		70	760	S4 E08					
	09.11-12.16	BWD					70	760	S4 E08						
		SSJ		70	760	S5 A08									
1.6 dCi [DZ]	01.12-12.16			70	760	S5 A08	77	780	S5 008	74	680	S4 008	70	640	S3 008
1.9/ 2.0 dCi [DZ]	01.09-12.16			74	750	S5 007	72	680	S4 007						
Megane III Grandtour															
1.2 [KZ]	01.12-12.15			70	760	S5 A08	77	780	S5 008	74	680	S4 008	70	640	S3 008
		SSJ					70	760	S4 E08						
	01.13-12.15	SSJ		70	760	S5 A08									
1.4/ 1.6 [KZ]	06.09-12.15			63	610	S5 005	60	540	S4 005						
2.0 [KZ]	06.09-12.15			54	530	S5 002	52	470	S4 002						
TCe [KZ]	06.09-12.15			54	530	S5 002	52	470	S4 002						
	11.12-12.15			63	610	S5 005	60	540	S4 005						
				77	780	S5 008	74	680	S4 008						
		SSJ		70	760	S5 A08				70	760	S4 E08			
				70	760	S5 A08									



			Ah A (EN)	Ah A (EN)	Ah A (EN)	Ah A (EN)
			0 092 ...0	0 092 ...0	0 092 ...0	0 092 ...0

Diesel										
1.5 dCi [KZ]	06.09-12.15				54	530	S5 002	52	470	S4 002
					63	610	S5 005	60	540	S4 005
			70	760	S5 A08					
		SSJ						70	760	S4 E08
	09.11-12.15	BWD						70	760	S4 E08
	09.13-12.15	SSJ	70	760	S5 A08			70	760	S4 E08
1.6 dCi [KZ]	01.12-12.15		70	760	S5 A08		77	780	S5 008	74 680 S4 008 70 640 S3 008
1.9 dCi [KZ]	06.09-12.15				74	750	S5 007	72	680	S4 007
2.0 dCi [KZ]	06.09-12.15				74	750	S5 007	72	680	S4 007
	11.10-12.15				77	780	S5 008	74	680	S4 008
Megane III Hatchback										
1.2 [BZ]	01.12-12.16	SSJ	70	760	S5 A08					
1.4 [BZ]	11.08-12.16				63	610	S5 005	60	540	S4 005
1.6 [BZ]	11.08-12.16				63	610	S5 005	60	540	S4 005
					74	750	S5 007			
					74	750	S5 007	72	680	S4 007
	11.11-12.16				54	530	S5 002	52	470	S4 002
2.0 [BZ]	11.08-12.16				54	530	S5 002	52	470	S4 002
TCe [BZ]	11.08-12.16				74	750	S5 007	72	680	S4 007
	11.12-12.16	SSJ	70	760	S5 A08			70	760	S4 E08
Diesel										
1.5 dCi [BZ]	11.08-12.16				54	530	S5 002	52	470	S4 002
					63	610	S5 005	60	540	S4 005
					77	780	S5 008			
		SSJ	70	760	S5 A08			70	760	S4 E08
	09.11-12.16	BWD						70	760	S4 E08
		SSJ	70	760	S5 A08					
1.6 dCi [BZ]	01.12-12.16		70	760	S5 A08		77	780	S5 008	74 680 S4 008 70 640 S3 008
1.9 dCi [BZ]	11.08-12.16				54	530	S5 002	52	470	S4 002
					74	750	S5 007			
2.0 dCi [BZ]	11.08-12.16				74	750	S5 007			
	11.10-12.16				77	780	S5 008	74	680	S4 008
Megane IV										
1.2 [B9]	12.15→	SSJ						60	640	S4 E05
								70	760	S4 E08
1.6 SCe [B9]	12.15→							60	540	S4 005
								74	680	S4 008
TCe [B9]	12.15→	SSJ	70	760	S5 A08			70	760	S4 E08
Diesel										
1.5/1.6 dCi [B9]	12.15→	SSJ	70	760	S5 A08			70	760	S4 E08
Megane IV Grandtour										
1.2 [K9]	04.16→	SSJ						60	640	S4 E05
								70	760	S4 E08
1.6 TCe [K9]	04.16→	SSJ	70	760	S5 A08			70	760	S4 E08
Diesel										
1.5/1.6 dCi [K9]	04.16→	SSJ	70	760	S5 A08			70	760	S4 E08
Modus										
1.2 [FP/JP]	09.04-12.15				61	600	S5 004	44	440	S4 001 53 500 S3 004
	11.04-12.15				54	530	S5 002	52	470	S4 002 53 500 S3 004
TCe [FP/JP]	10.07-12.15				54	530	S5 002	52	470	S4 002 53 500 S3 004
1.4 [FP/JP]	06.04-12.06				61	600	S5 004	44	440	S4 001 53 500 S3 004
	07.05-12.06				54	530	S5 002	52	470	S4 002 53 500 S3 004
1.6 [FP/JP]	09.04-12.15				61	600	S5 004	60	540	S4 004 53 500 S3 004
Diesel										
1.5 dCi [FP/JP]	09.04-12.06				74	750	S5 007	72	680	S4 007 70 640 S3 007
	09.04-12.15				74	750	S5 007	60	540	S4 004 70 640 S3 007
	10.10-12.15				61	600	S5 004			53 500 S3 004
R 19 Sedan										
1.8 i	02.93-04.98				54	530	S5 002	52	470	S4 002 45 400 S3 002
Safrane										
2.0/2.5 i 16V, i 20V [B54]	10.96-12.00		70	760	S5 A08		77	780	S5 008	60 540 S4 005
3.0 i [B54]	10.96-12.00				74	750	S5 007	72	680	S4 007 70 640 S3 007



											Ah A (EN)			Ah A (EN)			Ah A (EN)			Ah A (EN)			
◀RENAULT					0 092 ...0			0 092 ...0			0 092 ...0			0 092 ...0									
3.0 i 24V [B54]	03.99-12.00				74	750	S5 007	70	650	S4 E07													
Diesel																							
2.2 12VD Turbo [B54]	10.96-12.00	95	850	S5 A13	100	830	S5 013	74	680	S4 008	70	640	S3 007										
Sandero																							
1.4 [BS]	12.09-12.15				63	610	S5 005	60	540	S4 005													
1.6 [BS]	12.09-12.15				54	530	S5 002	52	470	S4 002													
16V [BS]	11.10-12.15				54	530	S5 002	52	470	S4 002													
Diesel																							
1.5 dCi [BS]	12.09→				63	610	S5 005	60	540	S4 005													
Sandero II																							
1.2/ 1.6, 16V [B8]	12.14→				54	530	S5 002	52	470	S4 002													
Scenic																							
2.0 i 16V	05.99-10.03	70	760	S5 A08	61	600	S5 004	60	540	S4 004	53	500	S3 004										
Scenic I																							
1.4 i [JA]	11.96-04.03	70	760	S5 A08	77	780	S5 008	60	540	S4 004	53	500	S3 004										
	08.98-04.03				52	520	S5 001	44	440	S4 001	41	360	S3 001										
1.6 i [JA]	01.96-04.03	70	760	S5 A08	77	780	S5 008	74	680	S4 008	70	640	S3 008										
	JEA	70	760	S5 A08	77	780	S5 008	74	680	S4 008	70	640	S3 008										
	08.98-04.03				52	520	S5 001	44	440	S4 001	41	360	S3 001										
	03.99-04.03	70	760	S5 A08	77	780	S5 008	60	540	S4 004	53	500	S3 004										
1.8/ 2.0 i [JA]	11.96-04.03	70	760	S5 A08	77	780	S5 008	60	540	S4 004	53	500	S3 004										
2.0 i RX4 [JA]	06.99-04.03	70	760	S5 A08	77	780	S5 008	60	540	S4 004	53	500	S3 004										
Diesel																							
1.9 D [JA]	11.96-09.99	70	760	S5 A08	77	780	S5 008	74	680	S4 008	70	640	S3 008										
	10.99-04.03				77	780	S5 008	60	540	S4 004													
D Turbo [JA]	11.96-04.03	70	760	S5 A08	77	780	S5 008	74	680	S4 008	70	640	S3 008										
DCI [JA]	06.97-04.03	70	760	S5 A08	77	780	S5 008	60	540	S4 004													
	03.99-04.03	70	760	S5 A08	77	780	S5 008	60	540	S4 004	70	640	S3 008										
DCI RX4 [JA]	06.97-04.03	70	760	S5 A08	77	780	S5 008	60	540	S4 004													
	06.00-01.03	70	760	S5 A08	77	780	S5 008	60	540	S4 004	70	640	S3 008										
DTI [JA]	06.97-02.99	70	760	S5 A08	77	780	S5 008	60	540	S4 004													
	03.99-04.03	70	760	S5 A08	77	780	S5 008	60	540	S4 004	70	640	S3 008										
Scenic II																							
1.4 16V [JM]	05.03-04.09				74	750	S5 007	60	540	S4 004	53	500	S3 004										
1.6 16V [JM]	05.03-04.09				74	750	S5 007	60	540	S4 004	53	500	S3 004										
	05.05-04.09				74	750	S5 007	60	540	S4 004													
		60	680	S5 A05	63	610	S5 005																
	07.05-04.09				61	600	S5 004	60	540	S4 004	53	500	S3 004										
2.0 16V [JM]	05.03-04.09				74	750	S5 007	60	540	S4 004	53	500	S3 004										
16V Turbo [JM]	06.03-04.09				74	750	S5 007	60	540	S4 004	53	500	S3 004										
Diesel																							
1.5/ 1.9 dCi [JM]	05.03-04.09				74	750	S5 007	60	540	S4 004	70	640	S3 007										
2.0 dCi [JM]	09.04-04.09				74	750	S5 007	60	540	S4 004	70	640	S3 007										
		70	760	S5 A08	77	780	S5 008	72	680	S4 007	70	640	S3 007										
Scenic III																							
1.2 [JZ]	05.12-12.16	70	760	S5 A08	77	780	S5 008	74	680	S4 008	70	640	S3 008										
	01.13-12.16										53	500	S3 004										
		SSJ	70	760	S5 A08																		
1.4 [JZ]	05.09-12.16				61	600	S5 004	60	540	S4 004	53	500	S3 004										
1.6 [JZ]	05.09-12.16				54	530	S5 002				53	500	S3 004										
					61	600	S5 004				53	500	S3 004										
		SSJ	70	760	S5 A08																		
	05.12-12.16				54	530	S5 002	52	470	S4 002	53	500	S3 004										
2.0 [JZ]	05.09-12.16				74	750	S5 007	72	680	S4 007	70	640	S3 007										
Diesel																							
1.5 dCi [JZ]	05.09-12.16				63	610	S5 005	60	540	S4 005													
					74	750	S5 007																
					85	800	S5 011																
		SSJ	70	760	S5 A08																		
	11.10-12.16				61	600	S5 004	60	540	S4 004													
1.6 dCi [JZ]	03.11-12.16	SSJ	70	760	S5 A08	77	780	S5 008	74	680	S4 008	70	640	S3 008									
	02.16-12.16	SSJ	70	760	S5 A08																		



			Ah A (EN) S5A			Ah A (EN) S5			Ah A (EN) S4			Ah A (EN) S3		
			0 092 ...0			0 092 ...0			0 092 ...0			0 092 ...0		
1.9 dCi [JZ]	05.09-12.16					77	780	S5 008	74	680	S4 008			
						85	800	S5 011	74	680	S4 008			
2.0 dCi [JZ]	05.09-12.16					74	750	S5 007	72	680	S4 007			
Scenic IV														
1.2 TCe [J9]	11.16→	SSJ	70	760	S5 A08				70	760	S4 E08			
Diesel														
1.5/ 1.6 dCi [J9]	11.16→	SSJ	70	760	S5 A08				70	760	S4 E08			
Sport Spider														
2.0	05.96-10.99					63	610	S5 005	60	540	S4 005	56	480	S3 005
Symbol														
0.9 [L8]	03.13→	SSJ	70	760	S5 A08									
1.2 [L8]	03.13→					54	530	S5 002	52	470	S4 002			
Diesel														
1.5 dCi [L8]	03.13→					63	610	S5 005	60	540	S4 005			
Talisman														
1.6 TCe 150, TCe 200 [LP]	12.15→	SSJ	70	760	S5 A08				70	760	S4 E08			
Diesel														
1.5 dCi [LP]	12.15→	SSJ	70	760	S5 A08				70	760	S4 E08			
1.6 dCi [LP]	12.15→					77	780	S5 008						
		SSJ	70	760	S5 A08				70	760	S4 E08			
Talisman Grandtour														
1.6 TCe 150, TCe 200 [KP]	03.16→	SSJ	70	760	S5 A08				70	760	S4 E08			
Diesel														
1.5/ 1.6 dCi [KP]	03.16→	SSJ	70	760	S5 A08				70	760	S4 E08			
Thalia														
1.0/ 1.2 i 16V [LB]	06.01-10.07					54	530	S5 002	52	470	S4 002			
1.2 i [LB]	06.01-10.07					54	530	S5 002	52	470	S4 002			
1.2/ 1.6 [LU]	10.08-06.14					63	610	S5 005	60	540	S4 005			
1.4 [LU]	10.08-06.14					63	610	S5 005	52	470	S4 002	45	400	S3 002
	01.09-06.14					52	520	S5 001	44	440	S4 001			
i [LB]	10.99-10.07					63	610	S5 005	52	470	S4 002	45	400	S3 002
i 16V [LB]	06.01-10.07					63	610	S5 005	52	470	S4 002	45	400	S3 002
	11.01-10.07					63	610	S5 005	52	470	S4 002			
16V [LU]	10.08-06.14					63	610	S5 005	52	470	S4 002	45	400	S3 002
1.6 i [LB]	10.99-10.07					63	610	S5 005	52	470	S4 002			
	06.01-10.07					63	610	S5 005	52	470	S4 002	45	400	S3 002
	01.04-10.07					54	530	S5 002	52	470	S4 002			
Diesel														
1.5 dCi [LB]	06.01-10.07					54	530	S5 002	52	470	S4 002			
dCi [LU]	10.08-06.14					74	750	S5 007	72	680	S4 007			
	01.09-06.14					63	610	S5 005	60	540	S4 005			
1.9 D [LB]	10.99-10.07		70	760	S5 A08	77	780	S5 008	60	540	S4 005			
Twingo I														
1.0 i [CO./SO.]	01.00-05.07					63	610	S5 005	60	540	S4 005			
i 16V [CO./SO.]	03.01-05.07					63	610	S5 005	60	540	S4 005			
1.2 i [CO./SO.]	01.96-05.07					52	520	S5 001	44	440	S4 001	45	400	S3 002
	05.98-05.07					54	530	S5 002	44	440	S4 001	41	360	S3 001
	09.98-05.07					52	520	S5 001	44	440	S4 001	41	360	S3 001
						54	530	S5 002	52	470	S4 002	45	400	S3 002
i 16V [CO./SO.]	09.00-05.07					54	530	S5 002	44	440	S4 001	41	360	S3 001
	10.03-05.07					54	530	S5 002	52	470	S4 002			
Twingo II														
1.2 , TCe, 16V [CN/GN]	04.07-12.15					54	530	S5 002	52	470	S4 002			
1.6 R.S. [CN/GN]	07.07-12.15					52	520	S5 001	44	440	S4 001	41	360	S3 001
Diesel														
1.5 dCi [CN/GN]	04.07-12.15					63	610	S5 005	60	540	S4 005			
	04.10-12.15					63	610	S5 005	60	540	S4 005	56	480	S3 005
Twingo III														
0.9 [BC]	09.14→	SSJ	60	680	S5 A05				60	640	S4 E05			
GT [BC]	11.16→	SSJ	60	680	S5 A05									
1.0 [BC]	09.14→					54	530	S5 002	52	470	S4 002			
		SSJ	60	680	S5 A05				60	640	S4 E05			



			Ah A (EN)	Ah A (EN)	Ah A (EN)	Ah A (EN)
			0 092 ...0	0 092 ...0	0 092 ...0	0 092 ...0

◀ RENAULT

Vel Satis											
2.0 [BJ]	04.02-12.06					85	800	S5 010	80	740	S4 010
						85	800	S5 010	80	740	S4 011
						85	800	S5 011	72	680	S4 007
						85	800	S5 011	80	740	S4 010
						85	800	S5 010	80	740	S4 010
						85	800	S5 011	80	740	S4 010
T [BJ]	07.05-12.09					85	800	S5 010	80	740	S4 010
						85	800	S5 010	80	740	S4 011
						85	800	S5 011	80	740	S4 010
3.5 V6 [BJ]	04.02-12.09					85	800	S5 011	72	680	S4 007
	06.05-12.09					85	800	S5 011	80	740	S4 010
									70	640	S3 007
Diesel											
2.0 DCI [BJ]	08.05-12.09					85	800	S5 011	80	740	S4 010
2.2 DCI [BJ]	04.02-12.09					85	800	S5 011	80	740	S4 010
						85	800	S5 011	80	740	S4 010
						85	800	S5 011	80	740	S4 011
						85	800	S5 011	80	740	S4 010
3.0 DCI V6 [BJ]	04.02-12.09					85	800	S5 011	80	740	S4 010
Wind											
1.2/ 1.6 [E4]	04.10-12.14					63	610	S5 005	60	540	S4 005
Zoe											
[BF]	01.13→					54	530	S5 002	52	470	S4 002
									45	400	S3 002
19											
1.2/ 1.4 , i [X53]	09.88-12.01					54	530	S5 002	52	470	S4 002
									45	400	S3 002
Diesel											
1.9 D, D Turbo [X53]	09.88-12.01	70	760	S5 A08		77	780	S5 008	74	680	S4 008
									70	640	S3 007

ROLLS-ROYCE

Corniche Cabriolet											
6.8 Turbo	01.00-12.02	ZE	70	760	S5 A08				70	630	S4 027
Dawn											
6.6 [RR6]	09.15→		95	850	S5 A13	100	830	S5 013			
Ghost											
6.6 , V-Specification [RR4]	12.09→		95	850	S5 A13	100	830	S5 013	95	800	S4 013
Park Ward											
5.4	03.00-12.02								70	630	S4 027
Phantom											
6.8	01.88-12.99								70	630	S4 027
[RR1]	03.03-12.16		95	850	S5 A13						
Phantom Coupé											
6.8 [RR3]	09.08-12.16		95	850	S5 A13						
Phantom Drophead											
6.8 [RR2]	06.07-12.16		95	850	S5 A13						
Silver Seraph											
5.4	03.98-12.02	ZE	70	760	S5 A08				70	630	S4 027
Silver Spirit											
6.8	03.94-05.98								70	630	S4 027
Silver Spur											
6.8 , Turbo	04.93-12.98								70	630	S4 027
Wraith											
6.6 [RR5]	08.13→		95	850	S5 A13	100	830	S5 013	95	800	S4 013

ROVER

City Rover											
1.4	09.03-05.05					63	610	S5 005	60	540	S4 005
Mini											
1.3 i	02.91-09.00								45	300	S3 016
Mini Cabrio											
1.3 i	02.91-09.00								45	300	S3 016
Mini Cooper											
1.3	10.96-09.00								45	300	S3 016



		Ah A (EN) S5A			Ah A (EN) S5			Ah A (EN) S4			Ah A (EN) S3		
		0 092 ...0	0 092 ...0	0 092 ...0	0 092 ...0	0 092 ...0	0 092 ...0	0 092 ...0	0 092 ...0	0 092 ...0	0 092 ...0	0 092 ...0	
Mini Cooper Cabrio													
1.3	02.91-09.00									45	300	S3 016	
Mini Margrave													
1.4 i	09.95-09.00									45	300	S3 016	
Serie 200													
211 i	11.95-03.00		52 520	S5 001	44	440	S4 001	41	360			S3 001	
214 i	10.95-03.00		54 530	S5 002	52	470	S4 002	45	400			S3 002	
216 16V	10.95-03.00		52 520	S5 001	44	440	S4 001	41	360			S3 001	
218 i 16V	09.95-03.00		63 610	S5 005	60	540	S4 005	53	500			S3 004	
			63 610	S5 005	60	540	S4 005	56	480			S3 005	
Diesel													
220 SD, SDI	09.95-03.00		61 600	S5 004	60	540	S4 004	53	500			S3 004	
Serie 200 Cabrio													
214/ 216 , i 16V	10.92-03.00		52 520	S5 001	44	440	S4 001	41	360			S3 001	
Serie 200 Coupé													
214 16V	10.95-03.00		52 520	S5 001	44	440	S4 001	41	360			S3 001	
216 i 16V	03.96-03.00		52 520	S5 001	44	440	S4 001	41	360			S3 001	
218 i 16V	03.96-03.00		63 610	S5 005	60	540	S4 005	56	480			S3 005	
Serie 400													
414	03.96-12.99		52 520	S5 001	44	440	S4 001	41	360			S3 001	
			61 600	S5 004	44	440	S4 001	41	360			S3 001	
			61 600	S5 004	44	440	S4 001	53	500			S3 004	
			61 600	S5 004	60	540	S4 004	41	360			S3 001	
414/ 416 i 16V, Si 16V	05.95-03.00		52 520	S5 001	44	440	S4 001	41	360			S3 001	
420 16V	10.95-03.00		63 610	S5 005	60	540	S4 005	53	500			S3 004	
			63 610	S5 005	60	540	S4 005	56	480			S3 005	
Diesel													
420 SD, SDI	10.95-03.00		61 600	S5 004	60	540	S4 004	53	500			S3 004	
Serie 400 Coupé													
418 GSi 16V	01.97-12.98		54 530	S5 002	52	470	S4 002	45	400			S3 002	
Serie 400 Tourer													
416 i 16V	02.96-03.00		52 520	S5 001	44	440	S4 001	41	360			S3 001	
418 i 16V	03.96-12.98		54 530	S5 002	52	470	S4 002	45	400			S3 002	
Diesel													
418 TD	02.96-03.00		61 600	S5 004	60	540	S4 004	53	500			S3 004	
Serie 600													
618/ 620/ 623 i 16V, i 16V Turbo	04.93-09.00		63 610	S5 005	60	540	S4 005	56	480			S3 005	
Diesel													
620 SDi	03.95-12.98		61 600	S5 004	60	540	S4 004						
Serie 800													
820/ 825 i, i Coupé, i 16V, i 16V Turbo	01.92-09.99		63 610	S5 005	60	540	S4 005	56	480			S3 005	
Diesel													
825 TD	10.91-12.98	70 760	S5 A08	77 780	S5 008	74 680	S4 008	70 640				S3 008	
Streetwise													
1.4/ 1.6/ 1.8	09.03-12.05		63 610	S5 005	60	540	S4 005						
Diesel													
2.0 TD	09.03-05.05	70 760	S5 A08	77 780	S5 008	74 680	S4 008						
25													
1.1 i	07.01-05.04		52 520	S5 001	44	440	S4 001	41	360			S3 001	
i 16V	02.03-05.05		52 520	S5 001	44	440	S4 001	41	360			S3 001	
1.4/ 1.6 i 16V	02.00-05.05		63 610	S5 005	44	440	S4 001	41	360			S3 001	
1.8 i 16V	02.00-10.04		77 780	S5 008	60	540	S4 004	53	500			S3 004	
Diesel													
2.0 iDT	02.00-05.05		77 780	S5 008	72 680	S4 007	70 640					S3 007	
	02.03-05.05		74 750	S5 007	72 680	S4 007							
45													
1.4/ 1.6 16V	02.00-05.05		54 530	S5 002	44	440	S4 001	41	360			S3 001	
1.8 16V	02.00-05.05		63 610	S5 005	60	540	S4 004	53	500			S3 004	
2.0 V6	02.00-05.05		63 610	S5 005	60	540	S4 004	53	500			S3 004	
Diesel													
2.0 iDT	02.00-05.05		77 780	S5 008	60	540	S4 004	53	500			S3 004	



			0 092 ...0			0 092 ...0			0 092 ...0			0 092 ...0		
			Ah	A (EN)	S5A	Ah	A (EN)	S5	Ah	A (EN)	S4	Ah	A (EN)	S3
◀ ROVER														
2.0 iDT	02.03-05.05		74	750	S5 007	72	680	S4 007						
75														
1.8 i T 16V	09.02-05.05		63	610	S5 005	60	540	S4 005						
i 16V	01.99-05.05		63	610	S5 005	60	540	S4 005	56	480	S3 005			
2.0/ 2.5 i 24V	01.99-05.05		77	780	S5 008	72	680	S4 007	70	640	S3 008			
4.6 i Power	10.03-05.05		74	750	S5 007	72	680	S4 007						
Diesel														
2.0 CDT, CDTi	01.99-05.05		77	780	S5 008	72	680	S4 007	70	640	S3 008			
75 Tourer														
1.8 i T 16V	09.02-05.05		63	610	S5 005	60	540	S4 005	56	480	S3 005			
i 16V	01.01-05.05		63	610	S5 005	60	540	S4 005						
2.0 i 24V	01.01-05.05		63	610	S5 005	60	540	S4 005						
2.5 i 24V	01.01-05.05		77	780	S5 008	72	680	S4 007	70	640	S3 008			
4.6 i Power	10.03-05.05		74	750	S5 007	72	680	S4 007						
Diesel														
2.0 CDT, CDTi	01.01-05.05		77	780	S5 008	72	680	S4 007	70	640	S3 008			
100 Metro														
1.1/ 1.4 i	09.90-12.98		54	530	S5 002	52	470	S4 002	45	400	S3 002			
1.4 i 16V	04.97-10.98		54	530	S5 002	52	470	S4 002	41	360	S3 001			
Diesel														
1.5 D	12.94-12.98		61	600	S5 004	60	540	S4 004	53	500	S3 004			
100 Metro Cabrio														
1.4 i	09.90-03.98		54	530	S5 002	52	470	S4 002	45	400	S3 002			
i 16V	04.97-10.98		54	530	S5 002	44	440	S4 001	41	360	S3 001			

SAAB (SAAB AUTOMOBILE AB)

9-3														
1.8 i [9440]	09.04-09.10		63	610	S5 005	60	540	S4 005						
T [9440]	09.02-02.11		63	610	S5 005	60	540	S4 005	56	480	S3 005			
T BioPower [9440]	05.09-02.11		63	610	S5 005	60	540	S4 005						
2.0 T [9440]	02.03-02.11		63	610	S5 005	60	540	S4 005	56	480	S3 005			
	05.09-06.12		63	610	S5 005	60	540	S4 005						
	09.10-06.12		77	780	S5 008	74	680	S4 008						
T BioPower [9440]	09.02-06.12		63	610	S5 005	60	540	S4 005						
	09.10-12.11		77	780	S5 008	74	680	S4 008						
T BioPower XWD [9440]	07.09-06.12		77	780	S5 008	74	680	S4 008						
T Sport [9440]	09.02-02.11		63	610	S5 005	60	540	S4 005	56	480	S3 005			
T XWD [9440]	09.08-06.12		63	610	S5 005	60	540	S4 005						
	09.10-12.11		77	780	S5 008	74	680	S4 008						
2.0/ 2.3 i 16V, i 16V Turbo [9400]	02.98-09.02		63	610	S5 005	60	540	S4 005	56	480	S3 005			
2.8 [9440]	04.05-06.12		77	780	S5 008	74	680	S4 008						
T [9440]	09.05-06.12		63	610	S5 005	60	540	S4 005	56	480	S3 005			
	04.08-06.12		63	610	S5 005	60	540	S4 005						
T XWD [9440]	05.08-06.12		63	610	S5 005	60	540	S4 005						
Diesel														
1.9 TiD [9440]	09.04-12.10	70	760	S5 A08	85	800	S5 010	74	680	S4 008				
TTiD [9440]	02.08-02.11	70	760	S5 A08	85	800	S5 010	74	680	S4 008				
	09.10-06.12		85	800	S5 010									
			85	800	S5 010	80	740	S4 010						
2.2 TiD [9440]	09.02-08.04	70	760	S5 A08	85	800	S5 010	74	680	S4 008	70	640	S3 008	
16V D Turbo [9400]	02.98-11.00	95	850	S5 A13	100	830	S5 013	95	800	S4 013	90	720	S3 013	
	11.00-09.02		100	830	S5 013	95	800	S4 013						
9-3 Cabriolet														
1.8 T [9440]	08.03-02.11		63	610	S5 005	60	540	S4 005	56	480	S3 005			
T BioPower [9440]	01.07-06.12		63	610	S5 005	60	540	S4 005						
2.0 T [9440]	08.03-02.11		63	610	S5 005	60	540	S4 005	56	480	S3 005			
	09.10-06.12		77	780	S5 008	74	680	S4 008						
T BioPower [9440]	06.07-06.12		63	610	S5 005	60	540	S4 005						
	09.10-06.12		77	780	S5 008	74	680	S4 008						



		Ah A (EN) S5A			Ah A (EN) S5			Ah A (EN) S4			Ah A (EN) S3		
		0 092 ...0			0 092 ...0			0 092 ...0			0 092 ...0		
2.0/ 2.3 i 16V, i 16V Turbo, T [9400]	02.98-08.03				63	610	S5 005	60	540	S4 005	56	480	S3 005
2.8 [9440]	04.05-06.12				77	780	S5 008	74	680	S4 008			
T [9440]	09.05-02.11				77	780	S5 008	74	680	S4 008			
	09.08-06.12				63	610	S5 005	60	540	S4 005			
Diesel													
1.9 TiD [9440]	01.06-09.10				74	750	S5 007	72	680	S4 007			
TTiD [9440]	02.08-02.11				74	750	S5 007	72	680	S4 007			
	09.10-06.12				85	800	S5 010						
9-3 Coupé													
2.0/ 2.3 i 16V, i 16V Turbo [9400]	02.98-08.03				63	610	S5 005	60	540	S4 005	56	480	S3 005
Diesel													
2.2 16V D Turbo [9400]	11.00-09.02	95	850	S5 A13	100	830	S5 013	95	800	S4 013	90	720	S3 013
9-3 Kombi													
1.8 i [9440]	03.05-12.09				63	610	S5 005	60	540	S4 005	56	480	S3 005
T [9440]	03.05-06.12				63	610	S5 005	60	540	S4 005			
T BioPower [9440]	01.07-06.12				63	610	S5 005	60	540	S4 005			
2.0 T [9440]	03.05-06.12				63	610	S5 005	60	540	S4 005	56	480	S3 005
	02.09-06.12				63	610	S5 005	60	540	S4 005			
	09.10-06.12				77	780	S5 008	74	680	S4 008			
T BioPower [9440]	06.07-06.12				63	610	S5 005	60	540	S4 005			
	09.10-06.12				77	780	S5 008	74	680	S4 008			
T BioPower XWD [9440]	07.07-06.12				77	780	S5 008	74	680	S4 008			
T XWD [9440]	09.08-06.12				63	610	S5 005	60	540	S4 005			
	09.10-06.12				77	780	S5 008	74	680	S4 008			
2.8 T [9440]	03.05-06.12				63	610	S5 005	60	540	S4 005	56	480	S3 005
	03.08-06.12				63	610	S5 005	60	540	S4 005			
					77	780	S5 008	74	680	S4 008			
T XWD [9440]	01.08-06.12				63	610	S5 005	60	540	S4 005			
Diesel													
1.9 TiD [9440]	03.05-09.10	70	760	S5 A08	85	800	S5 010	74	680	S4 008	70	640	S3 008
TTiD [9440]	02.08-02.11	70	760	S5 A08	85	800	S5 010	74	680	S4 008			
	09.10-06.12				85	800	S5 010	70	650	S4 E10			
9-3X													
2.0 T BioPower XWD [9440]	03.10-06.12				63	610	S5 005	60	540	S4 005			
	03.11-06.12				77	780	S5 008	74	680	S4 008			
T XWD [9440]	03.10-06.12				63	610	S5 005	60	540	S4 005			
	09.10-06.12				77	780	S5 008	74	680	S4 008			
Diesel													
1.9 TTiD [9440]	03.10-06.12	70	760	S5 A08	85	800	S5 010	74	680	S4 008			
9-5													
1.6 T [650]	03.10-06.12	70	760	S5 A08	77	780	S5 008	74	680	S4 008			
2.0 BioPower, BioPower XWD [650]	03.10-06.12	70	760	S5 A08	77	780	S5 008	74	680	S4 008			
T [650]	03.10-06.12	70	760	S5 A08	77	780	S5 008						
T BioPower [9600]	01.05-02.10	70	760	S5 A08	77	780	S5 008	74	680	S4 008			
	09.05-02.10	70	760	S5 A08	77	780	S5 008	74	680	S4 008	70	640	S3 008
Turbo [9600]	06.97-02.10	70	760	S5 A08	77	780	S5 008	74	680	S4 008	70	640	S3 008
2.0/ 2.3 [9600]	09.99-02.10	70	760	S5 A08	77	780	S5 008	74	680	S4 008	70	640	S3 008
2.0/ 2.8 T XWD [650]	03.10-06.12	70	760	S5 A08	77	780	S5 008						
2.3 Turbo [9600]	06.97-08.00	70	760	S5 A08	77	780	S5 008	74	680	S4 008	70	640	S3 008
	05.99-02.10	70	760	S5 A08	77	780	S5 008	74	680	S4 008			
	09.01-02.10	70	760	S5 A08	77	780	S5 008	74	680	S4 008	70	640	S3 008
Turbo BioPower [9600]	11.06-02.10	70	760	S5 A08	77	780	S5 008	74	680	S4 008			
3.0 Turbo [9600]	06.97-08.03	70	760	S5 A08	77	780	S5 008	74	680	S4 008	70	640	S3 008
Diesel													
1.9/ 2.2 TiD [9600]	03.02-02.10	70	760	S5 A08	77	780	S5 008	74	680	S4 008	70	640	S3 008
2.0 TiD4 [650]	03.10-06.12				85	800	S5 010						
TTiD4, TTiD4 XWD [650]	03.10-06.12				85	800	S5 010	70	650	S4 E10			
3.0 TiD [9600]	09.01-08.05	70	760	S5 A08	77	780	S5 008	74	680	S4 008			
9-5 Kombi													
2.0 T [9600]	07.00-07.01	70	760	S5 A08	77	780	S5 008	74	680	S4 008	70	640	S3 008



											Ah A (EN)			Ah A (EN)			Ah A (EN)			Ah A (EN)		
		0 092 ...0			0 092 ...0			0 092 ...0			0 092 ...0											
◀ SAAB																						
2.0 T BioPower [9600]	01.06-02.10	70	760	S5 A08	77	780	S5 008	74	680	S4 008	70	640	S3 008									
Turbo [9600]	06.98-02.10	70	760	S5 A08	77	780	S5 008	74	680	S4 008	70	640	S3 008									
2.3 Turbo [9600]	05.99-02.10	70	760	S5 A08	77	780	S5 008	74	680	S4 008	70	640	S3 008									
	04.08-02.10	70	760	S5 A08	77	780	S5 008	74	680	S4 008												
Turbo BioPower [9600]	11.06-02.10	70	760	S5 A08	77	780	S5 008	74	680	S4 008												
3.0 Turbo [9600]	06.97-08.03	70	760	S5 A08	77	780	S5 008	74	680	S4 008	70	640	S3 008									
Diesel																						
1.9 TiD [9600]	01.06-02.10	70	760	S5 A08	85	800	S5 010	74	680	S4 008	70	640	S3 008									
	01.07-02.10	70	760	S5 A08	85	800	S5 010	74	680	S4 008												
2.2/ 3.0 TiD [9600]	07.01-08.05	70	760	S5 A08	77	780	S5 008	74	680	S4 008	70	640	S3 008									
9-7X																						
4.2/ 5.3 4x4	09.04-08.09	70	760	S5 A08	77	780	S5 008															
900 I Cabriolet																						
2.3 i	09.93-08.98				63	610	S5 005	60	540	S4 005	56	480	S3 005									
900 II																						
2.0 i Turbo	09.93-08.98	70	760	S5 A08	77	780	S5 008	60	540	S4 005	56	480	S3 005									
2.0/ 2.3 i	09.93-08.98	70	760	S5 A08	77	780	S5 008	60	540	S4 005	56	480	S3 005									
2.5 i	09.93-10.98	70	760	S5 A08	77	780	S5 008	74	680	S4 008	70	640	S3 008									
900 II Cabriolet																						
2.0 i	03.94-08.98	70	760	S5 A08	63	610	S5 005	60	540	S4 005	56	480	S3 005									
	09.94-08.98	70	760	S5 A08	77	780	S5 008	60	540	S4 005	56	480	S3 005									
i Turbo	03.94-08.98	70	760	S5 A08	77	780	S5 008	60	540	S4 005	56	480	S3 005									
2.3 i	03.94-08.98	70	760	S5 A08	77	780	S5 008	60	540	S4 005	56	480	S3 005									
2.5 i	03.94-10.98	70	760	S5 A08	77	780	S5 008	74	680	S4 008	70	640	S3 008									
900 II Coupé																						
2.0 i Turbo	03.94-08.98	70	760	S5 A08	77	780	S5 008	60	540	S4 005	56	480	S3 005									
2.0/ 2.3 i	03.94-08.98	70	760	S5 A08	77	780	S5 008	60	540	S4 005	56	480	S3 005									
2.5 i	03.94-10.98	70	760	S5 A08	77	780	S5 008	74	680	S4 008	70	640	S3 008									
9000																						
2.0 CD Turbo 16V	09.92-12.98				63	610	S5 005	60	540	S4 005	56	480	S3 005									
CS	09.93-12.98				63	610	S5 005	60	540	S4 005	56	480	S3 005									
CS Turbo	09.94-12.98				63	610	S5 005	60	540	S4 005	56	480	S3 005									
2.3 CS Aero Turbo, CS Turbo Ecopower, CS 16V, CSE Turbo	09.92-12.98	70	760	S5 A08	77	780	S5 008	74	680	S4 008	70	640	S3 008									
2.3/ 3.0 CD, CD Turbo Ecopower, CD 16V, CDE Turbo, CDE Turbo Ecopower	09.92-12.98	70	760	S5 A08	77	780	S5 008	74	680	S4 008	70	640	S3 008									
3.0 CS	09.94-12.98	70	760	S5 A08	77	780	S5 008	74	680	S4 008	70	640	S3 008									
9000 Griffin																						
3.0	09.94-12.98	70	760	S5 A08	77	780	S5 008	74	680	S4 008	70	640	S3 008									



SANTANA

Land Rover													
Diesel													
2.8 TD PS-10, TD PS-10 4x4	03.03→	70	760	S5 A08	77	780	S5 008	74	680	S4 008			
Land Rover PS-10													
Diesel													
2.8 TD 4x4	03.03→	70	760	S5 A08	77	780	S5 008	74	680	S4 008			

SEAT

Alhambra													
1.4 TSI [710]	05.10-12.12	BWD	70	760	S5 A08	54	530	S5 002	52	470	S4 002		
	06.11-07.15		70	760	S5 A08	54	530	S5 002	52	470	S4 002		
TSI [711]	05.15→	BWD,SSJ	70	760	S5 A08				70	760	S4 E08		
1.8 T [7V8]	05.98-02.00	VAD	70	760	S5 A08	77	780	S5 008	60	540	S4 005	56	480
T [7V9]	06.00-03.10		70	760	S5 A08	77	780	S5 008	60	540	S4 005	56	480

			Ah A (EN) S5A			Ah A (EN) S5			Ah A (EN) S4			Ah A (EN) S3		
			0 092 ...0			0 092 ...0			0 092 ...0			0 092 ...0		
1.8 TSI [710]	11.12-07.15		60	680	S5 A05	63	610	S5 005	60	540	S4 005			
			60	680	S5 A05	63	610	S5 005	60	640	S4 E05			
2.0 [7V8]	03.96-02.00	VAD				77	780	S5 008	60	540	S4 005	56	480	S3 005
[7V9]	06.00-03.10		70	760	S5 A08	77	780	S5 008	60	540	S4 005	56	480	S3 005
TFSI [711]	05.15→	BWD,SSJ	70	760	S5 A08				70	760	S4 E08			
		SSJ							80	800	S4 E11			
TSI [710]	12.10-07.15	BWD,SSJ, VAD	70	760	S5 A08				70	760	S4 E08			
			80	800	S5 A11				70	760	S4 E08			
		VAD				63	610	S5 005	60	540	S4 005			
2.8 [7V9]	06.00-03.10		70	760	S5 A08	77	780	S5 008	74	680	S4 008	70	640	S3 008
4Motion [7V9]	06.00-03.10		70	760	S5 A08	77	780	S5 008	74	680	S4 008	70	640	S3 008
Diesel														
1.9 TDI [7V8]	07.96-02.00	VAD				100	830	S5 013	95	800	S4 013	90	720	S3 013
	05.97-02.00	VAD				100	830	S5 013	74	680	S4 008	90	720	S3 013
TDI [7V9]	06.00-03.10		70	760	S5 A08	100	830	S5 013	74	680	S4 008	70	640	S3 008
			95	850	S5 A13	85	800	S5 011	74	680	S4 008	70	640	S3 008
	11.02-11.08		95	850	S5 A13	85	800	S5 011	74	680	S4 008			
TDI 4Motion [7V9]	06.00-03.10		95	850	S5 A13	85	800	S5 011	80	740	S4 010	70	640	S3 008
	06.05-11.08		95	850	S5 A13	85	800	S5 011	80	740	S4 010			
	06.05-03.10					85	800	S5 011	80	740	S4 011			
2.0 TDI [7V9]	11.05-03.10		95	850	S5 A13	85	800	S5 011	80	740	S4 010			
TDI [710]	05.10-07.15					77	780	S5 008	74	680	S4 008			
		BWD,SSJ	70	760	S5 A08									
	05.11-07.15	BWD,SSJ	80	800	S5 A11									
TDI [711]	05.15-10.15					77	780	S5 008	74	680	S4 008			
		BWD,SSJ	70	760	S5 A08									
	05.15→		70	760	S5 A08									
		BWD,SSJ							70	760	S4 E08			
		SSJ							80	800	S4 E11			
TDI 4Drive [710]	05.11-07.15	BWD				77	780	S5 008	74	680	S4 008			
		BWD,SSJ	70	760	S5 A08									
			80	800	S5 A11									
TDI 4Drive [711]	05.15-10.15		70	760	S5 A08									
		BWD,SSJ							70	760	S4 E08			
		SSJ							80	800	S4 E11			
	06.16→		70	760	S5 A08									
		BWD,SSJ							70	760	S4 E08			
		SSJ							80	800	S4 E11			
Altea														
1.2 TSI [5P1]	05.10-07.15	BWD				77	780	S5 008	60	540	S4 005	45	400	S3 002
		BWD,SSJ	70	760	S5 A08									
1.4 [5P1]	05.06-05.10					54	530	S5 002	52	470	S4 002	45	400	S3 002
	05.10-05.13					54	530	S5 002	52	470	S4 002			
TSI [5P1]	11.07-07.15					54	530	S5 002	52	470	S4 002			
		BWD,SSJ	70	760	S5 A08									
1.6 [5P1]	03.04-05.13		70	760	S5 A08	77	780	S5 008	52	470	S4 002	45	400	S3 002
	09.09-07.15					63	610	S5 005	60	540	S4 005			
MultiFuel [5P1]	12.07-11.10					54	530	S5 002	52	470	S4 002			
1.8 TSI [5P1]	01.07-06.07					63	610	S5 005	60	540	S4 005	56	480	S3 005
	06.07-07.15		70	760	S5 A08	77	780	S5 008	60	540	S4 005	56	480	S3 005
2.0 FSI [5P1]	05.04-03.09		70	760	S5 A08	77	780	S5 008	74	680	S4 008	70	640	S3 008
TFSI [5P1]	05.06-03.09		70	760	S5 A08	77	780	S5 008	60	540	S4 005	56	480	S3 005
Diesel														
1.6 TDI [5P1]	10.09-07.15					77	780	S5 008	60	540	S4 005			
		BWD,SSJ	70	760	S5 A08									
		SSJ	70	760	S5 A08									
	05.10-07.15					77	780	S5 008	74	680	S4 008			
1.9 TDI [5P1]	04.04-12.10		70	760	S5 A08	77	780	S5 008	74	680	S4 008	70	640	S3 008
	08.09-12.10					77	780	S5 008	74	680	S4 008			
2.0 TDI [5P1]	03.04-07.15					77	780	S5 008	60	540	S4 005	70	640	S3 008
		BWD,SSJ	70	760	S5 A08									
		SSJ	70	760	S5 A08									



				Ah	A (EN)		Ah	A (EN)		Ah	A (EN)		Ah	A (EN)	
				0 092 ...0			0 092 ...0			0 092 ...0			0 092 ...0		
◀ SEAT															
2.0 TDI [5P1]	04.04-11.10			70	760	S5 A08	77	780	S5 008	74	680	S4 008	70	640	S3 008
	11.05-03.09						77	780	S5 008	60	540	S4 005	56	480	S3 005
	03.09-05.10	BWD		70	760	S5 A08	77	780	S5 008	60	540	S4 005			
Altea Freetrack															
1.4 TSI [5P5/5P8]	05.10-07.15						63	610	S5 005	52	470	S4 002	45	400	S3 002
		BWD,SSJ		70	760	S5 A08									
2.0 TFSI [5P5/5P8]	07.09-07.15						63	610	S5 005	60	540	S4 005			
TFSI 4WD [5P5/5P8]	06.07-06.09			70	760	S5 A08	77	780	S5 008	60	540	S4 005	56	480	S3 005
	07.09-07.15						63	610	S5 005	60	540	S4 005			
Diesel															
1.6 TDI [5P5/5P8]	05.10-05.13			70	760	S5 A08	77	780	S5 008	74	680	S4 008	70	640	S3 008
2.0 TDI [5P5/5P8]	06.07-10.10			70	760	S5 A08	77	780	S5 008	60	540	S4 005	56	480	S3 005
TDI 4WD [5P5/5P8]	06.07-06.09						77	780	S5 008	60	540	S4 005	56	480	S3 005
	06.07-05.13	BWD,SSJ		70	760	S5 A08									
	02.08-07.15			70	760	S5 A08	77	780	S5 008	74	680	S4 008	70	640	S3 008
	03.09-10.10	BWD		70	760	S5 A08	77	780	S5 008	60	540	S4 005			
	09.10-05.13			70	760	S5 A08	77	780	S5 008	60	540	S4 005	56	480	S3 005
Altea XL															
1.2 TSI [5P5]	04.10-07.15	BWD					77	780	S5 008	60	540	S4 005	45	400	S3 002
		BWD,SSJ		70	760	S5 A08									
1.4 [5P5]	10.06-05.10						54	530	S5 002	52	470	S4 002	45	400	S3 002
	05.10-05.13						54	530	S5 002	52	470	S4 002			
TSI [5P5]	11.07-07.15						54	530	S5 002	52	470	S4 002			
		BWD,SSJ		70	760	S5 A08									
1.6 [5P5]	10.06-05.13						63	610	S5 005	52	470	S4 002	45	400	S3 002
	09.09-07.15						63	610	S5 005	60	540	S4 005			
MultiFuel [5P5]	12.07-11.10			70	760	S5 A08	77	780	S5 008	52	470	S4 002	45	400	S3 002
1.8 TSI [5P5]	01.07-06.07						63	610	S5 005	60	540	S4 005	56	480	S3 005
	06.07-03.09						54	530	S5 002	52	470	S4 002			
	03.09-07.15						63	610	S5 005	60	540	S4 005			
2.0 FSI [5P5]	10.06-03.09						63	610	S5 005	60	540	S4 005	56	480	S3 005
TFSI [5P5]	10.06-03.09			70	760	S5 A08	77	780	S5 008	74	680	S4 008			
Diesel															
1.6 TDI [5P5]	10.09-07.15			70	760	S5 A08	77	780	S5 008	74	680	S4 008	70	640	S3 008
	05.10-07.15						77	780	S5 008	74	680	S4 008			
1.9 TDI [5P5]	10.06-12.10			70	760	S5 A08	77	780	S5 008	60	540	S4 005	56	480	S3 005
	08.09-12.10						77	780	S5 008	74	680	S4 008			
2.0 TDI [5P5]	05.06-07.15						77	780	S5 008	60	540	S4 005			
		BWD,SSJ		70	760	S5 A08									
		SSJ		70	760	S5 A08									
	10.06-03.09			70	760	S5 A08	77	780	S5 008	74	680	S4 008	70	640	S3 008
	10.06-11.10			70	760	S5 A08	77	780	S5 008	60	540	S4 005	56	480	S3 005
	03.09-05.10	BWD		70	760	S5 A08	77	780	S5 008	60	540	S4 005			
TDI 4WD [5P5]	10.10-07.15						77	780	S5 008	60	540	S4 005	70	640	S3 008
							77	780	S5 008	74	680	S4 008	70	640	S3 008
		BWD,SSJ		70	760	S5 A08									
		SSJ		70	760	S5 A08									
Arosa															
1.0 [6H1]	02.97-06.04												40	340	S3 000
	10.97-02.00									44	440	S4 001	41	360	S3 001
1.4 [6H1]	05.97-06.04						54	530	S5 002	52	470	S4 002	45	400	S3 002
16V [6H1]	01.99-06.04						63	610	S5 005	60	540	S4 005	56	480	S3 005
Diesel															
1.4 TDI [6H1]	01.98-06.04						63	610	S5 005	60	540	S4 005	56	480	S3 005
1.7 SDI [6H1]	08.97-10.03	VAD					63	610	S5 005	60	540	S4 005	56	480	S3 005
Ateca															
1.0 TSI [KH7]	05.16->			70	760	S5 A08									
		BWD,SSJ								60	640	S4 E05			
		SSJ								70	760	S4 E08			
1.4 TSI [KH7]	06.16->			70	760	S5 A08									
		BWD,SSJ								70	760	S4 E08			
TSI 4Drive [KH7]	06.16->			70	760	S5 A08									
		BWD,SSJ								70	760	S4 E08			



						Ah A (EN) S5A		Ah A (EN) S5		Ah A (EN) S4		Ah A (EN) S3		
				0 092 ...0		0 092 ...0		0 092 ...0		0 092 ...0		0 092 ...0		
Diesel														
1.6 TDI [KH7]	04.16-06.18		70	760	S5 A08									
		BWD,SSJ						70	760	S4 E08				
2.0 TDI [KH7]	04.16→		70	760	S5 A08									
		BWD,SSJ						70	760	S4 E08				
TDI 4Drive [KH7]	04.16→		70	760	S5 A08									
		BWD,SSJ						70	760	S4 E08				
Cordoba														
1.0 [6K2]	09.96-06.99	VAD				52	520	S5 001	44	440	S4 001	41	360	S3 001
	05.99-12.02					54	530	S5 002	52	470	S4 002	45	400	S3 002
1.2 [6L2]	10.02-04.04					54	530	S5 002	52	470	S4 002			
	11.04-06.06					54	530	S5 002	52	470	S4 002			
	05.06-11.09					54	530	S5 002	52	470	S4 002	45	400	S3 002
1.4 [6K2]	07.96-12.02	VAD				61	600	S5 004	60	540	S4 004	53	500	S3 004
	12.97-06.99	VAD				52	520	S5 001	44	440	S4 001	41	360	S3 001
	05.99-12.02					54	530	S5 002	52	470	S4 002	45	400	S3 002
[6L2]	09.02-11.06					63	610	S5 005	60	540	S4 005			
	05.04-11.09					63	610	S5 005	60	540	S4 005	56	480	S3 005
1.6 [6K2]	05.94-06.99	VAD				61	600	S5 004	60	540	S4 004	53	500	S3 004
	03.97-12.02					52	520	S5 001	44	440	S4 001	41	360	S3 001
	05.99-12.02					54	530	S5 002	52	470	S4 002	45	400	S3 002
						63	610	S5 005	52	470	S4 002	45	400	S3 002
[6L2]	04.03-11.09					63	610	S5 005	60	540	S4 005	56	480	S3 005
1.8 [6K2]	07.94-12.02	VAD				61	600	S5 004	60	540	S4 004	53	500	S3 004
T Cupra [6K2]	12.99-12.02					63	610	S5 005	60	540	S4 005	56	480	S3 005
2.0 [6K2]	04.96-12.02	VAD				61	600	S5 004	60	540	S4 004	53	500	S3 004
[6L2]	09.02-04.05		70	760	S5 A08	63	610	S5 005	60	540	S4 005			
	04.03-11.09					63	610	S5 005	60	540	S4 005	56	480	S3 005
Diesel														
1.4 TDI [6L2]	10.02-12.05		70	760	S5 A08	77	780	S5 008	74	680	S4 008			
	05.05-11.09		70	760	S5 A08	77	780	S5 008	74	680	S4 008	70	640	S3 008
	06.06-11.09		70	760	S5 A08	77	780	S5 008	74	680	S4 008			
1.9 D [6K2]	09.93-06.99	VAD				74	750	S5 007	72	680	S4 007	70	640	S3 007
	07.99-12.02					74	750	S5 007	72	680	S4 007	70	640	S3 007
SDI [6K2]	12.95-06.99	VAD				74	750	S5 007	72	680	S4 007	70	640	S3 007
	05.99-08.02	VAD	70	760	S5 A08	77	780	S5 008	74	680	S4 008	70	640	S3 008
	06.99-08.02		70	760	S5 A08	77	780	S5 008	74	680	S4 008	70	640	S3 008
SDI [6L2]	09.02-12.05		70	760	S5 A08	77	780	S5 008	74	680	S4 008			
TDI [6K2]	07.96-06.99	VAD				74	750	S5 007	72	680	S4 007	70	640	S3 007
	05.99-12.02		70	760	S5 A08	77	780	S5 008	74	680	S4 008	70	640	S3 008
TDI [6L2]	09.02-11.09		70	760	S5 A08	77	780	S5 008	74	680	S4 008	70	640	S3 008
	10.02-09.05		70	760	S5 A08	77	780	S5 008	74	680	S4 008			
Cordoba Vario														
1.4 [6K5]	09.97-06.99	VAD				52	520	S5 001	44	440	S4 001	41	360	S3 001
	05.99-12.02					54	530	S5 002	52	470	S4 002	45	400	S3 002
	06.00-08.03					54	530	S5 002	52	470	S4 002			
1.6 [6K5]	04.97-06.99					52	520	S5 001	44	440	S4 001	41	360	S3 001
	09.97-12.02					54	530	S5 002	52	470	S4 002	45	400	S3 002
1.8 [6K5]	07.96-06.99	VAD				52	520	S5 001	44	440	S4 001	41	360	S3 001
Diesel														
1.9 SDI [6K5]	06.97-06.99	VAD				74	750	S5 007	72	680	S4 007	70	640	S3 007
	06.99-08.02		70	760	S5 A08	77	780	S5 008	74	680	S4 008	70	640	S3 008
TDI [6K5]	06.97-06.99	VAD				74	750	S5 007	72	680	S4 007	70	640	S3 007
	05.99-08.02		70	760	S5 A08	77	780	S5 008	74	680	S4 008	70	640	S3 008
Exeo														
1.6 [3R2]	03.09-09.10					63	610	S5 005	60	540	S4 005			
		BWD,SSJ	70	760	S5 A08									
1.8 [3R2]	12.08-05.10		70	760	S5 A08	77	780	S5 008	74	680	S4 008	70	640	S3 008
TSI [3R2]	05.10-08.13					77	780	S5 008	74	680	S4 008			
		BWD,SSJ	70	760	S5 A08									
2.0 TFSI [3R2]	03.09-08.13		70	760	S5 A08	77	780	S5 008	74	680	S4 008	70	640	S3 008
TSI [3R2]	05.10-08.13					77	780	S5 008	74	680	S4 008			
		BWD,SSJ	70	760	S5 A08									

						Ah A (EN) S5A		Ah A (EN) S5		Ah A (EN) S4		Ah A (EN) S3			
				0 092 ...0		0 092 ...0		0 092 ...0		0 092 ...0		0 092 ...0			
◀ SEAT															
Diesel															
2.0 TDI [3R2]	12.08-08.13		70	760	S5 A08	77	780	S5 008	74	680	S4 008	70	640	S3 008	
	02.09-12.11					77	780	S5 008	74	680	S4 008				
		BWD,SSJ	70	760	S5 A08										
Exeo ST															
1.6/ 1.8 [3R5]	06.09-09.10		70	760	S5 A08	77	780	S5 008	74	680	S4 008	70	640	S3 008	
1.8 TSI [3R5]	05.10-08.13					77	780	S5 008	74	680	S4 008				
		BWD,SSJ	70	760	S5 A08										
2.0 TSI [3R5]	06.09-08.13		70	760	S5 A08	77	780	S5 008	74	680	S4 008	70	640	S3 008	
	05.10-08.13					77	780	S5 008	74	680	S4 008				
		BWD,SSJ	70	760	S5 A08										
Diesel															
2.0 TDI [3R5]	06.09-08.13		70	760	S5 A08	77	780	S5 008	74	680	S4 008	70	640	S3 008	
Ibiza															
1.0 [6K1]	09.96-10.99								44	420	S4 000	40	340	S3 000	
	05.99-05.02					52	520	S5 001				40	340	S3 000	
	10.99-05.02	JEA				61	600	S5 004							
	05.00-05.02	JEA				63	610	S5 005	44	440	S4 001	41	360	S3 001	
MPI [6P1]	05.15-05.17								60	640	S4 E05				
TSI [6P1]	05.15-05.17								60	640	S4 E05				
1.2 [6J5]	03.08-05.11	BWD,SSJ	60	680	S5 A05										
			70	760	S5 A08										
	03.08-05.15					54	530	S5 002	52	470	S4 002				
	06.09-05.15					54	530	S5 002	52	470	S4 002	45	400	S3 002	
						54	530	S5 002	60	640	S4 E05	45	400	S3 002	
	07.09-05.15					54	530	S5 002	60	640	S4 E05				
	[6L1]	11.01-06.06	JEA			63	610	S5 005	44	440	S4 001	41	360	S3 001	
		05.06-11.09				63	610	S5 005	52	470	S4 002	45	400	S3 002	
		06.07-05.08				63	610	S5 005	52	470	S4 002				
	TSI [6J5]	09.10-05.15				61	600	S5 004	60	540	S4 004				
					61	600	S5 004	60	640	S4 E05					
		BWD,SSJ	60	680	S5 A05										
	08.12-05.15					54	530	S5 002	52	470	S4 002				
		BWD,SSJ							60	640	S4 E05				
TSI [6P1]	05.15-05.17								60	640	S4 E05				
	09.15-05.17	BWD,SSJ	60	680	S5 A05				60	640	S4 E05				
1.4 [6J5]	03.08-05.11					54	530	S5 002	52	470	S4 002				
			BWD,SSJ	60	680	S5 A05				60	640	S4 E05			
				70	760	S5 A08				60	640	S4 E05			
	04.10-05.15					63	610	S5 005	60	540	S4 005	56	480	S3 005	
						63	610	S5 005	60	640	S4 E05	56	480	S3 005	
	[6K1]	05.97-06.99	JEA			63	610	S5 005	60	540	S4 005	56	480	S3 005	
		12.97-05.02	JEA			63	610	S5 005	44	440	S4 001	41	360	S3 001	
		01.98-05.98	JEA			61	600	S5 004	52	470	S4 002	45	400	S3 002	
	[6L1]	09.01-11.09	JEA			63	610	S5 005	60	540	S4 005	56	480	S3 005	
		01.02-12.07				63	610	S5 005	52	470	S4 002	45	400	S3 002	
	05.06-11.09				63	610	S5 005	60	540	S4 005	56	480	S3 005		
TSI [6J5]	03.09-05.15					54	530	S5 002	52	470	S4 002	45	400	S3 002	
						54	530	S5 002	60	640	S4 E05	45	400	S3 002	
	10.13-05.15					63	610	S5 005	74	680	S4 008	40	340	S3 000	
		BWD,SSJ							60	640	S4 E05				
TSI [6P1]	11.15-05.17	BWD,SSJ	70	760	S5 A08										
1.6 [6J5]	05.08-05.15					54	530	S5 002	52	470	S4 002	45	400	S3 002	
						54	530	S5 002	60	640	S4 E05	45	400	S3 002	
	[6K1]	05.94-10.99	JEA			63	610	S5 005	52	470	S4 002	45	400	S3 002	
		03.97-05.02	JEA			63	610	S5 005	44	440	S4 001	41	360	S3 001	
		05.99-05.02	JEA			63	610	S5 005	60	540	S4 005	56	480	S3 005	
		07.00-05.02				63	610	S5 005	60	540	S4 005	56	480	S3 005	
	GLP [6J5]	05.11-05.15				63	610	S5 005	60	540	S4 005				
			BWD,SSJ	60	680	S5 A05				60	640	S4 E05			
				70	760	S5 A08				60	640	S4 E05			
	1.6/ 2.0 [6L1]	07.02-11.09				63	610	S5 005	60	540	S4 005	56	480	S3 005	
1.8 T [6L1]	12.03-11.09				63	610	S5 005	60	540	S4 005	56	480	S3 005		



			Ah A (EN) S5A			Ah A (EN) S5			Ah A (EN) S4			Ah A (EN) S3		
			0 092 ...0			0 092 ...0			0 092 ...0			0 092 ...0		
1.8/ 2.0 [6K1]	07.94-10.99	JEA				63	610	S5 005	52	470	S4 002	45	400	S3 002
Diesel														
1.2 TDI [6J5]	06.10-05.15					77	780	S5 008	60	540	S4 005			
						77	780	S5 008	60	640	S4 E05			
		BWD,SSJ	60	680	S5 A05									
1.4 TDI [6J5]	08.08-06.10		70	760	S5 A08	77	780	S5 008	74	680	S4 008	70	640	S3 008
TDI [6L1]	05.02-11.09		70	760	S5 A08	77	780	S5 008	74	680	S4 008	70	640	S3 008
TDI [6P1]	05.15-05.17								60	640	S4 E05			
1.6 TDI [6J5]	05.09-05.15		70	760	S5 A08	77	780	S5 008	60	640	S4 E05	70	640	S3 008
			70	760	S5 A08	77	780	S5 008	74	680	S4 008	70	640	S3 008
1.9 D [6K1]	03.93-10.99	JEA				63	610	S5 006	60	540	S4 006	56	480	S3 006
SDI [6K1]	12.95-10.99					63	610	S5 006	60	540	S4 006	56	480	S3 006
	05.99-05.02		70	760	S5 A08	77	780	S5 008	74	680	S4 008	70	640	S3 008
SDI [6L1]	01.02-12.05		70	760	S5 A08	77	780	S5 008	74	680	S4 008	70	640	S3 008
TDI [6J5]	02.08-06.10		70	760	S5 A08	77	780	S5 008	74	680	S4 008	70	640	S3 008
TDI [6K1]	12.96-06.99	VAD				63	610	S5 006	60	540	S4 006	56	480	S3 006
	03.97-06.99	VAD				77	780	S5 008	60	540	S4 006	56	480	S3 006
	05.99-05.02		70	760	S5 A08	77	780	S5 008	74	680	S4 008	70	640	S3 008
TDI [6L1]	09.01-11.09		70	760	S5 A08	77	780	S5 008	74	680	S4 008	70	640	S3 008
	05.05-11.09		70	760	S5 A08	77	780	S5 008	74	680	S4 008			
2.0 TDI [6J5]	01.10-05.15		70	760	S5 A08	77	780	S5 008	60	640	S4 E05	70	640	S3 008
			70	760	S5 A08	77	780	S5 008	74	680	S4 008	70	640	S3 008
Ibiza Cupra														
1.4 TSI [6J1]	03.09-05.15					54	530	S5 002	52	470	S4 002	45	400	S3 002
						54	530	S5 002	60	640	S4 E05	45	400	S3 002
1.8 T [6K1]	12.99-10.00	JEA				63	610	S5 005	60	540	S4 005	56	480	S3 005
	09.00-05.02	JEA				63	610	S5 005	60	540	S4 005			
Ibiza Cupra R														
1.8 T [6L1]	05.04-02.08					63	610	S5 005	60	540	S4 005	56	480	S3 005
	04.05-02.08					63	610	S5 005	60	540	S4 005			
Diesel														
1.9 TDI [6L1]	03.04-11.05		70	760	S5 A08	77	780	S5 008	74	680	S4 008	70	640	S3 008
	11.05-02.08		70	760	S5 A08	77	780	S5 008	74	680	S4 008			
Ibiza SC														
1.0 TSI [6P5]	05.15-05.17		70	760	S5 A08				52	470	S4 002			
			70	760	S5 A08				60	640	S4 E05			
1.2 [6J1]	07.08-05.11					54	530	S5 002	52	470	S4 002			
		BWD,SSJ	60	680	S5 A05									
			70	760	S5 A08									
	06.09-05.15					54	530	S5 002	52	470	S4 002	45	400	S3 002
						54	530	S5 002	60	640	S4 E05	45	400	S3 002
TSI [6J1]	09.10-09.12								60	640	S4 E05			
		BWD				61	600	S5 004						
		BWD,SSJ	70	760	S5 A08									
	08.12-05.15					85	800	S5 011	74	680	S4 008	40	340	S3 000
		BWD,SSJ							60	640	S4 E05			
TSI [6P5]	05.15-05.17		70	760	S5 A08				52	470	S4 002			
			70	760	S5 A08				60	640	S4 E05			
1.4 [6J1]	07.08-05.10					54	530	S5 002	52	470	S4 002			
		BWD,SSJ	60	680	S5 A05				60	640	S4 E05			
			70	760	S5 A08				60	640	S4 E05			
	05.10-05.15					54	530	S5 002	52	470	S4 002	45	400	S3 002
						54	530	S5 002	60	640	S4 E05	45	400	S3 002
TSI [6J1]	03.09-05.15					54	530	S5 002	52	470	S4 002	45	400	S3 002
						54	530	S5 002	60	640	S4 E05	45	400	S3 002
	10.13-05.15					63	610	S5 005	74	680	S4 008	40	340	S3 000
		BWD,SSJ							60	640	S4 E05			
1.4/ 1.8 TSI [6P1; 6P5]	11.15-05.17	BWD,SSJ	70	760	S5 A08									
1.6 [6J1]	07.08-05.15					54	530	S5 002	52	470	S4 002	45	400	S3 002
						54	530	S5 002	60	640	S4 E05	45	400	S3 002
GLP [6J1]	05.11-05.15					63	610	S5 005	60	540	S4 005			
		BWD,SSJ	60	680	S5 A05				60	640	S4 E05			
			70	760	S5 A08				60	640	S4 E05			



			Ah A (EN)	Ah A (EN)	Ah A (EN)	Ah A (EN)
			0 092 ...0	0 092 ...0	0 092 ...0	0 092 ...0

◀ SEAT

Diesel														
1.2 TDI [6J1]	05.10-05.15				77	780	S5 008	60	540	S4 005				
					77	780	S5 008	60	640	S4 E05				
		BWD,SSJ	70	760	S5 A08									
		SSJ	70	760	S5 A08									
1.4 TDI [6J1]	07.08-06.10		70	760	S5 A08	77	780	S5 008	74	680	S4 008	70	640	S3 008
TDI [6P5]	05.15-05.17								60	640	S4 E05			
1.6 TDI [6J1]	05.09-05.15		70	760	S5 A08	77	780	S5 008	60	640	S4 E05	70	640	S3 008
			70	760	S5 A08	77	780	S5 008	74	680	S4 008	70	640	S3 008
1.9 TDI [6J1]	02.08-06.10		70	760	S5 A08	77	780	S5 008	74	680	S4 008	70	640	S3 008
2.0 TDI [6J1]	01.10-05.15		70	760	S5 A08	77	780	S5 008	60	640	S4 E05	70	640	S3 008
			70	760	S5 A08	77	780	S5 008	74	680	S4 008	70	640	S3 008
Ibiza ST														
1.0 TSI [6P8]	05.15-05.17								60	640	S4 E05			
1.2 [6J8]	05.10-05.15					54	530	S5 002	52	470	S4 002			
						54	530	S5 002	60	640	S4 E05			
TSI [6J8]	09.10-05.15					61	600	S5 004	60	540	S4 004			
						61	600	S5 004	60	640	S4 E05			
		BWD,SSJ	60	680	S5 A05									
	08.12-05.15					54	530	S5 002	52	470	S4 002			
		BWD,SSJ	60	680	S5 A05				60	640	S4 E05			
TSI [6P8]	05.15-05.17								60	640	S4 E05			
	09.15-05.17					54	530	S5 002	52	470	S4 002			
		BWD,SSJ	60	680	S5 A05				60	640	S4 E05			
1.4 [6J8]	04.10-05.15					54	530	S5 002	52	470	S4 002			
						54	530	S5 002	60	640	S4 E05			
TSI [6J8]	02.12-05.15								60	640	S4 E05			
	04.12-05.15	BWD	70	760	S5 A08									
	10.13-05.15					63	610	S5 005	74	680	S4 008	40	340	S3 000
		BWD,SSJ							60	640	S4 E05			
TSI [6P8]	11.15-05.17		70	760	S5 A08				52	470	S4 002			
1.6 [6J8]	02.12-05.15					54	530	S5 002	52	470	S4 002	45	400	S3 002
						54	530	S5 002	60	640	S4 E05	45	400	S3 002
Diesel														
1.2 TDI [6J8]	04.10-05.15					77	780	S5 008	60	540	S4 005			
						77	780	S5 008	60	640	S4 E05			
		BWD,SSJ	60	680	S5 A05									
1.4 TDI [6P8]	05.15-05.17								60	640	S4 E05			
1.6 TDI [6J8]	05.09-05.15								60	640	S4 E05			
		BWD	70	760	S5 A08	77	780	S5 008	60	540	S4 005			
		BWD,SSJ	70	760	S5 A08									
	03.10-05.15	SSJ	70	760	S5 A08									
	05.10-05.15					77	780	S5 008	60	540	S4 005			
		BWD	70	760	S5 A08									
Leon														
1.0 TSI [5F1]	05.15→		70	760	S5 A08				52	470	S4 002			
			70	760	S5 A08				60	540	S4 005			
		BWD,SSJ							60	640	S4 E05			
									70	760	S4 E08			
1.2 TSI [1P1]	02.10-12.12	BWD				77	780	S5 008	60	540	S4 005	45	400	S3 002
		BWD,SSJ	60	680	S5 A05									
TSI [5F1]	12.12-12.18					54	530	S5 002	52	470	S4 002	45	400	S3 002
						54	530	S5 002	60	640	S4 E05	45	400	S3 002
	01.13-12.18								60	640	S4 E05			
1.4 [1M1]	12.99-02.02	VAD				54	530	S5 002	52	470	S4 002			
	12.99-04.04					54	530	S5 002	52	470	S4 002	45	400	S3 002
[1P1]	06.06-05.10					54	530	S5 002	52	470	S4 002			
	05.10-12.12					54	530	S5 002	52	470	S4 002	45	400	S3 002
TGI [5F1]	10.13-12.18								60	640	S4 E05			
TSI [1P1]	11.07-12.12	BWD				77	780	S5 008	60	540	S4 005	45	400	S3 002
		BWD,SSJ	60	680	S5 A05				60	640	S4 E05			
TSI [5F1]	09.12-05.15		70	760	S5 A08				60	640	S4 E05			



			Ah A (EN) S5A			Ah A (EN) S5			Ah A (EN) S4			Ah A (EN) S3		
			0 092 ...0			0 092 ...0			0 092 ...0			0 092 ...0		
1.4 TSI [5F1]	05.14-12.18		70	760	S5 A08	77	780	S5 008	74	680	S4 008			
		SSJ							70	760	S4 E08			
1.6 [1M1]	10.98-07.04	VAD				63	610	S5 005	60	540	S4 005	56	480	S3 005
	04.02-06.06					63	610	S5 005	60	540	S4 005	56	480	S3 005
	10.05-06.06					63	610	S5 005	60	540	S4 005			
[1P1]	07.05-12.12					63	610	S5 005	60	540	S4 005	56	480	S3 005
	12.09-12.12					63	610	S5 005	60	540	S4 005			
1.6/2.0 FSI, MultiFuel [1P1]	07.05-12.12					63	610	S5 005	60	540	S4 005	56	480	S3 005
1.8 [1M1]	10.98-12.03					63	610	S5 005	60	540	S4 005	56	480	S3 005
	12.99-07.04	VAD				63	610	S5 005	60	540	S4 005			
T [1M1]	12.99-12.00					63	610	S5 005	60	540	S4 005	56	480	S3 005
	09.00-04.04	VAD				63	610	S5 005	60	540	S4 005			
T Syncro [1M1]	03.00-04.04					63	610	S5 005	60	540	S4 005			
TSI [1P1]	06.07-12.12					63	610	S5 005	60	540	S4 005			
TSI [5F1]	02.13-12.18								60	640	S4 E05			
		BWD,SSJ	70	760	S5 A08									
2.0 TFSI [1P1]	05.05-05.09					63	610	S5 005	60	540	S4 005	56	480	S3 005
	06.09-12.12					63	610	S5 005	60	540	S4 005			
2.8 [1M1]	10.00-07.01					63	610	S5 005	60	540	S4 005			
	05.02-04.04					63	610	S5 005	60	540	S4 005			
Diesel														
1.6 TDI [1P1]	02.10-12.12	BWD				77	780	S5 008	60	540	S4 005			
		BWD,SSJ	70	760	S5 A08									
		SSJ	70	760	S5 A08									
	11.10-12.12					77	780	S5 008	74	680	S4 008			
TDI [5F1]	09.12-05.15		70	760	S5 A08				60	640	S4 E05			
	11.12-05.15					63	610	S5 005	60	640	S4 E05			
	11.12→					63	610	S5 005	60	540	S4 005			
	08.13-10.16								60	640	S4 E05			
	05.15-10.16	BWD	70	760	S5 A08									
	05.15-12.16	BWD,SSJ	70	760	S5 A08									
	11.16-12.18		70	760	S5 A08									
		BWD,SSJ							70	760	S4 E08			
	01.17→	BWD	70	760	S5 A08									
1.9 SDI, TDI [1M1]	10.98-06.06		70	760	S5 A08	77	780	S5 008	74	680	S4 008	70	640	S3 008
TDI [1P1]	07.05-12.10		70	760	S5 A08	77	780	S5 008	74	680	S4 008	70	640	S3 008
	06.07-12.10		70	760	S5 A08	77	780	S5 008	74	680	S4 008			
TDI Syncro [1M1]	09.00-07.04		70	760	S5 A08	77	780	S5 008	74	680	S4 008			
2.0 TDI [1P1]	07.05-03.09		70	760	S5 A08	77	780	S5 008	74	680	S4 008			
	07.05-12.12		70	760	S5 A08	77	780	S5 008	74	680	S4 008	70	640	S3 008
	03.09-12.12	BWD				77	780	S5 008	60	540	S4 005			
		BWD,SSJ	70	760	S5 A08									
TDI [5F1]	10.12-12.18								60	640	S4 E05			
Leon Cupra														
2.0 TFSI [1P1]	09.09-12.12					63	610	S5 005	60	540	S4 005			
TSI [5F1]	10.13-10.16								60	640	S4 E05			
	10.15→		70	760	S5 A08									
		BWD,SSJ							70	760	S4 E08			
2.8 Syncro [1M1]	10.00-04.04					63	610	S5 005	60	540	S4 005			
Leon Cupra R														
1.8 T [1M1]	05.02-05.03	VAD				63	610	S5 005	60	540	S4 005			
	05.03-06.06					63	610	S5 005	60	540	S4 005	56	480	S3 005
Leon Cupra SC														
2.0 TSI [5F5]	10.13-10.16								60	640	S4 E05			
	10.15-12.18		70	760	S5 A08									
		BWD,SSJ							70	760	S4 E08			
Leon FR														
2.0 TFSI [1P1]	07.06→		70	760	S5 A08	77	780	S5 008	60	540	S4 005			
Leon SC														
1.0 TSI [5F5]	05.15-12.18		70	760	S5 A08				52	470	S4 002			
			70	760	S5 A08				60	540	S4 005			
		BWD,SSJ							60	640	S4 E05			
									70	760	S4 E08			



		Ah A (EN) S5A			Ah A (EN) S5			Ah A (EN) S4			Ah A (EN) S3		
		0 092 ...0			0 092 ...0			0 092 ...0			0 092 ...0		
SEAT													
1.2 TSI [5F5]	01.13-12.18				63	610	S5 005	60	640	S4 E05			
					63	610	S5 005	74	680	S4 008			
	SSJ							70	760	S4 E08			
	03.13-05.15	BWD,SSJ						60	640	S4 E05			
	05.14-12.18		70	760	S5 A08	77	780	S5 008	74	680	S4 008		
1.4 TSI [5F5]	02.13-05.15				63	610	S5 005	60	640	S4 E05			
					63	610	S5 005	74	680	S4 008			
	BWD,SSJ							70	760	S4 E08			
	08.13-05.15							60	640	S4 E05			
	05.14-12.18				77	780	S5 008	74	680	S4 008			
		BWD,SSJ	70	760	S5 A08			70	760	S4 E08			
TSI ACT [5F5]	05.14-12.18				77	780	S5 008	74	680	S4 008			
								70	760	S4 E08			
1.8 TSI [5F5]	02.13-12.18				63	610	S5 005	60	640	S4 E05			
					63	610	S5 005	74	680	S4 008			
	BWD,SSJ							70	760	S4 E08			
Diesel													
1.6 TDI [5F5]	02.13-10.16							60	640	S4 E05			
	05.15-10.16		70	760	S5 A08	63	610	S5 005	60	540	S4 005		
			70	760	S5 A08								
	11.16-12.18		70	760	S5 A08								
								70	760	S4 E08			
2.0 TDI [5F5]	02.13-12.18							60	640	S4 E05			
Leon ST													
1.0 TSI [5F8]	05.15→		70	760	S5 A08								
								60	640	S4 E05			
								70	760	S4 E08			
1.2 TSI [5F8]	08.13-08.18							60	640	S4 E05			
	05.14-08.18		70	760	S5 A08	77	780	S5 008	74	680	S4 008		
								70	760	S4 E08			
1.4 TGI [5F8]	08.14-08.18							60	640	S4 E05			
TSI [5F8]	08.13-05.15							60	640	S4 E05			
								60	640	S4 E05			
	05.14-08.18				77	780	S5 008	74	680	S4 008			
			70	760	S5 A08			70	760	S4 E08			
1.8 TSI [5F8]	08.13-08.18							60	640	S4 E05			
TSI 4Drive [5F8]	11.14-08.18							60	640	S4 E05			
	06.15-08.18							70	760	S4 E08			
			70	760	S5 A08								
Diesel													
1.6 TDI [5F8]	08.13-10.16							60	640	S4 E05			
	05.15-10.16				63	610	S5 005	60	540	S4 005			
			70	760	S5 A08	63	610	S5 005	60	540	S4 005		
			70	760	S5 A08								
	11.16→		70	760	S5 A08								
								70	760	S4 E08			
TDI 4Drive [5F8]	02.14-10.16							60	640	S4 E05			
2.0 TDI [5F8]	08.13-08.18							60	640	S4 E05			
	06.14-08.18		70	760	S5 A08								
TDI 4Drive [5F8]	08.13-12.16		70	760	S5 A08	77	780	S5 008	74	680	S4 008		
								70	760	S4 E08			
	05.14-08.18				77	780	S5 008	74	680	S4 008			
			70	760	S5 A08								
	06.14-08.18							60	640	S4 E05			
TSI [5F8]	08.13-12.16							60	640	S4 E05			
Leon ST Cupra													
2.0 TSI [5F8]	07.14-10.16							60	640	S4 E05			
	10.15-08.18		70	760	S5 A08								
								70	760	S4 E08			
TSI 4WD [5F8]	11.16-08.18		70	760	S5 A08								
								70	760	S4 E08			
Marbella													
0.9 i	01.95-05.98								45	400	S3 003		



			Ah	A (EN)		Ah	A (EN)		Ah	A (EN)		Ah	A (EN)	
			0 092 ...0			0 092 ...0			0 092 ...0			0 092 ...0		

Mii														
1.0 [KF1]	10.11→								44	420	S4 000			
		BWD,SSJ	60	680	S5 A05				60	640	S4 E05			
Toledo														
1.2 [KG3]	07.12-06.15					54	530	S5 002	52	470	S4 002			
		BWD,SSJ	70	760	S5 A08				60	640	S4 E05			
TSI [KG3]	07.12-06.15					54	530	S5 002	52	470	S4 002			
						54	530	S5 002	60	640	S4 E05			
	07.12-04.19	BWD,SSJ	70	760	S5 A08				60	640	S4 E05			
	05.15-04.19								52	470	S4 002			
									60	540	S4 005			
			70	760	S5 A08				52	470	S4 002			
			70	760	S5 A08				60	540	S4 005			
		BWD,SSJ							60	640	S4 E05			
1.4 [1M2]	01.00-05.02		60	680	S5 A05				60	640	S4 E05			
		VAD				63	610	S5 005	60	540	S4 005	56	480	S3 005
[5P2]	05.06-05.09					63	610	S5 005	60	540	S4 005			
TSI [KG3]	07.12-06.15					54	530	S5 002	52	470	S4 002			
	07.12-04.19	BWD,SSJ	70	760	S5 A08				60	640	S4 E05			
	05.15-04.19								52	470	S4 002			
									60	540	S4 005			
1.6 [KG3]	07.12-06.15		70	760	S5 A08									
		BWD,SSJ							70	760	S4 E08			
[1M2]	10.98-05.02	VAD				63	610	S5 005	60	540	S4 005	56	480	S3 005
	04.02-07.04					63	610	S5 005	60	540	S4 005	56	480	S3 005
[5P2]	09.04-05.09		70	760	S5 A08	77	780	S5 008	60	540	S4 005	70	640	S3 008
MultiFuel [5P2]	12.07-05.09		70	760	S5 A08	77	780	S5 008	60	540	S4 005	70	640	S3 008
1.6/ 1.8/ 2.0 [1L2]	05.91-03.99	VAD				61	600	S5 004	44	440	S4 001	41	360	S3 001
1.8 [1M2]	10.98-12.03	VAD				63	610	S5 005	60	540	S4 005	56	480	S3 005
T [1M2]	09.00-07.04					63	610	S5 005	60	540	S4 005	56	480	S3 005
TSI [5P2]	01.07-05.09		70	760	S5 A08	77	780	S5 008	74	680	S4 008	70	640	S3 008
2.0 FSI [5P2]	09.04-03.09		70	760	S5 A08	77	780	S5 008	74	680	S4 008	70	640	S3 008
	11.05-03.09		70	760	S5 A08	77	780	S5 008	74	680	S4 008			
TFSI [5P2]	11.05-05.09		70	760	S5 A08	77	780	S5 008	74	680	S4 008			
2.3 [1M2]	10.98-11.00	VAD				63	610	S5 005	60	540	S4 005	56	480	S3 005
	09.00-11.03	VAD				63	610	S5 005	60	540	S4 005			
Diesel														
1.4 TDI [KG3]	05.15-04.19	BWD,SSJ	70	760	S5 A08				60	640	S4 E05			
			70	760	S5 A08				70	760	S4 E08			
1.6 TDI [KG3]	07.12-06.15					63	610	S5 005	60	540	S4 005			
		BWD							60	640	S4 E05			
		BWD,SSJ	70	760	S5 A08									
	07.12-04.19	BWD,SSJ	70	760	S5 A08				60	640	S4 E05			
	10.13-06.15					63	610	S5 005	74	680	S4 008	40	340	S3 000
		BWD,SSJ							60	640	S4 E05			
	05.15-04.19	BWD,SSJ	70	760	S5 A08				70	760	S4 E08			
1.9 D, TDI [1L2]	05.91-03.99	VAD				74	750	S5 007	72	680	S4 007			
TDI [1M2]	10.98-07.04	VAD	70	760	S5 A08	77	780	S5 008	74	680	S4 008	70	640	S3 008
TDI [5P2]	09.04-09.05		70	760	S5 A08	77	780	S5 008	74	680	S4 008	70	640	S3 008
	09.04-05.09		70	760	S5 A08	77	780	S5 008	74	680	S4 008			
	02.06-05.09		70	760	S5 A08	77	780	S5 008	74	680	S4 008	70	640	S3 008
2.0 TDI [5P2]	09.04-05.09		70	760	S5 A08	77	780	S5 008	74	680	S4 008			

SKODA

Citigo

1.0 [NF1]	10.11→					63	610	S5 005	44	420	S4 000			
		BWD,SSJ	60	680	S5 A05				60	640	S4 E05			
G-Tec [NF1]	11.12→					63	610	S5 005	44	420	S4 000			
		BWD,SSJ	60	680	S5 A05				60	640	S4 E05			

								Ah A (EN)		Ah A (EN)		Ah A (EN)		Ah A (EN)	
				0 092 ...0		0 092 ...0		0 092 ...0		0 092 ...0		0 092 ...0		0 092 ...0	
SKODA															
Fabia															
1.0 MPI [NJ3]	08.14→		70	760	S5 A08	77	780	S5 008	60	540	S4 005				
		BWD,SSJ							60	640	S4 E05				
1.2 [5J2]	12.06-05.09	BWD,SSJ	70	760	S5 A08				70	760	S4 E08				
	12.06-06.09					54	530	S5 002	52	470	S4 002				
	01.08-11.11	SSJ	60	680	S5 A05										
	01.08-12.14					63	610	S5 005	52	470	S4 002	45	400	S3 002	
	03.09-06.09	BWD	70	760	S5 A08				70	760	S4 E08				
	03.09-12.14	BWD	60	680	S5 A05										
	03.10-12.14					63	610	S5 005	60	540	S4 005	45	400	S3 002	
		BWD,SSJ	60	680	S5 A05				60	640	S4 E05				
	11.11-12.14					54	530	S5 002	52	470	S4 002				
		BWD,SSJ	70	760	S5 A08				70	760	S4 E08				
TSI [NJ3]	08.14→		70	760	S5 A08	77	780	S5 008	60	540	S4 005				
		BWD,SSJ							60	640	S4 E05				
1.2/ 1.4/ 2.0 [6Y3]	09.99-12.07					63	610	S5 005	52	470	S4 002	45	400	S3 002	
1.4 [5J2]	01.07-03.10					54	530	S5 002	52	470	S4 002				
		BWD,SSJ	70	760	S5 A08				70	760	S4 E08				
	03.10-12.14		60	680	S5 A05	63	610	S5 005	52	470	S4 002	45	400	S3 002	
1.6 [5J2]	04.07-07.10	BWD,SSJ	70	760	S5 A08				70	760	S4 E08				
	04.07-12.14					63	610	S5 005	60	540	S4 005				
	06.10-12.14	BWD							70	760	S4 E08				
		BWD,SSJ	70	760	S5 A08										
MPI [NJ3]	01.15→		70	760	S5 A08	54	530	S5 002	52	470	S4 002				
		BWD,SSJ							60	640	S4 E05				
Diesel															
1.2 TDI [5J2]	03.10-12.14	BWD				63	610	S5 005	60	540	S4 005	45	400	S3 002	
		BWD,SSJ	70	760	S5 A08										
1.4 TDI [NJ3]	08.14→					77	780	S5 008	60	540	S4 005				
		BWD,SSJ	70	760	S5 A08				60	640	S4 E05				
	11.15→		70	760	S5 A08										
		BWD,SSJ							60	640	S4 E05				
TDI [5J2]	01.07-03.10					77	780	S5 008	74	680	S4 008	70	640	S3 008	
			70	760	S5 A08	77	780	S5 008	74	680	S4 008	70	640	S3 008	
		BWD,SSJ	70	760	S5 A08										
1.4/ 1.9 SDI, TDI [6Y3]	09.99-12.07		70	760	S5 A08	77	780	S5 008	74	680	S4 008	70	640	S3 008	
1.6 TDI [5J2]	03.10-12.14	BWD				77	780	S5 008	60	540	S4 005				
		BWD,SSJ							70	760	S4 E08				
1.9 TDI [5J2]	04.07-03.10		70	760	S5 A08	77	780	S5 008	74	680	S4 008				
			70	760	S5 A08	77	780	S5 008	74	680	S4 008	70	640	S3 008	
Fabia Combi															
1.0 MPI [NJ5]	08.14→		70	760	S5 A08	77	780	S5 008	60	540	S4 005				
		BWD,SSJ							60	640	S4 E05				
1.2 [5J5]	12.06-05.09	BWD,SSJ	70	760	S5 A08				70	760	S4 E08				
	12.06-12.14					54	530	S5 002	52	470	S4 002				
	01.08-03.09	BWD							70	760	S4 E08				
		BWD,SSJ	70	760	S5 A08										
	03.09-11.11		70	760	S5 A08	54	530	S5 002	52	470	S4 002	45	400	S3 002	
			70	760	S5 A08	54	530	S5 002	74	680	S4 008	45	400	S3 002	
			70	760	S5 A08	77	780	S5 008	52	470	S4 002	45	400	S3 002	
	03.09-12.14	BWD	70	760	S5 A08				70	760	S4 E08				
	03.10-12.14					63	610	S5 005	60	540	S4 005	45	400	S3 002	
		BWD,SSJ							60	640	S4 E05				
	11.11-12.14	BWD,SSJ	70	760	S5 A08				70	760	S4 E08				
TSI [NJ5]	08.14→		70	760	S5 A08				52	470	S4 002				
			70	760	S5 A08	77	780	S5 008	60	540	S4 005				
		BWD,SSJ							60	640	S4 E05				
1.2/ 1.4/ 2.0 [6Y5]	12.99-12.07					63	610	S5 005	52	470	S4 002	45	400	S3 002	
1.4 [5J5]	10.07-03.10	BWD,SSJ	70	760	S5 A08				70	760	S4 E08				
	10.07-12.14					54	530	S5 002	52	470	S4 002				
	03.10-12.14	BWD							70	760	S4 E08				
		BWD,SSJ	70	760	S5 A08										
1.6 [5J5]	10.07-07.10	BWD,SSJ	70	760	S5 A08				70	760	S4 E08				



			Ah A (EN) S5A			Ah A (EN) S5			Ah A (EN) S4			Ah A (EN) S3		
			0 092 ...0			0 092 ...0			0 092 ...0			0 092 ...0		
1.6 [5J5]	10.07-12.14					63	610	S5 005	60	540	S4 005			
	06.10-12.14	BWD							70	760	S4 E08			
		BWD,SSJ	70	760	S5 A08									
Diesel														
1.2 TDI [5J5]	03.10-12.14		70	760	S5 A08	77	780	S5 008	74	680	S4 008			
		BWD				63	610	S5 005	60	540	S4 005	45	400	S3 002
		BWD,SSJ	70	760	S5 A08									
1.4 TDI [NJ5]	08.14→					77	780	S5 008	60	540	S4 005			
		BWD,SSJ	70	760	S5 A08				60	640	S4 E05			
	11.15→	BWD	70	760	S5 A08									
		BWD,SSJ							60	640	S4 E05			
TDI [5J5]	10.07-03.10					77	780	S5 008	74	680	S4 008	70	640	S3 008
			70	760	S5 A08	77	780	S5 008	74	680	S4 008	70	640	S3 008
		BWD,SSJ	70	760	S5 A08									
1.4/ 1.9 SDI, TDI [6Y5]	08.00-12.07		70	760	S5 A08	77	780	S5 008	74	680	S4 008	70	640	S3 008
1.6 TDI [5J5]	03.10-12.14	BWD				77	780	S5 008	60	540	S4 005			
		BWD,SSJ	70	760	S5 A08				70	760	S4 E08			
1.9 TDI [5J5]	10.07-03.10		70	760	S5 A08	77	780	S5 008	74	680	S4 008			
			70	760	S5 A08	77	780	S5 008	74	680	S4 008	70	640	S3 008
Fabia Combi RS														
1.4 TSI [5J5]	05.10-05.12	BWD,SSJ	70	760	S5 A08				70	760	S4 E08			
	05.10-12.14					54	530	S5 002	52	470	S4 002			
	05.12-12.14	BWD							70	760	S4 E08			
		BWD,SSJ	70	760	S5 A08									
Fabia RS														
1.4 TSI [5J2]	05.10-05.12	BWD,SSJ	70	760	S5 A08				70	760	S4 E08			
	05.10-12.14					54	530	S5 002	52	470	S4 002			
	05.12-12.14	BWD							70	760	S4 E08			
		BWD,SSJ	70	760	S5 A08									
Fabia Schrägheck														
1.0/ 1.2/ 1.4/ 2.0 [6Y2]	09.99-04.07					63	610	S5 005	52	470	S4 002	45	400	S3 002
Diesel														
1.4/ 1.9 SDI, TDI [6Y2]	09.99-03.08		70	760	S5 A08	77	780	S5 008	74	680	S4 008	70	640	S3 008
Fabia Schrägheck RS														
Diesel														
1.9 TDI [6Y2]	06.03-04.07		70	760	S5 A08	77	780	S5 008	74	680	S4 008	70	640	S3 008
Favorit														
136 i.e.	07.93-12.98					63	610	S5 005	60	540	S4 005	45	400	S3 002
Felicia														
1.3/ 1.6 i [6U1]	05.95-08.01					63	610	S5 005	52	470	S4 002	45	400	S3 002
Diesel														
1.9 D [6U1]	10.95-08.01					63	610	S5 005	60	540	S4 005	56	480	S3 005
Felicia Combi														
1.3/ 1.6 i [6U5]	10.95-08.01					63	610	S5 005	52	470	S4 002	45	400	S3 002
Diesel														
1.9 D [6U5]	10.95-08.01					63	610	S5 005	60	540	S4 005	56	480	S3 005
Felicia Fun														
1.3 i [6UF]	08.96-03.01					54	530	S5 002	52	470	S4 002	45	400	S3 002
	08.96-04.01					63	610	S5 005	52	470	S4 002	45	400	S3 002
1.6 i [6UF]	08.96-03.01					63	610	S5 005	60	540	S4 005	56	480	S3 005
Diesel														
1.9 D [6UF]	08.96-03.01					63	610	S5 005	60	540	S4 005	56	480	S3 005
Kodiaq														
1.4/ 2.0 TSI, TSI 4x4 [NS, NV]	03.17→	BWD,SSJ	70	760	S5 A08									
Diesel														
2.0 TDI, TDI 4x4 [NS, NV]	03.17→	BWD,SSJ	70	760	S5 A08									
Octavia														
1.0 TSI [5E3]	05.15-02.17					52	520	S5 001	60	540	S4 005			
		BWD,SSJ	70	760	S5 A08				60	640	S4 E05			
	06.16→	BWD,SSJ	70	760	S5 A08				70	760	S4 E08			
1.2 TSI [1Z3]	02.10-06.13					63	610	S5 005	60	540	S4 005			
	TSI [5E3]	11.12-05.15				54	530	S5 002	52	470	S4 002			
		BWD,SSJ	70	760	S5 A08				70	760	S4 E08			



											Ah A (EN)			Ah A (EN)			Ah A (EN)			Ah A (EN)		
					0 092 ...0			0 092 ...0			0 092 ...0			0 092 ...0								
◀ SKODA																						
1.2 TSI [5E3]	02.17→				54	530	S5 002	52	470	S4 002												
		BWD							70	760	S4 E08											
		BWD,SSJ	70	760	S5 A08																	
1.4 [1U2]	06.99-12.10				63	610	S5 005	52	470	S4 002	45	400	S3 002									
[1Z3]	05.04-06.13				63	610	S5 005	52	470	S4 002	45	400	S3 002									
TSI [1Z3]	11.08-06.13				54	530	S5 002	52	470	S4 002												
		BWD,SSJ	60	680	S5 A05																	
			70	760	S5 A08																	
TSI [5E3]	11.12-05.15				63	610	S5 005	60	540	S4 005												
	11.12→	BWD,SSJ	70	760	S5 A08					70	760	S4 E08										
TSI G-Tec [5E3]	11.13→				77	780	S5 008	74	680	S4 008												
		BWD,SSJ	70	760	S5 A08					60	640	S4 E05										
1.6 [1U2]	09.96-09.04				63	610	S5 005	52	470	S4 002												
	08.00-12.10				63	610	S5 005	52	470	S4 002	45	400	S3 002									
[1Z3]	05.04-06.13				63	610	S5 005	52	470	S4 002	45	400	S3 002									
	11.07-05.10		60	680	S5 A05	63	610	S5 005	52	470	S4 002	56	480	S3 005								
			60	680	S5 A05	63	610	S5 005	60	540	S4 005	45	400	S3 002								
			60	680	S5 A05	63	610	S5 005	60	540	S4 005	56	480	S3 005								
			60	680	S5 A05	63	610	S5 005	60	640	S4 E05	56	480	S3 005								
	08.09-06.13				63	610	S5 005	60	540	S4 005												
[5E3]	01.14→		60	680	S5 A05	63	610	S5 005	60	540	S4 005											
		BWD,SSJ								60	640	S4 E05										
1.6/2.0 FSI [1Z3]	05.04-10.08				63	610	S5 005	60	540	S4 005	56	480	S3 005									
1.8 i [1U2]	09.96-04.99				63	610	S5 005	52	470	S4 002												
T [1U2]	03.98-12.10				63	610	S5 005	52	470	S4 002	56	480	S3 005									
T 4x4 [1U2]	01.00-07.00				63	610	S5 005	52	470	S4 002												
	08.00-12.10				63	610	S5 005	52	470	S4 002	56	480	S3 005									
TSI [1Z3]	06.07-06.13				63	610	S5 005	60	540	S4 005												
	03.09-06.13				77	780	S5 008	74	680	S4 008												
TSI [5E3]	11.12→				63	610	S5 005	60	540	S4 005												
		BWD,SSJ								70	760	S4 E08										
	05.14→	BWD								70	760	S4 E08										
TSI 4x4 [5E3]	05.14→	BWD,SSJ								70	760	S4 E08										
2.0 FSI 4x4 [1Z3]	12.04-10.08				63	610	S5 005	60	540	S4 005												
i [1U2]	06.99-05.07				63	610	S5 005	60	540	S4 005	56	480	S3 005									
	03.02-09.04				63	610	S5 005	60	540	S4 005												
4x4 [1U2]	08.00-09.04				63	610	S5 005	60	540	S4 005												
Diesel																						
1.6 TDI [1Z3]	06.09-04.13				77	780	S5 008	74	680	S4 008												
		BWD,SSJ	70	760	S5 A08																	
		SSJ	70	760	S5 A08																	
TDI [5E3]	11.12-05.15				70	760	S5 A08	63	610	S5 005	60	540	S4 005									
		BWD,SSJ								60	640	S4 E05										
	11.12→				63	610	S5 005	60	540	S4 005												
		BWD,SSJ	70	760	S5 A08																	
	05.15→	BWD	70	760	S5 A08																	
	02.17→	BWD,SSJ	70	760	S5 A08					70	760	S4 E08										
TDI 4x4 [5E3]	09.14-05.15				70	760	S5 A08	77	780	S5 008	60	540	S4 005									
		BWD,SSJ								60	640	S4 E05										
	05.15→	BWD,SSJ	70	760	S5 A08					70	760	S4 E08										
1.9 SDI, TDI [1U2]	09.96-12.10		70	760	S5 A08	77	780	S5 008	74	680	S4 008	70	640	S3 008								
TDI [1Z3]	05.04-12.10		70	760	S5 A08	77	780	S5 008	74	680	S4 008	70	640	S3 008								
	03.06-04.13		70	760	S5 A08	77	780	S5 008	74	680	S4 008											
TDI 4x4 [1Z3]	05.06-05.10		70	760	S5 A08	77	780	S5 008	74	680	S4 008											
2.0 TDI [1Z3]	05.04-05.10		70	760	S5 A08	77	780	S5 008	74	680	S4 008											
	05.04-05.13		70	760	S5 A08	77	780	S5 008	74	680	S4 008	70	640	S3 008								
	03.10-06.13				77	780	S5 008	74	680	S4 008												
TDI [5E3]	11.12-06.13				63	610	S5 005	60	540	S4 005												
		BWD,SSJ	70	760	S5 A08					60	640	S4 E05										
	11.12-05.15				77	780	S5 008	74	680	S4 008												
	05.13→	BWD,SSJ	70	760	S5 A08																	
	08.14→		70	760	S5 A08	77	780	S5 008	74	680	S4 008											
		BWD								60	640	S4 E05										



					Ah A (EN) S5A			Ah A (EN) S5			Ah A (EN) S4			Ah A (EN) S3		
		0 092 ...0			0 092 ...0			0 092 ...0			0 092 ...0					
2.0	TDI 4x4 [1Z3]	05.10-05.13						70	760	S4 E08						
			BWD	70	760	S5 A08										
	TDI 4x4 [5E3]	09.14-05.15						70	650	S4 E07						
			BWD,SSJ	70	760	S5 A08										
		02.17→	BWD,SSJ	70	760	S5 A08										
Octavia Combi																
1.0	TSI [5E5]	06.16→	BWD,SSJ	70	760	S5 A08		70	760	S4 E08						
1.2	TSI [1Z5]	02.10-06.13					63	610	S5 005	60	540	S4 005				
	TSI [5E5]	11.12-05.15					54	530	S5 002	52	470	S4 002				
				70	760	S5 A08										
			BWD,SSJ					70	760	S4 E08						
				70	760	S5 A08										
		05.15-02.17					52	520	S5 001	60	540	S4 005				
			BWD,SSJ	70	760	S5 A08										
								60	640	S4 E05						
1.4	[1Z5]	05.04-06.06					54	530	S5 002	52	470	S4 002				
		05.06-06.13					63	610	S5 005	52	470	S4 002	45	400	S3 002	
	TSI [1Z5]	11.08-06.13					54	530	S5 002	52	470	S4 002				
			BWD,SSJ	60	680	S5 A05										
				70	760	S5 A08										
	TSI [5E5]	11.12-05.15						60	540	S4 005						
		11.12→	BWD,SSJ	70	760	S5 A08										
	TSI G-Tec [5E5]	11.13→					77	780	S5 008	74	680	S4 008				
			BWD,SSJ	70	760	S5 A08										
								60	640	S4 E05						
1.4/1.6	[1U5]	02.97-12.10					63	610	S5 005	52	470	S4 002	45	400	S3 002	
1.6	[1Z5]	05.04-06.13					63	610	S5 005	52	470	S4 002				
		08.09-06.13					63	610	S5 005	60	540	S4 005				
	[5E5]	01.14→		60	680	S5 A05	63	610	S5 005	60	540	S4 005				
			BWD,SSJ							60	640	S4 E05				
	FSI [1Z5]	05.04-10.08					63	610	S5 005	52	470	S4 002				
1.8	i [1U5]	10.96-04.99					63	610	S5 005	52	470	S4 002				
	T [1U5]	03.98-12.10					63	610	S5 005	52	470	S4 002	56	480	S3 005	
	T 4x4 [1U5]	01.00-07.00					63	610	S5 005	52	470	S4 002				
		08.00-12.10					63	610	S5 005	52	470	S4 002	56	480	S3 005	
	TDI 4x4 [5E5]	09.14→					63	610	S5 005	60	540	S4 005				
			BWD							70	760	S4 E08				
	TSI [1Z5]	06.07-06.13		70	760	S5 A08	77	780	S5 008	74	680	S4 008				
		05.09-06.13					77	780	S5 008	74	680	S4 008				
	TSI [5E5]	11.12→								60	540	S4 005				
			BWD,SSJ							70	760	S4 E08				
		05.14→								60	540	S4 005	56	480	S3 005	
	TSI 4x4 [1Z5]	11.08-06.13		70	760	S5 A08	77	780	S5 008	74	680	S4 008				
		03.09-06.13					63	610	S5 005	60	540	S4 005				
	TSI 4x4 [5E5]	05.13→		70	760	S5 A08	63	610	S5 005	60	540	S4 005				
			BWD,SSJ							60	640	S4 E05				
1,2	TSI [5E5]	02.17→					54	530	S5 002	52	470	S4 002				
			BWD							70	760	S4 E08				
			BWD,SSJ	70	760	S5 A08										
2.0	FSI [1Z5]	11.04-10.08					63	610	S5 005	60	540	S4 005	56	480	S3 005	
	FSI 4x4 [1Z5]	11.04-10.08					63	610	S5 005	60	540	S4 005	56	480	S3 005	
	i [1U5]	08.00-09.04					63	610	S5 005	60	540	S4 005				
		08.00-01.06					63	610	S5 005	60	540	S4 005	56	480	S3 005	
	4x4 [1U5]	11.99-12.00					63	610	S5 005	60	540	S4 005	56	480	S3 005	
		08.00-01.05					63	610	S5 005	60	540	S4 005				
		03.02-01.06					63	610	S5 005	60	540	S4 005	56	480	S3 005	
Diesel																
1.6	TDI [1Z5]	06.09-04.13					77	780	S5 008	74	680	S4 008				
			BWD,SSJ	70	760	S5 A08										
			SSJ	70	760	S5 A08										
	TDI [5E5]	11.12-05.15								60	540	S4 005				
				70	760	S5 A08	63	610	S5 005	60	540	S4 005				
			BWD,SSJ							60	640	S4 E05				
		11.12→	BWD,SSJ	70	760	S5 A08										
		11.13-05.15	SSJ							60	640	S4 E05				



											Ah A (EN)			Ah A (EN)			Ah A (EN)			Ah A (EN)		
		0 092 ...0			0 092 ...0			0 092 ...0			0 092 ...0											
◀ SKODA																						
1.6 TDI [5E5]	05.15→				63	610	S5 005	60	540	S4 005												
		BWD	70	760	S5 A08																	
	02.17→	BWD,SSJ	70	760	S5 A08				70	760	S4 E08											
	TDI 4x4 [1Z5]	06.09-04.13				63	610	S5 005	60	540	S4 005											
TDI 4x4 [5E5]	05.13-05.15		70	760	S5 A08	63	610	S5 005	60	540	S4 005											
		SSJ							60	640	S4 E05											
	05.15→	BWD,SSJ	70	760	S5 A08				70	760	S4 E08											
1.9 SDI [1U5]	05.97-12.03		70	760	S5 A08	77	780	S5 008	74	680	S4 008	70	640	S3 008								
	TDI [1U5]	08.97-12.10		70	760	S5 A08	77	780	S5 008	74	680	S4 008	70	640	S3 008							
TDI [1Z5]	08.00-03.10		70	760	S5 A08	77	780	S5 008	74	680	S4 008											
	05.04-04.13		70	760	S5 A08	77	780	S5 008	74	680	S4 008	70	640	S3 008								
TDI 4x4 [1U5]	08.00-12.09		70	760	S5 A08	77	780	S5 008	74	680	S4 008	70	640	S3 008								
	TDI 4x4 [1Z5]	11.04-10.08		70	760	S5 A08	77	780	S5 008	74	680	S4 008	70	640	S3 008							
2.0 TDI [1Z5]	05.06-05.10		70	760	S5 A08	77	780	S5 008	74	680	S4 008											
	05.04-05.10		70	760	S5 A08	77	780	S5 008	74	680	S4 008											
TDI [1Z5]	05.04-05.13		70	760	S5 A08	77	780	S5 008	74	680	S4 008	70	640	S3 008								
	03.10-06.13					77	780	S5 008	74	680	S4 008											
TDI [5E5]	11.12-06.13		70	760	S5 A08	63	610	S5 005	60	540	S4 005											
		SSJ							60	640	S4 E05											
	11.12-05.15				77	780	S5 008	74	680	S4 008												
	05.13→	BWD	70	760	S5 A08																	
	08.14→		70	760	S5 A08	77	780	S5 008	74	680	S4 008											
BWD									60	640	S4 E05											
TDI 4x4 [1Z5]	12.05-05.10		70	760	S5 A08	77	780	S5 008	74	680	S4 008	70	640	S3 008								
	05.10-05.13					77	780	S5 008	74	680	S4 008											
TDI 4x4 [5E5]	05.13-05.15		70	760	S5 A08				70	650	S4 E07											
		BWD,SSJ							70	760	S4 E08											
	09.14-05.15				77	780	S5 008	60	540	S4 005												
	05.15→	BWD,SSJ	70	760	S5 A08				60	640	S4 E05											
BWD		70	760	S5 A08																		
Octavia Combi RS																						
1.8 T [1U5]	01.03-01.06				63	610	S5 005	60	540	S4 004	56	480	S3 005									
2.0 , TSI [1Z5]	10.05-02.13		70	760	S5 A08	77	780	S5 008	74	680	S4 008	70	640	S3 008								
	TSI [5E5]	11.12-02.17				63	610	S5 005	60	540	S4 005											
	11.12→	BWD,SSJ	70	760	S5 A08				60	640	S4 E05											
	05.15→				52	520	S5 001	60	540	S4 005												
Diesel																						
2.0 TDI [1Z5]	04.06-02.13		70	760	S5 A08	77	780	S5 008	74	680	S4 008											
TDI [5E5]	05.13-05.15		70	760	S5 A08	63	610	S5 005	60	540	S4 005											
		SSJ							60	640	S4 E05											
	09.14→	BWD	70	760	S5 A08																	
TDI 4x4 [5E5]	09.14→	BWD	70	760	S5 A08																	
Octavia Combi RS 245																						
2.0 [5E5]	02.17→	BWD	70	760	S5 A08																	
		BWD,SSJ							70	760	S4 E08											
Octavia RS																						
1.8 T [1U2]	08.00-09.04				63	610	S5 005	60	540	S4 004	56	480	S3 005									
2.0 , TSI [1Z3]	10.05-02.13		70	760	S5 A08	77	780	S5 008	74	680	S4 008	70	640	S3 008								
	TSI [5E3]	05.13-02.17				63	610	S5 005	60	540	S4 005											
	05.13→	BWD,SSJ	70	760	S5 A08				60	640	S4 E05											
	05.15→				52	520	S5 001	60	540	S4 005												
Diesel																						
2.0 TDI [1Z3]	04.06-02.13		70	760	S5 A08	77	780	S5 008	74	680	S4 008											
TDI [5E3]	05.13-05.15		63	610	S5 005	60	540	S4 005														
		BWD,SSJ	70	760	S5 A08				60	640	S4 E05											
	09.14→	BWD,SSJ	70	760	S5 A08																	
TDI 4x4 [5E3]	09.14→	BWD,SSJ	70	760	S5 A08																	
Octavia RS 245																						
2.0 [5E3]	02.17→	BWD	70	760	S5 A08																	
		BWD,SSJ							70	760	S4 E08											



			Ah	A (EN)		Ah	A (EN)		Ah	A (EN)		Ah	A (EN)	
			0 092 ...0			0 092 ...0			0 092 ...0			0 092 ...0		

Rapid

1.2 [NH3]	07.12-06.15				54	530	S5 002	52	470	S4 002			
					63	610	S5 005	52	470	S4 002			
		BWD,SSJ						60	640	S4 E05			
TSI [NH3]	07.12-05.15	70	760	S5 A08	54	530	S5 002	52	470	S4 002			
	05.15→	70	760	S5 A08	52	520	S5 001	60	540	S4 005			
		BWD,SSJ						60	640	S4 E05			
1.4 TSI [NH3]	07.12-06.15				54	530	S5 002	52	470	S4 002			
					63	610	S5 005	52	470	S4 002			
	07.12→	BWD,SSJ						60	640	S4 E05			
	05.15→	70	760	S5 A08	52	520	S5 001	60	540	S4 005			
1.6 [NH3]	07.12-06.15	70	760	S5 A08	63	610	S5 005	60	540	S4 005			
	05.15→				63	610	S5 005	60	540	S4 005			
		BWD	70	760	S5 A08								
		BWD,SSJ						60	640	S4 E05			

Diesel

1.4 TDI [NH3]	05.15→				52	520	S5 001	60	540	S4 005			
		BWD,SSJ	70	760	S5 A08			60	640	S4 E05			
1.6 TDI [NH3]	07.12-05.15	70	760	S5 A08	63	610	S5 005	60	540	S4 005			
	07.12→				63	610	S5 005	60	540	S4 005			
		BWD						60	640	S4 E05			
	08.13-05.15	70	760	S5 A08	63	610	S5 005	60	540	S4 005	40	340	S3 000
		70	760	S5 A08	63	610	S5 005	74	680	S4 008	40	340	S3 000
		BWD,SSJ						60	640	S4 E05			
	05.15→				52	520	S5 001	60	540	S4 005			
		BWD,SSJ	70	760	S5 A08			60	640	S4 E05			

Rapid Spaceback

1.2 [NH1]	09.14-06.15				54	530	S5 002	52	470	S4 002			
					63	610	S5 005	52	470	S4 002			
		BWD,SSJ						60	640	S4 E05			
TSI [NH1]	10.13-05.15	70	760	S5 A08									
	10.13→	BWD,SSJ						60	640	S4 E05			
	05.15→	70	760	S5 A08	52	520	S5 001	60	540	S4 005			
1.4 TSI [NH1]	10.13-06.15	70	760	S5 A08	63	610	S5 005	60	540	S4 005			
	10.13→	BWD,SSJ						60	640	S4 E05			
	05.15→	70	760	S5 A08	52	520	S5 001	60	540	S4 005			
1.6 [NH1]	10.13-06.15				54	530	S5 002	52	470	S4 002			
					63	610	S5 005	52	470	S4 002			
		BWD,SSJ						60	640	S4 E05			

Diesel

1.4 TDI [NH1]	05.15→				52	520	S5 001	60	540	S4 005			
		BWD,SSJ	70	760	S5 A08			60	640	S4 E05			
1.6 TDI [NH1]	10.13-05.15	70	760	S5 A08									
		70	760	S5 A08	63	610	S5 005	60	540	S4 005			
		BWD,SSJ						60	640	S4 E05			
	10.13→				63	610	S5 005	60	540	S4 005			
		BWD						60	640	S4 E05			
		BWD,SSJ	70	760	S5 A08								
	05.15→				52	520	S5 001	60	540	S4 005			
		BWD,SSJ	70	760	S5 A08			60	640	S4 E05			

Roomster

1.2 [5J7]	05.06-01.07				63	610	S5 005	52	470	S4 002	45	400	S3 002
	01.07-05.15				54	530	S5 002	52	470	S4 002			
		BWD,SSJ	70	760	S5 A08								
TSI [5J7]	03.10-05.15				63	610	S5 005	60	540	S4 005	45	400	S3 002
		BWD,SSJ						60	640	S4 E05			
1.4/ 1.6 [5J7]	05.06-05.15				63	610	S5 005	52	470	S4 002	45	400	S3 002
Diesel													
1.2 TDI [5J7]	03.10-05.15	BWD,SSJ	70	760	S5 A08								
		SSJ	70	760	S5 A08								
1.4 TDI [5J7]	05.06-03.10	70	760	S5 A08	63	610	S5 005	60	540	S4 005	56	480	S3 005
1.6 TDI [5J7]	03.10-05.15				63	610	S5 005	60	540	S4 005	45	400	S3 002
		BWD,SSJ						60	640	S4 E05			



											Ah A (EN)			Ah A (EN)			Ah A (EN)			Ah A (EN)		
		0 092 ...0			0 092 ...0			0 092 ...0			0 092 ...0											
◀ SKODA																						
1.9 TDI [5J7]	03.06-05.06				77	780	S5 008	74	680	S4 008												
	05.06-03.10	70	760	S5 A08	63	610	S5 005	60	540	S4 005	56	480	S3 005									
Superb																						
1.4 TSI [3T4]	04.08-05.15	80	800	S5 A11	54	530	S5 002															
		BWD,SSJ																				
		70	760	S5 A08																		
TSI [3V3]	05.15→				52	520	S5 001	60	540	S4 005												
		BWD,SSJ																				
		70	760	S5 A08																		
		70	760	S5 A08				60	640	S4 E05												
TSI 4x4 [3V3]	05.15→	BWD,SSJ																				
		70	760	S5 A08																		
1.8 T [3U4]	12.01-03.08	70	760	S5 A08	77	780	S5 008	74	680	S4 008	70	640	S3 008									
TSI [3T4]	03.08-05.09				63	610	S5 005	60	540	S4 005												
		BWD,SSJ																				
		80	800	S5 A11																		
		BWD,SSJ																				
		70	760	S5 A08	63	610	S5 005	60	540	S4 005												
		80	800	S5 A11				60	540	S4 005												
		80	800	S5 A11																		
TSI [3V3]	05.15→	BWD,SSJ																				
		70	760	S5 A08																		
TSI 4x4 [3T4]	11.08-05.15	70	760	S5 A08	77	780	S5 008	74	680	S4 008												
		BWD,SSJ																				
		80	800	S5 A11				60	540	S4 005												
		70	760	S5 A08																		
2.0 [3U4]	12.01-03.08	70	760	S5 A08	77	780	S5 008	60	540	S4 005	70	640	S3 008									
TSI [3T4]	05.10-05.15	80	800	S5 A11	77	780	S5 008	74	680	S4 008												
		BWD,SSJ																				
		70	760	S5 A08				70	760	S4 E08												
TSI [3V3]	05.15→				52	520	S5 001	60	540	S4 005												
		BWD,SSJ																				
		70	760	S5 A08				60	640	S4 E05												
TSI 4x4 [3V3]	05.15→				52	520	S5 001	60	540	S4 005												
		BWD,SSJ																				
		70	760	S5 A08				60	640	S4 E05												
2.8 [3U4]	12.01-03.08	70	760	S5 A08	85	800	S5 011	74	680	S4 008	70	640	S3 008									
		BWD,SSJ																				
		70	760	S5 A08	77	780	S5 008	74	680	S4 008												
3.6 V6 4x4 [3T4]	11.08-05.15	80	800	S5 A11	77	780	S5 008	74	680	S4 008												
		BWD,SSJ																				
		70	760	S5 A08																		
Diesel																						
1.6 TDI [3T4]	09.10-05.15	BWD,SSJ																				
		80	800	S5 A11																		
		SSJ																				
		80	800	S5 A11																		
TDI [3V3]	05.15→				52	520	S5 001	60	540	S4 005												
		BWD,SSJ																				
		70	760	S5 A08				60	640	S4 E05												
		70	760	S5 A08				60	540	S4 005												
		BWD																				
		60	640	S4 E05																		
1.9 TDI [3T4]	03.08-11.10	70	760	S5 A08	85	800	S5 011	74	680	S4 008												
TDI [3U4]	12.01-03.08	70	760	S5 A08	77	780	S5 008	74	680	S4 008	70	640	S3 008									
2.0 TDI [3T4]	03.08-05.15	70	760	S5 A08	85	800	S5 011	74	680	S4 008												
		BWD,SSJ																				
		70	760	S5 A08	77	780	S5 008	74	680	S4 008												
TDI [3U4]	10.05-03.08	70	760	S5 A08	85	800	S5 011	74	680	S4 008	70	640	S3 008									
		BWD,SSJ																				
		70	760	S5 A08	77	780	S5 008	74	680	S4 008												
TDI [3V3]	05.15→				52	520	S5 001	60	540	S4 005												
		BWD,SSJ																				
		70	760	S5 A08																		
		70	760	S5 A08				60	640	S4 E05												
		BWD																				
		70	760	S5 A08																		
TDI 4x4 [3T4]	09.08-05.15	70	760	S5 A08	85	800	S5 011	74	680	S4 008												
		BWD,SSJ																				
		70	760	S5 A08	77	780	S5 008	74	680	S4 008												
TDI 4x4 [3V3]	05.15→				52	520	S5 001	60	540	S4 005												
		BWD,SSJ																				
		70	760	S5 A08																		
		70	760	S5 A08				60	640	S4 E05												
		BWD																				
		70	760	S5 A08																		
2.5 TDI [3U4]	12.01-03.08	70	760	S5 A08	85	800	S5 011	74	680	S4 008	70	640	S3 008									
Superb Combi																						
1.4 TSI [3T5]	09.09-05.15	80	800	S5 A11	77	780	S5 008	74	680	S4 008												
		BWD,SSJ																				
		70	760	S5 A08																		
TSI [3V5]	05.15→				52	520	S5 001	60	540	S4 005												
		BWD,SSJ																				
		70	760	S5 A08																		
		70	760	S5 A08				60	640	S4 E05												
1.4/2.0 TSI 4x4 [3V5]	05.15→	BWD,SSJ																				
		70	760	S5 A08																		
1.8 TSI [3T5]	03.09-05.15	80	800	S5 A11				60	540	S4 005												
		BWD,SSJ																				
		70	760	S5 A08																		



			Ah A (EN) S5A			Ah A (EN) S5			Ah A (EN) S4			Ah A (EN) S3		
			0 092 ...0			0 092 ...0			0 092 ...0			0 092 ...0		
1.8	TSI [3T5]	09.09-05.15	80	800	S5 A11	63	610	S5 005	60	540	S4 005			
	TSI [3V5]	05.15→	BWD,SSJ	70	760	S5 A08								
	TSI 4x4 [3T5]	03.09-05.15		80	800	S5 A11	77	780	S5 008	74	680	S4 008		
			BWD,SSJ	70	760	S5 A08								
		09.09-05.15		80	800	S5 A11	63	610	S5 005	60	540	S4 005		
2.0	TSI [3T5]	05.10-05.15		80	800	S5 A11	77	780	S5 008	74	680	S4 008		
			BWD,SSJ	70	760	S5 A08				70	760	S4 E08		
	TSI [3V5]	05.15→				52	520	S5 001	60	540	S4 005			
			BWD,SSJ	70	760	S5 A08				60	640	S4 E05		
3.6	V6 4x4 [3T5]	09.09-05.15		80	800	S5 A11	77	780	S5 008	74	680	S4 008		
			BWD,SSJ	70	760	S5 A08								
Diesel														
1.6	TDI [3T5]	09.10-05.15	BWD,SSJ	80	800	S5 A11								
			SSJ	80	800	S5 A11								
	TDI [3V5]	05.15→				52	520	S5 001	60	540	S4 005			
			BWD,SSJ	70	760	S5 A08				60	640	S4 E05		
		11.15→		70	760	S5 A08	52	520	S5 001	60	540	S4 005		
			BWD							60	640	S4 E05		
1.9	TDI [3T5]	09.09-09.10		70	760	S5 A08	77	780	S5 008	74	680	S4 008		
		09.09-11.10		80	800	S5 A11	77	780	S5 008	74	680	S4 008		
			BWD							70	760	S4 E08		
			BWD,SSJ	70	760	S5 A08								
2.0	TDI [3T5]	09.09-03.10		80	800	S5 A11	77	780	S5 008	74	680	S4 008		
			BWD,SSJ	70	760	S5 A08								
		09.09-05.15		70	760	S5 A08	85	800	S5 011	74	680	S4 008		
		02.10-05.15		70	760	S5 A08	77	780	S5 008	74	680	S4 008		
	TDI [3V5]	05.10-05.15		70	760	S5 A08	85	800	S5 011	74	680	S4 008		
		05.15→				52	520	S5 001	60	540	S4 005			
			BWD,SSJ	70	760	S5 A08								
				70	760	S5 A08				60	640	S4 E05		
	TDI 4x4 [3T5]	09.09-05.10		70	760	S5 A08	85	800	S5 011	74	680	S4 008		
		11.10-05.15		80	800	S5 A11	77	780	S5 008	74	680	S4 008		
			BWD,SSJ	70	760	S5 A08								
	TDI 4x4 [3V5]	05.15→				52	520	S5 001	60	540	S4 005			
			BWD,SSJ	70	760	S5 A08								
				70	760	S5 A08				60	640	S4 E05		
		07.17→	BWD	70	760	S5 A08								
Yeti														
1.2	TSI [5L7]	09.09-05.15								60	540	S4 005		
			BWD,SSJ	70	760	S5 A08				70	760	S4 E08		
		05.15-12.17				52	520	S5 001	60	540	S4 005			
			BWD,SSJ	70	760	S5 A08				60	640	S4 E05		
1.4	TSI [5L7]	06.10-11.15	BWD			77	780	S5 008	60	540	S4 005			
			BWD,SSJ						70	760	S4 E08			
		05.15-12.17	BWD,SSJ	70	760	S5 A08								
	TSI 4x4 [5L7]	05.15-12.17				52	520	S5 001	60	540	S4 005			
			BWD,SSJ	70	760	S5 A08				60	640	S4 E05		
1.6	[5L7]	04.14-12.17		60	680	S5 A05	63	610	S5 005	60	540	S4 005		
			BWD,SSJ							60	640	S4 E05		
1.8	TSI 4x4 [5L7]	05.09-12.17								60	540	S4 005		
			BWD,SSJ	70	760	S5 A08				70	760	S4 E08		
		11.09-12.17		70	760	S5 A08	77	780	S5 008	74	680	S4 008		
Diesel														
1.6	TDI [5L7]	11.10-05.15	BWD,SSJ	70	760	S5 A08								
			SSJ	70	760	S5 A08								
2.0	TDI [5L7]	11.09-12.17		70	760	S5 A08	85	800	S5 011	74	680	S4 008		
		11.11-12.17				77	780	S5 008	74	680	S4 008			
			BWD,SSJ	70	760	S5 A08								
		05.15-12.17	BWD	70	760	S5 A08								
	TDI 4x4 [5L7]	05.09-12.17		70	760	S5 A08	85	800	S5 011	74	680	S4 008		
		05.15-12.17				77	780	S5 008	74	680	S4 008			
			BWD	70	760	S5 A08								
			BWD,SSJ	70	760	S5 A08								



			Ah A (EN)	Ah A (EN)	Ah A (EN)	Ah A (EN)
			0 092 ...0	0 092 ...0	0 092 ...0	0 092 ...0

SMART

Forfour											
0.9 [453]	11.14→	SSJ						60	640	S4 E05	
Brabus [453]	07.16→	SSJ	60	680	S5 A05			60	640	S4 E05	
1.0 [453]	11.14→	SSJ	60	680	S5 A05			60	640	S4 E05	
1.1/ 1.3/ 1.5 , Brabus, Sportstyle [454]	01.04-06.07					54	530	S5 002	52	470	S4 002 45 400 S3 002
Diesel											
1.5 cdi [454]	09.04-06.07		70	760	S5 A08	77	780	S5 008	74	680	S4 008 70 640 S3 008
Fortwo Cabrio											
ED [451]	05.07-05.12					54	530	S5 002	52	470	S4 002
	06.12-12.15								60	540	S4 005
[453]	09.15→								60	540	S4 005
Brabus [451]	06.12-12.15								60	540	S4 005
0.7 , Brabus [450]	01.04-03.07					54	530	S5 002	52	470	S4 002 45 400 S3 002
0.9 Brabus [453]	10.15→	SSJ	60	680	S5 A05				60	640	S4 E05
0.9/ 1.0 [453]	09.15→	SSJ							60	640	S4 E05
1.0 [451]	04.07-09.07					54	530	S5 002	52	470	S4 002
		SSJ	60	680	S5 A05						
	04.07-12.15					54	530	S5 002	52	470	S4 002 45 400 S3 002
Brabus [451]	04.07-12.15					54	530	S5 002	52	470	S4 002 45 400 S3 002
	04.12-12.15					54	530	S5 002	52	470	S4 002
mhd [451]	10.07-12.15					54	530	S5 002	52	470	S4 002
		SSJ	60	680	S5 A05						
Diesel											
0.8 cdi [450]	02.04-03.07					63	610	S5 005	60	540	S4 005 56 480 S3 005
cdi [451]	04.07-07.09					63	610	S5 005	60	540	S4 005 56 480 S3 005
	08.09-09.13					63	610	S5 005	60	540	S4 005 45 400 S3 002
Fortwo Coupé											
ED [451]	05.07-05.12								60	540	S4 005
	06.12-12.15		60	680	S5 A05	63	610	S5 005	60	540	S4 005 56 480 S3 005
			60	680	S5 A05	63	610	S5 005	60	640	S4 E05 56 480 S3 005
[453]	09.15→		60	680	S5 A05	63	610	S5 005	60	540	S4 005 56 480 S3 005
			60	680	S5 A05	63	610	S5 005	60	640	S4 E05 56 480 S3 005
Brabus [451]	06.12-12.15								60	540	S4 005
0.7 , Brabus [450]	02.04-03.07					54	530	S5 002	52	470	S4 002 45 400 S3 002
0.9 [453]	11.14→	SSJ	60	680	S5 A05				60	640	S4 E05
Brabus [453]	07.16→	SSJ	60	680	S5 A05				60	640	S4 E05
1.0 [451]	04.07-05.08					63	610	S5 005			
		SSJ	60	680	S5 A05				60	540	S4 005
	04.07-12.15					54	530	S5 002	52	470	S4 002 45 400 S3 002
[453]	11.14→	SSJ	60	680	S5 A05				60	640	S4 E05
			60	680	S5 A05				60	640	S4 E05
Brabus [451]	04.07-12.15					54	530	S5 002	52	470	S4 002 45 400 S3 002
mhd [451]	10.07-12.15	SSJ	60	680	S5 A05						
	06.08-12.15					63	610	S5 005	60	540	S4 005 45 400 S3 002
						63	610	S5 005	60	640	S4 E05 45 400 S3 002
Diesel											
0.8 cdi [450]	02.04-03.07					63	610	S5 005	60	540	S4 005 56 480 S3 005
cdi [451]	04.07-09.13					63	610	S5 005	60	540	S4 005
Roadster											
0.7 , Brabus [452]	04.03-11.05					54	530	S5 002	52	470	S4 002 45 400 S3 002
Roadster Coupé											
0.7 , Brabus [452]	04.03-11.05					54	530	S5 002	52	470	S4 002 45 400 S3 002
Smart Cabrio											
0.6 [450]	08.98-12.06					54	530	S5 002	52	470	S4 002
	01.01-01.04					54	530	S5 002	52	470	S4 002 45 400 S3 002
0.7 [450]	11.02-01.04					54	530	S5 002	52	470	S4 002 45 400 S3 002
Brabus [450]	01.03-01.04					54	530	S5 002	52	470	S4 002 45 400 S3 002
Diesel											
0.8 cdi [450]	03.01-01.04					63	610	S5 005	60	540	S4 005



			Ah A (EN)	Ah A (EN)	Ah A (EN)	Ah A (EN)
			0 092 ...0	0 092 ...0	0 092 ...0	0 092 ...0

Smart Coupé										
0.6 [450]	07.98-01.04	54	530	S5 002	52	470	S4 002	45	400	S3 002
	08.98-12.06	54	530	S5 002	52	470	S4 002			
0.7 [450]	08.98-12.06	54	530	S5 002	52	470	S4 002			
	11.02-01.04	54	530	S5 002	52	470	S4 002	45	400	S3 002
Brabus [450]	01.03-01.04	54	530	S5 002	52	470	S4 002	45	400	S3 002
Diesel										
0.8 cdi [450]	11.99-01.04	63	610	S5 005	60	540	S4 005			
Smart Crossblade										
0.6 [450]	10.02-01.04	54	530	S5 002	52	470	S4 002			

SSANGYONG

Actyon										
2.0/ 2.3 e-XGi, e-XGi 4x4, i 4WD	11.06→				95	830	S4 029			
2.3 4WD	09.06-12.10				70	630	S4 027			
Diesel										
2.0 CRDI	10.05-12.10				95	830	S4 029			
e-XDi, e-XDi 4x4	05.11-12.15				95	830	S4 029			
Xdi, Xdi 4WD	09.06-12.10				95	830	S4 029			
Chairman										
2.3 i	01.99-09.03	100	830	S5 013						
Chairman New										
2.8/ 3.2 i	09.03-01.08	100	830	S5 013						
Korando										
2.0 XGi, XGi AWD [CK]	06.12→				60	540	S4 025			
2.0/ 2.3/ 3.2 i, i 4WD, i 16V [KJ]	07.96-12.05				95	830	S4 029			
Diesel										
2.0/ 2.2 DT, DT AWD, XDi, XDi AWD [CK]	07.10→				95	830	S4 029			
2.3/ 2.9 D, D 4WD, TD Intercooler 4WD [KJ]	07.96-12.05				95	830	S4 029			
Kyron										
2.3 i	01.10-12.15				60	540	S4 025			
i 4WD	11.05-12.15				60	540	S4 025			
3.2 i 4WD	11.05-12.15				95	830	S4 029			
Diesel										
2.0 Xdi	05.05-12.15				60	540	S4 025			
					95	830	S4 029			
2.0/ 2.7 Xdi 4WD	05.05-12.15				95	830	S4 029			
Musso										
2.0/ 2.3/ 3.2 i [MJ]	01.96-12.05				60	540	S4 024			
Diesel										
2.3/ 2.9 D, TD Intercooler [MJ]	07.93-12.05				95	830	S4 029			
Rexton										
2.3/ 3.2 i, i 4WD	09.01→				95	830	S4 029			
Diesel										
2.7/ 2.9 CRDi 4WD, TD, Xdi 4WD	09.02-12.10				95	830	S4 029			
Rexton RX200										
Diesel										
2.0 e-XDi, e-XDi 4WD	09.12-04.17				95	830	S4 029			
Rexton RX220										
Diesel										
2.2 e-XDi, e-XDi 4WD	08.15→				95	830	S4 029			
Rexton RX230										
2.3 4WD	05.02-12.06				95	830	S4 029			



			Ah A (EN)	Ah A (EN)	Ah A (EN)	Ah A (EN)
			0 092 ...0	0 092 ...0	0 092 ...0	0 092 ...0

◀ SSANGYONG

Rexton RX270										
Diesel										
2.7 XDI 4WD, XVT 4WD	10.08-12.12						95	830	S4 029	
Rodius										
3.2 , 4WD	11.06-12.10						95	830	S4 029	
Diesel										
2.7 Xdi, Xdi 4WD	05.05-12.12						95	830	S4 029	
Rodius SV200										
Diesel										
2.0 e-XDI, e-XDI 4WD	05.13→						95	830	S4 029	
Rodius SV220										
Diesel										
2.2 e-XDI, e-XDI 4WD	08.15→						95	830	S4 029	
Stavic										
Diesel										
2.7 Xdi	08.05→						95	830	S4 029	
Tivoli										
1.6 e-XGI	07.15→		70	760	S5 A08		52	470	S4 002	
			70	760	S5 A08		60	540	S4 005	
e-XGI AWD	07.15→		70	760	S5 A08		52	470	S4 002	
			70	760	S5 A08		60	540	S4 005	
Diesel										
1.6 e-XDI	07.15→						70	630	S4 026	
		SSJ	70	760	S5 A08					
e-XDI AWD	07.15→						70	630	S4 026	
		SSJ	70	760	S5 A08					
XLV										
1.6 e-XGI	04.16→						52	470	S4 002	
							60	540	S4 005	
							70	630	S4 026	
		SSJ	70	760	S5 A08					
Diesel										
1.6 e-XDI	04.16→		70	760	S5 A08		52	470	S4 002	
			70	760	S5 A08		70	630	S4 026	
e-XDI AWD	04.16→						52	470	S4 002	
							70	630	S4 026	
		SSJ	70	760	S5 A08					



STEYR (STEYR-DAIMLER-PUCH AG)

G														
320/ 500 , V8	01.98→		70	760	S5 A08	77	780	S5 008	74	680	S4 008	70	640	S3 008
Diesel														
300 DT	01.98→		70	760	S5 A08	77	780	S5 008	74	680	S4 008	70	640	S3 008

SUBARU

BRZ										
2.0 [Z10]	06.12→						60	540	S4 024	
Forester										
2.0 i [S12]	12.07-12.10						60	540	S4 024	
	09.10-12.12						70	630	S4 026	
i [S13]	11.12→						70	630	S4 026	
		SSJ					65	650	S4 E40	
XT [S13]	11.12→						70	630	S4 026	
2.0/ 2.5 i S Turbo 4X4, i Turbo 4X4, i 4x4, i 4X4 [SF; SG]	01.97-11.07						60	540	S4 024	
2.5 i [S12]	12.07-12.10						70	630	S4 026	
i Turbo [S12]	12.07-12.12						60	540	S4 024	
X [S12]	09.10-12.12						70	630	S4 026	
							72	760	S4 E41	

			Ah A (EN) S5A	Ah A (EN) S5	Ah A (EN) S4	Ah A (EN) S3
			0 092 ...0	0 092 ...0	0 092 ...0	0 092 ...0

Diesel						
2.0 D [S12; S13]	12.07→				70 630	S4 026
Impreza						
1.5/ 1.6/ 2.0/ 2.5 i, i Turbo	11.92-11.11				60 540	S4 024
4WD, i 4WD, i 4WD Turbo, i 4WD Turbo STI [GC; GC, GF; GD; GD, GG; GH; GR]						
1.5/ 2.0 R, R Crossover 4x4, R 4x4 [G12]	06.07-12.11				60 540	S4 024
1.6 [G14]	10.17→				65 650	S4 E40
i [G23]	10.11-11.17				60 540	S4 024
		SSJ			65 650	S4 E40
i 4x4 [G13]	10.11-12.15				65 650	S4 E40
i 4x4 [G23]	10.11-11.17				60 540	S4 024
		SSJ			65 650	S4 E40
2.0 i 4WD [G12]	06.07-09.11				52 470	S4 002
					60 540	S4 024
i 4x4 [G23]	10.11-11.17				40 330	S4 018
					60 540	S4 024
					65 650	S4 E40
Diesel						
2.0 D Crossover 4x4 [G12]	03.10-12.11				95 830	S4 028
D 4x4 [G12]	09.08-12.11				70 630	S4 026
					95 830	S4 029
Impreza Coupé						
1.6/ 2.0 i, i 4WD [GC, GF]	10.93-09.00				60 540	S4 024
Impreza Kombi						
1.5/ 1.6/ 2.0/ 2.5 i, i 4WD, i 4WD Turbo [GC, GF; GD, GG; GG]	12.93-06.07				60 540	S4 024
Impreza Outback						
2.0 i 4WD [GD, GG]	10.00-06.07				60 540	S4 024
Impreza STI						
2.0/ 2.5 i 4WD Turbo, i 4WD Turbo S202 [GD, GG]	06.02-06.07				60 540	S4 024
Impreza WRX						
2.5 [G22]	09.10-01.14				60 540	S4 024
					65 650	S4 E40
STI [G22]	09.10-01.14				60 540	S4 024
		SSJ			65 650	S4 E40
STI 320R [G22]	04.11-12.12				60 540	S4 024
					65 650	S4 E40
Impreza WRX Hatchback						
2.5 [G12]	06.07-12.11				60 540	S4 024
[G22]	09.10-01.14				60 540	S4 024
STI [G22]	06.07-01.14				60 540	S4 024
		SSJ			65 650	S4 E40
STI 320R [G22]	04.11-12.12				60 540	S4 024
					65 650	S4 E40
Impreza WRX Wagon						
2.5 STI AWD [G22]	06.07-01.14				60 540	S4 024
Jusy						
1.0 [M3]	09.07-12.10				40 330	S4 018
1.3 4x4 [G3X]	09.03-08.07	52	520	S5 001	45 330	S4 020 41 360 S3 001
4x4 [MS]	10.96-08.03				45 330	S4 020
4x4 [M3]	07.09-12.10				45 330	S4 020
1.5 4x4 [G3X]	09.03-08.07	52	520	S5 001	44 440	S4 001 41 360 S3 001
Legacy						
1.8 i 4WD	06.94-11.98				60 540	S4 024
1.8/ 2.0 i	10.93-11.98				60 540	S4 024
2.0 [B14]	06.09-12.14				60 540	S4 025
i CNG 4WD, i Turbo 4WD	05.03-05.09				60 540	S4 024
i 4WD	10.93-11.98				60 540	S4 024



			Ah A (EN)	Ah A (EN)	Ah A (EN)	Ah A (EN)
			0 092 ...0	0 092 ...0	0 092 ...0	0 092 ...0
◀ SUBARU						
2.0 i 4WD	05.03-05.09			60 540	S4 024	
2.0/ 2.5/ 3.0 R 4WD, 4WD [BL/BP]	07.03-05.09			60 540	S4 024	
2.5 [B14]	06.09-12.14			60 540	S4 025	
	03.12-12.14			60 540	S4 024	
GT [B14]	06.09-12.14			60 540	S4 025	
i 4WD	10.94-11.98			60 540	S4 024	
	05.01-04.03			60 540	S4 024	
3.0 i 4WD	01.02-04.03			60 540	S4 024	
	09.03-05.09			60 540	S4 024	
Diesel						
2.0 D [B14]	06.09-12.14			70 630	S4 027	
				95 830	S4 029	
D 4WD [BL/BP]	04.07-05.09			70 630	S4 026	
				95 830	S4 029	
Legacy Kombi						
2.0/ 2.5/ 3.0 i, i 4WD, R 4WD, 4WD [BD/BG; BE/BH; BL/BP]	01.94-05.09			60 540	S4 024	
2.5 [B14]	06.09-12.12			60 540	S4 025	
Diesel						
2.0 D 4WD [BL/BP]	04.07-05.09			70 630	S4 026	
				95 830	S4 029	
Legacy Outback						
2.5/ 3.0 i 4WD, 4WD [BD/BG; BE/BH; BL/BP]	01.96-06.09			60 540	S4 024	
Diesel						
2.0 D 4WD [BL/BP]	04.07-05.09			70 630	S4 026	
				95 830	S4 029	
Legacy Sedan						
1.8/ 2.0/ 2.2/ 2.5 i, i Turbo 4WD, i 4WD [BD/BG; BE/BH]	01.94-06.03			60 540	S4 024	
Legacy Station Wagon						
2.0/ 2.5 [B14]	06.09-12.14			60 540	S4 025	
Diesel						
2.0 D [B14]	06.09-12.14			70 630	S4 027	
				95 830	S4 029	
Legacy Station Wagoni						
2.5 GT [B14]	06.09-12.14			60 540	S4 025	
Levorg						
1.6 GT [V10]	09.15→		63 610	S5 005		
Liberty						
2.0	05.03-05.09			60 540	S4 024	
Outback						
2.5 [B14]	06.09-04.15			60 540	S4 025	
[B15]	03.15→			70 630	S4 027	
3.6 [B14]	06.09-04.15			70 630	S4 027	
				95 830	S4 029	
Diesel						
2.0 D [B14]	06.09-04.15			70 630	S4 027	
				95 830	S4 029	
D [B15]	03.15→			70 630	S4 027	
Trezia						
1.3 [NSP]	03.11-12.14			60 640	S4 E05	
Diesel						
1.4 D [NLP]	03.11-12.14		63 610	S5 005	60 540	S4 005
Tribeca						
3.0/ 3.6 R, 4x4 [B9; W10]	04.06-01.14			60 540	S4 024	
Vivio						
660 , i, i 4WD [R13]	08.93-04.00			40 330	S4 018	



			Ah A (EN) S5A	Ah A (EN) S5	Ah A (EN) S4	Ah A (EN) S3
			0 092 ...0	0 092 ...0	0 092 ...0	0 092 ...0

WRX STI						
2.5 AWD [V10]	05.14→					60 540 S4 024
		SSJ				65 650 S4 E40
WRX STI Wagon						
2.5 AWD [V10]	09.12-08.14					60 540 S4 024
XV						
1.6/ 2.0 AWD, i [G33]	09.11-11.17	SSJ	70 760	S5 A08		70 760 S4 E08
Diesel						
2.0 D, DL [G33]	08.11-11.17					70 630 S4 026

SUZUKI

Alto						
1.1 i 16V [MA]	02.02-12.06					40 330 S4 019
Alto Hatchback						
1.0 [AMF]	12.08-03.15		52 520	S5 001		40 330 S4 019
, i [EF]	10.94-02.02					40 330 S4 019
Baleno						
1.0	06.16→					40 330 S4 018
						45 330 S4 021
1.2	06.16→					40 330 S4 018
						45 330 S4 021
Baleno Hatchback						
1.3/ 1.6/ 1.8 i 16V, i 16V	04.95-09.06					40 330 S4 019
4WD, 16V						
Diesel						
1.9 D Turbo	04.98-05.02					70 630 S4 026
Baleno Sedan						
1.3/ 1.5/ 1.6/ 1.8 i 16V, i 16V	04.95-09.05					40 330 S4 019
4WD, 16V						
Diesel						
1.9 D Turbo	12.98-05.02					70 630 S4 026
Baleno Wagon						
1.3/ 1.6/ 1.8 i 16V, i 16V 4WD	09.95-09.07					40 330 S4 019
Diesel						
1.9 D Turbo	12.98-05.02					70 630 S4 026
Cappuccino						
660 Turbo	08.93-08.03					40 330 S4 019
Celerio						
1.0 i	10.14→					45 330 S4 021
Grand Vitara						
1.6 [JT]	03.15-12.16					45 330 S4 020
4x4 [JT]	10.05-12.14					45 330 S4 020
	03.15-12.16					45 330 S4 020
1.6/ 2.0/ 2.5 i 4x4, i 16V [FT]	03.98-12.05					60 540 S4 024
2.0 4x4 [JT]	10.05-12.09					60 540 S4 024
2.4 4x4	09.08→					60 540 S4 024
						72 760 S4 E41
2.7 XL-7 [HT]	06.01-03.03					60 540 S4 024
	04.03-08.08					70 630 S4 026
3.2 4x4 [JT]	09.08-12.10					70 630 S4 026
Diesel						
1.9/ 2.0 D Turbo, DDiS 4x4	03.98-12.14					70 630 S4 026
[FT; JT]						
Grand Vitara Cabrio						
1.6/ 2.0 i 16V [GT]	03.98-03.08					60 540 S4 024
Ignis						
1.2 , 4WD [MF]	10.16→					45 330 S4 021
Ignis Hatchback						
1.3 i 16V	10.00-09.03		52 520	S5 001		44 440 S4 001
			52 520	S5 001		44 440 S4 001
	10.03-12.07					45 330 S4 021



				Ah	A (EN)		Ah	A (EN)		Ah	A (EN)		Ah	A (EN)	
				0 092 ...0			0 092 ...0			0 092 ...0			0 092 ...0		
◀ SUZUKI															
1.3 i 16V 4WD	10.00-09.03			52	520	S5 001	44	440	S4 001	41	360	S3 001			
	10.03-12.07						45	330	S4 021						
1.5 i 16V	10.03-12.07			52	520	S5 001	44	440	S4 001	41	360	S3 001			
i 16V Sport	12.03-12.07			52	520	S5 001	44	440	S4 001	41	360	S3 001			
i 16V 4WD	10.03-12.07			52	520	S5 001	44	440	S4 001	41	360	S3 001			
Diesel															
1.3 DDiS Turbo	10.03-12.07			74	750	S5 007	44	440	S4 001	41	360	S3 001			
Jimny															
1.3 i 16V [FJ]	10.98-10.08						45	330	S4 022						
i 16V 4WD [FJ]	10.98-10.08	JEA					45	330	S4 022						
	10.00→						45	330	S4 022						
Diesel															
1.5 DDiS 4WD [FJ]	12.03-06.12						60	540	S4 024						
Kizashi															
2.4 i, i 4WD	06.10-12.14						70	630	S4 026						
Liana Hatchback															
1.3/ 1.6/ 1.8 i 16V, i 16V 4WD	03.01-04.08						45	330	S4 020						
Diesel															
1.4 D	03.05-12.07						40	330	S4 019						
Liana Sedan															
1.3/ 1.6/ 1.8 i 16V, i 16V 4WD	03.02-12.07						45	330	S4 020						
Diesel															
1.4 D	03.05-12.07						70	630	S4 026						
Samurai															
1.3 , i, i 4x4	08.88-12.04						40	330	S4 019						
Diesel															
1.9 D Turbo 4x4	08.93-12.04						70	630	S4 026						
Samurai Cabrio															
1.3 i	04.95-12.04						40	330	S4 019						
Diesel															
1.9 D Turbo 4x4	08.93-12.04						70	630	S4 026						
Splash															
1.0 [A5B]	01.08-12.14			52	520	S5 001	44	440	S4 001						
		SSJ	60	680	S5 A05		60	640	S4 E05						
	06.11-12.14	BWD	60	680	S5 A05										
		SSJ					60	640	S4 E05						
1.2 [A5B]	01.08-08.14			52	520	S5 001	44	440	S4 001	41	360	S3 001			
	11.10-12.14			52	520	S5 001	44	440	S4 001						
		SSJ	60	680	S5 A05		60	640	S4 E05						
Diesel															
1.3 DDiS [A5B]	01.08-10.10			74	750	S5 007	72	680	S4 007	70	640	S3 007			
Swift															
1.0/ 1.3/ 1.5 i, i 4WD, i 16V [MA; MZ/EZ]	03.96-03.06						40	330	S4 019						
1.3 i [ZC]	11.04-09.10			52	520	S5 001	44	440	S4 001						
i 4WD [Z]	11.04-09.10			52	520	S5 001	44	440	S4 001						
1.5 i [ZC]	11.04-09.10			52	520	S5 001	44	440	S4 001						
				52	520	S5 001	45	330	S4 022						
1.6 i [ZC]	09.05-09.10			52	520	S5 001	44	440	S4 001						
	12.11-01.17			54	530	S5 002	52	470	S4 002						
Swift Hatchback															
1.0 i [MA]	03.96-12.04						40	330	S4 019						
1.2 [AZG]	09.10→			54	530	S5 002	52	470	S4 002						
		BWD					60	640	S4 E05						
[AZH]	01.11→		60	680	S5 A05										
		BWD					60	640	S4 E05						
Dualjet, Dualjet 4WD [AZG]	06.14→		54	530	S5 002	52	470	S4 002							
4WD [AZG]	10.10-12.15		60	680	S5 A05	54	530	S5 002	60	640	S4 E05				
			60	680	S5 A05	54	530	S5 002	60	640	S4 E05				
4WD [AZH]	01.11→		54	530	S5 002	52	470	S4 002							
		BWD					60	640	S4 E05						
1.3 [MZ/EZ]	11.04-12.14			52	520	S5 001	40	330	S4 019						



						Ah A (EN) S5A		Ah A (EN) S5		Ah A (EN) S4		Ah A (EN) S3		
				0 092 ...0		0 092 ...0		0 092 ...0		0 092 ...0		0 092 ...0		
1.3	i [MA]	06.96-03.01						40	330	S4 019				
								45	330	S4 022				
	i 16V [MA]	04.01-12.04						40	330	S4 019				
	4WD [MZ/EZ]	11.04-12.14			52	520	S5 001	44	440	S4 001	41	360	S3 001	
1.4	[AZH]	01.11→			52	520	S5 001	44	440	S4 001				
1.5/ 1.6	[MZ/EZ]	11.04-12.14			52	520	S5 001	44	440	S4 001	41	360	S3 001	
Diesel														
1.3	DDiS [AZG]	09.10-12.14			54	530	S5 002	52	470	S4 002				
					54	530	S5 002	60	640	S4 E05				
	DDiS D Turbo [AZG]	09.10-12.14			54	530	S5 002	52	470	S4 002				
					54	530	S5 002	60	640	S4 E05				
	DDiS, DDiS D Turbo [MZ/EZ]	08.05-12.14			61	600	S5 004	60	540	S4 004	53	500	S3 004	
Swift Sport Hatchback														
1.6	[AZG]	10.11→			54	530	S5 002	52	470	S4 002				
SX4														
1.6	VVT	12.07-12.15			52	520	S5 001	44	440	S4 001	53	500	S3 004	
					52	520	S5 001	60	540	S4 004	53	500	S3 004	
					61	600	S5 004	44	440	S4 001	53	500	S3 004	
		09.09-12.14						45	330	S4 020				
2.0	i, i 4x4	07.06-11.14									53	500	S3 004	
SX4 Hatchback														
1.5		05.06→			61	600	S5 004	60	540	S4 004	53	500	S3 004	
1.6	VVT	05.06-09.10			61	600	S5 004	45	330	S4 020		53	500	
		09.09-12.14						45	330	S4 020				
		09.09-09.16			61	600	S5 004	60	540	S4 004	53	500	S3 004	
	VVT 4WD	05.06-09.16			61	600	S5 004	60	540	S4 004	53	500	S3 004	
2.0		03.07-09.10						45	330	S4 020				
	VVT	03.07-09.10						45	330	S4 020				
Diesel														
1.6/ 1.9/ 2.0	DDiS, DDiS 4WD	05.06-12.13		70	760	S5 A08	77	780	S5 008	74	680	S4 008	70	640
SX4 S-Cross														
1.6	, 4WD	10.13-07.16	SSJ		70	760	S5 A08			70	760	S4 E08		
Diesel														
1.6	DDiS	10.13-07.16	SSJ							70	760	S4 E08		
		10.13→		70	760	S5 A08	77	780	S5 008	74	680	S4 008		
		08.16→		70	760	S5 A08	77	780	S5 008	70	760	S4 E08		
	DDiS 4WD	10.13-07.16	SSJ							70	760	S4 E08		
		10.13→		70	760	S5 A08	77	780	S5 008	74	680	S4 008		
		08.16→		70	760	S5 A08	77	780	S5 008	70	760	S4 E08		
SX4 S-Cross Hatchback														
1.0		08.16→			52	520	S5 001	44	440	S4 001				
			SSJ	60	680	S5 A05				60	640	S4 E05		
	4WD	08.16→			52	520	S5 001	44	440	S4 001				
			SSJ	60	680	S5 A05				60	640	S4 E05		
1.4		08.16→			52	520	S5 001	44	440	S4 001				
			SSJ	60	680	S5 A05				60	640	S4 E05		
	4WD	08.16→			52	520	S5 001	44	440	S4 001				
			SSJ	60	680	S5 A05				60	640	S4 E05		
Vitara														
1.6	[ET]	03.88-03.98						40	330	S4 019				
	[LY]	02.15→	SSJ	60	680	S5 A05				60	640	S4 E05		
	i [ET]	03.88-03.98			52	520	S5 001	40	330	S4 019				
					52	520	S5 001	44	440	S4 001				
					52	520	S5 001	45	330	S4 022				
		09.91-03.98						40	330	S4 019				
	i 4x4	09.95-03.04						40	330	S4 019				
	4x4 [LY]	02.15→		60	680	S5 A05				60	640	S4 E05		
				70	760	S5 A08				60	640	S4 E05		
1.6/ 2.0/ 2.5	i 16V, i 24V [ET]	07.90-03.98						40	330	S4 019				
2.5	i 24V [SV]	04.97-12.98						40	330	S4 019				
Diesel														
1.6	DDiS [LY]	02.15→	SSJ	70	760	S5 A08				70	760	S4 E08		



				Ah	A (EN)		Ah	A (EN)		Ah	A (EN)		Ah	A (EN)	
				0 092 ...0			0 092 ...0			0 092 ...0			0 092 ...0		
◀ SUZUKI															
1.6 DDiS 4x4 [LY]	02.15→			70	760	S5 A08				70	760	S4 E08			
1.9 D [SV]	08.96-12.98									70	630	S4 026			
1.9/2.0 D Turbo, D Turbo Interc., D 4x4 [ET]	12.94-03.98									70	630	S4 026			
2.0 HDi [ET]	03.02-12.05						77	780	S5 008	74	680	S4 008			
Vitara Cabrio															
1.6/2.0 , i, i 16V [ET; OS]	03.88-03.98									40	330	S4 019			
Diesel															
1.9 D 4x4 [ET]	01.95-03.98									70	630	S4 026			
Vitara S															
1.4 , 4x4 [LY]	09.15→	SSJ		60	680	S5 A05				60	640	S4 E05			
Wagon R+															
1.0 i 16V [MM]	05.00-08.03									40	330	S4 019			
i 16V Turbo [EM]	05.00-08.08									40	330	S4 019			
i 16V 4WD [EM]	10.96-05.00									40	330	S4 018			
1.0/1.2 i 16V [EM]	09.97-05.00						52	520	S5 001	44	440	S4 001	41	360	S3 001
1.2 i [MM]	05.04-08.08						52	520	S5 001	44	440	S4 001	41	360	S3 001
i 16V 4WD [EM]	07.98-05.00						52	520	S5 001	44	440	S4 001	41	360	S3 001
1.3 i 16V [MM]	05.00-08.03						52	520	S5 001	44	440	S4 001	41	360	S3 001
	09.03-03.06									40	330	S4 019	45	300	S3 016
i 16V 4WD [MM]	10.01-03.06						52	520	S5 001	44	440	S4 001	41	360	S3 001
Diesel															
1.3 DDiS D Turbo [MM]	09.03-03.06									40	330	S4 019	45	300	S3 016
X-90															
1.6 i	09.95-08.98									40	330	S4 019			
i 4x4	09.95-08.98									60	540	S4 024			

TATA (TELCO)

Indica															
1.4 i [T4]	02.98→									60	540	S4 024			
Safari															
2.0 i 4x4 [T3]	02.00→									70	630	S4 027			
Diesel															
2.0 D Turbo 4x4 [T3]	02.00→									70	630	S4 027			

TOYOTA

Auris															
1.2 Turbo [E18]	05.15→	SSJ		60	680	S5 A05				60	640	S4 E05			
				60	680	S5 A05				65	650	S4 E40			
1.3 VVT-i [E15, JTN]	09.08-10.09	SSJ								60	640	S4 E05			
	11.08-10.12			60	680	S5 A05	54	530	S5 002	52	470	S4 002			
				60	680	S5 A05	54	530	S5 002	60	640	S4 E05			
VVT-i [E15, NMT, SB1]	11.08-10.12	SSJ								60	640	S4 E05			
VVT-i [E18]	08.12→			60	680	S5 A05	54	530	S5 002	52	470	S4 002			
		SSJ								60	640	S4 E05			
	10.12→						54	530	S5 002	52	470	S4 002			
		SSJ		60	680	S5 A05				60	640	S4 E05			
1.4 [E15, JTN; E15, NMT, SB1]	10.06-03.09						63	610	S5 005	52	470	S4 002	45	400	S3 002
1.5 i [E15]	10.06-07.12						54	530	S5 002	52	470	S4 002	45	400	S3 002
1.6 [E15, JTN]	10.06-08.12						63	610	S5 005	60	540	S4 005			
							63	610	S5 005	60	540	S4 005	56	480	S3 005
[E15, NMT, SB1]	02.07-10.12						63	610	S5 005	52	470	S4 002			
	02.09-10.12						63	610	S5 005	60	540	S4 005			
[E18]	10.12→						54	530	S5 002	52	470	S4 002			
1.8 [E15, NMT, SB1]	02.09-10.12						63	610	S5 005	60	540	S4 005			
i [E15]	10.06-10.09						63	610	S5 005	60	540	S4 005	56	480	S3 005
i [E15, JTN]	12.08-10.09						63	610	S5 005	60	540	S4 005			
VVT-i HSD [E18]	10.12→									40	330	S4 018			

			Ah	A (EN)		Ah	A (EN)		Ah	A (EN)		Ah	A (EN)	
			0 092 ...0			0 092 ...0			0 092 ...0			0 092 ...0		

Diesel														
1.4 D-4D [E18]	10.12→					63	610	S5 005	60	540	S4 005			
		SSJ	70	760	S5 A08				70	760	S4 E08			
1.4/2.0 D-4D [E15, JTN; E15, NMT, SB1]	10.06-10.12		70	760	S5 A08	85	800	S5 010	74	680	S4 008	70	640	S3 008
1.6 D-4D [E18]	05.15-04.18	SSJ							70	760	S4 E08			
									80	800	S4 E11			
2.0 D-4D [E18]	10.12-05.15								80	740	S4 011			
2.2 D-CAT [E15, NMT, SB1]	02.07-10.12		70	760	S5 A08	85	800	S5 010	74	680	S4 008			
Auris Touring Sports														
1.2 Turbo [E18]	05.15→	SSJ	60	680	S5 A05				60	640	S4 E05			
			60	680	S5 A05				65	650	S4 E40			
1.3 [E18]	07.13→					54	530	S5 002	52	470	S4 002			
		SSJ	60	680	S5 A05				60	640	S4 E05			
1.6 [E18]	07.13→					54	530	S5 002	52	470	S4 002			
Diesel														
1.4 D-4D [E18]	07.13→	SSJ	60	680	S5 A05				60	640	S4 E05			
1.6 D-4D [E18]	05.15-04.18	SSJ							70	760	S4 E08			
									80	800	S4 E11			
2.0 D-4D [E18]	07.13-05.15		70	760	S5 A08	85	800	S5 011	70	760	S4 E08	70	640	S3 008
			70	760	S5 A08	85	800	S5 011	80	740	S4 011	70	640	S3 008
Avensis														
1.6 [T27]	11.08-04.18					63	610	S5 005	60	540	S4 005			
		SSJ	60	680	S5 A05				60	640	S4 E05			
1.6/1.8/2.0 i 16V [T22]	09.97-01.03					63	610	S5 005	52	470	S4 002	45	400	S3 002
i 16V, i 16V 4WD [T25]	01.03-11.08					63	610	S5 005	60	540	S4 005			
1.8 [T27]	11.08-04.18					63	610	S5 005	60	540	S4 005			
		SSJ	60	680	S5 A05				60	640	S4 E05			
2.0 [T27]	11.08-04.18					63	610	S5 005	60	540	S4 005			
			60	680	S5 A05	63	610	S5 005	60	540	S4 005			
		SSJ							60	640	S4 E05			
			60	680	S5 A05				60	640	S4 E05			
2.4 i [T25]	09.03-11.08					63	610	S5 005	60	540	S4 005	56	480	S3 005
Diesel														
1.6 D-4D [T27]	05.15-04.18	SSJ	80	800	S5 A11				80	800	S4 E11			
2.0 D Turbo [T22]	09.97-01.03		70	760	S5 A08	77	780	S5 008	74	680	S4 008	70	640	S3 008
D Turbo [T25]	03.03-04.06		70	760	S5 A08	77	780	S5 008	74	680	S4 008			
D-4D [T25]	04.06-11.08		70	760	S5 A08	77	780	S5 008	74	680	S4 008	70	640	S3 008
D-4D [T27]	11.08-04.15		70	760	S5 A08	85	800	S5 010	74	680	S4 008			
	05.15-04.18	SSJ	80	800	S5 A11				80	800	S4 E11			
2.2 D-CAT, D-4D [T25; T27]	04.05-04.15					85	800	S5 010	80	740	S4 010			
Avensis Liftback														
1.6/1.8 i 16V [T22]	09.97-01.03					63	610	S5 005	52	470	S4 002	45	400	S3 002
1.6/1.8/2.0/2.4 i, i 16V [T25]	01.03-11.08					63	610	S5 005	60	540	S4 005			
2.0 i 16V [T22]	10.97-01.03					63	610	S5 005	52	470	S4 002			
	07.00-01.03					63	610	S5 005	52	470	S4 002	45	400	S3 002
Diesel														
2.0 D Turbo [T22]	10.97-01.03		70	760	S5 A08	77	780	S5 008	74	680	S4 008	70	640	S3 008
D Turbo [T25]	03.03-04.06		70	760	S5 A08	77	780	S5 008	74	680	S4 008			
D-4D [T25]	04.06-11.08		70	760	S5 A08	77	780	S5 008	74	680	S4 008	70	640	S3 008
2.2 D-CAT [T25]	04.05-11.08					85	800	S5 010	80	740	S4 010			
D-4D [T25]	04.05-11.08					85	800	S5 010	80	740	S4 010			
Avensis Verso														
2.0/2.4 i 16V [M2]	05.01-12.09								60	540	S4 024			
Diesel														
2.0 D Turbo [M2]	05.01-07.05		70	760	S5 A08	77	780	S5 008	74	680	S4 008			
Avensis Wagon														
1.6 [T27]	11.08-04.18					63	610	S5 005	60	540	S4 005			
		SSJ	60	680	S5 A05				60	640	S4 E05			
1.6/1.8 i 16V [T25]	01.03-11.08					63	610	S5 005	60	540	S4 005			
1.6/1.8/2.0 i 16V [T22]	09.97-01.03					63	610	S5 005	52	470	S4 002	45	400	S3 002



						Ah A (EN) S5A		Ah A (EN) S5		Ah A (EN) S4		Ah A (EN) S3			
				0 092 ...0		0 092 ...0		0 092 ...0		0 092 ...0		0 092 ...0			
◀ TOYOTA															
1.8 [T27]	11.08-04.18			63	610	S5 005		60	540	S4 005					
		SSJ		60	680	S5 A05		60	640	S4 E05					
2.0 [T27]	11.08-04.18			63	610	S5 005		60	540	S4 005					
				60	680	S5 A05		63	610	S5 005					
		SSJ						60	640	S4 E05					
				60	680	S5 A05		60	640	S4 E05					
i 16V [T25]	01.03-11.08			63	610	S5 005		60	540	S4 005					
				63	610	S5 005		60	540	S4 005	56	480	S3 005		
i 16V 4WD [T25]	09.03-11.08			63	610	S5 005		60	540	S4 005					
2.4 i [T25]	09.03-11.08			63	610	S5 005		60	540	S4 005	56	480	S3 005		
Diesel															
1.6 D-4D [T27]	05.15-04.18	SSJ		80	800	S5 A11		80	800	S4 E11					
2.0 D Turbo [T22]	10.97-01.03			70	760	S5 A08	77	780	S5 008	74	680	S4 008	70	640	S3 008
D Turbo, D-4D [T25]	03.03-11.08			70	760	S5 A08	77	780	S5 008	74	680	S4 008	70	640	S3 008
D-4D [T27]	11.08-04.15			77	780	S5 008		74	680	S4 008					
	05.15-04.18	SSJ		80	800	S5 A11		80	800	S4 E11					
2.2 D-CAT, D-4D [T25; T27]	04.05-04.15			85	800	S5 010		80	740	S4 010					
Aygo															
1.0 [B1]	02.05-12.14							44	420	S4 000	40	340	S3 000		
[B4]	05.14→			60	680	S5 A05	63	610	S5 005	60	540	S4 005	56	480	S3 005
				60	680	S5 A05	63	610	S5 005	60	640	S4 E05	56	480	S3 005
1.2 [B4]	05.14→			54	530	S5 002		52	470	S4 002					
Diesel															
1.4 [B1]	05.05-09.10			54	530	S5 002		52	470	S4 002					
Camry															
2.0 [V5]	08.12-11.14			77	780	S5 008	70	760	S4 E08						
	06.15→			77	780	S5 008	74	680	S4 008						
i 4WD [V4]	06.94-06.98							70	630	S4 027					
i 16V [V3]	08.01-01.06							60	540	S4 024					
2.2/ 3.0, i, i 16V, i 24V [V1; V2]	07.95-08.02							60	540	S4 024					
2.4 [V3]	08.02-08.09							70	630	S4 026					
i [V3]	06.02-09.06							70	630	S4 026					
	09.02-05.06							60	540	S4 024					
i 16V [V3]	07.01-02.06							60	540	S4 024					
	08.01-01.06							70	630	S4 026					
VVT-i [V4]	01.06-08.11							70	630	S4 026					
2.4/ 2.5/ 3.5, i [V4]	01.06→							70	630	S4 027					
2.5/ 3.5 [V5]	08.11→							70	630	S4 027					
3.0 i [V3]	09.02-06.06							60	540	S4 024					
i 24V [V3]	08.99-01.06							70	630	S4 026					
Camry Sedan															
2.4/ 3.0 i [V3]	03.03-12.05							70	630	S4 026					
Camry Wagon															
2.2 i [V1]	11.92-02.98							60	540	S4 024					
2.4 i [V3]	09.02-06.06							70	630	S4 026					
Celica Cabrio															
2.0 i 16V [T20]	08.94-05.99							60	540	S4 024					
Celica Coupé															
1.8 i 16V [T23]	08.99-09.05							60	540	S4 024					
2.2 i 16V [T18]	09.89-08.98							60	540	S4 024					
Celica Liftback															
1.8/ 2.0/ 2.2 i 16V, i 16V Turbo [T20]	11.93-08.99							60	540	S4 024					
C-HR															
1.2 Turbo [X1]	10.16→			63	610	S5 005		60	540	S4 005					
Turbo 4WD [X5]	10.16→			63	610	S5 005		60	540	S4 005					
1.8 [X1]	10.16→			54	530	S5 002									
Corolla															
1.3 [E11]	09.96-08.99							45	330	S4 021					
	04.97-07.01			63	610	S5 005		60	540	S4 005					
[E12]	08.00-08.07							45	330	S4 020					



											Ah A (EN)			Ah A (EN)			Ah A (EN)			Ah A (EN)		
					0 092 ...0			0 092 ...0			0 092 ...0			0 092 ...0								
1.3 i [E11]	05.95-08.00							40	330	S4 018												
i [E12]	08.00-10.06							40	330	S4 018												
i 16V [E11]	04.97-10.99							60	540	S4 024												
VVT-i [E15]	12.08-04.13				54	530	S5 002	52	470	S4 002												
VVT-i [E18]	06.13-01.19				54	530	S5 002	52	470	S4 002	45	400	S3 002									
		SSJ	60	680	S5 A05																	
1.4 i [E12]	01.02-02.07				63	610	S5 005	52	470	S4 002	45	400	S3 002									
i 16V [E12]	10.01-11.06				63	610	S5 005	52	470	S4 002	45	400	S3 002									
VVT-i [E15]	11.06-12.08				54	530	S5 002	52	470	S4 002												
1.5 i [E12]	08.00-12.04							45	330	S4 022												
	08.00-10.06				63	610	S5 005	60	540	S4 005	56	480	S3 005									
1.6 [E15]	12.08-04.10				54	530	S5 002	52	470	S4 002	45	400	S3 002									
[E18]	08.12→							60	540	S4 025												
i 16V [E12]	10.01-11.06				63	610	S5 005	60	540	S4 005	56	480	S3 005									
VVT-i [E14]	01.07-08.14				63	610	S5 005	60	540	S4 005												
VVT-i [E15]	11.06-04.13				54	530	S5 002	52	470	S4 002	45	400	S3 002									
1.6/ 1.8 i [E12]	01.02-07.07				63	610	S5 005	60	540	S4 005	56	480	S3 005									
VVT-i [E18]	06.13-08.19							60	540	S4 025												
1.8 [E12]	08.00-08.08				63	610	S5 005	60	540	S4 005	56	480	S3 005									
i [E15]	07.07-01.14				63	610	S5 005	60	540	S4 005	56	480	S3 005									
Diesel																						
1.4 D-4D [E15]	11.06-04.13		70	760	S5 A08	77	780	S5 008	74	680	S4 008	70	640	S3 008								
D-4D [E18]	06.13-01.19							77	780	S5 008	74	680	S4 008	70	640	S3 008						
		SSJ	70	760	S5 A08						70	760	S4 E08									
	06.13→		70	760	S5 A08	77	780	S5 008	70	760	S4 E08	70	640	S3 008								
			70	760	S5 A08	77	780	S5 008	74	680	S4 008	70	640	S3 008								
1.4/ 2.0 D Turbo [E12]	01.02-02.07		70	760	S5 A08	77	780	S5 008	74	680	S4 008	70	640	S3 008								
1.9 D [E11]	01.00-07.01							95	830	S4 028												
2.0 D [E11]	04.97-10.99							95	830	S4 028												
D Turbo [E11]	08.00-09.01							95	830	S4 028												
D-4D [E15]	11.06-02.10		70	760	S5 A08	77	780	S5 008	74	680	S4 008	70	640	S3 008								
	07.07-01.14							77	780	S5 008	74	680	S4 008									
Corolla Hatchback																						
1.3/ 1.4/ 1.6/ 1.8 i, i 16V [E10; E11]	07.94-07.01							60	540	S4 024												
1.4 [E12, JTD]	09.02-12.06				54	530	S5 002	52	470	S4 002												
i 16V [E12, SB1]	11.01-12.07				63	610	S5 005	52	470	S4 002	45	400	S3 002									
1.6 [E12, JTD]	09.02-12.06				54	530	S5 002	52	470	S4 002												
i 16V [E12, SB1]	11.01-02.07				54	530	S5 002	60	540	S4 005	56	480	S3 005									
1.8 i 16V [E12, SB1]	11.01-12.07				63	610	S5 005	60	540	S4 005												
Diesel																						
1.4 D Turbo [E12, SB1]	09.02-12.07		70	760	S5 A08	77	780	S5 008	74	680	S4 008											
TD [E12, JTD]	08.04-12.06							77	780	S5 008	74	680	S4 008									
1.9 D [E11]	01.00-07.01							95	830	S4 028												
2.0 D [E11]	04.97-09.99							95	830	S4 028												
D Turbo [E11]	08.00-07.01							95	830	S4 028												
D Turbo [E12, SB1]	11.01-05.04		70	760	S5 A08	77	780	S5 008	74	680	S4 008	70	640	S3 008								
TD [E12, JTD]	09.02-05.04							77	780	S5 008	74	680	S4 008									
Corolla II																						
1.3 i	09.94-07.99							45	330	S4 022												
Corolla Liftback																						
1.3/ 1.4/ 1.6 i 16V [E11]	04.97-11.01							60	540	S4 024												
Diesel																						
1.9 D [E11]	12.99-11.01							95	830	S4 028												
2.0 D [E11]	04.97-09.99							95	830	S4 028												
	12.99-11.01							95	830	S4 028												
D Turbo [E11]	08.00-09.01							95	830	S4 028												
Corolla Sedan																						
1.4/ 1.6 i 16V [E11]	04.97-09.01							60	540	S4 024												



			Ah A (EN) S5A			Ah A (EN) S5			Ah A (EN) S4			Ah A (EN) S3		
			0 092 ...0			0 092 ...0			0 092 ...0			0 092 ...0		
◀ TOYOTA														
Diesel														
2.0 D Turbo [E12]	10.01-05.04		70	760	S5 A08	77	780	S5 008	74	680	S4 008			
Corolla Verso														
1.6 i 16V [E12]	09.01-01.04					63	610	S5 005	60	540	S4 005			
1.6/ 1.8 i 16V [R1]	02.04-02.09					63	610	S5 005	60	540	S4 005			
1.8 i 16V [E12]	09.01-01.04								60	540	S4 024	56	480	S3 005
16V [R11]	02.04-02.09					63	610	S5 005	60	540	S4 005	56	480	S3 005
Diesel														
1.6 D4D-D [R2]	01.14→		80	800	S5 A11									
	SSJ								80	800	S4 E11			
2.0 D Turbo [E12;R1]	09.01-08.05		70	760	S5 A08	77	780	S5 008	74	680	S4 008	70	640	S3 008
2.2 D-CAT, D-4D [R1]	08.05-02.09					85	800	S5 010	80	740	S4 010			
Corolla Wagon														
1.3/ 1.4/ 1.6/ 1.8 i 16V, i 16V 4x4 [E11]	04.97-09.01								60	540	S4 024			
1.4 i [E12]	08.02-02.07					63	610	S5 005	52	470	S4 002	45	400	S3 002
i 16V [E12]	10.01-11.06					63	610	S5 005	52	470	S4 002	45	400	S3 002
1.6 i [E12]	08.02-02.07					63	610	S5 005	60	540	S4 005	56	480	S3 005
i 16V [E12]	10.01-11.06					63	610	S5 005	60	540	S4 005	56	480	S3 005
1.8 i 16V [E12]	08.00-12.06					63	610	S5 005	60	540	S4 005			
Diesel														
1.4 D Turbo [E12]	04.04-02.07		70	760	S5 A08	77	780	S5 008	74	680	S4 008			
1.9 D [E11]	01.00-07.01								95	830	S4 028			
D 4x4 [E11]	01.00-07.01								95	830	S4 028			
2.0 D [E11]	04.97-10.99								95	830	S4 028			
D Turbo [E11]	08.00-09.01								95	830	S4 028			
D Turbo [E12]	10.01-02.07		70	760	S5 A08	77	780	S5 008	74	680	S4 008	70	640	S3 008
D 4x4 [E11]	04.97-10.99								95	830	S4 028			
Corona Sedan														
1.8 [T14]	12.86-07.99								60	540	S4 024			
									70	630	S4 026			
Cynos Convertible														
1.3 i	10.96-07.99								60	540	S4 025			
Cynos Coupé														
1.5 i	08.95-07.99								60	540	S4 025			
Echo														
1.5 i 16V	09.99→								45	330	S4 023	45	400	S3 002
	06.03→								45	330	S4 022			
FJ Cruiser														
4.0 , 4WD	07.07→								70	630	S4 026			
GT 86														
2.0	08.16→								60	540	S4 025			
GT86														
2.0	04.12-12.16								60	540	S4 024			
Hiace Wagon														
2.4 i [H10]	08.89-09.02								60	540	S4 025			
Diesel														
2.4 D [H10]	08.89-02.06								95	830	S4 029			
3.0 D [H10]	08.98-02.06								60	540	S4 025			
Hilux Surf														
2.7 i 4WD [N21]	08.04-07.09								70	630	S4 027			
iQ														
1.0	11.08-05.14								45	330	S4 023			
1.3 VVT-i	05.09-05.14	BWD							45	330	S4 023			
									60	640	S4 E05			
Diesel														
1.4	11.08-05.12								70	630	S4 027			
Land Cruiser														
3.4 i 24V [J9]	04.96-12.06								60	540	S4 024			
4.0/ 4.5/ 4.7/ 5.7 , i 4x4, i 24V, i 32V 4x4, 4x4 [J2; J8; J10; J12; J15]	08.92→								95	830	S4 028			
4.6/ 4.7 , i 4x4, 4x4 [J20]	08.07→								70	630	S4 026			



			Ah A (EN) S5A	Ah A (EN) S5	Ah A (EN) S4	Ah A (EN) S3
			0 092 ...0	0 092 ...0	0 092 ...0	0 092 ...0

Diesel						
2.8 D-4D [J15]	06.15-12.17			95	830	S4 028
3.0 D-4D [J12]	09.02-08.09			95	830	S4 028
		ASB		95	830	S4 028
D-4D [J15]	08.09-12.17			70	630	S4 026
				70	630	S4 027
D-4D 4x4 [J15]	08.09-08.17			70	630	S4 026
				70	630	S4 027
3.0/4.2 D, D Turbo, D Turbo Interc., D Turbo 4x4, 24V D Turbo [J8; J9; J10]	01.90-07.08			95	830	S4 028
4.2 D, D Turbo 4x4 [J7]	01.90→			95	830	S4 028
D 4x4 [J7/10]	03.98-10.07			95	830	S4 029
	03.98→			95	830	S4 028
Diesel 4x4 [105]	03.98-10.07			70	630	S4 027
4.5 D-4D 4x4 [J20]	09.07→			95	830	S4 028
				95	830	S4 029
Land Cruiser Prado						
2.7 i 4x4, i 16V 4x4, 4x4 [J9; J12]	04.96-09.09			95	830	S4 028
4x4 [J15]	09.09-08.13			70	630	S4 026
3.4 i 24V, 4x4 [J9]	04.96-09.03			60	540	S4 024
Diesel						
3.0 D Turbo 4x4 [J9]	03.00-09.02			95	830	S4 028
D Turbo 4x4 [J12]	11.02-07.07	ASB		95	830	S4 028
				95	830	S4 029
Mirai						
	06.15→			40	330	S4 018
MR2 Cabrio						
1.8 16V [W3]	12.99-05.06			45	330	S4 021
MR2 Coupé						
2.0 i [W2]	12.89-08.99			45	330	S4 021
Paseo Cabrio						
1.5 i 16V [L5]	09.96-08.98			60	540	S4 025
Paseo Coupé						
1.5 i 16V [L5]	08.95-08.99			60	540	S4 025
Picnic						
2.0 i 16V	09.96-05.01			60	540	S4 024
Diesel						
2.2 D Turbo	08.97-05.01			95	830	S4 028
Previa						
2.4 , i, i 16V, i 16V 4x4, 4x4 [; R1/R2; R3/R4]	05.90→			60	540	S4 024
Diesel						
2.0 D Turbo	02.01-01.06			95	830	S4 028
2.2 D Turbo	01.92-12.01			60	540	S4 024
Prius						
1.5 i [W11]	09.00-08.03			40	330	S4 018
i [W20]	09.03-03.09	BWD		45	330	S4 022
1.8 [W50]	11.15→		54 530	S5 002		
Prius+						
1.8 i [W40]	03.12→			40	330	S4 030
Prius Alpha						
1.8 i [W4]	05.11→			40	330	S4 030
RAV4						
1.8 i 16V [A2]	05.00-11.05			45	330	S4 021
2.0 [A3]	02.96-08.00			45	330	S4 020
	12.08-11.12			60	540	S4 024
[A4]	12.12→			60	540	S4 025
i 16V 4x4, 4x4 [A1]	04.94-08.00			60	540	S4 024
WVT-i 4x4 [A2]	05.00-11.05			45	330	S4 021
				45	330	S4 023
4x4 [A3]	11.05-11.12			45	330	S4 021



								Ah A (EN)		Ah A (EN)		Ah A (EN)		Ah A (EN)	
								0 092 ...0		0 092 ...0		0 092 ...0		0 092 ...0	
◀ TOYOTA															
2.0	4x4 [A3]	12.08-11.12								60	540			S4 024	
	4x4 [A4]	12.12→								70	760			S4 E08	
2.4	[A3]	11.05-11.12								45	330			S4 021	
	i 4WD [A3]	11.05-08.16								45	330			S4 021	
	i 4x4 [A2]	07.03-01.06								60	540			S4 024	
	4x4 [A3]	11.05-11.12								45	330			S4 021	
2.5	4x4 [A4]	12.12→								60	540			S4 025	
										72	760			S4 E41	
3.5	4x4 [A3]	11.05→								60	540			S4 024	
Diesel															
2.0	D Turbo [A2]	05.01-11.05								95	830			S4 028	
	D-4D [A4]	12.12-10.15	SSJ							85	800			S4 E42	
		12.12-05.18								95	830			S4 028	
	D-4D 4x4 [A4]	11.13-10.15								95	830			S4 028	
			SSJ							85	800			S4 E42	
2.2	D-CAT 4x4 [A4]	12.12→								95	830			S4 028	
	D-CAT 4x4, D-4D 4x4 [A3]	11.05-11.12								95	830			S4 028	
	D-4D [A3]	11.05-11.12				100	830	S5 013							
	D-4D 4x4 [A4]	12.12→								95	830			S4 028	
RAV4 Cabrio															
2.0	i 16V 4x4 [A1]	11.95-08.00								60	540			S4 024	
Starlet															
1.3	i 16V [P9]	01.96-07.99	JEA							40	330			S4 019	
										45	330			S4 023	
	i 16V Turbo [P9]	01.96-07.99								60	540			S4 024	
	12V [P9]	01.96-07.99								40	330			S4 019	
Urban Cruiser															
1.3	VVT-i [P1]	01.09-12.16								45	330			S4 020	
			SSJ							60	640			S4 E05	
Diesel															
1.4	D-4D, D-4D 4x4 [P1]	01.09-12.16								60	540			S4 024	
Verso															
1.6	[R2]	02.09→				54	530	S5 002		52	470			S4 002	
1.8	VVT-i [R2]	02.09→				63	610	S5 005		60	540			S4 005	
						63	610	S5 005		60	640			S4 E05	
Diesel															
2.0/ 2.2	D-CAT, D-4D [R2]	02.09-03.15				77	780	S5 008							
Verso-S															
1.3	VVT-i	11.10-12.15								60	640			S4 E05	
Diesel															
1.4	D-4D	11.10-12.15				63	610	S5 005		60	540			S4 005	
Vitz															
1.3	i [P1]	09.99-02.05								45	330			S4 021	
Yaris															
1.0	i [P13, JTD]	08.11-12.14				54	530	S5 002		52	470			S4 002	
						54	530	S5 002		60	640			S4 E05	
	i [P13, VNK]	07.11-06.14				54	530	S5 002		52	470			S4 002	
						54	530	S5 002		60	640			S4 E05	
		07.14→								60	640			S4 E05	
	i 16V [P1]	01.99-12.02								45	330			S4 023	
		01.01-08.05								44	440			S4 001	
	VVT-i [P9]	08.05→				54	530	S5 002		52	470			S4 002	
						54	530	S5 002		60	640			S4 E05	
	VVT-i [P9, JTD]	08.05-07.11				54	530	S5 002		52	470		45	400	S3 002
						54	530	S5 002		60	640		45	400	S3 002
	VVT-i [P9, VNK]	11.05-07.11				54	530	S5 002		52	470		45	400	S3 002
						54	530	S5 002		60	640		45	400	S3 002
1.3	i [P12, VNK]	07.14→				60	680	S5 A05		54	530			S4 002	
						60	680	S5 A05		54	530			S4 E05	
	i [P13, JTD]	08.11-12.14								54	530			S4 002	
	i [P13, VNK]	07.11-06.14								54	530			S4 002	
										54	530			S4 E05	
	i 16V [P1]	08.99-12.02								45	330			S4 023	



			0 092 ...0			0 092 ...0			0 092 ...0			0 092 ...0		
			Ah	A (EN)	S5A	Ah	A (EN)	S5	Ah	A (EN)	S4	Ah	A (EN)	S3
1.3	i 16V [P1]	05.02-08.05				52	520	S5 001	44	440	S4 001	41	360	S3 001
	VVT-i [P1]	08.11→				54	530	S5 002	52	470	S4 002	45	400	S3 002
	VVT-i [P9]	08.05→				54	530	S5 002	52	470	S4 002	45	400	S3 002
		01.06→				54	530	S5 002	52	470	S4 002			
	VVT-i [P9, VNK]	11.05-10.08				54	530	S5 002	52	470	S4 002	45	400	S3 002
		11.08-07.11				54	530	S5 002	52	470	S4 002			
		SSJ							60	640	S4 E05			
1.5	HSD [P13, VNK]	04.12-06.14							40	330	S4 018			
	i [P9]	01.05→				52	520	S5 001	44	440	S4 001	41	360	S3 001
	i 16V [P1]	01.01-08.05							45	330	S4 023			
	Turbo [P1]	03.03-12.05				54	530	S5 002	52	470	S4 002	45	400	S3 002
1.8	VVT-i [P9, JTD]	11.06-07.11				63	610	S5 005	52	470	S4 002	45	400	S3 002
	Diesel													
1.4	D Turbo [P1]	10.01-08.06				63	610	S5 005	60	540	S4 005	56	480	S3 005
	D-4D [P9, VNK]	11.05-07.11							44	440	S4 001			
									60	540	S4 005			
									60	640	S4 E05			
	D-4D [P13, VNK]	07.11→				63	610	S5 005	60	540	S4 005			
	Yaris Verso													
1.3	i 16V [P2]	08.99-09.05	JEA						45	330	S4 022			
									45	330	S4 023			
1.5	i 16V [P2]	08.99-09.05							45	330	S4 023			
	Diesel													
1.4	D Turbo [P2]	08.01-09.05							60	540	S4 025			
	4-Runner													
2.7	i [N18]	11.95-08.00							70	630	S4 027			
3.4	i [N18]	11.95-08.02							70	630	S4 027			
									95	830	S4 029			
4.0/ 4.7	i, i 4x4 [N21]	09.02→							70	630	S4 027			
	Diesel													
3.0	D Turbo [N18]	11.95-08.00							95	830	S4 029			
	D Turbo AWD [N18]	08.00-08.02							70	630	S4 027			
TVR														
	Cerbera													
4.0		04.98-01.99				61	600	S5 004	60	540	S4 004			
		01.99-12.04							70	630	S4 027			
	i	01.00-12.05				61	600	S5 004	60	540	S4 004			
4.2	i V8	03.94-12.99				61	600	S5 004	60	540	S4 004			
		01.96-12.01							70	630	S4 027			
4.5	i	01.97-03.98				61	600	S5 004	60	540	S4 004			
	i V8	01.97-12.01							70	630	S4 027			
	i V8 GT	01.96-12.01							70	630	S4 027			
	Chimaera													
3.9/ 5.0	i V8	04.98-03.02				61	600	S5 004	60	540	S4 004			
4.5	i	01.00-02.03				61	600	S5 004	60	540	S4 004			
	i V8	01.97-12.02							70	630	S4 027			
	Griffith 500													
5.0	i, i V8	03.90-12.02							70	630	S4 027			
	Sagaris													
4.0		01.04-12.07							70	630	S4 026			
	Serie S													
TVR S		01.86-12.98							70	630	S4 027			
	Tamora													
3.6		01.02-12.07							74	680	S4 009			
	Tuscan													
3.6/ 4.0		01.98-12.07							74	680	S4 009			
	Tuscan Cabriolet													
3.6/ 4.0		01.01-12.06							70	630	S4 027			



			Ah A (EN)	Ah A (EN)	Ah A (EN)	Ah A (EN)
			0 092 ...0	0 092 ...0	0 092 ...0	0 092 ...0

VAUXHALL

Adam														
1.0	09.14→		70	760	S5 A08									
		SSJ						70	760	S4 E08				
1.2	04.13→					54	530	S5 002	52	470	S4 002			
		SSJ	60	680	S5 A05									
1.4	04.13→					54	530	S5 002	52	470	S4 002			
			60	680	S5 A05				52	470	S4 002			
		SSJ	60	680	S5 A05									
	06.15→	BWD	60	680	S5 A05									
Turbo	01.15→								52	470	S4 002			
									60	540	S4 005			
		SSJ	60	680	S5 A05									
Agila														
1.0 i [A]	09.99-08.03					52	520	S5 001	44	440	S4 001	41	360	S3 001
Twinport [B]	03.08-08.15					52	520	S5 001	44	440	S4 001			
1.0/1.2 Twinport [A]	08.03-02.08					52	520	S5 001	44	440	S4 001	41	360	S3 001
1.2 i [A]	09.00-06.04					52	520	S5 001	44	440	S4 001			
Twinport [B]	03.08-08.15					52	520	S5 001	44	440	S4 001	41	360	S3 001
VVT Twinport [B]	03.08-08.15					52	520	S5 001	44	440	S4 001			
						52	520	S5 001	60	640	S4 E05			
Diesel														
1.3 CDTI [B]	03.08-08.15					61	600	S5 004	60	540	S4 004			
Ampera														
1.4 Hybrid	10.11-12.15		60	680	S5 A05	63	610	S5 005	60	540	S4 005			
			60	680	S5 A05	63	610	S5 005	60	640	S4 E05			
Antara														
2.4	01.12-12.17								70	630	S4 027			
2.4/3.2 V6 4x4, 4x4	11.06-12.11								74	680	S4 009			
Diesel														
2.0 CDTI 4x4	11.06-12.11								74	680	S4 009			
									95	830	S4 029			
2.2 CDTI	11.10-12.17								95	800	S4 013			
									95	830	S4 029			
		SSJ	95	850	S5 A13									
CDTI 4x4	11.10-12.17								95	800	S4 013			
									95	830	S4 029			
		SSJ	95	850	S5 A13									
Astra														
1.0 [K]	09.15→	SSJ	70	760	S5 A08									
			80	800	S5 A11									
1.2 Twinport [H]	03.07-03.09					52	520	S5 001	44	440	S4 001			
1.2/1.4 i [G]	09.97-08.05					61	600	S5 004	44	440	S4 001	41	360	S3 001
1.4 [K]	09.15→								52	470	S4 002			
									60	540	S4 005			
		SSJ	70	760	S5 A08									
i [H]	09.04-12.05					61	600	S5 004				53	500	S3 004
i [J]	09.09-08.16					52	520	S5 001	44	440	S4 001			
	03.15-08.16					61	600	S5 004	60	540	S4 004			
Turbo [J]	09.09-08.16					52	520	S5 001	44	440	S4 001			
	09.11-08.16					61	600	S5 004				53	500	S3 004
	03.15-08.16					61	600	S5 004	60	540	S4 004			
Twinport [H]	03.04-03.10					61	600	S5 004	44	440	S4 001	41	360	S3 001
Twinport Dualfuel [H]	04.05-03.10					61	600	S5 004	44	440	S4 001			
1.4/1.6 i [F]	09.90-02.98					61	600	S5 004	44	440	S4 001	41	360	S3 001
1.6 [H]	03.07-03.10					52	520	S5 001	44	440	S4 001	41	360	S3 001
	01.11-09.13					61	600	S5 004	44	440	S4 001			
		SSJ	70	760	S5 A08									
[K]	09.15→													
i [G]	09.97-08.05					61	600	S5 004	44	440	S4 001	41	360	S3 001
	09.98-08.05					61	600	S5 004	44	440	S4 001			
i [J]	09.09-08.16					61	600	S5 004	60	540	S4 004			



											Ah A (EN)			Ah A (EN)			Ah A (EN)			Ah A (EN)		
		0 092 ...0			0 092 ...0			0 092 ...0			0 092 ...0											
1.6 i Dualfuel [G]	09.02-08.05				61	600	S5 004	44	440	S4 001	41	360	S3 001									
	i Turbo [J]	09.09-08.16				61	600	S5 004	60	540	S4 004											
	Turbo [H]	03.07-03.10				61	600	S5 004	60	540	S4 004											
		01.11-09.13				61	600	S5 004	44	440	S4 001											
	Twinport [H]	03.04-03.07				61	600	S5 004	44	440	S4 001	41	360	S3 001								
	03.07-03.09				61	600	S5 004	44	440	S4 001												
1.8 i [F]	09.91-02.98				61	600	S5 004	44	440	S4 001	41	360	S3 001									
					61	600	S5 004	44	440	S4 001	53	500	S3 004									
	i [G]	09.97-08.05				74	750	S5 007	60	540	S4 004	53	500	S3 004								
	i [H]	03.04-02.09				61	600	S5 004	44	440	S4 001	41	360	S3 001								
		08.05-03.10				61	600	S5 004	60	540	S4 004											
	07.10-09.13				61	600	S5 004	60	540	S4 004												
i Dualfuel [G]	09.02-08.05				74	750	S5 007	60	540	S4 004	53	500	S3 004									
2.0 GTC Turbo [J]	06.12→	70	760	S5 A08																		
	i [F]	09.91-02.98				61	600	S5 004	44	440	S4 001	41	360	S3 001								
	i [G]	09.97-08.05				74	750	S5 007	60	540	S4 004	53	500	S3 004								
		09.00-08.05				61	600	S5 004				53	500	S3 004								
	Turbo [G]	07.02-08.05				74	750	S5 007	60	540	S4 004	53	500	S3 004								
	Turbo [H]	03.04-03.10				74	750	S5 007	60	540	S4 004	53	500	S3 004								
	Turbo 16V [H]	03.04-03.10				74	750	S5 007	60	540	S4 004	53	500	S3 004								
2.2 i [G]	09.00-08.05				74	750	S5 007	72	680	S4 007	70	640	S3 007									
Diesel																						
1.3 CDTI [H]	01.06-03.10				74	750	S5 007	60	540	S4 004												
	CDTI [J]	09.09-08.16				74	750	S5 007	72	680	S4 007											
		SSJ	70	760	S5 A08																	
			80	800	S5 A11																	
1.6 [K]	09.15→				85	800	S5 010	74	680	S4 008												
			SSJ	80	800	S5 A11																
	CDTI [J]	10.13-08.16				77	780	S5 008	74	680	S4 008	70	640	S3 008								
			SSJ	70	760	S5 A08				70	760	S4 E08										
			80	800	S5 A11				70	760	S4 E08											
GTC [J]	06.14→	SSJ	70	760	S5 A08				70	760	S4 E08											
			80	800	S5 A11				70	760	S4 E08											
1.7 CDTI	01.12-08.16				61	600	S5 004	60	540	S4 004												
				70	760	S5 A08																
			BWD	70	760	S5 A08																
				80	800	S5 A11																
			SSJ	70	760	S5 A08																
				80	800	S5 A11																
	CDTI [H]	03.04-08.09				74	750	S5 007	60	540	S4 004	70	640	S3 007								
		03.07-09.09				74	750	S5 007	72	680	S4 007	70	640	S3 007								
		05.07-03.10				61	600	S5 004				53	500	S3 004								
	03.10-12.12				74	750	S5 007	60	540	S4 004												
CDTI [J]	09.09-08.16				61	600	S5 004	60	540	S4 004												
					74	750	S5 007	72	680	S4 007												
		SSJ	70	760	S5 A08																	
			80	800	S5 A11																	
	01.12-08.16				70	760	S5 A08															
CDTI 16V [G]	03.03-08.05				74	750	S5 007	72	680	S4 007	70	640	S3 007									
D/DR, DTL, TD [F]	12.91-02.98				74	750	S5 007	60	540	S4 004												
DT [G]	03.98-08.00				74	750	S5 007	72	680	S4 007	70	640	S3 007									
1.7/2.0 DTI [G]	09.00-08.05				74	750	S5 007	72	680	S4 007	70	640	S3 007									
1.9 CDTI [H]	03.04-03.10				74	750	S5 007	60	540	S4 004	70	640	S3 007									
	09.05-03.10				74	750	S5 007	60	540	S4 004												
					74	750	S5 007	72	680	S4 007												
2.0 CDTI [J]	09.09-08.16				74	750	S5 007	72	680	S4 007												
	09.11-08.16	SSJ	70	760	S5 A08																	
			80	800	S5 A11																	
	08.12-08.16				77	780	S5 008	74	680	S4 008	70	640	S3 008									
			SSJ	70	760	S5 A08				70	760	S4 E08										
			80	800	S5 A11				70	760	S4 E08											
DTL [G]	02.98-08.05				74	750	S5 007	72	680	S4 007	70	640	S3 007									
GTC [J]	08.12→	70	760	S5 A08																		



			0092 ...0			0092 ...0			0092 ...0			0092 ...0		
			Ah	A (EN)	S5A	Ah	A (EN)	S5	Ah	A (EN)	S4	Ah	A (EN)	S3
◀ VAUXHALL														
2.2 DTI [G]	09.01-08.05		74	750	S5 007	72	680	S4 007						
Astra Convertible														
1.6 i [F]	09.91-02.98		61	600	S5 004	44	440	S4 001	41	360	S3 001			
i [G]	09.00-08.05		61	600	S5 004	44	440	S4 001	41	360	S3 001			
i Twinport [G]	03.03-08.05		61	600	S5 004				53	500	S3 004			
1.8 i [F]	09.91-02.98		61	600	S5 004	44	440	S4 001	41	360	S3 001			
			61	600	S5 004	44	440	S4 001	53	500	S3 004			
i [G]	09.00-08.05		74	750	S5 007	60	540	S4 004	53	500	S3 004			
2.0 i [F]	09.91-02.98		61	600	S5 004	44	440	S4 001	41	360	S3 001			
i Turbo [G]	03.02-08.05		74	750	S5 007	60	540	S4 004	53	500	S3 004			
2.2 i [G]	09.00-08.05		74	750	S5 007	72	680	S4 007	70	640	S3 007			
Astra Coupé														
1.6 i Twinport [G]	03.03-08.05		61	600	S5 004				53	500	S3 004			
1.8 i [G]	09.97-08.05		74	750	S5 007	60	540	S4 004	53	500	S3 004			
1.8/ 2.0 i Dualfuel, i Turbo [G]	09.00-08.05		74	750	S5 007	60	540	S4 004	53	500	S3 004			
2.2 i [G]	09.00-08.05		74	750	S5 007	72	680	S4 007	70	640	S3 007			
Astra Estate														
1.2 Twinport [H]	03.07-03.09		52	520	S5 001	44	440	S4 001						
1.2/ 1.4 i [G]	09.97-08.05		61	600	S5 004	44	440	S4 001	41	360	S3 001			
1.4 [H]	08.04-12.05		61	600	S5 004				53	500	S3 004			
i [F]	09.90-02.98		61	600	S5 004	44	440	S4 001	41	360	S3 001			
	09.97-02.98		52	520	S5 001	44	440	S4 001	41	360	S3 001			
Twinport [H]	08.04-03.10		61	600	S5 004	44	440	S4 001	41	360	S3 001			
1.6 [H]	09.07-03.10		61	600	S5 004	44	440	S4 001						
i [F]	09.91-02.98		61	600	S5 004	44	440	S4 001	41	360	S3 001			
i [G]	09.97-08.05		61	600	S5 004	44	440	S4 001	41	360	S3 001			
	09.02-08.05		61	600	S5 004				53	500	S3 004			
i Dualfuel [G]	09.02-08.05		61	600	S5 004	44	440	S4 001	41	360	S3 001			
Turbo [H]	09.07-03.10		52	520	S5 001	44	440	S4 001	41	360	S3 001			
Twinport [H]	08.04-03.07		61	600	S5 004	44	440	S4 001	41	360	S3 001			
	09.07-03.09		52	520	S5 001	44	440	S4 001						
1.8 i [F]	09.91-02.98		61	600	S5 004	44	440	S4 001	41	360	S3 001			
			61	600	S5 004	44	440	S4 001	53	500	S3 004			
i [G]	09.97-08.05		74	750	S5 007	60	540	S4 004	53	500	S3 004			
i [H]	08.04-02.09		61	600	S5 004	44	440	S4 001	41	360	S3 001			
	08.05-03.10		61	600	S5 004	60	540	S4 004						
	07.10-09.13		61	600	S5 004	60	540	S4 004						
i Dualfuel [G]	09.02-08.05		74	750	S5 007	60	540	S4 004	53	500	S3 004			
2.0 i [F]	09.91-02.98		61	600	S5 004	44	440	S4 001	41	360	S3 001			
i [G]	09.97-08.05		74	750	S5 007	60	540	S4 004	53	500	S3 004			
	09.00-08.05		61	600	S5 004				53	500	S3 004			
Turbo [G]	09.02-08.05		61	600	S5 004	60	540	S4 004	53	500	S3 004			
Turbo [H]	08.04-02.09		74	750	S5 007	60	540	S4 004	53	500	S3 004			
	09.05-03.10		74	750	S5 007	60	540	S4 004						
Turbo 16V [H]	08.04-03.10		74	750	S5 007	60	540	S4 004	53	500	S3 004			
2.2 i [G]	09.00-08.05		74	750	S5 007	72	680	S4 007	70	640	S3 007			
Diesel														
1.3 CDTI [H]	06.05-03.10		74	750	S5 007	60	540	S4 004						
1.7 CDTI [H]	08.04-03.07		74	750	S5 007	72	680	S4 007						
	08.04-08.09		74	750	S5 007	60	540	S4 004	70	640	S3 007			
	03.07-03.10		74	750	S5 007	72	680	S4 007	70	640	S3 007			
	05.07-03.10		61	600	S5 004				53	500	S3 004			
	03.10-12.12		61	600	S5 004	60	540	S4 004						
		SSJ	70	760	S5 A08									
D/DR, DTL, TD [F]	12.91-02.98		74	750	S5 007	60	540	S4 004						
1.7/ 2.0 CDTI, DT, DTI, DTL [G]	03.98-08.05		74	750	S5 007	72	680	S4 007	70	640	S3 007			
1.9 CDTI [H]	08.04-03.10		74	750	S5 007	60	540	S4 004	70	640	S3 007			
	09.05-03.10		74	750	S5 007	60	540	S4 004						



			Ah	A (EN)		Ah	A (EN)		Ah	A (EN)		Ah	A (EN)	
			0 092 ...0			0 092 ...0			0 092 ...0			0 092 ...0		

Astra GTC

1.4 Turbo [J]	09.11-12.15					61	600	S5 004	60	540	S4 004	53	500	S3 004
			70	760	S5 A08									
		SSJ	70	760	S5 A08									
			80	800	S5 A11									
	03.15-12.15					61	600	S5 004	60	540	S4 004			
Twinport [H]	06.05-03.09					52	520	S5 001	44	440	S4 001			
	09.05-02.09					61	600	S5 004				53	500	S3 004
1.6 Turbo [J]	09.11→					61	600	S5 004				53	500	S3 004
	09.13→					77	780	S5 008	74	680	S4 008	70	640	S3 008
		SSJ	70	760	S5 A08				70	760	S4 E08			
			80	800	S5 A11				70	760	S4 E08			
	03.15→	SSJ	70	760	S5 A08									
			80	800	S5 A11									
Twinport [H]	09.05-03.08					61	600	S5 004	44	440	S4 001	41	360	S3 001
VVT [H]	12.06-12.12					61	600	S5 004				53	500	S3 004
1.6/ 1.8 , i VVT [H]	01.11-12.12					61	600	S5 004	44	440	S4 001			
1.8 i [H]	06.05-02.09					61	600	S5 004	44	440	S4 001	41	360	S3 001
2.0 Turbo [H]	06.05-02.09					74	750	S5 007	60	540	S4 004	53	500	S3 004
Turbo [J]	03.15→	BWD	70	760	S5 A08									
Turbo 16V [H]	06.05-03.09					74	750	S5 007	72	680	S4 007			
	06.05-12.09					74	750	S5 007	60	540	S4 004			

Diesel

1.7 [J]	11.11-12.15					61	600	S5 004	60	540	S4 004			
						61	600	S5 004	70	760	S4 E08	53	500	S3 004
		BWD	70	760	S5 A08									
		SSJ							70	760	S4 E08			
			70	760	S5 A08				70	760	S4 E08			
CDTI [H]	06.05-08.09					74	750	S5 007	60	540	S4 004			
	09.05-12.09					74	750	S5 007	72	680	S4 007			
1.9 CDTI [H]	06.05-12.09					74	750	S5 007	60	540	S4 004			
2.0 [J]	09.11→					74	750	S5 007	72	680	S4 007			
		SSJ	70	760	S5 A08									
			80	800	S5 A11									

Astra Sport Tourer

Diesel

1.7 CDTI	01.12-08.16		70	760	S5 A08									
-----------------	-------------	--	----	-----	---------------	--	--	--	--	--	--	--	--	--







Astra Sports Tourer

1.0 [K]	02.16→	SSJ	70	760	S5 A08									
			80	800	S5 A11									
1.4 [K]	02.16→								52	470	S4 002			
									60	540	S4 005			
		SSJ	70	760	S5 A08									
i [J]	09.10-08.16					61	600	S5 004				53	500	S3 004
	03.15-08.16					61	600	S5 004	60	540	S4 004			
i Turbo [J]	09.10-08.16					61	600	S5 004				53	500	S3 004
1.6 [K]	02.16→	SSJ	70	760	S5 A08									
i [J]	09.10-08.16					61	600	S5 004				53	500	S3 004
	03.15-08.16					61	600	S5 004	60	540	S4 004			
Diesel														
1.3 CDTI [J]	09.10-08.16					74	750	S5 007	60	640	S4 E05			
						74	750	S5 007	72	680	S4 007			
1.6 [K]	02.16→					85	800	S5 010	74	680	S4 008			
		SSJ	80	800	S5 A11									
CDTI [J]	10.13-08.16					77	780	S5 008	74	680	S4 008	70	640	S3 008
		SSJ	70	760	S5 A08				70	760	S4 E08			
			80	800	S5 A11				70	760	S4 E08			
1.7 CDTI	01.12-08.16					74	750	S5 007	72	680	S4 007			
			70	760	S5 A08									
		BWD	70	760	S5 A08									
			80	800	S5 A11									
		SSJ	70	760	S5 A08									
			80	800	S5 A11									



		Ah A (EN) S5A			Ah A (EN) S5			Ah A (EN) S4			Ah A (EN) S3		
		0 092 ...0			0 092 ...0			0 092 ...0			0 092 ...0		
◀ VAUXHALL													
1.7 CDTi [J]	09.10-08.16		74	750	S5 007	72	680	S4 007					
	SSJ	70	760	S5 A08									
		80	800	S5 A11									
2.0 CDTi [J]	09.10-08.16		74	750	S5 007	72	680	S4 007					
	09.11-08.16	SSJ	70	760	S5 A08								
			80	800	S5 A11								
	08.12-08.16		77	780	S5 008	74	680	S4 008	70	640	S3 008		
		SSJ	70	760	S5 A08		70	760	S4 E08				
			80	800	S5 A11		70	760	S4 E08				
Astra TwinTop													
1.6 i [H]	09.05-03.08		61	600	S5 004	44	440	S4 001	41	360	S3 001		
	03.07-12.09		61	600	S5 004	60	540	S4 004					
i Turbo [H]	03.07-12.09		61	600	S5 004	60	540	S4 004					
1.8 i [H]	03.06-03.09		61	600	S5 004	60	540	S4 004					
2.0 i Turbo [H]	09.05-12.09		74	750	S5 007	72	680	S4 007					
Diesel													
1.9 CDTi [H]	09.05-12.09		74	750	S5 007	72	680	S4 007					
Astra Van													
1.4/ 1.6 i [F; G]	09.90-08.05		61	600	S5 004	44	440	S4 001	41	360	S3 001		
Diesel													
1.7 D/DR, DTL [F]	12.91-02.98		74	750	S5 007	60	540	S4 004					
1.7/ 2.0 CDTi, DT, DTI, DTL [G]	03.98-08.05		74	750	S5 007	72	680	S4 007	70	640	S3 007		
Calibra													
2.0 i	03.90-03.98		74	750	S5 007	60	540	S4 004	53	500	S3 004		
Cascade													
1.4 Turbo	04.13→		77	780	S5 008	74	680	S4 008	70	640	S3 008		
			70	760	S5 A08	77	780	S5 008	70	760	S4 E08	70	
			70	760	S5 A08	77	780	S5 008	74	680	S4 008	70	
		SSJ	70	760	S5 A08		70	760	S4 E08				
			80	800	S5 A11		70	760	S4 E08				
	11.15→	SSJ	70	760	S5 A08								
			80	800	S5 A11								
1.6 Turbo	04.13→		77	780	S5 008	74	680	S4 008	70	640	S3 008		
		SSJ	70	760	S5 A08		70	760	S4 E08				
			80	800	S5 A11		70	760	S4 E08				
	11.15→	SSJ	70	760	S5 A08								
			80	800	S5 A11								
Diesel													
2.0 CDTi	04.13→		77	780	S5 008	74	680	S4 008	70	640	S3 008		
		SSJ	70	760	S5 A08		70	760	S4 E08				
			80	800	S5 A11		70	760	S4 E08				
	07.15→		80	800	S5 A11								
		BWD	70	760	S5 A08								
Corsa													
1.0 [E]	10.14→		54	530	S5 002	52	470	S4 002					
		SSJ	60	680	S5 A05								
Twinport [D]	07.06-10.09		54	530	S5 002				40	340	S3 000		
	12.09-08.14		54	530	S5 002	52	470	S4 002					
1.0/ 1.2/ 1.4/ 1.6 GSi, i [B]	09.94-09.00		61	600	S5 004	44	440	S4 001	41	360	S3 001		
1.0/ 1.2/ 1.4/ 1.8 i 12V, i 16V, 16V Dualfuel [C]	09.00-08.06		61	600	S5 004	44	440	S4 001	41	360	S3 001		
1.0/ 1.4 Twinport [C]	09.03-08.05		52	520	S5 001	44	440	S4 001	41	360	S3 001		
1.2 [E]	10.14→		52	520	S5 001	44	440	S4 001	41	360	S3 001		
i LPG [D]	12.09-12.11		52	520	S5 001	44	440	S4 001					
i Twinport [D]	12.09-08.14		52	520	S5 001	44	440	S4 001					
		SSJ	70	760	S5 A08								
Twinport [C]	09.04-09.06		52	520	S5 001	44	440	S4 001					
Twinport [D]	07.06-12.11		52	520	S5 001	44	440	S4 001					
	12.09-08.14		54	530	S5 002								
		SSJ	60	680	S5 A05								
			70	760	S5 A08								
Twinport Dualfuel [C]	09.04-09.06		61	600	S5 004	44	440	S4 001					



				Ah	A (EN)		Ah	A (EN)		Ah	A (EN)		Ah	A (EN)	
				0 092 ...0			0 092 ...0			0 092 ...0			0 092 ...0		
1.4 [E]	10.14→			70	760	S5 A08									
		SSJ								70	760	S4 E08			
	06.15→						54	530	S5 002	52	470	S4 002			
		SSJ		60	680	S5 A05									
LPG [D]	12.09-11.10						52	520	S5 001	44	440	S4 001			
Twinport [D]	07.06-11.10						63	610	S5 005	44	440	S4 001	41	360	S3 001
	12.09-08.14						52	520	S5 001	44	440	S4 001			
		SSJ		60	680	S5 A05									
				70	760	S5 A08									
Twinport Turbo [D]	07.12-08.14			70	760	S5 A08									
1.6 [E]	05.15→									52	470	S4 002			
		SSJ		60	680	S5 A05				60	540	S4 005			
i [C]	09.01-08.03						61	600	S5 004				53	500	S3 004
i OPC Turbo [D]	02.07-06.10						61	600	S5 004	60	540	S4 004	53	500	S3 004
	01.11-08.14						63	610	S5 005	52	470	S4 002	53	500	S3 004
	10.11-08.14						61	600	S5 004				53	500	S3 004
	02.15-08.15						61	600	S5 004	60	540	S4 004			
i Turbo [D]	10.07-08.14					61	600	S5 004	60	540	S4 004				
Diesel															
1.3 [E]	10.14→	SSJ		60	680	S5 A05									
				70	760	S5 A08									
CDTI [C]	09.03-09.06						74	750	S5 007	52	470	S4 002			
							74	750	S5 007	60	540	S4 004			
	09.05-09.06						61	600	S5 004				53	500	S3 004
CDTI [D]	07.06-03.09						74	750	S5 007	72	680	S4 007			
	07.06-07.10						74	750	S5 007	52	470	S4 002	70	640	S3 007
	12.09-09.10						74	750	S5 007	72	680	S4 007			
		SSJ		70	760	S5 A08									
	01.11-08.14						74	750	S5 007	72	680	S4 007			
		SSJ		60	680	S5 A05				60	640	S4 E05			
				70	760	S5 A08				60	640	S4 E05			
1.5 D [B]	09.94-08.00						74	750	S5 007	44	440	S4 001			
							74	750	S5 007	70	650	S4 E07			
	04.96-08.00						74	750	S5 007	60	540	S4 004			
TD, XTD [B]	09.94-08.00						74	750	S5 007	60	540	S4 004			
1.7 CDTI [C]	09.03-08.05						74	750	S5 007	60	540	S4 004	70	640	S3 007
CDTI [D]	07.06-02.09						74	750	S5 007	72	680	S4 007	70	640	S3 007
	07.06-08.14						74	750	S5 007	72	680	S4 007			
D [B]	09.94-08.00						74	750	S5 007	60	540	S4 004			
DI, DTI [C]	08.00-08.03						74	750	S5 007	60	540	S4 004	70	640	S3 007
Frontera															
2.0/ 2.2 i [A]	02.95-08.98			70	760	S5 A08	77	780	S5 008	74	680	S4 008	70	640	S3 008
2.2 i [B]	09.98-09.04			70	760	S5 A08	77	780	S5 008	74	680	S4 008	70	640	S3 008
3.2 i [B]	09.98-09.04			70	760	S5 A08	77	780	S5 008	70	630	S4 026	70	640	S3 008
Diesel															
2.2 DTI [B]	09.98-09.04			70	760	S5 A08	77	780	S5 008	70	630	S4 026	70	640	S3 008
2.5/ 2.8 TDI Turbo, TDS Turbo [A]	02.95-08.98			70	760	S5 A08	77	780	S5 008	74	680	S4 008	70	640	S3 008
Insignia															
1.4 Turbo [A]	09.11-12.17			70	760	S5 A08									
	02.14-12.17	SSJ		70	760	S5 A08									
1.6 [A]	11.08-12.17						52	520	S5 001	44	440	S4 001			
							61	600	S5 004	60	540	S4 004			
	07.13-12.17			70	760	S5 A08				70	760	S4 E08			
				95	850	S5 A13	100	830	S5 013	95	800	S4 013			
		SSJ								70	760	S4 E08			
	03.15-12.17	SSJ		70	760	S5 A08									
1.8 [A]	11.08-12.17						74	750	S5 007	72	680	S4 007			
	10.15-12.17						61	600	S5 004	60	540	S4 004			
2.0 Turbo [A]	11.08-12.17						74	750	S5 007	72	680	S4 007			
		SSJ		70	760	S5 A08									
				80	800	S5 A11									



			Ah A (EN) S5A			Ah A (EN) S5			Ah A (EN) S4			Ah A (EN) S3		
			0 092 ...0			0 092 ...0			0 092 ...0			0 092 ...0		
VAUXHALL														
2.0 Turbo [A]	04.14-12.17					77	780	S5 008	74	680	S4 008			
		SSJ	70	760	S5 A08				70	760	S4 E08			
Turbo 4x4 [A]	11.08-12.17					74	750	S5 007	72	680	S4 007			
		SSJ	70	760	S5 A08									
	05.13-12.17					74	750	S5 007	70	650	S4 E07			
						74	750	S5 007	72	680	S4 007	70	640	S3 007
2.8 Turbo 4x4 [A]	11.08-12.17					85	800	S5 010	74	680	S4 008			
			70	760	S5 A08	77	780	S5 008	74	680	S4 008			
	09.09-12.17					74	750	S5 007	72	680	S4 007			
Diesel														
1.6 [A]	07.15-12.17					85	800	S5 011	74	680	S4 008			
		SSJ	80	800	S5 A11									
Sports Tourer [A]	07.15-12.17					85	800	S5 011	74	680	S4 008			
		SSJ	80	800	S5 A11									
2.0 CDTI [A]	11.08-12.17					85	800	S5 010	80	740	S4 010	88	740	S3 012
		SSJ	80	800	S5 A11				80	800	S4 E11			
			80	800	S5 A11									
			95	850	S5 A13									
	03.12-12.17					74	750	S5 007	72	680	S4 007			
						85	800	S5 010	80	740	S4 010			
	09.13-12.17					80	800	S5 A11						
			95	850	S5 A13	100	830	S5 013	95	800	S4 013			
		SSJ							70	760	S4 E08			
									80	800	S4 E11			
CDTI 4x4 [A]	07.09-12.17					85	800	S5 010	80	740	S4 010			
						85	800	S5 010	80	800	S4 E11			
		SSJ	80	800	S5 A11				80	800	S4 E11			
	06.10-12.17					85	800	S5 010	80	740	S4 010	88	740	S3 012
		SSJ	80	800	S5 A11									
Insignia Sports Tourer														
1.4 [A]	09.11-12.17					70	760	S5 A08						
	02.14-12.17	SSJ	70	760	S5 A08									
1.6 [A]	02.09-12.17					52	520	S5 001	44	440	S4 001			
						61	600	S5 004	60	540	S4 004			
	07.13-12.17					95	850	S5 A13	100	830	S5 013	95	800	S4 013
		SSJ							70	760	S4 E08			
	03.15-12.17	SSJ	70	760	S5 A08									
1.8 [A]	02.09-12.17					74	750	S5 007	72	680	S4 007			
2.0 [A]	04.14-12.17					77	780	S5 008	74	680	S4 008			
		SSJ	70	760	S5 A08				70	760	S4 E08			
Turbo [A]	02.09-12.17					74	750	S5 007	72	680	S4 007			
		SSJ	70	760	S5 A08									
	05.13-12.17					74	750	S5 007	72	680	S4 007	70	640	S3 007
2.0/2.8 4x4 [A]	02.09-12.17					74	750	S5 007	72	680	S4 007			
2.8 Turbo 4x4 [A]	02.09-12.17					85	800	S5 010	74	680	S4 008			
	09.09-12.17					74	750	S5 007	72	680	S4 007			
Diesel														
2.0 CDTI [A]	02.09-12.17					85	800	S5 010	80	740	S4 010	88	740	S3 012
		SSJ	80	800	S5 A11				80	800	S4 E11			
			80	800	S5 A11									
			95	850	S5 A13									
	09.13-12.17					95	850	S5 A13	100	830	S5 013	95	800	S4 013
		SSJ							70	760	S4 E08			
CDTI 4x4 [A]	07.09-12.17	SSJ	80	800	S5 A11									
	06.10-12.17					85	800	S5 010	80	740	S4 010	88	740	S3 012
		SSJ	95	850	S5 A13									
	01.15-12.17	SSJ	80	800	S5 A11				80	800	S4 E11			
Meriva														
1.4 ecoFLEX [B]	04.10-12.17					61	600	S5 004	60	540	S4 004	53	500	S3 004
		SSJ	70	760	S5 A08									
Ecotec [B]	04.10-12.17					61	600	S5 004	60	540	S4 004	53	500	S3 004
		SSJ	70	760	S5 A08									
	09.13-12.17					61	600	S5 004	60	540	S4 004			



			Ah A (EN) S5A			Ah A (EN) S5			Ah A (EN) S4			Ah A (EN) S3		
			0 092 ...0			0 092 ...0			0 092 ...0			0 092 ...0		
1.4 Turbo [B]	10.12-12.17					61	600	S5 004	60	540	S4 004			
		SSJ	70	760	S5 A08									
16V Twinport [A]	07.04-03.10					74	750	S5 007	44	440	S4 001	53	500	S3 004
1.6 i, i OPC Turbo [A]	03.03-03.10					74	750	S5 007	44	440	S4 001	53	500	S3 004
i 16V [A]	03.03-03.10					74	750	S5 007	44	440	S4 001	53	500	S3 004
1.8 i 16V [A]	03.03-03.10					74	750	S5 007	60	540	S4 004	53	500	S3 004
Diesel														
1.3 CDTI [A]	09.03-03.10					74	750	S5 007	60	540	S4 004	53	500	S3 004
	09.05-03.10					61	600	S5 004				53	500	S3 004
CDTI [B]	06.10-12.17								60	640	S4 E05			
						61	600	S5 004	60	640	S4 E05	53	500	S3 004
1.6 CDTI [B]	10.13-12.17					77	780	S5 008	74	680	S4 008			
		SSJ	70	760	S5 A08				70	760	S4 E08			
	04.14-12.17	SSJ	70	760	S5 A08									
1.7 CDTI [A]	09.03-09.09					74	750	S5 007	72	680	S4 007	70	640	S3 007
	09.06-03.10					74	750	S5 007	72	680	S4 007			
CDTI [B]	04.10-12.17					74	750	S5 007	72	680	S4 007			
DTI [A]	03.03-09.05					74	750	S5 007	72	680	S4 007			
Mokka														
1.4 Turbo ecoFlex	01.13→					77	780	S5 008	74	680	S4 008			
		SSJ	70	760	S5 A08				70	760	S4 E08			
Turbo ecoFLEX	03.15→	SSJ	70	760	S5 A08									
Turbo ecoFLEX 4x4	09.12→		70	760	S5 A08									
Turbo 4x4	09.16→	SSJ	70	760	S5 A08									
1.6 ecoFlex	03.15→	SSJ	70	760	S5 A08									
Turbo ecoFLEX	09.12→		70	760	S5 A08									
Diesel														
1.6	02.15→								74	680	S4 008			
		SSJ	70	760	S5 A08				70	760	S4 E08			
	11.15→	SSJ	70	760	S5 A08									
4x4	02.15→		70	760	S5 A08				74	680	S4 008			
		SSJ							70	760	S4 E08			
1.7 CDTI ecoFLEX	09.12→		70	760	S5 A08	61	600	S5 004				53	500	S3 004
CDTI ecoFLEX 4x4	09.12→		70	760	S5 A08									
Monaro Coupé														
5.7/6.0, i [V2 III]	08.02→		70	760	S5 A08	77	780	S5 008	74	680	S4 008			
Monterey														
3.2 i [A]	06.92-08.98								70	630	S4 026			
3.5 i V6 [B]	02.98-12.99								74	680	S4 009			
Diesel														
3.0 DTI [B]	02.98-12.99		70	760	S5 A08	77	780	S5 008	74	680	S4 008	70	640	S3 008
3.1 TD [A]	09.91-08.98								70	630	S4 026			
Omega														
2.0 i [B]	09.93-12.00					74	750	S5 007	60	540	S4 004	53	500	S3 004
2.2/2.5/3.0 i [B]	04.94-09.04					74	750	S5 007	72	680	S4 007	70	640	S3 007
2.6/3.2 i [B]	09.00-09.04					74	750	S5 007	72	680	S4 007			
Diesel														
2.0 DTI [B]	09.97-08.00					85	800	S5 010	72	680	S4 007	70	640	S3 007
2.2 DTI [B]	06.00-09.03					85	800	S5 010	72	680	S4 007			
2.5 TD, TDI [B]	04.94-09.04					85	800	S5 010	72	680	S4 007	70	640	S3 007
Signum														
1.8 i	05.03-02.05					74	750	S5 007	72	680	S4 007	70	640	S3 007
	03.06-09.08					74	750	S5 007	72	680	S4 007	70	640	S3 007
2.0 Turbo	05.03-09.08					74	750	S5 007	72	680	S4 007	70	640	S3 007
2.2 Direct	05.03-09.08					74	750	S5 007	72	680	S4 007	70	640	S3 007
2.8 V6 Turbo	07.05-09.07					74	750	S5 007	72	680	S4 007	70	640	S3 007
	09.05-09.08					74	750	S5 007	72	680	S4 007			
3.2 i	05.03-09.05					85	800	S5 010	72	680	S4 007	70	640	S3 007
Diesel														
1.9 CDTI	04.04-09.08					74	750	S5 007	72	680	S4 007	70	640	S3 007
	09.05-09.08					74	750	S5 007	72	680	S4 007			
2.0/2.2 DTI	05.03-09.08					74	750	S5 007	72	680	S4 007	70	640	S3 007
3.0 CDTI	05.03-09.08					85	800	S5 010	74	680	S4 008	88	740	S3 012



			0092 ...0			0092 ...0			0092 ...0			0092 ...0		
			Ah	A (EN)	S5A	Ah	A (EN)	S5	Ah	A (EN)	S4	Ah	A (EN)	S3
◀ VAUXHALL														
Sintra														
2.2/ 3.0 i V6 24V, i 16V	09.96-09.99		61	600	S5 004	60	540	S4 004	53	500	S3 004			
Diesel														
2.2 TD	09.97-09.99		74	750	S5 007	60	540	S4 004						
Tigra														
1.4/ 1.6 i [A]	09.94-08.99		61	600	S5 004	44	440	S4 001	41	360	S3 001			
Tigra TwinTop														
1.4 i [B]	06.04-12.09		74	750	S5 007	44	440	S4 001	41	360	S3 001			
1.8 i [B]	06.04-12.09		74	750	S5 007	60	540	S4 004	53	500	S3 004			
Diesel														
1.3 CDTI [B]	06.04-03.09		74	750	S5 007	60	540	S4 004						
Vectra														
1.6 i [B]	09.95-08.00		61	600	S5 004	44	440	S4 001	41	360	S3 001			
i [C]	09.01-07.05		77	780	S5 008	60	540	S4 004	56	480	S3 005			
i GTS [C]	01.06-10.08		77	780	S5 008	60	540	S4 004	56	480	S3 005			
i 16V [B]	08.95-08.01		61	600	S5 004	44	440	S4 001	41	360	S3 001			
1.8 Dualfuel [C]	04.02-08.06	70 760 S5 A08	77	780	S5 008	60	540	S4 004	56	480	S3 005			
i [C]	09.01-08.05	70 760 S5 A08	77	780	S5 008	60	540	S4 004	56	480	S3 005			
	09.03-08.05	70 760 S5 A08	77	780	S5 008	60	540	S4 004	56	480	S3 005			
	01.06-10.08		77	780	S5 008	60	540	S4 004	56	480	S3 005			
i 16V [B]	09.95-08.99		61	600	S5 004	44	440	S4 001	41	360	S3 001			
			61	600	S5 004	44	440	S4 001	53	500	S3 004			
	09.00-08.01		61	600	S5 004	44	440	S4 001						
2.0 i [B]	09.95-09.02		74	750	S5 007	72	680	S4 007	70	640	S3 007			
	05.97-09.02		74	750	S5 007	72	680	S4 007	53	500	S3 004			
i 16V [B]	09.95-08.01		74	750	S5 007	72	680	S4 007	53	500	S3 004			
			74	750	S5 007	72	680	S4 007	70	640	S3 007			
Turbo [C]	03.03-10.08	70 760 S5 A08	77	780	S5 008	74	680	S4 008	70	640	S3 008			
2.2 Direct [C]	09.03-10.08	70 760 S5 A08	77	780	S5 008	74	680	S4 008	70	640	S3 008			
i [B]	10.99-08.01		74	750	S5 007	72	680	S4 007	70	640	S3 007			
i [C]	09.01-09.05	70 760 S5 A08	77	780	S5 008	74	680	S4 008						
i 16V [B]	09.00-08.01		74	750	S5 007	72	680	S4 007	53	500	S3 004			
2.5 i V6 [B]	09.95-08.01		74	750	S5 007	72	680	S4 007	53	500	S3 004			
			74	750	S5 007	72	680	S4 007	70	640	S3 007			
2.6 V6 [B]	09.00-08.01		74	750	S5 007	72	680	S4 007						
2.8 GTS Turbo [C]	08.05-10.08		74	750	S5 007	72	680	S4 007	70	640	S3 007			
	09.06-10.08		77	780	S5 008	74	680	S4 008						
Turbo [C]	09.05-10.08		74	750	S5 007	72	680	S4 007	70	640	S3 007			
3.2 i [C]	08.02-09.05	70 760 S5 A08	85	800	S5 010	74	680	S4 008	70	640	S3 008			
Diesel														
1.7 TD [B]	09.95-08.01		74	750	S5 007	72	680	S4 007	70	640	S3 007			
1.9 CDTI [C]	04.04-10.08		85	800	S5 010	74	680	S4 008						
2.0 DI [B]	09.96-08.00		74	750	S5 007	72	680	S4 007	70	640	S3 007			
DTI [B]	09.97-08.00		74	750	S5 007	72	680	S4 007	70	640	S3 007			
	09.00-08.01		74	750	S5 007	72	680	S4 007						
DTI [C]	04.02-09.05		85	800	S5 010	74	680	S4 008						
2.2 DTI [B]	09.00-08.01		74	750	S5 007	72	680	S4 007						
DTI [C]	04.02-09.05		85	800	S5 010	80	740	S4 010						
3.0 CDTI [C]	03.03-10.08	70 760 S5 A08	77	780	S5 008	74	680	S4 008						
Vectra Estate														
1.6 i [C]	09.03-05.04		61	600	S5 004	44	440	S4 001						
	07.04-10.08		77	780	S5 008	60	540	S4 004	56	480	S3 005			
i 16V [B]	09.95-08.01		61	600	S5 004	44	440	S4 001	41	360	S3 001			
1.8 i [C]	09.03-08.05		61	600	S5 004				53	500	S3 004			
		70 760 S5 A08	77	780	S5 008	60	540	S4 004	56	480	S3 005			
	01.06-10.08		77	780	S5 008	60	540	S4 004	56	480	S3 005			
i 16V [B]	09.95-08.99		61	600	S5 004	44	440	S4 001	41	360	S3 001			
			61	600	S5 004	44	440	S4 001	53	500	S3 004			
	09.00-08.01		61	600	S5 004	44	440	S4 001	41	360	S3 001			
2.0 i 16V [B]	09.95-08.01		74	750	S5 007	72	680	S4 007	53	500	S3 004			
			74	750	S5 007	72	680	S4 007	70	640	S3 007			
Turbo [C]	09.03-10.08	70 760 S5 A08	77	780	S5 008	74	680	S4 008	70	640	S3 008			



			Ah A (EN) S5A			Ah A (EN) S5			Ah A (EN) S4			Ah A (EN) S3		
			0 092 ...0			0 092 ...0			0 092 ...0			0 092 ...0		
2.2 Direct [C]	09.03-10.08		70	760	S5 A08	77	780	S5 008	74	680	S4 008	70	640	S3 008
i [C]	09.03-09.05					74	750	S5 007	72	680	S4 007			
i 16V [B]	09.00-08.01					74	750	S5 007	72	680	S4 007	53	500	S3 004
2.5 i V6 [B]	09.95-08.01					74	750	S5 007	72	680	S4 007	53	500	S3 004
						74	750	S5 007	72	680	S4 007	70	640	S3 007
2.6 V6 [B]	09.00-08.01					74	750	S5 007	72	680	S4 007			
2.8 GTS Turbo [C]	01.07-10.08					77	780	S5 008	74	680	S4 008			
Turbo [C]	08.05-10.08					74	750	S5 007	72	680	S4 007	70	640	S3 007
3.2 i [C]	09.03-09.05		70	760	S5 A08	85	800	S5 010	74	680	S4 008	70	640	S3 008
Diesel														
1.7 TD [B]	09.95-08.01					74	750	S5 007	72	680	S4 007	70	640	S3 007
1.9 CDTI [C]	04.04-10.08					85	800	S5 010	74	680	S4 008			
2.0 DI [B]	09.96-08.00					74	750	S5 007	72	680	S4 007	70	640	S3 007
DTI [B]	09.97-08.00					74	750	S5 007	72	680	S4 007	70	640	S3 007
	09.00-08.01					74	750	S5 007	72	680	S4 007			
2.0/ 2.2 DTI [C]	09.03-09.05					85	800	S5 010	74	680	S4 008			
2.2 DTI [B]	09.00-08.01					74	750	S5 007	72	680	S4 007			
3.0 CDTI [C]	09.03-10.08					85	800	S5 010	74	680	S4 008	88	740	S3 012
Viva														
1.0 [15]	05.15→								52	470	S4 002			
		BWD	70	760	S5 A08									
VX 220														
2.0/ 2.2 i 16V, i 16V Turbo	09.00-09.05					52	520	S5 001	44	440	S4 001	41	360	S3 001
VXR8														
6.0/ 6.2 V8	02.07→					74	750	S5 007	72	680	S4 007			
Zafira														
1.4 Turbo [C]	01.12→											53	500	S3 004
						61	600	S5 004				53	500	S3 004
		SSJ	70	760	S5 A08									
			80	800	S5 A11									
1.6 CNG, CNG Turbo [B]	09.05-07.10					61	600	S5 004				53	500	S3 004
i [A]	09.98-08.99					61	600	S5 004	44	440	S4 001	41	360	S3 001
	09.99-06.05					61	600	S5 004	44	440	S4 001			
i [B]	07.05-12.12					61	600	S5 004	44	440	S4 001	41	360	S3 001
	03.06-02.09					61	600	S5 004	44	440	S4 001			
	01.11-01.15					52	520	S5 001	44	440	S4 001			
i CNG [A]	09.01-06.05					61	600	S5 004	44	440	S4 001			
i Dualfuel [A]	09.99-06.05					74	750	S5 007	72	680	S4 007			
1.6/ 1.8 , CNG [C]	01.12→					61	600	S5 004				53	500	S3 004
1.8 i [A]	03.99-09.00					74	750	S5 007	60	540	S4 004	53	500	S3 004
	09.00-06.05					74	750	S5 007	60	540	S4 004			
i [B]	07.05-02.10					61	600	S5 004	44	440	S4 001	41	360	S3 001
	01.11-01.15					61	600	S5 004	44	440	S4 001	53	500	S3 004
	06.13-01.15					54	530	S5 002	52	470	S4 002	45	400	S3 002
i Dualfuel [A]	09.00-06.05					61	600	S5 004				53	500	S3 004
LPG [B]	03.10-12.10											53	500	S3 004
2.0 i Turbo [B]	07.05-12.10					74	750	S5 007	72	680	S4 007	70	640	S3 007
Turbo [A]	09.01-06.05					74	750	S5 007	60	540	S4 004	53	500	S3 004
2.2 [A]	09.00-06.05					74	750	S5 007	72	680	S4 007			
i Direkt [B]	07.05-12.10					74	750	S5 007	60	540	S4 004	53	500	S3 004
Diesel														
1.6 CDTI [C]	05.13→	SSJ	70	760	S5 A08									
1.7 CDTI [B]	03.08-01.15					63	610	S5 005	60	540	S4 005			
						74	750	S5 007	72	680	S4 007	70	640	S3 007
1.9 CDTI [B]	07.05-03.08					74	750	S5 007	72	680	S4 007			
	07.05-12.10					74	750	S5 007	60	540	S4 004	70	640	S3 007
						74	750	S5 007	72	680	S4 007	70	640	S3 007
2.0 CDTI [C]	01.12→					74	750	S5 007	72	680	S4 007			
			70	760	S5 A08									
		SSJ	80	800	S5 A11									
	01.13→		70	760	S5 A08	77	780	S5 008	74	680	S4 008			
		SSJ							70	760	S4 E08			



			Ah	A (EN)	S5A	Ah	A (EN)	S5	Ah	A (EN)	S4	Ah	A (EN)	S3
			0 092 ...0			0 092 ...0			0 092 ...0			0 092 ...0		
◀ VAUXHALL														
2.0 CDTI [C]	02.15→								70	650	S4 E07			
									70	650	S4 E10			
									72	680	S4 007			
									80	740	S4 010			
DI [A]	03.99-08.00		74	750	S5 007	72	680	S4 007	70	640	S3 007			
DTI [A]	04.99-06.05		74	750	S5 007	72	680	S4 007	70	640	S3 007			
2.2 DTI [A]	03.02-06.05		74	750	S5 007	72	680	S4 007						

VOLVO

C30														
Electric [P14]	08.11→		70	760	S5 A08	77	780	S5 008	74	680	S4 008			
1.6/ 1.8 [P14]	10.06-07.12	BWD	60	680	S5 A05	63	610	S5 005	60	540	S4 005	53	500	S3 004
1.8/ 2.0 F Flexifuel [P14]	10.06→		60	680	S5 A05	63	610	S5 005	60	540	S4 005			
2.0 [P14]	10.06→		60	680	S5 A05	63	610	S5 005	60	540	S4 005			
2.4/ 2.5 i, T5 [P14]	10.06→	BWD	70	760	S5 A08	77	780	S5 008	74	680	S4 008	70	640	S3 008
Diesel														
1.6 D DRIVE [P14]	10.06-07.11	BWD				85	800	S5 010	80	740	S4 010			
		BWD,SSJ	70	760	S5 A08									
D2 DRIVE [P14]	08.10→	BWD,SSJ	70	760	S5 A08									
2.0 D [P14]	10.06-07.07					85	800	S5 010	80	740	S4 010			
	10.06-09.10	BWD				85	800	S5 010	80	740	S4 010			
2.0/ 2.4 D3, D4, D5 [P14]	10.06→	BWD				85	800	S5 010	80	740	S4 010			
C70 I Cabrio														
2.0 T	03.98-03.06		60	680	S5 A05	63	610	S5 005	60	540	S4 005			
2.3 T5	02.98-07.02		60	680	S5 A05	63	610	S5 005	60	540	S4 005			
	08.02-03.06		70	760	S5 A08	77	780	S5 008	60	540	S4 005			
2.4	03.99-07.00		70	760	S5 A08	77	780	S5 008	74	680	S4 008	56	480	S3 005
T	08.98-07.02		70	760	S5 A08	77	780	S5 008	74	680	S4 008	56	480	S3 005
T5	08.02-03.06		70	760	S5 A08	77	780	S5 008	74	680	S4 008	56	480	S3 005
C70 I Coupé														
2.0/ 2.3/ 2.4/ 2.5 LPT, T, T5, 20V	01.97-07.02		60	680	S5 A05	63	610	S5 005	60	540	S4 005			
C70 II Cabrio														
2.4	03.06-07.10		60	680	S5 A05	63	610	S5 005	60	540	S4 005			
i	03.06-07.10	BWD	60	680	S5 A05	63	610	S5 005	60	540	S4 005			
2.5 T5	03.06-07.07		60	680	S5 A05	63	610	S5 005	60	540	S4 005			
	08.07-12.13	BWD	70	760	S5 A08	77	780	S5 008	60	540	S4 005	56	480	S3 005
		BWD,SSJ	70	760	S5 A08									
Diesel														
2.0 D	01.08-07.10	BWD	70	760	S5 A08	85	800	S5 010	80	740	S4 010			
		BWD,SSJ	70	760	S5 A08									
D3	10.10-07.13	BWD	70	760	S5 A08	85	800	S5 010	80	740	S4 010			
		BWD,SSJ	70	760	S5 A08									
D4	10.10-07.13	BWD	70	760	S5 A08	85	800	S5 010	80	740	S4 010			
		BWD,SSJ	70	760	S5 A08									
2.4 D	08.06-07.10	BWD	70	760	S5 A08	85	800	S5 010	80	740	S4 010			
		BWD,SSJ	70	760	S5 A08									
D5	08.06-07.10	BWD	70	760	S5 A08	85	800	S5 010	80	740	S4 010			
			95	850	S5 A13	85	800	S5 010	80	740	S4 010			
		BWD,SSJ	70	760	S5 A08									
		SSJ	95	850	S5 A13									
S40 I														
1.6/ 1.8/ 1.9/ 2.0 T, T 16V, T4, 16V	07.95-01.04		60	680	S5 A05	63	610	S5 005	60	540	S4 005			
Diesel														
1.9 D	05.96-01.04		70	760	S5 A08	77	780	S5 008	74	680	S4 008	70	640	S3 008
S40 II														
1.6/ 1.8 [P11]	04.04-08.12	BWD				63	610	S5 005	60	540	S4 005	53	500	S3 004
1.8 F Flexifuel [P11]	04.06-07.10	BWD				63	610	S5 005	60	540	S4 005	53	500	S3 004
2.0 [P11]	10.06-08.12	BWD				74	750	S5 007	72	680	S4 007			
F Flexifuel [P11]	08.09-08.12	BWD				74	750	S5 007	72	680	S4 007			



			Ah A (EN) S5A			Ah A (EN) S5			Ah A (EN) S4			Ah A (EN) S3		
			0 092 ...0			0 092 ...0			0 092 ...0			0 092 ...0		
2.4 [P11]	12.03-07.10	BWD				74	750	S5 007	72	680	S4 007			
	12.03→					74	750	S5 007	72	680	S4 007	70	640	S3 007
i [P11]	08.05-07.10					74	750	S5 007	72	680	S4 007			
2.5 T5 [P11]	12.03-07.07	BWD				74	750	S5 007	72	680	S4 007	70	640	S3 007
	12.03→					74	750	S5 007	72	680	S4 007			
	08.07-12.12	BWD				74	750	S5 007	72	680	S4 007			
T5 AWD [P11]	04.04-07.07	BWD				74	750	S5 007	72	680	S4 007	70	640	S3 007
	08.07-07.10	BWD				74	750	S5 007	72	680	S4 007			
Diesel														
1.6 D DRiVe [P11]	11.04-08.12	BWD	70	760	S5 A08	85	800	S5 010	80	740	S4 010			
		BWD,SSJ	70	760	S5 A08									
D2 [P11]	08.11-08.12	BWD,SSJ	70	760	S5 A08									
2.0/2.4 D, D3, D4, D5 [P11]	01.04-08.12	BWD				85	800	S5 010	80	740	S4 010			
S60 Cross Country														
2.0 T5 AWD	08.16→		70	760	S5 A08				70	760	S4 E08			
2.5 T5 AWD	08.15-07.16		70	760	S5 A08									
Diesel														
2.0/2.4 D3, D4, D5 AWD	08.15→	BWD,SSJ	70	760	S5 A08									
S60 I														
2.0 T	11.00-07.09	BWD	60	680	S5 A05	63	610	S5 005	60	540	S4 005			
2.3/2.4 T5	11.00-07.09	BWD	60	680	S5 A05	63	610	S5 005	60	540	S4 005			
2.4	11.00-07.09	BWD	60	680	S5 A05	63	610	S5 005	60	540	S4 005			
	11.02-08.06		70	760	S5 A08	77	780	S5 008	60	540	S4 005			
T	11.00-07.03	BWD	60	680	S5 A05	63	610	S5 005	60	540	S4 005			
	08.03-07.06	BWD	70	760	S5 A08	77	780	S5 008	60	540	S4 005			
T AWD	11.01-07.03	BWD	60	680	S5 A05	63	610	S5 005	60	540	S4 005			
	08.03-07.06	BWD	70	760	S5 A08	77	780	S5 008	60	540	S4 005			
2.4/2.5 Bi-Fuel CNG, Bi-Fuel LPG, R AWD	06.02-07.08	BWD	60	680	S5 A05	63	610	S5 005	60	540	S4 005			
2.5 T	04.04-07.09	BWD	60	680	S5 A05	63	610	S5 005	60	540	S4 005			
T AWD	07.02-07.09	BWD	60	680	S5 A05	63	610	S5 005	60	540	S4 005			
Diesel														
2.4 D	08.01-07.06		95	850	S5 A13	100	830	S5 013	95	800	S4 013	90	720	S3 013
	08.03-07.09	BWD	95	850	S5 A13	100	830	S5 013	95	800	S4 013			
	08.05-07.06					85	800	S5 010	80	740	S4 010			
	08.06-07.09	BWD	80	800	S5 A11	85	800	S5 010	80	740	S4 010			
D5	08.05-07.09		95	850	S5 A13	100	830	S5 013	95	800	S4 013	90	720	S3 013
S60 II														
1.5 T2	08.15→	BWD,SSJ	70	760	S5 A08				70	760	S4 E08			
1.5/2.0 T3	08.15→	BWD,SSJ	70	760	S5 A08				70	760	S4 E08			
1.6 T3	11.10-07.15	BWD,SSJ	70	760	S5 A08									
T4	11.10-07.15	BWD,SSJ	70	760	S5 A08									
T4F	11.10-07.15	BWD				77	780	S5 008	74	680	S4 008			
2.0 T	08.10-07.11	BWD				77	780	S5 008	74	680	S4 008	70	640	S3 008
T4	08.12-07.15	BWD,SSJ	70	760	S5 A08									
	08.15→								70	650	S4 E10	88	740	S3 012
									80	740	S4 010	88	740	S3 012
T5	11.10-07.14	BWD				77	780	S5 008	74	680	S4 008			
	08.13→					77	780	S5 008	74	680	S4 008			
		BWD,SSJ	70	760	S5 A08									
			80	800	S5 A11									
T6	08.13-07.17	BWD,SSJ	70	760	S5 A08									
T6 AWD	08.15-07.18	BWD,SSJ	70	760	S5 A08				70	760	S4 E08			
2.5 T5	08.11-07.12					77	780	S5 008	74	680	S4 008			
		BWD,SSJ	70	760	S5 A08									
	08.12-10.15		70	760	S5 A08									
T5 AWD	08.13-07.16					77	780	S5 008	74	680	S4 008			
		BWD,SSJ	70	760	S5 A08									
3.0 T6 AWD	08.10-07.16	BWD				77	780	S5 008	74	680	S4 008			
	09.13→	SSJ	70	760	S5 A08				70	760	S4 E08			
	08.14-12.15		70	760	S5 A08	77	780	S5 008	70	760	S4 E08			
			70	760	S5 A08	77	780	S5 008	74	680	S4 008			



			Ah A (EN)	Ah A (EN)	Ah A (EN)	Ah A (EN)
			0 092 ...0	0 092 ...0	0 092 ...0	0 092 ...0

◀ VOLVO

Diesel												
1.6/ 2.0 DRIVE, D2	08.11→	BWD,SSJ	70	760	S5 A08							
2.0 D3	08.10-07.11	BWD				85	800	S5 011	80	740	S4 011	
		BWD,SSJ	70	760	S5 A08							
	08.12-12.15	BWD,SSJ	80	800	S5 A11	85	800	S5 010	80	740	S4 010	88 740 S3 012
		BWD,SSJ	70	760	S5 A08							
D4	08.11-07.15	BWD				85	800	S5 010	80	740	S4 010	
	08.11→	BWD,SSJ	70	760	S5 A08							
	08.13-07.15	BWD,SSJ	80	800	S5 A11	63	610	S5 005	60	540	S4 005	
BWD,SSJ		70	760	S5 A08								
D5	08.15→	BWD,SSJ	70	760	S5 A08							
2.4 D4 AWD	08.15→	BWD,SSJ	70	760	S5 A08							
		BWD				85	800	S5 010	80	740	S4 010	
	08.10-07.11	BWD,SSJ	70	760	S5 A08							
		BWD,SSJ	70	760	S5 A08							
D5 AWD	08.10-07.15	BWD				85	800	S5 010	80	740	S4 010	
		BWD,SSJ	70	760	S5 A08							
	08.14-07.15	BWD,SSJ	70	760	S5 A08				70	760	S4 E08	
S60 II Polestar												
2.0 T6 AWD	08.15→	BWD,SSJ	70	760	S5 A08				70	760	S4 E08	
S70												
2.0/ 2.3/ 2.4/ 2.5 , AWD, Bifuel, T, T AWD, T 20V, T-5, 20V	01.97-07.00		60	680	S5 A05	63	610	S5 005	60	540	S4 005	
Diesel												
2.5 TDI	01.97-07.00		70	760	S5 A08	77	780	S5 008	74	680	S4 008	70 640 S3 008
S70 R												
2.3 T, T AWD	01.97-07.98		60	680	S5 A05	63	610	S5 005	60	540	S4 005	
S80 I												
2.0/ 2.3/ 2.4/ 2.5/ 2.9/ 3.0 , AWD, Bi-Fuel LPG, R, T, T 41AWD, T5	06.98-07.06	BWD	60	680	S5 A05	63	610	S5 005	60	540	S4 005	
2.4 T4 Bi-Fuel CNG	08.01-07.06	BWD	70	760	S5 A08	77	780	S5 008	60	540	S4 005	
2.8 T6	05.98-07.01	BWD	70	760	S5 A08	77	780	S5 008	74	680	S4 008	70 640 S3 008
	09.98-08.01	BWD	70	760	S5 A08	77	780	S5 008				
3.0 T6	08.01-07.06	BWD	70	760	S5 A08	77	780	S5 008	60	540	S4 005	
Diesel												
2.4 D, D5	08.01-07.06		95	850	S5 A13	100	830	S5 013	95	800	S4 013	90 720 S3 013
2.5 TDI	08.98-07.01	BWD	60	680	S5 A05	63	610	S5 005	60	540	S4 005	
S80 II												
1.6 T4	08.10-08.16	BWD				77	780	S5 008	74	680	S4 008	
		BWD,SSJ	70	760	S5 A08							
T4F	08.11-07.13		70	760	S5 A08	77	780	S5 008	74	680	S4 008	
2.0 B	01.08-07.12	BWD	70	760	S5 A08	77	780	S5 008				
		BWD	70	760	S5 A08	77	780	S5 008	74	680	S4 008	70 640 S3 008
	01.08-07.12	BWD	70	760	S5 A08	77	780	S5 008				
		BWD	70	760	S5 A08	77	780	S5 008				
	08.10-08.16	BWD	70	760	S5 A08	77	780	S5 008				
		BWD	70	760	S5 A08	77	780	S5 008				
		BWD,SSJ	70	760	S5 A08				70	760	S4 E08	
		BWD,SSJ	70	760	S5 A08							
		SSJ	80	800	S5 A11							
2.5 FT Flexifuel	05.08-07.10	BWD	70	760	S5 A08	77	780	S5 008	74	680	S4 008	70 640 S3 008
		BWD	60	680	S5 A05	63	610	S5 005				
	03.06-07.09	BWD	60	680	S5 A05	63	610	S5 005	60	540	S4 005	
		BWD	70	760	S5 A08	77	780	S5 008				
		BWD	70	760	S5 A08							
09.12-08.16		70	760	S5 A08								
3.0 T6 AWD	01.07-07.10	BWD	70	760	S5 A08	77	780	S5 008	74	680	S4 008	70 640 S3 008
	08.10-08.16	BWD	70	760	S5 A08	77	780	S5 008				
3.2 , AWD	08.06-08.16	BWD	70	760	S5 A08	77	780	S5 008	74	680	S4 008	
4.4 V8 AWD	03.06-12.10		70	760	S5 A08	77	780	S5 008	74	680	S4 008	70 640 S3 008



			Ah	A (EN)		Ah	A (EN)		Ah	A (EN)		Ah	A (EN)	
			0 092 ...0			0 092 ...0			0 092 ...0			0 092 ...0		

Diesel															
1.6 D DRIVE	08.09-07.11	BWD	70	760	S5 A08										
	DRIVE	08.11-08.16	BWD,SSJ	70	760	S5 A08									
			SSJ	70	760	S5 A08									
2.0 D	08.07-07.10		95	850	S5 A13	100	830	S5 013	95	800	S4 013	90	720	S3 013	
	D3	08.10-07.12	BWD				85	800	S5 010	80	740	S4 010			
		08.10-07.14	BWD,SSJ	70	760	S5 A08									
	D4	08.12-08.16					85	800	S5 010	80	740	S4 010			
				BWD	70	760	S5 A08								
		08.13-08.16					63	610	S5 005	60	540	S4 005			
		BWD,SSJ	70	760	S5 A08										
			80	800	S5 A11										
2.4 D	08.06-07.09		95	850	S5 A13	100	830	S5 013	95	800	S4 013	90	720	S3 013	
						85	800	S5 010	70	650	S4 E10	88	740	S3 012	
						100	830	S5 013							
	08.09-07.10														
			BWD	95	850	S5 A13									
	D5	03.06-07.09		95	850	S5 A13	100	830	S5 013						
		11.08-07.11	BWD				85	800	S5 010	70	650	S4 E10	88	740	S3 012
			08.11-08.16					85	800	S5 010	80	740	S4 010		
			BWD,SSJ	70	760	S5 A08									
D5 AWD	03.06-07.09		95	850	S5 A13	100	830	S5 013	95	800	S4 013	90	720	S3 013	
						85	800	S5 010	70	650	S4 E10	88	740	S3 012	
	08.09-07.11					85	800	S5 010	80	740	S4 010				
	08.11-08.16	BWD				85	800	S5 010	80	740	S4 010				
		BWD,SSJ	70	760	S5 A08										
S90 I															
2.5/2.9 , Exekutive, Exekutive Plus	11.96-12.99		60	680	S5 A05	63	610	S5 005	60	540	S4 005				
S90 II															
2.0 T5	03.16→		80	800	S5 A11										
			95	850	S5 A13										
	T6 AWD	03.16→		80	800	S5 A11									
				95	850	S5 A13									
	T8 TWIN ENGINE AWD	12.16→		80	800	S5 A11									
			95	850	S5 A13										
Diesel															
2.0 D3	03.16→		80	800	S5 A11										
			95	850	S5 A13										
	D4	03.16→		80	800	S5 A11									
				95	850	S5 A13									
	D4 AWD	03.16→		80	800	S5 A11									
				95	850	S5 A13									
D5 AWD	03.16→		80	800	S5 A11										
			95	850	S5 A13										
V40 Cross Country															
1.5 T3	08.15→	BWD	70	760	S5 A08										
		BWD,SSJ							70	760	S4 E08				
1.6 T4	01.13-07.15	BWD	70	760	S5 A08										
			80	800	S5 A11										
		BWD,SSJ							70	760	S4 E08				
2.0 T3	08.15→	BWD	70	760	S5 A08										
		BWD,SSJ							70	760	S4 E08				
	T4	01.13-07.15	BWD	80	800	S5 A11									
			BWD,SSJ	70	760	S5 A08				70	760	S4 E08			
	08.15→	BWD	70	760	S5 A08										
BWD,SSJ								70	760	S4 E08					
T4 AWD	09.13-07.15		70	760	S5 A08										
									70	760	S4 E08				
	08.15→	BWD,SSJ	70	760	S5 A08				70	760	S4 E08				
			80	800	S5 A11				70	760	S4 E08				
T5	01.13-07.15	BWD,SSJ	70	760	S5 A08										
			80	800	S5 A11										
T5 AWD	01.13-07.15	BWD,SSJ	80	800	S5 A11										
			70	760	S5 A08										
	01.13→	BWD,SSJ	70	760	S5 A08										



			Ah A (EN) S5A			Ah A (EN) S5			Ah A (EN) S4			Ah A (EN) S3		
			0 092 ...0			0 092 ...0			0 092 ...0			0 092 ...0		
◀ VOLVO														
2.0 T5 AWD	11.14→	SSJ	80	800	S5 A11									
2.5 T5	01.13-07.15	BWD,SSJ	70	760	S5 A08									
		SSJ	80	800	S5 A11									
T5 AWD	01.13-07.15	BWD,SSJ	70	760	S5 A08			70	760	S4 E08				
			80	800	S5 A11			70	760	S4 E08				
Diesel														
1.6 D2	01.13-08.16		70	760	S5 A08									
2.0 D2	09.15→	BWD	80	800	S5 A11									
		BWD,SSJ	70	760	S5 A08			70	760	S4 E08				
D3	09.15→	BWD,SSJ	70	760	S5 A08									
			80	800	S5 A11									
D4	09.14→	BWD,SSJ	70	760	S5 A08									
		SSJ	80	800	S5 A11									
V40 I														
1.6/ 1.8/ 1.9/ 2.0, T4, 16V, 16VT	01.95-06.04		60	680	S5 A05	63	610	S5 005	60	540	S4 005			
2.0 T, T4T	08.00-04.04		70	760	S5 A08	77	780	S5 008	60	540	S4 005			
Diesel														
1.9 D	01.96-04.04		70	760	S5 A08	77	780	S5 008	74	680	S4 008	70	640	S3 008
V40 II														
1.5/ 2.0 T2	09.15→	BWD,SSJ	70	760	S5 A08				70	760	S4 E08			
		T3	09.15→	BWD,SSJ	70	760	S5 A08			70	760	S4 E08		
1.6 T2	09.12-07.15	BWD,SSJ	70	760	S5 A08									
			80	800	S5 A11									
T3	09.12-07.15		70	760	S5 A08									
			70	760	S5 A08									
2.0 T4	09.12-08.15		70	760	S5 A08									
		BWD,SSJ							70	760	S4 E08			
T5	09.15→	BWD,SSJ	70	760	S5 A08				70	760	S4 E08			
			70	760	S5 A08				70	760	S4 E08			
T5	09.13-08.15	BWD,SSJ	70	760	S5 A08				70	760	S4 E08			
			70	760	S5 A08				70	760	S4 E08			
T5	09.14→	SSJ	80	800	S5 A11									
			80	800	S5 A11									
2.5 T5	09.13-08.14	BWD,SSJ	70	760	S5 A08									
			80	800	S5 A11									
Diesel														
1.6 D2	09.12-08.15		70	760	S5 A08									
2.0 D2	09.15→	BWD	70	760	S5 A08									
			80	800	S5 A11									
D3	09.12-08.15	BWD,SSJ							70	760	S4 E08			
			70	760	S5 A08									
D4	09.15→	BWD,SSJ	70	760	S5 A08									
		SSJ	80	800	S5 A11									
D4	09.12-08.14		70	760	S5 A08									
			80	800	S5 A11									
V50														
1.6/ 1.8 [P12]	04.04-12.12	BWD				63	610	S5 005	60	540	S4 005	53	500	S3 004
1.8 F Flexifuel [P12]	04.06-07.10	BWD				63	610	S5 005	60	540	S4 005	53	500	S3 004
2.0 [P12]	10.06-12.12	BWD				74	750	S5 007	60	540	S4 004			
		F Flexifuel [P12]	08.09-12.12	BWD			74	750	S5 007	60	540	S4 004		
2.4 [P12]	04.04-07.10	BWD	70	760	S5 A08	74	750	S5 007	72	680	S4 007	70	640	S3 007
		i [P12]	04.04-07.10	BWD	70	760	S5 A08	74	750	S5 007	72	680	S4 007	70
2.5 T5, T5 AWD [P12]	04.04-12.12	BWD	70	760	S5 A08	74	750	S5 007	72	680	S4 007			
Diesel														
1.6 D Drive [P12]	11.04-07.10	BWD				85	800	S5 010	80	740	S4 010			
		BWD,SSJ	70	760	S5 A08									
D2 Drive [P12]	08.11-12.12	BWD				85	800	S5 010	80	740	S4 010			
		BWD,SSJ	70	760	S5 A08									
2.0 D [P12]	04.04-07.10	BWD				85	800	S5 010	80	740	S4 010			
2.0/ 2.4 D3, D4, D5 [P12]	04.06-12.12	BWD				85	800	S5 010	80	740	S4 010			
V60 Cross Country I														
2.0 T5	08.16→		70	760	S5 A08	63	610	S5 005	60	540	S4 005			
		T5 AWD	08.16→		70	760	S5 A08	63	610	S5 005	60	540	S4 005	



			Ah A (EN) S5A			Ah A (EN) S5			Ah A (EN) S4			Ah A (EN) S3		
			0 092 ...0			0 092 ...0			0 092 ...0			0 092 ...0		
2.5 T5 AWD	09.13-10.15		70	760	S5 A08									
Diesel														
2.0 D3	08.15→	BWD,SSJ	70	760	S5 A08			70	760	S4 E08				
V60 I														
1.5 T2	09.15→	BWD,SSJ	70	760	S5 A08			70	760	S4 E08				
1.5/ 2.0 T3	09.15→	BWD,SSJ	70	760	S5 A08			70	760	S4 E08				
1.6 T3	09.10-08.15	BWD,SSJ	70	760	S5 A08									
T4	09.10-08.15	BWD,SSJ	70	760	S5 A08									
T4F	09.11-08.15	BWD				77	780	S5 008	74	680	S4 008			
		BWD,SSJ	70	760	S5 A08									
2.0 T	09.10-08.11	BWD				77	780	S5 008	74	680	S4 008	70	640	S3 008
T4	09.15→								70	650	S4 E10	88	740	S3 012
									80	740	S4 010	88	740	S3 012
T5	09.10-08.13	BWD				77	780	S5 008	74	680	S4 008	70	640	S3 008
	09.12-10.15		70	760	S5 A08				70	760	S4 E08			
	09.13→					63	610	S5 005	60	540	S4 005			
		BWD,SSJ	70	760	S5 A08									
			80	800	S5 A11									
T6	09.13→					63	610	S5 005	60	540	S4 005			
		BWD,SSJ	70	760	S5 A08									
T6 AWD	09.13→	BWD,SSJ	70	760	S5 A08									
3.0 T6 AWD	09.10-10.15	BWD				77	780	S5 008	74	680	S4 008	70	640	S3 008
	09.14-12.15					77	780	S5 008	74	680	S4 008			
		BWD,SSJ	70	760	S5 A08				70	760	S4 E08			
	09.14-08.16		70	760	S5 A08	77	780	S5 008	70	760	S4 E08			
			70	760	S5 A08	77	780	S5 008	74	680	S4 008			
Diesel														
1.6 D2 DRIVE	09.11-08.15	BWD,SSJ	70	760	S5 A08									
2.0 D2	09.15→	BWD,SSJ	70	760	S5 A08				70	760	S4 E08			
D3	09.10-08.11	BWD				85	800	S5 010	80	740	S4 010			
		BWD,SSJ	70	760	S5 A08									
	09.12-08.15					85	800	S5 010	80	740	S4 010	88	740	S3 012
		BWD,SSJ	70	760	S5 A08									
			80	800	S5 A11									
	09.15→	BWD	70	760	S5 A08									
		BWD,SSJ							70	760	S4 E08			
D4	09.11-08.15	BWD				85	800	S5 010	80	740	S4 010			
	09.11→	BWD,SSJ	70	760	S5 A08									
	09.13-08.15					63	610	S5 005	60	540	S4 005			
		BWD,SSJ	80	800	S5 A11									
D5	09.15→	BWD,SSJ	70	760	S5 A08									
			80	800	S5 A11									
2.4 D4 AWD	09.12-08.15					85	800	S5 010	80	740	S4 010	88	740	S3 012
	09.12→	BWD,SSJ	70	760	S5 A08									
			80	800	S5 A11									
	09.13-08.15					63	610	S5 005	60	540	S4 005			
D5	09.10-08.11	BWD				85	800	S5 010	80	740	S4 010			
	09.11-08.15		70	760	S5 A08									
		BWD,SSJ	70	760	S5 A08									
	09.14-12.15		70	760	S5 A08	77	780	S5 008	74	680	S4 008			
		BWD,SSJ							70	760	S4 E08			
D5 AWD	09.10-08.15	BWD				85	800	S5 010	80	740	S4 010			
	04.14-12.15		70	760	S5 A08	77	780	S5 008	70	760	S4 E08			
			70	760	S5 A08	77	780	S5 008	74	680	S4 008			
D6 Hybrid AWD	11.12-07.15		80	800	S5 A11									
	08.15→		70	760	S5 A08									
		BWD,SSJ	70	760	S5 A08									
			80	800	S5 A11									
V60 I Polestar														
2.0 AWD	09.15→	BWD,SSJ	70	760	S5 A08				70	760	S4 E08			



			Ah A (EN) S5A			Ah A (EN) S5			Ah A (EN) S4			Ah A (EN) S3		
			0 092 ...0			0 092 ...0			0 092 ...0			0 092 ...0		
◀ VOLVO														
V70 I														
2.0/ 2.3/ 2.4/ 2.5 , AWD,	01.97→		60	680	S5 A05	63	610	S5 005	60	540	S4 005			
BI-FUEL, i, R, R AWD, T, T AWD, T XC, T XC AWD, T 20V, Turbo, Turbo AWD, T-5, T-5 AWD, XC AWD, 20V														
Diesel														
2.5 TDI	01.97-03.00		70	760	S5 A08	77	780	S5 008	74	680	S4 008	70	640	S3 008
V70 II														
2.0 T	03.00-07.07	BWD	70	760	S5 A08	77	780	S5 008	60	540	S4 005			
2.3	03.00-07.04	BWD	70	760	S5 A08	77	780	S5 008	60	540	S4 005			
2.3/ 2.4 T5	03.00-07.07	BWD	70	760	S5 A08	77	780	S5 008	60	540	S4 005			
2.4	03.00-07.07	BWD	70	760	S5 A08	77	780	S5 008	60	540	S4 005			
	04.03-07.06		70	760	S5 A08	77	780	S5 008	60	540	S4 005			
T	03.00-07.03	BWD							60	540	S4 005	56	480	S3 005
									60	540	S4 005	70	640	S3 008
T AWD	09.00-07.03	BWD	70	760	S5 A08	77	780	S5 008	60	540	S4 005			
XC AWD	09.00-07.02	BWD	70	760	S5 A08	77	780	S5 008	74	680	S4 008			
2.5 BI-FUEL CNG, BI-FUEL	09.01-07.07	BWD	70	760	S5 A08	77	780	S5 008	60	540	S4 005			
LPG														
T	04.04-07.07	BWD	95	850	S5 A13	100	830	S5 013	95	800	S4 013			
T AWD	08.02-07.07	BWD	95	850	S5 A13	100	830	S5 013	95	800	S4 013			
T AWD R	03.03-07.07	BWD	95	850	S5 A13	100	830	S5 013	95	800	S4 013			
Diesel														
2.4 D	08.01-07.07		95	850	S5 A13	100	830	S5 013	95	800	S4 013	90	720	S3 013
	08.06-07.07	BWD	95	850	S5 A13	100	830	S5 013	95	800	S4 013			
D AWD	08.02-07.06		95	850	S5 A13	100	830	S5 013	95	800	S4 013	90	720	S3 013
D5	12.05-07.06	BWD	95	850	S5 A13	100	830	S5 013	95	800	S4 013			
	08.06-07.07		95	850	S5 A13	100	830	S5 013	95	800	S4 013	90	720	S3 013
D5 AWD	12.05-07.07	BWD	95	850	S5 A13	100	830	S5 013	95	800	S4 013			
2.5 D	03.00-07.01		95	850	S5 A13	100	830	S5 013	95	800	S4 013	90	720	S3 013
V70 III														
1.6 T4	08.10-07.15	BWD,SSJ	70	760	S5 A08									
T4F	08.11-07.15	BWD				77	780	S5 008	74	680	S4 008			
2.0 B	10.07-07.11	BWD				77	780	S5 008				88	740	S3 012
		BWD,SSJ	70	760	S5 A08									
F Flexifuel	10.07-07.11	BWD				85	800	S5 010	80	740	S4 010			
T	08.10-07.11	BWD				77	780	S5 008				88	740	S3 012
		BWD,SSJ	70	760	S5 A08									
			80	800	S5 A11									
T4	08.15-07.16	BWD,SSJ	70	760	S5 A08				70	760	S4 E08			
T5	08.10-07.14	BWD	70	760	S5 A08	77	780	S5 008	74	680	S4 008			
	08.12-07.15					77	780	S5 008	74	680	S4 008			
	08.12-07.16	BWD,SSJ	70	760	S5 A08									
			80	800	S5 A11									
	08.13-07.16					63	610	S5 005	60	540	S4 005			
2.5 FT Flexifuel	05.08-07.09					85	800	S5 010	80	740	S4 010			
	08.09-01.12	BWD				85	800	S5 010	80	740	S4 010			
T	08.07-07.10					85	800	S5 010	80	740	S4 010			
	08.09-07.12	BWD				85	800	S5 010	80	740	S4 010			
3.0 T6 AWD	08.07-07.10					85	800	S5 010	80	740	S4 010			
	08.10-07.15	BWD				85	800	S5 010	80	740	S4 010			
3.2	08.07-07.10					85	800	S5 010	80	740	S4 010			
	08.10-07.14	BWD	70	760	S5 A08	77	780	S5 008	74	680	S4 008			
AWD	08.07-07.10					85	800	S5 010	80	740	S4 010			
	08.10-07.14	BWD	70	760	S5 A08	77	780	S5 008	74	680	S4 008			
Diesel														
1.6 D DRIVE	01.10-07.11	BWD	70	760	S5 A08	74	750	S5 007	72	680	S4 007	70	640	S3 007
	08.11-07.15		70	760	S5 A08	74	750	S5 007	72	680	S4 007	70	640	S3 007
2.0 D	10.07-07.10					85	800	S5 010	80	740	S4 010	88	740	S3 012
D2	08.13-07.16	BWD,SSJ	70	760	S5 A08									
D3	08.10-07.11	BWD				85	800	S5 010	80	740	S4 010			
		BWD,SSJ	70	760	S5 A08									



			Ah A (EN) S5A			Ah A (EN) S5			Ah A (EN) S4			Ah A (EN) S3			
			0 092 ...0			0 092 ...0			0 092 ...0			0 092 ...0			
2.0 D3	08.12-07.15	BWD,SSJ	80	800	S5 A11										
	08.12-07.16	BWD,SSJ	70	760	S5 A08										
	D3/D4	08.11-07.15	BWD,SSJ	70	760	S5 A08									
	D4	08.13-07.16	BWD,SSJ	70	760	S5 A08									
			80	800	S5 A11										
2.4 D	08.07-07.10					85	800	S5 010	80	740	S4 010	88	740	S3 012	
		BWD,SSJ	70	760	S5 A08										
	D4 AWD	08.12-07.16	BWD,SSJ	70	760	S5 A08									
		08.13-07.16	BWD				85	800	S5 010	80	740	S4 010	88	740	S3 012
			BWD,SSJ	80	800	S5 A11									
	D5	08.07-07.09				85	800	S5 010	80	740	S4 010	88	740	S3 012	
		08.07-07.15	BWD,SSJ	70	760	S5 A08									
		08.09-07.15	BWD				85	800	S5 010	80	740	S4 010	88	740	S3 012
		08.11-07.15					85	800	S5 010	80	740	S4 010	88	740	S3 012
	D5 AWD	10.07-07.09					85	800	S5 010	80	740	S4 010	88	740	S3 012
	10.07-07.15	BWD,SSJ	70	760	S5 A08										
	08.09-07.15	BWD				85	800	S5 010	80	740	S4 010	88	740	S3 012	
V90 Cross Country															
2.0 T5 AWD	02.17→		80	800	S5 A11										
			95	850	S5 A13										
	T6 AWD	02.17→	80	800	S5 A11										
			95	850	S5 A13										
Diesel															
2.0 D4 AWD	02.17→		80	800	S5 A11										
			95	850	S5 A13										
	D5 AWD	02.17→	80	800	S5 A11										
			95	850	S5 A13										
V90 I															
2.9	01.97-07.98		60	680	S5 A05	63	610	S5 005	60	540	S4 005				
V90 II															
2.0 T5	03.16→		80	800	S5 A11										
			95	850	S5 A13										
	T6 AWD	03.16→	80	800	S5 A11										
			95	850	S5 A13										
	T8 Twin Engine AWD	12.16→	80	800	S5 A11										
			95	850	S5 A13										
Diesel															
2.0 D3	03.16→		80	800	S5 A11										
			95	850	S5 A13										
	D3 AWD	03.16→	80	800	S5 A11										
			95	850	S5 A13										
	D4	03.16→	80	800	S5 A11										
			95	850	S5 A13										
	D4 AWD	03.16→	80	800	S5 A11										
			95	850	S5 A13										
	D5 AWD	03.16→	80	800	S5 A11										
			95	850	S5 A13										
XC60 I															
2.0 T	08.10-07.11					77	780	S5 008	74	680	S4 008				
	T5	08.10-07.14	BWD			77	780	S5 008	74	680	S4 008				
		08.13-02.17				77	780	S5 008	74	680	S4 008				
			BWD,SSJ	70	760	S5 A08									
				80	800	S5 A11									
	T5 AWD	08.16-02.17	BWD,SSJ	70	760	S5 A08				70	760	S4 E08			
	T6	08.13-02.17				63	610	S5 005	60	540	S4 005				
			BWD,SSJ	70	760	S5 A08									
		08.13-02.17	BWD,SSJ	70	760	S5 A08									
	2.5 T5 AWD	04.14-02.17					77	780	S5 008	74	680	S4 008			
3.0 T6 AWD	03.09-07.10		70	760	S5 A08	77	780	S5 008	74	680	S4 008	70	640	S3 008	
		08.10-07.16	BWD			77	780	S5 008	74	680	S4 008				
		08.14-02.17		70	760	S5 A08	77	780	S5 008	70	760	S4 E08			
				70	760	S5 A08	77	780	S5 008	74	680	S4 008			



				Ah	A (EN)		Ah	A (EN)		Ah	A (EN)		Ah	A (EN)	
				0 092 ...0			0 092 ...0			0 092 ...0			0 092 ...0		
◀ VOLVO															
3.2 AWD	08.09-07.10			70	760	S5 A08	77	780	S5 008	74	680	S4 008	70	640	S3 008
	03.10-07.16						74	750	S5 007						
Diesel															
2.0 D3	08.12-02.17	BWD,SSJ		70	760	S5 A08									
D3 DRIVE	08.10-07.11	SSJ		70	760	S5 A08									
	08.10-07.12	BWD,SSJ		70	760	S5 A08									
	08.11-07.12						85	800	S5 010	80	740	S4 010	88	740	S3 012
		SSJ		80	800	S5 A11									
D4	08.12-07.15						85	800	S5 010	80	740	S4 010	88	740	S3 012
		BWD		70	760	S5 A08									
				80	800	S5 A11									
	08.13-07.15						63	610	S5 005	60	540	S4 005			
		BWD,SSJ		70	760	S5 A08									
				80	800	S5 A11									
	08.15-02.17									70	650	S4 E10	88	740	S3 012
										80	740	S4 010	88	740	S3 012
2.4 D AWD	03.09-07.09			95	850	S5 A13	100	830	S5 013	74	680	S4 008	90	720	S3 013
	08.09-07.11	BWD		95	850	S5 A13	100	830	S5 013	74	680	S4 008	90	720	S3 013
D DRIVE	08.09-07.10			95	850	S5 A13	100	830	S5 013	95	800	S4 013	90	720	S3 013
D3 AWD, D4 AWD	08.11-02.17	BWD		95	850	S5 A13	100	830	S5 013	74	680	S4 008	90	720	S3 013
D5 AWD	03.09-07.09			70	760	S5 A08	77	780	S5 008	74	680	S4 008	70	640	S3 008
	08.09-07.11	BWD		70	760	S5 A08	77	780	S5 008	74	680	S4 008	70	640	S3 008
	08.11-07.15	BWD,SSJ		70	760	S5 A08									
	08.14-02.17	BWD		95	850	S5 A13	100	830	S5 013	74	680	S4 008	90	720	S3 013
XC60 II															
2.0 T5 AWD	08.17→			80	800	S5 A11									
				95	850	S5 A13									
T6 AWD	08.17→			80	800	S5 A11									
				95	850	S5 A13									
T8 Twin Engine AWD	08.17→			80	800	S5 A11									
				95	850	S5 A13									
Diesel															
2.0 D4 AWD	03.17→			80	800	S5 A11									
				95	850	S5 A13									
D5 AWD	08.17→			80	800	S5 A11									
				95	850	S5 A13									
XC70 I															
2.3/ 2.4 T AWD	08.02-07.07	BWD		70	760	S5 A08	77	780	S5 008	74	680	S4 008			
2.5 T AWD	08.02-07.07	BWD		70	760	S5 A08	77	780	S5 008	74	680	S4 008	70	640	S3 008
Diesel															
2.4 D AWD, D5 AWD	08.02-07.07			95	850	S5 A13	100	830	S5 013	95	800	S4 013	90	720	S3 013
XC70 II															
2.0 T5	08.13-07.16						63	610	S5 005	60	540	S4 005			
		BWD,SSJ		70	760	S5 A08									
				80	800	S5 A11									
2.5 T5 AWD	08.15-07.16			70	760	S5 A08									
3.0 T6 AWD	08.08-07.15	BWD					85	800	S5 010	80	740	S4 010			
3.2	08.10-08.14	BWD					77	780	S5 008	74	680	S4 008			
							85	800	S5 010	80	740	S4 010			
AWD	08.07→	BWD					85	800	S5 010	80	740	S4 010			
	08.10-07.15	BWD		70	760	S5 A08	77	780	S5 008	74	680	S4 008			
Diesel															
2.0 D3 DRIVE	08.10-12.11	BWD,SSJ		70	760	S5 A08									
	08.11-07.15	BWD					85	800	S5 010	80	740	S4 010			
D4	08.13-07.16						63	610	S5 005	60	540	S4 005			
		BWD,SSJ		70	760	S5 A08									
				80	800	S5 A11									
2.4 D AWD	08.07-07.09						100	830	S5 013	95	800	S4 013			
	08.07-07.11	BWD,SSJ		70	760	S5 A08									
	08.09-07.11	BWD					100	830	S5 013	95	800	S4 013			
D DRIVE	08.09-07.10	BWD					85	800	S5 010	80	740	S4 010			
D3 AWD	08.11-07.16	BWD		70	760	S5 A08	100	830	S5 013	95	800	S4 013			



			0 092 ...0			0 092 ...0			0 092 ...0			0 092 ...0			
			Ah	A (EN)	S5A	Ah	A (EN)	S5	Ah	A (EN)	S4	Ah	A (EN)	S3	
2.4 D4 AWD	08.13-07.16	BWD				85	800	S5 011	80	740	S4 011				
		BWD,SSJ	70	760	S5 A08										
			80	800	S5 A11										
D5 AWD	08.07-07.09					85	800	S5 010	80	740	S4 010	88	740	S3 012	
	08.09-07.11	BWD				85	800	S5 010	80	740	S4 010				
	08.11-07.15	BWD				85	800	S5 010	80	740	S4 010	88	740	S3 012	
	08.11-07.16	BWD,SSJ	70	760	S5 A08										
	08.15-07.16								80	740	S4 010	88	740	S3 012	
		BWD,SSJ	80	800	S5 A11										
XC90 I															
2.5 T	01.03-07.07		70	760	S5 A08	77	780	S5 008	74	680	S4 008				
T5 AWD	08.12-07.16		70	760	S5 A08	77	780	S5 008	74	680	S4 008				
2.5/2.9/4.4 T AWD, T6 AWD, V8 AWD	10.02-10.12	BWD	70	760	S5 A08	77	780	S5 008	74	680	S4 008	70	640	S3 008	
3.2	08.06-07.10		95	850	S5 A13	100	830	S5 013	95	800	S4 013				
	08.10-07.15	BWD	95	850	S5 A13	100	830	S5 013	95	800	S4 013				
	AWD	08.06-07.10	BWD	70	760	S5 A08	77	780	S5 008	74	680	S4 008	70	640	S3 008
		08.10-07.15	BWD				77	780	S5 008	74	680	S4 008			
Diesel															
2.4 D3	08.10-07.15		95	850	S5 A13	100	830	S5 013							
D5 AWD	01.03-07.15	BWD	95	850	S5 A13	100	830	S5 013	95	800	S4 013				
	10.07-07.11		95	850	S5 A13	100	830	S5 013	95	800	S4 013	90	720	S3 013	
XC90 II															
2.0 T5 AWD	06.15→		80	800	S5 A11										
			95	850	S5 A13										
		BWD,SSJ	80	800	S5 A11										
			95	850	S5 A13										
T6 AWD	06.15→		70	760	S5 A08	77	780	S5 008	70	760	S4 E08				
			70	760	S5 A08	77	780	S5 008	74	680	S4 008				
T8 Twin Engine AWD	09.15→	BWD,SSJ	80	800	S5 A11										
			95	850	S5 A13										
Diesel															
2.0 D4 AWD	10.15→	BWD,SSJ	80	800	S5 A11										
			95	850	S5 A13										
D4 FWD	06.15→	BWD,SSJ	80	800	S5 A11										
			95	850	S5 A13										
D5 AWD	06.15-07.16		95	850	S5 A13	100	830	S5 013	95	800	S4 013				
	08.16→		80	800	S5 A11										
			95	850	S5 A13										
850															
2.3	09.97-07.98		60	680	S5 A05	63	610	S5 005	60	540	S4 005				
850 Kombi															
2.3	09.97-07.98		60	680	S5 A05	63	610	S5 005	60	540	S4 005				
940															
2.0 Turbo	04.96-09.98		70	760	S5 A08	77	780	S5 008	74	680	S4 008	70	640	S3 008	
2.3 Turbo	09.94-07.98		60	680	S5 A05	63	610	S5 005	60	540	S4 005				
	Turbo Interc.	09.90-10.98	70	760	S5 A08	77	780	S5 008	74	680	S4 008	70	640	S3 008	
960															
3.0	08.97-07.98		70	760	S5 A08	77	780	S5 008	74	680	S4 008	70	640	S3 008	

VW (VOLKSWAGEN)

Beetle															
1.2 TSI [5C1]	07.11-06.16					63	610	S5 005	60	540	S4 005				
		BWD,SSJ	70	760	S5 A08				70	760	S4 E08				
		12.14-06.16	BWD,SSJ	60	680	S5 A05				60	640	S4 E05			
	TSI [5C2]	07.16→					63	610	S5 005	60	540	S4 005			
BWD									60	640	S4 E05				
									70	760	S4 E08				
		BWD,SSJ	60	680	S5 A05										
			70	760	S5 A08										
1.4 TSI [5C1]	10.11-06.16					63	610	S5 005	60	540	S4 005				



				Ah	A (EN)		Ah	A (EN)		Ah	A (EN)		Ah	A (EN)	
				0 092 ...0			0 092 ...0			0 092 ...0			0 092 ...0		
◀ VW															
1.4 TSI [5C1]	12.14-06.16	BWD,SSJ	70	760	S5 A08					70	760	S4 E08			
TSI [5C2]	07.16→	BWD								70	760	S4 E08			
		BWD,SSJ	70	760	S5 A08										
2.0 TFSI [5C2]	07.16→	BWD								70	760	S4 E08			
		BWD,SSJ	70	760	S5 A08										
TSI [5C1]	04.11-06.16					63	610	S5 005		60	540	S4 005			
	12.12-06.16									70	760	S4 E08			
										74	680	S4 008			
	12.14-06.16	BWD,SSJ	70	760	S5 A08					70	760	S4 E08			
2.5 [5C1]	04.11-07.16					63	610	S5 005		60	540	S4 005			
Diesel															
1.6 TDI [5C1]	10.11-06.16					63	610	S5 005		60	540	S4 005			
		BWD,SSJ	70	760	S5 A08					70	760	S4 E08			
2.0 TDI [5C1]	04.12-06.16					63	610	S5 005		60	540	S4 005			
	12.14-06.16	BWD,SSJ	70	760	S5 A08										
TDI [5C2]	07.16-09.18	BWD,SSJ	70	760	S5 A08										
Beetle Cabriolet															
1.2 TSI [5C7]	01.13-07.16		70	760	S5 A08	63	610	S5 005		60	540	S4 005			
	12.14-07.16	BWD,SSJ	60	680	S5 A05					60	640	S4 E05			
TSI [5C8]	07.16→					63	610	S5 005		60	540	S4 005			
		BWD								60	640	S4 E05			
										70	760	S4 E08			
		BWD,SSJ	60	680	S5 A05										
			70	760	S5 A08										
1.4 TSI [5C7]	01.13-07.16					63	610	S5 005		60	540	S4 005			
	12.14-07.16	BWD,SSJ	70	760	S5 A08					70	760	S4 E08			
TSI [5C8]	07.16→	BWD								70	760	S4 E08			
		BWD,SSJ	70	760	S5 A08										
2.0 TFSI [5C8]	07.16-09.18	BWD								70	760	S4 E08			
		BWD,SSJ	70	760	S5 A08										
TSI [5C7]	01.13-07.16					63	610	S5 005		60	540	S4 005			
	12.14-07.16	BWD,SSJ	70	760	S5 A08					70	760	S4 E08			
Diesel															
1.6 TDI [5C7]	01.13-07.16		70	760	S5 A08	63	610	S5 005		60	540	S4 005			
2.0 TDI [5C7]	01.13-07.16					63	610	S5 005		60	540	S4 005			
	12.14-07.16	BWD,SSJ	70	760	S5 A08										
TDI [5C8]	07.16-09.18	BWD,SSJ	70	760	S5 A08										
Bora															
1.4/ 1.6 [1J2]	09.98-05.05					63	610	S5 005		52	470	S4 002	45	400	S3 002
1.6 FSI [1J2]	08.01-05.05					63	610	S5 005		52	470	S4 002	45	400	S3 002
1.8/ 2.0/ 2.3 [1J2]	09.98-05.05		70	760	S5 A08	77	780	S5 008		60	540	S4 005	56	480	S3 005
1.8/ 2.0/ 2.3/ 2.8 T, 4Motion [1J2]	01.99-05.05		70	760	S5 A08	77	780	S5 008		60	540	S4 005	56	480	S3 005
Diesel															
1.9 SDI, TDI, TDI 4Motion [1J2]	09.98-05.05		70	760	S5 A08	85	800	S5 011		74	680	S4 008	70	640	S3 008
Bora Variant															
1.4/ 1.6 [1J6]	05.99-05.05					63	610	S5 005		52	470	S4 002	45	400	S3 002
1.6 FSI [1J6]	08.01-05.05					63	610	S5 005		52	470	S4 002	45	400	S3 002
1.8/ 2.0/ 2.3/ 2.8 T, 4Motion [1J6]	05.99-05.05		70	760	S5 A08	77	780	S5 008		60	540	S4 005	56	480	S3 005
2.0/ 2.3 [1J6]	05.99-05.05		70	760	S5 A08	77	780	S5 008		60	540	S4 005	56	480	S3 005
Diesel															
1.9 TDI, TDI 4Motion [1J6]	09.98-05.05		70	760	S5 A08	85	800	S5 011		74	680	S4 008	70	640	S3 008
Caddy															
1.6 [2K]	06.04→					63	610	S5 005		52	470	S4 002			
CC															
1.4 TSI [358]	11.11-12.16		70	760	S5 A08										
	05.15-12.16		70	760	S5 A08	85	800	S5 011							
			80	800	S5 A11	85	800	S5 011							
		SSJ								80	800	S4 E11			
1.8/ 2.0 TSI [358]	11.11-12.16		70	760	S5 A08										
3.6 FSI 4Motion [358]	11.11-12.16		70	760	S5 A08										



			Ah	A (EN)		Ah	A (EN)		Ah	A (EN)		Ah	A (EN)	
			0 092 ...0			0 092 ...0			0 092 ...0			0 092 ...0		

Diesel														
2.0 TDI [358]	11.11-12.16		70	760	S5 A08									
		BWD,SSJ	70	760	S5 A08									
		SSJ	70	760	S5 A08									
	05.15-12.16		80	800	S5 A11	85	800	S5 011	60	540	S4 005			
TDI 4Motion [358]	11.11-12.16		70	760	S5 A08									
		BWD,SSJ	70	760	S5 A08				80	800	S4 E11			
	12.12-12.16					63	610	S5 005	60	540	S4 005	56	480	S3 005
	BWD,SSJ	70	760	S5 A08					70	760	S4 E08			
e-Golf														
[BE1]	03.14-02.17		60	680	S5 A05									
Eos														
1.4 TSI [1F7]	11.07-11.10	BWD,SSJ	70	760	S5 A08									
		SSJ	70	760	S5 A08									
TSI [1F8]	05.08-11.10					54	530	S5 002	52	470	S4 002			
						54	530	S5 002	52	470	S4 002	45	400	S3 002
	11.10-08.15	BWD				77	780	S5 008	60	540	S4 005	45	400	S3 002
		BWD,SSJ	60	680	S5 A05									
1.6 FSI [1F7]	05.06-05.08				63	610	S5 005	52	470	S4 002	45	400	S3 002	
2.0 FSI [1F7]	05.06-11.09		70	760	S5 A08	77	780	S5 008	60	540	S4 005	56	480	S3 005
		TSI [1F7]	05.06-11.10	70	760	S5 A08	77	780	S5 008	60	540	S4 005	56	480
TSI [1F8]	11.09-11.10		70	760	S5 A08	63	610	S5 005	60	540	S4 005	56	480	S3 005
			70	760	S5 A08	63	610	S5 005	60	540	S4 005	56	480	S3 005
	11.10-08.15		70	760	S5 A08	77	780	S5 008	60	540	S4 005	56	480	S3 005
3.2 [1F7]	05.06-11.10		70	760	S5 A08				74	680	S4 008	70	640	S3 008
FSI [1F7]	05.07-05.08		70	760	S5 A08				74	680	S4 008	70	640	S3 008
3.6 [1F7]	05.09-11.10		70	760	S5 A08	77	780	S5 008	74	680	S4 008	70	640	S3 008
Diesel														
2.0 TDI [1F7]	05.06-05.08		70	760	S5 A08	77	780	S5 008	60	540	S4 005			
		BWD,SSJ	70	760	S5 A08									
		SSJ	70	760	S5 A08									
	TDI [1F8]	11.10-08.15	BWD				77	780	S5 008	60	540	S4 005		
		BWD,SSJ	70	760	S5 A08									
e-up!														
[BL1]	07.13-06.16								44	420	S4 000	40	340	S3 000
Fox														
1.0 [Fase I]	10.03-04.05					54	530	S5 002				40	340	S3 000
1.2 [5Z1]	04.05-12.12		63	610	S5 005	52	470	S4 002	45	400	S3 002			
			54	530	S5 002	52	470	S4 002						
1.4 [5Z1]	04.05-12.12		63	610	S5 005	52	470	S4 002	45	400	S3 002			
Diesel														
1.4 TDI [5Z1]	04.05-12.12		63	610	S5 005	52	470	S4 002	45	400	S3 002			
Golf														
1.6 i	05.99→					63	610	S5 005						
Golf Alltrack														
1.8 TFSI, TSI 4Motion [BA5; BV5]	12.14→	BWD,SSJ	70	760	S5 A08									
Diesel														
1.6 TDI 4Motion [BA5]	11.14-03.17		70	760	S5 A08									
2.0 GTD 4Motion [BA5]	12.14-03.17	BWD,SSJ	70	760	S5 A08									
		GTD 4Motion [BV5]	11.16→	BWD,SSJ	70	760	S5 A08							
TDI 4Motion [BA5]	12.14-03.17		70	760	S5 A08									
		BWD,SSJ	70	760	S5 A08									
TDI 4Motion [BV5]	11.16-07.18	BWD	70	760	S5 A08									
Golf Cabriolet														
2.0 [1E, 1V]	08.95-06.02	VAD				61	600	S5 004	44	440	S4 001			
Golf III														
2.0 , Mi [; 1H1/1W1]	09.92-08.99		60	680	S5 A05	63	610	S5 005	60	540	S4 005			
Golf III Cabriolet														
1.6 [1E7]	12.95-04.98	VAD				63	610	S5 005	60	540	S4 005	45	400	S3 002
	07.97-04.98	VAD				63	610	S5 005	52	470	S4 002	45	400	S3 002
1.8 [1E7]	07.93-05.98	VAD	70	760	S5 A08	77	780	S5 008	60	540	S4 005	56	480	S3 005
	01.98-03.98	VAD				77	780	S5 008	60	540	S4 004	53	500	S3 004



				Ah	A (EN)		Ah	A (EN)		Ah	A (EN)		Ah	A (EN)	
				0 092 ...0			0 092 ...0			0 092 ...0			0 092 ...0		
◀ VW															
2.0 [1E7]	07.95-04.98	VAD	70	760	S5 A08	77	780	S5 008	60	540	S4 005	56	480	S3 005	
	04.97-04.98		60	680	S5 A05				60	540	S4 005				
		VAD				63	610	S5 005							
Diesel															
1.9 TDI [1E7]	07.96-05.98	VAD	70	760	S5 A08	100	830	S5 013	80	740	S4 010	70	640	S3 008	
	04.97-04.98	VAD				100	830	S5 013	74	680	S4 008	70	640	S3 008	
Golf III Variant															
1.4 [1H5]	07.95-02.99	VAD				63	610	S5 005	60	540	S4 005	45	400	S3 002	
	12.97-05.98	VAD				63	610	S5 005	44	440	S4 001	41	360	S3 001	
1.6 [1H5]	12.95-02.99	VAD				63	610	S5 005	60	540	S4 005	45	400	S3 002	
	05.97-02.99	VAD				63	610	S5 005	52	470	S4 002	45	400	S3 002	
1.8 [1H5]	07.93-02.99	VAD	70	760	S5 A08	77	780	S5 008	60	540	S4 005	56	480	S3 005	
	12.97-02.99		60	680	S5 A05										
		VAD				63	610	S5 005	60	540	S4 005	53	500	S3 004	
2.0 [1H5]	07.95-02.99	VAD	70	760	S5 A08	77	780	S5 008	60	540	S4 005	56	480	S3 005	
	05.97-02.99	VAD				77	780	S5 008	60	540	S4 005	56	480	S3 005	
Diesel															
1.9 D, SDI, TD [1H5]	07.93-02.99	VAD	70	760	S5 A08	100	830	S5 013	80	740	S4 010	70	640	S3 008	
TDI [1H5]	02.96-02.99	VAD	70	760	S5 A08	100	830	S5 013	80	740	S4 010	70	640	S3 008	
	05.97-02.99	VAD				85	800	S5 010	74	680	S4 008	70	640	S3 008	
Golf IV															
1.4/ 1.6 [1J1]	08.97-05.04					63	610	S5 005	52	470	S4 002	45	400	S3 002	
1.6 FSI [1J1]	08.01-05.04					63	610	S5 005	52	470	S4 002	45	400	S3 002	
1.8 T [1J1]	10.97-05.03		70	760	S5 A08	77	780	S5 008	60	540	S4 005	56	480	S3 005	
	06.01-05.04					63	610	S5 005	60	540	S4 005	56	480	S3 005	
1.8/ 2.0/ 2.3 [1J1]	08.97-05.04		70	760	S5 A08	77	780	S5 008	60	540	S4 005	56	480	S3 005	
4Motion [1J1]	05.98-06.05		70	760	S5 A08	77	780	S5 008	60	540	S4 005	56	480	S3 005	
2.0 BiFuel [1J1]	05.02-05.03		70	760	S5 A08	77	780	S5 008	60	540	S4 005	56	480	S3 005	
2.8 [1J1]	12.98-08.02					85	800	S5 011	80	740	S4 011				
4Motion [1J1]	05.99-06.05		70	760	S5 A08	85	800	S5 011	60	540	S4 005	56	480	S3 005	
Diesel															
1.9 SDI, TDI, TDI 4Motion [1J1]	08.97-06.05		70	760	S5 A08	85	800	S5 011	74	680	S4 008	70	640	S3 008	
Golf IV Cabriolet															
1.6 [1E7]	04.98-10.00	VAD				63	610	S5 005	52	470	S4 002	45	400	S3 002	
						63	610	S5 005	60	540	S4 005	56	480	S3 005	
1.8/ 2.0 [1E7]	04.98-06.02	VAD	70	760	S5 A08	77	780	S5 008	60	540	S4 005	56	480	S3 005	
Diesel															
1.9 TDI [1E7]	04.98-10.00	VAD	70	760	S5 A08	100	830	S5 013	80	740	S4 010	70	640	S3 008	
	04.98-12.01	VAD	70	760	S5 A08	77	780	S5 008	74	680	S4 008	70	640	S3 008	
Golf IV R32															
3.2 4Motion [1J1]	06.02-05.04		70	760	S5 A08	85	800	S5 011	60	540	S4 005	56	480	S3 005	
Golf IV Variant															
1.4 [1J5]	05.99-06.06					63	610	S5 005	52	470	S4 002	45	400	S3 002	
1.6 [1J5]	05.99-11.01					63	610	S5 005	52	470	S4 002	45	400	S3 002	
	05.99-06.06					63	610	S5 005	60	540	S4 005	56	480	S3 005	
FSI [1J5]	08.01-06.06					63	610	S5 005	60	540	S4 005	56	480	S3 005	
1.8/ 2.0/ 2.3/ 2.8 BiFuel, T, 4Motion [1J5]	05.99-06.06		70	760	S5 A08	77	780	S5 008	60	540	S4 005	56	480	S3 005	
2.0/ 2.3 [1J5]	05.99-06.06		70	760	S5 A08	77	780	S5 008	60	540	S4 005	56	480	S3 005	
Diesel															
1.9 SDI [1J5]	05.99-06.06		70	760	S5 A08	85	800	S5 011	74	680	S4 008	70	640	S3 008	
TDI [1J5]	05.99-06.06		70	760	S5 A08	85	800	S5 011	74	680	S4 008	70	640	S3 008	
	05.02-06.06					77	780	S5 008	74	680	S4 008				
TDI 4Motion [1J5]	05.99-06.06		70	760	S5 A08	85	800	S5 011	74	680	S4 008	70	640	S3 008	
	01.00-07.01		70	760	S5 A08	85	800	S5 011	80	740	S4 010	70	640	S3 008	
			70	760	S5 A08	85	800	S5 011	80	740	S4 011	70	640	S3 008	
			70	760	S5 A08	100	830	S5 013	80	740	S4 010	70	640	S3 008	
	05.02-06.06					77	780	S5 008	74	680	S4 008				
Golf Plus															
1.2 TSI [521]	08.09-12.13	BWD,SSJ	60	680	S5 A05										
	05.10-12.13	BWD				54	530	S5 002	52	470	S4 002				
1.4 [5M1]	01.05-12.08					63	610	S5 005	52	470	S4 002	45	400	S3 002	



						Ah A (EN) S5A		Ah A (EN) S5		Ah A (EN) S4		Ah A (EN) S3	
				0 092 ...0		0 092 ...0		0 092 ...0		0 092 ...0			
1.4 FSI [5M1]	07.05-05.06			63	610	S5 005		52	470	S4 002	45	400	S3 002
TSI [5M1]	05.06-06.08			63	610	S5 005		52	470	S4 002	45	400	S3 002
	07.07-12.08			54	530	S5 002							
		BWD,SSJ	60 680	S5 A05									
	05.08-12.08			63	610	S5 005		52	470	S4 002	56	480	S3 005
TSI [521]	01.09-09.12	BWD		63	610	S5 005		52	470	S4 002	56	480	S3 005
	01.09-01.14	BWD		54	530	S5 002							
		BWD,SSJ	60 680	S5 A05									
	05.12-12.13			63	610	S5 005		52	470	S4 002	56	480	S3 005
1.4/ 1.6 , FSI, MultiFuel [521]	01.09-12.13	BWD		63	610	S5 005		52	470	S4 002	45	400	S3 002
1.6 [5M1]	05.05-12.08			63	610	S5 005		60	540	S4 005	56	480	S3 005
BiFuel [521]	05.09-12.13	BWD		54	530	S5 002		52	470	S4 002			
		BWD,SSJ	60 680	S5 A05									
FSI [5M1]	01.05-01.09			63	610	S5 005		60	540	S4 005	56	480	S3 005
MultiFuel [5M1]	11.07-12.08			63	610	S5 005		52	470	S4 002	45	400	S3 002
2.0 FSI [5M1]	05.05-06.08		70 760	S5 A08	85	800	S5 011	60	540	S4 005	56	480	S3 005
Diesel													
1.6 TDI [521]	05.09-12.13	BWD		63	610	S5 005		60	540	S4 005			
		BWD,SSJ	70 760	S5 A08									
		SSJ	70 760	S5 A08									
1.9/ 2.0 TDI [5M1]	01.05-01.09		70 760	S5 A08	85	800	S5 011	74	680	S4 008	70	640	S3 008
2.0 TDI [521]	01.09-12.13	BWD		85	800	S5 011		74	680	S4 008			
			70 760	S5 A08	85	800	S5 011	74	680	S4 008	70	640	S3 008
		BWD,SSJ	70 760	S5 A08									
Golf Sportsvan													
1.0 TSI [AM1]	05.15-11.17	BWD,SSJ	60 680	S5 A05				60	640	S4 E05			
1.2 TSI [AM1]	04.14-11.17				77	780	S5 008	74	680	S4 008			
		BWD,SSJ	70 760	S5 A08				70	760	S4 E08			
	05.14-11.17		70 760	S5 A08	77	780	S5 008	74	680	S4 008			
		BWD,SSJ						70	760	S4 E08			
1.4 TSI [AM1]	02.14→				77	780	S5 008	74	680	S4 008			
		BWD,SSJ	70 760	S5 A08				70	760	S4 E08			
1.6 [AM1]	05.14-11.17		60 680	S5 A05	63	610	S5 005	60	540	S4 005			
		BWD,SSJ						60	640	S4 E05			
Diesel													
1.6 TDI [AM1]	02.14-11.14				77	780	S5 008	74	680	S4 008			
		BWD,SSJ	70 760	S5 A08				70	760	S4 E08			
	11.14-11.17		70 760	S5 A08	77	780	S5 008	74	680	S4 008			
		BWD						70	760	S4 E08			
	11.16-07.18	BWD	70 760	S5 A08									
		BWD,SSJ	70 760	S5 A08				70	760	S4 E08			
2.0 TDI [AM1]	02.14-11.17				77	780	S5 008	74	680	S4 008			
		BWD,SSJ	70 760	S5 A08				70	760	S4 E08			
	05.16-10.16		70 760	S5 A08	77	780	S5 008	74	680	S4 008			
		BWD						70	760	S4 E08			
	11.16-11.17	BWD	70 760	S5 A08									
	11.16-07.18	BWD,SSJ	70 760	S5 A08									
Golf V													
1.4 [1K1]	10.03-11.08			63	610	S5 005		52	470	S4 002	45	400	S3 002
FSI [1K1]	10.03-05.06			63	610	S5 005		52	470	S4 002	45	400	S3 002
TSI [1K1]	11.05-11.08			63	610	S5 005		52	470	S4 002	45	400	S3 002
1.6 [1K1]	01.04-05.05			63	610	S5 005		52	470	S4 002	45	400	S3 002
	06.05-11.08			63	610	S5 005		60	540	S4 005	56	480	S3 005
FSI [1K1]	10.03-02.05			63	610	S5 005		60	540	S4 005			
				63	610	S5 005		74	680	S4 008			
	01.05-07.08			63	610	S5 005		60	540	S4 005	56	480	S3 005
				63	610	S5 005		74	680	S4 008	56	480	S3 005
MultiFuel [1K1]	11.07-11.08			63	610	S5 005		52	470	S4 002			
2.0 FSI [1K1]	01.04-11.05	VAD	70 760	S5 A08	77	780	S5 008	60	540	S4 005	56	480	S3 005
	01.05-11.08		70 760	S5 A08	77	780	S5 008	60	540	S4 005	56	480	S3 005
FSI 4Motion [1K1]	08.04-10.08		70 760	S5 A08	77	780	S5 008	60	540	S4 005	56	480	S3 005
GTI [1K1]	09.04-07.07	VAD	70 760	S5 A08	77	780	S5 008	60	540	S4 005	56	480	S3 005



						Ah A (EN) S5A		Ah A (EN) S5		Ah A (EN) S4		Ah A (EN) S3			
				0 092 ...0		0 092 ...0		0 092 ...0		0 092 ...0		0 092 ...0			
◀ VW															
2.0 GTI [1K1]	11.05-11.08		70	760	S5 A08	77	780	S5 008	60	540	S4 005	56	480	S3 005	
		VAD	70	760	S5 A08	63	610	S5 005	60	540	S4 005	56	480	S3 005	
			70	760	S5 A08	63	610	S5 005	70	760	S4 E08	56	480	S3 005	
Diesel															
1.9 TDI [1K1]	10.03-11.08		70	760	S5 A08	77	780	S5 008	74	680	S4 008	70	640	S3 008	
	05.04-11.08		70	760	S5 A08	85	800	S5 011	74	680	S4 008	70	640	S3 008	
1.9/2.0 TDI 4Motion [1K1]	10.03-10.08		70	760	S5 A08	85	800	S5 011	74	680	S4 008	70	640	S3 008	
2.0 SDI [1K1]	01.04-11.08		70	760	S5 A08	85	800	S5 011	74	680	S4 008	70	640	S3 008	
	TDI [1K1]	10.03-11.08		70	760	S5 A08	85	800	S5 011	74	680	S4 008	70	640	S3 008
		11.05-11.08		70	760	S5 A08	63	610	S5 005	74	680	S4 008	70	640	S3 008
Golf V R32															
3.2 [1K1]	05.05-07.07		70	760	S5 A08	85	800	S5 011	74	680	S4 008				
		SSJ	70	760	S5 A08										
		4Motion [1K1]	11.05-11.08		70	760	S5 A08	85	800	S5 011	74	680	S4 008		
Golf V Variant															
1.4 TSI [1K5]	05.07-07.09					63	610	S5 005	52	470	S4 002	45	400	S3 002	
	06.07-11.08		60	680	S5 A05	63	610	S5 005	52	470	S4 002	45	400	S3 002	
			60	680	S5 A05	63	610	S5 005	60	640	S4 E05	45	400	S3 002	
1.4/1.6, MultiFuel [1K5]	05.07-11.08				63	610	S5 005	52	470	S4 002	45	400	S3 002		
2.0 GTI [1K5]	05.07-06.09				85	800	S5 011	52	470	S4 002	45	400	S3 002		
Diesel															
1.9 TDI [1K5]	05.07-11.08		70	760	S5 A08	85	800	S5 011	74	680	S4 008	70	640	S3 008	
	TDI 4Motion [1K5]	12.07-06.09		70	760	S5 A08	85	800	S5 011	74	680	S4 008	70	640	S3 008
2.0 TDI [1K5]	05.07-05.08		70	760	S5 A08	85	800	S5 011	74	680	S4 008	70	640	S3 008	
						85	800	S5 011	80	740	S4 011				
	07.08-07.09		70	760	S5 A08	85	800	S5 011	74	680	S4 008	70	640	S3 008	
TDI 4Motion [1K5]	05.07-06.09					77	780	S5 008	74	680	S4 008				
						77	780	S5 008	80	740	S4 011				
						85	800	S5 011	74	680	S4 008				
Golf VI															
1.2 TSI [5K1]	05.09-11.12	BWD,SSJ							70	760	S4 E08				
		4Motion [5K1]	05.10-11.12				54	530	S5 002	52	470	S4 002			
										70	760	S4 E08			
1.4 TSI [5K1]	10.08-11.12	BWD				63	610	S5 005	52	470	S4 002	56	480	S3 005	
		BWD,SSJ	70	760	S5 A08										
		SSJ	70	760	S5 A08										
	09.12-11.12		63	610	S5 005	52	470	S4 002	56	480	S3 005				
1.4/1.6 [5K1]	10.08-11.12	BWD			63	610	S5 005	52	470	S4 002	56	480	S3 005		
1.6 BiFuel [5K1]	11.08-11.12	BWD			63	610	S5 005	60	540	S4 005					
		BWD,SSJ	70	760	S5 A08				70	760	S4 E08				
MultiFuel [5K1]	10.08-11.12	BWD			63	610	S5 005	52	470	S4 002					
1.8 TSI [5K1]	06.09-01.11	BWD			63	610	S5 005	60	540	S4 005					
2.0 GTI [5K1]	04.09-11.12	BWD	70	760	S5 A08	85	800	S5 011	74	680	S4 008				
		BWD,SSJ	70	760	S5 A08										
TSI 4Motion [5K1]	05.11-11.12	BWD			63	610	S5 005	60	540	S4 005					
					63	610	S5 005	60	540	S4 005					
			70	760	S5 A08	85	800	S5 011	74	680	S4 008				
	11.09-11.12	BWD,SSJ	70	760	S5 A08										
Diesel															
1.6 TDI [5K1]	12.08-11.12	BWD							74	680	S4 008				
		BWD,SSJ	70	760	S5 A08				70	760	S4 E08				
	02.09-11.12	BWD			85	800	S5 011	74	680	S4 008					
		BWD,SSJ	70	760	S5 A08										
TDI 4Motion [5K1]	12.08-11.12				77	780	S5 008	60	540	S4 005					
		BWD	70	760	S5 A08										
		SSJ	70	760	S5 A08										
2.0 TDI [5K1]	10.08-11.12		70	760	S5 A08	63	610	S5 005	60	540	S4 005				
		BWD			85	800	S5 011	74	680	S4 008					
		BWD,SSJ	70	760	S5 A08										
	04.09-05.10				77	780	S5 008	60	540	S4 005					
					77	780	S5 008	80	740	S4 011					
					85	800	S5 011	60	540	S4 005					
	04.09-11.12	SSJ	70	760	S5 A08										



			Ah A (EN) S5A			Ah A (EN) S5			Ah A (EN) S4			Ah A (EN) S3		
			0 092 ...0			0 092 ...0			0 092 ...0			0 092 ...0		
2.0 TDI [5K1]	09.09-11.12					85	800	S5 011	74	680	S4 008			
		BWD	70	760	S5 A08									
	11.09-11.12		70	760	S5 A08	85	800	S5 010	74	680	S4 008			
TDI 4Motion [5K1]	10.08-11.09	BWD				85	800	S5 011	74	680	S4 008			
	10.08-11.12	BWD,SSJ	70	760	S5 A08									
	11.09-11.12	BWD				77	780	S5 008	74	680	S4 008			
Golf VI Cabriolet														
1.2 TSI [517]	03.11-05.16	BWD							52	470	S4 002			
		BWD,SSJ	70	760	S5 A08									
	11.13-05.16	BWD,SSJ	70	760	S5 A08				70	760	S4 E08			
	05.15-05.16		70	760	S5 A08									
		BWD							70	760	S4 E08			
1.4 TSI [517]	03.11-05.16	BWD	70	760	S5 A08	77	780	S5 008						
		BWD,SSJ	70	760	S5 A08									
	09.12-05.16					77	780	S5 008						
		BWD	70	760	S5 A08									
		SSJ	70	760	S5 A08									
	05.15-05.16	BWD,SSJ	60	680	S5 A05				60	640	S4 E05			
2.0 TFSI [517]	05.15-05.16	BWD,SSJ	70	760	S5 A08				70	760	S4 E08			
TSI [517]	05.12-05.16					77	780	S5 008						
		BWD	70	760	S5 A08									
		SSJ	70	760	S5 A08									
	01.13-05.16		70	760	S5 A08				70	760	S4 E08			
			70	760	S5 A08	63	610	S5 005	60	540	S4 005	56	480	S3 005
			70	760	S5 A08	63	610	S5 005	70	760	S4 E08	56	480	S3 005
Diesel														
1.6 TDI [517]	03.11-05.16	BWD				77	780	S5 008						
		BWD,SSJ	70	760	S5 A08									
2.0 TDI [517]	11.11-05.16	BWD				77	780	S5 008						
		BWD,SSJ	70	760	S5 A08									
	05.15-05.16	BWD,SSJ	70	760	S5 A08				70	760	S4 E08			
Golf VI Variant														
1.2 TSI [AJ5]	07.09-04.13	BWD,SSJ	70	760	S5 A08									
		SSJ	70	760	S5 A08									
	07.10-04.13	BWD				54	530	S5 002	52	470	S4 002			
						54	530	S5 002	60	640	S4 E05			
1.4 [AJ5]	07.09-04.13	BWD				63	610	S5 005	52	470	S4 002	56	480	S3 005
TSI [AJ5]	06.09-04.13	BWD				63	610	S5 005	52	470	S4 002	56	480	S3 005
	07.12-04.13					63	610	S5 005	52	470	S4 002	56	480	S3 005
1.6 [AJ5]	07.09-04.13	BWD	70	760	S5 A08	77	780	S5 008	60	540	S4 005	70	640	S3 008
		BWD,SSJ	70	760	S5 A08									
MultiFuel [AJ5]	07.09-04.13	BWD	70	760	S5 A08	77	780	S5 008	60	540	S4 005	70	640	S3 008
		BWD,SSJ	70	760	S5 A08									
	07.10-04.13	BWD				63	610	S5 005	52	470	S4 002			
2.0 TSI [AJ5]	07.09-04.13	BWD,SSJ	70	760	S5 A08									
Diesel														
1.6 TDI [AJ5]	07.09-04.13					85	800	S5 011	80	740	S4 011			
		BWD,SSJ	70	760	S5 A08									
		SSJ	70	760	S5 A08									
TDI 4Motion [AJ5]	07.09-04.13	BWD	70	760	S5 A08	85	800	S5 011	74	680	S4 008			
		BWD,SSJ	70	760	S5 A08									
2.0 TDI [AJ5]	07.09-04.13					85	800	S5 011	80	740	S4 011			
		BWD				77	780	S5 008	74	680	S4 008			
			70	760	S5 A08	85	800	S5 011	74	680	S4 008			
		BWD,SSJ	70	760	S5 A08									
	09.09-08.14	BWD				85	800	S5 011	80	740	S4 011			
	01.10-04.13		70	760	S5 A08				70	760	S4 E08			
Golf VII														
1.0 TSI [BQ1]	11.16→	BWD,SSJ	60	680	S5 A05				60	640	S4 E05			
TSI [5G1]	05.15-03.17	BWD	70	760	S5 A08									
1.2 TSI [BQ1]	11.16→		60	680	S5 A05									
		BWD	60	680	S5 A05									
		BWD,SSJ							60	640	S4 E05			



				Ah	A (EN)		Ah	A (EN)		Ah	A (EN)		Ah	A (EN)	
				0 092 ...0			0 092 ...0			0 092 ...0			0 092 ...0		
◀ VW															
1.2 TSI [5G1]	08.12-03.17			70	760	S5 A08									
	11.12-03.17	BWD		70	760	S5 A08									
	11.13-03.17			70	760	S5 A08	77	780	S5 008	74	680	S4 008	70	640	S3 008
		BWD		60	680	S5 A05									
		BWD,SSJ								60	640	S4 E05			
		SSJ							70	760	S4 E08				
1.4 GTE [BQ1]	01.17→	BWD		70	760	S5 A08									
		BWD,SSJ								70	760	S4 E08			
GTE [5G1]	05.14-03.17			70	760	S5 A08	77	780	S5 008	74	680	S4 008	70	640	S3 008
		BWD,SSJ								70	760	S4 E08			
TGI [BQ1]	11.16-07.18	BWD		60	680	S5 A05									
		SSJ								60	640	S4 E05			
TGI [5G1]	06.13-03.17			60	680	S5 A05									
		SSJ								60	640	S4 E05			
TSI [BQ1]	11.16→	BWD		70	760	S5 A08									
				70	760	S5 A08							70	760	S4 E08
		BWD,SSJ								70	760	S4 E08			
TSI [5G1]	08.12-03.17			70	760	S5 A08									
		BWD,SSJ								70	760	S4 E08			
	05.13-03.17			70	760	S5 A08					70	760	S4 E08		
	05.14-03.17			70	760	S5 A08	77	780	S5 008	74	680	S4 008			
TSI MultiFuel [BQ1]	11.16-07.18	BWD		70	760	S5 A08									
		BWD,SSJ								70	760	S4 E08			
TSI MultiFuel [5G1]	11.12-03.17			70	760	S5 A08									
	05.14-03.17			60	680	S5 A05	63	610	S5 005	60	540	S4 005	56	480	S3 005
		SSJ								60	640	S4 E05			
1.5 TGI [BQ1]	11.18→			70	760	S5 A08							70	760	S4 E08
1.6 [5G1]	05.14-03.17			60	680	S5 A05	63	610	S5 005	60	540	S4 005	56	480	S3 005
		BWD,SSJ								60	640	S4 E05			
SRE [BQ1]	11.16→	BWD		60	680	S5 A05									
		BWD,SSJ								60	640	S4 E05			
2.0 GTI [BQ1]	11.16→	BWD		70	760	S5 A08									
		BWD,SSJ								70	760	S4 E08			
	03.17→	BWD,SSJ		70	760	S5 A08									
GTI [5G1]	04.13-03.17			70	760	S5 A08									
	11.13-03.17	BWD		70	760	S5 A08									
		BWD,SSJ								70	760	S4 E08			
	09.14-08.16	SSJ		70	760	S5 A08					70	760	S4 E08		
	11.15-03.17			60	680	S5 A05									
		BWD								60	640	S4 E05			
GTI TCR [BQ1]	11.18→			70	760	S5 A08							70	760	S4 E08
R 4Motion [BQ1]	10.18→			70	760	S5 A08									
				70	760	S5 A08							70	760	S4 E08
		BWD,SSJ								70	760	S4 E08			
R-Line 4Motion [BQ1]	11.16→	BWD,SSJ		70	760	S5 A08									
R-Line 4Motion [5G1]	11.13-03.17						63	610	S5 005	74	680	S4 008			
				70	760	S5 A08									
		BWD,SSJ								70	760	S4 E08			
				70	760	S5 A08				70	760	S4 E08			
Diesel															
1.6 TDI [BQ1]	11.16-07.18	BWD		70	760	S5 A08									
		BWD,SSJ		70	760	S5 A08									
	11.16→	BWD,SSJ		70	760	S5 A08				70	760	S4 E08			
TDI [5G1]	08.12-03.17			70	760	S5 A08									
	01.13-03.17			60	680	S5 A05	63	610	S5 005	60	540	S4 005			
		BWD,SSJ								60	640	S4 E05			
	04.13-12.15	BWD								60	640	S4 E05			
	08.14-03.17	BWD		70	760	S5 A08									
	11.14-03.17	BWD,SSJ		70	760	S5 A08									
TDI 4Motion [5G1]	11.12-03.17			70	760	S5 A08									
	01.13-03.17	BWD,SSJ		70	760	S5 A08							70	760	S4 E08
	11.14-03.17	BWD,SSJ		70	760	S5 A08									



						Ah A (EN) S5A		Ah A (EN) S5		Ah A (EN) S4		Ah A (EN) S3	
				0 092 ...0		0 092 ...0		0 092 ...0		0 092 ...0			
2.0	GTD [BQ1]	11.16→	BWD,SSJ	70	760	S5 A08							
	GTD [5G1]	04.13-03.17		70	760	S5 A08							
	TDI [BQ1]	11.16→		70	760	S5 A08							
			BWD	70	760	S5 A08							
		11.18→		70	760	S5 A08			70	760	S4 E08		
	TDI [5G1]	08.12-03.17		70	760	S5 A08							
			BWD,SSJ	70	760	S5 A08			70	760	S4 E08		
		05.14-03.17	BWD						70	760	S4 E08		
		05.15-03.17	BWD,SSJ	70	760	S5 A08							
		05.16-03.17	BWD	70	760	S5 A08							
	TDI 4Motion [BQ1]	11.16-07.18	BWD	70	760	S5 A08							
	TDI 4Motion [5G1]	11.12-03.17		70	760	S5 A08							
	TSI 4Motion [5G1]	05.16-03.17	BWD	70	760	S5 A08							
Golf VII Variant													
1.0	TSI [BA5]	05.15-03.17	BWD,SSJ	60	680	S5 A05			60	640	S4 E05		
	TSI [BV5]	11.16→	BWD,SSJ	60	680	S5 A05			60	640	S4 E05		
1.2	TSI [BA5]	05.13-03.17		70	760	S5 A08							
			BWD,SSJ						70	760	S4 E08		
	TSI MultiFuel [BA5]	05.13-03.17	BWD	70	760	S5 A08							
			BWD,SSJ						70	760	S4 E08		
1.2/ 1.4	TSI [BV5]	11.16→	BWD	70	760	S5 A08			70	760	S4 E08		
1.4	TGI [BA5]	08.13-03.17		60	680	S5 A05							
			SSJ						60	640	S4 E05		
	TGI [BV5]	01.17-07.18	BWD	60	680	S5 A05							
			SSJ						60	640	S4 E05		
	TSI [BA5]	05.13-03.17		70	760	S5 A08							
			BWD,SSJ						70	760	S4 E08		
		05.14-12.15	BWD	70	760	S5 A08							
	TSI MultiFuel [BA5]	04.13-03.17		70	760	S5 A08		63	610	S5 005	60	540	S4 005
			BWD,SSJ						70	760	S4 E08		
	TSI MultiFuel [BV5]	11.16-07.18	BWD	70	760	S5 A08							
			BWD,SSJ						70	760	S4 E08		
1.5	TGI [BV5]	11.18→		70	760	S5 A08			70	760	S4 E08		
1.6	[BA5]	05.14-03.17		70	760	S5 A08							
	SRE [BV5]	05.14-03.17		70	760	S5 A08							
		11.16→	BWD	60	680	S5 A05							
			BWD,SSJ						60	640	S4 E05		
2.0	R-Line 4Motion [BA5]	03.15-03.17		70	760	S5 A08							
				70	760	S5 A08		52	520	S5 001	60	540	S4 005
	R-Line 4Motion [BV5]	11.16→	BWD,SSJ	70	760	S5 A08							
		11.18→		70	760	S5 A08							
				70	760	S5 A08							
			BWD,SSJ						70	760	S4 E08		
Diesel													
1.6	TDI [BA5]	05.13-12.15		70	760	S5 A08							
			BWD						70	760	S4 E08		
		05.13-03.17	BWD,SSJ	70	760	S5 A08							
				70	760	S5 A08							
		11.14-03.17	BWD	70	760	S5 A08							
	TDI [BV5]	11.16-07.18	BWD	70	760	S5 A08							
		11.16→	BWD,SSJ	70	760	S5 A08			70	760	S4 E08		
	TDI 4Motion [BA5]	05.13-03.17	BWD,SSJ	70	760	S5 A08			70	760	S4 E08		
		11.14-03.17	BWD,SSJ	70	760	S5 A08							
2.0	GTD [BV5]	11.16→	BWD,SSJ	70	760	S5 A08							
	TDI [BA5]	04.13-03.17		70	760	S5 A08							
			BWD						70	760	S4 E08		
		05.13-03.17	BWD,SSJ	70	760	S5 A08			70	760	S4 E08		
		11.14-03.17						52	520	S5 001	60	540	S4 005
			BWD,SSJ	70	760	S5 A08							
		11.15-03.17	BWD	70	760	S5 A08							
	TDI [BV5]	11.16→	BWD	70	760	S5 A08							
		11.18→		70	760	S5 A08			70	760	S4 E08		
	TDI 4Motion [BA5]	05.13-12.15	BWD,SSJ	70	760	S5 A08			70	760	S4 E08		



			Ah A (EN) S5A			Ah A (EN) S5			Ah A (EN) S4			Ah A (EN) S3		
			0 092 ...0			0 092 ...0			0 092 ...0			0 092 ...0		
◀ VW														
2.0 TDI 4Motion [BA5]	05.13-03.17		70	760	S5 A08									
		BWD							70	760	S4 E08			
TDI 4Motion [BV5]	11.16→	BWD	70	760	S5 A08									
Jetta														
1.2 TSI [162]	10.10-07.14	BWD,SSJ	70	760	S5 A08									
		SSJ	70	760	S5 A08									
TSI [163]	07.14-12.17		70	760	S5 A08									
		BWD,SSJ							70	760	S4 E08			
	08.14-12.17	SSJ							70	760	S4 E08			
1.4 Hybrid [162]	07.12-07.14					63	610	S5 005	60	540	S4 005			
		BWD							70	760	S4 E08			
		BWD,SSJ	70	760	S5 A08				70	760	S4 E08			
			70	760	S5 A08									
TSI [AV2]	03.13-10.14					63	610	S5 005	60	540	S4 005			
TSI [AV3]	10.14-12.15					63	610	S5 005	60	540	S4 005			
	09.15-04.18		60	680	S5 A05				60	640	S4 E05			
			70	760	S5 A08				70	760	S4 E08			
TSI [1K2]	07.06-10.10					63	610	S5 005	60	540	S4 005	56	480	S3 005
TSI [162]	04.11-07.14		70	760	S5 A08	54	530	S5 002	52	470	S4 002			
			70	760	S5 A08	63	610	S5 005	60	540	S4 005			
TSI [163]	08.14-12.17		70	760	S5 A08	63	610	S5 005	60	540	S4 005			
			70	760	S5 A08	63	610	S5 005	70	760	S4 E08			
			70	760	S5 A08	77	780	S5 008	60	540	S4 005			
			70	760	S5 A08	77	780	S5 008	70	760	S4 E08			
			70	760	S5 A08	77	780	S5 008	74	680	S4 008			
		BWD,SSJ							70	760	S4 E08			
		SSJ							70	760	S4 E08			
TSI Hybrid [163]	09.14-12.17		60	680	S5 A05	63	610	S5 005	60	540	S4 005			
			60	680	S5 A05	63	610	S5 005	60	640	S4 E05			
1.6 [AV2]	03.13-10.14					63	610	S5 005	60	540	S4 005			
	03.14-10.14		60	680	S5 A05	63	610	S5 005	60	540	S4 005	56	480	S3 005
		BWD,SSJ							60	640	S4 E05			
[AV3]	10.14-04.18					63	610	S5 005	60	540	S4 005			
						63	610	S5 005	60	640	S4 E05			
		BWD,SSJ	60	680	S5 A05									
[1K2]	10.05-10.10		70	760	S5 A08	77	780	S5 008	60	540	S4 005	56	480	S3 005
[162]	12.11-07.14					63	610	S5 005	60	540	S4 005			
FSI [1K2]	09.05-06.08		70	760	S5 A08	77	780	S5 008	60	540	S4 005	56	480	S3 005
MultiFuel [1K2]	01.08-10.10		70	760	S5 A08	77	780	S5 008	60	540	S4 005	56	480	S3 005
2.0 [162]	06.10-07.14		60	680	S5 A05	63	610	S5 005	60	540	S4 005	56	480	S3 005
			60	680	S5 A05	63	610	S5 005	60	640	S4 E05	56	480	S3 005
FSI [1K2]	08.05-06.08		70	760	S5 A08	85	800	S5 011	60	540	S4 005	56	480	S3 005
TFSI [1K2]	04.08-10.10					63	610	S5 005	60	540	S4 005			
TotalFlex [162]	10.10-02.16		70	760	S5 A08	54	530	S5 002	52	470	S4 002			
			70	760	S5 A08	54	530	S5 002	60	540	S4 005			
			70	760	S5 A08	63	610	S5 005	52	470	S4 002			
TSI [1K2]	06.05-10.10		70	760	S5 A08	85	800	S5 011	60	540	S4 005	56	480	S3 005
TSI [162]	10.10-07.14		70	760	S5 A08	54	530	S5 002	52	470	S4 002			
	12.12-07.14					63	610	S5 005	60	540	S4 005			
TSI [163]	10.14-12.17		60	680	S5 A05	63	610	S5 005	60	540	S4 005			
			60	680	S5 A05	63	610	S5 005	60	640	S4 E05			
2.5	09.09→					77	780	S5 008	74	680	S4 008			
[1K2]	01.05-10.10		70	760	S5 A08	85	800	S5 011	60	540	S4 005	56	480	S3 005
	09.06-06.07		70	760	S5 A08	54	530	S5 002	52	470	S4 002			
Diesel														
1.6 TDI [1K2]	07.09-10.10		70	760	S5 A08	77	780	S5 008	60	540	S4 005	56	480	S3 005
			70	760	S5 A08	85	800	S5 011	60	540	S4 005	56	480	S3 005
	12.09-10.10		70	760	S5 A08	63	610	S5 005	60	540	S4 005			
TDI [162]	10.10-07.14	BWD,SSJ	70	760	S5 A08									
		SSJ	70	760	S5 A08									
TDI [163]	08.14-12.17								70	760	S4 E08			
		BWD,SSJ	70	760	S5 A08									
1.9/2.0 TDI [1K2]	05.05-10.10		70	760	S5 A08	85	800	S5 011	74	680	S4 008	70	640	S3 008



			Ah A (EN) S5A			Ah A (EN) S5			Ah A (EN) S4			Ah A (EN) S3		
			0 092 ...0			0 092 ...0			0 092 ...0			0 092 ...0		
2.0 TDI [162]	10.10-07.14					77	780	S5 008	74	680	S4 008			
		BWD	70	760	S5 A08									
TDI [163]	07.14-12.17					77	780	S5 008	60	540	S4 005			
						77	780	S5 008	74	680	S4 008			
			70	760	S5 A08	77	780	S5 008	70	760	S4 E08			
			70	760	S5 A08	77	780	S5 008	74	680	S4 008			
		BWD,SSJ	70	760	S5 A08				70	760	S4 E08			
Jetta IV														
1.6/ 2.0 i [1J2]	09.99-12.05					77	780	S5 008	60	540	S4 005			
Käfer														
1600 i [1]	09.91-08.04	VAD				52	520	S5 001	44	440	S4 001	41	360	S3 001
	10.92-07.03					52	520	S5 001	44	440	S4 001	41	360	S3 001
Kombi														
2.5 i	07.93-05.05					85	800	S5 010	74	680	S4 008	70	640	S3 008
						100	830	S5 013	74	680	S4 008	70	640	S3 008
Lupo														
1.0/ 1.4 [6X1]	10.98-07.05					63	610	S5 005	52	470	S4 002	45	400	S3 002
1.4 FSI [6X1]	09.00-11.03		70	760	S5 A08	77	780	S5 008	52	470	S4 002	56	480	S3 005
1.6 GTI [6X1]	05.00-07.05		70	760	S5 A08	77	780	S5 008	60	540	S4 005	56	480	S3 005
Diesel														
1.2 TDI 3L [6X1]	10.98-11.00					77	780	S5 008	74	680	S4 008			
	11.00-07.05		70	760	S5 A08	77	780	S5 008	60	540	S4 005			
1.4/ 1.7 SDI, TDI [6X1]	06.98-07.05		70	760	S5 A08	77	780	S5 008	60	540	S4 005	70	640	S3 008
New Beetle														
1.4/ 1.6/ 1.8/ 2.0/ 2.3/ , RSI	01.98-12.10		70	760	S5 A08	77	780	S5 008	60	540	S4 005	56	480	S3 005
2.5/ 3.2 4x4, T [1C1/9C1]														
Diesel														
1.9 TDI [1C1/9C1]	01.98-12.10		70	760	S5 A08	77	780	S5 008	60	540	S4 005	70	640	S3 008
New Beetle Cabriolet														
1.4/ 1.6/ 1.8/ 2.0/ 2.5 , T	01.03-10.10		70	760	S5 A08	77	780	S5 008	60	540	S4 005	56	480	S3 005
[1Y7]														
Diesel														
1.9 TDI [1Y7]	06.03-09.10		70	760	S5 A08	77	780	S5 008	60	540	S4 005	70	640	S3 008
Passat														
1.4 GTE Hybrid [3G2]	05.15-11.18	BWD,SSJ	60	680	S5 A05				70	760	S4 E08			
			70	760	S5 A08				70	760	S4 E08			
TSI [3C2]	05.07-07.10	BWD,SSJ	70	760	S5 A08									
		SSJ	70	760	S5 A08									
TSI [3G2]	08.14-11.18	BWD,SSJ							70	760	S4 E08			
	08.14→		70	760	S5 A08									
	11.14-11.18	SSJ							70	760	S4 E08			
	02.15→	BWD							70	760	S4 E08			
TSI [362]	08.10-12.14	BWD,SSJ	70	760	S5 A08									
		SSJ	70	760	S5 A08									
	11.12-12.14		70	760	S5 A08									
TSI EcoFuel [3C2]	11.08-07.10	BWD	70	760	S5 A08									
		BWD,SSJ	70	760	S5 A08									
TSI EcoFuel [362]	09.10-12.14	BWD,SSJ	70	760	S5 A08									
TSI 4Motion [3G2]	02.15-11.18		70	760	S5 A08									
			95	850	S5 A13									
1.5 TSI [3G2]	08.18→		70	760	S5 A08				70	760	S4 E08			
1.6 [3B2; 3B3]	10.96-05.05					63	610	S5 005	52	470	S4 002	45	400	S3 002
[3C2]	03.05-07.10	BWD	70	760	S5 A08	77	780	S5 008	52	470	S4 002	45	400	S3 002
		BWD,SSJ	70	760	S5 A08									
FSI [3C2]	03.05-06.08	BWD	70	760	S5 A08	77	780	S5 008	52	470	S4 002	45	400	S3 002
		BWD,SSJ	70	760	S5 A08									
1.8 [3B2]	12.96-01.99		70	760	S5 A08	85	800	S5 010	60	540	S4 005	56	480	S3 005
			70	760	S5 A08	85	800	S5 010	60	540	S4 005	70	640	S3 008
			70	760	S5 A08	85	800	S5 010	74	680	S4 008	56	480	S3 005
			70	760	S5 A08	85	800	S5 010	80	740	S4 011	56	480	S3 005
			70	760	S5 A08	85	800	S5 011	60	540	S4 005	56	480	S3 005
	01.97-11.00		70	760	S5 A08	85	800	S5 010	74	680	S4 008	70	640	S3 008



											Ah A (EN)			Ah A (EN)			Ah A (EN)			Ah A (EN)		
◀ VW		0 092 ...0			0 092 ...0			0 092 ...0			0 092 ...0											
1.8 [3B2]	01.99-11.00	70	760	S5 A08	85	800	S5 010	80	740	S4 011	70	640	S3 008									
		70	760	S5 A08	85	800	S5 011	74	680	S4 008	70	640	S3 008									
	[3B3]	10.00-05.05	70	760	S5 A08	77	780	S5 008	60	540	S4 005	56	480	S3 005								
	Syncro [3B2]	06.97-11.00	70	760	S5 A08	85	800	S5 011	60	540	S4 005	56	480	S3 005								
	TFSI [3G2]	02.15-11.18	70	760	S5 A08	52	520	S5 001	60	540	S4 005											
		02.15→	BWD,SSJ	70	760	S5 A08			70	760	S4 E08											
				95	850	S5 A13			70	760	S4 E08											
	TSI [3C2]	05.08-07.10	BWD	70	760	S5 A08	77	780	S5 008	60	540	S4 005	70	640	S3 008							
			BWD,SSJ	70	760	S5 A08																
	TSI [362]	08.10-12.14	BWD,SSJ	70	760	S5 A08																
	02.11-12.14	SSJ	70	760	S5 A08																	
Turbo [3B2]	10.96-11.00		70	760	S5 A08	85	800	S5 010	74	680	S4 008	70	640	S3 008								
			70	760	S5 A08	85	800	S5 010	80	740	S4 011	70	640	S3 008								
2.0 [3B2]	01.00-08.00		70	760	S5 A08	85	800	S5 010	74	680	S4 008	70	640	S3 008								
			70	760	S5 A08	85	800	S5 010	80	740	S4 011	70	640	S3 008								
			70	760	S5 A08	85	800	S5 011	74	680	S4 008	70	640	S3 008								
	FSI [3C2]	03.05-07.10	BWD	70	760	S5 A08	85	800	S5 011	60	540	S4 005	56	480	S3 005							
	FSI 4Motion [3C2]	09.05-07.10	BWD	70	760	S5 A08	85	800	S5 011	60	540	S4 005	56	480	S3 005							
	TFSI [3G2]	11.14→		95	850	S5 A13																
			BWD,SSJ	70	760	S5 A08																
		11.15-11.18	BWD						70	760	S4 E08											
			SSJ	95	850	S5 A13																
	TFSI 4Motion [3G2]	05.15→		70	760	S5 A08																
			95	850	S5 A13																	
		BWD,SSJ						70	760	S4 E08												
	09.18→		70	760	S5 A08			70	760	S4 E08												
TSI [3C2]	03.05-11.05		70	760	S5 A08	85	800	S5 011	60	540	S4 005	56	480	S3 005								
	08.05-08.08		70	760	S5 A08	77	780	S5 008	60	540	S4 005											
	11.05-02.08	BWD	70	760	S5 A08	85	800	S5 011	60	540	S4 005	56	480	S3 005								
	05.08-07.10		70	760	S5 A08	85	800	S5 011	74	680	S4 008											
			BWD	70	760	S5 A08	85	800	S5 011	60	540	S4 005	56	480	S3 005							
		SSJ	70	760	S5 A08																	
	05.08-11.10		70	760	S5 A08	85	800	S5 011	60	540	S4 005	56	480	S3 005								
TSI [362]	11.10-12.14	BWD,SSJ	70	760	S5 A08																	
2.0/ 2.3 [3B3]	10.00-05.05		70	760	S5 A08	85	800	S5 011	60	540	S4 005	56	480	S3 005								
2.0/ 2.3/ 2.8/ 4.0 4Motion [3B3]	10.00-05.05		70	760	S5 A08	85	800	S5 011	60	540	S4 005	56	480	S3 005								
2.3 [3B2]	10.96-11.00		70	760	S5 A08	85	800	S5 010	74	680	S4 008	70	640	S3 008								
			70	760	S5 A08	85	800	S5 010	80	740	S4 011	70	640	S3 008								
			70	760	S5 A08	85	800	S5 011	74	680	S4 008	70	640	S3 008								
2.3/ 2.8 Syncro [3B2]	01.97-11.00		70	760	S5 A08	85	800	S5 011	74	680	S4 008	70	640	S3 008								
2.8 [3B2]	01.97-11.00		70	760	S5 A08	85	800	S5 010	80	740	S4 011	70	640	S3 008								
			70	760	S5 A08	85	800	S5 011	74	680	S4 008	70	640	S3 008								
			70	760	S5 A08	85	800	S5 011	80	740	S4 011	70	640	S3 008								
			70	760	S5 A08	85	800	S5 010	74	680	S4 008	70	640	S3 008								
	01.97-10.02		70	760	S5 A08	85	800	S5 010	74	680	S4 008	70	640	S3 008								
[3B3]	10.00-05.05		70	760	S5 A08	85	800	S5 011	74	680	S4 008											
		SSJ	70	760	S5 A08																	
3.2/ 3.6 FSI 4Motion [3C2]	09.05-07.10	BWD	95	850	S5 A13	100	830	S5 013	74	680	S4 008	70	640	S3 008								
3.6 FSI [3C2]	09.05-07.10	BWD	70	760	S5 A08	85	800	S5 011	74	680	S4 008											
		BWD,SSJ	70	760	S5 A08																	
FSI R36 4Motion [3C2]	04.07-07.10	BWD	95	850	S5 A13	85	800	S5 011	74	680	S4 008	70	640	S3 008								
		BWD,SSJ	95	850	S5 A13																	
V6 4Motion [362]	01.11-12.14	BWD	80	800	S5 A11																	
		SSJ	80	800	S5 A11																	
4.0 [3B3]	05.02-09.04		70	760	S5 A08	77	780	S5 008	60	540	S4 005											
			70	760	S5 A08	77	780	S5 008	80	740	S4 011											
			70	760	S5 A08	85	800	S5 011	60	540	S4 005											
Diesel																						
1.6 TDI [3C2]	08.09-07.10	BWD,SSJ	70	760	S5 A08																	
		SSJ	70	760	S5 A08																	
TDI [3G2]	08.14-11.18	BWD,SSJ	70	760	S5 A08				70	760	S4 E08											



			Ah A (EN) S5A			Ah A (EN) S5			Ah A (EN) S4			Ah A (EN) S3			
			0 092 ...0			0 092 ...0			0 092 ...0			0 092 ...0			
1.6 TDI [3G2]	05.15→	BWD,SSJ	70	760	S5 A08										
		SSJ	95	850	S5 A13										
TDI [362]	08.10-12.14	BWD,SSJ	70	760	S5 A08										
		SSJ	70	760	S5 A08										
1.9 TDI [3B2]	10.96-11.00		70	760	S5 A08	85	800	S5 010	74	680	S4 008	70	640	S3 008	
			70	760	S5 A08	85	800	S5 010	80	740	S4 011	70	640	S3 008	
			70	760	S5 A08	85	800	S5 011	74	680	S4 008	70	640	S3 008	
TDI [3B3]	10.00-05.05		70	760	S5 A08	85	800	S5 011	74	680	S4 008	70	640	S3 008	
TDI [3C2]	03.05-11.08	BWD				85	800	S5 011	74	680	S4 008	70	640	S3 008	
		BWD,SSJ	70	760	S5 A08										
	02.06-11.08	BWD	70	760	S5 A08	85	800	S5 011	74	680	S4 008	70	640	S3 008	
1.9/ 2.5 TDI Syncro [3B2]	06.97-11.00		70	760	S5 A08	85	800	S5 011	74	680	S4 008	70	640	S3 008	
TDI 4Motion [3B3]	10.00-05.05		70	760	S5 A08	85	800	S5 011	74	680	S4 008	70	640	S3 008	
2.0 TDI [3B3]	11.03-05.05		70	760	S5 A08	77	780	S5 008	60	540	S4 005				
			70	760	S5 A08	77	780	S5 008	80	740	S4 011				
			70	760	S5 A08	85	800	S5 011	60	540	S4 005				
			70	760	S5 A08	85	800	S5 011	74	680	S4 008	70	640	S3 008	
	TDI [3C2]	03.05-06.08	BWD	70	760	S5 A08	77	780	S5 008	74	680	S4 008	70	640	S3 008
		03.05-11.09	BWD	70	760	S5 A08	85	800	S5 011	74	680	S4 008			
		03.05-07.10	BWD	70	760	S5 A08	85	800	S5 011	74	680	S4 008	70	640	S3 008
		03.06-05.06	BWD,SSJ	70	760	S5 A08									
		11.08-07.10	BWD				85	800	S5 011	74	680	S4 008			
		11.08-11.10	BWD,SSJ	70	760	S5 A08				85	800	S5 011	80	740	S4 011
TDI [3G2]	08.14-11.18	BWD,SSJ	70	760	S5 A08							70	760	S4 E08	
		SSJ	80	800	S5 A11										
	05.15-11.18	BWD,SSJ	95	850	S5 A13										
	05.15→	BWD,SSJ	70	760	S5 A08										
		SSJ	95	850	S5 A13										
11.15→	BWD	70	760	S5 A08											
TDI [362]	08.10-12.14	BWD,SSJ	70	760	S5 A08										
		SSJ	70	760	S5 A08										
	12.12-12.14		70	760	S5 A08										
TDI 4Motion [3C2]	03.05-08.10	BWD	70	760	S5 A08	85	800	S5 011	74	680	S4 008	70	640	S3 008	
	05.09-07.10	BWD	70	760	S5 A08	85	800	S5 011	74	680	S4 008				
TDI 4Motion [3G2]	08.14→	BWD,SSJ	70	760	S5 A08							70	760	S4 E08	
		SSJ	95	850	S5 A13										
	02.15-07.18		95	850	S5 A13										
	02.15→	BWD,SSJ	70	760	S5 A08										
	05.15→	SSJ	95	850	S5 A13										
	11.17→		70	760	S5 A08							70	760	S4 E08	
TDI 4Motion [362]	08.10-12.14	BWD,SSJ	70	760	S5 A08										
		SSJ	70	760	S5 A08										
	12.12-12.14					63	610	S5 005	74	680	S4 008				
2.5 TDI [3B2]	08.98-11.00		70	760	S5 A08	85	800	S5 010	74	680	S4 008	70	640	S3 008	
			70	760	S5 A08	85	800	S5 010	80	740	S4 011	70	640	S3 008	
			70	760	S5 A08	85	800	S5 011	74	680	S4 008	70	640	S3 008	
TDI [3B3]	10.00-05.05		70	760	S5 A08	85	800	S5 011	74	680	S4 008	70	640	S3 008	
Passat Alltrack															
1.4 TSI 4Motion [3G5]	05.15-11.18	BWD,SSJ	60	680	S5 A05										
1.8 TFSI [365]	01.12-05.13					63	610	S5 005	60	540	S4 005				
		BWD,SSJ	70	760	S5 A08							70	760	S4 E08	
	01.12-12.14		70	760	S5 A08	63	610	S5 005	60	540	S4 005				
			70	760	S5 A08	63	610	S5 005	70	760	S4 E08				
2.0 TFSI 4Motion [3G5]	05.15→	BWD,SSJ	70	760	S5 A08							70	760	S4 E08	
	09.18→		60	680	S5 A05							60	640	S4 E05	
TSI 4Motion [365]	01.12-12.14	BWD,SSJ	70	760	S5 A08										
		SSJ	70	760	S5 A08										
Diesel															
2.0 TDI [3G5]	11.17→		70	760	S5 A08							70	760	S4 E08	



				Ah	A (EN)		Ah	A (EN)		Ah	A (EN)		Ah	A (EN)	
				0 092 ...0			0 092 ...0			0 092 ...0			0 092 ...0		
◀ VW															
2.0 TDI [365]	01.12-12.14	BWD,SSJ	70	760	S5 A08										
		SSJ	70	760	S5 A08										
TDI 4Motion [3G5]	05.15→		70	760	S5 A08					70	760	S4 E08			
		BWD,SSJ	70	760	S5 A08										
			95	850	S5 A13										
		SSJ	95	850	S5 A13										
TDI 4Motion [365]	01.12-12.14	BWD,SSJ	70	760	S5 A08										
		SSJ	70	760	S5 A08										
	01.13-12.14	BWD,SSJ	70	760	S5 A08					70	760	S4 E08			
Passat CC															
1.4 TSI [357]	01.11-05.12	BWD	70	760	S5 A08										
1.8 TSI [357]	05.08-05.10	BWD				63	610	S5 005	60	540	S4 005				
						63	610	S5 005	74	680	S4 008				
	05.08-05.12	BWD,SSJ	70	760	S5 A08										
	11.08-01.12	BWD	70	760	S5 A08										
	11.08-05.12					63	610	S5 005	60	540	S4 005				
						63	610	S5 005	74	680	S4 008				
2.0 TSI [357]	05.08-01.12	BWD				85	800	S5 011	74	680	S4 008				
	05.08-05.12	BWD	70	760	S5 A08	85	800	S5 011	74	680	S4 008				
		BWD,SSJ	70	760	S5 A08										
	11.10-05.12	BWD	70	760	S5 A08										
3.6 FSI 4Motion [357]	08.08-05.12	BWD	70	760	S5 A08	77	780	S5 008	74	680	S4 008	70	640	S3 008	
Diesel															
2.0 TDI [357]	05.08-05.12	BWD				85	800	S5 011	74	680	S4 008				
						85	800	S5 011	74	680	S4 008	70	640	S3 008	
		BWD,SSJ	70	760	S5 A08										
	05.09-11.10					85	800	S5 011	80	740	S4 011				
		BWD,SSJ	80	800	S5 A11										
		SSJ	80	800	S5 A11										
TDI 4Motion [357]	11.09-05.12	BWD				85	800	S5 011	74	680	S4 008				
		BWD,SSJ	70	760	S5 A08										
Passat Variant															
1.4 GTE Hybrid [3G5]	05.15-11.18	BWD,SSJ	60	680	S5 A05					70	760	S4 E08			
			70	760	S5 A08					70	760	S4 E08			
TSI [3C5]	05.07-11.10		70	760	S5 A08	77	780	S5 008	60	540	S4 005				
		BWD,SSJ	95	850	S5 A13										
		SSJ	95	850	S5 A13										
TSI [3G5]	08.14-11.18	BWD,SSJ	60	680	S5 A05					60	640	S4 E05			
	11.14-11.18		70	760	S5 A08										
		SSJ								70	760	S4 E08			
	02.15→		60	680	S5 A05										
		BWD								60	640	S4 E05			
TSI [365]	08.10-12.14	BWD,SSJ	70	760	S5 A08										
		SSJ	70	760	S5 A08										
	11.12-12.14		70	760	S5 A08										
TSI EcoFuel [3C5]	11.08-11.10	BWD	70	760	S5 A08	63	610	S5 005	60	540	S4 005				
TSI EcoFuel [365]	09.10-12.14	BWD,SSJ	70	760	S5 A08										
TSI 4Motion [3G5]	02.15-11.18		70	760	S5 A08										
			95	850	S5 A13										
1.5 TSI [3G5]	08.18→		70	760	S5 A08					70	760	S4 E08			
1.6 [3B5]	01.97-11.00					63	610	S5 005	52	470	S4 002	45	400	S3 002	
[3B6]	10.00-05.05					63	610	S5 005	52	470	S4 002	45	400	S3 002	
[3C5]	08.05-11.10	BWD				63	610	S5 005	52	470	S4 002	45	400	S3 002	
FSI [3C5]	08.05-06.08	BWD				63	610	S5 005	52	470	S4 002	45	400	S3 002	
1.8 [3B5]	05.97-11.00		70	760	S5 A08	85	800	S5 010	74	680	S4 008	70	640	S3 008	
			70	760	S5 A08	85	800	S5 010	80	740	S4 011	70	640	S3 008	
[3B6]	10.00-05.05					77	780	S5 008	60	540	S4 005	70	640	S3 008	
			70	760	S5 A08	77	780	S5 008	60	540	S4 005	56	480	S3 005	
		VAD	70	760	S5 A08										
Syncro [3B5]	06.97-08.00		70	760	S5 A08	85	800	S5 011	60	540	S4 005	70	640	S3 008	
TFSI [3G5]	02.15-11.18		70	760	S5 A08										
			95	850	S5 A13										



			Ah A (EN) S5A			Ah A (EN) S5			Ah A (EN) S4			Ah A (EN) S3		
			0 092 ...0			0 092 ...0			0 092 ...0			0 092 ...0		
1.8 TFSI [3G5]	02.15→	BWD,SSJ	70	760	S5 A08				70	760	S4 E08			
			95	850	S5 A13				70	760	S4 E08			
TSI [3C5]	05.07-11.10					77	780	S5 008	74	680	S4 008			
Turbo [3B5]	05.97-11.00		70	760	S5 A08	85	800	S5 010	74	680	S4 008	70	640	S3 008
			70	760	S5 A08	85	800	S5 010	80	740	S4 011	70	640	S3 008
			70	760	S5 A08	85	800	S5 011	74	680	S4 008	70	640	S3 008
1.8/ 2.0 TSI [365]	08.10-12.14	BWD,SSJ	70	760	S5 A08									
2.0 [3B5]	01.00-08.00					77	780	S5 008	74	680	S4 008			
FSI [3C5]	08.05-11.10	BWD	70	760	S5 A08	85	800	S5 011	60	540	S4 005	56	480	S3 005
FSI 4Motion [3C5]	09.05-11.10	BWD	70	760	S5 A08	85	800	S5 011	60	540	S4 005	56	480	S3 005
TFSI [3G5]	11.14→		95	850	S5 A13									
		BWD,SSJ	70	760	S5 A08									
	11.15-11.18	BWD							70	760	S4 E08			
		SSJ	95	850	S5 A13									
TFSI 4Motion [3G5]	05.15→		70	760	S5 A08									
			95	850	S5 A13									
	09.18→		60	680	S5 A05				60	640	S4 E05			
TSI [3C5]	08.05-12.07		70	760	S5 A08	85	800	S5 011	60	540	S4 005	56	480	S3 005
	08.05-11.10	BWD	70	760	S5 A08	85	800	S5 011	60	540	S4 005	56	480	S3 005
	05.08-11.10					85	800	S5 011	74	680	S4 008			
		BWD	70	760	S5 A08									
		SSJ	70	760	S5 A08									
4Motion [3B5]	01.00-08.00					77	780	S5 008	74	680	S4 008			
2.0/ 2.3 [3B6]	10.00-05.05		70	760	S5 A08	85	800	S5 011	60	540	S4 005	56	480	S3 005
2.0/ 2.3/ 2.8/ 4.0 4Motion [3B6]	10.00-05.05		70	760	S5 A08	85	800	S5 011	60	540	S4 005	56	480	S3 005
2.3 [3B5]	09.97-11.00		70	760	S5 A08	85	800	S5 010	74	680	S4 008	70	640	S3 008
			70	760	S5 A08	85	800	S5 010	80	740	S4 011	70	640	S3 008
			70	760	S5 A08	85	800	S5 011	74	680	S4 008	70	640	S3 008
2.3/ 2.8 Syncro [3B5]	01.97-08.00		70	760	S5 A08	85	800	S5 011	74	680	S4 008	70	640	S3 008
2.8 [3B5]	06.97-11.00		70	760	S5 A08	85	800	S5 010	74	680	S4 008	70	640	S3 008
			70	760	S5 A08	85	800	S5 010	80	740	S4 011	70	640	S3 008
			70	760	S5 A08	85	800	S5 011	74	680	S4 008	70	640	S3 008
	09.97-08.00					85	800	S5 011	80	740	S4 011			
[3B6]	10.00-05.05					77	780	S5 008	74	680	S4 008			
						77	780	S5 008	80	740	S4 011			
						85	800	S5 011	74	680	S4 008			
3.2 FSI 4Motion [3C5]	11.05-11.10	BWD	95	850	S5 A13	85	800	S5 011	74	680	S4 008			
3.6 FSI [3C5]	09.05-11.10	BWD	70	760	S5 A08	85	800	S5 011	74	680	S4 008			
FSI R36 4Motion [3C5]	04.07-11.10	BWD	95	850	S5 A13	85	800	S5 011	74	680	S4 008			
FSI 4Motion [3C5]	09.05-11.10	BWD	70	760	S5 A08	85	800	S5 011	74	680	S4 008			
V6 4Motion [365]	01.11-12.14	BWD	95	850	S5 A13									
		BWD,SSJ	95	850	S5 A13									
4.0 [3B6]	05.02-09.04					77	780	S5 008	74	680	S4 008			
						77	780	S5 008	80	740	S4 011			
						85	800	S5 011	74	680	S4 008			
Diesel														
1.6 TDI [3C5]	08.09-11.10		70	760	S5 A08	77	780	S5 008	60	540	S4 005			
TDI [3G5]	11.14-11.18					77	780	S5 008						
		BWD,SSJ	70	760	S5 A08				70	760	S4 E08			
	05.15→	BWD,SSJ	70	760	S5 A08									
		SSJ	95	850	S5 A13									
TDI [365]	08.10-12.14	BWD,SSJ	70	760	S5 A08									
		SSJ	70	760	S5 A08									
1.9 TDI [3B5]	05.97-11.00		70	760	S5 A08	85	800	S5 010	74	680	S4 008	70	640	S3 008
			70	760	S5 A08	85	800	S5 010	80	740	S4 011	70	640	S3 008
			70	760	S5 A08	85	800	S5 011	74	680	S4 008	70	640	S3 008
TDI [3C5]	08.05-11.08	BWD	70	760	S5 A08	85	800	S5 011	74	680	S4 008	70	640	S3 008
		BWD,SSJ	70	760	S5 A08									
1.9/ 2.0/ 2.5 TDI, TDI 4Motion [3B6]	10.00-05.05		70	760	S5 A08	85	800	S5 011	74	680	S4 008	70	640	S3 008
1.9/ 2.5 TDI Syncro [3B5]	06.97-08.00		70	760	S5 A08	85	800	S5 011	74	680	S4 008	70	640	S3 008



				Ah	A (EN)		Ah	A (EN)		Ah	A (EN)		Ah	A (EN)		
				0 092 ...0			0 092 ...0			0 092 ...0			0 092 ...0			
◀ VW																
2.0 TDI [3C5]	08.05-06.08	BWD	70	760	S5 A08	85	800	S5 011	74	680	S4 008					
		BWD,SSJ	70	760	S5 A08											
	08.05-11.10	BWD	70	760	S5 A08	85	800	S5 011	74	680	S4 008	70	640	S3 008		
	03.06-05.06	BWD				77	780	S5 008	74	680	S4 008					
	11.08-11.10	BWD				77	780	S5 008	74	680	S4 008					
		BWD,SSJ	70	760	S5 A08											
	TDI [3G5]	11.14-11.18	BWD,SSJ	70	760	S5 A08				70	760	S4 E08				
		05.15-11.18	BWD,SSJ	95	850	S5 A13										
		05.15→	BWD,SSJ	70	760	S5 A08										
			SSJ	95	850	S5 A13										
11.15→		BWD	70	760	S5 A08											
TDI [365]	08.10-12.14	BWD,SSJ	70	760	S5 A08											
		SSJ	70	760	S5 A08											
	12.12-12.14		70	760	S5 A08											
TDI 4Motion [3C5]	08.05-11.10	BWD	70	760	S5 A08	85	800	S5 011	74	680	S4 008	70	640	S3 008		
	05.09-11.10	BWD	70	760	S5 A08	85	800	S5 011	74	680	S4 008					
		BWD,SSJ	70	760	S5 A08											
TDI 4Motion [3G5]	08.14→	BWD,SSJ	70	760	S5 A08				70	760	S4 E08					
	02.15-07.18		95	850	S5 A13											
	02.15→	BWD,SSJ	70	760	S5 A08											
	05.15→	SSJ	95	850	S5 A13											
	11.17→		70	760	S5 A08				70	760	S4 E08					
TDI 4Motion [365]	08.10-12.14	BWD,SSJ	70	760	S5 A08											
		SSJ	70	760	S5 A08											
	12.12-12.14					63	610	S5 005	74	680	S4 008					
2.5 TDI [3B5]	08.98-11.00		70	760	S5 A08	85	800	S5 010	74	680	S4 008	70	640	S3 008		
			70	760	S5 A08	85	800	S5 010	80	740	S4 011	70	640	S3 008		
			70	760	S5 A08	85	800	S5 011	74	680	S4 008	70	640	S3 008		
Phaeton																
3.2 [3D]	05.02-05.05		70	760	S5 A08	77	780	S5 008	60	540	S4 005	70	640	S3 008		
3.2/ 4.2 4Motion [3D]	05.03-03.16		70	760	S5 A08	77	780	S5 008	60	540	S4 005	70	640	S3 008		
3.6 4Motion [3D]	11.08-03.16		70	760	S5 A08	63	610	S5 005	60	540	S4 005					
	05.10-03.16	SSJ	70	760	S5 A08											
6.0 4Motion [3D]	05.02-03.16		95	850	S5 A13	77	780	S5 008	60	540	S4 005	70	640	S3 008		
Diesel																
3.0 TDI 4Motion [3D]	09.04-05.07		70	760	S5 A08	77	780	S5 008	60	540	S4 005	70	640	S3 008		
	03.07-06.07		70	760	S5 A08	63	610	S5 005	60	540	S4 005					
	06.07-10.08		95	850	S5 A13				60	540	S4 005					
	06.08-03.16		70	760	S5 A08	63	610	S5 005	60	540	S4 005					
	11.13-03.16		60	680	S5 A05	63	610	S5 005	60	540	S4 005					
			60	680	S5 A05	63	610	S5 005	60	640	S4 E05					
5.0 TDI 4Motion [3D]	11.02-10.06		95	850	S5 A13	77	780	S5 008	60	540	S4 005	70	640	S3 008		
Polo																
1.0 [6C1]	02.14-10.17		60	680	S5 A05											
			70	760	S5 A08											
		BWD,SSJ								60	640	S4 E05				
									70	760	S4 E08					
TSI [6C1]	11.14-10.17		60	680	S5 A05											
			70	760	S5 A08											
		BWD,SSJ								60	640	S4 E05				
		SSJ								70	760	S4 E08				
									80	800	S4 E11					
1.0/ 1.3/ 1.4/ 1.6 [6N1]	10.94-12.99	VAD				54	530	S5 002	52	470	S4 002	45	400	S3 002		
1.0/ 1.4/ 1.6 , 16V [6N2]	07.98-09.01					54	530	S5 002	52	470	S4 002	45	400	S3 002		
1.2 [6R1]	06.09-02.14					54	530	S5 002	52	470	S4 002					
		BWD,SSJ	60	680	S5 A05				70	760	S4 E08					
			70	760	S5 A08				70	760	S4 E08					



			Ah A (EN) S5A			Ah A (EN) S5			Ah A (EN) S4			Ah A (EN) S3		
			0 092 ...0			0 092 ...0			0 092 ...0			0 092 ...0		
1.2 TSI [6C1]	02.14-10.17		60	680	S5 A05									
			70	760	S5 A08									
		BWD,SSJ						60	640	S4 E05				
		SSJ						70	760	S4 E08				
TSI [6R1]	06.09-05.14	BWD				54	530	S5 002	52	470	S4 002			
		BWD,SSJ	60	680	S5 A05				70	760	S4 E08			
			70	760	S5 A08				70	760	S4 E08			
	05.11-02.14					54	530	S5 002	52	470	S4 002			
		BWD,SSJ	60	680	S5 A05				60	640	S4 E05			
1.2/ 1.4/ 1.6 [9N3]	04.05-12.09					63	610	S5 005	52	470	S4 002	45	400	S3 002
1.2/ 1.4/ 1.6/ 2.0, FSI [: 9N1; 9N2]	09.01-05.07					63	610	S5 005	52	470	S4 002	45	400	S3 002
1.4 [6R1]	05.09→					63	610	S5 005	52	470	S4 002			
	06.09-02.14	BWD				63	610	S5 005	52	470	S4 002			
BiFuel [6R1]	03.10-01.11	BWD				54	530	S5 002	52	470	S4 002			
		BWD,SSJ	60	680	S5 A05				70	760	S4 E08			
			70	760	S5 A08				70	760	S4 E08			
FSI [9N3]	04.05-07.06					63	610	S5 005	52	470	S4 002			
GTI [6R1]	05.10-09.12	BWD				63	610	S5 005	60	540	S4 005			
	09.12-05.14					63	610	S5 005	52	470	S4 002			
TSI [6C1]	04.14-10.17					77	780	S5 008	74	680	S4 008	70	640	S3 008
		BWD,SSJ	70	760	S5 A08				70	760	S4 E08			
TSI [6R1]	10.12-02.14	BWD,SSJ	60	680	S5 A05				60	640	S4 E05			
1.6 [6C1]	04.14-10.17					54	530	S5 002	52	470	S4 002			
		BWD,SSJ	60	680	S5 A05									
			70	760	S5 A08									
BiFuel [6R1]	01.11-02.14	BWD				63	610	S5 005	60	540	S4 005			
		BWD,SSJ	60	680	S5 A05				70	760	S4 E08			
			70	760	S5 A08				70	760	S4 E08			
1.8 GTI [6C1]	11.14-10.17					77	780	S5 008	60	540	S4 005	56	480	S3 005
			70	760	S5 A08				77	780	S5 008	60	540	S4 005
		BWD							70	760	S4 E08			
		BWD,SSJ	70	760	S5 A08				70	760	S4 E08			
GTI [9N3]	09.05-11.09					77	780	S5 008	60	540	S4 005	70	640	S3 008
2.0 WRC [6R1]	08.13-02.14					54	530	S5 002	52	470	S4 002	45	400	S3 002
Diesel														
1.2 D	02.10-06.14		70	760	S5 A08	63	610	S5 005	60	540	S4 005	45	400	S3 002
			70	760	S5 A08	63	610	S5 005	70	760	S4 E08	45	400	S3 002
TDI [6R1]	10.09-02.14	BWD				63	610	S5 005	52	470	S4 002			
		BWD,KZO,SSJ	60	680	S5 A05									
		BWD,KZO,SSJ	70	760	S5 A08									
1.4 TDI [6C1]	02.14-10.17					77	780	S5 008	74	680	S4 008	70	640	S3 008
		BWD,SSJ	70	760	S5 A08				70	760	S4 E08			
	05.14-10.17	BWD							70	760	S4 E08			
		BWD,SSJ	70	760	S5 A08									
TDI [6N2]	10.99-09.01					77	780	S5 008	60	540	S4 005			
TDI [9N1; 9N2; 9N3]	09.01-12.09					77	780	S5 008	60	540	S4 005	70	640	S3 008
1.6 TDI [6R1]	06.09-02.14								60	540	S4 005			
		BWD				77	780	S5 008	60	540	S4 005			
		BWD,KZO,SSJ	60	680	S5 A05									
		BWD,KZO,SSJ	70	760	S5 A08									
		BWD,SSJ	70	760	S5 A08									
	06.09→	SSJ	70	760	S5 A08									
1.7 SDI [6N2]	10.99-09.01					77	780	S5 008	74	680	S4 008	70	640	S3 008
1.7/ 1.9 D, SDI [6N1]	10.94-12.99	VAD	70	760	S5 A08	77	780	S5 008	60	540	S4 005			
1.9 D [6N2]	10.99-09.01					77	780	S5 008	74	680	S4 008	70	640	S3 008
	10.99-09.01					77	780	S5 008	60	540	S4 005			
SDI [6N2]	10.99-09.01					77	780	S5 008	60	540	S4 005			
SDI [9N1]	09.01-05.05					77	780	S5 008	74	680	S4 008	70	640	S3 008
SDI [9N2]	11.03-05.07					77	780	S5 008	74	680	S4 008	70	640	S3 008
SDI [9N3]	04.05-12.09					77	780	S5 008	74	680	S4 008			
TDI [9N1]	09.01-05.05					77	780	S5 008	74	680	S4 008			
TDI [9N2]	07.03-05.07					77	780	S5 008	74	680	S4 008			



			Ah A (EN) S5A			Ah A (EN) S5			Ah A (EN) S4			Ah A (EN) S3		
			0 092 ...0			0 092 ...0			0 092 ...0			0 092 ...0		
◀ VW														
1.9 TDI [9N3]	04.05-12.09					77	780	S5 008	74	680	S4 008			
			70	760	S5 A08	77	780	S5 008	74	680	S4 008	70	640	S3 008
Polo Classic														
1.4 [6V2]	12.97-08.99	VAD				54	530	S5 002	52	470	S4 002	45	400	S3 002
	10.99-09.01	VAD				54	530	S5 002	52	470	S4 002	45	400	S3 002
1.6 [6V2]	12.95-09.01	VAD				54	530	S5 002	52	470	S4 002	45	400	S3 002
	10.99-09.01	VAD				54	530	S5 002	44	440	S4 001	41	360	S3 001
1.8 [6V2]	03.98-09.01	VAD				54	530	S5 002	52	470	S4 002	45	400	S3 002
2.0 [6V2]	08.99-09.01		70	760	S5 A08									
	SSJ,VAD		70	760	S5 A08									
	VAD					77	780	S5 008	52	470	S4 002	45	400	S3 002
Diesel														
1.7 SDI [6V2]	11.97-08.99	VAD	70	760	S5 A08	77	780	S5 008	60	540	S4 005	70	640	S3 008
1.9 SDI [6V2]	12.95-08.99	VAD	70	760	S5 A08	77	780	S5 008	60	540	S4 005			
	08.99-09.01	VAD	70	760	S5 A08	77	780	S5 008	60	540	S4 005	70	640	S3 008
TDI [6V2]	07.96-08.99	VAD	70	760	S5 A08	77	780	S5 008	60	540	S4 005			
	11.97-08.99	VAD	70	760	S5 A08	77	780	S5 008	60	540	S4 005	70	640	S3 008
	06.98-08.99	VAD	70	760	S5 A08	77	780	S5 008	60	540	S4 005	56	480	S3 005
	10.99-09.01	VAD	70	760	S5 A08	77	780	S5 008	60	540	S4 005	56	480	S3 005
			70	760	S5 A08	77	780	S5 008	60	540	S4 005	70	640	S3 008
Polo Hatchback														
1.4 i	01.01-07.08					63	610	S5 005	60	540	S4 005			
Polo Limousine														
1.6 [9N2]	07.03-05.07					63	610	S5 005	52	470	S4 002	45	400	S3 002
Polo Playa														
1.4 i [9V4]	10.98-10.02					54	530	S5 002	52	470	S4 002	45	400	S3 002
Polo Sedan														
1.6 [612]	09.10-05.15					54	530	S5 002	52	470	S4 002			
[614]	05.15-11.15					54	530	S5 002	52	470	S4 002			
	01.16→					54	530	S5 002	52	470	S4 002			
Diesel														
1.9 TDI	11.02-07.06		70	760	S5 A08	77	780	S5 008	74	680	S4 008	70	640	S3 008
Polo Variant														
1.4 [6V5]	12.97-08.99					54	530	S5 002	52	470	S4 002	45	400	S3 002
	01.98-08.99					54	530	S5 002	52	470	S4 002			
	10.99-06.00					54	530	S5 002	52	470	S4 002	45	400	S3 002
	10.99-09.01					54	530	S5 002	52	470	S4 002			
1.6 [6V5]	05.97-08.99	VAD				63	610	S5 005	52	470	S4 002	45	400	S3 002
	09.97-09.01	VAD				54	530	S5 002	52	470	S4 002	45	400	S3 002
	10.99-09.01	VAD				63	610	S5 005	52	470	S4 002	45	400	S3 002
Diesel														
1.7 SDI [6V5]	08.97-08.99	VAD	70	760	S5 A08	77	780	S5 008	60	540	S4 005	70	640	S3 008
1.9 SDI [6V5]	06.97-08.99	VAD	70	760	S5 A08	77	780	S5 008	60	540	S4 005	70	640	S3 008
	10.99-09.01	VAD	70	760	S5 A08	77	780	S5 008	60	540	S4 005	70	640	S3 008
TDI [6V5]	06.97-08.99	VAD	70	760	S5 A08	77	780	S5 008	60	540	S4 005	70	640	S3 008
	10.99-09.01	VAD	70	760	S5 A08	77	780	S5 008	60	540	S4 005	70	640	S3 008
Scirocco III														
1.4 TSI [137]	08.08-10.12	BWD,SSJ	70	760	S5 A08				70	760	S4 E08			
	08.08-05.14					63	610	S5 005	60	540	S4 005			
	11.08-05.14	BWD,SSJ	70	760	S5 A08									
		SSJ	70	760	S5 A08									
	05.11-05.14	BWD	70	760	S5 A08									
	09.12-05.14	BWD							70	760	S4 E08			
TSI [138]	05.14-11.17					63	610	S5 005	60	540	S4 005			
		BWD	70	760	S5 A08				70	760	S4 E08			
		BWD,SSJ	60	680	S5 A05				60	640	S4 E05			
	05.15-11.17	BWD,SSJ	70	760	S5 A08									
2.0 TSI [137]	08.08-05.14					77	780	S5 008	74	680	S4 008			
	11.09-05.14					63	610	S5 005	60	540	S4 005			
		BWD,SSJ	70	760	S5 A08				70	760	S4 E08			



						Ah A (EN) S5A		Ah A (EN) S5		Ah A (EN) S4		Ah A (EN) S3			
				0 092 ...0		0 092 ...0		0 092 ...0		0 092 ...0		0 092 ...0			
2.0 TSI [138]	05.14-11.17			63	610	S5 005	60	540	S4 005						
				77	780	S5 008	74	680	S4 008						
		BWD						70	760	S4 E08					
		BWD,SSJ		70	760	S5 A08					70	760	S4 E08		
		70	760	S5 A08					70	760	S4 E08				
Diesel															
2.0 TDI [137]	10.08-05.14							74	680	S4 008					
		BWD				77	780	S5 008							
		BWD,SSJ		70	760	S5 A08									
				70	760	S5 A08					70	760	S4 E08		
2.0 TDI [138]	05.14-11.17	05.09-01.13				85	800	S5 011	74	680	S4 008				
		11.10-05.14		70	760	S5 A08	63	610	S5 005	60	540	S4 005			
		BWD,SSJ		70	760	S5 A08					70	760	S4 E08		
				70	760	S5 A08					70	760	S4 E08		
Scirocco III R															
2.0 TSI [138]	05.14-11.17			63	610	S5 005	60	540	S4 005						
		BWD						70	760	S4 E08					
		BWD,SSJ		70	760	S5 A08					70	760	S4 E08		
				70	760	S5 A08					70	760	S4 E08		
Sharan															
1.4 TSI [7N1]	05.10-06.12	BWD,SSJ		70	760	S5 A08									
				80	800	S5 A11									
		10.11-11.15		SSJ	70	760	S5 A08								
		05.12-11.15		BWD	70	760	S5 A08								
				80	800	S5 A11									
			SSJ	80	800	S5 A11									
	TSI [7N2]		05.15→	BWD,SSJ	70	760	S5 A08			70	760	S4 E08			
1.8 T [7M8]	11.97-02.00	VAD		70	760	S5 A08	77	780	S5 008	60	540	S4 005	56	480	S3 005
	05.00-03.10	VAD		70	760	S5 A08	77	780	S5 008	60	540	S4 005	56	480	S3 005
2.0 [7M8]	09.95-02.00	VAD		70	760	S5 A08	77	780	S5 008	60	540	S4 005	56	480	S3 005
	05.00-03.10	VAD		70	760	S5 A08	77	780	S5 008	60	540	S4 005	56	480	S3 005
	11.10-11.15	BWD		77	780	S5 008	60	540	S4 005						
	05.15→	BWD		80	800	S5 A11									
		BWD,SSJ						70	760	S4 E08					
		SSJ						80	800	S4 E11					
2.8 [7M8]	09.95-02.00	VAD		70	760	S5 A08	100	830	S5 013	80	740	S4 010	70	640	S3 008
	05.00-03.10	VAD		70	760	S5 A08	77	780	S5 008	74	680	S4 008	70	640	S3 008
	07.96-02.00	VAD		70	760	S5 A08	100	830	S5 013	80	740	S4 010	70	640	S3 008
	05.00-03.10	VAD		70	760	S5 A08	77	780	S5 008	74	680	S4 008	70	640	S3 008
Diesel															
1.9 TDI [7M8]	07.96-02.00			85	800	S5 011	80	740	S4 011						
		VAD		70	760	S5 A08	100	830	S5 013	74	680	S4 008			
	03.99-02.00			95	850	S5 A13	100	830	S5 013	80	740	S4 010	90	720	S3 013
		TDI [7M9, 7M6]		04.00-03.10	95	850	S5 A13	100	830	S5 013	80	740	S4 010	90	720
			05.00-03.10	95	850	S5 A13	100	830	S5 013	80	740	S4 010	70	640	S3 008
	TDI 4Motion [7M9, 7M6]		05.00-03.10	95	850	S5 A13	100	830	S5 013	80	740	S4 010	70	640	S3 008
	2.0 TDI [7M9, 7M6]	11.05-03.10			70	760	S5 A08	85	800	S5 011	74	680	S4 008		
					70	760	S5 A08	85	800	S5 011	80	740	S4 011		
			70	760	S5 A08	100	830	S5 013	74	680	S4 008				
			95	850	S5 A13	100	830	S5 013	80	740	S4 010	90	720	S3 013	
TDI [7N1]	05.10-11.15	BWD,SSJ		70	760	S5 A08									
				80	800	S5 A11									
	05.11-11.15	SSJ		70	760	S5 A08									
		01.13-11.15				63	610	S5 005	74	680	S4 008				
		BWD,SSJ						70	760	S4 E08					
TDI [7N2]	05.15-11.15	BWD,SSJ		70	760	S5 A08									
				80	800	S5 A11									
	05.15→	BWD		80	800	S5 A11									
		BWD,SSJ						70	760	S4 E08					
			SSJ						80	800	S4 E11				
	11.15→		BWD		70	760	S5 A08								
TDI 4Motion [7N1]	05.10-05.12	BWD		70	760	S5 A08									
	05.10-11.15	BWD,SSJ		70	760	S5 A08									



			Ah A (EN) S5A			Ah A (EN) S5			Ah A (EN) S4			Ah A (EN) S3		
			0 092 ...0			0 092 ...0			0 092 ...0			0 092 ...0		
◀ VW														
2.0 TDI 4Motion [7N2]	05.15→	BWD	80	800	S5 A11									
		BWD,SSJ				70	760	S4 E08						
		SSJ				80	800	S4 E11						
Tiguan														
1.4 TSI [AD1]	02.16→	BWD,SSJ				60	640	S4 E05						
		SSJ				70	760	S4 E08						
	07.17-11.18	BWD				60	640	S4 E05						
						70	760	S4 E08						
TSI [5N1]	05.08-05.11	BWD,SSJ	70	760	S5 A08									
	08.10-05.11	SSJ	70	760	S5 A08									
TSI [5N2]	05.11-12.16	BWD	70	760	S5 A08									
		BWD,SSJ	70	760	S5 A08									
	09.12-12.16	SSJ	70	760	S5 A08									
	05.15-12.16	BWD,SSJ				60	640	S4 E05						
		SSJ				70	760	S4 E08						
TSI 4Motion [AD1]	05.16→	BWD,SSJ				60	640	S4 E05						
		SSJ				70	760	S4 E08						
TSI 4Motion [5N1]	11.07-11.08		63	610	S5 005	60	540	S4 005						
	11.07-05.11	BWD,SSJ	70	760	S5 A08									
	03.08-05.11	SSJ	70	760	S5 A08									
TSI 4Motion [5N2]	05.11-09.12	BWD	70	760	S5 A08	63	610	S5 005	60	540	S4 005			
	05.11-12.16	BWD	70	760	S5 A08									
	09.12-12.16		63	610	S5 005	60	540	S4 005						
			70	760	S5 A08									
2.0 TFSI [5N1]	11.07-08.11		70	760	S5 A08	77	780	S5 008	74	680	S4 008	70	640	S3 008
TFSI 4Motion [AD1]	02.16→	BWD	80	800	S5 A11									
		BWD,SSJ	70	760	S5 A08				70	760	S4 E08			
TFSI 4Motion [5N1]	11.07-05.11		63	610	S5 005	60	540	S4 005	56	480	S3 005			
TSI [5N1]	03.08-05.11		77	780	S5 008	74	680	S4 008						
TSI 4Motion [5N1]	11.07-07.11		63	610	S5 005	60	540	S4 005	56	480	S3 005			
TSI 4Motion [5N2]	05.11-12.16	BWD	63	610	S5 005	60	540	S4 005	56	480	S3 005			
			63	610	S5 005	60	540	S4 005	56	480	S3 005			
Diesel														
1.6 TDI [AD1]	05.16→	BWD,SSJ	70	760	S5 A08									
			80	800	S5 A11									
2.0 TDI [AD1]	02.16→	BWD,SSJ	70	760	S5 A08									
			80	800	S5 A11									
	10.16→	BWD,SSJ	70	760	S5 A08				70	760	S4 E08			
TDI [5N1]	03.08-05.11	BWD,SSJ	70	760	S5 A08									
		SSJ	70	760	S5 A08									
			80	800	S5 A11									
TDI [5N2]	05.11-12.16	BWD	70	760	S5 A08									
			80	800	S5 A11									
		BWD,SSJ	70	760	S5 A08									
			80	800	S5 A11									
TDI 4Motion [AD1]	01.16→	BWD,SSJ	70	760	S5 A08									
			80	800	S5 A11									
	10.16→	SSJ	80	800	S5 A11									
TDI 4Motion [5N1]	11.07-05.11	BWD,SSJ	80	800	S5 A11									
		SSJ	80	800	S5 A11									
	11.07-07.11		70	760	S5 A08	63	610	S5 005	74	680	S4 008	70	640	S3 008
			70	760	S5 A08	77	780	S5 008	74	680	S4 008	70	640	S3 008
	03.08-05.11		77	780	S5 008	74	680	S4 008						
TDI 4Motion [5N2]	05.11-12.16		63	610	S5 005									
		BWD	70	760	S5 A08	77	780	S5 008	74	680	S4 008	70	640	S3 008
	11.12-12.16		70	760	S5 A08									
	05.15-12.16	BWD,SSJ	70	760	S5 A08				70	760	S4 E08			
Touareg														
3.0 FSI Hybrid [7P5]	03.10-12.14	BWD				77	780	S5 008						
		BWD,SSJ	70	760	S5 A08									
			95	850	S5 A13									
			105	950	S5 A15									



		Ah	A (EN)		Ah	A (EN)		Ah	A (EN)		Ah	A (EN)		Ah	A (EN)		Ah	A (EN)				
		0 092 ...0			0 092 ...0			0 092 ...0			0 092 ...0											
3.0	FSI Hybrid [7P6]	08.14-03.18			77	780	S5 008															
		BWD	70	760	S5 A08																	
			95	850	S5 A13																	
			105	950	S5 A15																	
	FSI Hybrid 4x4 [7P5]	09.10-12.14	BWD		77	780	S5 008															
3.2	[7LA]	11.02-11.06			70	760	S5 A08	100	830	S5 013	74	680	S4 008									
					95	850	S5 A13	77	780	S5 008	70	760	S4 E08									
					95	850	S5 A13	77	780	S5 008	74	680	S4 008									
3.6	FSI [7LA]	08.05-11.06			70	760	S5 A08	100	830	S5 013	74	680	S4 008									
		10.05-11.06			70	760	S5 A08	77	780	S5 008	74	680	S4 008	70	640	S3 008						
	FSI [7L6]	12.06-05.10			70	760	S5 A08	100	830	S5 013	74	680	S4 008									
	FSI [7P5]	04.10-12.14	BWD		95	850	S5 A13															
		08.10-12.14	BWD		95	850	S5 A13	100	830	S5 013												
	FSI [7P6]	08.14-03.18			100	830	S5 013															
			BWD,SSJ		95	850	S5 A13															
			SSJ		105	950	S5 A15															
4.2	FSI [7LA]	06.06-11.06			95	850	S5 A13	100	830	S5 013	95	800	S4 013	90	720	S3 013						
	FSI [7L6]	12.06-05.10			95	850	S5 A13	100	830	S5 013	95	800	S4 013	90	720	S3 013						
	FSI [7P5]	01.11-12.14	BWD		95	850	S5 A13	100	830	S5 013												
	FSI [7P6]	08.14-03.18			100	830	S5 013				95	800	S4 013									
			BWD		95	850	S5 A13															
4.2/ 6.0	[7LA]	12.02-11.06			95	850	S5 A13	100	830	S5 013	95	800	S4 013									
6.0	[7L6]	12.06-05.10			95	850	S5 A13	100	830	S5 013	95	800	S4 013									
Diesel																						
2.5	TDI [7LA]	01.03-11.06			70	760	S5 A08	100	830	S5 013	74	680	S4 008									
		07.03-11.06			70	760	S5 A08	77	780	S5 008	74	680	S4 008	70	640	S3 008						
		01.06-11.06			95	850	S5 A13	100	830	S5 013	74	680	S4 008									
	TDI [7L6]	12.06-05.10			95	850	S5 A13	100	830	S5 013	74	680	S4 008									
3.0	TDI [7LA]	11.04-11.06			70	760	S5 A08	100	830	S5 013	74	680	S4 008									
		04.06-11.06			95	850	S5 A13	100	830	S5 013	74	680	S4 008									
	TDI [7L6]	12.06-05.08			70	760	S5 A08	100	830	S5 013	74	680	S4 008									
		12.06-05.10			95	850	S5 A13	100	830	S5 013	74	680	S4 008									
		11.07-05.10			70	760	S5 A08	77	780	S5 008	74	680	S4 008	70	640	S3 008						
	TDI [7P5]	01.10-05.11	BWD,SSJ		80	800	S5 A11															
					95	850	S5 A13															
					105	950	S5 A15															
		11.10-12.14	BWD		95	850	S5 A13															
	TDI [7P6]	08.14-03.18	BWD		95	850	S5 A13															
					105	950	S5 A15															
			BWD,SSJ		95	850	S5 A13															
					105	950	S5 A15															
			SSJ		105	950	S5 A15															
	TDI 4x4 [7P5]	09.12→	SSJ		105	950	S5 A15															
4.2	TDI [7P5]	01.10-12.14	BWD,SSJ		95	850	S5 A13															
					105	950	S5 A15															
	TDI [7P6]	08.14-03.18	BWD,SSJ		95	850	S5 A13															
					105	950	S5 A15															
5.0	TDI [7LA; 7L6]	11.02-05.10			95	850	S5 A13	100	830	S5 013	95	800	S4 013									
Touran																						
1.0/ 1.2/ 1.4/ 1.5	TSI [5T1]	05.15→			70	760	S5 A08															
1.2	TSI [1T3]	05.10-05.15	BWD,SSJ		70	760	S5 A08															
			SSJ		70	760	S5 A08															
1.4	TSI [1T3]	05.10-09.12	BWD		54	530	S5 002	52	470	S4 002												
		09.12-05.15			54	530	S5 002	52	470	S4 002												
	TSI EcoFuel [1T3]	05.10-05.15	BWD		54	530	S5 002	52	470	S4 002												
	TSI, TSI EcoFuel [1T1; 1T2]	02.06-05.10			63	610	S5 005	52	470	S4 002	45	400	S3 002									
1.6	[1T1; 1T2]	07.03-05.10			63	610	S5 005	52	470	S4 002	45	400	S3 002									
	FSI [1T1; 1T2]	02.03-01.07			63	610	S5 005	52	470	S4 002	45	400	S3 002									
1.8	TFSI [5T1]	11.15-07.18	BWD,SSJ		70	760	S5 A08				70	760	S4 E08									
2.0	EcoFuel [1T1; 1T2]	02.06-05.10			63	610	S5 005	60	540	S4 005												
	FSI [1T1; 1T2]	10.03-01.07			63	610	S5 005	60	540	S4 005												



			Ah A (EN)	Ah A (EN)	Ah A (EN)	Ah A (EN)
			0 092 ...0	0 092 ...0	0 092 ...0	0 092 ...0

◀ VW

Diesel											
1.6 TDI [1T3]	05.10-05.15	BWD				63	610	S5 005	60	540	S4 005
		BWD,SSJ	70	760	S5 A08						
		SSJ	70	760	S5 A08						
TDI [5T1]	05.15-05.16		70	760	S5 A08	52	520	S5 001	60	540	S4 005
	05.16→	BWD,SSJ	70	760	S5 A08				70	760	S4 E08
1.9 TDI [1T1]	02.03-11.06		70	760	S5 A08	100	830	S5 013	74	680	S4 008
1.9/2.0 TDI [1T2]	11.06-05.10		70	760	S5 A08	100	830	S5 013	74	680	S4 008
2.0 TDI [1T1]	02.03-11.06		70	760	S5 A08	100	830	S5 013	74	680	S4 008
	11.05-11.06		70	760	S5 A08	77	780	S5 008	74	680	S4 008 70 640 S3 008
TDI [1T3]	05.10-05.15	BWD				77	780	S5 008	74	680	S4 008
		BWD,SSJ	70	760	S5 A08						
TDI [5T1]	01.13-05.15					63	610	S5 005	74	680	S4 008
		BWD,SSJ							70	760	S4 E08
TDI [5T1]	05.15-05.16					52	520	S5 001	60	540	S4 005
	05.15→	BWD,SSJ	70	760	S5 A08						
	05.16-07.18	BWD	70	760	S5 A08						
up!											
1.0 [121]	08.11-07.16								44	420	S4 000
		BWD,SSJ	60	680	S5 A05				60	640	S4 E05
[122]	05.16→								60	640	S4 E05
		BWD,SSJ	60	680	S5 A05				60	640	S4 E05
EcoFuel [121]	11.12-07.16								44	420	S4 000
		BWD,SSJ	60	680	S5 A05				60	640	S4 E05
EcoFuel [122]	05.16→								60	640	S4 E05
		BWD,SSJ	60	680	S5 A05						

WIESMANN

GT MF4 Coupé											
4.4/ 4.8	09.07→		95	850	S5 A13						
GT MF4 Coupé S											
4.0	09.08→		95	850	S5 A13						
GT MF5 Coupé											
4.4/ 5.0	09.08→		95	850	S5 A13						
MF3 Roadster											
2.8/ 3.0/ 3.2	09.95-12.14		70	760	S5 A08				70	760	S4 E08
MF4 Roadster											
4.4/ 4.8	09.09→		95	850	S5 A13						
MF4 Roadster S											
4.0	09.09→		95	850	S5 A13						
MF5 Roadster											
4.4/ 5.0	09.09→		95	850	S5 A13						

ZASTAVA (YUGO)

Florida											
1.1	07.89-12.08					63	610	S5 006	60	540	S4 006 56 480 S3 006
Yugo Koral											
1.1 iL	05.03-11.08								52	470	S4 002
10											
1.2	02.06-12.08								44	440	S4 001

ZAZ

Lanos											
1.4 i	01.07→					63	610	S5 006	60	540	S4 006
1.5 i	08.96→					63	610	S5 006	60	540	S4 006 56 480 S3 006

		?	Ah		A (EN)		S5A		Ah		A (EN)		S5		Ah		A (EN)		S4		Ah		A (EN)		S3		
			0 092 ...0	0 092 ...0	0 092 ...0	0 092 ...0	0 092 ...0	0 092 ...0	0 092 ...0	0 092 ...0	0 092 ...0	0 092 ...0	0 092 ...0	0 092 ...0	0 092 ...0	0 092 ...0	0 092 ...0	0 092 ...0	0 092 ...0	0 092 ...0	0 092 ...0	0 092 ...0	0 092 ...0	0 092 ...0	0 092 ...0	0 092 ...0	
1.6 16V	08.96→		63	610	S5 006	60	540	S4 006	56	480	S3 006																
Lanos Cargo																											
1.4/ 1.5 i	08.96→		63	610	S5 006	60	540	S4 006	56	480	S3 006																
Lanos Hatchback																											
1.4/ 1.5/ 1.6 i, 16V	08.96→		63	610	S5 006	60	540	S4 006	56	480	S3 006																
Sens																											
1.3 Si [TF698]	01.02→		63	610	S5 005	60	540	S4 006	56	480	S3 006																
Vida																											
1.4/ 1.5	01.12→					60	540	S4 025																			
Vida Hatchback																											
1.4/ 1.5	01.12→					60	540	S4 025																			
1102 Tawrija																											
1.1/ 1.3 i	06.90→		63	610	S5 006	60	540	S4 006	45	400	S3 003																
1.2	01.98→		63	610	S5 006	60	540	S4 006	56	480	S3 006																
1103 Slavuta																											
1.1/ 1.2 i	06.90-12.12		63	610	S5 006	60	540	S4 006	56	480	S3 006																



			Ah A (EN)	Ah A (EN)	Ah A (EN)	Ah A (EN)	Ah A (EN)
			0 092 ...0	0 092 ...0	0 092 ...0	0 092 ...0	0 092 ...0

AIXAM

D-Truck							
Diesel							
	01.12→				44	420	S4 000

ASIA (ASIA MOTORS)

Hi-Topic							
Diesel							
2.7 D	06.93-12.99				95	830	S4 029

CADILLAC

Escalade							
6.0 AWD	09.01-08.06				74	680	S4 009

CHEVROLET

Blazer							
4.3 4x4	09.95-08.01				74	680	S4 009

CITROEN

Berlingo														
Electric [B9]	09.12→			54	530	S5 002	52	470	S4 002					
Electric [M49; M59]	10.98-04.08			63	610	S5 005	60	540	S4 005					
1.1/ 1.4/ 1.6/ 1.8 i, i 16V [M49; M59]	07.96-04.08			63	610	S5 005	60	540	S4 005	56	480	S3 005		
1.2 THP [B9]	12.15-12.18			63	610	S5 005	60	540	S4 005					
		SSJ	70	760	S5 A08									
1.4 [M49; M59]	10.96-11.02			63	610	S5 005	60	540	S4 005	56	480	S3 005		
i [M59]	11.02-03.10			54	530	S5 002								
1.6 [B9]	05.08-11.11						60	540	S4 005	56	480	S3 005		
VTi [B9]	11.09-12.18			63	610	S5 005	60	540	S4 005					
16V [B9]	05.08-11.11			63	610	S5 005	60	540	S4 005	56	480	S3 005		
Diesel														
1.6 BlueHDi [B9]	12.14-12.18						52	470	S4 002					
							60	540	S4 005					
			70	760	S5 A08									
			70	760	S5 A08		52	470	S4 002					
		SSJ	70	760	S5 A08		60	540	S4 005					
Hdi [B9]	05.08-12.16			77	780	S5 008	74	680	S4 008	70	640	S3 008		
	10.09-11.11		70	760	S5 A08	77	780	S5 008	74	680	S4 008	70	640	S3 008
		BWD					70	760	S4 E08					
	03.10-12.16			63	610	S5 005	60	540	S4 005					
	07.10-12.16	SSJ	70	760	S5 A08									
Hdi [M59]	07.05-04.08		70	760	S5 A08	77	780	S5 008	74	680	S4 008			
	07.05-10.11		70	760	S5 A08	77	780	S5 008	74	680	S4 008	70	640	S3 008
1.8 D [M49]	07.96-11.02		70	760	S5 A08	77	780	S5 008	74	680	S4 008			
1.9 D [M49]	07.96-11.02		70	760	S5 A08	77	780	S5 008	74	680	S4 008			
	07.98-11.02		70	760	S5 A08	77	780	S5 008	74	680	S4 008	70	640	S3 008
D [M59]	11.02-04.08		70	760	S5 A08	77	780	S5 008	74	680	S4 008	70	640	S3 008
2.0 HDi [M49]	12.99-11.02		70	760	S5 A08	77	780	S5 008	74	680	S4 008	70	640	S3 008
HDi [M59]	11.02-04.08		70	760	S5 A08	77	780	S5 008	74	680	S4 008	70	640	S3 008
C 15														
Diesel														
1.8/ 1.9 D	07.86-12.05			63	610	S5 005	52	470	S4 002					



			Ah A (EN)	Ah A (EN)	Ah A (EN)	Ah A (EN)	Ah A (EN)
			0 092 ...0	0 092 ...0	0 092 ...0	0 092 ...0	0 092 ...0

Jumper

2.0 i [23]	02.94-02.02	70 760	S5 A08	77 780	S5 008	74 680	S4 008	70 640	S3 008
i [U5]	02.02-05.06	70 760	S5 A08	77 780	S5 008	60 540	S4 005	56 480	S3 005
Diesel									
1.9 D [23]	02.94-02.02	95 850	S5 A13	100 830	S5 013	95 800	S4 013	90 720	S3 013
	01.99-02.02	70 760	S5 A08	77 780	S5 008	74 680	S4 008	70 640	S3 008
1.9/ 2.5/ 2.8 D Turbo, TDi [23]	02.94-02.02	95 850	S5 A13	100 830	S5 013	95 800	S4 013	90 720	S3 013
2.0 BlueHDi [U9]	07.15→			110 920	S5 015	95 800	S4 013		
	SSJ	70 760	S5 A08						
		95 850	S5 A13						
		105 950	S5 A15						
HDi [U5]	02.02-05.06	70 760	S5 A08	77 780	S5 008	74 680	S4 008	70 640	S3 008
2.0/ 2.8 HDi [23]	09.00-02.02	95 850	S5 A13	100 830	S5 013	95 800	S4 013	90 720	S3 013
2.2 HDi [U9]	06.06-12.11			110 920	S5 015				
	06.11-12.16	95 850	S5 A13	110 920	S5 015	95 800	S4 013		
2.2/ 2.8 HDi [U5]	02.02-12.06	95 850	S5 A13	100 830	S5 013	95 800	S4 013		
2.5/ 2.8 D [23]	02.94-02.02	95 850	S5 A13	100 830	S5 013	95 800	S4 013	90 720	S3 013
3.0 HDi [U6]	03.11-12.16	105 950	S5 A15	110 920	S5 015				
HDi [U9]	06.06-12.16	105 950	S5 A15	110 920	S5 015				

Jumpy

1.6 i [U64]	10.95-01.07			63 610	S5 006	60 540	S4 006		
2.0 i [U64]	04.00-01.07			63 610	S5 005	60 540	S4 005		
16V [G9]	02.07-12.16	70 760	S5 A08	77 780	S5 008	60 540	S4 005		
Diesel									
1.6 BlueHDi [KO]	03.16→			77 780	S5 008	74 680	S4 008		
	BWD	70 760	S5 A08						
	SSJ					70 760	S4 E08		
		70 760	S5 A08			70 760	S4 E08		
HDi [G9]	02.07-12.16	70 760	S5 A08	77 780	S5 008	74 680	S4 008	70 640	S3 008
1.9 D, D Turbo [U64]	10.95-01.07			63 610	S5 005	60 540	S4 005		
2.0 BlueHDi [KO]	03.16→			77 780	S5 008	74 680	S4 008		
	BWD	70 760	S5 A08						
	SSJ					70 760	S4 E08		
		70 760	S5 A08			70 760	S4 E08		
HDi [G9]	02.07-01.17	70 760	S5 A08	77 780	S5 008	74 680	S4 008		
HDi [U64]	10.99-01.07			63 610	S5 005	60 540	S4 005		
	06.00-01.07			77 780	S5 008	74 680	S4 008		

Nemo

1.4 [A9]	02.08→			54 530	S5 002	52 470	S4 002		
Diesel									
1.3 HDi [A9]	08.10→	SSJ				60 640	S4 E05		
	09.15→					52 470	S4 002		
						60 540	S4 005		
		SSJ	60 680	S5 A05		60 640	S4 E05		
1.4 HDi [A9]	02.08-12.15			63 610	S5 005	60 540	S4 005		

SpaceTourer

Diesel									
1.6 BlueHDi [KO]	03.16→			77 780	S5 008	74 680	S4 008		
	SSJ	70 760	S5 A08			70 760	S4 E08		
2.0 BlueHDi [KO]	03.16→			77 780	S5 008	74 680	S4 008		
	SSJ	70 760	S5 A08			70 760	S4 E08		

DACIA

Dokker

1.2 [FE/FK]	07.12-11.18			54 530	S5 002	52 470	S4 002		
	SSJ	70 760	S5 A08						
[FE/KE]	05.15-12.18			54 530	S5 002	52 470	S4 002		
	SSJ	70 760	S5 A08						
1.6 [FE/FK]	07.12-11.18			54 530	S5 002	52 470	S4 002		
[FE/KE]	07.12-12.17			54 530	S5 002	52 470	S4 002		



			Ah A (EN)	Ah A (EN)	Ah A (EN)	Ah A (EN)	Ah A (EN)
--	--	--	-----------	-----------	-----------	-----------	-----------

◀ DACIA 0 092 ...0 0 092 ...0 0 092 ...0 0 092 ...0 0 092 ...0

1.6 16V [FE/KE]	05.15-12.18		54	530	S5 002	52	470	S4 002
		SSJ	70	760	S5 A08			
Diesel								
1.5 dCi [FE/FK]	07.12-12.18		63	610	S5 005	60	540	S4 005
		SSJ	70	760	S5 A08			
Logan Pick-Up								
1.6 [US]	01.07-12.15		54	530	S5 002	52	470	S4 002
Diesel								
1.5 dCi [US]	01.07-12.14		61	600	S5 004		53	500 S3 004

DAEWOO

Lublin Diesel								
2.4/ 2.5 D, TD	09.97→					60	540	S4 024

DAIHATSU

Extol								
1.3	07.00-11.04					45	330	S4 020
Hijet Pick-up								
1.0/ 1.3 , i, 16V	12.92→					40	330	S4 019
Diesel								
1.2/ 1.4 D	03.96→		63	610	S5 005	60	540	S4 005
						56	480	S3 005
Hijet Van								
1.0 i	03.95-05.98		63	610	S5 005	60	540	S4 005
						56	480	S3 006
1.0/ 1.3 , 16V	12.92→					40	330	S4 018
Diesel								
1.2/ 1.4 D	03.96→		63	610	S5 005	60	540	S4 005
						56	480	S3 005

FIAT

Doblo Cargo								
1.2/ 1.4/ 1.6 i.e., i.e. 8V, i.e. 16V [223]	07.00-08.16		54	530	S5 002	52	470	S4 002
1.4 [263]	02.10→		77	780	S5 008	74	680	S4 008
		SSJ				70	760	S4 E08
	10.11→		77	780	S5 008	74	680	S4 008
		SSJ	70	760	S5 A08	70	760	S4 E08
Natural Power [263]	06.10→					60	640	S4 E05
1.6 i.e. 16V Bipower [223]	01.03-09.05		54	530	S5 002	52	470	S4 002
	10.05-12.10		54	530	S5 002	52	470	S4 002
Diesel								
1.3 MultiJet [263]	02.10→		60	680	S5 A05			
			70	760	S5 A08	63	610	S5 005
		SSJ				44	420	S4 000
						60	640	S4 E05
						70	760	S4 E08
1.3/ 1.9 JTD, JTD 16V, Multijet [223]	10.01-08.16		63	610	S5 005			
1.6 MultiJet [263]	02.10→					60	640	S4 E05
			54	530	S5 002			
			54	530	S5 002	44	420	S4 000
		SSJ				60	640	S4 E05
	04.15→		60	680	S5 A05	63	610	S5 005
			70	760	S5 A08	63	610	S5 005
						44	420	S4 000
		SSJ				70	760	S4 E08
			70	760	S5 A08	70	760	S4 E08
1.9 D [223]	07.00-09.05		60	680	S5 A05	63	610	S5 005
						44	420	S4 000
2.0 MultiJet [263]	02.10→	SSJ	70	760	S5 A08			
						70	760	S4 E08



			Ah A (EN)	Ah A (EN)	Ah A (EN)	Ah A (EN)	Ah A (EN)
			0 092 ...0	0 092 ...0	0 092 ...0	0 092 ...0	0 092 ...0

Ducato													
Diesel													
2.8 D	04.99-05.05	95	850	S5 A13	100	830	S5 013	95	800	S4 013	90	720	S3 013
D Turbo, D Turbo Interc.	04.99-05.05	95	850	S5 A13	100	830	S5 013	95	800	S4 013			
Ducato Cargo													
Diesel													
2.8 D Turbo	04.99-05.05	95	850	S5 A13	100	830	S5 013	95	800	S4 013			
Ducato Maxi 17													
Diesel													
120 Multijet [250]	06.06-12.14	95	850	S5 A13	100	830	S5 013	95	800	S4 013			
130 Multijet [250]	06.06-12.14	95	850	S5 A13	100	830	S5 013	95	800	S4 013	90	720	S3 013
160 Multijet [250]	06.06-12.14	105	950	S5 A15	110	920	S5 015						
Ducato Maxi 20													
Diesel													
120 Multijet [250]	06.06-12.14	95	850	S5 A13	100	830	S5 013	95	800	S4 013			
130 Multijet [250]	06.06-12.14	95	850	S5 A13	100	830	S5 013	95	800	S4 013	90	720	S3 013
160 Multijet [250]	06.06-12.14	105	950	S5 A15	110	920	S5 015						
Ducato 10													
2.0 , i.e. [230]	03.94-04.02				63	610	S5 005	60	540	S4 005	56	480	S3 005
i.e. Bipower CNG 4x4 [230]	03.94-03.02	70	760	S5 A08	77	780	S5 008	74	680	S4 008	70	640	S3 008
Diesel													
1.9/ 2.0/ 2.5/ 2.8 D, JTD, JTD	03.94-04.02	95	850	S5 A13	100	830	S5 013	95	800	S4 013	90	720	S3 013
EGR, JTD EGR 4x4, JTD 4x4, TD, TD CAT, TD ECO, TD EGR, TD EGR 4x4, TD 4x4 [230]													
Ducato 11													
2.0 i.e. [244]	04.02-08.06	70	760	S5 A08	77	780	S5 008	74	680	S4 008			
i.e. 4x4 [244]	04.02-08.06	70	760	S5 A08	77	780	S5 008	74	680	S4 008	70	640	S3 008
Diesel													
2.0 JTD [244]	04.02-08.06	95	850	S5 A13	100	830	S5 013	95	800	S4 013			
2.3 JTD [244]	04.02-08.06	95	850	S5 A13	100	830	S5 013	95	800	S4 013			
	01.08-12.11				77	780	S5 008	74	680	S4 008			
JTD EGR [244]	04.02-08.06	95	850	S5 A13	100	830	S5 013	95	800	S4 013			
2.8 JTD [244]	04.02-08.06	95	850	S5 A13	100	830	S5 013	95	800	S4 013	88	680	T3 013
JTD EGR [244]	04.02-08.06	95	850	S5 A13	100	830	S5 013	95	800	S4 013	88	680	T3 013
JTD EGR 4x4, TD EGR 4x4 [244]	04.02-08.06	95	850	S5 A13	100	830	S5 013	95	800	S4 013			
JTD 4x4 [244]	04.02-08.06	95	850	S5 A13	100	830	S5 013	95	800	S4 013	90	720	S3 013
TD, TD EGR [244]	10.02-08.06	95	850	S5 A13	100	830	S5 013	95	800	S4 013	88	680	T3 013
100 Multijet [250]	06.06-12.14				110	920	S5 015						
110/ 120 Multijet [250]	06.06-12.14	95	850	S5 A13	100	830	S5 013	95	800	S4 013			
115 Multijet [250]	06.11-12.14	70	760	S5 A08	77	780	S5 008	74	680	S4 008			
130 Multijet [250]	06.06-12.14	95	850	S5 A13	100	830	S5 013	95	800	S4 013	90	720	S3 013
150 Multijet [250]	06.11-12.14	95	850	S5 A13	77	780	S5 008	74	680	S4 008			
		SSJ	70	760	S5 A08			70	760	S4 E08			
160/ 180 Multijet [250]	06.06-12.14	105	950	S5 A15	110	920	S5 015						
Ducato 14													
2.0 , i.e. [230]	03.94-03.02	70	760	S5 A08	77	780	S5 008	74	680	S4 008	70	640	S3 008
i.e. Bipower CNG 4x4 [230]	03.94-03.02							74	680	S4 009			
140 Natural power [290]	10.14→	70	760	S5 A08	77	780	S5 008	70	760	S4 E08			
		70	760	S5 A08	77	780	S5 008	74	680	S4 008			
Diesel													
1.9/ 2.0/ 2.5/ 2.8 D, JTD, JTD	03.94-03.02	95	850	S5 A13	100	830	S5 013	95	800	S4 013	90	720	S3 013
EGR, JTD EGR 4x4, JTD 4x4, TD, TD CAT, TD ECO, TD ECO 4x4, TD EGR, TD EGR 4x4, TD 4x4 [230]													
110 MultiJet [290]	05.14-11.16	95	850	S5 A13	100	830	S5 013	95	800	S4 013			
115 MultiJet [290]	05.14-06.16	70	760	S5 A08	77	780	S5 008	70	760	S4 E08			
		70	760	S5 A08	77	780	S5 008	74	680	S4 008			



					Ah	A (EN)	S5A	Ah	A (EN)	S5	Ah	A (EN)	S4	Ah	A (EN)	S3	Ah	A (EN)	T3
FIAT		0 092 ...0			0 092 ...0			0 092 ...0			0 092 ...0			0 092 ...0					
115 MultiJet [290]	07.16→				77	780	S5 008	74	680	S4 008									
130 MultiJet [290]	05.14-11.16	70	760	S5 A08	77	780	S5 008	70	760	S4 E08									
		70	760	S5 A08	77	780	S5 008	74	680	S4 008									
	06.16→	70	760	S5 A08	100	830	S5 013	70	760	S4 E08									
		95	850	S5 A13	77	780	S5 008	70	760	S4 E08									
		95	850	S5 A13	100	830	S5 013	70	760	S4 E08									
		95	850	S5 A13	100	830	S5 013	74	680	S4 008									
150 EcoJet [290]	06.15→				110	920	S5 015	95	800	S4 013									
		SSJ	105	950	S5 A15														
	MultiJet [290]	05.14-11.16	70	760	S5 A08	77	780	S5 008	74	680	S4 008								
SSJ									70	760	S4 E08								
	06.16→				110	920	S5 015	95	800	S4 013									
		SSJ	105	950	S5 A15														
180 MultiJet [290]	05.14-11.16				110	920	S5 015												
	06.16→				110	920	S5 015	95	800	S4 013									
		SSJ	105	950	S5 A15														
Ducato 15																			
2.0 i.e., i.e. Bipower CNG, i.e. Bipower CNG 4x4, i.e. Bipower LPG, i.e. Bipower LPG 4x4, i.e. 4x4 [244]	04.02-08.06	70	760	S5 A08	77	780	S5 008	74	680	S4 008									
Diesel																			
2.0 JTD [244]	04.02-08.06	95	850	S5 A13	100	830	S5 013	95	800	S4 013									
2.3 JTD [244]	04.02-08.06	95	850	S5 A13	100	830	S5 013	95	800	S4 013									
	01.08-12.11				77	780	S5 008	74	680	S4 008									
JTD EGR [244]	04.02-08.06	95	850	S5 A13	100	830	S5 013	95	800	S4 013									
	01.08-12.11				77	780	S5 008	74	680	S4 008									
2.8 JTD [244]	04.02-08.06	95	850	S5 A13	100	830	S5 013	95	800	S4 013							88	680	T3 013
JTD CGV [244]	04.04-08.06	95	850	S5 A13	100	830	S5 013	95	800	S4 013									
JTD EGR [244]	04.02-08.06	95	850	S5 A13	100	830	S5 013	95	800	S4 013							88	680	T3 013
JTD EGR 4x4, JTD 4x4, TD EGR 4x4, TD 4x4 [244]	04.02-08.06	95	850	S5 A13	100	830	S5 013	95	800	S4 013									
TD, TD EGR [244]	10.02-08.06	95	850	S5 A13	100	830	S5 013	95	800	S4 013							88	680	T3 013
100 Multijet [250]	06.06-12.14				110	920	S5 015												
120 Multijet [250]	06.06-12.14	95	850	S5 A13	100	830	S5 013	95	800	S4 013									
130 Multijet [250]	06.06-12.14	95	850	S5 A13	100	830	S5 013	95	800	S4 013	90	720	S3 013						
160 Multijet [250]	06.06-12.14	105	950	S5 A15	110	920	S5 015												
Ducato 17																			
140 Natural Power [250]	06.06-12.14	70	760	S5 A08	77	780	S5 008	74	680	S4 008									
Diesel																			
100 Multijet [250]	06.06-12.14				110	920	S5 015												
120 Multijet [250]	06.06-12.14	95	850	S5 A13	100	830	S5 013	95	800	S4 013									
130 Multijet [250]	06.06-12.14	95	850	S5 A13	100	830	S5 013	95	800	S4 013	90	720	S3 013						
150 Multijet [250]	04.10-12.14	105	950	S5 A15	110	920	S5 015	95	800	S4 013									
160 Multijet [250]	06.06-12.14	105	950	S5 A15	110	920	S5 015												
Ducato 18																			
2.0 i.e. Bipower CNG [230]	03.94-03.02	70	760	S5 A08	77	780	S5 008	74	680	S4 008	70	640	S3 008						
i.e., i.e. Bipower CNG, i.e. Bipower CNG 4x4, i.e. Bipower LPG, i.e. Bipower LPG 4x4, i.e. 4x4 [244]	04.02-08.06	70	760	S5 A08	77	780	S5 008	74	680	S4 008									
Diesel																			
2.3 JTD [244]	04.02-08.06	95	850	S5 A13	100	830	S5 013	95	800	S4 013									
	01.08-12.11				77	780	S5 008	74	680	S4 008									
JTD EGR [244]	01.08-12.11				77	780	S5 008	74	680	S4 008									
2.5/2.8 D, D 4x4, JTD EGR 4x4, JTD 4x4, TD, TD ECO, TD EGR, TD EGR 4x4, TD 4x4 [230]	03.94-03.02	95	850	S5 A13	100	830	S5 013	95	800	S4 013	90	720	S3 013						
2.8 JTD [244]	04.02-08.06	95	850	S5 A13	100	830	S5 013	95	800	S4 013	90	720	S3 013	88	680	T3 013			
JTD CGV [244]	04.04-08.06	95	850	S5 A13	100	830	S5 013	95	800	S4 013				88	680	T3 013			
JTD EGR [244]	04.02-08.06	95	850	S5 A13	100	830	S5 013	95	800	S4 013				88	680	T3 013			

				Ah A (EN)	Ah A (EN)	Ah A (EN)	Ah A (EN)	Ah A (EN)		
				0 092 ...0	0 092 ...0	0 092 ...0	0 092 ...0	0 092 ...0		
2.8 JTD EGR 4x4, JTD 4x4 [244]	04.02-08.06	95	850	S5 A13	100	830	S5 013	95	800	S4 013
JTD, JTD EGR [230]	08.00-03.02	95	850	S5 A13	100	830	S5 013	95	800	S4 013
TD [244]	10.02-08.06	95	850	S5 A13	100	830	S5 013	95	800	S4 013
TD 4x4 [244]	10.02-08.06	95	850	S5 A13	100	830	S5 013	95	800	S4 013
								90	720	S3 013
Ducato 20										
140 Natural Power [250]	09.09-12.14	70	760	S5 A08	77	780	S5 008	74	680	S4 008
Diesel										
150 Multijet [250]	09.10-12.14				110	920	S5 015			
160 Multijet [250]	09.10-12.14	105	950	S5 A15	110	920	S5 015			
Fiorino										
1.3 [146]	09.93-12.01				63	610	S5 005	52	470	S4 002
1.4 [225]	12.07-12.16				54	530	S5 002	52	470	S4 002
	06.10-12.16				54	530	S5 002	52	470	S4 002
i.e. [146]	06.95-12.01				63	610	S5 005	52	470	S4 002
Natural Power [225]	10.09→				63	610	S5 005			
1.6 i.e. [146]	06.95-12.01	70	760	S5 A08	77	780	S5 008	74	680	S4 008
Diesel										
1.3 Multijet [225]	12.07→				63	610	S5 005			
	06.10→				54	530	S5 002	52	470	S4 002
	09.10→				63	610	S5 005	44	420	S4 000
	SSJ	60	680	S5 A05				60	640	S4 E05
	03.15→				63	610	S5 005	52	470	S4 002
					63	610	S5 005	60	640	S4 E05
		60	680	S5 A05	63	610	S5 005	44	420	S4 000
	SSJ							60	640	S4 E05
1.7 D, TDS [146]	09.93-12.01	70	760	S5 A08	77	780	S5 008	74	680	S4 008
Fullback										
Diesel										
2.4 4WD	05.16→				85	800	S5 010			
	SSJ	80	800	S5 A11				80	800	S4 E11
Qubo										
1.4 [300]	09.08-12.16				54	530	S5 002	52	470	S4 002
Natural Power [300]	10.09→				54	530	S5 002	52	470	S4 002
Diesel										
1.3 Multijet [300]	09.08→				54	530	S5 002	52	470	S4 002
	SSJ	60	680	S5 A05				60	640	S4 E05
	06.10→				54	530	S5 002	52	470	S4 002
	SSJ							60	640	S4 E05
	03.15→	60	680	S5 A05						
Scudo										
Diesel										
1.6 MultiJet [270]	01.07-04.16	70	760	S5 A08	77	780	S5 008	74	680	S4 008
	03.12-04.16				77	780	S5 008	74	680	S4 008
2.0 Multijet [270]	01.07-04.16	70	760	S5 A08	77	780	S5 008	74	680	S4 008
MultiJet [270]	01.07-04.16				77	780	S5 008	74	680	S4 008
		70	760	S5 A08	77	780	S5 008	74	680	S4 008
Scudo 04										
2.0 16V [220]	06.04-01.07				63	610	S5 005			
Diesel										
1.9/2.0 D, 16V JTD [220]	06.04-01.07	70	760	S5 A08	77	780	S5 008	74	680	S4 008
2.0 8V JTD [220]	06.04-01.07	70	760	S5 A08	77	780	S5 008	74	680	S4 008
Scudo 95										
1.6/2.0 i, 16V [220]	10.95-05.04				63	610	S5 005	60	540	S4 005
Diesel										
1.9 D [220]	10.95-08.01	70	760	S5 A08	77	780	S5 008	74	680	S4 008
	09.01-05.04	70	760	S5 A08	77	780	S5 008	74	680	S4 008
1.9/2.0 TD, 8V JTD, 16V JTD [220]	10.95-05.04	70	760	S5 A08	77	780	S5 008	74	680	S4 008
Strada										
1.2 MPI 8V [278]	03.99-06.05				63	610	S5 005	52	470	S4 002
Diesel										
1.3 JTD [278]	07.05-12.11				63	610	S5 005			



			Ah A (EN)	Ah A (EN)	Ah A (EN)	Ah A (EN)	Ah A (EN)
◀ FIAT			0 092 ...0	0 092 ...0	0 092 ...0	0 092 ...0	0 092 ...0
1.3 MultiJet [278]	12.11-12.14		54 530 S5 002	52 470 S4 002			
1.7 TDS [278]	03.99-03.03		63 610 S5 005	60 540 S4 005			
1.9 D [278]	11.00-06.05		63 610 S5 005	60 540 S4 005			
JTD [278]	04.03-06.05		63 610 S5 005	60 540 S4 005			

Talento 16							
Diesel							
1.6 [296]	06.16→		77 780 S5 008	74 680 S4 008			
			70 760 S5 A08	77 780 S5 008	74 680 S4 008		
		SSJ			70 760 S4 E08		
			70 760 S5 A08		70 760 S4 E08		
Twin Turbo [296]	06.16→		77 780 S5 008	74 680 S4 008			
		SSJ	70 760 S5 A08		70 760 S4 E08		

FORD

A							
0407/ 0510 , V6	01.86-12.99		61 600 S5 004	44 440 S4 001	41 360 S3 001		
Diesel							
0407	01.86-12.99		61 600 S5 004	44 440 S4 001	41 360 S3 001		
Econovan							
1.4	08.85-12.99			60 540 S4 024			
Diesel							
2.0 D	02.86-12.99			60 540 S4 024			
Explorer							
4.0 V6 SOHC 4x4	08.96-09.00			74 680 S4 009			
4x4	09.96-08.00		74 750 S5 007	72 680 S4 007	70 640 S3 007		
Ranger							
2.5 [12]	09.11→		74 750 S5 007	70 650 S4 E07			
			74 750 S5 007	72 680 S4 007			
4x4 [12]	09.11→		74 750 S5 007	72 680 S4 007			
Diesel							
2.2 TDCi [12]	09.11→		74 750 S5 007	72 680 S4 007			
			74 750 S5 007	72 680 S4 007	70 640 S3 007		
	09.15→			72 680 S4 007			
		BWD,SSJ 80 800 S5 A11					
TDCi 4x4 [12]	09.11→		74 750 S5 007	72 680 S4 007			
	09.15→			72 680 S4 007			
		BWD,SSJ 80 800 S5 A11					
2.5/ 3.0 D, D 4x4, TD, TD 4x4, TDCi, TDCi 4x4 [06; 99]	01.99-12.11			95 830 S4 029			
3.2 TDCi 4x4	07.12→		74 750 S5 007	80 740 S4 010			
TDCi 4x4 [12]	09.11→		74 750 S5 007	80 740 S4 010			
Tourneo Custom FT 300							
Diesel							
2.2 TDCi [13]	09.12-12.17		74 750 S5 007	72 680 S4 007	70 640 S3 007		
		SSJ		70 650 S4 E07			
Tourneo Custom FT 310							
Diesel							
2.0 TDCi [13]	05.16→			72 680 S4 007			
		BWD,SSJ 80 800 S5 A11					
Transit							
Euroline/ FT 080/ FT 100/ FT 120/ FT 150/ FT 190/ Nugget 2.0i [95]	08.94-07.00		74 750 S5 007	60 540 S4 004	53 500 S3 004		
FT 260 K/S/ FT 280 K/S/ FT 280 L/ FT 280 M/ FT 300 K/S/ FT 300 L/ FT 300 M/ FT 330 K/S 2.3i [00]	08.00-07.06		74 750 S5 007	60 540 S4 004	53 500 S3 004		
FT 300/ FT 330/ FT 350 2.3i [06]	04.06-09.11		61 600 S5 004	60 540 S4 004	53 500 S3 004		



			Ah A (EN)	Ah A (EN)	Ah A (EN)	Ah A (EN)	Ah A (EN)
			0 092 ...0	0 092 ...0	0 092 ...0	0 092 ...0	0 092 ...0

FT 330/ FT 350 2.3 CNG, 2.3 LPG, 2.3i CNG, 2.3i LPG [06]	04.06-09.11							53	500	S3 004	
FT 330 L 2.3i [00]	12.00-07.06	74	750	S5 007	60	540	S4 004	53	500	S3 004	
	08.01-07.06	61	600	S5 004	60	540	S4 004	53	500	S3 004	
FT 330 M 2.3i [00]	12.00-07.06	74	750	S5 007	60	540	S4 004	53	500	S3 004	
	08.01-07.06	61	600	S5 004	60	540	S4 004	53	500	S3 004	
FT 350 EL 2.3i [00]	12.00-07.06	74	750	S5 007	60	540	S4 004	53	500	S3 004	
	08.01-07.06	61	600	S5 004	60	540	S4 004	53	500	S3 004	
FT 350 L 2.3i [00]	12.00-07.06	74	750	S5 007	60	540	S4 004	53	500	S3 004	
	08.01-07.06	70	760	S5 A08	74	750	S5 007	60	540	S4 004	
FT 350 M 2.3i [00]	12.00-07.06	61	600	S5 004	60	540	S4 004	53	500	S3 004	
Diesel											
Euroline 2.2 TDCi [06]	04.06-09.11	74	750	S5 007	80	740	S4 010				
Euroline/ FT 080/ FT 100/ FT 120/ FT 150/ FT 190/ Nugget 2.5 D, 2.5 DI, 2.5 TD, 2.5 TDI [95]	08.94-08.00	74	750	S5 007	60	540	S4 004				
Euroline/ FT 240 K/S/ FT 260 K/S/ FT 280 K/S/ FT 280 L/ FT 280 M/ FT 280 S/ FT 300 K/S/ FT 300 L/ FT 300 M/ FT 300 S/ FT 310 S/ FT 330 K/S/ FT 330 L/ FT 330 M/ FT 330 S/ FT 350 E/ FT 350 EL/ FT 350 L/ FT 350 M/ FT 430 E/ FT 430 EL/ FT 430 M/ Nugget 2.0 TDE, 2.4 TD, 2.4 TDCi, 2.4 TDE, 2.4 TDI [00]	01.00-07.06	74	750	S5 007	80	740	S4 010				
Euroline/ FT 260 K/S/ FT 300 S 2.0 TDCi [00]	05.02-07.06	74	750	S5 007	80	740	S4 010				
FT 240 K/S/ FT 260 K/S/ FT 280 K/S/ FT 280 M/ FT 300 K/S/ FT 300 L/ FT 300 M 2.0 TD [00]	08.00-07.06	74	750	S5 007	80	740	S4 010				
FT 250 2.2 TDCi [12]	09.11-12.13	74	750	S5 007	80	740	S4 010				
FT 260 2.2 TDCi [06]	04.06-09.11	74	750	S5 007	80	740	S4 010				
	10.07-09.11	85	800	S5 010	80	740	S4 010	70	640	S3 007	
2.2 TDCi [12]	09.11-12.13	74	750	S5 007	80	740	S4 010				
		85	800	S5 010	80	740	S4 010	70	640	S3 007	
FT 280 2.2 TDCi [06]	04.06-09.11	74	750	S5 007	80	740	S4 010				
	10.07-09.11	85	800	S5 010	80	740	S4 010	70	640	S3 007	
2.2 TDCi [12]	09.11-12.13	74	750	S5 007	80	740	S4 010				
		85	800	S5 010	80	740	S4 010	70	640	S3 007	
FT 280 K/S/ FT 280 M/ FT 300 K/S/ FT 300 L/ FT 300 M/ FT 330 K/S/ FT 330 L/ FT 330 M/ FT 350 EL/ FT 350 L/ FT 350 M/ Nugget 2.0 TDCi [00]	05.02-07.06	74	750	S5 007	72	680	S4 007				
FT 290 2.0 TDCi [14]	06.16→				72	680	S4 007				
					95	800	S4 013				
		BWD,SSJ	80	800	S5 A11						
2.2 TDCi [14]	01.14-12.16		80	800	S5 A11	74	750	S5 007	72	680	S4 007
			80	800	S5 A11	85	800	S5 011	80	740	S4 011
			95	850	S5 A13	74	750	S5 007	72	680	S4 007
		SSJ						80	800	S4 E11	
2.2 TDCi HDT [14]	09.11-12.13		74	750	S5 007	72	680	S4 007			
FT 300 2.2 TDCi [06]	04.06-09.11	74	750	S5 007	80	740	S4 010				



		Ah A (EN) S5A			Ah A (EN) S5			Ah A (EN) S4			Ah A (EN) S3			Ah A (EN) T3		
◀ FORD		0 092 ...0			0 092 ...0			0 092 ...0			0 092 ...0			0 092 ...0		
FT 300 2.2 TDCi [12]	09.11-12.13				74	750	S5 007	80	740	S4 010						
		80	800	S5 A11	85	800	S5 010	80	740	S4 010						
		95	850	S5 A13	85	800	S5 010	80	740	S4 010						
		BWD,SSJ						70	650	S4 E10						
FT 300/ FT 330/ FT 350/ 2.4	07.06-09.11				74	750	S5 007	80	740	S4 010						
FT 430/ FT 460 TDCi, 2.4 TDCi																
4x4, 3.2 TDCi [06]																
FT 310 2.0 TDCi [14]	06.16→							72	680	S4 007						
								95	800	S4 013						
		BWD,SSJ			80	800	S5 A11									
2.2 TDCi [14]	01.14→	80	800	S5 A11	74	750	S5 007	72	680	S4 007						
		95	850	S5 A13												
		95	850	S5 A13	74	750	S5 007	72	680	S4 007						
FT 330 2.0 TDCi [14]	06.16→							72	680	S4 007						
								95	800	S4 013						
		BWD			80	800	S5 A11									
		BWD,SSJ			80	800	S5 A11									
2.2 TDCi [06]	04.06-09.11				74	750	S5 007	80	740	S4 010						
	10.07-09.11				85	800	S5 010	80	740	S4 010	70	640	S3 007			
2.2 TDCi [12]	09.11-12.13				74	750	S5 007	80	740	S4 010						
					85	800	S5 010	80	740	S4 010	70	640	S3 007			
		80	800	S5 A11	85	800	S5 010	80	740	S4 010						
		95	850	S5 A13	85	800	S5 010	80	740	S4 010						
		BWD,SSJ						70	650	S4 E10						
2.2 TDCi [14]	01.14-12.16	80	800	S5 A11	74	750	S5 007	72	680	S4 007						
		95	850	S5 A13												
		95	850	S5 A13	74	750	S5 007	72	680	S4 007						
	01.14→	80	800	S5 A11	85	800	S5 011	80	740	S4 011						
		SSJ						80	800	S4 E11						
FT 350 2.0 TDCi [14]	06.16→							72	680	S4 007						
								95	800	S4 013						
		BWD,SSJ			80	800	S5 A11									
2.2 TDCi [06]	04.06-09.11				74	750	S5 007	80	740	S4 010						
	10.07-09.11				85	800	S5 010	80	740	S4 010	70	640	S3 007			
2.2 TDCi [12]	09.11-12.13				74	750	S5 007	80	740	S4 010						
					85	800	S5 010	80	740	S4 010	70	640	S3 007			
		80	800	S5 A11	85	800	S5 010	80	740	S4 010						
		95	850	S5 A13	85	800	S5 010	80	740	S4 010						
		BWD,SSJ						70	650	S4 E10						
2.2 TDCi [14]	01.14→	80	800	S5 A11	74	750	S5 007	72	680	S4 007						
		80	800	S5 A11	85	800	S5 011	80	740	S4 011						
		95	850	S5 A13												
		95	850	S5 A13	74	750	S5 007	72	680	S4 007						
		SSJ						80	800	S4 E11						
FT 350/ FT 430 2.2 TDCi HDT [12]	09.11-12.13				74	750	S5 007	72	680	S4 007						
FT 370 2.2 TDCi [12]	09.11-12.13				74	750	S5 007	80	740	S4 010						
		80	800	S5 A11	85	800	S5 010	80	740	S4 010						
		95	850	S5 A13	85	800	S5 010	70	650	S4 E10						
		95	850	S5 A13	85	800	S5 010	80	740	S4 010						
2.2 TDCi [14]	01.14-12.16	80	800	S5 A11	74	750	S5 007	72	680	S4 007						
		95	850	S5 A13	74	750	S5 007	72	680	S4 007						
FT 410 2.2 TDCi [14]	01.14-12.16	80	800	S5 A11	74	750	S5 007	72	680	S4 007						
		95	850	S5 A13	74	750	S5 007	72	680	S4 007						
FT 430 2.2 TDCi [12]	09.11-12.13				74	750	S5 007	80	740	S4 010						
		80	800	S5 A11	85	800	S5 010	80	740	S4 010						
		95	850	S5 A13	85	800	S5 010	70	650	S4 E10						
		95	850	S5 A13	85	800	S5 010	80	740	S4 010						
2.2 TDCi [14]	01.14-12.16	80	800	S5 A11	74	750	S5 007	72	680	S4 007						
		95	850	S5 A13	74	750	S5 007	72	680	S4 007						
FT 440 2.2 TDCi [14]	01.14→	80	800	S5 A11	85	800	S5 011	80	740	S4 011						
		80	800	S5 A11	85	800	S5 011	80	800	S4 E11						



				Ah A (EN) S5A	Ah A (EN) S5	Ah A (EN) S4	Ah A (EN) S3	Ah A (EN) T3	
				0 092 ...0	0 092 ...0	0 092 ...0	0 092 ...0	0 092 ...0	
FT 460 2.2 TDCi [12]	09.11-12.13		80 800	S5 A11	85 800	S5 010	80 740	S4 010	
			95 850	S5 A13	85 800	S5 010	70 650	S4 E10	
			95 850	S5 A13	85 800	S5 010	80 740	S4 010	
2.2 TDCi [14]	01.14-12.16		80 800	S5 A11	74 750	S5 007	72 680	S4 007	
			95 850	S5 A13	74 750	S5 007	72 680	S4 007	
		01.14→	80 800	S5 A11	85 800	S5 011	80 740	S4 011	
		SSJ				80 800	S4 E11		
FT 470 2.0 TDCi [14]	06.16→						72 680	S4 007	
							95 800	S4 013	
		BWD	80 800	S5 A11					
		BWD,SSJ	80 800	S5 A11					
2.2 TDCi [14]	01.14-12.16		80 800	S5 A11	74 750	S5 007	72 680	S4 007	
			95 850	S5 A13	74 750	S5 007	72 680	S4 007	
		01.14→	80 800	S5 A11	85 800	S5 011	80 740	S4 011	
		SSJ				80 800	S4 E11		
Nugget 2.2 TDCi [06]	04.06-09.11				74 750	S5 007	80 740	S4 010	
2.2 TDCi [12]	09.11-12.13						70 650	S4 E10	
Transit Connect									
1.0 EcoBoost [13]	09.13→	BWD	80 800	S5 A11					
		BWD,SSJ					70 650	S4 E10	
1.6 EcoBoost [13]	09.13-12.17				74 750	S5 007	70 650	S4 E07	
					74 750	S5 007	72 680	S4 007	
1.8 i, LPG [02]	05.02-06.10				61 600	S5 004	60 540	S4 004 53 500 S3 004	
Diesel									
1.5 TDCi [13]	06.15→				74 750	S5 007	72 680	S4 007	
		BWD	80 800	S5 A11					
		BWD,SSJ					70 650	S4 E10	
1.6 TDCi [13]	09.13-12.17				74 750	S5 007	70 650	S4 E07	
					74 750	S5 007	72 680	S4 007	
1.8 TDCi [02]	05.02-12.13				85 800	S5 010	72 680	S4 007	
	08.06-12.13				74 750	S5 007	72 680	S4 007	
						74 750	S5 007	80 740	S4 010
TDDi [02]	05.02-06.10				74 750	S5 007	72 680	S4 007	
Transit Courier									
1.0 EcoBoost [14]	04.14→	BWD,SSJ					70 650	S4 E07	
Diesel									
1.5 TDCi [14]	04.14-12.17				74 750	S5 007	70 650	S4 E07	
	04.14→				74 750	S5 007	72 680	S4 007	
		BWD,SSJ						70 650	S4 E07
	06.15→	SSJ					70 650	S4 E10	
Transit Custom									
Diesel									
FT 250 2.2 TDCi [13]	09.12-04.16				74 750	S5 007	70 650	S4 E07 70 640 S3 007	
					74 750	S5 007	72 680	S4 007 70 640 S3 007	
FT 270 2.0 TDCi [13]	05.16→				74 750	S5 007	72 680	S4 007	
		BWD	80 800	S5 A11					
		BWD,SSJ						70 650	S4 E10
2.2 TDCi [13]	09.12-04.16	SSJ					70 650	S4 E07	
	09.12-12.17				74 750	S5 007	70 650	S4 E07 70 640 S3 007	
					74 750	S5 007	72 680	S4 007 70 640 S3 007	
FT 290 2.0 TDCi [13]	05.16→				74 750	S5 007	72 680	S4 007	
		BWD	80 800	S5 A11					
		BWD,SSJ						70 650	S4 E10
2.2 TDCi [13]	09.12-04.16				74 750	S5 007	70 650	S4 E07 70 640 S3 007	
					74 750	S5 007	72 680	S4 007 70 640 S3 007	
		SSJ						70 650	S4 E07
FT 300 2.0 TDCi [13]	01.18→				74 750	S5 007	72 680	S4 007	
		BWD	80 800	S5 A11				70 650	S4 E10
					74 750	S5 007	72 680	S4 007 70 640 S3 007	
		SSJ					70 650	S4 E07	
FT 310 2.0 TDCi [13]	05.16→				74 750	S5 007	72 680	S4 007	
		BWD	80 800	S5 A11					
		BWD,SSJ						70 650	S4 E10



			Ah A (EN)	Ah A (EN)	Ah A (EN)	Ah A (EN)	Ah A (EN)
--	--	--	-----------	-----------	-----------	-----------	-----------

◀ FORD 0 092 ...0 0 092 ...0 0 092 ...0 0 092 ...0 0 092 ...0

FT 310 2.2 TDCi [13]	09.12-12.17		74	750	S5 007	72	680	S4 007	70	640	S3 007
		SSJ				70	650	S4 E07			
FT 330 2.2 TDCi [13]	09.12-12.17		74	750	S5 007	70	650	S4 E07	70	640	S3 007
			74	750	S5 007	72	680	S4 007	70	640	S3 007
FT 340 2.0 TDCi [13]	05.16→		74	750	S5 007	72	680	S4 007			
		BWD	80	800	S5 A11						
		BWD,SSJ				70	650	S4 E10			
Transit Tourneo											
2.0 i [95]	08.94-07.00		74	750	S5 007	60	540	S4 004	53	500	S3 004
Diesel											
2.0/ 2.2 TDCi, TDE [00; 06]	08.00-09.11		74	750	S5 007	80	740	S4 010			
2.2 TDCi [12]	09.11-12.13		85	800	S5 010	80	740	S4 010			
2.5 D, DI, TD, TDI [95]	08.94-08.00		74	750	S5 007	60	540	S4 004			

GAZ









GAZelle											
2.3 i [2705,3221,3302]	11.97-03.13		63	610	S5 006	60	540	S4 006	56	480	S3 006
2.4 [2705,3221,3302]	07.05-03.13		61	600	S5 004	60	540	S4 004			
2.5 [2705,3221,3302]	09.97-03.13		63	610	S5 006	60	540	S4 006	56	480	S3 006
Diesel											
2.1 TD [2705,3221,3302]	07.10-03.13		61	600	S5 004	60	540	S4 004			
2.4 TD [2705,3221,3302]	08.93-03.13		63	610	S5 006	60	540	S4 006	56	480	S3 006
2.8 TD [2705,3221,3302]	08.10-03.13		61	600	S5 004	60	540	S4 004			
	08.10→		63	610	S5 006	60	540	S4 006	56	480	S3 006
	TD [3705,3221,3302]	08.10-03.13	61	600	S5 004	60	540	S4 004			
GAZelle Business											
2.9 , i [2705,3221,3302]	04.99→		63	610	S5 006	60	540	S4 006	56	480	S3 006
GAZelle Next											
2.9 [A2,A6]	04.13→		63	610	S5 006	60	540	S4 006	56	480	S3 006
Diesel											
2.8 TD [A2,A6]	04.13→		63	610	S5 006	60	540	S4 006	56	480	S3 006
GAZelle Next Citiline											
2.9 [A2,A6]	04.13→		63	610	S5 006	60	540	S4 006	56	480	S3 006
Diesel											
2.8 TD [A2,A6]	04.13→		63	610	S5 006	60	540	S4 006	56	480	S3 006
Sobol											
2.4 [2217,2310,2752]	01.94-04.13		61	600	S5 004	60	540	S4 004			
2.5 i 4x4 [2217,2310,2752]	01.08→		63	610	S5 006	60	540	S4 006			
Diesel											
2.1 TD [2217,2310,2752]	07.10→		61	600	S5 004	60	540	S4 004			
2.8 TD [2217,2310,2752]	08.10→		61	600	S5 004	60	540	S4 004			
			63	610	S5 006	60	540	S4 006			

HUMMER

H3											
3.5 4x4	09.05-08.06					60	540	S4 025			

HYUNDAI

Grace											
2.4 i Super	10.95→					60	540	S4 024			
						60	540	S4 025			
Diesel											
2.5 D	10.95→					70	630	S4 026			
H 100											
2.4 i	07.93-03.00					70	630	S4 026			
Diesel											
2.5 D	07.93-02.07					70	630	S4 026			

			Ah A (EN) 	Ah A (EN) 	Ah A (EN) 	Ah A (EN) 	Ah A (EN) 
			0 092 ...0	0 092 ...0	0 092 ...0	0 092 ...0	0 092 ...0

2.5 D Turbo	07.93-03.00			70	630	S4 026
	12.97-03.04			95	830	S4 029
	05.05→			95	830	S4 029
Intercooler, TCI	07.94-09.04			70	630	S4 026
H 350						
Diesel						
2.5 D Turbo	04.15→		110 920			S5 015
		SSJ	105 950			S5 A15
H-1						
2.4 , i	10.97-05.07			74	680	S4 009
Diesel						
2.5 CRDi, D	10.97-12.07			70	630	S4 026
TCi	10.99-12.07			95	830	S4 029
H-1 Cargo						
Diesel						
2.5 CRDi	03.08→			74	680	S4 009
	12.08→			95	830	S4 029
H-1 Travel						
2.4 i	10.08→			95	830	S4 029
Diesel						
2.5 CRDi	03.08→			95	830	S4 029
H100						
Diesel						
2.5/ 2.6 D, TDI	07.97→			70	630	S4 026
Porter						
Diesel						
2.6 D	09.00-12.03		63 610	S5 006	60 540	S4 006
Satellite						
Diesel						
2.5 D Turbo, D Turbo 4WD	10.97-08.02			70	630	S4 026
Starex						
2.4 i, i 4WD	10.97-05.07			74	680	S4 009
Diesel						
2.5 CRDi	10.02-01.07			70	630	S4 026
D, D Turbo, D Turbo 4WD	10.97-08.02			70	630	S4 026
TCi	10.02-12.07			74	680	S4 009

INFINITI

QX 56						
5.6 4x4 [Z62]	03.10-06.14			70	630	S4 026
				72	760	S4 E41

ISUZU

D-Max						
Diesel						
2.5 D Turbo	05.02-10.04			95	830	S4 028
	01.07→			70	630	S4 026
	04.12→			70	630	S4 027
D Turbo 4x4	05.02-10.04			95	830	S4 029
	01.07→			70	630	S4 026
	04.12→			70	630	S4 027
3.0 D Turbo	01.07→			95	830	S4 029
D Turbo 4x4	05.02→			95	830	S4 029
	01.07→			95	830	S4 028
Midi						
2.0 , 4WD	01.89-12.99			95	830	S4 029
Diesel						
2.0/ 2.2/ 2.4 D, D Turbo, D 4WD	01.89-12.99			95	830	S4 029



			Ah A (EN)	Ah A (EN)	Ah A (EN)	Ah A (EN)	Ah A (EN)
◀ ISUZU			0 092 ...0	0 092 ...0	0 092 ...0	0 092 ...0	0 092 ...0

N-Serie							
Diesel							
NKR/NPR/NQR 3.0 D Turbo,	03.96→			95	830	S4 029	
3.1 D, 4.8 D Turbo							
Pick-Up							
Diesel							
2.5 TD 4x4	11.98→			60	540	S4 025	
3.1 TD 4x4	05.97→			70	630	S4 027	
Rodeo							
Diesel							
3.0 4x4 D Turbo	05.02→			95	830	S4 029	
Rodeo D-Max							
Diesel							
3.0 D Turbo 4x4 I-TEQ	10.04→			95	830	S4 028	

IVECO

Daily																		
35 C 11 [00]	09.02-08.06			100	830	S5 013	95	800	S4 013		110	680	T3 035					
				100	830	S5 013	95	800	S4 013		110	680	T3 037					
35 C/ 35 S/ 40 C/ 50 C/ 65 C	04.07-12.11										110	680	T3 037					
14 [06; 09]																		
35 C/ 35 S/ 40 C/ 50 C/ 65 C/ 70 C	05.14-12.18			110	920	S5 015					110	680	T3 037					
14 CNG [14]																		
35 S 11 [00]	09.03-08.06			100	830	S5 013	95	800	S4 013		110	680	T3 035					
				100	830	S5 013	95	800	S4 013		110	680	T3 037					
50 C 11 [00]	09.02-08.06			100	830	S5 013	95	800	S4 013		110	680	T3 035					
				100	830	S5 013	95	800	S4 013		110	680	T3 037					
17 CNG [14]																		
50-140/ 70-140 [16]	09.16→			110	920	S5 015					110	680	T3 037					
65 C 11 [00]	09.02-08.06						95	800	S4 013		110	680	T3 035					
65-140 [16]	09.16→			110	920	S5 015												
		SSJ	105	950	S5 A15													
Diesel																		
A40/ A45/ A49 -10 Turbo, -12 Turbo	05.96-05.99			95	850	S5 A13	100	830	S5 013	95	800	S4 013	90	720	S3 013	88	680	T3 013
29 L 9 [00]	05.99-09.02										110	680	T3 035					
13 [00]	10.00-03.06										110	680	T3 035					
29 L/ 35 C 14 [00]	09.04-03.06										110	680	T3 035					
29 L/ 35 C/ 35 S 10 [00]	09.02-03.06										110	680	T3 035					
11 [00]	05.99-03.06										110	680	T3 035					
12 [00]	09.02-03.06										110	680	T3 035					
29 L/ 35 C/ 35 S/ 40 C/ 45 C/ 50 C/ 55 S/ 60 C/ 65 C/ 70 C	04.06-07.14										110	680	T3 037					
10, 11, 12, 13, 14, 15, 17, 18, 21 [06; 09; 12]																		
33 S/ 35 C/ 35 S/ 35-210/ 40 C/ 40-210/ 50 C/ 50-210/ 65 C/ 65-210/ 70C/ 70-210	05.14→			110	920	S5 015					110	680	T3 037					
, 11, 13, 15, 17, 21 [14; 16]																		
33-120 [16]	07.16→			110	920	S5 015												
		SSJ	105	950	S5 A15													
33-140 [16]	07.16→			110	920	S5 015												
		SSJ	105	950	S5 A15													
33-160 [16]	07.16→			110	920	S5 015												
		SSJ	105	950	S5 A15													
35 C 9 [00]	05.99-12.01										110	680	T3 035					
	08.01-09.04			100	830	S5 013	95	800	S4 013		110	680	T3 035					
35 C/ 35 S/ 40 C/ 50 C/ 65 C	05.00-03.06			100	830	S5 013	95	800	S4 013		110	680	T3 035					
15 [00]																		
	09.04-03.06										110	680	T3 035					
35 C/ 40 C/ 50 C 13 [00]	05.99-09.04			100	830	S5 013	95	800	S4 013		110	680	T3 035					

				Ah A (EN)	Ah A (EN)	Ah A (EN)	Ah A (EN)	Ah A (EN)
				0 092 ...0	0 092 ...0	0 092 ...0	0 092 ...0	0 092 ...0
35 S9 [00]	05.99-03.06							110 680 T3 035
13 [00]	05.99-03.06		95 850 S5 A13	100 830 S5 013	95 800 S4 013			110 680 T3 035
14 [00]	09.04-03.06							110 680 T3 035
				100 830 S5 013	95 800 S4 013			110 680 T3 035
35-120 [16]	07.16→			110 920 S5 015				
			105 950 S5 A15	110 920 S5 015				
		SSJ	105 950 S5 A15					
35-140 [16]	07.16→			110 920 S5 015				
			105 950 S5 A15	110 920 S5 015				
		SSJ	105 950 S5 A15					
35-150 [16]	07.16→			110 920 S5 015				
		SSJ	105 950 S5 A15					
35-160 [16]	07.16→			110 920 S5 015				
			105 950 S5 A15	110 920 S5 015				
		SSJ	105 950 S5 A15					
35-180 [16]	07.16→			110 920 S5 015				
		SSJ	105 950 S5 A15					
40 C/ 50 C/ 65 C 14 [00]	09.04-03.06							110 680 T3 035
50 C 11 [00]	05.99-09.04			100 830 S5 013	95 800 S4 013			110 680 T3 035
12 [00]	09.02-03.06			100 830 S5 013	95 800 S4 013			110 680 T3 035
				100 830 S5 013	95 800 S4 013			110 680 T3 037
50-180 [16]	07.16→			110 920 S5 015				
		SSJ	105 950 S5 A15					
55-180 [16]	07.16→			110 920 S5 015				
		SSJ	105 950 S5 A15					
60 C 17 [14]	05.14-12.18			110 920 S5 015				
65-150 [16]	07.16→			110 920 S5 015				
		SSJ	105 950 S5 A15					
70-150/ 70-180 [16]	07.16→		105 950 S5 A15	110 920 S5 015				
Daily, Grinta								
35/ 49/ 59 -11, -11 CNG	01.99-07.99				95 800 S4 013			110 680 T3 035
Diesel								
30/ 35/ 40/ 49 -8, -10 Turbo, -10 Turbo 4x4	05.96-05.99		95 850 S5 A13	100 830 S5 013	95 800 S4 013	90 720 S3 013	88 680 T3 013	
35/ 49/ 59 -12 Turbo	05.96-05.99		95 850 S5 A13	100 830 S5 013	95 800 S4 013	90 720 S3 013	88 680 T3 013	
42/ 45/ 54/ 66 -12 Turbo	05.99-12.00		95 850 S5 A13	100 830 S5 013	95 800 S4 013	90 720 S3 013		

JEEP

Cherokee								
2.5/ 4.0 , i 4x4 [XJ]	09.90-12.01				74 680 S4 009			
Diesel								
2.5 D Turbo [XJ]	10.95-12.01	VAD		74 750 S5 007	72 680 S4 007	70 640 S3 007		
Commander								
3.7/ 4.7/ 5.7 4x4 [XK]	09.05-08.10		70 760 S5 A08	77 780 S5 008	74 680 S4 008			

KIA

Besta								
Diesel								
2.2 D [TA]	03.90-07.00				95 830 S4 028			
K 2500								
Diesel								
2.5 Tci	09.01-12.06						125 1000 T3 042	
	11.06→				95 830 S4 028			
K 2700								
Diesel								
2.7 [SD]	04.98-08.04						125 1000 T3 042	
K 2900								
Diesel								
2.9 CRDi	05.07-12.16						125 1000 T3 042	



			Ah A (EN)	Ah A (EN)	Ah A (EN)	Ah A (EN)	Ah A (EN)
◀ KIA			0092 ...0	0092 ...0	0092 ...0	0092 ...0	0092 ...0

Pregio							
Diesel							
2.5 Tci [TB]	08.01-12.06					110 680	T3 035
						125 1000	T3 042
2.7 D [TB]	02.97-12.06					110 680	T3 035

LAND ROVER GROUP

Defender 130							
Diesel							
2.5 Td5	01.99-12.05					105 800	T3 050

LDV GROUP LIMITED

Convoy							
Diesel							
2.5	10.98-04.09			70 630			S4 027
				74 680			S4 009
Cub							
Diesel							
2.3 D	01.98-01.01			74 680			S4 009
Maxus							
Diesel							
2.5 CRD	01.05-06.11			95 800		90 720	S4 013 S3 013
	10.05-06.11			70 630			S4 027
Pilot							
Diesel							
1.9 D	06.01-10.05			70 630			S4 027

MAZDA

BT-50							
Diesel							
2.5/ 3.0 D Turbo, D Turbo 4x4	03.06→			95 830			S4 029
	[UN]						
MPV							
3.0	09.88-07.99			95 830			S4 029
Serie B							
2200/ 2600 , i 12V 4x4, 4x4	03.96-03.06			95 830			S4 029
	[UF; UN]						
Diesel							
2500/ 2500 Pickup D, D	03.96-10.07			95 830			S4 029
	Turbo, D Turbo 4x4, D 4x4, 12VD 4x4 [; UF; UN]						
Serie E							
2.0	02.03-12.06			60 540			S4 024
	i			60 540			S4 024
	03.97-12.01						
Diesel							
2.2 D, D 4WD	03.97-01.10			70 630			S4 026

MERCEDES-BENZ

Citan							
112 [415]	08.13→	SSJ	70 760				S5 A08
Diesel							
108/ 109/ 111 CDI [415]	07.12→	SSJ	70 760				S5 A08
Serie V							
200/ 230/ 280 [638]	04.96-09.03		95 850	100 830	95 800	90 720	S5 A13 S4 013 S3 013



			Ah A (EN)	Ah A (EN)	Ah A (EN)	Ah A (EN)	Ah A (EN)
			0 092 ...0	0 092 ...0	0 092 ...0	0 092 ...0	0 092 ...0

Diesel

200 CDI [447]	04.14→			77	780	S5 008	74	680	S4 008			
		SSJ	70 760 S5 A08									
			80 800 S5 A11									
			95 850 S5 A13									
200/ 220/ 230 CDI, TD [638]	04.96-09.03			95	850	S5 A13	100	830	S5 013	95	800 S4 013	90 720 S3 013
220 CDI [447]	04.14→			77	780	S5 008	74	680	S4 008			
		SSJ	70 760 S5 A08									
			80 800 S5 A11									
			95 850 S5 A13									
250 BlueTec [447]	04.14→			77	780	S5 008	74	680	S4 008			
		SSJ	70 760 S5 A08									
			80 800 S5 A11									
			95 850 S5 A13									

Sprinter

214/ 314/ 414, NGT [T1N]	02.95-05.06			100	830	S5 013	74	680	S4 008		88 680 T3 013
216/ 316 [NCV3]	09.08→			100	830	S5 013	95	800	S4 013	90	720 S3 013
224/ 324 [NCV3]	04.06→			100	830	S5 013	74	680	S4 008		
316 NGT [NCV3]	09.08→			100	830	S5 013	95	800	S4 013	90	720 S3 013
424/ 524 [NCV3]	04.06→			100	830	S5 013	74	680	S4 008		88 680 T3 013
516 [NCV3]	09.08→			77	780	S5 008	74	680	S4 008		
				77	780	S5 008	95	800	S4 013		
NGT [NCV3]	09.08→			77	780	S5 008	74	680	S4 008		
				77	780	S5 008	95	800	S4 013		

Diesel

208/ 210/ 212/ 308/ 408 D [T1N]	02.95-03.00			100	830	S5 013	74	680	S4 008		88 680 T3 013		
208/ 211/ 213/ 216/ 308/ 311/ 313 CDI [T1N]	04.00-05.06			100	830	S5 013	74	680	S4 008		88 680 T3 013		
209 CDI [NCV3]	04.06-12.09			100	830	S5 013	74	680	S4 008				
210 CDI [NCV3]	03.09→			77	780	S5 008	74	680	S4 008				
		SSJ	70 760 S5 A08										
211 CDI [NCV3]	04.06-09.11			100	830	S5 013	74	680	S4 008		88 680 T3 013		
	06.11→			77	780	S5 008	74	680	S4 008				
		SSJ	70 760 S5 A08										
213 CDI [NCV3]	04.06-09.11			77	780	S5 008	95	800	S4 013				
	04.06→			77	780	S5 008	74	680	S4 008				
		SSJ	70 760 S5 A08										
214 CDI [NCV3]	04.16→			77	780	S5 008	74	680	S4 008				
		SSJ	70 760 S5 A08										
215 CDI [NCV3]	04.06-12.11			100	830	S5 013	74	680	S4 008				
	06.11→			70	760	S5 A08	77	780	S5 008	74	680 S4 008		
		SSJ	70 760 S5 A08										
216 CDI [NCV3]	03.09→			77	780	S5 008	74	680	S4 008				
				77	780	S5 008	95	800	S4 013				
		SSJ	70 760 S5 A08										
			95 850 S5 A13										
218/ 318 CDI [NCV3]	04.06-03.09			95	850	S5 A13	100	830	S5 013				
219 CDI [NCV3]	03.09→			77	780	S5 008	74	680	S4 008				
				77	780	S5 008	95	800	S4 013				
		SSJ	70 760 S5 A08										
			95 850 S5 A13										
309 CDI [NCV3]	04.06-12.09			100	830	S5 013	74	680	S4 008				
310 CDI [NCV3]	03.09→			77	780	S5 008	74	680	S4 008				
		SSJ	70 760 S5 A08										
D	09.96-05.01			70	760	S5 A08	77	780	S5 008	74	680 S4 008	70 640 S3 008	88 680 T3 013
310/ 312/ 410/ 412 D [T1N]	02.95-03.00			95	850	S5 A13	100	830	S5 013	95	800 S4 013		
311 CDI [NCV3]	04.06-09.11			100	830	S5 013	74	680	S4 008				



			Ah	A (EN)	S5A	Ah	A (EN)	S5	Ah	A (EN)	S4	Ah	A (EN)	S3	Ah	A (EN)	T3
◀ MERCEDES-BENZ			0092 ...0			0092 ...0			0092 ...0			0092 ...0			0092 ...0		
311 CDI [NCV3]	06.11→					77	780	S5 008									
						100	830	S5 013									
		SSJ	70	760	S5 A08												
			95	850	S5 A13												
		SSJ									74	680	S4 008				
311/411 CDI [909]	11.13→	SSJ	95	850	S5 A13												
313 CDI	06.01-05.12					100	830	S5 013	74	680	S4 008						
CDI [NCV3]	04.06-09.11					77	780	S5 008	95	800	S4 013						
		SSJ	95	850	S5 A13												
	04.06→					77	780	S5 008	74	680	S4 008						
	03.09→	SSJ	70	760	S5 A08												
CDI 4x4 [T1N]	08.02-05.06					100	830	S5 013	74	680	S4 008				88	680	T3 013
314 CDI [NCV3]	05.16→					77	780	S5 008	74	680	S4 008						
		SSJ	70	760	S5 A08												
315 CDI [NCV3]	04.06-09.11					100	830	S5 013	74	680	S4 008						
	06.11→					77	780	S5 008	74	680	S4 008						
						77	780	S5 008	95	800	S4 013						
316 CDI [NCV3]	03.09→					77	780	S5 008	95	800	S4 013						
		SSJ	95	850	S5 A13												
		SSJ									74	680	S4 008				
CDI [T1N]	04.00-05.06					100	830	S5 013	74	680	S4 008				88	680	T3 013
	10.04-05.06					100	830	S5 013	74	680	S4 008						
319 CDI [NCV3]	03.09→					77	780	S5 008	95	800	S4 013						
		SSJ	70	760	S5 A08												
			95	850	S5 A13												
		SSJ									74	680	S4 008				
408/411/413/416/616 CDI [T1N]	04.00-05.06					100	830	S5 013	74	680	S4 008				88	680	T3 013
411 CDI [NCV3]	04.06-09.11		95	850	S5 A13	100	830	S5 013	95	800	S4 013						
412 D	10.99-05.01		95	850	S5 A13	100	830	S5 013	95	800	S4 013						
413 CDI [NCV3]	03.09→					77	780	S5 008	74	680	S4 008						
		SSJ	70	760	S5 A08												
414 CDI [NCV3]	05.16→					77	780	S5 008									
						100	830	S5 013									
		SSJ	70	760	S5 A08												
			95	850	S5 A13												
		SSJ									74	680	S4 008				
415 CDI [NCV3]	04.06-09.11					100	830	S5 013	74	680	S4 008						
416 CDI [NCV3]	03.09→					77	780	S5 008	95	800	S4 013						
		SSJ	95	850	S5 A13												
		SSJ									74	680	S4 008				
418/518 CDI [NCV3]	04.06-03.09		95	850	S5 A13	100	830	S5 013							88	680	T3 013
419 CDI [NCV3]	03.09→					77	780	S5 008	74	680	S4 008						
						77	780	S5 008	95	800	S4 013						
509 CDI [NCV3]	04.06-12.09					100	830	S5 013	74	680	S4 008				88	680	T3 013
510 CDI [NCV3]	03.09→					77	780	S5 008	74	680	S4 008						
		SSJ	70	760	S5 A08												
511 CDI [NCV3]	04.06-09.11		95	850	S5 A13	100	830	S5 013	95	800	S4 013						
	05.16→					77	780	S5 008									
						100	830	S5 013									
		SSJ	70	760	S5 A08												
			95	850	S5 A13												
		SSJ									74	680	S4 008				
513 CDI [NCV3]	03.09→					77	780	S5 008	74	680	S4 008						
		SSJ	70	760	S5 A08												
514 CDI [NCV3]	05.16→					77	780	S5 008									
						100	830	S5 013									
		SSJ	70	760	S5 A08												
			95	850	S5 A13												
		SSJ									74	680	S4 008				
515 CDI [NCV3]	04.06-09.11					100	830	S5 013	74	680	S4 008				88	680	T3 013
	06.11→					77	780	S5 008	74	680	S4 008						
						77	780	S5 008	95	800	S4 013						



			Ah A (EN) S5A			Ah A (EN) S5			Ah A (EN) S4			Ah A (EN) S3			Ah A (EN) T3		
			0 092 ...0	0 092 ...0	0 092 ...0	0 092 ...0	0 092 ...0	0 092 ...0	0 092 ...0	0 092 ...0	0 092 ...0	0 092 ...0	0 092 ...0	0 092 ...0			
516 CDI [NCV3]	03.09→		77	780	S5 008	74	680	S4 008									
			77	780	S5 008	95	800	S4 013									
		SSJ	95	850	S5 A13												
519 CDI [NCV3]	03.09→		77	780	S5 008	95	800	S4 013									
		SSJ	95	850	S5 A13												
		SSJ				74	680	S4 008									
Sprinter (James Cook)																	
314 [T1N]	02.95-05.06		100	830	S5 013	74	680	S4 008						88	680	T3 013	
Diesel																	
308 D [T1N]	02.95-03.00		100	830	S5 013	74	680	S4 008						88	680	T3 013	
310/312 D [T1N]	02.95-03.00	95	850	S5 A13	100	830	S5 013	95	800	S4 013							
316 CDI [T1N]	04.01-05.06		100	830	S5 013	74	680	S4 008						88	680	T3 013	
Vaneo																	
1.6/1.9 [414]	02.02-08.05	70	760	S5 A08	77	780	S5 008	74	680	S4 008							
Diesel																	
1.7 CDI [414]	02.02-08.05	70	760	S5 A08	77	780	S5 008	74	680	S4 008							
Viano																	
3.2/3.7 [639]	09.03-12.07	70	760	S5 A08	100	830	S5 013	74	680	S4 008							
3.5 [639]	09.07-12.14	95	850	S5 A13	77	780	S5 008	95	800	S4 013							
		95	850	S5 A13	100	830	S5 013	95	800	S4 013							
Diesel																	
2.0 CDI [639]	09.03-08.10	95	850	S5 A13	100	830	S5 013	95	800	S4 013							
	07.10-12.14				77	780	S5 008	74	680	S4 008							
		SSJ	70	760	S5 A08												
2.2 CDI [639]	09.03-12.10	95	850	S5 A13	100	830	S5 013	95	800	S4 013							
	07.10-12.14				77	780	S5 008	74	680	S4 008							
		SSJ	70	760	S5 A08												
3.0 CDI [639]	04.06-08.10	95	850	S5 A13	100	830	S5 013	95	800	S4 013							
	07.10-12.14	80	800	S5 A11													
Vito																	
E-Cell [639]	07.10-12.14				100	830	S5 013	95	800	S4 013							
		SSJ	95	850	S5 A13												
113/114 [638]	11.95-09.03	70	760	S5 A08	77	780	S5 008	74	680	S4 008							
119/122/123 [639]	10.03-12.10	70	760	S5 A08	77	780	S5 008	74	680	S4 008							
126 [639]	09.07-12.14	70	760	S5 A08	77	780	S5 008	74	680	S4 008							
		70	760	S5 A08	77	780	S5 008	95	800	S4 013							
Diesel																	
108 CDI [638]	04.99-09.03	70	760	S5 A08													
108/110 D [638]	11.95-09.03	95	850	S5 A13	100	830	S5 013	95	800	S4 013	90	720	S3 013				
109 CDI [447]	09.14→				77	780	S5 008	74	680	S4 008							
		SSJ	70	760	S5 A08												
			95	850	S5 A13												
CDI [639]	10.03-10.06	70	760	S5 A08	77	780	S5 008	74	680	S4 008							
	11.06-07.10				77	780	S5 008	74	680	S4 008							
		SSJ	70	760	S5 A08												
			80	800	S5 A11												
110 CDI [639]	07.10-12.14				77	780	S5 008	74	680	S4 008							
		SSJ	70	760	S5 A08												
110/112 CDI [638]	04.99-09.03	95	850	S5 A13	100	830	S5 013	95	800	S4 013	90	720	S3 013				
111 CDI [447]	09.14→				77	780	S5 008	74	680	S4 008							
		SSJ	70	760	S5 A08												
			95	850	S5 A13												
CDI [639]	10.03-12.14	70	760	S5 A08	77	780	S5 008	74	680	S4 008							
	07.10-12.14	SSJ	70	760	S5 A08												
113 CDI [639]	07.10-12.14				77	780	S5 008	74	680	S4 008							
		SSJ	70	760	S5 A08												
114 CDI [447]	09.14→				77	780	S5 008	74	680	S4 008							
		SSJ	70	760	S5 A08												
			95	850	S5 A13												
115 CDI [639]	10.03-07.10	70	760	S5 A08	77	780	S5 008	74	680	S4 008							
116 CDI [447]	09.14→				77	780	S5 008	74	680	S4 008							
		SSJ	70	760	S5 A08												
			95	850	S5 A13												



			Ah	A (EN)	S5A	Ah	A (EN)	S5	Ah	A (EN)	S4	Ah	A (EN)	S3	Ah	A (EN)	T3
			0 092 ...0			0 092 ...0			0 092 ...0			0 092 ...0			0 092 ...0		
◀ MERCEDES-BENZ																	
116 CDI [639]	07.10-12.14					77	780	S5 008	74	680	S4 008						
		SSJ	70	760	S5 A08												
119 CDI BlueTEC [447]	09.14→					77	780	S5 008	74	680	S4 008						
		SSJ	70	760	S5 A08												
			80	800	S5 A11												
			95	850	S5 A13												
120 CDI [639]	04.06-07.10		95	850	S5 A13	100	830	S5 013	95	800	S4 013						
122 CDI [639]	07.10-12.14		80	800	S5 A11												

MINI (BMW)

Cooper Clubvan																	
1.6 [R 55]	02.13-06.14	SSJ	70	760	S5 A08												
Diesel																	
1.6/ 2.0 D [R 55]	02.13-06.14	SSJ	70	760	S5 A08												
Cooper One Clubman																	
1.6 [R 55]	02.13-06.14	SSJ	70	760	S5 A08												

MITSUBISHI

Canter																	
Diesel																	
2.8 D [FE]	10.96-04.98	ZE													110	680	T3 036
Canter 35																	
Diesel																	
2.8 D Turbo Interc. [FE]	05.98-10.00	ZE													110	680	T3 036
Express L200																	
1.6 [MD]	01.86→					70	630	S4 027									
L 200																	
2.0/ 2.4 i 4WD, i 16V [K6/K7]	01.96-12.07					70	630	S4 027									
Diesel																	
2.4 DI-D 4WD [KL]	02.15→					70	630	S4 026									
						95	830	S4 028									
2.4/ 2.5 DI-D, DI-D 4WD [KA; KB; KK]	12.05→					95	830	S4 028									
2.5 D, D Turbo Interc. 2WD, D 2WD, D 4WD [K6/K7]	06.95-12.07					70	630	S4 027									
D Turbo Interc. 4WD [K6/K7]	01.96-12.07					95	830	S4 029									
D Turbo 4WD [K0-K3]	11.92-03.01					70	630	S4 027									
L 200 Forte																	
2.4 i 4WD [K7]	01.96→					70	630	S4 027									
Diesel																	
2.5 D Turbo Interc. 4WD [K7]	01.97→					70	630	S4 027									
L 300 Truck																	
2.0 i 16V [P]	06.94-04.00					60	540	S4 025									
Diesel																	
2.5 D Turbo [P]	06.94-12.01					95	830	S4 029									
L 300 Van																	
2.0 i 2WD [P]	06.94-12.01					60	540	S4 025									
Diesel																	
2.5 D Turbo 4WD, D 2WD [P]	11.86-12.01					95	830	S4 029									
L 300 Wagon																	
Diesel																	
2.5 D 2WD long [P]	11.86-12.00					60	540	S4 025									
L 400																	
2.0/ 2.4 i	12.94-03.01					60	540	S4 025									
Diesel																	
2.5 D Turbo 2WD, D Turbo 4WD	12.94-03.01					95	830	S4 029									



			Ah A (EN)	Ah A (EN)	Ah A (EN)	Ah A (EN)	Ah A (EN)
			0 092 ...0	0 092 ...0	0 092 ...0	0 092 ...0	0 092 ...0

MULTICAR

M26									
Diesel									
2.8/ 3.0, 4x4	01.03-09.10							88	680 T3 013

NISSAN

Cabstar									
Diesel									
2.5 D Turbo [F24]	11.11-08.16			77	780	S5 008			
Cabstar E									
Diesel									
2.3/ 2.7/ 3.0 D, D Turbo [TLO]	10.98-08.06						95	830	S4 028
Cabstar NT400									
Diesel									
3.0 DDTI [F24]	11.16→			77	780	S5 008			
Frontier									
Diesel									
2.5 TD 4x4 [D40]	02.12-12.16	70	760	S5 A08	77	780	S5 008	74	680 S4 008
Frontier LE									
Diesel									
2.5 TD [D40]	10.08-01.12	70	760	S5 A08	77	780	S5 008	74	680 S4 008
Frontier SE/XE									
Diesel									
2.5 TD [D40]	10.08-01.12	70	760	S5 A08	77	780	S5 008	74	680 S4 008
Interstar									
Diesel									
1.9/ 2.5/ 3.0 dCi 80, dCi 100, dCi 120, dCi 140 [X70]	07.02-06.10				100	830	S5 013	95	800 S4 013
2.2 dCi 90 [X70]	07.02-06.10	95	850	S5 A13	100	830	S5 013	95	800 S4 013
2.5 dCi 150 [X70]	09.06-06.10	95	850	S5 A13	100	830	S5 013	95	800 S4 013 90 720 S3 013
Kubistar									
Diesel									
1.1/ 1.6 i, i 8V, i 16V [X76]	07.03-03.09				52	520	S5 001	44	440 S4 001
Diesel									
1.5 D Turbo 60 [X76]	07.03-03.09	70	760	S5 A08	77	780	S5 008	74	680 S4 008
D Turbo 70, D Turbo 80 [X76]	07.03-03.09				77	780	S5 008	74	680 S4 008
L50									
Diesel									
4.0 D	02.93-12.04 ZE								88 680 T3 013
L60									
Diesel									
4.0 D	02.93-12.04 ZE								88 680 T3 013
M									
Diesel									
5.9 D	03.93-12.08								88 680 T3 013
Navara									
Diesel									
2.3 dCi 4x4 [D23M]	11.15→ SSJ	70	760	S5 A08				70	760 S4 E08
2.5 dCi [D40]	05.05-12.09	70	760	S5 A08	77	780	S5 008	74	680 S4 008 70 640 S3 008
	01.10-06.14	70	760	S5 A08	77	780	S5 008	74	680 S4 008
dCi 4x4 [D40]	05.05-12.09	70	760	S5 A08	77	780	S5 008	74	680 S4 008 70 640 S3 008
	01.10-06.14	70	760	S5 A08	77	780	S5 008	74	680 S4 008
3.0 dCi 4x4 [D40]	05.10-06.14							95	830 S4 028
Navara NP300									
Diesel									
2.3 dCi 4x4 [D23M]	11.15→ SSJ	70	760	S5 A08				70	760 S4 E08
NV200									
Diesel									
1.6 [M20; M20M]	08.09→				63	610	S5 005	60	540 S4 005



				Ah	A (EN)	S5A	Ah	A (EN)	S5	Ah	A (EN)	S4	Ah	A (EN)	S3	Ah	A (EN)	T3	
			0 092 ...0			0 092 ...0			0 092 ...0			0 092 ...0			0 092 ...0				
NISSAN																			
Diesel																			
1.5 dCi [M20; M20M]	08.09→		63	610	S5 005	60	540	S4 005											
NV300																			
Diesel																			
1.6 dCi [X82]	09.16→					70	630	S4 026											
		SSJ				70	760	S4 E08											
						80	800	S4 E11											
NV400																			
Diesel																			
2.3 dCi [X62]	07.14→		95	850	S5 A13														
	08.14→		95	850	S5 A13	100	830	S5 013											
dCi 100 FWD, dCi 125 FWD, dCi 125 RWD, dCi 150 FWD, dCi 150 RWD [X62]	09.11→		105	950	S5 A15	110	920	S5 015											
dCi 100 RWD [X62]	09.11→					110	920	S5 015											
		BWD	105	950	S5 A15														
dCi 110 [X62B]	12.15→					110	920	S5 015											
		BWD	105	950	S5 A15														
dCi 130 FWD, dCi 130 RWD [X62B]	09.16→	SSJ	95	850	S5 A13														
dCi 170 [X62B]	09.16→					100	830	S5 013											
		SSJ	95	850	S5 A13														
Pickup																			
2.4 i [D22]	02.98-01.08					60	540	S4 025											
i, i 4x4 [D21]	04.92-02.98					60	540	S4 025											
i 4WD [D22]	02.98-11.01					60	540	S4 025											
	11.01-01.08					60	540	S4 024											
3.3 i 4WD [D22]	10.99→					95	830	S4 029											
Diesel																			
2.5 D, D 4WD [D21]	08.87-02.98					95	830	S4 029											
dCi, dCi 4x4 [D22]	02.08-12.11	BWD				95	830	S4 029											
2.5/ 2.7/ 3.2 D, D Turbo, D Turbo 4WD, D 2WD, D 4WD [D22]	02.97-11.11					95	830	S4 029											
Primastar																			
2.0 i [X83]	02.03-11.11		85	800	S5 010	80	740	S4 010											
Diesel																			
1.9/ 2.5 dCi 80, dCi 100, dCi 135 [X83]	07.02-11.11		85	800	S5 010	80	740	S4 010											
2.0 dCi 90 [X83]	10.06→		70	760	S5 A08	85	800	S5 010	74	680	S4 008	70	640	S3 008					
dCi 115 [X83]	10.06→		70	760	S5 A08	85	800	S5 010	74	680	S4 008	70	640	S3 008					
			70	760	S5 A08	85	800	S5 010	80	740	S4 010	70	640	S3 008					
2.5 dCi 150 [X83]	10.06→		70	760	S5 A08	85	800	S5 010	74	680	S4 008	70	640	S3 008					
Titan																			
5.6 FFV 4x4 [A60]	10.03-04.08		77	780	S5 008	74	680	S4 008											
Trade																			
Diesel																			
2.0/ 2.3/ 2.8 D	03.87-12.00												66	510	T3 008				
3.0 D	04.93-12.98		77	780	S5 008	74	680	S4 008	70	640	S3 008								
			77	780	S5 008	95	830	S4 029	70	640	S3 008								
	02.94-12.98												66	510	T3 008				
D Turbo	06.96-12.98					95	830	S4 029					66	510	T3 008				
Vanette Cargo																			
1.6 i [C23M]	07.92-11.01					60	540	S4 025											
Diesel																			
2.3 D [C23M]	09.94-11.01					70	630	S4 027											



			Ah A (EN)	Ah A (EN)	Ah A (EN)	Ah A (EN)	Ah A (EN)
			0 092 ...0	0 092 ...0	0 092 ...0	0 092 ...0	0 092 ...0

OPEL

Arena													
Diesel													
1.9/ 2.5 D	03.98-08.01	70	760	S5 A08	77	780	S5 008	74	680	S4 008	70	640	S3 008
Campo Pick-Up													
Diesel													
2.5/ 3.1 DTI, TDS [TF1]	03.97-08.03										70	640	S3 007
Combo													
1.2 i	09.94-10.01				61	600	S5 004	44	440	S4 001	41	360	S3 001
1.4 i	09.94-10.01				61	600	S5 004	44	440	S4 001	41	360	S3 001
	08.08→				61	600	S5 004	44	440	S4 001	41	360	S3 001
i [D]	02.12→				61	600	S5 004				53	500	S3 004
					61	600	S5 004	60	540	S4 004	53	500	S3 004
		SSJ	60	680	S5 A05			70	650	S4 E07			
1.4/ 1.6 i, i Twinport [C]	10.01-01.11				61	600	S5 004	44	440	S4 001	41	360	S3 001
1.6 CNG [C]	04.05-05.06				52	520	S5 001	44	440	S4 001	41	360	S3 001
	06.06-01.11				61	600	S5 004	44	440	S4 001	41	360	S3 001
Diesel													
1.3 [D]	07.16→				74	750	S5 007	72	680	S4 007			
		SSJ	70	760	S5 A08								
CDTI [D]	02.12→				61	600	S5 004	60	640	S4 E05	53	500	S3 004
1.3/ 1.7 CDTI, D, DI, DTI [; C]	09.94-01.12				74	750	S5 007	60	540	S4 004	53	500	S3 004
1.6 CDTI [D]	02.12→				74	750	S5 007	72	680	S4 007			
		SSJ	60	680	S5 A05			70	650	S4 E07			
	10.15→	SSJ	70	760	S5 A08								
2.0 CDTI [D]	02.12→				74	750	S5 007	72	680	S4 007			
		SSJ	60	680	S5 A05			70	650	S4 E07			
Corsa													
1.4 i Utility [B]	08.00-12.02				61	600	S5 004	44	440	S4 001			
Movano													
Diesel													
1.9 DTI [A]	10.01-10.05				100	830	S5 013	95	800	S4 013	90	720	S3 013
1.9/ 2.5 D [A]	10.98-10.01				100	830	S5 013	95	800	S4 013	90	720	S3 013
2.2 DTI [A]	09.00-10.05				100	830	S5 013	95	800	S4 013	90	720	S3 013
	03.01-10.05	95	850	S5 A13	100	830	S5 013						
2.3 CDTI [B]	06.14→				100	830	S5 013	95	800	S4 013			
		SSJ	95	850	S5 A13								
	01.16→				100	830	S5 013						
					110	920	S5 015						
		SSJ	105	950	S5 A15								
	01.17→	BWD	95	850	S5 A13								
CDTI FWD [B]	04.10→				100	830	S5 013						
					100	830	S5 013	95	800	S4 013			
		SSJ	95	850	S5 A13								
	10.12→				100	830	S5 013	95	800	S4 013	90	720	S3 013
CDTI RWD [B]	04.10→				100	830	S5 013						
					100	830	S5 013	95	800	S4 013			
			95	850	S5 A13	100	830	S5 013					
		SSJ	95	850	S5 A13								
	10.12→		95	850	S5 A13	100	830	S5 013	95	800	S4 013		
2.5 DTI [A]	10.01-06.10				100	830	S5 013	95	800	S4 013	90	720	S3 013
2.8 DTI [A]	06.98-10.01				100	830	S5 013	95	800	S4 013	90	720	S3 013
	06.99-09.02	95	850	S5 A13	100	830	S5 013						
3.0 CDTI [A]	03.03-10.05				100	830	S5 013	95	800	S4 013	90	720	S3 013
Vivaro													
2.0 i 16V [A]	03.01-08.14	70	760	S5 A08	77	780	S5 008	74	680	S4 008			
Diesel													
1.6 CDTI [B]	10.14→		80	800	S5 A11	85	800	S5 011	80	740	S4 011		
		SSJ						80	800	S4 E11			



		Ah A (EN) S5A			Ah A (EN) S5			Ah A (EN) S4			Ah A (EN) S3			Ah A (EN) T3		
◀ OPEL		0 092 ...0			0 092 ...0			0 092 ...0			0 092 ...0			0 092 ...0		
1.6 CDTI [B]	04.15→	60	680	S5 A05	74	680	S4 008									
		60	680	S5 A05	80	740	S4 011									
		80	800	S5 A11	74	680	S4 008									
		SSJ			70	760	S4 E08									
CDTI BiTurbo [B]	04.15→	60	680	S5 A05	74	680	S4 008									
		60	680	S5 A05	80	740	S4 011									
		80	800	S5 A11	74	680	S4 008									
		SSJ			70	760	S4 E08	80	800	S4 E11						
1.9 CDTI [A]	03.01-08.06				85	800	S5 010	80	740	S4 010	88	740	S3 012			
DTI [A]	03.01-08.06				85	800	S5 010	80	740	S4 010	88	740	S3 012			
2.0 CDTI [A]	08.06-08.14	70	760	S5 A08	85	800	S5 010	74	680	S4 008	70	640	S3 008			
		12.10-08.14	60	680	S5 A05	77	780	S5 008	70	760	S4 E08					
		60	680	S5 A05	77	780	S5 008	74	680	S4 008						
2.5 CDTI [A]	09.02-08.06				85	800	S5 010	80	740	S4 010						
	08.06-08.14	95	850	S5 A13	100	830	S5 013	74	680	S4 008	70	640	S3 008			

PEUGEOT

Bipper																		
1.4 [A9]	02.08-12.18				54	530	S5 002	52	470	S4 002								
	04.10-12.18				54	530	S5 002	52	470	S4 002	45	400	S3 002					
Diesel																		
1.3 HDi [A9]	08.10-12.18	SSJ	60	680	S5 A05				60	640	S4 E05							
	09.15→			63	610	S5 005	60	540	S4 005									
1.4 HDi [A9]	02.08-12.18			63	610	S5 005	60	540	S4 005	56	480	S3 005						
Boxer																		
2.0 , i [U3; U5]	02.94-05.06			70	760	S5 A08	77	780	S5 008	74	680	S4 008	70	640	S3 008			
Diesel																		
1.9 D [U3]	02.94-02.02			70	760	S5 A08	77	780	S5 008	74	680	S4 008	70	640	S3 008			
	07.98-02.02			70	760	S5 A08	77	780	S5 008	74	680	S4 008	70	640	S3 008	88	680	T3 013
D Turbo [U3]	02.94-02.02			70	760	S5 A08	77	780	S5 008	74	680	S4 008	70	640	S3 008			
2.0 BlueHDi [U9]	07.15→				100	830	S5 013	95	800	S4 013								
			SSJ			105	950	S5 A15										
HDi [U3]	09.01-02.02			70	760	S5 A08	77	780	S5 008	74	680	S4 008	70	640	S3 008			
2.0/ 2.2 HDi [U5]	02.02-12.06			70	760	S5 A08	77	780	S5 008	74	680	S4 008	70	640	S3 008	88	680	T3 013
2.2 HDi [U9]	06.06-12.11				110	920	S5 015											
	06.11-12.15			77	780	S5 008	74	680	S4 008									
			SSJ			100	830	S5 013	74	680	S4 008							
2.5 D [U3]	02.94-02.02			95	850	S5 A13	100	830	S5 013	95	800	S4 013	70	640	S3 008			
	01.99-02.02				100	830	S5 013	95	800	S4 013	90	720	S3 013					
D Turbo [U3]	02.94-02.02			95	850	S5 A13	100	830	S5 013	95	800	S4 013	70	640	S3 008			
TDi [U3]	10.96-02.02			95	850	S5 A13	100	830	S5 013	95	800	S4 013	70	640	S3 008			
2.8 D [U3]	01.99-02.02			95	850	S5 A13	100	830	S5 013	95	800	S4 013						
	D Turbo [U3]	10.99-02.02			100	830	S5 013	95	800	S4 013	90	720	S3 013					
	D Turbo [U5]	02.02-05.06			100	830	S5 013	95	800	S4 013	90	720	S3 013	88	680	T3 013		
	HDi [U3]	09.00-02.02			100	830	S5 013	95	800	S4 013	90	720	S3 013					
	HDi [U5]	02.02-05.06	95	850	S5 A13	100	830	S5 013	95	800	S4 013	90	720	S3 013	88	680	T3 013	
	HDI	09.05-09.09			95	850	S5 A13	100	830	S5 013	95	800	S4 013					
3.0 HDi [U9]	06.06-12.15			95	850	S5 A13	100	830	S5 013	95	800	S4 013						
Expert																		
1.6/ 1.8/ 2.0 i, i 16V [U64]	09.95-01.07				63	610	S5 005	60	540	S4 005	56	480	S3 005					
2.0 16V [G9]	02.07-12.16	70	760	S5 A08	77	780	S5 008	74	680	S4 008	70	640	S3 008					
Diesel																		
1.6 BlueHDi [K0]	02.16→				77	780	S5 008	74	680	S4 008								
			SSJ			70	760	S5 A08	70	760	S4 E08							
HDi [G9]	02.07-12.16			70	760	S5 A08	77	780	S5 008	74	680	S4 008	70	640	S3 008			
1.9 D [U64]	09.95-05.00			70	760	S5 A08	63	610	S5 005	60	540	S4 005	56	480	S3 005			
	06.98-01.07			70	760	S5 A08	63	610	S5 005	60	540	S4 005						
D Turbo [U64]	09.95-05.00			70	760	S5 A08	63	610	S5 005	60	540	S4 005	56	480	S3 005			

			Ah A (EN)	Ah A (EN)	Ah A (EN)	Ah A (EN)	Ah A (EN)
			0 092 ...0	0 092 ...0	0 092 ...0	0 092 ...0	0 092 ...0

2.0 BlueHDi [K0]	03.16→			77	780	S5 008	74	680	S4 008					
		SSJ	70	760	S5 A08		70	760	S4 E08					
HDi [G9]	02.07-12.16		70	760	S5 A08	77	780	S5 008	74	680	S4 008	70	640	S3 008
	04.10-12.16								70	760	S4 E08			
		BWD	70	760	S5 A08									
HDi [U64]	10.99-01.07		70	760	S5 A08	77	780	S5 008	74	680	S4 008	70	640	S3 008

Partner														
Electric [B9]	09.12→					54	530	S5 002	52	470	S4 002	45	400	S3 002
Electrique [M4]	01.98-08.02					54	530	S5 002	52	470	S4 002			
1.1 i [M5]	09.02-10.05					63	610	S5 005	52	470	S4 002	45	400	S3 002
1.1/ 1.4/ 1.6/ 1.8 , i, i 16V [; M4]	07.96-12.03					63	610	S5 005	52	470	S4 002	45	400	S3 002
1.4 i [M5]	09.02-04.08					54	530	S5 002	52	470	S4 002			
						63	610	S5 005	52	470	S4 002	45	400	S3 002
1.6 i 16V [M5]	09.02-04.08					63	610	S5 005	52	470	S4 002	45	400	S3 002
VTi [B9]	09.09→					54	530	S5 002	52	470	S4 002			
	03.10→					63	610	S5 005	60	540	S4 005			
16V [B9]	05.08-02.12								60	540	S4 005			
						54	530	S5 002	52	470	S4 002			

Diesel														
1.6 BlueHDi [B9]	12.14→								60	540	S4 005			
		SSJ	70	760	S5 A08									
	03.15→		70	760	S5 A08				60	540	S4 005			
HDi [B9]	05.08-04.15					63	610	S5 005	60	540	S4 005			
	10.09-02.12	BWD	70	760	S5 A08									
	10.10-04.15	SSJ							70	760	S4 E08			
	06.11-03.15	BWD							70	760	S4 E08			
	03.12-03.15	SSJ	70	760	S5 A08									
1.6/ 2.0 HDi, HDi [; M4; M5]	12.99-10.11		70	760	S5 A08	77	780	S5 008	60	540	S4 005			
1.8/ 1.9 D [M4; M5]	07.96-03.07					63	610	S5 005	60	540	S4 005			
1.9 D	10.99-12.14					63	610	S5 005	60	540	S4 005			

Ranch														
1.4 i [M4]	07.97-08.02					54	530	S5 002	52	470	S4 002	45	400	S3 002
						63	610	S5 005	52	470	S4 002	45	400	S3 002

Diesel														
1.9 D [M4]	07.97-08.02					63	610	S5 005	60	540	S4 005			

Traveller													
Diesel													

1.6/ 2.0 BlueHDi [K0]	03.16→	SSJ	70	760	S5 A08				70	760	S4 E08			
------------------------------	--------	-----	----	-----	---------------	--	--	--	----	-----	---------------	--	--	--

205 Pickup														
Diesel														
1.8 D	05.85-09.98		70	760	S5 A08	77	780	S5 008	74	680	S4 008	70	640	S3 008

PIAGGIO

Porter														
1.0/ 1.3 , 4x4	10.94→											45	300	S3 016

Diesel														
1.2 D	01.95-12.00					63	610	S5 005	60	540	S4 005			
	01.11→					63	610	S5 005	60	540	S4 005			

1.4 D	10.99-12.11					63	610	S5 005	60	540	S4 005	56	480	S3 005
--------------	-------------	--	--	--	--	----	-----	---------------	----	-----	---------------	----	-----	---------------

Porter Maxxi														
1.3	01.11→											45	300	S3 016

Diesel														
1.2 D	01.11→		60	680	S5 A05	63	610	S5 005	60	540	S4 005	56	480	S3 005
			60	680	S5 A05	63	610	S5 005	60	640	S4 E05	56	480	S3 005

Quargo														
Diesel														
0.7 D	01.04→					54	530	S5 002	52	470	S4 002			



			Ah A (EN)	Ah A (EN)	Ah A (EN)	Ah A (EN)	Ah A (EN)
			0 092 ...0	0 092 ...0	0 092 ...0	0 092 ...0	0 092 ...0

PROTON

Arena Pickup							
1.5 i	01.01-01.07			60	540	S4 025	

RENAULT

B-Serie/Messenger								
Diesel								
B 80	06.96-06.99					88 680	T3 013	
B 110 4x4	06.96-06.99					155 900	T3 077	
B 110/B 120	06.96-06.01					155 900	T3 077	
Clio I								
1.2 i [X57]	06.90-02.98	54	530	S5 002	52	470	S4 002 45 400 S3 002	
Dokker								
1.6 [Fe/KE]	01.15→	54	530	S5 002	52	470	S4 002	
Express, Extra, Rapid								
1.2 i [F40]	05.95-11.98	52	520	S5 001	44	440	S4 001 41 360 S3 001	
Kangoo I								
1.0 i [FC./KC.]	09.98-12.07	63	610	S5 005	52	470	S4 002 45 400 S3 002	
i 16V [FC./KC.]	02.01-12.07	63	610	S5 005	52	470	S4 002	
1.2 GPL [FC./KC.]	10.97-12.07	63	610	S5 005	44	440	S4 001 41 360 S3 001	
i [FC./KC.]	10.97-12.07	63	610	S5 005	44	440	S4 001 41 360 S3 001	
	03.02-12.07	61	600	S5 004	44	440	S4 001 41 360 S3 001	
		63	610	S5 005	52	470	S4 002 45 400 S3 002	
i 16V [FC./KC.]	05.00-12.07	61	600	S5 004	44	440	S4 001 41 360 S3 001	
1.4 i [FC./KC.]	10.97-12.07	63	610	S5 005	44	440	S4 001 41 360 S3 001	
1.6 i [FC./KC.]	09.99-12.07	63	610	S5 005	52	470	S4 002 45 400 S3 002	
	09.01-12.07	63	610	S5 005	52	470	S4 002	
	06.05-12.06	54	530	S5 002	52	470	S4 002	
i 4x4 [FC./KC.]	06.00-12.07	63	610	S5 005	52	470	S4 002 45 400 S3 002	
		63	610	S5 005	52	470	S4 002 45 400 S3 002	
Diesel								
1.5 DCI [FC./KC.]	05.00-12.07	70	760	S5 A08	77	780	S5 008 60 540 S4 005 70 640 S3 008	
		70	760	S5 A08	77	780	S5 008 74 680 S4 008 70 640 S3 008	
	02.01-12.07	70	760	S5 A08	77	780	S5 008 72 680 S4 007 70 640 S3 007	
		70	760	S5 A08	77	780	S5 008 74 680 S4 008 70 640 S3 007	
	04.05-12.07	70	760	S5 A08	77	780	S5 008 74 680 S4 008	
1.9 D	01.99-10.08		63	610	S5 005	60	540	S4 005
D [FC./KC.]	10.97-12.07	70	760	S5 A08	77	780	S5 008 60 540 S4 005 70 640 S3 008	
		70	760	S5 A08	77	780	S5 008 74 680 S4 008 70 640 S3 007	
	01.98-12.07	70	760	S5 A08	77	780	S5 008 60 540 S4 005	
		70	760	S5 A08	77	780	S5 008 74 680 S4 008 70 640 S3 008	
		SSJ	70	760	S5 A08			
DCI [FC./KC.]	05.00-12.07	70	760	S5 A08	77	780	S5 008 60 540 S4 005 70 640 S3 008	
		70	760	S5 A08	77	780	S5 008 74 680 S4 008 70 640 S3 008	
DCI 4x4 [FC./KC.]	05.00-12.07	70	760	S5 A08	77	780	S5 008 60 540 S4 005 70 640 S3 008	
		70	760	S5 A08	77	780	S5 008 74 680 S4 008 70 640 S3 008	
DTI [FC./KC.]	09.98-12.07	70	760	S5 A08	77	780	S5 008 60 540 S4 005 70 640 S3 008	
		70	760	S5 A08	77	780	S5 008 74 680 S4 008 70 640 S3 008	
	02.00-12.07	70	760	S5 A08	77	780	S5 008 60 540 S4 005	
DTI 4x4 [FC./KC.]	05.00-12.07	70	760	S5 A08	77	780	S5 008 60 540 S4 005 70 640 S3 008	
		70	760	S5 A08	77	780	S5 008 74 680 S4 008 70 640 S3 008	
Kangoo II								
Z.E. [FW/KW]	11.11→					74 680	S4 008	
1.2 [FW/KW]	09.13-12.18		77	780	S5 008	74 680	S4 008	
		SSJ	70	760	S5 A08	70 760	S4 E08	
1.6 i, i 16V [FW/KW]	01.08-12.18		63	610	S5 005	52 470	S4 002 45 400 S3 002	
i 16V GPL [FW/KW]	01.08→		54	530	S5 002	52 470	S4 002	



			Ah A (EN)	Ah A (EN)	Ah A (EN)	Ah A (EN)	Ah A (EN)
			0 092 ...0	0 092 ...0	0 092 ...0	0 092 ...0	0 092 ...0

Diesel							
1.5 dCi [FW/KW]	01.08-12.18	70 760 S5 A08	77 780 S5 008	74 680 S4 008	70 640 S3 008		
		70 760 S5 A08	85 800 S5 011	74 680 S4 008	70 640 S3 008		
	01.08→		63 610 S5 005	60 540 S4 005			
		SSJ	70 760 S5 A08		70 760 S4 E08		
	03.11-12.18		77 780 S5 008	74 680 S4 008			
	03.11→	BWD			70 760 S4 E08		
		SSJ	70 760 S5 A08				
	02.16→		70 760 S5 A08	63 610 S5 005	60 540 S4 005		
			70 760 S5 A08	63 610 S5 005	70 760 S4 E08		
		BWD	70 760 S5 A08				
		SSJ			70 760 S4 E08		

Mascott Diesel							
90	01.99-06.04	95 850 S5 A13		95 800 S4 013		110 680 T3 035	
		95 850 S5 A13		95 800 S4 013		110 680 T3 037	
		95 850 S5 A13	100 830 S5 013	95 800 S4 013		110 680 T3 035	
110	01.99-06.04	95 850 S5 A13		95 800 S4 013		110 680 T3 035	
		95 850 S5 A13		95 800 S4 013		110 680 T3 037	
		95 850 S5 A13	100 830 S5 013	95 800 S4 013		110 680 T3 035	
.60	01.99-06.04	95 850 S5 A13	100 830 S5 013	95 800 S4 013		110 680 T3 035	
120	05.04-05.07					110 680 T3 035	
130	01.99-06.04	95 850 S5 A13	100 830 S5 013	95 800 S4 013		110 680 T3 035	
	06.07-12.10					110 680 T3 035	
140	01.01-06.04	95 850 S5 A13	100 830 S5 013	95 800 S4 013		110 680 T3 035	
150	10.01-06.04					110 680 T3 035	
	06.07-12.10					110 680 T3 035	
160	05.04-05.07					110 680 T3 035	

Master Diesel							
2.5 dCi 16V [ADCU]	10.04-02.12		100 830 S5 013	74 680 S4 008			

Master II Diesel							
1.9 dCi 80	05.00-10.06	95 850 S5 A13	100 830 S5 013	95 800 S4 013	90 720 S3 013		
	04.01-10.06	95 850 S5 A13	100 830 S5 013	95 800 S4 013			
dTi 80	01.00-09.03	95 850 S5 A13	100 830 S5 013	95 800 S4 013			
2.2 dCi 90	01.00-10.06	95 850 S5 A13	100 830 S5 013	95 800 S4 013			
	05.00-10.06	95 850 S5 A13	100 830 S5 013	95 800 S4 013	90 720 S3 013		
2.5 D	10.97-09.03	95 850 S5 A13	100 830 S5 013	95 800 S4 013			
	dCi 100	10.03-04.10	95 850 S5 A13	100 830 S5 013	95 800 S4 013	90 720 S3 013	
	dCi 110	10.03-10.06	95 850 S5 A13	100 830 S5 013	95 800 S4 013		
	dCi 120	05.00-01.10	95 850 S5 A13	100 830 S5 013	95 800 S4 013	90 720 S3 013	
	05.00-04.10	95 850 S5 A13	100 830 S5 013	95 800 S4 013			
2.5/3.0 dCi 120 FAP, dCi 150 FAP, dCi 160	10.05-10.10	95 850 S5 A13	100 830 S5 013	95 800 S4 013			
2.8 D	05.01-10.04		100 830 S5 013	74 680 S4 008			
	dTi 110	10.97-09.03	95 850 S5 A13	100 830 S5 013	95 800 S4 013	90 720 S3 013	
		01.98-09.03		100 830 S5 013	95 800 S4 013	90 720 S3 013	
	dTi 120	10.97-09.03	95 850 S5 A13	100 830 S5 013	95 800 S4 013		
		95 850 S5 A13	100 830 S5 013	95 800 S4 013	90 720 S3 013		
3.0 dCi 120	10.05-10.10	95 850 S5 A13	100 830 S5 013	95 800 S4 013			
	dCi 140	10.03-10.06	95 850 S5 A13	100 830 S5 013	95 800 S4 013	90 720 S3 013	

Master III Diesel							
2.3 dCi	02.10-12.15		100 830 S5 013	95 800 S4 013			
		SSJ		95 850 S4 E13			
			95 850 S5 A13				
	02.10→	95 850 S5 A13	100 830 S5 013	95 800 S4 013			



			Ah A (EN)	Ah A (EN)	Ah A (EN)	Ah A (EN)	Ah A (EN)
--	--	--	-----------	-----------	-----------	-----------	-----------

◀RENAULT 0 092 ...0 0 092 ...0 0 092 ...0 0 092 ...0 0 092 ...0

2.3 dCi 100 FWD, dCi 100 RWD, dCi 125 FWD, dCi 125 RWD, dCi 150 FWD, dCi 150 RWD	10.12→		95	850	S5 A13	100	830	S5 013	95	800	S4 013
dCi 110, dCi 165	05.14→	SSJ	95	850	S5 A13				95	850	S4 E13
dCi 135	05.14→	SSJ	95	850	S5 A13						
dCi 170	07.15→					110	920	S5 015	95	800	S4 013
		SSJ	95	850	S5 A13				95	850	S4 E13

Trafic Diesel

2.5 D 4x4	11.97-05.01					77	780	S5 008	74	680	S4 008	70	640	S3 008
------------------	-------------	--	--	--	--	----	-----	---------------	----	-----	---------------	----	-----	---------------

Trafic I

2.0/2.2	01.95-12.02					63	610	S5 005	60	540	S4 005	56	480	S3 005
----------------	-------------	--	--	--	--	----	-----	---------------	----	-----	---------------	----	-----	---------------

Diesel

1.9/2.1/2.5 D, D 4x4	07.86-11.03					77	780	S5 008	74	680	S4 008	70	640	S3 008
-----------------------------	-------------	--	--	--	--	----	-----	---------------	----	-----	---------------	----	-----	---------------

Trafic II

2.0 [EL/FL/JL]	06.01-12.14					85	800	S5 011	60	540	S4 004			
-----------------------	-------------	--	--	--	--	----	-----	---------------	----	-----	---------------	--	--	--

Diesel

1.9 dCi [EL/FL/JL]	05.01-12.06		70	760	S5 A08	85	800	S5 011	74	680	S4 008	70	640	S3 008
	01.06-12.14					85	800	S5 011	80	740	S4 011			

2.0 dCi [EL/FL/JL]	01.06-12.14					85	800	S5 010	80	740	S4 010	70	640	S3 008
---------------------------	-------------	--	--	--	--	----	-----	---------------	----	-----	---------------	----	-----	---------------

			70	760	S5 A08	85	800	S5 011	74	680	S4 008	70	640	S3 008
--	--	--	----	-----	---------------	----	-----	---------------	----	-----	---------------	----	-----	---------------

2.5 dCi [EL/FL/JL]	06.02-12.06					85	800	S5 011	80	740	S4 010			
---------------------------	-------------	--	--	--	--	----	-----	---------------	----	-----	---------------	--	--	--

	01.06-12.14		70	760	S5 A08	85	800	S5 011	74	680	S4 008	70	640	S3 008
--	-------------	--	----	-----	---------------	----	-----	---------------	----	-----	---------------	----	-----	---------------

Trafic III

Diesel

1.6 dCi [EG/FG/JG]	05.14→					77	780	S5 008	74	680	S4 008			
			70	760	S5 A08				70	760	S4 E08			
			70	760	S5 A08	77	780	S5 008	70	760	S4 E08			
			70	760	S5 A08	77	780	S5 008	74	680	S4 008			
		SSJ	70	760	S5 A08									
			70	760	S5 A08				70	760	S4 E08			
			80	800	S5 A11									
			80	800	S5 A11				70	760	S4 E08			
	08.15→					85	800	S5 010	74	680	S4 008			

Trafic Rodeo

Diesel

1.9/2.1 D	02.92-11.03					77	780	S5 008	74	680	S4 008	70	640	S3 008
------------------	-------------	--	--	--	--	----	-----	---------------	----	-----	---------------	----	-----	---------------

Winnebago

2.2 i	03.88-12.00					63	610	S5 005	60	540	S4 005	56	480	S3 005
--------------	-------------	--	--	--	--	----	-----	---------------	----	-----	---------------	----	-----	---------------

SEAT

Inca

1.4 [6K9]	09.97-06.03					54	530	S5 002	52	470	S4 002	45	400	S3 002
------------------	-------------	--	--	--	--	----	-----	---------------	----	-----	---------------	----	-----	---------------

1.6 [6K9]	06.97-09.00					63	610	S5 005	60	540	S4 005	56	480	S3 005
------------------	-------------	--	--	--	--	----	-----	---------------	----	-----	---------------	----	-----	---------------

Diesel

1.7 D [6K9]	09.96-09.00		70	760	S5 A08	61	600	S5 004	60	540	S4 004	53	500	S3 004
--------------------	-------------	--	----	-----	---------------	----	-----	---------------	----	-----	---------------	----	-----	---------------

1.9 D [6K9]	11.95-06.03		70	760	S5 A08	74	750	S5 007	72	680	S4 007	70	640	S3 007
--------------------	-------------	--	----	-----	---------------	----	-----	---------------	----	-----	---------------	----	-----	---------------

SDI [6K9]	12.95-09.00		70	760	S5 A08	74	750	S5 007	72	680	S4 007	70	640	S3 007
-----------	-------------	--	----	-----	---------------	----	-----	---------------	----	-----	---------------	----	-----	---------------

	09.00-06.03	VAD				74	750	S5 007	60	540	S4 004	53	500	S3 004
--	-------------	-----	--	--	--	----	-----	---------------	----	-----	---------------	----	-----	---------------

SKODA

Pick-Up

1.6 MPI [6U7]	10.95-03.01					63	610	S5 005	60	540	S4 005			
----------------------	-------------	--	--	--	--	----	-----	---------------	----	-----	---------------	--	--	--

135/136 MPI [6U7]	08.96-03.01					63	610	S5 005	60	540	S4 005	45	400	S3 002
--------------------------	-------------	--	--	--	--	----	-----	---------------	----	-----	---------------	----	-----	---------------









Diesel

1.9 D [6U7]	01.96-03.01					63	610	S5 005	60	540	S4 005			
--------------------	-------------	--	--	--	--	----	-----	---------------	----	-----	---------------	--	--	--

Praktik

1.2 [5J7]	03.07-05.15					54	530	S5 002	52	470	S4 002			
------------------	-------------	--	--	--	--	----	-----	---------------	----	-----	---------------	--	--	--



			Ah A (EN) 	Ah A (EN) 	Ah A (EN) 	Ah A (EN) 	Ah A (EN) 
			0 092 ...0	0 092 ...0	0 092 ...0	0 092 ...0	0 092 ...0
1.2 TSI [5J7]	03.10-05.15		70 760 S5 A08	63 610 S5 005	60 540 S4 005		
1.4 [5J7]	03.07-05.15			63 610 S5 005	52 470 S4 002	45 400 S3 002	
Diesel							
1.2 TDI [5J7]	03.10-05.15		70 760 S5 A08	63 610 S5 005	60 540 S4 005		
1.4 TDI [5J7]	03.07-03.10		70 760 S5 A08	77 780 S5 008	74 680 S4 008	70 640 S3 008	
1.6 TDI [5J7]	03.10-05.15			63 610 S5 005	60 540 S4 005		

SSANGYONG

Actyon Sports

2.3 i, i 4WD	09.13-12.17				95 830 S4 029		
Diesel							
2.0 E-Xdi, E-Xdi 4WD, Xdi	03.07→				95 830 S4 029		
Xdi 4WD	03.07-12.12				70 630 S4 027		
					95 830 S4 029		

Istana

Diesel

2.9 TD	06.95-11.03				95 830 S4 029		
--------	-------------	--	--	--	----------------------	--	--

SUBARU

Libero

1.2 i, i 4WD, i 4WD Transporter [FA]	12.92-11.98				45 330 S4 020		
-----------------------------------------	-------------	--	--	--	----------------------	--	--

SUZUKI

Carry

1.0/ 1.3, 16V [ED; FD]	10.85-03.09				40 330 S4 019		
Carry Van							
1.0 [ED]	10.85-03.99				40 330 S4 019		

TATA (TELCO)

Telcoline

Diesel

2.0 TDi	10.03→				95 830 S4 028		
---------	--------	--	--	--	----------------------	--	--

TL Pickup

Diesel

2.0 D 4WD	10.05→				95 830 S4 029		
-----------	--------	--	--	--	----------------------	--	--

613

Diesel

LPT 5.7 DT, 5.7 TCI	10.04→	ZE				180 1100 T3 079	
---------------------	--------	----	--	--	--	------------------------	--

TOYOTA

Dyna

Diesel

2.5 D-4D	08.01-10.06				95 830 S4 028		
----------	-------------	--	--	--	----------------------	--	--

3.0 D	07.01→				95 830 S4 028		
-------	--------	--	--	--	----------------------	--	--

4.6 D	10.01-02.08				95 830 S4 029		
-------	-------------	--	--	--	----------------------	--	--

Dyna 100

Diesel

2.5 D	05.95-08.01				70 630 S4 027		
-------	-------------	--	--	--	----------------------	--	--

3.0 D-4D [Y2]	09.06→				95 830 S4 028		
---------------	--------	--	--	--	----------------------	--	--

Dyna 150

Diesel

2.8/ 3.0 D [Y2]	05.95-08.01				70 630 S4 027		
-----------------	-------------	--	--	--	----------------------	--	--



			Ah	A (EN)	S5A	Ah	A (EN)	S5	Ah	A (EN)	S4	Ah	A (EN)	S3	Ah	A (EN)	T3
			0 092 ...0			0 092 ...0			0 092 ...0			0 092 ...0			0 092 ...0		
◀ TOYOTA																	
3.0 D-4D [Y2]	09.06→		95	830	S4 028												
Hiace																	
2.4 [H10; H20]	03.97-11.08		60	540	S4 025												
i [H10; H20]	08.95-11.08		60	540	S4 025												
i [RCH]	08.96-04.98		60	540	S4 025												
2.4/ 2.7 , i 4WD, 4x4 [RCH]	08.96-05.09		70	630	S4 027												
2.7 [H10; H20]	04.98→		70	630	S4 027												
Diesel																	
2.4 D, D Turbo [H10]	08.95-08.01		95	830	S4 028												
D, D Turbo, D Turbo 4WD [H20; LXH]	08.95-08.01		95	830	S4 028												
2.5 D Turbo	08.01→		60	540	S4 025												
D Turbo 4x4, D-4D [H10]	08.01→		60	540	S4 025												
D-4D 4x4 [H10]	08.01-11.11		70	630	S4 026												
Hiace Commuter																	
2.7 i 4WD [H20]	01.05→		70	630	S4 027												
Diesel																	
3.0 D Turbo [H20]	08.07→		95	830	S4 029												
Hiace Van																	
2.0/ 2.4 , i [H10]	08.89-02.06		60	540	S4 025												
2.7 i 4WD [H20]	01.05→		70	630	S4 027												
Diesel																	
2.4 D Turbo [LXH]	08.96-08.01		95	830	S4 028												
2.4/ 2.5/ 3.0 D, D Turbo 4WD [H10; H20]	08.89→		95	830	S4 029												
2.8 D [H10]	08.89-08.98		95	830	S4 028												
	08.89-08.00		70	630	S4 027												
Hilux																	
1.6 [N5/N6]	08.86-07.98		45	330	S4 023												
2.7 , VVTi 4x4 [N14; N26]	08.01→		70	630	S4 027												
Diesel																	
2.4 [N12/N13]	06.15→	85	800	S5 011	80	740	S4 011										
D [N5/N6]	08.84-07.98		70	630	S4 026												
4x4 [N12]	06.15→	85	800	S5 011	80	740	S4 011										
2.5 D-4D [N14...19]	07.05-08.11		70	630	S4 026												
	07.05→		95	830	S4 028												
2.5/ 3.0 D-4D 4x4, 4x4 [; N25; N26]	07.05→		95	830	S4 029												
2.8 [N12]	06.15→	77	780	S5 008	74	680	S4 008										
Hilux Pickup																	
2.4 i [N14...19]	08.97-08.99		45	330	S4 023												
			70	630	S4 026												
i 4WD [N14...19]	11.97-08.01		60	540	S4 025												
Diesel																	
2.4 D [N14...19]	08.97-08.01		70	630	S4 026												
	11.97-08.01		70	630	S4 027												
D Turbo [N14...19]	08.97-08.01		70	630	S4 026												
	08.99-08.01		70	630	S4 027												
2.5 D Turbo 4x4 [N14...19]	08.01-08.05		70	630	S4 026												
Hilux Vigo																	
Diesel																	
2.5 D Turbo	07.02→		95	830	S4 028												
D Turbo 4x4	10.04→		70	630	S4 026												
Land Cruiser																	
4.0 [J7]	05.10→		70	630	S4 026												
4.5 4x4 [J6/7/10]	10.99-02.07		95	830	S4 028												
Diesel																	
4.2 D 4x4 [J7/10]	03.99-02.07		95	830	S4 028												
4.5 4x4 [J7]	03.07→		70	630	S4 026												
			70	630	S4 027												



			Ah A (EN)	Ah A (EN)	Ah A (EN)	Ah A (EN)	Ah A (EN)
			0 092 ...0	0 092 ...0	0 092 ...0	0 092 ...0	0 092 ...0

Proace										
Diesel										
1.6 D-4D [G9]	06.13-01.16	60	680	S5 A05	63	610	S5 005	60	540	S4 005
		60	680	S5 A05	63	610	S5 005	60	640	S4 E05
D-4D [K0]	02.16→	70	760	S5 A08						
		70	760	S5 A08	77	780	S5 008			
2.0 D-4D [G9]	06.13-01.16	70	760	S5 A08	77	780	S5 008	70	760	S4 E08
		70	760	S5 A08	77	780	S5 008	74	680	S4 008
D-4D [K0]	02.16→	70	760	S5 A08						
Proace Verso										
Diesel										
1.6 D-4D [K0]	02.16→	70	760	S5 A08						
		70	760	S5 A08	77	780	S5 008			
2.0 D-4D [K0]	02.16→	70	760	S5 A08						
Quantum										
Diesel										
2.5 D-4D [H2]	03.05→							95	830	S4 029

VAUXHALL

Arena										
Diesel										
1.9/ 2.5 , D	03.98-08.01	70	760	S5 A08	77	780	S5 008	74	680	S4 008
								70	640	S3 008
Brava Pick-Up										
Diesel										
2.5 TD [TF1]	03.97-08.02	95	850	S5 A13	100	830	S5 013	95	800	S4 013
								90	720	S3 013
Combo										
1.2/ 1.4 i	09.94-10.01				61	600	S5 004	44	440	S4 001
								41	360	S3 001
1.4 [D]	02.12→				61	600	S5 004	60	540	S4 004
					61	600	S5 004	70	650	S4 E07
								53	500	S3 004
i Twinport [Tour]	01.04-01.12				52	520	S5 001	44	440	S4 001
i Twinport Dualfuel [Tour]	09.04-01.12				61	600	S5 004	44	440	S4 001
1.6 CNG [Tour]	04.05-01.12				61	600	S5 004		53	500
										S3 004
i [Tour]	09.01-08.04				61	600	S5 004	44	440	S4 001
								41	360	S3 001
Diesel										
1.3 [D]	02.12→				61	600	S5 004	60	540	S4 004
					61	600	S5 004	70	650	S4 E07
	07.16→				74	750	S5 007	72	680	S4 007
		SSJ	70	760	S5 A08					
CDTi [Tour]	09.04-01.12				61	600	S5 004		53	500
										S3 004
	03.06-01.12				74	750	S5 007	72	680	S4 007
								70	640	S3 007
1.6 [D]	02.12→				61	600	S5 004	60	540	S4 004
					61	600	S5 004	70	650	S4 E07
					74	750	S5 007	72	680	S4 007
		SSJ						70	650	S4 E07
1.7 CDTi [Tour]	09.04-01.12				74	750	S5 007	72	680	S4 007
								70	640	S3 007
D	09.94-10.01				74	750	S5 007	60	540	S4 004
DI, DTI [Tour]	09.01-08.04				74	750	S5 007	60	540	S4 004
								70	640	S3 007
2.0 [D]	02.12→				74	750	S5 007	72	680	S4 007
		SSJ						70	650	S4 E07
MIDI										
Diesel										
2.4 D	09.94-05.98							70	630	S4 027
Movano										
Diesel										
1.9/ 2.2/ 2.5/ 2.8/ 3.0 D, DTI [A]	06.98-03.10	95	850	S5 A13	100	830	S5 013	95	800	S4 013
								90	720	S3 013
2.3 CDTi [B]	06.14→				100	830	S5 013			
					110	920	S5 015			
		SSJ	95	850	S5 A13					
			105	950	S5 A15					
	01.17→	95	850	S5 A13	100	830	S5 013	95	800	S4 013



					Ah	A (EN)	S5A	Ah	A (EN)	S5	Ah	A (EN)	S4	Ah	A (EN)	S3	Ah	A (EN)	T3	
						0 092 ...0			0 092 ...0			0 092 ...0			0 092 ...0			0 092 ...0		
VAUXHALL																				
2.3	CDTI FFW [B]	06.14→	SSJ	95	850	S5 A13														
	CDTI FWD [B]	04.10→					100	830	S5 013	95	800	S4 013								
				95	850	S5 A13	100	830	S5 013	95	800	S4 013								
			SSJ	95	850	S5 A13														
	CDTI RWD [B]	04.10→					100	830	S5 013	95	800	S4 013								
				95	850	S5 A13	100	830	S5 013	95	800	S4 013								
			SSJ	95	850	S5 A13														
Vivaro																				
2.0	16V [A]	03.01-08.14		70	760	S5 A08	77	780	S5 008	72	680	S4 007	70	640	S3 007					
Diesel																				
1.6	CDTI [B]	10.14→		80	800	S5 A11	85	800	S5 011	80	740	S4 011								
			SSJ							80	800	S4 E11								
				80	800	S5 A11				80	800	S4 E11								
		11.15→					77	780	S5 008											
							85	800	S5 010											
			BWD	80	800	S5 A11														
			SSJ							70	760	S4 E08								
		09.16→		70	760	S5 A08				74	680	S4 008								
				70	760	S5 A08				80	740	S4 011								
				70	760	S5 A08				80	800	S4 E11								
				80	800	S5 A11				80	740	S4 011								
1.9	DI [A]	03.01-08.06					74	750	S5 007	72	680	S4 007	70	640	S3 007					
	DTI [A]	03.01-08.06					74	750	S5 007	72	680	S4 007	70	640	S3 007					
2.0	CDTI [A]	08.06-08.14		95	850	S5 A13	100	830	S5 013	74	680	S4 008								
		12.10-08.14		95	850	S5 A13	100	830	S5 013	95	800	S4 013								
2.5	CDTI [A]	08.06-06.08		95	850	S5 A13	100	830	S5 013	74	680	S4 008	70	640	S3 008					
		08.06-08.14		95	850	S5 A13	100	830	S5 013	95	800	S4 013								
	DTI [A]	04.04-08.06		95	850	S5 A13	100	830	S5 013	95	800	S4 013								

VW (VOLKSWAGEN)

Amarok																			
2.0	TSI [S6, S7; 2H, S1]	12.10-08.18		70	760	S5 A08	77	780	S5 008	74	680	S4 008							
Diesel																			
2.0	BiTDI [2H, S1]	09.10-05.12					100	830	S5 013	95	800	S4 013							
	BiTDI 4Motion [2H, S1]	09.10-05.12		95	850	S5 A13	100	830	S5 013										
			SSJ	95	850	S5 A13													
	TDI [S6, S7]	06.16→					100	830	S5 013	95	800	S4 013							
				80	800	S5 A11	100	830	S5 013	95	800	S4 013							
				95	850	S5 A13	100	830	S5 013	95	800	S4 013							
			BWD,SSJ	80	800	S5 A11													
	TDI [2H, S1]	09.10-10.16					100	830	S5 013	95	800	S4 013							
			BWD,SSJ	80	800	S5 A11													
		11.11-10.16	BWD,SSJ	95	850	S5 A13													
			SSJ	95	850	S5 A13													
	TDI 4Motion [S6, S7]	06.16→					100	830	S5 013	95	800	S4 013							
				80	800	S5 A11	100	830	S5 013	95	800	S4 013							
				95	850	S5 A13	100	830	S5 013	95	800	S4 013							
			BWD,SSJ	80	800	S5 A11													
	TDI 4Motion [2H, S1]	09.10-10.16					100	830	S5 013	95	800	S4 013							
			BWD,SSJ	80	800	S5 A11													
		11.11-10.16		95	850	S5 A13	100	830	S5 013	95	800	S4 013							
3.0	TDI 4Motion [S6, S7]	06.16→	BWD,SSJ	95	850	S5 A13													
Caddy																			
1.0	TSI [SA]	11.15→	BWD,SSJ	60	680	S5 A05				60	640	S4 E05							
1.2	TSI [2C]	09.10-05.15					54	530	S5 002	52	470	S4 002							
			BWD,SSJ	70	760	S5 A08				70	760	S4 E08							
1.2/ 1.4	TSI [SA]	05.15→		70	760	S5 A08				60	540	S4 005							
1.4	[9K9]	11.95-06.03	VAD				54	530	S5 002	52	470	S4 002	45	400	S3 002				
		11.97-09.00	VAD				63	610	S5 005	52	470	S4 002	45	400	S3 002				
		08.00-06.03					63	610	S5 005	52	470	S4 002	45	400	S3 002				
	TGI [SA]	05.15→		70	760	S5 A08				60	540	S4 005							

				Ah A (EN)	Ah A (EN)	Ah A (EN)	Ah A (EN)	Ah A (EN)
				0 092 ...0	0 092 ...0	0 092 ...0	0 092 ...0	0 092 ...0
1.4/ 1.6/ 2.0 , EcoFuel [2K]	02.04-08.10			63 610	S5 005	52 470	S4 002	45 400 S3 002
1.6 [SA]	11.15→		60 680	S5 A05		60 640	S4 E05	
[9K9]	06.97-09.00	VAD		63 610	S5 005	52 470	S4 002	45 400 S3 002
BiFuel [2C]	05.11-05.15			63 610	S5 005	60 540	S4 005	
		BWD,SSJ	70 760	S5 A08		70 760	S4 E08	
1.6/ 2.0 , EcoFuel [2C]	10.10-05.15			63 610	S5 005	52 470	S4 002	45 400 S3 002
Diesel								
1.6 TDI [SA]	05.15→					60 540	S4 005	45 400 S3 002
		BWD,SSJ	70 760	S5 A08				
TDI [2C]	08.10-05.15			63 610	S5 005	60 540	S4 005	56 480 S3 005
			70 760	S5 A08	63 610	S5 005	60 540	S4 005
		BWD,SSJ	70 760	S5 A08				
		SSJ	70 760	S5 A08				
1.7 SDI [9K9]	07.96-08.98	VAD	70 760	S5 A08	77 780	S5 008	60 540	S4 005
1.9 D [9K9]	11.95-08.98	VAD	70 760	S5 A08	77 780	S5 008	60 540	S4 005
	09.98-06.03		70 760	S5 A08	77 780	S5 008	60 540	S4 005
SDI [9K9]	11.95-08.98	VAD	70 760	S5 A08	77 780	S5 008	60 540	S4 005
	09.00-06.03		70 760	S5 A08	77 780	S5 008	60 540	S4 005
TDI [2K]	02.04-08.10		70 760	S5 A08	77 780	S5 008	60 540	S4 005
TDI [9K9]	09.96-08.98	VAD	70 760	S5 A08	77 780	S5 008	60 540	S4 005
	10.97-09.00	VAD	70 760	S5 A08	77 780	S5 008	60 540	S4 005
	09.00-06.03		70 760	S5 A08	77 780	S5 008	60 540	S4 005
TDI 4Motion [2K]	11.08-08.10			77 780	S5 008	70 760	S4 E08	
				77 780	S5 008	74 680	S4 008	
2.0 SDI [2K]	02.04-08.10		70 760	S5 A08	77 780	S5 008	60 540	S4 005
TDI [SA]	05.15-12.15					60 540	S4 005	
	05.15→					60 540	S4 005	45 400 S3 002
		BWD,SSJ	70 760	S5 A08				
	11.15→		70 760	S5 A08				
			70 760	S5 A08		60 540	S4 005	
		BWD	70 760	S5 A08				
TDI [2C]	08.10-05.15			63 610	S5 005	60 540	S4 005	
	11.10-05.15			77 780	S5 008	74 680	S4 008	
		BWD,SSJ	70 760	S5 A08				
	12.12-05.15		70 760	S5 A08	77 780	S5 008	74 680	S4 008
		BWD				70 760	S4 E08	
TDI [2K]	09.07-08.10		70 760	S5 A08	77 780	S5 008	74 680	S4 008
TDI 4Motion [SA]	05.15-11.15					60 540	S4 005	
	05.15→					60 540	S4 005	45 400 S3 002
		BWD,SSJ	70 760	S5 A08				
TDI 4Motion [2C]	08.10-05.15			77 780	S5 008	74 680	S4 008	
	11.10-05.15			63 610	S5 005	60 540	S4 005	
		BWD,SSJ	70 760	S5 A08				
Caddy Alltrack								
1.0 TSI [SA]	11.15→		60 680	S5 A05				
		BWD,SSJ				60 640	S4 E05	
1.2/ 1.4 TSI [SA]	05.15→		70 760	S5 A08		60 540	S4 005	
1.4 TGI [SA]	05.15→		70 760	S5 A08		60 540	S4 005	
1.6 [SA]	11.15→		60 680	S5 A05		60 640	S4 E05	
Diesel								
1.6 TDI [SA]	05.15→		70 760	S5 A08		60 540	S4 005	45 400 S3 002
2.0 TDI [SA]	05.15→		70 760	S5 A08		60 540	S4 005	45 400 S3 002
	11.15→		70 760	S5 A08				
			70 760	S5 A08		60 540	S4 005	
		BWD,SSJ	70 760	S5 A08				
TDI 4Motion [SA]	05.15→		70 760	S5 A08		60 540	S4 005	45 400 S3 002
	11.15→	BWD,SSJ	70 760	S5 A08				
Caddy Pickup								
1.6 [9U7]	06.96-12.00	VAD		63 610	S5 005	52 470	S4 002	45 400 S3 002
Diesel								
1.9 D [9U7]	06.96-08.98	VAD	70 760	S5 A08	77 780	S5 008	60 540	S4 005
California T4								
2.0 [70, 7D]	09.90-06.03	VAD	70 760	S5 A08	100 830	S5 013	80 740	S4 010



				Ah A (EN)	Ah A (EN)	Ah A (EN)	Ah A (EN)	Ah A (EN)
				0 092 ...0	0 092 ...0	0 092 ...0	0 092 ...0	0 092 ...0
◀ VW								
2.5 [70, 7D]	08.96-06.03	VAD		63 610 S5 005	52 470 S4 002	45 400 S3 002		
	05.99-06.03	VAD		100 830 S5 013	52 470 S4 002	45 400 S3 002		
Syncro [70, 7D]	08.96-06.03	VAD		63 610 S5 005	52 470 S4 002	45 400 S3 002		
	06.97-06.03	VAD		100 830 S5 013	74 680 S4 008	70 640 S3 008		
2.8 [70, 7D]	01.96-05.00	VAD	70 760 S5 A08	100 830 S5 013	80 740 S4 010	70 640 S3 008		
	05.00-06.03	VAD		100 830 S5 013	74 680 S4 008	70 640 S3 008		
Diesel								
1.9/ 2.4 D Syncro, D Turbo [70, 7D]	10.92-06.03	VAD	70 760 S5 A08	100 830 S5 013	80 740 S4 010	70 640 S3 008		
2.4 D [70, 7D]	09.90-05.98	VAD		63 610 S5 005	52 470 S4 002	45 400 S3 002		
	05.97-06.03	VAD	70 760 S5 A08	100 830 S5 013	74 680 S4 008	70 640 S3 008		
2.5 TDI [70, 7D]	07.95-06.03	VAD	70 760 S5 A08	100 830 S5 013	80 740 S4 010	70 640 S3 008		
	05.98-06.03	VAD	70 760 S5 A08	100 830 S5 013	74 680 S4 008	70 640 S3 008		
TDI Syncro [70, 7D]	03.98-06.03	VAD	70 760 S5 A08	100 830 S5 013	74 680 S4 008	70 640 S3 008		
California T5								
2.0 TSI [7E]	05.11-08.15			63 610 S5 005	60 540 S4 005			
		BWD,SSJ	70 760 S5 A08					
			80 800 S5 A11					
	07.12-08.15		95 850 S5 A13	100 830 S5 013	95 800 S4 013			
TSI 4Motion [7E]	07.11-08.15			63 610 S5 005	60 540 S4 005			
		BWD,SSJ	70 760 S5 A08					
2.0/ 3.2 , 4Motion [7H]	02.03-11.09		95 850 S5 A13	100 830 S5 013	60 540 S4 005	56 480 S3 005		
Diesel								
1.9 TDI [7H]	04.03-11.09		95 850 S5 A13	100 830 S5 013	80 740 S4 010			
2.0 TDI [7E]	09.09-08.15		95 850 S5 A13	100 830 S5 013	80 740 S4 010			
	06.10-08.15			77 780 S5 008	74 680 S4 008			
		BWD,SSJ	70 760 S5 A08					
			80 800 S5 A11					
		SSJ	80 800 S5 A11					
	05.11-08.15		70 760 S5 A08					
TDI 4Motion [7E]	11.09-08.15		95 850 S5 A13	100 830 S5 013	80 740 S4 010			
	06.10-08.15			77 780 S5 008	74 680 S4 008			
		BWD,SSJ	70 760 S5 A08					
			80 800 S5 A11					
		SSJ	80 800 S5 A11					
2.5 TDI [7H]	02.03-11.09		95 850 S5 A13	100 830 S5 013	80 740 S4 010			
	11.03-11.09		95 850 S5 A13	100 830 S5 013	60 540 S4 005	56 480 S3 005		
TDI 4Motion [7H]	07.04-11.09		95 850 S5 A13	100 830 S5 013	80 740 S4 010			
California T6								
2.0 TFSI [SG]	04.15→		80 800 S5 A11	85 800 S5 011	60 540 S4 005			
			80 800 S5 A11	85 800 S5 011	80 740 S4 011			
		BWD,SSJ	70 760 S5 A08		80 800 S4 E11			
TFSI 4Motion [SG]	04.15→			85 800 S5 011	60 540 S4 005			
				85 800 S5 011	80 740 S4 011			
		BWD,SSJ	70 760 S5 A08		80 800 S4 E11			
			80 800 S5 A11		80 800 S4 E11			
Diesel								
2.0 TDI [SG]	04.15→		70 760 S5 A08	85 800 S5 011	60 540 S4 005			
			70 760 S5 A08	85 800 S5 011	80 740 S4 011			
			80 800 S5 A11	85 800 S5 011	60 540 S4 005			
		BWD			80 800 S4 E11			
		BWD,SSJ	80 800 S5 A11		80 800 S4 E11			
	05.16→	BWD,SSJ	70 760 S5 A08					
			80 800 S5 A11					
	08.18→		70 760 S5 A08					
			80 800 S5 A11					
TDI 4Motion [SG]	04.15→		70 760 S5 A08	85 800 S5 011	60 540 S4 005			
			70 760 S5 A08	85 800 S5 011	80 740 S4 011			
		BWD,SSJ	80 800 S5 A11		80 800 S4 E11			
	08.15→	BWD,SSJ	80 800 S5 A11					
	08.18→		70 760 S5 A08					
			80 800 S5 A11					



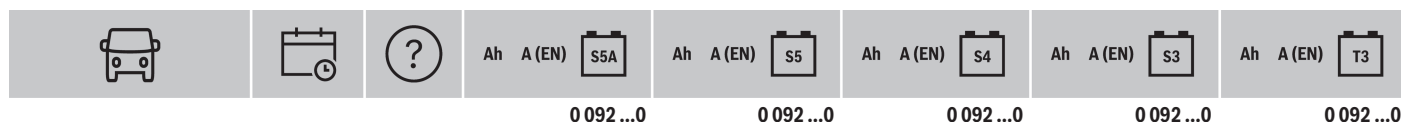

Caravelle T4																
2.0 [70, 7D]	09.90-04.99	VAD			63	610	S5 005	52	470	S4 002	45	400	S3 002			
	05.99-06.03				63	610	S5 005	52	470	S4 002						
2.5 [70, 7D]	08.96-06.03	VAD			63	610	S5 005	52	470	S4 002	45	400	S3 002			
	05.99-06.03	VAD			100	830	S5 013	52	470	S4 002	45	400	S3 002			
Syncro [70, 7D]	08.96-06.03	VAD			63	610	S5 005	52	470	S4 002	45	400	S3 002			
	06.97-11.01	VAD			100	830	S5 013	74	680	S4 008	70	640	S3 008			
	05.99-06.03	VAD			100	830	S5 013	52	470	S4 002	45	400	S3 002			
2.8 [70, 7D]	01.96-05.00	VAD			63	610	S5 005	52	470	S4 002	45	400	S3 002			
	05.00-06.03	VAD			100	830	S5 013	74	680	S4 008	70	640	S3 008			
Diesel																
1.9/ 2.4 D Syncro, D Turbo [70, 7D]	10.92-06.03	VAD	70	760			S5 A08	100	830	S5 013	80	740	S4 010	70	640	S3 008
2.4 D [70, 7D]	09.90-05.98	VAD			63	610	S5 005	52	470	S4 002	45	400	S3 002			
	05.97-06.03	VAD	70	760			S5 A08	100	830	S5 013	74	680	S4 008	70	640	S3 008
2.5 TDI [70, 7D]	07.95-06.03		95	850			S5 A13									
		VAD			63	610	S5 005	52	470	S4 002	45	400	S3 002			
	05.98-06.03	VAD	70	760			S5 A08	100	830	S5 013	74	680	S4 008	70	640	S3 008
TDI Syncro [70, 7D]	03.98-06.03	VAD	70	760			S5 A08	100	830	S5 013	74	680	S4 008	70	640	S3 008
Caravelle T5																
2.0 [7E]	09.09-08.15		95	850			S5 A13	100	830	S5 013	60	540	S4 005	56	480	S3 005
TSI [7E]	05.11-08.15				63	610	S5 005	60	540	S4 005						
		BWD,SSJ	70	760			S5 A08									
		SSJ	80	800			S5 A11									
	07.12-08.15		95	850			S5 A13	100	830	S5 013	95	800	S4 013			
TSI 4Motion [7E]	07.11-08.15				63	610	S5 005	60	540	S4 005						
		BWD,SSJ	70	760			S5 A08									
2.0/ 3.2, 4Motion [7H]	02.03-11.09		95	850			S5 A13	100	830	S5 013	60	540	S4 005	56	480	S3 005
Diesel																
1.9 TDI [7H]	04.03-11.09		95	850			S5 A13	100	830	S5 013	80	740	S4 010			
2.0 TDI [7E]	09.09-08.15		95	850			S5 A13	100	830	S5 013	80	740	S4 010			
	06.10-08.15				77	780	S5 008	74	680	S4 008						
		BWD	70	760			S5 A08									
			80	800			S5 A11									
	05.11-08.15		70	760			S5 A08									
TDI 4Motion [7E]	09.09-08.15		95	850			S5 A13	100	830	S5 013	80	740	S4 010			
	06.10-08.15				77	780	S5 008	74	680	S4 008						
		BWD	70	760			S5 A08									
			80	800			S5 A11									
2.5 TDI [7H]	02.03-11.09		95	850			S5 A13	100	830	S5 013	80	740	S4 010			
	11.03-11.09		95	850			S5 A13	100	830	S5 013	60	540	S4 005	56	480	S3 005
TDI 4Motion [7H]	07.04-11.09		95	850			S5 A13	100	830	S5 013	80	740	S4 010			
Caravelle T6																
2.0 TFSI [SG]	04.15→		70	760			S5 A08	85	800	S5 011	60	540	S4 005			
			70	760			S5 A08	85	800	S5 011	80	740	S4 011			
			80	800			S5 A11	85	800	S5 011	60	540	S4 005			
		BWD								80	800	S4 E11				
TFSI 4Motion [SG]	04.15→		70	760			S5 A08	85	800	S5 011	60	540	S4 005			
			70	760			S5 A08	85	800	S5 011	80	740	S4 011			
			80	800			S5 A11	85	800	S5 011	60	540	S4 005			
		BWD								80	800	S4 E11				
Diesel																
2.0 TDI [SG]	04.15-06.16	BWD,SSJ	80	800			S5 A11				80	800	S4 E11			
	04.15→		70	760			S5 A08	85	800	S5 011	60	540	S4 005			
			70	760			S5 A08	85	800	S5 011	80	740	S4 011			
			80	800			S5 A11	85	800	S5 011	60	540	S4 005			
				BWD								80	800	S4 E11		
	05.16→	BWD,SSJ	70	760			S5 A08									
	SSJ	80	800			S5 A11										
08.18→			70	760			S5 A08									
			80	800			S5 A11									



		Ah A (EN) S5A			Ah A (EN) S5			Ah A (EN) S4			Ah A (EN) S3			Ah A (EN) T3		
		0 092 ...0			0 092 ...0			0 092 ...0			0 092 ...0			0 092 ...0		
◀ VW																
2.0 TDI 4Motion [SG]	04.15→	70	760	S5 A08	85	800	S5 011	60	540	S4 005						
		70	760	S5 A08	85	800	S5 011	80	740	S4 011						
		80	800	S5 A11	85	800	S5 011	60	540	S4 005						
	BWD							80	800	S4 E11						
	08.15→	80	800	S5 A11												
	08.18→	70	760	S5 A08												
		80	800	S5 A11												
Crafter 30																
Diesel																
2.0 BiTDI [2E, 2F]	07.11-12.16				77	780	S5 008	74	680	S4 008						
	BWD,SSJ	70	760	S5 A08												
		95	850	S5 A13												
	10.13-12.16	70	760	S5 A08	77	780	S5 008	74	680	S4 008						
	BWD							70	760	S4 E08						
TDI [SY, SZ]	09.16→							74	680	S4 008						
								95	800	S4 013						
	BWD	95	850	S5 A13												
		95	850	S5 A13				70	760	S4 E08						
	BWD,SSJ							70	760	S4 E08						
TDI [2E, 2F]	05.11-12.16				77	780	S5 008	74	680	S4 008						
	BWD,SSJ	70	760	S5 A08												
		95	850	S5 A13												
	11.15-12.16							74	680	S4 008						
								95	800	S4 013						
	BWD	70	760	S5 A08												
		95	850	S5 A13												
TDI 4Motion [SY, SZ]	09.16→							74	680	S4 008						
								95	800	S4 013						
	BWD	95	850	S5 A13												
	BWD,SSJ							70	760	S4 E08						
2.5 TDI [2E, 2F]	04.06-05.13	95	850	S5 A13	100	830	S5 013	74	680	S4 008	70	640	S3 008			
Crafter 35																
Diesel																
2.0 BiTDI [2E, 2F]	07.11-12.16				77	780	S5 008	74	680	S4 008						
	BWD,SSJ	70	760	S5 A08												
	SSJ	95	850	S5 A13												
	10.13-12.16	70	760	S5 A08	77	780	S5 008	74	680	S4 008						
	BWD							70	760	S4 E08						
TDI [SY, SZ]	09.16→							74	680	S4 008						
								95	800	S4 013						
	BWD	95	850	S5 A13												
	BWD,SSJ							70	760	S4 E08						
	10.17→	95	850	S5 A13				70	760	S4 E08						
		95	850	S5 A13				74	680	S4 008						
		95	850	S5 A13				95	800	S4 013						
TDI [2E, 2F]	05.11-12.16				77	780	S5 008	74	680	S4 008						
	BWD,SSJ	70	760	S5 A08												
	SSJ	95	850	S5 A13												
	05.13-12.16	BWD,SSJ	95	850	S5 A13											
	11.15-12.16							74	680	S4 008						
								95	800	S4 013						
	BWD	70	760	S5 A08												
		95	850	S5 A13												
TDI 4Motion [SY, SZ]	09.16→							74	680	S4 008						
								95	800	S4 013						
	BWD	95	850	S5 A13												
		95	850	S5 A13				70	760	S4 E08						
	BWD,SSJ							70	760	S4 E08						
2.5 TDI [2E, 2F]	04.06-05.13	95	850	S5 A13	100	830	S5 013	74	680	S4 008	70	640	S3 008			
Crafter 50																
Diesel																
2.0 BiTDI [2E, 2F]	07.11-12.16	95	850	S5 A13												



			Ah A (EN) S5A			Ah A (EN) S5			Ah A (EN) S4			Ah A (EN) S3			Ah A (EN) T3		
			0 092 ...0	0 092 ...0	0 092 ...0	0 092 ...0	0 092 ...0	0 092 ...0	0 092 ...0	0 092 ...0	0 092 ...0	0 092 ...0	0 092 ...0	0 092 ...0			
2.0 BITDI [2E, 2F]	10.11-12.16			77	780	S5 008	74	680	S4 008								
		BWD	70	760	S5 A08												
			95	850	S5 A13												
	10.13-12.16		70	760	S5 A08	77	780	S5 008	74	680	S4 008						
		BWD	70	760	S4 E08				70	760	S4 E08						
TDI [SY, SZ]	05.17→						74	680	S4 008								
							95	800	S4 013								
		BWD	95	850	S5 A13				70	760	S4 E08						
	10.17→		95	850	S5 A13				70	760	S4 E08						
			95	850	S5 A13				74	680	S4 008						
			95	850	S5 A13				95	800	S4 013						
TDI [2E, 2F]	05.11-12.16			77	780	S5 008	74	680	S4 008								
		BWD	70	760	S5 A08												
			95	850	S5 A13												
	10.13-12.16		95	850	S5 A13	100	830	S5 013	74	680	S4 008						
		BWD	70	760	S4 E08				70	760	S4 E08						
	11.15-12.16						74	680	S4 008								
							95	800	S4 013								
2.5 TDI [2E, 2F]	04.06-05.13		95	850	S5 A13	100	830	S5 013	74	680	S4 008	70	640	S3 008			
Crafter 55 Diesel																	
2.0 TDI [SY, SZ]	10.18→		95	850	S5 A13				70	760	S4 E08						
			95	850	S5 A13				74	680	S4 008						
			95	850	S5 A13				95	800	S4 013						
Eurovan																	
2.8 [70]	09.96-06.03	VAD				63	610	S5 005	52	470	S4 002	45	400	S3 002			
LT																	
28/ 35/ 46 2.3 [2D, 2H]	05.96-11.01		70	760	S5 A08	100	830	S5 013	80	740	S4 010	70	640	S3 008	88	680	T3 013
Diesel																	
28 2.5 TDI [2D, 2H]	05.96-05.99		70	760	S5 A08	100	830	S5 013	80	740	S4 010	70	640	S3 008	88	680	T3 013
	05.99-04.06		95	850	S5 A13	100	830	S5 013	74	680	S4 008	70	640	S3 008	88	680	T3 013
28/ 35/ 46 2.5 SDI [2D, 2H]	05.96-04.01		70	760	S5 A08	100	830	S5 013	80	740	S4 010	70	640	S3 008	88	680	T3 013
	2.8 D Turbo, 2.8 TDI [2D, 2H]	07.97-04.06		95	850	S5 A13	100	830	S5 013	74	680	S4 008	70	640	S3 008	88	680
35 2.5 TDI [2D, 2H]	05.96-05.99		70	760	S5 A08	100	830	S5 013	80	740	S4 010	70	640	S3 008	88	680	T3 013
	05.99-04.06		95	850	S5 A13	100	830	S5 013	74	680	S4 008	70	640	S3 008	88	680	T3 013
46 2.5 TDI [2D, 2H]	05.96-05.99		70	760	S5 A08	100	830	S5 013	80	740	S4 010	70	640	S3 008	88	680	T3 013
	05.99-04.06		95	850	S5 A13	100	830	S5 013	74	680	S4 008	70	640	S3 008	88	680	T3 013
	12.02-04.06		95	850	S5 A13	100	830	S5 013	74	680	S4 008	70	640	S3 008			
Multivan T4																	
2.0 [70, 7D]	09.90-04.99	VAD				63	610	S5 005	52	470	S4 002	45	400	S3 002			
2.5 [70, 7D]	08.96-06.03	VAD				63	610	S5 005	52	470	S4 002	45	400	S3 002			
	05.99-06.03	VAD				100	830	S5 013	52	470	S4 002	45	400	S3 002			
	Syncro [70, 7D]	08.96-06.03	VAD			63	610	S5 005	52	470	S4 002	45	400	S3 002			
	06.97-11.01	VAD				100	830	S5 013	74	680	S4 008	70	640	S3 008			
	12.99-06.03	VAD				100	830	S5 013	52	470	S4 002	45	400	S3 002			
2.8 [70, 7D]	01.96-05.00	VAD				63	610	S5 005	52	470	S4 002	45	400	S3 002			
	05.00-06.03	VAD				100	830	S5 013	74	680	S4 008	70	640	S3 008			
Diesel																	
1.9/ 2.4 D Syncro, D Turbo [70, 7D]	10.92-04.99	VAD	70	760	S5 A08	100	830	S5 013	80	740	S4 010	70	640	S3 008			
2.4 D [70, 7D]	09.90-05.98					63	610	S5 005	52	470	S4 002	45	400	S3 002			
	05.97-06.03		70	760	S5 A08	100	830	S5 013	74	680	S4 008	70	640	S3 008			
2.5 TDI [70, 7D]	07.95-06.03	VAD				63	610	S5 005	52	470	S4 002	45	400	S3 002			
	05.98-06.03	VAD	70	760	S5 A08	100	830	S5 013	74	680	S4 008	70	640	S3 008			
TDI Syncro [70, 7D]	03.98-06.03	VAD	70	760	S5 A08	100	830	S5 013	74	680	S4 008	70	640	S3 008			
Multivan T5																	
2.0 [7E]	09.09-08.15		70	760	S5 A08	100	830	S5 013	74	680	S4 008	70	640	S3 008			
	[7H]	06.03-11.09	70	760	S5 A08	77	780	S5 008	60	540	S4 005	70	640	S3 008			
			70	760	S5 A08	77	780	S5 008	74	680	S4 008	70	640	S3 008			
			70	760	S5 A08	100	830	S5 013	60	540	S4 005	70	640	S3 008			
TSI [7E]	05.11-08.15					63	610	S5 005	60	540	S4 005						
		BWD,SSJ	70	760	S5 A08												



				Ah	A (EN)	S5A	Ah	A (EN)	S5	Ah	A (EN)	S4	Ah	A (EN)	S3	Ah	A (EN)	T3
			0 092 ...0			0 092 ...0			0 092 ...0			0 092 ...0			0 092 ...0			
VW																		
2.0 TSI [7E]	07.12-08.15		95	850	S5 A13	100	830	S5 013	95	800	S4 013							
TSI 4Motion [7E]	07.11-08.15					63	610	S5 005	60	540	S4 005							
		BWD,SSJ	70	760	S5 A08													
3.2 [7H]	02.03-06.04		70	760	S5 A08	100	830	S5 013	74	680	S4 008	70	640	S3 008				
	02.03-11.09		70	760	S5 A08	77	780	S5 008	60	540	S4 005	70	640	S3 008				
			70	760	S5 A08	77	780	S5 008	74	680	S4 008	70	640	S3 008				
	05.03-11.09		70	760	S5 A08	100	830	S5 013	60	540	S4 005	70	640	S3 008				
	05.08-11.09					85	800	S5 011	80	740	S4 011							
4Motion [7H]	07.04-11.09		70	760	S5 A08	77	780	S5 008	60	540	S4 005	70	640	S3 008				
			70	760	S5 A08	77	780	S5 008	74	680	S4 008	70	640	S3 008				
			70	760	S5 A08	100	830	S5 013	60	540	S4 005	70	640	S3 008				
	05.08-11.09		70	760	S5 A08	100	830	S5 013	74	680	S4 008	70	640	S3 008				
Diesel																		
1.9 TDI [7H]	04.03-11.09		70	760	S5 A08	85	800	S5 011	80	740	S4 010							
			70	760	S5 A08	85	800	S5 011	80	740	S4 011							
			70	760	S5 A08	100	830	S5 013	74	680	S4 008	70	640	S3 008				
			70	760	S5 A08	100	830	S5 013	80	740	S4 010							
2.0 TDI [7E]	09.09-08.15					85	800	S5 011	74	680	S4 008							
		BWD,SSJ	70	760	S5 A08													
		SSJ	70	760	S5 A08													
	06.10-08.15					85	800	S5 010	80	740	S4 010							
	05.11-08.15		70	760	S5 A08													
TDI 4Motion [7E]	09.09-08.15					85	800	S5 011	74	680	S4 008							
		BWD,SSJ	70	760	S5 A08													
		SSJ	70	760	S5 A08													
	06.10-08.15					85	800	S5 010	80	740	S4 010							
2.5 TDI [7H]	02.03-11.09		95	850	S5 A13	100	830	S5 013	74	680	S4 008	70	640	S3 008				
TDI 4Motion [7H]	07.04-11.09		95	850	S5 A13	100	830	S5 013	74	680	S4 008	70	640	S3 008				
Multivan T6																		
2.0 TFSI [SG]	04.15→					85	800	S5 011	60	540	S4 005							
						85	800	S5 011	80	740	S4 011							
		BWD,SSJ	70	760	S5 A08				80	800	S4 E11							
			80	800	S5 A11				80	800	S4 E11							
TFSI 4Motion [SG]	04.15→					85	800	S5 011	60	540	S4 005							
						85	800	S5 011	80	740	S4 011							
		BWD,SSJ	70	760	S5 A08				80	800	S4 E11							
			80	800	S5 A11				80	800	S4 E11							
	08.18→		70	760	S5 A08													
			80	800	S5 A11													
TDI 4Motion [SG]	04.15→					85	800	S5 011	60	540	S4 005							
						85	800	S5 011	80	740	S4 011							
		BWD,SSJ	70	760	S5 A08				80	800	S4 E11							
			80	800	S5 A11				80	800	S4 E11							
	08.15→	BWD,SSJ	70	760	S5 A08													
			80	800	S5 A11													
		SSJ	80	800	S5 A11													
	08.18→		70	760	S5 A08													
			80	800	S5 A11													
TDI 4Motion [SSG]	04.15→					85	800	S5 011	60	540	S4 005							
						85	800	S5 011	80	740	S4 011							
		BWD,SSJ	70	760	S5 A08				80	800	S4 E11							
			80	800	S5 A11				80	800	S4 E11							



			Ah A (EN)	Ah A (EN)	Ah A (EN)	Ah A (EN)	Ah A (EN)
			0 092 ...0	0 092 ...0	0 092 ...0	0 092 ...0	0 092 ...0

Transporter T4

2.0 [70, 7D]	09.90-06.03				63	610	S5 005	52	470	S4 002	45	400	S3 002
2.5 [70, 7D]	08.96-06.03	VAD			63	610	S5 005	52	470	S4 002	45	400	S3 002
	05.99-12.99				100	830	S5 013	72	680	S4 007	70	640	S3 008
	05.99-06.03				63	610	S5 005	52	470	S4 002	45	400	S3 002
	12.99-06.03				100	830	S5 013	52	470	S4 002	45	400	S3 002
	05.96-04.99	VAD			63	610	S5 005	52	470	S4 002	45	400	S3 002
Syncro [70, 7D]	06.97-06.03				100	830	S5 013	74	680	S4 008	70	640	S3 008
	05.99-06.03				63	610	S5 005	52	470	S4 002	45	400	S3 002
	01.96-05.00	VAD			63	610	S5 005	52	470	S4 002	45	400	S3 002
2.8 [70, 7D]	05.00-06.03	VAD			100	830	S5 013	74	680	S4 008	70	640	S3 008

Diesel

1.9 D Turbo [70, 7D]	10.92-04.99	VAD	70	760	S5 A08	100	830	S5 013	80	740	S4 010	70	640	S3 008
	05.99-06.03		70	760	S5 A08	100	830	S5 013	74	680	S4 008			
2.4 D [70, 7D]	09.90-05.98				100	830	S5 013	74	680	S4 008	70	640	S3 007	
	05.97-06.03				100	830	S5 013	74	680	S4 008	70	640	S3 008	
D Syncro [70, 7D]	11.92-09.98	VAD	70	760	S5 A08	100	830	S5 013	80	740	S4 010	70	640	S3 008
2.5 TDI [70, 7D]	07.95-06.03				85	800	S5 011	80	740	S4 011		90	540	T3 031
		VAD	95	850	S5 A13	100	830	S5 013	80	740	S4 010			
	05.98-09.00	VAD	70	760	S5 A08	100	830	S5 013	74	680	S4 008	70	640	S3 008
	05.98-06.03		70	760	S5 A08	100	830	S5 013	74	680	S4 008	70	640	S3 008
	05.99-06.03											90	540	T3 031
		VAD				100	830	S5 013	74	680	S4 008	70	640	S3 008
TDI Syncro [70, 7D]	03.98-06.03	VAD	70	760	S5 A08	100	830	S5 013	74	680	S4 008	70	640	S3 008

Transporter T5

2.0 [7E]	09.09-08.15		95	850	S5 A13	100	830	S5 013	60	540	S4 005	56	480	S3 005	
	[7F]	09.09-08.15		95	850	S5 A13	100	830	S5 013	60	540	S4 005	56	480	S3 005
	[7H]	06.03-11.09		95	850	S5 A13	100	830	S5 013	60	540	S4 005	56	480	S3 005
	TSI [7E]	05.11-08.15				63	610	S5 005	60	540	S4 005				
			BWD,SSJ	70	760	S5 A08									
			80	800	S5 A11										
	07.12-08.15		95	850	S5 A13	100	830	S5 013	95	800	S4 013				
TSI [7F]	07.12-08.15		95	850	S5 A13	100	830	S5 013	95	800	S4 013				
TSI 4Motion [7E]	07.11-08.15				63	610	S5 005	60	540	S4 005					
		BWD,SSJ	70	760	S5 A08										
2.0/3.2, 4Motion [7J]	06.03-11.09		95	850	S5 A13	100	830	S5 013	60	540	S4 005	56	480	S3 005	
3.2 [7H]	02.03-11.09		95	850	S5 A13	100	830	S5 013	60	540	S4 005	56	480	S3 005	
	05.08-11.09				85	800	S5 011	80	740	S4 011					
4Motion [7H]	07.04-11.09		95	850	S5 A13	100	830	S5 013	60	540	S4 005	56	480	S3 005	

Diesel

1.9 TDI [7H]	04.03-11.09		95	850	S5 A13	100	830	S5 013	80	740	S4 010			
1.9/2.5 TDI, TDI 4Motion [7J]	04.03-11.09		95	850	S5 A13	100	830	S5 013	80	740	S4 010			
2.0 TDI [7E]	09.09-08.15		95	850	S5 A13	100	830	S5 013	80	740	S4 010			
	06.10-08.15				85	800	S5 011	80	740	S4 011				
	05.11-08.15		70	760	S5 A08									
TDI [7F]	09.09-08.15		95	850	S5 A13	100	830	S5 013	80	740	S4 010			
	06.10-08.15				85	800	S5 011	80	740	S4 011				
	05.11-08.15	BWD,SSJ	70	760	S5 A08									
			80	800	S5 A11									
TDI 4Motion [7E]	09.09-08.15		95	850	S5 A13	100	830	S5 013	80	740	S4 010			
	06.10-08.15				85	800	S5 011	80	740	S4 011				
TDI 4Motion [7F]	09.09-08.15		95	850	S5 A13	100	830	S5 013	80	740	S4 010			
	06.10-08.15				85	800	S5 011	80	740	S4 011				
2.5 TDI [7H]	02.03-11.09		95	850	S5 A13	100	830	S5 013	80	740	S4 010			
	11.03-11.09		95	850	S5 A13	100	830	S5 013	60	540	S4 005	56	480	S3 005
TDI 4Motion [7H]	07.04-11.09		95	850	S5 A13	100	830	S5 013	80	740	S4 010			

Transporter T6

2.0 TFSI [SF]	04.15→		80	800	S5 A11	85	800	S5 011	60	540	S4 005			
		BWD,SSJ	70	760	S5 A08				80	800	S4 E11			
TFSI [SG]	04.15→		80	800	S5 A11	85	800	S5 011	60	540	S4 005			
			80	800	S5 A11	85	800	S5 011	80	740	S4 011			
		BWD,SSJ	70	760	S5 A08				80	800	S4 E11			



			Ah A (EN) S5A			Ah A (EN) S5			Ah A (EN) S4			Ah A (EN) S3			Ah A (EN) T3		
			0 092 ...0			0 092 ...0			0 092 ...0			0 092 ...0			0 092 ...0		
◀ VW																	
2.0 TFSI 4Motion [SG]	04.15→		70	760	S5 A08	85	800	S5 011	60	540	S4 005						
			70	760	S5 A08	85	800	S5 011	80	740	S4 011						
		BWD,SSJ	80	800	S5 A11				80	800	S4 E11						
Diesel																	
2.0 TDI [DI]	05.16→	BWD	80	800	S5 A11												
		BWD,SSJ	70	760	S5 A08				70	760	S4 E08						
TDI [SF]	04.15→		70	760	S5 A08	85	800	S5 011	60	540	S4 005						
		BWD,SSJ	80	800	S5 A11												
			80	800	S5 A11				80	800	S4 E11						
			80	800	S5 A11	85	800	S5 011	60	540	S4 005						
	07.15→	BWD						80	800	S4 E11							
	05.16→	BWD	80	800	S5 A11												
	05.16→	BWD,SSJ	70	760	S5 A08				70	760	S4 E08						
TDI [SG]	04.15→		70	760	S5 A08	85	800	S5 011	60	540	S4 005						
			70	760	S5 A08	85	800	S5 011	80	740	S4 011						
			80	800	S5 A11	85	800	S5 011	60	540	S4 005						
		BWD						80	800	S4 E11							
		05.16→	BWD,SSJ	80	800	S5 A11				80	800	S4 E11					
		05.16→	BWD	80	800	S5 A11											
		05.16→	BWD,SSJ	70	760	S5 A08				70	760	S4 E08					
		08.18→		70	760	S5 A08											
	08.18→		80	800	S5 A11												
TDI 4Motion [SF]	04.15→		70	760	S5 A08	85	800	S5 011	60	540	S4 005						
		BWD,SSJ	80	800	S5 A11				80	800	S4 E11						
			80	800	S5 A11												
	08.15→	BWD	80	800	S5 A11												
	08.15→	BWD,SSJ	70	760	S5 A08				70	760	S4 E08						
TDI 4Motion [SG]	04.15→		70	760	S5 A08	85	800	S5 011	60	540	S4 005						
			70	760	S5 A08	85	800	S5 011	80	740	S4 011						
		BWD,SSJ	80	800	S5 A11				80	800	S4 E11						
		08.15→	BWD,SSJ	80	800	S5 A11											
		08.18→		70	760	S5 A08											
	08.18→		80	800	S5 A11												



			Ah	A (EN)		Ah	A (EN)		Ah	A (EN)		Ah	A (EN)	
					0 092 ...0			0 092 ...0			0 092 ...0			0 092 ...0

ASTRA

HD7														
9.5/ 13.8/ 17.2	01.96-12.00	ZE				180	1000	T5 077	170	1000	T4 077	180	1400	T3 055
HD8														
13.0	01.05→	ZE				180	1000	T5 077	170	1000	T4 077	180	1400	T3 055

AUWÄRTER E.

Eurostar														
SHD 0 404	01.80→	ZE	190	1050	TE 077	180	1000	T5 077	170	1000	T4 077			
Teamstar														
City/ Kombi	01.80→	ZE	190	1050	TE 077	180	1000	T5 077	170	1000	T4 077			
813														
-42	01.73→	ZE	190	1050	TE 077	180	1000	T5 077	170	1000	T4 077			
913														
-47	01.73→	ZE	190	1050	TE 077	180	1000	T5 077	170	1000	T4 077			

AVIA

D														
75,75T 4.0	10.01-12.06	ZE										88	680	T3 013

AWD

TL														
	01.88→	ZE										125	720	T3 040

BOVA

Futura														
FHD/ FHM/ FLD 10-,12-, 13-340, 104,120,127 9.2, 104-,120-,127-360, 12-, 13-340, 12-,13-380, 14-, 15-430, 15-380	09.01→	ZE	210	1200	TA 080									
Lexio														
LD/ LLD 123,130 9.2, 123-, 130-310, 123-,130-365	09.05-10.10	ZE	210	1200	TA 080									
Magig														
HD 120,122 12.6	10.99-09.05	ZE	210	1200	TA 080									
Magiq														
HD/ MHD 120,122 12.6, 122-410, 131,139 12.6, 131-,139-,148-460	10.99-10.10	ZE	210	1200	TA 080									
Maiq														
HD 120,122 12.6	10.99-10.10	ZE	210	1200	TA 080									
Synergy														
DD/ SDD 130,138 12.6, 130-, 138 12.6, 130-,141-460, 130-,141-510	09.04→	ZE	210	1200	TA 080									



			Ah	A (EN)		Ah	A (EN)		Ah	A (EN)		Ah	A (EN)	
			0 092 ...0			0 092 ...0			0 092 ...0			0 092 ...0		

DAF

CF															
65	.180	03.98-05.00	ZE				180	1000	T5 077	170	1000	T4 077	155	900	T3 077
		02.01-07.06	ZE	190	1050	TE 077	180	1000	T5 077	170	1000	T4 077			
	.210	02.98-04.02	ZE				180	1000	T5 077	170	1000	T4 077	155	900	T3 077
65/75	.220, .240, .250, .280, .290, .300, .310, .320, .360	12.97→	ZE	190	1050	TE 077	180	1000	T5 077	170	1000	T4 077			
76	.290, .330, .370	09.13→	ZE	240	1200	TE 088	225	1150	T5 080	170	1000	T4 077			
	[Euro 6]			210	1200	TA 080									
85	.250, .340	10.97-07.02	ZE	190	1050	TE 077	180	1000	T5 077	170	1000	T4 077			
	.360	05.06→	ZE	190	1050	TE 077	180	1000	T5 077	170	1000	T4 077			
	.380	03.98-09.02	ZE	190	1050	TE 077	180	1000	T5 077	170	1000	T4 077			
		06.01-12.07	ZE				180	1000	T5 077	140	800	T4 075	155	900	T3 077
	.410	04.06→	ZE	190	1050	TE 077	180	1000	T5 077	170	1000	T4 077			
	.430	10.97-04.02	ZE	190	1050	TE 077	180	1000	T5 077	170	1000	T4 077			
		01.01-10.07	ZE				180	1000	T5 077	140	800	T4 075	155	900	T3 077
	.460	04.06→	ZE	190	1050	TE 077	180	1000	T5 077	170	1000	T4 077			
	.480	10.01-10.07	ZE				180	1000	T5 077	170	1000	T4 077	155	900	T3 077
	.510	05.06→	ZE	190	1050	TE 077	180	1000	T5 077	170	1000	T4 077			
86	.400, .410, .440 [Euro 6]	07.13→	ZE	210	1200	TA 080									
	.460 [Euro 6]	07.13→	ZE	240	1200	TE 088	225	1150	T5 080	170	1000	T4 077			
				210	1200	TA 080									
	.510 [Euro 6]	07.13→	ZE	210	1200	TA 080									
LF															
36	.180, .210, .220, .250	03.14→	ZE							170	1000	T4 077			
	[Euro 6]														
45	.130	11.01-09.06	ZE										110	680	T3 037
	.140	07.06→	ZE										125	720	T3 040
	.150	04.01-10.07	ZE										110	680	T3 035
	.160	05.06→	ZE										125	720	T3 040
	.160 Hybrid	10.10→	ZE							170	1000	T4 077			
	.170, .180	04.01-12.08	ZE										110	680	T3 035
	.210	09.09→	ZE							170	1000	T4 077			
	.220	11.01-01.09	ZE										110	680	T3 035
		09.06→	ZE										125	720	T3 040
	.250	09.06→	ZE										110	680	T3 037
46	.180, .210, .220, .250, .280 [Euro 6]	03.14→	ZE							170	1000	T4 077			
55	.180	04.01-08.08	ZE										125	720	T3 040
	.210	02.09→	ZE							170	1000	T4 077			
	.220, .250	04.01-08.08	ZE										125	720	T3 040
		04.06→	ZE										125	720	T3 040
56	.220, .250, .280, .310 [Euro 6]	03.14→	ZE							170	1000	T4 077			
XF															
95	.380, .430, .480	01.97-09.03	ZE	190	1050	TE 077	180	1000	T5 077	170	1000	T4 077			
		01.02-12.07	ZE							170	1000	T4 077	155	900	T3 077
	.530	01.97-09.03	ZE	190	1050	TE 077	180	1000	T5 077	170	1000	T4 077			
105	.410, .460, .510	01.06→	ZE	210	1200	TA 080									
	[Euro 6]			190	1050	TE 077	180	1000	T5 077	170	1000	T4 077			
106	.410, .440 [Euro 6]	11.12→	ZE	240	1200	TE 088									
				210	1200	TA 080									
	.460 [Euro 6]	11.12→	ZE	240	1200	TE 088	225	1150	T5 080	170	1000	T4 077			
				210	1200	TA 080									
	.510 [Euro 6]	11.12→	ZE	240	1200	TE 088									
				210	1200	TA 080									
45															
.150/.160/.180/.210		01.96-04.01	ZE										110	680	T3 035
55															
.180/.210/.230		08.95-12.02	ZE										125	720	T3 040



			Ah	A (EN)		Ah	A (EN)		Ah	A (EN)		Ah	A (EN)	
			0 092 ...0			0 092 ...0			0 092 ...0			0 092 ...0		

65														
.180 ATi	01.93-08.98	ZE				145	800	T5 075	140	800	T4 075	120	680	T3 075
.210 ATi	01.93-04.02	ZE	190	1050	TE 077	180	1000	T5 077	170	1000	T4 077			
.240 ATi	03.96-08.98	ZE				145	800	T5 075	140	800	T4 075	120	680	T3 075
75														
.240/ .270/ .300 ATi	03.93-04.02	ZE	190	1050	TE 077	180	1000	T5 077	140	800	T4 075			
85														
.330/ .360/ .400 ATi	02.90-12.99	ZE	190	1050	TE 077	180	1000	T5 077	170	1000	T4 077			
95														
.400/ .430 ATi	10.89-12.98	ZE	190	1050	TE 077	180	1000	T5 077	170	1000	T4 077			

ERF

Serie ECT														
18.380	06.03→					180	1000	T5 077	170	1000	T4 077	155	900	T3 077

GAZ

Valday														
3.8 TD [3310]	09.10→											110	680	T3 035

GINAF

Serie X														
X21../X22../X31../X32../X33../X42../X4345/X4446/X4449/X5250/X5350/X5450/X5460	07.99→	ZE	190	1050	TE 077	180	1000	T5 077	170	1000	T4 077	155	900	T3 077
, B, /S/B, TS, TS/TSV														

HEULIEZ

GX Access Bus														
127, 127 L	03.06→	ZE	240	1200	TE 088	225	1150	T5 080	215	1150	T4 080	200	1050	T3 080
			210	1200	TA 080									

HINO

Serie FS														
13.3/275, KA	05.85→	ZE	190	1050	TE 077	180	1000	T5 077	170	1000	T4 077			

IKARUS

Serie 400														
405	01.94→	ZE	240	1200	TE 088	225	1150	T5 080	170	1000	T4 077	155	900	T3 077

IRISBUS

Arway														
	09.06-12.13	ZE	210	1200	TA 080									
Axer														
	03.05-01.07	ZE	210	1200	TA 080									
Citelis														
/18, CNG	04.05-12.13	ZE	210	1200	TA 080									
Citelis Line														
	09.05-12.13	ZE	210	1200	TA 080									



			Ah	A (EN)		Ah	A (EN)		Ah	A (EN)		Ah	A (EN)	
			0 092 ...0			0 092 ...0			0 092 ...0			0 092 ...0		





◀ IRISBUS

Crossway														
7.8	06.06-12.13	ZE	240	1200	TE 088	225	1150	T5 080	215	1150	T4 080	200	1050	T3 080
			210	1200	TA 080									
Domino														
	10.03-12.13	ZE	210	1200	TA 080									
Evadys														
	12.06-12.13	ZE	210	1200	TA 080									
Recreo														
	10.03-01.07	ZE	210	1200	TA 080									

IVECO

EuroCargo															
60 E 13, 15	08.00-08.03	ZE	190	1050	TE 077				110	680	T3 037				
	14, 16 [03]	05.09-01.14	ZE	190	1050	TE 077				110	680	T3 037			
65 E 12	06.96-07.00	ZE							110	680	T3 035				
	13	08.00-08.03	ZE							110	680	T3 037			
	13, 14 [03]	09.03-08.06	ZE							110	680	T3 037			
	15	08.00-08.03	ZE							110	680	T3 037			
	[03]	09.03-08.05	ZE							110	680	T3 035			
	16 [03]	09.04-08.06	ZE							110	680	T3 037			
	75 E 12	01.94-08.00	ZE							110	680	T3 035			
13	09.00-08.03	ZE							110	680	T3 037				
	[03]	09.03-08.05	ZE							110	680	T3 037			
	14	01.93-08.00	ZE							110	680	T3 035			
	[03]	09.05-01.14	ZE							110	680	T3 037			
	15	01.93-08.00	ZE							110	680	T3 035			
		09.00-08.03	ZE							110	680	T3 037			
	[03]	09.03-08.05	ZE							110	680	T3 035			
	16 [03]	09.05-01.14	ZE							110	680	T3 037			
	17	09.00-08.03	ZE							110	680	T3 037			
	[03]	09.03-08.05	ZE							110	680	T3 035			
	18	09.00-08.03	ZE							110	680	T3 037			
	[03]	09.03-08.05	ZE							110	680	T3 037			
	[03]	09.05-01.14	ZE							110	680	T3 035			
	80 E 15	01.91-08.00	ZE							110	680	T3 035			
		09.00-08.03	ZE							110	680	T3 037			
[03]		09.03-08.05	ZE							110	680	T3 035			
16 [03]		09.05-01.14	ZE							110	680	T3 037			
17		09.00-08.03	ZE							110	680	T3 037			
[03]		09.03-08.05	ZE							110	680	T3 037			
18		01.91-08.00	ZE							110	680	T3 035			
		09.00-08.03	ZE							110	680	T3 037			
[03]		09.03-08.05	ZE							110	680	T3 035			
[03]		09.05-01.14	ZE							110	680	T3 037			
21	01.91-08.00	ZE							110	680	T3 035				
	09.00-08.03	ZE							110	680	T3 037				
	[03]	09.03-08.05	ZE							110	680	T3 035			
	22 [03]	09.05-01.14	ZE							110	680	T3 037			
85 E/90 E 15, 18	01.91-08.00	ZE							110	680	T3 035				
90 E 17	09.00-08.03	ZE							110	680	T3 037				
	[03]	09.03-09.05	ZE							110	680	T3 037			
	18	09.91-07.00	ZE							110	680	T3 035			
		09.00-08.03	ZE							110	680	T3 037			
	[03]	09.03-09.05	ZE							110	680	T3 037			
	[03]	09.05-01.14	ZE							110	680	T3 035			
	19 [03]	09.03-08.05	ZE							110	680	T3 035			
	21	01.91-12.00	ZE							110	680	T3 035			
		09.00-08.03	ZE							110	680	T3 037			
		22 [03]	09.05-01.14	ZE							110	680	T3 037		
100 E 15	01.91-08.00	ZE							110	680	T3 035				
	17	09.00-08.03	ZE							110	680	T3 037			



			Ah A (EN) 			Ah A (EN) 			Ah A (EN) 			Ah A (EN) 		
			0 092 ...0			0 092 ...0			0 092 ...0			0 092 ...0		
100 E [03]	09.03-08.05	ZE										110	680	T3 035
18	01.91-11.00	ZE										110	680	T3 035
	09.00-08.03	ZE										110	680	T3 037
[03]	09.03-08.05	ZE										110	680	T3 035
	09.05-01.14	ZE										110	680	T3 037
21	01.91-11.00	ZE										110	680	T3 035
	09.00-08.03	ZE										110	680	T3 037
[03]	09.03-08.05	ZE										110	680	T3 035
100 E/110 E 22, 25 [03]	09.05-01.14	ZE										110	680	T3 037
120 E 15	12.91-07.00	ZE	190	1050	TE 077	180	1000	T5 077	170	1000	T4 077	110	680	T3 035
17	09.00-08.03	ZE	190	1050	TE 077	180	1000	T5 077	170	1000	T4 077	110	680	T3 037
[03]	09.03-08.05	ZE	190	1050	TE 077	180	1000	T5 077	170	1000	T4 077	110	680	T3 035
18	09.91-08.03	ZE	190	1050	TE 077	180	1000	T5 077	170	1000	T4 077	110	680	T3 037
[03]	09.03-01.14	ZE	190	1050	TE 077	180	1000	T5 077	170	1000	T4 077	110	680	T3 037
21	01.91-08.00	ZE	190	1050	TE 077	180	1000	T5 077	170	1000	T4 077	110	680	T3 035
	09.00-08.03	ZE	190	1050	TE 077	180	1000	T5 077	170	1000	T4 077	110	680	T3 037
21, 22 [03]	09.03-01.14	ZE	190	1050	TE 077	180	1000	T5 077	170	1000	T4 077	110	680	T3 037
23	10.91-08.00	ZE	190	1050	TE 077	180	1000	T5 077	170	1000	T4 077	110	680	T3 035
24	09.00-08.03	ZE	190	1050	TE 077	180	1000	T5 077	170	1000	T4 077	110	680	T3 037
24, 25 [03]	09.03-01.14	ZE	190	1050	TE 077	180	1000	T5 077	170	1000	T4 077	110	680	T3 037
28	09.00-08.03	ZE	190	1050	TE 077	180	1000	T5 077	170	1000	T4 077	110	680	T3 037
[03]	09.03-01.14	ZE	190	1050	TE 077	180	1000	T5 077	170	1000	T4 077	110	680	T3 037
120 EL 18 [03]	09.05-01.14	ZE	190	1050	TE 077	180	1000	T5 077	170	1000	T4 077	110	680	T3 035
130 E 15	12.91-07.00	ZE	190	1050	TE 077	180	1000	T5 077	170	1000	T4 077	110	680	T3 035
18	09.91-07.00	ZE	190	1050	TE 077	180	1000	T5 077	170	1000	T4 077	110	680	T3 035
	09.00-08.03	ZE	190	1050	TE 077	180	1000	T5 077	170	1000	T4 077	110	680	T3 037
[03]	09.03-01.14	ZE	190	1050	TE 077	180	1000	T5 077	170	1000	T4 077	110	680	T3 037
21	09.01-08.03	ZE	190	1050	TE 077	180	1000	T5 077	170	1000	T4 077	110	680	T3 035
[03]	09.03-08.05	ZE	190	1050	TE 077	180	1000	T5 077	170	1000	T4 077	110	680	T3 037
23	11.91-07.00	ZE	190	1050	TE 077	180	1000	T5 077	170	1000	T4 077	110	680	T3 035
24	09.00-08.03	ZE	190	1050	TE 077	180	1000	T5 077	170	1000	T4 077	110	680	T3 037
24, 25 [03]	09.03-01.14	ZE	190	1050	TE 077	180	1000	T5 077	170	1000	T4 077	110	680	T3 037
28	09.00-08.03	ZE	190	1050	TE 077	180	1000	T5 077	170	1000	T4 077	110	680	T3 037
[03]	09.03-08.05	ZE	190	1050	TE 077	180	1000	T5 077	170	1000	T4 077	110	680	T3 037
135 E 18, 23	01.94-07.00	ZE	190	1050	TE 077	180	1000	T5 077	170	1000	T4 077	110	680	T3 035
140 E 18, 24	09.00-08.03	ZE	190	1050	TE 077	180	1000	T5 077	170	1000	T4 077	110	680	T3 037
18, 21, 22, 24, 25 [03]	09.03-01.14	ZE	190	1050	TE 077	180	1000	T5 077	170	1000	T4 077	110	680	T3 037
28 [03]	09.03-08.05	ZE	190	1050	TE 077	180	1000	T5 077	170	1000	T4 077	110	680	T3 035
	09.05-01.14	ZE	190	1050	TE 077	180	1000	T5 077	170	1000	T4 077	110	680	T3 037
150 E 15	12.91-07.00	ZE	190	1050	TE 077	180	1000	T5 077	170	1000	T4 077	110	680	T3 035
18	09.91-07.00	ZE	190	1050	TE 077	180	1000	T5 077	170	1000	T4 077	110	680	T3 035
	09.00-08.03	ZE	190	1050	TE 077	180	1000	T5 077	170	1000	T4 077	110	680	T3 037
18, 21, 22, 24, 25, 28, 30 [03]	09.03-01.14	ZE	190	1050	TE 077	180	1000	T5 077	170	1000	T4 077	110	680	T3 037
21	01.91-08.03	ZE	190	1050	TE 077	180	1000	T5 077	170	1000	T4 077	110	680	T3 035
23, 27	10.91-07.00	ZE	190	1050	TE 077	180	1000	T5 077	170	1000	T4 077	110	680	T3 035
24, 28	09.00-08.03	ZE	190	1050	TE 077	180	1000	T5 077	170	1000	T4 077	110	680	T3 037
160 E 18, 21, 22, 24, 25, 28, 30 [03]	09.03-01.14	ZE	190	1050	TE 077	180	1000	T5 077	170	1000	T4 077	110	680	T3 037
170 E/170 R 15, 18, 23, 27	09.91-07.00	ZE	190	1050	TE 077	180	1000	T5 077	170	1000	T4 077	110	680	T3 035
180 E 21	04.92-07.00	ZE	190	1050	TE 077	180	1000	T5 077	170	1000	T4 077	110	680	T3 035
	09.00-08.03	ZE	190	1050	TE 077	180	1000	T5 077	170	1000	T4 077	110	680	T3 037
[03]	09.03-08.05	ZE	190	1050	TE 077	180	1000	T5 077	170	1000	T4 077	110	680	T3 037
24	09.00-08.03	ZE	190	1050	TE 077	180	1000	T5 077	170	1000	T4 077	110	680	T3 037
24, 25 [03]	09.03-01.14	ZE	190	1050	TE 077	180	1000	T5 077	170	1000	T4 077	110	680	T3 037
28	09.00-08.03	ZE	190	1050	TE 077	180	1000	T5 077	170	1000	T4 077	110	680	T3 037
28, 30 [03]	09.03-01.14	ZE	190	1050	TE 077	180	1000	T5 077	170	1000	T4 077	110	680	T3 037
260 E 23, 27	09.91-07.00	ZE	190	1050	TE 077	180	1000	T5 077	170	1000	T4 077	155	900	T3 077
28 [03]	09.03-08.05	ZE	190	1050	TE 077	180	1000	T5 077	170	1000	T4 077	110	680	T3 035
280 E 23	12.91-11.00	ZE	190	1050	TE 077	180	1000	T5 077	170	1000	T4 077	155	900	T3 077
320 E 27	10.91-08.00	ZE	190	1050	TE 077	180	1000	T5 077	170	1000	T4 077	155	900	T3 077
28	09.00-08.03	ZE	190	1050	TE 077	180	1000	T5 077	170	1000	T4 077	155	900	T3 077



			Ah			A (EN)			TE/TA			Ah			A (EN)			T5			Ah			A (EN)			T4			Ah			A (EN)			T3		
			0 092 ...0			0 092 ...0			0 092 ...0			0 092 ...0			0 092 ...0			0 092 ...0			0 092 ...0			0 092 ...0			0 092 ...0			0 092 ...0			0 092 ...0					
◀ IVECO																																						
EuroClass																																						
380	.10.29, .10.35, .12.29, .12.35, .12.38	01.93-11.02	ZE	190	1050	TE 077	180	1000	T5 077	170	1000	T4 077																										
EuroMover																																						
190 E/ 260 E	24	08.00-03.06	ZE	190	1050	TE 077	180	1000	T5 077	170	1000	T4 077	155	900	T3 077																							
EuroStar																																						
180 E/ 190 E/ 240 E/ 260 E/ 400 E/ 440 E	38, 39, 40, 42, 43, 46, 47, 48, 52	04.92-09.04	ZE	240	1200	TE 088	225	1150	T5 080	170	1000	T4 077																										
EuroTech																																						
175 E/ 179 E	27	04.92-07.00	ZE	190	1050	TE 077	180	1000	T5 077	170	1000	T4 077	110	680	T3 035																							
180 E/ 190 E/ 240 E	24, 25, 27, 30, 31, 34, 35, 38, 39, 40, 42, 43, 52	04.92-09.04	ZE	190	1050	TE 077	180	1000	T5 077	170	1000	T4 077	155	900	T3 077																							
240 E	24, 27, 31, 35, 39, 40, 42, 43	04.92-12.00	ZE	190	1050	TE 077	180	1000	T5 077	170	1000	T4 077	155	900	T3 077																							
	38	09.92-11.00	ZE	190	1050	TE 077	180	1000	T5 077	170	1000	T4 077	155	900	T3 077																							
	240			240	1200	TE 088	225	1150	T5 080	170	1000	T4 077	155	900	T3 077																							
260 E	24, 27, 31, 35, 38, 39, 40, 42, 43	06.92-09.04	ZE	190	1050	TE 077	180	1000	T5 077	170	1000	T4 077	155	900	T3 077																							
	52	04.92-07.00	ZE	240	1200	TE 088	225	1150	T5 080	170	1000	T4 077																										
325 E	27	07.92-07.00	ZE	190	1050	TE 077	180	1000	T5 077	170	1000	T4 077	155	900	T3 077																							
400 E	30, 34	04.92-12.00	ZE	190	1050	TE 077	180	1000	T5 077	170	1000	T4 077	155	900	T3 077																							
	31, 34, 35, 38, 40, 42, 52	04.92-12.00	ZE	190	1050	TE 077	180	1000	T5 077	170	1000	T4 077	155	900	T3 077																							
	38	09.92-11.00	ZE	190	1050	TE 077	180	1000	T5 077	170	1000	T4 077	155	900	T3 077																							
	240			240	1200	TE 088	225	1150	T5 080	170	1000	T4 077	155	900	T3 077																							
440 E	31, 34, 35, 38, 40, 42, 52	04.92-09.04	ZE	190	1050	TE 077	180	1000	T5 077	170	1000	T4 077	155	900	T3 077																							
	43	08.00-08.03	ZE	190	1050	TE 077	180	1000	T5 077	170	1000	T4 077	155	900	T3 077																							
440 E/S	43	04.02→	ZE	240	1200	TE 088	225	1150	T5 080																													
EuroTrakker																																						
180 E/ 190 E	24, 25, 27, 30, 31, 34, 35, 37	04.92-08.04	ZE	190	1050	TE 077	180	1000	T5 077	170	1000	T4 077	155	900	T3 077																							
190 E	30, 31, 34, 35, 37, 42, 44, 47, 48	04.92-08.04	ZE	190	1050	TE 077	180	1000	T5 077	170	1000	T4 077	155	900	T3 077																							
	38	08.00-12.07	ZE	190	1050	TE 077	180	1000	T5 077	170	1000	T4 077	155	900	T3 077																							
260 E	30, 31, 34, 35, 37, 38, 42, 44, 47, 48	04.92-08.04	ZE	190	1050	TE 077	180	1000	T5 077	170	1000	T4 077	155	900	T3 077																							
330 E/ 340 E/ 380 E	34, 35, 37, 38, 42, 44	04.92-08.04	ZE	240	1200	TE 088	225	1150	T5 080	170	1000	T4 077																										
380 E	47	06.92-12.00	ZE	210	1200	TA 080	225	1150	T5 080	170	1000	T4 077																										
	48			240	1200	TE 088																																
	48	08.00-08.04	ZE	240	1200	TE 088	225	1150	T5 080	170	1000	T4 077																										
400 E	34	04.92-12.00	ZE	190	1050	TE 077	180	1000	T5 077	170	1000	T4 077	155	900	T3 077																							
	34, 35, 37, 38, 42, 44, 48	04.92-08.04	ZE	240	1200	TE 088	225	1150	T5 080	170	1000	T4 077																										
	35	08.00-08.04	ZE	190	1050	TE 077	180	1000	T5 077	170	1000	T4 077	155	900	T3 077																							
410 E/ 440 E	34, 35, 37, 38, 42, 44, 48	04.92-08.04	ZE	240	1200	TE 088	225	1150	T5 080	170	1000	T4 077																										
440 E	39	08.00-08.04	ZE	190	1050	TE 077	180	1000	T5 077	170	1000	T4 077	155	900	T3 077																							
440 E/ 720 E	42, 44, 47, 48	04.92-08.04	ZE	240	1200	TE 088	225	1150	T5 080	170	1000	T4 077																										
Stralis																																						
L 190 S/ L 260 S	42, 45, 50, 56 [07]	04.07-12.12	ZE	210	1200	TA 080																																
L 440 S	33, 42, 45, 50, 56 [07]	04.07-12.12	ZE	210	1200	TA 080																																
	48 [07]	08.06-12.12	ZE	210	1200	TA 080	225	1150	T5 080																													
				240	1200	TE 088																																
N 440 S	33, 50, 56 [07]	04.07-12.12	ZE	210	1200	TA 080																																
	36 [07]	04.07-12.12	ZE	210	1200	TA 080	225	1150	T5 080																													
				240	1200	TE 088																																
190 S	27, 30, 31, 33, 35, 36	08.03-12.12	ZE	240	1200	TE 088	225	1150	T5 080	170	1000	T4 077																										



			0 092 ...0			0 092 ...0			0 092 ...0			0 092 ...0		
			Ah	A (EN)	TE/TA	Ah	A (EN)	T5	Ah	A (EN)	T4	Ah	A (EN)	T3
190 S 40	08.02-03.06	ZE	210	1200	TA 080	225	1150	T5 080	170	1000	T4 077			
			240	1200	TE 088									
42, 43, 45	08.02-12.12	ZE	240	1200	TE 088	225	1150	T5 080	170	1000	T4 077			
48, 50	08.02-12.12	ZE	210	1200	TA 080	225	1150	T5 080	170	1000	T4 077			
			240	1200	TE 088									
260 S 27, 30, 31, 33, 35, 36	08.03-12.12	ZE	240	1200	TE 088	225	1150	T5 080	170	1000	T4 077			
40	08.02-03.06	ZE	210	1200	TA 080	225	1150	T5 080	170	1000	T4 077			
			240	1200	TE 088									
42	04.06-12.12	ZE	240	1200	TE 088	225	1150	T5 080	170	1000	T4 077			
43	08.02-03.06	ZE	210	1200	TA 080	225	1150	T5 080	170	1000	T4 077			
			240	1200	TE 088									
44, 45, 48	08.02-12.12	ZE	240	1200	TE 088	225	1150	T5 080	170	1000	T4 077			
50, 54, 56	08.03-12.12	ZE	210	1200	TA 080	225	1150	T5 080	170	1000	T4 077			
			240	1200	TE 088				170	1000	T4 077			
440 S 31	08.03-03.06	ZE	240	1200	TE 088	225	1150	T5 080				220	1150	T3 081
33, 35, 40, 42, 43	08.02-12.12	ZE	210	1200	TA 080	225	1150	T5 080				220	1150	T3 081
			240	1200	TE 088									
44	08.03-03.06	ZE	240	1200	TE 088	225	1150	T5 080				220	1150	T3 081
45	04.06-12.12	ZE	210	1200	TA 080	225	1150	T5 080				220	1150	T3 081
			240	1200	TE 088									
48	08.02-03.06	ZE	210	1200	TA 080									
50, 54, 56	08.03-12.12	ZE	210	1200	TA 080	225	1150	T5 080				220	1150	T3 081
			240	1200	TE 088									
Stralis Hi-Way														
310/ 330/ 360/ 400/ 420/ 460/ 480	07.12→	ZE	210	1200	TA 080									
	07.13→	ZE	240	1200	TE 088	225	1150	T5 080	170	1000	T4 077			
500/ 560	07.12→	ZE	210	1200	TA 080									
Trakker														
AD 380 T 44W, 48	01.10→	ZE	240	1200	TE 088	225	1150	T5 080	215	1150	T4 080	220	1150	T3 081
N 190 T 31, 33, 36 [07]	07.07-06.13	ZE	210	1200	TA 080									
41 [07]	07.07-06.13	ZE	210	1200	TA 080	225	1150	T5 080	215	1150	T4 080	220	1150	T3 081
			240	1200	TE 088									
45 [07]	07.07-06.13	ZE	210	1200	TA 080	180	1000	T5 077	170	1000	T4 077	155	900	T3 077
			190	1050	TE 077									
N 260 T 33, 36 [07]	07.07-06.13	ZE	210	1200	TA 080									
41, 45, 50 [07]	07.07-06.13	ZE	210	1200	TA 080	180	1000	T5 077	170	1000	T4 077	155	900	T3 077
			190	1050	TE 077									
N 340 T 36 [07]	07.07-06.13	ZE	210	1200	TA 080									
N 340 T/ N 380 T 41, 45, 50 [07]	07.07-06.13	ZE	210	1200	TA 080	180	1000	T5 077	170	1000	T4 077	155	900	T3 077
			190	1050	TE 077									
N 400 T 36 [07]	07.07-06.13	ZE	210	1200	TA 080									
N 400 T/ N 410 T/ N 440 T/ N 720 T 41, 45, 50 [07]	07.07-06.13	ZE	210	1200	TA 080	180	1000	T5 077	170	1000	T4 077	155	900	T3 077
			190	1050	TE 077									
180 T 24	09.04-03.06	ZE	190	1050	TE 077	180	1000	T5 077	170	1000	T4 077	155	900	T3 077
27	09.04-03.06	ZE	210	1200	TA 080	180	1000	T5 077	170	1000	T4 077	155	900	T3 077
			190	1050	TE 077									
31	09.04-03.06	ZE	190	1050	TE 077	180	1000	T5 077	170	1000	T4 077	155	900	T3 077
190 T 27, 31, 33, 35, 36, 38, 41, 44, 45	09.04-12.12	ZE	210	1200	TA 080	225	1150	T5 080	215	1150	T4 080	220	1150	T3 081
			240	1200	TE 088									
31 [13]	07.13→	ZE	210	1200	TA 080									
33 [13]	11.13→	ZE	210	1200	TA 080	225	1150	T5 080	170	1000	T4 077			
			240	1200	TE 088									
36 [13]	11.13→	ZE	210	1200	TA 080	225	1150	T5 080	170	1000	T4 077			
			240	1200	TE 088									
45 [13]	11.13→	ZE	210	1200	TA 080	225	1150	T5 080	170	1000	T4 077			
			240	1200	TE 088									
260 T 31, 33, 35, 36, 38, 41, 44, 45, 48, 50	09.04-12.12	ZE	210	1200	TA 080	225	1150	T5 080	215	1150	T4 080	220	1150	T3 081
			240	1200	TE 088									
33, 36, 45, 50 [13]	01.13→	ZE	210	1200	TA 080									
340 T 35, 36, 38, 41, 44, 45	09.04-12.12	ZE	210	1200	TA 080	180	1000	T5 077	170	1000	T4 077	155	900	T3 077
			190	1050	TE 077									
36, 45 [13]	01.13→	ZE	210	1200	TA 080									
380 T 35	09.04-03.06	ZE	190	1050	TE 077	180	1000	T5 077	170	1000	T4 077	155	900	T3 077



				Ah	A (EN)		Ah	A (EN)		Ah	A (EN)		Ah	A (EN)	
				0 092 ...0			0 092 ...0			0 092 ...0			0 092 ...0		
IVECO															
380 T 36	04.06-12.12	ZE	210	1200	TA 080										
[13]	01.13→	ZE	210	1200	TA 080										
38, 41	09.04-12.12	ZE	210	1200	TA 080	180	1000	T5 077	170	1000	T4 077	155	900	T3 077	
			190	1050	TE 077										
41 [13]	11.13→	ZE	210	1200	TA 080	225	1150	T5 080	170	1000	T4 077				
			240	1200	TE 088										
42	04.06-12.12	ZE	190	1050	TE 077	180	1000	T5 077	170	1000	T4 077	155	900	T3 077	
44, 45, 48, 50	09.04-12.12	ZE	210	1200	TA 080	180	1000	T5 077	170	1000	T4 077	155	900	T3 077	
			190	1050	TE 077										
45 [13]	11.13→	ZE	210	1200	TA 080	225	1150	T5 080	170	1000	T4 077				
			240	1200	TE 088										
50 [13]	01.13→	ZE	210	1200	TA 080										
400 T 35, 36, 38, 41	09.04-12.12	ZE	210	1200	TA 080	180	1000	T5 077	170	1000	T4 077	155	900	T3 077	
			190	1050	TE 077										
36, 50 [13]	01.13→	ZE	210	1200	TA 080										
42	04.06-12.12	ZE	190	1050	TE 077	180	1000	T5 077	170	1000	T4 077	155	900	T3 077	
44, 50	09.04-12.12	ZE	210	1200	TA 080	180	1000	T5 077	170	1000	T4 077	155	900	T3 077	
			190	1050	TE 077										
410 T 35	09.04-03.06	ZE	190	1050	TE 077	180	1000	T5 077	170	1000	T4 077	155	900	T3 077	
36	04.06-12.12	ZE	210	1200	TA 080										
38, 41	09.04-12.12	ZE	210	1200	TA 080	180	1000	T5 077	170	1000	T4 077	155	900	T3 077	
			190	1050	TE 077										
42	04.06-12.12	ZE	190	1050	TE 077	180	1000	T5 077	170	1000	T4 077	155	900	T3 077	
44, 45, 48, 50	09.04-12.12	ZE	210	1200	TA 080	180	1000	T5 077	170	1000	T4 077	155	900	T3 077	
			190	1050	TE 077										
45, 50 [13]	01.13→	ZE	210	1200	TA 080										
440 T 38, 41, 44, 45, 50	09.04-12.12	ZE	210	1200	TA 080	180	1000	T5 077	170	1000	T4 077	155	900	T3 077	
			190	1050	TE 077										
50 [13]	01.13→	ZE	210	1200	TA 080										
720 T 38, 41	09.04-12.12	ZE	210	1200	TA 080	180	1000	T5 077	170	1000	T4 077	155	900	T3 077	
			190	1050	TE 077										
42	04.06-12.12	ZE	190	1050	TE 077	180	1000	T5 077	170	1000	T4 077	155	900	T3 077	
44, 45, 48, 50	09.04-12.12	ZE	210	1200	TA 080	180	1000	T5 077	170	1000	T4 077	155	900	T3 077	
			190	1050	TE 077				170	1000	T4 077	155	900	T3 077	
50 [13]	01.13→	ZE	210	1200	TA 080										
TurboStar															
190/ 240/ 260 -36, -38 PT, -48	03.89-12.00	ZE	190	1050	TE 077	180	1000	T5 077	170	1000	T4 077				
TurboTech															
190/ 220/ 240/ 260 -24, -26, -32, -36	10.88-01.01	ZE	190	1050	TE 077	180	1000	T5 077	170	1000	T4 077				
110															
110 -17 W	07.87-12.99	ZE											143	950	T3 047
115 -17	01.86-12.99	ZE	190	1050	TE 077	180	1000	T5 077	170	1000	T4 077				
180															
180 -23 AH, -23 AHW, -25 AH, -25 AHW, -34 AH, -34 AHW	07.91-07.00	ZE	190	1050	TE 077	180	1000	T5 077	170	1000	T4 077				
190															
190 -36 P	07.90-11.98	ZE	190	1050	TE 077	180	1000	T5 077	170	1000	T4 077				
220															
220 -34 HTM	09.91-11.00	ZE	190	1050	TE 077	180	1000	T5 077	170	1000	T4 077				
240															
240 -25 ANW, -35 ANW	07.91-12.00	ZE	190	1050	TE 077	180	1000	T5 077	170	1000	T4 077				
260															
260 -23 AH, -25 AH..., -34 AH, -34 AHW	04.89-12.99	ZE	190	1050	TE 077	180	1000	T5 077	170	1000	T4 077				
300															
300 -32 AH...	04.89-12.99	ZE	190	1050	TE 077	180	1000	T5 077	170	1000	T4 077				
330															
330 -36 H, -36 HW	01.89-12.99	ZE	190	1050	TE 077	180	1000	T5 077	170	1000	T4 077				
340															
-34 AH	03.89-12.98	ZE	190	1050	TE 077	180	1000	T5 077	170	1000	T4 077				



			Ah	A (EN)		Ah	A (EN)		Ah	A (EN)		Ah	A (EN)	
			0 092 ...0			0 092 ...0			0 092 ...0			0 092 ...0		

KAROSA

C													
734 .1340	08.93→	ZE	190	1050	TE 077	180	1000	T5 077	170	1000	T4 077		
LC													
735/736/757 .1022, .1024, .1030, .1031, .1060	12.91→	ZE	190	1050	TE 077	180	1000	T5 077	170	1000	T4 077		

KÄSSBOHRER

Setra													
S 215/ S 300/ S 309/ S 312	09.91-07.01	ZE	190	1050	TE 077	180	1000	T5 077	170	1000	T4 077		
HD, HDH, N, NC													

KRAZ

16t													
5133VE	01.00→	ZE	240	1200	TE 088	225	1150	T5 080					
17t													
5444	01.00→	ZE	240	1200	TE 088	225	1150	T5 080					
18t													
5133N2	01.00→	ZE	240	1200	TE 088	225	1150	T5 080					
23t													
6322/ 6446, -02	01.00→	ZE	240	1200	TE 088	225	1150	T5 080					
26t													
6510/ 65101	01.00→	ZE	240	1200	TE 088	225	1150	T5 080					
27t													
64372/ 65032, -02	01.00→	ZE	240	1200	TE 088	225	1150	T5 080					
28t													
6230C4/ 6233M6/ 6443/ 64431/ 65032/ 65053/ 65055, -000, -02	01.00→	ZE	240	1200	TE 088	225	1150	T5 080					
29t													
7133C4/ 7133N4	01.00→	ZE	240	1200	TE 088	225	1150	T5 080					
32t													
6133C6	01.00→	ZE	240	1200	TE 088	225	1150	T5 080					
34t													
6446	01.00→	ZE	240	1200	TE 088	225	1150	T5 080					

LEYLAND-DAF

45														
.120/ .130/ .150/ .160, Turbo	05.90-12.01	ZE										110	680	T3 035
50														
.160	01.90-12.01	ZE										110	680	T3 035
60														
.180/ .210	01.90-12.01	ZE										110	680	T3 035
80														
.330 ATi	01.90-12.01	ZE										125	720	T3 040
95														
.310/ .350/ .380/ .400	04.89-12.01	ZE	190	1050	TE 077	180	1000	T5 077	170	1000	T4 077			



			Ah	A (EN)		Ah	A (EN)		Ah	A (EN)		Ah	A (EN)	
			0 092 ...0			0 092 ...0			0 092 ...0			0 092 ...0		

LIAZ (CZ)

Serie 18t-33,5t

18.23/ 19.38/ 34.33 KB 05, SD/S3, TBV	01.88-12.00	ZE	190	1050	TE 077	180	1000	T5 077	170	1000	T4 077
---------------------------------------	-------------	----	-----	------	---------------	-----	------	---------------	-----	------	---------------

Serie 100-300

100/ 110/ 230 , .55 p, .573 DD	03.87-09.03	ZE	190	1050	TE 077	180	1000	T5 077	170	1000	T4 077
--------------------------------	-------------	----	-----	------	---------------	-----	------	---------------	-----	------	---------------

MAN

Bus 8t

8.150/ 8.160/ 8.220 FOC, FOCL [L50; L51; L52; L53]	02.95-09.01	ZE				145	800	T5 075	140	800	T4 075	120	680	T3 075
----------------------------------------------------	-------------	----	--	--	--	-----	-----	---------------	-----	-----	---------------	-----	-----	---------------

Bus 11t

11.220 HOCL [469]	11.95-12.04	ZE				145	800	T5 075	140	800	T4 075
-------------------	-------------	----	--	--	--	-----	-----	---------------	-----	-----	---------------

Bus 12t

12.220 HOCL-NL [A76]	07.98-09.06	ZE	190	1050	TE 077	180	1000	T5 077	140	800	T4 075	120	680	T3 075
HOCL-SR [A77]	03.03-09.06	ZE	190	1050	TE 077	180	1000	T5 077	140	800	T4 075	120	680	T3 075
12.280 HOCL-NL [A76]	01.01-09.02	ZE	240	1200	TE 088	225	1150	T5 080	215	1150	T4 080	200	1050	T3 080

Bus 13t

13.220/ 13.230 HOCL [A53]	11.95-05.04	ZE	240	1200	TE 088	225	1150	T5 080	170	1000	T4 077	155	900	T3 077
---------------------------	-------------	----	-----	------	---------------	-----	------	---------------	-----	------	---------------	-----	-----	---------------

Bus 14t

14.220 HOCL-NL [A66]	07.98-09.06	ZE	190	1050	TE 077	180	1000	T5 077	140	800	T4 075	120	680	T3 075
14.290 HOCL-NL [A66]	06.11→	ZE	210	1200	TA 080	225	1150	T5 080						
			240	1200	TE 088									

Bus 18t

18.220/ 18.260/ 18.280 HOCL-NL [A69]	07.98-09.06	ZE	190	1050	TE 077	180	1000	T5 077	170	1000	T4 077	155	900	T3 077
18.310 HOCL-NL [A69]	07.98-09.06	ZE	190	1050	TE 077	180	1000	T5 077	170	1000	T4 077			
18.400 HOCL [A51]	09.96-12.00	ZE	190	1050	TE 077	180	1000	T5 077	170	1000	T4 077			

Bus 22t

22.400/ 22.420 HOCLN	11.95-12.00	ZE	240	1200	TE 088	225	1150	T5 080	215	1150	T4 080	200	1050	T3 080
----------------------	-------------	----	-----	------	---------------	-----	------	---------------	-----	------	---------------	-----	------	---------------

Bus 24t

24.360/ 24.400/ 24.410/ 24.460 HOCLLN, HOCLN [474]	07.96-09.06	ZE	240	1200	TE 088	225	1150	T5 080	215	1150	T4 080	200	1050	T3 080
----------------------------------------------------	-------------	----	-----	------	---------------	-----	------	---------------	-----	------	---------------	-----	------	---------------

EL / EM

EL 202 F [A16,A17]	02.94-05.99	ZE				225	1150	T5 080						
EL 222 [A12]	11.95-09.01	ZE	210	1200	TA 080	225	1150	T5 080						
			240	1200	TE 088									
F [A16,A17]	06.97-05.99	ZE	240	1200	TE 088	225	1150	T5 080						
EL 262 [A12]	07.94-09.01	ZE	210	1200	TA 080									
	02.96-09.01	ZE	240	1200	TE 088	225	1150	T5 080						
F [A16,A17]	06.97-05.99	ZE	240	1200	TE 088	225	1150	T5 080						
EM 11.222 [469]	02.96-09.01	ZE	190	1050	TE 077	180	1000	T5 077	170	1000	T4 077	155	900	T3 077
EM 13.222 [A53]	06.97-09.01	ZE	190	1050	TE 077	180	1000	T5 077	170	1000	T4 077	155	900	T3 077
EM 13.222/ EM 220 [469]	06.97-12.04	ZE	190	1050	TE 077	180	1000	T5 077	170	1000	T4 077	155	900	T3 077



			Ah	A (EN)		Ah	A (EN)		Ah	A (EN)		Ah	A (EN)	
					0 092 ...0			0 092 ...0			0 092 ...0			0 092 ...0

E2000

19.293/ 19.314/ 19.343/ 19.364/ 19.403/ 19.414/ 19.463/ 19.464/ 26.233/ 26.293/ 26.314/ 26.343/ 26.364/ 26.403/ 26.414/ 26.463/ 26.464/ 27.604/ 28.233/ 28.293/ 28.314/ 28.343/ 28.364/ 28.403/ 28.414/ 28.463/ 28.464/ 30.293/ 30.314/ 30.343/ 30.364/ 30.403/ 30.414/ 30.463/ 30.464/ 32.293/ 32.314/ 32.343/ 32.364/ 32.403/ 32.414/ 32.463/ 32.464/ 33.293/ 33.343/ 33.364/ 33.403/ 33.414/ 33.463/ 33.464/ 33.604/ 35.343/ 35.364/ 35.403/ 35.414/ 35.463/ 35.464/ 40.604/ 41.343/ 41.364/ 41.403/ 41.414/ 41.463/ 41.464/ 41.604/ 42.414/ 42.464/ 50.414/ 50.464/ 50.604 , DFAL, DFAS, DFAS, DFALS, DFL, DFLS, DFVL, DFVLS, F, FA, FALS/FALK, FANL, FANLC, FAV, FAVL, FL, FLS/FLK, FNL, FNLC, FV, VF, VFA, VFAK, VFAS, VFAVK, VFK, VFL, VFCL, VFNL, VFVK	06.96-09.02	ZE	190	1050	TE 077	180	1000	T5 077	170	1000	T4 077	155	900	T3 077
----------------------------------------------------------------------------------------------------------------------------------------------------------------------------------------------------------------------------------------------------------------------------------------------------------------------------------------------------------------------------------------------------------------------------------------------------------------------------------------------------------------------------------------------------------------------------------------------------------------------------------------------------------------------------------------------------------------------------------------------------------------------------------------------------------------------------------------------------------	-------------	----	-----	------	---------------	-----	------	---------------	-----	------	---------------	-----	-----	---------------

E2000 Evol. (FE)

19.310/ 19.360/ 19.410/ 19.460/ 26.360/ 26.410/ 26.460/ 28.310/ 28.360/ 28.410/ 28.460/ 30.360/ 30.410/ 30.460/ 32.360/ 32.410/ 32.460/ 33.360/ 33.410/ 33.460/ 35.360/ 35.410/ 35.460/ 41.410/ 41.460/ 50.410/ 50.460/ 310A/ 360A/ 410A/ 460A DA, DF, F, FA, F, FL, FVA, FVF, FVN, VA, VF	01.00-12.03	ZE	190	1050	TE 077	180	1000	T5 077	170	1000	T4 077	155	900	T3 077
-----------------------------------------------------------------------------------------------------------------------------------------------------------------------------------------------------------------------------------------------------------------------------------------------------------------------------	-------------	----	-----	------	---------------	-----	------	---------------	-----	------	---------------	-----	-----	---------------

FR / FRH

FRH 352 [A03]	09.95-11.99	ZE	210	1200	TA 080	225	1150	T5 080						
			240	1200	TE 088									
F [A33]	07.98-09.01	ZE	210	1200	TA 080	225	1150	T5 080						
			240	1200	TE 088									
FRH 402 [A03]	09.95-11.99	ZE	210	1200	TA 080	225	1150	T5 080						
			240	1200	TE 088									
F [A33]	07.98-09.01	ZE	210	1200	TA 080	225	1150	T5 080						
			240	1200	TE 088									

F2000

17.373/ 17.374 DF	01.94-12.03	ZE	190	1050	TE 077	180	1000	T5 077	170	1000	T4 077			
-------------------	-------------	----	-----	------	---------------	-----	------	---------------	-----	------	---------------	--	--	--



			Ah	A (EN)		Ah	A (EN)		Ah	A (EN)		Ah	A (EN)	
--	--	--	----	--------	--	----	--------	--	----	--------	--	----	--------	--

◀ MAN 0 092 ...0 0 092 ...0 0 092 ...0 0 092 ...0

19.233/ 19.293/ 19.314/ 19.343/ 19.364/ 19.403/ 19.414/ 19.463/ 19.464/ 19.603/ 19.604/ 23.293/ 23.314/ 23.343/ 23.364/ 23.403/ 23.414/ 23.463/ 23.464/ 24.293/ 24.314/ 24.343/ 24.364/ 24.403/ 24.414/ 24.463/ 24.464/ 26.233/ 26.293/ 26.314/ 26.343/ 26.364/ 26.403/ 26.414/ 26.463/ 26.464/ 26.603/ 26.604/ 27.293/ 27.314/ 27.343/ 27.364/ 27.403/ 27.414/ 27.463/ 27.464/ 27.603/ 27.604/ 32.293/ 32.314/ 32.343/ 32.364/ 32.403/ 32.414/ 32.463/ 32.464/ 33.343/ 33.364/ 33.373/ 33.374/ 33.403/ 33.414/ 33.463/ 33.464/ 33.603/ 33.604/ 35.343/ 35.364/ 35.403/ 35.414/ 35.463/ 35.464/ 40.414/ 40.464/ 41.343/ 41.364/ 41.403/ 41.414/ 41.463/ 41.464, DF, DFA, DFC, DFK, DFL, DFLS, DFS, DFS/DFK/DF-TM/DFC, F, FA, FAS/FAC/FAK, FL, FLL, FLL-P, FLLR-P, FLLS/FLLC/ FLCW, FLS, FLS/FLK/FLC, FNL, FNLC, FNLL, FNLLC, FNLLC/FNLLW, FNLLC/L, FNLLRC, FNLS/FNLC, FVL, K/L, VF, VF-TM	01.94→	ZE	190	1050	TE 077	180	1000	T5 077	170	1000	T4 077	155	900	T3 077
----------------------------------------------------------------------------------------------------------------------------------------------------------------------------------------------------------------------------------------------------------------------------------------------------------------------------------------------------------------------------------------------------------------------------------------------------------------------------------------------------------------------------------------------------------------------------------------------------------------------------------------------------------------------------------------------------------------------------------------------------------------------------------------------------------------------------------------------------------------------------------------------------------------------------------------------------------------------------------------------------	--------	----	-----	------	---------------	-----	------	---------------	-----	------	---------------	-----	-----	---------------

F2000 Evol. (FE)														
35.310/ 35.410/ 310A/ 360A/ 410A/ 460A DA, DF, F, FA, F, FL, VF	07.99-09.03	ZE	190	1050	TE 077	180	1000	T5 077	170	1000	T4 077			

Lion's City / Hybrid [A37]	08.05→	ZE	240	1200	TE 088	225	1150	T5 080						
--------------------------------------	--------	----	-----	------	---------------	-----	------	---------------	--	--	--	--	--	--

Lion's City / NL / NL 223/ NL 243 [A21]	07.98-09.06	ZE	240	1200	TE 088	225	1150	T5 080						
NL 243 [A37]	01.02-09.06	ZE	240	1200	TE 088	225	1150	T5 080						
NL 283 [A21]	01.01-09.06	ZE	240	1200	TE 088	225	1150	T5 080						
[A37]	01.02-09.06	ZE	240	1200	TE 088	225	1150	T5 080						
NL 313 [A21]	01.01-09.06	ZE	240	1200	TE 088	225	1150	T5 080						

Lion's City DD / ND ND 313/ ND 363 [A39]	08.03-08.14	ZE	240	1200	TE 088	225	1150	T5 080						
----------------------------------------------------	-------------	----	-----	------	---------------	-----	------	---------------	--	--	--	--	--	--

Lion's City G / NG NG 243/ NG 263/ NG 313/ NG 353/ NG 363 [A23]	07.98-09.06	ZE	240	1200	TE 088	225	1150	T5 080						
------------------------------------------------------------------------------	-------------	----	-----	------	---------------	-----	------	---------------	--	--	--	--	--	--

Lion's City LL / NL NL 263/ NL 313/ NL 353/ NL 363 [A26]	08.98-09.06	ZE	240	1200	TE 088	225	1150	T5 080						
-----------------------------------------------------------------------	-------------	----	-----	------	---------------	-----	------	---------------	--	--	--	--	--	--

Lion's City M / NM [A47]	04.04-09.06	ZE	240	1200	TE 088	225	1150	T5 080						
------------------------------------	-------------	----	-----	------	---------------	-----	------	---------------	--	--	--	--	--	--

Lion's City T / Tü / EL [A78]	06.04-09.06	ZE	240	1200	TE 088	225	1150	T5 080						
-----------------------------------------	-------------	----	-----	------	---------------	-----	------	---------------	--	--	--	--	--	--

Lion's City Ü / NÜ [A20]	06.04-09.06	ZE	240	1200	TE 088	225	1150	T5 080						
NÜ 233 [A20]	07.97-12.01	ZE	240	1200	TE 088	225	1150	T5 080	215	1150	T4 080			



			Ah			A (EN)			Ah			A (EN)		
			TE/TA	T5	T4	T3								
			0 092 ...0			0 092 ...0			0 092 ...0			0 092 ...0		
NÜ 263 [A20]	09.96-09.01	ZE	190	1050	TE 077	180	1000	T5 077						
	01.01-09.06	ZE	240	1200	TE 088	225	1150	T5 080						
NÜ 283 [A20]	01.01-09.06	ZE	240	1200	TE 088	225	1150	T5 080	215	1150	T4 080			
			240	1200	TE 088									
NÜ 313 [A20]	07.98-09.06	ZE	190	1050	TE 077	180	1000	T5 077						
Lion's City ÜLL / NÜ														
NÜ 313/ NÜ 353/ NÜ 363 [A25]	02.98-09.06	ZE	240	1200	TE 088	225	1150	T5 080						
Lion's Classic G / SG														
SG 263/ SG 313 [A75]	06.03-09.06	ZE	240	1200	TE 088	225	1150	T5 080	215	1150	T4 080	200	1050	T3 080
Lion's Classic SL														
SL 223/ SL 283 [A74]	06.03-10.06	ZE	240	1200	TE 088	225	1150	T5 080	215	1150	T4 080	200	1050	T3 080
Lion's Classic Ü / SÜ														
SÜ 223/ SÜ 283/ SÜ 313/ SÜ 363 [A72]	06.04-09.06	ZE	240	1200	TE 088	225	1150	T5 080	215	1150	T4 080	200	1050	T3 080
Lion's Coach														
C,L [R07,R08,R09]	09.02-09.06	ZE	240	1200	TE 088	225	1150	T5 080						
Lion's Coach RHC														
RHC 414/ RHC 464 [R07,R08,R09]	09.02-09.06	ZE	210	1200	TA 080	225	1150	T5 080						
			240	1200	TE 088									
Lion's Comfort														
R 313 [A01,A04]	01.98-12.01	ZE	210	1200	TA 080	225	1150	T5 080						
			240	1200	TE 088									
Lion's Regio														
/ ÜL 314/ ÜL 364 [R12,R13,R14]	06.04→	ZE	240	1200	TE 088	225	1150	T5 080						
Lion's Regio C														
[R12,R13,R14]	10.06-05.07	ZE	240	1200	TE 088	225	1150	T5 080						
Lion's Regio L														
[R12,R13,R14]	10.06-05.07	ZE	240	1200	TE 088	225	1150	T5 080						
Lion's Star														
RH 352/ RH 402 [A03]	07.98-09.01	ZE	210	1200	TA 080	225	1150	T5 080						
			240	1200	TE 088									
RH 463 [A03]	06.99-09.01	ZE	240	1200	TE 088	225	1150	T5 080						
RHS 414/ RHS 464 [R02, R03]	10.01-09.06	ZE	210	1200	TA 080	225	1150	T5 080						
			240	1200	TE 088									
Lion's Star L														
RHS 414/ RHS 464 [R02, R03]	10.01-09.06	ZE	210	1200	TA 080	225	1150	T5 080						
			240	1200	TE 088									
Lion's Top Coach														
RH 403/ RH 463 [A32]	06.99-01.04	ZE	210	1200	TA 080	225	1150	T5 080						
			240	1200	TE 088									
Lion's Top Star														
RHS 414/ RHS 464 [R03]	01.02-09.06	ZE	210	1200	TA 080	225	1150	T5 080						
			240	1200	TE 088									
L2000														
8.113/ 8.163/ 8.185/ 8.224/ 9.163/ 9.185/ 9.224/ 10.145/ 10.153/ 10.160/ 10.163/ 10.220/ 10.224 F, FL, FOC, FOCL, L, LA, LC, LC, LK, LK-L, LK, L-KI, LK-LV, LL, LLC, LLS	07.94→	ZE				145	800	T5 075	140	800	T4 075	120	680	T3 075
12.153/ 12.163/ 12.224/ 14.153/ 14.163/ 14.224/ 14.264/ 15.163/ 15.223/ 15.224/ 15.264/ 18.224/ 18.264/ 20.224/ 20.264 L, LA, LL	01.95→	ZE	190	1050	TE 077	180	1000	T5 077	140	800	T4 075	120	680	T3 075



				Ah	A (EN)		0 092 ...0	Ah	A (EN)		0 092 ...0	Ah	A (EN)		0 092 ...0	Ah	A (EN)		0 092 ...0	
◀ MAN																				
L2000 Evol. (LE)																				
8.140/ 8.150/ 8.180/	09.00-12.06	ZE					145	800	T5 075		140	800	T4 075		120	680	T3 075			
8.220/ 9.140/ 9.150/																				
9.180/ 9.220/ 10.150/																				
10.180/ 10.220/ 140C/																				
160B/ 160C/ 180C/ 220C																				
F, FA, F, FL																				
M2000																				
12.224/ 12.255/ 12.264/	08.95-08.02	ZE	190	1050	TE 077		180	1000	T5 077		140	800	T4 075		120	680	T3 075			
12.284/ 12.285/ 14.224/																				
14.264/ 14.284/ 15.284/																				
18.224/ 18.264/ 18.284/																				
20.284/ 25.224/ 25.264/																				
25.284 LA-AF, LAC, LAK, LAK-LV, LC, LC, LRC, LK, LRK, LK-LV, L-KO, LLC, LLK, LLLC, LNLC, LNLLC, M, MA, MAC, MAK, MAK-LV, MA-KO, MA-LF, MC, MK-LV, M-KO, ML, MLC, MLK, MLLC, MLS, MNLC, MNLLC, MVL, MVLC																				
M2000 Evol. (LE)																				
12.180/ 12.220/ 12.250/	09.02-06.06	ZE					145	800	T5 075		140	800	T4 075		120	680	T3 075			
12.280 F, FL																				
14.220 F, FL	09.02-06.06	ZE	190	1050	TE 077		180	1000	T5 077		140	800	T4 075		120	680	T3 075			
14.225/ 14.250/ 14.255/	09.02-09.06	ZE	190	1050	TE 077		180	1000	T5 077		140	800	T4 075		120	680	T3 075			
14.285/ 14.285/ 15.180/																				
15.220/ 15.250/ 15.280/																				
18.220/ 18.250B/ 18.280/																				
20.220/ 20.250/ 20.280																				
DF, F, FA, F, FL																				
160B F, FA	09.00-09.01	ZE	190	1050	TE 077		180	1000	T5 077		140	800	T4 075		120	680	T3 075			
160B/ 180B F, FL	09.00-08.02	ZE	190	1050	TE 077		180	1000	T5 077		140	800	T4 075		120	680	T3 075			
180C F, FL	07.01-09.02	ZE					145	800	T5 075		140	800	T4 075		120	680	T3 075			
220B DF, F, FA	09.00-09.02	ZE	190	1050	TE 077		180	1000	T5 077		140	800	T4 075		120	680	T3 075			
F, FL	08.00-08.02	ZE	190	1050	TE 077		180	1000	T5 077		140	800	T4 075		120	680	T3 075			
220C F, FL	07.01-08.02	ZE					145	800	T5 075		140	800	T4 075		120	680	T3 075			
250B/ 280B DF, F, FA, F, FL	09.00-09.02	ZE	190	1050	TE 077		180	1000	T5 077		140	800	T4 075		120	680	T3 075			
M2000 Evol. (ME)																				
12.220/ 12.250/ 12.280/	08.00-07.05	ZE	190	1050	TE 077		180	1000	T5 077		140	800	T4 075		120	680	T3 075			
14.220/ 14.250/ 14.280/																				
18.220/ 18.250/ 18.280/																				
25.250/ 25.280/ 220B/																				
250B/ 280B DF, F, FA, F, FL																				
M2000L																				
26.225/ 26.255 DLK	01.99-06.02	ZE	190	1050	TE 077		180	1000	T5 077		140	800	T4 075		120	680	T3 075			
26.284/ 26.285 DL, DLK,	01.99-12.02	ZE	190	1050	TE 077		180	1000	T5 077		140	800	T4 075							
DL-TM																				
NG-Serie																				
NG 232 [A18]	04.94-11.99	ZE									140	800	T4 076		110	760	T3 038			
NG 262 [A11]	06.97-11.99	ZE	190	1050	TE 077		180	1000	T5 077											
NG 263 F [A24]	07.98-09.06	ZE	190	1050	TE 077		180	1000	T5 077											
NG 312 [A11]	09.95-11.99	ZE	190	1050	TE 077		180	1000	T5 077											
NG 313/ NG 363 F [A24]	07.98-09.06	ZE	190	1050	TE 077		180	1000	T5 077											



			Ah	A (EN)		Ah	A (EN)		Ah	A (EN)		Ah	A (EN)	
			0 092 ...0			0 092 ...0			0 092 ...0			0 092 ...0		

NL-Serie

NL 222 [A10]	11.95-11.99	ZE	190	1050	TE 077	180	1000	T5 077						
F [898]	02.96-09.01	ZE	190	1050	TE 077	180	1000	T5 077						
NL 223 F [A22]	02.96-09.06	ZE	190	1050	TE 077	180	1000	T5 077						
NL 232 [A15]	04.94-11.99	ZE							140	800	T4 076	110	760	T3 038
NL 233 [A21]	07.98-12.01	ZE	240	1200	TE 088	225	1150	T5 080	215	1150	T4 080			
F [A22]	08.99-12.01	ZE	240	1200	TE 088	225	1150	T5 080	215	1150	T4 080			
NL 262 [A10]	02.96-11.99	ZE	190	1050	TE 077	180	1000	T5 077						
F [898]	02.96-09.01	ZE	190	1050	TE 077	180	1000	T5 077						
NL 263 [A21]	07.98-09.01	ZE	190	1050	TE 077	180	1000	T5 077						
F [A22]	07.98-09.01	ZE	190	1050	TE 077	180	1000	T5 077						
[A30]	11.99-09.02	ZE	190	1050	TE 077	180	1000	T5 077						
NL 273/ NL 283 F [A22]	04.06→	ZE	210	1200	TA 080									
			240	1200	TE 088	225	1150	T5 080						
NL 312 [A10]	11.95-07.98	ZE	190	1050	TE 077	180	1000	T5 077						
F [898]	02.96-09.01	ZE	190	1050	TE 077	180	1000	T5 077						
NL 313 [A21]	07.98-12.01	ZE	190	1050	TE 077	180	1000	T5 077						
F [A22]	07.98-09.06	ZE	190	1050	TE 077	180	1000	T5 077						
	04.06→	ZE	210	1200	TA 080									
	01.07→	ZE	240	1200	TE 088	225	1150	T5 080						
[A30]	11.99-03.06	ZE	190	1050	TE 077	180	1000	T5 077						
NL 323 F [A22]	01.09→	ZE	210	1200	TA 080	225	1150	T5 080						
			240	1200	TE 088									

NM-Serie

NM 222/ NM 223 F [A35]	06.97-09.06	ZE	190	1050	TE 077	180	1000	T5 077						
NM 253 F [A35]	01.09-08.14	ZE	210	1200	TA 080	225	1150	T5 080						
			240	1200	TE 088									
NM 283 F [A35]	10.01-09.06	ZE	240	1200	TE 088	225	1150	T5 080	215	1150	T4 080			
NM 293 F [A35]	07.08-12.13	ZE	210	1200	TA 080	225	1150	T5 080						
			240	1200	TE 088									
11.222/ 11.223 [469]	02.96-09.01	ZE	190	1050	TE 077	180	1000	T5 077						

RH

352/ 402 [A13]	07.98-09.01	ZE	240	1200	TE 088	225	1150	T5 080						
403 F [A33]	06.99-09.01	ZE	240	1200	TE 088	225	1150	T5 080						

RN

313/ 353 [A02]	09.96-03.98	ZE	210	1200	TA 080	225	1150	T5 080						
			240	1200	TE 088									

SL

202 FR-SDK [A08]	04.96-01.98	ZE	190	1050	TE 077	180	1000	T5 077						
-------------------------	-------------	----	-----	------	---------------	-----	------	---------------	--	--	--	--	--	--







SÜ

223 [A72]	11.99-09.01	ZE	240	1200	TE 088	225	1150	T5 080	215	1150	T4 080			
263 [A72]	11.99-09.01	ZE	190	1050	TE 077	180	1000	T5 077						
283 F [A91]	06.04-09.06	ZE	190	1050	TE 077	180	1000	T5 077						
313 [A72]	11.99-06.01	ZE	190	1050	TE 077	180	1000	T5 077						
313/ 363 F [A91]	06.04-09.06	ZE	190	1050	TE 077	180	1000	T5 077						

TGA

18.310/ 18.320/ 18.350/ 18.360/ 18.390/ 18.400/ 18.410/ 18.430/ 18.440/ 18.460/ 18.480/ 18.510/ 18.530/ 18.540/ 19.350/ 19.360/ 19.390/ 19.400/ 19.430/ 19.440/ 19.480	09.02-05.10	ZE	190	1050	TE 077	180	1000	T5 077	170	1000	T4 077	155	900	T3 077
F, FA, F, FL, FA, FA, FC, FH, FK, FL, FA, FC, FK, FL, FA, FH, FA, FL, FC, FK, FL, FL-, FC-, FK-WW														









			Ah	A (EN)		Ah	A (EN)		Ah	A (EN)		Ah	A (EN)	
◀ MAN			0 092 ...0			0 092 ...0			0 092 ...0			0 092 ...0		
24.350/ 24.360/ 24.390/ 24.400/ 24.410/ 24.430/ 24.440/ 24.460/ 24.480/ 24.510/ 24.530/ 24.540/ 26.280/ 26.310/ 26.320/ 26.330/ 26.350/ 26.360/ 26.390/ 26.400/ 26.410/ 26.430/ 26.440/ 26.460/ 26.480/ 26.510/ 26.530/ 26.540/ 28.310/ 28.320/ 28.350/ 28.360/ 28.390/ 28.400/ 28.410/ 28.430/ 28.440/ 28.460/ 28.480/ 28.510/ 28.530/ 28.540/ 32.310/ 32.350/ 32.360/ 32.390/ 32.400/ 32.410/ 32.430/ 32.440/ 32.460/ 32.480/ 32.530/ 33.310/ 33.350/ 33.360/ 33.390/ 33.400/ 33.410/ 33.430/ 33.440/ 33.460/ 33.480/ 33.510/ 33.530/ 35.310/ 35.350/ 35.360/ 35.390/ 35.400/ 35.410/ 35.430/ 35.440/ 35.460/ 35.480/ 35.530/ 37.350/ 37.360/ 37.390/ 37.400/ 37.410/ 37.430/ 37.440/ 37.460/ 37.480/ 37.530/ 39.390/ 39.400/ 39.430/ 39.440/ 39.480/ 40.390/ 40.400/ 40.410 , DA, DF, F, FL, FD, FD, FDA, FD-, FDA-WW, FD, FFD, FD, FFD, FV, FD, FH, FN, FV, FD, FV, FDA, FDA-WW, FD- WW, FFD, FFDC, FFDK, FFD-WW, FN, FN, FP, FN, FP, FV, FV, FV-WW, L, FL, VF	06.01-05.10	ZE	240	1200	TE 088	225	1150	T5 080	170	1000	T4 077	155	900	T3 077
24.430 FN, FP	09.04-09.06	ZE	240	1200	TE 088	225	1150	T5 080	170	1000	T4 077	155	900	T3 077
40.430/ 40.440/ 40.480/ 41.350/ 41.360/ 41.390/ 41.400/ 41.410/ 41.430/ 41.440 , DA, DF, F, FL, FD, FD, FDA, FD-, FDA-WW, FD, FFD, FD, FFD, FV, FD, FH, FN, FV, FD, FV, FDA, FDA- WW, FD-WW, FFD, FFDC, FFDK, FFD-WW, FN, FN, FP, FN, FP, FV, FV, FV-WW, L, FL, VF	09.02-05.10	ZE	240	1200	TE 088	225	1150	T5 080	170	1000	T4 077	155	900	T3 077
41.460 F-, FL-WW	09.03-05.10	ZE										155	900	T3 077
41.460/ 41.480/ 41.530/ 41.540/ 41.660 FFD, FFD-WW, FV, FV-WW, VF	09.02-05.10	ZE	240	1200	TE 088	225	1150	T5 080	170	1000	T4 077	155	900	T3 077
TGA 18t														
310/ 360/ 410/ 460/ 510 F, FL, F-, FL-WW	03.99-04.07	ZE	190	1050	TE 077	180	1000	T5 077	170	1000	T4 077	155	900	T3 077
TGA 26t														
310/ 360/ 410/ 460/ 510 D, DF	03.99-08.02	ZE	240	1200	TE 088	225	1150	T5 080	170	1000	T4 077	155	900	T3 077
TGD														
18.400 WW	06.10→	ZE										155	900	T3 077



			Ah	A (EN)		Ah	A (EN)		Ah	A (EN)		Ah	A (EN)	
			0 092 ...0			0 092 ...0			0 092 ...0			0 092 ...0		

TGL														
7.150/ 7.180/ 8.150/ 8.180/ 8.210 , L	05.05→	ZE				145	800	T5 075	140	800	T4 075	120	680	T3 075
8.220	04.09-04.19	ZE				145	800	T5 075	140	800	T4 075	88	680	T3 013
8.240 L	05.05-12.13	ZE				145	800	T5 075	140	800	T4 075	120	680	T3 075
8.250	04.09-06.16	ZE				145	800	T5 075	140	800	T4 075	88	680	T3 013
10.180/ 10.210 L	05.05→	ZE				145	800	T5 075	140	800	T4 075	120	680	T3 075
10.220	04.09-04.19	ZE				145	800	T5 075	140	800	T4 075	88	680	T3 013
10.240 L	05.05→	ZE				145	800	T5 075	140	800	T4 075	120	680	T3 075
10.250	04.09-06.16	ZE				145	800	T5 075	140	800	T4 075	88	680	T3 013
12.180/ 12.210 L	05.05→	ZE				145	800	T5 075	140	800	T4 075	120	680	T3 075
12.220	04.09-04.19	ZE				145	800	T5 075	140	800	T4 075	88	680	T3 013
12.240 L	05.05→	ZE				145	800	T5 075	140	800	T4 075	120	680	T3 075
12.250	04.09-06.16	ZE				145	800	T5 075	140	800	T4 075	88	680	T3 013
TGM														
12.240/ 12.280 L	04.06→	ZE	190	1050	TE 077	180	1000	T5 077	140	800	T4 075	120	680	T3 075
12.290	04.09-04.19	ZE				180	1000	T5 077	140	800	T4 075	120	680	T3 075
13.240/ 13.280/ 15.240 , L	04.06→	ZE	190	1050	TE 077	180	1000	T5 077	140	800	T4 075	120	680	T3 075
15.250	04.09-06.16	ZE				180	1000	T5 077	140	800	T4 075	120	680	T3 075
15.280	09.11→	ZE	190	1050	TE 077	180	1000	T5 077	140	800	T4 075	120	680	T3 075
L	04.06→	ZE	190	1050	TE 077	180	1000	T5 077	140	800	T4 075	120	680	T3 075
15.290	04.09-04.19	ZE				180	1000	T5 077	140	800	T4 075	120	680	T3 075
15.330	09.11→	ZE	190	1050	TE 077	180	1000	T5 077	140	800	T4 075	120	680	T3 075
L	04.06→	ZE	190	1050	TE 077	180	1000	T5 077	140	800	T4 075	120	680	T3 075
15.340	04.09-04.19	ZE				180	1000	T5 077	140	800	T4 075	120	680	T3 075
18.240 L	10.05→	ZE	190	1050	TE 077	180	1000	T5 077	140	800	T4 075	120	680	T3 075
18.250	04.09-06.16	ZE				180	1000	T5 077	140	800	T4 075	120	680	T3 075
18.280	09.07→	ZE	190	1050	TE 077	180	1000	T5 077	140	800	T4 075	120	680	T3 075
L	10.05→	ZE	190	1050	TE 077	180	1000	T5 077	140	800	T4 075	120	680	T3 075
18.290	04.09-04.19	ZE				180	1000	T5 077	140	800	T4 075	120	680	T3 075
18.330	09.07→	ZE	190	1050	TE 077	180	1000	T5 077	140	800	T4 075	120	680	T3 075
L	10.05→	ZE	190	1050	TE 077	180	1000	T5 077	140	800	T4 075	120	680	T3 075
18.340	04.09-04.19	ZE				180	1000	T5 077	140	800	T4 075	120	680	T3 075
22.240 L	09.07→	ZE				145	800	T5 075	140	800	T4 075	120	680	T3 075
22.280	09.07→	ZE				145	800	T5 075	140	800	T4 075	120	680	T3 075
												145	1150	T3 054
26.280 L	09.06→	ZE	190	1050	TE 077	180	1000	T5 077	140	800	T4 075	120	680	T3 075
26.290	04.09-04.19	ZE				180	1000	T5 077	140	800	T4 075	120	680	T3 075
26.330 L	07.06→	ZE	190	1050	TE 077	180	1000	T5 077	140	800	T4 075	120	680	T3 075
26.340	04.09-04.19	ZE				180	1000	T5 077	140	800	T4 075	120	680	T3 075
TGS														
18.320/ 18.360/ 18.400	10.07-06.16	ZE	190	1050	TE 077	180	1000	T5 077	170	1000	T4 077	155	900	T3 077
18.430 WW	06.10-12.13	ZE	190	1050	TE 077									
18.440	10.07→	ZE	190	1050	TE 077	180	1000	T5 077	170	1000	T4 077	155	900	T3 077
18.480 ,F, FL	10.07-06.16	ZE	190	1050	TE 077	180	1000	T5 077	170	1000	T4 077	155	900	T3 077
18.540	10.07-05.11	ZE	190	1050	TE 077	180	1000	T5 077	170	1000	T4 077	155	900	T3 077
24.320/ 24.360/ 24.400/ 24.440/ 24.480	10.07-12.13	ZE	240	1200	TE 088	225	1150	T5 080	170	1000	T4 077	155	900	T3 077
26.320/ 26.360/ 26.400/ 26.430 , WW	10.07-06.16	ZE	190	1050	TE 077									
26.440/ 26.480	10.07-06.16	ZE	190	1050	TE 077							155	900	T3 077
	10.12-06.16	ZE												
26.540	10.07-05.11	ZE	190	1050	TE 077									
28.320	09.07-05.11	ZE				145	800	T5 075						
						180	1000	T5 077						
	09.07-06.16	ZE	190	1050	TE 077				170	1000	T4 077	155	900	T3 077
28.360/ 28.400	09.07-06.16	ZE	190	1050	TE 077									
28.430 WW	04.10-12.13	ZE	190	1050	TE 077	145	800	T5 075						
						180	1000	T5 077						
28.440	09.07-06.16	ZE	190	1050	TE 077				170	1000	T4 077	155	900	T3 077
28.480	09.07-06.16	ZE	190	1050	TE 077									
	10.12-06.16	ZE										155	900	T3 077
28.540/ 32.360/ 32.400	09.07-06.16	ZE	190	1050	TE 077									



				Ah	A (EN)		Ah	A (EN)		Ah	A (EN)		Ah	A (EN)	
	0 092 ...0						0 092 ...0			0 092 ...0			0 092 ...0		
◀ MAN															
32.440	10.07-06.16	ZE	190	1050	TE 077					170	1000	T4 077	155	900	T3 077
	10.09-04.18	ZE	190	1050	TE 077	145	800	T5 075							
						180	1000	T5 077							
32.480	06.13-06.16	ZE											155	900	T3 077
33.360/ 33.400	10.07-05.11	ZE	190	1050	TE 077					170	1000	T4 077	155	900	T3 077
33.400 WW	02.11→	ZE				145	800	T5 075							
						180	1000	T5 077							
33.440	10.07-05.11	ZE	190	1050	TE 077					170	1000	T4 077	155	900	T3 077
	06.13-06.16	ZE											155	900	T3 077
33.480	10.07-06.16	ZE	190	1050	TE 077										
	06.13-06.16	ZE											155	900	T3 077
33.540/ 35.400	10.07-06.16	ZE	190	1050	TE 077										
35.440	06.13-06.16	ZE											155	900	T3 077
35.480	10.07-12.13	ZE	190	1050	TE 077										
	06.13-06.16	ZE											155	900	T3 077
37.320	10.07-12.13	ZE	190	1050	TE 077					170	1000	T4 077	155	900	T3 077
37.360	10.07-12.13	ZE	190	1050	TE 077										
37.400	10.07-12.13	ZE	190	1050	TE 077					170	1000	T4 077	155	900	T3 077
37.440/ 37.480	10.07-12.13	ZE	190	1050	TE 077					170	1000	T4 077	155	900	T3 077
	06.13-06.16	ZE											155	900	T3 077
37.540	10.07-05.11	ZE	190	1050	TE 077										
40.360 WW	09.11→	ZE	190	1050	TE 077	145	800	T5 075							
						180	1000	T5 077							
40.400/ 40.440 WW	03.10→	ZE	190	1050	TE 077										
41.390 WW	01.10-12.13	ZE				145	800	T5 075							
						180	1000	T5 077							
41.440/ 41.480	06.13-06.16	ZE											155	900	T3 077
41.540	10.07-05.11	ZE	190	1050	TE 077										
TGX															
18.360/ 18.400	10.07-06.16	ZE	190	1050	TE 077	180	1000	T5 077	170	1000	T4 077	155	900	T3 077	
18.440	10.07-06.16	ZE	190	1050	TE 077	180	1000	T5 077	170	1000	T4 077	155	900	T3 077	
18.480	10.07-06.16	ZE	190	1050	TE 077	180	1000	T5 077	170	1000	T4 077	155	900	T3 077	
F, FL	04.08-05.11	ZE	190	1050	TE 077	180	1000	T5 077	170	1000	T4 077	155	900	T3 077	
18.540/ 18.680	10.07-05.11	ZE	190	1050	TE 077	180	1000	T5 077	170	1000	T4 077	155	900	T3 077	
24.360/ 24.400	10.07-12.13	ZE	240	1200	TE 088	225	1150	T5 080	170	1000	T4 077	155	900	T3 077	
24.440/ 24.480	10.07-12.13	ZE	240	1200	TE 088	225	1150	T5 080	170	1000	T4 077	155	900	T3 077	
	10.12-06.16	ZE											155	900	T3 077
24.540	09.09-04.18	ZE	190	1050	TE 077										
26.360/ 26.400	10.07-06.16	ZE	240	1200	TE 088	225	1150	T5 080	170	1000	T4 077	155	900	T3 077	
26.440	10.07-06.16	ZE	240	1200	TE 088	225	1150	T5 080	170	1000	T4 077	155	900	T3 077	
26.480	10.07-06.16	ZE	240	1200	TE 088	225	1150	T5 080	170	1000	T4 077	155	900	T3 077	
26.540	10.07-05.11	ZE	240	1200	TE 088	225	1150	T5 080	170	1000	T4 077	155	900	T3 077	
	09.09→	ZE	190	1050	TE 077										
28.360/ 28.400	10.07-06.16	ZE	240	1200	TE 088	225	1150	T5 080	170	1000	T4 077	155	900	T3 077	
28.440/ 28.480	10.07-06.16	ZE	240	1200	TE 088	225	1150	T5 080	170	1000	T4 077	155	900	T3 077	
28.540/ 33.360/ 33.400	10.07-06.16	ZE	240	1200	TE 088	225	1150	T5 080	170	1000	T4 077	155	900	T3 077	
33.440/ 33.480	10.07-06.16	ZE	240	1200	TE 088	225	1150	T5 080	170	1000	T4 077	155	900	T3 077	
33.480 DF	04.08-05.11	ZE	240	1200	TE 088	225	1150	T5 080	170	1000	T4 077	155	900	T3 077	
33.540/ 33.680	10.07-05.11	ZE	240	1200	TE 088	225	1150	T5 080	170	1000	T4 077	155	900	T3 077	
35.440/ 35.480	12.13-06.16	ZE											155	900	T3 077
TRX															
26.480	10.12-06.16	ZE											155	900	T3 077
ÜL															
313/ 353 [A01,A04]	09.96-09.06	ZE	190	1050	TE 077	180	1000	T5 077							
363 [A01,A04]	01.01-09.06	ZE	240	1200	TE 088	225	1150	T5 080	215	1150	T4 080				



			Ah	A (EN)		Ah	A (EN)		Ah	A (EN)		Ah	A (EN)	
			0 092 ...0			0 092 ...0			0 092 ...0			0 092 ...0		

MERCEDES-BENZ

Actros I													
1824/ 1827/ 1830/ 1832/ 1833/ 1835/ 1836/ 1840/ 1842/ 1843/ 1845/ 1848/ 1851/ 1852/ 1858/ 1863 L, LS [963]	07.12→	ZE	210	1200	TA 080								
			240	1200	TE 088								
1831/ 1835/ 1840/ 1843/ 1846/ 1848/ 1853 / 1857 , AK, L [SKN]	09.96-09.03	ZE	210	1200	TA 080	225	1150	T5 080	170	1000	T4 077		
			240	1200	TE 088								
2024/ 2027/ 2030/ 2032/ 2033/ 2035/ 2036/ 2040/ 2042/ 2043/ 2045/ 2048 L,LS [963]	07.12→	ZE	210	1200	TA 080								
			240	1200	TE 088								
2051 L,LS [963]	09.11→	ZE	210	1200	TA 080	225	1150	T5 080	170	1000	T4 077		
			240	1200	TE 088								
2031/ 2035/ 2040/ 2053 , A [SKN]	09.96-09.03	ZE	210	1200	TA 080	225	1150	T5 080	170	1000	T4 077		
			240	1200	TE 088				170	1000	T4 077		
2043/ 2046/ 2048 AS [SKN]	09.96-09.03	ZE	210	1200	TA 080	225	1150	T5 080	170	1000	T4 077		
			240	1200	TE 088				170	1000	T4 077		
2427/ 2430/ 2432/ 2433/ 2435/ 2436/ 2440/ 2442/ 2443/ 2445/ 2448/ 2451 LS [963]	07.12→	ZE	210	1200	TA 080								
2527/ 2530/ 2532/ 2533/ 2535/ 2536/ 2540/ 2542/ 2543/ 2545 / 2548/ 2551 L,LS [963]	07.12→	ZE	210	1200	TA 080								
			240	1200	TE 088								
2531/ 2535/ 2540/ 2543/ 2546/ 2548/ 2553/ 2557 , L [SKN]	09.96-09.03	ZE	210	1200	TA 080	225	1150	T5 080	170	1000	T4 077		
			240	1200	TE 088								
2627/ 2630/ 2632/ 2633/ 2635/ 2636/ 2640/ 2642/ 2643/ 2645/2648/ 2651 L, LS [963]	07.12→	ZE	210	1200	TA 080								
			240	1200	TE 088								
2631/ 2635/ 2640/ 2643/ 2646/ 2648 , L [SKN]	04.97-09.03	ZE	210	1200	TA 080	225	1150	T5 080	170	1000	T4 077		
			240	1200	TE 088								
2653/ 2657/ 3231/ 3235/ 3240/ 3243/ 3246 , A, L [SKN]	09.96-09.03	ZE	210	1200	TA 080	225	1150	T5 080	170	1000	T4 077		
			240	1200	TE 088								
3331 , A, L [SKN]	04.97-09.03	ZE	210	1200	TA 080	225	1150	T5 080	170	1000	T4 077		
			240	1200	TE 088								
3333/ 3336/ 3340/ 3342/ 3343/ 3345/ 3348/ 3351 L, LS [963]	03.13→	ZE	210	1200	TA 080								
			240	1200	TE 088								
3335/ 3340/ 3343/ 3346/ 3348/ 3353/ 3357/ 4140/ 4143 , A [SKN]	04.97-09.03	ZE	210	1200	TA 080	225	1150	T5 080	170	1000	T4 077		
			240	1200	TE 088								
4146/ 4148 , A [SKN]	04.97-09.03	ZE	210	1200	TA 080	225	1150	T5 080	170	1000	T4 077		
			240	1200	TE 088								
Actros II													
1832/ 1836/ 1841/ 1844/ 1846/ 1848/ 1850/ 1851/ 1854/ 1855/ 1858/ 1860/ 1861 , Black Edition, BlueTec [MP2]	04.03-12.08	ZE	210	1200	TA 080	225	1150	T5 080	170	1000	T4 077		
			240	1200	TE 088								
2032/ 2036/ 2041/ 2044/ 2046/ 2048/ 2050/ 2051/ 2054/ 2055 BlueTec [MP2]	04.03-12.08	ZE	210	1200	TA 080	225	1150	T5 080	170	1000	T4 077		
			240	1200	TE 088								



			Ah			A (EN)			TE/TA			Ah			A (EN)			T5			Ah			A (EN)			T4			Ah			A (EN)			T3		
			0 092 ...0			0 092 ...0			0 092 ...0			0 092 ...0			0 092 ...0			0 092 ...0			0 092 ...0			0 092 ...0			0 092 ...0			0 092 ...0			0 092 ...0					
◀ MERCEDES-BENZ																																						
2532/ 2536/ 2541/ 2544/ 2546/ 2548/ 2550/ 2551/ 2554/ 2555/ 2558/ 2560			04.03-12.08	ZE	210	1200	TA 080	225	1150	T5 080	170	1000	T4 077																									
					240	1200	TE 088																															
, BlueTec [MP2]																																						
2632/ 2636/ 2641/ 2644/ 2646/ 2648/ 2650/ 2651/ 2654/ 2655/ 2658			04.03-12.08	ZE	210	1200	TA 080	225	1150	T5 080	170	1000	T4 077																									
					240	1200	TE 088																															
, BlueTec [MP2]																																						
3232/ 3236/ 3241/ 3244/ 3246/ 3248			04.03-12.08	ZE	210	1200	TA 080	225	1150	T5 080	170	1000	T4 077																									
					240	1200	TE 088																															
, BlueTec [MP2]																																						
3332/ 3336/ 3341/ 3344/ 3346/ 3348/ 3350/ 3351/ 3354/ 3355/ 3358/ 3360			04.03-12.08	ZE	210	1200	TA 080	225	1150	T5 080	170	1000	T4 077																									
					240	1200	TE 088																															
, BlueTec [MP2]																																						
4141/ 4144/ 4146/ 4148/ 4150/ 4151			04.03-12.08	ZE	210	1200	TA 080	225	1150	T5 080	170	1000	T4 077																									
					240	1200	TE 088																															
, BlueTec [MP2]																																						
Actros III																																						
1832/ 1836/ 1841/ 1844/ 1846 AK			07.10→	ZE	210	1200	TA 080																															
BlueTec [MP3]																																						
			06.08→	ZE	240	1200	TE 088	225	1150	T5 080	170	1000	T4 077																									
			07.10→	ZE	210	1200	TA 080																															
1848/ 1851			06.08→	ZE	240	1200	TE 088	225	1150	T5 080	170	1000	T4 077																									
BlueTec [MP3]																																						
1855/ 1860			06.08→	ZE	210	1200	TA 080	225	1150	T5 080	170	1000	T4 077																									
					240	1200	TE 088																															
BlueTec [MP3]																																						
2032/ 2036/ 2040/ 2041/ 2044 A/AK/AS			06.08→	ZE	210	1200	TA 080																															
BlueTec, BlueTec, S [MP3]																																						
2046			06.08→	ZE	210	1200	TA 080	225	1150	T5 080	170	1000	T4 077																									
BlueTec [MP3]					240	1200	TE 088																															
2432/ 2436			06.08→	ZE	210	1200	TA 080																															
BlueTec [MP3]																																						
2441/ 2444/ 2446/ 2448			06.08→	ZE	210	1200	TA 080	225	1150	T5 080	170	1000	T4 077																									
					240	1200	TE 088																															
BlueTec, LS BlueTec [MP3]																																						
2451/ 2455/ 2460			06.08→	ZE	210	1200	TA 080																															
BlueTec [MP3]																																						
2532/ 2536/ 2541/ 2544/ 2546/ 2548/ 2551/ 2555/ 2560			06.08→	ZE	210	1200	TA 080	225	1150	T5 080	170	1000	T4 077																									
					240	1200	TE 088																															
BlueTec [MP3]																																						
2632/ 2636/ 2641/ 2644			06.08→	ZE	210	1200	TA 080																															
BlueTec [MP3]					240	1200	TE 088																															
2648/ 2651/ 2655/ 2660			06.08→	ZE	210	1200	TA 080	225	1150	T5 080	170	1000	T4 077																									
					240	1200	TE 088																															
BlueTec [MP3]																																						
2665 LS			08.08→	ZE	210	1200	TA 080																															
Blue Tec [MP3]																																						
2732/ 2736/ 2741/ 2744/ 2746/ 2748			06.08→	ZE	210	1200	TA 080																															
AE/AKE BlueTec [MP3]					240	1200	TE 088																															
[MP3]																																						
3232			07.10→	ZE	210	1200	TA 080																															
BlueTec [MP3]																																						
3236/ 3241/ 3244			06.08→	ZE	210	1200	TA 080	225	1150	T5 080	170	1000	T4 077																									
					240	1200	TE 088																															
BlueTec [MP3]																																						
3246			12.09→	ZE	210	1200	TA 080																															
BlueTec [MP3]																																						
3248			06.08→	ZE	240	1200	TE 088	225	1150	T5 080	170	1000	T4 077																									
BlueTec [MP3]																																						
3332 AK/AS			07.10→	ZE	210	1200	TA 080																															
BlueTec [MP3]					240	1200	TE 088																															
			06.08→	ZE	240	1200	TE 088	225	1150	T5 080	170	1000	T4 077																									
			07.10→	ZE	210	1200	TA 080																															
BlueTec [MP3]																																						
3336/ 3341/ 3344/ 3346			06.08→	ZE	210	1200	TA 080																															
A/AK/AS BlueTec, AK/AS BlueTec, BlueTec [MP3]																																						
3348/ 3351/ 3355/ 3360			06.08→	ZE	240	1200	TE 088	225	1150	T5 080	170	1000	T4 077																									
BlueTec [MP3]																																						
4141/ 4144 AK			12.09→	ZE	210	1200	TA 080																															
BlueTec [MP3]																																						
			06.08→	ZE	240	1200	TE 088	225	1150	T5 080	170	1000	T4 077																									
BlueTec [MP3]																																						



				0 092 ...0			0 092 ...0			0 092 ...0			0 092 ...0		
				Ah	A (EN)	TE/TA	Ah	A (EN)	T5	Ah	A (EN)	T4	Ah	A (EN)	T3
4141/ 4144 BlueTec [MP3]	12.09→	ZE	210	1200	TA 080										
4146/ 4148 BlueTec [MP3]	06.08→	ZE	210	1200	TA 080										
			240	1200	TE 088	225	1150	T5 080	170	1000	T4 077				
4151/ 4155/ 4160 BlueTec [MP3]	06.08→	ZE	240	1200	TE 088	225	1150	T5 080	170	1000	T4 077				
Antos															
1824/ 1827/ 1830/ 1832/ 1833/ 1835/ 1836/ 1840/ 1842/ 1843/ 1845/ 1848/ 1851/ L,LS	09.12→	ZE	210	1200	TA 080	225	1150	T5 080	170	1000	T4 077				
			240	1200	TE 088										
2024/ 2027/ 2030/ 2032/ 2033/ 2035/ 2036/ 2040/ 2042/ 2043/ 2045/ 2048/ 2051 L,LS	09.12→	ZE	210	1200	TA 080	225	1150	T5 080	170	1000	T4 077				
			240	1200	TE 088										
2427/ 2430/ 2432/ 2433/ 2435/ 2436/ 2440/ 2442/ 2443/ 2445/ 2448/ 2451 LS	09.12→	ZE	210	1200	TA 080										
2527/ 2530/ 2532/ 2533/ 2535/ 2536/ 2540/ 2542/ 2543/ 2545/ 2548/ 2551 L,LS,LS	09.12→	ZE	210	1200	TA 080	225	1150	T5 080	170	1000	T4 077				
			240	1200	TE 088										
2627/ 2630/ 2632/ 2633/ 2635/ 2636/ 2640/ 2642/ 2643/ 2645/ 2648/ 2651 L,LS	09.12→	ZE	210	1200	TA 080	225	1150	T5 080	170	1000	T4 077				
			240	1200	TE 088										
3333/ 3336/ 3340/ 3342/ 3343/ 3345/ 3348/ 3351 L,LS	09.12→	ZE	210	1200	TA 080	225	1150	T5 080	170	1000	T4 077				
			240	1200	TE 088				170	1000	T4 077				
Arocs															
1824/ 1827/ 1830/ 1833/ 1835/ 1836/ 1840/ 1842/ 1843/ 1845/ 1848/ 1851 [964]	04.13→	ZE	210	1200	TA 080	225	1150	T5 080	170	1000	T4 077	220	1150	T3 081	
			240	1200	TE 088										
2024/ 2027/ 2030/ 2032/ 2033/ 2035/ 2036/ 2040/ 2042/ 2043/ 2045/ 2048/ 2051 [964]	04.13→	ZE	210	1200	TA 080	225	1150	T5 080	170	1000	T4 077	220	1150	T3 081	
			240	1200	TE 088										
2527/ 2530/ 2532/ 2533/ 2535/ 2536/ 2540/ 2542/ 2543/ 2545/ 2548/ 2551/ 2552/ 2558/ 2563/ 2627/ 2630/ 2632/ 2633/ 2635/ 2636/ 2640/ 2642/ 2643/ 2645/ 2648/ 2651 [964]	04.13→	ZE	210	1200	TA 080	225	1150	T5 080	170	1000	T4 077	220	1150	T3 081	
			240	1200	TE 088										
3227/ 3230/ 3232/ 3233/ 3235/ 3236/ 3240/ 3242/ 3243/ 3245/ 3251/ 3333/ 3336/ 3340/ 3342/ 3343/ 3345/ 3348/ 3351 [964]	04.13→	ZE	210	1200	TA 080	225	1150	T5 080	170	1000	T4 077	220	1150	T3 081	
			240	1200	TE 088										
4133/ 4136/ 4140/ 4142/ 4143/ 4145/ 4148/ 4151 [964]	04.13→	ZE	210	1200	TA 080	225	1150	T5 080	170	1000	T4 077	220	1150	T3 081	
			240	1200	TE 088										
Atego															
712/ 714/ 715/ 717 , L [LKN]	01.98-09.04	ZE	190	1050	TE 077	180	1000	T5 077	140	800	T4 075	120	680	T3 075	
716 [967]	08.13→	ZE	210	1200	TA 080										
812/ 814/ 815/ 817/ 818/ 823 , F, L [LKN]	01.98-10.04	ZE	190	1050	TE 077	180	1000	T5 077	140	800	T4 075	120	680	T3 075	
816/ 818/ 823 [967]	08.13→	ZE	210	1200	TA 080										
824 [967]	08.13→	ZE	210	1200	TA 080	225	1150	T5 080	170	1000	T4 077	220	1150	T3 081	
			240	1200	TE 088										
915/ 917/ 918/ 923/ 925 , AF, KO, L [LKN]	09.00-09.04	ZE	190	1050	TE 077	180	1000	T5 077	140	800	T4 075	120	680	T3 075	



			0 092 ...0			0 092 ...0			0 092 ...0			0 092 ...0		
			Ah	A (EN)	TE/TA	Ah	A (EN)	T5	Ah	A (EN)	T4	Ah	A (EN)	T3
◀ MERCEDES-BENZ														
916/918/921/923/924/927 [967]	08.13→	ZE									120	680	T3 075	
1015/1017/1018/1023 , A, AK, KO, L [LKN]	01.98-09.04	ZE	190	1050	TE 077	180	1000	T5 077	140	800	T4 075	120	680	T3 075
1016/1018/1021/1023 [967]	08.13→	ZE	210	1200	TA 080									
1024 [967]	08.13→	ZE	210 240	1200 1200	TA 080 TE 088	225	1150	T5 080	170	1000	T4 077	220	1150	T3 081
1214/1215/1217/1218/1223/1228 , KO, L [LKN]	01.98-09.04	ZE	190	1050	TE 077	180	1000	T5 077	140	800	T4 075	120	680	T3 075
1216/1218 [967]	08.13→	ZE	210 240	1200 1200	TA 080 TE 088	225	1150	T5 080	170 170	1000 1000	T4 077 T4 077	220	1150	T3 081
1221/1223 [967]	08.13→	ZE	210	1200	TA 080									
1224 [967]	08.13→	ZE	210 240	1200 1200	TA 080 TE 088	225	1150	T5 080	170	1000	T4 077			
1225 AF, F [LKN]	01.98-09.04	ZE	190	1050	TE 077	180	1000	T5 077	140	800	T4 075	120	680	T3 075
1227/1230 [967]	08.13→	ZE	210	1200	TA 080									
1317/1318/1323 , A, AK, KO, L [LKN]	01.98-09.04	ZE	190	1050	TE 077	180	1000	T5 077	140	800	T4 075	120	680	T3 075
1318/1321/1323 [967]	08.13→	ZE	210	1200	TA 080									
1323/1325/1328 , AF, F, L, LKO [LKN]	01.98-09.04	ZE	190	1050	TE 077	180	1000	T5 077	140	800	T4 075	120	680	T3 075
1517/1518 , AF, F, L, LKO [LKN]	09.00-09.04	ZE	190	1050	TE 077	180	1000	T5 077	140	800	T4 075	120	680	T3 075
1518/1521/1523 [967]	08.13→	ZE	190	1050	TE 077	180	1000	T5 077	170	1000	T4 077			
1523/1525/1528/1823/1828/1833 , A, AF, AK, F, K, KO, L, LS [LKN]	01.98-09.04	ZE	190	1050	TE 077	180	1000	T5 077	140	800	T4 075	120	680	T3 075
2523/2528/2533/2628/2633 , B, K, L [LKN]	05.98-09.04	ZE	190	1050	TE 077	180	1000	T5 077	140	800	T4 075	120	680	T3 075
Atego II														
713/716 BlueTec	02.06→	ZE	190	1050	TE 077	180	1000	T5 077	140	800	T4 075	120	680	T3 075
813/816/818/822/824/826/829 , BlueTec	09.04→	ZE	190	1050	TE 077	180	1000	T5 077	140	800	T4 075	120	680	T3 075
916/918/922/924/926/929 , BlueTec	09.04→	ZE	190	1050	TE 077	180	1000	T5 077	140	800	T4 075	120	680	T3 075
1016/1017/1018/1022/1024/1026/1029 , BlueTec, L BlueTec Hybrid	09.04→	ZE	190	1050	TE 077	180	1000	T5 077	140	800	T4 075	120	680	T3 075
1216/1218/1222/1224/1226/1229 , BlueTec, L BlueTec Hybrid	09.04→	ZE	190	1050	TE 077	180	1000	T5 077	140	800	T4 075	120	680	T3 075
1317/1318/1322/1324/1326/1329 , BlueTec, F, F BlueTec, L BlueTec	09.04→	ZE	190	1050	TE 077	180	1000	T5 077	140	800	T4 075	120	680	T3 075
1422/1426/1429 , BlueTec, F, F BlueTec, L BlueTec	09.04→	ZE	190	1050	TE 077	180	1000	T5 077	140	800	T4 075	120	680	T3 075
1518/1522/1524/1526/1529 , BlueTec, F, F BlueTec, L BlueTec	09.04→	ZE	190	1050	TE 077	180	1000	T5 077	140	800	T4 075	120	680	T3 075
1924/1926/1929 , BlueTec, F, F BlueTec, L BlueTec	09.04→	ZE	190	1050	TE 077	180	1000	T5 077	140	800	T4 075	120	680	T3 075
2224/2226/2229 , BlueTec, F, F BlueTec, L BlueTec	09.04→	ZE	190	1050	TE 077	180	1000	T5 077	140	800	T4 075	120	680	T3 075
Axor														
1823	01.02-08.06	ZE	210 240	1200 1200	TA 080 TE 088	225	1150	T5 080	170	1000	T4 077			
1828	01.02-08.06	ZE	240	1200	TE 088	225	1150	T5 080	170	1000	T4 077			
1835/1840/1843 LS	01.02-08.06	ZE	240	1200	TE 088	225	1150	T5 080	170	1000	T4 077			
2523/2528	01.02-08.06	ZE	210 240	1200 1200	TA 080 TE 088	225	1150	T5 080	170	1000	T4 077			
2535/2540/2543 LS	01.02-08.06	ZE	240	1200	TE 088	225	1150	T5 080	170	1000	T4 077			



			0 092 ...0			0 092 ...0			0 092 ...0			0 092 ...0		
			Ah	A (EN)	TE/TA	Ah	A (EN)	T5	Ah	A (EN)	T4	Ah	A (EN)	T3
2628	01.02-08.06	ZE	210	1200	TA 080	225	1150	T5 080	170	1000	T4 077			
			240	1200	TE 088									
3028	03.03→	ZE							170	1000	T4 077			
Axor II														
1824	09.06→	ZE	210	1200	TA 080	225	1150	T5 080	170	1000	T4 077			
			240	1200	TE 088									
1826/ 1829/ 1833/ 1836/ 1840/ 1843/ 2529/ 2533/ 2536/ 2540/ 2543	09.04→	ZE	240	1200	TE 088	225	1150	T5 080	170	1000	T4 077			
2623 L	09.05→	ZE							140	800	T4 076			
2629	09.06→	ZE	240	1200	TE 088	225	1150	T5 080	170	1000	T4 077			
2633	09.04→	ZE	210	1200	TA 080	225	1150	T5 080	170	1000	T4 077			
			240	1200	TE 088									
2635	09.04→	ZE	210	1200	TA 080									
2636/ 2640/ 2643	09.06→	ZE	210	1200	TA 080	225	1150	T5 080	170	1000	T4 077			
			240	1200	TE 088									
3229	09.05→	ZE							170	1000	T4 077			
3236/ 3240/ 3243/ 3335/ 3340/ 3343	09.04→	ZE	210	1200	TA 080	225	1150	T5 080	170	1000	T4 077			
			240	1200	TE 088									
4135	09.04→	ZE	210	1200	TA 080	180	1000	T5 077						
			190	1050	TE 077									
4140	09.04→	ZE	210	1200	TA 080									
	09.06→	ZE	240	1200	TE 088				170	1000	T4 077	220	1150	T3 081
4143	09.04→	ZE	210	1200	TA 080									
Citaro														
0 530	10.06→	ZE	210	1200	TA 080	225	1150	T5 080				220	1150	T3 081
			240	1200	TE 088									
Citaro L														
0 530 N3	01.99-09.06	ZE	210	1200	TA 080	225	1150	T5 080						
			240	1200	TE 088									
Cito														
0 520	01.99-09.03	ZE	210	1200	TA 080	225	1150	T5 080						
			240	1200	TE 088									
Conecto														
6.4/ 12.0 [671]	05.01-08.07	ZE	210	1200	TA 080	225	1150	T5 080						
			240	1200	TE 088									
Econic														
1823/ 1824/ 1828/ 1829 , L, NGT [957]	03.98→	ZE	210	1200	TA 080	225	1150	T5 080	170	1000	T4 077			
			240	1200	TE 088									
1830 LL [956]	09.13→	ZE	210	1200	TA 080									
1833 [957]	03.00→	ZE	210	1200	TA 080	225	1150	T5 080	170	1000	T4 077			
			240	1200	TE 088									
1835 LL [956]	09.13→	ZE	210	1200	TA 080									
2628/ 2629 , L, NGT [957]	03.98→	ZE	210	1200	TA 080	225	1150	T5 080	170	1000	T4 077			
			240	1200	TE 088									
2630/ 2635 LL [956]	09.13→	ZE	210	1200	TA 080							220	1150	T3 081
2633 [957]	03.00→	ZE	210	1200	TA 080	225	1150	T5 080	170	1000	T4 077			
			240	1200	TE 088									
3233 [957]	09.06→	ZE	210	1200	TA 080	225	1150	T5 080	170	1000	T4 077			
			240	1200	TE 088									
Integro II														
/L/M	09.06→	ZE	210	1200	TA 080	225	1150	T5 080						
			240	1200	TE 088									
Intouro														
	03.07→	ZE	240	1200	TE 088	225	1150	T5 080	215	1150	T4 080			
O 301														
F	06.86-02.01	ZE				145	800	T5 075	140	800	T4 075	120	680	T3 075
O 345														
/G	10.01-08.07	ZE	210	1200	TA 080									
O 402														
/F	02.86-02.01	ZE	190	1050	TE 077	180	1000	T5 077	140	800	T4 075	120	680	T3 075



			0 092 ...0			0 092 ...0			0 092 ...0			0 092 ...0		
			Ah	A (EN)	TE/TA	Ah	A (EN)	T5	Ah	A (EN)	T4	Ah	A (EN)	T3
◀ MERCEDES-BENZ														
O 404														
	09.91-10.99	ZE	210	1200	TA 080	225	1150	T5 080	170	1000	T4 077			
			240	1200	TE 088									
O 405														
/ G/ GAS/ GN-G/ GTD/ GTZ/ N/ N-G	01.85-02.01	ZE	210	1200	TA 080	225	1150	T5 080	170	1000	T4 077			
			240	1200	TE 088									
O 407														
	03.87-02.01	ZE	210	1200	TA 080	225	1150	T5 080	170	1000	T4 077			
			240	1200	TE 088									
O 408														
	01.91-12.01	ZE							170	1000	T4 078			
Tourino														
O 510	01.04→	ZE	210	1200	TA 080	225	1150	T5 080						
			240	1200	TE 088									
Tourismo														
O 350/ 15 , RHD/SHD	10.95-09.06	ZE	210	1200	TA 080	225	1150	T5 080						
			240	1200	TE 088									
Touro														
OC 500	10.02-08.08	ZE	210	1200	TA 080	225	1150	T5 080						
			240	1200	TE 088									
Travego														
O 580	02.06→	ZE	210	1200	TA 080	225	1150	T5 080	215	1150	T4 080			
			240	1200	TE 088									
RHD	10.99→	ZE	210	1200	TA 080	225	1150	T5 080						
			240	1200	TE 088									
Unimog														
U 90/ U 100/ U 130/ U 140 , L, T [, 408; 417; 418]	07.92-09.01	ZE				145	800	T5 075	140	800	T4 075	120	680	
U 300/ U 300/400/ U 400 [, 405]	04.00→	ZE				145	800	T5 075	140	800	T4 075	120	680	
U 423 [405]	11.13→	ZE										120	680	
U 500 [, 405]	02.01→	ZE				145	800	T5 075	140	800	T4 075	120	680	
U 600/ U 650 [407]	05.88-02.01	ZE										110	850	
U 900/ U 1100/ U 1150 , L, T [, 408; 417; 418]	05.88-02.01	ZE				145	800	T5 075	140	800	T4 075	120	680	
U 1200/ U 1250/ U 1300/ U 1350/ U 1400/ U 1450/ U 1550/ U 1600/ U 1650/ U 1700/ U 1750/ U 1800/ U 1850/ U 2100/ U 2150/ U 2400/ U 2450 , L, T, TG [, 405]	11.86-09.02	ZE				145	800	T5 075	140	800	T4 075	120	680	
U 3000/4000/ U 5000 [437]	09.02→	ZE										100	600	
UX														
100	08.96-09.01								140	800	T4 076			
Vario														
614/ 618/ 815/ 818 D [T2W]	01.01-09.06	ZE										88	680	
Zetros														
1833/ 2733	09.08→	ZE	210	1200	TA 080									
5t														
508/ 510 , D	04.86-02.01					145	800	T5 075	140	800	T4 075	88	680	
6t														
609/ 611 D	04.86-09.01	ZE				145	800	T5 075	140	800	T4 075	88	680	
7t														
709/ 711/ 714 , D [LK]	04.86-02.01	ZE				145	800	T5 075	140	800	T4 075	88	680	
8t														
809/ 810/ 811/ 814/ 817 , D, DA, DT, F, KO, L, LO, O [LK]	04.86-02.01	ZE				145	800	T5 075	140	800	T4 075	88	680	
9t														
L 911/ LA 911 B	10.68-02.01	ZE										100	600	
914 , AK, KO [LK]	02.92-12.99	ZE							140	800	T4 076	88	680	
917	01.85-12.01	ZE							140	800	T4 076	88	680	



			0092...0			0092...0			0092...0			0092...0		
			Ah	A (EN)	TE/TA	Ah	A (EN)	T5	Ah	A (EN)	T4	Ah	A (EN)	T3
917 , AF, AK, KO [LK]	12.92-12.99	ZE							140	800	T4 076	88	680	T3 013
11t														
L 1113/ LA 1113/ LKO 1113 B	10.69-02.01	ZE				145	800	T5 075	140	800	T4 075	120	680	T3 075
O 1114/ 1114/ 1117/ 1120/ 1124 , A, AF, AK, F, L, LO, O [LK]	02.92-12.99	ZE							140	800	T4 076	88	680	T3 013
12t														
1217 KO [LK]	03.94-12.99	ZE							140	800	T4 076	88	680	T3 013
13t														
L 1313/ LA 1313/ LF 1313	01.67-02.01	ZE										100	600	T3 072
1314/ 1317/ 1320/ 1324 , AK, KO, L [LK]	01.91-02.01	ZE							140	800	T4 076	88	680	T3 013
15t														
L 1513/ LA 1513	10.69-02.01	ZE										100	600	T3 072
1514/ 1517/ 1520/ 1524 , L [LK]	02.91-02.01	ZE							140	800	T4 076	88	680	T3 013
17t														
1720 [LK]	01.84-12.98	ZE							140	800	T4 076	88	680	T3 013
[MK]	01.91-02.01	ZE	190	1050	TE 077	180	1000	T5 077	140	800	T4 075	120	680	T3 075
1724 [LK]	01.91-02.01	ZE							140	800	T4 076	88	680	T3 013
18t														
1820/ 1827/ 1831/ 1834 , L [MK]	12.90-02.01	ZE	190	1050	TE 077	180	1000	T5 077	140	800	T4 075	120	680	T3 075
1838/ 1850 , L [SK]	12.90-02.01	ZE	190	1050	TE 077	180	1000	T5 077	140	800	T4 075	120	680	T3 075
19t														
L 1924/ L 1928	05.79-02.01	ZE				145	800	T5 075	140	800	T4 075	120	680	T3 075
20t														
2020/ 2024 , L [LK]	01.84-02.01	ZE							140	800	T4 076	88	680	T3 013
2050/ 2055 , S [SK]	01.91-02.01	ZE	190	1050	TE 077	180	1000	T5 077	140	800	T4 075	120	680	T3 075
25t														
2534 , L [MK]	01.91-02.01	ZE	190	1050	TE 077	180	1000	T5 077	140	800	T4 075	120	680	T3 075
26t														
L 2624/ L 2628	01.78-02.01	ZE				145	800	T5 075	140	800	T4 075	120	680	T3 075
30t														
3050 [SK]	02.91-02.01	ZE	190	1050	TE 077	180	1000	T5 077	140	800	T4 075	120	680	T3 075
32t														
3238/ 3244/ 3250 [SK]	10.90-02.01	ZE	190	1050	TE 077	180	1000	T5 077	140	800	T4 075	120	680	T3 075
44t														
4435 K [SK]	10.89-02.01	ZE	190	1050	TE 077	180	1000	T5 077	140	800	T4 075	120	680	T3 075

MITSUBISHI

Canter 35														
2.8/ 3.0 D Turbo, D Turbo Interc. [FB; FE]	05.96-02.05											110	680	T3 036
Canter 55														
3.0 D Turbo Interc. [FE]	11.00-02.05											110	680	T3 036
Canter 60														
3.9 D Turbo [FE]	05.96-02.05											110	680	T3 036
Canter 75														
3.9 D Turbo [FE; FH]	06.97→											110	680	T3 036

NEOPLAN

Cityliner														
HD/ HDC	01.06→	ZE	240	1200	TE 088	225	1150	T5 080	170	1000	T4 077			
N 113	09.88-05.00	ZE	240	1200	TE 088	225	1150	T5 080	170	1000	T4 077			
N 116/3...	09.85→	ZE	210	1200	TA 080	225	1150	T5 080	170	1000	T4 077			
			240	1200	TE 088									
N 118/3...	09.98→	ZE	240	1200	TE 088	225	1150	T5 080						



			Ah	A (EN)		Ah	A (EN)		Ah	A (EN)		Ah	A (EN)	
			0 092 ...0			0 092 ...0			0 092 ...0			0 092 ...0		
NEOPLAN														
N 121 ...	01.06→	ZE	210	1200	TA 080	225	1150	T5 080	170	1000	T4 077			
			240	1200	TE 088									
Euroliner														
N 3316/ N 3318 Ü,K, /3 Ü, /3 ÜL,KL	10.98-12.06	ZE	210	1200	TA 080									
Jetliner														
N 208/ N 212/ N 213/ N 214/ N 216/ N 218/ N 221 ..., , H,SHD, /3, /3...	01.76-05.01	ZE	190	1050	TE 077	180	1000	T5 077	170	1000	T4 077			
Metroliner														
MIC 4008/ MIC 4012/ MIC 4016	04.90-12.00	ZE	240	1200	TE 088	225	1150	T5 080						
N														
4020	09.88-09.99	ZE	240	1200	TE 088	225	1150	T5 080						
Skyliner														
N 122	09.82-05.01	ZE	210	1200	TA 080	225	1150	T5 080	215	1150	T4 080	220	1150	T3 081
			240	1200	TE 088									
N 122/ N 128 /3..., /4	09.88-05.01	ZE	240	1200	TE 088	225	1150	T5 080	215	1150	T4 080	220	1150	T3 081
N 1122 ..	03.06-05.10	ZE	210	1200	TA 080									
Spaceliner														
N 117 , /3...	08.83-05.01	ZE	210	1200	TA 080	225	1150	T5 080	215	1150	T4 080	220	1150	T3 081
			240	1200	TE 088									
Starliner														
N 521 ...	08.04→	ZE	210	1200	TA 080	225	1150	T5 080	215	1150	T4 080	220	1150	T3 081
			240	1200	TE 088									
N 516 ...	08.96→	ZE	210	1200	TA 080	225	1150	T5 080	215	1150	T4 080	220	1150	T3 081
			240	1200	TE 088									
Tourline														
2216 SHD, /3 SHD-L	11.03→	ZE	210	1200	TA 080	225	1150	T5 080	215	1150	T4 080	220	1150	T3 081
			240	1200	TE 088									
Tourliner														
N 2216/ 2216 ... SHD	01.06→		210	1200	TA 080									
Transliner														
N 316/ N 321 H, K, Ü, /3 K	06.89→	ZE	210	1200	TA 080	225	1150	T5 080	170	1000	T4 077			
			240	1200	TE 088									
Trendliner														
N 3516 ..	01.06-03.10	ZE	210	1200	TA 080	225	1150	T5 080	215	1150	T4 080	200	1050	T3 080

NISSAN

Atleon														
110 3.0	09.99-10.06								88	680				T3 013
									110	680				T3 037
120 3.0	09.00-10.06								110	680				T3 035
									110	680				T3 037
									88	680				T3 013
140/ 165 4.0, 6.0	09.00-08.06	ZE							110	680				T3 035
									110	680				T3 037

PEGASO (ENASA)

Serie 1200														
1210/ 1215 .6, .8, .9	01.87→	ZE							88	680				T3 013
1234 R, T	10.85→	ZE	190	1050	TE 077	180	1000	T5 077	170	1000	T4 077	155	900	T3 077
1236 .38 R, T, Troner	04.87→	ZE							180	1100				T3 079
Serie 1400														
1431/ 1434/ 1436 , G, .38 G	10.85→	ZE							180	1100				T3 079
Serie 2300														
2331/ 2334 .26 K, .38 K, T, .38 R, .38 T	04.87→	ZE	190	1050	TE 077	180	1000	T5 077	170	1000	T4 077	155	900	T3 077

			Ah	A (EN)		Ah	A (EN)		Ah	A (EN)		Ah	A (EN)	
			0 092 ...0			0 092 ...0			0 092 ...0			0 092 ...0		

Serie 5000															
5036 S/1, /1	01.85→	VE							150	760	T3 063				
5064 A, B	01.86→	ZE							180	1100	T3 079				
Serie 5100															
5117	01.84→	VE							150	760	T3 063				
Serie 5300															
5317	01.86→	ZE							180	1100	T3 079				
Serie 6000															
6100/ 6420 , S	03.84→	ZE							180	1100	T3 079				

RENAULT

C															
230 6.2 [Ligne 3]	05.92-10.98	ZE							140	800	T4 076	135	1000	T3 045	
250/ 280/ 320 7.7	01.13→	ZE			145	800	T5 075								
300/ 340 9.8 [Ligne 3]	02.92-10.98	ZE							140	800	T4 076	135	1000	T3 045	
380/ 430/ 440/ 460/ 480/ 520 10.8, 12.8	06.13→	ZE	210	1200	TA 080	225	1150	T5 080	170	1000	T4 077				
			240	1200	TE 088										
CBH															
320/ 385 6x4, 6x4T, 6x6, 6x6T	10.92-10.98	ZE							140	800	T4 076	135	1000	T3 045	
CLM															
320/ 385 , TR	10.92-10.98	ZE							140	800	T4 076	135	1000	T3 045	
CLR															
230	10.90-10.98	ZE							140	800	T4 076	135	1000	T3 045	
D															
210/ 240/ 250/ 280/ 320 5.1, 7.7	06.13→	ZE			145	800	T5 075								
K															
380/ 430/ 440/ 460/ 480/ 520 10.8, 12.8	06.13→	ZE	210	1200	TA 080	225	1150	T5 080	170	1000	T4 077				
			240	1200	TE 088										
Kerax															
260/ 270/ 300/ 320/ 340/ 350/ 370/ 385/ 400/ 410/ 420/ 450/ 460/ 500	06.97-03.09	ZE	190	1050	TE 077	180	1000	T5 077	170	1000	T4 077	155	900	T3 077	
Magnum															
390/ 430/ 470/ 560 AE	09.96-05.00	ZE	190	1050	TE 077	180	1000	T5 077	170	1000	T4 077	155	900	T3 077	
400/ 440/ 460/ 480/ 500 E.TECH	11.99-03.09	ZE	240	1200	TE 088	225	1150	T5 080	170	1000	T4 077	155	900	T3 077	
440/ 480/ 520	04.09-12.14	ZE	190	1050	TE 077					170	1000	T4 077	155	900	T3 077
Midliner															
CE 160/ M 150/ M 180/ M 210/ M 250/ ME 160/ ME 180	10.86-12.01	ZE							140	800	T4 076	135	1000	T3 045	
Midlum															
135/ 150/ 180/ 210/ 220/ 250/ 260/ 270 , 4x2, 4x4	02.00-04.06	ZE	190	1050	TE 077	180	1000	T5 077	170	1000	T4 077	155	900	T3 077	
Midlum II															
160/ 190/ 220/ 240/ 280	05.06-03.09	ZE	190	1050	TE 077	180	1000	T5 077	170	1000	T4 077	155	900	T3 077	
Premium															
210/ 220/ 250/ 260/ 270/ 300/ 320/ 340/ 370/ 385/ 400/ 420 Distribution, Lander, Route, SP	02.96-04.06	ZE	190	1050	TE 077	180	1000	T5 077	170	1000	T4 077	155	900	T3 077	
Premium II															
280 Distribution	06.06-03.09	ZE	190	1050	TE 077	180	1000	T5 077	170	1000	T4 077	155	900	T3 077	
310 Distribution	04.09-12.14	ZE					180	1000	T5 077	170	1000	T4 077	155	900	T3 077
Lander	04.09-12.14	ZE					180	1000	T5 077	170	1000	T4 077	155	900	T3 077
320 Distribution	05.06-03.09	ZE	190	1050	TE 077	180	1000	T5 077	170	1000	T4 077	155	900	T3 077	
340 Distribution	04.09-12.14	ZE					180	1000	T5 077	170	1000	T4 077	155	900	T3 077
Lander	04.09-12.14	ZE					180	1000	T5 077	170	1000	T4 077	155	900	T3 077
370 Distribution	05.06-03.09	ZE	190	1050	TE 077	180	1000	T5 077	170	1000	T4 077	155	900	T3 077	



				Ah	A (EN)		Ah	A (EN)		Ah	A (EN)		Ah	A (EN)	
				0 092 ...0			0 092 ...0			0 092 ...0			0 092 ...0		
◀ RENAULT															
380 Distribution	04.09-12.14	ZE					180	1000	T5 077	170	1000	T4 077	155	900	T3 077
Lander, Route	04.09-12.14	ZE					180	1000	T5 077	170	1000	T4 077	155	900	T3 077
410 Distribution, Route	05.06-03.09	ZE	190	1050	TE 077		180	1000	T5 077	170	1000	T4 077	155	900	T3 077
430/ 440 Distribution, Lander, Route	10.05-12.14	ZE					180	1000	T5 077	170	1000	T4 077	155	900	T3 077
440/ 450 Distribution, Route	09.05-03.09	ZE	190	1050	TE 077		180	1000	T5 077	170	1000	T4 077	155	900	T3 077
460 Distribution, Lander, Route	04.09-12.14	ZE					180	1000	T5 077	170	1000	T4 077	155	900	T3 077
S															
135/ 150/ 180/ 210 Midliner	05.96-01.00	ZE								140	800	T4 076	135	1000	T3 045
T															
380/ 430/ 440/ 460/ 480/ 520 10.8, 12.8	06.13→	ZE	210	1200	TA 080		225	1150	T5 080	170	1000	T4 077			
			240	1200	TE 088										

SCANIA

G															
230	09.07→	ZE	190	1050	TE 077		180	1000	T5 077	170	1000	T4 077	155	900	T3 077
			240	1200	TE 088		225	1150	T5 080	215	1150	T4 080	200	1050	T3 080
270	09.07→	ZE	240	1200	TE 088		225	1150	T5 080	215	1150	T4 080	200	1050	T3 080
280	09.07→	ZE	190	1050	TE 077		180	1000	T5 077	170	1000	T4 077	155	900	T3 077
310	07.09→	ZE	210	1200	TA 080										
320	09.07→	ZE	190	1050	TE 077		180	1000	T5 077	170	1000	T4 077	155	900	T3 077
400	09.08→	ZE	190	1050	TE 077					170	1000	T4 077	155	900	T3 077
			210	1200	TA 080										
410	03.13→	ZE	190	1050	TE 077		180	1000	T5 077	140	800	T4 075			
420	09.07→	ZE	240	1200	TE 088		225	1150	T5 080	170	1000	T4 077	155	900	T3 077
440	09.07→	ZE	210	1200	TA 080		180	1000	T5 077	140	800	T4 075			
			190	1050	TE 077										
450	03.13→	ZE	190	1050	TE 077		180	1000	T5 077	140	800	T4 075			
480	09.07→	ZE	190	1050	TE 077					170	1000	T4 077	155	900	T3 077
	09.08→	ZE	210	1200	TA 080		180	1000	T5 077	140	800	T4 075			
							225	1150	T5 080						
490	03.13→	ZE	190	1050	TE 077		180	1000	T5 077	140	800	T4 075			
P															
230	09.04→	ZE	190	1050	TE 077		180	1000	T5 077	170	1000	T4 077	155	900	T3 077
	09.09→	ZE	210	1200	TA 080										
250	10.12→	ZE	190	1050	TE 077		180	1000	T5 077	140	800	T4 075			
270	09.04→	ZE	190	1050	TE 077		180	1000	T5 077	170	1000	T4 077	155	900	T3 077
280	09.07→	ZE	210	1200	TA 080		180	1000	T5 077	170	1000	T4 077	155	900	T3 077
			190	1050	TE 077										
310	09.04→	ZE	190	1050	TE 077		180	1000	T5 077	170	1000	T4 077	155	900	T3 077
	07.09→		210	1200	TA 080										
320	09.07→	ZE	210	1200	TA 080		180	1000	T5 077	140	800	T4 075	155	900	T3 077
			190	1050	TE 077		225	1150	T5 080	170	1000	T4 077			
340	09.04→	ZE	210	1200	TA 080		180	1000	T5 077	170	1000	T4 077	155	900	T3 077
			190	1050	TE 077										
360	09.07→	ZE	210	1200	TA 080		180	1000	T5 077	170	1000	T4 077	155	900	T3 077
			190	1050	TE 077										
370	11.13→		210	1200	TA 080										
380	09.04→	ZE	210	1200	TA 080		180	1000	T5 077	170	1000	T4 077	155	900	T3 077
			190	1050	TE 077										
400	09.07→	ZE	210	1200	TA 080		180	1000	T5 077	170	1000	T4 077	155	900	T3 077
			190	1050	TE 077										
410	03.13→	ZE	190	1050	TE 077		180	1000	T5 077	140	800	T4 075			
420	09.04→	ZE	240	1200	TE 088		225	1150	T5 080	170	1000	T4 077	155	900	T3 077
450	03.13→	ZE	190	1050	TE 077		180	1000	T5 077	140	800	T4 075			
470/ 480	09.04→	ZE	240	1200	TE 088		225	1150	T5 080	170	1000	T4 077	155	900	T3 077
R															
124 GA	04.05→	ZE	240	1200	TE 088		225	1150	T5 080	170	1000	T4 077			
230/ 270/ 310/ 340	03.04→	ZE	190	1050	TE 077		180	1000	T5 077	170	1000	T4 077	155	900	T3 077
360	09.07→	ZE	190	1050	TE 077		180	1000	T5 077	140	800	T4 075			



			Ah A (EN) TE/TA			Ah A (EN) T5			Ah A (EN) T4			Ah A (EN) T3		
			0 092 ...0			0 092 ...0			0 092 ...0			0 092 ...0		
380	03.04→	ZE	190	1050	TE 077	180	1000	T5 077	170	1000	T4 077	155	900	T3 077
400	09.07→	ZE	210	1200	TA 080	180	1000	T5 077	170	1000	T4 077	155	900	T3 077
			190	1050	TE 077									
410	10.11→	ZE	190	1050	TE 077	180	1000	T5 077	140	800	T4 075			
420	02.04→	ZE	210	1200	TA 080	225	1150	T5 080	170	1000	T4 077	155	900	T3 077
			240	1200	TE 088									
440	09.07→	ZE	190	1050	TE 077				170	1000	T4 077	155	900	T3 077
450	03.13→	ZE				145	800	T5 075						
470	04.04→	ZE	240	1200	TE 088	225	1150	T5 080	170	1000	T4 077	155	900	T3 077
480	09.06→	ZE	240	1200	TE 088	225	1150	T5 080	170	1000	T4 077	155	900	T3 077
			210	1200	TA 080									
500	03.04→	ZE	240	1200	TE 088	225	1150	T5 080	170	1000	T4 077	155	900	T3 077
520	03.13→	ZE	210	1200	TA 080	180	1000	T5 077	140	800	T4 075			
			190	1050	TE 077									
560	02.06→	ZE	210	1200	TA 080	225	1150	T5 080	170	1000	T4 077	155	900	T3 077
			240	1200	TE 088									
580	04.04→	ZE	240	1200	TE 088	225	1150	T5 080	170	1000	T4 077	155	900	T3 077
	03.13→	ZE				145	800	T5 075						
LA	01.08→	ZE	190	1050	TE 077				170	1000	T4 077	155	900	T3 077
620	02.06→	ZE	210	1200	TA 080	225	1150	T5 080	170	1000	T4 077	155	900	T3 077
			240	1200	TE 088									
730	04.10→	ZE	210	1200	TA 080	180	1000	T5 077	140	800	T4 075			
			190	1050	TE 077									
Serie 86														
BF , S [BUS]	06.82-01.99	ZE										135	680	T3 044
Serie 93														
F/K CL, HL/HR [BUS]	06.90-12.01	ZE	190	1050	TE 077	180	1000	T5 077	140	800	T4 075	120	680	T3 075
Serie 94														
K/L/N/E, IB, UB [BUS]	03.97→	ZE	240	1200	TE 088	225	1150	T5 080	170	1000	T4 077	155	900	T3 077
P,R/T 220, 230, 260, 300, 310	08.96-09.04	ZE	190	1050	TE 077	180	1000	T5 077	170	1000	T4 077	155	900	T3 077
Serie 111														
B/BF, CKD [BUS]	06.90-01.99	ZE	190	1050	TE 077	180	1000	T5 077	170	1000	T4 077	135	680	T3 044
Serie 112														
BK/N CLB [BUS]	05.82-12.00	ZE	190	1050	TE 077	180	1000	T5 077	170	1000	T4 077	155	900	T3 077
Serie 113														
BN/ CN/ F, A, ALB, CLB, HL/HR [BUS]	01.90-08.98	ZE	190	1050	TE 077	180	1000	T5 077	170	1000	T4 077	155	900	T3 077
K CLA/CRA, CLB, TLA/TRA, TLB [BUS]	05.82-08.98	ZE	240	1200	TE 088	225	1150	T5 080	170	1000	T4 077	155	900	T3 077
203	01.90-12.99	ZE	190	1050	TE 077	180	1000	T5 077	140	800	T4 075	120	680	T3 075
L CLB, CLL [BUS]	01.90-08.98	ZE	240	1200	TE 088	225	1150	T5 080	170	1000	T4 077	155	900	T3 077
N ALB [BUS]	09.91-08.98	ZE	190	1050	TE 077	180	1000	T5 077	170	1000	T4 077	155	900	T3 077
CLB [BUS]	04.91-08.98	ZE	240	1200	TE 088	225	1150	T5 080	170	1000	T4 077	155	900	T3 077
CLL/CRL [BUS]	04.91-08.98	ZE	190	1050	TE 077	180	1000	T5 077	140	800	T4 075	120	680	T3 075
CR, DRB [BUS]	12.88-08.98	ZE	190	1050	TE 077	180	1000	T5 077	170	1000	T4 077	155	900	T3 077
P/T, 215	05.88-12.00	ZE	190	1050	TE 077	180	1000	T5 077	140	800	T4 075	120	680	T3 075
T 320, 360, 380	05.88-05.00	ZE	190	1050	TE 077	180	1000	T5 077	170	1000	T4 077	155	900	T3 077
Serie 114														
K EB, IB [BUS]	08.97→	ZE	240	1200	TE 088	225	1150	T5 080	170	1000	T4 077	155	900	T3 077
P 260	02.01-09.04	ZE	240	1200	TE 088	225	1150	T5 080	170	1000	T4 077	155	900	T3 077
P,R/T 320, 340, 360, 380	02.96-09.04	ZE	190	1050	TE 077	180	1000	T5 077	170	1000	T4 077	155	900	T3 077
Serie 124														
K EB, IB [BUS]	08.97→	ZE	240	1200	TE 088	225	1150	T5 080	215	1150	T4 080	220	1150	T3 081
P,R/T 360, 400, 420, 420 HPI, 440, 470	03.95-09.04	ZE	210	1200	TA 080	225	1150	T5 080	215	1150	T4 080	220	1150	T3 081
			240	1200	TE 088									
T 440	09.00-09.04	ZE	240	1200	TE 088	225	1150	T5 080	215	1150	T4 080	220	1150	T3 081
470	09.00-09.04	ZE	210	1200	TA 080	225	1150	T5 080	215	1150	T4 080	220	1150	T3 081
			240	1200	TE 088									
Serie 143														
R 450	10.96-06.98	ZE	240	1200	TE 088	225	1150	T5 080	170	1000	T4 077	155	900	T3 077



			Ah	A (EN)		Ah	A (EN)		Ah	A (EN)		Ah	A (EN)	
			0 092 ...0			0 092 ...0			0 092 ...0			0 092 ...0		

◀ SCANIA

Serie 144														
R/T 460, 530	01.96-08.01	ZE	210	1200	TA 080	225	1150	T5 080	215	1150	T4 080	220	1150	T3 081
			240	1200	TE 088									
Serie 164														
R/T 480, 580	04.00-09.04	ZE	210	1200	TA 080	225	1150	T5 080	215	1150	T4 080	220	1150	T3 081
			240	1200	TE 088									
T														
470	09.04-10.05	ZE	240	1200	TE 088	225	1150	T5 080	170	1000	T4 077	155	900	T3 077

SEDDON DIESEL

201														
	01.80→	ZE										90	540	T3 030
301														
	01.80→	ZE										125	720	T3 040
400														
	01.80→	ZE										125	720	T3 040

SETRA

Serie 200														
215 HD, HDH	06.96-06.01	ZE	190	1050	TE 077	180	1000	T5 077	170	1000	T4 077			
Serie 300														
S 309/ S 312/ S 315 H, HD, HD, HDH	03.95-09.05	ZE	190	1050	TE 077	180	1000	T5 077	170	1000	T4 077			
Serie 400														
S 411 TopClass/ S 415 ComfortClass GT, GT-HD, HD, HD/HDH	02.03→	ZE	210	1200	TA 080	225	1150	T5 080	215	1150	T4 080	220	1150	T3 081
			240	1200	TE 088									
S 415 TopClass HD	10.01→	ZE	210	1200	TA 080	225	1150	T5 080	215	1150	T4 080	220	1150	T3 081
			240	1200	TE 088									
HD, HDH	08.07→	ZE	240	1200	TE 088	225	1150	T5 080	215	1150	T4 080	220	1150	T3 081
S 416 ComfortClass GT-HD	02.03→	ZE	210	1200	TA 080	225	1150	T5 080	215	1150	T4 080	220	1150	T3 081
			240	1200	TE 088									
S 416 TopClass HDH	08.07→	ZE	240	1200	TE 088	225	1150	T5 080	215	1150	T4 080	220	1150	T3 081
S 417 ComfortClass/ S 417 TopClass/ S 431 TopClass DT, GT-HD, HDH	02.03→	ZE	210	1200	TA 080	225	1150	T5 080	215	1150	T4 080	220	1150	T3 081
			240	1200	TE 088									

STEYR (STEYR-DAIMLER-PUCH AG)

8 S																
14/ 18	05.89-12.98	ZE						145	800	T5 075	140	800	T4 075	110	760	T3 038
9 S																
14/ 18	04.86-12.98	ZE								140	800	T4 076	135	1000	T3 045	
10 S																
14/ 18	04.86-12.98	ZE								140	800	T4 076	135	1000	T3 045	
11 S																
14/ 18	07.89-12.98	ZE										88	680	T3 013		
12 M																
18/ 21	09.86-12.03	ZE						145	800	T5 075	140	800	T4 075	120	680	T3 075
12 S																
14/ 18/ 21	04.86-12.03	ZE								140	800	T4 076	135	1000	T3 045	
13 S																
14/ 18/ 21/ 23	09.88-12.98	ZE								140	800	T4 076	135	1000	T3 045	
14 S																
14/ 18/ 21	04.86-12.98	ZE								140	800	T4 076	135	1000	T3 045	
15 S																
14/ 18/ 21/ 23	04.86-12.98	ZE						145	800	T5 075	140	800	T4 075	120	680	T3 075



			Ah A (EN) TE/TA			Ah A (EN) T5			Ah A (EN) T4			Ah A (EN) T3		
			0 092 ...0			0 092 ...0			0 092 ...0			0 092 ...0		
16 S														
18/21/23	04.86-12.98	ZE				145	800	T5 075	140	800	T4 075	120	680	T3 075
17 S														
18/21/23	09.88-12.98	ZE				145	800	T5 075	140	800	T4 075	120	680	T3 075
19 S														
24/28, 4WD	01.88-12.98	ZE				145	800	T5 075	140	800	T4 075	120	680	T3 075
31, 4WD	10.87-12.98	ZE	190	1050	TE 077	180	1000	T5 077	170	1000	T4 077	155	900	T3 077
22 S														
28	01.88-12.98	ZE				145	800	T5 075	140	800	T4 075	120	680	T3 075
31, 4WD	10.87-12.98	ZE	190	1050	TE 077	180	1000	T5 077	170	1000	T4 077	155	900	T3 077
26 S														
28	01.88-12.98	ZE				145	800	T5 075	140	800	T4 075	120	680	T3 075
31	10.87-12.98	ZE	190	1050	TE 077	180	1000	T5 077	170	1000	T4 077	155	900	T3 077
32 S														
28	01.88-12.98	ZE				145	800	T5 075	140	800	T4 075	120	680	T3 075
31	10.87-12.98	ZE	190	1050	TE 077	180	1000	T5 077	170	1000	T4 077	155	900	T3 077
33 S														
31	10.87-12.98	ZE	190	1050	TE 077	180	1000	T5 077	140	800	T4 075	120	680	T3 075
40 S														
31	01.88-12.98	ZE	190	1050	TE 077	180	1000	T5 077	140	800	T4 075	120	680	T3 075

TATRA

Serie 815														
T 815 NT/NTH/P/TP/V, PJ 28 170, S/P/PJ/PR/ RN/VS, -2	03.83→	ZE	240	1200	TE 088	225	1150	T5 080	215	1150	T4 080	200	1050	T3 080
2 NT 4x4	01.92→	ZE							140	800	T4 076	110	760	T3 038

URAL AUTOMOBIL PLANT

11t														
32552	12.02→	ZE	190	1050	TE 077	180	1000	T5 077				200	1050	T3 080
12t														
43206	12.02→	ZE	190	1050	TE 077	180	1000	T5 077				200	1050	T3 080
13t														
43203/ 43206	12.02→	ZE	190	1050	TE 077	180	1000	T5 077				200	1050	T3 080
14t														
3255/ 325512, -41	12.02→	ZE	190	1050	TE 077	180	1000	T5 077				200	1050	T3 080
15t														
43202/ 43203	12.02→	ZE	190	1050	TE 077	180	1000	T5 077				200	1050	T3 080
16t														
5557-10	12.02→	ZE	190	1050	TE 077	180	1000	T5 077				200	1050	T3 080
17t														
43203/ 55571-10	12.02→	ZE	190	1050	TE 077	180	1000	T5 077				200	1050	T3 080
19t														
5557-31	12.02→	ZE	190	1050	TE 077	180	1000	T5 077				200	1050	T3 080
20t														
4320/ 55571-30	12.02→	ZE	190	1050	TE 077	180	1000	T5 077				200	1050	T3 080
21t														
4320/ 55571/ 532301	12.02→	ZE	190	1050	TE 077	180	1000	T5 077				200	1050	T3 080
25t														
632302	12.02→	ZE	190	1050	TE 077	180	1000	T5 077				200	1050	T3 080
26t														
53236	12.02→	ZE	190	1050	TE 077	180	1000	T5 077				200	1050	T3 080
30t														
44202, -03	12.02→	ZE	190	1050	TE 077	180	1000	T5 077				200	1050	T3 080
33t														
6329/ 6529/ 63621	12.02→	ZE	190	1050	TE 077	180	1000	T5 077				200	1050	T3 080
39t														
542301	12.02→	ZE	190	1050	TE 077	180	1000	T5 077				200	1050	T3 080



			Ah	A (EN)		Ah	A (EN)		Ah	A (EN)		Ah	A (EN)	
			0 092 ...0			0 092 ...0			0 092 ...0			0 092 ...0		







◀ URAL AUTOMOBIL PLANT

43t														
542362	12.02→	ZE	190	1050	TE 077	180	1000	T5 077				200	1050	T3 080
88t														
632911	01.03→	ZE	190	1050	TE 077	180	1000	T5 077				200	1050	T3 080

VOLVO

B														
7	F	01.99→	ZE						140	800	T4 076	110	760	T3 038
	L	05.99-09.06	ZE	240	1200	TE 088	225	1150	T5 080	170	1000	T4 077		
9	L, L CNG, LA, LA CNG	09.06→	ZE	210	1200	TA 080								
10	L	05.94-09.05	ZE	190	1050	TE 077	180	1000	T5 077	170	1000	T4 077		
	M	01.94-09.01	ZE						140	800	T4 076	110	760	T3 038
	R	01.02→	ZE						140	800	T4 076	110	760	T3 038
11	33 R, 370 R, 380 R, 410 R, 430 R, 460 R	09.11→	ZE	210	1200	TA 080								
12	B	06.01→	ZE	210	1200	TA 080	180	1000	T5 077	170	1000	T4 077		
				190	1050	TE 077								
		10.01→	ZE						140	800	T4 076	110	760	T3 038
	CH 5000-	10.95-09.11	ZE	190	1050	TE 077	180	1000	T5 077	170	1000	T4 077		
	M	10.01→	ZE						140	800	T4 076	110	760	T3 038
FE														
240		05.06→	ZE	240	1200	TE 088	225	1150	T5 080	170	1000	T4 077		
		05.09→	ZE	190	1050	TE 077			170	1000	T4 077	155	900	T3 077
250		05.13→	ZE	190	1050	TE 077	180	1000	T5 077	170	1000	T4 077		
260		05.09→	ZE	240	1200	TE 088	225	1150	T5 080	170	1000	T4 077		
280/ 320		05.06→	ZE	240	1200	TE 088	225	1150	T5 080	170	1000	T4 077		
		05.13→	ZE	190	1050	TE 077	180	1000	T5 077	170	1000	T4 077		
FH														
12/ 16	340, 380, 420, 460, 470, 500, 520	08.93-08.06	ZE	190	1050	TE 077	180	1000	T5 077	170	1000	T4 077		
16	540	12.06→	ZE	190	1050	TE 077	180	1000	T5 077	170	1000	T4 077		
		01.09→	ZE	210	1200	TA 080								
	550	01.03-09.08	ZE	210	1200	TA 080	180	1000	T5 077	170	1000	T4 077		
				190	1050	TE 077								
		01.08→	ZE	190	1050	TE 077	180	1000	T5 077	170	1000	T4 077	155	900
	580	01.06→	ZE	190	1050	TE 077			170	1000	T4 077	155	900	T3 077
	600	01.09→	ZE	210	1200	TA 080								
	610	01.03-09.08	ZE	210	1200	TA 080	180	1000	T5 077	170	1000	T4 077		
				190	1050	TE 077								
	660	01.06→	ZE	240	1200	TE 088	225	1150	T5 080	170	1000	T4 077	155	900
	700	01.09→	ZE	190	1050	TE 077			170	1000	T4 077	155	900	T3 077
				210	1200	TA 080								
	750	09.11→	ZE	210	1200	TA 080	180	1000	T5 077	170	1000	T4 077	220	1150
				190	1050	TE 077								
400		09.06→	ZE	210	1200	TA 080	225	1150	T5 080	215	1150	T4 080	220	1150
				240	1200	TE 088								
420		01.09→	ZE	210	1200	TA 080	225	1150	T5 080					
				240	1200	TE 088								
440		09.06→	ZE	210	1200	TA 080	225	1150	T5 080	215	1150	T4 080	220	1150
				240	1200	TE 088								
460		01.09→	ZE	210	1200	TA 080	225	1150	T5 080					
				240	1200	TE 088								
480		09.06-12.11	ZE	240	1200	TE 088	225	1150	T5 080	215	1150	T4 080	220	1150
500		09.06→	ZE	210	1200	TA 080	225	1150	T5 080	215	1150	T4 080	220	1150
				240	1200	TE 088								
520		09.06-12.11	ZE	240	1200	TE 088	225	1150	T5 080	215	1150	T4 080	220	1150
540		01.09→		210	1200	TA 080	225	1150	T5 080					
				240	1200	TE 088								
FH II														
420		09.12→	ZE	210	1200	TA 080	180	1000	T5 077	170	1000	T4 077	220	1150
				190	1050	TE 077								



				0 092 ...0			0 092 ...0			0 092 ...0			0 092 ...0		
				Ah	A (EN)		Ah	A (EN)		Ah	A (EN)		Ah	A (EN)	
460	09.12→	ZE	210	1200	TA 080	180	1000	T5 077	170	1000	T4 077	220	1150	T3 081	
			190	1050	TE 077	225	1150	T5 080							
500	09.12→	ZE	210	1200	TA 080	180	1000	T5 077	170	1000	T4 077	220	1150	T3 081	
			190	1050	TE 077										
540	09.12→	ZE	210	1200	TA 080	180	1000	T5 077	170	1000	T4 077	220	1150	T3 081	
			190	1050	TE 077										
550	08.14→	ZE	210	1200	TA 080										
750	09.12→	ZE				180	1000	T5 077							
						225	1150	T5 080							
FL															
6	180, 220, 250	05.00-05.06	ZE	190	1050	TE 077	180	1000	T5 077	140	800	T4 076			
7/ 10/ 12	380, 420	09.85-12.01	ZE	190	1050	TE 077	180	1000	T5 077	140	800	T4 075	120	680	
240	05.06→	ZE	210	1200	TA 080	180	1000	T5 077	170	1000	T4 077				
			190	1050	TE 077										
	04.09→	ZE	210	1200	TA 080	180	1000	T5 077	170	1000	T4 077	155	900	T3 077	
			190	1050	TE 077										
250	05.13→	ZE	190	1050	TE 077	180	1000	T5 077	170	1000	T4 077				
260	04.09→	ZE	210	1200	TA 080										
280	05.06→	ZE	210	1200	TA 080	180	1000	T5 077	170	1000	T4 077				
			190	1050	TE 077										
608/ 611/ 612/ 614/ 615/ 618	02.95-08.00	ZE				145	800	T5 075	140	800	T4 075	90	540	T3 030	
FLC															
	09.96-09.00	ZE										110	680	T3 035	
FM															
7/ 9	250, 260, 290, 300, 310, 340, 380	09.98-08.05	ZE	190	1050	TE 077	180	1000	T5 077	170	1000	T4 077			
10/ 12	320, 340, 345, 360, 380, 385, 420, 425, 460, 500	09.98-12.05	ZE	240	1200	TE 088	225	1150	T5 080	170	1000	T4 077			
300	09.05-07.09	ZE	210	1200	TA 080	225	1150	T5 080	170	1000	T4 077				
			240	1200	TE 088										
330	05.09→	ZE	210	1200	TA 080										
340/ 360	09.05-07.09	ZE	210	1200	TA 080	225	1150	T5 080	170	1000	T4 077				
			240	1200	TE 088										
370	05.09→	ZE	210	1200	TA 080										
380	09.05-07.09	ZE	240	1200	TE 088	225	1150	T5 080	170	1000	T4 077				
	09.05→	ZE	210	1200	TA 080										
390	06.08-09.10	ZE	210	1200	TA 080	225	1150	T5 080							
			240	1200	TE 088	225	1150	T5 080							
400	09.05→	ZE	210	1200	TA 080	225	1150	T5 080	170	1000	T4 077				
			240	1200	TE 088										
410/ 420	05.09→	ZE	210	1200	TA 080										
			240	1200	TE 088										
440	09.05→	ZE	210	1200	TA 080	225	1150	T5 080							
			240	1200	TE 088										
450/ 460	05.09→	ZE	210	1200	TA 080										
			240	1200	TE 088										
480	09.05-09.09	ZE	210	1200	TA 080	225	1150	T5 080	170	1000	T4 077				
			240	1200	TE 088										
500	05.09→	ZE	210	1200	TA 080										
			240	1200	TE 088										
	04.13→	ZE	210	1200	TA 080	180	1000	T5 077	170	1000	T4 077				
			190	1050	TE 077										
FMX															
330/ 370/ 380/ 410	03.10→	ZE	210	1200	TA 080										
420	03.10→	ZE	210	1200	TA 080	180	1000	T5 077	170	1000	T4 077				
			190	1050	TE 077										
450	03.10→	ZE	210	1200	TA 080										
460	03.10→	ZE	210	1200	TA 080	180	1000	T5 077	170	1000	T4 077				
			190	1050	TE 077										
500	03.10→	ZE	210	1200	TA 080										



			Ah	A (EN)		Ah	A (EN)		Ah	A (EN)		Ah	A (EN)	
--	--	--	----	--------	--	----	--------	--	----	--------	--	----	--------	--

0 092 ...0

0 092 ...0

0 092 ...0

0 092 ...0







◀ VOLVO

N														
12	280, 315, 350, 370, 380	01.86-01.98	ZE	190	1050	TE 077	180	1000	T5 077	140	800	T4 076		
NH														
12	380, 420	05.99→	ZE	190	1050	TE 077	180	1000	T5 077	170	1000	T4 077		
NL														
10/ 12	275, 285, 320, 350, 360, 390, 400	05.91-09.01	ZE	190	1050	TE 077	180	1000	T5 077	170	1000	T4 077		
7700														
260/ 310/ 360	06.06→	ZE	210	1200	TA 080	225	1150	T5 080	215	1150	T4 080	220	1150	T3 081
			240	1200	TE 088									
9700														
	04.01→	ZE	210	1200	TA 080	225	1150	T5 080	215	1150	T4 080	220	1150	T3 081
			240	1200	TE 088									
9900														
	10.01→	ZE	210	1200	TA 080	225	1150	T5 080	215	1150	T4 080	220	1150	T3 081
			240	1200	TE 088									

VW (VOLKSWAGEN)

L80														
[2V]	01.95-12.99	ZE										88	680	T3 013



			Ah A (EN) 	Ah A (EN) 	Ah A (EN) 	Ah A (EN) 
			0 092 ...0	0 092 ...0	0 092 ...0	0 092 ...0

ATLAS COPCO

Serie PT-PTS

PT 900	12.74-12.89			100	600	T3072
--------	-------------	--	--	-----	-----	-------

BARBER-GREENE

SA-Serie

41	01.76-09.90			125	720	T3040
----	-------------	--	--	-----	-----	-------

SB-Serie

111	01.76-09.90			125	720	T3040
-----	-------------	--	--	-----	-----	-------

BERTOLINI

Serie 300

310 S	01.69-01.01			45	300	S3017
-------	-------------	--	--	----	-----	-------

Serie 400

450	01.70-07.83			45	400	S3003
-----	-------------	--	--	----	-----	-------

CASE

DH

4	01.80-01.95			110	680	T3035
---	-------------	--	--	-----	-----	-------

Serie 1000

1194/ 1294/ 1394/ 1494/ 1694	01.84-06.89			125	720	T3041
---------------------------------	-------------	--	--	-----	-----	-------

1270	09.71-12.86			110	680	T3035
------	-------------	--	--	-----	-----	-------

CASE IH (CASE INTERNATIONAL)

Serie 100

100 B	01.86-06.86			125	720	T3041
-------	-------------	--	--	-----	-----	-------

Serie 485-885

585/ 685 L, XL	06.83-06.98			110	680	T3036
----------------	-------------	--	--	-----	-----	-------

Serie 500

531/ 541	01.86-06.86			150	760	T3063
----------	-------------	--	--	-----	-----	-------

Serie 700

745 XL, A	01.86-01.01			135	1000	T3045
-----------	-------------	--	--	-----	------	-------

Serie 800

844 XL, A	01.86-01.01			135	1000	T3045
-----------	-------------	--	--	-----	------	-------

Serie 900

923/ 933/ 943/ 953	01.86-06.86			150	760	T3063
--------------------	-------------	--	--	-----	-----	-------

Serie 4000

4300	01.86-06.86			110	680	T3035
------	-------------	--	--	-----	-----	-------

CLAAS

Dominator

48	01.78-10.88			88	680	T3013	90	720	S3013
----	-------------	--	--	----	-----	-------	----	-----	-------

66/ 76/ 85/ 86/ 96	10.74-10.85			135	1000	T3045
--------------------	-------------	--	--	-----	------	-------

108 SL Maxi	09.90-09.05	170	1000	T4078
-------------	-------------	-----	------	-------

Jaguar

80 SF	01.76-10.83			135	1000	T3045
-------	-------------	--	--	-----	------	-------

675/ 680	10.74-10.87	170	1000	T4078
----------	-------------	-----	------	-------

685 SL	01.87-01.02	170	1000	T4078
--------	-------------	-----	------	-------

690	10.74-10.87 ZE			135	1000	T3045
-----	----------------	--	--	-----	------	-------

690/ 695 SL	10.74-06.02			135	1000	T3045
-------------	-------------	--	--	-----	------	-------



			Ah A (EN)	Ah A (EN)	Ah A (EN)	Ah A (EN)
◀ CLAAS			0 092 ...0	0 092 ...0	0 092 ...0	0 092 ...0

Lexion						
405/ 410/ 420/ 430/ 440/ 450/ 460	01.97-12.01				135 1000	T3 045
Mega						
202/ 203/ 204/ 208/ 218	01.90-09.98				135 1000	T3 045

CLAYSON

8000-Serie						
8070	01.77-11.86				95 800	S4 013
					100 830	S5 013
8080	01.77-11.86				74 750	S5 007
					77 780	S5 008

DEUTZ-FAHR

D 07						
7007	06.86-06.01	145 800	T5 075	140 800	T4 075	
DX						
3 .10 A	06.86-06.01				88 680	T3 013 90 720 S3 013
.30 A	06.86-06.01				88 680	T3 013 90 720 S3 013
.50 A	06.86-06.01	145 800	T5 075	140 800	T4 075	120 680 T3 075
.51, .60, .70 A, .90 A	06.86-06.01	145 800	T5 075	140 800	T4 075	120 680 T3 075
4 .10	06.86-06.01	145 800	T5 075	140 800	T4 075	120 680 T3 075
.30 A	06.86-06.01	145 800	T5 075	140 800	T4 075	120 680 T3 075
.50 A	06.86-06.01	145 800	T5 075	140 800	T4 075	120 680 T3 075
.51, .60, .70 A, .90 A	06.86-01.05	145 800	T5 075	140 800	T4 075	120 680 T3 075
6 .30 A	06.86-06.01	145 800	T5 075	140 800	T4 075	120 680 T3 075
.50 A	06.86-06.01	180 1000	T5 077	170 1000	T4 077	
		190 1050	TE 077	170 1000	T4 077	
7 .10 A	06.86-06.01	180 1000	T5 077	170 1000	T4 077	
		190 1050	TE 077	170 1000	T4 077	
Intrac						
6 .60 turbo	01.88-01.03	145 800	T5 075	140 800	T4 075	
2004	05.78-12.88				135 1000	T3 045
M						
1080	01.81-01.96	145 800	T5 075	140 800	T4 075	
1202	01.80-01.95				88 680	T3 013 90 720 S3 013
2385	01.82-01.97	145 800	T5 075	140 800	T4 075	
3330/ 3360	03.87-03.02				135 1000	T3 045
3570	03.87-03.02	145 800	T5 075	140 800	T4 075	
3580	03.87-03.02	145 800	T5 075	140 800	T4 075	
3610	03.87-03.02	145 800	T5 075	140 800	T4 075	120 680 T3 075
3630	03.87-03.02	145 800	T5 075	140 800	T4 075	120 680 T3 075
3640	03.87-03.02 ZE	145 800	T5 075	140 800	T4 075	120 680 T3 075

EICHER

Serie 3700						
3728 A	03.82-12.84				135 1000	T3 045

FENDT

F						
255 GT	02.77-02.92				100 830	S5 013
275 GT	02.76-02.91				135 1000	T3 045

			Ah A (EN)	Ah A (EN)	Ah A (EN)	Ah A (EN)
			0 092 ...0	0 092 ...0	0 092 ...0	0 092 ...0

Farmer 100-Serie						
102/ 103 S/FW 135, S/FW 138	02.77-02.92				135 1000	T3 045
105 S/FW 258	02.77-02.92	140	800	T4 076	135 1000	T3 045
Farmer 200-Serie						
200 S	10.74-10.89					95 800 S4 013 100 830 S5 013
200/ 203 V/FL 145, V/FL 155	02.74-02.89					100 830 S5 013
203/ 204/ 205 P, P/FL 156, P/FL 166	02.75-02.94					100 830 S5 013
Farmer 300-Serie						
305 LS/FW 162, LS/FW 168, LS/FW 178	02.80-02.95	140	800	T4 076	135 1000	T3 045
306 LS/FW 162, LS/FW 168, LS/FW 178	02.80-02.95	140	800	T4 076	135 1000	T3 045
308 LS/FW 162, LS/FW 168, LS/FW 178	02.80-02.95	140	800	T4 076	135 1000	T3 045
310 LSA	09.84-08.90				135 1000	T3 045
Favorit						
600/ 610/ 611/ 612/ 614/ 615/ 622/ 626 FWA 285.260, LS, LS/FW 280, LS/FW 281, LS/FW 282, LS/FW 291, LS/FWA 283, LS/FWA 284, LS/ FWA 285	02.76-02.97	170	1000	T4 078		

FERRARI

Serie 70						
72/ 76 , S	01.71→					45 400 S3 003
Serie 90						
94/ 95/ 96	06.80-09.04					45 400 S3 003
95 RS	11.88-11.03					45 400 S3 003 70 630 S4 027
Serie 700						
733/ 745	06.80-12.83					70 630 S4 027
Serie 800						
	12.85-12.89					45 400 S3 003
Serie 900						
933	01.82-12.89					70 630 S4 027
Serie 1000						
1100	12.85-12.00					45 400 S3 003
T						
93	01.88-01.03					45 400 S3 003

FIAT

50-Serie						
55 .46, .65, .90	03.84-08.88				88 680	T3 013 90 720 S3 013
60-Serie						
60 .46, .65, .66, .90	09.84-08.88				88 680	T3 013 90 720 S3 013
	10.84-08.88				88 680	T3 013 90 720 S3 013
65 .46, .65, .66, .90	04.85-08.88				88 680	T3 013 90 720 S3 013
70-Serie						
70 .65, .66, .90	03.84-08.88				88 680	T3 013 90 720 S3 013
80-Serie						
85 .55	10.84-08.88				88 680	T3 013 90 720 S3 013



			Ah A (EN)	Ah A (EN)	Ah A (EN)	Ah A (EN)
--	--	--	-----------	-----------	-----------	-----------

0 092 ...0

0 092 ...0

0 092 ...0

0 092 ...0

◀ FIAT

90-Serie										
90/ 95 .55, .90	06.84-08.88							143	900	T3 046
100-Serie										
100/ 130/ 140 .90	01.84-08.88							143	900	T3 046
115.90	01.84-08.88							143	900	T3 046
160 .90	01.84-04.88	180	1000	T5 077						
		190	1050	TE 077						
400-Serie										
400	01.68-12.85 ZE				140	800	T4 076	110	760	T3 038
420	01.77-12.85				140	800	T4 076	110	760	T3 038
465 C, DT	06.82-12.84				140	800	T4 076	110	760	T3 038 90 720 S3 013
466	02.82-12.84				140	800	T4 076	110	760	T3 038
C, DT	02.82-12.84				140	800	T4 076	110	760	T3 038 90 720 S3 013
474	04.83-12.84				140	800	T4 076	110	760	T3 038 95 830 S4 028
500-Serie										
565 C, F, V	06.82-12.84							88	680	T3 013 90 720 S3 013
566	02.82-12.84	180	1000	T5 077	170	1000	T4 077			
		190	1050	TE 077	170	1000	T4 077			
DT	02.82-12.84	180	1000	T5 077	170	1000	T4 077			90 720 S3 013
		190	1050	TE 077	170	1000	T4 077			90 720 S3 013
570 C, F, V	09.80-12.84							88	680	T3 013 90 720 S3 013
580 DT	12.77-02.84	180	1000	T5 077	170	1000	T4 077			
		190	1050	TE 077	170	1000	T4 077			
600-Serie										
665/ 666/ 690 C, DT, N1, T2	01.69-12.84							143	900	T3 046
666	02.82-12.84	145	800	T5 075	140	800	T4 075			
682 N3, N4	01.69-12.84									95 830 S4 028
700-Serie										
765/ 766 , C, DT	02.82-12.84							143	900	T3 046
780 , DT	01.75-02.84	180	1000	T5 077	170	1000	T4 077			
		190	1050	TE 077	170	1000	T4 077			
900-Serie										
980 , DT	01.80-06.84							143	900	T3 046

FORD

Serie 3000										
3430/ 3930	06.90-06.05							110	680	T3 035
3610	01.81-01.96							130	680	T3 043 100 830 S5 013
Serie 4000										
4130/ 4630/ 4830	06.90-06.05							110	680	T3 035
Serie 5000										
5610	06.90-06.05							130	680	T3 043
Serie 6000										
6410/ 6610/ 6810	01.81-06.05							130	680	T3 043
Serie 7000										
7610/ 7810	06.90-06.05							130	680	T3 043
Serie 8000										
8210/ 8630/ 8730/ 8830	06.90-06.05							130	680	T3 043

FORD NEW HOLLAND

Serie 35											
3435	06.95-01.99								95	800	S4 013
									100	830	S5 013
3935	06.95-01.99							95	800	S4 013	
								100	830	S5 013	

			Ah	A (EN)		Ah	A (EN)		Ah	A (EN)		Ah	A (EN)	
			0 092 ...0			0 092 ...0			0 092 ...0			0 092 ...0		

4135	06.95-01.99											95	800	S4 013
												100	830	S5 013
4635/ 4835/ 5635/ 6635/ 7635	06.95-01.99					135	1000	T3 045						
Serie 8000														
8030	11.86-11.01					88	680	T3 013				90	720	S3 013
8050/ 8060/ 8070	01.85-12.01											74	680	S4 008
TF														
42	03.83-12.01											74	680	S4 008
44	03.83-03.98					88	680	T3 013				90	720	S3 013
46	06.85-06.00					88	680	T3 013				90	720	S3 013
TW														
15/ 25/ 35	01.86-01.01					130	680	T3 043						
TX														
34	06.86-04.02											74	680	S4 008

GUTBROD

2000-Serie														
2500 D	03.73-12.84											45	400	S3 002

HAKO

Flipper														
	03.77-12.84					180	1000	T5 077						
						190	1050	TE 077						

HOLDER

A														
40	07.79-12.88											60	540	S4 005
												63	610	S5 005
50	07.79-12.88											60	540	S4 005
												63	610	S5 005
60	10.78-07.85											95	800	S4 013
												100	830	S5 013
C														
500	05.81-02.97											95	800	S4 013
												100	830	S5 013
P														
60	01.79-02.83											56	480	S3 005

IH (INTERNATIONAL HARV.)

H														
90 E	01.72-12.85					225	1150	T5 080	215	1150	T4 080	200	1050	T3 080
						240	1200	TE 088	215	1150	T4 080	200	1050	T3 080
Serie 400														
431	11.72-12.85											150	760	T3 063
433 , V	06.73-12.85											100	830	S5 013
Serie 500														
531/ 541	01.72-12.85											150	760	T3 063
Serie 600														
644 [B]	01.74-12.85											135	1000	T3 045
Serie 700														
743/ 744 [B]	02.74-12.85											135	1000	T3 045
Serie 800														
844 , A [B]	01.74-12.85					140	800	T4 076	135	1000	T3 045			



			Ah A (EN)	Ah A (EN)	Ah A (EN)	Ah A (EN)
◀ IH			0 092 ...0	0 092 ...0	0 092 ...0	0 092 ...0

Serie 900							
923/933/943/953	03.76-12.85				135	1000	T3 045
956 XLA [C]	09.82-12.85	140	800	T4 076	135	1000	T3 045
Serie 1000							
1255, XLA [D]	07.79-12.85	180	1000	T5 077	170	1000	T4 077
		190	1050	TE 077	170	1000	T4 077
1455, XLA [D]	07.79-12.85	180	1000	T5 077	170	1000	T4 077
		190	1050	TE 077	170	1000	T4 077

IRION

DFG-Serie							
15 S	01.65-12.83				90	720	S3 013

JOHN DEERE

Serie 70-140									
140	01.73-12.87				45	400	S3 002		
Serie 800									
840	09.79-10.86				55	420	T3 005		
56					480		S3 005		
Serie 900									
940	09.79-10.86				55	420	T3 005		
56					480		S3 005		
Serie 1000									
1040	09.79-10.86				60	540	S4 005		
					63	610	S5 005		
1085	11.82-12.87				95	800	S4 013		
					100	830	S5 013		
Serie 1100									
1140	09.79-10.86				60	540	S4 005		
					63	610	S5 005		
1188	01.88-01.03				95	800	S4 013		
					100	830	S5 013		
Hydro 4	01.91-12.92				95	800	S4 013		
					100	830	S5 013		
Serie 1600									
1640	09.79-10.86				74	750	S5 007		
					77	780	S5 008		
Serie 2000									
2040	09.79-10.86				74	750	S5 007		
					77	780	S5 008		
Serie 2100									
2140	09.79-10.86				74	750	S5 007		
					77	780	S5 008		
Serie 2200									
2258	06.96→				95	800	S4 013		
					100	830	S5 013		
Serie 3000									
3040	05.82-10.86			88	680	T3 013	90	720	S3 013
Serie 3100									
3140	05.82-10.86				95	800	S4 013		
					100	830	S5 013		
Serie 4000									
4050	06.87-12.89				105	800	T3 050		
4055	01.89-06.92				100	600	T3 072		
					105	800	T3 050		
4100/ 4200/ 4600	08.98→						45	300	S3 016
4250	06.87-12.88				105	800	T3 050		
4255	01.89-01.92				100	600	T3 072		
					105	800	T3 050		
4450	05.83-10.88				100	600	T3 072		



			Ah A (EN) T5			Ah A (EN) T4			Ah A (EN) T3			Ah A (EN) S3-S6			
			0 092 ...0			0 092 ...0			0 092 ...0			0 092 ...0			
4650	03.85-10.88							100	600	T3 072					
								105	800	T3 050					
4755	01.89-02.89							100	600	T3 072					
	03.89-06.91							100	600	T3 072					
								105	800	T3 050					
	07.91-05.94							100	600	T3 072					
								105	800	T3 050					
4850	05.88-10.88							100	600	T3 072					
								105	800	T3 050					
	03.89-03.04							105	800	T3 050					
4955 R.C.	09.87-09.02							105	800	T3 050					
Serie 5000															
5820/ 5830	11.82-10.04							105	800	T3 050					
Serie 6000															
6100	01.92→	ZE						100	600	T3 072			100	830	S5 013
6200	01.92→	ZE						100	600	T3 072			100	830	S5 013
6400	01.92→	ZE						100	600	T3 072			100	830	S5 013
6600	01.92→	ZE	145	800	T5 075	140	800	T4 075							
6800	01.92→	ZE	145	800	T5 075	140	800	T4 075							
6810	08.91→		145	800	T5 075	140	800	T4 075							
6900	01.94→	ZE	145	800	T5 075	140	800	T4 075							
Serie 7000															
7600/ 7610/ 7700/ 7710/ 7730/ 7800/ 7810/ 7830/ 7930	09.92→							105	800	T3 050					
Serie 7020															
7720/ 7820/ 7920	01.03→							105	800	T3 050					
Serie 8000															
8100	08.94→							105	800	T3 050					
		ZE						110	680	T3 035					
8120/ 8220/ 8320/ 8420/ 8520	01.02→							105	800	T3 050					
8200	08.94→							105	800	T3 050					
		ZE						110	680	T3 035					
8300	08.94→							105	800	T3 050					
		ZE						110	680	T3 035					
8400	08.94→							105	800	T3 050					
		ZE						110	680	T3 035					
8450	07.88-07.03							105	800	T3 050					
8650 -4 WD	01.80-10.84							105	800	T3 050					
8850	11.82-11.88							105	800	T3 050					
Serie 8030															
8230/ 8330/ 8430/ 8530	01.06→							105	800	T3 050					
Serie 9000															
9120/ 9220/ 9320/ 9420/ 9520/ 9600	09.87→							105	800	T3 050					

KHD



D 4000-Serie															
4007	07.80-10.84							88	680	T3 013			90	720	S3 013
D 6000-Serie															
6007 , C	07.82-10.84		145	800	T5 075	140	800	T4 075	120	680	T3 075				
6507 , C	07.82-10.84		145	800	T5 075	140	800	T4 075	120	680	T3 075				
D 7000-Serie															
7807	06.83-10.84		145	800	T5 075	140	800	T4 075	120	680	T3 075				
DX-Serie															
85	05.78-10.85		145	800	T5 075	140	800	T4 075	120	680	T3 075				
86	01.82-10.85		145	800	T5 075	140	800	T4 075	120	680	T3 075				
	07.82-10.85		145	800	T5 075	140	800	T4 075	120	680	T3 075				
90	05.78-10.85		145	800	T5 075	140	800	T4 075	120	680	T3 075				

		Ah A (EN) T5			Ah A (EN) T4			Ah A (EN) T3			Ah A (EN) S3-S6		
◀ KHD		0 092 ...0			0 092 ...0			0 092 ...0			0 092 ...0		
92	01.82-10.85	145	800	T5 075	140	800	T4 075	120	680	T3 075			
	09.82-10.85	145	800	T5 075	140	800	T4 075	120	680	T3 075			
110	05.78-10.85	145	800	T5 075	140	800	T4 075	120	680	T3 075			
120	07.80-10.85	145	800	T5 075	140	800	T4 075	120	680	T3 075			
140	05.78-10.85	180	1000	T5 077	170	1000	T4 077						
		190	1050	TE 077	170	1000	T4 077						
145	07.80-10.85	180	1000	T5 077	170	1000	T4 077						
		190	1050	TE 077	170	1000	T4 077						
160	05.78-10.85	180	1000	T5 077	170	1000	T4 077						
		190	1050	TE 077	170	1000	T4 077						
250	01.82-10.85	145	800	T5 075	140	800	T4 075	120	680	T3 075			
Intrac													
2004	05.78-06.87							135	1000	T3 045			

KUBOTA

Serie 6030-8030												
6030/ 7030	12.87-09.88							88	680	T3 013		

LAMBORGHINI

R												
754	01.82-12.85							135	1000	T3 045		
700-Serie												
700	03.89-12.99									95	830	S4 028
900-Serie												
956 DT	01.84-12.99				170	1000	T4 078					
1000-Serie												
1506 Turbo	01.84-12.99	225	1150	T5 080	215	1150	T4 080	200	1050	T3 080		
		240	1200	TE 088	215	1150	T4 080	200	1050	T3 080		
1706 Turbo	01.84-12.99	225	1150	T5 080	215	1150	T4 080	200	1050	T3 080		
		240	1200	TE 088	215	1150	T4 080	200	1050	T3 080		

LANDINI

4000-Serie												
4500	01.69-06.86							110	680	T3 035		
5000-Serie												
5500	01.71-06.86							110	680	T3 035		

LAVERDA (FIATAGRI)

MX												
300	03.87-10.90 ZE	180	1000	T5 077								
		190	1050	TE 077								
Serie 3000												
3300	01.83-12.86	180	1000	T5 077								
		190	1050	TE 077								
3350	01.83-06.86	180	1000	T5 077								
		190	1050	TE 077								
3400	05.86-05.01	180	1000	T5 077								
		190	1050	TE 077								
3450	01.83-12.84	180	1000	T5 077								
		190	1050	TE 077								
3500	01.85-01.00	180	1000	T5 077								
		190	1050	TE 077								
3550	03.85-03.00	180	1000	T5 077								
		190	1050	TE 077								



		?	0 092 ...0			0 092 ...0			0 092 ...0			0 092 ...0		
			Ah	A (EN)	T5	Ah	A (EN)	T4	Ah	A (EN)	T3	Ah	A (EN)	S3-S6
3550 AL	03.86-03.01		180	1000	T5 077									
			190	1050	TE 077									
3600	01.83-06.86		180	1000	T5 077									
			190	1050	TE 077									
3650	06.85-06.00		180	1000	T5 077									
			190	1050	TE 077									
3700	01.83-12.85		180	1000	T5 077									
			190	1050	TE 077									
3750	06.85-06.00		180	1000	T5 077									
			190	1050	TE 077									
3790	06.85-06.00		180	1000	T5 077									
			190	1050	TE 077									
3850	04.85→		180	1000	T5 077									
			190	1050	TE 077									
3890	03.86-03.01		180	1000	T5 077									
			190	1050	TE 077									
3900	01.83-12.85 ZE		180	1000	T5 077									
			190	1050	TE 077									

MASSEY FERGUSON (MF)

30-Serie														
33	01.73-12.89										150	760	T3 063	
200-Serie														
203/ 205	01.70-12.88										125	720	T3 040	
244	01.70-12.88										110	680	T3 035	
400-Serie														
450	01.73-12.87											95	830	S4 028
3000-Serie														
3366	01.71-01.86										150	760	T3 063	

MITSUBISHI

FD														
10/ 30/ 70	01.73-12.83											70	630	S4 027
FG														
20/ 25	01.73-12.87											45	300	S3 016

MUIR HILL

100-Serie													
121	01.73-12.86										130	680	T3 043

NEW HOLLAND

Serie 8000														
8030	03.82-11.86											95	800	S4 013
												100	830	S5 013
8040	03.80-11.86											95	800	S4 013
												100	830	S5 013
												95	800	S4 013
												100	830	S5 013
8050	03.82-11.86											74	750	S5 007
												77	780	S5 008
8060	03.82-11.86											74	750	S5 007
												77	780	S5 008
8070	03.80-11.86											95	800	S4 013
												100	830	S5 013



			Ah A (EN)	Ah A (EN)	Ah A (EN)	Ah A (EN)
◀ NEW HOLLAND			0 092 ...0	0 092 ...0	0 092 ...0	0 092 ...0

TF						
44	03.83-11.86					95 800 S4 013
						100 830 S5 013







REFORMWERKE BAUER

Metrac						
3000	01.79-06.87			88	680	T3 013
Muli						
33/ 40/ 50/ 150	01.75-06.85			88	680	T3 013

SAME (SLH)

Antares						
100	03.89-03.04					95 800 S4 013
						100 830 S5 013
Aster						
60	03.89-03.04					95 800 S4 013
						100 830 S5 013
70	03.89-03.04					95 800 S4 013
						100 830 S5 013
Condor						
55	07.82-10.87			143	900	T3 046
Corsaro Frutteto						
70	10.81-03.88			143	900	T3 046
Delfino						
35	01.72-01.86					74 680 S4 008
Drago						
120	01.78-05.86		170 1000			T4 078
Explorer						
60 Special	06.86-06.01			88	680	T3 013 90 720 S3 013
70 Special	07.86-07.01			88	680	T3 013 90 720 S3 013
Falcon						
	07.75-10.87			112	510	T3 061
Frutteto						
60	04.87-04.02			88	680	T3 013 90 720 S3 013
75	04.87-04.02			88	680	T3 013 90 720 S3 013
Jaguar						
100	03.82-03.84			120	760	T3 039
Laser						
110/ 130	03.83-04.98			180	1100	T3 079
150	03.83-03.98		170 1000			T4 078
Leopard						
C	06.80-12.85	145	800	T5 075	140 800	T4 075
90 Turbo	02.82-03.84				120 760	T3 039
Ranger						
45	02.82-02.97					74 680 S4 008
Solar						
50	06.86-06.01					95 800 S4 013
						100 830 S5 013
60	06.86-06.01					95 800 S4 013
						100 830 S5 013
Taurus						
C	06.80-12.83	145	800	T5 075	140 800	T4 075
Vigneron						
50/ 62	02.82-03.03					74 680 S4 008
60/ 75	03.78-03.03					95 830 S4 028
70	06.82-02.88			120	760	T3 039



			Ah A (EN) 	Ah A (EN) 	Ah A (EN) 	Ah A (EN) 
			0 092 ...0	0 092 ...0	0 092 ...0	0 092 ...0

STEINBOCK

Serie DFG										
1D/1.25/1.6 DA	01.73-12.88				88	680	T3 013	90	720	S3 013
2.5	01.73-12.88	180	1000	T5 077						
		190	1050	TE 077						
R	01.73-12.88				88	680	T3 013	90	720	S3 013
4 D	01.73-12.88	180	1000	T5 077						
		190	1050	TE 077						

STEYR (STEYR-DAIMLER-PUCH AG)

Serie 8000											
8055	02.82-09.01							95	800	S4 013	
								100	830	S5 013	
8060	01.80-02.87	140	800	T4 076	130	680	T3 043				
, a	01.80-02.87	140	800	T4 076	130	680	T3 043				
8070	01.80-09.84	140	800	T4 076	135	1000	T3 045				
		, a	01.80-09.84	140	800	T4 076	130	680	T3 043		
	10.84-10.99	140	800	T4 076	130	680	T3 043				
8075 , a	01.84-01.99	140	800	T4 076	135	1000	T3 045				
8080	01.80-06.85	140	800	T4 076	135	1000	T3 045				
		, a	01.80-06.85	140	800	T4 076	130	680	T3 043		
			06.84-06.99	140	800	T4 076	130	680	T3 043		
8090 , a	01.84-01.99	140	800	T4 076	135	1000	T3 045				
8100 , a	12.78-12.88				130	680	T3 043				
8130 , a	07.84-07.99	140	800	T4 076	135	1000	T3 045				
8180	04.87-04.02				110	680	T3 035				

ZETOR

Serie 5000										
5211	01.88-01.03	180	1000	T5 077	170	1000	T4 077			
		190	1050	TE 077	170	1000	T4 077			
5245	01.88-01.03	180	1000	T5 077	170	1000	T4 077			
		190	1050	TE 077	170	1000	T4 077			
Serie 6000										
6211	01.88-01.03	180	1000	T5 077	170	1000	T4 077			
		190	1050	TE 077	170	1000	T4 077			
6245	01.88-01.03	180	1000	T5 077	170	1000	T4 077			
		190	1050	TE 077	170	1000	T4 077			
Serie 7000										
7245	01.88-01.03	180	1000	T5 077	170	1000	T4 077			
		190	1050	TE 077	170	1000	T4 077			
7745	01.88-01.03	180	1000	T5 077	170	1000	T4 077			
		190	1050	TE 077	170	1000	T4 077			
Serie 8000										
8045	01.75-06.85				88	680	T3 013	90	720	S3 013
8145	01.72-07.87				88	680	T3 013	90	720	S3 013
Serie 10000										
10145	01.88-01.03				88	680	T3 013	90	720	S3 013
Serie 12000										
12045	01.75-06.85				88	680	T3 013	90	720	S3 013
12145	01.72-07.87				88	680	T3 013	90	720	S3 013
Serie 16000										
16145	01.88-01.03				88	680	T3 013	90	720	S3 013
								95	800	S4 013
								100	830	S5 013



			Ah	A (EN)		Ah	A (EN)		Ah	A (EN)	
					0 092 ...0			0 092 ...0			0 092 ...0

AHLMANN

AS

12	06.72-06.87	ZE				135	1000	T3 045
----	-------------	----	--	--	--	-----	------	---------------

ALLIS-CHALMERS

D

DD	01.69-12.84					150	760	T3 063
----	-------------	--	--	--	--	-----	-----	---------------

ATLAS COPCO

PR

PR 365, 600	12.71-12.86					110	680	T3 036
700	05.72-12.86	ZE				100	600	T3 072

ST

71/95	02.73-12.86					100	600	T3 072
-------	-------------	--	--	--	--	-----	-----	---------------

STS

71/95	02.73-12.86					100	600	T3 072
-------	-------------	--	--	--	--	-----	-----	---------------

XA/XAS/XASS

80	01.74-12.89					135	1000	T3 045
120/160	01.74-12.89					100	600	T3 072

AVELING BARFORD

GN-Serie

GN	01.77-12.88					150	760	T3 063
----	-------------	--	--	--	--	-----	-----	---------------

T-Serie

TR 3	01.72-12.87					150	760	T3 063
------	-------------	--	--	--	--	-----	-----	---------------

BARBER-GREENE

800-Serie

873	01.71-12.86					125	720	T3 041
-----	-------------	--	--	--	--	-----	-----	---------------

BOMAG

Serie BW 200

200	01.73-06.86					180	1100	T3 079
-----	-------------	--	--	--	--	-----	------	---------------

BROOM AND WADE

CV-Serie

125/160/250 S, SS	01.71-12.89					110	680	T3 035
-------------------	-------------	--	--	--	--	-----	-----	---------------

CASE

Serie 600

680 E	09.74-03.88					110	680	T3 036
-------	-------------	--	--	--	--	-----	-----	---------------







Serie 800

850 B	11.75-04.87					110	680	T3 036
-------	-------------	--	--	--	--	-----	-----	---------------

Serie 1000

1450	10.73-05.84		145	800	T5 075	140	800	T4 075
------	-------------	--	-----	-----	---------------	-----	-----	---------------



			Ah	A (EN)		Ah	A (EN)		Ah	A (EN)	
					0 092 ...0				0 092 ...0		

W											
7	E	04.71-04.87	ZE						110	680	T3 036
14		01.72-12.85							110	680	T3 036

CATERPILLAR

900-Serie											
916		02.93→	ZE						110	680	T3 036

CLARK

RW											
140		01.72-12.89	145	800	T5 075	140	800	T4 075			
TV											
80		01.72-12.87	145	800	T5 075	140	800	T4 075			

DEMAG

SC-Serie											
10	D	01.76-12.91	145	800	T5 075	140	800	T4 075	120	680	T3 075

DYNAPAC

C-Serie											
CF/CH/ CH	33/44/46, 60/61	01.71-12.86							135	680	T3 044

FIAT-ALLIS

FE											
18		01.82-12.88	ZE						110	680	T3 036
20/ 28		10.81-12.88	ZE						180	1100	T3 079
FL											
9		01.78-07.85	ZE						110	680	T3 035
20		05.79-10.92	ZE			170	1000	T4 078			
FR											
7/ 10/ 12/ 20		01.80-12.90	ZE						110	680	T3 035
9/ 15		03.82-09.87	ZE						180	1100	T3 079
35		01.85-12.91							88	680	T3 013
Serie 900											
945 B		01.74-01.84				170	1000	T4 078	180	1100	T3 079

FORD NEW HOLLAND

Serie 55											
555/ 655 C		01.80-12.95							130	680	T3 043

GALION

100-Serie											
118/ 160 A, C, L, B		01.73-12.88							180	1100	T3 079

GRADALL

G-Serie											
800		01.73-12.88							125	720	T3 040



			Ah	A (EN)		Ah	A (EN)		Ah	A (EN)	
			0 092 ...0			0 092 ...0			0 092 ...0		

HANOMAG GMBH

C										
44	C	02.80-07.92	ZE	140	800	T4 076	135	1000	T3 045	
55	C	02.80-03.96	ZE	140	800	T4 076	135	1000	T3 045	
66	C	02.80-03.96	ZE	140	800	T4 076	135	1000	T3 045	
D										
600	D	02.80-03.96	ZE				135	1000	T3 045	
Serie 20										
22	C	02.80-02.95	ZE				135	1000	T3 045	
Serie 30										
33	C	07.80-07.95	ZE				135	1000	T3 045	
Serie 40										
44	C	02.80-03.96	ZE	140	800	T4 076	135	1000	T3 045	
Serie 50										
55	C	02.80-03.96	ZE	140	800	T4 076	135	1000	T3 045	
Serie 60										
66	C	02.80-03.96	ZE	140	800	T4 076	135	1000	T3 045	
Serie 70										
77	C	02.80-03.96	ZE				143	950	T3 047	

HYDROVANE

Serie 100-200										
130/180	GT	01.68-12.83					125	720	T3 040	

IH (INTERNATIONAL HARV.)

Serie 400										
431		05.74-06.86					150	760	T3 063	

INGERSOLL-RAND

DR-Serie										
DR	125	01.76-12.88					125	720	T3 040	
DRAF	125	01.73-12.88					112	510	T3 061	
DR/DRF/DRAF/DRAP	250	01.69-12.84					150	760	T3 063	







JCB

3 Serie										
3	CX, D	04.69-09.90					125	720	T3 040	
400 Serie										
413		04.73-09.90					125	720	T3 040	
800 Serie										
805/806/807/808	, B	09.73-09.90					125	720	T3 040	

JOHN DEERE

JD										
350/450	A	03.71→					105	800	T3 050	
410		03.74→					143	950	T3 047	



			Ah	A (EN)		Ah	A (EN)		Ah	A (EN)	
					0 092 ...0				0 092 ...0		
					0 092 ...0				0 092 ...0		

KOMATSU

D-Serie

85 A	02.91→	ZE							180	1100	T3 079
------	--------	----	--	--	--	--	--	--	-----	------	--------

LANDINI

9500-Serie

9500	01.73-06.86		145	800	T5 075	140	800	T4 075	120	680	T3 075
------	-------------	--	-----	-----	--------	-----	-----	--------	-----	-----	--------

LIEBHERR

A

902/ 912/ 922	01.79-01.02	ZE							135	1000	T3 045
---------------	-------------	----	--	--	--	--	--	--	-----	------	--------

R

902/ 911/ 912/ 922	04.72-06.90								135	1000	T3 045
--------------------	-------------	--	--	--	--	--	--	--	-----	------	--------

921 , B	04.72-06.90								135	1000	T3 045
---------	-------------	--	--	--	--	--	--	--	-----	------	--------

932/ 942	04.72-06.90	ZE							135	1000	T3 045
----------	-------------	----	--	--	--	--	--	--	-----	------	--------

MASSEY FERGUSON (MF)

2000-Serie

2203, 2205	10.73-12.88								125	720	T3 040
------------	-------------	--	--	--	--	--	--	--	-----	-----	--------

3000-Serie

3303, 3305	10.73-12.88								125	720	T3 040
------------	-------------	--	--	--	--	--	--	--	-----	-----	--------

O & K (ORENSTEIN & KOPPEL)

G-Serie

16	04.74-06.87	ZE							135	1000	T3 045
----	-------------	----	--	--	--	--	--	--	-----	------	--------

L-Serie

6/ 35	01.69-06.90								135	1000	T3 045
-------	-------------	--	--	--	--	--	--	--	-----	------	--------

10/ 25	01.74-12.86	ZE							135	1000	T3 045
--------	-------------	----	--	--	--	--	--	--	-----	------	--------

MH-Serie

4/ 6	09.76-06.90	ZE							135	1000	T3 045
------	-------------	----	--	--	--	--	--	--	-----	------	--------

RH-Serie

4/ 6/ 9	01.72-06.90	ZE							135	1000	T3 045
---------	-------------	----	--	--	--	--	--	--	-----	------	--------

12	05.76-06.90		145	800	T5 075	140	800	T4 075			
----	-------------	--	-----	-----	--------	-----	-----	--------	--	--	--

POCLAIN

Serie 60

60 C, CL, P	03.76-03.01	ZE							135	1000	T3 045
-------------	-------------	----	--	--	--	--	--	--	-----	------	--------

Serie 70

75 P	09.75-09.90	ZE							180	1100	T3 079
------	-------------	----	--	--	--	--	--	--	-----	------	--------







Serie 90

90 P	01.76-01.01	ZE							180	1100	T3 079
------	-------------	----	--	--	--	--	--	--	-----	------	--------

Serie 100

115 P	06.75-07.84	ZE							180	1100	T3 079
-------	-------------	----	--	--	--	--	--	--	-----	------	--------



			Ah	A (EN)		Ah	A (EN)		Ah	A (EN)	
					0 092 ...0			0 092 ...0			0 092 ...0

VOLVO BM

A											
20	08.86-08.01	ZE	145	800	T5 075	140	800	T4 075			
DR											
861	01.79-07.86								135	1000	T3 045
L											
50/ 70/ 90	11.91→								110	680	T3 035
120	01.87-01.02		145	800	T5 075	140	800	T4 075			
160	01.87-01.02		145	800	T5 075	140	800	T4 075			
LM 1000											
1240	12.72-12.87	ZE							125	720	T3 040
Serie 4000											
4400	01.79-06.86	ZE							110	680	T3 035
4500	12.79-06.86	ZE							125	720	T3 040
4600	07.80-06.84	ZE							135	680	T3 044

ZETTELMAYER

ZL-Serie											
1000	06.74-06.83					170	1000	T4 078			
2000	04.76-12.89								135	1000	T3 045



AGM Für dieses Fahrzeug nur AGM (Absorbent Glass Mat) - Batterie verwenden

AHB Achtung! Keine abweichende Kapazität (Ah) zur vorher verwendeten Batterie verbauen. Sonst reicht das Anmelden am Steuergerät nicht aus, sondern es wird ein Flashen des Steuergerätes notwendig

ASB Anschluss beachten

BAW Bei Einbau der Alternativtype, Batteriewanne austauschen

BWD Achtung! Batteriewechsel muss mit Diagnosetester, z.B. KTS Serie, am Steuergerät angemeldet werden

FAD Ford Pol-Adapter 0 189 999 021 erforderlich

JEA Je nach Erstausrüstungs-Bestückung

KZO Kalte Zonen

KZO Nicht für kalte Zonen

SSJ Für Fahrzeuge mit Start-Stopp-Funktion

SSJ Für Fahrzeuge ohne Start-Stopp-Funktion

VAD VW-Bodenleistenadapter Nr. 0 189 999 020 erforderlich

VE Vier erforderlich

ZE Zwei erforderlich



Pkw



Transporter



Nkw



Schräg-/Steilheck-Limousine



SUV



Reisebus



Linienbus



Transporter



Kommunalfahrzeug



NKW 7.5 t



NKW 40 t



Land- oder Baumaschine



Wohnmobil



Caddy



Bagger



Motorrad



Bootsmotor



Bosch-Bestellnummer



Information / Erläuterung



Suchnummer



Seitenverweis



Gegenüberstellung



Batterie-Schaltung



Batterie-Endpole



Batterie-Bodenbefestigung



Spannung in Volt



Kälteprüfstrom Batterie



Kapazität Batterie in Ah



EAN Code



Europ. Typnummer



Größtmaß der Batterie



Circa Gewicht der Batterie mit Säure



Circa Gewicht der Batterie ohne Säure



Säure in Liter



Batterien, max. Stückzahl pro Palette



Datum / Einbauzeitraum



Sonderfälle



EFB



Batterie T5



Batterie T4



Batterie T3



Batterie S3



Batterie S4



Batterie S5



S5 AGM Batterie



Batterie S3 - S6



AGM



Batterie Eco Line

de



EFB oder AGM Batterie



Rekuperation



Start-Stopp



viele Verbraucher



Langstrecke



Kälteprüfstrom bei -18°C



Kurzstrecke



















Batterie Reservekapazität





































AGM	Only use AGM (Absorbent Glass Mat) battery for this vehicle
AHB	Attention! Do not use different battery capacity (Ah) than installed before. Otherwise registration at control unit not sufficient and reprogramming of control unit necessary
ASB	Note connection

BAW	On installation of alternative type, replace battery tray
BWD	Attention! Battery replacement must be entered in control unit with diagnostic tester, e.g. KTS Series.
FAD	Ford pole adapter 0 189 999 021 required
JEA	Depending on original equipment fitted

KZO	Cold climates
KZ0	Not for cold climates
SSJ	For vehicles with Start-Stop function
SSJ	For vehicles without Start-Stop function
VAD	VW bottom rail adapter 0 189 999 020 required
VE	Four required
ZE	Two required

	Passenger car
	Transporter
	Commercial vehicle
	Squareback/hatchback limousine
	SUV
	Coach
	Bus
	Transporter
	Municipal vehicle
	COMMERCIAL VEHICLE 7.5 t
	COMMERCIAL VEHICLE 40 t
	Agricultural machine / construction machine
	Mobile home
	Caddy
	Excavator
	Motorcycle
	Marine engine

	Bosch order number
	Information/Explanations
	Search number
	Page reference
	Cross-reference
	Battery circuit
	Battery terminal posts
	Battery bottom attachment
	Voltage in volts
	Battery low-temperature test current
	Battery capacity in Ah
	EAN code
	European type number
	Maximum battery dimension
	Approximate battery weight with acid
	Approximate battery weight without acid
	Acid in litre

	Batteries, max. qty. per pallet
	Date/ Production period
	Special case
	EFB
	Battery T5
	Battery T4
	Battery T3
	Battery S3
	Battery S4
	Battery S5
	S5 AGM battery
	Battery S3 - S6
	AGM
	Eco Line battery
	EFB or AGM battery
	numerous loads
	Short distance

en



Recuperation



Battery reserve capacity



Low-temperature test current at -18°C



Long distance



Start/stop



AGM	Utiliser uniquement une batterie AGM (Absorbent Glass Mat) pour ce véhicule
AHB	Attention ! N'installer aucune capacité différente (Ah) de l'ancienne batterie utilisée. Dans le cas contraire, l'inscription à la centrale de commande ne suffit pas. Il faut procéder au flashage de la centrale de commande
ASB	Vérifier les connexions

BAW	Pour montage de l'autre type, remplacer le bac de batterie
BWD	Attention ! Le changement de batterie doit être signalé à la centrale de commande avec le testeur de diagnostic, p. ex. Série KTS
FAD	Adaptateur Ford 0 189 999 021 nécessaire
JEA	Selon équipement de première monte
KZO	Zones froides

KZO	Pas pour zones froides
SSJ	Pour véhicules avec fonction démarrage-arrêt
SSJ	Pour véhicules sans fonction démarrage-arrêt
VAD	Adaptateur rebord de fixation VW n° 0 189 999 020 nécessaire
VE	Quatre nécessaires
ZE	2 nécessaires

	Voiture(s) personnelle(s)		Moteur pour bateau		Poids approximatif de la batterie sans acide
	Camionnette		Référence Bosch		Acide en litres
	Véhicule utilitaire		Information / explication		Batteries, nombre max. par palette
	Berline arrière incliné/droit		Code d'identification		Date/période de montage
	SUV		Renvoi à la page		Cas spécial
	Autocar		Comparaison		EFB
	Autobus de ligne		Commande de la batterie		Batterie T5
	Camionnette		Pôles terminaux de la batterie		Batterie T4
	Véhicule municipal		Fixation au plancher de la batterie		Batterie T3
	UTILITAIRE 7,5 t		Tension en volts		Batterie S3
	UTILITAIRE 40 t		Courant de contrôle à froid de la batterie		Batterie S4
	Machine agricole ou machine de travaux publics		Capacité de la batterie en Ah		Batterie S5
	Camping-car		Code EAN		Batterie S5 AGM
	Caddy		Numéro de type Europ.		Batterie S3 - S6
	Excavateur		Cote maximale de la batterie		AGM
	Moto		Poids approximatif de la batterie avec acide		Batterie Eco Line

fr



Batterie EFB ou AGM



Récupération



Start/Stop



nombreux consommateurs



Longue distance



Courant d'essai à froid à -18°C



Petits trajets



















































Batterie capacité de réserve



AGM	Per questo veicolo utilizzare solo batteria AGM (Absorbent Glass Mat)
AHB	Attenzione! Non montare una batteria con una capacità diversa (Ah) da quella precedente. In caso contrario non è sufficiente accedere alla centralina ma occorre aggiornare la memoria flash della centralina
ASB	Prestare attenzione alla connessione

BAW	Se si monta il tipo alternativo, sostituire il vano batteria
BWD	Attenzione! La sostituzione della batteria deve essere segnalata preliminarmente con il tester di diagnosi, ad es. serie KTS, alla centralina
FAD	Necessario adattatore poli Ford 0 189 999 021
JEA	A seconda della dotazione di primo equipaggiamento

KZO	Per zone fredde
KZO	Non per zone fredde
SSJ	Per veicoli con funzione di avviamento/arresto
SSJ	Per veicoli senza funzione di avviamento/arresto
VAD	Necessario adattatore listello pavimento VW n. 0 189 999 020
VE	Quattro necessari
ZE	Sono necessari due pezzi

	Autovettura		Motore nautico		Peso approssimativo della batteria senza acido
	Furgone		Numero di ordinazione Bosch		Acido in litri
	Veicoli commerciali		Informazione / dichiarazione		Batterie, max. numero di pezzi per pallet
	Berlina a coda obliqua/verticale		Numero ricerca		Data/Periodo di montaggio
	SUV		Rimando ad un'altra pagina		Caso specifico
	Autobus da turismo		Confronto		EFB
	Bus di linea		Circuito batteria		Batteria T5
	Furgone		Poli terminali batteria		Batteria T4
	Veicolo municipale		Fissaggio sul fondo batteria		Batteria T3
	Autocarro 7,5 t		Tensione in Volt		Batteria S3
	Autocarro 40 t		Corrente di prova a freddo batteria		Batteria S4
	Trattore o macchina per l'edilizia		Capacità batteria in Ah		Batteria S5
	Camper		Codice EAN		Batteria AGM S5
	Caddy		N. tipo europ.		Batteria S3 - S6
	Escavatore		Dimensione massima della batteria		AGM
	Motociclo		Peso approssimativo della batteria con acido		Batteria Eco Line

it



Batteria EFB o AGM



Recupero energia



Start/Stop



Multi utilizzatori



Lunga distanza



Corrente prova a freddo a -18°C



Breve distanza



Batteria capacità di riserva



AGM	Para este vehículo, sólo utilizar batería AGM (Absorbent Glass Mat)
AHB	¡Atención! No montar una capacidad (Ah) divergente a la batería previamente montada. En caso contrario, no alcanza el registro en la unidad de mando, sino es necesaria una programación flash de la unidad de mando
ASB	Observar la conexión

BAW	En caso de montaje de los tipos alternativos, cambiar la bandeja de la batería
BWD	¡Atención! El cambio de batería debe comunicarse a la unidad de mando con comprobador de diagnóstico, p.e. serie KTS
FAD	Adaptador de polos Ford 0 189 999 021 necesario
JEA	Según equipamiento original

KZO	Para zonas frías
KZO	No para zonas frías
SSJ	Para vehículos con función de arranque/parada
SSJ	Para vehículos sin función de arranque/parada
VAD	Adaptador de regleta de piso VW Núm. 0 189 999 020 necesario
VE	Cuatro necesarios
ZE	2 necesarios

	Turismo		Motor náutico		Peso aprox. de la batería sin ácido
	Transporte		Número de pedido Bosch		Ácido en litros
	Vehículos industriales		Información / explicación		Baterías; máx. número de piezas por palet
	berlina fastback/notchback		Referencia comercial		Fecha/periodo de fabricación
	SUV		Referencia de página		Caso especial
	Autocar		Confrontación		EFB
	Autobús urbano		Conmutación de baterías		Batería T5
	Transporte		Polos finales de batería		Batería T4
	Vehículo municipal		Fijación de piso de batería		Batería T3
	NKW 7.5 t		Tensión en voltios		Batería S3
	NKW 40 t		corriente de ensayo en frío de la batería		Batería S4
	Maquinaria agrícola o de construcción		Capacidad de la batería en Ah		Batería S5
	autocaravana		Código EAN		Batería S5 AGM
	Caddy		Norma Europea		Batería S3 - S6
	Excavadora		Medida máxima de batería		AGM
	Motocicletas		Peso aprox. de la batería con ácido		Batería Eco Line

es



Batería EFB o AGM



Recuperación



Arranque/Paro



muchos consumidores



Larga distancia



Corriente de prueba de frío a -18°C



Corta distancia



Capacidad de reserva de batería



AGM Para este veículo utilizar apenas bateria AGM (Absorbent Glass Mat)

AHB Atenção! Não instalar qualquer capacidade (Ah) divergente em relação à bateria anteriormente utilizada. Senão, o registo na unidade de comando não será suficiente e será antes necessária uma sobregravação da unidade de comando

ASB Observar a conexão

BAW Aquando da montagem do modelo alternativo, substituir o alojamento da bateria

BWD Atenção! Troca de bateria deve ser registrada com aparelho de teste de diagnóstico, por ex. série KTS, na unidade de comando

FAD Necessário adaptador Ford 0 189 999 021

JEA Consoante equipamento original/equipamento

KZO Regiões frias

KZQ Não adequado para regiões frias

SSJ Para veículos com função de arranque/paragem

SSJ Para veículos sem função de arranque/paragem

VAD Necessário adaptador VW n.º 0 189 999 020

VE Necessários quatro

ZE Necessários dois



Veículo de passeio



Transportador



Veículos utilitários



Limusine 3 ou 5 port./2 vol.



SUV



Ônibus rodoviário



Ônibus urbano



Veículos comerciais



Veículo de serviços urbanos



Veículos utilitários 7.5 t



Veículos utilitários 40 t



Máquinas agrícolas / de construção



Caravana



Caddy



Escavadeira



Motocicleta



Motor de barco



N.º de pedido Bosch



Informação / explicação



Número de consulta



Referência do lado



Confrontação



Circuito de bateria



Terminais da bateria



Fixação da base da bateria



Tensão em Volt



Corrente de teste a frio bateria



Capacidade da bateria em Ah



Código EAN



Norma europeia



Dimensões máximas da bateria



Peso aproximado da bateria com ácido



Peso aproximado da bateria sem ácido



Ácido em litro



Baterias, n.º máx. de unidades por palete



Data/Período de instalação



Caso especial



EFB



Bateria T5



Bateria T4



Bateria T3



Bateria S3



Bateria S4



Bateria S5



Bateria S5 AGM



Bateria S3 - S6



AGM



Bateria Eco Line

pt



Bateria EFB ou AGM



Recuperação



Start/Stop



Vários consumidores



Trajeto longo



Corrente ensaio a frio a -18°C



Trajeto curto

































capacidade de reserva da bateria



AGM	Käytä vain AGM-akkaa (Absorbent Glass Mat) tässä ajoneuvossa
AHB	Huomio! Älä asenna poikkeavaa kapasiteettiä (Ah) aikaisemmin käytettyyn akkuun verrattuna. Muutoin se ei riitä ohjainlaitteen ilmoituksiin, jolloin ohjainlaitteen flashaus on suoritettava
ASB	Huomioi liitäntä

BAW	Vaihtoehtotyypin asennuksen yhteydessä, vaihda akun alusta
BWD	Huomio! Akun vaihto on ilmoitettava ohjainlaitteeseen diagnoositesteriä, esim. KTS, käyttäen
FAD	Ford-napa-adaptteri 0 189 999 021 on tarpeen
JEA	Ensiasennuksen varustuksesta riippuen
KZO	kylmä ilmastovyöhyke

KZO	Ei kylmiin ilmastovyöhykkeisiin
SSJ	Ajoneuvoihin, joissa on Start-/Stop-toiminto
SSJ	Ajoneuvoihin ilman Start-/Stop-toimintoa
VAD	VW-lattialistasovitin n:o 0 189 999 020 on tarpeen
VE	Tarvittava määrä = 4
ZE	Tarvittava määrä: 2

	Henkilöauto		Venemoottori		Akun paino suunnilleen ilman happoa
	Transportteri		Bosch-tilausnumero		Happo litroissa
	hyötyajoneuvo		Informaatio / selitys		Akut, suurin kappalemäärä/suurpakkaus
	Viiisto-/pystyperäinen sedan (limousine)		Hakunumero		Päiväys/asennusaikaväli
	SUV -kaupunkimaasturi		Sivuviite		Erytystapaus
	turistibussi		Vertailu		EFB-akku
	Linja-auto		Akun kytkentä		Akku T5
	Transporter		Akun päätenapa		Akku T4
	Kunnallinen huoltoajoneuvo		Akun pohjakiinnitys		Akku T3
	Hyötyajoneuvot NKW 7,5 t		Jännite, V		Akku S3
	Hyötyajoneuvot NKW 40 t		Akun kylmäkäynnistysvirta		Akku S4
	Maatalouskone tai työkone		Akkukapasiteetti Ah		Akku S5
	Matkailuauto		EAN-koodi		S5 AGM -akku
	Caddy		Tyyppinumero Eurooppa		Akku S3 - S6
	Kaivinkone		Akun suurin koko		AGM
	Moottoripyörä		Akun paino suunnilleen hapon kanssa		Akku Eco Line

fi



EFB- tai AGM-akku



Energian talteenotto



Start/stop



Useampi sähkönkuluttaja



Pitkä ajomatka



Kylmättestivirta lt. -18°C



Lyhyt ajomatka



Akun varakapasiteetti



AGM W tym pojeździe stosować wyłącznie akumulatory AGM (Absorbent Glass Mat)

AHB Uwaga! Nie montować pojemności (Ah) innej niż wykazywał wcześniejszy akumulator. W przeciwnym razie nie wystarczy zarejestrowanie sterownika, lecz będzie potrzebne jego wgranie.

ASB Zwrócić uwagę na przyłączy

BAW W przypadku zamontowania typu alternatywnego, wymienić miskę akumulatora

BWD Uwaga! Wymiana akumulatora musi zostać zgłoszona do sterownika przez tester diagnostyczny w sterowniku, np. serii KTS

FAD Wymagana przejściówka Ford 0 189 999 021

JEA Zależnie od pierwszego wyposażenia

KZO Zimne strefy

KZO Nie do zimnych stref klimatycznych

















SSJ Dla pojazdów z funkcją start/stop

SSJ Dla pojazdów bez funkcji start/stop

















VAD Wymagana przejściówka listwy podłogowej VW nr 0 189 999 020

VE Konieczne cztery

ZE Konieczne dwa

	Samochód osobowy
	Pojazd transportowy
	Pojazdy użytkowe
	Hatchback/Liftback
	SUV
	Autobus turystyczny
	Autobus liniowy
	Transporter
	Pojazd komunalny
	NKW 7,5 t
	NKW 40 t
	Maszyny rolnicze / budowlane
	Pojazd mieszkalny
	Caddy
	Koparka
	Motocykle

	Silniki do łodzi
	Nr katalogowy firmy Bosch
	Informacja / objaśnienie
	Nr referencyjny
	Odesłanie do strony
	Zestawienie
	Obwód akumulatora
	Bieguny akumulatora
	Mocowanie akumulatora
	Napięcie w voltach
	Prąd kontroli akumulatora na zimno
	Pojemność akum. w Ah
	Kod EAN
	Kod EAN
	Największy rozmiar akumulatora
	Orient. masa akumulatora z elektrolitem

	Orient. masa akumulatora bez elektrolitu
	Kwas w litrach
	Akumulatory, maks. ilość na palecie
	Data produkcji
	Informacje dodatkowe
	EFB
	Akumulator T5
	Akumulator T4
	Akumulator T3
	Akumulator S3
	Akumulator S4
	Akumulator S5
	Akumulator S5 AGM
	Akumulator S3 - S6
	AGM
	Akumulator Eco Line

pl



Akumulator EFB lub AGM



Rekuperacja



Start/stop



Duża liczba odbiorników



Długa trasa



Zimny strumień kontrolny o temperaturze
-18°C





























Krótką trasą



Pojemność rezerwowa akumulatora



AGM	Pro toto vozidlo používejte pouze akumulátor AGM (Absorbent Glass Mat)	BAW	Při zabudování alternativního typu vyměňte vanu akumulátoru	KZO	Ne pro chladné oblasti
AHB	Pozor! Neinstalujte odlišnou kapacitu (Ah) od dříve použitého akumulátoru. Jinak není přihlášení u řídicí jednotky dostačující, ale je nutné nové naprogramování řídicí jednotky	BWD	Pozor! Výměna akumulátoru musí být pomocí diagnostického testeru, např. řady KTS, ohlášena řídicí jednotce	SSJ	Pro vozidla s funkcí Start-Stop
ASB	Dbejte na přípojku	FAD	Je nezbytný pól. adaptér Ford 0 189 999 021	SSJ	Pro vozidla bez funkce Start- Stop
		JEA	Podle originální výbavy vozidla	VAD	Je nezbytný adaptér pro podlah. lištu č. 0 189 999 020
		KZO	Chladné oblasti	VE	Jsou nutné čtyři
				ZE	Jsou nutné dva

	Osobní vozidlo		Lodní motor		Cca hmotnost akumulátoru bez kyseliny
	Transportér		Objednací číslo Bosch		Kyselina v litrech
	Užitkové motorové vozidlo		Informace/vysvětlení		Akumul., max. počet ks v paletě
	Limuzína se šikmou/příkr. zádí		Vyhledávací číslo		Datum/období montáže
	SUV		Odkaz na stránky		Zvláštní případ
	Zájezdový autobus		Porovnání		EFB
	Linkový autobus		Zapojení akumulátoru		Akumulátor T5
	Transportér		Koncové póly akumulátoru		Akumulátor T4
	Vozidlo komunálních služeb		Uchycení akumulátoru k podložce		Akumulátor T3
	Užitkové vozidlo 7,5 t		Napětí ve V		Akumulátor S3
	Užitkové vozidlo 40 t		Prou zk. chlad. akumul.		Akumulátor S4
	Zemědělský nebo stavební stroj		Kapacita akumulátoru v Ah		Akumulátor S5
	Obytné vozidlo		Kód EAN		Akumulátor S5 AGM
	Caddy		Evrop. typ. číslo		Akumulátor S3 - S6
	Bagr		Horní mez. rozměr akumulátoru		AGM
	Motocykl		Cca hmotnost akumulátoru s kyselinou		Akumulátor Eco Line

CS



Akumulátor EFB nebo AGM



Rekuperace



Start/Stop



mnoho spotřebičů



Dlouhá jízda



Studený zkušební proud při teplotě -18°C



Krátká jízda-{}-



















Akumulátor, rezervní kapacita



















AGM	Для этого автомоб.используется только аккумулял.АGM (Absorbent Glass Mat)
AHB	Внимание! Запрещается устанавливать аккумуляторную батарею емкости, отличной от используемой. В противном случае регистрации в блоке управления недостаточно, потребуется его программирование.
ASB	обратить внимание на соединение

BAW	При монтаже альтернативного типа заменить поддон аккумуляторной батареи
BWD	Внимание! Замена аккумуляторной батареи должна быть зарегистрирована в блоке управления с помощью тестера диагностики, например, серии KTS.
FAD	Необходим адаптер Ford O 189 999 021
JEA	В зависимости от первичной комплектации

KZO	Холодные зоны
KZO	Не для холодных зон
SSJ	Для автомобилей с функцией пуск-останов
SSJ	Для автомобилей без функции пуск-останов
VAD	Необходим адаптер отбортовки VW Nr. O 189 999 020
VE	необходимо четыре
ZE	необходимо два

	Легковой автомобиль
	Автофургон малой грузоподъемности
	Грузовые автомобили
	Седан—накл.з.ч./б.накл.з.части
	SUV
	Туристский автобус
	Маршрутный автобус
	Грузовой автомобиль
	Автомобиль коммунального хозяйства
	Коммерческий автомобиль 7,5 т
	Коммерческий автомобиль 40 т
	Сельскохозяйственная или строительная машина
	Жилой автомобиль
	Caddy
	Экскаватор
	Мотоцикл

	Лодочный мотор
	Номер заказа Bosch
	Информация / Пояснение
	Поисковый номер
	Сторонняя ссылка
	Сравнение
	Подключение аккумуляторов
	Полюсные выводы аккумуляторов
	Крепление аккумуляторов
	Напряжение в вольтах
	Испытательный ток аккумулятора на морозе
	Емкость аккумуляторной батареи в Ач
	EAN-код
	Европейский типовой номер
	Максим.размер аккумулятора
	Прибл. вес аккумуляторной батареи с кислотой

	Прибл. вес аккумуляторной батареи без кислоты
	Кислота в литрах
	Аккумуляторы, макс.кол-во в контейнере
	Дата / Период сборки
	Особый случай
	EFB
	Аккумуляторная батарея T5
	Аккумуляторная батарея T4
	Аккумуляторная батарея T3
	Аккумуляторная батарея S3
	Аккумуляторная батарея S4
	Аккумуляторная батарея S5
	Аккумуляторная батарея S5 AGM
	Аккумулятор S3 - S6
	AGM
	Аккумуляторная батарея Eco Line

ru



Аккумуляторная батарея EFB или AGM



Рекуперация



Старт/стоп



Множество потребителей



Длинное расстояние



Ток испытания на морозостойкость при -18°C



Короткое расстояние



Резервная емкость аккумулятора



