

REV.	DESCRIPTION	DATE	APPROVED
A	Engineering Release	05/12/17	J. C.

*Length "X.XXX"	Tolerance
2.000" ~ 16.000"	±0.050"
16.001" ~ 40.000"	±0.150"
40.001" ~ 80.000"	±0.300"
80.001" ~ 500.000"	±0.5%

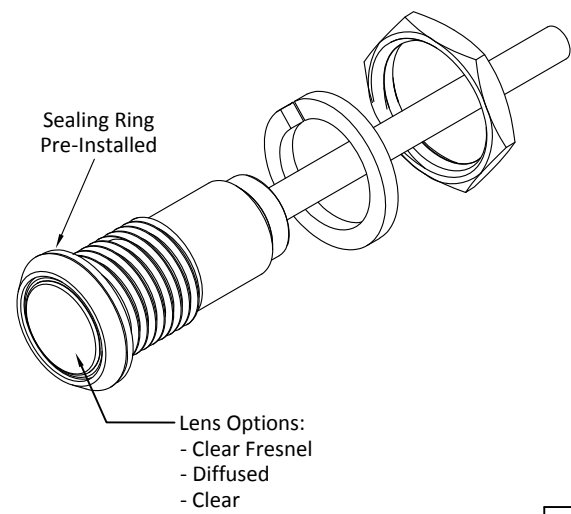
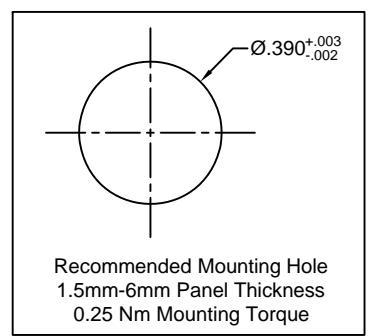
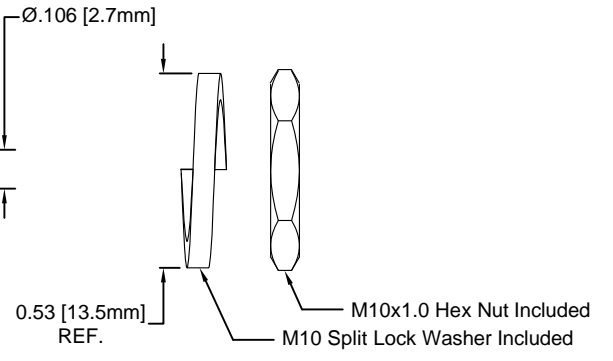
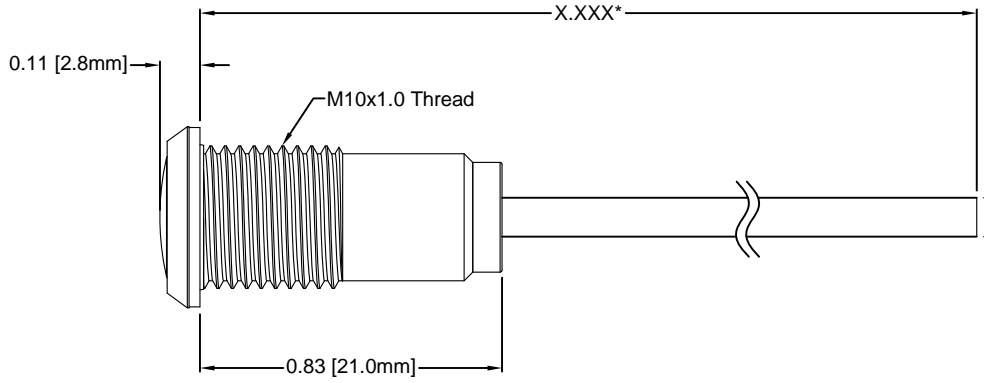
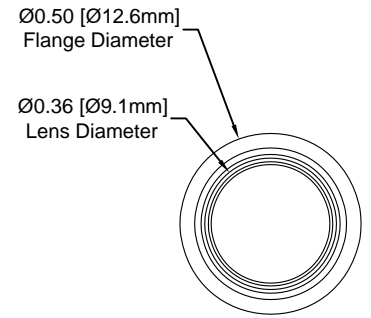

Part Number Configuration
LC3-6.500-F9PX67PR

Lens Options:
Z - Clear Fresnel
D - Diffused
Blank - Clear

Length in 0.001"
Increments Only

- NOTES:
1. SEALED TO IP67 RATING
 2. ROHS COMPLIANT
 3. MOUNTING HARDWARE SHIPPED NON-ASSEMBLED
 4. MINIMUM BEND RADIUS OF FLEXIBLE LIGHT PIPE: 1.06" [27mm]

STANDARD TOLERANCE (UNLESS OTHERWISE SPECIFIED)		 4 THOMAS, IRVINE, CA. 92618 TEL: (949) 951-8808 FAX: (949) 951-3974	
DECIMALS	ANGULAR		
.X ±.1	X° ± 1°	 TITLE: IP67 RATED PANEL MOUNT FLEXIBLE LIGHT PIPE INDICATOR	REVISION: A
.XX ±.02			
.XXX ±.010			
DESIGNED: TD. Nguyen	DATE: 04/30/17	PART NO: LC3-X.XXX-F9PX67PR	SHEET # 1 OF 1
CHECKED: K. Baron	DATE: 04/30/17	CAGE CODE : 32559	DO NOT MEASURE DRAWING.