

BIRK & BLYME **PRESSROOM** SUPPLIES & PARTS



PRODUCT CATALOGUE

"YOUR ONE STOP SUPPLIER" FOR PRESSROOM
SUPPLIES & REPLACEMENT PARTS.



YOUR ONE STOP SUPPLIER

Since 1988 Birk & Blyme have been dedicated to the supply of premium quality consumables, specialised service and reliable support to the printing and Print Finishing industry.

Our operation carries a comprehensive range of knives and bindery components, sourced from only leading manufactures worldwide.

Compare our quality and price for VALUE!

OUR GUARANTEE

We guarantee the quality of our products.

If a product is faulty we will replace or refund your money. Claims on faulty or damaged product must be lodged within 14 days of receipt of goods.

MALAYSIA & SINGAPORE

Printech Industrial Supply

C3-05-20 - Wisma SP Setia
Jalan Indah 15, Taman Bukit Indah
81200 Johor Bahru, Johor
Malaysia

T: +60 7 241 2316

F: +60 7 241 2319

CONTACT:

Mr Perumal Naidu

HP: 012 669 6819

E: peru_pis@birk-blyme.com

Mr Sharan Gunasekaran

HP: 016 760 0046

E: sharan_pis@birk-blyme.com

At **Birk & Blyme** we offer

- A wide range of quality products
- Fast delivery service
- Helpful friendly service

30 Day accounts subject to approved account applicants.

We accept:



All orders are subject to Birk & Blyme's Payment Terms and Recovery Policy. Please contact us to obtain a copy of these Terms and Conditions.

DISCLAIMER:

**Brand names and trademarks published herein are registered trademarks of their respective companies. Birk & Blyme has no association or affiliation with these companies. All mentioned spare parts are alternative parts to those of the OEM. Birk & Blyme supply compatible high quality replacement parts. All indicated reference numbers are only used for identification purposes.*

CONTENTS

04

FEEDER PARTS

- 04 Sheet separators
- 08 Feeder brushes
- 10 Brush wheels & rubber wheels
- 14 Feeder belts
- 17 Slowdown belts & o-rings

20

INK DUCT FOIL & CPC CONSUMABLES

- 20 Ink duct foil & CPC consumables
- 22 Ink duct end blocks
- 23 Duct insulating strips, scrape cleaners, cleaning felt & dampening seals

25

DOCTOR BLADES & CHAMBER ACCESSORIES

- 25 Steel & plastic doctor blades
- 26 Tower coater blades & Tresu* consumables for chamber doctor blade systems

27

GRIPPER FINGERS

- 27 Heidelberg gripper fingers

28

WASH-UP BLADES

- 28 Wash-up blades

35

HICKEY REMOVERS

- 35 Hickey removers Heidelberg, Fuji-Shinohara, KBA, Planeta, Roland, Komori, Ryobi & Sakurai

38

FILTERS

- 38 Recirculation filters
- 41 Recirculation, foam and misting filters, filter mats and eliminator
- 42 Air filters
- 43 Oil filters

44

MISCELLANEOUS

- 44 Sheet stops & CPC buttons
- 45 Sheet smoother (sheet hold downs)
- 46 Sheet stops, pneumatic springs - gauged steel & parts for platen T and GT
- 47 Tools
- 48 Wash-up bottles, viskovita sponges, blanket scrubber & wiper pad
- 49 Magnifying glasses & bluenet
- 50 Ink knives & ink keys
- 51 CPC servo motor, paper wedges & deletion/addition pens

52

PERFORATORS, SLITTERS & SCORERS

- 52 Perforating strips
- 54 Slitters, scorers, perforators and micro perforators

57

ANTI-MARKING JACKETS

- 57 Red anti-marking jackets

59

SUCTION DISCS AND CUPS

- 59 Suction discs
- 60 Lifting sucker
- 64 Suction cups

68

CYLINDER JACKETS

- 68 Cylinder jackets

69

DIE CUTTING

- 69 Die cutting
- 70 Jackets kris N.E.K. Matrix

71

PRINT FINISHING

- 71 Paper cutting knives
- 72 Cutting sticks
- 73 Cutting accessories
- 74 Paper drilling
- 78 Interscrews

79

ROTARY UNIONS

- 79 Rotary unions

80

VACUUM PUMP ACCESSORIES

- 80 Air filters, exhaust filters, carbon vanes
- 81 Carbon Vanes
- 82 Filters



SHEET SEPERATORS



Sheet Seperators, Sheet Smoother Plate Springs and Rubber Hoods are available for most Presses including Heidelberg, Fuji, Komori, Roland Hamada, KBA, Ryobi, Itek, Mitsubishi and Multilith.

Sheet Seperators are manufactured from the highest quality steel and brass material. Rubber Hoods (for Heidelberg GTO machines) are moulded in a high quality natural rubber compound.

BB-P9022

81 x 12 x 0.2 mm

Model: Heidelberg Speedmaster/S-Offset

Like 66.028.110F/01

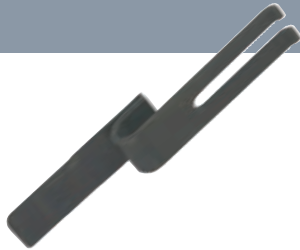

BB-P9023

81 x 12 x 0.2 mm

Model: Heidelberg Speedmaster/S-Offset

Like 66.028.810F/01



BB-P9025

81 x 12 x 0.2 mm

Model: Heidelberg Speedmaster/S-Offset



BB-P9026

81 x 12 x 0.2 mm

Model: Heidelberg Speedmaster/S-Offset

Like 66.028.810F

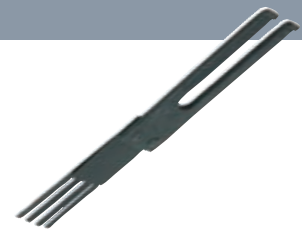

BB-P9035

79 x 0.2 mm

Model: Heidelberg SM52/CD102/XL105



BB-P9097

82 x 0.2 mm

Model: Heidelberg SM52/CD102/XL105



BB-P9029 (LH) & BB-P9030 (RH)

81 x 32 x 0.2 mm

Model: Heidelberg SM52/74

Like L4.028.164S

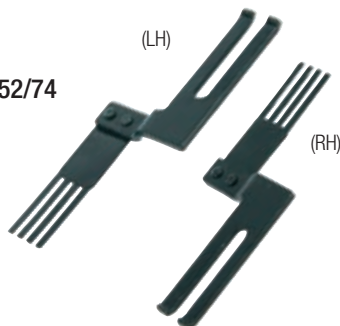

BB-P9027(LH) & BB-P9028 (RH)

81 x 32 x 0.2 mm

Model: Heidelberg SM52/74

Like L4.028.167F

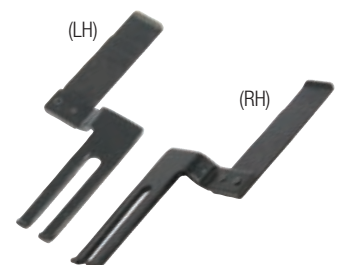

BB-P9037

88 x 78 x 0.2 mm
Model: Heidelberg
Speedmaster

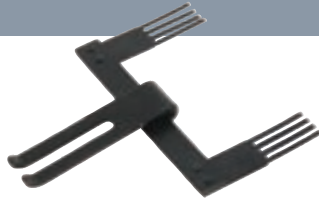
**BB-P9038**

88 x 78 X 0.2 mm
Model: Heidelberg
Speedmaster

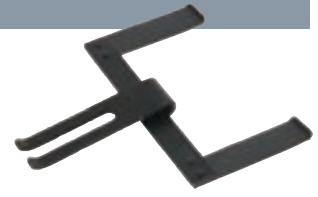
**BB-P9411**

85 x 12 mm
Model: Heidelberg
CD74/XL75
Like M3.028.825S/01

**BB-P9371**

130 x 5 x 1 mm
Model: Heidelberg
GTO 52

**BB-P9032**

110 x 12 x 1 mm
Model: Heidelberg
GTO 52

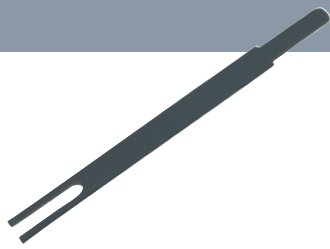
**BB-P9034**

39.5 x 12.3 mm
 Rubber Hood
Model: Heidelberg
GTO 46/52
Like 36.017.084

**BB-P9033**

110 x 12 x 0.3 mm
Model: Heidelberg
GTO 52/M0

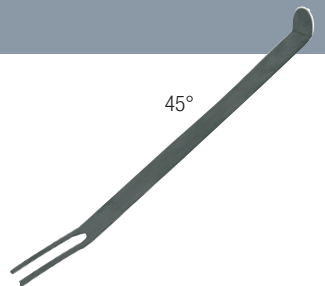
**BB-P9031**

85 x 12 x 1 mm
Model: Heidelberg
GTO 46

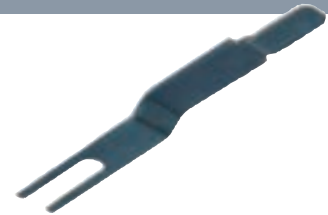
**BB-P9372**

105 x 6.5 x 1 mm
Model: Heidelberg
GTO 46

**BB-P9193**

116 x 12 x 0.3 mm
Model: Heidelberg
GTO 46/KORD64

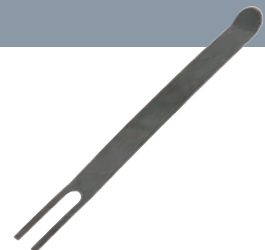
**BB-P9039/40/41**

42.0 x 15.0 mm
BB-P9039 - 0.10 mm
BB-P9040 - 0.20 mm
BB-P9041 - 0.30 mm
Model: Fuji, Komori, Hashimoto



FLAT SIDE SHEET SEPERATORS

BB-P9179

150 mm x 6 x 0.30 mm

Platen T/GT, Cylinders, KORD, KORS, GT046/52 machines

Packing: 12 pcs/bag



BB-P9177

90 mm x 6 x 0.15 mm

Platen T/GT, Cylinders, KORD, KORS, GT046/52 machines

Packing: 12 pcs/bag



BB-P9178

150 mm x 6 x 0.20 mm

Platen T/GT, Cylinders, KORD, KORS, GT046/52 machines

Packing: 12 pcs/bag



BB-P9180 (Complete Set- 8pcs)

BB-P9177 - 90 x 6 x 0.15 mm - 4 pcs

BB-P9178 - 120 x 6 x 0.20 mm - 2 pcs

BB-P9179 - 150 x 6 x 0.30 mm - 2 pcs

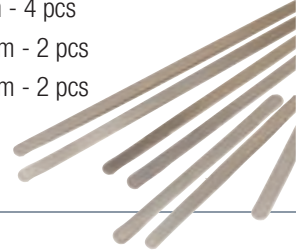

BB-P9036

69 x 16 x 0.15 mm

Model: Komori SX40

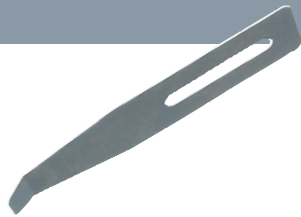

BB-P9196

45 x 15 x 0.08 mm

Model: Komori LS



SSF013/20

42.0 x 14.3 mm

Model: Fuji, Komori, Hashimoto

SSF013 - 0.13 mm

SSF020 - 0.20 mm



BB-P9042/43/44

54.0 x 15.0 mm

Model: Fuji, Komori, Hashimoto

BB-P9042 - 0.10 mm

BB-P9043 - 0.20 mm

BB-P9044 - 0.30 mm



BB-P9046/47/48

65.0 x 11.5 mm

Model: Mitsubishi

BB-P9046 - 0.10 mm

BB-P9047 - 0.20 mm

BB-P9048 - 0.30 mm



BB-P9049 & BB-P9472

50.0 x 11.5

Model: Mitsubishi

BB-P9049 - 0.15 mm

BB-P9072 - 0.20 mm



BB-P9050

50.0 x 11.5 x 0.15mm

Model: Mitsubishi



BB-P9094 (Complete Set)

84 x 19 mm

Model: Roland
200/500/700/800/900

A 37 mm

B 38 mm

C 39 mm

D 40 mm

E 41 mm



BB-P9476

46.5 x 15 x 0.10 mm

Model: KBA 104/105/142/162

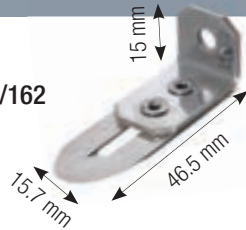
**BB-P9093**

50 x 25 mm x 0.10mm

Model: KBA 104/105/142/162

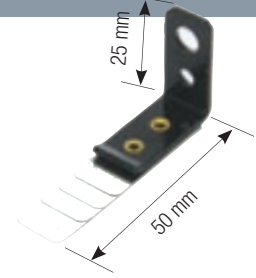
**BB-P9091**

45 x 14 x 0.10 mm

Model: KBA 104/105/142/162

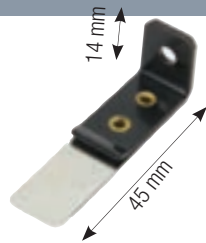
**BB-P9092**

45 x 25 x 0.10 mm

Model: KBA 104/105/142/162

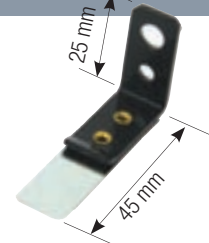
**BB-P9192**

45 x 26 x 0.30 mm

Model: KBA 104/105/142/162

**BB-P9191**

45 x 26 x 0.20 mm

Model: KBA 104/105/142/162

**BB-P9051/52/53**

47.0 x 10.0 mm

Model: Sakurai

BB-P9051 - 0.13 mm

BB-P9052 - 0.20 mm

BB-P9053 - 0.30 mm

**BB-P9054**

41 x 10 x 0.15 mm

Model: Ryobi 750/680/520

**BB-P9473**

39.0 x 15.9 x 0.15 mm

Model: Ryobi, Itek

**BB-P9474**

32 x 16 x 0.15 mm

Model: Hamada, Multilith 2

**BB-P9475**

80 x Ø6 mm

Model: Heidelberg,
KBA RAPIDA 104/105/142/162**CAN'T FIND YOUR SHEET SEPERATORS?**

Please call us with details and we can quote you.
These pages are for guidance only and does not include
all available Sheet Separators.

FEEDER BRUSHES

For Heidelberg, MAN Roland , KBA, Komori, Mabeg and Spies.

BRUSH DIMENSIONS

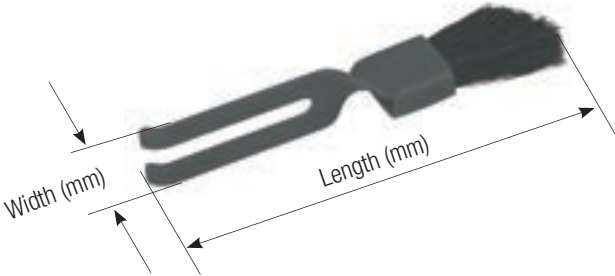

BB-P9199

80 x 12 mm
 Model: Heidelberg SM72/74/102

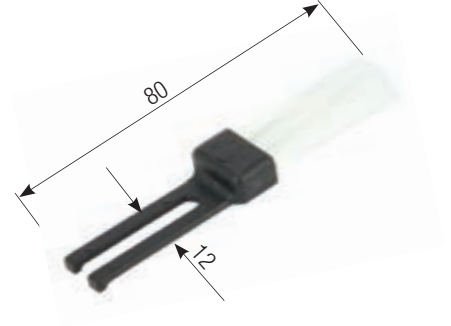

BB-P9198

68 x 12 mm
 Model: Heidelberg QM46

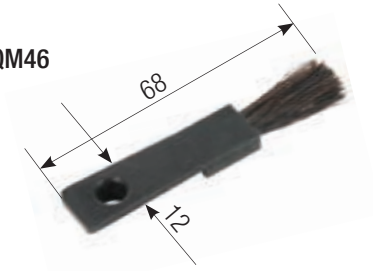

BB-P9095

71 x 16 mm
 Model: Heidelberg GTO/MO

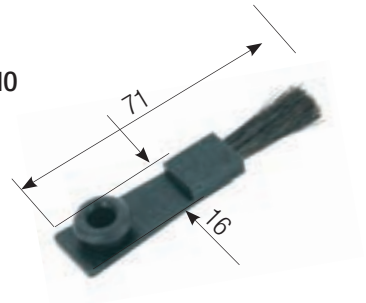

BB-P9203

86 X 15 mm
 Model: Komori L40

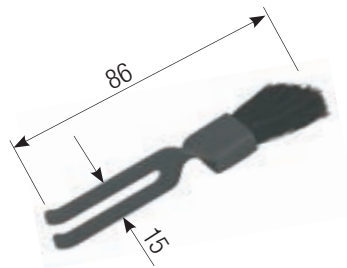

BB-P9095 & BB-P9095C

Brush and Brush & Holder complete
 Model: Heidelberg GTO/MO



BB-P9201

93 x 15 mm
 Model: MAN Roland

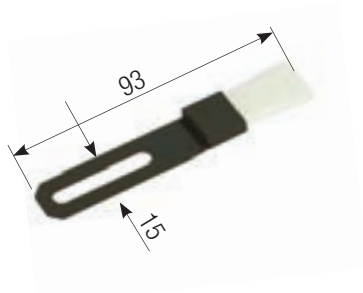

BB-P9200

84 x 19 mm
 Model: MAN Roland

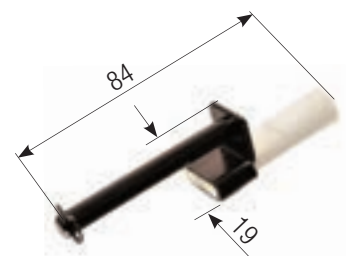

BB-P9202

95 x 15 mm
Model: Roland 800

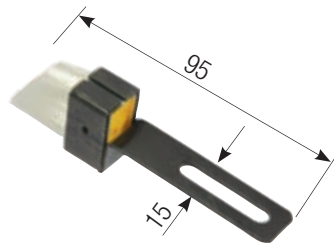

BB-P9205

107 x 16 mm
Model: Mabeg

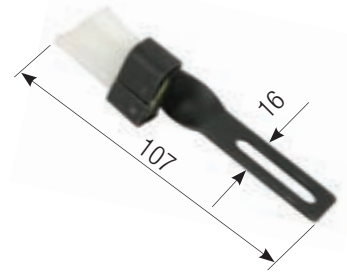

BB-P9204

115 x 16 mm
**Model: MAN
 Roland, Spies**

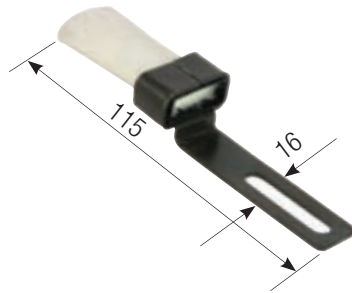

BB-P8017/18

100 x 15.2 mm
**BB-P8017 - Hard
 BB-P8018 - Soft
 Model: Mabeg**

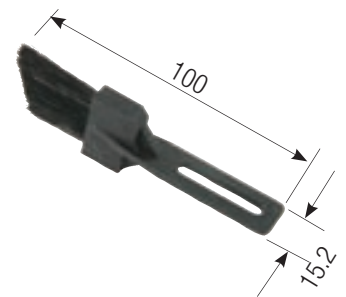

BB-P9207

53 x 15 mm
**Model: KBA Rapida
 105/142/162**



BB-P9208

39.5 x 15 mm
**Model: KBA Rapida
 105/142/162**



BB-P9209

51 x 16 mm
**Model: KBA Rapida
 105/142/162**



BB-P9206 (PAIR)

51 x 16 mm
Model: All Komori models



FEEDER BELTS



FOR THE FULL LIST SEE PAGES 14-16

BRUSH WHEELS & RUBBER WHEELS

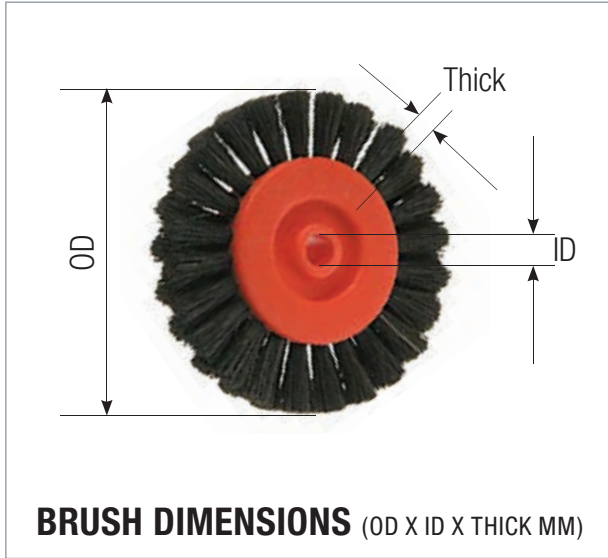

BB-P9215

60 x 6 x 11 mm
For paper

Model: Heidelberg SORM/SORD/
SORS SM52/72/74/102



BB-P9216

60 x 6 x 11 mm
For cardboard

Model: Heidelberg SORM/
SORD/SORS SM52/72/74/102



BB-P9212

60 x 6 x 11 mm
For paper

Model: Komori, Roland,
Mabeg



BB-P9217

60 x 6 x 11 mm
For cardboard

Model: Roland, Mabeg,
Komori



BB-P9214

47 X 6 X 11 mm
For paper

Model: MAN Roland,
Komori



BB-P9213

47 x 6 x 11 mm
For cardboard

Model: Roland, Mabeg,
Komori



BB-P9220

26 x 6 x 10 mm
Model: Komori



BB-P9218

47 x 6 x 14 mm
For paper

Model: Komori, Roland
600/700



BB-P9219

47 x 6 x 14 mm
For cardboard

Model: Komori, Roland
600/700



BB-P9490

50 x 7 x 12 mm
For paper

Model: Shinohara

**BB-P9491**

32 x 7 x 14.5 mm
For cardboard

Model: Shinohara

**BB-P9222**

45 x 7 x 12 mm
For paper

Model: Shinohara

**BB-P9223**

32 x 7 x 14.5 mm
For paper

Model: Shinohara

**BB-P9479**

60 x 6 x 22 mm
For paper

**Model: KBA RAPIDA 104/
KBA 105**

Like 50022367

**BB-P9090**

60 x 6 x 22 mm
For cardboard

**Model: KBA RAPIDA 104/
KBA 105**

Like 50022366

**BB-P9211**

60 x 6 x 16 mm
For paper

**Model: KBA RAPIDA 104/
KBA 105**

**BB-P9478**

60 x 6 x 16 mm
Soft bristles

**Model: KBA RAPIDA 104/
KBA 105**

**BB-P9480**

60 x 8 x 35 mm
For cardboard

Model: KBA/Planeta

**BB-P9481**

60 x 8 x 35 mm
For paper

Model: KBA/Planeta

**BB-P9429**

48 x 6 x 16 mm
For paper

Model: KBA RAPIDA 142/162

**BB-P9430**

48 x 6 x 16 mm
For cardboard

**Model: KBA RAPIDA
142/162**



BB-P9397

48 x 8 x 22 mm

Model: KBA RAPIDA 105**BB-P9221**

55 x 10 x 16 mm

Model: Akiyama**BB-P9224**

40 x 8 x 15 mm

For cardboard

Model: Ryobi**BB-P9485**

37 x 6 x 15 mm

For paper

Model: RYOBI**BB-P9486**

45 x 6 x 15 mm

For paper

Model: RYOBI**BB-P9487**

40 x 8 x 15 mm

For paper

Model: RYOBI**BB-P9488**

50 x 8 x 15 mm

For cardboard

Model: RYOBI**BB-P9489**

50 x 8 x 15 mm

For paper

Model: RYOBI**BB-P9483**

40 x 6 x 14 mm

Model: Mabeg**BB-P9484**

54 x 6 x 14 mm

Model: Mabeg**BB-P9452**

65 x 7 x 12 mm

For paper

Model: Mitsubishi**BB-P9456**

65 x 7 x 12 mm

For cardboard

Model: Mitsubishi

BB-P9210

80 x 32 x 28 mm
Nylon body
Model: BOBST

**BB-P9477**

70 x 24 x 31 mm
Model: BOBST

**BB-P9482**

66 x 8 x 16 mm
Model: MIEHLE/MAN/
ROLAND

**BB-P9492**

48 x 12 x 18 mm
Model: Roland

**BB-P9061**

47 x 8 x 11 mm
For feeder
Model: Heidelberg
SORM/SORD/SORS/
SM52/72/74/102

**BB-P9062**

47 x 8 x 11 mm
For feeder
Model: Heidelberg
SORM/SORD/SORS/
SM52/72/74/102

**BB-P9361**

48 x 6 x 16.5 mm
Model: KBA SRO 72/
KBA RAPIDA 72/74

**BB-P9460**

48 x 10 x 16 mm
Model: KBA RAPIDA
104/142/162

**BB-P9406**

48 x 10 x 18 mm
Model: KBA RAPIDA 104/
KBA 105

**BB-P9412**

75 x 15 x 16 mm
Model: KBA RAPIDA 142/
KBA 162



NEED TO FIND YOUR SLOWDOWN BELT?

Our Slowdown Belts can be found
on pages 17-19



FEEDER BELTS HEIDELBERG

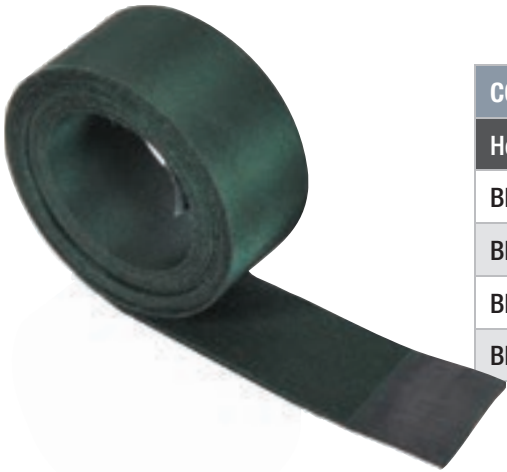

CODE	Fits machine	Size
Heidelberg		
BB-P9239	Heidelberg SM102/72	2015 x 27mm
BB-P9241	Heidelberg SORKZ/SORMZ/SORDZ	2015 x 28mm
BB-P9240	Heidelberg SORK/SORM/SORD	1465 x 28mm
BB-P9278	Heidelberg MO	1375 x 25mm

BB-P9242

Model: Heidelberg GT052 - Perforated
 1220 x 89 mm
 Like 89.020.007

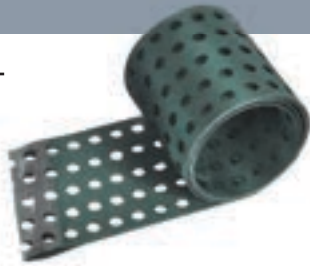

BB-P9248

Model: Heidelberg SM74, CD74 and XL75
 2420 x 138 mm
 Like L2.020.014



BB-P9243

Model: Heidelberg SM52 - Endless
 950 x 60 mm
 Like G2.020.009

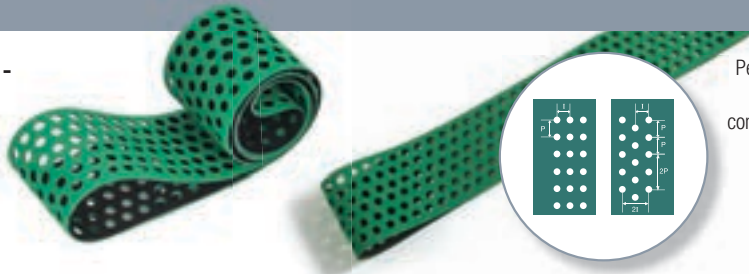

Perforations enable the belts to have air suction ensuring the material is conveyed as intended and also allows for cooling air to pass through. Examples of precise perforation patterns. Perforations can be executed according to customer's specifications.

BB-P9245

Model: Heidelberg SM74
 1305 x 54 mm



BB-P9246

Model: Heidelberg SM74 - Perforated
 1305 x 54 mm



BB-P9247

Model: Heidelberg SM102, CD102 and XL105
 2890 x 210 mm
 Like F4.020.292/02



BB-P9244

Model: Heidelberg SM74
 1305 x 54 mm
 1 set comprising of BB-P9245 and BB-P9244



FEEDER BELTS KBA

CODE	Fits machine	Size
KBA		
BB-P9270	KBA Rapida 104/105	2600 x 28mm
BB-P9271	KBA Rapida 142/162	3185 x 40mm



CODE	Fits machine	Size
KBA		
BB-P9272	KBA Rapida	2060 x 80mm
BB-P9273	KBA Rapida 142/162	3160 x 80mm
BB-P9501	KBA Rapida 142/162	3190 x 100mm

FEEDER BELTS ROLAND

CODE	Fits machine	Size
Roland		
BB-P9281	Roland OB	1356 x 28mm
BB-P9282	Roland Rekord 3B	1977 x 28mm
BB-P9283	Roland 600	1500 x 28mm



CODE	Fits machine	Size
Roland		
BB-P9284	Roland OB - Perforated	1356 x 50mm
BB-P9285	Roland 200 - Perforated	1440 x 50mm
BB-P9286	Roland 300 - Perforated	1070 x 50mm

CODE	Fits machine	Size
Roland		
BB-P9502	Roland 600/RZK3B - Perforated	1575 x 80mm
BB-P9503	Roland 700 - Perforated	2880 x 80mm



FEEDER BELTS AKIYAMA & RYOBI

BB-P9288

Model: Akiyama Bestech 28
1660 x 28mm



BB-P9533

Model: Ryobi 755
1780 x 50mm

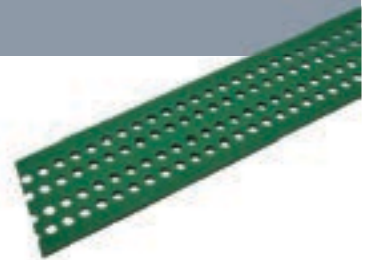

FEEDER BELTS KOMORI

CODE	Fits machine	Size
Komori		
BB-P9274	Komori Sprint 26"	1325 x 28mm
BB-P9275	Komori Lithrone 26"	1680 x 25mm
BB-P9276	Komori Lithrone 28"	2000 x 25mm
BB-P9277	Komori Lithrone 40"	2300 x 25mm



BELT GLUING UNIT

BB-P9289

Glue unit for belt width up to 90mm

- Even heat distribution
- Automatic temperature regulation
- Light, handy and easy to use



BB-P9290

Strong glue for belts
10ml/bottle - 15 bottles/box



SLOWDOWN BELTS HEIDELBERG

BB-P9000

Model: Heidelberg CD74/
SM52/SM74/SM102/CD102/
XL105/XL75

Description: Grey/Flat
225 x 20mm

Like F4.514.578



BB-P9001

Model: Heidelberg SM52/
SM74/CD74/XL75/SM102/
CD102/XL105

Description: Grey/9mm raised
225 x 20mm

Like M2.015.871



BB-P9002

Model: Heidelberg SM52/
SM74/CD74/SM102/XL105/
XL75

Description: Grey/5mm raised
225 x 20mm

Like M2.015.898



BB-P9003

Model: Heidelberg SM52/
SM74/SM102/CD74/XL105/
XL75

Description: Grey/1.5mm raised
225 x 20mm

Like M2.015.872.01



BB-P9004

Model: Heidelberg SM52/
SM74/CD74/SM102/CD102/
XL105/XL145/XL162

Description: Yellow/Flat
225 x 20mm

Like M2.015.878



BB-P9005

Model: Heidelberg SM52/
SM74/CD74/XL75/SM102/
CD102/XL105

Description: Yellow/9mm raised
229 x 20mm

Like M2.015.870



BB-P9006

Model: Heidelberg SM52/
SM74/CD74/SM102/CD102/
XL105

Description: Yellow/5mm
raised

229 x 20mm

Like M2.015.895



BB-P9007

Model: Heidelberg XL75/
XL105/XL145/XL162/
SM102/CD102

Description: Green/Flat
235 x 20mm

Like M2.015.880



BB-P9008

Model: Heidelberg SM74

Description: Pink/10mm raised
centre band

220 x 38mm

Like M2.015.357/01



BB-P9009

Model: Heidelberg SM102/
SM74

Description: Green/13mm
raised compressible

215 x 38mm

Like C3.015.653



SLOWDOWN BELTS HEIDELBERG

BB-P9010

Model: Heidelberg SM74/
SM102/CD102

Description: Green/Perforated
215 x 37mm
CD102 s/n 543064+
SM74 s/n 621124+



BB-P9465

Model: Heidelberg SM102/
CD102/XL75/XL105/XL145/
XL162

Description: Grey/Flat
247 x 20mm
Like F4.614.831F



BB-P9505

Model: Heidelberg XL75/
XL162/SM102/CD102/
XL105/XL145

Description: Grey/9mm raised
247 x 20mm
Like F4.614.821



BB-P9506

Model: Heidelberg XL75/
SM102/XL105/XL106/
XL145/XL162

Description: Grey/7mm
wide center
245 x 10mm
Like F4.614.862F



BB-P9140

Model: Heidelberg SM102/
XL75/XL105/XL145/XL162

Description: Blue/Flat
245 x 10mm
Like F4.614.560/01



BB-P9441

Model: Heidelberg SM102/
XL75/XL105/XL145/XL162

Description: White/Flat
245 x 10mm
Like F4.614.881F



BB-P9528

Model: Heidelberg SM102/
XL75/XL105/XL145/XL162/
XL162

Description: Red Slow
Down Belt
245 x 10mm
Like F4.614.570



BB-P9464

Model: Heidelberg SM102/
XL75/XL105/XL145/XL162

Description:
Yellow (Tan)/Flat
245 x 10mm
Like F4.614.885F



BB-P9557

Model: Heidelberg SM102/
XL75/XL105/XL145/XL162

Description:
Pink/Flat
245 x 10mm
Like F4.614.891F



BB-P9556

Model: Heidelberg SM102/
XL75/XL105/XL145/XL162

Description:
Blue/7mm wide center
245 x 10mm
Like F4.614.871



SLOWDOWN BELTS KOMORI

BB-P9015

Model: KOMORI

Description: Black/
8mm raised/26 holes and slits
210 x 14mm
Like GFH-8310-956



BB-P9017

Model: KOMORI

Description: Black/
7mm raised/26 holes and slits
210 x 14mm
Like GFH-8310-902



BB-P9018

Model: KOMORI

Description: Black/
5mm raised/35 holes and slits
210 x 14mm
Like ZPO-8300-101



BB-P9016

Model: KOMORI

Description: Black/
5mm raised/52 holes
210 x 14mm
Like GFH-8310-950



BB-P9531

Model: KOMORI

Description: Blue Raised/
15 holes
213 x 14mm



BB-P9532

Model: KOMORI

Description: Blue Raised/
26 holes
213 x 14mm
Like YP-130507



O-RINGS - HEIDELBERG

CODE	Fits machine	Inside ø	Packing	Like
Heidelberg				
BB-P9014	Heidelberg MO/GTO	46mm	6 pcs/pack	00.580.1069
BB-P9013	Heidelberg SM52	62mm	6 pcs/pack	00.580.4270
BB-P9012	Heidelberg SM102 (new)	68mm	6 pcs/pack	00.580.6953
BB-P9011	Heidelberg SM102 (old)	80mm	6 pcs/pack	00.580.1617



INK DUCT FOIL AND CPC CONSUMABLES

The Elite Foil range is manufactured to high tolerances from top-grade PET material ensuring:

- Maximum chemical, thermal and mechanical strength for long life without ink duct contamination.
- Only virgin resin suppliers are used - no recycled polyester.
- Tested using both conventional and UV inks.
- Permanently formed for a secure and accurate fit.
- Compact, low volume packaging for safe, easy and cost effective transportation and storage.



0.19 mm (standard)	0.25 mm	0.30 mm	Fits machine	Length	Qty box
FOILGT052	FOIL25GT052	FOIL30GT052	Heidelberg GT0 52	547 mm	100 pcs
FOILS52N	FOIL25S52N	FOIL30S52N	Heidelberg SM52	547 mm	100 pcs
FOILM0	FOIL25M0	FOIL30M0	Heidelberg M0	676 mm	100 pcs
FOIL72	FOIL2572	FOIL3072	Heidelberg SM72	775 mm	100 pcs
FOIL74	FOIL2574	FOIL3074	Heidelberg CD74	775 mm	100 pcs
FOIL75	FOIL2575	FOIL3075	Heidelberg XL75	775 mm	100 pcs
FOIL102	FOIL25102	FOIL30102	Heidelberg SM102	1068 mm	100 pcs
FOIL102CD	FOIL25102CD	FOIL30102CD	Heidelberg SM102CD	1068 mm	100 pcs
FOIL105	FOIL25105	FOIL30105	Heidelberg XL105	1068 mm	100 pcs
FOIL145	FOIL25145	FOIL30145	Heidelberg XL145	1478 mm	100 pcs
FOIL8	FOIL258	FOIL308	Heidelberg Web8	548 mm	50 pcs
FOIL16	FOIL2516	FOIL3016	Heidelberg Web16/Goss M600	1002 mm	50 pcs
FOIL16WC	FOIL2516WC	FOIL3016WC	Heidelberg Goss M600 (cut outs)	1002 mm	50 pcs
FOIL110	FOIL25110	FOIL30110	Harris M110	740 mm	50 pcs

TESAM OIL STRIP

BB-P9066

9mm x 6mm x 10m

An adhesive foam for placement under the Ink duct foil.

Packed in a convenient clear plastic container with perforated opening for easy removal and safe storage.



PROTECTIVE UNDERLAY FOIL

BB-P9067-68

A two-band bi-adhesive foil for placement under the ink duct foil.

Packed in a convenient clear plastic container for safe storage.

BB-P9067 - sheet fed presses

Size: 70mm x 25m/roll

BB-P9068 - 8 & 16 page Web

Size: 95mm x 25m/roll

Also available in rolls of 12 pieces pre-cut to individual press sizes.



NEW PROTECTIVE UNDERLAY FOIL

BB-P9069-71

New style protective underlay foil with bi-adhesive tape and hard edge profile for easy fit.

BB-P9069 - SM52

Size: 90 x 547mm

Packing: 12 pieces/box

BB-P9070 - SM74 and XL75

Size: 90 x 775mm

Packing: 12 pieces/box

BB-P9071 - SM102/105

Size: 90 x 1068mm

Packing: 12 pieces/box

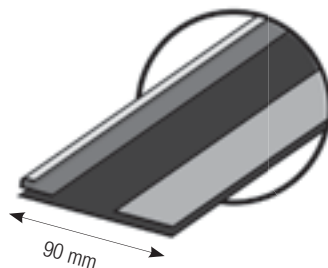

INK DUCT END BLOCKS FOR HEIDELBERG

BB-P9075

Model: Heidelberg QM46-DI

103.5 mm long
1 pair/bag

Like A4.008.323 - O/S
Like A4.008.324 - D/S



BB-P9076

Model: Heidelberg QM46

95.5 mm long
1 pair/bag

Like A1.008.104/01



BB-P9077

Model: Heidelberg GT052 without CPT

97 mm long
1 pair/bag

Like MV.037.346



BB-P9078

Model: Heidelberg GT052 with CPC and CPT

106 mm long
1 pair/bag

Like MV.022.805



BB-P9236

Model: Heidelberg GT052 without CPT

97 mm long
1 pair/bag

Like 69.008.012



BB-P9079

Model: Heidelberg SM52 with CPC and CPT

108 mm long
1 pair/bag

Like G2.008.113F - O/S
Like G2.008.112F - D/S



BB-P9413

Model: Heidelberg SM52 without CPC and CPT

102 mm long
1 pair/bag

Like G2.008.309 - DS
Like G2.008.310F - OS



BB-P9080

Model: Heidelberg MO S/N 608117+

131 mm long
1 pair/bag

Like 43.008.021/02



BB-P9461

Model: Heidelberg MO

127.5 mm long
1 pair/bag

Like 63.008.113



BB-P9081

Model: Heidelberg SM74/PM74

144 mm long
1 pair/bag

Like M2.008.113F/02



BB-P9403

Model: Heidelberg SM74 without CPC

140 mm long
1 pair/bag

Like M1.008.113
Like MV.016.780/01 - OS
Like MV.016.778/01 - DS



BB-P9082

Model: Heidelberg CD74/XL75

149 mm long
1 pair/bag

Like L2.008.114F - O/S
Like L2.008.113F - D/S



BB-P9083

Model: Heidelberg SM102 and SM72

163 mm long – 1 pair/bag

Like MV.025.468

Like 91.008.013/91.008.014



BB-P9237

Model: Heidelberg XL105

162 mm long

1 pair/bag

Like F2.008.109

Like F2.008.110



BB-P9089

Model: Heidelberg XL162

161.5 mm long

1 pair/bag

Like G7.008.113/01

Like G7.008.114/01



BB-021-200

Model: Heidelberg WEB8/WEB12/WEB16/Harris M600

77.5 mm long – 1 pair/bag

Like 5E.008.216



BB-P9446

Model: Goss M600

179 mm long

1 pair/bag

Like 4ME008145

Like 4ME008146



DAMPENING SEALS FOR HEIDELBERG

BB-P9019

Model: Heidelberg PrintMaster 46

Like MV.034.739

Packing: 1 set (DS/OS)



BB-P9020

Model: Heidelberg QuickMaster 46

Like MV.027.163

Packing: 1 set (DS/OS)



SCRAPE CLEANERS FOR HEIDELBERG

BB-P9074

For ink duct end blocks on Heidelberg sheet fed presses.

Like 91.008.033

25 pcs/bag



BB-P9073

For ink duct end blocks on Heidelberg WEB16

Like WM4ME008054

25 pcs/bag



DUCT INSULATING STRIPS

BB-P9366

A bi-adhesive for placement under the edge of the ink duct end block.

Size: 150 x 16 mm

10pcs/pack



BB-P9088

Left and right spare tabs with screws

1 set with screws/bag



KOMPAC DAMPENING SEALS & CLEANING FELTS

BB-P9084

Teflon seals for Kompac II Systems

35.7 mm long
1 pair/bag
Like 92370



BB-P9085

Teflon seals for Kompac III system, GT046/52, M0 and Practika 00/01

43.6 mm long –1 pair/bag
Like 90850



BB-P9086

Cleaning felt for Kompac II Systems

36.5 mm long
25 pcs/bag
Like 93930



BB-P9087

Cleaning felt for Kompac III Systems

44.5 mm long
25 pcs/bag
Like 94900



CLEANING FELT FOR KOMORI

BB-P9451

Cleaning felt for Komori Lithrone 28

21 x 21 x 19mm
20 pcs/pack



BB-P9440

Cleaning felt for Komori

43 x 30 x 17mm
20 pcs/pack
Like 374-9608-401



CLEANING FELTS FOR HEIDELBERG

BB-P9229

Cleaning felt for PM46

360 x 30 x 3 mm
Packing: 5 pcs/pack



BB-P9230

Cleaning felt for PM46

360 x 37 x 3 mm
Packing: 5 pcs/pack



BB-P9231

Cleaning felt for PM46

360 x 70 x 4mm
Packing: 5 pcs/pack



CLEANING FELT FOR KBA

BB-P9457

Cleaning felt for KBA RAPIDA 74

20 x 30 x 10 mm
20 pcs/pack



BB-P9511

Cleaning felt for KBA 104/105

20 x 38 x 12 mm
20 pcs/pack



BB-P9442

Cleaning felt for KBA 142/162

20 x 45 x 12 mm
20 pcs/pack



STEEL DOCTOR BLADES

Preground Doctor Blades for Offset, Flexo and Gravure Printing.

Unger Doctor Blades are manufactured on CNC controlled precision machines under permanent observation. Steel blades are normally preferred for high-end flexo printing due to the fine contact area, producing precise metering. Blade widths between 10-80 mm available with or without lamella.

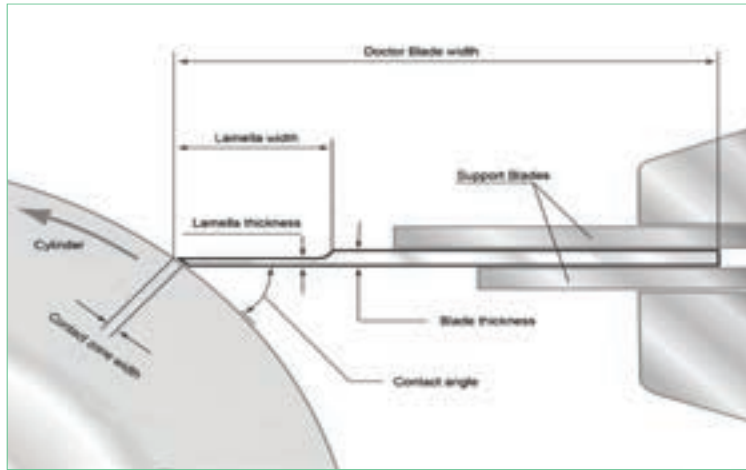
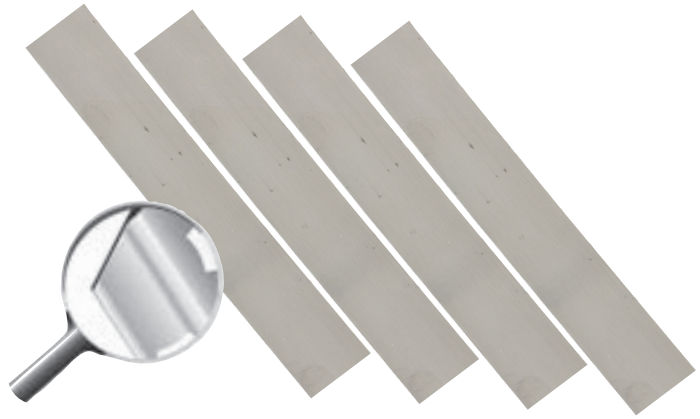

SPECIFICATIONS STEEL BLADES

Specifications STEEL Blades	
Blade Thickness	0.15 - 0.20 mm
Doctor Blade width	10.0 - 80.0 mm
Lamella thickness	from 0.05 mm
Lamella width	0.80 - 1.7 mm
Contact angle (w/ cylinder)	as requested
Length of Blade	coil or fixed length

PLASTIC DOCTOR BLADES

Various plastic and composite materials available including Acetal, UHMW and Polyester.

Both Ultraflex (composite) and Polyester blades are available for Chambered Doctor Blade Systems. For Tresu* Ultraflex is recommended for both the metering and the containment position. For Harris & Bruno systems, it is recommended that Ultraflex is used in the metering position and Polyester in the containment position.



Please contact us for further details.

SPECIFICATIONS STEEL BLADES

BEVELED

Provides the finest contact area for jobs with moderate to difficult requirements.



STRAIGHT

Provides extended blade life for jobs with simple graphic requirements.



LAMELLA

Provides a consistent contact area as the tip wears for custom applications.



Specifications PLASTIC Blades

Blade thickness	
Ultraflex	0.37 and 0.5 mm
Polyester	0.19, 0.25, 0.37 and 0.5 mm
Blade Width	
Ultraflex	Maximum 63.5 mm
Polyester	Maximum 101.6 mm
Profile Angle	
Ultraflex	22°, 15° or 10°
Polyester	15° Straight

TOWER COATER BLADES

BB-P9167 & BB-P9168

Model: SM102
C4.721.074,
C4721.075

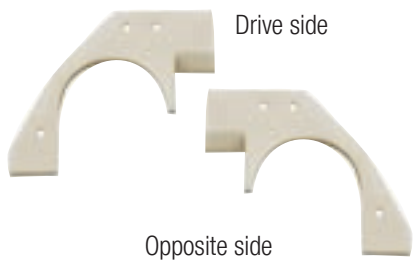

BB-P9169 & BB-P9170

Model: SM102
C4.721.091,
C4721.092

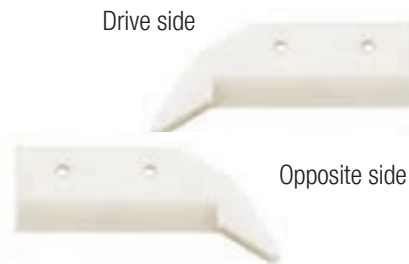

TRESU* CONSUMABLES FOR CHAMBER DOCTOR BLADE SYSTEMS

Part #	DESCRIPTION
Desmopan (white)	
4000022	Seal D1 Desmopan (white)
4000024	Seal D2 Desmopan (white)
4000029	Seal D3 Desmopan (white)
4000044	Seal D4 Desmopan (white)
4000050	Seal D5 Desmopan (white)
EPDM (black)	
4027925	Seal D1 EPDM (black)
4002628	Seal D2 EPDM (black)
4000027	Seal D2 EPDM (black – THICK)
4000042	Seal D3 EPDM (black)
4002672	Seal D4 EPDM (black)
4000052	Seal D5 EPDM (black)
Clip for Seal	
4000018	Clip for Seal D1 - D2
4000076	Clip for Seal D3 - D5
Accessories	
3010070	Hose 17mm, 2bar
3000253	Doctor Blade Blade Cutter
5004560	Blade Change Tool
3000518	Clip Change Tool
3018773	Brush for Anilox Roller Cleaning
Doctor blade	
BB-2051	Doctor Blade, Stainless Steel 35 x 0.2 mm. Lamella 1.4 x 0.1 mm
BB-2052	Doctor Blade, Stainless Steel 35 x 0.3 mm. Lamella 1.4 x 0.1 mm
BB-2053	Plastic Blade 35 x 0.35 mm, 17°
BB-2054	Plastic Blade 35 x 0.2 mm, with Lamella

4002628 & 400024



5004560



3010070



400018 & 400076



3000253



3000518

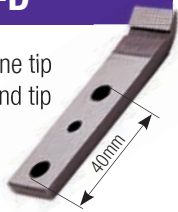
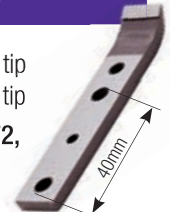

HEIDELBERG GRIPPER FINGERS

BB-P8251**Model: Heidelberg S/
SB/SBG**76.3 x 13 mm
Carriage gripper
with rubber pad
Packing: 5 pcs/bag
Like 03.014.051F**BB-P8262****Model: Heidelberg GTO/
MO/KORD**51 x 9mm
Gripper for feeder
with rubber pad
Packing: 5 pcs/bag
Like 43.020.35F**BB-P9407****Model: Heidelberg SBB/
SBG/SBD/S-Line**54.2 x 12.6mm
Delivery chain
grripper with
rubber pad
Packing: 5 pcs/bag**BB-P9439****Model: Heidelberg
KOR/KORA/KORD62/
KORD64/KORS**51 x 9mm
Gripper for feeder
with rubber pad
Packing: 5 pcs/bag**BB-P9416****Model: Heidelberg
GTO/K-offset**55 x 13mm
Delivery gripper
with rubber pad
Packing: 5 pcs/bag
Like 14.875.001F/02**BB-P8260****Model: Heidelberg MO,
SORSZ 40, SM72, 102
ZP, SOR-MZ**43.5 x 18mm
Swing arm gripper
(Urethane tip)
Packing: 5 pcs/bag**BB-P8264-U/-D****BB-P8264-U** - Urethane tip
BB-P8264-D - Diamond tip**Model: Heidelberg S-line,
SB, SBG, SBD**45.3 x 9 mm
Carriage gripper
Like 03.020.035**BB-P8270-U/-D****BB-P8270-U** - Urethane tip
BB-P8270-D - Diamond tip**Model: Heidelberg
SM72, SM102**73.75 x 18.9mm
Impression Cylinder gripper
*Like 91.581.727N
Like 91.581.827N***BB-P8273-U/-D****BB-P8273-U** - Urethane tip
BB-P8273-D - Diamond tip**Model: Heidelberg
SM72, SM102**74 16 mm
Impression Cylinder gripper
*Like C3.581.627N
Like C3.581.727N***BB-P8276-U/-D****BB-P8276-U** - Urethane tip
BB-P8276-D - Diamond tip**Model: Heidelberg
SM72, SM102, SORD**84.25 x 19 mm
Impression cylinder gripper
*Like 49.011.027, 49.011.027N,
49.011.827F***BB-P8277-U/-D****BB-P8277-U** - Urethane tip
BB-P8277-D - Diamond tip**Model: Heidelberg SBB,
SBG, SB, S, KORD64**76.9 x 18 mm
Impression Cylinder gripper
*Like 03.011.027, 03.011.027F,
08.011.027F***BB-P8291-U/-D****BB-P8291-U** - Urethane tip
BB-P8291-D - Diamond tip**Model: Heidelberg SM72,
SM102**84.25 x 15.8 mm
Impression Cylinder gripper
*Like 03.011.727/03,
03.011.0627/03***CAN'T FIND WHAT YOU
ARE LOOKING FOR?**

The above listed parts are only a partial selection of Grippers and Pads available.

- Diamond Coating
- Machine Grooved
- Urethane Coating

Call us for coating options.

WASH-UP BLADES

Our wash-up blades are manufactured to fine tolerances for perfect fit on old and new presses alike. They are resistant to chemical attack from inks and solvents and are highly efficient and durable.

A perfect profile ensures excellent wash-up results each time, reducing the amount of wash-up chemicals used and reducing down-time on the press.

Our blades are available for the vast majority of offset sheet-fed, web and continuous form presses in either metal/rubber, metal/urethane, rubber (EPDM), plastic or Tufnol format. Each individual blade is presented in a plastic sleeve with the machine reference for easy identification.

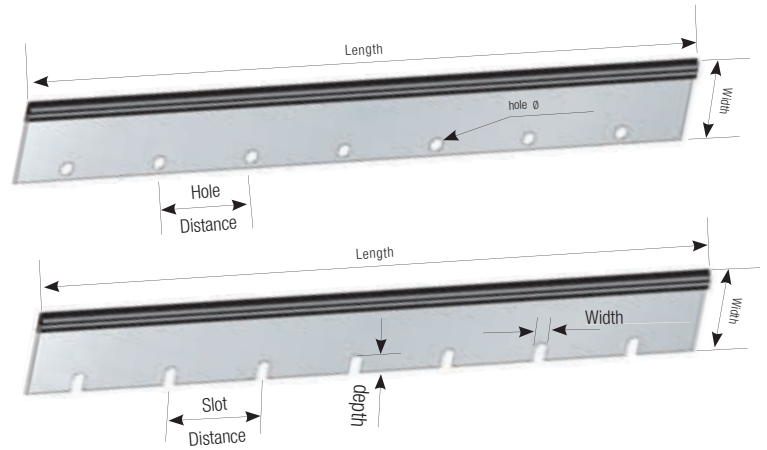

Part #	To Suit	Dimensions in mm			Number of holes/Slots	Material
		Length	Width	Thickness		
HEIDELBERG						
HEID03	Quickmaster	375	43	3.0	5	Plastic
HEID04	GTO 46	500	60	0.5	5	Metal/Rubber
HEID35	GTO 46 Numbering Unit	448	40	6.0	3	Combination
HEID05	GTO 52 & PM52	560	60	0.5	6	Metal/Rubber
HEID36	GTO 52 Numbering Unit	508	40	6.0	3	Combination
HEID06	MO	710	60	0.5	8	Metal/Rubber
HEID56	MO Rigid	710	60	2.0	8	Metal/Rubber
HEID07	MO Blanket	692	60	0.5	7	Metal/Rubber
HEID37	MO Numbering Unit	648	52	6.0	3	Combination
HEID09	Speedmaster 52	605	46	0.5	7	Metal/Rubber
HEID59	Speedmaster 52 Numb. unit	536	28	0.5	6	Metal/Rubber
HEID10	Speedmaster 72	790	60	0.5	11	Metal/Rubber

Part #	To Suit	Dimensions in mm			Number of holes/Slots	Material
		Length	Width	Thickness		
HEIDELBERG <i>continued</i>						
HEID11	Speedmaster 72 VP	753	40	0.5	9	Metal/Rubber
HEID54	Speedmaster 72 AW	742	60	0.5	8	Metal/Rubber
HEID13	Speedmaster 74	822	57	0.5	9	Metal/Rubber
HEID08	Printmaster 74	822	57	0.5	9	Metal/Rubber
HEID57	Speedmaster 74CD	847	46	0.5	9	Metal/Rubber
HEID12	Speedmaster 102 (holes)	1090	60	0.5	11	Metal/Rubber
HEID14	Speedmaster 102+CD (slots)	1090	60	0.5	11	Metal/Rubber
HEID16	Speedmaster 102-57mm (slots)	1090	57	0.5	11	Metal/Rubber
HEID17	Speedmaster 102 A/W	1042	60	0.5	11	Metal/Rubber
HEID46	Speedmaster 102 A/W New	1042	57	0.5	11	Metal/Rubber
HEID18	Speedmaster 102 VP	1052	40	0.5	11	Metal/Rubber
HEID58	Speedmaster 105 XL	1125	41	0.5	21	Metal/Rubber
HEID60	SOR (Flexible) - new model	890	60	0.5	9	Metal/Rubber
HEID24	SOR Rigid - old model	890	50	2.0	10	Metal/Rubber
HEID55	SORZ Rigid	890	51	2.0	9	Metal Rubber
HEID27	SORK (Flexible)	710	60	0.5	8	Metal Rubber
HEID28	SORK 64 Rigid	721	50	2.0	12	Metal Rubber
HEID30	SORM Rigid	790	50	2.0	12	Metal Rubber
HEID31	SORM/Z (Flexible)1995	753	42	0.5	9	Metal Rubber
HEID47	SORM/Z 9 holes and 2 slots	790	60	0.5	11	Metal Rubber
HEID25	SORD (Flexible)	960	60	0.5	10	Metal Rubber
HEID26	SORD Rigid	960	50	2.0	12	Metal Rubber
HEID32	SORS	1090	60	0.5	11	Metal Rubber
HEID19	KOR	600	50	2.0	10	Metal Rubber
HEID20	KORA	622	50	2.0	10	Metal/Rubber
HEID21	KORD 62	650	50	2.0	10	Metal/Rubber
HEID22	KORD 64	690	50	2.0	12	Metal/Rubber
HEID23	KORS	760	50	2.0	12	Metal/Rubber
HEID33	Platen 10 x 15	390	51	6.0	5	Combination
HEID34	Platen 13 x 18	470	51	6.0	6	Combination
HEID84	KS -	530	46	1.0	8	Tufnol
HEID85	KSB-KSBA	575	46	1.0	8	Tufnol
HEID 86	Rotaspeed	1050	60	0.5	11	Metal/Rubber

Part #	To Suit	Dimensions in mm			Number of holes/Slots	Material
		Length	Width	Thickness		
KOMORI						
KOM038	Lithrone 20 Rigid	580	36	0.5	5	Metal/Rubber
KOM001	Lithrone 20 Rigid	590	36	2.0	5	Metal/Rubber
KOM007	Lithrone 26 AW Narrow	700	42	0.5	10	Metal/Rubber
KOM002	Sprint 710 (Flexible)	710	42	0.5	6	Metal/Rubber
KOM022	Sprint 710 (Rigid)	710	42	2.0	6	Metal/Rubber
KOM003	Sprint 715 (Flexible)	715	50	0.5	6	Metal/Rubber
KOM032	Sprint 715 (Rigid)	715	50	2.0	6	Metal/Rubber
KOM008	Lithrone 26 AW Wide	716	47	0.5	10	Metal/Rubber
KOM004	Sprint 719 (Flexible)	719	44	0.5	6	Metal/Rubber
KOM023	Sprint 719 (Rigid)	719	44	2.0	6	Metal/Rubber
KOM005	Lithrone 26 (Flexible)	726	36	0.5	6	Metal/Rubber
KOM006	Lithrone 26 Rigid	726	36	2.0	6	Metal/Rubber
KOM051	Lithrone LS 26	730	35	1.0	10	Plastic
KOM052	Lithrone LS 26	730	35	0.5	10	Metal/Rubber
KOM012	Lithrone 28 AW	765	47	5.0	11	Plastic
KOM011	Lithrone 28 AW	766	47	0.5	11	Metal/Rubber
KOM042	Lithrone 28	775	47	0.5	11	Metal/Rubber
KOM075	Lithrone 28	780	42	0.5	9	Metal/Rubber
KOM009	Lithrone 28 (Flexible)	785	42	0.5	6	Metal/Rubber
KOM037	Lithrone 28 (Flexible) (New style)	785	37	0.5	6	Metal/Rubber
KOM010	Lithrone 28 Rigid	785	37	2.0	6	Metal/Rubber
KOM013	Lithrone 28 (Spec for UV)	790	36	5.8	6	Plastic
KOM076	Spica 29 -	805	47	5.0	11	Plastic
KOM045	Spica 29	805	47	0.5	11	Metal/Rubber
KOM077	Spica 29 -	806	38	1.0	11	Plastic
KOM078	S29P (LSX-29/429-529-629-829)	820	36	1.0	11	Plastic
KOM054	Lithrone 32	892	43	5.0	6	Plastic
KOM053	Lithrone 32	892	43	5.0	6	Metal/Rubber
KOM019	Lithrone 40 Coating Unit	1050	51	0.5	9	Metal/Rubber
KOM025	Lithrone 40 AW	1076	47	5.0	8	Plastic
KOM017	Lithrone 40 AW	1076	47	5.0	15	Plastic
KOM026	Lithrone 40 AW	1076	50	5.0	8	Plastic
KOM027	Lithrone 40 AW	1076	50	5.0	15	Plastic

Part #	To Suit	Dimensions in mm			Number of holes/Slots	Material
		Length	Width	Thickness		
KOMORI <i>continued</i>						
KOM055	Lithrone 40 AW	1077	42	0.5	15	Metal/Rubber
KOM031	L40 AW (Old - 47mm wide)	1077	47	0.5	15	Metal/Rubber
KOM028	Lithrone 40 AW	1094	47	5.0	15	Plastic
KOM018	Lithrone 40 AW	1094	47	5.0	15	Plastic
KOM016	Lithrone 40 AW	1094	50	5.0	8	Plastic
KOM029	Lithrone 40 AW	1094	50	5.0	15	Plastic
KOM024	Lithrone 40 AW (Teflon)	1094	47	5.0	15	Plastic
KOM036	Lithrone 40 AW (Teflon)	1094	50	5.0	15	Plastic
KOM014	Lithrone 40 (Flexible)	1094	50	0.5	8	Metal/Rubber
KOM015	Lithrone 40 Rigid	1094	50	2.0	8	Metal/Rubber
KOM048	Lithrone 40	1105	50	1.0	15	Plastic
KOM047	Lithrone S40 (New Model)	1110	47	1.0	15	Plastic
KOM030	Lithrone 40 AW (Old 47mm wide)	1110	47	0.5	15	Metal/Rubber
KOM041	Lithrone 40 AW	1111	50	1.0	15	Plastic
KOM079	Lithrone 44	1178	47	0.5	17	Metal/Rubber
KOM039	Lithrone 44	1190	50	2.0	9	Metal/Rubber
KOM049	Lithrone 44	1192	50	0.5	17	Metal/Rubber
KOM021	Lithrone 50	1380	42	5.0	19	Plastic
KOM050	Lithrone 50	1380	48	0.5	19	Metal/Rubber
MAN ROLAND						
PRAK51	00	557	67	0.5	6	Metal/Rubber
PRAK52	00 Numbering Unit	520	35	0.5	11	Metal/Rubber
PRAK54	01 Numbering Unit	670	35	0.5	14	Metal/Rubber
ROLA01	Formall/Junior Print	415	60	0.5	5+4	Metal/Rubber
ROLA02	100	705	65	0.5	7	Metal/Rubber
ROLA24	100 (With slots)	726	65	0.5	9	Metal/Rubber
ROLA03	Favorit RF 01	720	65	0.5	8	Metal/Rubber
ROLA04	200 (Pre No 235)	785	65	0.5	8	Metal/Rubber
ROLA05	Favorit RF 0B/02/200	800	65	0.5	8	Metal/Rubber
ROLA06	300 (Plastic)	816	60	1.0	8	Plastic
ROLA35	500 (80.07V30-A078/AK)	818	60	1.0	8	Plastic
ROLA36	500 (Plastic)	818	40	1.0	0	Plastic
ROLA07	Parva RP 1	900	65	0.5	9	Metal/Rubber

Part #	To Suit	Dimensions in mm			Number of holes/Slots	Material
		Length	Width	Thickness		
MAN ROLAND <i>continued</i>						
ROLA08	Parva RP/RZP2	920	65	0.5	10	Metal/Rubber
ROLA09	Parva RP2C	995	65	0.5	10	Metal/Rubber
ROLA10	Rekord 3	1042	65	0.5	11	Metal/Rubber
ROLA11	Rekord RVK 3B	1075	65	0.5	11	Metal/Rubber
ROLA12	Rekord RZK 3B and 604 Lower unit	1100	65	0.5	11	Metal/Rubber
ROLA13	Rekord RWK 3B	1132	65	0.5	12	Metal/Rubber
ROLA14	700 (Old)	1091	56	0.5	13	Metal/Rubber
ROLA15	700 New	1100	56	0.5	13	Metal/Rubber
ROLA26	700 New version W/slots	1100	56	0.5	13	Metal/Rubber
ROLA25	700 (007V143930)	1102	56	1.0	13	Plastic
ROLA28	700 New version - solid - no holes	1105	40	0.5	0	Metal/Rubber
ROLA38	700 (007V172730)	1108	40	1.0	13	Plastic
ROLA39	700 (007V172730)	1108	40	3.0	13	Plastic
ROLA16	Ultra 4 (1st Model)	1145	65	0.5	11	Metal/Rubber
ROLA17	Ultra 4 (2nd Model)	1195	65	0.5	11	Metal/Rubber
ROLA18	Ultra V	1335	65	0.5	13	Metal/Rubber
ROLA37	Ultra V	1335	65	0.5	0	Metal/Rubber
ROLA19	Ultra VI	1475	65	0.5	14	Metal/Rubber
ROLA20	Ultra VII & VIIB	1675	65	0.5	16	Metal/Rubber
ROLA21	Ultra VII & VIIB	1710	65	0.5	16	Metal/Rubber
ROLA22	800 V/VW	1410	65	0.5	13	Metal/Rubber
ROLA23	800 VI	1510	65	0.5	14	Metal/Rubber
ROLA29	900	1410	60	0.5	14	Metal/Rubber
ROLA32	900XXL (40mm)	1420	40	0.5	TBA	Metal/Rubber
ROLA33	900XXL (60mm)	1420	60	0.5	TBA	Metal/Rubber
ROLA27	900 (07V146730)	1529	60	1.0	16	Plastic
ROLA31	900	1529	60	0.5	16	Metal/Rubber
ROLA61	900 (Special 70mm)	1529	70	0.5	16	Metal/Rubber
KBA						
KBA02	SRO	770	50	1.0	8	Plastic
KBA01	SRO	770	50	0.5	8	Metal/Rubber
KBA05	Rapida 72	780	46	0.5	11	Metal/Rubber

Part #	To Suit	Dimensions in mm			Number of holes/Slots	Material
		Length	Width	Thickness		
KBA						
KBA03	Rapida 104 (Narrow)	1130	46	0.5	0	Metal/Rubber
KBA06	Rapida 104 (Wide)	1130	51	0.5	12	Metal/Rubber
KBA10	Rapida 105	1140	46	0.5	0	Metal/Rubber
KBA07	Rapida 105	1140	55	0.5	11	Metal/Rubber
KBA12	Rapida 105	1140	35	2.0	0	Plastic
KBA11	Rapida 142	1510	65	0.5	17	Metal/Rubber
KBA08	Rapida 160	1700	65	0.5	19	Metal/Rubber
KBA09	Rapida 162	1710	65	0.5	19	Metal/Rubber
AKIYAMA						
AKIY01	Bestech 28	800	47	5.0	11	Rubber
AKIY02	Bestech 40	1120	55	5.0	12	Rubber
AKIY03	Bestech 40 (EPDM)	1120	45	5.0	12	Rubber
AKIY33	Bestech 40 (Plastic)	1120	45	5.0	12	Plastic
AKIY04	Bestech 40-640 IIC	1120	70	5.0	12	Rubber
AKIY05	Bestech 40-640 IIC	1120	70	5.0	12	Plastic
FUJI / SHINOHARA						
FUJI01	50 (Tip to H/C = 38mm)	550	48	2.0	8	Metal/Rubber
FUJI02	50 (Tip to H/C = 29mm)	550	48	2.0	8	Metal/Rubber
FUJI03	50 (Two rows of holes)	550	48	2.0	16	Metal/Rubber
FUJI04	52 New Shinohara	550	42	2.0	7	Metal/Rubber
FUJI10	52 New Shinohara - Flexible	550	42	0.5	9	Metal/Rubber
FUJI05	52 Special	570	42	2.0	8	Metal/Rubber
FUJI06	52 Standard	580	42	2.0	8	Metal/Rubber
FUJI09	58	620	48	2.0	9	Metal/Rubber
FUJI07	65 /66	700	48	2.0	11	Metal/Rubber
FUJI08	66AW	693	30	1.0	9	Plastic
FUJI12	74 Shinohara - Flexible	795	48	0.5	13	Metal/Rubber
FUJI13	74 Shinohara - Rigid	795	48	2.0	13	Metal/Rubber
FUJI17	75	835	48	0.5	13	Metal/Rubber
FUJI15	MTP - Flexi	1252	65	0.5	13	Metal/Rubber
FUJI16	MTP - Rigid	1252	65	2.0	13	Metal/Rubber
RYOBI / ITEK*						
RYOB15	3302M New	286	44	4.0	4	Plastic

Part #	To Suit	Dimensions in mm			Number of holes/Slots	Material
		Length	Width	Thickness		
<i>RYOBI / ITEK continued</i>						
RYOB22	2700/2800	305	40	5.0	6	Plastic
RYOB01	2700/2800	305	40	5.0	6	Rubber
RYOB16	3200 & 3302M Old	354	40	5.0	6	Plastic
RYOB03	3200 -	354	28	5.0	6	Rubber
RYOB02	3200 & 3302M (Old)	355	40	5.0	6	Rubber
RYOB14	3302	360	40	5.0	6	Rubber
RYOB17	3304H	364	40	5.0	6	Plastic
RYOB20	3304H	364	40	5.0	6	Rubber
RYOB04	4502	453	41	5.0	6	Rubber
RYOB05	480N / 500N	507	45	5.0	9	Rubber
RYOB06	480K / 480D / 500K	508	45	5.0	11	Rubber
RYOB07	500 KNP Number. Unit	510	42	0.5	11	Metal/Rubber
RYOB11	522 Numbering Unit	522	42	0.5	11	Metal/Rubber
RYOB08	512	560	28	5.0	9	Rubber
RYOB09	520/522	572	24.5	5.0	9	Rubber
RYOB19	520/522	572	24.5	5.0	9	Plastic
RYOB10	520/522 (Teflon for UV)	572	24.5	5.0	9	Plastic
RYOB12	530 / 560	602	39	5.0	13	Rubber
RYOB18	640K	736	47	5.0	16	Rubber
RYOB13	662 PFH	760	40	5.0	11	Rubber
RYOB21	750	855	34	5.0	12	Plastic
RYOB23	920	1006	35	5.0	14	Plastic

PLEASE CALL FOR MAKES AND MODELS NOT LISTED ABOVE INCLUDING:

- Mitsubishi
- Hamada
- Sakurai Oliver
- Solna
- Dominant
- Gestetner etc...

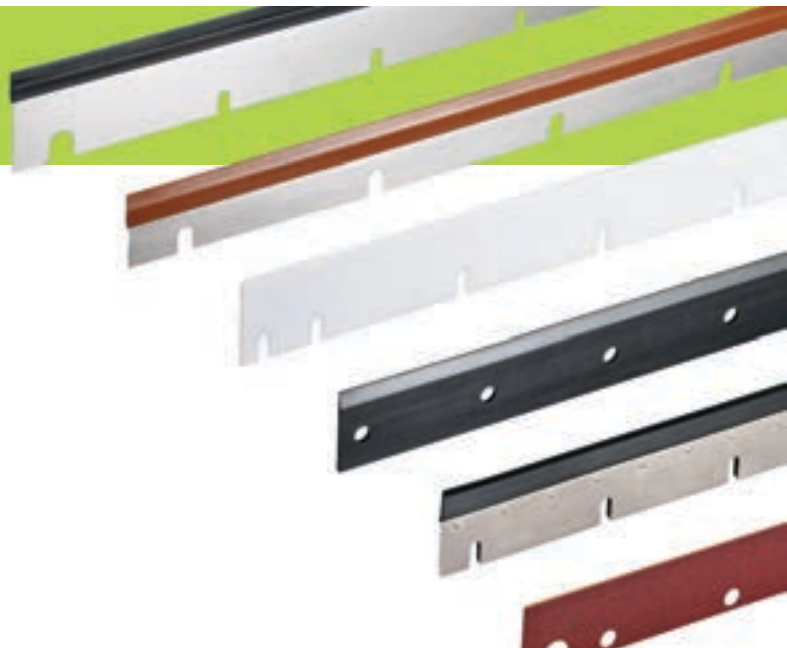

HICKEY REMOVERS HEIDELBERG

Hickey removers are designed and manufactured to original specifications. We use the highest quality raw materials including corrosion-proof steel and chemical resistant rubber. The molded rubber tips are chemically bonded to the steel preventing separation.



BB-P9166

Model: Heidelberg SM72/ SM102 with Alcolor

Description: Hickey remover complete

Packing: 1 piece



BB-P9269

Model: Heidelberg SM102 Hickey remover

Description: Replacement rubber

Packing: 5 pieces



BB-P9350

Model: Heidelberg SM52

Description: Hickey remover complete



BB-P9249

Model: Heidelberg MO/S-Offset/SM72

Description: Hickey remover complete



BB-P9250

Model: Heidelberg XL105

Description: Hickey remover complete



BB-P9251

Model: Heidelberg SM74/ PM74

Description: Hickey remover complete

Packing: 1 piece



BB-P9252

Model: Heidelberg CD74

Description: Hickey remover complete

Like L2.032.003S



HICKEY REMOVERS FUJI-SHINOHARA

BB-P9253

Model: Fuji-Shinohara 52

Description: Hickey remover
38 x 22mm



BB-P9254

Model: Fuji-Shinohara 52HP

Description: Hickey remover
32 x 30mm



HICKEY REMOVERS KBA

BB-P9255

Model: KBA Rapida 142/162
 Description: Hickey remover
 46 x 30mm



BB-P9256

Model: KBA Rapida 142/162
 Description: Hickey remover
 50 x 30mm



BB-P9257

Model: KBA Rapida 104/105
 Description: Hickey remover
 Width: 40mm



BB-P9258

Model: KBA Rapida 104/105
 Description: Hickey remover complete
 30mm width



BB-P9259

Model: KBA Rapida 75
 Description: Hickey remover
 40mm



HICKEY REMOVERS PLANETA

BB-P9524

Model: Planeta 40
 Description: Hickey remover
 38 x 32 x 3mm
 Packing: 5 pieces



BB-P9525

Model: Planeta 40
 Description: Hickey remover
 51 x 38 x 3mm
 Packing: 5 pieces



BB-P9526

Model: Planeta 50
 Description: Hickey remover
 51 x 38 x 3mm
 Packing: 5 pieces



BB-P9527

Model: Planeta 3
 Description: Hickey remover
 85 x 32 x 6mm
 Packing: 5 pieces



HICKEY REMOVERS ROLAND

BB-P9263

Model: Roland 300

Description: Hickey remover
28 x 28 x 3mm
Packing: 5 pieces



BB-P9264

Model: Roland 300

Description: Plastic hickey remover
27 x 27 x 1mm
Packing: 5 pieces



BB-P962

Model: Roland 600/REKORD 3B/ Parva/Favorit/ OB/200

Description: Hickey remover
22 x 16 x 5mm
Packing: 5 pieces



BB-P9265

Model: Roland 800

Description: Hickey remover
76 x 34 x 3mm
Packing: 5 pieces



BB-P9266

Model: MAN - Roland

Description: Hickey remover
25 x 96 x 3mm
Packing: 5 pieces



HICKEY REMOVERS KOMORI

BB-P9260

Model: Komori Lithrone 40/440/540/640/840

Description: Hickey remover
Size: 52 x 29mm
Like 444-4271-02A



BB-P9261

Model: Komori Lithrone 50/550

Description: Hickey remover
Size: 53 x 57mm



HICKEY REMOVERS MITSUBISHI

BB-P9523

Model: Mitsubishi 1E/1F/ Diamond

Description: Hickey remover
30 x 46 x 5mm



BB-P9257

Model: Mitsubishi 3F/ Diamond

Description: Hickey remover
39 x 45 x 5mm



HICKEY REMOVERS RYOBI

BB-P9267

Model: Ryobi 522

Description: Hickey remover
77 x 24mm



HICKEY REMOVERS SAKURAI

BB-P9268

Model: Sakurai

Description: Hickey remover
26 x 25 x 3mm
Packing: 5 pieces



RECIRCULATION FILTERS

Our long line of replacement and custom designed re-circulation filters are tough, long lasting – and guaranteed to meet or exceed every printer's expectations.

Made in high quality felt, polyester or nylon, Master recirculation filters are carefully fabricated and come with a wide assortment of fittings ensuring ease of installation and compatibility with most press models on the market.

All our filters undergo extensive field testing and provide a high contaminant loading and long service life.



BB-P9101

215 x 165 mm

For Royse systems and many Heidelberg, Komori and Roland presses where a hose can easily be fitted to return-flow



BB-P9102

430 x 275 x 190 mm

For Master Flow systems. Also used on some Royse systems.



BB-P9103

305 x 240 mm

For Technotrans systems (old style)



BB-P9104

255 x 205 mm

For Technotrans systems (new style)



BB-P9105

300 x 235 mm



BB-P9106

225 x 215 mm

Mainly used on Technotrans Alpha D systems fitted to Heidelberg, Komori and Roland presses. Can also be used on Baldwin units which have similar neck fittings.



BB-P9107

460 x 325 mm



BB-P9108

320 x 205 mm
Technotrans



BB-P9109

570 x 255 mm



BB-P9110

310 x 175 mm



BB-P9111

410 x 125 mm
For Technotrans systems



BB-P9112

495 x 155 mm
90 mm opening



BB-P9113

500 x 307 mm
For Technotrans and other systems



BB-P9114

300 x 235 mm
For Royce systems



BB-P9115

210 x 70 mm
For Baldwin (KBA/Planeta)



BB-P9116

390 x 200 mm
Outer material nylon



BB-P9117

390 x 200 mm
Outer material felt



BB-P9118

750 x 300 mm
160 mm opening



BB-P9119

370 x 170 mm



BB-P9120

550/410 x 370 mm
140 mm opening



BB-P9121

340 x 320 mm
85 mm opening



BB-P9123

450 x 350 mm
86 mm opening
For Technotrans systems



BB-P9122

450 x 290 mm
180 mm opening



BB-P9518

230 x 230 mm
For Technotrans Alpha D5 and Aquapress
Heid SM52/SM74/SM102
Komori L28/L40
Ryobi 520/524



Note: Avoid mistake between BB-P9518 and BB-P9106. BB-P9106 is a bit smaller and the most popular size.

BB-P9125

180 x 90 mm
Like WH.095833291



BB-P9124

130 x 90 mm
Like WH.095833290



BB-P9519

450 x 350mm
85 mm opening
For Technotrans systems



Note: Avoid mistake between BB-P9519 and BB-P9123. BB-P9519 has a smaller dia. of fitting, different handle and size. BB-P9123 is the most popular size.

BB-P9520

220 x 70 mm



Note: Avoid mistake between BB-P9520 and BB-P9115. BB-P9115 is 10mm shorter and the most popular size.

FOAM FILTERS

BB-P9238

1050 x 120 x 20 mm
Packing: 6 pcs per pack
2 packs per box



MISTING FILTERS

BB-P9216

187 x 368 x 19 mm
Packing: 6 pcs per pack



FILTER MATS



ALL OTHER SIZES MADE ON REQUEST.

Common Sizes

CODE	Size
FM250x470	250 x 470 mm
FM200x400	200 x 400 mm
FM250x300	250 x 300 mm

ELIMINATOR

200 x 115 x 25 mm
Packing: 4 pcs per bag (8 pcs per box)



Removes emulsified ink!

The Eliminator is a durable nylon mesh bag filled with ink absorbant material which effectively prevents contamination of the dampening system.

Simply place The Eliminator in the circulation tank and it will float on the surface of the fountain solution removing all emulsified ink.

AIR FILTERS



BB-P9494

84 x 60 mm
54mm opening

Air filter for spray powder unit SORM/SORD/SORS/MO/SM102/CD102

Like 00.780.3702



BB-P9495

93 x 145 mm
45mm opening

Air filter for SM74/CD74/SM102/CD102

Like 47.018.106



BB-P9127

750 x 480 x 47 mm

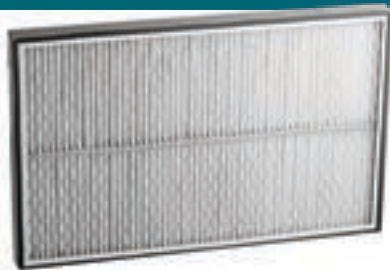

BB-P9128

495 x 394 x 45 mm

Like F2.179.1821

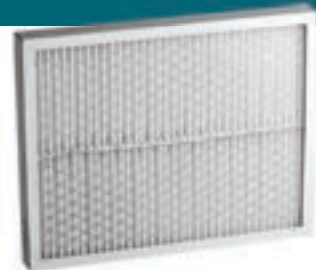

BB-P9129

730 x 160 x 47 mm

Like 00.580.5832



BB-P9130

700 x 140 x 47 mm

Like C2.102.1911



BB-P9131

128.5 x 44 x 84 mm
Large air filter for Heidelberg



BB-P9132

43 x 20 x 89 mm
Small air filter for Heidelberg



BB-P9133

170 x 140 x 47 mm



LOOKING FOR VACUUM PUMP FILTERS?
 Please see page 81

OIL FILTERS

BB-P9408

46 x 170 mm
Oil filter for Roland 700



BB-P9510

Oil filter for Komori
 Like 3Z0-2601-140



BB-P9143

200 x 45 x 20 mm
Main oil filter for Heidelberg Speedmasters



BB-P9144

199 x 70 x 27 mm
Main oil filter for Heidelberg Speedmasters
 Like 00.580.1558/02



TAB FOR SHEET PICK-UP & SHEET GUIDES

BB-P9136 (2 pcs set)

A 145 x 50 x 0.30 mm

B 150 x 44 x 0.10 mm

Model: KBA 142/162

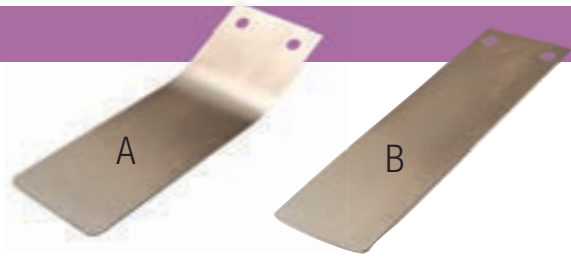

BB-P9137

202 x 80 x 0.20 mm

Model: KBA RAPIDA 142/162

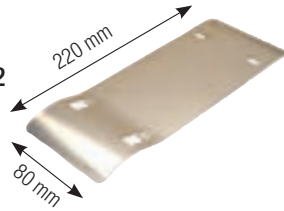

BB-P9138

229 x 35 x 0.20 mm

Model: KBA 104

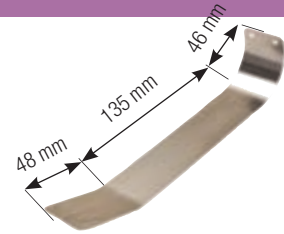

BB-P9162

38 mm wide

Model: Komori

Like 364-6800-400



BB-P9163

90 mm wide

Model: Komori

Like 274-6823-301

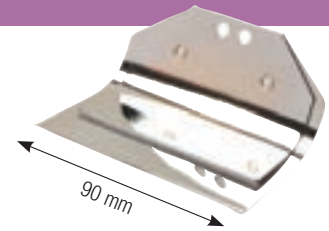

BB-P9232

38 mm wide

Model: Komori



BB-P9233

122 mm wide

Model: Komori

Like 274-6821-301

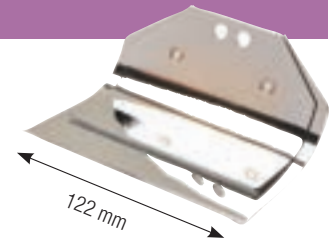

CPC BUTTONS

BB-P9148 & 49

BB-P9148 4 prong square

Like 81.186.3855/02

BB-P9149 4 prong rectangular

Like 81.186.3815

Model: Heidelberg



BB-P9174 & 75

BB-P9174: Bulb for CPC Push Button 28v

BB-P9175 : Bulb for CPC Push Button 12v

Model: Heidelberg

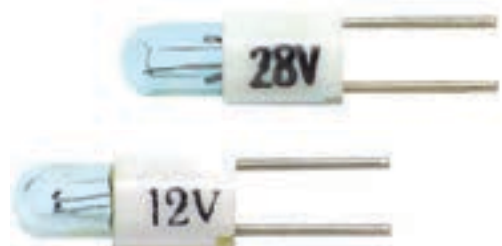

SHEET SMOOTHER (SHEET HOLD DOWNS)

BB-P9173

80mm

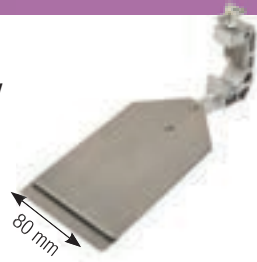
**Model: Heidelberg SM102/
SM74/SM72/S-Offset**Small – complete
unit with holder

BB-P9058

120mm

**Model: Heidelberg SM102/
SM74/SM72/S-Offset**Large – complete
unit with holder*Like 66.072.084F*

BB-P9060

120mm

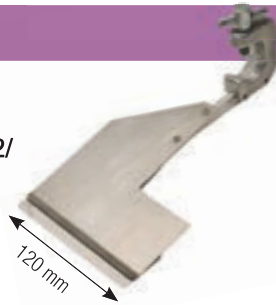
**Model: Heidelberg SM102/
SM74/SM72/S-Offset**Lateral right – complete
unit with holder*Like C4.372.384F*

BB-P9375

120mm

**Model: Heidelberg SM102/
SM74/SM72/S-Offset**Lateral left – complete
unit with holder*Like C4.372.383F*

BB-P9373

210mm

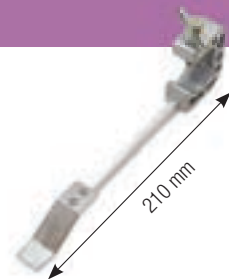
**Model: Heidelberg SM102/
SM74/SM72/S-Offset**Narrow – complete
unit with holder

BB-P9374

230mm

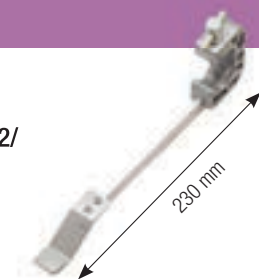
**Model: Heidelberg SM102/
SM74/SM72/S-Offset**Narrow – complete
unit with holder

BB-P9444

Model: Heidelberg SM102Lateral right – complete
unit with holder

BB-P9445

Model: Heidelberg SM102Lateral left – complete
unit with holder

BB-P9056

80mm

**Model: Heidelberg SM102/
SM74/SM72/S-Offset**

Just sheet

Like 58.022.396

BB-P9057

120mm

**Model: Heidelberg SM102/
SM74/SM72/S-Offset**

Just sheet

Like 66.072.096

BB-P9055

120mm

**Model: Heidelberg SM102/
SM74/SM72/S-Offset**

Just sheet



**YOUR ONE
STOP SUPPLIER**

Can't find what you are looking for,
contact us on 02 9452 0222

SHEET STOPS (GUIDE STRAPS)

BB-P9181

Model: Heidelberg for KORD64 with top finger



BB-P9182

Model: Heidelberg for KORD64



BB-P9183

Model: Heidelberg for GT046/GT052



PLATE SPRINGS

BB-P9146

57 x 20 x 0.3 mm

Model: Heidelberg SM102/SM74/SM72/S-Offset

Like C4.372.338

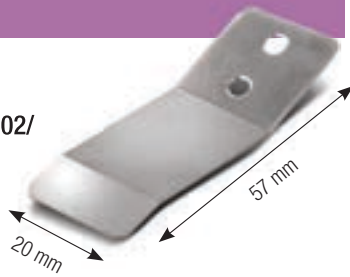

BB-P9134

30 x 40 mm

Model: Heidelberg SM102/SM74/SM72/S-Offset

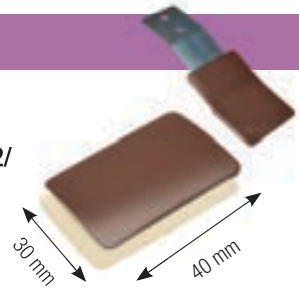

BB-P9135

20 x 25 mm

Model: Heidelberg GT046/52

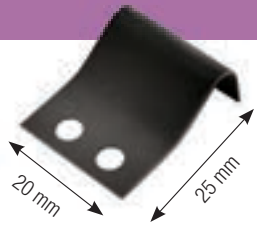

BB-P9172

20 x 56 x 0.3 mm

Model: Heidelberg GT0



PNEUMATIC SPRINGS & GAUGED STEEL BLADE

BB-P9333

300 mm

Model: Heidelberg SM102

For SM102 delivery

Like 00.580.3118

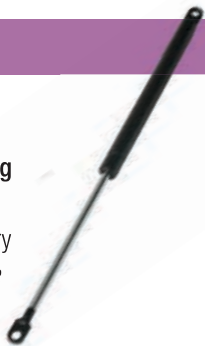

BB-P9334

420 mm

Model: Heidelberg SM102

For SM102 safety guard

Like 04.024.061



BB-P9499

198 x 25 mm

Model: Heidelberg

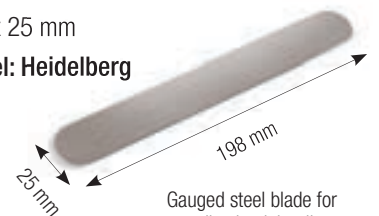

Gauged steel blade for adjusting ink rollers

PARTS FOR PLATEN T AND GT

LAY PINS

BB-P9184 - 35 mm

BB-P9185 - 45 mm

BB-P9186 - 55 mm

BB-P9187 - 65 mm

BB-P9188 - 75 mm

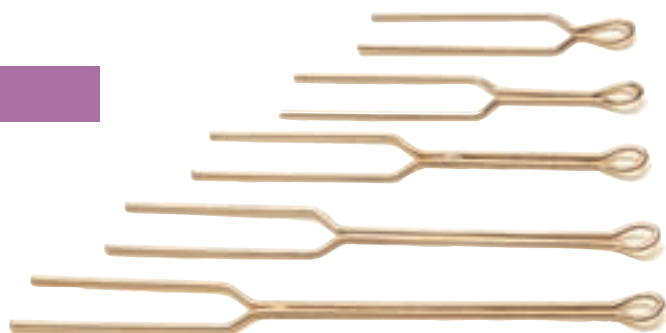

PARTS FOR PLATEN T AND GT

BB-P9226

Centre sheet separator,
forked for T and G
18 x 52 mm
Model: Heidelberg



BB-P9176

Lateral spring, long for
T and GT
15 x 124 mm
Model: Heidelberg



BB-P9226

Cutting Jacket Platen GT
13" x 18"
Model: Heidelberg



BB-P9176

Cutting Jacket Platen T
10" x 15"
Model: Heidelberg



TOOLS FOR HEIDELBERG GTO/MO/72/74/102

BB-P9150

0.4 x 117 x 0.4mm



BB-P9151

0.6 x 225 x 0.8mm



BB-P9152

210 x 0.8mm



BB-P9153

0.6 x 245 x 0.6mm



BB-P9154

0.6 x 225 x 0.8mm



BB-P9155

10 x 300 x 10mm



BB-P9156

0.4 x 210 x 11mm



BB-P9157

233 x 10mm



BB-P9431

0.4 x 150 x 0.4mm



TOOL FOR KOMORI

BB-P9393

17mm x ø8mm x L181
Like 261.9700.402



WASH-UP BOTTLES

BB-P9342

Wash-up bottle - 500 ml/16 oz

All supplied in a box with 4 bottles



BB-P9343

1 set comprising of 4 bottles and 7 caps with straws: 4 red, 1 yellow, 1 blue and 1 black



VISKOVITA SPONGES

BB-P9376

This 115 x 35mm compressed cellulose sponge swells to a handy 150 x 100mm. Highly durable it does not break down even after prolonged use with pressroom chemicals.



BLANKET SCRUBBER

BB-P9496 & BB-P9497

BB-P9496 - Medium - Green
114 x 159mm

BB-P9497 - Large - Green
140 x 180mm



The Blanket Scrubber effortlessly cleans off ink, gum, varnish, paper lint, clay and spray powder from the blanket as well as rollers and press frames.

The scrubbing action of the Blanket Scrubber completely cleans and rejuvenates the blanket surface.

One scrubber will replace hundreds of shop towels.

Simply soak the Blanket Scrubber in your favorite blanket wash, squeeze out excess liquid and it is ready to use.

WIPER PAD

BB-P9498

75 x 175 x 125mm



MAGNIFYING GLASSES

BB-P9362

Large magnifying glass with **6X magnification**



BB-P9065

Medium magnifying glass with **8X magnification**



BB-P9355

Small magnifying glass with **10X magnification**



BB-P9064

Large magnifying glass with **5X magnification.**

This model is produced in black plastic with plastic lens and supplied in individual cardboard boxes.



BB-P9063

Large magnifying glass with **6X magnification.**

Solid back.



BB-P9382

Illuminated Microscope with focus and **50X magnification.**

This model is produced in black and clear hard durable plastic and delivered in individual black vinyl pouches in printed cardboard boxes.



BB-P9378

Openbrig magnifying glass with **10X magnification.**

The Openbrig magnifying glass is produced in strong black and clear PVC and delivered in individual round vinyl pouch with zipper.



BB-P9453

Measuring magnifying glass with **10X magnification.**

The measuring glass has an aluminium stand with a glass bottom, showing millimeter measurements.



BLUENET

- Less Marking
- More production time
- Reduce paper waste
- Prevent ink build-up on transfer cylinders

BB-P9337 - 60" (154 cm)

BB-P9338 - 40" (102 cm)

BB-P9339 - 29" (74 cm)

BB-P9340 - 26" (66 cm)

BB-P9341 - 23" (58 cm)



METAL INK KNIVES



IKMT45

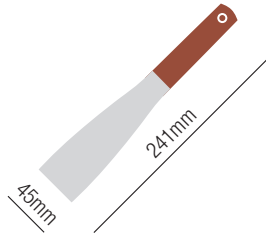

IKMT60

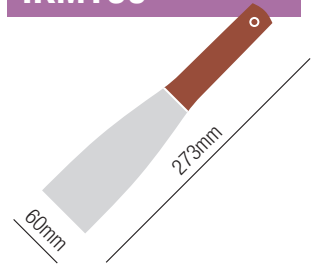

IKMT75

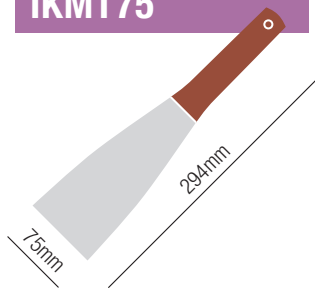

IKMT90

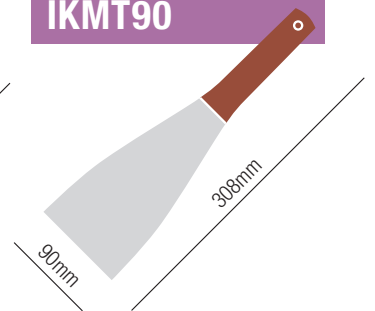

PLASTIC INK KNIVES

BB-P0141

4 knives/box
270 x 70mm

Yellow, red, blue
and black



REEL CUTTER

BB-P9225

Large wedge
245 x 95 mm



FLEXIBLE PLASTIC INK KNIVES

BB-P9142

White flexible plastic ink knife
300 x 80mm

Packing: 1 pc

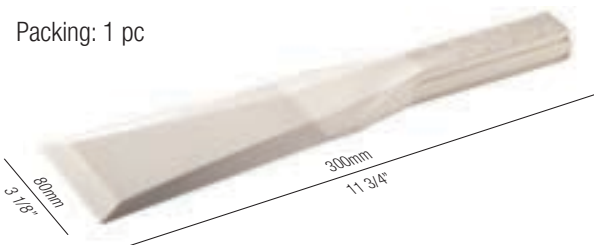

INK KEYS

IKL10

Ink Key Large
Ink key for standard vacuum
ink cans



IKS10

Ink Key Small
Ink key for Japanese and
small ink cans



VUERTECHNIK CPC SERVO MOTOR

BB-9425

Model: PM52/SM52/SM72/SM74/
CD74/SM102/CD102 and some MO
with CPC

Description: These servo motors control the ink zones in each printing unit on presses equipped with CPC

Packing: 1 piece/box – 10 boxes/carton

Like 12V 61.186.5311/03



12V

PAPER WEDGES

Manufactured with thin, smooth and extra strong lead edges, these paper wedges are easily inserted in paper stacks without damaging stock.

Made with finger sized holes for easy removal from the paper pile.

Three sizes available to suit various size presses from duplicators to large sheet fed presses.



PW3033

Baby wedge
100 x 33 x 29 mm



PW3030

Small wedge
200 x 30 x 30 mm



PW6030

Medium wedge
200 x 60 x 30 mm



PW7525

Large wedge
200 x 80 x 25 mm



DELETION/ADDITION PENS

Deletion Pens: Removes image quickly and safely on all positive and most negative plates.

BB-P9344 Deletion pen with fine tip

BB-P9345 Deletion pen with medium/large tip

CTP Deletion Pens: Only for thermal CTP plates and not for use with violet plates.

BB-P9346 CTP deletion pen with fine tip

BB-P9347 CTP deletion pen with medium/large tip



Addition Pens: Great touch up pens to fill in pin holes, repair broken solids and add image on all metal plates.

BB-P9348 Addition pen with fine tip

BB-P9349 Addition pen with medium/large tip

PERFORATING STRIPS

SCORE

The scoring rule with rounded edge produces a perfect fold on jobs like newsletters, folders, greeting cards and invitations.

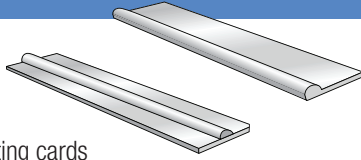

The rounded edge prevents surface cracking when scoring through stock with heavy solid ink coverage or coating.

SLIT

The sharp durable edge makes a clean, exact cut creating an opening for insertions or slits on cards. Can also be used to create sharp fold on heavier card.

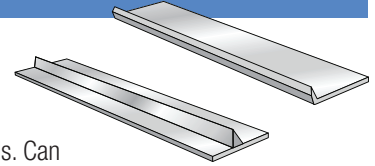

PERF

Excellent for reply cards, coupons, and tickets. Precise clean perforation which easily tears apart.

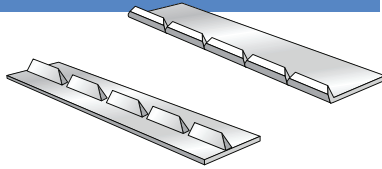

SNAP

Use for quick separation "snap apart" forms like cards, invoices, order forms, receipts etc. Available in 3 or 4 TPI.

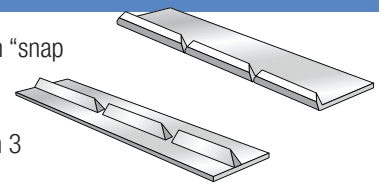

MICRO PERF

The tight 30, 40 & 50 TPI rule is ideal for continuous forms. When separated the perf line is clean and straight without rough edges.

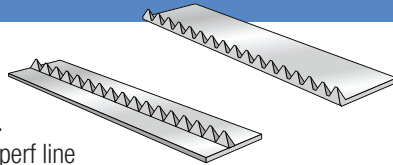

All Perf rules are supplied with a double sided adhesive tape on the bottom edge so the rules can be easily mounted both vertically and horizontally on the impression cylinder or on a carrier sheet.

FEATURES

Our perforating strips are manufactured from extremely durable heat treated steel and can be used repeatedly from short to long runs.

They are supplied with double sided tape so they can be applied directly onto the impression cylinder in either horizontal or vertical positions.

Also, they are designed for high volume sheet fed or web offset printing jobs.

Models	Rules for both Card & Paper	Models
Centre Perf	6 TPI 8 TPI 12TPI 16TPI	Side Perf
Centre Snap	3 TPI 4 TPI	Side Snap
Centre Micro-Perf	30 TPI 40 TPI 50 TPI	Side Micro-Perf
Centre Score		Side Score
Centre Slit		Side Slit

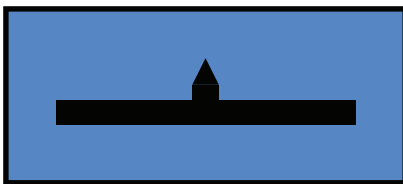

Centre rules are very stable - will not tilt or bend - and therefore excellent for high volume offset or web runs.



Side rules are designed for perfect corner and ends.

Available in lengths of both 3M/10ft and 6M/20ft. All sizes and models available are listed in our price list and more technical information can be supplied on request.

OFFSET RULE SIDE SERIES



Description	Part Number	
	10 ft roll (3.05 mtr)	20 ft roll (6.1 mtr)
LITHO-PERF		
6 Tooth PAPER	800	808
8 Tooth PAPER	802	810
12 Tooth PAPER	804	812
16 Tooth PAPER	806	814
6 Tooth CARD	801	809
8 Tooth CARD	803	811
12 Tooth CARD	805	813
16 Tooth CARD	807	815
MICRO-PERF		
30 Tooth PAPER & Lightweight card stocks	302	303
30 Tooth PAPER/CARD	300	301
30 Tooth PAPER/CARD (special high .029")	n/a	3001
40 Tooth PAPER/CARD	400	401
40 Tooth PAPER/CARD (special high .029")	n/a	4001
50 Tooth PAPER/CARD	500	501
LITHO-SCORE		
Standard Score PAPER	826	827
Standard Score CARD	826-3	827-3
LITHO-SNAP		
3 Tooth PAPER	820	821
4 Tooth PAPER	822	824
4 Tooth CARD	823	825
LITHO-SLIT		
Cut PAPER	828	830
Cut CARD	829	831
Straight Cut CARD	833	832

OFFSET RULE CENTRE SERIES



Description	Part Number	
	10 ft roll (3.05 mtr)	20 ft roll (6.1 mtr)
LITHO-PERF		
6 Tooth PAPER	600	608
8 Tooth PAPER	602	610
12 Tooth PAPER	604	612
16 Tooth PAPER	606	614
6 Tooth CARD	601	609
8 Tooth CARD	603	611
12 Tooth CARD	605	613
16 Tooth CARD	607	615
MICRO-PERF		
30 Tooth PAPER & Lightweight card stocks	302	303
LITHO-SCORE		
Standard Score PAPER	626	627
Standard Score CARD	626-1	627-2
LITHO-SCORE WideTrac		
Wide Score	626-3	627-3
LITHO-SLIT		
Cut PAPER	628	630
Cut CARD	629	631

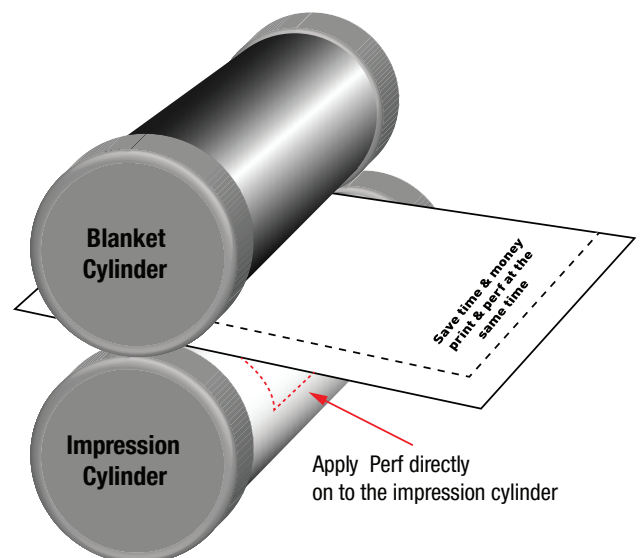

SLITTERS, SCORERS, PERFORATORS AND MICRO PERFORATORS

PERFORATING, SLIT & SCORE

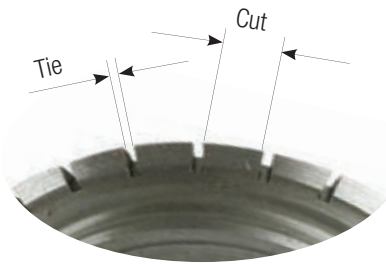

Standard ties are 0.8 mm and 1.0 mm. When ordering non standard perforators, please specify tie and cut widths

MICRO PERFING

25, 30, 40, 50, 60 and 72 TPI.



SCORING

Available as single or double scoring



STANDARD PERFING

2, 4, 6, 8, 10, 12, 14 and 16 TPI.

STANDARD TIES: 0.6, 0.8 & 1.0 mm (0.23", 0.32" & 0.40")



SLITTING

Standard bevels: 30°, 45°, 60° and 90°



W02

19 x 12 x 4 mm

Model: Grafix

Supplied with sealed bearing 12 x 4 mm

7 TPI – 3 mm cut x 0.6 mm tie



W21

25 x 13 x 5 mm

Model: Heidelberg Speedmaster

Supplied with sealed bearing 13 x 4 mm

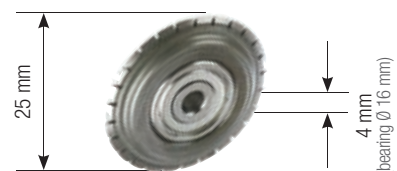

W22

30 x 12 x 4 mm

Model: Sakurai, Oliver

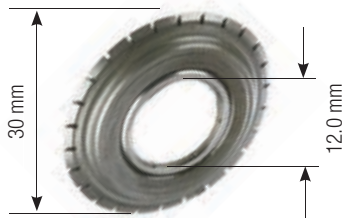

W01

30 x 16 x 5 mm

Model: Heidelberg GTO, MO

Supplied with sealed bearing 16 x 5mm

7 TPI – 3 mm cut x 0.6 mm tie

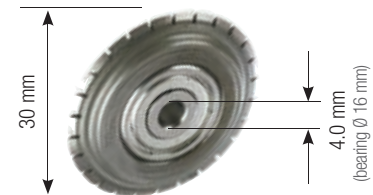

W11

30 x 16 x 5 mm

Model: Kopack

Supplied with sealed bearing 16 x 5 x 5mm

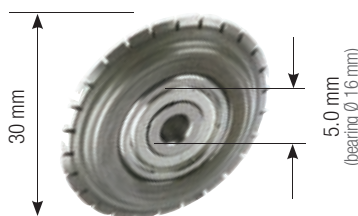

W26

31.75 x 15.8 x 5 mm (1.25" x 5/8" x .198")

Model: Digicon, Rotometrics

Supplied with sealed bearing 15.87 x 6.3 x 5mm

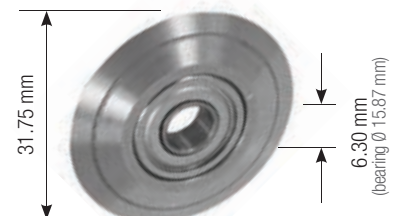

W09

40 x 13 x 4.85 mm
Model: Fuji



W03

40 x 19 x 6 mm
Model: Ryobi, Itek

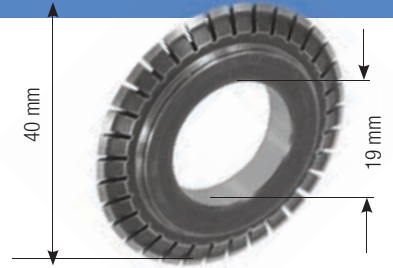

W06

50 x 22 x 7 mm
Model: Solna



W32

50 x 30 x 2.6 mm
Model: Dominant
 Supplied with sealed bearing 16 x 4 x 5 mm



W24

55 x 44 x 13 mm
Model: Heidelberg Quickmaster



W13

77 x 19 x 5.2 mm
Model: Dusenbury

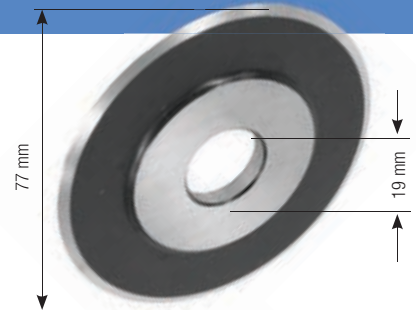

W14

77 x 19 x 6.35 mm
Model: Cameron Hunkeler

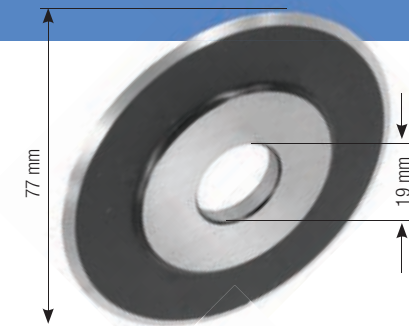

W15

77 x 22 x 6.2 mm
Model: Cameron Kidder

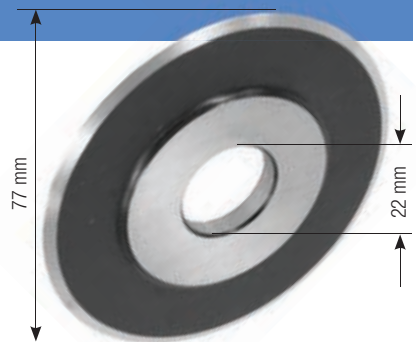

W34

76.2 x 24 x 5 mm
Model: Hunkeler

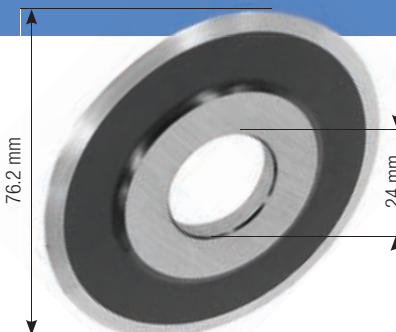

31904

57 x 31.75 x 13 mm
Model: Arpeco
 Holder for dished blade #OBN-64-2
(supplied complete except slitter blade)



31903

46.6 x 20 x 5 mm
(1.834" x .788" x .200")

Model: Bowe
Lower Blade



31902

46.6 x 20 x 5 mm
(1.834" x .788" x .200")

Model: Bowe
Upper Blade

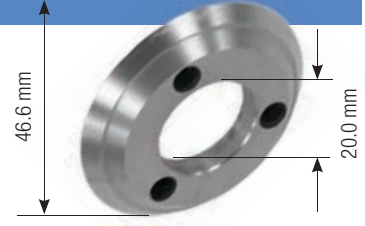

18801

64.8 x 38.7 x 3.2 mm
(2.55" x 1.52" x 1/8")

Model: Arpeco
Lower Blade



18420

64.7 x 38.7 x 3.2 mm
(2.549" x 1.52" x 1/8")

Model: Arpeco
Upper Blade

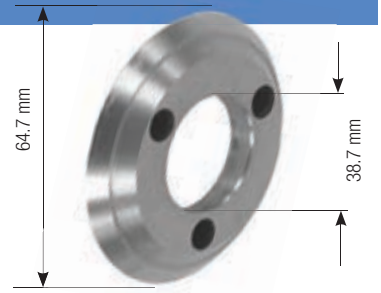

OBN-64-2

64.3 x 43.5 x 1.0 mm
Model: Arpeco

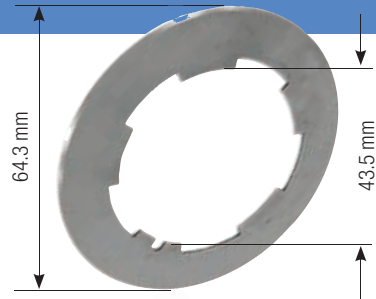

ON-64-2

64.3 x 40 x 1.0 mm
Model: Arpeco



31310

Inside dia.
31.75mm

Model: Arpeco
Holder for Lower
Blade # 18801

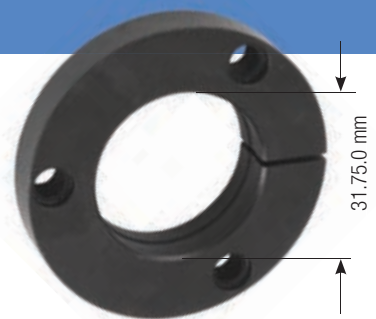

31311

Inside dia.
31.75mm

Model: Arpeco
Holder for Upper
Blade # 18420



Please call us for more information on circular blades and accessories.

Our "Converting" catalogue is available on request.

- Dished Slitters
- Bottom Knives (Anvils)
- Knife Holders
- Holder Accessories



RED ANTI-MARKING JACKETS

Marking on printed sheets is a common problem for all printers. The main cause is that during printing, ink builds up on the cylinders and later smears off on printed sheets. The result is down time, wasted paper, interrupted work flow and increased cost.

Over the years many products have been developed in an effort to eliminate this marking problem. Some are extremely expensive and some are less effective.

The Red Anti-marking Jacket was developed to offer the printer a highly effective yet very affordable and durable solution. The Red Anti-marking Jacket replaces all existing systems and is installed quickly and easily on transfer cylinders.

The Red Anti-marking Jacket are available with different fittings depending on the model and age of your Heidelberg press. These include clip-on for SM74 presses and loop fixing fo SM102 presses. Loop fittings are made of solvent resistant durable elastic material with controlled stretch for quick and easy installation.

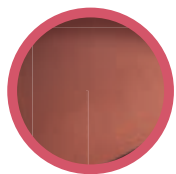

Solvent resistant adhesive between glass bead matrix and the extremely durable fabric backing.



Individual fittings according to your machine model.

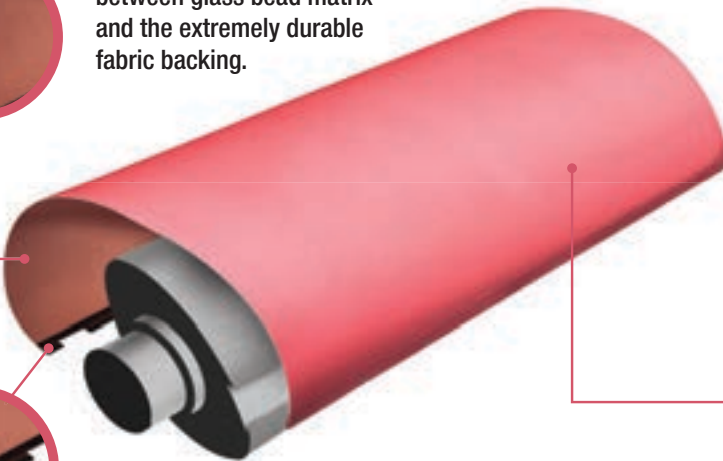

The Red Anti-Marking Jackets are offered with the traditional "fine" (smaller) glass beads but the "coarse" (larger) glass bead version is also increasingly popular especially with packaging printers. Let the printer decide!

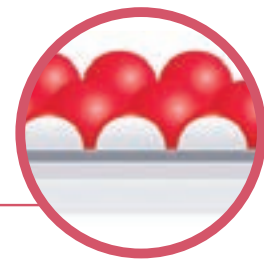

SM102 RIVET LOOP



Coarse code	Fine code	Model/description	Cylinder
AJCH102TRL	AJFH102TRL	SM102 774mm rivet-loop	Transfer (after 1993/4)

SM74 / PM74 CLAMP - EDGE



Coarse code	Fine code	Model/description	Cylinder
AJCH74T	AJFH74T	SM74 + PM74 577mm clamp-edge	Transfer (all models)

SM102 / SM72 LOOP-LOOP



Coarse code	Fine code	Model/description	Cylinder
AJCH102TLL	AJFH102TLL	SM102 770mm loop-loop	Transfer (before 1993/4)
AJCH102D705	AJFH102D705	SM102 705mm loop-loop	Delivery (before 1993/4)
AJCH72T645	AJFH72T645	SM102 645mm loop-loop	Transfer

M026/GT052 LOOP-EDGE



Coarse code	Fine code	Model/description	Cylinder
AJCHM026T561	AJFHM026T561	M026 561mm loop-edge	Transfer
AJCHGT052T413	AJFHGT052T413	GT052 413mm loop-edge	Transfer

SM52 EDGE-EDGE

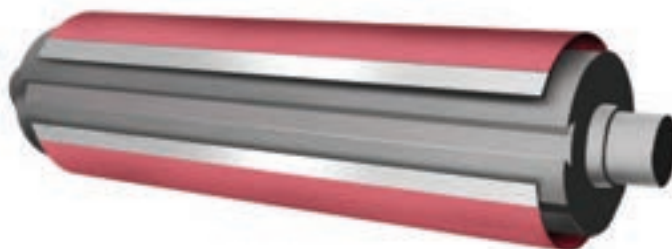

Coarse code	Fine code	Model/description	Cylinder
AJCH52T422	AJFH52T422	SM52 422mm edge-edge	Transfer
AJCH52T425	AJFH52T425	SM52 425mm edge-edge	Transfer

LIFTING SUCKER HEIDELBERG

BB-P9227

**Model: Heidelberg SM102/
MO/SORS/SORD/SORM**

Description: Lifting
sucker nozzle

Ø 25 x □ 25 x H 40 mm

Like C4.028.009/02



BB-P9228

**Model: Heidelberg SM102/
MO/SORS/SORD/SORM**

Description: Lifting
sucker nozzle

Ø 24.5 x □ 25 x H 37mm

Like 66.028.009/01



BB-P9357

**Model: Heidelberg
SM102/CD102**

Description: Lifting sucker
nozzle

Ø 25 x □ 29 x H 45mm

Like F2.028.280S/01



BB-P9358

**Model: Heidelberg
SM102/CD102**

Description: Lifting
sucker nozzle

Ø 25 x □ 29 x H 45mm

Like F2.028.267S/01



BB-P9359

**Model: Heidelberg SM102/
CD102**

Description: Lifting sucker
nozzle

Ø 24.5 x □ 25 x H 37mm

Like 66.028.809/01



BB-P9360

**Model: Heidelberg
SM102/CD102**

Description: Lifting sucker
nozzle

Ø 24.5 x □ 25 x H 36mm

Like 66.028.409/



BB-P9493

Model: Heidelberg SM52

Description: Lifting sucker

Like G2.028.0105



BB-P9513

Model: Heidelberg SM52

Description: Lifting sucker
with magnet

Like G2.028.010N



LIFTING SUCKER ROLAND

BB-P9514

Model: Roland Mabeg

Description: Lifting
sucker - paper

24 x 49 x 47mm



BB-P9515

Model: Roland Mabeg

Description: Lifting
sucker - cardboard

24 x 49 x 47mm



SUCTION DISCS

Ever increasing running speeds of todays sheet fed printing machines and collators demand the highest performance from the feeder system.

Birk & Blyme stocks a full range of flat rubber suckers for all types of machines. The range have been developed to offer a durable and consistent performance when used in sheet feeders. All flat suckers are colour coded which indicates thickness. Please refer to the table.

Key	Thickness	Material	Colour
A	0.5 mm (0.015")	Rubber	White
B	0.8 mm (0.032")	Rubber	Pink
C	1.0 mm (0.040")	Rubber	Tan
D	1.6 mm (0.062")	Rubber	Beige
E	2.0 mm (0.080")	Rubber	Green
F	0.8 mm (0.032")	Poly	Clear
*	1.0 & 1.5 mm	Silicone	Clear

HOW TO ORDER

Thickness Range (see top table) Part numbers

- A 99024
- B 99070
- C 99115
- D 99161
- E 99207
- F 99253

OD x ID

30.2 x 12.7 mm'
(1 3/16" x 1/2")

PRE-PACKED IN 25, 50 OR 100 PCS PER BAG!

- A 99001
- B 99047
- C 99092
- D 99138
- E 99184
- F 99230

12.7 x 1.6 mm
(1/2" x 1/16")

- A 99002
- B 99048
- C 99093
- D 99139
- E 99185
- F 99231

15.9 x 1.6 mm
(5/8" x 1/16")

- A 99003
- B 99049
- C 99094
- D 99140
- E 99186
- F 99232

15.9 x 3.2 mm
(5/8" x 1/8")

- A 99004
- B 99050
- C 99095
- D 99141
- E 99187
- F 99233

17.5 x 3.2 mm
(11/16" x 1/8")

- A 99006
- B 99052
- C 99097
- D 99143
- E 99189
- F 99235

19 x 1.6 x 1 mm
(3/4" x 1/16")

- A 99005
- B 99051
- C 99096
- D 99142
- E 99188
- F 99234

19 x 1.6 mm
(3/4" x 1/16")

- A 99007
- B 99053
- C 99098
- D 99144
- E 99190
- F 99236

19 x 4.8 mm
(3/4" x 3/16")

- A 99008
- B 99054
- C 99099
- D 99145
- E 99191
- F 99237

19 x 6.4 mm
(3/4" x 1/4")

- A 99009
- B 99055
- C 99100
- D 99146
- E 99192
- F 99238

20.6 x 4.8 mm
(12/16" x 3/16")

- A 99010
- B 99056
- C 99101
- D 99150
- E 99193
- F 99239

22.2 x 3.2 mm
(7/8" x 1/8")

- A 99011
- B 99057
- C 99102
- D 99147
- E 99194
- F 99240

22.2 x 4.8 mm
(7/8" x 3/16")

- A 99012
- B 99058
- C 99103
- D 99148
- E 99195
- F 99241

22.2 x 6.4 mm
(7/8" x 1/4")

- A 99013
- B 99059
- C 99104
- D 99149
- E 99196
- F 99242

23.8 x 9.5 mm
(15/16" x 3/8")

- A 99014
- B 99060
- C 99105
- D 99151
- E 99197
- F 99243

25.4 x 4.8 mm
(1" x 3/16")

- A 99015
- B 99061
- C 99106
- D 99152
- E 99198
- F 99244

25.4 x 6.4 mm
(1" x 1/4")

- A 99016
- B 99062
- C 99107
- D 99153
- E 99199
- F 99245

25.4 x 9.5 mm
(1" x 3/8")

- A 99017
- B 99063
- C 99108
- D 99154
- E 99200
- F 99246

27 x 3.2 mm
(1 1/16" x 1/8")

- A 99018
- B 99064
- C 99109
- D 99155
- E 99201
- F 99247

27 x 6.4 mm
(1 1/16" x 1/4")

- A 99019
- B 99065
- C 99110
- D 99156
- E 99202
- F 99248

27 x 9.5 mm
(1 1/16" x 3/8")

- A 99020
- B 99066
- C 99111
- D 99157
- E 99203
- F 99249

28.6 x 6.4 mm
(1 1/8" x 1/4")

- A 99021
- B 99067
- C 99112
- D 99158
- E 99204
- F 99250

28.6 x 12.7 mm
(1 1/8" x 1/2")

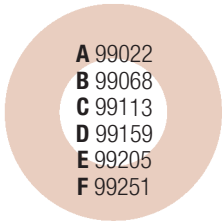

28.6 x 14.3 mm
(1 1/8" x 9/16")

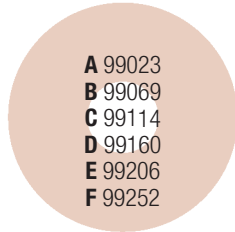

30.2 x 9.5 mm
(1 3/16" x 3/8")

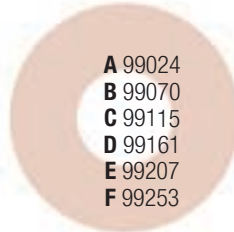

30.2 x 12.7 mm
(1 3/16" x 1/2 ")

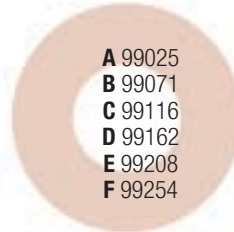

30.2 x 14.3 mm
(1 3/16" x 9/16")

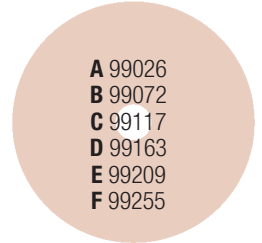

31.8 x 4.8 mm
(1 1/4" x 3/16")



31.8 x 9.5 mm
(1 1/4" x 3/8")



31.8 x 12.7 mm
(1 1/4" x 1/2")

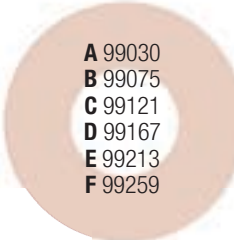

31.8 x 14.3 mm
(1 1/4" x 9/16 ")

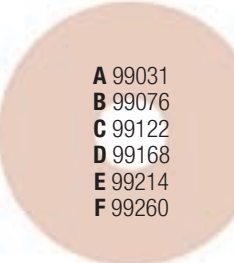

35 x 9.5 mm
(1 3/8" x 3/8")

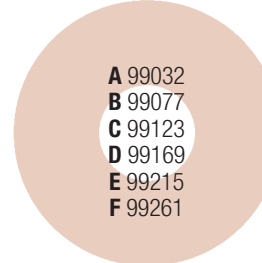

35 x 12.7 mm
(1 3/8" x 1/2")

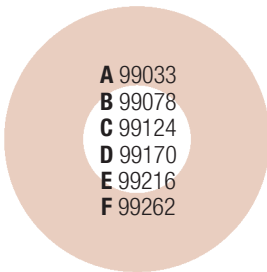

35 x 14.3 mm
(1 3/8" x 9/16")

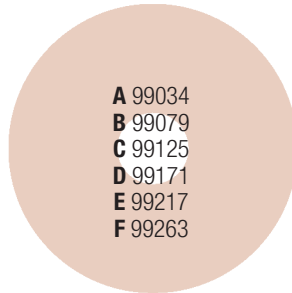

38.1 x 9.5 mm
(1 1/2" x 3/8")

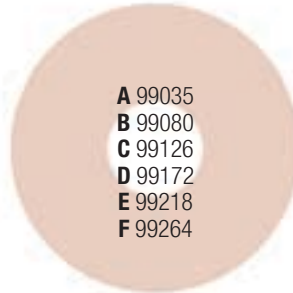

38.1 x 12.7 mm
(1 1/2" x 1/2")

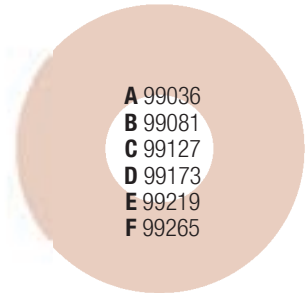

38.1 x 14.3 mm
(1 1/2" x 9/16")

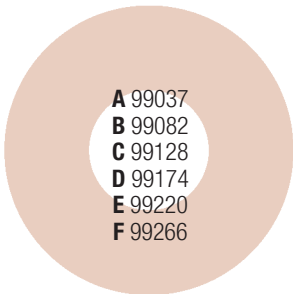

38.1 x 15.9mm
(1 1/2" x 5/8")

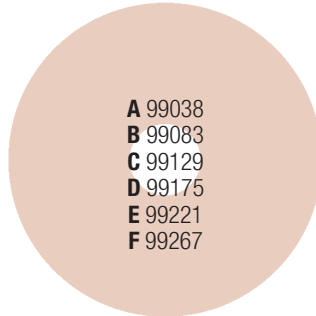

41.3 x 9.5 mm
(1 5/8" x 3/8")

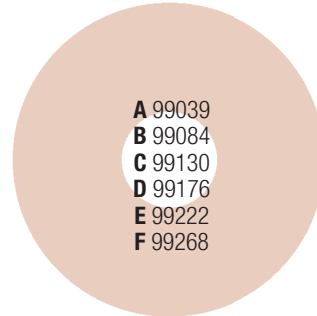

41.3 x 12.7 mm
(1 5/8" x 1/2")

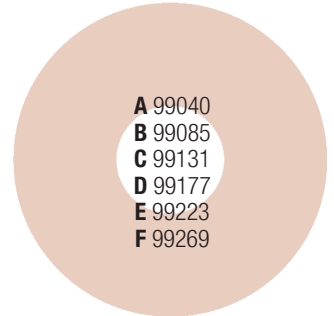

41.3 x 14.3 mm
(1 5/8" x 9/16")

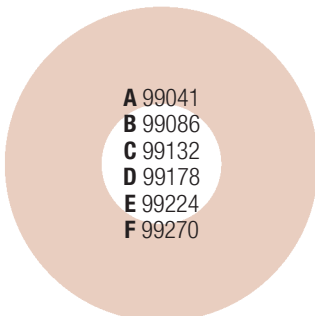

41.3 x 15.9 mm
(1 5/8" x 5/8")

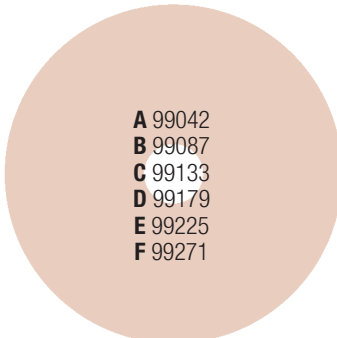

44.5 x 7.9 mm
(1 3/4" x 5/16")

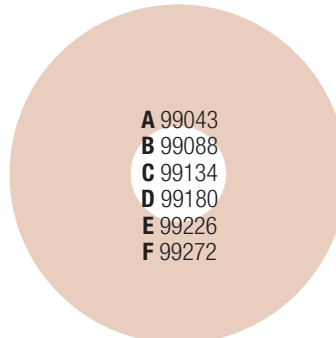

44.5 x 12.7 mm
(1 3/4" x 1/2")

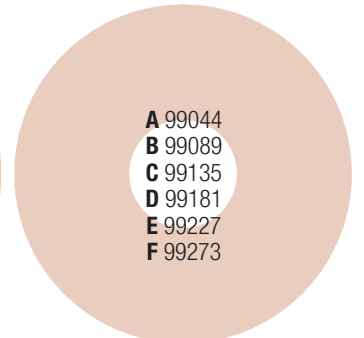

44.5 x 14.3 mm
(1 3/4" x 9/16")

BOBST FLAT SUCKERS - IN DURABLE SILICON

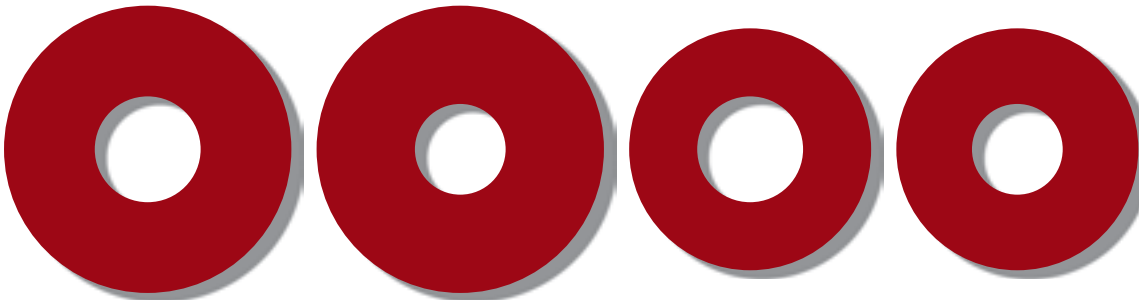

99127-SIL

99126-SIL

99121-SIL

99120-SIL

**QUICK
REFERENCE
GUIDE**

CODE	MATERIAL	COLOR	OUTSIDE		INSIDE		THICKNESS		PACKING
99127-SIL	Silicon	Red	38mm	1 1/2"	14mm	35/64"	1.0mm	3/64"	25 pcs/pack
99126-SIL	Silicon	Red	38mm	1 1/2"	12mm	15/32"	1.0mm	3/64"	25 pcs/pack
99121-SIL	Silicon	Red	32mm	1 1/4"	14mm	35/64"	1.0mm	3/64"	25 pcs/pack
99120-SIL	Silicon	Red	32mm	1 1/4"	12mm	15/32"	1.0mm	3/64"	25 pcs/pack

Refer to page 64 for Bobst shaped suction cups

KOMORI / RYOBI FLAT SUCKERS IN ORIGINAL COLORS

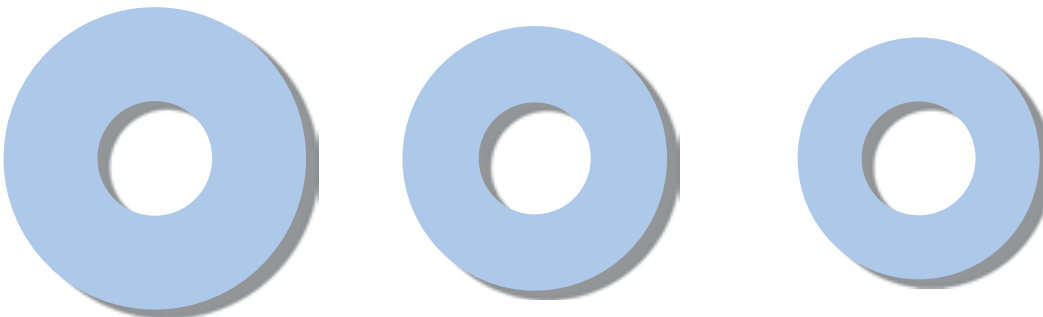

BB-P9535
Like 6ZZ-4015-10I

BB-P9338
Like 6ZZ-3515-10I

BB-P9398
Like 374-1693-400

**QUICK
REFERENCE
GUIDE**

***Popular with Ryobi**

CODE	MATERIAL	COLOR	OUTSIDE		INSIDE		THICKNESS		PACKING
BB-P9535 6ZZ-4015-10I	Natural Rubber	Blue	40mm	1 37/64"	15mm	19/32"	1.0mm	3/64"	25 pcs/pack
BB-P9536 6ZZ-4014-081	Natural Rubber	Blue	40mm	1 37/64"	14mm	35/64"	0.8mm	1/32"	25 pcs/pack
BB-P9537 6ZZ-4014-051	Natural Rubber	Blue	40mm	1 37/64"	14mm	35/64"	0.5mm	1/64"	25 pcs/pack
BB-P9399 444-1680-014	Natural Rubber	Blue	38mm	1 1/2"	15mm	19/32"	0.8mm	1/32"	25 pcs/pack
BB-P9590	Natural Rubber	Blue	38mm	1 1/2"	13mm	1/2"	0.8mm	1/32"	25 pcs/pack
BB-P9538 6ZZ-3515-10I	Natural Rubber	Blue	35mm	1 3/8"	15mm	19/32"	1.0mm	3/64"	25 pcs/pack
BB-P9539 444-1679-014	Natural Rubber	Blue	35mm	1 3/8"	15mm	19/32"	0.8mm	1/32"	25 pcs/pack
BB-P9541	Natural Rubber	Blue	35mm	1 3/8"	13mm	1/2"	0.8mm	1/32"	25 pcs/pack
BB-P9392 6ZZ-3414-081	Natural Rubber	Blue	34mm	1 11/32"	14mm	35/64"	0.8mm	1/32"	25 pcs/pack
BB-P9398 374-1693-400	Natural Rubber	Blue	32mm	1 1/4"	15mm	19/32"	0.8mm	1/32"	25 pcs/pack
BB-P9542 6ZZ-3212-081	Natural Rubber	Blue	32mm	1 1/4"	12mm	15/32"	0.8mm	1/32"	25 pcs/pack
BB-P9400 374-1676-400	Natural Rubber	Blue	32mm	1 1/4"	11mm	7/16"	0.8mm	1/32"	25 pcs/pack

HEIDELBERG, ROLAND, HAMADA AND SAKURAI

QUICK REFERENCE GUIDE

All flat rubber suckers for press models from these four manufacturers, are kept in their original colors and have special product codes for easy identification:



HEIDELBERG									
CODE	MATERIAL	COLOR	OUTSIDE		INSIDE		THICKNESS		PACKING
99126-RED	SILICON	Red	38mm	1 1/2"	13mm	1/2"	1.0mm	3/64"	25 pcs/pack
99080-RED	SILICON	Red	38mm	1 1/2"	13mm	1/2"	0.8mm	1/32"	25 pcs/pack
99035-RED	SILICON	Red	38mm	1 1/2"	13mm	1/2"	0.5mm	1/64"	25 pcs/pack
99120-RED	SILICON	Red	32mm	1 1/4"	13mm	1/2"	1.0mm	3/64"	25 pcs/pack
99074-RED 66.028.406/C	SILICON	Red	32mm	1 1/4"	13mm	1/2"	0.8mm	1/32"	25 pcs/pack
99029-RED	SILICON	Red	32mm	1 1/4"	13mm	1/2"	0.5mm	1/64"	25 pcs/pack
99126-CLEAR 66.028.404/B	"PER" Synthetic	Clear	38mm	1 1/2"	13mm	1/2"	1.0mm	3/64"	25 pcs/pack
99120-CLEAR	"PER" Synthetic	Clear	32mm	1 1/4"	13mm	1/2"	0.5mm	1/64"	25 pcs/pack
99161-CLEAR	"PER" Synthetic	Clear	30mm	1 3/16"	13mm	1/2"	1.5mm	1/16"	25 pcs/pack
99070-CLEAR	"PER" Synthetic	Clear	30mm	1 3/16"	13mm	1/2"	0.8mm	1/32"	25 pcs/pack
99059-YELLOW 89.028.401/01	"PER" Synthetic	Yellow	24mm	15/16"	10mm	3/8"	0.8mm	1/32"	25 pcs/pack
99126-GREY 66.028.402	Natural Rubber	Grey	38mm	1 1/2"	13mm	1/2"	1.0mm	3/64"	25 pcs/pack
99070-GREY 66.028.401	Natural Rubber	Grey	30mm	1 3/16"	13mm	1/2"	0.8mm	1/32"	25 pcs/pack
99244-RED	Natural Rubber	Red	26mm	1 1/32"	6mm	15/64"	2.0mm	5/64"	25 pcs/pack
99147-RED	Natural Rubber	Red	22mm	7/8"	5mm	3/16"	1.6mm	1/16"	25 pcs/pack
99193-WHITE	Natural Rubber	White	22mm	7/8"	3mm	1/8"	2.0mm	5/64"	25 pcs/pack
SAKURAI									
99059-RED	SILICON	Red	24mm	15/16"	9.8mm	25/64"	0.85mm	1/32"	25 pcs/pack
ROLAND									
99132-BLUE	Natural Rubber	Blue	42mm	1 21/32"	15mm	19/32"	1.0mm	3/64"	25 pcs/pack
99127-BLUE S99Z702195	Natural Rubber	Blue	38mm	1 1/2"	15mm	19/32"	1.0mm	3/64"	25 pcs/pack
99081-BLUE 090R600440	Natural Rubber	Blue	38mm	1 1/2"	15mm	19/32"	0.7mm	1/32"	25 pcs/pack
99124-BLUE 090R600340	Natural Rubber	Blue	35mm	1 3/8"	15mm	19/32"	1.0mm	3/64"	25 pcs/pack
99078-BLUE	Natural Rubber	Blue	35mm	1 3/8"	15mm	19/32"	0.7mm	1/32"	25 pcs/pack
99033-BLUE	Natural Rubber	Blue	35mm	1 3/8"	15mm	19/32"	0.5mm	1/64"	25 pcs/pack
99121-BLUE 090R600240	Natural Rubber	Blue	32mm	1 1/4"	15mm	19/32"	1.0mm	3/64"	25 pcs/pack
99075-BLUE	Natural Rubber	Blue	32mm	1 1/4"	15mm	19/32"	0.7mm	1/32"	25 pcs/pack

FLAT RUBBER SUCKERS

SUCTION DISCS AND CUPS

SUCTION CUPS

Extensive range in Rubber, Vinyl, Urethane and Silicone for equipment such as: **AB Dick, ATF Chief, Bobst, Bourg, Duplo, Ferag, Fuji, Hamada, Heidelberg, Horizon, Itek, MAN Roland, Komori, Phillipsburg, Ryobi, Sakurai, Solna and Shinohara** etc.

- Please call us for Suckers not listed.
- Extensive range available for most machines.
- Please refer to our "BINDERY CATALOGUE" for suckers used on bindery equipment.



24CHIEFL

Model: ATF Chief
 Colour: Beige
 OUT Ø 36 x IN Ø 17 x H 8mm

24CHIEFL

Model: ATF Chief
 Colour: Beige
 OUT Ø 30 x IN Ø 14 x H 6mm

BB-P9390

Model: Bobst
 Colour: Clear
 OUT Ø 46 x IN Ø 17 x H 9.5mm

BB-P9449

Model: Bobst
 Colour: Clear
 OUT Ø 41 x IN Ø 16 x H 14mm

0186-SIL

Model: Fuji-Shinohara
 Colour: Clear
 OUT Ø 25 x IN Ø 15 x H 6mm

BB-P9543

Model: Duplo
 Colour: Clear
 OUT Ø 20 x IN Ø 6 x H 10mm

104AMBER

Model: Duplo
 Colour: Natural
 OUT Ø 20 x IN Ø 3.5 x H 10mm

BB-P9389

Model: Heidelberg
 Colour: Red
 OUT Ø 28 x IN Ø 16 x H 3.6mm
 Like XL 105/XL 106
 Like F6. 582. 263

83

Model: Heidelberg
 Colour: Red
 OUT Ø 19 x IN Ø 7 x H 3mm
 Like 42.016.072

BB-P9544

Model: Heidelberg
 Colour: Black
 OUT Ø 21 x IN Ø 5 x H 4mm

BB-P9545

Model: Heidelberg
 Colour: Black
 OUT Ø 30.5 x IN Ø 5.5 x H 12mm
 Excellent for thin paper

99

Model: Heidelberg
 Colour: Black
 OUT Ø 16.5 x IN Ø 7 x H 7mm
 Like 42.016.073

BB-P9546

Model: Heidelberg, Komori
 Colour: Black
 OUT Ø 29 x IN Ø 7 x H 9mm
 Excellent for thin paper

BB-P9364

Model: Heidelberg
 Colour: Black
 OUT Ø 15.5 x IN Ø 4 x H 16.5mm
 Like A1.016.327/04

80

Model: Heidelberg
 Colour: Grey
OUT Ø 27 x IN Ø 17 x H 7mm
 Like SM52-G2.028.405



Ø 27mm

80-PPL

Model: Heidelberg, Komori & Roland
 Colour: Black
OUT Ø 28 x IN Ø 17 x H 6mm
 Like 66.028.405



Ø 28mm

92

Model: Heidelberg
 Colour: Grey
OUT Ø 15.5 x IN Ø 5 x H 31mm



BB-P9165

Model: Heidelberg
 Colour: Red
OUT Ø 23 x IN Ø 12 x H 3.5mm
 Like CD74
 Like F3.582.263/



BB-P9450

Model: Heidelberg
 Colour: Natural
OUT Ø 31 x IN Ø 16 x H 14mm
 Like 00.580.6723/02



BB-P9351

Model: Komori
 Colour: Black
OUT Ø 28 x IN Ø 16 x H 8mm
 Like 444-1682-004



BB-P9421

Model: Komori
 Colour: Black
OUT Ø 26 x IN Ø 9 x H 8mm
 L28/L29/LSX29
 Like 294-1612-400



BB-P9547

Model: Komori
 Colour: Black
OUT Ø 24 x IN Ø 6 x H 8mm



BB-P9548

Model: Roland
 Colour: Beige
OUT Ø 26 x IN Ø 7 x H 9mm



BB-P9549

Model: Roland
 Colour: Beige
OUT Ø 25 x IN Ø 10 x H 24.5mm



BB-P9550

Model: Roland
 Colour: Beige
OUT Ø 27 x IN Ø 10 x H 25mm



BB-P9551

Model: Roland
 Colour: Beige
OUT Ø 31 x IN Ø 10 x H 25mm



BB-P9426

Model: Roland
 Colour: Beige
OUT Ø 35 x IN Ø 10 x H 27mm
 Hard



BB-P9552

Model: Roland
 Colour: Yellow
OUT Ø 35 x IN Ø 10 x H 27mm
 Soft



BB-P9553

Model: Roland
 Colour: Beige
OUT Ø 39 x IN Ø 16 x H 49mm



BB-P9554

Model: Roland
 Colour: Natural
OUT Ø 30.5 x IN Ø 15.5 x H 15.5mm
 Standard



BB-P9555

Model: Roland
 Colour: Blue
OUT Ø 30.5 x IN Ø 15.5 x H 15.5mm
 Hard
 Like 021F013230



109

Model: Phillipsburg
 Colour: Blue
OUT Ø 18 x IN Ø 3 x H 13mm



82

Model: Ryobi
 Colour: Beige
OUT Ø 16 x IN Ø 4 x H 4.5mm



PLEASE CONTACT US FOR SUCTION CUPS FOR BINDERY EQUIPMENT!

82 BLUE

Model: Ryobi
 Colour: Blue
OUT Ø 18 x IN Ø 3 x H 4mm

BB-P9414

Model: Ryobi
 Colour: Natural
OUT Ø 22 x IN Ø 6 x H 22mm

BB-P9415

Model: Ryobi
 Colour: Red
OUT Ø 19 x IN Ø 6.5 x H 24mm

BB-P9396

Model: Ryobi
 Colour: Clear
OUT Ø 22.5 x IN Ø 6.2 x H 20.5mm

BB-P9424

Model: Ryobi
 Colour: Clear
OUT Ø 19 x IN Ø 6.5 x H 20mm

0198

Model: Sakurai
 Colour: Red
OUT Ø 28 x IN Ø 16 x H 9mm
 Now extra durable

RVC2E-A

Model: Plate Sucker (Festo)

630A

Model: Ferag
 Colour: Blue
OUT Ø 19.1 x IN Ø 4.8 x H 6.4mm

630B

Model: Ferag
 Colour: Blue
OUT Ø 19.1 x IN Ø 6.4 x H 6.4mm

630C

Model: Ferag
 Colour: Blue
OUT Ø 25.4 x IN Ø 6.4 x H 6.4mm

RVCB15

Model: Ferag
 Colour: Blue
OUT Ø 15.5 x IN Ø 3.6 x H 20.6mm

RVCB10-3

Model: Ferag, Kolbus
 Colour: Blue
OUT Ø 10.9 x IN Ø 3.8 x H 16.3mm

F20

Model: Ferag
 Colour: Black
OUT Ø 22 x IN Ø 5 x H 8mm

B20

Model: Ferag
 Colour: Black
OUT Ø 21 x IN Ø 5 x H 20mm

370685

Model: Ferag
 Colour: Natural
OUT Ø 20 x IN Ø 5.5 x H 7mm

RVCB20P

Model: Ferag
 Colour: Blue
OUT Ø 22 x IN Ø 7.1 x H 19.1mm

BB-P2396

Model: Ferag
 Colour: Natural
OUT Ø 29 x H 10mm

7200

Model: Various
 Colour: Black
OUT Ø 19.1 x IN Ø 3.8 x H 19.1mm

9200

Model: Various
 Colour: Black
OUT Ø 13 x IN Ø 3.5 x H 14.5mm

9200POLY

Model: Various
 Colour: Blue
OUT Ø 14.2 x IN Ø 3.8 x H 14.2mm

PLATE HANGER SUCKER

BB-0633

Model: Komori

Description: Plate hanger sucker

Packing: 10 pcs/bag



SUCKER KBA

BB-P9529

Model: KBA

Description: KBA (Strecksauger)

Sucker for perfecting cylinders

Packing: 16 pieces/bag



PLATE GRABBERS

Model	Lift capacity*	Diameter
Miss	5 lbs	2.12"
Mrs	8 lbs	2.62"
Mr	10 lbs	3.25"
Super	25 lbs	4.75"

* Based on vertical lift, surface must be non-porous

- No pump required
- High holding power
- Release button
- Easy use
- Available in 4 different sizes

SUPER GRABBER



MR GRABBER



MRS GRABBER



MISS GRABBER



VACUUM CUPS FOR PACKAGING AND MORE...

We supply vacuum cups for many different packaging machines, robotics, parts handling and other industrial handling machinery. We have over 1000 different vacuum cups, with a variety of fittings and styles. We supply cups in rubber, vinyl, silicone, polyurethane, neoprene, and other materials.



- Canning, Box Making
- Cartoning & Bagging
- Filling & Sealing, Capping
- Pick and Place Machinery
- Labeling, Automation
- Tray Making

Please send a sample for us to identify your vacuum cup. Write, phone, fax, or email for our complete printed catalogues.

CYLINDER JACKETS

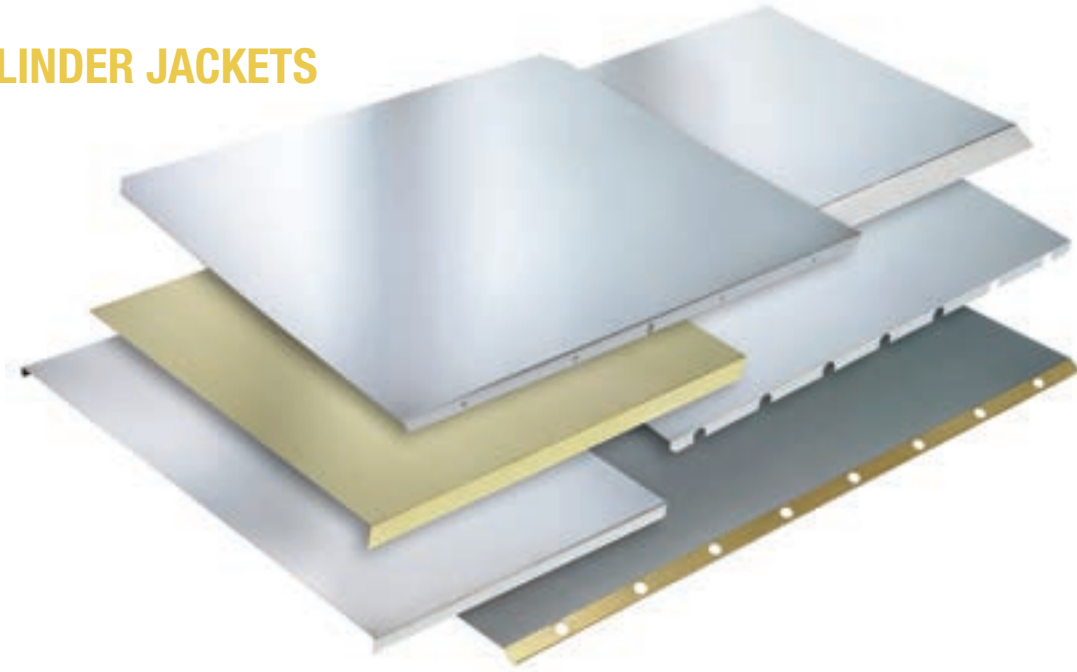

Model	Dimensions in mm			Material / Part #	
	Length	Width	Thickness	Steel	Brass
GT0 46	320	460	0.3	BB-P9307	BB-P9307BR
GT0 52	360	520	0.3	BB-P9308	BB-P9308BR
MO	480	650	0.3	BB-P9309	BB-P9309BR
SM52	360	520	0.3	BB-P9310	BB-P9310BR
SM72	520	720	0.3	BB-P9311	BB-P9311BR
SM74/PM74	520	740	0.3	BB-P9312	n/a
CD74	620	740	0.3	BB-P9326	n/a
QM46	320	460	0.3	BB-P9313	BB-P9313BR
SM102	720	1020	0.3	BB-P9325	n/a
Sakurai 6 (Oliver)	385	485	0.3	BB-P9323	n/a
Sakurai 52	515	580	0.3	BB-P9324	n/a
Ryobi/Itek 3200	473	340	0.3	BB-P9316	n/a
Ryobi 480	413	483	0.3	BB-P9319	n/a
Ryobi 500k-KP	362	482	0.3	BB-P9320	n/a
Ryobi 520	415	522	0.3	BB-P9321	n/a
Ryobi 522	395	523	0.3	BB-P9322	n/a
Praktika 00 (45 dgr lip)	510	417	0.3	BB-P9318	n/a
Praktika 00 (90 dgr lip)	510	400	0.3	BB-P9317	n/a
Fuji 52	408	525	0.3	BB-P9314	n/a
Fuji 65/66 IIP	524	666	0.3	BB-P9315	n/a
KBA 104	720	1020	0.3	BB-P9327	n/a
Komori Sprint 26	513	674	0.3	BB-P9353	n/a
Komori Sprint 28	605	733	0.5	BB-P9354	n/a

DIE CUTTING JACKETS



Part #	Model	Dimensions in mm		
		Length	Width	Thickness
BB-P9291	KOR	570	400	0.5
BB-P9292	KORA 57	570	460	0.5
BB-P9293	KORD 62	620	460	0.5
BB-P9294	KORD 64	640	460	0.5
BB-P9295	KORS 72	720	520	0.5
BB-P9296	KS	520	380	0.7
BB-P9297	KSB (standard)	570	400	0.7
BB-P9298	KSBZ (special)	585	400	0.7
BB-P9299	KSBA (standard)	585	460	0.7
BB-P9300	KSBAZ (special)	570	460	0.7
BB-P9301	KSD	640	460	0.7
BB-P9302	S (OHZ)	720	540	0.7
BB-P9303	SB-SBG	770	560	0.7
BB-P9304	SBG	770	540	0.7
BB-P9305	SBB	820	570	0.8
BB-P9306	SBD	900	640	0.8

Are you unable to find your size Cylinder Jacket?

Please contact us. Other sizes are available on request.

KRIS N.E.K. MATRIX

Easy to remove
 Reduces makeready time
 Kris is the first manufacturer of
 creasing matrix to introduce the
 "fingerlift" system.

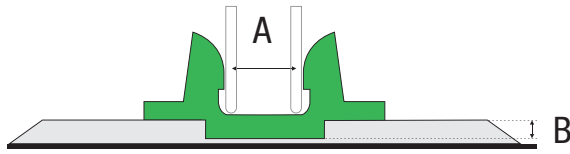

ASK US
 ABOUT THE
 COMPLETE RANGE
 AND STYLES OF
 MATRIX AND
 TOOLS

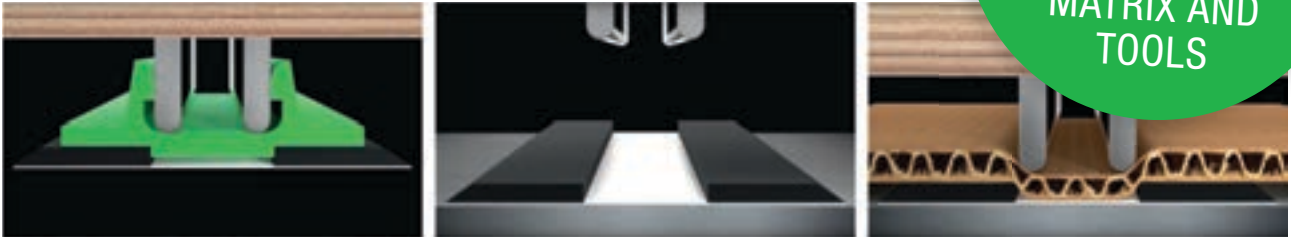

Part #	Dims	Pack	Part #	Part #
Standard	A mm B	m	offcentre	mini
PINK				
K0804	0.8 X 0.4	50	KS0804	KM0804
K0805	0.8 X 0.5	50	KS0805	KM0805
K0806	0.8 X 0.6	50	KS0806	KM0806
ORANGE				
K1204	1.2 X 0.4	50	KS1204	KM1204
K1205	1.2 X 0.5	50	KS1205	KM1205
K1206	1.2 X 0.6	50	KS1206	KM1206
SAND				
K1404	1.4 X 0.4	50	KS1404	KM1404
K1405	1.4 X 0.5	50	KS1405	KM1405
K1406	1.4 X 0.6	50	KS1406	KM1406
RED				
K1604	1.6 X 0.4	50	KS1604	KM1604
K1605	1.6 X 0.5	50	KS1605	KM1605
K1606	1.6 X 0.6	50	KS1606	KM1606

Part #	Dims	Pack	Part #	Part #
Standard	A mm B	m	offcentre	mini
WHITE				
K1304	1.3 X 0.4	50	KS1304	KM1304
K1305	1.3 X 0.5	50	KS1305	KM1305
K1306	1.3 X 0.6	50	KS1306	KM1306
GREY				
K1004	1.0 X 0.4	50	KS1004	KM1004
K1005	1.0 X 0.5	50	KS1005	KM1005
K1006	1.0 X 0.6	50	KS1006	KM1006
BLUE				
K1504	1.5 X 0.4	50	KS1504	KM1504
K1505	1.5 X 0.5	50	KS1505	KM1505
K1506	1.5 X 0.6	50	KS1506	KM1506
YELLOW				
K1704	1.7 X 0.4	50	KS1704	KM1704
K1705	1.7 X 0.5	50	KS1705	KM1705
K1706	1.7 X 0.6	50	KS1706	KM1706

ACCESSORIES

V2500

50 mm Quoins



V2212

Quoins key



V2300

Quoins screw



V2250

Quoins wedge



PAPER CUTTING KNIVES

Compare our quality and prices for value! We supply a range of high quality paper cutting knives imported from Germany's two leading knife manufacturers, **Schönenberger** and **Fassco**. Knives are available to suit both guillotines and three knife trimmers for all makes and models including: *Müller Martini, Polar, Sheridan, Wohlenberg, Harris Macey, Kolbus, McCain, Schneider, Heidelberg/Stahl, Osako and more!

STEEL QUALITIES

We offer the following selection of knife grades, so you can choose the right knife for your requirements.

STANDARD INLAID TOOL STEEL - F-220 (52/100)

The quality of the hardened cutting steel is well proven and suitable for universal use.

HIGH CARBON/HIGH CHROME - F-236 (12% Chromium, D2)

Widely used for lower knives in three knife trimmers. Out performs standard steel 2:1

HIGH SPEED STEEL HSS (18% Tungsten, M2)

Designed to be more abrasion resistant. This knife will reduce down-time with approx 3-5 times longer life than Tool Steel F-220.

TCT Tungsten Carbide Tipped

Well known quality with high wear resistance. Out performs F-3000 up to 3 times.

LOGLIFE Super Fine Grain Tungsten

For applications wher knife changes must be avoided as long as possible. Approx 2 times longer life than standard TCT knives.

MEGALIFE Super-Micro Fine Grain Tungsten

Improved cutting quality with less dust. Reduced tendency of cutting edge breaking. Approximately 6 times longer life than standard TCT knives.



SAVE ON
OEM
QUALITY
KNIVES



All Guillotine knives longer than 700 mm are supplied in a solid timber box for extra protection and safety

KNIFE GUARDS

For 3 Knife Trimmers & Guillotines

- Great protection while transporting knives
- Adds protection while servicing machine
- Magnetic strip holds guard firmly in place
- All plastic construction from yellow uPVC

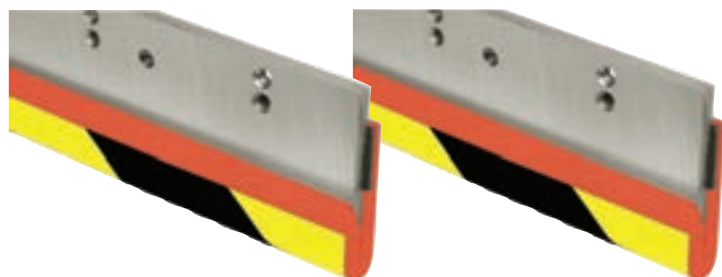

CUTTING STICKS

Our premium quality imported cutting sticks will extend knife life and reduce machine downtime.

Do NOT compromise your knives with poor quality cutting sticks.

AVAILABILITY

Cuttings sticks are available for most Guillotines and Trimmers including: *Polar, Wohlenberg, Itoh, Ideal, Horizon, Schneider, Sheridan, Müller Martini, Kolbus, Perfecta and many more.



COMMONLY STOCKED SIZES

Part #	Fits machine	Colour / type	Length	Square
CS-POL-92R	Polar 92, Perfecta	Red wavy	930	10 x 4.5 mm
CS-POL-92G	Polar 92, Perfecta	Grey wavy	930	10 x 4.5 mm
CS-POL-115R	Polar 115, Perfecta	Red wavy	1160	10 x 4.5 mm
CS-POL-115G	Polar 115, Perfecta	Grey wavy	1160	10 x 4.5 mm
CS-POL-137R	Polar 137, Perfecta	Red wavy	1380	10 x 4.5 mm
CS-POL-137G	Polar 137, Perfecta	Grey wavy	1380	10 x 4.5 mm
CS-WOL-92R	Wohlenberg 92, Schneider	Red wavy	930	10 x 4 mm
CS-WOL-92G	Wohlenberg 92, Schneider	Grey wavy	930	10 x 4 mm
CS-WOL-115R	Wohlenberg 115, Schneider	Red wavy	1159	10 x 4 mm
CS-WOL-115G	Wohlenberg 115, Schneider	Grey wavy	1159	10 x 4 mm
CS-WOL-137R	Wohlenberg 137, Schneider	Red wavy	1380	10 x 4 mm
CS-WOL-137G	Wohlenberg 137, Schneider	Grey wavy	1380	10 x 4 mm
CS-ITOH-1193R	Itoh 115	Red straight	1193	15.9 x 15.9 mm
CS-IDEAL-570	Ideal 4700 / 4810 / 4850	Red straight	570	14 x 14 mm
CS-IDEAL-885	Ideal 7228	Red straight	885	14 x 14 mm
CS-298-WHITE	Horizon HT 70	White	298	15 x 7 mm
CS-335-WHITE	Horizon HT 70	White	335	12 x 12 mm
CS-1000-WHITE	Muller Martini, Kolbus	White straight	1000	10 x 10 mm
CS-1000-GREY	Muller Martini, Kolbus	Grey straight	1000	10 x 10 mm
CS-1050-GREY	Wohlenberg	Grey straight	1050	24 x 4 mm

**All other sizes available on request*



BOOK HOLD DOWN/GUIDES

Book Guides is an essential tool to assure an even cut when trimming books on a guillotine.

Attaches to the back gauge and compress the spine of the books to assure a quality cut.

47 C-SHAPE



CH5-7-M361



ANGLE GUIDES

Angle Guides for printers that need to cut corners, this is the right little tool.

- Cuts on any angle from 0-170°
- Slides and locks onto back gauge

BBS39

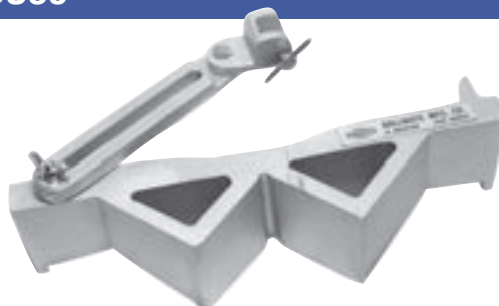

JOGGER BLOCKS



Jogger Blocks are made from tough, durable HDPE plastic and come with a Tufnell wear strip ensuring bottom sheet accuracy is maintained throughout the jogger blocks long working life.

Each jogger block is equipped with a magnetic strip in the base to help jog bottom sheets perfectly.

All medium and large jogger blocks are supplied with the "pistol grip" handle for comfortable long term use.

Part #	Description
JB100x200	Plastic 100 x 200 mm
JB100x250	Plastic 100 x 250 mm
JB100x300	Plastic 100 x 300 mm
JB125x250	Plastic 125 x 250 mm
JB125x300	Plastic 125 x 300 mm
JB125x400	Plastic 125 x 400 mm
JB125x450	Plastic 125 x 450 mm
JB150x300	Plastic 150 x 300 mm
JB150x400	Plastic 150 x 400 mm
JB150x450	Plastic 150 x 450 mm
JB150x600	Plastic 150 x 600 mm
JB150x650	Plastic 150 x 650 mm

MAG PADS

For just a few dollars you can put the Mag Pad to work protecting your delicate paper stocks from cutter clamp marks and damage. The durable magnetic rubber surface on one side holds the pad securely in position on the clamp while cutting. The high density foam pad prevents sharp edges of the clamp fingers from marking stock.

Pack includes two (2) 3" x 15" pads.

Part # MAGPAD

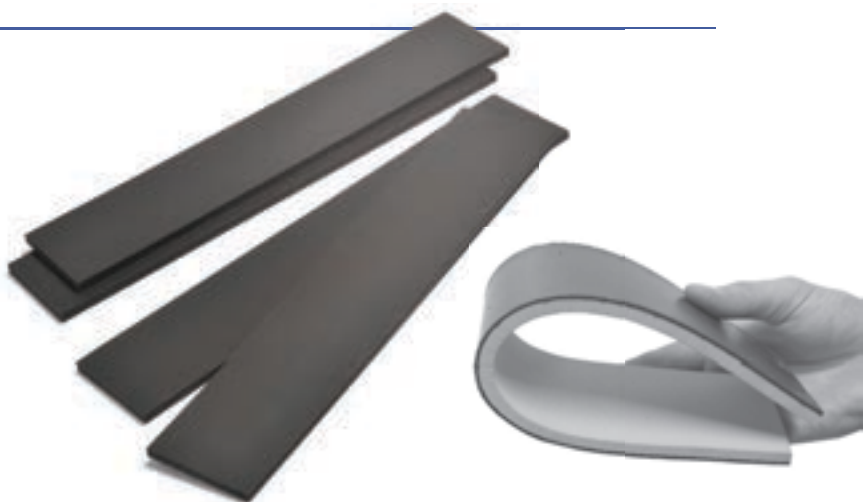

PAPER DRILLS

Paper Drills, Baseboards and sharpening tools to suit Lihit, Sterling, Uchida, Iram, Citoborma, Hang etc.

TEFLON COATED

Teflon Coated drills are available in many sizes. Provide lubricity to the inside and outside of your drills. Slugs flow smoothly without binding. Friction is reduced to increase the wear life of the cutting edge. This is a very good coating for keeping slugs from building up and breaking the drills. Works better on varnished or laminated stock.



HOW TO ORDER

EXAMPLE

Lihit Drill, 6.5 mm hole

PART NUMBER

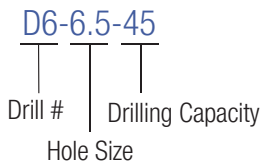

DRILL DIAMETERS CONVERSION TABLE

1/8" (3mm)	5/32" (4mm)	3/16" (4.7mm)	7/32" (5.4mm)	1/4" (6.4mm)	9/32" (7mm)	5/16" (8mm)
11/32" (8.7mm)	3/8" (9mm)	13/32" (10.3mm)	7/16" (11mm)	1/2" (12.3mm)	9/16" (14mm)	

D1



UCHIDA VS10 & VS15

Head Dia. 11 mm - Overall Length 65 mm

Hole Size	Drilling Capacity	Part #
3.0 mm	30 mm	D1-3-30
4.0 mm	30 mm	D1-4-30
5.0 mm	30 mm	D1-5-30
6.0 mm	30 mm	D1-6-30

D2



UCHIDA VS25, VS55 & VS200, CITOBORMA, STAGO, HANG, CORTA ETC.

Head Dia. 16 mm - Overall Length 65 mm

Hole Size	Drilling Capacity	Part #
10.0 mm	50 mm	D2-10-50
11.0 mm	50 mm	D2-11-50
12.0 mm	50 mm	D2-12-50
13.0mm	50 mm	D2-13-50

D3



UCHIDA VS25, VS55 & VS200, CITOBORMA, STAGO, HANG, CORTA ETC.

Head Dia. 11 mm - Overall Length 85 mm

Hole Size	Drilling Capacity	Part #
3.0 mm	30 mm	D3-3-30
4.0 mm	40 mm	D3-4-40
5.0 mm	50 mm	D3-5-50
5.5 mm	50 mm	D3-5.5-50
6.0 mm	50 mm	D3-6-50
<i>As above - *Teflon Coated</i>		
6.5 mm	50 mm	D3-6.5-50
7.0 mm	50 mm	D3-7-50
8.0 mm	50 mm	D3-8-50
9.0 mm	50 mm	D3-9-50

D4



LIHIT 2001

Head Conical- Overall Length 53 mm

Hole Size	Drilling Capacity	Part #
4.0 mm	26 mm	D4-4-26
5.0 mm	26 mm	D4-5-26
6.0 mm	26 mm	D4-6-26
6.5 mm	26 mm	D4-6.5-26

D5



LIHIT 2003

Head Conical- Overall Length 60 mm

Hole Size	Drilling Capacity	Part #
6.5 mm	32 mm	D5-6.5-32

D6



LIHIT 1013 & 1015

Head Conical - Overall Length 80 mm

Hole Size	Drilling Capacity	Part #
3.0 mm	25 mm	D6-3-25
4.0 mm	55 mm	D6-4-55
5.0 mm	55 mm	D6-5-55
6.0 mm	55 mm	D6-6-55
6.5 mm	55 mm	D6-6.5-55
7.0 mm	55 mm	D6-7-55
8.0 mm	55 mm	D6-8-55

D7



STERLING, CUSTOM, PDC, IRAM ETC.

Screw in type head

Hole Size	Drilling Capacity	Part #
1/8"	20 mm	D7-1/8-20
5/32"	25 mm	D7-5/32-25
3/16"	30 mm	D7-3/16-30
7/32"	35 mm	D7-7/32-35
1/4"	50 mm	D7-1/4-50
9/32"	50 mm	D7-9/32-50
5/16"	50 mm	D7-5/16-50
3/8"	50 mm	D7-3/8-50
7/16"	50 mm	D7-7/16-50

CAN'T FIND YOUR DRILL?

Please call us with details and we can quote you. These pages are for guidance only and does not include all available drills.

D8



IRAM, CITOBORMA, HANG, NAGEL, UCHIDA, CORTA ETC.

Head Dia. 11 mm - Overall Length 100 mm

Hole Size	Drilling Capacity	Part #
3.0 mm*	30 mm	D8-3-30
4.0 mm	65 mm	D8-4-65
5.0 mm	65 mm	D8-5-65
6.0 mm	65 mm	D8-6-65
As above - *Teflon Coated		
7.0 mm	65 mm	D8-7-65
8.0 mm	65 mm	D8-8-65
9.0 mm	65 mm	D8-9-65
10.0 mm	65 mm	D8-10-65

* Overall length 75 mm

D9



CHALLENGE

Head Conical - Teflon Coated

Hole Size	Drilling Capacity	Part #
1/8"	32 mm	D9-1/8-32
5/32"	45 mm	D9-5/32-45
3/16"	45 mm	D9-3/16-45
7/32"	*64 mm	D9-7/32-64
1/4"	*64 mm	D9-1/4-64
9/32"	*64 mm	D9-9/32-64
5/16"	*64 mm	D9-5/16-64
3/8"	*64 mm	D9-3/8-64
13/32"	*64 mm	D9-13/32-64
1/2"	*64 mm	D9-1/2-64

* available on request in 54 mm and 76 mm capacity

D10



DEXTER - LAWSON

Overall length 3", 3.5" and 4"

Hole Size	Drilling Capacity	Part #
1/8"	32 mm	D10-1/8-32
5/32"	45 mm	D10-5/32-45
3/16"	45 mm	D10-3/16-45
7/32"	^a 64 mm	D10-7/32-64
1/4"	^a 64 mm	D10-1/4-64
9/32"	^a 64 mm	D10-9/32-64
5/16"	^a 64 mm	D10-5/16-64
3/8"	^a 64 mm	D10-3/8-64
13/32"	^a 64 mm	D10-13/32-64
1/2"	^a 64 mm	D10-1/2-64

^a available on request in 50 mm and 76 mm capacity

D11

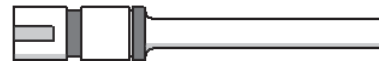

LAWSON

Overall length 3.5"

Hole Size	Drilling Capacity	Part #
1/8"	32 mm	D11-1/8-32
5/32"	45 mm	D11-5/32-45
3/16"	45 mm	D11-3/16-45
7/32"	^o 64 mm	D11-7/32-64
1/4"	^o 64 mm	D11-1/4-64
9/32"	^o 64 mm	D11-9/32-64
5/16"	^o 64 mm	D11-5/16-64
3/8"	^o 64 mm	D11-3/8-64
13/32"	^o 64 mm	D11-13/32-64
1/2"	^o 64 mm	D11-1/2-64

^o available on request in 54 mm, 76 mm and 88 mm capacity

CAN'T FIND YOUR DRILL?

Please call us with details and we can quote you. These pages are for guidance only and does not include all available drills.

PAPER DRILL SHARPENERS – HAND HELD TOOLS

SHP-AM-01

Model: ALL types of Drill Bits
 All metal
 Replacement Tips **SHP-AM-RP**



SHP-AM-01

Model: D1, D3, D7, D8 & D9 Drill Bits
 All metal
 Replacement Tips **SHP-STL-RP**



BASEBOARDS



Part #	Description
BB-UCH-15-25	Uchida VS-15 & VS-25. PK of 5
BB-UCH-55	Uchida VS-55. PK of 5
BB-IRAM	Iram 1300 x 25 x 5 mm
BB-LIH-01-03	Lihit 2001 & 2003. PK of 5
BB-LIH-13-15	Lihit 1013 & 1015. PK of 5
BB-STL-753	Sterling 753x 24.4 x 4.5 mm
BB-STA-1160	Stago 1160 x 18 x 5 mm
BB-CITO-111	Citoborma 111. 298 x 40 x 3 mm PVC
BB-CITO-190	Citoborma 190. 497 x 40 x 3 mm PVC
BB-CITO-490	Citoborma 490. 465 x 34 x 3 mm PVC

DRILL EASE WAX STICKS

Drill-Ease12 Packs of 12 pcs
 # **Drill-Ease** Any quantity



REAMERS



AVAILABLE ON REQUEST!

DOME HEAD STYLE

Sold as Male/Female pairs in boxes of 100

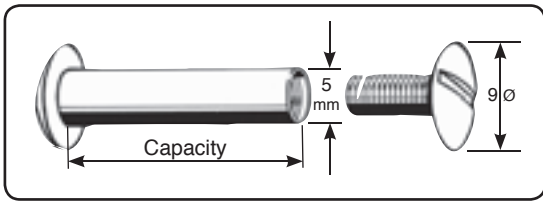

Size capacity	Part Numbers		
	Brass	Nickel	Black
3.5 mm	C8003	C8303	C8503
4.0 mm	C8004	C8304	C8504
5.0 mm	C8005	C8305	C8505
6.0 mm	C8006	C8306	C8506
8.0 mm	C8008	C8308	C8508
10.0 mm	C8010	C8310	C8510
12.0 mm	C8012	C8312	C8512
15.0 mm	C8015	C8315	C8515
20.0 mm	C8020	C8320	C8520
Screws	C8000S	C8300S	C8500S

KNURLED HEAD STYLE

Sold as Male/Female pairs in boxes of 100

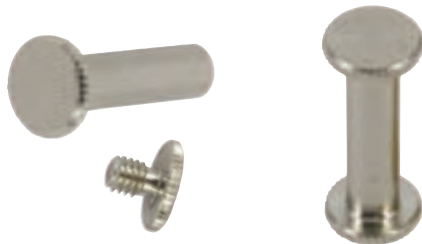
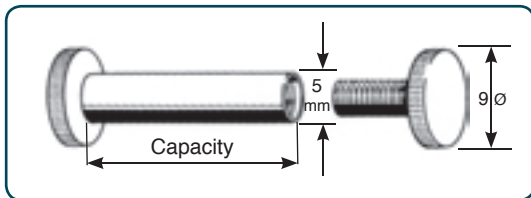

Size capacity	Part Numbers		
	Brass	Nickel	Black
2 mm	CH1002	CH3002	CH3502
3 mm	CH1003	CH3003	CH3503
4 mm	CH1004	CH3004	CH3504
5 mm	CH1005	CH3005	CH3505
6 mm	CH1006	CH3006	CH3506
8 mm	CH1008	CH3008	CH3508
10 mm	CH1010	CH3010	CH3510
12 mm	CH1012	CH3012	CH3512
15 mm	CH1015	CH3015	CH3515
20 mm	CH1020	CH3020	CH3520
Screws	C1000S	C3000S	C3800S

EXTENSIONS

Sold in boxes of 100 pcs

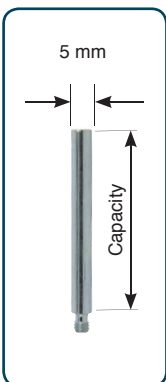

Size capacity	Part Numbers
7 mm	CH7007E
10 mm	CH7010E
15 mm	CH7015E
20 mm	CH7020E
25 mm	CH7025E
30 mm	CH7030E
35 mm	CH7035E
40 mm	CH7040E
45 mm	CH7045E
50 mm	CH7050E
55 mm	CH7055E

LOCKING KEY

C1500LK

Locking Key



BRASS CHICAGO INTERSCREWS & EXTENSIONS. BINDING SCREWS, BOOKSCREWS, BOOKBINDING SCREWS.

- Point of sale displays
- Albums
- Menus
- Office and Artistic Uses

ROTARY UNION

The quality of ROTOFLUX is “consistent quality” warranted by the stringent testing of every single union before dispatch. Only high quality materials (stainless steel, special steels, brass, carbide) are used in making ROTOFLUX union. The careful control of the manufacturing process involved in producing the necessary parts warrants that all the unions are manufactured within the technical specification.



- Top Quality European Made
- For all presses including Heidelberg*, Komori* and MAN-ROLAN*
- **Call us for your Rotary Union requirements!**

Part #	Interchangeable with Deublin* model #	Rotor Thread
S15-2386-33R	157-400-201	M20 x 1.5 RH PT 21 for pipe 10 mm
S15-2386-34L	157-400-403	M20 x 1.5 LH PT 21 for pipe 10 mm
S15-2386-31R	157-400-404	G 1/2" RH for pipe 10 mm
S15-2386-32L	157-400-405	G 1/2" LH for pipe 10 mm
S15-2386-37R	157-400-953	M20 x 1.5 RH PT 22 for pipe 10 mm
S15-2386-38L	157-400-954	M20 x 1.5 LH PT 22 for pipe 10 mm
S10-2382-33R	157-410-401	M16 x 1.5 RH PT 18 for pipe 8 mm
S10-2382-34L	157-410-402	M16 x 1.5 LH PT 18 for pipe 8 mm
S15-2382-33R	157-410-201	M20 x 1.5 RH PT 21 for pipe 8 mm
S15-2382-34L	157-410-403	M20 x 1.5 LH PT 21 for pipe 8 mm
S15-2382-31R	157-410-404	G 1/2" RH for pipe 8 mm
S15-2382-32L	157-410-405	G 1/2" LH for pipe 8 mm
S15-2386-33R-426	157-400-201-936	M20 x 1.5 RH PT 21 for pipe 10 mm
S15-2386-34R-426	157-400-403-936	M20 x 1.5 LH PT 21 for pipe 10 mm
S15-2386-31R-426	157-400-404-936	G 1/2" RH for pipe 10 mm
S15-2386-32L-426	157-400-405-936	G 1/2" LH for pipe 10 mm
S15-2386-37R-426	157-400-953-936	M20 x 1.5 RH PT 22 for pipe 10 mm
S15-2386-38L-426	157-400-954-936	M20 x 1.5 LH PT 22 for pipe 10 mm
S10-2382-33R-401	157-410-401-929	M16 x 1.5 RH PT 18 for pipe 8 mm
S10-2382-34L-401	157-410-402-929	M16 x 1.5 LH PT 18 for pipe 8 mm
S15-2383-33R-401	157-410-201-929	M20 x 1.5 RH PT 21 for pipe 8 mm
S15-2383-34L-401	157-410-403-929	M20 x 1.5 LH PT 21 for pipe 8 mm
S15-2383-31R-401	157-410-404-929	G 1/2" RH for pipe 8 mm
S15-2383-32L-401	157-410-405-929	G 1/2" LH for pipe 8 mm
S15-2382-31R-402	157-410-404-927	G 1/2" RH for pipe 8 mm L29 mm
S15-2382-31R-403	157-410-404-928 ^o	G 1/2" RH for pipe 8 mm L 181 mm
S15-1393-10R	157-016-738	M20 x 1/2" RH pt 22 G6
S15-1300-01R	127-016-151	1/2" BSP RH (157-016-151, 157-041-151)
S32-1300-01R	527-012-498	1" 3/4 BSP RH

The above Rotary Unions are the most commonly used on presses like MAN Roland*, Heidelberg*, Komori*, GOSS* and KBA* etc.



AIR FILTERS

Model: BUSCH™, RIETSCHLE™, BECKER and MANN™



EXHAUST FILTERS

Model: BUSCH™, RIETSCHLE™, BECKER and MANN™



CARBON VANES

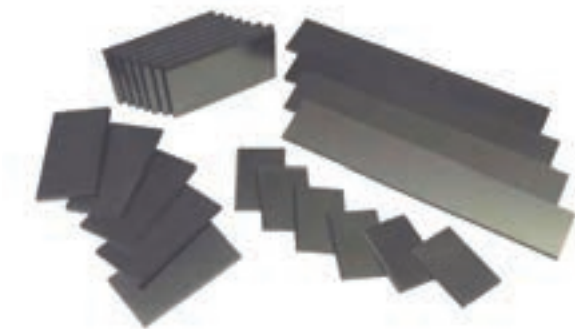

24 PAGES
PDF CATALOGUE
AVAILABLE
ON REQUEST



REBUILD KITS



RIETSCHLE PUMP VANES

OEM Ref No	Model	Qty/pump
507107	CLFT-41-DV	8
507108	CLFT-61-all	8
507109	CLFT-81-DV	8
507110	CLFT-101-DV	8
524142	CLFT-141-DV	8
518943	KTA-40-all / TR-41all	6
523777	KTA-60-all	6
523778	KTA-80/1,2,3,4	6
524436	KTA-80/5	8
523889	KTA-100	6
523885	KTA-140	6
513431	TR-26-all	7
515642	TR-61-all	7
514870	TR-81-all	7

ORION PUMP VANES

OEM Ref No	Model	Qty/pump
04009564010	KRX3 / CBX15	4
04009565010	KRX5 / CBX25	4
04041811011*	KRX6	4
04012865010°	KRS7A (old) thin	4
04012865010 ^a	KRS7A (new) thick	4
04007480010	KRA8	6
04009564010	CBX15 (2-KRX3)	8
04009565010	CBX25 (2-KRX5)	8
04041811011*	CBX40 (2-KRX6)	8
04012865010	CBX61 (2-KRXA)(old)	8
04039395010	CBX61 (2-KRXA)(new)	4

*Vanes Old# 0400456601 ° KRS7A takes old vanes
^a KRS7D OR KRX 7D takes new vanes

BECKER PUMP VANES

OEM Ref No	Model	Qty/pump
90132900	DVT2.60	8
90133000	DVT3.60, DVT3.80, DVT3.100	7
90133000	DVT2.80, DVT2.100	8
90133400	DVT2.140/3.140	7
90133200	T16DS	8
90130800	T25DS	8
90133100	T40DS	7
90134700	T.316DSK	7
90134900	T.325/4.25 DSK	7
90135200	T.340/4.40 DSK	7
90137200	T.360DSK	7

BUSCH PUMP VANES

OEM Ref No	Model	Qty/pump	BB Part #
722.000.270	RA/RC.0025	3	BUV-25
722.000.300	RA/RC.0040	3	BUV-40
722.000.330	RA/RC.0063	3	BUV-63
722.000.360	RA/RC.0100	3	BUV-100
722.000.452	RA/RC.0160B	3	BUV-160B
722.000.454	RA/RC.0400	3	BUV-400
722.000.455	RA/RC.0630	3	BUV-630
722.000.456	RA.1000	3	BUV-1000
722.515.895	RA/RC.0012, 0021	3	BUV-12/21
722.516.054	RA/RC.0502B	3	BUV-502B
722.516.573	RA/RC.0160-205, C/D	3	BUV-160/205
722.516.729	RA/RC.0250/ 305/B/C/D	3	BUV-250/305
722.000.016	SV 1063 B / DC 0063	4 / 7	BUV-1063B
722.000.017	SV 1080 B / DC 0080	4 / 7	BUV-1080B
722.000.189	SV 1025 B	7	BUV-1025B
722.000.242	SV 1010 B	7	BUV-1010B
722.000.489	SV 1016 B&C	7	BUV-1016BC
722.500.050	SV 1140 C / DC 0140C	4 / 8	BUV-1140C
722.500.122	SV 1100 C / DC 0100	4 / 8	BUV-1100C
722.510.168	SV 1250 A	4	BUV-1250A
722.533.535	SV 1010 C	7	BUV-1010C
722.533.536	SV 1025 C	7	BUV-1025C
722.534.079	SV 1040 B&C	7	BUV-1040BC

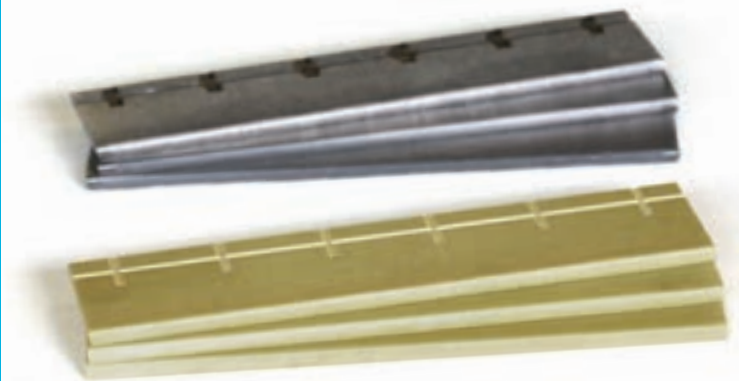

**PLEASE CALL US FOR VANES
NOT LISTED ABOVE**

PUMP MANN FILTERS

COE

Closed one end



STD

Standard double end open



COEB

losed one end, end with
bolt hole

G

Gaskets on both ends



Mann	ID	OD	Height	Code	Rietschle	Becker	Orion	Busch
C31/1	3/8"	1-1/8"	1-1/2"	COEB	730501			
C32	3/8"	1-1/8"	2-7/16"	COEB	730502	90953100		
C37	3/8"	1-3/16"	5-1/16"	COEB	515339			515339
C42/1	1/2"	1-1/2"	1-1/2"	COEB	730504	90953900		
C42/2	1/2"	1-1/2"	1-1/8"	COEB	730503	90953800		
C43	1/2"	1-1/2"	2-7/16"	COEB	730505	90953700		
C44	1/2"	1-1/2"	1-1/2"	COE		90951800		532032
C46	1/2"	1-1/2"	5-1/8"	COEB	515340			
C48	1/2"	1-1/2"	3-5/8"	COEB	513458			
C64/1	11/16"	2-5/16"	1-9/16"	COEB	730506	90953600		
C64/3	11/16"	2-5/16"	1-9/16"	COE		90951900		
C66	11/16"	2-5/16"	2-7/16"	COEB	730507	90953500		
C66/1	11/16"	2-5/16"	2-1/16"	COEB	730524			
C69/1	1-1/4"	2"	5-11/16"	COEB	515411	90953300		
C74	1"	2-11/16"	1-1/16"	STD, G		90950800		
C75	1-1/2"	2-1/2"	2-11/16"	COE	730542	84040105		532005
C75/2	1-1/2"	2-1/2"	2-13/16"	COE	730354	90950500		532015
C76/2	1-1/2"	2-1/2"	1-3/4"	COE	730587	90952100		
C78/6	1-1/2"	2-1/2"	1-1/4"	COE		90952900		
C79/1	1"	2-1/2"	2-7/8"	COEB	730508	90953200		
C610/2	1-3/16"	2"	6-5/16"	COEB	515310	90957100		
C612/1	1-1/8"	2-1/8"	6"	COE	731148			
C711/1	1-1/2"	2-11/16"	2-3/4"	STD, G	730511			
C713	1-1/2"	2-1/2"	4-1/2"	COEB,G	730545	90951000		
C713/1	1-1/4"	2-1/2"	3-1/16"	COE	731142			
C717/1	1-1/2"	2-1/2"	5-7/8"	COE	731143			532019
C718	1-1/2"	2-1/2"	6-9/16"	COEB,G		90951400		
C912	2-3/8"	3-5/16"	2-3/4"	COE	730392	90950600		
C1049	1-3/4"	3-5/8"	5-5/8"	STD	730512	90957400		
C1112	2-3/8"	3-7/8"	2-3/4"	STD	730514	84040107		532002
C1112/2	2-3/8"	3-7/8"	2-3/4"	COE		90950700		
C1132	2-3/8"	3-7/8"	3-15/16"	STD	730080	84040209		
C1337	2-9/16"	5"	4-3/4"	STD	730519	84040207		532003
C1574	3-1/2"	5-7/8"	4-7/8"	STD	730515	84040910		
C15124/1	3-1/2"	5-7/8"	8-1/2"	STD,G	730517	84040110		532004
C21138/1	5-3/4"	8-3/8"	6-3/8"	STD,G	730513	84040122		
C22215	5-3/4"	8-3/8"	6-3/8"	COE		90953400		
	7/8"	1-3/4"	3-1/4"	COEB,G			04000028010	
	7/8"	1-3/4"	4-7/8"	COEB,G			04009779010	
	1-1/4"	2-1/2"	4-1/2"	COEB,G			04000451010	

CAN'T FIND YOUR FILTER? CALL US FOR A FULL FILTER CATALOGUE

BIRK & BLYME BINDERY SUPPLIES & EQUIPMENTS

We also carry an extensive line of parts and accessories to suit various Print Finishing machines. Please request our **BINDERY SUPPLIES & EQUIPMENT** catalogue which includes available parts for:

- Folding
- Sewing
- Stitching
- Suckers
- Perfect binding
- And more.....
- Cutting



ASK US
FOR THE FULL
CATALOGUE



BIRK & BLYME WEB PRESS KNIVES & PARTS

Please call us for Knives & Replacement Parts to suit popular presses like *GOSS, MAN Roland, Komori, KBA, Mitsubishi & Timson.

- Cutting Knives
- Gripper Fingers & Sheet Guides
- Perforating knives
- Bearer Felts
- Slitters
- Brushes
- Pressure Bars
- Web Up-Kites
- Cutting Sticks
- Inline Trimmer Knives for RIMA and Gämmerler
- Folder Pins
- Inline Stitcher Parts
- Tucker Blades
- Jaw Blades
- Transport Rollers

**REQUEST A PDF CATALOGUE OR
VIEW ONLINE AT WWW.BIRK-BLYME.COM**



CONTACT DETAILS

BIRK & BLYME PTY LTD

ABN 62 051 319 629

ADDRESS: Building 5
49 Frenchs Forest Road
Frenchs Forest NSW 2086
Australia

PHONE: 02 9452 0222

FAX: 02 9972 7901

EMAIL: info@birk-blyme.com

WEB: www.birk-blyme.com

