

Product Data and Part Numbers
Syringes

Contents

Autosampler	4
Diamond Headspace	4
Product Data	4
Part Numbers	5
Diamond MS	6
Product Data	6
Part Numbers	7
GC Autosampler	9
Product Data	9
Part Numbers	10
HPLC Autosampler	14
Product Data	14
Part Numbers	15
MEPS®	16
Product Data	16
Part Numbers	17
Manual	18
Diamond	18
Product Data	18
Part Numbers	19
Diamond	
Gas Tight	20
Product Data	20
Part Numbers	21
Guided Plunger	22
Product Data	22
Part Numbers	23
Jumbo	24
Product Data	24
Part Numbers	25
For Rheodyne	
and Valco Valves	26
Product Data	26
Part Numbers	27
Autosampler	
and Manual	28
NanoVolume	28
Product Data	28
Part Numbers	29
Dispenser	
and Pump	30
For Hamilton C	
and CX	30
Product Data	30
Part Numbers	31
For PSD/3	
and PSD/4 Pumps	32
Product Data	32
Part Numbers	33
For V3 Pumps	34
Product Data	34
Part Numbers	35
For V6 Pumps	36
Product Data	36
Part Numbers	37
eVol®	38
eVol® XR	38
Product Data	38
Part Numbers	39
eVol® XR Kits	40
Product Data	40
Part Numbers	41
Replacement	
Parts	42
Replacement	
Needles	42
Product Data	42
Part Numbers	43
Replacement	
Plungers	47
Product Data	47
Cross Reference	48
Hamilton	48
Part Numbers	48

Syringes | Diamond Headspace

Higher Limits in Headspace Analysis

SGE Diamond Headspace Syringes feature a unique energized plunger tip design to maintain a gas tight seals for outstanding performance with temperature cycling and high temperatures. The PTFE plunger tip enables the use of a broader range of samples and solvents compared with polymers used in plungers of other high temperature syringes. This provides greater flexibility for your headspace analyses and a longer lasting syringe.

Features and Benefits

- Outstanding reproducibility (%RSD) maintained during temperature cycling.
- Highest operating temperature.
- Save time and improve analysis workflow.
- No dead space.

Recommended Applications

GC Headspace injections.

Product Specifications

Available in 1 mL, 2.5 mL and 5 mL for CTC and Thermo RSH autosamplers.

Accuracy and Reproducibility	± 1 % (displaced volume)
Temperature Range	25-150 °C
International Standards Traceability	

For more information about this product visit www.sge.com or contact techsupport@sge.com.



Syringes | Diamond Headspace

New Limits in Headspace Analysis

Part Number	Part Description and Detail	Replacement Plunger
CTC Head Space		
008131	1 mL Fixed Needle CTC Head Space Syringe with Energized GT Plunger and 5.6 cm 0.63 mm OD Side-hole Needle	031841
008136	1 mL Fixed Needle CTC Head Space Syringe with Energized GT Plunger and 5.6 cm 0.47 mm OD Side-hole Needle	031841
008631	2.5 mL Fixed Needle CTC Head Space Syringe with Energized GT Plunger and 5.6 cm 0.63 mm OD Side-hole Needle	031851
008636	2.5 mL Fixed Needle CTC Head Space Syringe with Energized GT Plunger and 5.6 cm 0.47 mm OD Side-hole Needle	031851
CTC RTC & Thermo RSH Head Space		
008155	1 mL Fixed Needle CTC RTC & Thermo RSH Head Space Syringe with Energized GT Plunger and 6.5 cm 0.63 mm OD Side-hole Needle	032841
008655	2.5 mL Fixed Needle CTC RTC & Thermo RSH Head Space Syringe with Energized GT Plunger and 6.5 cm 0.63 mm OD Side-hole Needle	032846

For more information about this product visit www.sge.com or contact techsupport@sge.com.

Syringes | Diamond MS

The Choice for Sensitivity

Understanding how important your MS results are, and how precious your sample is, the SGE Diamond MS syringe and needle range is designed to improve the sensitivity of your MS results.

Features and Benefits

- Lowest syringe carryover.
- Reduced non specific sample interaction and increased analyte recovery.
- Ultra smooth removable needles with choice of surface treatment.

Recommended Applications

Diamond MS syringes and needles are MS ready.

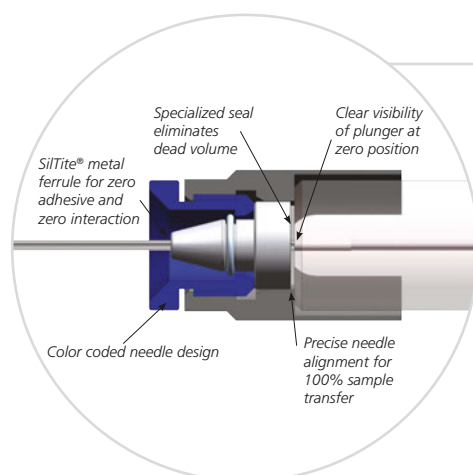

Product Specifications

Available in 10 μ L to 500 μ L manual syringes, 10 μ L to 100 μ L CTC and Thermo RSH autosampler syringes, 10 μ L and 25 μ L Agilent autosampler syringes, 10 μ L Shimadzu autosamplers syringes. Ultra Smooth, Ultra Smooth Hydrophilic, and Ultra Smooth Hydrophobic needles.

Accuracy and Reproducibility	± 1 % (displaced volume)
Temperature Range	5-120 °C
International Standards Traceability	

For more information about this product visit www.sge.com or contact techsupport@sge.com.

Syringes | Diamond MS

The Choice for Sensitivity

Diamond MS Syringes (supplied without needles)

Part Number	Part Description and Detail	Replacement Plunger
Manual		
002750	10 µL Removable Needle Diamond MS Syringe with GT Plunger	0355101
003750	25 µL Removable Needle Diamond MS Syringe with GT Plunger	0355102
004750	50 µL Removable Needle Diamond MS Syringe with GT Plunger	0355105
005750	100 µL Removable Needle Diamond MS Syringe with GT Plunger	0355110
006750	250 µL Removable Needle Diamond MS Syringe with GT Plunger	0355120
007750	500 µL Removable Needle Diamond MS Syringe with GT Plunger	0355150
Agilent		
002760	10 µL Removable Needle Agilent Diamond MS Syringe with GT Plunger	0355160
003760	25 µL Removable Needle Agilent Diamond MS Syringe with GT Plunger	0355161
CTC		
002770	10 µL Removable Needle CTC Diamond MS Syringe with GT Plunger	0355170
003770	25 µL Removable Needle CTC Diamond MS Syringe with GT Plunger	0355171
004770	50 µL Removable Needle CTC Diamond MS Syringe with GT Plunger	0355172
005770	100 µL Removable Needle CTC Diamond MS Syringe with GT Plunger	0355173
CTC RTC & Thermo RSH		
002790	10 µL Removable Needle CTC RTC & Thermo RSH Diamond MS Syringe with GT Plunger	0355190
003790	25 µL Removable Needle CTC RTC & Thermo RSH Diamond MS Syringe with GT Plunger	0355191
004790	50 µL Removable Needle CTC RTC & Thermo RSH Diamond MS Syringe with GT Plunger	0355192
005790	100 µL Removable Needle CTC RTC & Thermo RSH Diamond MS Syringe with GT Plunger	0355193
Shimadzu		
002780	10 µL Removable Needle Shimadzu Diamond MS Syringe with GT Plunger	0355180

Needles for Diamond MS Syringes

Part Number	Part Description and Detail
Ultra Smooth Hydrophilic Needles	
Manual and Autosampler	
0355310	Ultra Smooth Hydrophilic Coated 50 mm 0.47 mm OD 0.11 mm ID Bevel Tipped Needle for 10-50 µL Manual Diamond MS Syringes
0355311	Ultra Smooth Hydrophilic Coated 50 mm 0.50 mm OD 0.20 mm ID Bevel Tipped Needle for 10-50 µL Manual Diamond MS Syringes
0355312	Ultra Smooth Hydrophilic Coated 50 mm 0.50 mm OD 0.20 mm ID Bevel Tipped Needle for 100-500 µL Manual Diamond MS Syringes
0355313	Ultra Smooth Hydrophilic Coated 50 mm 0.63 mm OD 0.32 mm ID Bevel Tipped Needle for 100-500 µL Manual Diamond MS Syringes
0355210	Ultra Smooth Hydrophilic Coated 51 mm 0.72 mm OD 0.17 mm ID LC Tipped Needle for 10-50 µL Manual and Autosampler Diamond MS Syringes
0355211	Ultra Smooth Hydrophilic Coated 51 mm 0.72 mm OD 0.17 mm ID LC Tipped Needle for 100-500 µL Manual and Autosampler Diamond MS Syringes
0355213	Ultra Smooth Hydrophilic Coated 51 mm 0.72 mm OD 0.37 mm ID LC Tipped Needle for 100-500 µL Manual and Autosampler Diamond MS Syringes
0355215	Ultra Smooth Hydrophilic Coated 57 mm 0.72 mm OD 0.17 mm ID LC Tipped Needle for 10-50 µL Manual and Autosampler Diamond MS Syringes
0355216	Ultra Smooth Hydrophilic Coated 57 mm 0.72 mm OD 0.17 mm ID LC Tipped Needle for 100-500 µL Manual and Autosampler Diamond MS Syringes
Agilent & Shimadzu GC Autosampler	
0355411	Ultra Smooth Hydrophilic Coated 42 mm 0.63 mm OD 0.11 mm ID Cone Tipped Needle for 10-50 µL Agilent & Shimadzu GC Autosampler Diamond MS Syringes
0355410	Ultra Smooth Hydrophilic Coated 42 mm 0.63 mm OD 0.24 mm ID Cone Tipped Needle for 10-50 µL Agilent & Shimadzu GC Autosampler Diamond MS Syringes
CTC GC Autosampler	
0355512	Ultra Smooth Hydrophilic Coated 50 mm 0.63 mm OD 0.11 mm ID Cone Tipped Needle for 10-50 µL CTC GC Autosampler Diamond MS Syringes
0355510	Ultra Smooth Hydrophilic Coated 50 mm 0.63 mm OD 0.24 mm ID Cone Tipped Needle for 10-50 µL CTC GC Autosampler Diamond MS Syringes
0355511	Ultra Smooth Hydrophilic Coated 50 mm 0.63 mm OD 0.24 mm ID Cone Tipped Needle for 100-500 µL CTC GC Autosampler Diamond MS Syringes
CTC RTC & Thermo RSH GC Autosampler	
0355612	Ultra Smooth Hydrophilic Coated 57 mm 0.63 mm OD 0.11 mm ID Cone Tipped Needle for 10-50 µL CTC RTC & Thermo RSH GC Autosampler Diamond MS Syringes
0355610	Ultra Smooth Hydrophilic Coated 57 mm 0.63 mm OD 0.24 mm ID Cone Tipped Needle for 10-50 µL CTC RTC & Thermo RSH GC Autosampler Diamond MS Syringes
0355611	Ultra Smooth Hydrophilic Coated 57 mm 0.63 mm OD 0.24 mm ID Cone Tipped Needle for 100-500 µL CTC RTC & Thermo RSH GC Autosampler Diamond MS Syringes

Part Number	Part Description and Detail
Ultra Smooth Hydrophobic Needles	
Manual and Autosampler	
0355320	Ultra Smooth Hydrophobic Coated 50 mm 0.47 mm OD 0.11 mm ID Bevel Tipped Needle for 10-50 µL Manual Diamond MS Syringes
0355321	Ultra Smooth Hydrophobic Coated 50 mm 0.50 mm OD 0.20 mm ID Bevel Tipped Needle for 10-50 µL Manual Diamond MS Syringes
0355322	Ultra Smooth Hydrophobic Coated 50 mm 0.50 mm OD 0.20 mm ID Bevel Tipped Needle for 100-500 µL Manual Diamond MS Syringes
0355323	Ultra Smooth Hydrophobic Coated 50 mm 0.63 mm OD 0.32 mm ID Bevel Tipped Needle for 100-500 µL Manual Diamond MS Syringes
0355220	Ultra Smooth Hydrophobic Coated 51 mm 0.72 mm OD 0.17 mm ID LC Tipped Needle for 10-50 µL Manual and Autosampler Diamond MS Syringes
0355221	Ultra Smooth Hydrophobic Coated 51 mm 0.72 mm OD 0.17 mm ID LC Tipped Needle for 100-500 µL Manual and Autosampler Diamond MS Syringes
0355223	Ultra Smooth Hydrophobic Coated 51 mm 0.72 mm OD 0.37 mm ID LC Tipped Needle for 100-500 µL Manual and Autosampler Diamond MS Syringes
0355225	Ultra Smooth Hydrophobic Coated 57 mm 0.72 mm OD 0.17 mm ID LC Tipped Needle for 10-50 µL Manual and Autosampler Diamond MS Syringes
0355226	Ultra Smooth Hydrophobic Coated 57 mm 0.72 mm OD 0.17 mm ID LC Tipped Needle for 100-500 µL Manual and Autosampler Diamond MS Syringes
Agilent & Shimadzu GC Autosampler	
0355421	Ultra Smooth Hydrophobic Coated 42 mm 0.63 mm OD 0.11 mm ID Cone Tipped Needle for 10-50 µL Agilent & Shimadzu GC Autosampler Diamond MS Syringes
0355420	Ultra Smooth Hydrophobic Coated 42 mm 0.63 mm OD 0.24 mm ID Cone Tipped Needle for 10-50 µL Agilent & Shimadzu GC Autosampler Diamond MS Syringes
CTC GC Autosampler	
0355522	Ultra Smooth Hydrophobic Coated 50 mm 0.63 mm OD 0.11 mm ID Cone Tipped Needle for 10-50 µL CTC GC Autosampler Diamond MS Syringes
0355520	Ultra Smooth Hydrophobic Coated 50 mm 0.63 mm OD 0.24 mm ID Cone Tipped Needle for 10-50 µL CTC GC Autosampler Diamond MS Syringes
0355521	Ultra Smooth Hydrophobic Coated 50 mm 0.63 mm OD 0.24 mm ID Cone Tipped Needle for 100-500 µL CTC GC Autosampler Diamond MS Syringes
CTC RTC & Thermo RSH GC Autosampler	
0355622	Ultra Smooth Hydrophobic Coated 57 mm 0.63 mm OD 0.11 mm ID Cone Tipped Needle for 10-50 µL CTC RTC & Thermo RSH GC Autosampler Diamond MS Syringes
0355620	Ultra Smooth Hydrophobic Coated 57 mm 0.63 mm OD 0.24 mm ID Cone Tipped Needle for 10-50 µL CTC RTC & Thermo RSH GC Autosampler Diamond MS Syringes
0355621	Ultra Smooth Hydrophobic Coated 57 mm 0.63 mm OD 0.24 mm ID Cone Tipped Needle for 100-500 µL CTC RTC & Thermo RSH GC Autosampler Diamond MS Syringes
Ultra Smooth Needles	
Manual and Autosampler	
0355330	Ultra Smooth 50 mm 0.47 mm OD 0.11 mm ID Bevel Tipped Needle for 10-50 µL Manual Diamond MS Syringes
0355331	Ultra Smooth 50 mm 0.50 mm OD 0.20 mm ID Bevel Tipped Needle for 10-50 µL Manual Diamond MS Syringes
0355332	Ultra Smooth 50 mm 0.50 mm OD 0.20 mm ID Bevel Tipped Needle for 100-500 µL Manual Diamond MS Syringes
0355333	Ultra Smooth 50 mm 0.63 mm OD 0.32 mm ID Bevel Tipped Needle for 100-500 µL Manual Diamond MS Syringes
0355230	Ultra Smooth 51 mm 0.72 mm OD 0.17 mm ID LC Tipped Needle for 10-50 µL Manual and Autosampler Diamond MS Syringes
0355231	Ultra Smooth 51 mm 0.72 mm OD 0.17 mm ID LC Tipped Needle for 100-500 µL Manual and Autosampler Diamond MS Syringes
0355233	Ultra Smooth 51 mm 0.72 mm OD 0.37 mm ID LC Tipped Needle for 100-500 µL Manual and Autosampler Diamond MS Syringes
0355235	Ultra Smooth 57 mm 0.72 mm OD 0.17 mm ID LC Tipped Needle for 10-50 µL Manual and Autosampler Diamond MS Syringes
0355236	Ultra Smooth 57 mm 0.72 mm OD 0.17 mm ID LC Tipped Needle for 100-500 µL Manual and Autosampler Diamond MS Syringes
Agilent & Shimadzu GC Autosampler	
0355431	Ultra Smooth 42 mm 0.63 mm OD 0.11 mm ID Cone Tipped Needle for 10-50 µL Agilent & Shimadzu GC Autosampler Diamond MS Syringes
0355430	Ultra Smooth 42 mm 0.63 mm OD 0.24 mm ID Cone Tipped Needle for 10-50 µL Agilent & Shimadzu GC Autosampler Diamond MS Syringes
CTC GC Autosampler	
0355532	Ultra Smooth 50 mm 0.63 mm OD 0.11 mm ID Cone Tipped Needle for 10-50 µL CTC GC Autosampler Diamond MS Syringes
0355530	Ultra Smooth 50 mm 0.63 mm OD 0.24 mm ID Cone Tipped Needle for 10-50 µL CTC GC Autosampler Diamond MS Syringes
0355531	Ultra Smooth 50 mm 0.63 mm OD 0.24 mm ID Cone Tipped Needle for 100-500 µL CTC GC Autosampler Diamond MS Syringes
CTC RTC & Thermo RSH GC Autosampler	
0355632	Ultra Smooth 57 mm 0.63 mm OD 0.11 mm ID Cone Tipped Needle for 10-50 µL CTC RTC & Thermo RSH GC Autosampler Diamond MS Syringes
0355630	Ultra Smooth 57 mm 0.63 mm OD 0.24 mm ID Cone Tipped Needle for 10-50 µL CTC RTC & Thermo RSH GC Autosampler Diamond MS Syringes
0355631	Ultra Smooth 57 mm 0.63 mm OD 0.24 mm ID Cone Tipped Needle for 100-500 µL CTC RTC & Thermo RSH GC Autosampler Diamond MS Syringes

For more information visit www.sge.com or contact techsupport@sge.com.



Syringes | GC Autosampler

Diamond Syringe - Syringe Brilliance

The SGE comprehensive range of GC autosampler syringes are designed and tested to meet critical autosampler specifications.

Features and Benefits

Unique plunger design minimizes bending and seizing, and the cone tip needle point style has been developed specifically to withstand multiple fast septum injections.

Recommended Applications

Metal plungers are individually fitted to the syringe glass barrel for a perfect “feel”, optimized life with minimal carry over, a liquid tight seal between the barrel and plunger and excellent performance.

PTFE tipped replaceable plunger syringes reduce the risk of plunger seizing when working with dirty samples, reducing instrument downtime, and minimizing the risk of instrument shutdown during the processing of large batches of samples.

Product Specifications

Wide range of fixed needle and removable needle options available for Agilent, CTC, PerkinElmer, Shimadzu, Thermo Scientific, and Varian/Bruker autosamplers. PTFE tipped replaceable plunger versions are available for use with gas and headspace samples.

In addition, multi-packs are available for most popular autosamplers.

For NanoVolume Syringes	
Accuracy and Reproducibility	± 2 % (displaced volume)
Temperature Range	5-70 °C
International Standards Traceability	
For Fixed Needle Syringes	
Accuracy and Reproducibility	± 1 % (displaced volume)
Temperature Range	5-70 °C
International Standards Traceability	
For Removable Needle Syringes	
Accuracy and Reproducibility	± 1 % (displaced volume)
Temperature Range	5-120 °C
International Standards Traceability	

For more information about this product visit www.sge.com or contact techsupport@sge.com.



Syringes | GC Autosampler

Diamond Syringe - Syringe Brilliance

Part Number	Part Description and Detail	Replacement Needle (* Needle & Plunger Kit)	Replacement Plunger
Agilent			
000400	0.5 µL NanoVolume Agilent Syringe with 4.2 cm 0.47 mm OD Cone Tipped Needle	033708*	
000410	0.5 µL NanoVolume Agilent Syringe with 4.2 cm 0.63 mm OD Cone Tipped Needle	033715*	
000415	0.5 µL NanoVolume Agilent Syringe with 4.2 cm 0.63/0.47 mm OD Dual Gauge Cone Tipped Needle	033730*	
000610	1.0 µL NanoVolume Agilent Syringe with 4.2 cm 0.63 mm OD Cone Tipped Needle	034715*	
001800	5 µL Fixed Needle Agilent Syringe with 4.2 cm 0.47 mm OD Cone Tipped Needle		
001804	5 µL Fixed Needle Agilent Syringe with 4.2 cm 0.47 mm OD Cone Tipped Needle PK6		
001810	5 µL Fixed Needle Agilent Syringe with 4.2 cm 0.63 mm OD Cone Tipped Needle		
001814	5 µL Fixed Needle Agilent Syringe with 4.2 cm 0.63 mm OD Cone Tipped Needle PK6		
001821	5 µL Fixed Needle Agilent Syringe with 4.2 cm 0.63/0.47 mm OD Cone Tipped Dual Gauge Needle		
001822	5 µL Fixed Needle Agilent Syringe with 4.2 cm 0.63/0.47 mm OD Cone Tipped Dual Gauge Needle PK6		
002800	10 µL Fixed Needle Agilent Syringe with 4.2 cm 0.47 mm OD Cone Tipped Needle		
002804	10 µL Fixed Needle Agilent Syringe with 4.2 cm 0.47 mm OD Cone Tipped Needle PK6		
002831	10 µL Fixed Needle Agilent Syringe with Superflex Plunger and 4.2 cm 0.47 mm OD Cone Tipped Needle PK6		
002811	10 µL Fixed Needle Agilent Syringe with 4.2 cm 0.63 mm OD Side Hole Needle		
002810	10 µL Fixed Needle Agilent Syringe with 4.2 cm 0.63 mm OD Cone Tipped Needle		
002814	10 µL Fixed Needle Agilent Syringe with 4.2 cm 0.63 mm OD Cone Tipped Needle PK6		
002838	10 µL Fixed Needle Agilent Syringe with Superflex Plunger and 4.2 cm 0.63 mm OD Cone Tipped Needle PK6		
002813	10 µL Fixed Needle Agilent Syringe with 4.2 cm 0.63 mm OD Cone Tipped Needle PK25		
002821	10 µL Fixed Needle Agilent Syringe with 4.2 cm 0.63/0.47 mm OD Cone Tipped Dual Gauge Needle		
002822	10 µL Fixed Needle Agilent Syringe with 4.2 cm 0.63/0.47 mm OD Cone Tipped Dual Gauge Needle PK6		
002824	10 µL Fixed Needle Agilent Syringe with 4.2 cm 0.63/0.47 mm OD Cone Tipped Dual Gauge Needle PK25		
002812	10 µL Fixed Needle Agilent Syringe with GT Plunger & 4.2 cm 0.63 mm OD Cone Tipped Needle		031808
002816	10 µL Fixed Needle Agilent Syringe with GT Plunger & 4.2 cm 0.63 mm OD Cone Tipped Needle PK25		031808
002826	10 µL Fixed Needle Agilent Syringe with GT Plunger & 4.2 cm 0.63/0.47 mm OD Cone Tipped Dual Gauge Needle		031808
002827	10 µL Fixed Needle Agilent Syringe with GT Plunger & 4.2 cm 0.63/0.47 mm OD Cone Tipped Dual Gauge Needle PK6		031808
002805	10 µL Removable Needle Agilent Syringe with 4.2 cm 0.47 mm OD Cone Tipped Needle	037715	
002815	10 µL Removable Needle Agilent Syringe with 4.2 cm 0.63 mm OD Cone Tipped Needle	037717	
002760	10 µL Removable Needle Agilent Diamond MS Syringe with GT Plunger	Refer Diamond MS PDPN-1005-G	0355160
002820	10 µL Removable Needle Agilent Syringe with GT Plunger & 4.2 cm 0.63 mm OD Cone Tipped Needle PK10	037717	031809
002829	10 µL Removable Needle Agilent Syringe with GT Plunger & 4.2 cm 0.63/0.47 mm OD Cone Tipped Dual Gauge Needle	037730	031809
003668	25 µL Fixed Needle Agilent Syringe with GT Plunger & 4.2 cm 0.63/0.47 mm OD Cone Tipped Dual Gauge Needle		
003760	25 µL Removable Needle Agilent Diamond MS Syringe with GT Plunger	Refer Diamond MS PDPN-1005-G	0355161
004668	50 µL Fixed Needle Agilent Syringe with GT Plunger & 4.2 cm 0.63/0.47 mm OD Cone Tipped Dual Gauge Needle		
004665	50 µL Removable Needle Agilent Syringe with 4.2 cm 0.63 mm OD Cone Tipped Needle	038717	
005668	100 µL Fixed Needle Agilent Syringe with GT Plunger & 4.2 cm 0.63/0.47 mm OD Cone Tipped Dual Gauge Needle		031823
005292	100 µL Removable Needle Agilent MEPS Syringe with GT Plunger	Refer MEPS PDPN-1030-G	0318263
006293	250 µL Removable Needle Agilent MEPS Syringe with GT Plunger	Refer MEPS PDPN-1030-G	0318303

Part Number	Part Description and Detail	Replacement Needle (* Needle & Plunger Kit)	Replacement Plunger
CTC			
002700	10 µL Fixed Needle CTC Syringe with 5 cm 0.47 mm OD Cone Tipped Needle		
002983	10 µL Fixed Needle CTC Syringe with GT Plunger & 5 cm 0.72 mm OD Side Hole Needle		031803 (PK1) 0318120 (PK2)
002770	10 µL Removable Needle CTC Diamond MS Syringe with GT Plunger	Refer Diamond MS PDPN-1005-G	0355170
003700	25 µL Fixed Needle CTC Syringe with GT Plunger & 5 cm 0.47 mm OD Cone Tipped Needle		0318922
003770	25 µL Removable Needle CTC Diamond MS Syringe with GT Plunger	Refer Diamond MS PDPN-1005-G	0355171
004770	50 µL Removable Needle CTC Diamond MS Syringe with GT Plunger	Refer Diamond MS PDPN-1005-G	0355172
005700	100 µL Fixed Needle CTC Syringe with GT Plunger & 5 cm 0.47 mm OD Cone Tipped Needle		0318261
005770	100 µL Removable Needle CTC Diamond MS Syringe with GT Plunger	Refer Diamond MS PDPN-1005-G	0355173
006700	250 µL Fixed Needle CTC Syringe with GT Plunger & 5 cm 0.47 mm OD Cone Tipped Needle		0318926
006292	250 µL Removable Needle CTC MEPS Syringe with GT Plunger	Refer MEPS PDPN-1030-G	0318301
008136	1 mL Fixed Needle CTC Head Space Syringe with Energized GT Plunger & 5.6 cm 0.47 mm OD Side Hole Needle		031841
008131	1 mL Fixed Needle CTC Head Space Syringe with Energized GT Plunger & 5.6 cm 0.63 mm OD Side Hole Needle		031841
008636	2.5 mL Fixed Needle CTC Head Space Syringe with Energized GT Plunger & 5.6 cm 0.47 mm OD Side Hole Needle		031851
008631	2.5 mL Fixed Needle CTC Head Space Syringe with Energized GT Plunger & 5.6 cm 0.63 mm OD Side Hole Needle		031851
PerkinElmer			
000475	0.5 µL NanoVolume PerkinElmer Syringe with 7 cm 0.47 mm OD Cone Tipped Needle	033750*	
000478	0.5 µL NanoVolume PerkinElmer Syringe with 7 cm 0.63 mm OD Cone Tipped Needle	033765*	
001953	5 µL Fixed Needle PerkinElmer Syringe with 7 cm 0.47 mm OD Cone Tipped Needle		
001954	5 µL Fixed Needle PerkinElmer Syringe with 7 cm 0.63 mm OD Cone Tipped Needle		
001955	5 µL Fixed Needle PerkinElmer Syringe with GT Plunger & 7 cm 0.47 mm OD Cone Tipped Needle		031807
001957	5 µL Fixed Needle PerkinElmer Syringe with GT Plunger & 7 cm 0.63 mm OD Cone Tipped Needle		031807
004670	50 µL Fixed Needle PerkinElmer Syringe with 7 cm 0.63 mm OD Cone Tipped Needle		
Shimadzu			
000440	0.5 µL NanoVolume Shimadzu Syringe with 4.2 cm 0.47 mm OD Cone Tipped Needle	033738*	
000445	0.5 µL NanoVolume Shimadzu Syringe with 4.2 cm 0.63 mm OD Cone Tipped Needle	033745*	
002897	10 µL Removable Needle Shimadzu Syringe with 4.2 cm 0.47 mm OD Cone Tipped Needle	037745	
002898	10 µL Removable Needle Shimadzu Syringe with 4.2 cm 0.63 mm OD Cone Tipped Needle	037747	
002780	10 µL Removable Needle Shimadzu Diamond MS Syringe with GT Plunger	Refer Diamond MS PDPN-1005-G	0355180
002902	10 µL Removable Needle Shimadzu Syringe with GT Plunger & 4.2 cm 0.63 mm OD Cone Tipped Needle	037747	031798
CTC/Thermo			
000490	0.5 µL NanoVolume CTC/Thermo Syringe with 5 cm 0.47 mm OD Cone Tipped Needle	033770*	
000492	0.5 µL NanoVolume CTC/Thermo Syringe with 5 cm 0.63 mm OD Cone Tipped Needle	033772*	
000790	2.0 µL NanoVolume CTC/Thermo Syringe with 5.0 cm 0.63 mm OD Cone Tipped Needle	034905*	
001982	5 µL Fixed Needle CTC/Thermo Syringe with 5 cm 0.47 mm OD Cone Tipped Needle		
0019821	5 µL Fixed Needle CTC/Thermo (Classic Button) Syringe with 5 cm 0.47 mm OD Cone Tipped Needle		
001981	5 µL Fixed Needle CTC/Thermo Syringe with 5 cm 0.63 mm OD Cone Tipped Needle		
0019811	5 µL Fixed Needle CTC/Thermo (Classic Button) Syringe with 5 cm 0.63 mm OD Cone Tipped Needle		
001984	5 µL Removable Needle CTC/Thermo Syringe with 5 cm 0.63 mm OD Cone Tipped Needle	36011	
002980	10 µL Fixed Needle CTC/Thermo Syringe with 5 cm 0.47 mm OD Cone Tipped Needle		
0029801	10 µL Fixed Needle CTC/Thermo (Classic Button) Syringe with 5 cm 0.47 mm OD Cone Tipped Needle		
002986	10 µL Fixed Needle CTC/Thermo Syringe with 5 cm 0.47 mm OD Cone Tipped Needle PK6		
0029861	10 µL Fixed Needle CTC/Thermo (Classic Button) Syringe with 5 cm 0.47 mm OD Cone Tipped Needle PK6		
002967	10 µL Fixed Needle CTC/Thermo Syringe with 5 cm 0.5 mm OD Cone Tipped Needle		
0029671	10 µL Fixed Needle CTC/Thermo (Classic Button) Syringe with 5 cm 0.5 mm OD Cone Tipped Needle		
002981	10 µL Fixed Needle CTC/Thermo Syringe with 5 cm 0.63 mm OD Cone Tipped Needle		
002971	10 µL Fixed Needle CTC/Thermo Syringe with 5 cm 0.63 mm OD Cone Tipped Needle PK6		
002992	10 µL Fixed Needle CTC/Thermo Syringe with 8 cm 0.47 mm OD Cone Tipped Needle		
0029781	10 µL Fixed Needle CTC/Thermo (Classic Button) Syringe with 7 cm 0.47 mm OD Cone Tipped Needle		
0029921	10 µL Fixed Needle CTC/Thermo (Classic Button) Syringe with 8 cm 0.47 mm OD Cone Tipped Needle		
0029891	10 µL Fixed Needle CTC/Thermo (Classic Button) Syringe with 8 cm 0.63 mm OD Cone Tipped Needle		
0029741	10 µL Fixed Needle CTC/Thermo (Classic Button) Syringe with 8 cm 0.72 mm OD Cone Tipped Needle		
002977	10 µL Fixed Needle CTC/Thermo Syringe with GT Plunger & 5 cm 0.47 mm OD Cone Tipped Needle		031803 (PK1) 0318120 (PK2)
002976	10 µL Fixed Needle CTC/Thermo Syringe with GT Plunger & 5 cm 0.47 mm OD Cone Tipped Needle PK6		031803 (PK1) 0318120 (PK2)

Part Number	Part Description and Detail	Replacement Needle (* Needle & Plunger Kit)	Replacement Plunger
0029771	10 µL Fixed Needle CTC/Thermo (Classic Button) Syringe with GT Plunger & 5 cm 0.47 mm OD Cone Tipped Needle		03181201
0029761	10 µL Fixed Needle CTC/Thermo (Classic Button) Syringe with GT Plunger & 5 cm 0.47 mm OD Cone Tipped Needle PK6		03181201
002987	10 µL Fixed Needle CTC/Thermo Syringe with GT Plunger & 5 cm 0.63 mm OD Cone Tipped Needle		031803 (PK1) 0318120 (PK2)
002972	10 µL Fixed Needle CTC/Thermo Syringe with GT Plunger & 5 cm 0.63 mm OD Cone Tipped Needle PK6		031803 (PK1) 0318120 (PK2)
0029871	10 µL Fixed Needle CTC/Thermo (Classic Button) Syringe with GT Plunger & 5 cm 0.63 mm OD Cone Tipped Needle		03181201
002982	10 µL Removable Needle CTC/Thermo Syringe with 5 cm 0.47 mm OD Cone Tipped Needle	037010	
002984	10 µL Removable Needle CTC/Thermo Syringe with 5 cm 0.63 mm OD Cone Tipped Needle	037787	
0029841	10 µL Removable Needle CTC/Thermo (Classic Button) Syringe with 5 cm 0.63 mm OD Cone Tipped Needle	037787	
002993	10 µL Removable Needle CTC/Thermo Syringe with 8 cm 0.47 mm OD Cone Tipped Needle	031535	
0029931	10 µL Removable Needle CTC/Thermo (Classic Button) Syringe with 8 cm 0.47 mm OD Cone Tipped Needle	031535	
002985	10 µL Removable Needle CTC/Thermo Syringe with GT Plunger & 5 cm 0.47 mm OD Cone Tipped Needle	037010	0318121
003987	25 µL Fixed Needle CTC/Thermo Syringe with GT Plunger & 5 cm 0.63 mm OD Cone Tipped Needle		031817
0039871	25 µL Fixed Needle CTC/Thermo (Classic Button) Syringe with GT Plunger & 5 cm 0.63 mm OD Cone Tipped Needle		0318171
003988	25 µL Removable Needle CTC/Thermo Syringe with GT Plunger & 5 cm 0.47 mm OD Side Hole Needle	038749	031816
005335	100 µL Fixed Needle CTC/Thermo Syringe with GT Plunger & 5 cm 0.63 mm OD Cone Tipped Needle		0318261
005291	100 µL Removable Needle CTC/Thermo MEPS Syringe with GT Plunger	Refer MEPS PDPN-1030-G	
005333	100 µL Removable Needle CTC/Thermo Syringe with GT Plunger & 5 cm 0.47 mm OD Cone Tipped Needle	038732	031826
CTC RTC & Thermo RSH			
000480	0.5 µL NanoVolume CTC RTC & Thermo RSH Syringe with 5.7 cm 0.63 mm OD Cone Tipped Needle	033780*	
000680	1.0 µL NanoVolume CTC RTC & Thermo RSH Syringe with 5.7 cm 0.63 mm OD Cone Tipped Needle	034780*	
001865	5 µL Fixed Needle CTC RTC & Thermo RSH Syringe with 5.7 cm 0.47 mm OD Cone Tipped Needle		
001861	5 µL Fixed Needle CTC RTC & Thermo RSH Syringe with 5.7 cm 0.63 mm OD Cone Tipped Needle		
001867	5 µL Fixed Needle CTC RTC & Thermo RSH Syringe with 8.5 cm 0.47 mm OD Cone Tipped Needle		
001863	5 µL Fixed Needle CTC RTC & Thermo RSH Syringe with 8.5 cm 0.63 mm OD Cone Tipped Needle		
001875	5 µL Removable Needle CTC RTC & Thermo RSH Syringe with 5.7 cm 0.47 mm OD Cone Tipped Needle	036875	
001871	5 µL Removable Needle CTC RTC & Thermo RSH Syringe with 5.7 cm 0.63 mm OD Cone Tipped Needle	036871	
001877	5 µL Removable Needle CTC RTC & Thermo RSH Syringe with 8.5 cm 0.47 mm OD Cone Tipped Needle	036877	
001873	5 µL Removable Needle CTC RTC & Thermo RSH Syringe with 8.5 cm 0.63 mm OD Cone Tipped Needle	036873	
002865	10 µL Fixed Needle CTC RTC & Thermo RSH Syringe with 5.7 cm 0.47 mm OD Cone Tipped Needle		
002861	10 µL Fixed Needle CTC RTC & Thermo RSH Syringe with 5.7 cm 0.63 mm OD Cone Tipped Needle		
002869	10 µL Fixed Needle CTC RTC & Thermo RSH Syringe with 8.5 cm 0.47 mm OD Bevel Tipped Needle		
002867	10 µL Fixed Needle CTC RTC & Thermo RSH Syringe with 8.5 cm 0.47 mm OD Cone Tipped Needle		
002863	10 µL Fixed Needle CTC RTC & Thermo RSH Syringe with 8.5 cm 0.63 mm OD Cone Tipped Needle		
002866	10 µL Fixed Needle CTC RTC & Thermo RSH Syringe with GT Plunger & 5.7 cm 0.47 mm OD Cone Tipped Needle		032810
002862	10 µL Fixed Needle CTC RTC & Thermo RSH Syringe with GT Plunger & 5.7 cm 0.63 mm OD Cone Tipped Needle		032810
002868	10 µL Fixed Needle CTC RTC & Thermo RSH Syringe with GT Plunger & 8.5 cm 0.47 mm OD Cone Tipped Needle		032810
002864	10 µL Fixed Needle CTC RTC & Thermo RSH Syringe with GT Plunger & 8.5 cm 0.63 mm OD Cone Tipped Needle		032810
002875	10 µL Removable Needle CTC RTC & Thermo RSH Syringe with 5.7 cm 0.47 mm OD Cone Tipped Needle	037875	
002871	10 µL Removable Needle CTC RTC & Thermo RSH Syringe with 5.7 cm 0.63 mm OD Cone Tipped Needle	037871	
002877	10 µL Removable Needle CTC RTC & Thermo RSH Syringe with 8.5 cm 0.47 mm OD Cone Tipped Needle	037877	
002873	10 µL Removable Needle CTC RTC & Thermo RSH Syringe with 8.5 cm 0.63 mm OD Cone Tipped Needle	037873	
002790	10 µL Removable Needle CTC RTC & Thermo RSH Diamond MS Syringe with GT Plunger	Refer Diamond MS PDPN-1005-G	0355190
002876	10 µL Removable Needle CTC RTC & Thermo RSH Syringe with GT Plunger & 5.7 cm 0.47 mm OD Cone Tipped Needle	037875	032810
002872	10 µL Removable Needle CTC RTC & Thermo RSH Syringe with GT Plunger & 5.7 cm 0.63 mm OD Cone Tipped Needle	037871	032810
002878	10 µL Removable Needle CTC RTC & Thermo RSH Syringe with GT Plunger & 8.5 cm 0.47 mm OD Cone Tipped Needle	037877	032810
002874	10 µL Removable Needle CTC RTC & Thermo RSH Syringe with GT Plunger & 8.5 cm 0.63 mm OD Cone Tipped Needle	037873	032810
003866	25 µL Fixed Needle CTC RTC & Thermo RSH Syringe with GT Plunger & 5.7 cm 0.47 mm OD Cone Tipped Needle		032815
003862	25 µL Fixed Needle CTC RTC & Thermo RSH Syringe with GT Plunger & 5.7 cm 0.63 mm OD Cone Tipped Needle		032815
003868	25 µL Fixed Needle CTC RTC & Thermo RSH Syringe with GT Plunger & 8.5 cm 0.47 mm OD Cone Tipped Needle		032815
003864	25 µL Fixed Needle CTC RTC & Thermo RSH Syringe with GT Plunger & 8.5 cm 0.63 mm OD Cone Tipped Needle		032815

Part Number	Part Description and Detail	Replacement Needle (* Needle & Plunger Kit)	Replacement Plunger
003790	25 µL Removable Needle CTC RTC & Thermo RSH Diamond MS Syringe with GT Plunger	Refer Diamond MS PDPN-1005-G	0355191
004866	50 µL Fixed Needle CTC RTC & Thermo RSH Syringe with GT Plunger & 5.7 cm 0.47 mm OD Cone Tipped Needle		032821
004862	50 µL Fixed Needle CTC RTC & Thermo RSH Syringe with GT Plunger & 5.7 cm 0.63 mm OD Cone Tipped Needle		032821
004868	50 µL Fixed Needle CTC RTC & Thermo RSH Syringe with GT Plunger & 8.5 cm 0.47 mm OD Cone Tipped Needle		032821
004864	50 µL Fixed Needle CTC RTC & Thermo RSH Syringe with GT Plunger & 8.5 cm 0.63 mm OD Cone Tipped Needle		032821
004790	50 µL Removable Needle CTC RTC & Thermo RSH Diamond MS Syringe with GT Plunger	Refer Diamond MS PDPN-1005-G	0355192
005866	100 µL Fixed Needle CTC RTC & Thermo RSH Syringe with GT Plunger & 5.7 cm 0.47 mm OD Cone Tipped Needle		032825
005862	100 µL Fixed Needle CTC RTC & Thermo RSH Syringe with GT Plunger & 5.7 cm 0.63 mm OD Cone Tipped Needle		032825
005890	100 µL Fixed Needle CTC RTC & Thermo RSH Syringe with GT Plunger & 5.7 cm 0.63 mm OD Side Hole Needle		032825
005868	100 µL Fixed Needle CTC RTC & Thermo RSH Syringe with GT Plunger & 8.5 cm 0.47 mm OD Cone Tipped Needle		032825
005864	100 µL Fixed Needle CTC RTC & Thermo RSH Syringe with GT Plunger & 8.5 cm 0.63 mm OD Cone Tipped Needle		032825
005891	100 µL Fixed Needle CTC RTC & Thermo RSH Syringe with GT Plunger & 8.5 cm 0.63 mm OD Side Hole Needle		032825
005790	100 µL Removable Needle CTC RTC & Thermo RSH Diamond MS Syringe with GT Plunger	Refer Diamond MS PDPN-1005-G	0355193
006866	250 µL Fixed Needle CTC RTC & Thermo RSH Syringe with GT Plunger & 5.7 cm 0.47 mm OD Cone Tipped Needle		032831
006862	250 µL Fixed Needle CTC RTC & Thermo RSH Syringe with GT Plunger & 5.7 cm 0.63 mm OD Cone Tipped Needle		032831
006890	250 µL Fixed Needle CTC RTC & Thermo RSH Syringe with GT Plunger & 5.7 cm 0.63 mm OD Side Hole Needle		032831
006868	250 µL Fixed Needle CTC RTC & Thermo RSH Syringe with GT Plunger & 8.5 cm 0.47 mm OD Cone Tipped Needle		032831
006864	250 µL Fixed Needle CTC RTC & Thermo RSH Syringe with GT Plunger & 8.5 cm 0.63 mm OD Cone Tipped Needle		032831
006891	250 µL Fixed Needle CTC RTC & Thermo RSH Syringe with GT Plunger & 8.5 cm 0.63 mm OD Side Hole Needle		032831
007866	500 µL Fixed Needle CTC RTC & Thermo RSH Syringe with GT Plunger & 5.7 cm 0.47 mm OD Cone Tipped Needle		032835
007862	500 µL Fixed Needle CTC RTC & Thermo RSH Syringe with GT Plunger & 5.7 cm 0.63 mm OD Cone Tipped Needle		032835
007890	500 µL Fixed Needle CTC RTC & Thermo RSH Syringe with GT Plunger & 5.7 cm 0.63 mm OD Side Hole Needle		032835
007868	500 µL Fixed Needle CTC RTC & Thermo RSH Syringe with GT Plunger & 8.5 cm 0.47 mm OD Cone Tipped Needle		032835
007864	500 µL Fixed Needle CTC RTC & Thermo RSH Syringe with GT Plunger & 8.5 cm 0.63 mm OD Cone Tipped Needle		032835
007891	500 µL Fixed Needle CTC RTC & Thermo RSH Syringe with GT Plunger & 8.5 cm 0.63 mm OD Side Hole Needle		032835
008155	1 mL Fixed Needle CTC RTC & Thermo RSH Head Space Syringe with Energized GT Plunger & 6.5 cm 0.63 mm OD Side Hole Needle		032841
008655	2.5 mL Fixed Needle CTC RTC & Thermo RSH Head Space Syringe with Energized GT Plunger & 5.6 cm 0.63 mm OD Side Hole Needle		032846
Varian			
000655	1.0 µL NanoVolume Varian (8035, 8100, 8200) Syringe with 5.1 cm 0.47 mm OD Cone Tipped Needle	034720*	
002950	10 µL Fixed Needle Varian 8400 Syringe with 5 cm 0.47 mm OD Bevel Tipped Needle		
002951	10 µL Fixed Needle Varian 8400/CTC/Thermo (Classic Button) Syringe with 5 cm 0.63 mm OD Cone Tipped Needle		
0029851	10 µL Removable Needle Varian (Classic Button) Syringe with GT Plunger & 5 cm 0.47 mm OD Cone Tipped Needle	037010	03181211
002952	10 µL Removable Needle Varian 8400 Syringe with 5 cm 0.47 mm OD Cone Tipped Needle	037010	
002924	10 µL Removable Needle Varian (8035, 8100, 8200) Syringe with GT Plunger & 5.3 cm mm OD Side Hole Needle	037777 037779 037780 037776	031218

For more information visit www.sge.com or contact techsupport@sge.com.

Syringes | HPLC Autosampler

Diamond Syringe - Syringe Brilliance

Known for 50 years in chromatography syringes, the SGE range of HPLC autosampler syringes are designed and tested to meet critical autosampler specifications.

Product Specifications

Available for CTC, Spark Holland, Hitachi, Thermo Scientific, PerkinElmer, Waters WISP, HPLC autosamplers.

Accuracy and Reproducibility	± 1 % (displaced volume)
Temperature Range	5-70 °C Fixed Needle, 5-120 °C Removable Needle
International Standards Traceability	

For more information about this product visit www.sge.com or contact techsupport@sge.com.



Syringes | HPLC Autosampler

Diamond Syringe - Syringe Brilliance

Part Number	Part Description and Detail	Replacement Needle	Replacement Plunger
CTC			
002710	10 µL Fixed Needle CTC Syringe with 5.1 cm 0.72 mm OD LC Needle		
003715	25 µL Fixed Needle CTC Syringe with GT Plunger & 5.1 cm 0.72 mm OD LC Needle (8 mm OD barrel)		0318922
004810	50 µL Fixed Needle CTC Syringe with GT Plunger & 5.1 cm 0.72 mm OD LC Needle		031821
005715	100 µL Fixed Needle CTC Syringe with GT Plunger & 5.1 cm 0.72 mm OD LC Needle		0318261
005720	100 µL Fixed Needle CTC Syringe with GT Plunger & 5.1 cm 0.72 mm OD (0.4 mm ID) LC Needle		0318261
006330	250 µL Fixed Needle CTC Syringe with GT Plunger & 5.1 cm 0.72 mm OD (0.4 mm ID) LC Needle	038250	031831
007720	500 µL Fixed Needle CTC Syringe with GT Plunger & 5.1 cm 0.72 mm OD (0.4 mm ID) LC Needle		0318928
CTC/Thermo			
005331	100 µL Fixed Needle CTC/Thermo Syringe with GT Plunger & 5.1 cm 0.72 mm OD LC needle		0318261
005330	100 µL Removable Needle CTC/Thermo Syringe with GT Plunger & 5.1 cm 0.72 mm OD LC needle	038250	031826
CTC RTC & Thermo RSH			
002880	10 µL Removable Needle CTC RTC & Thermo RSH Syringe with GT Plunger & 5.7 cm 0.72 mm OD LC Needle	037880	0318121
008150	1 mL Fixed Needle CTC RTC & Thermo RSH Syringe with GT Plunger & 5.7 cm 0.72 mm OD LC Tipped Needle		032842
008151	1 mL Removable Needle CTC RTC & Thermo RSH Syringe with GT Plunger & 5.7 cm 0.72 mm OD LC Tipped Needle	039280	032842
008950	10 mL Fixed Needle CTC RTC & Thermo RSH Syringe with GT Plunger & 5.7 cm 1.07 mm OD LC Tipped Needle		032855
008951	10 mL Removable Needle CTC RTC & Thermo RSH Syringe with GT Plunger & 5.7 cm 1.07 mm OD LC Tipped Needle	031590	032855
Hitachi			
007660	500 µL Syringe with GT Plunger and M10 Termination		031837
PerkinElmer			
004995	50 µL Syringe with GT Plunger and 1/4-28 UNF Termination		
005990	100 µL Syringe with GT Plunger and 1/4-28 UNF Termination		
006995	250 µL Syringe with GT Plunger and 1/4-28 UNF Termination		031833
007995	500 µL Syringe with GT Plunger and 1/4-28 UNF Termination		
008185	1 mL Syringe with GT Plunger and 1/4-28 UNF Termination		0318441
008687	2.5 mL Syringe with GT Plunger and 1/4-28 UNF Termination		031854
Spark			
006683	250 µL Spark Syringe with GT Plunger		0318348
Thermospec			
006660	250 µL Thermospec Syringe		
Waters			
003990	25 µL Waters Wisp Syringe with GT Plunger		031819
006690	250 µL Waters Wisp Syringe with GT Plunger		031834

For more information about this product visit www.sge.com or contact techsupport@sge.com.

Syringes | MEPS®

Extraction to Injection in a Single Process

MEPS® is Micro Extraction by Packed Sorbent, the miniaturization of conventional SPE packed bed devices from milliliter bed volumes to microliter volumes. The MEPS approach to sample preparation is suitable for reversed phases, normal phases, mixed mode or ion exchange chemistries.

The MEPS Barrel Insert and Needle (BIN) assembly contains the stationary phase, and is built into the syringe needle. Using MEPS requires both a suitable syringe and a MEPS BIN.

With MEPS, the sample processing, extraction and injection steps are performed using the same syringe.

Features and Benefits

- MEPS syringes are compatible for use with MEPS BINs.
- Save hours in sample preparation.
- Reduce solvent usage and sample volume.

Recommended Applications

SPE method development, and/or proofing before transition to fully automated platforms. Processing small sample batches, or urgent samples.

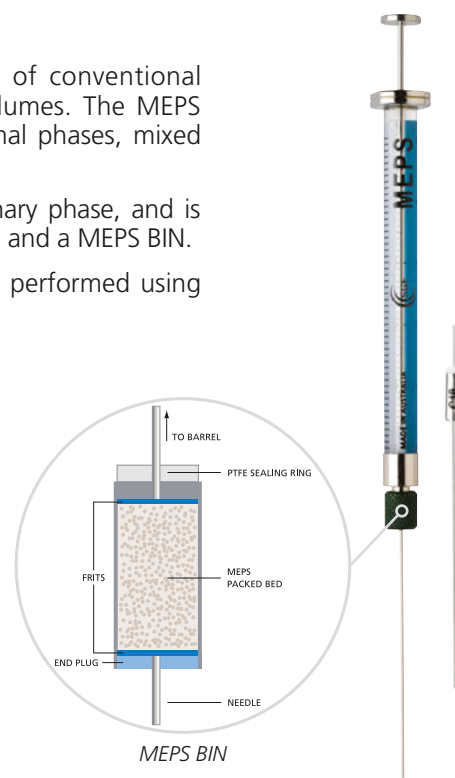

Product Specifications

- 100 µL and 250 µL removable needle MEPS syringes available to suit a range of autosamplers or can be used manually.
- MEPS syringes are easily identifiable with MEPS printed on the barrel, and a green removable nut.
- MEPS BINs are available separately.

For more information about this product refer to product data sheet PD-1095-G Separations | MEPS BINs, visit www.sge.com or contact techsupport@sge.com.

Syringes | MEPS®

Extraction to Injection in a Single Process

Part Number	Part Description and Detail	Replacement Plunger
eVol MEPS Syringes		
2910027	50 µL eVol MEPS Syringe with GT Plunger	2910382
2910028	100 µL eVol MEPS Syringe with GT Plunger	2910383
2910026	500 µL eVol MEPS Syringe with GT Plunger	2910384
Agilent & Shimadzu MEPS Syringes		
005292	100 µL Agilent & Shimadzu MEPS Syringe	0318263
006293	250 µL Agilent & Shimadzu MEPS Syringe	0318303
CTC & Thermo MEPS Syringes		
005291	100 µL CTC & Thermo MEPS Syringe	031826
006292	250 µL CTC MEPS Syringe	0318301
006291	250 µL Thermo MEPS Syringe	031831

For more information about this product visit www.sge.com or contact techsupport@sge.com.

Syringes | Diamond

Diamond Syringe Range – Syringe Brilliance

The comprehensive range of SGE syringes are designed and tested to meet critical specifications. The Diamond Syringe Range offers a never before seen level of Durability, Clarity and Accuracy in the laboratory.

No other syringe range provides such brilliance.

Features and Benefits

- Improved solvent resistance.
- Greater temperature ranges.
- Increased operational smoothness.
- Longer syringe life.
- Reduced carry over, adhesive contamination, and sample interaction.
- Each plunger is individually fitted for each micro syringe for perfect sealing.
- Plunger protection on 5 μ L and 10 μ L syringes helps prevent plunger bending during injection.
- Metal back flange with flat sides prevents syringe rolling off benches.
- Bright white backing strip with black scale markings for accurate reading of the syringe scale.
- Metal cap on fixed needle syringes protects the syringe barrel from chipping and breakage.

Recommended Applications

Manual GC and LC sample injection. Liquid dispensing.

Product Specifications

Accuracy and Reproducibility	± 1 % (dispensed volume)
Borosilicate Glass Barrel Outer Diameter (OD)	6.5 mm for 5 - 10 μ L, 8 mm for guided plunger syringes and 50 - 500 μ L
Scale Length	54.1 mm for 5 - 10 μ L, 60 mm for 50 - 500 μ L
Volume Range	5 μ L - 500 μ L
International Standards Traceability	

Option of either SuperfleX™ flexible plunger or guided plungers on 5 μ L and 10 μ L syringes. Fixed and removable needle version are available.

For more information about this product visit www.sge.com or contact techsupport@sge.com.



Syringes | Diamond

Diamond Syringe Range – Syringe Brilliance

Part Number	Long Description	Replacement Needle
001000	5 µL Fixed Needle Syringe with 5 cm 0.47 mm OD Bevel Tipped Needle	
001050	5 µL Removable Needle Syringe with 5 cm 0.47 mm OD Bevel Tipped Needle	036110
001100	5 µL Fixed Needle Syringe with Flexible Plunger & 5 cm 0.47 mm OD Bevel Tipped Needle	
002000	10 µL Fixed Needle Syringe with 5 cm 0.47 mm OD Bevel Tipped Needle	
002005	10 µL Fixed Needle Syringe with 5 cm 0.47 mm OD Cone Tipped Needle	
002030	10 µL Fixed Needle Syringe with 5 cm 0.47 mm OD Bevel Tipped Needle PK6	
002033	10 µL Fixed Needle Syringe with 5 cm 0.47 mm OD Bevel Tipped Needle PK10	
002035	10 µL Fixed Needle Syringe with 5 cm 0.47 mm OD Bevel Tipped Needle PK25	
002003	10 µL Fixed Needle Syringe with 7 cm 0.47 mm OD Bevel Tipped Needle	
002050	10 µL Removable Needle Syringe with 5 cm 0.47 mm OD Bevel Tipped Needle	037110
002080	10 µL Removable Needle Syringe with 5 cm 0.47 mm OD Bevel Tipped Needle PK6	037110
002100	10 µL Fixed Needle Syringe with Flexible Plunger & 5 cm 0.47 mm OD Bevel Tipped Needle	
002105	10 µL Fixed Needle Syringe with Flexible Plunger & 5 cm 0.47 mm OD Cone Tipped Needle	
002130	10 µL Fixed Needle Syringe with Flexible Plunger & 5 cm 0.47 mm OD Bevel Tipped Needle PK6	
002133	10 µL Fixed Needle Syringe with Flexible Plunger & 5 cm 0.47 mm OD Cone Tipped Needle PK6	
002135	10 µL Fixed Needle Syringe with Flexible Plunger & 5 cm 0.63 mm OD Cone Tipped Needle PK6	
002180	10 µL Removable Needle Syringe with Flexible Plunger & 5 cm 0.47 mm OD Bevel Tipped Needle PK6	037110
003000	25 µL Fixed Needle Syringe with 5 cm 0.5 mm OD Bevel Tipped Needle	
003050	25 µL Removable Needle Syringe with 5 cm 0.5 mm OD Bevel Tipped Needle	038110
004000	50 µL Fixed Needle Syringe with 5 cm 0.5 mm OD Bevel Tipped Needle	
004050	50 µL Removable Needle Syringe with 5 cm 0.5 mm OD Bevel Tipped Needle	038110
005000	100 µL Fixed Needle Syringe with 5 cm 0.5 mm OD Bevel Tipped Needle	
005050	100 µL Removable Needle Syringe with 5 cm 0.5 mm OD Bevel Tipped Needle	038110
005055	100 µL Removable Needle Syringe with 7 cm 0.5 mm OD Bevel Tipped Needle	038130
006000	250 µL Fixed Needle Syringe with 5 cm 0.5 mm OD Bevel Tipped Needle	
006050	250 µL Removable Needle Syringe with 5 cm 0.5 mm OD Bevel Tipped Needle	038110
007000	500 µL Fixed Needle Syringe with 5 cm 0.5 mm OD Bevel Tipped Needle	
007050	500 µL Removable Needle Syringe with 5 cm 0.5 mm OD Bevel Tipped Needle	038110

For more information about this product visit www.sge.com or contact techsupport@sge.com.

Syringes | Diamond Gas Tight

Diamond Syringe Range – Syringe Brilliance

The comprehensive range of SGE syringes are designed and tested to meet critical specifications. The Diamond Syringe Range offers a never before seen level of Durability, Clarity and Accuracy in the laboratory.

No other syringe range provides such brilliance.

Features and Benefits

- PTFE plunger tip for perfect sealing.
- Metal back flange with flat sides prevents syringe rolling off benches.
- Bright white backing strip with black scale markings for accurate reading of the syringe scale.
- Metal cap on fixed needle syringes protects the syringe barrel from chipping and breakage.

Recommended Applications

Manual GC and LC sample injection. Liquid dispensing.



Product Specifications

Accuracy and Reproducibility	± 1 % (dispensed volume)
Borosilicate Glass Barrel Outer Diameter (OD)	10 µL = 6.5 mm, 25-500 µL = 8 mm, 1 mL = 8.8 mm, 2.5 mL = 10.8 mm, 5 mL = 13.7 mm, 10 mL = 18 mm, 25 mL = 27 mm, 50 mL = 32.6 mm, 100 mL = 40.6 mm
Scale Length	10 µL = 54.1 mm, 25 µL - 25 mL = 60 mm, 50 mL = 81 mm, 100 mL = 114 mm
Volume Range	10 µl - 100 mL
International Standards Traceability	

Fixed and removable needle, luer and luer lock versions are available.

For more information about this product visit www.sge.com or contact techsupport@sge.com.

Syringes | Diamond Gas Tight Diamond Syringe Range – Syringe Brilliance

Part Number	Long Description	Replacement Needle	Replacement Plunger
002200	10 µL Fixed Needle Syringe with GT Plunger & 5 cm 0.47 mm OD Bevel Tipped Needle		031810
002202	10 µL Fixed Needle Syringe with GT Plunger & 5 cm 0.47 mm OD Bevel Tipped Needle PK6		031810
002208	10 µL Fixed Needle Syringe with GT Plunger & 7 cm 0.47 mm OD Bevel Tipped Needle		031810
002250	10 µL Removable Needle Syringe with GT Plunger & 5 cm 0.47 mm OD Bevel Tipped Needle	037110	031811
002252	10 µL Removable Needle Syringe with GT Plunger & 5 cm 0.47 mm OD Bevel Tipped Needle PK6	037110	031811
003200	25 µL Fixed Needle Syringe with GT Plunger & 5 cm 0.5 mm OD Bevel Tipped Needle		031815
003250	25 µL Removable Needle Syringe with GT Plunger & 5 cm 0.5 mm OD Bevel Tipped Needle	038110	031815
004200	50 µL Fixed Needle Syringe with GT Plunger & 5 cm 0.5 mm OD Bevel Tipped Needle		031820
004229	50 µL Fixed Luer Tip Syringe with GT Plunger		031820
004230	50 µL Fixed Luer Lock Syringe with GT Plunger		031820
004232	50 µL Fixed Luer Lock Syringe with GT Plunger & Plunger Stop		0318221
004250	50 µL Removable Needle Syringe with GT Plunger & 5 cm 0.5 mm OD Bevel Tipped Needle	038110	031820
004279	50 µL Syringe with Removable Needle Valve & GT Plunger		031820
005200	100 µL Fixed Needle Syringe with GT Plunger & 5 cm 0.5 mm OD Bevel Tipped Needle		031825
005229	100 µL Fixed Luer Tip Syringe with GT Plunger		031825
005230	100 µL Fixed Luer Lock Syringe with GT Plunger		031825
005232	100 µL Fixed Luer Lock Syringe with GT Plunger & Plunger Stop		0318271
005250	100 µL Removable Needle Syringe with GT Plunger & 5 cm 0.5 mm OD Bevel Tipped Needle	038110	031825
005279	100 µL Syringe with Removable Needle Valve & GT Plunger		031825
006200	250 µL Fixed Needle Syringe with GT Plunger & 5 cm 0.5 mm OD Bevel Tipped Needle		031830
006229	250 µL Fixed Luer Tip Syringe with GT Plunger		031830
006230	250 µL Fixed Luer Lock Syringe with GT Plunger		031830
006232	250 µL Fixed Luer Lock Syringe with GT Plunger & Plunger Stop		031833
006250	250 µL Removable Needle Syringe with GT Plunger & 5 cm 0.5 mm OD Bevel Tipped Needle	038110	031830
006279	250 µL Syringe with Removable Needle Valve & GT Plunger		031830
007200	500 µL Fixed Needle Syringe with GT Plunger & 5 cm 0.5 mm OD Bevel Tipped Needle		031835
007229	500 µL Fixed Luer Tip Syringe with GT Plunger		031835
007230	500 µL Fixed Luer Lock Syringe with GT Plunger		031835
007232	500 µL Fixed Luer Lock Syringe with GT Plunger & Plunger Stop		0318381
007250	500 µL Removable Needle Syringe with GT Plunger & 5 cm 0.5 mm OD Bevel Tipped Needle	038110	031835
007279	500 µL Syringe with Removable Needle Valve & GT Plunger		031835
008020	1 mL Fixed Luer Tip Syringe with GT Plunger		031842
008025	1 mL Fixed Luer Lock Syringe with GT Plunger		031842
008100	1 mL Removable Needle Syringe with GT Plunger & 5 cm 0.63 mm OD Bevel Tipped Needle	039110	031842
008102	1 mL Fixed Needle Syringe with GT Plunger & 5 cm 0.72 mm OD Bevel Tipped Needle		031842
008110	1 mL Syringe with Removable Needle Valve & GT Plunger		031842
008160	1 mL Syringe with Removable Luer Lock Valve & GT Plunger		031842
008420	2.5 mL Fixed Luer Tip Syringe with GT Plunger		031852
008425	2.5 mL Fixed Luer Lock Syringe with GT Plunger		031852
008500	2.5 mL Removable Needle Syringe with GT Plunger & 5 cm 0.63 mm OD Bevel Tipped Needle	039110	031852
008502	2.5 mL Fixed Needle Syringe with GT Plunger & 5 cm 0.72 mm OD Bevel Tipped Needle		031852
008510	2.5 mL Syringe with Removable Needle Valve & GT Plunger		031852
008560	2.5 mL Syringe with Removable Luer Lock Valve & GT Plunger		031852
008700	5 mL Removable Needle Syringe with GT Plunger & 5 cm 0.63 mm OD Bevel Tipped Needle	031516	031856
008760	5 mL Removable Luer Lock Syringe with GT Plunger		031856
008762	5 mL Fixed Luer Lock Syringe with GT Plunger		0318562
008770	5 mL Syringe with Removable Luer Lock Valve & GT Plunger		031856
008900	10 mL Removable Needle Syringe with GT Plunger & 5 cm 0.63 mm OD Bevel Tipped Needle	031516	031862
008960	10 mL Removable Luer Lock Syringe with GT Plunger		031862
008962	10 mL Fixed Luer Lock Syringe with GT Plunger		031864
008970	10 mL Syringe with Removable Luer Lock Valve & GT Plunger		031862
009462	25 mL Removable Luer Lock Syringe with GT Plunger		031870
009463	25 mL Fixed Luer Lock Syringe with GT Plunger		031874
009472	25 mL Syringe with Removable Luer Lock Valve & GT Plunger		031870
009660	50 mL Removable Luer Lock Syringe with GT Plunger		0312170
009670	50 mL Syringe with Removable Luer Lock Valve & GT Plunger		0312170
009760	100 mL Removable Luer Lock Syringe with GT Plunger		0312176
009770	100 mL Syringe with Removable Luer Lock Valve & GT Plunger		0312176

For more information about this product visit www.sge.com or contact techsupport@sge.com.

Syringes | Guided Plunger

Diamond Syringe - Syringe Brilliance

Guided plunger syringes are the most rugged syringe available, making them perfect for industrial environments.

Features and Benefits

- Extended barrel guides plunger during injection.
- Robust and rugged.

Recommended Applications

Ideal for student and industrial use.



Product Specifications

Available in 5 μ L to 10 μ L capacities.

Accuracy and Reproducibility	± 1 % (displaced volume)
Temperature Range	5-70 °C Fixed Needle, 5-120 °C Removable Needle
International Standards Traceability	

For more information about this product visit www.sge.com or contact techsupport@sge.com.

Syringes | Guided Plunger

Diamond Syringe - Syringe Brilliance

Part Number	Part Description and Detail	Replacement Needle	Replacement Plunger
001400	5 µL Fixed Needle Guided Plunger Syringe with 5 cm 0.47 mm OD Bevel Tipped Needle		
001450	5 µL Removable Needle Guided Plunger Syringe with 5 cm 0.47 mm OD Bevel Tipped Needle	036110	
001495	5 µL Removable Needle Guided Plunger Syringe with 5 cm 0.47 mm OD Bevel Tipped Needle (Half Scale)	037110	
002400	10 µL Fixed Needle Guided Plunger Syringe with 5 cm 0.47 mm OD Bevel Tipped Needle		
002450	10 µL Removable Needle Guided Plunger Syringe with 5 cm 0.47 mm OD Bevel Tipped Needle	037110	
002455	10 µL Removable Needle Guided Plunger Syringe with GT Plunger & 5 cm 0.47 mm OD Bevel Tipped Needle	037110	031805

For more information about this product visit www.sge.com or contact techsupport@sge.com.

Syringes | Jumbo

For the handling of large volumes of gas, SGE Jumbo syringes offer convenient use as well as versatility and reliability.

Features and Benefits

Heavy duty acrylic barrels. Easy access to sample for the addition of standards or removal of subsample via secondary port. Plunger stem is removable for ease of transportation and storage.

Compatible with a range of fittings; has a 7/16" UNEF thread and designed to be used with Luer Lock fittings and needles.

Recommended Applications

Ideal for calibration of medical equipment such as respirators and spirometers, and for stack and air sampling.

Do not subject Jumbo syringes to temperatures in excess of 80 °C.

Product Specifications

Accuracy and Reproducibility	± 2 % (dispensed volume)
Acrylic Barrel Outer Diameter (OD)	0.5 L = 70 mm, 1 L = 100 mm and 2 L = 130 mm
Scale Length	0.5 L = 179.2 mm, 1 L = 159.1 mm and 2 L = 179 mm
International Standards Traceability	

Syringe Volume	Barrel Length (mm)	Barrel OD (mm)	Major Scale Divisions (mL)	Minor Scale Divisions (mL)
0.5 L	245	70	50	25
1 L	245	100	100	50
2 L	245	130	200	100



For more information about this product visit www.sge.com or contact techsupport@sge.com.

Syringes | Jumbo

Part Number	Part Description and Detail	Replacement Plunger O-Ring
009910	500 mL Jumbo Luer Lock Syringe	032527
009920	1000 mL Jumbo Luer Lock Syringe	032532
009930	2000 mL Jumbo Luer Lock Syringe	032537

For more information about this product visit www.sge.com or contact techsupport@sge.com.

Syringes | For Rheodyne® and Valco® Valves

Diamond Syringe - Syringe Brilliance

A range of SGE syringes specifically designed for use with Rheodyne® and Valco® injection valves. Syringes use a 22 gauge (0.028" OD), 5.1 cm (2") long needle with a square cut (90 °) needle tip style and no electrotaper. Selection of the syringe capacity will depend on the injection technique.

Features and Benefits

- Metal back flange with flat sides prevents syringe rolling off benches.
- Bright white backing strip with black scale markings for accurate reading of the syringe scale.
- Metal cap on fixed needle syringes protects the syringe barrel from chipping and breakage.

Recommended Applications

For partial HPLC injection loop fill, the injection volume should be no greater than half the loop capacity. The injection size sets the injection volume.

For complete loop fill, the syringe capacity should be greater than twice the loop volume. A luer lock syringe fitted with a Rheodyne/Valco luer lock needle is ideal for this purpose. The loop capacity sets the injection volume.

Product Specifications

Available in 5 µL to 500 µL fixed needle capacities, and 10 µL to 2.5 mL removable needle capacities.

Accuracy and Reproducibility	± 1 % (displaced volume)
Temperature Range	5-70 °C Fixed Needle, 5-120 °C Removable Needle
International Standards Traceability	

For more information about this product visit www.sge.com or contact techsupport@sge.com.



Syringes | For Rheodyne® and Valco® Valves

Diamond Syringe - Syringe Brilliance

Part Number	Part Description and Detail	Replacement Needle	Replacement Plunger
001301	5 µL Fixed Needle Syringe with 5.1 cm 0.72 mm OD LC Needle		
002301	10 µL Fixed Needle Syringe with 5.1 cm 0.72 mm OD LC Needle		
002315	10 µL Fixed Needle Syringe with 5.1 cm 0.72 mm OD LC Needle PK6		
002300	10 µL Fixed Needle Syringe with SuperFlex Plunger & 5.1 cm 0.72 mm OD LC Needle		
002330	10 µL Fixed Needle Syringe with SuperFlex Plunger & 5.1 cm 0.72 mm OD LC Needle PK6		
002335	10 µL Fixed Needle Syringe with GT Plunger & 5.1 cm 0.72 mm OD LC Needle		031801
002313	10 µL Removable Needle Syringe with GT Plunger & 5.1 cm 0.72 mm OD LC Needle	037250	031811
003300	25 µL Fixed Needle Syringe with 5.1 cm 0.72 mm OD LC Needle		
003312	25 µL Removable Needle Syringe with GT Plunger & 5.1 cm 0.72 mm OD LC Needle	038250	031815
004300	50 µL Fixed Needle Syringe with 5.1 cm 0.72 mm OD LC Needle		
004312	50 µL Removable Needle Syringe with GT Plunger & 5.1 cm 0.72 mm OD LC Needle	038250	031820
005300	100 µL Fixed Needle Syringe with 5.1 cm 0.72 mm OD LC Needle		
005312	100 µL Removable Needle Syringe with GT Plunger & 5.1 cm 0.72 mm OD LC Needle	038250	031825
006300	250 µL Fixed Needle Syringe with 5.1 cm 0.72 mm OD LC Needle		
006310	250 µL Removable Needle Syringe with 5.1 cm 0.72 mm OD LC Needle	038250	
006312	250 µL Removable Needle Syringe with GT Plunger & 5.1 cm 0.72 mm OD LC Needle	038250	031830
007300	500 µL Fixed Needle Syringe with & 5.1 cm 0.72 mm OD LC Needle		
007310	500 µL Removable Needle Syringe with 5.1 cm 0.72 mm OD LC Needle	038250	
007312	500 µL Removable Needle Syringe with GT Plunger & 5.1 cm 0.72 mm OD LC Needle	038250	031835
008105	1 mL Removable Needle Syringe with GT Plunger & 5.1 cm 0.72 mm OD LC Needle	039250	031842
008505	2.5 mL Removable Needle Syringe with GT Plunger & 5.1 cm 0.72 mm OD LC Needle	039250	031852

For more information about this product visit www.sge.com or contact techsupport@sge.com.

Syringes | NanoVolume

With the ability to inject down to 50 nL with high precision and accuracy, SGE NanoVolume Syringes are perfect for NanoVolume capillary chromatography injection as well as making accurate standards that require small volumes. The sample is only drawn into the needle, not the syringe barrel. When the plunger is depressed, the sample is completely dispensed by the NanoVolume plunger that extends to the tip of the needle.

Features and Benefits

- Plunger extends into the needle tip.
- Sample is contained only in the needle, i.e. no glass contact.
- Ideal for dispensing very small liquid volumes. Virtually zero dead volume and carry over between injections.

Recommended Applications

Recommended for use when sample volume is less than 1000 nL (1 μ L).

Product Specifications

Available in 500 nL (0.5 μ L), 1000 nL (1 μ L) and 5000 nL (5 μ L).

Accuracy and Reproducibility	± 2 % (dispensed volume)
Temperature Range	5-70 °C
International Standards Traceability	

For more information about this product visit www.sge.com or contact techsupport@sge.com.

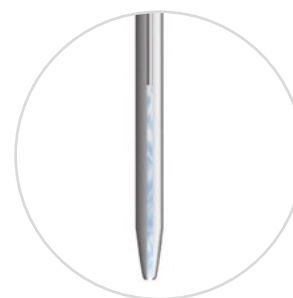

Syringes | NanoVolume

Part Number	Part Description and Detail	Replacement Needle and Plunger Kit
Manual		
000303	0.5 µL NanoVolume Syringe with 5 cm 0.47 mm OD Cone Tipped Needle	033012
000353	0.5 µL NanoVolume Syringe with 5 cm 0.47 mm OD Cone Tipped Needle & Repeating Adaptor	033012
000301	0.5 µL NanoVolume Syringe with 5 cm 0.63 mm OD Bevel Tipped Needle	033011
000300	0.5 µL NanoVolume Syringe with 5 cm 0.63 mm OD Cone Tipped Needle	033010
000350	0.5 µL NanoVolume Syringe with 5 cm 0.63 mm OD Cone Tipped Needle & Repeating Adaptor	033010
000311	0.5 µL NanoVolume Syringe with 7 cm 0.63 mm OD Bevel Tipped Needle	033060
000310	0.5 µL NanoVolume Syringe with 7 cm 0.63 mm OD Cone Tipped Needle	033057
000355	0.5 µL NanoVolume Syringe with 7 cm 0.63 mm OD Cone Tipped Needle & Repeating Adaptor	033057
000376	0.5 µL NanoVolume On-Column Syringe with 7 cm 0.47 mm OD Needle	033630
000380	0.5 µL NanoVolume On-Column Syringe with 7.5 cm 0.23 mm OD Needle	033620
000501	1.0 µL NanoVolume Syringe with 5 cm 0.63 mm OD Bevel Tipped Needle	034056
000500	1.0 µL NanoVolume Syringe with 5 cm 0.63 mm OD Cone Tipped Needle	034055
000550	1.0 µL NanoVolume Syringe with 5 cm 0.63 mm OD Cone Tipped Needle & Repeating Adaptor	034055
000570	1.0 µL NanoVolume Syringe with 7 cm 0.47 mm OD Cone Tipped Needle	034610
000506	1.0 µL NanoVolume Syringe with 7 cm 0.63 mm OD Bevel Tipped Needle	034060
000505	1.0 µL NanoVolume Syringe with 7 cm 0.63 mm OD Cone Tipped Needle	034057
000553	1.0 µL NanoVolume Syringe with 7 cm 0.63 mm OD Cone Tipped Needle & Repeating Adaptor	034057
000510	1.0 µL NanoVolume Syringe with 11.5 cm 0.63 mm OD Bevel Tipped Needle	034059
000800	5.0 µL NanoVolume Syringe with 5 cm 0.63 mm OD Cone Tipped Needle	035055
000801	5.0 µL NanoVolume Syringe with 5 cm 0.63 mm OD Bevel Tipped Needle	035056
000850	5.0 µL NanoVolume Syringe with 5 cm 0.63 mm OD Cone Tipped Needle & Repeating Adaptor	035055
000803	5.0 µL NanoVolume Syringe with 7 cm 0.63 mm OD Bevel Tipped Needle	035058
000802	5.0 µL NanoVolume Syringe with 7 cm 0.63 mm OD Cone Tipped Needle	035057
000852	5.0 µL NanoVolume Syringe with 7 cm 0.63 mm OD Cone Tipped Needle & Repeating Adaptor	035057
000805	5.0 µL NanoVolume Syringe with 7 cm 0.63 mm OD Nozzle Tipped Needle	035060
000804	5.0 µL NanoVolume Syringe with 11.5 cm 0.63 mm OD Cone Tipped Needle	035059
Agilent		
000400	0.5 µL NanoVolume Agilent Syringe with 4.2 cm 0.47 mm OD Cone Tipped Needle	033708
000410	0.5 µL NanoVolume Agilent Syringe with 4.2 cm 0.63 mm OD Cone Tipped Needle	033715
000415	0.5 µL NanoVolume Agilent Syringe with 4.2 cm 0.63/0.47 mm OD Dual Gauge Cone Tipped Needle	033730
000610	1.0 µL NanoVolume Agilent Syringe with 4.2 cm 0.63 mm OD Cone Tipped Needle	034715
CTC/Thermo		
000490	0.5 µL NanoVolume CTC/Thermo Syringe with 5 cm 0.47 mm OD Cone Tipped Needle	033770
000492	0.5 µL NanoVolume CTC/Thermo Syringe with 5 cm 0.63 mm OD Cone Tipped Needle	033772
000480	0.5 µL NanoVolume CTC RTC & Thermo RSH Syringe with 5.7 cm 0.63 mm OD Cone Tipped Needle	033780
000680	1.0 µL NanoVolume CTC RTC & Thermo RSH Syringe with 5.7 cm 0.63 mm OD Cone Tipped Needle	034780
000790	2.0 µL NanoVolume CTC/Thermo Syringe with 5.0 cm 0.63 mm OD Cone Tipped Needle	034905
Shimadzu		
000440	0.5 µL NanoVolume Shimadzu Syringe with 4.2 cm 0.47 mm OD Cone Tipped Needle	033738
000445	0.5 µL NanoVolume Shimadzu Syringe with 4.2 cm 0.63 mm OD Cone Tipped Needle	033745
PerkinElmer		
000475	0.5 µL NanoVolume PerkinElmer Syringe with 7 cm 0.47 mm OD Cone Tipped Needle	033750
000478	0.5 µL NanoVolume PerkinElmer Syringe with 7 cm 0.63 mm OD Cone Tipped Needle	033765
Varian		
000655	1.0 µL NanoVolume Varian (8035, 8100, 8200) Syringe with 5.1 cm 0.47 mm OD Cone Tipped Needle	034720

For more information about this product visit www.sge.com or contact techsupport@sge.com.

Syringes | For Hamilton C and CX

The Choice for Dispenser and Pump Syringes

SGE Dispenser and Pump Syringes incorporate Diamond Technology, taking advantage of new and innovative technologies and bringing those benefits to your laboratory.

For over 50 years, SGE syringes have been designed and manufactured for a variety of instruments and customer applications.

At the heart of your pump or dispenser, and combined with the rest of the system components, syringes must provide the superior performance you demand and rely upon.

Designed and optimized with outstanding quality and precise fit, SGE syringes provide greater reliability for applications run on your systems.

Features and Benefits

- Improved accuracy and precision.
- Robust and durable for longer life, less maintenance downtime and reduced maintenance costs.
- Do not contaminate the aspirated fluid
- Designed to perfectly fit your instrument making them easy to use and install.

Recommended Applications

Replacement for Hamilton C and CX Syringes.

Product Specifications

- 60 mm stroke.
- 1/4-28 UNF thread connection.
- 6-32 UNC thread in plunger button. CX has a button stop.
- 25 µL to 10 mL capacities.
- Operating temperature range (10 °C to 40 °C).

Volume	Front Fitting Diameter (mm)	Back Fitting Diameter (mm)	Glass Barrel Diameter (mm)	Plunger Button Diameter (mm)	Orifice (mm)
25 µL	9.9	14.2	8	12.7	1.0
50 µL	9.9	14.2	8	12.7	1.0
100 µL	9.9	14.2	8	12.7	1.0
250 µL	9.9	14.2	8	12.7	1.0
500 µL	9.9	14.2	8	12.7	1.0
1 mL	10.4	14.2	9	12.6	1.5
2.5 mL	12.0	15.6	11	11.9	1.5
5 mL	15.0	23.1	14	11.9	1.5
10 mL	20	28.0	18.5	14	1.5



For more information about this product visit www.sge.com or contact techsupport@sge.com.

Syringes | For Hamilton C and CX

The Choice for Dispenser and Pump Syringes

Part Number	Long Description	Replacement Plunger
004995	50 µL Syringe with GT Plunger and 1/4-28 UNF Termination	
005990	100 µL Syringe with GT Plunger and 1/4-28 UNF Termination	
006995	250 µL Syringe with GT Plunger and 1/4-28 UNF Termination	031833
007995	500 µL Syringe with GT Plunger and 1/4-28 UNF Termination	
008185	1 mL Syringe with GT Plunger and 1/4-28 UNF Termination	0318441
008687	2.5 mL Syringe with GT Plunger and 1/4-28 UNF Termination	031854
008787	5 mL Syringe with GT Plunger and 1/4-28 UNF Termination	0318562
008987	10 mL Syringe with GT Plunger and 1/4-28 UNF Termination	031864

For more information about this product visit www.sge.com or contact techsupport@sge.com.

Syringes | For PSD/3 and PSD/4 Pumps

The Choice for Dispenser and Pump Syringes

SGE Dispenser and Pump Syringes incorporate Diamond Technology, taking advantage of new and innovative technologies and bringing those benefits to your laboratory.

For over 50 years, SGE syringes have been designed and manufactured for a variety of instruments and customer applications.

At the heart of your pump or dispenser, and combined with the rest of the system components, syringes must provide the superior performance you demand and rely upon.

Designed and optimized with outstanding quality and precise fit, SGE syringes provide greater reliability for applications run on your systems.

Features and Benefits

- Improved accuracy and precision.
- Robust and durable for longer life, less maintenance downtime and reduced maintenance costs.
- Do not contaminate the aspirated fluid.
- Designed to perfectly fit your instrument making them easy to use and install.
- Broad functional temperature range and high chemical resistance.
- Reduced downtime due to leakage.
- Inert flow path. Only high quality borosilicate glass and premium PTFE contact aspirated fluid.

Recommended Applications

For use with PSD/3 and PSD/4 pumps.



Product Specifications

- 30 mm stroke.
- Luer Lock connection.
- 12.5 μ L to 12.5 mL capacities.
- Operating temperature range (10 $^{\circ}$ C to 40 $^{\circ}$ C)

Volume	Front Fitting Diameter (mm)	Plunger Button Diameter (mm)	Orifice (mm)
12.5 μ L	9.7	12.6	0.52
25 μ L	9.7	12.6	0.6
50 μ L	9.7	12.6	0.6
125 μ L	9.7	12.6	1.0
100 μ L	9.7	12.6	0.6
250 μ L	9.7	12.6	1.2
500 μ L	10.1	12.6	1.4
1.25 mL	12.2	12.6	1.8
1 mL	10.8	12.6	1.6
2.5 mL	14.9	14.5	1.8
5 mL	19.8	14.5	1.8
12.5 mL	29	14.5	1.8

For more information about this product visit www.sge.com or contact techsupport@sge.com.

Syringes | For PSD/3 and PSD/4 Pumps

The Choice for Dispenser and Pump Syringes

Part Number	Part Description and Detail
002692	12.5 µL PSD/3 & PSD/4 Dispenser Syringe
003694	25 µL PSD/3 & PSD/4 Dispenser Syringe
004694	50 µL PSD/3 & PSD/4 Dispenser Syringe
005694	100 µL PSD/3 & PSD/4 Dispenser Syringe
005692	125 µL PSD/3 & PSD/4 Dispenser Syringe
006694	250 µL PSD/3 & PSD/4 Dispenser Syringe
007694	500 µL PSD/3 & PSD/4 Dispenser Syringe
008194	1.0 mL PSD/3 & PSD/4 Dispenser Syringe
008192	1.25 mL PSD/3 & PSD/4 Dispenser Syringe
008594	2.5 mL PSD/3 & PSD/4 Dispenser Syringe
008794	5.0 mL PSD/3 & PSD/4 Dispenser Syringe
008994	12.5 mL PSD/3 & PSD/4 Dispenser Syringe

For more information about this product visit www.sge.com or contact techsupport@sge.com.

Syringes | For V3 Pumps

The Choice for Dispenser and Pump Syringes

SGE Dispenser and Pump Syringes incorporate Diamond Technology, taking advantage of new and innovative technologies and bringing those benefits to your laboratory.

For over 50 years, SGE syringes have been designed and manufactured for a variety of instruments and customer applications.

At the heart of your pump or dispenser, and combined with the rest of the system components, syringes must provide the superior performance you demand and rely upon.

Designed and optimized with outstanding quality and precise fit, SGE syringes provide greater reliability for applications run on your systems.

Features and Benefits

- Improve the accuracy and precision of your results.
- Robust and durable for longer life, less maintenance downtime and reduced maintenance costs.
- Do not contaminate the aspirated fluid.
- Are designed to perfectly fit your instrument making them easy to use and install.
- Increase flexibility with a broad functional temperature range and high chemical resistance.
- Reduce downtime due to leakage.
- Have an inert flow path. Only high quality borosilicate glass and premium PTFE contact aspirated fluid.

Recommended Applications

For use with V3 pumps.



Product Specifications

- 30 mm stroke.
- 1/4-28 UNF thread connection.
- 1/4" hole in plunger.
- 50 µL to 5.0 mL capacities.

Volume	Front Fitting Diameter (mm)	Orifice (mm)
50 µL	10.1	0.6
100 µL	10.1	0.6
250 µL	10.1	1.2
500 µL	10.1	1.5
1 mL	10.8	1.7
2.5 mL	14.5	1.9
5 mL	19.8	1.9

For more information about this product visit www.sge.com or contact techsupport@sge.com.

Syringes | For V3 Pumps

The Choice for Dispenser and Pump Syringes

Part Number	Part Description and Detail
004693	50 µL V3 Dispenser Syringe
005693	100 µL V3 Dispenser Syringe
006693	250 µL V3 Dispenser Syringe
007693	500 µL V3 Dispenser Syringe
008193	1.0 mL V3 Dispenser Syringe
008593	2.5 mL V3 Dispenser Syringe
008793	5.0 mL V3 Dispenser Syringe

For more information about this product visit www.sge.com or contact techsupport@sge.com.

Syringes | For V6 Pumps

The Choice for Dispenser and Pump Syringes

SGE Dispenser and Pump Syringes incorporate Diamond Technology, taking advantage of new and innovative technologies and bringing those benefits to your laboratory.

For over 50 years, SGE syringes have been designed and manufactured for a variety of instruments and customer applications.

At the heart of your pump or dispenser, and combined with the rest of the system components, syringes must provide the superior performance you demand and rely upon.

Designed and optimized with outstanding quality and precise fit, SGE syringes provide greater reliability for applications run on your systems.

Features and Benefits

- Improve the accuracy and precision of your results.
- Robust and durable for longer life, less maintenance downtime and reduced maintenance costs.
- Do not contaminate the aspirated fluid.
- Are designed to perfectly fit your instrument making them easy to use and install.
- Increase flexibility with a broad functional temperature range and high chemical resistance.
- Reduce downtime due to leakage.
- Have an inert flow path. Only high quality borosilicate glass and premium PTFE contact aspirated fluid.

Recommended Applications

For use with V6 pumps.

Product Specifications

- 60 mm stroke.
- 1/4-28 UNF thread connection.
- 1/4" hole in plunger.
- 25 μ L to 25 mL capacities.
- Operating temperature range (10 $^{\circ}$ C to 40 $^{\circ}$ C).

Volume	Front Fitting Diameter (mm)	Orifice (mm)
25 μ L	10.1	0.7
50 μ L	10.1	0.6
100 μ L	10.1	0.6
250 μ L	10.1	1.0
500 μ L	10.1	1.2
1 mL	10.1	1.5
2.5 mL	12.2	1.9
5 mL	14.5	1.9
10 mL	19.8	1.9
25 mL	29.0	1.9



For more information about this product visit www.sge.com or contact techsupport@sge.com.

Syringes | For V6 Pumps

The Choice for Dispenser and Pump Syringes

Part Number	Part Description and Detail
003696	25 µL V6 Dispenser Syringe
004696	50 µL V6 Dispenser Syringe
005696	100 µL V6 Dispenser Syringe
006696	250 µL V6 Dispenser Syringe
007696	500 µL V6 Dispenser Syringe
008196	1.0 mL V6 Dispenser Syringe
008596	2.5 mL V6 Dispenser Syringe
008796	5.0 mL V6 Dispenser Syringe
008996	10 mL V6 Dispenser Syringe
009496	25 mL V6 Dispenser Syringe

For more information about this product visit www.sge.com or contact techsupport@sge.com.

Syringes | eVol® XR

Every One an Expert

eVol® XR digital analytical syringe is the coupling of two precision devices: a digitally controlled electronic drive and an XCHANGE® enabled analytical syringe.

eVol XR syringes are easily and quickly changed allowing them to be dedicated to individual liquids or methods to prevent possible cross-contamination of reagents.

Features and Benefits

- Syringes compatible for use with eVol XR.
- Suitable for use with volatile samples.
- Variable speed of operation.
- Easily calibrated and calibration factors saved for each syringe, enabling laboratories to comply with stringent global laboratory standards (e.g. GLP, GMP, FDA).
- Programmable and able to store a laboratory workflow (up to 98 steps).
- Password protection options enabling standardization of work processes.
- Reduces the need for serial dilutions.

Recommended Applications

- Preparation and addition of standards.
- Precise dispensing of aqueous and non-aqueous liquids.
- TLC spotting.
- Micro titrations.
- GC and LC instrument injections.
- NMR sample preparation.
- MEPS®



Product Specifications

Available are:

- 5 µL eVol XR syringes available with 50 mm and 115 mm long needles.
- 50 µL eVol XR syringes available with 50 mm, 115 mm, and 180 mm long needles.
- 100 µL eVol XR syringes available with a 50 mm long needle.
- 500 µL eVol XR syringes available with 50 mm, 70 mm, 115 mm, and 180 mm long needles.
- 1 mL eVol XR syringes available with 50 mm, and 70 mm long needles.
- 50 µL, 100 µL and 500 µL removable needle eVol XR MEPS syringes available to fit MEPS BINs.

Volume Range of eVol XR Syringes

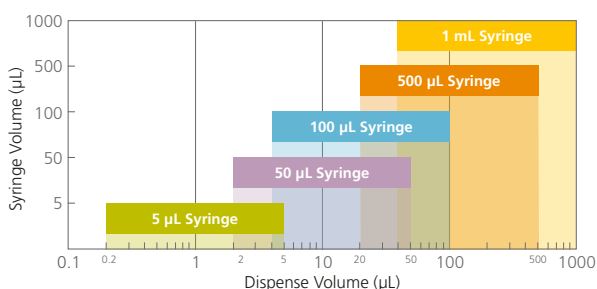

Accuracy and Precision

Volume	Inaccuracy	Precision
5 µL	± 0.2 % for calibrated syringe at full scale ± 1.0 % for calibrated syringe at 10 % scale ± 1.0 % for uncalibrated syringe at full scale	0.5 % RSD at full scale 1.0 % RSD at 10 % scale
50 µL	± 0.2 % for calibrated syringe at full scale ± 0.5 % for calibrated syringe at 10 % scale ± 1.0 % for uncalibrated syringe at full scale	0.4 % RSD at full scale 0.8 % RSD at 10 % scale
100 µL	± 0.2 % for calibrated syringe at full scale ± 0.5 % for calibrated syringe at 10 % scale ± 0.7 % for uncalibrated syringe at full scale	0.4 % RSD at full scale 0.7 % RSD at 10 % scale
500 µL	± 0.2 % for calibrated syringe at full scale ± 0.5 % for calibrated syringe at 10 % scale ± 0.5 % for uncalibrated syringe at full scale	0.3 % RSD at full scale 0.6 % RSD at 10 % scale
1 mL	± 0.2 % for calibrated syringe at full scale ± 0.5 % for calibrated syringe at 10 % scale ± 0.5 % for uncalibrated syringe at full scale	0.3 % RSD at full scale 0.6 % RSD at 10 % scale

Specifications are subject to change without notification.

For more information about this product refer to product data sheets PD-1013-G Syringes | eVol XR Kits and PD-1016-G Separations | eVol MEPS BINs, visit www.sge.com or contact techsupport@sge.com.

Syringes | eVol® XR

Every One an Expert

Part Number	Long Description	Replacement Needle	Replacement Plunger
eVol Syringes			
2910020	5 µL eVol Syringe with GT Plunger & 5 cm 0.5 mm OD Bevel Tipped Needle	036910	2910380
2910320	5 µL eVol Syringe with GT Plunger & 5 cm 0.5 mm OD Bevel Tipped Needle PK3	036910	2910380
2910021	5 µL eVol Syringe with GT Plunger. No Needle.		2910380
2910022	50 µL eVol Syringe with GT Plunger & 5 cm 0.5 mm OD Bevel Tipped Needle	038110	2910382
2910322	50 µL eVol Syringe with GT Plunger & 5 cm 0.5 mm OD Bevel Tipped Needle PK3	038110	2910382
2910023	50 µL eVol Syringe with GT Plunger. No Needle.		2910382
2910029	100 µL eVol Syringe with GT Plunger & 5 cm 0.5 mm OD Bevel Tipped Needle	038110	2910383
2910329	100 µL eVol Syringe with GT Plunger & 5 cm 0.5 mm OD Bevel Tipped Needle PK3	038110	2910383
2910037	100 µL eVol Syringe with GT Plunger. No Needle.		2910383
2910024	500 µL eVol Syringe with GT Plunger & 5 cm 0.63 mm OD Bevel Tipped Needle	039110	2910384
2910324	500 µL eVol Syringe with GT Plunger & 5 cm 0.5 mm OD Bevel Tipped Needle PK3	039110	2910384
2910025	500 µL eVol Syringe with GT Plunger. No Needle.		2910384
2910035	1 mL eVol Syringe with GT Plunger & 5 cm 0.63 mm OD Bevel Tipped Needle	039110	2910385
2910335	1 mL eVol Syringe with GT Plunger & 5 cm 0.63 mm OD Bevel Tipped Needle PK3	039110	2910385
eVol MEPS Syringes			
2910027	50 µL eVol MEPS Syringe with GT Plunger		2910382
2910028	100 µL eVol MEPS Syringe with GT Plunger		2910383
2910026	500 µL eVol MEPS Syringe with GT Plunger		2910384
eVol Kits and Components			
2910200	eVol XR Starter Kit (eVol XR Handle, Charger, Stand. 3 eVol Syringes with 5 cm Bevel Tipped Needles: 5 µL , 100 µL , 1 mL)		
2910100	eVol XR Starter Kit for NMR (eVol XR Handle, Charger, Stand. 3 eVol Syringes with Bevel Tipped Needles: 5 µL with 11.5 cm Needle, 50 µL with 11.5 cm and 18 cm Needles, 500 µL with 11.5 cm and 18 cm Needles)		
2910205	eVol XR (Handle Only)		
2910010	eVol Stand (Acrylic)		
2910012	eVol Charger		
2910030	eVol Charging Stand		
2910040	eVol Replacement Battery		

For more information about this product visit www.sge.com or contact techsupport@sge.com.

Syringes | eVol® XR Kits

Every One an Expert

eVol® XR digital analytical syringe is the coupling of two precision devices: a digitally controlled electronic drive and an XCHANGE® enabled analytical syringe.

eVol XR syringes are easily and quickly changed allowing them to be dedicated to individual liquids or methods to prevent possible cross-contamination of reagents.

Features and Benefits

- Suitable for use with volatile samples.
- Variable speed of operation.
- Easily calibrated and calibration factors saved for each syringe, enabling laboratories to comply with stringent global laboratory standards (e.g. GLP, GMP, FDA).
- Programmable and able to store a laboratory workflow (up to 98 steps).
- Password protection options enabling standardization of work processes.
- Reduces the need for serial dilutions.

Recommended Applications

- Preparation and addition of standards.
- Precise dispensing of aqueous and non-aqueous liquids.
- TLC spotting.
- Micro titrations.
- GC and LC instrument injections.
- NMR sample preparation.
- MEPS®



Product Specifications



eVol XR Starter Kit

Kit includes:

- Handle.
- Charger.
- Stand.
- 3 eVol XR syringes with 5 cm bevel tipped needles: 5 µL, 100 µL and 1 mL.

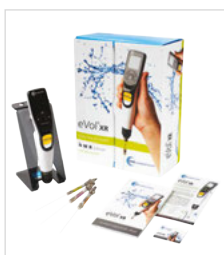

eVol XR Starter Kit for NMR

Kit includes:

- Handle.
- Charger.
- Stand.
- 3 eVol XR syringes with bevel tipped needles: 5 µL with 11.5 cm needle, 50 µL with 11.5 cm and 18 cm needles, and 500 µL with 11.5 cm and 18 cm needles.

For more information about this product visit www.sge.com or contact techsupport@sge.com.

Syringes | eVol® XR Kits

Every One an Expert







Part Number	Part Description and Detail
2910200	eVol XR Starter Kit (eVol XR Handle, Charger, Stand. 3 eVol Syringes with 5 cm Bevel Tipped Needles: 5 µL , 100 µL , 1 mL)
2910100	eVol XR Starter Kit for NMR (eVol XR Handle, Charger, Stand. 3 eVol Syringes with Bevel Tipped Needles: 5 µL with 11.5 cm Needle, 50 µL with 11.5 cm and 18 cm Needles, 500 µL with 11.5 cm and 18 cm Needles)

For more information about this product visit www.sge.com or contact techsupport@sge.com.

Syringes | Replacement Needles

Wide range of needles available to suit SGE 5 µL, 10 µL, 25-500 µL, 1-2.5 mL, 5-10 mL, luer lock and NanoVolume syringes.

Recommended Applications

Needle Tip Style	Application	Specifications
 Bevel	Manual GC	The standard general purpose needle tip style supplied with many SGE syringes is a 20 ° bevel tip. It is the preferred option for manual injection where piercing the septum in exactly the same place is difficult. The bevel tip is designed for optimum septum penetration and prevention of septum coring. Bevel tip needles are also known as point style 2.
 Cone	GC Autosampler	The cone shaped needle tip is specially developed to withstand multi injection demands and improve septum lifetime when used with an autosampler. The cone design effectively “parts” the septum during piercing instead of cutting it, as would a bevel needle. Cone tip needles are also known as point style AS for autosampler.
 Dual Gauge	On Column Injection - Autosampler	Dual gauge needles have a narrow gauge at the tip suitable for megabore on-column injection. The wider gauge for the remainder of the needle gives increased strength to the needle for autosampler use.
 LC	HPLC	These needles are used for LC and HPLC valve injection and have a 90 ° square tip with rounded and polished edges. This eliminates damage to the valve's rotor seal and stator face. LC/ HPLC tips are also known as point style 3. This needle tip style is a good choice for general liquid dispensing.
 Dome	With Pre-drilled Septa	This style needle is recommended for use with pre-drilled septa. The tip is rounded and polished to help septum penetration.
 Side Hole	LV Injection	Samples are filled and dispensed through the side hole eliminating septum plugging of the needle. Ideal for large volume gas injection. The solid domed tip minimizes septum damage. Side hole/dome tips are also known as point style 5.
 Sheathed/Bevel	Manual GC	This needle tip style is the same as the bevel tip, except a 0.7 mm OD reinforcing sheath is silver soldered over the standard needle to within 10 mm of the tip. The sheath provides exceptional strength to the needle. Sheathed/Bevel needles are also known as point style 4.

Product Specifications

Stainless steel, available in various lengths and OD configurations.

For more information about this product visit www.sge.com or contact techsupport@sge.com.

Syringes | Replacement Needles

Part Number	Part Description and Detail
Needles for 5 µL Syringes	
Bevel Tipped	
036110	5 cm 0.47 mm OD Bevel Tipped Needle for 5 µL Syringes PK5
036910	5 cm 0.50 mm OD Bevel Tipped Needle for 5 µL eVol Syringes PK5
036916	7 cm 0.50 mm OD Bevel Tipped Needle for 5 µL eVol Syringes PK5
036920	11.5 cm 0.50 mm OD Bevel Tipped Needle for 5 µL eVol Syringes PK2
Cone Tipped	
036710	4.2 cm 0.47 mm OD Cone Tipped Needle for 5 µL Agilent Syringes PK2
036720	4.2 cm 0.63 mm OD Cone Tipped Needle for 5 µL Agilent Syringes PK2
036011	5 cm 0.63 mm OD Cone Tipped Needle for 5 µL Syringes PK2
036914	5 cm 0.63 mm OD Cone Tipped Needle for 5 µL eVol Syringes PK5
036875	5.7 cm 0.47 mm OD Cone Tipped Needle for 5 µL CTC RTC & Thermo RSH Syringes PK2
036871	5.7 cm 0.63 mm OD Cone Tipped Needle for 5 µL CTC RTC & Thermo RSH Syringes PK2
036918	7 cm 0.47 mm OD Cone Tipped Needle for 5 µL eVol Syringes PK5
036877	8.5 cm 0.47 mm OD Cone Tipped Needle for 5 µL CTC RTC & Thermo RSH Syringes PK2
036873	8.5 cm 0.63 mm OD Cone Tipped Needle for 5 µL CTC RTC & Thermo RSH Syringes PK2
036922	11.5 cm 0.50 mm OD Cone Tipped Needle for 5 µL eVol Syringes PK2
LC Tipped	
036912	5.1 cm 0.72 mm OD LC Tipped Needle for 5 µL eVol Syringes PK5
036920	11.5 cm 0.50 mm OD Bevel Tipped Needle for 5 µL eVol Syringes PK2
Needles for 10 µL Syringes	
Bevel Tipped	
037110	5 cm 0.47 mm OD Bevel Tipped Needle for 10 µL Syringes PK5
037776	5 cm 0.50 mm OD Bevel Tipped Needle for 10 µL Varian 8200 series Syringes PK2
037111	5 cm 0.63 mm OD Bevel Tipped Needle for 10 µL Syringes PK5
037130	7 cm 0.47 mm OD Bevel Tipped Needle for 10 µL Syringes PK5
037788	8 cm 0.47 mm OD Bevel Tipped Needle for 10 µL CTC/Thermo Syringes PK3
037160	11.5 cm 0.47 mm OD Bevel Tipped Needle for 10 µL Syringes PK5
Cone Tipped	
037715	4.2 cm 0.47 mm OD Cone Tipped Needle for 10 µL Agilent Syringes PK2
037745	4.2 cm 0.47 mm OD Cone Tipped Needle for 10 µL Shimadzu Syringes PK2
037730	4.2 cm 0.47/0.63 mm OD Dual Gauge Cone Tipped Needle for 10 µL Agilent Syringes PK2
037717	4.2 cm 0.63 mm OD Cone Tipped Needle for 10 µL Agilent Syringes PK2
037747	4.2 cm 0.63 mm OD Cone Tipped Needle for 10 µL Shimadzu Syringes PK2
037010	5 cm 0.47 mm OD Cone Tipped Needle for 10 µL Syringes PK2
037011	5 cm 0.63 mm OD Cone Tipped Needle for 10 µL Syringes PK2
037787	5 cm 0.63 mm OD Cone Tipped Needle for 10 µL CTC/Thermo Syringes PK2
037875	5.7 cm 0.47 mm OD Cone Tipped Needle for 10 µL CTC RTC & Thermo RSH Syringes PK2
037871	5.7 cm 0.63 mm OD Cone Tipped Needle for 10 µL CTC RTC & Thermo RSH Syringes PK2
037030	7 cm 0.47 mm OD Cone Tipped Needle for 10 µL Syringes PK2
037031	7 cm 0.63 mm OD Cone Tipped Needle for 10 µL Syringes PK2
031535	8 cm 0.47 mm OD Cone Tipped Needle for 10 µL CTC/Thermo Syringes PK3
037040	8 cm 0.63 mm OD Cone Tipped Needle for 10 µL Syringes PK2
037877	8.5 cm 0.47 mm OD Cone Tipped Needle for 10 µL CTC RTC & Thermo RSH Syringes PK2
037873	8.5 cm 0.63 mm OD Cone Tipped Needle for 10 µL CTC RTC & Thermo RSH Syringes PK2
Side Hole, Dome Tipped	
037410	5 cm 0.47 mm OD Side Hole Dome Tipped Needle for 10 µL Syringes PK2
037780	5.3 cm 0.50 mm OD Side Hole Dome Tipped Needle for 10 µL Varian 8200 series Syringes PK1
037777	5.3 cm 0.50 mm OD Side Hole Dome Tipped Needle for 10 µL Varian 8200 series Syringes PK2
037779	5.3 cm 0.63 mm OD Side Hole Dome Tipped Needle for 10 µL Varian 8200 series Syringes PK2
LC Tipped	
037250	5.1 cm 0.72 mm OD LC Tipped Needle for 10 µL Syringes PK5
037880	5.7 cm 0.72 mm OD LC Tipped Needle for 10 µL CTC RTC & Thermo RSH Syringes PK2

Part Number	Part Description and Detail
Needles for 25-500 µL Syringes (Note: 500 µL eVol Syringes use "Needles for 1-2.5 mL Syringes" - see below)	
Bevel Tipped	
038110	5 cm 0.50 mm OD Bevel Tipped Needle for 25-500 µL Syringes PK5
038111	5 cm 0.63 mm OD Bevel Tipped Needle for 25-500 µL Syringes PK5
038130	7 cm 0.50 mm OD Bevel Tipped Needle for 25-500 µL Syringes PK5
038131	7 cm 0.63 mm OD Bevel Tipped Needle for 25-500 µL Syringes PK5
038160	11.5 cm 0.50 mm OD Bevel Tipped Needle for 25-500 µL Syringes PK5
038161	11.5 cm 0.63 mm OD Bevel Tipped Needle for 25-500 µL Syringes PK5
038138	18 cm 0.63 mm OD Bevel Tipped Needle for 25-500 µL Syringes PK2
Cone Tipped	
038717	4.2 cm 0.63 mm OD Cone Tipped Needle for 25-500 µL Agilent Syringes PK2
038732	5 cm 0.47 mm OD Cone Tipped Needle for 25-500 µL CTC/Thermo Syringes PK2
038010	5 cm 0.50 mm OD Cone Tipped Needle for 25-500 µL Syringes PK2
038030	7 cm 0.50 mm OD Cone Tipped Needle for 25-500 µL Syringes PK2
038040	8 cm 0.63 mm OD Cone Tipped Needle for 25-500 µL Syringes PK2
038060	11.5 cm 0.50 mm OD Cone Tipped Needle for 25-500 µL Syringes PK2
038038	18 cm 0.63 mm OD Cone Tipped Needle for 25-500 µL Syringes PK2
Side Hole, Dome Tipped	
038749	5 cm 0.47 mm OD Side Hole Dome Tipped Needle for 25-500 µL Syringes PK2
038410	5 cm 0.50 mm OD Side Hole Dome Tipped Needle for 25-500 µL Syringes PK2
038736	5 cm 0.63 mm OD Side Hole Dome Tipped Needle for 25-500 µL CTC/Thermo Syringes PK2
LC Tipped	
038260	5 cm 0.50 mm OD LC (Waters) Tipped Needle for 25-500 µL Syringes PK5
038250	5.1 cm 0.72 mm OD LC Tipped Needle for 25-500 µL Syringes PK5
038270	7 cm 0.72 mm OD LC Tipped Needle for 25-500 µL Syringes PK5
038270	7 cm 0.72 mm OD LC Tipped Needle for 25-500 µL Syringes PK5
Needles for 1-2.5 mL Syringes (& 500 µL eVol Syringes)	
Bevel Tipped	
039112	5 cm 0.47/0.63 mm OD Dual Gauge Bevel Tipped Needle for 1-2.5 mL Syringes (& 500 µL eVol Syringes) PK2
039110	5 cm 0.63 mm OD Bevel Tipped Needle for 1-2.5 mL Syringes (& 500 µL eVol Syringes) PK5
039115	5 cm 0.72 mm OD Bevel Tipped Needle for 1-2.5 mL Syringes (& 500 µL eVol Syringes) PK2
039125	5.6 cm 0.63 mm OD Bevel Tipped Needle for 1-2.5 mL Syringes (& 500 µL eVol Syringes) PK5
039130	7 cm 0.63 mm OD Bevel Tipped Needle for 1-2.5 mL Syringes (& 500 µL eVol Syringes) PK5
039160	11.5 cm 0.63 mm OD Bevel Tipped Needle for 1-2.5 mL Syringes (& 500 µL eVol Syringes) PK5
039138	18 cm 0.63 mm OD Bevel Tipped Needle for 1-2.5 mL Syringes (& 500 µL eVol Syringes) PK2
Cone Tipped	
039161	7 cm 0.63 mm OD Cone Tipped Needle for 1-2.5 mL Syringes (& 500 µL eVol Syringes) PK2
039040	8 cm 0.63 mm OD Cone Tipped Needle for 1-2.5 mL Syringes (& 500 µL eVol Syringes) PK2
039060	11.5 cm 0.63 mm OD Cone Tipped Needle for 1-2.5 mL Syringes (& 500 µL eVol Syringes) PK5
039038	18 cm 0.63 mm OD Cone Tipped Needle for 1-2.5 mL Syringes (& 500 µL eVol Syringes) PK2
Side Hole, Dome Tipped	
039116	5 cm 0.63 mm OD Dome Tipped Needle for 1-2.5 mL Syringes (& 500 µL eVol Syringes) PK2
039120	5 cm 0.63 mm OD Side Hole Dome Tipped Needle for 1-2.5 mL Syringes (& 500 µL eVol Syringes) PK2
039440	8 cm 0.63 mm OD 0.24 mm ID Dual Side Hole Dome Tipped Needle for 1-2.5 mL Syringes (& 500 µL eVol Syringes) PK2
LC Tipped	
039260	5 cm 0.50 mm OD LC (Waters) Tipped Needle for 1-2.5 mL Syringes (& 500 µL eVol Syringes) PK5
039250	5.1 cm 0.72 mm OD LC Tipped Needle for 1-2.5 mL Syringes (& 500 µL eVol Syringes) PK5
039256	5.6 cm 0.72 mm OD LC Tipped Needle for 1-2.5 mL Syringes (& 500 µL eVol Syringes) PK5
039280	5.7 cm 0.72 mm OD LC Tipped Needle for 1-2.5 mL CTC RTC & Thermo RSH Syringes PK2
Needles for 5-10 mL Syringes	
Bevel Tipped	
031516	5 cm 0.63 mm OD 0.32 mm ID Bevel Tipped Needle for 5-10 mL Syringes PK5
Dome Tipped	
0315440	8 cm 0.63 mm OD 0.37 mm ID Dual Side Hole Dome Tipped Needle for 5-10 mL Syringes PK2
LC Tipped	
0315234	5 cm 0.50 mm OD 0.20 mm ID LC (Waters) Tipped Needle for 5-10 mL Syringes PK5
0315233	5.1 cm 0.72 mm OD 0.37 mm ID LC Tipped Needle for 5-10 mL Syringes PK5
031590	5.7 cm 1.07 mm OD 0.65 mm ID LC Tipped Needle for 5-10 mL CTC RTC & Thermo RSH Syringes PK2
Needles for Syringe Valves	
038810	5 cm 0.63 mm OD Cone Tipped Needle for 25 µL -2.5 mL Syringe Valve PK1
038815	5 cm 0.63 mm OD Side Hole Dome Tipped Needle for 25 µL -2.5 mL Syringe Valve PK1
Needles for Luer Locks	
Bevel Tipped	
039802	Luer Lock 5 cm 0.63 mm OD Bevel Tipped Needle PK5
039822	Luer Lock 5 cm 1.07 mm OD Bevel Tipped Needle PK5
039842	Luer Lock 5 cm 1.27 mm OD Bevel Tipped Needle PK5

Part Number	Part Description and Detail
039862	Luer Lock 5 cm 1.57 mm OD Bevel Tipped Needle PK5
039880	Luer Lock 5 cm 2.1 mm OD Bevel Tipped Needle PK5
039807	Luer Lock 7 cm 0.63 mm OD Bevel Tipped Needle PK5
039827	Luer Lock 7 cm 1.07 mm OD Bevel Tipped Needle PK5
039847	Luer Lock 7 cm 1.27 mm OD Bevel Tipped Needle PK5
039867	Luer Lock 7 cm 1.57 mm OD Bevel Tipped Needle PK5
039811	Luer Lock 11.5 cm 0.63 mm OD Bevel Tipped Needle PK5
039831	Luer Lock 11.5 cm 1.07 mm OD Bevel Tipped Needle PK5
039851	Luer Lock 11.5 cm 1.27 mm OD Bevel Tipped Needle PK5
039871	Luer Lock 11.5 cm 1.57 mm OD Bevel Tipped Needle PK5
039891	Luer Lock 11.5 cm 2.1 mm OD Bevel Tipped Needle PK5
Side Hole, Dome Tipped	
039803	Luer Lock 5 cm 0.63 mm OD Side Hole Dome Tipped Needle PK2
039823	Luer Lock 5 cm 1.07 mm OD Side Hole Dome Tipped Needle PK2
039808	Luer Lock 7 cm 0.63 mm OD Side Hole Dome Tipped Needle PK2
039809	Luer Lock 7 cm 0.63 mm OD Dual Side Hole Dome Tipped Needle (TOC2) PK2
LC Tipped	
039897	Luer Lock 5 cm 0.50 mm OD LC (Waters) Tipped Needle PK2
039895	Luer Lock 5.1 cm 0.72 mm OD LC Tipped Needle PK2
Needles for On-Column Syringes	
037675	7.5 cm 0.23 mm OD Needle for 10 µL On-Column Syringes PK2
037610	10 cm 0.17 mm OD Vitreous Silica Needle for 10 µL On-Column Syringes PK2
Needles for Diamond MS Syringes	
Ultra Smooth Hydrophilic Coated	
Manual and Autosampler	
0355310	Ultra Smooth Hydrophilic Coated 50 mm 0.47 mm OD 0.11 mm ID Bevel Tipped Needle for 10-50 µL Manual Diamond MS Syringes
0355311	Ultra Smooth Hydrophilic Coated 50 mm 0.50 mm OD 0.20 mm ID Bevel Tipped Needle for 10-50 µL Manual Diamond MS Syringes
0355312	Ultra Smooth Hydrophilic Coated 50 mm 0.50 mm OD 0.20 mm ID Bevel Tipped Needle for 100-500 µL Manual Diamond MS Syringes
0355313	Ultra Smooth Hydrophilic Coated 50 mm 0.63 mm OD 0.32 mm ID Bevel Tipped Needle for 100-500 µL Manual Diamond MS Syringes
0355210	Ultra Smooth Hydrophilic Coated 51 mm 0.72 mm OD 0.17 mm ID LC Tipped Needle for 10-50 µL Manual and Autosampler Diamond MS Syringes
0355211	Ultra Smooth Hydrophilic Coated 51 mm 0.72 mm OD 0.17 mm ID LC Tipped Needle for 100-500 µL Manual and Autosampler Diamond MS Syringes
0355213	Ultra Smooth Hydrophilic Coated 51 mm 0.72 mm OD 0.37 mm ID LC Tipped Needle for 100-500 µL Manual and Autosampler Diamond MS Syringes
0355215	Ultra Smooth Hydrophilic Coated 57 mm 0.72 mm OD 0.17 mm ID LC Tipped Needle for 10-50 µL Manual and Autosampler Diamond MS Syringes
0355216	Ultra Smooth Hydrophilic Coated 57 mm 0.72 mm OD 0.17 mm ID LC Tipped Needle for 100-500 µL Manual and Autosampler Diamond MS Syringes
Agilent & Shimadzu GC Autosampler	
0355411	Ultra Smooth Hydrophilic Coated 42 mm 0.63 mm OD 0.11 mm ID Cone Tipped Needle for 10-50 µL Agilent & Shimadzu GC Autosampler Diamond MS Syringes
0355410	Ultra Smooth Hydrophilic Coated 42 mm 0.63 mm OD 0.24 mm ID Cone Tipped Needle for 10-50 µL Agilent & Shimadzu GC Autosampler Diamond MS Syringes
CTC GC Autosampler	
0355512	Ultra Smooth Hydrophilic Coated 50 mm 0.63 mm OD 0.11 mm ID Cone Tipped Needle for 10-50 µL CTC GC Autosampler Diamond MS Syringes
0355510	Ultra Smooth Hydrophilic Coated 50 mm 0.63 mm OD 0.24 mm ID Cone Tipped Needle for 10-50 µL CTC GC Autosampler Diamond MS Syringes
0355511	Ultra Smooth Hydrophilic Coated 50 mm 0.63 mm OD 0.24 mm ID Cone Tipped Needle for 100-500 µL CTC GC Autosampler Diamond MS Syringes
CTC RTC & Thermo RSH GC Autosampler	
0355612	Ultra Smooth Hydrophilic Coated 57 mm 0.63 mm OD 0.11 mm ID Cone Tipped Needle for 10-50 µL CTC RTC & Thermo RSH GC Autosampler Diamond MS Syringes
0355610	Ultra Smooth Hydrophilic Coated 57 mm 0.63 mm OD 0.24 mm ID Cone Tipped Needle for 10-50 µL CTC RTC & Thermo RSH GC Autosampler Diamond MS Syringes
0355611	Ultra Smooth Hydrophilic Coated 57 mm 0.63 mm OD 0.24 mm ID Cone Tipped Needle for 100-500 µL CTC RTC & Thermo RSH GC Autosampler Diamond MS Syringes
Ultra Smooth Hydrophobic Coated	
Manual and Autosampler	
0355320	Ultra Smooth Hydrophobic Coated 50 mm 0.47 mm OD 0.11 mm ID Bevel Tipped Needle for 10-50 µL Manual Diamond MS Syringes
0355321	Ultra Smooth Hydrophobic Coated 50 mm 0.50 mm OD 0.20 mm ID Bevel Tipped Needle for 10-50 µL Manual Diamond MS Syringes
0355322	Ultra Smooth Hydrophobic Coated 50 mm 0.50 mm OD 0.20 mm ID Bevel Tipped Needle for 100-500 µL Manual Diamond MS Syringes
0355323	Ultra Smooth Hydrophobic Coated 50 mm 0.63 mm OD 0.32 mm ID Bevel Tipped Needle for 100-500 µL Manual Diamond MS Syringes
0355220	Ultra Smooth Hydrophobic Coated 51 mm 0.72 mm OD 0.17 mm ID LC Tipped Needle for 10-50 µL Manual and Autosampler Diamond MS Syringes
0355221	Ultra Smooth Hydrophobic Coated 51 mm 0.72 mm OD 0.17 mm ID LC Tipped Needle for 100-500 µL Manual and Autosampler Diamond MS Syringes
0355223	Ultra Smooth Hydrophobic Coated 51 mm 0.72 mm OD 0.37 mm ID LC Tipped Needle for 100-500 µL Manual and Autosampler Diamond MS Syringes
0355225	Ultra Smooth Hydrophobic Coated 57 mm 0.72 mm OD 0.17 mm ID LC Tipped Needle for 10-50 µL Manual and Autosampler Diamond MS Syringes
0355226	Ultra Smooth Hydrophobic Coated 57 mm 0.72 mm OD 0.17 mm ID LC Tipped Needle for 100-500 µL Manual and Autosampler Diamond MS Syringes
Agilent & Shimadzu GC Autosampler	
0355421	Ultra Smooth Hydrophobic Coated 42 mm 0.63 mm OD 0.11 mm ID Cone Tipped Needle for 10-50 µL Agilent & Shimadzu GC Autosampler Diamond MS Syringes
0355420	Ultra Smooth Hydrophobic Coated 42 mm 0.63 mm OD 0.24 mm ID Cone Tipped Needle for 10-50 µL Agilent & Shimadzu GC Autosampler Diamond MS Syringes

Part Number	Part Description and Detail
CTC GC Autosampler	
0355522	Ultra Smooth Hydrophobic Coated 50 mm 0.63 mm OD 0.11 mm ID Cone Tipped Needle for 10-50 µL CTC GC Autosampler Diamond MS Syringes
0355520	Ultra Smooth Hydrophobic Coated 50 mm 0.63 mm OD 0.24 mm ID Cone Tipped Needle for 10-50 µL CTC GC Autosampler Diamond MS Syringes
0355521	Ultra Smooth Hydrophobic Coated 50 mm 0.63 mm OD 0.24 mm ID Cone Tipped Needle for 100-500 µL CTC GC Autosampler Diamond MS Syringes
CTC RTC & Thermo RSH GC Autosampler	
0355622	Ultra Smooth Hydrophobic Coated 57 mm 0.63 mm OD 0.11 mm ID Cone Tipped Needle for 10-50 µL CTC RTC & Thermo RSH GC Autosampler Diamond MS Syringes
0355620	Ultra Smooth Hydrophobic Coated 57 mm 0.63 mm OD 0.24 mm ID Cone Tipped Needle for 10-50 µL CTC RTC & Thermo RSH GC Autosampler Diamond MS Syringes
0355621	Ultra Smooth Hydrophobic Coated 57 mm 0.63 mm OD 0.24 mm ID Cone Tipped Needle for 100-500 µL CTC RTC & Thermo RSH GC Autosampler Diamond MS Syringes
Ultra Smooth	
Manual and Autosampler	
0355330	Ultra Smooth 50 mm 0.47 mm OD 0.11 mm ID Bevel Tipped Needle for 10-50 µL Manual Diamond MS Syringes
0355331	Ultra Smooth 50 mm 0.50 mm OD 0.20 mm ID Bevel Tipped Needle for 10-50 µL Manual Diamond MS Syringes
0355332	Ultra Smooth 50 mm 0.50 mm OD 0.20 mm ID Bevel Tipped Needle for 100-500 µL Manual Diamond MS Syringes
0355333	Ultra Smooth 50 mm 0.63 mm OD 0.32 mm ID Bevel Tipped Needle for 100-500 µL Manual Diamond MS Syringes
0355230	Ultra Smooth 51 mm 0.72 mm OD 0.17 mm ID LC Tipped Needle for 10-50 µL Manual and Autosampler Diamond MS Syringes
0355231	Ultra Smooth 51 mm 0.72 mm OD 0.17 mm ID LC Tipped Needle for 100-500 µL Manual and Autosampler Diamond MS Syringes
0355233	Ultra Smooth 51 mm 0.72 mm OD 0.37 mm ID LC Tipped Needle for 100-500 µL Manual and Autosampler Diamond MS Syringes
0355235	Ultra Smooth 57 mm 0.72 mm OD 0.17 mm ID LC Tipped Needle for 10-50 µL Manual and Autosampler Diamond MS Syringes
0355236	Ultra Smooth 57 mm 0.72 mm OD 0.17 mm ID LC Tipped Needle for 100-500 µL Manual and Autosampler Diamond MS Syringes
Agilent & Shimadzu GC Autosampler	
0355431	Ultra Smooth 42 mm 0.63 mm OD 0.11 mm ID Cone Tipped Needle for 10-50 µL Agilent & Shimadzu GC Autosampler Diamond MS Syringes
0355430	Ultra Smooth 42 mm 0.63 mm OD 0.24 mm ID Cone Tipped Needle for 10-50 µL Agilent & Shimadzu GC Autosampler Diamond MS Syringes
CTC GC Autosampler	
0355532	Ultra Smooth 50 mm 0.63 mm OD 0.11 mm ID Cone Tipped Needle for 10-50 µL CTC GC Autosampler Diamond MS Syringes
0355530	Ultra Smooth 50 mm 0.63 mm OD 0.24 mm ID Cone Tipped Needle for 10-50 µL CTC GC Autosampler Diamond MS Syringes
0355531	Ultra Smooth 50 mm 0.63 mm OD 0.24 mm ID Cone Tipped Needle for 100-500 µL CTC GC Autosampler Diamond MS Syringes
CTC RTC & Thermo RSH GC Autosampler	
0355632	Ultra Smooth 57 mm 0.63 mm OD 0.11 mm ID Cone Tipped Needle for 10-50 µL CTC RTC & Thermo RSH GC Autosampler Diamond MS Syringes
0355630	Ultra Smooth 57 mm 0.63 mm OD 0.24 mm ID Cone Tipped Needle for 10-50 µL CTC RTC & Thermo RSH GC Autosampler Diamond MS Syringes
0355631	Ultra Smooth 57 mm 0.63 mm OD 0.24 mm ID Cone Tipped Needle for 100-500 µL CTC RTC & Thermo RSH GC Autosampler Diamond MS Syringes

For more information visit www.sge.com or contact techsupport@sge.com.



Syringes | Replacement Plungers

Wide range of replacement plungers available to suit SGE gas tight syringes 10 μ L - 100 mL.

Recommended Applications

Spare parts for gas tight syringes.

Product Specifications

PTFE plunger tip, and either stainless steel (10 μ L - 1 mL), black anodized aluminium (2.5 mL - 25 mL), or polyacetal resin (50 mL - 100 mL), plunger stems.

For more information about this product visit www.sge.com or contact techsupport@sge.com.



Syringes | Cross Reference Hamilton

Variation Notes:
 FN = Fixed Needle, GT = Gas Tight, with PTFE Tipped plunger, H = Hamilton, LL = Luer Lock, LT = Luer Tip, RN = Removable Needle, WO = Without

Hamilton Part Number	Part Description and Detail	SGE Part Number	Part Description and Detail	Equivalent or Option	Variation
0160310	1750 HITACHI SYRINGE	007660	500 µL Hitachi LC Autosampler Syringe with GT Plunger with M10 - 1.0 Screw Thread	E	
202640	701RSN AOC 14/17(22s/1.69 "/2)	002898	10 µL Removable Needle Shimadzu Syringe with 4.2 cm 0.63 mm OD Cone Tipped Needle	O	23 g Needle
202660	1002LTN CTC SYR (22/56/5)	008631	2.5 mL Fixed Needle CTC Head Space Syringe with Energized GT Plunger and 5.6 cm 0.63 mm OD Side-hole Needle	O	23 g Needle
202880	701RN VARIAN 8100/8200	002924	10 µL Removable Needle CTC/Thermo (Classic Button) Syringe with GT Plunger & 5.3 cm 0.5 mm OD Needle	O	25 g Needle
203043	1702N CTC SYRINGE (26s/51/AS)	003700	25 µL Fixed Needle CTC Syringe with GT Plunger & 5 cm 0.47 mm OD Cone Tipped Needle	E	
203072	SYR,701 CTC,SLIM (26s/51/2)	002980	10 µL Fixed Needle CTC/Thermo Syringe with 5 cm 0.47 mm OD Cone Tipped Needle	O	Cone Tipped Needle
203073	701N CTC SYRINGE (22s/51/3)	002710	10 µL Fixed Needle CTC Syringe with 5.1 cm 0.72 mm OD LC Needle	E	
203074	SYR,1702CTC,SLIM (26s/51/AS)	0039871	25 µL Fixed Needle CTC/Thermo (Classic Button) Syringe with GT Plunger & 5 cm 0.63 mm OD Cone Tipped Needle	E	23 g Needle
203075	1702N CTC SYRINGE (22s/51/3)	003715	25 µL Fixed Needle CTC Syringe with GT Plunger & 5.1 cm 0.72 mm OD LC Needle (8 mm OD barrel)	E	
203076	SYR,1710 CTC,SLIM (26s/51/AS)	005700	100 µL Fixed Needle CTC Syringe with GT Plunger & 5 cm 0.47 mm OD Cone Tipped Needle	E	
203077	SYR,1710N CTC,SLIM (22s/51/3)	005715	100 µL Fixed Needle CTC Syringe with GT Plunger & 5.1 cm 0.72 mm OD LC Needle	E	
203078	1725N CTC SYRINGE (26/51/AS)	006700	250 µL Fixed Needle CTC Syringe with GT Plunger & 5 cm 0.47 mm OD Cone Tipped Needle	E	
203082	1001LTN CTC SYRINGE (23/51/5)	008131	1 mL Fixed Needle CTC Head Space Syringe with Energized GT Plunger and 5.6 cm 0.63 mm OD Side-hole Needle	E	
203084	1002LTN CTC SYRINGE (23/51/5)	008631	2.5 mL Fixed Needle CTC Head Space Syringe with Energized GT Plunger and 5.6 cm 0.63 mm OD Side-hole Needle	E	
203141	1001LTN CTC SYRINGE (26/51/5)	008136	1 mL Fixed Needle CTC Head Space Syringe with Energized GT Plunger and 5.6 cm 0.47 mm OD Side-hole Needle	E	
203181	1002LTN CTC SYRINGE (26/51/5)	008636	2.5 mL Fixed Needle CTC Head Space Syringe with Energized GT Plunger and 5.6 cm 0.47 mm OD Side-hole Needle	E	
203185	7701.2 CTC SYRINGE (26/51/AS)	000790	2.0 µL NanoVolume CTC/Thermo Syringe with 5.0 cm 0.63 mm OD Cone Tipped Needle	O	2 µL Instead of 1 µL
203189	75N CTC SYRINGE (26s/51/AS)	001982	5 µL Fixed Needle CTC/Thermo Syringe with 5 cm 0.47 mm OD Cone Tipped Needle	E	
203205	701N CTC SYRINGE (26s/51/AS)	002700	10 µL Fixed Needle CTC Syringe with 5 cm 0.47 mm OD Cone Tipped Needle	E	
203235	1710N CTC SYRINGE (22/51/3)	005720	100 µL Fixed Needle CTC Syringe with GT Plunger & 5.1 cm 0.72 mm OD (0.4 mm ID) LC Needle	E	
203349	1750N CTC SYR (22/51/3)	007720	500 µL Fixed Needle CTC Syringe with GT Plunger & 5.1 cm 0.72 mm OD (0.4 mm ID) LC Needle	E	
203361	701N CTC SYR (23S/51/AS)	002981	10 µL Fixed Needle CTC/Thermo Syringe with 5 cm 0.63 mm OD Cone Tipped Needle	E	
203362	701N CTC SYR (23S-26S/51/AS)	002980	10 µL Fixed Needle CTC/Thermo Syringe with 5 cm 0.47 mm OD Cone Tipped Needle	O	26 g Needle
203363	701N CTC SYR (23S/2 "/2)	002981	10 µL Fixed Needle CTC/Thermo Syringe with 5 cm 0.63 mm OD Cone Tipped Needle	O	Cone Tipped Needle
203566	1710 CTC A200S SYR (22s/2/3)	005331	100 µL Fixed Needle CTC/Thermo Syringe with GT Plunger & 5.1 cm 0.72 mm OD LC Needle	E	
204000	SYRINGE,75N(26S/50/2)	0019821	5 µL Fixed Needle CTC/Thermo (Classic Button) Syringe with 5 cm 0.47 mm OD Cone Tipped Needle	O	Cone Tipped Needle
204001	SYRINGE,701SN(26S/50/2)	0029801	10 µL Fixed Needle CTC/Thermo (Classic Button) Syringe with 5 cm 0.47 mm OD Cone Tipped Needle	O	Cone Tipped Needle
204051	SYRINGE,75SN(26S/50/AS)	0019821	5 µL Fixed Needle CTC/Thermo (Classic Button) Syringe with 5 cm 0.47 mm OD Cone Tipped Needle	E	
204052	SYRINGE,701SN 26S/50/AS)	0029801	10 µL Fixed Needle CTC/Thermo (Classic Button) Syringe with 5 cm 0.47 mm OD Cone Tipped Needle	E	

Syringes | Cross Reference Hamilton Continued

Hamilton Part Number	Part Description and Detail	SGE Part Number	Part Description and Detail	Equivalent or Option	Variation
207189	701 PAL3 (565/85/AS)	002867	10 µL Fixed Needle CTC RTC & Thermo RSH Syringe with 8.5 cm 0.47 mm OD Cone Tipped Needle	E	
207290	1002 CTC PAL3 (23/65/5)HS	008655	2.5 mL Fixed Needle CTC RTC & Thermo RSH Head Space Syringe with Energized GT Plunger and 5.6 cm 0.63 mm OD Side-hole Needle	E	
207292	1010 CTC PAL3(19/57/3)	008951	10 mL Removable Needle CTC RTC & Thermo RSH Syringe with GT Plunger & 5.7 cm 1.07 mm OD LC Tipped Needle	E	
207803	701 PAL3 (235/57/AS)	002861	10 µL Fixed Needle CTC RTC & Thermo RSH Syringe with 5.7 cm 0.63 mm OD Cone Tipped Needle	E	
207807	701 PAL3 (265/57/AS)	002865	10 µL Fixed Needle CTC RTC & Thermo RSH Syringe with 5.7 cm 0.47 mm OD Cone Tipped Needle	E	
207813	1701 PAL3 (225/57/3)	002880	10 µL Removable Needle CTC RTC & Thermo RSH Syringe with GT Plunger & 5.7 cm 0.72 mm OD LC Needle	E	
207829	1725 PAL3 (23/57/AS)	006862	250 µL Fixed Needle CTC RTC & Thermo RSH Syringe with GT Plunger & 5.7 cm 0.63 mm OD Cone Tipped Needle	E	
207831	1725 PAL3 (26/85/AS)	006862	250 µL Fixed Needle CTC RTC & Thermo RSH Syringe with GT Plunger & 5.7 cm 0.63 mm OD Cone Tipped Needle	E	
207836	1001 PAL3 (22/57/3)	008150	1 mL Fixed Needle CTC RTC & Thermo RSH Syringe with GT Plunger & 5.7 cm 0.72 mm OD LC Tipped Needle	E	
207837	1701 PAL3 (265/57/AS)	002866	10 µL Fixed Needle CTC RTC & Thermo RSH Syringe with GT Plunger & 5.7 cm 0.47 mm OD Cone Tipped Needle	E	
207839	1701 PAL3 (235/57/AS)	002862	10 µL Fixed Needle CTC RTC & Thermo RSH Syringe with GT Plunger & 5.7 cm 0.63 mm OD Cone Tipped Needle	E	
207840	1710 PAL3 (265/57/AS)	005866	100 µL Fixed Needle CTC RTC & Thermo RSH Syringe with GT Plunger & 5.7 cm 0.47 mm OD Cone Tipped Needle	E	
207853	1001 CTC PAL3 (23/65/5)HS	008155	1 mL Fixed Needle CTC RTC & Thermo RSH Head Space Syringe with Energized GT Plunger and 6.5 cm 0.63 mm OD Side-hole Needle	E	
208311	1710 CTC SYR X PAL3 (22/57/3)	008950	10 mL Fixed Needle CTC RTC & Thermo RSH Syringe with GT Plunger & 5.7 cm 1.07 mm OD LC Tipped Needle	E	
208312	1710 CTC SYR X PAL3 (225/57/3)	008950	10 mL Fixed Needle CTC RTC & Thermo RSH Syringe with GT Plunger & 5.7 cm 1.07 mm OD LC Tipped Needle	E	
54658-01	SYRINGE,1710C,AUTO SAMPLER	005696	100 µL V6 Dispenser Syringe	E	
54659-01	SYRINGE,1725C,AUTO SAMPLER	006696	250 µL V6 Dispenser Syringe	E	
54660-01	SYRINGE, 1750C,AUTO SAMPLER	007696	500 µL V6 Dispenser Syringe	E	
54661-01	SYRINGE,1001C,AUTO SAMPLER	008196	1.0 mL V6 Dispenser Syringe	E	
54662-01	SYRINGE,1002C,AUTO SAMPLER	008596	2.5 mL V6 Dispenser Syringe	E	
62161-01	SYRINGE,1702C,SPARK AUTO	003696	25 µL V6 Dispenser Syringe	E	
67430-01	SYR,1702N,(23/51/AS),CTC-S	003700	25 µL Fixed Needle CTC Syringe with GT Plunger & 5 cm 0.47 mm OD Cone Tipped Needle	E	
67432-01	SYR,1710N,(225/51/3),CTC-S-X	005331	100 µL Fixed Needle CTC/Thermo Syringe with GT Plunger & 5.1 cm 0.72 mm OD LC Needle	E	
67434-01	SYR,1710N,(23/51/AS),CTC-S	005335	100 µL Fixed Needle CTC/Thermo Syringe with GT Plunger & 5 cm 0.63 mm OD Cone Tipped Needle	E	
67436-01	SYR,75N,(265/51/AS),CTC-S	0019821	5 µL Fixed Needle CTC/Thermo (Classic Button) Syringe with 5 cm 0.47 mm OD Cone Tipped Needle	E	
67438-01	SYR,701N,(265/51/AS),CTC-S	0029801	10 µL Fixed Needle CTC/Thermo (Classic Button) Syringe with 5 cm 0.47 mm OD Cone Tipped Needle	E	
67440-01	SYR,701SN,(235/51/AS),CTC-S	002951	10 µL Fixed Needle Varian 8400/CTC/Thermo (Classic Button) Syringe with 5 cm 0.63 mm OD Cone Tipped Needle	E	
67442-01	SYR,1725N,(22/51/3),CTC-S	006330	250 µL Removeable Needle CTC Syringe with GT Plunger & 5.1 cm 0.72 mm OD (0.4 mm ID) LC Needle	E	
67446-01	SYR,1702N,(225/51/3),CTC-S	003715	25 µL Fixed Needle CTC Syringe with GT Plunger & 5.1 cm 0.72 mm OD LC Needle (8 mm OD barrel)	E	
67448-01	SYR,1750N,(22/51/3),CTC-S	007720	500 µL Fixed Needle CTC Syringe with GT Plunger & 5.1 cm 0.72 mm OD (0.4 mm ID) LC Needle	E	
67450-01	SYR,1705N,(22/51/3),CTC-S	004810	50 µL Fixed Needle CTC Syringe with GT Plunger & 5.1 cm 0.72 mm OD LC Needle	E	
67452-01	SYR,17105N,(225/51/3),CTC-S	005715	100 µL Fixed Needle CTC Syringe with GT Plunger & 5.1 cm 0.72 mm OD LC Needle	E	
67454-01	SYR,1701SN,(235/51/AS),CTC-S	0029871	10 µL Fixed Needle CTC/Thermo (Classic Button) Syringe with GT Plunger & 5 cm 0.63 mm OD Cone Tipped Needle	E	
80000	1701N 10 µL SYR (26s/2 "/2)	002200	10 µL Fixed Needle Syringe with GT Plunger & 5 cm 0.47 mm OD Bevel Tipped Needle	E	
80004	1701NCH 10 µL SYR (26s/2 "/2)	002200 + 031930	10 µL Fixed Needle Syringe with GT Plunger & 5 cm 0.47 mm OD Bevel Tipped Needle and Repeating Adaptor	E	
80020	1702 WISP SYR 25 µL	003990	25 µL Waters Wisp Syringe with GT Plunger	E	
80024	1725 WISP SYR 250 µL	006690	250 µL Waters Wisp Syringe with GT Plunger	E	
80030	1701RN 10 µL SYR (26s/2 "/2)	002250	10 µL Removable Needle Syringe with GT Plunger & 5 cm 0.47 mm OD Bevel Tipped Needle	E	
80039	1701NPT5 10 µL SYR (26s/2 "/5)	002250 + 037410	10 µL Removable Needle Syringe with GT Plunger & 5 cm Side Hole Dome Tipped Needle	E	

Syringes | Cross Reference Hamilton Continued

Hamilton Part Number	Part Description and Detail	SGE Part Number	Part Description and Detail	Equivalent or Option	Variation
80065	1701RNR 10 µL SYR (22s/2 "/3)	002313	10 µL Removable Needle Syringe with GT Plunger & 5.1 cm 0.72 mm OD LC Needle	E	
80074	SYRINGE,175ASN,23S GA,1.71	001810	5 µL Fixed Needle Agilent Syringe with 4.2 cm 0.63 mm OD Cone Tipped Needle	O	Not GT (Note that H is Half Scale 10 µL)
80074	SYRINGE,175ASN,23S GA,1.71	002812	10 µL Fixed Needle Agilent Syringe with GT Plunger & 4.2 cm 0.63 mm OD Cone Tipped Needle	O	Full Scale 10 µL Instead of Half Scale 5 µL
80075	1701N 10 µL SYR (26s/2 "/3)	002335	10 µL Fixed Needle Syringe with GT Plunger & 5.1 cm 0.72 mm OD LC Needle	O	22 g Needle
80076	175ASN SYR (23-26/1.71 "/HP)	001821	5 µL Fixed Needle Agilent Syringe with 4.2 cm 0.63/0.47 mm OD Cone Tipped Dual Gauge Needle	O	Not GT (Note that H is Half Scale 10 µL)
80076	175ASN SYR (23-26/1.71 "/HP)	002826	10 µL Fixed Needle Agilent Syringe with GT Plunger & 4.2 cm 0.63/0.47 mm OD Cone Tipped Dual Gauge Needle	O	Full Scale 10 µL Instead of Half Scale 5 µL
80079	1701ASN SYR(23S/26S/1.71 "/HP)	002826	10 µL Fixed Needle Agilent Syringe with GT Plunger & 4.2 cm 0.63/0.47 mm OD Cone Tipped Dual Gauge Needle	E	
80080	1701ASN SYR (23s/1.71 "/HP)	002812	10 µL Fixed Needle Agilent Syringe with GT Plunger & 4.2 cm 0.63 mm OD Cone Tipped Needle	E	
80084	175ASRN(23s/1.71 "/HP)	002829	10 µL Removable Needle Agilent Syringe with GT Plunger & 4.2 cm 0.63/0.47 mm OD Cone Tipped Dual Gauge Needle	O	Dual Gauge Needle (Note that H 5 µL is Half Scale 10 µL)
80085	1701N 10 µL SYR (26/2 "/3)	002335	10 µL Fixed Needle Syringe with GT Plunger & 5.1 cm 0.72 mm OD LC Needle	O	22 g Needle
80086	175ASRN SYR (23-26/1.71 "/HP)	002829	10 µL Removable Needle Agilent Syringe with GT Plunger & 4.2 cm 0.63/0.47 mm OD Cone Tipped Dual Gauge Needle	O	Full Scale 10 µL Instead of Half Scale 5 µL
80087	1701ASRN 10 µL SYR 23s/1.71 "/HP)	002829	10 µL Removable Needle Agilent Syringe with GT Plunger & 4.2 cm 0.63/0.47 mm OD Cone Tipped Dual Gauge Needle	O	Dual Gauge Needle
80088	1701ASRN 10 µL SYR 26s/1.71 "/HP)	002829	10 µL Removable Needle Agilent Syringe with GT Plunger & 4.2 cm 0.63/0.47 mm OD Cone Tipped Dual Gauge Needle	O	Dual Gauge Needle
80089	1701ASRN SYR (23S/26S/1.71/HP)	002829	10 µL Removable Needle Agilent Syringe with GT Plunger & 4.2 cm 0.63/0.47 mm OD Cone Tipped Dual Gauge Needle	E	
80090	175ASN 5 µL (23S/1.71 "/HP) 6/PK	002812	10 µL Fixed Needle Agilent Syringe with GT Plunger & 4.2 cm 0.63 mm OD Cone Tipped Needle	O	Full Scale 10 µL Instead of Half Scale 5 µL
80090	175ASN 5 µL (23S/1.71 "/HP) 6/PK	002816	10 µL Removable Needle Agilent Syringe with 4.2 cm 0.63 mm OD Cone Tipped Needle PK25	O	Full Scale 10 µL Instead of Half Scale 5 µL
80092	175ASN 5 µL (23-26/1.71 "/HP)6/PK	002827	5 µL Fixed Needle Agilent Syringe with GT Plunger & 4.2 cm 0.63/0.47 mm OD Cone Tipped Dual Gauge Needle PK6	O	Full Scale 10 µL Instead of Half Scale 5 µL
80094	1701ASN SYR (23s/1.71 "/HP)6/PK	002812	10 µL Fixed Needle Agilent Syringe with GT Plunger & 4.2 cm 0.63 mm OD Cone Tipped Needle	O	
80094	1701ASN SYR (23s/1.71 "/HP)6/PK	002816	10 µL Fixed Needle Agilent Syringe with GT Plunger & 4.2 cm 0.63 mm OD Cone Tipped Needle PK25	O	
80096	1701ASN (23-26/1.71 "/HP) 6/PK	002827	5 µL Fixed Needle Agilent Syringe with GT Plunger & 4.2 cm 0.63/0.47 mm OD Cone Tipped Dual Gauge Needle PK6	E	
80100	7001KH 1 µL SYR (25/2.75 "/3)	000570	1.0 µL NanoVolume Syringe with 7 cm 0.47 mm OD Cone Tipped Needle	O	26 g, Cone Tipped Needle
80104	7001KHCH 1 µL SYR (25/2.75 "/3)	000570 + 031930	1.0 µL NanoVolume Syringe with 7 cm 0.47 mm OD Cone Tipped Needle and Repeating Adaptor	O	26 g, Cone Tipped Needle
80107	7001KHWG 1 µL SYR (25s/2.75 "/3)	000570 + 031930	1.0 µL NanoVolume Syringe with 7 cm 0.47 mm OD Cone Tipped Needle and Repeating Adaptor	O	26 g, Cone Tipped Needle
80135	7001KH 1.0 µL SYR (25/2.75 "/2)	000506	1.0 µL NanoVolume Syringe with 7 cm 0.63 mm OD Bevel Tipped Needle	O	23 g Needle
80175	7001ASRN (26/1.71 "/HP)	000610	1.0 µL NanoVolume Agilent Syringe with 4.2 cm 0.63 mm OD Cone Tipped Needle	O	23 g Needle
80176	7001ASRN (23/1.71 "/HP)	000610	1.0 µL NanoVolume Agilent Syringe with 4.2 cm 0.63 mm OD Cone Tipped Needle	E	
80200	1702N 25 µL SYR (22s/2 "/2)	003200	25 µL Fixed Needle Syringe with GT Plunger & 5 cm 0.5 mm OD Bevel Tipped Needle	O	25 g Needle
80201	1702LT 25 µL SYR	004229	50 µL Fixed Luer Tip Syringe with GT Plunger	O	50 µL
80222	1702TLLX 25 µL SYR	004232	50 µL Fixed Luer Lock Syringe with GT Plunger & Plunger Stop	O	50 µL
80223	1702TLLX SYR W/BSHG STD BTN	004232	50 µL Fixed Luer Lock Syringe with GT Plunger & Plunger Stop	O	50 µL
80230	1702RN 25 µL SYR (22s/2 "/2)	003250	25 µL Removable Needle Syringe with GT Plunger & 5 cm 0.5 mm OD Bevel Tipped Needle	O	25 g Needle
80238	1702RNW 25 µL SYR(25s/1.97 "/3)	003250 + 038260	25 µL Removable Needle Syringe with GT Plunger & Waters LC Tipped Needle	E	
80239	1702NPT5 25 µL SYR (22s/2 "/5)	003250 + 038410	25 µL Removable Needle Syringe with GT Plunger & 5 cm Side Hole Dome Tipped Needle	O	RN, 25 g Needle
80265	1702RNR 25 µL SYR (22s/2 "/3)	003312	25 µL Removable Needle Syringe with GT Plunger & 5.1 cm 0.72 mm OD LC Needle	E	

Syringes | Cross Reference Hamilton Continued

Hamilton Part Number	Part Description and Detail	SGE Part Number	Part Description and Detail	Equivalent or Option	Variation
80275	1702N 25 µL SYR (22s/2 "/3)	003300	25 µL Fixed Needle Syringe with 5.1 cm 0.72 mm OD LC Needle	O	Not GT
80285	1702N 25 µL SYR (22/2 "/3)	003300	25 µL Fixed Needle Syringe with 5.1 cm 0.72 mm OD LC Needle	O	Not GT
80300	701N 10 µL SYR (26s/2 "/2)	002000	10 µL Fixed Needle Syringe with 5 cm 0.47 mm OD Bevel Tipped Needle	E	Manual Use
80300	701N 10 µL SYR (26s/2 "/2)	002950	10 µL Fixed Needle Varian 8400 Syringe with 5 cm 0.47 mm OD Cone Tipped Needle	E	Bruker/Varian Autosamplers
80304	701NCH 10 µL SYR (26s/2 "/2)	002000 + 031930	10 µL Fixed Needle Syringe with 5 cm 0.47 mm OD Bevel Tipped Needle and Repeating Adaptor	E	
80307	701NWG 10 µL SYR (26s/2 "/2)	002000 + 031930	10 µL Fixed Needle Syringe with 5 cm 0.47 mm OD Bevel Tipped Needle and Repeating Adaptor	E	
80318	701SN 10 µL SYR (26s/3.15 "/HP)	0029921	10 µL Fixed Needle CTC/Thermo (Classic Button) Syringe with 8 cm 0.47 mm OD Cone Tipped Needle	E	
80330	701RN 10 µL SYR (26s/2 "/2)	002050	10 µL Removable Needle Syringe with 5 cm 0.47 mm OD Bevel Tipped Needle	E	
80334	701RNCH 10 µL SYR (26s/2 "/2)	002050 + 031930	10 µL Removable Needle Syringe with 5 cm 0.47 mm OD Bevel Tipped Needle and Repeating Adaptor	E	
80336	701RN 10 µL SYR 6/PK (26s/2 "/2)	002080	10 µL Removable Needle Syringe with 5 cm 0.47 mm OD Bevel Tipped Needle PK6	E	
80337	701RNWG 10 µL SYR (26s/2 "/2)	002050 + 031930	10 µL Removable Needle Syringe with 5 cm 0.47 mm OD Bevel Tipped Needle and Repeating Adaptor	E	
80339	701NPT5 10 µL SYR (26s/2 "/5)	002050 + 037410	10 µL Removable Needle Syringe with 5 cm Side Hole Dome Tipped Needle	O	RN
80342	701SN 10 µL SYR (23s/2 "/HP)	002005	10 µL Fixed Needle Syringe with 5 cm 0.47 mm OD Cone Tipped Needle	E	
80350	701SN 10 µL SYR (26s/2.75 "/2)	002003	10 µL Fixed Needle Syringe with 7 cm 0.47 mm OD Bevel Tipped Needle	E	
80357	701ASRN 10 µL SYR (23s/1.71 "/HP)	002815	10 µL Removable Needle Agilent Syringe with 4.2 cm 0.63 mm OD Cone Tipped Needle	E	
80358	701ASRN 10 µL SYR (26s/1.71 "/HP)	002805	10 µL Removable Needle Agilent Syringe with 4.2 cm 0.47 mm OD Cone Tipped Needle	E	
80359	701ASRN 10 µL (23-26/1.71 "/HP)	002829	10 µL Removable Needle Agilent Syringe with GT Plunger & 4.2 cm 0.63/0.47 mm OD Cone Tipped Dual Gauge Needle	O	GT
80360	901N 10 µL SYR (26s/2 "/2)	002400	10 µL Fixed Needle Guided Plunger Syringe with 5 cm 0.47 mm OD Bevel Tipped Needle	O	
80365	701SNR 10 µL SYR (22s/2 "/3)	002301	10 µL Fixed Needle Syringe with 5.1 cm 0.72 mm OD LC Needle	E	
80366	701N 10 µL SYR 6/PK (26s/2 "/2)	002030	10 µL Fixed Needle Syringe with 5 cm 0.47 mm OD Bevel Tipped Needle PK6	E	Manual Use
80370	901RN 10 µL SYR (26s/2 "/2)	002450	10 µL Removable Needle Guided Plunger Syringe with 5 cm 0.47 mm OD Bevel Tipped Needle	E	
80383	701SN 10 µL SYR (26s/2 "/3)	002301	10 µL Fixed Needle Syringe with 5.1 cm 0.72 mm OD LC Needle	E	
80384	701SN 10 µL SYR (26s/3 "/2)	002003	10 µL Fixed Needle Syringe with 7 cm 0.47 mm OD Bevel Tipped Needle	O	7 cm Needle
80387	701ASN 10 µL SYR (23s/1.71 "/HP)	002810	10 µL Fixed Needle Agilent Syringe with 4.2 cm 0.63 mm OD Cone Tipped Needle	E	
80388	701ASN 10 µL SYR (26s/1.71 "/HP)	002800	10 µL Fixed Needle Agilent Syringe with 4.2 cm 0.47 mm OD Cone Tipped Needle	E	
80389	701ASN 10 µL SYR-HP 26s (6/PK)	002804	10 µL Fixed Needle Agilent Syringe with 4.2 cm 0.47 mm OD Cone Tipped Needle PK6	E	
80390	701ASN 10 µL SYR-HP 23s (6/PK)	002814	10 µL Fixed Needle Agilent Syringe with 4.2 cm 0.63 mm OD Cone Tipped Needle PK6	E	
80391	701ASN 6/PK (23-26/1.71 "/HP)	002822	10 µL Fixed Needle Agilent Syringe with 4.2 cm 0.63/0.47 mm OD Cone Tipped Dual Gauge Needle PK6	E	
80393	701ASN SYR (23-26/1.71 "/HP)	002821	10 µL Fixed Needle Agilent Syringe with 4.2 cm 0.63/0.47 mm OD Cone Tipped Dual Gauge Needle	E	
80398	701ASN 10 µL SYR (23s/1.71 "/2)	002810	10 µL Fixed Needle Agilent Syringe with 4.2 cm 0.63 mm OD Cone Tipped Needle	O	Cone Tipped Needle
80399	701ASN 10 µL SYR (26s/1.71 "/2)	002800	10 µL Fixed Needle Agilent Syringe with 4.2 cm 0.47 mm OD Cone Tipped Needle	O	Cone Tipped Needle
80400	702N 25 µL SYR (22s/2 "/2)	003000	25 µL Fixed Needle Syringe with 5 cm 0.5 mm OD Bevel Tipped Needle	E	
80404	702NCH 25 µL SYR (22s/2 "/2)	003000 + 031930	25 µL Fixed Needle Syringe with 5 cm 0.5 mm OD Bevel Tipped Needle and Repeating Adaptor	E	
80407	702NWG 25 µL SYR (22s/2 "/2)	003000 + 031930	25 µL Fixed Needle Syringe with 5 cm 0.5 mm OD Bevel Tipped Needle and Repeating Adaptor	E	
80419	702SN 25 µL SYR (22/2 "/3)	003300	25 µL Fixed Needle Syringe with 5.1 cm 0.72 mm OD LC Needle	E	
80430	702RN 25 µL SYR (22s/2 "/2)	003050	25 µL Removable Needle Syringe with 5 cm 0.5 mm OD Bevel Tipped Needle	E	
80439	702NPT5 25 µL SYR (22s/2 "/5)	003050 + 038410	25 µL Removable Needle Syringe with 5 cm Side Hole Dome Tipped Needle	O	RN, 25 g Needle
80465	702SNR 25 µL SYR (22s/2 "/3)	003300	25 µL Fixed Needle Syringe with 5.1 cm 0.72 mm OD LC Needle	E	
80500	705N 50 µL SYR (22s/2 "/2)	004000	50 µL Fixed Needle Syringe with 5 cm 0.5 mm OD Bevel Tipped Needle	E	

Syringes | Cross Reference Hamilton Continued

Hamilton Part Number	Part Description and Detail	SGE Part Number	Part Description and Detail	Equivalent or Option	Variation
80501	705LT 50 µL SYR	004229	50 µL Fixed Luer Tip Syringe with GT Plunger	E	
80505	705NCH 50 µL SYR (22s/2 °/2)	004000 + 031930	50 µL Fixed Needle Syringe with 5 cm 0.5 mm OD Bevel Tipped Needle and Repeating Adaptor	E	
80521	705SN 50 µL SYR (22/2 °/3)	004300	50 µL Fixed Needle Syringe with 5.1 cm 0.72 mm OD LC Needle	E	
80530	705RN 50 µL SYR (22s/2 °/2)	004050	50 µL Removable Needle Syringe with 5 cm 0.5 mm OD Bevel Tipped Needle	E	
80539	705NPT5 50 µL SYR (22s/2 °/5)	004050 + 038410	50 µL Removable Needle Syringe with 5 cm Side Hole Dome Tipped Needle	O	RN, 25 g Needle
80565	705SNR 50 µL SYR (22s/2 °/3)	004300	50 µL Fixed Needle Syringe with 5.1 cm 0.72 mm OD LC Needle	E	
80600	710N 100 µL SYR (22s/2 °/2)	005000	100 µL Fixed Needle Syringe with 5 cm 0.5 mm OD Bevel Tipped Needle	E	
80601	710LT 100 µL SYR	005229	100 µL Fixed Luer Tip Syringe with GT Plunger	E	
80605	710NCH 100 µL SYR (22s/2 °/2)	005000 + 031930	100 µL Fixed Needle Syringe with 5 cm 0.5 mm OD Bevel Tipped Needle and Repeating Adaptor	E	
80621	710SN 100 µL SYR (22/2 °/3)	005300	100 µL Fixed Needle Syringe with 5.1 cm 0.72 mm OD LC Needle	E	
80630	710RN 100 µL SYR (22s/2 °/2)	005050	100 µL Removable Needle Syringe with 5 cm 0.5 mm OD Bevel Tipped Needle	E	
80639	710NPT5 100 µL SYR (22s/2 °/5)	005050 + 038410	100 µL Removable Needle Syringe with 5 cm Side Hole Dome Tipped Needle	O	RN, 25 g Needle
80665	710SNR 100 µL SYR (22s/2 °/3)	005300	100 µL Fixed Needle Syringe with 5.1 cm 0.72 mm OD LC Needle	E	
80700	725N 250 µL SYR (22S/2 °/2)	006000	250 µL Fixed Needle Syringe with 5 cm 0.5 mm OD Bevel Tipped Needle	E	
80701	725LT 250 µL SYR	006229	250 µL Fixed Luer Tip Syringe with GT Plunger	E	
80730	725RN 250 µL SYR (22s/2 °/2)	006050	250 µL Removable Needle Syringe with 5 cm 0.5 mm OD Bevel Tipped Needle	E	
80739	725N 250 µL SYR (22S/2 °/5)	006050 + 038410	250 µL Removable Needle Syringe with 5 cm Side Hole Dome Tipped Needle	O	RN, 25 g Needle
80765	725NR 250 µL (22/2 °/3)	006300	250 µL Fixed Needle Syringe with 5.1 cm 0.72 mm OD LC Needle	E	
80800	750N 500 µL SYR (22/2 °/2)	007000	500 µL Fixed Needle Syringe with 5 cm 0.5 mm OD Bevel Tipped Needle	E	
80801	750LT 500 µL SYR	007229	500 µL Fixed Luer Tip Syringe with GT Plunger	E	
80830	750RN 500 µL SYR (22/2 °/2)	007050	500 µL Removable Needle Syringe with 5 cm 0.5 mm OD Bevel Tipped Needle	E	
80839	750N 500 µL SYR (22/2 °/5)	007050 + 038410	500 µL Removable Needle Syringe with 5 cm Side Hole Dome Tipped Needle	O	RN, 25 g Needle
80865	750N 500 µL SYR (22/2 °/3)	007300	500 µL Fixed Needle Syringe with & 5.1 cm 0.72 mm OD LC Needle	E	
80900	1705N 50 µL SYR (22s/2 °/2)	004200	50 µL Fixed Needle Syringe with GT Plunger & 5 cm 0.5 mm OD Bevel Tipped Needle	E	
80901	1705LT 50 µL SYR	004229	50 µL Fixed Luer Tip Syringe with GT Plunger	E	
80920	1705TLL 50 µL SYR	004230	50 µL Fixed Luer Lock Syringe with GT Plunger	E	
80922	1705TLLX 50 µL SYR	004232	50 µL Fixed Luer Lock Syringe with GT Plunger & Plunger Stop	E	
80927	1705TLL 50 µL SYR W/SLOTS	004230	50 µL Fixed Luer Lock Syringe with GT Plunger	E	
80930	1705RN 50 µL SYR (22s/2 °/2)	004250	50 µL Removable Needle Syringe with GT Plunger & 5 cm 0.5 mm OD Bevel Tipped Needle	E	
80938	1705RNW 50 µL SYR(25s/1.97 °/3)	004250 + 038260	50 µL Removable Needle Syringe with GT Plunger & Waters LC Tipped Needle	E	
80939	1705NPT5 50 µL SYR (22s/2 °/5)	004250 + 038410	50 µL Removable Needle Syringe with GT Plunger & 5 cm Side Hole Dome Tipped Needle	O	RN, 25 g Needle
80956	1705SL 50 µL SYR (22s/2 °/2)L	004279	50 µL Syringe with Removable Needle Valve & GT Plunger	E	
80962	1705CX 50 µL SYR W/STOP	004995	50 µL Syringe with GT Plunger and 1/4-28 UNF Termination	E	
80965	1705RNR 50 µL SYR (22s/2 °/3)	004312	50 µL Removable Needle Syringe with GT Plunger & 5.1 cm 0.72 mm OD LC Needle	E	
80975	1705N 50 µL SYR (22s/2 °/3)	004312	50 µL Removable Needle Syringe with GT Plunger & 5.1 cm 0.72 mm OD LC Needle	O	RN
80985	1705N 50 µL SYR (22/2 °/3)	004312	50 µL Removable Needle Syringe with GT Plunger & 5.1 cm 0.72 mm OD LC Needle	O	RN
81000	1710N 100 µL SYR (22s/2 °/2)	005200	100 µL Fixed Needle Syringe with GT Plunger & 5 cm 0.5 mm OD Bevel Tipped Needle	O	25 g Needle
81001	1710LT 100 µL SYR	005229	100 µL Fixed Luer Tip Syringe with GT Plunger	E	
81020	1710TLL 100 µL SYR	005230	100 µL Fixed Luer Lock Syringe with GT Plunger	E	
81022	1710TLLX 100 µL SYR	005232	100 µL Fixed Luer Lock Syringe with GT Plunger & Plunger Stop	E	
81027	1710TLL 100 µL SYR W/SLOTS	005230	100 µL Fixed Luer Lock Syringe with GT Plunger	E	
81030	1710RN 100 µL SYR (22s/2 °/2)	005250	100 µL Removable Needle Syringe with GT Plunger & 5 cm 0.5 mm OD Bevel Tipped Needle	E	
81038	1710RNW 100 µL SYR(25s/1.97 °/3)	005250 + 038260	100 µL Removable Needle Syringe with GT Plunger & Waters LC Tipped Needle	E	
81039	1710NPT5 100 µL SYR (22s/2 °/5)	005250 + 038410	100 µL Removable Needle Syringe with GT Plunger & 5 cm Side Hole Dome Tipped Needle	O	RN, 25 g Needle

Syringes | Cross Reference Hamilton Continued

Hamilton Part Number	Part Description and Detail	SGE Part Number	Part Description and Detail	Equivalent or Option	Variation
81056	1710SL 100 µL SYR (22s/2 *1/2)L	005279	100 µL Syringe with Removable Needle Valve & GT Plunger	E	
81060	1710C 100 µL SYR	005990	100 µL Syringe with GT Plunger and 1/4-28 UNF Termination	E	
81062	1710CX 100 µL SYR W/STOP	005990	100 µL Syringe with GT Plunger and 1/4-28 UNF Termination	E	
81065	1710RNR 100 µL SYR (22s/2 *1/3)	005312	100 µL Removable Needle Syringe with GT Plunger & 5.1 cm 0.72 mm OD LC Needle	E	
81075	1710N 100 µL SYR (22s/2 *1/3)	005312	100 µL Removable Needle Syringe with GT Plunger & 5.1 cm 0.72 mm OD LC Needle	O	RN
81085	1710N 100 µL SYR (22/2 *1/3)	005312	100 µL Removable Needle Syringe with GT Plunger & 5.1 cm 0.72 mm OD LC Needle	O	RN
81100	1725LTN 250 µL SYR (22s/2 *1/2)	006200	250 µL Fixed Needle Syringe with GT Plunger & 5 cm 0.5 mm OD Bevel Tipped Needle	O	Not LT
81101	1725LT 250 µL SYR	006229	250 µL Fixed Luer Tip Syringe with GT Plunger	E	
81120	1725TLL 250 µL SYR	006230	250 µL Fixed Luer Lock Syringe with GT Plunger	E	
81122	1725TLLX 250 µL SYR	006232	250 µL Fixed Luer Lock Syringe with GT Plunger & Plunger Stop	E	
81127	1725TLL 250 µL SYR W/SLOTS	006230	250 µL Fixed Luer Lock Syringe with GT Plunger	E	
81130	1725RN 250 µL SYR (22s/2 *1/2)	006250	250 µL Removable Needle Syringe with GT Plunger & 5 cm 0.5 mm OD Bevel Tipped Needle	E	
81138	1725RNW 250 µL SYR(25s/1.97 *1/3)	006250 + 038260	250 µL Removable Needle Syringe with GT Plunger & Waters LC Tipped Needle	O	RN
81139	1725LTN 250 µL SYR (22S/2 *1/5)	006250 + 038410	250 µL Removable Needle Syringe with GT Plunger & 5 cm Side Hole Dome Tipped Needle	O	
81156	1725SL 250 µL SYR (22s/2 *1/2)L	006279	250 µL Syringe with Removable Needle Valve & GT Plunger	E	
81162	1725CX 250 µL SYR W/STOP	006995	250 µL Syringe with GT Plunger and 1/4-28 UNF Termination	E	
81165	1725RNR 250 µL SYR (22/2 *1/3)	006312	250 µL Removable Needle Syringe with GT Plunger & 5.1 cm 0.72 mm OD LC Needle	E	
81175	1725LTN 250 µL SYR (22S/2 *1/3)	006312	250 µL Removable Needle Syringe with GT Plunger & 5.1 cm 0.72 mm OD LC Needle	O	RN
81185	1725LTN 250 µL SYR (22/2 *1/3)	006312	250 µL Removable Needle Syringe with GT Plunger & 5.1 cm 0.72 mm OD LC Needle	O	RN
81201	1750LT 500 µL SYR	007229	500 µL Fixed Luer Tip Syringe with GT Plunger	E	
81216	1750LTN 500 µL SYR (22/2 *1/3)	007312	500 µL Removable Needle Syringe with GT Plunger & 5.1 cm 0.72 mm OD LC Needle	O	RN
81217	1750LTN 500 µL SYR (22/2 *1/2)	007200	500 µL Fixed Needle Syringe with GT Plunger & 5 cm 0.5 mm OD Bevel Tipped Needle	E	Not LT
81220	1750TLL 500 µL SYR	007230	500 µL Fixed Luer Lock Syringe with GT Plunger	E	
81222	1750TLLX 500 µL SYR	007232	500 µL Fixed Luer Lock Syringe with GT Plunger & Plunger Stop	E	
81227	1750TLL 500 µL SYR W/SLOTS	007230	500 µL Fixed Luer Lock Syringe with GT Plunger	E	
81230	1750RN 500 µL SYR (22/2 *1/2)	007250	500 µL Removable Needle Syringe with GT Plunger & 5 cm 0.5 mm OD Bevel Tipped Needle	E	
81243	1750LTNPT5 500 µL SYR (22/2 *1/5)	007250 + 038410	500 µL Removable Needle Syringe with GT Plunger & 5 cm Side Hole Dome Tipped Needle	O	Not LT, 25 g Needle
812560	1750SL	007279	500 µL Syringe with Removable Needle Valve & GT Plunger	E	23 g Needle
81262	1750CX 500 µL SYR W/STOP	007995	500 µL Syringe with GT Plunger and 1/4-28 UNF Termination	E	
81265	1750RNR 500 µL SYR (22/2 *1/3)	007312	500 µL Removable Needle Syringe with GT Plunger & 5.1 cm 0.72 mm OD LC Needle	E	
81301	1001LT 1.0 mL SYR	008020	1 mL Fixed Luer Tip Syringe with GT Plunger	E	
81316	1001LTN 1.0 mL SYR (22/2 *1/3)	008105	1 mL Removable Needle Syringe with GT Plunger & 5.1 cm 0.72 mm OD LC Needle	O	RN
81317	1001LTN 1.0 mL SYR (22/2 *1/2)	008102	1 mL Fixed Needle Syringe with GT Plunger & 5 cm 0.72 mm OD Bevel Tipped Needle	O	Not LT
81318	1001LTNCH 1.0 mL SYR (22/2 *1/2)	008102	1 mL Fixed Needle Syringe with GT Plunger & 5 cm 0.72 mm OD Bevel Tipped Needle	O	WO Adaptor
81320	1001TLL 1.0 mL SYR	008025	1 mL Fixed Luer Lock Syringe with GT Plunger	E	
81324	1001TLLCH 1.0 mL SYR	008025	1 mL Fixed Luer Lock Syringe with GT Plunger	O	WO Adaptor
81327	1001TLL 1.0 mL SYR W/SLOTS	008025	1 mL Fixed Luer Lock Syringe with GT Plunger	E	
81330	1001RN 1.0 mL SYR (22/2 *1/2)	008100	1 mL Removable Needle Syringe with GT Plunger & 5 cm 0.63 mm OD Bevel Tipped Needle	E	
81343	1001LTNPT5 1.0 mL SYR (22/2 *1/5)	008100 + 039120	1 mL Removable Needle Syringe with GT Plunger & 5 cm Side Hole Dome Tipped Needle	O	Not LT, 23 g Needle
81356	1001SL 1.0 mL SYR (22/2 *1/2)L	008110	1 mL Syringe with Removable Needle Valve & GT Plunger	E	
81360	1001C 1.0 mL SYR	008185	1 mL Fixed Needle CTC RTC & Thermo RSH Head Space Syringe with Energized GT Plunger and 6.5 cm 0.63 mm OD Side-hole Needle	E	
81365	1001RNR 1.0 mL SYR (22/2 *1/3)	008105	1 mL Removable Needle Syringe with GT Plunger & 5.1 cm 0.72 mm OD LC Needle	E	
81401	1002LT 2.5 mL SYR	008420	1.0 mL V6 Dispenser Syringe	E	
81403	1002LTCH 2.5 mL SYR	008020	1 mL Fixed Luer Tip Syringe with GT Plunger	O	WO Adaptor
81416	1002LTN 2.5 mL SYR (22/2 *1/3)	008505	2.5 mL Removable Needle Syringe with GT Plunger & 5.1 cm 0.72 mm OD LC Needle	O	RN
81417	1002LTN 2.5 mL SYR (22/2 *1/2)	008502	2.5 mL Fixed Needle Syringe with GT Plunger & 5 cm 0.72 mm OD Bevel Tipped Needle	E	
81418	1002LTNCH 2.5 mL SYR (22/2 *1/2)	008502	2.5 mL Fixed Needle Syringe with GT Plunger & 5 cm 0.72 mm OD Bevel Tipped Needle	O	WO Adaptor
81420	1002TLL 2.5 mL SYR	008425	2.5 mL Fixed Luer Tip Syringe with GT Plunger	E	

Syringes | Cross Reference Hamilton Continued

Hamilton Part Number	Part Description and Detail	SGE Part Number	Part Description and Detail	Equivalent or Option	Variation
81424	1002TLLCH 2.5 mL SYR	008425	2.5 mL Fixed Luer Lock Syringe with GT Plunger	O	WO Adaptor
81427	1002TLL 2.5 mL SYR W/SLOTS	008425	2.5 mL Fixed Luer Lock Syringe with GT Plunger	E	
81430	1002RN 2.5 mL SYR (22/2 °/2)	008500	2.5 mL Removable Needle Syringe with GT Plunger & 5 cm 0.63 mm OD Bevel Tipped Needle	E	
81443	1002LTNP5 2.5 mL SYR (22/2 °/5)	008500 + 039120	2.5 mL Removable Needle Syringe with GT Plunger & 5 cm Side Hole Dome Tipped Needle	O	Not LT, 23 g Needle
81456	1002SL 2.5 mL SYR (22/2 °/2)L	008510	2.5 mL Syringe with Removable Needle Valve & GT Plunger	E	
81460	1002C 2.5 mL SYR	008687	2.5 mL Syringe with GT Plunger and 1/4-28 UNF Termination	E	
81501	1005LT 5.0 mL SYR	008760	5 mL Removable Luer Lock Syringe with GT Plunger	O	LL Not LT
81516	1005LTN 5 mL SYR (22/2 °/3)	008700 + 0315233	5 mL Removable Needle Syringe with GT Plunger & LC Needle	O	RN
81517	1005LTN 5.0 mL SYR (22/2 °/2)	008700	5 mL Removable Needle Syringe with GT Plunger & 5 cm 0.63 mm OD Bevel Tipped Needle	O	RN
81518	1005LTNCH 5.0 mL SYR (22/2 °/2)	008762	5 mL Fixed Luer Lock Syringe with GT Plunger	O	LL Not LT. WO Adaptor
81520	1005TLL 5.0 mL SYR	008762	5 mL Fixed Luer Lock Syringe with GT Plunger	E	
81524	1005TLLCH 5.0 mL SYR	008762	5 mL Fixed Luer Lock Syringe with GT Plunger	O	WO Adaptor
81527	1005TLL 5 mL SYR W/SLOTS	008762	5 mL Fixed Luer Lock Syringe with GT Plunger	E	
81530	1005RN 5.0 mL SYR (22/2 °/2)	008700	5 mL Removable Needle Syringe with GT Plunger & 5 cm 0.63 mm OD Bevel Tipped Needle	E	
81560	1005C 5.0 mL SYR	008787	5 mL Syringe with GT Plunger and 1/4-28 UNF Termination	E	
81601	1010LT 10.0 mL SYR	008962	10 mL Fixed Luer Lock Syringe with GT Plunger	O	LL Not LT
81610	1010W 10.0 mL (WATERS) SYR	008962	10 mL Fixed Luer Lock Syringe with GT Plunger	E	
81616	1010LTN 10 mL SYR (22/2 °/3)	008900 + 0315233	10 mL Removable Needle Syringe with GT Plunger & LC Needle	O	RN
81617	1010LTN 10.0 mL SYR (22/2 °/2)	008900	10 mL Removable Needle Syringe with GT Plunger & 5 cm 0.63 mm OD Bevel Tipped Needle	O	RN
81618	1010LTNCH 10.0 mL SYR (22/2 °/2)	008962	10 mL Fixed Luer Lock Syringe with GT Plunger	O	LL Not LT. WO Adaptor
81620	1010TLL 10.0 mL SYR	008962	10 mL Fixed Luer Lock Syringe with GT Plunger	E	
81624	1010TLLCH 10.0 mL SYR	008962	10 mL Fixed Luer Lock Syringe with GT Plunger	O	WO Adaptor
81627	1010TLL 10 mL SYR W/SLOTS	008962	10 mL Fixed Luer Lock Syringe with GT Plunger	E	
81630	1010RN 10.0 mL SYR (22/2 °/2)	008900	10 mL Removable Needle Syringe with GT Plunger & 5 cm 0.63 mm OD Bevel Tipped Needle	E	
81660	1010C 10.0 mL SYR	008987	10 mL Syringe with GT Plunger and 1/4-28 UNF Termination	E	
82017	1001.25LTN 1.25 mL SYR (22/2 °/2)	009462	25 mL Removable Luer Lock Syringe with GT Plunger	O	LL. Select Needle Separately
82520	1025TLL 25.0 mL SYR	009463	25 mL Fixed Luer Lock Syringe with GT Plunger	E	
82525	1025TLL W/O FL 25 mL SYR W/ SLOT	009463	25 mL Fixed Luer Lock Syringe with GT Plunger	O	WO Adaptor
82527	1025TLL 25 mL SYR W/SLOTS	009463	25 mL Fixed Luer Lock Syringe with GT Plunger	E	
84850	85N 5 µL SYR (26s/2 °/2)	001400	5 µL Fixed Needle Guided Plunger Syringe with 5 cm 0.47 mm OD Bevel Tipped Needle	O	
84851	85RN 5 µL SYR (26s/2 °/2)	001450	5 µL Removable Needle Guided Plunger Syringe with 5 cm 0.47 mm OD Bevel Tipped Needle	O	
84852	801N 10 µL SYR (26s/2 °/2)	002400	10 µL Fixed Needle Guided Plunger Syringe with 5 cm 0.47 mm OD Bevel Tipped Needle	O	
84853	801RN 10 µL SYR (26s/2 °/2)	002450	10 µL Removable Needle Guided Plunger Syringe with 5 cm 0.47 mm OD Bevel Tipped Needle	O	
85020	1050TLL 50.0 mL SYR	009660	50 mL Removable Luer Lock Syringe with GT Plunger	E	
85027	1050TLL 50 mL SYR W/SLOTS	009660	50 mL Removable Luer Lock Syringe with GT Plunger	E	
86020	1100TLL 100.0 mL SYR	009760	100 mL Removable Luer Lock Syringe with GT Plunger	E	
86204	7101KHCH 1 µL SYR (22/2.75 °/3)	000553	1.0 µL NanoVolume Syringe with 7 cm 0.63 mm OD Cone Tipped Needle & Repeating Adaptor	O	Cone Tip
86207	7101KHWG 1 µL SYR (22/2.75 °/3)	000553	1.0 µL NanoVolume Syringe with 7 cm 0.63 mm OD Cone Tipped Needle & Repeating Adaptor	O	Cone Tip
86211	7101KH 1 µL SYR (22s/2.75 °/2)	000505	1.0 µL NanoVolume Syringe with 7 cm 0.63 mm OD Cone Tipped Needle	O	23 g Needle
86250	7000.5KH 0.5 µL SYR (25/2.75 °/3)	000310	0.5 µL NanoVolume Syringe with 7 cm 0.63 mm OD Cone Tipped Needle	O	Cone Tip
86252	7000.5KHCH .5 µL SYR(25/2.75/3)	000355	0.5 µL NanoVolume Syringe with 7 cm 0.63 mm OD Cone Tipped Needle & Repeating Adaptor	O	Cone Tip
86254	7000.5KHWG .5 µL SYR(25/2.75/3)	000355	0.5 µL NanoVolume Syringe with 7 cm 0.63 mm OD Cone Tipped Needle & Repeating Adaptor	O	Cone Tip
86259	7000.5KH 0.5 µL SYR (25/2.75 °/2)	000311	0.5 µL NanoVolume Syringe with 7 cm 0.63 mm OD Bevel Tipped Needle	O	23 g Needle
86274	7000.5ASRN (26/1.71 °/HP)	000400	0.5 µL NanoVolume Agilent Syringe with 4.2 cm 0.47 mm OD Cone Tipped Needle	E	
86276	7000.5ASRN (23/1.71 °/HP)	000410	0.5 µL NanoVolume Agilent Syringe with 4.2 cm 0.63 mm OD Cone Tipped Needle	E	
86311	S0500 0.5L SYR (TLL)	009910	500 mL Jumbo Luer Lock Syringe	E	
86312	S1000 1.0L SYR (TLL)	009920	1000 mL Jumbo Luer Lock Syringe	E	
86313	S1500 1.5L SYR (TLL)	009930	2000 mL Jumbo Luer Lock Syringe	O	2 L Instead of 1.5 L
86314	S2000 2.0L SYR (TLL)	009930	2000 mL Jumbo Luer Lock Syringe	E	

Syringes | Cross Reference Hamilton Continued

Hamilton Part Number	Part Description and Detail	SGE Part Number	Part Description and Detail	Equivalent or Option	Variation
86326	1025SL 25 mL SYR (22/2 "/2)L	009472	25 mL Syringe with Removable Luer Lock Valve & GT Plunger	O	LL. Select Needle Separately
863260	1025SL	009472	25 mL Syringe with Removable Luer Lock Valve & GT Plunger	O	Select Needle Separately
86336	1050SL 50 mL SYR (22/2 "/2)L	009670	50 mL Syringe with Removable Luer Lock Valve & GT Plunger	O	LL. Select Needle Separately
863360	1050SL	009670	50 mL Syringe with Removable Luer Lock Valve & GT Plunger	O	Select Needle Separately
86346	1100SL 100 mL SYR (22/2 "/2)L	009770	100 mL Syringe with Removable Luer Lock Valve & GT Plunger	O	LL. Select Needle Separately
87402	701RNFS 10 µL SYR(.17mm/10cm/3)	002050 + 037610	10 µL Removable Needle Syringe with 10 cm 0.17 mm OD Needle	E	
87404	1701RNFS 10 µL SYR(.17mm/10cm/3)	002250 + 037610	10 µL Removable Needle Syringe with GT Plunger & 5 cm 0.47 mm OD Bevel Tipped Needle	E	
87900	75N 5 µL SYR (26s/2 "/2)	001000	5 µL Fixed Needle Syringe with 5 cm 0.47 mm OD Bevel Tipped Needle	E	
87919	75N 5 µL SYR (26s/2 "/3)	001301	5 µL Fixed Needle Syringe with 5.1 cm 0.72 mm OD LC Needle	E	
87930	75RN 5.0 µL SYR (26s/2 "/2)	001050	5 µL Removable Needle Syringe with 5 cm 0.47 mm OD Bevel Tipped Needle	E	
87943	65RNR 5.0 µL SYR (22s/2 "/3)	001450	5 µL Removable Needle Guided Plunger Syringe with 5 cm 0.47 mm OD Bevel Tipped Needle	E	
87957	75ASRN 5 µL SYR (23s/1.71 "/HP)	001810	5 µL Fixed Needle Agilent Syringe with 4.2 cm 0.63 mm OD Cone Tipped Needle	O	FN
87958	75ASRN 5 µL SYR (26s/1.71 "/HP)	001800	5 µL Fixed Needle Agilent Syringe with 4.2 cm 0.47 mm OD Cone Tipped Needle	O	FN
87959	75ASRN SYR (23S/26S/1.71 "/HP)	001821	5 µL Fixed Needle Agilent Syringe with 4.2 cm 0.63/0.47 mm OD Cone Tipped Dual Gauge Needle	O	FN
87987	75ASN 5 µL SYR (23s/1.71 "/HP)	001810	5 µL Fixed Needle Agilent Syringe with 4.2 cm 0.63 mm OD Cone Tipped Needle	E	
87988	75ASN 5 µL SYR (26s/1.71 "/HP)	001800	5 µL Fixed Needle Agilent Syringe with 4.2 cm 0.47 mm OD Cone Tipped Needle	E	
87989	75ASN 5 µL SYR(26s/1.71 "/HP)6PK	001804	5 µL Fixed Needle Agilent Syringe with 4.2 cm 0.47 mm OD Cone Tipped Needle PK6	E	
87990	75ASN 5 µL SYR(23s/1.71 "/HP)6PK	001814	5 µL Fixed Needle Agilent Syringe with 4.2 cm 0.63 mm OD Cone Tipped Needle PK6	E	
87991	75ASN 5 µL SYR (23s/1.71 "/2)	001810	5 µL Fixed Needle Agilent Syringe with 4.2 cm 0.63 mm OD Cone Tipped Needle	O	Cone Tipped Needle
87992	75ASN 5 µL SYR (26s/1.71 "/2)	001800	5 µL Fixed Needle Agilent Syringe with 4.2 cm 0.47 mm OD Cone Tipped Needle	O	Cone Tipped Needle
87993	75ASN 5 µL SYR (23-26/1.71 "/HP)	001821	5 µL Fixed Needle Agilent Syringe with 4.2 cm 0.63/0.47 mm OD Cone Tipped Dual Gauge Needle	E	
87994	75ASN 5 µL 6/PK(23-26/1.71 "/HP)	001822	5 µL Fixed Needle Agilent Syringe with 4.2 cm 0.63/0.47 mm OD Cone Tipped Dual Gauge Needle PK6	E	
88000	7105KH 5.0 µL SYR (24/2.75 "/3)	000802	5.0 µL NanoVolume Syringe with 7 cm 0.63 mm OD Cone Tipped Needle	E	
88004	7105KHCH 5.0 µL SYR (24/2.75 "/3)	000852	5.0 µL NanoVolume Syringe with 7 cm 0.63 mm OD Cone Tipped Needle & Repeating Adaptor	E	
88007	7105KHWG 5.0 µL SYR (24/2.75 "/3)	000852	5.0 µL NanoVolume Syringe with 7 cm 0.63 mm OD Cone Tipped Needle & Repeating Adaptor	E	
88011	7105KH 5.0 µL SYR (24/2.75 "/2)	000803	5.0 µL NanoVolume Syringe with 7 cm 0.63 mm OD Bevel Tipped Needle	E	
88035	75ASN/PE SYR 5 µL 0.63 mm OD	001954	5 µL Fixed Needle PerkinElmer Syringe with 7 cm 0.63 mm OD Cone Tipped Needle	E	
88040	75ASN/PE SYR 5 µL 0.47 mm OD	001953	5 µL Fixed Needle PerkinElmer Syringe with 7 cm 0.47 mm OD Cone Tipped Needle	E	

Every effort has been made to ensure the SGE branded Equivalents and similar close Options suggested here are suitable alternative products, however the appropriateness for individual applications must remain the responsibility of the user.

For more information visit www.sge.com or contact techsupport@sge.com.



Product Data and Part Numbers

Syringes

SGE Analytical Science (SGE) is a world renowned brand for components and consumables used in scientific analysis.

Primarily in the field of scientific glass engineering for liquid handling and separation science, since its beginnings in 1960, SGE has become the global market leader in niche areas such as autosampler syringes and GC inlet liners.

Completing the transition into Trajan after acquisition in 2013, SGE products make up a solid foundation of Trajan's portfolio and will continue to be created and supported by Trajan customer service and distribution networks worldwide.

For more information visit
www.bgb-info.com/sge-syringes



BGB GC|LC
MS|CE

www.bgb-info.com

Switzerland: BGB Analytik AG • Rohrmattstrasse 4 • 4461 Böckten • Phone +41 61 991 00 46 • Fax +41 61 991 00 25 • sales@bgb-analytik.com
BGB Analytik SA • Route de Pré-Bois 20 • 1215 Genève 15 • Phone +41 22 788 49 43 • Fax +41 22 788 49 45 • sales.fr@bgb-analytik.com

Benelux: BGB Analytik Benelux B.V. • Engelsef 35 • 3843 BD Harderwijk • Phone +31 341 700270 • Fax +31 341 700271 • sales.benelux@bgb-analytik.com

France: BGB Analytik France S.A.S. • 81 Vie de l'Etraz • 01630 Saint Jean de Gonville • Phone 04 50 48 85 67 • Fax 04 50 56 23 78 • sales.fr@bgb-analytik.com

Germany: BGB Analytik Vertrieb GmbH • Josefstrasse 19a • 79618 Rheinfelden • Phone +49 7623 7173110 • Fax +49 7623 7173199 • sales.de@bgb-analytik.com