

 **BD** FACSymphony™ A1 Flow
Cytometer
User's Guide

Copyrights

No part of this publication may be reproduced, transmitted, transcribed, stored in retrieval systems, or translated into any language or computer language, in any form or by any means: electronic, mechanical, magnetic, optical, chemical, manual, or otherwise, without prior written permission from BD.

The information in this guide is subject to change without notice. BD reserves the right to change its products and services at any time. Although this guide has been prepared with every precaution to ensure accuracy, BD assumes no liability for any errors or omissions, nor for any damages resulting from the application or use of this information. BD welcomes customer input on corrections and suggestions for improvement.

Trademarks

BD, the BD Logo, BD FACSClean, BD FACSDiva, BD FACFlow, BD FACSymphony, BD Horizon Brilliant, FACS and Horizon are trademarks of Becton, Dickinson and Company or its affiliates. All other trademarks are the property of their respective owners. © 2022 BD. All rights reserved.

Alexa Fluor™ and Pacific Blue™ are trademarks of Life Technologies Corporation.

Cy™ is a trademark of GE Healthcare. Cy™ dyes are subject to proprietary rights of GE Healthcare and Carnegie Mellon University, and are made and sold under license from GE Healthcare only for research and in vitro diagnostic use. Any other use requires a commercial sublicense from GE Healthcare, 800 Centennial Avenue, Piscataway, NJ 08855-1327, USA.

Laser safety information

Class 1 Laser Product.

Regulatory information

For Research Use Only. Not for use in diagnostic or therapeutic procedures.

FCC information

WARNING: Changes or modifications to this unit not expressly approved by the party responsible for compliance could void the user's authority to operate the equipment.

NOTICE: This equipment has been tested and found to comply with the limits for a Class A digital device, pursuant to Part 15 of the FCC Rules. These limits are designed to provide reasonable protection against harmful interference when the equipment is operated in a commercial environment. This equipment generates, uses, and can radiate radio frequency energy and, if not installed and used in accordance with the instruction manual, may cause harmful interference to radio communications. Operation of this equipment in a residential area is likely to cause harmful interference in which case the user will be required to correct the interference at his or her own expense. Shielded cables must be used with this unit to ensure compliance with the Class A FCC limits. This Class A digital apparatus meets all requirements of the Canadian Interference-Causing Equipment Regulations. Cet appareil numérique de la classe A respecte toutes les exigences du Règlement sur le matériel brouilleur du Canada.

History

Revision	Date	Change made
23-23437-00	2021-05	Initial release
23-23437(01)	2022-07	Changed page size to 8.5 × 11 inches. Removed need for small particle filter assembly. Changed procedures in Small Particle Detector chapter. Modified cytometer troubleshooting.

Contents

1 ABOUT THIS GUIDE	7
What this guide covers	8
Conventions	8
About the BD FACSymphony™ A1 documentation	8
Instrument technical support	9
2 INTRODUCTION	11
System overview	12
Cytometer overview	13
Control panel	15
Fluidics system	16
Sheath and waste tanks	21
Optics	22
Workstation	23
3 CYTOMETER SETUP	25
Starting the cytometer and computer	26
Preparing the sheath tank	27
Removing air bubbles	29
Preparing the waste tank	30
Preparing the fluidics	32
About the optical filters and mirrors	34
Custom configurations and baselines	35
4 MAINTENANCE	37
Maintenance overview	38
Cleaning the fluidics	39
Shutting down the cytometer	40
Flushing the system	40
Replacing the waste tank cap	42

Changing the sheath filter	43
Changing the Bal seal	46
Changing the sample tube O-ring	48
Cleaning or replacing the sheath gasket	49
Accessing the red laser detector array	49
5 OPTIMIZING CYTOMETER SETTINGS	51
Cytometer settings workflow	52
Verifying the configuration and user preferences	53
Running a performance check	55
Setting up an experiment	58
Creating application settings	62
Recording compensation controls	64
Calculating compensation	66
6 RECORDING AND ANALYZING DATA	67
Data recording and analysis workflow	68
Preparing the workspace	68
Recording data	69
Analyzing data	71
Reusing an analysis	75
7 TECHNICAL OVERVIEW	77
About fluidics	78
About optics	79
About electronics	84
8 TROUBLESHOOTING	89
Cytometer troubleshooting	90
Electronics troubleshooting	95
9 DETECTOR ARRAY CONFIGURATIONS	97
Fluorescence spectra	98
About configuration maps	99
About configurations	100
Base configuration polygon maps	101
10 SMALL PARTICLE DETECTOR	105
Overview	106
SPD components	106
Preparing the system for small particle detection	107
Confirming small particle detection	109
Aligning the small particle detector	113
Small particle detector troubleshooting	116

11 SUPPLIES AND CONSUMABLES	117
Ordering information	118
Beads	118
Reagents	118
Equipment	119
INDEX	121

1

About this guide

This chapter covers the following topics:

- [What this guide covers \(page 8\)](#)
- [Conventions \(page 8\)](#)
- [About the BD FACSymphony™ A1 documentation \(page 8\)](#)
- [Instrument technical support \(page 9\)](#)

What this guide covers

This guide describes the procedures necessary to operate and maintain your BD FACSymphony™ A1 flow cytometer. Because many cytometer functions are controlled by BD FACSDiva™ software, this guide also contains information about software features required for basic cytometer setup and operation.





This guide assumes you have a working knowledge of basic Microsoft® Windows® operation. If you are not familiar with the Windows operating system, see the documentation provided with your computer.

Conventions

Introduction

The following table lists the safety symbols used in this guide to alert you to potential hazards.

Safety symbols

Symbol	Meaning
	Caution! Identifies a hazard or unsafe practice that could result in data loss, material damage, minor injury, severe injury, or death
	Biological hazard
	Electrical hazard
	Laser hazard

About the BD FACSymphony™ A1 documentation

Introduction

This topic describes the documentation available with the BD FACSymphony™ A1 flow cytometer.

Documentation USB Card

This user's guide is provided in PDF format on the Documentation USB card.

Help system

The help system installed with BD FACSDiva™ software includes the documents listed below. Access the BD FACSymphony™ A1 help system from the Help menu in the BD FACSDiva™ software. Internet access is not required to use the help system.

The help system includes the following documents:

- *BD FACSDiva™ Software Reference Manual*: Includes instructions or descriptions for installation and setup, workspace components, acquisition controls, analysis tools, and data management. Access this manual from the BD FACSDiva™ Software Help menu (Help > Documentation > Reference Manual), or by double-clicking the shortcut on the desktop.
- *BD Cytometer Setup and Tracking Application Guide*: Describes how to use the BD® Cytometer Setup and Tracking (CS&T) features in BD FACSDiva™ software.

Instrument technical support

Introduction

This topic describes how to get technical assistance.

Contacting technical support

If technical assistance is required, contact your local BD Biosciences customer support representative or supplier.

When contacting BD Biosciences, have the following information available:

- Product name, part number, and serial number
- Version of BD FACSDiva™ software you are using
- Any error messages
- Details of recent system performance

To contact customer support:

1. Go to bdbiosciences.com.
2. Select your region. You will see information in your local language.
3. Click **Go**.
4. Click the **Support** link for details for your local region.

This page intentionally left blank

2

Introduction

This chapter covers the following topics:

- [System overview \(page 12\)](#)
- [Cytometer overview \(page 13\)](#)
- [Control panel \(page 15\)](#)
- [Fluidics system \(page 16\)](#)
- [Sheath and waste tanks \(page 21\)](#)
- [Optics \(page 22\)](#)
- [Workstation \(page 23\)](#)

System overview

About the system

The BD FACSymphony™ A1 system includes the BD FACSymphony™ A1 flow cytometer, BD FACSDiva™ software running on the system workstation, the optional BD FACFlow™ supply system (FFSS), and the optional BD® High Throughput Sampler (HTS). Each component is described in detail in the following sections.

In addition, the BD® Small Particle Detector (SPD) is an optional side scatter detector optimized to improve resolution of small particles such as extracellular vesicles. For more information, see [Small Particle Detector \(page 105\)](#).

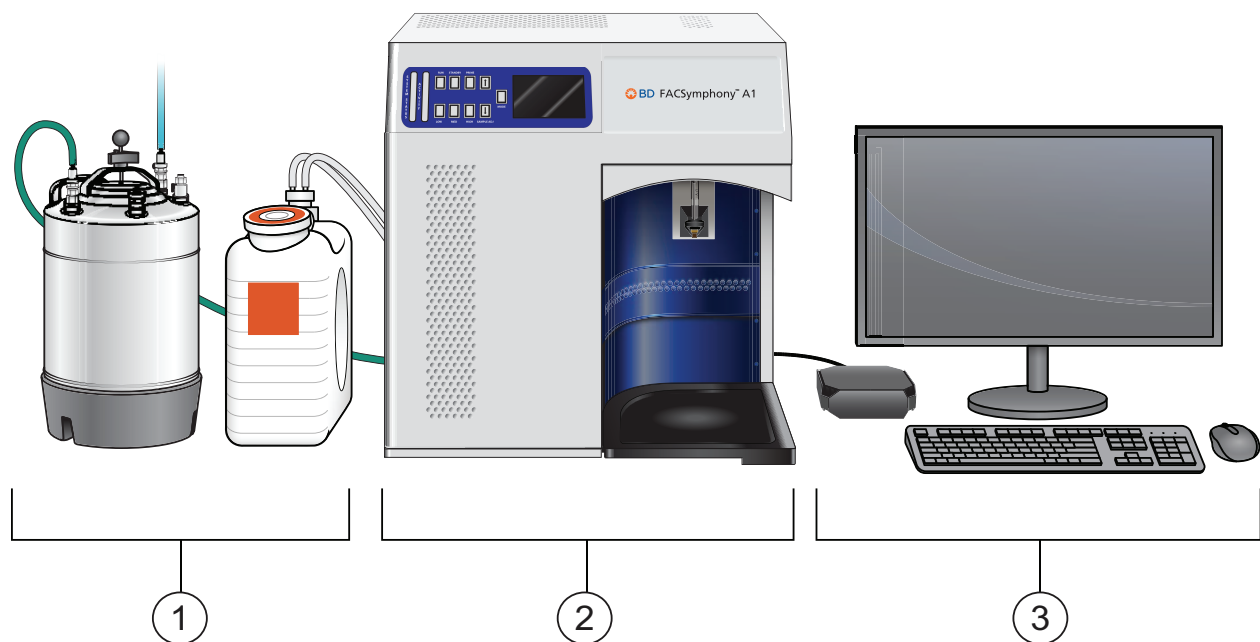

Number	Components
1	Sheath and waste tanks
2	BD FACSymphony™ A1 flow cytometer
3	Computer workstation

Cytometer overview

Introduction

The BD FACSymphony™ A1 flow cytometer is an air-cooled multi-laser benchtop flow cytometer with the ability to acquire 14 or 16 fluorescent parameters. It uses fixed-alignment lasers that transmit light through a flow cell to collect and translate the resulting fluorescence signals into electronic signals. Cytometer electronics convert these signals into digital data.

Components

The following figures show the main components on the front and right side of the BD FACSymphony™ A1 flow cytometer. The descriptions are listed in the tables.



Number	Component
1	Heat ventilation slots (top)
2	Control panel
3	Sample injection port (SIP)
4	Heat ventilation slots (left side)
5	Optics access door (polygon detector arrays)

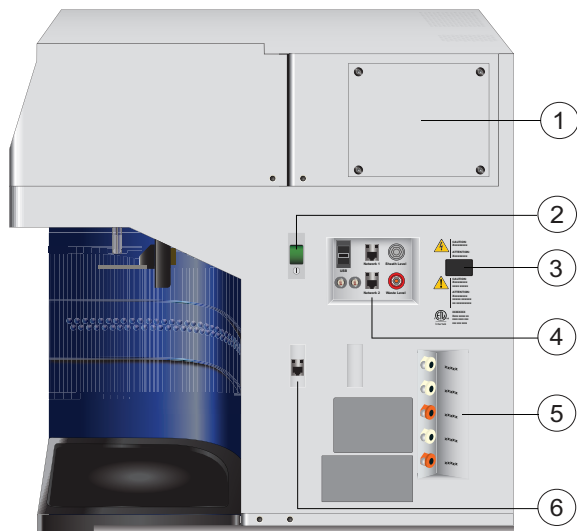

Number	Component
1	Red laser detector array access panel
2	Power button
3	Electrical plug
4	Fluidic sensor ports
5	Air and fluidic ports
6	USB port for Small Particle Detector to workstation



Do not place any objects on top of the instrument. Blocking the ventilation may cause the instrument to overheat.



Do not place liquids on top of the instrument. Any spill of liquid into the ventilation openings could cause electrical shock or damage to the instrument.

Control panel

Overview

The fluidics display controller enables the monitoring of the sheath tank level, waste tank level, and air pressure status through a combination of status LEDs and text display. It also controls sample flow rate and fluidic controls.

The following figure shows the components in the control panel, which are listed in the table.

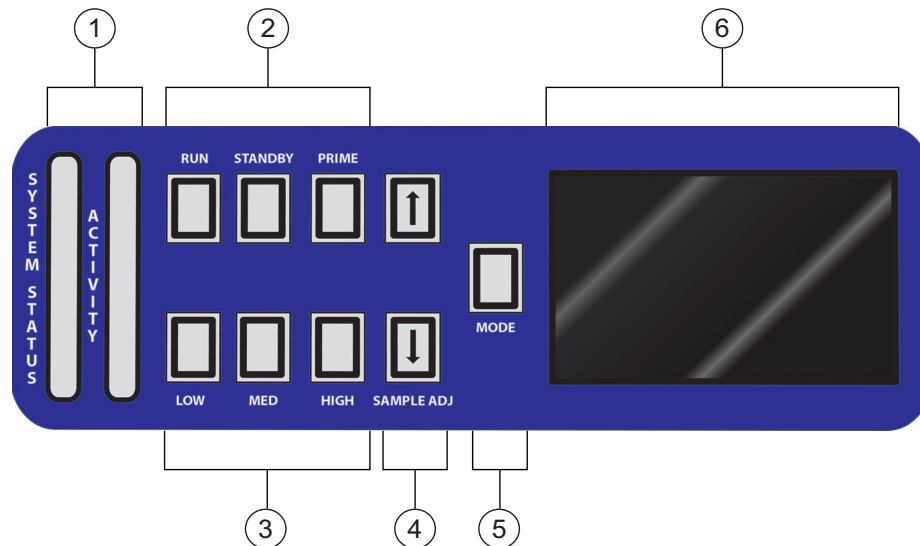

Number	Component
1	System status and activity bar
2	Fluid control buttons
3	Sample flow rate buttons
4	Sample fine adjust buttons
5	MODE button
6	Touch screen and status display

More information

- [Fluidics system \(page 16\)](#)
- [Optics \(page 22\)](#)

Fluidics system

Introduction



The fluidics system carries the sample out of the sample tube and into the interrogation region of the flow cell. Cells are carried in the sample core stream in single file and measured individually.

Note: If your system has the HTS option, see the *BD® High Throughput Sampler User's Guide* for additional information on the sample flow rates and fluidic controls.

System indicators

There are two system indicators (System Status and Activity) on the control panel as well as Sheath Tank Air Pressure, Sheath, and Waste indicators on the graphic display.

- **System Status bar.** Shows the status of the system by displaying a green, yellow, or red LED indicator. The following table describes the LED indicators, conditions that trigger them, and any action that must be taken.

LED color	Status	Action	Condition
Green	Good	None	Good
Yellow	 Sheath and/or waste tanks need attention.	Check tank levels	Sheath low and/or waste nearly full
Red	 Take immediate action.	<ul style="list-style-type: none"> • Empty waste tank • Fill sheath tank • Check air pressure 	Sheath empty and/or waste full Air pressure is out of specification

System status is also displayed on the Status screen. See [Status screen \(page 18\)](#) for a description of the Status screen.

- **Activity.** Shows whether the cytometer power is on and the status of acquisition. The following table describes the indicator LEDs, and status that triggers them.

Indicator	LED color	Status
Steady pulse	blue	Cytometer is powered on
Fluctuates	blue	Forward scatter is registering cells or particles

Fluid control

The three fluid buttons (RUN, STANDBY, and PRIME) control the fluidics subsystem.

- **RUN** Pressurizes the sample tube to transport the sample through the sample injection tube and into the flow cell.

The RUN button is green when the sample tube is on and the support arm is centered and the sample tube is pressurized. When the tube support arm is moved left or right to remove a sample tube, the cytometer switches to an automatic standby status to conserve sheath fluid, and the RUN button changes to orange.

The RUN button will also turn orange if the sample tube is cracked or the BAL seal is bad. See [Troubleshooting \(page 89\)](#).

- **STANDBY** Stops fluid flow to conserve sheath fluid.

When you leave the cytometer for more than a few minutes, place a tube containing less than 1 mL of deionized (DI) water on the sample injection port (SIP) and press STANDBY.

- **PRIME** Prepares the fluidics system by draining and filling the flow cell with sheath fluid.

Note: Remove sample tubes during the prime cycle.

The fluid flow initially stops, and pressure is reversed to force fluid out of the flow cell and into the waste container. After a preset time, the flow cell fills with sheath fluid at a controlled rate to prevent bubble formation or entrapment. At completion, the cytometer switches to standby mode.

Sample flow rate control

The three flow rate buttons (LOW, MED, HIGH) control the sample rate through the flow cell. The three fluidic control buttons (RUN, STANDBY, PRIME) enable you to control the sample acquisition rate.

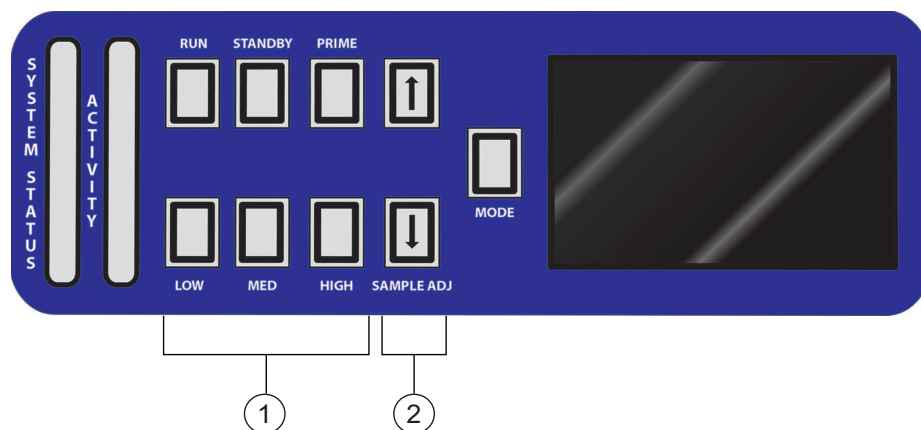

Number	Component
1	Sample flow rate buttons
2	Sample fine adjust buttons

When sample adjust is set to 250 (as shown on the status screen on the control panel) the sample flow rates at the Low, Med, and High settings are approximately 12, 35, and 60 $\mu\text{L}/\text{min}$ of sample, respectively. Each time you press one of the SAMPLE ADJ buttons, the fine adjust of the indicated sample increases or decreases by 10. The following table shows the approximate sample flow rate range for low, medium, and high.

Settings	Sample flow rate ($\mu\text{L}/\text{min}$)
Low	6–24
Med	17.5–70
High	30–120

Status screen

The status screen display is a touchscreen color LCD screen which displays operational data while the system is running and toggles between two different displays: Normal Mode and Setup Mode.

Normal Mode displays the current settings of the Fine Adjust Potentiometer, the three programmable potentiometer Set Points, Sheath Tank Pressure Status, Sheath Level, and Waste Level while the system is running.

The Normal Mode screen is shown in the following illustration.

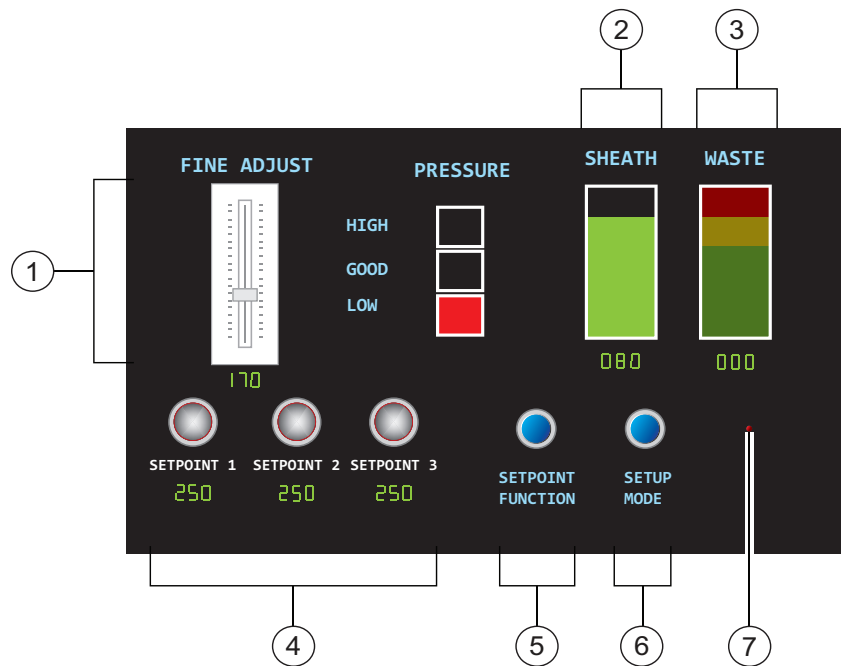

Number	Definition
1	Fine Adjust. Shows the current setting of fine adjust. The slider enables quick changes to the potentiometer setting by moving the slider up or down. Fine adjust can be set in increments of 10 from 0 to 500. The normal set point is 250. The last value persists, even after cytometer shutdown.
2	Sheath Level. Shows range from 0 to 100. The display line decreases from top to bottom in sequences of 20% from full level. System status turns yellow at 20%, and red at 0%.
3	Waste Level. Shows range from 0 (empty) to 100 (full). The display line increases from bottom to top in sequences of 20%. System status turns yellow at 80%, and red at 100% full.
4	Setpoint. Stores up to three potentiometer setpoints. A setpoint is set by tapping the Setpoint Function button, moving the Fine Adjust slider up or down to the desired point, and tapping one of the setpoint buttons. The Setpoint enables you to store three different settings and quickly change between them.
5	Setpoint Function. Button enables the setting of a Setpoint.
6	Setup Mode. Button to enter Setup Mode (Setup Mode can also be entered by pushing the Mode button on the control panel).
7	Alarm Silenced Indicator. When the alarm sounds are silenced, the indicator will turn on.

Setup Mode displays the current settings of Sound, FFSS Mode, and Altitude while the system is running. The Setup Mode screen is shown in the following illustration.

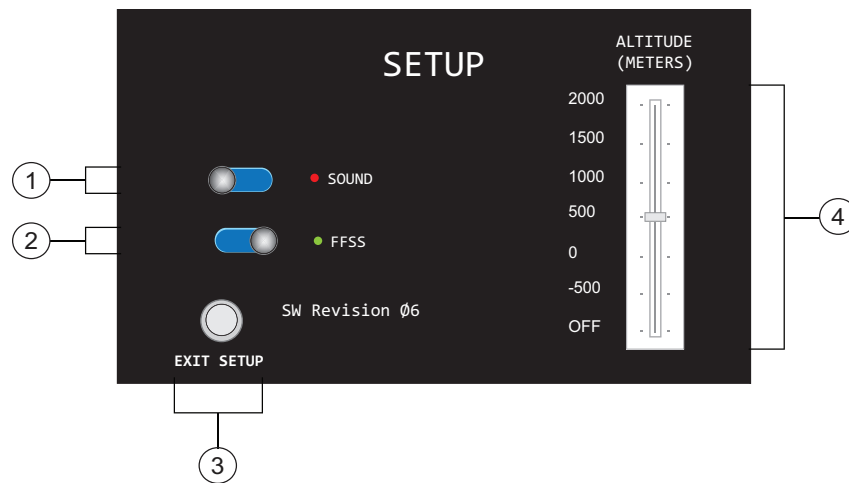

Number	Definition
1	Sound. Turns the warning alarm sounds on or off. To turn off the alarm, slide the slider to the left position. To turn on the alarm, slide the slider to the right position. A green light indicates the alarm is active. A red light indicates the alarm is inactive.
2	FFSS Mode. Turns FFSS Mode on or off. To turn off FFSS Mode, slide the slider to the left position. To turn on FFSS Mode, slide the slider to the right position. A green light indicates FFSS Mode is active. A red light indicates FFSS Mode is inactive.
3	Exit Setup. Button to exit Setup Mode.
4	Altitude. Shows the current setting of Altitude. The slider enables quick changes to the Altitude setting by moving the slider up or down. Altitude can be set from -500 to 2000 meters. Sliding the slider down to the Off position turns the air pressure warning off.

Fluidic alarms and the Mode button

The fluidic alarms are triggered by the waste and sheath fluid levels in the tanks and by low or high sheath tank air pressure levels. The alarms sound when the waste tank is nearly 100% full and the sheath tank is empty. The fluidic alarms and system status will also show warnings when you start up the cytometer until the tank pressure reaches the correct level.

To silence the alarm sounds, press the **Setup Mode** in the touchscreen. Slide the **Sound** slider to the left. To turn the alarm sounds back on, slide the **Sound** slider to the right. If the alarm sounds are turned off, the **Normal Mode** screen will also indicate the sounds are off.

Note: The system status indicators are not affected by the alarm sounds on/off state.



Turning off the sound may result in overflow of waste and may result in running out of sheath fluid.

Note: When the cytometer is in FFSS mode, both visual and audible alarms are deactivated.

Note: The function of the system is sensitive to air pressure for flow rates. The system needs to know the altitude, in meters, of the location of the system in order to accurately report the air pressure.

Sample injection port (SIP)

The SIP is where the sample tube is installed. The SIP includes the sample injection tube (SIT) and the tube support arm. Samples are introduced through a stainless steel injection tube equipped with an outer droplet containment sleeve. The sleeve works in conjunction with a vacuum pump to eliminate droplet formation of sheath fluid as it backflushes from the sample injection tube.

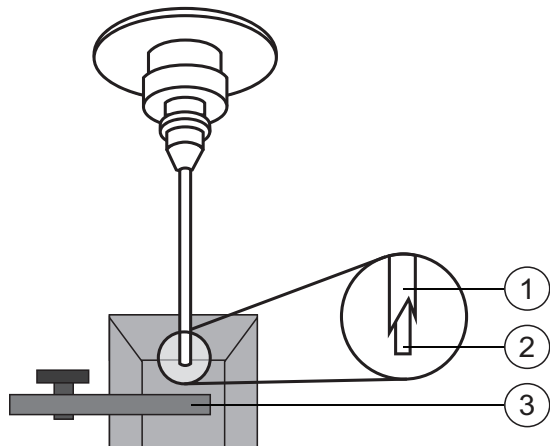

Number	Component
1	Outer sleeve
2	Sample injection tube (SIT)
3	Tube support arm

Sample injection tube (SIT). Stainless steel tube that carries sample from the sample tube to the flow cell. This tube is covered with an outer sleeve that serves as part of the droplet containment system.

Tube support arm. Arm that supports the sample tube and activates the droplet containment system vacuum. The vacuum is on when the arm is positioned to the side and off when the arm is centered.

Note: If a sample tube is left on the SIP with the tube support arm to the side (vacuum on), the sample will be aspirated into the waste container.

Precautions when using the HTS option



When using the BD FACSymphony™ A1 flow cytometer with the HTS, ensure that the HTS is completely pushed into the operating position before removing the droplet containment module (DCM) sleeve or disconnecting the sample coupler from the SIP. This is to avoid accidental leakage of potentially biohazardous liquids directly onto the instrument. With the HTS in the proper location, the containment dish with padding is directly below the SIP.



If you are using the HTS option, always slide the HTS mount slowly to prevent sample cross-contamination when the wells are full. Never move the HTS when it is in operation.



Do not lean on or put any weight on the HTS as it could damage the instrument.

Droplet containment module

The DCM prevents sheath fluid from dripping from the SIP and provides biohazard protection.

The DCM vacuum is activated when the tube support arm is moved to the side. Sheath fluid is aspirated as it backflushes the sample injection tube. This backflush helps prevent carryover of cells between samples.

Sheath and waste tanks

Introduction

This topic describes the sheath and waste tanks. The sheath and waste tanks are outside the cytometer and can be positioned on the floor.

Note: Only BD service engineers should change the location of the sheath and waste tanks.

If you are using the BD FACSTFlow™ supply system (FFSS), see the BD FACSTFlow™ Supply System User's Guide for more information.

Sheath tank

The sheath tank has a capacity of 10 L. Sheath fluid is filtered through an in-line, interchangeable filter that prevents small particles from entering the sheath fluid lines. An alarm sounds when the tank is empty.



Do not fill the sheath tank to its maximum capacity. When an overfull tank is pressurized, erratic cytometer performance can result.

Waste tank

The waste tank has a capacity of 10 L. An alarm sounds when the tank is full.

Cable management

Arrange the cables, air lines, and fluidics lines from the instrument to the sheath and waste tanks away from high traffic area. Also ensure that the cables and lines are placed so they do not interfere with normal instrument operation.

Routing the cables and lines from the back of the instrument to the underside of the table and then to the tanks is preferable. Any excess lines or tubing should be loosely coiled but out of the way of the tanks.

More information

- [Preparing the sheath tank \(page 27\)](#)
- [Preparing the waste tank \(page 30\)](#)
- [Status screen \(page 18\)](#)
- [Fluidic alarms and the Mode button \(page 19\)](#)

Optics

Introduction

This topic describes the optical components for the BD FACSymphony™ A1 flow cytometer including:

- Detector arrays
- Lasers
- Optical filters
- Signal detectors

Detector arrays

The BD FACSymphony™ A1 detector arrays consist of polygons. Each polygon can be configured with one to six fluorescent detectors. The configuration of detectors may limit the actual number of detectors on each polygon. To access the red laser detector array, see [Accessing the red laser detector array \(page 49\)](#).

Lasers

The BD FACSymphony™ A1 flow cytometer is configured with four lasers as listed in the following table.

Laser	Wavelength (nm)	Power (mW)
Blue	488	100
Red	637	100
Violet	405	100
Yellow Green	561	100

Optical filters

Optical filters attenuate light or help direct it to the appropriate detectors. The name and spectral characteristics of each filter appear on its holder.

There are two types of optical filters in the BD FACSymphony™ A1:

- **Longpass dichroic filters (LPs)** Transmit wavelengths at or longer than the specified value and reflect all light below the specified wavelength.
- **Bandpass filters (BPs)** Pass a narrow spectral band of light.

When dichroic filters are used as steering optics to direct different color light signals to different detectors, they are called dichroic mirrors. Longpass dichroic mirrors transmit longer wavelengths to one detector while reflecting shorter wavelengths to a different detector.

The BD FACSymphony™ A1 flow cytometer polygon detector arrays use dichroic longpass mirrors on the inside, and bandpass filters on the outside of the filter holders.

Signal detectors

Light signals are generated as particles pass through the laser beam in a fluid stream. When these optical signals reach a detector, electrical pulses are created that are then processed by the electronics system.

There are two types of signal detectors in the BD FACSymphony™ A1 flow cytometer:

- **Photomultiplier tubes (PMTs).** Used to detect the weaker signals generated by side scatter and all fluorescence channels. These signals are amplified by applying a voltage to the PMTs.
- **Photodiodes.** Less sensitive to light signals than the PMTs. A photodiode is used to detect the stronger forward scatter (FSC) signal.

More information

- [Optical filter theory \(page 80\)](#)
- [About configurations \(page 100\)](#)

Workstation

Introduction

This topic describes the components of the BD FACSymphony™ A1 workstation.

Workstation components

Acquisition, analysis, and most instrument functions are controlled by the BD FACSymphony™ A1 workstation. It includes a PC and one or two monitors.

Your workstation is equipped with the following:

- Microsoft Windows operating system
- BD FACSDiva™ software version 9.0.2 or later for data acquisition and analysis
- Software documentation including the help system

More information

- [About the BD FACSymphony™ A1 documentation \(page 8\)](#)

This page intentionally left blank

3

Cytometer setup

This chapter covers the following topics:

- [Starting the cytometer and computer \(page 26\)](#)
- [Preparing the sheath tank \(page 27\)](#)
- [Removing air bubbles \(page 29\)](#)
- [Preparing the waste tank \(page 30\)](#)
- [Preparing the fluidics \(page 32\)](#)
- [About the optical filters and mirrors \(page 34\)](#)
- [Custom configurations and baselines \(page 35\)](#)

Starting the cytometer and computer

Introduction

This topic describes how to start the cytometer and turn on the computer.

Note: If your system is using the BD FACSTFlow™ supply system, make sure that the BD FACSTFlow™ supply system is powered on before the cytometer.

Procedure

To start the cytometer:

1. Turn on the power to the flow cytometer.

Allow 30 minutes for the optical system temperature to stabilize.



Failure to warm up and stabilize the instrument could affect sample data.

2. Turn on the computer and log in to Windows.

Note: You can turn on the power to the flow cytometer and the workstation in any order.

3. Start BD FACSDiva™ software by double-clicking the shortcut on the desktop, and log in to the software.
4. Check the **Cytometer** window in BD FACSDiva™ software to ensure that the cytometer is connected to the workstation.

The cytometer connects automatically. While connecting, the message *Cytometer Connecting* is displayed in the status area of the Cytometer window. When connection completes, the message changes to *Cytometer Connected*.

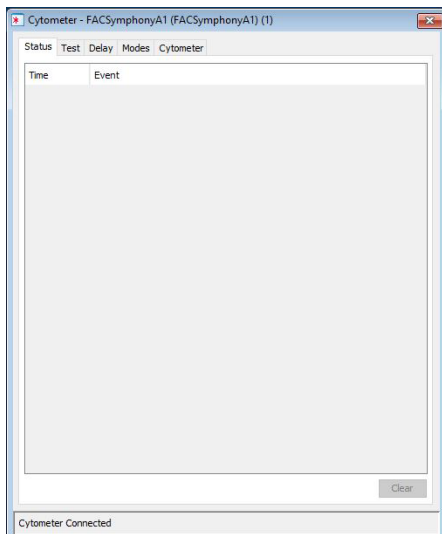

If the message *Cytometer Disconnected* appears, see [Electronics troubleshooting \(page 95\)](#).

Preparing the sheath tank

Introduction

This topic describes how to prepare the sheath tank.

Note: If your system is using the BD FACSTFlow™ supply system, see the BD FACSTFlow™ Supply System User's Guide for more information.

When to check the sheath tank

Check the fluid levels in the sheath tank every time you use the cytometer. This ensures that you do not run out of sheath fluid during an experiment.

Sheath tank components

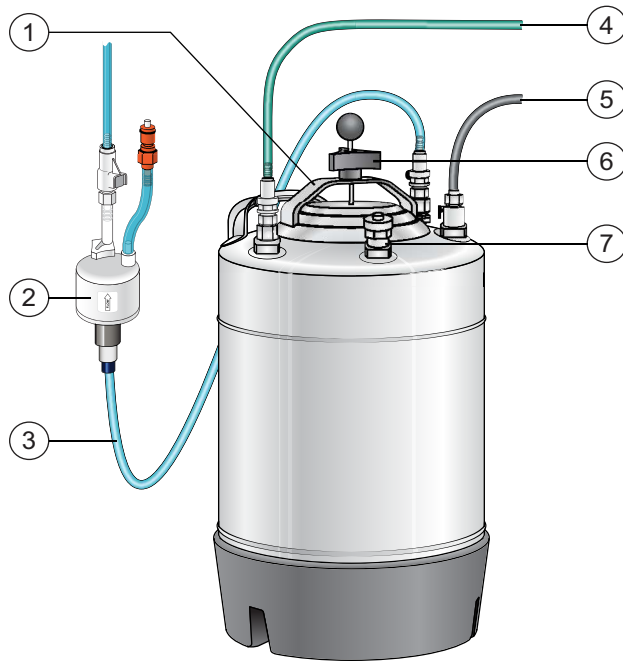

Number	Component
1	Cap handle
2	Filter assembly
3	Sheath fluid line (blue) to sheath tank
4	Air line (green)
5	Alarm sensor
6	Clamp knob

Number	Component
7	Vent valve

Procedure

Note: Be careful to avoid damaging the alarm sensor line or any of the tubing when disconnecting and filling the sheath tank.

To prepare the sheath tank:

1. Verify that the flow cytometer is in standby mode.
Press the STANDBY button on the control panel if necessary.
2. Disconnect the green air line and blue sheath fluid line from the sheath tank.
3. Disconnect the alarm line from the alarm sensor socket by pulling lightly on both ends of the plug. See the following illustration.

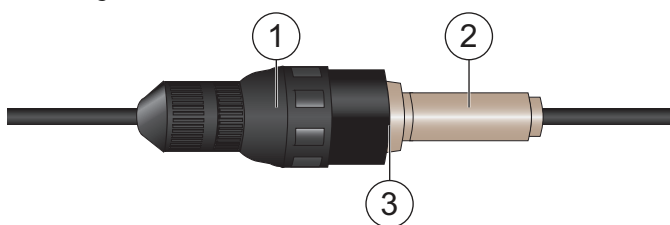

Number	Component
1	Alarm sensor socket
2	Alarm sensor line
3	Disconnect at this point

4. Depressurize the sheath tank by pulling up on the vent valve.
5. Remove the sheath tank lid.
Unscrew the clamp knob and push down to loosen, if necessary. Tilt the cap to the side to remove it from the tank.
6. Add up to 10 L of sheath fluid, such as BD FACSFlow™ solution, to the sheath tank.
Note: 10 L will reach the interior line on the sheath tank. Do not fill the sheath tank further.
7. Replace the sheath tank lid.
8. Make sure the gasket on the inside lip of the sheath lid is seated correctly and has not slipped out of position.
Note: If the gasket is not seated correctly, the tank will not pressurize properly.
9. Close the sheath lid and tighten the clamp knob to finger-tight.
10. Reconnect the green air line, alarm line and the blue sheath line.
Ensure that the blue sheath fluid line is not kinked.
Note: Make sure the alarm sensor socket is off the ground by looping the line through the handle of the sheath tank.

More information

- [Removing air bubbles \(page 29\)](#)
- [Changing the sheath filter \(page 43\)](#)
- [Cleaning or replacing the sheath gasket \(page 49\)](#)

Removing air bubbles

Introduction

This topic describes how to remove trapped air bubbles in the sheath filter and the sheath line. Air bubbles can occasionally dislodge and pass through the flow cell, resulting in inaccurate data.

Note: Perform this activity every time the sheath tank is refilled.

Procedure

To remove air bubbles:

1. Check the sheath filter for trapped air bubbles.

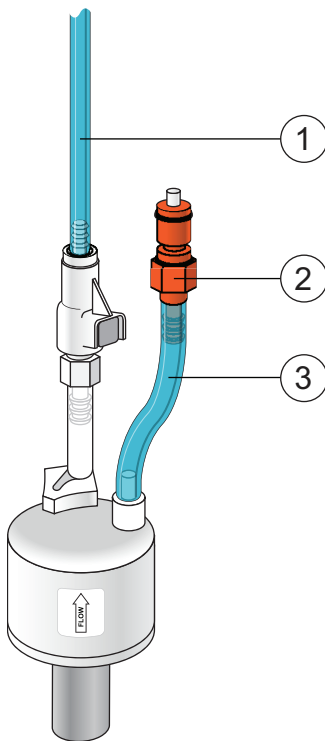

Number	Components
1	Cytometer fluid line (roller clamp not visible)
2	Vent fitting
3	Vent line

- If bubbles are visible, gently tap the filter body with your fingers to dislodge the bubbles and force them to the top.



When removing air bubbles, do not vigorously shake, bend, or rattle the sheath filter or you might damage it.

- Direct the vent line into a beaker and press the small button at the end of the vent fitting against the side of the beaker until a steady stream of fluid empties from the filter.

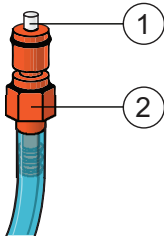

Number	Components
1	Button
2	Vent fitting

- Tilt the filter and verify that no trapped air remains in the filter.
- Repeat steps 3 and 4 until no air is observed in the filter.
- Check the sheath line for air bubbles.
- Open the roller clamp at the fluidics interconnect (if necessary) to bleed off any air in the line. Collect any excess fluid in a waste container.

Note: The roller clamp can be found close to the fluidics ports of the cytometer.

- Close the roller clamp.

Preparing the waste tank

Introduction

This topic describes how to prepare the waste tank. Prevent waste overflow by emptying the waste tank daily or whenever the system status indicator turns yellow.

Note: If your system is connected to the FFSS, see the BD FACFlow™ Supply System User's Guide for more information.



All biological specimens and materials coming into contact with them are considered biohazardous. Handle as if capable of transmitting disease. Dispose of waste using proper precautions and in accordance with local regulations. Never pipette by mouth. Wear suitable protective clothing, eyewear, and gloves.

Waste tank components

The following figure shows the main components of the waste tank.



Number	Component
1	Moisture trap
2	User replaceable cap
3	Air line
4	Alarm sensor
5	Waste fluid line

Biological precautions



Contact with biological specimens and materials can transmit potentially fatal disease.

To prevent exposure to biohazardous agents:

- Put the cytometer in standby mode before disconnecting the waste tank to avoid leakage of biohazardous waste.
- Always disconnect the waste tank from the cytometer before you empty it. Wait at least 30 seconds for pressure to dissipate before you remove the waste cap or sensor.
- Expose waste tank contents to bleach (10% of total volume) for 30 minutes before disposal.
- Do not wet the waste tank cap. If wet, the filter in the cap will cause the tank to malfunction. To keep the cap dry, place it on the bench label side up when it is not on the tank.

Procedure

To prepare the waste tank:

1. Verify that the flow cytometer is in standby mode.
Press the STANDBY button on the control panel if necessary.
2. Disconnect the orange waste tubing from the waste tank.
3. Disconnect the alarm line from the alarm sensor socket by pulling lightly on both ends of the plug. See the following illustration.

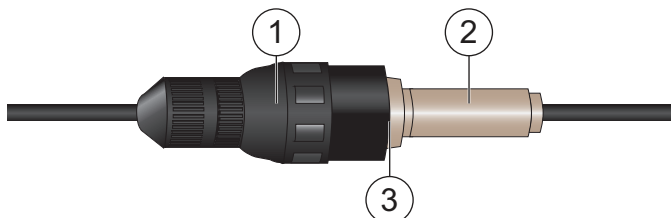

Number	Component
1	Alarm sensor socket
2	Alarm sensor line
3	Disconnect at this point

Keep the lid and moisture trap on the waste tank until you are ready to empty it.

4. Remove the lid and moisture trap before emptying the waste tank. Keep the cap label side up at all times. Empty the waste tank.



The waste tank is heavy when full. When emptying it, use good body mechanics to prevent injury.

5. Add approximately 1 L of bleach to the waste tank and close it. Reattach the moisture trap and lid.
6. Reconnect the orange waste tubing and make sure it is not kinked.
7. Reconnect the black alarm sensor line.

Note: Make sure the alarm sensor socket is off the ground by looping the line through the handle of the waste tank.

Preparing the fluidics

Introduction

This topic describes how to prepare the fluidics system.

When to prime the fluidics

Sometimes, air bubbles and debris may become lodged in the flow cell. This is indicated by excessive noise in the forward and side scatter parameters (FSC and SSC, respectively). In these cases, it is necessary to prime the fluidics system. Priming introduces air to the flow cell. Performing the following procedures should minimize the need for priming and make priming more effective when needed.

Procedure

Start up the fluidics:

1. Turn on the computer and instrument as described in [Starting the cytometer and computer \(page 26\)](#).
2. Install a tube with 3 mL of 1.5% dilution of BD[®] Detergent Solution Concentrate on the SIP and put the tube support arm underneath the tube.

Note: The BD[®] Detergent Solution Concentrate must be diluted before use. Mix one full 15 mL bottle of BD[®] Detergent Solution Concentrate into 985 mL of DI water to make 1 L total.

3. Press **RUN** and **HIGH** on the cytometer fluid control panel. Run for 10 minutes.
4. Remove the tube of detergent from the SIP and replace with a tube containing 3 mL of DI water.
5. Press **RUN** and **HIGH** on the cytometer fluid control panel. Run for 10 minutes.

Determine whether or not the fluidics need to be debubbled by priming:

1. Open or create an experiment to view BD[®] CS&T Beads. For details on using the beads, see [Running a performance check \(page 55\)](#).
2. Create a new tube in the experiment.
3. Load a tube of BD[®] CS&T Beads.
4. Press **RUN** and **LOW** on the cytometer fluid control panel.
5. Observe the plots for the scatter channel and fluorescent channels. There should be two distinct peaks for each scatter channel and three distinct peaks for each fluorescent channel. The coefficient of variation (CV) for bright peaks should be narrow. If either the CVs are very wide on a detector or no signal is observed, the fluidics need to be primed as described in the following procedure.

To prime the fluidics:

1. Move the tube support arm to the side
2. Remove tube from the SIP or leave the HTS connected to the SIT.
3. Press the **PRIME** fluid control button to force the fluid out of the flow cell and into the waste container. Once drained, the flow cell automatically fills with sheath fluid at a controlled rate to prevent bubble formation or entrapment. The **STANDBY** button turns amber after completion.
4. When Standby light is on, install a tube of DI water or leave the HTS hooked up to the SIT.
5. Press the **RUN** fluid control button and run for 10 seconds.
6. Press the **PRIME** button immediately followed by the **RUN** button.
7. Repeat step 6 ten times. If more than 2 seconds pass between Prime and Run in step 4, restart the procedure
8. Install a 12 × 75 mm tube with 1 mL of DI water on the SIP and place the support arm under the tube. Leave the cytometer in standby mode.

More information

- [Cytometer troubleshooting \(page 90\)](#)

About the optical filters and mirrors

Introduction

This topic provides a description of the optical filters and mirrors.

Filter and mirror configurations

Each detector has an optic holder in front of it. The optic holders are labeled with numbers indicating the wavelengths of the bandpass filter and longpass dichroic mirror they contain (for example, 780/60 and 750 LP, respectively). The optic holder in front of the last detector in the detector array contains only a bandpass filter and is marked accordingly.

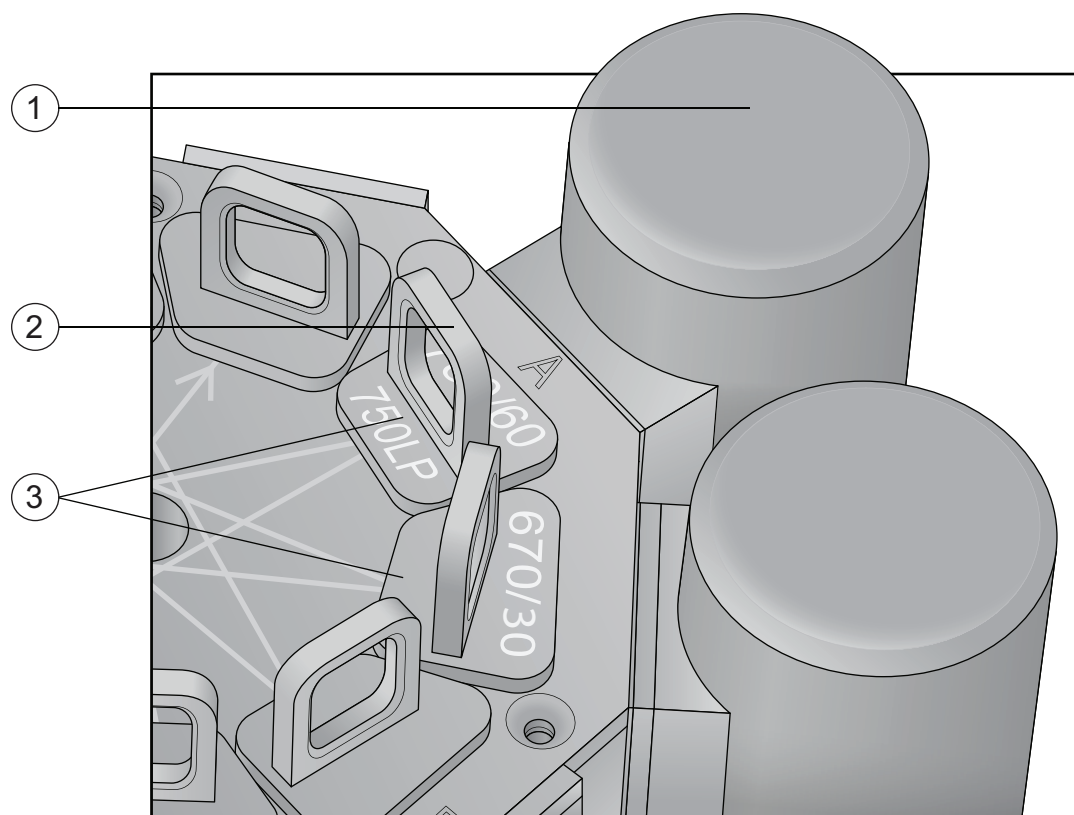

Number	Components
1	PMT A
2	Optic holder handle
3	Optic holders

The filters steer progressively shorter wavelengths of light to the next detector in the array as indicated by the lines and arrows on the top of the polygon.

Optic holders, filters, and mirrors

Optic holders house filters and mirrors. Your cytometer includes several blank (empty) optic holders.



To ensure data integrity, do not leave any slots empty in a detector array when you are using the associated laser. Always use a blank optic holder.

Base configurations

Each BD FACSymphony™ A1 flow cytometer has a base cytometer configuration that corresponds to the layout of the installed lasers and optics in your cytometer. This base configuration is set by your field service engineer.

BD FACSDiva™ cytometer configuration

Before you acquire data using BD FACSDiva™ software, you must specify a cytometer configuration. The cytometer configuration defines which filters and mirrors are installed at each detector.

BD FACSDiva™ software provides a BD base configuration for your BD FACSymphony™ A1 flow cytometer. Select **Cytometer > View Configuration** to create, modify, or delete custom cytometer configurations. (See the Cytometer and Acquisition Controls chapter of the *BD FACSDiva™ Software Reference Manual* for details.)

More information

- [About configurations \(page 100\)](#)

Custom configurations and baselines

Introduction

This topic describes where to find information on how to create a custom configuration and define a baseline for a performance check.

Overview

BD Cytometer Setup and Tracking (CS&T) software is used to define the baseline performance of your cytometer. A baseline provides a starting point for the tracking of cytometer performance. When running a performance check, you compare the results to the baseline.

See [Optimizing cytometer settings \(page 51\)](#). Also see the *BD Cytometer Setup and Tracking Application Guide* for information on creating custom configurations and defining a baseline.

More information

- [Running a performance check \(page 55\)](#)

This page intentionally left blank

4

Maintenance

This chapter covers the following topics:

- [Maintenance overview \(page 38\)](#)
- [Cleaning the fluidics \(page 39\)](#)
- [Shutting down the cytometer \(page 40\)](#)
- [Flushing the system \(page 40\)](#)
- [Replacing the waste tank cap \(page 42\)](#)
- [Changing the sheath filter \(page 43\)](#)
- [Changing the Bal seal \(page 46\)](#)
- [Changing the sample tube O-ring \(page 48\)](#)
- [Cleaning or replacing the sheath gasket \(page 49\)](#)
- [Accessing the red laser detector array \(page 49\)](#)

Maintenance overview

Introduction

This topic provides an overview of the BD FACSymphony™ A1 flow cytometer routine maintenance and cleaning procedures.

General use guidelines



Contact with biological specimens and materials can transmit potentially fatal disease.

Follow these guidelines whenever operating or maintaining the cytometer:

- Wear suitable protective clothing, eyewear, and gloves.
- Handle all biological specimens and materials in accordance with applicable regulations and manufacturer specifications.
- Dispose of waste using proper precautions and in accordance with local regulations.
- Never pipette by mouth.

For fluidics maintenance, we recommend the following cleaning solutions:

- BD FACSClean™ solution
- BD® Detergent Solution Concentrate
- 10% bleach solution

Use DI water to dilute bleach to appropriate concentrations.



Higher concentrations of bleach and use of other cleaning solutions might damage the cytometer.

When to perform maintenance procedures

Perform maintenance procedures in the following frequencies.

Frequency	Maintenance procedure
Daily	<ul style="list-style-type: none"> • Cleaning the fluidics (page 39) • Shutting down the cytometer (page 40)
Scheduled (every 2 weeks)	<ul style="list-style-type: none"> • Flushing the system (page 40)
Periodic (frequency depends on how often you run the cytometer)	<ul style="list-style-type: none"> • Changing the sheath filter (page 43) • Changing the Bal seal (page 46) • Changing the sample tube O-ring (page 48) • Cleaning or replacing the sheath gasket (page 49)

Cleaning the fluidics

Introduction

This topic describes how to perform the daily fluidics cleaning.

Overview

Cleaning the fluidics daily prevents the sample injection tube from becoming clogged and removes dyes that can remain in the tubing.

In addition to daily cleaning, follow this procedure immediately after running viscous samples or nucleic acid dyes such as Hoechst, DAPI, propidium iodide (PI), acridine orange (AO), or thiazole orange (TO).

Procedure

To clean the fluidics:

1. Press RUN and HIGH on the cytometer fluid control panel.
2. Install a tube containing 3 mL of a 10% bleach solution on the SIP with the support arm to the side (vacuum on) and let it run for 1 minute.
3. Move the tube support arm under the tube (vacuum off) and allow the cleaning solution to run for 5 minutes with the sample flow rate set to HIGH.
4. Repeat steps 2 and 3 with a 1.5% dilution of BD[®] Detergent Solution Concentrate.

Note: The BD[®] Detergent Solution Concentrate must be diluted before use. Mix one full 15 mL bottle of BD[®] Detergent Solution Concentrate into 985 mL of DI water to make 1 L total.



Never mix BD[®] Detergent Solution Concentrate and bleach because they create chlorine gas.

5. Repeat steps 2 and 3 with DI water.
6. Press the STANDBY button on the fluidics control panel.
7. Place a tube containing less than 1 mL of DI water on the SIP.

A tube with less than 1 mL of DI water should remain on the SIP to prevent salt deposits from forming in the injection tube. This tube also catches back drips from the flow cell.



Do not leave more than 1 mL of water on the SIP. When the instrument is turned off or left in standby mode, a small amount of fluid will drip back into the sample tube. If there is too much fluid in the tube, it could overflow and affect the cytometer performance.

Shutting down the cytometer

Before you begin

Each time you shut down the cytometer, perform the daily cleaning as described in [Cleaning the fluidics \(page 39\)](#).

Procedure

To shut down the cytometer:

1. Place a tube of DI water on the SIP.
2. Turn off the flow cytometer.
3. Close BD FACSDiva™ software.
4. Select **Start > Shutdown** to turn off the computer (if needed).
5. If your system is connected to the FFSS, shut off the FFSS.

If the cytometer will not be used for a week or longer, perform a system flush and leave the fluidics system filled with DI water to prevent saline crystals from clogging the fluidics.

More information

- [Cleaning the fluidics \(page 39\)](#)
- [Flushing the system \(page 40\)](#)

Flushing the system

Introduction

This topic describes how to perform an overall fluidics cleaning to remove debris and contaminants from the sheath tubing, waste tubing, and flow cell. Perform the system flush at least every 2 weeks. The flush should be performed more often when the system is first installed or after a major fluidics repair.

Note: If you are using the BD FACFlow™ supply system, see the *BD FACFlow™ Supply System User's Guide* for instructions on flushing the system.



The cytometer hardware might be contaminated with biohazardous material. Use 10% bleach to decontaminate the instrument.

Procedure

To perform a system flush:

1. Remove the sheath filter.
 - a. Press the quick-disconnects on both sides of the filter assembly.
 - b. Remove the filter assembly.
 - c. Connect the two fluid lines.



Do not run detergent, bleach, or ethanol through the sheath filter. They can break down the filter paper within the filter body, causing particles to escape into the sheath fluid, possibly clogging the flow cell.

2. Empty the sheath tank and rinse it with DI water.
3. Fill the sheath tank with at least 1 L of BD FACSClean™.
4. Empty the waste tank, if needed.
5. Open the roller clamp by the fluidics interconnect, and drain the fluid into a beaker for 5 seconds.
6. Remove the DI water tube from the SIP.
7. Prime the instrument twice:
 - a. Press the PRIME button on the fluidics control panel.
 - b. When the STANDBY button light is amber, press the PRIME button again.
8. Install a tube with 3 mL of BD FACSClean™ on the SIP and put the tube support arm underneath the tube. See [Maintenance overview \(page 38\)](#) for other recommended cleaning solutions.
9. Press RUN and HIGH on the cytometer fluid control panel. Ensure that the sample fine adjust is set to 250. Run for 30 minutes.
10. Press the STANDBY fluid control button and depressurize the sheath tank by lifting the vent valve.
11. Empty the waste tank to avoid the mixing of bleach and BD® Detergent Solution Concentrate.



Never mix BD® Detergent Solution Concentrate and bleach because they create chlorine gas.

12. Repeat steps 2 through 11 with 1.5% BD® Detergent Solution Concentrate.

Note: The BD® Detergent Solution Concentrate must be diluted before use. Mix one full 15 mL bottle of BD® Detergent Solution Concentrate into 985 mL of DI water to make 1 L total.

13. Leave the system filled with 1.5% dilution of BD® Detergent Solution Concentrate overnight to soak (if possible, up to 18 hours) to reduce air adhesion throughout the system. When soaking, the system power should be disconnected and secured. Upon completion of the soak period, restore power and continue to the next step in this procedure .
14. Repeat steps 2 through 11 with DI water.
15. Replace the sheath filter and refill the sheath tank with sheath fluid.
16. Install a tube with less than 1 mL of DI water onto the SIP.

Replacing the waste tank cap

Introduction

This topic describes how to replace the waste tank cap. Replace the cap once a month.

Biological precautions



Contact with biological specimens and materials can transmit potentially fatal disease.

To prevent exposure to biohazardous agents:

- Put the cytometer in standby mode before disconnecting the waste tank to avoid leakage of biohazardous waste.
- The waste tank can become pressurized when the cytometer is running. Always disconnect the waste tank from the cytometer before you empty it. Wait at least 30 seconds for pressure to dissipate before you remove the waste cap or sensor.
- Expose waste tank contents to bleach (10% of total volume) for 30 minutes before disposal.

Procedure

To replace the cap:

1. Put the cytometer in standby mode.
2. Disconnect the orange waste line from the waste tank.
3. Disconnect the alarm sensor line from the alarm sensor socket.

Note: Wait at least 30 seconds for pressure to dissipate.

4. Remove the waste cap and attached trap from the tank and place on the bench label-side up.
5. Detach the cap from the trap.
6. Place a new cap on the trap.
7. Write the date in the white space on the cap label.



8. Screw the cap assembly onto the waste tank and hand-tighten until it is fully closed.



To prevent waste tank overpressurization, do not overtighten the trap or attached filter cap. Tighten each component only until it is hand-tight. Do not use sealants such as Teflon® tape or other adhesives.

9. Re-attach the alarm sensor line and waste line to the waste tank.

Changing the sheath filter

Introduction

This topic describes how to change the sheath filter. The sheath filter is connected in-line with the sheath line. It filters the sheath fluid as it comes from the sheath tank.

When to change the sheath filter

We recommend changing the sheath filter assembly every six months. Increased debris appearing in an FSC vs SSC plot can indicate that the sheath filter needs to be replaced. See [Supplies and consumables \(page 117\)](#) for ordering information.

When working with the small particle detector, we recommend using a sheath filter with a pore size smaller than the particles of interest.

Confirm you have a new sheath filter and Teflon® tape before you start the procedure.

Sheath filter assembly

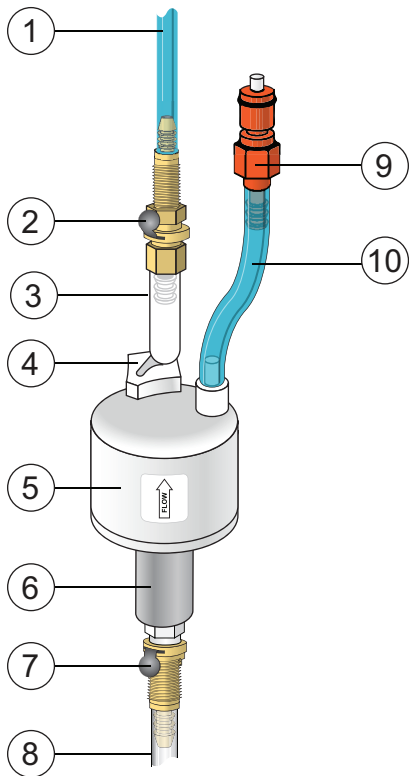

Number	Components	Number	Components
1	Sheath line to cytometer	6	Filter base
2	Quick-disconnect	7	Quick-disconnect
3	Post-filtered sheath line	8	Sheath fluid line from tank
4	Hose clamp	9	Vent fitting
5	Sheath filter	10	Vent line

Removing the old filter

To remove the old filter:

1. Place the cytometer in standby mode.
2. Remove the sheath filter assembly by pressing the quick-disconnect on both sides of the filter assembly.
3. To replace the standard sheath filter, continue the steps in this section, then move to [Attaching the new standard filter \(page 45\)](#).
4. Over a sink or beaker:
 - Remove the vent line from the filter and save it to use again.
 - Remove the filter base and save it to use again.
 - Remove the post-filtered sheath line by using a screwdriver to gently pop the hose clamp off the filter and save it to use again.
5. Discard the used filter in an appropriate receptacle.

Attaching the new standard filter

To attach the new standard filter:

1. Connect the vent line to the new sheath filter assembly. Twist to attach.
2. Wrap Teflon[®] tape around the filter threads, then connect the filter to the filter base.
3. Install the hose clamp onto the post-filtered sheath line then attach it to the filter.
4. Connect the sheath line (coming from the sheath tank) to the filter assembly via the quick-disconnect.
5. Connect sheath line (going into the cytometer) to the post-filtered sheath line via quick-disconnect
Note: Ensure that the new filter is installed with the directional flow arrow pointing toward the sheath line that goes to the cytometer.
6. Confirm that the cytometer is on.
7. Direct the vent line into a receptacle and press the small button at the end of the vent fitting against the side of the receptacle until a steady stream of fluid empties from the filter.
8. Tilt the filter and verify that no trapped air remains in the filter.
9. Repeat steps 7 and 8 as necessary to remove all trapped air.
10. If necessary, to remove trapped air in the filter and sheath line, dispense fluid from sheath line via the roller clamp that is connected to the sheath line past the sheath filter assembly. See [Removing air bubbles \(page 29\)](#).

Changing the Bal seal

Introduction

This topic describes how to replace the Bal seal.

The sample injection tube Bal seal is a ring that forms a seal with the sample tube and ensures proper tube pressurization.

When to change the Bal seal

Over time, the Bal seal becomes worn or cracked and requires replacement. Replacement is necessary if a proper seal is not formed when a sample tube is installed on the SIP. Indications that a proper seal has not formed include:

- The tube will not stay on the SIP without the tube support arm.
- When the tube is installed and RUN is pressed on the cytometer, the RUN button is orange (not green).



Cytometer hardware might be contaminated with biohazardous material. Wear suitable protective clothing, eyewear, and gloves whenever cleaning the cytometer or replacing parts.

Procedure

To replace the Bal seal:

1. Remove the outer sleeve from the sample injection tube by turning the retainer counter-clockwise. Slide the outer sleeve down and off of the sample injection tube.

Work carefully. The outer sleeve can fall off as you loosen the retainer. See the following illustration.

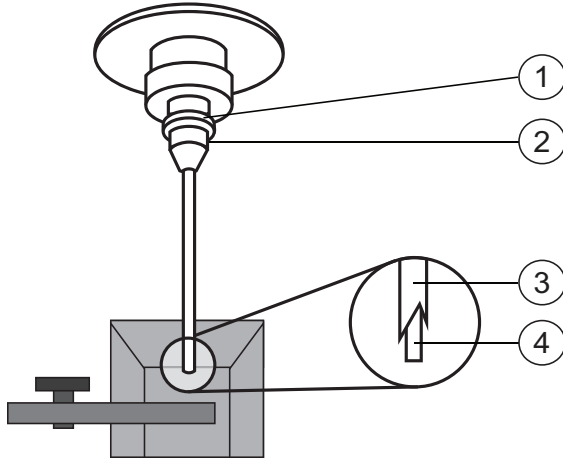

Number	Components
1	Bal seal
2	Retainer
3	Outer sleeve
4	Sample injection tube (SIT)

2. Remove the Bal seal by gripping it between your thumb and index finger and pulling down. See the following illustration.

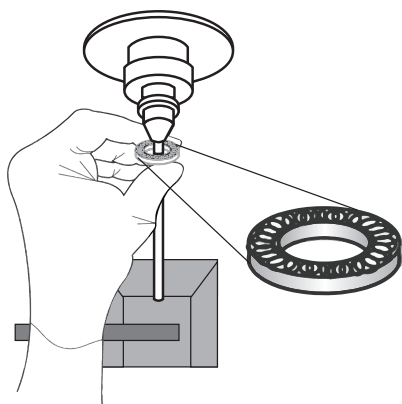

3. Install the new Bal seal spring-side up.
Ensure that the sample tube O-ring is still in place inside the retainer.
4. Re-install the retainer and outer sleeve over the sample injection tube. Push the outer sleeve all the way up into the sample injection port and then screw the retainer into place and tighten to finger tight. This will seat the Bal seal.

- Install a sample tube on the SIP to ensure that the outer sleeve has been properly installed.
If the sleeve hits the bottom of the tube, loosen the retainer slightly and push the sleeve up as far as it will go. Tighten the retainer.

Changing the sample tube O-ring

Introduction

This topic describes how to replace the sample tube O-ring.

The sample tube O-ring, located within the retainer, forms a seal that allows the droplet containment vacuum to function properly.

When to replace the O-ring

Replace the O-ring when droplets form at the end of the sample injection tube while the vacuum is operating.



Cytometer hardware might be contaminated with biohazardous material. Wear suitable protective clothing, eyewear, and gloves whenever cleaning the cytometer or replacing parts.

Procedure

To change the O-ring:

- Remove the outer sleeve from the sample injection tube by turning the retainer counter-clockwise.
- Slide the outer sleeve from the retainer. See the following illustration.

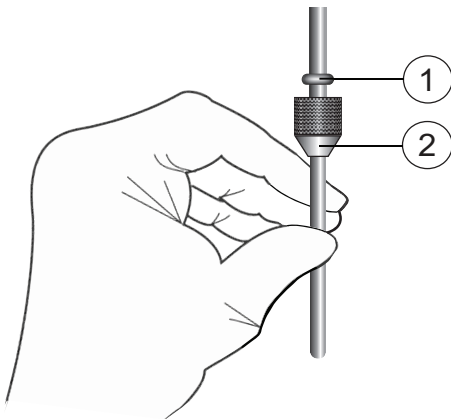

Number	Components
1	O-ring
2	Retainer

- Invert the outer droplet sleeve and allow the O-ring to fall onto the benchtop.
If the O-ring does not fall out initially, hold the O-ring with your free hand and slide the outer sleeve to remove the O-ring.
- Place the new O-ring into the retainer. Make sure the O-ring is seated properly in the bottom of the retainer.
- Replace the outer sleeve in the retainer.

6. Re-install the retainer and the outer sleeve.
7. Install a sample tube on the SIP to ensure that the outer sleeve has been properly installed.
If the sleeve hits the bottom of the tube, loosen the retainer slightly and push the sleeve up as far as it will go. Tighten the retainer.

Cleaning or replacing the sheath gasket

Introduction

This topic describes how to clean or replace the gasket of the sheath tank lid.

When to change the sheath gasket

We recommend cleaning the sheath gasket when needed.

Procedure

To clean or replace the gasket:

1. Put the cytometer in standby mode.
2. Depressurize the sheath container by pulling up on the vent valve.
3. Remove the lid from the sheath tank.
4. Remove the black gasket from the lid.
5. Rinse it with water to clean the gasket.
6. Place the clean gasket or the new gasket on the lid and make sure the gasket is seated properly on the lid.

Accessing the red laser detector array

This topic describes how to access the red laser detector array for the purpose of checking or changing the optical filters. The access panel is located on the right-hand side of the cytometer.

To remove the access panel:

1. Locate the red laser detector array access panel on the side of the cytometer, see [Cytometer overview \(page 13\)](#).
2. Remove the thumb screws and set them aside.
3. Place a small stiff object such as a thin screwdriver in one of the thumbscrew holes.
4. Tilt the screwdriver handle close to the cytometer and pull outwards to pop the panel off the cytometer.

To replace the access panel:

1. Position the panel over the the red laser detector array.
2. Push evenly on both sides to pop the panel back onto the cytometer.
3. Screw in the thumbscrews.

This page intentionally left blank

5

Optimizing cytometer settings

This chapter covers the following topics:

- [Cytometer settings workflow \(page 52\)](#)
- [Verifying the configuration and user preferences \(page 53\)](#)
- [Running a performance check \(page 55\)](#)
- [Setting up an experiment \(page 58\)](#)
- [Creating application settings \(page 62\)](#)
- [Recording compensation controls \(page 64\)](#)
- [Calculating compensation \(page 66\)](#)

Cytometer settings workflow

Introduction

This topic describes how to optimize cytometer settings. The optimization is performed using the Cytometer Setup and Tracking, Application Settings, and Compensation Setup features of BD FACSDiva™ software.

When to optimize settings

Before you record data for a sample, optimize the cytometer settings for the sample type and fluorochromes used.

Manual compensation

Compensation setup automatically calculates compensation settings. If you choose to perform compensation manually, not all of the following instructions apply. For detailed instructions, see the *BD FACSDiva™ Software Reference Manual*.

First-time users

If you are performing the procedures in this workflow for the first time, you should be familiar with BD FACSDiva™ software concepts: workspace components, cytometer and acquisition controls, and tools for data analysis.

For additional details, see the *BD FACSDiva Software Reference Manual*.

Before you begin

Start the BD FACSymphony™ A1 flow cytometer and perform the setup and QC procedures. See [Cytometer setup \(page 25\)](#).

Workflow for optimizing settings

Cytometer optimization consists of the following steps.

Step	Description
1	Verifying the configuration and user preferences (page 53)
2	Running a performance check (page 55)
3	Setting up an experiment (page 58)
4	Creating application settings (page 62)
5	Recording compensation controls (page 64)
6	Calculating compensation (page 66)

Note: Application settings are optional and do not have to be saved for the experiments. However, they are useful for optimizing cytometer settings.

About the examples

The examples in this chapter use a 4-color bead sample with the following fluorochromes:

- FITC
- PE
- PerCP-Cy5.5
- APC

If you follow this workflow with a different bead sample (or another sample type), your software views, data plots, and statistics might differ from the example. Additionally, you might need to modify some of the instructions in the procedure.

The information shown in italics is for example only. You can substitute your own names for folders and experiments.

Verifying the configuration and user preferences

Introduction

This topic describes how to verify the cytometer configuration and user preferences before you create an experiment.



To obtain accurate data results, the current cytometer configuration must reflect your BD FACSymphony™ A1 flow cytometer optics.

Procedure

To verify the configuration and preferences before you create an experiment:

1. Select **Cytometer > View Configurations** and verify the current configuration.

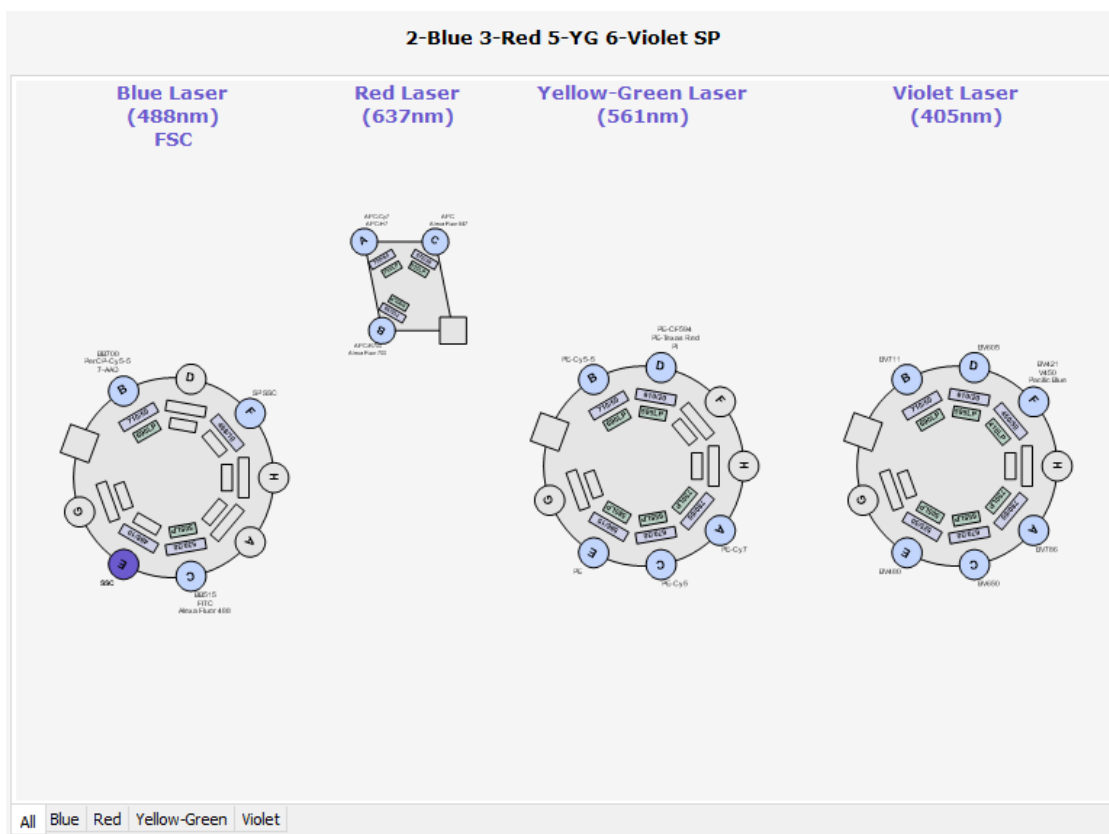

Your cytometer might include only the base configuration when your cytometer is installed. You can create additional configurations later as needed.

In this example, the cytometer configuration must include the following parameters: FITC, PE, PerCP-Cy5.5, and APC.

2. If you need to select a configuration other than the current configuration:
 - a. In the **Configurations** tab, select a configuration.
 - b. Click **Set Configuration**.
 - c. Click **OK**.
 - d. Verify that the configuration you just set matches your BD FACSymphony™ A1 flow cytometer optics.
3. Click **OK** to close the **Cytometer Configuration** window.
4. Select **File > Exit** to close CS&T.
5. Select **Edit > User Preferences**.
6. Click the **General** tab and select the **Load data after recording** checkbox.

See the *BD FACSDiva™ Software Reference Manual* for more information about cytometer configurations and user preferences.

More information

- [Setting up an experiment \(page 58\)](#)

Running a performance check

Introduction

This topic describes how to run a performance check as part of quality control.

Overview

The CS&T application is designed to monitor performance on a daily basis and to optimize laser delay.

Running a performance check on a regular basis provides a standard for monitoring changes in performance due to degradation of laser power, aging of PMTs, and other potential cytometer service issues. Performance results are also affected by fluidics performance. We strongly recommend following the fluidics maintenance procedures as described in [Cleaning the fluidics \(page 39\)](#).

Considerations

Some BP filters might not be normalized to CS&T settings. In this case, CS&T will generate Qr and Br numbers that are not comparable from instrument to instrument. They are however, still trackable on one cytometer. Part of the process for optimizing cytometer settings includes verifying PMT voltages set by CS&T for all parameters. Carefully examine any channel with a non-CS&T normalized filter. If the baseline settings are not appropriate for your applications, adjust the PMT voltage as necessary and use the Application Settings to maintain Target Values.

Before you begin

Define the performance baseline for any configuration before running a performance check. See [Custom configurations and baselines \(page 35\)](#).

Procedure

To run a performance check:

1. Select **Cytometer > CST**.
2. Verify that the bead lot information under **Setup Beads** matches the Cytometer Setup and Tracking bead lot.

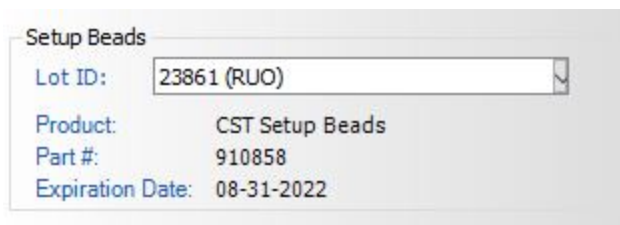

3. Verify that the cytometer configuration is correct for your experiment.

System Summary: OK	
Cytometer Configuration:	Copy of Copy (2) of 2-Blue 3-Red 5-YG 6-Violet SP (BD Default)
Lot ID:	23861

If the cytometer is not set to the correct configuration:

- a. Click **Select Configuration** in the **Setup Control** window.
 - b. Select the correct configuration from the list.
 - c. Click **Set Configuration** and then click **OK**.
4. Verify that the current configuration has a valid baseline defined.
If not, see the *BD Cytometer Setup and Tracking Application Guide* for more information on defining a baseline.
 5. Prepare the CS&T beads according to the technical data sheet provided with the beads or available on the BD Biosciences website (bdbiosciences.com).
 6. Install the bead tube onto the SIP.
 7. In the **Setup Control** window, select **Check Performance** from the **Characterize** menu.

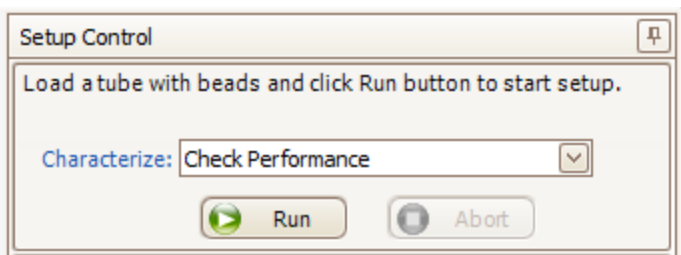

8. Click **Run**.
9. Ensure that Fine Adjust is set to 250, press RUN, and LOW.
Plots appear under the Setup tab and the performance check is run. The performance check takes approximately 5 minutes to complete.
10. Once the performance check is complete, click **View Report**.
11. Verify that the cytometer performance passed.
In the Setup tab, the cytometer performance results should have a green checkbox displayed and the word *Passed* next to it.



If any parameters did not pass, see the *BD Cytometer Setup and Tracking Application Guide* for troubleshooting information.

12. Select **File > Exit** to close the CS&T window and return to the BD FACSDiva™ interface.

The CST Mismatch dialog opens.

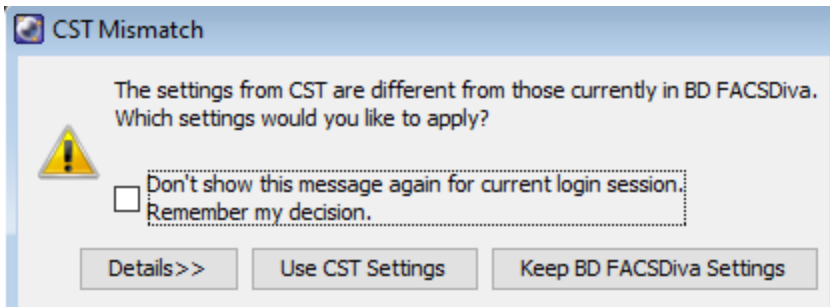

Click the **Details** button to verify which cytometer settings will be updated.

13. Click **Use CST Settings**.

By selecting Use CST Settings, the laser delay, area scaling, and other cytometer settings will be updated to the latest settings from the performance check.

Setting up an experiment

Introduction

This topic describes how to create an experiment in a new folder, specify the parameters of the experiment, and add compensation tubes.

Creating an experiment

To create an experiment:

1. Click the buttons on the **Workspace** toolbar to display the following windows as needed:

- Browser
- Cytometer
- Inspector
- Worksheet
- Acquisition Dashboard

When you add elements or make selections in the Browser, the Inspector displays details, properties, and options that correspond to your selection.

2. Click the **New Folder** button on the **Browser** toolbar to add a new folder.
3. Click the folder and rename it *MyFolder*.
4. Click *MyFolder*, then click the **New Experiment** button on the **Browser** toolbar.



- a. Click the new experiment in the **Browser** and rename it *MyExperiment*.
5. Select *MyExperiment* in the **Browser**.
The Inspector displays details for the experiment.

Specifying parameters

To specify the parameters for the new experiment:

1. Select **Cytometer Settings** for the experiment in the **Browser**.



Cytometer settings appear in the **Inspector**.

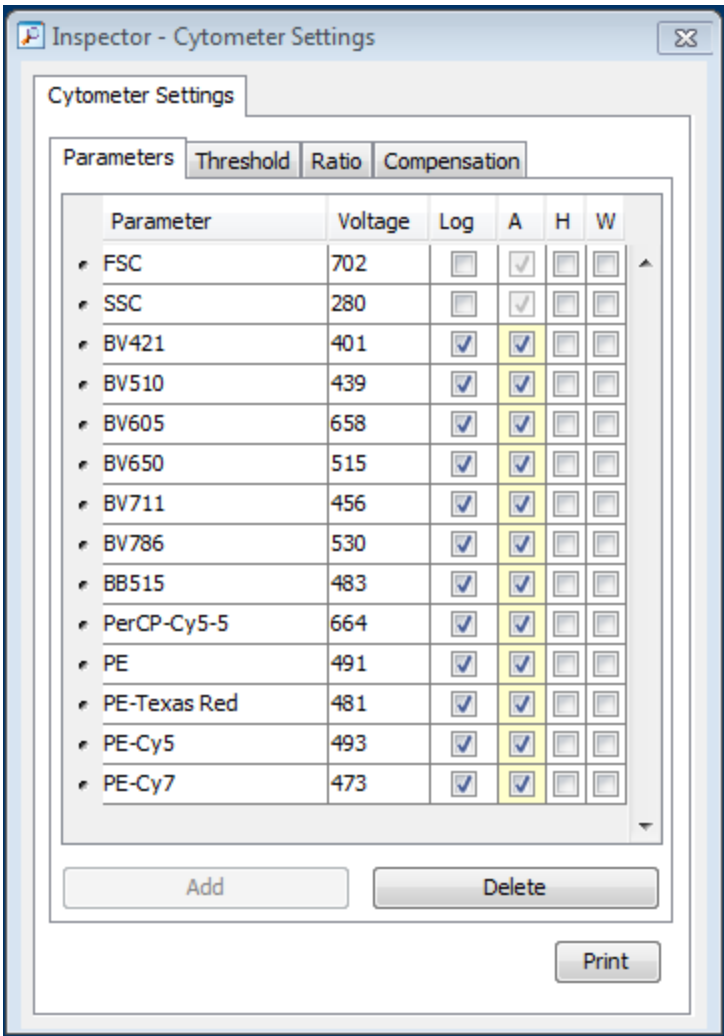

- 2. Make sure the parameters you need appear on the **Parameters** tab in the **Inspector**.
If more than one parameter is available for a particular detector, you might have to select the one you need from a menu. For example, you can set Detector D for the blue laser as FITC or BB515.

- a. Click the **Parameter** name to display the available fluorochromes in the **Parameters** list.

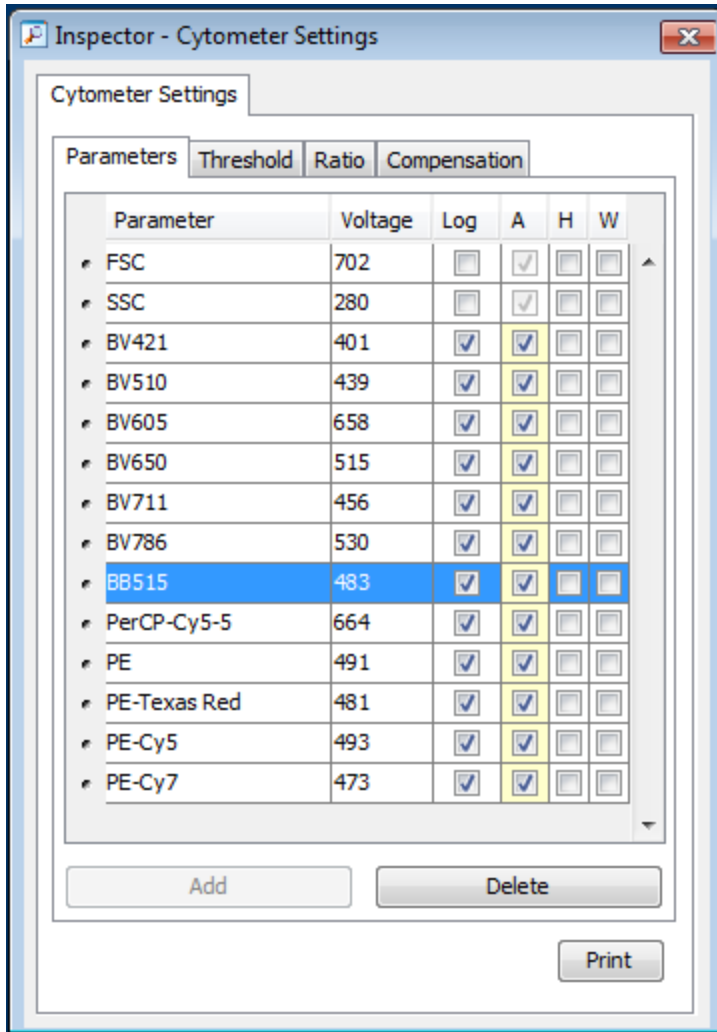

- b. Select the specific parameter from the menu. Your selection appears as the selected parameter.

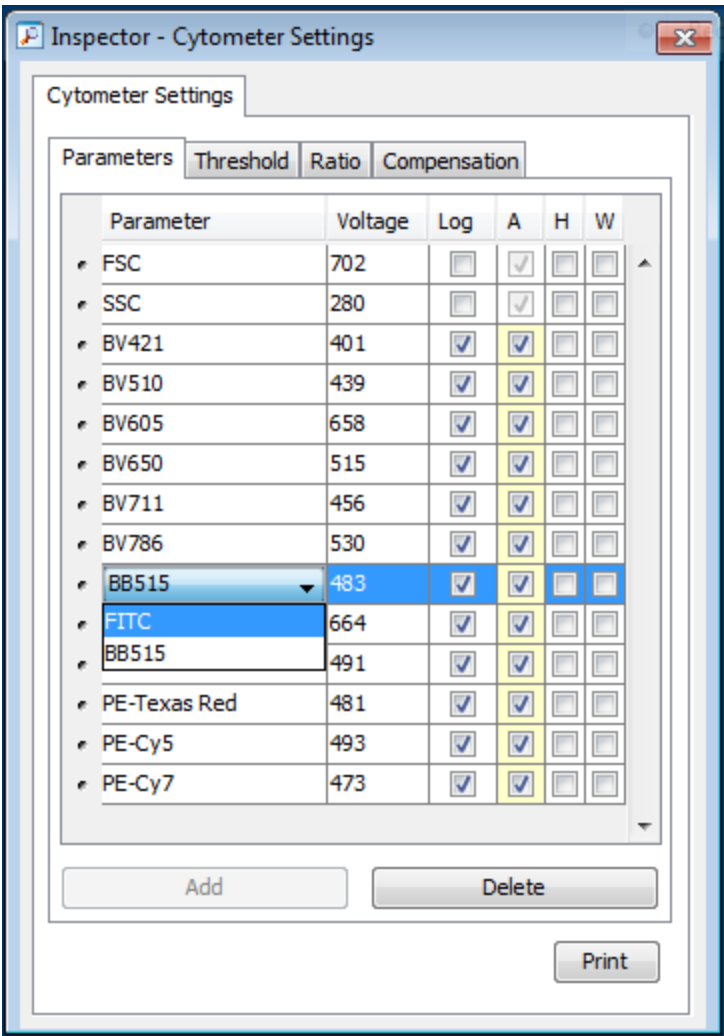

- c. For this example, select **FITC** from the menu.
- 3. Delete any unnecessary parameters.

- a. Click the selection button (to the left of the parameter name) to select the parameter.

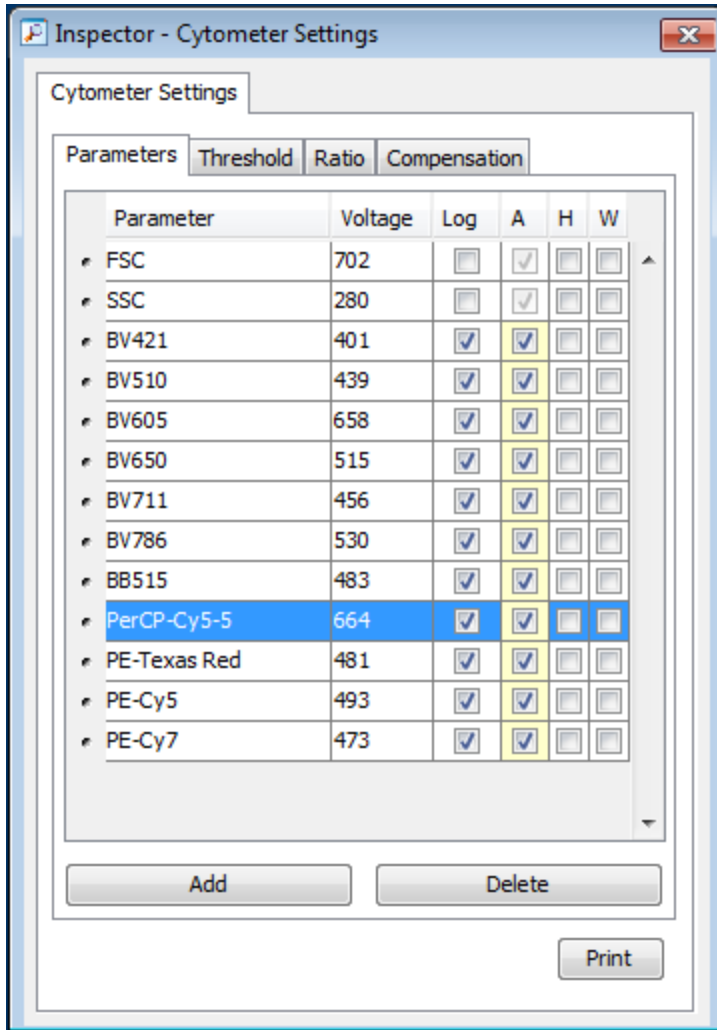

- b. Click **Delete**.
The parameter is deleted.

Creating application settings

Introduction

This topic describes how to create application settings.

About application settings

Application settings are associated with a cytometer configuration and include the parameters for the application, area scaling values, PMT voltages, and threshold values, but not compensation. Each time a performance check is run for a configuration, the application settings associated with that configuration are updated to the latest run.

Using application settings provides a consistent and reproducible way to reuse cytometer settings for commonly used applications.

Before you begin

Perform the cytometer setup procedure and run a performance check for the configuration that will be used for the application.

Procedure

To create application settings:

1. In the open experiment, right-click **Cytometer Settings** in the **Browser**, then select **Application Settings > Create Worksheet**.

A second global worksheet is added with the plots created according to the selections in the Parameters tab.

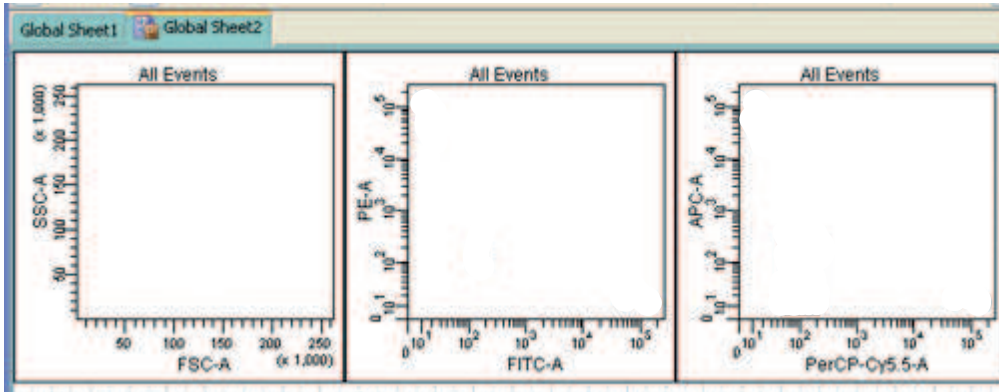

2. Load the unstained control tube onto the cytometer.
3. In the **Cytometer** window, optimize the PMT voltages for the application.
 - Optimize the FSC and SSC voltages to place the population of interest on scale.
 - Optimize the FSC threshold value to eliminate debris without interfering with the population of interest.
 - If needed, increase the fluorescence PMT voltages to place the negative population appropriately for your sample type.
4. Unload the unstained control tube from the cytometer.
5. Load the multicolor sample onto the cytometer or load single-color control tubes and verify each fluorochrome signal separately.
6. Verify that the positive populations are on scale.

If a positive population is off scale, lower the PMT voltage for that parameter until the positive population can be seen entirely on scale.
7. Unload the multicolor sample.
8. Place a tube containing less than 1 mL DI water on the SIP and put the cytometer on standby.
9. (Optional) Save the application settings by right-clicking **Cytometer settings** in the **Browser**, then selecting **Application Settings > Save**.
10. In the **Save Application Settings** dialog, enter a descriptive name for the application settings.

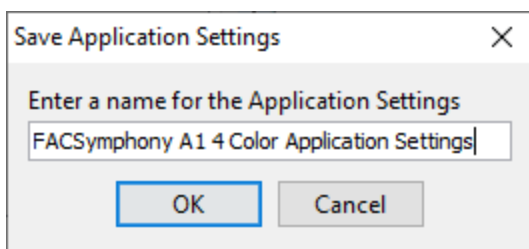

11. Click **OK**.

The application settings are saved to the catalog.

Recording compensation controls

Introduction

This topic describes how to create and record compensation controls using the Compensation Setup feature of BD FACSDiva™ software and an experiment with optimized settings.

Creating compensation tubes

To create compensation control tubes:

1. Select **Experiment > Compensation Setup > Create Compensation Controls**.

The Create Compensation Controls dialog opens.

For this bead example, you do not need to provide non-generic tube labels.

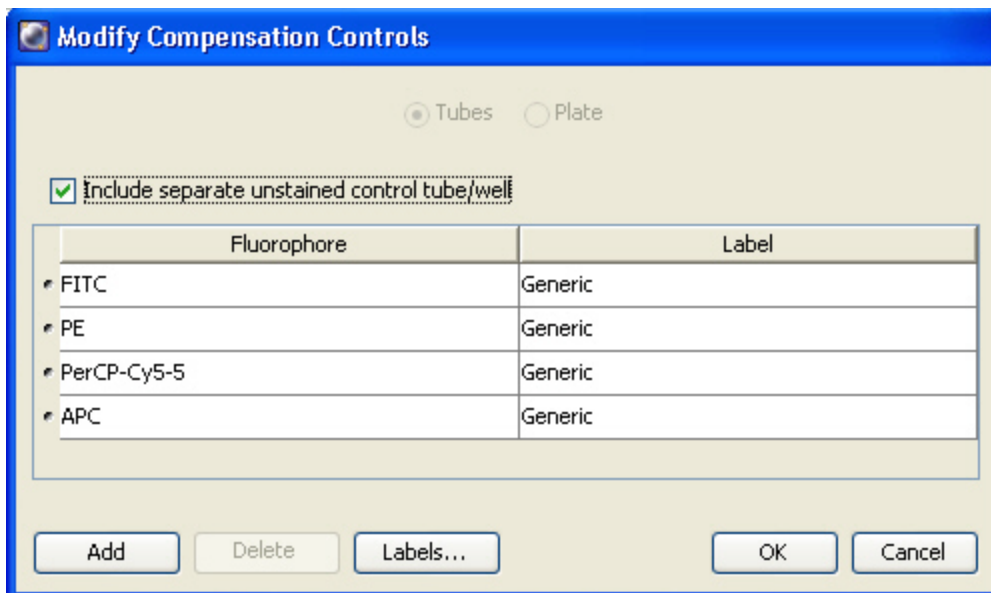

2. Click **OK**.

Compensation control tubes are added to the experiment. Worksheets containing appropriate plots and gates are added for each compensation tube.

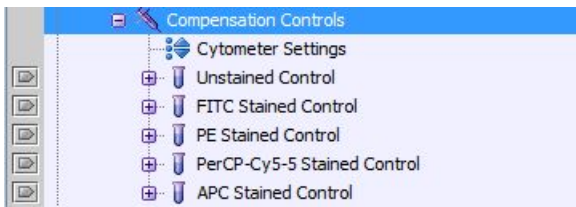

Recording compensation settings

To record compensation settings:

1. Press RUN and HIGH on the cytometer fluid control panel.
2. Install the unstained control tube onto the SIP.
3. Expand the **Compensation Controls** specimen in the **Browser**.
4. Set the current tube pointer to the unstained control tube (it becomes green), then click **Acquire Data** in the **Acquisition Dashboard**.
5. Verify that the population of interest is displayed appropriately on the FSC vs SSC plot and adjust voltages if necessary.

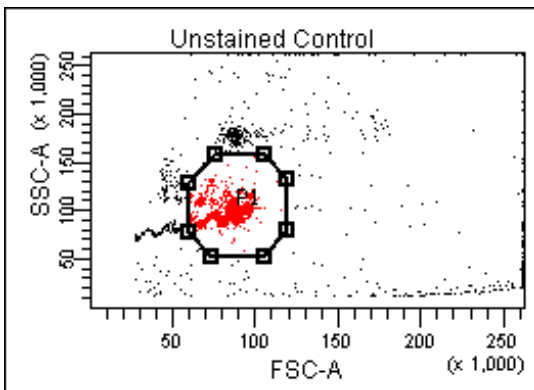

Since the application settings have been optimized for your sample, the cytometer settings should not require adjustment other than the changing of FSC and SSC voltages to place the beads on scale.

6. Adjust the P1 gate to surround only the singlets.
7. Right-click the P1 gate and select **Apply to All Compensation Controls**.
The P1 gate on each stained control worksheet is updated with your changes.
8. Click **Record Data**.
9. When recording is finished, remove the unstained control tube from the cytometer.
10. Click **Next Tube**.



Do not change the PMT voltages after the first compensation control has been recorded. In order to calculate compensation, all controls must be recorded with the same PMT voltage settings. If you need to adjust the PMT voltage for a subsequent compensation control, you must record all compensation controls again.

11. Install the next tube onto the cytometer and repeat steps 8 through 10 until data for all stained control tubes has been recorded.
12. Double-click the first stained control tube to display the corresponding worksheet.
13. Verify that the snap-to interval gate encompasses the positive population.

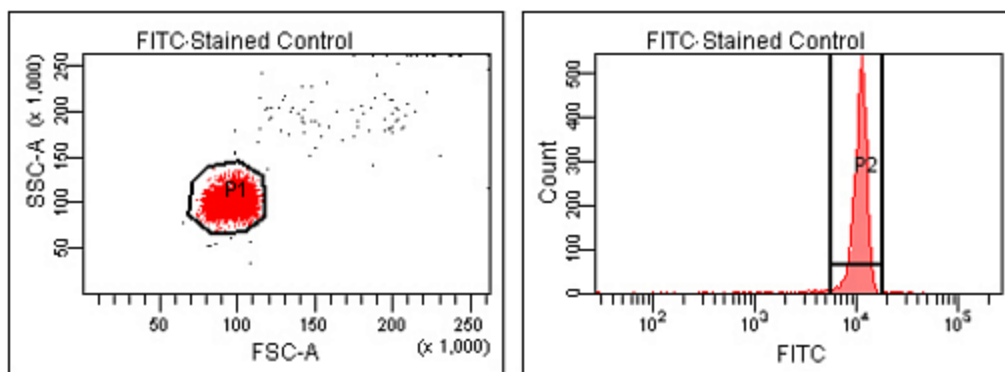

14. Repeat steps 12 and 13 for the remaining compensation tubes.

Next step

After you have recorded data for each single-stained control, calculate compensation as described in [Calculating compensation \(page 66\)](#).

Calculating compensation

Introduction

This topic describes how to calculate compensation.

Before you begin

Before you can calculate compensation, you need to record the data for each single-stained control.

Procedure

To calculate compensation:

1. Select **Experiment > Compensation Setup > Calculate Compensation**.

Note: If the calculation is successful, a dialog prompts you to enter a name for the compensation setup. The default name is year/month/day/time.

2. Enter a setup name and click **Link & Save**.

The compensation is linked to the cytometer settings and saved to the catalog.

To help track compensation setups, include the experiment name, date, or both in the setup name.

The compensation setup is linked to the *MyExperiment* cytometer settings, and subsequent acquisitions in *MyExperiment* are performed with the new compensation settings.

We recommend that you always visually and statistically inspect automatically calculated spectral overlap values. The medians of the positive controls should be aligned with the medians of the negative controls.

More information

- [Recording compensation controls \(page 64\)](#)

6

Recording and analyzing data

This chapter covers the following topics:

- [Data recording and analysis workflow \(page 68\)](#)
- [Preparing the workspace \(page 68\)](#)
- [Recording data \(page 69\)](#)
- [Analyzing data \(page 71\)](#)
- [Reusing an analysis \(page 75\)](#)

Data recording and analysis workflow

Introduction

This topic outlines the basic acquisition and analysis tasks using BD FACSDiva™ software.

About the examples

The examples in this chapter are from two 4-color bead samples with the following fluorochromes:

- FITC
- PE
- PerCP-Cy5.5
- APC

If you use a different sample type or if you have skipped the optimization steps in [Optimizing cytometer settings \(page 51\)](#), your software window content, names of folders and experiments, and your data plots and statistics might differ from those shown here. You might also need to modify some of the instructions in the procedure.

For additional details on completing some of the following steps, see the *BD FACSDiva™ Software Reference Manual*.

Workflow for recording and analyzing data

Recording and analyzing data consists of the following steps.

Step	Description
1	Preparing the workspace (page 68)
2	Recording data (page 69)
3	Analyzing data (page 71)
4	Reusing an analysis (page 75)

Preparing the workspace

Introduction

This topic describes how to prepare the workspace and apply application settings to your experiment before recording data.

Procedure

To prepare the workspace:

1. Using the **Browser** toolbar, create a new specimen in *MyExperiment* and rename it *FourColorBeads*.
2. Create two tubes for the *FourColorBeads* specimen. Rename the tubes *Beads_001* and *Beads_002*.

3. Expand the **Global Worksheets** folder in *MyExperiment* to access the default global worksheet, and rename the worksheet *MyData*.
4. On the *MyData* worksheet, create the following plots for previewing the data:
 - FSC vs SSC
 - FITC vs PE
 - FITC vs PerCP-Cy5.5
 - FITC vs APC

Applying saved application settings to a new experiment

When applications settings are applied to an experiment, the cytometer settings are updated with the parameters included in the application settings, optimized PMT voltages, threshold settings, area scaling factors, and window extension values.

To apply saved application settings to your experiment:

1. Right-click the experiment-level Cytometer Settings and select **Application Settings > Apply**.
2. In the **Application Settings** catalog, select the application settings file you saved previously and click **Apply**.
If the parameters are not the same, a mismatch dialog opens.
 - Click **Overwrite** to update all settings.
 - Click **Apply** to change only the common parameters.

For more information, see the *BD FACSDiva™ Software Reference Manual*.

The cytometer settings are renamed application settings and the cytometer settings icon in the Browser changes.

More information

- [Creating application settings \(page 62\)](#)
- [Recording data \(page 69\)](#)

Recording data

Introduction

This topic provides an example of how to preview and record data for multiple samples.

Before you begin

Prepare the sample tubes.

Note: If you need to run samples at an event rate greater than 10,000 events/second, consider changing your Window extension. See the *BD FACSDiva™ Software Reference Manual* for more information.

Recording data

To record data:

1. Press RUN and HIGH on the cytometer fluid control panel.
2. Install the first sample tube onto the SIP.

3. Set the current tube pointer to *Beads_001*.
4. Click **Acquire Data** in the **Acquisition Dashboard** to begin acquisition.
5. While data is being acquired:
 - a. Draw a gate around the singlets on the FSC vs SSC plot.
 - b. Rename the P1 gate to *Singlets*.
 - c. Use the **Inspector** to set the other plots to show only the singlet population by selecting the Singlets checkbox.



6. Click **Record Data**.
7. When event recording has completed, remove the first tube from the cytometer.
The *MyData* worksheet plots should look like the following.

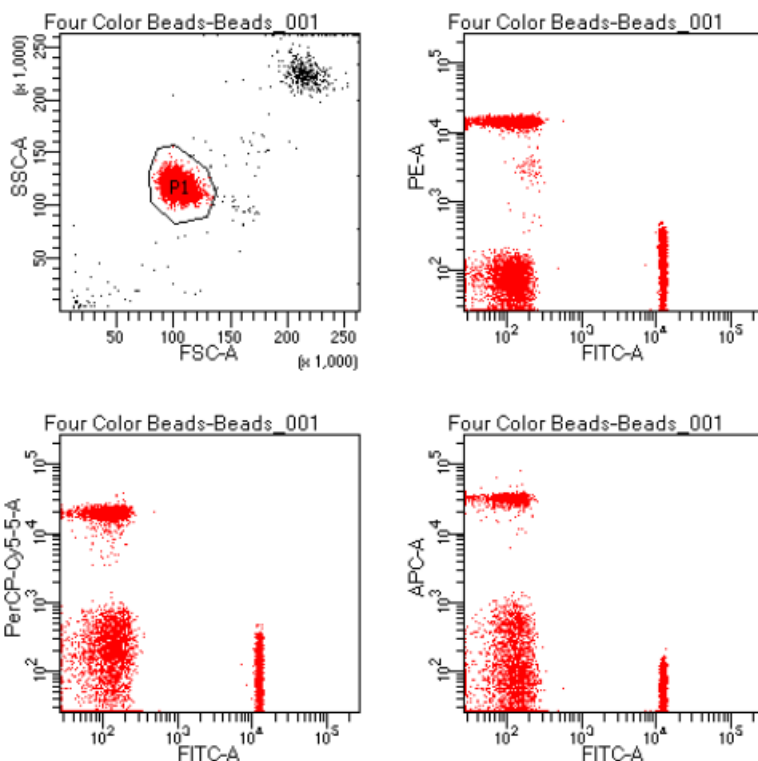

8. Install the second sample tube onto the SIP.
9. Set the current tube pointer to *Beads_002*.
10. Click **Acquire Data** to begin acquisition.
11. Before recording, preview the data on the *MyData* worksheet to verify that all expected populations are visible and the data is similar to the previous sample.
12. Click **Record Data**.
13. When event recording has completed, remove the second tube from the cytometer.
14. If you are recording more than two tubes, repeat steps 8 through 13 for the remaining tubes.

15. Print the experiment-level cytometer settings by right-clicking the **Cytometer Settings** icon in the **Browser** and selecting **Print**.
16. Install a tube with less than 1 mL of DI water onto the SIP.
17. Place the cytometer in standby mode.

Analyzing data

Introduction

This topic describes how to analyze recorded tubes by creating plots, gates, a population hierarchy, and statistics views on a new global worksheet.

Analyzing data

To analyze data:

1. Use the **Browser** toolbar to create a new global worksheet. Rename it *MyDataAnalysis*.
2. Create the following plots on the *MyDataAnalysis* worksheet:
 - FSC vs SSC
 - FITC vs PE
 - FITC vs PerCP-Cy5.5
 - FITC vs APC
3. Create a population hierarchy and a statistics view, and set them below the plots on the worksheet.
 - Right-click any plot and select **Show Population Hierarchy**.
 - Right-click any plot and select **Create Statistics View**.
4. Set the current tube pointer to *Beads_001*.
5. Draw a gate around the singlets on the FSC vs SSC plot.
6. Use the population hierarchy to rename the population *Singlets*.
7. Select all plots except the FSC vs SSC plot, and use the **Plot** tab in the **Inspector** to specify to show only the singlet population.

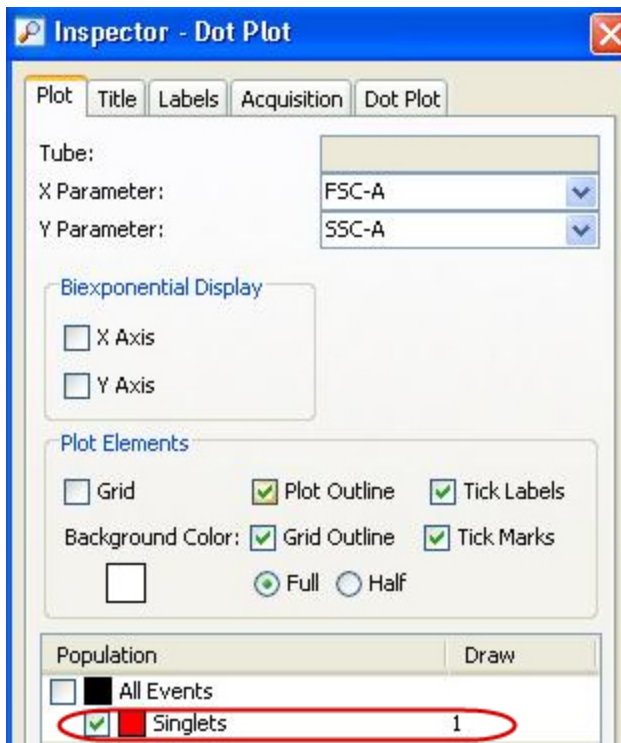

8. Select all plots, and click the **Title** tab in the **Inspector**.
9. Select the **Tube** and **Populations** checkboxes to display their names in plot titles.

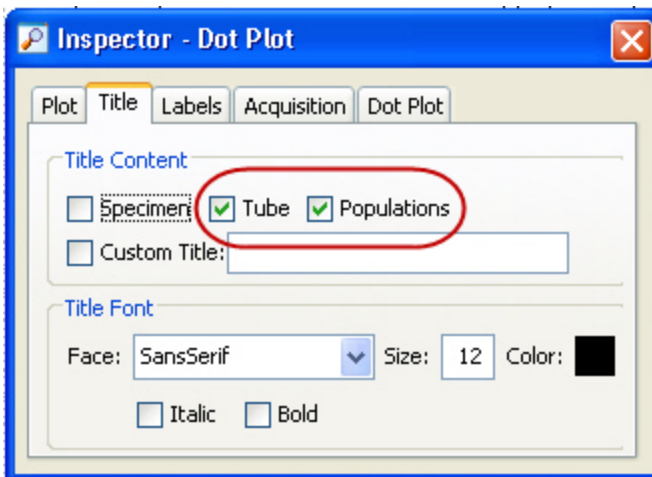

10. On all fluorescence plots:
 - Make all plots biexponential. Select all fluorescence plots and select the **X Axis** and **Y Axis** checkboxes in the **Plot** tab of the **Inspector**.

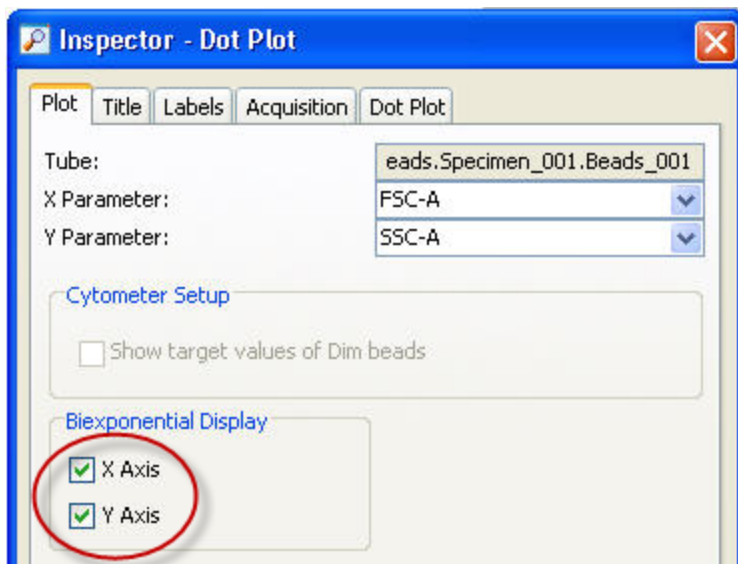

- In the FITC vs PE plot, draw a gate around the FITC-positive population. Name the population *FITC positive* in the population hierarchy.
- In the FITC vs PE plot, draw a gate around the PE-positive population. Name the population *PE positive* in the population hierarchy.
- In the FITC vs PerCP-Cy5.5 plot, draw a gate around the PerCP-Cy5.5-positive population. Name the population *PerCP-Cy5.5 positive* in the population hierarchy.
- In the FITC vs APC plot, draw a gate around the APC-positive population. Name the population *APC positive* in the population hierarchy.

11. Format the statistics view.

- Right-click the statistics view and select **Edit Statistics View**.
- Click the **Header** tab and select the **Specimen Name** and **Tube Name** checkboxes.
- Click the **Populations** tab and select all populations except **All Events**. Clear the **%Parent**, **%Total**, and **#Events** checkboxes.
- Click the **Statistics** tab and select the mean for each of the fluorescence parameters.

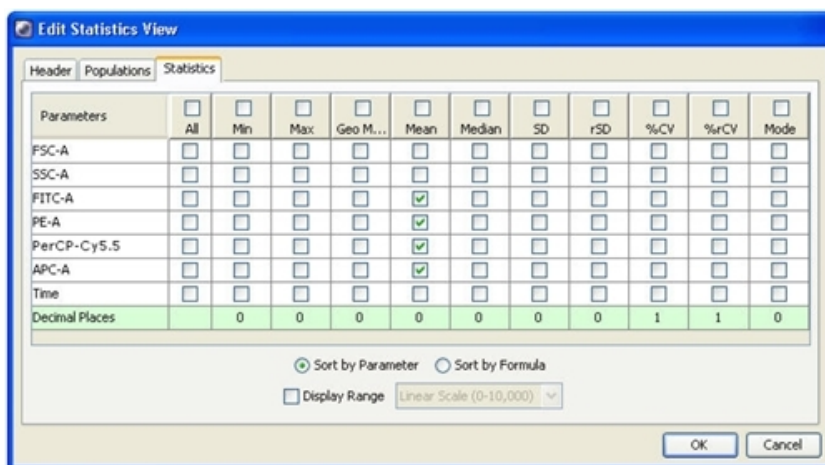

- Click **OK**.

12. Print the analysis.

Your global worksheet analysis objects should look like the following.

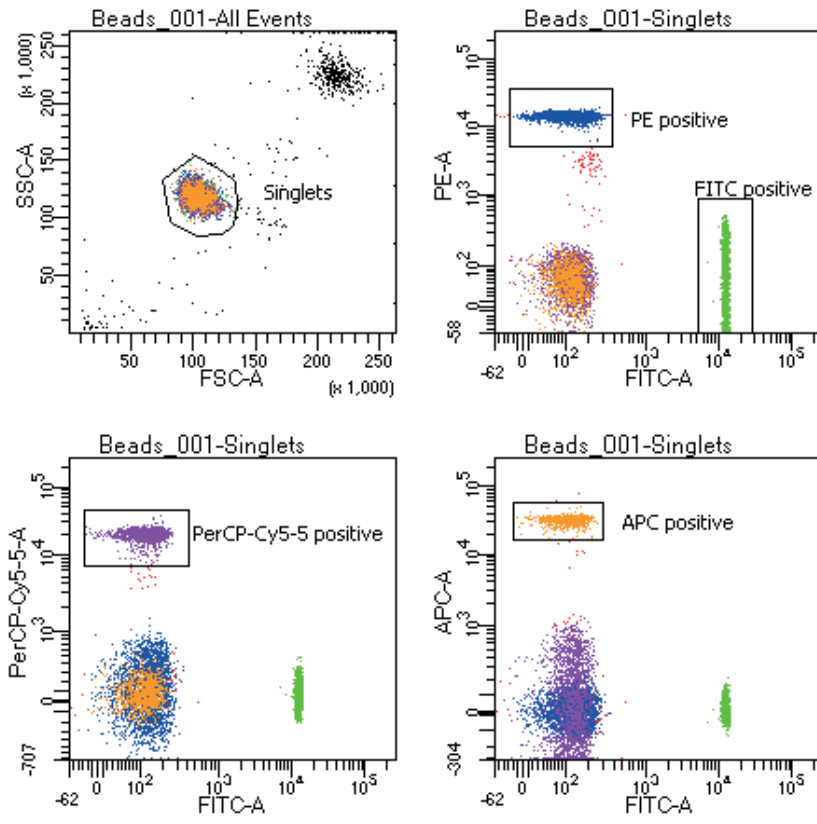

Tube: Beads_001

Population	#Events	%Parent	%Total
All Events	10,000	####	100.0
Singlets	9,412	94.1	94.1
FITC positive	3,795	40.3	38.0
PE positive	2,511	26.7	25.1
PerCP-Cy5-5 positive	2,085	22.2	20.8
APC positive	918	9.8	9.2

Specimen Name: Four Color Beads
 Tube Name: Beads_001

Population	FITC-A Mean	PE-A Mean	PerCP-C... Mean	APC-A Mean
All Events	5,330	4,221	4,910	3,313
Singlets	5,016	3,952	4,593	3,195
FITC positive	12,244	86	63	20
PE positive	126	14,508	122	7
PerCP-Cy5-5 positive	118	68	20,354	22
APC positive	107	57	71	32,298

Reusing an analysis

Introduction

This topic describes how to use a global worksheets to apply the same analysis to a series of recorded tubes. Once you define an analysis for a tube, you can use it to analyze the remaining tubes in the experiment. After viewing the data, print the analysis or save it to a normal worksheet.

Reusing an analysis

To reuse the analysis:

1. Set the current tube pointer to the *Beads_002* tube.
2. View the *Beads_002* data on your analysis worksheet. Adjust the gates as needed.
Adjustments apply to subsequent tubes viewed on the worksheet. To avoid altering a global worksheet, save an analysis to a normal worksheet, then make adjustments on the normal worksheet.
3. Print the analysis.

Saving the analysis

When you perform analysis with a global worksheet, the analysis does not save with the tube.

If you define your analysis on a global worksheet before recording data, you can specify to automatically save the analysis after recording data. You set this option in User Preferences.

To save a copy of the analysis with a tube:

1. Expand the *MyDataAnalysis* global worksheet icon in the **Browser**.
2. Right-click its analysis and select **Copy**.



3. Click the **Worksheets View** button on the **Worksheet** toolbar to switch to the normal worksheet view.
4. Select **Worksheet > New Worksheet** to create a new normal worksheet.
5. Right-click the *Beads_001* tube icon in the **Browser**, and select **Paste**.

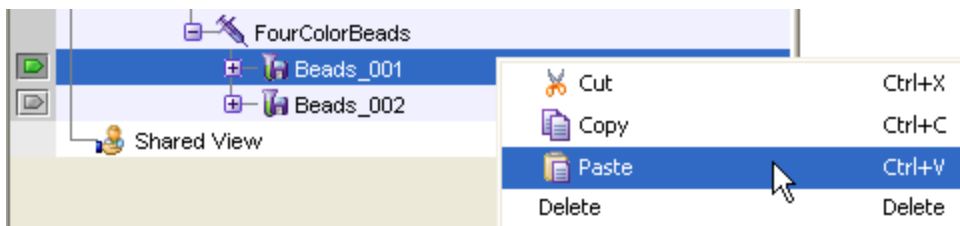

The analysis objects from the *MyDataAnalysis* global worksheet are copied to the *Beads_001_Analysis* normal worksheet. Double-click the *Beads_001* tube in the Browser to view the analysis.

Applying an analysis to normal worksheets

You can apply the global worksheet analysis to multiple tubes (on a single normal worksheet) by selecting multiple tubes before pasting the analysis. Ensure that you collapse all tube elements in the Browser before you paste them to multiple tubes.

More information

- [Analyzing data \(page 71\)](#)

7

Technical overview

This chapter provides a technical overview of the following topics:

- [About fluidics \(page 78\)](#)
- [About optics \(page 79\)](#)
- [About electronics \(page 84\)](#)

About fluidics

Introduction

This topic describes the BD FACSymphony™ A1 flow cytometer fluidics system.

Pressure-driven fluidics system

The fluidics system in the BD FACSymphony™ A1 flow cytometer operates at a pressure of 5.5 psi. After passing through the sheath filter, sheath fluid is introduced into the lower chamber of the quartz flow cell.

Hydrodynamic focusing

The sample to be analyzed arrives in a separate pressurized stream. When a sample tube is placed on the SIP, the sample is forced up and injected into the lower chamber of the flow cell by a slight overpressure relative to the sheath fluid. The conical shape of the lower chamber creates a laminar sheath flow that carries the sample core upward through the center of the flow cell, where the particles to be measured are intercepted by the laser beam. This process is known as hydrodynamic focusing.

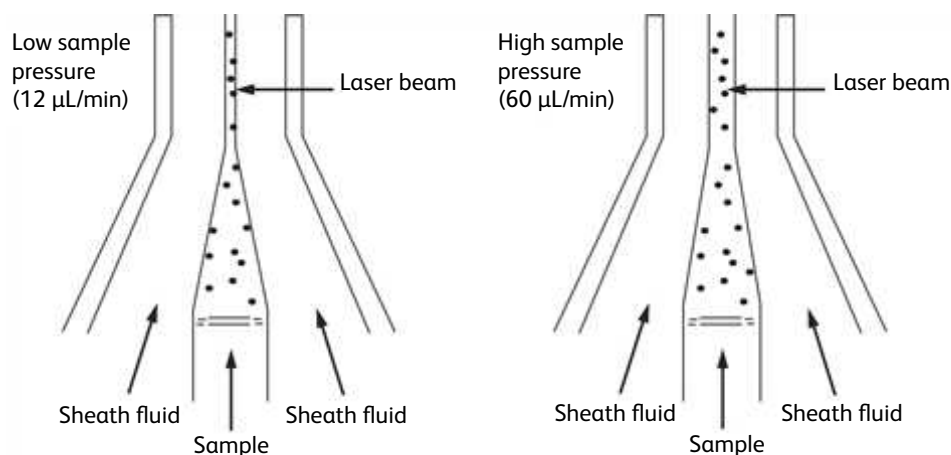

The objective in flow cytometric analysis is to have at most one cell or particle moving through a laser beam at a given time. The difference in pressure between the sample stream and sheath fluid stream can be used to vary the diameter of the sample core.

Changing the sample flow rate changes the sample pressure thereby changing the core diameter. The flow rate should be set according to the type of application you are running.

- A higher flow rate is generally used for qualitative measurements such as immunophenotyping. The data is less resolved, but is acquired more quickly.
- A lower flow rate is generally used in applications where greater resolution and quantitative measurements are critical, such as DNA analysis.

Proper operation of fluidic components is critical for particles to intercept the laser beam properly. Always ensure that the fluidics system is free of air bubbles and debris, and is properly pressurized.

About optics

Introduction

This topic describes the optics system and provides information about:

- [Light scatter \(page 79\)](#)
- [Fluorescence \(page 79\)](#)
- [Optical filter theory \(page 80\)](#)
- [Compensation theory \(page 83\)](#)

Optics system

The optics system consists of lasers, optical filters, and detectors. Lasers illuminate the cells or particles in the sample and optical filters direct the resulting light scatter and fluorescence signals to the appropriate detectors.

Light scatter

When a cell or particle passes through a focused laser beam, laser light is scattered in all directions. Light that scatters axial to the laser beam is called forward scatter (FSC) and light that scatters perpendicular to the laser beam is called side scatter (SSC).

FSC and SSC are related to certain physical properties of cells.

- **FSC** Indicates relative differences in the size of the cells or particles. Larger cells scatter more light and therefore they are higher in FSC.
- **SSC** Indicates relative differences in the internal complexity or granularity of the cells or particles. More granular cells deflect more light than less granular cells, and therefore are higher in SSC.

Fluorescence

When cells or particles stained with fluorochrome-conjugated antibodies or other dyes pass through a laser beam, the dyes can absorb photons (energy) and be promoted to an excited electronic state. In returning to their ground state, the dyes release energy, most of which is emitted as light. This light emission is known as fluorescence.

Fluorescence is always a longer wavelength (lower-energy photon) than the excitation wavelength. The difference between the excitation wavelength and the emission wavelength is known as the Stokes shift. Some fluorescent compounds such as PerCP exhibit a large Stokes shift, absorbing blue light (488 nm) and emitting red light (675 nm), while other fluorochromes such as FITC have a smaller Stokes shift, absorbing blue light (488 nm) and emitting green light (530 nm).

Actual emission intensity will depend on excitation wavelength. See [Fluorescence spectra \(page 98\)](#) for more information on excitation and emission of fluorochromes. An interactive spectrum viewer is also available at bdbiosciences.com.

Optical filter theory

Optical filters modify the spectral distribution of light scatter and fluorescence directed to the detectors. When photons encounter an optical filter, they are either transmitted, absorbed, or reflected.

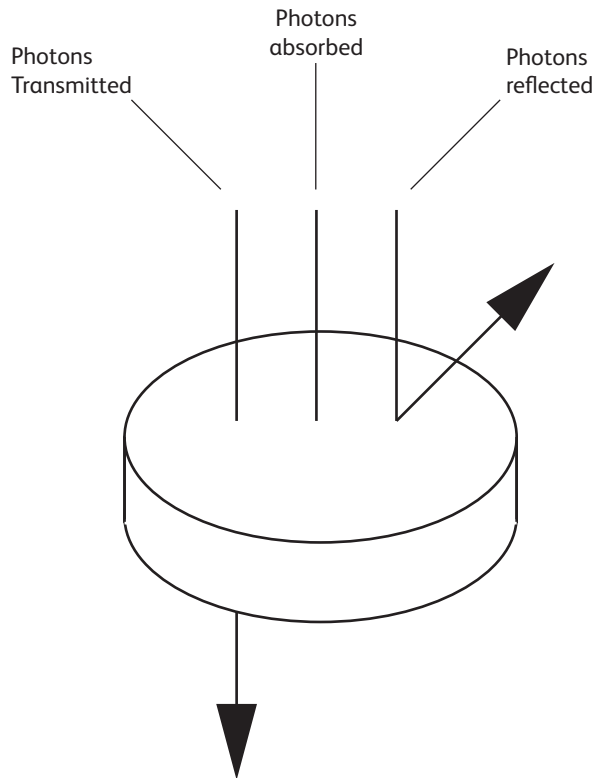

Even though an optical filter is rated at its 50% transmission point, the filter passes (lets through) a minimal amount of light outside of this indicated rating.

The slope of an optical filter transmission curve indicates filter performance. A relatively steep slope indicates a high-performance, high-quality optical filter that provides deep attenuation of out-of-band wavelengths. A less steep slope indicates that more light outside the rated bandwidth is being transmitted.

Types of optical filters

There are four types of filters.

- **Longpass (LP) filters** Transmit wavelengths at or longer than the specified value.
- **Shortpass (SP) filters** Transmit wavelengths at or shorter than the specified value. This type of filter is not recommended.
- **Bandpass (BP) filters** Pass a narrow spectral band of light by combining the characteristics of shortpass filters, longpass filters, and absorbing layers.
- **Notch filters** Pass all frequencies except those in a stop band centered on a center frequency. They are the opposite of bandpass filters.

The BD FACSymphony™ A1 uses LP filters and BP filters.

Longpass (LP) filters

LP filters pass wavelengths longer than the filter rating. For example, a 500-LP filter permits wavelengths 500 nm or longer to pass through it and either absorbs or reflects wavelengths shorter than 500 nm.

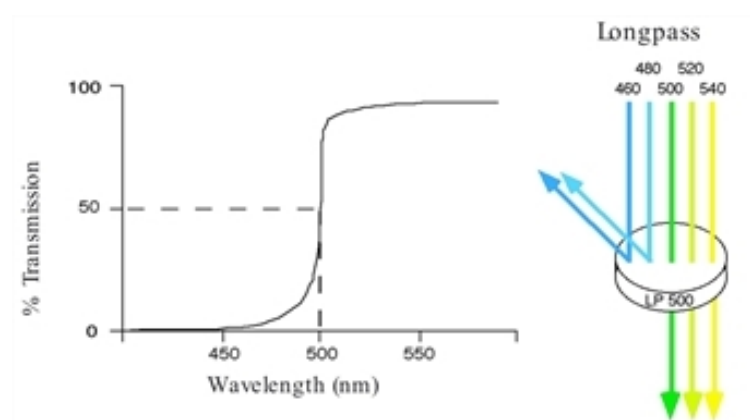

Shortpass (SP) filters

An SP filter has the opposite properties of an LP filter. An SP filter passes light with a shorter wavelength than the filter rating. For example, a 500-SP filter passes wavelengths of 500 nm or shorter, and reflects or absorbs wavelengths longer than 500 nm.

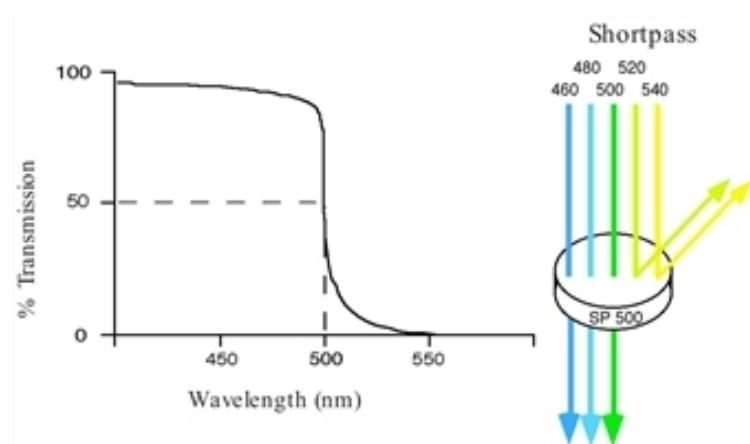

Bandpass (BP) filters

A BP filter transmits a relatively narrow range or band of light. BP filters are typically designated by two numbers. The first number indicates the center wavelength and the second refers to the width of the band of light that is passed. For example, a 500/50-BP filter transmits light that is centered at 500 nm and has a total bandwidth of 50 nm. Therefore, this filter transmits light between 475 and 525 nm.

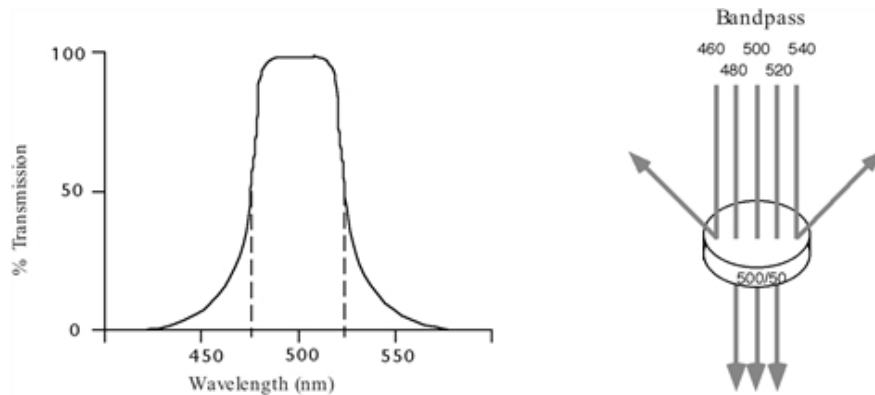

The performance of an optical BP filter depends on the optical transmission. Sample transmission curves are shown in the following figure. A filter with a narrower (steeper) transmission curve generally yields higher performance. The transmission specifications depend on the construction of the filter.

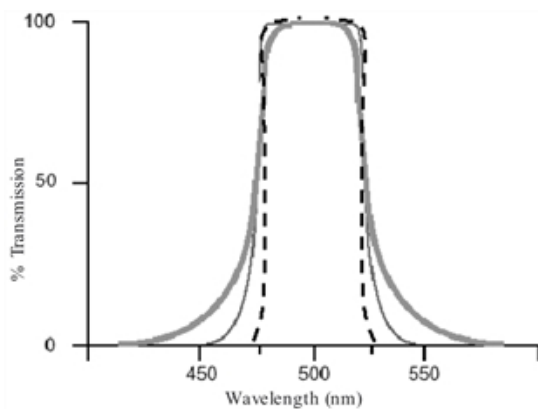

Dichroic mirrors

Dichroic filters that are used to direct different color light signals to different detectors are called dichroic mirrors.

Although some of the properties of LP and SP filters are similar to dichroic mirrors (for example, allowing a specific wavelength range to pass), filters and mirrors cannot be used interchangeably, especially if used as dichroic mirrors. A dichroic mirror must have a surface coating that reflects certain wavelengths, but many LP or SP filters are absorbance filters that do not have any specific reflective characteristics. Also, optical filters and dichroic mirrors are rated at a specific angle of incidence. When used in front of the fluorescence detectors, they are perpendicular to the incident light, and when used as a dichroic mirror, they are placed at an angle relative to the light source. Their optical properties are therefore designed for that angle of incidence.

Reflective mirrors

Reflective mirrors reflect all light in their performance band. They are intended to pass light to the next optic with minimal loss regardless of wavelength. These are used when a detector position needs to be bypassed due to space constraints.

Compensation theory

Fluorochromes emit light over a range of wavelengths. Optical filters are used to limit the range of frequencies measured by a given detector. However, when two or more fluorochromes are used, the overlap in wavelength ranges often makes it impossible for optical filters to isolate light from a given fluorochrome. As a result, light emitted from one fluorochrome appears in a detector intended for another. This is referred to as spillover. Spillover can be corrected mathematically by using a method called compensation.

In the following example, FITC emission appears primarily in the FITC detector, but some of its fluorescence spills over into the PE detector. The spillover must be corrected or compensated for. Alternatively, the spillover can be minimized by discrete excitation of fluorochromes. In the following example, excitation with a yellow-green configuration will help minimize spillover.

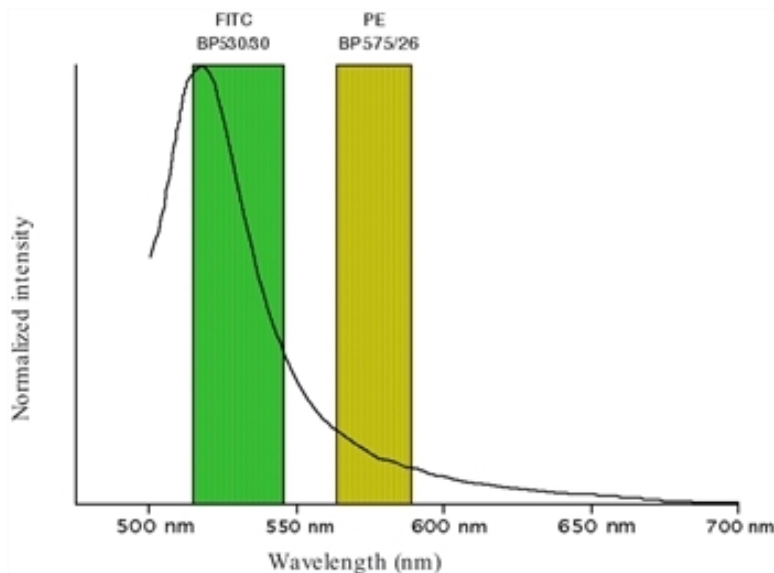

This spillover can be seen in a dot plot of FITC vs PE. The FITC spillover in the PE detector must be corrected as demonstrated in the two figures that follow.

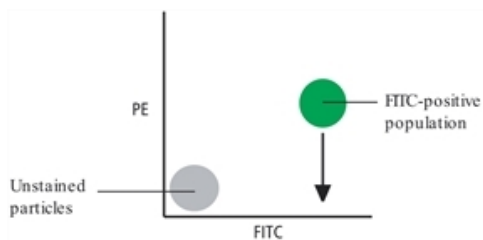

Using the Compensation tab of the Cytometer window in BD FACSDiva™ software, you can adjust the PE-%FITC spectral overlap value. Compensation is optimal when the positive and negative FITC populations have the same medians in the PE parameter statistics.

The following image shows the FITC spillover optimally compensated out of the PE parameter.

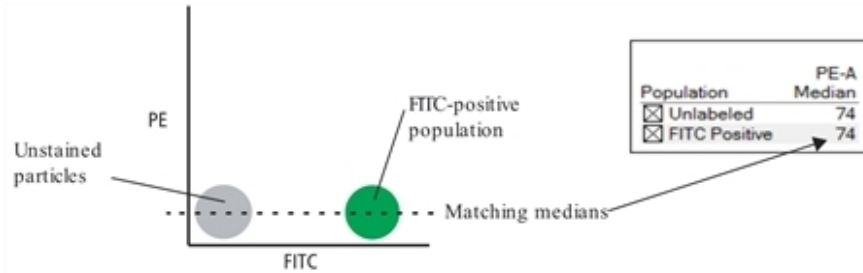

Once fluorescence compensation has been set for any sample, the compensation setting remains valid for a subsequent dim or bright sample (provided the signal is not saturated), because compensation subtracts a percentage of the fluorescence intensity. The following figure illustrates this principle. Although the signals differ in intensity, the percentage of the FITC spillover into the PE detector remains constant.

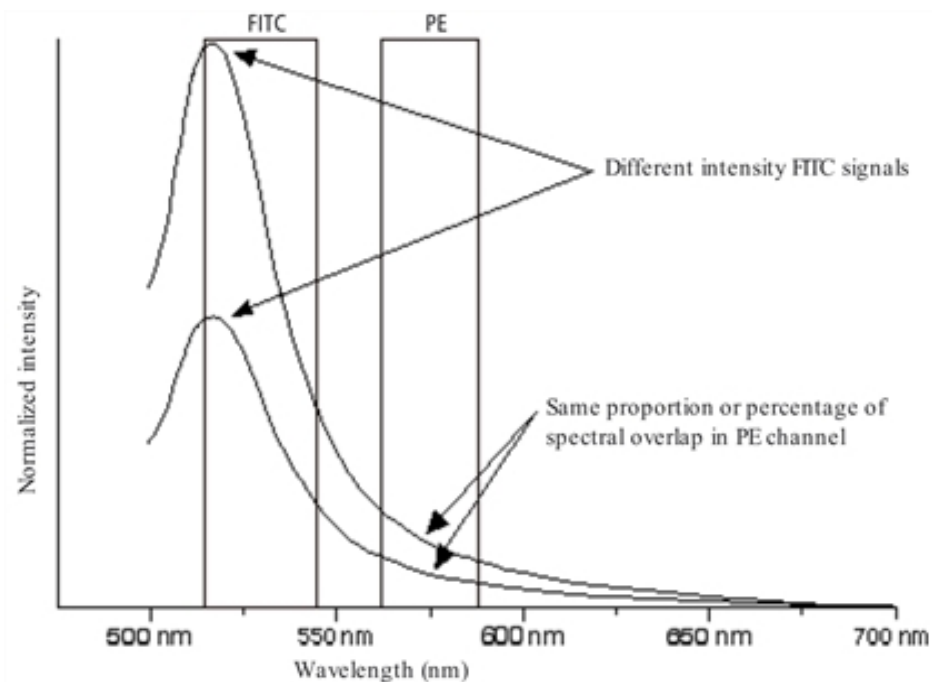

About electronics

Introduction

This topic describes the electronics in the BD FACSymphony™ A1 flow cytometer.

Pulse

As cells or other particles pass through a focused laser beam, they scatter the laser light and can emit fluorescence. Because the laser beam is focused on a small spot and particles move rapidly through the flow cell, the scatter or fluorescence emission signal has a very brief duration—only a few microseconds. This brief flash of light is converted into an electrical signal by the detectors. The electrical signal is called a pulse. The following figures illustrate the anatomy of a pulse.

1. A pulse begins when a particle enters the laser beam. At this point, both the beam intensity and signal intensity are low.

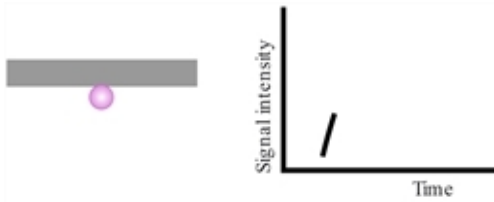

2. The pulse reaches a maximum intensity or height when the particle reaches the middle of the beam, where the beam and signal intensity are the brightest. The peak intensity, or height of the pulse, is measured at this point.

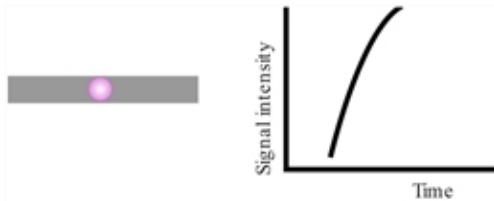

3. As the particle leaves the beam, the pulse trails off below the threshold.



Pulse measurements

The pulse processors measure pulses by three characteristics: height, area, and width.

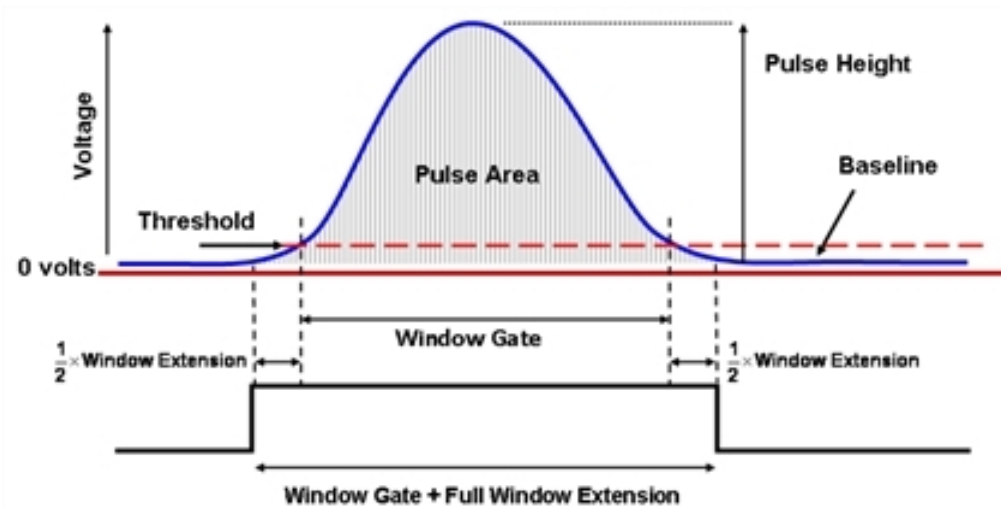

- **Height** The maximum digitized intensity measured for the pulse.
- **Area** The integration of all the digitized samples over time, where time is the window gate plus $\frac{1}{2}$ the window extension added before the initial threshold, plus the other half of the window extension value

added after the pulse drops below the threshold. The window gate extends until the pulse is 75% of the initial threshold.

- **Width** The current width is measured by the electronics.

Digital electronics

BD FACSymphony™ A1 electronics digitize the signal intensity produced by a detector. The digitized data is stored in memory and further processed by the electronics to calculate:

- Pulse height and area
- Compensation
- Parameter ratios

These results are transferred to your workstation computer for further processing by BD FACSDiva™ software. For more information about digital theory, see Digital Theory in the *BD FACSDiva™ Software Reference Manual*.

Threshold

The threshold is the level at which the system starts to measure signal pulses. A threshold is defined for a specific detector signal. The system continuously samples the digitized signal data and calculates pulse area and height for all channels based on the time interval during which the threshold is exceeded.

Thresholds can also be set for more than one parameter, and pulse measures are based on either of the following:

- Intervals during which ALL signals exceed their threshold value (AND threshold in the software)
- Intervals during which ANY signal exceeds its threshold value (OR threshold in the software)

Laser controls

Controls in the Laser tab of the Cytometer window are used to manually set the (laser) delay, area scaling, and window extension values.

These parameters are set by BD Biosciences service personnel during instrument installation and performance check and are updated each time you run a performance check.

Note: Do not otherwise change the settings in the Laser tab unless instructed to do so by BD Biosciences. Changing the settings affects your data.

See the following screen capture for the correct settings.

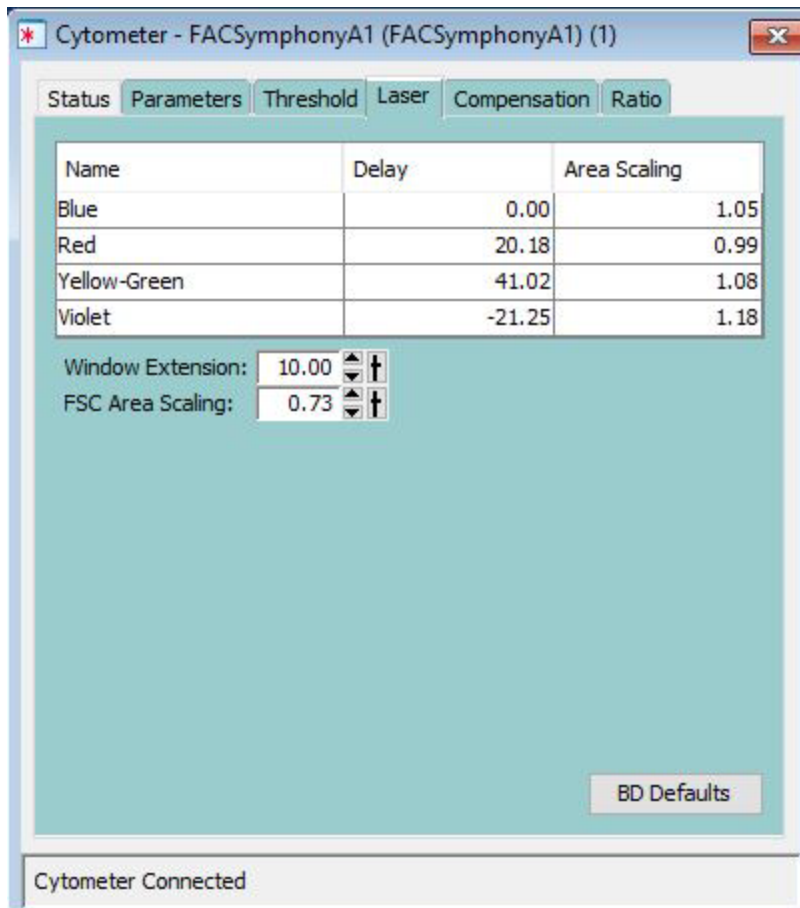

More information

- [Running a performance check \(page 55\)](#)

This page intentionally left blank

8

Troubleshooting

This chapter covers the following topics:

- [Cytometer troubleshooting \(page 90\)](#)
- [Electronics troubleshooting \(page 95\)](#)

Cytometer troubleshooting

Introduction

This topic describes possible problems and recommended solutions for BD FACSymphony™ A1 flow cytometer issues.

Droplets are visible on the SIT

Possible causes	Recommended solutions
Worn O-ring in the retainer	Replace the O-ring. See Changing the sample tube O-ring (page 48) .
Outer sleeve is not seated in the retainer	<ol style="list-style-type: none"> Loosen the retainer. Push the outer sleeve up into the retainer until seated. Tighten the retainer.
Outer sleeve is not on the sample injection tube	Replace the outer sleeve. <ol style="list-style-type: none"> Loosen the retainer. Slide the outer sleeve over the sample injection tube until it is seated. Tighten the retainer.
Waste line is pinched, preventing proper aspiration	Check the waste line.
Waste tank is full	Empty the waste tank.
Droplet containment vacuum is not functioning	Call your BD service representative.
Acquisition Mode switch set to Plate	Make sure Acquisition Mode switch is set to Tube when HTS is not attached.
The mode is not set to HTS.	Change the mode to HTS by pressing down the MODE button for more than 3 seconds.

Sample tube not fitting on SIP

Possible causes	Recommended solutions
Sample tube other than Falcon® tubes used	Use Falcon® 12 x 75-mm polystyrene sample tubes. See Equipment (page 119) .
Worn Bal seal	Replace the Bal seal. See Changing the Bal seal (page 46) .
Sample tube is cracked	Transfer contents to a new tube.

Rapid sample aspiration

Possible causes	Recommended solutions
Support arm is to the side	Place the support arm under the sample tube.

Possible causes	Recommended solutions
Droplet containment module is failing	Try the solutions in Droplets are visible on the SIT (page 90) . If the issue is not resolved, call your BD service representative.

No events in acquisition display and RUN button is green

Possible causes	Recommended solutions
Threshold is not set to the correct parameter (usually FSC)	Set the threshold to the correct parameter for your application.
Threshold level is too high	Lower the threshold level.
PMT voltage for threshold parameter is set too low	Set the PMT voltage higher for the threshold parameter.
Gating issue	See the <i>BD FACSDiva™ Software Reference Manual</i> for information on setting gates.
Air in the sheath filter	Purge the filter. See Removing air bubbles (page 29) .
Air bubble or debris in the flow cell	Prime the fluidics system. See Preparing the fluidics (page 32) .
No sample in the tube	Verify that sample remains in the tube and if necessary, add sample to the tube or install a new sample tube.
Sample is not mixed properly	Mix the sample to suspend the cells.
Waste tank is full	Empty the waste tank.
PMT voltages set too low or too high for display parameter	Adjust the PMT voltages.
Too few events are displayed	Increase the number of events to display.
Sample injection tube is clogged	Remove the sample tube to allow backflushing. If the event rate is still erratic, clean the sample injection tube. See Cleaning the fluidics (page 39) .
Bal seal is worn	Replace the Bal seal. See Changing the Bal seal (page 46) .
Instrument is not warmed up	Wait 30 minutes for the instrument to warm up.
Laser is not functioning	Verify the malfunction by changing the threshold to an alternative laser while running the appropriate sample. If unsuccessful, contact BD Biosciences.
Tube is cracked or misshapen	Replace the sample tube. Waste tank is pressurized. Disconnect the waste container for at least 30 seconds to allow the pressure to dissipate.

No events in acquisition display and RUN button is orange

Possible causes	Recommended solutions
RUN is not activated	Press the RUN button.
Sample tube is not installed or is not properly seated	Install the sample tube correctly on the SIP.
Sample tube is cracked	Replace the sample tube.
Waste tubing line is disconnected from the waste container tank	Connect the waste tubing line to the waste container tank.
Sheath container is not pressurized	<ul style="list-style-type: none"> Ensure that the sheath container lid and all connectors are securely seated. Inspect the sheath container O-ring inside the lid and replace it if necessary. See Cleaning or replacing the sheath gasket (page 49).
Bal seal is worn	Replace the Bal seal. See Changing the Bal seal (page 46) .
Air leak at sheath container	Ensure that the sheath container lid and all connectors are securely seated.
Sheath container is empty	Fill the sheath container.
Air in sheath filter	Purge the filter. See Removing air bubbles (page 29) .

No fluorescence signal

Possible causes	Recommended solutions
Incorrect fluorochrome assignment	Make sure that the cytometer configuration in the software matches the optical filters in the cytometer and the configuration is as expected.
Laser is not functioning	Call your BD service representative.

No signal in red laser channels (when red laser is installed)

Possible causes	Recommended solutions
Incorrect laser delays due to a change in the sheath tank fluid level	<ul style="list-style-type: none"> Check the fluid level in the sheath tank and refill if necessary.

High event rate

Possible causes	Recommended solutions
Air bubbles in the sheath filter or flow cell	Remove the air bubbles. See Removing air bubbles (page 29) .
Threshold level is too low	Increase the threshold level. See the <i>BD FACSDiva™ Software Reference Manual</i> for instructions.

Possible causes	Recommended solutions
PMT voltage for the threshold parameter is set too high	Set the PMT voltage lower for the threshold parameter.
Sample is too concentrated	Dilute the sample.
Sample flow rate is set to HIGH	Set the sample flow rate to MED or LOW.

Low event rate

Possible causes	Recommended solutions
Threshold level is too high	Lower the threshold level. See the <i>BD FACSDiva™ Software Reference Manual</i> for instructions.
Air bubble or debris in the flow cell	Prime the fluidics system. See Preparing the fluidics (page 32) .
PMT voltage for the threshold parameter is set too low	Set the PMT voltage higher for the threshold parameter. See the <i>BD FACSDiva™ Software Reference Manual</i> for instructions.
Sample is not adequately mixed	Mix the sample to suspend the cells.
Sample is too diluted	Concentrate the sample. If the flow rate setting is not critical to the application, set the flow rate switch to MED or HIGH.
Sample injection tube is clogged	Remove the sample tube to allow backflushing. If the event rate is still erratic, clean the sample injection tube. See Cleaning the fluidics (page 39) .

Erratic event rate

Possible causes	Recommended solutions
Sample tube is cracked	Replace the sample tube.
Air bubble or debris in the flow cell	Prime the fluidics system. See Preparing the fluidics (page 32) .
Bal seal is worn	Replace the Bal seal. See Changing the Bal seal (page 46) .
Sample injection tube is clogged	Remove the sample tube to allow backflushing. If the event rate is still erratic, clean the sample injection tube. See Cleaning the fluidics (page 39) .
Contaminated sample	Prepare the specimen again. Ensure that the tube is clean.
Sheath filter is dirty	Replace the filter. See Changing the sheath filter (page 43) .

Distorted scatter parameters

Possible causes	Recommended solutions
Cytometer settings are improperly adjusted	Optimize the scatter parameters. See the <i>BD FACSDiva™ Software Reference Manual</i> for instructions.
Air bubble in the sheath filter or flow cell	Purge the air from the filter. See Removing air bubbles (page 29) .
Flow cell is dirty	Flush the system. See Flushing the system (page 40) .
Air leak at sheath container	Ensure that the sheath container lid is tight and all connectors are secure.
Hypertonic buffers or fixative	Replace the buffers or fixative.

Excessive amount of debris in display

Possible causes	Recommended solutions
Threshold level is too low	Increase the threshold level.
Sheath filter is dirty	Replace the filter. See Changing the sheath filter (page 43) .
Flow cell is dirty	Flush the system. See Flushing the system (page 40) .
Dead cells or debris in the sample	Examine the sample under a microscope.
Sample is contaminated	Re-stain the sample. Ensure that the tube is clean.
Stock sheath fluid is contaminated	Rinse the sheath container with DI water, then fill the container with sheath fluid from another (or new lot) bulk container.

High CV or poor QC results

Possible causes	Recommended solutions
Air bubble in sheath filter or flow cell	<ul style="list-style-type: none"> Purge the filter. See Removing air bubbles (page 29). Prime the fluidics system. See Preparing the fluidics (page 32).
Sample flow rate is set too high	Set the sample flow rate lower.
Air leak at sheath container	Ensure that the sheath container lid is tight and all connectors are secure.
Flow cell is dirty	Flush the system. See Flushing the system (page 40) .
Waste tank is pressurized	Replace the waste container cap. See Replacing the waste tank cap (page 42) .
Poor sample preparation	Repeat sample preparation.
Sample was not diluted in the same fluid as the sheath fluid	Dilute the sample in the same fluid as you are using for sheath.
Old or contaminated QC particles	Make new QC samples and perform the quality control procedure again.

Possible causes	Recommended solutions
Instrument is not warmed up	Wait 30 minutes for the instrument to warm up.
Laser is not functioning	Contact BD Biosciences.
Optical alignment problem	Contact BD Biosciences.

Electronics troubleshooting

Introduction

This topic describes possible problems and recommended solutions for BD FACSymphony™ A1 electronics issues.

“Cytometer Disconnected” in cytometer window

Possible causes	Recommended solutions
Cytometer power is off	Turn on the cytometer main power.
Communication failure between workstation and cytometer	<ol style="list-style-type: none"> 1. In BD FACSDiva™ software, select Cytometer > Connect. 2. If connecting does not work, restart the cytometer. Turn the cytometer off, wait 1 minute, and turn on the cytometer main power. 3. If connecting still does not work, contact BD Biosciences.

This page intentionally left blank

9

Detector array configurations

This chapter covers the following topics:

- [Fluorescence spectra \(page 98\)](#)
- [About configuration maps \(page 99\)](#)
- [About configurations \(page 100\)](#)
- [Base configuration polygon maps \(page 101\)](#)

Fluorescence spectra

Introduction

This topic shows sample emission spectra from common fluorochromes, as well as the more common laser excitation lines. This information is useful for designing multicolor panels. An interactive fluorescence viewer is available at bdbiosciences.com. You can also look for training by selecting Support > Training.

Designing multicolor panels

The BD FACSymphony™ A1 flow cytometer is designed specifically for multicolor research. Results depend on the excitation and emission spectra of the individual dye, the number of fluorescently labeled binding sites on the cell, as well as spectral overlap and spillover to other detectors. For more information about designing multicolor panels, see *Selecting Reagents for Multicolor Flow Cytometry* (Part No. 23-9538-02).

Example laser and dye interactions

The following figures show the emission spectra of some common dyes, based on laser excitation. In many cases, a given dye can be excited by multiple laser wavelengths, yielding different emission intensities.

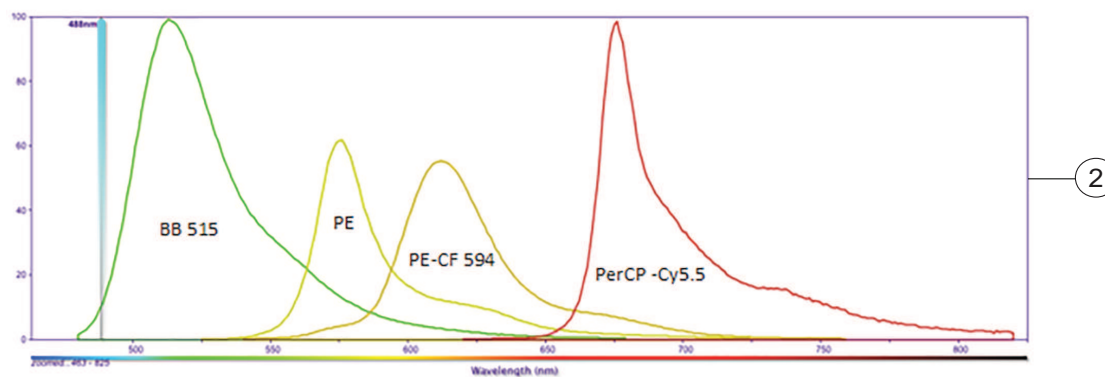
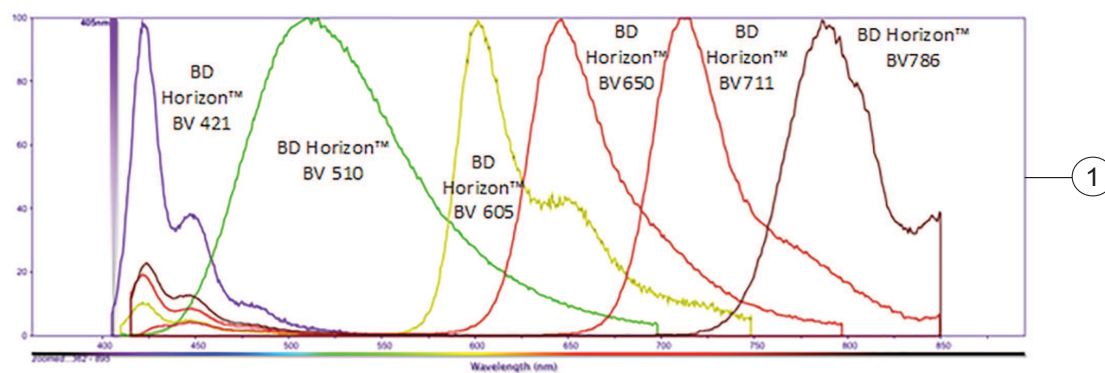

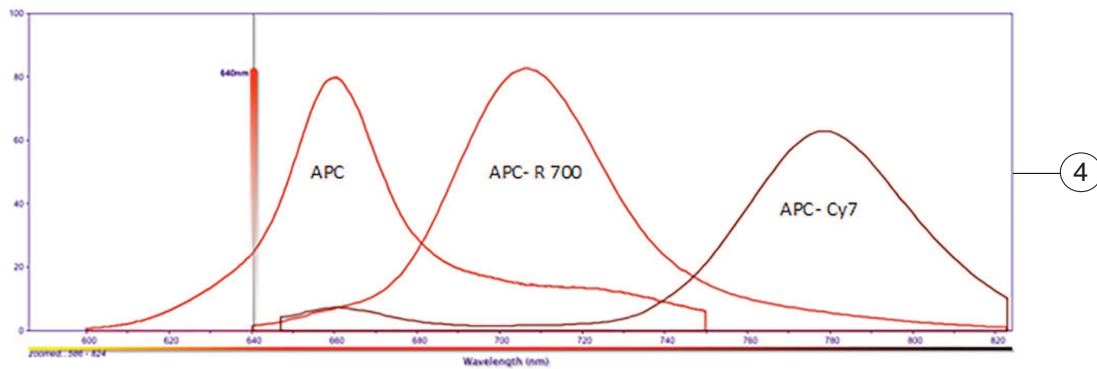
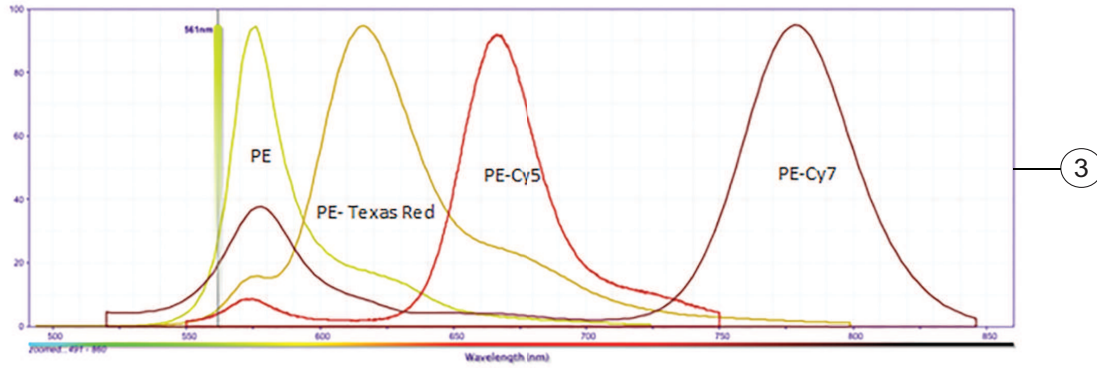

No	Definition
1	Violet (405 nm)
2	Blue (488 nm)
3	Yellow-Green (561 nm)
4	Red (637 nm)

About configuration maps

Filter and mirror arrangement

The filters are arranged in the detector array to steer progressively shorter wavelengths of light to the next detector in the array. The longest wavelength should be in the A position and the shortest wavelength should be in the last position used.

There should not be any empty slots for any laser being used. Always use a blank optic holder.

If a slot is filled with a filter or mirror, an identifying number appears in that position on the configuration map. If a slot is filled with a blank optic holder, that position on the configuration map is unlabeled.

About configurations

Available configurations

The configurations for the BD FACSymphony™ A1 flow cytometer supports detectors, filters, and mirrors for four lasers to provide either 14 or 16 colors. The Small Particle Detector can be added to either the 14 or 16 color configuration.

Colors	Configuration	Small Particle Detector
14	2-Blue 2-Red 4-Yellow-green 6-Violet	No
14	2-Blue 2-Red 4-Yellow-green 6-Violet SP	Yes
16	2-Blue 3-Red 5-Yellow-green 6-Violet	No
16	2-Blue 3-Red 5-Yellow-green 6-Violet SP	Yes

Base configuration

The BD FACSymphony™ A1 flow cytometer has one base configuration at installation. The following image shows a default base cytometer configuration.

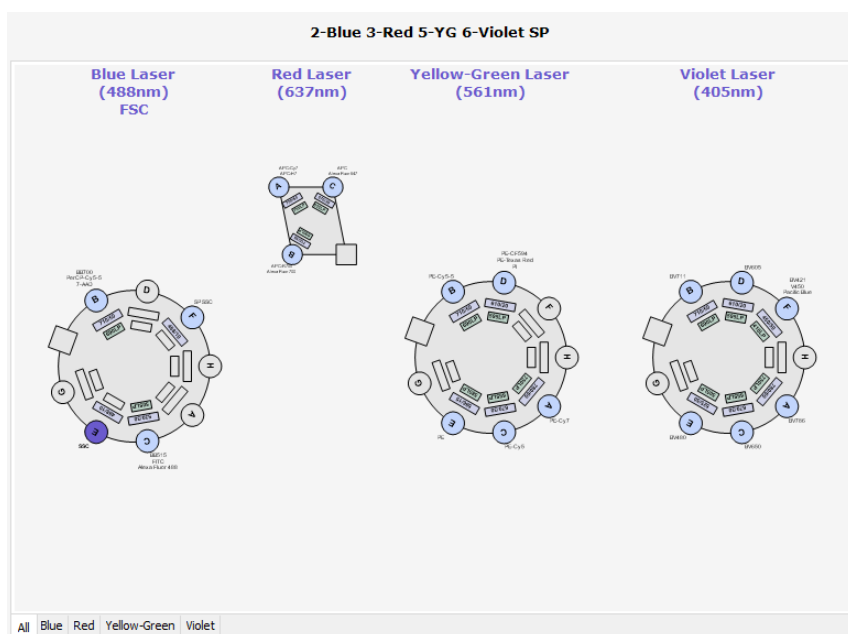

More information

- [Verifying the configuration and user preferences \(page 53\)](#)

Two-color blue laser configuration

The following table and map show the two-color configuration for the 488-nm blue laser.

Note: Detector F is used only when the optional Small Particle Detector installed.

Note: Because there are no fluorochromes associated with detectors A and D, the configuration displayed by BD FACSDiva™ does not indicate the existence of mirrors for these detectors, but mirrors are installed during manufacture to direct the laser beam along the path A-B-C-D-E/F.

Laser	Detector	Mirror	BP filter	Fluorochromes
Blue 488 nm	A	595/255R	–	–
	B	690LP	710/50	BD Horizon™ BB700, PerCP-Cy5.5, 7-AAD
	C	505LP	530/30	BD Horizon™ BB515, Alexa Fluor™ 488, FITC
	D	595/255R	–	–
	E	–	488/10	SSC
	F*	–	488/10	SP SSC Only when SPD installed

* Not physically located in polygon but treated as the detector for SP SSC by BD FACSDiva™ software.

Configuration displayed by BD FACSDiva™ software

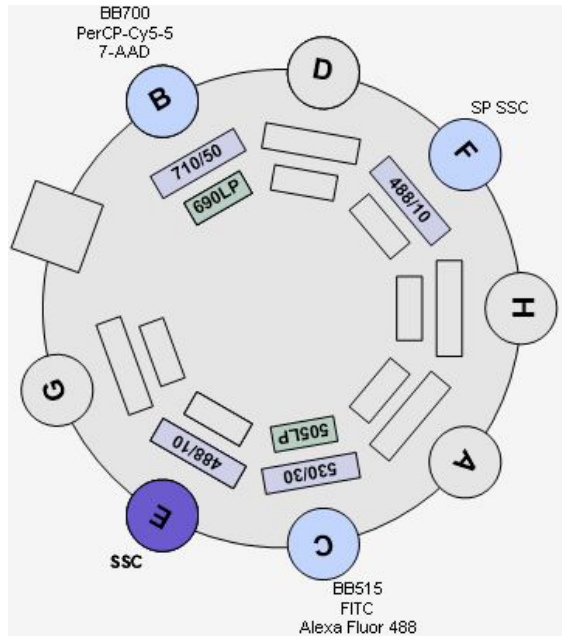

Physical configuration showing mirrors in detectors with no fluorochrome

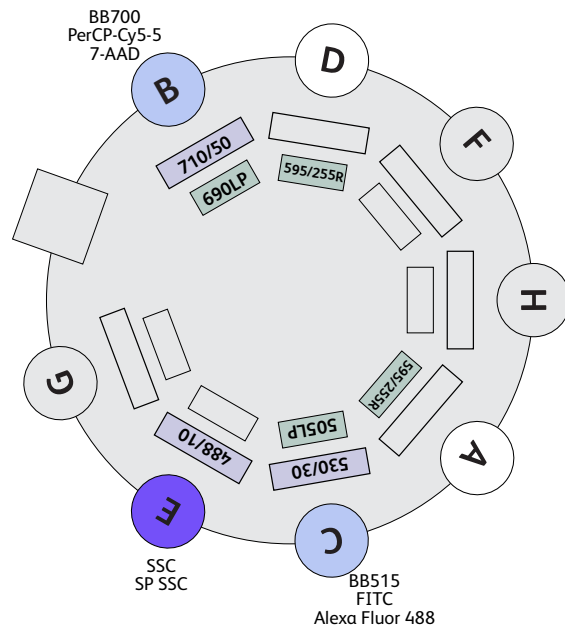

Five-color yellow-green laser configuration

The following table and map shows the five-color configuration for the 561-nm yellow-green laser.

Note: Detector C is not used in the 14-color configuration.

Laser	Detector	LP mirror	BP filter	Fluorochromes
Yellow-Green 561 nm	A	750	780/60	PE-Cy7
	B	690	710/50	PE-Cy5.5
	C	655	670/30	PE-Cy5
	D	595	610/20	BD Horizon™ PE-CF594, PE-Texas Red, PI
	E	580	586/15	PE

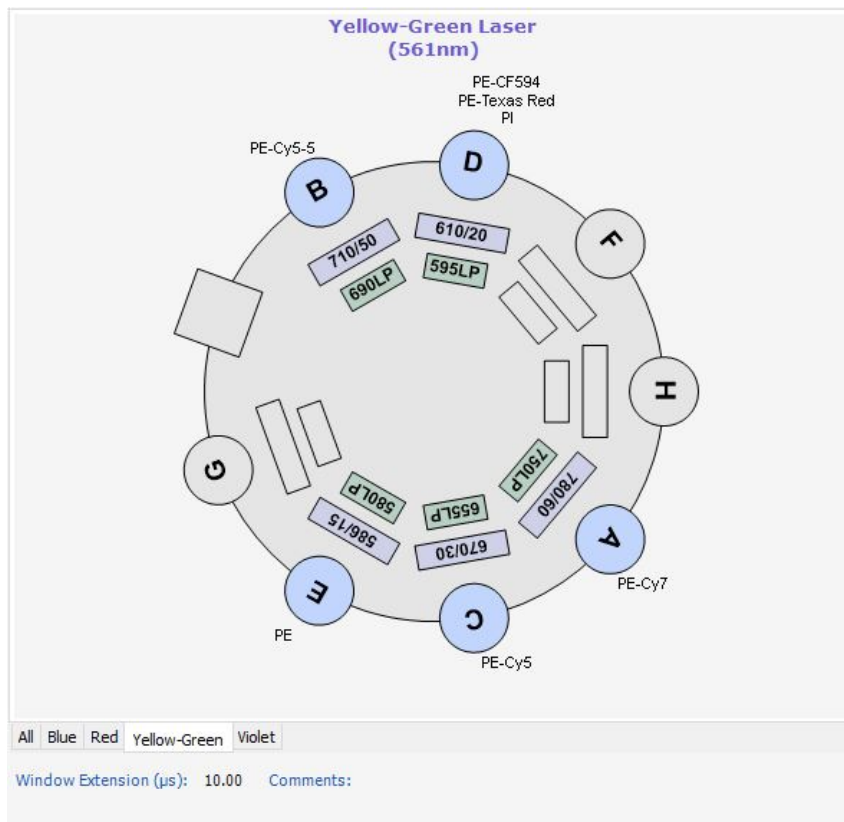

Three-color red laser configuration

The following table and map shows the three-color configuration for the 637-nm red laser.

Note: Detector B is not used in the 14-color configuration.

Laser	Detector	LP mirror	BP filter	Fluorochromes
Red 637 nm	A	750	780/60	AP-Cy7, BD Horizon™ APC-H7
	B	690	710/50	BD Horizon™ APC-R700, Alexa Fluor™ 700
	C	655	670/30	APC, Alexa Fluor™ 647

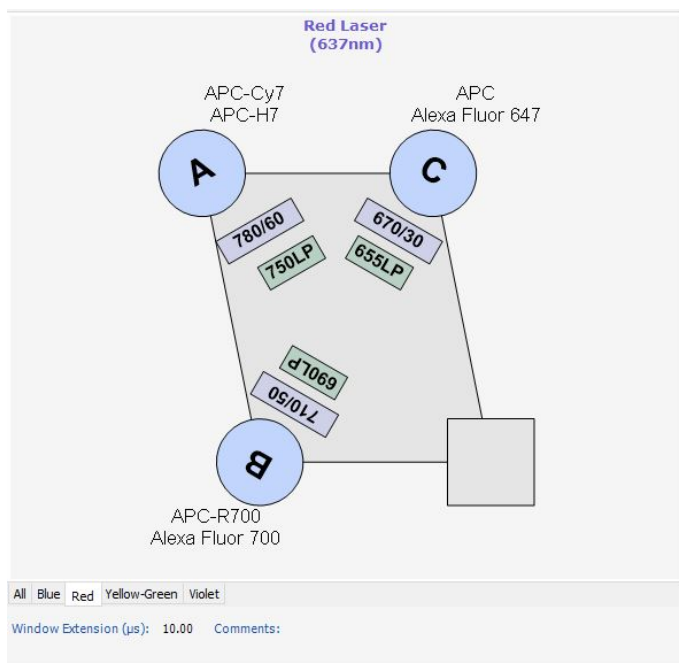

More information

- [About configurations \(page 100\)](#)

10

Small Particle Detector

This chapter covers the following topics:

- [Overview \(page 106\)](#)
- [SPD components \(page 106\)](#)
- [Preparing the system for small particle detection \(page 107\)](#)
- [Confirming small particle detection \(page 109\)](#)
- [Aligning the small particle detector \(page 113\)](#)
- [Small particle detector troubleshooting \(page 116\)](#)

Overview

The BD® Small Particle Detector (SPD) is a side-scatter detector optimized to enhance resolution of small particles such as extracellular vesicles. This device can be included as an option on a new or existing system.

Note: The SPD is a separate device installed inside the BD FACSymphony™ A1 flow cytometer, and the output is captured on the blue laser detector array. For more information, see the blue laser configuration map in [Base configuration polygon maps \(page 101\)](#). For small particle analysis, low background noise level is critical. The system must have a low event rate to ensure that the target cells are separated from noise.

SPD components

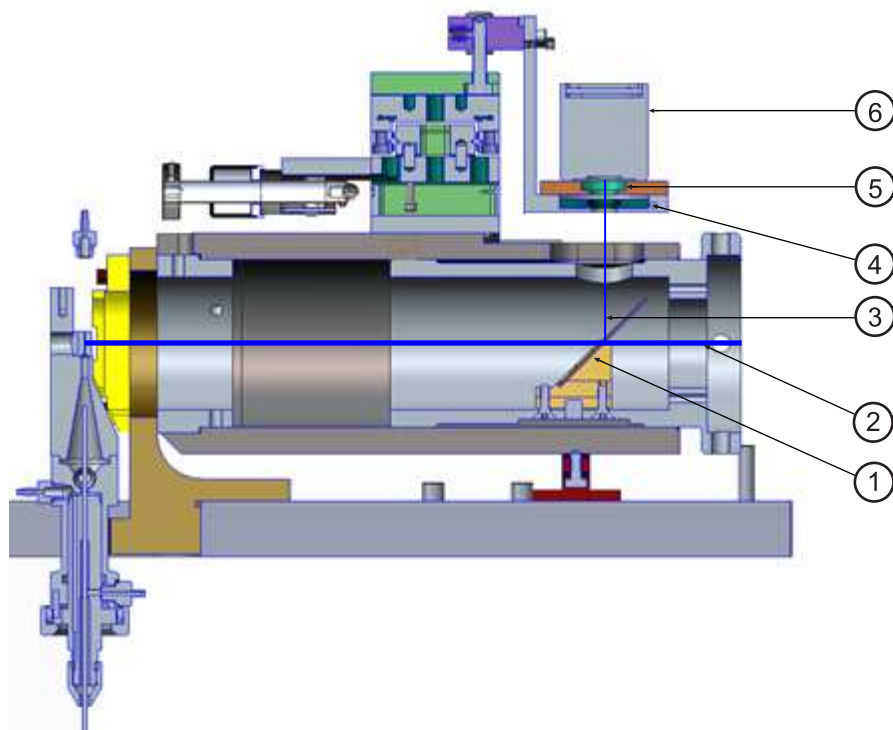

Item	Description
1	Beam splitter
2	Unredirected laser beam
3	Redirected laser beam
4	Pinhole
5	Bandpass filter
6	Small particle PMT with integrated preamplifier

Beam splitter

The 488 90/10 nm beam splitter directs 90% of the 488 nm scattered light towards the pinhole.

Unredirected laser beam

The straight-line path of the laser beam is from the flow cell to the fiber optics.

Redirected laser beam

The portion of the laser beam being redirected by the beam splitter through the pinhole and bandpass filter to the SPD.

Pinhole

A 200 μm pinhole, which focuses on the 488 nm laser intercept and blocks stray light and the other laser intercepts.

Bandpass filter

The 488/10 bandpass filter blocks non-SSC wavelengths from the PMT.

Small particle PMT with integrated preamplifier

Detects 488 nm scattered light and converts it into a digital signal for acquisition by the card-cage.

Preparing the system for small particle detection

Required materials

The following list specifies the materials needed to perform all the procedures described in this chapter.

- BioCytex™ Megamix-Plus SSC Beads (BioCytex reference: 7803)
- 1.5% dilution of BD® Detergent Solution Concentrate

Note: The BD® Detergent Solution Concentrate must be diluted before use. Mix one full 15 mL bottle of BD® Detergent Solution Concentrate into 985 mL of DI water to make 1 L total.

- Filtered DI water
- Filtered diluent (0.2 μm -filtered 1X PBS)
- BD® CS&T Beads
- BD FACFlow™ sheath fluid (do not use sheath fluid with surfacant)

Best practices

The following best practices apply to all the procedures described in this chapter:

- Ensure that system flush is performed no more than 2 weeks before using the SPD. See [Flushing the system \(page 40\)](#).
- If possible, sheath tanks should be filled the day before running a small particle experiment to allow settlement of microbubbles.
- Ensure diluents and buffers that are run on the system are filtered and are made fresh every day.
- Ensure that test tubes are clean. Capped tubes are recommended because uncapped tubes can have sub-micron plastic contamination. If uncapped tubes must be used, rinse the tubes out several times with filtered diluent.
- Wipe the SIP when changing tubes.
- If high background noise is noticed when running samples, clean the fluidics between samples. See [Managing background noise \(page 112\)](#).
- Once starting a small particle experiment, keep the instrument in RUN and do not switch back to STANDBY or PRIME or leave tube support arm to the side for more than 10 seconds as this will cause fluctuations in background noise levels. It is better to always leave the instrument in RUN and on LOW after starting a small particle experiment, even when waiting between samples.

Daily preparation before small particle experiments

1. Ensure the sheath tank is full and the waste tank is empty.
2. Turn on the cytometer and computer.
3. Allow the system to stabilize for 30 minutes before proceeding to run a sample (bead or biological). During this time, steps 4 and 5 can be completed.
4. Bleed the sheath filter and sheath line of air bubbles:
 - a. For the filter, activate the quick disconnect on the bleed line at the top of the filter to release a few milliliters of fluid. If air bubbles are still present, repeat the procedure while lightly tapping on the filter to release the bubbles.
 - b. For the sheath line from the filter to the instrument, place a beaker under the extension line and open/close the roller clamp until several milliliters of sheath are removed.

For illustrated details, see [Removing air bubbles \(page 29\)](#).

5. Install a tube with 3 mL of filtered diluent on the SIP. Press RUN and LOW on the cytometer fluidic control panel for the remainder of the system stabilization time.
6. Ensure that the cytometer configuration windows extension is set to 4. Refer to the *BD Cytometer Setup and Tracking Application Guide* for details.
7. Install a tube of BD[®] CS&T Beads, run a performance check, and verify that it passes. For details, see [Running a performance check \(page 55\)](#).
8. Change the tubes on the SIP:
 - a. While still running on LOW, remove the BD[®] CS&T Beads.
 - b. Wipe the SIP with a delicate task wipe.

- c. Move the tube support arm to the side for 10 seconds.
- d. Place a tube containing 3 mL of filtered diluent on the SIP.



To avoid adverse fluctuations in background event rate, ensure that the tube support arm is to the side for no longer than 15 seconds.

- e. Place the tube support arm under the new tube.
9. Run tube on LOW for 30 seconds to 1 minute and check that the event rate has stabilized.

Confirming small particle detection

This topic covers setting up the SPD QC experiment, setting up PMT voltages for small particles, and managing the background event rate.

Note: For future experiments, you can use the SPD QC experiment as an experiment template. Also, after setting up the PMT voltages, you can save the cytometer settings for use as application settings.

Setting up the SPD QC experiment

1. In the BD FACSDiva™ software, create a new experiment and add a specimen.
2. Add two tubes to the specimen.
3. Rename the first tube to *MegaMix beads* and rename the second tube to *Diluent background*.
4. Set the current tube pointer to the MegaMix beads.
5. In the Cytometer window, click the **Parameter** tab and delete all parameters except FSC, SSC, SP SSC, and BB515.
6. Ensure Height and Log are selected for the parameters.
7. In the Threshold tab, select parameter **BB515** and set the threshold value to **200**.
8. In the Laser tab, verify that the window extension is set to 4.
9. Create the following plots in a global worksheet:
 - a. SP SSC-H histogram
 - b. BB515-H vs SP SSC-H dot plot
10. Select all the plots.
11. Using the Plot tab in the Inspector window, enable both **X Axis** and **Y Axis** checkboxes on the Biexponential Display panel.
12. Right-click any plot and select **Show Population Hierarchy**.
13. Create a 200 nm bead gate on the BB515-H vs SP SSC-H dot plot.
14. Create a statistics view and enable the SP SSC-H median for 200 nm Beads population:
 - a. Right-click any plot and select **Create Statistics View**.
 - b. Right-click the Statistics view and select **Edit Statistics View**.
 - c. In the Populations tab, select the 200 nm Beads population.
 - d. In the Statistics tab, select the **Median** checkbox for the SP SSC-H parameter.
 - e. Click **OK**.

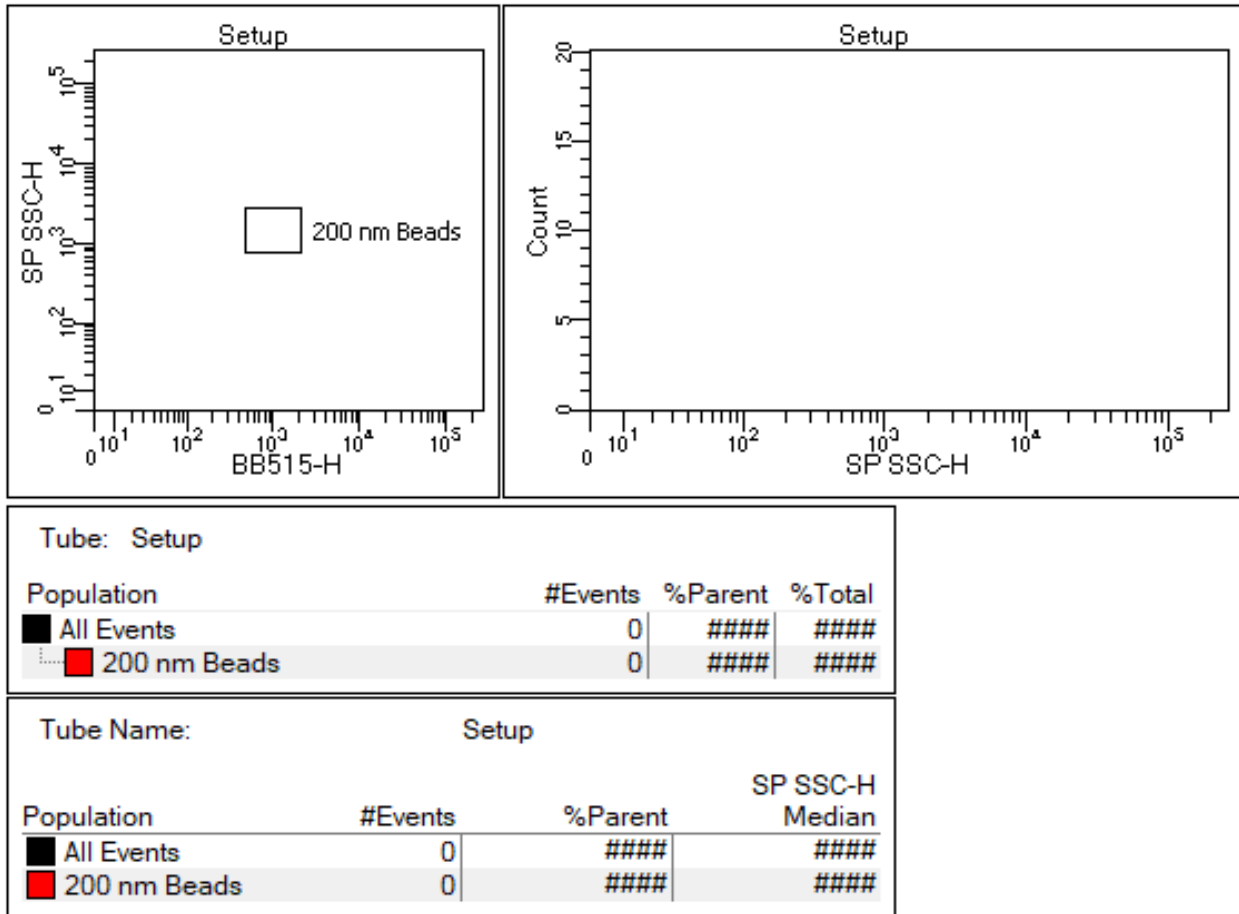

Setting up PMT voltages for small particles

This topic assumes that you have created an SPD QC experiment as detailed in the preceding topic.

Note: Cytometer settings used for the following procedure are for SPD alignment.

1. If the SPD QC experiment created using the previous procedure has been closed, reopen it.
2. Vortex a Megamix-Plus SSC beads vial and add 500 µL of the bead solution to a clean BD FACS™ tube.
3. Install the Megamix tube and acquire the sample on LOW.
4. Adjust the voltage for BB515 parameter to display bead populations in the middle of the SP SSC-H vs BB515-H dot plot.

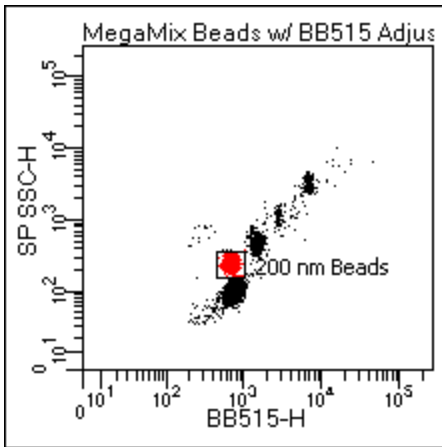

5. Align detector as described in [Aligning the small particle detector \(page 113\)](#).
6. Adjust the voltage for the SP SSC parameter until the median of 200 nm bead population is at channel 10^5 . The bead peak at 500 nm will be off-scale and the bead peak at 240 nm will be either off-scale or close to it. Position the 200 nm bead gate to fully encompass the 200 nm population.

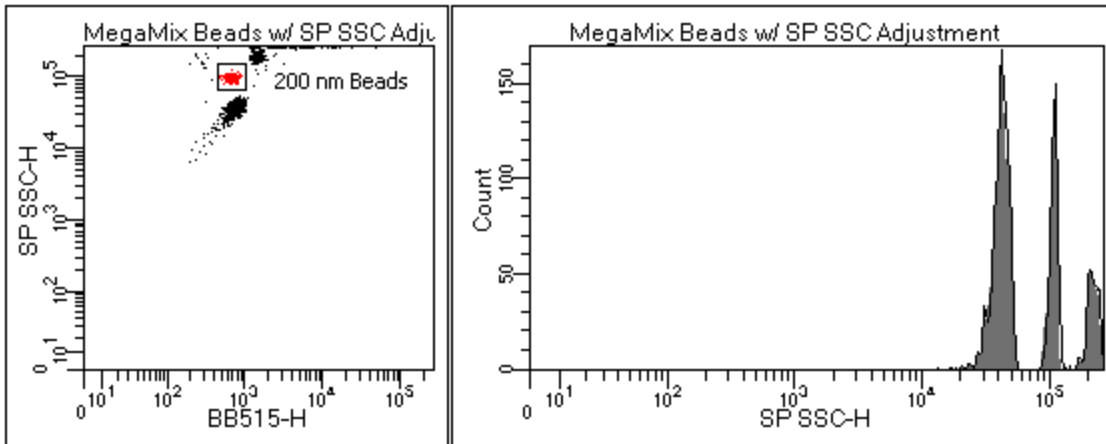

Tube: MegaMix Beads w/ SP SSC Adjustment			
Population	#Events	%Parent	%Total
All Events	1,986	####	100.0
200 nm Beads	481	24.2	24.2

Tube Name: MegaMix Beads w/ SP SSC Adj...			
Population	#Events	%Parent	SP SSC-H Median
All Events	1,986	####	46.592
200 nm Beads	481	24.2	100.864

7. Record the MegaMix-Plus beads mixture.

Managing background noise

Reducing background noise

The procedure in this topic should be performed at least once after the previous setup procedures, to remove traces of the MegaMix-Plus beads before checking the background noise. The following procedure assumes that the system is currently running on LOW with a tube of MegaMix-Plus mixture or filtered diluent on the SIP.

1. Prepare a tube with 3 mL of a 1.5% dilution of BD[®] Detergent Solution Concentrate. See [Required materials \(page 107\)](#).



Never mix BD[®] Detergent Solution Concentrate and bleach because they create chlorine gas.

2. Change the tubes on the SIP:
 - a. While still running the system on LOW, remove the tube containing MegaMix-Plus beads or filtered diluent.
 - b. Wipe the SIP with a delicate task wipe.
 - c. Move the tube support arm to the side for 10 seconds.
 - d. Install the tube containing detergent solution on the SIP.



To avoid adverse fluctuations in background event rate, ensure that the tube support arm is to the side for no longer than 15 seconds.

- e. Place the tube support arm under the new tube.
3. Continue to run the detergent solution on LOW for 15 minutes. During this time, prepare a clean tube containing 3 mL of filtered diluent—see [Required materials \(page 107\)](#).
 4. Change the tubes on the SIP:
 - a. While still running the system on LOW, remove the tube containing detergent solution.
 - b. Wipe the SIP with a delicate task wipe.
 - c. Move the tube support arm to the side for 10 seconds.
 - d. Place a tube containing 3 mL of filtered diluent on the SIP.



To avoid adverse fluctuations in background event rate, ensure that the tube support arm is to the side for no longer than 15 seconds.

- e. Place the tube support arm under the new tube.
5. Continue to run the filtered diluent for 1 minute on LOW.

Analyzing background noise

To confirm that the background noise has stabilized, the following procedure should be performed after the previous noise-reduction procedure. In other words, the SPD QC experiment is open, a tube of filtered diluent is loaded on the SIP, and the system is running on LOW.

1. Move the pointer to a new tube with no data recorded.
2. In the Cytometer window, select the **Threshold** tab.
3. Change the parameter to **SP SSC** and set the threshold value to **200**.

4. Acquire and observe the threshold rate for 5 minutes.
 - a. If the event rate stops decreasing, record 1 minute of data for the filtered diluent on LOW.
 - b. If the event rate does not decrease, see [Small particle detector troubleshooting \(page 116\)](#).

Aligning the small particle detector

The New Focus Picomotor application can be used to align the SPD if needed.

To use the New Focus Picomotor Application:

1. Open the New Focus Picomotor Application by double-clicking the icon on the desktop.

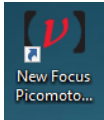

2. In the Controller area in the upper left of the dialog, select the Controller, as shown in the following screen capture.

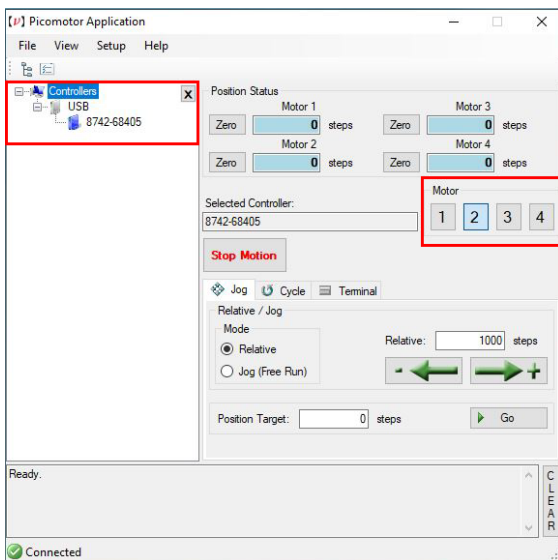

3. In the Motor area, you can select the motors that are configured for your system. Typically, Motor 1 is for the X direction and Motor 2 is for the Y direction.
4. The Position Status shows the relative position of the motors. Zero the positions so you have a reference established for the starting point. If you cannot hear Motors 1 and 2 responding, return to the preceding step and select Motors 3 and 4.
5. Select Relative mode and set the steps value to 1000, as highlighted in the following screen capture.

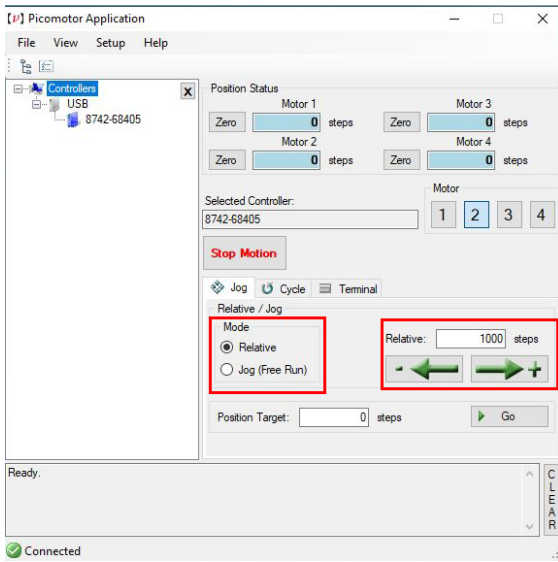

6. In the Relative steps area, you can select – (minus) or + (plus) to move the motor stage in small increments.
7. While acquiring your MegaMix-Plus bead mixture and examining the SP SSC-H v BB515-H plot and SP-SSC-H histogram, move the motors one step at a time. The SPD is aligned when the bead peaks are tight and well separated.

The following plot diagrams and statistics views show an example of a poorly aligned SPD:

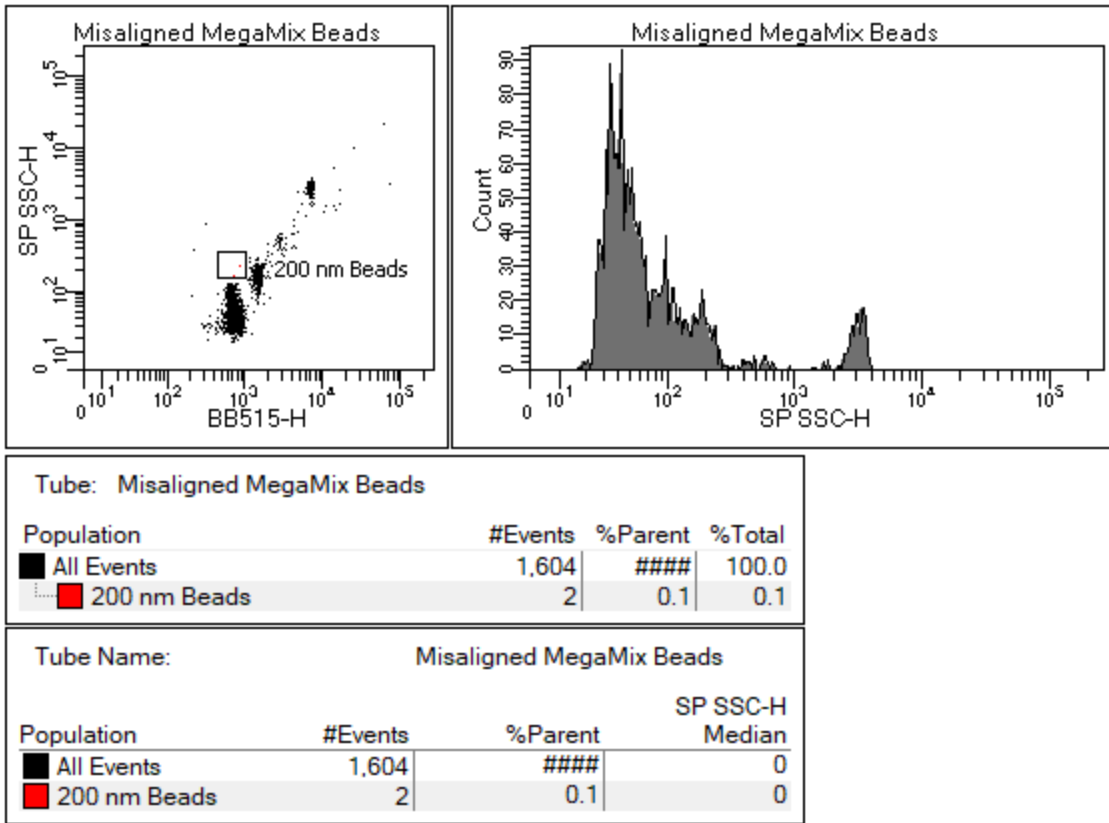

The following plot diagrams and statistics views represent an example after alignment using Picomotor Application:

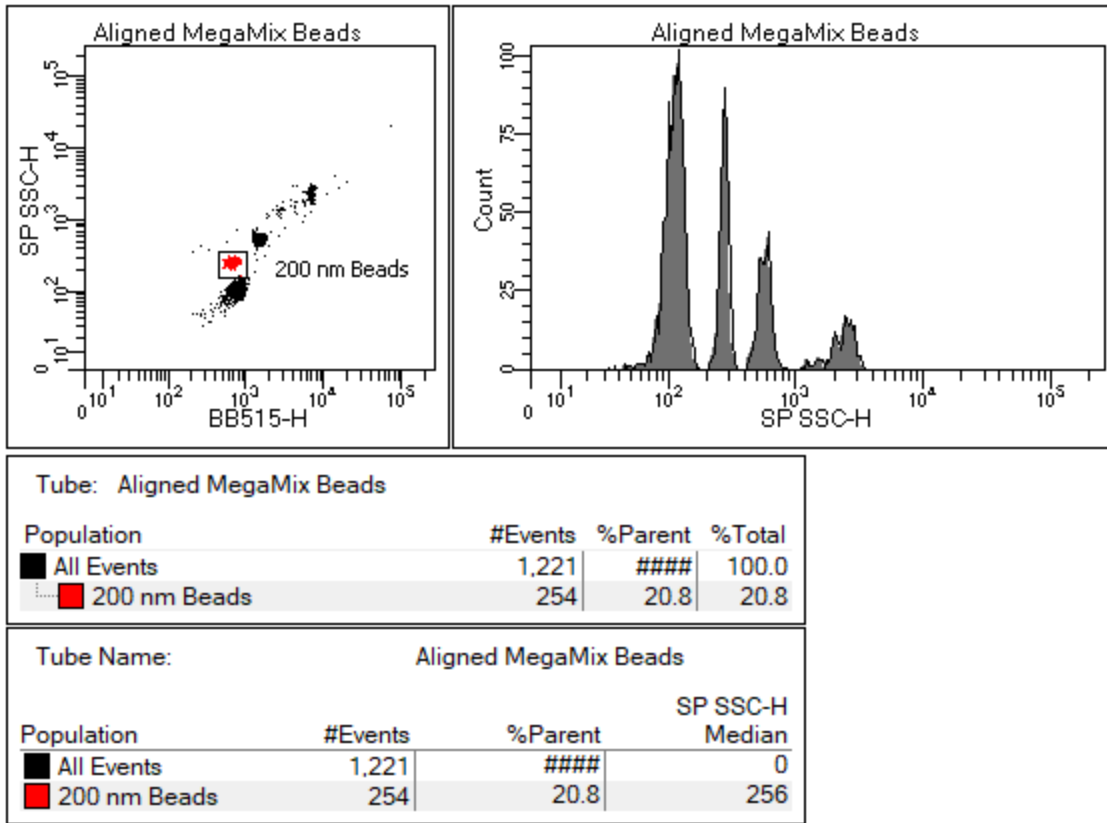

- After alignment, close the New Focus Picomotor Application and return to [Setting up PMT voltages for small particles \(page 110\)](#).

Small particle detector troubleshooting

Event rate or background noise is higher than expected

Possible causes	Recommended solutions
Your sample diluent may be the source of the noise or there may be leftover beads in the system.	<ol style="list-style-type: none"> 1. Acquire filtered diluent on LOW and observe event rate for 5 minutes. If event rate is decreasing, continue to run until desired rate is achieved or rate stops falling. 2. Repeat the noise-reduction procedure—see Reducing background noise (page 112). 3. Prepare a clean new tube of filtered diluent. 4. While still running on LOW, remove the tube of filtered diluent used in step 1. 5. Wipe the SIP with a delicate task wipe. 6. Move the tube support arm to the side for 10 seconds. 7. Place the new tube of filtered diluent on the SIP. <div style="display: flex; align-items: center; margin: 10px 0;">  <p>To avoid adverse fluctuations in background event rate, ensure that the tube support arm is to the side for no longer than 15 seconds.</p> </div> <ol style="list-style-type: none"> 8. Place the tube support arm under the new tube of filtered diluent and continue to run on LOW.

STANDBY or PRIME mode is initiated in the middle of the small particle experiment

Possible causes	Recommended solutions
Tube support arm is left to the side for longer than 15 seconds	<ol style="list-style-type: none"> 1. Acquire filtered diluent on LOW and observe event rate for at least 2 minutes. 2. Check the background event rate. 3. Continue running filtered diluent until the event rate stops decreasing.

11

Supplies and consumables

This chapter covers the following topics:

- [Ordering information \(page 118\)](#)
- [Beads \(page 118\)](#)
- [Reagents \(page 118\)](#)
- [Equipment \(page 119\)](#)

Ordering information

To order spare parts and consumables from BD Biosciences:

- Within the US, call (877) 232-8995.
- Outside the US, contact your local BD Biosciences customer support representative.

Worldwide contact information can be found at bdbiosciences.com.

Beads

Introduction

This topic lists the QC and CS&T beads available.

QC particles

Particle	Laser	Supplier	Catalog No.
SPHERO™ Rainbow Calibration Particles (8 peaks)	Blue, Violet, Yellow-Green and Red	BD Biosciences	559123
SPHERO Ultra Rainbow Fluorescent Particles (single peak)	Blue, Violet, Yellow-Green and Red	Spherotech, Inc.	URFP-30-2
BD DNA QC Particles	Blue (488 nm)	BD Biosciences	349523

CS&T beads

Bead	Laser	Supplier	Catalog No.
BD FACSDiva™ 2.0 CS&T research beads	<ul style="list-style-type: none"> • Violet (405 nm) • Blue (488 nm) • Red (637 nm) • Yellow-green (561 nm) 	BD Biosciences	<ul style="list-style-type: none"> • 655050 (50 tests) • 655051 (150 tests)

Reagents

Reagent	Supplier	Catalog No.
MegaMix-Plus SSC Beads	BioCytex™	7803
BD FACSTFlow™ sheath fluid	BD Biosciences	342003
BD FACS™ Sheath Solution with Surfactant (recommended for use with the HTS option)	BD Biosciences	336524 (USA), 336911 (Europe)
Monoclonal antibodies	BD Biosciences	See the BD Biosciences Product Catalog or the BD Biosciences website (bdbiosciences.com)

Reagent	Supplier	Catalog No.
BD FACS™ Lysing Solution	BD Biosciences	349202
BD® Detergent Solution Concentrate	BD Biosciences	660585
BD FACSClean™ solution	BD Biosciences	340345
Dyes and fluorochromes	BD Biosciences, Sigma, or Life Technologies	–
Chlorine bleach (5% sodium hypochlorite)	Clorox® or other major supplier (to ensure that the bleach is at the correct concentration and free of particulate matter)	–

Equipment

Equipment item	Supplier	Catalog No.
Bal seal	BD Biosciences	343509
O-ring, sample tube		343615
Sheath filter assembly		345743
Falcon polystyrene test tubes, 12 x 75-mm	Corning	

This page intentionally left blank

4

405-nm violet laser 101

488-nm blue laser 102

5

571-nm yellow-green laser 103

6

637-nm red laser 104

A

acridine orange (AO) 39

air bubbles, removing 29

alarm

 waste container 21

Alexa Fluor 102, 104

analysis

 data 68

 reusing 75

 saving 75

antibodies 79

AO See acridine orange 39

application settings

 applying 69

 creating 63

aspiration (sample), rapid 90

assistance, technical 9

B

Bal seal

 ordering 119

 replacing 46

bandpass (BP) filters

 detector array placement 22

 theory 82

BD FACSClean 38, 41

BD FACSClean solution 119

BD FACSDiva software See software 8

BD FACSDiva sheath fluid 118

BD FACSDiva solution 28

BD FACSDiva supply system 26, 40

BD FACSDiva A1

 configurations 101

 documentation 8

 flow cytometer overview 12

 lasers and optics 22

BD High Throughput Sampler (HTS) 12, 16, 20, 90

BD Horizon fluorochromes 101

blank optical holders 35

bleach 38, 119

BP See bandpass filters 22

bubbles, removing air 29

buttons

 fluid control 16

 sample flow rate control 17

C

calculating compensation 66

capacity, waste container 21

cleaning solutions 38

compensation

 calculating 66

 control tubes 64

 recording settings 65

 theory 83

components

 sheath container shown 27

 sheath filter shown 44

 waste container shown 31

computer system, about 23

configuration

 BD FACSDiva 53

- containers
 - sheath 21, 27
 - waste 21, 30, 32
- control panel, cytometer 15
- controls
 - fluidics 15
 - single-stained 53, 68
- conventions
 - safety symbols 8
- creating
 - analysis objects 71
 - global worksheets 68
 - statistics view 71
- CS&T beads 118
- CV, troubleshooting 94
- cytometer 13
 - configuration 35, 53
 - disconnect error 95
 - setup 52
 - starting 26
 - troubleshooting 90

D

- Daily cleaning 39
- DAPI, cleaning after using 39
- data
 - analyzing 68, 71
 - gating 71
 - recording 68-69
- debris, excessive 94
- detector arrays 22
- detectors 23
- dichroic mirrors
 - theory 82
- digital data 13
- digital electronics 86
- Diva software See software 8
- DNA, flow rate for analysis 78
- droplet containment system 21

E

- electronics
 - digital 86
 - laser controls 86
 - pulse 84
 - pulse measurements 85
 - threshold 86
 - troubleshooting 95
- emission duration 84
- event rate
 - erratic 93
 - high 92
 - low 93
 - zero 91-92
- excessive debris 94
- excitation wavelength 79
- experiments
 - creating 58
 - immunophenotyping 68
 - sample optimization 58
 - specifying parameters 58

F

- FACSClean 38, 41, 119
- FACSFlow sheath fluid 118
- FACSFlow solution 28
- Falcon tubes 90
- filters, optical
 - bandpass (BP) 22, 82
 - dichroic See dichroic mirrors 82
 - longpass (LP) 80-81
 - notch 80
 - shortpass (SP) 80-81
 - theory 80
- filters, sheath
 - attaching new 45
 - replacing 43
- FITC and Stokes shift 79
- fixed-alignment lasers 13
- flow cell
 - draining 32

- fluidics 78
- flow rate control buttons 17
- fluid control buttons
 - PRIME 17
 - RUN 16
 - STANDBY 17
- fluidics
 - description 16, 78
 - flow rate control 17
 - flushing system 40
 - preparing 32
 - removing air bubbles 29
 - run mode 16
 - sample injection port (SIP) 20
- fluidics controls, cytometer 15
- fluidics interconnect 30
- fluorescence
 - defined 79
 - emission 84
- fluorescence signal, none 92
- fluorochromes
 - compensation theory 83
 - measured 35
 - role in light emission 79
- flushing the system 40
- forward scatter (FSC) 79
- FSC See forward scatter 79

G

- gating data 71
- global worksheets
 - analyzing data 71
 - creating 68
 - previewing data 68, 75

H

- hazard symbol definitions 8
- Help, accessing 8
- High Throughput Sampler (HTS) 12, 16, 20, 90
- Horizon fluorochromes 101
- hydrodynamic focusing 78

I

- immunophenotyping
 - analysis 71
 - experiment 68
 - hydrodynamic focusing 78

L

- lasers
 - performance check 55
 - quality control (QC) particles 118
 - wavelengths and power 22
- longpass (LP) filters
 - defined 80
 - theory 81
- LP See longpass filters 80

M

- maintenance
 - Bal seal 46
 - cytometer shutdown 40
 - replacing waste tank cap 42
 - sample tube O-ring 48
 - schedule 38
 - sheath filter 43
 - system flush 40
- mirrors, dichroic longpass (LP) filter 22

N

- notch filters 80

O

- O-ring
 - ordering 119
 - replacing 48
 - worn 90
- online Help 8
- optic holder 35
- optics
 - components 22
 - configuration 53-54
 - dichroic mirrors 82

- filters 22, 80
- optimization, sample 52
- ordering spare parts 118

P

- Pacific Blue fluorochrome 101
- particles 118
- PerCP, Stokes shift 79
- performance check 55
- photodiode 23
- photomultiplier tubes (PMTs) 23
- PMT See photomultiplier tubes 23
- population hierarchy 71
- PRIME, fluid control button 17
- priming fluidics system 32
- propidium iodide (PI) 39
- pulse
 - definition 84
 - measurements 85
 - processors 85

Q

- quality control (QC)
 - particles 118
 - troubleshooting 94

R

- recording
 - compensation settings 65
 - compensation tubes 64
 - data 68-69
- removing air bubbles, filter 29
- replacing
 - Bal seal 46
 - sample tube O-ring 48
 - sheath filter 43
 - waste air filter 49
 - waste tank cap 42
- reusing analyses 75
- RUN
 - button orange 92
 - fluid control button 16

S

- safety symbol definitions 8
- safety symbols 8
- sample
 - optimization 52
 - optimization experiment 58
 - optimization, single-stained controls 53, 68
- sample injection port (SIP)
 - components 20
 - hydrodynamic focusing 78
 - replacing Bal seal 46
 - replacing sample tube O-ring 48
- sample tube
 - injection 20
 - not fitting 90
 - requirements 90
- samples, running 69
- saving analyses 75
- scatter
 - light 79
 - parameter distortion 94
- setup, cytometer 52
- sheath
 - flow 78
- sheath container
 - components shown 27
 - defined 21
 - preparing 28
- sheath filter
 - components shown 44
 - ordering 119
 - removing air bubbles 29
 - replacing 43
- sheath fluid 78
 - BD FACFlow sheath fluid 118
- sheath tank
 - depressurize 28
- shortpass (SP) filters 80-81
- side scatter (SSC) 79
- signals, amplifying 23
- SIP See sample injection port 78

- small particle detector
 - Picomotor application 113
 - troubleshooting 116
- software
 - cytometer control 8
 - version 23
- spare parts, ordering 118
- spillover 83
- SSC See side scatter 79
- STANDBY, fluid control button 17
- starting cytometer 26
- statistics views 71
- Stokes shift 79
- support, technical 9

T

- technical assistance 9
- thiazole orange (TO) 39
- threshold, defined 86
- TO See thiazole orange 39
- troubleshooting
 - cytometer 90
 - electronics 95
 - small particle detector 116
- tubes
 - Falcon 90
 - requirements 90

U

- user preferences 54

W

- waste air filter
 - component shown 31
- waste container 21
 - alarm 21
 - capacity 21
 - components shown 31
 - defined 21
 - emptying 30
- workstation, about 23

Becton, Dickinson and Company
BD Biosciences
2350 Qume Drive
San Jose, California 95131 USA

BD Biosciences
European Customer Support
Tel +32.53.720.600
help.biosciences@bd.com

bdbiosciences.com
ResearchApplications@bd.com