



Empire
mouldings
& boards

2016 Midwest Edition

Mouldings

Stair Parts

Boards

Exterior Millwork



The mark of
responsible forestry





Ask about our FSC® availability

COMBINE AND DESIGN

General Requirements / Recommendations

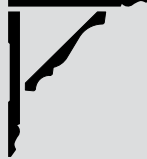

Built-Up Mouldings

- 
 - 7163 BASE
 - L 45 CROWN
- 
 - 1X6 BOARD
 - 93 COVE
 - 956W BACKER BEAD
 - L 300 CHAIR RAIL
- 
 - 185 PANEL MOULD
- 
 - L P815 BASE
 - L P813 BASE
 - L 210 SHINGLE MOULD

General Grade Information

GRADE: Wood mouldings are available in two grades. "**N-Grade**" is intended for natural or clear finishes and the exposed face must be of one single piece. "**P-Grade**" is intended for opaque paint finishes or overlays and can be finger jointed and/or "**edge glued**".

These grades may have a few minor characteristics such as light checks, small pitch pockets, light torn grain, occasional medium stain or a small amount of medium pitch. A serious combination of these is not admissible in any one piece. The number and extent of characteristics permitted varies as the area of the piece increases or diminishes.

N-GRADE: Suitable for natural, stain, paint or enamel finish. On the basis of net 2" face and 12' length, this grade will admit the following characteristics or their equivalent.

- a. A small spot of torn grain, one foot of medium pitch, light skip in dressing on back, or
- b. One small and one very small pitch pocket, or
- c. One short tight season check and a light snipe at one end, or
- d. Medium stain in occasional (10%) pieces for one third the area in on otherwise perfect piece.

Characteristics that will not show when piece is laid shall not be given the same consideration as characteristics elsewhere.

P-GRADE: (paint or overlay grade). The same quality as N-Grade except stain is no defect. Glue joints (laminated or finger joints) must be precision machined and assembled with tight joints. Patching, filling or plugging is permitted providing paintable surface results.

It is recommended that when installing finger joint mouldings that the mouldings be acclimated for 72 hours at the installation site before installing them.

General Requirements – MDF

GRADE: MDF mouldings are intended for opaque paint finishes or overlays. **MDF** moulding and millwork will be manufactured from panel boards of varying densities. Thickness and width tolerance + or - 1/32 per WMMPA grade rules. Trimbacks – not more than 10% permitted in any one item.

WMMPA recommends that all **MDF** mouldings be purchased paint primed. Raw **MDF** has a tendency to absorb water vapor from the surrounding air and this could cause fiber pop. This will be the customer's liability if they choose raw material.

It is recommended that when installing **MDF** mouldings that the mouldings be acclimated for 72 hours at the installation site before installing them.

****DISCLAIMER** All product should be inspected for manufacturing defects prior to installation or painting.**

Table of Contents

GRADE / SPECIE INFORMATION3	BASE	CEILING
BOARDS & SHEETS4	Base13-19	Bed Mould22
WINDOW & DOOR	Base Cap13	Cove22
Casing5-9	CHAIR & WALL	Crown22-27
Mullions10	Chair Rail20	GENERAL PURPOSE28-29
Stops10	Backer Bead20	RAIL29
Brick Mould11	Panel Mould21	PVC Moulding / Boards / Sheets30-31
Shingle Mould11	Ply Cap21	BLOCKS32-33
Stool11	Wainscoting21	INDEX34
Jambs / Frames12	Wainscoting Cap21	EMPIRE PRODUCT LINES35
Pre-Mitered Casings12		

Species Definitions

BIRVN Birch Veneer over FJ wood	PINEV Pine Veneer
CLAY COAT (FJPC) Finger Joint Primed Pine Clay Coat	SPINE Southern Yellow Pine
DFIR Doug Fir	PRIMED (FJPM) Finger Joint Primed Pine
DOUBLE PRIMED (FJDP) ... Finger Joint Primed Pine (Double Pass)	POPLAR (POPLR) Poplar
MAPLE Maple	POPBD Poplar Board
MAPLS Maple Boards	POPFP FJ Poplar
MDF (FBDPM) Primed MDF Fiber Board	POPVW Poplar Veneer Wrap
OAK (OAKSL) Red Oak	PVC PVC Vinyl
OAKBD Oak Board	WHITE PVC Vinyl
OAKOV Oak Veneer over FJ wood core	WBIRVN Birch Veneer Wrap
OAKVN Oak Veneer over particle board	WOAKVN Oak Veneer Wrap
PINE Pine	

SOFTWOOD | MDF

L 248 (1X2)	11/16 x 1-3/4	CLEAR PINE 8' 16' RL PRIMED 16'
L 246 (1X3)	11/16 x 2-3/4 11/16 x 2-3/4	CLEAR PINE 8' 10' RL PRIMED 16'
1X4	3/4 x 3-1/2	CLEAR PINE 6' 8' 10' 12' 14' 16' RL PRIMED 16'
	23/32 x 3-1/2	MDF 8' 16'
	(18mm) 11/16 x 3-1/2	
1X6	3/4 x 5-1/2	CLEAR PINE 6' 8' 10' 12' 14' 16' RL PRIMED 16'
	23/32 x 5-1/2	MDF 8' 16'
	(18mm) 11/16 x 5-1/2	
1X8	3/4 x 7-1/4	CLEAR PINE 6' 8' 10' 12' 14' 16' RL PRIMED 16'
	23/32 x 7-1/4	MDF 8' 16'
	(18mm) 11/16 x 7-1/4	
1X10	3/4 x 9-1/4	CLEAR PINE 6' 8' 10' 12' 14' 16' RL PRIMED 16'
	23/32 x 9-1/4	MDF 8' 16'
	(18mm) 11/16 x 9-1/4	
1X12	3/4 x 11-1/4	CLEAR PINE 6' 8' 10' 12' 14' 16' RL PRIMED 16'
	23/32 x 11-1/4	MDF 8' 16'
	(18mm) 11/16 x 11-1/4	
5/4X4	(25mm) 1 x 3-1/2	MDF 16'
5/4X6	(25mm) 1 x 5-1/2	MDF 16'
5/4X8	(25mm) 1 x 7-1/4	MDF 16'
5/4X12	(25mm) 1 x 11-1/4	MDF 16'

EASED EDGE BOARDS

L 250E (18mm)	11/16 x 1-1/2	MDF 8' 10'
E1X3 (18mm)	11/16 x 2-1/2	MDF 8'
E1X4 (18mm)	11/16 x 3-1/2	MDF 8' 10' 16'
E1X6 (18mm)	11/16 x 5-1/2	MDF 8' 16'
E1X8 (18mm)	11/16 x 7-1/4	MDF 8' 16'

HARDWOOD

248 (1X2)	3/4 x 1-3/4	OAK 4' 6' 8' 10' RL POPLAR 4' 6' 8' 10' 12' RL
246 (1X3)	3/4 x 2-3/4	OAK 4' 6' 8' POPLAR 4' 6' 8' 10' RL POPLAR, OAK 4' 6' 8' 10' 12' 14' 16' RL PRIMED FJ POPLAR 16'
1X4	3/4 x 3-1/2	MAPLE 6' 8' RL POPLAR, OAK 4' 6' 8' 10' 12' 14' 16' RL PRIMED FJ POPLAR 16'
1X6	3/4 x 5-1/2	MAPLE 6' 8' RL POPLAR, OAK 4' 6' 8' 10' 12' 14' 16' RL PRIMED FJ POPLAR 16'
1X8	3/4 x 7-1/4	MAPLE 6' 8' RL POPLAR, OAK 4' 6' 8' 10' 12' 14' 16' RL PRIMED FJ POPLAR 16'
1X10	3/4 x 9-1/4	MAPLE 6' 8' RL POPLAR, OAK 4' 6' 8' 10' 12' 14' 16' RL OAK VENEER 16'
1X12	3/4 x 11-1/4	MAPLE 4' 6' 8' RL MAPLE VENEER 16'
1X4	3/4 x 3-1/2	POPLAR 4' 6' 8' 10' 12' 14' 16' RL PRIMED FJ POPLAR 16'
1X6	3/4 x 5-1/2	OAK 6' 8' 10' 12' 14' RL

SKIRTBOARDS

1X12	3/4 x 11-1/4	OAK VENEER, MAPLE VENEER 16' 18' POPLAR VENEER 18'
5/4X4	1-1/16 x 3-1/2	PRIMED RL
5/4X6	1-1/16 x 5-1/4 1-1/16 x 5-1/2	POPLAR RL PRIMED RL
5/4X8	1-1/16 x 7-1/4	POPLAR RL PRIMED RL
5/4X10	1-1/16 x 9-1/4	POPLAR RL PRIMED RL
5/4X12	1-1/16 x 11-1/4	POPLAR RL PRIMED RL

PVC

TRIM BOARD - EMBOSSED / SMOOTH			
1X2	3/4 x 1-1/2	7832	PVC 8' 12'
1X3	3/4 x 2-1/2	7833	PVC 8'
1X4	3/4 x 3-1/2	7834	PVC 8' 12' 18'
1X6	3/4 x 5-1/2	7835	PVC 8' 12' 18'
1X8	3/4 x 7-1/4	7836	PVC 8' 12' 18'
1X10	3/4 x 9-1/4	7837	PVC 8' 12' 18'
1X12	3/4 x 11-1/4	7838	PVC 18'
5/4X4	1 x 3-1/2	7840	PVC 10' 18' 20'
5/4X6	1 x 5-1/2	7841	PVC 10' 18' 20'
5/4X8	1 x 7-1/4	7842	PVC 18'
5/4X10	1 x 9-1/4	7843	PVC 18'
5/4X12	1 x 11-1/4	7844	PVC 18'
TRIM PLANK - SMOOTH			
1X4	3/4 x 3-1/2	7318	PVC 8'
1X6	3/4 x 5-1/2	7311	PVC 8'

SHEETS

LITE MDF UNPRIMED SHEETS
L 344 18mm thick x 49" wide x 97" long
Unprimed MDF
*Sold in unit quantities only:
 22 sheets per unit**

* Unit quantities subject to change

PVC SHEETS - SMOOTH OR EMBOSSED
 4' x 8' PVC Sheets

Available in thicknesses:
 3/8" | 1/2" | 3/4" | 1"

Reversible Finish
 Embossed / Smooth

E 2878	3/8"	PVC
E 2871	1/2"	PVC
E 2837	3/4"	PVC
E 2864	1"	PVC



316 11/16 x 2-1/4 PINE 7' 8' 10' 12' 14' PRIMED 7' 10' 14' OAK 7' 8' 10' RL	321 11/16 x 2-1/4 PINE 7' 10' RL	324 11/16 x 2-1/4 PINE 7' 10' 14' RL	L 324 1/2 x 2-1/4 OAK 7' 10' RL	327 11/16 x 2-1/4 PINE 7' 8' 10' 14' RL PRIMED 7' 10' 14'
356C 11/16 x 2-1/4 CLAY COAT 7' 1" 15'	L 356 1/2 x 2-1/4 OAK 7' 8' 10' RL L 356 (14mm) 9/16 x 2-1/4 MDF 7' 10'	356 11/16 x 2-1/4 PINE 7' 8' 10' 12' 14' 16' RL PRIMED 7' 10' 14' CLAY COAT 7' 14' 19/32 x 2-1/4 MDF 7' 14' 5/8 x 2-1/4 OAK 7' 8' 10' 12' RL POPLAR 7' 12' RL	366 11/16 x 2-1/4 PINE 7' 8' 10' 14' PRIMED 7' 10' 14' CLAY COAT 7' 7'2" 14' 5/8 x 2-1/4 OAK 7' RL POPLAR 7' 12' RL	
L 366 1/2 x 2-1/4 OAK 7' L 366 (14mm) 9/16 x 2-1/4 MDF 7'	366A 19/32 x 2-1/4 MDF 7' 14'	376 11/16 x 2-1/4 PINE 7' PRIMED 7' 10' 19/32 x 2-1/4 MDF 14'	473 E2E 9/16 x 2-1/4 PINE 7' 8' RL	L 473 E2E 19/32 x 2-1/4 MDF 7'6" 15' 1/2 x 2-1/4 OAK 7' 8' 10' RL POPLAR 7' RL



351
11/16 x 2-1/2
PINE 7' | 14'
PRIMED 7' | 10' | 14'
19/32 x 2-1/2
MDF 7'



361
11/16 x 2-1/2
PINE 7' | 10' | RL
PRIMED 7' | 10' | 14'
CLAY COAT 7' | 14'
19/32 x 2-1/2
MDF 7' | 10' | 14'
OAK 7' | RL



4532
11/16 x 2-1/2
MDF 7'6" | 15'



P 380
11/16 x 2-3/4
PINE 7'6" | RL
PRIMED 7'4" | 10'
CLAY COAT 7'6" | 15'
MDF 7'6" | 16'
POPLAR 7'4" | RL



L 471 E2E
19/32 x 2-3/4
MDF 15'



474
11/16 x 2-3/4
CLAY COAT 7'6" | 15'
OAK 7'4" | 12' | RL



685
11/16 x 2-3/4
MDF 16'
POPLAR 7'6" | RL



4520
11/16 x 2-3/4
MDF 7'6" | 15'



2496
11/16 x 3
PRIMED 8' | 16'



312
19/32 x 3
MDF 8' | 12' | 16'



411
11/16 x 3
MDF 8' | 16'



8901
1/2 x 3
OAK 7'



L FLTD
7/16 x 3
PINE 7'



195
11/16 x 3-1/4
OAK 7'



L 366
11/16 x 3-1/4
CLAY COAT 15'



40
9/16 x 3-1/4
OAK 7'6" | 10' | RL



L 444
11/16 x 3-1/4
PINE 8' | 10' | 12' |
16' | RL
CLAY COAT 7'6" | 15'
POPLAR 7'6" | RL
19/32 x 3-1/4
MDF 8' | 16'
3/4 x 3-1/4
OAK 7'4" | 8' | 10' |
12' | RL



445
11/16 x 3-1/4
PINE 8'
PRIMED 8' | 11' | 16'
CLAY COAT 7'6" | 15'
19/32 x 3-1/4
MDF 8' | 12'



445A
11/16 x 3-1/4
MDF 8' | 16'

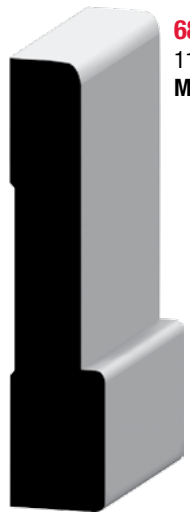

683
11/16 x 3-1/4
MDF 16'



L 434
11/16 x 3-1/4
POPLAR 7'6" | RL
OAK 8' | RL



682
1 x 3-1/4
MDF 7'6" | 8' | 12' | 16'
13/16 x 3-1/4
POPLAR 7'6" | RL



L CC14
3/4 x 3-1/4
MDF 16'



PT3
1 x 3-1/4
MDF 8' | 12' | 16'



REV
5/8 x 3-1/4
PINE 7'

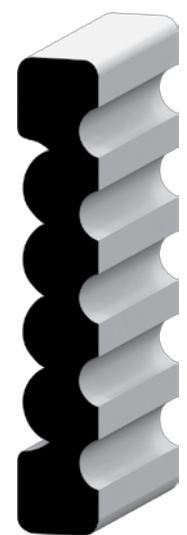

L 338
9/16 x 3-3/8
MDF 8'



SC312
1 x 3-1/2
MDF 8' | 16'



L 361
11/16 x 3-1/2
PINE 7'4" | RL
PRIMED 7'4" | 15'



L 361C
11/16 x 3-1/2
PINE 8' | 16'
CLAY COAT 8' | 16'



374
11/16 x 3-1/2
CLAY COAT 7'6" | 16'
MDF 8' | 16'
3/4 x 3-1/2
OAK RL



G 412
9/16 x 3-1/2
MDF 16'

Lengths in RED subject to availability

Lengths in RED subject to availability



412 E2E
19/32 x 3-1/2
MDF 8' | 12' | 16'
E412 E2E
11/16 x 3-1/2
PRIMED 16'
432 E2E
9/16 x 3-1/2
PRIMED 16'



444
11/16 x 3-1/2
PRIMED 16'



444A
11/16 x 3-1/2
MDF 16'



446
11/16 x 3-1/2
MDF 16'



8954
11/16 x 3-1/2
MDF 16'



535
11/16 x 3-1/2
MDF 8' | 16'

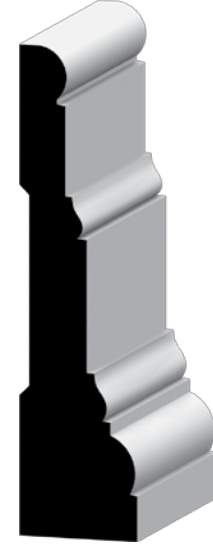

L FECA
7/8 x 3-1/2
MDF 8'



L PRCA
7/8 x 3-1/2
MDF 8'



5000
1-3/16 x 3-3/4
MDF 16'

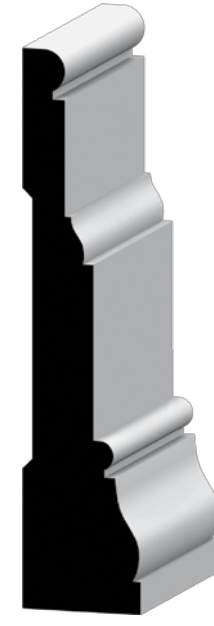

L APCA
7/8 x 4
MDF 8'

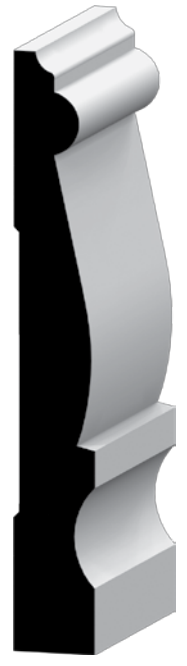

284
19/32 x 4-1/4
MDF 8' | 12'



EDC97
1 x 3-1/2
MDF 16'



P 450
11/16 x 3-1/2
PRIMED 7'4" | 10'
CLAY COAT 7'4" | 15' | 16'
POPLAR 7'4" | RL
MDF 16'

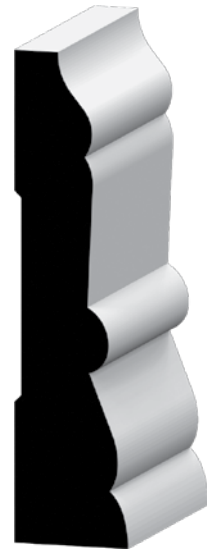

C PT11
3/4 x 3-1/2
MDF 16'



RB3
1 x 3-1/2
MDF 16'



S RB3
1-1/16 x 3-1/2
PRIMED 16'



465
11/16 x 4-1/4
MDF 16'



5010 ARCHITRAVE
1-3/16 x 4-1/4
MDF 16'

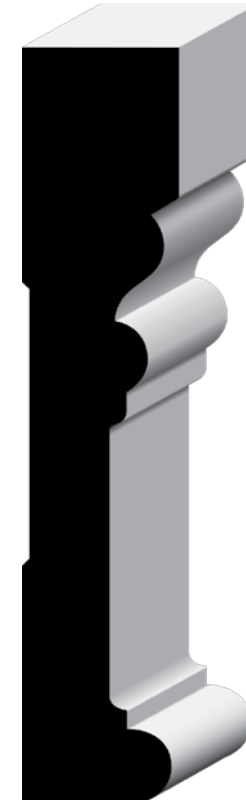

5021 ARCHITRAVE
1-1/8 x 5-5/16
MDF 16'



5030 ARCHITRAVE
1-3/16 x 6-1/4
MDF 16'



SA612 ARCHITRAVE
1-1/2 x 6-1/2
MDF 16'



857
3/8 x 1-1/4
PINE 7' | 8' | 10' | RL



L 887 E2E
3/8 x 1-1/4
PINE 7' | 8' | 10' | RL
OAK 7' | 8' | RL
POPLAR 7' | RL
PRIMED 7'
MDF 7' | 8' | 16'



Pg. 12
Double Mitered
Set Available

N 947
3/8 x 1-1/4
PINE 7' | 8' | 10' | RL
OAK 7' | 8' | 10' | RL
POPLAR 7' | RL
PRIMED 7' | 16'
DOUBLE PRIMED 7'
N 947
3/8 x 1-1/4
MDF 7'



846
7/16 x 1-3/8
PINE 7' | 8' | RL
OAK 7' | RL



856
3/8 x 1-3/8
PINE 7' | RL



876 E1E
7/16 x 1-3/8
PINE 7' | 10'
POPLAR 7' | RL
PRIMED 8' 2" | 16'



L 876 E2E
7/16 x 1-3/8
PRIMED 7'



936
7/16 x 1-3/8
PINE 7' | 8' | 10' | 12' | RL
PRIMED 16'
CLAY COAT 7'
OAK 7' | RL
POPLAR 7'



N 946
3/8 x 1-3/8
PINE 7'
MDF 7'
946
3/8 x 1-3/8
PRIMED 7'



935
7/16 x 1-5/8
PINE RL



845
7/16 x 1-5/8
PINE RL



BFOLD
3/4 x 1-5/8
OAK 7'



L 973
3/8 x 1-5/8
PINE 8'



L 983
3/8 x 1-5/8
PINE 8'



1305 T-ASTRAGAL
1-1/4 X 2
PINE 7'
PRIMED 7'



972 E2E
3/8 x 2
PINE 8' | RL



982
3/8 x 2
PINE 8' | RL



L 473 E2E
7/16 x 2-1/4
PRIMED 8' | 16'



493 E2E
7/16 x 2-1/4
PINE 8' | RL



962
1/4 x 2-1/4
OAK 8'

Lengths in RED subject to availability

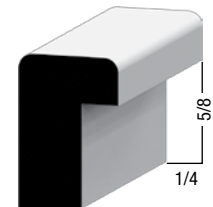

280 BACK BAND
11/16 x 1-1/16
PINE 8'
Fits up to 11/16 Profile

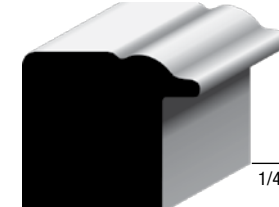

279 BACK BAND
1-1/16 x 1-1/8
PRIMED 16'

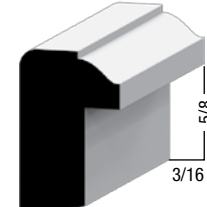

281 BACK BAND
11/16 x 1-1/8
PINE RL
Fits up to 11/16 Profile



H 282 BACK BAND
2 x 1-1/4
POPLAR RL

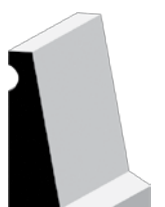

L 197 DRIP CAP
5/8 x 1-5/8
PINE RL



Pg. 12
Pre-Mitered Set
& Legs Available

180 BRICK
1-1/4 x 2
PRIMED 8' | 10' | 17'
2448
1-1/4 x 2
PVC 8' | 10' | 17'



E 208 SHINGLE
5/8 x 2-1/4
PRIMED 16'



L 210 SHINGLE
5/8 x 1-5/8
PINE 8'
PRIMED 8' | 16'



1153 STOOL
11/16 x 3-1/4
PINE 8' | 10' | RL



200 STOOL
1-1/4 x 1-3/4
PRIMED 16'



N/L STOOL
11/16 x 2-1/4
PINE 8' | RL



4 1021
11/16 x 4-1/2
PRIMED 16'



1155 STOOL
11/16 x 2-1/2
PINE 8'



1021 STOOL
11/16 x 5-1/4
PINE 8' | RL
MDF 8' | 16'
PRIMED 16'



E 1035 EXTENDED HALF ROUND
1/2 x 1-3/8
POPLAR 8' | RL



7 1021 STOOL
19/32 x 7-1/4
MDF 16'
11/16 x 7-1/4
PRIMED 16'



358 THRESHOLD
5/8 x 3-5/8
OAK 37" | 73"

Lengths in RED subject to availability

Jamb and Frame Collection

Dimensions	Below Dado	PRIMED	PINE	PINEV	MDF	BIRVN	WBIRVN	OAKVN	OAKOV	WOAKVN	POPVW	POPP
FLAT JAMBS, 6-8												
11/16 x 4-9/16	81"	X		X	X	X	X	X	X	X	X	X
11/16 x 4-7/8	81"	X		X	X							
11/16 x 5-1/4	81"	X		X								
11/16 x 6-9/16	81"	X		X								X
11/16 x 6-7/8	81"	X										
FLAT JAMBS, 7-0												
11/16 x 4-9/16	85"	X										
11/16 x 4-7/8	85"	X										
11/16 x 6-9/16	85"	X										
FLAT JAMBS, 8-0												
11/16 x 4-9/16	97"	X										X
11/16 x 4-7/8	97"	X										
11/16 x 6-9/16	97"	X		X								
11/16 x 6-7/8	97"	X										
11/16 x 7-1/4	97"	X										
FLAT JAMBS												
11/16 x 4-9/16 x 7'	PET	X										
11/16 x 4-3/4 x 7'	PET	X										
11/16 x 6-9/16 x 7'	PET	X										
11/16 x 6-9/16 x 10'	PET	X										
11/16 x 5 x 14'	PET	X										
11/16 x 4-9/16 x 17'	PET	X										
JAMB SET, 3-0 6-8												
11/16 x 4-9/16	81"	X		X								
SPLIT JAMB, 1-1/16 x 4-9/16												
2-3/4 FM x 2-1/2 M, 6-8	80-9/16"	X	X									
EXTERIOR FRAMES WITH WEATHER STRIP, 6-8 (ARMWL)												
1-1/4 x 4-9/16	83-5/8"	X										

Empire Pre-Mitered Collection

PRE-MITERED CASING OR FRAME SETS, 6-8

Profile	Casing Dimension	2-8	3-0	Species
L 324	1/2 x 2-1/4		X	OAK
L 356	1/2 x 2-1/4		X	OAK
180	1-1/4 x 2	X	X	PRIMED
316	11/16 x 2-1/4		X	PINE, PRIMED
327	11/16 x 2-1/4		X	PINE
356	11/16 x 2-1/4		X	PINE, PRIMED
366	11/16 x 2-1/4		X	PINE, PRIMED
4916	1-1/4 x 4-9/16		X	PRIMED w/Weather Strip

PRE-MITERED CASING LEGS, 7'

Profile	Casing Dimension	Species
180	1-1/4 x 2 (Left/Right)	PRIMED

DOUBLE MITERED STOP LEGS, 7'

TRIM ONE END FOR A LEFT OR RIGHT LEG

947	3/8 x 1-1/4	MDF
-----	-------------	-----



L 167 BASE CAP
5/8 x 1-1/8
PINE 8' | 10'



166 BASE CAP
11/16 x 1-1/4
PINE 8' | RL
PRIMED 8' | 16'



163 BASE CAP
11/16 x 1-3/8
MDF 16'
POPLAR 8' | RL



8740 BASE CAP
5/8 x 1-3/4
PRIMED 16'



L 627
7/16 x 2-1/2
PINE 8'



L 717
7/16 x 2-1/2
PINE 8'



L 634
7/16 x 3
PINE 8' | 10' | 12' | 16' | RL
PRIMED 8' | 10' | 12' | 16'
CLAY COAT 8' | 16'
3/8 x 2-3/4
OAK 8' | 10' | 12' | RL

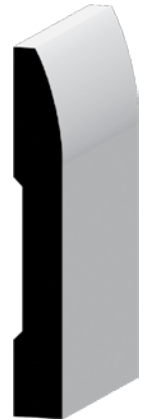

L 724
7/16 x 3
PINE 8' | 10' | 12' | 16'
PRIMED 8' | 10' | 12' | 16'
3/8 x 2-3/4
OAK 8' | 12' | RL



634
1/2 x 3
OAK 8' | 12' | RL



H 634
1/2 x 3
POPLAR RL



L 635
3/8 x 3
OAK 8' | 10' | 12' | RL



664
9/16 x 3
PINE 8'



714
9/16 x 3
PINE 8' | RL

Lengths in RED subject to availability



L 433 E2E
7/16 x 3-1/4
PINE 8' | RL
3/8 x 3
OAK 8' | 12' | RL
POPLAR RL



L 433E E1E
1/2 x 3-1/4
MDF 16'



623
9/16 x 3-1/4
PINE 8' | 10' | 12' | 16' | RL
PRIMED 8' | 10' | 12' | 16'
CLAY COAT 8' | 16'
1/2 x 3-1/4
MDF 8' | 12' | 16'



L 633
7/16 x 3-1/4
PINE 8' | 12' | RL
CLAY COAT 8' | 16'



633
1/2 x 3-1/4
OAK 8' | 10' | 12' | RL



H 633
1/2 x 3-1/4
OAK 8' | RL
POPLAR 8' | RL



L 414 E1E
9/16 x 4-1/4
PRIMED 16'



414 E1E
1/2 x 4-1/4
MDF 16'



435E E1E
7/16 x 4-1/4
OAK RL
POPLAR RL



410
19/32 x 4-1/4
MDF 8' | 16'



620
9/16 x 4-1/4
PINE 8' | 12' | 16' | RL
PRIMED 8' | 10' | 16'
CLAY COAT 8' | 16'
1/2 x 4-1/4
MDF 8' | 12' | 16'

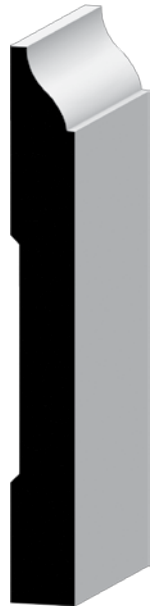

L 620
1/2 x 4-1/4
OAK 8' | 10' | 12' | RL
POPLAR 8' | RL



663
9/16 x 3-1/4
PINE 8' | 16' | RL
PRIMED 8' | 10' | 12'
CLAY COAT 16'
1/2 x 3-1/4
MDF 8' | 16'



713
9/16 x 3-1/4
PINE 8' | 10' | 12' | 16'
PRIMED 8' | 10' | 12' | 16'
1/2 x 3-1/4
MDF 8' | 12'



723
1/2 x 3-1/4
OAK 8' | 12'



L 723
7/16 x 3-1/4
PINE 8' | 12' | RL



P 805
9/16 x 3-1/4
PRIMED 8' | 12'
CLAY COAT 16'



675
1/2 x 4-1/4
OAK 8' | RL



BC14
11/16 x 4-1/4
MDF 16'



P 808
9/16 x 4-1/4
PINE 8' | RL
PRIMED 8' | 10' | 12'
CLAY COAT 8' | 16'
1/2 x 4-1/4
MDF 8' | 16'
OAK 8' | 12' | RL
POPLAR RL



L P808
19/32 x 4-1/4
MDF 16'



B PT11
9/16 x 4-1/2
MDF 16'



545
19/32 x 5
MDF 8' | 16'



163E
19/32 x 5-1/4
MDF 8' | 16'
L 163E
9/16 x 5-1/4
PRIMED 16'



L 514 E1E
7/16 x 5-1/4
POPLAR RL
9/16 x 5-1/4
PRIMED 16'



G 514
1/2 x 5-1/4
MDF 16'



763
19/32 x 5-1/4
MDF 16'



B 312
19/32 x 5-1/4
MDF 8' | 16'

8740 BASE CAP
5/8 x 1-3/4
PRIMED 16'



P 813
9/16 x 5-1/4
PINE RL
PRIMED 8' | 12'
CLAY COAT 8' | 16'
1/2 x 5-1/4
MDF 8' | 16'
POPLAR RL



512 E2E
1/2 x 5-1/2
MDF 8' | 12' | 16'



L PRBA
11/16 x 5-1/2
MDF 8' | 12'

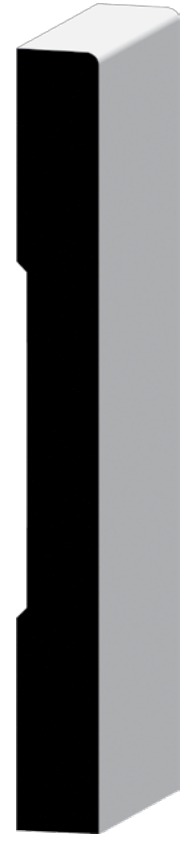

L 512E E1E
19/32 x 5-1/2
MDF 16'



512E E1E
1/2 x 5-1/2
MDF 16'



658
9/16 x 5-1/4
CLAY COAT 16'



7055
19/32 x 5-1/4
MDF 8' | 16'



L 618
1/2 x 5-1/4
MDF 16'
618
9/16 x 5-1/4
PINE 8' | RL
CLAY COAT 16'



674
9/16 x 5-1/4
CLAY COAT 8' | 16'
1/2 x 5-1/4
OAK 8' | 12' | RL



695
1/2 x 5-1/4
OAK 8' | RL



8741
9/16 x 5-1/4
PRIMED 16'



L P813
19/32 x 5-1/4
MDF 16'

Lengths in RED subject to availability



SB512
3/4 x 5-1/2
MDF 16'



8955
19/32 x 5-9/16
MDF 16'

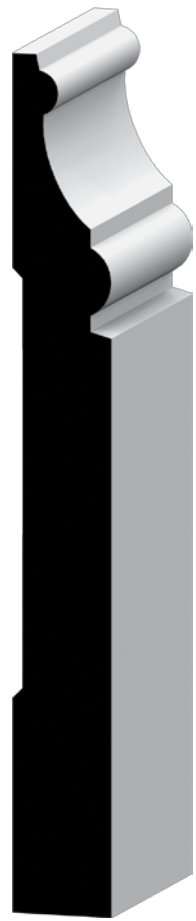

L FEBA
11/16 x 6
MDF 8' | 12'



8263
19/32 x 6-1/2
MDF 8' | 16'



L APBA
11/16 x 7
MDF 8' | 12'



L P815
19/32 x 7-1/4
MDF 16'



765
19/32 x 7-1/4
MDF 16'



7163
19/32 x 7-1/4
MDF 8' | 16'

L 7163 (14mm)
9/16 x 7-1/4
MDF 8' | 12'



714E E1E
1/2 x 7-1/4
MDF 16'



207
19/32 x 7-1/4
MDF 16'



9623 SKIRTBOARD
1/2 x 9-1/4
MDF 10' | 16'

Chair Rail

Wainscoting

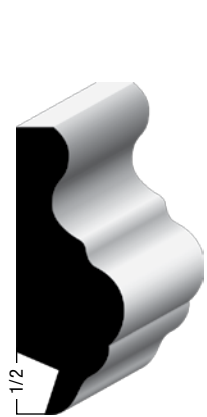

5/16
2464
3/4 X 2
PRIMED 16'



391
11/16 x 2-1/4
PINE 8' | 10' | 12' | RL



L APCH
7/8 x 2-1/2
MDF 8'



390
11/16 x 2-5/8
PINE 8' | 12' | 16' | RL
CLAY COAT 8' | 16'
19/32 x 2-5/8
MDF 8' | 16'
5/8 x 2-5/8
OAK 8' | RL
POPLAR 8' | RL

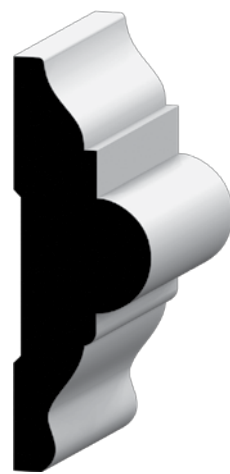

L 300
1 x 2-7/8
MDF 8' | 12'



L 301
1 x 3-1/4
MDF 16'



L PRCH
7/8 x 3-1/2
MDF 8'



L FECH
7/8 x 4
MDF 8'



956W
1/2 x 4-1/4
MDF 8'



1X4 EC WAINSCOTING
23/32 x 3-1/2
PRIMED 16'



WC16 WAINSCOTING
19/32 x 5
MDF 8' | 16'

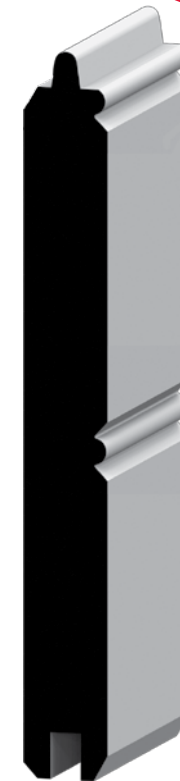

L WP4 WAINSCOTING
19/32 x 5
MDF 16'



L SBW4 WAINSCOTING
19/32 x 5-1/4
MDF 8' | 16'



1X6 EC WAINSCOTING
23/32 x 5-1/2
PRIMED 16'



185 PANEL MOULD
9/32 x 1-3/8
PINE 8' | RL



L 184 PANEL MOULD
1/2 x 1-1/2
PRIMED 16'



2448 PANEL MOULD
3/4 x 1-1/2
PRIMED 16'



182 PANEL MOULD
11/16 x 1-5/8
PRIMED 16'



190 PANEL MOULD
1 x 2
POPLAR 8' | RL



158 LIP
3/4 x 1-5/8
OAK 8'



L WCAP WAINSCOTING CAP
11/16 x 2
MDF 8'

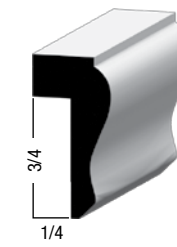

292 PLY CAP
9/16 x 1-1/8
PINE 8' | RL
1/2 x 1-1/16
OAK 8'

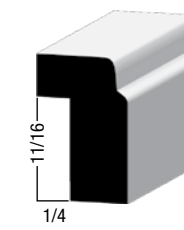

L 294 CAP
11/16 x 1-1/16
OAK 8'

4 Pc - 8'
Pre-packed
Kits Available

4 Pc - 8'
Pre-packed
Kits Available

4 Pc - 8'
Pre-packed
Kits Available

6 Pc - 8'
Pre-packed
Kits Available



**C2480 CROWN
BACKER**
11/16 x 2-1/2
MDF 16'

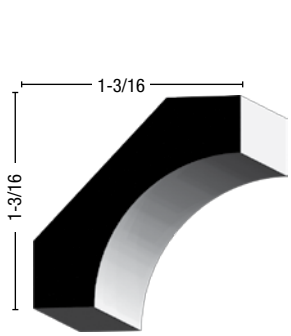

85
9/16 x 1-3/4
PINE 8' | 12' | RL

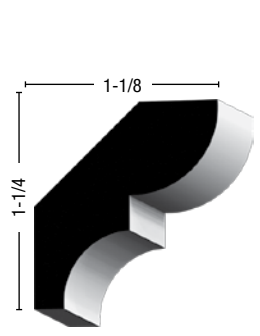

75
9/16 x 1-5/8
PINE 8' | 12' | RL

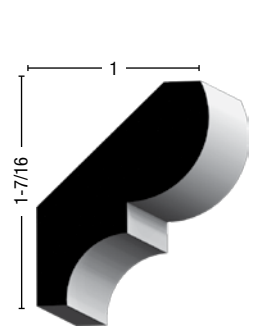

74
9/16 x 1-3/4
PINE 8' | RL
PRIMED 16'

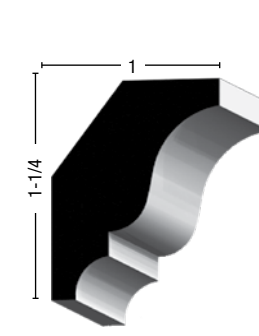

68
9/16 x 1-5/8
PINE 8' | 12' | RL
L 68
5/8 x 1-5/8
OAK RL

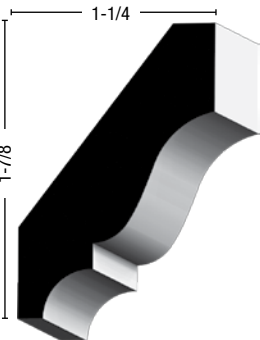

54
9/16 x 2-1/4
PINE 8' | 10' | 16' | RL
PRIMED 8' | 16'

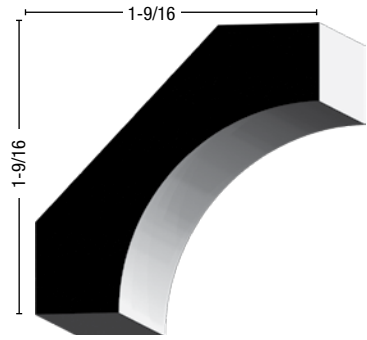

84
9/16 x 2-1/4
PINE 8' | 12' | RL

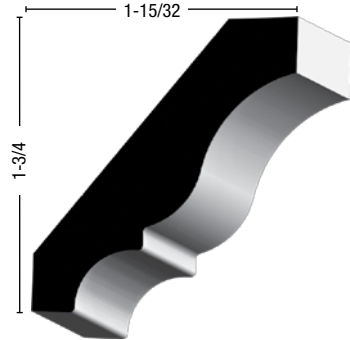

L 54
1/2 x 2-1/4
OAK 8' | 10' | 12' | RL

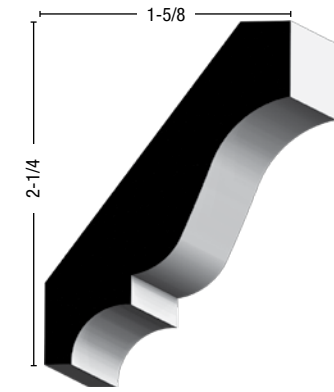

52
9/16 x 2-3/4
PINE 8' | 12' | RL
1/2 x 2-3/4
OAK RL

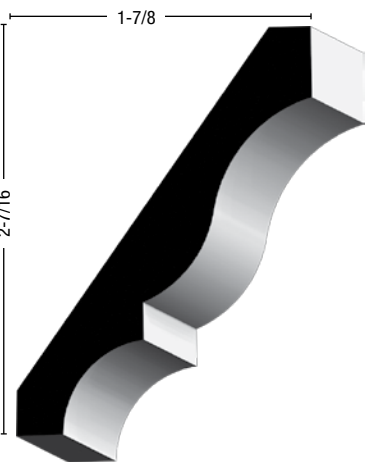

51
1/2 x 3-1/4
OAK 8' | 10' | 12' | RL

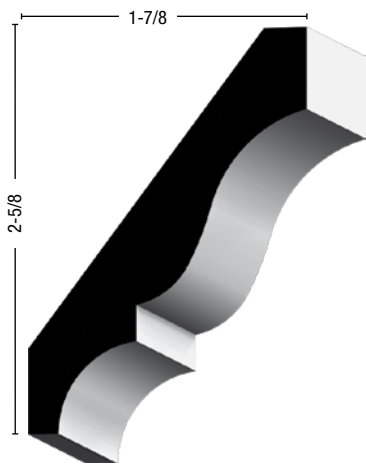

L 51
9/16 x 3-1/4
PINE 8' | 10' | 12' | 16' | RL
PRIMED 8' | 10' | 12' | 16'
CLAY COAT 16'
POPLAR 10' | 12' | RL

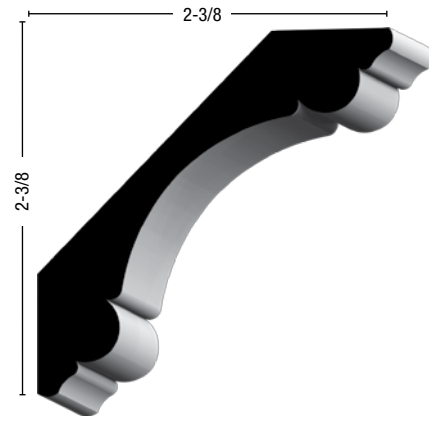

L 340
11/16 x 3-3/8
MDF 8' | 12' | 16'

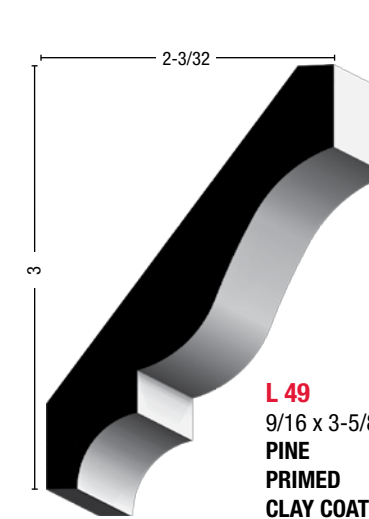

L 49
9/16 x 3-5/8
PINE 8' | 10' | 12' | 16' | RL
PRIMED 8' | 12'
CLAY COAT 8' | 16'
19/32 x 3-5/8
MDF 8' | 16'

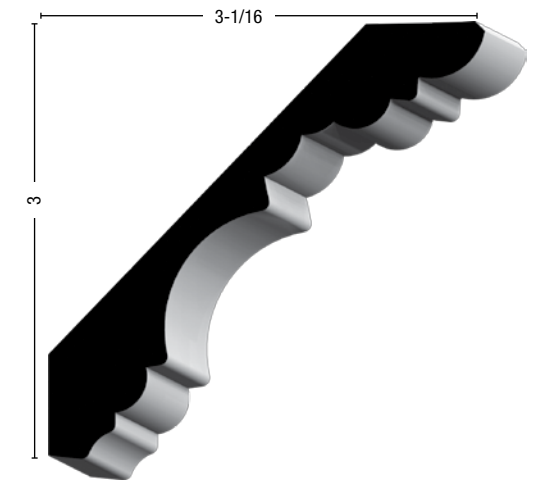

L 326
11/16 x 4-1/4
MDF 8' | 12' | 16'

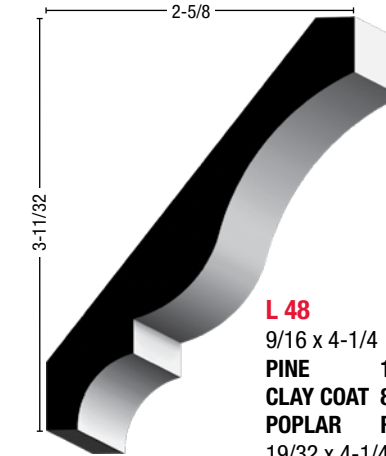

L 48
9/16 x 4-1/4
PINE 12' | RL
CLAY COAT 8' | 16'
POPLAR RL
19/32 x 4-1/4
MDF 8' | 16'
3/4 x 4-1/4
OAK 8' | RL

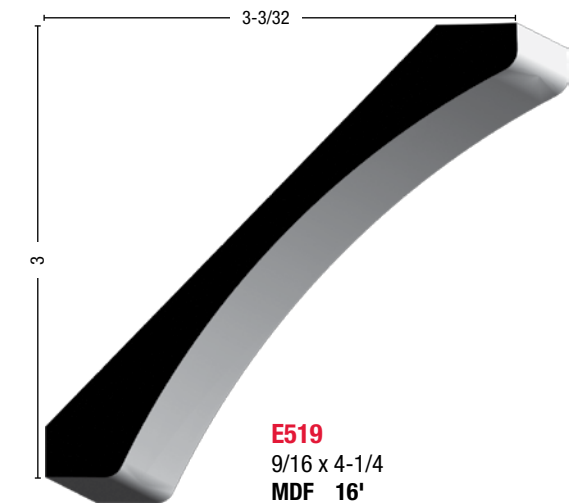

E519
9/16 x 4-1/4
MDF 16'

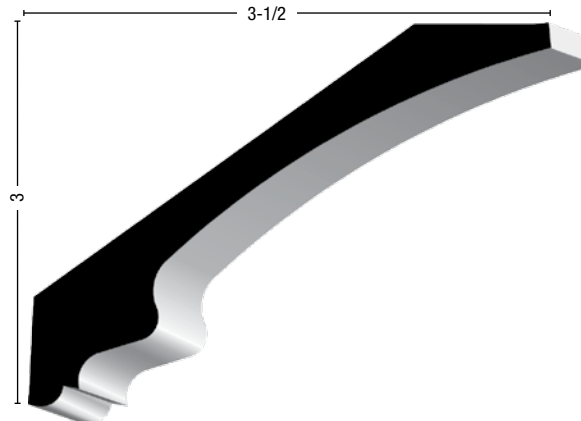

L PRCR
11/16 x 4-1/2
MDF 8' | 12'

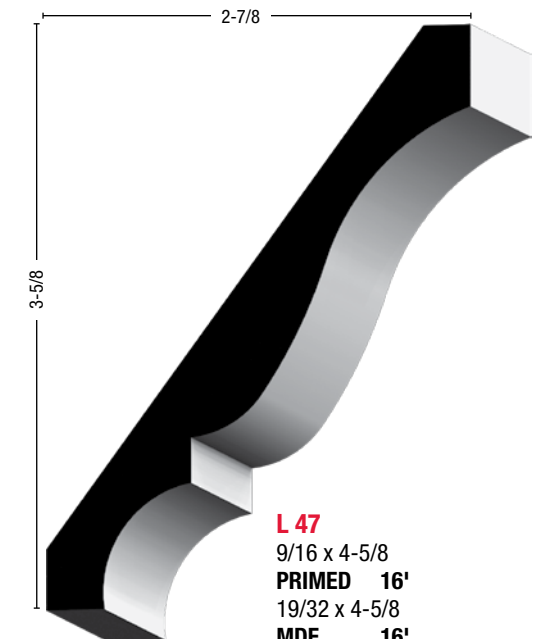

L 47
9/16 x 4-5/8
PRIMED 16'
19/32 x 4-5/8
MDF 16'

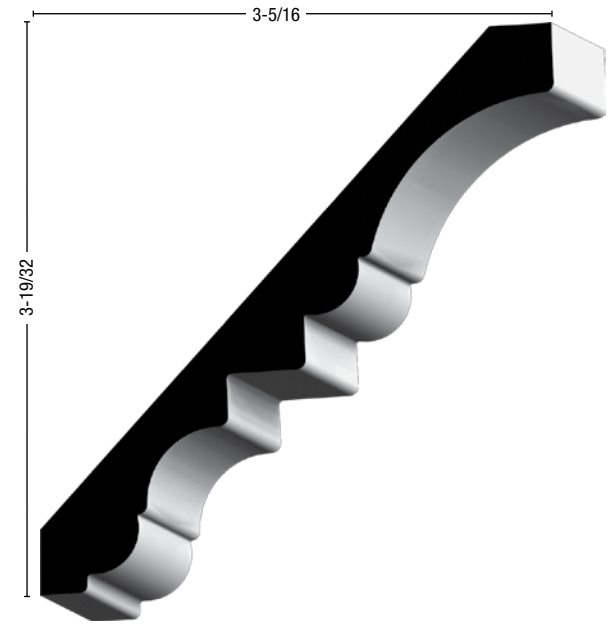

CURT
19/32 x 5
MDF 16'

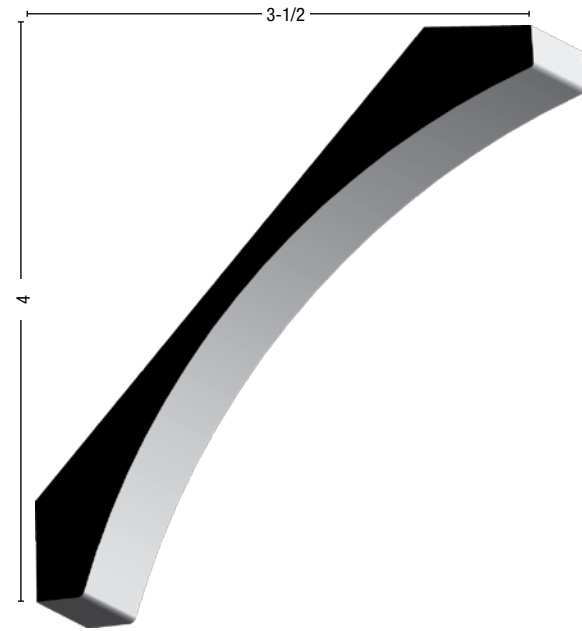

CR291
3/4 x 5-1/4
MDF RL

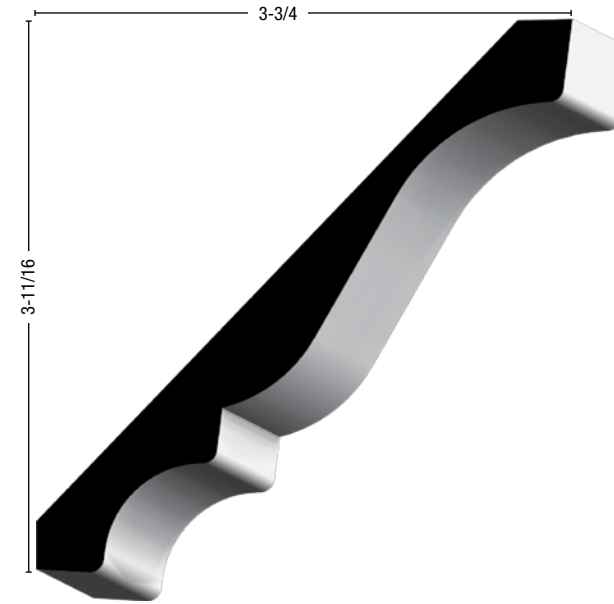

L 45
19/32 x 5-1/4
MDF 8' | 16'

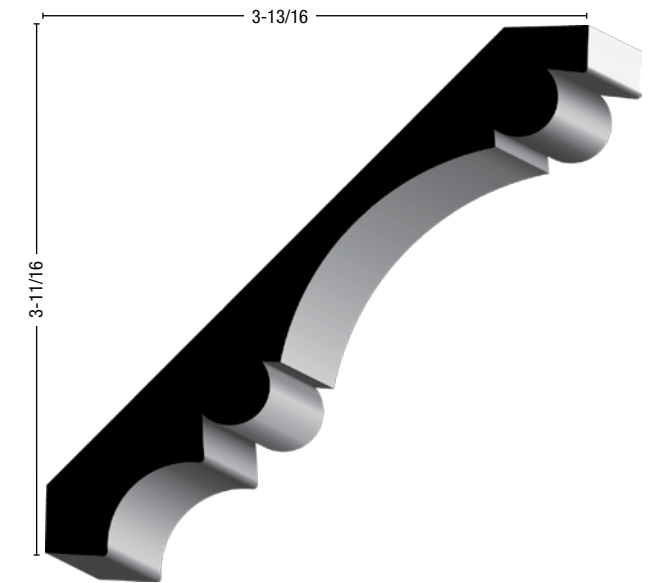

825
11/16 x 5-1/4
MDF 16'

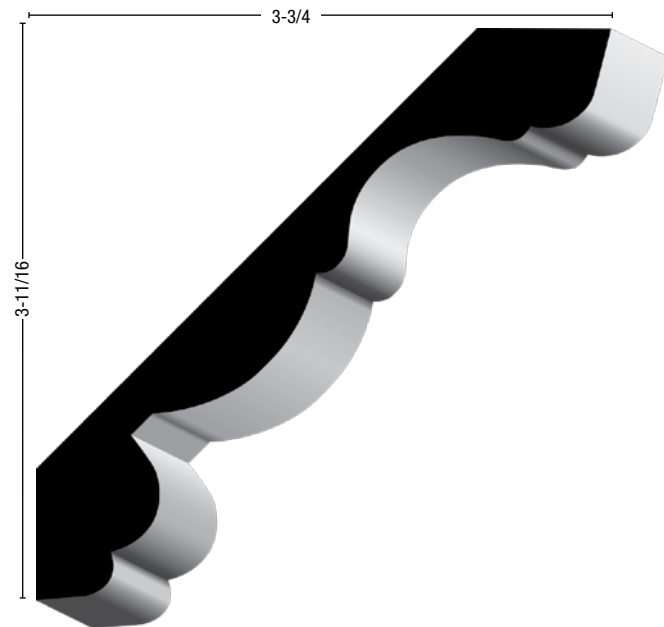

247
7/8 x 5-1/4
MDF 16'

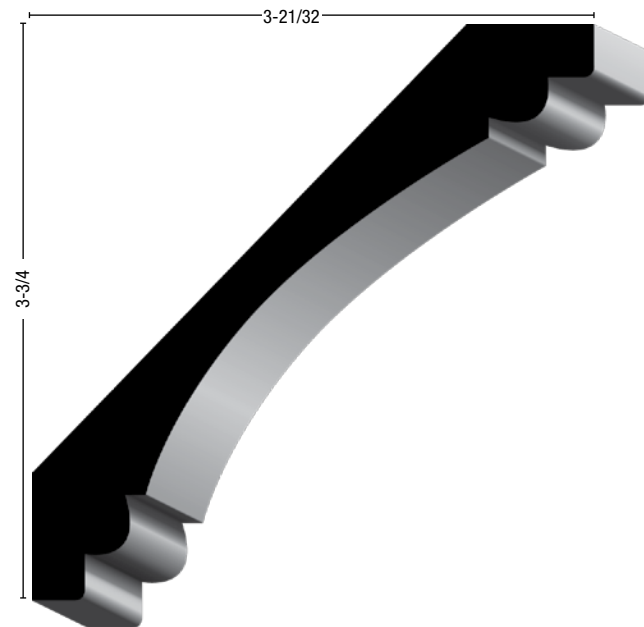

525
11/16 x 5-1/4
MDF 16'

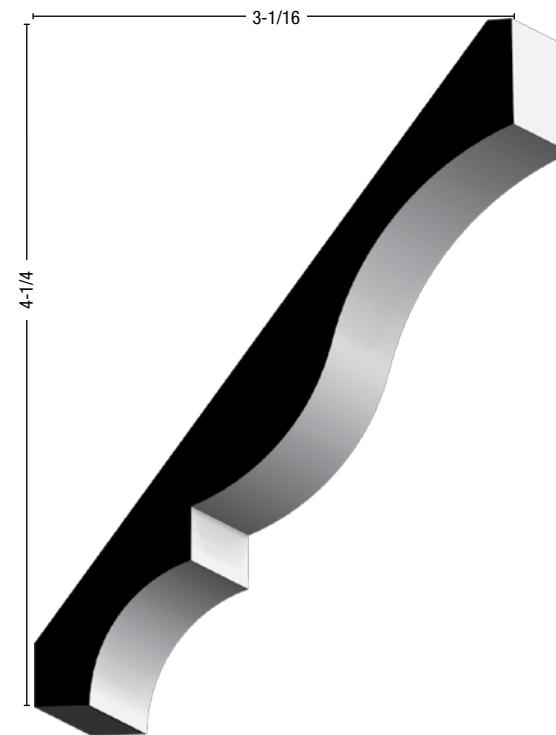

L 46
9/16 x 5-1/4
PINE RL
CLAY COAT 8' | 16'
POPLAR RL
3/4 x 5-1/4
OAK 12' | RL

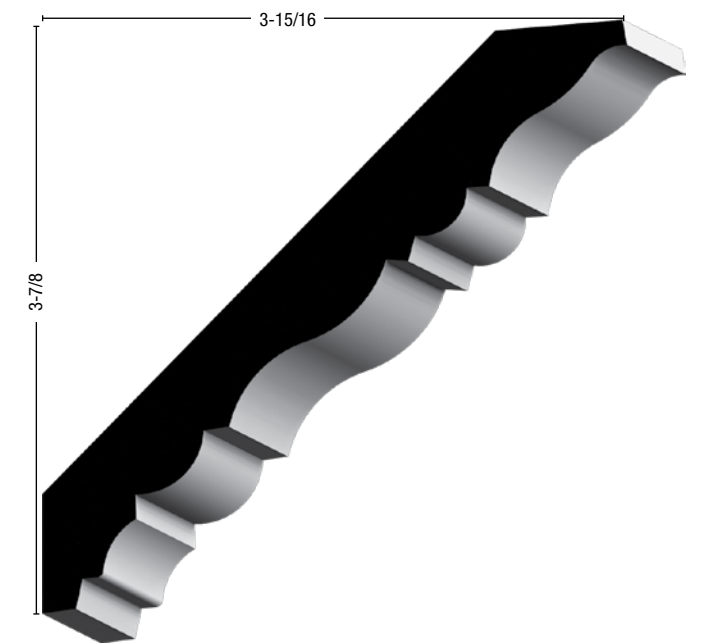

L FECR
11/16 x 5-1/2
MDF 8' | 12'

Lengths in RED subject to availability

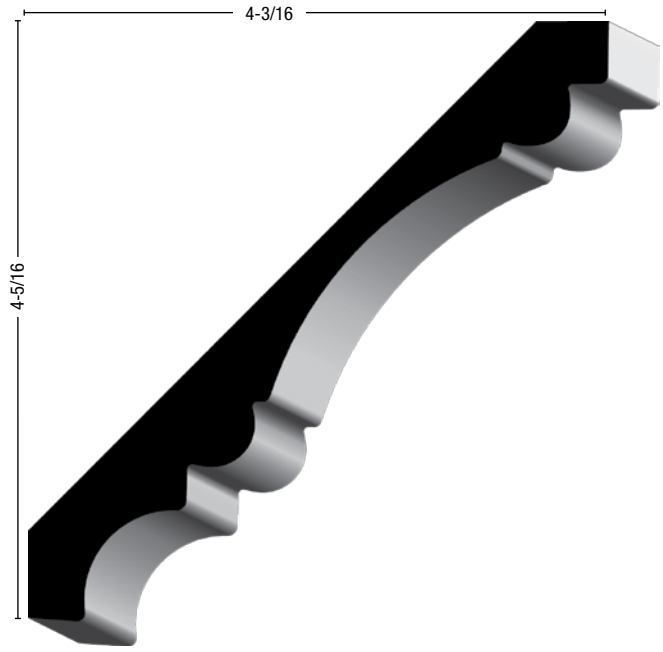

826
13/16 x 6
MDF 16'

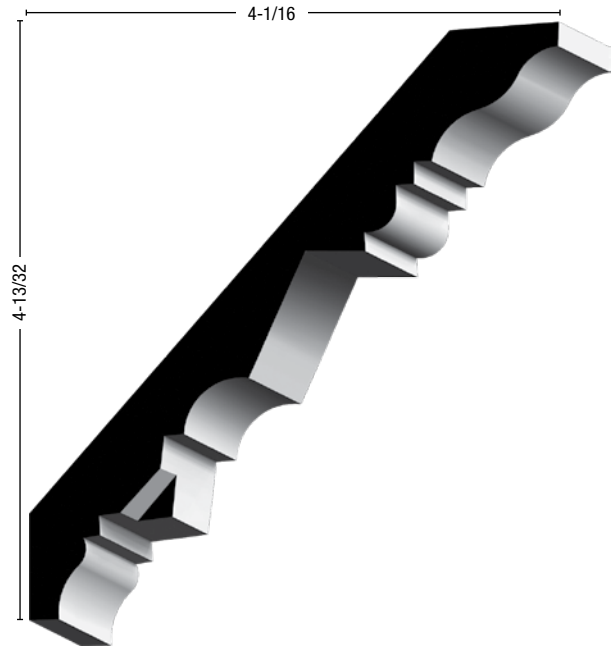

L APCR
11/16 x 6
MDF 8' | 12'

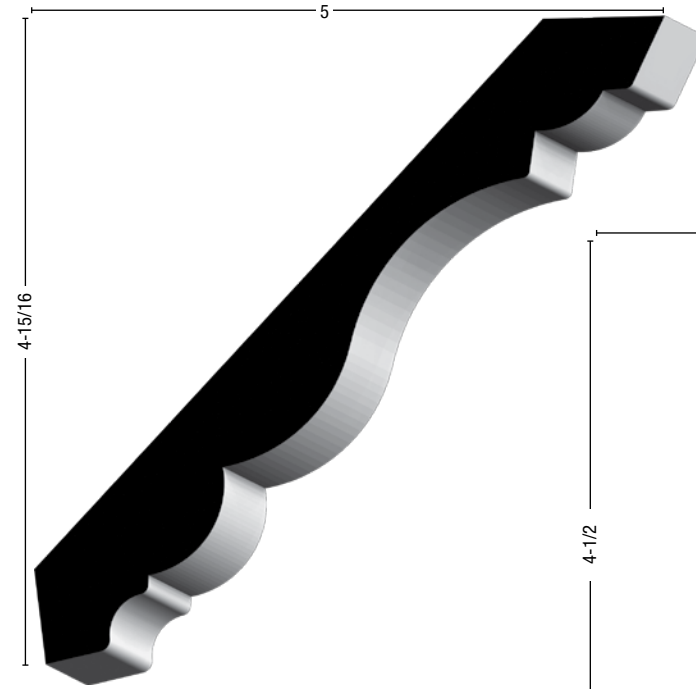

CR75
13/16 x 6-15/16
MDF 16'

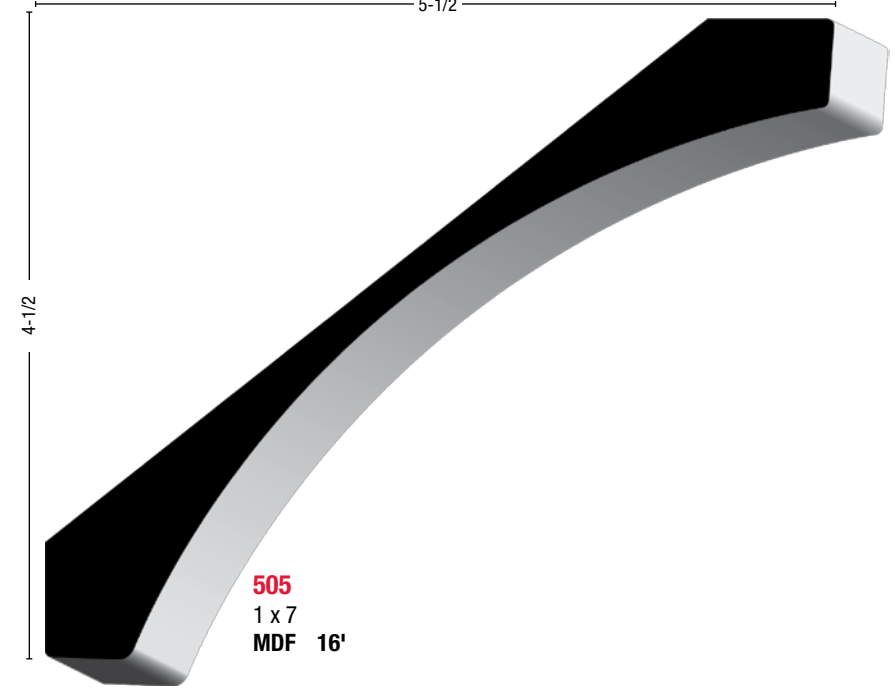

505
1 x 7
MDF 16'

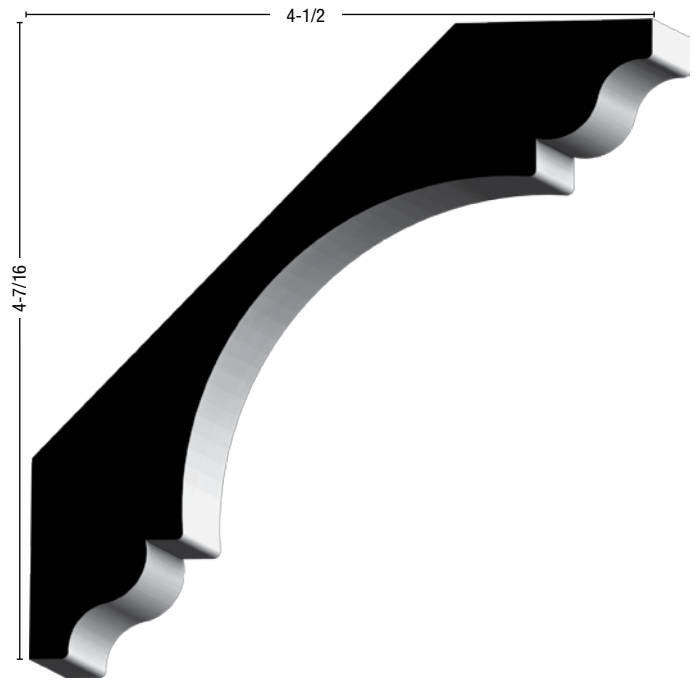

041
1-3/16 x 6-5/16
MDF 8' | 16'

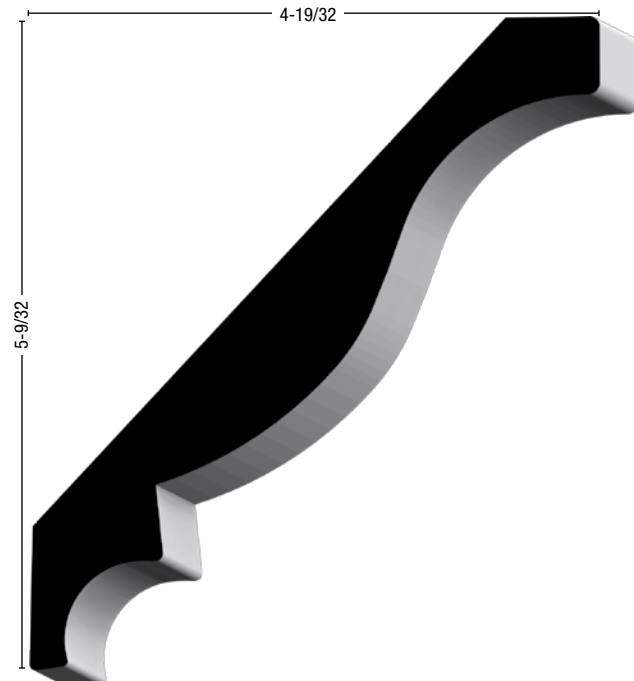

043
1 x 6-15/16
MDF 16'

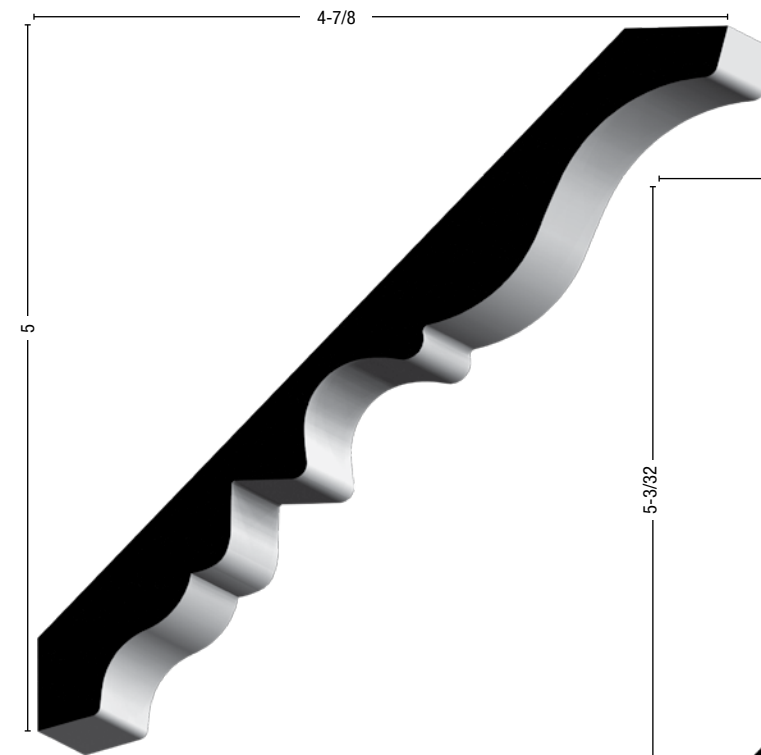

42
11/16 x 7
MDF 8' | 16'

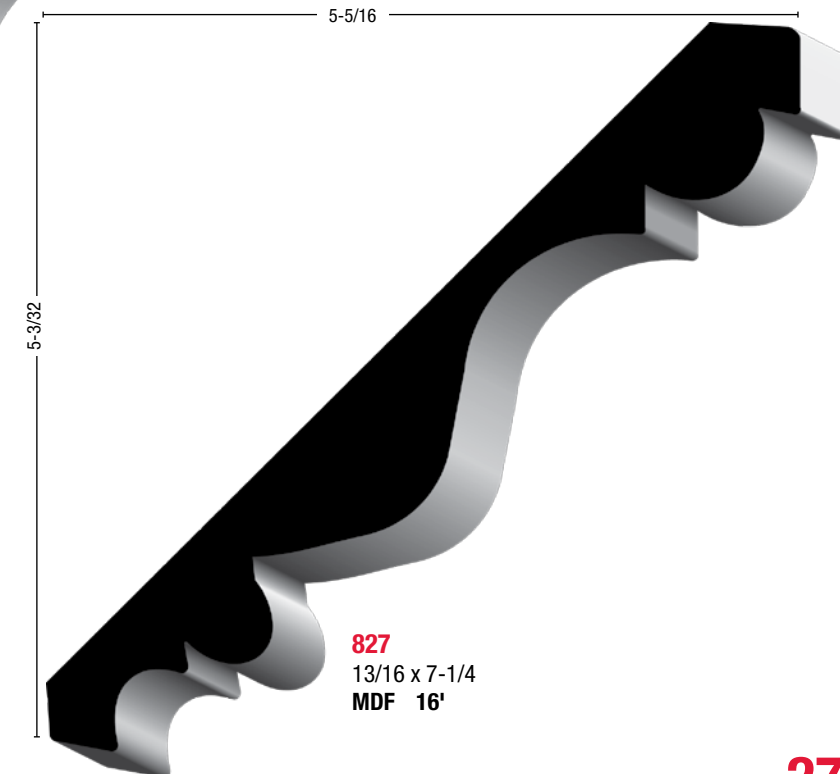

827
13/16 x 7-1/4
MDF 16'

Lengths in RED subject to availability

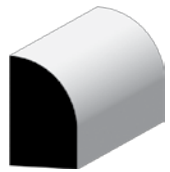

226 SHOE
1/2 x 3/4
PINE 8' | 10' | 12' | RL
PRIMED 8' | 16'
OAK 8' | 10' | 12' | RL
POPLAR 8' | 10' | RL
POPPF 16'
MAPLE RL
129
7/16 x 11/16
PINE 8' | 10' | 12'
PRIMED 8' | 12'



34 CLOVER LEAF SHOE
3/4 x 3/4
PINE RL
OAK 8' | RL

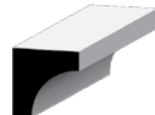

93 COVE
3/4 x 3/4
PINE 8' | 10' | 16' | RL
PRIMED 8' | 16'
OAK 8' | 10' | 12' | RL
100
11/16 x 11/16
PINE 8' | 10' | 12' | RL
PRIMED 8'
POPLAR 8' | RL
101
1/2 x 1/2
PINE 8' | RL



L 94 COVE
5/8 x 1-1/8
PINE 8' | 12' | RL



L 263 LATTICE
1/4 x 2-1/4
PINE 8'
L 265
1/4 x 1-3/4
PINE 8' | 10' | RL
L 266
1/4 x 1-1/2
PINE 8' | 10'
PRIMED 8' | 12'
L 267
1/4 x 1-3/8
PINE 8' | 10' | 12' | RL
L 268
1/4 x 1-1/8
PINE 8' | 10' | RL



L 246 SCREEN STOCK
11/16 x 2-3/4
PINE 8' | 10' | RL
PRIMED 16'
246
3/4 x 2-3/4
OAK 4' | 6' | 8'
POPLAR 4' | 6' | 8' | 10' | RL
L 248
11/16 x 1-3/4
PINE 8' | 16' | RL
PRIMED 16'
248
3/4 x 1-3/4
OAK 4' | 6' | 8' | 10' | RL
POPLAR 4' | 6' | 8' | 10' | 12' | RL



L 250E E2E
11/16 x 1-1/2
MDF 8' | 10'

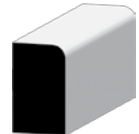

L 254 CRAFTSMAN SHOE
7/16 x 3/4
PRIMED 16'
POPLAR RL



103 QUARTER ROUND
1-1/16 x 1-1/16
PINE 8' | 10' | RL
105
3/4 x 3/4
PINE 8' | 10' | 12' | RL
OAK 8' | RL
PRIMED 16'
POPLAR 8' | RL
106
11/16 x 11/16
PINE 8' | 10' | 12' | RL
PRIMED 8' | 12' | 16'
108
1/2 x 1/2
PINE 8' | 10' | 12' | RL
110
1/4 x 1/4
PINE 8'



137 SCREEN MOULD-CLOVER
3/8 x 3/4
PINE 8'



142 SCREEN MOULD
1/4 x 3/4
PINE 8' | 10' | 12' | RL
OAK 8' | RL
POPLAR RL



171 SHELF EDGE
9/16 x 3/4
OAK 8'
POPLAR 8'



144 SCREEN MOULD-BEADED
1/4 x 3/4
PINE 8'



123 HALF ROUND
5/16 x 5/8
PINE 8' | RL



260 SHELF EDGE
11/16 x 1-1/4
OAK 8'
POPLAR 8'



E 1035 EXTENDED HALF ROUND
1/2 x 1-3/8
POPLAR 8' | RL



147 GLASS BEAD
1/2 x 9/16
PINE 8' | RL



995 CHAMFER
3/4 x 3/4
PINE 8' | RL

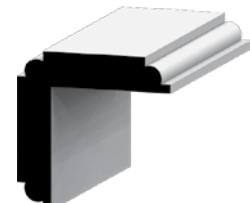

202 CORNER GUARD
1-1/8 x 1-1/8
PINE 8'

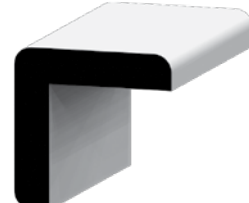

204 CORNER GUARD
1-5/16 x 1-5/16
PINE 8' | RL
205
1-1/8 x 1-1/8
PINE 8' | RL'
PRIMED 8'
1-1/16 x 1-1/16
OAK 8' | RL
206
3/4 x 3/4
PINE 8' | RL
OAK 8'

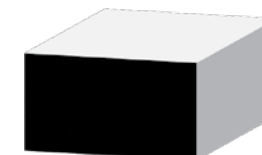

L 252 BLIND STOP
11/16 x 1-1/4
PINE 8' | RL

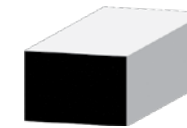

254 CHECK STOP
1/2 x 3/4
PINE 8' | 10' | 12' | RL

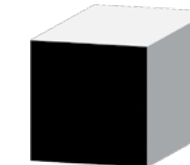

238 SQUARE
1-1/16 x 1-1/16
PINE 8'
239
3/4 x 3/4
PINE 8' | RL

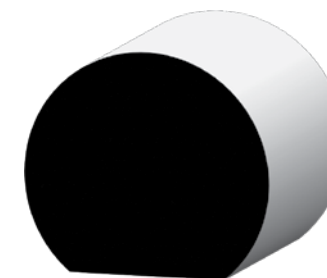

231 HAND RAIL
1-1/2 x 1-11/16
DFIR 8' | 12' | 14' | 16' | RL
SPINE 8' | 12' | 16'
POPLAR 8' | 12' | 14' | 16'



240 HAND RAIL
1-1/4 x 2-1/4
DFIR 14' | 16' | RL
SPINE 8' | 12'

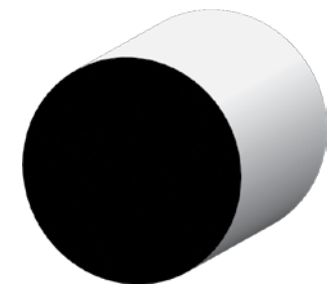

L 232 CLOSET POLE
1-9/16 Full Round
DFIR 8'
233
1-15/16 Full Round Vinyl Wrapped Wood
VNLVL 6' | 8' | 10'
L 233
1-1/4 Full Round
DFIR 6' | 8' | 10' | 12' | 14' | RL
SPINE 8' | 16'

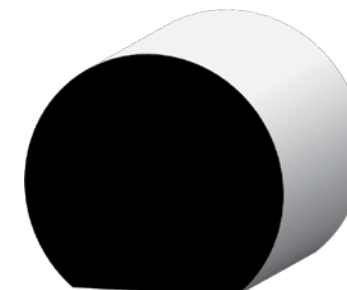



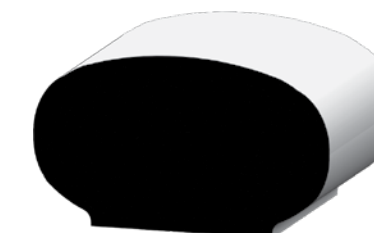















































6040 HAND RAIL
1-3/4 x 1-5/8
OAK 8' | 10' | 12' | 14' | 16'
POPLAR 8' | 10' | 12' | 14' | 16'
MAPLE 8' | 10' | 12' | 14' | 16'



6042 HAND RAIL
2-1/4 x 1-9/32
OAK 8' | 10' | 12' | 14' | 16'
MAPLE 8' | 10' | 12' | 14' | 16'



L 230 HAND RAIL
1-1/4 x 2
DFIR 8' | 12' | 16'
1-3/32 x 2
POPLAR 8' | 10' | 12' | 14' | 16' | RL

 S9702 PVC SMOOTH S4S SKIRT BOARD 3/4 x 3-1/2 WHITE 18'	 2100 THERMO STOP 7/16 x 1-7/8 WHITE 7' 9' 16'	 2258 EXTERIOR BEAD 1/2 x 13/32 WHITE 8'	 7716 CHAIR RAIL/CAP 5/8 x 3 WHITE 8'	 7719 PVC SMOOTH OS CRNR(WM205) 1-1/8 x 1-1/8 WHITE 12'	 S7973 PVC SMOOTH SOLID CORNER 1 x 5-11/16 WHITE 20'
 E9702 PVC EMBOSSED S4S SKIRT BOARD 3/4 x 3-1/2 WHITE 18'	 2150 STOP 5/8 x 1-1/2 WHITE 12'	 2330 BLIND STOP 5/8 x 5/8 WHITE 8'	 2352 EXTERIOR PLANKING 5/8 x 5-15/32 WHITE 8'	 S7970 PVC SMOOTH RABBET CORNER 1 x 5-11/16 WHITE 20'	 E7973 PVC EMBOSSED SOLID CORNER 1 x 5-11/16 WHITE 20'
 S9703 PVC SMOOTH S4S SKIRT BOARD 3/4 x 5-1/2 WHITE 18'	 2449 DRIP CAP 11/16 x 1-5/8 WHITE 12' 16'	 S9706 SMOOTH S4S J-CHANNEL TRIM 1 x 3-1/2 WHITE 18'	 7718 WAINSCOTING KIT 1/4 x 7-1/2 WHITE 34" 8'	 E7970 PVC EMBOSSED RABBET CORNER 1 x 5-11/16 WHITE 20'	 2 1064 WHITE PVC ADHESIVE FILL & FLEX (12) 10 OZ TUBES PER PK
 E9703 PVC EMBOSSED S4S SKIRT BOARD 3/4 x 5-1/2 WHITE 18'	 7901 SHINGLE PANEL 21/32 x 1-23/32 WHITE 8'	 E9706 EMBOSSED S4S J-CHANNEL TRIM 1 x 3-1/2 WHITE 18'	 7527 BASE 9/16 x 3-1/4 WHITE 12'	 S7971 PVC SMOOTH SOLID CORNER 1 x 3-11/16 WHITE 20'	 2 0941 SMOOTH CORTEX HIDDEN FASTENER-SMOOTH WHITE 50/BOX
 2497 JAMB 3/4 x 5-7/8 WHITE 7' 10'	 2599 SHINGLE MOULDING 11/16 x 1-5/8 WHITE 8'	 S7994 SMOOTH S4S J-CHANNEL TRIM 1 x 5-1/2 WHITE 18'	 2450 BASE CAP 11/16 x 1-1/8 WHITE 8'	 E7971 PVC EMBOSSED SOLID CORNER 1 x 3-11/16 WHITE 20'	 2 0942 GRAIN CORTEX HIDDEN FASTENER-GRAIN WHITE 50/BOX
 7181 EXTERIOR DOOR FRAME 1-1/4 x 4-9/16 WHITE 7'	 2448 BRICK MOULD (180) 1-1/4 x 2 BROWN 8' 10' 17' SANDSTONE 8' 10' WHITE 8' 10' 17'	 E7994 EMBOSSED S4S J-CHANNEL TRIM 1 x 5-1/2 WHITE 18'	 2709 FLAT UTILITY TRIM 5/16 x 5-3/16 WHITE 8'	 S7972 PVC SMOOTH RABBET CORNER 1 x 3-11/16 WHITE 20'	 2 0943 SMOOTH CORTEX HIDDEN FASTENER-SMOOTH WHITE 250/BOX
 7117 MAIN SILL 1-1/4 x 5-1/4 WHITE 7'	 7526 BRICK MOULD 1-1/4 x 2 WHITE 8' 10' 17' (3-0 mitered sets available)	 2435 CROWN 9/16 x 3-5/8 WHITE 12'	 2018 LATTICE 1/4 x 1-1/2 WHITE 8'	 E7972 PVC EMBOSSED RABBET CORNER 1 x 3-11/16 WHITE 20'	 2 0944 GRAIN CORTEX HIDDEN FASTENER-GRAIN WHITE 250/BOX
 7118 NOSE SILL 1-5/16 x 1-3/8 WHITE 7'	 7252 BRICK MOULD (L 176) 11/16 x 1-5/8 WHITE 8' 10'	 2598 BED MOULD 9/16 x 1-5/8 WHITE 12'			
 2355 CASING (356) 11/16 x 2-1/4 WHITE 12'	 2024 QUARTER ROUND 1/2 x 1/2 WHITE 8'	 7158 RAMS CROWN 1-13/32 x 2-1/16 WHITE 12'			
 2590 CASING WITH BACK BAND 1-13/16 x 4-1/2 WHITE 12'	 2689 QUARTER ROUND 3/4 x 3/4 WHITE 8'	 2021 COVE 3/4 x 3/4 WHITE 8'			

PVC Boards & Sheets

TRIM BOARD - EMBOSSED / SMOOTH					
1X2	3/4 x 1-1/2	7832	PVC 8' 12'	1X12	3/4 x 11-1/4 7838 PVC 8' 18'
1X3	3/4 x 2-1/2	7833	PVC 8'	5/4X4	1 x 3-1/2 7840 PVC 10' 18' 20'
1X4	3/4 x 3-1/2	7834	PVC 8' 12' 16' 18'	5/4X6	1 x 5-1/2 7841 PVC 10' 18' 20'
1X6	3/4 x 5-1/2	7835	PVC 8' 12' 16' 18'	5/4X8	1 x 7-1/4 7842 PVC 18'
1X8	3/4 x 7-1/4	7836	PVC 8' 12' 16' 18'	5/4X10	1 x 9-1/4 7843 PVC 18'
1X10	3/4 x 9-1/4	7837	PVC 8' 12' 18'	5/4X12	1 x 11-1/4 7844 PVC 18'

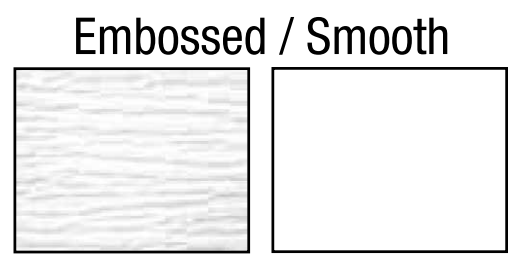

PVC SHEETS - EMBOSSED / SMOOTH
4' x 8' PVC Sheets

3/8"	E 2878
1/2"	E 2871
3/4"	E 2837
1"	E 2864



BULLSEYE ROSETTE
642
5/8 x 2-1/2 **PINE**
WHITE WOOD
OAK

734
27/32 x 3-1/2 **PINE**
WHITE WOOD
OAK

740
13/16 x 3-1/2
27/32 x 4-1/2 **WHITE WOOD**



PLINTH BLOCK - BEVELED
1401
7/8 x 2-3/4 x 4-1/2 **PRIMED**
OAK



BASE BLOCK - OUTSIDE CORNER
892
1-1/8 x 6-3/4 **WHITE WOOD**

8920
1-1/8 x 6-3/4 **PINE**
OAK

9 OS
1-1/4 x 9 **MDF**

BASE BLOCK - INSIDE CORNER
895
7/8 x 6-3/4 **WHITE WOOD**

8951
7/8 x 6-3/4 **PINE**
OAK

9 IS
7/8 x 9 **MDF**



BULLSEYE ROSETTE - BEVELED
1400
7/8 x 2-3/4 **PRIMED**
OAK

1402
7/8 x 3-3/4 **PRIMED**
OAK

1403
7/8 x 3-3/4 x 6 **PRIMED**
OAK

917
1-1/8 x 3-1/2 x 6-1/2 **PINE**
OAK



BULLSEYE ROSETTE - BEVELED
3
7/8 x 3 **MDF**

334
7/8 x 3-3/4 **MDF**

438
1 x 4-3/8 **MDF**



PLINTH BLOCK - MOULDED
887
27/32 x 2-1/2 x 5-3/4 **WHITE WOOD**

742
1-1/8 x 3-1/2 x 6-1/2 **PINE**
OAK

334
1-1/16 x 3-1/2 x 6-1/2 **WHITE WOOD**

438
1 x 3-3/4 x 9 **MDF**

438
1 x 4-3/8 x 9 **MDF**

743
1-1/16 x 4-1/2 x 8 **WHITE WOOD**



BASE BLOCK - OUTSIDE CORNER
1892
1-1/8 x 6-1/2 **PRIMED**
OAK

BASE BLOCK - INSIDE CORNER
1895
1-1/8 x 6-1/2 **PRIMED**
OAK



FLORAL ROSETTE - BEVELED
871
1-1/16 x 3-1/2 **PINE**
WHITE WOOD
OAK

915
27/32 x 2-1/2 **PINE**
WHITE WOOD
OAK



STAR ROSETTE
1200
1-1/16 x 3-1/2 **WHITE WOOD**



BULLSEYE ROSETTE - BEVELED
P 358 35
1 x 3-5/8 **POPLAR**



RADIUS BASE BLOCK
P 808
9/16 x 4-1/4 x 3/4 RAD **POPLAR**

P 813
9/16 x 5-1/4 x 3/4 RAD **POPLAR**

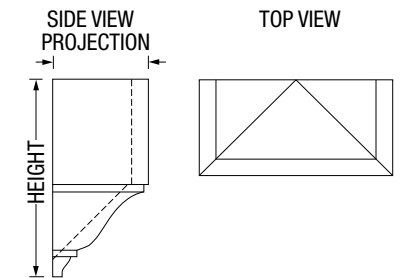
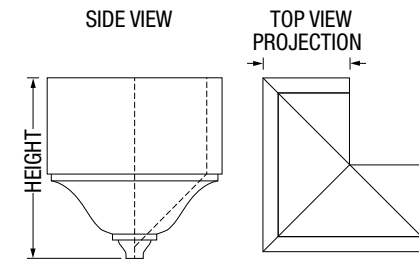
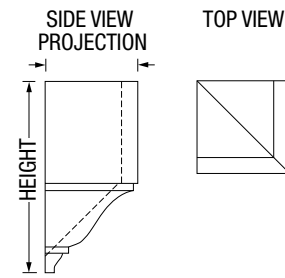

INSIDE CORNER	OUTSIDE CORNER	MIDDLE
1897 - SMALL 4-1/8 height x 2-1/8 projection WHITE WOOD	1897 - SMALL 4-1/8 height x 2-1/8 projection WHITE WOOD	
1888 - MEDIUM 5-5/8 height x 2-5/8 projection PINE PRIMED	1888 - MEDIUM 5-5/8 height x 2-5/8 projection PINE PRIMED	1888 - MEDIUM 5-5/8 height x 2-5/8 projection PRIMED
1898 - MEDIUM 5-7/8 height x 2-27/32 projection WHITE WOOD	1898 - MEDIUM 5-7/8 height x 2-27/32 projection WHITE WOOD	
1899 - LARGE 7-3/4 height x 3-11/16 projection WHITE WOOD	1899 - LARGE 7-3/4 height x 3-11/16 projection WHITE WOOD	



INSIDE CORNER
1889 - LARGE
7-1/2 height x 3-1/2 projection **PINE**



OUTSIDE CORNER
1889 - LARGE
7-1/2 height x 3-1/2 projection **PINE**

Species in **RED** subject to availability

Species in **RED** subject to availability

Quality Products

Part#	Pg#
3	32
9 IS	32
9 OS	32
34	28
40	6
041	26
42	27
043	26
L 45	25
L 46	25
L 47	23
L 48	23
L 49	23
L 51	22
51	22
52	22
L 54	22
54	22
L 68	22
68	22
74	22
CR75	27
75	22
84	22
85	22
86	22
93	28
L 94	28
EDC97	8
100	28
101	28
103	28
105	28
106	28
108	28
110	28
123	28
126	28
129	28
137	28
142	28
144	28
147	28
158	21
L163E	16
163E	16
163	13
166	13
L 167	13
171	28
180	11
182	21
L 184	21
185	21
190	21
195	6
L 197	11
200	11
202	28
204	28
205	28

Part#	Pg#
206	28
207	19
E 208	11
L 210	11
L 230	29
231	29
L 232	29
233	29
L 233	29
238	29
239	29
240	29
L 246	29
246	29
247	24
L 248	29
248	29
L 250E	29
L 252	29
L 254	28
254	29
260	28
L 263	29
L 265	29
L 266	29
L 267	29
L 268	29
279	11
280	11
281	11
H 282	11
284	9
CR291	24
292	21
L 294	21
L 300	20
L 301	20
312	6
SC312	7
B 312	16
316	5
321	5
L 324	5
324	5
L 326	23
327	5
334	32
L 338	7
L 340	22
351	6
L 356	5
356C	5
356	5
P358 35	32
358	11
L 361	7
361	6
L 361C	7
L 366	5, 6
366	5
366A	5

Part#	Pg#
374	7
376	5
P 380	6
390	20
391	20
410	15
411	6
412	8
E412	8
G 412	7
414	15
L 414	15
432	8
L 433	14
L 433E	14
L 434	7
435	15
438	32
L 444	7
444A	8
444	8
445	7
445A	7
446	8
P 450	8
465	9
L 471	6
L 473	5, 10
473	5
474	6
493	10
505	27
512	17
512E	17
SB512	18
L 512E	17
G 514	16
L 514	16
E519	23
525	24
535	8
545	15
SA612	9
L 618	16
618	16
L 620	15
620	15
623	14
L 627	13
L 633	14
H 633	14
633	14
L 634	13
H 634	13
634	13
L 635	13
642	32
658	16
663	14
664	13
674	16

Part#	Pg#
675	15
682	7
683	7
685	6
695	16
713	14
714	13
714E	19
L 717	13
L 723	14
723	14
L 724	13
734	32
740	32
742	32
743	32
763	16
765	19
P 805	14
L P808	15
P 808	15, 32
L P813	17
P 813	17, 32
L P815	19
825	25
826	26
827	27
845	10
846	10
856	10
857	10
871	32
L 876	10
876	10
L 887	10
887	32
892	32
895	32
915	32
917	32
935	10
936	10
2 0941	31
2 0942	31
2 0943	31
2 0944	31
946	10
N 946	10
947	10
N947	10
956W	20
962	10
972	10
L 973	10
982	10
L 983	10
995	28
4 1021	11
7 1021	11
1021	11
E 1035	11, 28

Part#	Pg#
2 1064	31
1153	11
1155	11
1200	32
1305	10
1400	32
1401	32
1402	32
1403	32
1888	33
1889	33
1892	32
1895	32
1897	33
1898	33
1899	33
2018	31
2021	30
2024	30
2100	30
2150	30
2258	30
2330	30
2352	31
2355	30
2435	30
2448	21
2448 (180)	11, 30
2449	30
2450	31
2464	20
C2480	22
2496	6
2497	30
2590	30
2598	30
2599	30
2689	30
2709	31
4520	6
4532	6
5000	9
5010	9
5021	9
5030	9
6040	29
6042	29
7055	16
7117	30
7118	30
7158	30
7163	19
L 7163	19
7181	30
7252	30
7526	30
7527	31
7716	31
7718	31
7719	31
7901	30

Part#	Pg#
E7970	31
S7970	31
E7971	31
S7971	31
E7972	31
S7972	31
E7973	31
S7973	31
E7994	30
S7994	30
8263	18
8740	13, 17
8741	17
8901	6
8920	32
8951	32
8954	8
8955	18
9623	19
E9702	30
S9702	30
E9703	30
S9703	30
E9706	30
S9706	30
1X4 EC	21
1X6 EC	21
L APBA	18
L APCA	9
L APCH	20
L APCR	26
BC14	15
BFOLD	10
L CC14	7
CURT	24
L FEBA	18
L FECA	9
L FECH	20
L FECR	25
L FLTD	6
L PRBA	17
L PRCA	9
L PRCH	20
L PRCR	23
C PT11	8
B PT11	15
PT3	7
RB3	8
S RB3	8
REV	7
L SBW4	21
N/L STOOL	11
WC16	21
L WCAP	21
L WP4	21



Mouldings

- Softwood Mouldings
- Hardwood Mouldings
- Decorative Wood Mouldings
- Blocks
- Mantels
- Flexible Mouldings
- Green Mouldings & Boards (FSC Chain of Custody Certified)



Stair Parts

- Wood Balusters & Newels
- Iron Balusters & Newels
- Post to Post Components
- Over the Post Components
- Stock, Special Order, Custom



Boards

- Ultralite MDF • Finger Joint Primed • Finger Joint Pine
- Oak Veneer • Oak • Clear Radiata Pine • Poplar • Maple
- Finger Joint Poplar • PVC

S4S Boards:

- 1 x 2 • 1 x 3 • 1 x 4 • 1 x 6 • 1 x 8 • 1 x 10 • 1 x 12
- 5/4 x 4 • 5/4 x 6 • 5/4 x 8 • 5/4 x 10 • 5/4 x 12

E2E Boards:

- 1 x 2 • 1 x 3 • 1 x 4 • 1 x 6 • 1 x 8



Columns

- Architectural Wood
- Wood Colonial
- Poly-Classic
- Poly-Classic Durastone
- Poly-Classic DuraGlass Square
- Poly-Classic Craftsman
- Poly-Classic Railing Systems
- Poly-Classic Porch Posts
- Wood Porch Posts



PVC Millwork

- Mouldings
- Door Frames
- Boards
- Siding Accessories
- Trim Boards
- Garage Solutions
- Ceiling & Wall Solutions
- Pole & Post Surrounds



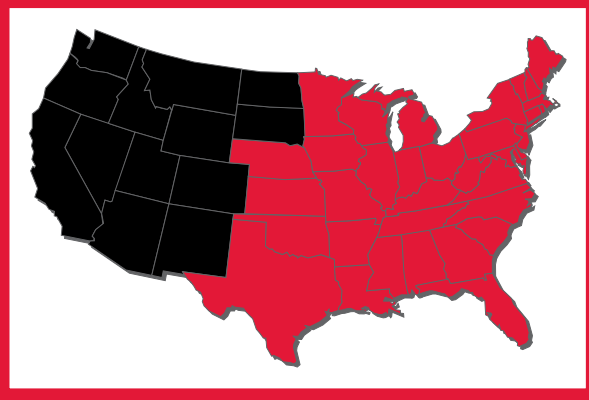

Experience the WEB

Special Offers

New Products

Inspiration

Videos

Innovation

Customer Portal

www.empireco.com



Empire
mouldings
& boards

Midwest Distribution Center

P.O. Box 17

8181 Logistic Drive

Zeeland, MI 49464

Phone: 800.253.9000

Fax: 800.748.7670

www.empireco.com

© 2016 EMPIRE CO. E1PGFY16

Empire reserves the right to make changes to the products listed in this catalog without notice and without responsibility for existing units.

Drawings may not be to exact scale.