

Paperless Recorder

Model ARF100

Overview

The ARF100 Paperless Recorder features a highly visible 5.6-inch TFT color LCD, incorporates advanced functions, is easy to use, and is network-compatible.

A sampling rate of 100 ms for all 12 channels and a precision of $\pm 0.1\%$ are achieved, and measured data can be stored in internal memory or on a CF (CompactFlash) card.

Ethernet compatibility enables monitoring in a web browser running on PCs through an intranet or the internet. Also, data files can be sent by FTP and notifications can be sent by e-mail.

Features

• Clear 5.6-inch TFT color LCD

The highly visible large display has a wide range of built-in display functions.

The user can choose from real time/historical trend display, bar graph display, and numeric display according to the specific requirements.

• Large data memory and various recording modes

A CF (CompactFlash) card slot is provided as a standard feature for as external memory. This allows large amounts of data up to 2 GB to be recorded and saved.

Various data save modes can be selected such as schedule recording based on day of the week, time and date, or time; or based on recording of data before and after trigger points (e.g. alarms). Data can be saved in CSV or binary format to suit your specific requirements.



• Easy manual operation and setup

Dedicated keys for specific functions are arranged on the keyboard for improved operability.

A USB port is also provided on the front panel to enable writing of various settings or data files to a PC, for example, from the recorder.

• LAN environment network compatibility

Ethernet is supported as standard, which allows remote monitoring on a browser, as well as FTP client/server transactions, e-mail notifications, and various other applications. Also, with the Network Instrumentation Modules communication (Ethernet) option, data from Network Instrumentation Modules can be recorded, the number of recording points can be expanded, and remote measurement can be performed.

Function block diagram

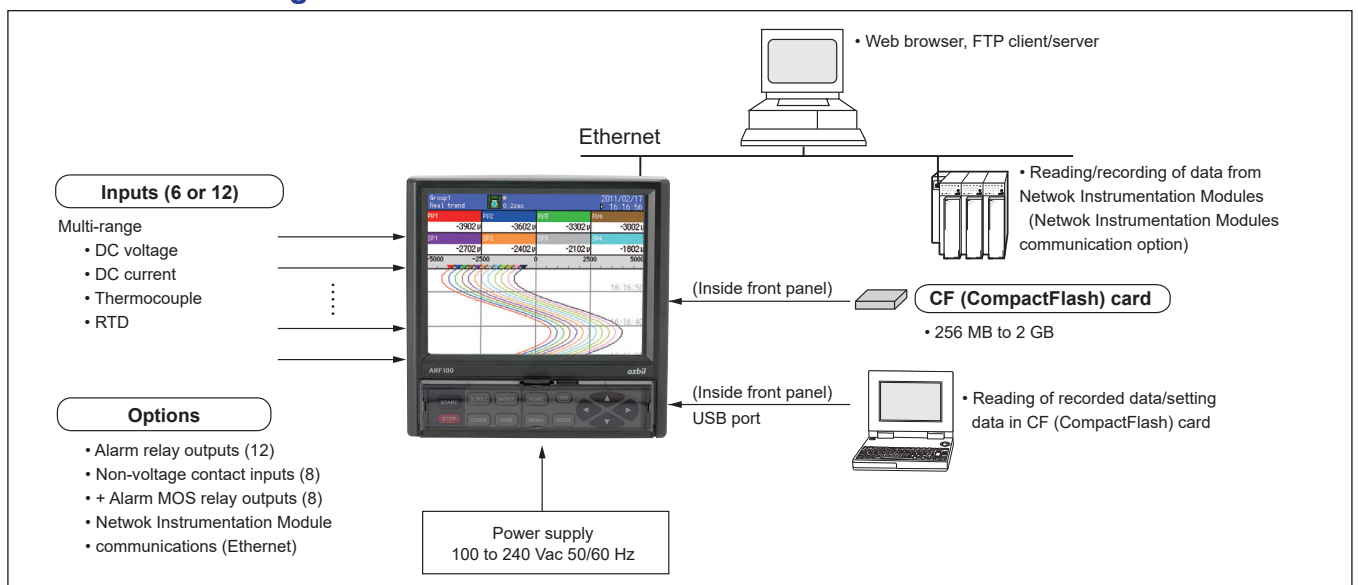

Specifications

Input specifications	Input type	DC voltage/DC current/thermocouple/RTD (See Table 1. Input type/Accuracy ratings) Note: DC current input is supported by adding an external reception resistor.
	Number of input channels	6 or 12
	Input measurement cycle	Approx. 100 ms for all inputs
	Allowable signal source resistance	Thermocouple input (burnout disabled) and DC voltage input (± 2 V or less): 1 k Ω or less. DC voltage input (± 5 V to ± 50 V): 100 Ω or less. RTD: 10 Ω or less per wire (must be equal on all 3 wires).
	Input resistance	DC voltage, thermocouple input: approx. 1 M Ω
	Maximum input voltage	DC voltage input (± 2 V or less) and thermocouple input (burnout disabled): ± 10 Vdc max. DC current input (± 5 V to ± 50 V): ± 60 Vdc max. Thermocouple input (burnout enabled) and RTD input: ± 6 Vdc max.
	Insulation withstand voltage across channels	1000 Vac or more across each channel (high withstand voltage semiconductor relay used)
	Burnout	Signal disconnection detection for thermocouple and RTD inputs. Upscale burnout, downscale burnout or no burnout indication can be selected for each input.
	Scaling	Any range/scale for DC voltage/current input.
	Digital filter	FIR filter set for each input (common for all inputs)
	Accuracy rating	(See Table 1. Input type/Accuracy ratings)
	Reference junction compensation accuracy	K, E, J, T, N, Platine II: ± 0.5 °C max. R, S, W-WRe26, WRe5-WRe26, NiMo-Ni, CR-AuFe, U, L: ± 1.0 °C max.
Display specifications	Display	5.6-inch TFT color LCD
	Display type	Measurement data displays (trend display, numerical value display, bar graph display) Historical trend displays (can be displayed simultaneously with real-time trends) Information displays (alarm display, marker list, file list) Settings screens (alarms, arithmetic operations, memory, system, maintenance, communications, etc.)
	Trend display	Display colors: 12 (selectable) Number of screens: 5 (5 groups) Number of channels per screen: max. 44 Time axis orientation: vertical or horizontal Line thickness: 1, 3 or 5 dots (selectable) Scale display: 4 scales Direct tag or numerical value display (can be enabled or disabled) Marker display
	Data numerical value display	Number of screens: 5 (5 groups) Number of channels per screen: max. 44 Display details: measured values, channels/tags, units, alarm states
	Bar graph display	Display colors: 12 (selectable) Number of screens: 5 (5 groups) Number of channels per screen: max. 44 Display direction: vertical or horizontal Scale display: 1 scale
	Information display	Alarm display (alarm generation/cancellation history display) Marker list File list
	LCD backlight	Auto/manual OFF function Brightness adjustable in 4 steps Half-life of backlight brightness is approx. 5 years when used at brightness level 3 (the default) of the 4 brightness levels. To replace the LCD backlight, the display must be sent back to the factory for repair.
Recording specifications	Internal memory	Flash memory (capacity: 4 MB)
	External memory	CF (CompactFlash) card (capacity: 256 MB to 2 GB)
	Recording cycle	100, 200, 500 ms* 1, 2, 3, 5, 10, 15, 20, 30 s 1, 2, 3, 5, 10, 15, 20, 30, 60 min * When recording at a cycle of 100, 200 and 500 ms, up to 3 groups of 12 channels/group can be registered. When recording at a cycle of 1 s or more, up to 5 groups of 44 channels/group can be registered. (A total of 100 channels can be registered.)
	Number of recorded files	250 divided by the number of groups used
	Recorded data	• Measurement data: File name (group name), recording start date/time, tag, measurement data, alarm status/type • Settings
	Save format	Binary* / CSV format * To handle binary format data on a PC, the ARF Data Analysis Tool (ARF990DA0000, sold separately) is required.
	Save method	Manual start/stop (with START/STOP keys), schedule (day of week/time, date/time setting), trigger signal (alarm event). Pre-trigger recording is also possible (number of measurements: max. 950 data records)

Computation specifications	Number of operations	Max. 44	
	Operation type	<p>Arithmetic operations: addition, subtraction, multiplication, division, power</p> <p>Comparison operations: equal to, not equal to, greater than, less than, equal to or greater than, equal to or less than</p> <p>Logical operations: AND, OR, exclusive OR, NOT</p> <p>General functions: rounding up to nearest integer past decimal point, discarding digit past decimal point, absolute value square root, power of e, natural logarithm, common logarithm</p> <p>Integration operations: analog integration, digital integration</p> <p>Channel data operations: operations on measured data, operations on operation results</p>	
Alarm functions	Number of settings	Max. 4 can be set for each channel.	
	Alarm types	Upper limit, lower limit, diff. upper limit, diff. lower limit (dead band can be set), error data	
	Alarm ON delay	Delay time setting range 1 to 3600 s	
	Alarm setting	AND/OR can be set.	
	Alarm output	See Option specifications.	
Communication specifications	Network	Type	Ethernet (10BASE-T/100BASE-TX)
		FTP server	Data files are read from a computer on the network.
		FTP client	Data files are manually or automatically transferred to the server PC (FTP server) on the network.
		Web server	HTTP 1.0 compliant: displays, alarms, maintenance information, etc. are displayed in the browser (Internet Explorer 5.0 or later, Netscape 6.0 or later, Opera 7.0 or later). User passwords can be set.
		E-mail	Mail notification at specified times or when there is an alarm. E-mailed data can be selected from a report at a specified time or from all recorded data. Notified addresses: max. 8
	USB	USB standard	USB 1.1
Setting/ operation specifications	Operation keys	HOME, MENU, DISP, MARKER, SCROLL, CURSOR, START, STOP, ↑, ↓, ←, →, ENTER, ESC	
	HOME settings	Easy recording setting: input all data with the same settings Parameter batch settings, recording cycle, selection settings	
	MENU settings	<p>Input/operation settings: input parameters, operation parameters</p> <p>Display settings: data channel parameters, group parameters, common parameters (combination display, trend vertical/horizontal)</p> <p>Alarm settings</p> <p>File settings (5 files individually): save method setting</p> <p>Marker text settings</p> <p>System settings: communication, clock, maintenance, key lock, password, screen, etc.</p>	
	DISP operations	<p>Operation screen selection: trends, data, bar graph, historical trends, alarm display, marker list</p> <p>Display selection in each screen: groups 1 to 5 selectable</p>	
Option specifications	Alarm relay outputs	<p>Relay contact output upon alarm occurrence and input errors</p> <p>Number of outputs: 12</p> <p>Contact capacity: 240 Vac 0.2 A (resistive load) 30 Vac 0.3 A (resistive load)</p>	
	Non-voltage contact inputs (8) + Alarm MOS relay outputs (8)	<p>Contact input functions: contact inputs, pulse inputs, integration reset, marker write, start/stop record to data file in internal memory</p> <p>Alarm functions: relay contacts are output at alarm generation and input errors</p> <p>Number of outputs: 8</p> <p>Contact capacity: 240 Vac 50 mA DC, regardless of load type</p>	
	Network Instrumentation Module communication (Ethernet)	<p>Reading and recording of data of Network Instrumentation Modules connected over Ethernet</p> <p>Number of connected modules: max. 16 (1 communication per module*)</p> <p>Maximum number of recordings</p> <p>ARF106: total 36 (6 analog + 30 max. comm. data)</p> <p>ARF112: total 36 (12 analog + 24 max. comm. data)</p> <p>* 64 continuous data streams max. from 1 module can be read and transmitted in 1 communication, and a max. of 16 communications can be set up on 1 ARF unit</p> <p>Note: Updating of transmitted data recorded on the ARF is dependent on the NetworkInstrumentation Module sampling cycle, ARF communication cycle and ARF recording cycle.</p>	
General specifications	Transportation conditions	<p>As originally packaged:</p> <p>Ambient temperature/humidity range: -20 to +60 °C, 5 to 90 % RH (without condensation)</p> <p>Vibration: 10 to 60 Hz, 4.9 m/s² or less</p> <p>Shock 392 m/s² or less</p>	
	Storage conditions	Ambient temperature/humidity range: -20 to +60 °C, 5 to 90 % RH (without condensation)	
	Power failure protection	<p>Settings and data are held in flash memory</p> <p>A lithium battery backs up the clock and RAM for about 5 years.</p> <p>Note: Lithium battery replacement requires return of the recorder to the factory.</p>	
	Insulation resistance	<p>Across secondary terminals and ground: 20 MΩ min. at 500 Vdc</p> <p>Across primary terminals and ground: 20 MΩ min. at 500 Vdc</p> <p>Across primary and secondary terminals: 20 MΩ min. at 500 Vdc</p>	
	Dielectric strength	<p>Across secondary terminals and ground: 1 minute at 500 Vac</p> <p>Across primary terminals and ground: 1 minute at 1500 Vac</p> <p>Across primary and secondary terminals: 1 minute at 2300 Vac</p>	

General specifications	Case assembly	Front frame: ABS resin Case: ordinary steel plate
	Color	Front frame: black (Munsell N3.0) Case: gray (Munsell N7.0)
	Weight	Approx. 2.2 kg
	Mounting method	Panel mount
	Terminal screws	Power terminals/protective ground terminals/communication terminals: M4.0 Measurement input terminals/alarm output terminals/external drive terminals: M3.5
	Safety standard	CE marking

Table 1. Input type/Accuracy ratings

Input type	Measurement range	Indication accuracy	
DC voltage	-13.80 to +13.80 mV -27.60 to +27.60 mV -69.00 to +69.00 mV -200.0 to +200.0 mV -500.0 to +500.0 mV -2.000 to +2.000 V	±0.1 % FS ±1 digit	
(resistor divider built-in)	-5.000 to +5.000 V -10.00 to +10.00 V -20.00 to +20.00 V -50.00 to +50.00 V		
Thermo-couple	K	-200.0 to +300.0 °C -200.0 to +600.0 °C -200 to +1370 °C	±0.1 % FS ±1 digit * -200 to 0 °C: ±0.2 % FS ±1 digit
	E	-200.0 to +200.0 °C -200.0 to +350.0 °C -200 to +900 °C	
	J	-200.0 to +250.0 °C -200.0 to +500.0 °C -200 to +1200 °C	
	T	-200.0 to +250.0 °C -200.0 to +400.0 °C	
	R	0 to 1200 °C 0 to 1760 °C	±0.1 % FS ±1 digit * 0 to 400 °C: ±0.2 % FS ±1 digit
	S	0 to 1300 °C 0 to 1760 °C	
	B	0 to 1820 °C	±0.1 % FS ±1 digit * 0 to 400 °C: Non-standard * 400 to 800 °C: 0.15 % FS ±1 digit
	N	-200.0 to +400.0 °C -200.0 to +750.0 °C -200 to +1300 °C	±0.15 % FS ±1 digit * -200 to 0 °C: ±0.3 % FS ±1 digit
	W-WRe26	0 to 2315 °C	±0.15 % FS ±1 digit * 0 to 100 °C: ±4 % FS ±1 digit * 100 to 400 °C: ±0.5 % FS ±1 digit
	WRe5-WRe26	0 to 2315 °C	±0.2 % FS ±1 digit

Input type	Measurement range	Indication accuracy	
Thermo-couple	PtRh40-PtRh20	0 to 1888 °C	±0.2 % FS ±1 digit * 0 to 300 °C: ±1.5 % FS ±1 digit * 300 to 800 °C: ±0.8 % FS ±1 digit
	NiMo-Ni	-50.0 to to 299.0 °C -50.0 to to 600.0 °C -50 to +1310 °C	±0.2 % FS ±1 digit
	CR-Aube	0.0 to 280.0 K	±0.2 % FS ±1 digit * 0 to 20 K: ±0.5 % FS ±1 digit * 20 to 50 K: ±0.3 % FS ±1 digit
	Palatine II	0.0 to 350.0 °C 0.0 to 650.0 °C 0 to 1395 °C	±0.15 % FS ±1 digit
	U	-200.0 to +250.0 °C -200.0 to +500.0 °C -200.0 to +600.0 °C	±0.15 % FS ±1 digit * -200 to 0 °C: ±0.3 % FS ±1 digit
	L	-200.0 to +250.0 °C -200.0 to +500.0 °C -200 to +900 °C	±0.1 % FS ±1 digit * -200 to 0 °C: ±0.2 % FS ±1 digit
RTD	Pt100	-140.0 to +150.0 °C -200.0 to +300.0 °C -200.0 to +850.0 °C	±0.1 % FS ±1 digit * -140.0 to +150.0 °C, 700 to 800 °C: ±0.15 % FS ±1 digit
	JPt100	-140.0 to +150.0 °C -200.0 to +300.0 °C -200.0 to +649.0 °C	±0.1 % FS ±1 digit * -140.0 to + 150.0 °C: ±0.15 % FS ±1 digit
	Pt50	-200.0 to +649.0 °C	±0.1 % FS ±1 digit
	Pt-Co	4.0 to 374.0 K	±0.15 % FS ±1 digit * 4 to 50 K: ±0.3 % FS ±1 digit

Note: The indication accuracy applies under standard conditions. Thermocouple input does not include reference junction compensation accuracy.
Sources: K, E, J, T, R, S, B, N: IEC 584, JIS C1602-1995
W-WRe26, WRe5-WRe26, PtRh40-PtRh20, Platine II, NiMo-Ni, CR-AuFe: ASTM Vol 14.03
U(Cu-CuNi), L(Fe-CuNi): DIN 43710
Pt100: IEC 751(1995), JIS C1604-1997, JPt10
0: JIS C1606-1989

■ Key Operations

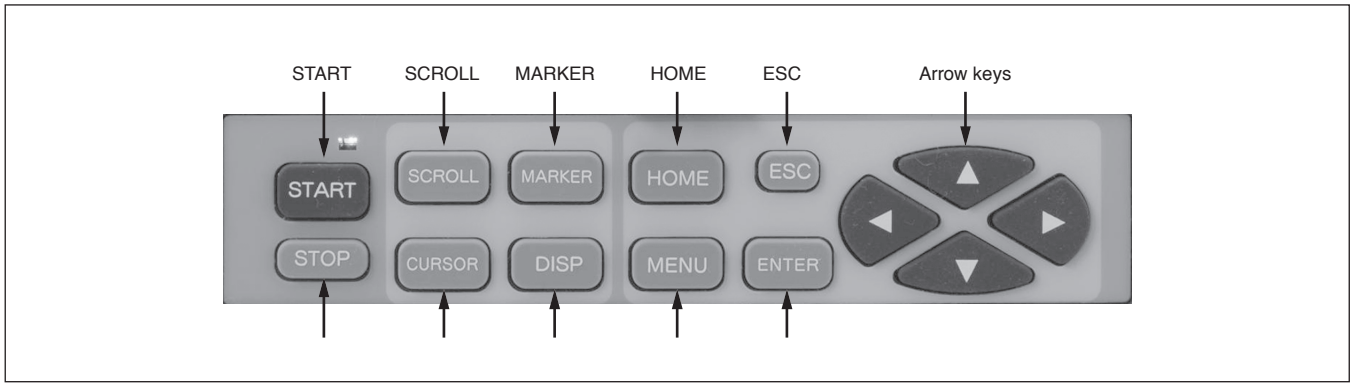

■ Display Functions

● Real-time trend screen

- The measured values of each input channel are displayed as trends in real time.
- Tag, numerical value display, scale gradation hide/display and vertical/horizontal switching are possible.

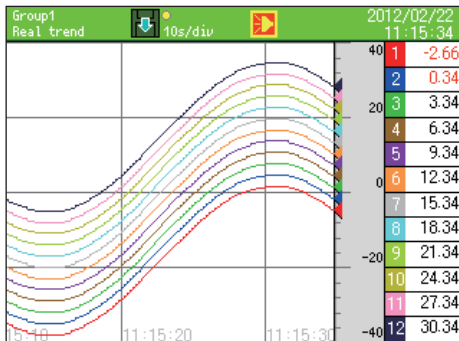

● Bar graph screen

- The measured values of each input channel are displayed as a bar graph in real time.

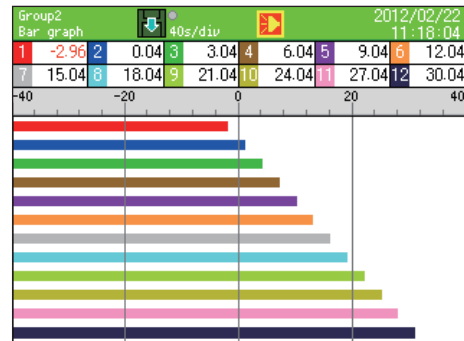

● Dual trend screen

- Historical trends and real-time trends are displayed simultaneously.
- This screen is handy for comparing waveforms.

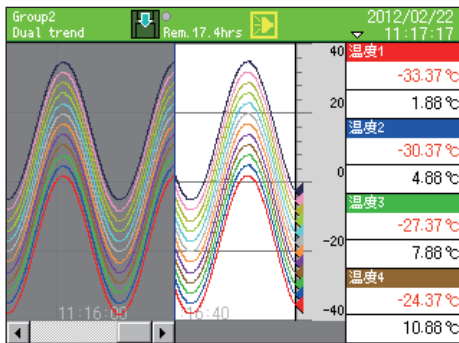

● Data display

- The measured values from each input channel are displayed in numerical form in real time.

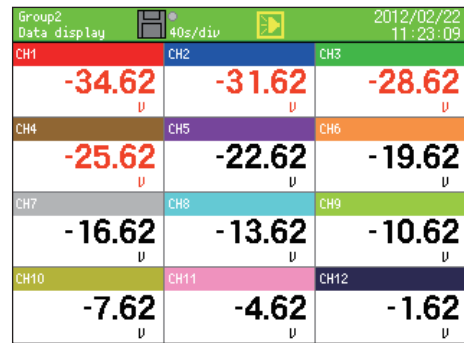

● Marker input

- Markers (comments) can be written on real-time trends.
- When writing markers, either select from pre-registered text strings or input text directly.

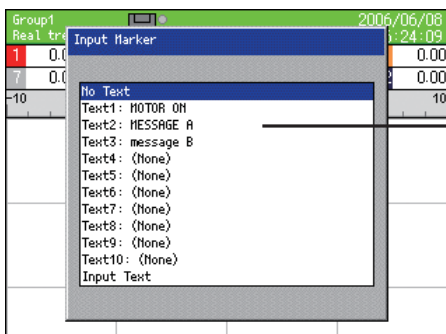

* Only alphanumeric characters and katakana can be input when inputting text directly on screen.

- **Alarm display**

- A list of alarms that were generated and alarm cancellation times are displayed.
- You can jump to historical trends by selecting a specific alarm.

Activation time	Cancel time	CH	Type
02/22 11:31:50		CH4	AL2 Lower
02/22 11:31:49		CH3	AL2 Lower
02/22 11:31:48		CH2	AL2 Lower
02/22 11:31:46		CH1	AL2 Lower
02/22 11:31:42	02/22 11:31:46	CH4	AL1 Upper
02/22 11:31:18	02/22 11:31:38	CH4	AL2 Lower
02/22 11:31:17	02/22 11:31:39	CH3	AL2 Lower
02/22 11:31:16	02/22 11:31:40	CH2	AL2 Lower
02/22 11:31:15	02/22 11:31:42	CH1	AL2 Lower
02/22 11:31:11	02/22 11:31:14	CH4	AL1 Upper
02/22 11:30:47	02/22 11:31:07	CH4	AL2 Lower
02/22 11:30:46	02/22 11:31:08	CH3	AL2 Lower
02/22 11:30:45	02/22 11:31:09	CH2	AL2 Lower
02/22 11:30:43	02/22 11:31:10	CH1	AL2 Lower
02/22 11:30:40	02/22 11:30:43	CH4	AL1 Upper
02/22 11:30:15	02/22 11:30:36	CH4	AL2 Lower

- **Input setting screen**

- Range and other information can be set in menu format for each individual input channel.

CH	Range type	Tag	Unit
01	10V	CH1	V
02	10V	CH2	V
03	10V	CH3	V
04	10V	CH4	V
05	10V	CH5	V
06	10V	CH6	V
07	10V	CH7	V
08	10V	CH8	V
09	10V	CH9	V
10	10V	CH10	V
11	10V	CH11	V
12	10V	CH12	V
13	----		V
14	----		V

- **Alarm settings screen**

- Information can be set for each individual input channel. Up to four alarms can be set for each channel from among upper limit, lower limit, differential upper limit, differential lower limit, and error data.

No.	Type	Value	Ref. CH	Deadband	Delay
AL1	Upper	10.00	01	0.00	0
AL2	Lower	0.00	01	0.00	0
AL3	None	0.00	01	0.00	0
AL4	None	0.00	01	0.00	0

No.	Relay	AND/OR	MARKER
AL1	0	OR	0
AL2	0	OR	0
AL3	0	OR	0
AL4	0	OR	0

- **Schedule settings screen**

- Recording start/stop schedules can be set.
- Schedules can be set by specific date/time or day of the week.

Date settings	Date	Time
Start date and time	12/01/01	00:00
End date and time	12/06/01	01:00

Day setting	Sun	Mon	Tue	Wed	Thu	Fri	Sat
Usage days	<input type="checkbox"/>	<input type="checkbox"/>	<input type="checkbox"/>	<input type="checkbox"/>	<input type="checkbox"/>	<input type="checkbox"/>	<input type="checkbox"/>
Start time	00:00						
End time	01:00						

- **Network Instrumentation Module Communication (Ethernet) Option**

ARF100 supporting the Network Instrumentation Module communication (Ethernet) option can connect to Yamatake's Network Instrumentation Modules by Ethernet to read, display and record any data on the network modules. In the same way as with actual analog input, display, group, scale, decimal point position, tags, and units also can be set. For example, when there are many measurement inputs or when the ARF100 is located a long way from sensors, making wiring difficult, the Network Instrumentation Modules can be distributed between different sites and connected by Ethernet to save wiring.

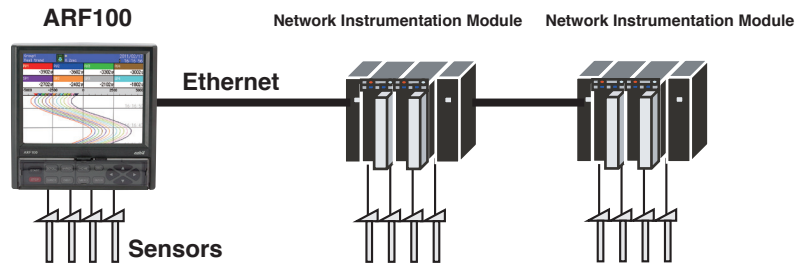

Model number configuration

I II III IV V VI VII VIII

Ex.: ARF106AS00000

I	II	III	IV	V	VI	VII	VIII	Notes
Basic model No.	Power supply	Input	Additional Function 1	Additional Function 2	Additional Function 3	Additional Treatment 1	Additional Treatment 2	
ARF106								6 inputs, CF card (256 MB) provided
ARF112								12 inputs, CF card (256 MB) provided
	A							100 to 240 Vac 50/60 Hz
		S						Standard multi-input (input cycle 100 ms)
			0					No additional functions
			1					12 relay outputs (1a normally open contacts)
			7					8 non-voltage contact inputs + 8 alarm MOS relay outputs
				0				No additional functions
				3				Network Instrumentation Module communications (Ethernet)
					0			No additional functions
						0		No additional treatment
						D		Inspection results included
						Y		Traceability certificate included
							0	No additional treatment

■ Related Parts

Model No.	Part Name
ARF910CF0256	CF (CompactFlash) card 256 MB
ARF910CF0512	CF (CompactFlash) card 512 MB
ARF910CF1000	CF (CompactFlash) card 1 GB
ARF910CF2000	CF (CompactFlash) card 2 GB
ARF990DA0000	ARF Data Analysis Tool

Model No.	Part Name
81401325	250 Ω resistors, accuracy ±0.02 %, 1 pc
81446642-001	250 Ω resistors, accuracy ±0.05 %, 2 pcs

External Dimensions

(Unit: mm)

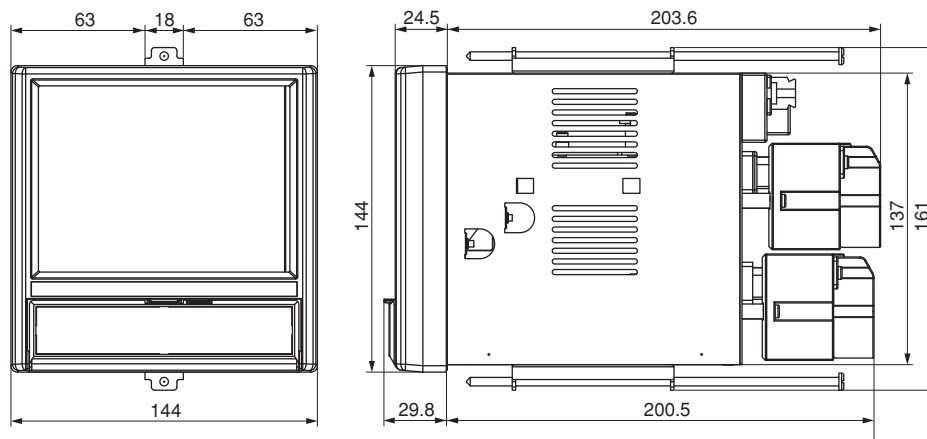

Panel Cutout Dimensions

(Unit: mm)

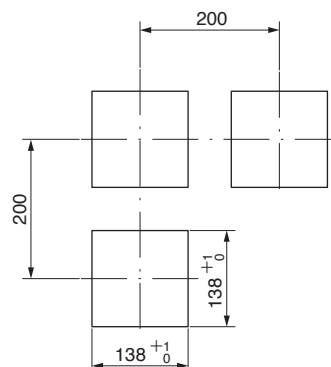

Terminal Connection Diagram

(Example) ARF112AS10000

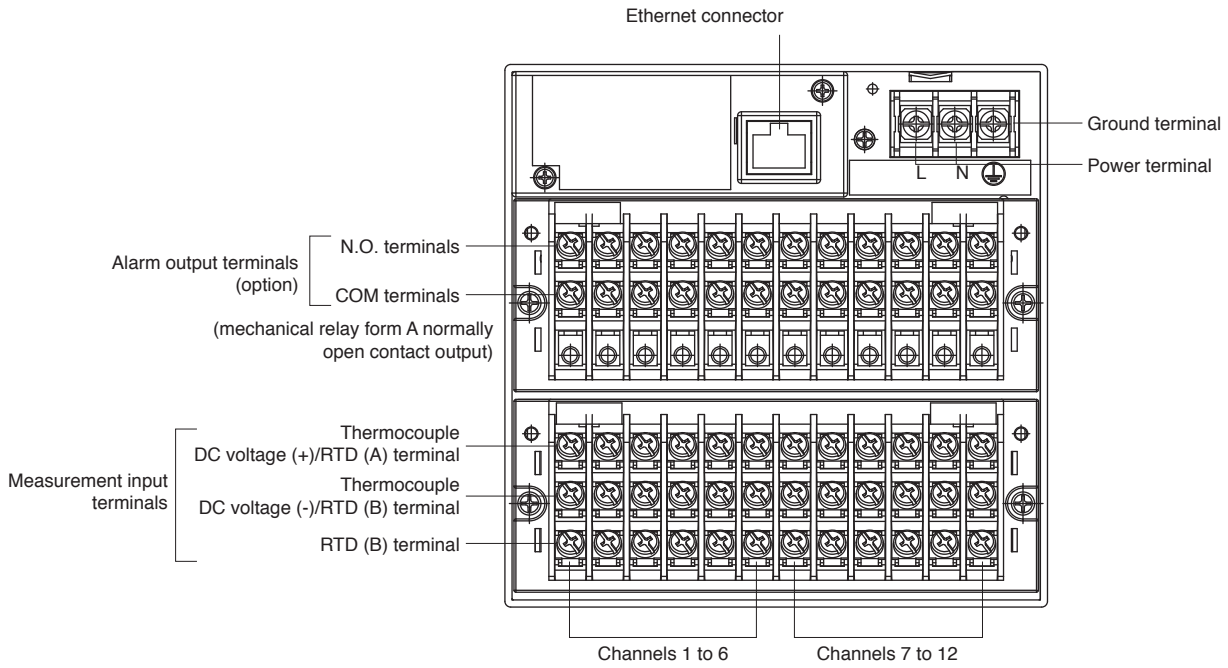

- Ethernet is a trademark of FUJIFILM Business Innovation Corp.
- Modbus is a trademark and the property of Schneider Electric SE , its subsidiaries and affiliated companies.

Please read "Terms and Conditions" from the following URL before ordering and use.

<https://www.azbil.com/products/factory/order.html>

Specifications are subject to change without notice.

azbil

Azbil Corporation
Advanced Automation Company

1-12-2 Kawana, Fujisawa
Kanagawa 251-8522 Japan
URL: <https://www.azbil.com/>

1st edition: Mar. 2011
3rd edition: Dec. 2023

No part of this publication may be reproduced or duplicated without the prior written permission of Azbil Corporation.