



A U R I O N

Carrelli Multifunzionali per Ospedali



Italiano

English

Español



Compact LINE

Pagine 3 - 18
AURION COMPACT

Page 3 - 18
AURION COMPACT

Páginas 3 - 18
AURION COMPACT



Monodose LINE

Pagine 19 - 25
COMPACT MONODOSE

Page 19 - 25
COMPACT MONODOSE

Páginas 19 - 25
COMPACT MONODOSE



Mega LINE

Pagine 26 - 39
AURION MEGA

Page 26 - 39
AURION MEGA

Páginas 26 - 39
AURION MEGA

AURION Compact



Compact è semplicemente rivoluzionario; il design innovativo permette al carrello di essere spostato e ruotato con estrema facilità.

Compact è poco ingombrante ma ottimizza al massimo lo spazio disponibile. Sono previsti 40 accessori per ogni esigenza ospedaliera.

Compact offre soluzioni efficienti per le Vostre esigenze di distribuzione / logistica dei farmaci. I cassetti **Aurion** sono utilizzabili contemporaneamente a cesti e vassoi ISO 600 x 400 mm con infinite combinazioni. E' sempre possibile ridefinire la posizione di cassetti, cesti e vassoi.



Compact is simply revolutionary, a new design allows the cart to be easily moved and turned around with a fingertip.

Compact occupies less room but maximizes space available. It also provides more than 40 personalised solutions to all hospital needs.

Compact is the most efficient solution to your medicine distribution and logistic needs: **Aurion** drawers can be used with any ISO 600 x 400 mm tray and/or basket with infinite possible combinations. Most important, you may always redefine the positions of drawers, trays or baskets.



Compact es simplemente revolucionario, un nuevo diseño permite al carro ser movido y girado con un dedo.

Compact es apto para habitaciones pequeñas pero maximiza el espacio disponible. Proporciona más de 40 soluciones personalizadas para todas las necesidades del Hospital.

Compact es la solución más eficiente para sus necesidades médicas de distribución y logística: **Aurion** cajones puede utilizarse con cualquier bandeja y/o cesta ISO 600 x 400 mm con infinitas combinaciones posibles. Más importante, usted puede siempre redefinir las posiciones de los cajones, bandejas o cestas.

Compact: Massimizza la tua Flessibilità





CARATTERISTICHE STANDARD:

Il corpo del carrello è composto da un monoblocco arrotondato in Poliuretano Baydur (prodotto dalla Bayer AG). Può essere lavato e disinfettato. Il materiale non reagisce con acidi diluiti, alcali e solventi. E' auto estinguente in base alla classe UL V0.

Tutti i carrelli sono prodotti senza utilizzare Latex.

Per ragioni di sicurezza, le maniglie sono stampate ed integrate nel corpo del carrello.

Il piano di lavoro ha un bordo perimetrale stampato e rialzato sui 4 lati anti-sgocciolamento e di contenimento.

Il paracolpi perimetrale evita danni al personale, al carrello e agli apparati medicali.

Specifiche

Aurion Compact: S

0620

Dispenser / Dispenser / Dispenser

0761

Vassoio porta monitor/defibrillatore
Monitor/defibrillator holder tray
Bandeja porta-monitor/desfibrilador

Piano di scrittura (*)
Writing surface (*)
Tablero para escritura (*)

Piano superiore con
bordo sui 4 lati (*)
Top surface with
4-sided rim (*)
Tablero superior
con borde de 4 lados (*)

Superficie per gel (*)
Gel space (*)
Espacio para gel (*)

Rompi fiala (*)
Ampoules opener (*)
Abridor de ampollas (*)

0141

Cassetto 100 mm
Drawer 100 mm
Cajón de 100 mm

0241

Cassetto 150 mm
Drawer 150 mm
Cajón de 150 mm

0512

Vassoio in ABS 100 mm
ABS tray 100 mm
Bandeja ABS de 100 mm

0502

Cesto metallico 150 mm
Wirebasket 150 mm
Cesta de alambre de 150 mm

(*) INCLUSI IN OGNI CORPO BASE.
(*) INCLUDED IN ANY BASIC BODY.
(*) INCLUIDO EN TODOS LOS CUERPOS BÁSICOS.

Specifiche Tecniche

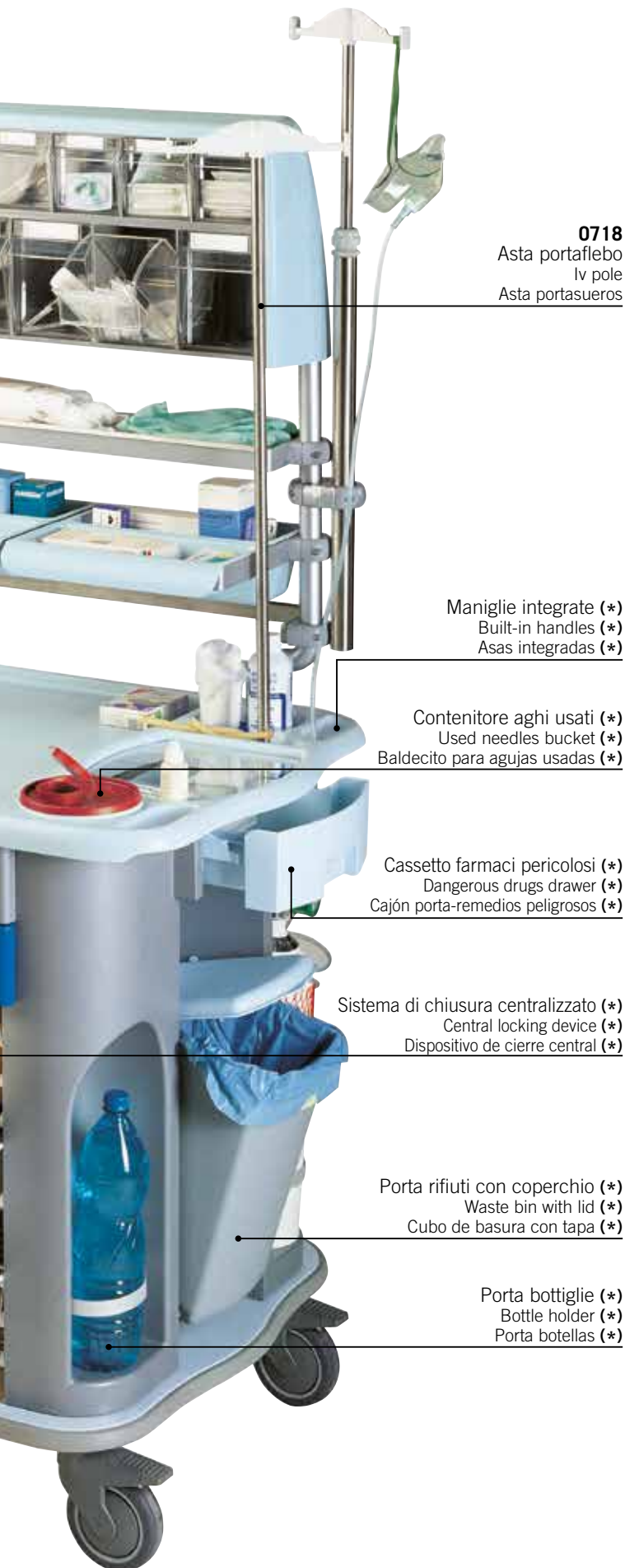

STANDARD FEATURES:

Body is composed of a single rounded piece of Baydur polyurethane material manufactured by Bayer AG; it can be washed and disinfected. It does not react with diluted acids, alkali and solvents. It is self-extinguishing according to class UL V0.

All carts are Latex free.

For safety, handles are moulded into the body. Trolley's top have a 4-sided moulded containing rim to avoid any spilling/falling of materials. All around bumper protection is included to avoid any damage to the personnel, cart and medical devices.



CARACTERISTICAS DE SERIE:

El cuerpo está compuesto por una sencilla pieza redondeada de Baydur, material poliuretano fabricado por Bayer AG; puede ser lavado y desinfectado. No reacciona con ácidos diluídos, lejías y disolventes. Es auto-extinguible de acuerdo a la clase UL V0.

Todos los carros están libres de Latex.

Por seguridad, las asas se moldean en el cuerpo. La parte superior del carro tiene las 4 caras moldeadas con bordes que impiden que se derramen o resbalen cosas.

Una parachoques en su perímetro impide cualquier daño al personal, carro o aparato médico.



CARATTERISTICHE STANDARD:

Un cassetto per farmaci controllati / salva-vita è incluso nella struttura del carrello. Grazie ad una superficie trasparente, l'identificazione del farmaco necessario ad una emergenza è immediata.

La chiusura dei cassetti può essere garantita da una sistema centralizzato a scelta: chiave, sigillo oppure sigillo con led luminosi di controllo.

Ogni cassetto è dotato di un porta etichetta utile ad indicare il contenuto dello stesso.

Una bacinella medicazione autoclavabile in acciaio inox 18/10 è posizionata uno specifico cassetto.

Il portarifiuti con coperchio è facilmente accessibile ed integrato nella struttura del carrello.

Una vasta gamma di 40 accessori permette di proporre soluzioni personalizzabili.

Specifiche

Aurion Compact: S

0719

Asta portaflebo regolabile in altezza
Height adj. iv pole
Asta portasueros de altura ajustable

0612

Telaio di supporto grande
Holding frame large
Armazón de soporte grande

0690

Barra di supporto in acciaio inox
Stainless steel holding bar
Asta de soporte de acero inoxidable

0810

Alimentazione elettrica
Electrical feeding
Alimentación eléctrica

1812

Supporto bombola ossigeno supplementare
Additional oxygen tank holder
Soporte de botella de oxígeno adicional

1820

Bombola ossigeno
Oxygen bottle
Botella de oxígeno

1881

Tavola per massaggio cardiaco CPR
Cardiac CPR massage board
Tabla de masaje cardíaco de CPR

Supporto bombola ossigeno (*)
Oxygen tank holder (*)
Soporte de bombona de oxígeno (*)

(*) INCLUSI IN OGNI CORPO BASE.
(*) INCLUDED IN ANY BASIC BODY.
(*) INCLUIDO EN TODOS LOS CUERPOS BÁSICOS.

Specifiche Tecniche

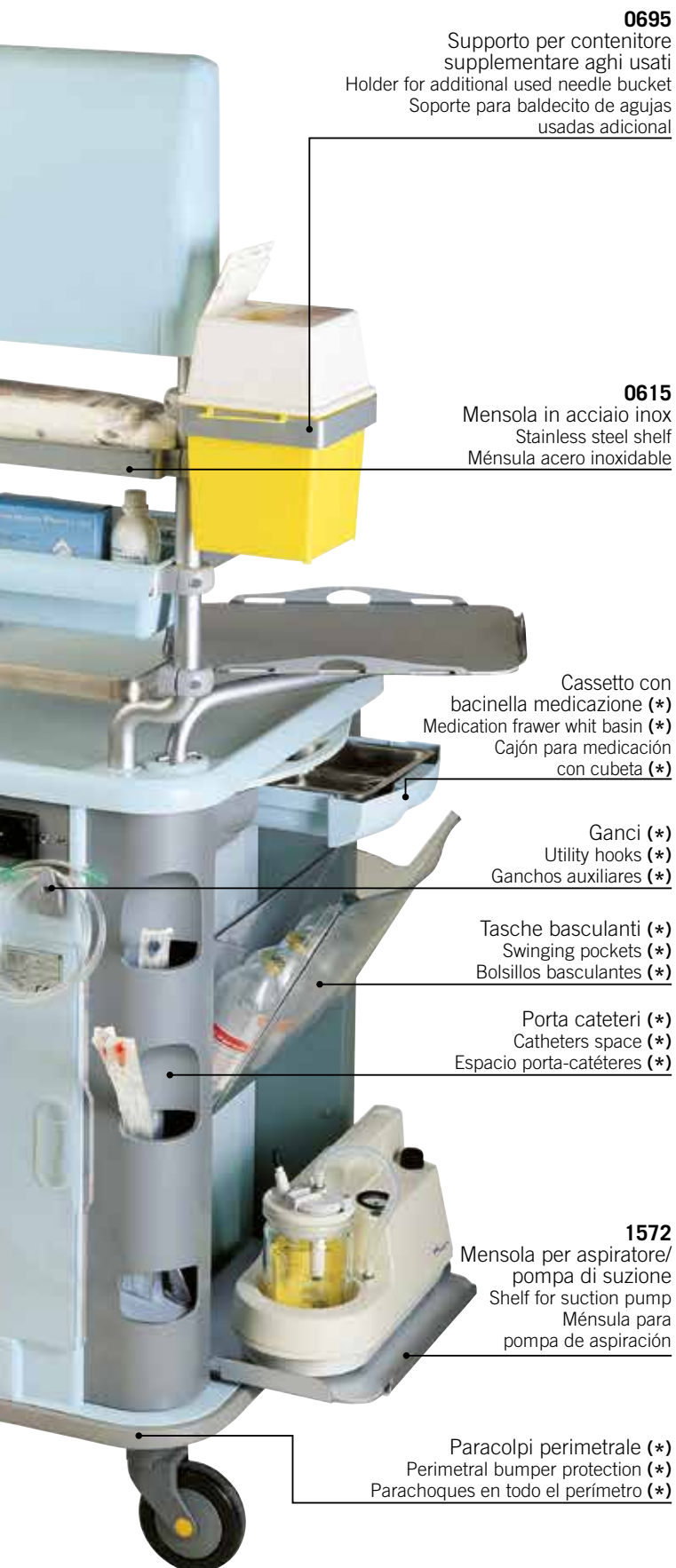

0695

Supporto per contenitore
supplementare aghi usati
Holder for additional used needle bucket
Soporte para baldecito de agujas
usadas adicional

0615

Mensola in acciaio inox
Stainless steel shelf
Ménsula acero inoxidable

Cassetto con
bacinella medicazione (*)
Medication drawer with basin (*)
Cajón para medicación
con cubeta (*)

Ganci (*)
Utility hooks (*)
Ganchos auxiliares (*)

Tasche basculanti (*)
Swinging pockets (*)
Bolsillos basculantes (*)

Porta cateteri (*)
Catheters space (*)
Espacio porta-catéteres (*)

1572

Mensola per aspiratore/
pompa di suzione
Shelf for suction pump
Ménsula para
pompa de aspiración

Paracolpi perimetrale (*)
Perimetral bumper protection (*)
Parachoques en todo el perímetro (*)



STANDARD FEATURES:

It has a drawer for life-saving drugs/medication. The content of this drawer is always visible to rapidly access the needed emergency medications.

Drawers are lockable with a central locking device of your choice: key lock, break away seal lock or seal lock with flashing leds.

Each drawer has an individual tag for labeling the content of the drawer.

Medication basin is built in the trolley. The medication basin is made in AISI304 (18-10) stainless steel fully autoclaveable.

Waste container with top lid is easy to access and, most important, built-in the structure.

A wide range of 40 accessories with personalised solutions.



CARACTERISTICAS DE SERIE:

Dispone de un cajón para drogas o medicaciones peligrosas. El interior de este cajón es siempre visible para acceder rápidamente a los medicamentos en una emergencia.

Los cajones disponen de un cierre centralizado a elegir entre cerradura de llave, cerradura de sello o cerradura de sello con luces.

Cada cajón tiene una etiqueta individual para la descripción del material guardado en él.

La cubeta para medicación está integrada en el carro. Está hecha en acero inoxidable 18/10 totalmente esterilizable en autoclave.

El contenedor de desechos con tapa superior es de fácil acceso y, más importante, integrado en la estructura.

Una amplia gama de 40 accesorios con soluciones personalizadas.

COSTRUISCI IL TUO CARRELLO AURION COMPACT
BUILD YOUR CUSTOM MADE AURION COMPACT TROLLEY
CONSTRUYE TU CARRO AURION COMPACT

Step
Scegli il



The AURION COMPACT Basic Body includes:

- (A)** A Single piece BAYDUR body; top surface with containing rim. Your choice of BLUE or BEIGE colour
- (B)** 2 clear plastic swinging pockets (for IV bottles/ patient files)
- (C)** Catheters compartments
- (D)** Used needle bucket/ used cotton waste container
- (E)** Life-saving drugs drawer
- (F)** Centralised locking system. Your choice of KEY lock, SEAL lock or SEAL lock with leds
- (G)** Ampoule opener
- (H)** Water bottle holder
- (I)** Front space
- (J)** Waste bin with lid
- (K)** Sliding working/ writing surface
- (L)** Stainless steel 18/10 medication basin (into drawer)
- (M)** Drawer for medication basin
- (N)** 2 utility hooks
- (O)** Oxygen tank holder
- (P)** 4 wheels (3 with break and 1 antistatic)

Dimensions Basic Body
mm 830x715x910h

Il corpo del carrello AURION COMPACT include:



Dimensioni Corpo Base: mm 830x715x910h





Scegliere il corpo base selezionando il colore e il sistema di chiusura:

Corpo base senza chiusura
Basic Body no lock
Cuerpo básico sin cierre

0021 0031

0023  Corpo base con chiusura a chiave
Basic Body with key lock

0033  *Cuerpo básico con cierre a llave*

0025  Corpo base con chiusura a sigillo
Basic Body with seal lock

0035  *Cuerpo básico con cierre a sello*



1 Corpo Base

AURION
Compact



El cuerpo básico AURION COMPACT incluye lo siguiente:

- (A) Cuerpo en una pieza de BAYDUR, cara superior con reborde: su elección en color AZUL o BEIGE
- (B) 2 bolsillos basculantes en plástico transparente
- (C) Compartimento para cateteres
- (D) Contenedor de residuos: cubo para agujas/algodones usados
- (E) Cajón para remedios de urgencia
- (F) Sistema de cierre centralizado: a elegir entre cerradura de LLAVE, cerradura de SELLO o cerradura de SELLO con luces
- (G) Abridor de ampollas
- (H) Soporte para botella de agua
- (I) Espacio frontal
- (J) Cubo de basura con tapa
- (K) Superficie deslizante para trabajar/escribir
- (L) Cubeta para medicación en acero inoxidable (dentro del cajón)
- (M) Cajón para cubeta de medicación
- (N) 2 ganchos traseros
- (O) Soporte para botella de oxígeno
- (P) 4 ruedas (3 sin freno, 1 antiestática)

 Please choose a Basic Body by selecting the colour and the locking device:

Corpo base con chiusura a sigillo e LED luminosi di controllo
Basic Body with seal lock and flashing LED
Cuerpo básico con cierre a sello y LED

0027  0037 



 Por favor elije el color deseado para el cuerpo básico y el sistema de cierre:

Corpo base con chiusura a sigillo, LED e reset
Basic Body with seal lock, LED and reset
Cuerpo básico con cierre a sello, LED y reinicio

0029  0039 

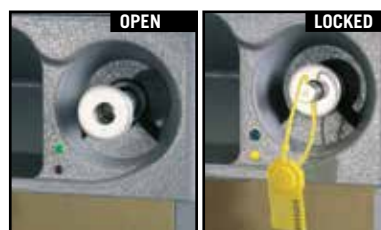

Tamaño Cuerpo Base
mm 830x715x910h



CASSETTI - CESTI - VASSOI

I carrelli **AURION COMPACT** possono essere completati con:

- A)** Cassetti (100 o 150 mm)
- B)** Vassoi acrilici / ABS, norma ISO 60x40
- C)** Cesti metallici, norma ISO 60x40
- D)** Cassette Monodose

Importante: qualsiasi combinazione può essere successivamente modificata dall'utente.

Scelga la combinazione desiderata.



DRAWERS - TRAYS - BASKETS MONODOSE CASSETTES

Any of the **AURION COMPACT** Basic Bodies may be fitted with combinations of:

- A)** Drawers (100 or 150 mm)
- B)** ISO 600 x 400mm ABS/acrylic trays
- C)** ISO 600 x 400mm wirebaskets
- D)** Monodose Cassettes

Any of these desired combinations may be quickly modified by the end user.

Please choose your desired combination.



CAJONES - BANDEJAS - CESTAS CASSETTES UNIDOSIS

Cualquiera de los cuerpos básicos

AURION COMPACT puede completarse con:

- A)** Cajones (100 o 150 mm)
- B)** Bandejas acrílicas/ABS ISO 600x400 mm
- C)** Cesta de alambre ISO 600x400
- D)** Cassettes Unidosis

Más importante, cualquiera de esta combinaciones elegidas puede ser rápidamente modificada por el usuario final.

Por favor, elije la combinación deseada.

Cassetti - Vassoi - Cesti - Cassetti Monodose



(A)



(A+B)



(A+C)



(A+D)

2 Vassoi - Cesti - Cassette Monodose

CASSETTO 100mm DRAWER 100mm CAJÓN 100mm



Rosso/red/rojo **0111**



Giallo/yellow/amarillo **0131**



Verde/green/verde **0121**



Blu/blue/azul **0141**

CASSETTO 150mm DRAWER 150mm CAJÓN 150mm



Rosso/red/rojo **0211**



Giallo/yellow/amarillo **0231**



Verde/green/verde **0221**



Blu/blue/azul **0241**

CASSETTO 200mm DRAWER 200mm CAJÓN 200mm



Rosso/red/rojo **0311**



Giallo/yellow/amarillo **0331**



Verde/green/verde **0321**



Blu/blue/azul **0341**

CASSETTO 300mm DRAWER 300mm CAJÓN 300mm



Rosso/red/rojo **0411**



Giallo/yellow/amarillo **0431**



Verde/green/verde **0421**



Blu/blue/azul **0441**

DIMENSIONE INTERNA CASSETTO mm 585x365 INNER DIMENSION TAMAÑO INTERIOR

100mm - Massimo 6 pezzi per carrello
100mm - Max. 6 pieces each trolley
100mm - Máx 6 piezas cada carro

200mm - Massimo 3 pezzi per carrello
200mm - Max. 3 pieces each trolley
200mm - Máx 3 piezas cada carro

150mm - Massimo 4 pezzi per carrello
150mm - Max. 4 pieces each trolley
150mm - Máx 4 piezas cada carro

300mm - Massimo 2 pezzi per carrello
300mm - Max. 2 pieces each trolley
300mm - Máx 2 piezas cada carro



0250 - 0253 - 0254 - 0256

Cassetti Monodose a 15 - 10 - 9 - 6 cassettoni
Monodose Cassette. Please refer to Aurion Monodose Medication Trolley catalogue
Cassette Unidose á 15 - 10 - 9 - 6 cajetines individuales

Cassetti - Vassoi - Cesti - Cassetti Monodose



0501
Cesto metallico 70H mm
Wirebasket 70H mm
Cesta de alambre de 70H mm

0502
Cesto metallico 150H mm
Wirebasket 150H mm
Cesta de alambre de 150H mm

0503
Cesto metallico 190H mm
Wirebasket 190H mm
Cesta de alambre de 190H mm

600x400mm ISO Cesto metallico
600x400mm ISO Wirebasket
600x400mm ISO Cesta de alambre



0511
Vassoio in ABS 50H mm
ABS tray 50H mm
Bandeja ABS de 50H mm

0512
Vassoio in ABS 100H mm
ABS tray 100H mm
Bandeja ABS de 100H mm

0538
Divisorio in ABS 400x100 mm
ABS divider 400x100 mm
Separador ABS de 400x100 mm

0539
Divisorio in ABS 600x100 mm
ABS divider 600x100 mm
Separador ABS de 600x100 mm

600x400mm ISO ABS vassoio
600x400mm ISO ABS Tray
600x400mm ISO ABS bandeja



0521
Vassoio trasparente in acrilico 50H mm
Clear acrylic tray 50H mm
Bandeja de acrilico trasparente de 50H mm

0522
Vassoio trasparente in acrilico 100H mm
Clear acrylic tray 100H mm
Bandeja de acrilico trasparente de 100H mm

600x400mm ISO
vassoio trasparente
600x400mm
ISO Clear Acrylic Tray
600x400mm
ISO bandeja trasparente



0551
Mensola
Shelf
Estante



0597
2 sportelli da 500mm
con chiusura a sigillo
2 doors 500mm with seal lock
2 puertas de 500mm con sello

0598
2 sportelli da 600mm
con chiusura a sigillo
2 doors 600mm with seal lock
2 puertas de 600mm con sello

0091
 Ruote per carrello
 risonanza magnetica
 Anti magnetic wheels for MRI trolley
 (optional)
 Rueda para el carro de
 resonancia magnética



0097
 Dispenser di bicchieri
 Cup dispenser
 Dispenser de vasos



0611
 Telaio di supporto **piccolo**, con 2 vaschette (H 45mm)
 Holding frame, **small** with 2 basins
 Armazón de soporte, **pequeño** con 2 cubetas

0616
 Telaio di supporto **piccolo**, con 2 vaschette (H 45mm)
 Holding frame, **small** with 2 basins
 Armazón de soporte, **pequeño** con 2 cubetas

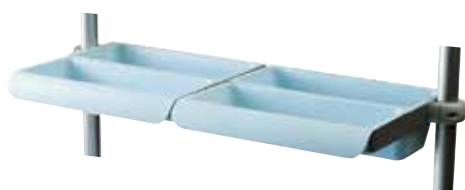

0612
 Telaio di supporto **grande**, con 4 vaschette (2-H 45mm/ 2-H 90mm)
 Holding frame, **large** with 4 basins
 Armazón de soporte, **grande** con 4 cubetas

0617
 Telaio di supporto **grande**, con 4 vaschette (2-H 45mm/ 2-H 90mm)
 Holding frame, **large** with 4 basins
 Armazón de soporte, **grande** con 4 cubetas



0613
 Telaio di supporto **doppio**, con 6 vaschette (4-H 45mm/ 2-H 90mm)
 Holding frame, **double** with 6 basins
 Armazón de soporte, **doppio** con 6 cubetas

0618
 Telaio di supporto **doppio**, con 6 vaschette (4-H 45mm/ 2-H 90mm)
 Holding frame, **double** with 6 basins
 Armazón de soporte, **doppio** con 6 cubetas



0614
 Mensola **grande** in acciaio inox
 Stainless steel shelf **large**
 Estante de acero inoxidable **grande**



0615
 Mensola **piccola** in acciaio inox
 Stainless steel shelf **small**
 Estante de acero inoxidable **pequeña**



0620
 Dispenser
 Dispenser
 Dispensador

0630
 Dispenser
 Dispenser
 Dispensador



0621 **0631**
 Dispenser e struttura di supporto
piccola con 2 bacinelle
 Dispenser and holding frame
small with 2 basins
 Dispensador y armazón de soporte
pequeña con 2 cubetas



0622 **0632**
 Dispenser e struttura di supporto
grande con 4 bacinelle
 Dispenser and holding frame
large with 4 basins
 Dispensador y armazón de soporte
grande con 4 cubetas



0623 **0633**
 Dispenser e struttura di supporto
doppio con 6 bacinelle
 Dispenser and holding frame
double with 6 basins
 Dispensador y armazón de soporte
doppio con 6 cubetas

A
C
C
E
S
S
O
R
I

Vaschette supplementari (facoltative):

Additional basins (optional):

Cubetas adicionales (opcionales):

0681 0682

Vaschette 90H mm
Basin 90H mm
Cubetas 90H mm



0683 0684

Vaschette 45H mm
Basin 45H mm
Cubetas 45H mm



0690

Barra di supporto in acciaio inox 25x10mm
Stainless steel holding rail 25x10mm
Barra de soporte de acero inoxidable de 25x10mm

0691

Barra di supporto in acciaio inox 30x10mm
Stainless steel holding rail 30x10mm
Barra de soporte de acero inoxidable de 30x10mm



0695

Supporto regolabile per
contenitore aghi usati
Adjustable Holder for used
needles bucket
Ajustable soporte para balcedito
de agujas usadas

0696

Supporto per contenitore
aghi usati, **rotondo**
Holder for used
needles bucket, **round**
Soporte para balcedito
de agujas usadas, **redondo**

0697

Cronografo contasecondi
Stop watch chronograph
Cronómetro cronógrafo



0698

Supporto per scatola guanti, **singolo**
Gloves box holder, **single**
Soporte de cajas de guantes, **individual**



0699

Supporto per scatola guanti, **multiple**
Gloves box holder, **multiple**
Soporte de cajas de guantes, **múltiple**



0718

Asta portaflebo
(supporto incluso)
IV pole
(holder included)
Asta porta sueros
(soporte incluido)



0719

Asta portaflebo regolabile in altezza
(supporto incluso)
Height adjustable IV pole
(holder included)
Asta porta sueros de altura ajustable
(soporte incluido)



0762 - 0763 (stainless steel)

Supporto porta defibrillatore, **girevole**
(incluso tappettino anti slittamento)
Rotating defibrillator holder tray, **lockable**
(including anti-sliding pad)
Bandeja de soporte de desfibrilador giratoria, **de rotación libre**
(incluido alfombrilla antideslizante)



0781

Protezione perimetrale per carrello pediatrico
Perimetral protection for pediatric trolley
Protección perimetral para carro pediátrico



0782

Materasso pediatrico
Pediatric mattress / Colchón pediátrico

A C C E S S O R I



0810
Alimentazione elettrica (spine) spine di tipo Europeo
Electrical feeding (plugs) European type plugs
Alimentación eléctrica (enchufes) Enchufes de tipo Europeo

0811
Alimentazione elettrica (spine) spine di tipo Usa
Electrical feeding (plugs) Usa/Jap type plugs
Alimentación eléctrica (enchufes) Enchufes de tipo Usa

0812
Alimentazione elettrica (spine) spine di tipo Uk
Electrical feeding (plugs) Uk type plugs
Alimentación eléctrica (enchufes) Enchufes de tipo Uk



0851
Porta catetere supplementare
Additional catheters holder
Porta-catéteres adicional



0912
Kit divisori cassetti:
1 distanziatore verticale e 6 divisori regolabili
Drawer divider kit:
1 vertical divider and 6 adjustable individual dividers
Kit de separadores para cajones:
1 espaciador vertical y 6 separadores individuales ajustable



0932
Porta flaconi per flebo
IV bottles holder
Porta-botellas fleboclisis



1572
Mensola per aspiratore/pompa di aspirazione
Shelf for aspirator/suction pump
Estante para aspirador /bomba da aspiración

Accessori per Emergenza



1812
Porta bombola supplementare per ossigeno, **piccolo**
Additional oxygen tank holder **small**
Soporte de bombona de oxígeno adicional **pequeña**

1813
Porta bombola supplementare per ossigeno, **grande**
Additional oxygen tank holder **large**
Soporte de bombona de oxígeno adicional **grande**



Bombola per ossigenoterapia:
con riduttore di pressione e flussometro regolabile (da 0 a 12 l/min.)
Tank for oxygen therapy:
with pressure reducer and adjustable flowmeter (0 to 12 l/min)
Botella para oxigenoterapia:
con reductor de presión y flujómetro ajustable (de 0 a 12 l/min)

1820
Bombola ossigeno da 3 L.
Oxygen bottle 3 L.
Botella de oxígeno de 3 L.



1881
Tavola per massaggio cardiaco CPR
Cardiac CPR massage board
Tabla de masaje cardíaco de CPR



9007
Sigilli in plastica numerati (kit di 100 pezzi)
Breakaway plastic seals (kit of 100 pcs)
Sellos plásticos (kit de 100 pedazos)

Configurazioni Standard

Operating Room
CP/OPR



- 0033
- 0141 (3X)
- 0241 (2X)
- 0614
- 0690
- 0699

Utility 6
CP/UT6



- 0023
- 0141 (6X)

Standard configurations

Configuraciones Recomendadas

Anaesthesia 1
CP/AN1



- 0021
- 0121 (3X)
- 0221 (2X)
- 0615
- 0620
- 0690
- 0718

Anaesthesia 2
CP/AN2



- 0033
- 0141 (3X)
- 0241 (2X)
- 0614
- 0616
- 0718

Configurazioni Standard

Storage
CP/STO



- 0025
- 0141
- 0551
- 0597

ISO Wirebaskets
CP/WB4



- 0031
- 0131
- 0501 (3X)
- 0502

Standard configurations

Configuraciones Recomendadas

ISO Acrylic Trays
CP/AT5



- 0031
- 0111
- 0521 (3X)
- 0522 (2X)

ISO ABS Trays
CP/TR6



- 0021
- 0511 (4X)
- 0512 (2X)

Configurazioni Standard

Emergency 1
CP/EM 1



- 0021
- 0141
- 0241
- 0718
- 0762

Emergency 2
CP/EM 2



- 0035
- 0111 (2X)
- 0211
- 0503
- 0718
- 0762
- 1881

Standard configurations

Configuraciones Recomendadas

Emergency 3
CP/EM 3



- 0025
- 0141 (3X)
- 0241 (2X)
- 0718
- 0762
- 0810
- 1881

Emergency 4
CP/EM 4



- 0037
- 0111 (3X)
- 0211 (2X)
- 0719
- 0762
- 0810
- 1572
- 1881

Configurazioni Standard

Medication
CP/MED



- 0033
- 0131 (3X)
- 0231 (2X)
- 0633

Therapy
CP/TER



- 0025
- 0221 (4X)
- 0620
- 0718

Standard configurations

Configuraciones Recomendadas

MRI Antimagnetic
CP/MRI



- 0021
- 0091
- 0241 (4X)

Pediatric
CP/PED



- 0031
- 0111
- 0121
- 0131
- 0141
- 0502
- 0781
- 0782
- 1572

Compact Monodose: Il Sistema per la Distribuzione del Farmaco



Sistema Monodose



SISTEMA DI MEDICAZIONE MONODOSE AURION

Il nostro concetto più innovativo per consentire un'integrazione sicura e rapida della logistica dei farmaci e della distribuzione, dalla farmacia al paziente.

L'elemento centrale del sistema è il carrello Aurion Compact su cui si possono inserire fino a 3 CASSETTE MONODOSE (CM), Ogni CASSETTA MONODOSE (CM) può avere, a scelta, da 6 a 15 CONTENITORI INDIVIDUALI!

Il sistema di medicazione monodose Aurion Compact è:

- **SICURO** perché il CONTENITORE di ogni paziente viene chiuso nella CASSETTA MONODOSE.
- **RAPIDO** perché con un'unica manovra del SISTEMA DI CHIUSURA si avrà accesso a tutti i CONTENITORI dei pazienti nelle CASSETTE MONODOSE.

Vantaggi del sistema:

- **CHIUSURA:** A scelta, un corpo base Aurion Compact con un sistema di chiusura a CHIAVE oppure a SIGILLO.
- **CHIUSURA UNICA:** il sistema di chiusura Aurion chiuderà tutti i cassette e le CASSETTE MONODOSE nel corpo del carrello e, nel contempo, tutti i contenitori dei PAZIENTI nelle CASSETTE MONODOSE.
- **FLESSIBILITÀ:** Sul corpo base Aurion Compact si può installare virtualmente qualsiasi combinazione di cassette, CASSETTE MONODOSE, vassoi e cesti. L'utente finale può modificare in qualsiasi momento le combinazioni.

- **POSSIBILITÀ DI AGGIORNAMENTO:** Scelga una delle configurazioni raccomandate in questo catalogo e successivamente potrà aggiungere tutti gli accessori che le servono. Consulti il catalogo generale Aurion Compact.

Cassette Monodose (CM):

- **IMPIEGO:** La CM funziona come un cassetto normale e può facilmente essere rimossa dal corpo base.
- **MANIGLIA:** Ogni CM è dotata di una maniglia per il trasferimento più agevole dal deposito ai carrelli.
- **CONTENITORI DEI PAZIENTI:** i contenitori vengono forniti con la CM; sono dotati di un'etichetta, 3 divisori e un coperchio scorrevole in plastica trasparente per evitare che le medicine cadano dal contenitore.
- **CHIUSURA INDIVIDUALE DELLA CM:** Se la CM è nel corpo del carrello, la chiusura centralizzata del carrello garantisce la sicurezza. Quando la CM non è inserita nel carrello i contenitori individuali possono essere chiusi all'interno della CM con un SIGILLO.
- **IMPILAGGIO:** Le CM possono essere impilate riducendo al minimo lo spazio di stoccaggio.



AURION MONODOSE SYSTEM

Our latest concept to allow you safe and quick integration of medicine logistics and distribution, from pharmacy to patients.

The core of the system is the Aurion Compact trolley which may be fitted with up to 3 MONODOSE CASSETTES (MC). Each MONODOSE CASSETTE (MC) may have from 6 to 15 patient BINS: your choice !

Aurion Compact Monodose Medication System is:

- **SAFE** as every patient BIN will be securely locked into the MONODOSE CASSETTE.
- **QUICK** as a single action LOCK will allow access to all patient BINS in any MONODOSE CASSETTE.

System Advantages:

- **LOCKING:** Choose a Aurion Compact basic body with a KEY or a SEAL locking system.
 - **SINGLE LOCK:** Aurion locking system will secure all drawers and MONODOSE CASSETTES into the trolley body and, at the same time, all patient BINS into the MONODOSE CASSETTES.
 - **FLEXIBILITY:** The Aurion Compact basic body may fit virtually any combination of drawers, MONODOSE CASSETTES, trays and baskets. Combinations may be modified by the end user at any time.
 - **UPGRADEABILITY:** Select one of the recommended configurations in this catalogue, later add any accessories you may need. Please refer to Aurion Compact general catalogue.
- Monodose Cassette (MC):
- **USE:** The MC acts as a normal drawer; it is easy to remove from the basic body.
 - **HANDLE:** Each MC includes a handle to make transfer from storage to trolleys easiest.
 - **PATIENT BINS:** They are provided with the MC; they have a label, 3 dividers and a clear plastic sliding top to make sure that medicines are not falling out of the bin.
 - **INDIVIDUAL MC LOCK:** If the MC is into the trolley body, the trolley central locking guarantees the security. Once the MC is free standing, locking of the individual bins is provided by a SEAL.
 - **STACKING:** The MCs are stackable to reduce space requirements in your storage / pharmacy.



SISTEMA DE MEDICACIÓN UNIDOSIS AURION

Nuestro último concepto nos permite ofrecer una integración rápida y segura entre la logística de los medicamentos y su distribución, desde la farmacia hasta el paciente. La base del sistema es el Carro Aurion Compact, que puede ser cargado hasta con tres CASSETTES UNIDOSIS (MC), cada uno de los cuales pueden tener de 6 a 15 cajetines individuales, a su elección.

Ventajas del sistema:

- **SISTEMA DE CIERRE:** Elija un cuerpo básico Aurion Compact con un sistema de cierre de LLAVE o de JUNTA.
 - **CIERRE INDIVIDUAL:** El sistema de cierre Aurion fijará todos los cajones y CASSETTES UNIDOSIS en el interior del cuerpo del carro y, al mismo tiempo, todos los CAJETINES individuales en los CASSETTES UNIDOSIS.
 - **FLEXIBILIDAD:** El cuerpo básico Aurion Compact acepta prácticamente cualquier combinación de cajones, CASSETTES UNIDOSIS, bandejas y cestas. El usuario final puede modificar las combinaciones en cualquier momento.
 - **CAPACIDAD DE ACTUALIZACIÓN:** Seleccione una de las configuraciones recomendadas en este catálogo y añada posteriormente los accesorios que necesite. Consulte el catálogo general de Aurion Compact.
- Cassette unidosis (MC):
- **USO:** El MC actúa como un cajón normal; es fácil de extraer del cuerpo básico.
 - **ASA:** Cada MC incluye un asa para facilitar el transporte desde el lugar de almacenamiento a los carros.
 - **CAJETINES INDIVIDUALES:** Se suministran con el MC; tienen una etiqueta, 3 tabiques y una parte superior deslizante de plástico transparente para asegurar que los medicamentos no se caigan del cajetín.
 - **CIERRE MC INDIVIDUAL:** Si el MC está en el cuerpo del carro, el cierre central del carro garantiza la seguridad. Una vez que el MC esté suelto, un SELLO permite el cierre de los cajetines individuales.
 - **APILAMIENTO:** Los MC son apilables para reducir la necesidad de espacio en los lugares de almacenamiento y en las farmacias.

Costruisca il suo Carrello Personalizzato Aurion per Farmaci Monodose in 3 Semplici Fasi:
Build your own Aurion Monodose Medication Trolley in 3 Easy Steps:
Construye tu Carro de Medicación Unidosis Aurion en 3 Pasos:



0023
 Corpo base BLU, con chiusura a CHIAVE
 Basic Body BLUE, KEY lock
 Cuerpo básico AZUL, cierre de LLAVE

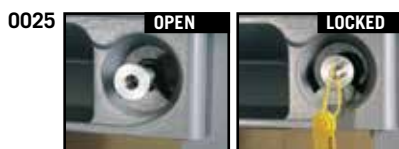

0025
 Corpo base BLU, con chiusura a SIGILLO
 Basic Body BLUE, SEAL lock
 Cuerpo básico AZUL, cierre de JUNTA

Step 1

SCELGA UN CORPO BASE
CHOOSE A BASIC BODY
ELIJA UN CUERPO BÁSICO

Per le specifiche del corpo base consulti il catalogo generale Aurion Compact.

Please refer to Aurion Compact general catalogue for Aurion Basic Body specifications.

Consulte las especificaciones del cuerpo básico Aurion en el catálogo general de Aurion Compact.



0253
0250



0254
0256

0250 CM, 15 CONTENITORI codice 0281
 MC, 15 BINS code 0281
 MC, 15 CAJETINES código 0281

0254 CM, 9 CONTENITORI codice 0282
 MC, 9 BINS code 0282
 MC, 9 CAJETINES código 0282

0253 CM, 10 CONTENITORI codice 0283
 MC, 10 BINS code 0283
 MC, 10 CAJETINES código 0283

0256 CM, 6 CONTENITORI codice 0284
 MC, 6 BINS code 0284
 MC, 6 CAJETINES código 0284

Step 2

SCELGA LE SUE CASSETTE MONODOSE (CM)
CHOOSE YOUR MONODOSE CASSETTES (MC)
ELIJA SUS CASSETTES UNIDOSIS (MC)

Dati tecnici: le dimensioni di ogni CM sono 450x330x200H mm. Lo spazio frontale disponibile sul corpo base Aurion è di 600 mm; è possibile inserire fino a 3 CM.

Technical data: each MC is 450x330x200H mm. Aurion Basic Body available front space is 600mm: you may place up to 3 MC.

Datos técnicos: las medidas de todos los MC son 450x330x200H mm. El espacio frontal disponible del cuerpo básico Aurion es de 600 mm: puede colocar hasta 3 MC.



0097 Dispenser di bicchieri / Cup dispenser / Dispenser de vasos

Step 3

OPTIONAL
OPTIONAL
OPTIONAL

Per altri accessori consultare la sezione Aurion Compact.

Please refer to Aurion Compact section for other accessories.

Para obtener información sobre otros accesorios, consulte sección de Aurion Compact.

Accessori



SPECIFICHE DEI CONTENITORI DEI PAZIENTI PATIENT BINS SPECIFICATIONS ESPECIFICACIONES DE LOS CAJETINES INDIVIDUALES

Ogni contenitore è dotato di un'etichetta, 3 divisori e un coperchio scorrevole in plastica trasparente. Etichette, divisori e coperchi scorrevoli in plastica trasparente possono essere ordinati separatamente.

Each bin includes a label, 3 dividers and a clear plastic sliding top. Labels, dividers and clear plastic sliding tops may be ordered separately.

Cada cajetín incluye una etiqueta, 3 separadores y una parte superior deslizante de plástico transparente. Las etiquetas, los separadores y las partes superiores deslizantes de plástico transparente pueden ser pedido por separado.

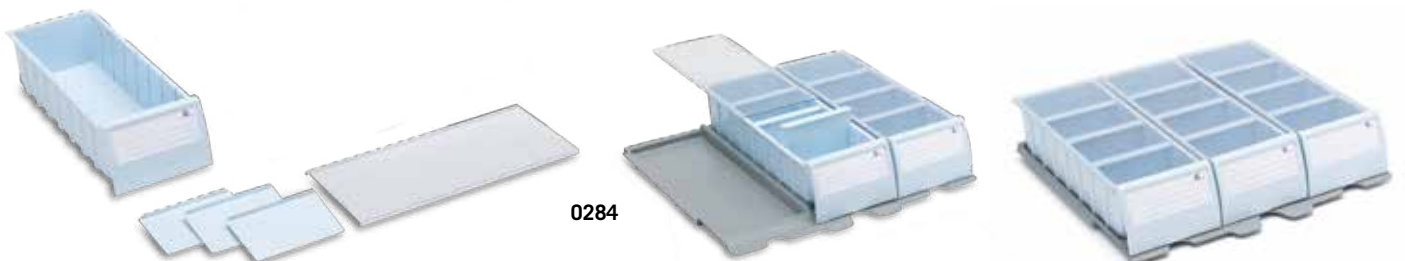
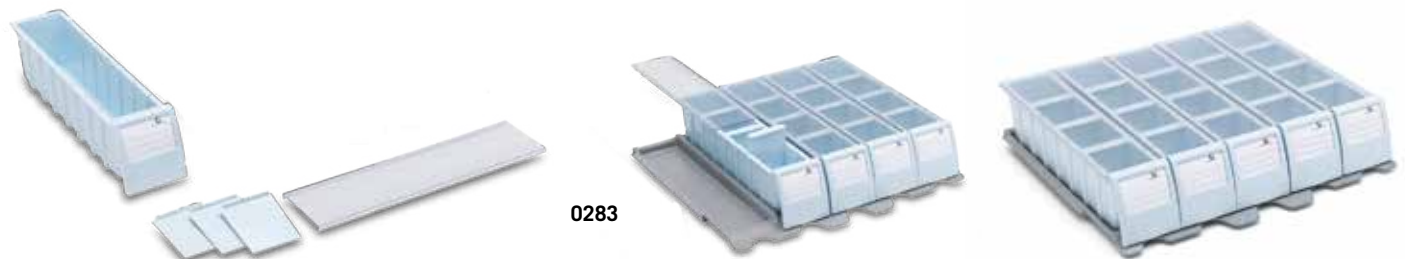
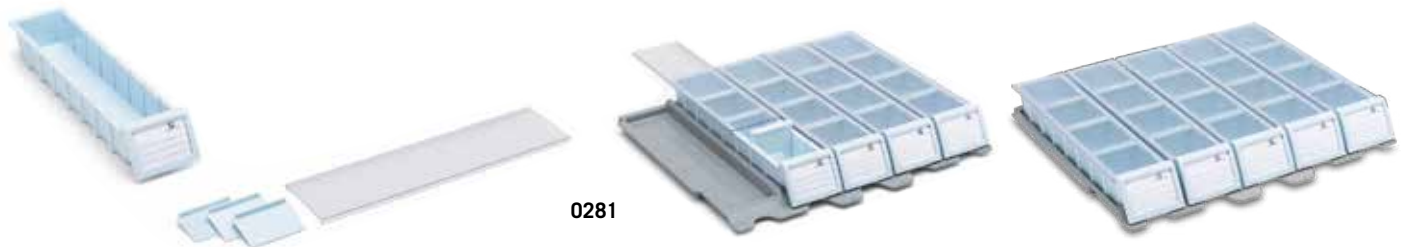

0281 - CASSETTO INDIVIDUALE
PICCOLO 70x290x45H mm
PB, SMALL 70x290x45H mm
PB, PEQUEÑO 70x290x45 H mm

0282 - CASSETTO INDIVIDUALE
MEDIO 115x290x45H mm
PB, MEDIUM 115x290x45H mm
PB, MEDIO 115x290x45H mm

0283 - CASSETTO INDIVIDUALE
LARGE 70x290x75H mm
PB, LARGE 70x290x75H mm
PB, GRANDE 70x290x75H mm

0284 - CASSETTO INDIVIDUALE
EXTRA LARGE 70x290x45H mm
PB, X LARGE 115x290x75H mm
PB, EXTRAGRANDE 115x290x75H mm

Sistema Monodose

Monodose 45
CP/M 45



- 0023
- 0250 (3X)

Monodose 40D
CP/M 40



- 0023
- 0250 (2X)
- 0253

Standard configurations

Configuraciones Recomendadas

Monodose 30D
CP/M 30D



- 0023
- 0141 (2X)
- 0250 (2X)
- 0623

Monodose 30
CP/M 30



- 0023
- 0141 (2X)
- 0250 (2X)

Configurazioni Standard

Monodose 25
CP/M 25



- 0023
- 0141 (2X)
- 0250
- 0253

Monodose 15D
CP/M 15D



- 0023
- 0141
- 0241 (2X)
- 0250
- 0623

Standard configurations

Configuraciones Recomendadas

Monodose 10
CP/M 10



- 0023
- 0141
- 0241 (2X)
- 0253

Monodose 15
CP/M 15



- 0023
- 0141
- 0250
- 0551



Mega è stato completamente ridisegnato per migliorare la compatibilità con gli accessori Aurion.

Mega è costruito utilizzando il poliuretano Baydur. Questo materiale è molto solido e difficile da scheggiare.

Può essere pulito con detergenti aggressivi ed è capace di resistere a soluzioni di acidi, basi e solventi. È anche autoestinguente.

Mega ha moltissimo spazio per i vostri medicinali. Sono previste specifiche soluzioni come il contenitore aghi usati, apri fiale, cestino a pedale e cassetto con chiave per farmaci controllati e molti altri.



Mega has been redesigned to allow compatibility with most Aurion Compact accessories.

Mega is built with Baydur polyurethane. The material is extremely solid and will not chip. It can be easily cleaned with any detergent as it is capable to withstand diluted acids, alkali and solvents. It is also self-extinguishing.

Mega has a huge capacity for your medications and narcotics. Specific solution such as built-in used needle container, ampoula opener, waste bin with lid-pedal operated, lockable dangerous drugs drawer and much more.



Mega está completamente rediseñado para permitir la compatibilidad con la mayoría de accesorios de Aurion Compact.

Mega está fabricado con poliuretano Baydur. Este material es extremadamente sólido, el cual es imposible de astillarse. Puede ser limpiado fácilmente con cualquier detergente y es capaz de soportar ácidos diluidos y disolventes. También es autoestinguible.

Mega tiene una gran capacidad para alojar medicamentos y narcóticos. Incorpora soluciones específicas como contenedor de ampollas, papelera con apertura de pedal, cerradura para medicamentos peligrosos ó drogas y mucho más.

Mega: Organizza il tuo spazio



AURION

Mega



CARATTERISTICHE STANDARD:

Il corpo del carrello è una scocca monoblocco in Poliuretano Baydur. Può essere lavato e disinfettato. Il materiale non reagisce con acidi diluiti, alcali e solventi. E' auto estinguente in base alla classe UL V0.

Tutti i carrelli sono prodotti senza utilizzare Latex.

Per ragioni di sicurezza, le maniglie sono stampate ed integrate nel corpo del carrello.

Il piano di lavoro ha un bordo perimetrale stampato e rialzato sui 4 lati anti-sgocciamento e di contenimento.

Una bacinella medicazione autoclavabile in acciaio inox 18/10 è posizionata uno specifico cassetto.

Il portarifiuti con coperchio è facilmente accessibile ed integrato nella struttura del carrello.

Specifiche

Aurion Mega: Sp

0640

Dispenser / Dispenser / Dispenser

0718

Asta portaflebo
Iv pole
Asta porta sueros

0770

Lampada
Lamp
Lámpara

0761

Ripiano porta monitor/defibrillatore
Monitor/defibrillator holder tray
Bandeja porta-monitor/desfibrilador

Piano superiore con
bordo sui 4 lati (*)
Top surface with
4-sided rim (*)
Tablero superior
con borde de 4 lados (*)

Ribaltina
per gel (*)
Gel space (*)
Espacio para gel (*)

Rompi fiala (*)
Ampoules opener (*)
Abridor de ampollas (*)

0140

Cassetto 100 mm
Drawer 100 mm
Cajón de 100 mm

0240

Cassetto 150 mm
Drawer 150 mm
Cajón de 150 mm

(*) INCLUSI IN OGNI CORPO BASE.
(*) INCLUDED IN ANY BASIC BODY.
(*) INCLUIDO EN TODOS LOS CUERPOS BÁSICOS.

Specifiche Tecniche

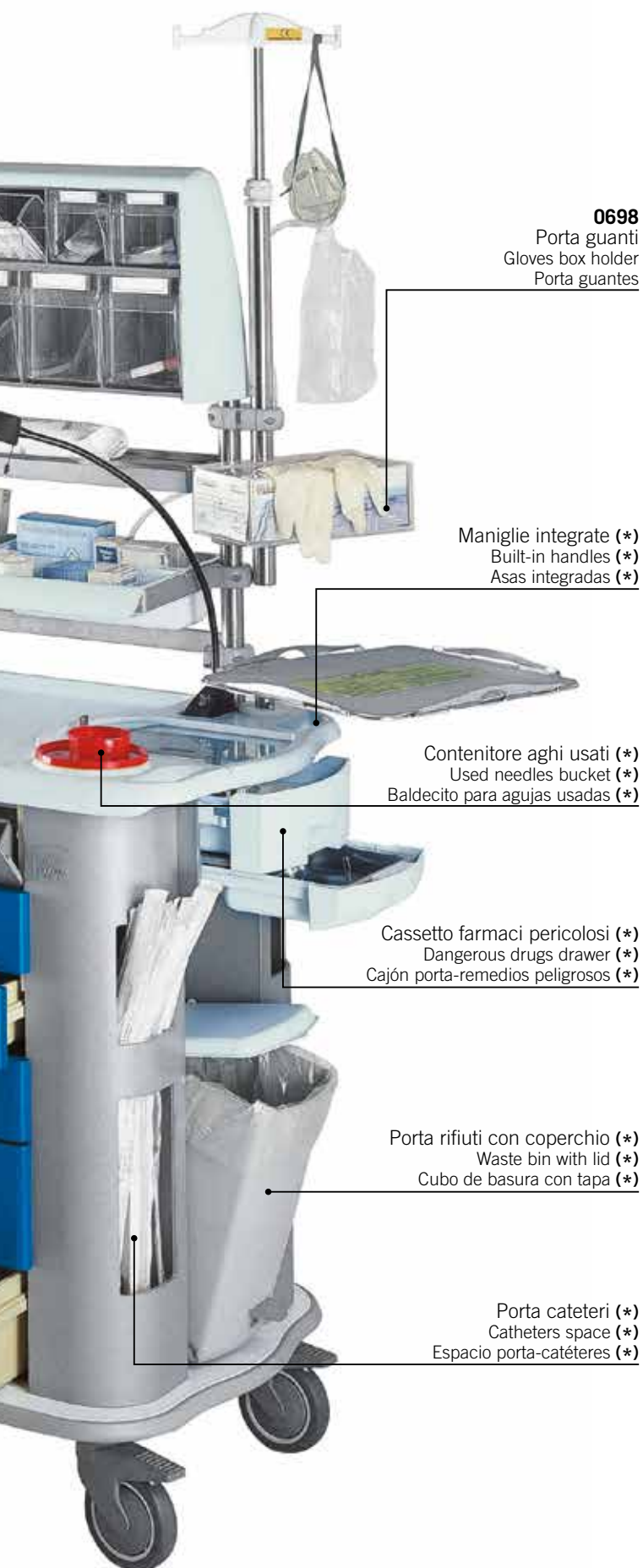

0698

Porta guanti
Gloves box holder
Porta guantes

Maniglie integrate (*)
Built-in handles (*)
Asas integradas (*)

Contenitore aghi usati (*)
Used needles bucket (*)
Baldecito para agujas usadas (*)

Cassetto farmaci pericolosi (*)
Dangerous drugs drawer (*)
Cajón porta-remedios peligrosos (*)

Porta rifiuti con coperchio (*)
Waste bin with lid (*)
Cubo de basura con tapa (*)

Porta cateteri (*)
Catheters space (*)
Espacio porta-catéteres (*)



STANDARD FEATURES:

Body is composed of a single rounded piece of Baydur polyurethane material manufactured by Bayer AG; it can be washed and disinfected. It does not react with diluted acids, alkali and solvents. It is self-extinguishing according to class UL V0.

All carts are Latex free.

For safety, handles are moulded into the body.

Trolley's top have a 4-sided moulded containing rim to avoid any spilling/falling of materials. A medication basin is included. It is made in AISI 304 (18/10) stainless steel fully autoclaveable.

Waste container with top lid is easy to access and, most important, built-in the structure.



CARACTERISTICAS DE SERIE:

El cuerpo está compuesto por una sencilla pieza redondeada de Baydur, material poliuretano fabricado por Bayer AG; puede ser lavado y desinfectado. No reacciona con ácidos diluidos, lejías y disolventes. Es auto-extinguible de acuerdo a la clase UL V0.

Todos los carros están libres de Latex.

Por seguridad, las asas se moldean en el cuerpo.

La parte superior del carro tiene las 4 caras moldeadas con bordes que impiden que se derramen o resbalen cosas.

La cubeta para medicación está hecha en acero inoxidable 18/10 totalmente esterilizable en autoclave.

El contenedor de desechos con tapa superior es de fácil acceso y, más importante, integrado en la estructura.

AURION

M e g a



CARATTERISTICHE STANDARD:

La chiusura dei cassetti può essere garantita da un sistema centralizzato a scelta: chiave oppure sigillo posto nel retro del carrello.

Un cassetto per farmaci controllati / salvavita è incluso nella struttura del carrello. Grazie ad una superficie trasparente, l'identificazione del farmaco necessario ad una emergenza è immediata. Tale cassetto è dotato di una chiave diversa da quella che permette la chiusura centralizzata dei cassetti frontali.

Ogni cassetto è dotato di un porta etichetta utile ad indicare il contenuto dello stesso.

Il paracolpi perimetrale evita danni al personale, al carrello e agli apparati medici.

Una gamma di 38 accessori permette di proporre soluzioni personalizzabili. Esclusivi per il Mega sono la lampada per visite notturne (art. 0770) e cassetto porta lastre (art. 0420).

Specifiche

Aurion Mega: Sp

0719

Asta portaflebo
regolabile in altezza
Height adj. iv pole
Asta fleboclisis
de altura ajustable

0602

Telaio porta vaschette
Holding frame large
Armazón de soporte grande

0690

Barra di supporto
in acciaio inox
Stainless steel holding bar
Asta de soporte de
acero inoxidable

0810

Alimentazione elettrica
Electrical feeding
Alimentación eléctrica

1820

Bombola ossigeno
Oxygen bottle
Botella de oxígeno

1881

Tavola per massaggio cardiaco CPR
Cardiac CPR massage board
Tablero para masaje cardíaco de CPR

1810

Supporto bombola ossigeno
Oxygen tank holder
Soporte de botella de oxígeno

Paracolpi perimetrale (*)
Perimetral bumper protection (*)
Parachoques en todo el perímetro (*)

(*) INCLUSI IN OGNI CORPO BASE.

(*) INCLUDED IN ANY BASIC BODY.

(*) INCLUIDO EN TODOS LOS CUERPOS BÁSICOS.

Specifiche Tecniche



0695

Supporto per contenitore
supplementare aghi usati
Holder for additional used needle bucket
Soporte para baldecito de agujas
usadas adicional

0625

Mensola in acciaio inox
Stainless steel shelf
Ménsula acero inoxidable

Cassetto con
piano di scrittura (*)
Drawer with writing surface(*)
Cajón con tableta
para escritura (*)

Sistema di chiusura
centralizzato (*)
Central locking device (*)
Dispositivo de
cierre central (*)

Tasche basculanti (*)
Swinging pockets (*)
Bolsillos basculantes (*)

Ganci (*)
Utility hooks (*)
Ganchos auxiliares (*)

1571

Mensola per aspiratore/
pompa di aspirazione
Shelf for suction pump
Ménsula para
bomba de aspiración



STANDARD FEATURES:

Drawers are lockable with a central locking device of your choice: key lock or break away seal lock.

It has a drawer for life-saving drugs/medication. The content of this drawer is always visible to rapidly access the needed emergency medications. Such drawer has an independent key lock (will not be operated from the central locking).

Each drawer has an individual tag for labeling the content of the drawer.

All around bumper protection is included to avoid any damage to the personnel, cart and medical devices.

A wide range of 38 accessories with personalised solutions: exclusive accessories for the Mega trolley are the visiting lamp (item 0770) and patient files/x-ray drawer (item 0420).



CARACTERISTICAS DE SERIE:

Los cajones disponen de un cierre centralizado a elegir entre cerradura de llave o cerradura de sello.

Dispone de un cajón para drogas o medicaciones peligrosas. El interior de este cajón es siempre visible para acceder rápidamente a los medicamentos en una emergencia.

Este cajón tiene una llave independiente (no será abierto con la llave central de carro).

Cada cajón tiene una etiqueta individual para la descripción del material guardado en él.

Una parachoques en su perímetro impide cualquier daño al personal, carro o aparato médico.

Una amplia gama de 38 accesorios con soluciones personalizadas. Accesorios exclusivos para el Mega son la lampara de visita (ref. 0770) y el cajone por carpetas radiografias (ref. 0420).



The AURION MEGA Basic Body includes:

- (A)** A Single piece BAYDUR body; top surface with containing rim. Your choice of BLUE or BEIGE colour
- (B)** Front Flap
- (C)** Life-saving drugs drawer
- (D)** Stainless steel 18/10 medication basin (into drawer)
- (E)** Drawer for medication basin
- (F)** Ampoule opener
- (G)** Waste bin with lid pedal operated
- (H)** Water bottle holder
- (I)** Catheters compartments
- (J)** Used needle bucket/ used cotton waste container
- (K)** Pen holder
- (L)** Sliding working/writing surface
- (M)** Centralised locking system. Your choice of KEY lock, SEAL lock.
- (N)** 2 utility hooks
- (O)** 2 clear plastic swinging pockets (for IV bottles/ patients files)
- (P)** 4 wheels (3 with break and 1 antistatic)

Dimensions Basic Body
mm 970x625x960h

Il corpo del carrello AURION MEGA include:

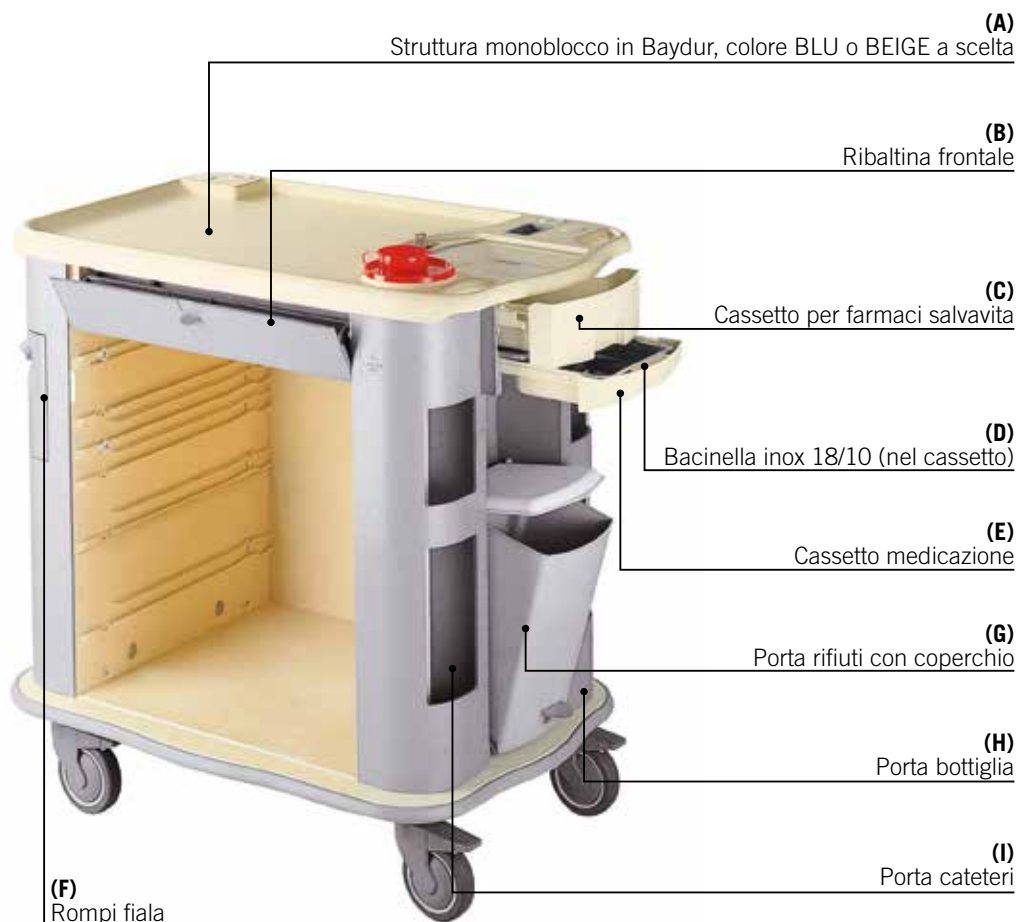

Dimensioni Corpo Base: mm 970x625x960h



Porta Penne.
 Details of the pen holder located on the trolley top.
 Porta lapis.



Cassetto laterale con ripiano.
 Details of the slide-out side drawer with writing surface.
 Cajón lateral con estante.



Scegliere il corpo base selezionando il colore e il sistema di chiusura:



Please choose a Basic Body by selecting the colour and the locking device:



Por favor elije el color deseado para el cuerpo básico y el sistema de cierre:

1 Corpo Base

AURION

M e g a



Serratura indipendente per cassetti farmaci salvavita.

Any Aurion Mega basic body includes an independent lock for the drug drawer (central locking system will not operate this drawer). This lock may be removed at customer request.

Cerradura independiente para cajón para fármacos.

Corpo base senza chiusura
Basic Body no lock
Cuerpo básico sin cierre

0061 0071



Corpo base con chiusura a chiave
Basic Body with key lock
Cuerpo básico con cierre a llave

0063 0073



Corpo base con chiusura a sigillo
Basic Body with seal lock
Cuerpo básico con cierre a sello

0065 0075



El cuerpo básico AURION MEGA incluye lo siguiente:

- (A) Cuerpo en una pieza de BAYDUR, cara superior con reborde: su elección en color AZUL o BEIGE
- (B) Tapa abatible frontal
- (C) Cajón para remedios de urgencia
- (D) Cubeta para medicación en acero inoxidable (dentro del cajón)
- (E) Cajón para cubeta de medicación
- (F) Abridor de ampollas
- (G) Cubo de basura con tapa
- (H) Soporte para botella de agua
- (I) Compartimento para cateteres
- (J) Contenedor de residuos: cubo para agujas/ algodones usados
- (K) Porta lapis
- (L) Superficie deslizante para trabajar / escribir
- (M) Sistema de cierre centralizado: a elegir entre cerradura a LLAVE, cerradura a SELLO.
- (N) 2 ganchos traseros
- (O) 2 bolsillos basculantes en plástico transparente
- (P) 4 ruedas (3 sin freno, 1 antiestática)

Tamaño Cuerpo Base
mm 970x625x960h

Costruisci il tuo carrello AURION MEGA
BUILD YOUR CUSTOM MADE AURION MEGA TROLLEY
CONSTRUYE TU CARRO AURION MEGA

Step 2

Cassetti

1 CASSETTI: i carrelli AURION MEGA possono essere completati con cassetti da 100, 150, 300 o 400mm. **Scelga la combinazione desiderata.**

1 DRAWER: any of the AURION MEGA Basic Bodies may be fitted with combinations of 100, 150, 300, 400mm. **Please choose your desired combination.**

1 CAJONES: Cualquiera de los cuerpos básicos AURION MEGA puede completarse con cajones (100, 150, 300, 400mm). **Por favor, elije la combinación deseada.**



CASSETTO 100mm DRAWER 100mm CAJÓN 100mm

Rosso/red/ rojo **0110** 

Verde/green/verde **0120** 

Giallo/yellow/amarillo **0130** 

Blu/blue/azul **0140** 

Dimensione interna cassetto: mm 500x500 - Massimo 6 pezzi per carrello
 Inner drawer dimension: mm 500x500 - Max. 6 pieces each trolley
 Tamaño interior del cajón: mm 500x500 - Máx 6 piezas cada carro

CASSETTO 150mm DRAWER 150mm CAJÓN 150mm

Rosso/red/ rojo **0210** 

Verde/green/verde **0222** 

Giallo/yellow/amarillo **0230** 

Blu/blue/azul **0240** 

Dimensione interna cassetto: mm 510x510 - Massimo 4 pezzi per carrello
 Inner drawer dimension: mm 510x510 - Max. 4 pieces each trolley
 Tamaño interior del cajón: mm 510x510 - Máx 4 piezas cada carro

CASSETTO 300mm DRAWER 300mm CAJÓN 300mm

Rosso/red/ rojo **0310** 

Verde/green/verde **0320** 

Giallo/yellow/amarillo **0330** 

Blu/blue/azul **0340** 

Dimensione interna cassetto: mm 510x510 - Massimo 1 pezzi per carrello
 Inner drawer dimension: mm 510x510 - Max. 1 pieces each trolley
 Tamaño interior del cajón: mm 510x510 - Máx 1 piezas cada carro

CASSETTO 400mm DRAWER 400mm CAJÓN 400mm

(porta lastre)
 Verde/green/verde **0420** 

Dimensione interna cassetto: mm 480x360 - Massimo 1 pezzi per carrello
 Inner drawer dimension: mm 480x360 - Max. 1 pieces each trolley
 Tamaño interior del cajón: mm 480x360 - Máx 1 piezas cada carro

Cassetti

Step 3 Accessori

0550
Mensola
Shelf
Estante



0601
Telaio di supporto **piccolo**, con 2 vaschette (H 45mm)
Holding frame, **small** with 2 basins
Armazón de soporte, **pequeño** con 2 cubetas



0606
Telaio di supporto **piccolo**, con 2 vaschette (H 45mm)
Holding frame, **small** with 2 basins
Armazón de soporte, **pequeño** con 2 cubetas

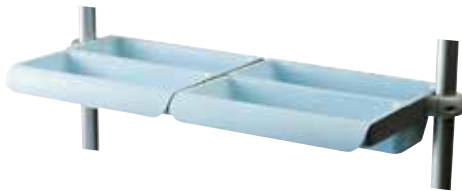

0602
Telaio di supporto **grande**, con 4 vaschette (2-H 45mm/ 2-H 90mm)
Holding frame, **large** with 4 basins
Armazón de soporte, **grande** con 4 cubetas

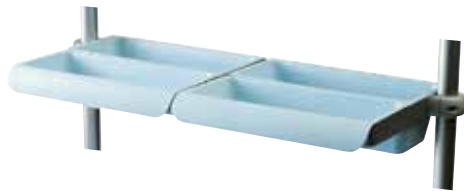

0607
Telaio di supporto **grande**, con 4 vaschette (2-H 45mm/ 2-H 90mm)
Holding frame, **large** with 4 basins
Armazón de soporte, **grande** con 4 cubetas



0603
Telaio di supporto **doppio**, con 6 vaschette (4-H 45mm/ 2-H 90mm)
Holding frame, **double** with 6 basins
Armazón de soporte, **double** con 6 cubetas

0608
Telaio di supporto **doppio**, con 6 vaschette (4-H 45mm/ 2-H 90mm)
Holding frame, **double** with 6 basins
Armazón de soporte, **double** con 6 cubetas



0624
Mensola **grande** in acciaio inox
Stainless steel shelf **large**
Estante de acero inoxidable **grande**



0625
Mensola **piccola** in acciaio inox
Stainless steel shelf **small**
Estante de acero inoxidable **pequeña**



0640
Dispenser
Dispensador

0650
Dispenser
Dispensador



0641
0651
Dispenser e struttura di supporto **piccola** con 2 bacinelle
Dispenser and holding frame **small** with 2 basins
Dispensador y armazón de soporte **pequeña** con 2 cubetas



0642
0652
Dispenser e struttura di supporto **grande** con 4 bacinelle
Dispenser and holding frame **large** with 4 basins
Dispensador y armazón de soporte **grande** con 4 cubetas



0643
0653
Dispenser e struttura di supporto **doppio** con 6 bacinelle
Dispenser and holding frame **double** with 6 basins
Dispensador y armazón de soporte **double** con 6 cubetas

A C C E S S O R I

COSTRUISCI IL TUO CARRELLO AURION MEGA
BUILD YOUR CUSTOM MADE AURION MEGA TROLLEY
CONSTRUYE TU CARRO AURION MEGA

Step 3

Accessori

Vaschette supplementari (facoltative):
Additional basins (optional):
Cubetas adicionales (opcionales):

0681 **0682**
 Vaschette 90H mm
 Basin 90H mm
 Cubetas 90H mm



0683 **0684**
 Vaschette 45H mm
 Basin 45H mm
 Cubetas 45H mm



0690
 Barra in acciaio inox 25x10mm
 Stainless steel holding rail 25x10mm
 Barra de soporte de acero inoxidable de 25x10mm

0691
 Barra in acciaio inox 30x10mm
 Stainless steel holding rail 30x10mm
 Barra de soporte de acero inoxidable de 30x10mm



0695
 Supporto regolabile per
 contenitore aghi usati
 Adjustable Holder for used
 needles bucket
 Ajustable soporte para balcedito
 de agujas usadas



0696
 Supporto per contenitore
 aghi usati, **rotondo**
 Holder for used needles
 bucket, **round**
 Soporte para balcedito de
 agujas usadas, **redondo**

0697
 Cronografo contasecondi
 Stop watch chronograph
 Cronómetro cronógrafo



0698
 Supporto per scatola guanti, **singolo**
 Gloves box holder, **single**
 Soporte de cajas de guantes, **individual**



0699
 Supporto per scatola guanti, **multiple**
 Gloves box holder, **multiple**
 Soporte de cajas de guantes, **múltiple**



0718
 Asta portaflebo
 (supporto incluso)
 IV pole
 (holder included)
 Asta porta sueros
 (soporte incluido)



0719
 Asta portaflebo regolabile in altezza
 (supporto incluso)
 Height adjustable IV pole
 (holder included)
 Asta porta sueros de altura
 ajustable
 (soporte incluido)



0762 - 0763 (stainless steel)
 Supporto porta defibrillatore, **girevole**
 (incluso tappettino anti slittamento)
 Rotatinf defibrillator holder tray, **lockable**
 (including anti-sliding pad)
 Bandeja de soporte de desfibrilador giratoria, **de rotación libre**
 (incluido alfombrilla antideslizante)



0770
 Lampada 12V
 Lamps 12V, battery operated
 (charger not included)
 Lampara 12V

0771
 Lampada 12V con caricabatteria
 Lamps 12V, battery operated
 charger included
 Lampara 12V y cargador de batería

A
C
C
E
S
S
O
R
I



0810
Alimentazione elettrica (spine) spine di tipo Europeo
Electrical feeding (plugs) European type plugs
Alimentación eléctrica (enchufes) Enchufes de tipo Europeo

0811
Alimentazione elettrica (spine) spine di tipo Usa
Electrical feeding (plugs) Usa/Jap type plugs
Alimentación eléctrica (enchufes) Enchufes de tipo Usa

0812
Alimentazione elettrica (spine) spine di tipo Uk
Electrical feeding (plugs) Uk type plugs
Alimentación eléctrica (enchufes) Enchufes de tipo Uk



0910
Kit divisori cassettei 100H mm:
2 distanziatori verticali e 9 divisori regolabili
Drawer divider kit 100H mm:
2 vertical dividers and 9 adjustable individual dividers
Kit de separadores para cajones 100H mm:
2 espaciador vertical y 9 tabiques individuales ajustable



0931
Vassoio porta soluzioni
per cassetto
IV bottles holder
Porta-botellas fleboclisis



0960
Cartelle sospese
(kit 10pz)
Files holders
(kit 10 pcs)
Carpetas por
radiografías



1571
Mensola per aspiratore/pompa di aspirazione
Shelf for aspirator/suction pump
Estante para aspirador /bomba da aspiración

A C C E S S O R I



1810
Porta bombola supplementare
per ossigeno, **piccolo**
Additional oxygen tank holder **small**
Soporte de botella de oxígeno adicional
pequeño

1811
Porta bombola supplementare
per ossigeno, **grande**
Additional oxygen tank holder **large**
Soporte de botella de oxígeno adicional
grande



Bombola per ossigenoterapia:
con riduttore di pressione e flussometro
regolabile (da 0 a 12 l/min.)
Tank for oxygen therapy:
with pressure reducer
and adjustable flowmeter (0 to 12 l/min.)
Botella para oxigenoterapia:
con reductor de presión y flujómetro ajustable
(de 0 a 12 l/min)

1820
Bombola ossigeno da 3 L.
Oxygen bottle 3 L.
Botella de oxígeno de 3 L.



1881
Tavola per massaggio cardiaco CPR
Cardiac CPR massage board
Tabla de masaje cardíaco de CPR



9007
Sigilli in plastica numerati (kit di 100 pezzi)
Breakaway plastic seals (kit of 100 pcs)
Sellos plásticos (kit de 100 pedazos)

Configurazioni Standard

Medication
MG/MED



- 0073
- 0130 (3X)
- 0230 (X)
- 0653

Utility 3
MG/UT 3

Utility 4
MG/UT 4

Utility 5
MG/UT 5



- 0061
- 0240
- 0210
- 0220
- 0230

Standard configurations

Configuraciones Recomendadas

Emergency 1
MG/EM 1



- 0063
- 0140
- 0240
- 0550
- 0718
- 0762
- 1881

Emergency 2
MG/EM 2



- 0073
- 0210 (2X)
- 0310
- 0718
- 0762
- 0771
- 0810
- 1881

Configurazioni Standard

Examinations Rounds

MG / GIV



0063

0220

0420

MRI Antimagnetic

MG / MRI



0071

0091

0210 (4X)

Standard configurations

Configuraciones Recomendadas

Therapy

MG / TER



0063

0240 (2X)

0340

0640

0718

0771

Anaesthesia 2

MG / AN 2



0037

0130 (3X)

0320 (2X)

0606

0614

0718

AURION
COMPACT



A U R I O N



GAMMA POLIURETANI S.r.l.

Via Padova, 9 - 31046 Oderzo (TV) - ITALY

Tel. **+39 0422 207008** - Fax **+39 0422 712154**

www.gammapoliuretani.com - aurion@gammapoliuretani.com