

ARISTA

Quick Start Guide

7010 Series 1RU Data Center Switches

DCS-7010T-48, DCS-7010TX-48
DCS-7010T-48-DC, DCS-7010TX-48-DC

Arista Networks

www.arista.com

PDOC-00061-06

Headquarters 5453 Great America Parkway, Santa Clara, CA 95054 USA +1-408 547-5500	Support +1-408 547-5502 +1-866 476-0000	Sales +1-408 547-5501 +1-866 497-0000
https://www.arista.com/en/	mailto:support@arista.com	mailto:support@arista.com

© Copyright 2024 Arista Networks, Inc. All rights reserved. The information contained herein is subject to change without notice. The trademarks, logos and service marks ("Marks") displayed in this documentation are the property of Arista Networks in the United States and other countries. Use of the Marks are subject to Arista Network Term of Use Policy, available at <http://www.arista.com/en/terms-of-use>. Use of marks belonging to other parties is for informational purposes only.

Contents

Chapter 1: Overview.....	1
1.1 Scope.....	1
1.2 Receiving and Inspecting the Equipment.....	1
1.3 Installation Process.....	1
1.4 Safety Information.....	2
1.5 Obtaining Technical Assistance.....	2
1.6 Specifications.....	3
Chapter 2: Preparation.....	5
2.1 Site Selection.....	5
2.2 Tools and Parts Required for Installation.....	6
2.3 Electrostatic Discharge (ESD) Precautions.....	7
Chapter 3: Rack Mounting the Switch.....	9
3.1 Two-Post or Four-Post Rack Mount.....	9
3.1.1 Attaching Mounting Brackets to the Chassis.....	9
3.1.2 Inserting the Switch into the Rack.....	10
3.2 Flat Surface Placement.....	10
Chapter 4: Cabling the Switch.....	13
4.1 Grounding the Switch.....	13
4.1.1 Grounding Lug Preparation.....	14
4.2 Connecting Power Cables.....	14
4.2.1 Connecting AC Power.....	15
4.2.2 Connecting DC Power.....	15
4.2.3 Connecting DC Power Supply to Power Source.....	16
4.3 Connecting Serial and Management Cables.....	17
Chapter 5: Configuring the Switch.....	19
Appendix A: Status Indicators.....	21
A.1 Front Indicators.....	21
A.1.1 Switch Indicators.....	21
A.1.2 Port Indicators.....	22
A.2 Rear Status Indicators.....	23
Appendix B: Parts List.....	25
B.1 Installation Parts.....	25
B.2 Cables.....	25
Appendix C: Front Panel.....	27

Appendix D: Rear Panel.....	29
Appendix E: Maintenance and Field Replacement.....	31
Appendix F: Regulatory Model Numbers.....	33
Appendix G: Taiwan RoHS Information.....	35

Overview

Data centers demand high performance networking solutions. The Arista 7010T offers a purpose built high performance and power efficient solution for high density data center deployments. The Arista 7010T series delivers line rate switching at Layer 2 and Layer 3 to enable simpler network designs for data centers that lowers the network capital and operational expenses. When used in conjunction with the Arista 7000 series of fixed and modular switches it allows networks to scale out in a high performance two-tier network that provides predictable and consistent application performance.

The Overview section reviews the following topics:

- [Scope](#)
- [Receiving and Inspecting the Equipment](#)
- [Safety Information](#)
- [Obtaining Technical Assistance](#)
- [Specifications](#)

1.1 Scope

This guide is intended for properly trained service personnel and technicians who need to install the following Arista Networks Data Center Switches:

DCS-7010T-48

DCS-7010T-48-DC

DCS-7010TX-48

DCS-7010TX-48-DC



Important:

Only qualified personnel should install, service, or replace this equipment.

Seul le personnel qualifié doit installer, service, ou remplacer cet équipement.

1.2 Receiving and Inspecting the Equipment

Upon receiving the switch, inspect the shipping boxes and record any external damage. Retain packing materials if you suspect that part of the shipment is damaged; the carrier may need to inspect them.

If the boxes were not damaged in transit, unpack them carefully. Ensure that you do not discard any accessories that may be packaged in the same box as the main unit.

Inspect the packing list and confirm that you received all listed items. Compare the packing list with your purchase order. [Parts List](#) provides a list of components included with the switch.

1.3 Installation Process

Tasks required to install and use the switch.

The following tasks are required to install and use the switch:

1. Select and prepare the installation site ([Site Selection](#)).
2. Assemble the installation tools ([Tools and Parts Required for Installation](#)).
3. Attach the mounting brackets ([Attaching Mounting Brackets to the Chassis](#)).
4. Install the switch in an equipment rack ([Inserting the Switch into the Rack](#)).
5. Connect the switch to the power source and network devices ([Connecting Power Cables](#)).
6. Configure the switch ([Configuring the Switch](#)).

1.4 Safety Information

Refer to the Arista Networks document *Safety Information and Translated Safety Warnings* available at: <https://www.arista.com/en/support/product-documentation>.



Important:

Class 1 Laser Product: This product has provisions to install Class 1 laser transceivers which provide optical coupling to the communication network. Once a Class 1 laser product is installed, the equipment is a Class 1 Laser Product. The customer is responsible for selecting and installing the Class 1 laser transceiver and for insuring that the Class 1 AEL (Allowable Emission Limit) per EN/IEC 60825, CSA E60825-1, and Code of Federal Regulations 21 CFR 1040 is not exceeded after the laser transceiver have been installed. Do not install laser products whose class rating is greater than 1. Refer to all safety instructions that accompanied the transceiver prior to installation. Only Class 1 laser devices, certified for use in the country of installation by the cognizant agency are to be utilized in this product.

Appareil à laser de classe 1 Cet appareil comporte des dispositions permettant d'installer des émetteurs-récepteurs fournissant un couplage optique au réseau de communication. Une fois l'appareil à laser de classe 1 installé, l'équipement devient un appareil à laser de classe 1. Le client est responsable du choix et de l'installation de l'émetteur-récepteur à laser de classe 1 et il doit s'assurer que les limites d'émission admissibles pour la classe 1 régularisées par les normes EN/IEC 60825 et CAN/CSA E60825-1 et par le Code of Federal Regulations 21 CFR 1040 ne soient pas dépassées après l'installation de l'émetteur-récepteur à laser. N'installez pas d'appareils à laser dont la classification est supérieure à 1. Avant l'installation, lisez attentivement les instructions de sécurité fournies avec l'émetteur-récepteur. Seuls les appareils à laser de classe 1 qui ont été certifiés par l'autorité agréée pour une utilisation dans le pays d'installation peuvent être utilisés dans ce produit.



Important:

Ultimate disposal of this product should be in accordance with all applicable laws and regulations.

Élimination définitive de ce produit devrait être en conformité avec toutes les lois et règlements applicables.

1.5 Obtaining Technical Assistance

Any customer, partner, reseller, or distributor holding a valid Arista Service Contract can obtain technical support in any of the following ways:

- **Email:** support@arista.com. This is the easiest way to create a new service request. Include a detailed description of the problem and the output of “show tech-support”.
- **Web:** <https://www.arista.com/en/support>.

A support case may be created through the support portal on our website. You may also download the most current software and documentation, as well as view FAQs, Knowledge Base articles, Security Advisories, and Field Notices.

- **Phone:** +1 866-476-0000 or +1 408-547-5502.



Important:

No user serviceable parts inside. Refer all servicing to qualified service personnel.

Aucune pièce réparable par l'utilisateur à l'intérieur. Confiez toute réparation à un technicien qualifié.

1.6 Specifications

Specifications for the 7010X 1RU Series switches.

Table 1: Switch Specifications (Dimensions and Weights)

Switch	Size (W x H x D)	Weight
DCS-7010T-48	48.3 x 4.4 x 25.8 cm (19 x 1.75 x 10.0 inches)	4.3 kg (9.5 lbs.)
DCS-7010T-48-DC	48.3 x 4.4 x 25.8 cm (19 x 1.75 x 10.0 inches)	4.3 kg (9.5 lbs.)
DCS-7010TX-48	48.3 x 4.4 x 25.8 cm (19 x 1.75 x 10.0 inches)	3.9 kg (8.6 lbs.)
DCS-7010TX-48-DC	48.3 x 4.4 x 25.8 cm (19 x 1.75 x 10.0 inches)	3.9 kg (8.6 lbs.)

Table 2: Switch Specifications (Operational and Storage)

Switch	Operating Temperature	Storage Temperature	Operating Altitude	Relative Humidity
All	0° to 40°C (32° to 104°F)	-25° to 70°C (-13° to 158°F)	0 to 3,000 meters (0 to 10,000 feet)	5 to 90% (non-condensing)

Table 3: Switch Specifications (Power Draw)

Switch	Power Draw (Typical/Maximum)	Power Supply Ratings
DCS-7010T-48	52 W / 65 W	100 - 240 VAC, 0.96 to 0.48 A, 50/60 Hz
DCS-7010T-48-DC	52 W / 65 W	-40 to -72 VDC, 2.5 A
DCS-7010TX-48	75 W / 100 W	100 - 240 VAC, 2.2 A, 50/60 Hz
DCS-7010TX-48-DC	75 W / 100 W	-48 to -60 VDC, 3.2 A

Preparation

The Preparation Section reviews the following topics:

- [Preparation](#)
- [Tools and Parts Required for Installation](#)
- [Electrostatic Discharge \(ESD\) Precautions](#)

2.1 Site Selection

Criteria to be considered when selecting a site to install the switch.

- **Temperature and Ventilation:** For proper ventilation, install the switch where there is ample airflow to the front and back of the switch. The ambient temperature should not go below 0°C or exceed 40°C.



Important:

To prevent the switch from overheating, do not operate it in an area where the ambient temperature exceeds 40°C (104°F).

Pour empêcher l'interrupteur de surchauffe, ne pas utiliser il dans une zone où la température ambiante est supérieure à 40°C (104°F).

- **Airflow Orientation:**

The fans determine the airflow direction through the switch. The labels indicate the airflow direction.



Note: The figure shown uses a representative Arista switches to illustrate airflow directions.

The following figure shows the airflow through the switch:

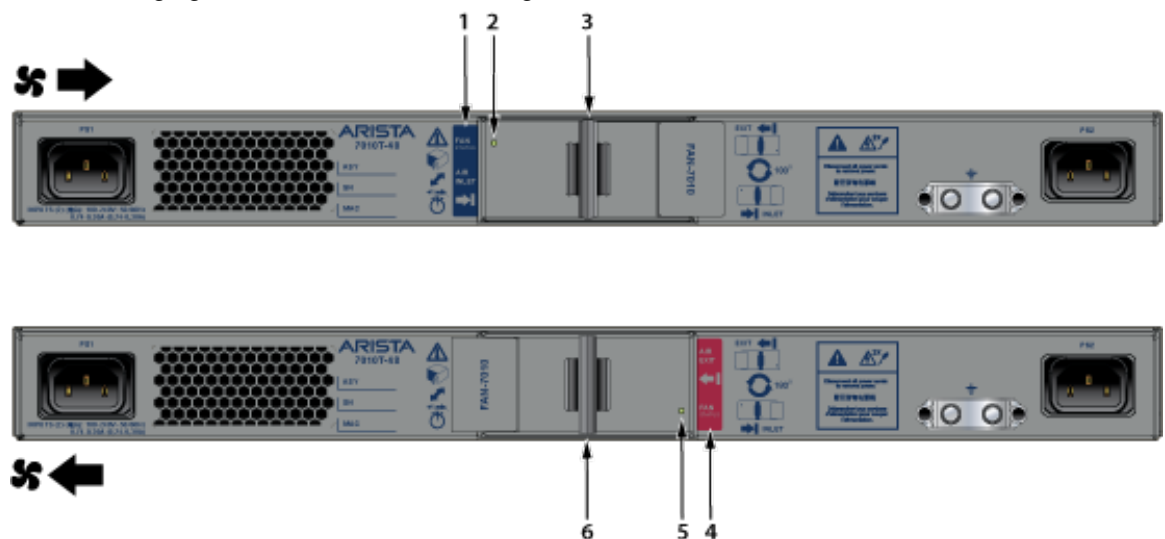

1 Airflow direction indicator label	3 Fan module handle and release	5 Fan status LED
2 Fan status LED	4 Airflow direction indicator label	6 Fan module handle and release

Orient the switch such that the airflow through the switch is from the cooler to the hotter aisle. If the airflow direction is not compatible with the installation site, reorient the fan module to circulate air in the opposite direction.

To change the airflow direction, change the fan module orientation:

1. While squeezing the fan module handle, pull the fan module out of the switch.
 2. Rotate the fan module 180°.
 3. Insert the fan module back into the switch.
- **Rack Space:** Install the switch in a 19" rack or cabinet. The switch height is 1 RU. The accessory kit provides mounting brackets for two-post racks.

When mounting the switch in a partially filled rack, load the rack from bottom to top, with the heaviest equipment at the bottom. Load the switch at the bottom if it is the only item in the rack.

- **Power Requirements:** Power requirements vary by switch and power supply model. Refer to [Table 3: Switch Specifications \(Power Draw\)](#) for information regarding your specific system.



Important:

The power input plug-socket combination must be accessible at all times; it provides the primary method of disconnecting power from the system.

La combinaison de la puissance-prise d'entrée doit être accessible en tout temps ; Il fournit le principal moyen de coupure d'alimentation du système.

- **Other Requirements:** Select a site where liquids or objects cannot fall onto the equipment and foreign objects are not drawn into the ventilation holes. Verify these guidelines are met:
 - Clearance areas to the front and rear panels allow for unrestricted cabling.
 - All front and rear panel indicators can be easily read.
 - Power cords can reach from the power outlet to the connector on the rear panel.



Important:

All power connections must be removed to de-energize the unit.

Toutes les connexions d'alimentation doivent être enlevées pour hors tension l'appareil.



Important:

This unit is intended for installation in restricted access areas.

Cet appareil est prévu pour une installation dans les zones d'accès restreintes.

2.2 Tools and Parts Required for Installation

Tools and equipment are required to install the switch.

Two-Post Rack

- Screws or rack mounting nuts and bolts.
- Screwdriver

Four-Post Rack (Tool-less)

No additional equipment required.

Four-Post Rack (Conventional)

- Screws or rack mounting nuts and bolts.
- Screwdriver

The accessory kit does not include screws for attaching the switch to the equipment rack. When installing the switch into an equipment rack with unthreaded post holes, nuts are also required to secure the switch to the rack posts.

2.3 Electrostatic Discharge (ESD) Precautions

Guidelines to avoid ESD damage when installing or servicing the switch.

- Assemble or disassemble equipment only in a static-free work area.
- Use a conductive work surface (such as an anti-static mat) to dissipate static charge.
- Wear a conductive wrist strap to dissipate static charge accumulation.
- Minimize handling of assemblies and components.
- Keep replacement parts in their original static-free packaging.
- Remove all plastic, foam, vinyl, paper, and other static-generating materials from the work area.
- Use tools that do not create ESD.

Rack Mounting the Switch

The Rack Mounting the Switch section covers the following topics:

- [Two-Post or Four-Post Rack Mount](#)
- [Flat Surface Placement](#)



Important: The rack mounting procedure is identical for all switches covered by this guide.

Les procédure de montage du bâti est identique pour tous les commutateurs visés par ce guide.

- [Two-Post or Four-Post Rack Mount](#) provides instructions for mounting the switch in a two-post or four-post rack.

After completing the instructions for your rack type, proceed to [Cabling the Switch](#).



Note: Illustrations use a representative Arista switch. Your device may be different in appearance.

3.1 Two-Post or Four-Post Rack Mount

The switch can be installed in a two-post or four-post rack. The installation process is identical because the switch attaches to only two posts of a rack.

To mount the switch in a rack, assemble the mounting brackets to the chassis, then attach the brackets to the rack posts. Rack mount accessory kits include the following parts:

- Two mounting brackets
- Six M4x5 flat head Phillips screws.

The following figure displays proper bracket placement for rack mount.

Figure 1: Proper Bracket Placement



3.1.1 Attaching Mounting Brackets to the Chassis

This procedure attaches mounting brackets to the switch chassis.

1. Align the mounting brackets with the chassis holes at the front of the switch.
2. Attach the brackets with two M4x5 flat head Philips screws as shown in the following figure.

Figure 2: Attaching Mounting Brackets

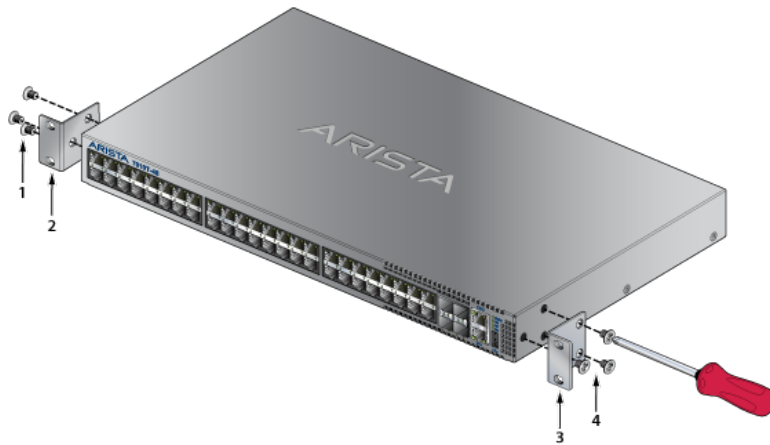

3.1.2 Inserting the Switch into the Rack

This procedure attaches the switch to the rack.

1. Lift the chassis into the rack. Position the flanges against the rack posts.
2. Select mounting screws that fit your equipment rack.
3. Attach the bracket flanges to the rack posts.

Figure 3: Inserting Switch into the Rack

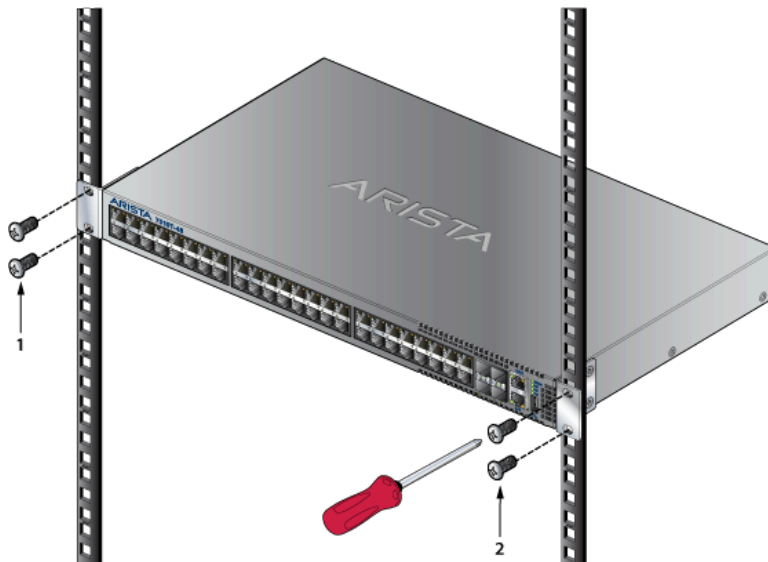

After completing the rack mount, proceed to [Cabling the Switch](#).

3.2 Flat Surface Placement

The switch is prepared for flat surface placement by attaching four rubber pads on the bottom of the chassis to prevent the switch from sliding on the table and to protect the surface of the table.

The installation kit provides the following flat surface placement parts.

- Four rubber switch pads

Figure 4: Rubber Pads for Flat Surface Placement

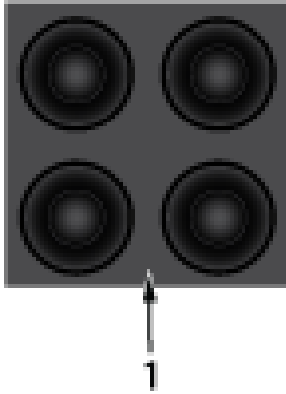

1 Sheet with four rubber pads

To prepare the switch for placement on a flat surface, peel the four rubber pads from the master sheet and attach one in each indentation near each corner on the bottom of the switch.

The following figure displays the rubber pads placement on the bottom of the switch.

Figure 5: Pad Locations for Flat Surface Placement

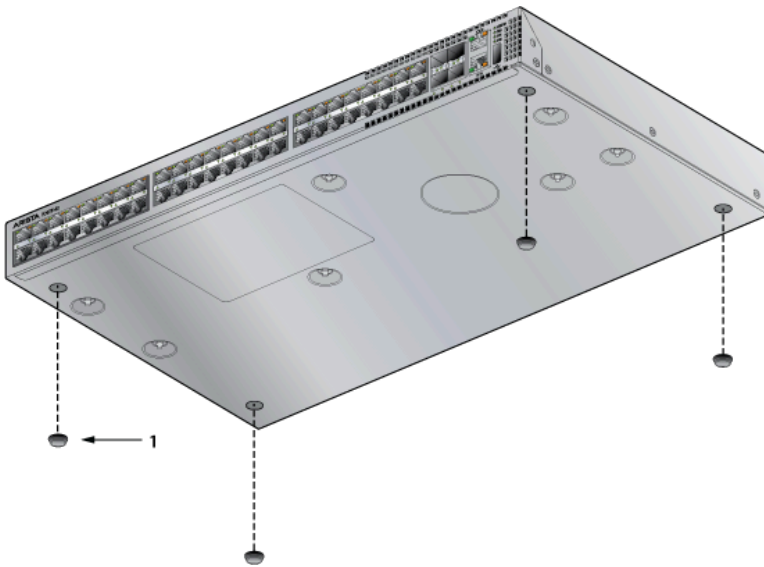

1 Rubber pad

Cabling the Switch

The Cabling the Switch section reviews the following topics:

- [Grounding the Switch](#)
- [Connecting Power Cables](#)
- [Connecting Serial and Management Cables](#)

4.1 Grounding the Switch

Describes grounding the device to the data center ground.

After mounting the switch into the rack, connect the switch to the data center ground. The following figure shows the grounding location and the power sockets for the 7010T-48 and 7010TX-48 switches.

Figure 6: Grounding Points and Power Sockets for 7010T-48 and 7010TX-48 Switches

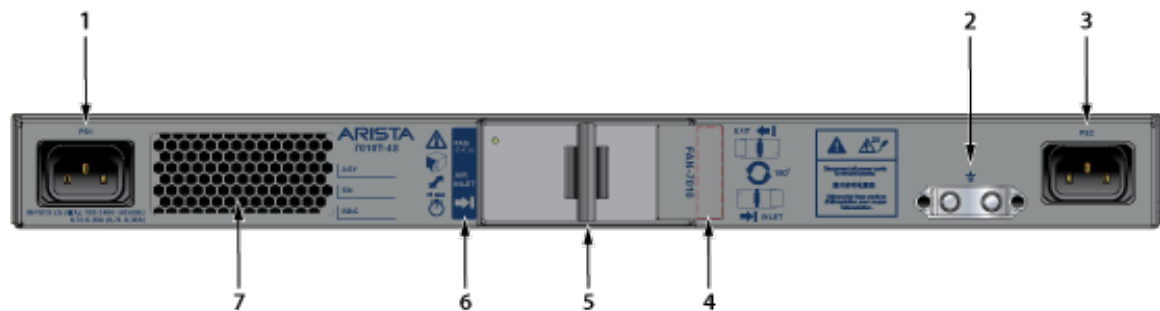

- | | | |
|-----------------------------|------------------------------------|------------|
| 1 Power supply module 1 | 4 Air exit indicator (Red label) | 7 Air vent |
| 2 Grounding location | 5 Fan module handle | |
| 3 Power supply module 2 | 6 Air inlet indicator (Blue label) | |

The following figure shows the grounding location and the power terminals for the 7010T-48-DC and 7010TX-48-DC switches.

Figure 7: Grounding Points and Power Terminals for 7010T-48-DC and 7010TX-48-DC Switches



- | | |
|-------------------------|------------------------------------|
| 1 Power supply module 1 | 4 Power supply module 2 |
| 2 PSU 1 cover | 5 Grounding location |
| 3 PSU 2 cover | 6 Air inlet indicator (Blue label) |

The switches operate with two internal power supplies. At least one of the supplies must connect to a power source. Two circuits provide redundancy protection.



Important:

Grounding wires and grounding lugs (M4 x 0.7) are not supplied. Wire size should meet local and national installation requirements. Commercially available 6 AWG wire is recommended for installations in the U.S.

À la terre et de mise à la terre fils cosses (M4 x 0.7) ne sont pas fournis. Calibre des fils doit satisfaire des exigences de l'installation locale et nationale. Disponible dans le commerce 6 fils AWG est recommandé pour les installations aux États-Unis.

4.1.1 Grounding Lug Preparation

The following procedure describes the lug preparation to connect the chassis to the data center ground:

1. Prepare the (stranded) copper wiring for the ground wire.
2. Use agency-approved compression (pressure) lugs for wiring terminations.
3. Slip on heat-shrink tubing on the wire end before assembling the lugs on to the wire.
4. Crimp the lugs with the proper tool, and ensure that the tubing extends over the barrel of the lug and the insulation on the wire as shown in the following figure.

Figure 8: Lug Preparation

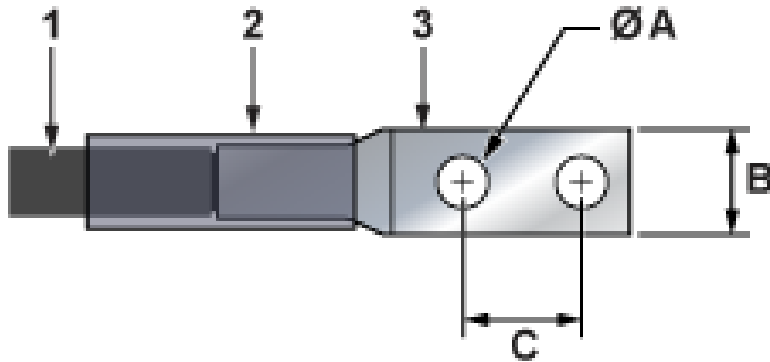

- | | |
|----------------------|--------|
| 1 Insulated wire | A 1/4" |
| 2 Heat-shrink tubing | B 1/2" |
| 3 Lug | C 5/8" |

5. Shrink the tubing with a heat gun.

4.2 Connecting Power Cables

Describes the installation requirements for connecting the power cables to the device.

**Important:**

Installation of this equipment must comply with local and national electrical codes. If necessary, consult with the appropriate regulatory agencies and inspection authorities to ensure compliance.

Read all installation instructions before connecting the system to the power source.

This equipment must be grounded. Never defeat the ground conductor.

This unit requires overcurrent protection.

Installation de cet équipement doit être conformes aux codes électriques locaux et nationaux. Si nécessaire, consulter les organismes de réglementation appropriés et des autorités de contrôle pour assurer la conformité.

Lire toutes les instructions d'installation avant de brancher le système à la source d'alimentation.

Cet équipement doit être mis à la terre. Ne jamais modifier le conducteur de terre.

Cet appareil requiert une protection contre les surintensités.

4.2.1 Connecting AC Power

Describes how to connect the AC power supply to the device.

Power requirements vary by switch. Refer to [Table 3: Switch Specifications \(Power Draw\)](#) for information regarding your specific switch.

[Rear Panel](#) shows the location of the power supply connections on the rear panel of the switch.

Power Configurations

- **Non-redundant:** Connect power to either of the two power supplies.
- **Redundant:** Connect each AC power supply to a separate circuit that provides the required power.

**Note:**

To power down the Switch, remove all power cords and wires from the power supplies.

Input power and power Supply redundancy is dependent on the actual system power draw.

For maximum Input Power redundancy, each power supply should be connected to its own input overcurrent protection.

Power supplies use cables that comply with IEC-320 and have a C13 plug. The accessory kit provides two IEC-320 C13 to C14 power cables.

4.2.2 Connecting DC Power

Describes how to connect the DC power supply to the device.

Power requirements vary by switch. Refer to [Table 3: Switch Specifications \(Power Draw\)](#) for information regarding your specific switch.

[Rear Panel](#) displays the location of the power supplies on the rear panel of the switch. There is a cover over the DC supply terminals.

**Important:**

A disconnect device must be provided as part of the installation.

Ensure power is removed from DC circuits before performing any installation actions. Locate the disconnect device, circuit breakers or fuses on DC power lines servicing the circuits. Turn off the power line circuits or remove the fuses.

Wire size must comply with local and national requirements and electrical codes. Use only copper wire.

Apply ground connection to the switch first during installation and remove last when removing power.

Un dispositif de sectionnement doit être fourni dans le cadre de l'installation.

Pouvoir assurer qu'il est retiré de circuits DC avant d'effectuer des actions d'installation . Localiser les disjoncteurs ou des fusibles sur les lignes de courant continu desservant les circuits. Coupez les circuits de lignes d'alimentation ou retirer les fusibles.

Le calibre du fil doit être conforme aux exigences locales et nationales et les codes électriques. Utiliser du fil de cuivre.

Appliquer connexion à la terre à l'interrupteur premier lors de l'installation et de supprimer la dernière alimentation lors du débranchement.

Power Configurations

- **Non-redundant:** Connect power to either of the two power supplies.
- **Redundant:** Connect each DC power supply to a circuit that provides the required power.

4.2.3 Connecting DC Power Supply to Power Source

Describes how to connect the DC power supply to the power source.



Important:

Wire size must comply with local and national requirements and electrical codes. Use only copper wire.

Apply the ground connection first during installation and remove last when removing power.

Calibre doit respecter les exigences locales et nationales et les codes de l'électricité. Utiliser seulement du fil de cuivre.

Appliquer le motif connexion tout d'abord pendant l'installation et supprimer dernière lors du retrait de puissance.

To connect a DC power supply to the power source perform the following:

1. Remove the terminal cover to expose the connectors on the terminal block on the face.
2. Attach the appropriate lugs to the source DC wires.

Use DC cables with either insulated crimp-on spade lugs or insulated crimp-on ring connectors.

3. Connect the DC-input wires to the terminal block in this order:
 - a. Ground cable to the ground connector on the face of the power supply.
 - b. Negative (–) source DC cable to the negative (–) connector on the terminal block.
 - c. Positive (+) source DC cable to the positive (+) connector on the terminal block.
 - d. Torque the screws as specified in the following table.

Table 4: Wiring, Lug, and Tightening Torques for DC PSUs

Switch	Wire Size		Lug Type	Tightening Torque	
	(AWG)	(mm ²)		N·m	in·lbs
DCS-7010T-48-DC	12 to 22	3.3 to 0.33	ring ¹	0.8	7.0
DCS-7010TX-48-DC	14 to 18	1.5 to 0.75	ring ¹	0.8	7.0

¹ Single #6 hole

- Replace the terminal cover.

4.3 Connecting Serial and Management Cables

Cables required to connect the device.

The accessory kit includes the following cables:

- RJ-45 to DB-9 serial adapter cable
- RJ-45 Ethernet cable

The following RJ-45 to DB-9 table lists the pin connections of the RJ-45 to DB-9 adapter cable.

Table 5: RJ-45 to DB-9 Connections

RJ-45		DB-9		RJ-45		DB-9	
RTS	1	8	CTS	GND	5	5	GND
DTR	2	6	DSR	RXD	6	3	TXD
TXD	3	2	RXD	DSR	7	4	DTR
GND	4	5	GND	CTS	8	7	RTS

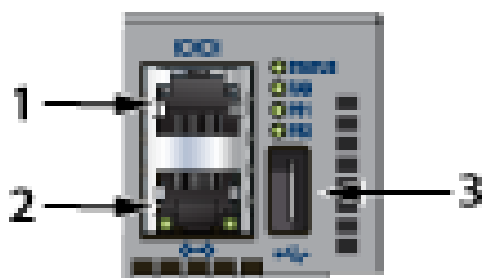
Figure 9: Front Panel Ports

- 1 Console serial port
- 2 Ethernet management port
- 3 USB port

Connect the front panel ports as follows:

- **Console (Serial) Port:** Connect to a PC with the RJ-45 to DB-9 serial adapter cable. The switch uses the following default settings:
 - 9600 baud
 - No flow control
 - 1 stop bit
 - No parity bits
 - 8 data bits
- **Ethernet Management Port:** Connect to 10/100/1000 management network with RJ-45 Ethernet cable.
- **USB Port:** The USB port may be used for software or configuration updates.



Important:

Excessive bending can damage interface cables, especially optical cables.

Flexion excessive peut endommager les câbles d'interface, notamment des câbles optiques.

Configuring the Switch

Arista switches ship from the factory in Zero Touch Provisioning (ZTP) mode. ZTP configures the switch without user intervention by downloading a startup configuration file or a boot script from a location specified by a DHCP server. To manually configure a switch, ZTP is bypassed. The initial configuration provides one username (admin) accessible only through the console port because it has no password.

When bypassing ZTP, initial switch access requires logging in as admin, with no password, through the console port. Then you can configure an admin password and other password protected usernames.

This manual configuration procedure cancels ZTP mode, logs into the switch, assigns a password to admin, assigns an IP address to the management port, and defines a default route to a network gateway.

1. Provide power to the switch ([Connecting Power Cables](#)).
2. Connect the console port to a PC ([Connecting Serial and Management Cables](#)).

As the switch boots without a startup-config file, it displays the following through the console:

```
The device is in Zero Touch Provisioning mode and is
attempting to download the startup-config from a remote system.
The device will not be fully functional until either a valid
startup-config is downloaded from a remote system or Zero Touch
Provisioning is cancelled. To cancel Zero Touch Provisioning, login
as admin and type 'zerotouch cancel' at the CLI.
localhost login:
```

3. Log into the switch by typing **admin** at the login prompt.

```
localhost login: admin
```

4. Cancel ZTP mode by typing **zerotouch cancel**.

IMPORTANT: This step initiates a switch reboot.

```
localhost>zerotouch cancel
```

5. After the switch boots, log into the switch again by typing **admin** at the login prompt.

```
Arista EOS
localhost login:admin
Last login: Fri Mar 15 13:17:13 on console
```

6. Enter global configuration mode.

```
localhost>enable
localhost#config
```

7. Assign a password to the admin username with the **username secret** command.

```
localhost(config)#username admin secret pxq123
```

8. Configure a default route to the network gateway.

```
localhost(config)#ip route 0.0.0.0/0 192.0.2.1
```

9. Assign an IP address (192.0.2.8/24 in this example) to an Ethernet management port.

```
localhost(config)#interface management 1
localhost(config-if-Ma1/1)#ip address 192.0.2.8/24
```

10. Save the configuration by typing **write memory** or **copy running-config startup-config**.

```
localhost#copy running-config startup-config
```

11. When the management port IP address is configured, use this command to access the switch from a host, using the address configured in step 9:

```
ssh admin@192.0.2.8
```

Refer to the *Arista Networks User Manual* for complete switch configuration information.

Status Indicators

The Status Indicators section reviews the following topics:

- [Front Indicators](#)
- [Rear Status Indicators](#)

A.1 Front Indicators

System and port status LED indicators are located on the front of the switches.

A.1.1 Switch Indicators

Front panel LEDs are located on the right side of the chassis and display system, fan, and power supply status. [Front Panel](#) displays the front panels of all switches covered by this guide.

[Figure 10: System Status Indicators](#) displays the front panel LEDs.

Figure 10: System Status Indicators

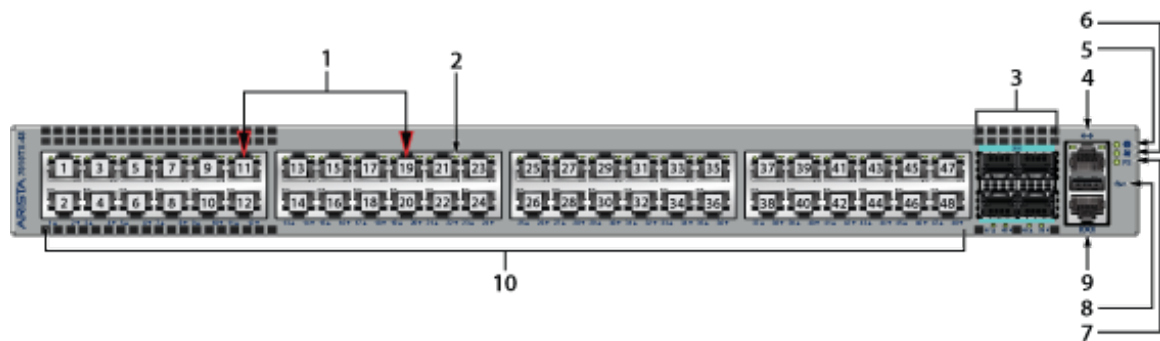

- | | | |
|----------------------------|----------------------------------|-----------------------|
| 1 Port numbers | 5 System status LED | 9 Console serial port |
| 2 Port status LED | 6 Fan tray status LED | 10 RJ-45 ports |
| 3 SFP25 Ports | 7 Power supply status LED | |
| 4 Ethernet management port | 8 USB port | |

Table 6: Switch Indicators LED States

LED Name	LED State	Device Status
System Status	Blinking Green	System powering up.
	Green	All power supplies and fans are operating normally.
	Blue	The locator function is active.
	Red	A power supply or fan is missing or in a failed state.
Fan Status	Green	All fans are operating normally.
	Red	One or more fans are not inserted or have failed.
Power Supply Status	Off	Power supply is not inserted or is not powered.
	Green	Power supply operating normally.
	Red	Power supply has failed.

A.1.2 Port Indicators

Port LEDs, located in the vicinity of their corresponding ports, provide link and operational status. The following figure displays the Port LED location on a representative switch.

Figure 11: Port LEDs

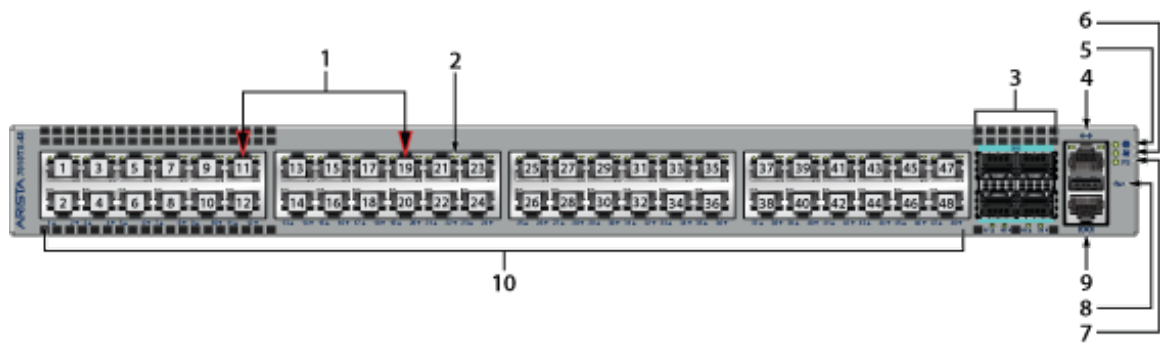

- 1 Port numbers
- 2 Port status LED
- 3 SFP25 Ports
- 4 Ethernet management port
- 5 System status LED
- 6 Fan tray status LED
- 7 Power supply status LED
- 8 USB port
- 9 Console serial port
- 10 RJ-45 ports

[Table 7: Port LED States](#) provide status conditions that correspond to port LED states. Port LED behavior for QSFP+ and SFP+ ports is consistent.

Table 7: Port LED States

LED State	Status
Off	Port link is down.
Green	Port link is up.
Yellow	Port is software disabled.
Flashing Yellow	Port failed diagnostics.

A.2 Rear Status Indicators

The fan module contains an LED that reports the module status. Fan Status LEDs are on the fan modules and are visible through the cover.

The fan module orientation determines the direction of air flowing through the switch. The fan module, when inserted, covers one of the two airflow labels with the visible label indicating the current airflow direction.

The switch shuts down when the fan module is removed for more than one minute.

Figure 12: Fan Status LED

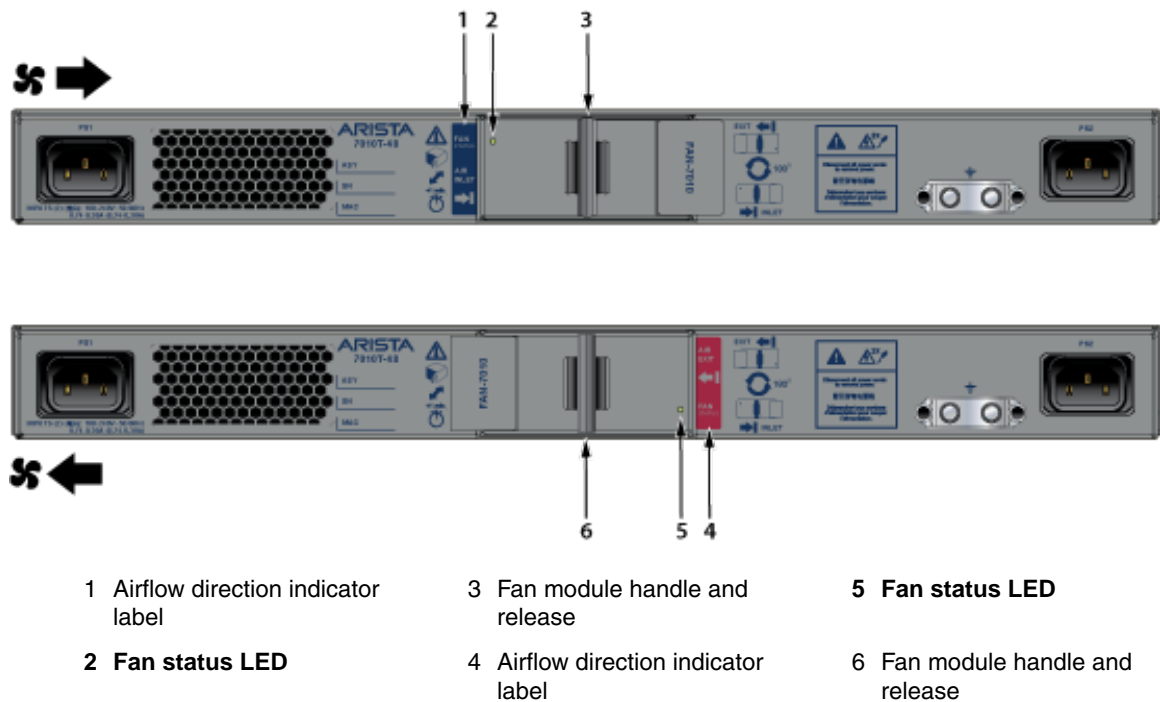

The following table provides status conditions that correspond to fan status LED states.

Table 8: Fan Status LED States

LED State	Status
Off	The fan module is inserted but not receiving power – it may not be properly seated.
Green	The fan is operating normally.
Red	The fan has failed.



Note: You can narrow down the error condition by logging in to the switch to view the specific device state. Refer to the *Arista User Manual's Switch Environment Control* chapter, under the topic *Viewing Environment Status*, for further information on the **show environment** commands.

Parts List

Each switch provides an accessory kit that contains parts that are required to install the switch. This appendix lists the installation parts contained in the switch accessory kit.

The Parts List section reviews the following topics:

- [Installation Parts](#)
- [Cables](#)

B.1 Installation Parts

The accessory kit includes rack mount parts and rubber pads.

Figure 13: Rack Mount Parts



Figure 14: Surface Mount Rubber Pads

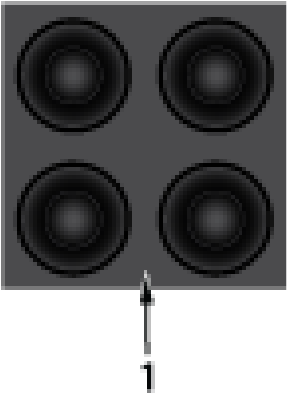

1 Rubber pads

B.2 Cables

Describes the cables required to install the device.

Quantity	Description
2	Power cables: IEC-320/C13-C14, 10 A, 250 V



Note: All provided power cables are for use only with Arista products.

警告

すべての電源コードは提供する製品で使用するためだけを目的としている。

電源コードの他の製品での使用の禁止

Aristaが提供するすべての電源コードは、Aristaの製品でのみ使用してください。

Front Panel

This appendix displays the front panel of all switches covered by this guide.

Figure 15: DCS-7010T-48 and DCS-7010T-48-DC

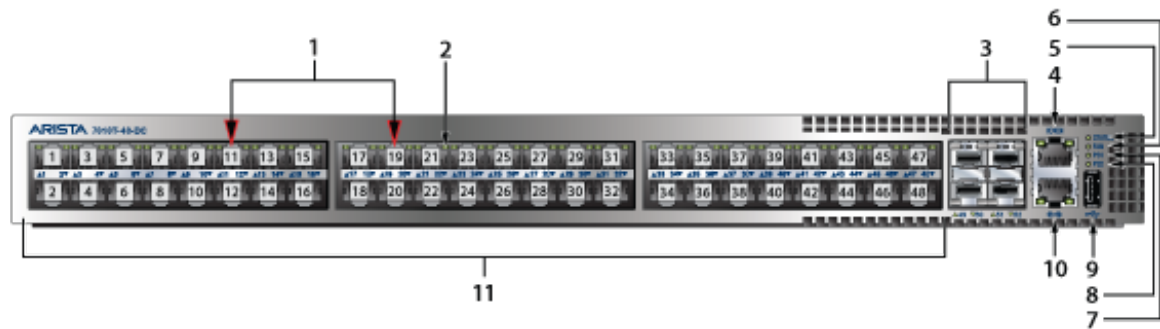

- | | | |
|-----------------------|-----------------------------|-----------------------------|
| 1 Port numbers | 5 System status LED | 9 USB port |
| 2 Port status LED | 6 Fan tray status LED | 10 Ethernet management port |
| 3 SFP+ Ports | 7 Power supply 1 status LED | 11 RJ-45 ports |
| 4 Console serial port | 8 Power supply 2 status LED | |

Figure 16: DCS-7010TX-48 and DCS-7010TX-48-DC

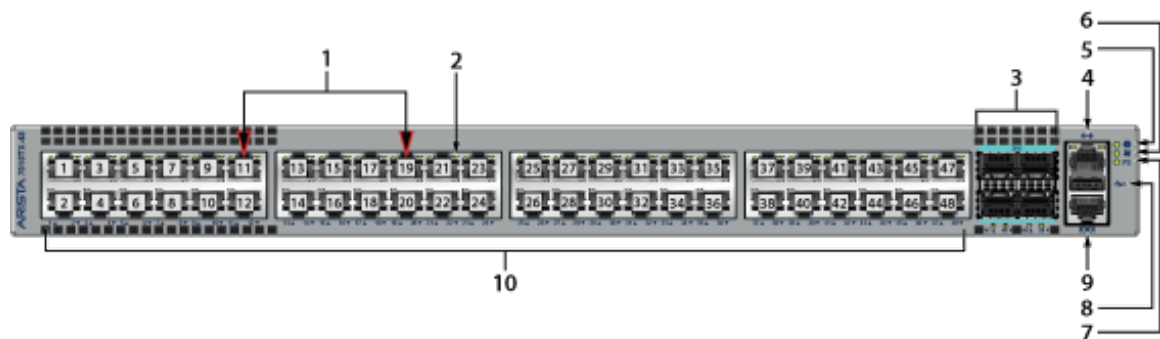

- | | | |
|----------------------------|---------------------------|-----------------------|
| 1 Port numbers | 5 System status LED | 9 Console serial port |
| 2 Port status LED | 6 Fan tray status LED | 10 RJ-45 ports |
| 3 SFP25 Ports | 7 Power supply status LED | |
| 4 Ethernet management port | 8 USB port | |

Rear Panel

This appendix displays the rear panel of all switches covered by this guide. Depending on the modules installed, the rear panel on your switch may appear slightly different.

Figure 17: DCS-7010T-48

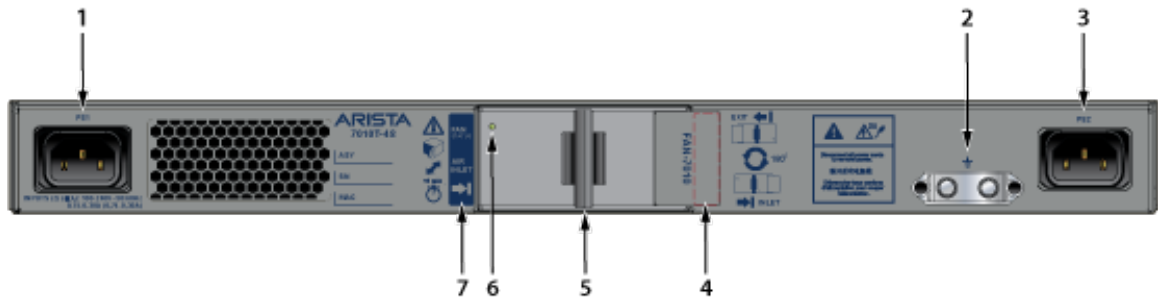

- | | | |
|-------------------------|------------------------------------------------|----------------------------------------------|
| 1 Power Supply Module 1 | 4 Airflow direction indicator label (inactive) | 7 Airflow direction indicator label (active) |
| 2 Grounding location | 5 Fan release handle | |
| 3 Power Supply Module 2 | 6 Fan status LED | |

Figure 18: DCS-7010TX-48

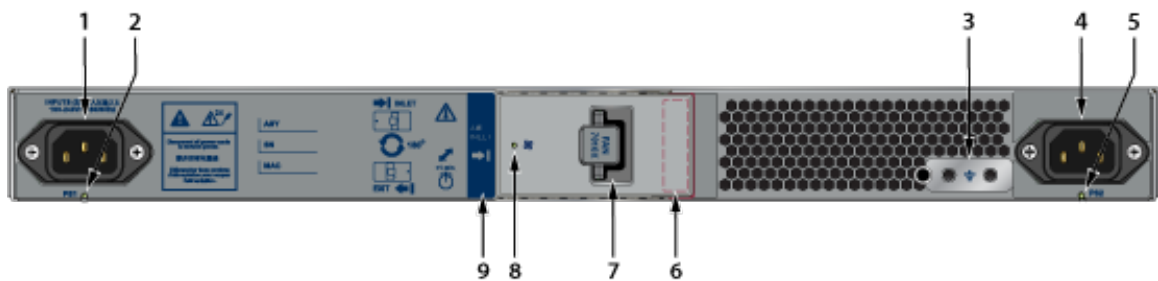

- | | | |
|-----------------------------|------------------------------------------------|----------------------------------------------|
| 1 Power supply module 1 | 4 Power supply module 2 | 7 Fan release handle |
| 2 Power supply 1 status LED | 5 Power supply 2 status LED | 8 Fan status LED |
| 3 Grounding location | 6 Airflow direction indicator label (inactive) | 9 Airflow direction indicator label (active) |

Figure 19: DCS-7010T-48-DC



- | | | |
|---------------------------------|---------------------------------|----------------------|
| 1 Power supply 1 terminals | 3 Power supply 2 terminal cover | 5 Grounding location |
| 2 Power supply 1 terminal cover | 4 Power supply 2 terminals | |

Figure 20: DCS-7010TX-48-DC

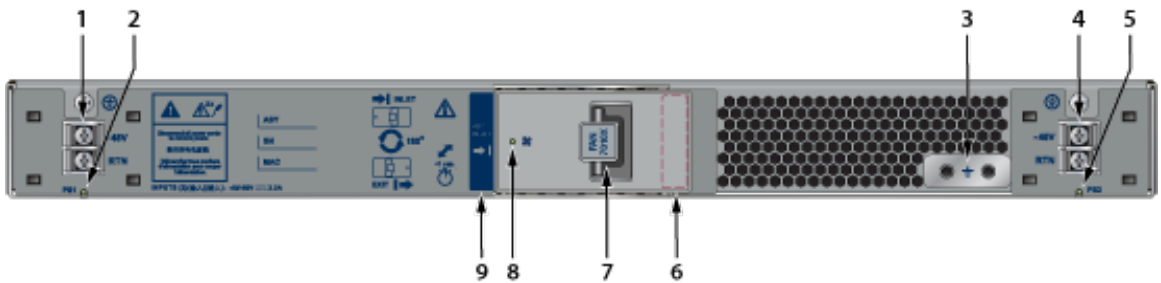

- | | | |
|-----------------------------|------------------------------------------------|----------------------------------------------|
| 1 Power supply 1 terminals | 4 Power supply 2 terminals | 7 Fan release handle |
| 2 Power supply 1 status LED | 5 Power supply 2 status LED | 8 Fan status LED |
| 3 Grounding location | 6 Airflow direction indicator label (inactive) | 9 Airflow direction indicator label (active) |

Maintenance and Field Replacement

Only the fan module is field replaceable.



Note: Hot swap or reorient fans within one minute to prevent the switch from overheating and shutting down.

Ensure that the module you are replacing matches those already installed in the switch.

Considerations

- The fan module is hot swappable and can be reoriented for airflow direction.
- The switch will shut down if the fan module is disconnected for more than a minute.
- Before you begin, refer to the Arista Networks document *Safety Information and Translated Safety Warnings* available at: <https://www.arista.com/en/support/product-documentation>.

Removing a Fan Module

The following steps are required when removing or replacing fans from a switch.

1. Ground yourself with an ESD wrist strap.
2. While squeezing the fan module handle, pull the fan module out of the switch.

Installing a Fan Module

You must make space for installing the fan module by removing an existing one ([Removing a Fan Module](#)).

1. Remove the replacement fan from its packaging.
2. Slide the new fan module into the switch until the module is fully seated and the release lever snaps into place.
3. Verify that the fan module is working normally.



Note: The fan module status LED should be a steady green for normal operation.

Regulatory Model Numbers

This appendix lists the Regulatory Model Numbers (RMNs) for the product models for the switches described in this document.

Table 9: Regulatory Model Numbers and Product Numbers

Regulatory Model Number (RMN)	Product Name(s)
DCS-7010T-48	DCS-7010T-48, DCS-7010T-48-DC
AN1738	DCS-7010TX-48
AN1764	DCS-7010TX-48-DC

Taiwan RoHS Information

This appendix provides Taiwan RoHS information for switches covered by this guide.

For Taiwan BSMI RoHS Table, go to <https://www.arista.com/assets/data/pdf/AristaBSMIRoHS.pdf>.

