

Power Operational Amplifier

FEATURES

- HIGH INTERNAL DISSIPATION — 400 Watts
- HIGH CURRENT — 40A Continuous, 100A PEAK
- HIGH SLEW RATE — 50V/ μ s
- OPTIONAL BOOST VOLTAGE INPUTS

APPLICATIONS

- SEMI-CONDUCTOR TESTING

DESCRIPTION

The PA50 is a MOSFET power operational amplifier that extends the performance limits of power amplifiers in slew rate and power bandwidth, while maintaining high current and power dissipation ratings.

Boost voltage inputs allow the small signal portion of the amplifier to operate at a higher voltage than the high current output stage. The amplifier is then biased to achieve close linear swings to the supply rails at high currents for extra efficient operation.

EQUIVALENT SCHEMATIC

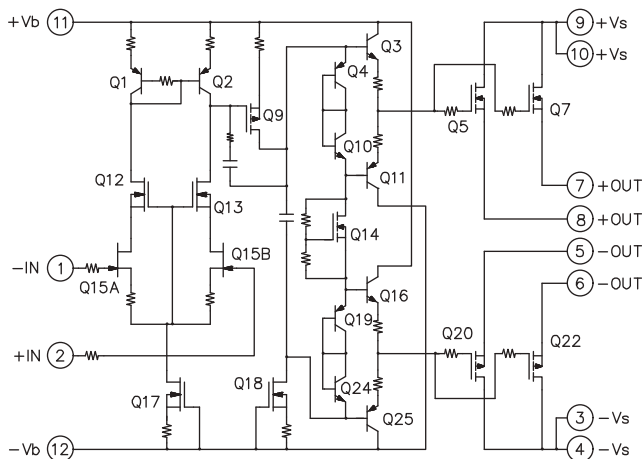

**12-PIN DIP
PACKAGE STYLE CR**

The JEDEC MO-127 12-pin Power Dip™ package (see Package Outlines) is hermetically sealed and isolated from the internal circuits. The use of compressible thermal washers and/or improper mounting torque will void the product warranty. Please see “General Operating Considerations Application Note 1”.

EXTERNAL CONNECTIONS

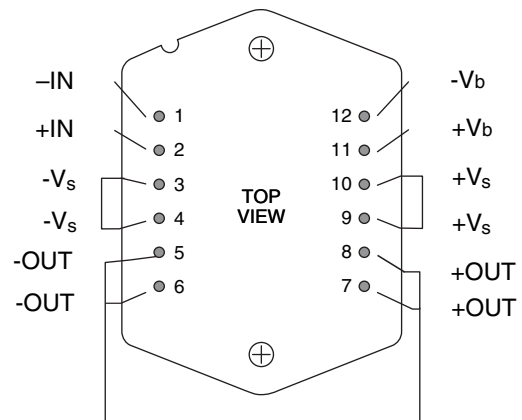

ABSOLUTE MAXIMUM RATINGS

| | |
|--|-----------------|
| SUPPLY VOLTAGE, +V _S to -V _S | 100V |
| BOOST VOLTAGE, +V _b to -V _b | 130V |
| OUTPUT CURRENT, within SOA | 100A |
| POWER DISSIPATION, internal | 400W |
| INPUT VOLTAGE, differential | ±20V |
| INPUT VOLTAGE, common mode | ±V _b |
| TEMPERATURE, pin solder - 10s | 350°C |
| TEMPERATURE, junction ² | 150°C |
| TEMPERATURE, storage | -65 to +150°C |
| OPERATING TEMPERATURE RANGE, case | -55 to +125°C |

SPECIFICATIONS

| PARAMETER | TEST CONDITIONS ¹ | PA50 | | | PA50A | | | UNITS |
|---|---|--|----------------------|------|----------------------|----------------------|-----|-------|
| | | MIN | TYP | MAX | MIN | TYP | MAX | |
| INPUT | | | | | | | | |
| OFFSET VOLTAGE, initial | | | 5 | 10 | | 2 | 5 | mV |
| OFFSET VOLTAGE, vs. temperature | Full temperature range | | 20 | 50 | | * | * | μV/°V |
| OFFSET VOLTAGE, vs. supply | | | 10 | 30 | | * | * | μV/V |
| BIAS CURRENT, initial | | | 10 | 50 | | * | * | pA |
| BIAS CURRENT vs. supply | | | 0.01 | | | * | * | pA/V |
| OFFSET CURRENT, initial | | | 10 | 50 | | * | * | pA |
| INPUT IMPEDANCE, DC | | | 10 | | | * | * | Ω |
| INPUT CAPACITANCE | | | 13 | | | * | * | pF |
| COMMON MODE VOLTAGE RANGE | Full temperature range | -V _B +12 +V _B -14 | | | * | | | V |
| COMMON MODE REJECTION,DC | Full temp, range, V _{CM} = ±20V | 90 | 100 | | | * | * | dB |
| INPUT NOISE | 100 kHz BW, R _S =1 kΩ | | 10 | | | * | * | μVrms |
| GAIN | | | | | | | | |
| OPEN LOOP,@ 15 Hz | Full temperature range | 94 | 102 | | * | * | | dB |
| GAIN BANDWIDTH PRODUCT | R _L =10 Ω | | 3 | | | * | | MHz |
| POWER BANDWIDTH | R _L =4 Ω, V _o = 80V _{P-P} , A _v = -10 Full temperature range | | 200 | | | * | | kHz |
| OUTPUT | | | | | | | | |
| VOLTAGE SWING | I _o = 40A | ±V _S ±9.5 | ±V _S ±8.0 | | * | * | | V |
| VOLTAGE SWING, PA50 | ±V _{BOOST} =±V _S ±10V, I _o =40A | ±V _S ±5.8 | ±V _S ±4.0 | | | | | V |
| VOLTAGE SWING, PA50A | ±V _{BOOST} =±V _S ±10V, I _o =50A | | | | ±V _S ±5.8 | ±V _S ±5.0 | | V |
| CURRENT, peak | 3ms 10% Duty Cycle | 100 | | | * | * | | A |
| SETTLING TIME TO 0.1% | A _v = -10, 10V STEP, R _L =4 Ω | | 1 | | | * | | μs |
| SLEW RATE | A _v =-10 | 50 | | | * | * | | V/μs |
| RESISTANCE | I _o =0, NO LOAD, 2 MHZ | | 2.5 | | | * | | Ω |
| POWER SUPPLY | | | | | | | | |
| VOLTAGE, ±V _{BOOST} | Full temperature range | +14, -12 | ±15 | ±65 | * | * | * | V |
| VOLTAGE, ±V _S | Full temperature range | ±3 | | ±50 | * | * | * | V |
| CURRENT, quiescent, boost supply | | | 26 | 32 | | * | * | mA |
| CURRENT, quiescent, total | | | 30 | 36 | | * | * | mA |
| THERMAL | | | | | | | | |
| RESISTANCE, AC, junction to case ³ | Full temperature range, F>60 HZ | | 0.2 | 0.25 | | * | * | °C/W |
| RESISTANCE, DC, junction to case | Full temperature range, F>60 HZ | | 0.25 | 0.31 | | * | * | °C/W |
| RESISTANCE, junction to air | Full temperature range | | 12 | | | * | * | °C/W |
| TEMPERATURE RANGE, case | Meets full range specification | -25 | | 85 | * | | * | °C |

- NOTES: * The specification of PA50A is identical to the specification for PA50 in applicable column to the left
1. Unless otherwise noted: T_C = 25°C, DC input specifications are ± value given. Power supply voltage is typical rating. ±V_{BOOST} = ±V_S.
 2. Long term operation at the maximum junction temperature will result in reduced product life. Derate internal power dissipation to achieve high MTTF. For guidance, refer to the heatsink data sheet.
 3. Rating applies if the output current alternates between both output transistors at a rate faster than 60 Hz.

CAUTION The PA50 is constructed from MOSFET transistors. ESD handling procedures must be observed.

The internal substrate contains beryllia (BeO). Do not break the seal. If accidentally broken, do not crush, machine, or subject to temperatures in excess of 850°C to avoid generating toxic fumes.

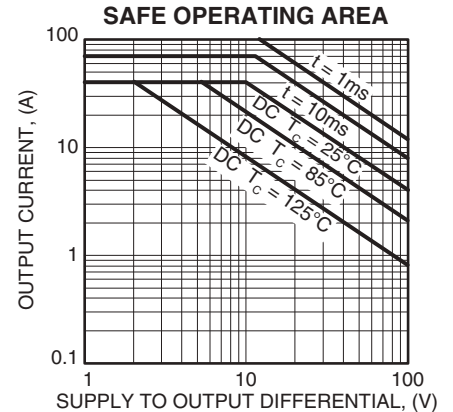
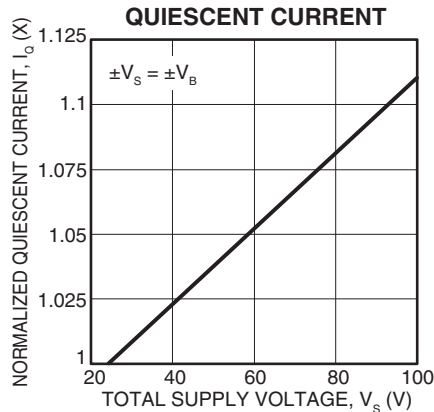
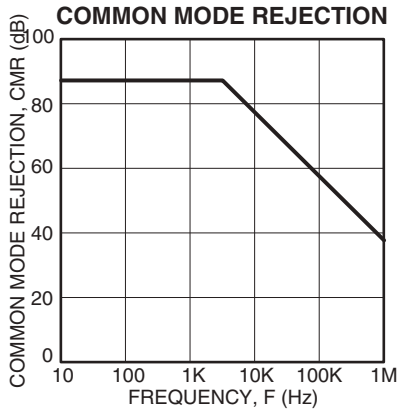
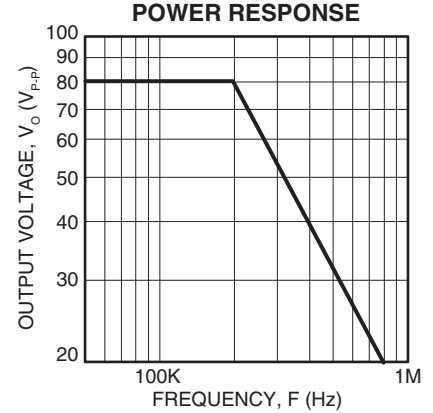
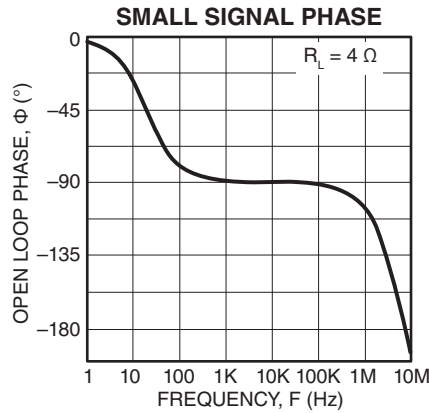
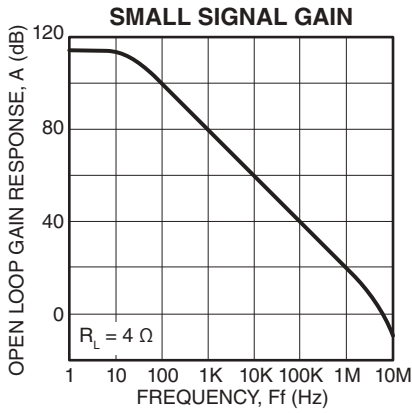
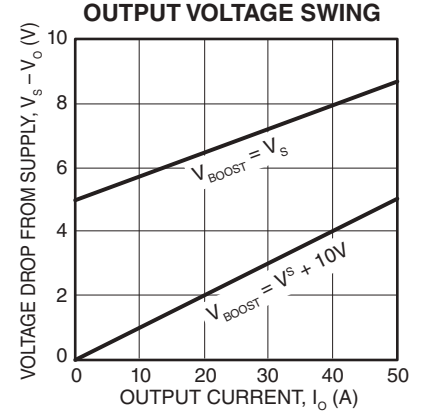
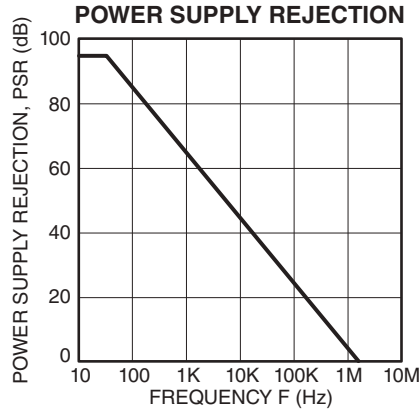
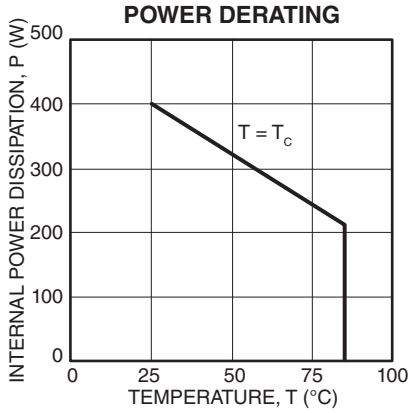

GENERAL

Please read Application Note 1 "General Operating Considerations" which covers stability, supplies, heat sinking, mounting, current limit, SOA interpretation, and specification interpretation. Visit www.apexanalog.com for Apex Microtechnology's complete Application Note library, Technical Seminar Workbook, and Evaluation Kits.

CURRENT LIMIT

There is no internal circuit provision for current limit in the PA50. However, the PA50 circuit board in the PA50 evaluation kit does provide a means whereby the output current can be sensed. An external circuit current limit can thereby be implemented if needed.

BOOST OPERATION

With the V_{BOOST} feature the small signal stages of the amplifier are operated at higher supply voltages than the amplifier's high current output stage. $+V_{\text{BOOST}}$ (pin 11) and $-V_{\text{BOOST}}$ (pin 12) are connected to the small signal circuitry of the amplifier. $+V_{\text{S}}$ (pin 9,10) and $-V_{\text{S}}$ (pin 3,4) are connected to the high current output stage. An additional 10V on the V_{BOOST} pins is sufficient to allow the small signal stages to drive the

output transistors into saturation and improve the output voltage swing for extra efficient operation when required. When close swings to the supply rails is not required the $+V_{\text{BOOST}}$ and $+V_{\text{S}}$ pins must be strapped together as well as the $-V_{\text{BOOST}}$ and $-V_{\text{S}}$ pins. The boost voltage pins must not be at a voltage lower than the V_{S} pins.

COMPENSATION

Compensation is internally fixed for a gain of 3 or more and is not adjustable by the user. The PA50 therefore is not unity gain stable.

POWER SUPPLY BYPASSING

Proper and sufficient power supply bypassing is crucial to proper operation of the PA50. Bypass the $+V_{\text{b}}$ and $-V_{\text{b}}$ supply pins with a minimum 0.1 μF ceramic capacitors directly at the supply pins. On the $+V_{\text{S}}$ and $-V_{\text{S}}$ pins use a combination of ceramic and electrolytic capacitors. Use 1 μF ceramic capacitors and an electrolytic capacitor at least 10 μF for each amp of output current required.

NEED TECHNICAL HELP? CONTACT APEX SUPPORT!

For all Apex Microtechnology product questions and inquiries, call toll free 800-546-2739 in North America.

For inquiries via email, please contact apex.support@apexanalog.com.

International customers can also request support by contacting their local Apex Microtechnology Sales Representative.

To find the one nearest to you, go to www.apexanalog.com

IMPORTANT NOTICE

Apex Microtechnology, Inc. has made every effort to insure the accuracy of the content contained in this document. However, the information is subject to change without notice and is provided "AS IS" without warranty of any kind (expressed or implied). Apex Microtechnology reserves the right to make changes without further notice to any specifications or products mentioned herein to improve reliability. This document is the property of Apex Microtechnology and by furnishing this information, Apex Microtechnology grants no license, expressed or implied under any patents, mask work rights, copyrights, trademarks, trade secrets or other intellectual property rights. Apex Microtechnology owns the copyrights associated with the information contained herein and gives consent for copies to be made of the information only for use within your organization with respect to Apex Microtechnology integrated circuits or other products of Apex Microtechnology. This consent does not extend to other copying such as copying for general distribution, advertising or promotional purposes, or for creating any work for resale.

APEX MICROTECHNOLOGY PRODUCTS ARE NOT DESIGNED, AUTHORIZED OR WARRANTED TO BE SUITABLE FOR USE IN PRODUCTS USED FOR LIFE SUPPORT, AUTOMOTIVE SAFETY, SECURITY DEVICES, OR OTHER CRITICAL APPLICATIONS. PRODUCTS IN SUCH APPLICATIONS ARE UNDERSTOOD TO BE FULLY AT THE CUSTOMER OR THE CUSTOMER'S RISK.

Apex Microtechnology, Apex and Apex Precision Power are trademarks of Apex Microtechnology, Inc. All other corporate names noted herein may be trademarks of their respective holders.