

# Cisco Aironet Antennas and Accessories

## Overview

### Executive Overview

This antenna reference guide explains issues and concerns about antennas used with a Cisco® Aironet® wireless LAN system or wireless bridge system. It details deployment and design, limitations and capabilities, and basic theories of antennas. This document also contains information about the Cisco antennas and accessories, as well as installation scenarios, regulatory information, and technical specifications and diagrams of the available antennas.

### Overview of Antennas

Each Cisco Aironet radio product is designed to perform in a variety of environments. Implementing the antenna system can greatly improve coverage and performance.

To optimize the overall performance of a Cisco wireless LAN, it is important to understand how to maximize radio coverage with the appropriate antenna selection and placement. An antenna system comprises numerous components, including the antenna, mounting hardware, connectors, antenna cabling, and in some cases, a lightning arrestor. For a consultation, please contact a Cisco Aironet partner at:

[http://tools.cisco.com/WWChannels/LOCATR/jsp/partner\\_locator.jsp](http://tools.cisco.com/WWChannels/LOCATR/jsp/partner_locator.jsp).

Cisco partners can provide onsite engineering assistance for complex requirements.

### Radio Technologies

In the mid-1980s, the U.S. Federal Communications Commission (FCC) modified Part 15 of the radio spectrum regulation, which governs unlicensed devices. The modification authorized wireless network products to operate in the industrial, scientific, and medical (ISM) bands using spread spectrum modulation. This type of modulation had formerly been classified and permitted only in military products. The ISM frequencies are in three different bands, located at 900 MHz, 2.4 GHz, and 5 GHz. This document covers both the 2.4- and 5-GHz bands.

The ISM bands typically allow users to operate wireless products without requiring specific licenses, but this will vary in some countries. In the United States, there is no requirement for FCC licenses. The products themselves must meet certain requirements to be certified for sale, such as operation under 1-watt transmitter output power (in the United States) and maximum antenna gain or effective isotropic radiated power (EIRP) ratings.

The Cisco Aironet product lines utilize both the 2.4- and 5-GHz bands. In the United States, three bands are defined as unlicensed and known as the ISM bands. The ISM bands are as follows:

- 900 MHz (902-928 MHz)
- 2.4 GHz (2.4-2.4835 GHz) - IEEE 802.11b
- 5 GHz (5.15-5.35 and 5.725-5.825 GHz) - IEEE 802.11a, HIPERLAN/1 and HIPERLAN/2. This band is also known as the UNII band, and has three subbands: UNII1 (5.150-5.250 GHz), UNII2 (5.250-5.350 GHz), and UNII3 (5.725-5.825 GHz)

---

Each set of bands has different characteristics. The lower frequencies exhibit better range, but with limited bandwidth and hence lower data rates. The higher frequencies have less range and are subject to greater attenuation from solid objects.

### **802.11 Modulation Techniques**

The IEEE 802.11 standard makes provisions for the use of several different modulation techniques to encode the transmitted data onto the RF signal. These modulation techniques are used to enhance the probability of the receiver correctly receiving the data and thus reducing the need for retransmissions. The techniques vary in their complexities and robustness to RF signal propagation impairments.

#### **Direct-Sequence Spread Spectrum**

The direct-sequence spread spectrum (DSSS) approach involves encoding redundant information into the RF signal. Every data bit is expanded to a string of chips called a **chipping sequence** or **Barker sequence**. The chipping rate, as mandated by the U.S. FCC, is 10 chips at the 1- and 2-Mbps rates and 8 chips at the 11-Mbps rate. So, at 11 Mbps, 8 bits are transmitted for every one bit of data. The chipping sequence is transmitted in parallel across the spread spectrum frequency channel.

#### **Frequency-Hopping Spread Spectrum**

Frequency-hopping spread spectrum (FHSS) uses a radio that moves or hops from one frequency to another at predetermined times and channels. The regulations require that the maximum time spent on any one channel is 400 milliseconds. For the 1- and 2-Mb FHSS systems, the hopping pattern must include 75 different channels, and must use every channel before reusing any one. For wide-band frequency hopping (WBFH) systems, which permit up to 10-Mb data rates, the rules require the use of at least 15 channels, and they cannot overlap. With only 83 MHz of spectrum, WBFH limits the systems to 15 channels, thus causing scalability issues.

In every case, for the same transmitter power and antennas, a DSSS system will have greater range, scalability, and throughput than an FHSS system. For this reason, Cisco has chosen to support only direct-sequence systems in the spread spectrum products.

#### **Orthogonal Frequency Division Multiplexing**

The orthogonal frequency division multiplexing (OFDM) used in 802.11a and 802.11g data transmissions offers greater performance than the older direct-sequence systems. In the OFDM system, each tone is orthogonal to the adjacent tones and therefore does not require the frequency guard band needed for direct sequence. This guard band lowers the bandwidth efficiency and wastes up to 50 percent of the available bandwidth. Because OFDM is composed of many narrow-band tones, narrow-band interference degrades only a small portion of the signal, with little or no effect on the remainder of the frequency components.

#### **Antenna Properties and Ratings**

An antenna gives the wireless system three fundamental properties - gain, direction, and polarization. **Gain** is a measure of increase in power. **Direction** is the shape of the transmission pattern. A good analogy for an antenna is the reflector in a flashlight. The reflector concentrates and intensifies the light beam in a particular direction similar to what a parabolic dish antenna would do to a RF source in a radio system.

Antenna gain is measured in decibels, which is a ratio between two values. The gain of a specific antenna is compared to the gain of an isotropic antenna. An isotropic antenna is a theoretical antenna with a uniform three-dimensional radiation pattern (similar to a light bulb with no reflector). dBi is used to compare the power level of a given antenna to the theoretical isotropic antenna. The U.S. FCC uses dBi in its calculations. An isotropic antenna is said to have a power rating of 0 dB, meaning that it has zero gain/loss when compared to itself.

---

Unlike isotropic antennas, dipole antennas are real antennas. Dipole antennas have a different radiation pattern compared to isotropic antennas. The dipole radiation pattern is 360 degrees in the horizontal plane and 75 degrees in the vertical plane (assuming the dipole antenna is standing vertically) and resembles a donut in shape. Because the beam is “slightly” concentrated, dipole antennas have a gain over isotropic antennas of 2.14 dB in the horizontal plane. Dipole antennas are said to have a gain of 2.14 dBi (in comparison to an isotropic antenna).

Some antennas are rated in comparison to dipole antennas. This is denoted by the suffix dBd. Hence, dipole antennas have a gain of 0 dBd (= 2.14 dBi).

Note that the majority of documentation refers to dipole antennas as having a gain of 2.2 dBi. The actual figure is 2.14 dBi, but is often rounded up.

## Types of Antennas

Cisco offers several different styles of antennas for use with access points and bridges in both 2.4-GHz and 5-GHz products. Every antenna offered for sale has been FCC-approved. Each type of antenna will offer different coverage capabilities. As the gain of an antenna increases, there is some tradeoff to its coverage area. Usually high-gain antennas offer longer coverage distances, but only in a certain direction. The radiation patterns below will help to show the coverage areas of the styles of antennas that Cisco offers: omnidirectional, Yagi, and patch antennas.

### Omnidirectional Antennas

An omnidirectional antenna (Figure 1) is designed to provide a 360-degree radiation pattern. This type of antenna is used when coverage in all directions from the antenna is required. The standard 2.14-dBi “Rubber Duck” is one style of omnidirectional antenna.

**Figure 1.** Omnidirectional Antenna

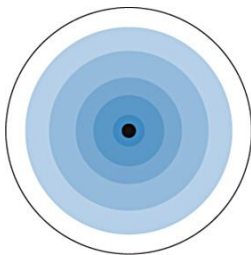

### Directional Antennas

Directional antennas come in many different styles and shapes. An antenna does not offer any added power to the signal; it simply redirects the energy it receives from the transmitter. By redirecting this energy, it has the effect of providing more energy in one direction, and less energy in all other directions. As the gain of a directional antenna increases, the angle of radiation usually decreases, providing a greater coverage distance, but with a reduced coverage angle. Directional antennas include patch antennas (Figure 2), Yagi antennas (Figure 3), and parabolic dishes. Parabolic dishes have a very narrow RF energy path, and the installer must be accurate in aiming these types of antennas these at each other.

**Figure 2.** Directional Patch Antenna

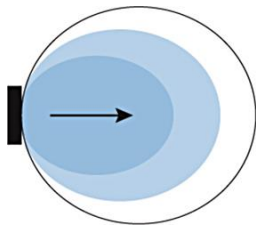

**Figure 3.** Yagi Antenna

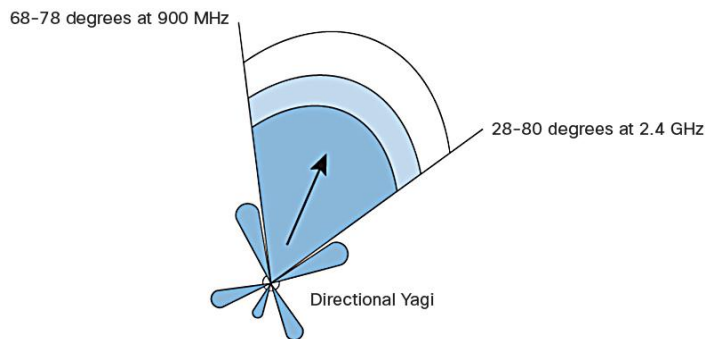

### Diversity Antenna Systems

Diversity antenna systems are used to overcome a phenomenon known as **multipath distortion** or **multipath interference**. A diversity antenna system uses two identical antennas, located a small distance apart, to provide coverage to the same physical area.

#### Multipath Distortion

Multipath interference occurs when an RF signal has more than one path between a receiver and a transmitter. This occurs in sites that have a large amount of metallic or other RF reflective surfaces.

Just as light and sound bounce off of objects, so does RF. This means there can be more than one path that RF takes when going from a transmit (TX) and receive (RX) antenna. These multiple signals combine in the RX antenna and receiver to cause distortion of the signal.

Multipath interference can cause the RF energy of an antenna to be very high, but the data would be unrecoverable. Changing the type of antenna and location of the antenna can eliminate multipath distortion (Figure 4).



**Figure 4.** Multipath Distortion

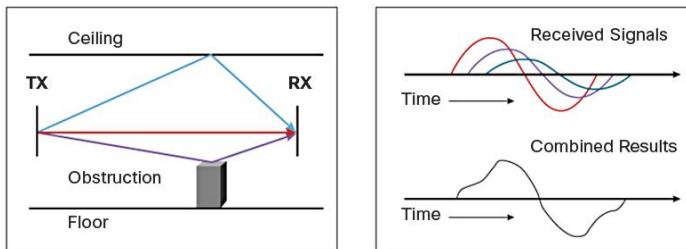

You can relate multipath distortion to a common occurrence in your car. As you pull up to a stop, you may notice static on the radio. But as you move forward a few inches or feet, the station starts to come in more clearly. By rolling forward, you move the antenna slightly, out of the point where the multiple signals converge.

### **How Diversity Antenna Systems Reduce Multipath Distortion**

A diversity antenna system can be compared to a switch that selects one antenna or another, never both at the same time. The radio in receive mode will continually switch between antennas listening for a valid radio packet. After the beginning sync of a valid packet is heard, the radio will evaluate the sync signal of the packet on one antenna, and then switch to the other antenna and evaluate. Then the radio will select the best antenna and use only that antenna for the remaining portion of that packet.

On transmit, the radio will select the same antenna it used the last time it communicated to that given radio. If a packet fails, it will switch to the other antenna and retry the packet.

One caution with diversity antenna systems is that they are not designed for using two antennas covering two different coverage cells. The problem in using it this way is that if antenna number 1 is communicating to device number 1 while device number 2 (which is in the antenna number 2 cell) tries to communicate, antenna number 2 is not connected (due to the position of the switch), and the communication fails. Diversity antennas should cover the same area from only a slightly different location.

With the introduction of the latest direct-spread physical layer chips, and the use of diversity antenna systems, direct-spread systems have equaled or surpassed frequency-hopping systems in handling multipath interference. While the introduction of WBFH does increase the bandwidth of frequency-hopping systems, it drastically affects the ability to handle multipath issues, further reducing its range compared to present direct-spread systems in sites that are highly RF reflective.

## **Wireless LAN Design**

Before the physical environment is examined, it is critical to identify the mobility of the application, the means for coverage, and system redundancy. An application such as point-to-point, which connects two or more stationary users, may be best served by a directional antenna, while mobile users will generally require a number of omnidirectional micro cells. These individual micro cells can be linked together through the wired LAN infrastructure or by using the wireless repeater functionality built into every Cisco Aironet access point.

---

## The Physical Environment

After mobility issues are resolved, the physical environment must be examined. While the area of coverage is the most important factor for antenna selection, it is not the sole decision criterion. Building construction, ceiling height, internal obstructions, available mounting locations, and the customer's aesthetic desires also must be considered.

Cement and steel construction have different radio propagation characteristics. Internal obstructions such as product inventory and racking in warehousing environments are factors. In outdoor environments, many objects can affect antenna patterns, including trees, vehicles, and buildings, to name a few.

## The Network Connections

Cisco Aironet access points use a 10/100/1000-Mb Ethernet connection. Typically the access point is in the same location as the antenna. While it may seem that the best place to put the access point is in a wiring closet with the other network components, such as switches, hubs, and routers, this is not the case. The antenna must be placed in an area that provides the best coverage (determined by a site survey).

Many people new to wireless LANs want to locate the access points in the wiring closet and connect the antenna using RF coax. Antenna cable introduces losses in the antenna system on both the transmitter and the receiver. As the length of cable increases, so does the amount of loss introduced. To operate at optimum efficiency, cable runs should be kept as short as possible. (See the [Cabling](#) section in this document for more information.)

## Building Construction

The density of the materials used in a building's construction determines the number of walls the RF signal can pass through and still maintain adequate coverage. Following are a few examples. The actual effect on the RF must be tested at the site, and therefore a site survey is recommended.

Paper and vinyl walls have very little effect on signal penetration. Solid walls and floors and precast concrete walls can limit signal penetration to one or two walls without degrading coverage. This may vary widely based on any steel reinforcing within the concrete. Concrete and concrete block walls may limit signal penetration to three or four walls. Wood or drywall typically allow for adequate penetration through five or six walls. A thick metal wall reflects signals, resulting in poor penetration. Steel-reinforced concrete flooring will restrict coverage between floors to perhaps one or two floors.

Recommendations for some common installation environments are outlined below:

- **Warehousing/manufacturing:** In most cases, these installations require a large coverage area. Experience has shown that an omnidirectional antenna mounted at 20 to 25 feet typically provides the best overall coverage. Of course, this also depends upon the height of the racking, material on the rack, and ability to locate the antenna at this height. Mounting the antenna higher will sometimes actually reduce coverage, as the angle of radiation from the antenna is more outward than down. The antenna should be placed in the center of the desired coverage cell and in an open area for best performance. In cases where the radio unit will be located against a wall, a directional antenna such as a patch or Yagi can be used for better penetration of the area. The coverage angle of the antenna will affect the coverage area.
- **Small office/small retail store:** The standard dipole may provide adequate coverage in these areas depending on the location of the radio device. However, in a back corner office a patch antenna may provide better coverage. It can be mounted to the wall above most obstructions for best performance. Coverage of this type antenna depends on the surrounding environment.

- **Enterprise/large retail store:** In most cases, these installations require a large coverage area. Experience has shown that omnidirectional antennas mounted just below the ceiling girders or just below the drop ceiling typically provide the best coverage (this will vary with stocking, type of material, and building construction). The antenna should be placed in the center of the desired coverage cell and in an open area for best performance. In cases where the radio unit will be located in a corner, or at one end of the building, a directional antenna such as a patch or Yagi can be used for better penetration of the area.  
Also, for areas that are long and narrow - such as long rows of racking - a directional antenna at one end may provide better coverage. The radiation angle of the antennas will also affect the coverage area.
- **Point-to-point:** When connecting two points together (such as a wireless bridge), the distance, obstructions, and antenna location must be considered. If the antennas can be mounted indoors and the distance is very short (several hundred feet), the standard dipole or mast mount 5.2 dBi omnidirectional may be used. An alternative is to use two patch antennas. For very long distances (1/2 mi. or more), directional high-gain antennas must be used. These antennas should be installed as high as possible, and above obstructions such as trees, buildings, and so on; and if directional antennas are used, they must be aligned so that their main radiated power lobes are directed at each other. With a line-of-site configuration, distances of up to 25 miles at 2.4 GHz and 12 miles at 5 GHz can be reached using parabolic dish antennas, if a clear line-of-site is maintained. With the use of directional antennas, fewer interference possibilities exist and there is less possibility of causing interference to anyone else.
- **Point-to-multipoint bridge:** In this case (in which a single point is communicating to several remote points), the use of an omnidirectional antenna at the main communication point must be considered. The remote sites can use a directional antenna that is directed at the main point antenna.

## Cabling

As stated above, cabling introduces losses into the system, negating some of the gain an antenna introduces and reducing range of the RF coverage.

### Interconnect Cable

Attached to all antennas (except the standard dipoles), this cable provides a 50 ohm impedance to the radio and antenna, with a flexible connection between the two items. It has a high loss factor and should not be used except for very short connections (usually less than 10 feet). Typical length on all antennas is 36 in. (or 12 in. on some outdoor antennas).

### Low-Loss/Ultra-Low-Loss Cable

Cisco offers two styles of cables for use with the 2.4-GHz and 5-GHz product lines. These cables provide a much lower loss factor than standard interconnect cable, and they can be used when the antenna must be placed at any distance from the radio device. While these are low-loss cables, they should still be kept to a minimum length.

There are two types of cable supplied by Cisco for mounting the antenna away from the radio unit. The 100- and 150-foot cables are LMR600 type cable, while the 20- and 50-foot cables are LMR400 type cables. All four lengths are supplied with one RP-TNC plug and one RP-TNC jack connector attached. This allows for connection to the radio unit and to the interconnect cable supplied on the antennas.

---

## Connectors

According to the U.S. Federal Code of Regulations, products used in the 2.4- and 5-GHz ISM bands manufactured after June 1994 must either use connectors that are unique and nonstandard (meaning not readily available on the market by the average user) or be designed to be professionally installed (“professional” here indicates a person trained in RF installation and regulations). Since many of the 2.4-GHz products are installed by non-RF trained personnel, these products must comply with the unique connector ruling. The Cisco outdoor access and bridge products are designed for installation by a RF professional, and therefore may use a standard N style connector. Cisco Aironet indoor products use reverse polarity-TNC (RP-TNC) connectors. While they are similar to the normal TNC connectors, they cannot be mated to the standard connectors.

To ensure compatibility with Cisco Aironet products, use antennas and cabling from Cisco.

## Mounting Hardware

Each antenna requires some type of mounting. The standard dipole antenna simply connects to the RP-TNC connector on the unit. Mast mount antennas are designed to mount to a variety of mast diameters and each comes with mounting hardware for attachment. The Yagi antennas have an articulating mount option. Patch antennas are designed to mount flat against a wall or ceiling, and ceiling-mount antennas are equipped with a drop-ceiling cross-member attachment. The 2.4-GHz 21-dBi parabolic dish mounts to a 1.625- up to a 2.375-in. mast. In this dish antenna, fine-threaded turn-buckles allow accurate aiming of the antenna.

For most indoor applications, a .75- or 1-in. electrical conduit provides a suitable mounting. For outdoor applications, use a heavy galvanized or aluminum wall mast that will withstand the wind-loading rating of the selected antenna.

## Lightning Arrestors

When using outdoor antenna installations, it is always possible that an antenna will suffer damage from potential charges developing on the antenna and cable, or surges induced from nearby lightning strikes. The Cisco Aironet lightning arrestor is designed to protect 2.4-GHz to 5.8- GHz radio equipment from static electricity and lightning-induced surges that travel on coaxial transmission lines. Both systems need to be properly grounded as identified in the hardware installation manuals of the products. These protection mechanisms will not prevent damage in the event of a direct lightning hit.

## Theory of Operation

The Cisco Aironet Lightning Arrestor (Figure 5) prevents energy surges from reaching the RF equipment by the shunting effect of the device. Surges are limited to less than 50 volts, in about .000001 seconds (100 nanoseconds). A typical lightning surge is about .000002 (2 micro seconds).

**Figure 5.** Cisco Aironet Lightning Arrestor

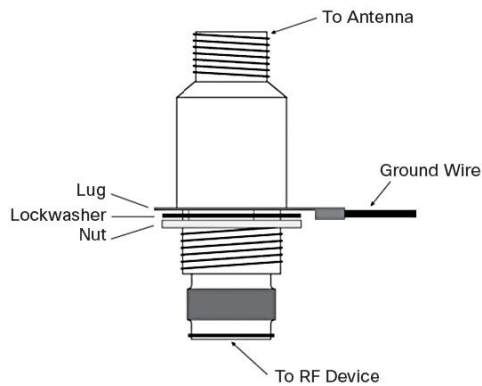

The accepted IEEE transient (surge) suppression is .000008 seconds (8 micro seconds). The Cisco Aironet Lightning Arrestor is a 50-ohm transmission line with a gas discharge tube positioned between the center conductor and ground. This gas discharge tube changes from an open circuit to a short circuit almost instantaneously in the presence of voltage and energy surges, providing a path to ground for the energy surge.

**Installation**

This arrestor is designed to be installed between your antenna cable and the Cisco Aironet access point. Installation should be indoors, or inside a protected area. A good ground must be attached to the arrestor. This can be accomplished by attaching a ground lug to the arrestor and using a heavy wire (number 6 solid copper) to connect the lug to a good earth ground (see Figure 6).

**Understanding RF Power Values**

Radio frequency (RF) signals are subject to various losses and gains as they pass from transmitter through cable to antenna, through air (or solid obstruction), to receiving antenna, cable, and receiving radio. With the exception of solid obstructions, most of these figures and factors are known and can be used in the design process to determine whether an RF system such as a WLAN will work.

**Decibels**

The decibel (dB) scale is a logarithmic scale used to denote the ratio of one power value to another. For example:

$$X \text{ dB} = 10 \log_{10} (\text{Power A} / \text{Power B})$$

An increase of 3 dB indicates a doubling (2x) of power. An increase of 6 dB indicates a quadrupling (4x) of power. Conversely, a decrease of 3 dB reduces power by one half, and a decrease of 6 dB results in a one fourth of the power. Some examples are shown below in Table 1.

**Table 1.** Decibel Values and Corresponding Factors

Increase	Factor	Decrease	Factor
0 dB	1 x (same)	0 dB	1 x (same)
1 dB	1.25 x	-1 dB	0.8 x
3 dB	2 x	-3 dB	0.5 x
6 dB	4 x	-6 dB	0.25 x
10 dB	10 x	-10 dB	0.10 x
12 dB	16 x	-12 dB	0.06 x

Increase	Factor	Decrease	Factor
20 dB	100 x	-20 dB	0.01 x
30 dB	1000 x	-30 dB	0.001 x
40 dB	10,000 x	-40 dB	0.0001 x

## Power Ratings

WLAN equipment is usually specified in decibels compared to known values. Transmit Power and Receive Sensitivity are specified in “dBm,” where “m” means 1 milliwatt (mW). So, 0 dBm is equal to 1 mW; 3 dBm is equal to 2 mW; 6 dBm is equal to 4 mW, and so on, as shown in Table 2.

**Table 2.** Common mW Values to dBm Values

dBm	mW	dBm	mW
0 dBm	1 mW	0 dBm	1 mW
1 dBm	1.25 mW	-1 dBm	0.8 mW
3 dBm	2 mW	-3 dBm	0.5 mW
6 dBm	4 mW	-6 dBm	0.25 mW
7 dBm	5 mW	-7 dBm	0.20 mW
10 dBm	10 mW	-10 dBm	0.10 mW
12 dBm	16 mW	-12 dBm	0.06 mW
13 dBm	20 mW	-13 dBm	0.05 mW
15 dBm	32 mW	-15 dBm	0.03 mW
17 dBm	50 mW	-17 dBm	0.02 mW
20 dBm	100 mW	-20 dBm	0.01 mW
30 dBm	1000 mW (1 W)	-30 dBm	0.001 mW
40 dBm	10,000 mW (10 W)	-40 dBm	0.0001 mW

## Outdoor Range

The range of a wireless link is dependent upon the maximum allowable path loss. For outdoor links, this is a straightforward calculation as long as there is clear line of sight between the two antennas with sufficient clearance for the Fresnel zone. For line of sight, you should be able to visibly see the remote locations antenna from the main site. (Longer distances may require the use of binoculars). There should be no obstructions between the antennas themselves. This includes trees, buildings, hills, and so on.

As the distance extends beyond six miles, the curve of the earth (commonly called earth bulge) affects installation, requiring antennas to be placed at higher elevations.

## Fresnel Zone

Fresnel zone is an elliptical area immediately surrounding the visual path. It varies depending on the length of the signal path and the frequency of the signal. The Fresnel zone can be calculated, and it must be taken into account when designing a wireless link (Figure 6).

**Figure 6.** Fresnel Zone

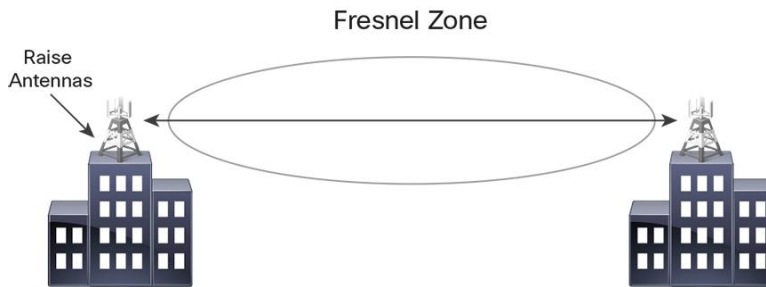

Based on both line-of-sight and Fresnel zone requirements, Table 3 provides a guideline on height requirements for 2.4-GHz antennas as various distances. This refers to height above any obstacles located in the middle of the RF path.

**Table 3.** Guideline on Height Requirements for 2.4-GHz Antennas

Wireless Link Distance (miles)	Approx. Value "F" (60% Fresnel Zone) Ft. at 2.4 GHz	Approx. Value "C" (Earth Curvature)	Value "H" (mounting Ht.) Ft. with No Obstructions
1	10	3	13
5	30	5	35
10	44	13	57
15	55	28	83
20	65	50	115
25	72	78	150

A 10-dB fade margin is included for 2.4-GHz calculations, while the included 5-dB fade margin for 5-GHz calculations is sufficient for dependable communications in all weather conditions. The distances given are only theoretical and should only be used to determine the feasibility of a particular design.

In outdoor deployments, and as a rule or thumb, every increase of 6 dB will result in a doubling of the distance. Likewise, a 6dB decrease will halve the distance. Shorter-cable runs and higher-gain antennas can make a significant difference to the range. The following links provide range calculations for the outdoor mesh products:

- Cisco Aironet 1550 Series: <http://www.cisco.com/c/en/us/support/wireless/aironet-1550-series/products-implementation-design-guides-list.html>
- Cisco Aironet 1530 Series: <http://www.cisco.com/c/en/us/support/wireless/aironet-1530-series/products-implementation-design-guides-list.html>

## Regulations

### North America

#### Connectors

In 1985, the FCC enacted standards for the commercial use of spread-spectrum technology in the ISM frequency bands. Spread spectrum is currently allowed in the 900-, 2400-, and 5200- MHz bands.

In 1989, the FCC drafted an amendment governing spread-spectrum systems in the unlicensed ISM band, and Congress enacted this amendment into law in 1990. This amendment is commonly referred to as the "new rules" or "94 rules" because it impacts all spread-spectrum products manufactured after June 23, 1994. Products manufactured before June 23, 1994, are not affected by the amendment.

---

The FCC 1994 rules are intended to discourage use of amplifiers, high-gain antennas, or other means of significantly increasing RF radiation. The rules are further intended to discourage “home brew” systems that are installed by inexperienced users and that - either accidentally or intentionally - do not comply with FCC regulations for use in the ISM band.

Both the original rules and the amendments sought to enable multiple RF networks to “coexist” with minimum impact on one another by exploiting properties of spread-spectrum technology. Fundamentally, the FCC 1994 rules intend to limit RF communications in the ISM band to a well-defined region, while ensuring multiple systems can operate with minimum impact on one another. These two needs are addressed by limiting the type and gain of antennas used with a given system, and by requiring a greater degree of RF energy “spreading.”

### **Antenna Gain and Power Output**

FCC regulations specify maximum power output and antenna gain. For the UNII3 band, the FCC limits the transmitter power to 1 watt or 30 dBm, and the antenna gain of an omnidirectional antenna to 6 dBi. For directional antennas operating in a point-to-point system, gains of up to 23 dBi are permitted. For antennas with gain higher than 23 dBi, the transmitter output power must be reduced 1 dB for every 1 dB above 23 dBi increase in the antenna gain.

At 2.4 GHz, the maximum transmitter power is also 1 watt. Using this maximum power, the maximum antenna gain is 6 dBi. However, the regulations also define the maximum values in regards to the following two different system scenarios.

### **Point-to-Point and Point-to-Multipoint Systems**

In point-to-multipoint systems, the FCC has limited the maximum EIRP to 36 dBm.  $EIRP = TX \text{ power} + \text{antenna gain}$ . For every dB that the transmitter power is reduced, the antenna may be increased by 1 dB. Thus, 29 dBm TX, +7 dB antenna = 36 dBm EIRP; 28 dBm TX +8 dB antenna = 36 dBm EIRP.

In point-to-point systems for 2.4-GHz systems using directional antennas, the rules have changed. Because a high-gain antenna has a narrow beamwidth, the likelihood is great that it will cause interference to other area users. Under the rule change, for every dB the transmitter is reduced below 30 dBm, the antenna may be increased from the initial 6 dBi, by 3 dB. Thus, a 29-dB transmitter means 9-dBi antenna; a 28-dB transmitter means 12-dBi antenna. Because we are operating at 20 dBm, which is 10 dB below the 30 dBm level, we can increase the antenna gain by 30 dB. Note that Cisco has never tested, and therefore has not certified, any antenna with gain greater than 21 dBi.

The main issue that comes up here is: What differentiates a point-to-point from a multipoint system.

In Figure 7, point A communicates to a single point (point B), and point B communicates to a single point A; therefore, it is simple to see that both locations see this as a point-to-point installation.

In Figure 8, point A communicates to more than one (or multiple) points; therefore, point A is operating in a multipoint configuration, and the largest antenna permitted is 16 dBi. Point B or point C can each communicate to only one point (point A); therefore, point B and point C actually operate in a single-point or point-to-point operation, and a larger antenna may be used.



**Figure 7.** Point-to-Point Wireless Bridge Solution



**Figure 8.** Point-to-Multipoint Wireless Bridge Solution

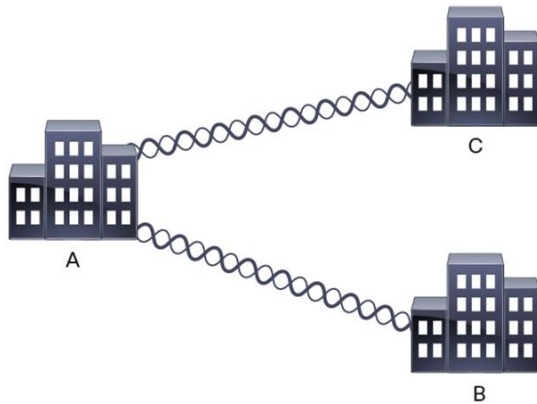

### Amplifiers

In the FCC rules, Section 15.204-Part C states: “External radio frequency power amplifiers shall not be marketed as separate products.” Part D states: “Only the antenna with which an intentional radiator (transmitter) is originally authorized may be used with the intentional radiator.” This means that unless the amplifier manufacturer submits the amplifier for testing with the radio and antenna, it cannot be sold in the United States. If it has been certified, it must be marketed and sold as a complete system, including transmitter, antenna, and coaxial cable. It also must be installed exactly this way.

If you are using a system that includes an amplifier, remember that these rules concerning power are still in effect. If the amplifier is one-half (.5) watt (27 dBm), this means in a multipoint system, the maximum antenna gain is only 9 dBi, and in a point-to-point system it is only 15 dBi.

### ETSI

The European Telecommunication Standardization Institute (ETSI) has developed standards that have been adopted by many European countries as well as many others. Under the ETSI regulations, the power output and EIRP regulations are much different than in the United States.

#### Antenna Gain and Power Output

The ETSI regulations specify maximum EIRP as 20 dBm. Since this includes antenna gain, this limits the antennas that can be used with a transmitter. To use a larger antenna, the transmitter power must be reduced so that the overall gain of the transmitter, plus the antenna gain, less any losses in coax, is equal to or less than +20 dBm. This drastically reduces the overall distance an outdoor link can operate.

### Amplifiers

Since the ETSI regulation has such a low EIRP, the use of amplifiers is typically not permitted in any ETSI system.

## Frequencies and Channel Sets

### IEEE 802.11b/g Direct Sequence Channels

Fourteen channels are defined in the IEEE 802.11b/g direct-sequence channel set. Each direct-sequence channel as transmitted is 22 MHz wide; however, the channel center separation is only 5 MHz. This leads to channel overlap such that signals from neighboring channels can interfere with each other. In a 14-channel direct-sequence system (11 usable in the United States), only three nonoverlapping (and hence, noninterfering) channels, 25 MHz apart, are possible (for example, channels 1, 6, and 11).

This channel spacing governs the use and allocation of channels in a multiple-access-point environment such as an office or campus. Access points are usually deployed in “cellular” fashion within an enterprise, where adjacent access points are allocated nonoverlapping channels. Alternatively, access points can be collocated using channels 1, 6, and 11 to deliver 33 Mbps bandwidth to a single area (but only 11 Mbps to a single client).

The channel allocation scheme is illustrated in Figure 9, and the available channels in the different regulatory domains are defined in Table 4.

**Figure 9.** IEEE 802.11b/g DSSS Channel Allocations

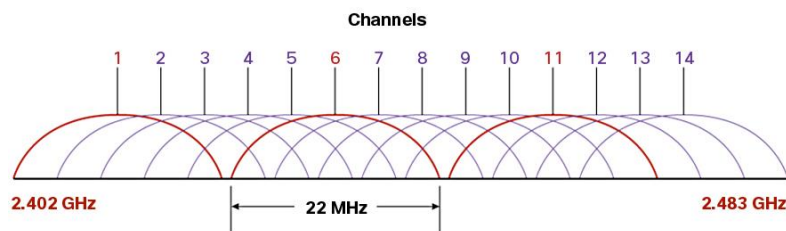

Table 4 shows the channels permitted in the corresponding approval areas.

**Table 4.** DSSS PHY Frequency Channel Plan

Channel ID	Frequency (MHz)	Regulatory Domains (Maximum Conducted Average Power Levels in dBm)																	
		-A	-C	-E	-I	-J	-K	-N	-P	-S	-T								
<b>2400-2484 MHz</b>																			
Mode		B	G	B	G	B	G	B	G	B	G	B	G	B	G	B	G	B	G
1	2412	X	X	X	X	X	X			X	X	X	X	X	X	X	X	X	X
2	2417	X	X	X	X	X	X			X	X	X	X	X	X	X	X	X	X
3	2422	X	X	X	X	X	X			X	X	X	X	X	X	X	X	X	X
4	2427	X	X	X	X	X	X			X	X	X	X	X	X	X	X	X	X
5	2432	X	X	X	X	X	X	X	X	X	X	X	X	X	17	X	X	X	X
6	2437	X	X	X	X	X	X	X	X	X	X	X	X	X	X	X	X	X	X
7	2442	X	X	X	X	X	X	X	X	X	X	X	X	X	X	X	X	X	X
8	2447	X	X	X	X	X	X	X	X	X	X	X	X	X	X	X	X	X	X
9	2452	X	X	X	X	X	X	X	X	X	X	X	X	X	X	X	X	X	17
10	2457	X	X	X	X	X	X	X	X	X	X	X	X	X	X	X	X	X	X
11	2462	X	X	X	X	X	X	X	X	X	X	X	X	X	X	X	X	X	X
12	2467			X	X	X	X	X	X	X	X	X			X	X	X	X	
13	2472			X	X	X	X	X	X	X	X	X			X	X	X	X	
14	2484									X					X				

## IEEE 802.11a Channels

The 802.11a specification today specifies four channels for the UNII1 band, four channels for the UNII2 band, and four channels for the UNII3 band. These channels are spaced at 20 MHz apart and are considered noninterfering; however, they do have a slight overlap in frequency spectrum. It is possible to use adjacent channels in adjacent cell coverage, but it is recommended when possible to separate adjacent cell channels by at least 1 channel.

Figure 10 shows the channel scheme for the 802.11 bands, and Table 5 lists the North American frequency allocations.

**Figure 10.** 802.11a Channel Allocation

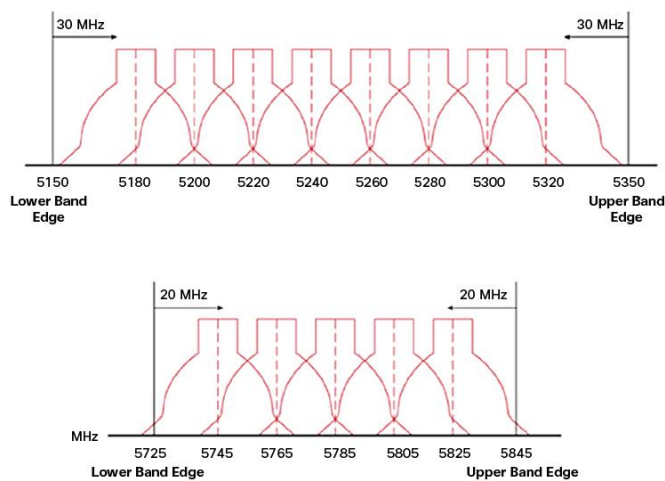

**Table 5.** 802.11a Frequency Plan

Regulatory Domain	Frequency Band	Channel Number	Centre Frequencies
USA	<ul style="list-style-type: none"> <li>UNII lower band</li> <li>5.15-5.25 GHz</li> </ul>	<ul style="list-style-type: none"> <li>36</li> <li>40</li> <li>44</li> <li>48</li> </ul>	<ul style="list-style-type: none"> <li>5.180 GHz</li> <li>5.200 GHz</li> <li>5.220 GHz</li> <li>5.240 GHz</li> </ul>
USA	<ul style="list-style-type: none"> <li>UNII middle + extended</li> <li>5.25-5.700 GHz</li> </ul>	<ul style="list-style-type: none"> <li>52</li> <li>56</li> <li>60</li> <li>64</li> <li>100</li> <li>104</li> <li>108</li> <li>112</li> <li>116</li> <li>120</li> <li>124</li> <li>128</li> <li>132</li> <li>136</li> <li>140</li> </ul>	<ul style="list-style-type: none"> <li>5.260 GHz</li> <li>5.280 GHz</li> <li>5.300 GHz</li> <li>5.320 GHz</li> <li>5.500 GHz</li> <li>5.520 GHz</li> <li>5.540 GHz</li> <li>5.560 GHz</li> <li>5.580 GHz</li> <li>5.600 GHz</li> <li>5.620 GHz</li> <li>5.640 GHz</li> <li>5.660 GHz</li> <li>5.680 GHz</li> <li>5.700 GHz</li> </ul>
USA	<ul style="list-style-type: none"> <li>UNII upper band</li> <li>5.725-5.825 GHz</li> </ul>	<ul style="list-style-type: none"> <li>149</li> <li>153</li> <li>157</li> <li>161</li> </ul>	<ul style="list-style-type: none"> <li>5.745 GHz</li> <li>5.765 GHz</li> <li>5.785 GHz</li> <li>5.805 GHz</li> </ul>

Regulatory Domain	Frequency Band	Channel Number	Centre Frequencies
USA	<ul style="list-style-type: none"> <li>ISM band</li> <li>5.725-5.825 GHz</li> </ul>	<ul style="list-style-type: none"> <li>149</li> <li>153</li> <li>157</li> <li>161</li> <li>165</li> </ul>	<ul style="list-style-type: none"> <li>5.745 GHz</li> <li>5.765 GHz</li> <li>5.785 GHz</li> <li>5.805 GHz</li> <li>5.825 GHz</li> </ul>

\* Not supported in US due to weather radars.

## Cisco Aironet Antenna Descriptions

Table 6 below defines the various 2.4 GHz antennas that are offered by Cisco for the Cisco Aironet product line, and Table 7 lists the available antennas for the Cisco Aironet 5 GHz bridge products. Table 8 defines the dual band antennas that are offered for use with the Cisco Aironet G2 Access Points.

**Table 6.** 2.4 GHz Antennas with RP-TNC Connectors

Cisco Part Number	Antenna Type	Description	Gain
<b>AIR-ANT2422DB-R</b> <b>AIR-ANT4941</b>	Black dipole, 1 port	Single black dipole antenna with an RP-TNC connector. The antenna provides indoor omnidirectional coverage and is designed for use in the 2400-2500 MHz frequency band. It has a 90-degree articulation radius. It can be used with all radios that utilize an RP-TNC antenna connector.	2.2 dBi
<b>AIR-ANT2422DW-R</b> <b>AIR-ANT2422DW-R=</b>	White dipole, 1 port	Single white dipole antenna with an RP-TNC connector. The antenna provides indoor omnidirectional coverage and is designed for use in the 2400-2500 MHz frequency band. It has a 90-degree articulation radius. It can be used with all radios that utilize an RP-TNC antenna connector.	2.2 dBi
<b>AIR-ANT2422DG-R</b> <b>AIR-ANT2422DG-R=</b>	Gray dipole, 1 port	Single gray dipole antenna with an RP-TNC connector. The antenna provides indoor omnidirectional coverage and is designed for use in the 2400-2500 MHz frequency band. It does not articulate as the other dipole antennas. It can be used with all radios that utilize an RP-TNC antenna connector.	2.2 dBi
<b>AIR-ANT2422SDW-R</b> <b>AIR-ANT2422SDW-R=</b>	White monopole, 1 port	Single white monopole antenna with RP-TNC connector. The antenna provides indoor omnidirectional coverage and is designed for use in the 2400-2500 MHz frequency band. It does not articulate as the other dipole antennas. It can be used with the 1260 and 3500 access points.	2.2 dBi
<b>AIR-ANT2450S-R</b>	Sector, 1 port	Wall mount indoor/outdoor antenna with RP-TNC connector for use with any 2.4 GHz radio. Capable of covering large areas. The plenum rated cable is 36" long.	5 dBi
<b>AIR-ANT1728</b>	Omnidirectional	Ceiling-mount indoor antenna with RP-TNC connector - This antenna was designed for WLAN applications with frequencies of 2400-2500 MHz. The antenna is omnidirectional and has a nominal gain of 5.2 dBi. It comes with a clip that allows it to be mounted to a drop-ceiling cross member.	5.2 dBi
<b>AIR-ANT2506</b>	Omnidirectional, 1 port	Mast-mount indoor/outdoor antenna with a RP-TNC connector - This antenna was designed for WLAN applications for frequencies of 2400-2500 MHz. The antenna is omnidirectional and has a nominal gain of 5.2 dBi. It is designed to be mounted on a round mast.	5.2 dBi
<b>AIR-ANT2460P-R</b>	Patch, 1 port	Wall mount, indoor/outdoor directional patch antenna. Designed for use with any radio that features an RP-TNC antenna connector. For use in the 2400-2500 MHz frequency band. The pigtail cable is plenum rated, 36" long.	6 dBi
<b>AIR-ANT2485P-R</b>	Patch, 1 port	Wall mount indoor/outdoor antenna with a RP-TNC connector-Designed for use with any radio that features a RP-TNC connector. For use in the 2400-2500 MHz frequency band. The plenum rated pigtail cable is 36" long.	8.5 dBi
<b>AIR-ANT2410Y-R</b>	Yagi, 1 port	High-gain outdoor directional antenna with a RP-TNC connector - This WLAN antenna is a completely enclosed yagi. It is designed to be used as a bridge antenna between two networks or for point-to-point communications The gain is 10 dBi and the half-power beamwidth is 55 degrees. This antenna is normally mounted on a mast and is vertically polarized.	10 dBi
<b>AIR-ANT24120</b>	Omnidirectional, 1 port	Mast mount outdoor high gain antenna with a RP-TNC connector - This antenna was designed for WLAN applications for frequencies of 2400-2500 MHz. The antenna is omnidirectional and has a nominal gain of 12 dBi. This design uses an elevated center-feed to produce an elevation pattern with very little "squint" or beam-tilt. It is designed to be mounted on a round mast.	12 dBi

Cisco Part Number	Antenna Type	Description	Gain
<b>AIR-ANT1949</b>	Yagi, 1 port	High-gain outdoor directional antenna with a RP-TNC connector - This WLAN antenna is a completely enclosed 16-element yagi. It is designed to be used as a bridge antenna between two networks or for point-to-point communications. The gain is 13.5 dBi and the half-power beamwidth is 30 degrees. This antenna is normally mounted on a mast and is vertically polarized.	13.5 dBi
<b>AIR-ANT2414S-R</b>	Sector, 1 port	Mast mount outdoor sector antenna with a RP-TNC connector - This antenna was designed for WLAN applications for frequencies of 2400-2500 MHz. The antenna is directional and has a nominal gain of 14 dBi. Its flexible mounting bracket allows for either mast or wall mounting options.	14 dBi
<b>AIR-ANT3338</b>	Dish, 1 port	Very high-gain outdoor antenna with a RP-TNC connector - This WLAN antenna is a parabolic dish designed to be used as a bridge antenna between two networks or for point-to-point communications. It consists of an aluminum parabolic reflector and feed antenna. The antenna features a rugged mount. It also offers 20 degree fine adjustment for both horizontal and vertical planes. The antenna is provided with hardware for mast mounting.	21 dBi
<b>AIR-ANT24020V-R=</b>	Omnidirectional, 2 port	Ceiling mount indoor antenna with two RP-TNC connectors. Supports diversity antennas in a single package for areas where multipath problems exist. The pigtail cable is plenum rated and 36" long.	2.0 dBi
<b>AIR-ANT2452V-R</b>	Omnidirectional, 2 port	Pillar-mount diversity, indoor antenna with two RP-TNC connectors. Antenna is ideal for the retail or hospital environment. Includes 36 in. of white RG-58 cable with a separation of coaxial cables that are joined together to form a 10 in. length. Included are two mounting brackets that will keep the antenna 6 in. off the wall.	5.2 dBi
<b>AIR-ANT2465P-R</b>	Patch, 2 port	Wall-mount indoor/outdoor antenna with two RP-TNC connectors-Similar to AIR-ANT2460P-R, but providing diversity antennas in the same package for areas where multipath problems exist. The pigtail cable is plenum rated and 36" long.	6.5 dBi
<b>AIR-ANT2430V-R=</b>	Omnidirectional, 3 port	Ceiling-mount indoor omni-directional antenna with three cables terminating in RP-TNC connectors. For use with 802.11n access points. For use in the 2400-2500 MHz frequency band. The pigtail cables are plenum rated and 36" long each.	3 dBi
<b>Air-ANT2440NV-R=</b>	Omnidirectional, 3 port	Wall or mast -mount 2.4 GHz indoor/outdoor omni-directional antenna with three cables terminating in RP-TNC connectors. For use with 802.11n access points. The pigtail cables are plenum rated and 36" long each.	4 dBi
<b>AIR-ANT2460NP-R=</b>	Patch, 3 port	Wall or mast -mount 2.4 GHz indoor/outdoor patch antenna with three cables terminating in RP-TNC connectors. For use with 802.11n access points. The pigtail cables are plenum rated and 36" long each.	6 dBi

**Table 7.** 5 GHz Antennas with RP-TNC Connectors

Cisco Part Number	Antenna Type	Description	Gain
<b>AIR-ANT5135DB-R</b> <b>AIR-ANT5135D-R</b>	Omnidirectional, 1 port	Single black dipole antenna with an RP-TNC connector. The antenna provides indoor omnidirectional coverage and is designed for use in the 5 GHz frequency band. It has a 90-degree articulation radius. It can be used with radios that utilize an RP-TNC antenna connector.	3.5 dBi
<b>AIR-ANT5135DW-R</b> <b>AIR-ANT5135DW-R=</b>	Omnidirectional, 1 port	Single white dipole antenna with an RP-TNC connector. The antenna provides indoor omnidirectional coverage and is designed for use in the 5 GHz frequency band. It has a 90-degree articulation radius. It can be used with radios that utilize an RP-TNC antenna connector.	3.5 dBi
<b>AIR-ANT5135DG-R</b> <b>AIR-ANT5135DG-R=</b>	Omnidirectional, 1 port	Indoor-only gray, non-articulating dipole like omnidirectional antenna for 5 GHz. It can be used with radios that utilize an RP-TNC antenna connector.	3.5 dBi
<b>AIR-ANT5135SDW-R</b> <b>AIR-ANT5135SDW-R=</b>	White monopole, 1 port	Single white monopole antenna with RP-TNC connector. The antenna provides indoor omnidirectional coverage and is designed for use in the 5100-5900 MHz frequency band. It does not articulate as the other dipole antennas. It can be used with the 1260 and 3500 access points.	3.5 dBi
<b>AIR-ANT5160V-R</b>	Omnidirectional, 1 port	Indoor or outdoor use omnidirectional 5 GHz antenna for use with the 1200 Series and the 802.11a module (AIR-RM22A). Can be mast or ceiling mounted.	6 dBi
<b>AIR-ANT5195P-R</b>	Patch, 1 port	Wall or Mast Mount Patch Antenna - Designed for use indoor or outdoors, this antenna comes with a wall mount and a plate that adapts to articulating mounting hardware (AIR-ACC2662), which is sold separately. It has a plenum rated pigtail cable of 36 in.	9.5 dBi
<b>AIR-ANT5145V-R</b>	Omnidirectional, 2 port	Indoor-only ceiling mounted diversity omnidirectional 5 GHz antenna	4.5 dBi

Cisco Part Number	Antenna Type	Description	Gain
<b>AIR-ANT5170P-R</b>	Patch, 2 port	Wall Mount diversity patch antenna with RP-TNC Connectors - Designed for use in both indoor and outdoor applications. It comes with wall mount hardware, and has a gain of 7 dBi. It has a plenum rated pigtail cable of 36".	7 dBi
<b>AIR-ANT5140V-R=</b>	Omnidirectional, 3 port	Ceiling mount indoor omni-directional antenna with three cables terminating in RP-TNC connectors. Designed for use with 802.11n access points. The plenum rated pigtail cables are 36" long each.	4 dBi
<b>AIR-ANT5140NV-R=</b>	Omnidirectional, 3 port	Wall or mast mount 5GHz indoor/outdoor omni-directional antenna with three cables terminating in RP-TNC connectors. Designed for use with 802.11n access points. The plenum rated pigtail cables are 36" long each.	4 dBi
<b>AIR-ANT5160NP-R=</b>	Patch, 3 port	Indoor or outdoor wall mounted 5 GHz patch antenna with three cables terminating in RP-TNC connectors. Designed for use with 802.11n access points. The plenum rated pigtail cables are 36" long each.	6 dBi

**Table 8.** Dual Band Antennas for 2.4 and 5 GHz Access Points with RP-TNC Connectors

Cisco Part Number	Antenna Type	Description	Gain
<b>AIR-ANT2524DB-R</b> <b>AIR-ANT2524DB-R=</b>	Black dipole, 1 port	Single white dipole antenna with RP-TNC connector. The antenna provides indoor omnidirectional coverage. It has a 90-degree articulation radius and can be used with the 1600/2600/3600/3700 APs	2.4 GHz: 2 dBi 5 GHz: 4 dBi
<b>AIR-ANT2524DG-R</b> <b>AIR-ANT2524DG-R=</b>	Gray dipole, 1 port	Single white dipole antenna with RP-TNC connector. The antenna provides indoor omnidirectional coverage. It has a 90-degree articulation radius and can be used with the 1600/2600/3600/3700 APs	2.4 GHz: 2 dBi 5 GHz: 4 dBi
<b>AIR-ANT2524DW-R</b> <b>AIR-ANT2524DW-R=</b>	White dipole, 1 port	Single white dipole antenna with RP-TNC connector. The antenna provides indoor omnidirectional coverage. It has a 90-degree articulation radius and can be used with the 1600/2600/3600/3700 APs	2.4 GHz: 2 dBi 5 GHz: 4 dBi
<b>AIR-ANT2535SDW-R</b> <b>AIR-ANT2535SDW-R=</b>	White dipole, 1 port	Single white dipole antenna with RP-TNC connector. The antenna provides indoor omnidirectional coverage. It does not articulate as the other dipole antennas. It can be used with the 1600/2600/3600/3700 APs	2.4 GHz: 3 dBi 5 GHz: 5 dBi
<b>AIR-ANT2451V-R=</b>	Omnidirectional 4 port (2 ports for 2.4 GHz, 2 port for 5 GHz)	Ceiling Mount Omni-directional Antenna - Designed for use indoor, this antenna comes with ceiling mount hardware. It has 4 plenum rated pigtail cables, 18 inches each, with 4 right angle RP-TNC connectors.	2.4 GHz: 2 dBi 5 GHz: 3 dBi
<b>AIR-ANT2451NV-R=</b>	Omnidirectional, 6 port (2 ports for 2.4 GHz, 2 port for 5 GHz)	Ceiling Mount Omni-directional Antenna - Designed for use indoor, this antenna comes with ceiling mount hardware. It has 6 plenum rated pigtail cables, 18 inches each, with 6 RP-TNC connectors.	2.4 GHz: 2 dBi 5 GHz: 3 dBi
<b>AIR-ANT25137NP-R=</b>	Patch, 6 port (2 ports for 2.4 GHz, 2 port for 5 GHz)	Designed for high density wireless applications such as stadiums and arena. Wall mounted patch antenna with 6 plenum rated pigtail cables, 36 inches each and 6 RP-TNC connectors. Only certified for use with AP3502P access point.	2.4 GHz: 13 dBi 5 GHz: 7 dBi
<b>AIR-ANT2524V4C-R=</b>	Omnidirectional 4, port (all ports dual band)	Ceiling mount omnidirectional antenna - Designed for use indoor, this antenna comes with ceiling mount hardware. It has 4 plenum rated pigtail cables, 3 foot each, with four RP-TNC connectors.	2.4 GHz: 2 dBi 5 GHz: 4 dBi
<b>AIR-ANT2544V4M-R=</b>	Omnidirectional, 4 port (all ports dual band)	Indoor/outdoor wall or mast mounted dual band omnidirectional antenna with four plenum rated, 36 inch cables and RP-TNC connectors. Designed for use with access points having dual band ports such as 1600, 2600 or 3600.	2.4 GHz: 4 dBi 5 GHz: 4 dBi
<b>AIR-ANT2566P4W-R=</b>	Patch, 4 port (all ports dual band))	Indoor/outdoor wall mounted dual band patch antenna with four plenum rated, 36 inch cables and RP-TNC connectors. Designed for use with access points having dual band ports such as 1600, 2600 or 3600.	2.4 GHz: 6 dBi 5 GHz: 6 dBi

**Table 9.** 2.4 GHz and 5 GHz Access Point and Bridge Antennas with N Type Connectors

Cisco Part Number	Antenna Type	Description	Gain
<b>AIR-ANT2420V-N (=)</b>	Omnidirectional	2.4 GHz omnidirectional antenna for mesh access points. Suitable for use on Cisco Aironet 1552CU Mesh Access Points. It is only 5 inches long, mounts directly to the access point, and has no cable attachments.	2 dBi
<b>AIR-ANT2450V-N (=)</b>	Omnidirectional	2.4 GHz omnidirectional antenna for mesh access points. Suitable for use on Cisco Aironet 1520/1550 Series Mesh Access Points. It mounts directly to the access point and has no cable attachments.	5 dBi
<b>AIR-ANT2455V-N=</b>	Omnidirectional	2.4 GHz omnidirectional antenna for mesh access points. Suitable for use on Cisco Aironet 1520 Series Mesh Access Points. It mounts directly to the access point and has no cable attachments.	5.5 dBi
<b>AIR-ANT2480V-N (=)</b>	Omnidirectional	2.4 GHz omnidirectional antenna for mesh access points. Suitable for use on Cisco Aironet 1520/1550 Series Mesh Access Points. It mounts directly to the access point and has no cable attachments.	8 dBi
<b>AIR-ANT2413P2M-N=</b>	Patch, 2 port	2.4 GHz, 13 dBi directional antenna with two orthogonally polarized ports. Antenna comes with two 30 inch cables terminated in right angle N-type connectors.	13 dBi
<b>AIR-ANT5140V-N (=)</b>	Omnidirectional	5 GHz omnidirectional antenna for mesh access points. Suitable for use on Cisco Aironet 1552CU Mesh Access Points. It mounts directly to the access point and has no cable attachments.	4 dBi
<b>AIR-ANT5175V-N (=)</b>	Omnidirectional	A 7.5 dBi antenna which supports 4900-5825 MHz. It has a 12" pigtail cable and a N-type connector.	7.5 dBi
<b>AIR-ANT5180V-N (=)</b>	Omnidirectional	5 GHz omnidirectional antenna for mesh access points. Suitable for use on Cisco Aironet 1520/1550 Series Mesh Access Points. It mounts directly to the access point and has no cable attachments.	8 dBi
<b>AIR-ANT58G9VOA-N</b>	Omnidirectional	An omnidirectional antenna, for use with the Cisco Aironet 1400 Series Wireless Bridge. This non-diversity, vertically polarized antenna operates in the UNII-3 band (5725 to 5825 MHz). The antenna is designed to be mast mounted in an outdoor environment. The antenna is not compatible with other Cisco Aironet radio products operating in the 5 GHz frequency band.	9 dBi
<b>AIR-ANT58G10SSA-N</b>	Sector	A sector antenna for use with the Cisco Aironet 1400 Series Wireless Bridge. This non-diversity symmetric antenna operates in the UNII-3 band (5725-5825 MHz). The antenna is designed to be mounted outdoors on a mast or a suitable vertical surface. The antenna is not compatible with other Cisco Aironet radio products operating in the 5 GHz frequency band.	9.5 dBi
<b>AIR-ANT5114P-N=</b>	Patch	5 GHz, 14 dBi patch antenna for use in the 4950-5850 MHz frequency band. The antenna has an N-type connector, and will require a separate low loss cable for mounting to the access point. Articulating mount included. Fits mast pole sizes 2" diameter maximum.	14 dBi
<b>AIR-ANT5114P2M-N=</b>	Patch, 2 port	5 GHz, 14 dBi directional antenna with two orthogonally polarized ports. Antenna comes with two 30 inch cables terminated in right angle N-type connectors.	14 dBi
<b>AIR-ANT5117S-N=</b>	Sector	5 GHz, 17 dBi sector antenna for use in the 4950-5850 MHz frequency band. The antenna has an N-type connector, and will require a separate low loss cable for mounting to the access point. Fits mast pole sizes 1.5 to 3" diameter maximum.	17 dBi
<b>AIR-ANT58G28SDA-N</b>	Dish	A parabolic dish antenna for use with the Cisco Aironet 1400 Series Wireless Bridge. This non-diversity parabolic antenna operates in the UNII-3 band (5725-5825 MHz). The antenna is designed to be mounted outdoors on a mast. The antenna is designed to be used at the hub or client site of a point-to-point installation, or point-to-multipoint client sites, providing extended range. The antenna is not compatible with other Cisco Aironet radio products operating in the 5 GHz frequency band.	28 dBi



**Table 10.** 2.4 GHz and 5 GHz Dual-band Antennas with N Type Connectors

Cisco Part Number	Antenna Type	Description	Gain
<b>AIR-ANT2547V-N (=)</b> <b>AIR-ANT2547VG-N (=)</b>	Omnidirectional	2.4 GHz, 4 dBi and 5 GHz 7 dBi dual band omnidirectional antenna which utilizes an N-type connector. It mounts directly to the access point and has no cable attachments. AIR-ANT2547VG-N has a gray radome.	2.4 GHz: 4 dBi 5 GHz: 7 dBi
<b>AIR-ANT2588P3M-N=</b>	Patch, 3 port	2.4 GHz, 8 dBi and 5 GHz 8 dBi dual band directional antenna with three N-type connectors. It can be used with the outdoor Access Points and has no cable attachments.	2.4 GHz: 8 dBi 5 GHz: 8 dBi
<b>AIR-ANT2513P4M-N=</b>	Patch, 4 port	2.4 GHz, 13 dBi and 5 GHz 13 dBi dual band directional antenna with four(4) N-type connectors. It is outdoor rated and has no cable attachments.	2.4 GHz: 13 dBi 5 GHz: 13 dBi

**Table 11.** 2.4 GHz and 5 GHz Access Point and Bridge Integrated Antennas

Cisco Part Number	Antenna Type	Description	Gain
<b>Integrated AP 3500 Antenna</b>	Omnidirectional	802.11n antenna package for both 2.4 GHz and 5 GHz designed for high performance in both ceiling and wall mount applications. Antennas provide hemispherical coverage and cannot be removed from the Access Point. No connectors are offered for additional external antennas.	2.4 GHz: 4 dBi 5 GHz: 3 dBi
<b>Integrated OEAP600 Antenna</b>	Omnidirectional	802.11n antenna package for both 2.4 GHz and 5 GHz designed for high performance in both ceiling and wall and desk mount applications. Antennas provide hemispherical coverage and cannot be removed from the Access Point. No connectors are offered for additional external antennas.	2.4 GHz: 2 dBi 5 GHz: 2 dBi
<b>Integrated AP 1600 Antenna</b>	Omnidirectional	802.11n antenna package for both 2.4 GHz and 5 GHz designed for high performance in both ceiling and wall mount applications. Antennas provide hemispherical coverage and cannot be removed from the Access Point. No connectors are offered for additional external antennas.	2.4 GHz: 4 dBi 5 GHz: 4 dBi
<b>Integrated AP 2600 Antenna</b>	Omnidirectional	802.11n antenna package for both 2.4 GHz and 5 GHz designed for high performance in both ceiling and wall mount applications. Antennas provide hemispherical coverage and cannot be removed from the Access Point. No connectors are offered for additional external antennas.	2.4 GHz: 4 dBi 5 GHz: 4 dBi
<b>Integrated AP 3600 Antenna</b>	Omnidirectional	802.11n antenna package for both 2.4 GHz and 5 GHz designed for high performance in both ceiling and wall mount applications. Antennas provide hemispherical coverage and cannot be removed from the Access Point. No connectors are offered for additional external antennas.	2.4 GHz: 4 dBi 5 GHz: 4 dBi
<b>Integrated AP 3700 Antenna</b>	Omnidirectional	802.11ac antenna package for both 2.4 GHz and 5 GHz designed for high performance in both ceiling and wall mount applications. Antennas provide hemispherical coverage and cannot be removed from the Access Point. No connectors are offered for additional external antennas.	2.4 GHz: 4 dBi 5 GHz: 6 dBi
<b>Integrated AP 2700 Antenna</b>	Omnidirectional	802.11ac antenna package for both 2.4 GHz and 5 GHz designed for high performance in both ceiling and wall mount applications. Antennas provide hemispherical coverage and cannot be removed from the Access Point. No connectors are offered for additional external antennas.	2.4 GHz: 4 dBi 5 GHz: 6 dBi
<b>Integrated AP 1550 Antenna</b>	Omnidirectional	802.11n antenna package for both 2.4 GHz and 5 GHz When the integrate antenna version is ordered, this antenna is attached to the Access Point and provides omnidirectional coverage in a low-profile package. No connectors are offered for additional external antennas.	2.4 GHz: 2 dBi 5 GHz: 4 dBi
<b>Integrated AP 1530 Antenna</b>	Omnidirectional	802.11n antenna package for both 2.4 GHz and 5 GHz When the integrate antenna version is ordered, this antenna is attached to the Access Point and provides omnidirectional coverage in a low-profile package. No connectors are offered for additional external antennas.	2.4 GHz: 3 dBi 5 GHz: 5 dBi



## Cisco Aironet Cable Descriptions

Table 12 below defines the cables available for interconnecting the antennas and the radio devices for the Cisco Aironet product line.

**Table 12.** Cisco Cables

Cisco Part Number	Type of Cable	Description	Loss at 2.4 GHz	Loss at 5.8 GHz
<b>AIR-CAB002L240-N=</b>	Interconnect	2-ft low loss cable, one straight N connector, one 90-degree N connector	0.5 dB	0.8 dB
<b>AIR-CAB005LL-N</b>	Interconnect	5-ft low loss cable, one straight N connector, one 90-degree N connector	0.5 dB	0.8 dB
<b>AIR-CAB005LL-R</b>	Interconnect	5-ft low loss cable, one RP-TNC plug, one RP-TNC jack	0.5 dB	0.8 dB
<b>AIR-CAB005LL-R-N=</b>	Interconnect	5-ft low loss cable, one RP-TNC plug, one 90-degree N male connector	0.5 dB	0.8 dB
<b>AIR-CAB010LL-N</b>	Interconnect	10-ft low loss cable, one straight N connector, one 90-degree N connector	0.9 dB	1.5 dB
<b>AIR-CAB020LL-R</b>	Interconnect	20-ft low loss cable, one RP-TNC plug, one RP-TNC jack	1.3 dB	2.5 dB
<b>AIR-CAB050LL-R</b>	Interconnect	50-ft low loss cable, one RP-TNC plug, one RP-TNC jack	3.4 dB	5.75 dB
<b>AIR-CAB100ULL-R</b>	Interconnect	100-ft ultra low loss cable, one RP-TNC plug, one RP-TNC jack	4.4 dB	7.25 dB
<b>AIR-CAB150ULL-R</b>	Interconnect	150-ft ultra low loss cable, one RP-TNC plug, one RP-TNC jack	6.6 dB	11 dB
<b>AIR-CAB025HZ-N=</b>	Interconnect	25-ft ultra low loss cable, two straight N male connectors, ruggedized jacket for use in hazardous locations	2.0 dB	3.5 dB
<b>AIR-ACC2537-060</b>	Bulkhead Extender	5-ft (60 inches) RG-58 type cable with one RP-TNC plug and one RP-TNC jack	2 dB	3 dB

**Table 13.** Accessories

Cisco Part Number	Name	Description
<b>AIR-ACC2662</b>	Yagi Articulating Mount	This mount permits the Yagi antenna to be mounted to a flat surface or a mast, and then be adjusted in both horizontal and vertical angles.
<b>AIR-ACC245LA-R</b>	Lightning Arrestor	Supports both 2.4 GHz and 5 GHz operation with RP-TNC connectors. Provides lightning and related energy surges at the antenna from reaching the radio circuitry. A ground ring is included.
<b>AIR-ACC245LA-N=</b>	Lightning Arrestor	Supports both 2.4 GHz and 5 GHz operation with N-Type connectors. Provides lightning and related energy surges at the antenna from reaching the radio circuitry. A ground ring is included.

## Cisco Aironet Antenna Specifications

The following section provides detailed descriptions, including physical and electrical specifications for the antennas offered by Cisco for the Cisco Aironet product line. Full detailed installation guides for each antenna can be found at the following:

[http://www.cisco.com/en/US/products/hw/wireless/ps469/prod\\_installation\\_guides\\_list.html](http://www.cisco.com/en/US/products/hw/wireless/ps469/prod_installation_guides_list.html).

## 2.2 dBi Dipole

**AIR-AT2422DB-R=/AIR-ANT4941**



Dimensions and Mounting Specifications	Azimuth Plane Radiation Pattern	Elevation Plane Radiation Pattern
<b>Frequency Range</b>	2.4-2.484 GHz	
<b>VSWR</b>	Less than 2:1	
<b>Power</b>	5 watts	
<b>Gain</b>	2.2 dBi	
<b>Polarization</b>	Linear	
<b>Azimuth 3dB Beamwidth</b>	Omnidirectional	
<b>Elevations 3dB Beamwidth</b>	65 degrees	
<b>Antenna Connector</b>	RP-TNC	
<b>Cable Length</b>	None	
<b>Dimensions</b>	5.5 in.	
<b>Mounting</b>	To RP-TNC Connector	

## 2.2 dBi Dipole

### AIR-ANT2422DW-R

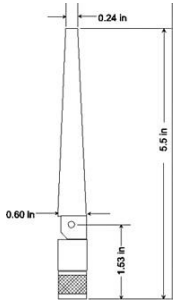
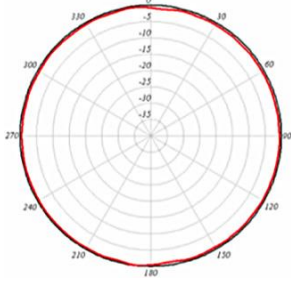
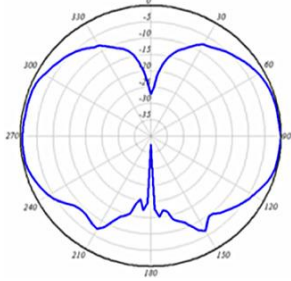

Dimensions and Mounting Specifications	Azimuth Plane Radiation Pattern	Elevation Plane Radiation Pattern
		
<b>Frequency Range</b>	2.4-2.484 GHz	
<b>VSWR</b>	Less than 2:1	
<b>Power</b>	5 watts	
<b>Gain</b>	2.2 dBi	
<b>Polarization</b>	Linear	
<b>Azimuth 3dB Beamwidth</b>	Omnidirectional	
<b>Elevations 3dB Beamwidth</b>	65 degrees	
<b>Antenna Connector</b>	RP-TNC	
<b>Cable Length</b>	None	
<b>Dimensions</b>	5.5 in.	
<b>Mounting</b>	To RP-TNC Connector	

2.2 dBi Dipole  
AIR-ANT2422DG-R

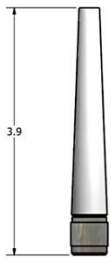
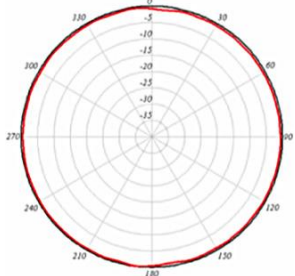
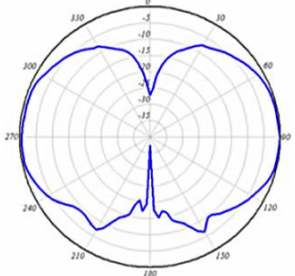

Dimensions and Mounting Specifications	Azimuth Plane Radiation Pattern	Elevation Plane Radiation Pattern
		
<b>Frequency Range</b>	2.4-2.484 GHz	
<b>VSWR</b>	Less than 2:1	
<b>Power</b>	5 watts	
<b>Gain</b>	2.2 dBi	
<b>Polarization</b>	Linear	
<b>Azimuth 3dB Beamwidth</b>	Omnidirectional	
<b>Elevations 3dB Beamwidth</b>	65 degrees	
<b>Antenna Connector</b>	RP-TNC	
<b>Cable Length</b>	None	
<b>Dimensions</b>	3.9 in.	
<b>Mounting</b>	To RP-TNC Connector	

2.2 dBi Monopole  
AIR-ANT2422SDW-R



Dimensions and Mounting Specifications	Azimuth and Elevation Plane Radiation Pattern
<b>Frequency Range</b>	2400 - 2500 MHz
<b>VSWR</b>	Less than 2:1
<b>Gain</b>	2.2 dBi
<b>Polarization</b>	Linear
<b>Azimuth 3dB Beamwidth</b>	Omnidirectional
<b>Elevations 3dB Beamwidth</b>	50 degrees
<b>Antenna Connector</b>	RP-TNC
<b>Cable Length</b>	None
<b>Dimensions</b>	1.7 in.
<b>Mounting</b>	To RP-TNC Connector

5 dBi Sector  
**AIR-ANT2450S-R**

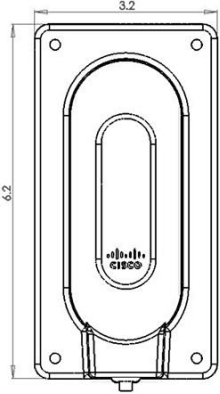
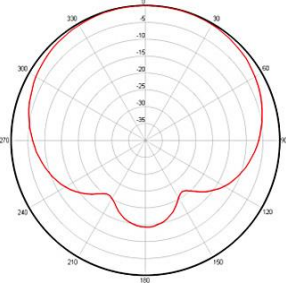
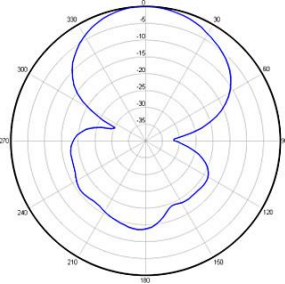

Dimensions and Mounting Specifications	Azimuth Plane Radiation Pattern	Elevation Plane Radiation Pattern
		
<b>Frequency Range</b>	2.4-2.5 GHz	
<b>VSWR</b>	1.5 or less	
<b>Gain</b>	5.0 dBi	
<b>Polarization</b>	Linear vertical	
<b>Azimuth 3dB Beamwidth</b>	135 degrees	
<b>Elevations 3dB Beamwidth</b>	54 degrees	
<b>Antenna Connector</b>	RP-TNC	
<b>Cable Length</b>	3 ft. (91 cm)	
<b>Dimensions</b>	6 x 3 x 2 in (15.2 x 7.6 x 5 cm)	
<b>Mounting</b>	Wall Mount	

## 5.2 dBi Ceiling Mount Omnidirectional AIR-ANT1728

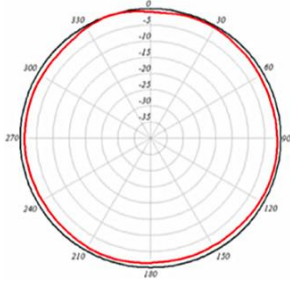
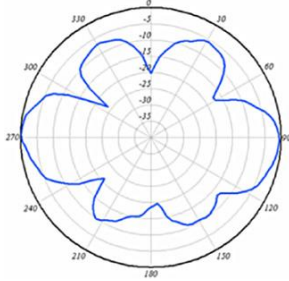

Dimensions and Mounting Specifications	Azimuth Plane Radiation Pattern	Elevation Plane Radiation Pattern
		
<b>Frequency Range</b>	2.4-2.83 GHz	
<b>VSWR</b>	Less than 2:1, 1.5:1 Nominal	
<b>Gain</b>	5.2 dBi	
<b>Polarization</b>	Vertical	
<b>Azimuth 3dB Beamwidth</b>	Omnidirectional 360 degrees	
<b>Elevations Plan (3dB Beamwidth)</b>	36 degrees	
<b>Antenna Connector</b>	RP-TNC	
<b>Cable Length</b>	3 ft. (91 cm)	
<b>Dimensions</b>	11.25 in. x 1 in. (28.57 cm x 2.54)	
<b>Mounting</b>	Drop ceiling cross member - indoor only	

## 5.2 dBi Mast Mount Omnidirectional AIR-ANT2506



Dimensions and Mounting Specifications	Azimuth Plane Radiation Pattern	Elevation Plane Radiation Pattern
<b>Frequency Range</b>	2.4-2.83 GHz	
<b>VSWR</b>	Less than 2:1, 1.5:1 Nominal	
<b>Gain</b>	5.2 dBi	
<b>Polarization</b>	Vertical	
<b>Azimuth 3dB Beamwidth</b>	Omnidirectional 360 degrees	
<b>Elevations Plan (3dB Beamwidth)</b>	36 degrees	
<b>Antenna Connector</b>	RP-TNC	
<b>Cable Length</b>	3 ft (91 cm)	
<b>Dimensions</b>	11.5 in. x 1.125 in. (29.21 cm x 2.85 cm)	
<b>Mounting</b>	Mast Mount - indoor/outdoor	



6 dBi Wall Mount Directional  
AIR-ANT2460P-R

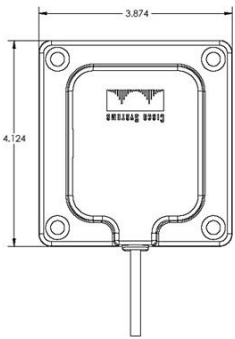
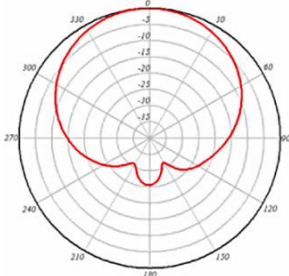
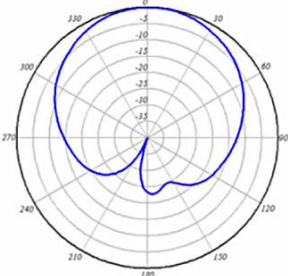

Dimensions and Mounting Specifications	Azimuth Plane Radiation Pattern	Elevation Plane Radiation Pattern
		
<b>Frequency Range</b>	2.4-2.5 GHz	
<b>VSWR</b>	Less than 2:1	
<b>Gain</b>	6 dBi	
<b>Polarization</b>	Vertical	
<b>Azimuth 3dB Beamwidth</b>	75 degrees	
<b>Elevation Plan (3dB Beamwidth)</b>	73 degrees	
<b>Antenna Connector</b>	RP-TNC	
<b>Cable Length</b>	3 ft. (91 cm)	
<b>Dimensions</b>	4.1 in. x 3.9 in. x .75 in. (10.41 cm x 9.90 cm x 1.90 cm)	
<b>Mounting</b>	Wall Mount	

8.5 dBi Wall Mount  
AIR-ANT2485P-R

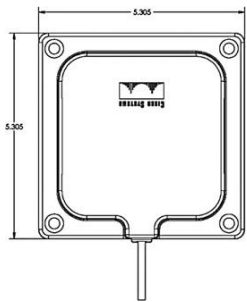
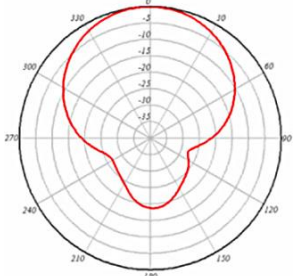
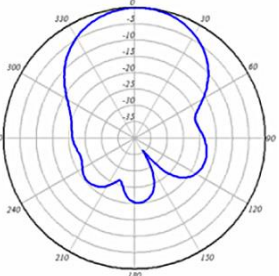

Dimensions and Mounting Specifications	Azimuth Plane Radiation Pattern	Elevation Plane Radiation Pattern
		
<b>Frequency Range</b>	2.4-2.5 GHz	
<b>VSWR</b>	2:1 Max, 1.5:1 Nominal	
<b>Gain</b>	8.5 dBi	
<b>Polarization</b>	Vertical	
<b>Azimuth 3dB Beamwidth</b>	66 degrees	
<b>Elevations 3dB Beamwidth</b>	56 degrees	
<b>Antenna Connector</b>	RP-TNC	
<b>Cable Length</b>	3 ft. (91 cm)	
<b>Dimensions</b>	5.3 in. x 5.3 in. x .90 in. (13.5 cm x 13.5 cm x 2.2 cm)	
<b>Mounting</b>	Wall Mount	

10 dBi Wall/Mast Mount YAGI  
**AIR-ANT2410Y-R**



Dimensions and Mounting Specifications	Azimuth Plane Radiation Pattern	Elevation Plane Radiation Pattern
<b>Frequency Range</b>	2.4-2.483 GHz	
<b>VSWR</b>	Less than 2:1	
<b>Gain</b>	10 dBi	
<b>Polarization</b>	Vertical	
<b>Azimuth 3dB Beamwidth</b>	55 degrees	
<b>Elevations Plan 3dB Beamwidth</b>	47 degrees	
<b>Antenna Connector</b>	RP-TNC	
<b>Cable Length</b>	3 ft. (91 cm)	
<b>Dimensions</b>	3 in. x 7.25 in. (7.62 cm x 18.42 cm)	
<b>Mounting</b>	Wall/Mast Mount	

## 12 dBi Mast Mount Omnidirectional AIR-ANT24120



Dimensions and Mounting Specifications	Azimuth Plane Radiation Pattern	Elevation Plane Radiation Pattern
<b>Frequency Range</b>	2400-2500 MHz	
<b>VSWR</b>	1.5:1	
<b>Gain</b>	12 dBi	
<b>Polarization</b>	Linear, Vertical	
<b>Azimuth 3dB Beamwidth</b>	Omnidirectional 360 degrees	
<b>Elevation (3dB Beamwidth)</b>	7 degrees	
<b>Antenna Connector</b>	RP-TNC	
<b>Cable Length</b>	1 ft. (30.48 cm)	
<b>Dimensions</b>	42 in. x 1.25 in. (106.68 cm x 3.17 cm)	
<b>Wind Rating</b>	125 MPH	
<b>Mounting</b>	Mast Mount	

13.5 dBi Mast/Wall Mount YAGI  
**AIR-ANT1949**

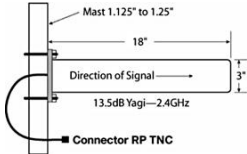
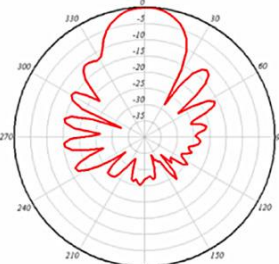
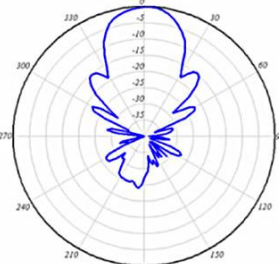

Dimensions and Mounting Specifications	Azimuth Plane Radiation Pattern	Elevation Plane Radiation Pattern
 <p>Mast 1.125" to 1.25"  18"  Direction of Signal →  13.5dB Yagi—2.4GHz  Connector RP TNC</p>		
<b>Frequency Range</b>	2.4-2.83 GHz	
<b>VSWR</b>	Less than 2:1, 1.5:1 Nominal	
<b>Gain</b>	13.5 dBi	
<b>Front to Back Ratio</b>	Greater than 25 dB	
<b>Polarization</b>	Vertical	
<b>Azimuth 3dB Beamwidth</b>	30 degrees	
<b>Elevations 3dB Beamwidth</b>	25 degrees	
<b>Antenna Connector</b>	RP-TNC	
<b>Cable Length</b>	3 ft. (91 cm)	
<b>Dimensions</b>	18 in. x 3 in. (45.72 cm x 7.62 cm)	
<b>Wind Rating</b>	110 MPH	
<b>Mounting</b>	Mast/Wall Mount	

14 dBi Mast Mount Sector  
AIR-ANT2414S-R



Dimensions and Mounting Specifications	Azimuth Plane Radiation Pattern	Elevation Plane Radiation Pattern
<b>Frequency Range</b>	2.4-2.5 GHz	
<b>VSWR</b>	1.5:1	
<b>Gain</b>	14 dBi	
<b>Polarization</b>	Linear, Vertical	
<b>Azimuth 3dB Beamwidth</b>	90 degrees	
<b>Elevations 3dB Beamwidth</b>	8.5 degrees	
<b>Antenna Connector</b>	RP-TNC	
<b>Cable Length</b>	5 ft. (152.4 cm)	
<b>Dimensions</b>	36 in. x 6 in. x 4 in. (91.44 cm x 15.24 cm x 10.16 cm)	
<b>Mounting</b>	Mast Mount	

21 dBi Mast Mount Parabolic Dish  
**AIR-ANT3338**



Dimensions and Mounting Specifications	Azimuth Plane Radiation Pattern	Elevation Plane Radiation Pattern
<b>Frequency Range</b>	2.4-2.83 GHz	
<b>VSWR</b>	Less than 1.8:1, 15:1 Nominal	
<b>Power</b>	5 watts	
<b>Gain</b>	21 dBi	
<b>Front to Back Ratio</b>	Greater than 25 dB	
<b>Maximum Side Lobe</b>	-17 dB	
<b>Polarization</b>	Vertical	
<b>Azimuth 3dB Beamwidth</b>	12 degrees	
<b>Elevation 3dB Beamwidth</b>	12 degrees	
<b>Antenna Connector</b>	RP-TNC	
<b>Cable Length</b>	2 ft. (60.96 cm)	
<b>Dimensions</b>	24 in. x 15.5 in. (60.96 cm x 39.37 cm)	
<b>Wind Rating</b>	110 MPH	
<b>Mounting</b>	Mast Mount	

2 dBi Omnidirectional, 2 Element  
**AIR-ANT24020V-R=**

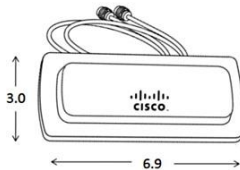
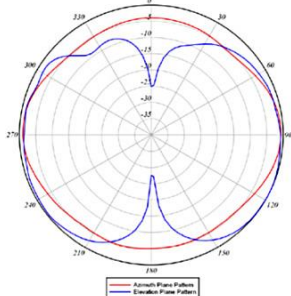
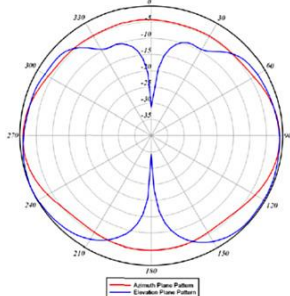

Dimensions and Mounting Specifications	Left Antenna Patterns	Right Antenna Patterns
		
<b>Frequency Range</b>	2.4-2.5 GHz	
<b>VSWR</b>	1.5:1	
<b>Gain</b>	2.2 dBi	
<b>Polarization</b>	Vertical	
<b>Azimuth 3dB Beamwidth</b>	360 degrees	
<b>Elevations Plan (3dB Beamwidth)</b>	97 degrees	
<b>Antenna Connector</b>	RP-TNC	
<b>Cable Length</b>	3 ft. (91 cm)	
<b>Dimensions</b>	6.9 in. x 3 in. x .90 in. (17.5 cm x 7.6 cm x 2.5 cm)	
<b>Mounting</b>	Ceiling Mount	



## 5.2 dBi Wall Mount AIR-ANT2452V-R



Dimensions and Mounting Specifications	Left Antenna Patterns	Right Antenna Patterns
<b>Frequency Range</b>	2.4-2.5 GHz	
<b>VSWR</b>	< 2:1	
<b>Gain</b>	5 dBi	
<b>Polarization</b>	Vertical	
<b>Azimuth 3dB Beamwidth</b>	360 degrees	
<b>Elevations Plan (3dB Beamwidth)</b>	27 degrees	
<b>Antenna Connector</b>	RP-TNC	
<b>Cable Length</b>	3 ft. (91 cm)	
<b>Dimensions</b>	11 in. x 5 in. x 1 in. (27.2 cm x 12.7 cm x 2.5 cm)	
<b>Mounting</b>	Wall Mount	

6.5 dBi Wall Mount  
AIR-ANT2465P-R

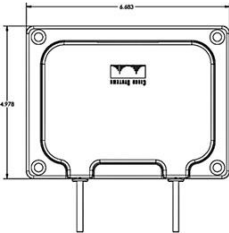
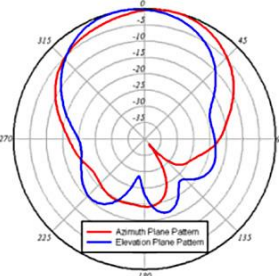
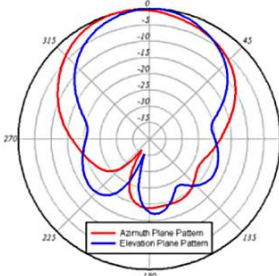

Dimensions and Mounting Specifications	Left Antenna Patterns	Right Antenna Patterns
		
<b>Frequency Range</b>	2.4-2.5 GHz	
<b>VSWR</b>	1.7:1 Nominal	
<b>Gain</b>	6.5 dBi	
<b>Polarization</b>	Vertical	
<b>Azimuth 3dB Beamwidth</b>	75 degrees	
<b>Elevations Plan (3dB Beamwidth)</b>	57 degrees	
<b>Antenna Connector</b>	RP-TNC	
<b>Cable Length</b>	3 ft. (91 cm)	
<b>Dimensions</b>	5 in. x 6.7 in. x .90 in. (12.7 cm x 17.0 cm x 2.2 cm)	
<b>Mounting</b>	Wall Mount	

Omnidirectional, 3 Element Ceiling Mount  
**AIR-ANT2430V-R=**



Antenna A Radiation Pattern	Antenna B Radiation Pattern	Antenna C Radiation Pattern
<b>Frequency Range</b>	2402 - 2485 MHz	
<b>VSWR</b>	2:1	
<b>Gain</b>	3 dBi	
<b>Polarization</b>	Linear	
<b>Azimuth 3dB Beamwidth</b>	Omni	
<b>Elevations 3dB Beamwidth</b>	60	
<b>Antenna Connector</b>	(3) RP-TNC male	
<b>Cable Length</b>	36 in (91.4 cm) plenum rated	
<b>Dimensions</b>	12.1 in . x 4.2 in x 1.6 in (30.7 cm x 10.6cm x 4.0 cm)	
<b>Mounting</b>	Ceiling	

Omnidirectional, 3 Element Wall Mount  
**AIR-ANT2440NV-R=**



Antenna A Radiation Pattern	Antenna B Radiation Pattern	Antenna C Radiation Pattern
<b>Frequency Range</b>	2402 - 2484 MHz	
<b>VSWR</b>	2:1	
<b>Gain</b>	4 dBi	
<b>Polarization</b>	Linear	
<b>Azimuth 3dB Beamwidth</b>	Omni	
<b>Elevations 3dB Beamwidth</b>	36	
<b>Antenna Connector</b>	(3) RP-TNC male	
<b>Cable Length</b>	36 in (91.4 cm) plenum rated	
<b>Dimensions</b>	8.6 in x 6.3 in dia. (21.8 cm x 16 cm dia.)	
<b>Mounting</b>	Wall Mount	

6 dBi Patch, 3 Element Wall Mount  
**AIR-ANT2460NP-R=**



Antenna A Radiation Pattern	Antenna B Radiation Pattern	Antenna C Radiation Pattern
<b>Frequency Range</b>	2402 - 2484 MHz	
<b>VSWR</b>	2:1	
<b>Gain</b>	6 dBi	
<b>Polarization</b>	Linear	
<b>Azimuth 3dB Beamwidth</b>	80 degrees	
<b>Elevations 3dB Beamwidth</b>	75 degrees	
<b>Antenna Connector</b>	(3) RP-TNC male	
<b>Cable Length</b>	36 in (91.4 cm) plenum rated	
<b>Dimensions</b>	5.8 in x 11.25 in x 1.13 in (14.7 cm x 28.6 cm x 2.9 cm)	
<b>Mounting</b>	Wall Mount	

3.5 dBi Dipole  
AIR-ANT5135D-R

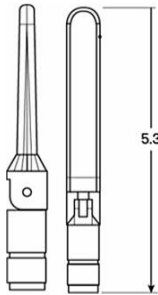
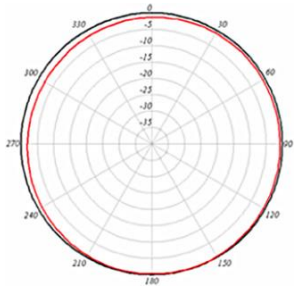
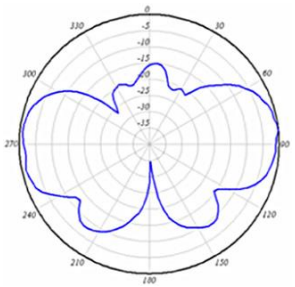

Dimensions and Mounting Specifications	Azimuth Plane Radiation Pattern	Elevation Plane Radiation Pattern
		
<b>Frequency Range</b>	5.15-5.85 GHz	
<b>VSWR</b>	2:1 or better	
<b>Gain</b>	3.5 dBi	
<b>Polarization</b>	Linear	
<b>Azimuth 3dB Beamwidth</b>	Omnidirectional	
<b>Elevations 3dB Beamwidth</b>	40 degrees	
<b>Antenna Connector</b>	RP-TNC	
<b>Cable Length</b>	None	
<b>Dimensions</b>	5.3 in. (13.46 cm)	
<b>Mounting</b>	RP-TNC Connector	

3.5 dBi Dipole  
AIR-ANT5135DW-R

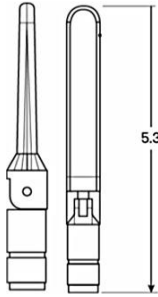
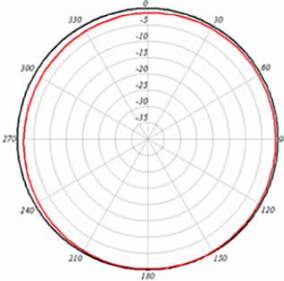
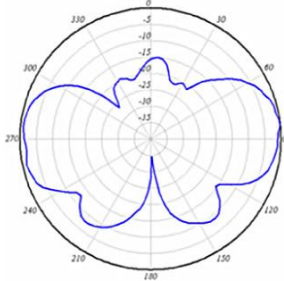

Dimensions and Mounting Specifications	Azimuth Plane Radiation Pattern	Elevation Plane Radiation Pattern
		
<b>Frequency Range</b>	5.15-5.85 GHz	
<b>VSWR</b>	2:1 or better	
<b>Gain</b>	3.5 dBi	
<b>Polarization</b>	Linear	
<b>Azimuth 3dB Beamwidth</b>	Omnidirectional	
<b>Elevations 3dB Beamwidth</b>	40 degrees	
<b>Antenna Connector</b>	RP-TNC	
<b>Cable Length</b>	None	
<b>Dimensions</b>	5.3 in. (13.46 cm)	
<b>Mounting</b>	RP-TNC Connector	

3.5 dBi Dipole  
AIR-ANT5135DG-R

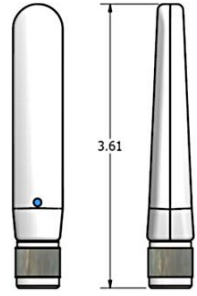
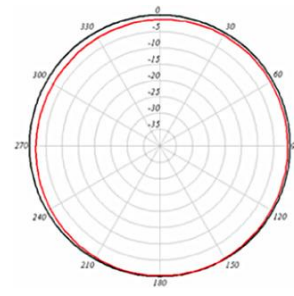
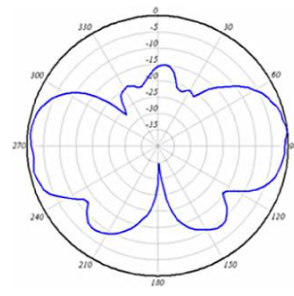

Dimensions and Mounting Specifications	Azimuth Plane Radiation Pattern	Elevation Plane Radiation Pattern
		
<b>Frequency Range</b>	5.15-5.85 GHz	
<b>VSWR</b>	2:1 or better	
<b>Gain</b>	3.5 dBi	
<b>Polarization</b>	Linear	
<b>Azimuth 3dB Beamwidth</b>	Omnidirectional	
<b>Elevations 3dB Beamwidth</b>	40 degrees	
<b>Antenna Connector</b>	RP-TNC	
<b>Cable Length</b>	None	
<b>Dimensions</b>	3.6 in. (9.14 cm)	
<b>Mounting</b>	RP-TNC Connector	



## 2.2 dBi Monopole AIR-ANT5135SDW-R



Dimensions And Mounting Specifications	Azimuth and Elevation Plane Radiation Pattern
<b>Frequency Range</b>	5150 - 5850 MHz
<b>VSWR</b>	Less than 2:1
<b>Gain</b>	2.2 dBi
<b>Polarization</b>	Linear
<b>Azimuth 3dB Beamwidth</b>	Omnidirectional
<b>Elevations 3dB Beamwidth</b>	40 degrees
<b>Antenna Connector</b>	RP-TNC
<b>Cable Length</b>	None
<b>Dimensions</b>	1.7 in.
<b>Mounting</b>	To RP-TNC Connector

6 dBi Omnidirectional  
AIR-ANT5160V-R



Dimensions and Mounting Specifications	Azimuth Plane Radiation Pattern	Elevation Plane Radiation Pattern
<b>Frequency Range</b>	5.15-5.85 GHz	
<b>VSWR</b>	2:1 or better	
<b>Gain</b>	6 dBi	
<b>Polarization</b>	Vertical	
<b>Azimuth 3dB Beamwidth</b>	Omnidirectional 360 degrees	
<b>Elevation 3dB Beamwidth</b>	17 degrees	
<b>Antenna Connector</b>	RP-TNC	
<b>Cable Length</b>	3 ft. (91 cm)	
<b>Dimensions</b>	12 in. x 1 in. (30.48 cm x 2.54 cm)	

9.5 dBi Patch Wall or Articulating Mast Mount  
**AIR-ANT5195P-R**

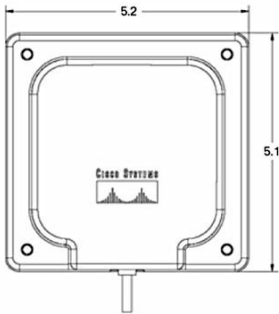
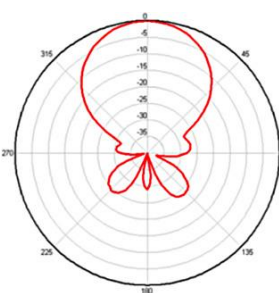
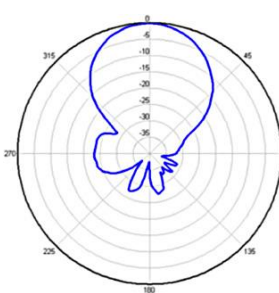

Dimensions and Mounting Specifications	Azimuth Plane Radiation Pattern	Elevation Plane Radiation Pattern
		
<b>Frequency Range</b>	5.1-5.8 GHz	
<b>VSWR</b>	2:1 or better	
<b>Gain</b>	9.5 dBi	
<b>Polarization</b>	Linear and vertical	
<b>Azimuth Plane</b>	50 degrees	
<b>Elevation Plane</b>	43 degrees	
<b>Connectors</b>	RP-TNC	
<b>Cable Length</b>	3 ft. (91 cm)	
<b>Dimensions</b>	5.1 in. x 5.1 in. x 1.0 in. (12.9 cm x 12.9 cm x 2.5 cm)	
<b>Mounting</b>	Wall Mount or Articulating Mast Mount	

4.5 dBi Diversity Omnidirectional  
AIR-ANT5145V-R

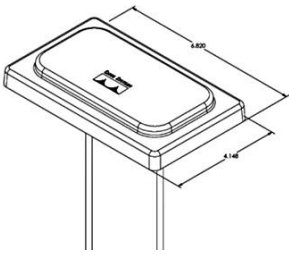
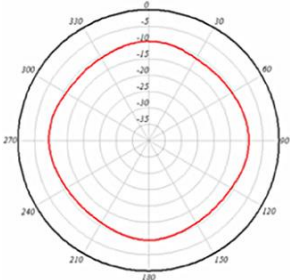
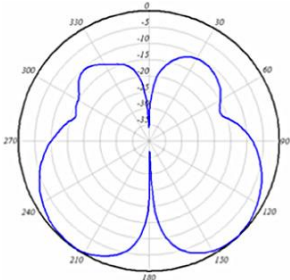

Dimensions and Mounting Specifications	Azimuth Plane Radiation Pattern	Elevation Plane Radiation Pattern
		
<b>Frequency Range</b>	5.15-5.85 GHz	
<b>VSWR</b>	2:1 or better	
<b>Gain</b>	4.5 dBi	
<b>Polarization</b>	Linear	
<b>Azimuth 3dB Beamwidth</b>	Diversity Omnidirectional	
<b>Elevations 3dB Beamwidth</b>	50 degrees	
<b>Antenna Connector</b>	RP-TNC	
<b>Cable Length</b>	3 ft. (91 cm)	
<b>Dimensions</b>	6.75 in. x 4.1 in. x 1 in. (17.15 cm x 10.41 x 2.54 cm)	
<b>Mounting</b>	Drop Ceiling Cross Member Mount	

## 7 dBi Diversity Patch Wall Mount AIR-ANT5170P-R

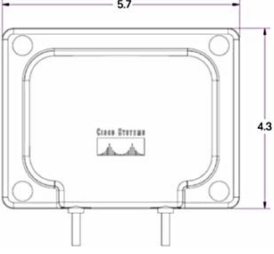
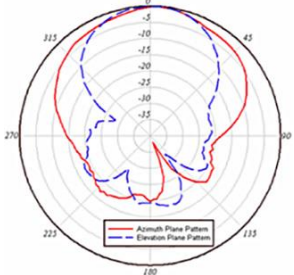
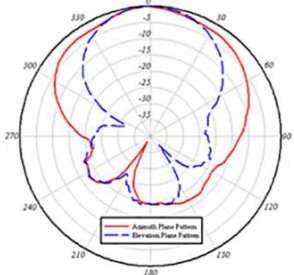

Dimensions and Mounting Specifications	Left Antenna Radiation Pattern	Right Antenna Radiation Pattern
		
<b>Frequency Range</b>	5.1-5.8 GHz	
<b>VSWR</b>	2:1 or better	
<b>Gain</b>	7 dBi	
<b>Polarization</b>	Linear and vertical	
<b>Azimuth Plane</b>	70 degrees	
<b>Elevation Plane</b>	50 degrees	
<b>Connectors</b>	RP-TNC	
<b>Cable Length</b>	3 ft. (91 cm)	
<b>Dimensions</b>	5.7 in x 4.3 in. x 0.7 in. (14.5 cm x 10.9 cm x 1.8 cm)	
<b>Mounting</b>	Wall Mount	

Omnidirectional, 3 Element Ceiling Mount  
AIR-ANT5140V-R=

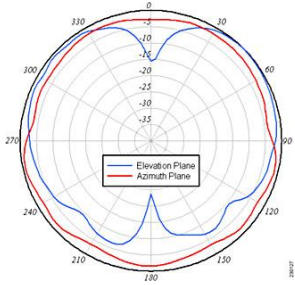
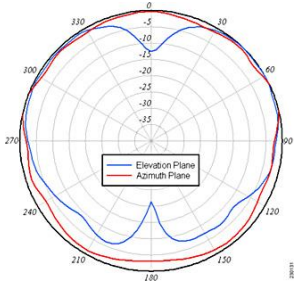
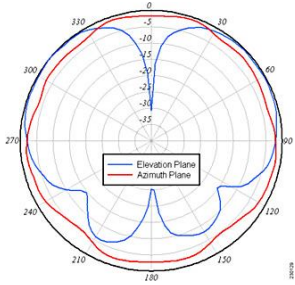

Antenna A Radiation Pattern	Antenna B Radiation Pattern	Antenna C Radiation Pattern
		
<b>Frequency Range</b>	4900 - 5850 MHz	
<b>VSWR</b>	1.5:1	
<b>Gain</b>	4 dBi	
<b>Polarization</b>	Linear	
<b>Azimuth 3dB Beamwidth</b>	Omni	
<b>Elevations 3dB Beamwidth</b>	45 degrees	
<b>Antenna Connector</b>	(3) RP-TNC male	
<b>Cable Length</b>	36 in (91.4 cm) plenum rated	
<b>Dimensions</b>	6.9 in x 3 in x 1 in (17.5 cm x 7.6cm x 2.5 cm)	
<b>Mounting</b>	Ceiling	

Omnidirectional, 3 Element Wall Mount  
**AIR-ANT5140NV-R=**



Antenna A Radiation Pattern	Antenna B Radiation Pattern	Antenna C Radiation Pattern
<b>Frequency Range</b>	5150 - 5850 MHz	
<b>VSWR</b>	2:1	
<b>Gain</b>	4 dBi	
<b>Polarization</b>	Linear	
<b>Azimuth 3dB Beamwidth</b>	Omni	
<b>Elevations 3dB Beamwidth</b>	36	
<b>Antenna Connector</b>	(3) RP-TNC male	
<b>Cable Length</b>	36 in (91.4 cm) plenum rated	
<b>Dimensions</b>	8.6in x 6.3 in dia. (21.8 cm dia x 16 cm dia.)	
<b>Mounting</b>	Wall Mount	

6 dBi Patch, 3 Element Wall Mount  
**AIR-ANT5160NP-R=**



Antenna A Radiation Pattern	Antenna B Radiation Pattern	Antenna C Radiation Pattern
<p>Left Antenna</p>	<p>Right Antenna</p>	<p>Middle Antenna</p>
<b>Frequency Range</b>	5150 - 5850 MHz	
<b>VSWR</b>	2:1	
<b>Gain</b>	6 dBi	
<b>Polarization</b>	Linear	
<b>Azimuth 3dB Beamwidth</b>	65 degrees	
<b>Elevations 3dB Beamwidth</b>	65 degrees	
<b>Antenna Connector</b>	(3) RP-TNC male	
<b>Cable Length</b>	36 in (91.4 cm) plenum rated	
<b>Dimensions</b>	4 in x 7 in x 1 in (10.2 cm x 17.8 cm x 2.5 cm)	
<b>Mounting</b>	Wall Mount	



## Dual Band Ceiling Mount Omnidirectional, 2 Element AIR-ANT2451V-R=

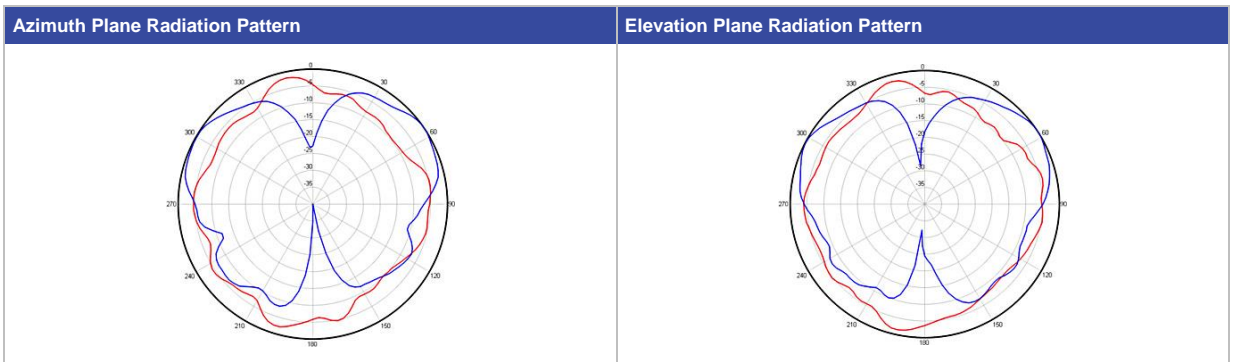
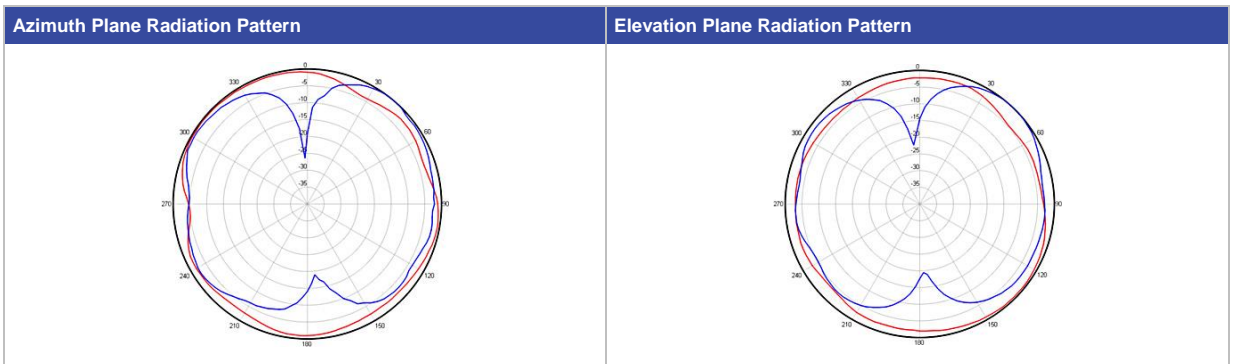

Dimensions and Mounting Specifications	Azimuth Plane Radiation Pattern	Elevation Plane Radiation Pattern
<b>Frequency Range</b>	2.4-2.5 GHz; 5.1-5.8 GHz	
<b>VSWR</b>	2:1	
<b>Gain</b>	<ul style="list-style-type: none"> <li>• 2 dBi in 2.4 GHz</li> <li>• 3 dBi in 5 GHz</li> </ul>	
<b>Polarization</b>	Linear	
<b>Azimuth 3dB Beamwidth</b>	Omni	
<b>Elevations 3dB Beamwidth</b>	<ul style="list-style-type: none"> <li>• 80 degrees in 2.4 GHz</li> <li>• 50 degrees in 5 GHz</li> </ul>	
<b>Antenna Connector</b>	(4) Right angle RP-TNC male	
<b>Cable Length</b>	18in (45.7 cm) plenum rated	
<b>Dimensions</b>	8.5 in. x 6 in. x .93 in (21.5 cm x 15.2 cm x 2.4cm)	
<b>Mounting</b>	Ceiling	

## Dual Band Ceiling Mount Omnidirectional, 3 Element AIR-ANT2451NV-R=

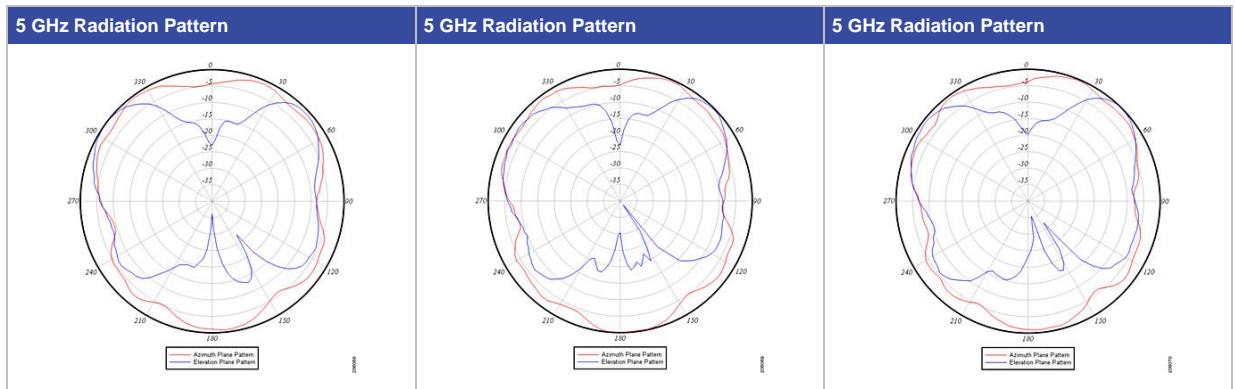
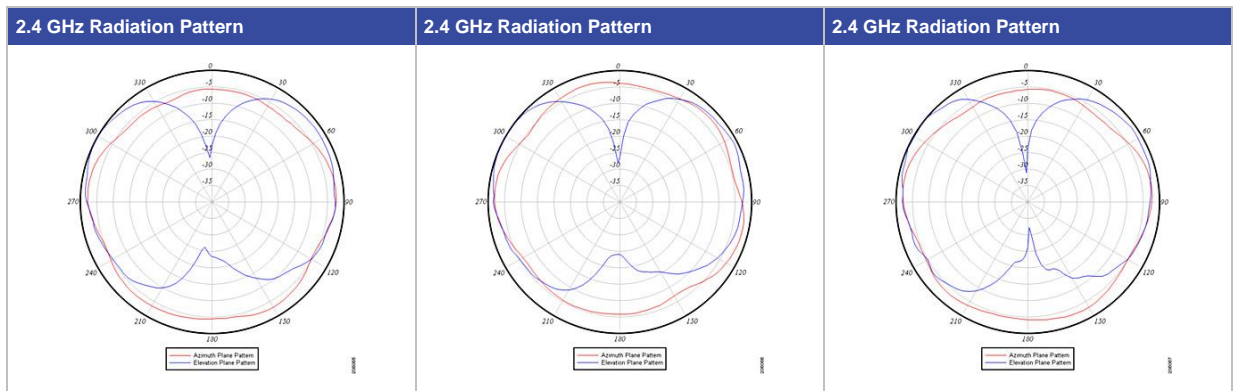

<b>Frequency Range</b>	2.400 - 2.500 GHz; 5.150 - 5.850 GHz
<b>VSWR</b>	2:1
<b>Gain</b>	<ul style="list-style-type: none"> <li>• 2.5 dBi in 2.4 GHz</li> <li>• 3.5 dBi in 5 GHz</li> </ul>
<b>Polarization</b>	Linear
<b>Azimuth 3dB Beamwidth</b>	Omni
<b>Elevations 3dB Beamwidth</b>	<ul style="list-style-type: none"> <li>• 63 degrees in 2.4 GHz</li> <li>• 55 degrees in 5 GHz</li> </ul>
<b>Antenna Connector</b>	(6) Right angle RP-TNC male
<b>Cable Length</b>	36 in (91.4 cm) plenum rated
<b>Dimensions</b>	8.6 in dia. x 1.8 in (21.8 cm x 4.6cm)
<b>Mounting</b>	Ceiling

## Dual Band Patch Antenna AIR-ANT25137NP-R=

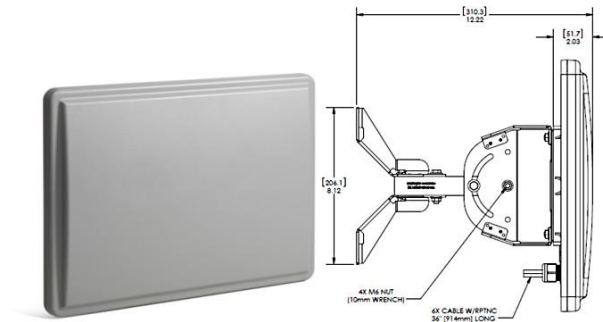

2.4 GHz, 4 dBi Azimuth Plane Radiation Pattern	5 GHz, 3 dBi Azimuth Plane Radiation Pattern	2.4 GHz, 4 dBi Elevation Plane Radiation Pattern	5 GHz, 3 dBi Elevation Plane Radiation Pattern
<b>Frequency Range</b>		<ul style="list-style-type: none"> <li>• 2.4-2.5 GHz</li> <li>• 5.15-5.85 GHz</li> </ul>	
<b>Gain</b>		<ul style="list-style-type: none"> <li>• 2.4 GHz: 13 dBi</li> <li>• 5 GHz: 7 dBi</li> </ul>	
<b>Polarization</b>		Cable A = Horizontal, Cables B and C = Vertical	
<b>Azimuth 3dB Beamwidth</b>		2.4 GHz = 36 degrees 5 GHz = 55 degrees	
<b>Elevations 3dB Beamwidth</b>		2.4 GHz = 36 degrees 5 GHz = 48 degrees	
<b>Antenna Connector</b>		RP-TNC	
<b>Mounting</b>		Integrated	
<b>Dimensions (w/ out Mount)</b>		18 in x 13 in x 2 in (45.7 cm x 33 cm x 5.1 cm)	
<b>Antenna Type</b>		MIMO Patch Array	

## Dual-Band Articulating Dipole

AIR-AN2524DB-R/AIR-ANT2524DG-R/AIR-ANT2524DW-R



Dimensions and Mounting Specifications	Azimuth and Elevation Plane Radiation Pattern	
<b>Frequency Range</b>	2.4 - 2.5 GHz 5.150 - 5.925 GHz	
<b>VSWR</b>	Less than 2:1	
<b>Gain</b>	2.4 GHz: 2 dBi 5 GHz: 4 dBi	
<b>Polarization</b>	Linear	
<b>Azimuth 3dB Beamwidth</b>	Omnidirectional	
<b>Elevations 3dB Beamwidth</b>	40 degrees	
<b>Antenna Connector</b>	RP-TNC	
<b>Cable Length</b>	None	
<b>Dimensions</b>	6.6 in.	
<b>Mounting</b>	To RP-TNC Connector	

## Dual-Band Short Dipole AIR-AN2535SDW-R

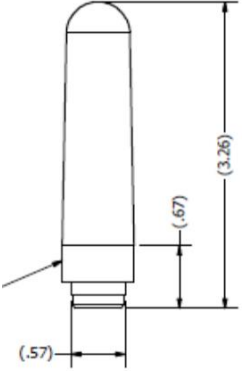
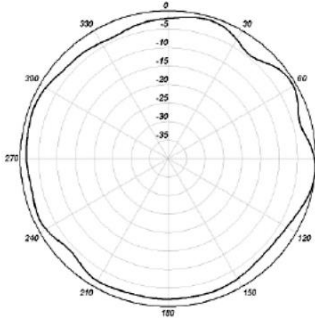
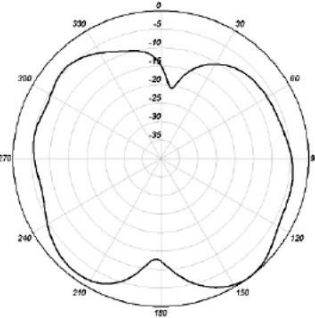
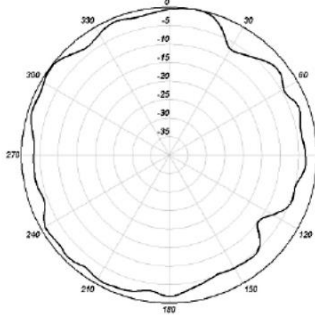
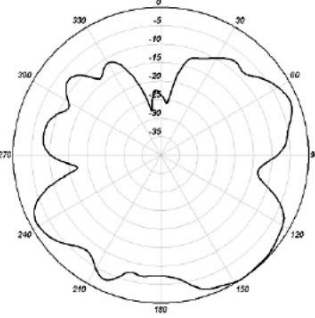

Dimensions and Mounting Specifications	Azimuth and Elevation Plane Radiation Pattern	
	<p><b>Azimuth Radiation Pattern (2.4 GHz)</b></p> 	<p><b>Elevation Radiation Pattern (2.4 GHz)</b></p> 
<p><b>Frequency Range</b></p> <p>2.4 - 2.5 GHz 5.150 - 5.925 GHz</p> <p><b>VSWR</b></p> <p>Less than 2:1</p> <p><b>Gain</b></p> <p>2.4 GHz: 3 dBi 5 GHz: 5 dBi</p> <p><b>Polarization</b></p> <p>Linear</p> <p><b>Azimuth 3dB Beamwidth</b></p> <p>Omnidirectional</p> <p><b>Elevations 3dB Beamwidth</b></p> <p>40 degrees</p> <p><b>Antenna Connector</b></p> <p>RP-TNC</p> <p><b>Cable Length</b></p> <p>None</p> <p><b>Dimensions</b></p> <p>3.3 in.</p> <p><b>Mounting</b></p> <p>To RP-TNC Connector</p>	<p><b>Azimuth Radiation Pattern (5 GHz)</b></p> 	<p><b>Elevation Radiation Pattern (5 GHz)</b></p> 

Dual Band Ceiling Mount Omnidirectional, 4 Element  
**AIR-ANT2524V4C-R=**

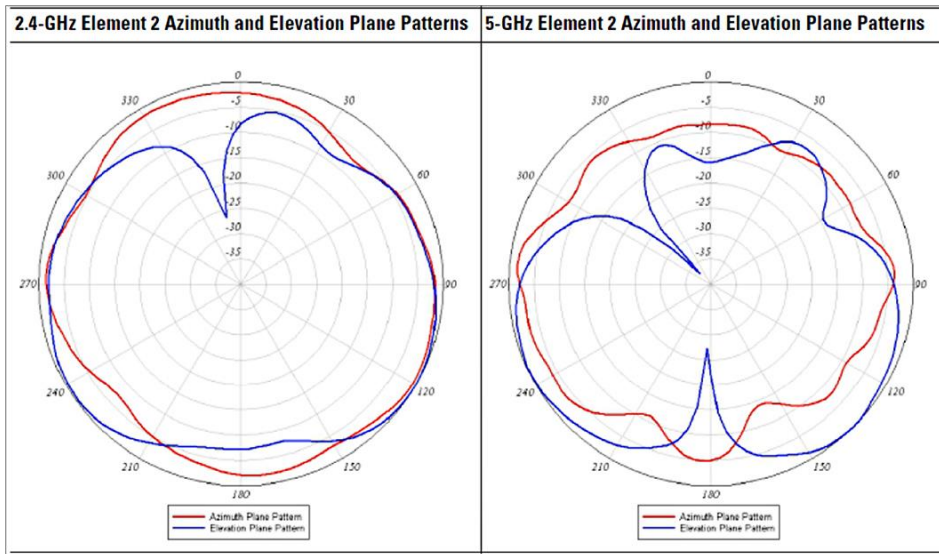
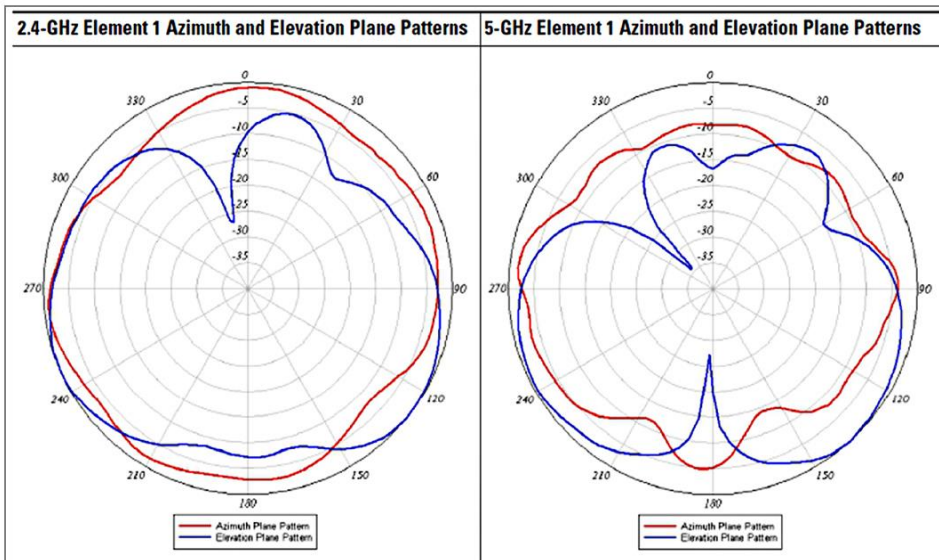



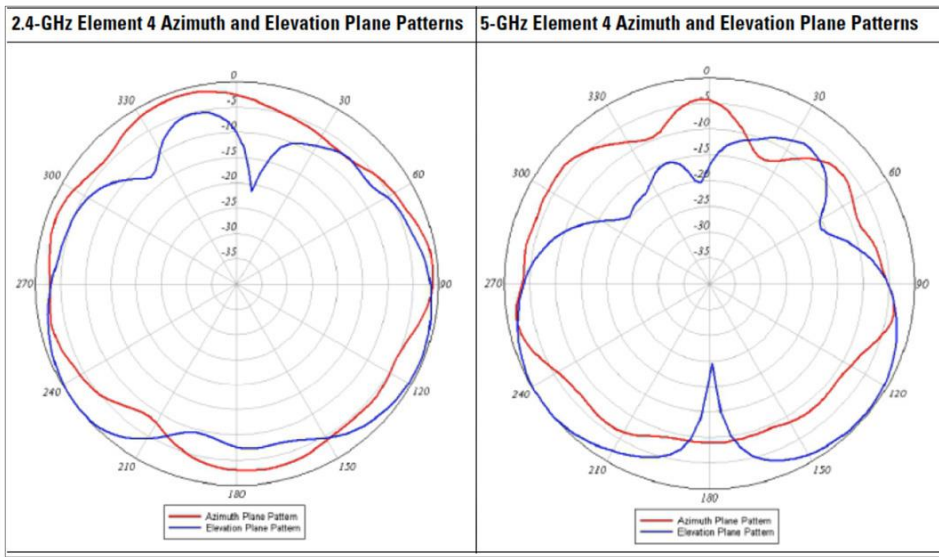
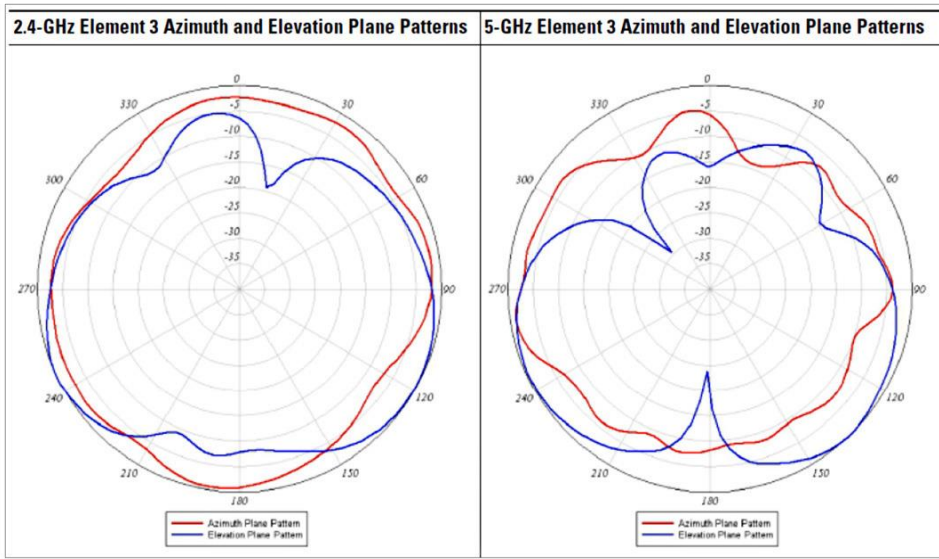

<b>Frequency Range</b>	2.400 - 2.484 GHz 5.150 - 5.850 GHz
<b>VSWR</b>	2:1
<b>Gain</b>	<ul style="list-style-type: none"> <li>• 2 dBi in 2.4 GHz</li> <li>• 4 dBi in 5 GHz</li> </ul>
<b>Polarization</b>	Linear
<b>Azimuth 3dB Beamwidth</b>	Omni
<b>Elevations 3dB Beamwidth</b>	<ul style="list-style-type: none"> <li>• 69 degrees in 2.4 GHz</li> <li>• 60 degrees in 5 GHz</li> </ul>
<b>Antenna Connector</b>	(4) RP-TNC male
<b>Cable Length</b>	36 in (91 cm) plenum rated
<b>Dimensions</b>	7.25 x 7.25 x 1 in (18.4 x 18.4 x 2.5 cm)
<b>Mounting</b>	Ceiling

Dual Band Wall Mount Omnidirectional, 4 Element  
AIR-ANT2544V4M-R=

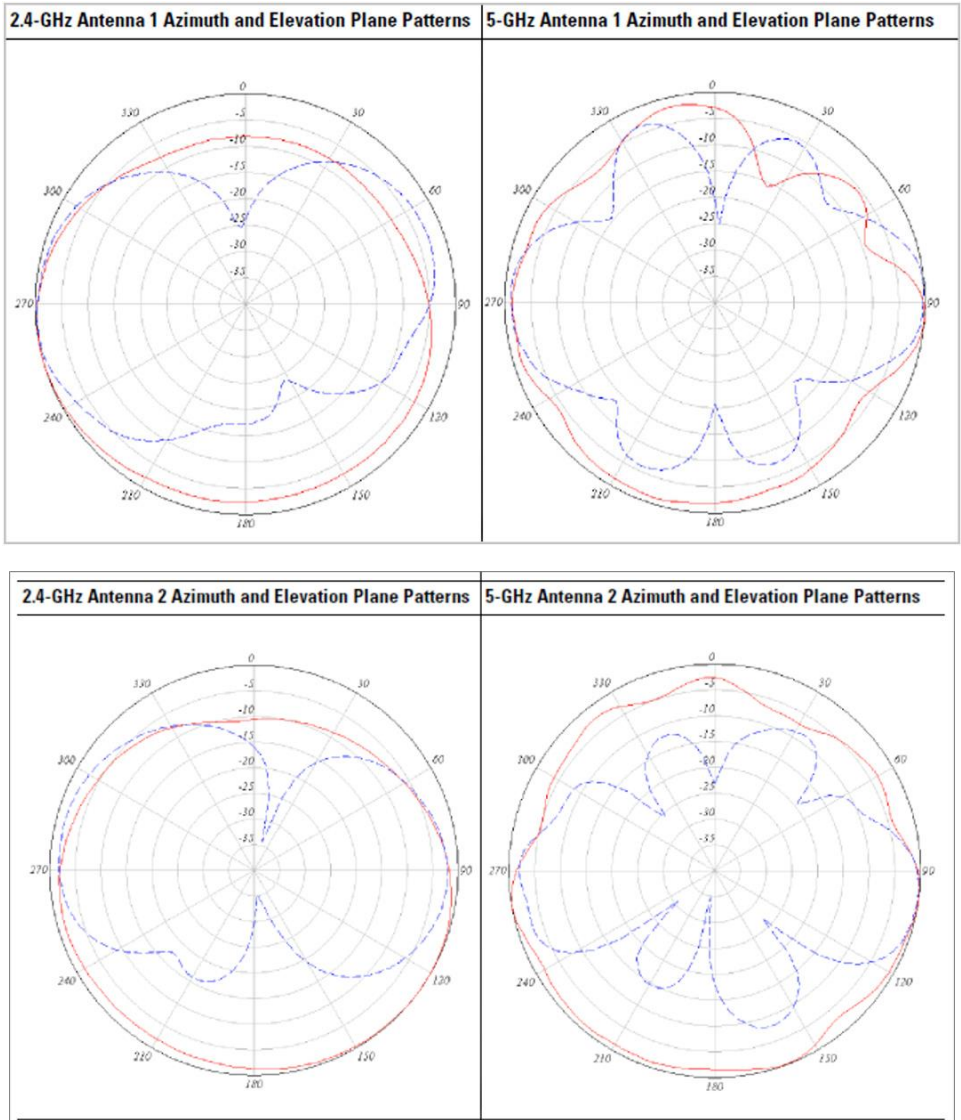



**2.4-GHz Antenna 3 Azimuth and Elevation Plane Patterns**      **5-GHz Antenna 3 Azimuth and Elevation Plane Patterns**

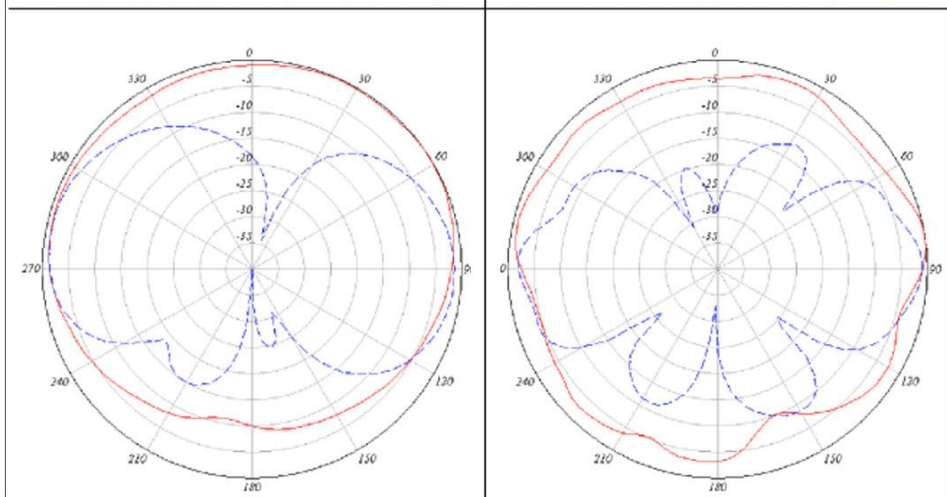

**2.4-GHz Antenna 4 Azimuth and Elevation Plane Patterns**      **5-GHz Antenna 4 Azimuth and Elevation Plane Patterns**

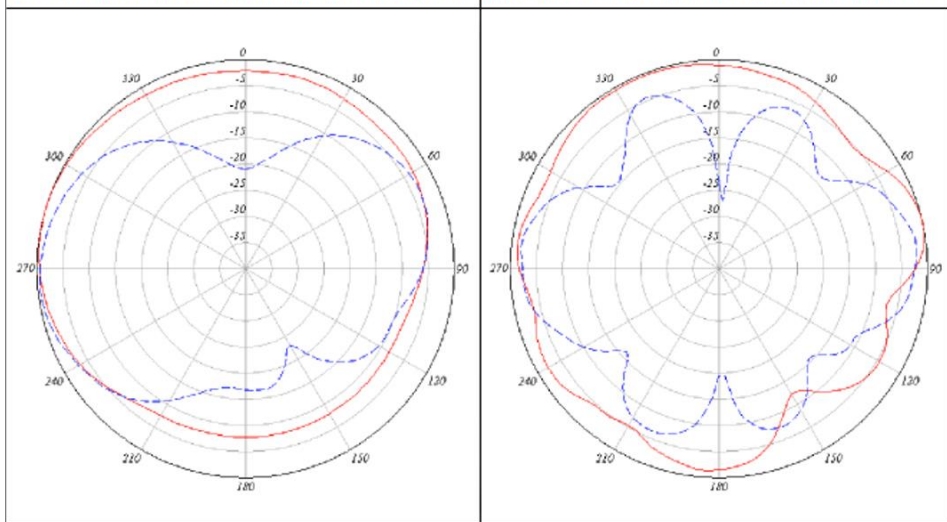

<b>Frequency Range</b>	2.400 - 2.484 GHz; 5.150 - 5.850 GHz
<b>VSWR</b>	2:1
<b>Gain</b>	<ul style="list-style-type: none"> <li>• 4 dBi in 2.4 GHz</li> <li>• 4 dBi in 5 GHz</li> </ul>
<b>Polarization</b>	Linear
<b>Azimuth 3dB Beamwidth</b>	Omni
<b>Elevations 3dB Beamwidth</b>	<ul style="list-style-type: none"> <li>• 60 degrees in 2.4 GHz</li> <li>• 33 degrees in 5 GHz</li> </ul>
<b>Antenna Connector</b>	(4) RP-TNC male
<b>Cable Length</b>	36 in (91 cm) plenum rated
<b>Dimensions</b>	8.6 in x 6.3 in dia. (21.8 cm x 16 cm dia.)
<b>Mounting</b>	Wall/Mast

Dual Band Wall Mount Patch, 4 Element  
**AIR-ANT2566P4W-R=**



**Azimuth and Elevation Radiation Patterns  
Left Antenna - 2.4 GHz Band**

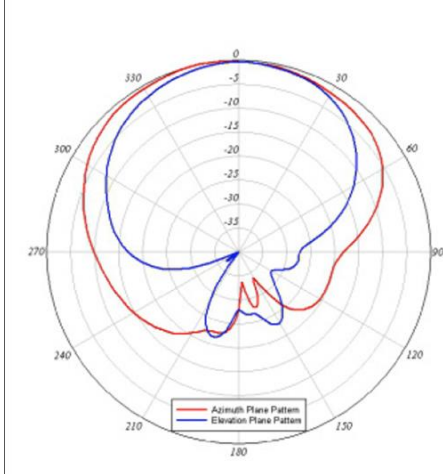

**Azimuth and Elevation Radiation Patterns  
Left Antenna - 5 GHz Band**

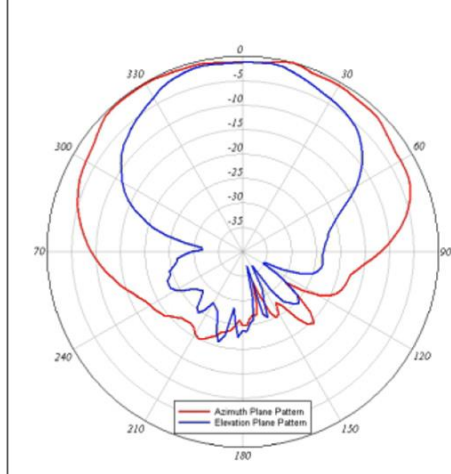

**Azimuth and Elevation Radiation Patterns  
Left Center Antenna - 2.4 GHz Band**

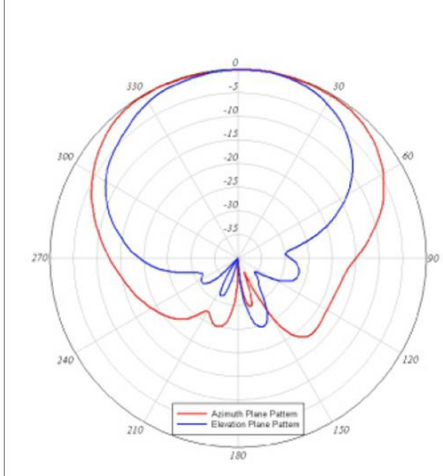

**Azimuth and Elevation Radiation Patterns  
Left Center Antenna - 5 GHz Band**

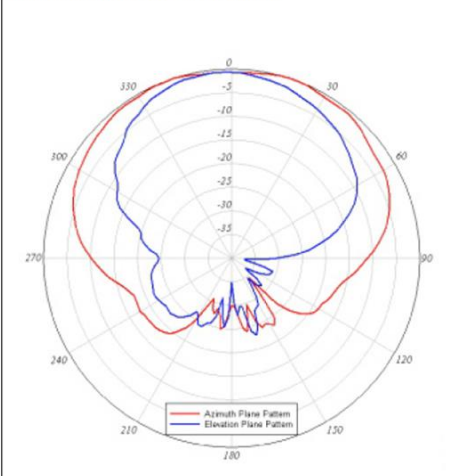

**Azimuth and Elevation Radiation Patterns  
Right Antenna - 2.4 GHz Band**

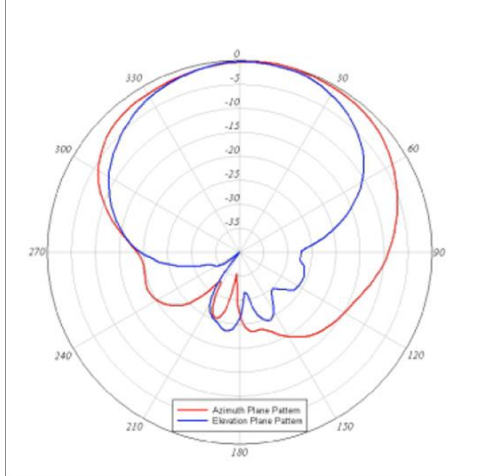

**Azimuth and Elevation Radiation Patterns  
Right Antenna - 5 GHz Band**

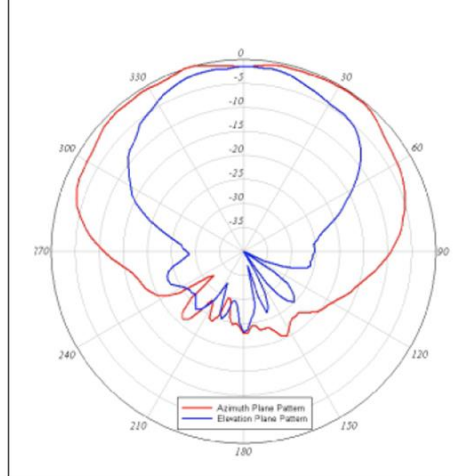

**Azimuth and Elevation Radiation Patterns  
Right Antenna - 2.4 GHz Band**

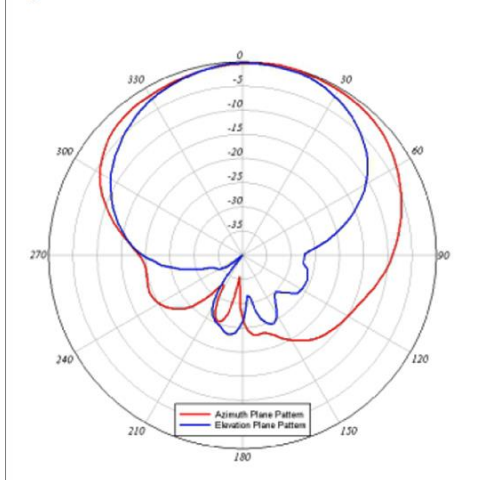

**Azimuth and Elevation Radiation Patterns  
Right Antenna - 5 GHz Band**

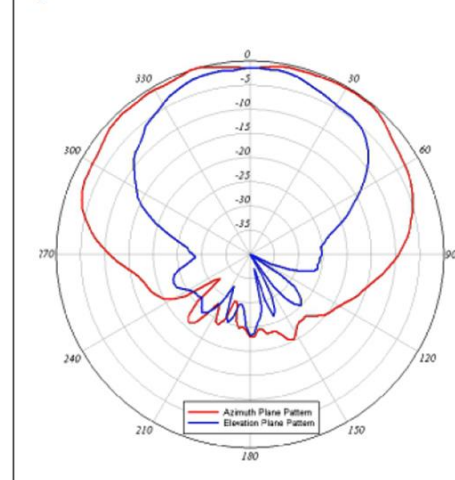

<b>Frequency Range</b>	2.400 - 2.484 GHz 5.150 - 5.850 GHz
<b>VSWR</b>	2:1
<b>Gain</b>	<ul style="list-style-type: none"> <li>• 6 dBi in 2.4 GHz</li> <li>• 6 dBi in 5 GHz</li> </ul>
<b>Polarization</b>	Linear
<b>Azimuth 3dB Beamwidth</b>	<ul style="list-style-type: none"> <li>• 105 degrees in 2.4 GHz</li> <li>• 125 degrees in 5 GHz</li> </ul>
<b>Elevations 3dB Beamwidth</b>	<ul style="list-style-type: none"> <li>• 70 degrees in 2.4 GHz</li> <li>• 60 degrees in 5 GHz</li> </ul>
<b>Antenna Connector</b>	(4) RP-TNC male
<b>Cable Length</b>	36 in (91 cm) plenum rated
<b>Dimensions</b>	11 x 6.3 x 1.2 in (28 x 16 x 3 cm)
<b>Mounting</b>	Wall

## 2 dBi Direct Mount Omnidirectional AIR-ANT2420V-N



Dimensions and Mounting Specifications	
Frequency Range	2.4-2.5 GHz
VSWR	<2:1
Gain	2 dBi
Polarization	Linear, Vertical
Azimuth 3dB Beamwidth	Omni
Elevations 3dB Beamwidth	TBD degrees
Antenna Connector	N-male
Cable Length	None
Dimensions	5 in. x 1 in. (12.7 cm x 2.54 cm)
Mounting	Direct Mount
Wind Rating (Operational)	125 mph
Wind Rating (Survival)	165 mph

5 dBi Direct Mount Omnidirectional  
AIR-ANT2450V-N



Dimensions and Mounting Specifications	Azimuth Plane Radiation Pattern	Elevation Plane Radiation Pattern
<b>Frequency Range</b>	2.4-2.5 GHz	
<b>VSWR</b>	1:7:1	
<b>Gain</b>	5dBi	
<b>Polarization</b>	Linear, Vertical	
<b>Azimuth 3dB Beamwidth</b>	Omni	
<b>Elevations 3dB Beamwidth</b>	30 degrees	
<b>Antenna Connector</b>	N-male	
<b>Cable Length</b>	None	
<b>Dimensions</b>	11 in. x 1 in. (27.93 cm x 2.54 cm)	
<b>Mounting</b>	Direct Mount	
<b>Wind Rating (Operational)</b>	125 mph	
<b>Wind Rating (Survival)</b>	165 mph	

5.5 dBi Omnidirectional  
AIR-ANT2455V-N



Dimensions and Mounting Specifications	Azimuth Plane Radiation Pattern	Elevation Plane Radiation Pattern
<b>Frequency Range</b>	2.4-2.83 GHz	
<b>VSWR</b>	2:1 or better	
<b>Gain</b>	5.5 dBi	
<b>Polarization</b>	Linear	
<b>Azimuth Plane</b>	Omnidirectional	
<b>Elevation Plane</b>	25 degrees	
<b>Connectors</b>	N	
<b>Cable Length</b>	None	
<b>Dimensions</b>	12.5 in. x 1 in. (31.75 cm x 2.54 cm)	
<b>Mounting</b>	Direct Mount	

8 dBi Omnidirectional  
AIR-ANT2480V-N

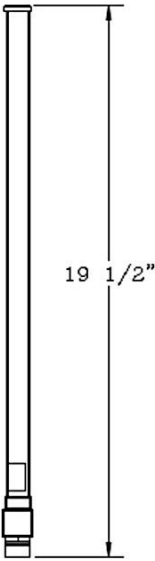
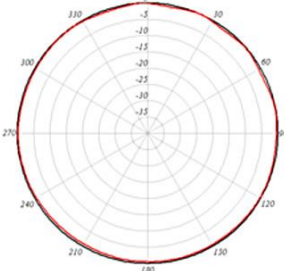
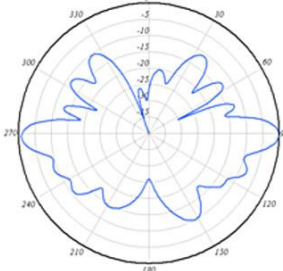

Dimensions and Mounting Specifications	Azimuth Plane Radiation Pattern	Elevation Plane Radiation Pattern
		
<b>Frequency Range</b>	2.4-2.5 GHz	
<b>VSWR</b>	1:6:1	
<b>Gain</b>	8 dBi	
<b>Polarization</b>	Linear, Vertical	
<b>Azimuth 3dB Beamwidth</b>	10 degrees	
<b>Elevations Plan (3dB Beamwidth)</b>	Omnidirectional	
<b>Antenna Connector</b>	N-male	
<b>Cable Length</b>	None	
<b>Dimensions</b>	19.5 in. x 7/8 in. (49.52 cm x 2.22 cm)	
<b>Mounting</b>	Direct Mount	
<b>Wind Rating (operational)</b>	100 mph	
<b>Wind Rating (survival)</b>	165 mph	

**13 dBi Dual Port Patch**  
**AIR-ANT2413P2M-N=**



Azimuth/Elevation Radiation Pattern	
<b>Frequency Range</b>	2.400 - 2.484 GHz
<b>VSWR</b>	2:1
<b>Gain</b>	13 dBi
<b>Polarization</b>	Linear, dual
<b>Azimuth 3dB Beamwidth</b>	30 degrees
<b>Elevations Plane (3dB Beamwidth)</b>	30 degrees
<b>Antenna Connector</b>	(2) right angle N-male
<b>Cable Length</b>	30 inches
<b>Dimensions</b>	7.8 x 7.8 x 1.2 in. (19.8 x 19.8 x 3 cm)
<b>Mounting</b>	Wall/Mast

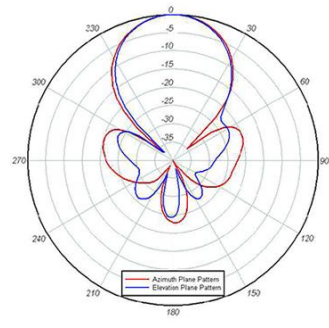

3344627



4 dBi Direct Mount Omnidirectional  
**AIR-ANT5140V-N**



Dimensions and Mounting Specifications	
Frequency Range	5.25 - 5.875 GHz
VSWR	<2:1
Gain	4 dBi
Polarization	Linear, Vertical
Azimuth 3dB Beamwidth	Omni
Elevations 3dB Beamwidth	TBD degrees
Antenna Connector	N-male
Cable Length	None
Dimensions	5 in. x 1 in. (12.7 cm x 2.54 cm)
Mounting	Direct Mount
Wind Rating (Operational)	125 mph
Wind Rating (Survival)	165 mph

7.5 dBi Omnidirectional  
AIR-ANT5175V-N

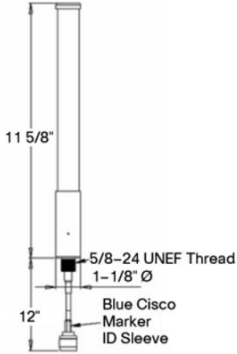
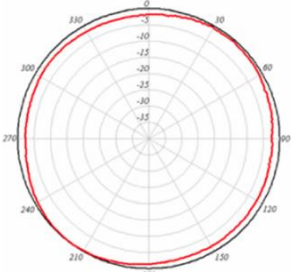
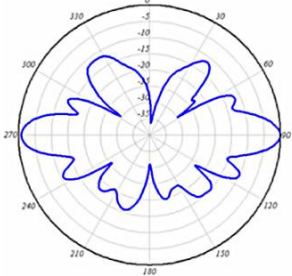

Dimensions and Mounting Specifications	Azimuth Plane Radiation Pattern	Elevation Plane Radiation Pattern
		
<b>Frequency Range</b>	4.9-5.8 GHz	
<b>VSWR</b>	2:1 or better	
<b>Gain</b>	7.5 dBi for 5GHz bands. 6 dBi for 4.9GHz bands.	
<b>Polarization</b>	Linear	
<b>Azimuth Plane</b>	Omnidirectional	
<b>Elevation Plane</b>	16 degrees	
<b>Connectors</b>	N	
<b>Cable Length</b>	1 ft. (0.30 m)	
<b>Dimensions</b>	11.65 in. x 1 in. (29.5 cm x 2.54 cm)	
<b>Mounting</b>	Direct Mount	

8 dBi Direct Mount Omnidirectional  
AIR-ANT5180V-N



Dimensions and Mounting Specifications	Azimuth Plane Radiation Pattern	Elevation Plane Radiation Pattern
<b>Frequency Range</b>	4.9-5.85 GHz	
<b>VSWR</b>	1:7:1	
<b>Gain</b>	8 dBi	
<b>Polarization</b>	Linear, Vertical	
<b>Azimuth 3dB Beamwidth</b>	Omnidirectional	
<b>Elevations Plane (3dB Beamwidth)</b>	16 degrees	
<b>Antenna Connector</b>	N-male	
<b>Cable Length</b>	None	
<b>Dimensions</b>	11 in. x 1 in. (27.93 cm x 2.54 cm)	
<b>Mounting</b>	Direct Mount	
<b>Wind Rating (operational)</b>	125 mph	
<b>Wind Rating (survival)</b>	165 mph	

9 dBi MAST Mount Omnidirectional  
AIR-ANT58G9VOA-N

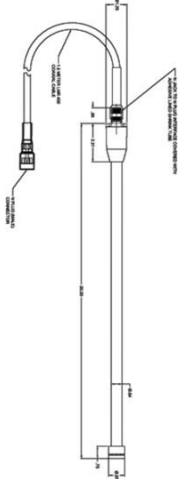
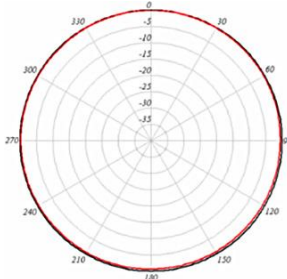
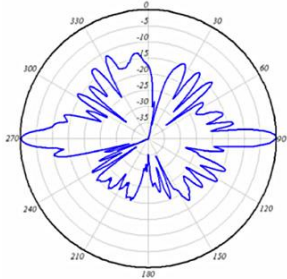

Dimensions and Mounting Specifications	Azimuth Plane Radiation Pattern	Elevation Plane Radiation Pattern
		
<b>Frequency Range</b>	5.725-5.825 GHz	
<b>Antenna Connector</b>	N-Male	
<b>VSWR</b>	1.5:1 Nominal	
<b>Maximum Power</b>	4 watts	
<b>Gain</b>	9 dBi	
<b>Polarization</b>	Vertical	
<b>Dimensions</b>	20.25 in x .64 in.	
<b>Cable Length</b>	4.9 ft. (1.5 m)	
<b>Mounting</b>	1.5-2.5 in. Mast Mount	
<b>Azimuth 3dB Beamwidth</b>	Omnidirectional	
<b>Wind Speed (operational)</b>	100 MPH	
<b>Elevations Plan (3dB Beamwidth)</b>	6 degrees	
<b>Wind Speed (survival)</b>	125 MPH	
<b>Beamtilt</b>		

9.5 dBi Mast Mount Sector  
AIR-ANT58G10SSA-N

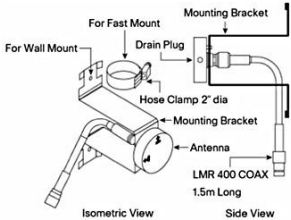
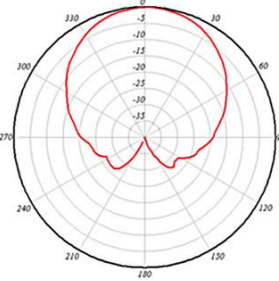
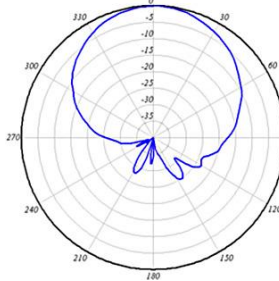

Dimensions and Mounting Specifications	Azimuth Plane Radiation Pattern	Elevation Plane Radiation Pattern
		
<b>Frequency Range</b>	5.725-5.825 GHz	
<b>VSWR</b>	1.5:1 Nominal	
<b>Gain</b>	9.5 dBi	
<b>Polarization</b>	H or V	
<b>Azimuth 3dB Beamwidth</b>	60 degrees	
<b>Elevations Plan (3dB Beamwidth)</b>	60 degrees	
<b>Antenna Connector</b>	N-Male	
<b>Dimensions</b>	4.9 ft. (1.5 m)	
<b>Maximum Power</b>	4 watts	
<b>Temperature (Operating)</b>	-20°F Min, +60°C Max	
<b>Mounting</b>	1.5-2.5 in. Mast Mount	
<b>Wind Speed (Operational)</b>	100 MPH	
<b>Wind Speed (Survival)</b>	125 MPH	

14 dBi Patch  
**AIR-ANT5114P-N**



Dimensions and Mounting Specifications	Azimuth Plane Radiation Pattern	Elevation Plane Radiation Pattern
<b>Frequency Range</b>	4.9-5.85 GHz	
<b>VSWR</b>	2:1	
<b>Gain</b>	<ul style="list-style-type: none"> <li>• 4.9-5.4 GHz: 13 dBi</li> <li>• 5.4-5.85 GHz: 14 dBi</li> </ul>	
<b>Polarization</b>	Linear, Vertical	
<b>Azimuth 3dB Beamwidth</b>	25 degrees	
<b>Elevations Plane (3dB Beamwidth)</b>	29 degrees	
<b>Antenna Connector</b>	N-female	
<b>Cable Length</b>	1 ft. (0.30 m)	
<b>Dimensions</b>	4 1/8 in. x 4 1/8 in. (1.27 cm x 1.27 cm)	
<b>Mounting</b>	Wall/Mast	

14 dBi Dual Port Patch  
**AIR-ANT5114P2M-N=**



Azimuth/Elevation Radiation Pattern	
<b>Frequency Range</b>	5.150 - 5.900 GHz
<b>VSWR</b>	2:1
<b>Gain</b>	14 dBi
<b>Polarization</b>	Linear, dual
<b>Azimuth 3dB Beamwidth</b>	30 degrees
<b>Elevations Plane (3dB Beamwidth)</b>	30 degrees
<b>Antenna Connector</b>	(2) right angle N-male
<b>Cable Length</b>	30 inches
<b>Dimensions</b>	7.8 x 7.8 x 1.2 in. (19.8 x 19.8 x 3 cm)
<b>Mounting</b>	Wall/Mast

17 dBi Sector  
**AIR-ANT5117S-N**



Dimensions and Mounting Specifications	Azimuth Plane Radiation Pattern	Elevation Plane Radiation Pattern
<b>Frequency Range</b>	4.9-5.85 GHz	
<b>VSWR</b>	2:1	
<b>Gain</b>	17 dBi	
<b>Polarization</b>	Linear, Vertical	
<b>Azimuth 3dB Beamwidth</b>	90 degrees	
<b>Elevations Plane (3dB Beamwidth)</b>	8 degrees	
<b>Antenna Connector</b>	N-female	
<b>Cable Length</b>	None	
<b>Dimensions</b>	24 1/2 in. x 2 1/2 in. (30.48 cm x 2.54 cm)	
<b>Mounting</b>	Mast Mount	
<b>Wind Rating (Operational)</b>	125 mph	
<b>Wind Rating (Survival)</b>	165 mph	



28 dBi Mast Mount Dish - 5.8 GHz  
**AIR-ANT58G28SDA-N**



Dimensions and Mounting Specifications	Azimuth Plane Radiation Pattern	Elevation Plane Radiation Pattern
<p>Side View</p>		
<b>Frequency Range</b>	5.725-5.825 GHz	
<b>Wind Speed (survival)</b>	125 MPH	
<b>VSWR</b>	1.5:1 Nominal	
<b>Antenna Connector</b>	N-Male	
<b>Dimensions</b>	4.9 ft (1.5 m)	
<b>Gain</b>	28 dBi	
<b>Maximum Power</b>	4 watts	
<b>Polarization</b>	V or H	
<b>Azimuth 3dB Beamwidth</b>	4.75 degrees	
<b>Mounting</b>	1.5-2.5 in. Mast Mount	
<b>Elevations Plan (3dB BW)</b>	4.75 degrees	
<b>Wind Speed (operational)</b>	100 MPH	
<b>Dimensions</b>	29 in. Diameter	

## Dual Band Omnidirectional AIR-ANT2547V-N/AIR-ANT2547VG-N

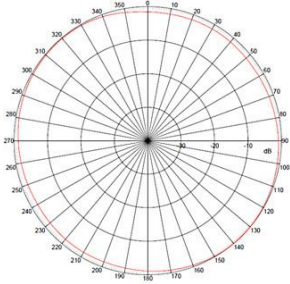
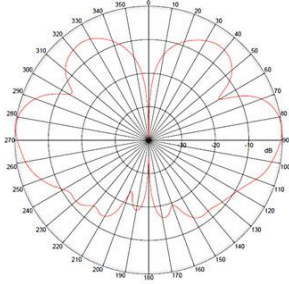
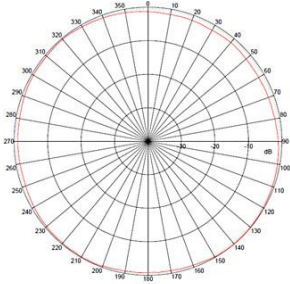
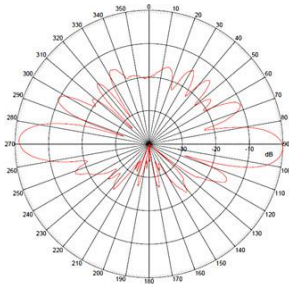
2.4 GHz Azimuth Plane Radiation Pattern	2.4 GHz Elevation Plane Radiation Pattern
	
5 GHz Azimuth Plane Radiation Pattern	5 GHz Elevation Plane Radiation Pattern
	
<b>Frequency Range</b>	2400-2483 MHz 5150 - 5875 MHz
<b>VSWR</b>	2:1
<b>Gain</b>	<ul style="list-style-type: none"> <li>• 4 dBi in 2.4 GHz</li> <li>• 7 dBi in 5 GHz</li> </ul>
<b>Polarization</b>	Linear, vertical
<b>Azimuth 3dB Beamwidth</b>	Omni
<b>Elevations 3dB Beamwidth</b>	<ul style="list-style-type: none"> <li>• 30 degrees in 2.4 GHz</li> <li>• 14 degrees in 5 GHz</li> </ul>
<b>Antenna Connector</b>	N-type male
<b>Cable Length</b>	None
<b>Dimensions</b>	11.1 in. x 1.25 in.dia. (28.2 cm x 3.2 cm dia)
<b>Mounting</b>	Direct Mount
<b>Wind Rating (operational)</b>	100 mph (161 km/h)
<b>Wind Rating (survival)</b>	165 mph (265 km/h)

## 8 dBi Dual Band Patch

**AIR-ANT2588P3M-N=**



<b>Frequency Range</b>	2.400 - 2.500 GHz 5.150 - 5.900 GHz
<b>VSWR</b>	2:1
<b>Gain</b>	8 dBi, both bands
<b>Polarization</b>	Linear, dual (two vertical, one horizontal)
<b>Azimuth 3dB Beamwidth</b>	120 degrees
<b>Elevations Plane (3dB Beamwidth)</b>	30 degrees
<b>Antenna Connector</b>	(3) N-female
<b>Cable Length</b>	None
<b>Dimensions</b>	12 x 7 x 1.1 in. (30.5 x 17.8 x 2.8 cm)
<b>Mounting</b>	Wall/Mast

## Cisco Aironet 1040, 1140, 3500i Series Integrated Antennas\*

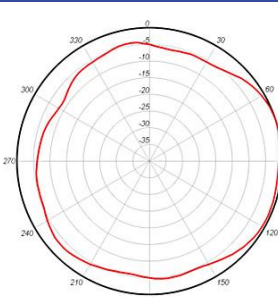
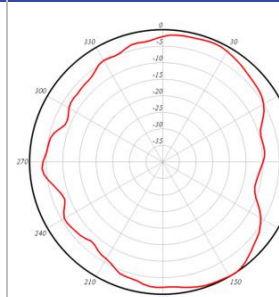
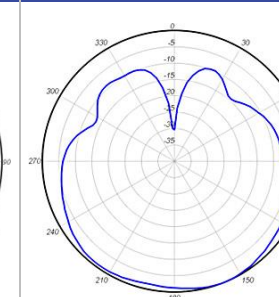
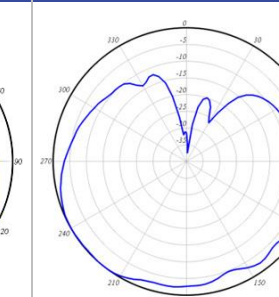

2.4 GHz, 4 dBi Azimuth Plane Radiation Pattern	5 GHz, 3 dBi Azimuth Plane Radiation Pattern	2.4 GHz, 4 dBi Elevation Plane Radiation Pattern	5 GHz, 3 dBi Elevation Plane Radiation Pattern
			
<b>Frequency Range</b>	<ul style="list-style-type: none"> <li>• 2.4-2.5 GHz</li> <li>• 5.15-5.85 GHz</li> </ul>		
<b>Gain</b>	<ul style="list-style-type: none"> <li>• 2.4 GHz: 4 dBi</li> <li>• 5 GHz: 3 dBi</li> </ul>		
<b>Polarization</b>	Linear, Vertical		
<b>Azimuth 3dB Beamwidth</b>	Omnidirectional		
<b>Elevations 3dB Beamwidth</b>	2.4 GHz = 120 degrees, 5 GHz = 120 degrees		
<b>Antenna Connector</b>	Integrated		
<b>Mounting</b>	Integrated		
<b>Antenna Type</b>	Omnidirectional		

**Note:** Same integrated antennas used on these devices but AP-1040 only has two elements per band

## Cisco Aironet OEAP600 Series Integrated Antenna



2.4 GHz, 4 dBi Azimuth Plane Radiation Pattern	5 GHz, 3 dBi Azimuth Plane Radiation Pattern	2.4 GHz, 4 dBi Elevation Plane Radiation Pattern	5 GHz, 3 dBi Elevation Plane Radiation Pattern
<b>Frequency Range</b>	<ul style="list-style-type: none"> <li>• 2.4-2.5 GHz</li> <li>• 5.15-5.85 GHz</li> </ul>		
<b>Gain</b>	<ul style="list-style-type: none"> <li>• 2.4 GHz: 2 dBi</li> <li>• 5 GHz: 2 dBi</li> </ul>		
<b>Polarization</b>	Linear, Vertical		
<b>Azimuth 3dB Beamwidth</b>	Omnidirectional		
<b>Elevations 3dB Beamwidth</b>	2.4 GHz = 120 degrees, 5 GHz = 120 degrees		
<b>Antenna Connector</b>	Integrated		
<b>Mounting</b>	Integrated		
<b>Antenna Type</b>	Omnidirectional		

## Cisco Aironet 3600i Series Integrated Antennas

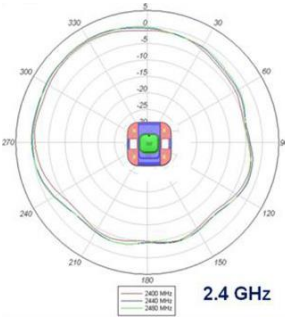
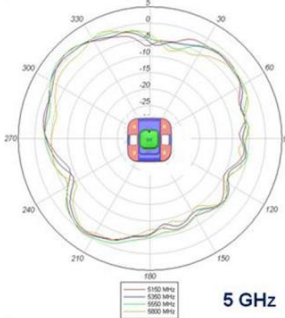
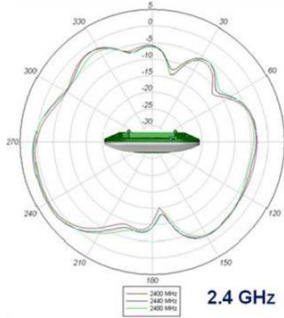
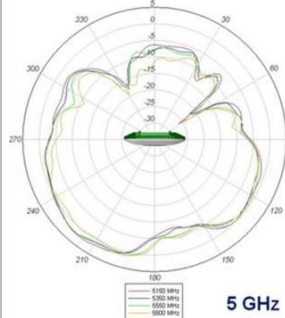

2.4 GHz, Azimuth Plane Radiation Pattern	5 GHz, Azimuth Plane Radiation Pattern	2.4 GHz, Elevation Plane Radiation Pattern	5 GHz, Elevation Plane Radiation Pattern
 <p style="text-align: center;"><b>2.4 GHz</b></p>	 <p style="text-align: center;"><b>5 GHz</b></p>	 <p style="text-align: center;"><b>2.4 GHz</b></p>	 <p style="text-align: center;"><b>5 GHz</b></p>
<b>Frequency Range</b>	<ul style="list-style-type: none"> <li>• 2.4-2.5 GHz</li> <li>• 5.15-5.85 GHz</li> </ul>		
<b>Gain</b>	<ul style="list-style-type: none"> <li>• 2.4 GHz: 2 dBi</li> <li>• 5 GHz: 5 dBi</li> </ul>		
<b>Polarization</b>	Linear, Vertical		
<b>Azimuth 3dB Beamwidth</b>	Omnidirectional		
<b>Elevations 3dB Beamwidth</b>	2.4 GHz = 120 degrees, 5 GHz = 120 degrees		
<b>Antenna Connector</b>	Integrated		
<b>Mounting</b>	Integrated		
<b>Antenna Type</b>	Omnidirectional		

## Cisco Aironet 2600i Series Integrated Antennas



2.4 GHz, Azimuth Plane Radiation Pattern	5 GHz, Azimuth Plane Radiation Pattern	2.4 GHz, Elevation Plane Radiation Pattern	5 GHz, Elevation Plane Radiation Pattern
<b>Frequency Range</b>		<ul style="list-style-type: none"> <li>• 2.4-2.5 GHz</li> <li>• 5.15-5.85 GHz</li> </ul>	
<b>Gain</b>		<ul style="list-style-type: none"> <li>• 2.4 GHz: 4 dBi</li> <li>• 5 GHz: 4 dBi</li> </ul>	
<b>Polarization</b>		Linear, Vertical	
<b>Azimuth 3dB Beamwidth</b>		Omnidirectional	
<b>Elevations 3dB Beamwidth</b>		2.4 GHz = 120 degrees, 5 GHz = 120 degrees	
<b>Antenna Connector</b>		Integrated	
<b>Mounting</b>		Integrated	
<b>Antenna Type</b>		Omnidirectional	

## Cisco Aironet 1600i Series Integrated Antennas



2.4 GHz, Azimuth Plane Radiation Pattern	5 GHz, Azimuth Plane Radiation Pattern	2.4 GHz, Elevation Plane Radiation Pattern	5 GHz, Elevation Plane Radiation Pattern
<b>Frequency Range</b>		<ul style="list-style-type: none"> <li>• 2.4-2.5 GHz</li> <li>• 5.15-5.85 GHz</li> </ul>	
<b>Gain</b>		<ul style="list-style-type: none"> <li>• 2.4 GHz: 4 dBi</li> <li>• 5 GHz: 4 dBi</li> </ul>	
<b>Polarization</b>		Linear, Vertical	
<b>Azimuth 3dB Beamwidth</b>		Omnidirectional	
<b>Elevations 3dB Beamwidth</b>		2.4 GHz = 120 degrees, 5 GHz = 120 degrees	
<b>Antenna Connector</b>		Integrated	
<b>Mounting</b>		Integrated	
<b>Antenna Type</b>		Omnidirectional	



## Cisco Aironet 3700i Series Integrated Antennas



2.4 GHz, Azimuth Plane Radiation Pattern	5 GHz, Azimuth Plane Radiation Pattern	2.4 GHz, Elevation Plane Radiation Pattern	5 GHz, Elevation Plane Radiation Pattern
			
<b>Frequency Range</b>	<ul style="list-style-type: none"> <li>• 2.4-2.5 GHz</li> <li>• 5.15-5.85 GHz</li> </ul>		
<b>Gain</b>	<ul style="list-style-type: none"> <li>• 2.4 GHz: 4 dBi</li> <li>• 5 GHz: 6 dBi</li> </ul>		
<b>Polarization</b>	Linear, Vertical		
<b>Azimuth 3dB Beamwidth</b>	Omnidirectional		
<b>Elevations 3dB Beamwidth</b>	2.4 GHz = 120 degrees, 5 GHz = 120 degrees		
<b>Antenna Connector</b>	Integrated		
<b>Mounting</b>	Integrated		
<b>Antenna Type</b>	Omnidirectional		

## Cisco Aironet 2700i Series Integrated Antennas



2.4 GHz, Azimuth Plane Radiation Pattern	5 GHz, Azimuth Plane Radiation Pattern	2.4 GHz, Elevation Plane Radiation Pattern	5 GHz, Elevation Plane Radiation Pattern
<b>Frequency Range</b>	<ul style="list-style-type: none"> <li>• 2.4-2.5 GHz</li> <li>• 5.15-5.85 GHz</li> </ul>		
<b>Gain</b>	<ul style="list-style-type: none"> <li>• 2.4 GHz: 4 dBi</li> <li>• 5 GHz: 6 dBi</li> </ul>		
<b>Polarization</b>	Linear, Vertical		
<b>Azimuth 3dB Beamwidth</b>	Omnidirectional		
<b>Elevations 3dB Beamwidth</b>	2.4 GHz = 120 degrees, 5 GHz = 120 degrees		
<b>Antenna Connector</b>	Integrated		
<b>Mounting</b>	Integrated		
<b>Antenna Type</b>	Omnidirectional		

## Cisco Aironet 1550 Series Integrated Antenna



2.4 GHz, 4 dBi Azimuth Plane Radiation Pattern	5 GHz, 3 dBi Azimuth Plane Radiation Pattern	2.4 GHz, 4 dBi Elevation Plane Radiation Pattern	5 GHz, 3 dBi Elevation Plane Radiation Pattern
<b>Frequency Range</b>		<ul style="list-style-type: none"> <li>• 2.4-2.5 GHz</li> <li>• 5.15-5.85 GHz</li> </ul>	
<b>Gain</b>		<ul style="list-style-type: none"> <li>• 2.4 GHz: 2 dBi</li> <li>• 5 GHz: 4 dBi</li> </ul>	
<b>Polarization</b>		Linear, Vertical	
<b>Azimuth 3dB Beamwidth</b>		Omnidirectional	
<b>Elevations 3dB Beamwidth</b>		2.4 GHz = 120 degrees, 5 GHz = 120 degrees	
<b>Antenna Connector</b>		Integrated	
<b>Mounting</b>		Integrated	
<b>Antenna Type</b>		Omnidirectional	

## Cisco Aironet 1530 Series Integrated Antenna



2.4 GHz, 3 dBi Azimuth Plane Radiation Pattern	5 GHz, 5 dBi Azimuth Plane Radiation Pattern	2.4 GHz, 3 dBi Elevation Plane Radiation Pattern	5 GHz, 5 dBi Elevation Plane Radiation Pattern
<b>Frequency Range</b>		<ul style="list-style-type: none"> <li>• 2.4-2.5 GHz</li> <li>• 5.15-5.85 GHz</li> </ul>	
<b>Gain</b>		<ul style="list-style-type: none"> <li>• 2.4 GHz: 3 dBi</li> <li>• 5 GHz: 5 dBi</li> </ul>	
<b>Polarization</b>		Linear, Vertical	
<b>Antenna Connector</b>		Integrated	
<b>Mounting</b>		Integrated	
<b>Antenna Type</b>		Omnidirectional	



Americas Headquarters  
Cisco Systems, Inc.  
San Jose, CA

Asia Pacific Headquarters  
Cisco Systems (USA) Pte. Ltd.  
Singapore

Europe Headquarters  
Cisco Systems International BV Amsterdam,  
The Netherlands

Cisco has more than 200 offices worldwide. Addresses, phone numbers, and fax numbers are listed on the Cisco Website at [www.cisco.com/go/offices](http://www.cisco.com/go/offices).

Cisco and the Cisco logo are trademarks or registered trademarks of Cisco and/or its affiliates in the U.S. and other countries. To view a list of Cisco trademarks, go to this URL: [www.cisco.com/go/trademarks](http://www.cisco.com/go/trademarks). Third party trademarks mentioned are the property of their respective owners. The use of the word partner does not imply a partnership relationship between Cisco and any other company. (1110R)