

IE200 Series

Industrial Ethernet Switches

- AT-IE200-6GT
- AT-IE200-6GP
- AT-IE200-6FT
- AT-IE200-6FP



Installation Guide

Copyright © 2014 Allied Telesis, Inc.

All rights reserved. No part of this publication may be reproduced without prior written permission from Allied Telesis, Inc.

Allied Telesis and the Allied Telesis logo are trademarks of Allied Telesis, Incorporated. All other product names, company names, logos or other designations mentioned herein are trademarks or registered trademarks of their respective owners.

Allied Telesis, Inc. reserves the right to make changes in specifications and other information contained in this document without prior written notice. The information provided herein is subject to change without notice. In no event shall Allied Telesis, Inc. be liable for any incidental, special, indirect, or consequential damages whatsoever, including but not limited to lost profits, arising out of or related to this manual or the information contained herein, even if Allied Telesis, Inc. has been advised of, known, or should have known, the possibility of such damages.

Electrical Safety and Emissions Standards

U.S. Federal Communications Commission

Interference Statement

This device complies with part 15 of the FCC Rules. Operation is subject to the following two conditions: (1) This device may not cause harmful interference, and (2) this device must accept any interference received, including interference that may cause undesired operation.

This equipment has been tested and found to comply with the limits for a Class A digital device, pursuant to part 15 of the FCC Rules. These limits are designed to provide reasonable protection against harmful interference in a controlled environment, such as a cabinet, hut or telecom closet. This equipment generates, uses and can radiate radio frequency energy and, if not installed and used in accordance with the instruction manual, may cause harmful interference to radio communications. However, there is no guarantee that interference will not occur in a particular installation. If this equipment does cause harmful interference to radio or television reception, which can be determined by turning the equipment off and on, the user is encouraged to try to correct the interference by one or more of the following measures:

- Reorient or relocate the receiving antenna.
- Increase the separation between the equipment and receiver.
- Connect the equipment into an outlet on a circuit different from that to which the receiver is connected.
- Consult the dealer or an experienced radio/TV technician for help.

The Federal Communications Commission warns that changes or modifications of the unit not expressly approved by the party responsible for compliance could void the user's authority to operate the equipment and any assurances of safety or performance, and could result in violation of part 15 of the FCC Rules.

Industry Canada

This Class A digital apparatus complies with Canadian ICES-003.

Cet appareil numérique de la classe A est conforme à la norme NMB-003 du Canada.

This equipment complies with radio frequency exposure limits set forth by Industry Canada for a controlled environment.

Cet équipement est conforme aux limites d'exposition aux radiofréquences définies par Industrie Canada pour un environnement contrôlé.

**European Union Restriction of the Use of Certain Hazardous Substances
(RoHS) in Electrical and Electronic Equipment**

This Allied Telesis RoHS-compliant product conforms to the European Union Restriction of the Use of Certain Hazardous Substances (RoHS) in Electrical and Electronic Equipment. Allied Telesis ensures RoHS conformance by requiring supplier Declarations of Conformity, monitoring incoming materials, and maintaining manufacturing process controls.

RFI Emissions

FCC Part 15B Class A
EN55022:2010 Class A
EN61000-3-2:2006+A1:2009+A2:2009
EN61000-3-3:2008
VCCI- Class A

RFI Immunity

EN55024:2010
EN61000-4-2:2009
EN61000-4-3:2006 + A2:2010
EN61000-4-4:2012
EN61000-4-5:2006
EN61000-4-6:2009
EN61000-4-8:2010
EN61000-4-11:2004

Electrical Safety

UL/E/IEC60950-1
CSA 22.2:60950-1
2006/95/EC Low Voltage Directive

All Allied Telesis approved SFP modules

EN60825-1
EN60825-2
EN/IEC/UL60950-1
FCC CDRH registered

Translated Safety Statements

Important: The  indicates that a translation of the safety statement is available in a PDF document titled “Translated Safety Statements” on the Allied Telesis web site at <http://www.alliedtelesis.com/support>.

Contents

Preface	10
Document Conventions	11
Contacting Allied Telesis	12
Chapter 1: Overview	13
Features	14
IE200 Models.....	14
Twisted Pair Ports	14
Power Over Ethernet.....	14
SFP Slots.....	14
Alarm Ports.....	15
LEDs.....	15
Installation Options	15
MAC Address Table.....	15
Management Software and Interfaces	15
Management Methods.....	16
Front Panels.....	17
Top Panels.....	19
10/100Base-T Twisted Pair Ports	21
Speed	21
Duplex Mode	21
Wiring Configuration.....	21
Maximum Distance.....	21
Power Over Ethernet.....	22
Cable Requirements.....	22
Port Pinouts	22
10/100/1000Base-T Twisted Pair Ports.....	23
Speed	23
Duplex Mode	23
Wiring Configuration.....	23
Maximum Distance.....	24
Power Over Ethernet.....	24
Cable Requirements.....	24
Port Pinouts	24
SFP Slots	25
Power Over Ethernet.....	26
PoE Standards.....	26
Powered Device Classes.....	26
Power Budget.....	27
Port Prioritization.....	27
Wiring Implementation	28
Alarms.....	29
Alarm Input	29
Alarm Output	29
LEDs	30
Status LEDs	30

Twisted Pair Port LEDs.....	31
SFP LEDs.....	33
Console Port.....	35
Power Supplies.....	36
Chapter 2: Beginning the Installation	37
Reviewing Safety Precautions	38
Selecting a Site for the Switch	41
Unpacking the Switch	42
Chapter 3: Installing the Switch on a DIN Rail or Wall Mount	43
Installing the Switch on a DIN Rail.....	44
Installing the Switch on a Wall Mount.....	46
Chapter 4: Cabling the Networking Ports	48
Cabling the Twisted Pair Ports	49
Installing SFP Transceivers.....	51
Chapter 5: Powering on the Switch	55
Connecting the Power	56
Connecting the Ground Wiring.....	57
Monitoring the Initialization Processes	58
Starting a Management Session	59
Local Management	59
Telnet Management.....	59
Secure Shell Management	60
Web Browser Management	60
SNMP	60
Starting a Local Management Session	61
Specifying Ports in the Command Line Interface.....	62
Chapter 6: Troubleshooting	63
Appendix A: Technical Specifications	66
Physical Specifications.....	66
Environmental Specifications	67
Power Specifications	67
Certifications	68
RJ-45 Twisted Pair Port Pinouts	68
RJ-45 Style Serial Console Port Pinouts.....	69

Figures

- Figure 1: Front panel of the AT-IE200-6GT switch..... 17
- Figure 2: Front panel of the AT-IE200-6GP switch..... 18
- Figure 3: Top panel of the AT-IE200-6GT and AT-IE200-6FT switches..... 19
- Figure 4: Top panel of the AT-IE200-6GP and AT-IE200-6FP switches. 20
- Figure 5: Status LEDs 30
- Figure 6: Port LEDs on the AT-IE200-6FT and AT-IE200-6GT switches..... 31
- Figure 7: Port LEDs on the AT-IE200-6FP and AT-IE200-6GP switches..... 32
- Figure 8: SFP Link/Activity LEDs..... 34
- Figure 9: Attaching the switch to a DIN rail. 44
- Figure 10: Attaching the wall mount brackets. 46
- Figure 11: Spacing between mounting holes..... 47
- Figure 12: Removing the dust plug from an SFP slot. 51
- Figure 13: Installing an SFP transceiver. 52
- Figure 14: Removing the dust cover from an SFP transceiver. 53
- Figure 15: Connecting a fiber optic cable to an SFP transceiver. 54
- Figure 16: RJ-45 Socket Pin Layout (Front View)..... 69

Tables

Table 1: Twisted Pair Cable Requirements for the 10/100Base-T Ports.....	22
Table 2: Twisted Pair Cable Requirements for the 10/100/1000Base-T Ports	24
Table 3: IEEE Powered Device Classes.....	26
Table 4: SFP Link/Activity LED Descriptions.....	30
Table 5: Port LED Descriptions for the AT-IE200-6GT and AT-IE200-6FT Switches	31
Table 6: Port LED Descriptions for the AT-IE200-6GP and AT-IE200-6FP Switches	33
Table 7: SFP Link/Activity LED Descriptions.....	34
Table 8: Product Dimensions.....	66
Table 9: Product Weights	66
Table 10: Ventilation Requirements for Cabinet Installation.....	66
Table 11: Ventilation Requirements for Wall Mount Installation.....	67
Table 12: Cabinet Dimensions.....	67
Table 13: Environmental Specifications.....	67
Table 14: Maximum Power Consumptions.....	67
Table 15: Input Voltages.....	68
Table 16: Product Certifications	68
Table 17: Pin Signals for 10 and 100 Mbps.....	69
Table 18: Pin Signals for 1000 Mbps	69
Table 19: RJ-45 Style Serial Console Port Pin Signals.....	70

Preface

This guide contains instructions on how to install the IE200 series models. This preface contains the following sections:

- ❑ “Document Conventions” on page 11
- ❑ “Contacting Allied Telesis” on page 12

Document Conventions

This document uses the following conventions:

Note

Notes provide additional information.



Caution

Cautions inform you that performing or omitting a specific action may result in equipment damage or loss of data.



Warning

Warnings inform you that performing or omitting a specific action may result in bodily injury.



Warning

Warnings inform you that an eye and skin hazard exists due to the presence of a Class I Laser device.



Warning

Warnings inform you that a surface may be hot.

Contacting Allied Telesis

If you need assistance with this product, you may contact Allied Telesis technical support by going to the Support & Services section of the Allied Telesis web site at <http://www.alliedtelesis.com/support>. You can find links for the following services on this page:

- ❑ 24/7 Online Support - Enter our interactive support center to search for answers to your questions in our knowledge database, check support tickets, learn about Return Merchandise Authorization (RMA), and contact Allied Telesis technical experts.
- ❑ USA and EMEA phone support - Select the phone number that best fits your location and customer type.
- ❑ Hardware warranty information - Learn about Allied Telesis warranties and register your product online.
- ❑ Replacement Services - Submit an RMA request via our interactive support center.
- ❑ Documentation - View the most recent installation guides, user guides, software release notes, white papers and data sheets for your product.
- ❑ Software Updates - Download the latest software releases for your managed products. Some products require an account to access the restricted software site.

For sales or corporate contact information, go to <http://www.alliedtelesis.com/purchase> and select your region.

Chapter I

Overview

The IE200 Industrial Ethernet Switch provides managed layer two connectivity. This chapter provides an overview of the device's features and includes the following sections:

- ❑ “Features” on page 14
- ❑ “Front Panels” on page 17
- ❑ “Top Panels” on page 19
- ❑ “10/100Base-T Twisted Pair Ports” on page 21
- ❑ “10/100/1000Base-T Twisted Pair Ports” on page 23
- ❑ “SFP Slots” on page 25
- ❑ “Power Over Ethernet” on page 26
- ❑ “Alarms” on page 29
- ❑ “LEDs” on page 30
- ❑ “Console Port” on page 35
- ❑ “Power Supplies” on page 36

Features

IE200 Models

The IE200 models are:

- AT-IE200-6FP
- AT-IE200-6FT
- AT-IE200-6GP
- AT-IE200-6GT

Twisted Pair Ports

The IE200 includes “G” and “F” models. The “F” models support 10/100 Mbps twisted pair ports. The “G” models support 10/100/1000 twisted pair ports.

- 4 ports per switch
- 10Base-T, 100Base-T, and 1000Base-T compliant
- IEEE 802.3u Auto-Negotiation compliant
- Auto-MDI/MDIX
- 100 meters (328 feet) maximum operating distance
- IEEE 802.3x flow control in 10/100Base-T full-duplex mode
- IEEE 802.3x backpressure in 10/100Base-T half-duplex mode
- IEEE 802.3ab 1000Base-T
- Jumbo frames up to 9KB
- RJ-45 connectors

Power Over Ethernet

The AT-IE200-6GP and AT-IE200-6FP models support Power over Ethernet (PoE) on the twisted pair ports.

- Supports PoE (15.4 watts maximum) and PoE+ (30 watts maximum) powered devices
- Supports powered device classes 0 to 4
- Maximum power budget of 120 watts
- Port prioritization
- Mode A wiring

SFP Slots

The IE200 contains two SFP slots. Each slot supports:

- 100Base-FX and 1000Base-SX/LX SFP transceivers

- Single-port BiDi 1000Base-LX SFP transceivers
- 1000Base-ZX SFP transceivers
- 1000Base-T twisted pair transceivers

Note

SFP transceivers must be purchased separately. For a list of supported transceivers, contact your Allied Telesis distributor or reseller.

Alarm Ports

The IE200 contains two alarm ports: One for alarm input and one for alarm output.

LEDs

The IE200 contains LEDs to report device status and link/activity port LEDs.

- Link/activity and duplex mode LEDs for the twisted pair ports on non-PoE switches
- Link/activity and PoE status LEDs for the twisted pair ports on PoE switches
- Link/activity LEDs for SFP slots
- Status LEDs for fault alarms and both power supplies

Installation Options

There are two installation options for the IE200:

- DIN rail standard EN 50022
- Wall mount

MAC Address Table

IE200 MAC address tables support:

- Storage capacity of 4,000 MAC address entries
- Automatic learning and aging

Management Software and Interfaces

The IE200 supports the following management software and interfaces:

- AlliedWare Plus management software
- Command line interface
- Web browser interface

Management Methods

You can manage the IE200 in the following ways:

- ❑ Local management through the console port
- ❑ Remote Telnet and secure shell management
- ❑ Remote HTTP and HTTPS web browser management
- ❑ SNMPv1, v2c, and v3

Front Panels

Figure 1 shows the front panel of the AT-IE200-6GT model. The AT-IE200-6FT model is functionally equivalent, but includes 10/100Base-T twisted pair ports.

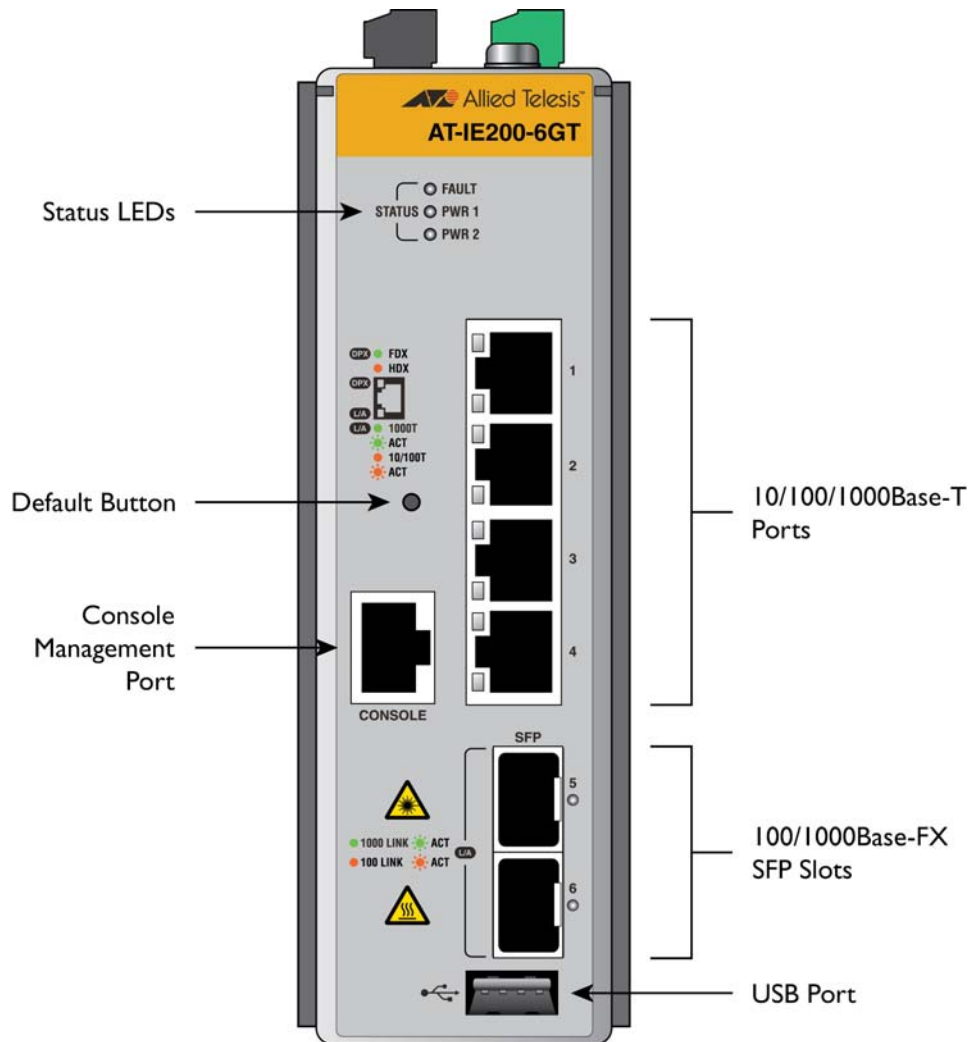

Figure 1: Front panel of the AT-IE200-6GT switch.

Figure 2 shows the front panel of the AT-IE200-6GP model. The AT-IE200-6FP model is functionally equivalent, but includes 10/100Base-T twisted pair ports.

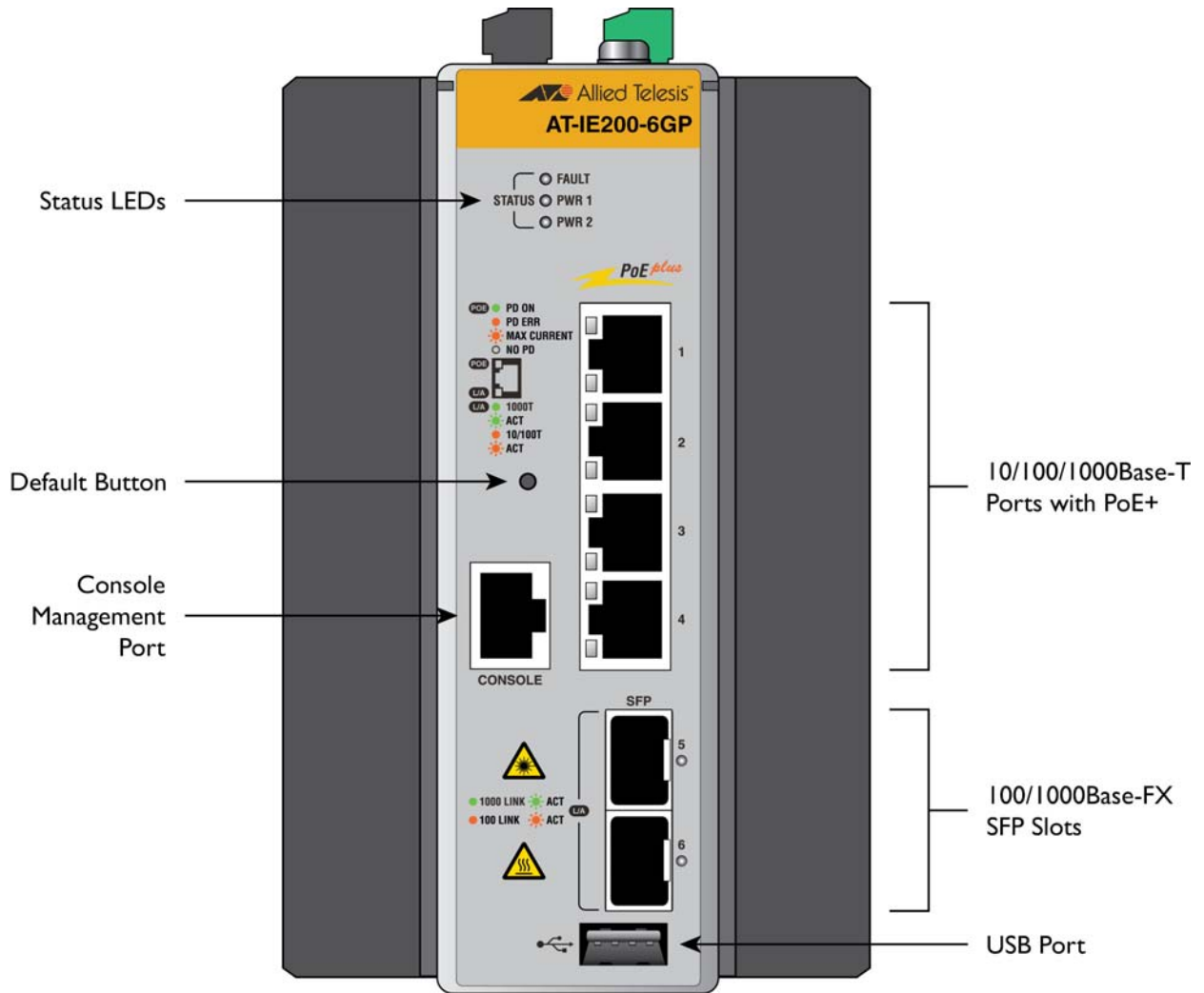

Figure 2: Front panel of the AT-IE200-6GP switch.

Top Panels

Figure 3 shows the top panel of the AT-IE200-6GT and AT-IE200-6FT models. Figure 4 shows the top panel of the AT-IE200-6GP and AT-IE200-6FP models.

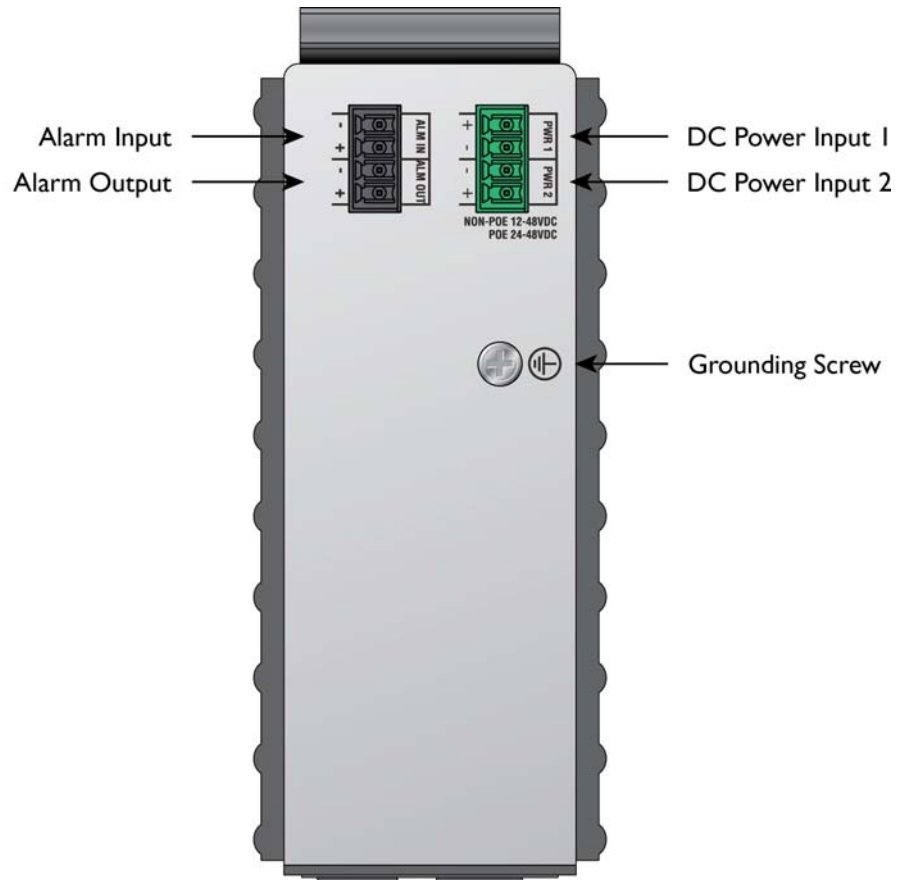

Figure 3: Top panel of the AT-IE200-6GT and AT-IE200-6FT switches.

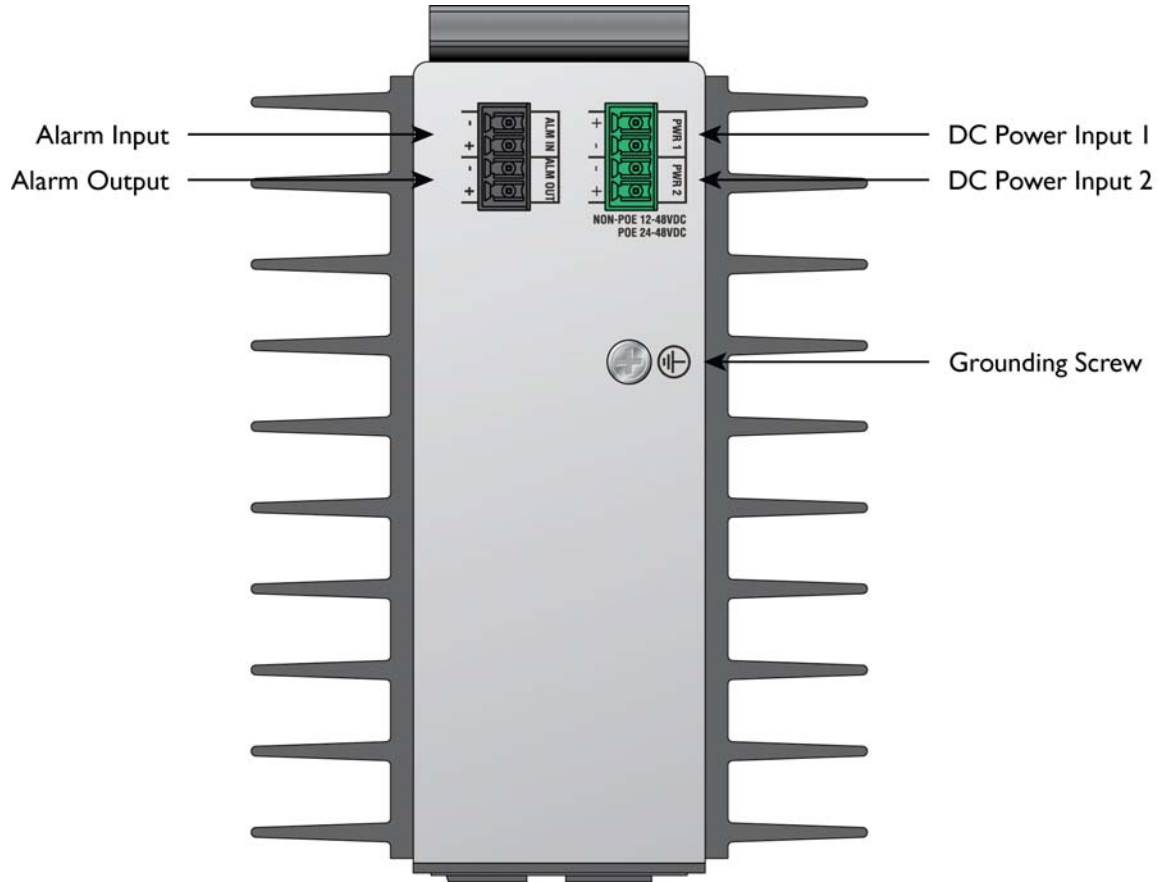

Figure 4: Top panel of the AT-IE200-6GP and AT-IE200-6FP switches.

10/100Base-T Twisted Pair Ports

The AT-IE200-6FT and AT-IE200-6FP switches have four 10/100Base-T ports.

Speed

The ports can operate at either 10 or 100 Mbps. The speeds may be set manually using the management software or automatically with Auto-Negotiation (IEEE 802.3u), the default setting.

Duplex Mode

The twisted pair ports can operate in either half- or full-duplex mode. The duplex mode determines the manner in which a port transmits data. A port set to half-duplex can either transmit or receive data at one time, while a port operating in full-duplex can transmit and receive data at the same time. The best network performance is achieved with the full-duplex setting, but not all network equipment is designed to support that duplex mode.

The duplex modes, like port speeds, may be set manually using the management software or automatically with Auto-Negotiation (IEEE 802.3u), the default setting.

The speed and duplex mode settings of a port may be set independently of each other. For example, a port may be configured such that its speed is set manually while its duplex mode is established through Auto-Negotiation.

Note

A switch port that is connected to a network device that does not support Auto-Negotiation and has a fixed duplex mode of full-duplex should not set its duplex mode with Auto-Negotiation. A duplex-mode mismatch in which a switch port and a network device operate at different duplex modes, may occur. The duplex modes of switch ports that are connected to network devices that do not support Auto-Negotiation should be set manually through the management software.

Wiring Configuration

The wiring configuration of a port can be MDI or MDI-X. The wiring configurations of a switch port and a network device connected with straight-through twisted pair cabling have to be opposite, such that one device is using MDI and the other MDI-X. For instance, a switch port has to be set to MDI-X if it is connected to a network device set to MDI.

You may set the wiring configurations of the ports manually or let the switch configure them automatically with auto-MDI/MDI-X (IEEE 802.3ab-compliant). This feature enables the switch to negotiate with network devices to establish the proper settings, so that the ports on the devices are using different wiring configurations.

Maximum Distance

The ports have a maximum operating distance of 100 meters (328 feet).

Power Over Ethernet

The 10/100Base-T ports on the AT-IE200-6FP switch support Power over Ethernet (PoE), which is a standard whereby DC power is provided by the switch to network devices over the network twisted pair cables. The switches support PoE (IEEE 802.3af) and PoE+ (IEEE 802.3at). For more information, refer to “Power Over Ethernet” on page 26.

Cable Requirements

The cable requirements of the ports are given in Table 1.

Table 1: Twisted Pair Cable Requirements for the 10/100Base-T Ports

Cable Type	10Mbps			100Mbps		
	Non-PoE	PoE	PoE+	Non-PoE	PoE	PoE+
Standard TIA/EIA 568-B-compliant Category 3 shielded or unshielded cabling with 100 ohm impedance and a frequency of 16 MHz.	Yes	No	No	Yes	No	No
Standard TIA/EIA 568-A-compliant Category 5 shielded or unshielded cabling with 100 ohm impedance and a frequency of 100 MHz.	Yes	Yes	No	Yes	Yes	No
Standard TIA/EIA 568-B-compliant Enhanced Category 5 (Cat 5e) shielded or unshielded cabling with 100 ohm impedance and a frequency of 100 MHz.	Yes	Yes	Yes	Yes	Yes	Yes
Standard TIA/EIA 568-B-compliant Category 6 or 6a shielded cabling.	Yes	Yes	Yes	Yes	Yes	Yes

Port Pinouts

Refer to Table 17 on page 69 for the port pinouts of the 10/100Base-T twisted pair ports.

10/100/1000Base-T Twisted Pair Ports

The AT-IE200-6GT and AT-IE200-6GP switches have four 10/100/1000Base-T ports.

Speed

The ports can operate at 10, 100, or 1000 Mbps. You can set the speed manually by using the management software or automatically with Auto-Negotiation (IEEE 802.3u), the default setting.

Note

The ports must be set to Auto-Negotiation to function at 1000 Mbps. They are not compatible with devices that are not IEEE 802.3u compliant.

Duplex Mode

The twisted pair ports can operate in either half- or full-duplex mode. The duplex modes, like port speeds, may be set manually using the management software or automatically with Auto-Negotiation (IEEE 802.3u), the default setting.

You can set the speed and duplex mode settings of a port independently of each other. For example, a port may be configured such that its speed is set manually while its duplex mode is established through Auto-Negotiation.

Note

A switch port that is connected to a network device that does not support Auto-Negotiation and has a fixed duplex mode of full-duplex should not set its duplex mode with Auto-Negotiation. A duplex-mode mismatch in which a switch port and a network device operate at different duplex modes, may occur. The duplex modes of switch ports that are connected to network devices that do not support Auto-Negotiation should be set manually through the management software.

Wiring Configuration

The wiring configuration of a port operating at 10 or 100 Mbps can be MDI or MDI-X. The wiring configurations of a switch port and a network device connected with straight-through twisted pair cabling have to be opposite, such that one device is using MDI and the other MDI-X. For instance, a switch port has to be set to MDI-X if it is connected to a network device set to MDI.

You may set the wiring configurations of the ports manually or let the switch configure them automatically with auto-MDI/MDI-X (IEEE 802.3ab-compliant). This feature enables the switch to automatically negotiate with network devices to establish the proper settings.

The MDI and MDI-X settings do not apply when the ports are operating at 1000 Mbps.

Maximum Distance

The ports have a maximum operating distance of 100 meters (328 feet).

Power Over Ethernet

The 10/100/1000Base-T ports on the AT-IE200-6GP switch support Power over Ethernet (PoE), which is a standard whereby DC power is provided by the switch to network devices over the network twisted pair cables. The switches support PoE (IEEE 802.3af) and PoE+ (IEEE 802.3at). For more information, refer to “Power Over Ethernet” on page 26.

Cable Requirements

The cable requirements of the ports are given in Table 2.

Table 2: Twisted Pair Cable Requirements for the 10/100/1000Base-T Ports

Cable Type	10Mbps	100Mbps	1000Mbps
Standard TIA/EIA 568-B-compliant Category 3 shielded or unshielded cabling with 100 ohm impedance and a frequency of 16 MHz.	Yes	Yes	No
Standard TIA/EIA 568-A-compliant Category 5 or TIA/EIA 568-B-compliant Enhanced Category 5 (Cat 5e) shielded or unshielded cabling with 100 ohm impedance and a frequency of 100 MHz.	Yes	Yes	Yes
Standard TIA/EIA 568-B-compliant Category 6 or 6a shielded cabling.	Yes	Yes	Yes

Port Pinouts

Refer to Table 18 on page 69 for the port pinouts of the 10/100/1000Base-T twisted pair ports.

SFP Slots

The switches have two slots for 100M/1G MSA compliant fiber optic based SFP modules. The transceivers can be used to connect the switches to other network devices over large distances, build a high-speed backbone network between network devices, or connect high-speed devices, such as servers, to your network.

The switches support a variety of short and long distance, 100 and 1000 Mbps fiber optic SFP modules. For a list of supported SFP modules, contact your Allied Telesis representative or visit our web site.

Power Over Ethernet

The AT-IE200-6GP and AT-IE200-6FP switches feature Power over Ethernet (PoE) on the 10/100Base-T or 10/100/1000Base-T ports. PoE is used to supply power to network devices over the same twisted pair cables that carry the network traffic.

One of the advantages of PoE is that it makes it easier to install a network. The placement of network devices is often limited by whether there are power sources nearby. This often limits equipment placement or requires the added time and cost of having additional electrical sources installed. But with PoE, you can install PoE-compatible devices wherever they are needed without having to worry about whether there are power sources nearby.

A device that provides PoE to other network devices is referred to as *power sourcing equipment* (PSE). The switches act as PSE units by adding DC power to the network cable, thus functioning as a central power source for other network devices.

Devices that receive their power from a PSE are called *powered devices* (PD). Examples include wireless access points, IP telephones, webcams, and even other Ethernet switches.

The switch automatically determines whether or not a device connected to a port is a powered device. Ports that are connected to network nodes that are not powered devices (that is, devices that receive their power from another power source) function as regular Ethernet ports, without PoE. The PoE feature remains activated on the ports but no power is delivered to the devices.

PoE Standards

The AT-IE200-6GP and AT-IE200-6FP switches support these PoE standards:

- ❑ PoE (IEEE 802.3af): This standard provides up to 15.4 watts at the switch port to support powered devices that require up to 12.95 watts.
- ❑ PoE+ (IEEE 802.3at): This standard provides up to 30.0 watts at the switch port to support powered devices that require up to 25.5 watts.

Powered Device Classes

Powered devices are grouped into the five classes listed in Table 3. The classes are based on the amount of power the devices require. The switches support all five classes.

Table 3: IEEE Powered Device Classes

Class	Maximum Power Output from a Switch Port	PD Power Range
0	15.4W	0.44W to 12.95W
1	4.0W	0.44W to 3.84W
2	7.0W	3.84W to 6.49W

Table 3: IEEE Powered Device Classes

Class	Maximum Power Output from a Switch Port	PD Power Range
3	15.4W	6.49W to 12.95W
4	30.0W	12.95W to 25.5W

Power Budget

The AT-IE200-6GP and AT-IE200-6FP switches have a PoE power budget of 120 watts. This is the maximum amount of power the switches can provide at one time to the powered devices.

The power requirements of the PoE devices determine the maximum number of devices the switch can support at one time. So long as the total power requirements of the powered devices is less than the power budget of the switch, the switch can supply power to all of the devices. If the total power requirements exceed the power budget, the switch denies power to one or more ports using a mechanism referred to as port prioritization.

To determine whether the power requirements of the PoE devices you plan to connect to the switch exceed its power budget, refer to their documentation for their power requirements and add the requirements together. The switch should be able to power all of the devices simultaneously as long as the total is below its power budget. If the total exceeds the available power budget, you should consider reducing the number of PoE devices so that all of the devices receive power. Otherwise, the switch powers a subset of the devices, based on port prioritization.

The switch can handle different power requirements on different ports. This enables you to connect different classes of PoE equipment to the ports on the switch.

Port Prioritization

If the power requirements of the powered devices exceed the switch's power budget, the switch denies power to some ports based on a system called port prioritization. You may use this mechanism to ensure that powered devices critical to the operations of your network are given preferential treatment by the switch in the distribution of power should the demands of the devices exceed the available capacity.

There are three priority levels:

- Critical
- High
- Low

Ports set to the Critical level, the highest priority level, are guaranteed power before any of the ports assigned to the other two priority levels. Ports assigned to the other priority levels receive power only if all the Critical ports are receiving power. Ports that are connected to your most critical powered devices should be assigned to this level. If there is not enough power to support all the ports set to the Critical priority level, power is provided to the ports based on port number, in ascending order.

The High level is the second highest level. Ports set to this level receive power only if all the ports set to the

Critical level are already receiving power. If there is not enough power to support all of the ports set to the High priority level, power is provided to the ports based on port number, in ascending order.

The lowest priority level is Low. This is the default setting. Ports set to this level only receive power if all of the ports assigned to the other two levels are already receiving power. As with the other levels, if there is not enough power to support all of the ports set to the Low priority level, power is provided to the ports based on port number, in ascending order.

Power allocation is dynamic. Ports supplying power to powered devices may cease power transmission if the switch's power budget is at maximum usage and new powered devices, connected to ports with higher priorities, become active.

Wiring Implementation

The IEEE 802.3at standard defines two methods by which a PSE, such as the switch, can transmit DC power over twisted pair cables to PDs. These methods, known as Alternatives or Modes A and B, identify the wire strands the switch should use when sending DC power to a PD.

Twisted pair cabling typically consists of eight strands. With 10Base-T and 100Base-T devices, the strands connected to pins 1, 2, 3, and 6 on the RJ-45 connectors carry the network traffic while strands connected to pins 4, 5, 7, and 8 are unused. With 1000Base-T devices, all eight strands are used to carry network data.

It takes four strands to deliver DC power to a PD. With Alternative/Mode A, the power is delivered on pins 1, 2, 3, and 6. These are the same pins in 10Base-T and 100Base-T devices that carry the network data. With Alternative/Mode B, the power is provided over the spare strands.

The ports on the AT-IE200-6GP and AT-IE200-6FP switches deliver the power using pins 1, 2, 3 and 6, which corresponds to Alternative/Mode A in the IEEE 802.3at standard.

Powered devices that comply with the IEEE 802.3at standard are required to support both power delivery methods. Legacy devices that do not comply with the standard will work with the switch if they are powered on pins 1, 2, 3, and 6.

Alarms

The IE200 contains two alarm ports: One for alarm input and one for alarm output.

To connect either the alarm input or alarm output, use 24 to 18 AWG cable properly rated for the deployment environment. The maximum length of an alarm cable is two meters.

An alarm cable must be contained within the cabinet (for cabinet applications), or within the building. Do not expose an alarm cable to the outside environment.

Alarm Input

You can connect the alarm input to a dry contact switch, such as a door switch. There are no polarity requirements if the port is connected to a non-powered mechanical switch.



Caution

Do not apply external power to any of the alarm input's leads.

Alarm Output

The alarm output can sync 10 mA of current at a maximum voltage of 48V DC. You must provide a series resistance that will limit the current accordingly.

Connect the RELAY_OUT_RTN pin, connector pin 3, to the negative side of the alarm load.

Connect the RELAY_OUT pin, connector pin 4, to the positive side of the alarm load.

LEDs

The switch contains LEDs to report device status and link/activity port LEDs.

Status LEDs

The STATUS LEDs include the FAULT, PWR 1 and PWR 2 LEDs.

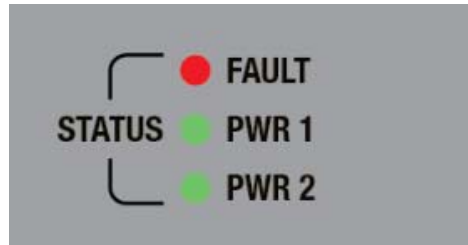

Figure 5: Status LEDs

Table 4: SFP Link/Activity LED Descriptions

LED	Status	Description
FAULT	Off	The switch is receiving power and operating normally.
	Solid red	The system is booting up.
	5 flashes followed by a pause	Indicates the presence of an active alarm. Use the SHOW FACILITY-ALARM STATUS command to view active alarms.
	6 flashes in 2 seconds	Indicates the switch's temperature has exceeded the recommended threshold and the system is overheating.
PWR 1	Off	The switch is not receiving power on the PWR 1 input or the input power is operating outside the normal range.
	Solid green	The switch is receiving DC power from the PWR 1 input and is operating normally.
PWR 2	Off	The switch is not receiving power on the PWR 2 input or the input power is operating outside the normal range.
	Solid green	The switch is receiving DC power from the PWR 2 input and is operating normally.

Twisted Pair Port LEDs

The twisted pair ports each contain two LEDs. The bottom LED indicates link/activity status on all models. On the AT-IE200-6GT and AT-IE200-6FT models, the top LED indicates duplex mode. On the AT-IE200-6GP and AT-IE200-6FP models, the top LED indicates PoE status.

Figure 6 shows the port LEDs on the AT-IE200-6GT and AT-IE200-6FT models.

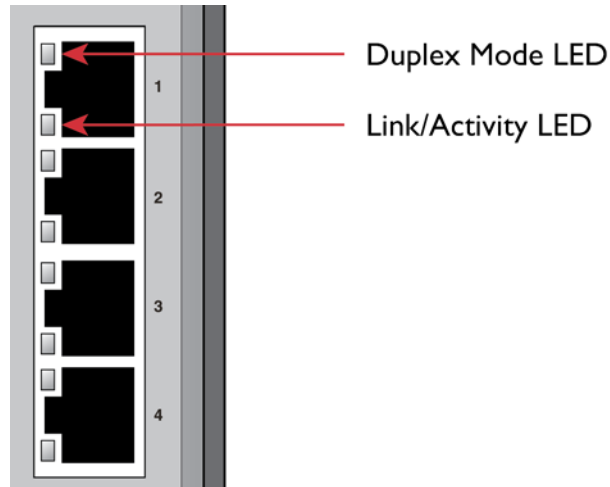

Figure 6: Port LEDs on the AT-IE200-6FT and AT-IE200-6GT switches.

Table 5: Port LED Descriptions for the AT-IE200-6GT and AT-IE200-6FT Switches

LED	Status	Description
Duplex Mode	Off	The port is not operating in duplex mode or the LEDs are turned off. To turn on the LEDs, use the NO ECOFRIENDLY LED command.
	Solid green	The port is operating in full duplex mode.
	Solid amber	The port is operating in half duplex mode.

Table 5: Port LED Descriptions for the AT-IE200-6GT and AT-IE200-6FT Switches (Continued)

LED	Status	Description
Link/Activity	Off	The port has not established a link with another network device or the LEDs are turned off. To turn on the LEDs, use the NO ECOFRIENDLY LED command.
	Solid green	The port has established a 100 Mbps (AT-IE200-6FT) or 1000 Mbps (AT-IE200-6GT) link to a network device.
	Flashing green	The port is transmitting or receiving data at 100 Mbps (AT-IE200-6FT) or 1000 Mbps (AT-IE200-6GT).
	Solid amber	The port has established a 10 Mbps (AT-IE200-6FT) or 10/100 Mbps (AT-IE200-6GT) link to a network device.
	Flashing amber	The port is transmitting or receiving data at 10 Mbps (AT-IE200-6FT) or 10/100 Mbps (AT-IE200-6GT).

Figure 7 shows the port LEDs on the AT-IE200-6GP and AT-IE200-6FP models.

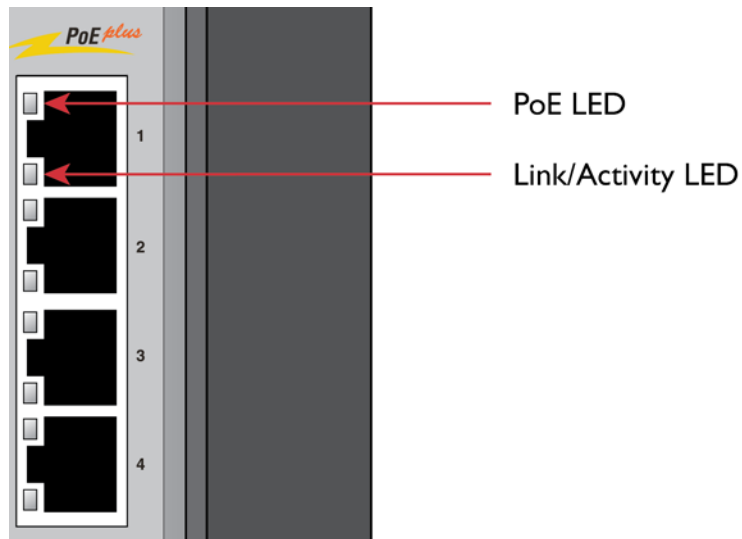

Figure 7: Port LEDs on the AT-IE200-6FP and AT-IE200-6GP switches.

Table 6: Port LED Descriptions for the AT-IE200-6GP and AT-IE200-6FP Switches

LED	Status	Description
PoE	Off	Indicates one of the following: <ul style="list-style-type: none"> <input type="checkbox"/> The port is not connected to a powered device (PD). <input type="checkbox"/> The PD is powered off. <input type="checkbox"/> The port is disabled in the management software. <input type="checkbox"/> PoE is disabled on the port. <input type="checkbox"/> The LEDs are turned off. To turn on the LEDs, use the NO ECOFRIENDLY LED command.
	Solid green	A PD is receiving power from the port.
	Solid amber	The switch has shut down PoE+ on the port due to a fault condition.
	Flashing amber	The switch is detecting a PD on the port but is not delivering power to it because the maximum power budget has been reached
Link/Activity	Off	The port has not established a link with another network device or the LEDs are turned off. To turn on the LEDs, use the NO ECOFRIENDLY LED command.
	Solid green	The port has established a 100 Mbps (AT-IE200-6FP) or 1000 Mbps (AT-IE200-6GP) link to a network device.
	Flashing green	The port is transmitting or receiving data at 100 Mbps (AT-IE200-6FP) or 1000 Mbps (AT-IE200-6GP).
	Solid amber	The port has established a 10 Mbps (AT-IE200-6FP) or 10/100 Mbps (AT-IE200-6GP) link to a network device.
	Flashing amber	The port is transmitting or receiving data at 10 Mbps (AT-IE200-6FP) or 10/100 Mbps (AT-IE200-6GP).

SFP LEDs

The SFP LEDs are located to the right of the slots. Each slot has one LED that indicates the speed and link/activity status of the SFP.

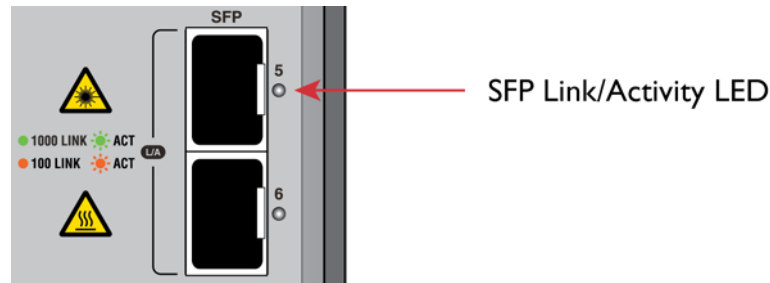

Figure 8: SFP Link/Activity LEDs.

Table 7 describes the Link/Activity LEDs for the SFP slots.

Table 7: SFP Link/Activity LED Descriptions

LED Status	Description
Off	The slot is empty, the SFP transceiver has not established a link to a network device, or the LEDs are turned off. To turn on the LEDs, use the NO ECOFRIENDLY LED command.
Solid green	The SFP has established a link to a network device at 1 Gbps, but is not transmitting or receiving network packets.
Flashing green	The SFP transceiver is transmitting or receiving network packets at 1 Gbps.
Solid amber	The SFP has established a link to a network device at 100 Mbps, but is not transmitting or receiving network packets.
Flashing amber	The SFP transceiver is transmitting or receiving network packets at 100 Mbps.

Console Port

The console port is used to configure the features and parameter settings of the switch. This type of management uses serial RS-232 and is commonly referred to as local or out-of-band management because it is not conducted over your network. To perform local management, you must be at the location of the switch and use a cable that has RJ-45 RJ-style (8P8C) and DB-9 (D-sub 9-pin) connectors.

To establish a local management session with the switch, connect a terminal or a personal computer with a terminal emulation program to the console port, which has an RJ-45 style (8P8C) connector.

The console port is set to the following specifications:

- Default baud rate: 9600 bps (range is 9600 to 115200 bps)
- Data bits: 8
- Parity: None
- Stop bits: 1
- Flow control: None

Note

These settings are for a DEC VT100 or ANSI terminal, or an equivalent terminal emulation program.

Power Supplies

IE200 models have connections for inputs from two separate DC power sources on the top panel.

Connecting two separate DC sources to the switch provides power redundancy and protects against interruptions to network operations in the event one power input fails. Power redundancy is available only when both DC power connections are connected to power sources.

The AT-IE200-6GP and AT-IE200-6FP models operate in a load sharing manner. Each external DC power supply must be capable of sourcing 155W over the operating temperature range.

Refer to Appendix A, “Technical Specifications” on page 66 for the input voltage range.



Warning

Power connector is used as a disconnection device. To de-energize equipment, unplug the power connector from the unit.

Chapter 2

Beginning the Installation

This chapter contains the safety precautions and guidelines for selecting a site for the switch. The chapter contains the following sections:

- ❑ “Reviewing Safety Precautions” on page 38
- ❑ “Selecting a Site for the Switch” on page 41
- ❑ “Unpacking the Switch” on page 42

Reviewing Safety Precautions

Review the following safety precautions before you install the switch.

Note

The  indicates that a translation of the safety statement is available in a PDF document titled “Translated Safety Statements” (613-000405) on the Allied Telesis website at <http://www.alliedtelesis.com>.



Warning

Class I Laser product.  L1



Warning

Do not stare into the laser beam.  L2



Warning

Do not look directly at the fiber optic cable ends or inspect the cable ends with an optical lens.  L6



Warning

For all Allied Telesis approved SFP models:

Laser Radiation.

Do not view directly with optical instruments.

Class I Laser product.

Rayonnement Laser.

Ne pas observer directement à l'aide d'instruments d'optique.

Appareil à Laser de classe I.



Warning

To prevent electric shock, do not remove the cover. No userserviceable parts inside. This unit contains hazardous voltages and should only be opened by a trained and qualified technician. To avoid the possibility of electric shock, disconnect electric power to the product before connecting or disconnecting the LAN cables.  E1



Warning

Do not work on equipment or cables during periods of lightning activity. ⚡ E2



Warning

Power cord is used as a disconnection device. To de-energize the equipment, unplug the power connector from the unit.



Warning

This equipment must be earthed. The ground lug on the switch must be connected to a properly earthed bonding point.

Note

Ground resistance from the building primary bonding point to earth should be less than 25 ohms.



Caution

A minimum of 4 inches open space shall be provided underneath the unit.
A minimum of 8 inches open space shall be provided on top of the unit.
A minimum of 4 inches open space shall be provided in front of the unit.
A minimum of 1" distance shall be kept between the sides of the unit and adjacent equipment.

Note

All Countries: Install product in accordance with local and National Electrical Codes. ⚡ E8



Warning

Operating Temperature. Maximum ambient temperature is installation dependent. Please see "Environmental Specifications" on page 67 for details.



Warning

Only trained and qualified service personnel are allowed to install or to replace this equipment.



Caution

Circuit Overloading: Consideration should be given to the connection of the equipment to the supply circuit and the effect that overloading of circuits might have on over current protection and supply wiring. Appropriate consideration of equipment nameplate ratings should be used when addressing this concern. ⚡ E2I



Warning

This unit might have more than one power cord. To reduce the risk of electric shock, disconnect all power cords before servicing the unit. ⚡ E30



Caution

The unit does not contain serviceable components. Please return damaged units for servicing. ⚡ E42



Warning

This equipment shall be installed in a Restricted Access location. ⚡ E45



Warning

When the unit is operational it will be hot. Exercise caution when handling with unprotected hands.



Warning

Per NEC section 800.90 all exposed cables, service wires, or drops when entering a building must have primary over voltage protection if they are classified as exposed plant.

Note

This equipment meets EN61000-4-5 Class 3 on the DC input and Class 2 on the ETHERNET I/O lines.



Warning

Allied Telesis does not warrant against lightening or power surges causing damage to the device. Such damage will be the responsibility of the equipment owner.

Selecting a Site for the Switch

The switch is designed for standalone or DIN rail mounting. Observe the following general requirements when choosing a site for the switch:

- Install the switch close to the DC power supplies
- Verify that the site provides easy access to the ports on the front of the switch. This will make it easy to connect and disconnect cables, as well as view the port LEDs.
- Check that the site allows for adequate air flow around the unit and through its vents on the top and bottom. Air vents should not be restricted so that the switch can maintain adequate cooling.
- Do not place objects on top of the switch.
- Do not expose the switch to moisture or water.
- You should use dedicated power circuits or power conditioners to supply reliable electrical power to the network devices.

Unpacking the Switch

The following items come with the switch. If any item is missing or damaged, contact your Allied Telesis sales representative for assistance.

Note

Retain the original packaging material in the event you need to return the unit to Allied Telesis.

- Two wall mounting brackets
- Five bracket screws

Chapter 3

Installing the Switch on a DIN Rail or Wall Mount

This chapter contains the following sections:

- “Installing the Switch on a DIN Rail” on page 44
- “Installing the Switch on a Wall Mount” on page 46

Installing the Switch on a DIN Rail

Observe the following requirements when choosing a DIN rail site for your switch:

- ❑ The DC PSU(s) should be located near the switch and be easily accessible.
- ❑ The site should allow for easy access to the ports on the front of the switch, so that you can easily connect and disconnect cables, and view the port LEDs.
- ❑ The site should allow for adequate air flow around the unit and through the cooling fins.
- ❑ The site should not expose the switch to moisture or water.
- ❑ The site should be a dust-free environment.
- ❑ The site should include dedicated power circuits or power conditioners to supply reliable electrical power to the network devices.

To install the switch on the DIN rail, hook the switch's mounting bracket onto the DIN rail and rotate the switch down to snap it into place.

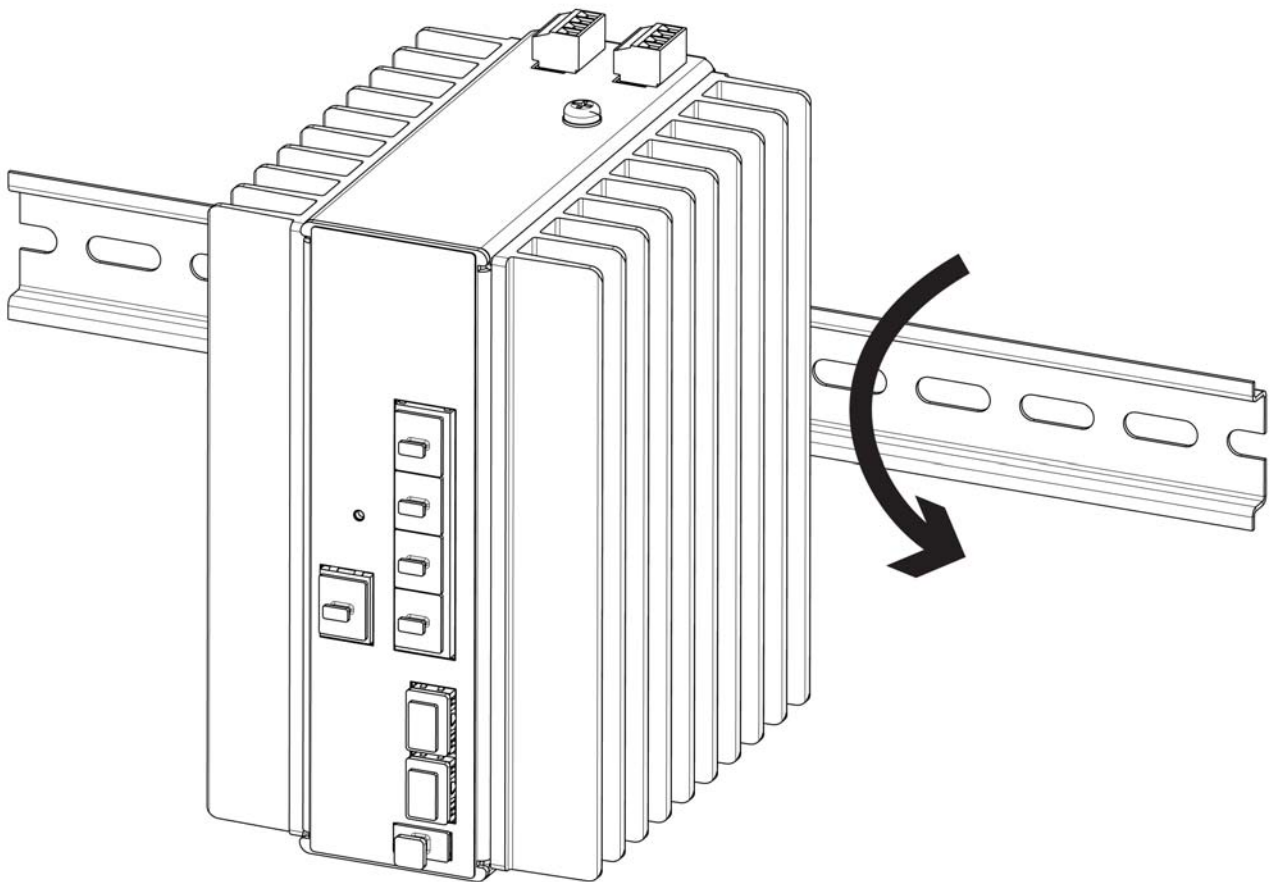

Figure 9: Attaching the switch to a DIN rail.

After snapping the switch onto the DIN rail, go to Chapter 4, “Cabling the Networking Ports” on page 48 to connect the network cables to the ports on the switch.

Installing the Switch on a Wall Mount

To install the switch on a wall mount:

1. Mount a piece of $\frac{3}{4}$ -inch plywood to the wall. The plywood must be securely mounted to the wall using appropriate methods based on the wall surface.
2. Attach the wall mount brackets to the unit with four screws, as shown in Figure 10.

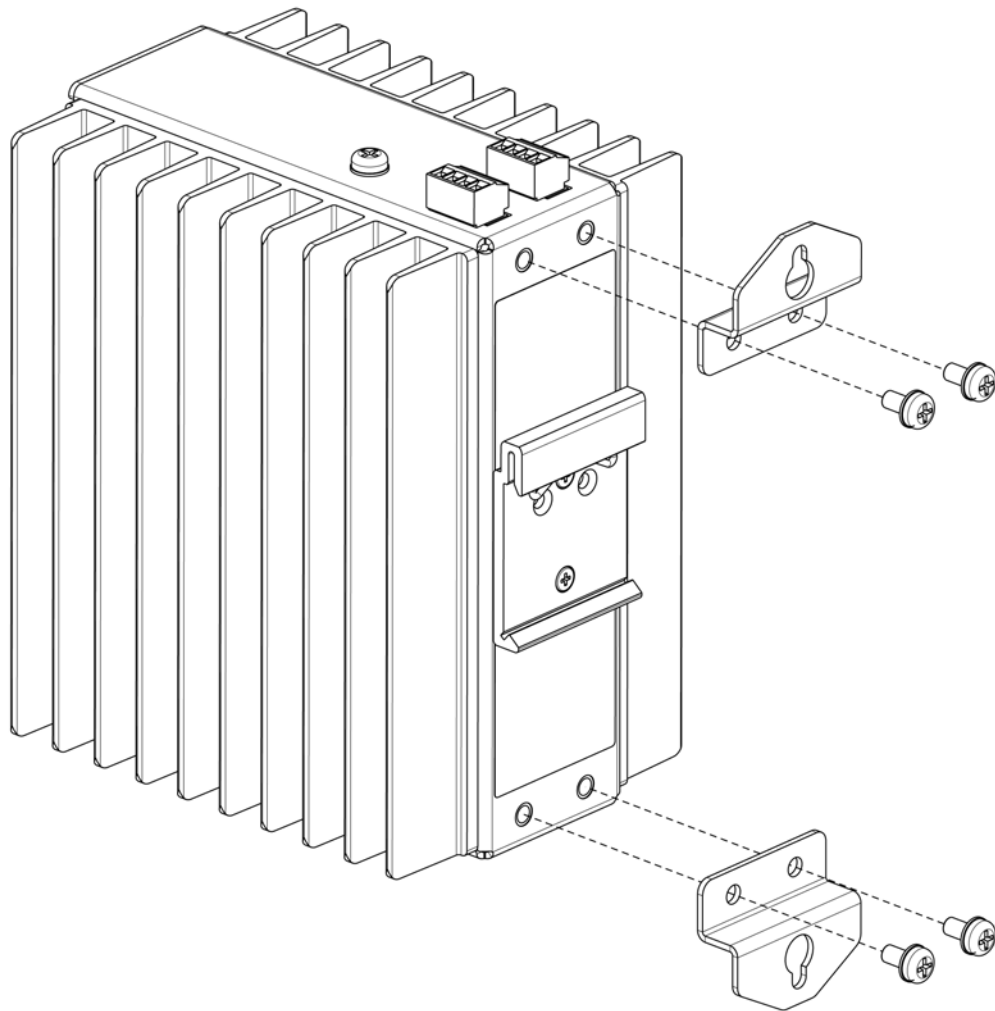

Figure 10: Attaching the wall mount brackets.

3. Fasten the switch to the wall with #8 x 1.5" pan head wood screws. The distance between the mounting holes is 175 mm. (6.9 in.), as shown in Figure 11.

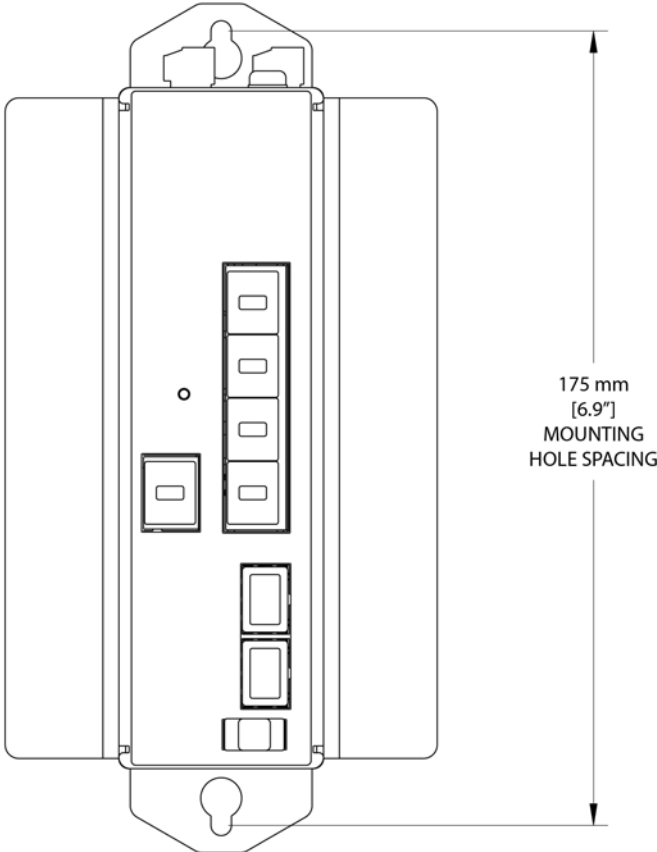

Figure 11: Spacing between mounting holes.

Chapter 4

Cabling the Networking Ports

This chapter contains the following sections:

- “Cabling the Twisted Pair Ports” on page 49
- “Installing SFP Transceivers” on page 51

Cabling the Twisted Pair Ports

The guidelines for cabling the 10/100Base-T and 10/100/1000Base-T twisted pair ports are:

- ❑ The cable specifications for the 10/100Base-T and 10/100/1000Base-T twisted pair ports are listed in Table 1 on page 22 and Table 2 on page 24, respectively.
- ❑ The connectors on the cables should fit snugly into the ports, and the tabs should lock the connectors into place.
- ❑ The default setting for the wiring configurations of the ports is auto-MDI/MDI-X. The default setting is appropriate for switch ports that are connected to 10/100Base-T network devices that also support auto-MDI/MDI-X.
- ❑ The default auto-MDI/MDI-X setting is not appropriate for switch ports that are connected to 10/100Base-T network devices that do not support auto-MDI/MDI-X and have a fixed wiring configuration. For switch ports connected to those types of network devices, you should disable auto-MDI/MDI-X and set the wiring configurations manually.
- ❑ The appropriate MDI/MDI-X setting for a switch port connected to a 10/100Base-T network device with a fixed wiring configuration depends on the setting of the network device and whether the switch and network device are connected with straight-through or crossover cable. If you are using straight-through twisted pair cable, the wiring configurations of a port on the switch and a port on a network device must be opposite each other, such that one port uses MDI and the other MDI-X. For example, if a network device has a fixed wiring configuration of MDI, you must disable auto-MDI/MDI-X on the corresponding switch port and manually set it to MDI-X. If you are using crossover twisted pair cable, the wiring configurations of a port on the switch and a port on a network device must be the same.
- ❑ The default speed setting for the ports is Auto-Negotiation. This setting is appropriate for ports connected to network devices that also support Auto-Negotiation.
- ❑ The default speed setting of Auto-Negotiation is not appropriate for ports connected to 10/100Base-T network devices that do not support Auto-Negotiation and have fixed speeds. For those switch ports, you should disable Auto-Negotiation and set the port's speed manually to match the speeds of the network devices.
- ❑ The 10/100/1000Base-T ports must be set to Auto-Negotiation, the default setting, to operate at 1000Mbps.
- ❑ The default duplex mode setting for the ports is Auto-Negotiation. This setting is appropriate for ports connected to network devices that also support Auto-Negotiation for duplex modes.
- ❑ The default duplex mode setting of Auto-Negotiation is not appropriate for ports connected to network devices that do not support Auto-Negotiation and have a fixed duplex mode. You should disable Auto-Negotiation on those ports and set their duplex modes manually to avoid the possibility of duplex mode mismatches. A switch port using Auto-Negotiation defaults to half duplex if it detects that the end node is not using Auto-Negotiation, which can result in a mismatch if the end node is operating at a fixed duplex mode of full-duplex.
- ❑ If the Ethernet cables will be connected to equipment that is located outdoors, such as a

CCTV mounted on a pole, the cables will be subjected to surge from lightning or power cross events. A properly rated primary protection device must be installed on the cable prior to connection to the switch.

Installing SFP Transceivers

General guidelines for installing SFP transceivers are:

- ❑ SFP transceivers are hot-swappable. You may install them while the switch is powered on.
- ❑ Your Allied Telesis sales representative can provide you with a list of supported transceivers for the units.
- ❑ The operational specifications and fiber optic cable requirements of the transceivers are provided in the documents included with the devices.
- ❑ You should install a transceiver before connecting the fiber optic cable.
- ❑ Fiber optic transceivers are dust sensitive. Always keep the plug in the optical bores when a fiber optic cable is not installed, or when you store the transceiver. When you do remove the plug, keep it for future use.
- ❑ Unnecessary removal and insertion of a transceiver can lead to premature failure.
- ❑ The SFP cages on the switch use an internal heat sink that requires an additional amount of force to remove and install an SFP module.

To install an SFP transceiver:

- I. Remove the dust plug from a transceiver slot on the switch.



Figure 12: Removing the dust plug from an SFP slot.

2. Remove the transceiver from its shipping container and store the packaging material in a safe location.
3. Position the transceiver with the Allied Telesis label facing to the right.
4. Slide the transceiver into the slot until it clicks into place.



Figure 13: Installing an SFP transceiver.

5. Remove the dust cover from the transceiver module.



Figure 15: Connecting a fiber optic cable to an SFP transceiver.

Repeat the procedure to install a second SFP transceiver.

Chapter 5

Powering on the Switch

This chapter contains the following sections:

- ❑ “Connecting the Power” on page 56
- ❑ “Connecting the Ground Wiring” on page 57
- ❑ “Monitoring the Initialization Processes” on page 58
- ❑ “Starting a Management Session” on page 59
- ❑ “Starting a Local Management Session” on page 61
- ❑ “Specifying Ports in the Command Line Interface” on page 62

Connecting the Power

Figure 3 on page 19 and Figure 4 on page 20 show the location of the power connector on the top panel of the switch. The power connector has four positions for connecting two DC power sources.

Note

The power connector on the switch is green. The alarm connector is black.

The switch requires a DC power supply. The power supply requirements for the AT-IE200-6FP and AT-IE200-6GP models are:

- DC voltage between 24 and 48V DC.
- DC voltage shall not exceed 50V.
- The DC power supply must be capable of providing 155 watts continuous over the operating temperature range of -40 to +75 degrees C.

The power supply requirements for the AT-IE200-6FT and AT-IE200-6GT models are:

- DC voltage between 12 and 48V DC.
- DC voltage shall not exceed 50V.
- The DC power supply must be capable of providing 32 watts continuous over the operating temperature range of -40 to +75 degrees C.

Note

A 24V PSU must have an absolute minimum tolerance of -3% or 23.25V at the input to the switch.

A 48V PSU must have an absolute maximum tolerance of +2.5% or 49.25V at the input to the switch.

The wiring requirements for the switch are:

- Use two separate conductors of 18 AWG twisted pair properly rated cable to wire the DC power supply to the switch.
- Stranded cable is recommended.

To wire the power, insert the cable into the terminal block and fasten it securely.

Connecting the Ground Wiring

Figure 3 on page 19 and Figure 4 on page 20 show the location of the grounding screw on the top panel of the switch. The grounding requirements are:

- Use a minimum of #16 AWG solid copper conductor to connect the switch's grounding screw to the earth.
- Keep the wire length as short as possible.
- Continuity from the grounding screw to the earth ground rod must be less than 0.05 ohms.
- If a terminal is used, it should be double crimped.

Monitoring the Initialization Processes

You can monitor the bootup sequence by connecting a terminal or computer that has a terminal emulator program to the console port on the switch.

After the switch has initialized its management software, go to “Starting a Management Session” on page 59.

Starting a Management Session

You can use the following methods and tools to manage the switch:

- Local management
- Telnet client
- Secure shell client
- HTTP non-secure and HTTPs secure Web browser
- SNMPv1, v2C, v3

Local Management

Local management uses the console port on the switch. It is commonly referred to as out-of-band management because the management sessions are not conducted over your network. The requirements for local management are:

- A terminal or computer with a terminal emulator program
- An RJ-45 management cable

This management method uses the command line interface, which gives you access to all of the features and parameters on the switch. For instructions on how to start a local management session, refer to “Starting a Local Management Session” on page 61.

Telnet Management

The switch has a Telnet server. You can use the server to manage the unit over your network with the Telnet application protocol. It is commonly referred to as in-band management because it is conducted over the network. The requirements for Telnet management are:

- Your management workstation must have a Telnet client.
- The Telnet server on the switch must be activated. By default, the Telnet server is activated.
- The switch must have an IP address, either from DHCP or statically assigned.
- You must be able to reach the switch from your management workstation.

Telnet management uses the command-line interface, giving you access to all of the features and parameter settings on the switch.

Telnet management sessions are not secure and are vulnerable to snooping because the packets exchanged between the switch and your workstation are sent in plain text. The security of the switch may be jeopardized if an intruder captures the packet containing your username and password. For secure remote management, see “Secure Shell Management” on page 60.

Secure Shell Management

Secure shell (SSH) management is similar to Telnet management in that you can use it, together with the command line interface, to manage all of the features and functions of the switch from a workstation on your network. The difference is that this management method encrypts the packets exchanged by your computer and the switch to protect your management sessions.

The requirements for SSH management are:

- Your management workstation must have an SSH client.
- The SSH server on the switch must be activated. The server's default setting is disabled.
- You must create an encryption key on the switch.
- The switch must have an IP address, either from DHCP or statically assigned.
- You must be able to reach the switch from your management workstation.

For instructions on how to configure the switch for SSH management, refer to the *Software Reference for AT-IE200 Switches*.

Web Browser Management

You can remotely manage the switch with a web browser. A special web browser interface, featuring both non-secure (HTTP) and secure (HTTPS) operation, lets you monitor and configure many of the switch's features from a series of windows. The interface, however, may only be used to configure a subset of the features. To configure those features the web browser interface does not support, you have to use the command line interface from another management method.

The requirements for non-secure HTTP web browser management are:

- Your management workstation must have a web browser.
- The web browser server on the switch is activated by default. This is the default setting in the default BOOT.CFG and QSTART.CFG files.
- The switch must have an IP address, either from DHCP or statically assigned.
- You must be able to reach the switch from your management workstation.

Refer to the *Software Reference for AT-IE200 Switches* for instructions on how to configure the switch for secure HTTPS web browser management.

SNMP

Refer to the *Software Reference for AT-IE200 Switches* for instructions on how to configure the switch for SNMP management. The switch does not have any default SNMP community strings.

Starting a Local Management Session

This procedure requires a terminal or a terminal emulator program and an RJ-45 management cable. To start a local management session on the switch, perform the following procedure:

1. Connect the RJ-45 connector on the management cable to the console port on the front panel of the switch.
2. Connect the other end of the cable to an RS-232 port on a terminal or PC with a terminal emulator program.
3. Configure the terminal or terminal emulator program as follows:
 - Baud rate: 9600 bps (The baud rate of the console port is adjustable from 1200 to 115200 bps. The default is 9600 bps.)

Note

The BootLoader can only be managed at 9600 bps. If you set the baud rate to 115200 bps the BootLoader will not work.

- Data bits: 8
- Parity: None
- Stop bits: 1
- Flow control: None

Note

The port settings are for a DEC VT100 or ANSI terminal, or an equivalent terminal emulator program.

4. Press Enter. You are prompted for a username and password.
5. Enter the username and password to log on the switch. If this is the initial management session of the switch, enter “manager” as the user name “friend” as the password. The user name and password are case sensitive.

The local management session starts when the AlliedWare Plus™ command line prompt is displayed.

For information on the command line interface, refer to the *Software Reference for AT-IE200 Switches*.

Specifying Ports in the Command Line Interface

The command line interface of the Local, Telnet, and SSH management methods gives you the ability to configure all the features and parameters on the switch. Many of the commands have the PORT parameter, which you use to identify the networking ports on the switch. This parameter has the following format:

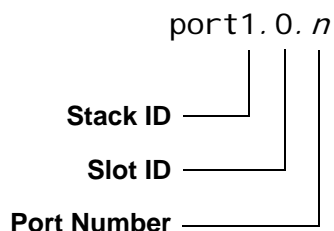

The first number is the switch's stack ID number. This number is always 1 for IE200 switches.

The slot ID value, which is used to specify slot numbers in a multi-module chassis, also does not apply to IE200 switches and is always 0.

The third value is a port number on the switch. You can specify only one port number in a PORT parameter, but you can specify more than one PORT parameter in many of the commands where the parameter is supported.

Here is an example of the PORT parameter. It uses the INTERFACE command to enter the Port Interface mode for ports 2 and 4:

```
awpl us> enable
awpl us# configure terminal
awpl us(config)# interface port1.0.2, port1.0.4
```

You can specify port ranges. This example displays the port settings for ports 1 to 3:

```
awpl us# show interface port1.0.1-port1.0.3
```

Note that you must include the prefix "port1.0." in the last number of a range.

For instructions on the command line interface and the PORT parameter, refer to the *Software Reference for AT-IE200 Switches*.

Chapter 6

Troubleshooting

This chapter contains information on how to troubleshoot the switch if a problem occurs.

Note

For further assistance, please contact Allied Telesis Technical Support at www.alliedtelesis.com/support.

Problem: The PWR1 and PWR2 LEDs on the front of the switch are off.

Solution: The unit is not receiving power. Try the following:

- Verify the power cable is securely fastened in the terminal block.
- Verify the DC power supply is providing power by connecting another device to it.
- Verify the DC power supply is providing enough power. The AT-IE200-6GT and AT-IE200-6FT models require a minimum of 12 volts. The AT-IE200-6GP and AT-IE200-6FP models require a minimum of 24 volts. See “Power Specifications” on page 67 for more information.
- Try connecting the unit to another DC power source.
- Try a different power cable.
- Verify that the voltage from the power source is within the required levels for your region.

Problem: A twisted pair port on the switch is connected to a network device but the port’s link/activity LED is off.

Solution: The port is unable to establish a link to a network device. Try the following:

- Verify that the network device connected to the twisted pair port is powered on and is operating properly.
- Verify that the twisted pair cable is securely connected to the port on the switch and to the port on the remote network device.
- Verify that the port is connected to the correct twisted pair cable. This is to eliminate the possibility that the port is connected to the wrong network device, such as a powered off device.
- Try connecting another network device to the twisted pair port with a different cable. If the twisted pair port is able to establish a link, then the problem is with the cable or the other network device.
- Verify that the twisted pair cable does not exceed 100 meters (328 feet).
- Verify that you are using the appropriate category of twisted pair cable: Category 3 or better for 10 Mbps operation and Category 5 and Category 5E for 100 and 1000 Mbps

operation.

Note

A 1000Base connection may require five to ten seconds to establish a link.

Problem: The link/activity LED for an SFP transceiver is off.

Solution: The fiber optic port on the transceiver is unable to establish a link to a network device. Try the following:

- Verify that the network device connected to the fiber optic port is operating properly.
- Verify that the fiber optic cable is securely connected to the port on the switch and to the port on the remote network device.
- Check that the SFP module is fully inserted in the slot.
- Verify that the operating specifications of the fiber optic ports on the SFP transceiver and the remote network device are compatible.
- Verify that the correct type of fiber optic cabling is being used.
- Verify that the port is connected to the correct fiber optic cable. This is to eliminate the possibility that the port is connected to the wrong remote network device, such as a powered off device.
- Try connecting another network device to the fiber optic port using a different cable. If the port is able to establish a link, then the problem is with the cable or with the other network device.
- Use the switch's management software to verify that the port is enabled.
- If the remote network device is a management device, use its management firmware to determine whether its port is enabled.
- Test the attenuation on the fiber optic cable with a fiber optic tester to determine whether the optical signal is too weak (sensitivity) or too strong (maximum input power).

Problem: Network performance between a twisted pair port on the switch and a network device is slow.

Solution: There might be a duplex mode mismatch between the port and the network device. This occurs when a twisted pair port using Auto-Negotiation is connected to a device with a fixed duplex mode of full duplex. If this is the cause of the problem, adjust the duplex mode of the port on the network device or on the switch so that both ports are using the same duplex mode.

Problem: A port's link/activity LED is blinking.

Solution: The link between the port and the network device is intermittent. Try the following:

- Connect another network device with a different cable to the port. If the Link LED remains steady on, then the problem is with the original cable or the network device.
- If the problem is with an SFP transceiver, check that the transceiver is fully inserted in the slot.

Problem: The AT-IE200-6FP or AT-IE200-6GP switch is not providing power to a PoE device.

Solution: Try the following:

- ❑ Review the PD's documentation to confirm that the device supports Mode A of the IEEE 802.3at standard. Mode A is one of two modes that define the connector pins that deliver the power from the port on the switch to the PD. In Mode A, the power is carried on pins 1, 2, 3, and 6 on the RJ-45 port, the same pins that carry the network traffic. The second mode, Mode B, defines pins 4, 5, 7, and 8 as the power carriers. The switches do not support Mode B. Most powered devices are designed to accept power by either mode, but some legacy devices may only support one mode. This can be verified by reviewing the device's documentation or data sheet. Legacy devices that only support Mode B will not work with the switch.
- ❑ Check that the device's power requirements do not exceed 30 watts. This can be verified by reviewing the device's documentation or data sheet.
- ❑ Verify that you are using the appropriate category of twisted-pair cable.
- ❑ Use the management software on the switch to determine whether PoE is enabled on the port. The default setting for PoE is enabled.
- ❑ Use the management software on the switch to determine whether the PoE power setting for the port has been reduced to a value below the power requirements of the device.
- ❑ Try connecting the device to a different port on the switch.

Appendix A

Technical Specifications

Physical Specifications

Dimensions (W x H x D)

Table 8: Product Dimensions

AT-IE200-6GT AT-IE200-6FT	5.5 cm. x 15.9 cm. x 13.4 cm. (2.17 in. x 6.25 in. x 5.28 in.)
AT-IE200-6GP AT-IE200-6FP	9.5 cm. x 15.9 cm. x 13.4 cm. (3.74 in. x 6.25 in. x 5.28 in.)

Weights

Table 9: Product Weights

AT-IE200-6GT AT-IE200-6FT	0.9 kg. (2.0 lb.)
AT-IE200-6GP AT-IE200-6FP	1.3 kg. (2.5 lb.)

Ventilation

Table 10: Ventilation Requirements for Cabinet Installation

Minimum open space below	10.2 cm. (4 in.)
Minimum open space above	20.3 cm. (8 in.)
Minimum open space in front	10.2 cm. (4 in.)
Minimum open space on sides	2.5 cm. (1 in.)

Table 11: Ventilation Requirements for Wall Mount Installation

Minimum open space around unit (below, above, front and sides)	61 cm. (24 in.)
----------------------------------------------------------------	-----------------

Cabinet Dimensions

Table 12: Cabinet Dimensions

Minimum Cabinet Size	50.8 cm. x 50.8 cm. x 30.5 cm. (20 in. x 20 in. x 12 in.)
----------------------	--------------------------------------------------------------

Environmental Specifications

Table 13: Environmental Specifications

Operating Temperature, Metal Cabinet	-40° C to 75° C (-40° F to 167° F)
Operating Temperature, Wall Mount	-40° C to 70° C (-40° F to 158° F)
Storage Temperature	-40° C to 85° C (-40° F to 185° F)
Operating Humidity	5% to 95% noncondensing
Storage Humidity	5% to 95% noncondensing
Operating Altitude Range	Up to 3,000 m (9,843 ft)
Maximum Nonoperating Altitude	4,000 m (13,100 ft)

If the switch is installed in an outdoor cabinet that is directly ventilated to outdoor air, the conformally coated model should be used.

Power Specifications

Maximum Power Consumptions

Table 14: Maximum Power Consumptions

AT-IE200-6GT AT-IE200-6FT	32 watts
AT-IE200-6GP AT-IE200-6FP	155 watts

Input Voltages

Table 15: Input Voltages

AT-IE200-6GT AT-IE200-6FT	12-48 VDC, 2.5A maximum
AT-IE200-6GP AT-IE200-6FP	24-48 VDC, 7.0A maximum

Note

A 24V PSU must have an absolute minimum tolerance of -3% or 23.25V at the input to the switch.

A 48V PSU must have an absolute maximum tolerance of +2.5% or 49.25V at the input to the switch.

Certifications

Table 16: Product Certifications

RMI Emissions	FCC Part 15B Class A EN55022:2010 Class A EN61000-3-2:2006+A1:2009+A2:2009 EN61000-3-3:2008 VCCI- Class A
RFI Immunity	EN55024:2010 EN61000-4-2:2009 EN61000-4-3:2006 + A2:2010 EN61000-4-4:2012 EN61000-4-5:2006 EN61000-4-6:2009 EN61000-4-8:2010 EN61000-4-11:2004
Electrical and Laser Safety	UL/E/IEC60950-1 CSA 22.2:60950-1 2006/95/EC Low Voltage Directive
All Allied Telesis approved SFP modules	EN60825-1 EN60825-2 EN/IEC/UL60950-1 FCC CDRH registered

RJ-45 Twisted Pair Port Pinouts

Figure 16 illustrates the pin layout of the RJ-45 connectors and ports.

Figure 16: RJ-45 Socket Pin Layout (Front View)

Table 17 lists the pin signals for 10 and 100 Mbps.

Table 17: Pin Signals for 10 and 100 Mbps

Pin	MDI Signal	MDI-X Signal
1	TX+	RX+
2	TX-	RX-
3	RX+	TX+
4	Not used	Not used
5	Not used	Not used
6	RX-	TX-
7	Not used	Not used
8	Not used	Not used

Table 18 lists the pin signals when a port operating at 1000 Mbps.

Table 18: Pin Signals for 1000 Mbps

Pinout	Pair
1	Pair 1 +
2	Pair 1 -
3	Pair 2 +
4	Pair 3 +
5	Pair 3 -
6	Pair 2 -
7	Pair 4 +
8	Pair 4 -

RJ-45 Style Serial Console Port Pinouts

Table 19 lists the pin signals of the RJ-45 style serial console port.

Table 19: RJ-45 Style Serial Console Port Pin Signals

Pin	Signal
1	Open
2	Looped to pin 7
3	Transmit Data
4	Ground
5	Ground
6	Receive Data
7	Looped to pin 2
8	Open